

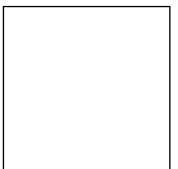

Booklet available in English on  
Livret disponible en français sur  
Folleto disponible en español en





## WE'RE MAKING OUR PACKAGING MORE SUSTAINABLE

We're transitioning from single-use plastic to paper-based packaging. As we progress, you may find a mix of paper and plastic in our boxes.

## NOUS RENDONS NOS EMBALLAGES PLUS DURABLES

Nous passons des emballages en plastique à usage unique aux emballages à base de papier. Durant la transition, vous pourriez trouver un mélange de papier et de plastique dans nos boîtes.

## QUEREMOS HACER MÁS SUSTENTABLES NUESTROS MATERIALES DE EMBALAJE

Estamos cambiando las bolsas de plástico desechables por bolsas con base de papel. Conforme avanzamos en este propósito, puedes encontrar una mezcla de papel y de plástico en nuestras cajas.

[LEGO.com/sustainable-packaging](https://www.lego.com/sustainable-packaging)



# BUILDER



Apple and the Apple logo are trademarks of Apple Inc., registered in the U.S. and other countries and regions. App Store is a service mark of Apple Inc. Google Play and the Google Play logo are trademarks of Google LLC. Tencent and the Tencent logo are trademarks of Tencent Inc.

LEGO.com/devicecheck



LEGO® Builder

# Meet the fan designer

The Family Tree idea was submitted by Ivan Guerrero (LEGO® Ideas name BulldozerBuilder), an avid LEGO fan from the Philippines. When he's not building sets, he directs videos and commercials.

"First of all, thanks to everyone who supported this project! I hope you will enjoy building this unique keepsake and find creative ways to represent YOUR own family. My family members are spread out across the world, but we remain close and continue to be a big part of each other's lives. During one of our reunions, we shot portrait photos of the entire family. I later printed and displayed them across

a large wall in my home. I then had an artist paint a tree mural to connect all our family's branches. Every year, we refresh the mural with photos of new members, so the tree has become a 'living' map of our ancestry and the stories we share with our kids and grandkids. It brings everyone together in the same room.

"I wanted this model to be a unique kind of tree that differed from other LEGO sets. I gave it a black tree trunk and some striking red leaves and branches to give it a real sense of warmth and personality. The result is a set that can be customized by every family that builds it, and hopefully become a cherished heirloom and a place to save treasured photos. You might even 'grow' a whole forest of trees to represent your entire clan!

"Notice the butterfly element? It was inspired by the species *Graphium idaeoides* which used to appear on Filipino coins. In Philippine culture, seeing a butterfly flying around the house represents an ancestor visiting their loved ones. I think it's a beautiful symbol for keeping memories of family members alive."



Ivan in front of his family tree mural that inspired the model · Ivan devant son arbre familial qui a inspiré le modèle · Ivan delante del mural con fotos de su familia que inspiró el modelo



# Rencontre avec le concepteur amateur

L'idée de l'arbre familial a été soumise par Ivan Guerrero (pseudonyme LEGO® Ideas : BulldozerBuilder), un passionné de LEGO originaire des Philippines. Quand il n'est pas en train de construire des ensembles, il réalise des vidéos et des publicités.

« Tout d'abord, merci à tous ceux qui ont soutenu ce projet ! J'espère que vous prendrez plaisir à construire ce souvenir unique et que vous trouverez des façons créatives de représenter VOTRE famille. Les membres de ma famille sont dispersés dans le monde entier, mais nous restons proches et continuons à jouer un rôle important dans la vie de chacun. Lors de l'une de nos réunions, nous avons pris des photos de toute la famille. Plus tard, je les ai imprimées et exposées sur un grand mur de

ma maison. J'ai ensuite demandé à un artiste de peindre un arbre pour relier toutes les branches de notre famille. Chaque année, nous ajoutons à l'arbre les photos des nouveaux membres. Il est donc devenu une carte "vivante" de nos ancêtres et des histoires que nous partageons avec nos enfants et nos petits-enfants. Il rassemble tout le monde dans la même pièce.

Je voulais que ce modèle soit un arbre unique, différent des autres ensembles LEGO. Je lui ai donné un tronc noir et des feuilles et des branches d'un rouge saisissant pour qu'il dégage chaleur et personnalité. Le résultat est un ensemble qui peut être personnalisé par chaque famille qui le construit et qui, je l'espère, deviendra un héritage précieux et un endroit où conserver de précieuses photos. Vous pourriez même faire pousser toute une forêt d'arbres pour représenter tout votre clan !

Vous avez remarqué l'élément de papillon ? Il a été inspiré par l'espèce *Graphium idaeoides*, qui figurait autrefois sur les pièces de monnaie philippines. Dans la culture philippine, un papillon qui vole autour d'une maison représente un ancêtre qui rend visite à ses proches. Je pense qu'il s'agit d'un beau symbole pour garder en vie les souvenirs des membres de la famille. »

## Conoce al fan diseñador

La idea del Árbol de la Familia fue enviada por Ivan Guerrero (conocido en LEGO® Ideas como BulldozerBuilder), un ávido fan de LEGO originario de las Filipinas. Cuando no está construyendo sets, se dedica a dirigir videos y comerciales.

"En primer lugar, ¡quiero agradecer a todos los que apoyaron este proyecto! Espero que disfruten de construir este original recuerdo y que encuentren formas creativas de representar a SUS PROPIAS familias. Tengo familiares repartidos por todo el mundo, aunque no por ello perdemos la cercanía. La familia tiene un lugar primordial en la vida de todos nosotros. Durante una de nuestras reuniones, todos los presentes nos tomamos retratos como recuerdo. Después los imprimí y los coloqué en una gran pared de mi casa. Posteriormente, se me ocurrió la idea de encargar a un artista que pintara un mural en forma de árbol para conectar todas

las ramas de nuestra familia. Cada año renovamos el mural con fotos de los nuevos miembros, de modo que el árbol se ha convertido en un mapa 'vivo' de nuestra ascendencia y de las historias que compartimos con nuestros hijos y nietos. Es maravilloso que haya algo que nos reúna a todos en la misma habitación.

Mi intención con este modelo fue crear un original árbol que se distinguiera de otros sets LEGO. Hice el tronco negro y le puse hojas y ramas en vibrantes tonos rojos para infundirle una verdadera sensación de calidez y personalidad. El resultado es un set que puede personalizarse al gusto de cada familia que lo construya y que, con suerte, se convertirá en una preciada reliquia y en un lugar donde se preserven las fotos más entrañables. ¡Los constructores incluso podrían 'cultivar' un bosque lleno de árboles para representar a todo su clan!

¿Notan el elemento que representa una mariposa? Está inspirado en la especie *Graphium idaeoides*, que solía aparecer en las monedas filipinas. En la cultura de este país, ver una mariposa volando por la casa significa la visita de un antepasado a sus seres queridos. Creo que es un bonito símbolo de que mantenemos viva la memoria de los miembros de nuestra familia".



# What does Family mean to you?

*“Family is hugely important to all of us, but could you show off exactly what that means to you with some LEGO® bricks?”*

“In 2022, we launched a challenge on ideas.LEGO.com with this question. We received hundreds of amazing ideas from all over the world and got a glimpse of just how creative and diverse family bonds can be! We were so inspired by the gratitude and love expressed in each submission and the personal stories they represent – and how universal they are. From outdoor adventures and travels to family pets, important milestones and cozy game nights. Generations sharing stories or cooking family meals together, community celebrations, holiday traditions and just the precious everyday moments of life.”

- Monica Pedersen, LEGO® Ideas Marketing Director

# Que signifie la famille pour vous ?

« En 2022, nous avons lancé un défi sur ideas.LEGO.com avec cette question. Nous avons reçu des centaines d'idées incroyables du monde entier et avons découvert à quel point les liens familiaux peuvent être créatifs et diversifiés ! Nous avons été très impressionnés par la gratitude et l'amour exprimés dans chaque proposition, par les histoires personnelles qu'elles représentent, et par leur universalité. Des aventures en plein air aux voyages, en passant par les animaux de compagnie, les étapes importantes et les soirées de jeux chaleureuses. Des générations qui partagent des histoires ou qui préparent des repas en famille, des célébrations communautaires, des traditions festives et tout simplement des moments précieux de la vie de tous les jours. »

- Monica Pedersen, directrice du marketing LEGO® Ideas

*“La famille est extrêmement importante pour chacun d'entre nous, mais pourriez-vous montrer exactement ce qu'elle représente pour vous avec des briques LEGO® ?”*

# ¿Qué significa para ti la familia?

*“La familia es enormemente importante para todos nosotros, ¿pero podrías mostrar exactamente lo que significa para ti usando unos cuantos bricks LEGO®?”*

“En 2022, lanzamos un desafío en ideas.LEGO.com con esta pregunta. Recibimos cientos de increíbles ideas de todo el mundo que pusieron de manifiesto lo creativos y diversos que pueden ser los vínculos familiares. Nos inspiró mucho la gratitud y el amor expresados en cada propuesta y las historias personales que se representan en estas, así como lo universales que son estos valores. Los fans enviaron expresiones de todo tipo, desde recuerdos de aventuras al aire libre, viajes y mascotas familiares hasta alusiones a hitos importantes y memorables noches de juegos. También hubo referencias a la transmisión de historias y recetas familiares de una generación a otra, celebraciones comunitarias, tradiciones navideñas y momentos cotidianos”.

- Monica Pedersen, directora de mercadotecnia de LEGO® Ideas

# Our life witnesses

The bonds we build and the memories we share with our loved ones enrich us throughout our lives. They help sustain us in both good times and tough ones.

They are the people you don't remember not knowing, simply because they've always been there. They are the extended family you can't wait to spend time with over the holidays. They are the chosen families and communities you become part of as your roots grow and you build your future. They may push your buttons one minute but then make you burst out laughing the next.



Ivan's original submission

Contribution originale d'Ivan

Propuesta original de Ivan

# Los testigos de nuestra vida

Los lazos que construimos y los recuerdos que compartimos con nuestros seres queridos nos enriquecen a lo largo de toda nuestra existencia. Nos ayudan a mantener nuestro centro tanto en los buenos momentos como en tiempos difíciles.

Tus familiares son esas personas a quienes no recuerdas haber conocido sencillamente porque siempre han estado presentes en tu vida. Son ellos en quienes piensas cuando se abre un espacio en tu agenda para compartir tiempo libre. Las comunidades a las que eliges pertenecer a lo largo de la vida y con las que construyes un futuro también se convierten en parte de tu familia. Nadie más tiene el poder de sacarte de tus casillas un momento y hacerte estallar en carcajadas inmediatamente después.

No importa cómo esté construido tu árbol genealógico, siempre puedes encontrar refugio en el sentimiento de pertenencia que surge de compartir incontables momentos, ya sean grandes acontecimientos o vivencias aparentemente pequeñas. La familia crea ese espacio único en el que podemos compartir victorias, errores, consejos, apoyo y amor incondicional.

No matter how your family tree is built, you can always find sanctuary in the sense of belonging that comes from sharing millions of moments, big and small. Family creates that unique space between us where we can take part in each other's victories, mistakes, guidance, support and unconditional love.

# Nos témoins de vie

Les liens que nous tissons et les souvenirs que nous partageons avec nos proches nous enrichissent tout au long de notre vie. Ils nous soutiennent dans les bons moments comme dans les plus difficiles.

Ce sont les personnes qui ne vous ont jamais été inconnues, tout simplement parce qu'elles ont toujours été là. Elles sont la famille élargie avec laquelle vous avez hâte de passer les fêtes. Ce sont les familles et les communautés choisies que vous intégrez au fur et à mesure que vos racines se développent et que vous construisez votre avenir. Elles peuvent vous pousser à bout un instant, et vous faire éclater de rire l'instant d'après.

Quelle que soit la façon dont votre arbre familial est construit, vous pouvez toujours trouver refuge dans le sentiment d'appartenance que procure le partage de millions de moments, petits et grands. La famille crée cet espace unique entre nous où nous pouvons prendre part aux victoires, aux erreurs, aux conseils, au soutien et à l'amour inconditionnel de chacun.



## Play your part

With more than eight billion people living on our little blue planet, there are infinite ways for us to meet, get to know each other and form lifelong bonds. However you define your roots or how far your branches reach, you can find ways to customize your LEGO® Family Tree and add the little gems that connect you. You can fill the 16 hanging photo frames with passport or printed photos of your loved ones, fun memories, ticket stubs, or maybe a miniature drawing or two? Change the colors of the tree blossoms and surrounding flower beds to reflect your favorite season. Display accessories that remind you of all the fun moments you have shared together, from a child's first artwork or a creative masterpiece to cozy family picnics, and many more!

## Jouez votre rôle

Avec plus de huit milliards de personnes vivant sur notre petite planète bleue, il existe une infinité de façons de se rencontrer, d'apprendre à se connaître et de tisser des liens pour la vie. Quelle que soit la définition de vos racines ou la portée de vos branches, vous pouvez trouver des moyens de personnaliser votre arbre familial LEGO® et d'ajouter les petites merveilles qui vous lient à votre famille. Vous pouvez remplir les 16 cadres photo avec des photos de vos proches, des souvenirs amusants, des talons de billets, ou peut-être un ou deux dessins miniatures. Changez les couleurs des fleurs de l'arbre et des fleurs environnantes pour refléter votre saison préférée. Exposez des accessoires qui vous rappellent tous les moments agréables que vous avez partagés ensemble, du premier dessin d'un enfant ou d'un chef-d'œuvre créatif aux pique-niques familiaux chaleureux, et bien d'autres choses encore !



## Asume tu papel

Con más de ocho mil millones de personas viviendo en nuestro pequeño planeta azul, hay incontables maneras de encontrarnos, conocernos y formar vínculos para toda la vida. Independientemente de cómo definas tus raíces o de lo lejos que lleguen las ramas de tu familia, puedes encontrar formas de personalizar tu Árbol de la Familia LEGO® e incluir las pequeñas joyas que conectan a sus integrantes. Puedes llenar los 16 marcos de fotos colgantes con pequeños retratos o fotos familiares de tus seres queridos, recuerdos divertidos, boletos de avión o autobús, e incluso dibujos en miniatura. Cambia los colores de las flores del árbol y de las plantas que lo rodean para reflejar tu estación favorita. Exhibe accesorios que te recuerden todos los momentos divertidos que hayan compartido juntos, desde la primera obra de arte de un niño o una obra maestra llena de creatividad hasta entrañables excursiones familiares, ¡y muchos más!





## Build together

Who will play the biggest part in your LEGO Family Tree? Invite your loved ones to help you build and customize your model. Download the free LEGO® Builder app, search for this set and have fun building and playing together!

## Construisez ensemble

Qui jouera le rôle le plus important dans votre arbre familial LEGO ? Invitez vos proches à vous aider à construire et à personnaliser votre modèle. Téléchargez l'application gratuite LEGO® Builder, recherchez cet ensemble et amusez-vous à construire et à jouer ensemble !

## Construye en compañía

¿Quién desempeñará el papel más importante en tu Árbol de la Familia LEGO? Invita a tus seres queridos a ayudarte a construir y personalizar tu modelo. Descarga la app gratuita LEGO® Builder, busca este set, y organiza una reunión familiar para construir y jugar!



# Meet the LEGO® designer family

## Rencontre avec la famille des concepteurs LEGO®

## Conoce a la familia de diseñadores de LEGO®

*The LEGO® Ideas design team worked with Ivan to get his Family Tree ready to be planted in homes all over the world. In the process, they got to reflect on what family meant to them as well.*

"Family, to me, is a supportive and loving community that shows up in many forms and changes and grows over time. I am so thankful for the wonderful people (and pets) who have helped me and have been part of my life! Special shoutout to my parents and sister, brother-in-law, niece and nephew, my relatives and grandparents, my husband and his welcoming family, my friends and colleagues, and my cats. We've created so many precious memories together! Like camping in the Canadian Rockies, running from coaster to coaster at amusement parks and walking on the beach in Maui. But also at our kitchen table, playing Canasta with my grandparents or dominos with my in-laws, eating dinners and celebrating holidays together!"

- Laura Perron, LEGO® Ideas Model Designer



*Laura and her husband in the middle, in-laws to the left and parents to the right · Laura et son mari au milieu, les beaux-parents à gauche et les parents à droite · Laura y su marido en el centro, sus suegros a la izquierda y sus padres a la derecha*

« Pour moi, la famille est une communauté de soutien et d'amour qui se manifeste sous différentes formes et qui évolue et s'agrandit au fil du temps. Je suis tellement reconnaissante aux formidables personnes (et animaux) qui m'ont aidée et qui ont fait partie de ma vie ! Je remercie tout particulièrement mes parents, ma sœur, mon beau-frère, ma nièce et mon neveu, ma famille et mes grands-parents, mon mari et sa famille accueillante, mes amis et mes collègues, ainsi que mes chats. Nous avons créé tellement de précieux souvenirs ensemble, comme camper dans les Rocheuses canadiennes, passer d'une montagne russe à l'autre dans les parcs d'attractions et marcher sur la plage de Maui. Il y a aussi eu ces moments passés autour de la table de notre cuisine, à jouer à la canasta avec mes grands-parents ou aux dominos avec mes beaux-parents, à dîner et à célébrer les fêtes ensemble ! »

- Laura Perron, conceptrice de modèles LEGO® Ideas

"Para mí, la familia es una comunidad solidaria y afectuosa que se manifiesta de muchas formas y que cambia y crece con el tiempo. ¡Siento un profundo agradecimiento hacia a las maravillosas personas (y mascotas) que me han ayudado y que han estado presentes en mi vida! Hago una mención especial de mis padres y hermana, cuñado, sobrina y sobrino, mis parientes y abuelos, mi marido y su acogedora familia, mis amigos y colegas, y mis gatos. ¡Hemos creado infinidad de preciosos recuerdos juntos! Siempre tengo presentes nuestras acampadas en las Montañas Rocosas canadienses, incontables recorridos en parques de diversiones y agradables paseos por la playa en Maui. Pero también los momentos que hemos compartido en la mesa de nuestra cocina, jugando a la canasta con mis abuelos o al dominó con mis suegros, ¡y cenando y celebrando fiestas juntos! "

- Laura Perron, modelista de LEGO® Ideas

*L'équipe de conception LEGO® Ideas a travaillé avec Ivan pour que son arbre familial soit prêt à être planté dans les maisons du monde entier. Ce faisant, les concepteurs ont pu réfléchir à ce que la famille signifiait pour eux.*

*Los miembros del equipo de diseño de LEGO® Ideas trabajaron con Ivan a fin de que su Árbol de la Familia estuviera listo para plantarse en hogares de todo el mundo. El proceso también les dio la oportunidad de reflexionar acerca de lo que significa la familia para ellos mismos.*



*Ashwin (left) with his parents and brother · Ashwin (à gauche) avec ses parents et son frère · Ashwin (izquierda) con sus padres y su hermano*

"Family is a very important part of my life. It gives me a feeling of connection and belonging towards the people that have raised me, and I grew up with. Now that I live in Denmark, and therefore am further away from my own family, it gives new meaning to the connection I have with my family. It makes our contacts stronger and more meaningful and seeing each other in real life is always a joy. Especially now that my brother and his wife have their first child and our family has started to grow. My strongest family memories from growing up are driving to Spain for our holidays. It was always a long drive but when we arrived, we were in a new world. I have always loved exploring new things with my family. I still do."

*- Ashwin Visser, LEGO® Ideas Senior Graphic Designer*

« La famille est une partie très importante de ma vie. Elle me donne un sentiment de connexion et d'appartenance à l'égard des personnes qui m'ont élevé et avec lesquelles j'ai grandi. Maintenant que je vis au Danemark et que je suis donc plus éloigné de ma propre famille, le lien que j'ai avec elle prend un sens nouveau. Nos contacts sont plus forts et plus significatifs, et se voir dans la vraie vie est toujours source de bonheur, surtout depuis que mon frère et sa femme ont eu leur premier enfant et que notre famille a commencé à s'agrandir. Les souvenirs familiaux les plus marquants de mon enfance sont les voyages en voiture vers l'Espagne pour les vacances. La route était toujours longue, mais lorsque nous arrivions, nous étions dans un nouveau monde. J'ai toujours aimé découvrir de nouvelles choses avec ma famille. Et c'est encore le cas aujourd'hui. »

*- Ashwin Visser, graphiste principal LEGO® Ideas*

"Mi familia es una parte muy importante de mi vida. Me da un sentimiento de conexión y pertenencia con las personas que me criaron y con las que he crecido. Ahora que vivo en Dinamarca y estoy más lejos de mis seres queridos, la conexión que tengo con mi familia ha adquirido una mayor trascendencia. Nuestros contactos se han vuelto más fuertes y significativos, y vernos en la vida real es siempre un motivo de alegría, sobre todo ahora que mi hermano y su mujer han tenido a su primer hijo y nuestra familia ha empezado a crecer. Los mejores recuerdos familiares que tengo de mi infancia son de cuando viajábamos en auto a España para pasar las vacaciones. Siempre era un viaje largo, pero, cuando llegábamos, nos recibía un mundo totalmente nuevo. Siempre me gustó explorar cosas nuevas con mi familia. Y me sigue gustando".

*- Ashwin Visser, diseñador gráfico sénior de LEGO® Ideas*

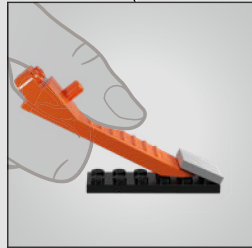
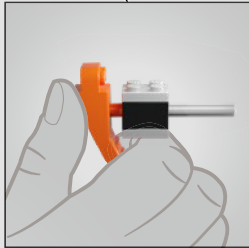
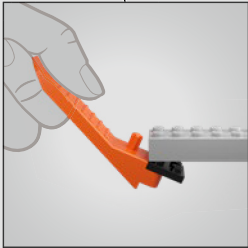
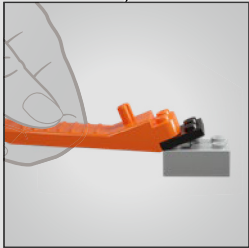
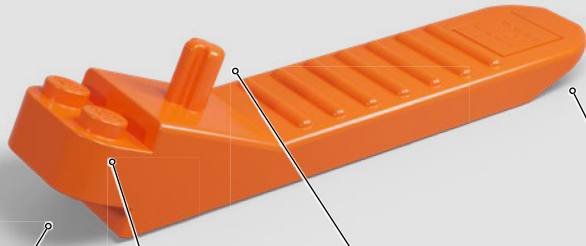

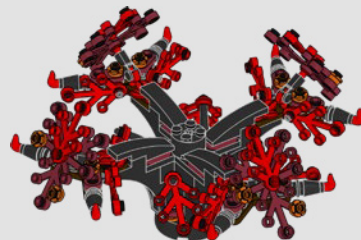
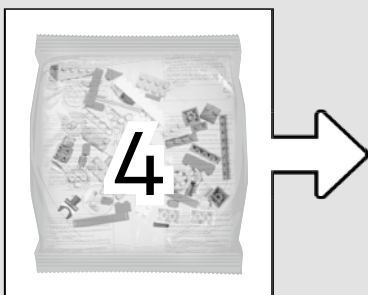
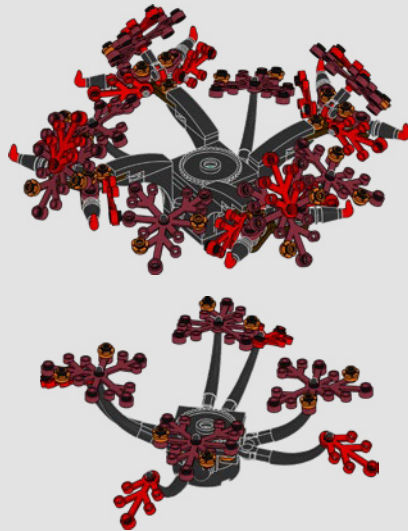
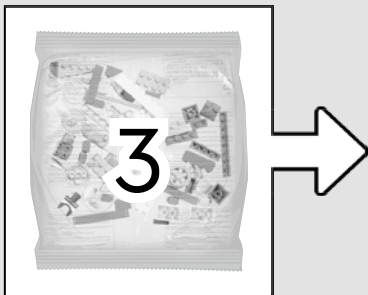
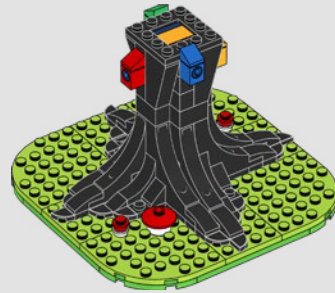
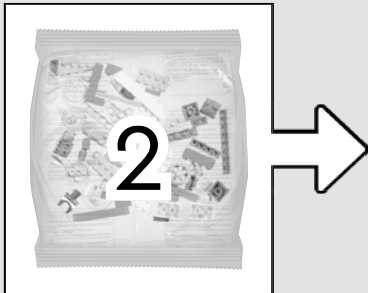
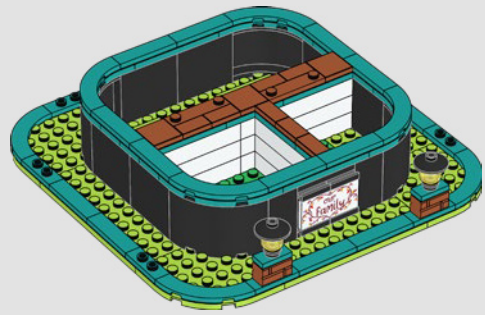
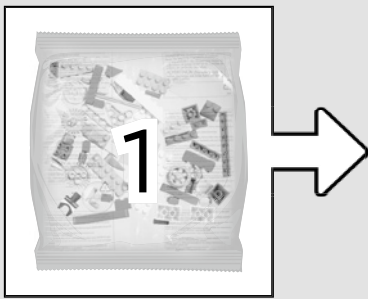



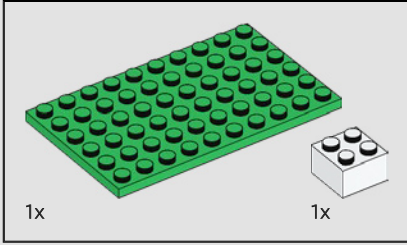

1

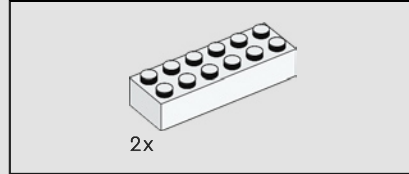
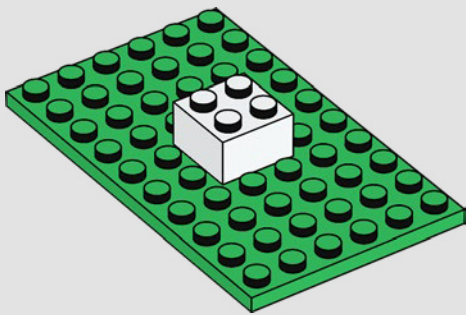

2

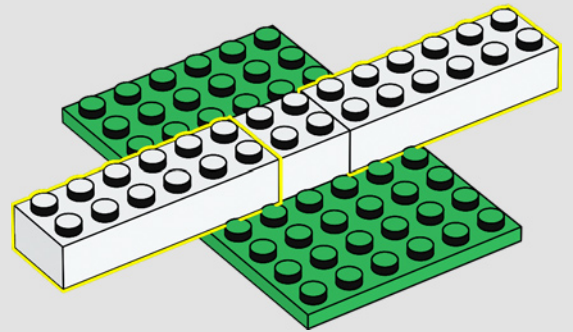

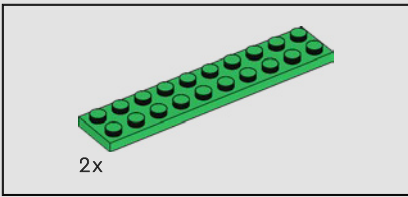

3

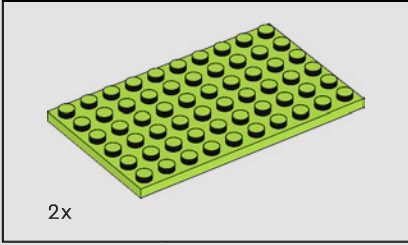
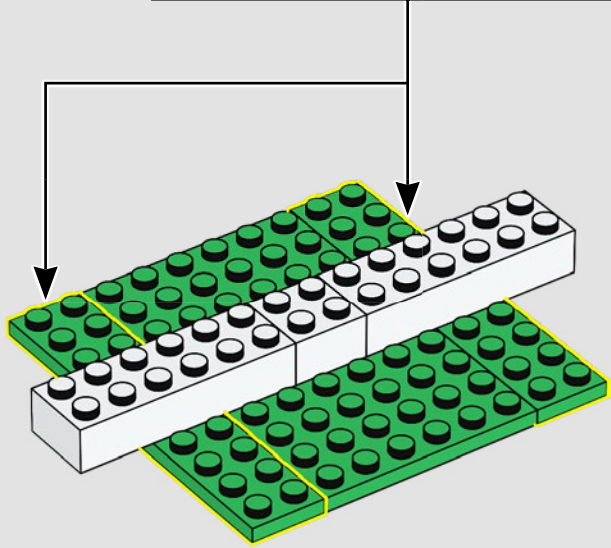
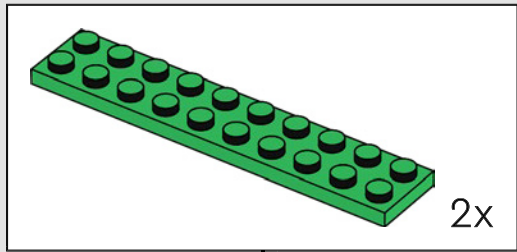

4

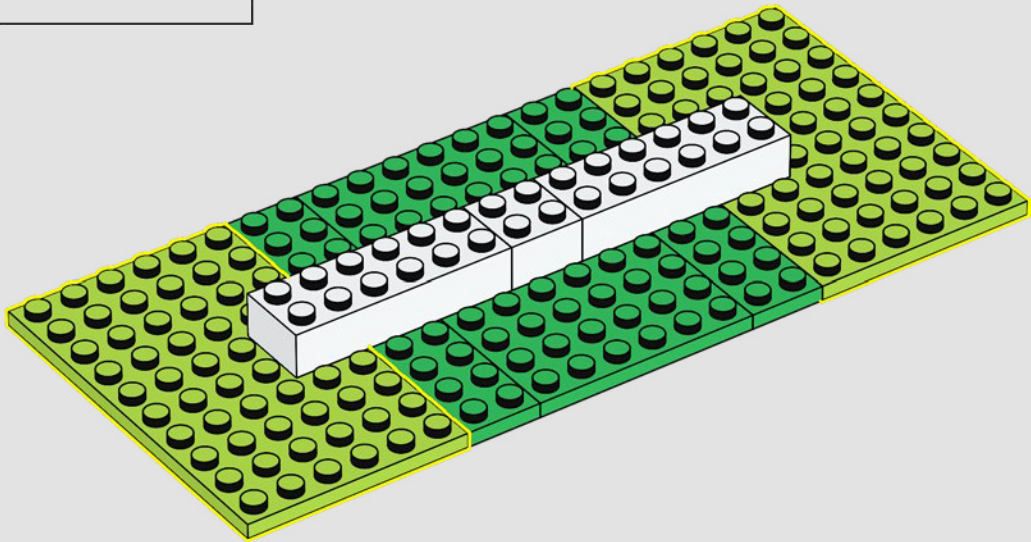



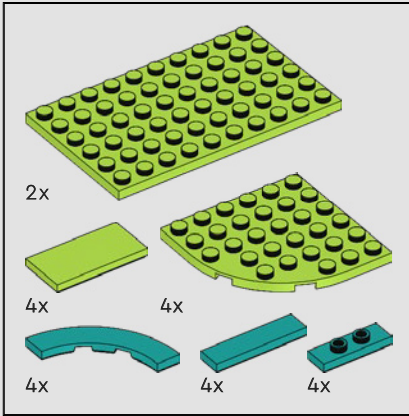
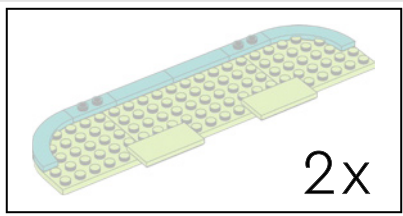

5

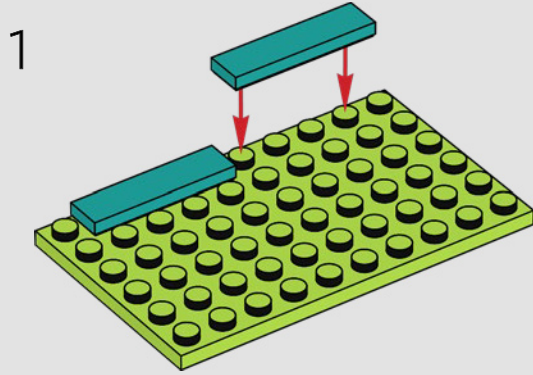

2

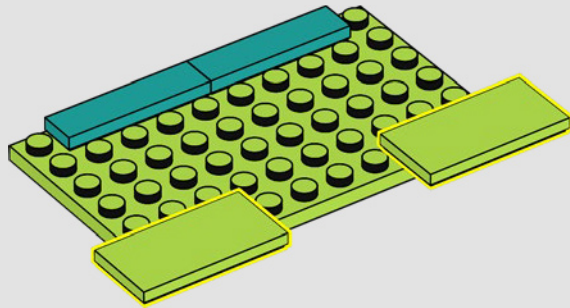

3

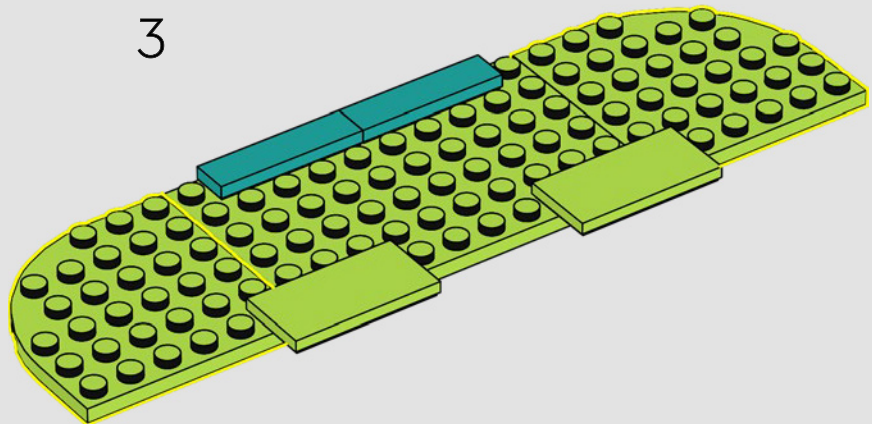

4

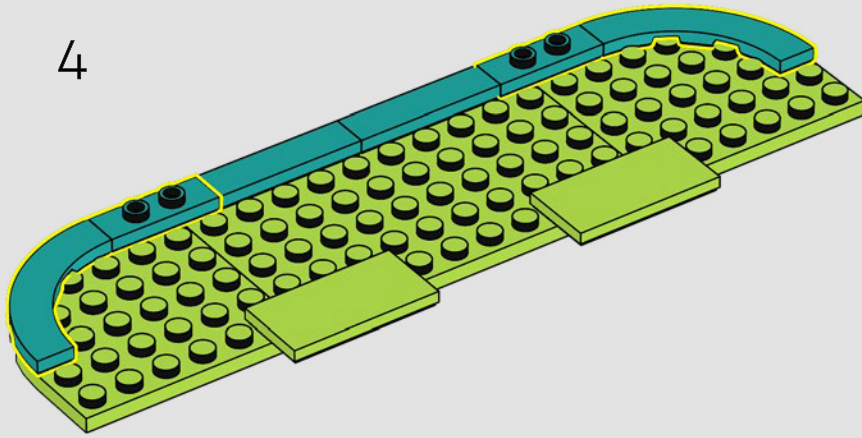

2x

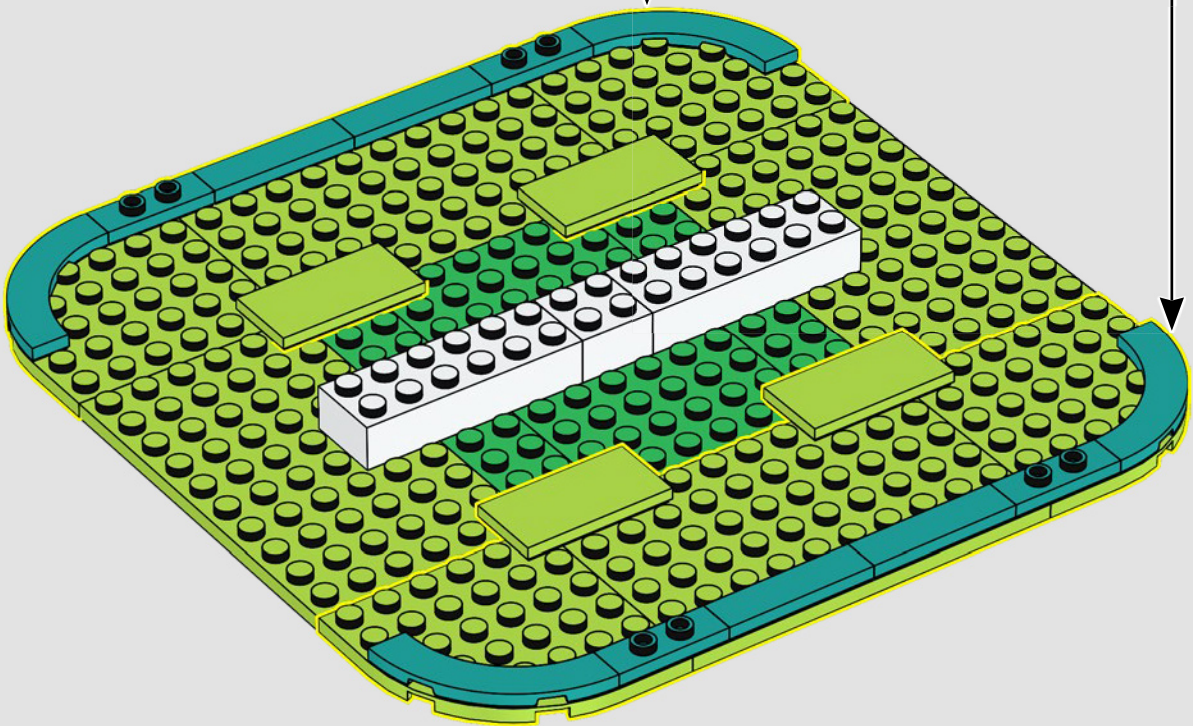

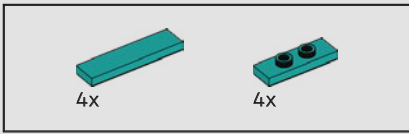

6

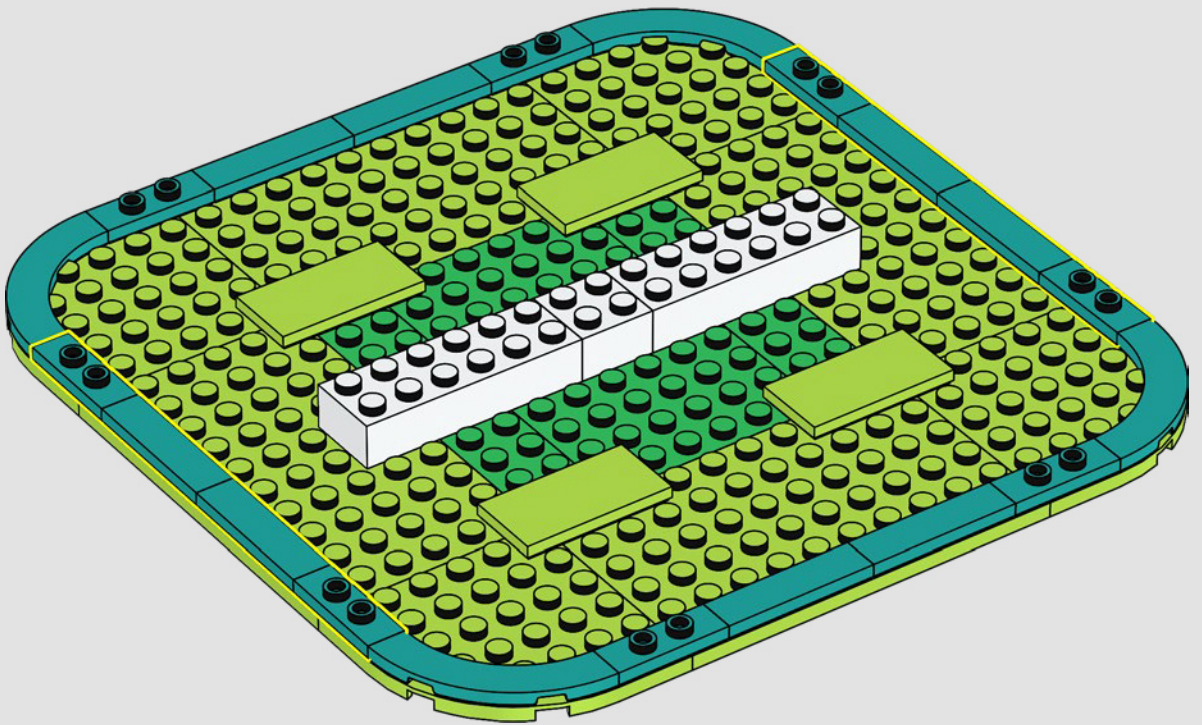

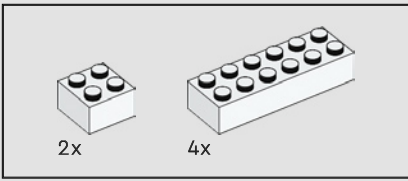

7

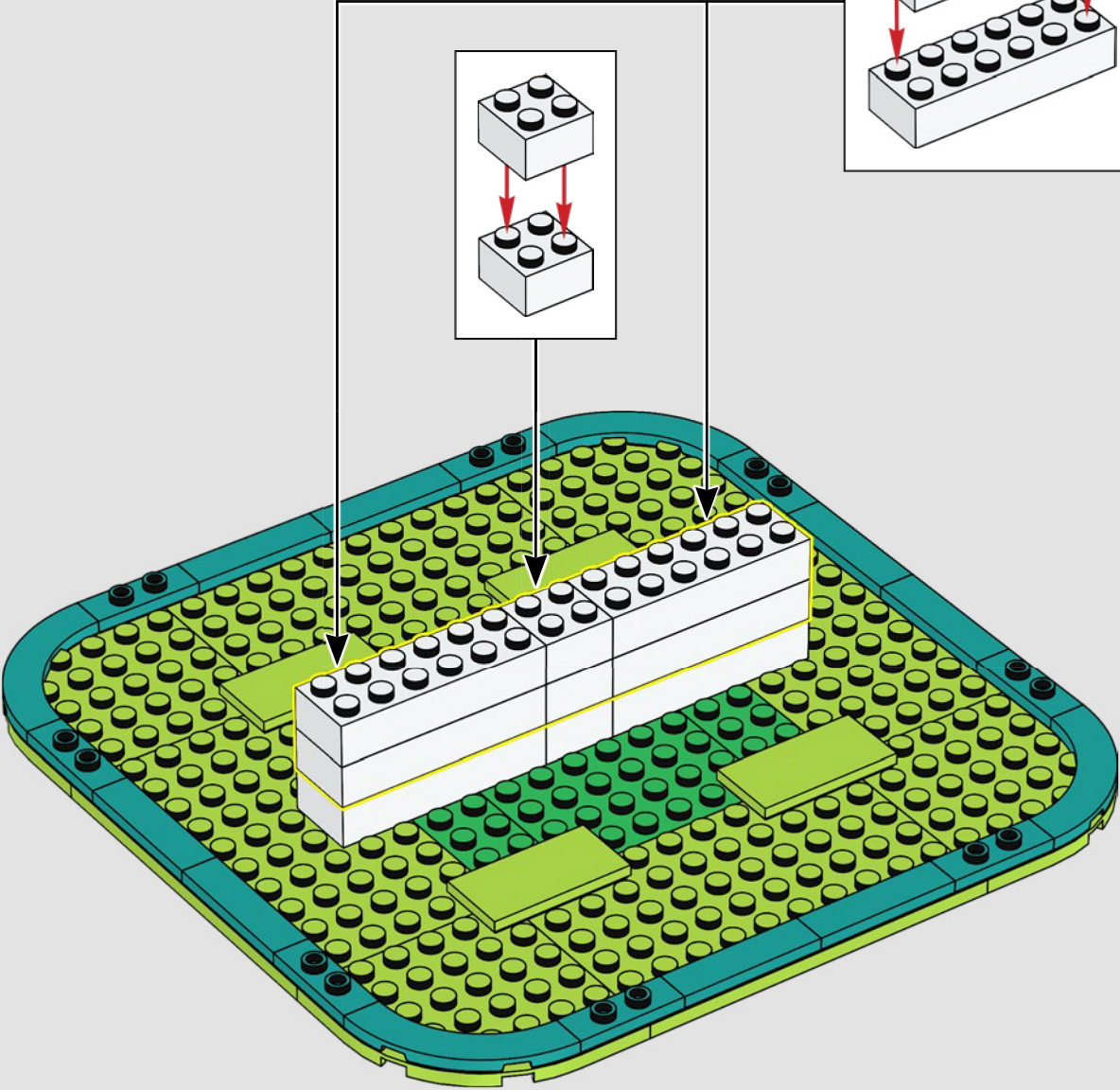
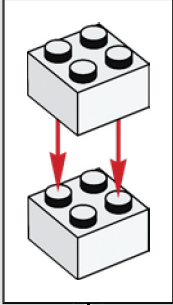
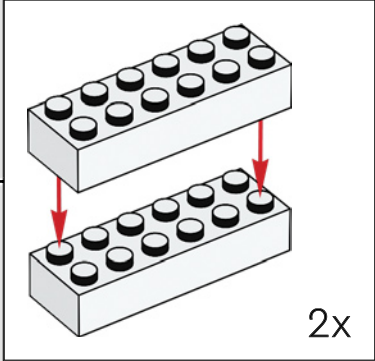

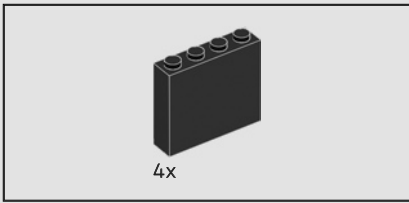

8

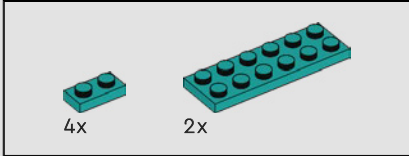
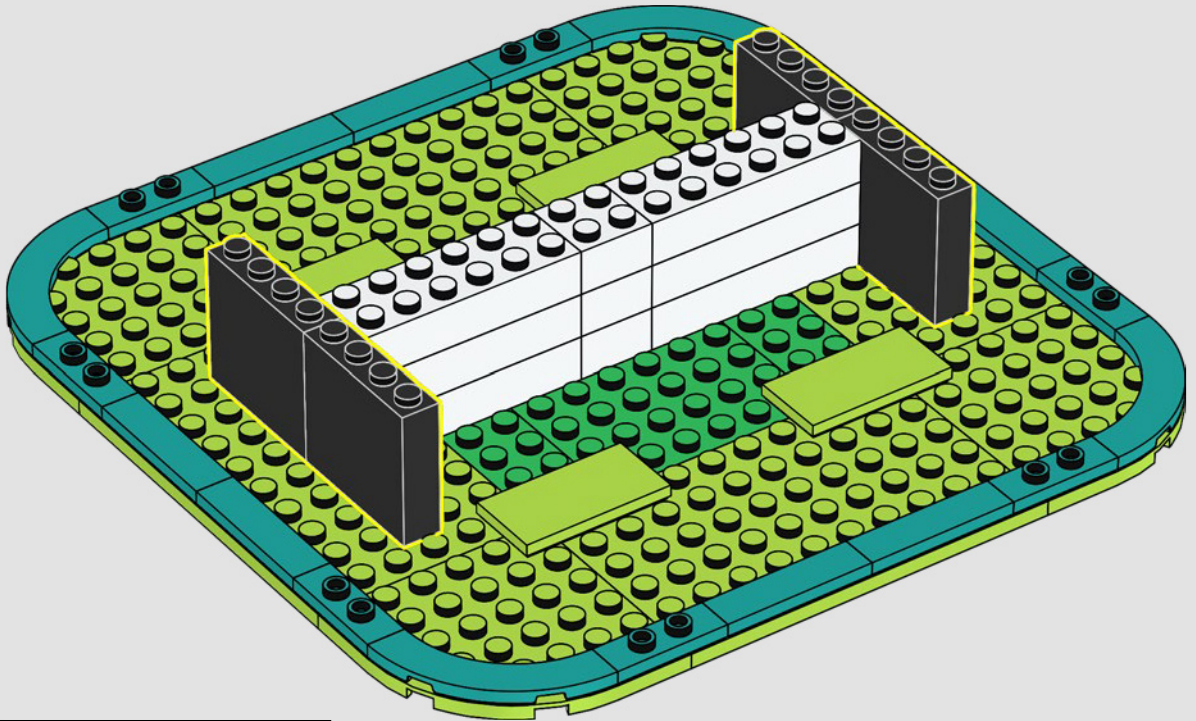

9

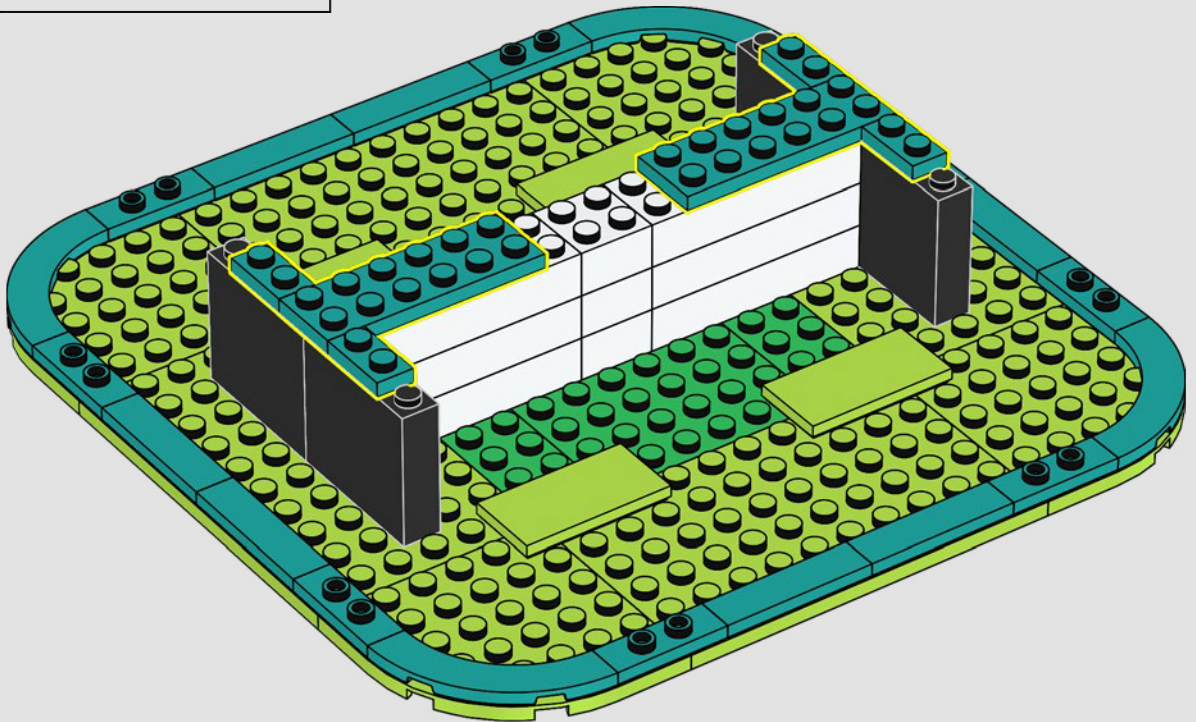

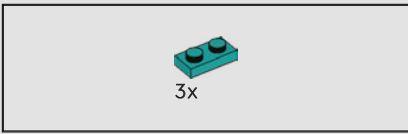

10

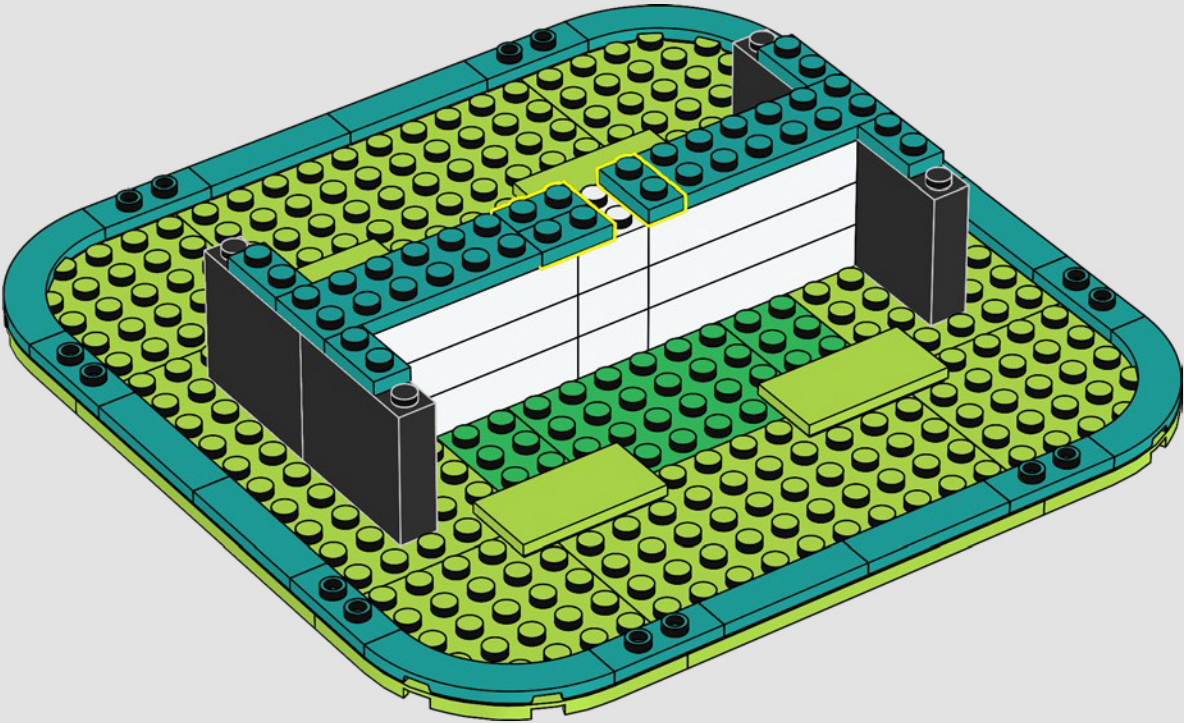

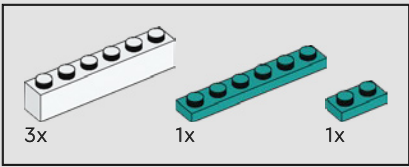

11

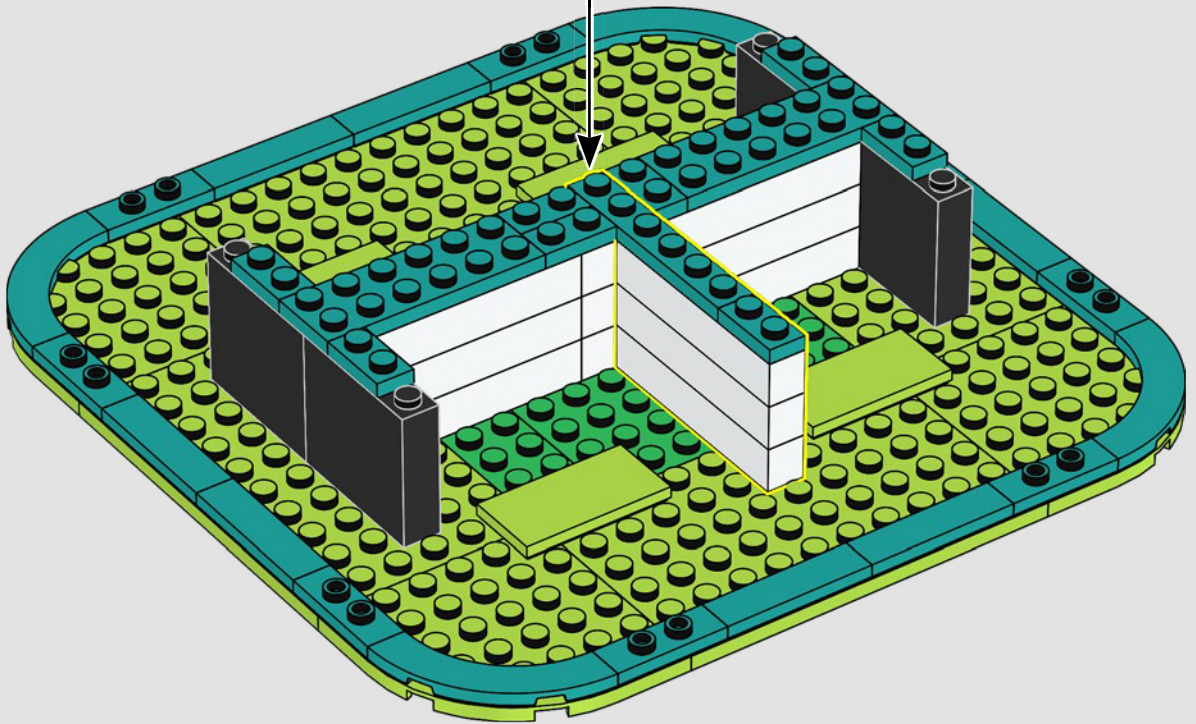
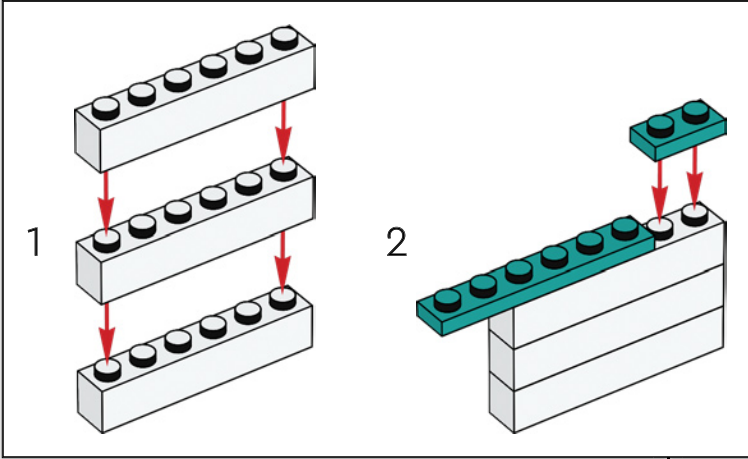

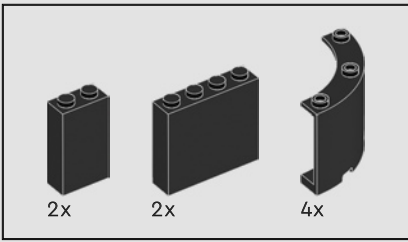

12

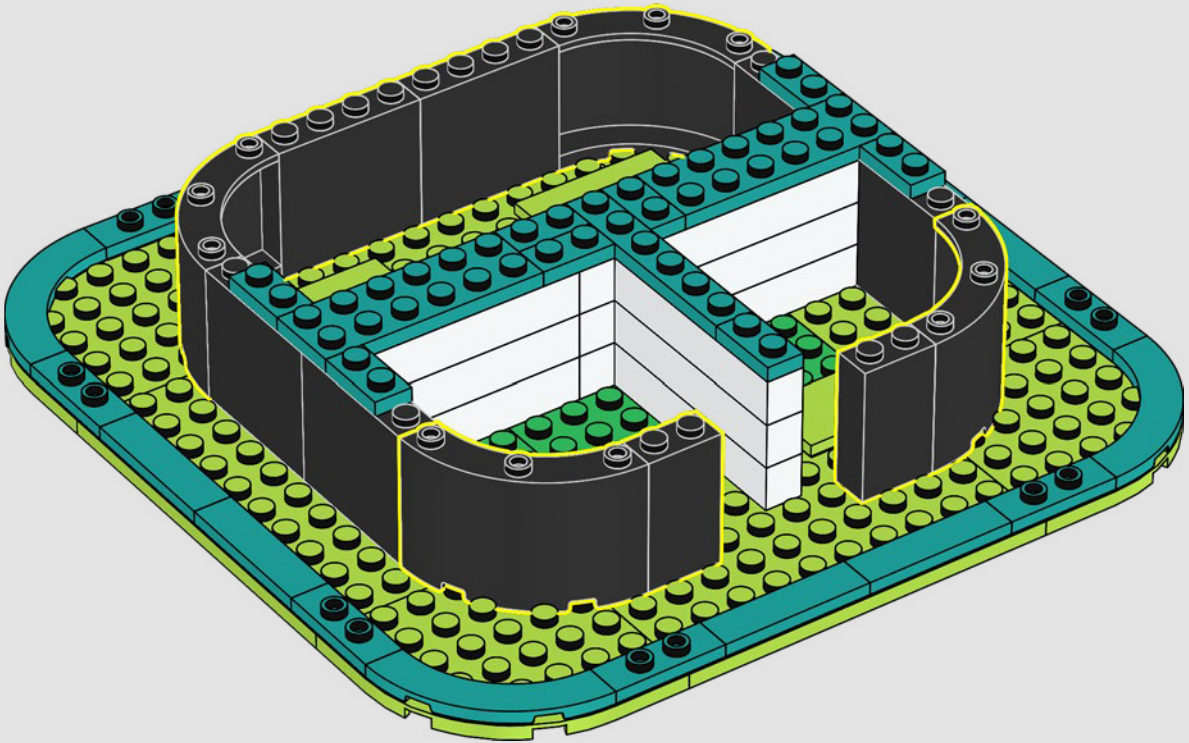



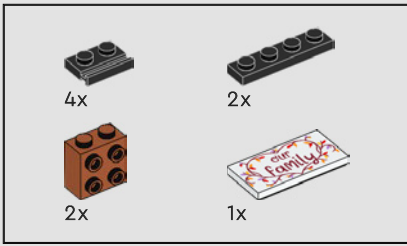

13

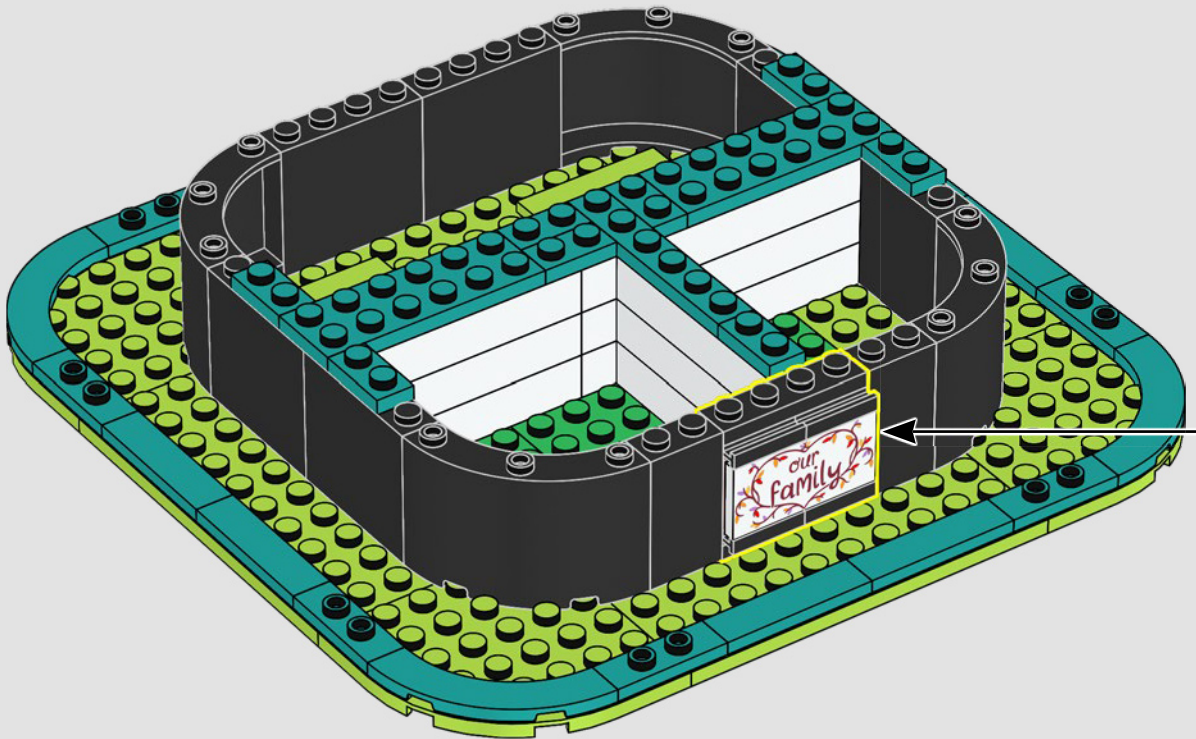
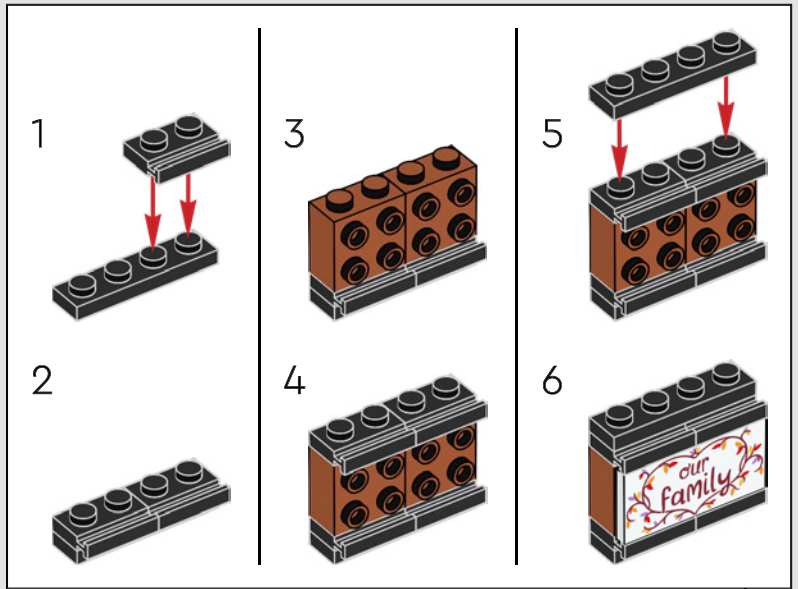

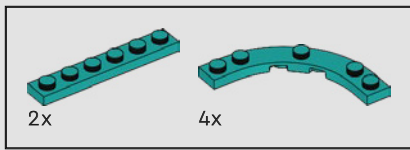

14

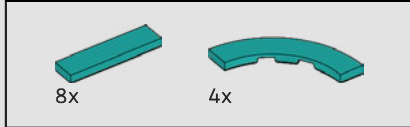
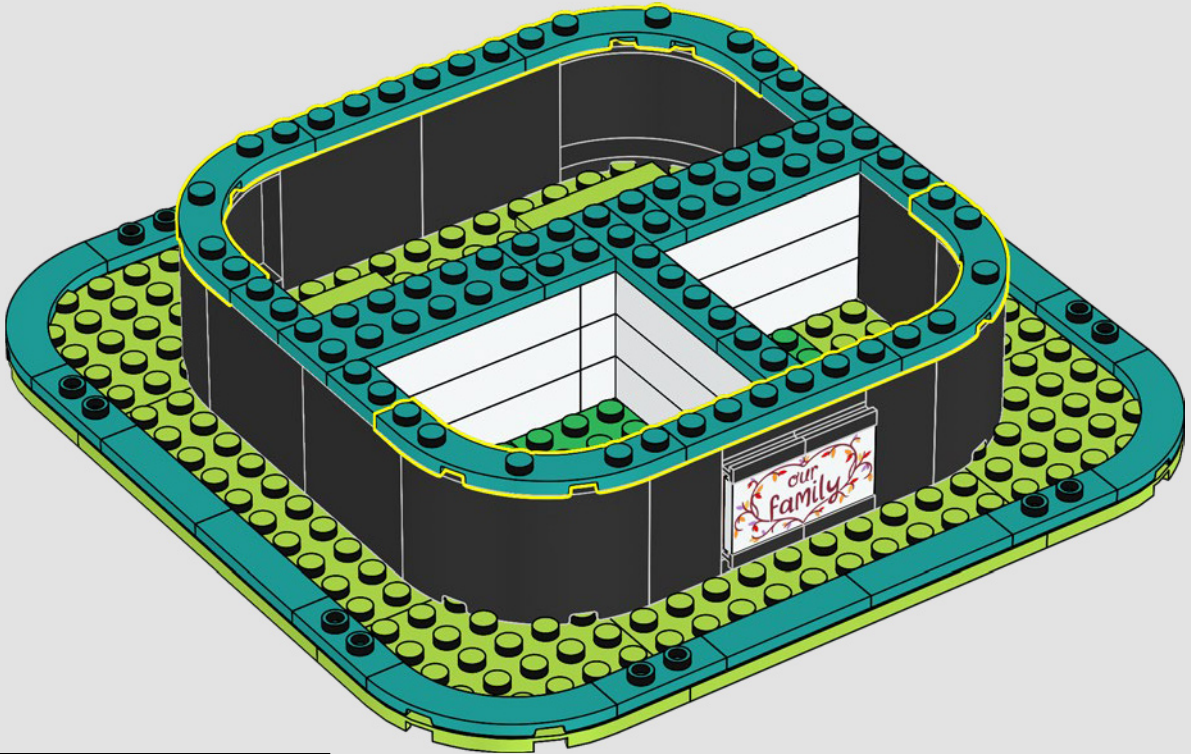

15

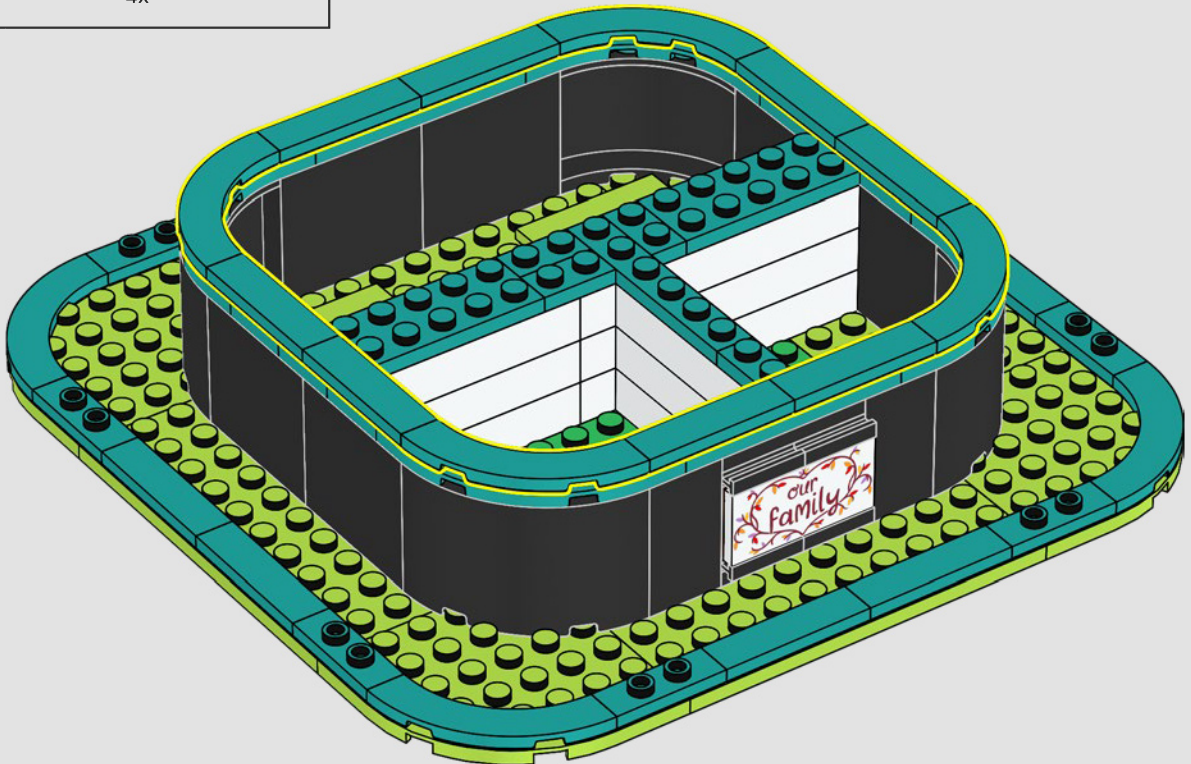

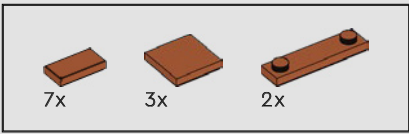

16

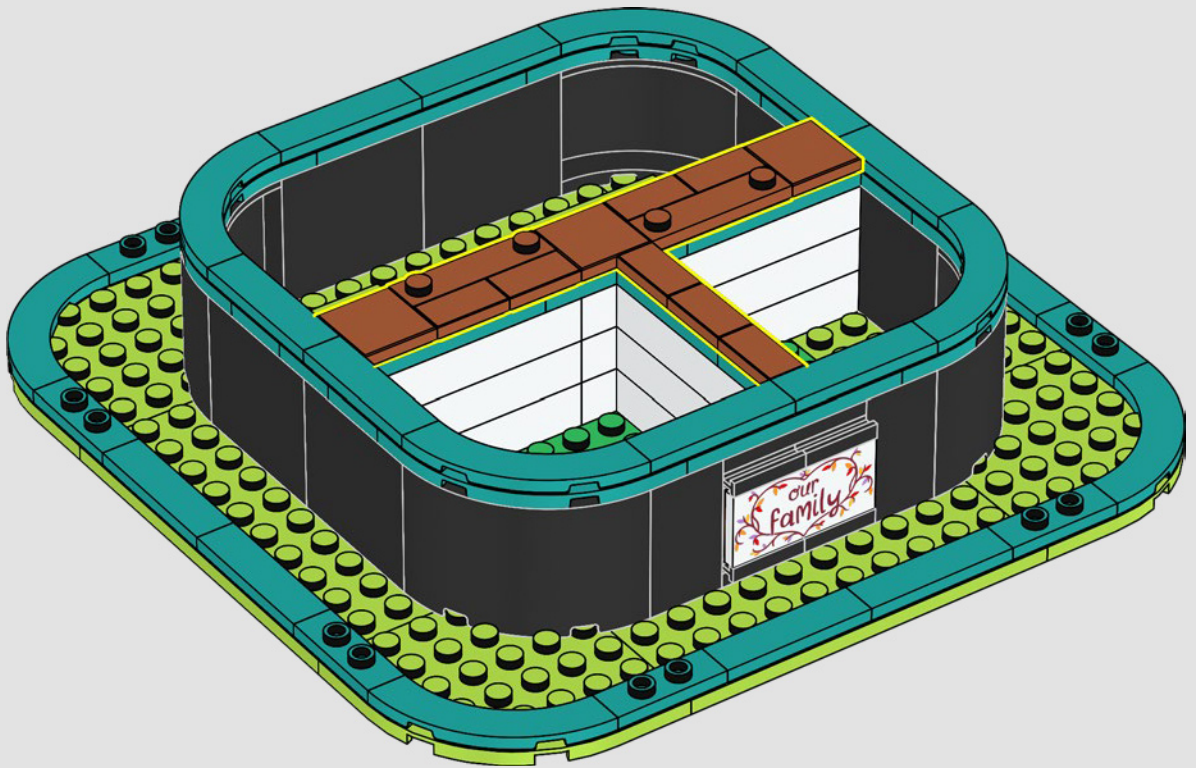

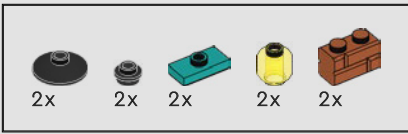

17

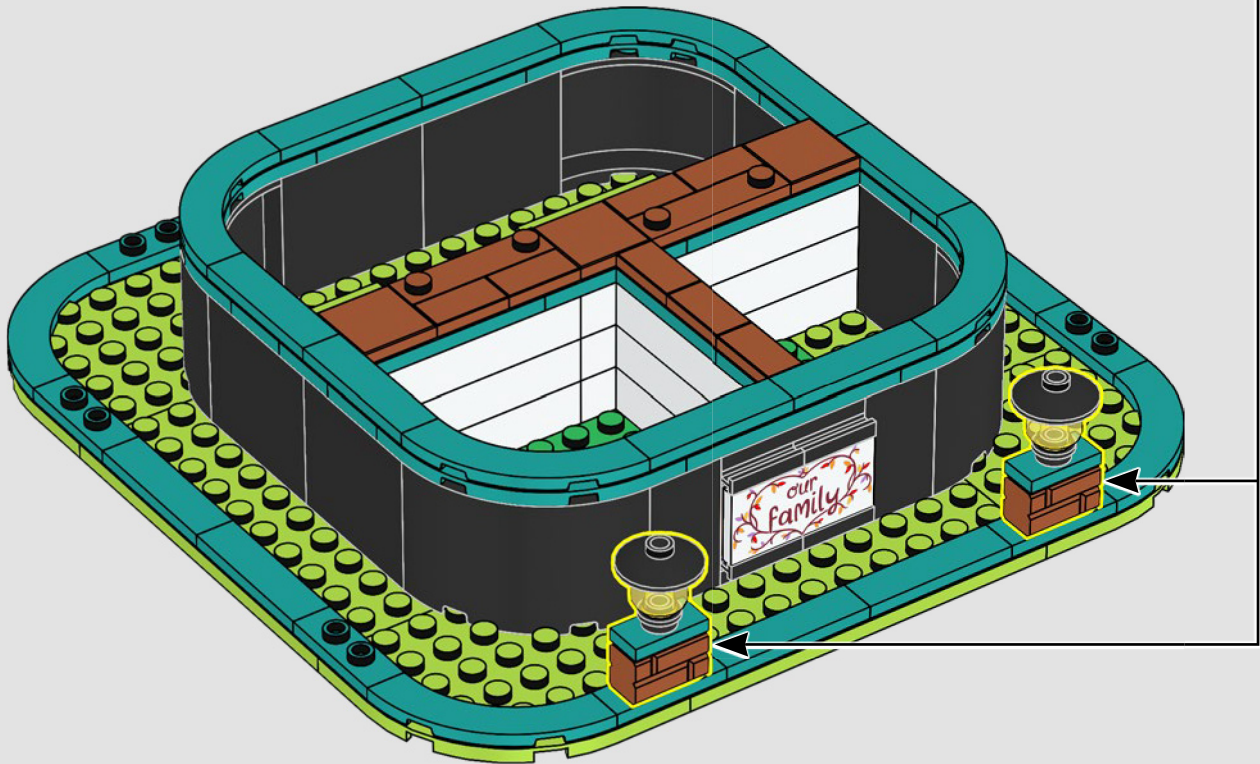
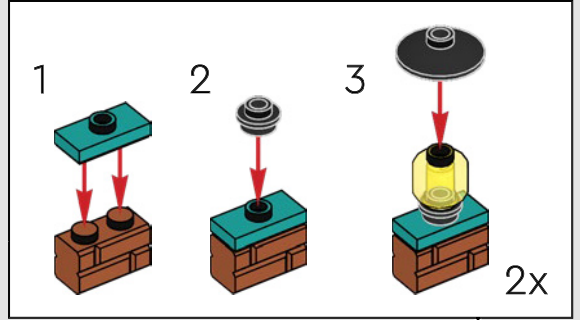

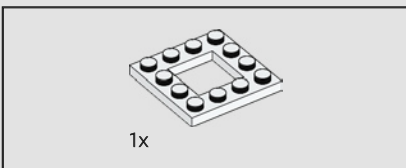
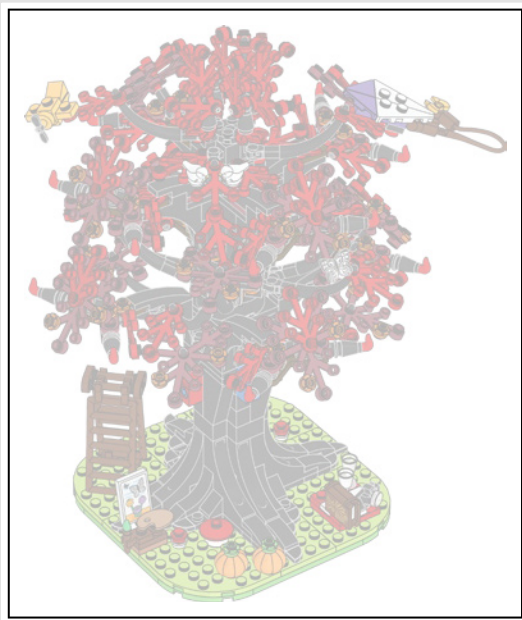

18

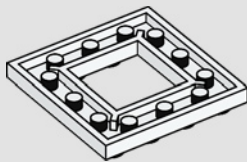

19

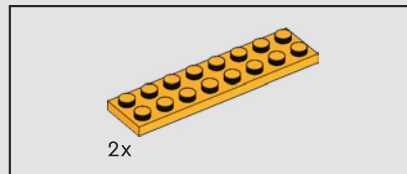
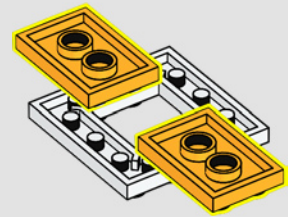

20

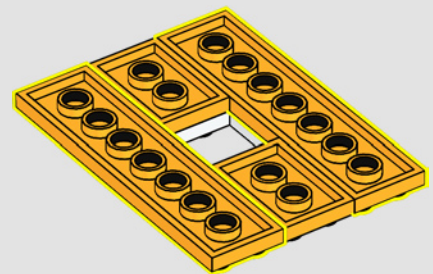

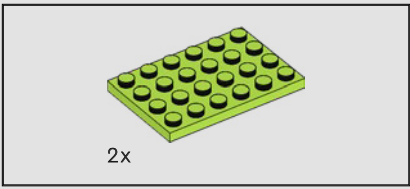

21

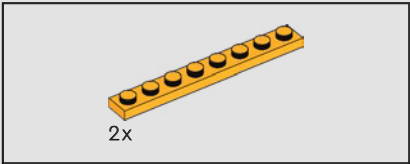
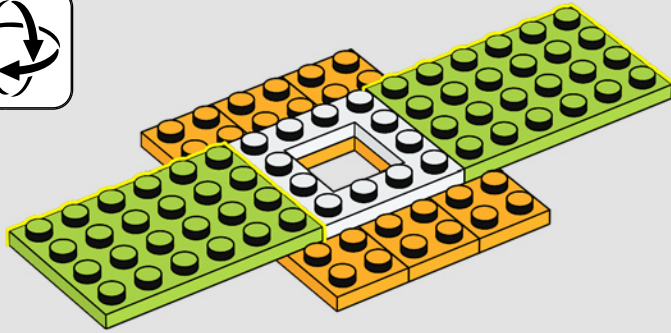

22

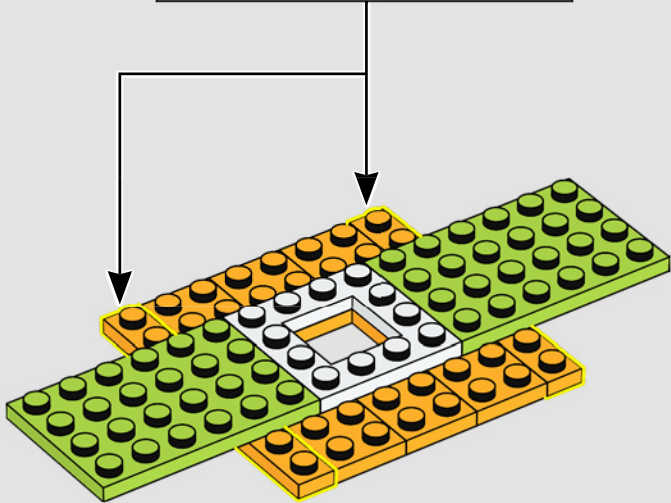
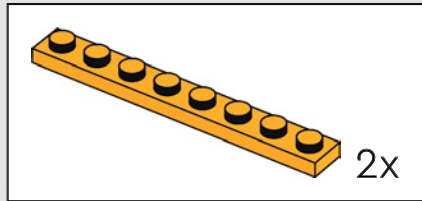

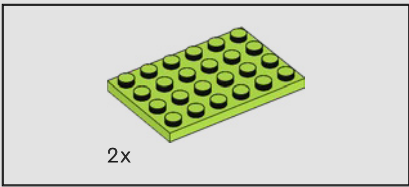

23

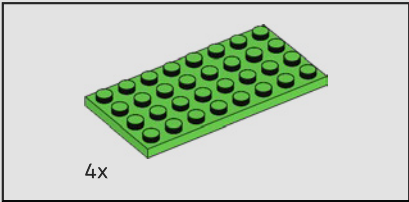
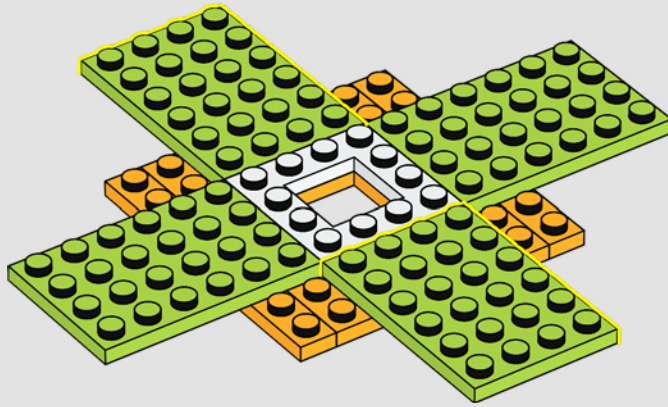

24

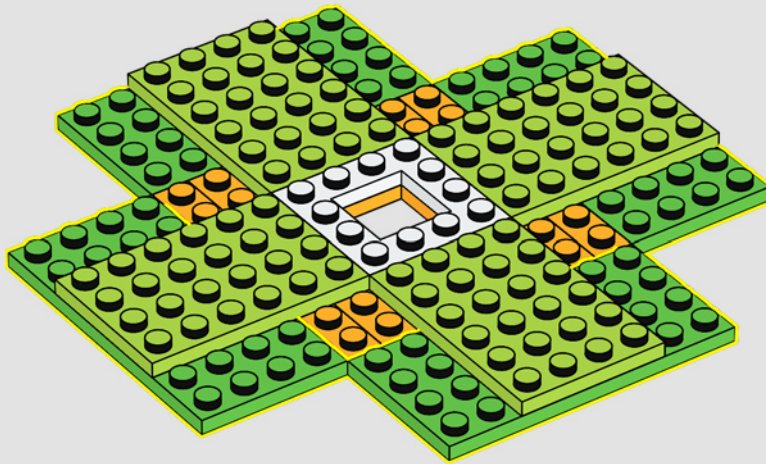

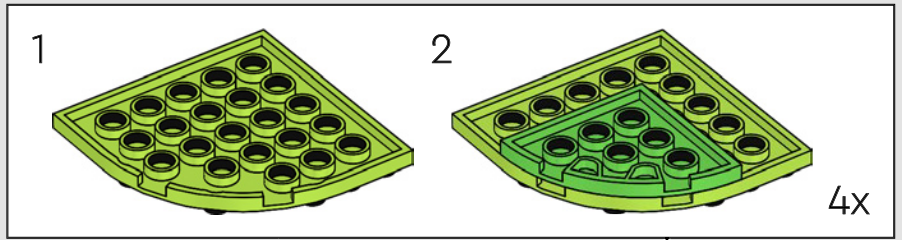
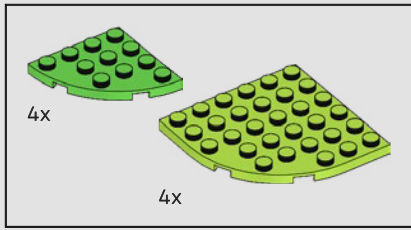

25

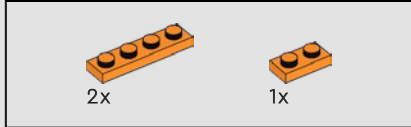
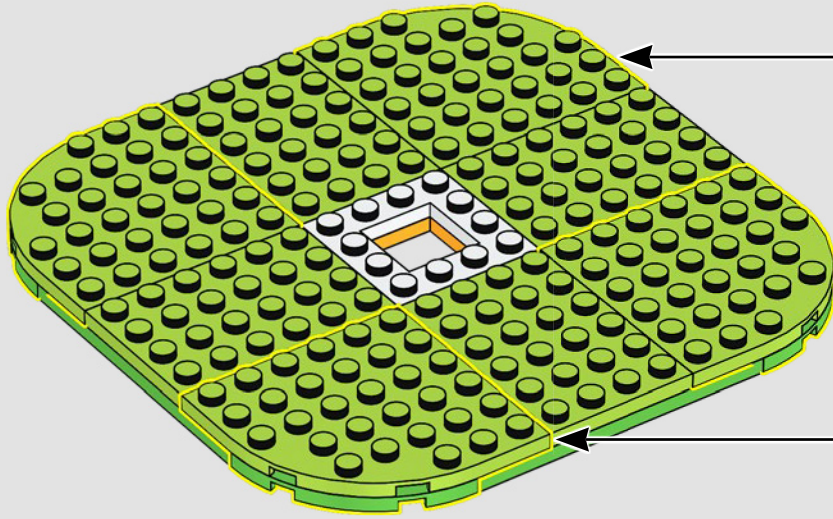

26

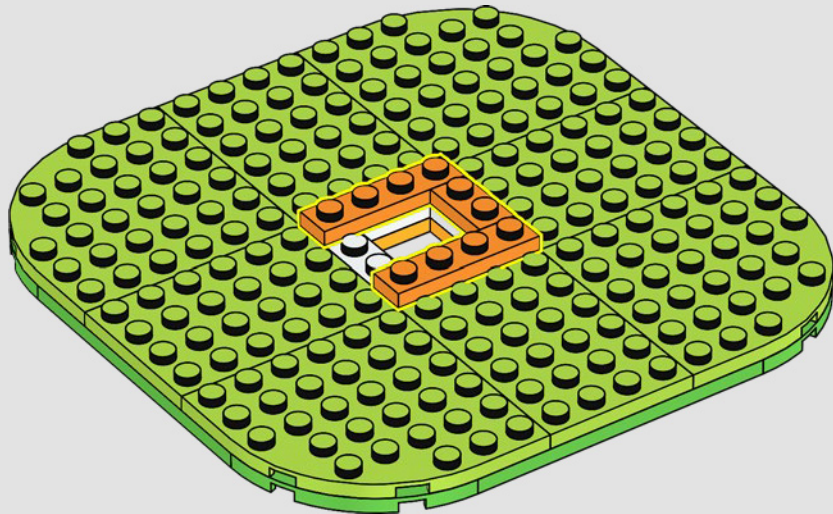



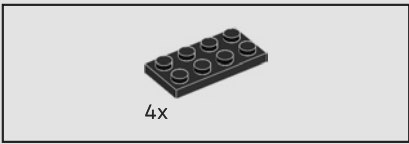

27

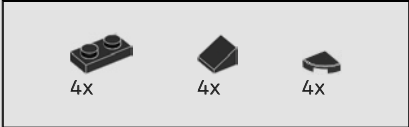
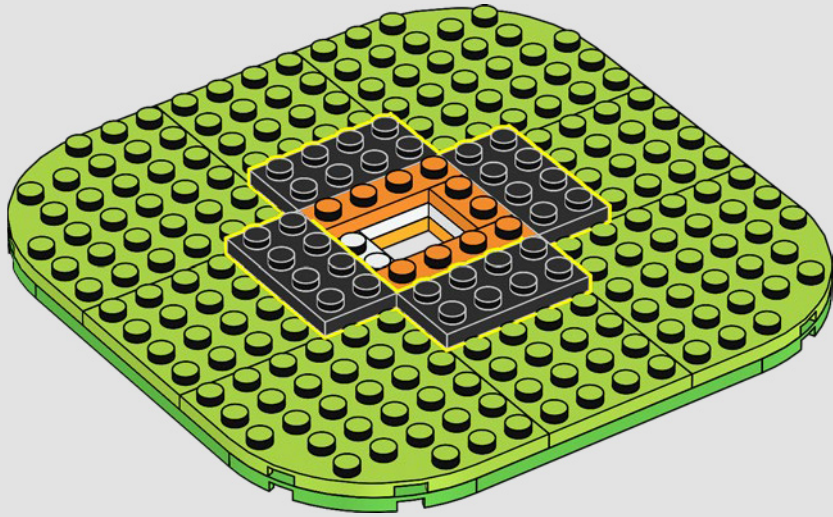

28

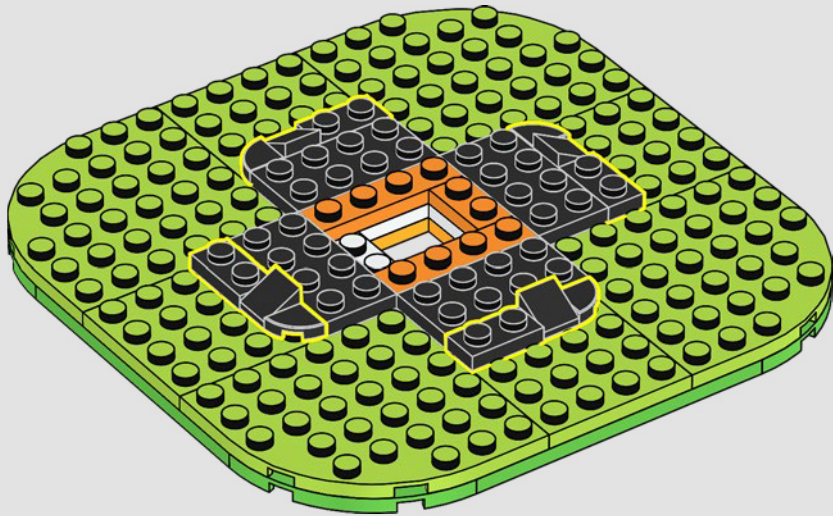



29

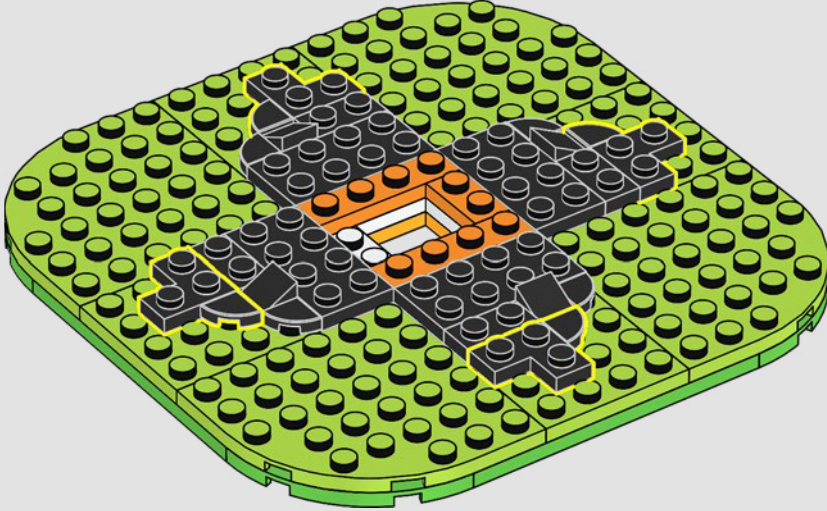

30

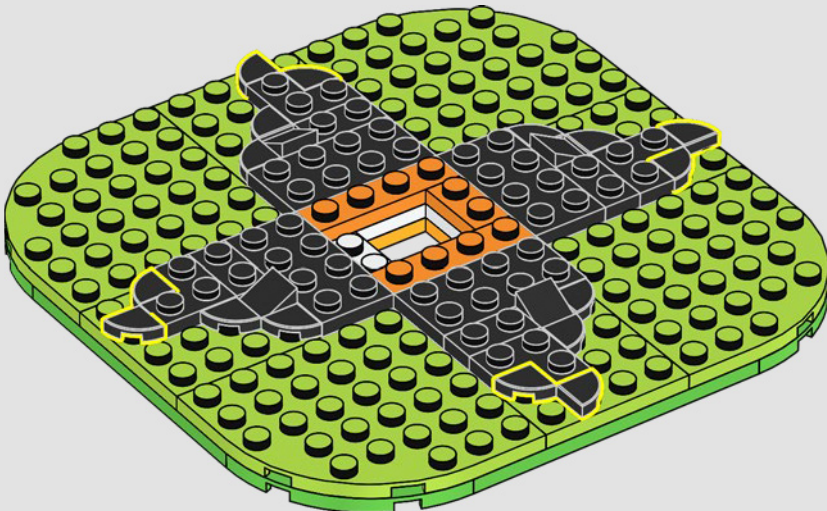

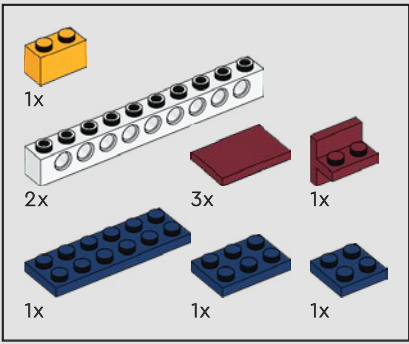

31

1

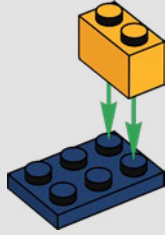

2

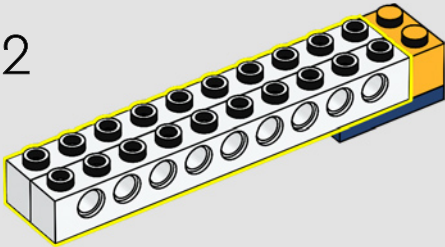

3

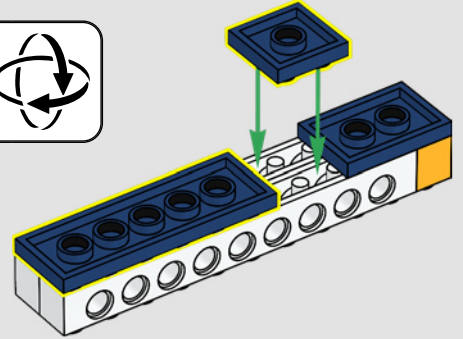
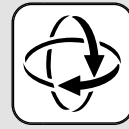

4

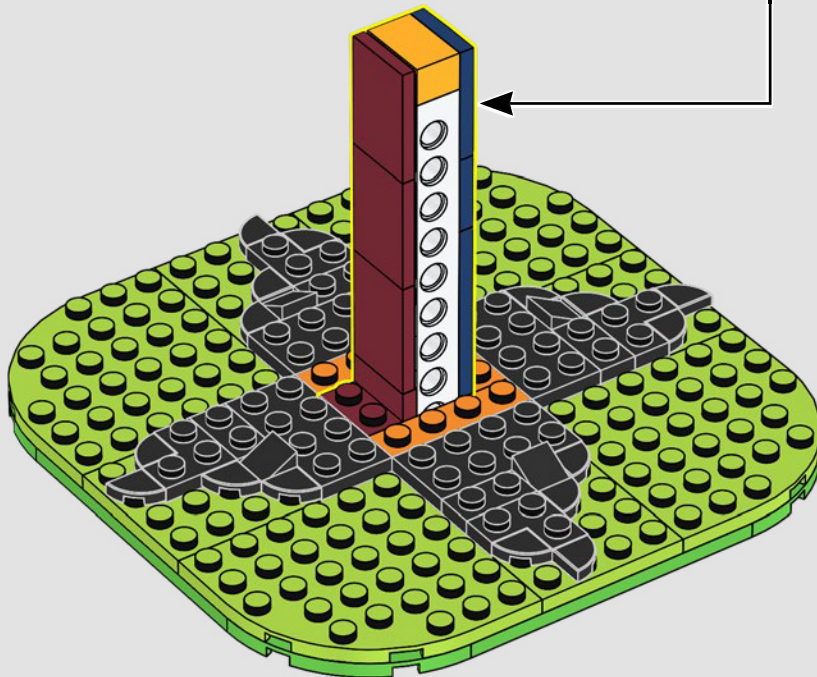
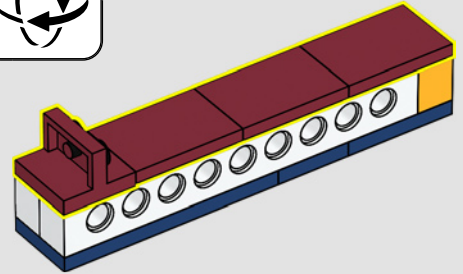
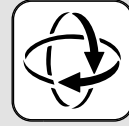

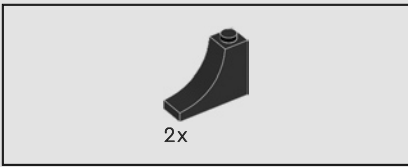

32

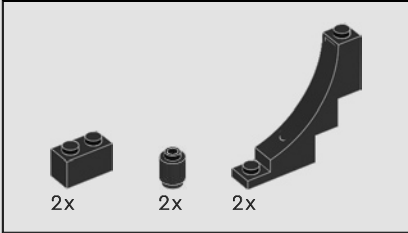
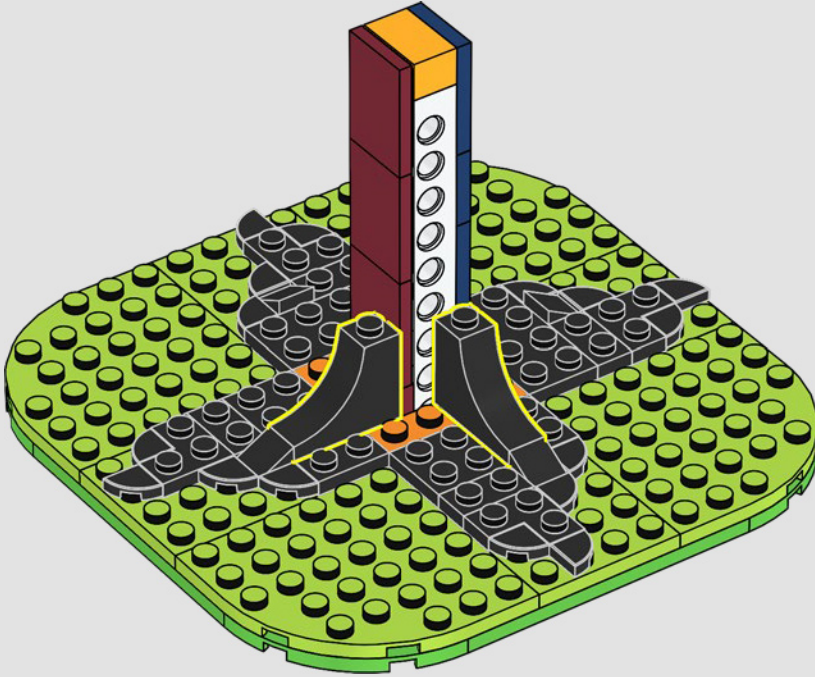

33

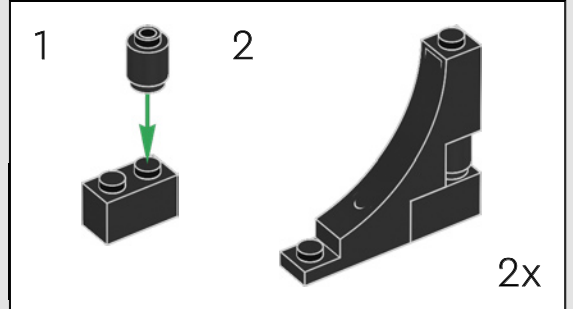
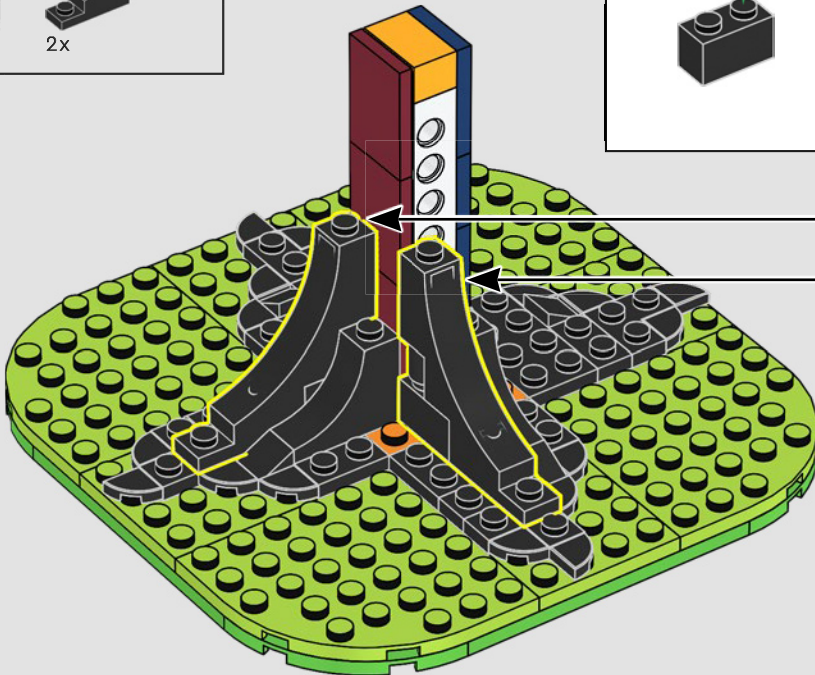



34

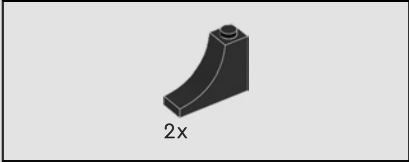
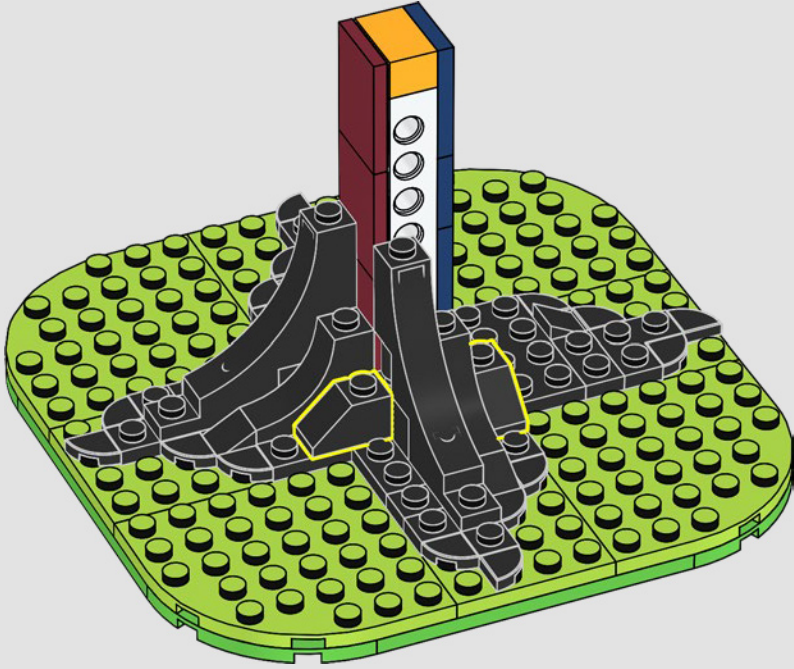

35

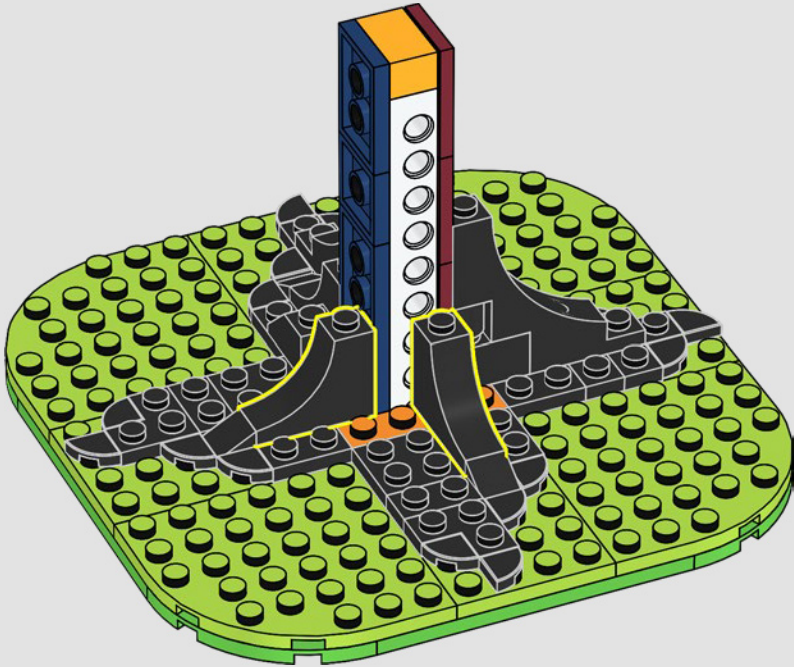

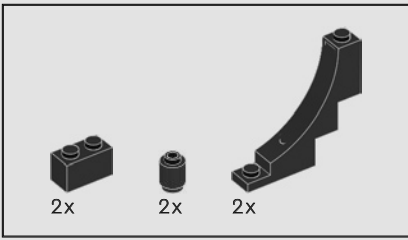

36

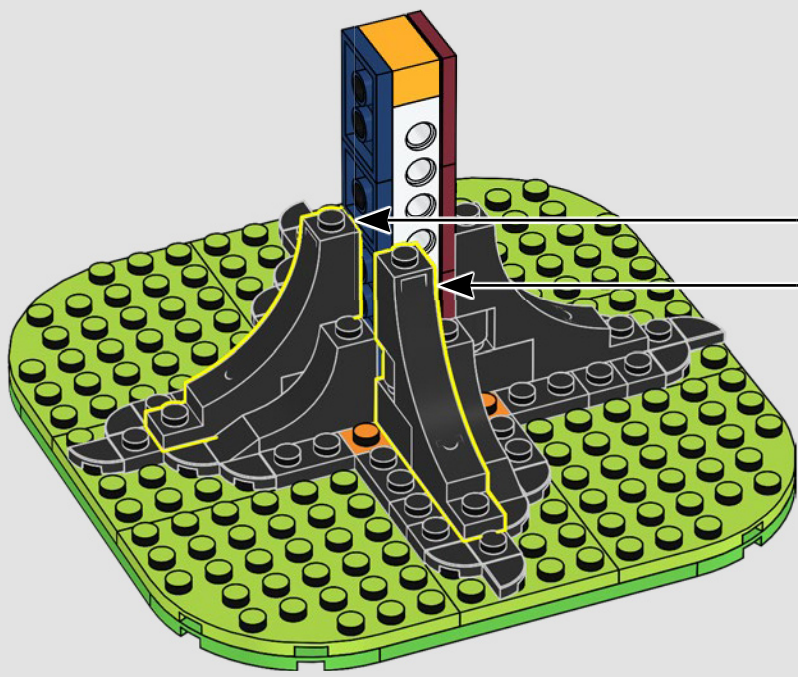
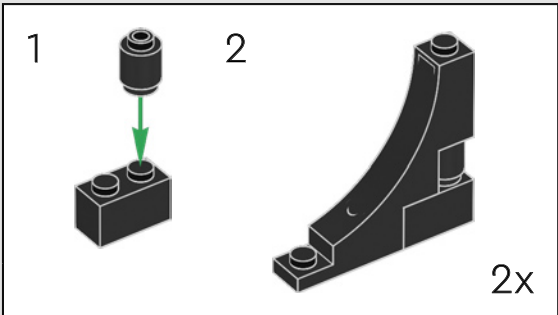



37

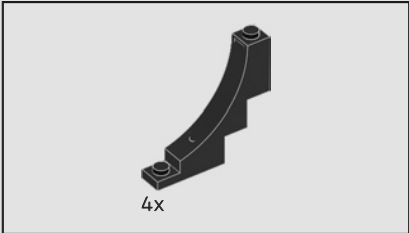
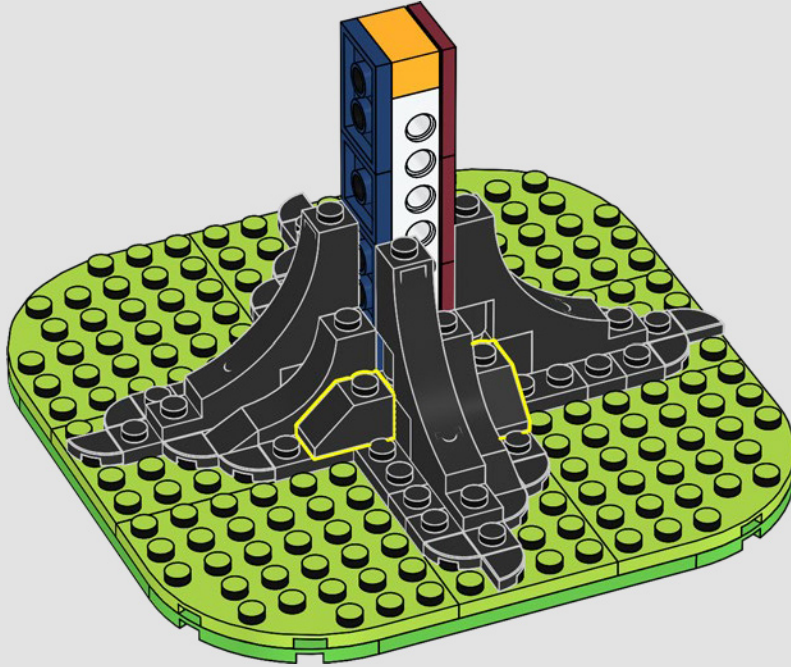

38

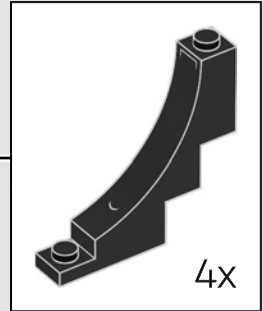
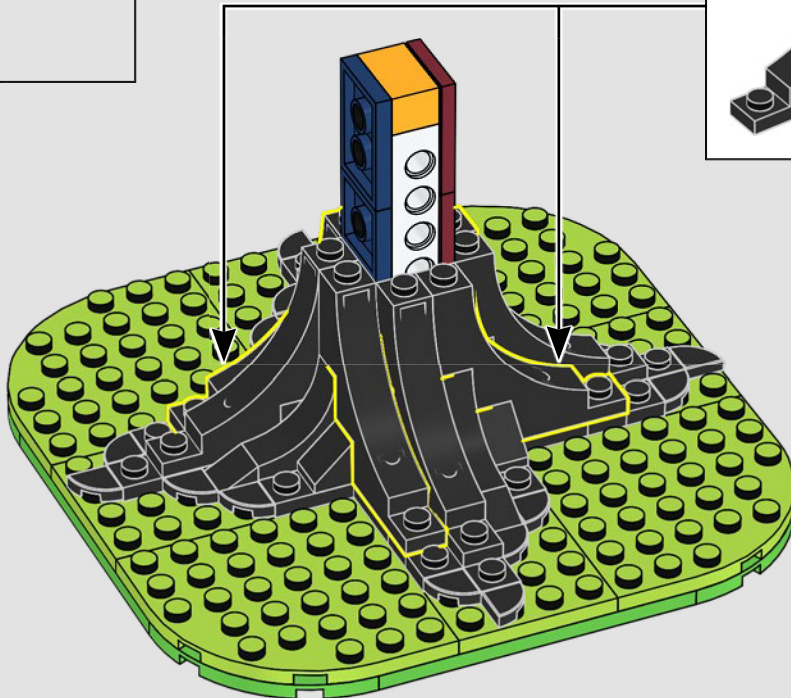



39

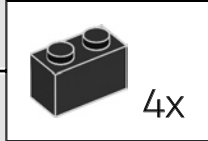
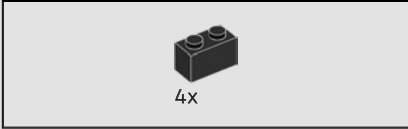
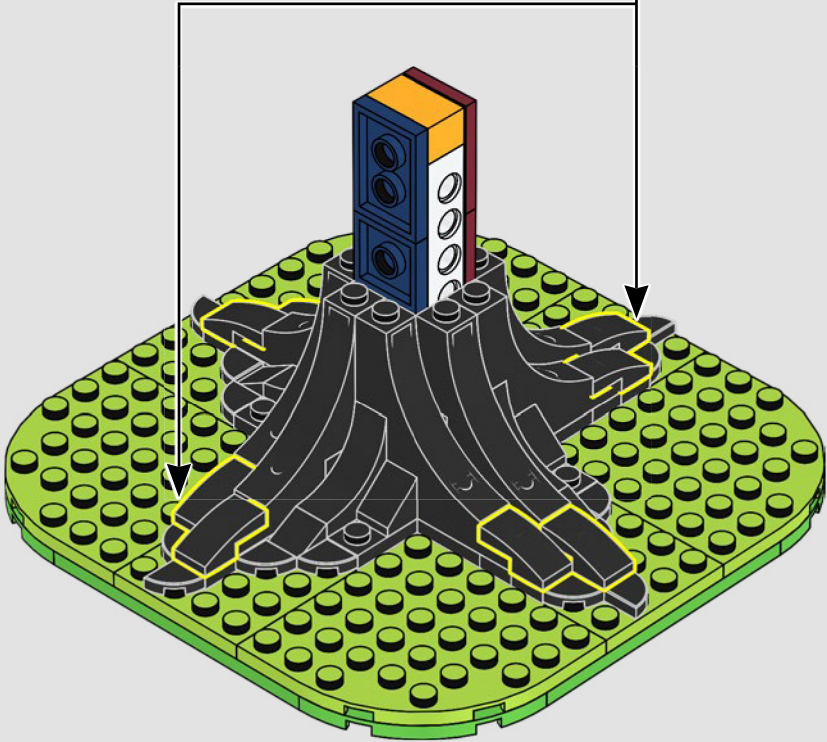

40

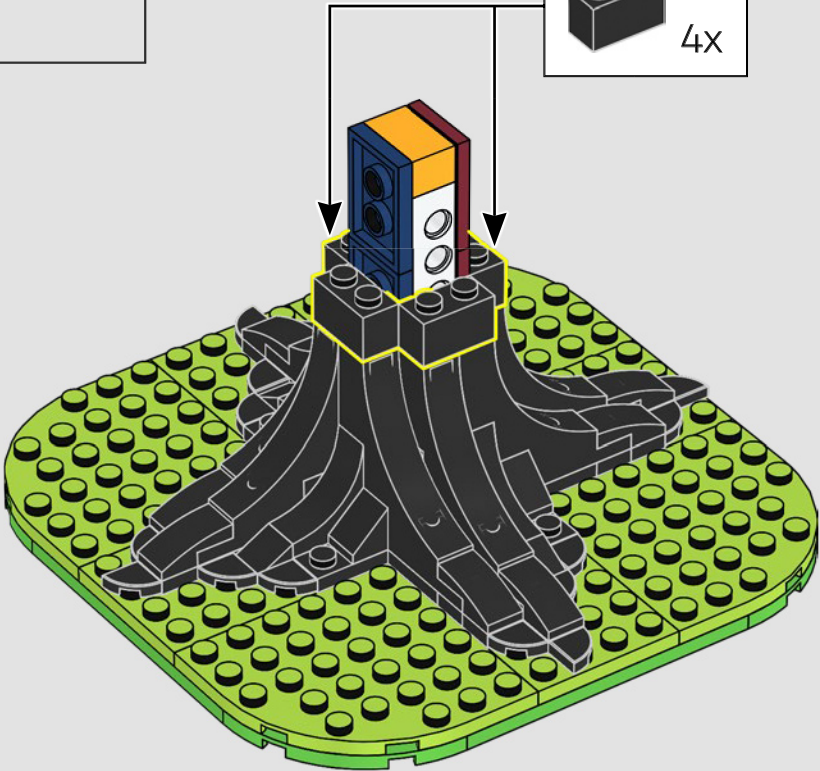



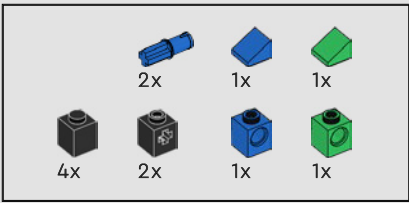

# 41

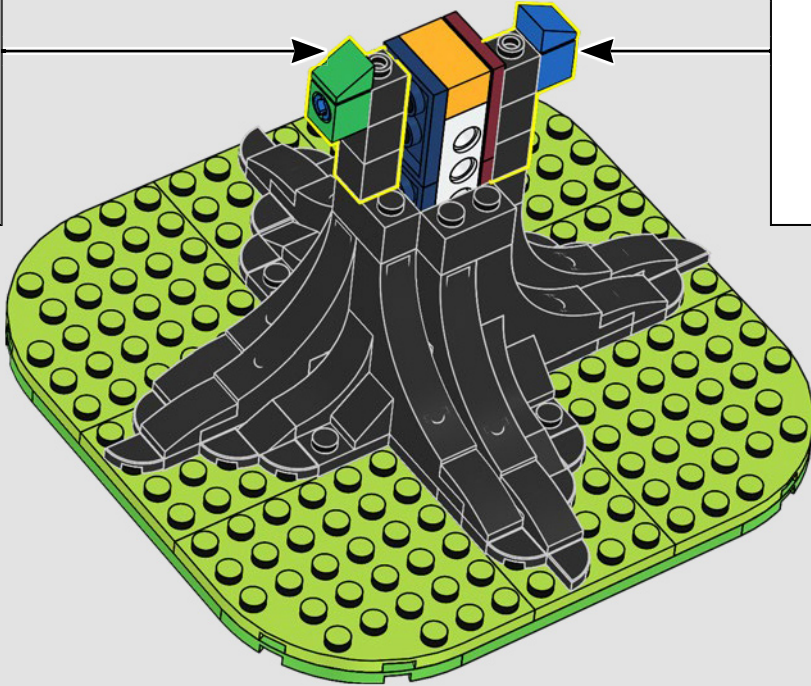
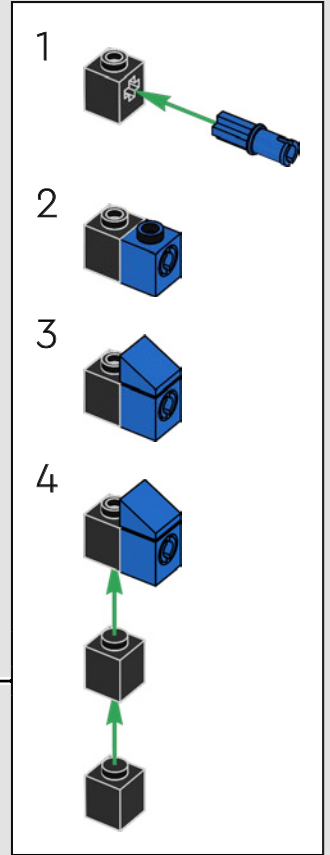
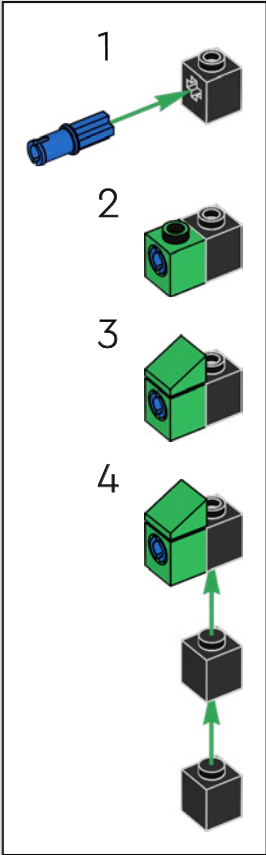

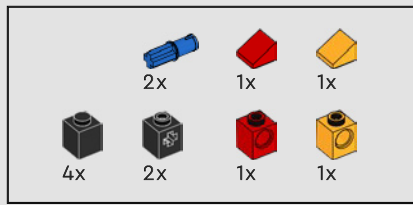

42

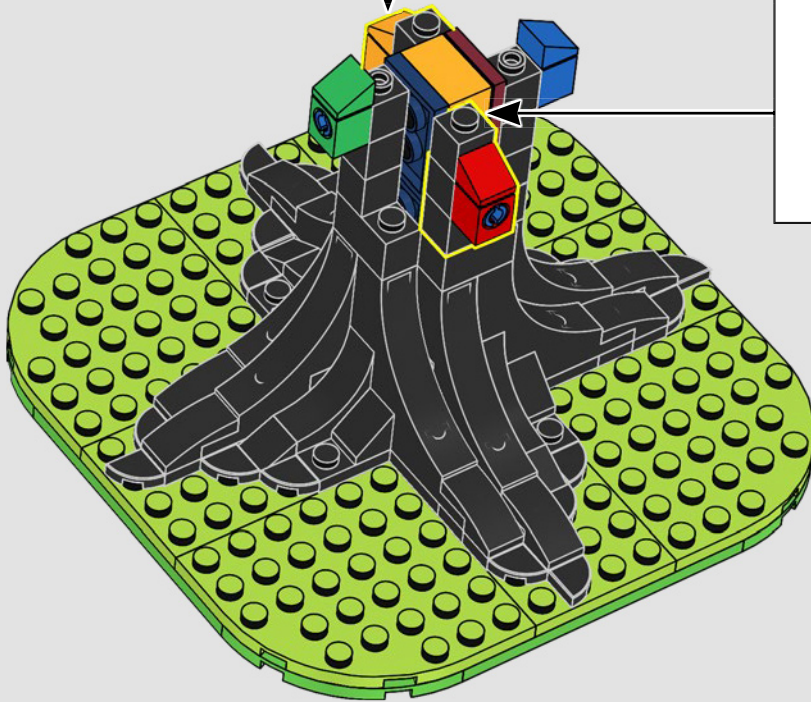
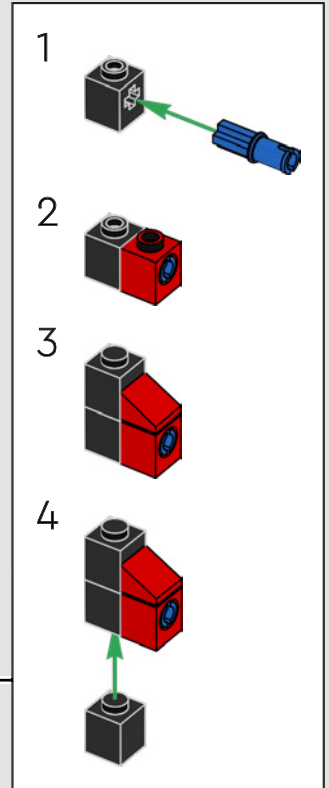
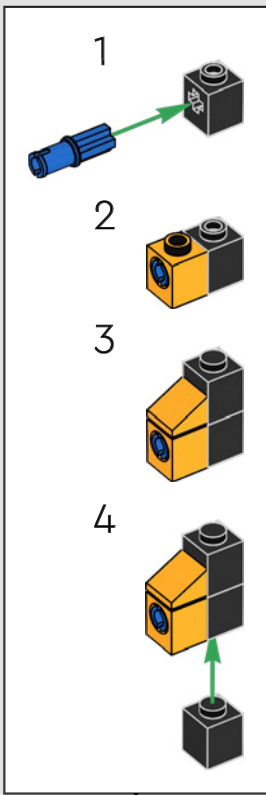

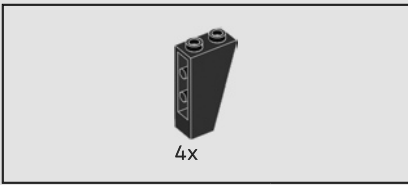

43

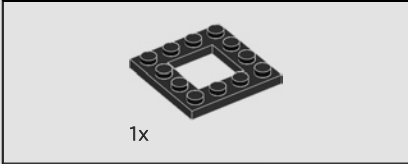
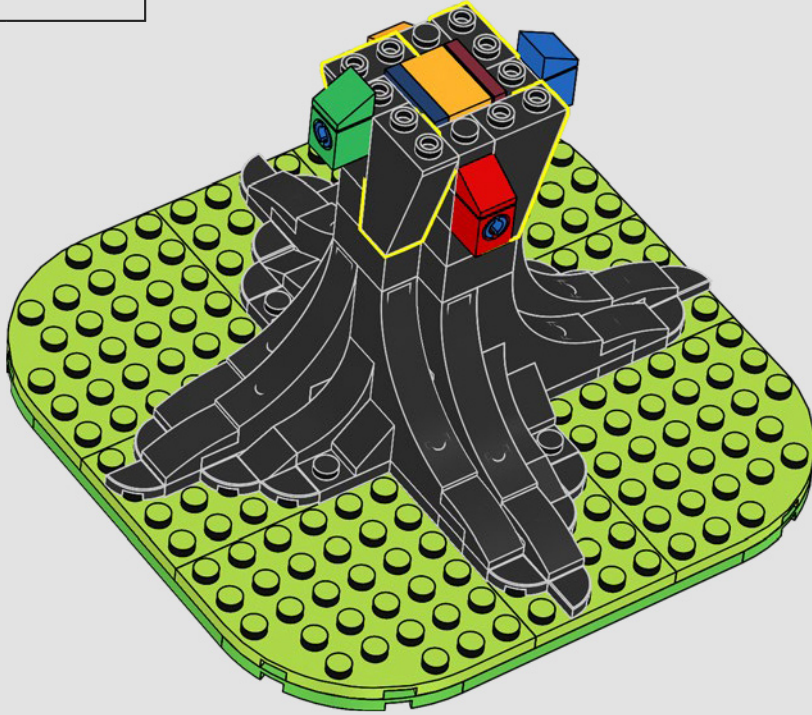

44

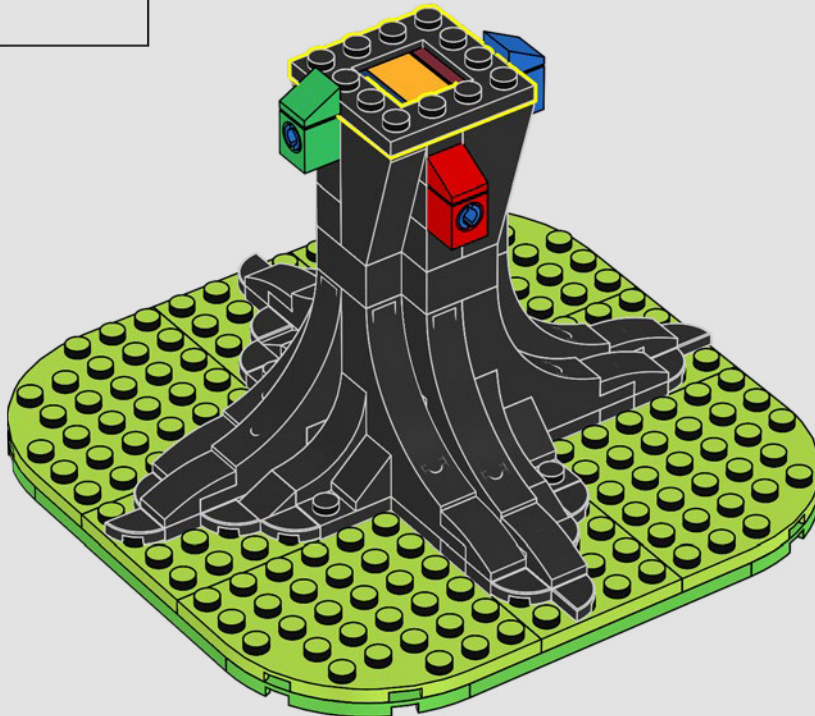



45

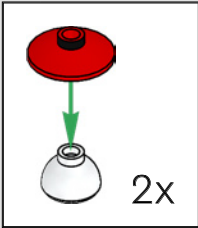
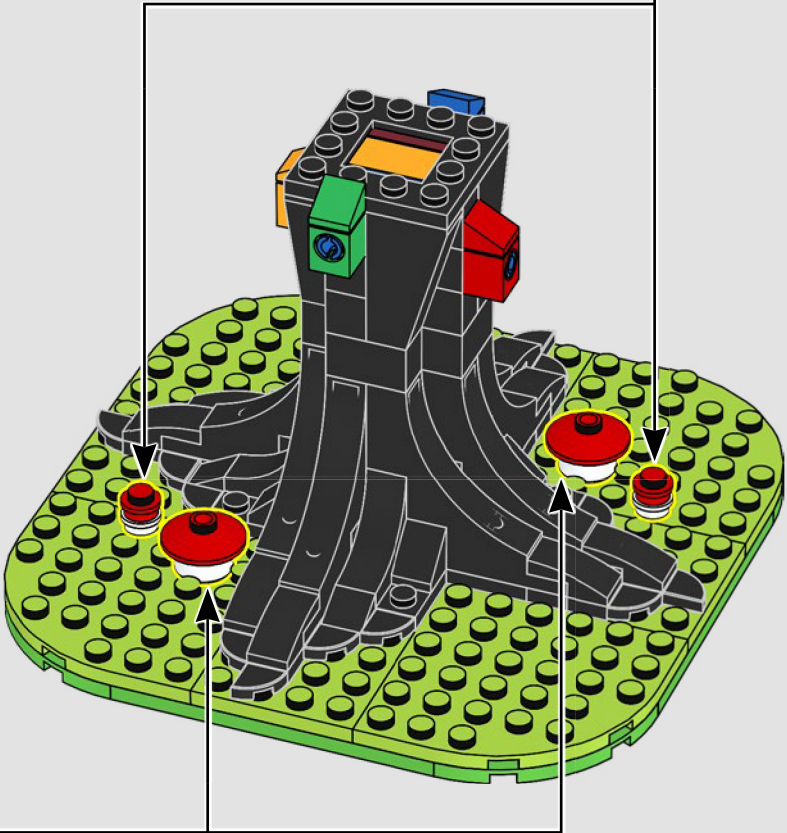
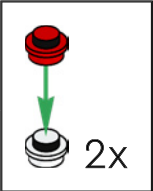

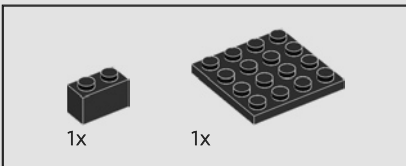
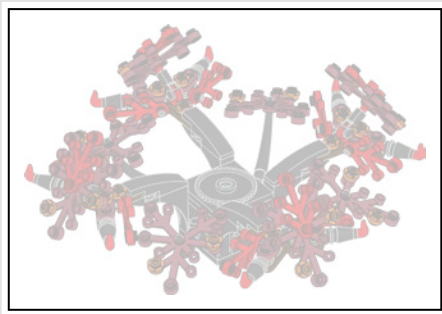

46

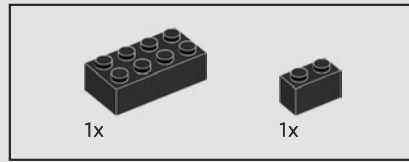
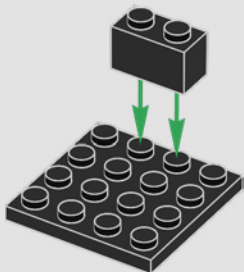

47

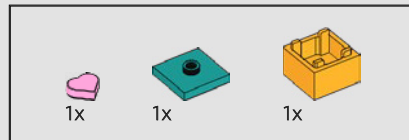
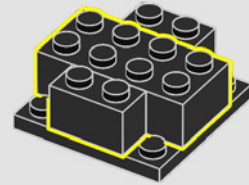

48

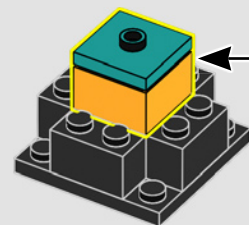
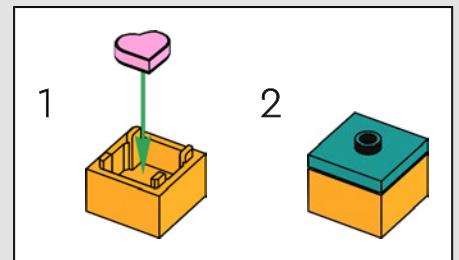



49

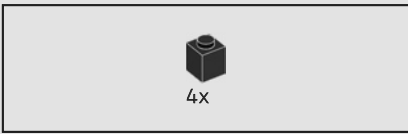
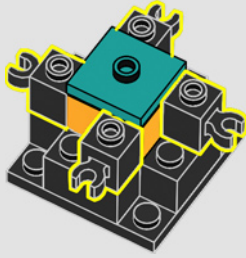

50

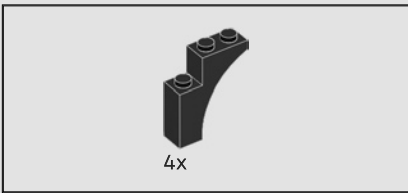
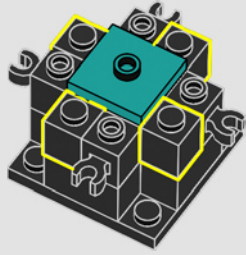

51

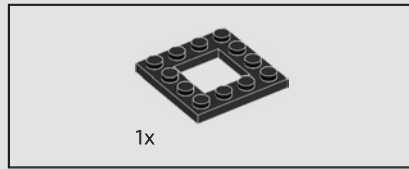
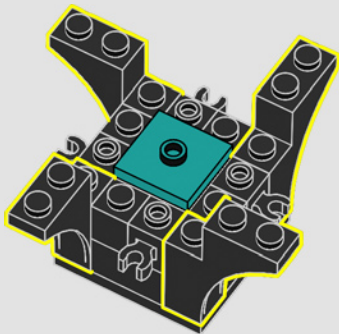

52

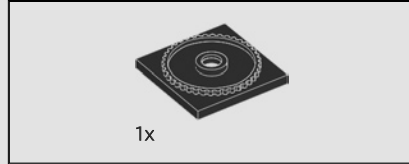
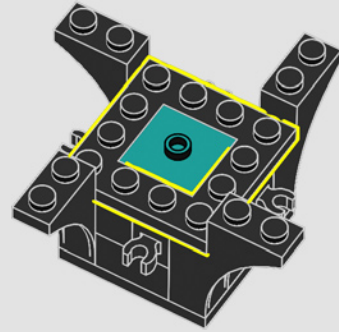

53

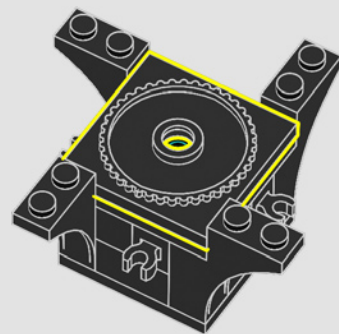

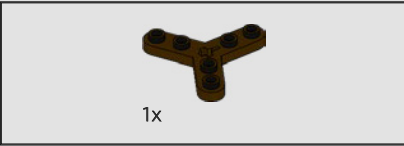
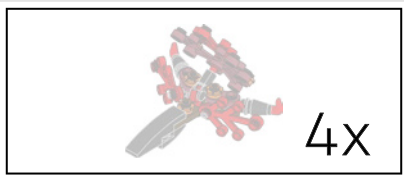

54

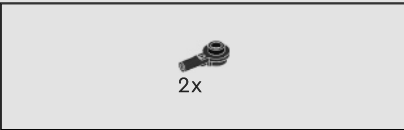

55



56

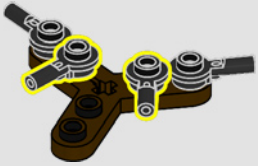

57

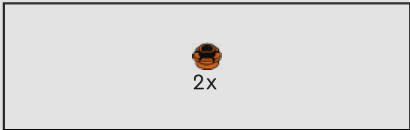

58

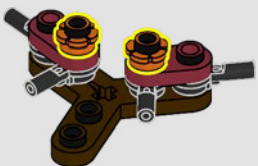



59

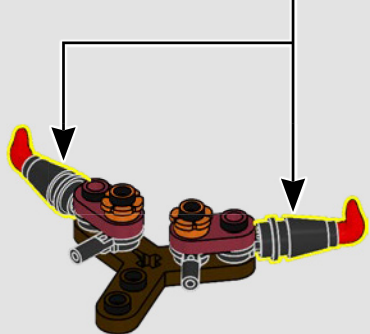
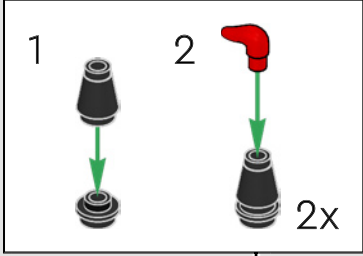

60

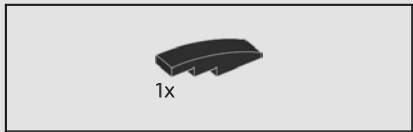
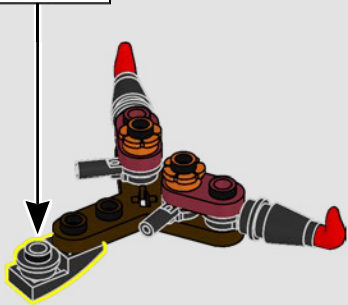
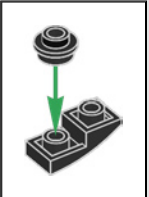

61

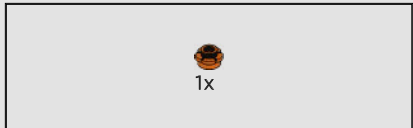
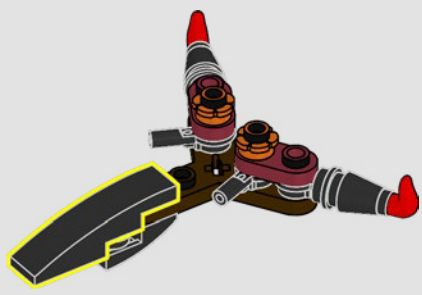

62

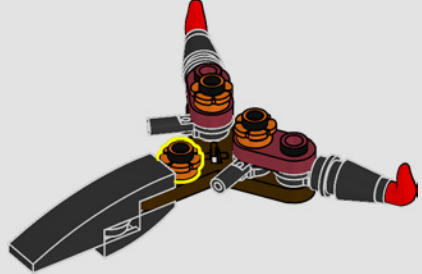

63

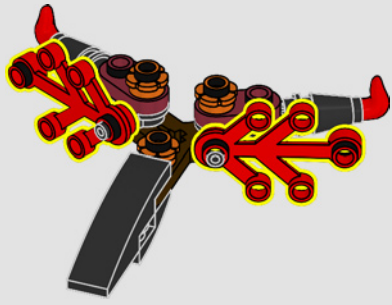



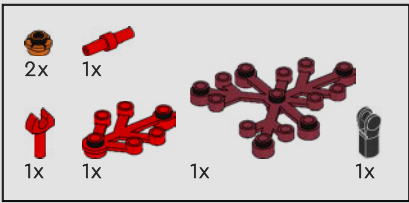

64

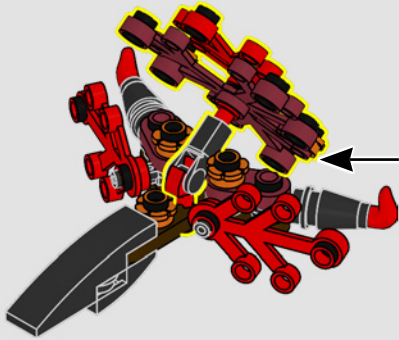
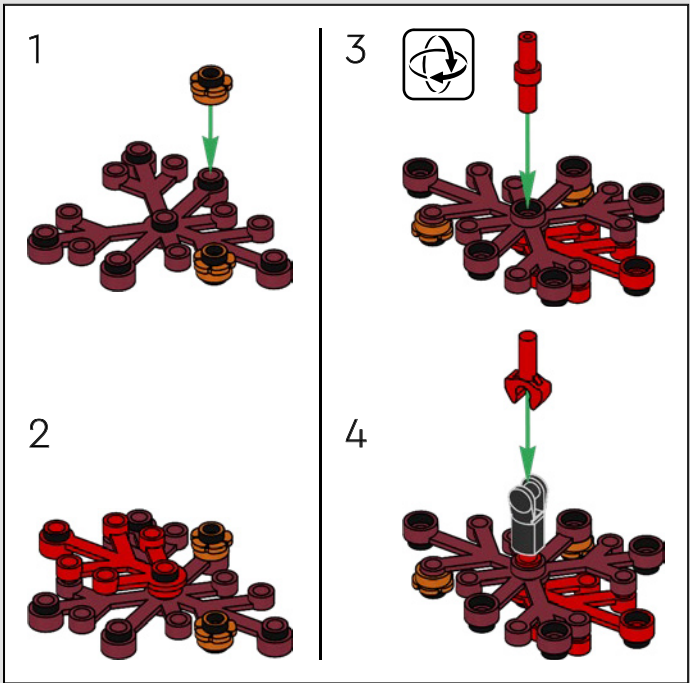

4x

65

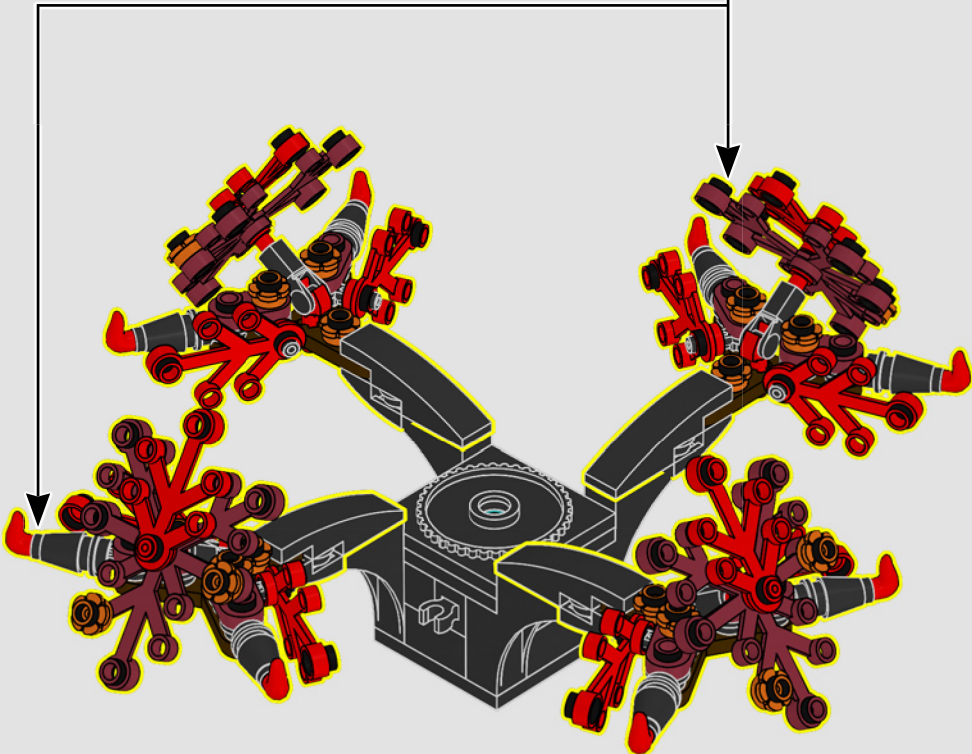

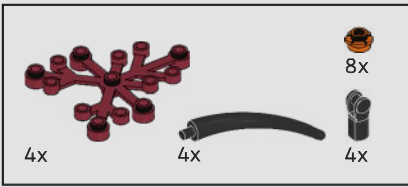

66

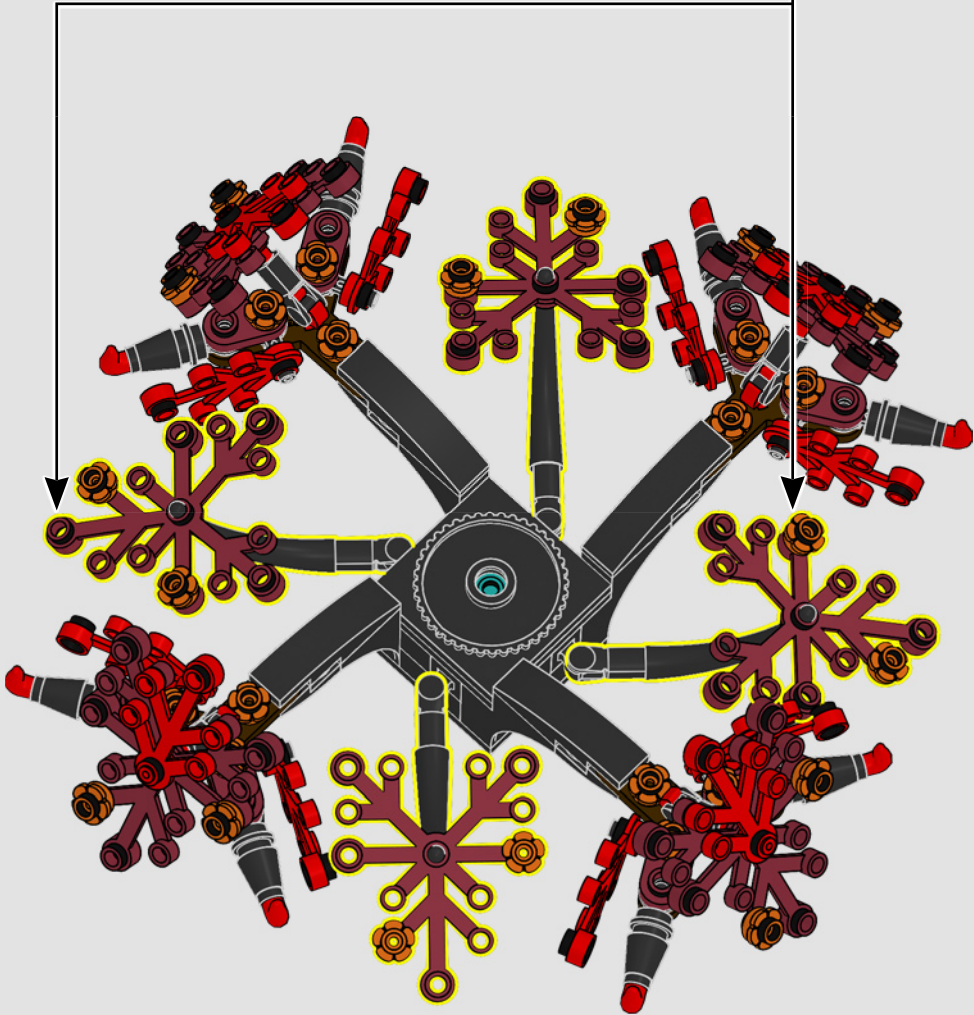
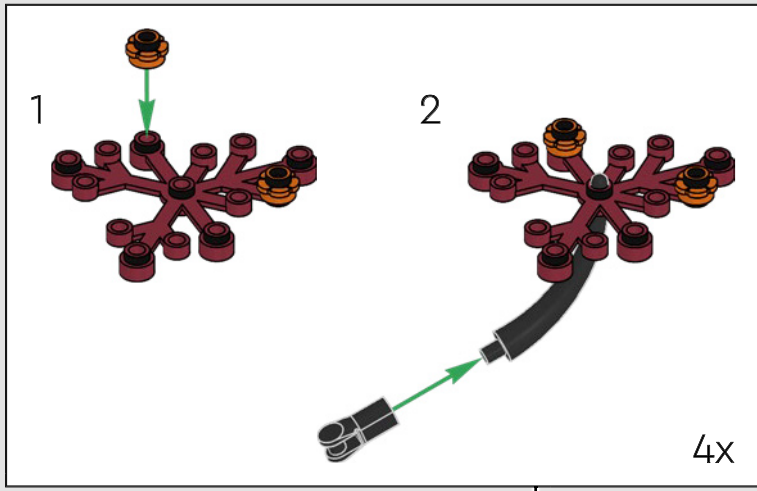

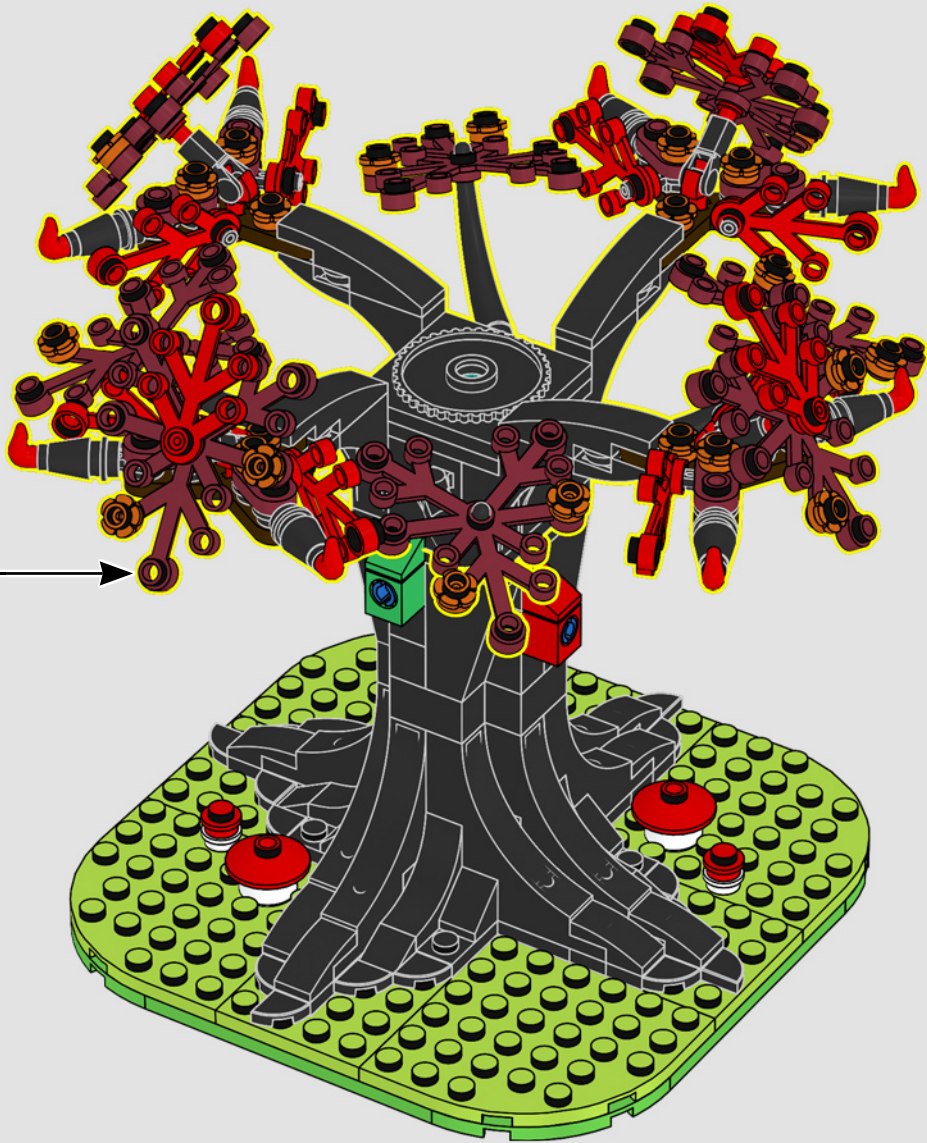

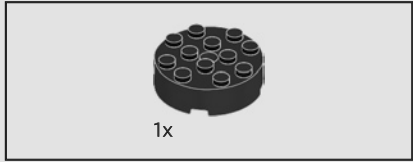
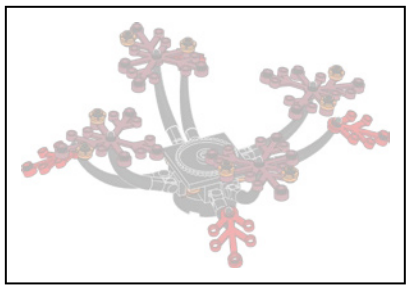

68

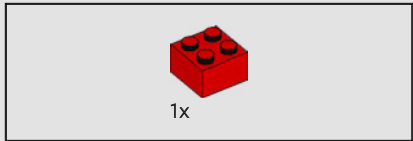
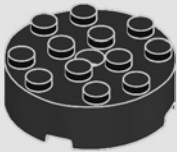

69

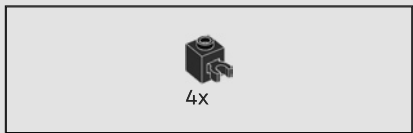
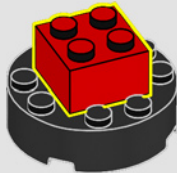

70



71

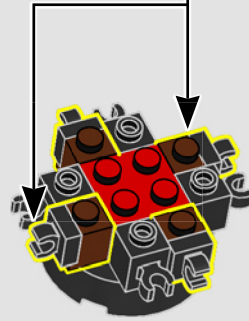
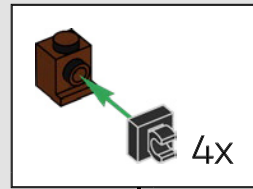

72

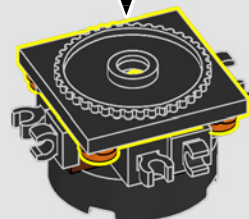
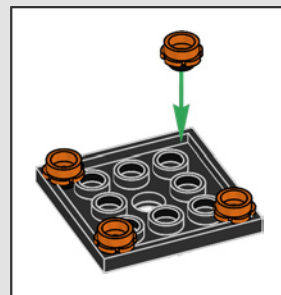

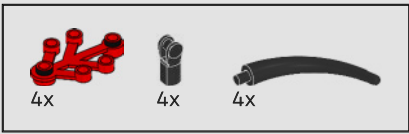

73

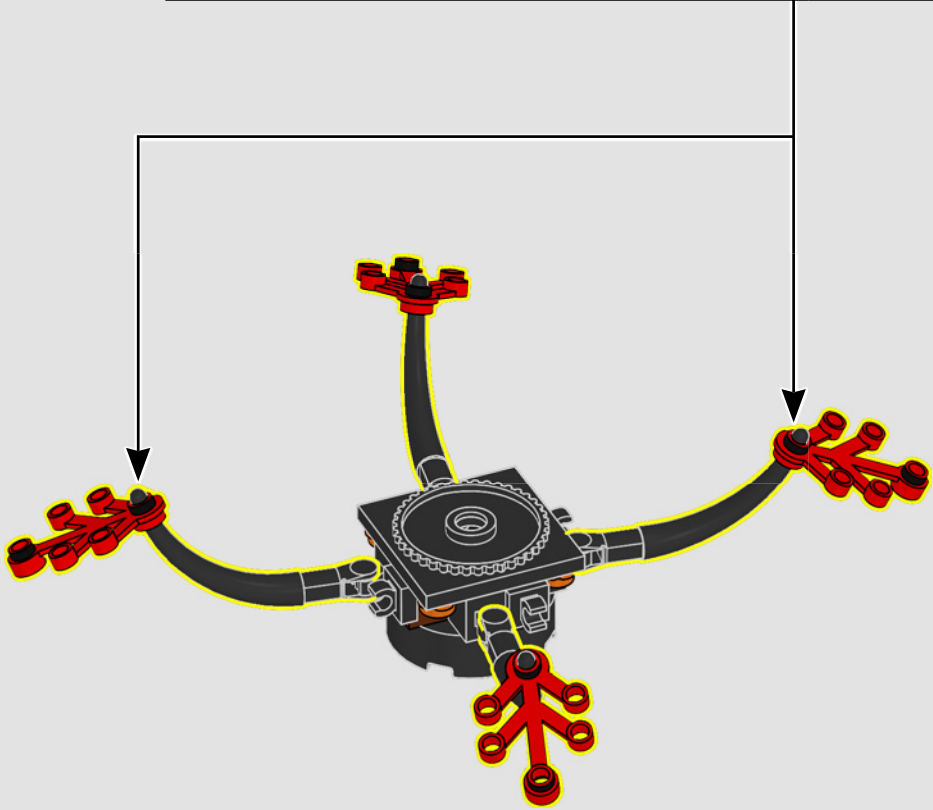
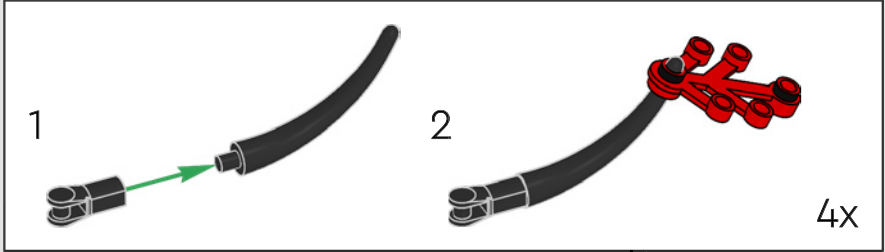

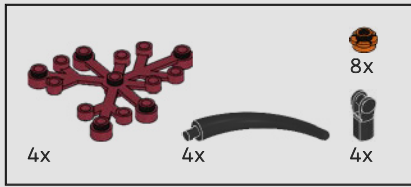

74

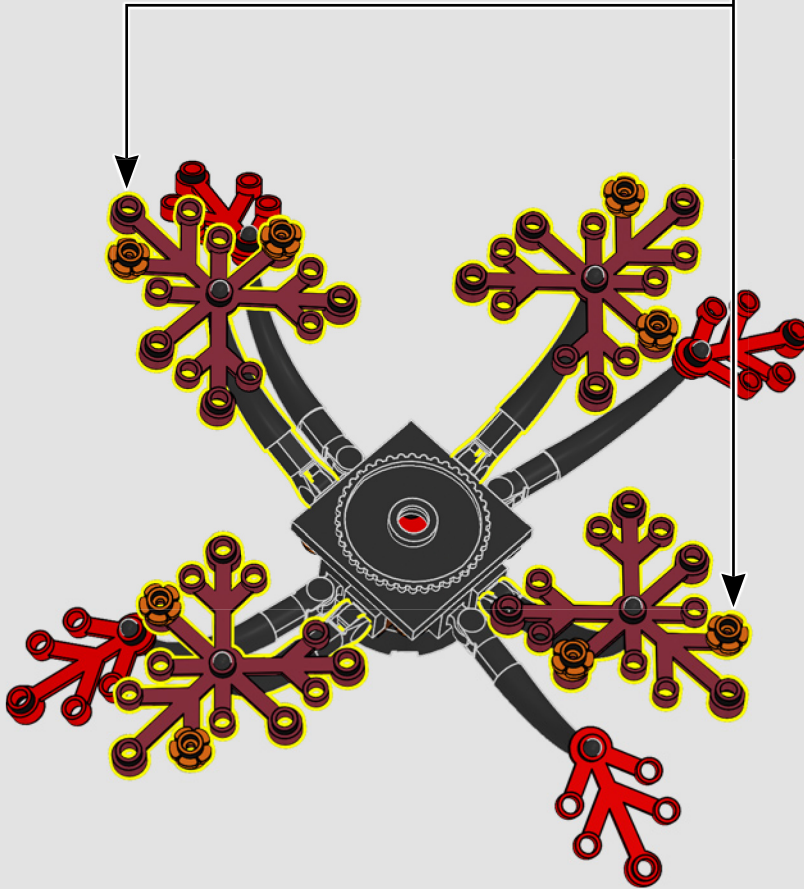
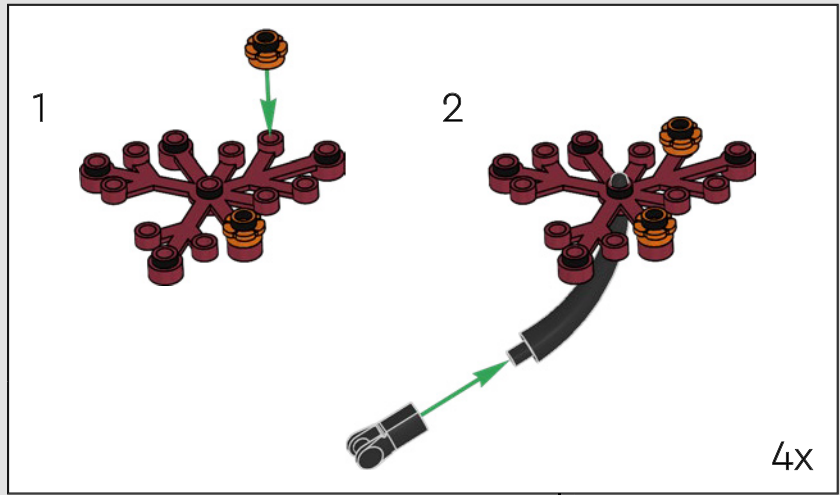

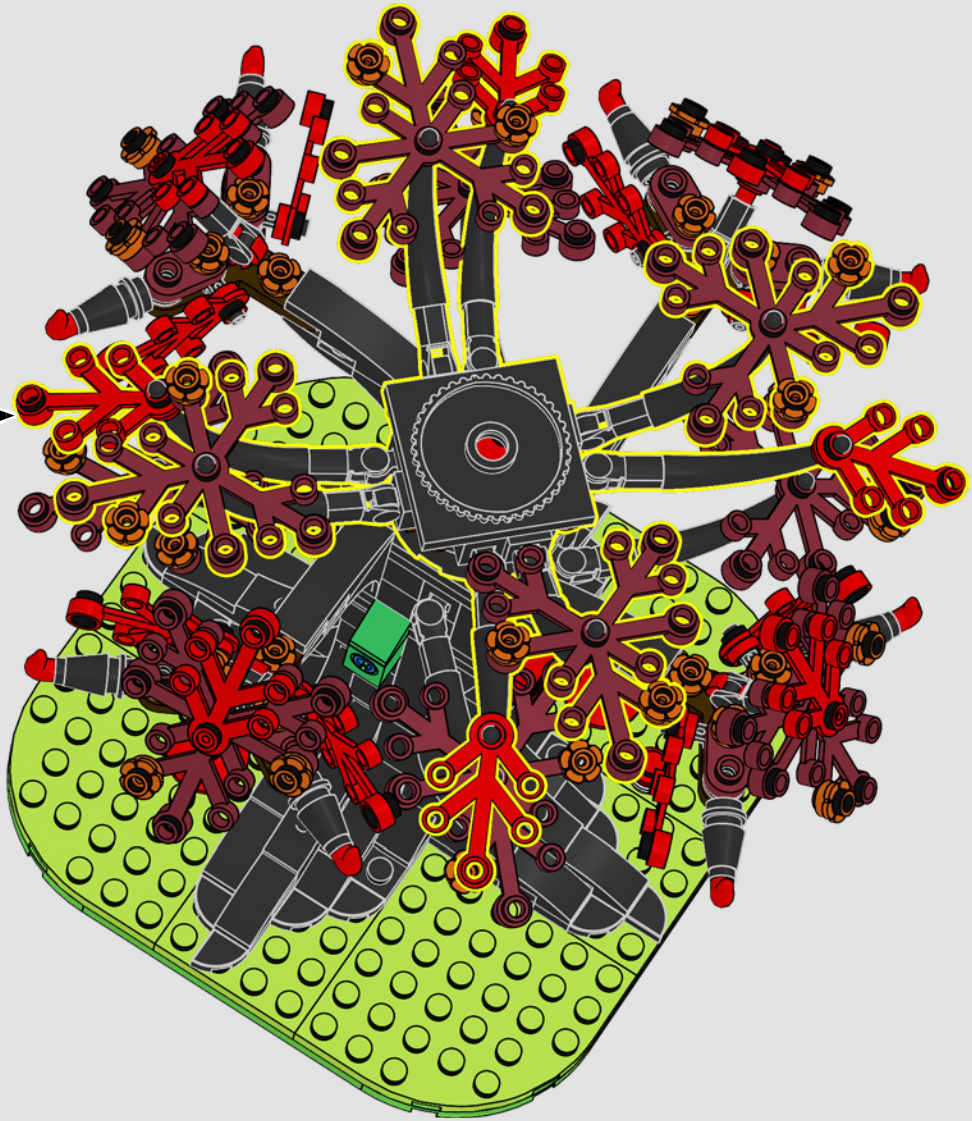

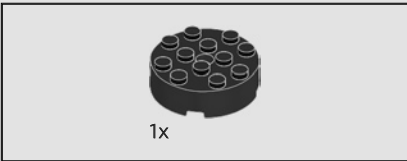
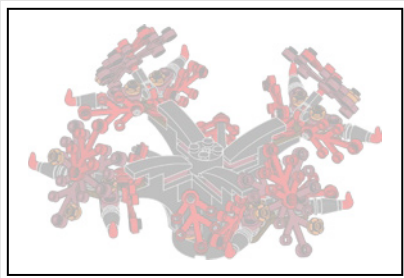

76

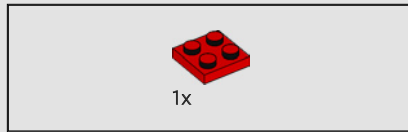
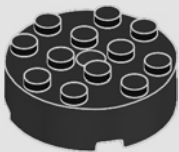

1x

77

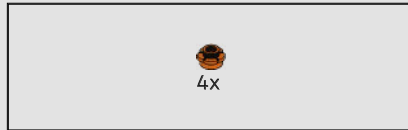
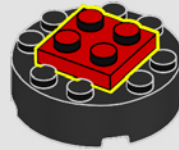

4x

78

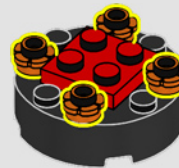





79

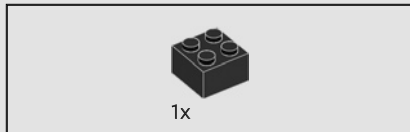

81

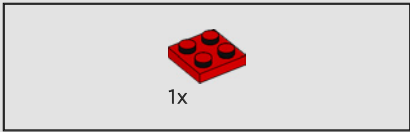
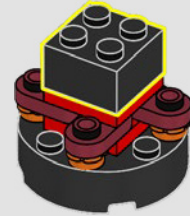

80

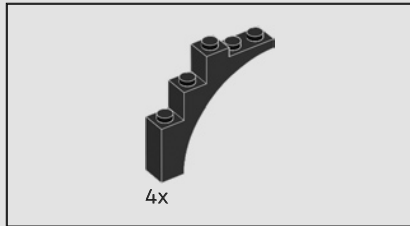
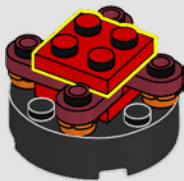

82

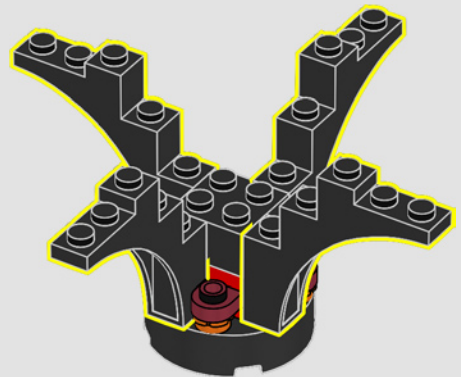

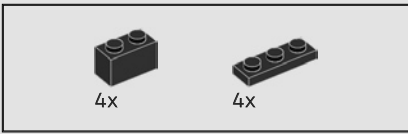

83

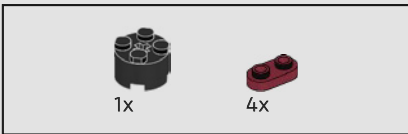
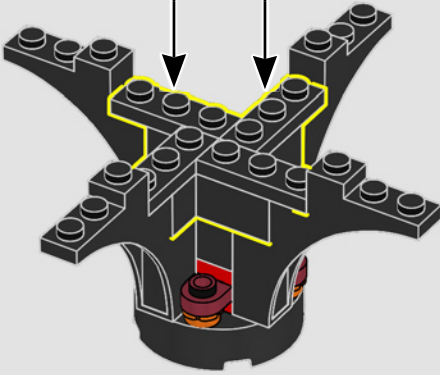
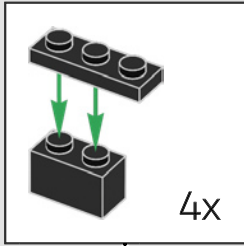

84

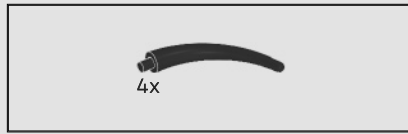
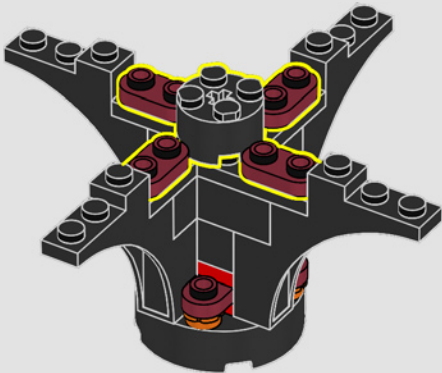

85

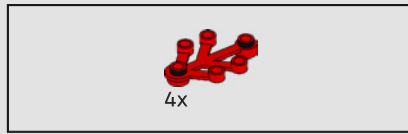
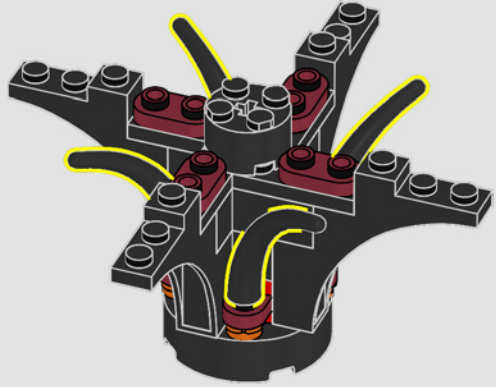

86

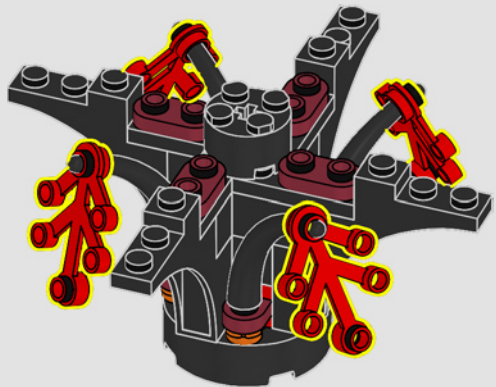

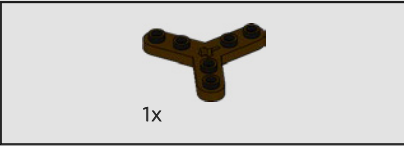
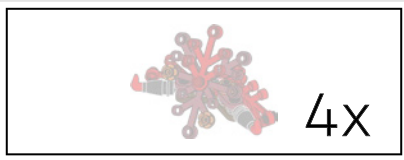

87

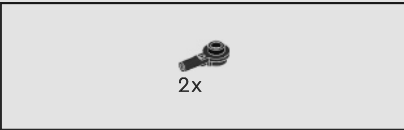
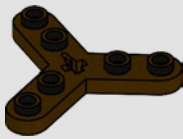

88

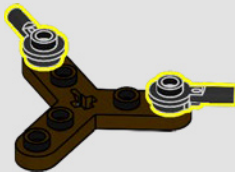

89

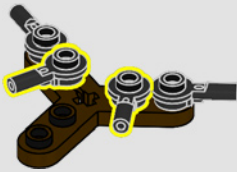

90

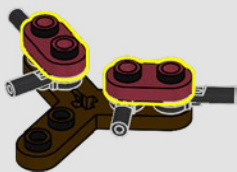

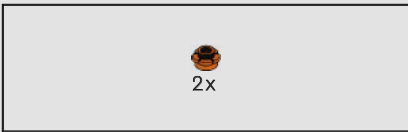

91

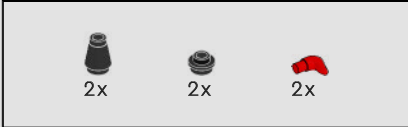
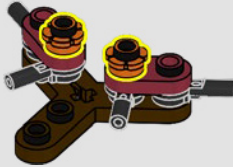

92

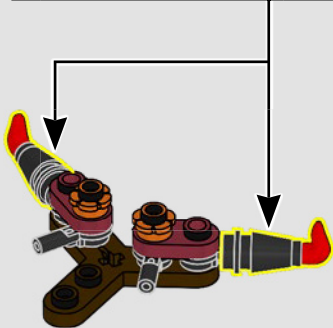
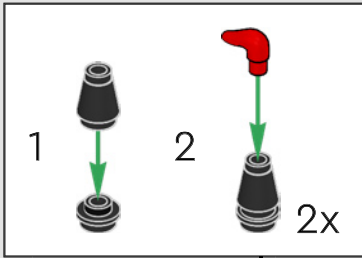

93



94

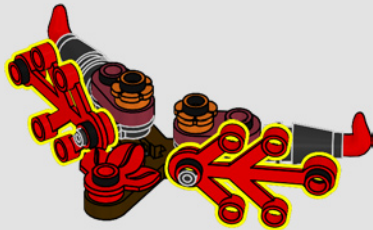

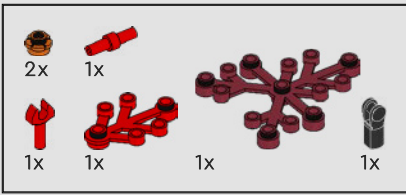

95

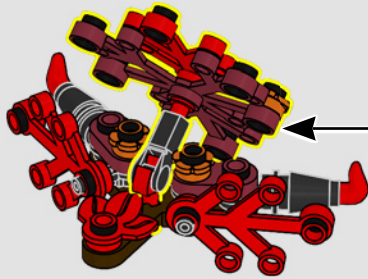
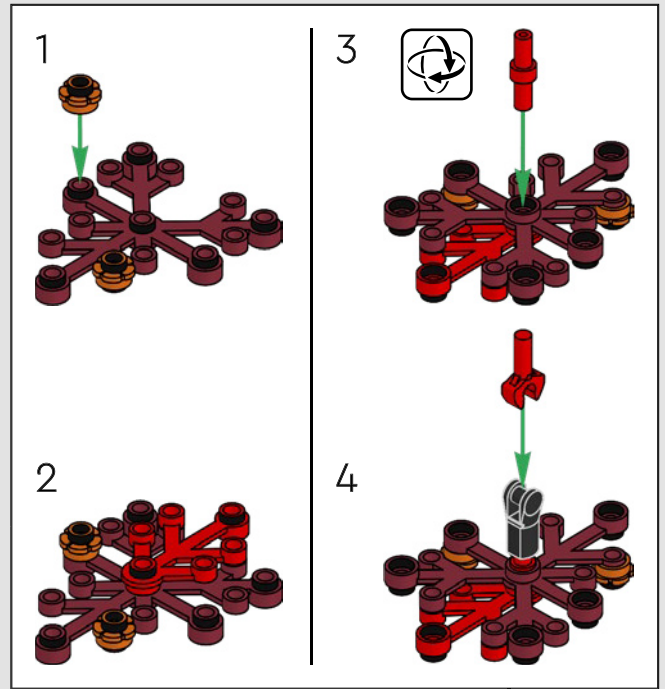

4x

96

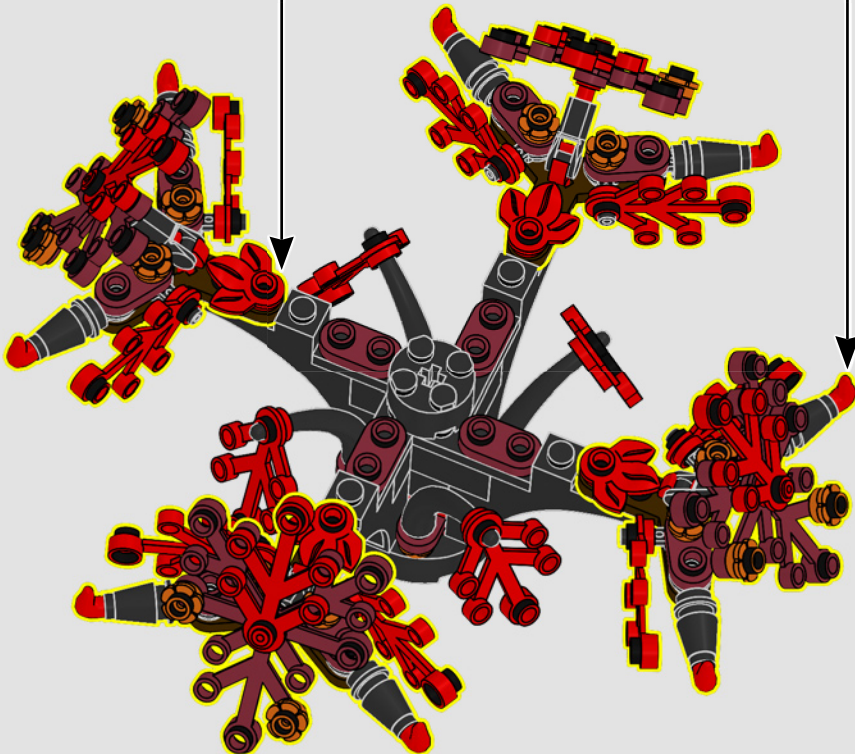

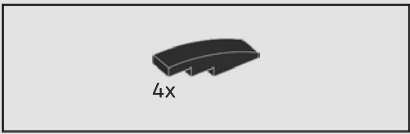

97

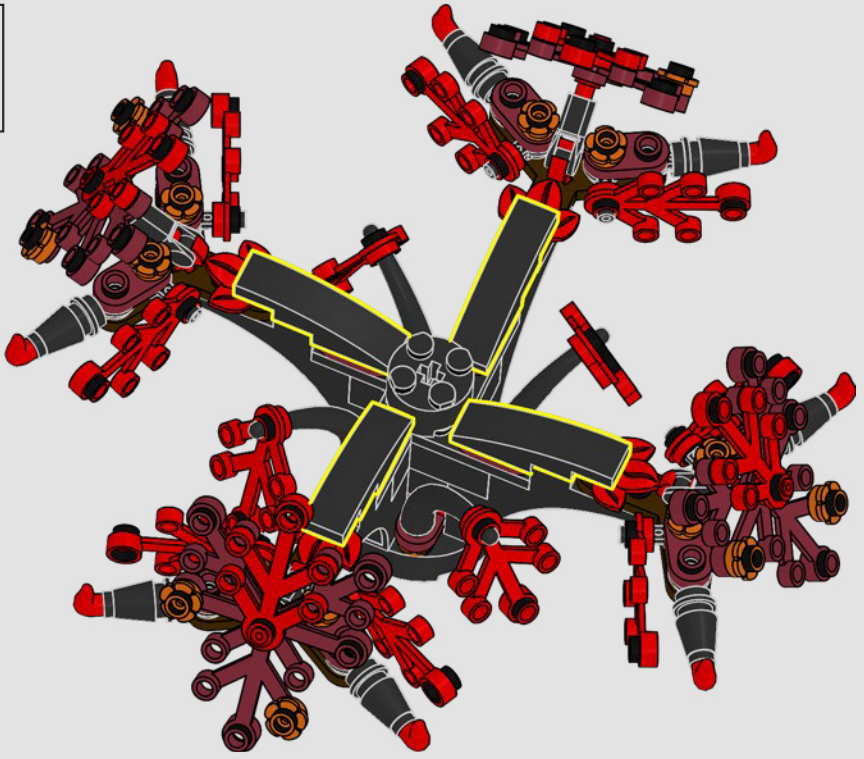

98

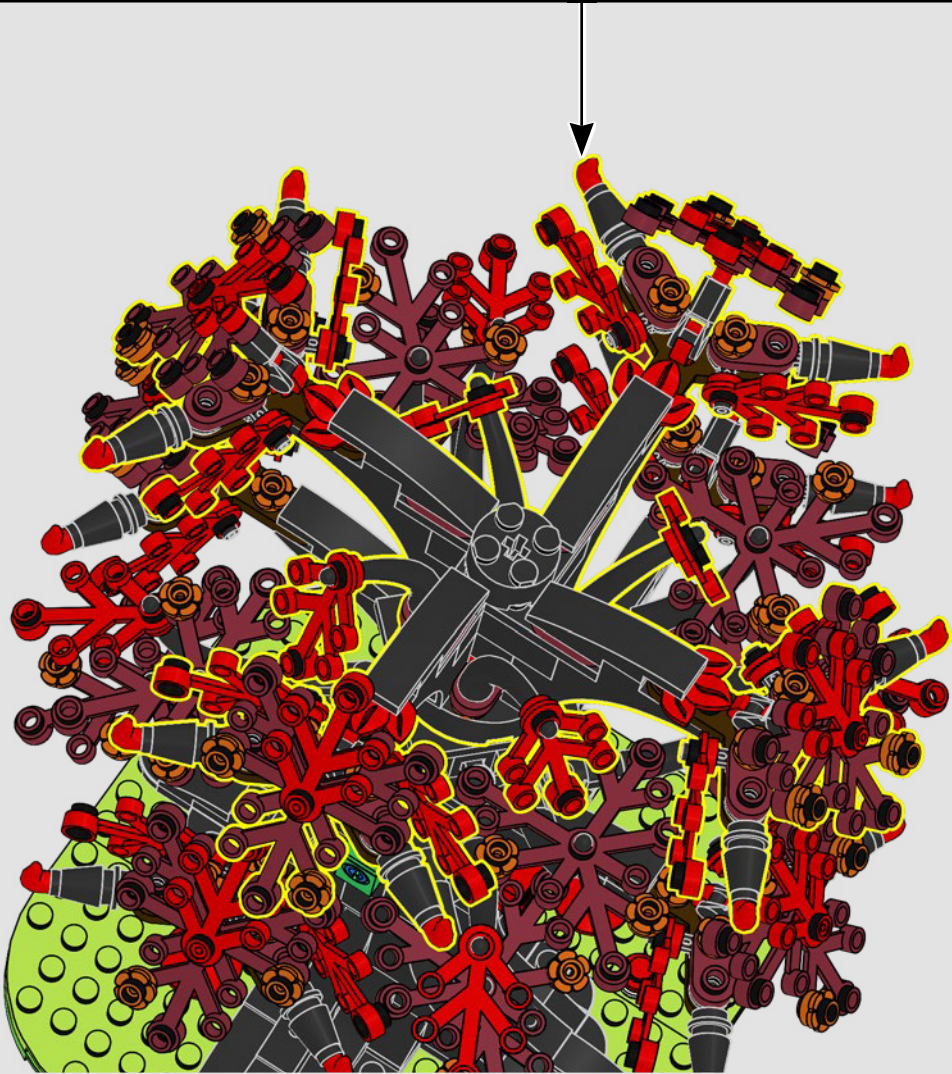

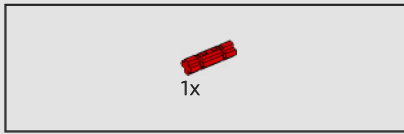

99



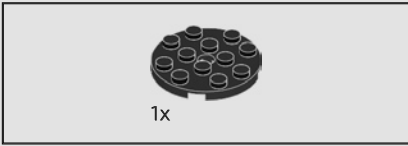
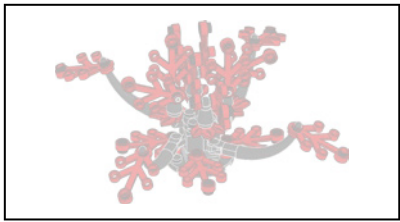

100

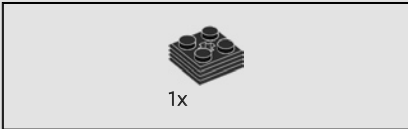

101

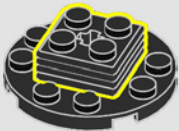

102

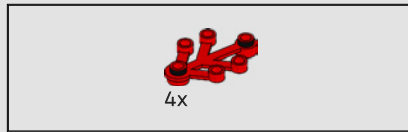
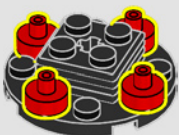

103

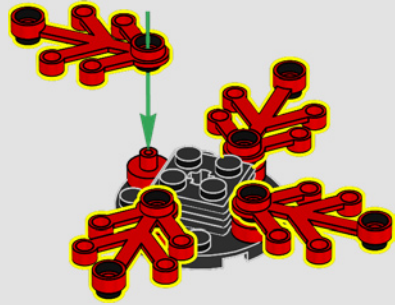

104

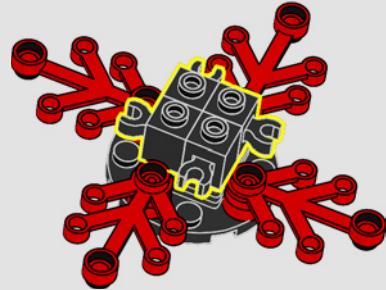

105

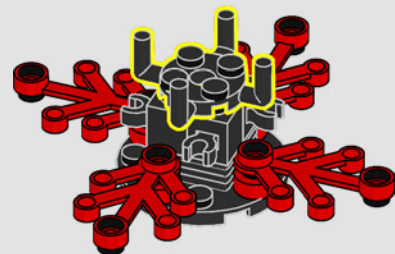





106

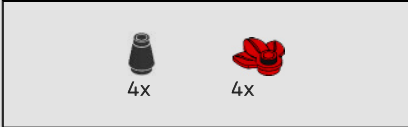
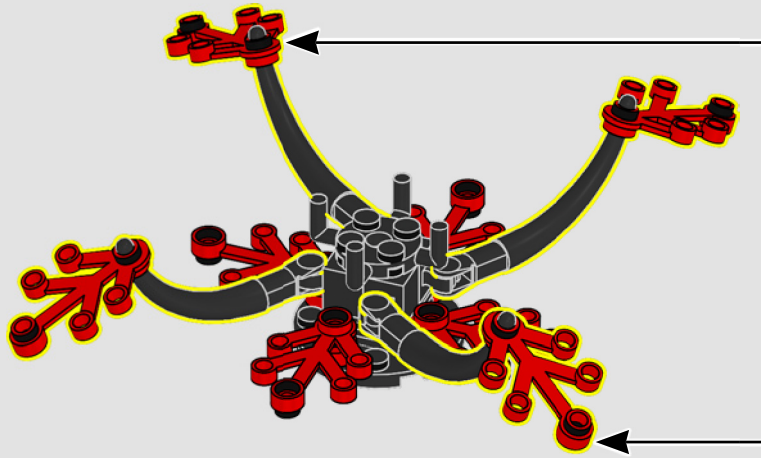
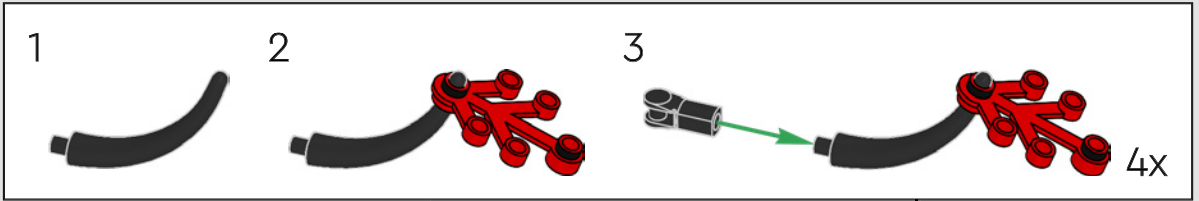

107

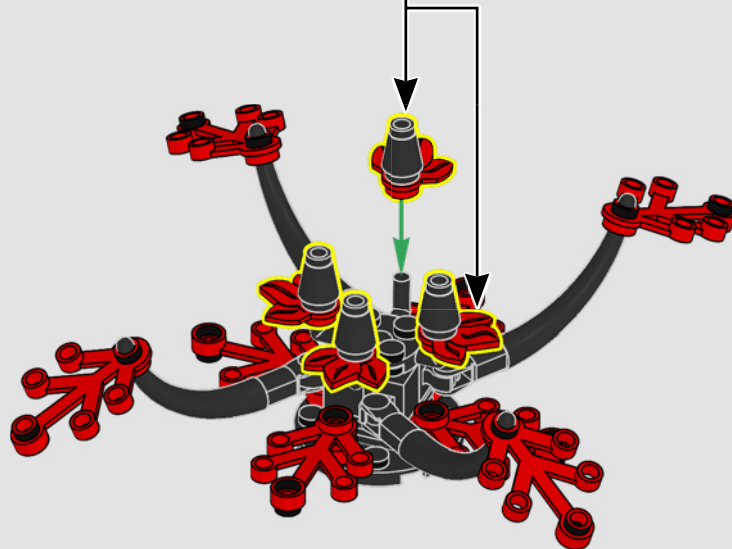
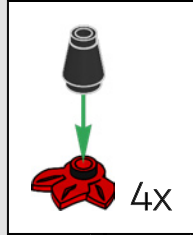



108

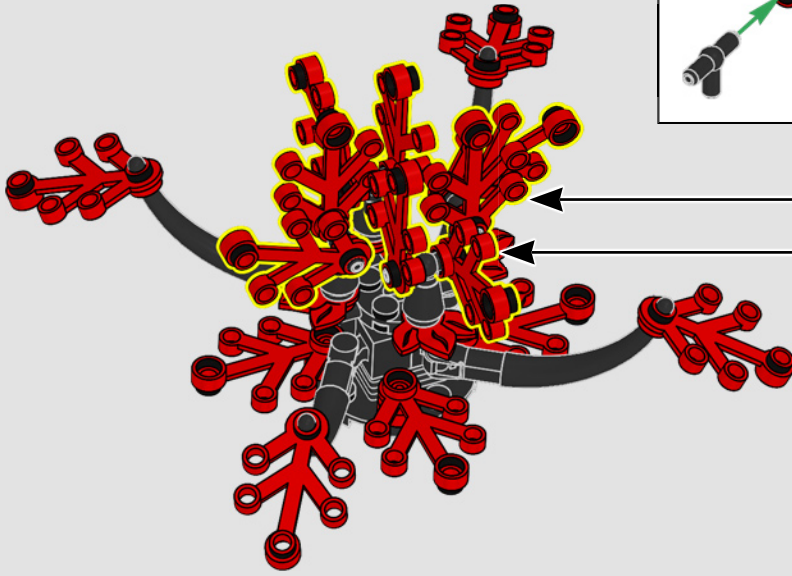
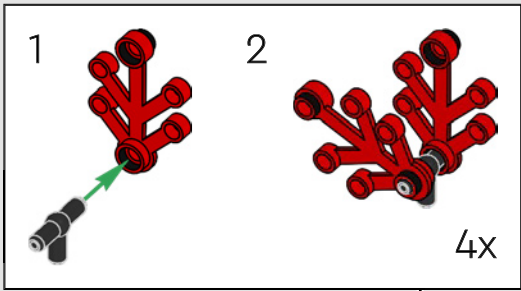

109





110

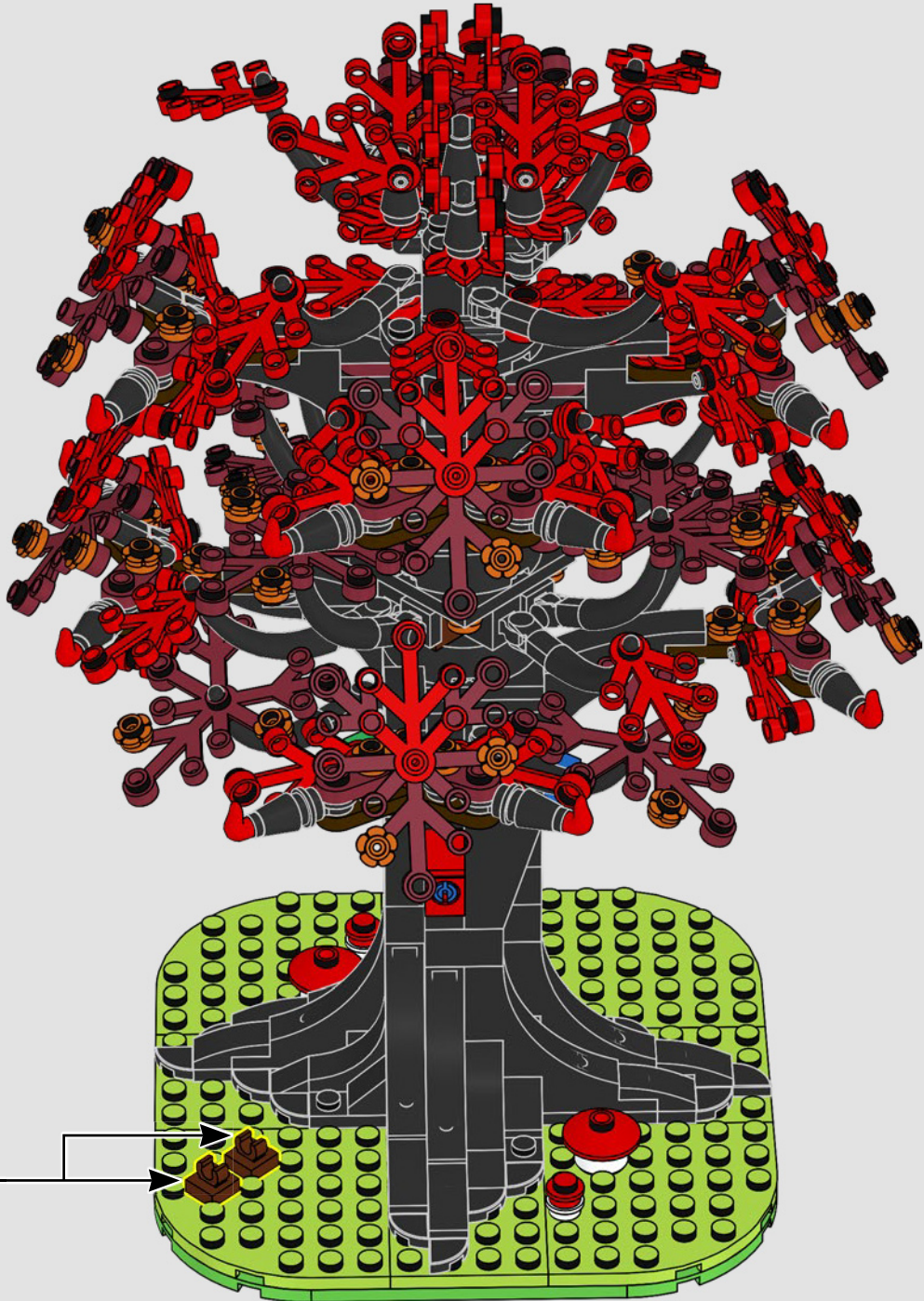

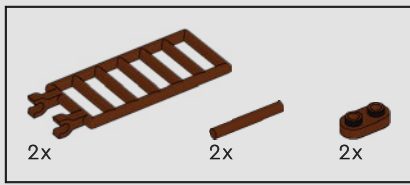

111

1

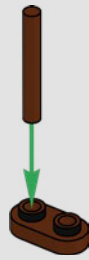

2

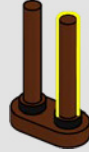

3



4

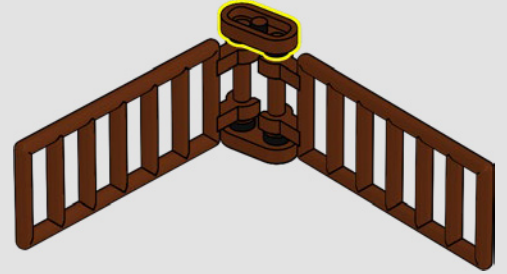

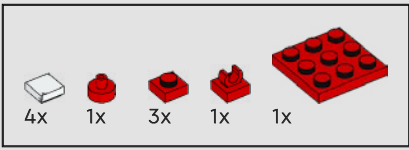

112

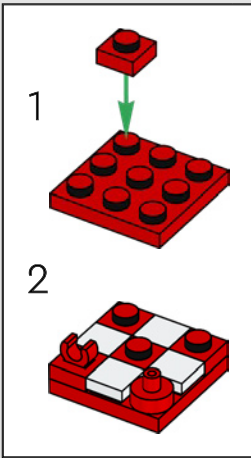
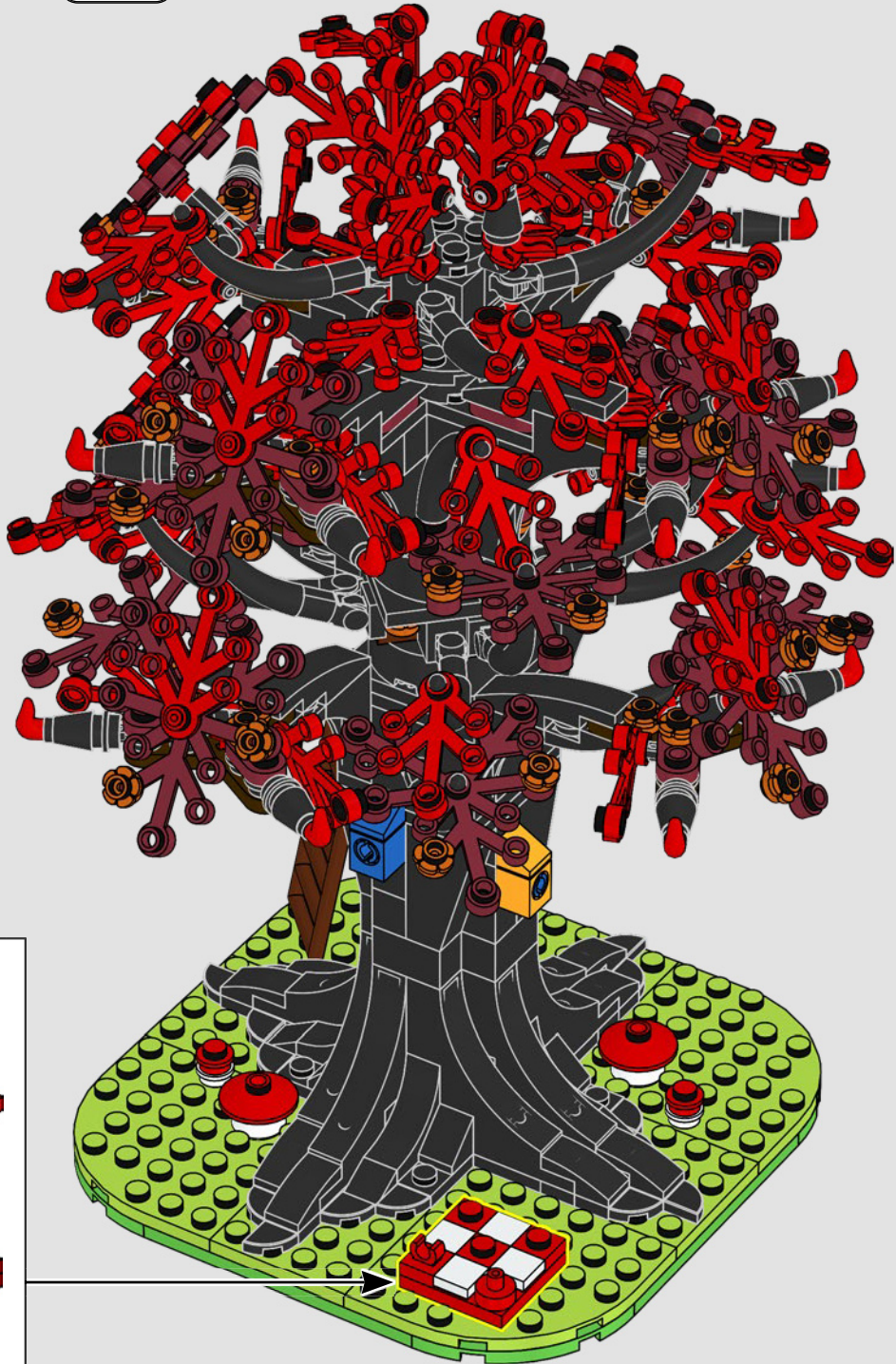

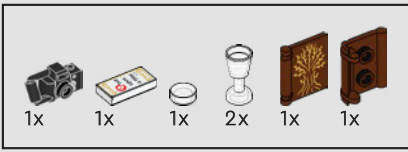

113

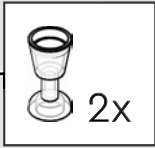
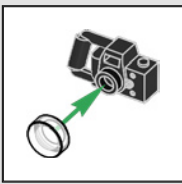
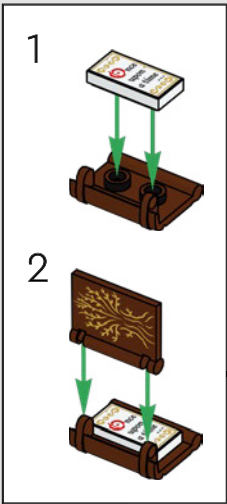
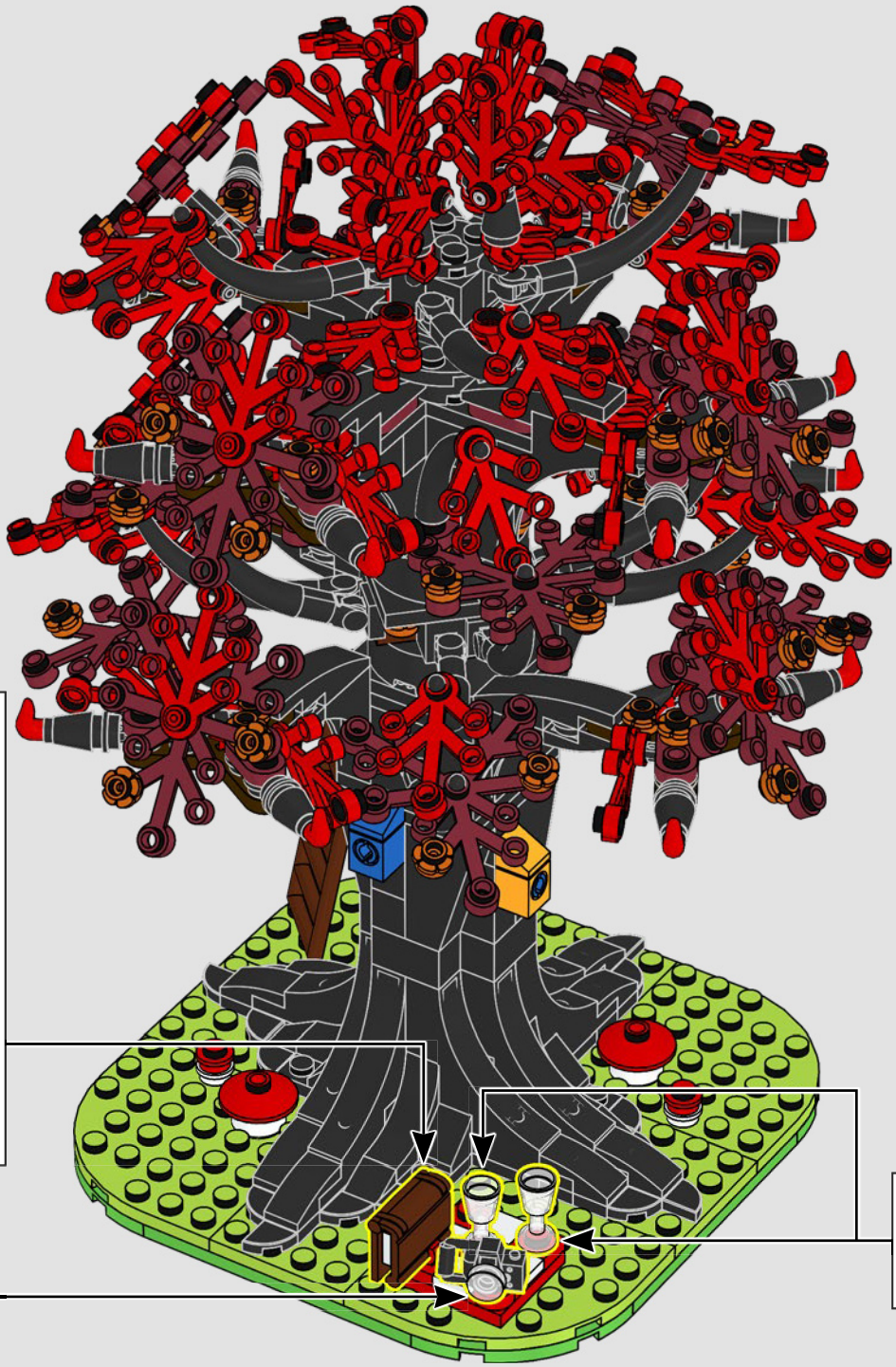

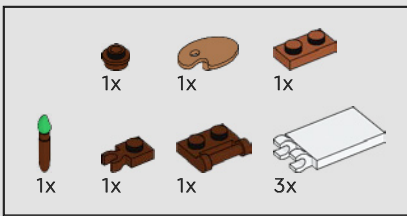

114

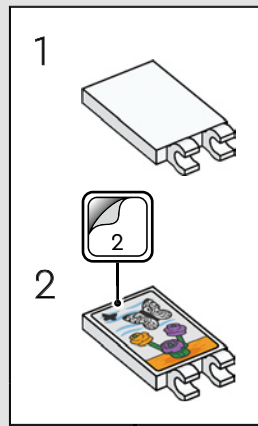
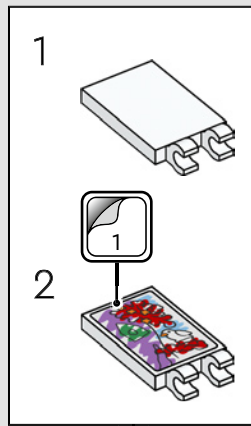
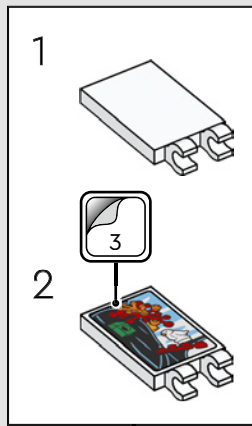
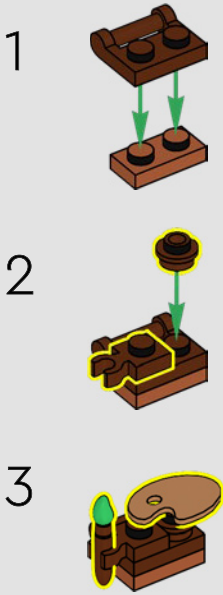

4

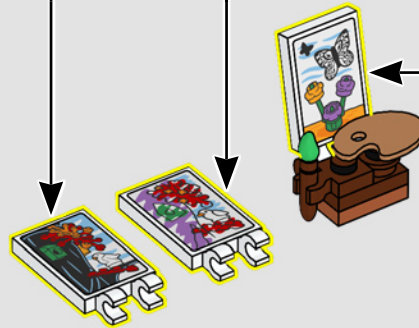

- 1x
- 1x
- 1x
- 1x
- 1x
- 1x
- 2x
- 1x

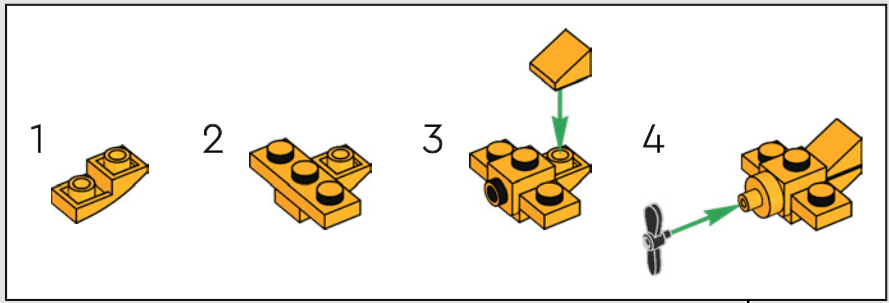

115

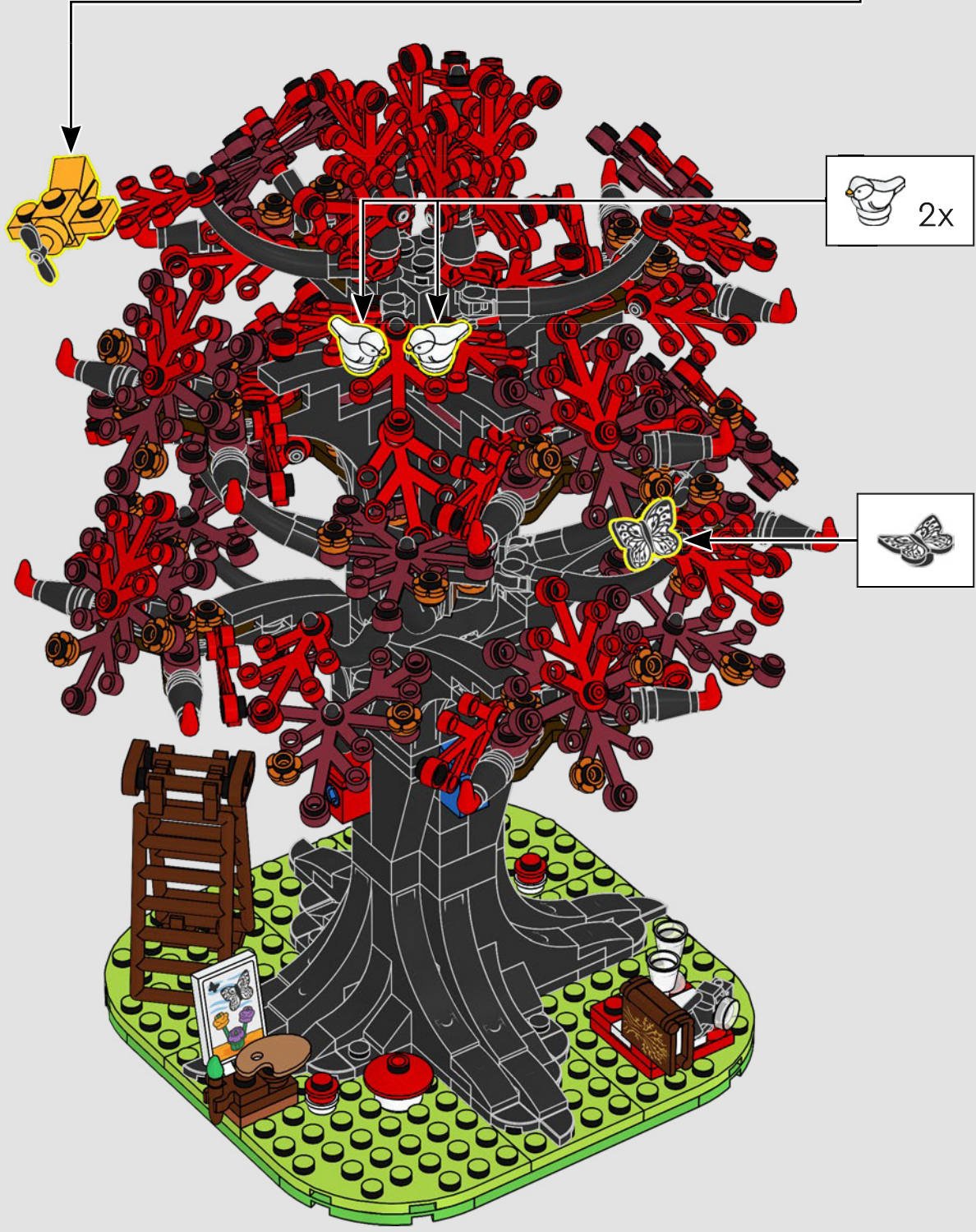



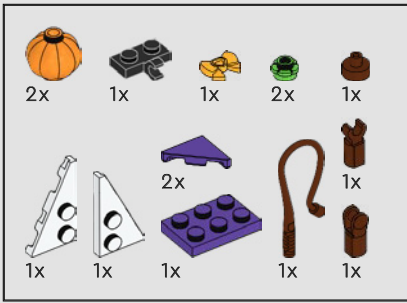

116

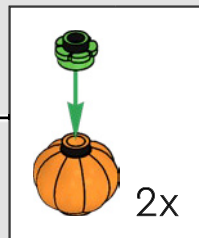
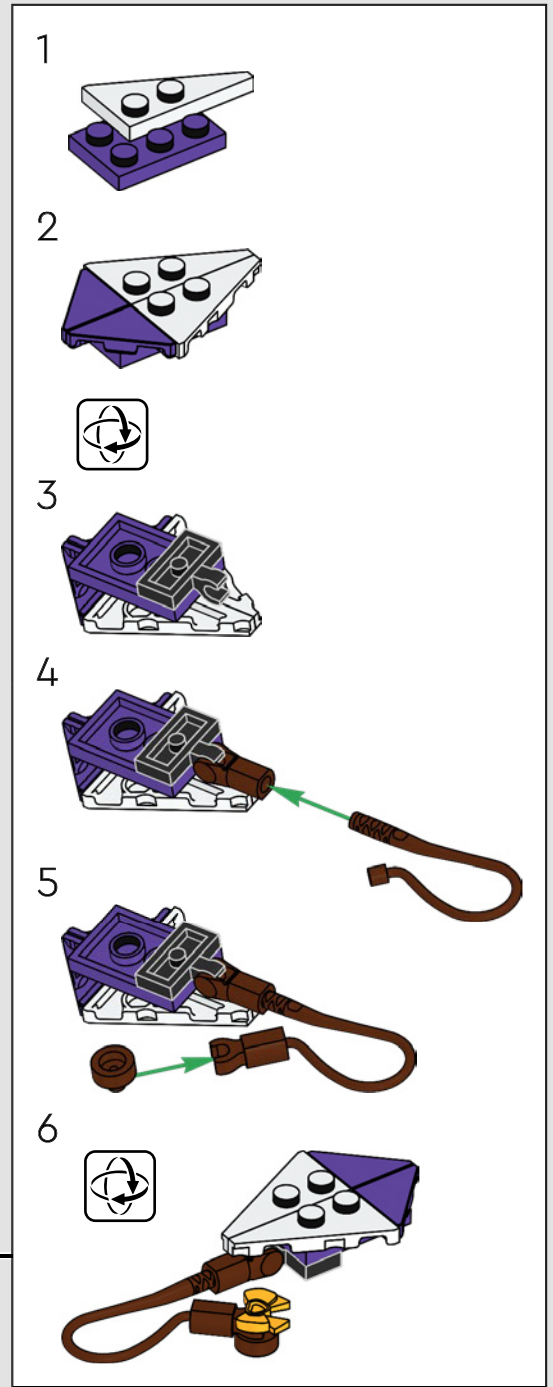
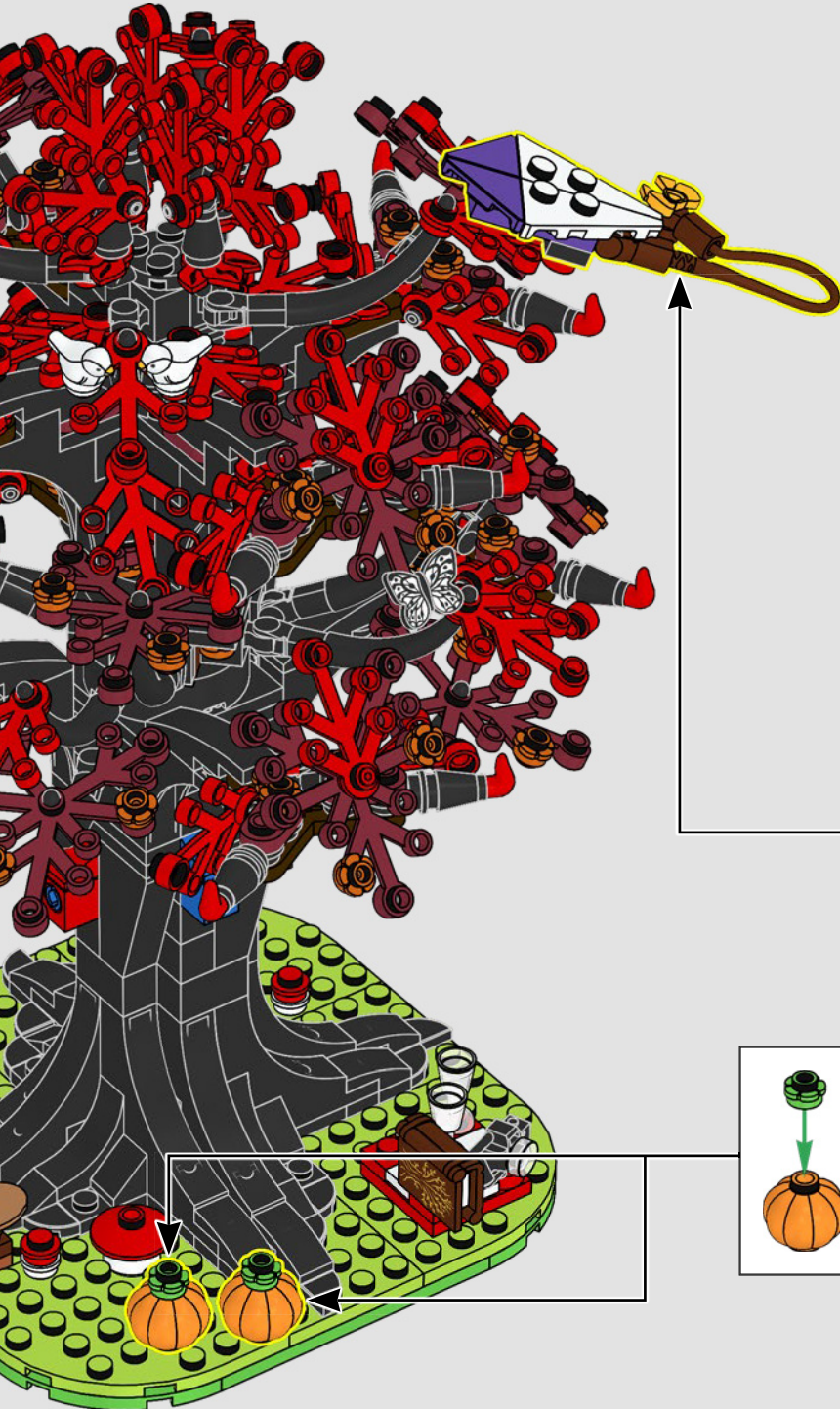





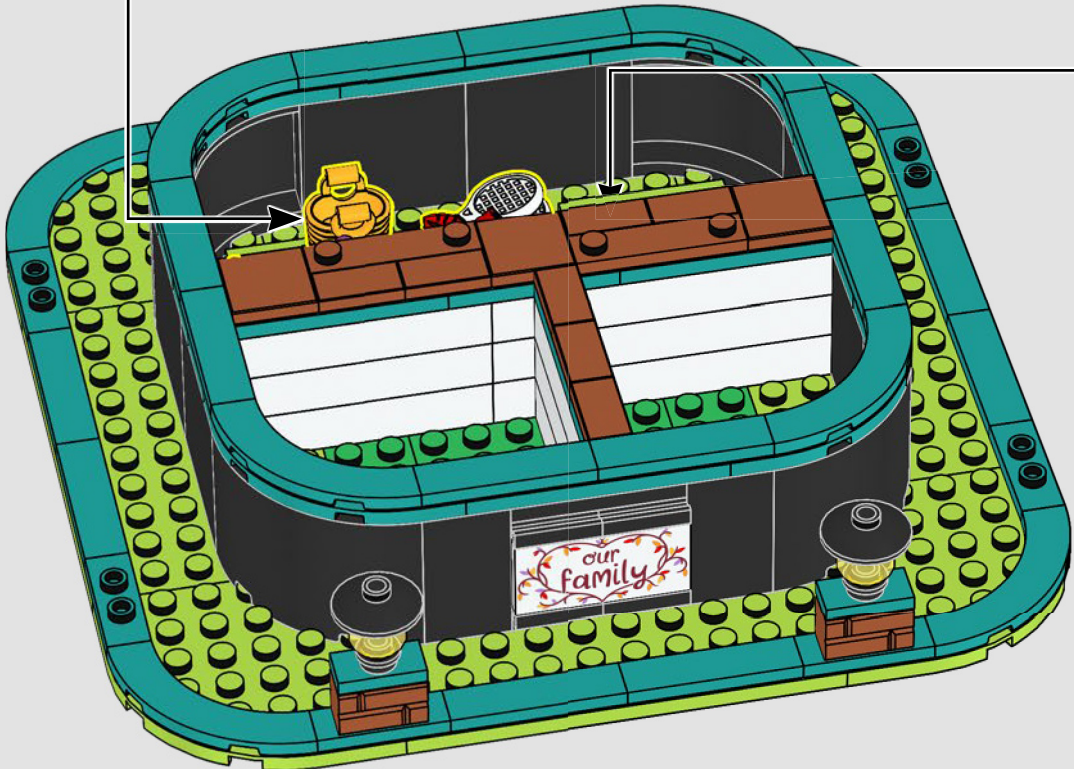
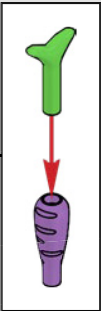
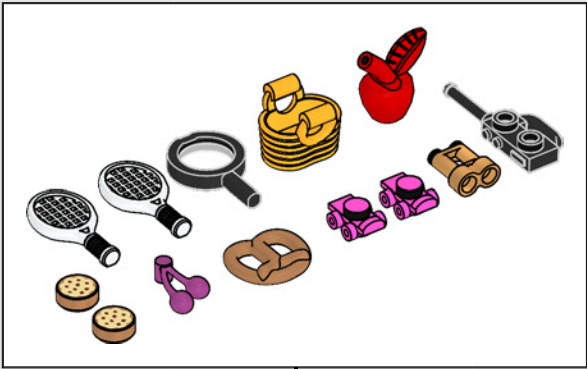

117





			
24x	24x	8x	8x

118

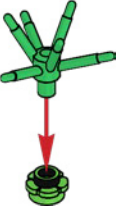
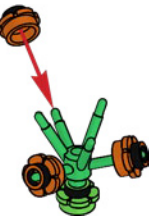
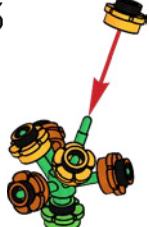
- 1 
- 2 
- 3 

8x

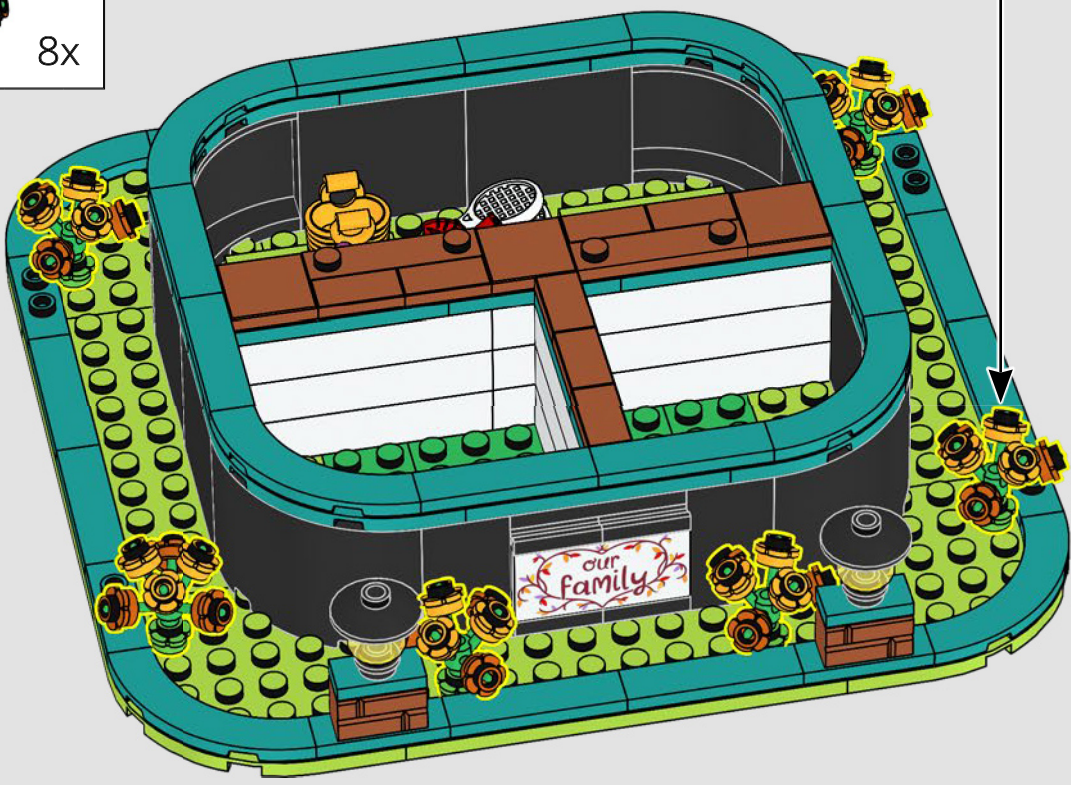

- 48x
- 24x
- 48x
- 48x

119



- 48x
- 48x

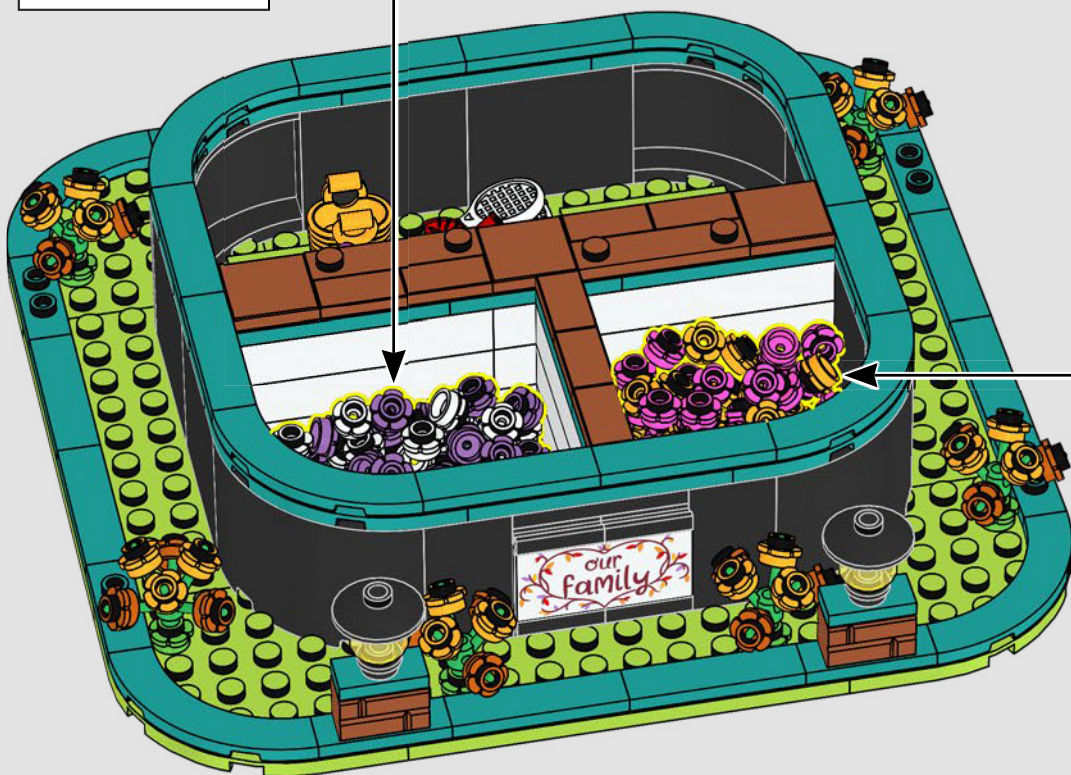

- 48x
- 24x

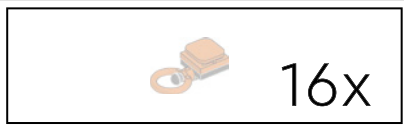

120

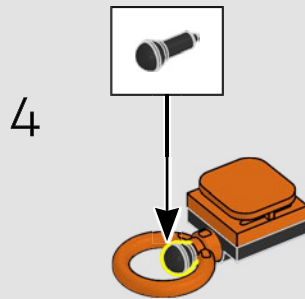
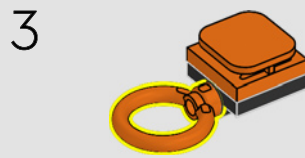
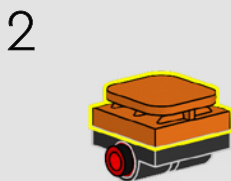
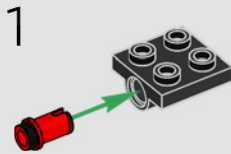



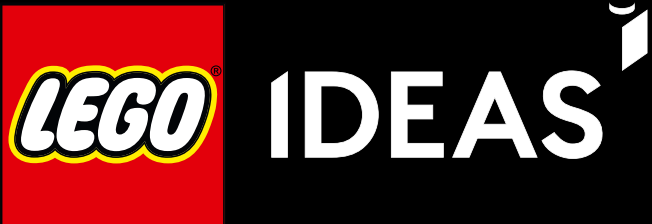

GATHER SUPPORT  
OBTENEZ DE L'APPUI  
OBTÉN APOYOS

SHARE YOUR IDEA  
PARTAGEZ VOTRE IDÉE  
COMPARTE TU IDEA

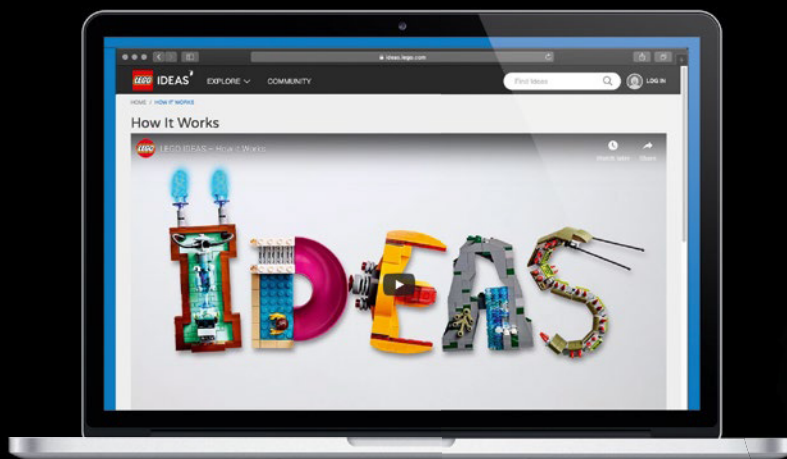
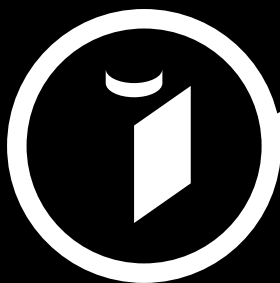
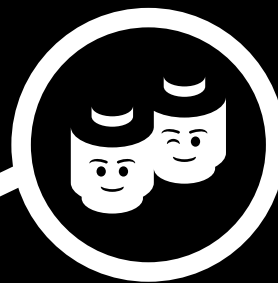



NEW LEGO® PRODUCT  
NOUVEAU PRODUIT LEGO®  
NUEVO PRODUCTO LEGO®

LEGO® REVIEW  
EXAMEN LEGO®  
REVISIÓN DE LEGO®

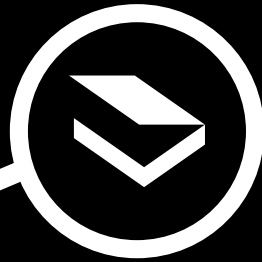
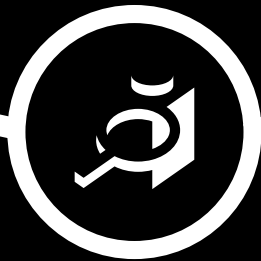

[ideas.LEGO.com](https://ideas.LEGO.com)

- 48x 6206149
- 2x 614101
- 2x 6253309
- 4x 307001
- 2x 6263451
- 2x 6221783
- 1x 6354822
- 1x 6354823
- 1x 6157985
- 3x 300301
- 3x 6360131
- 1x 6475768
- 1x 6167450
- 3x 300901
- 6x 4181142
- 2x 273001
- 1x 6359662
- 1x 6341968
- 1x 6476174
- 1x 6215659
- 1x 6186673
- 2x 6348057
- 2x 6248944
- 4x 4225469
- 1x 6337003
- 1x 6167879
- 1x 6475769
- 1x 6359864
- 1x 6236915
- 2x 6428805
- 2x 6030812
- 2x 4118782
- 1x 6240515
- 2x 6267125
- 1x 4177932
- 16x 6088550
- 24x 6321194
- 20x 4529236
- 22x 6168646
- 4x 306226
- 1x 6170545
- 16x 6172383
- 4x 4504382
- 4x 6335388
- 4x 6344819
- 12x 300526
- 12x 6336977
- 1x 6305094
- 4x 6104209
- 32x 6196548
- 1x 6325525
- 1x 6313116
- 4x 4107761
- 16x 281726
- 1x 6313508
- 4x 302326
- 4x 6147050
- 8x 6047276
- 14x 300426
- 4x 4121966
- 1x 6476480
- 1x 6475767
- 2x 474026
- 1x 614326
- 4x 4636202
- 4x 6475520
- 2x 6228588
- 4x 242026
- 1x 6325254
- 1x 300326
- 4x 362326
- 4x 6038531
- 4x 6154860
- 8x 6037746
- 2x 371026
- 4x 302026
- 4x 6147050
- 8x 6047276
- 2x 4558957
- 6x 6349112
- 1x 300126
- 8x 4116854
- 4x 6075062
- 20x 6055070
- 2x 6058118
- 1x 4243819
- 2x 4517986
- 8x 6213777
- 2x 6210399
- 1x 6290269
- 8x 6334098
- 16x 6292786
- 3x 6291782
- 8x 6458170
- 2x 6259794
- 4x 637247
- 1x 6166107
- 2x 6300208
- 48x 6209679
- 2x 6346263
- 2x 6287854
- 1x 6359941
- 1x 6341592
- 1x 6034543
- 1x 6495136
- 1x 6100562
- 84x 6475523
- 16x 6475522
- 16x 6475521
- 48x 6209684
- 1x 6398503
- 2x 6424624
- 1x 4225142
- 1x 4119479
- 24x 6212040
- 1x 6359692
- 3x 6359681
- 16x 6431823
- 8x 6328094
- 2x 6192539
- 16x 6368619
- 8x 6439048
- 16x 6378120
- 1x 6348058
- 1x 4504379
- 3x 302421
- 1x 654121
- 1x 6054438
- 8x 6399645
- 1x 4142865
- 2x 4585146
- 1x 300321
- 8x 6372723
- 2x 302221
- 48x 6172658
- 1x 6217123
- 48x 6209681
- 1x 6223719
- 1x 6359040
- 2x 6023173
- 1x 6318085
- 1x 6263103
- 1x 6096091
- 2x 614121
- 5x 6215539
- 16x 6368619
- 8x 6439048
- 16x 6378120
- 1x 6348058
- 1x 4504379
- 3x 302421
- 1x 654121
- 1x 6054438
- 8x 6399645
- 1x 4142865
- 2x 4585146
- 1x 300321
- 8x 6372723
- 2x 302221
- 48x 6172658
- 1x 6217123
- 48x 6209681
- 1x 6223719
- 1x 6359040
- 2x 6023173
- 1x 6318085
- 1x 6263103
- 1x 6096091
- 2x 6192205
- 2x 6133817
- 2x 6097503
- 1x 6037890
- 1x 4530028
- 1x 6097420
- 4x 6212989
- 4x 6060848
- 8x 6129601
- 4x 6289699
- 1x 6290260
- 2x 383228
- 4x 6021996
- 4x 6070506
- 10x 6206150
- 1x 4546705
- 1x 4522678
- 8x 6269940
- 1x 6145215
- 1x 6003003
- 1x 6439231
- 1x 6073042
- 1x 4504380
- 1x 4119014
- 4x 4206482
- 1x 6145215
- 1x 6003003
- 1x 6439231
- 1x 6073042
- 1x 4504380
- 1x 4119014
- 4x 4206482
- 1x 6145215
- 1x 6003003
- 1x 6439231
- 1x 6073042
- 1x 4504380
- 1x 4119014
- 4x 4206482
- 1x 6145215
- 1x 6003003
- 1x 6439231
- 1x 6073042
- 1x 4504380
- 1x 4119014
- 4x 4206482

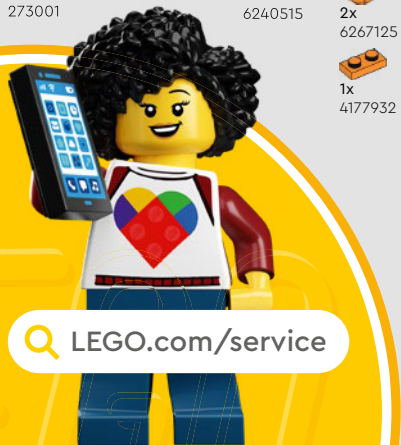



# YOU COULD WIN



## YOU COULD WIN

Your feedback will help shape the future development of this product series.

Visit:

## DU KÖNNTEST GEWINNEN

Dein Feedback trägt zur Weiterentwicklung dieser Produktreihe bei.

Geh auf:

## VOUS POURRIEZ GAGNER

Vos commentaires nous aideront à concevoir les futurs produits de cette gamme.

Visitez :

## POTRESTI VINCERE TU

La tua opinione ci aiuterà a migliorare la creazione futura di questa linea di prodotti.

Visita:

## PUEDES GANAR

Tu opinión contribuirá al futuro de esta serie de productos.

Visita:

## 轻松获奖

您的反馈将有助于我们在今后改进本产品系列。

请访问:

---

# LEGO.com/productfeedback

---

You also have the chance to win a LEGO® set.

Terms and conditions apply.\*

Außerdem hast du die Chance, ein LEGO® Set zu gewinnen.

Es gelten die Teilnahmebedingungen.\*

Vous pourriez également gagner un ensemble LEGO®.

Des conditions s'appliquent.\*

Hai anche la possibilità di vincere un set LEGO®.

Termini e condizioni sono applicabili.\*

También tienes la oportunidad de ganar un set LEGO®.

Aplican términos y condiciones.\*

您还有机会赢取乐高®套装。

条款和条件适用。\*

\*LEGO.com/productfeedback-terms

