

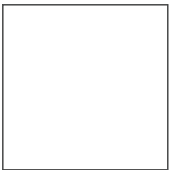

Booklet available in English on
Heft in deutscher Sprache erhältlich auf
Livret disponible en français sur
Libretto disponibile in italiano su
Folleto en español disponible en
如需中文版手册, 请访问





LEGO.com/sustainable-packaging

LEGO® VIP

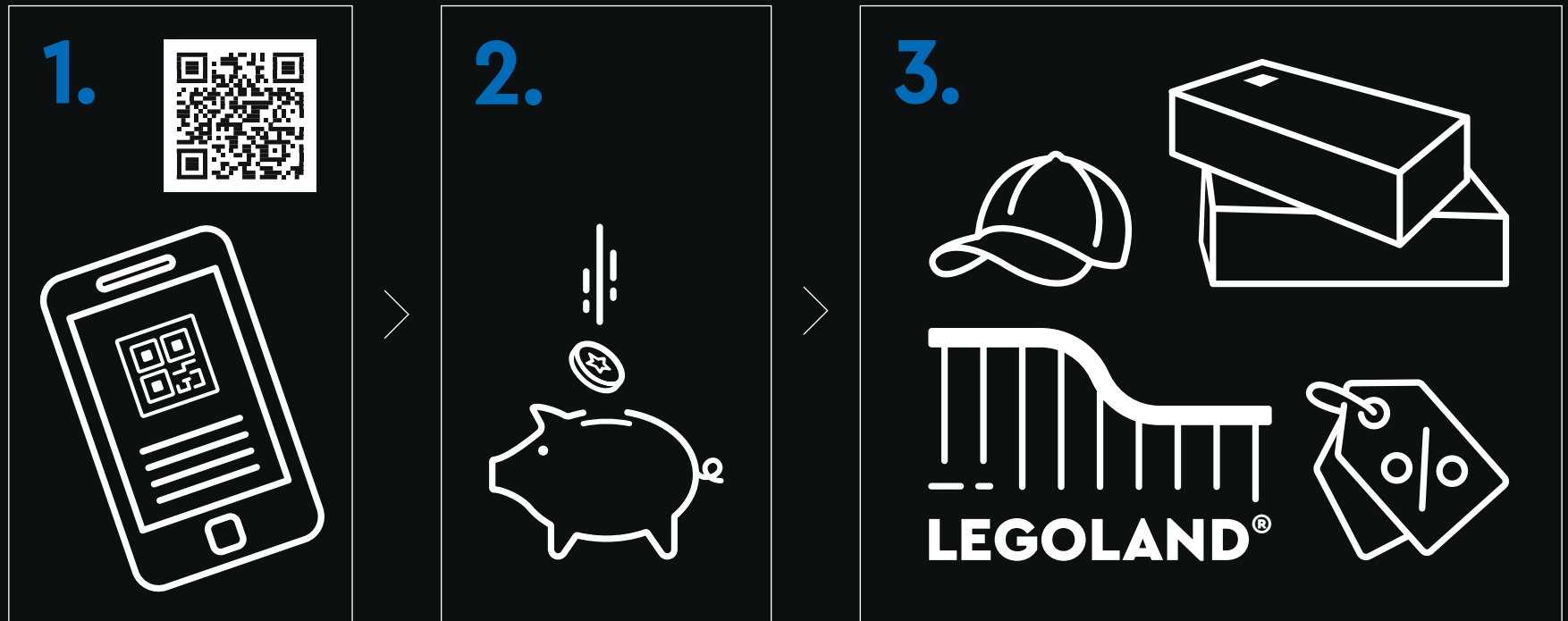

1. Sign up **2.** Earn points for purchases **3.** Redeem points for rewards, experiences, discounts & more | **1.** Melde dich an **2.** Sammle Punkte bei jedem Kauf **3.** Löse die Punkte für Belohnungen, Erlebnisse, Rabatte und Ähnliches ein | **1.** Inscrivez-vous **2.** Gagnez des points lors de vos achats **3.** Échangez vos points contre des récompenses, des expériences, des remises et bien plus encore | **1.** Iscriviti **2.** Guadagna punti con i tuoi acquisti **3.** Riscatta punti per premi, esperienze, sconti e altro ancora | **1.** Regístrate **2.** Gana puntos por tus compras **3.** Canjea puntos por recompensas, experiencias, descuentos y mucho más | **1.** Registe-se **2.** Ganhe pontos em compras **3.** Troque os pontos para prémios, experiências, descontos e muito mais | **1.** 注册 **2.** 购物赚积分 **3.** 用积分兑换奖励、体验、折扣等 | **1.** Zarejestruj się **2.** Zdobywaj punkty za zakupy **3.** Wymieniaj punkty na rabaty, przygody i inne nagrody | **1.** Zaregistrujte se **2.** Sbírejte body za nákupy **3.** Vyměňujte body za odměny, zážitky, slevy a spoustu dalšího | **1.** Zaregistrujte se **2.** Získavajte body za nákupy **3.** Uplatnite si body a získajte odmeny, rôzne zážitky, zľavy a ešte viac | **1.** Regisztrálj **2.** Szerezz pontokat minden vásárlással **3.** Váltsd be pontjaidat jutalmakra, élményekre, kedvezményekre és egyebekre | **1.** Înscric-te **2.** Câștigă puncte pentru achiziții **3.** Valorifică puncte pentru recompense, experiențe, reduceri și multe altele | **1.** Регистрируйте се **2.** Получайте точки за покупки **3.** Используйте точки за награды, услуги, отстъпки и т.н. | **1.** Reģistrējies **2.** Pelni punktus par pirkumiem **3.** Izmanto punktus, lai saņemtu balvas, izklaides iespējas, atlaides un daudz ko citu | **1.** Registreeru **2.** Teeni ostude eest punkte **3.** Lunasta punktide eest preemiad, elamused, allahindlused ja muu | **1.** Užsiregistruokite **2.** Pelnykite taškų už pirkinius **3.** Panaudokite taškus atlygiui, funkcijoms, nuolaidoms ir ne tik





**MEET THE
FAN DESIGNER**

E

French director and screenwriter Thomas Lajon (LEGO® Ideas name L.Et.sGO) got his first LEGO set at age four and still loves to build. Today, he shares his LEGO passion (and bricks) with the people he loves the most.

'I have always been a great fan of locomotives, and if I could travel back in time (and could afford a ticket), I would take the *Orient Express*! It's almost as if it's from another world, that's what I love about it. This sumptuous train took passengers across Europe in luxury carriages for almost a century and remains at the heart of many stories and myths. And for me, who comes from screenwriting and cinema, the *Orient Express* inspires tales of adventure and invites me to travel. The *Orient Express* is *the* train of dreams with its magnificent carriages created by great craftsmen

and designers. It has an air of inaccessibility and feeds our fantasies. It belongs in fabulous stories, literature, songs and film.

'This model is my very first LEGO Ideas project and it took hours, days and nights of preparation, designing and patience! I built my model by looking at pictures of the Pacific 231 K 8 locomotive/hundreds of pictures of both the exterior and interior of the cars. The final set is beautiful, and the LEGO designer team has done a fantastic job bringing this dream to life. My favourite detail is the convex mirror that reflects the interior of the sleeping car. To me, that's the icing on the cake. And I want to send my thoughts and thanks to every one of the 10,000 LEGO Ideas supporters who made this moment of happiness a reality!'



Thomas's original submission

LAYING THE TRACKS TO A NEW WORLD



During the Industrial Revolution, trains and railways became symbols of technological progress and political power. Thousands of miles of new tracks and routes sprouted between regions, transcending borders and bringing a new life with them. They facilitated efficient transportation of goods, new jobs, economic growth and exotic new travel opportunities for millions worldwide.

International passenger travel was still in its infancy, with limited coordination or efficiency across borders. With political tension spreading throughout Europe, Belgium's neutral status would play an important part in laying the tracks for global progress as the nation established strategically important railway connections to and through large parts of the continent and the colonies.

A DIPLOMATIC BREAKTHROUGH

- In 1876, the visionary Belgian engineer and entrepreneur Georges Nagelmackers founded the Compagnie Internationale des Wagons-Lits (CIWL) (International Sleeping-Car Company). He had seen the potential in luxury travel that would cater to the upper class. Inspired by dining and sleeping cars that were gaining popularity in the United States, he pioneered the first chain of luxury trains that would eventually spread across the world. Through extensive diplomatic negotiations and, undoubtedly, unparalleled perseverance and optimism, Nagelmackers obtained the necessary permits and contracts with neighbouring states to allow his trains to pass unhindered across Europe, all the way from Paris to Constantinople. The design, construction and maintenance were the absolute pinnacle of quality, perfection and innovation, overseen by talented men and women all over the world. And most importantly, the new trains brought intriguing and romantic new horizons closer, new dreams to life and opened doors to new worlds.



E

A GATEWAY TO ADVENTURE

- The capital city of the Ottoman Empire had become a popular new destination and inspiration for European artists and writers as a gateway to the mystery and allure of the Far East. As the first European transcontinental train, the *Orient Express* lived up to its promise of adventure travel. The train itself was a travelling advertisement for Nagelmackers' new company, and extensive advertising campaigns featured colourful posters, postcards and collectible memorabilia. All included images of Ottoman landmarks and symbols, sandy colours and compositions, or models wearing Egyptian or Arabic-inspired clothing. The company's official Wagons-Lits magazine promoted both services, routes and articles for entertainment, but also featured photographs of celebrities enjoying the luxuries onboard, from exquisite dining and sleeping cars to immaculately dressed baggage handlers and conductors, perpetuating the glamour, myth and exclusivity of the *Orient Express*.



S

IF THESE TRAIN CARS COULD TALK...



After the successful maiden voyage of the *Orient Express* in October 1883, the CIWL continuously added new routes to its services over the next decades and well into the 20th century. As Nagelmackers had foreseen, people were drawn to the quality, luxury and promise of adventure. But a pivotal turning point for the *Orient Express* came in 1934. The release of

Agatha Christie's bestselling novel *Murder on the Orient Express* cast the train in an invaluable spotlight with glamour, excitement and mystery, propelling it onto the world stage as a cultural phenomenon of the 20th century. A modern legend was born. Even four decades later, the first film adaptation still captured the imagination of new audiences.

THE *ORIENT EXPRESS* IN TIMES OF CHANGE



1867

During a trip to the United States, Georges Nagelmackers discovers modern dining cars and sleeping cars and sees their potential to redefine travel.

1883

On 4 October, the *Orient Express* embarks on its maiden journey – a round trip from Paris to Constantinople, returning on 16 October. Two dozen passengers are invited on this “press trip” to the shores of the Black Sea, where the last part of the journey is completed by steamboat.

1889

The *Orient Express* now connects Paris to Constantinople via Budapest, Belgrade and Sofia in 67 hours and 46 minutes.

1918

Legend says the Armistice of 1918 was signed onboard the *Orient Express*. In fact, it was signed in a car belonging to another of the company’s trains: dining car no. 2419, in the Rethondes clearing, in the forest of Compiègne.

1919

Inauguration of the *Simplon-Orient Express* train from London and Paris to Constantinople via Italy. A collaborative initiative between allies, the route reflects the new geopolitical situation in Europe after the First World War.



Travel through time and revisit iconic moments in the history of the *Orient Express*.

1922

A large number of cars destroyed or confiscated during World War I need repair or replacement. Teak replaces steel where appropriate, and cars are upgraded with the signature midnight blue livery.

1929

For days, a snowstorm traps the *Orient Express* in the Turkish town of Cherkeskoy. The event inspires Agatha Christie's classic, *Murder on the Orient Express* (released in 1934).

1934

The release of Agatha Christie's bestselling novel *Murder on the Orient Express*, featuring the fictional Belgian detective Hercule Poirot, propels the train to new heights of fame as a cultural icon.

1946

After service throughout Europe was disrupted during World War II, service to Istanbul is finally restored.

1974

The first film based on Agatha Christie's *Murder on the Orient Express* premieres worldwide and would go on to become a modern classic.

1977

Facing fierce competition from modern luxury air travel, the *Orient Express* makes its last journey to Istanbul on 20 May.



MEET THE LEGO® DESIGNERS

- ‘Thomas’s original submission was next-level in terms of accuracy and detail – his passion for the age of steam really shows. We pulled out all the stops to represent the original experience of world-class luxury travel within the final LEGO® model as well. We have the dining car as well as a sleeping car, and after extensive research and consultation with experts, we were able to recreate LEGO interpretations of details like the wood veneer panelling and cut-glass mirrors seen on the original service. I hope our LEGO train fans find lots of desirable pieces made for this set; a brand-new beam element made for the locomotive’s coupling rods, pens used for the whistles and a bucket used for the funnel are a just a few of my favourites. The model is also larger than traditional LEGO trains, which means extra space inside to have details and, of course, play!’

–Ollie Gregory, LEGO® Ideas
Senior Model Designer

W

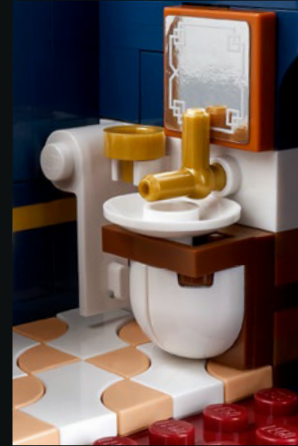

“Thomas’s model was a truly nostalgic and fantastic set to work on! I really liked the wood panels, glass, convex mirror, the mirror with the birds and all the details inspired by the original. We wanted the decorations to really bring the interior to life and add a bit of LEGO® DNA. All the birds, flowers and leaves are LEGO elements, but it was still a puzzle to find the right fit and combination of colours and details, and we tested a lot of designs and prints, logo and text fonts to get it right. Another part that is always fun,

but also challenging, is the design of new minifigures. The *Orient Express* is iconic in popular culture, so we have an intriguing cast of characters you can use to create your own stories, including a new waiter and a journalist, plus a conductor, a fireman, a concierge, a baggage porter, a distinguished duchess, a scientist and more. I hope the set stirs your imagination!

–Kjeld Walther Sørensen,
LEGO® Ideas Graphic Designer

S

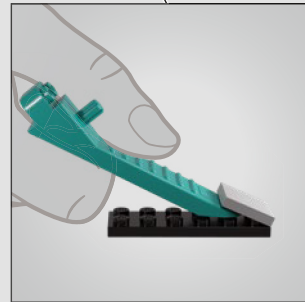
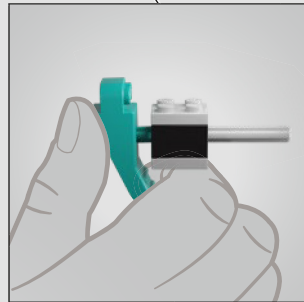
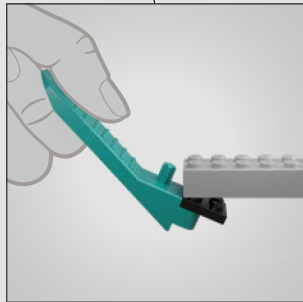
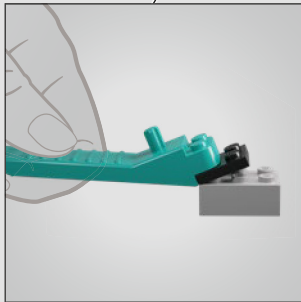
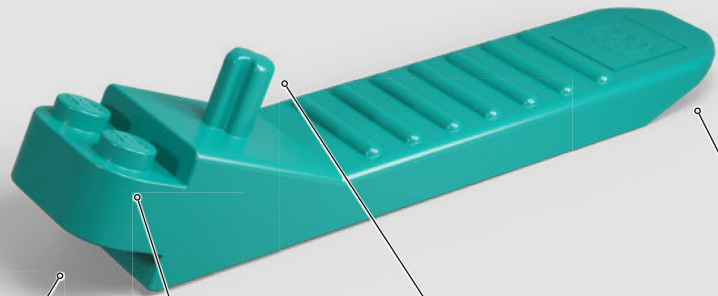

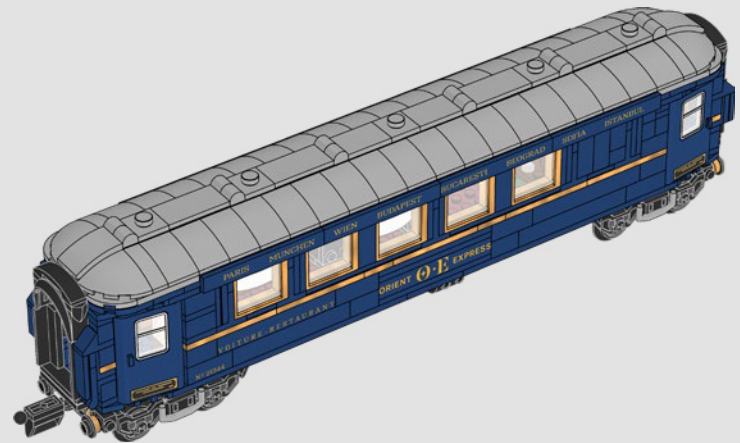
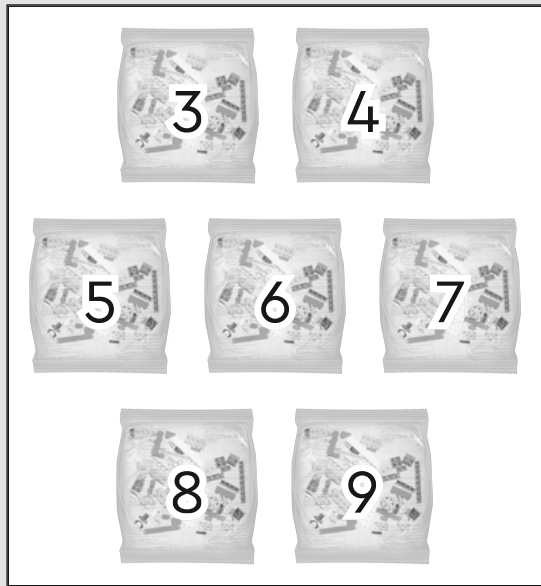
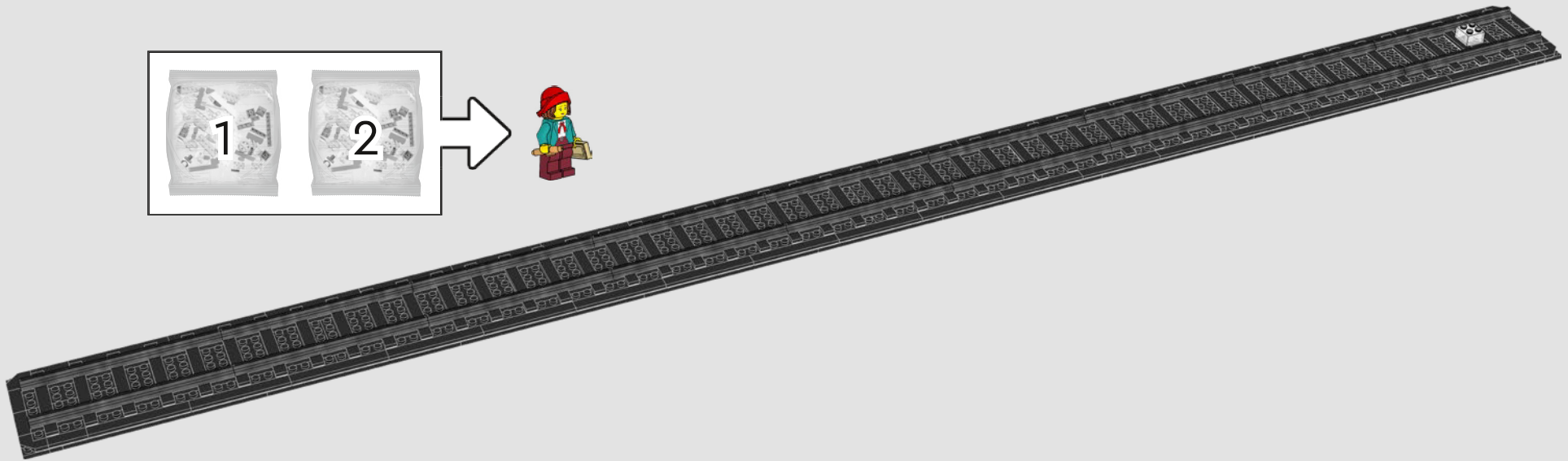

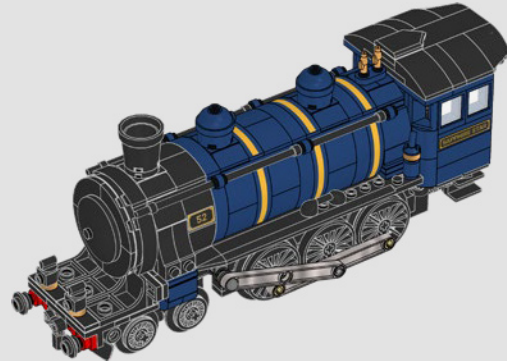
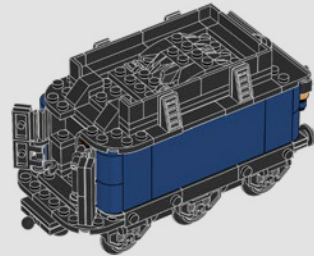
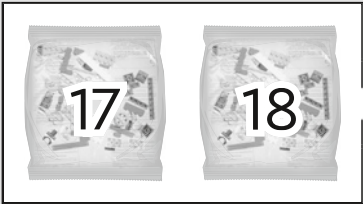
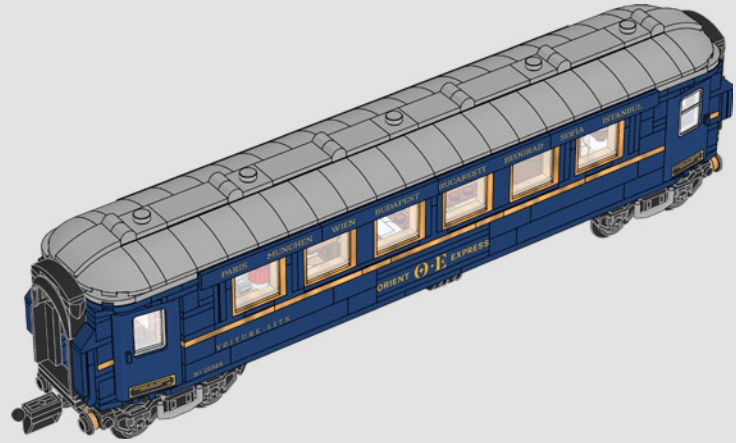
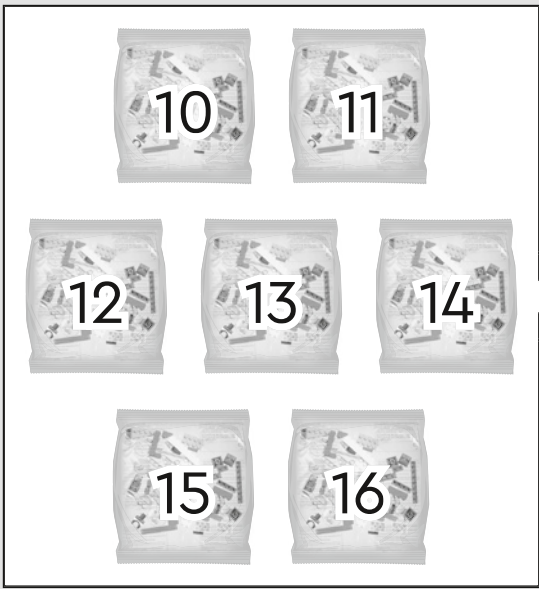

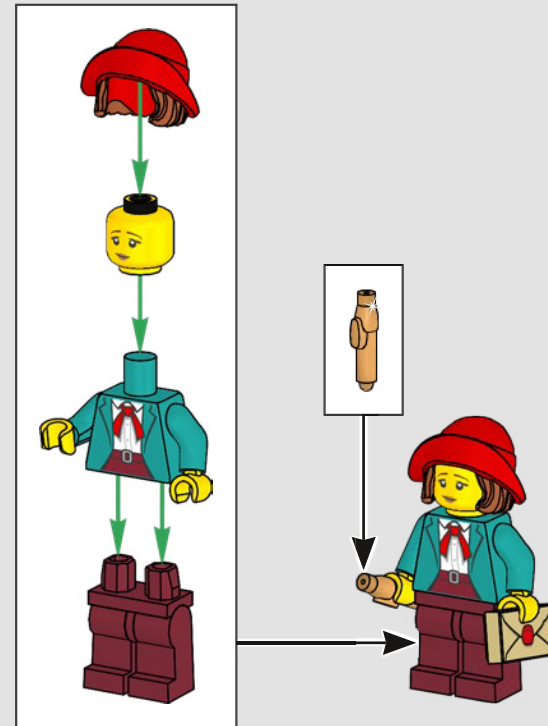
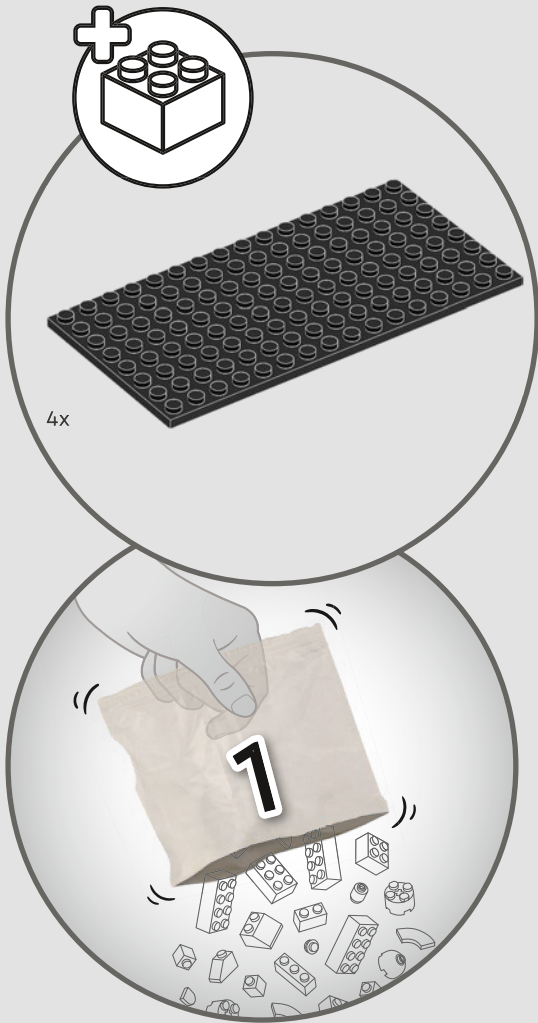

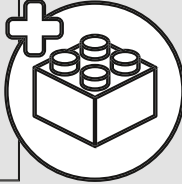
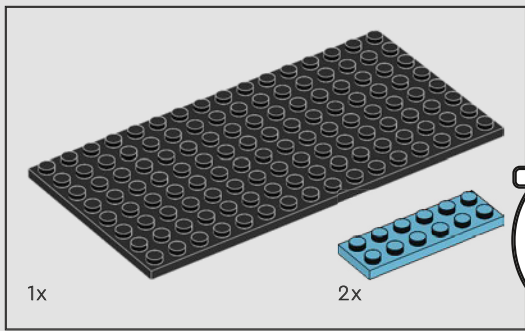

1

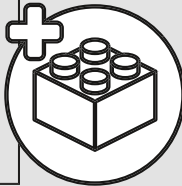
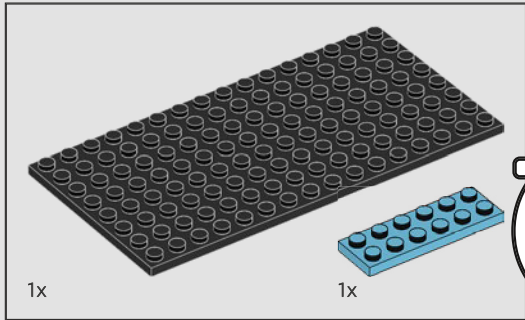
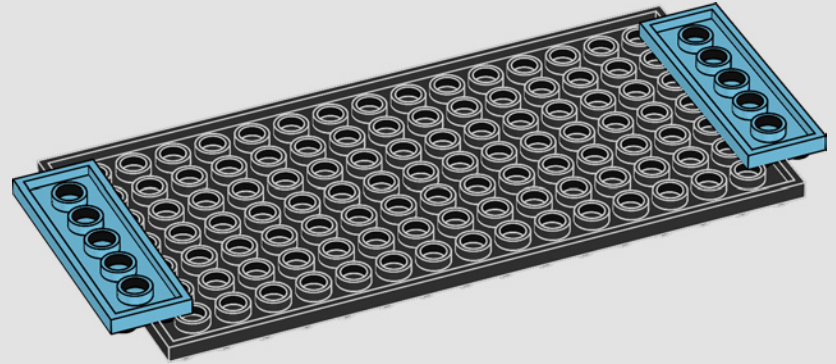

2

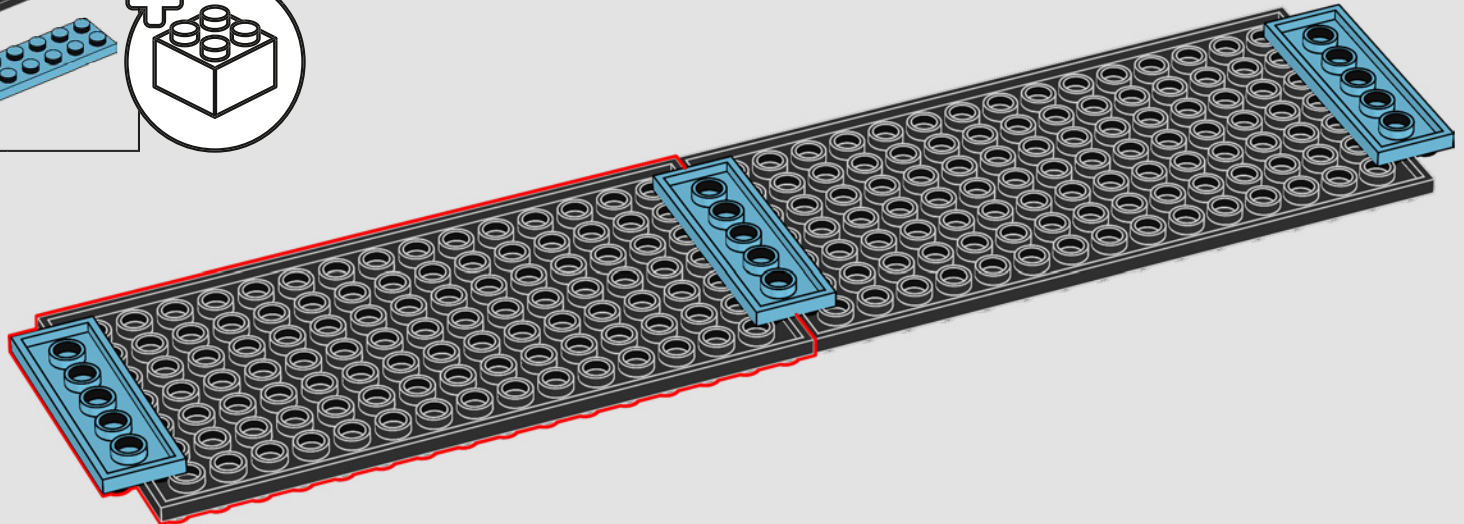

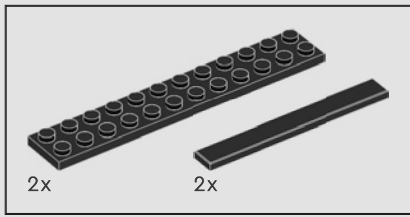

3

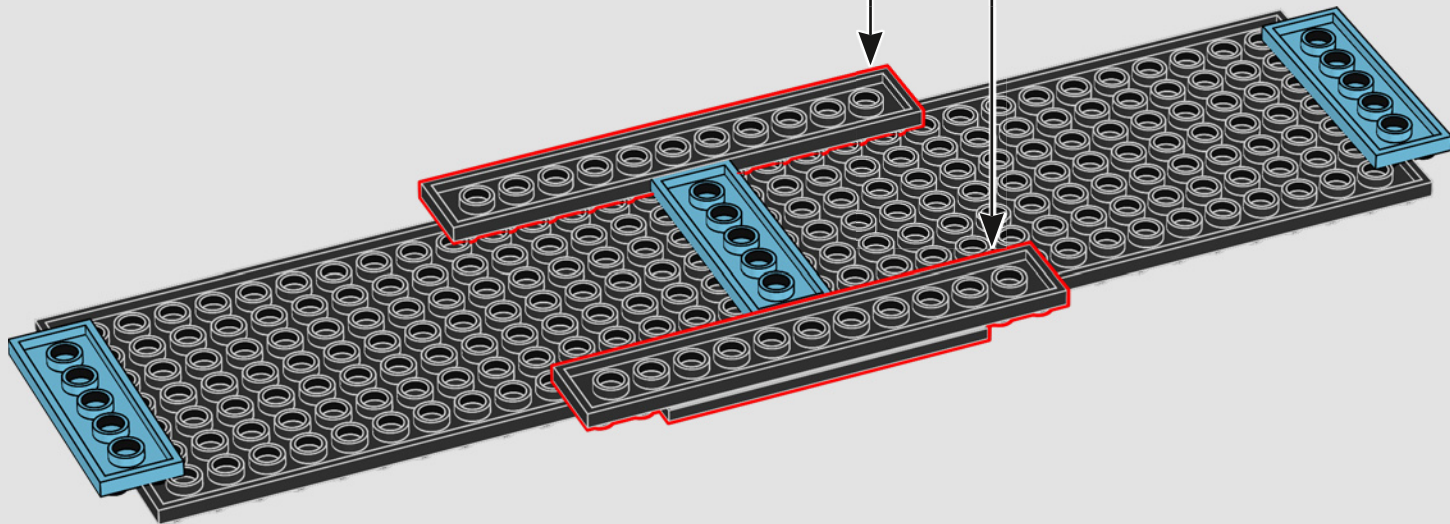
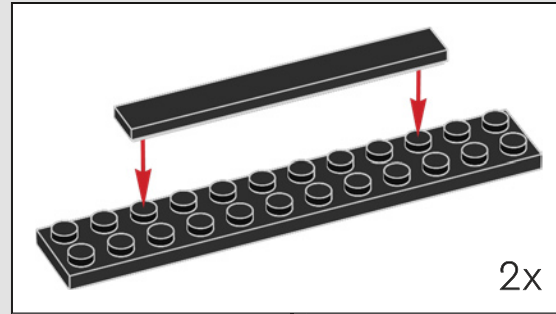

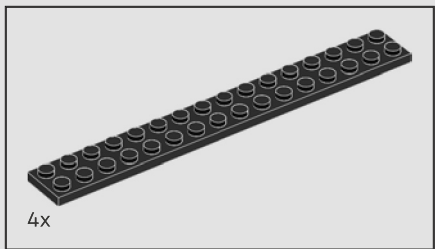

4

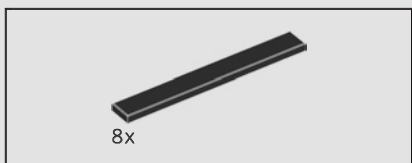
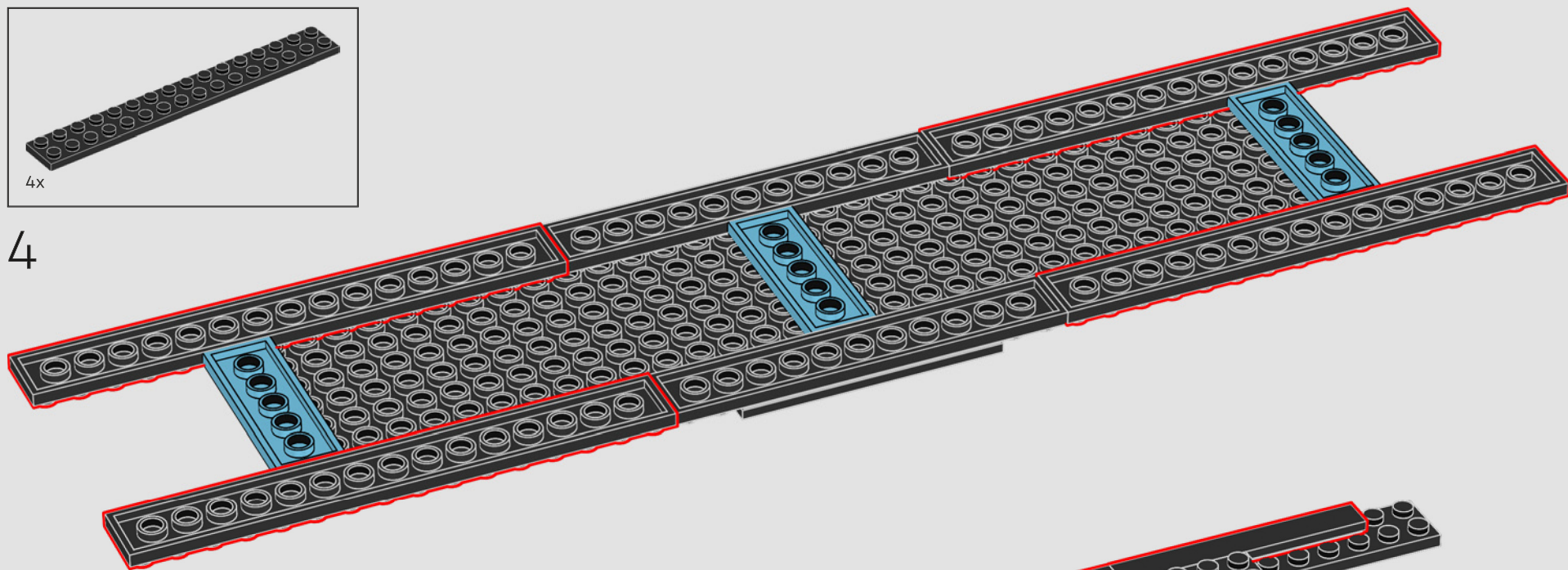

5

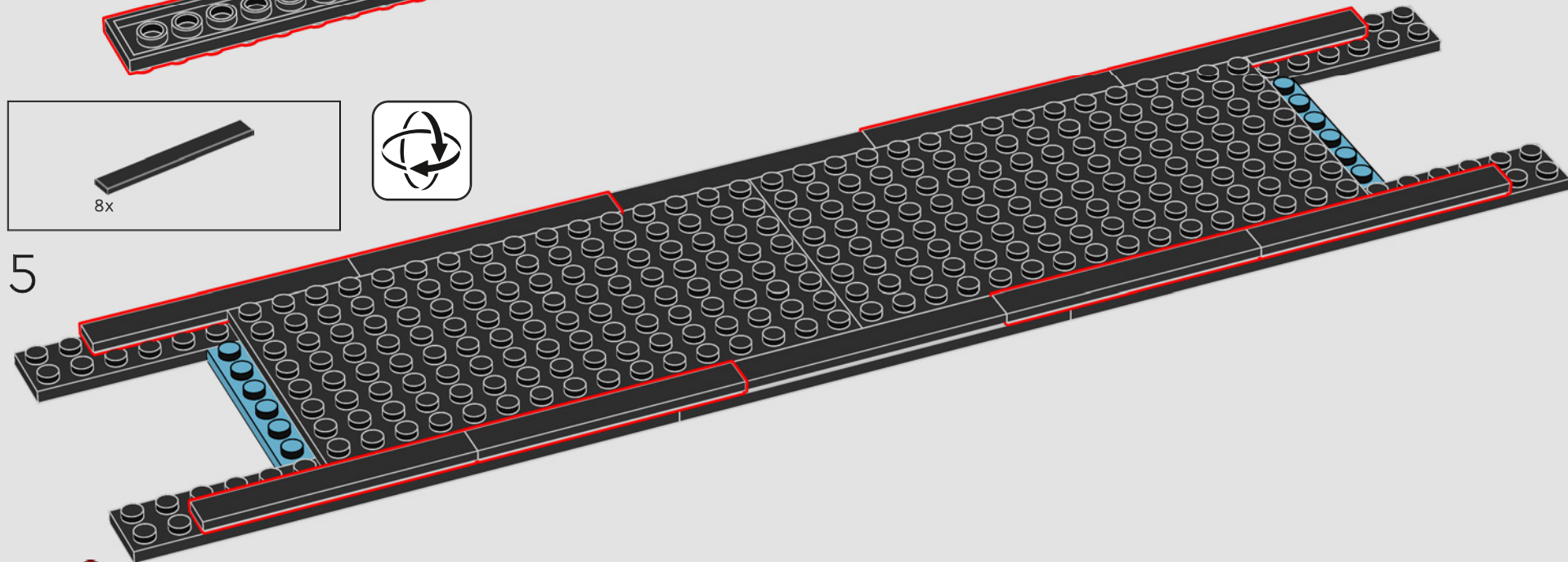

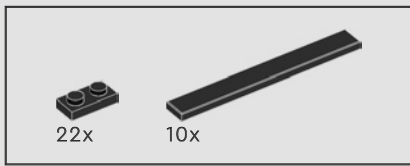

6

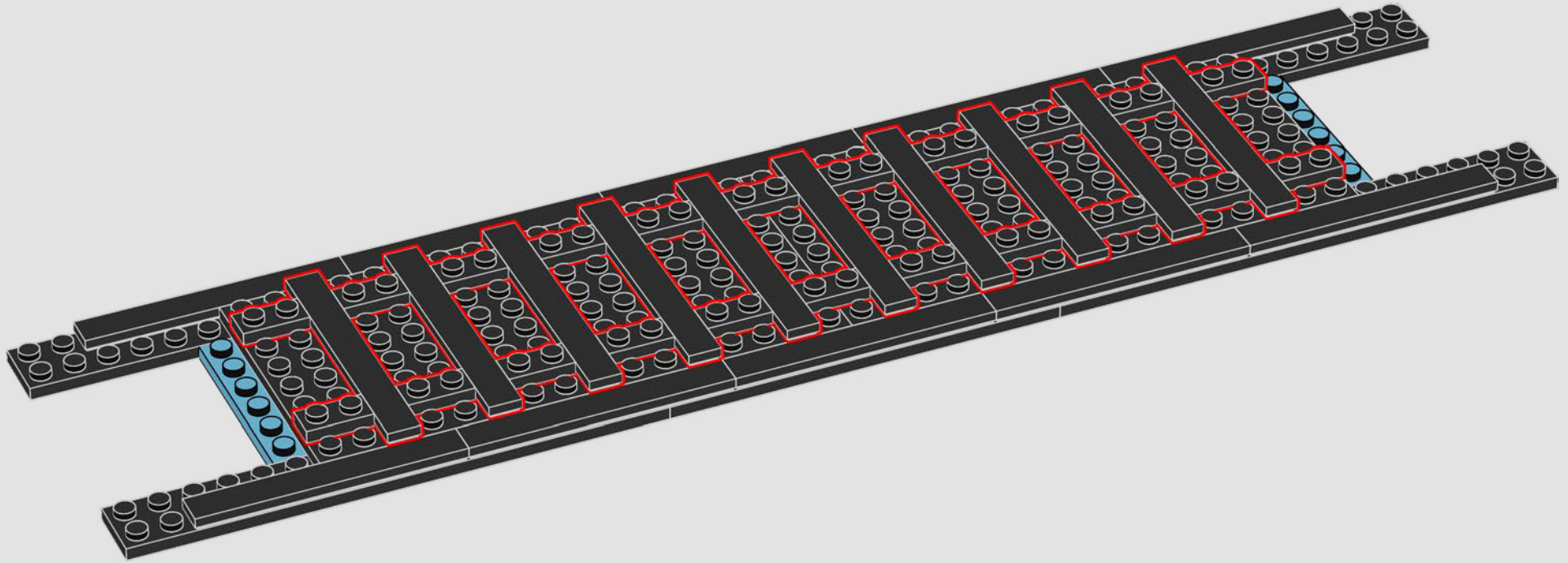

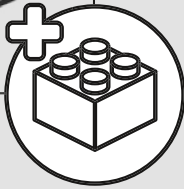
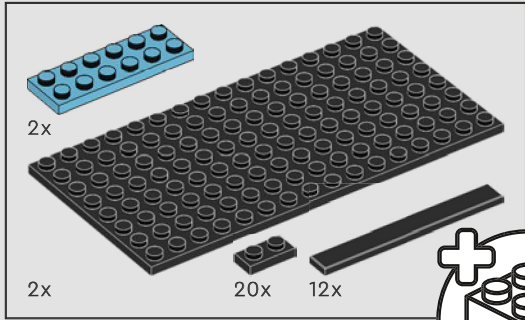
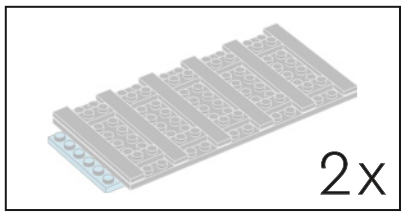

7

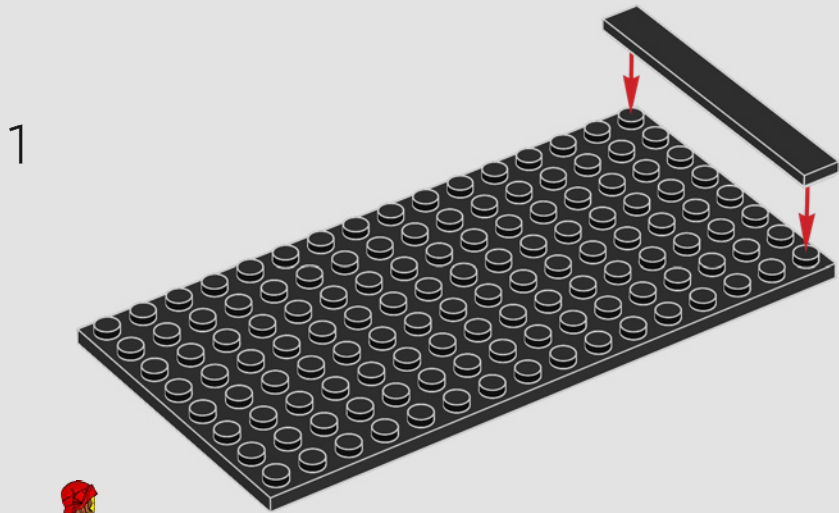

2

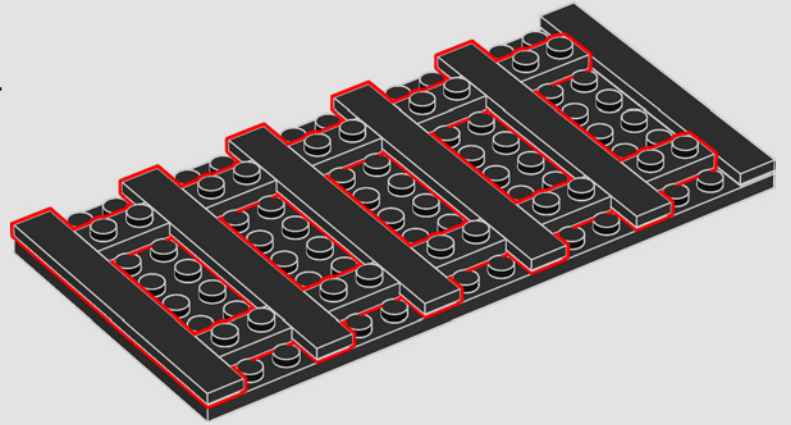

3

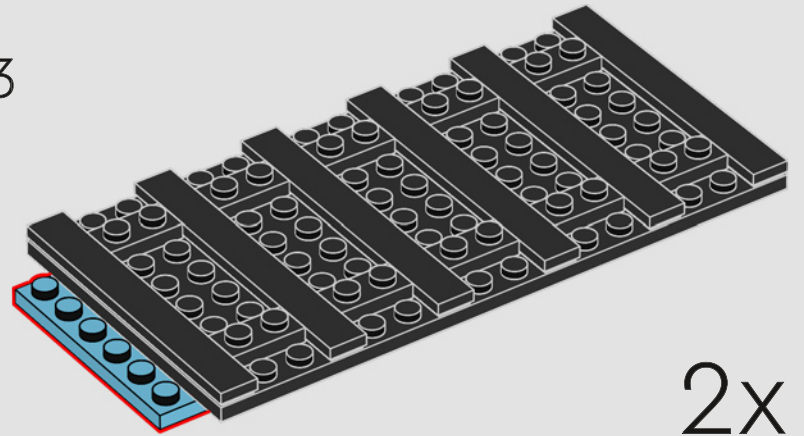

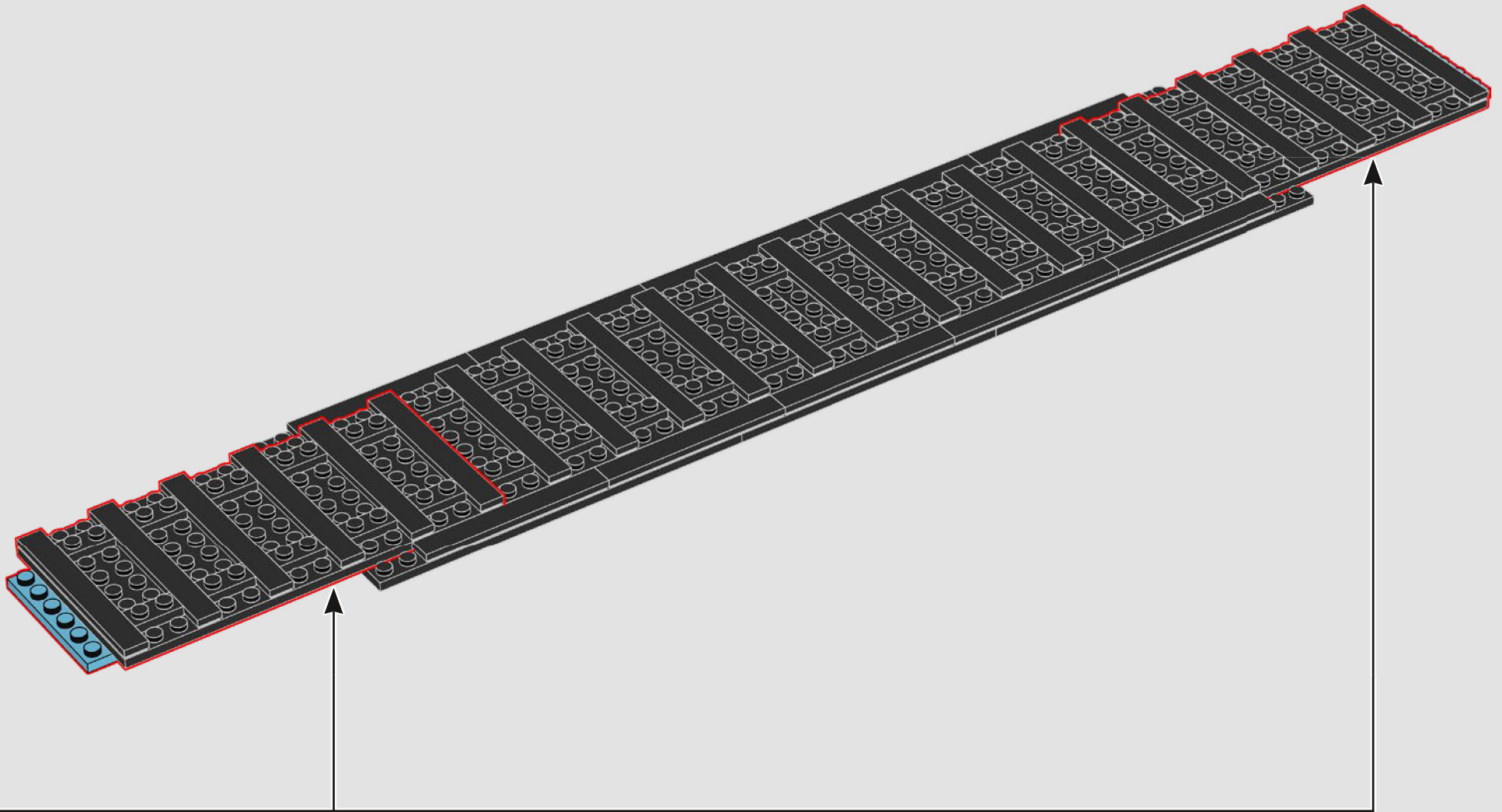

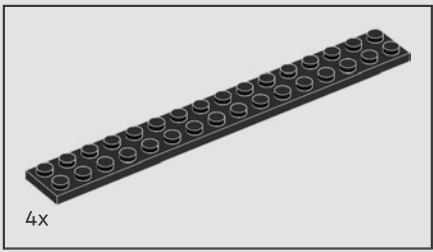

8

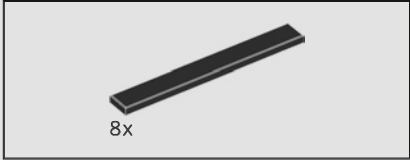
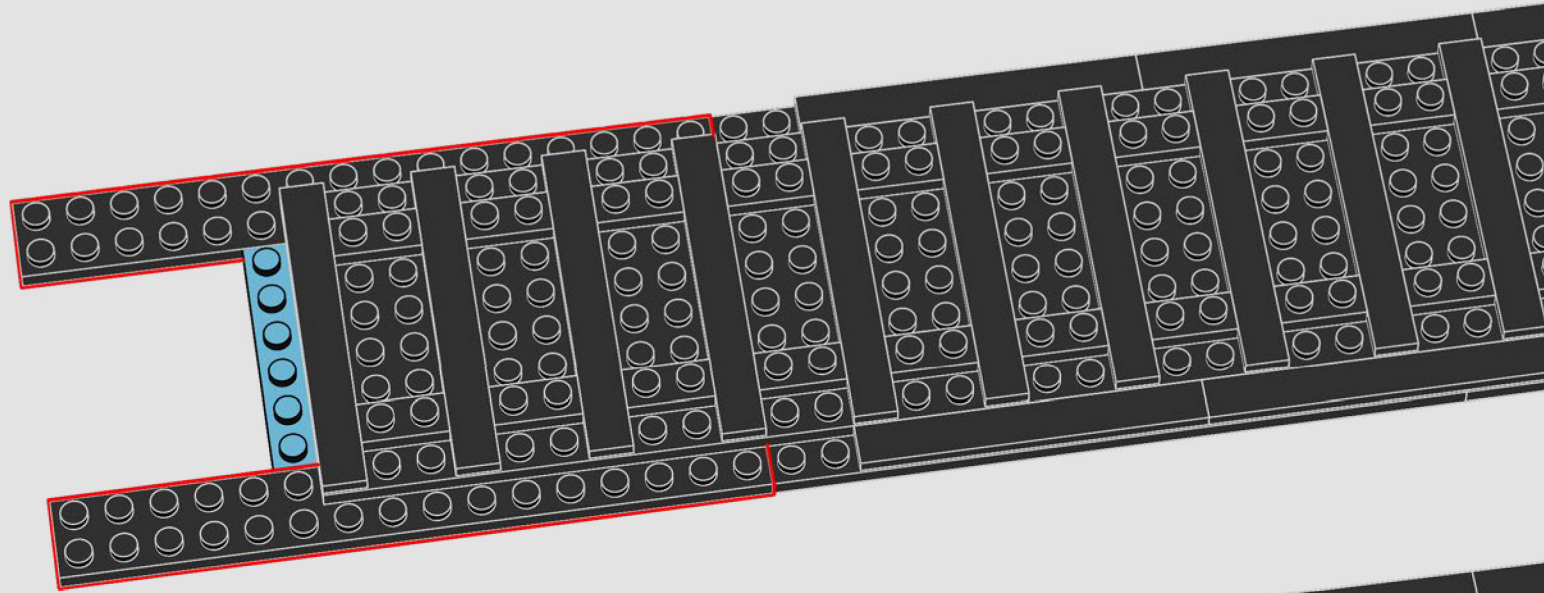

9

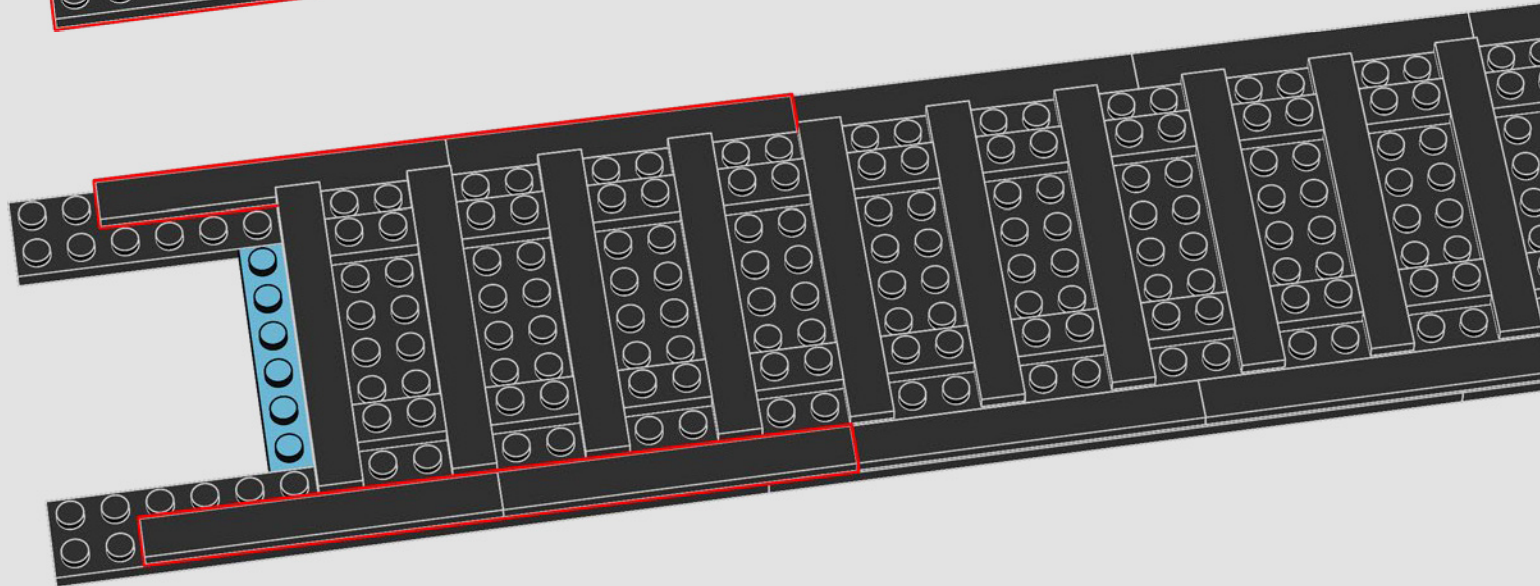

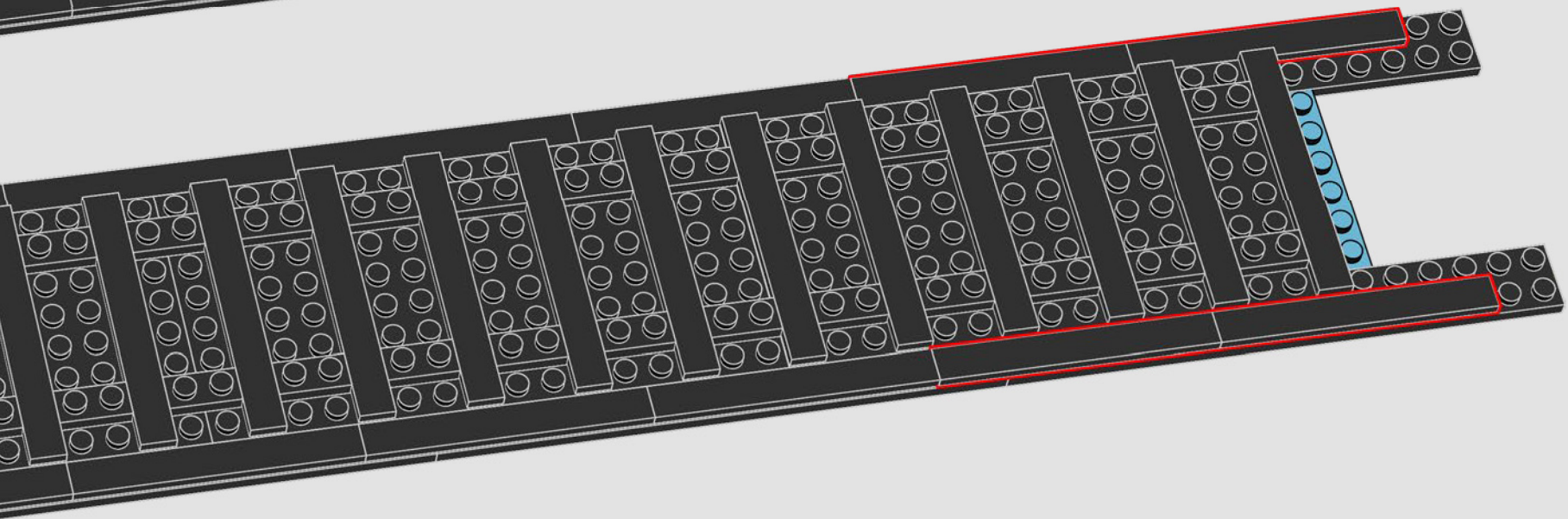
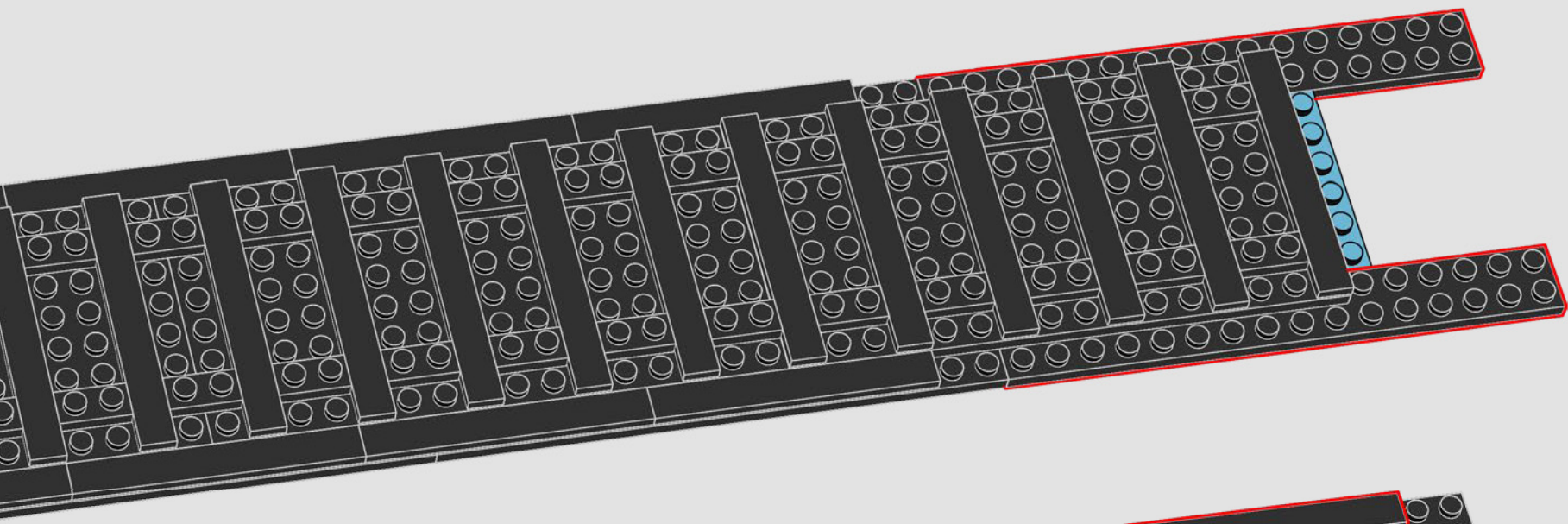

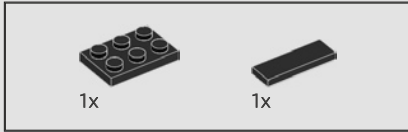
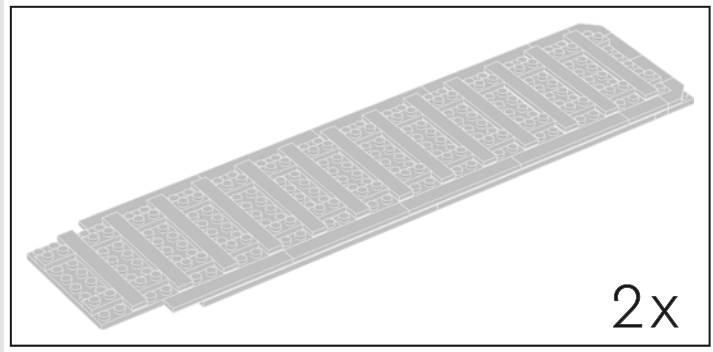
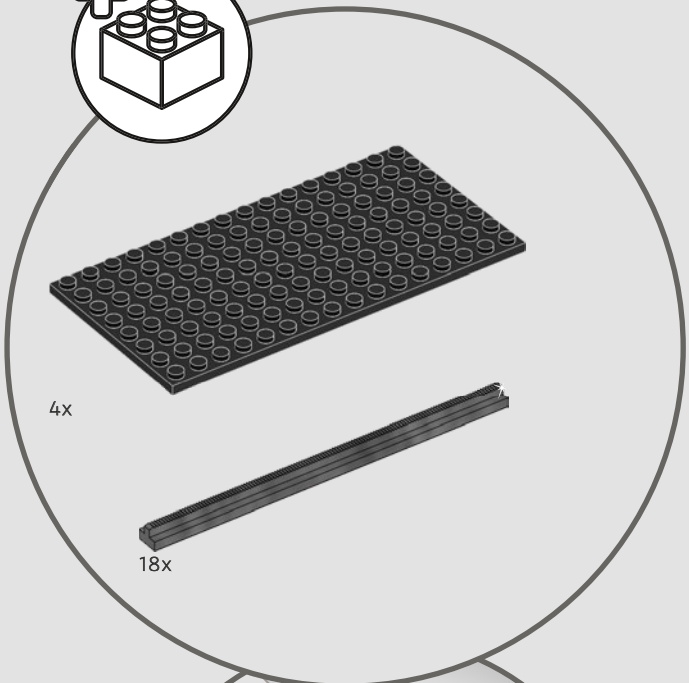
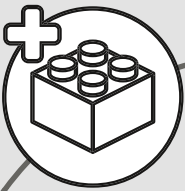

10

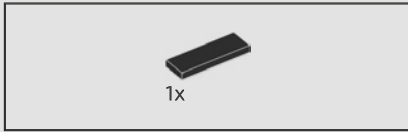
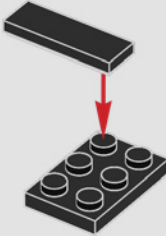

11

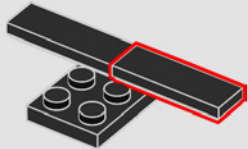

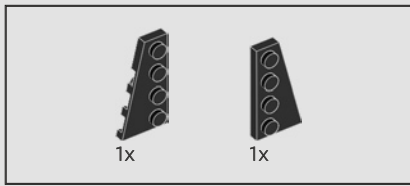

12

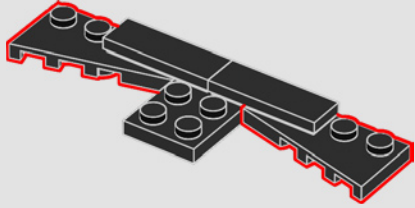

13

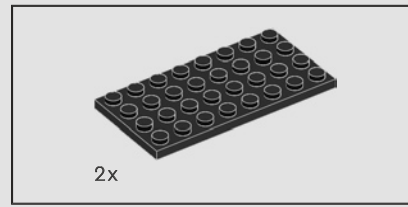
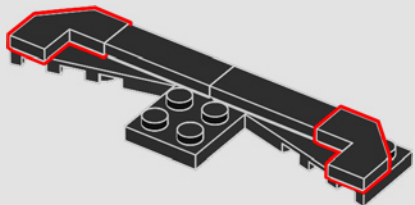

14

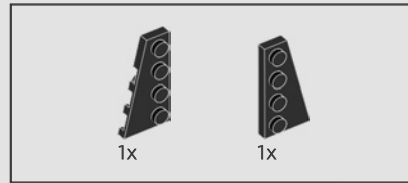
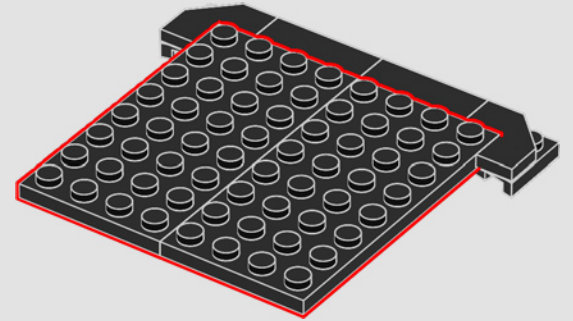

15

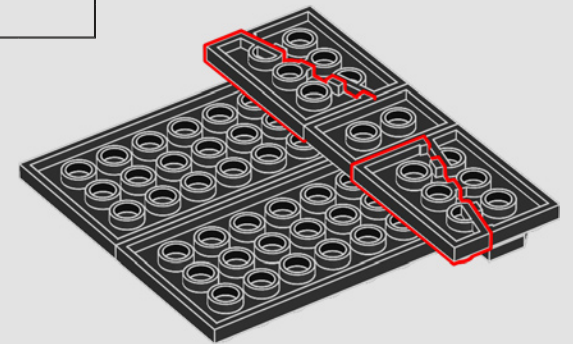

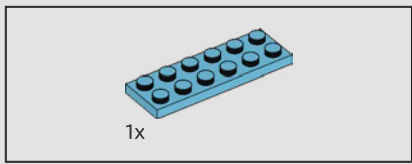

16

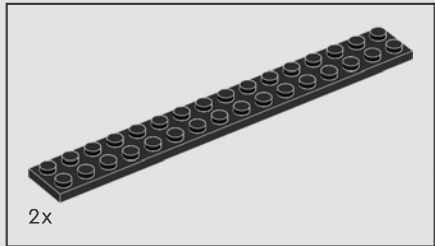
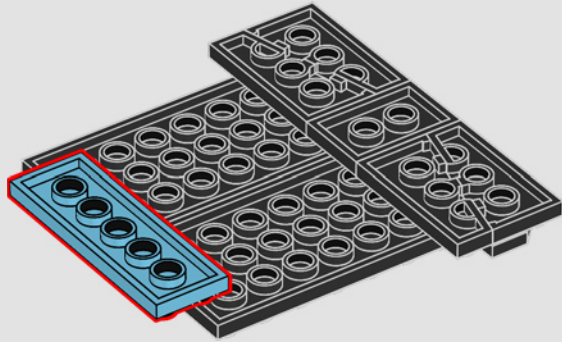

17

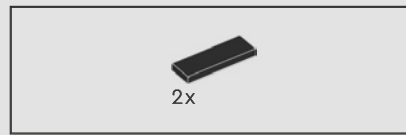
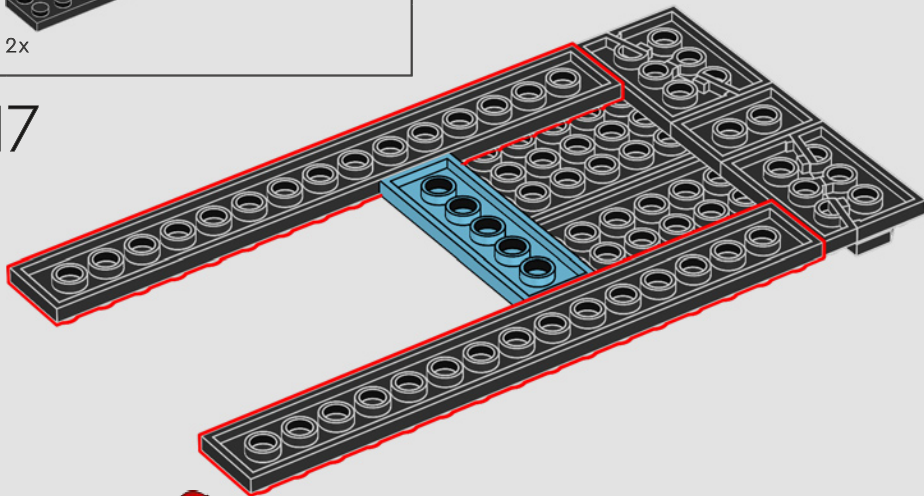

18

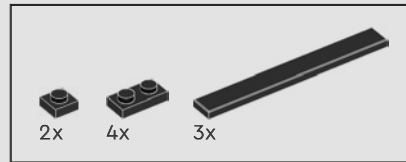
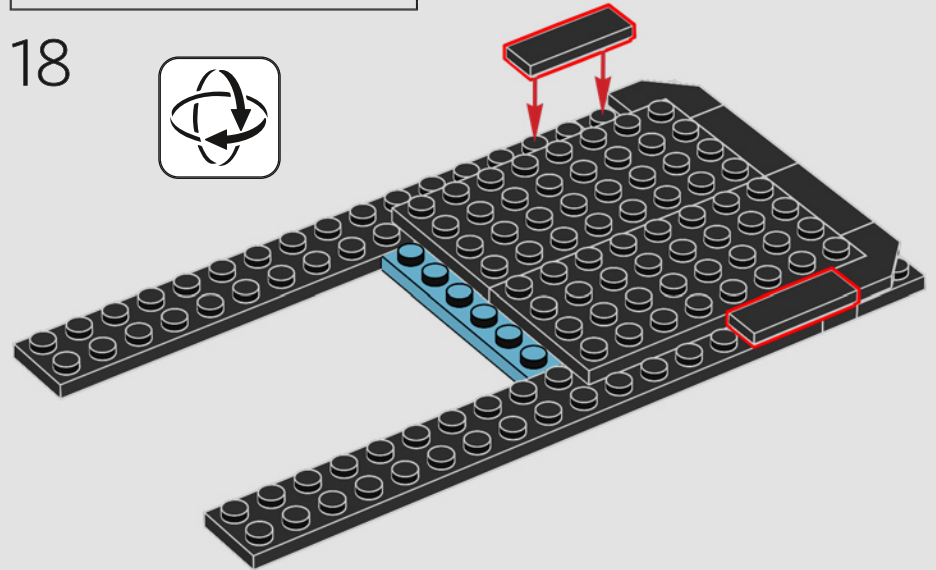

19

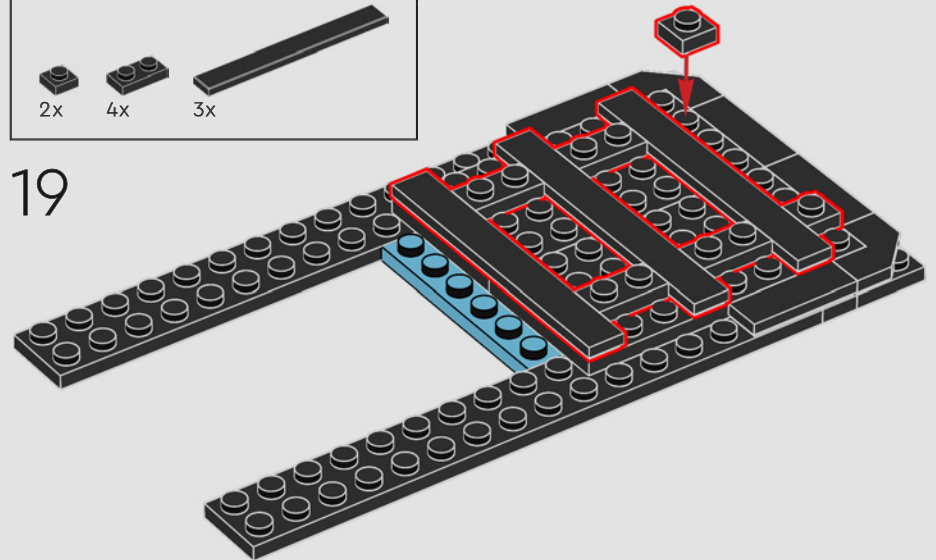

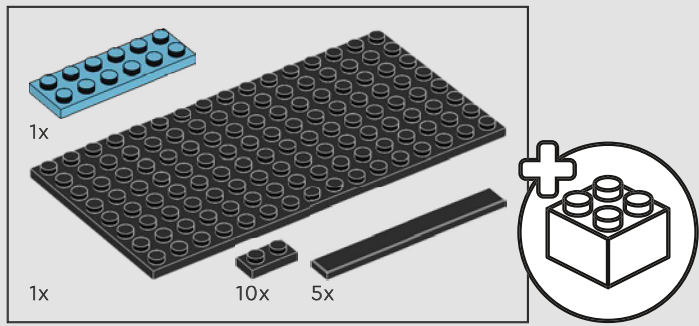

20

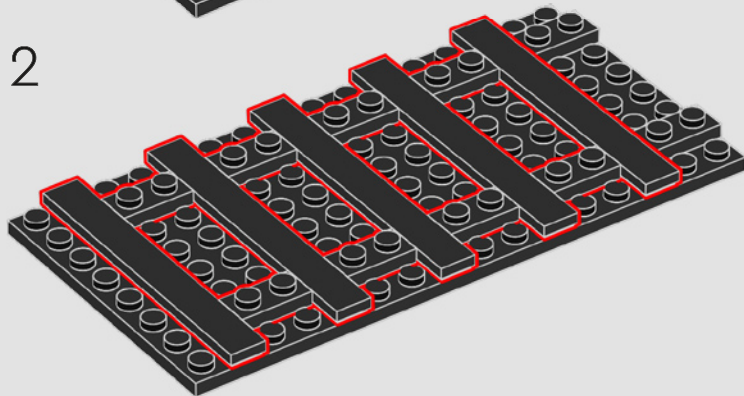
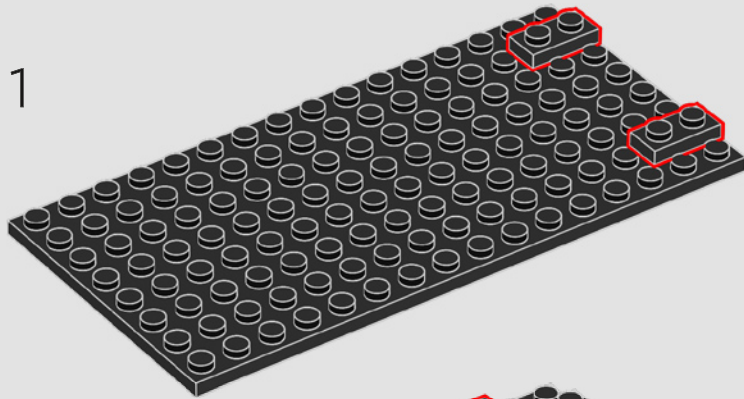

3

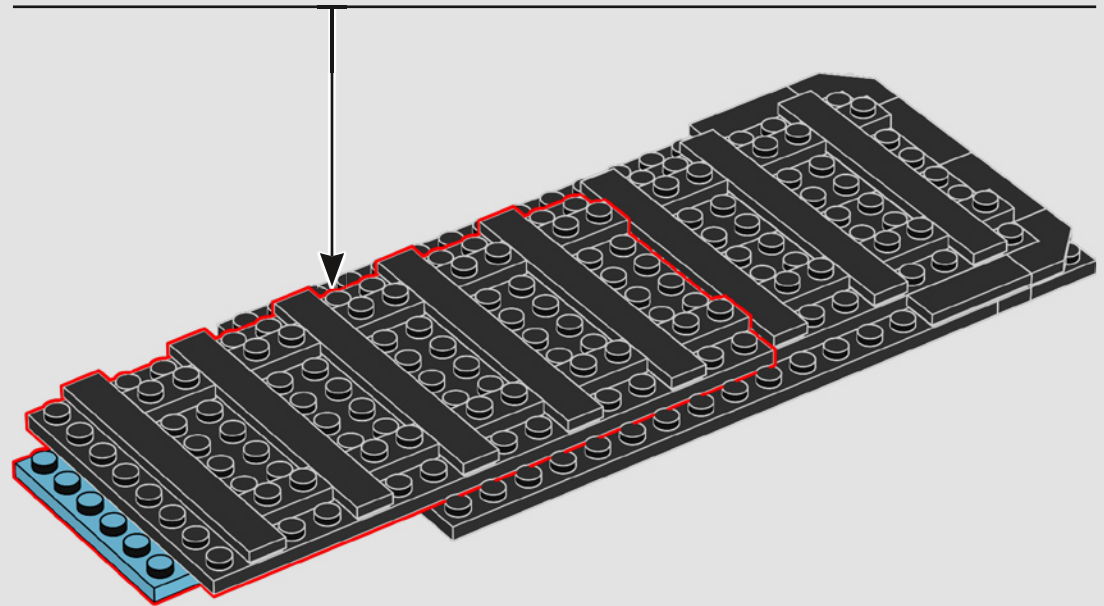
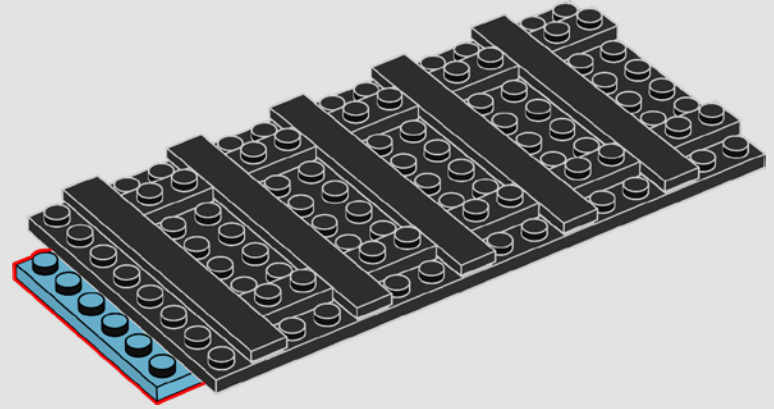

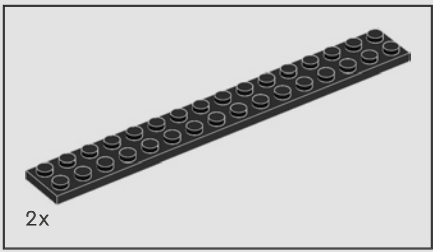

21

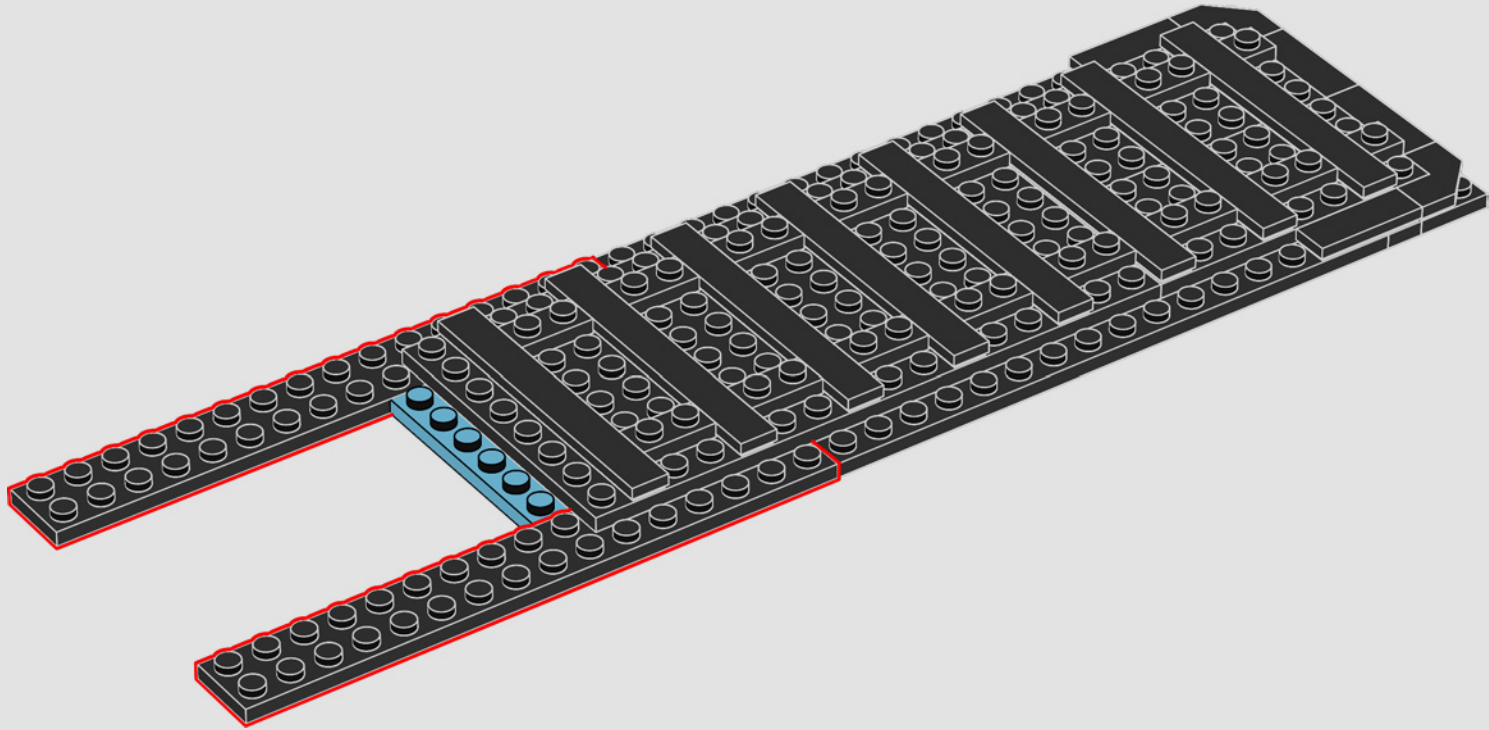

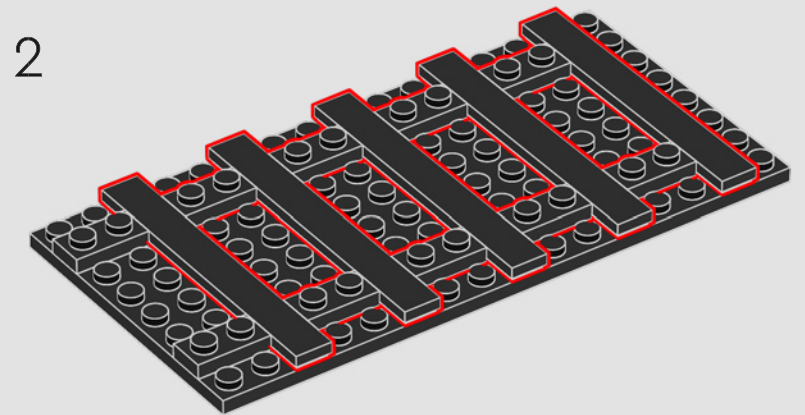
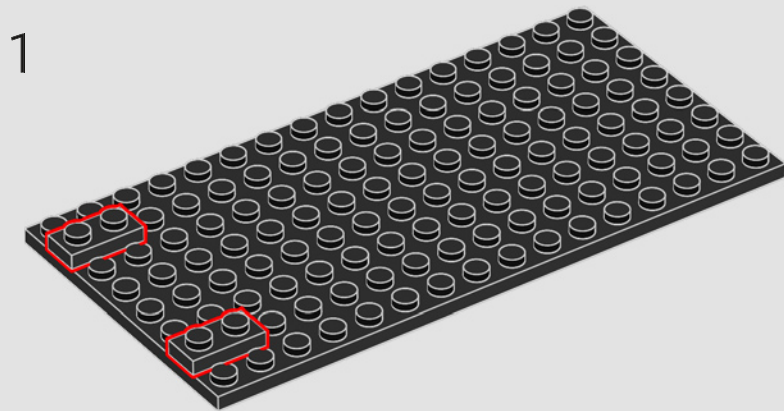
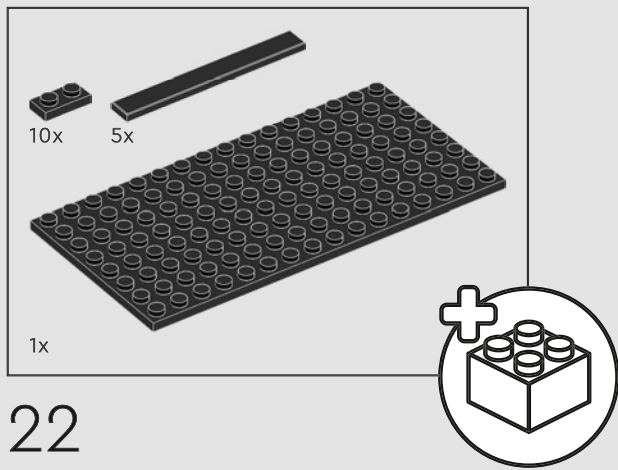

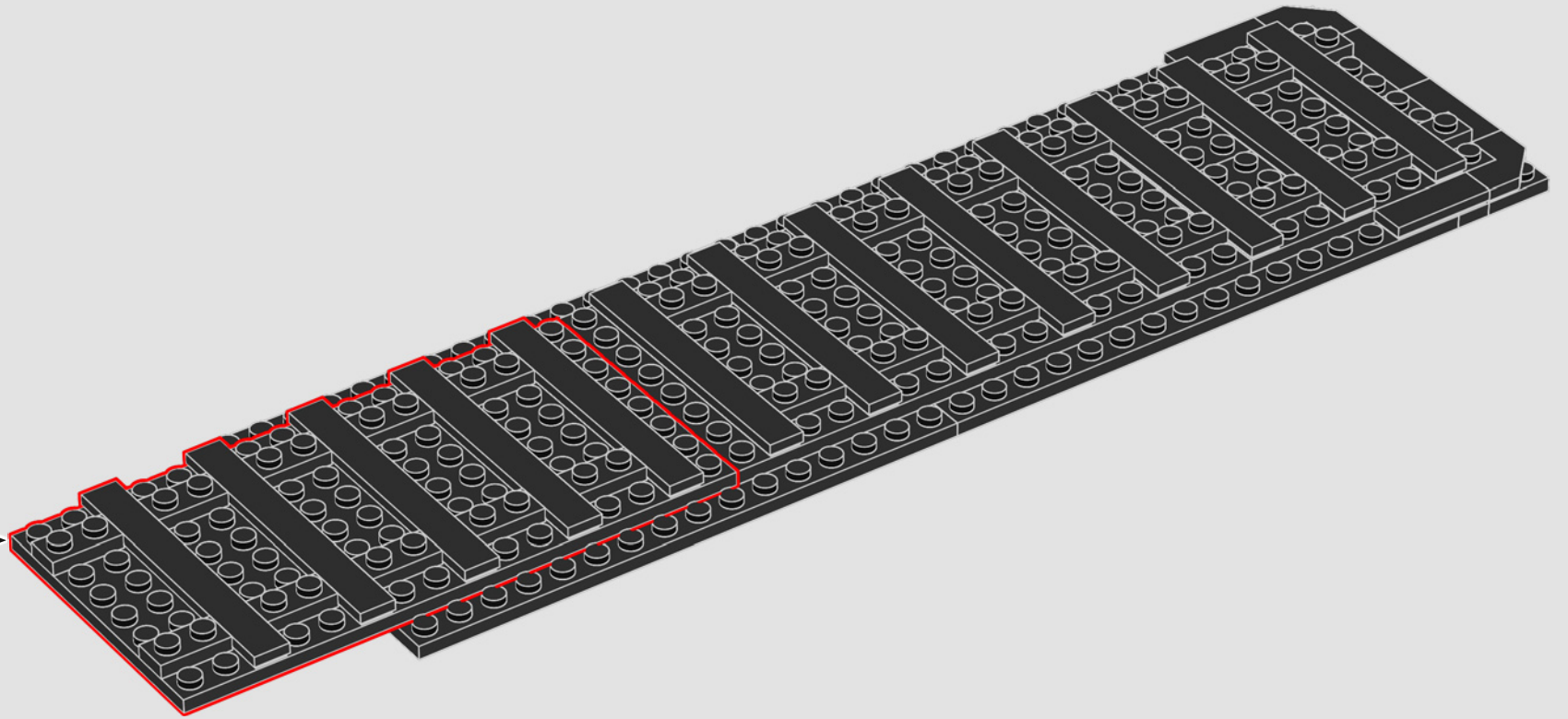

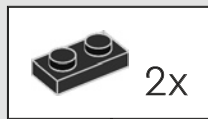

23

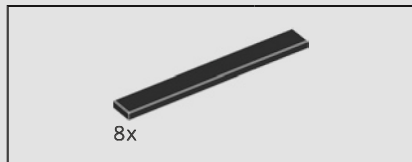
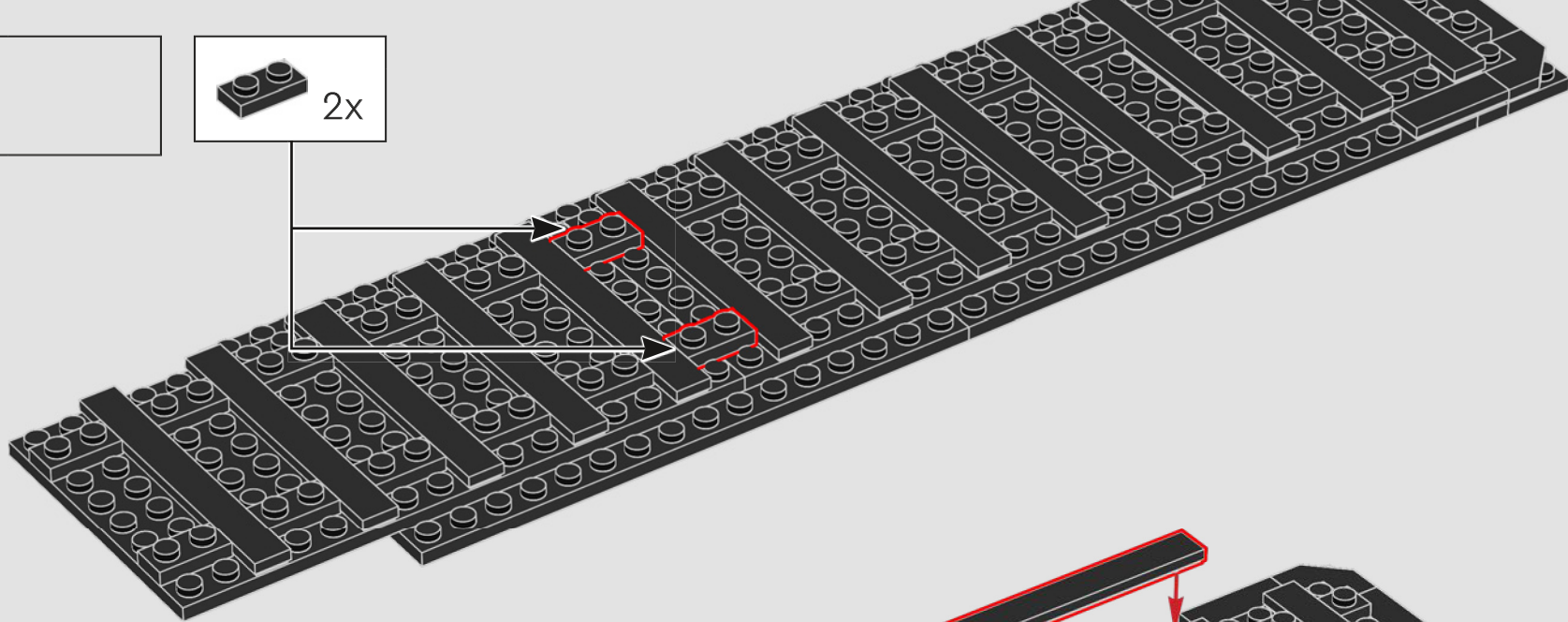

24

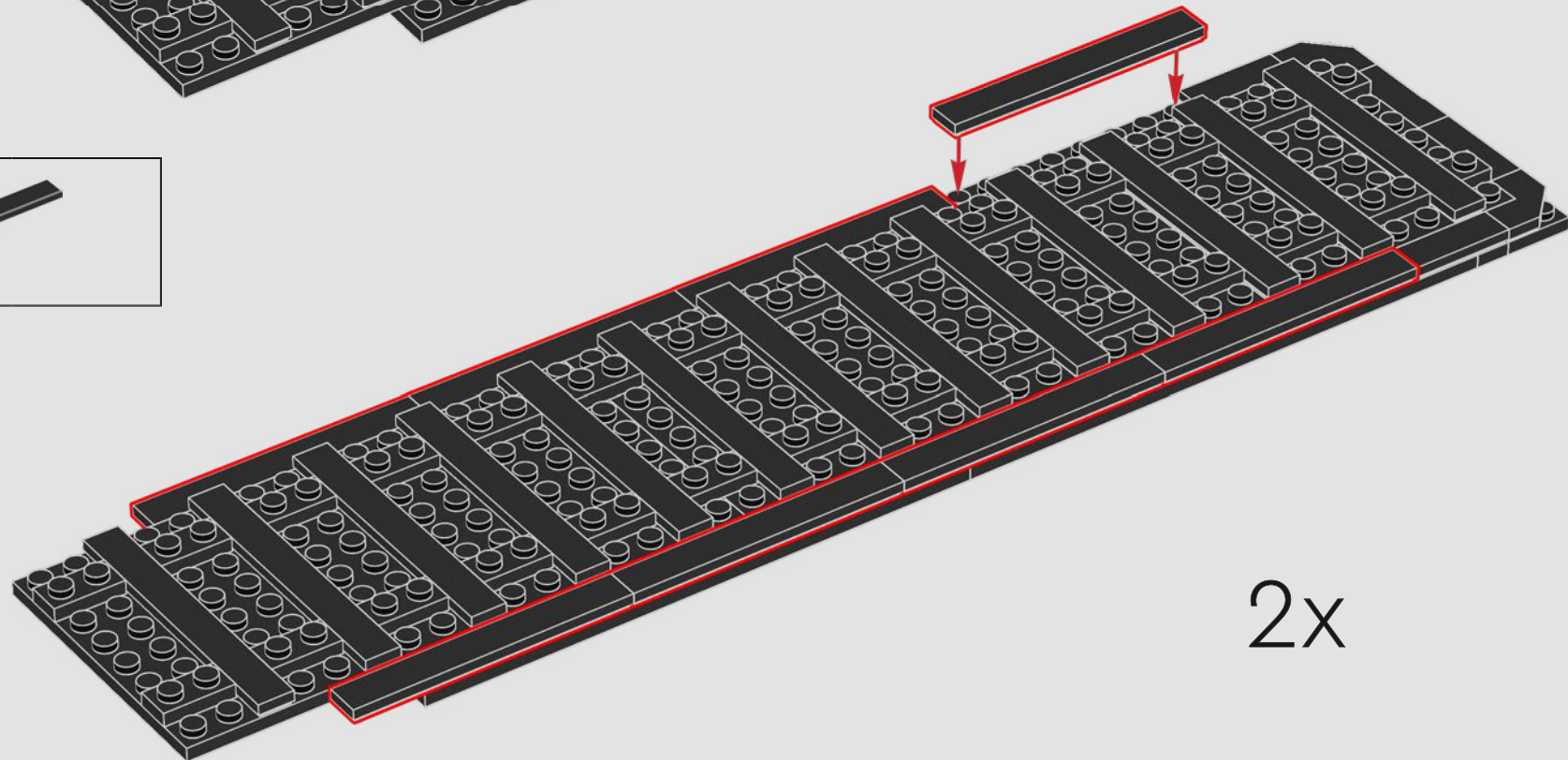

2x



2x

25

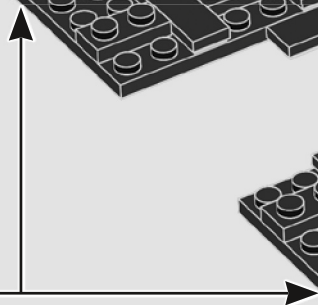
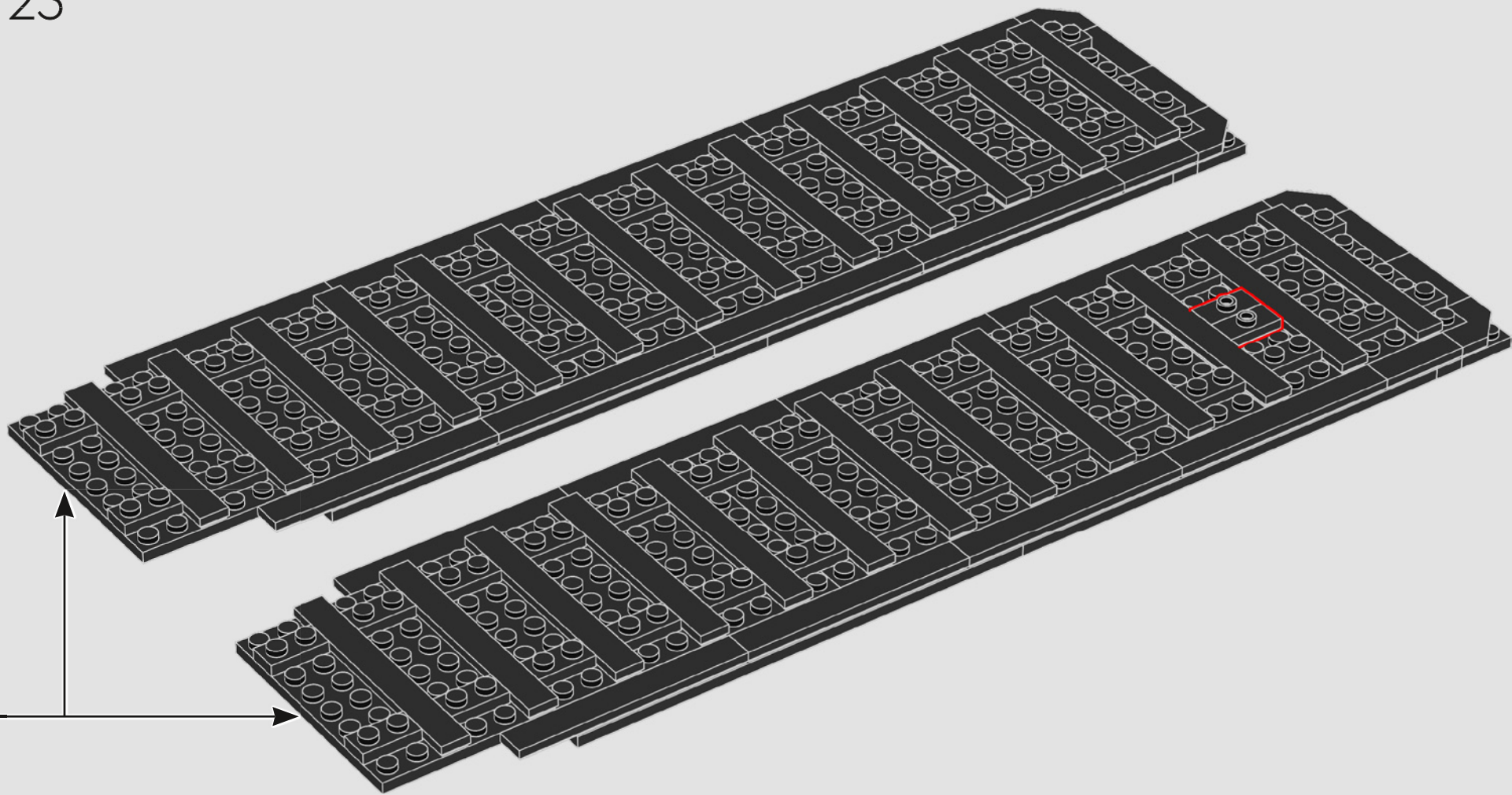

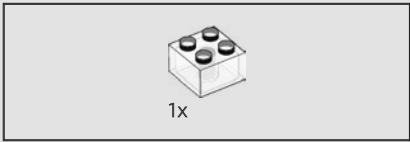

26

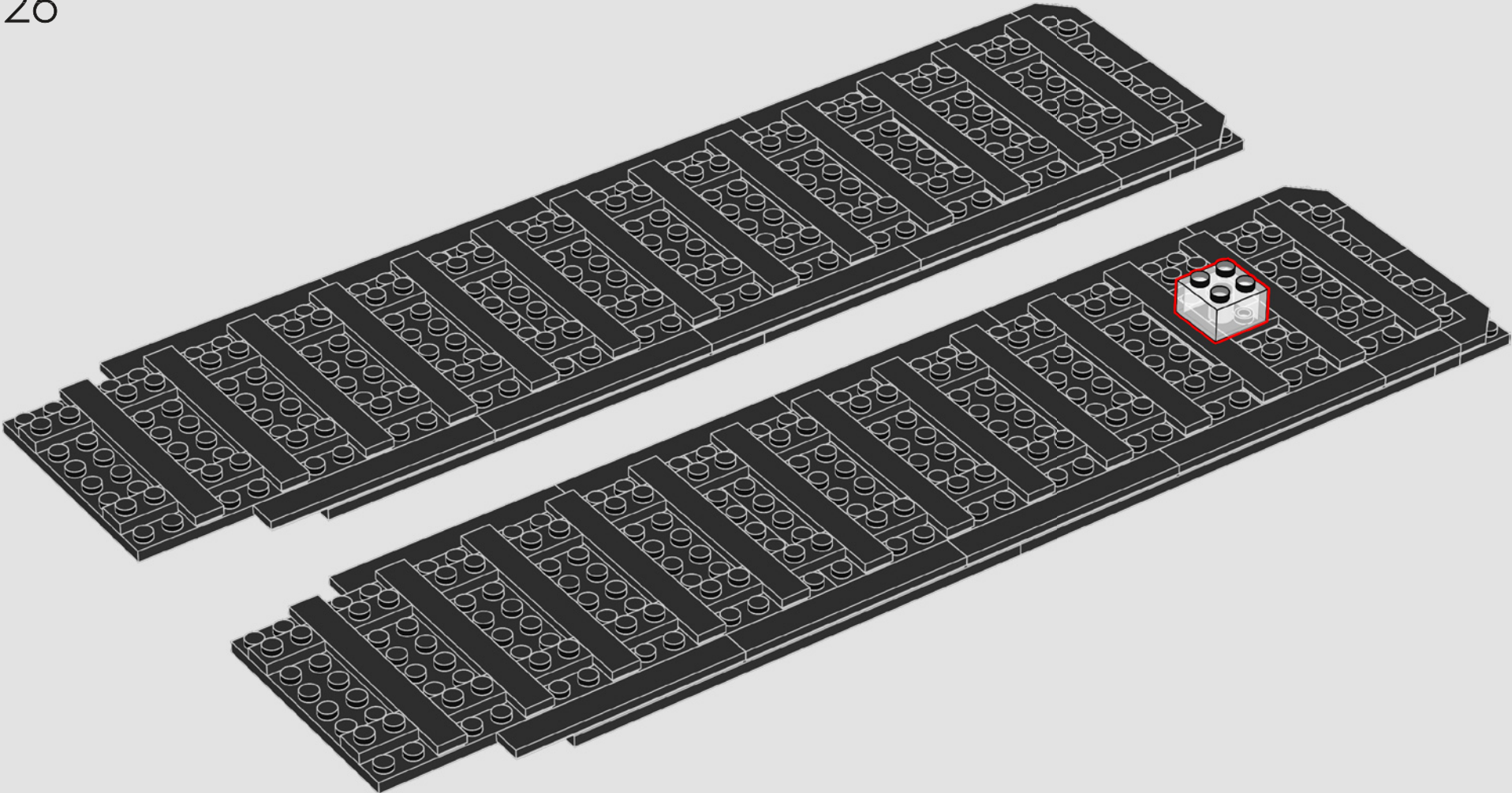

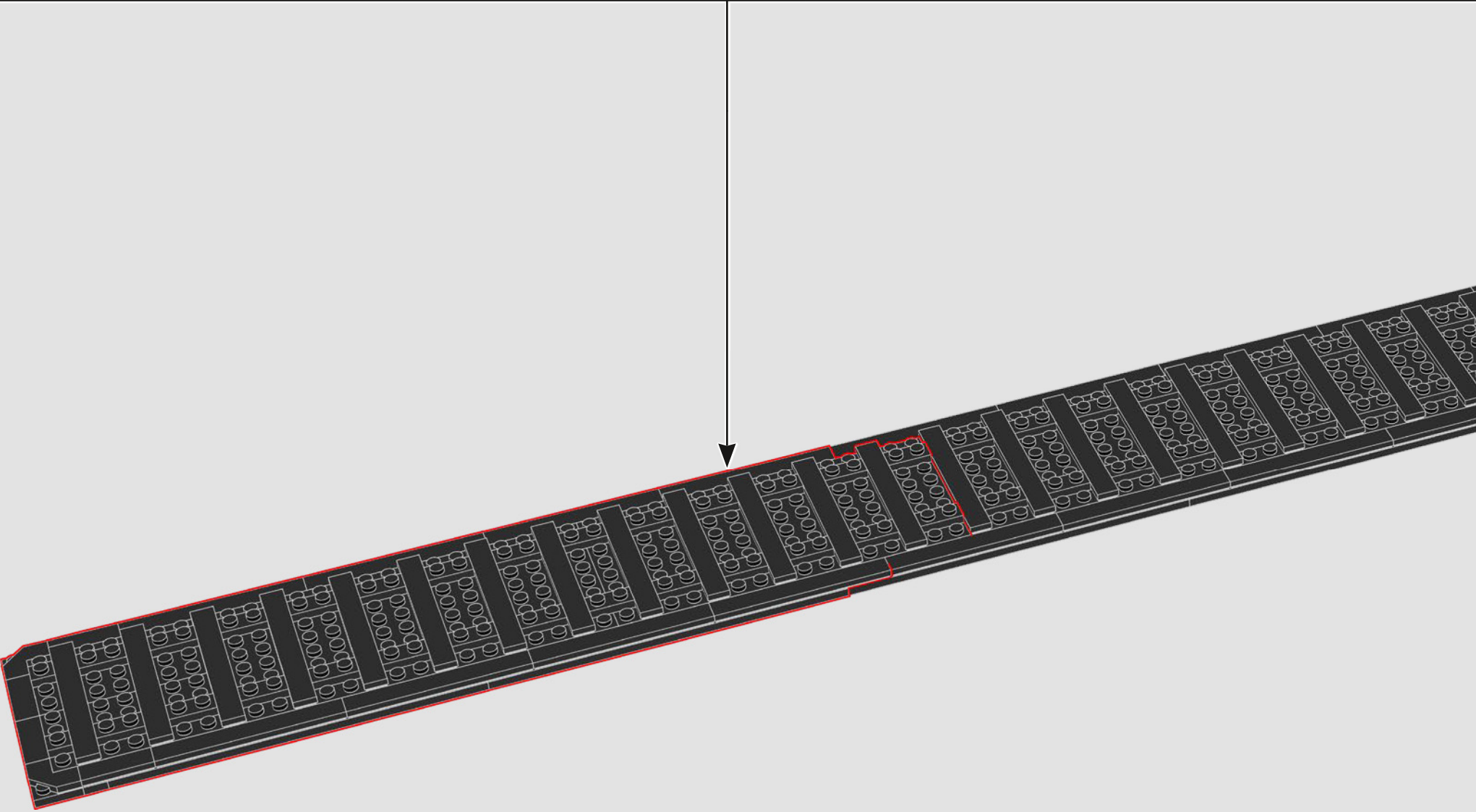

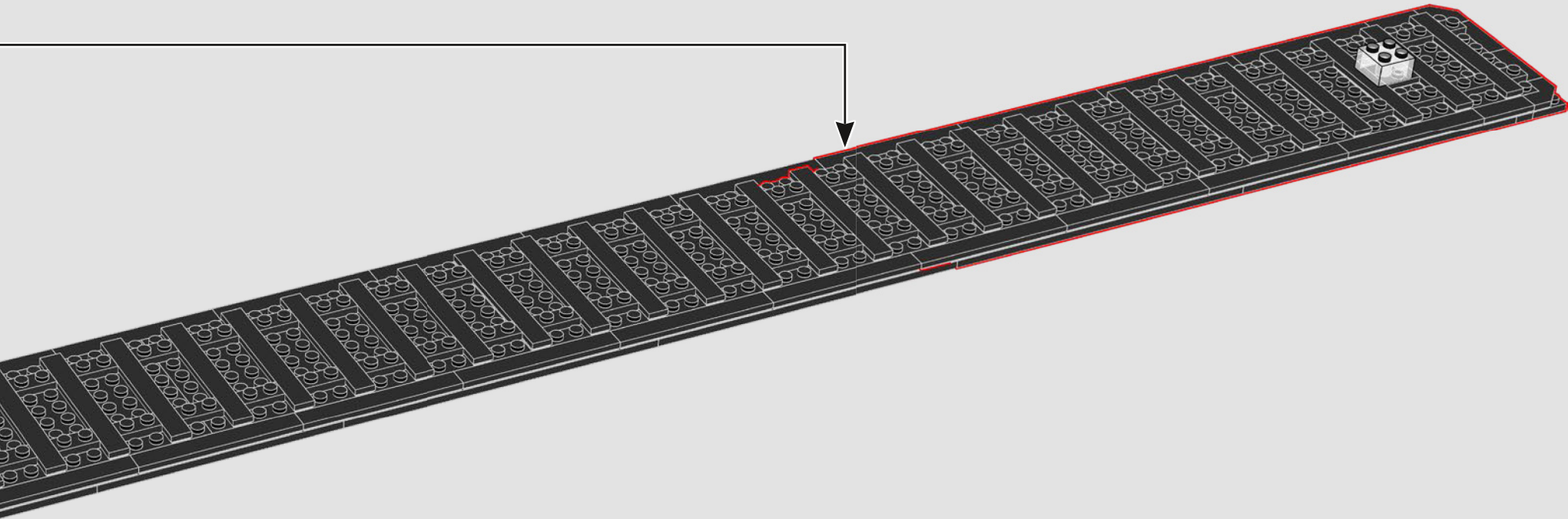

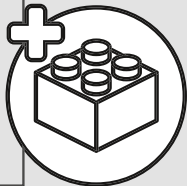
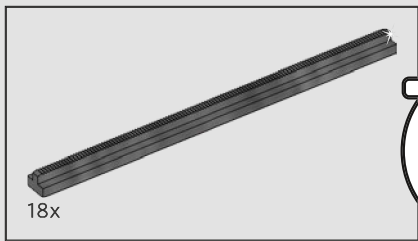

28

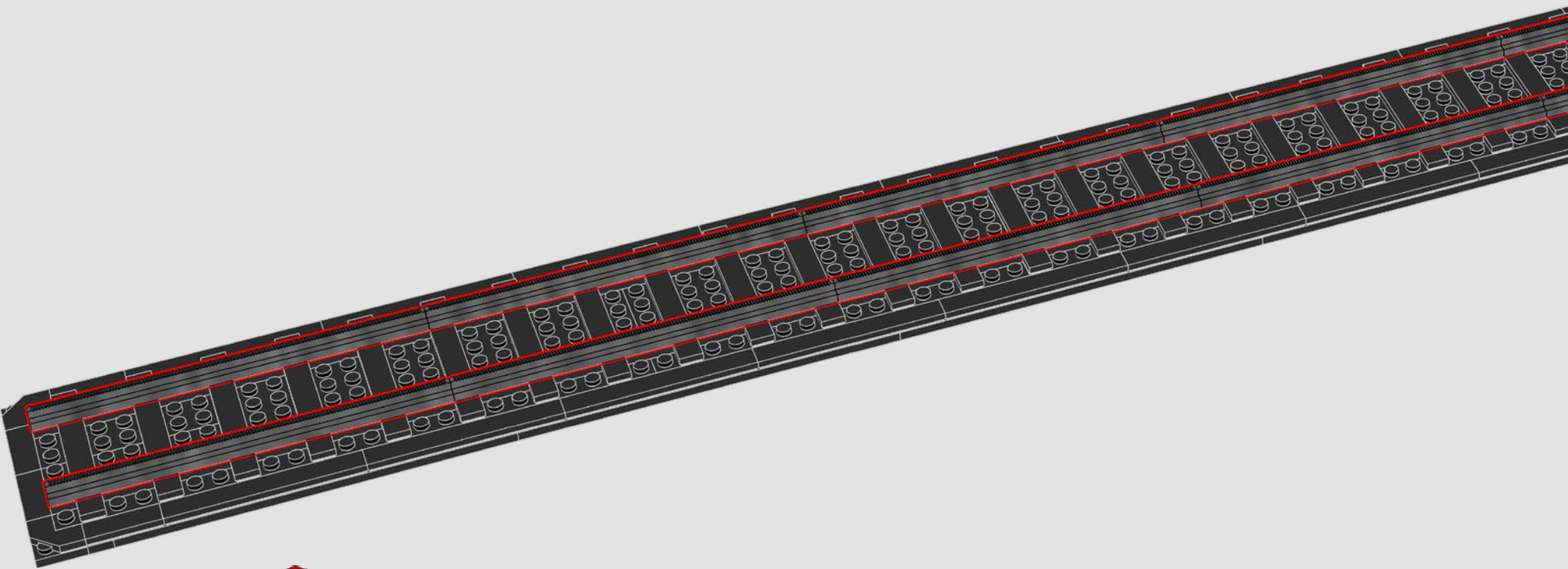

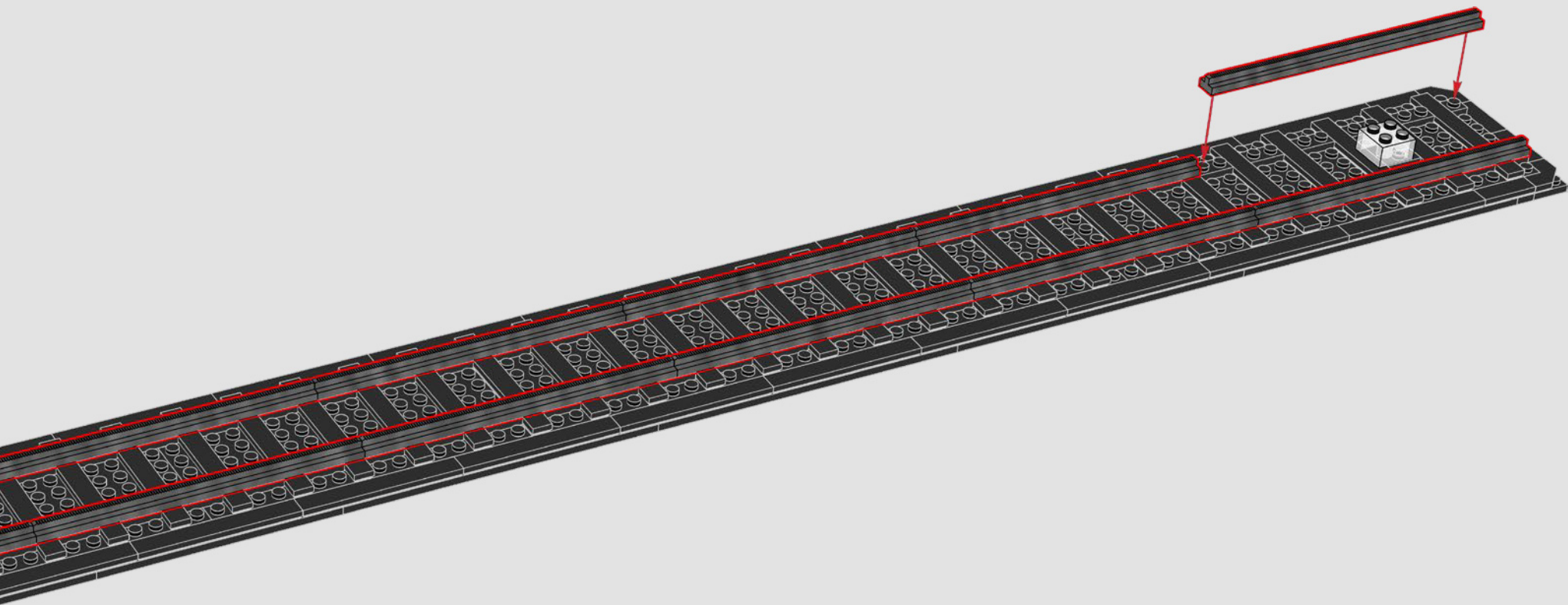

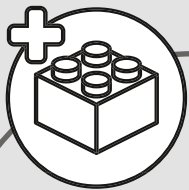

Departure: PARIS
 'The Journey began at Gare de l'Est Station, passengers eagerly awaited the arrival of the train.'

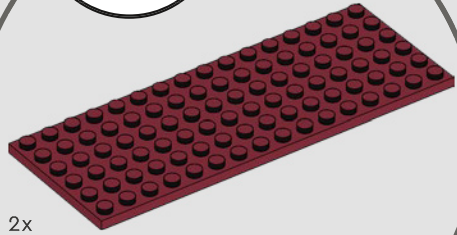

2x

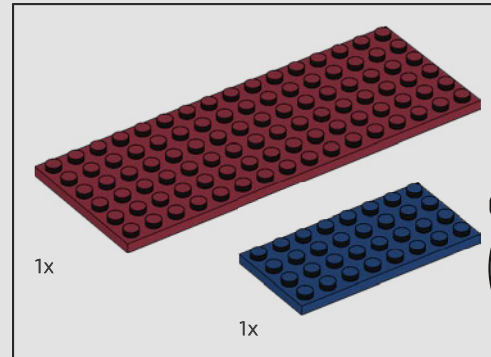
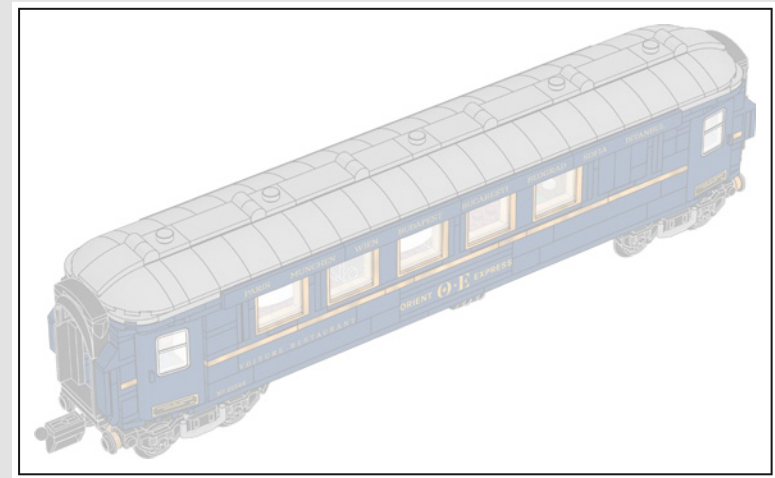
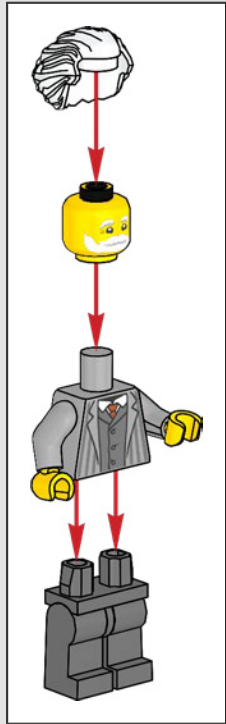

1x

1x

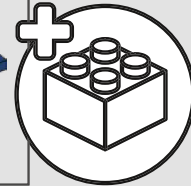

29

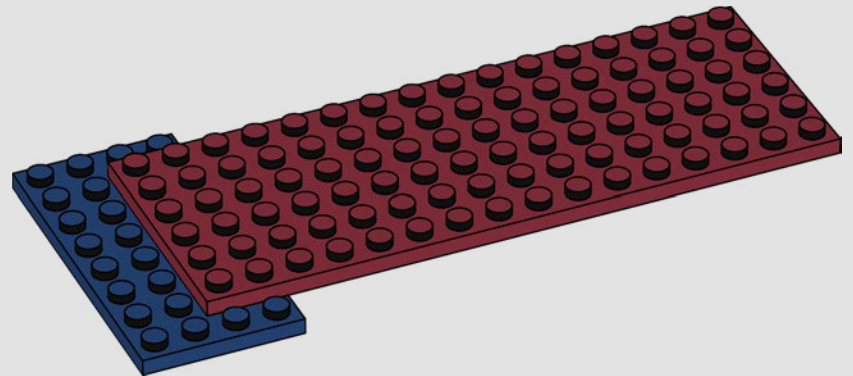

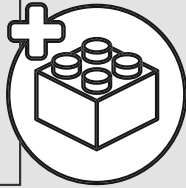
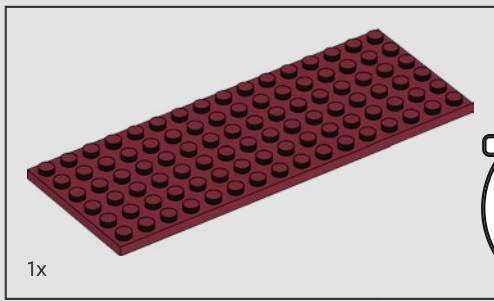

30

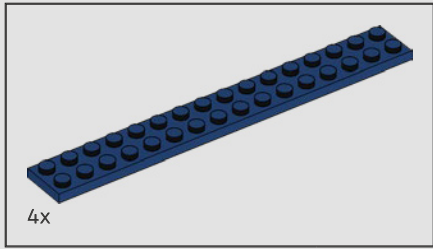
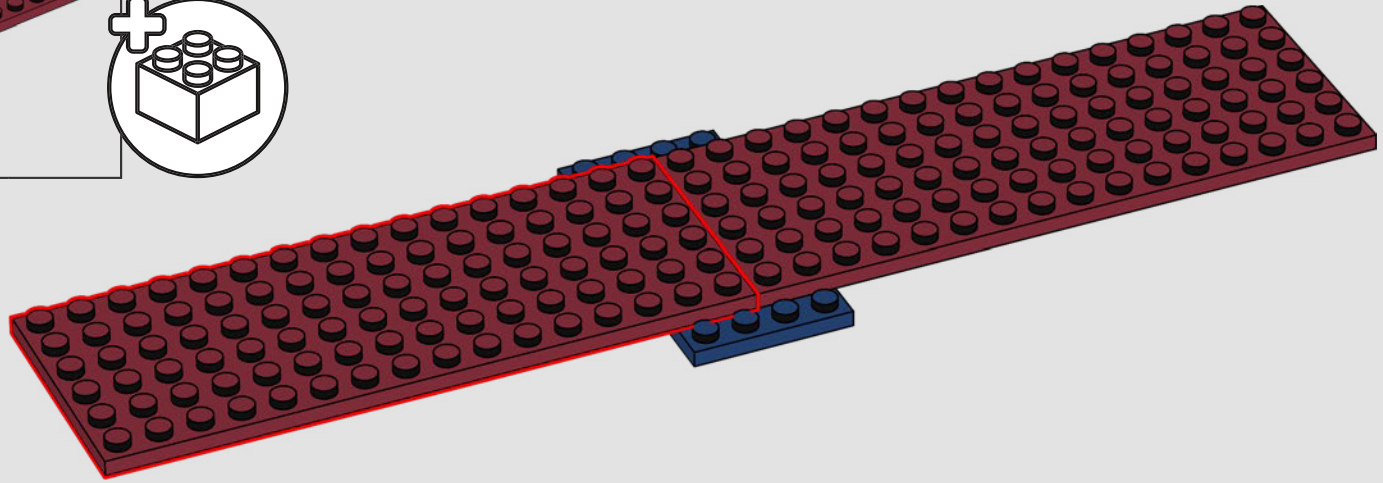

31

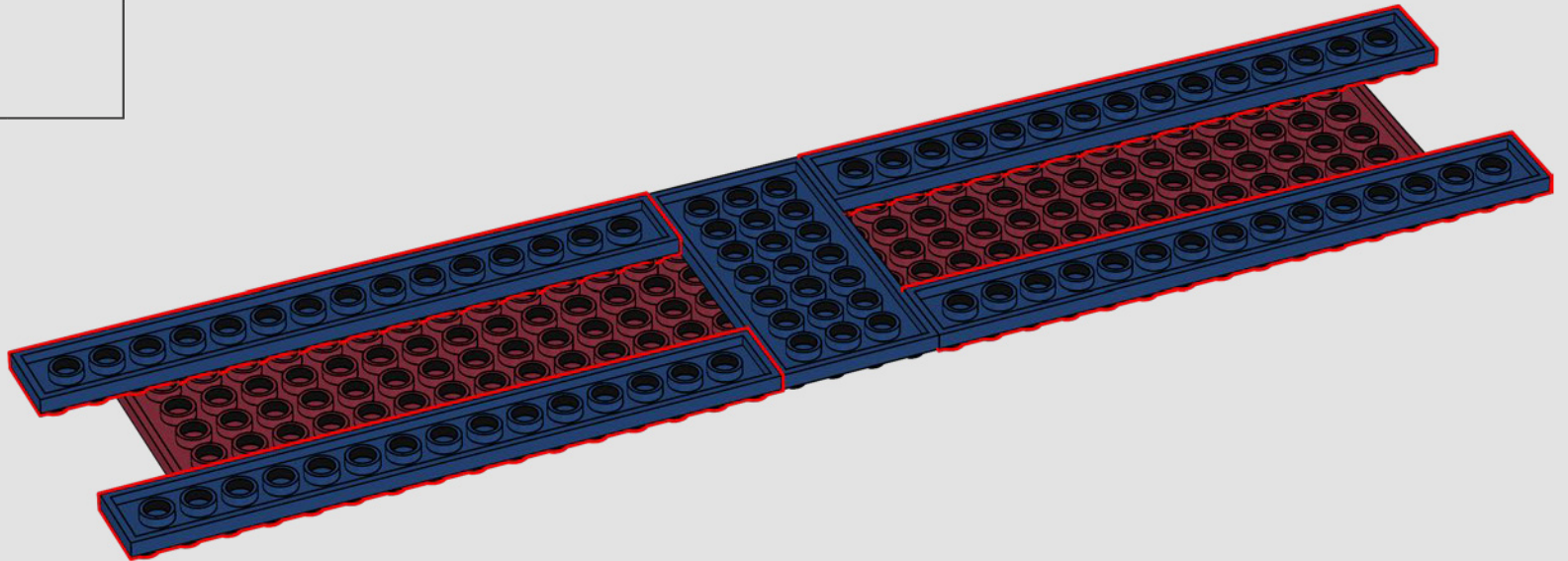

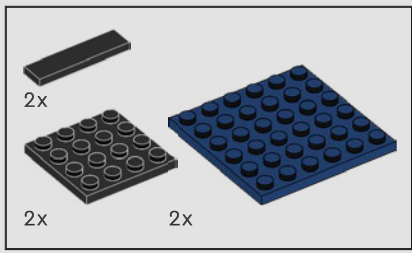

32

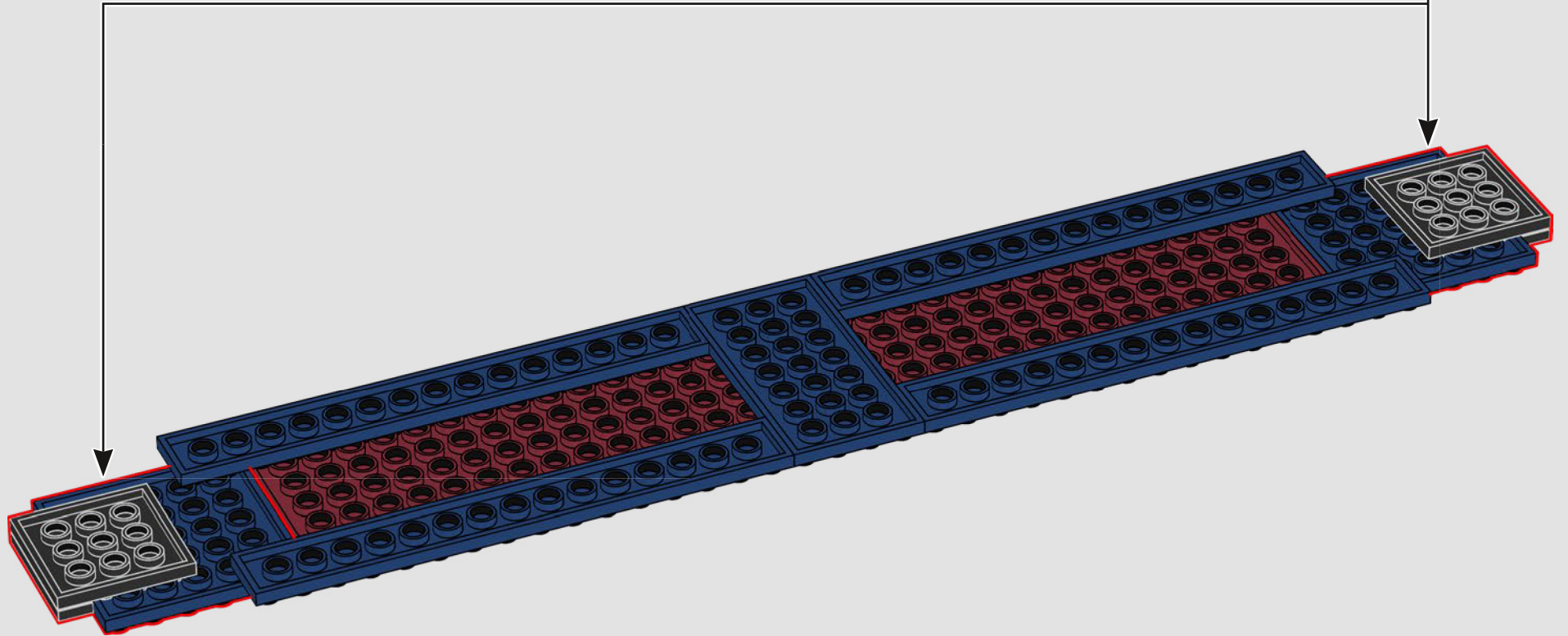
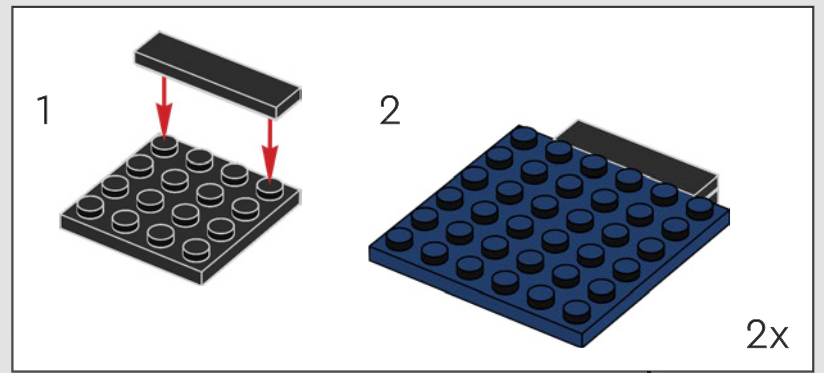

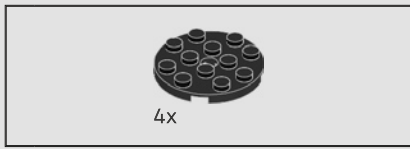

33

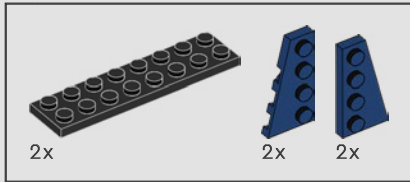
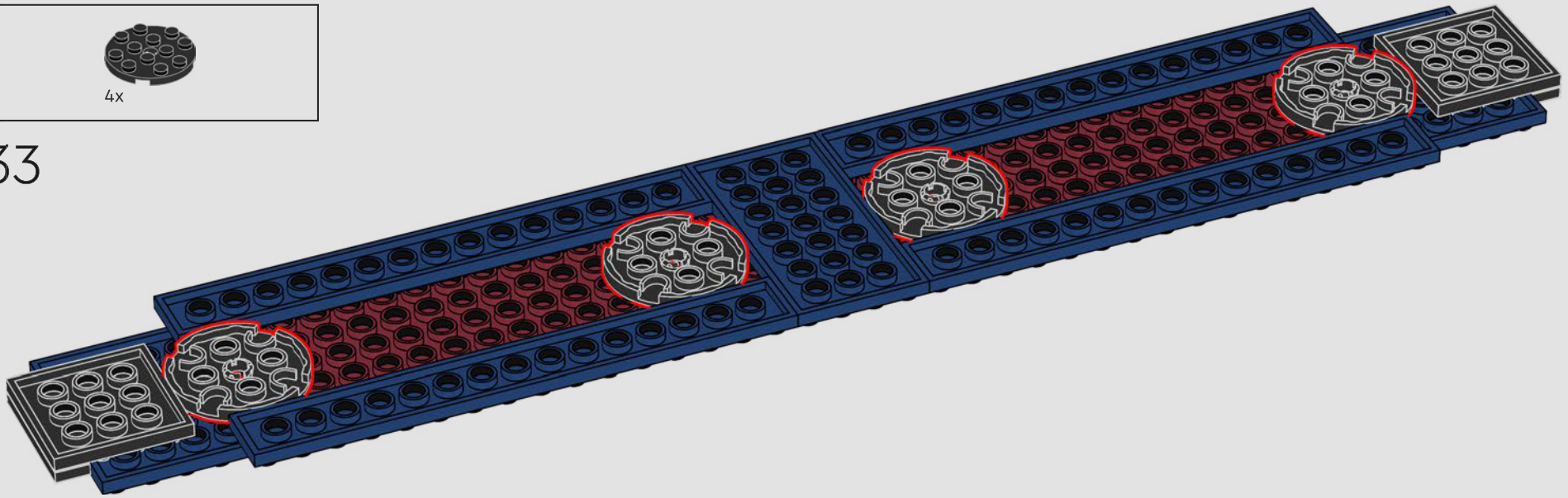

34

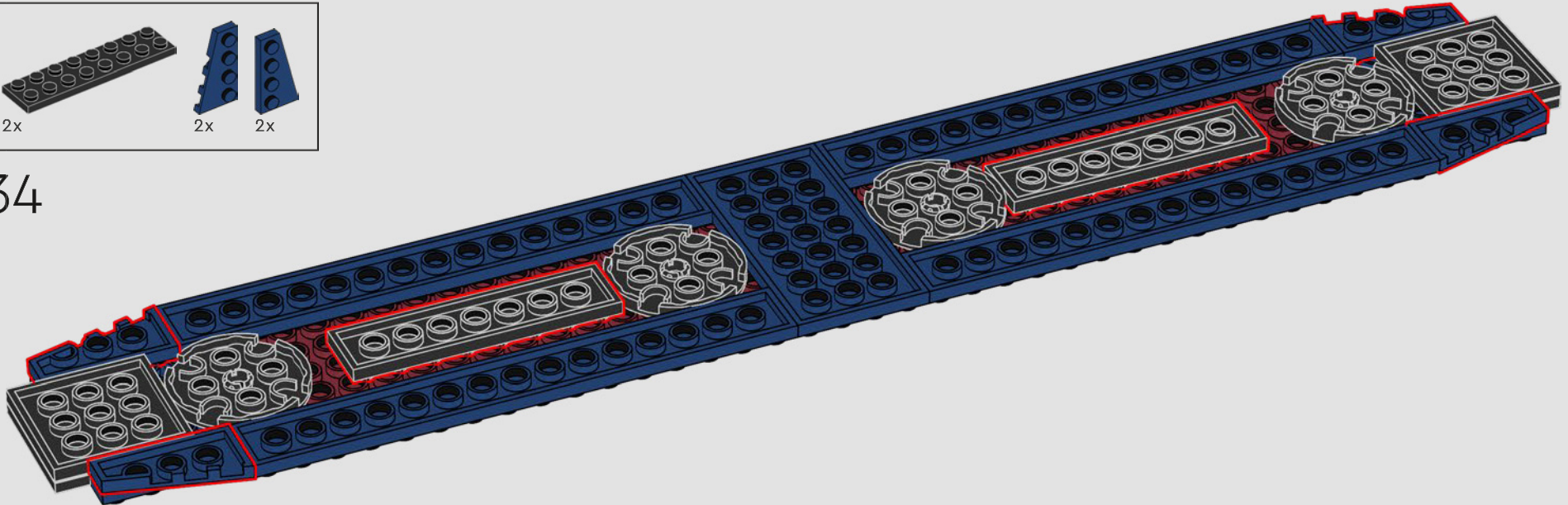



35

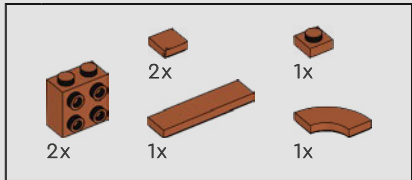
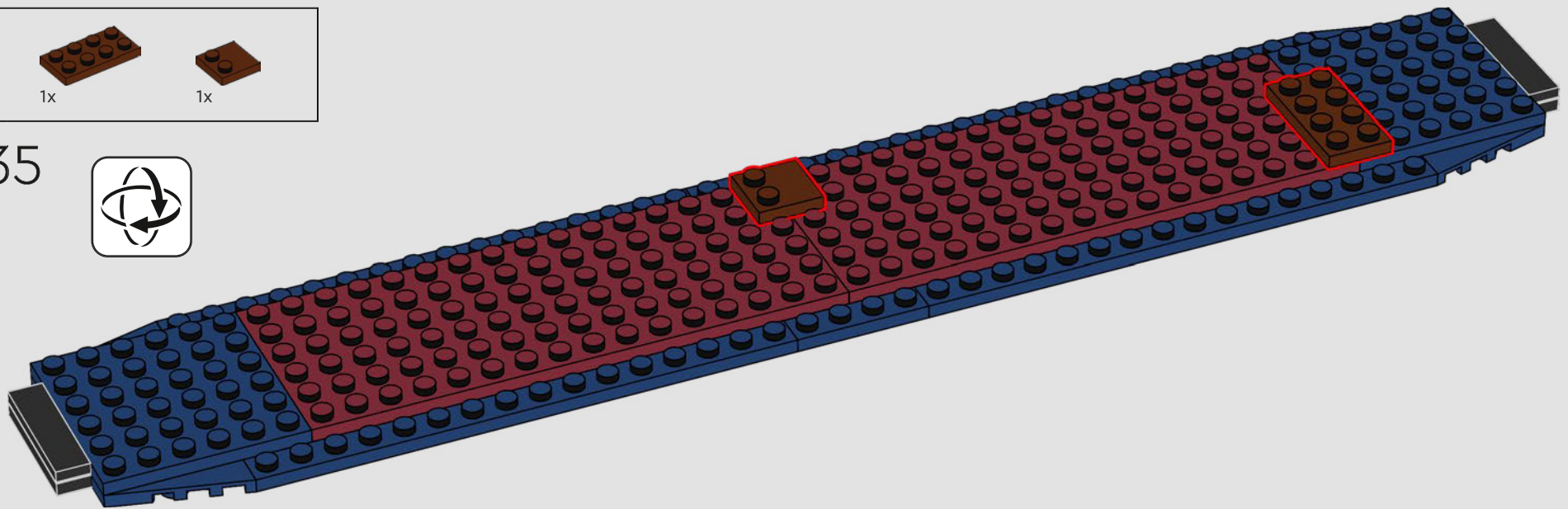

36

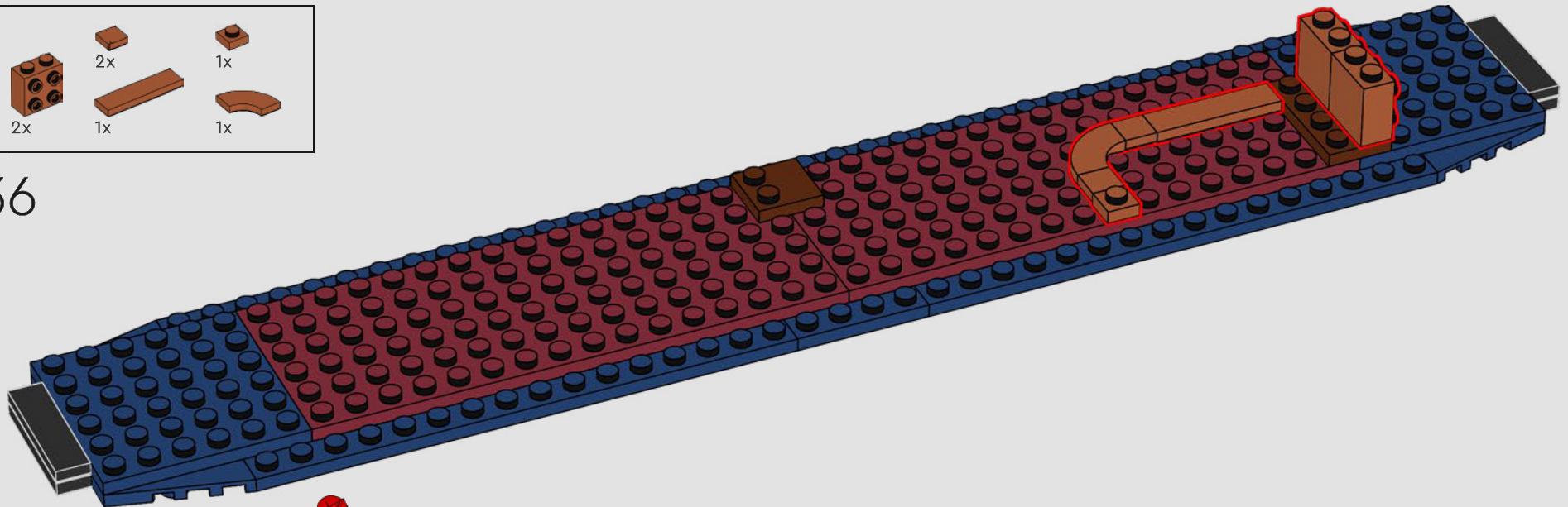



37

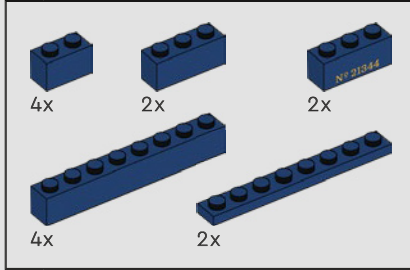
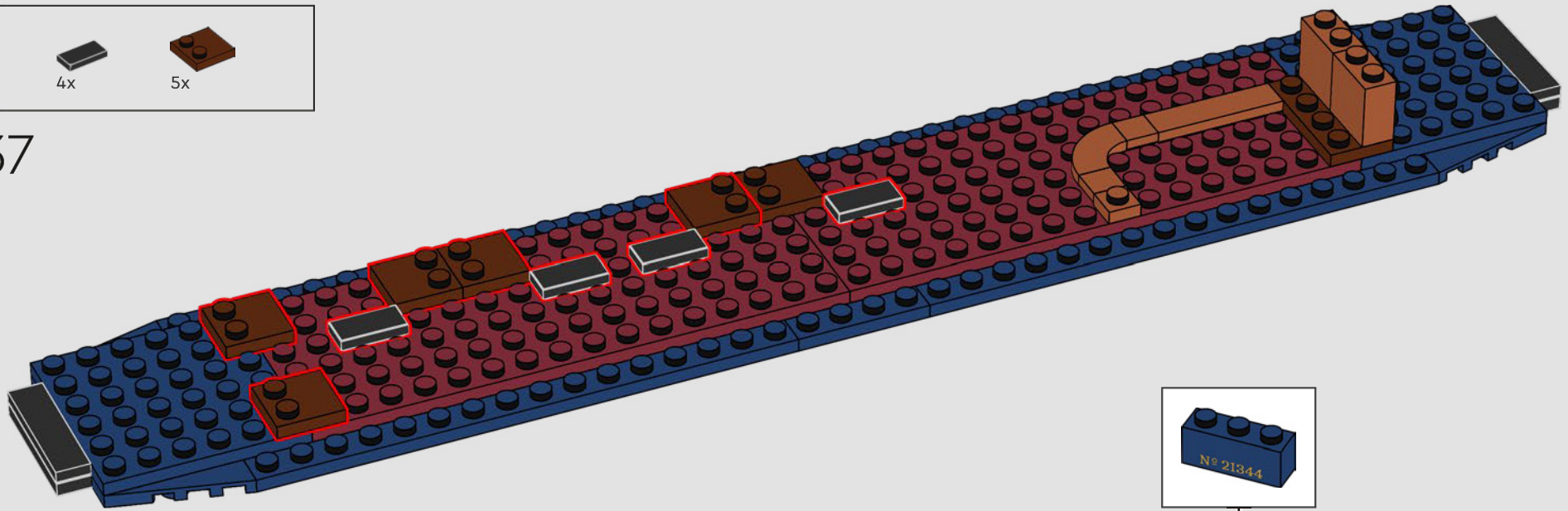

38

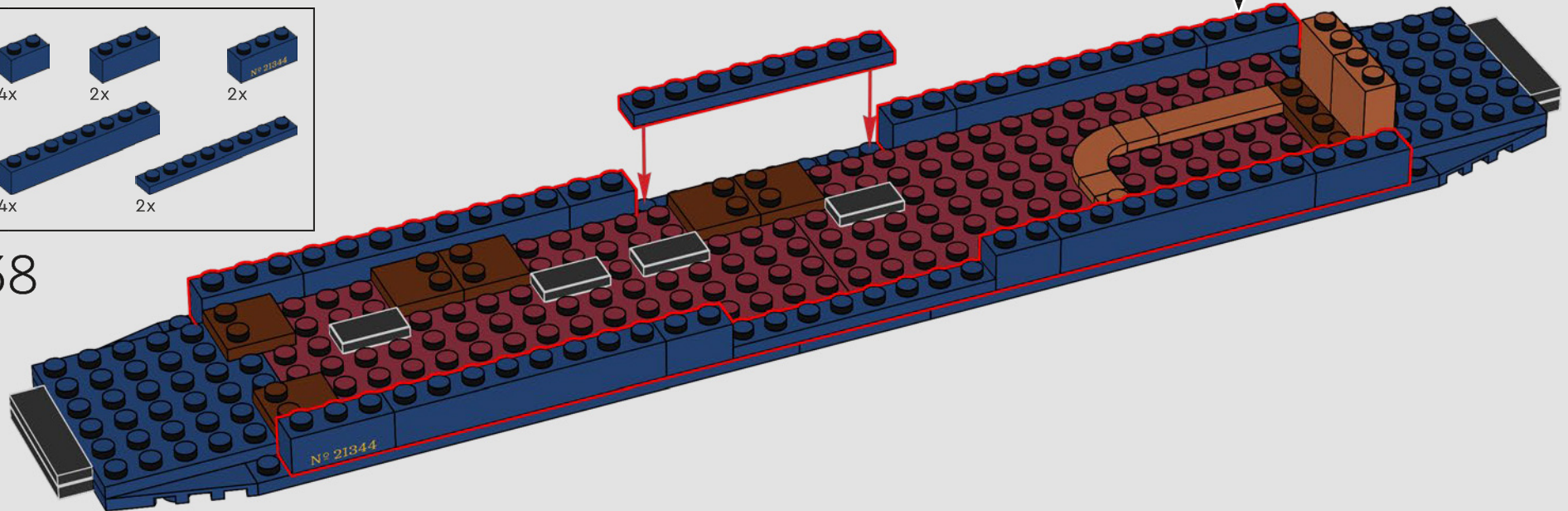

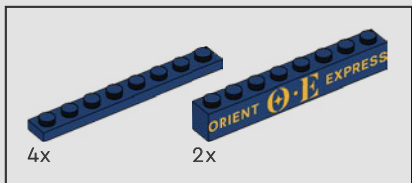

39

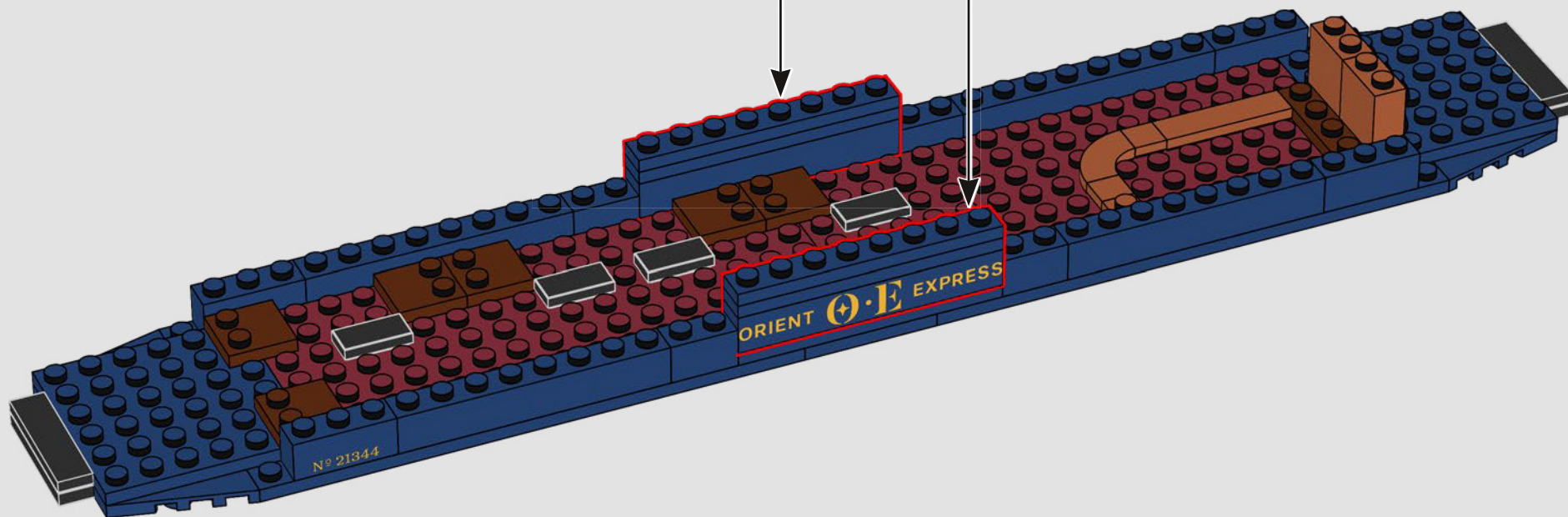
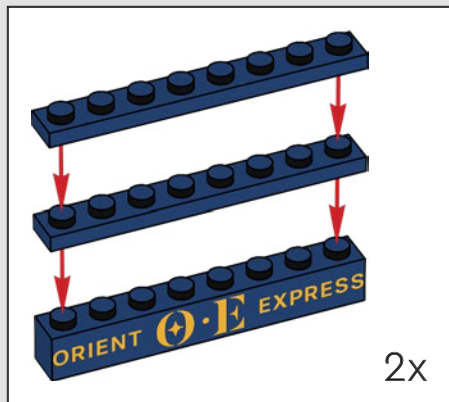

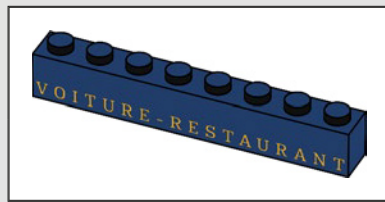
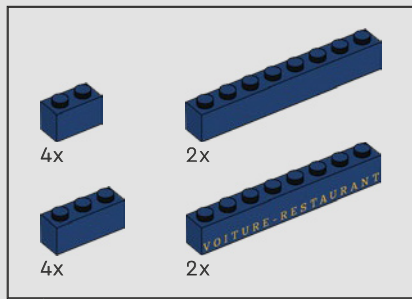

40

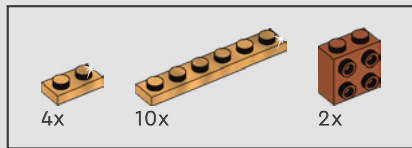
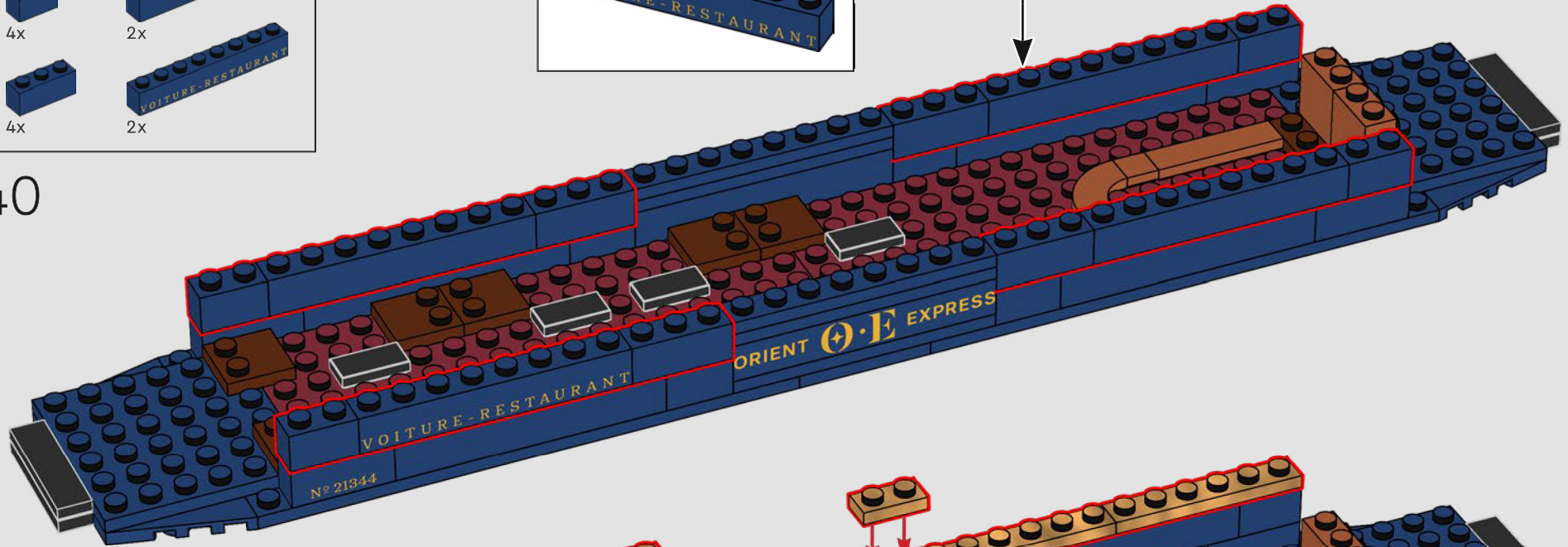

41

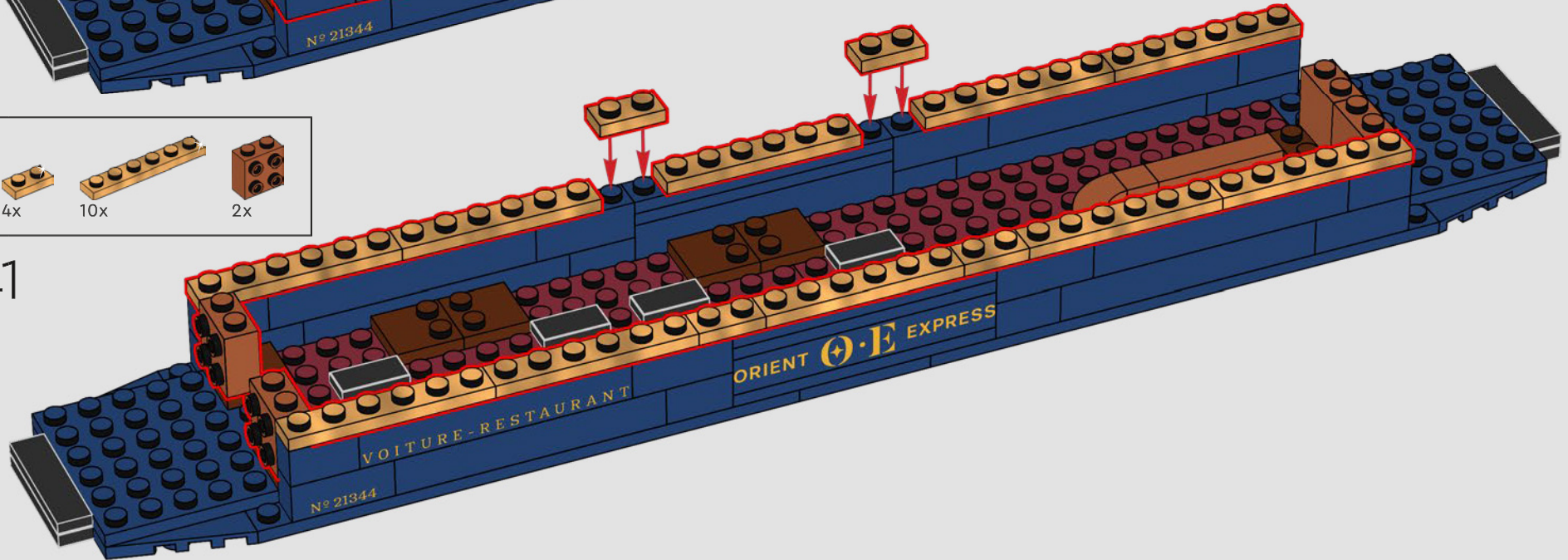

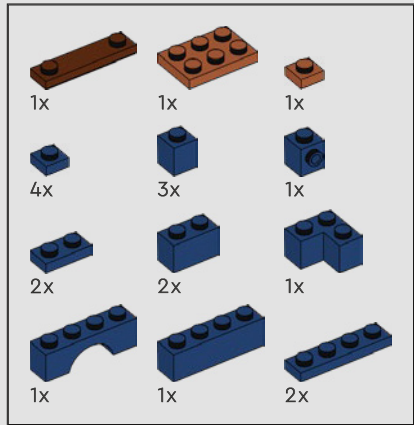

42

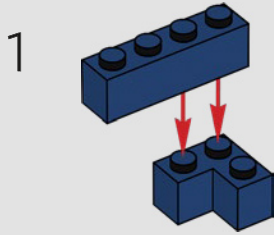

2

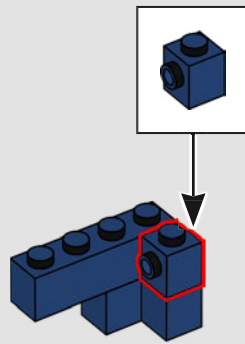

3

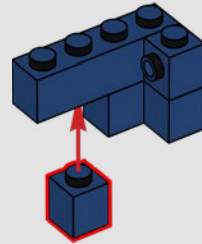

4

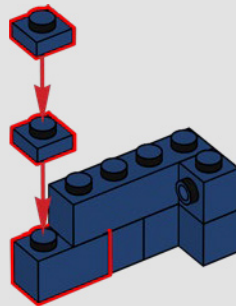

5

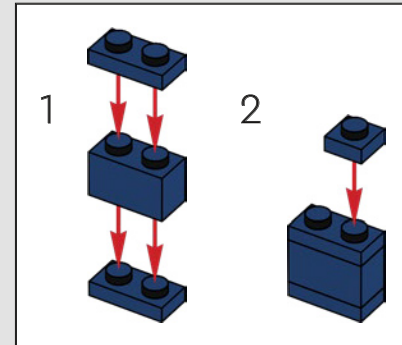
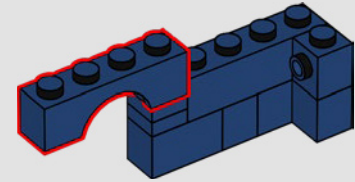

6

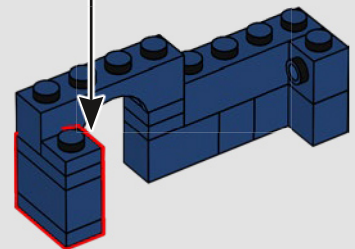

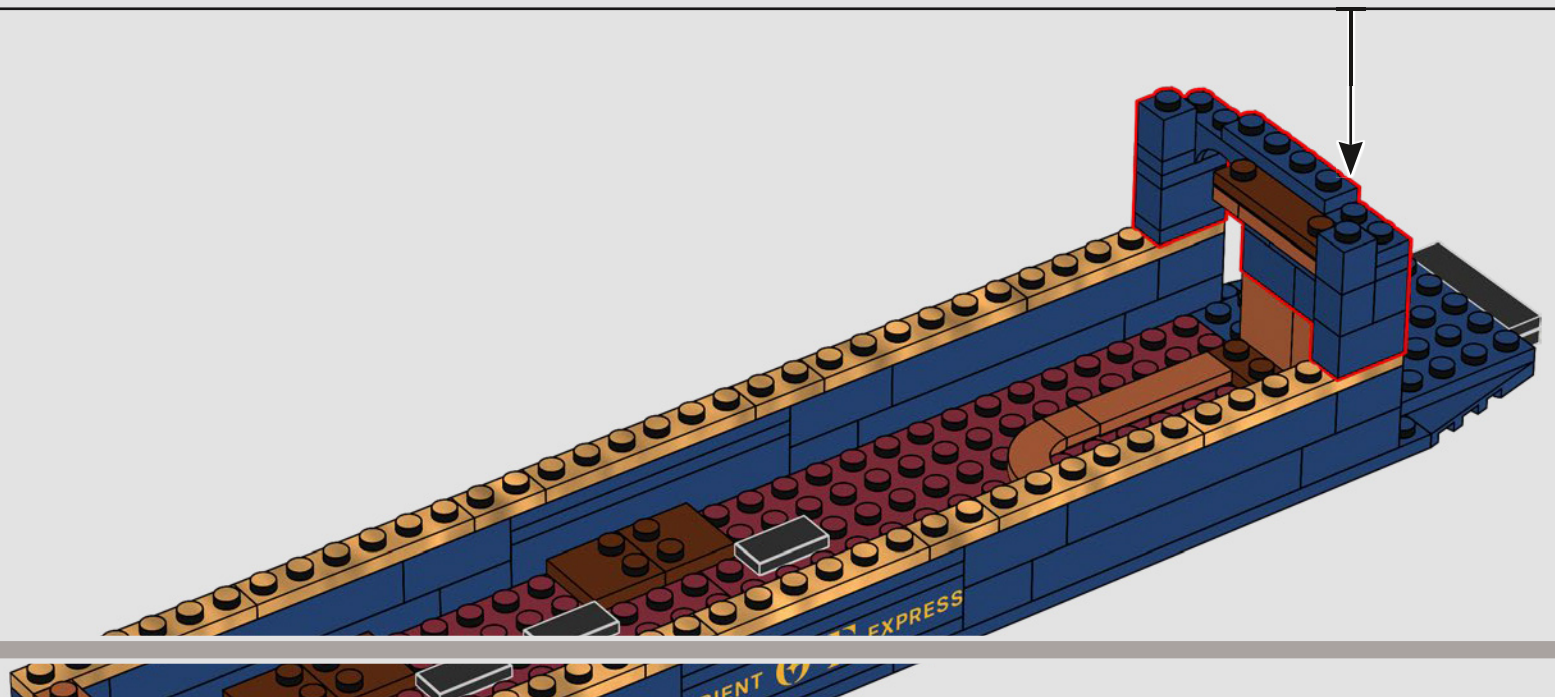
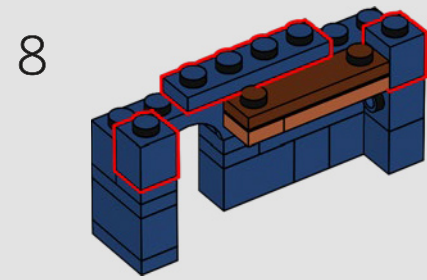
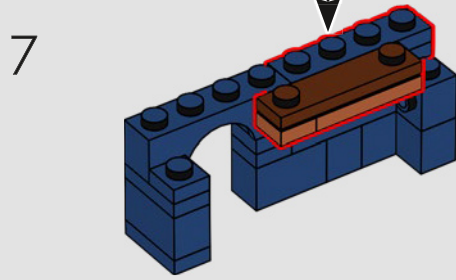
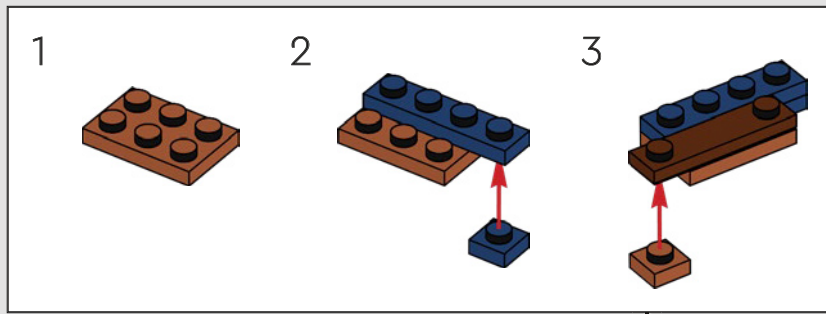

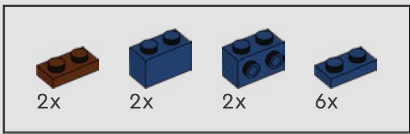

43

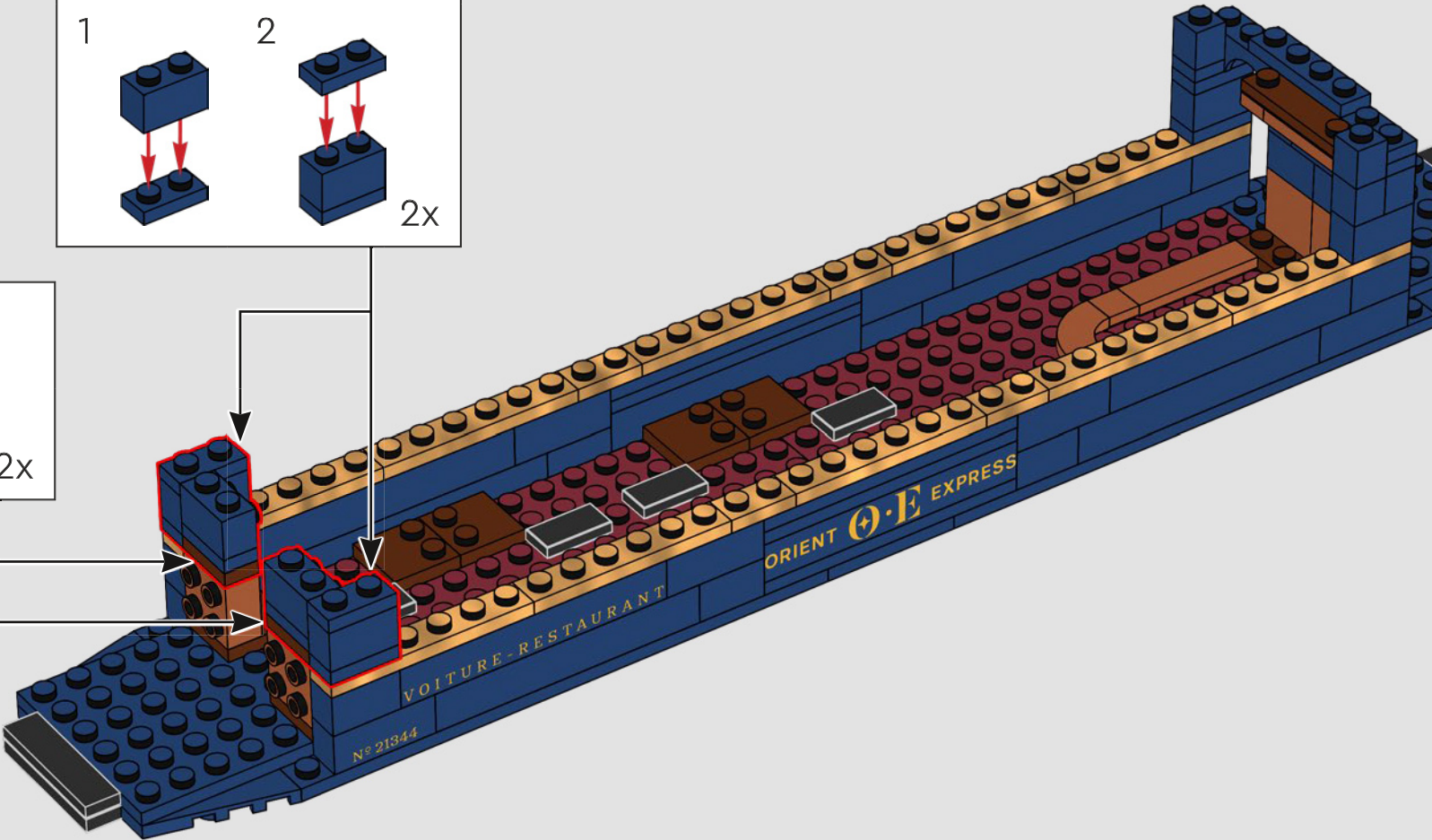
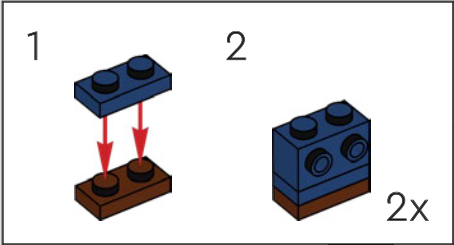
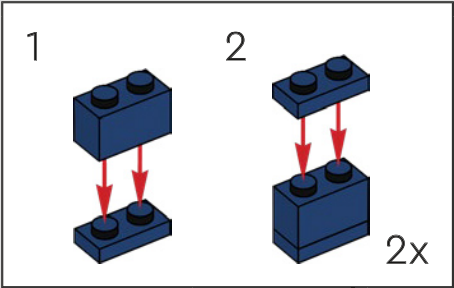

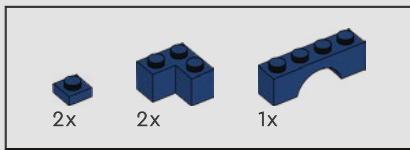

44

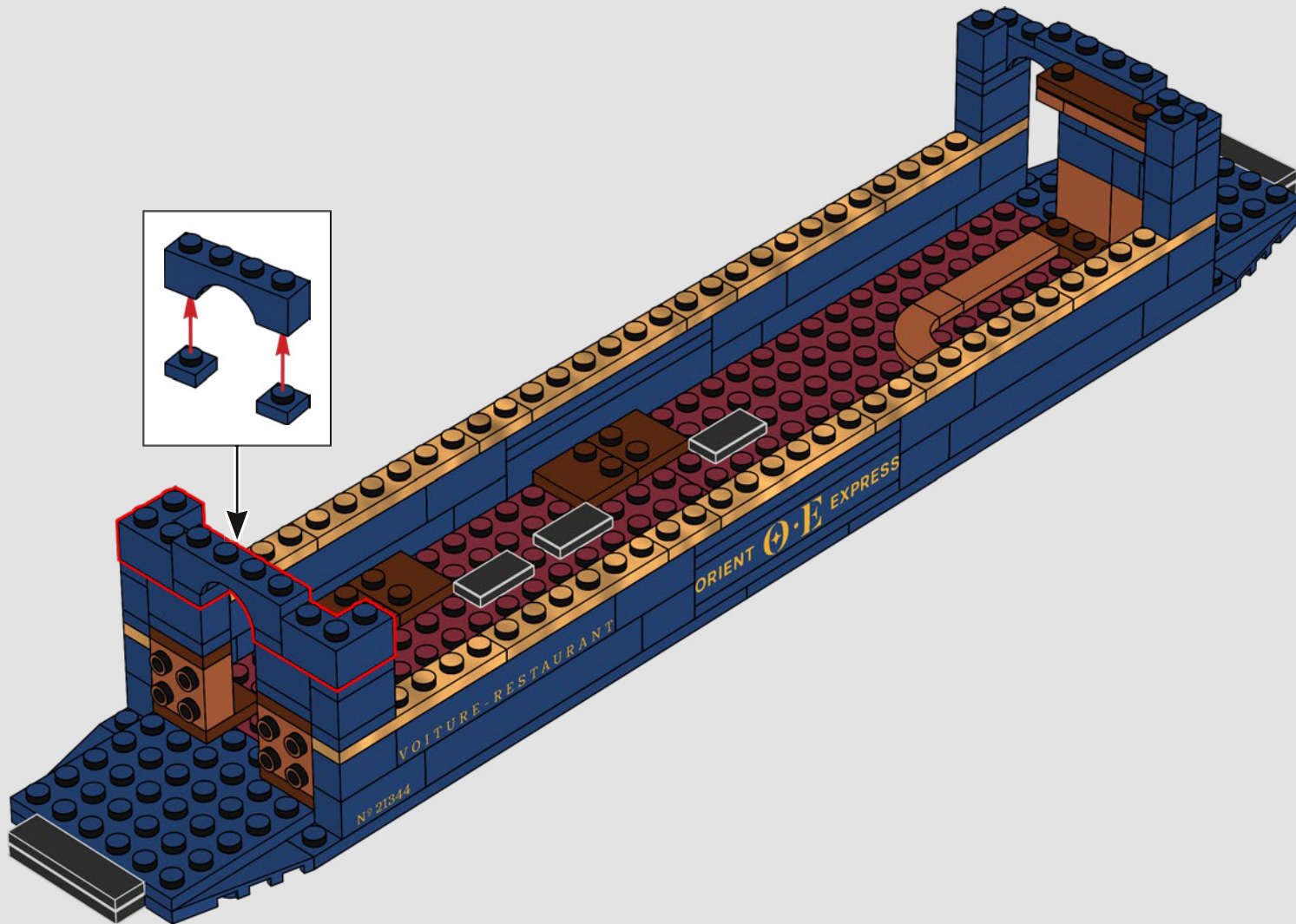

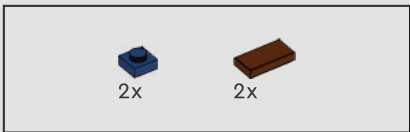

45

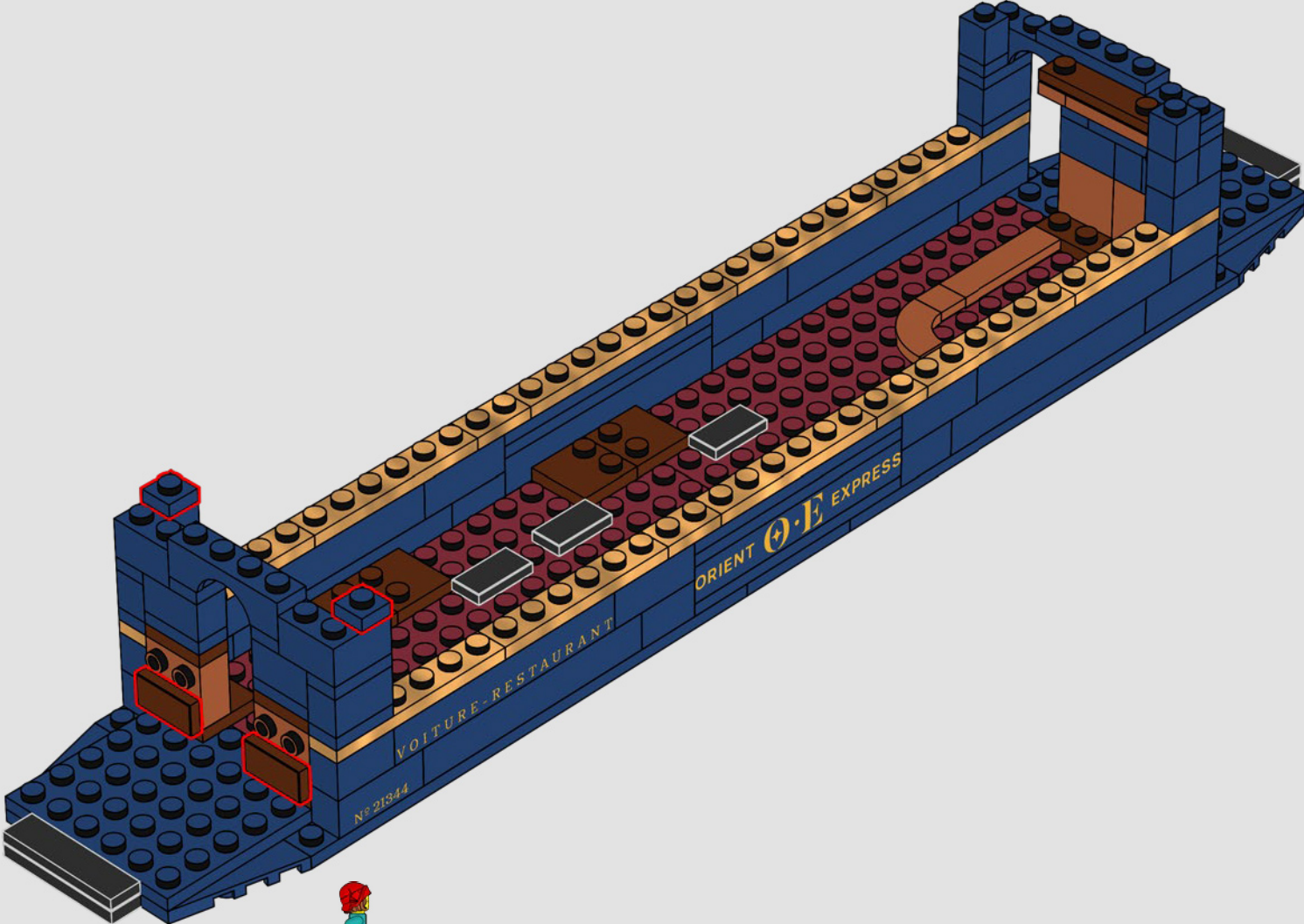

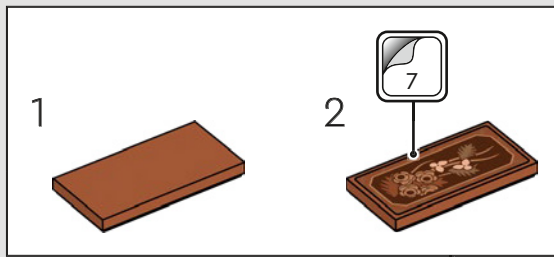
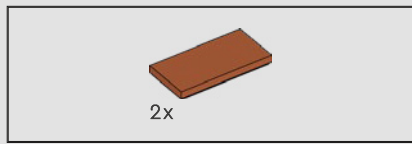

46

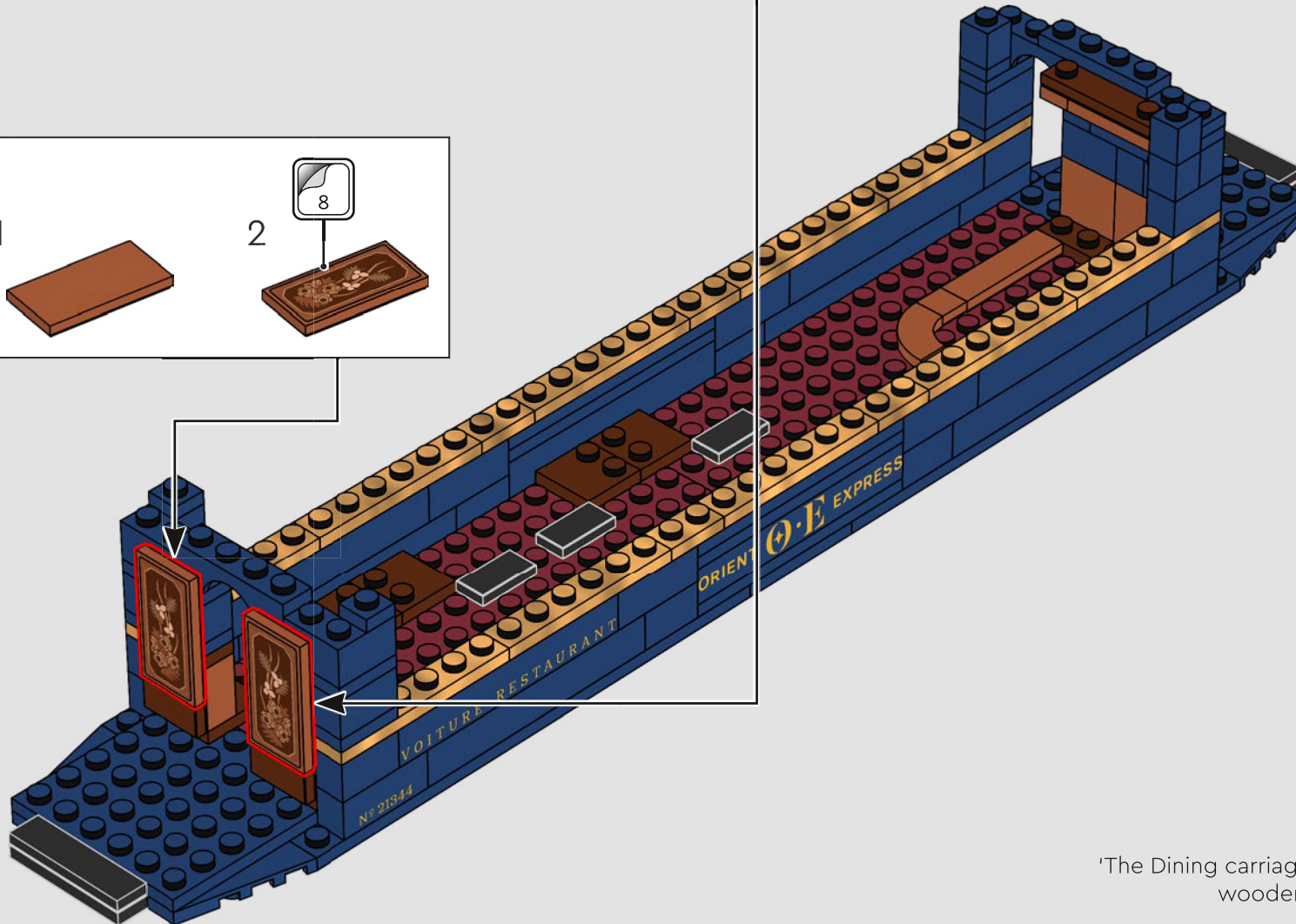
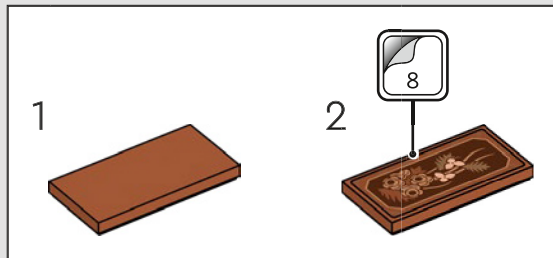

'The Dining carriage is decorated with beautiful wooden panelling of exotic flowers.'

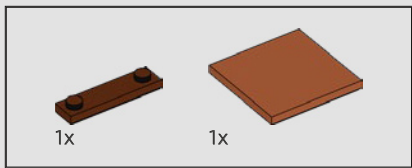

47

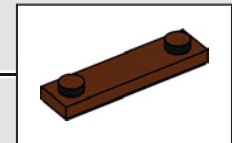
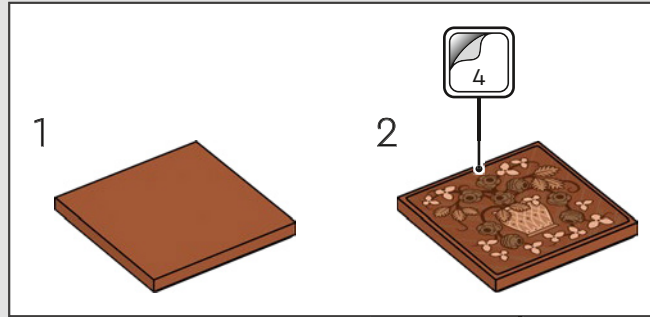
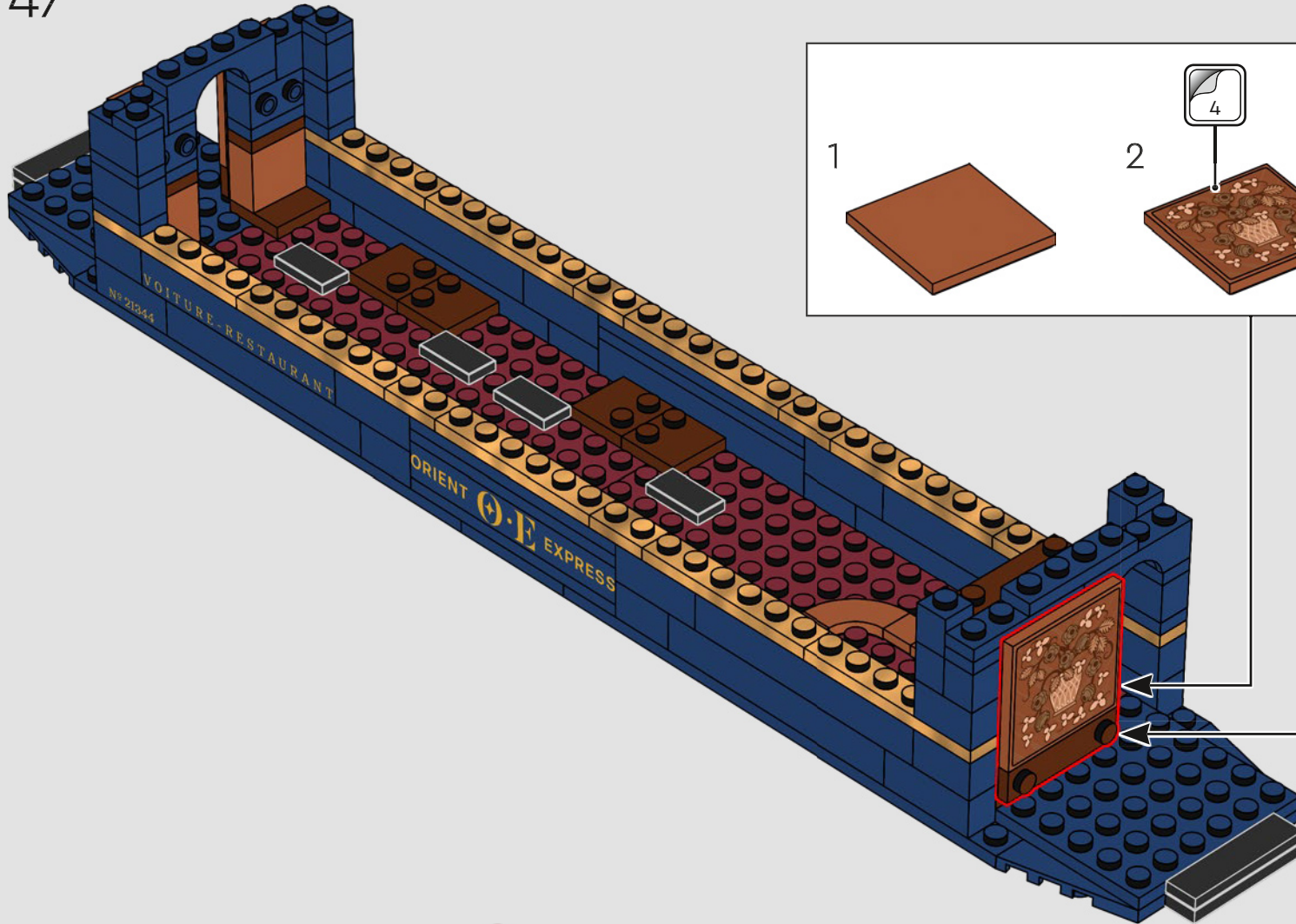

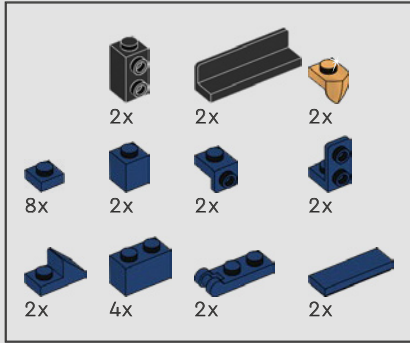
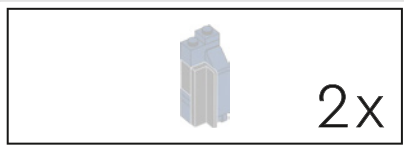

48

1

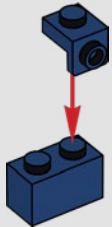

2

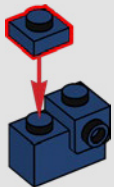

3

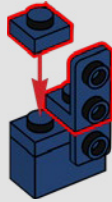

4

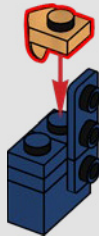

5

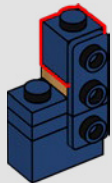

6

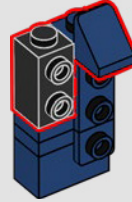

7

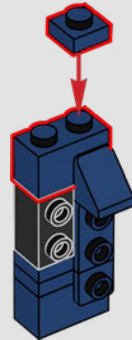

8

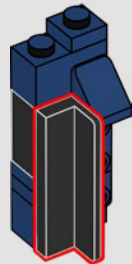

9

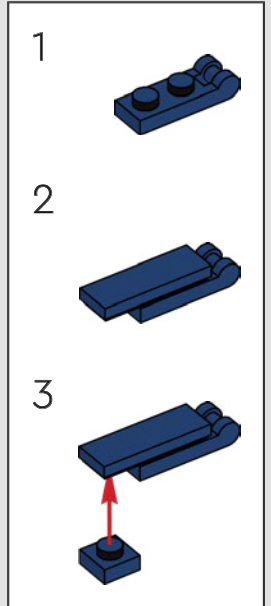
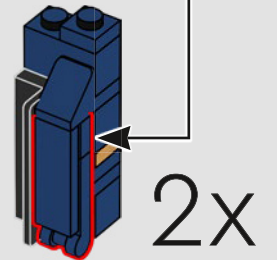

2x

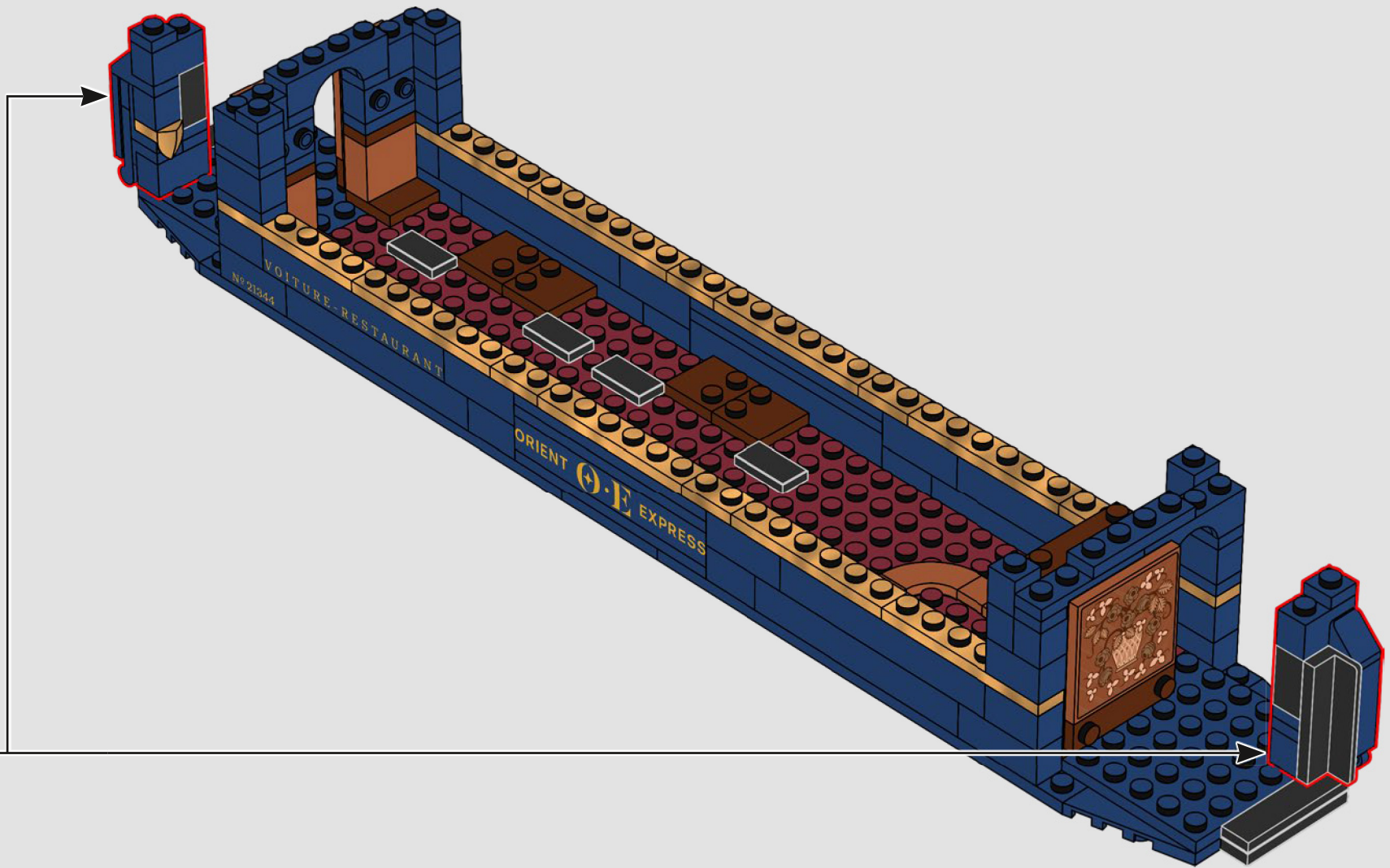

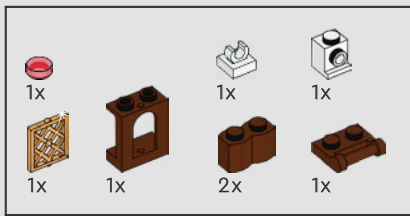

49

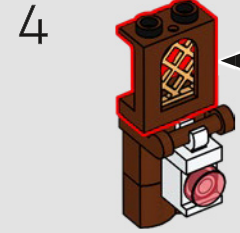
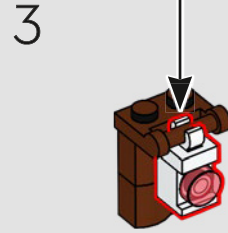
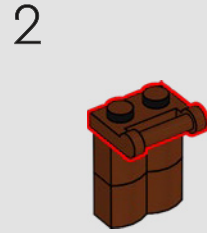
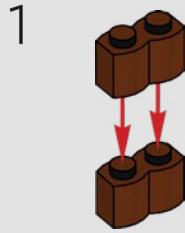
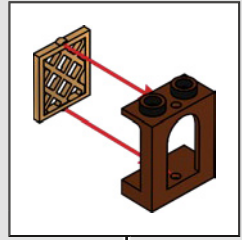
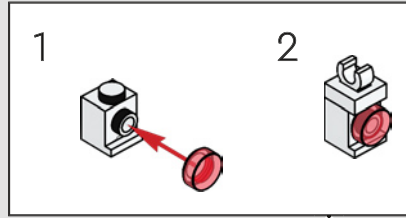



2x



2x



4x



2x



4x



2x



4x



2x



2x



2x



2x

50

1

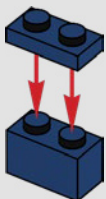

2

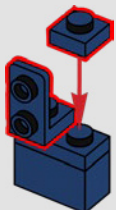

3

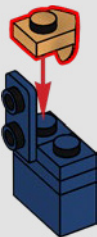

4

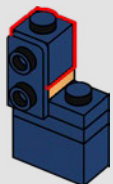

5

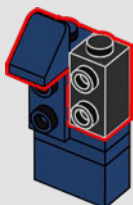

6

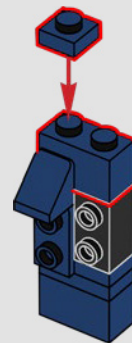

7

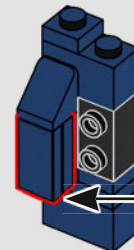

8

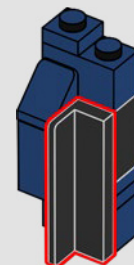

2x



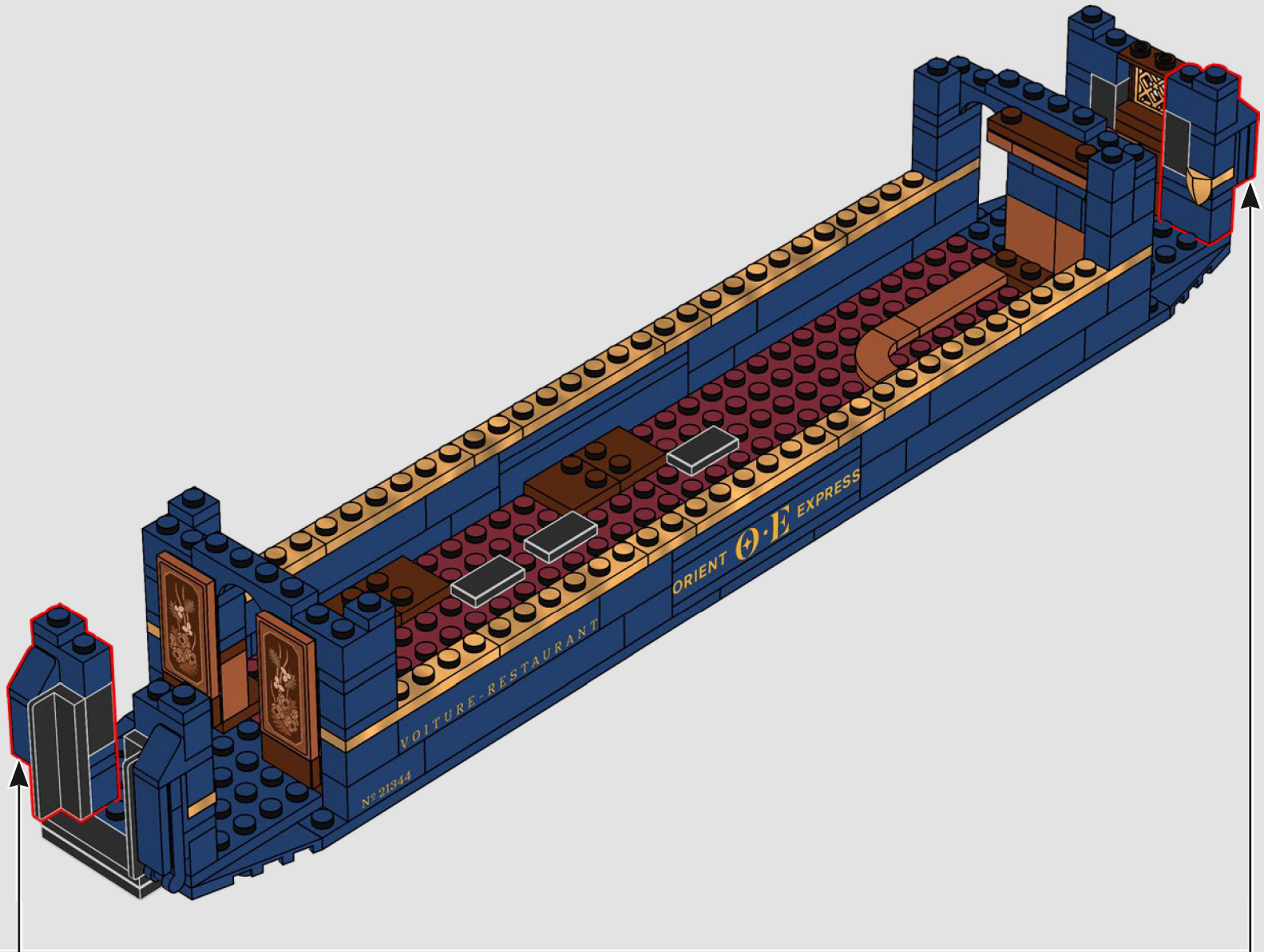

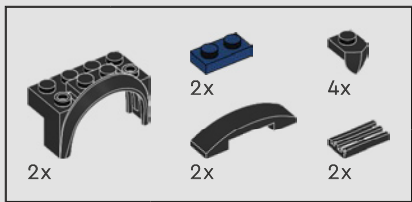

51

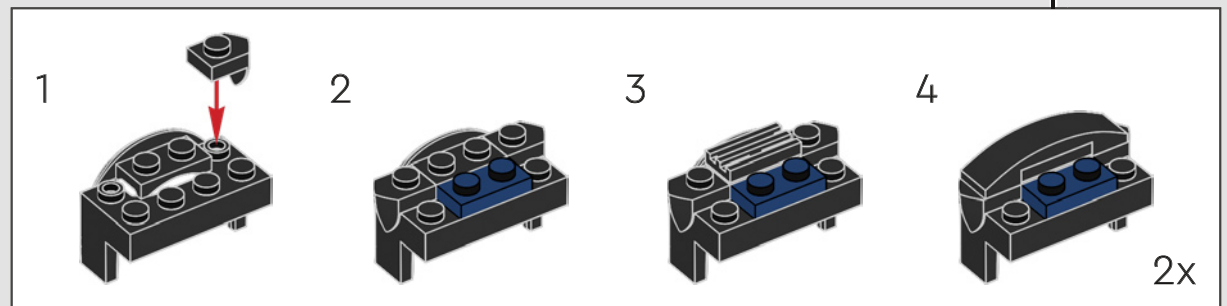
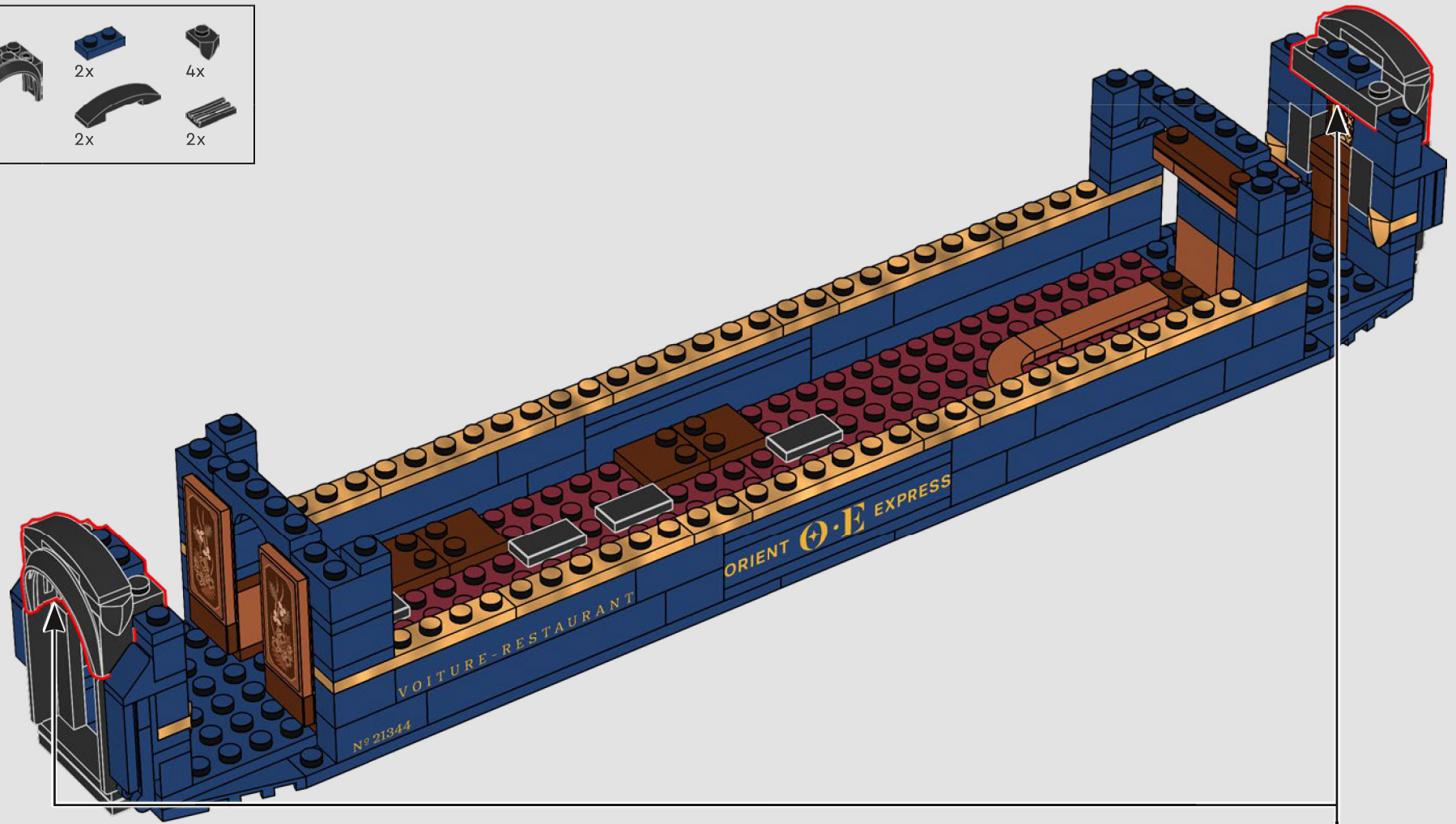

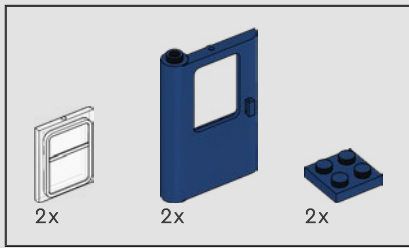

52

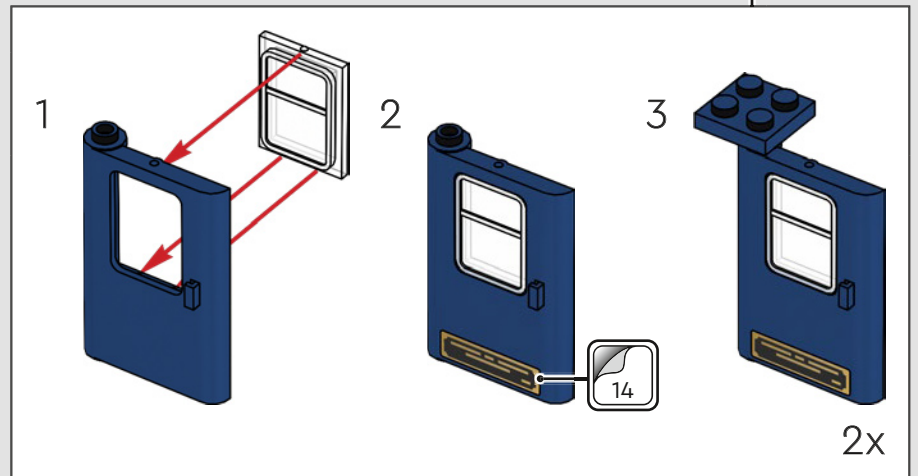
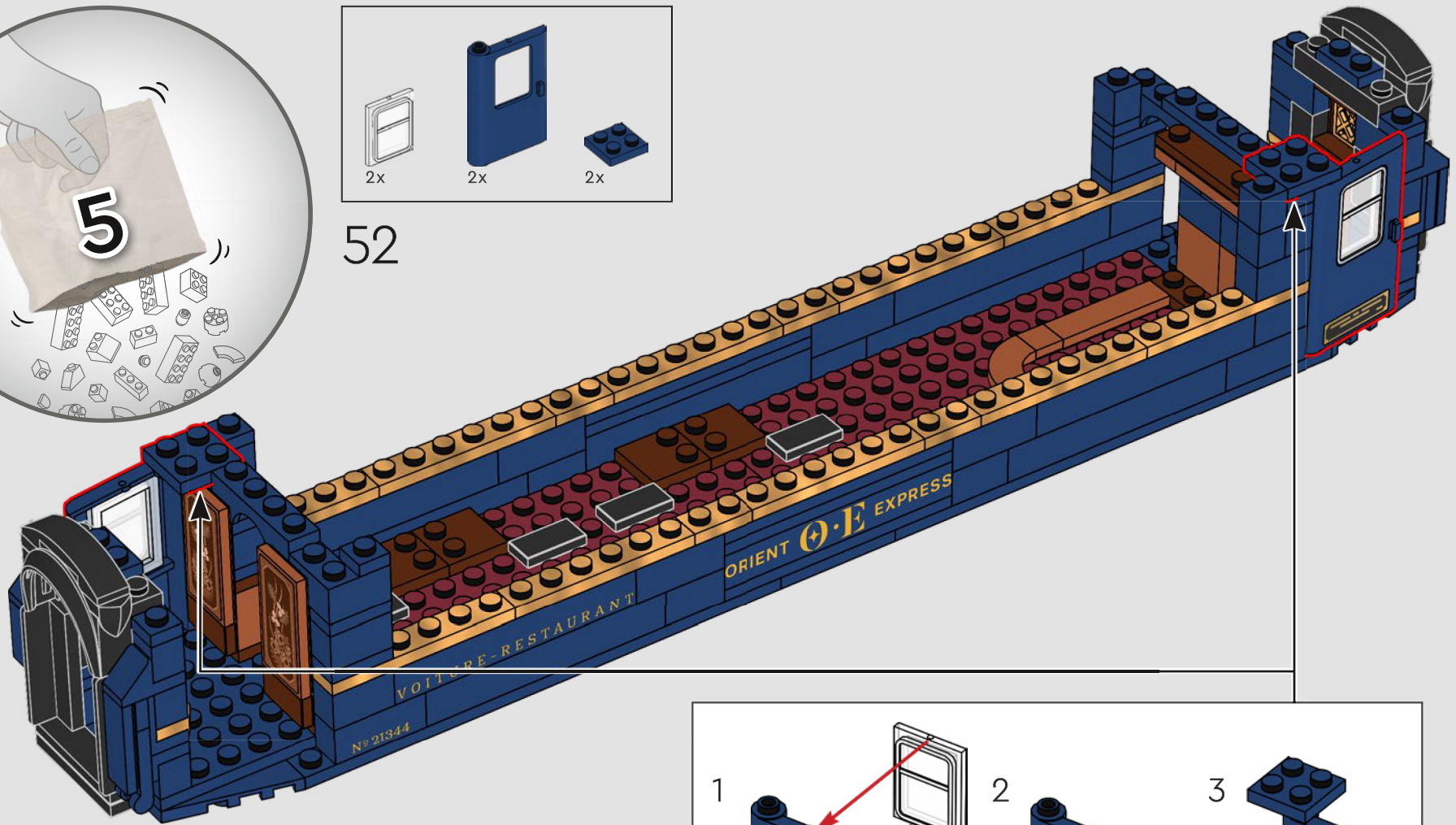

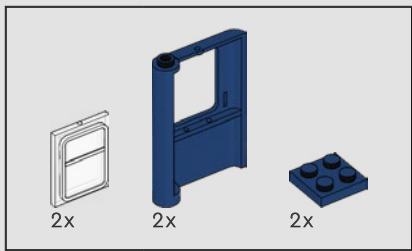

53

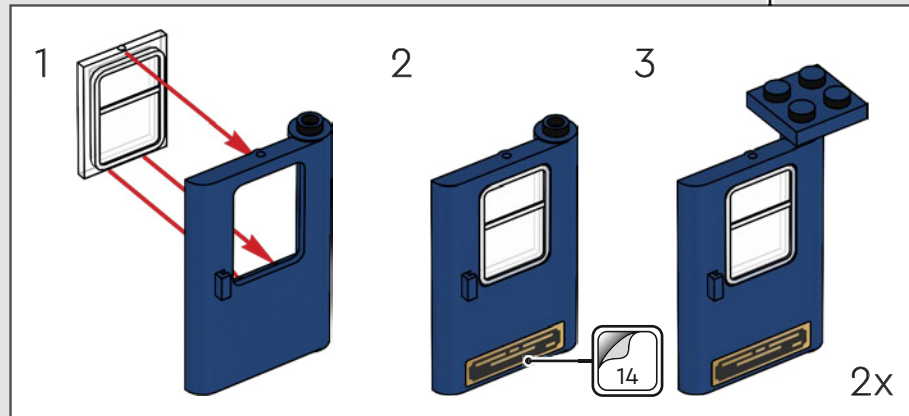
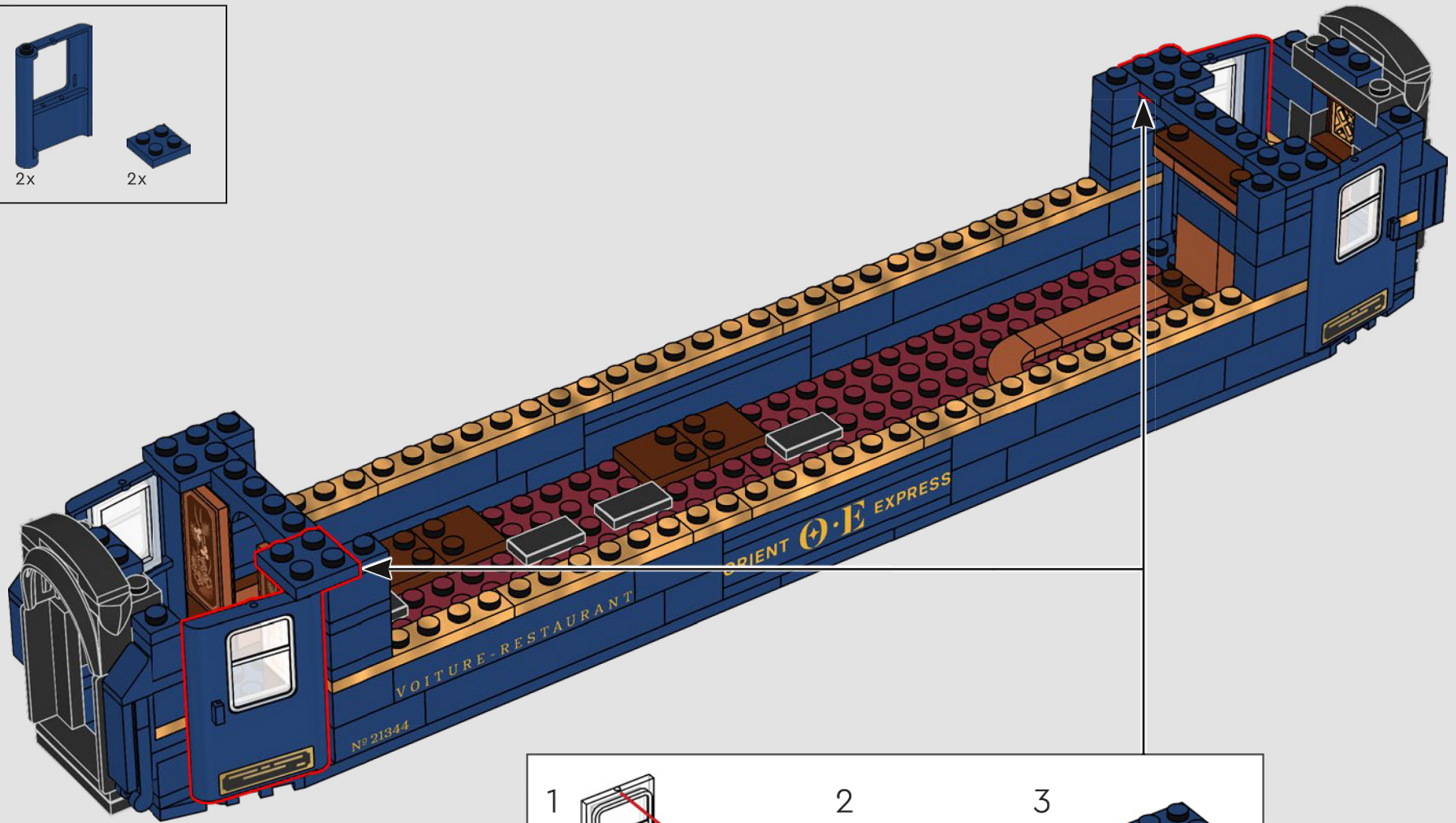

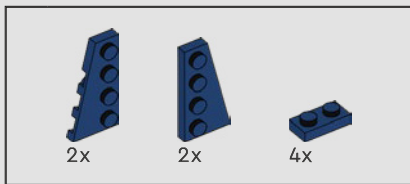

54

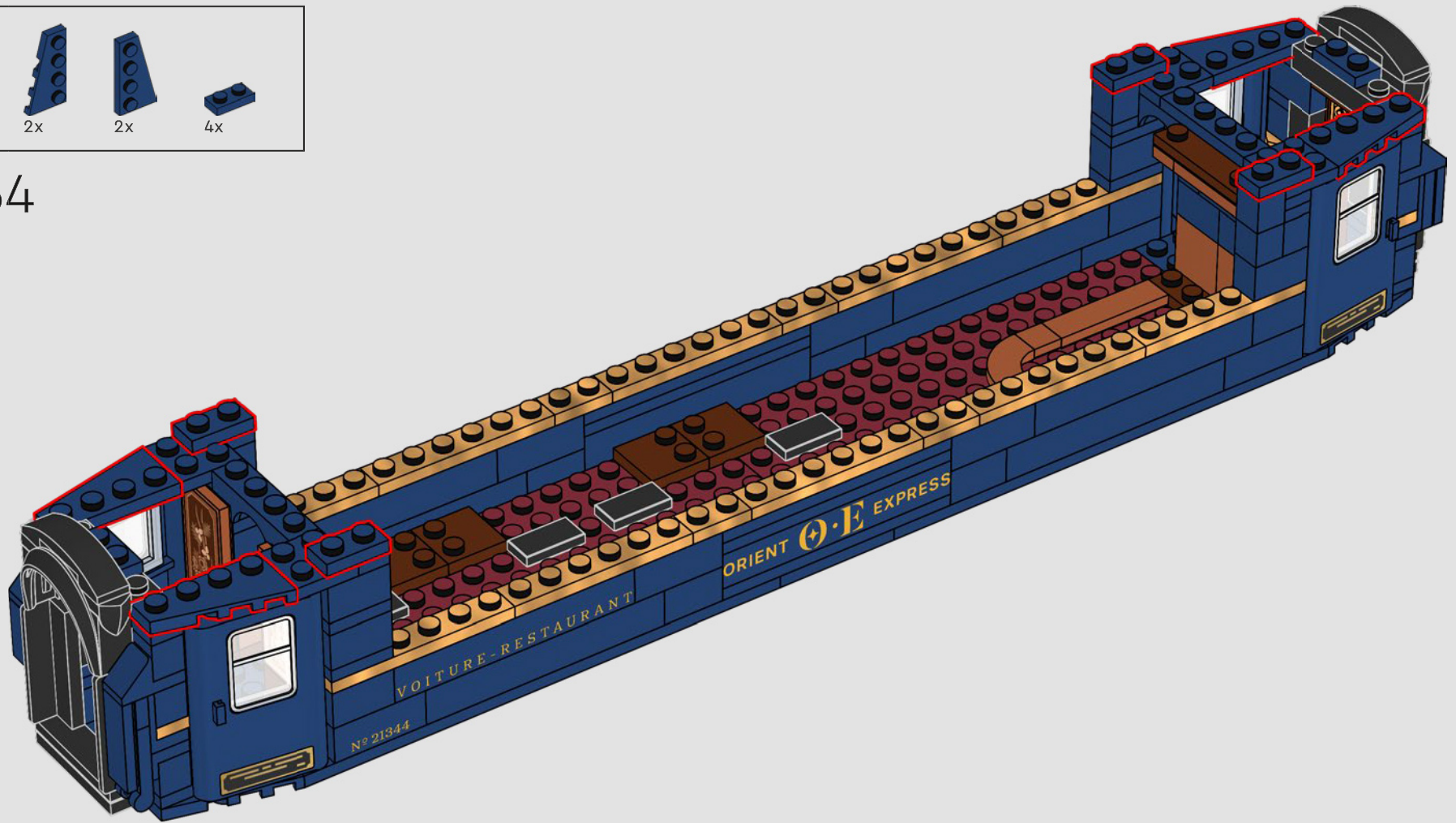

..... ●
'Each door features a brass maker's plaque as a sign of quality.'

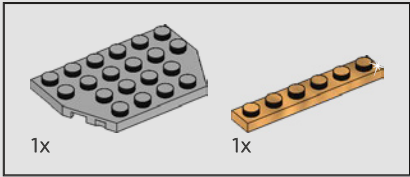
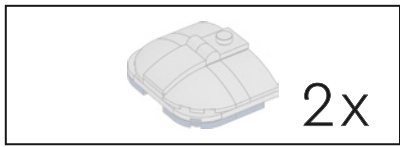

55

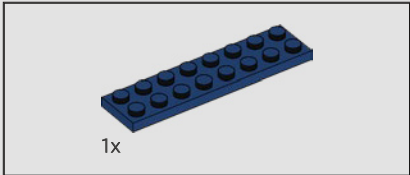
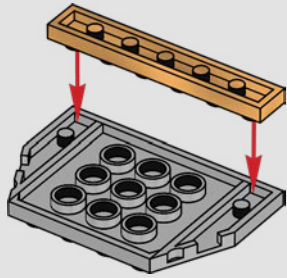

56

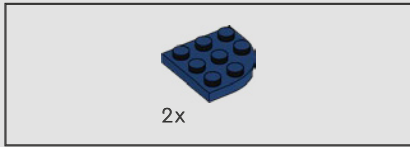
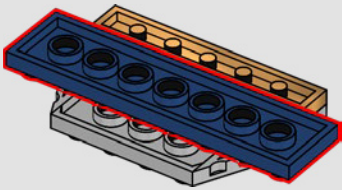

57

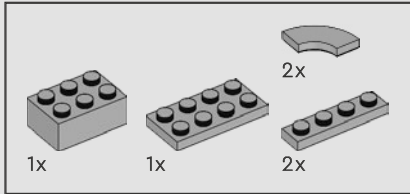
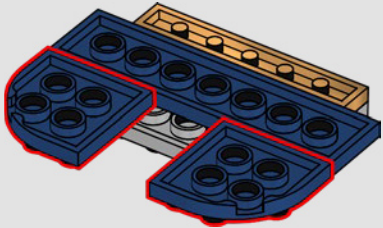

58

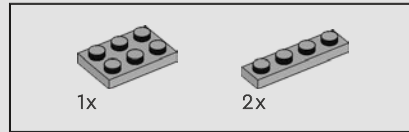
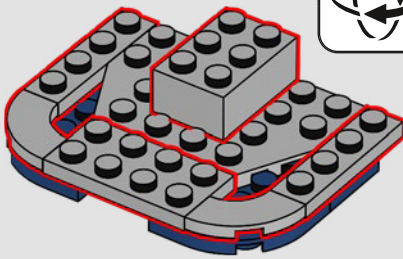

59

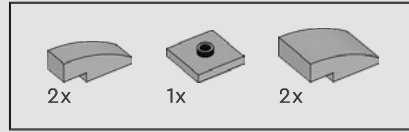
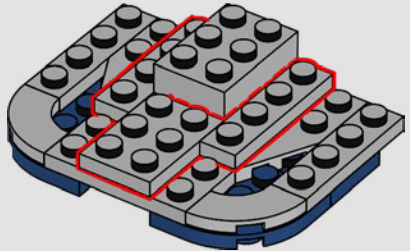

60

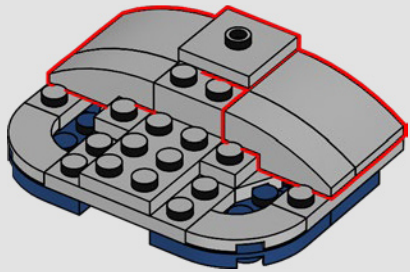

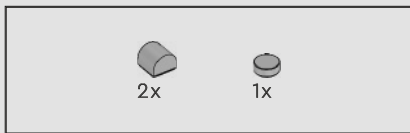

61

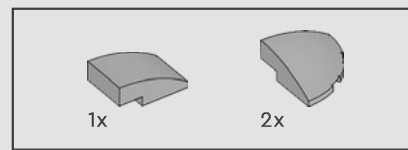
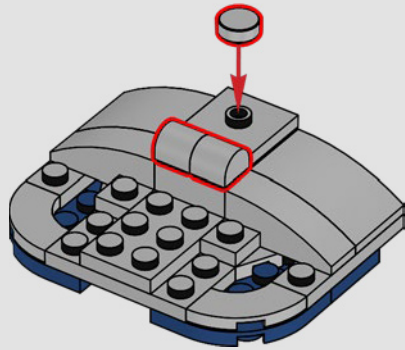

62

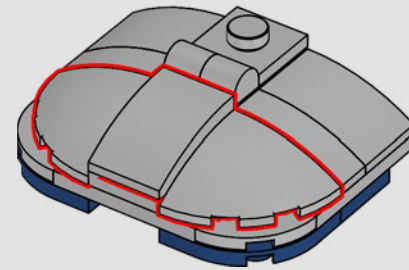

2x

63

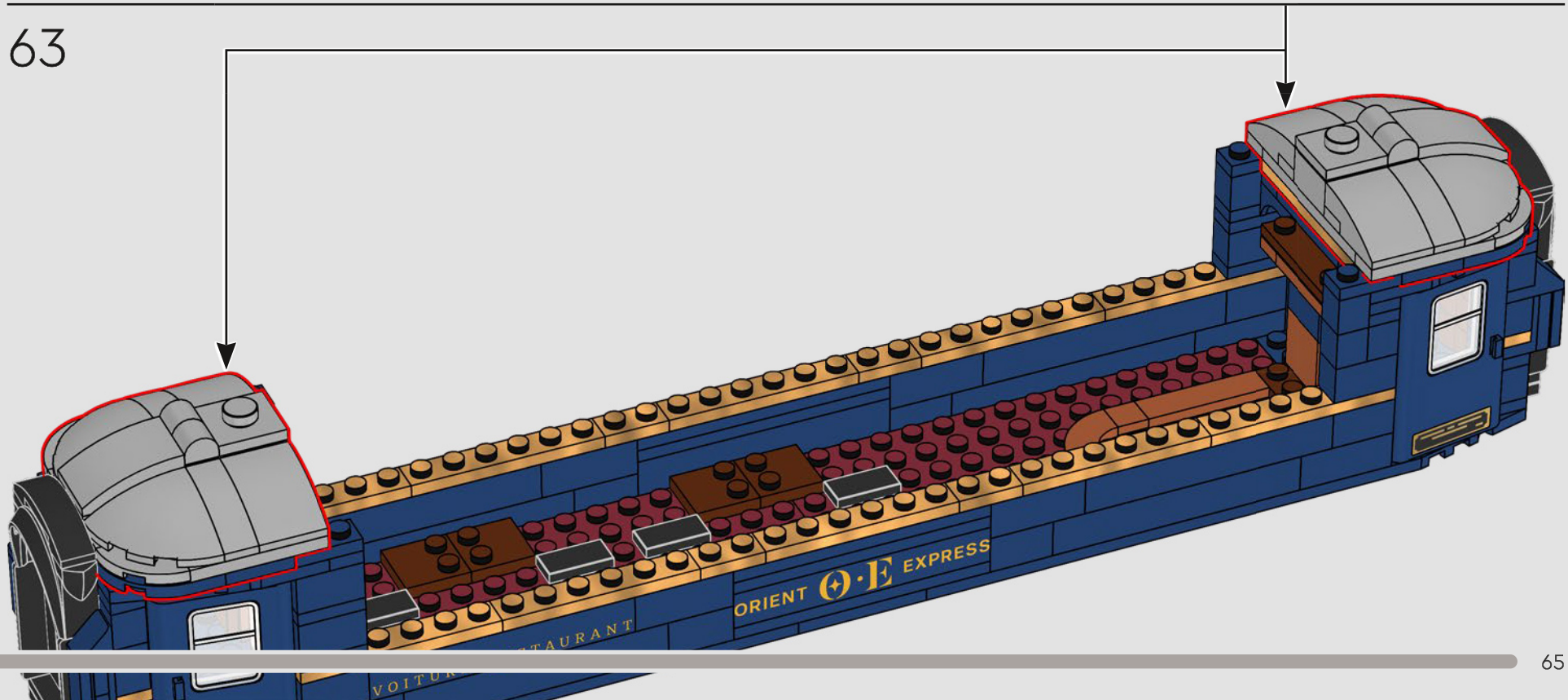

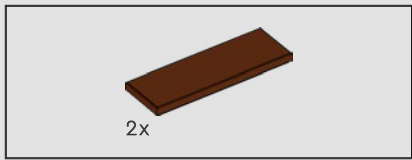

64

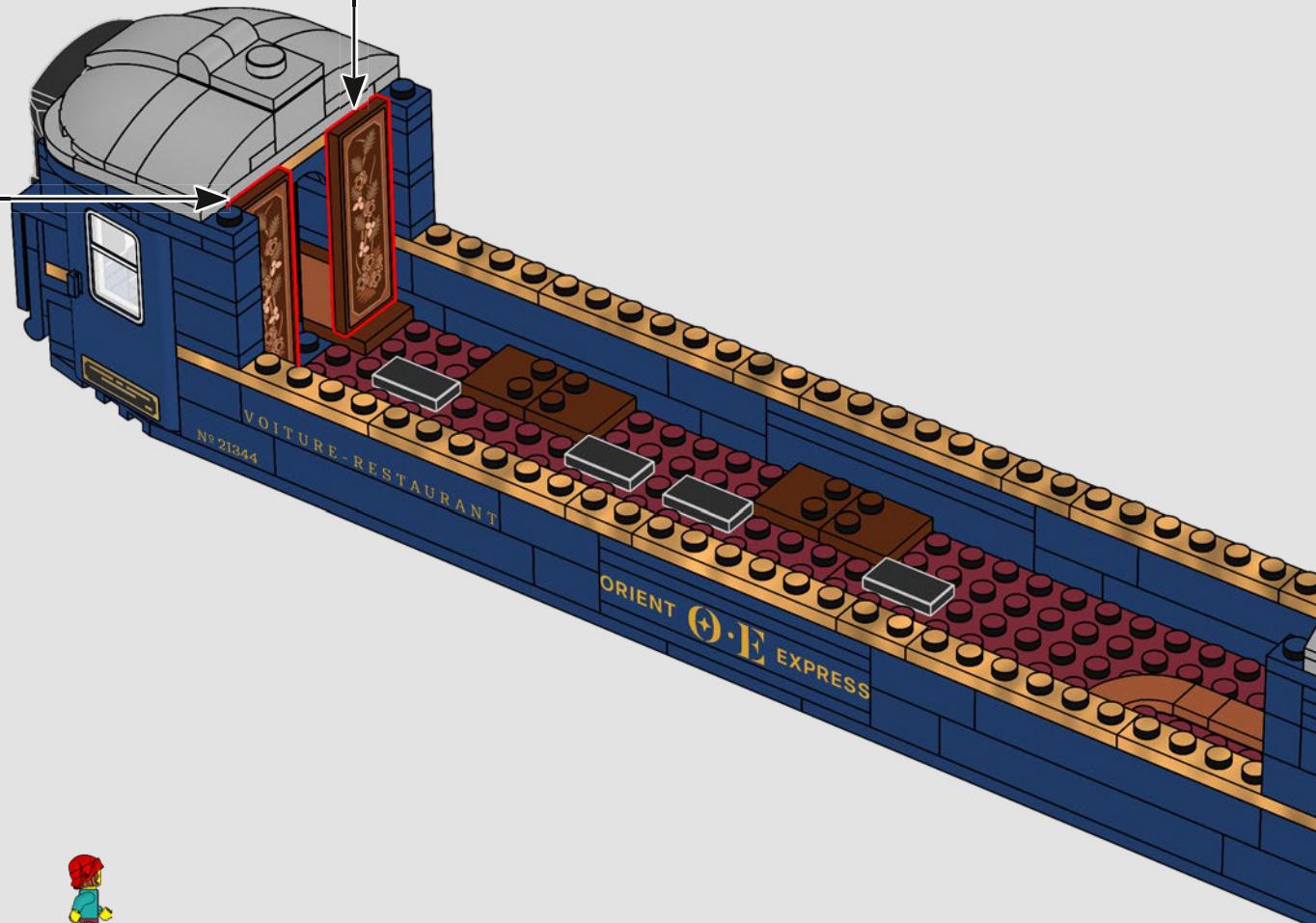
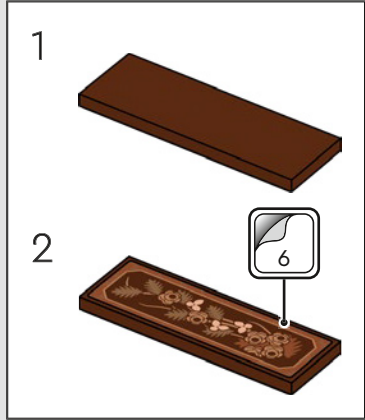
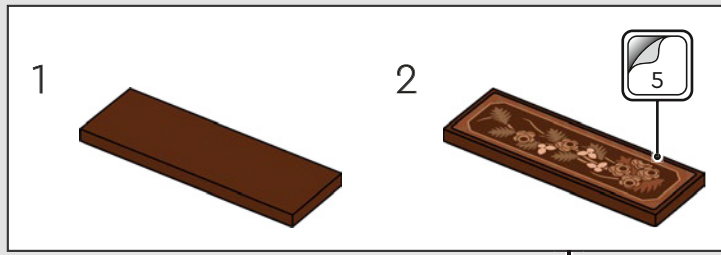

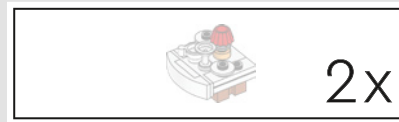
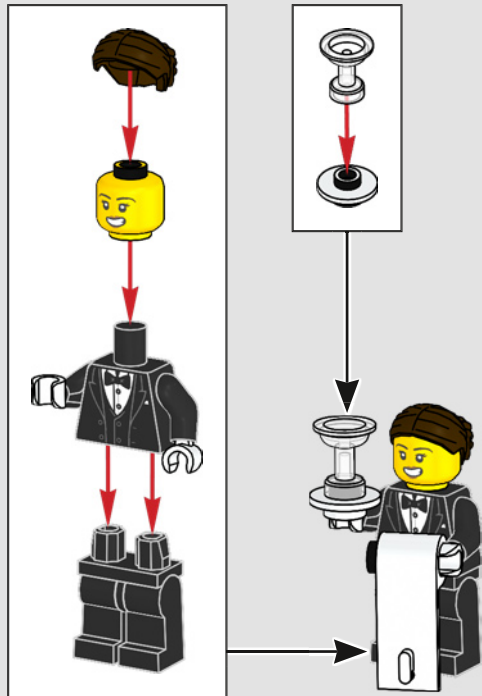

65

1

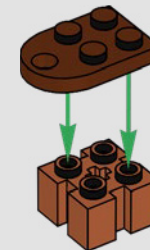

Next Stop: MUNICH
 'On-board service features waiter service
 and a restaurant carriage.'

2



3

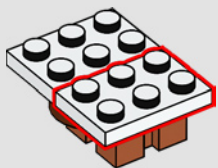

4

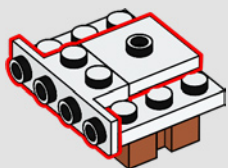

5

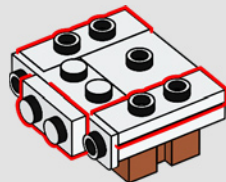

6

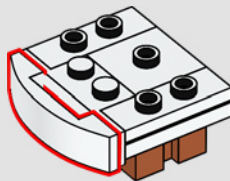

7

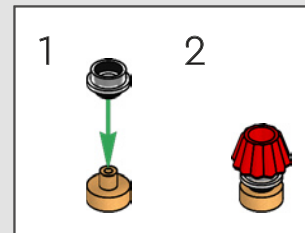
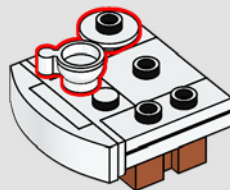

8



9

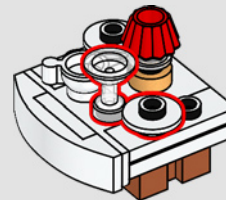

2x



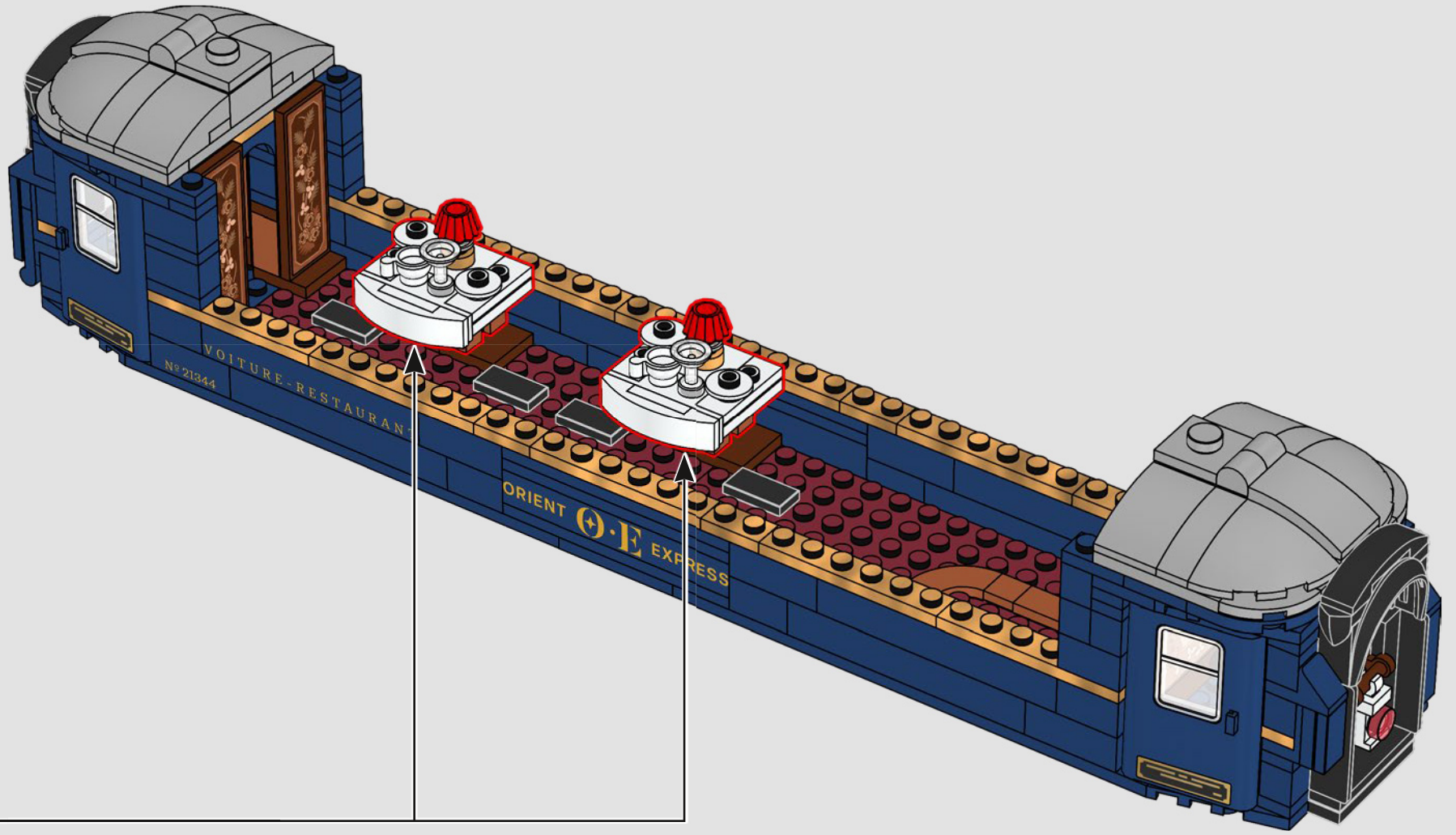

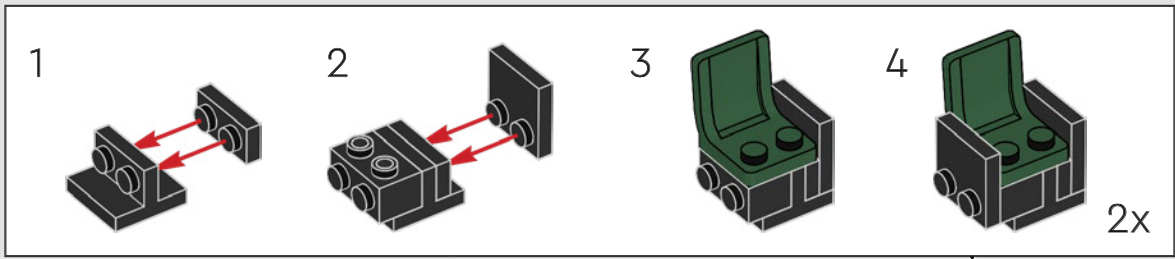
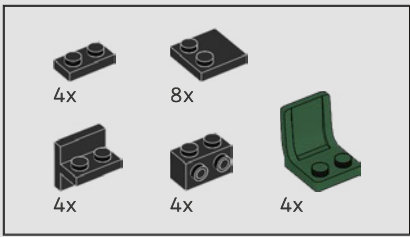

66

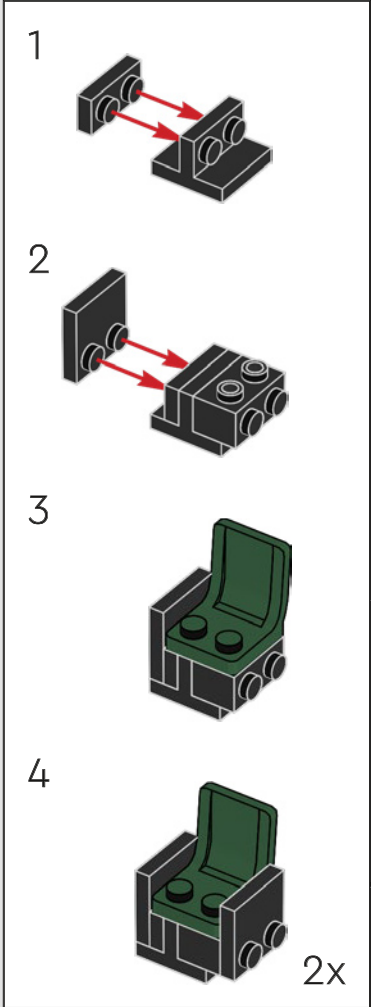

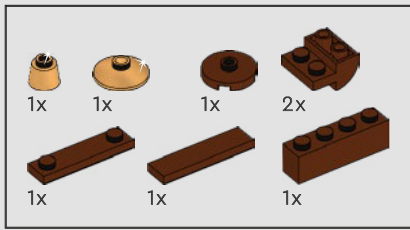

67

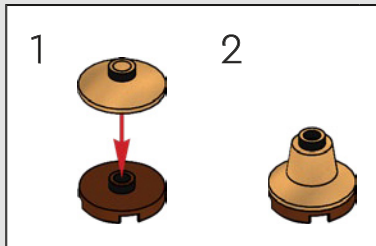
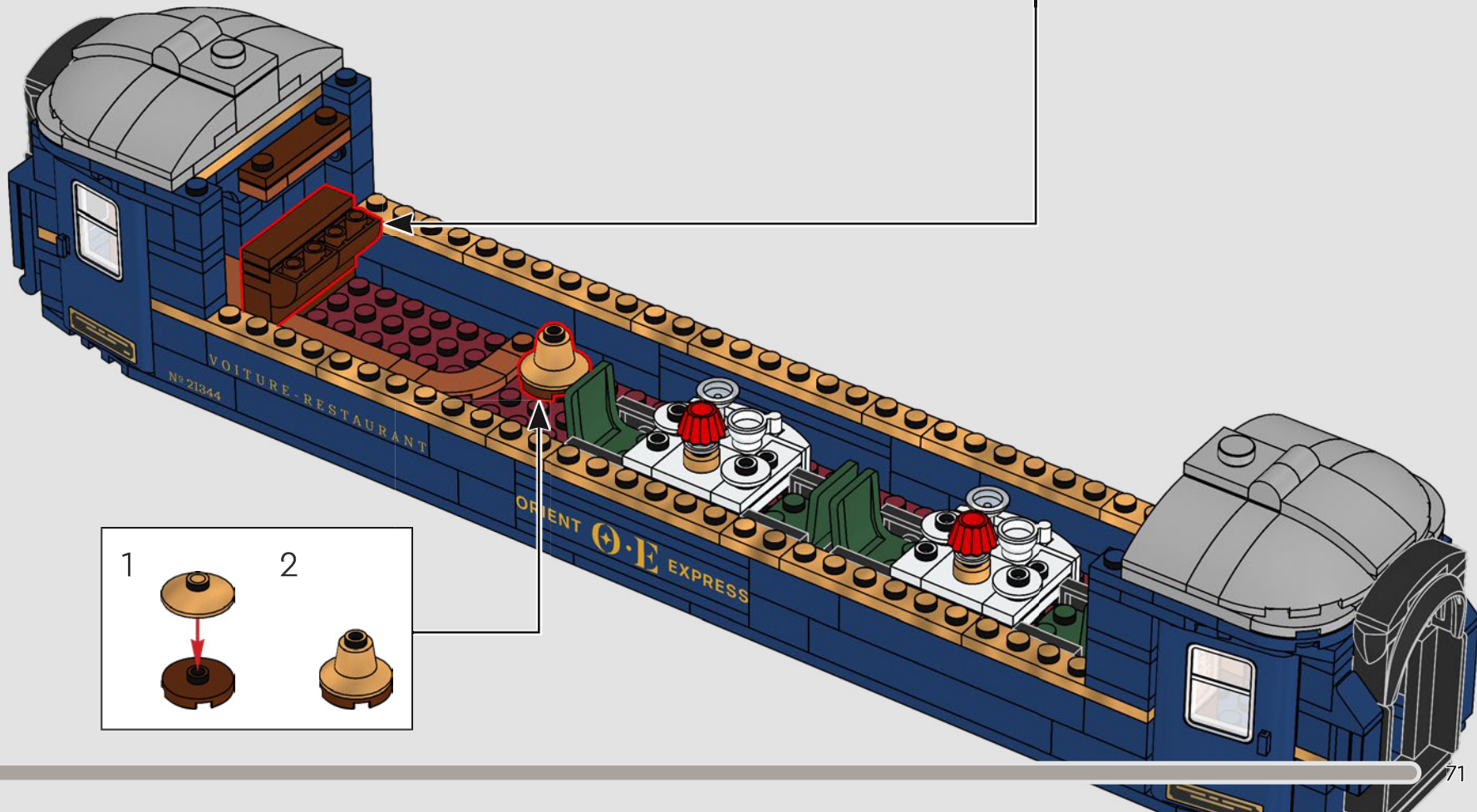
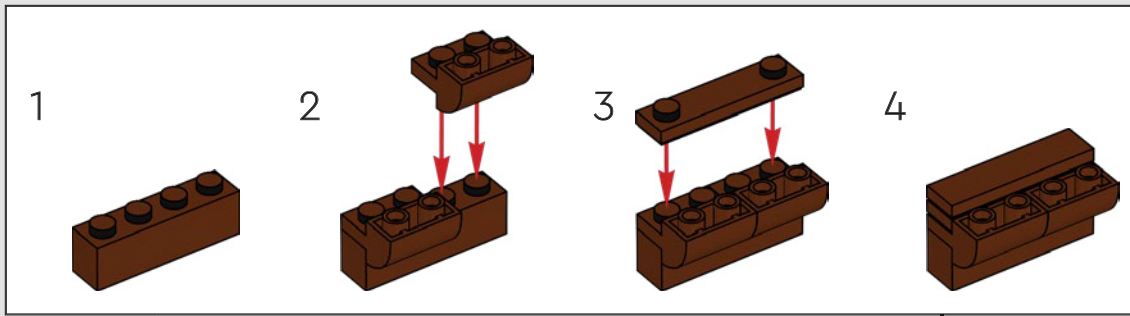

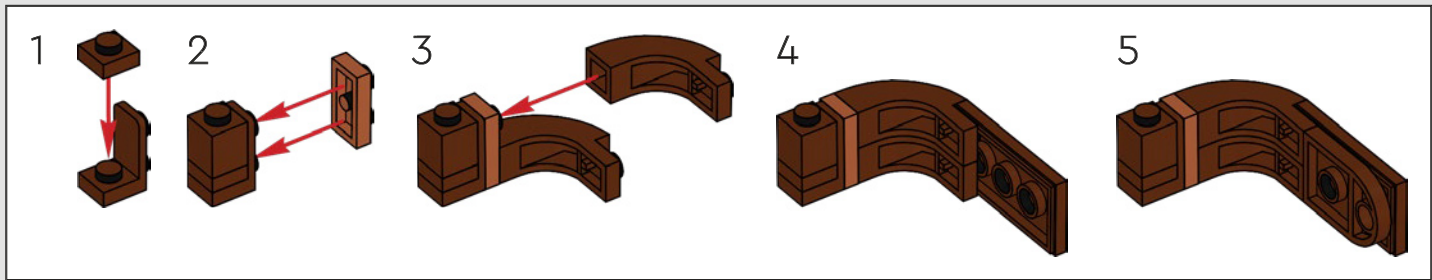
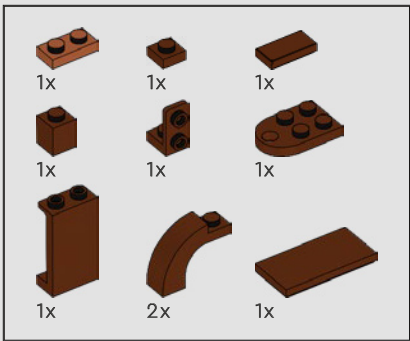

68

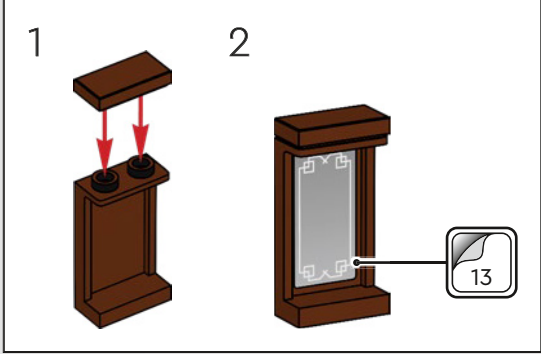
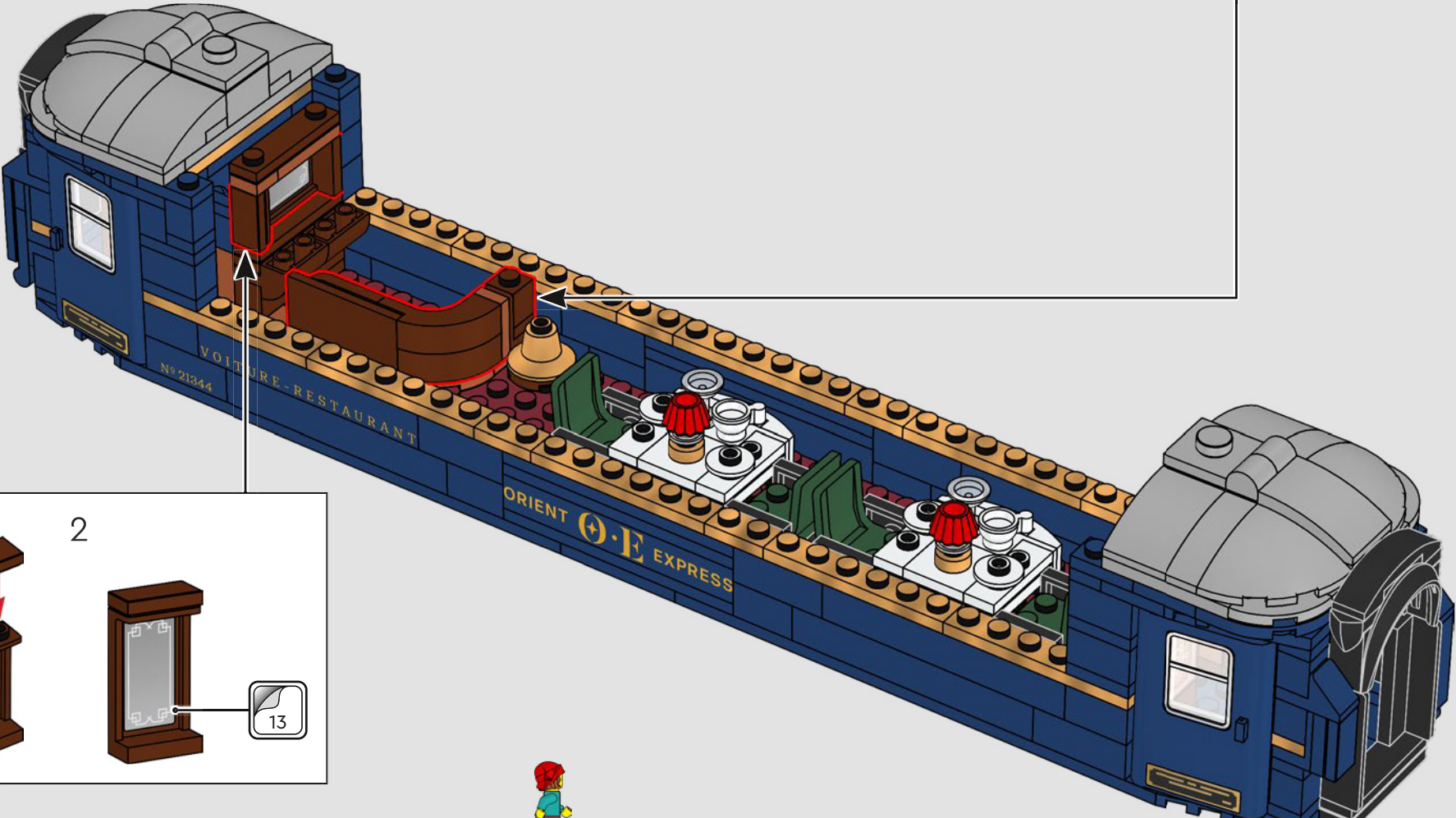



69

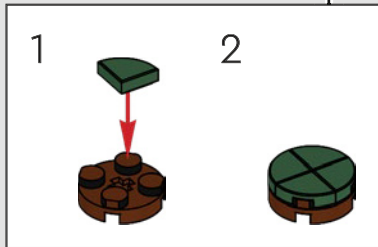
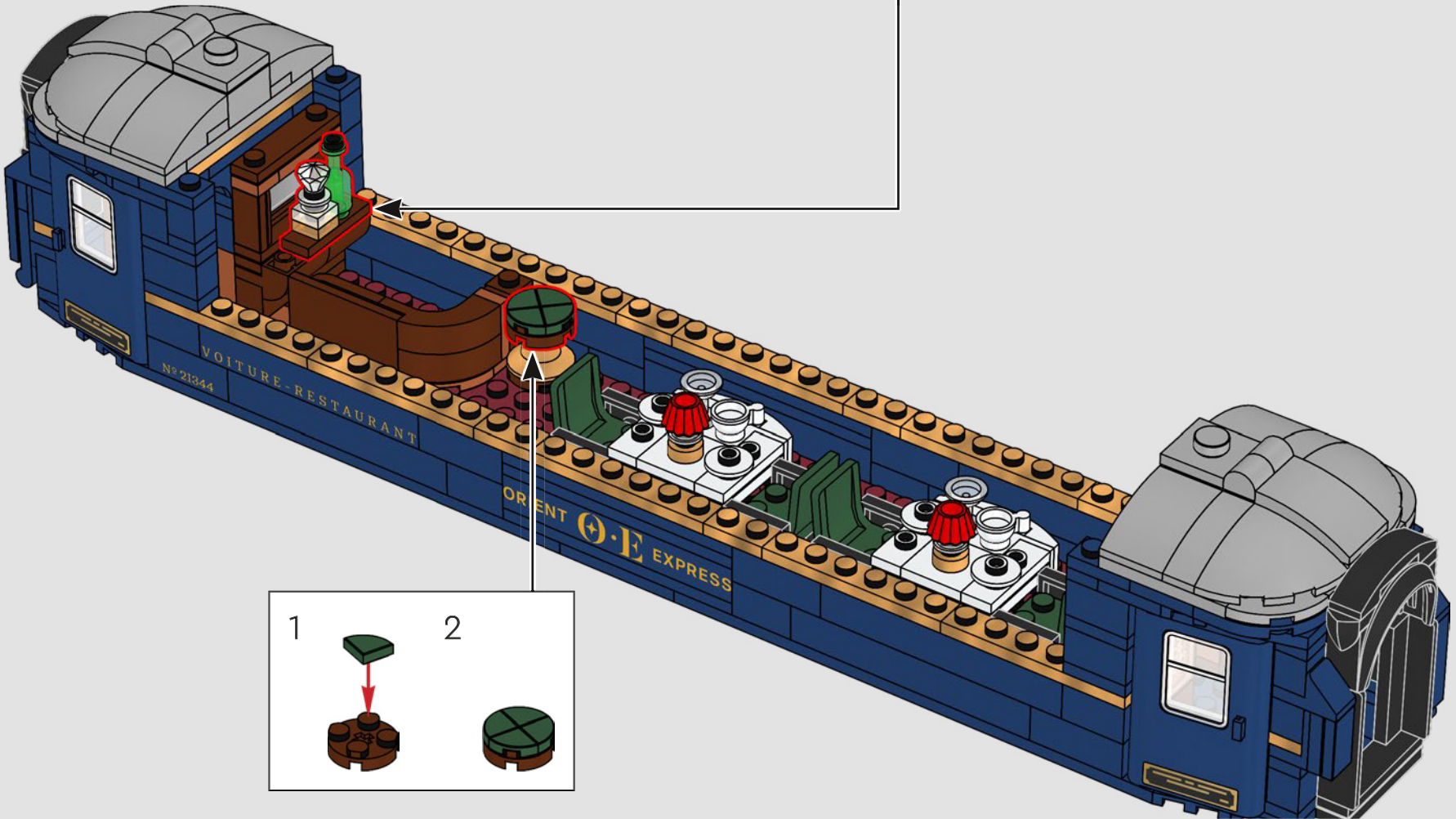
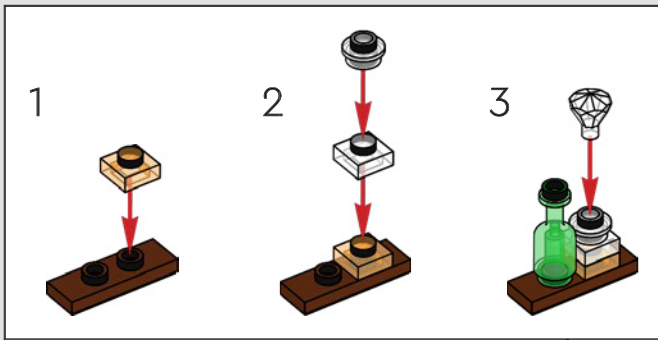

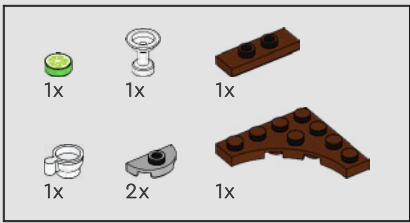

70

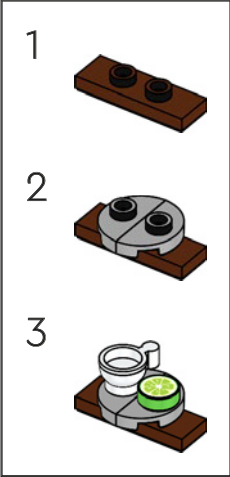
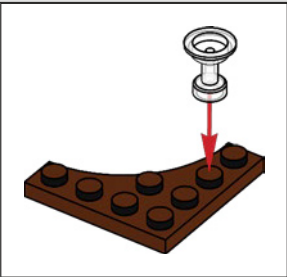

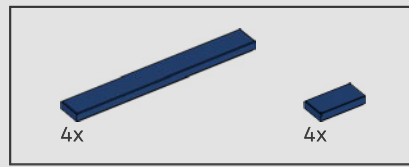

71



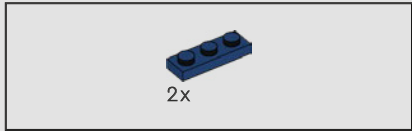
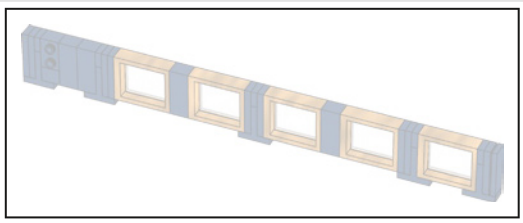

72

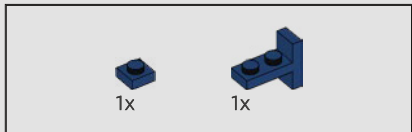
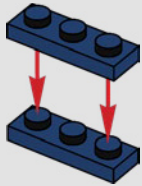

73

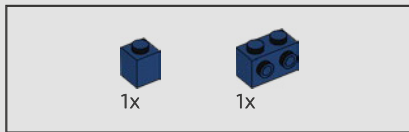
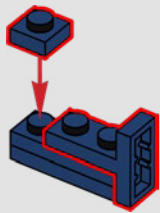

74

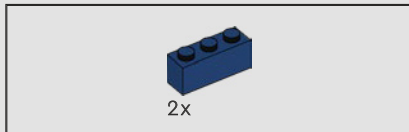
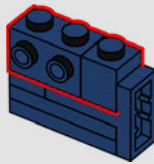

75

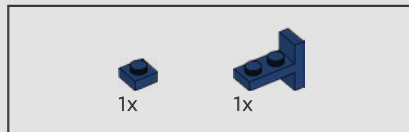
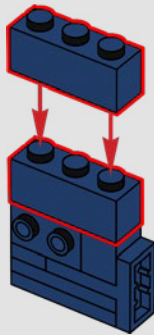

76

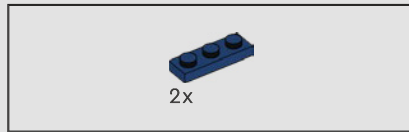
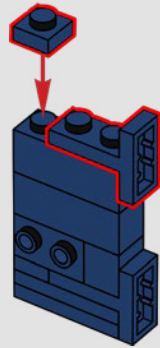

77

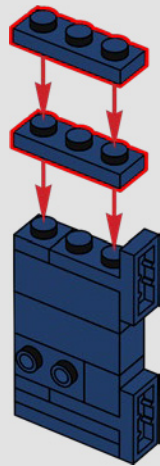

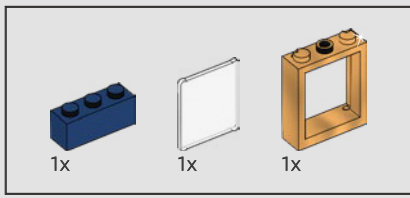

78

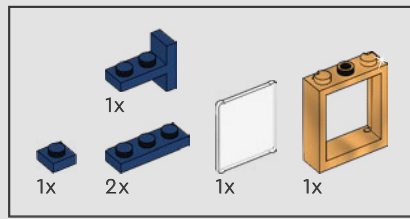
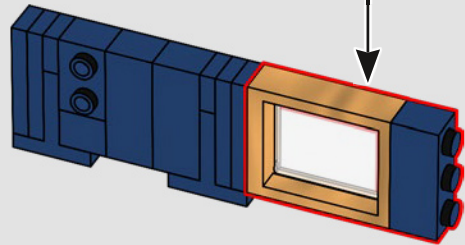
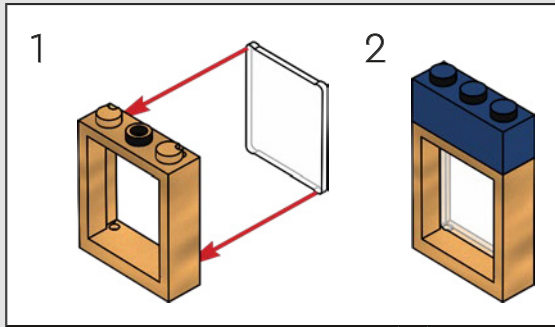

79

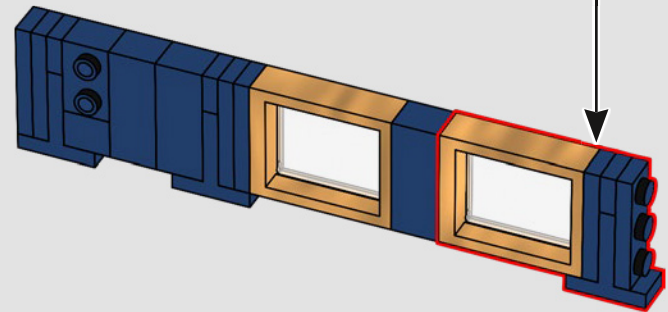
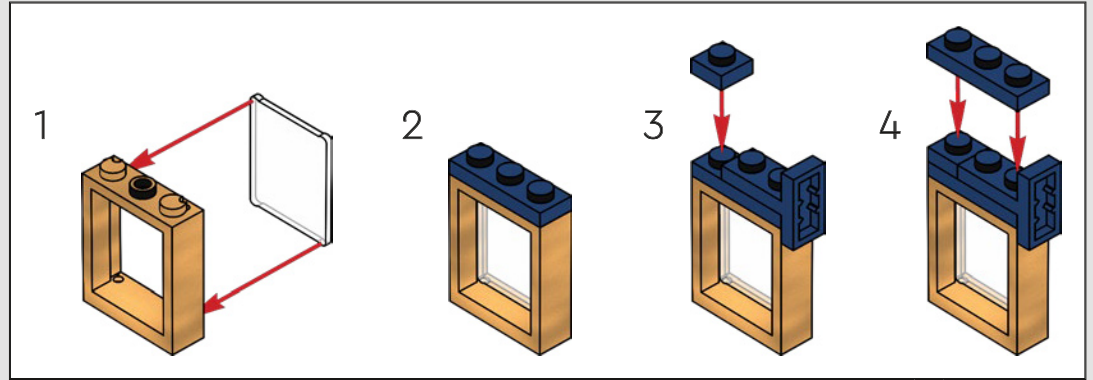

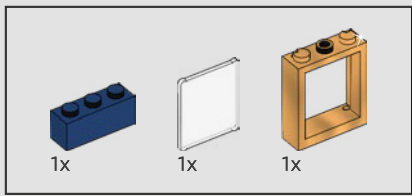

80

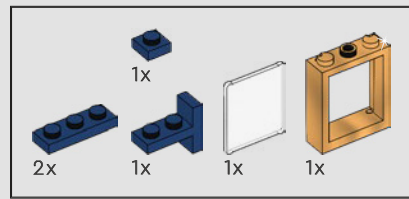
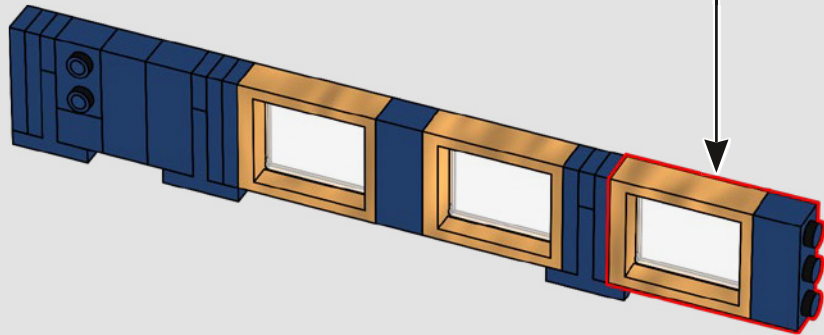
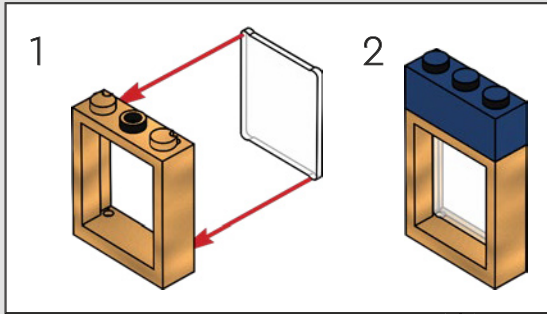

81

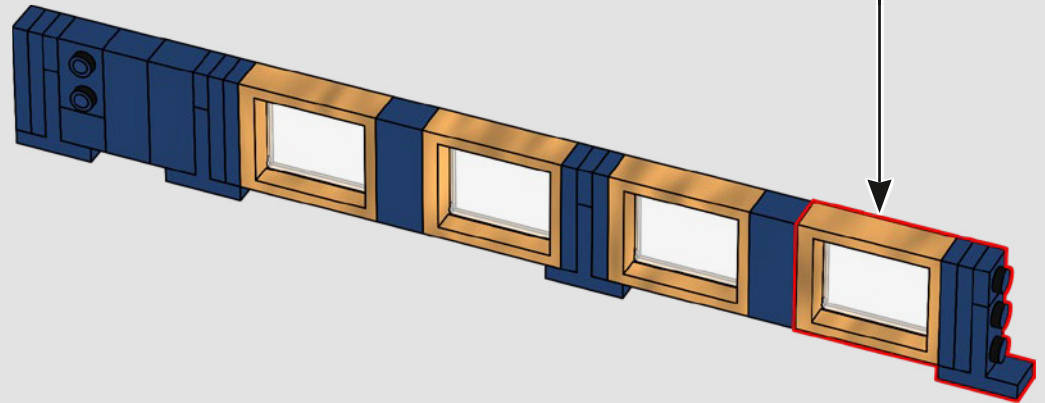
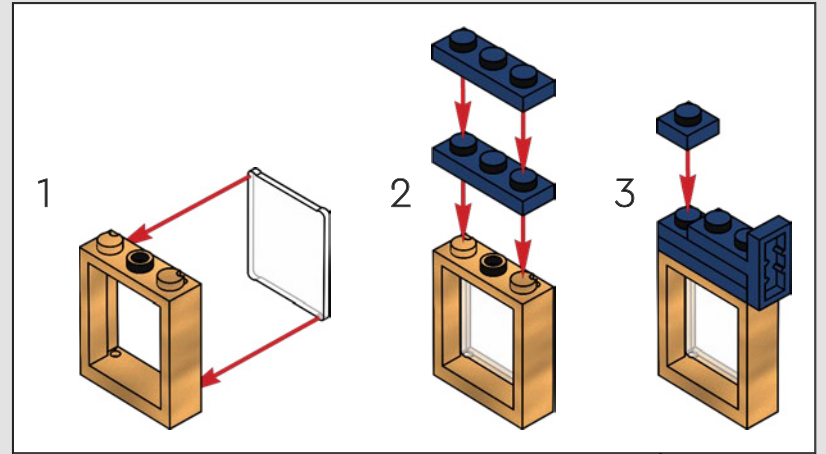

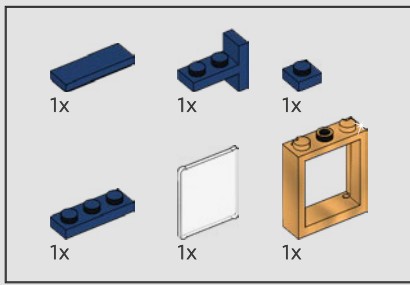

82

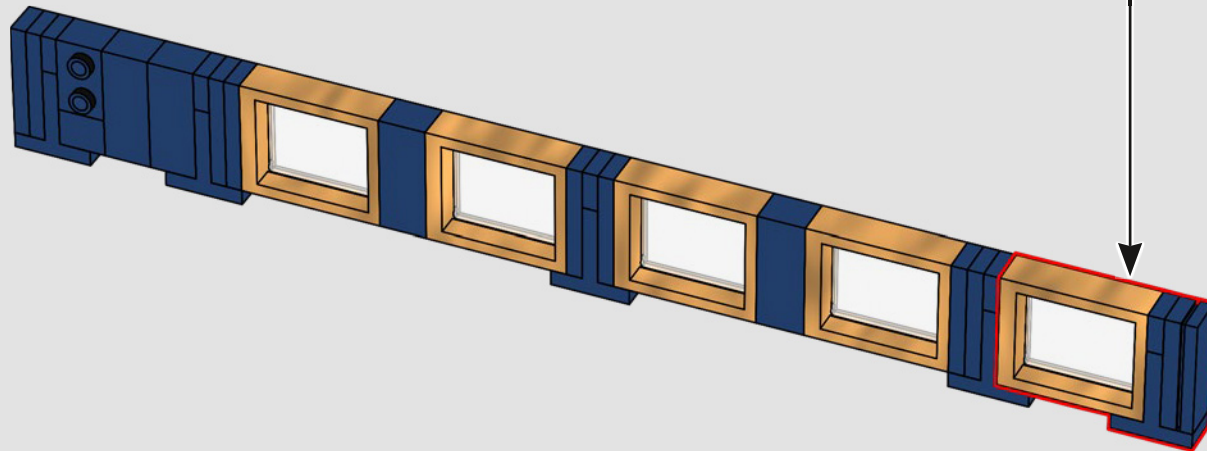
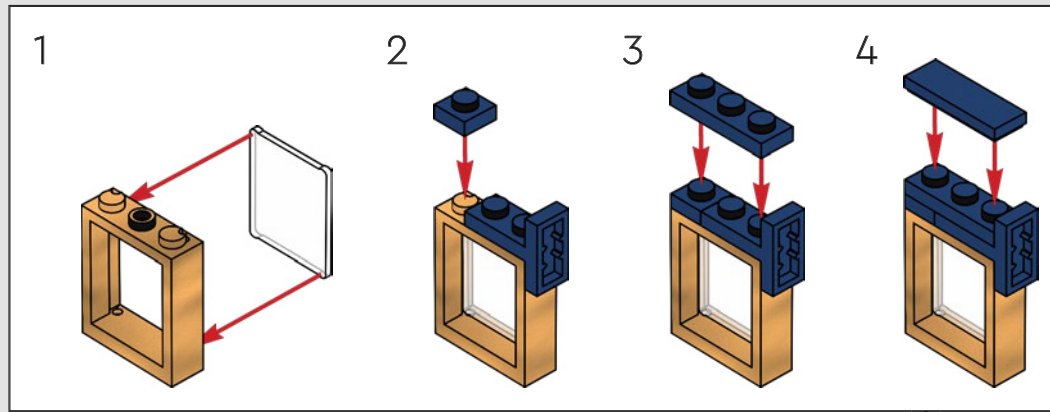

83

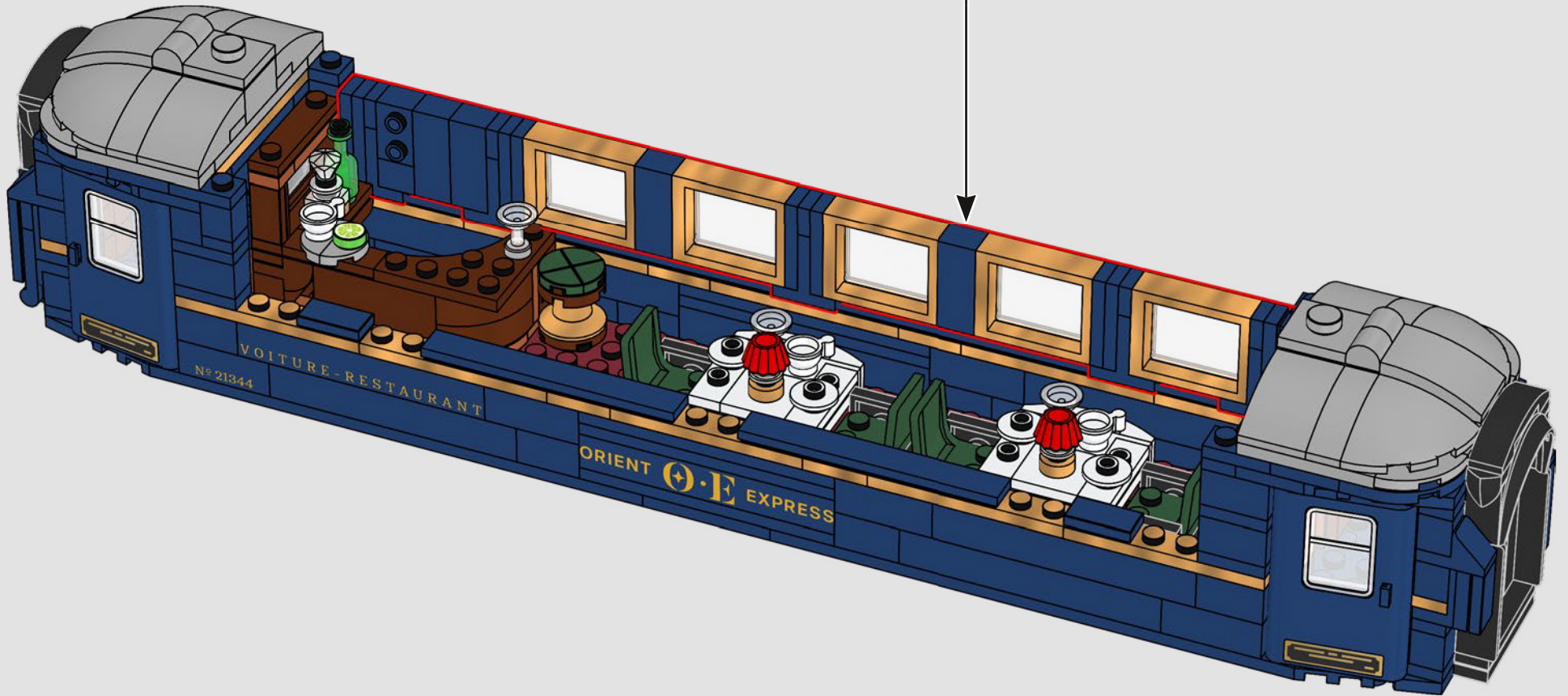

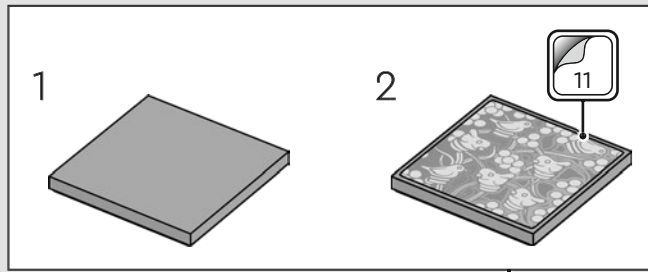
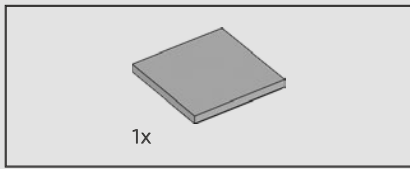

84

'Exquisite cut-glass mirrors adorn the interior of this carriage.'

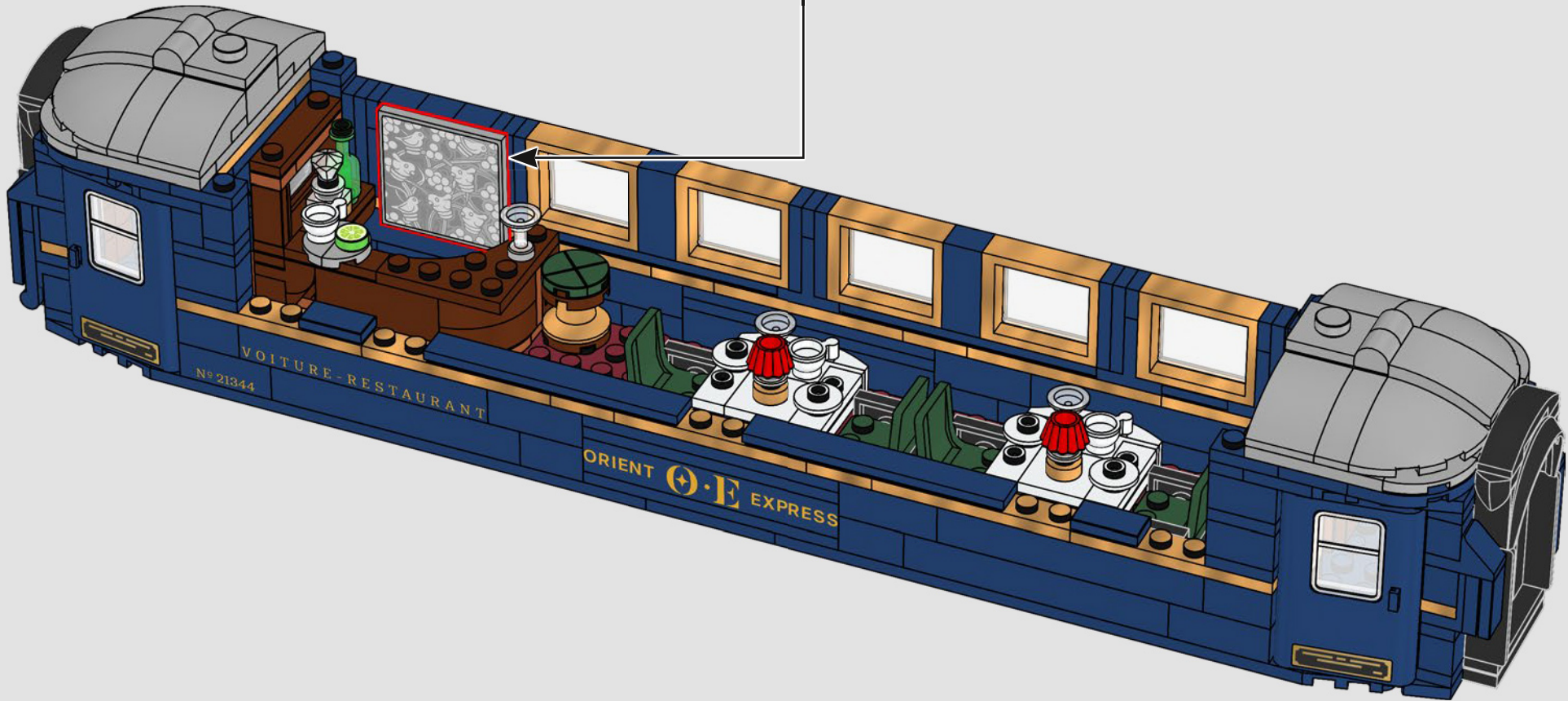

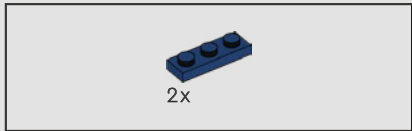
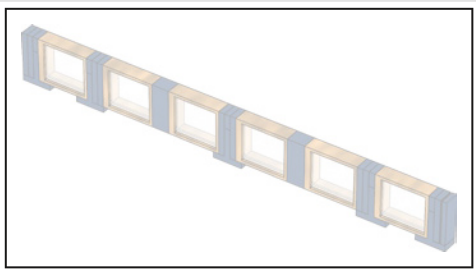

85

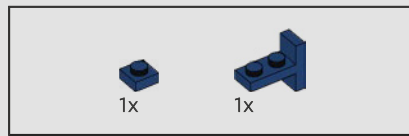
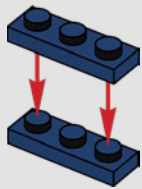

86

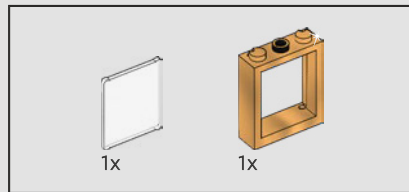
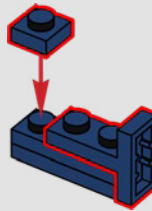

87

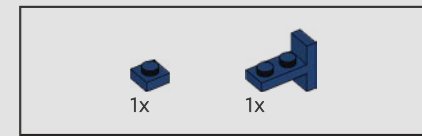
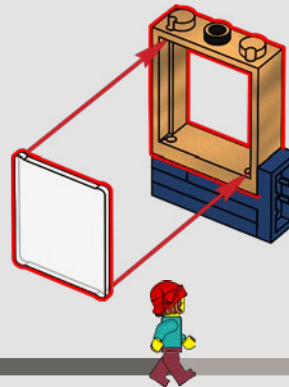

88

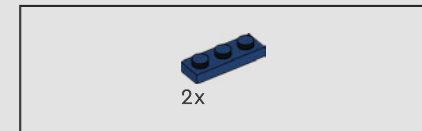
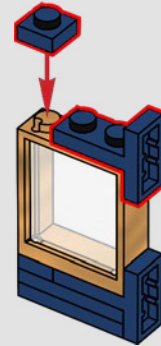

89

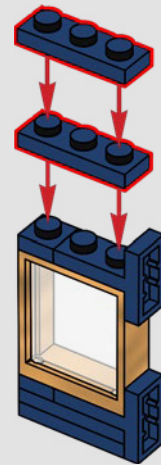

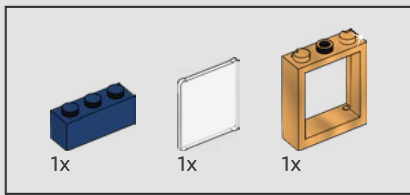

90

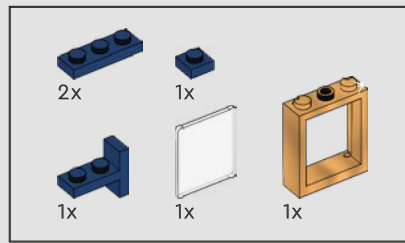
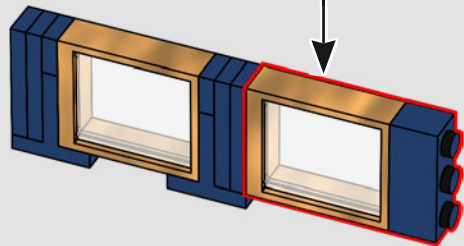
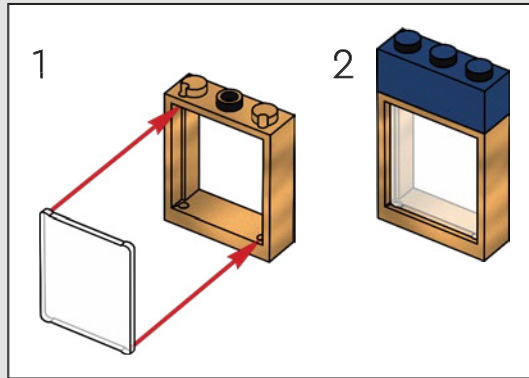

91

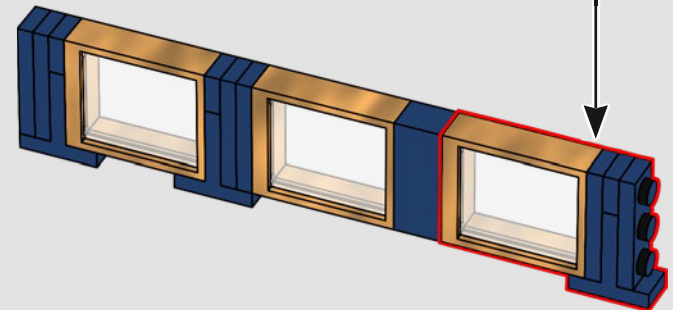
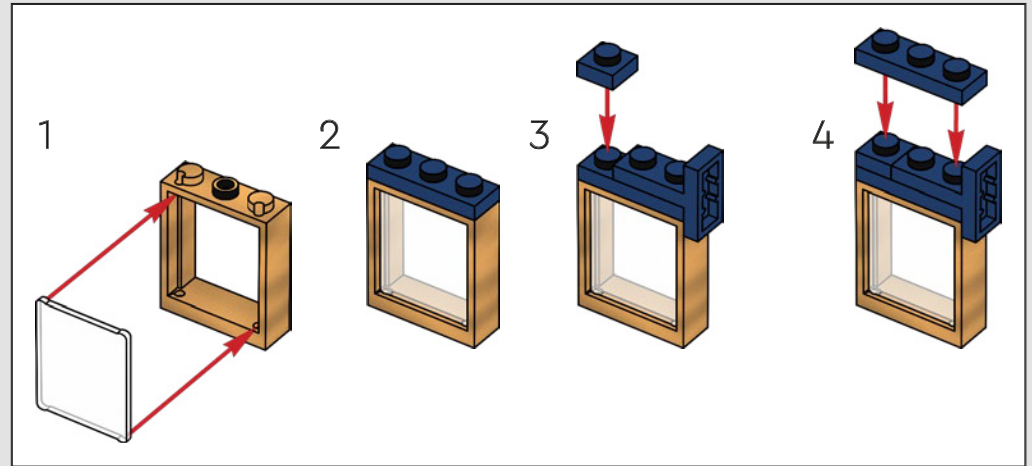

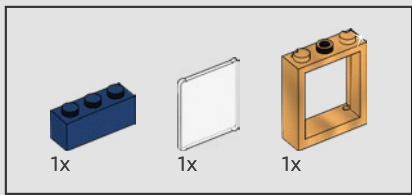

92

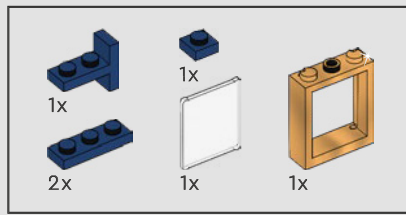
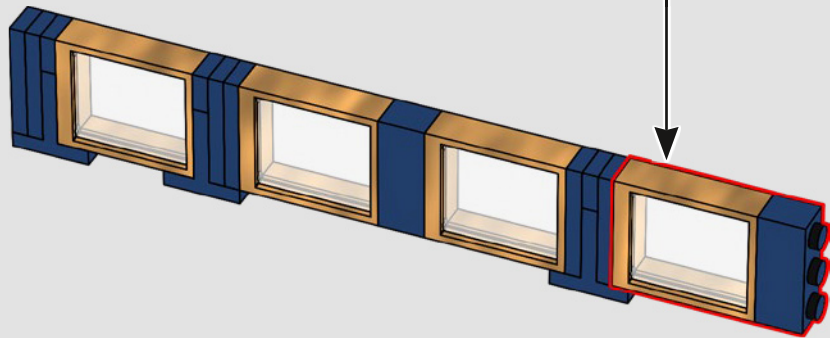
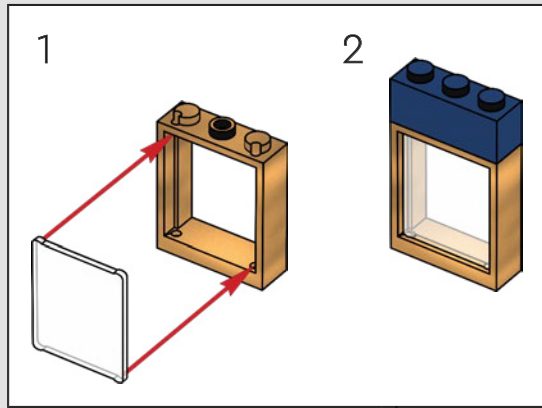

93

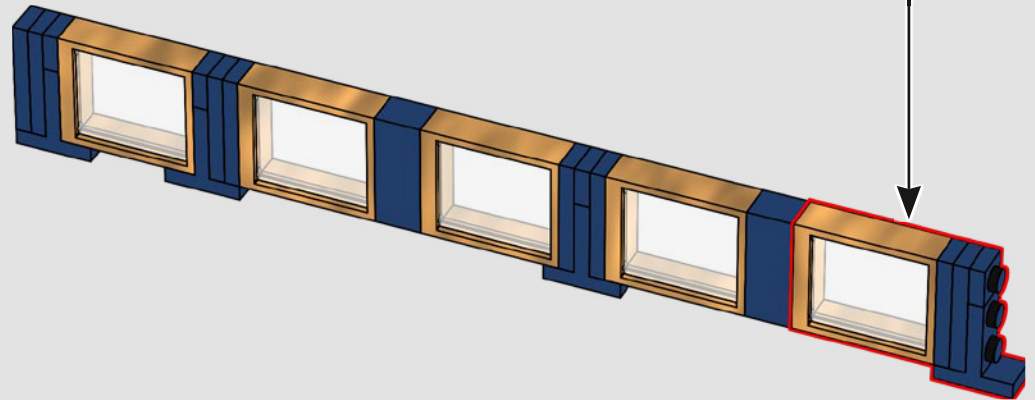
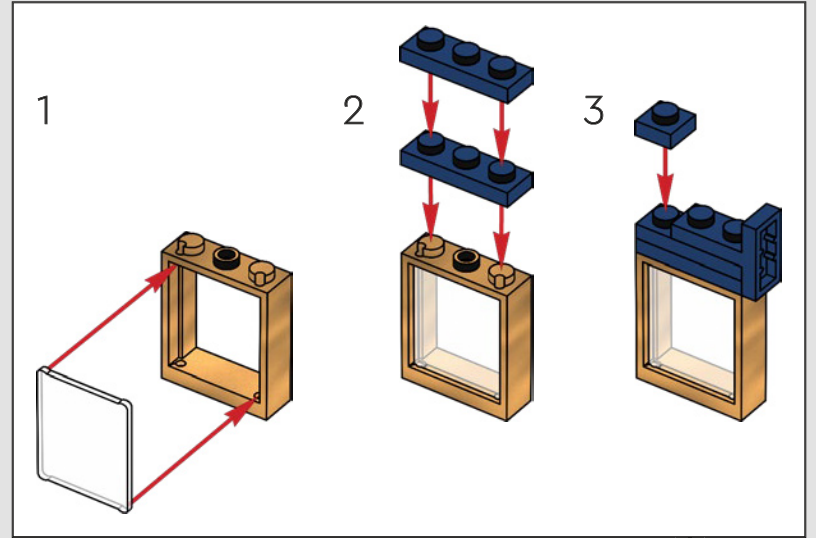

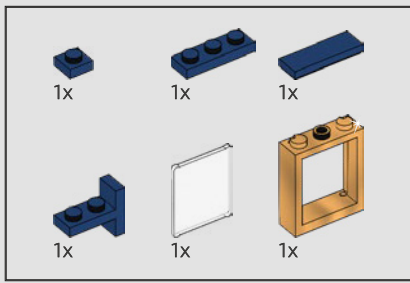

94

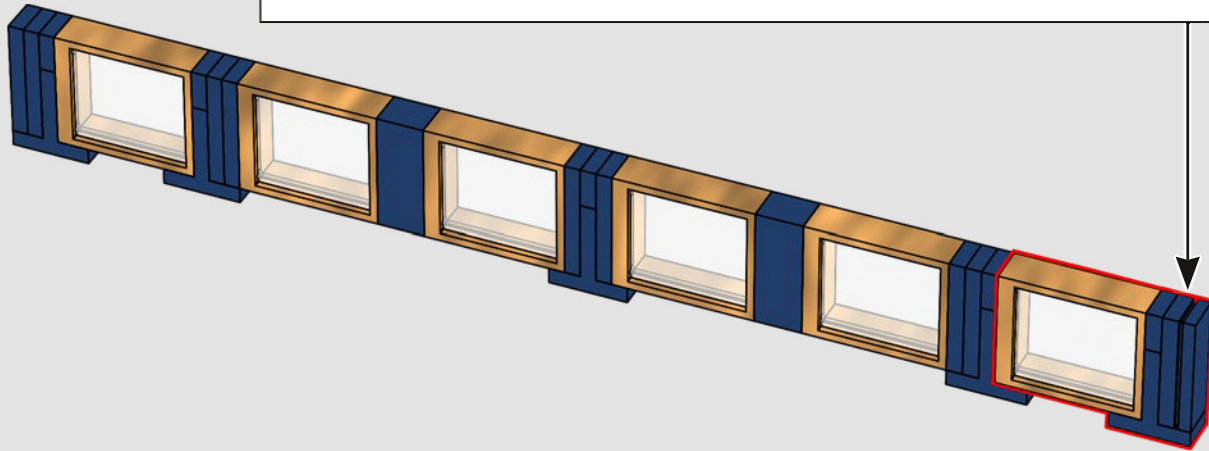
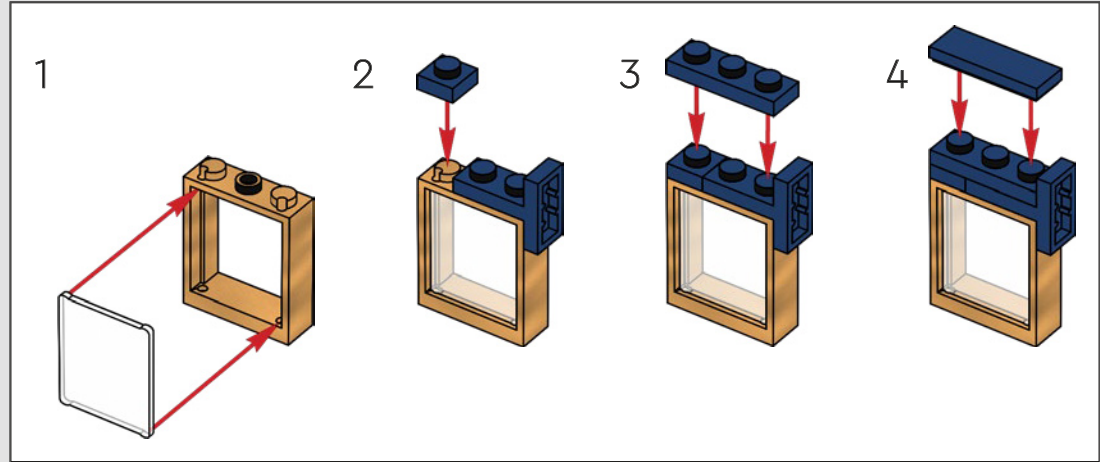



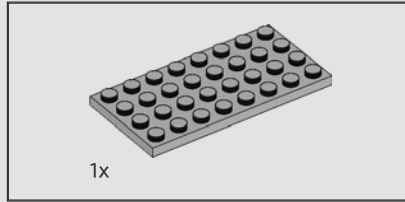
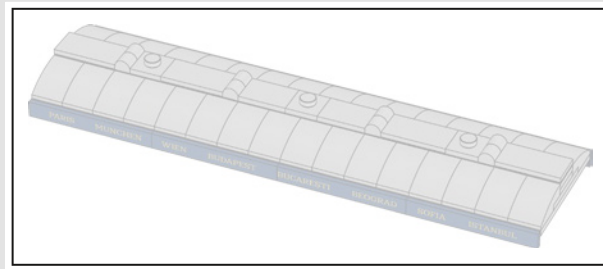

96

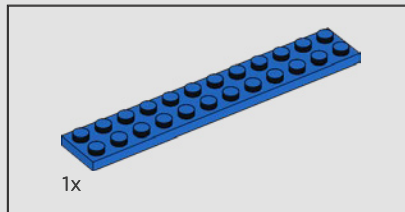
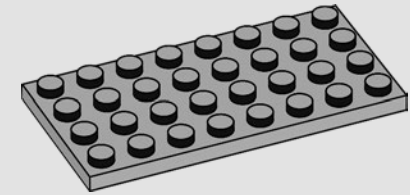

97

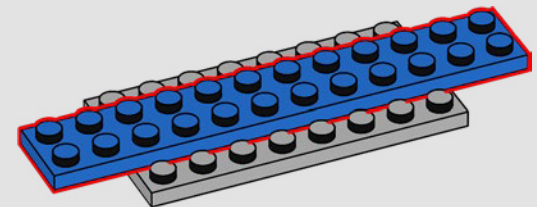

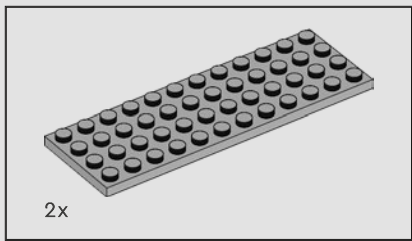

98

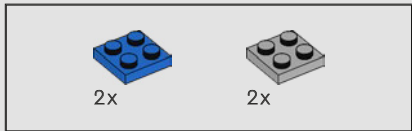
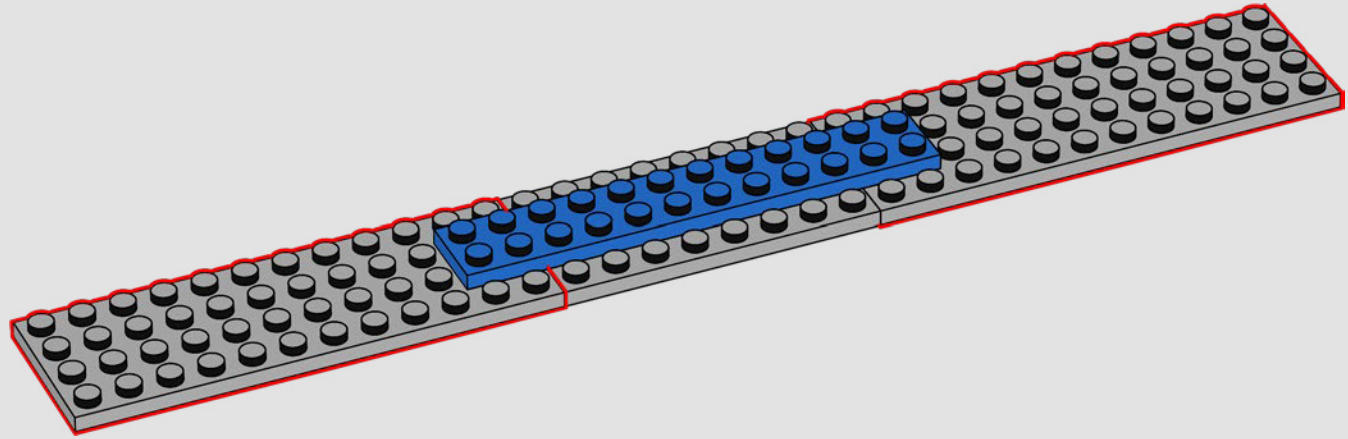

99

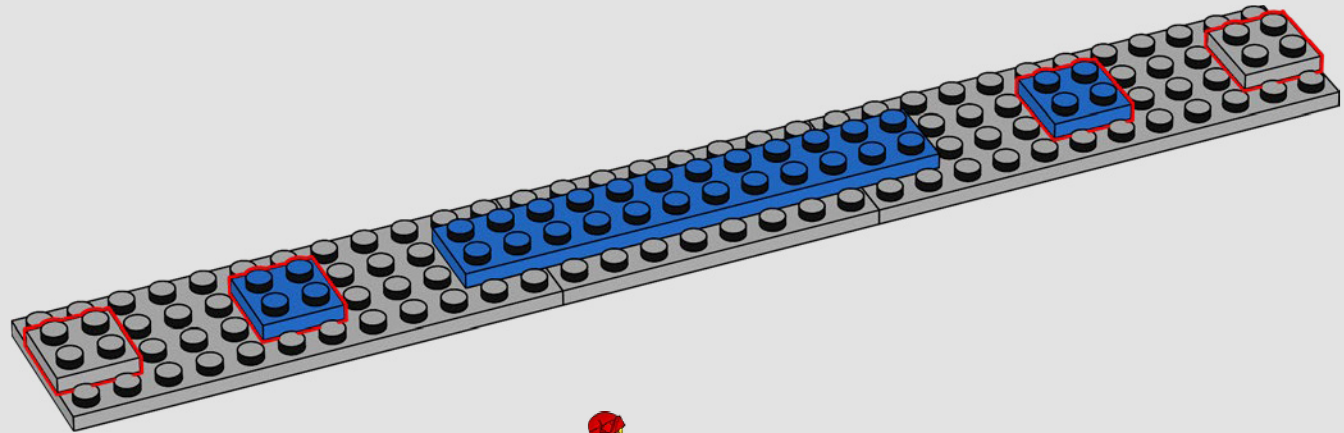

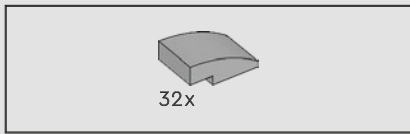

100

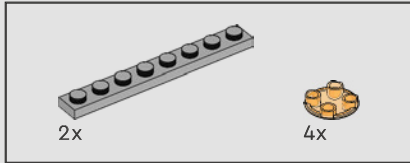
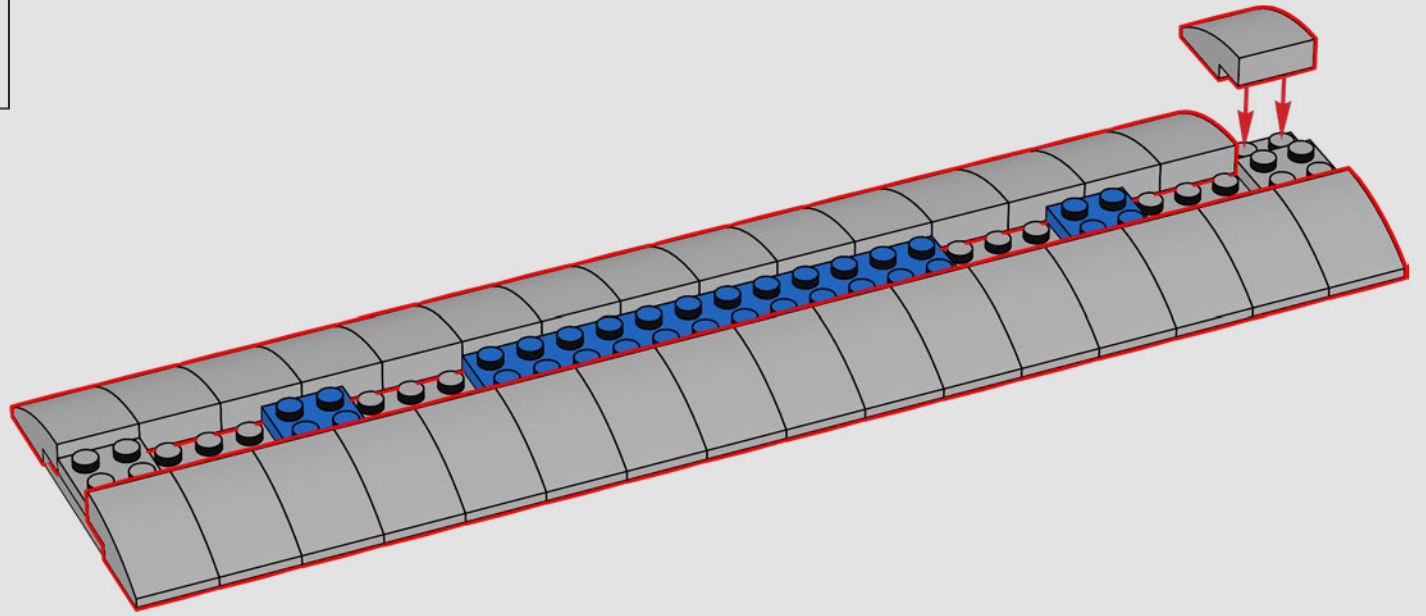

101

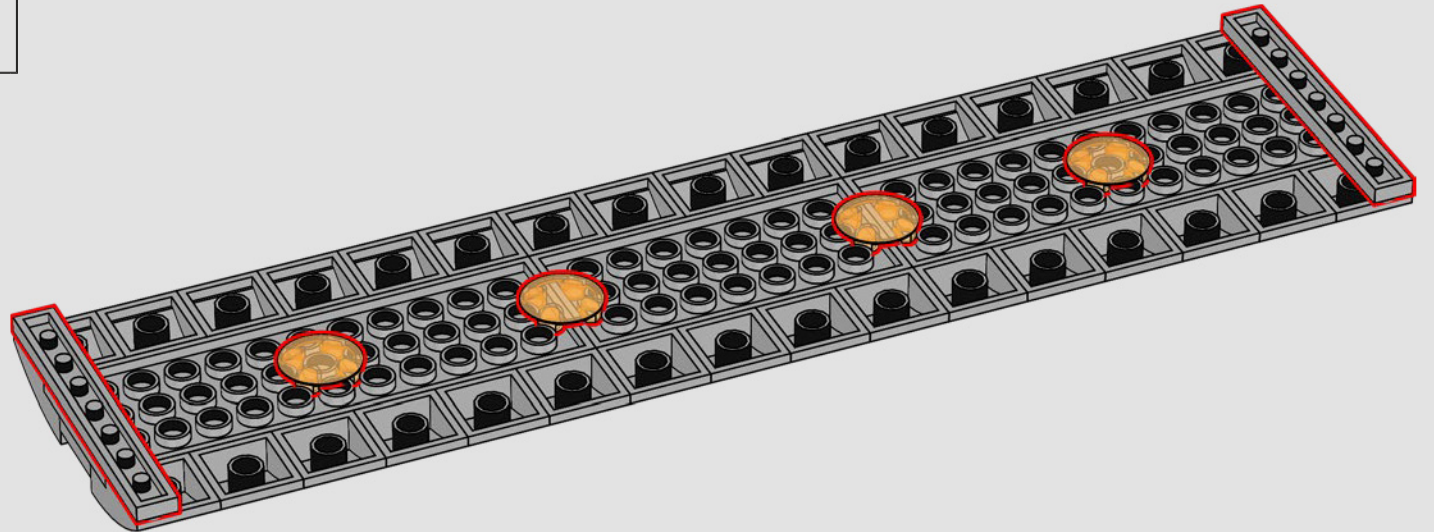

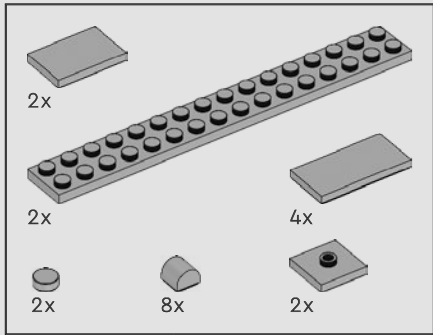
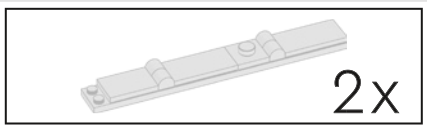

102

1

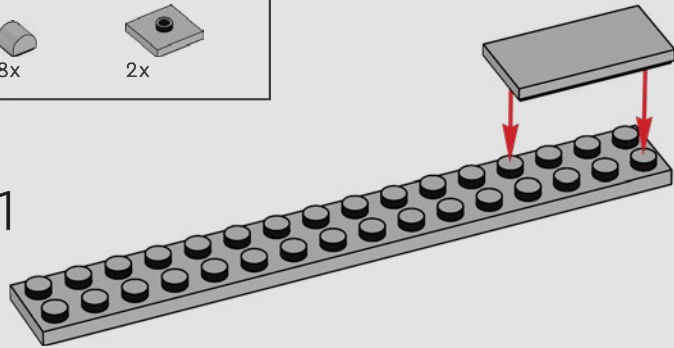

2

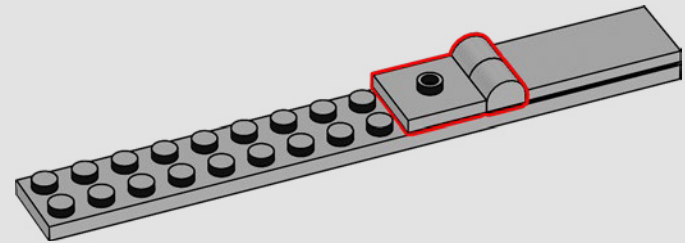

3

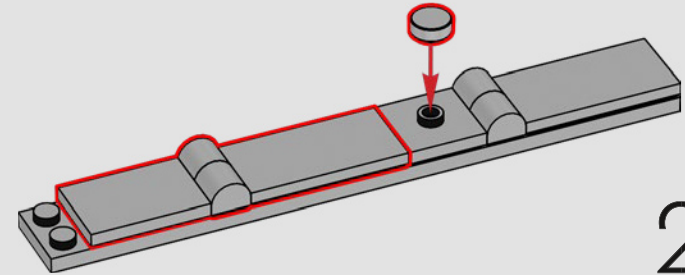

2x

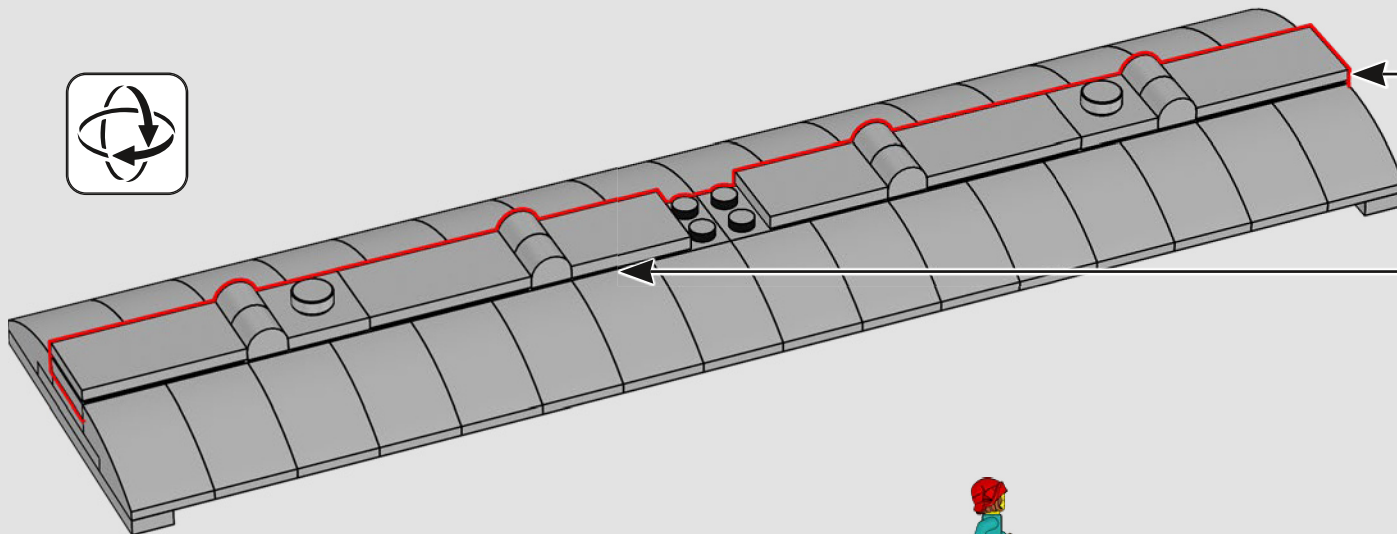

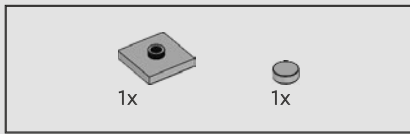

103

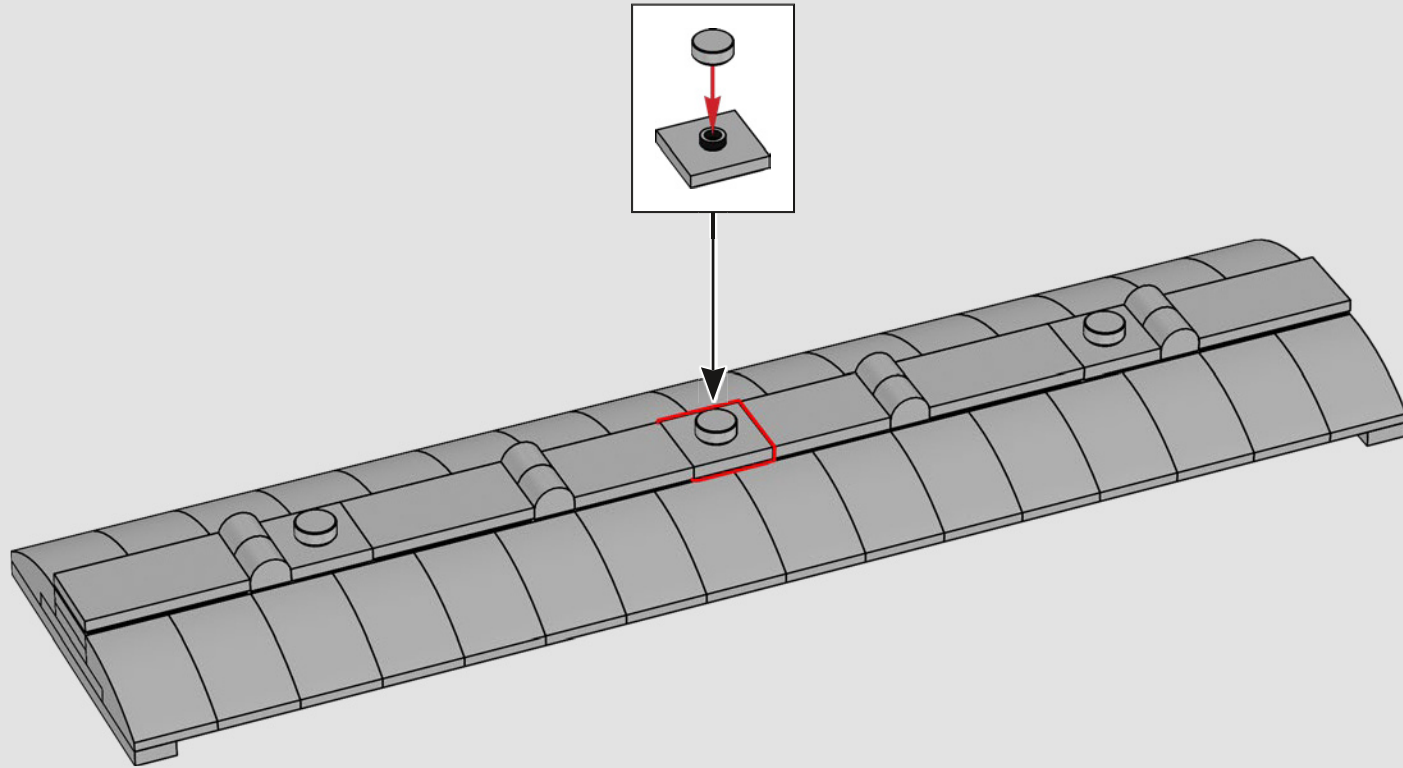

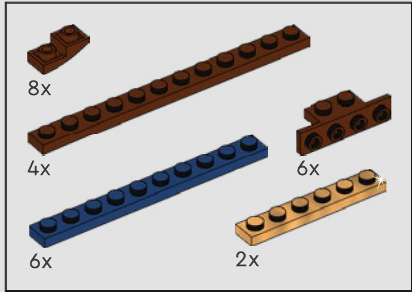
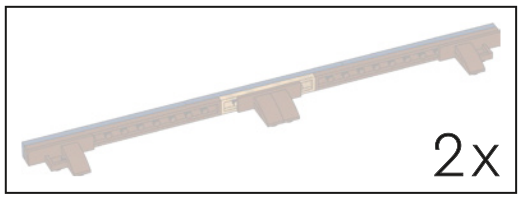

104

1

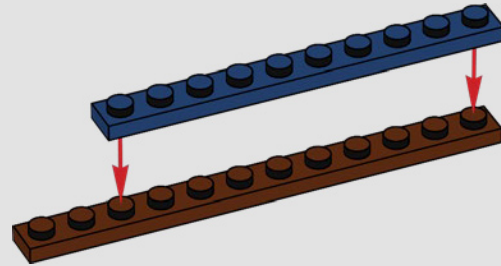

2

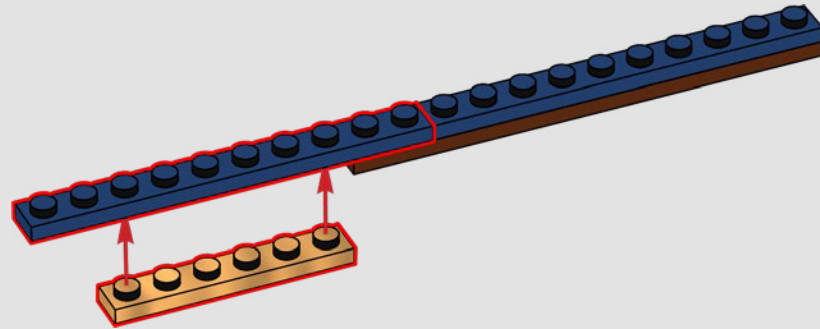

3

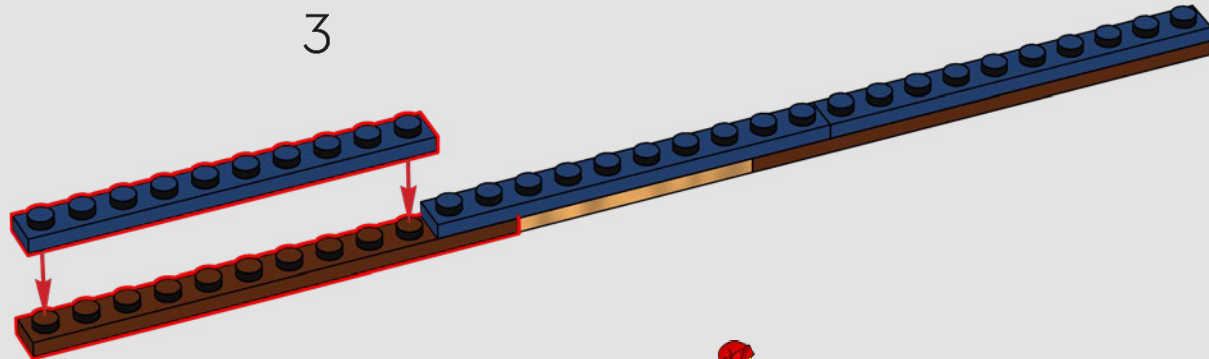

4

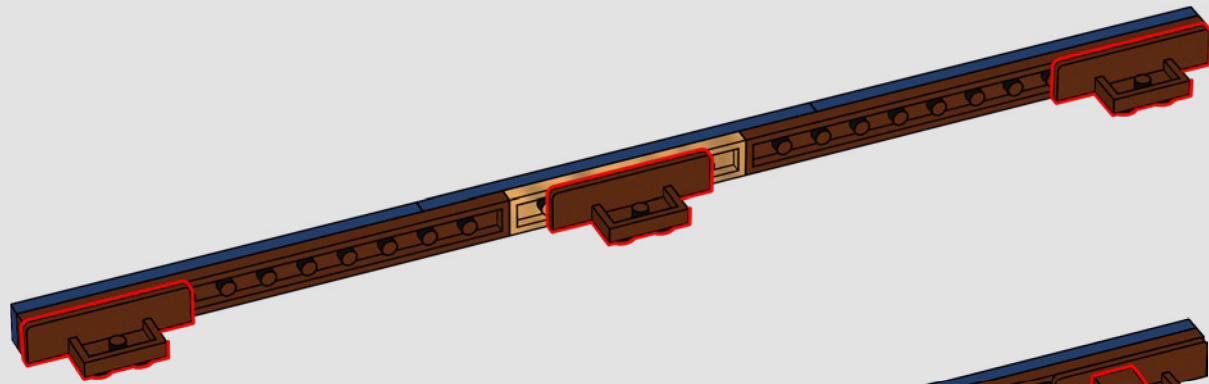

5

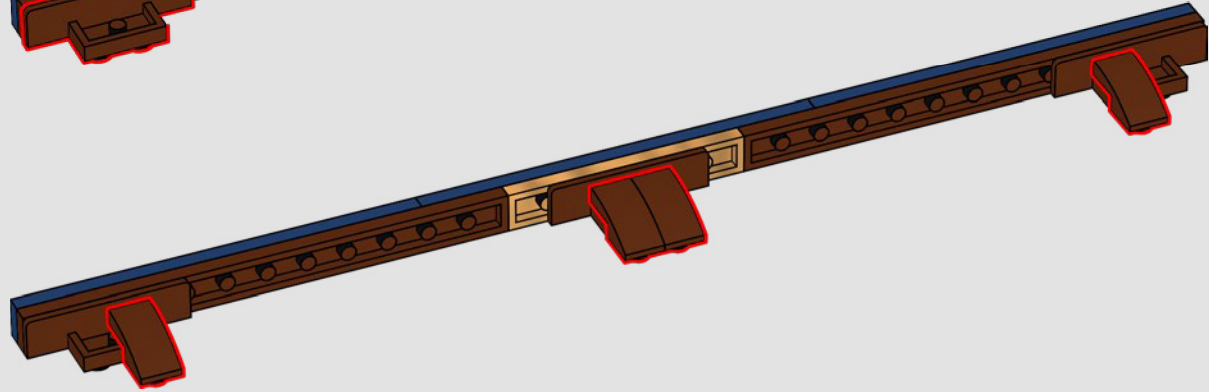

2x

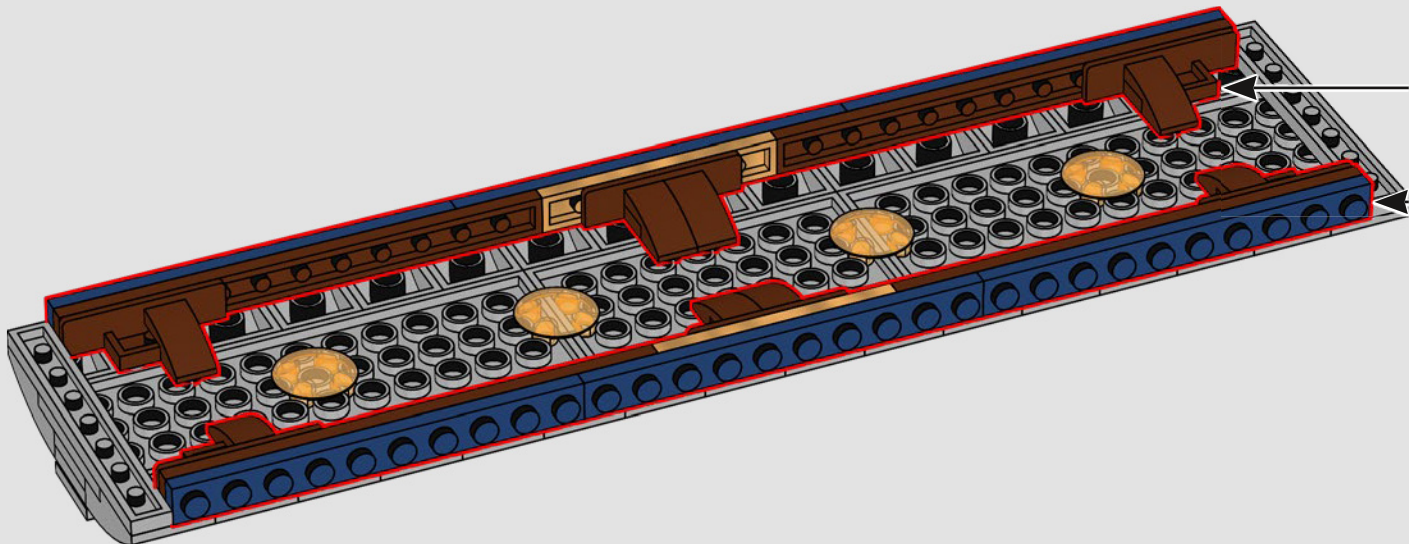

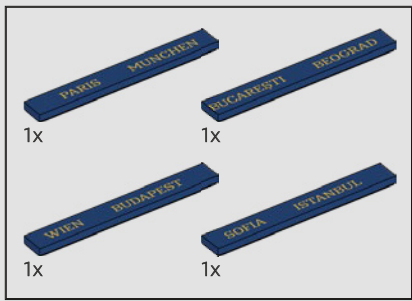

105

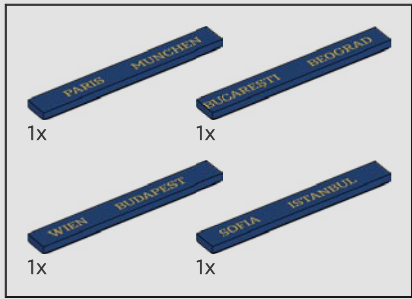
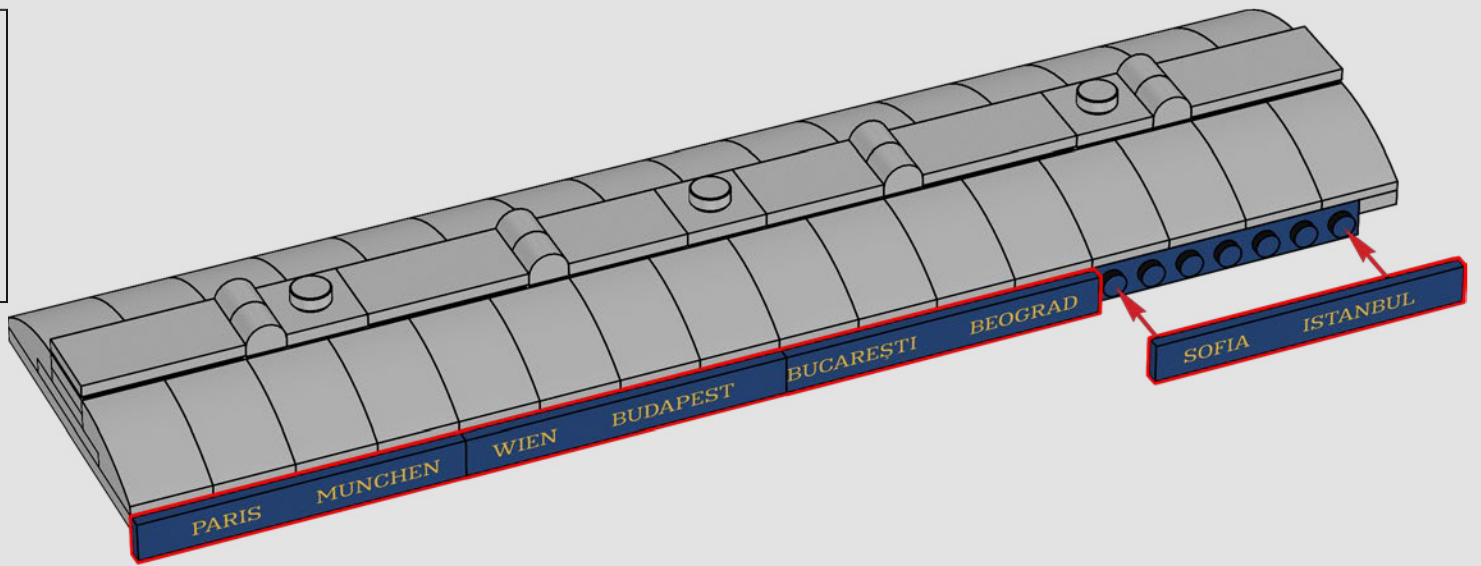

106

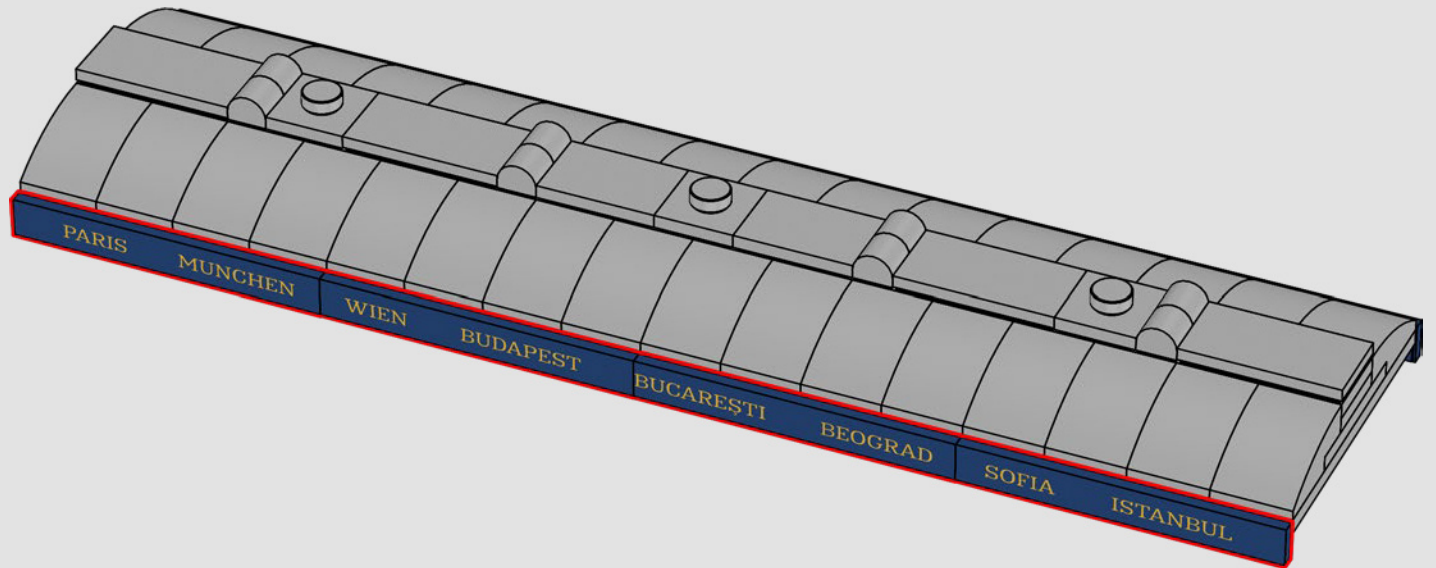

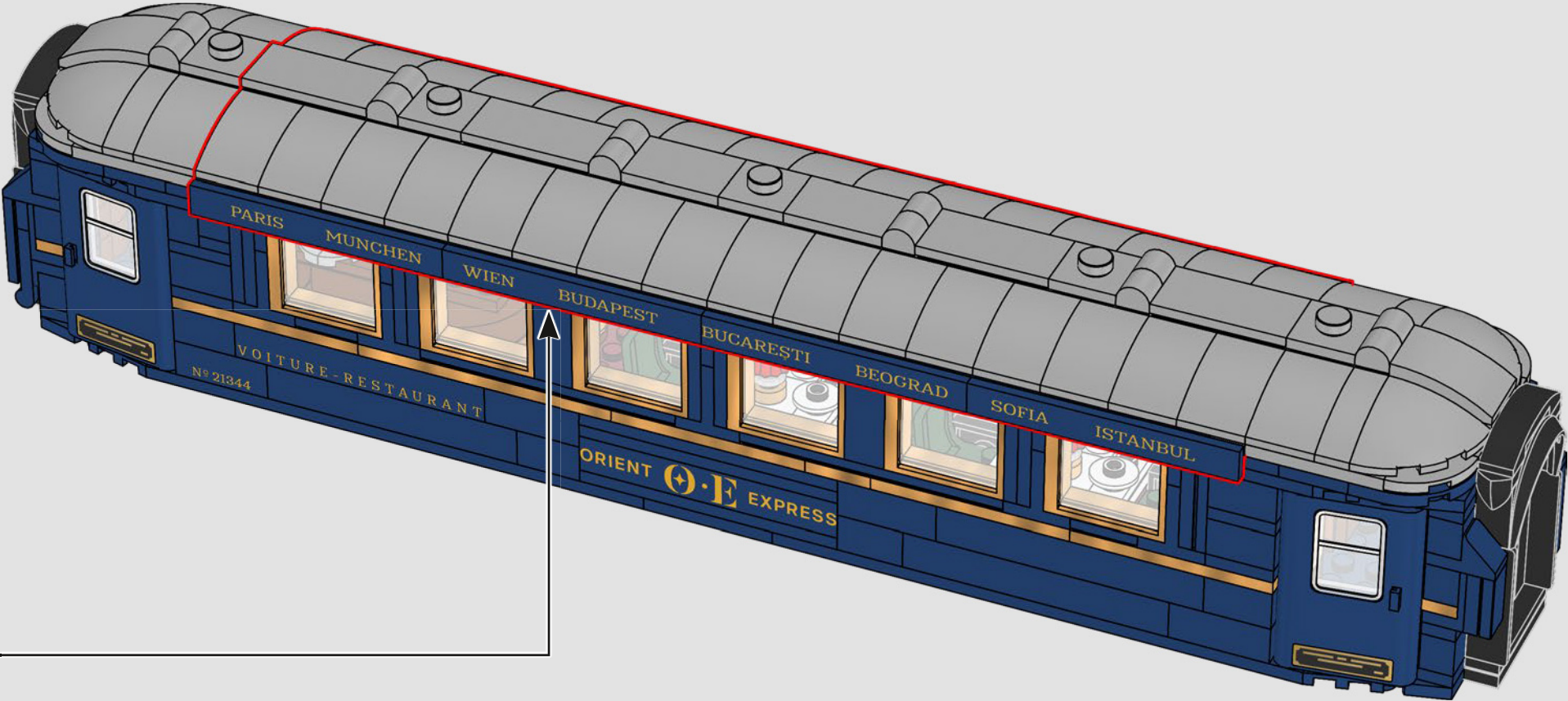

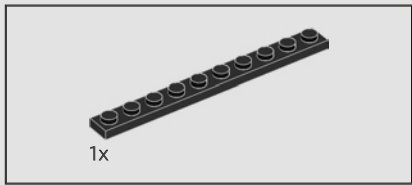
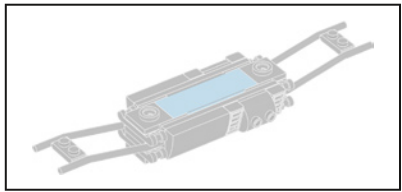

108

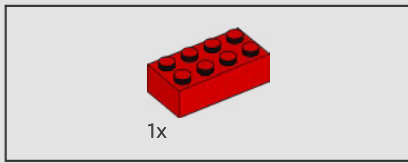
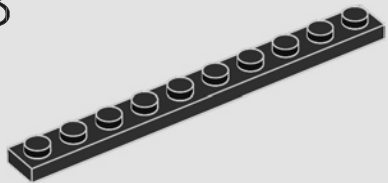

109

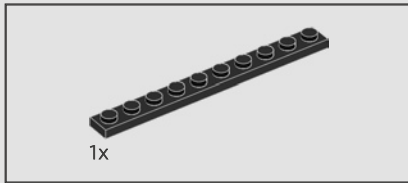
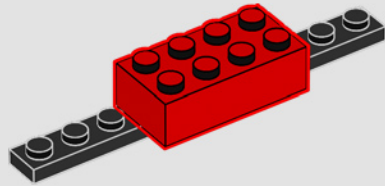

110

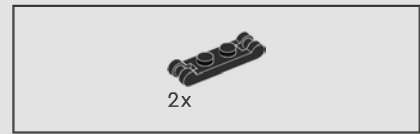
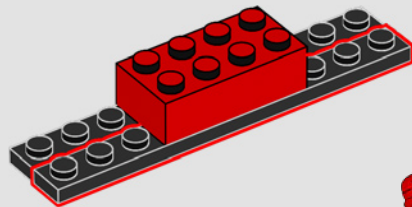

111

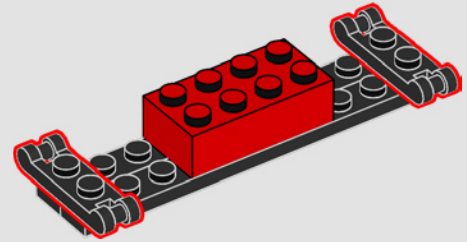

112

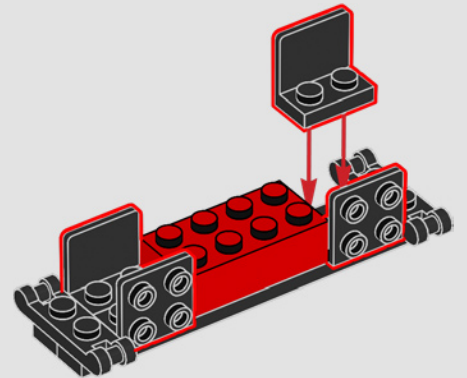

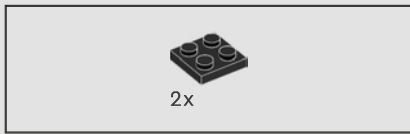

113

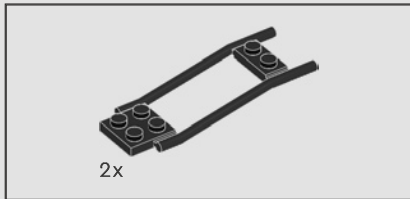
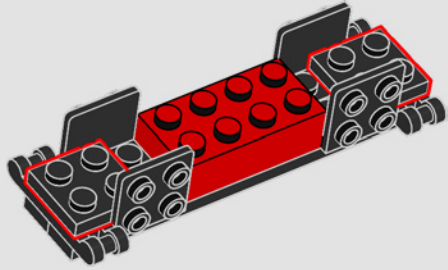

114

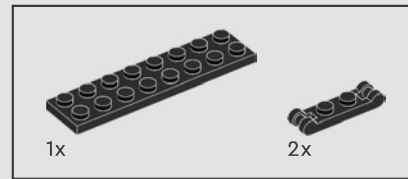
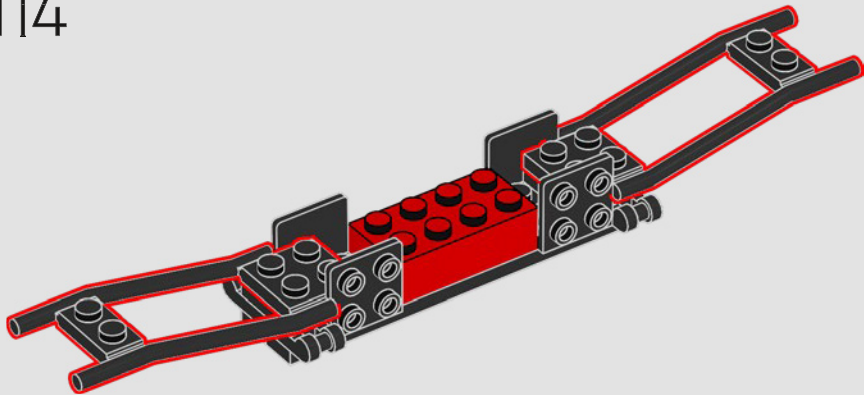

115

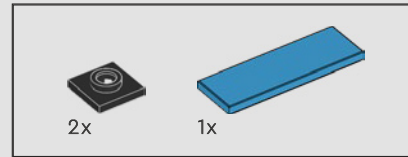
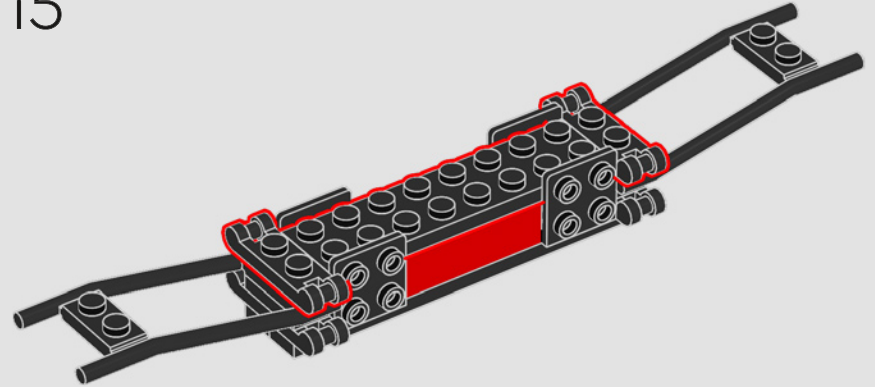

116

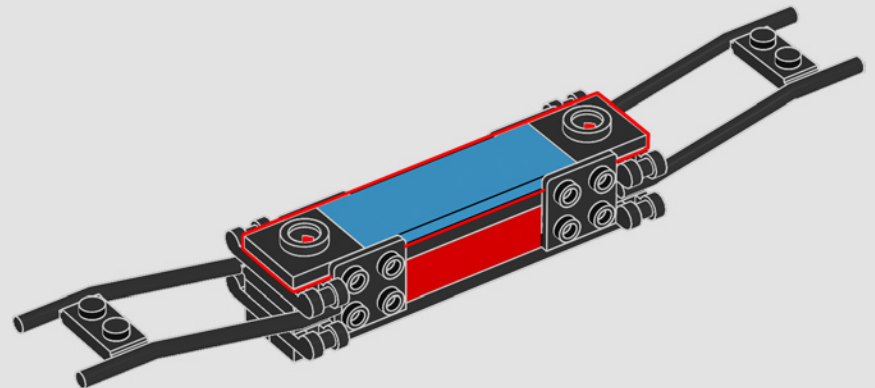

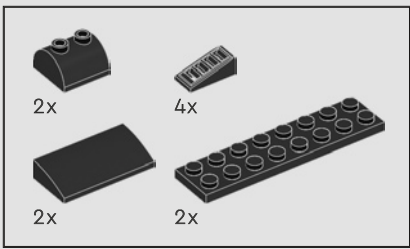

117

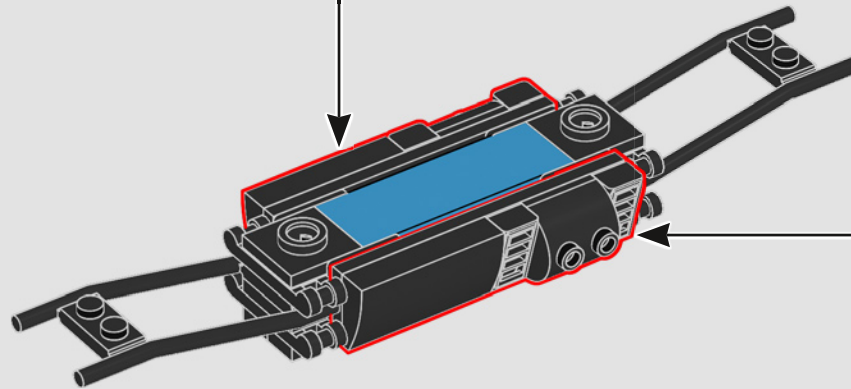
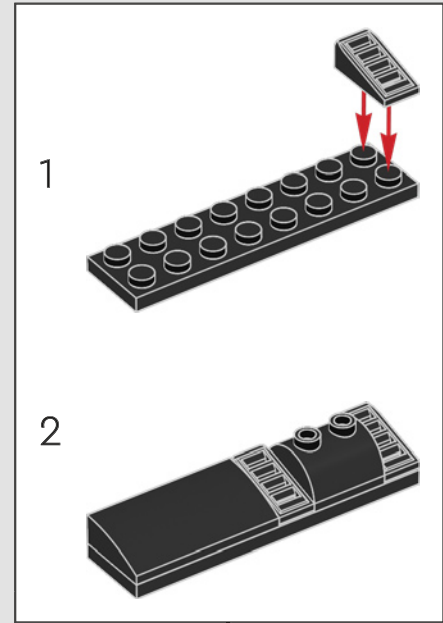
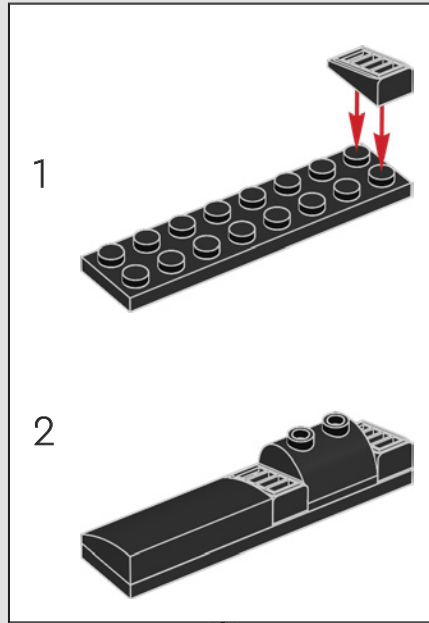

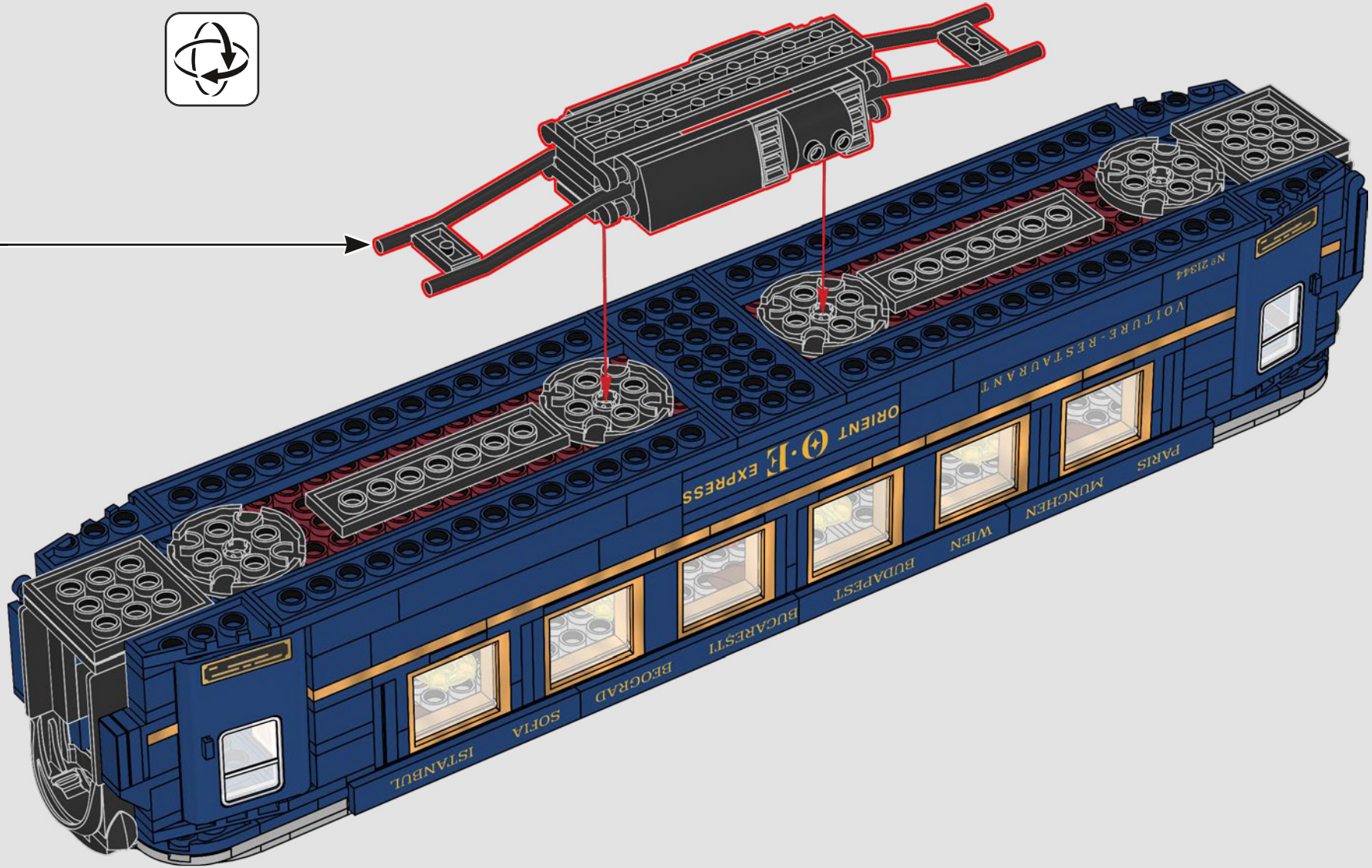

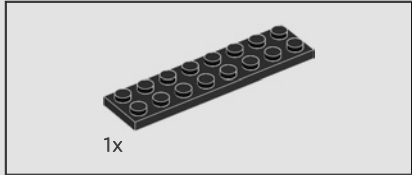
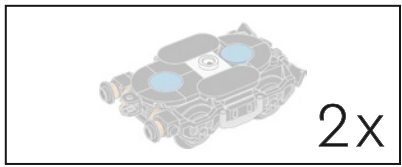

119

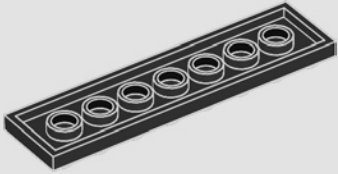

120

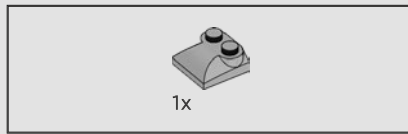
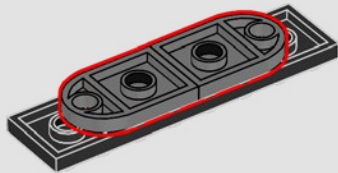

121

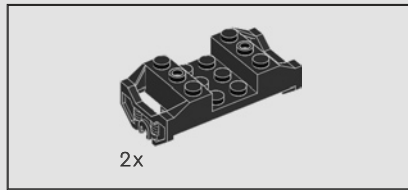
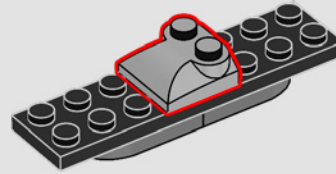

122

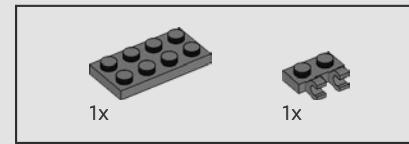
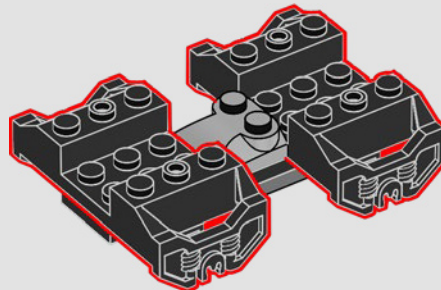

123

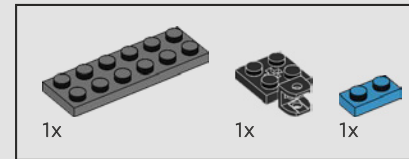
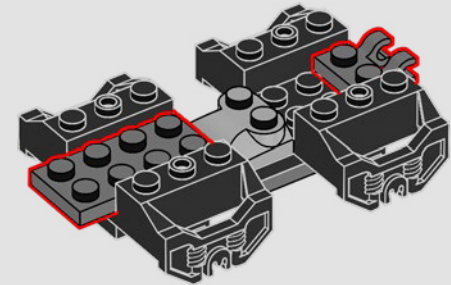

124

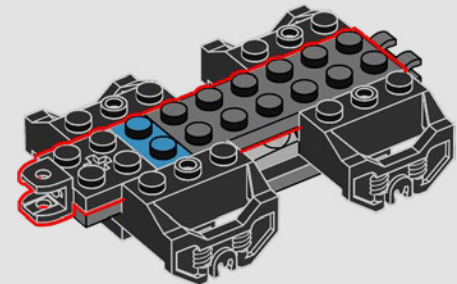

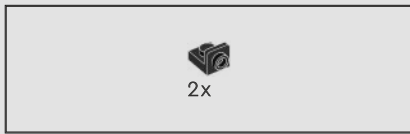

125

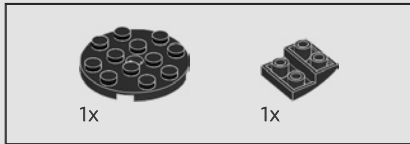
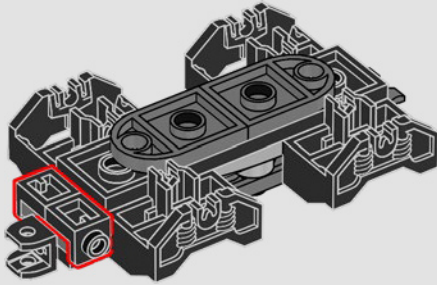

126

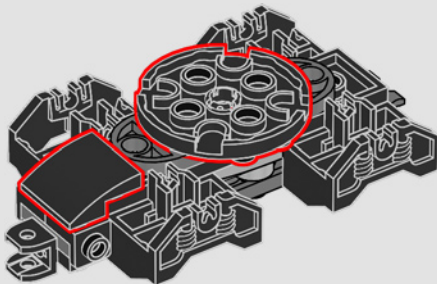

127

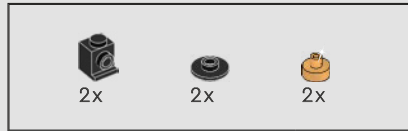
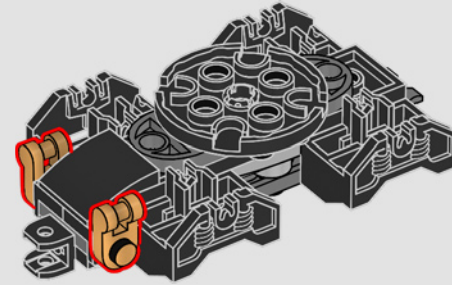

128

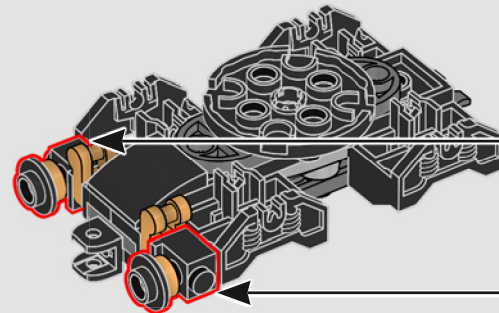
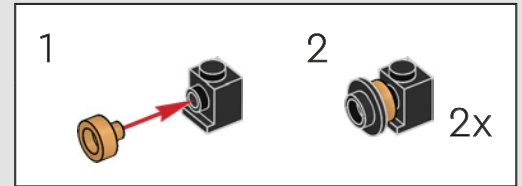

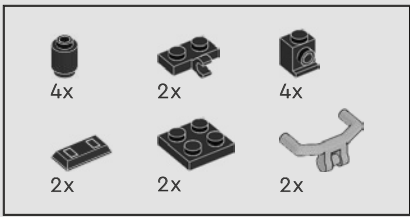

129

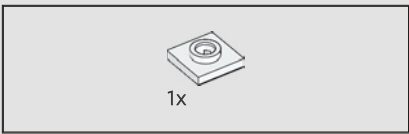
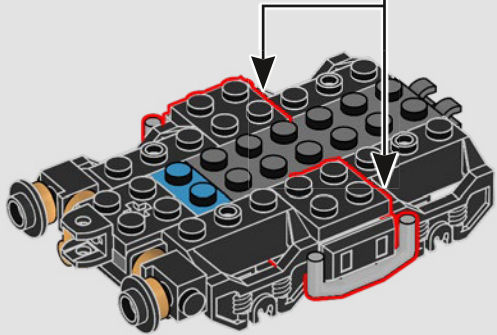
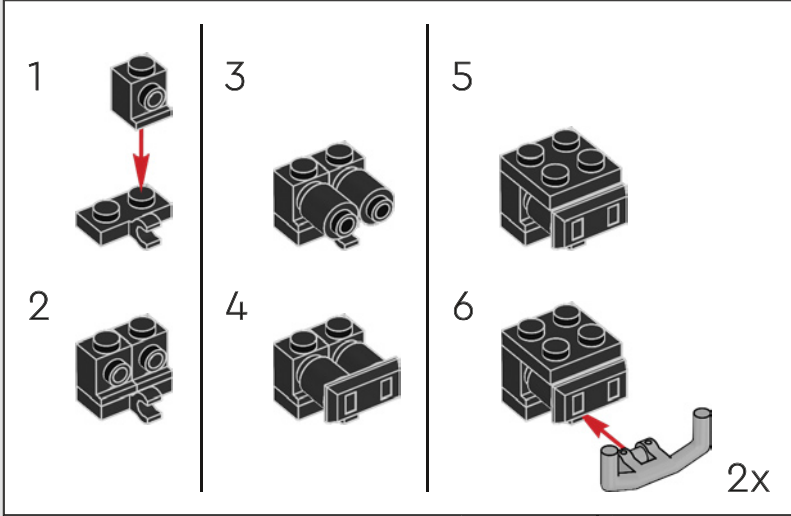

130

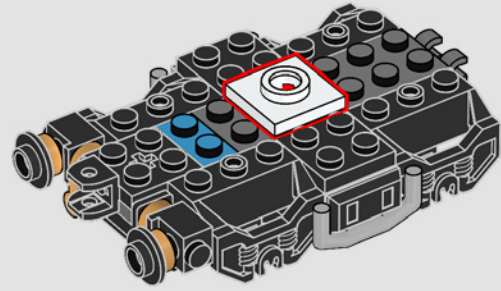

131

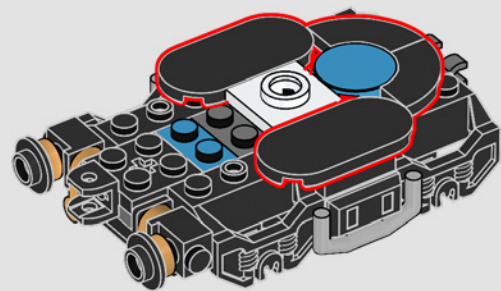



132

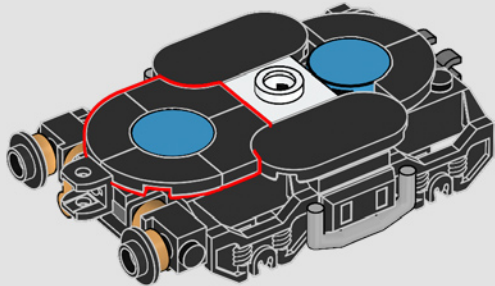

133

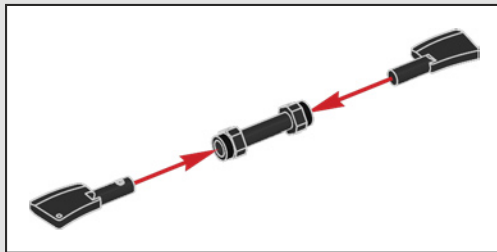
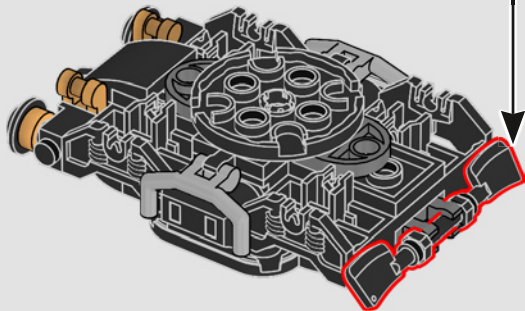

134

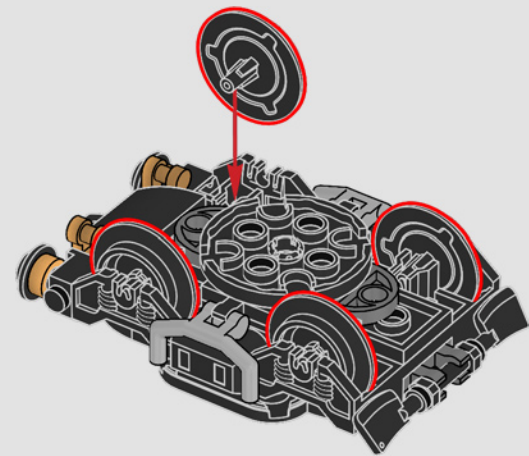

2x

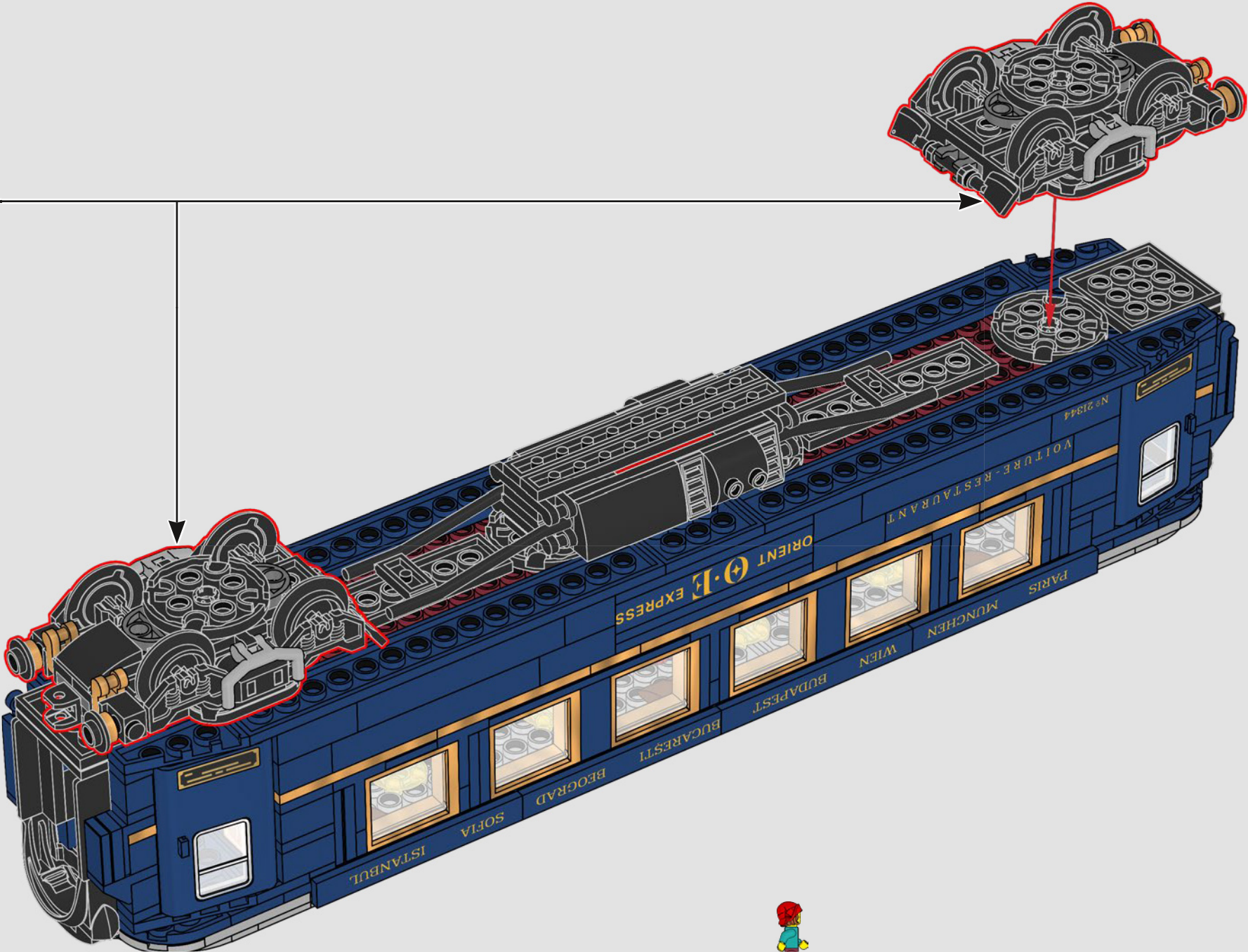



●
Next Stop: VIENNA
'After a wonderful evening of fine dining,
it was time to find the sleeper carriage.'

136

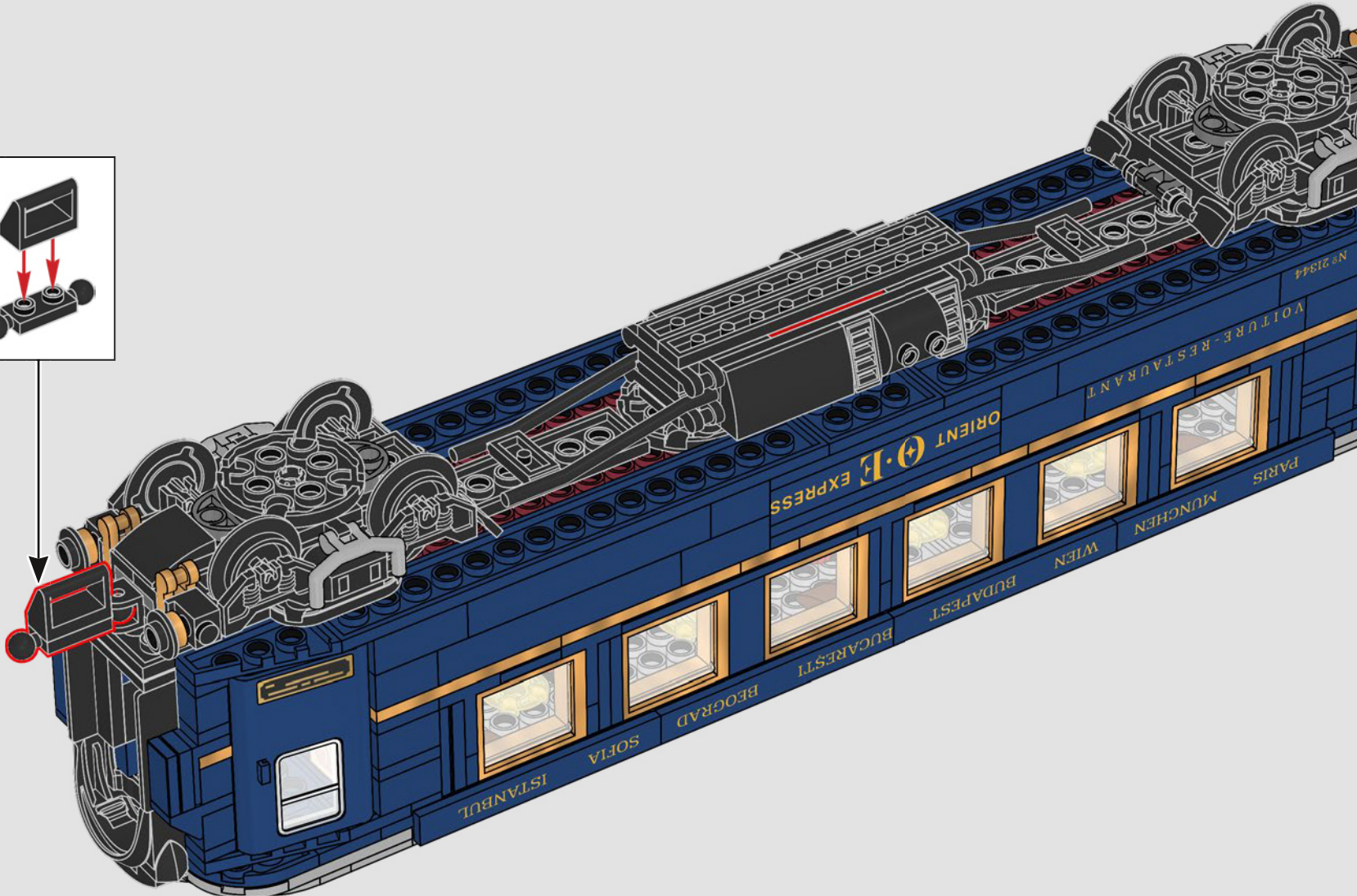
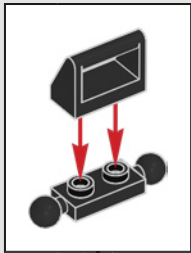

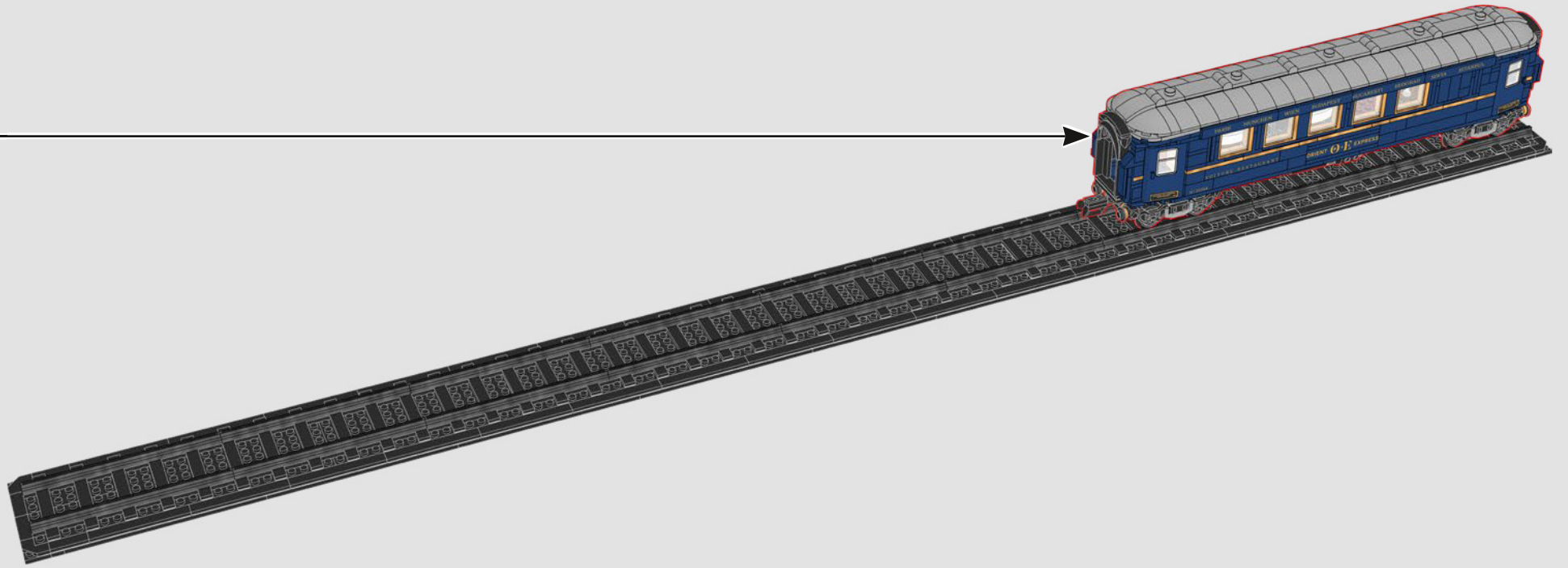

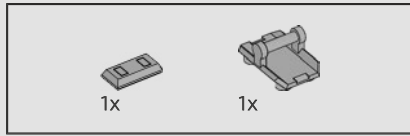
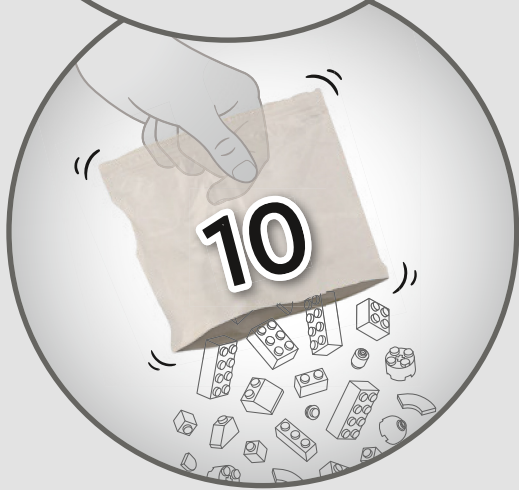
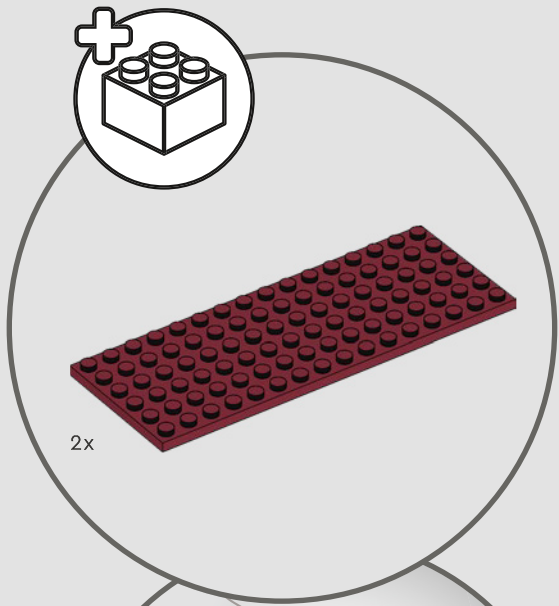

1

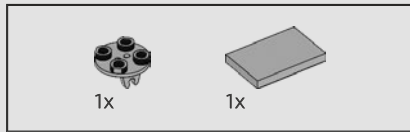
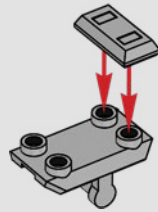

2

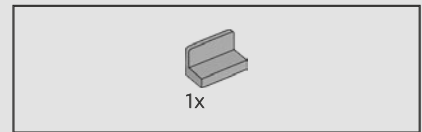
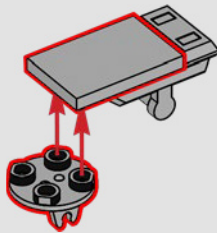

3

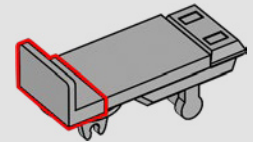

4

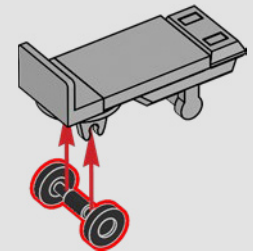

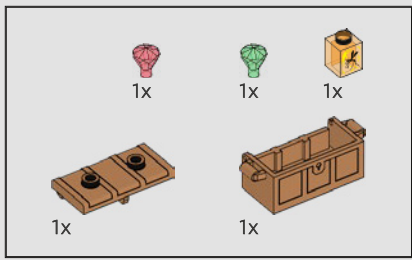

5

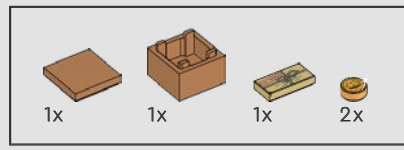
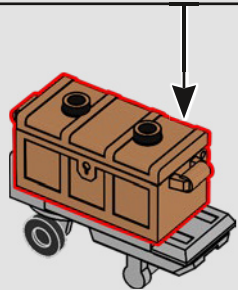
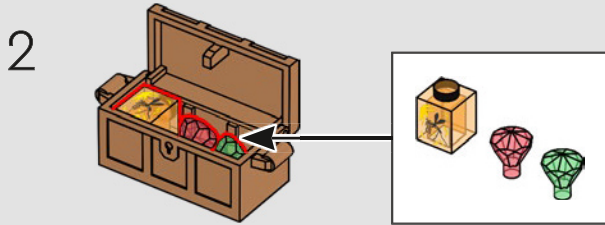
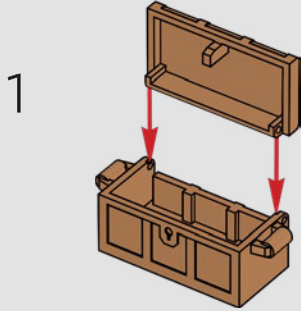

6

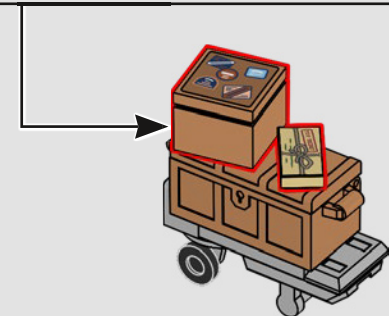
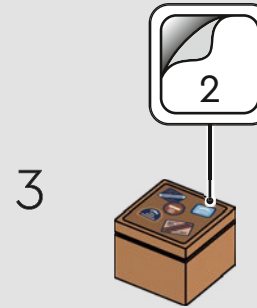
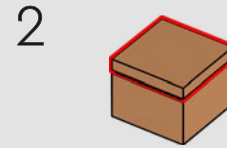
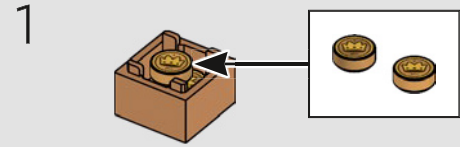

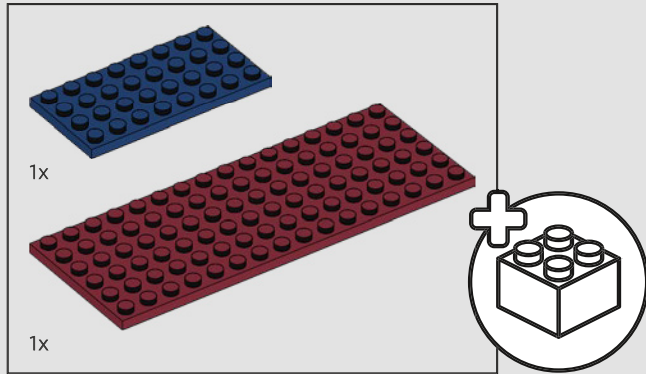
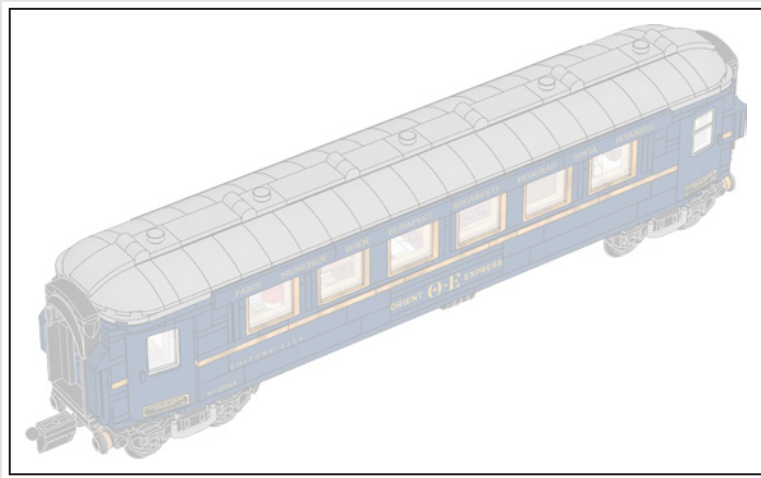

138

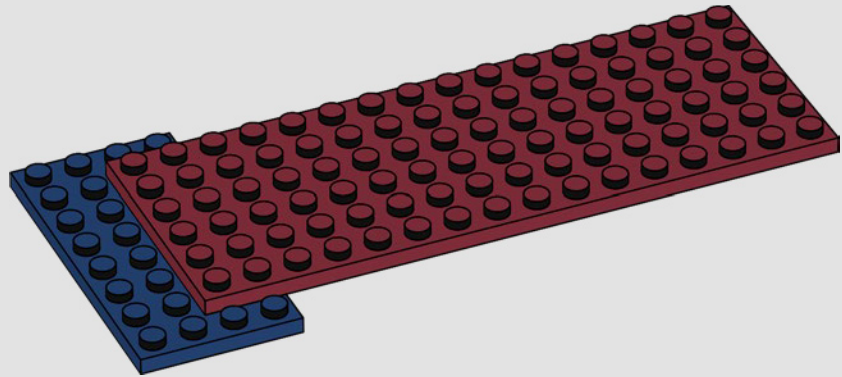

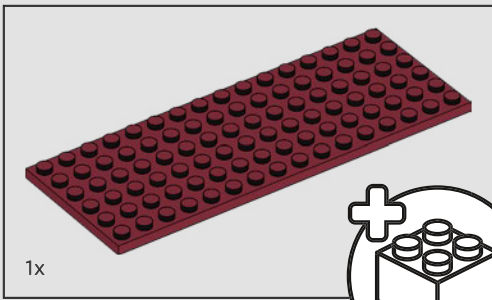

1x

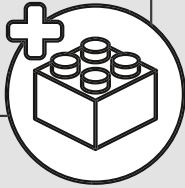

139

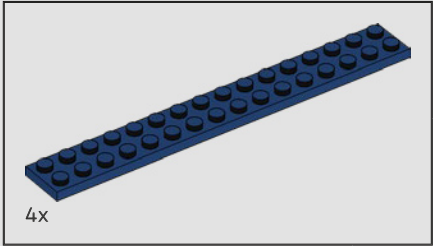
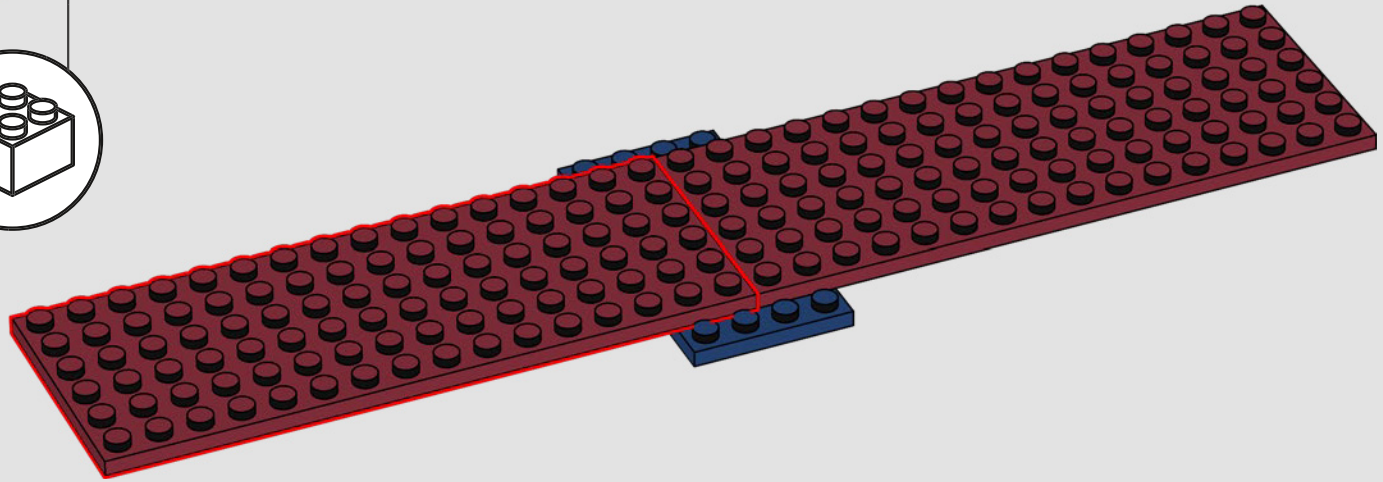

4x

140

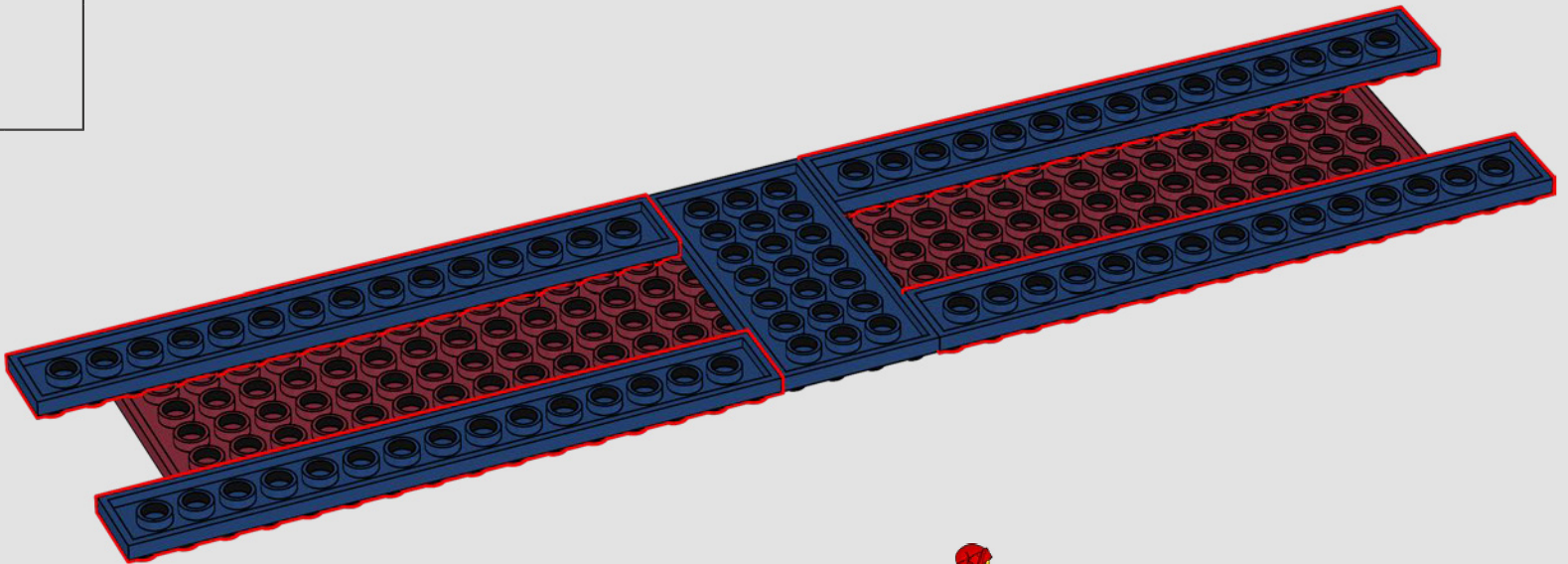

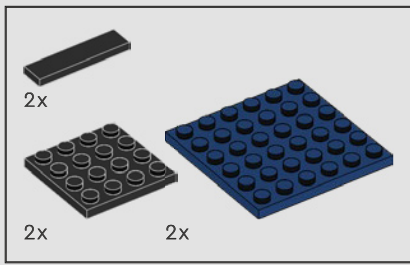

141

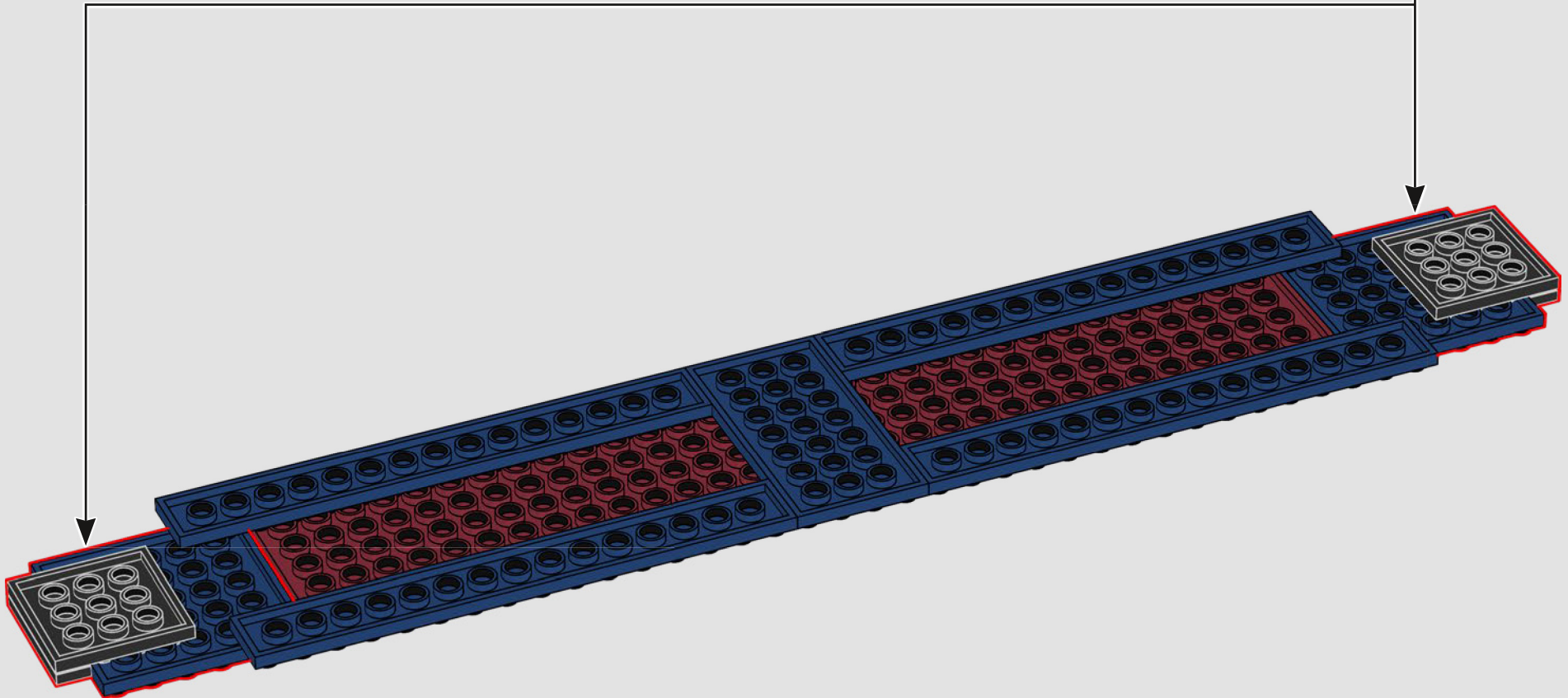
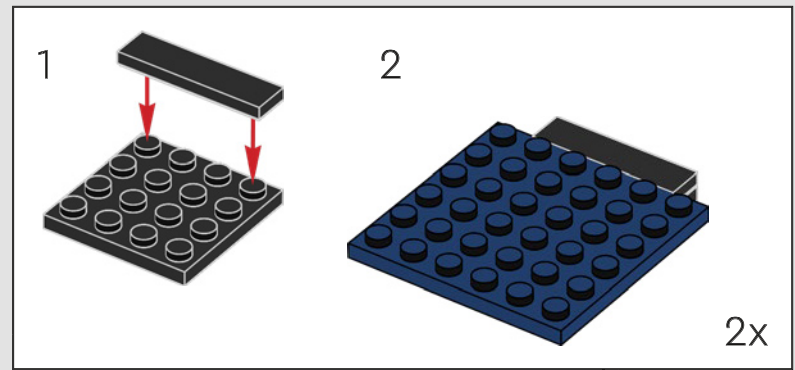

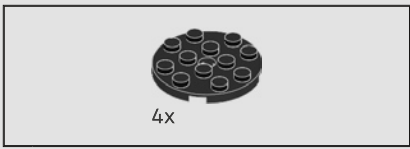

142

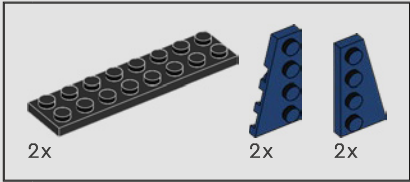

143

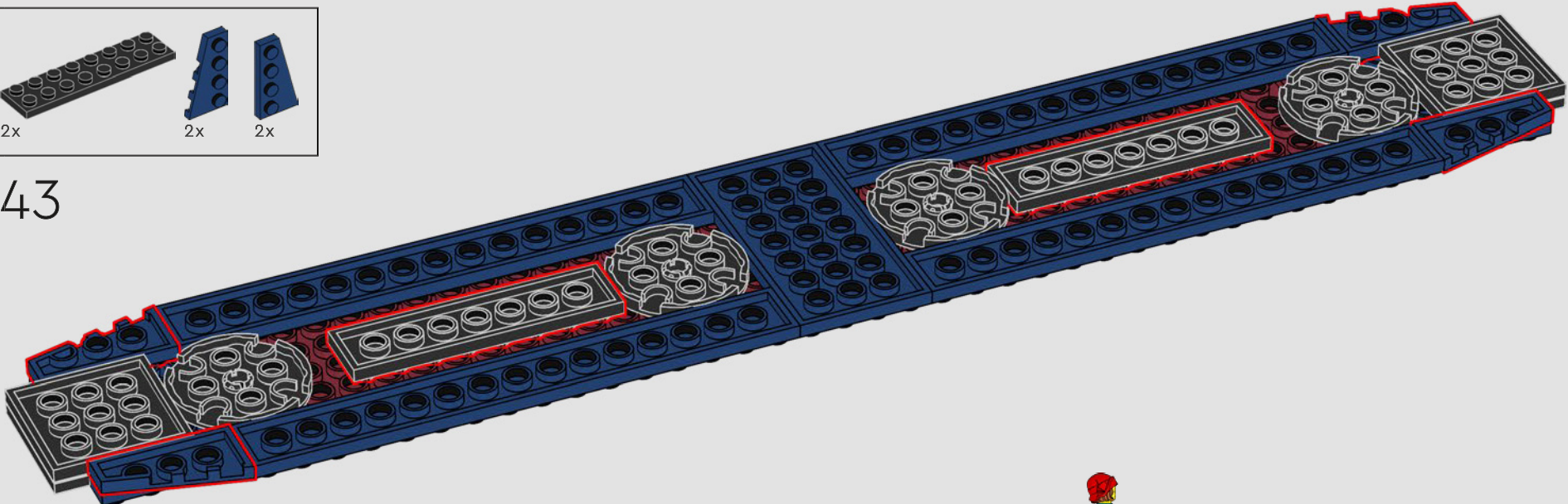

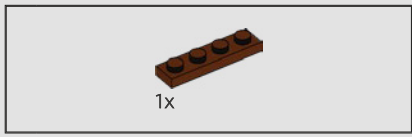

144

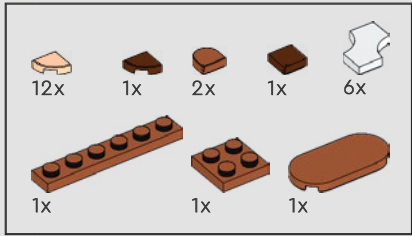
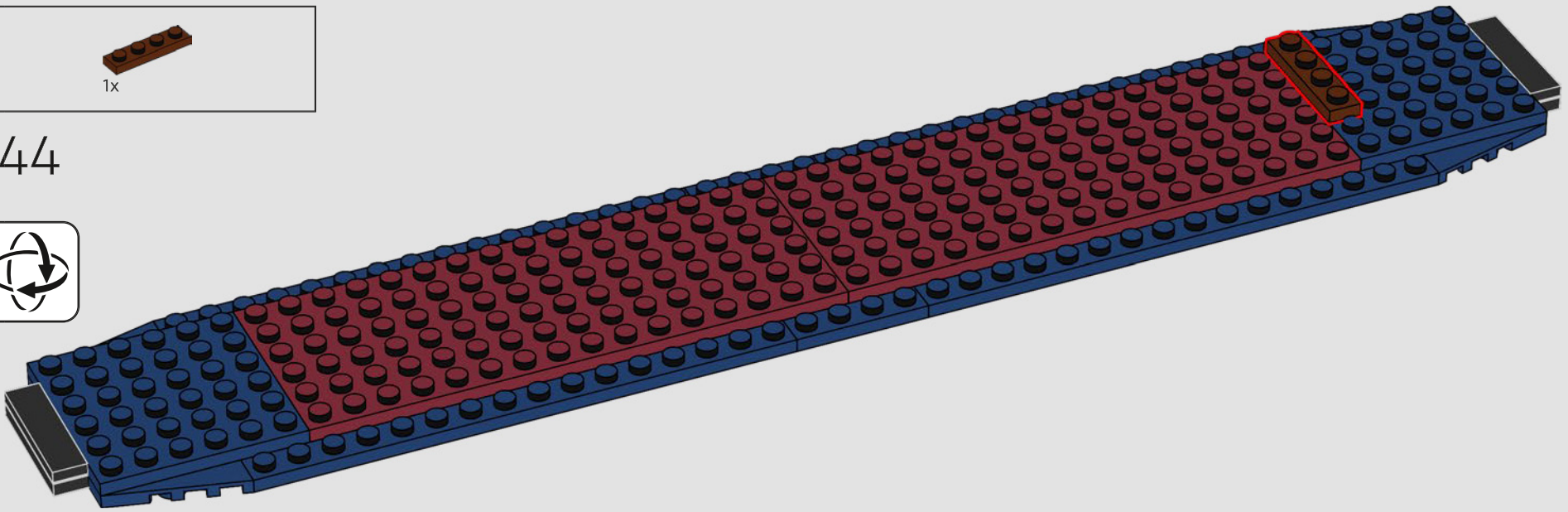

145

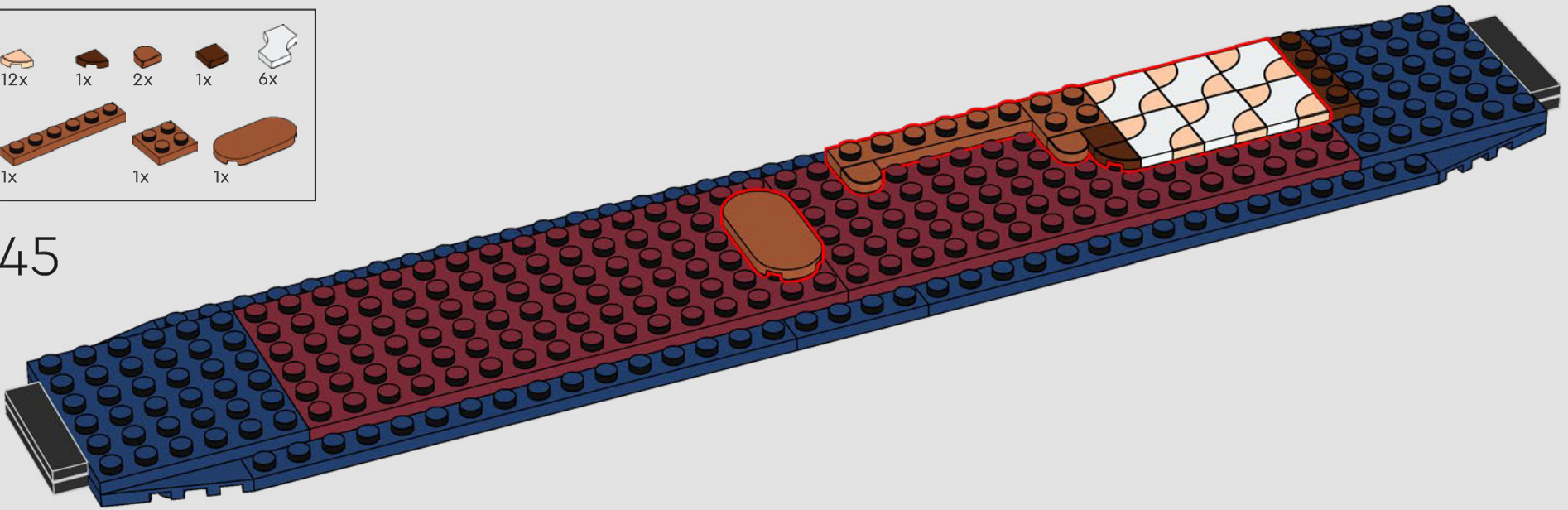

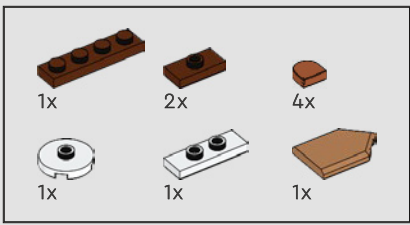

146

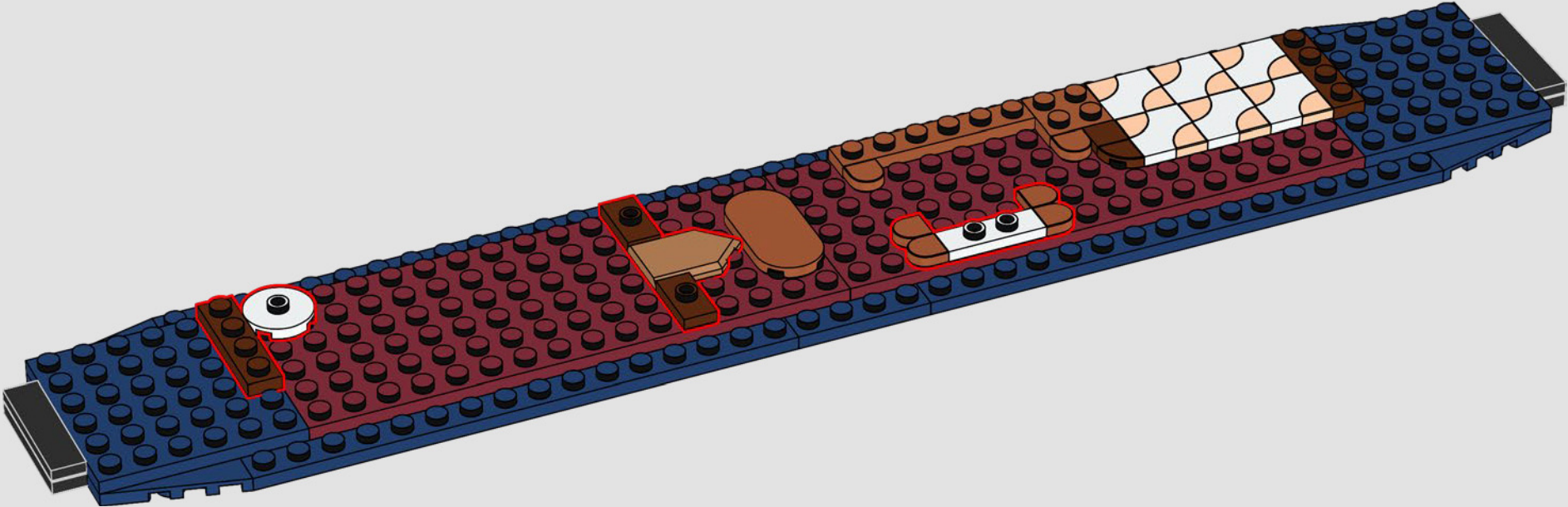

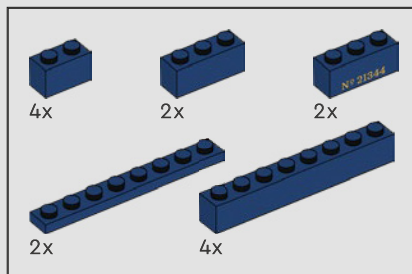

147

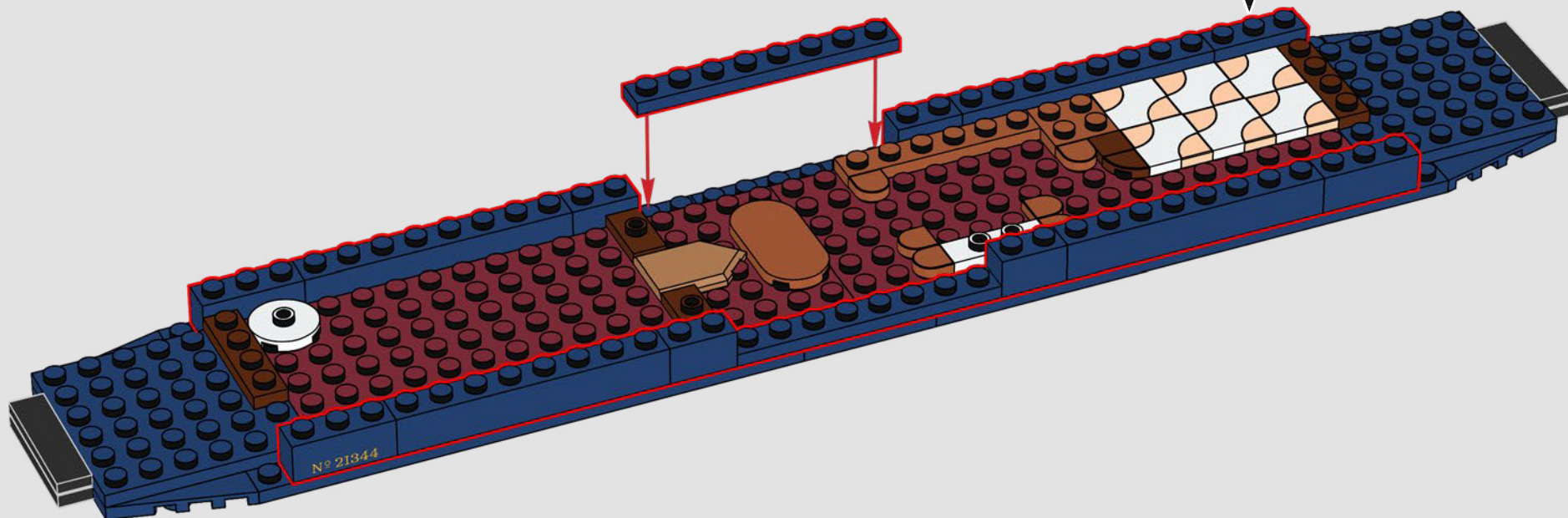

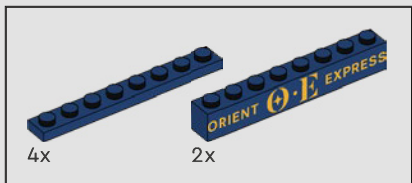

148

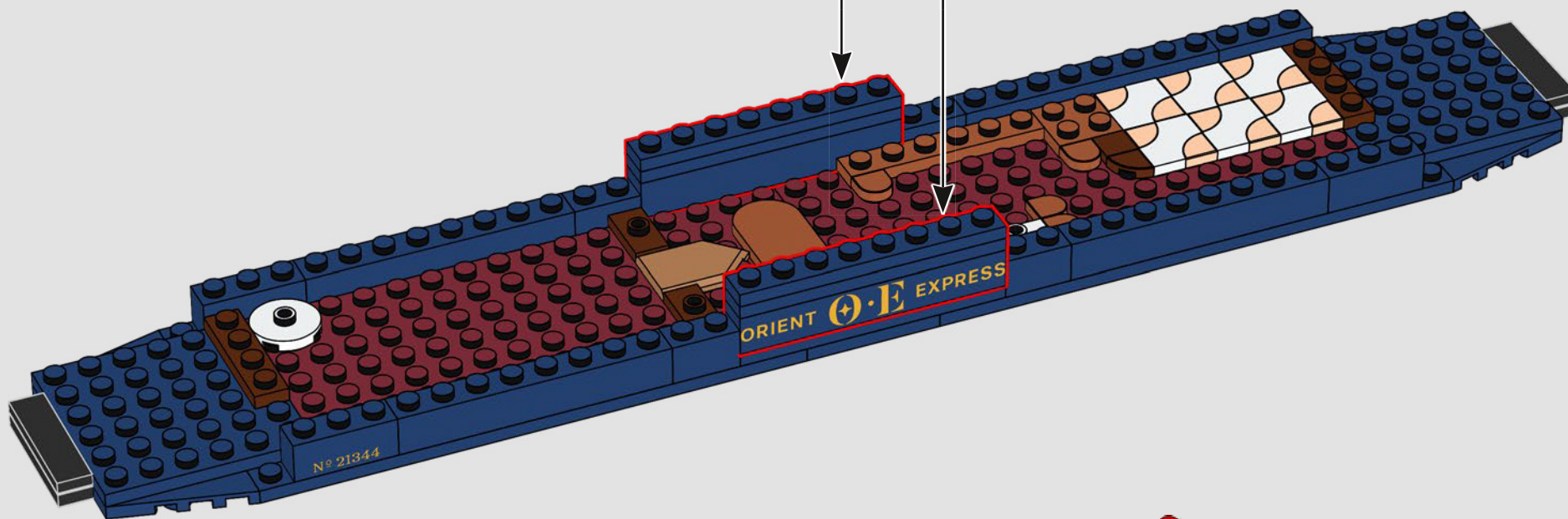
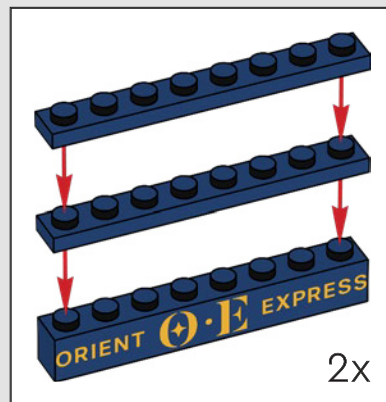

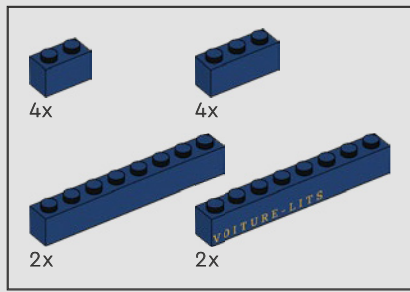

149

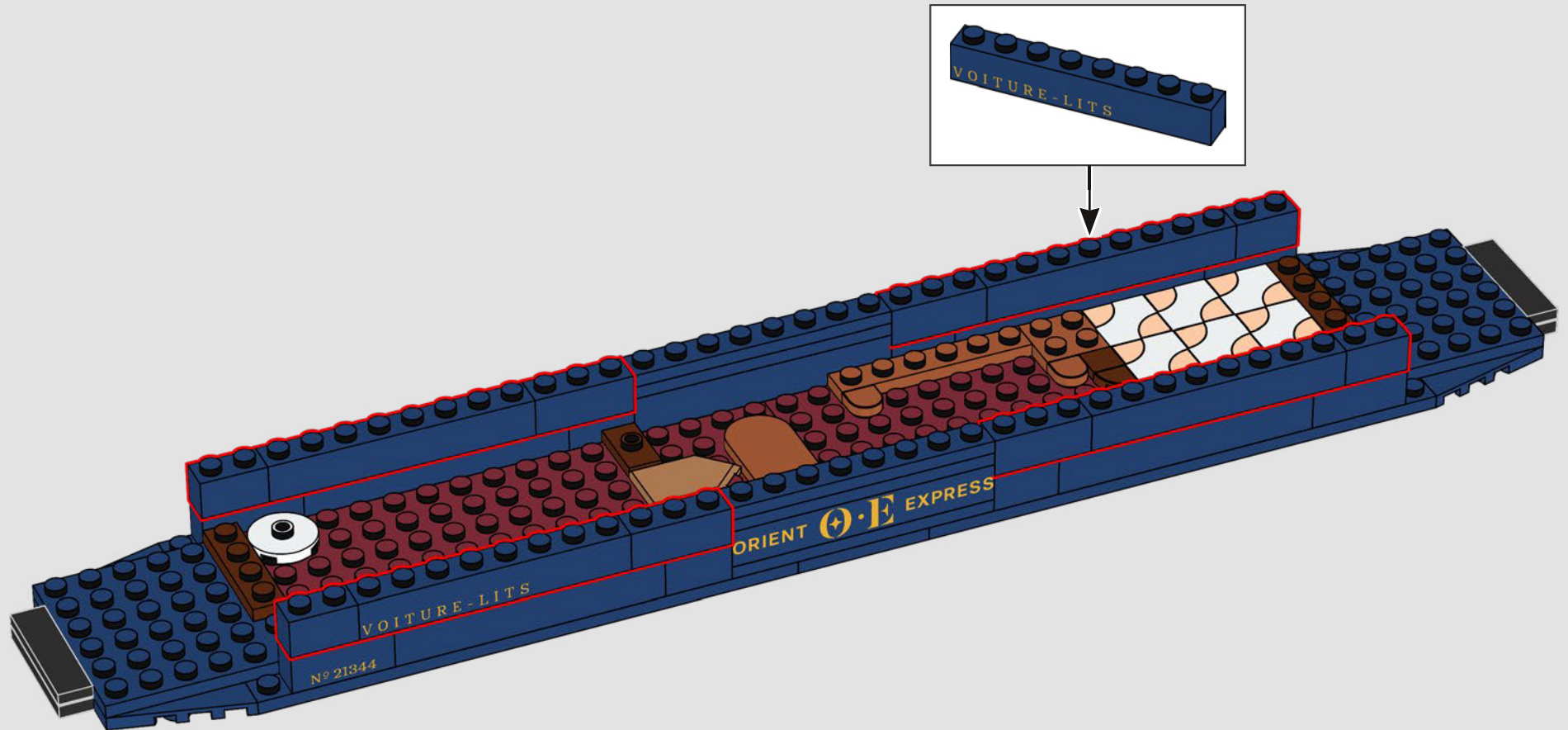

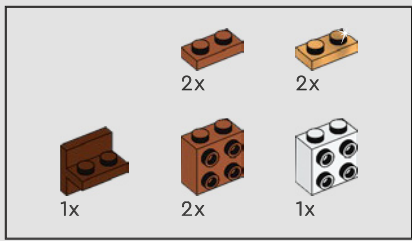

150

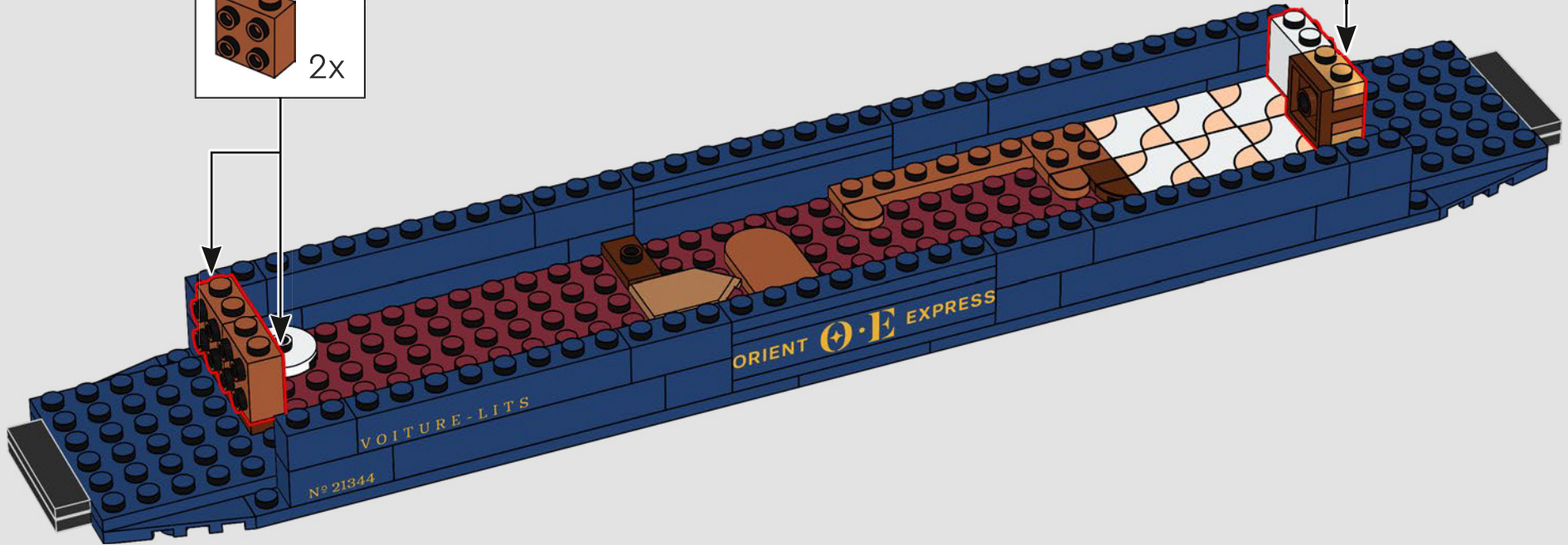
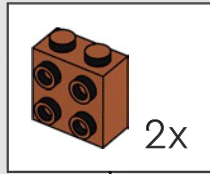
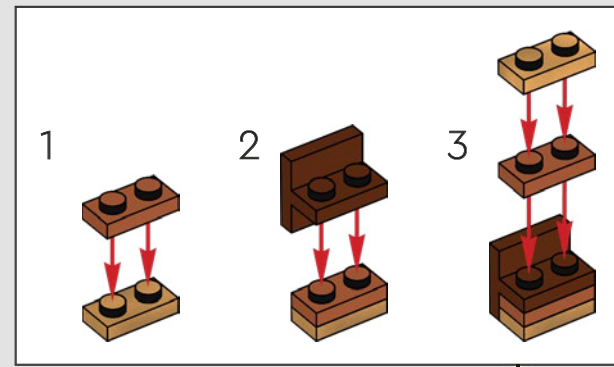

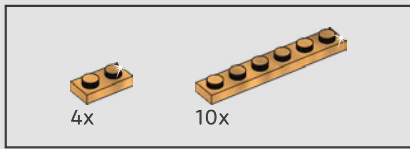

151

Next Stop: BUDAPEST

'Steaming along the Danube River towards
Budapest the water shone like gold.'

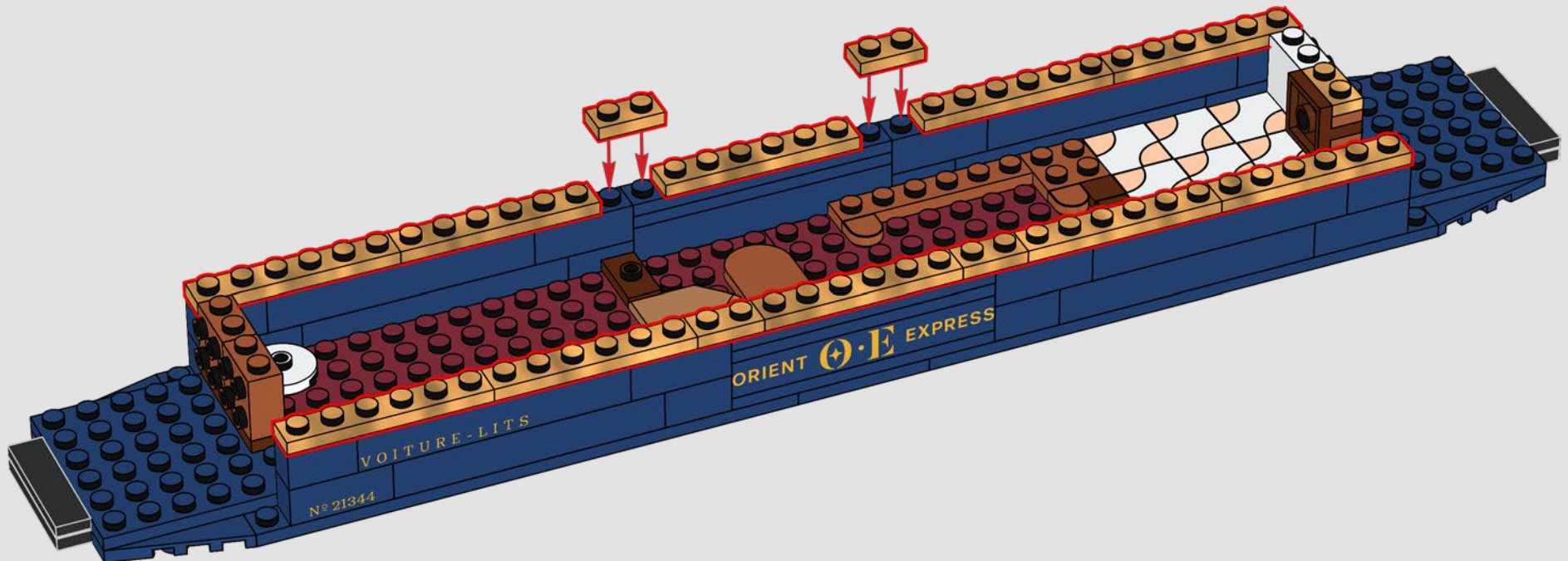

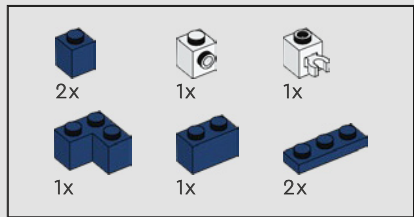

152

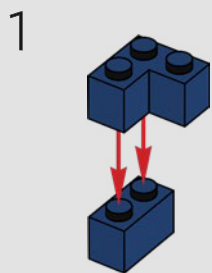

2

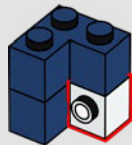

3

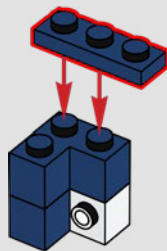

4

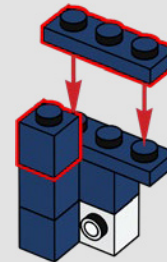

5

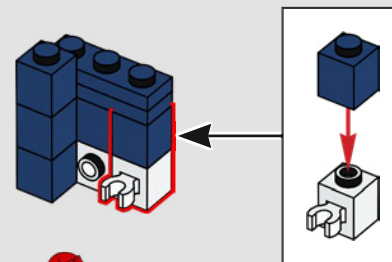

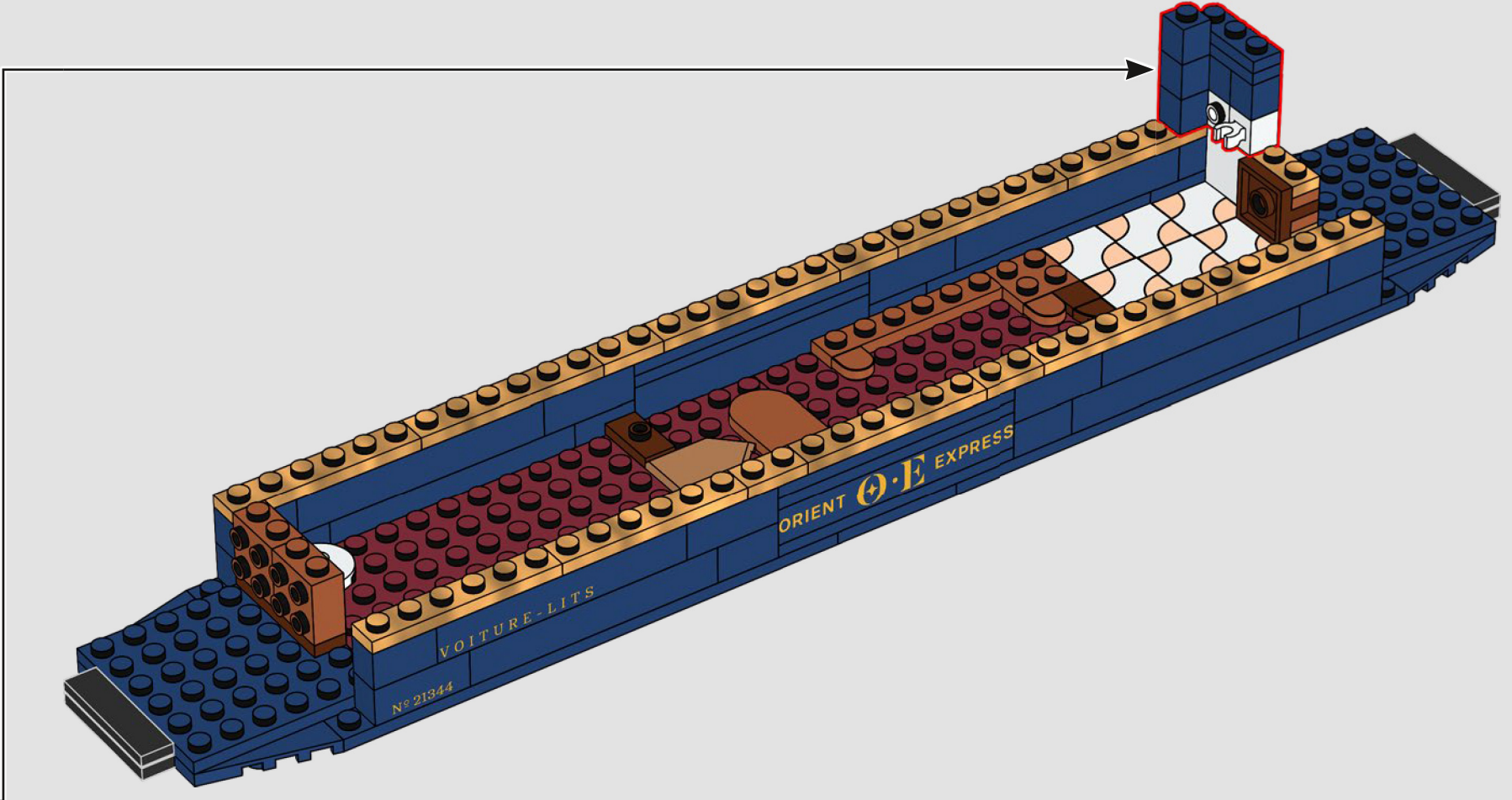

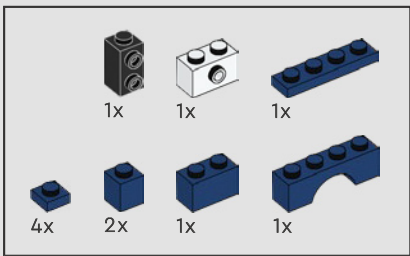

153

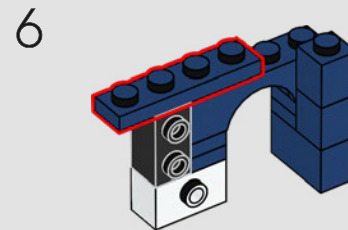
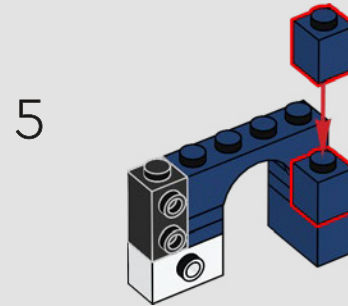
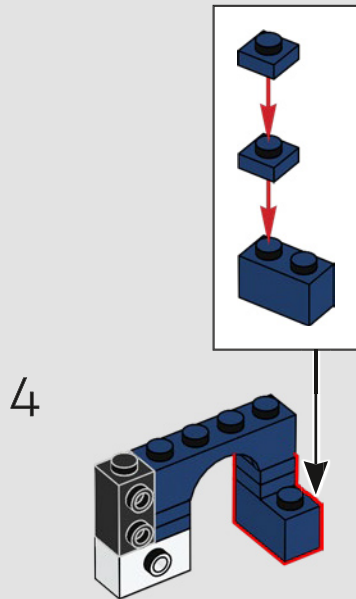
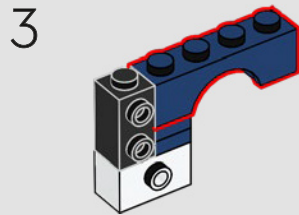
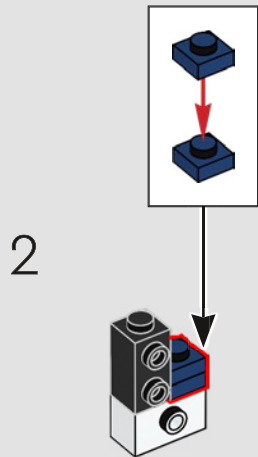
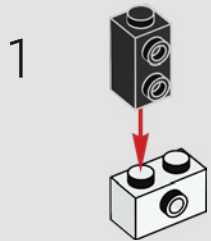

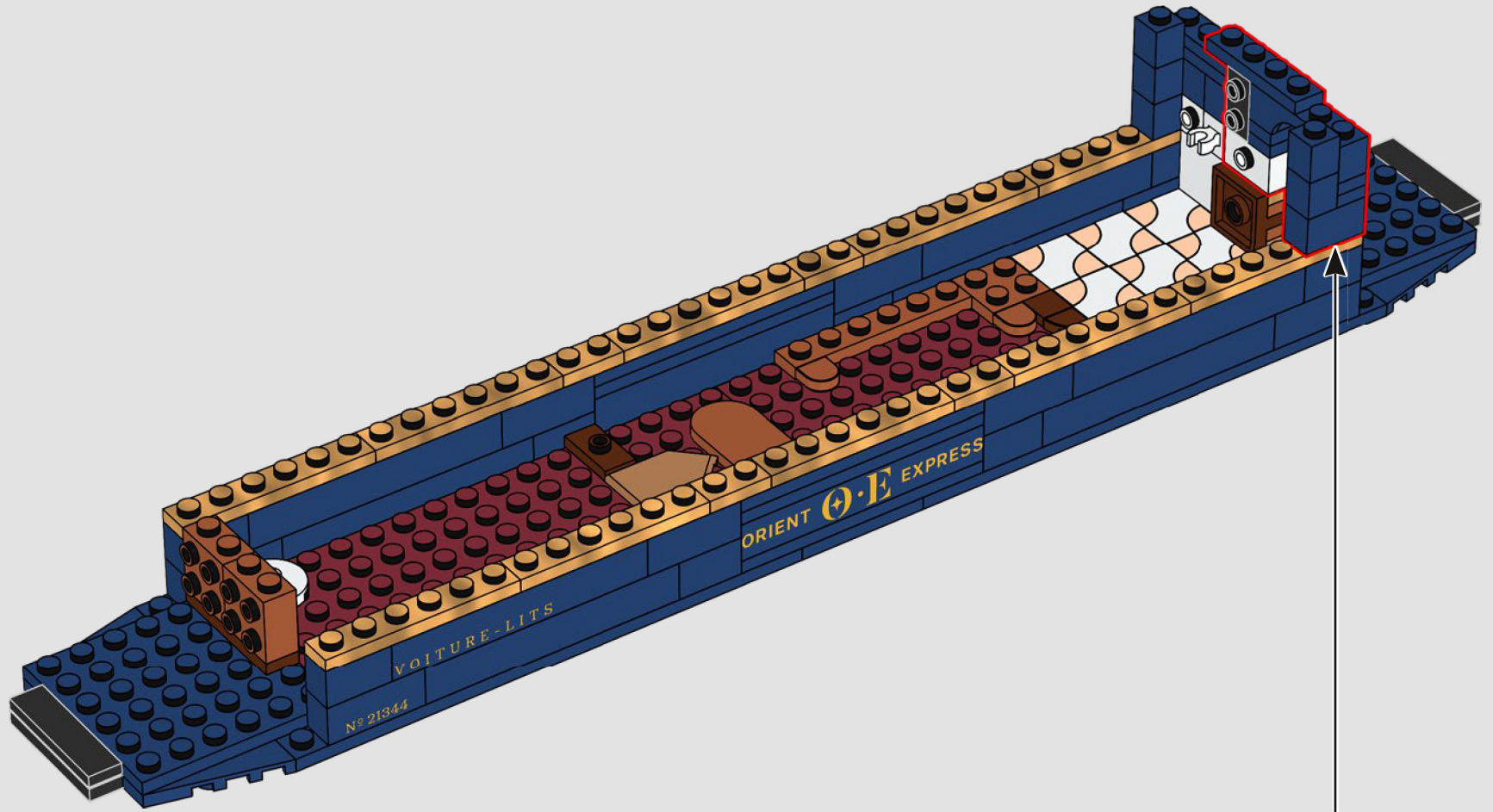

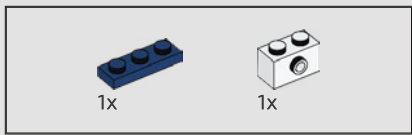

154

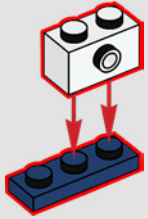

155

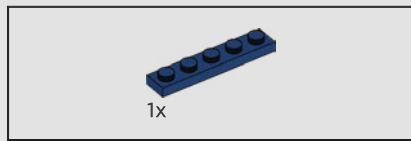
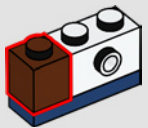

156

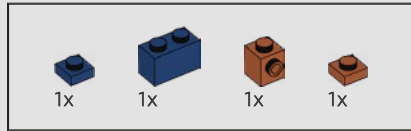
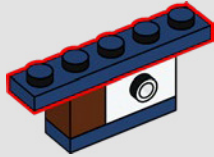

157

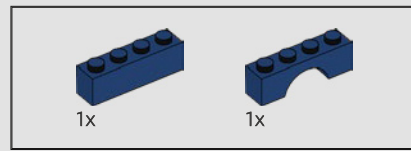
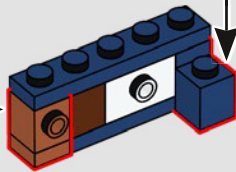
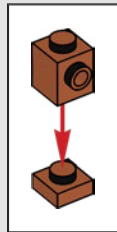
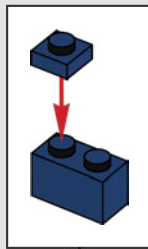

158

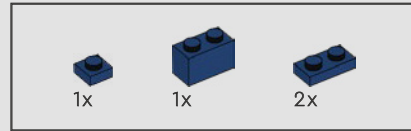
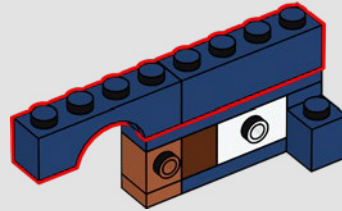

159

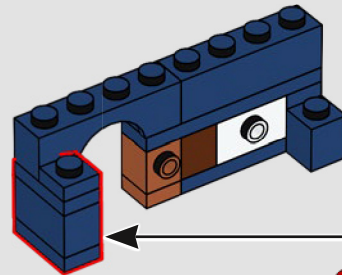
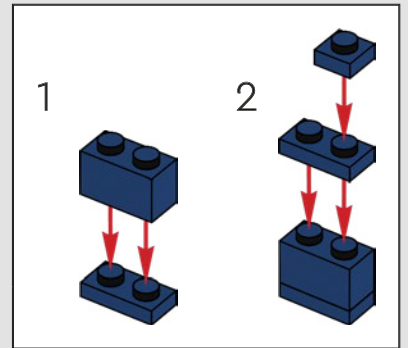

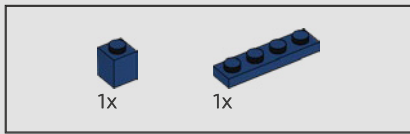

160

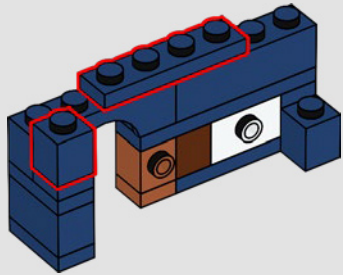

161

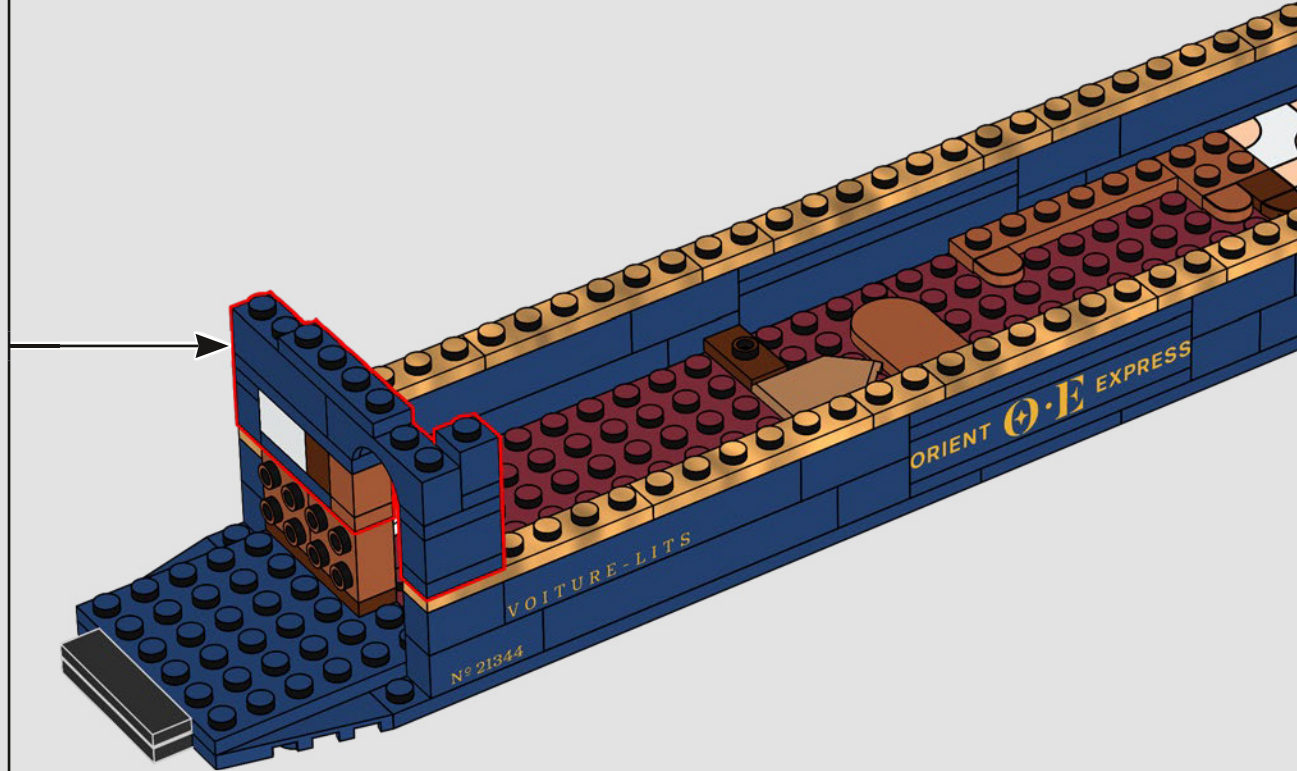

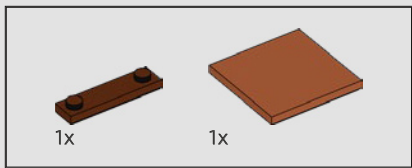

162

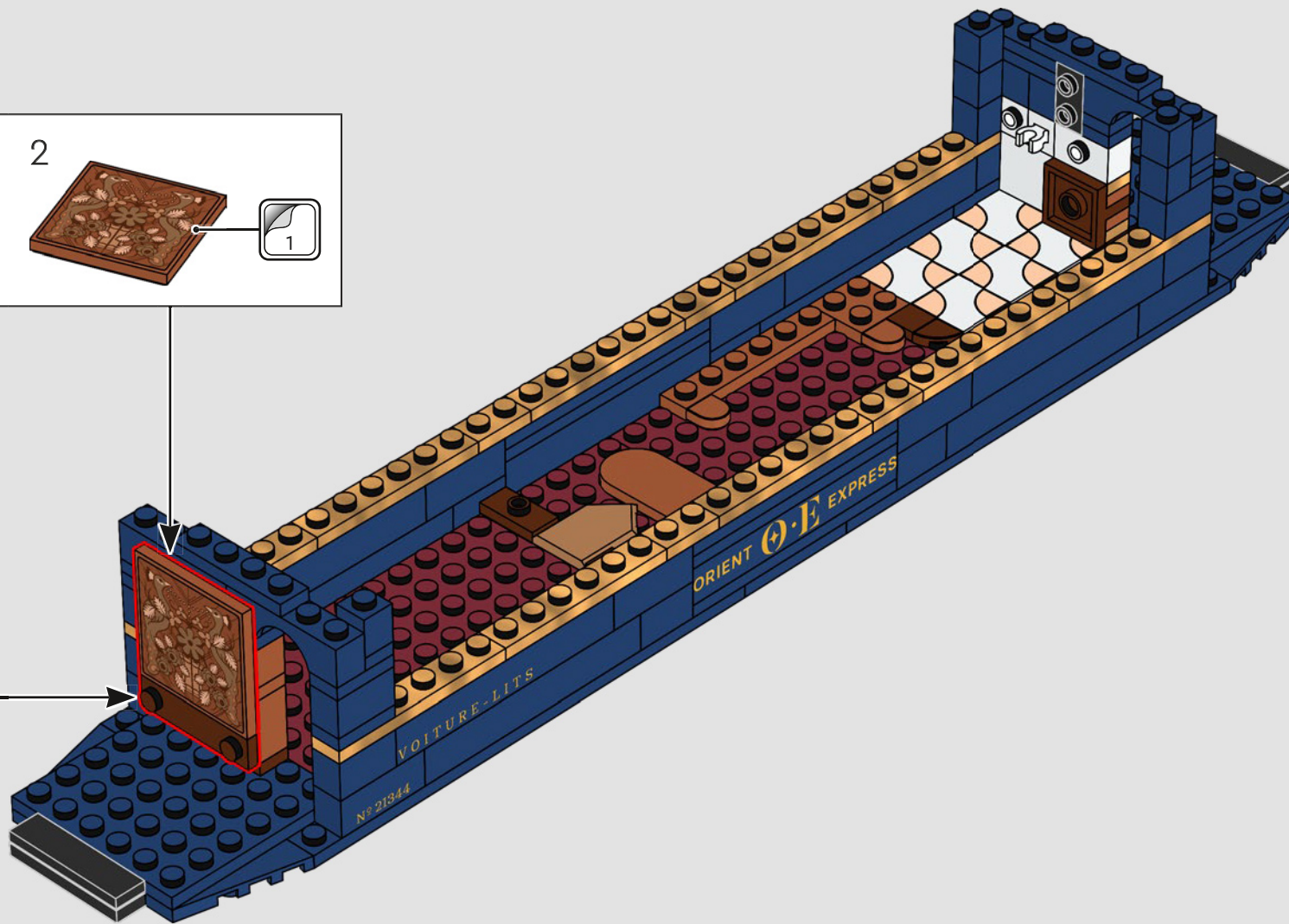
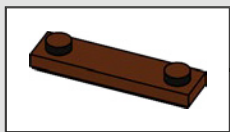

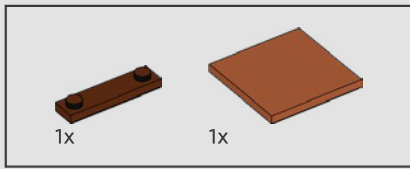

163

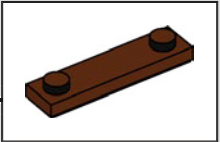
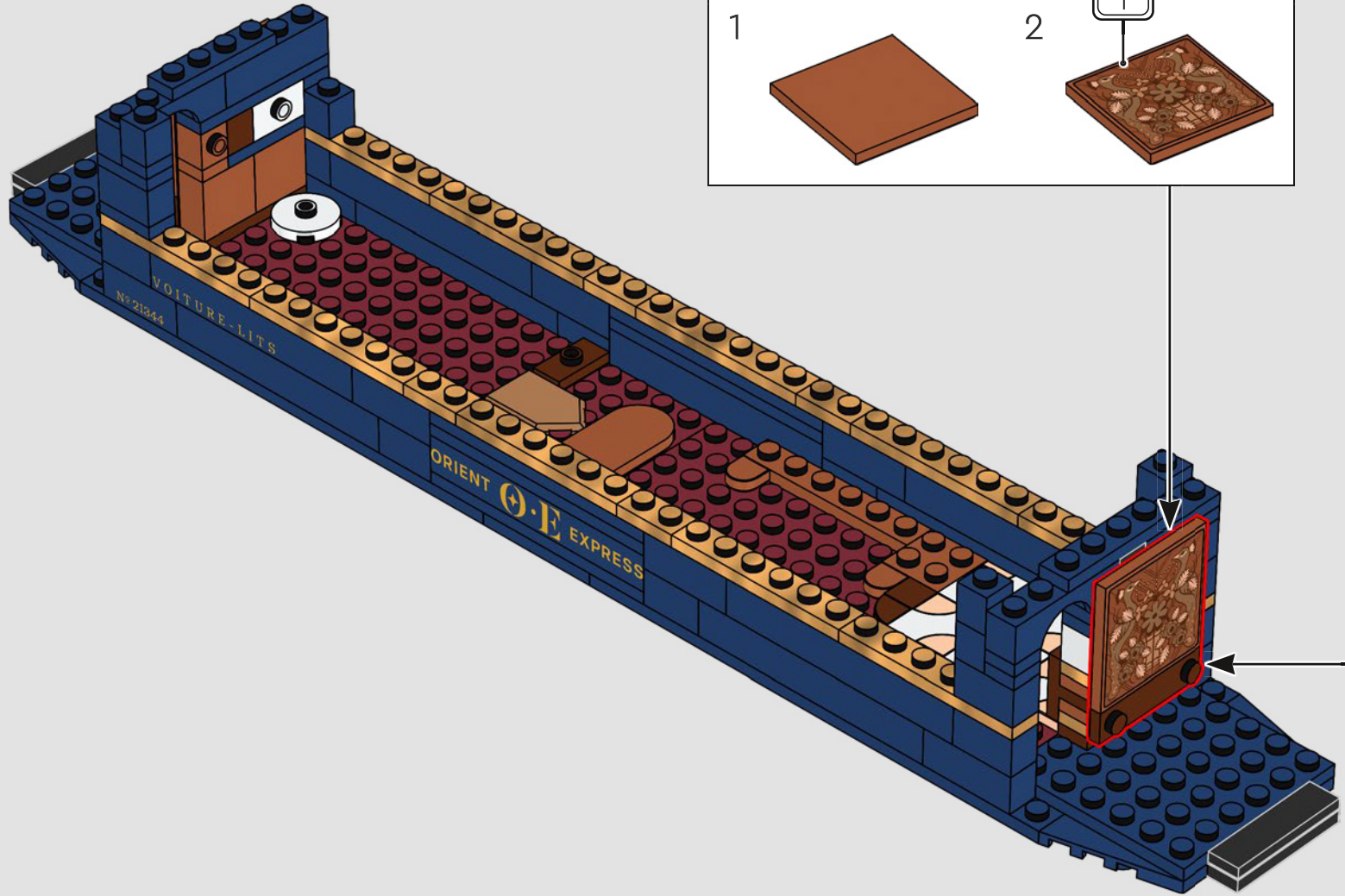

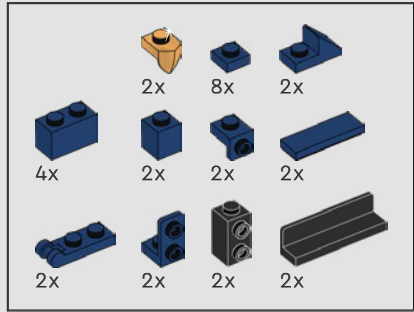
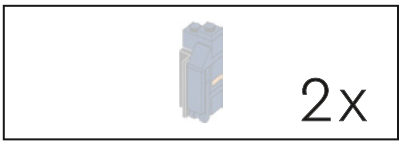

164

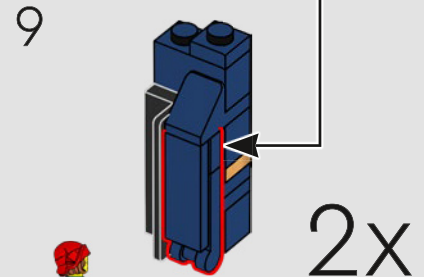
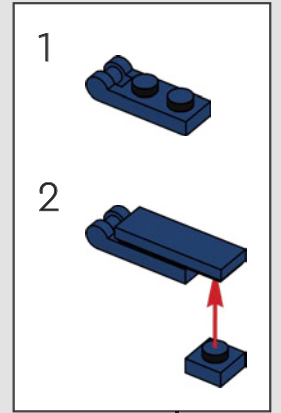
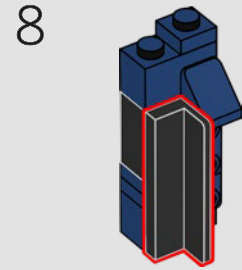
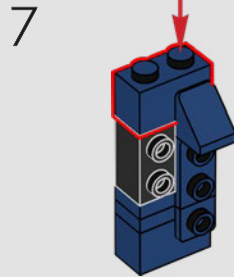
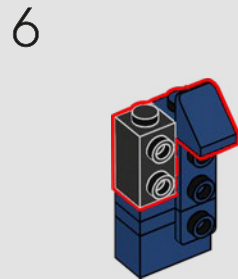
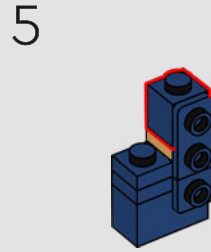
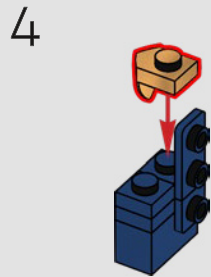
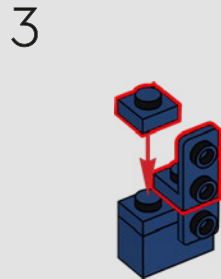
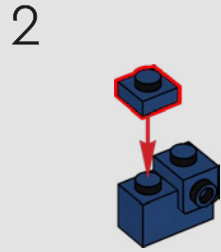
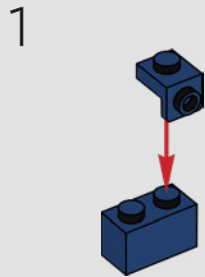

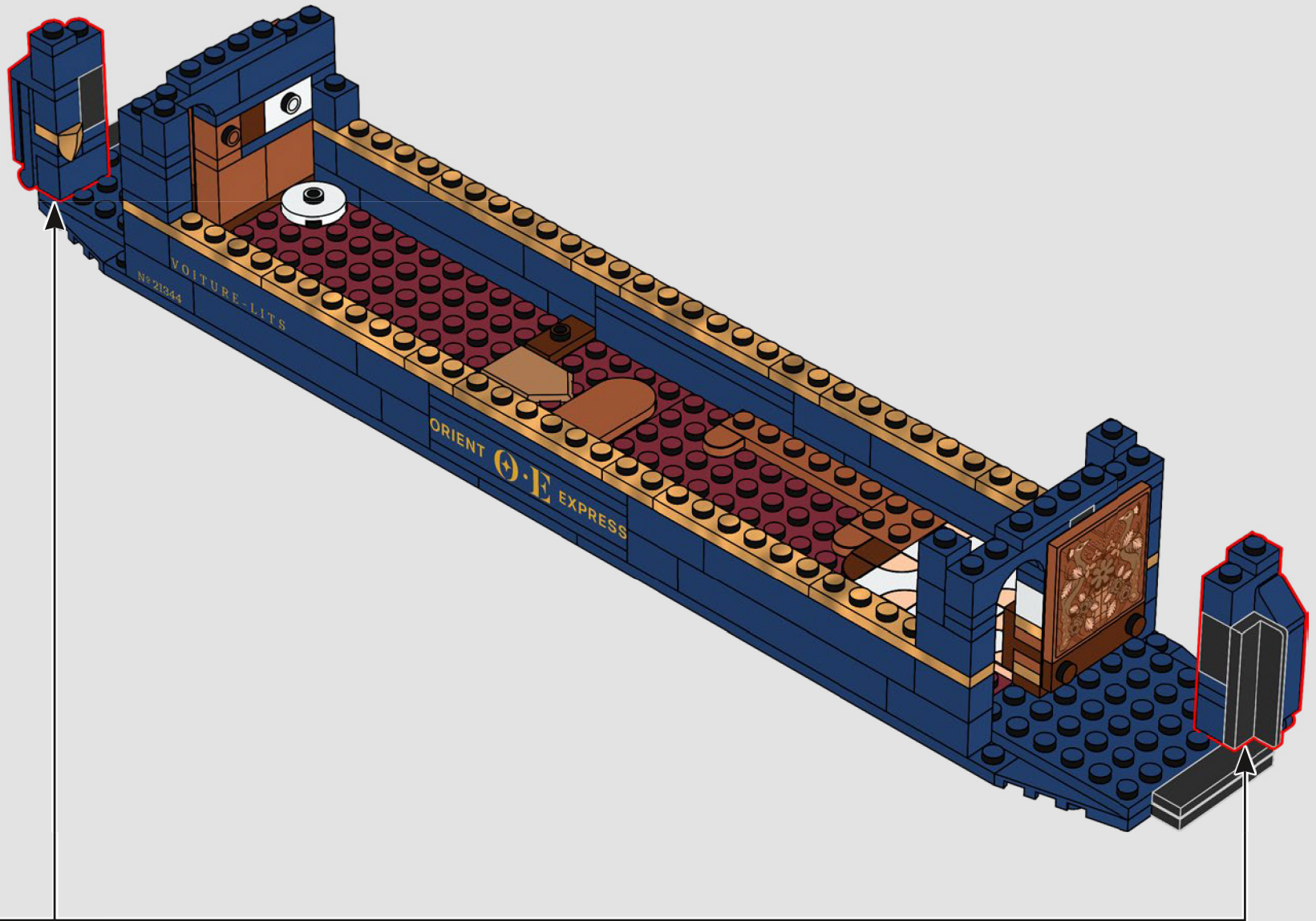



2x

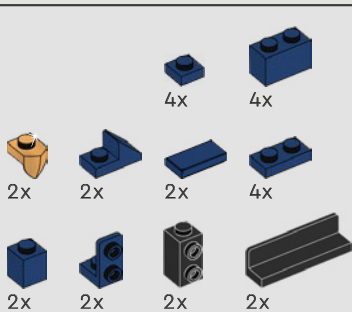

165

1

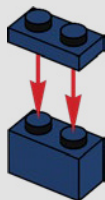

2

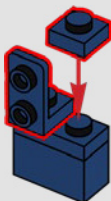

3

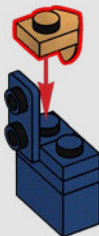

4

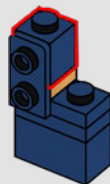

5

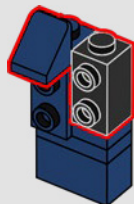

6

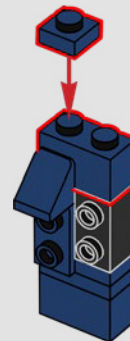

7

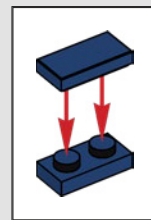

8

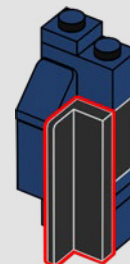

2x



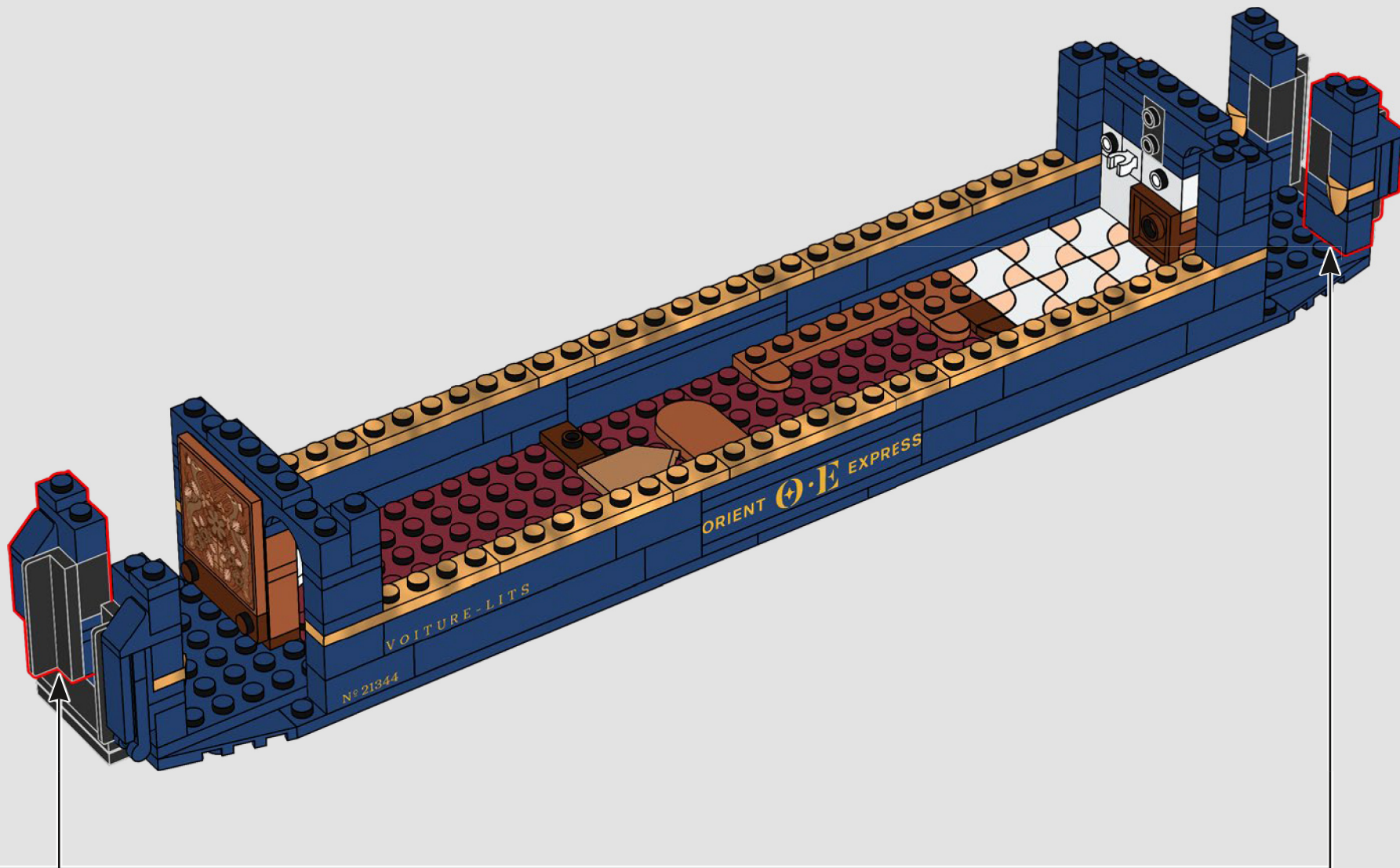

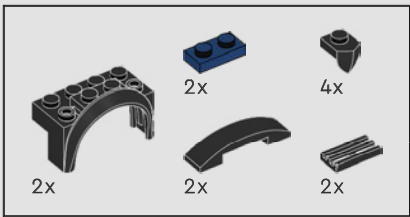

166

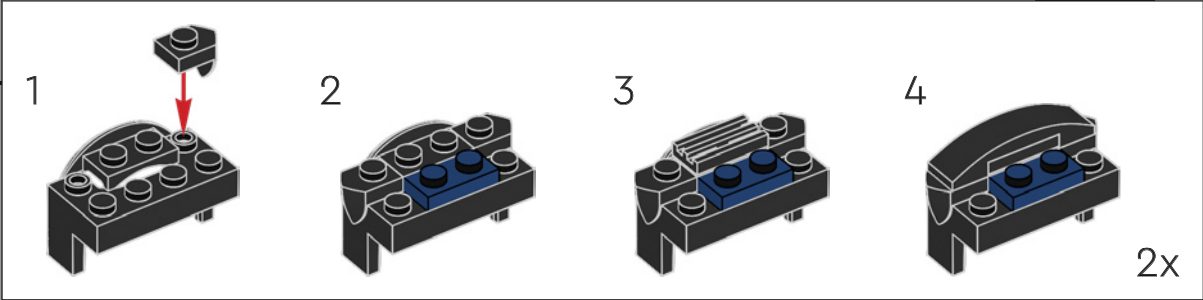
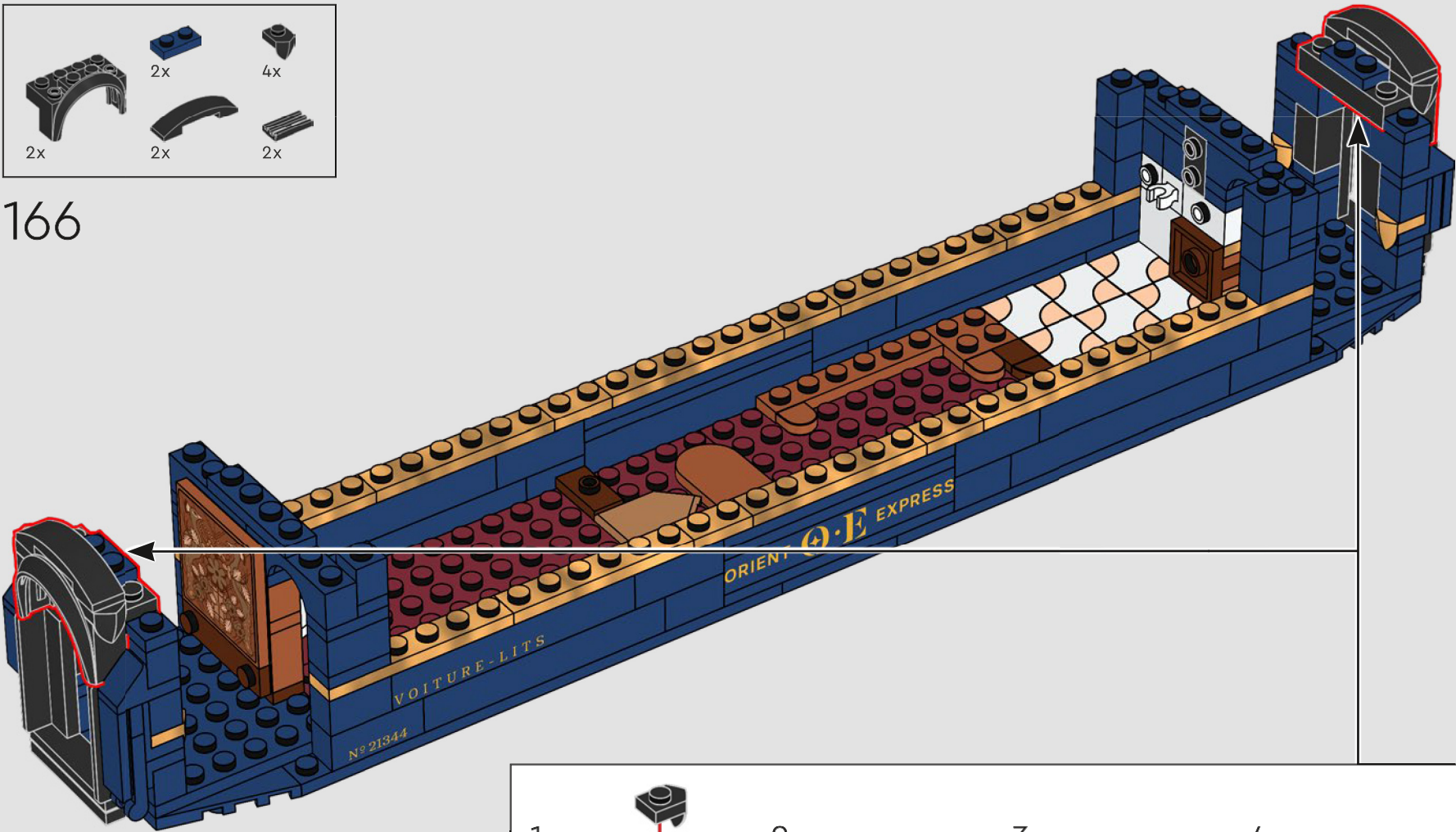

..... ●
'Each sleeper carriage has its own conductor
to cater to our every need.'

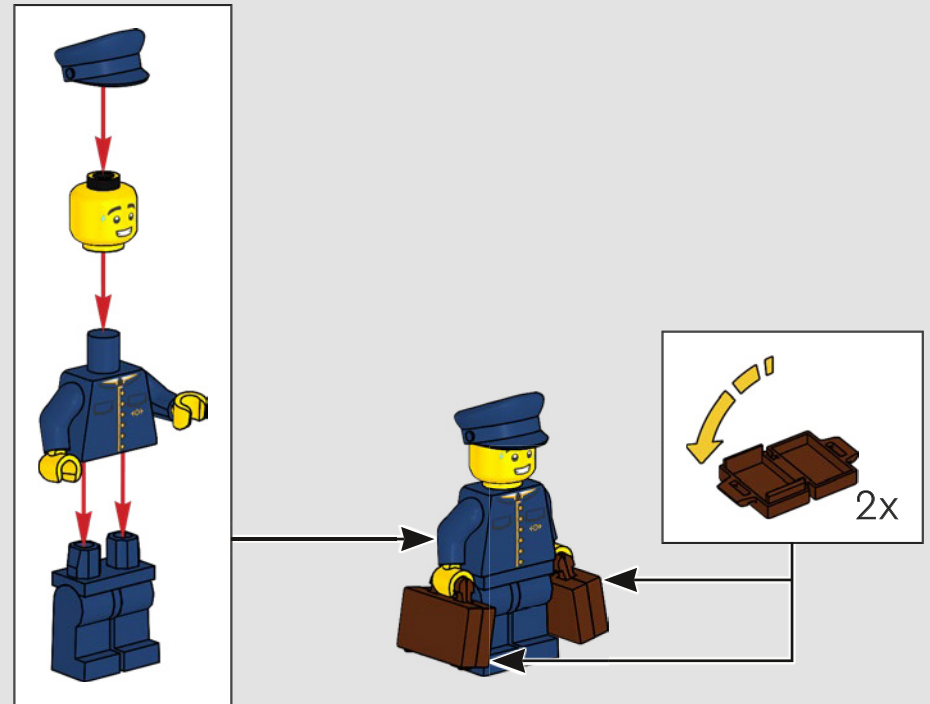

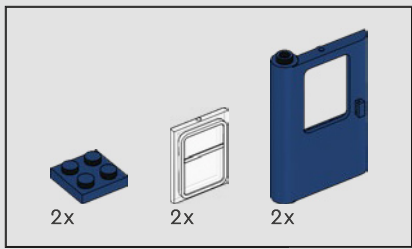

167

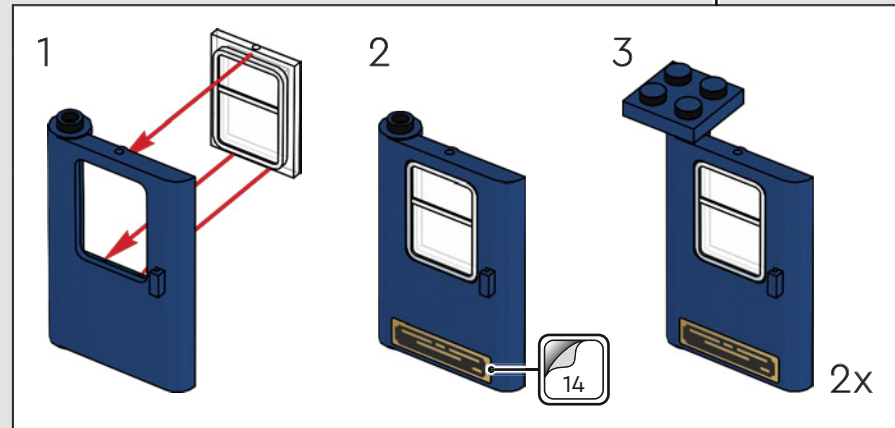
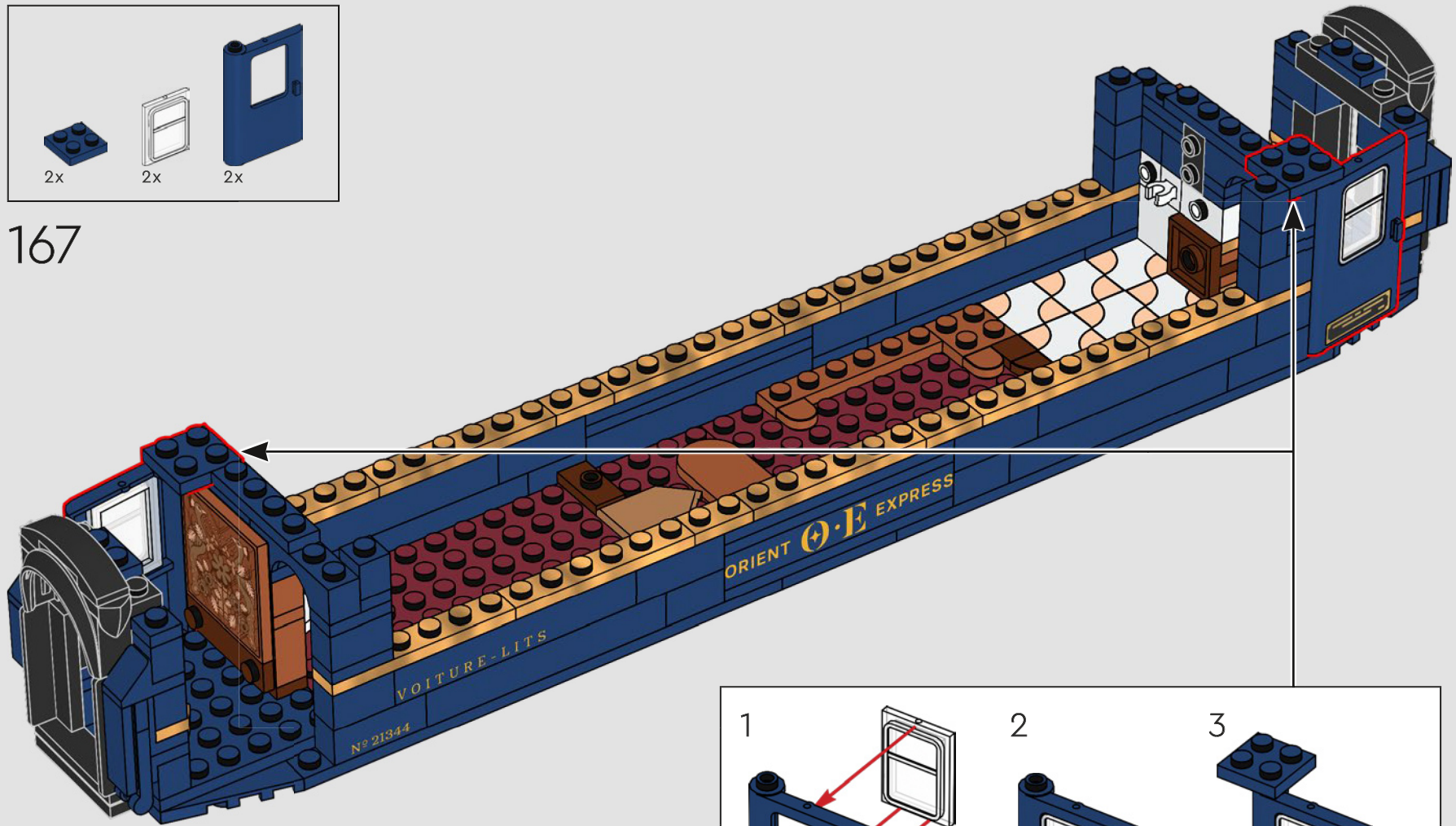

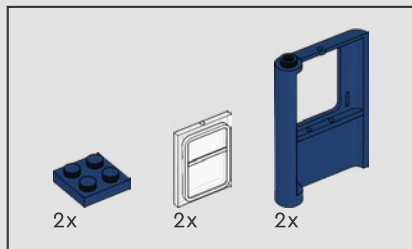

168

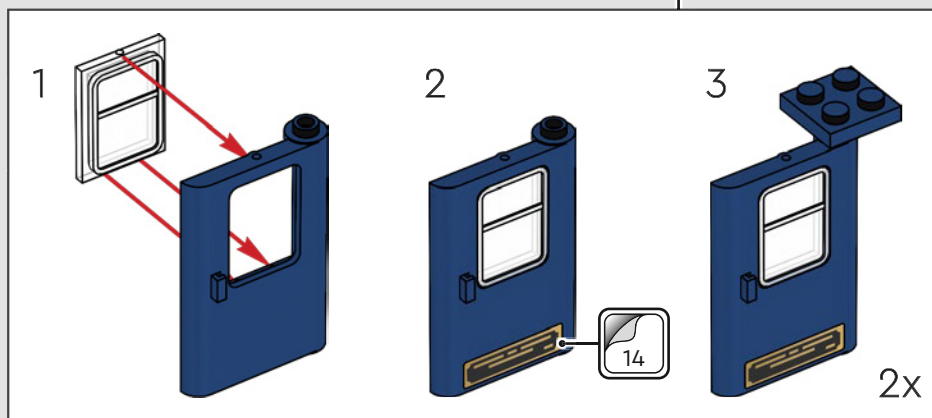
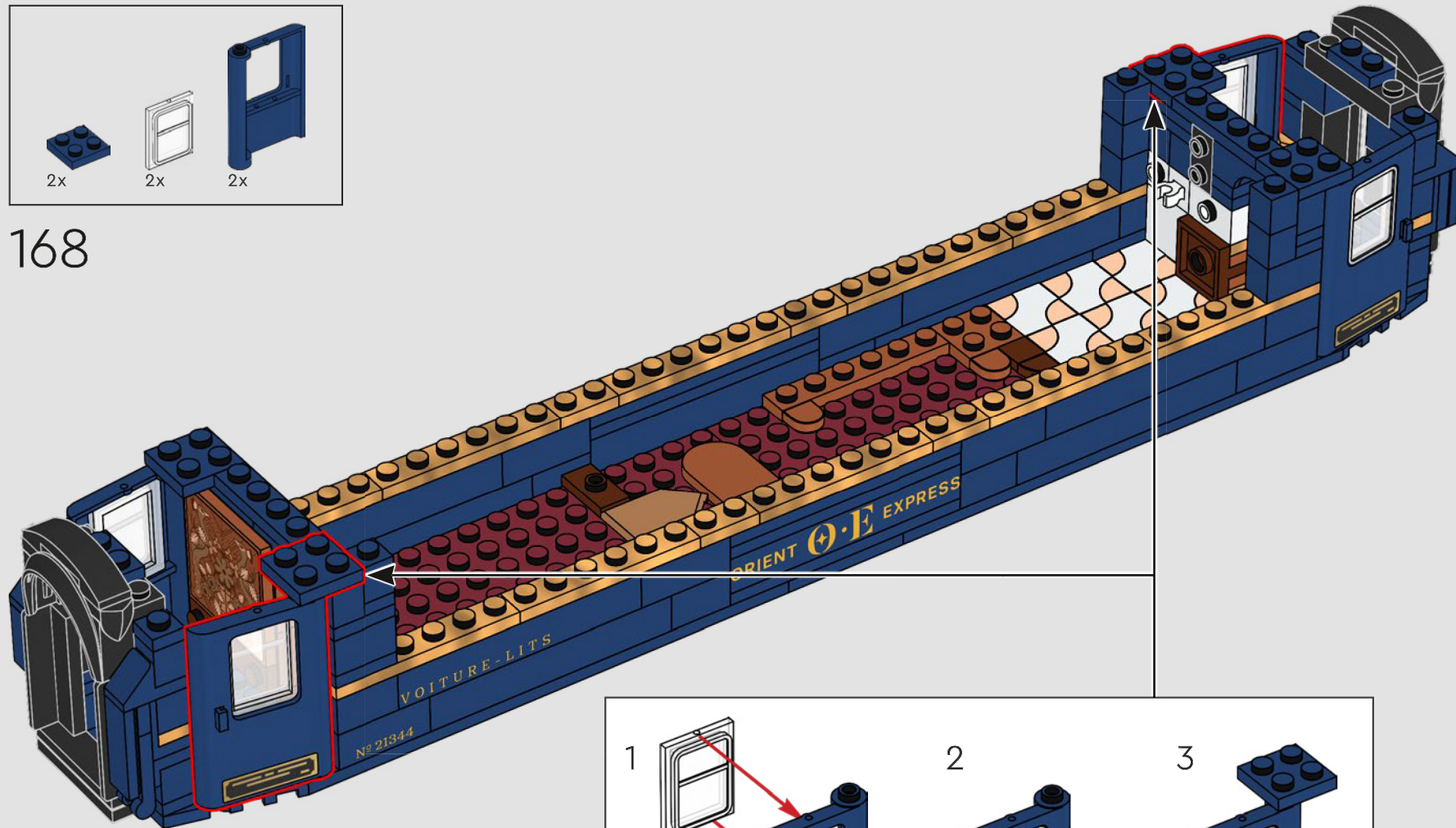

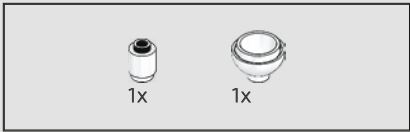

169

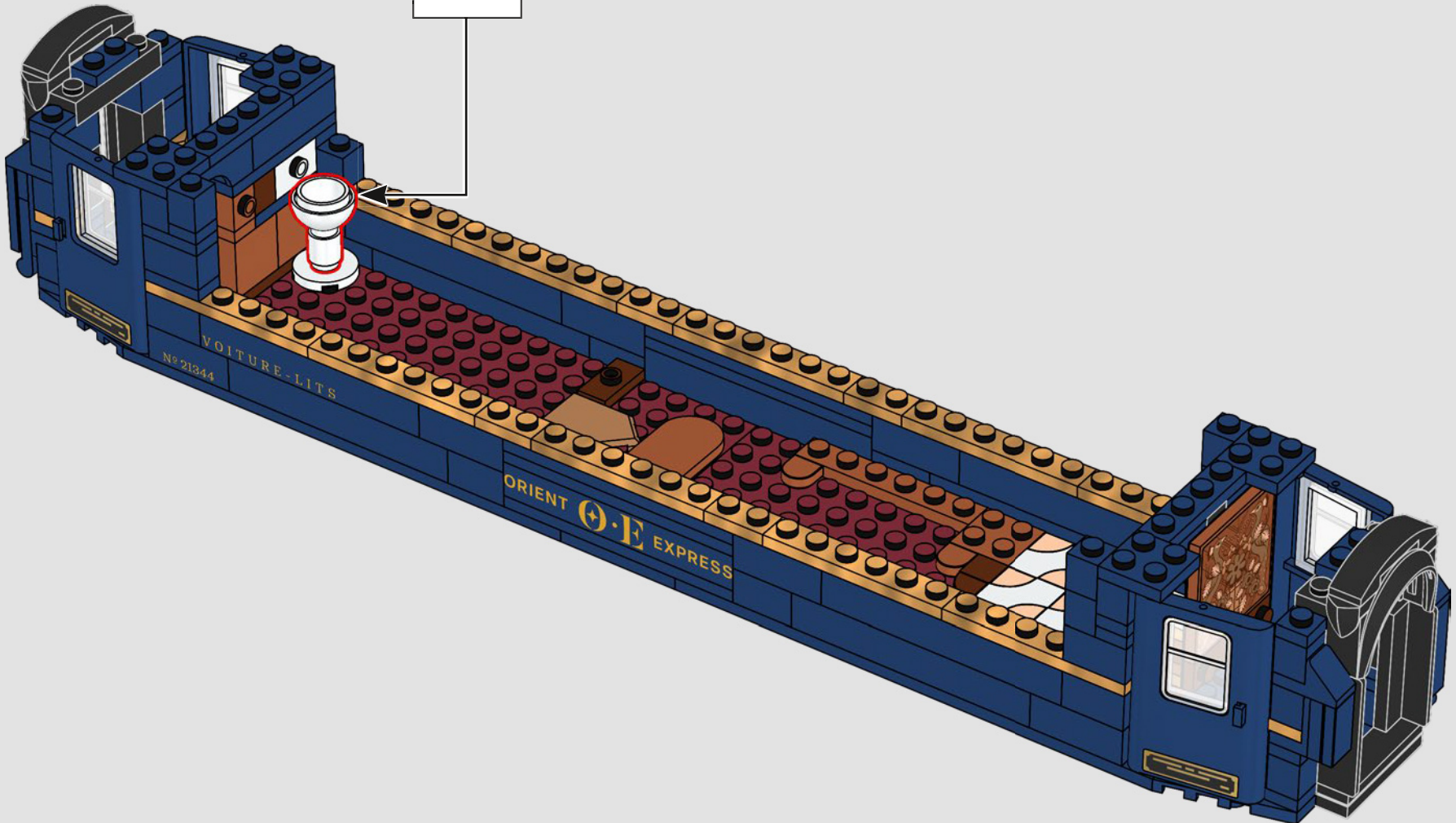



170

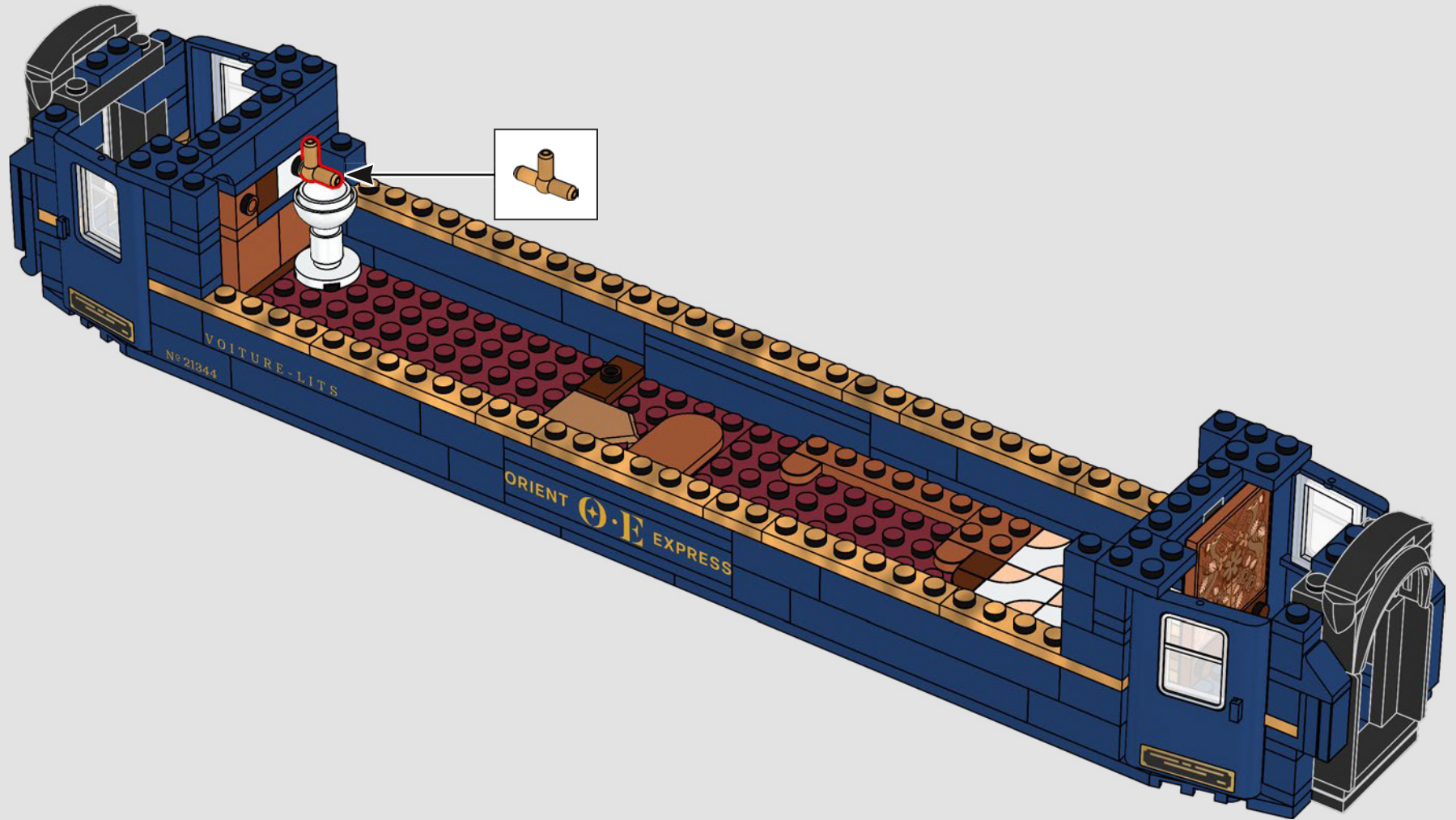

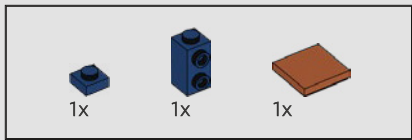

171

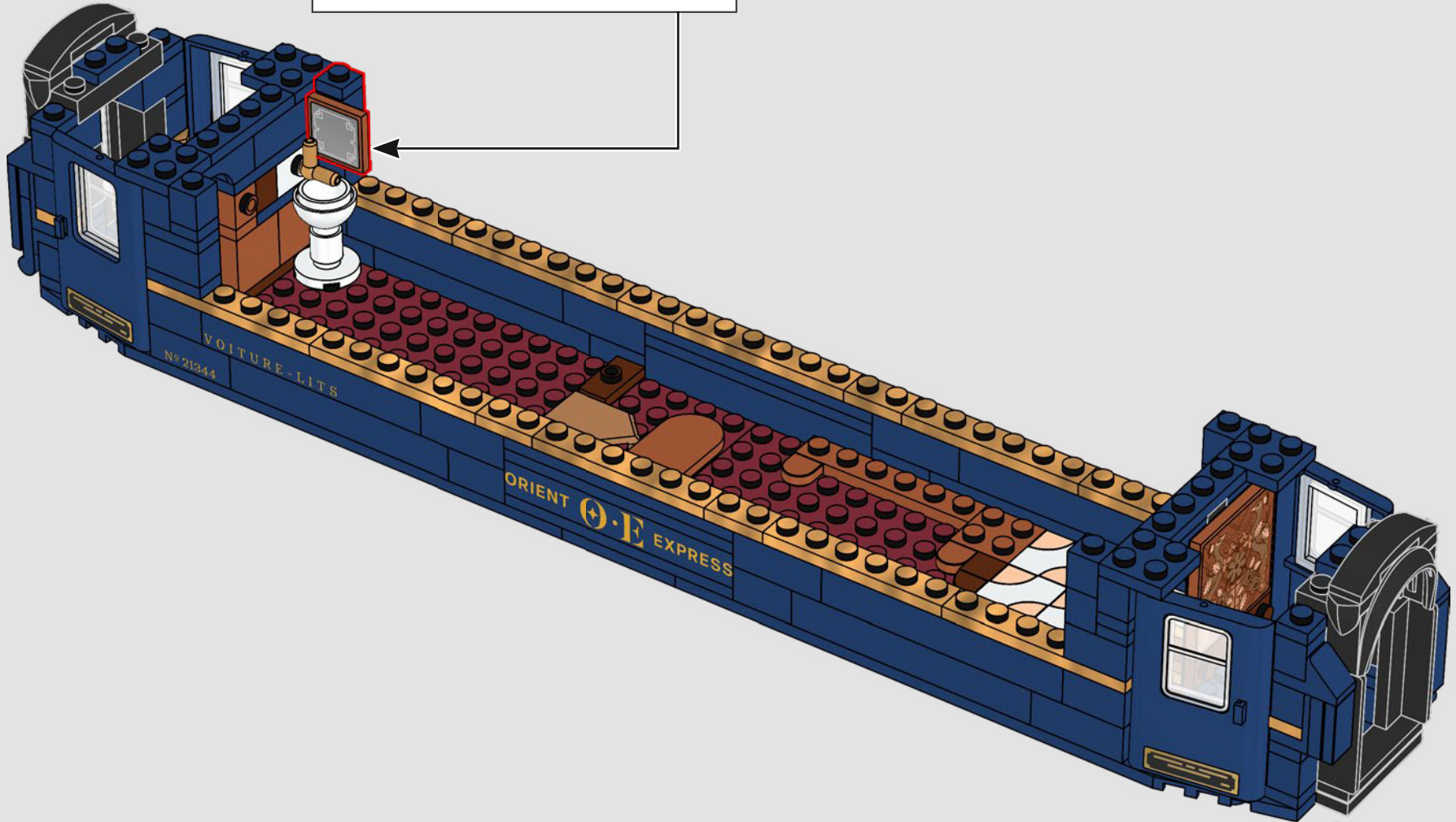
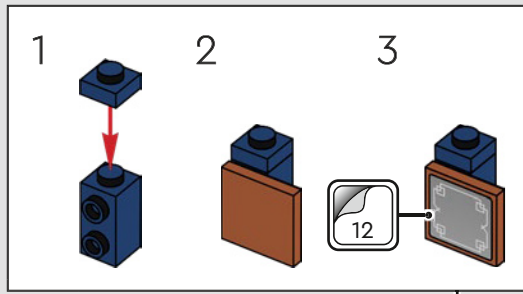

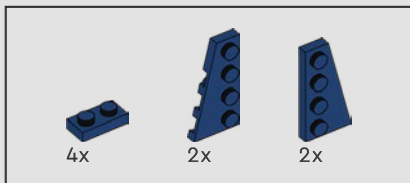

172

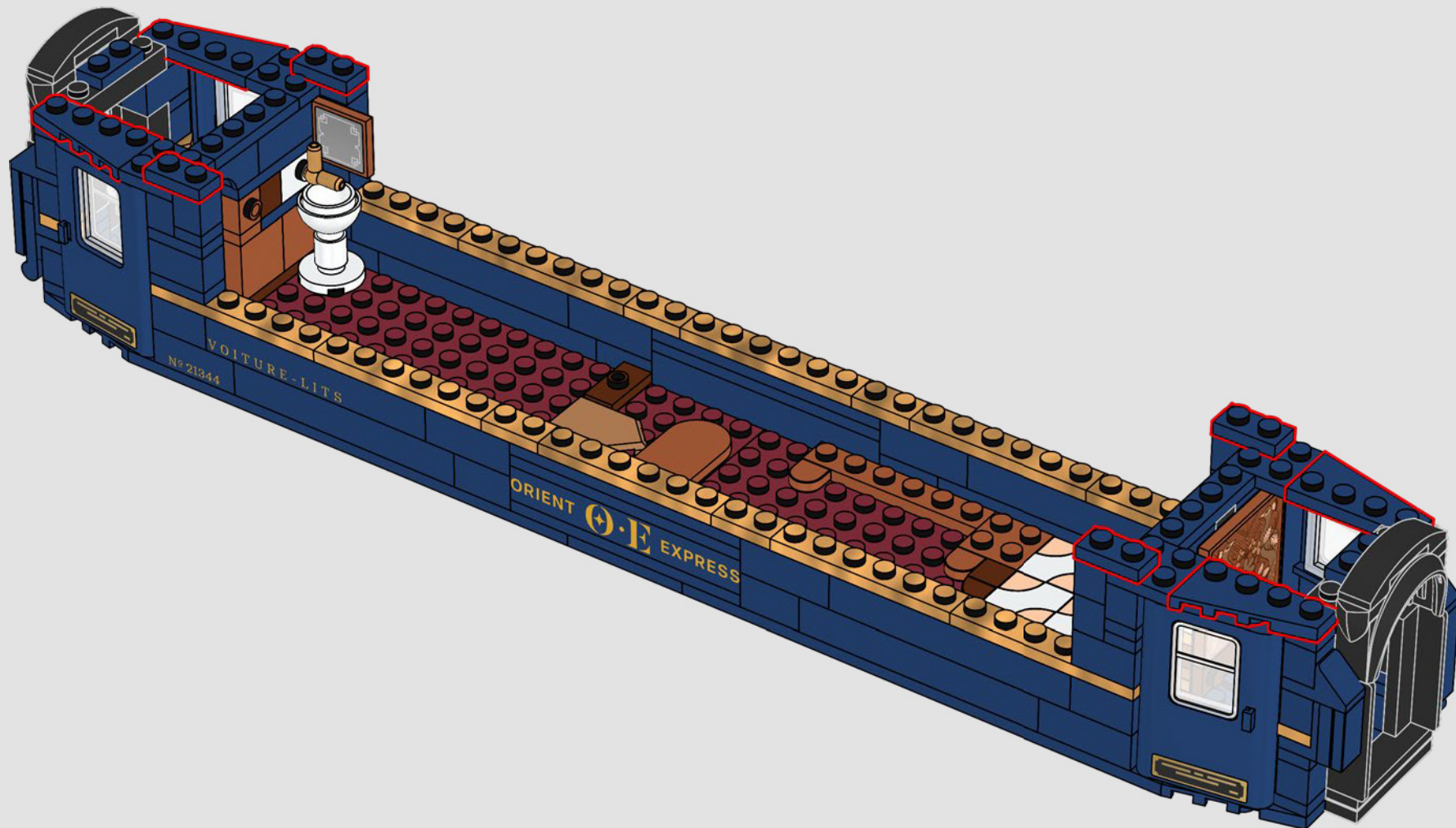

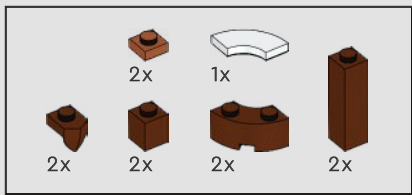

173

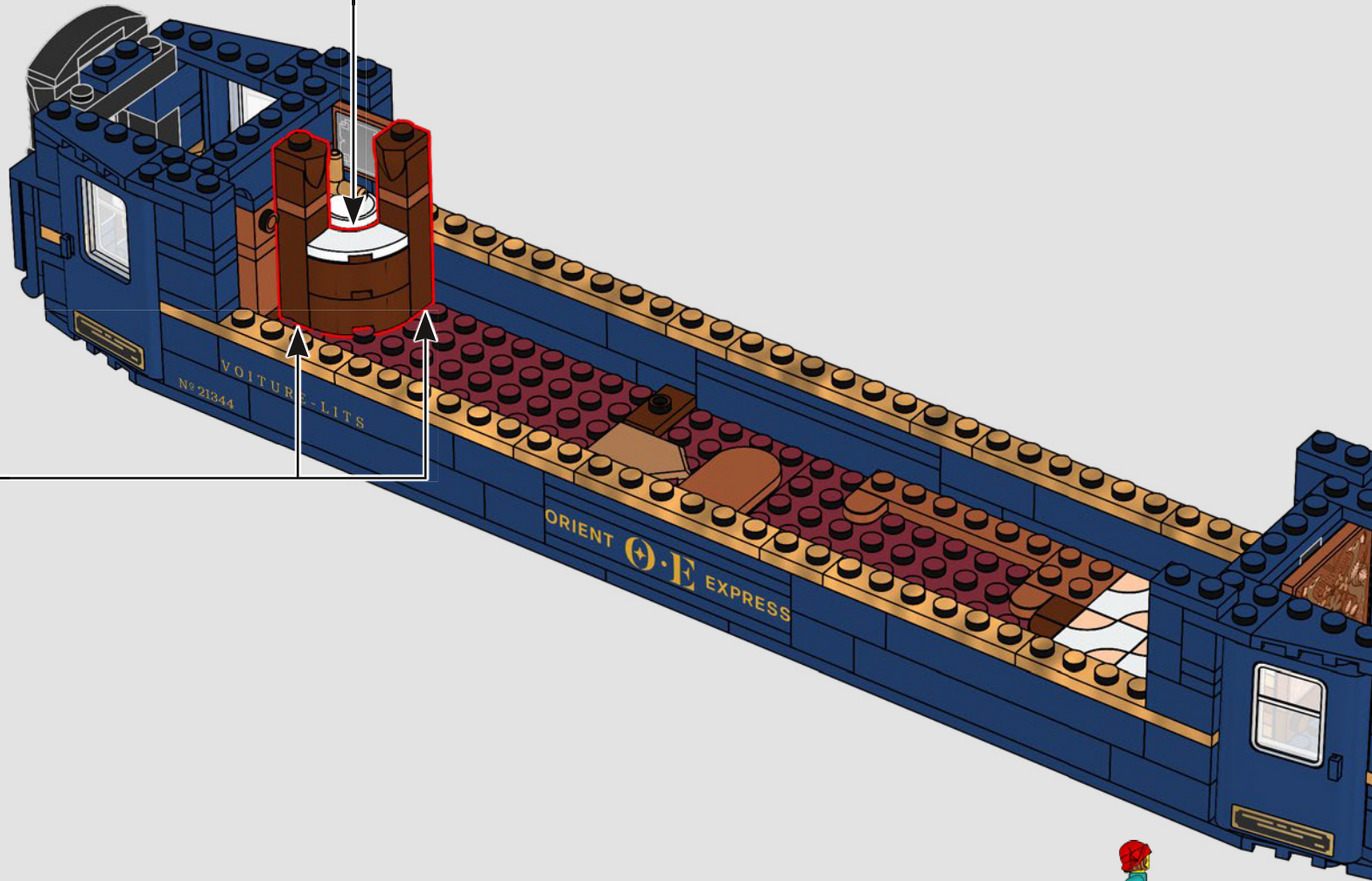
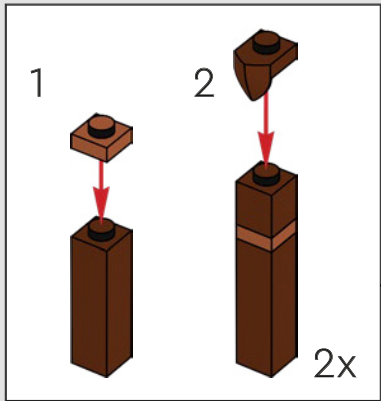
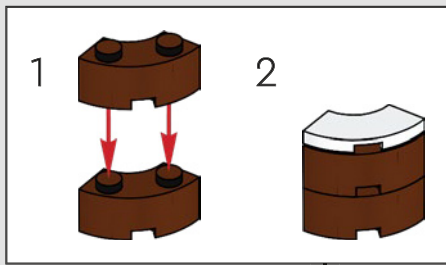

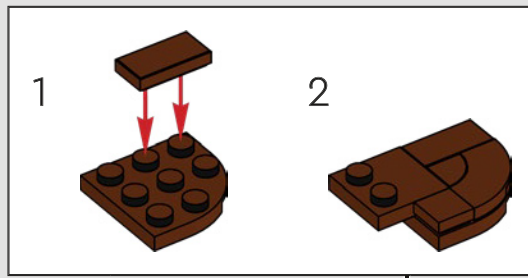
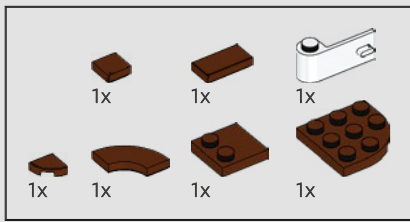

174

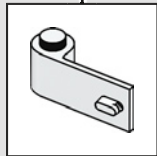
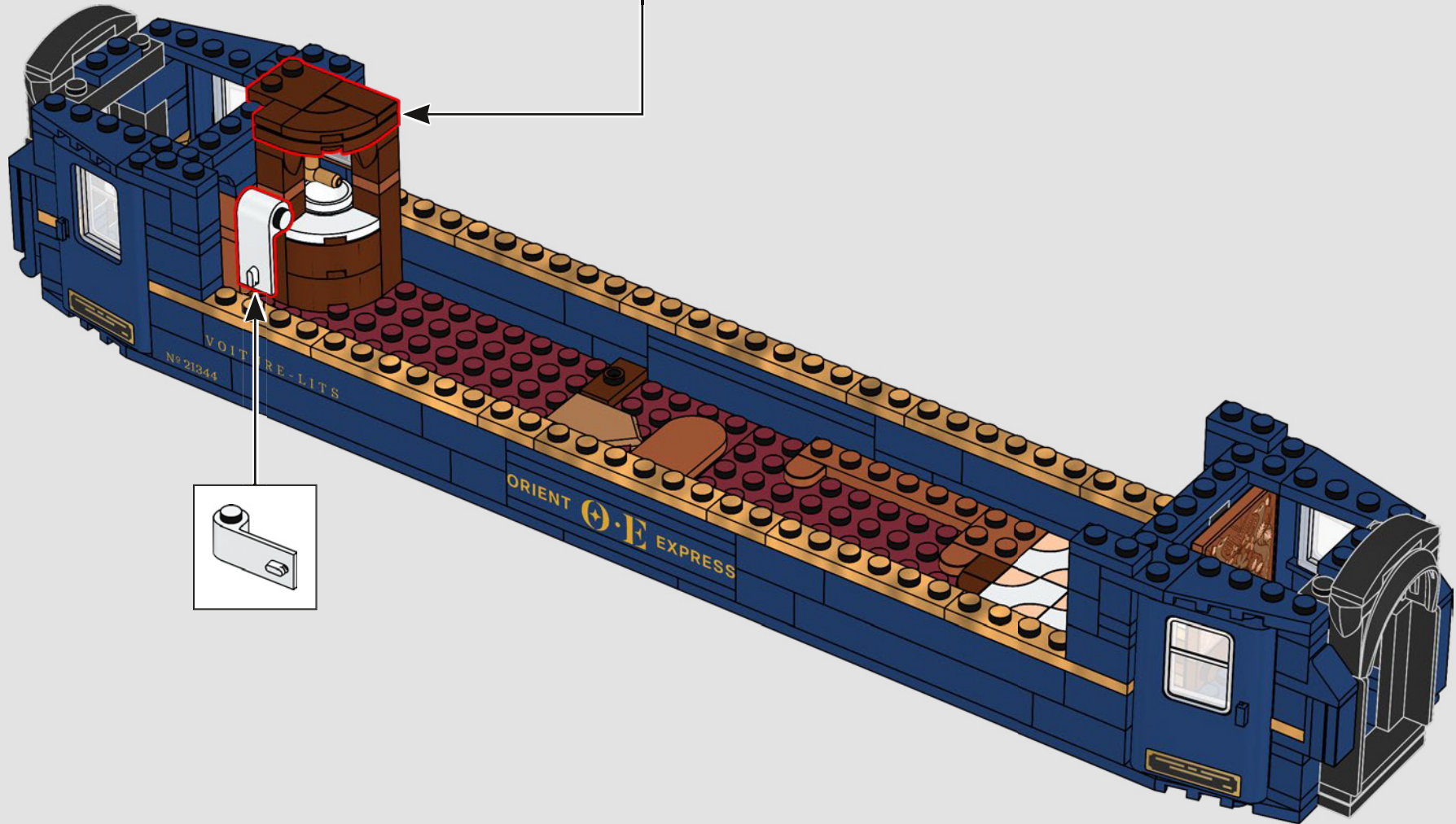



175

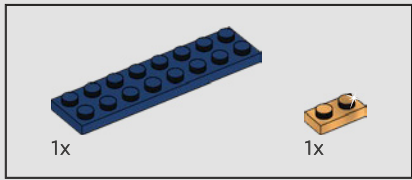
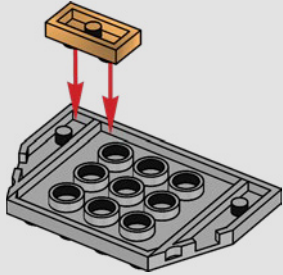

176

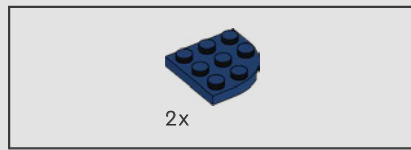
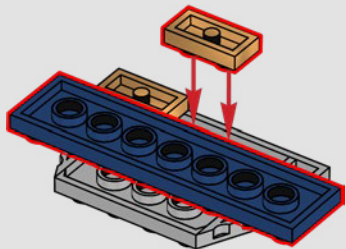

177

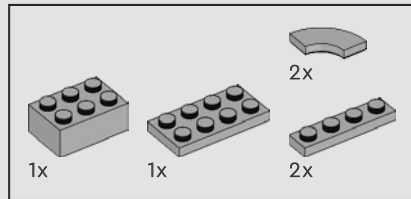
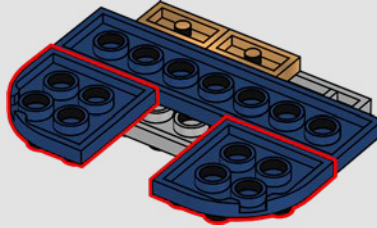

178

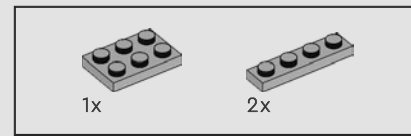
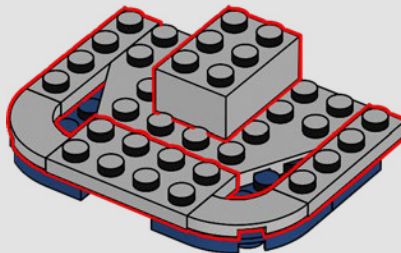

179

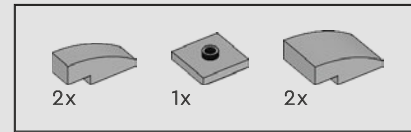
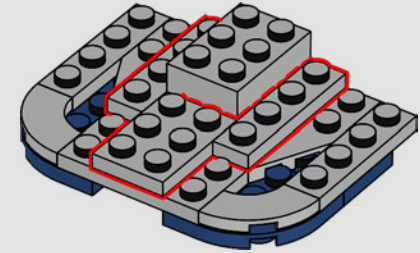

180

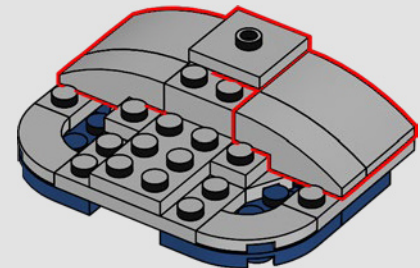



181

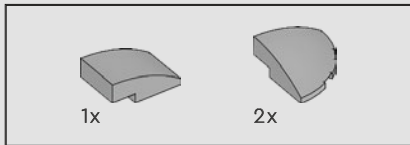
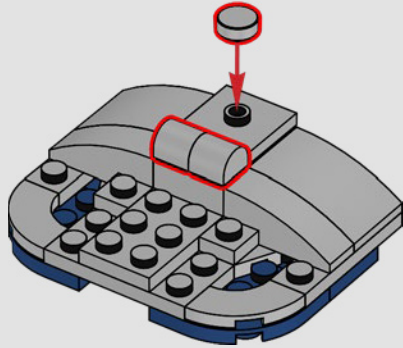

182

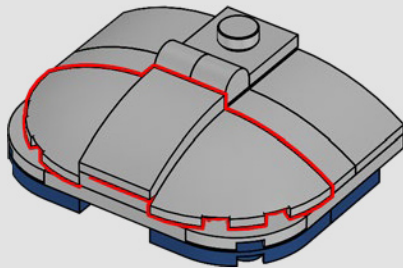

183

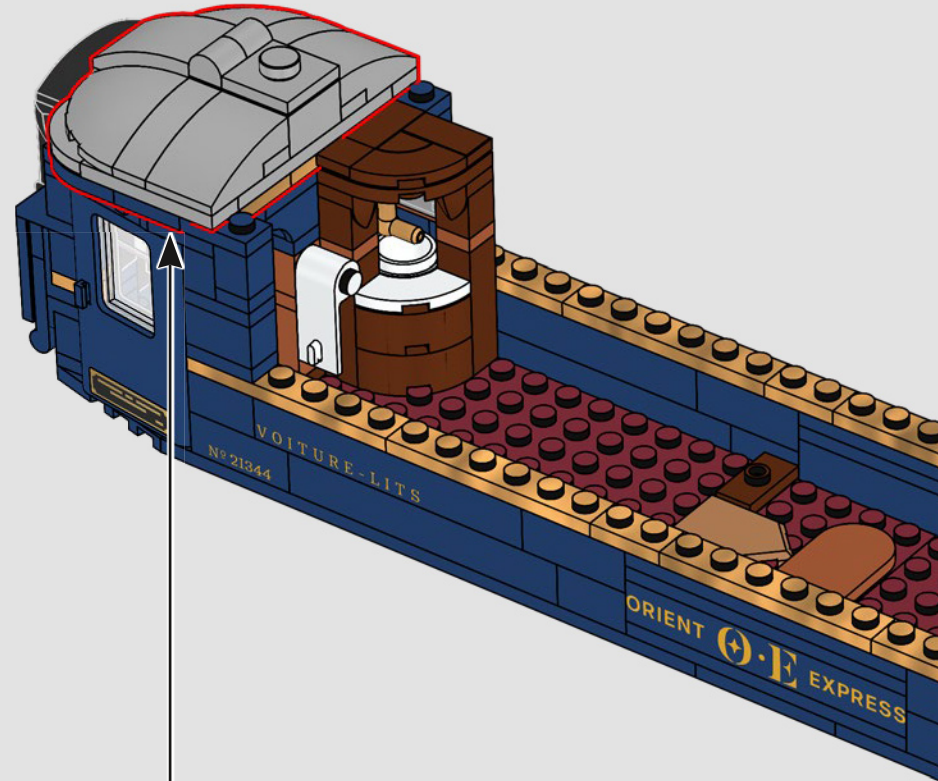

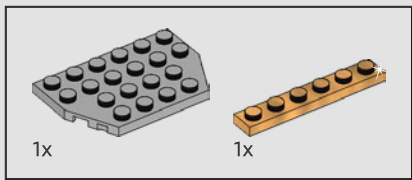

184

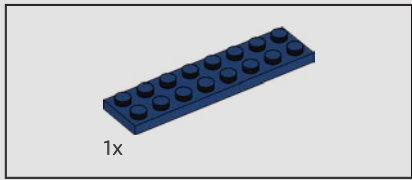
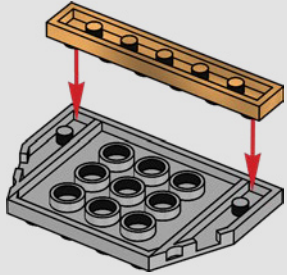

185

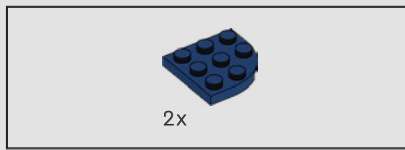
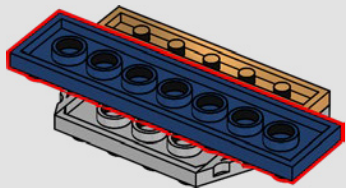

186

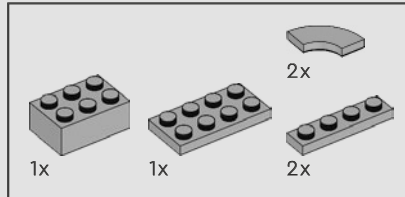
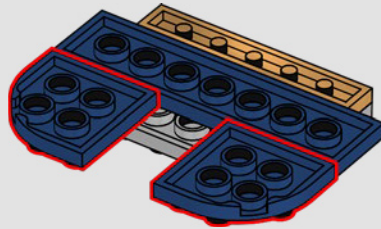

187

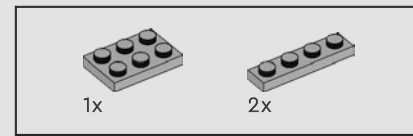
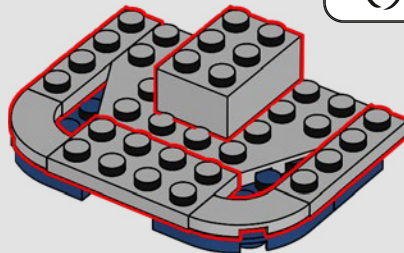

188

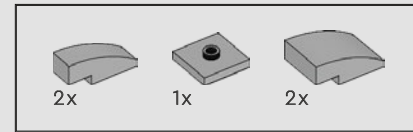
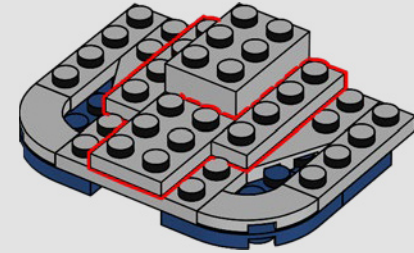

189

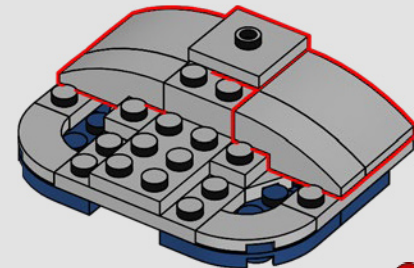

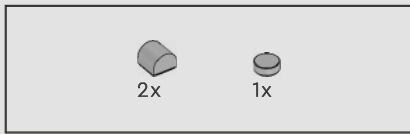

190

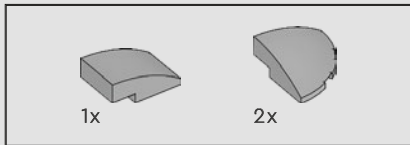
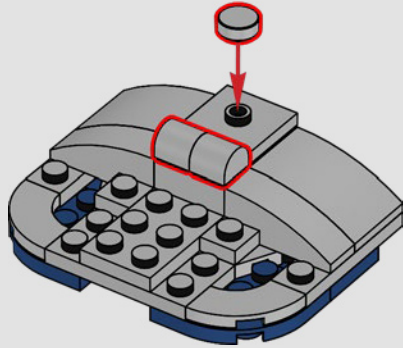

191

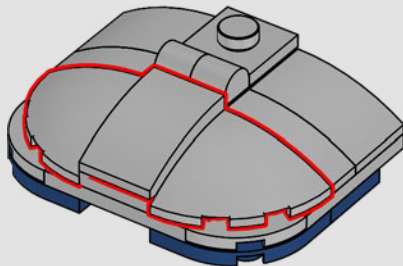

192

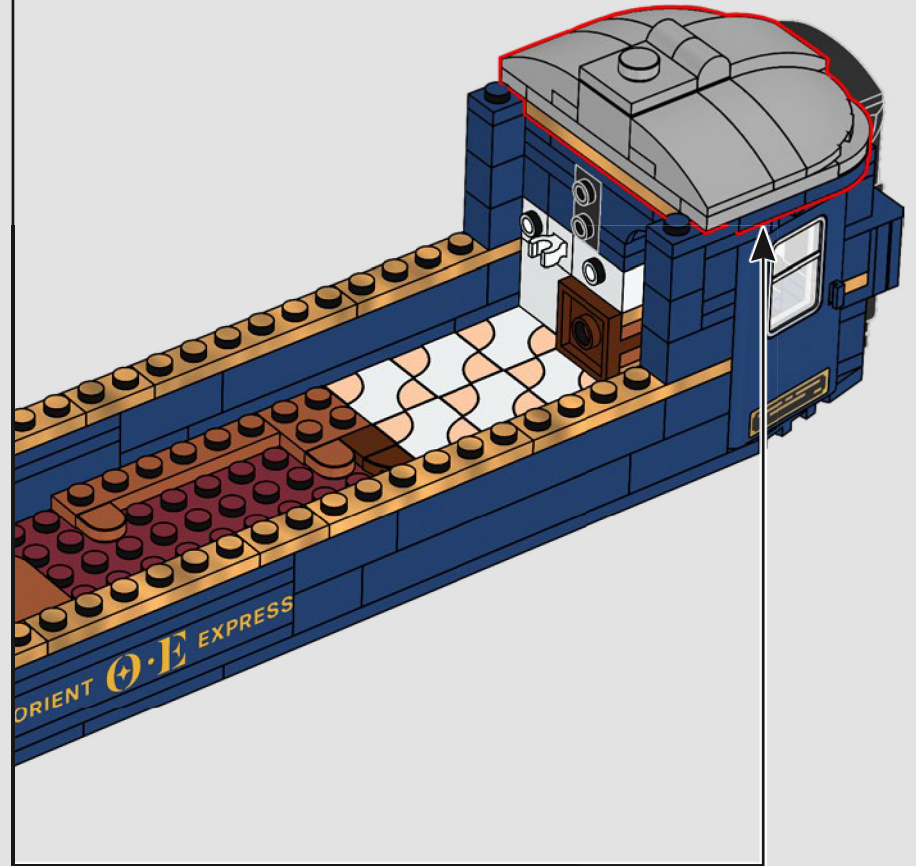

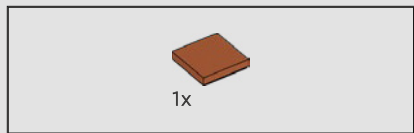

193

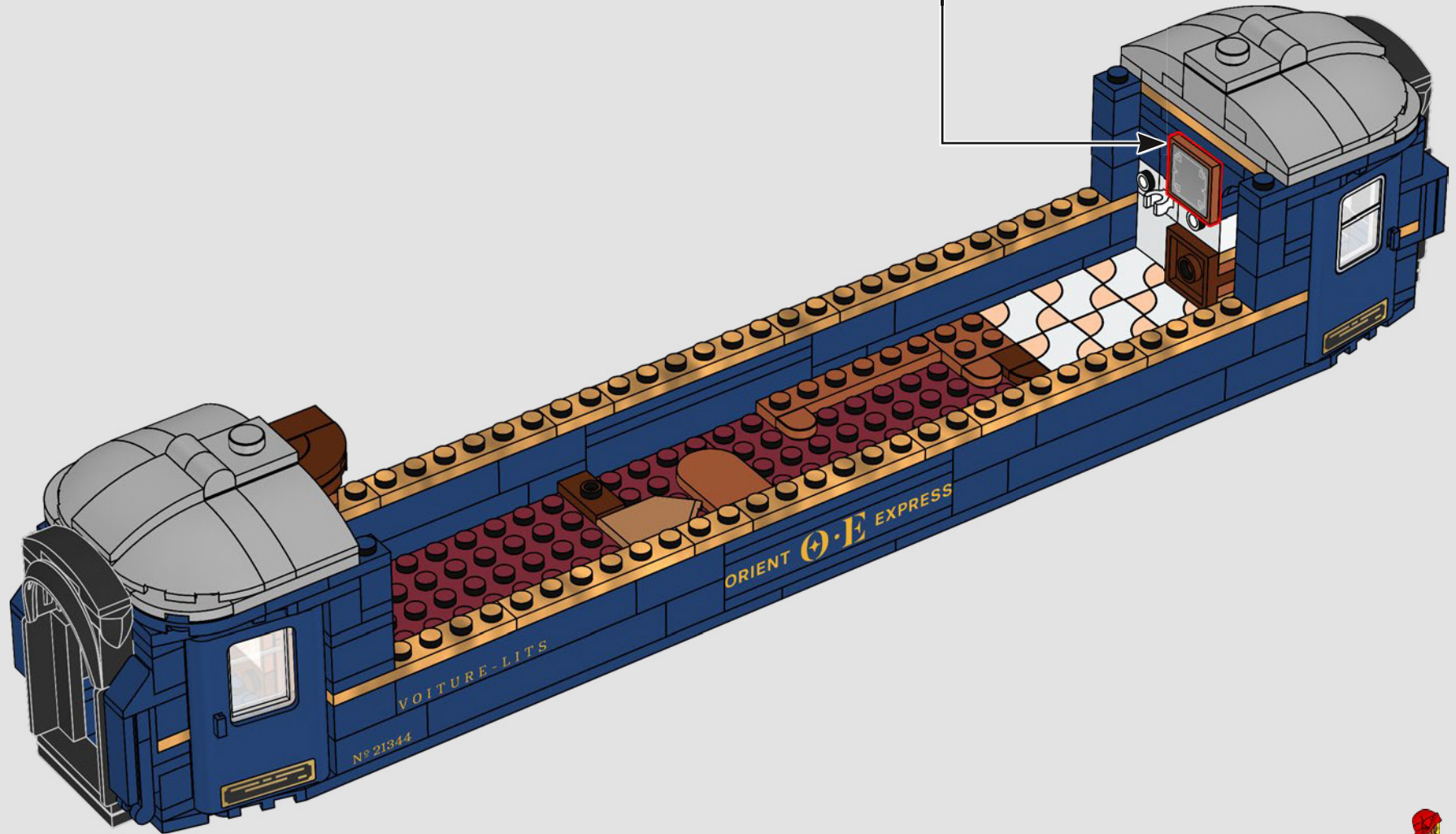
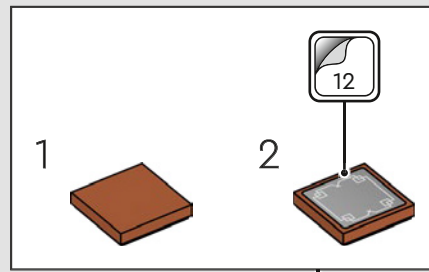

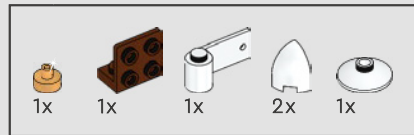

194

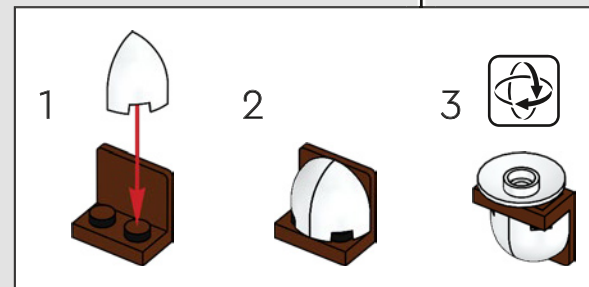
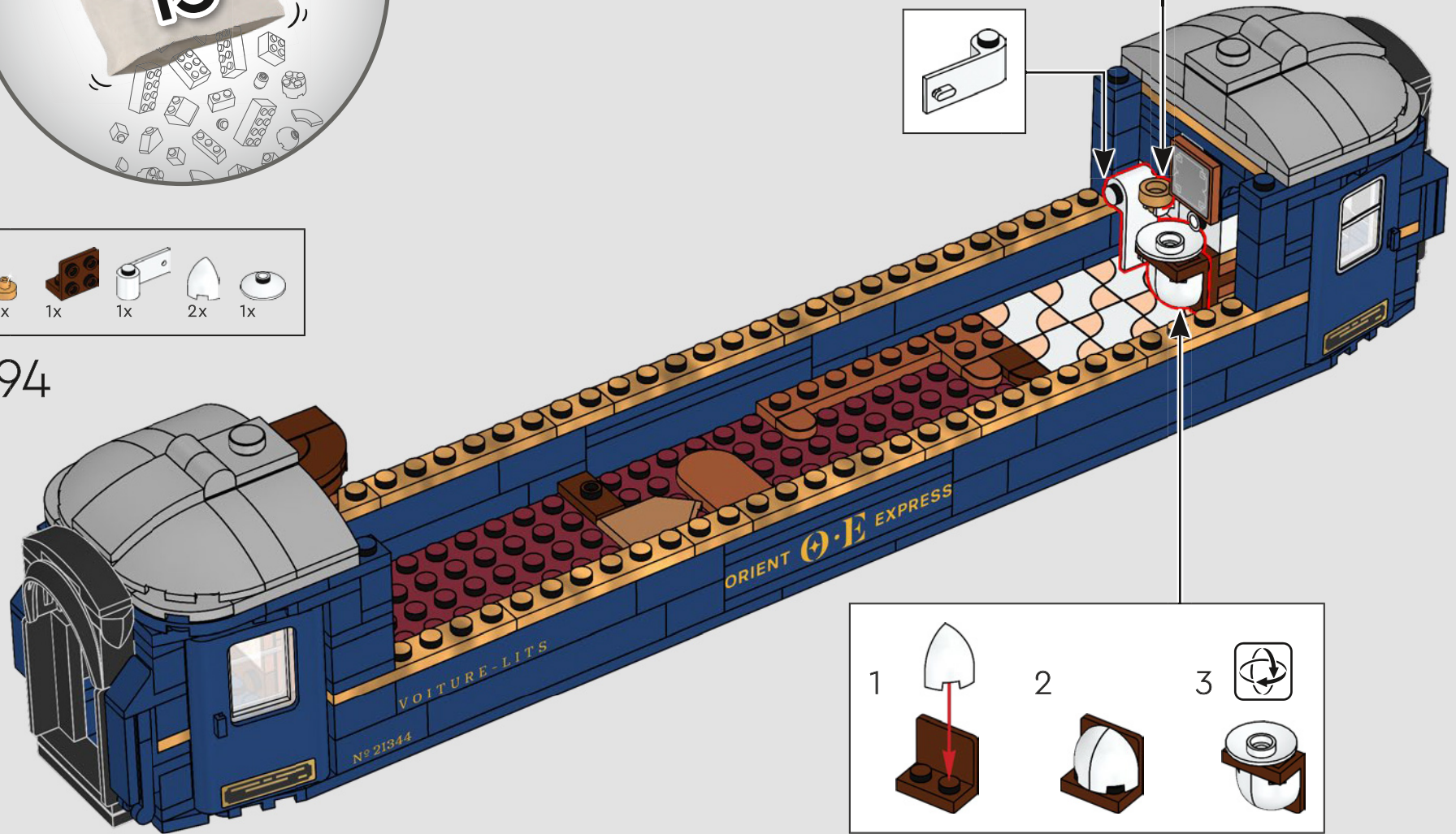

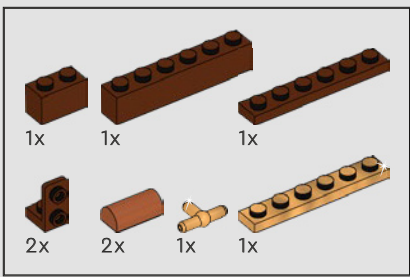

195

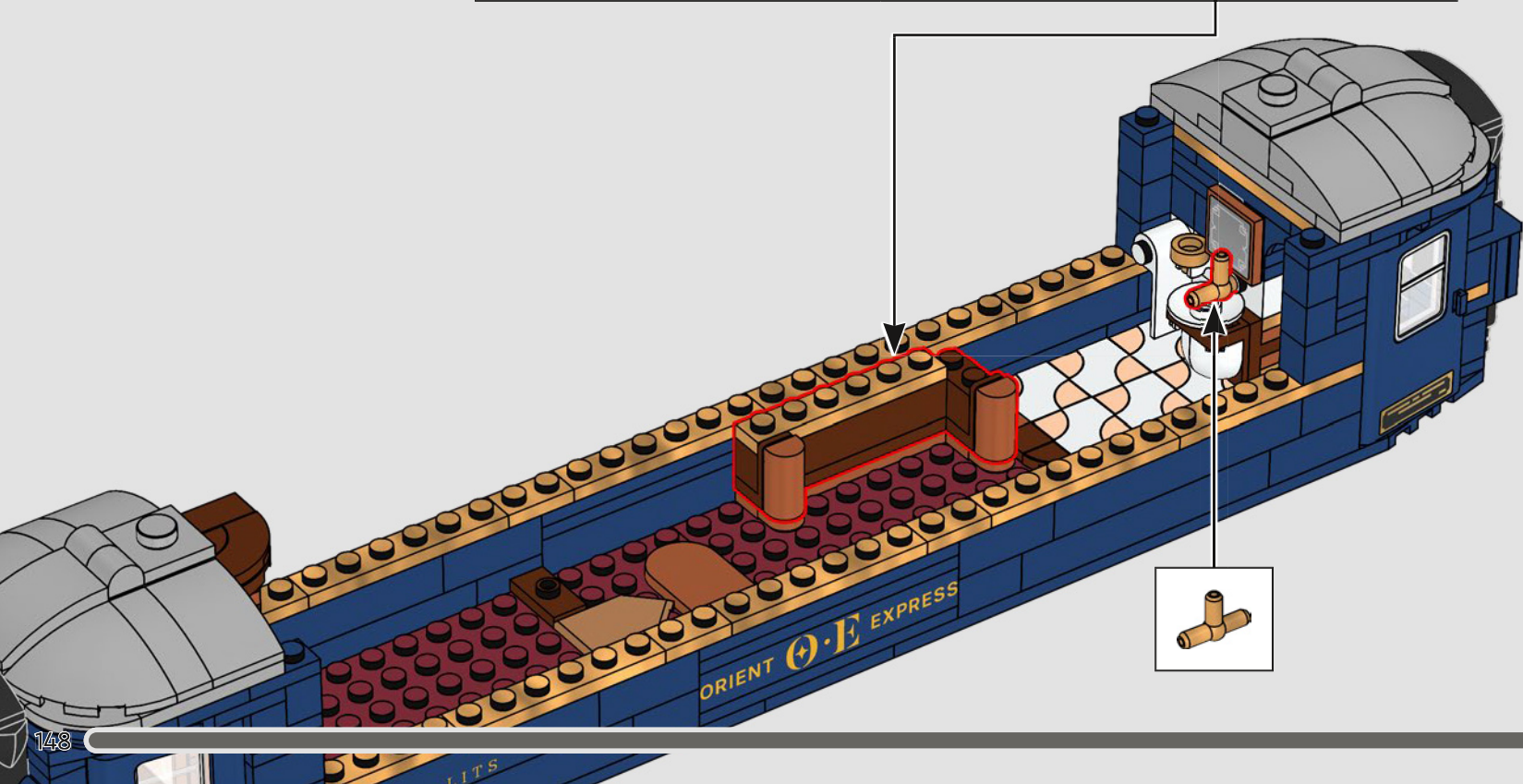
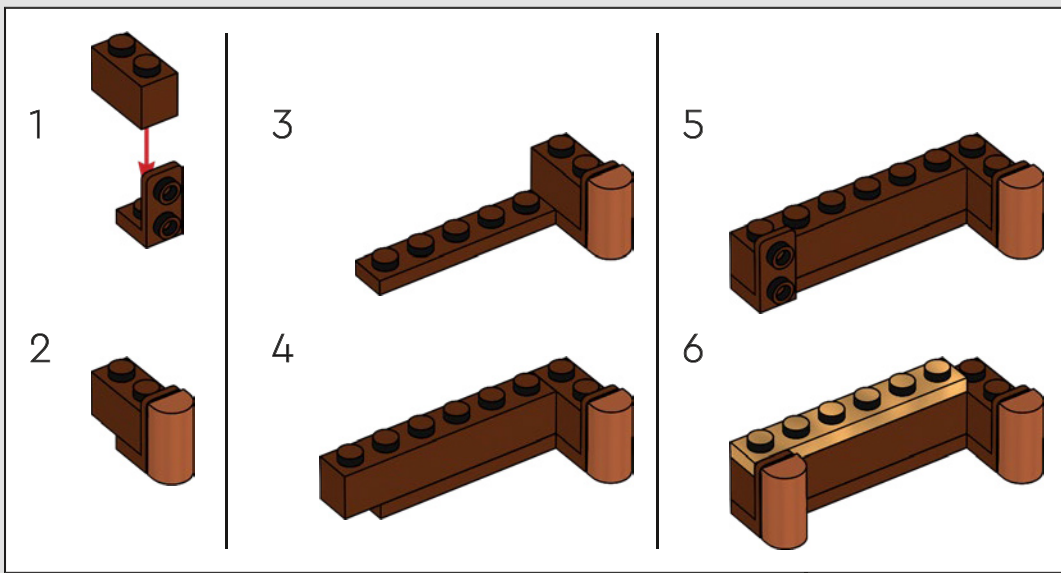

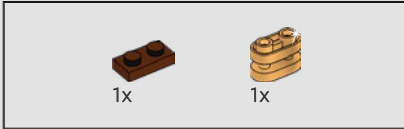
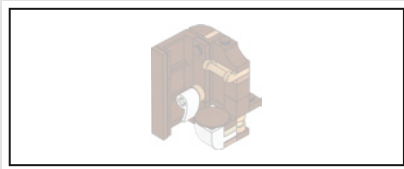

196

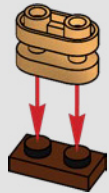

197



198

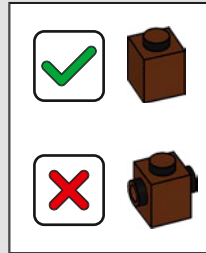

199

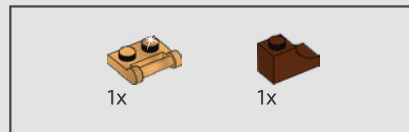

200

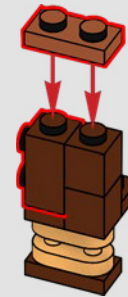
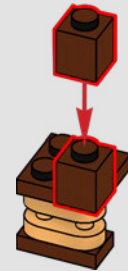

201

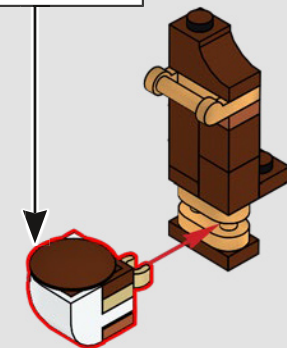
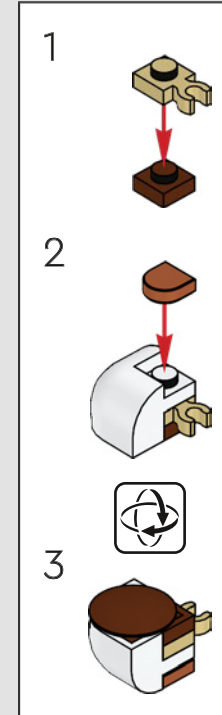

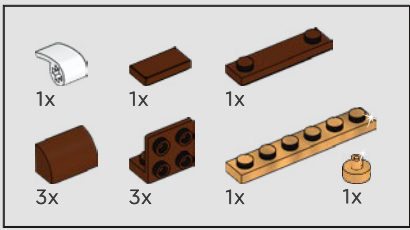

202

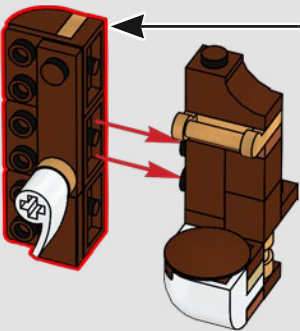
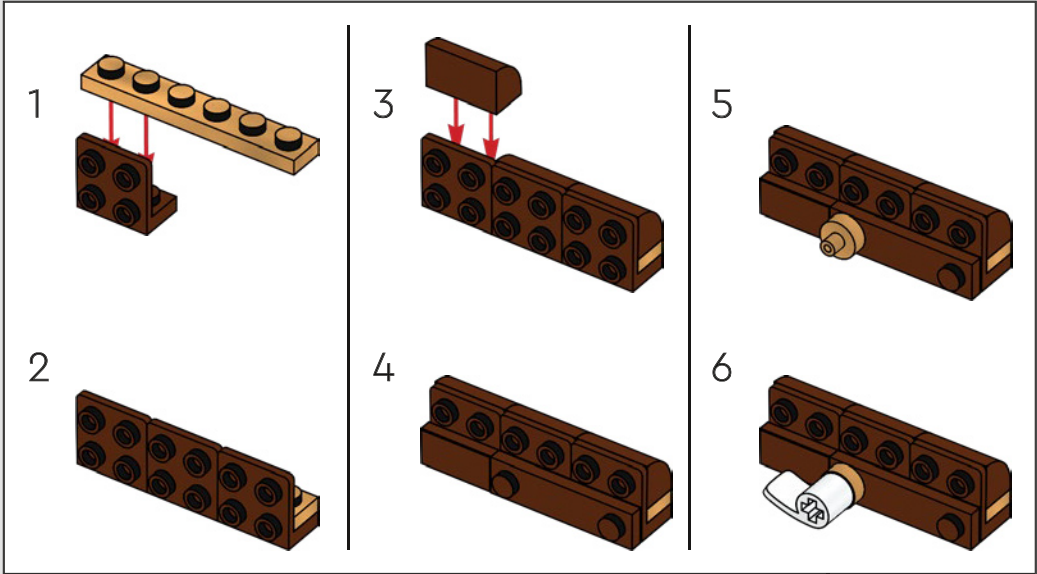

203

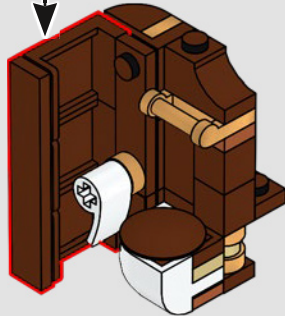
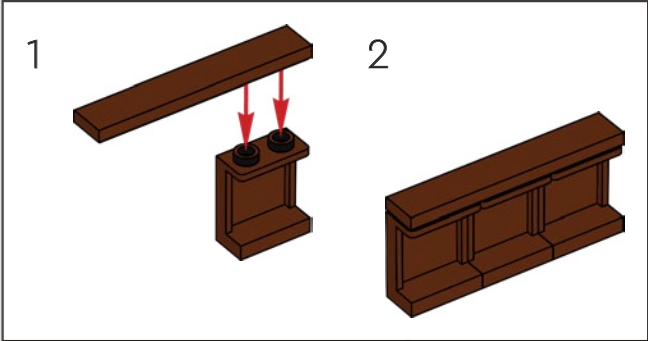

204

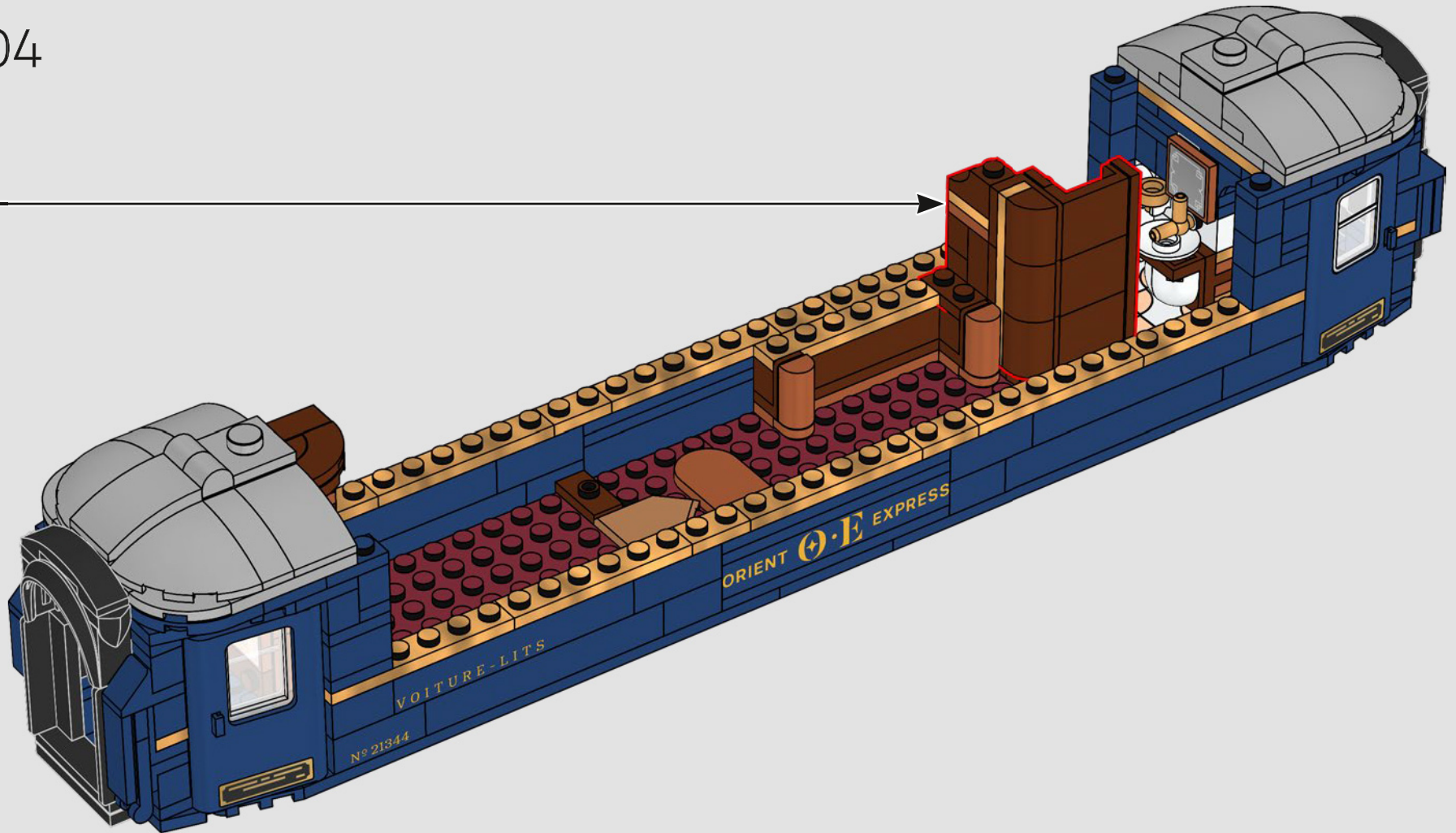

..... ●
'First-class cabins feature an ensuite bathroom with charming tile work.'

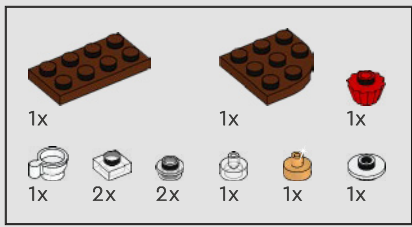

205

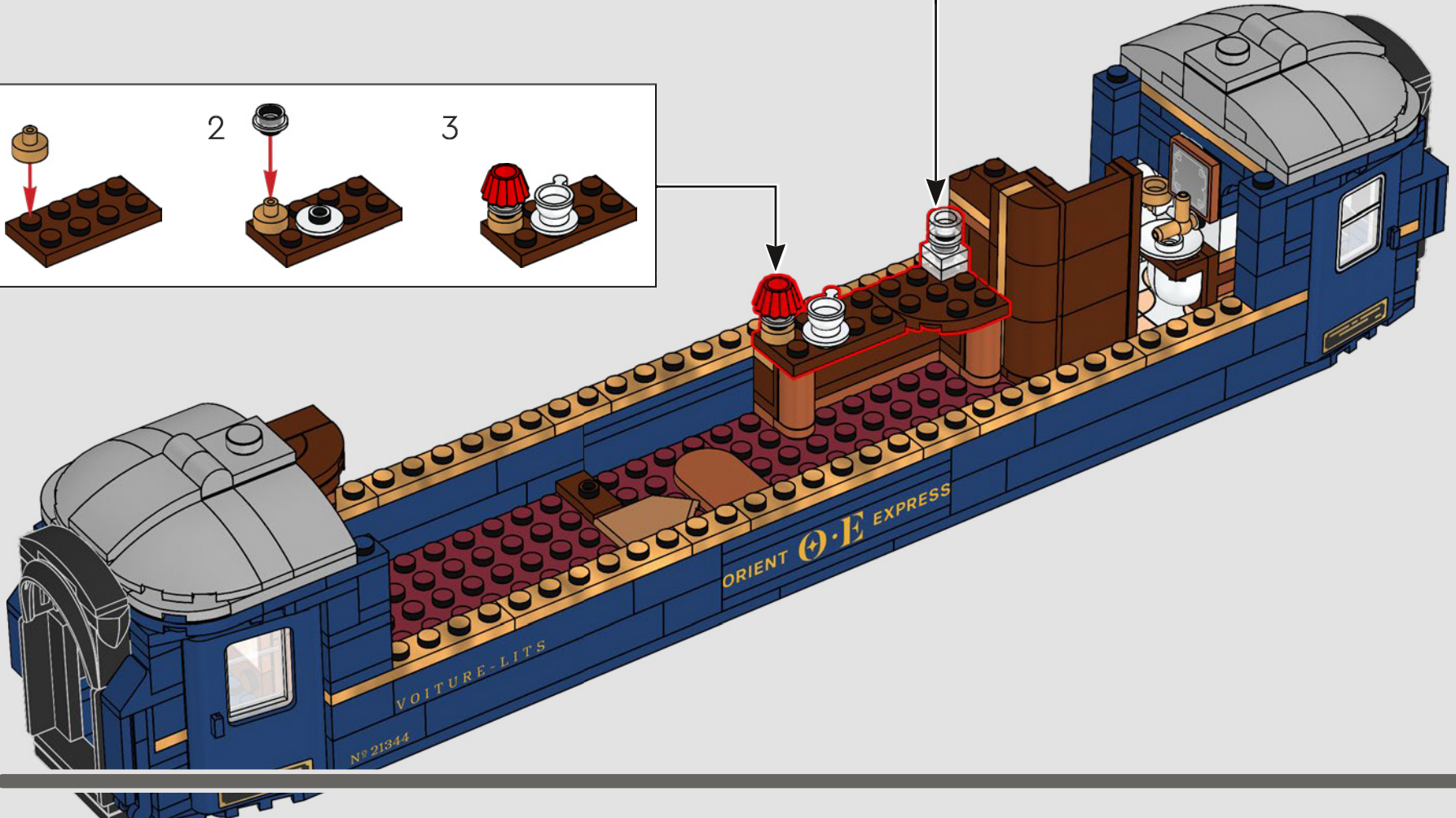
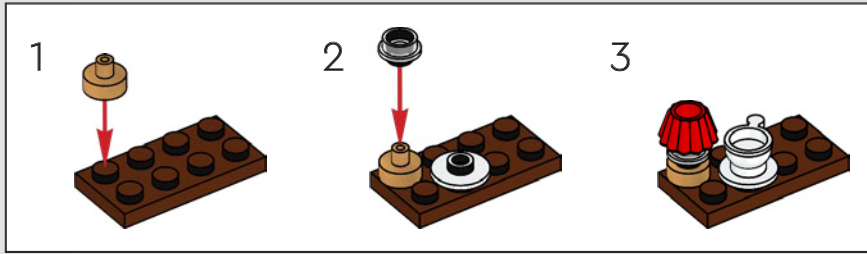
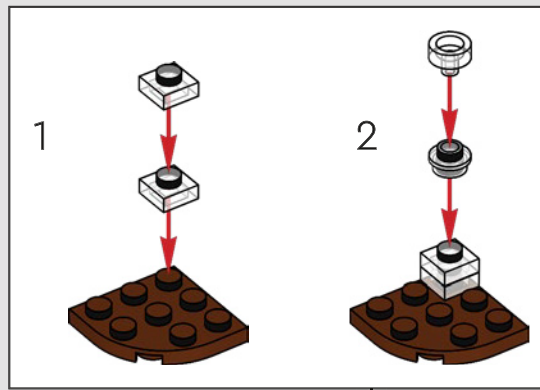

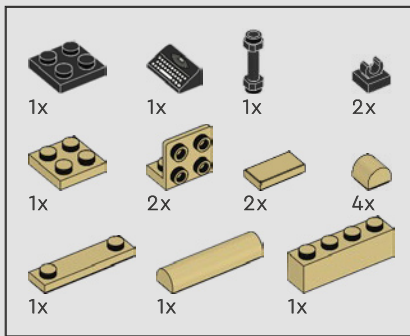

206

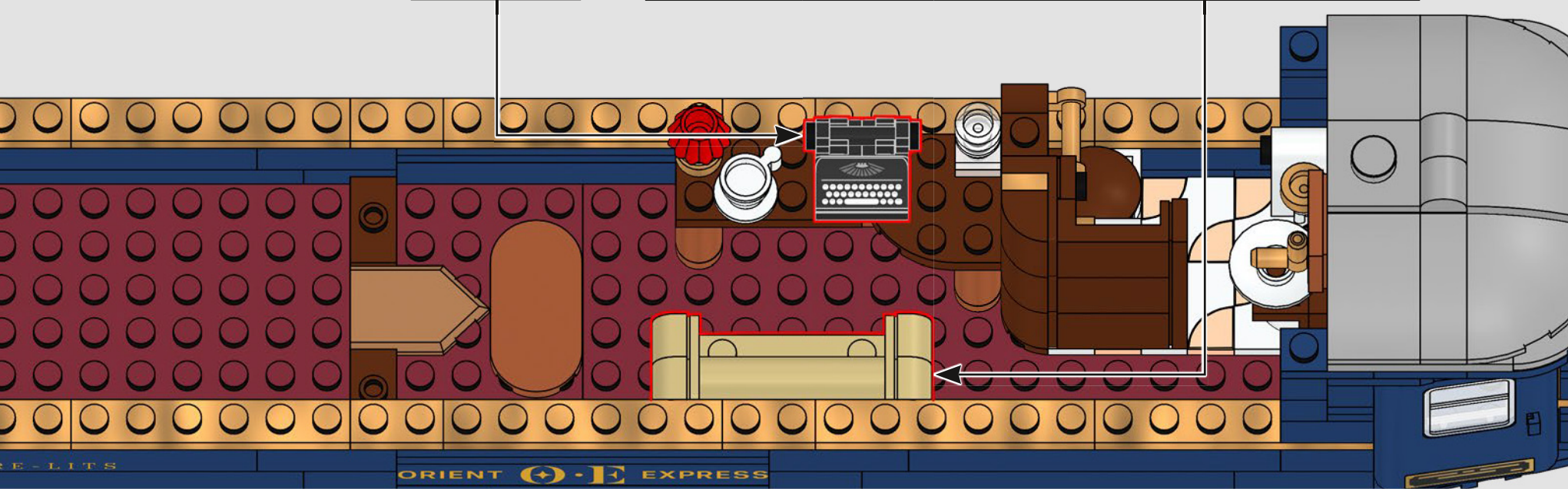
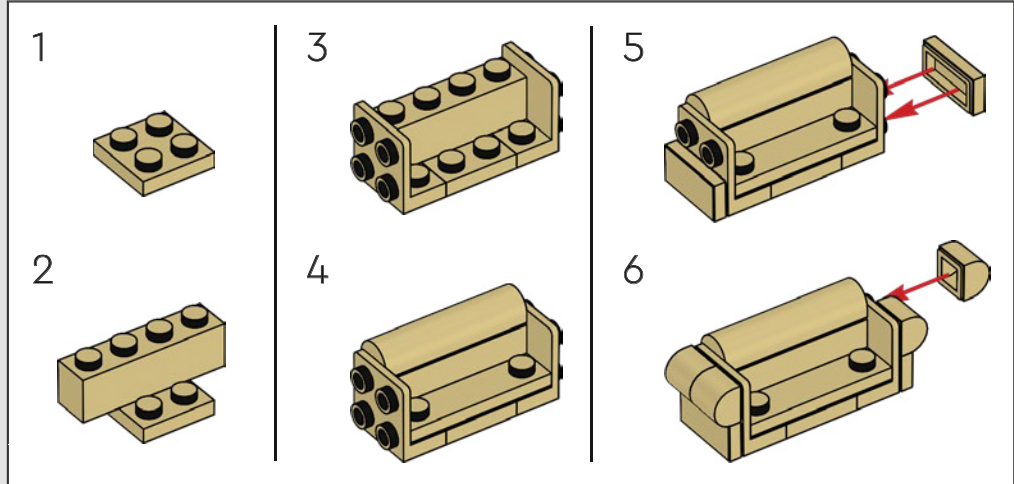
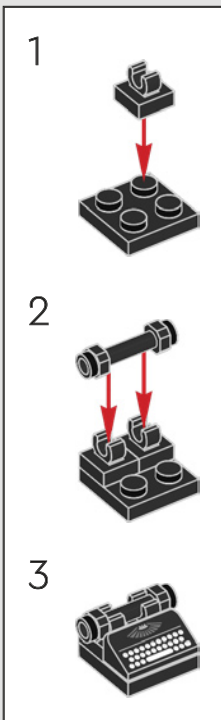

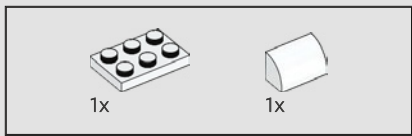

207

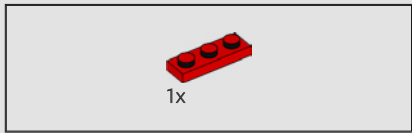
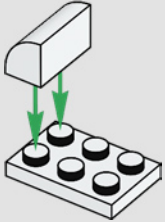

208

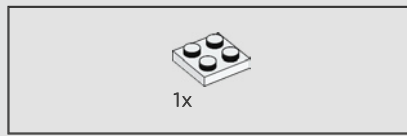
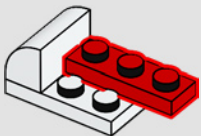

209

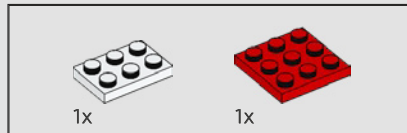
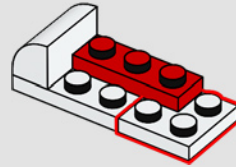

210

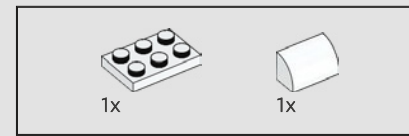
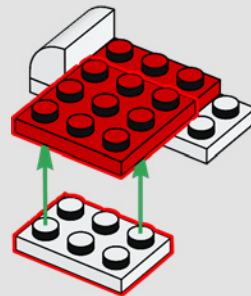

211

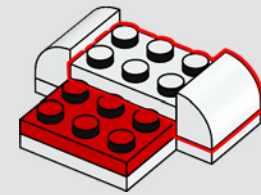

212

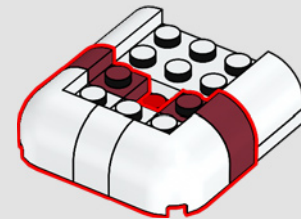

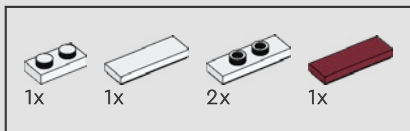

213

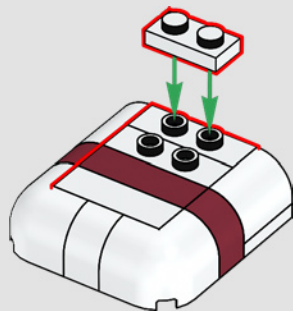

214

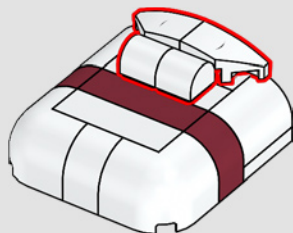

215

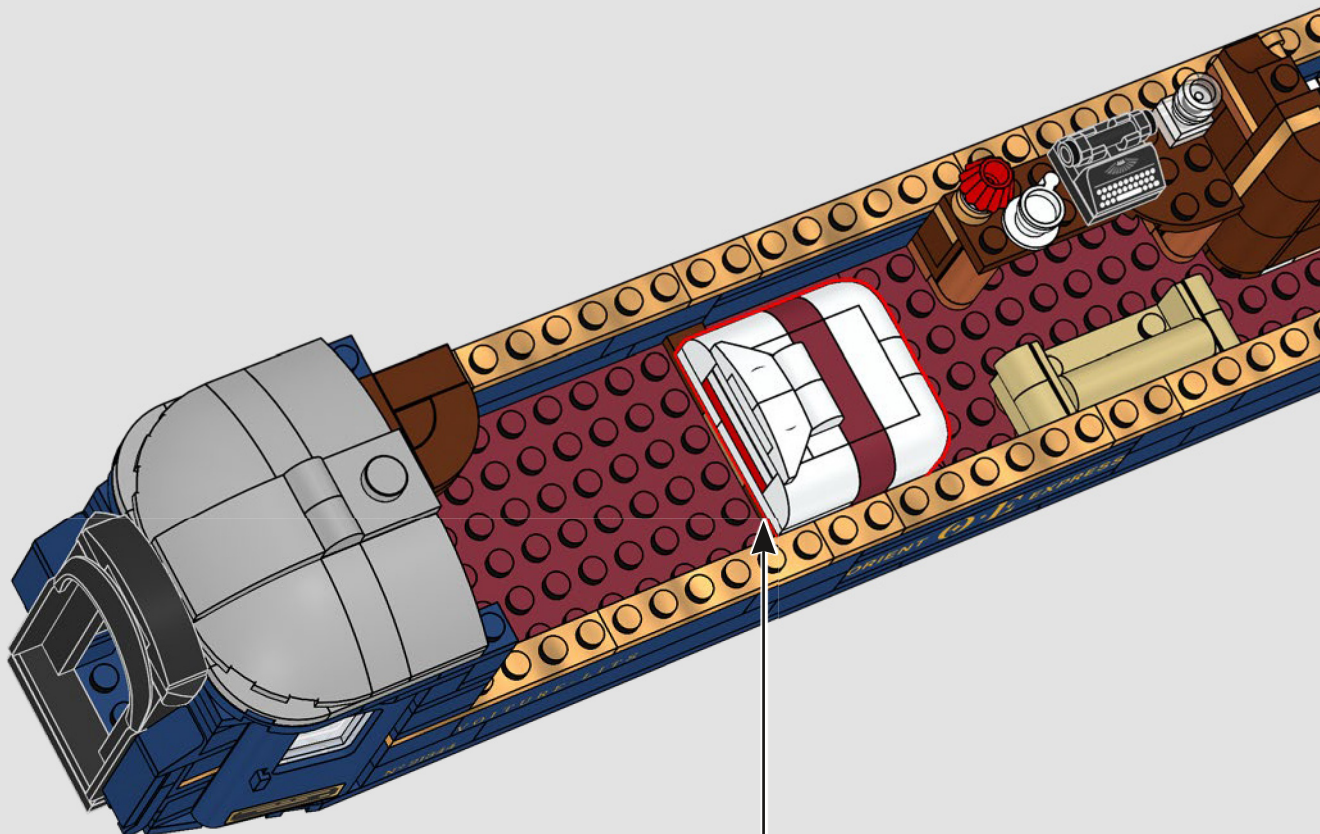

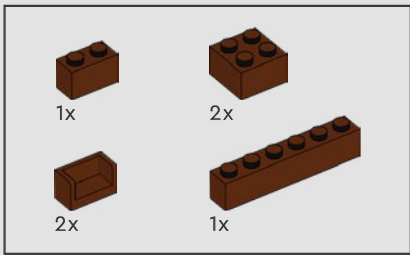

216

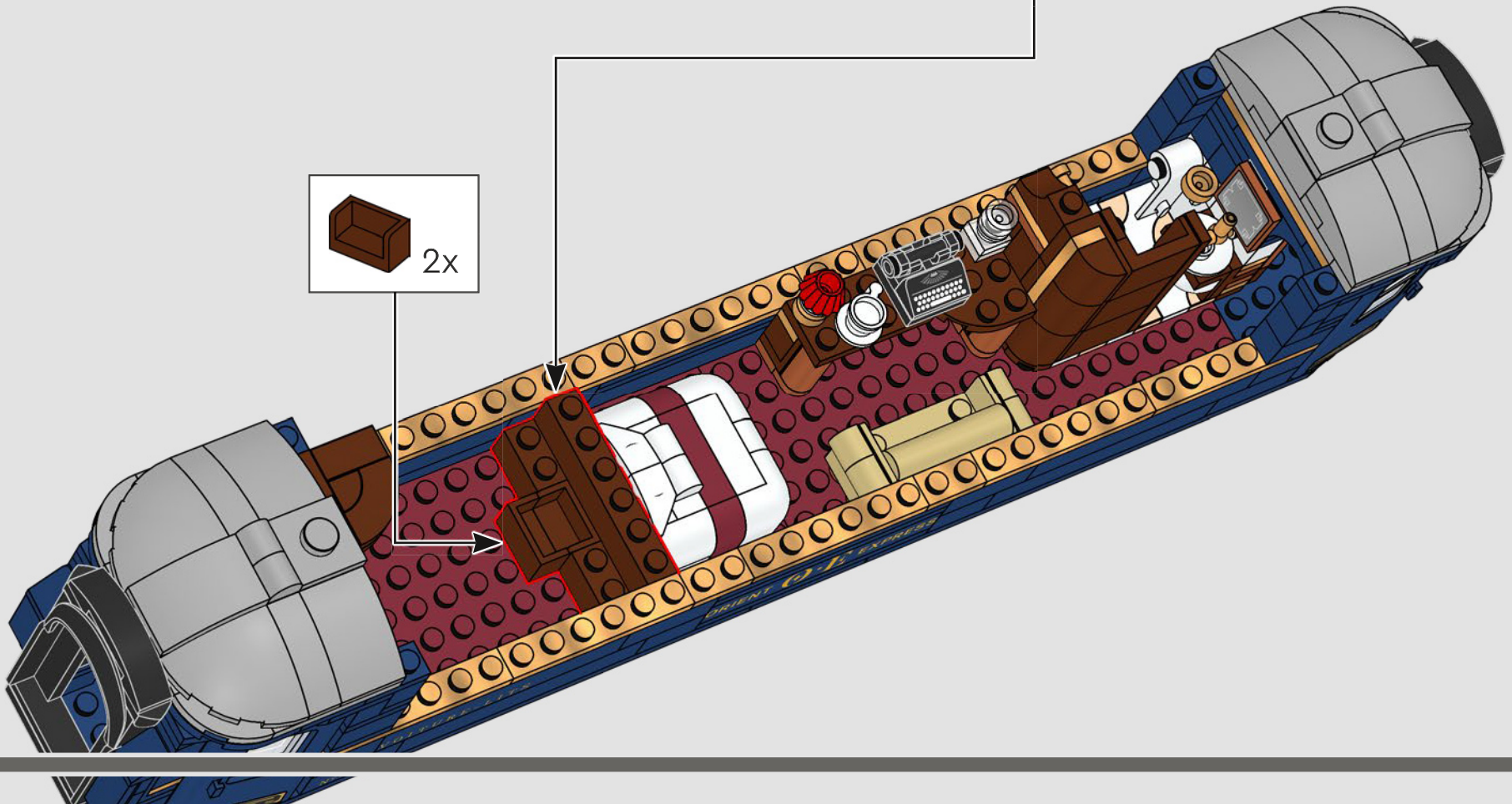
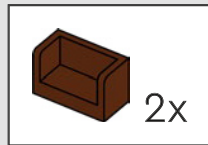
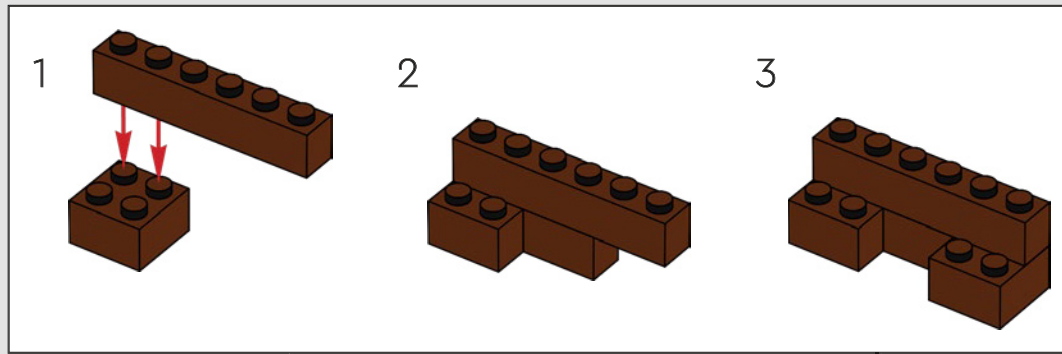



217

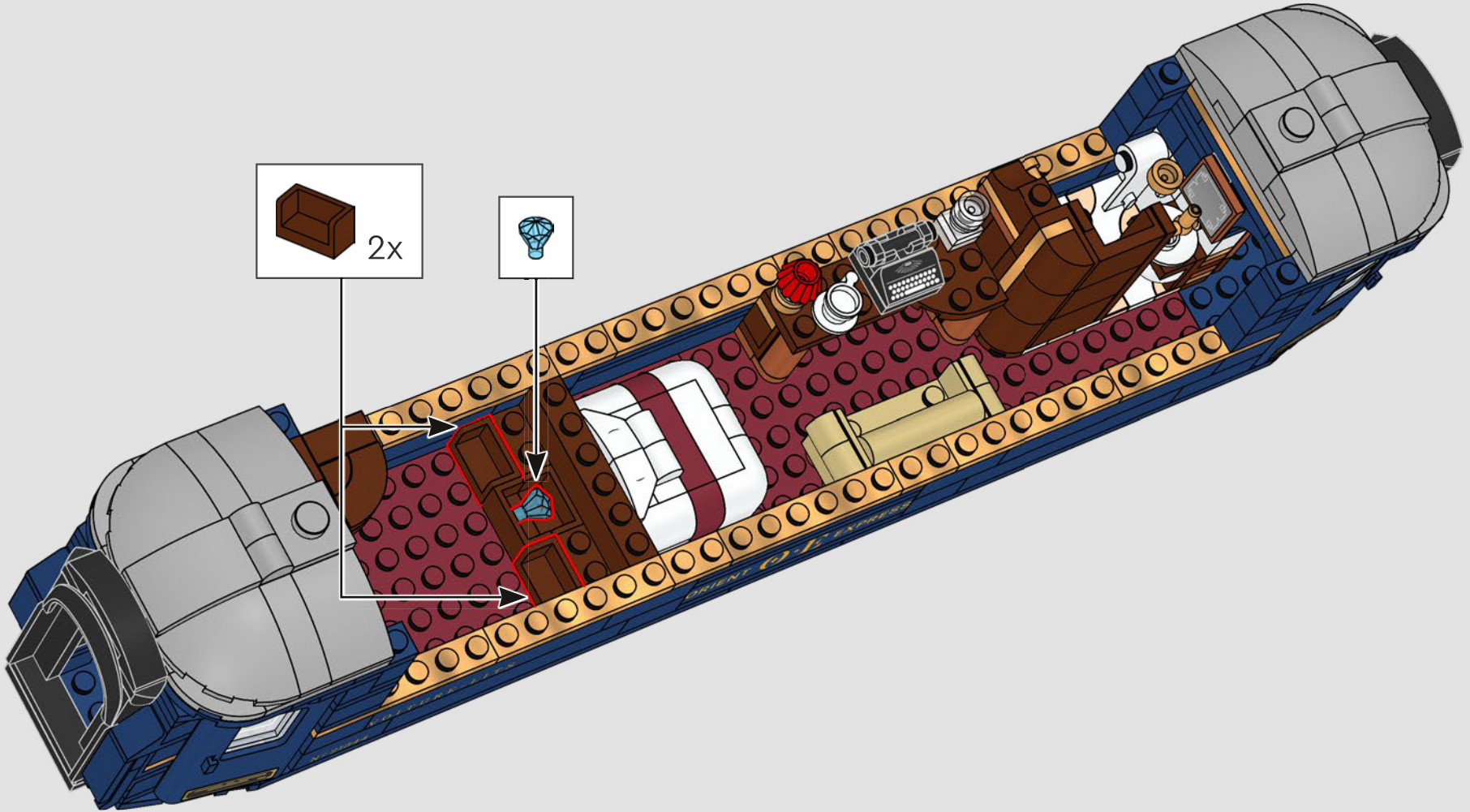

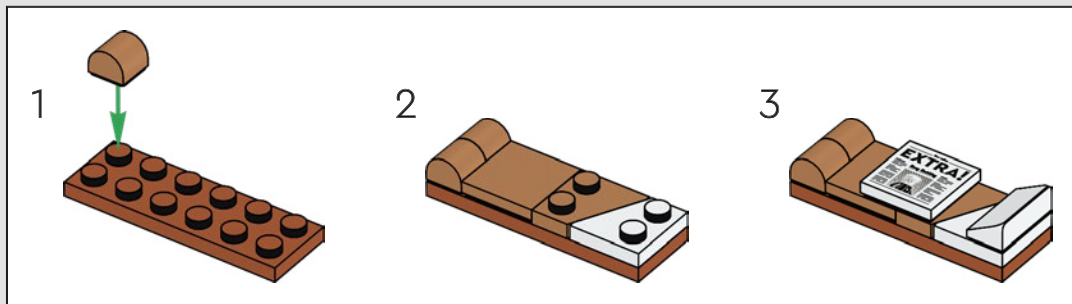
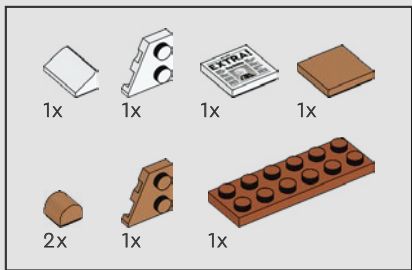

218

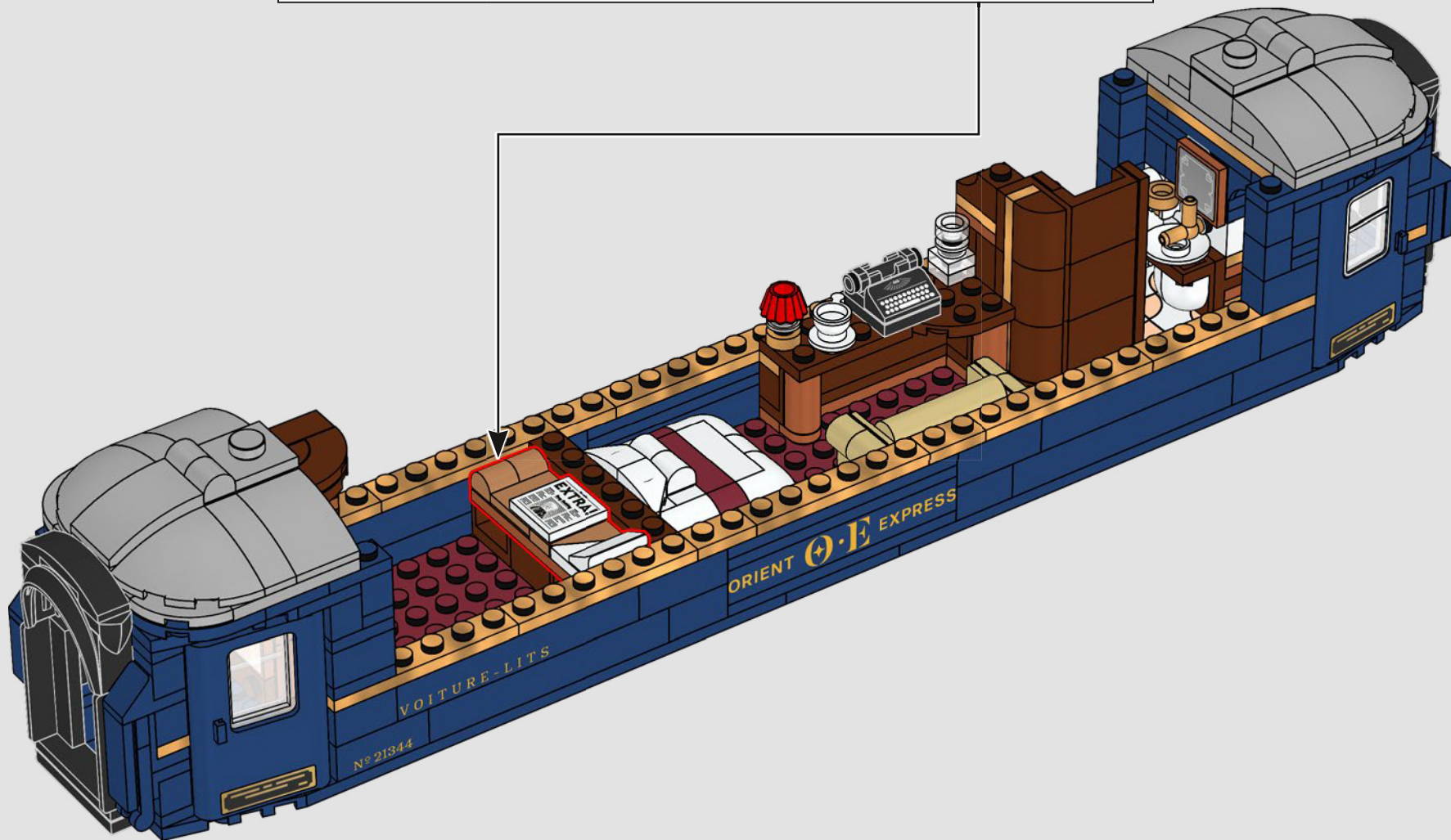



219

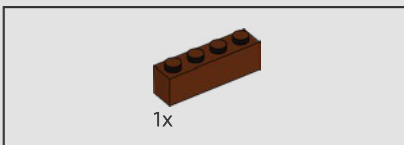
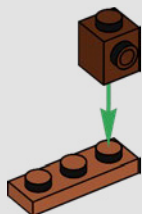

220

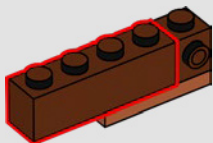

221

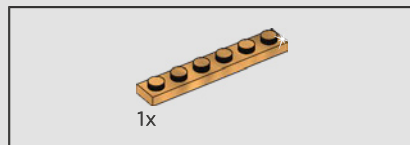
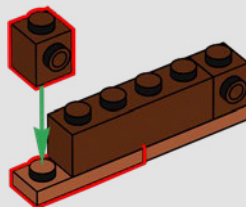

222

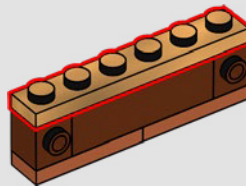

223

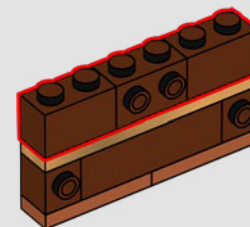

224

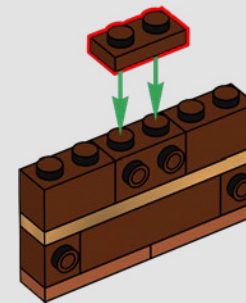



225

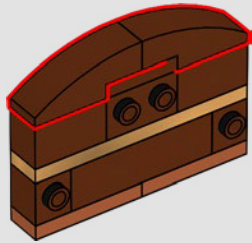

226

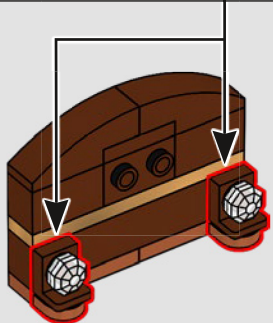
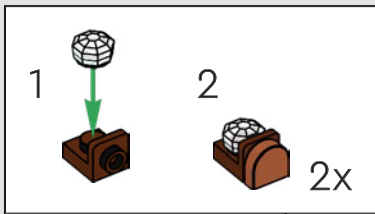

227

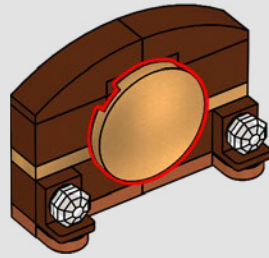

228

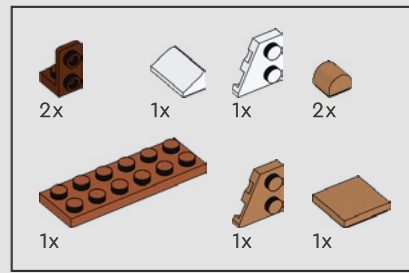
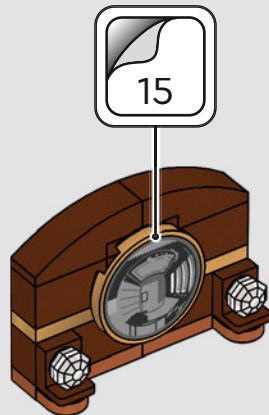

229

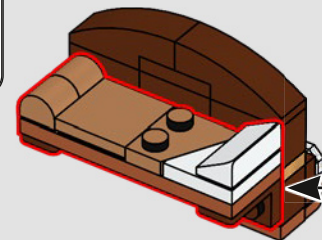
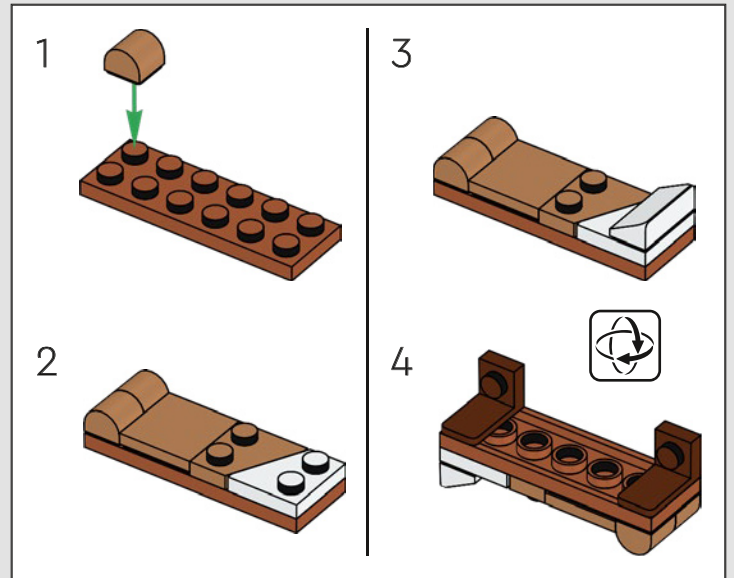

230

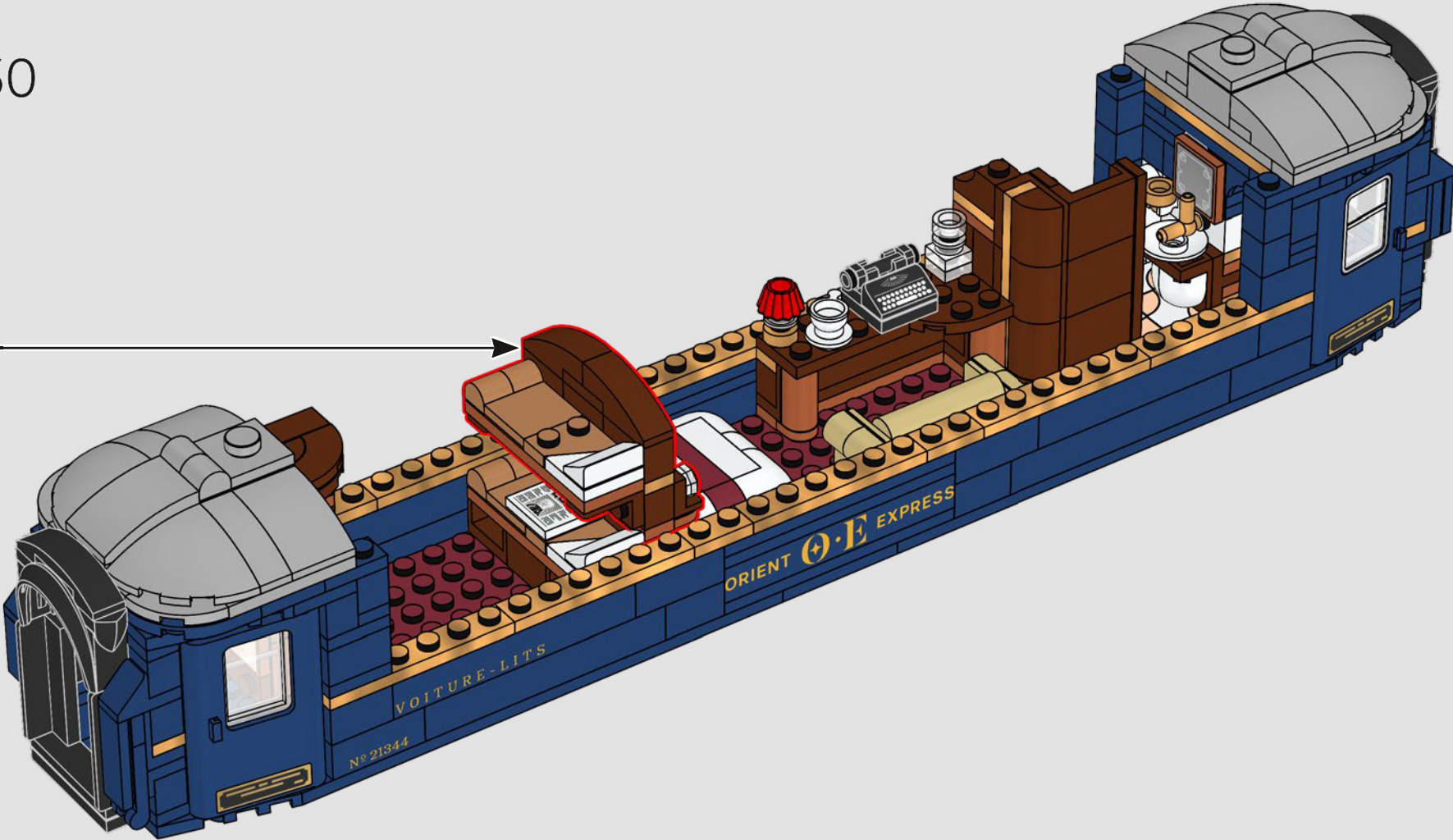

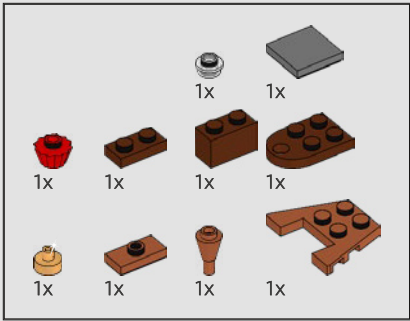

231

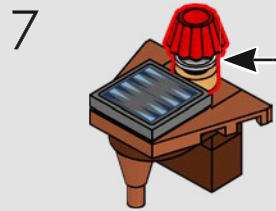
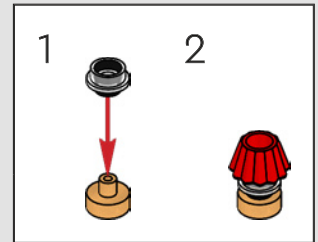
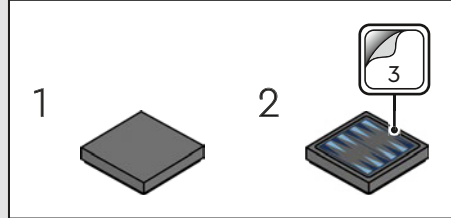
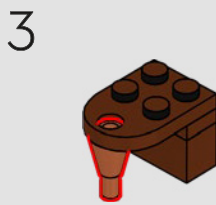
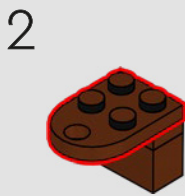
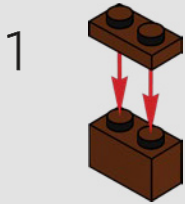

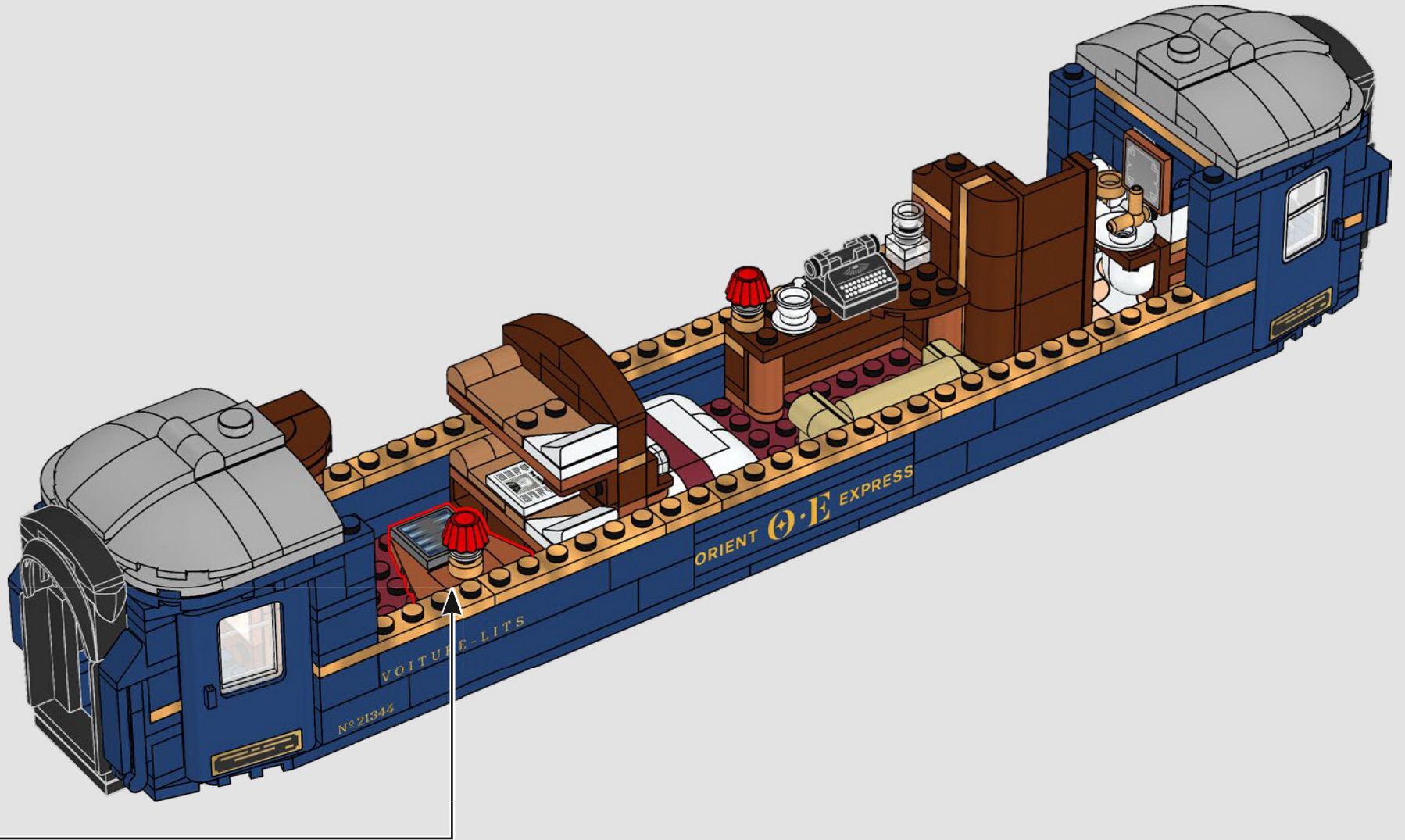



Next Stop: BUCHAREST
'This vibrant city is our next stop.
The grand boulevards bustle with activity.'

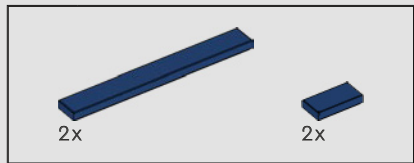

232

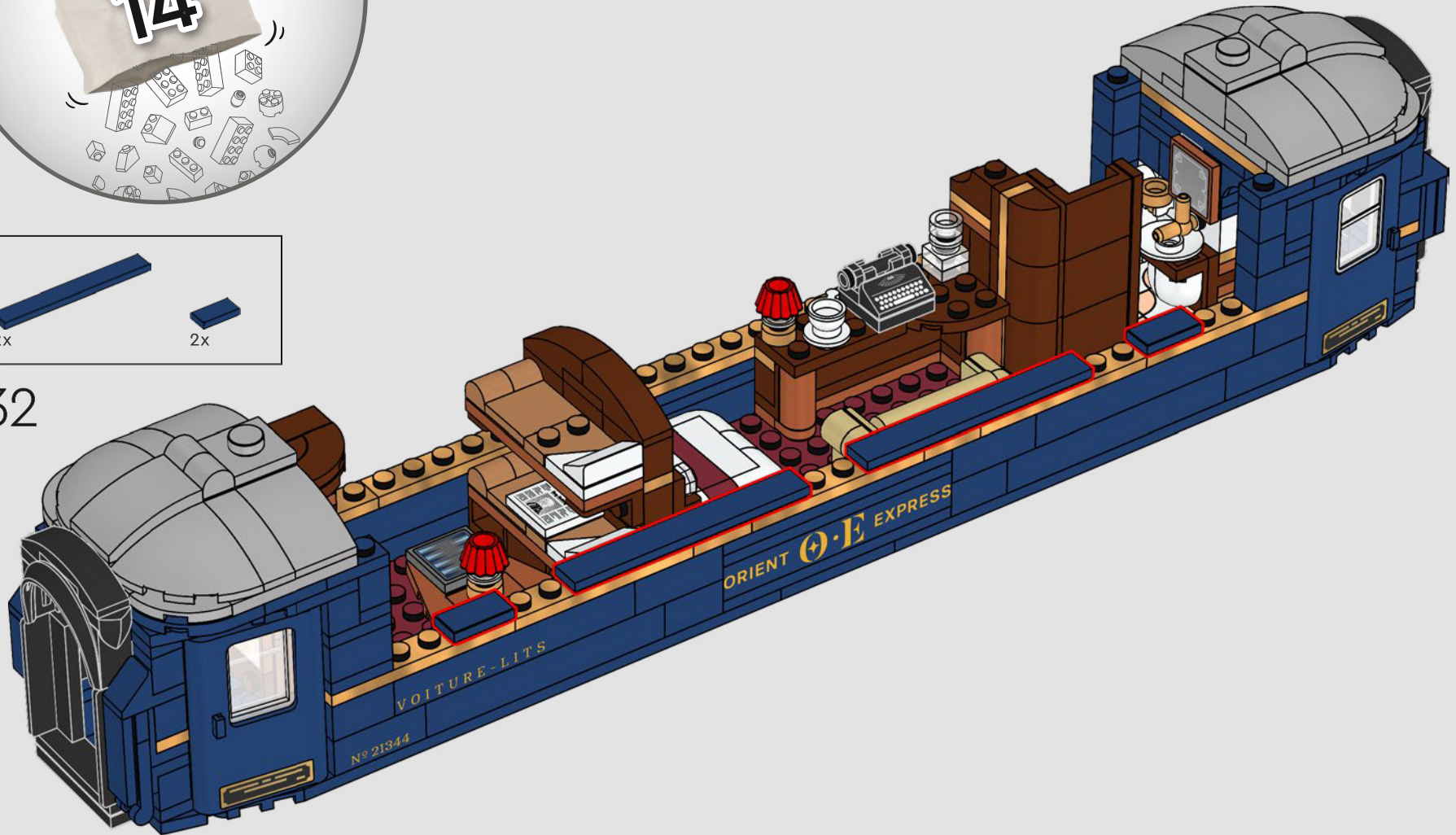

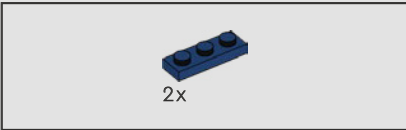
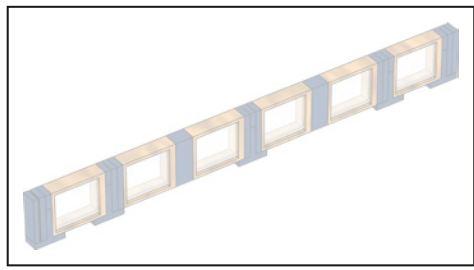

2x

233

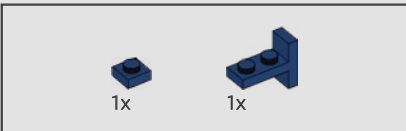
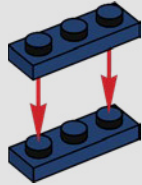

1x

1x

234

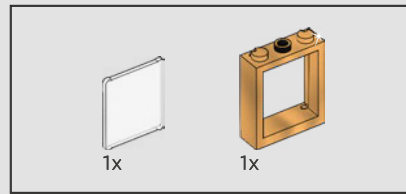
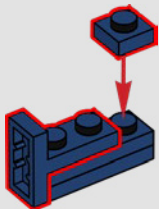

1x

1x

235

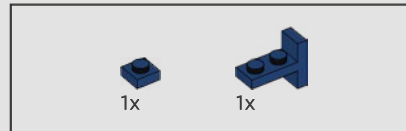
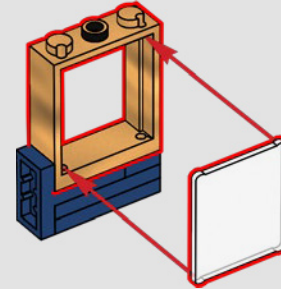

1x

1x

236

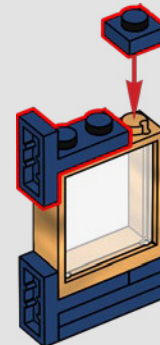

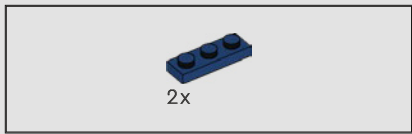

237

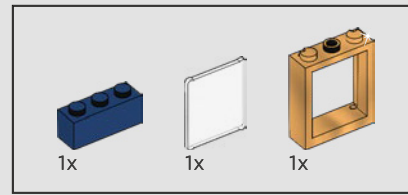
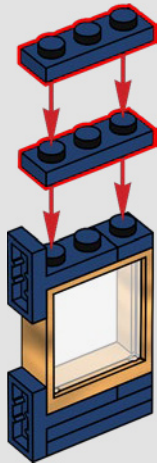

238

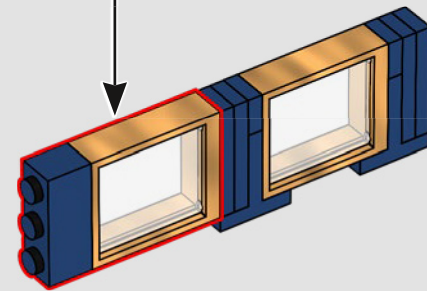
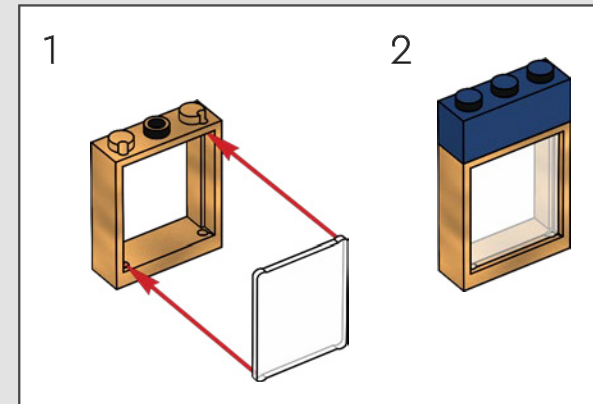

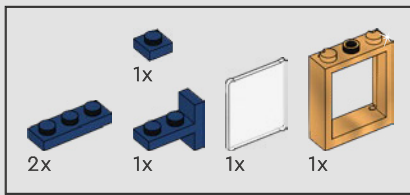

239

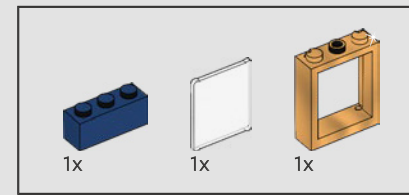
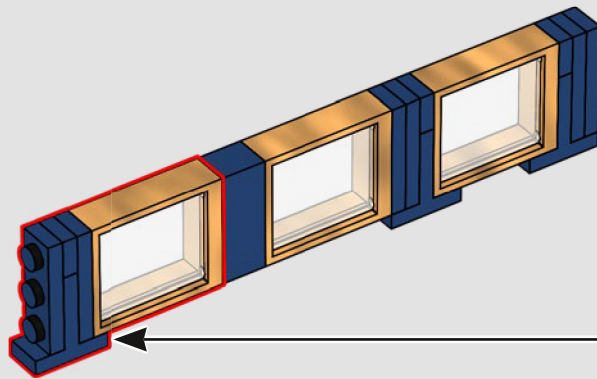
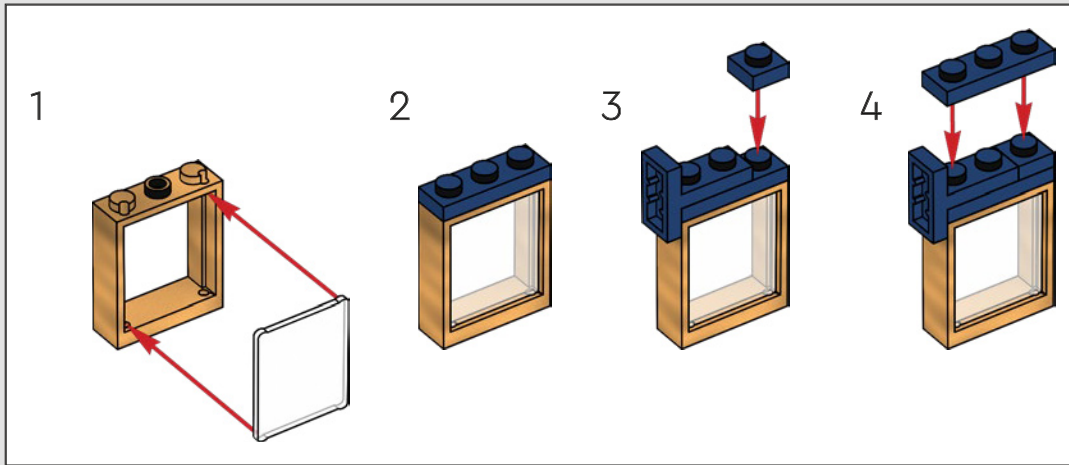

240

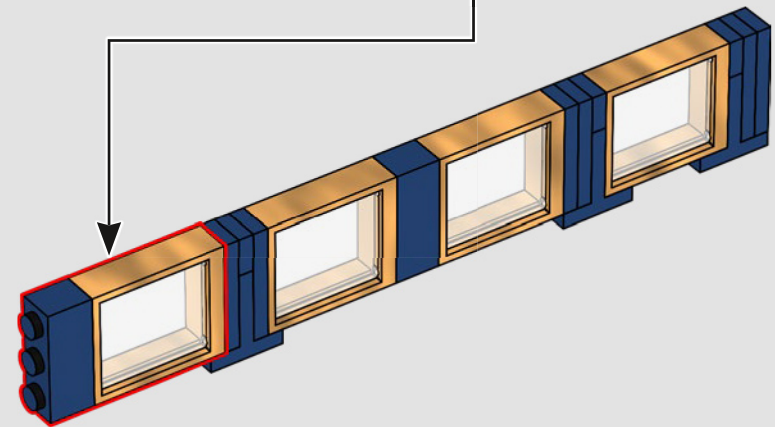
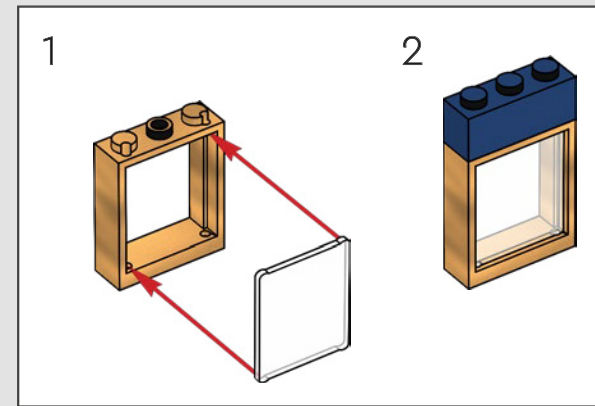

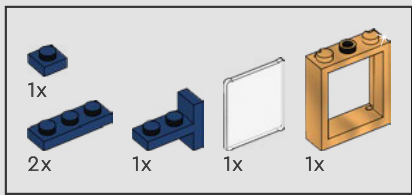

241

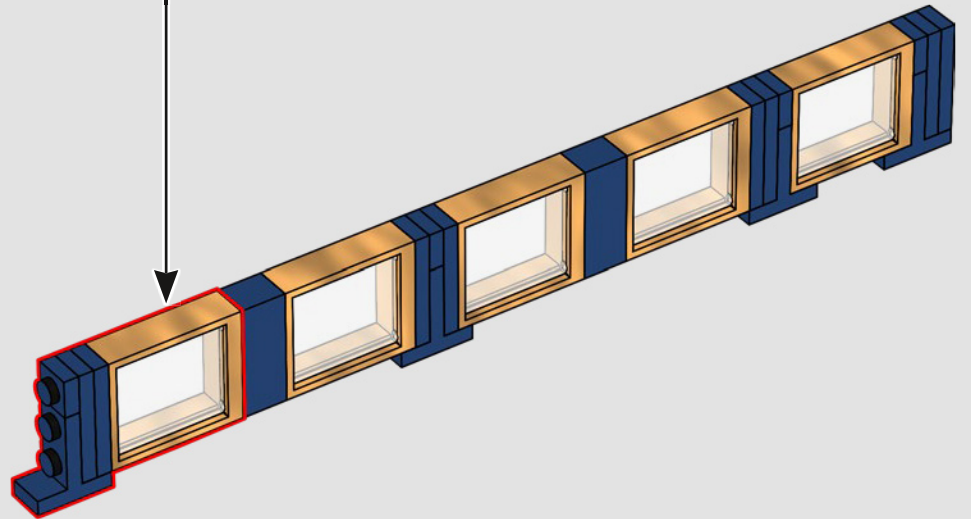
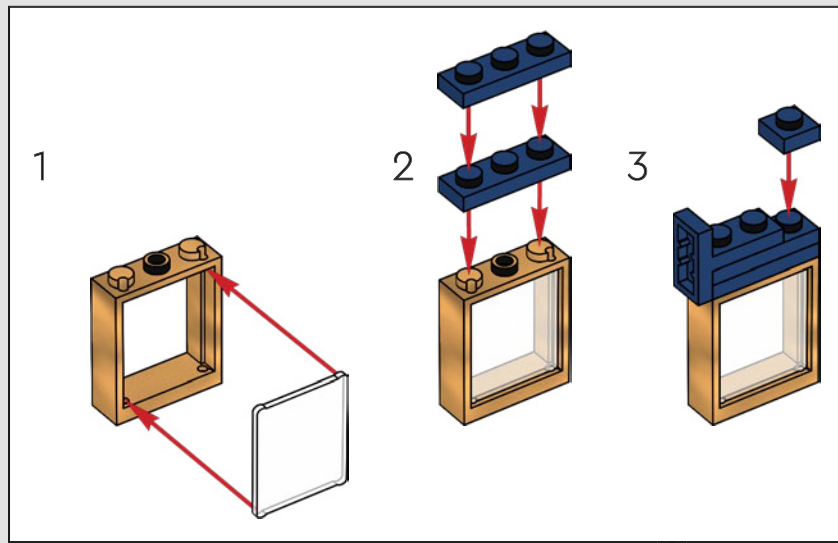

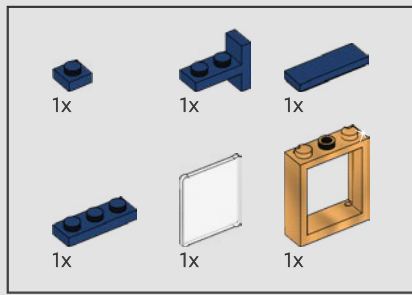

242

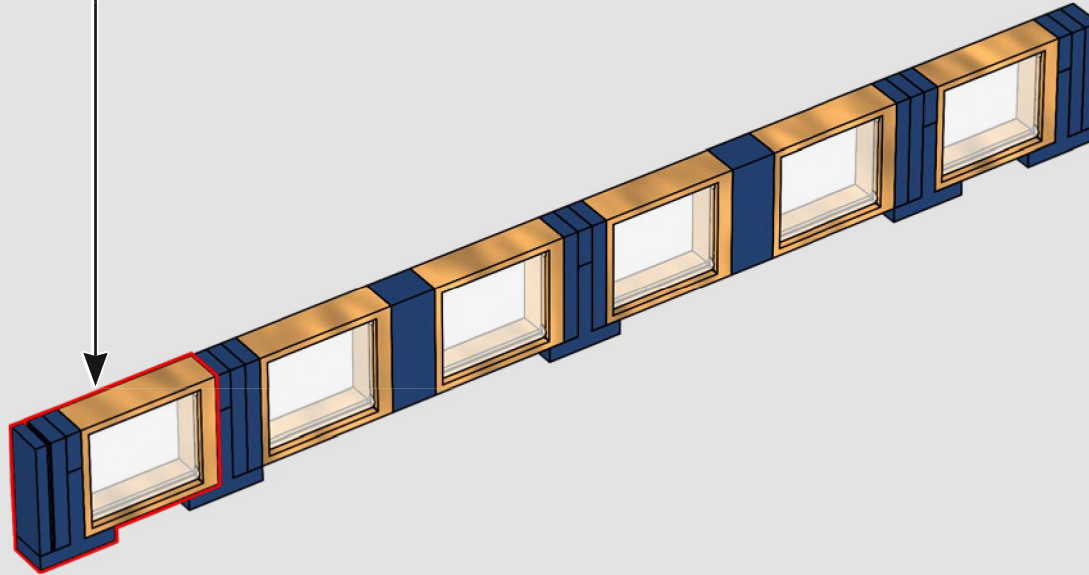
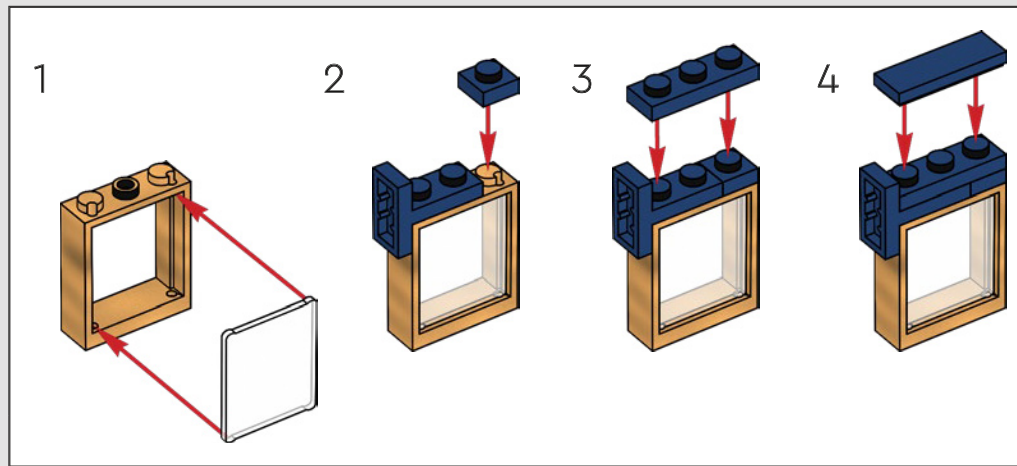

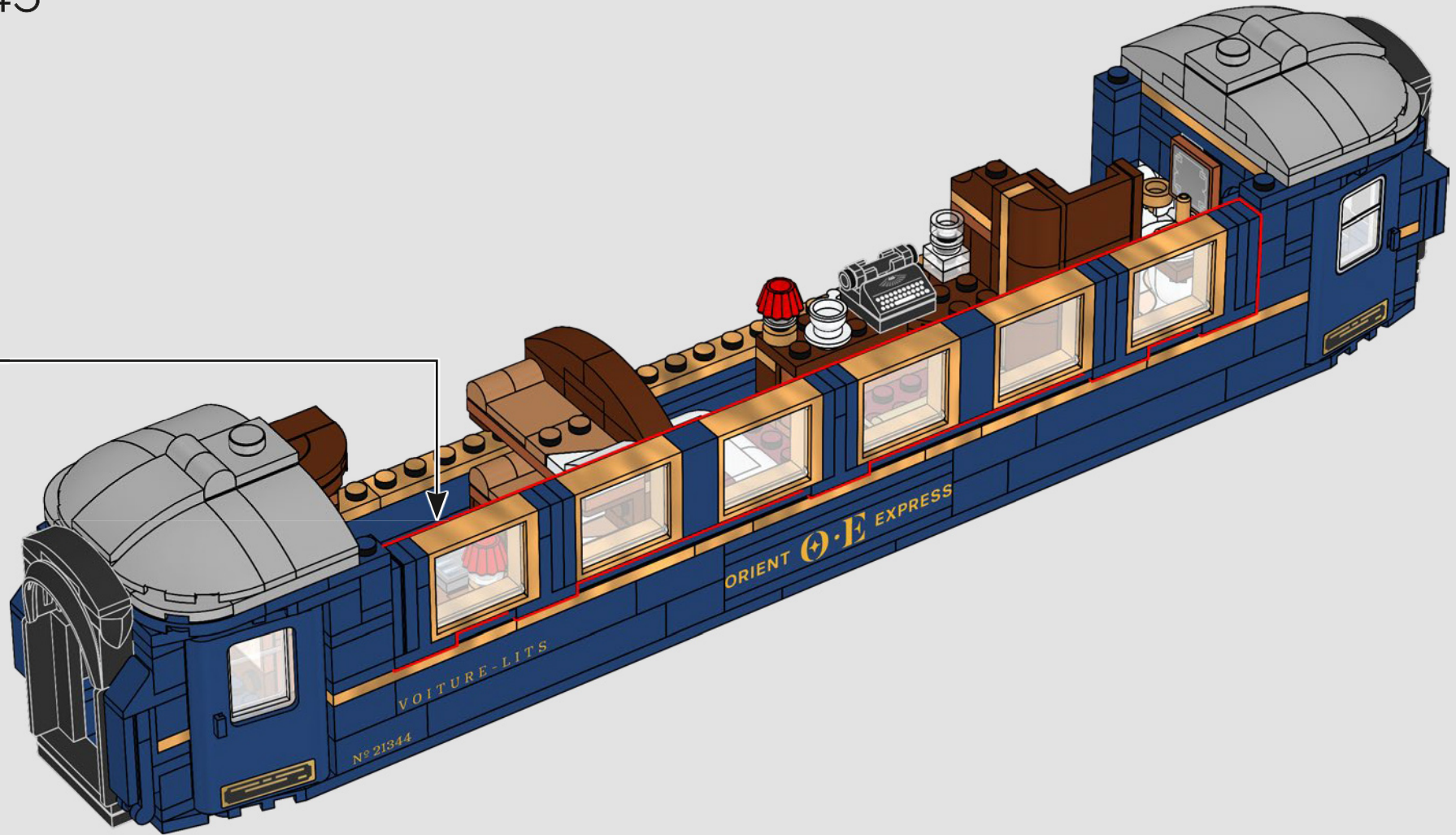

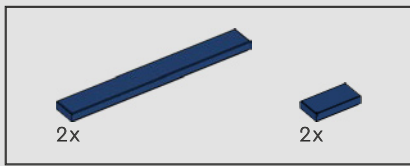

244

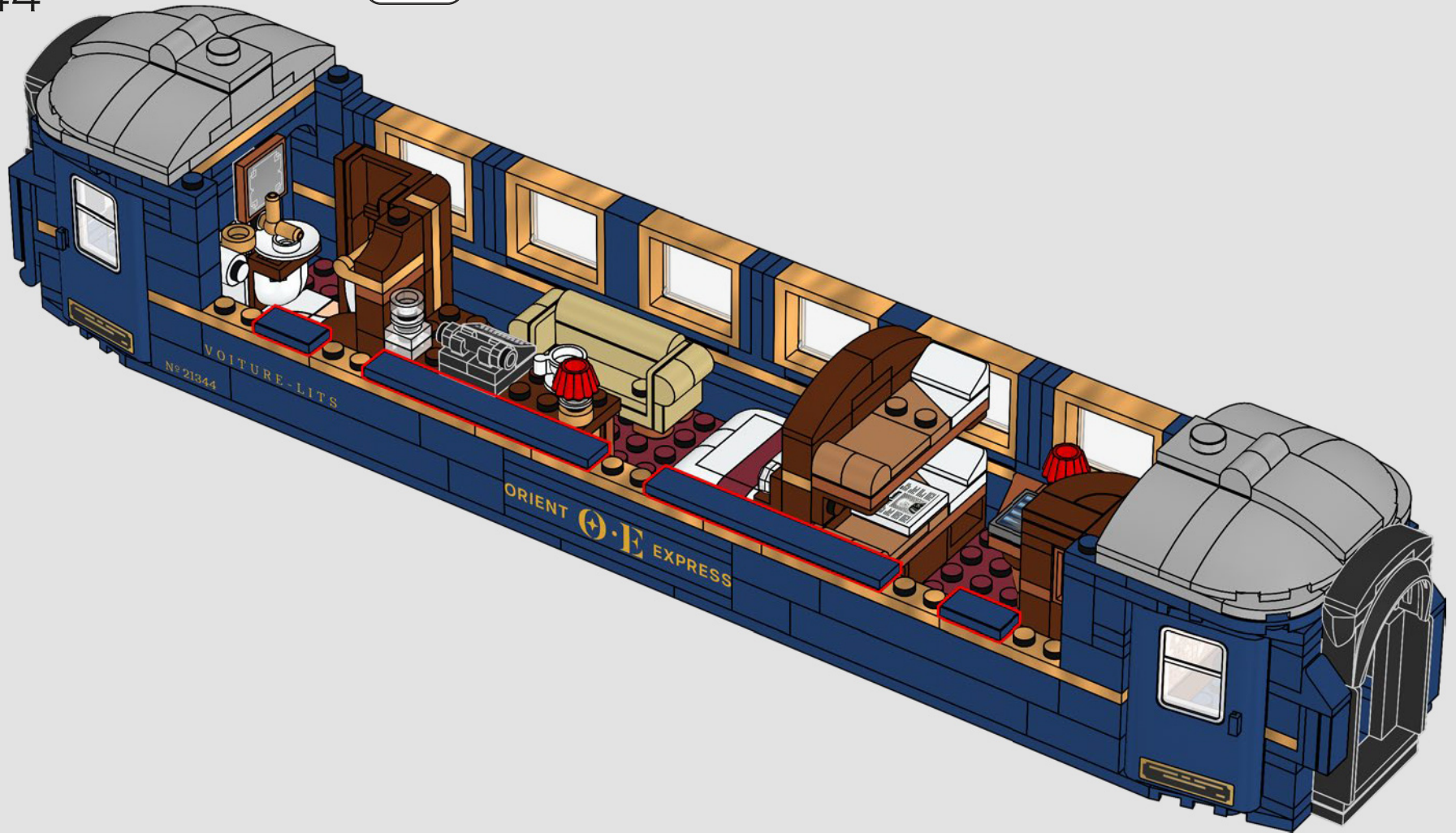

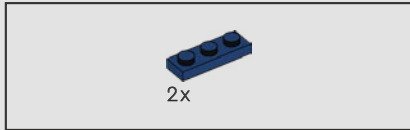
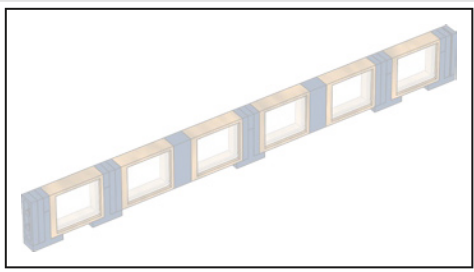

245

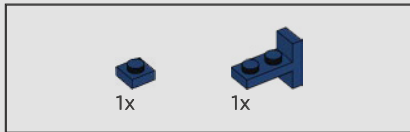
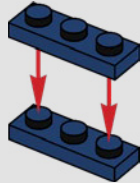

246

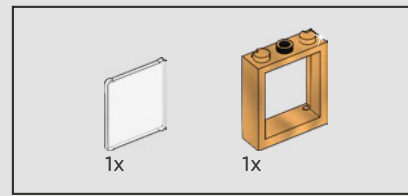
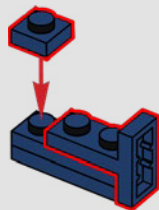

247

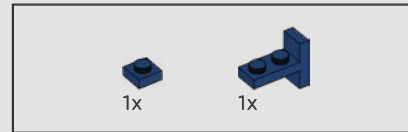
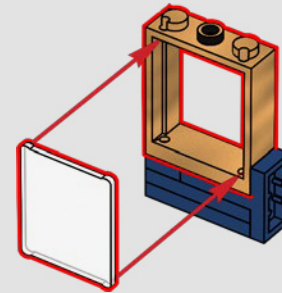

248

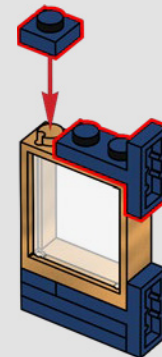

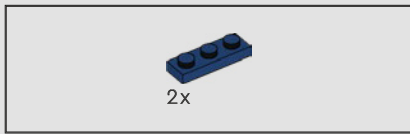

249

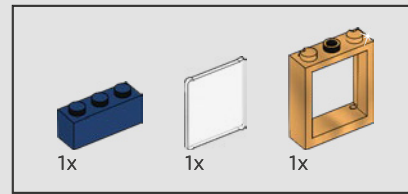
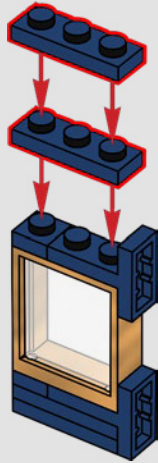

250

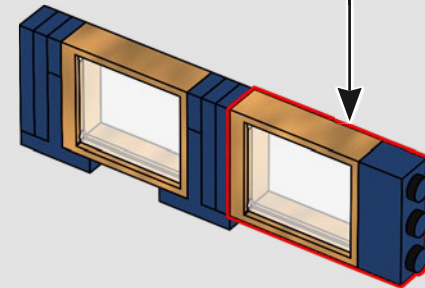
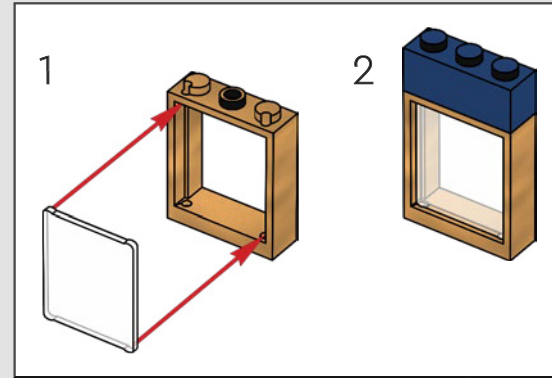

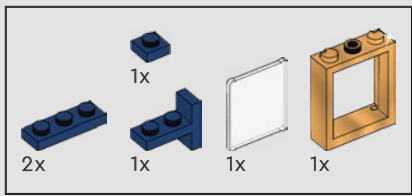

251

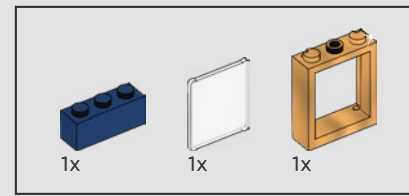
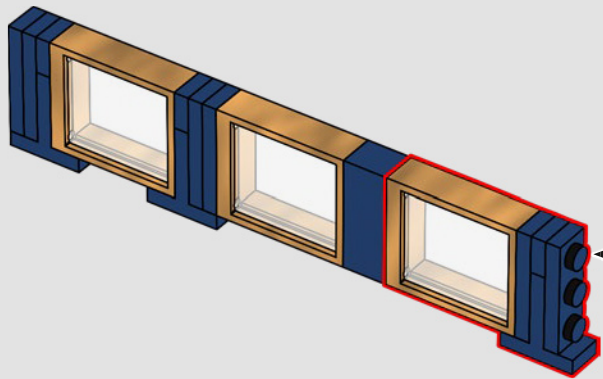
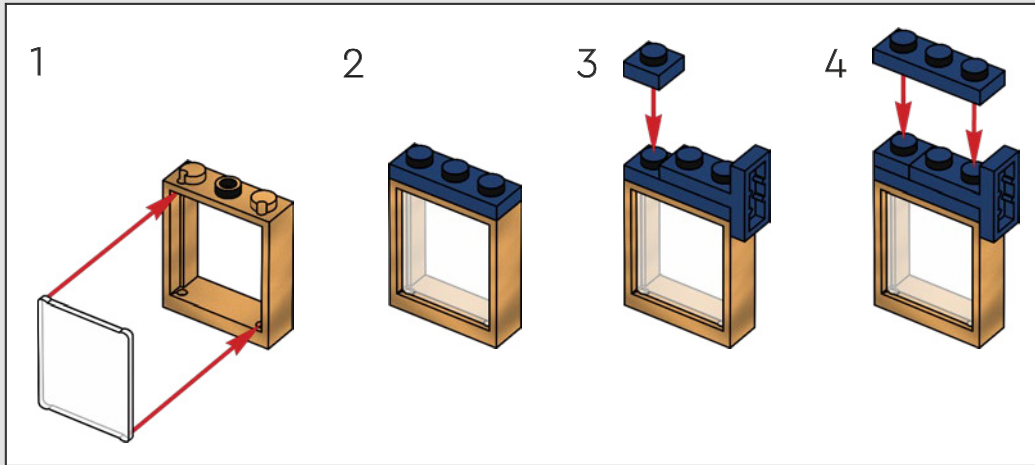

252

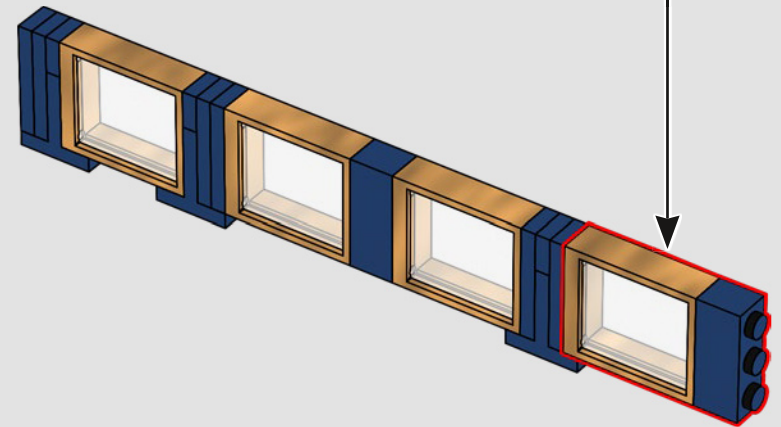
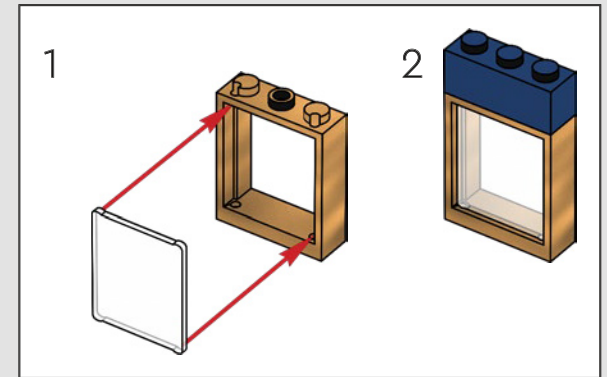

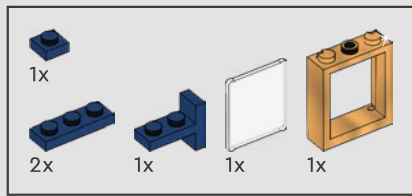

253

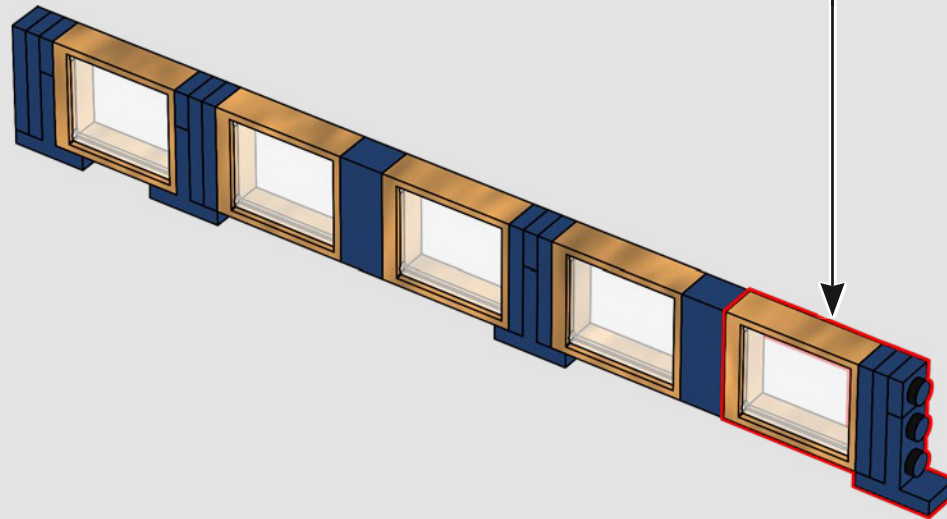
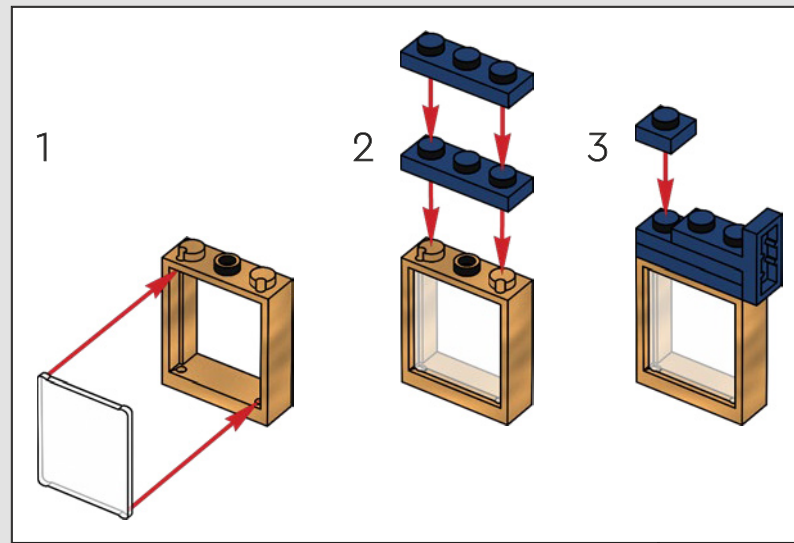

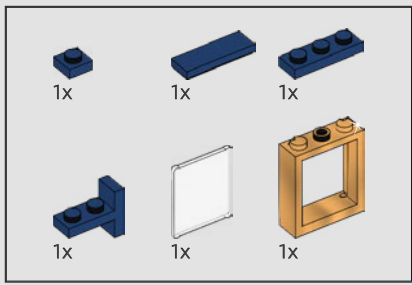

254

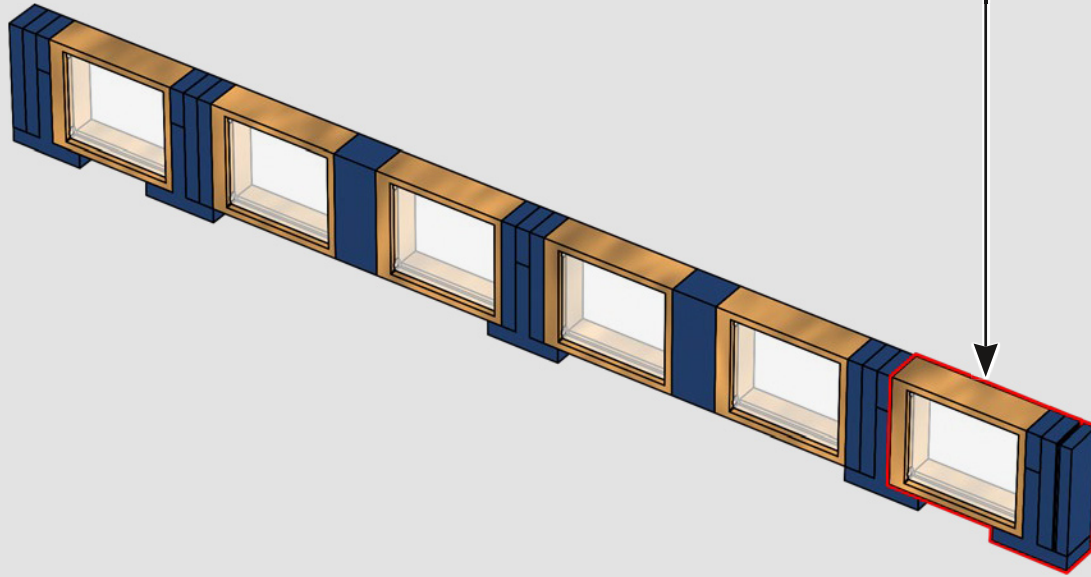
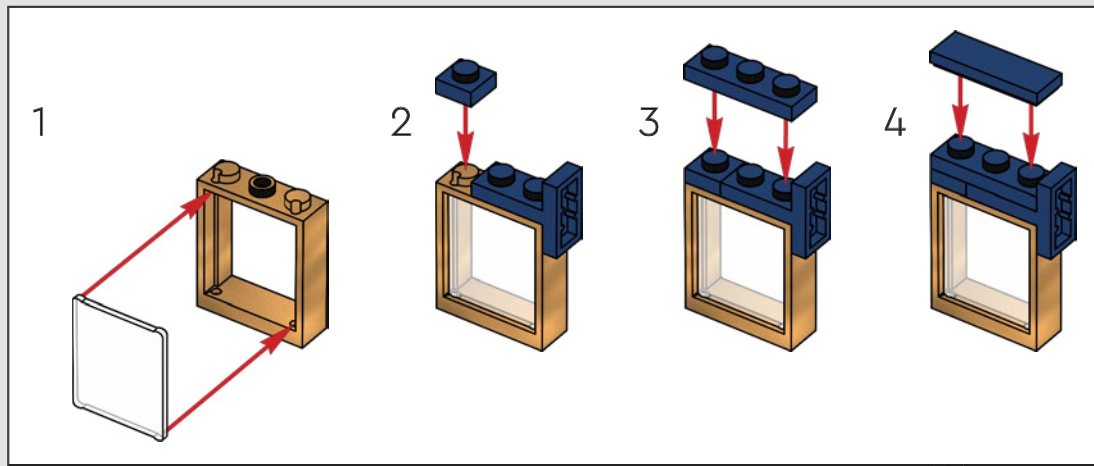

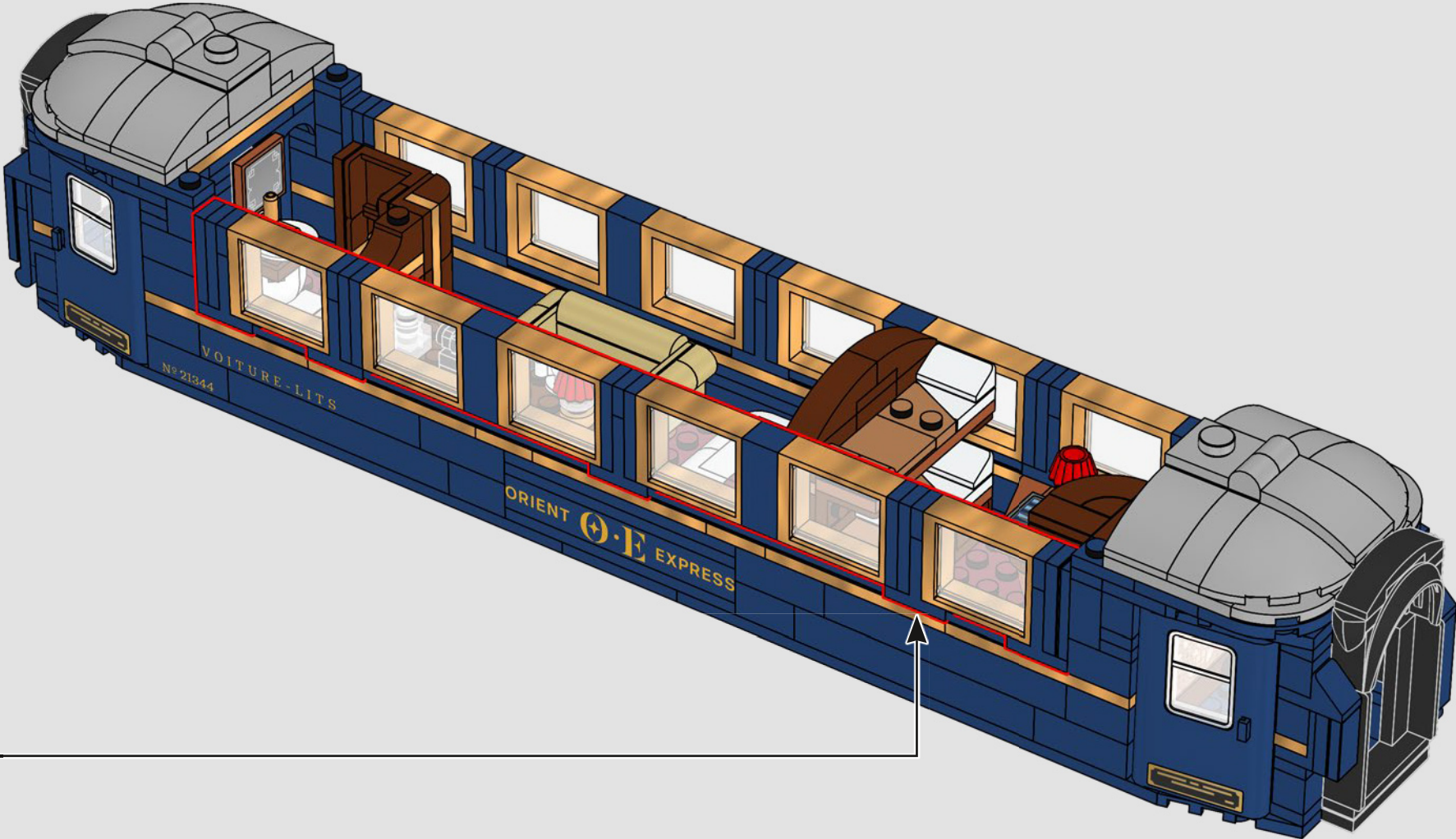



●
'The passengers carry all sorts of luggage,
from artefacts to personal items...
some have A LOT of luggage!'

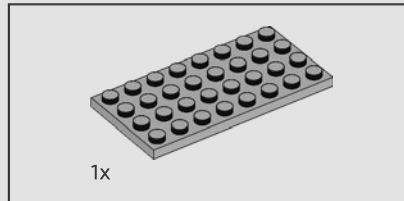
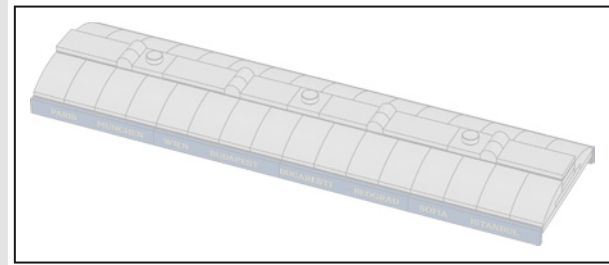
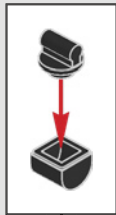
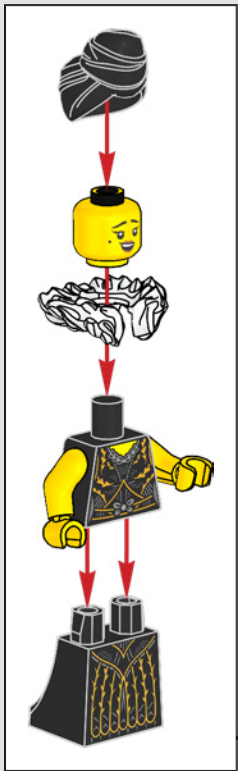

256

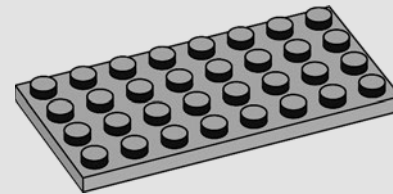

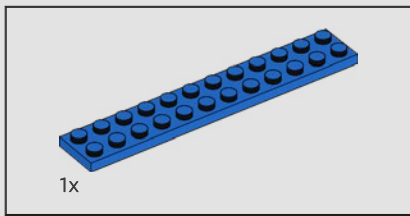

257

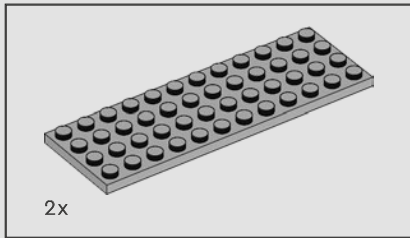
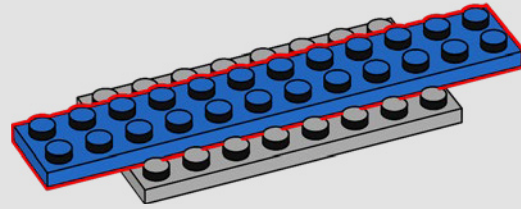

258

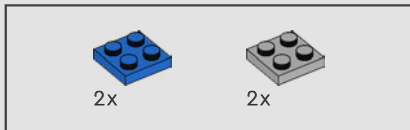
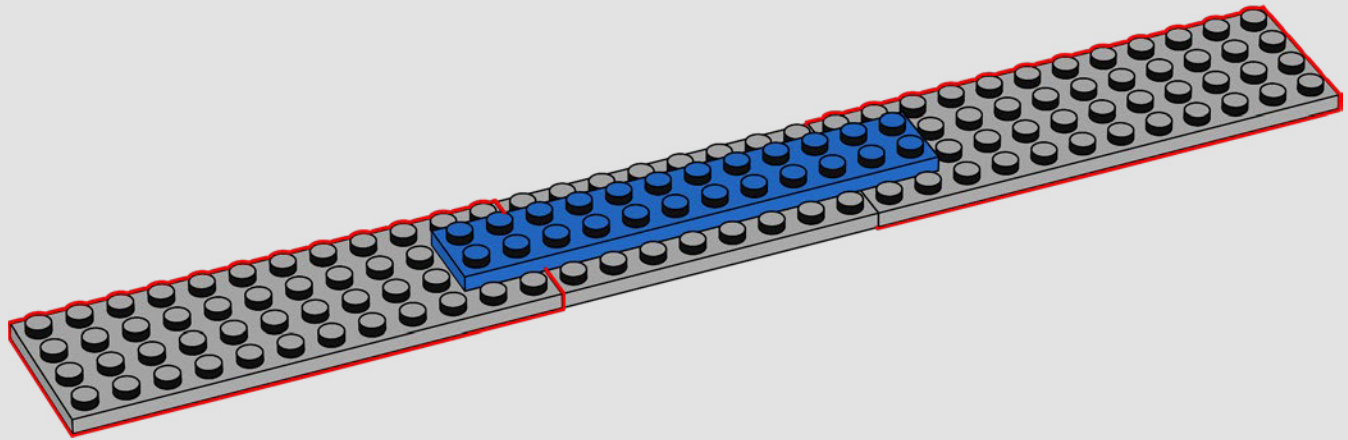

259

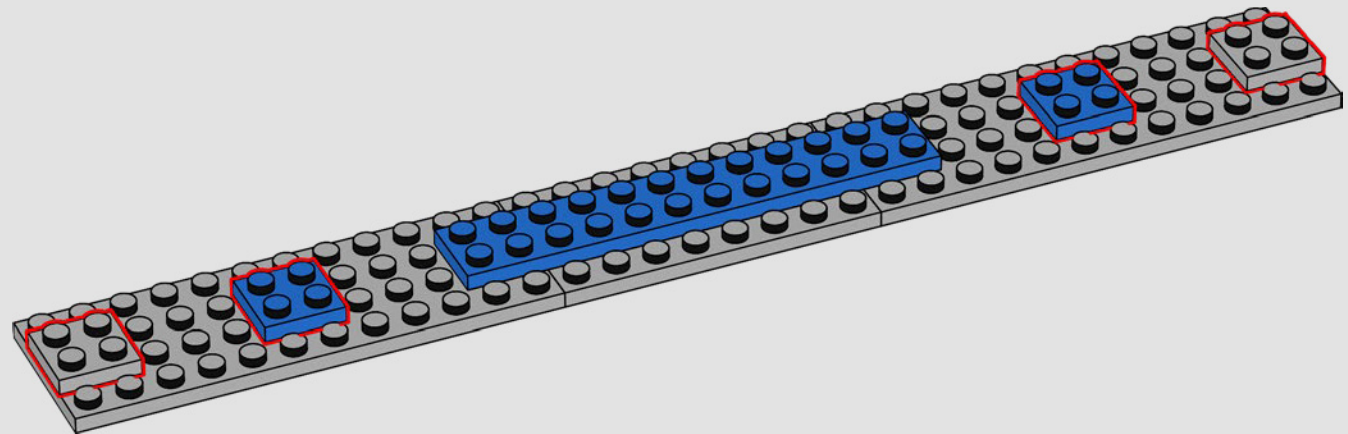

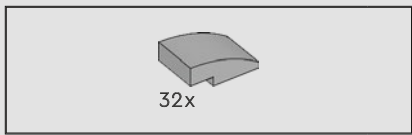

260

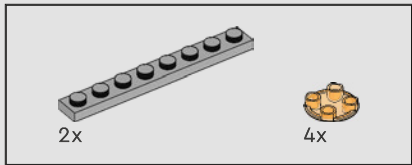
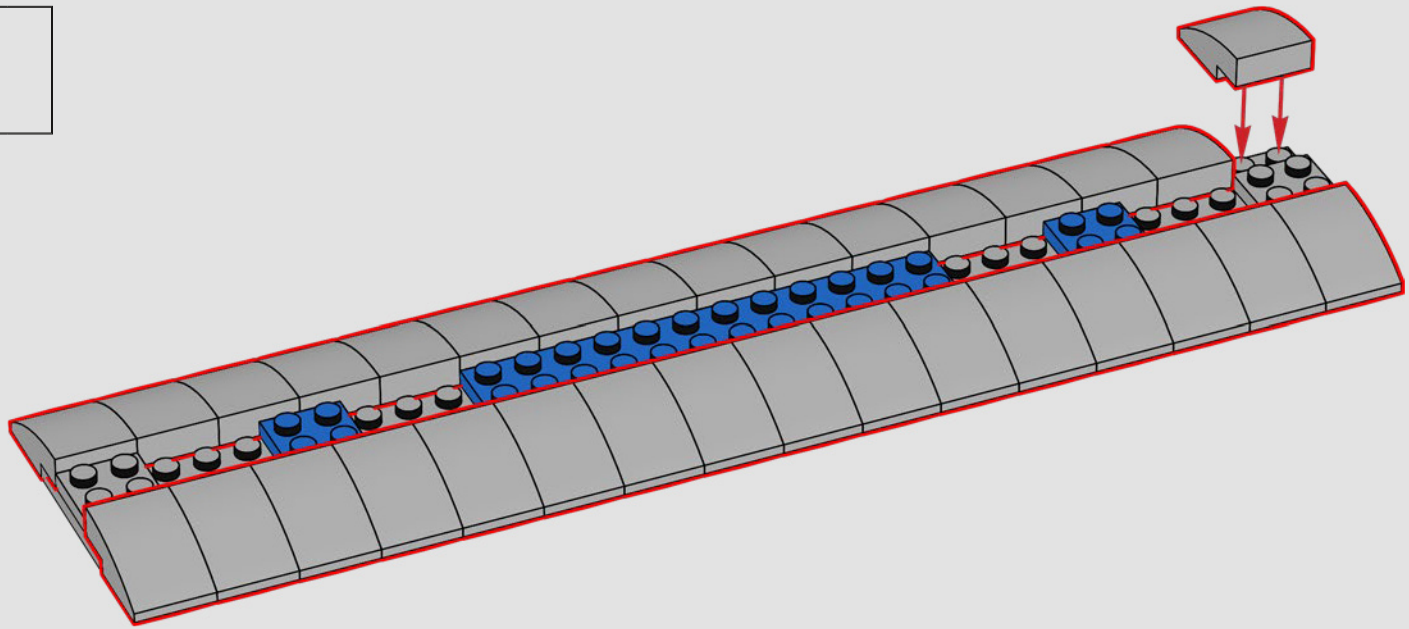

261

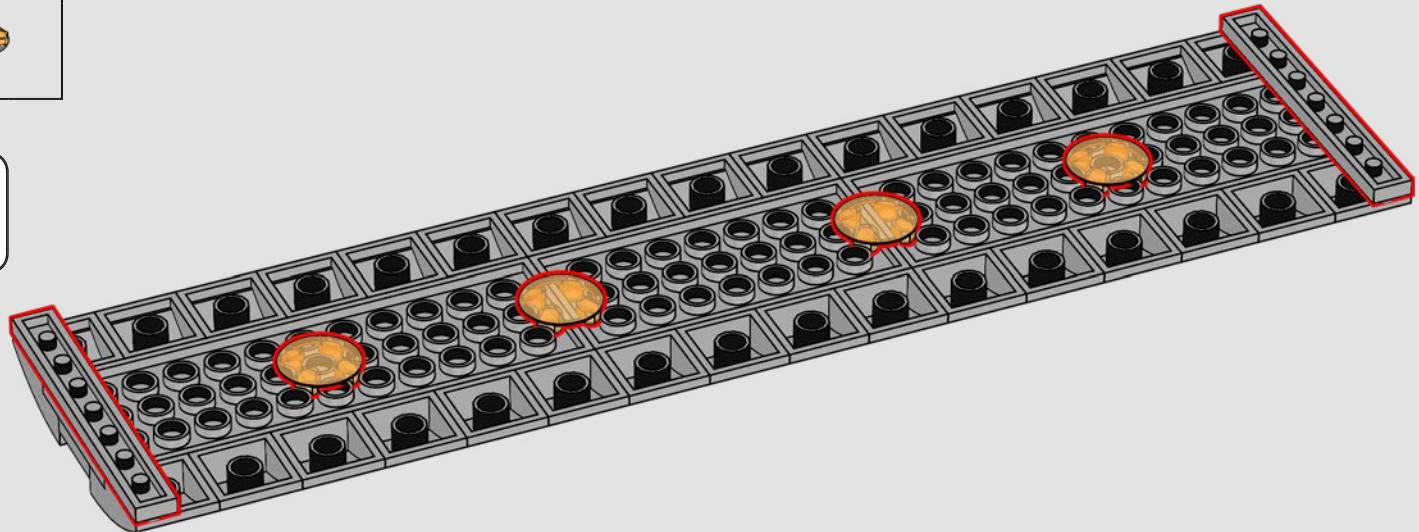

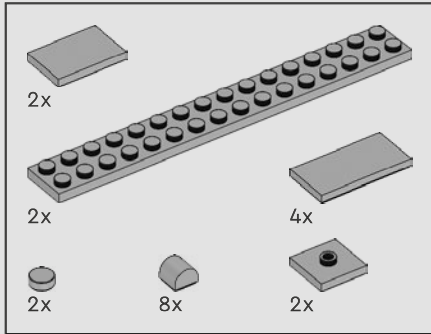
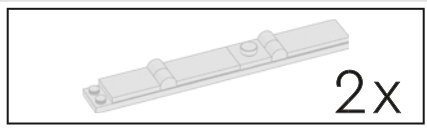

262

1

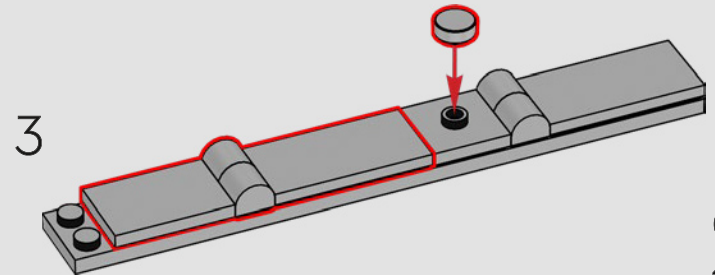
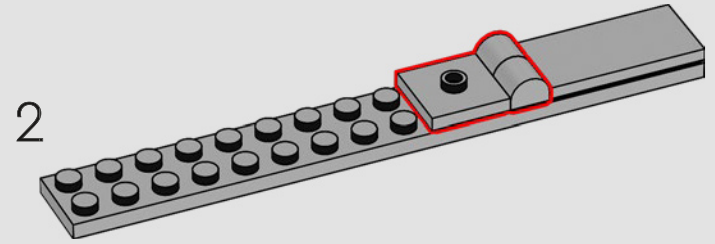
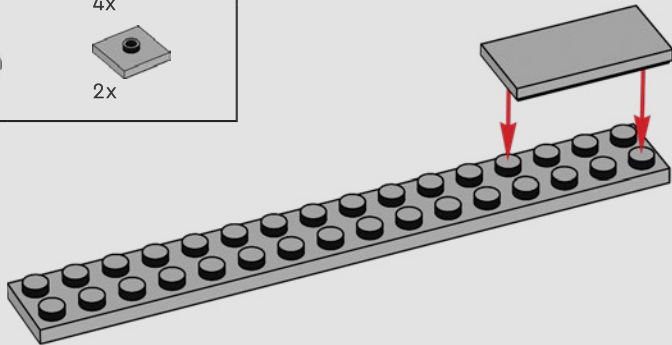

2x

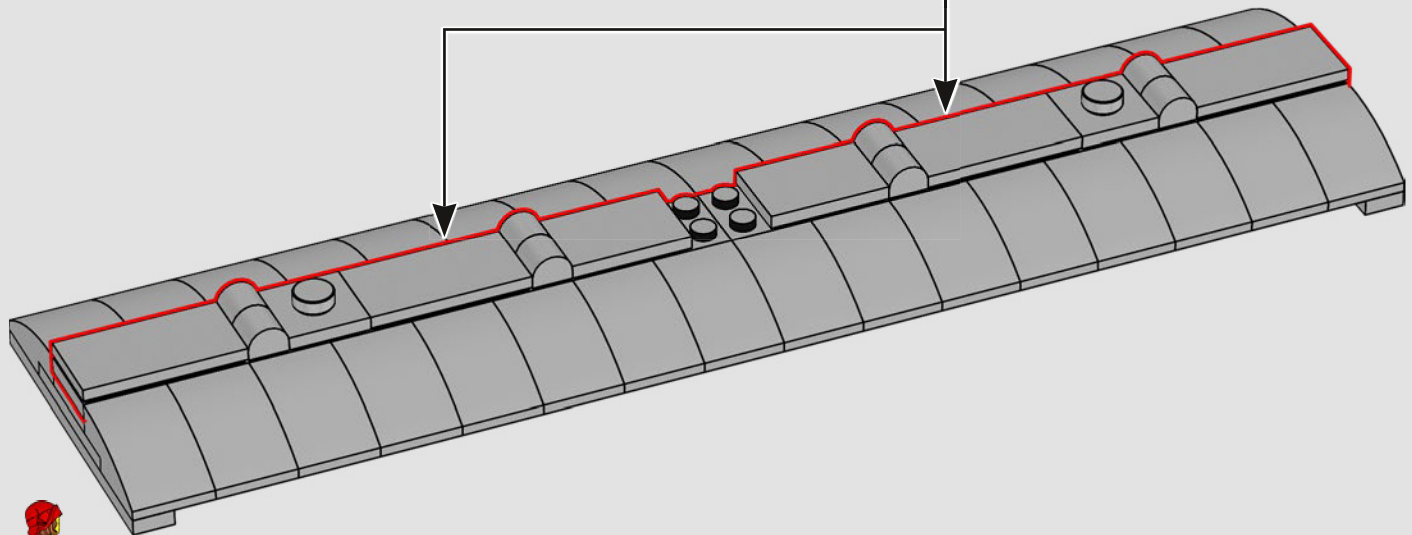

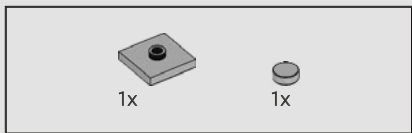

263

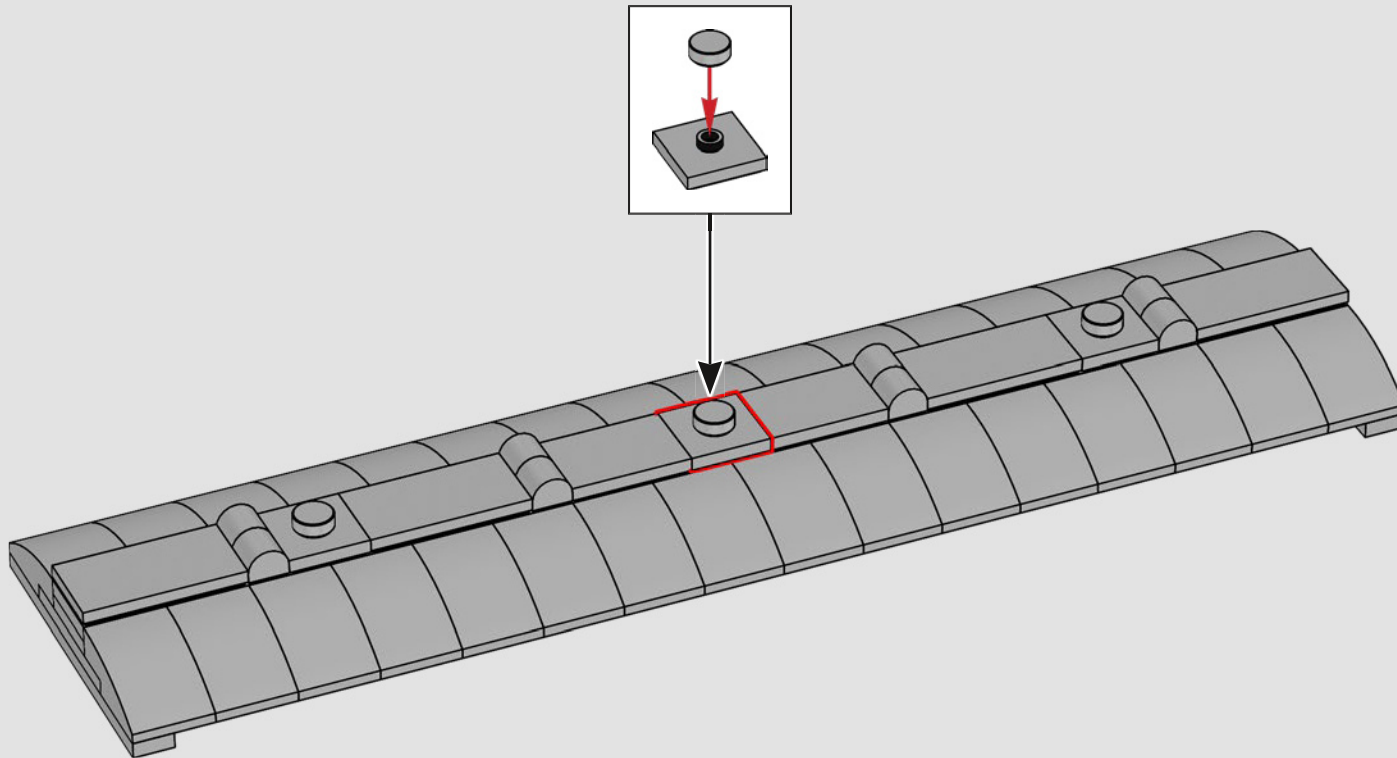

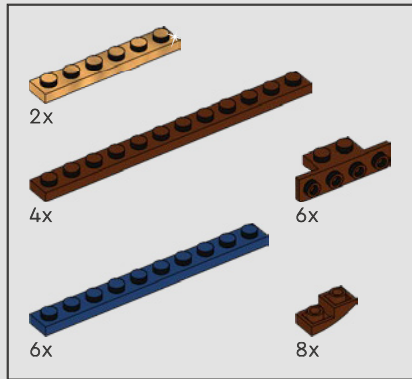
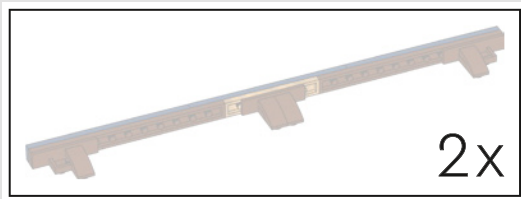

264

1

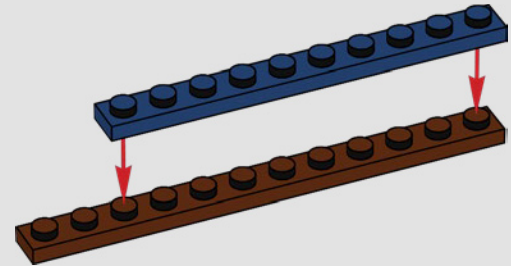

2

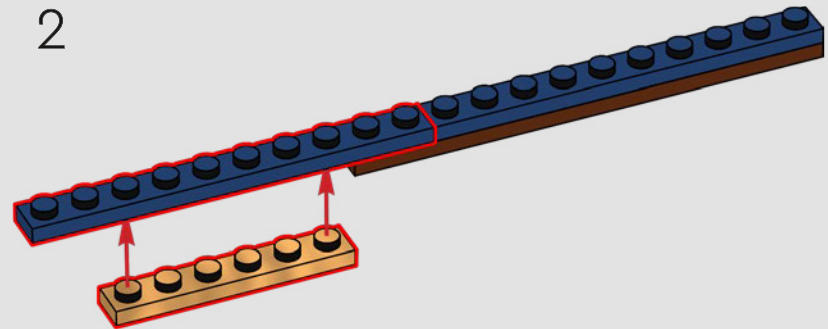

3

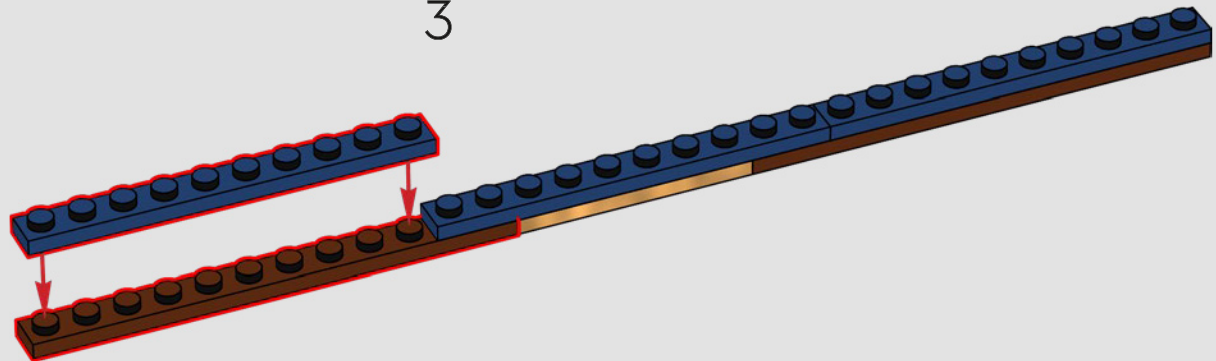

4

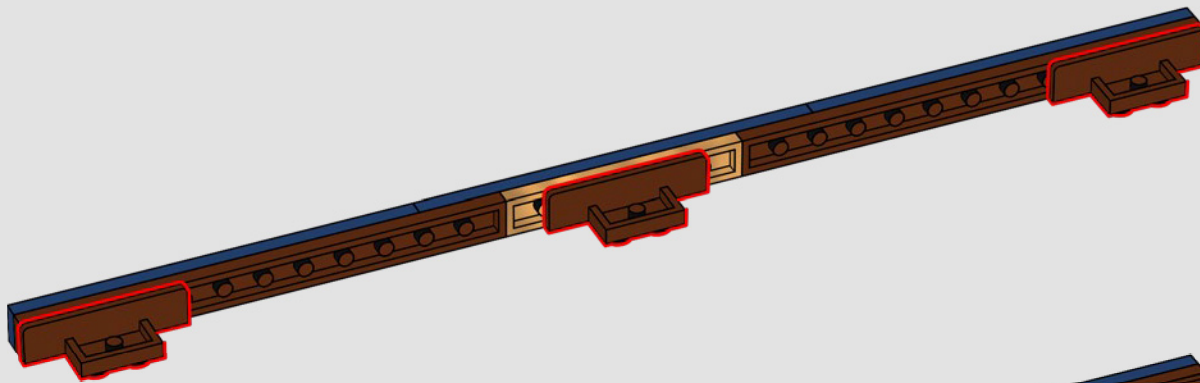

5

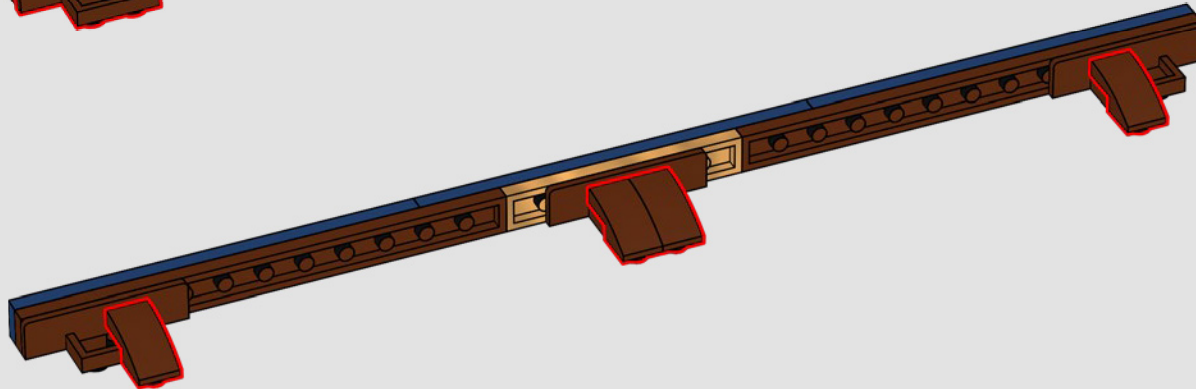

2x

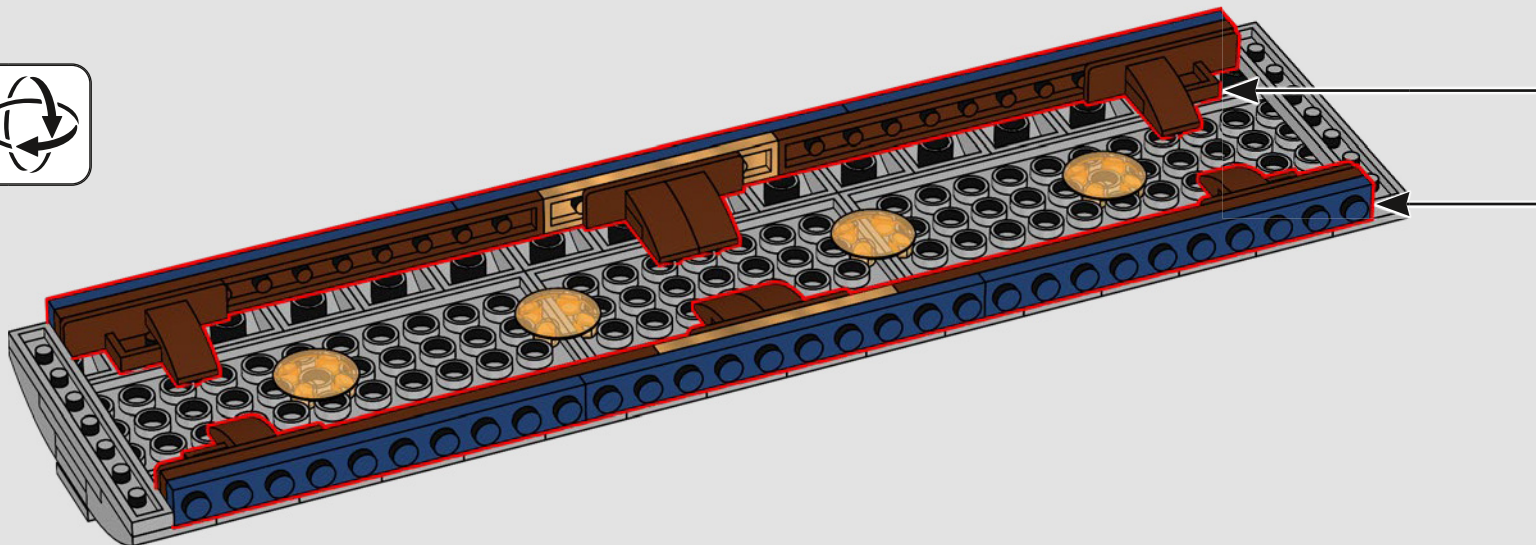

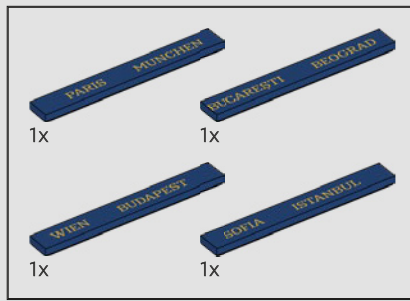

265

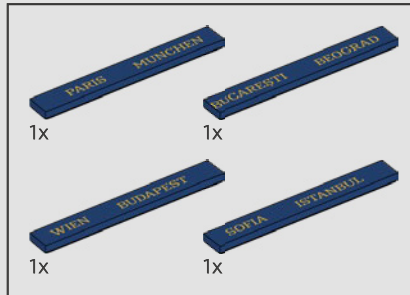
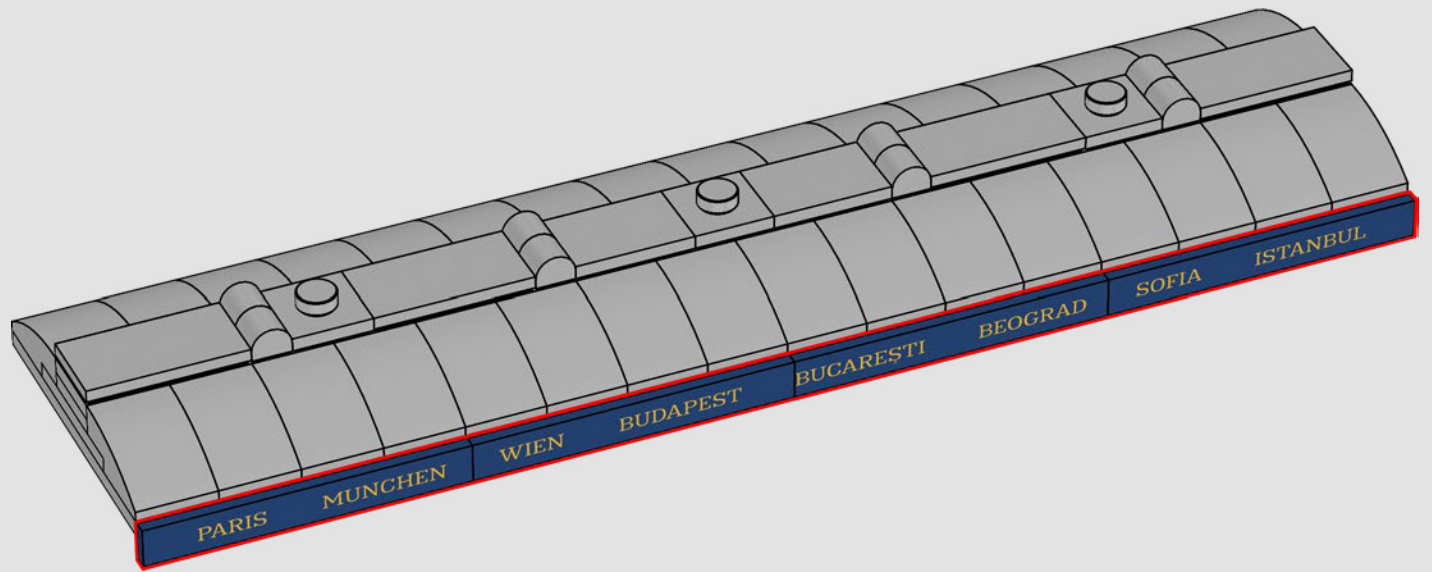

266

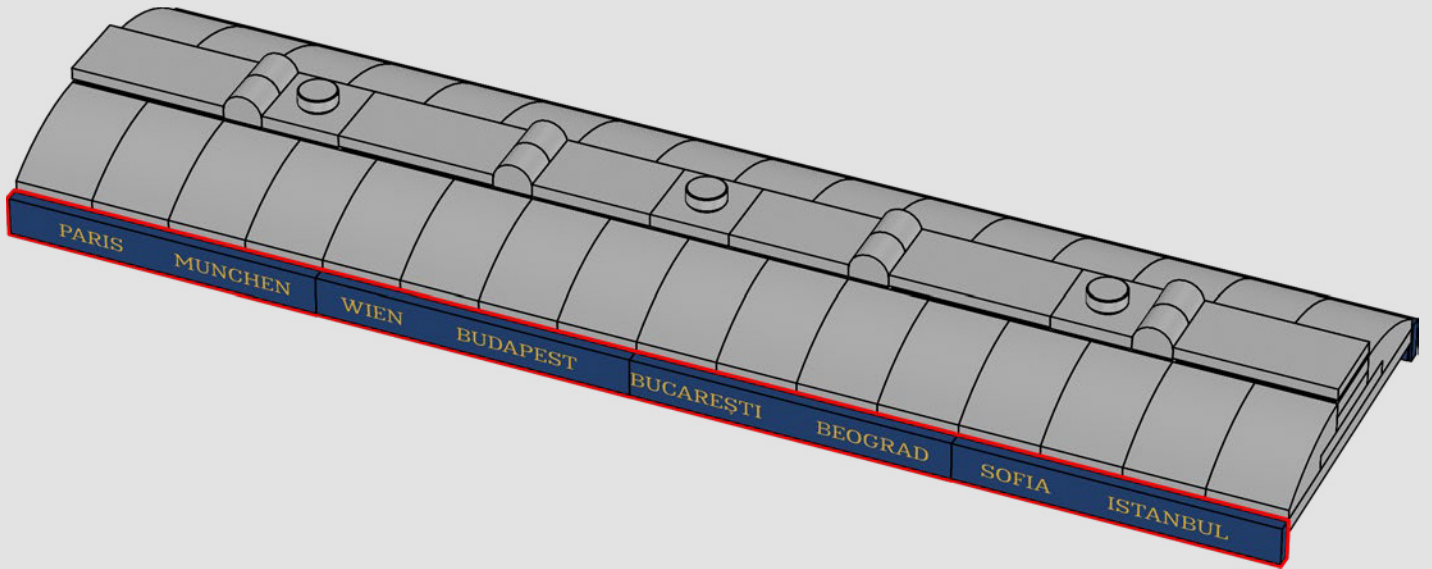

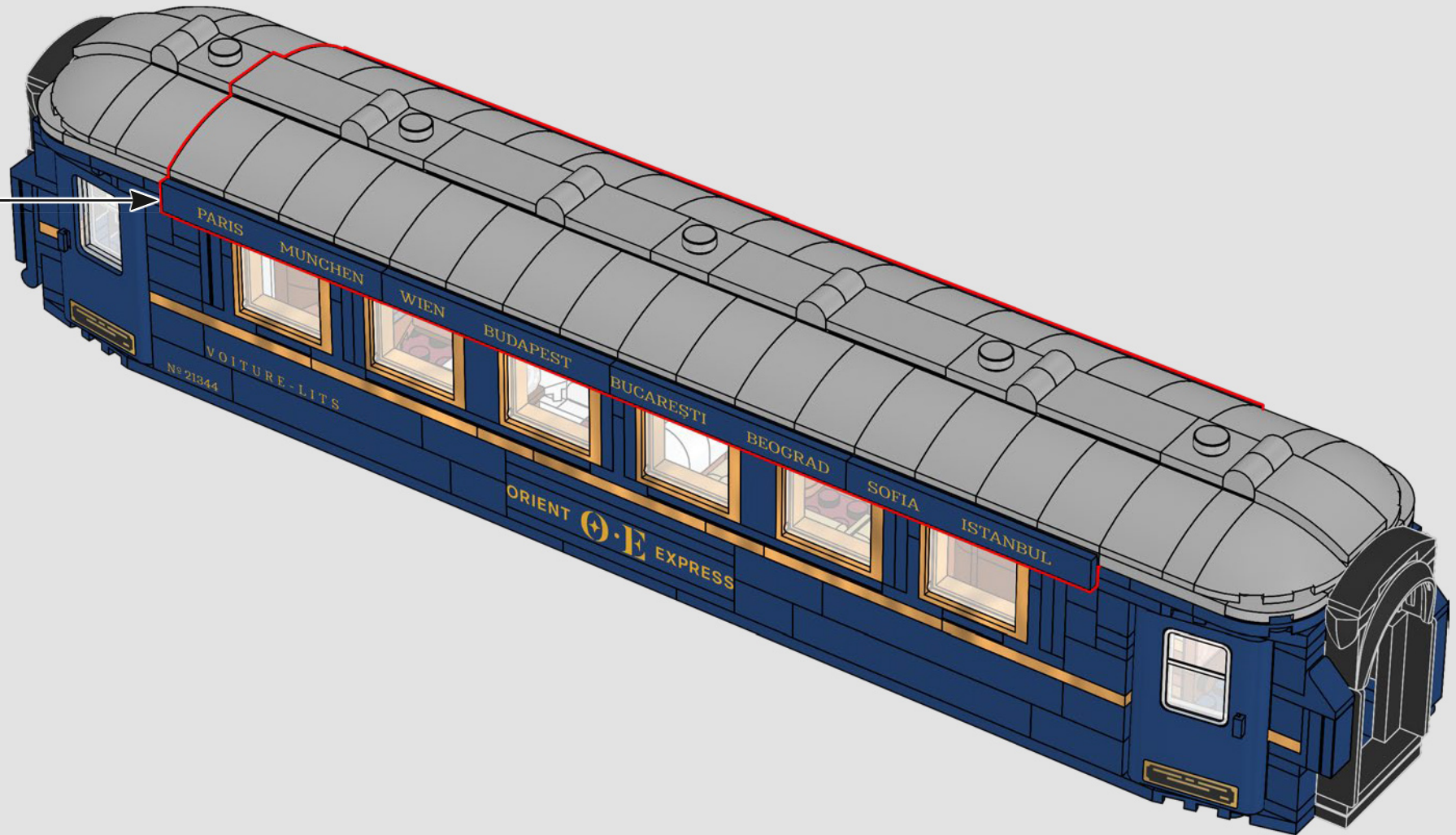

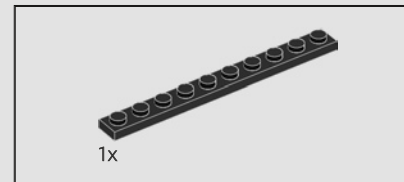
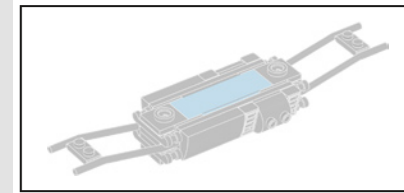
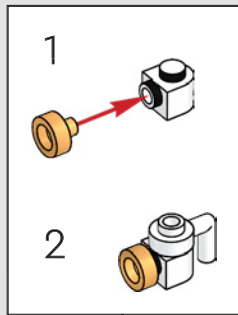
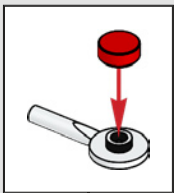
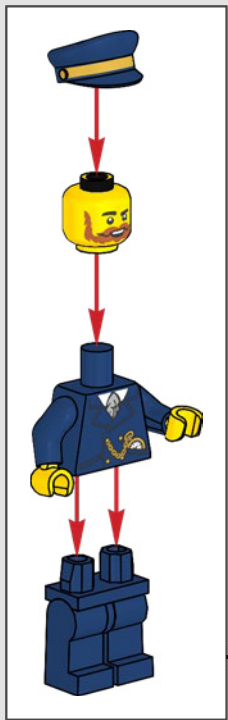

268

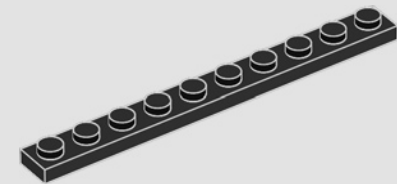

Next Stop: BELGRADE

'The Station Manager oversees the coupling up of each carriage to the train.'

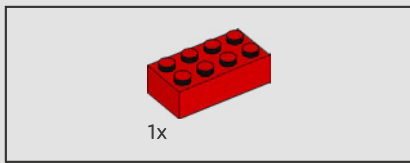

269

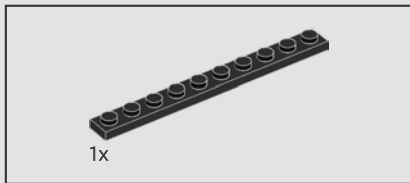
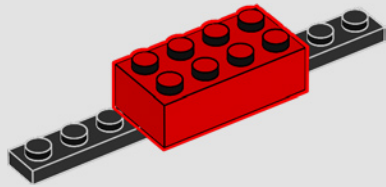

270

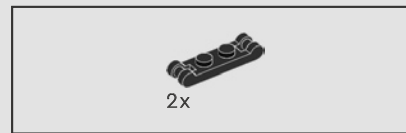
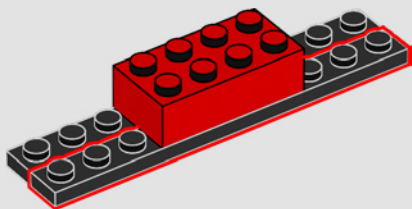

271

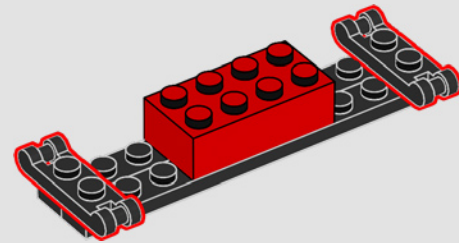

272

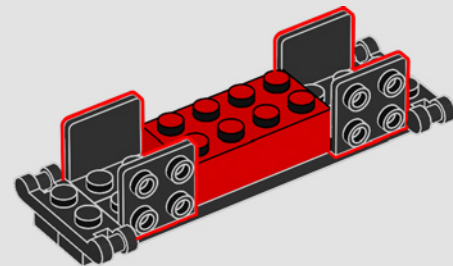

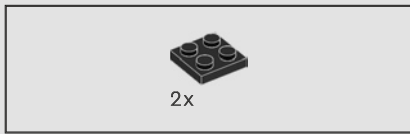

273

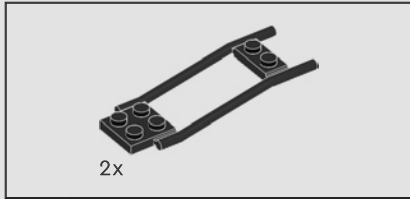
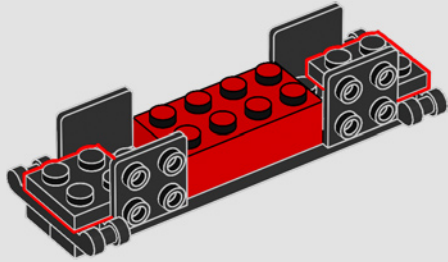

274

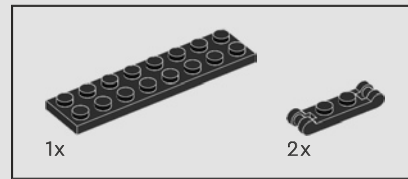
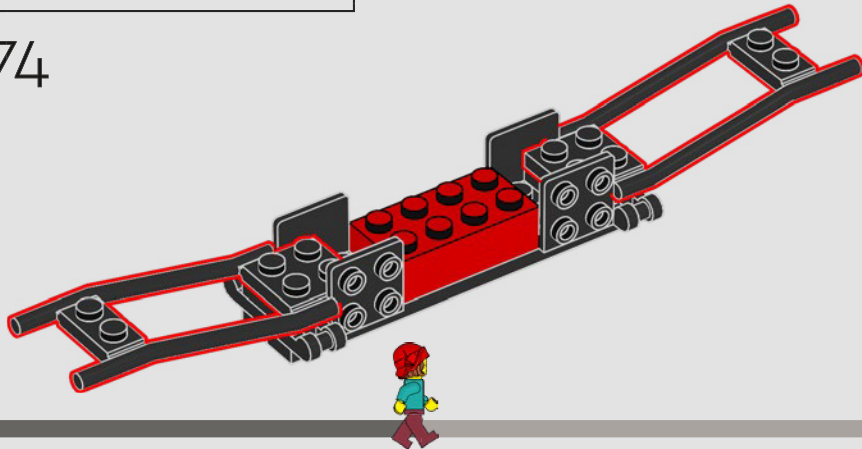

275

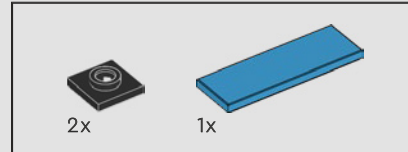
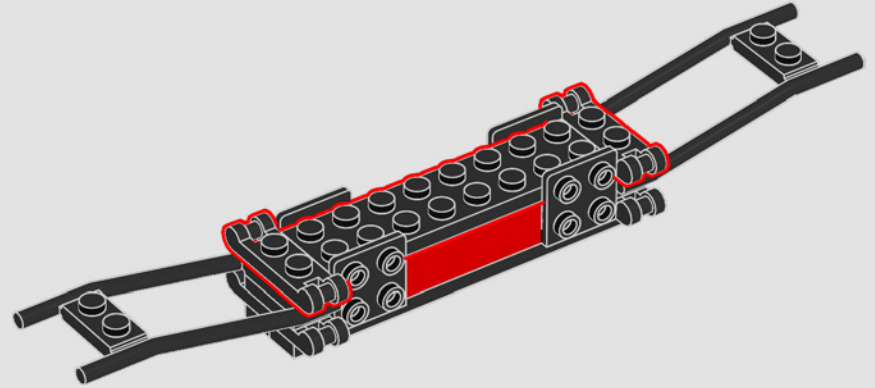

276

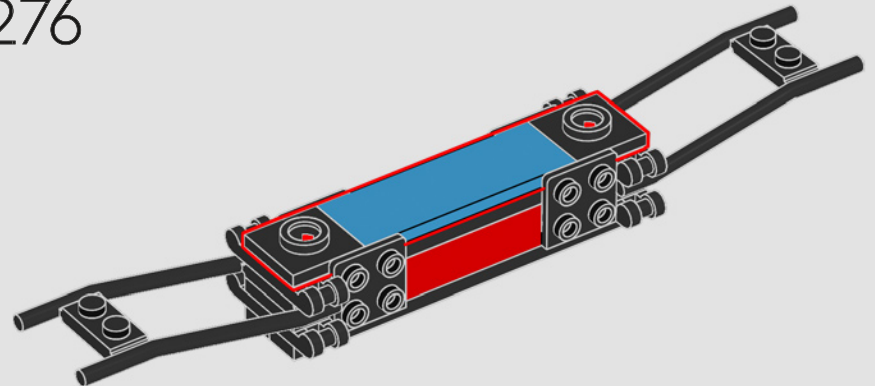

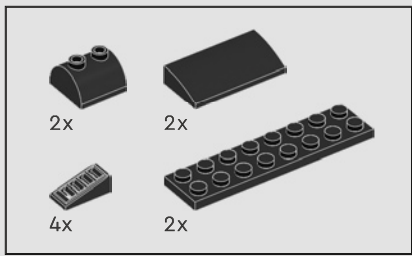

277

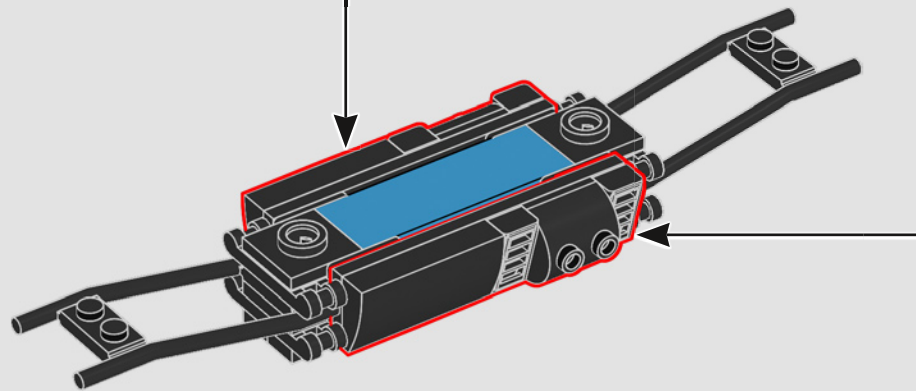
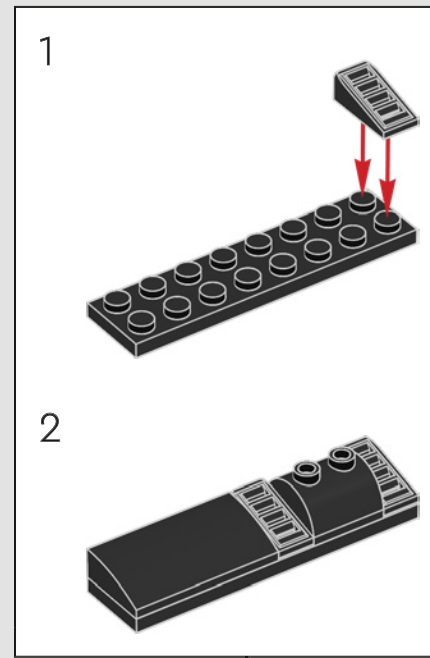
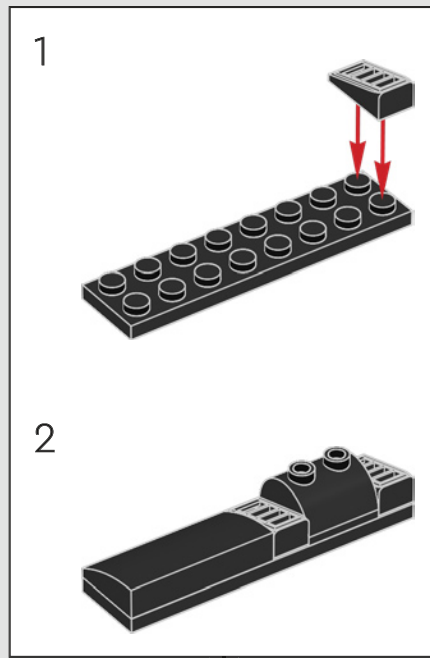

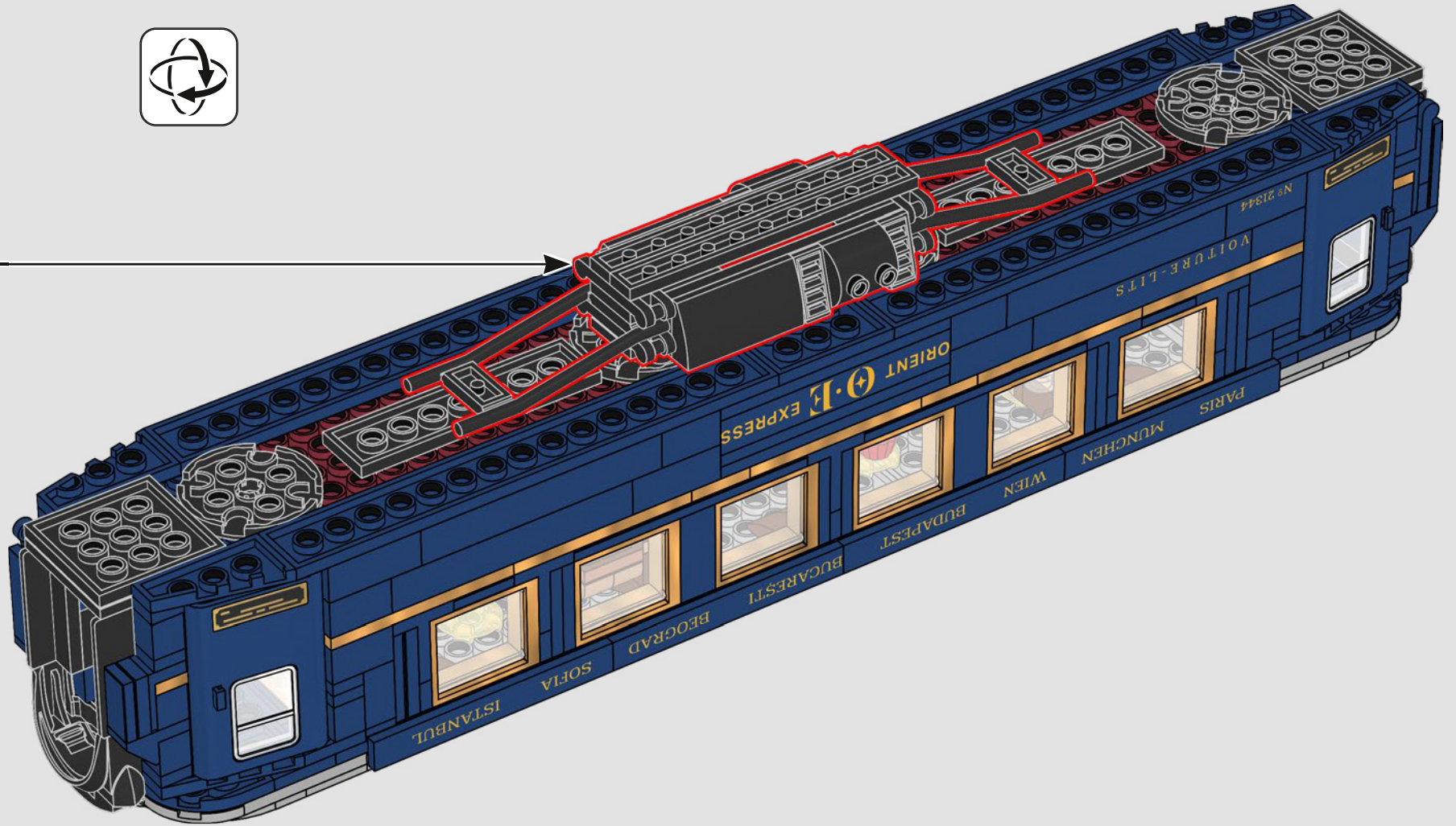

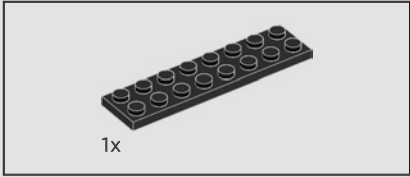
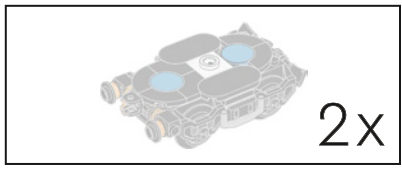

279

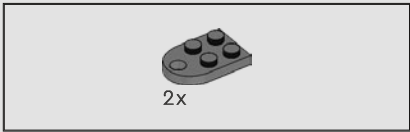
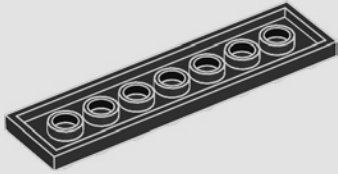

280

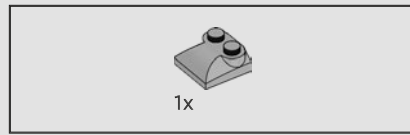
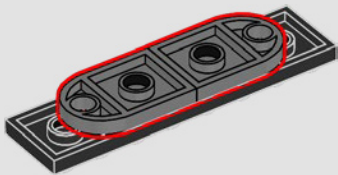

281

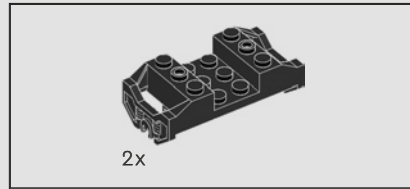
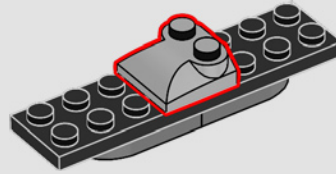

282

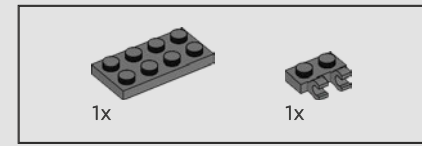
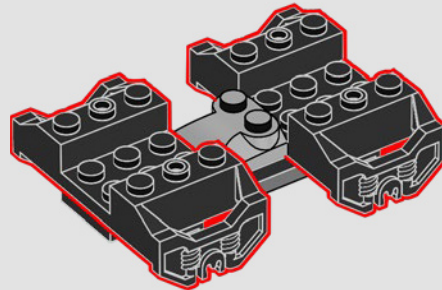

283

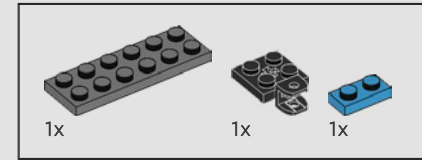
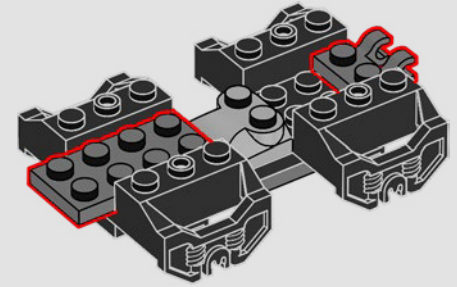

284

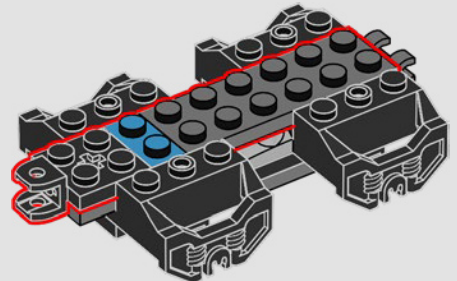



285

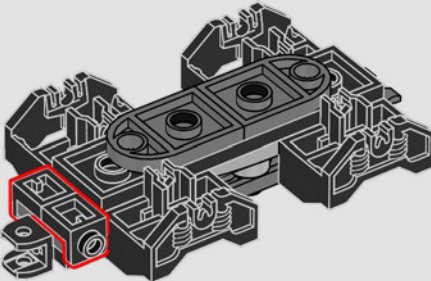

286

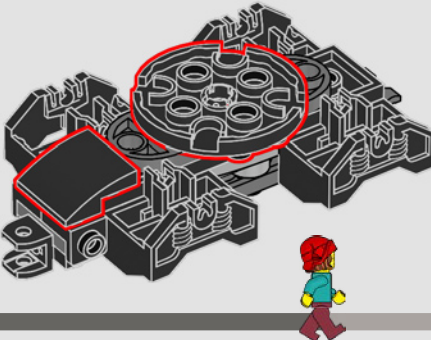

287

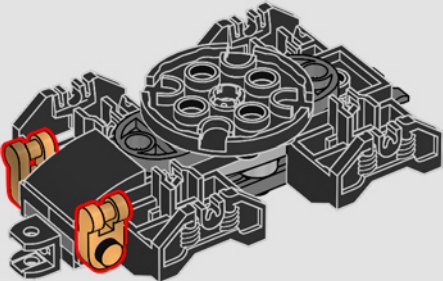

288

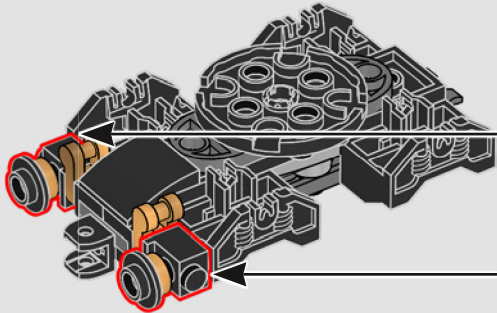
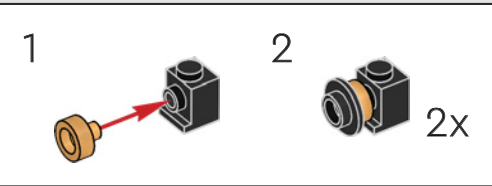

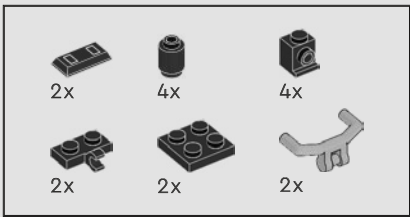

289

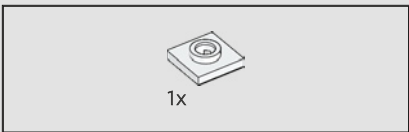
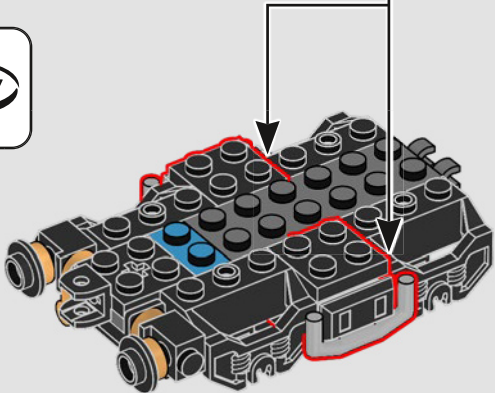
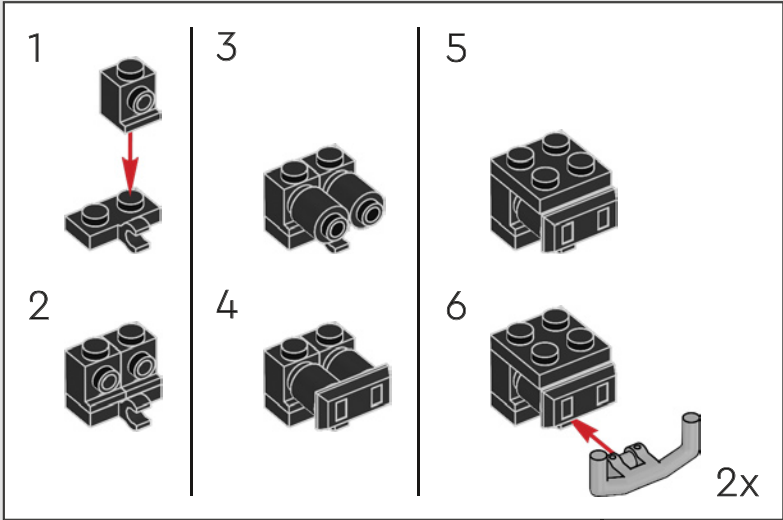

290

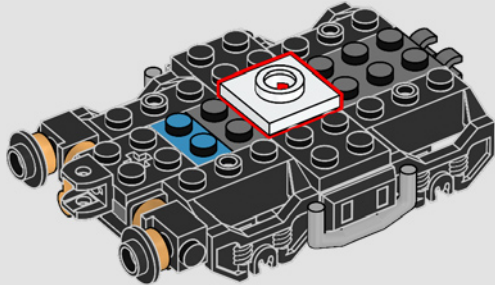

291

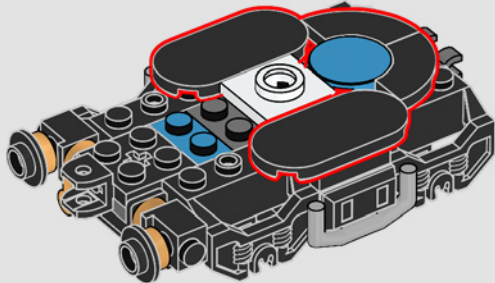

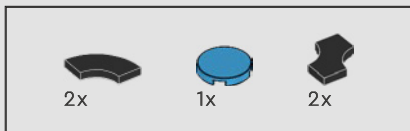

292

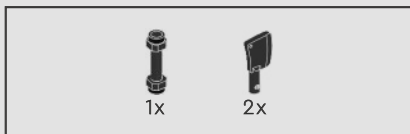
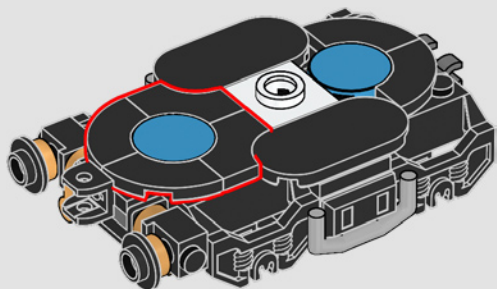

293

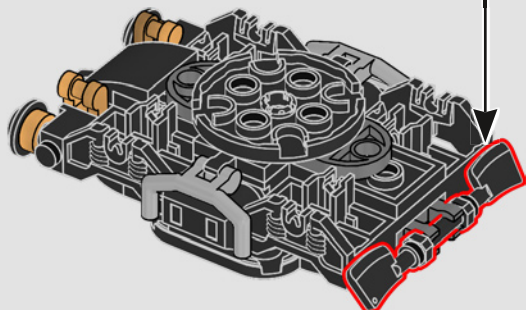
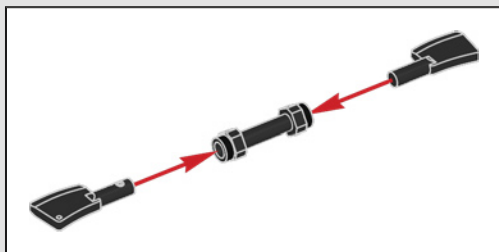

294

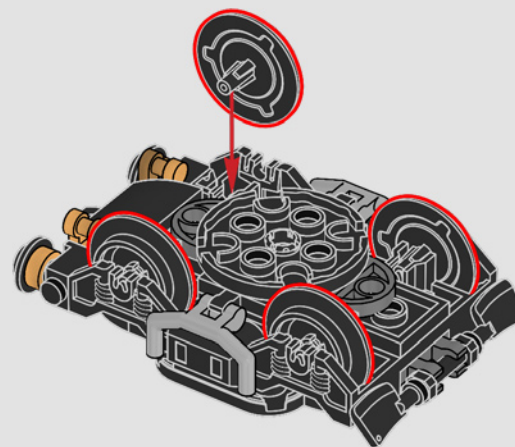

2x

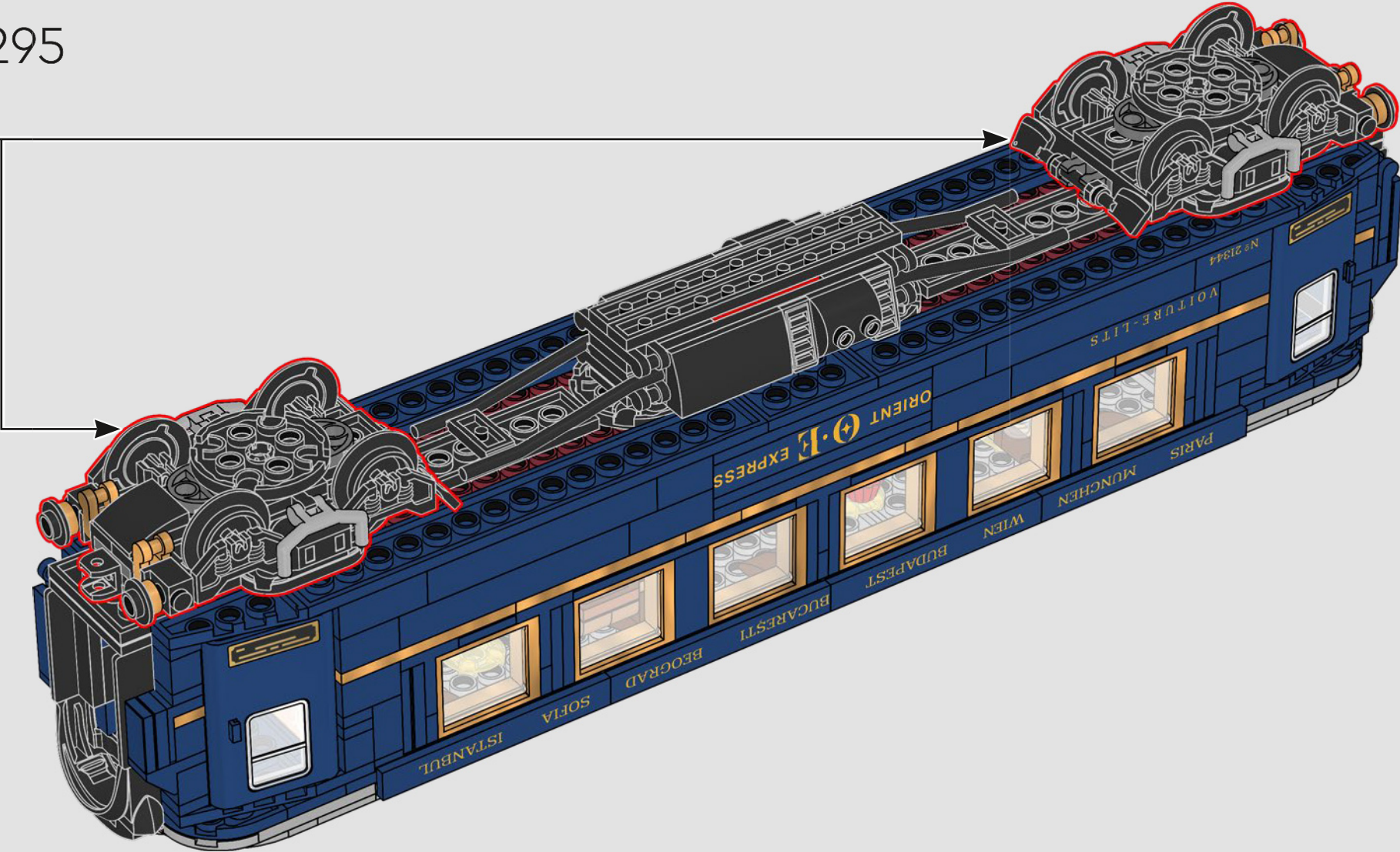



296

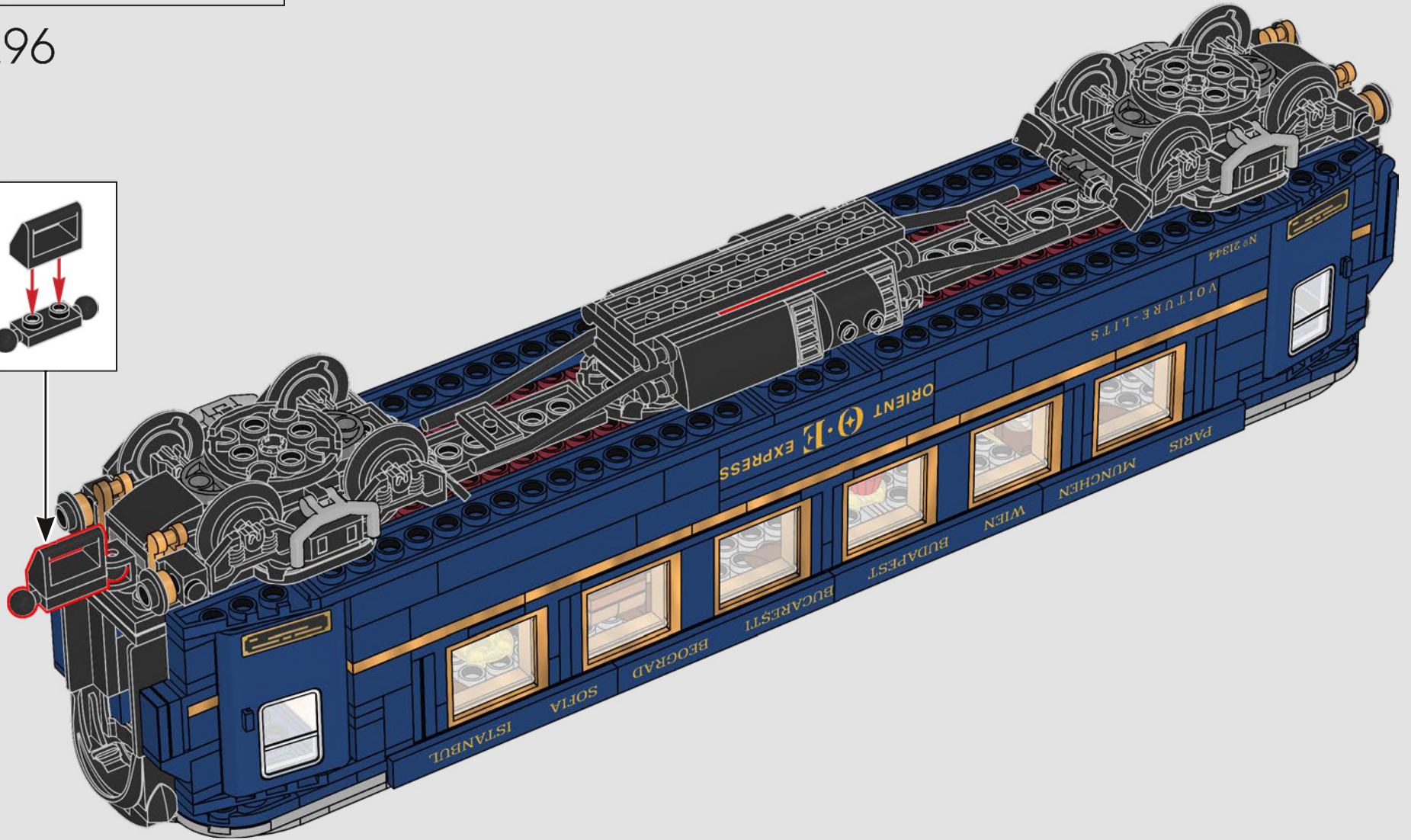
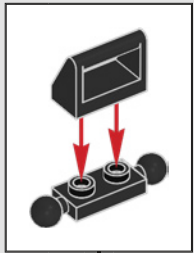

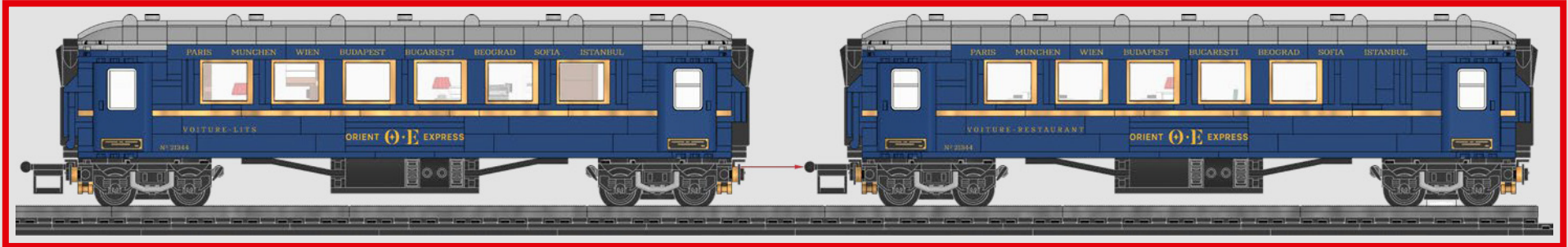
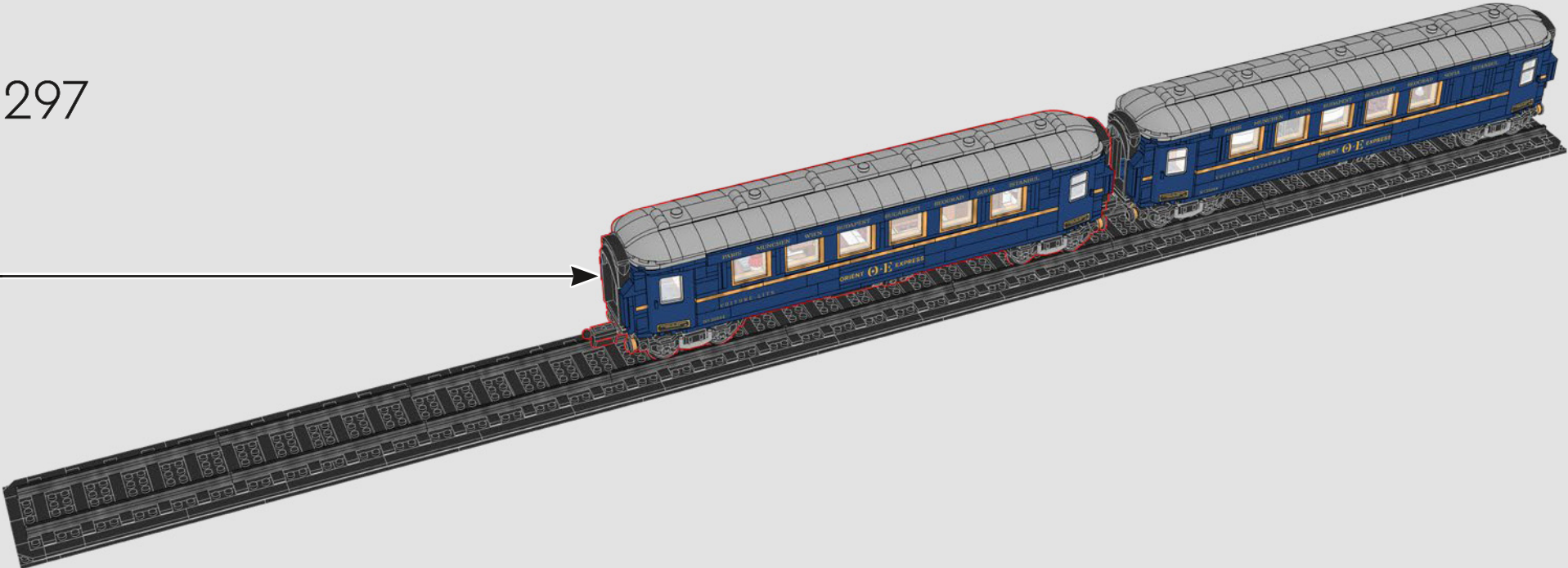

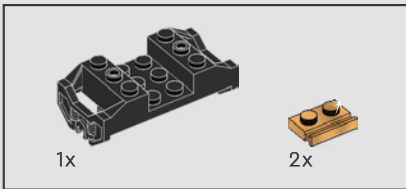
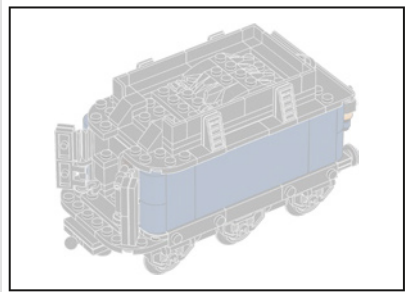

298

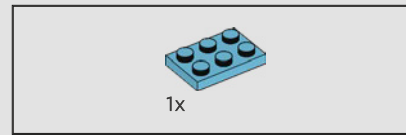
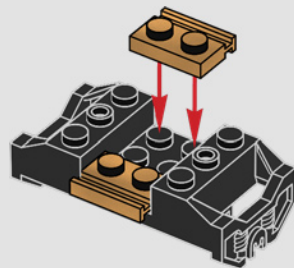

299

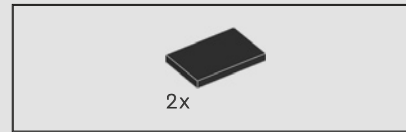
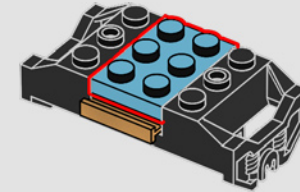

300

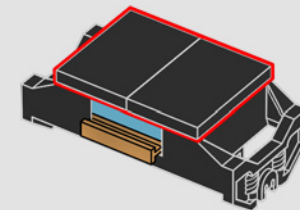

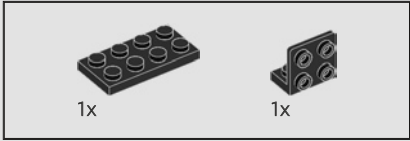
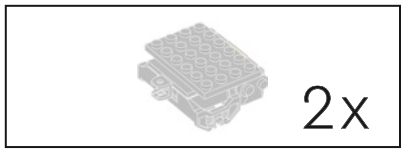

301

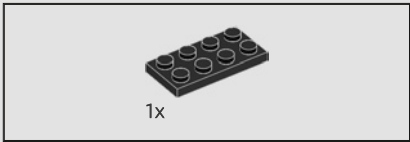
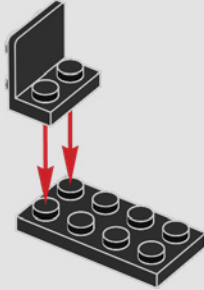

302

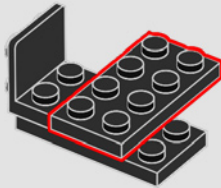

303

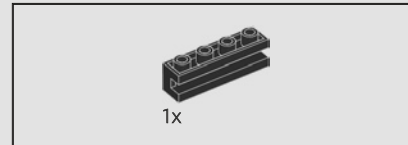
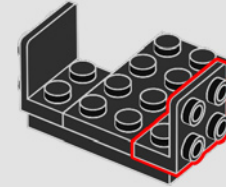

304

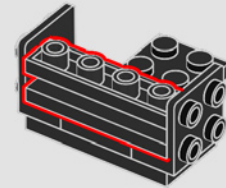



305

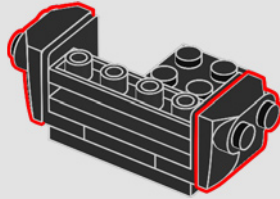

306

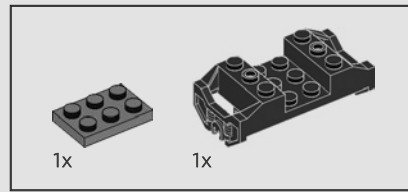
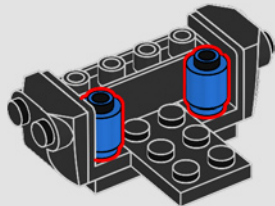

307

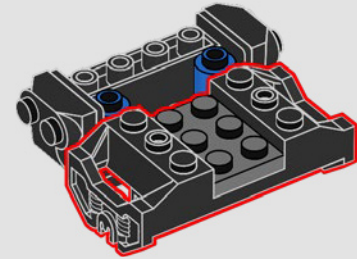
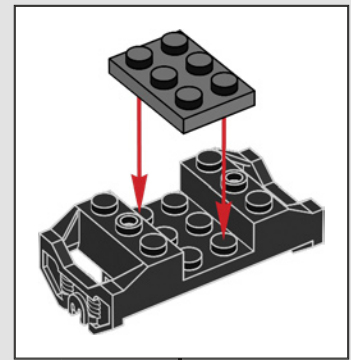

308

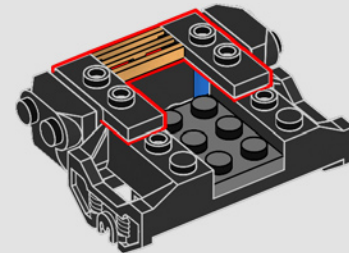

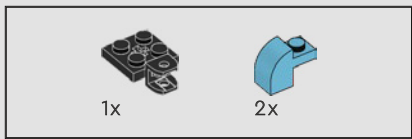

309

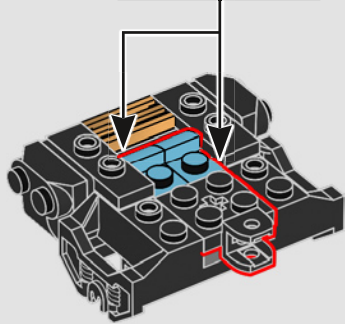
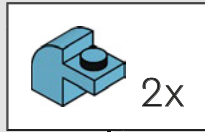

310

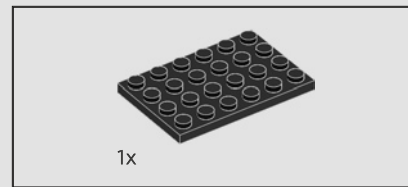
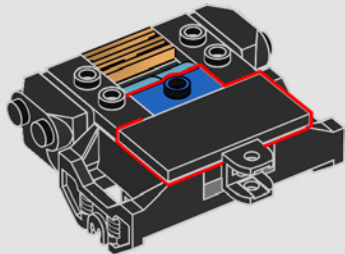

311

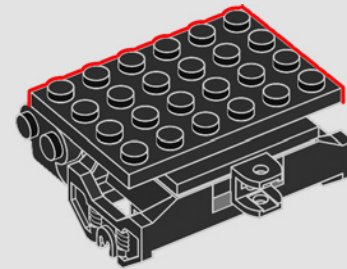

2x

312

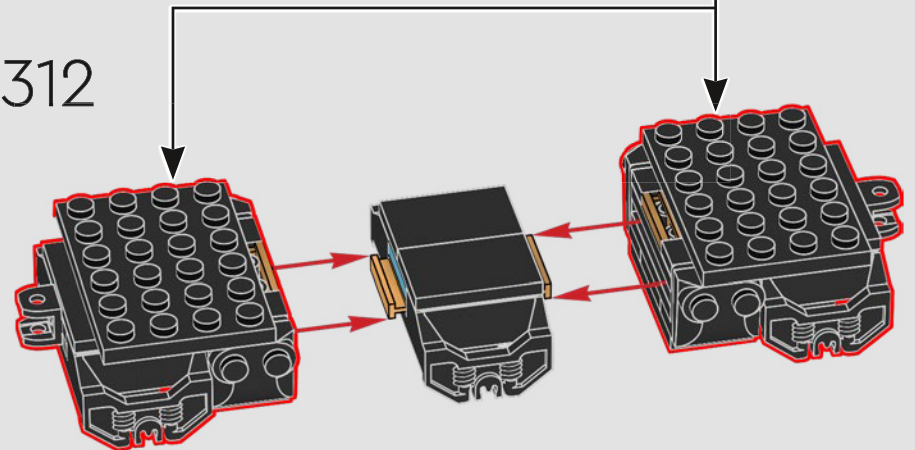

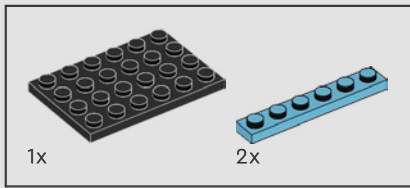

313

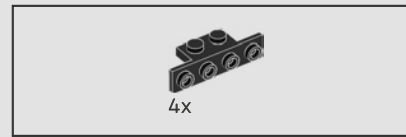
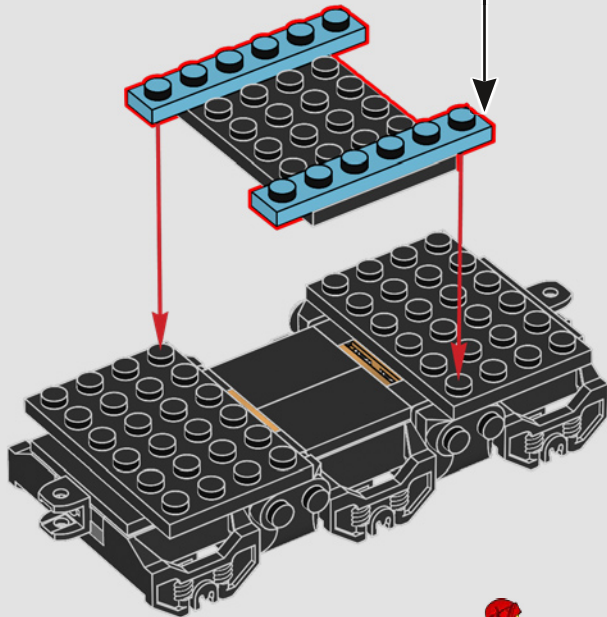
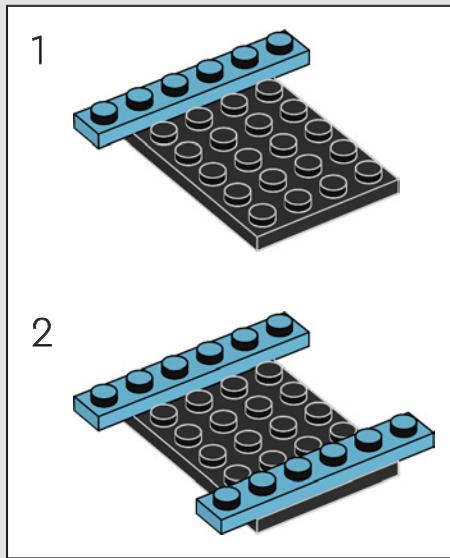

314

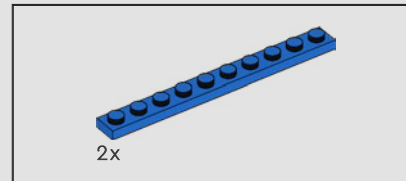
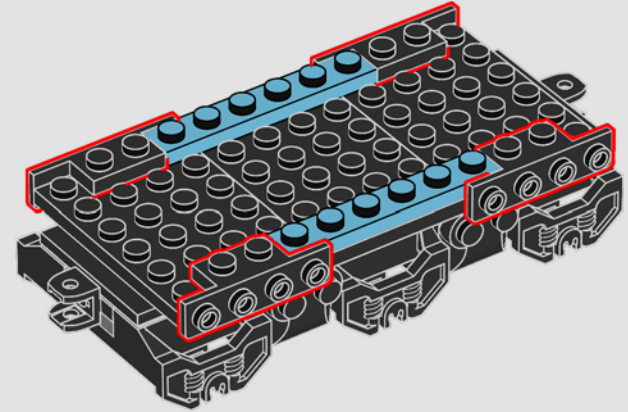

315

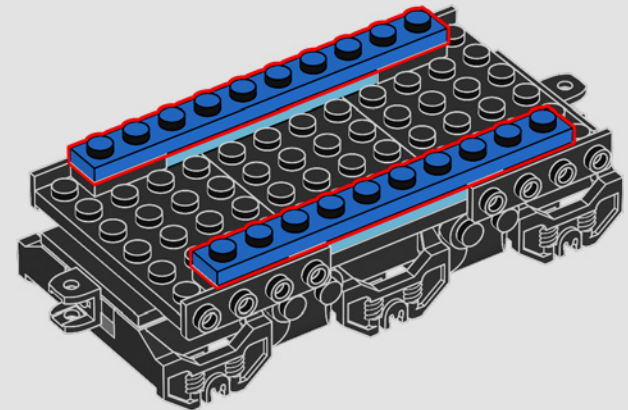

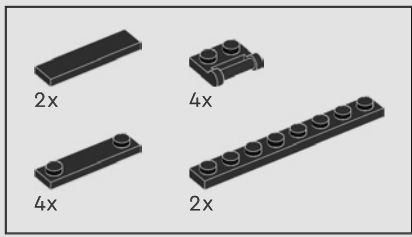

316

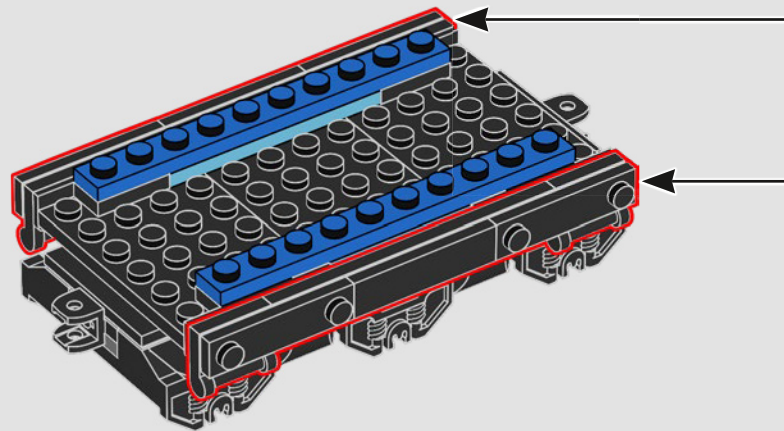
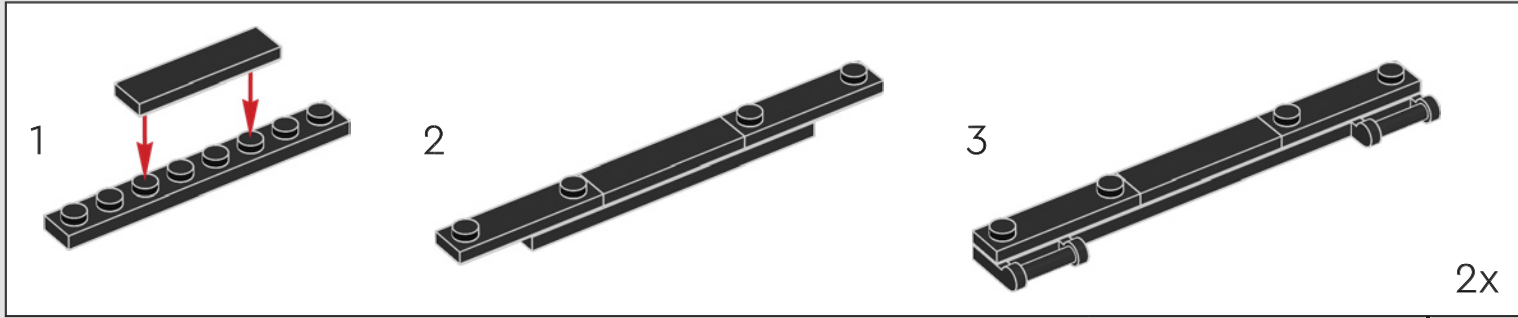

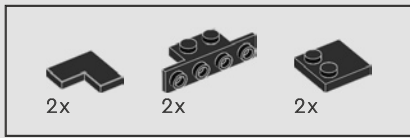

317

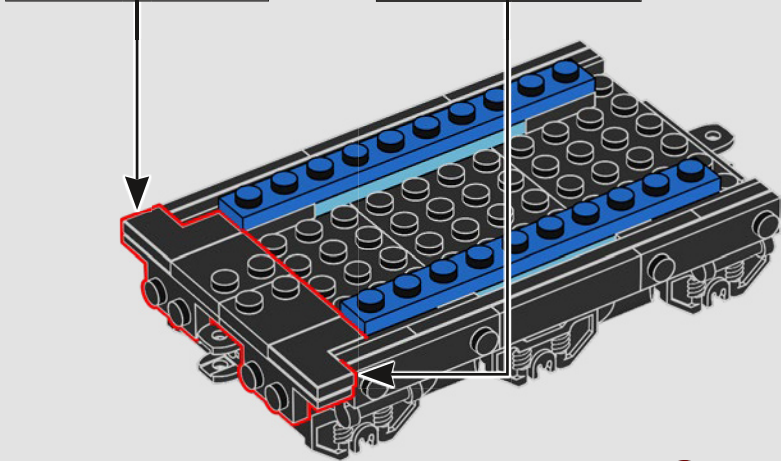
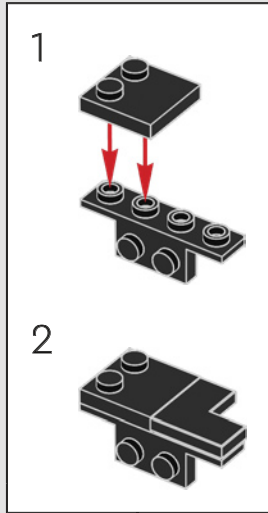
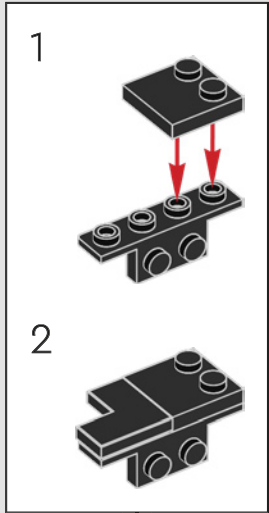

318

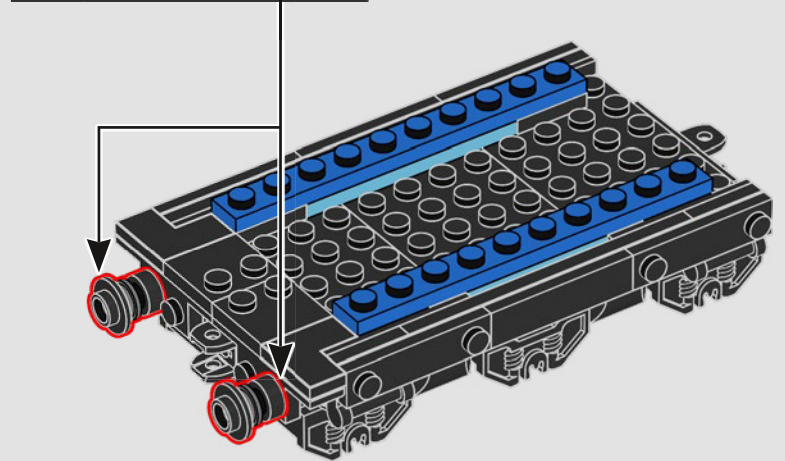
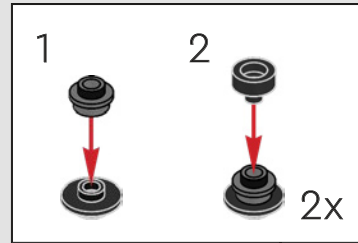

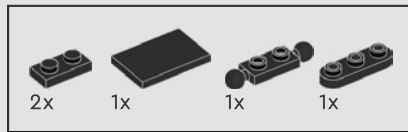

319

..... ●
'Steam continues to billow from the engine.
The coal tender needs to be large to fuel
such a locomotive.'

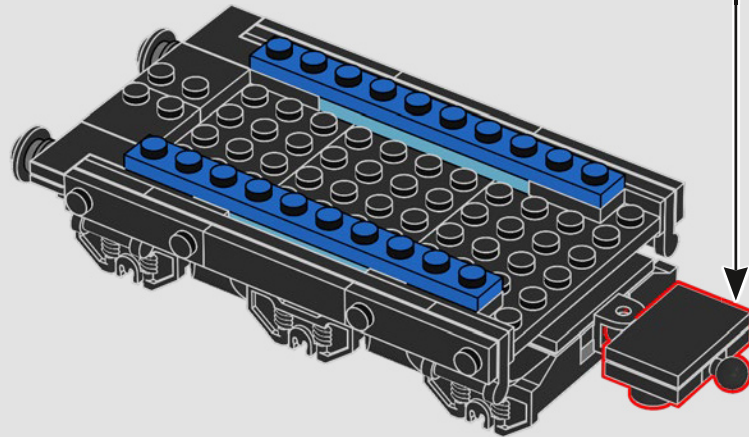
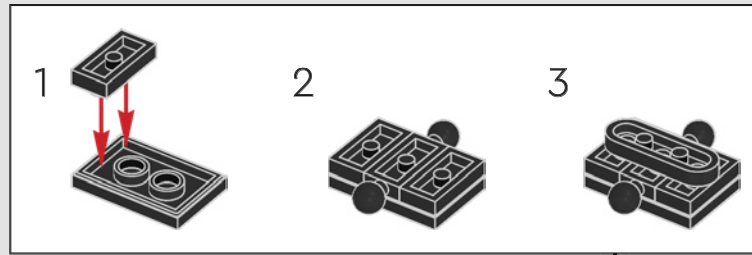

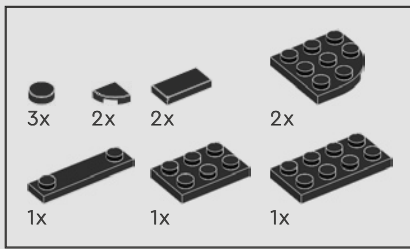

320

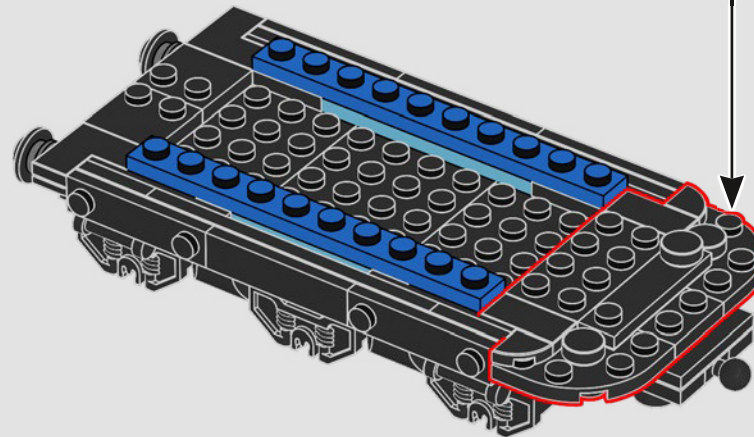
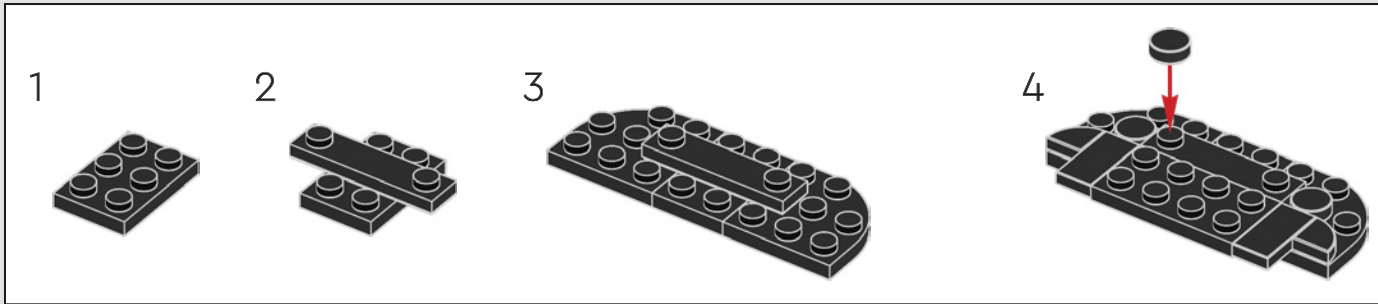

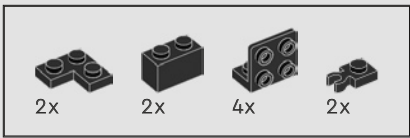

321

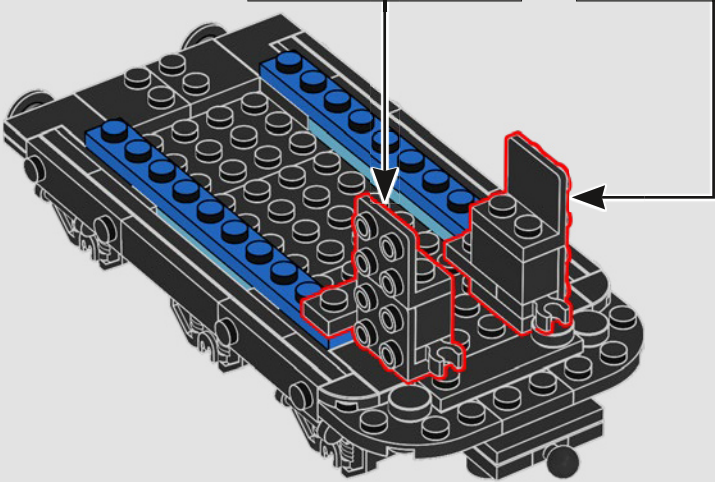
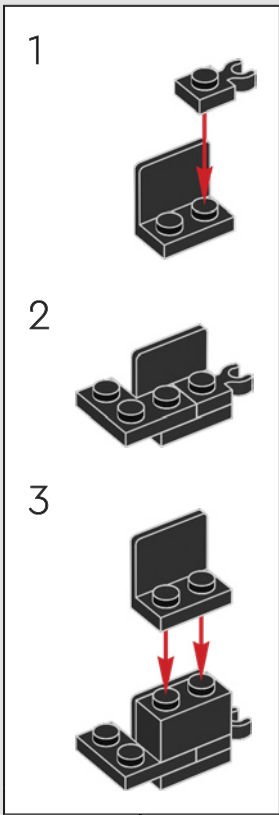
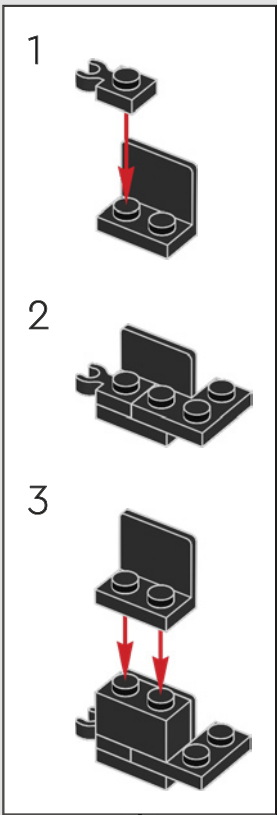



322

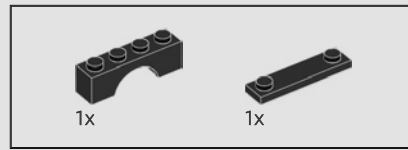
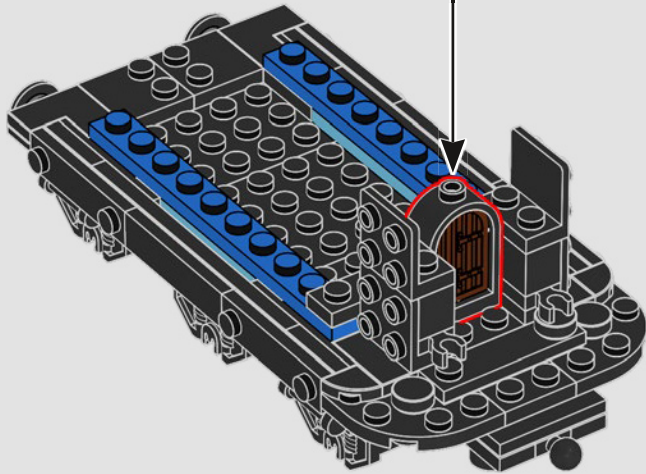
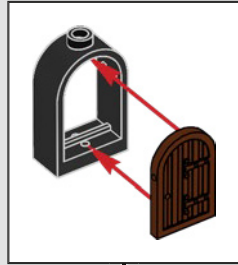

323

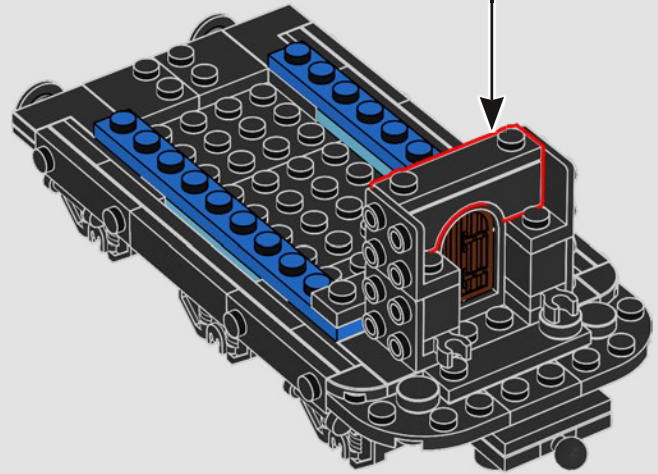
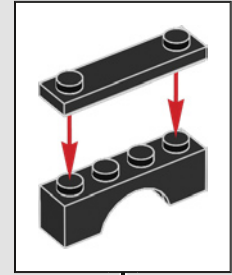

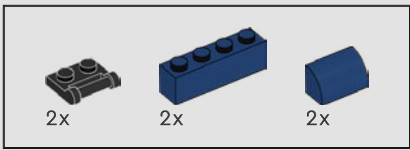

324

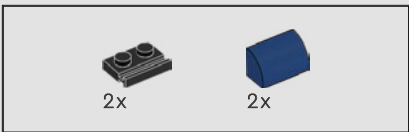
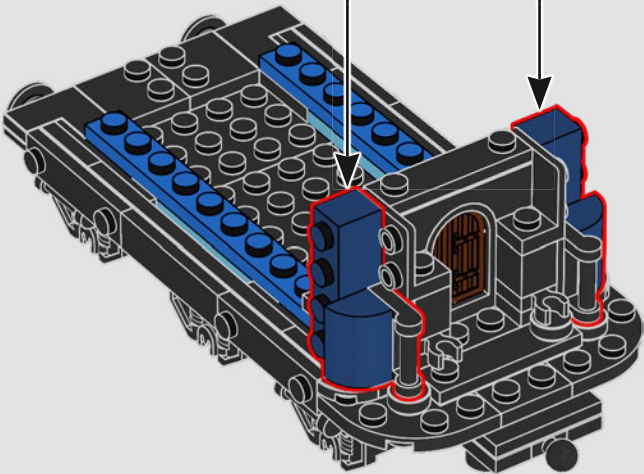
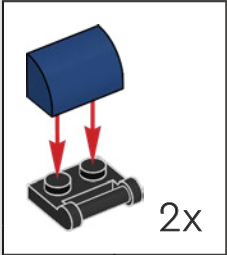

325

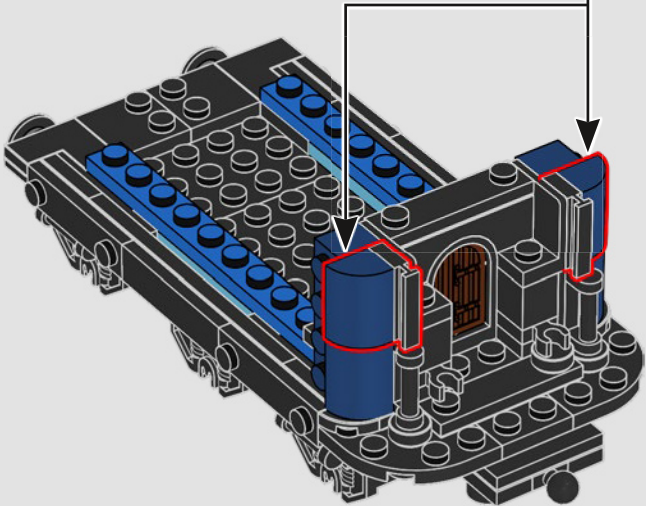
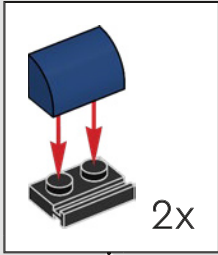



326

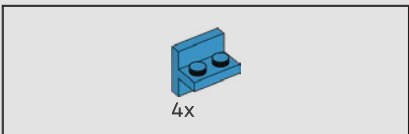
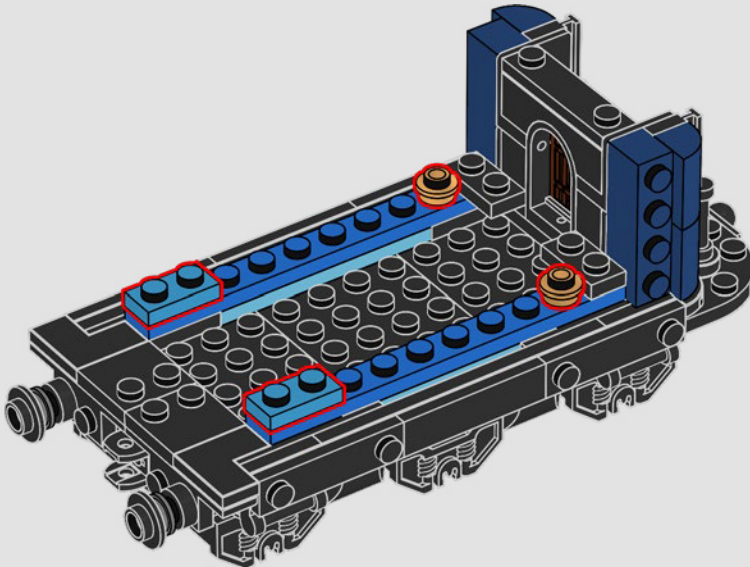

327

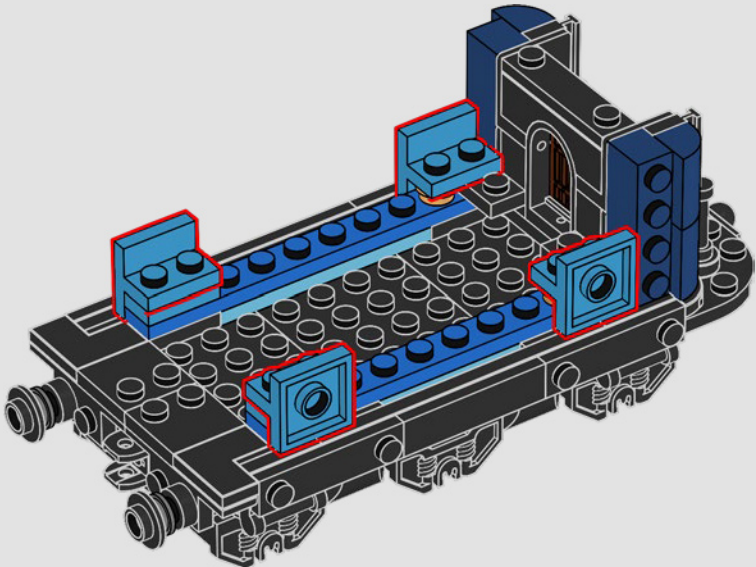



2x

328

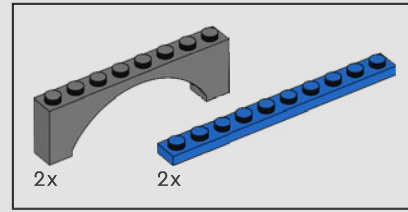
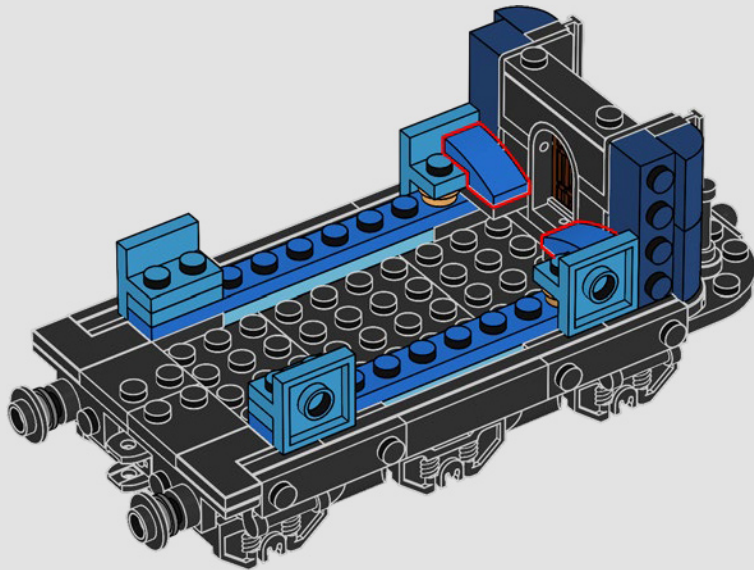

2x

2x

329

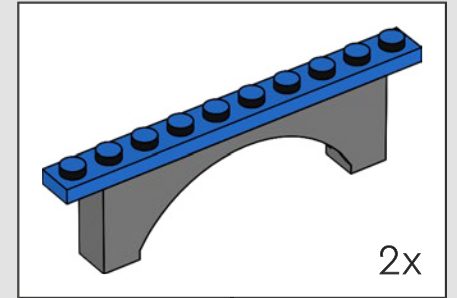

2x

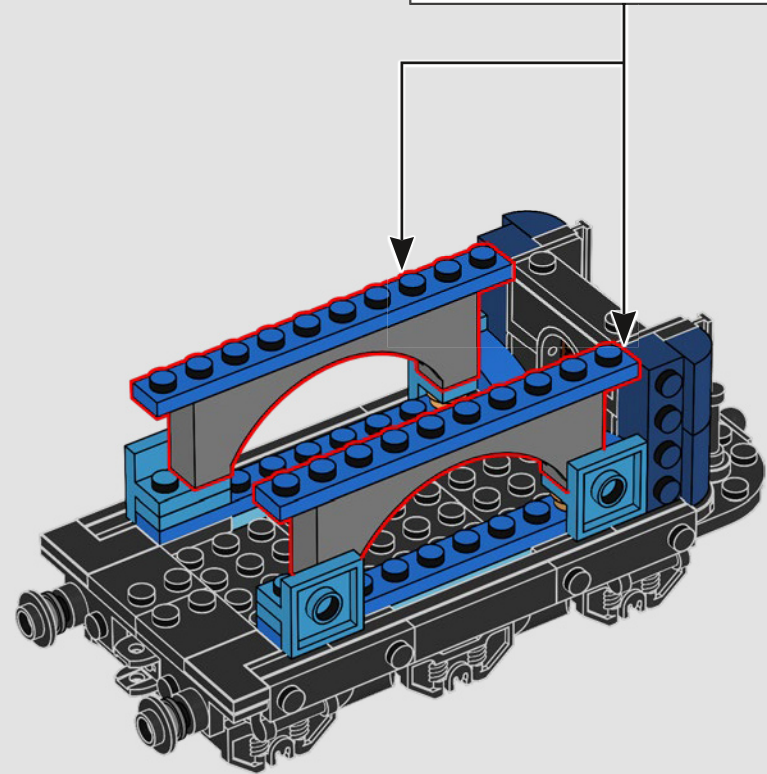

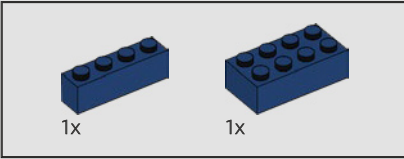
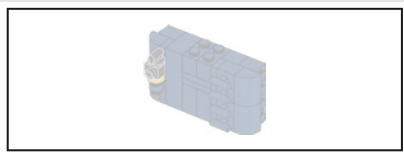

330

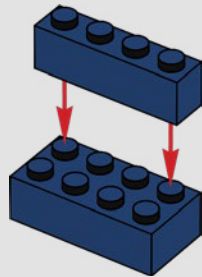

331

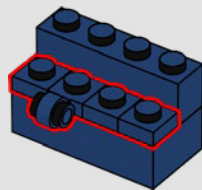

2x

332

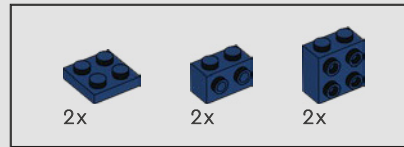
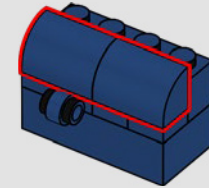

2x

2x

2x

333

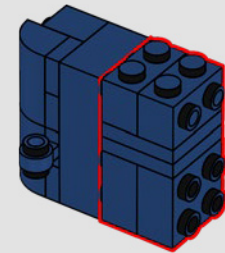
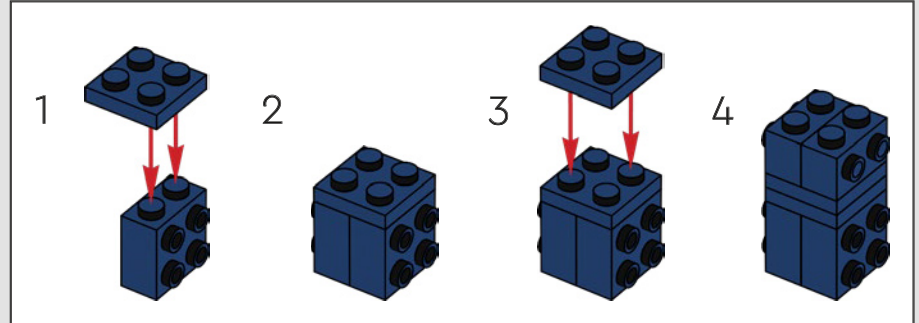

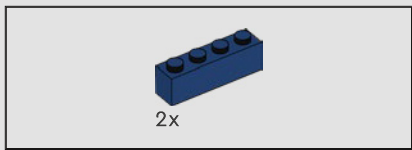

334

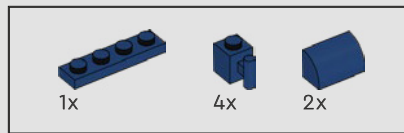
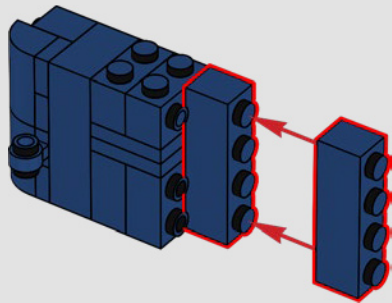

335

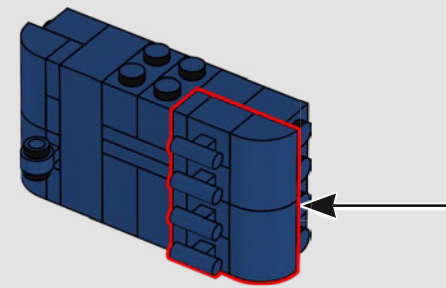
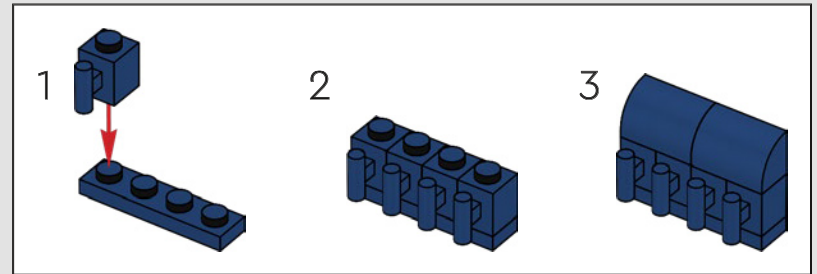



336

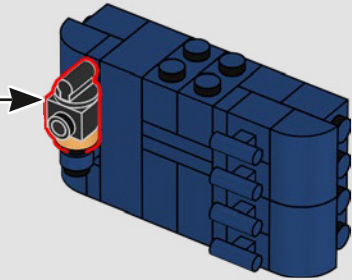
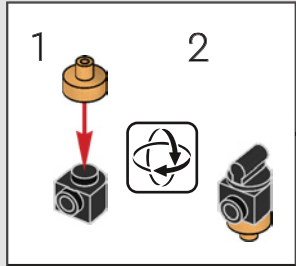

337

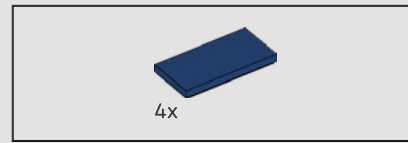
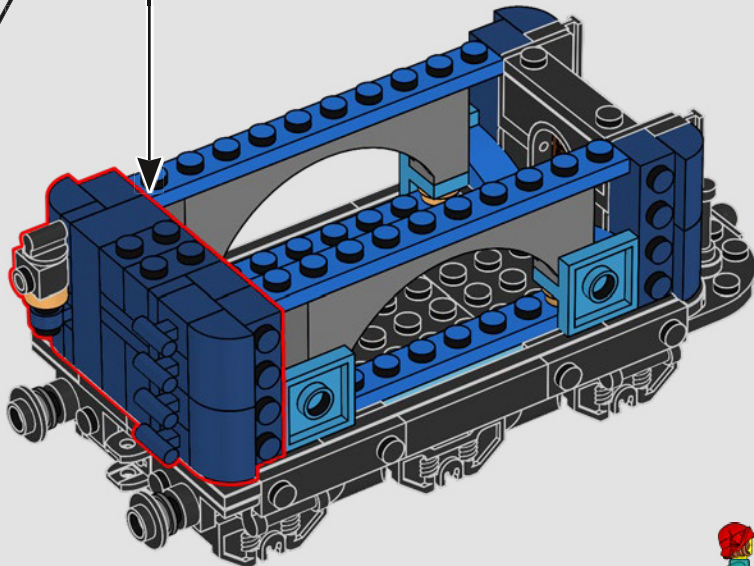

338

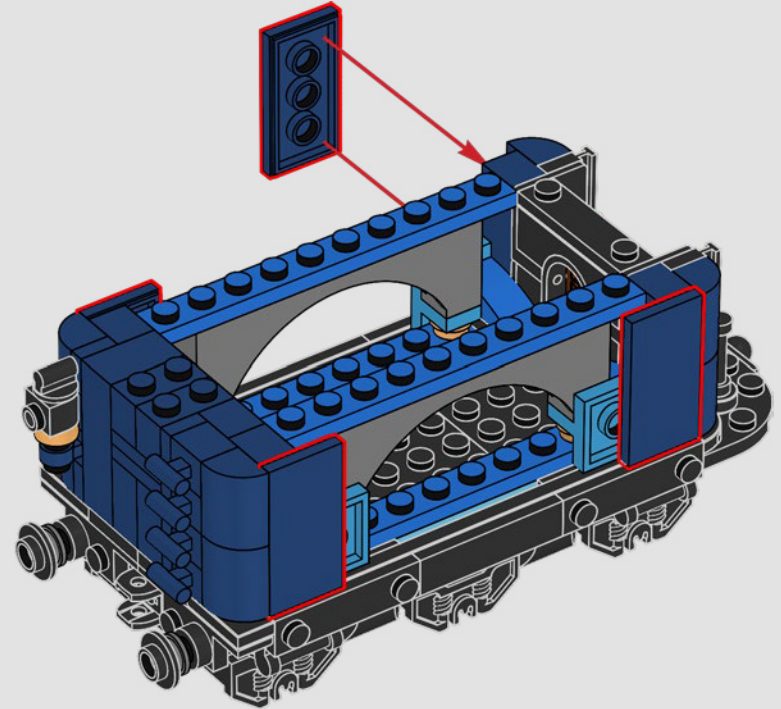

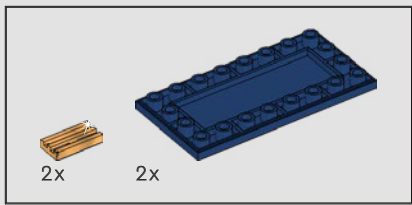

339

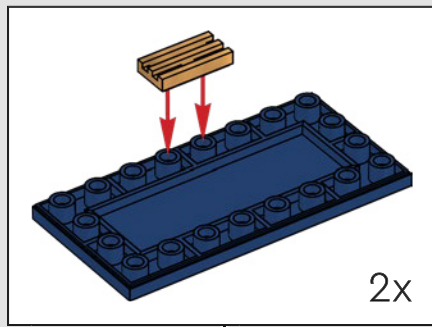

340

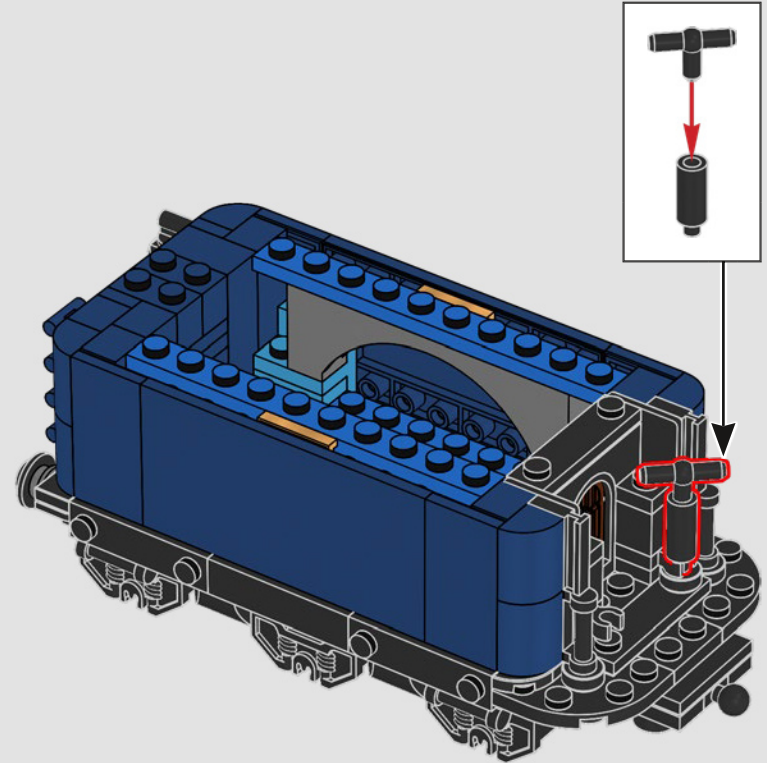
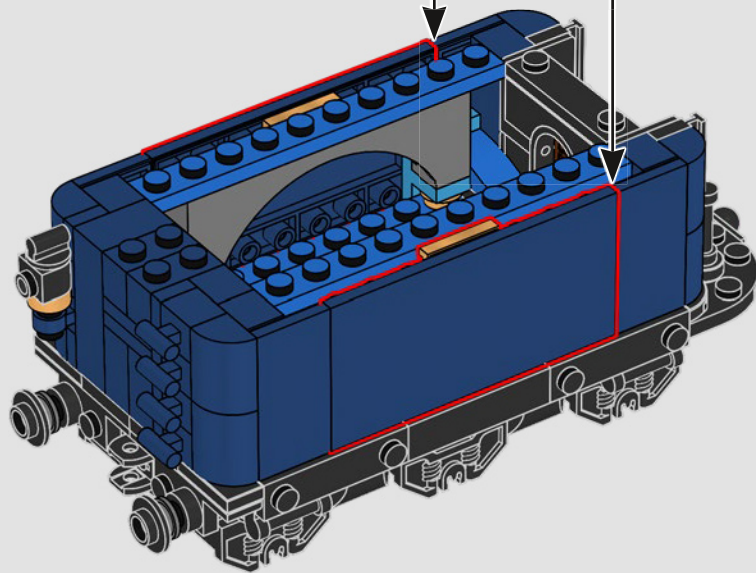

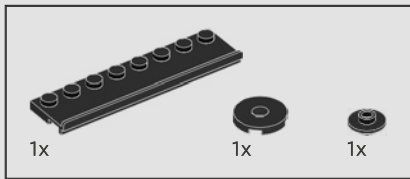

341

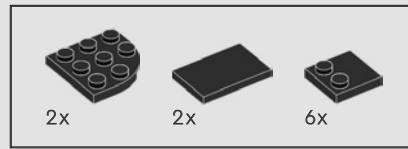
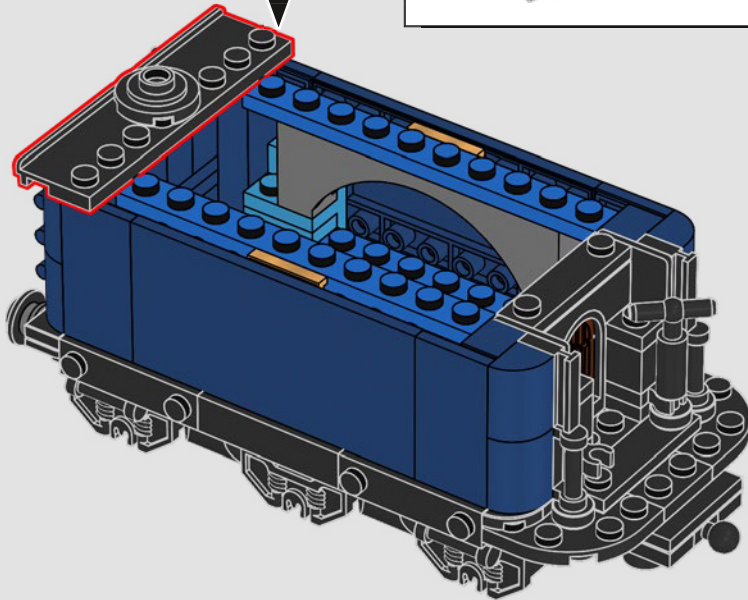
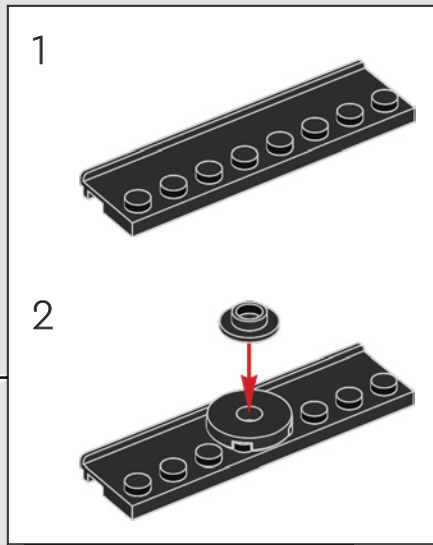

342

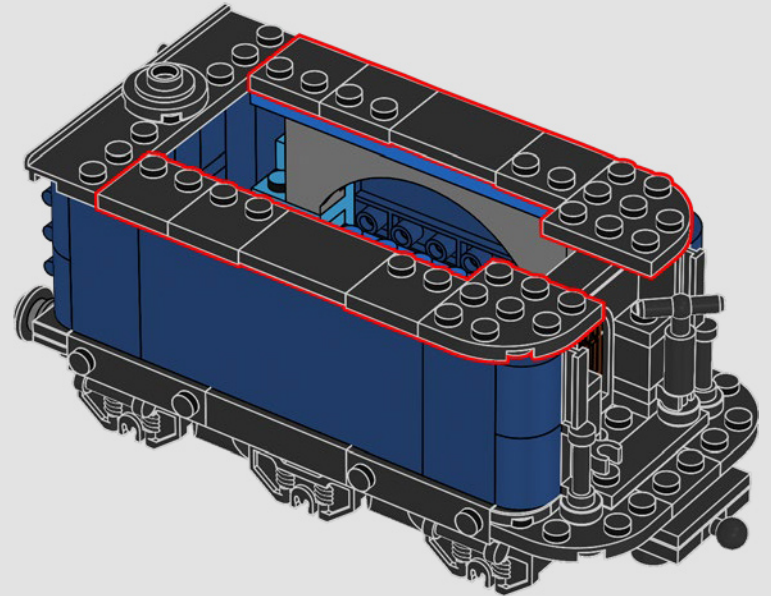

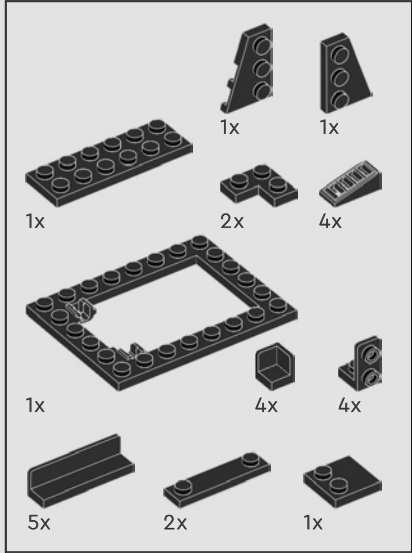
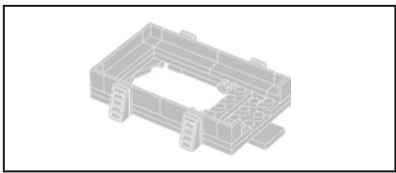

343

1

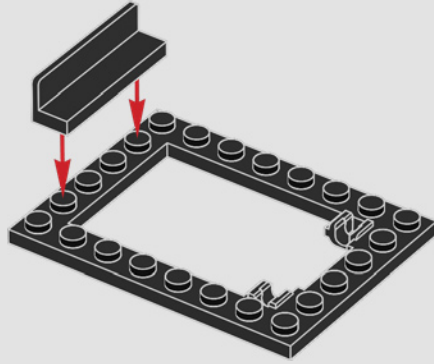

2

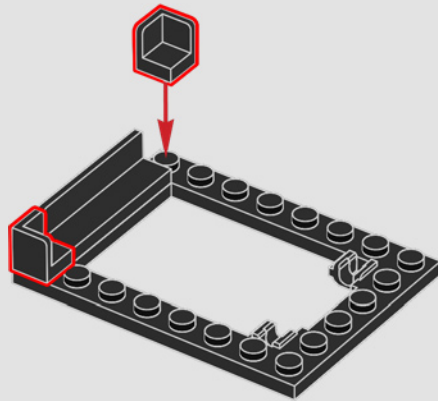

3

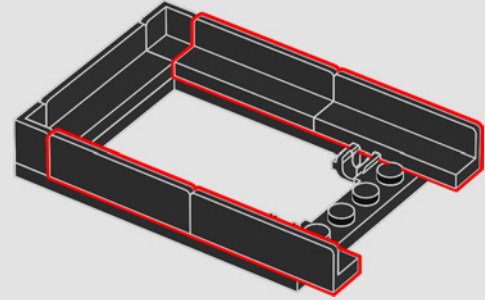

4

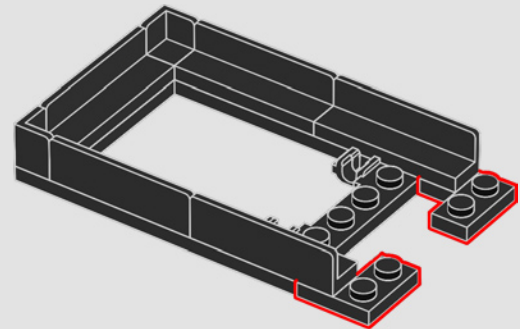

5

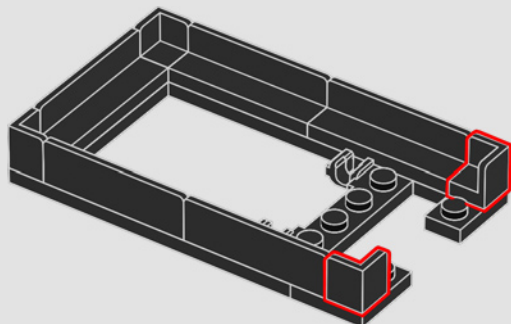

6

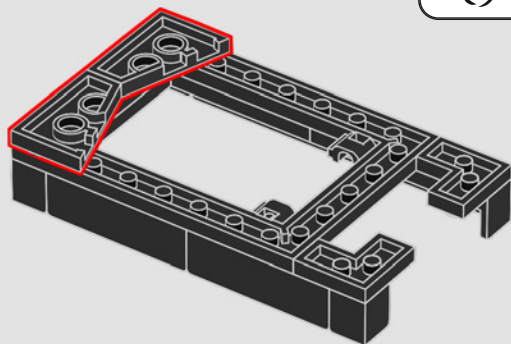

7

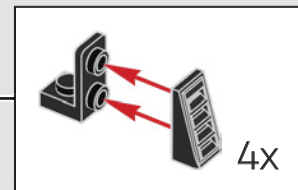
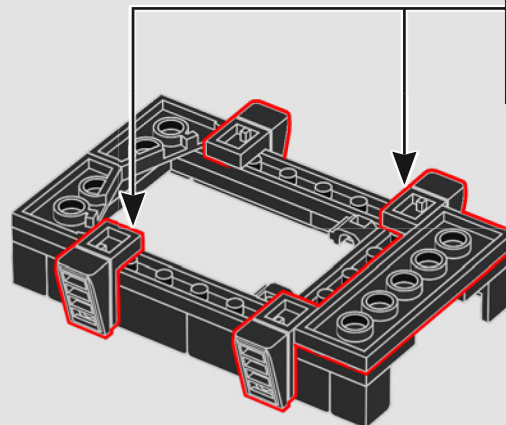

8

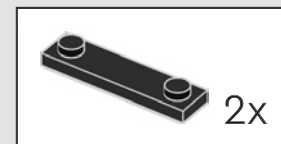
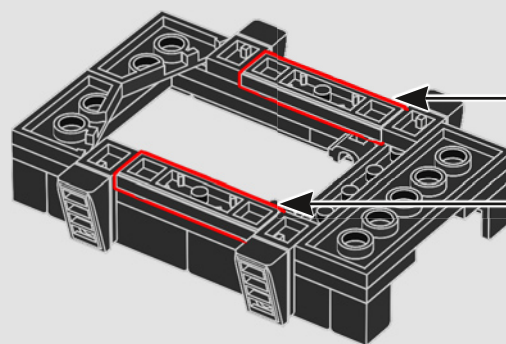



9

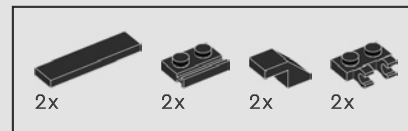
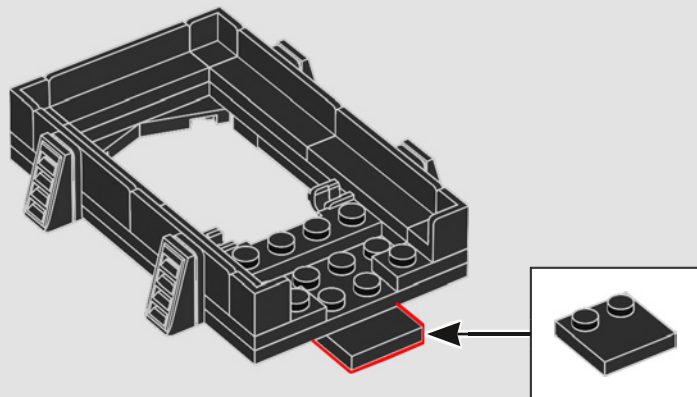

344

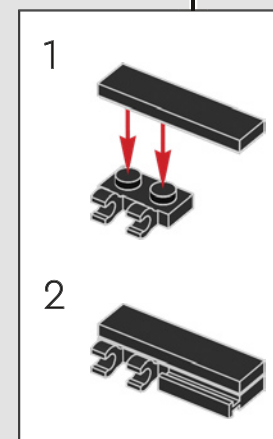
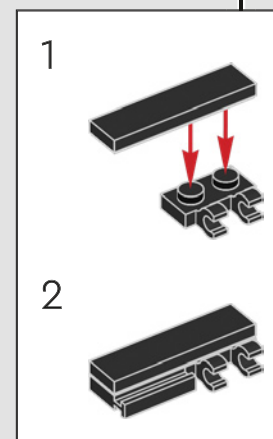
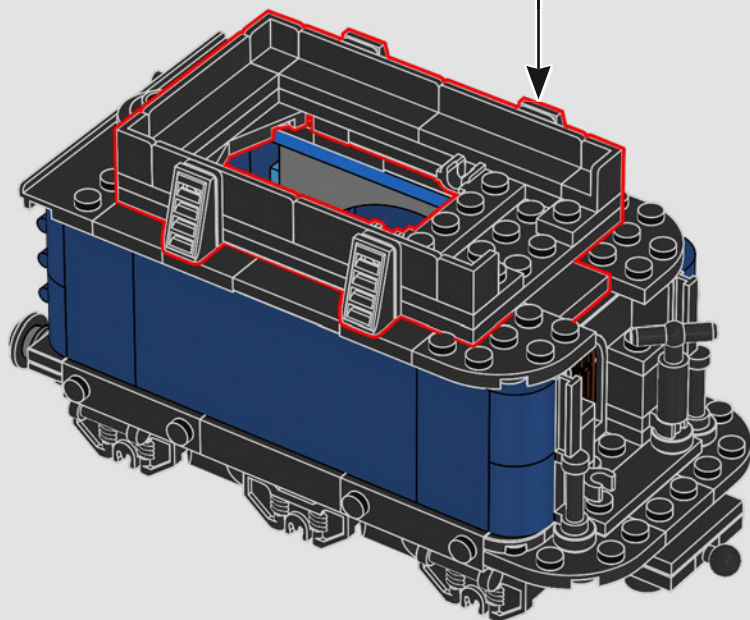
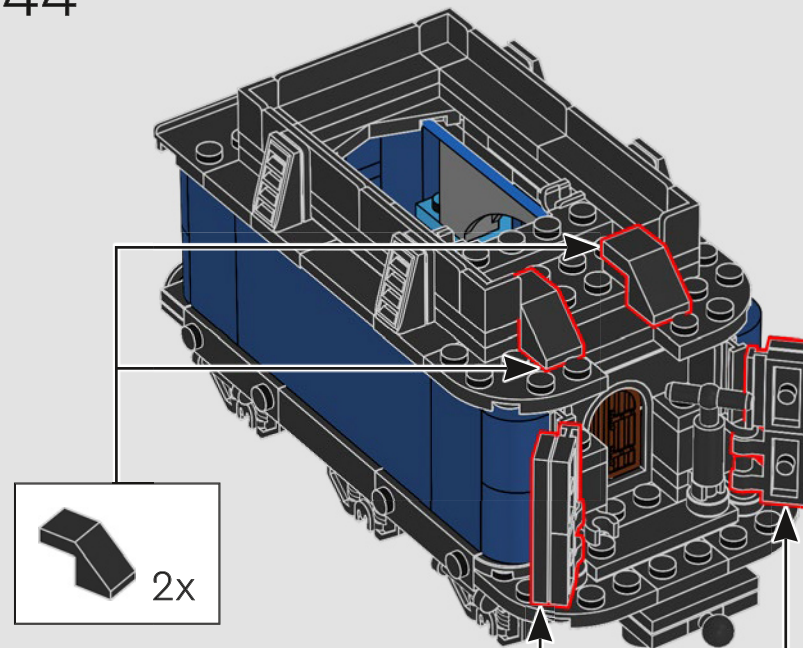



345

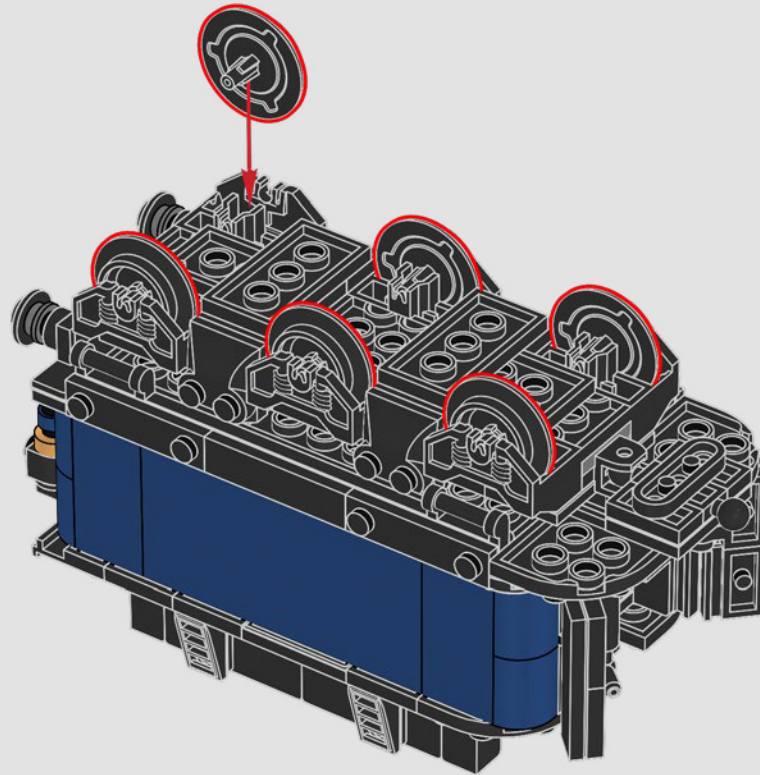

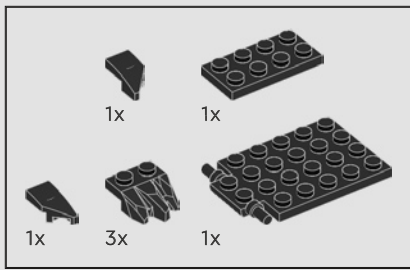

346

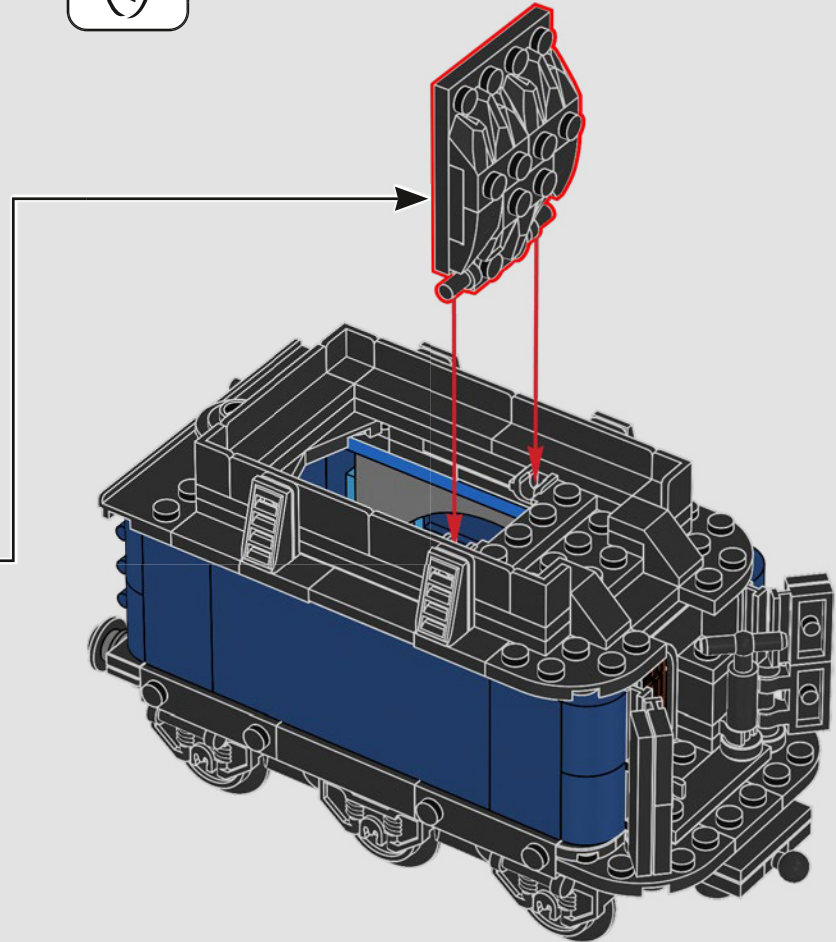
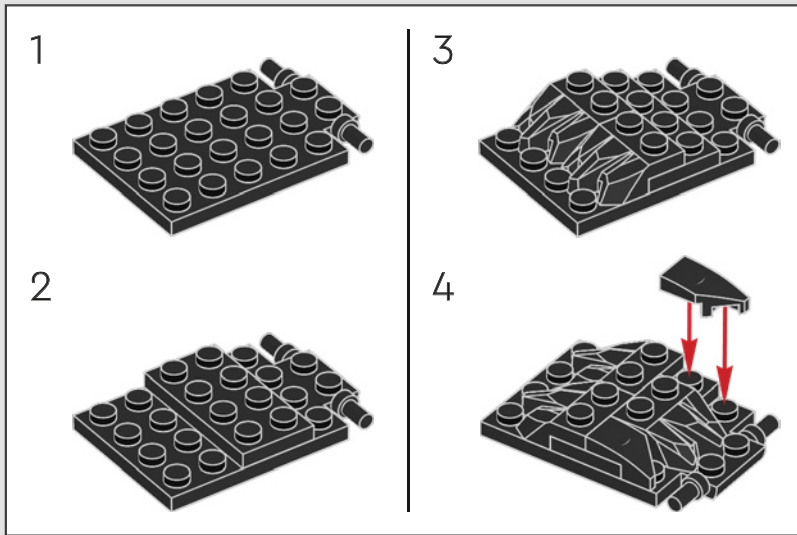

347



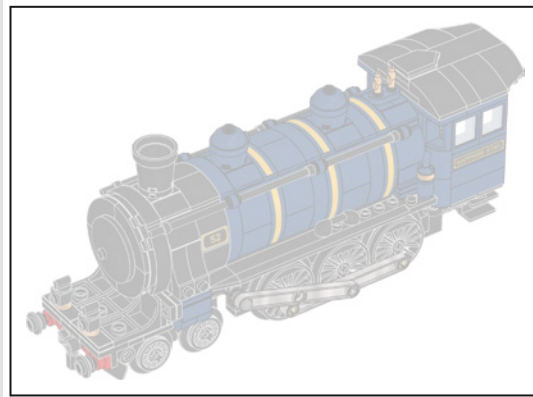
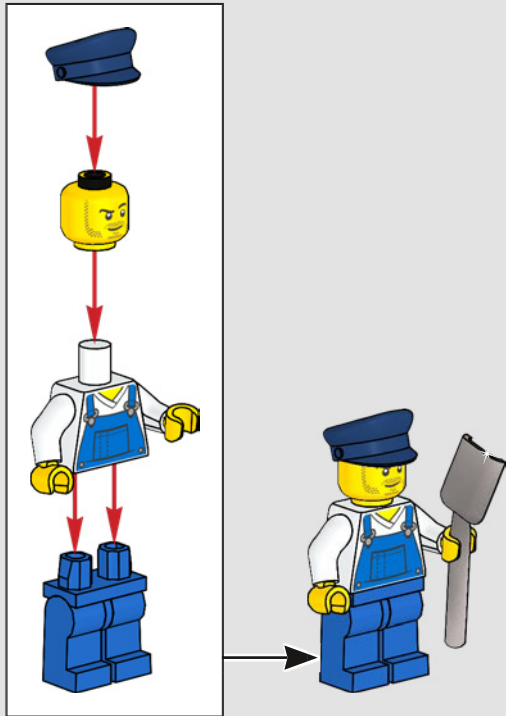

348

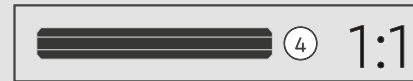
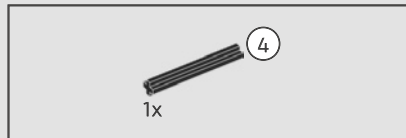

349

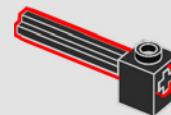

..... ●
'The Train Driver stokes the fire and keeps the engine in fine health throughout our journey.'



350

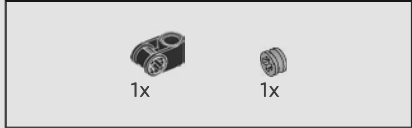
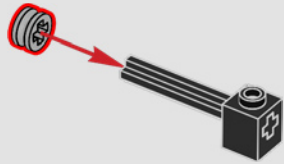

351

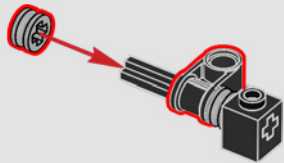

352

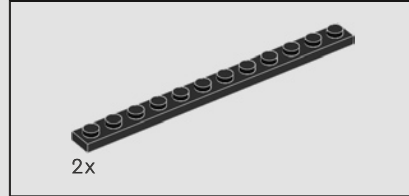
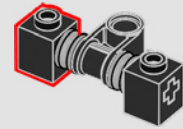

353

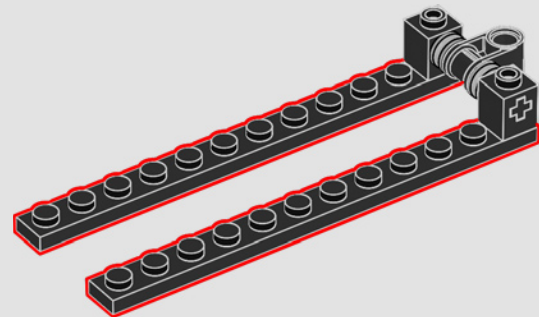

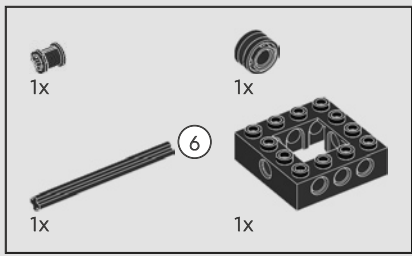

354

1

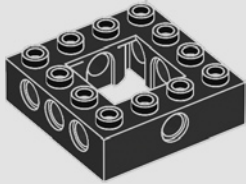

2

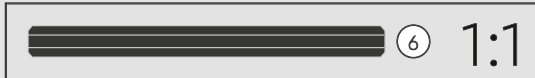
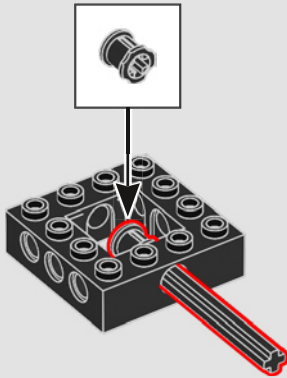

3

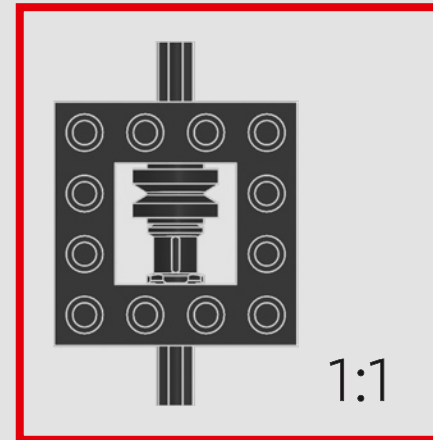
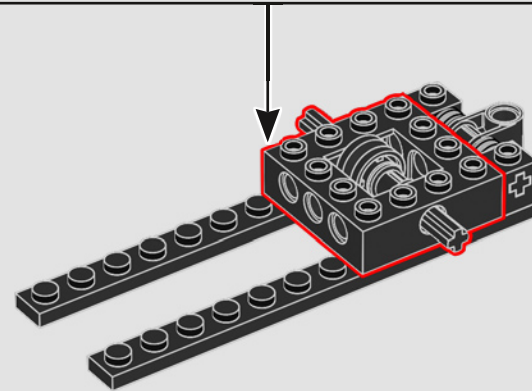
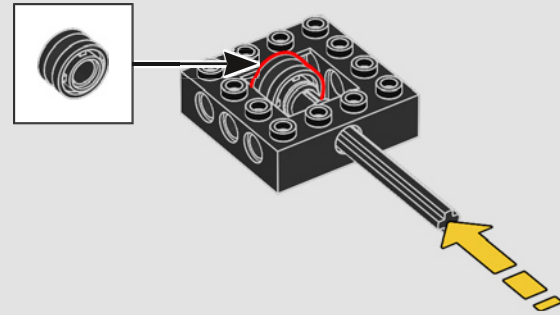

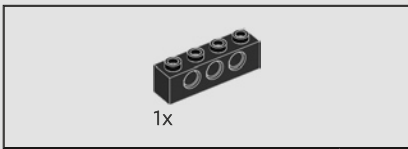

355

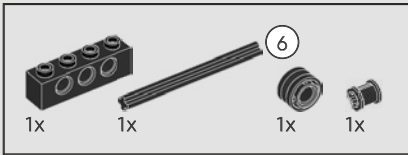
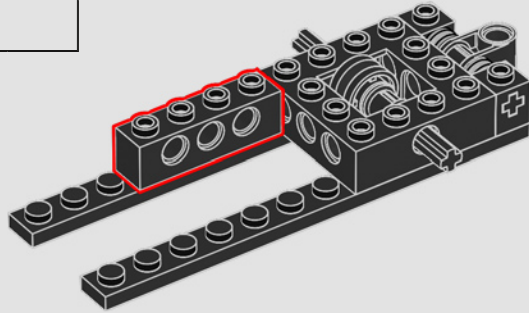

356

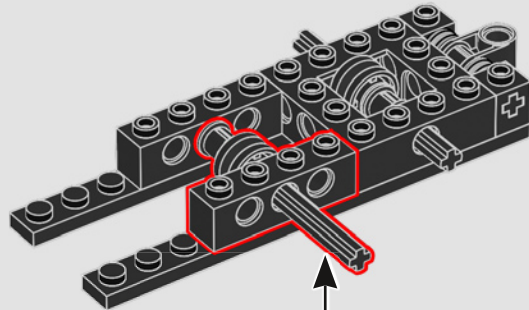
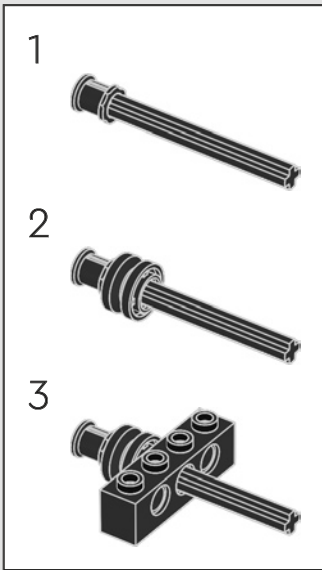

357

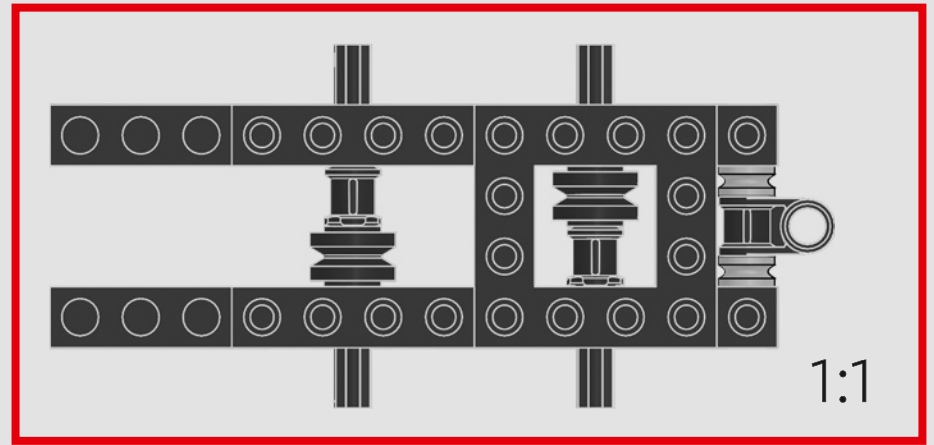
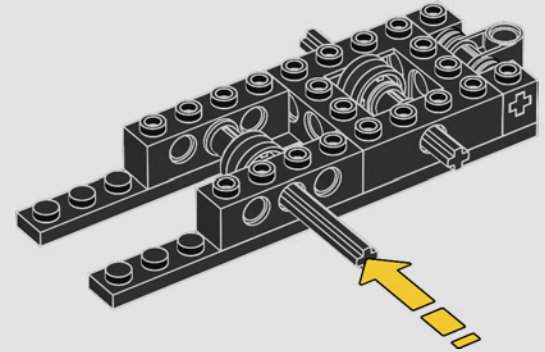

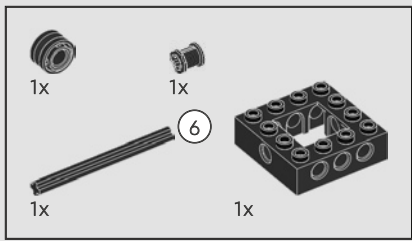

358

1

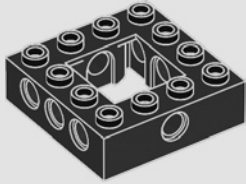

2

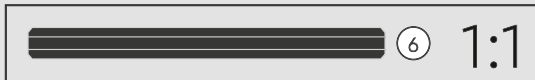
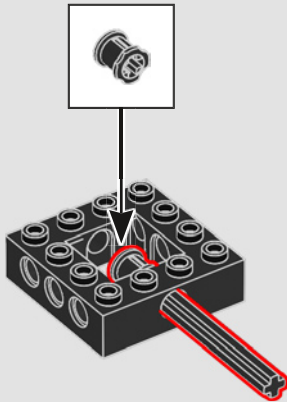

3

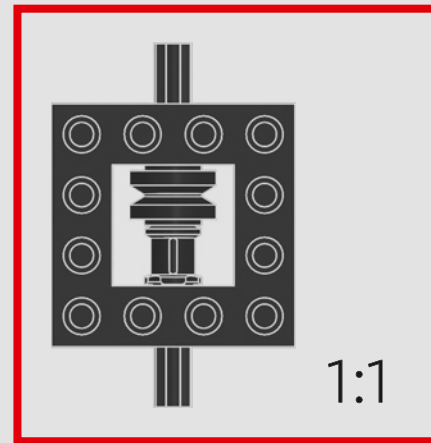
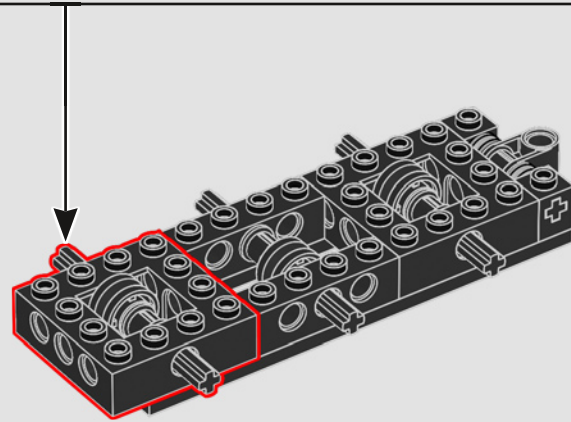
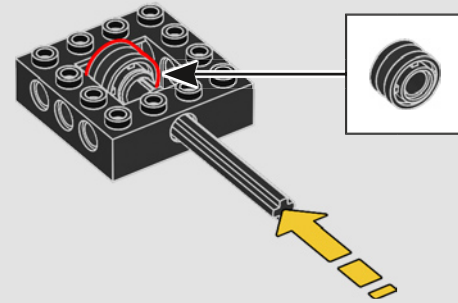

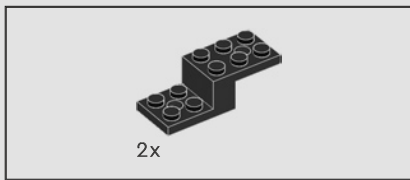

359

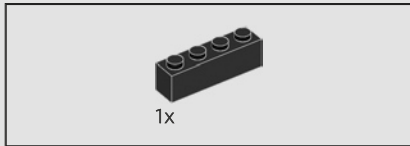
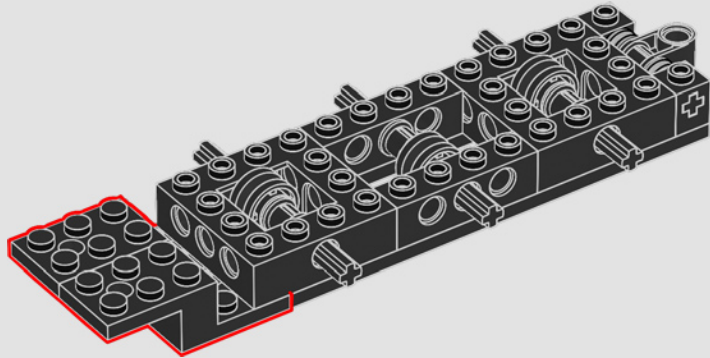

360

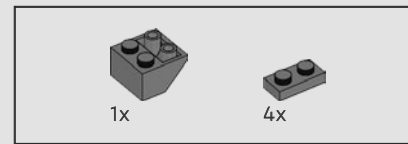
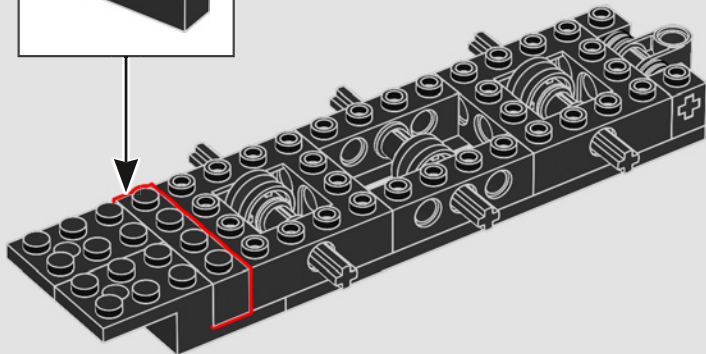
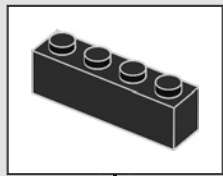

361

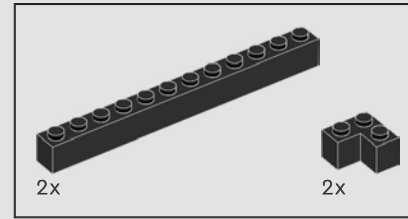
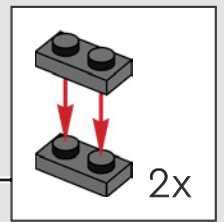
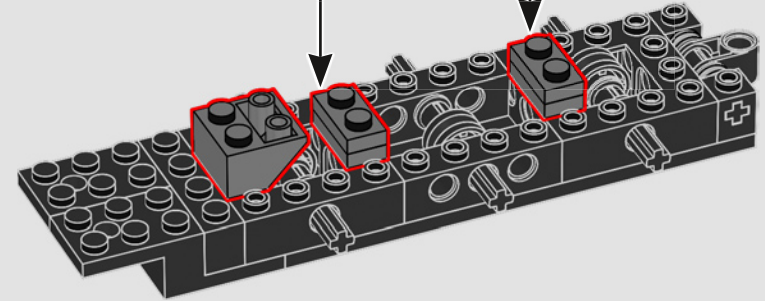

362

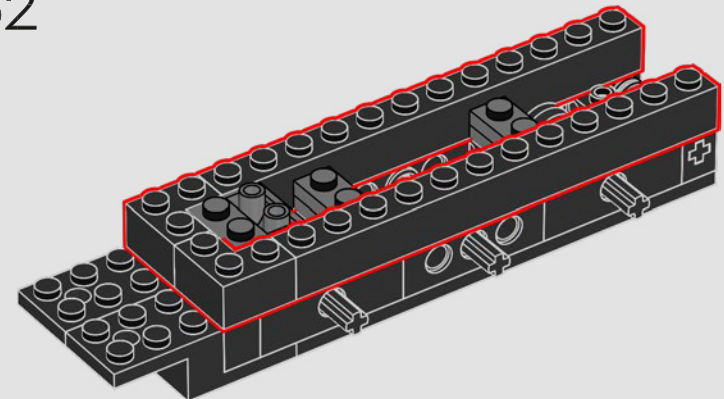

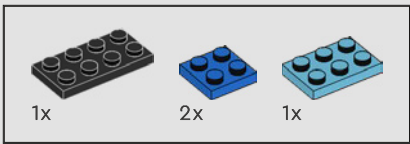

363

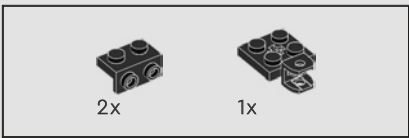
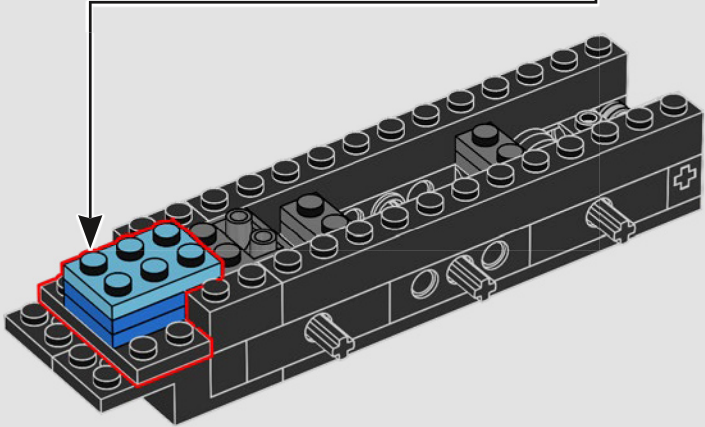
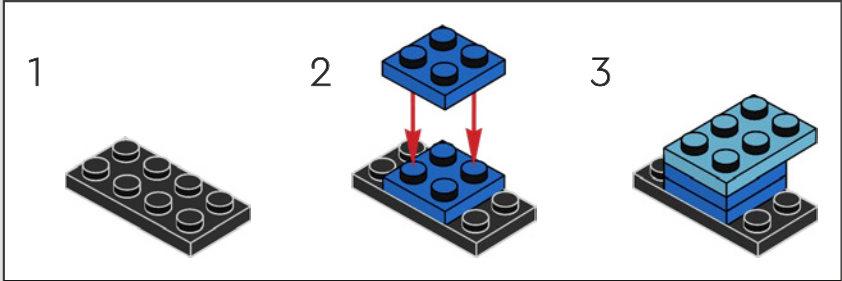

364

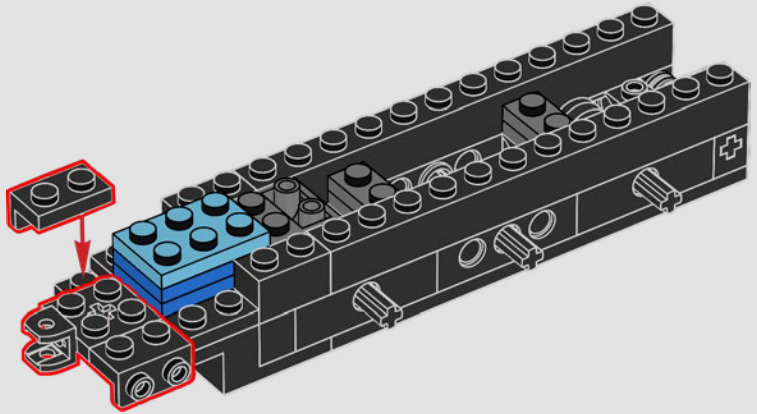

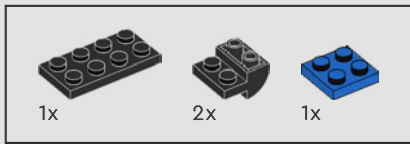

365

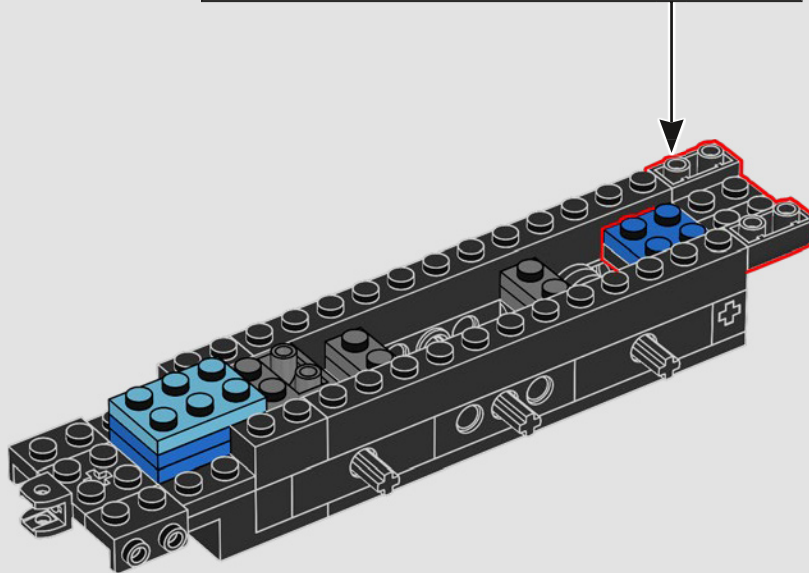
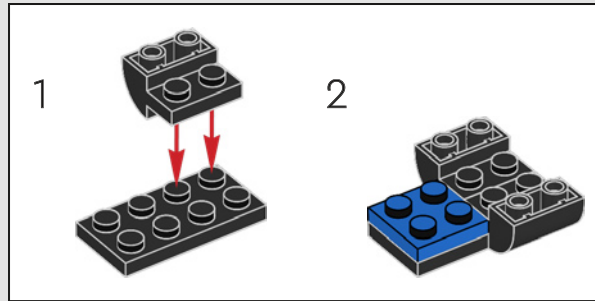

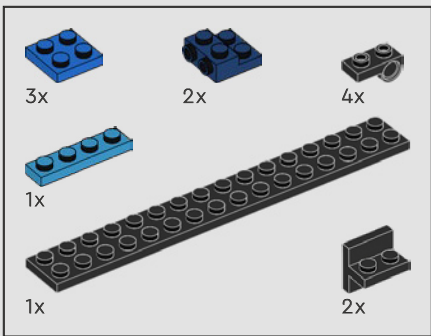

366

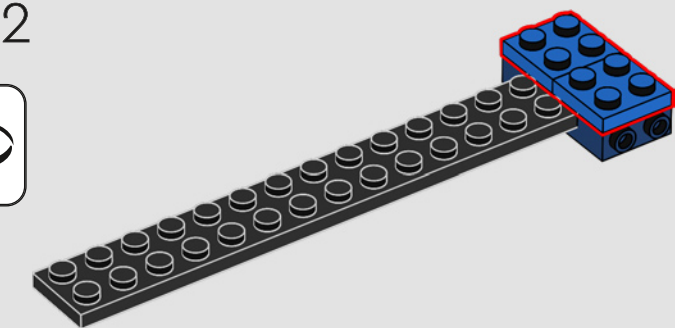
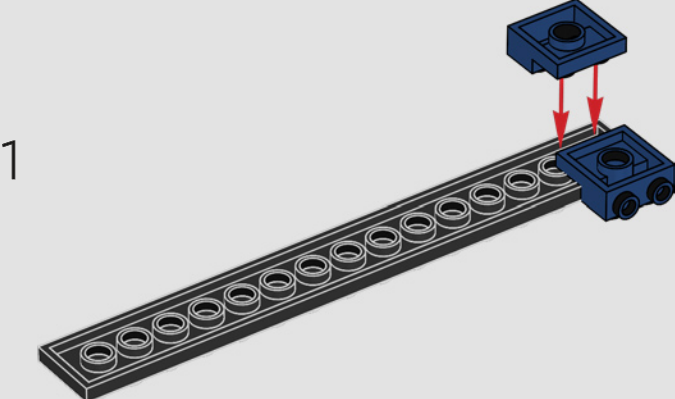

3

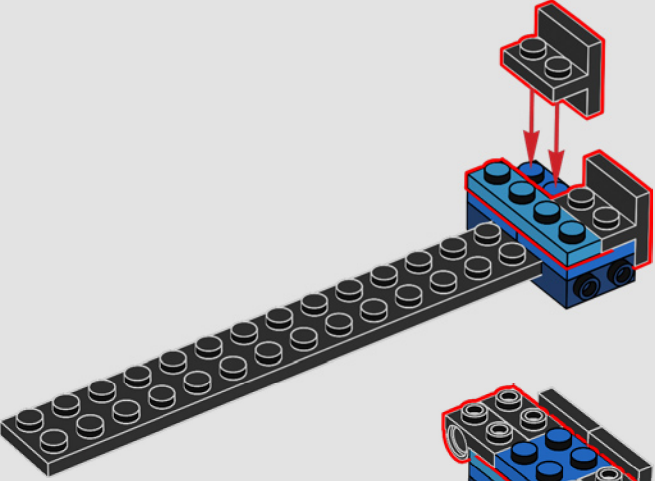

4

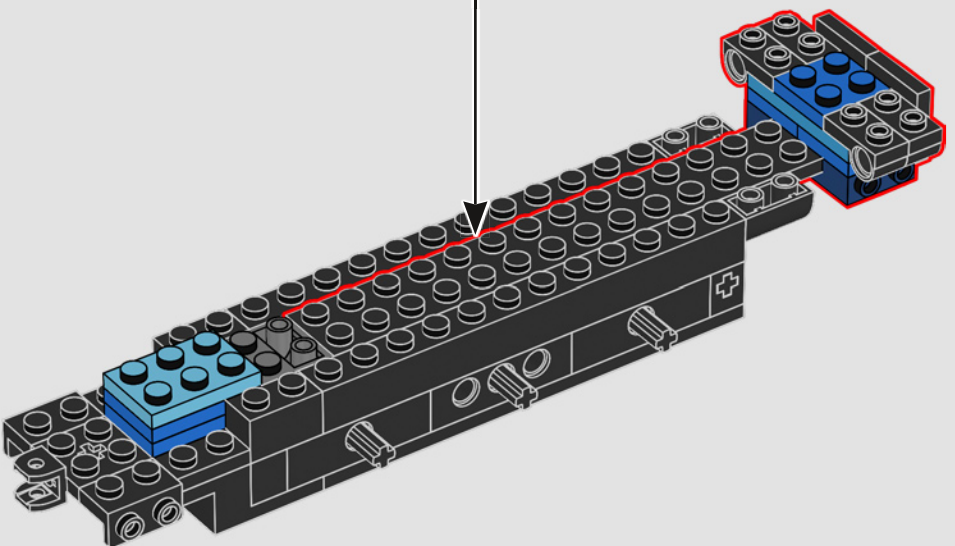
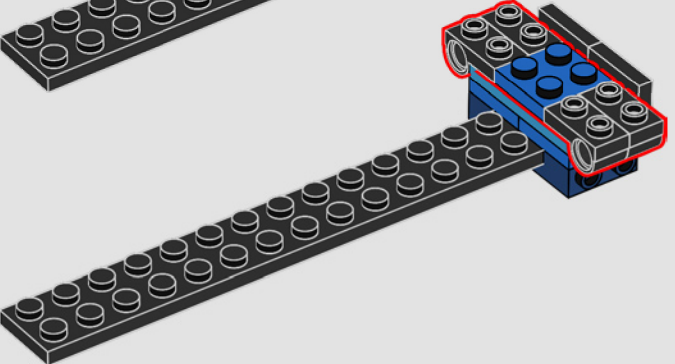

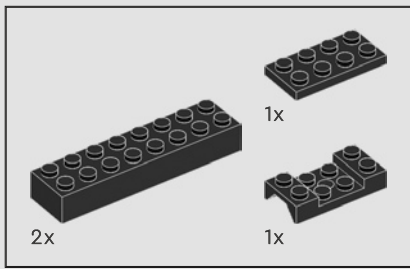

367

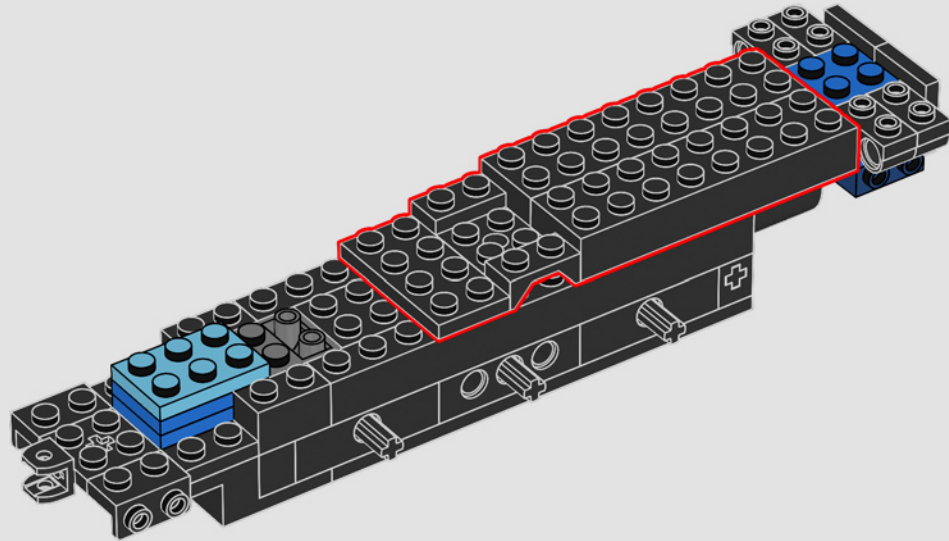

368

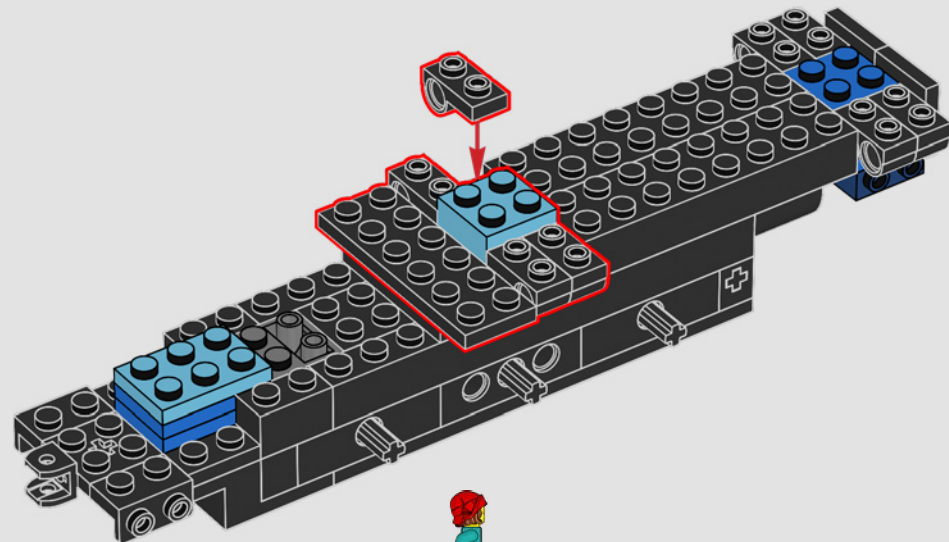

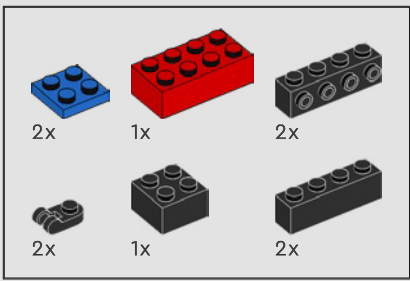

369

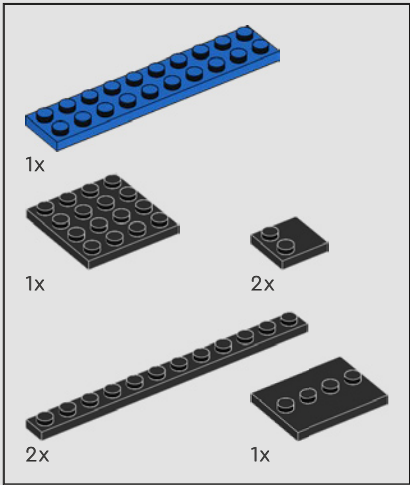
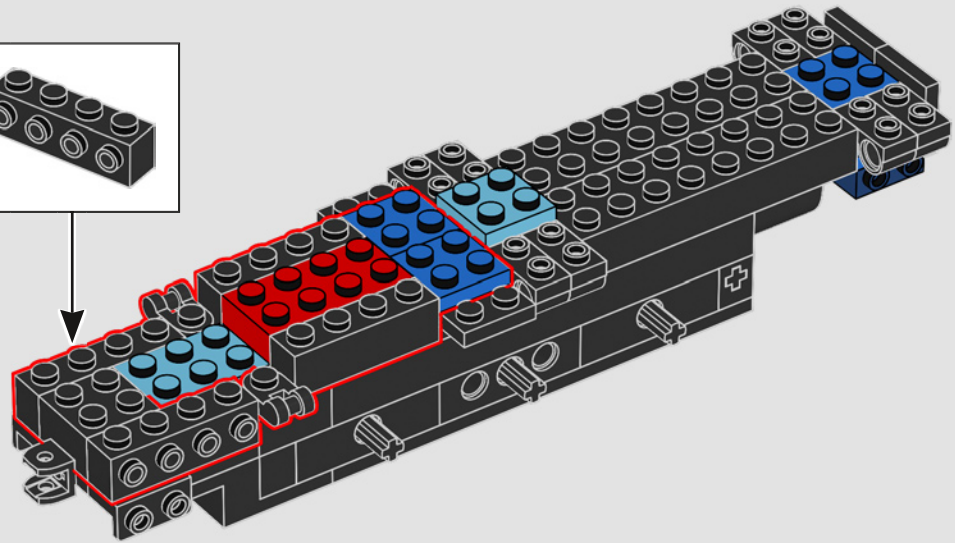
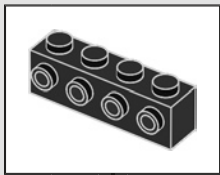

370

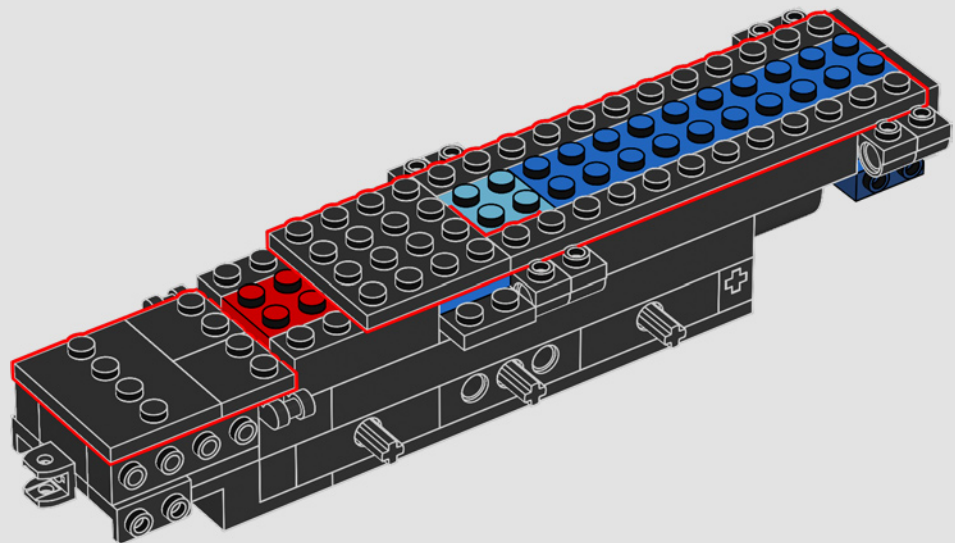



371

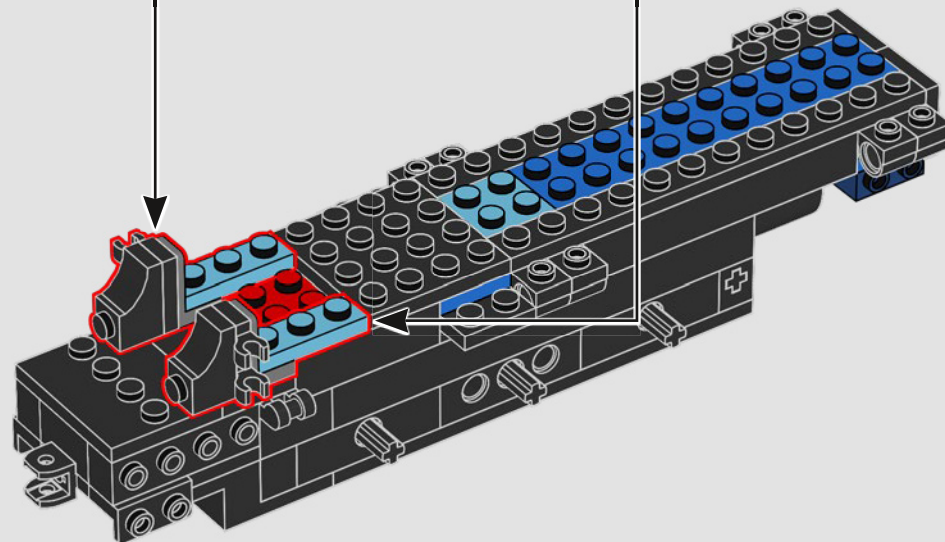
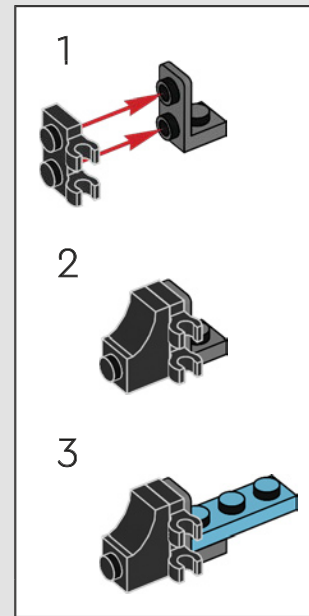
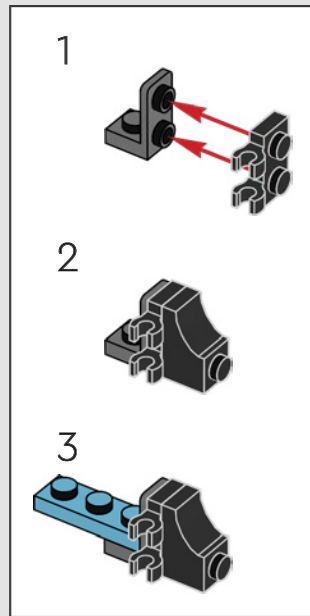

Next Stop: SOFIA

'Full steam ahead through the Balkan Mountains toward our next city stop.'



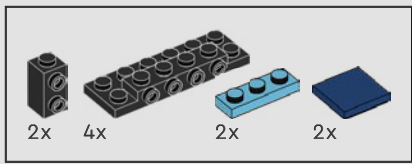

372

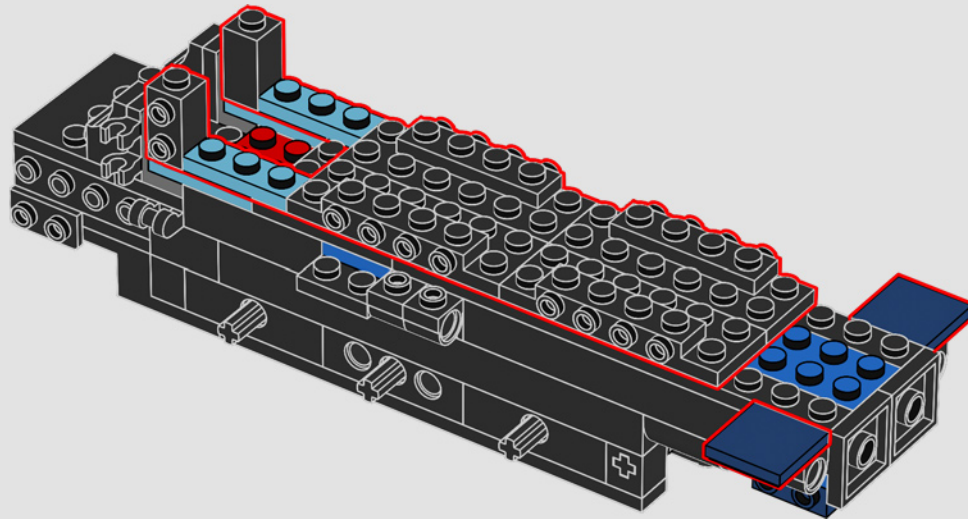

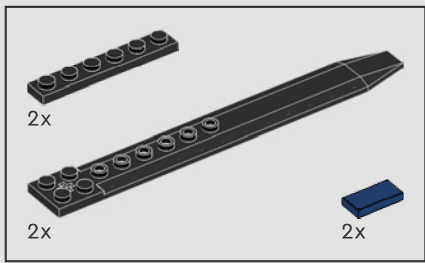

373

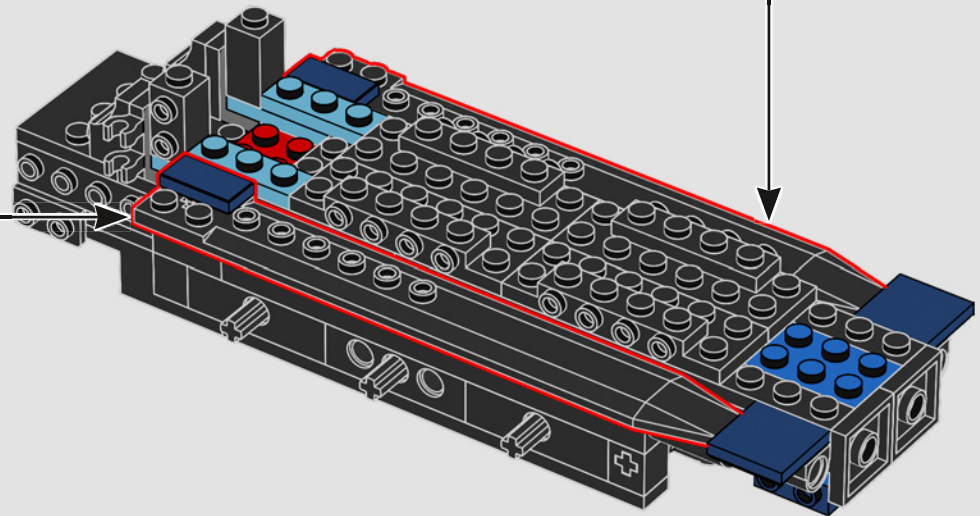
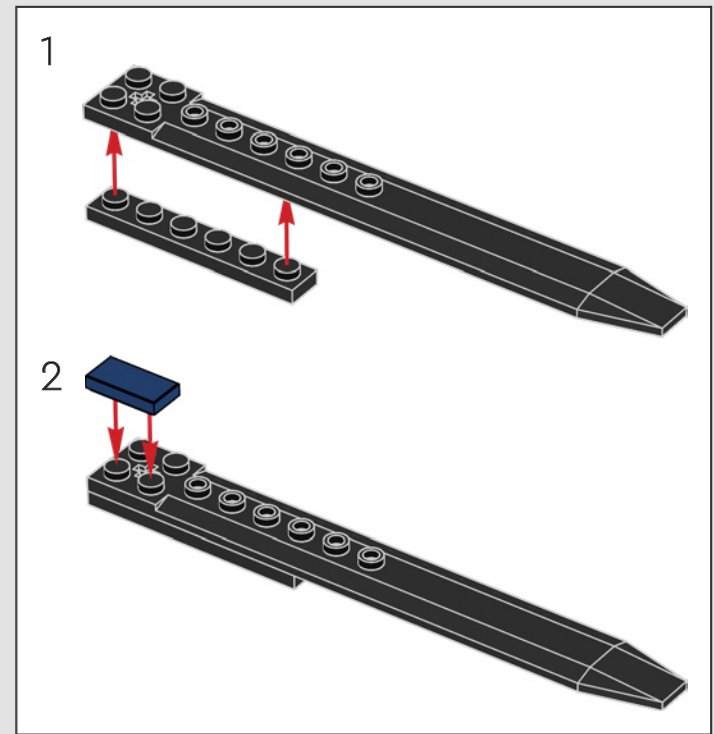
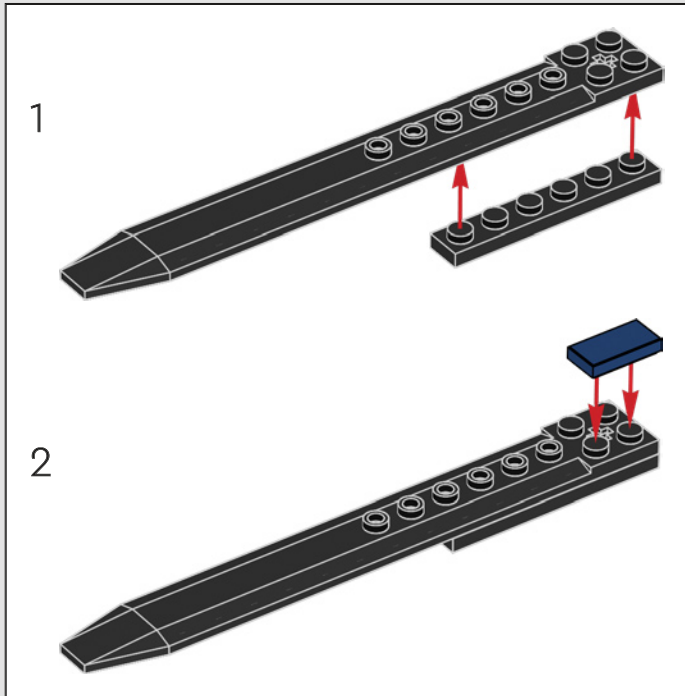

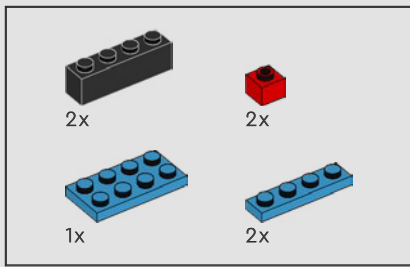

374

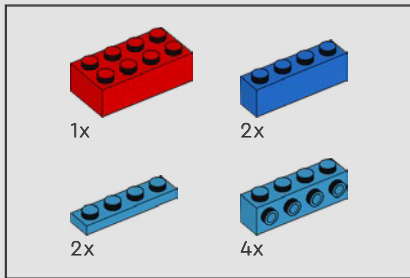
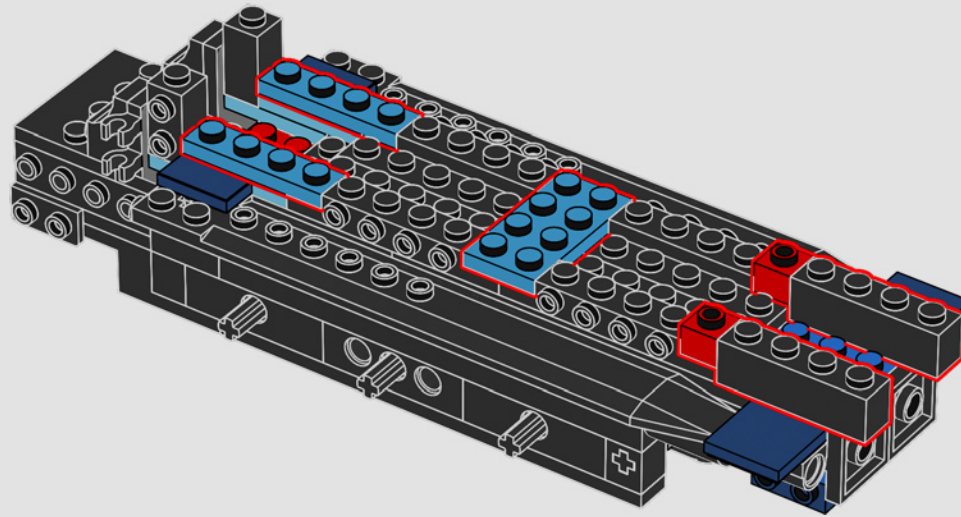

375

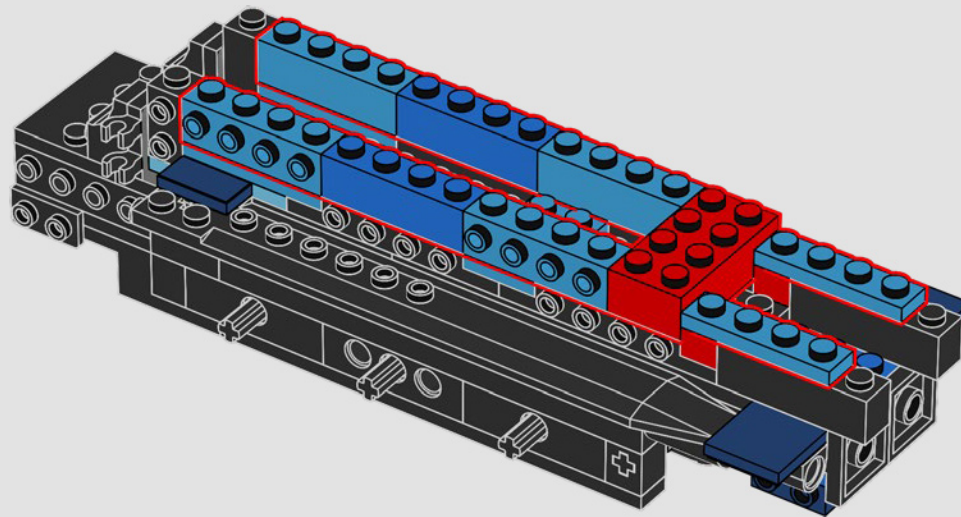

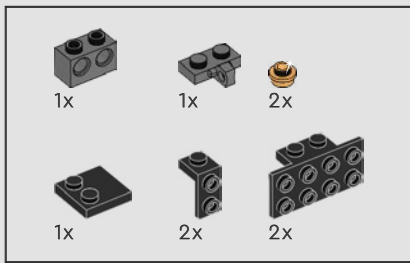

376

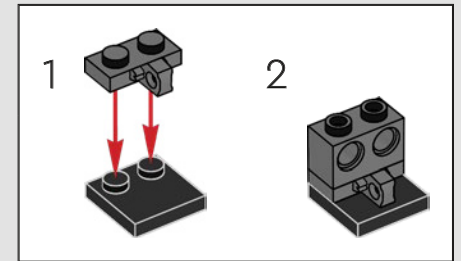
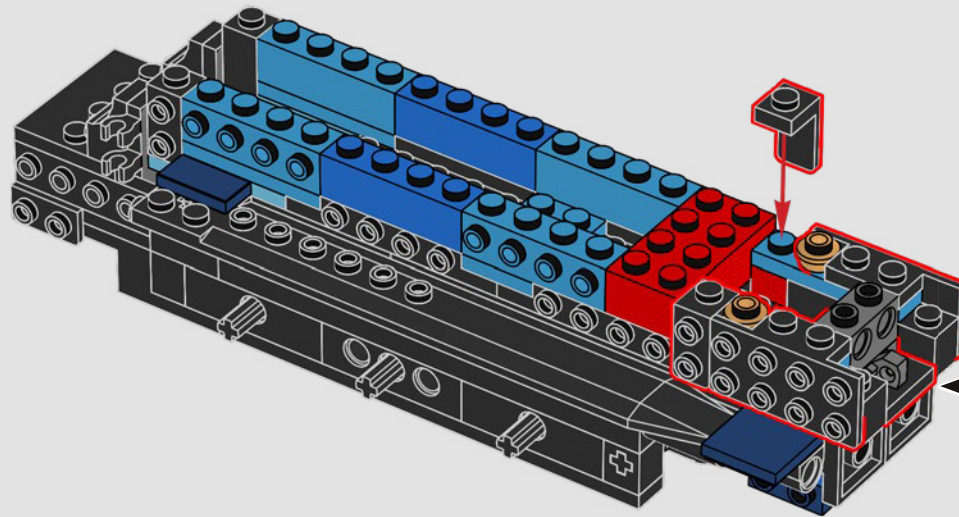

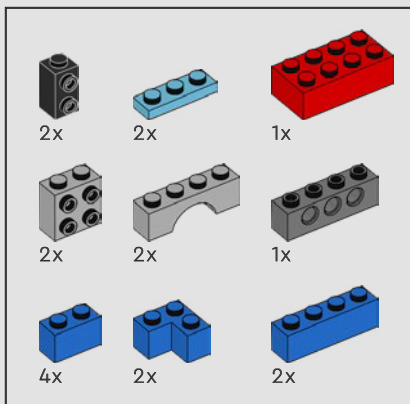

377

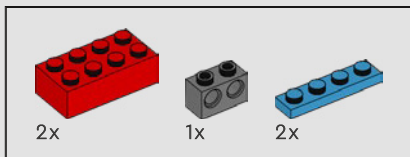
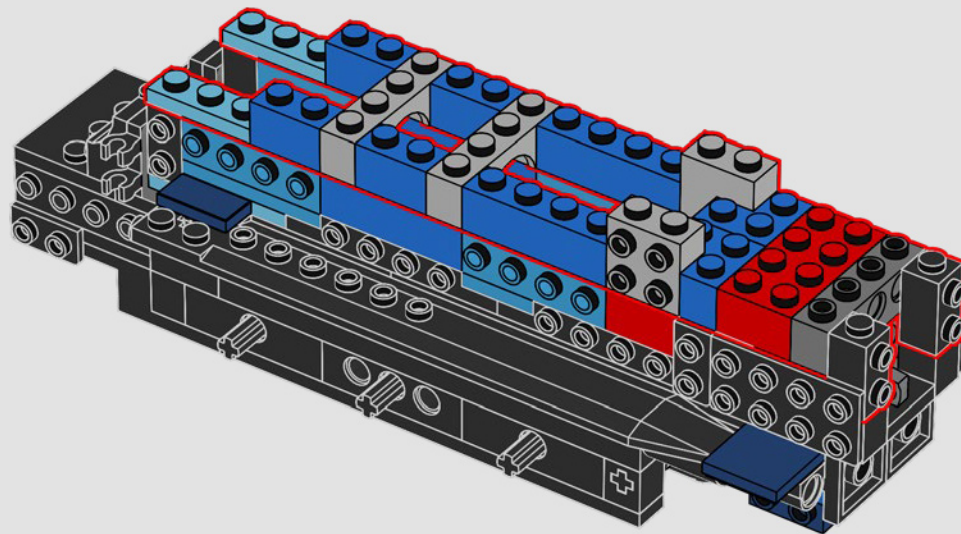

378

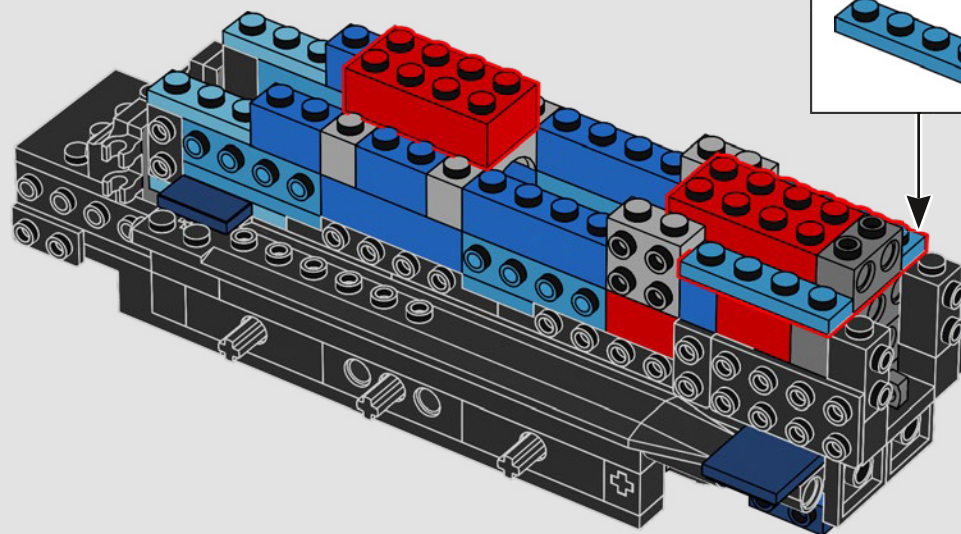

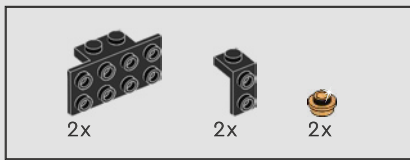

379

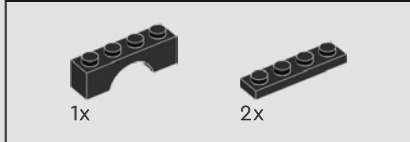
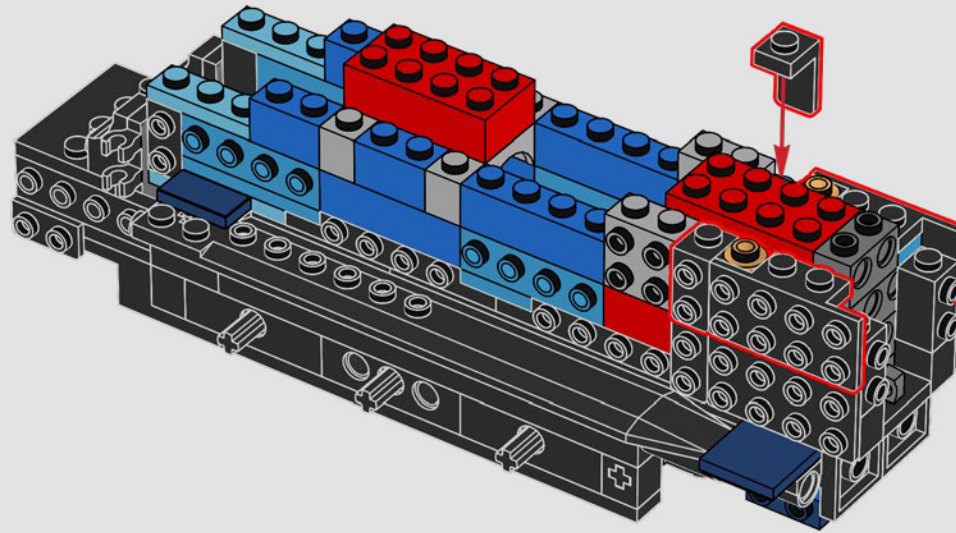

380

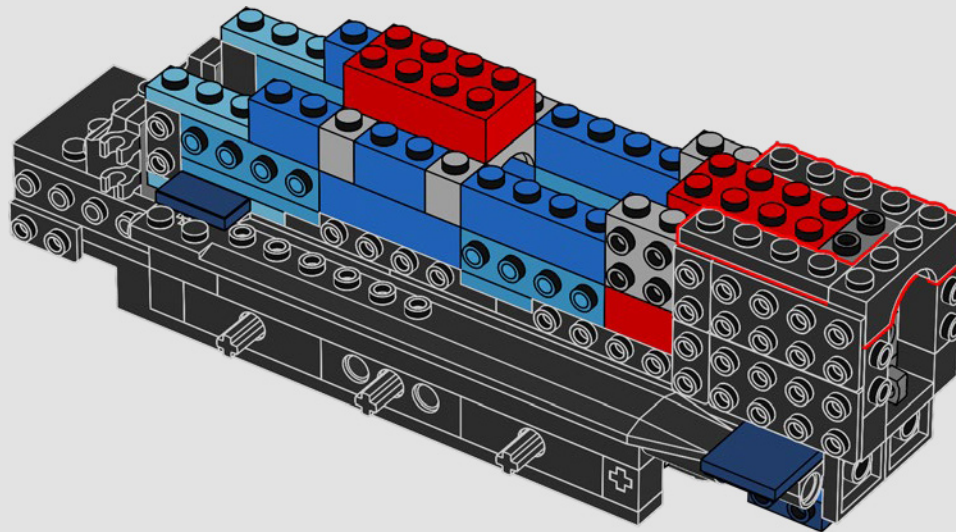

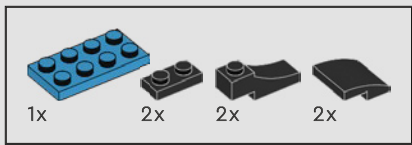

381

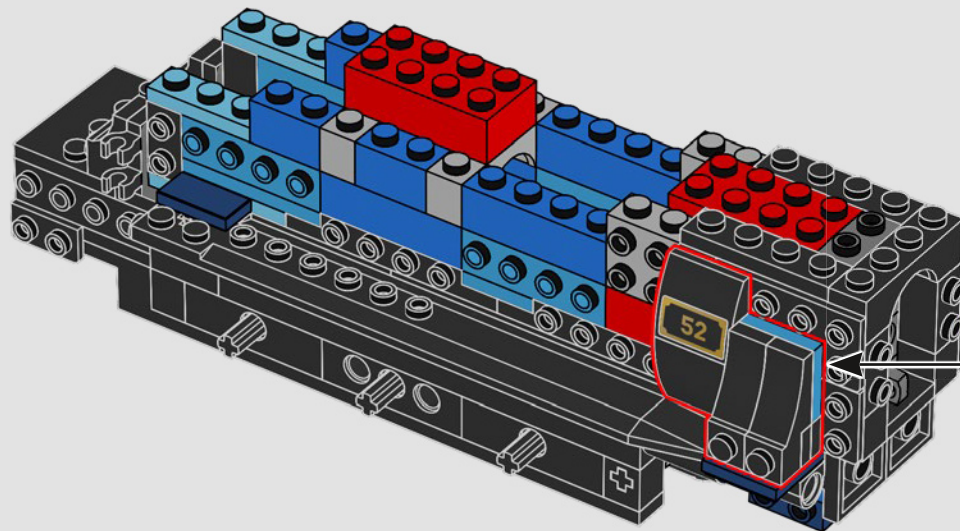
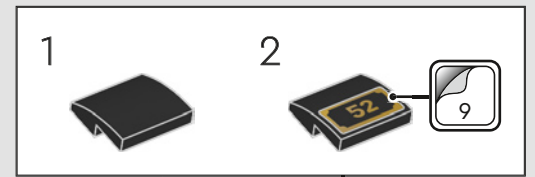
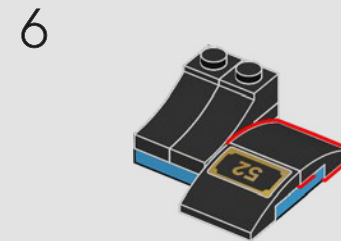
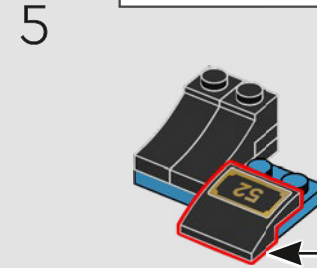
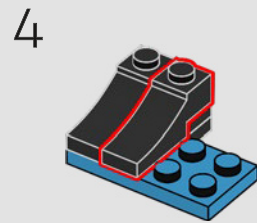
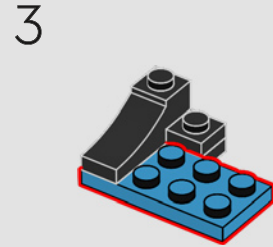
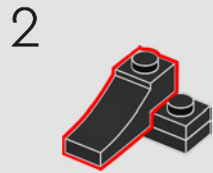
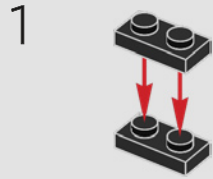

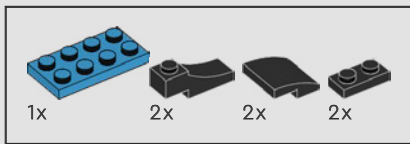

382

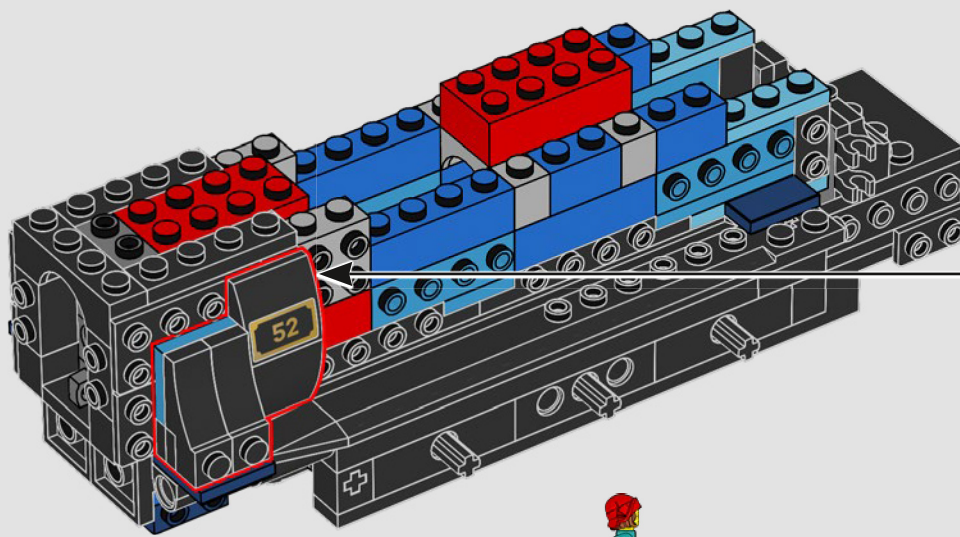
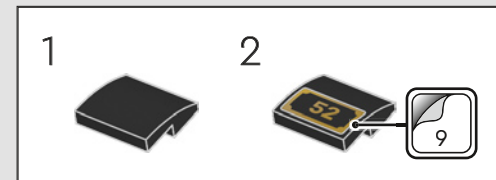
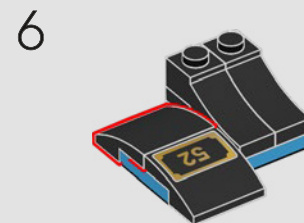
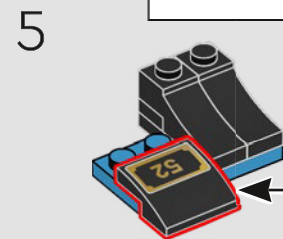
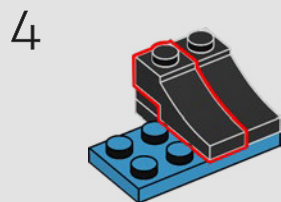
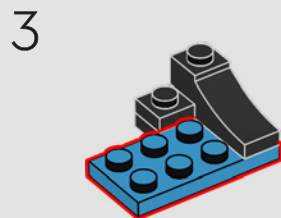
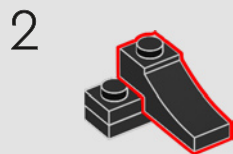
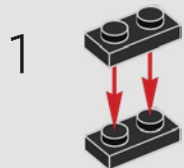

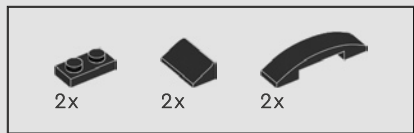

383

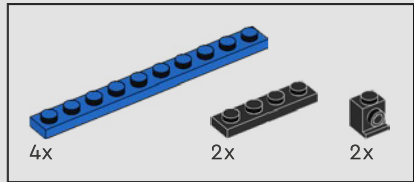
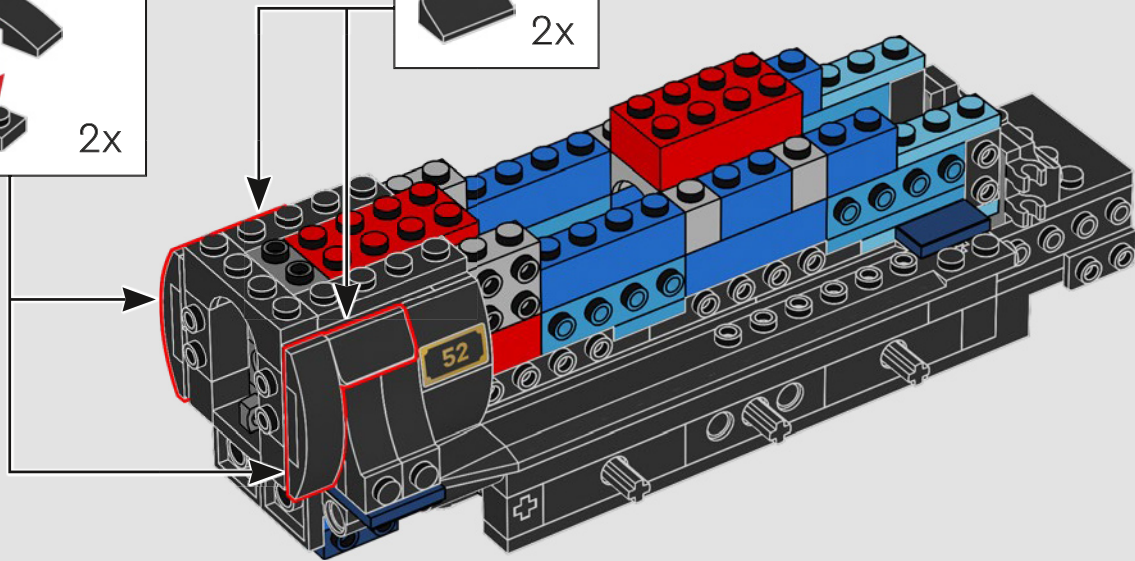
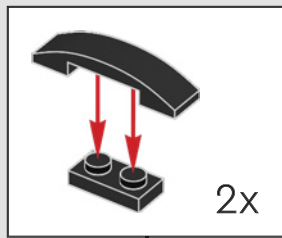

384

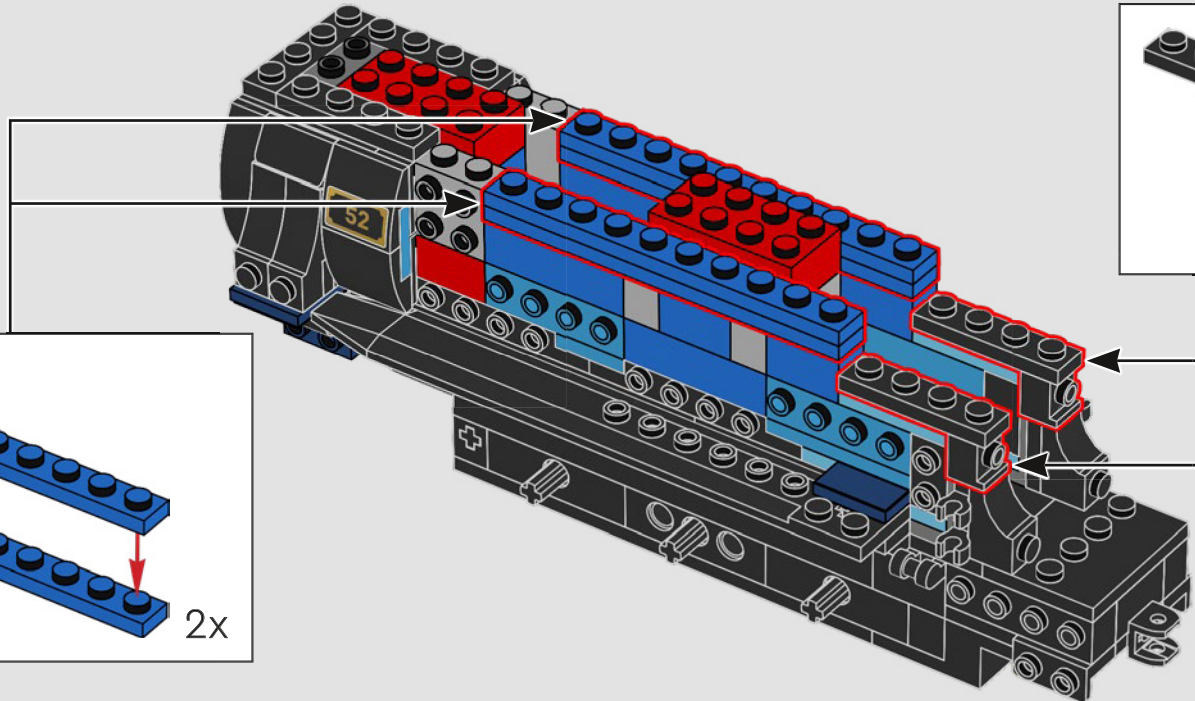
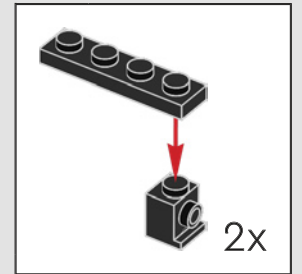
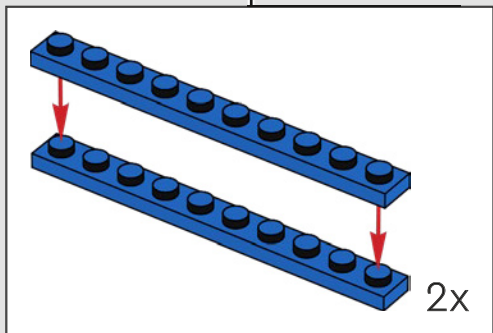

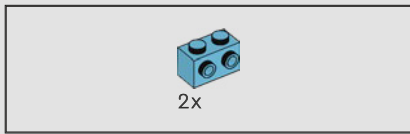

385

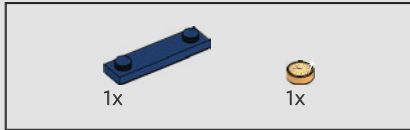
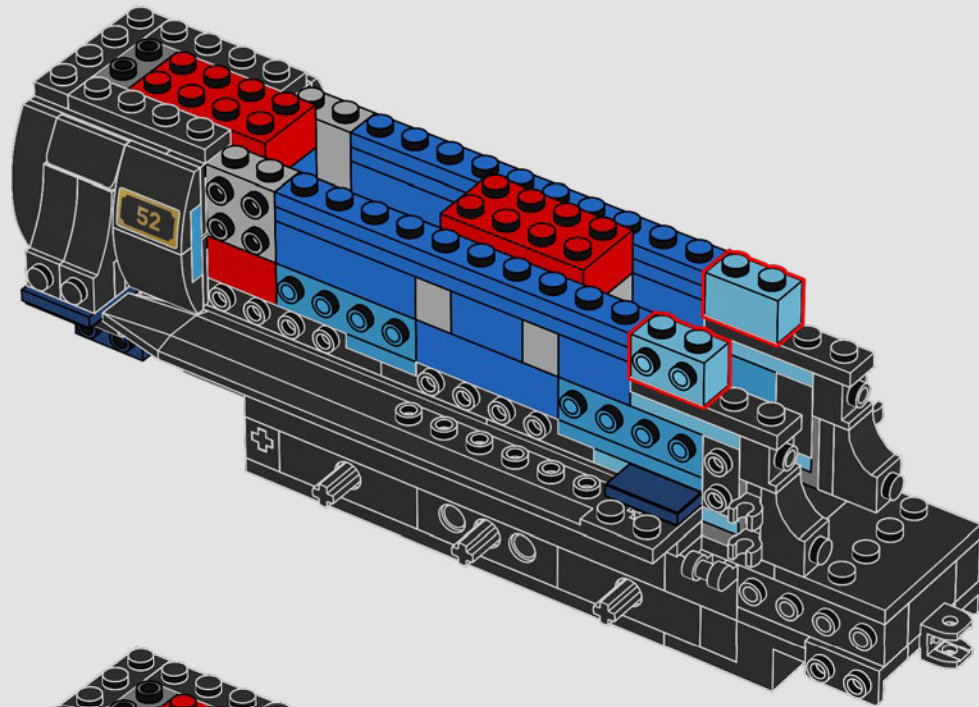

386

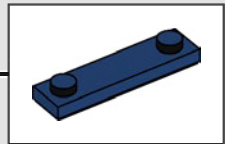
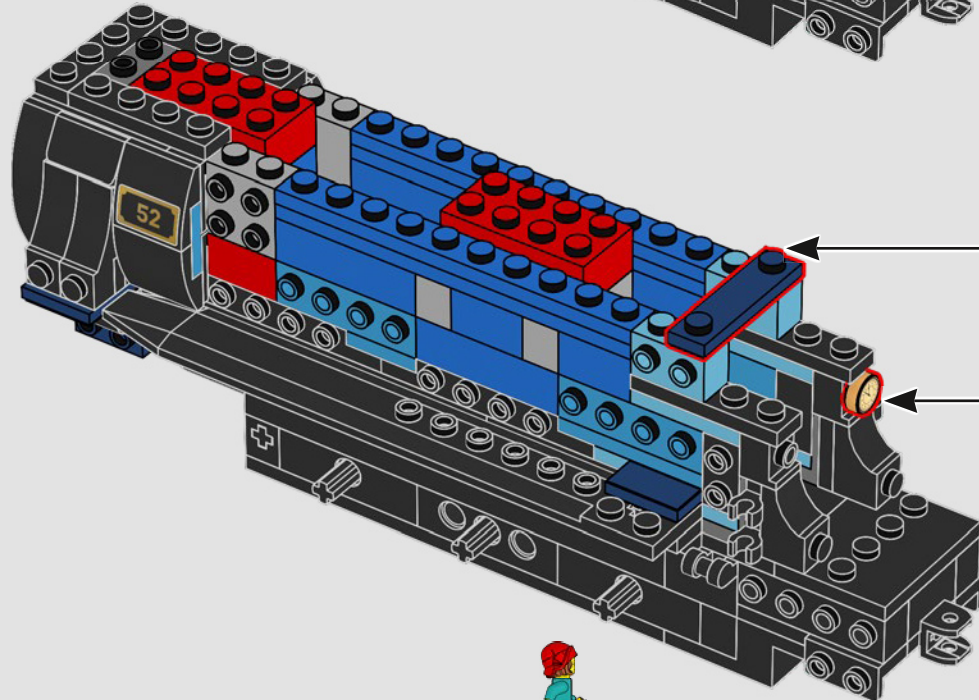

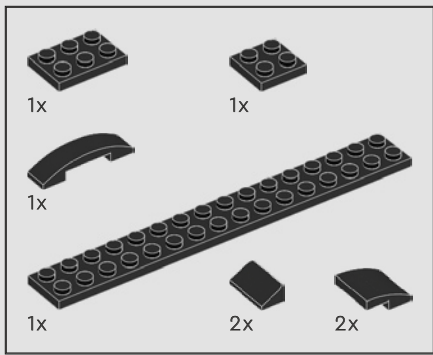

387

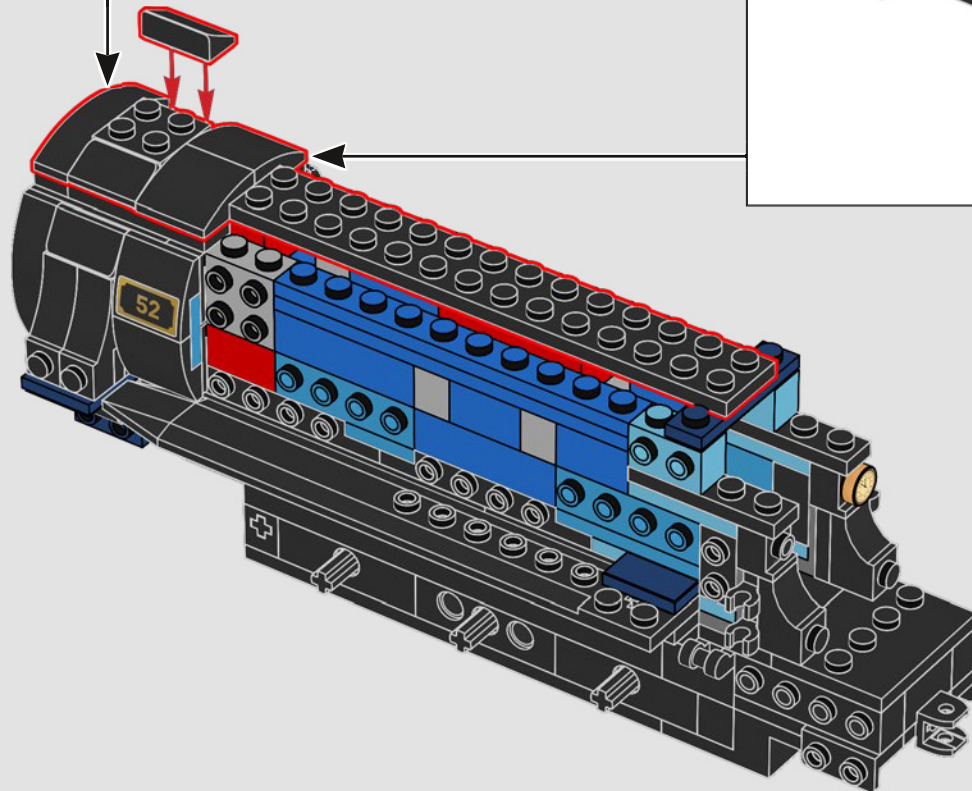
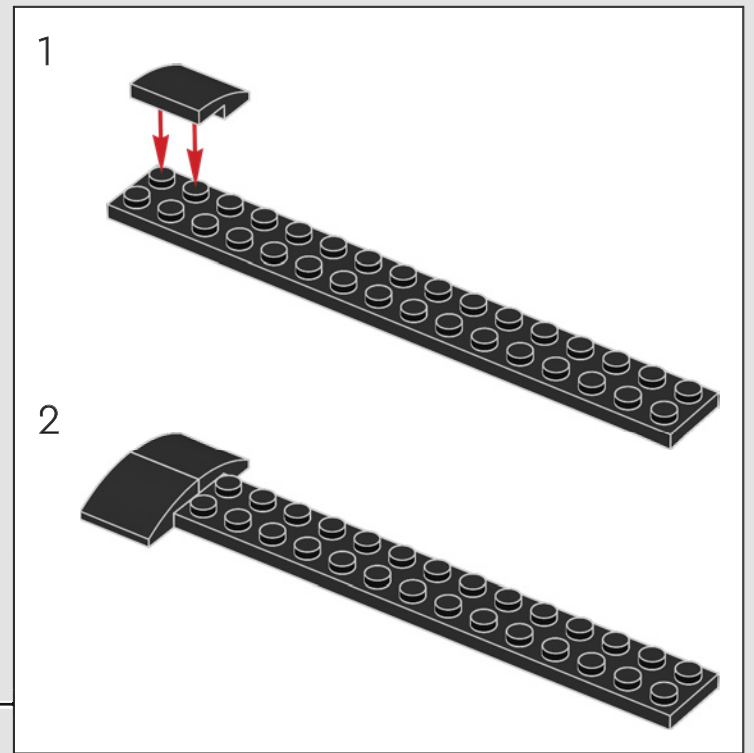
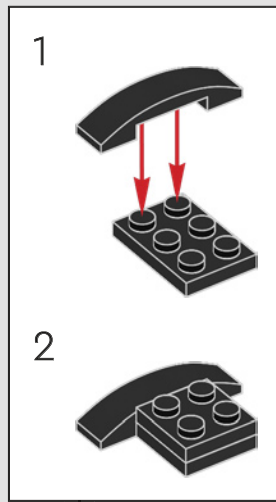

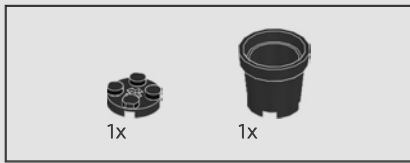

388

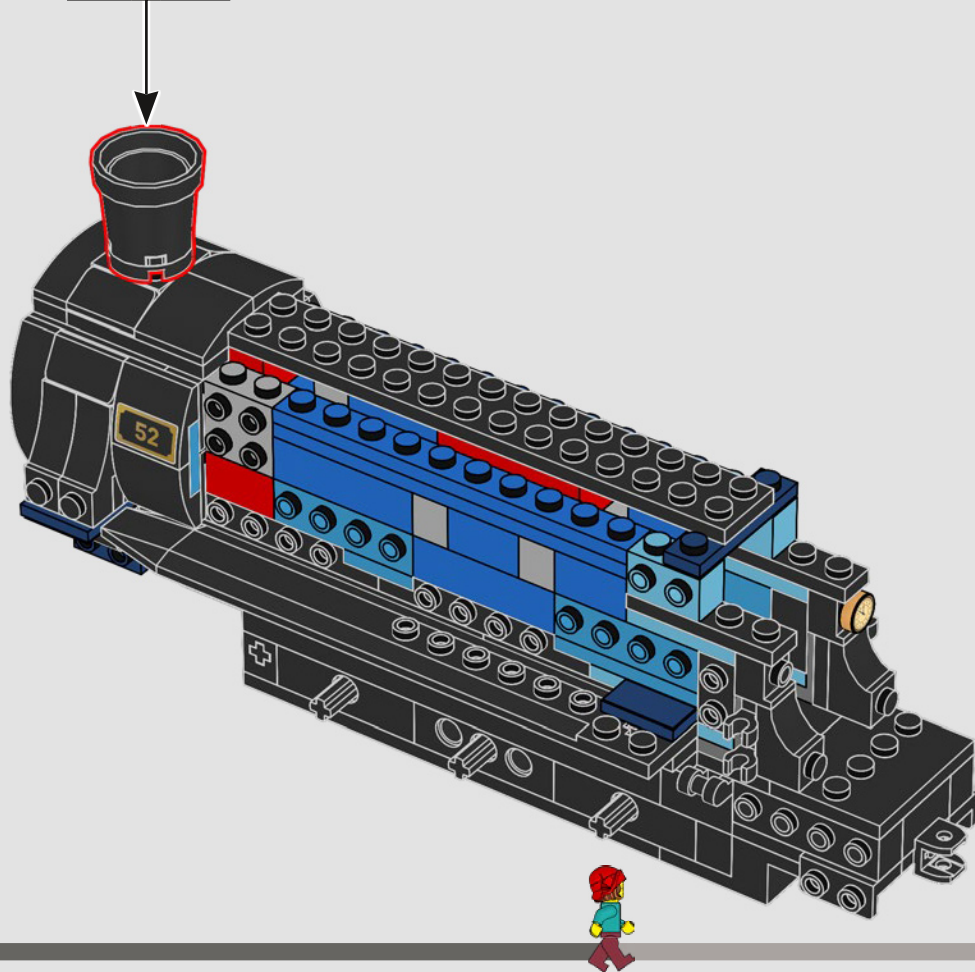
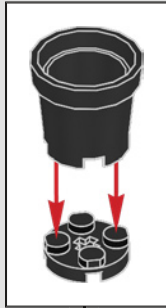

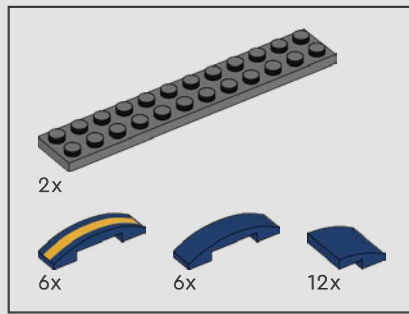

389

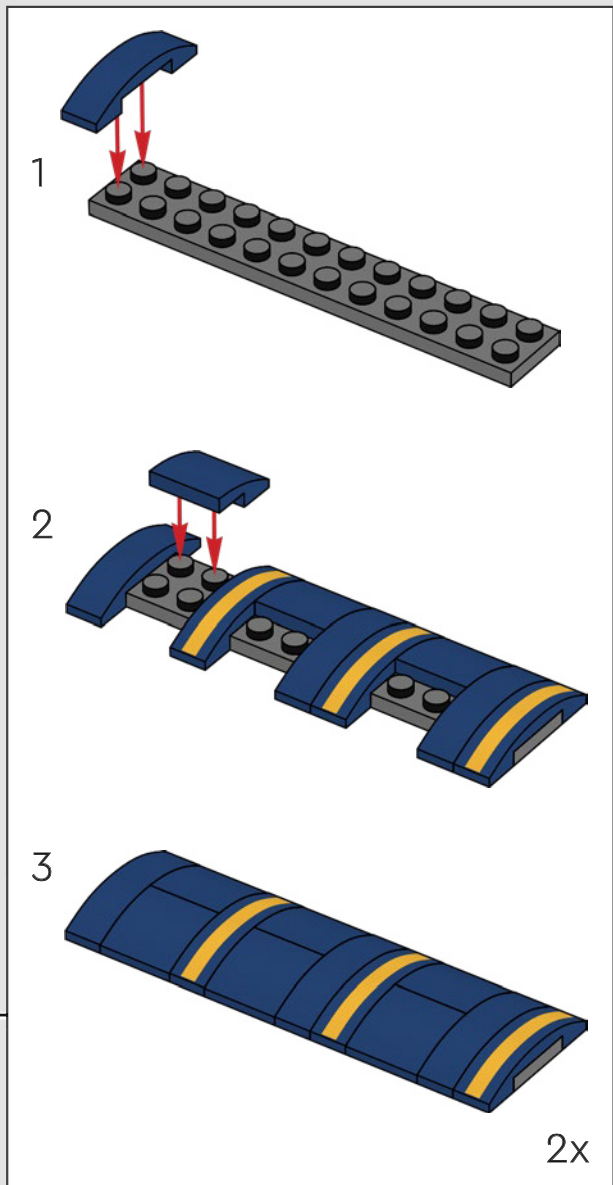
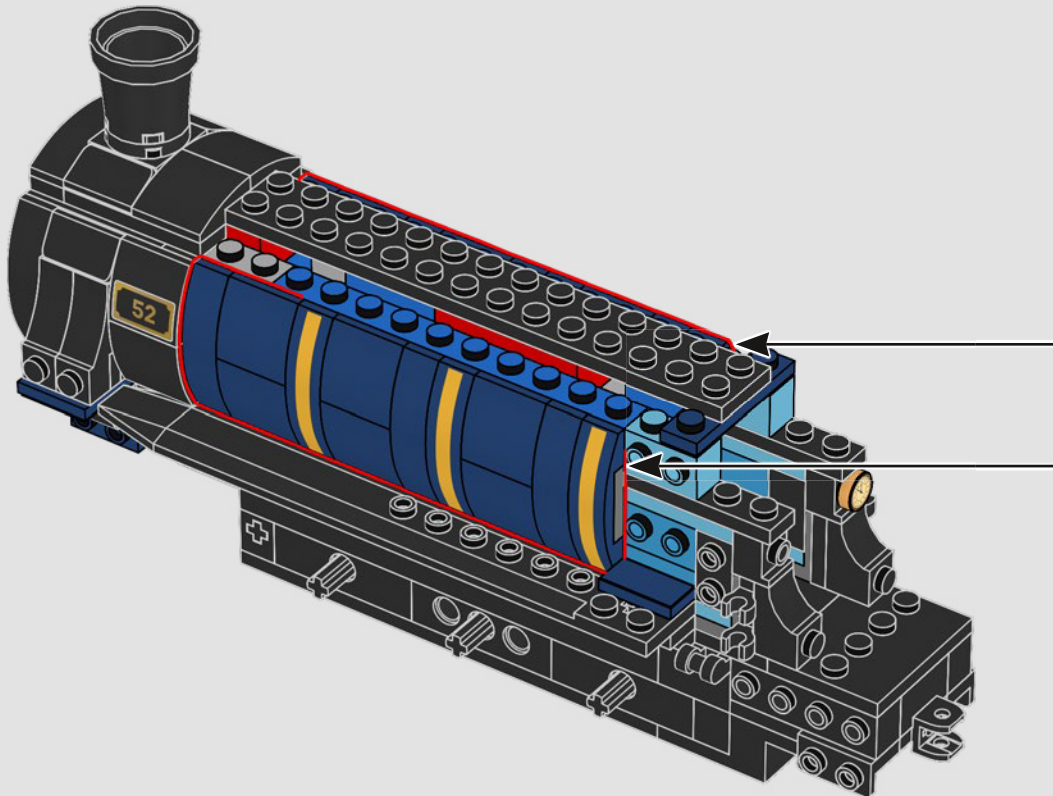

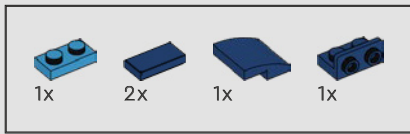

390

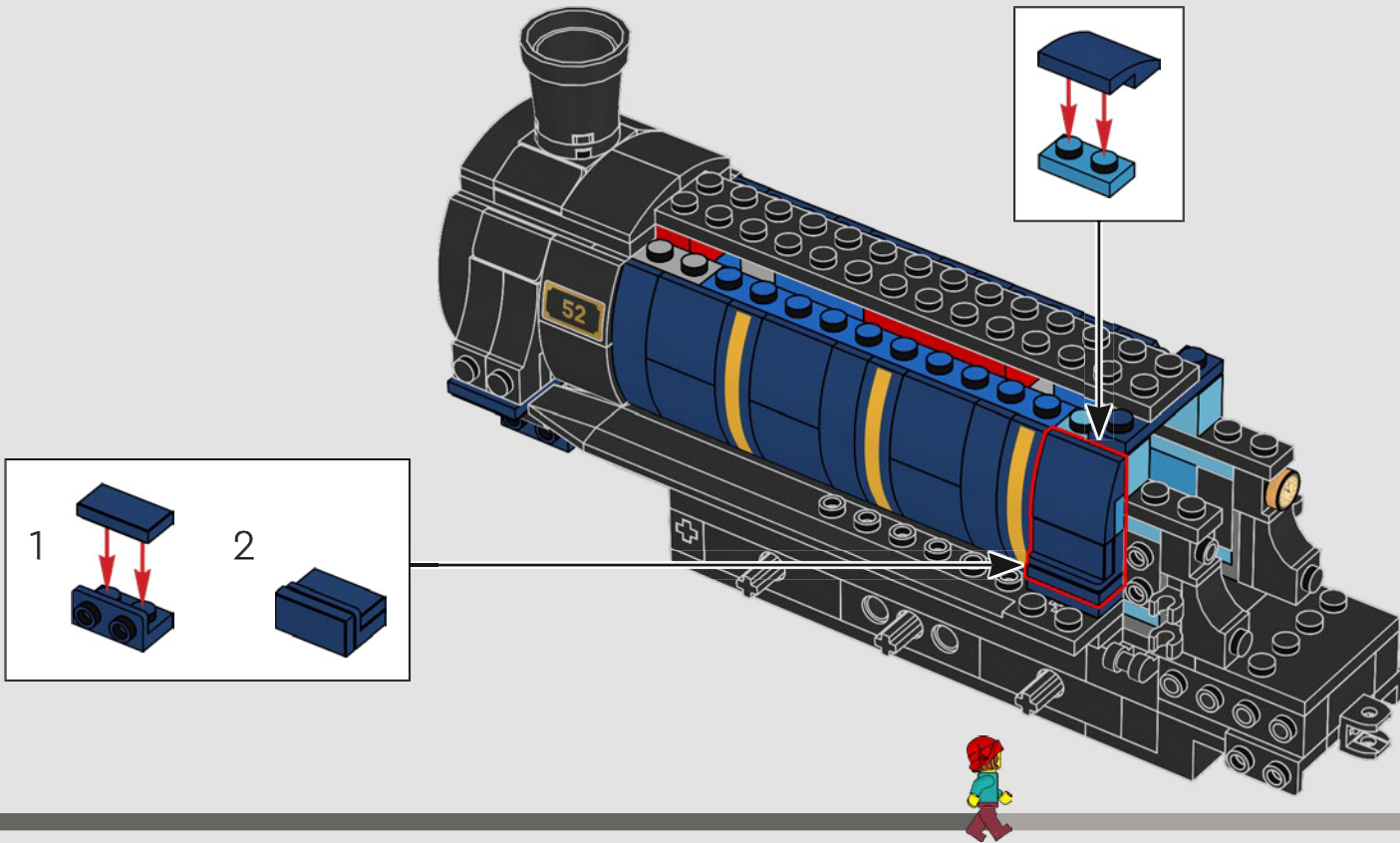

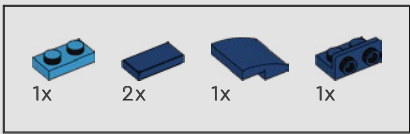

391

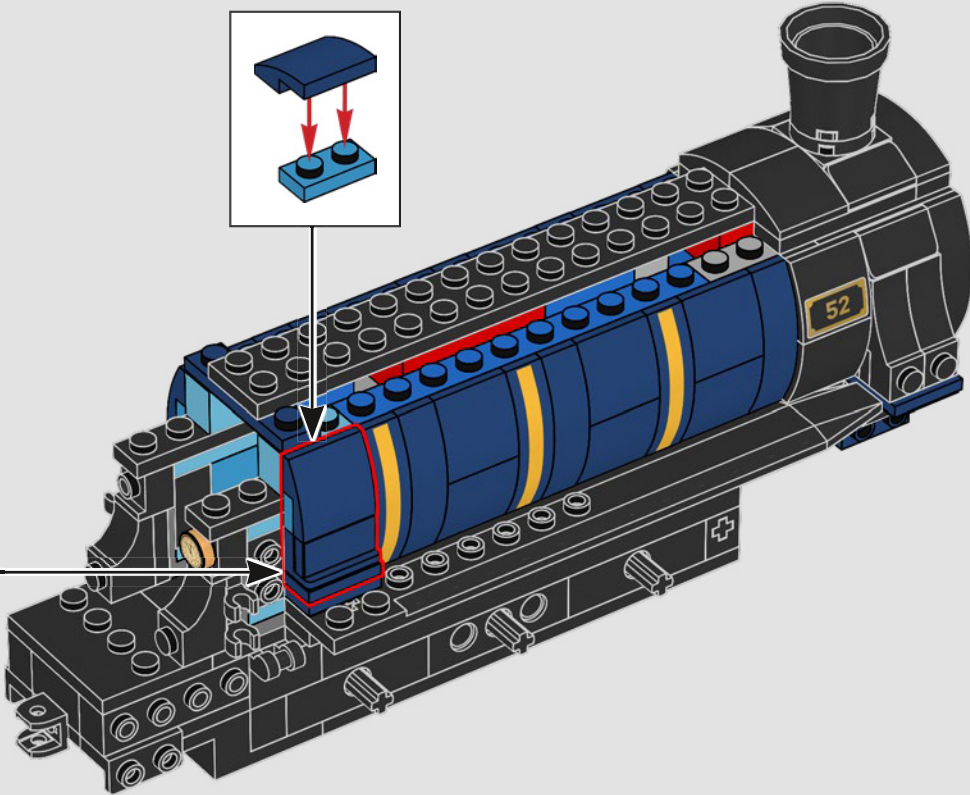
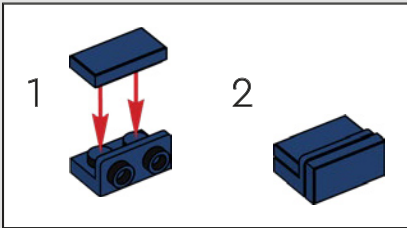
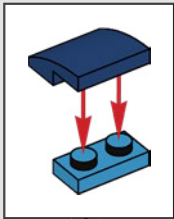

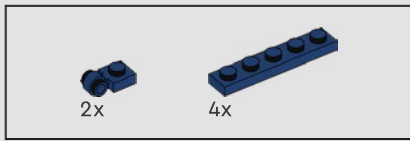

392

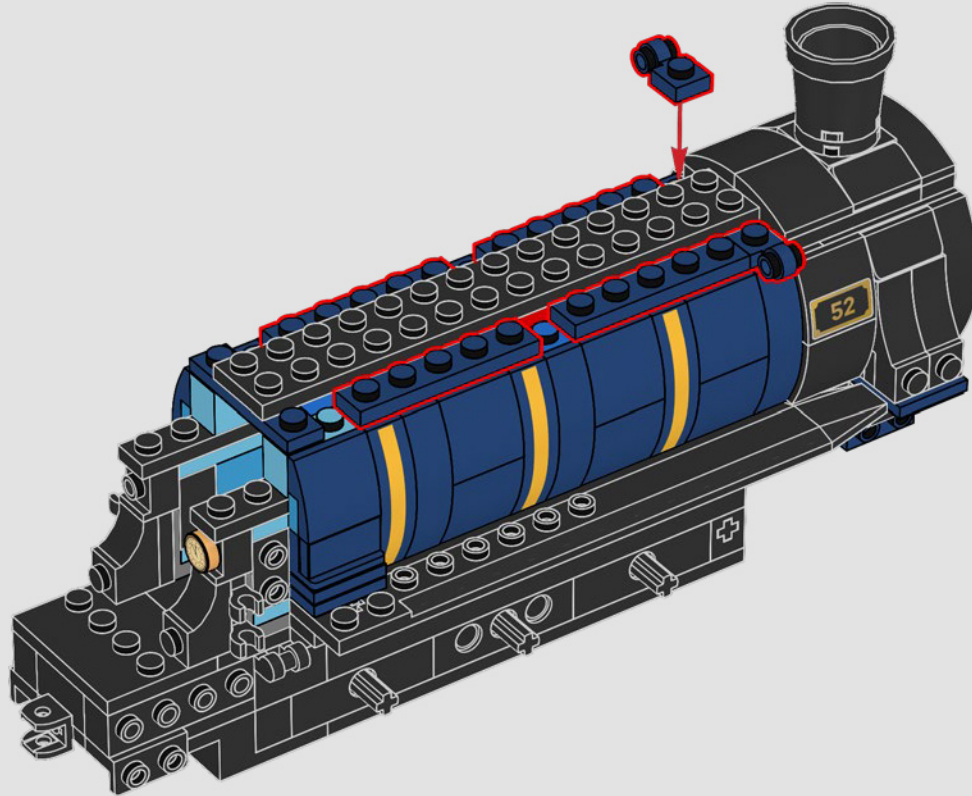

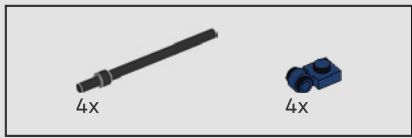

393

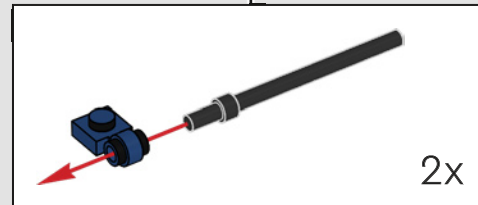
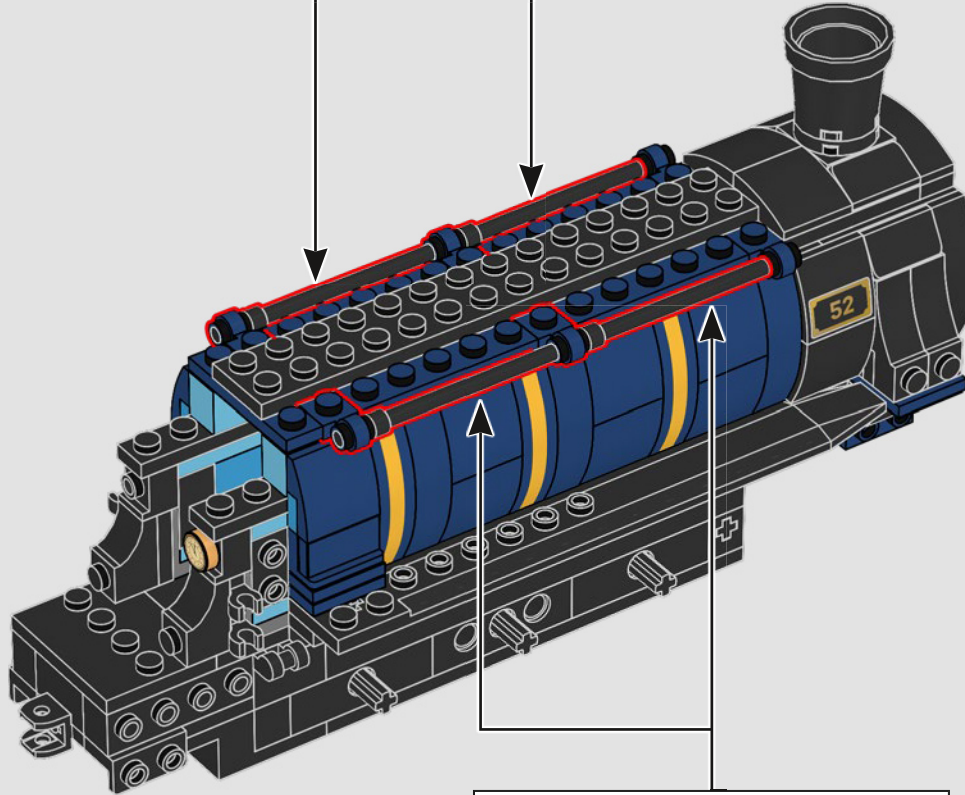
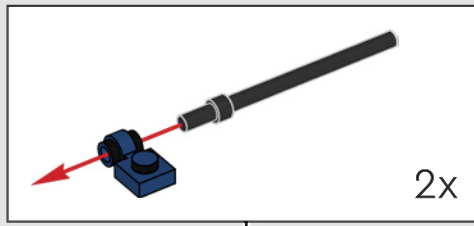

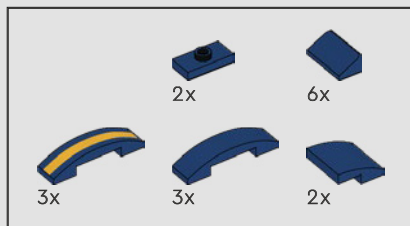

394

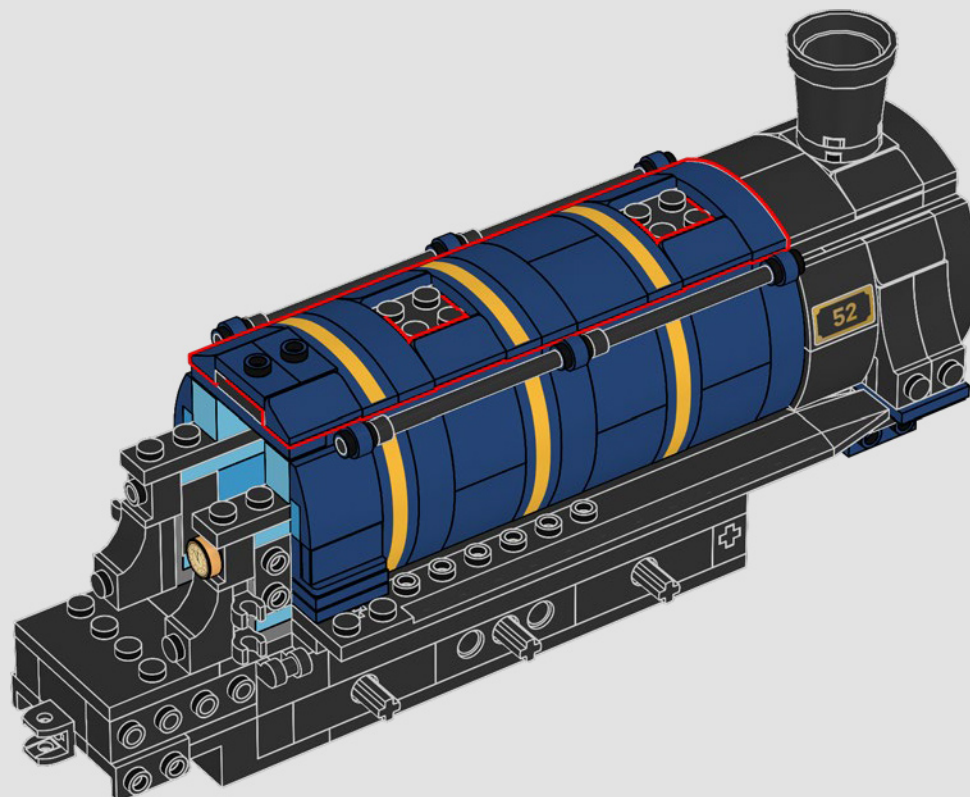



395

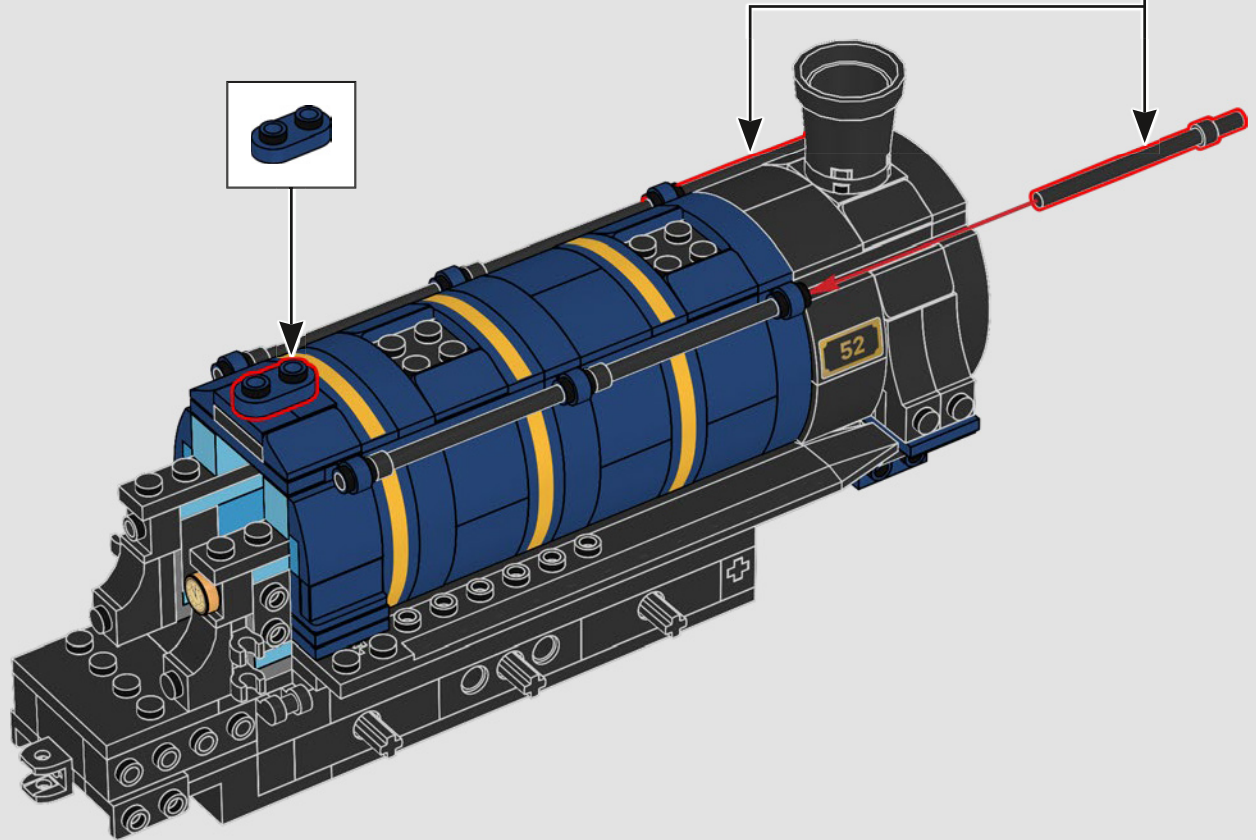

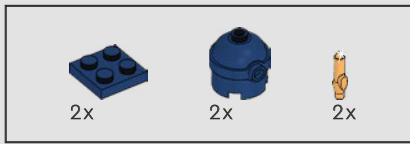

396

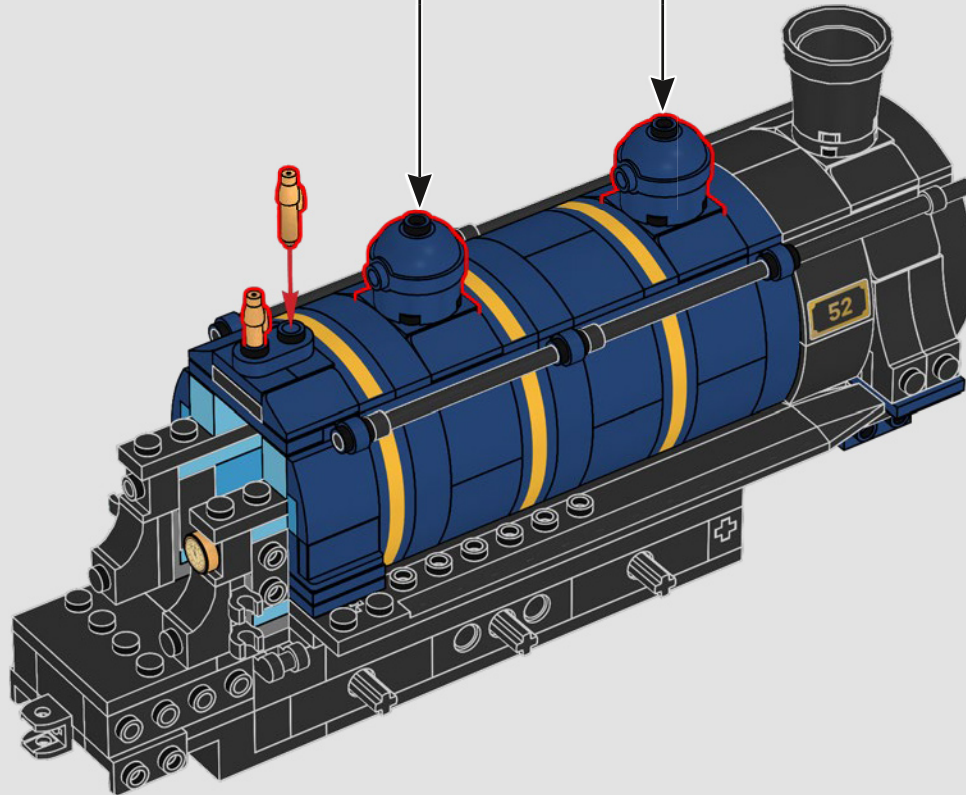
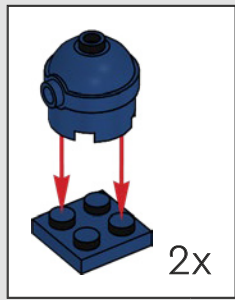

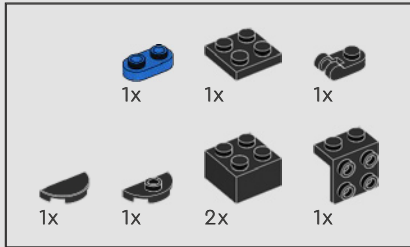
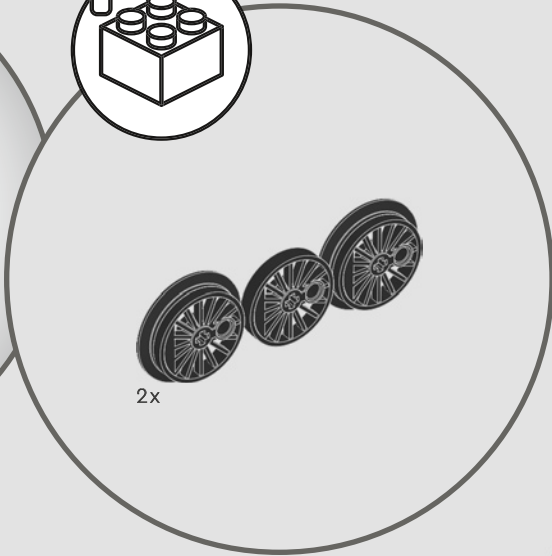
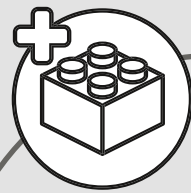

397

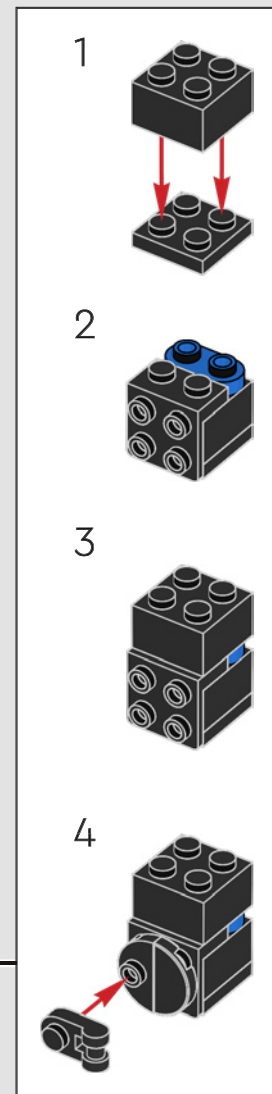
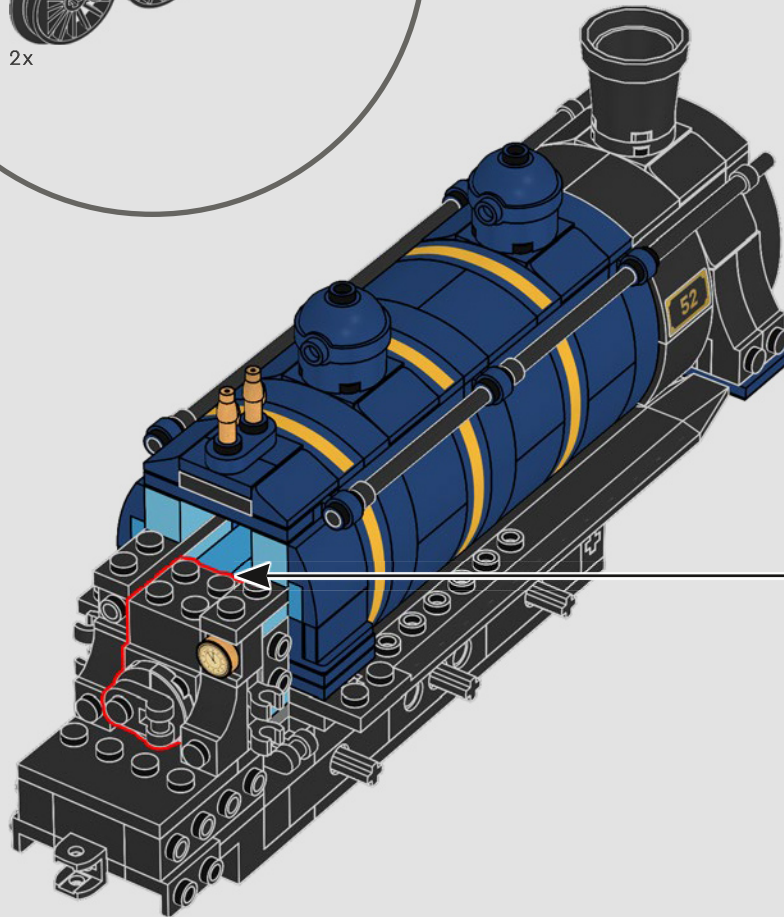



398

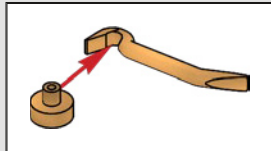
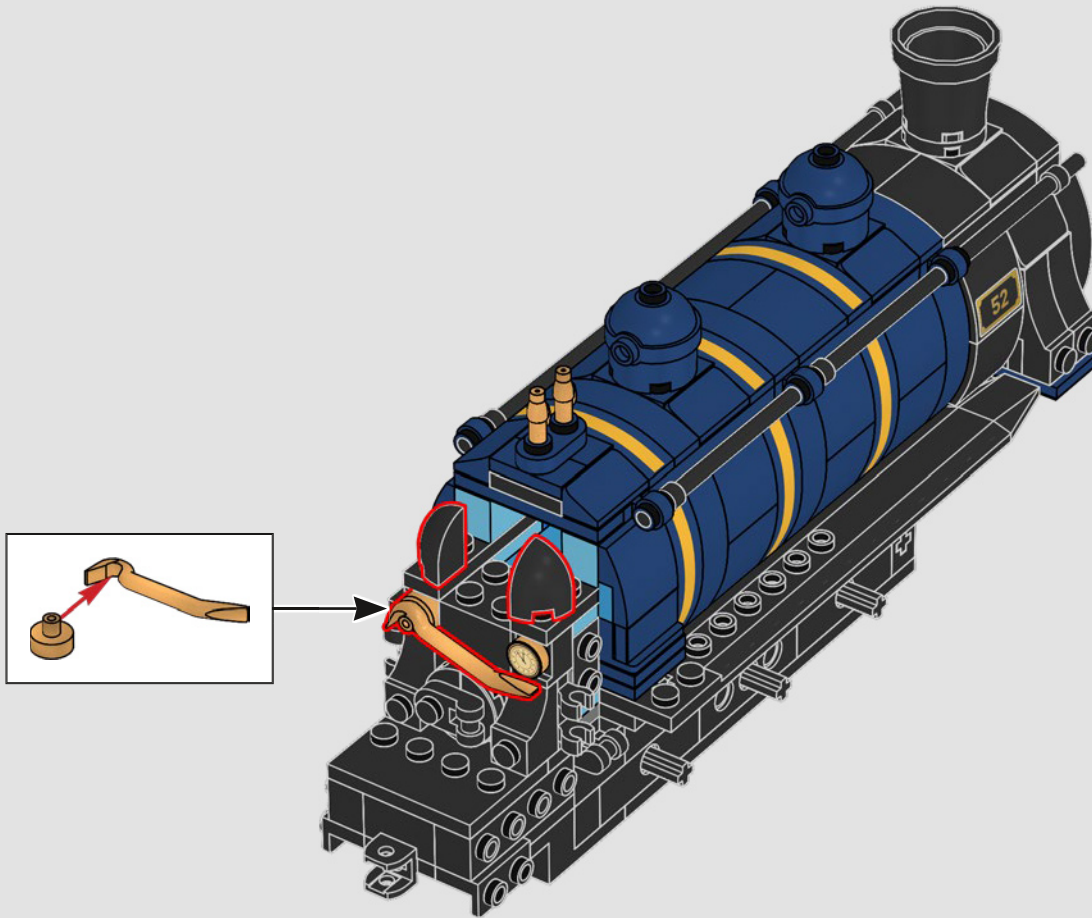

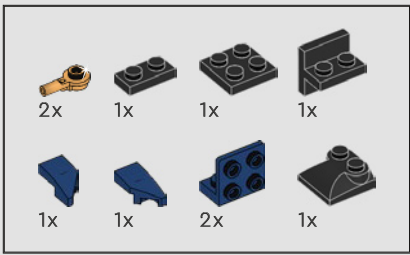

399

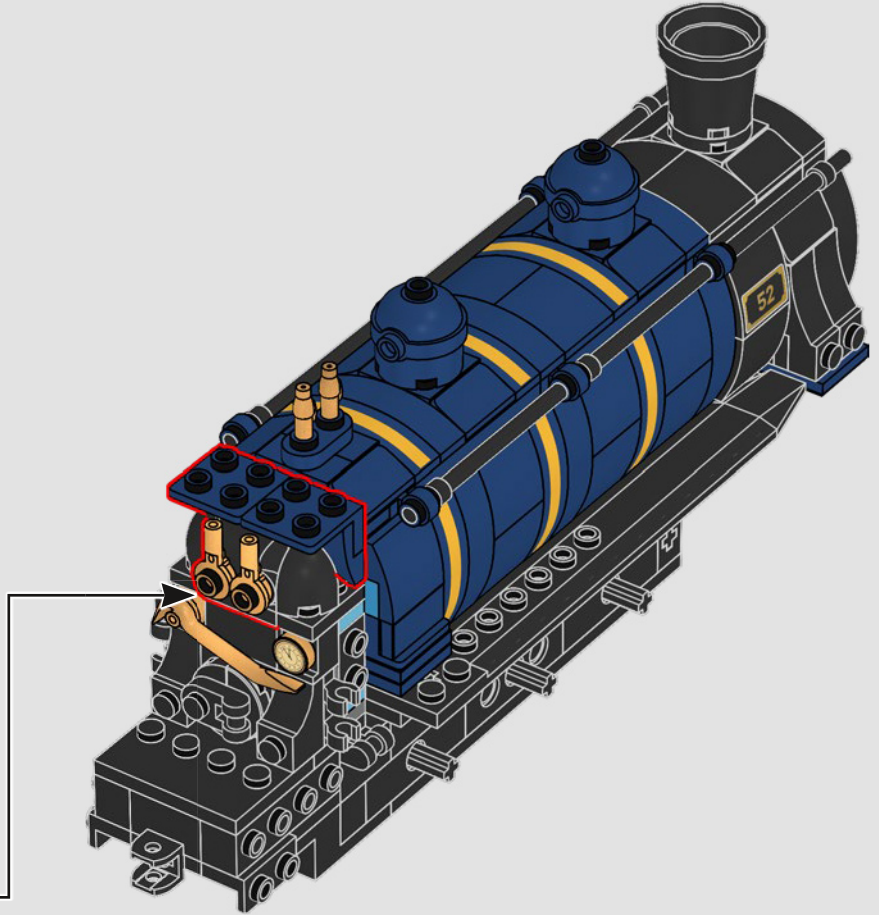
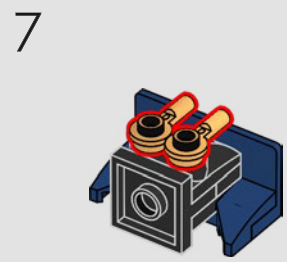
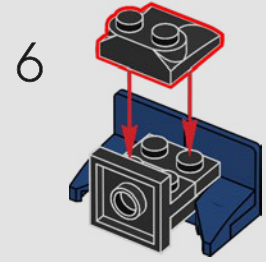
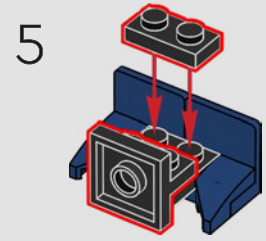
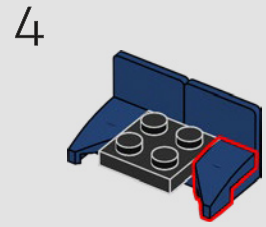
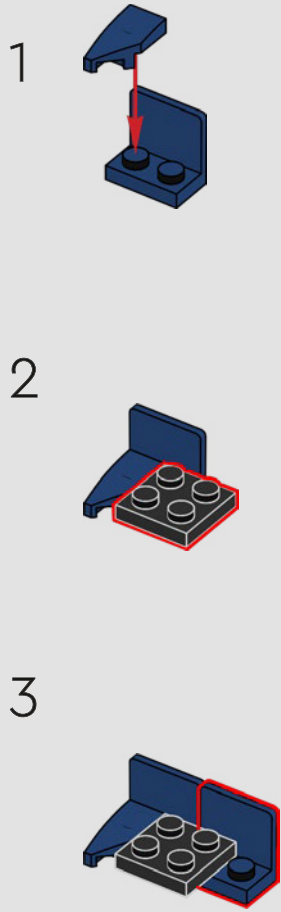

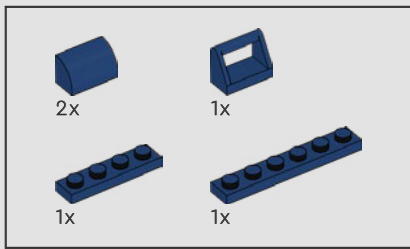

400

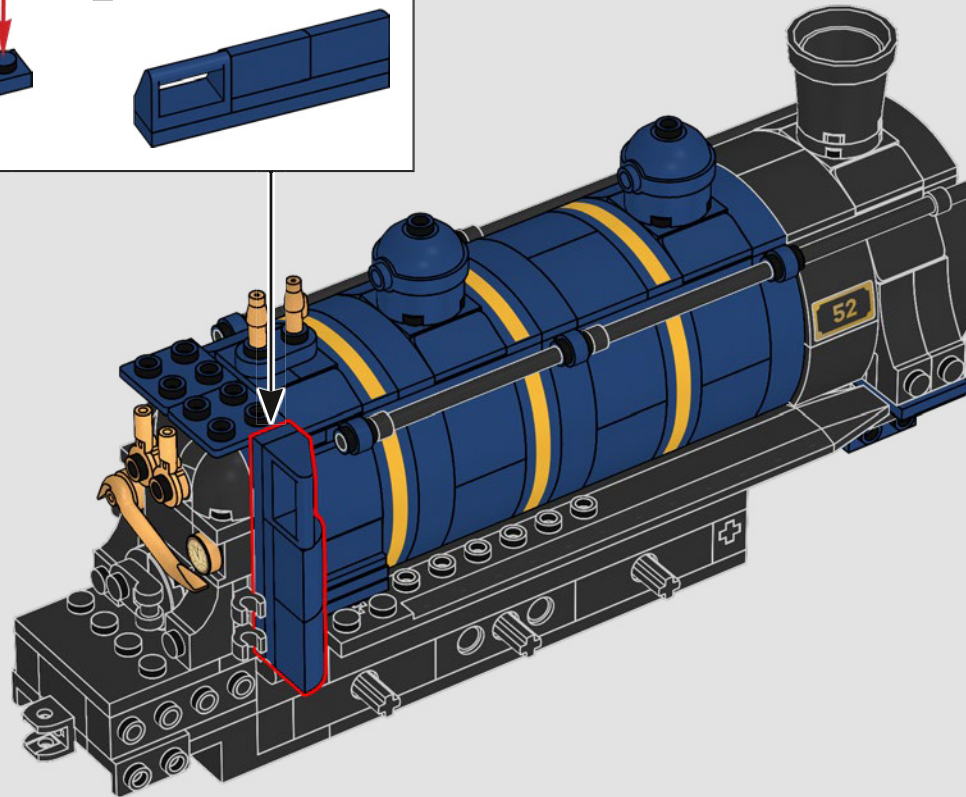
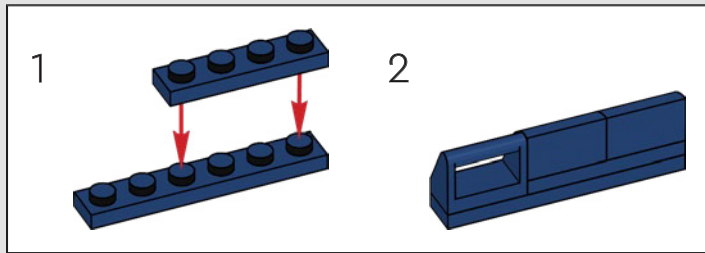

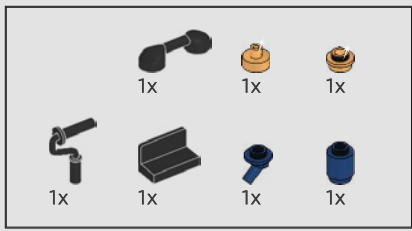

401

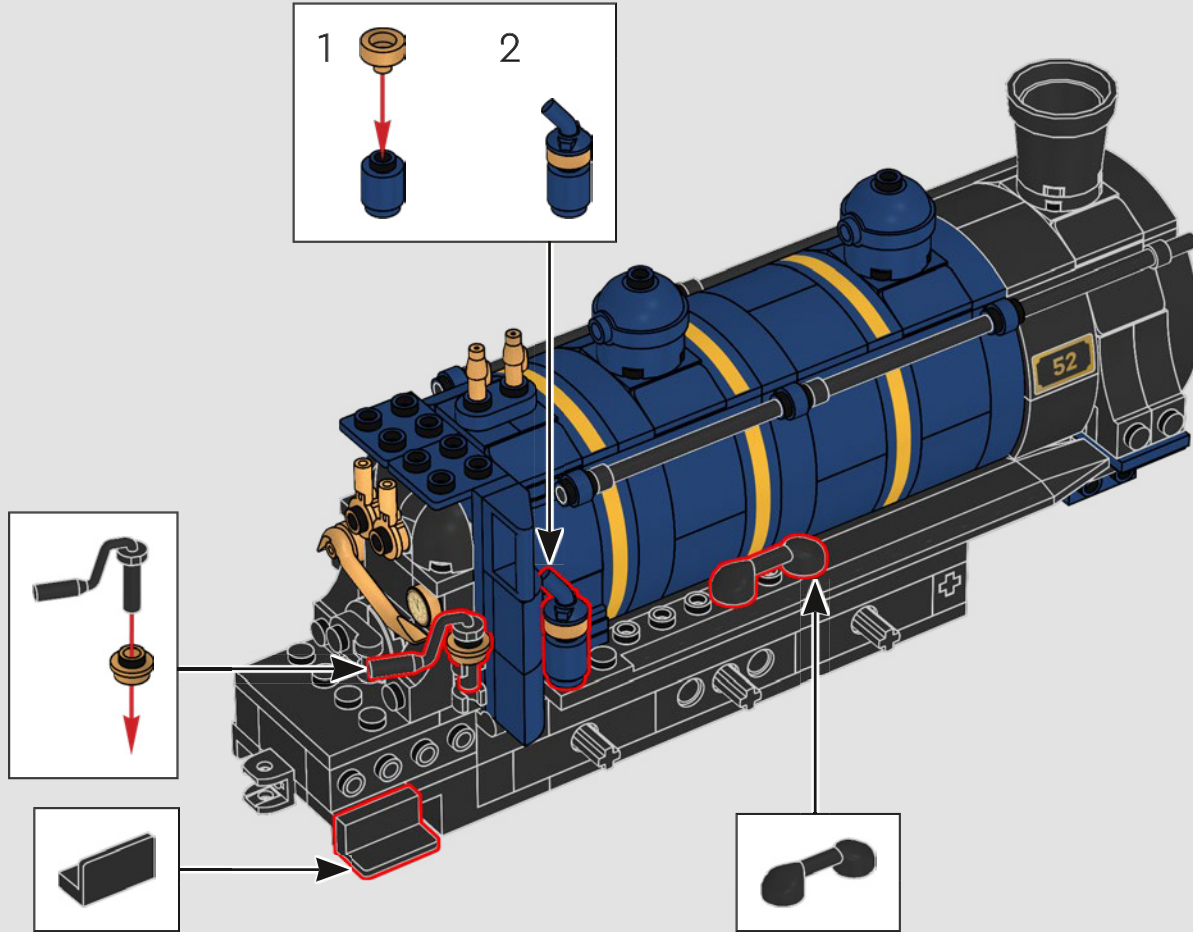

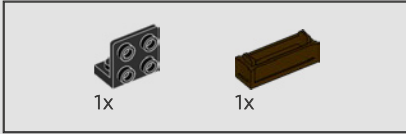
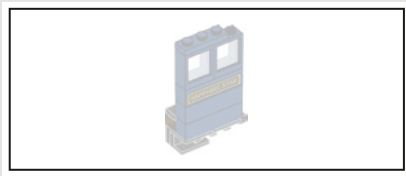

402

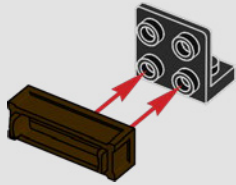

403

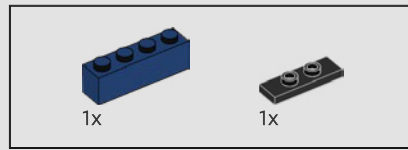
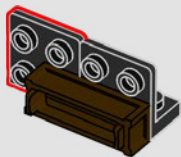

404

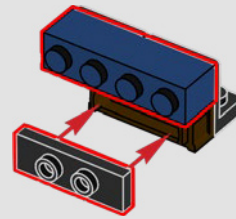

405

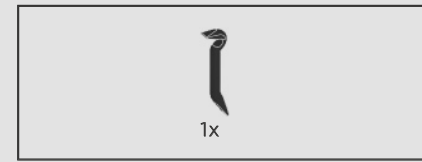
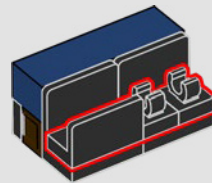

406

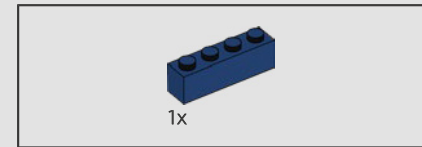
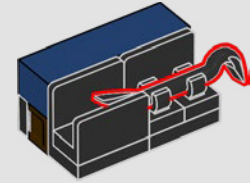

407

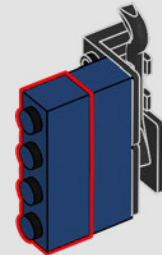
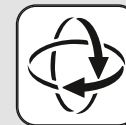

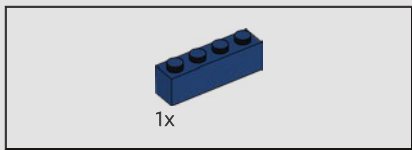

408

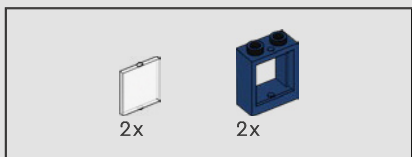
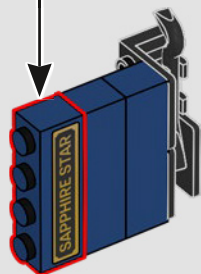
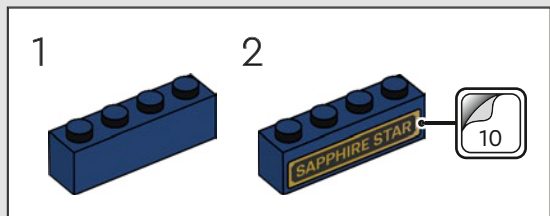

409

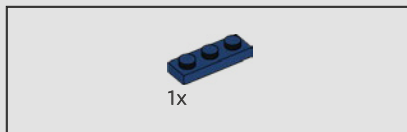
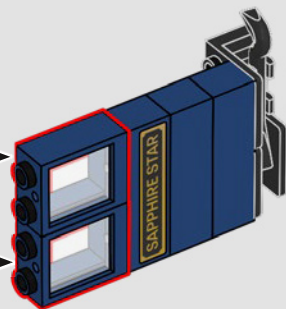
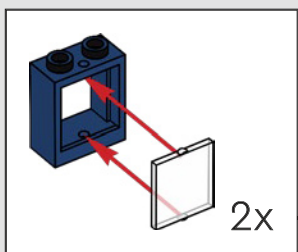

410

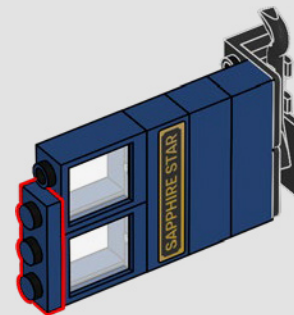

411

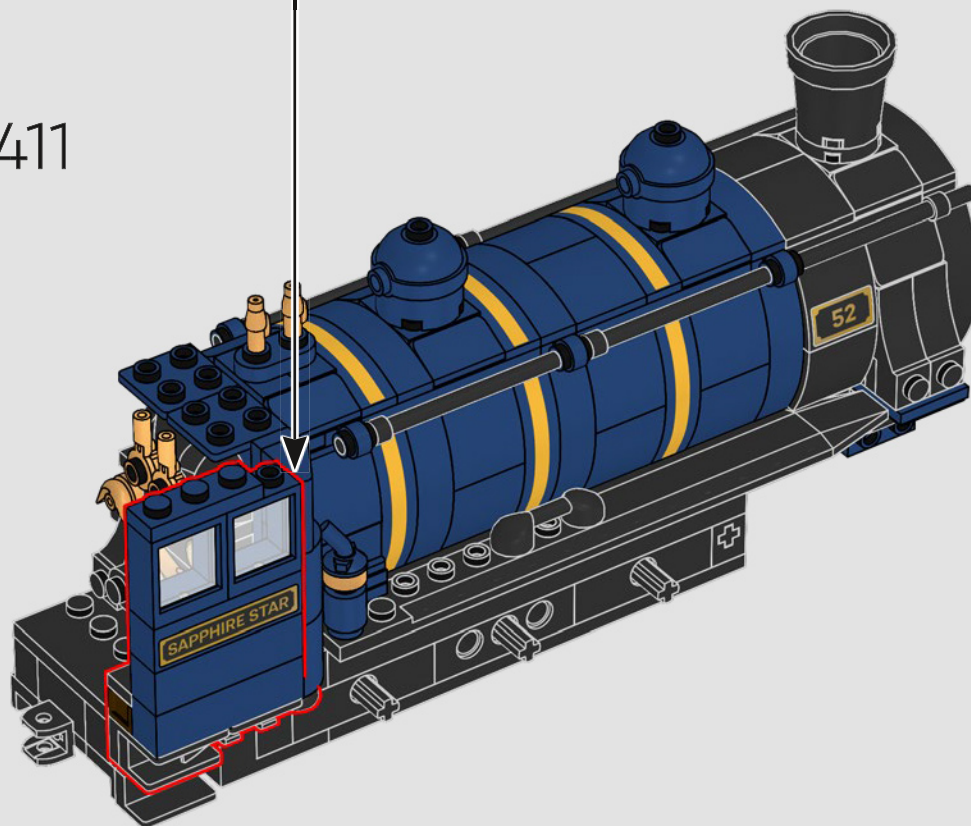

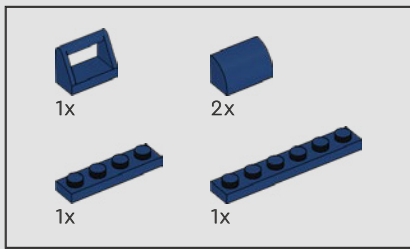

412

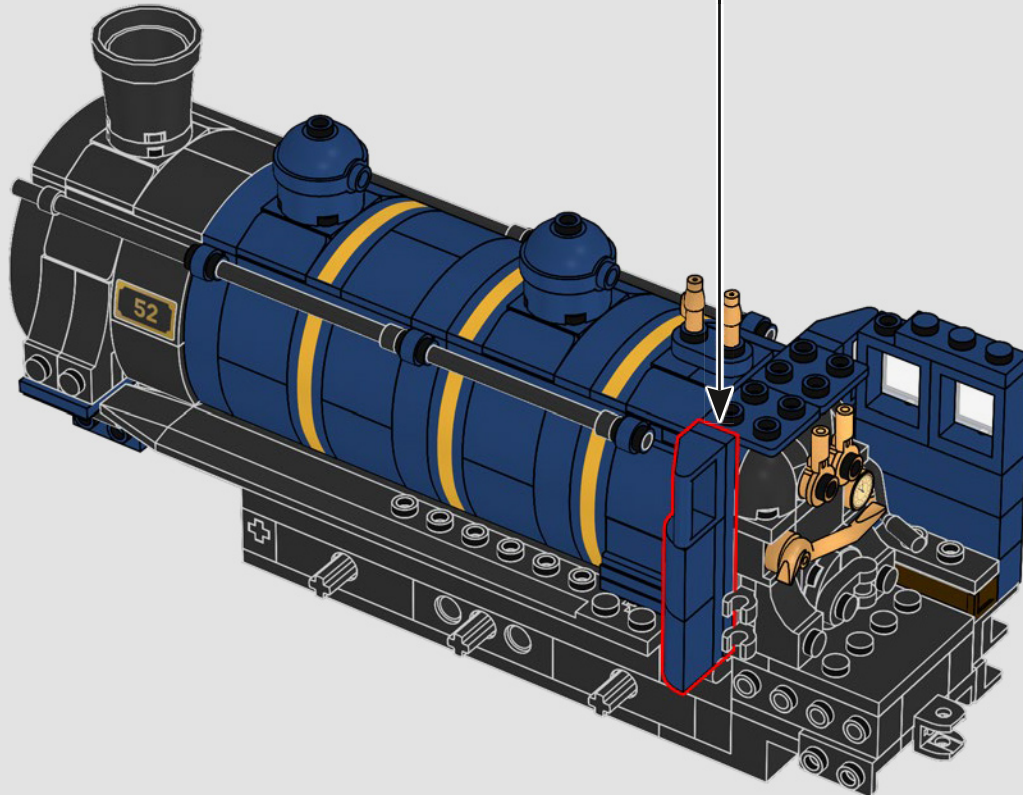
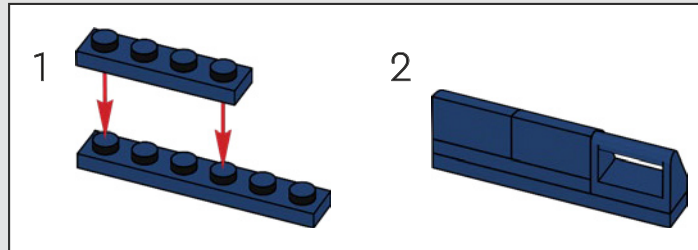

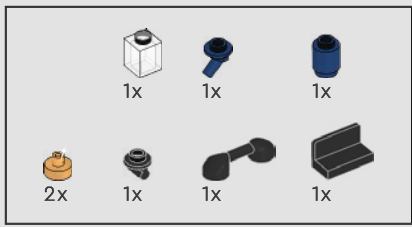

413

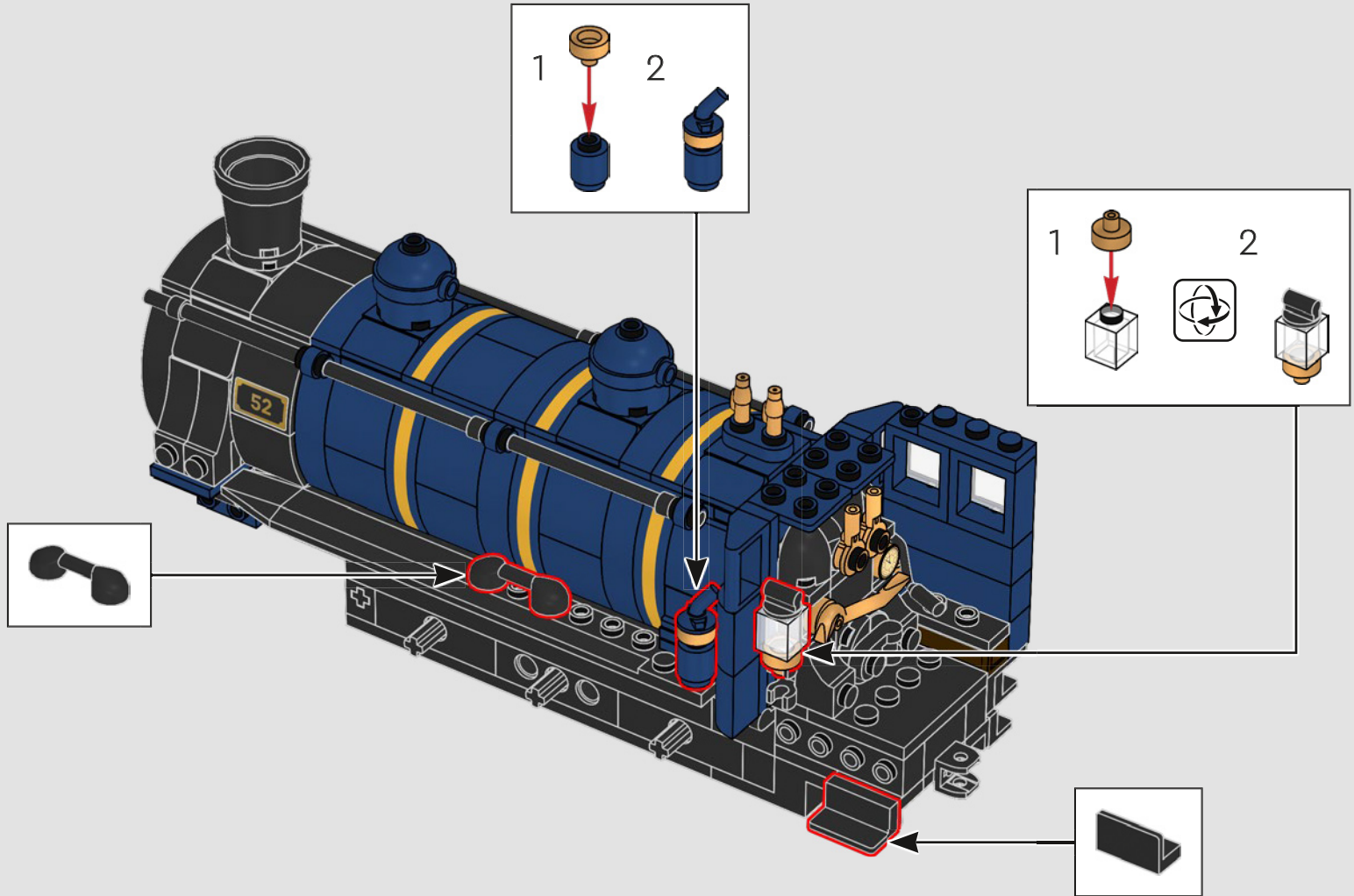

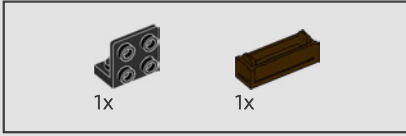
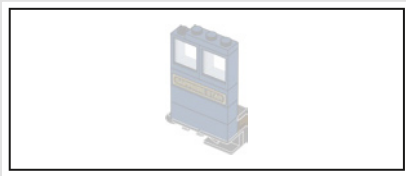

414

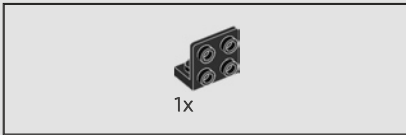
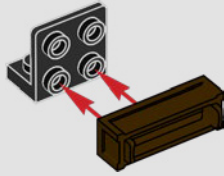

415

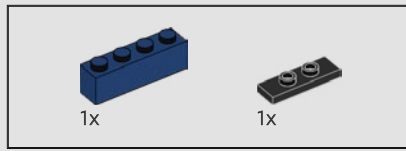
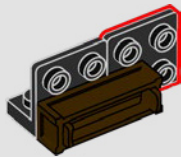

416

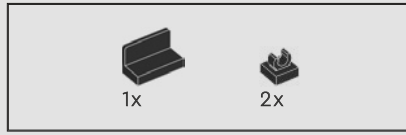
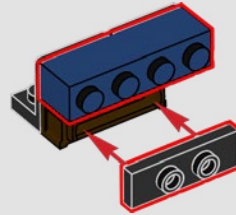

417

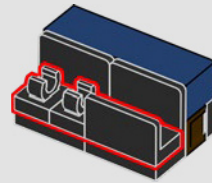

418

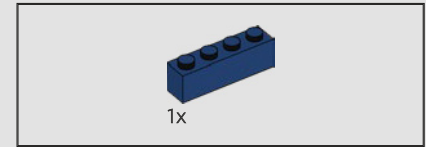
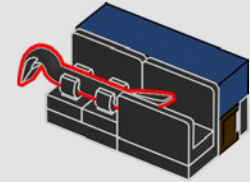

419

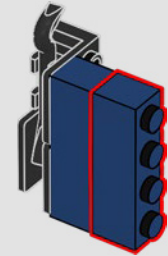

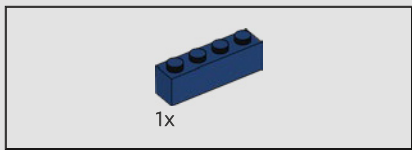

420

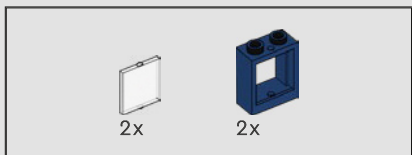
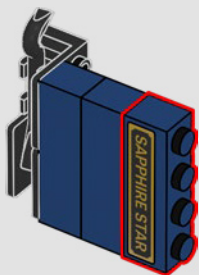
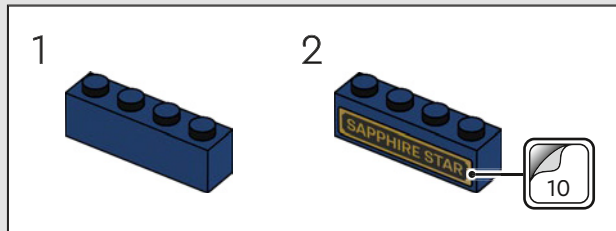

421

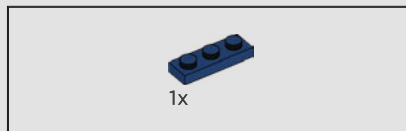
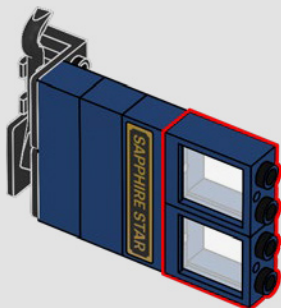
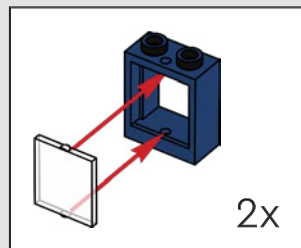

422

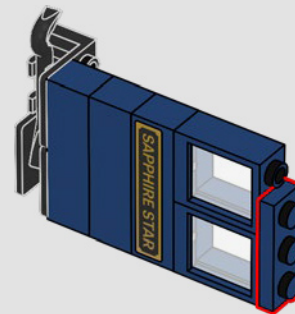

423

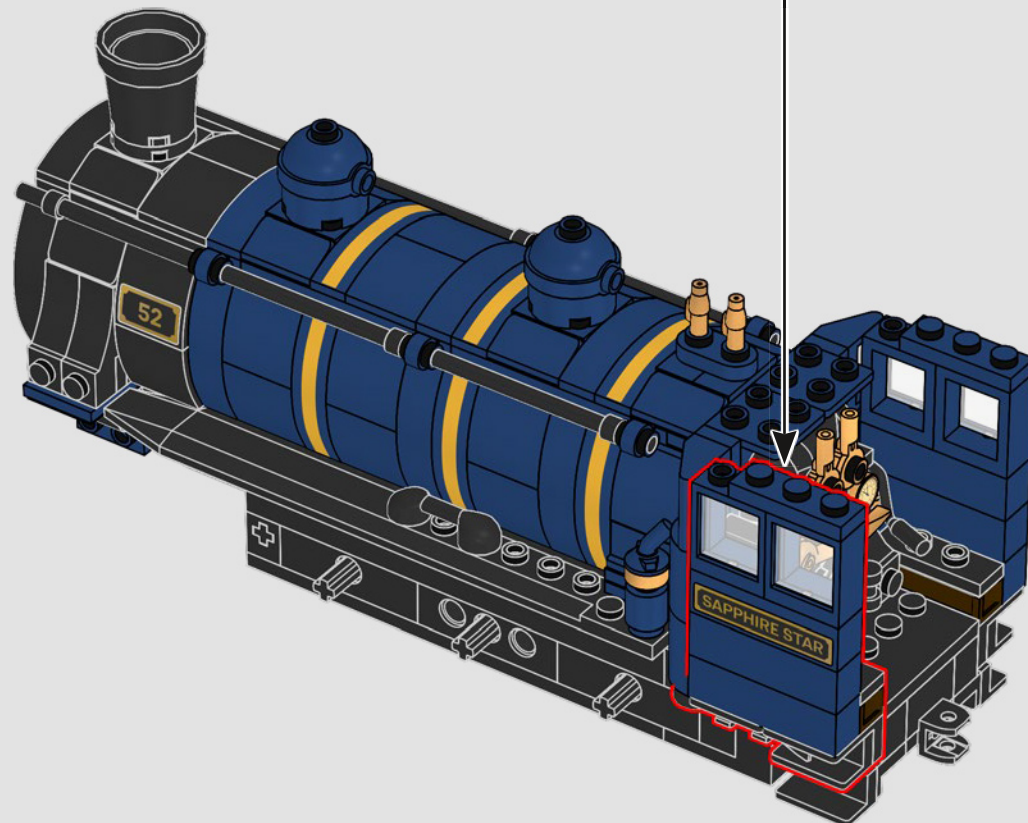

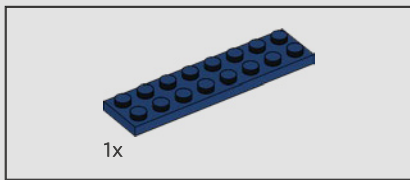

424

.....●
'The Sapphire Star – what a gem it is!
I'm reminded of a night train I took on
the Emerald Isle years back.'

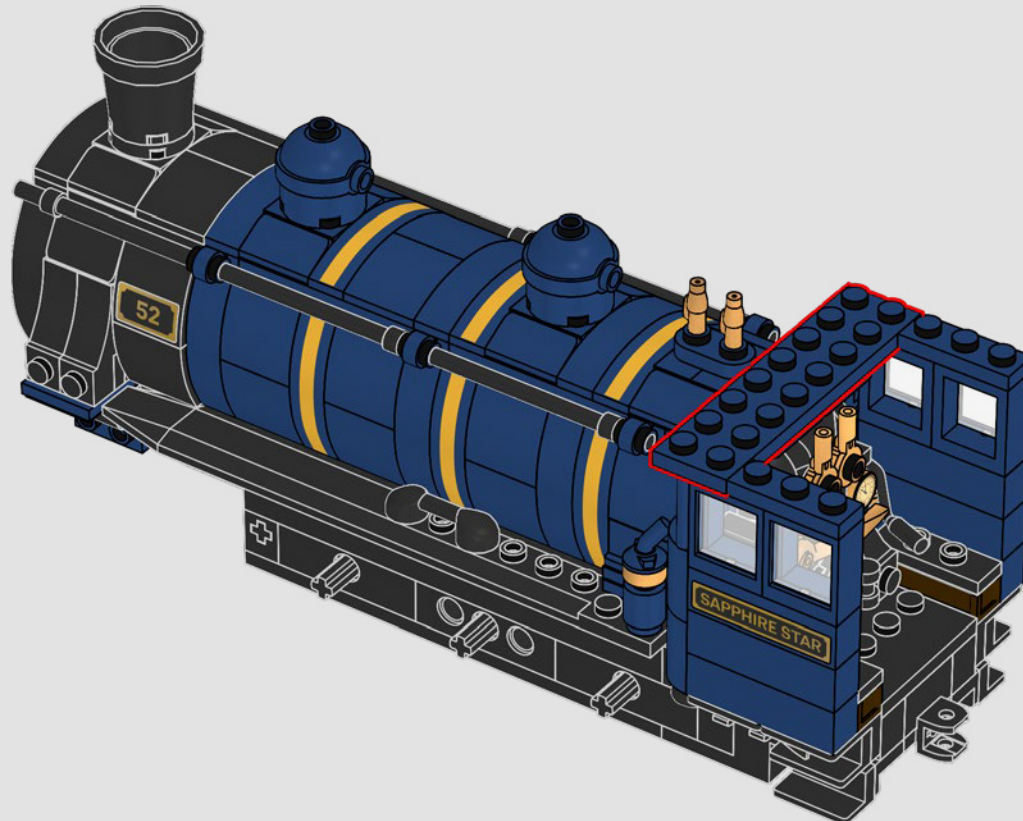

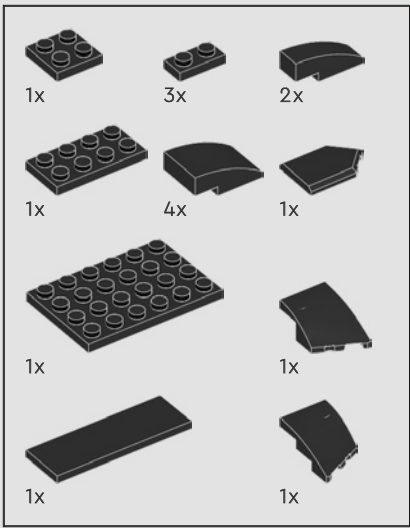

425

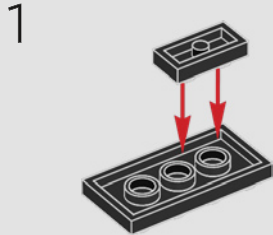

2

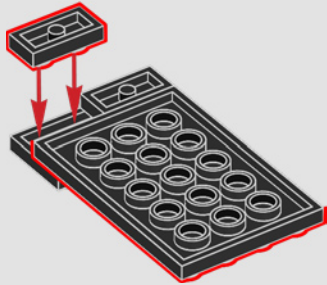

3

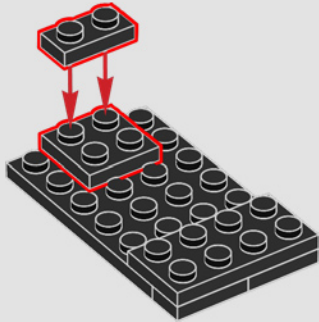

4

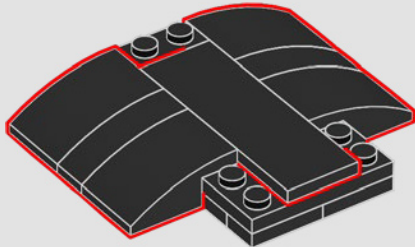

5

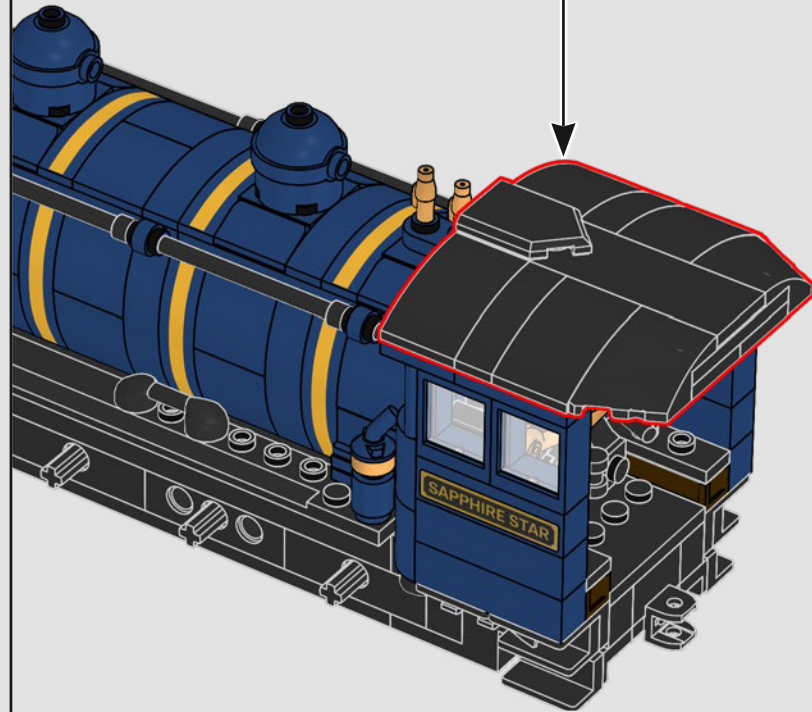
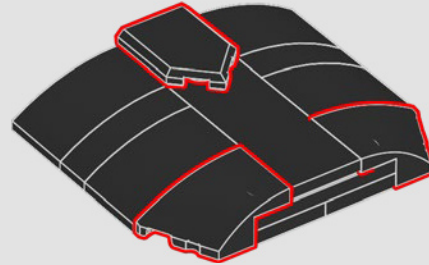

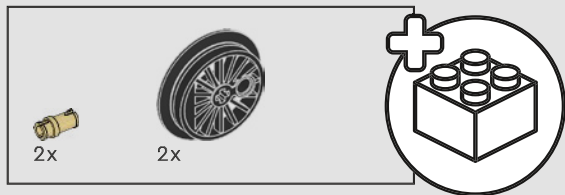

426

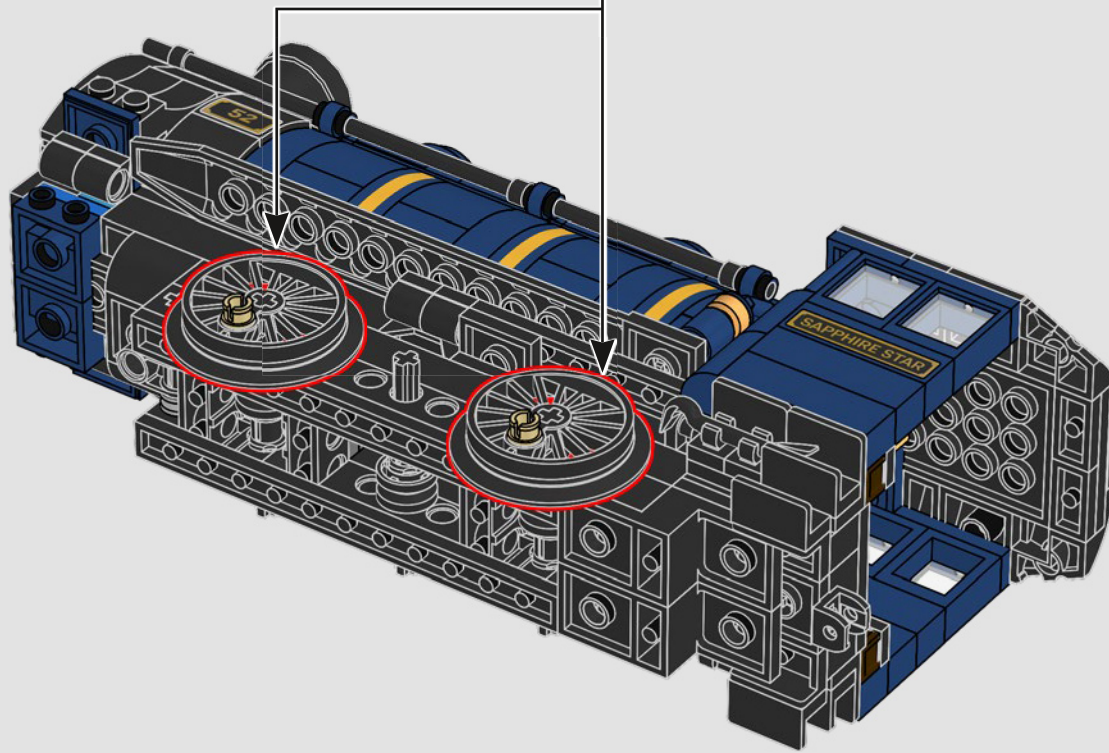
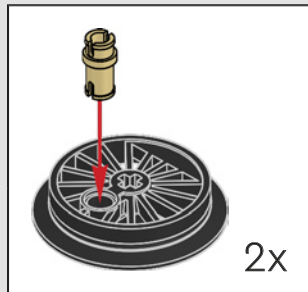

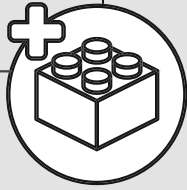
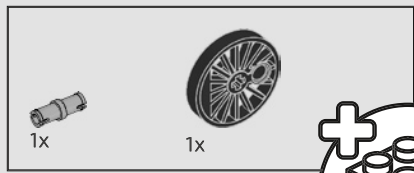

427

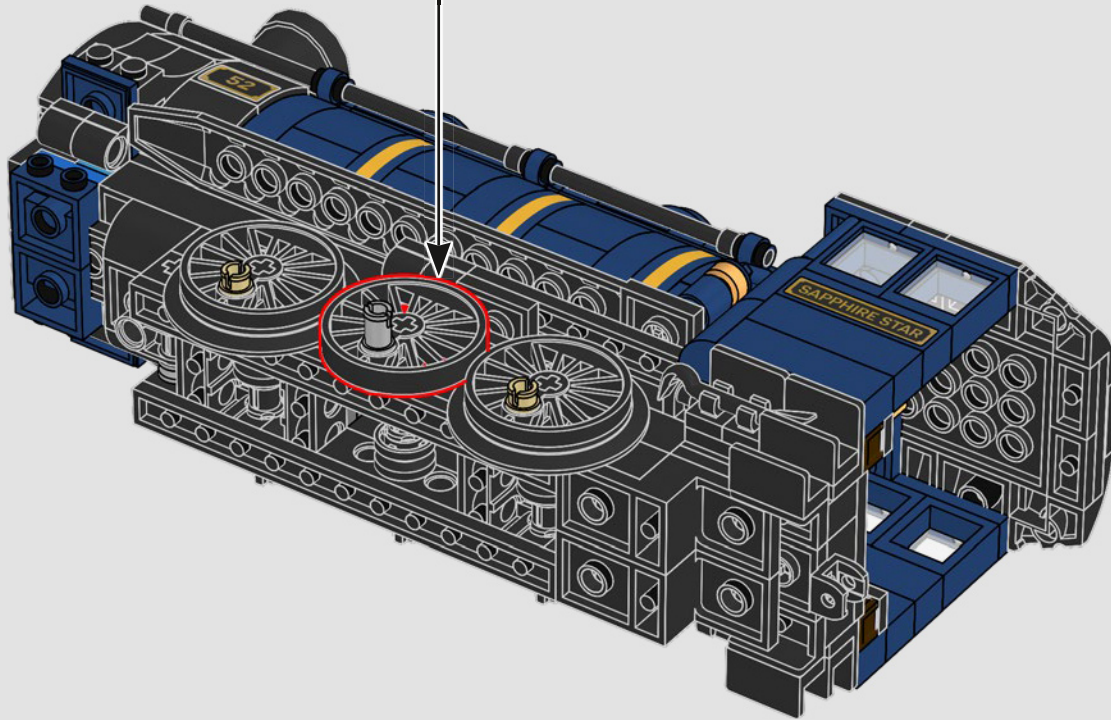
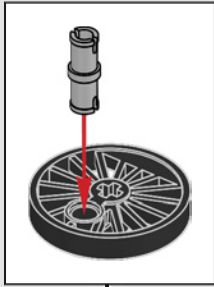

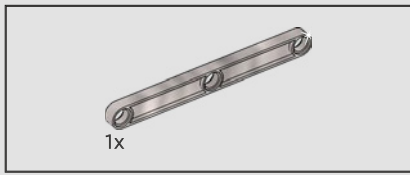

428

..... ●
'These silver coupling rods are a brand-new design,
created especially for this locomotive.'

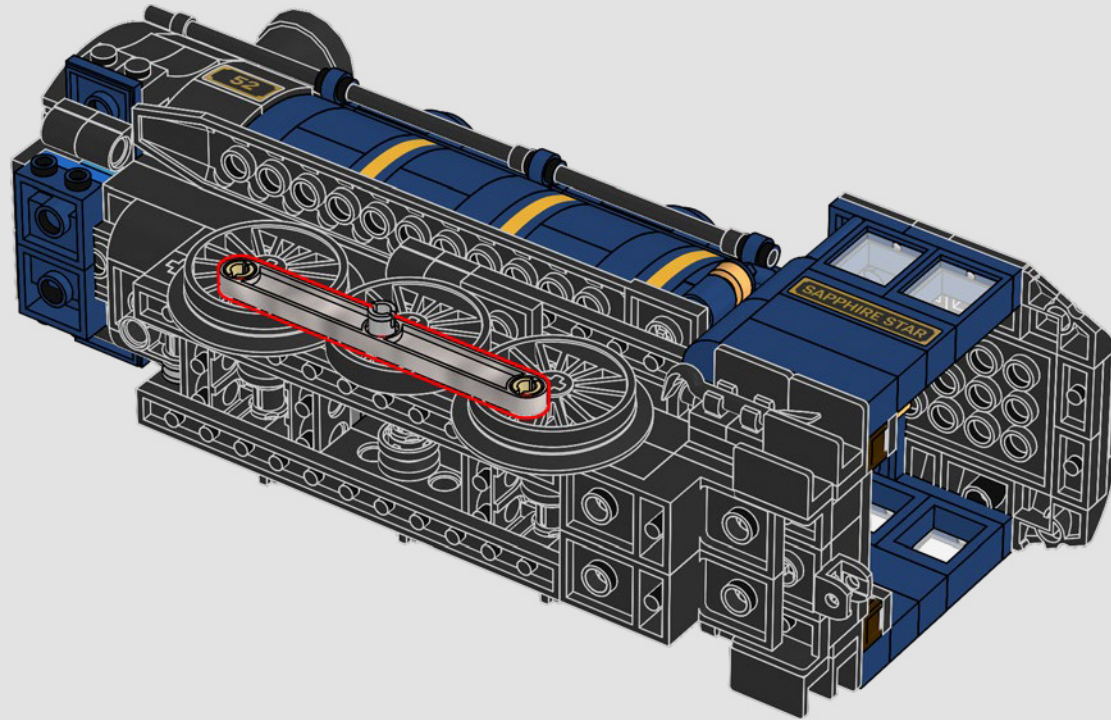



429

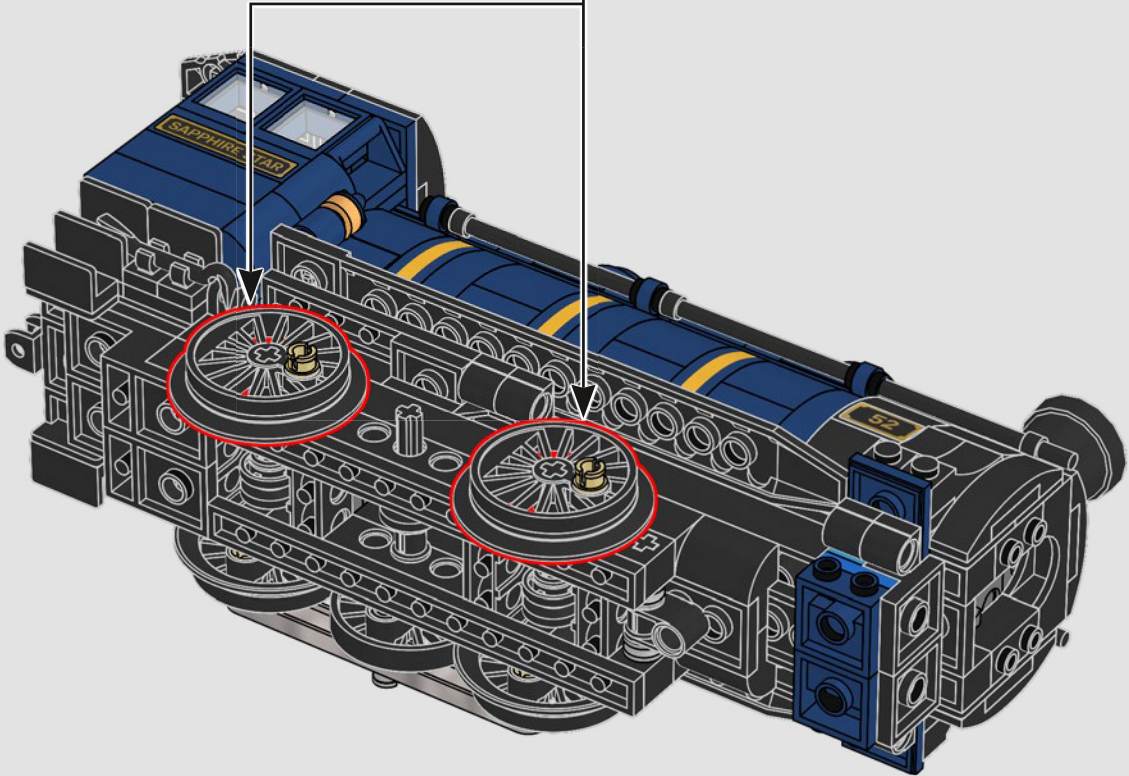
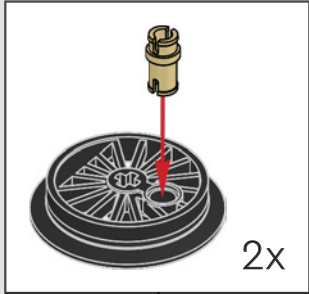
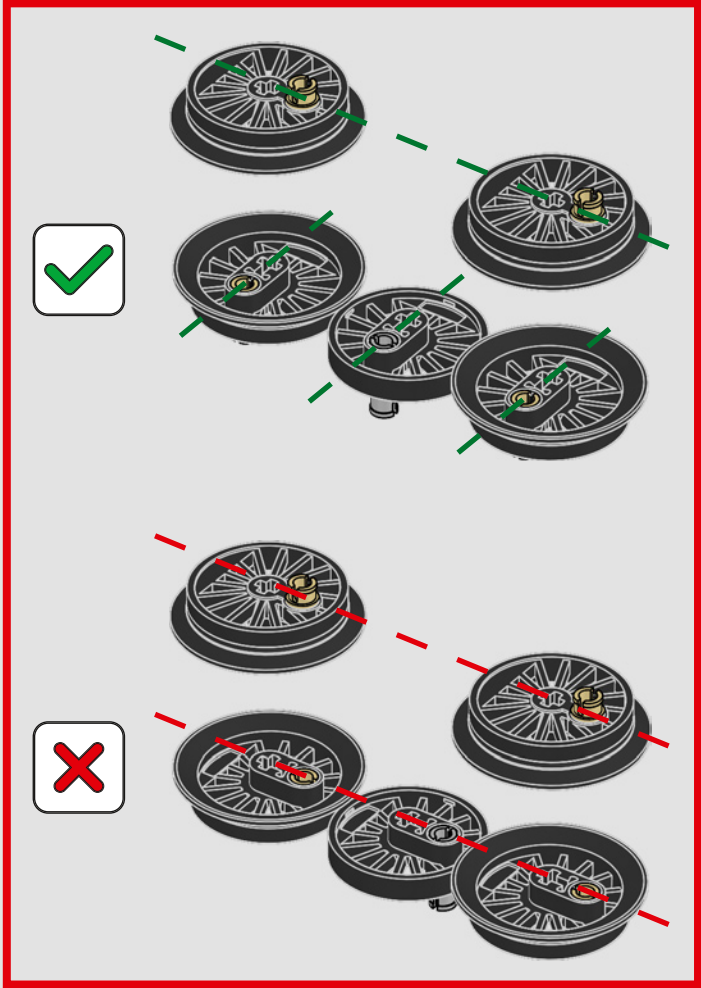



430

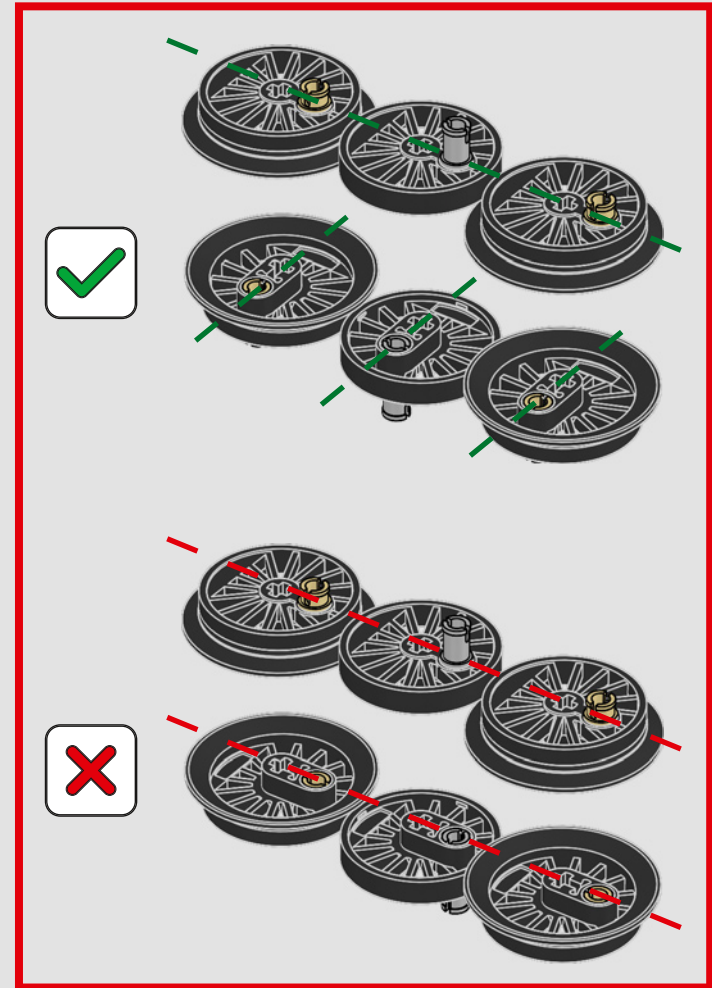
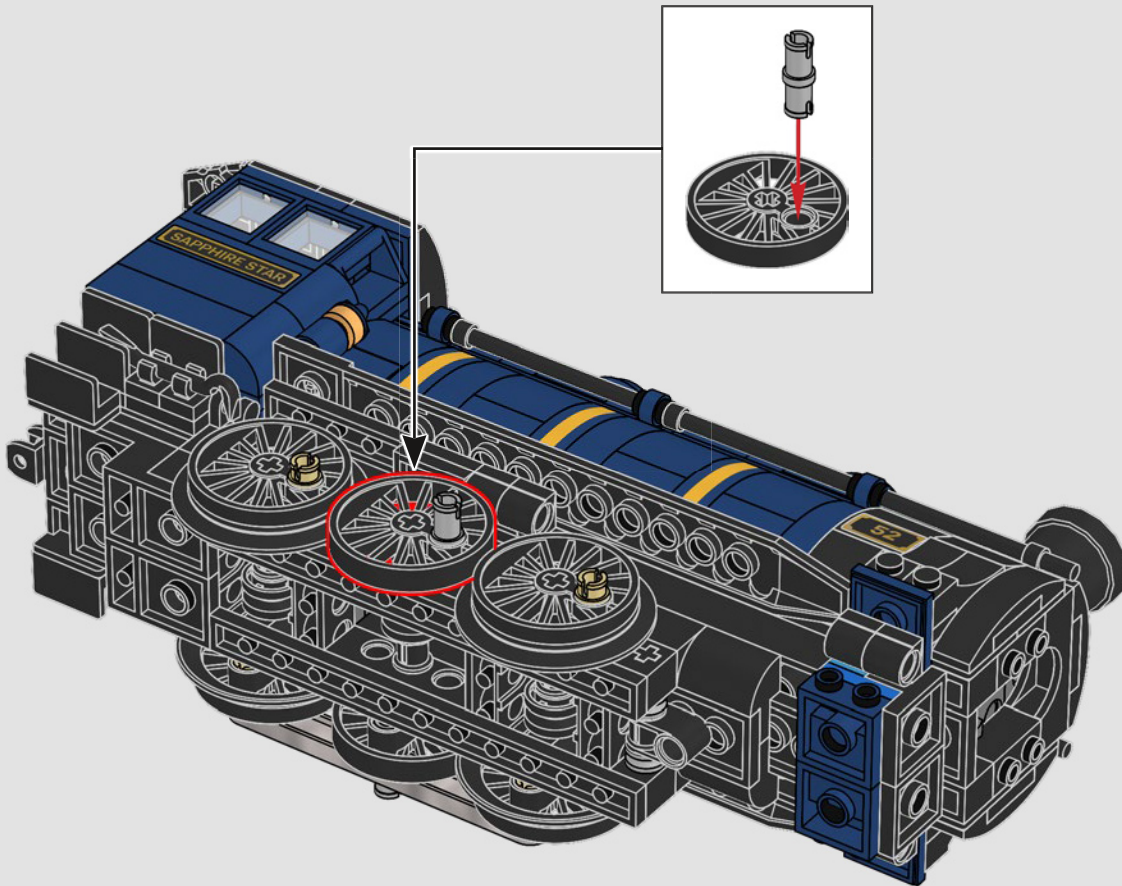

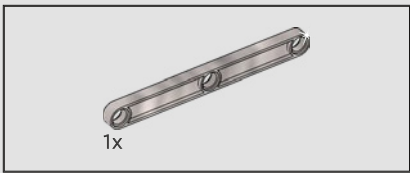

431

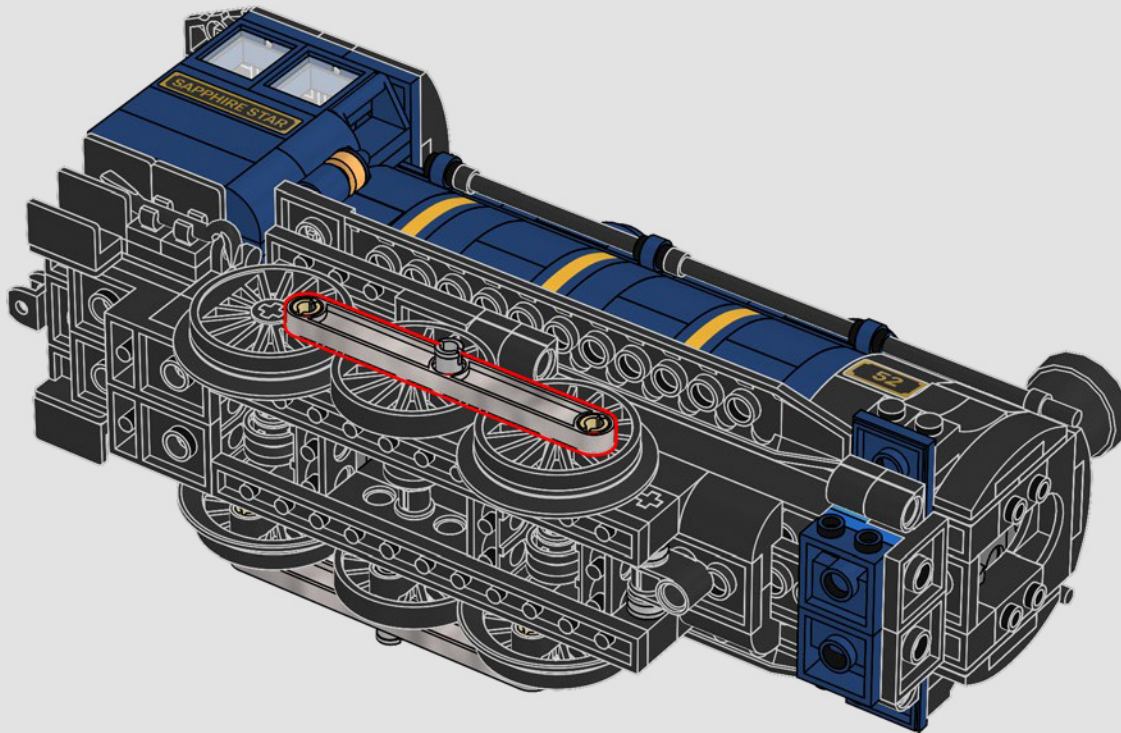

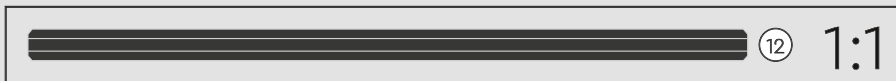
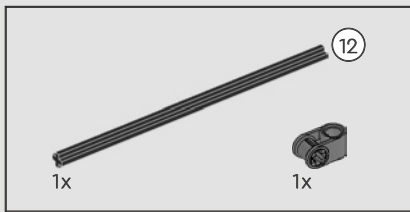

432

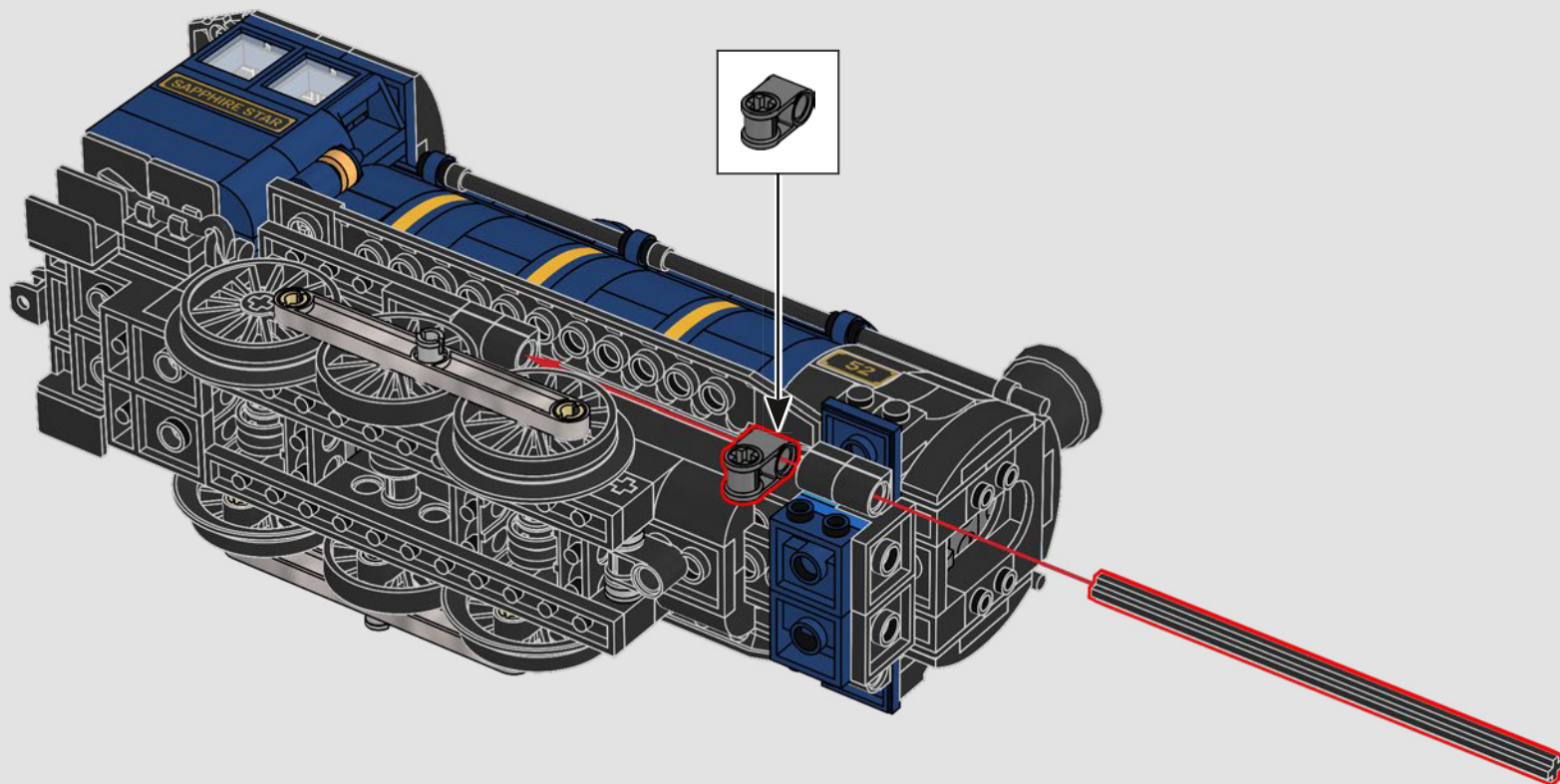

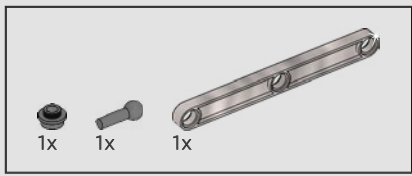

433

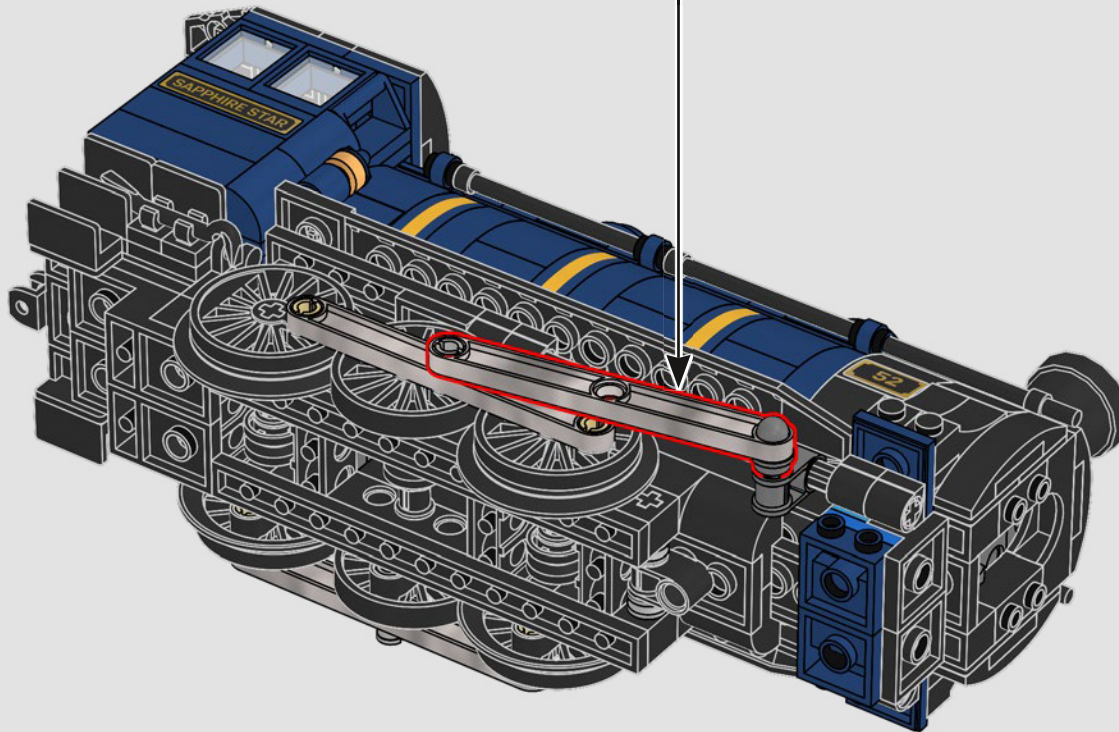
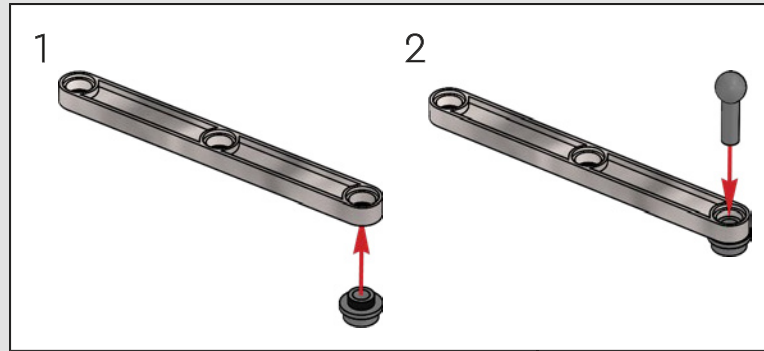

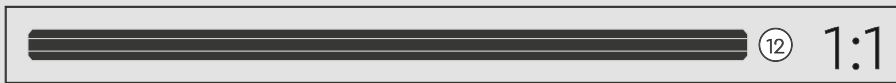
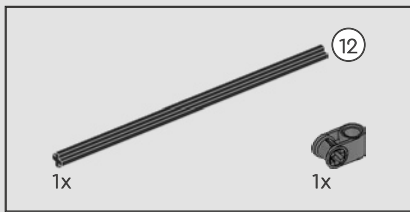

434

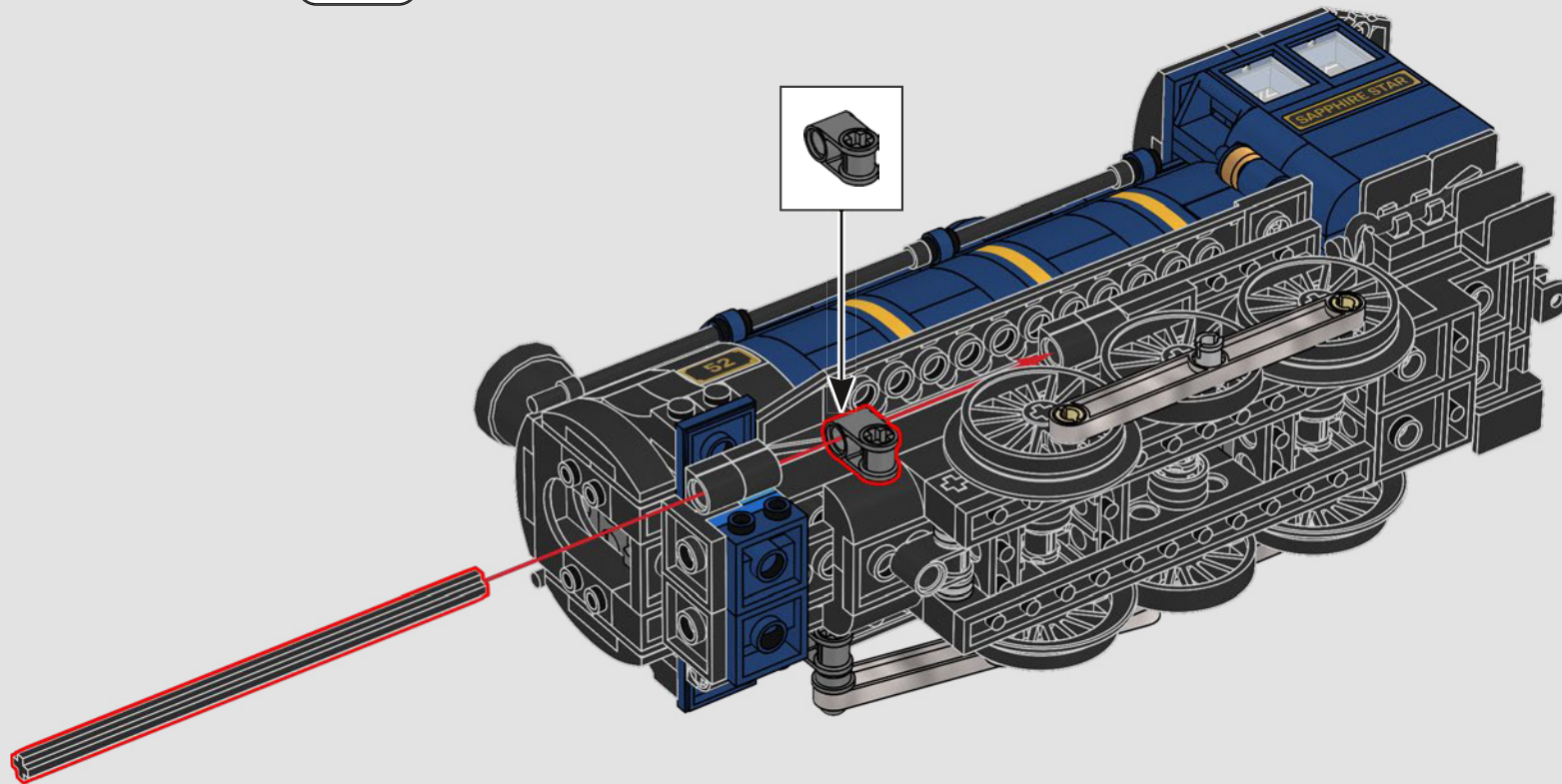

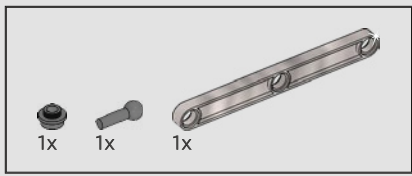

435

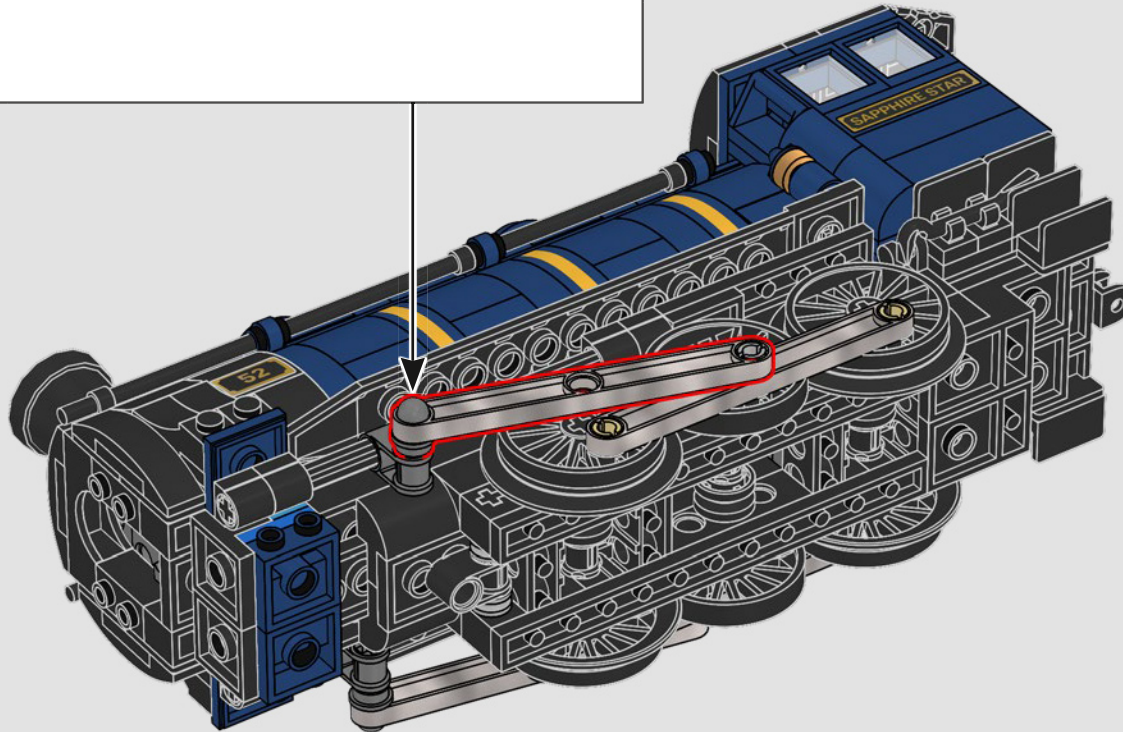
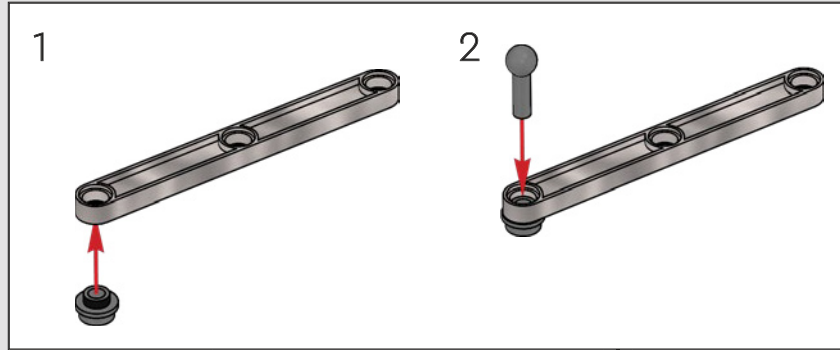

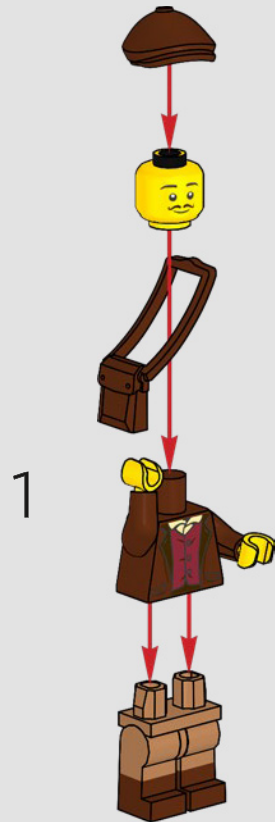
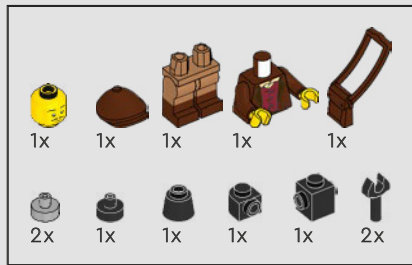

1

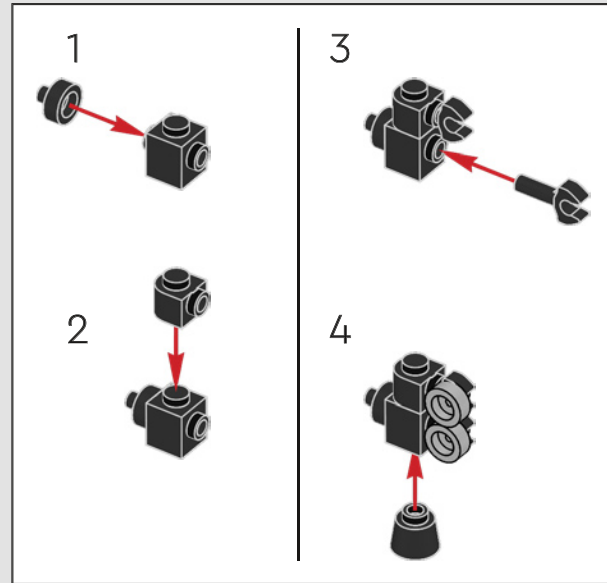

2



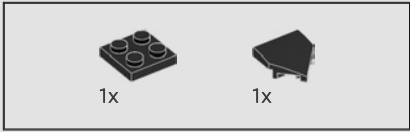
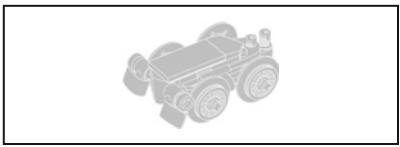

436

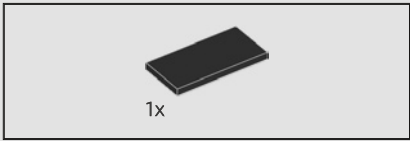
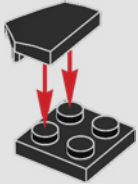

437

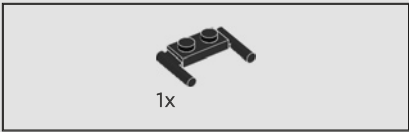
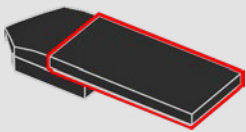

438

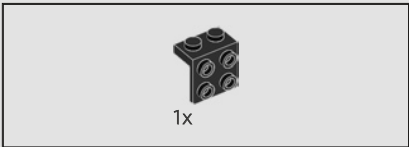
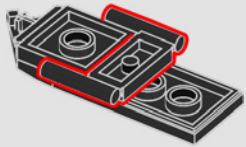

439

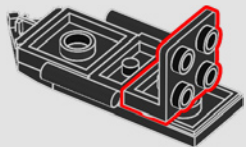

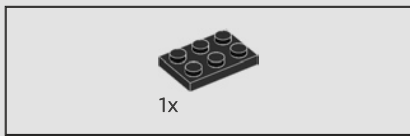

440

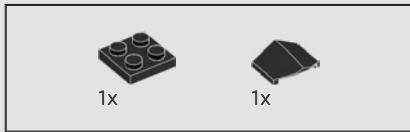
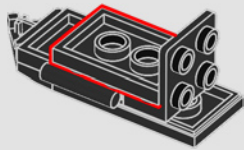

441

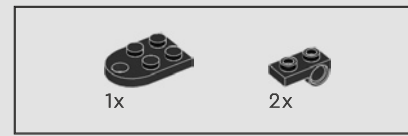
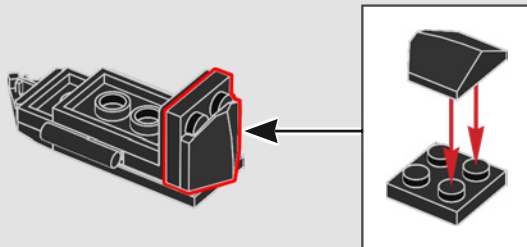

442

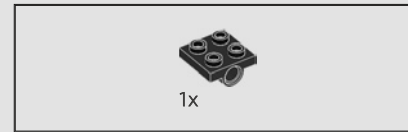
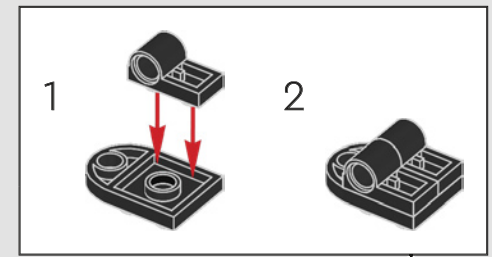
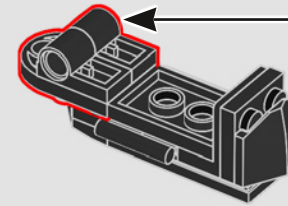

443

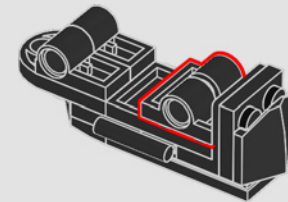

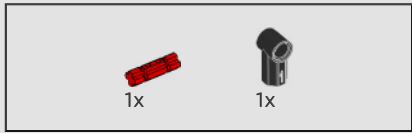
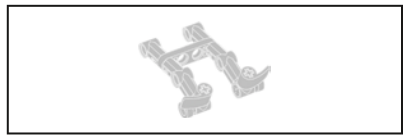

444

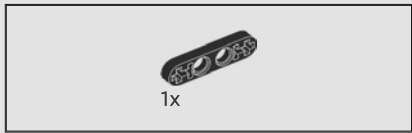
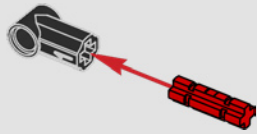

445

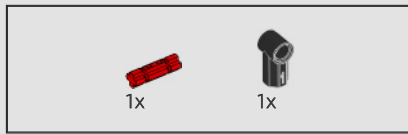

446

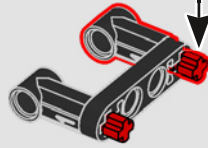
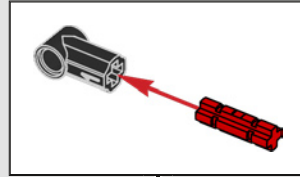

447

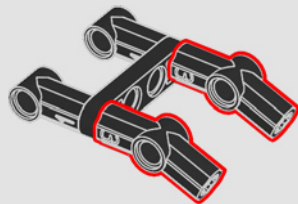

448

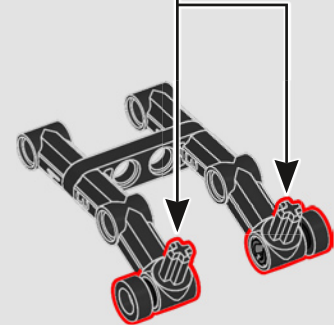
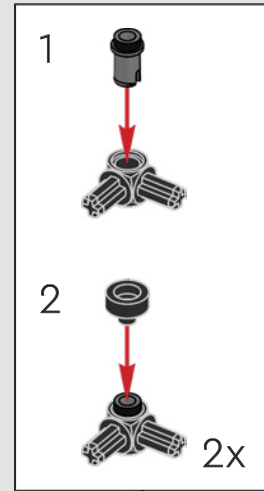



449

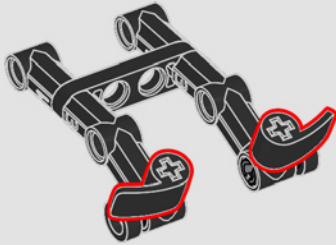

450

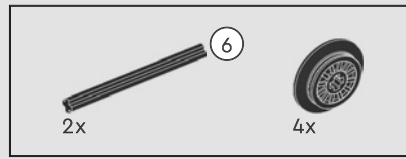
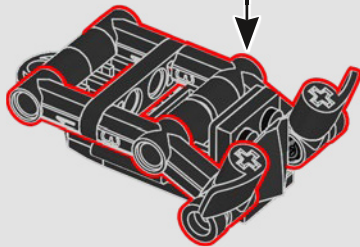

451

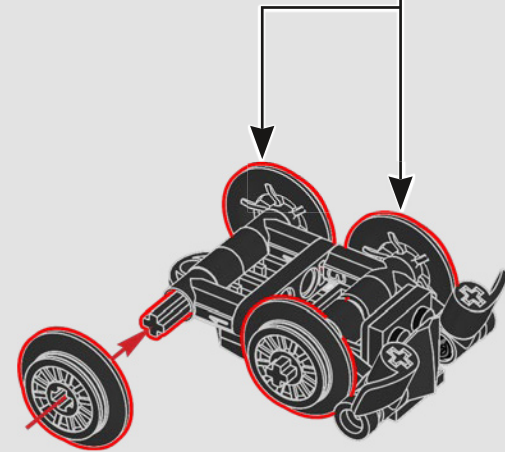
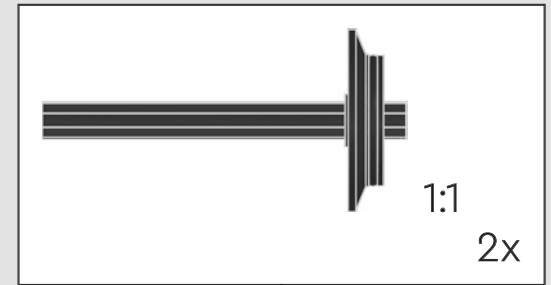
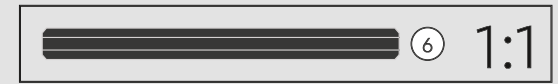

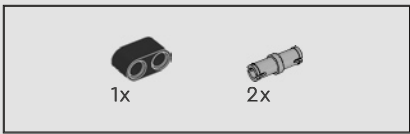

452

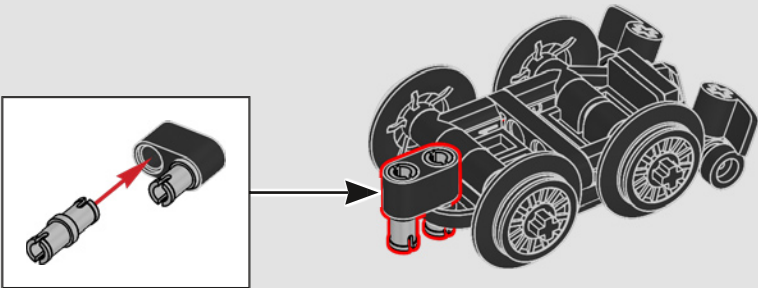

453

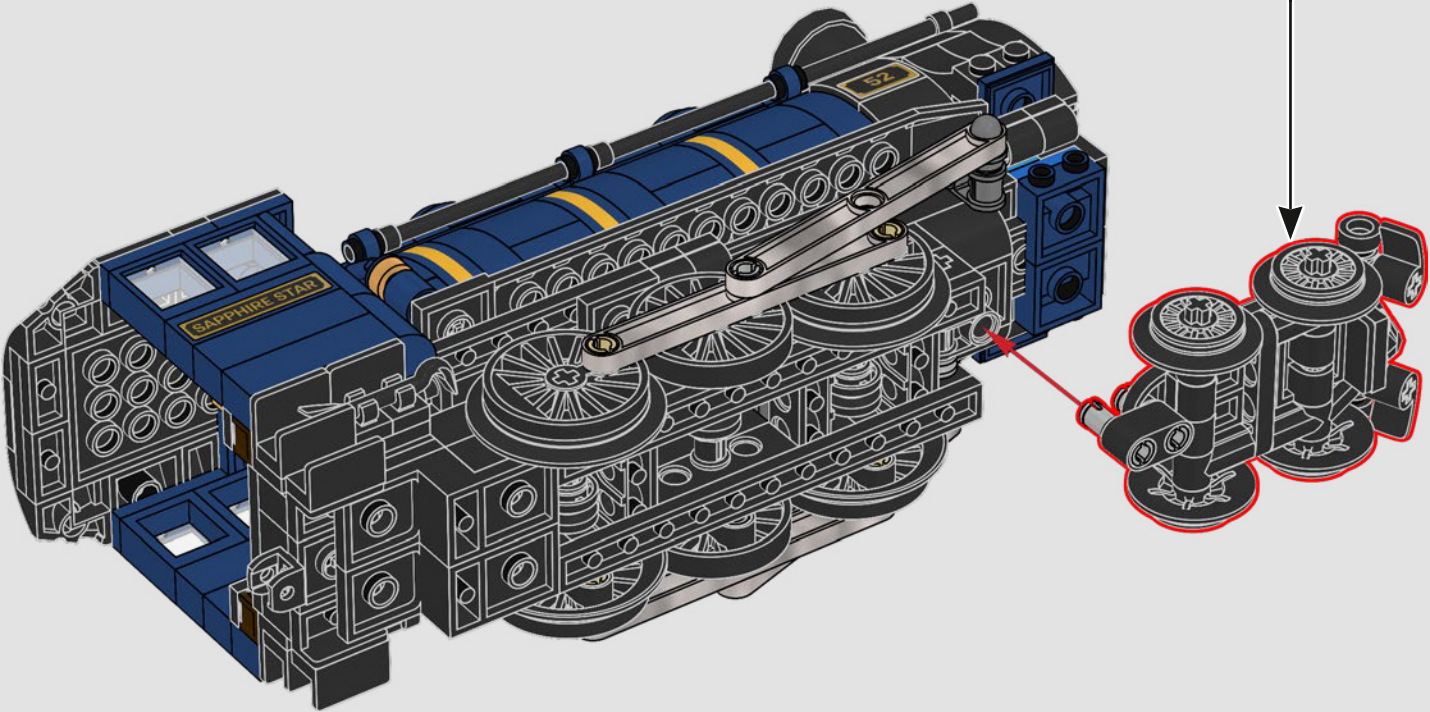

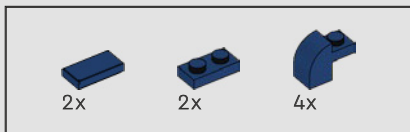

454

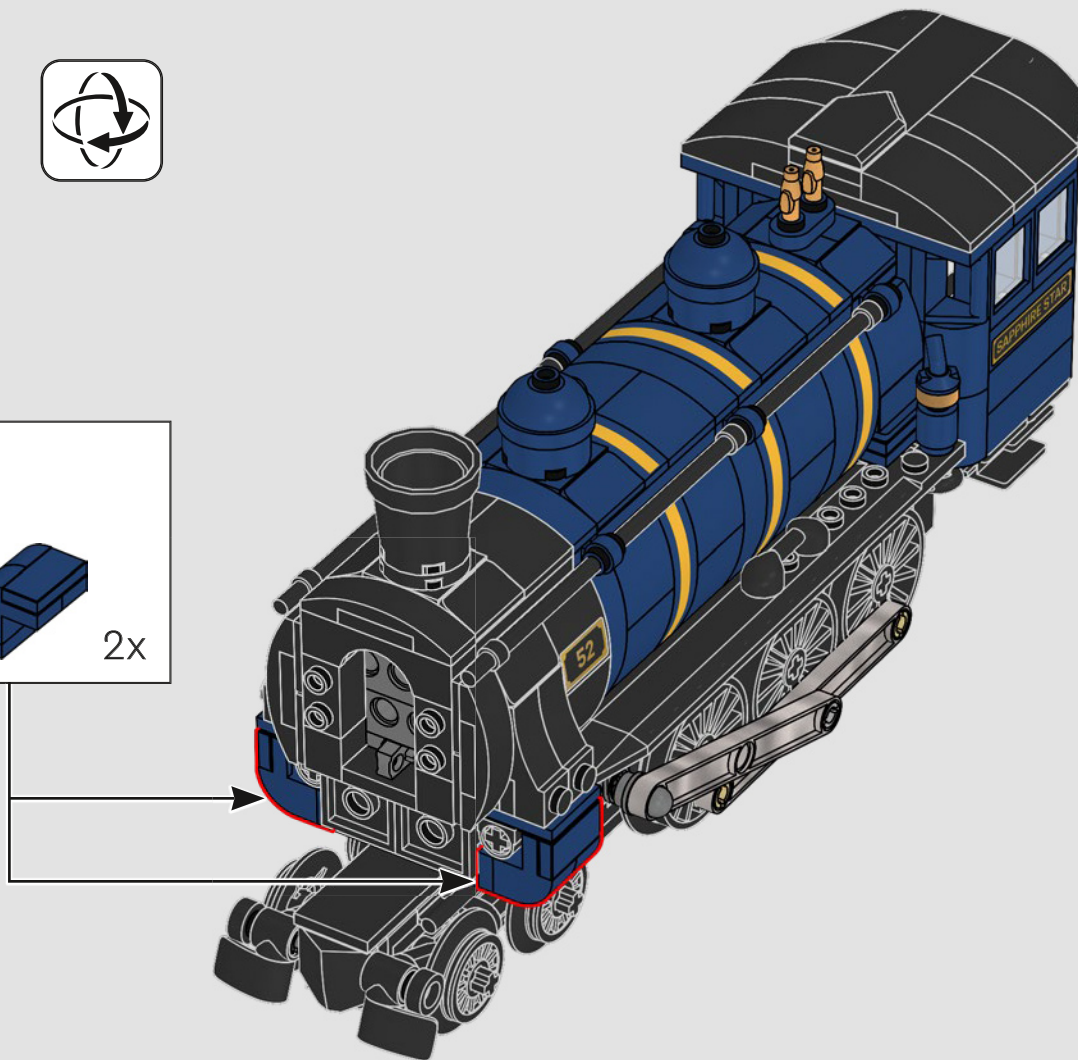
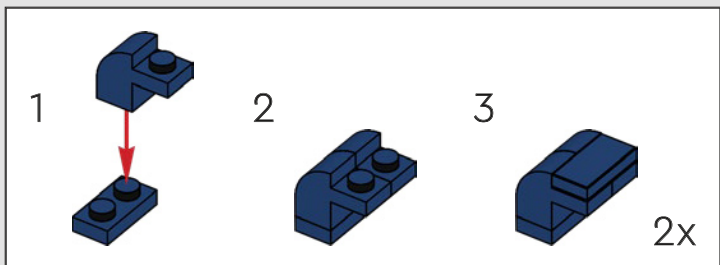

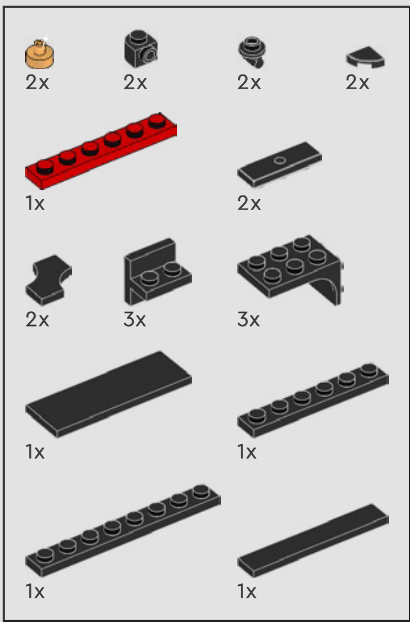

455

1

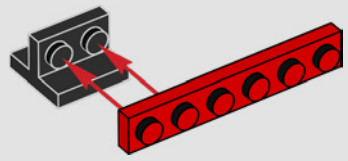

2

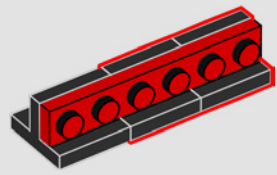

3

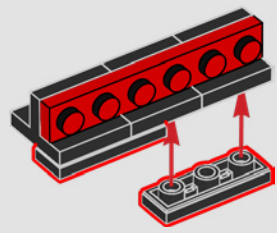

4

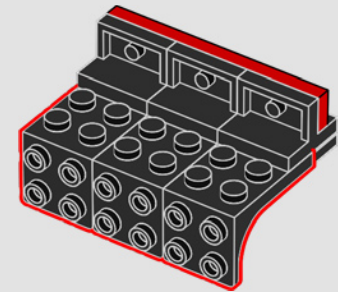

5

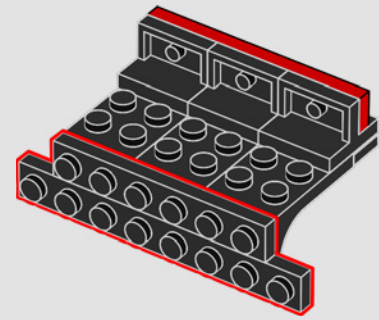

6

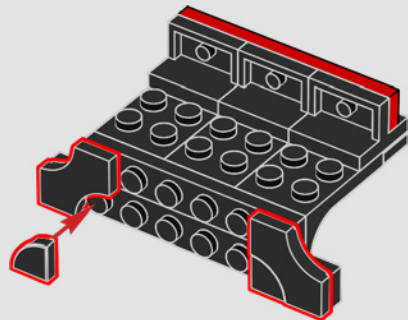

7

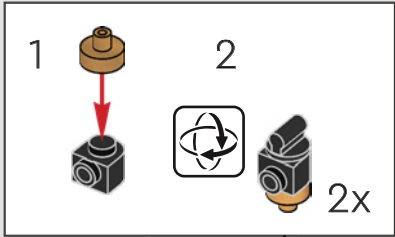
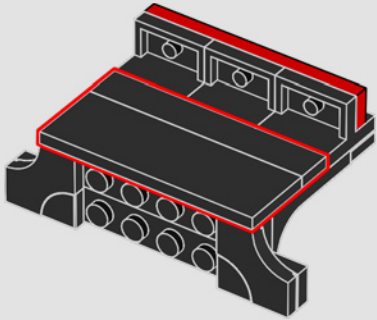

8

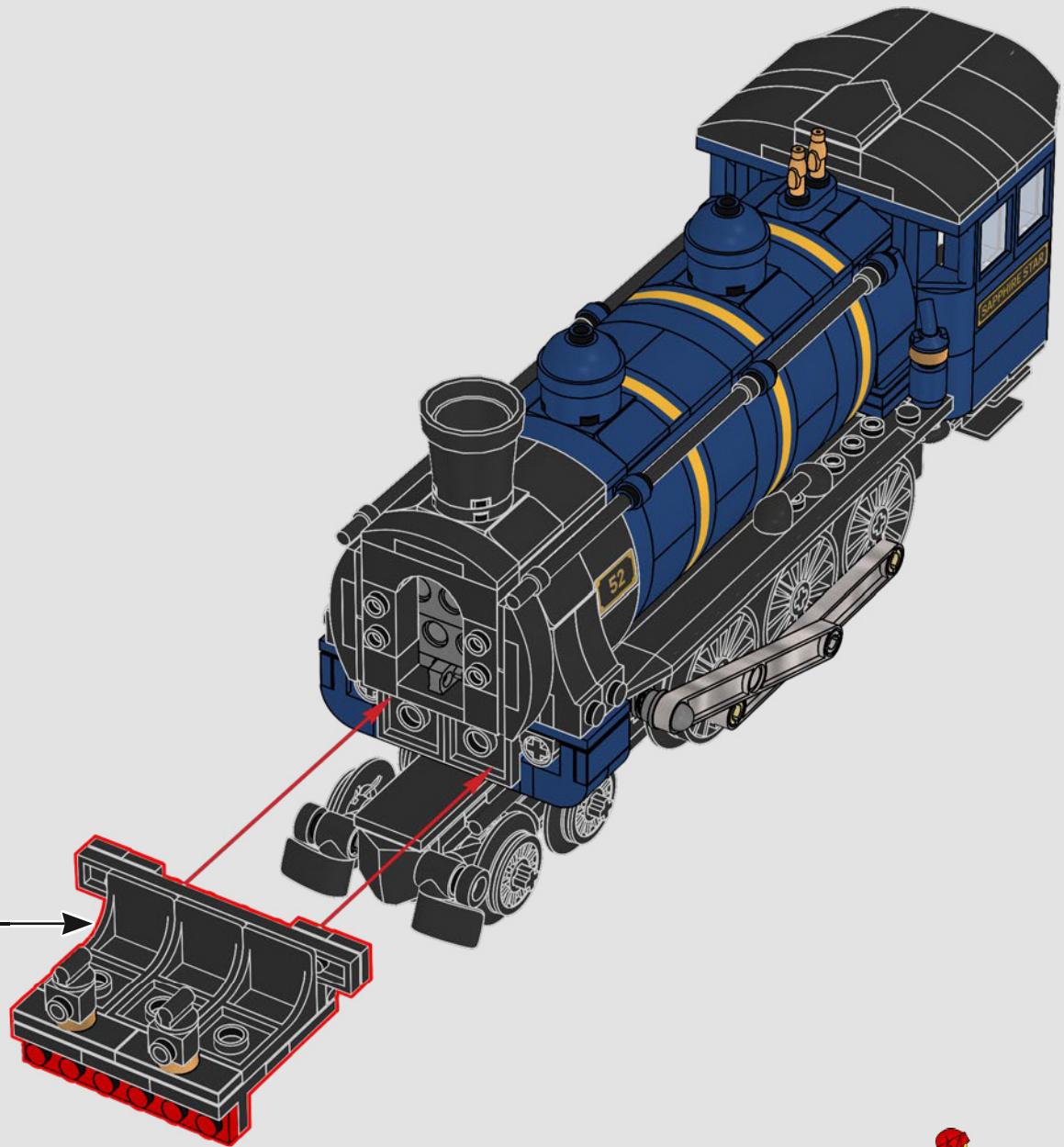
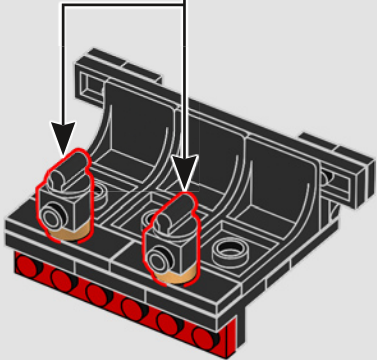

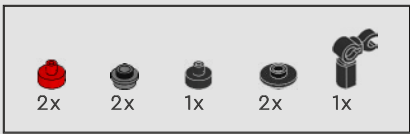

456

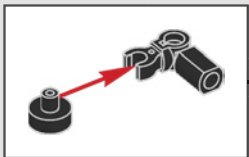
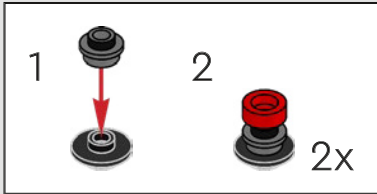
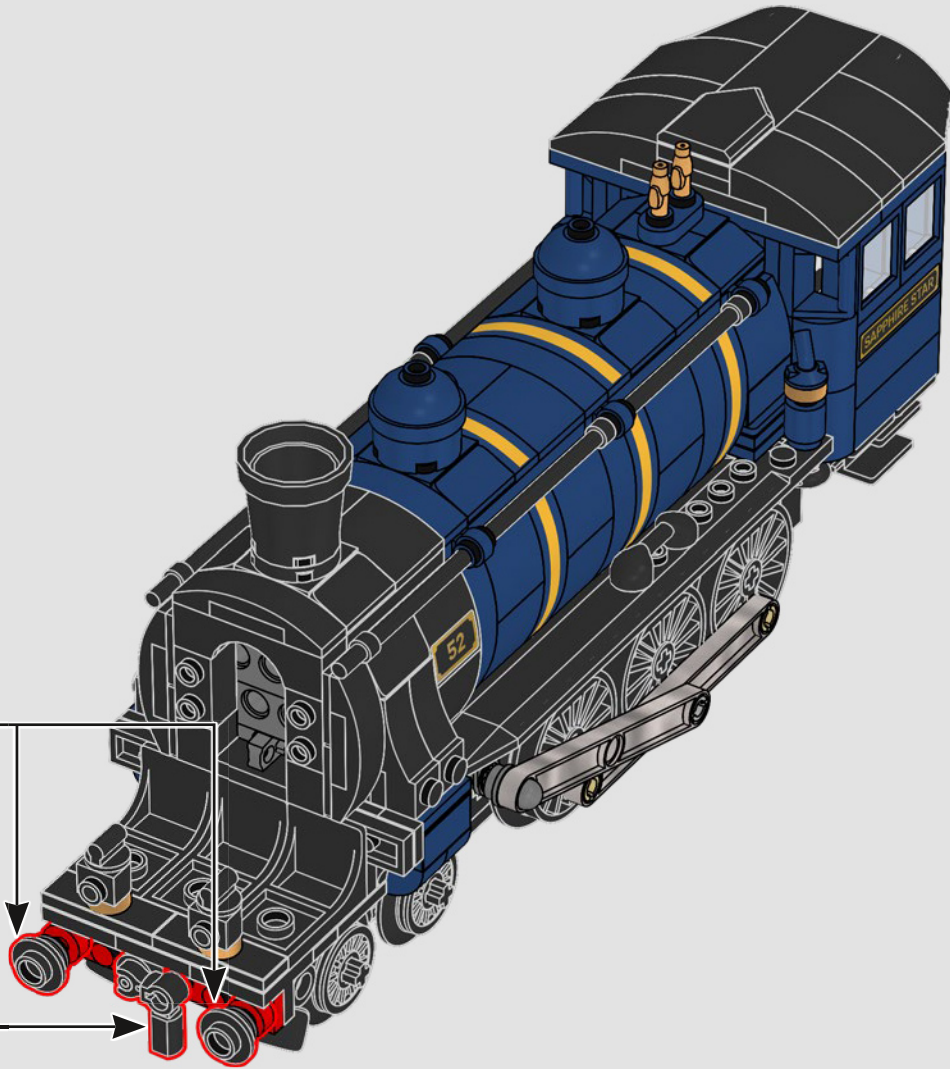

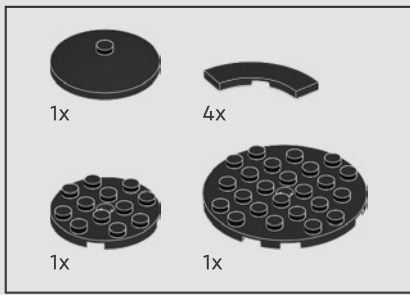

457

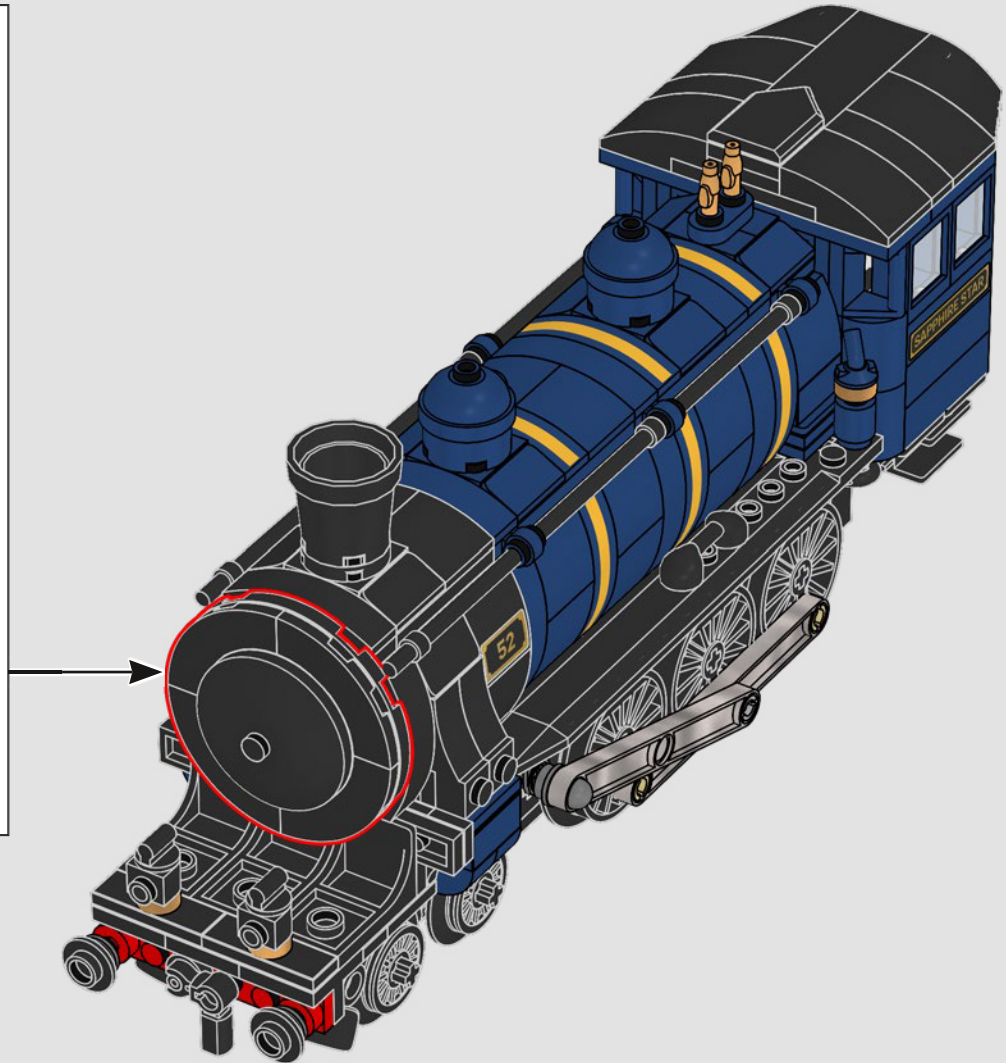
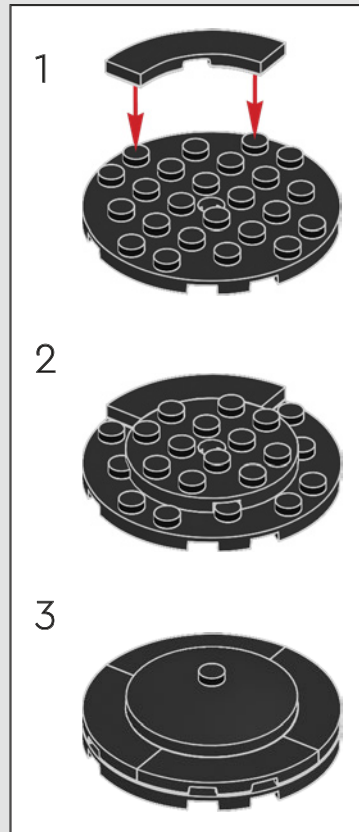

Destination: ISTANBUL

'The final stop. From here you can get connections to exotic locations like Baghdad, Cairo, Teheran, Jerusalem or Bombay!'

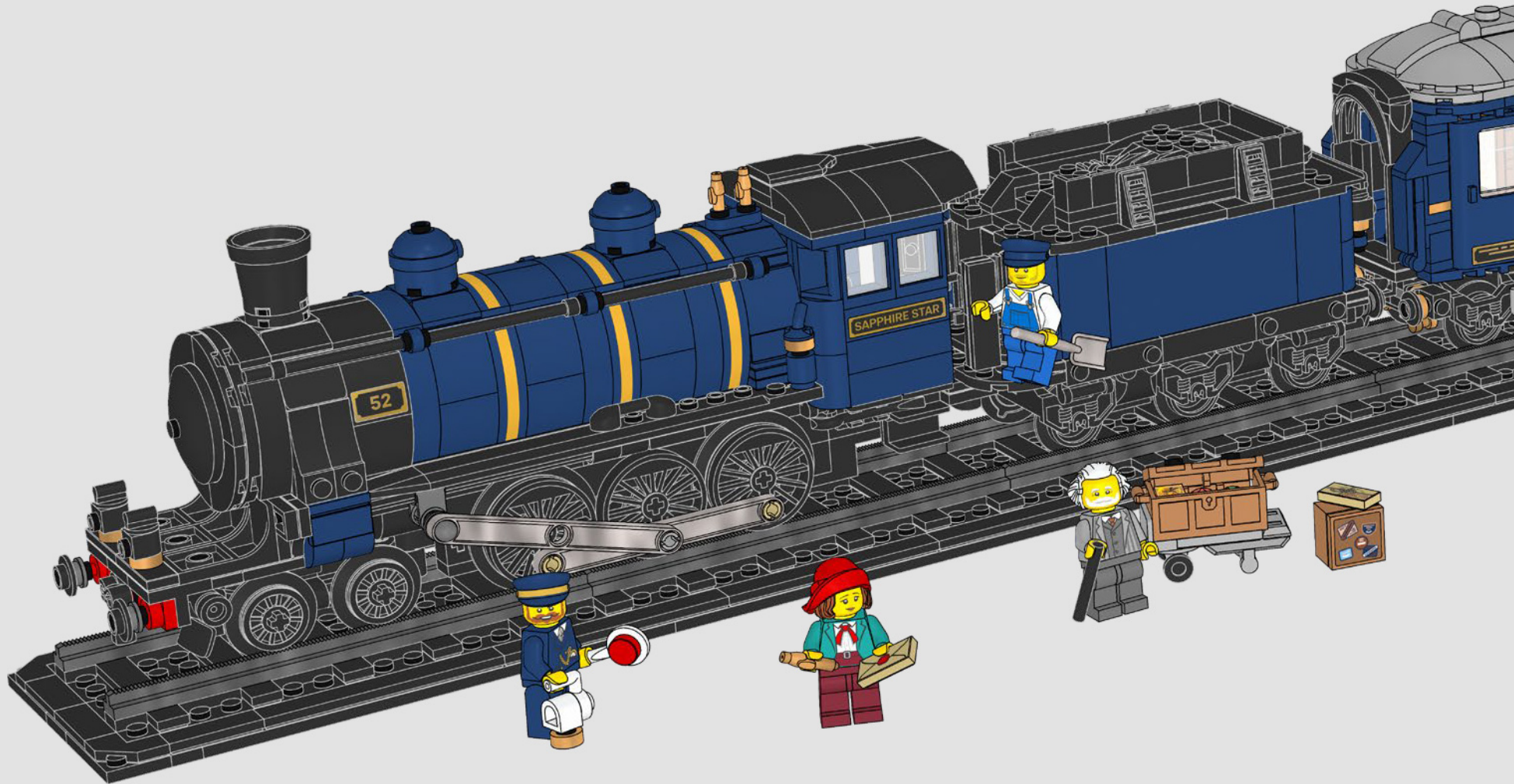

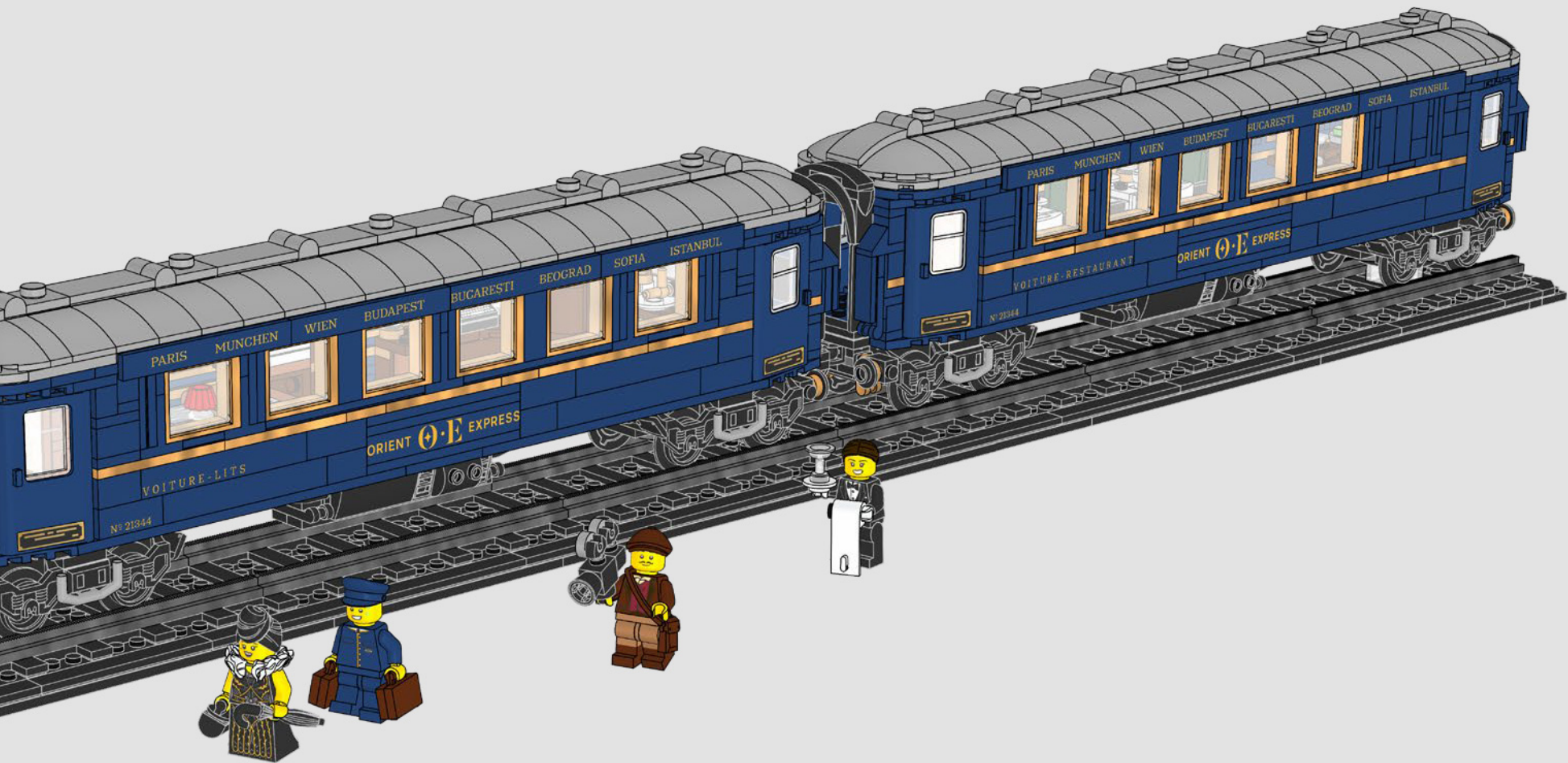



IDEAS

SHARE YOUR IDEA
TEILE DEINE IDEE
PARTAGEZ VOTRE IDÉE
CONDIVIDI LA TUA IDEA
COMPARTÉ TU IDEA
PARTILHA A TUA IDEIA
分享创意
PODZIEL SIĘ POMYSŁEM

SDÍLEJTE SVÉ NÁPADY
ZDIEĽAJTE SVOJE NÁPADY
OSZD MEG AZ ÖTLETED!
ÎMPĂRȚĂȘEȘTE IDEEA TA
СПОДЕЛЕТЕ ИДЕИТЕ СИ
PARĂDI SAVU IDEJU
JAGA OMA IDEED
PASIDALINK SAVO IDĚJA

GATHER SUPPORT
HOL DIR UNTERSTÜTZUNG
RECUEILLES DES VOTES
CHIEDI DI ESSERE SUPPORTATO
CONSIGUE APOYOS
OBTÉM APOIO
争取支持
ZDOBĄDŹ GŁOSY

ZÍŠKEJTE PODPORU
ZÍSKAJTE PODPORU
SZEREZZ TÁMOGATÁST!
CERE SPRIJIN
ПОЛУЧЕТЕ ПОДКРЕПА
IEGŪSTI ATBALSTU
KOGU TOETUST
RINK PALAIKYMĄ

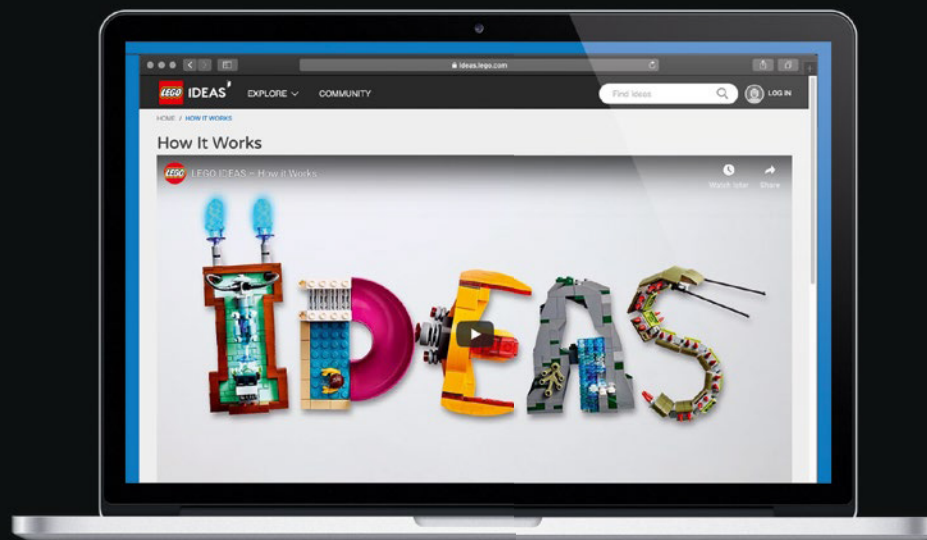
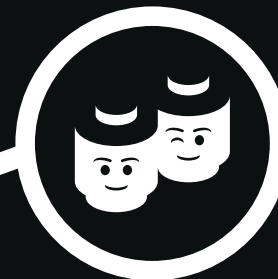

LEGO® REVIEW
LEGO® PRÜFUNG
EXAMEN PAR LEGO®
REVIEW LEGO®
REVISIÓN DE LEGO®
AVALIAÇÃO LEGO®
乐高®审核
OCENA LEGO®

OUZENÍ DESIGNÉRY LEGO®
POSÚDENÉ DIZAJNÉRMÍ LEGO®
LEGO® VÉLEMÉNYEZÉS
VERIFICARE LEGO®
ПРЕГЛЕД НА LEGO®
LEGO® RECENZIJA
LEGO® ARVUSTUS
LEGO® APŽVALGA

NEW LEGO® PRODUCT
NEUES LEGO® PRODUKT
NOUVEAU PRODUIT LEGO®
NUOVO PRODOTTO LEGO®
NUEVO PRODUCTO LEGO®
NOVO PRODUTO LEGO®
全新乐高®产品
NOWY PRODUKT LEGO®

NOVÁ STAVEBNICE LEGO®
NOVÁ STAVEBNICA LEGO®
ÚJ LEGO® TERMÉK
PRODUS LEGO® NOU
НОВ ПРОДУКТ LEGO®
JAUNS LEGO® PRODUKTS
UUS LEGO® TOODE
NAUJAS LEGO® PRODUKTAS

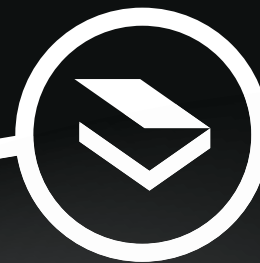
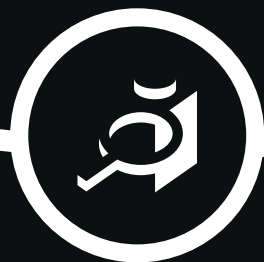

























































































ideas.LEGO.com

1x 407001	1x 6434569	1x 474001	1x 4114084	4x 306223	1x 6123730	16x 306226	1x 6181713	1x 4177444	5x 301026	4x 303226
1x 4558952	3x 302301	1x 6172674	1x 6257600	2x 6055065	1x 6218310	2x 6436425	2x 6369578	1x 6261371	4x 371026	14x 303426
1x 6321349	1x 302201	2x 4537987	1x 6352222	2x 6092582	1x 6384058	2x 6344819	1x 6308912	2x 6396456	8x 6254045	3x 346026
1x 6218823	2x 6126046	1x 4527637	2x 6174925	12x 302223	1x 6384051	4x 4548180	4x 6211476	4x 302426	8x 243126	3x 346026
1x 6218823	1x 6415097	1x 6219621	4x 6013938	1x 6315482	1x 6434805	1x 6323421	2x 6458098	110x 302326	8x 243126	3x 346026
2x 6383982	1x 4558168	1x 6334236	2x 6215539	4x 6315482	1x 6288000	2x 6267487	4x 4200023	6x 306926	10x 302026	4x 447726
1x 306201	7x 6195371	1x 390001	1x 6284574	1x 9341	1x 6372016	1x 6273589	6x 6053077	4x 241226	3x 4560182	4x 303526
2x 6442360	7x 302101	6x 6475151	1x 6465499	4x 300423	1x 6352820	1x 6181720	1x 6390748	2x 6092585	1x 6076678	2x 6037390
1x 6050914	1x 6446788	4x 6235083	4x 6454454	2x 4558606	6x 6186675	4x 6138173	4x 6328095	4x 242026	1x 663626	4x 4514845
2x 4547489	1x 6348055	1x 6396958	2x 4142865	4x 301023	26x 407026	2x 265326	2x 4251161	19x 302226	3x 366626	2x 611226
1x 6213880	1x 6437184	4x 6238334	2x 6397571	8x 447723	13x 6228987	2x 4162443	1x 6390749	20x 6192346	5x 4243819	2x 244526
2x 6258135	2x 6168618	2x 4114026	1x 6284163	1x 362321	1x 4214559	2x 370126	4x 6147790	2x 6133722	2x 6318582	18x 428226
1x 6213881	6x 6449595	1x 6284163	1x 6455324	1x 6217123	2x 300426	2x 6039194	7x 4613153	8x 4558170	2x 379526	8x 6094066
2x 6248827	2x 6132203	4x 6286329	1x 6286329	1x 383223	2x 235726	2x 365926	2x 365926	6x 6199908	2x 379526	
1x 6285777	1x 6093053	1x 6375672	1x 6455324	7x 300121	2x 235726	2x 365926	2x 365926	5x 302126	2x 379526	
3x 6299937	2x 6023806	1x 4113916	1x 4113916	1x 366621	3x 300326	2x 6222427	4x 4587844	5x 6162892	82x 416226	

6x 6335388	4x 6424674	3x 6284070	1x 403226	1x 6104209	4x 6172383	8x 6156991	1x 4666322	1x 6134251	1x 6247798
2x 6272184	4x 6380236	6x 4225201	1x 6143850	1x 6093525	10x 6433936	12x 4541191	6x 6361813	2x 6058089	4x 6454463
4x 6310981	4x 6335317	1x 281726	1x 6428168	6x 6170421	1x 6420852	1x 6452332	6x 6315198	1x 6186867	1x 6186867
4x 4161332	8x 6234695	7x 6273226	16x 6191630	1x 9339	1x 6438919	3x 6195185	2x 6315198	6x 6449836	1x 6186867
4x 4161332	3x 6157554	1x 317626	4x 4227392	1x 9339	8x 6173959	5x 6394979	2x 6441768	1x 6253418	6x 6449836
1x 4180536	2x 6330189	3x 6416838	8x 6331483	1x 6431021	1x 6192778	1x 6245251	2x 6143431	3x 6408240	4x 6254552
4x 4160869	8x 6313116	4x 6118829	1x 396026	1x 6430624	1x 6454452	5x 6356406	5x 6186012	8x 6410188	4x 6254552
1x 4180508	2x 243226	6x 6168620	13x 4515350	1x 6438667	2x 6151289	2x 6439039	1x 6092602	23x 6278710	1x 6258607
4x 6284697	10x 6192309	8x 6099483	4x 6434275	1x 6203937	5x 6331084	3x 6332148	4x 4570877	9x 6359273	1x 6258607
1x 6057902	2x 6117973	1x 383926	1x 6187587	1x 6454457	1x 249626	2x 6284699	1x 6092602	1x 6340042	1x 6247785
4x 6284697	20x 6000650	3x 6468138	1x 6327548	1x 6290456	22x 6253473	1x 6338384	4x 4615606	1x 6359041	1x 6247793
2x 6236464	2x 6016172	4x 6401209	4x 4106347	1x 6359833	4x 6284110	3x 6291068	2x 6186423	1x 6429033	1x 6247788
1x 6057902	4x 6310268	1x 6057903	4x 6146220	2x 6186698	1x 4600178	2x 6099801	2x 6186007	3x 6252041	1x 6247364
2x 370826	4x 4107761	1x 6057903	4x 6146220	8x 6395769	1x 4600178	2x 6261386	2x 6186007	1x 6220959	1x 6464185
2x 4527604	10x 6250020	1x 6161298	1x 6408578	13x 6475153	4x 6443446	1x 370526	1x 6074893	1x 6239418	1x 6464185
					11x 6253474	1x 370526			
						5x 370626			

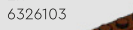
- 17x 4255413
- 40x 4249891
- 2x 6454453
- 4x 6228123
- 4x 6453215
- 22x 6233955
- 13x 4264569
- 1x 6275133
- 2x 6463543
- 4x 6465404
- 2x 6463544
- 12x 6277303
- 1x 6224377
- 4x 6256616
- 2x 6429965
- 5x 6135606
- 2x 4177741
- 6x 6216905
- 8x 6186683
- 1x 6214811
- 1x 6214812
- 12x 6384915
- 4x 6411363
- 16x 6061569
- 9x 6037886
- 9x 6453216
- 4x 6464198
- 62x 4184108
- 2x 6092588
- 32x 4528981
- 20x 4528488
- 12x 6037890
- 2x 4205004
- 8x 6132566
- 41x 4177735
- 7x 4502089
- 1x 6256610
- 4x 4569836
- 5x 6384913
- 2x 4508313
- 4x 6453208
- 12x 6250216
- 4x 6453207
- 8x 4507080
- 4x 6453209
- 4x 6453210
- 5x 6027627
- 4x 6106692
- 12x 6200663
- 2x 6429734
- 2x 6454464
- 8x 6120642
- 7x 6328107
- 2x 6097457
- 2x 6224472
- 2x 6371455
- 20x 6464203
- 2x 6470186
- 4x 6407191
- 1x 6236571
- 8x 4502091
- 8x 4529954
- 8x 6251836
- 4x 6382723
- 1x 6253883
- 8x 6450823
- 4x 6254479
- 2x 6409752
- 1x 6410902
- 2x 6391515
- 2x 4162916
- 1x 6463580
- 1x 6409766
- 4x 6454450
- 4x 6454451
- 4x 6315608
- 1x 6435099
- 1x 6308322
- 1x 6252040
- 8x 6171727
- 4x 4538760
- 2x 4210762
- 1x 4213607
- 1x 4211000
- 2x 6336390
- 1x 6266248
- 4x 6350292
- 8x 4225733
- 6x 6231765
- 1x 4222693
- 2x 6261374
- 4x 4211063
- 1x 4211055
- 2x 4211043
- 4x 4211065
- 4x 4211002
- 2x 6313652
- 2x 4211067

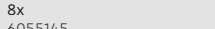
 2x 6258831	 5x 6171894	 1x 6146223	 1x 6201911	 2x 6253167	 2x 6149677	 1x 6236915
 10x 6284071	 4x 4211396	 1x 6468371	 1x 6468374	 1x 6397820	 5x 6341553	 4x 6172636
 4x 4211386	 16x 4211445	 1x 6195471	 1x 6408343	 2x 6322211	 2x 6238874	 12x 6168623
 2x 6123809	 4x 4211395	 1x 6152344	 2x 6268857	 3x 6311210	 4x 6226436	 1x 4211159
 8x 6407412	 8x 4560183	 1x 6195471	 1x 6270078	 16x 6172922	 1x 6290983	 1x 6037289
 24x 6262085	 1x 6402193	 8x 4644102	 2x 6329114	 1x 6365885	 2x 6251470	 1x 6102360
 8x 4251163	 4x 4211425	 4x 4494475	 6x 4211242	 2x 6409552	 1x 4211194	 2x 6342958
 76x 6132207	 4x 4211425	 2x 6271165	 2x 6177699	 2x 6299939	 6x 6257604	 1x 6228841
 2x 4211435	 2x 4211407	 4x 4211807	 2x 4211180	 2x 6325975	 2x 4211186	 1x 6424037
 4x 4211397	 4x 4211401	 1x 6134378	 5x 4211149	 2x 4211288	 1x 4579690	 1x 6398342
 10x 6126082	 4x 4211486	 2x 6420741	 2x 4211210	 2x 4221744	 1x 4211204	 1x 6063447
	 4x 4211725	 8x 6163990	 2x 4211225	 5x 4211151	 1x 4221590	 4x 6291040
		 4x 4211725	 2x 4211193	 1x 4211257	 2x 6326103	 3x 6064188
				 7x 6196221	 8x 6055145	

2x
6395635

2x
6364352

3x
6464199

12x
6218047

4x
4490599

22x
6186672

2x
6335111

8x
6212377

2x
6338242

30x
6449109



 [LEGO.com/service](https://www.LEGO.com/service)

2x
6375358

1x
6372427

7x
6190252

1x
6400656

1x
6327553

1x
6477142

1x
6173139

1x
6056774

8x
6083975

1x
6370621

2x
6452472

1x
4585493

23x
6459521

1x
6451126

2x
6310366

4x
6296061

3x
6102990

2x
6433733

1x
6435640

1x
6467618

1x
6435310

1x
6394960

1x
6102984

2x
6287309

12x
6275872

8x
4653988

4x
6424641

8x
6346764

7x
6133728

4x
6250001

3x
6210675

2x
6337197

4x
6453350

1x
6210601

18x
6454456

1x
4653970

2x
6348142

4x
6335566

6x
6119107

2x
4619513

2x
4625036

9x
6146926

2x
6411330

1x
4583299

1x
4541496

4x
6411595



YOU COULD WIN



YOU COULD WIN

Your feedback will help shape the future development of this product series.

Visit:

DU KÖNNTEST GEWINNEN

Dein Feedback trägt zur Weiterentwicklung dieser Produktreihe bei.

Geh auf:

VOUS POURRIEZ GAGNER

Vos commentaires nous aideront à concevoir les futurs produits de cette gamme.

Visitez :

POTRESTI VINCERE TU

La tua opinione ci aiuterà a migliorare la creazione futura di questa linea di prodotti.

Visita:

PUEDES GANAR

Tu opinión contribuirá al futuro de esta serie de productos.

Visita:

轻松获奖

您的反馈将有助于我们在今后改进本产品系列。

请访问:

LEGO.com/productfeedback

You also have the chance to win a LEGO® set.

Terms and conditions apply.*

Außerdem hast du die Chance, ein LEGO® Set zu gewinnen.

Es gelten die Teilnahmebedingungen.*

Vous pourriez également gagner un ensemble LEGO®.

Des conditions s'appliquent.*

Hai anche la possibilità di vincere un set LEGO®.

Termini e condizioni sono applicabili.*

También tienes la oportunidad de ganar un set LEGO®.

Aplican términos y condiciones.*

您还有机会赢取乐高®套装。

条款和条件适用。*

*LEGO.com/productfeedback-terms

ORIENT EXPRESS



LEGO and the LEGO logo are trademarks of the LEGO Group. ©2023 The LEGO Group. 6487802
ORIENT EXPRESS™ is a registered trade mark of Orient Express. All rights reserved.