

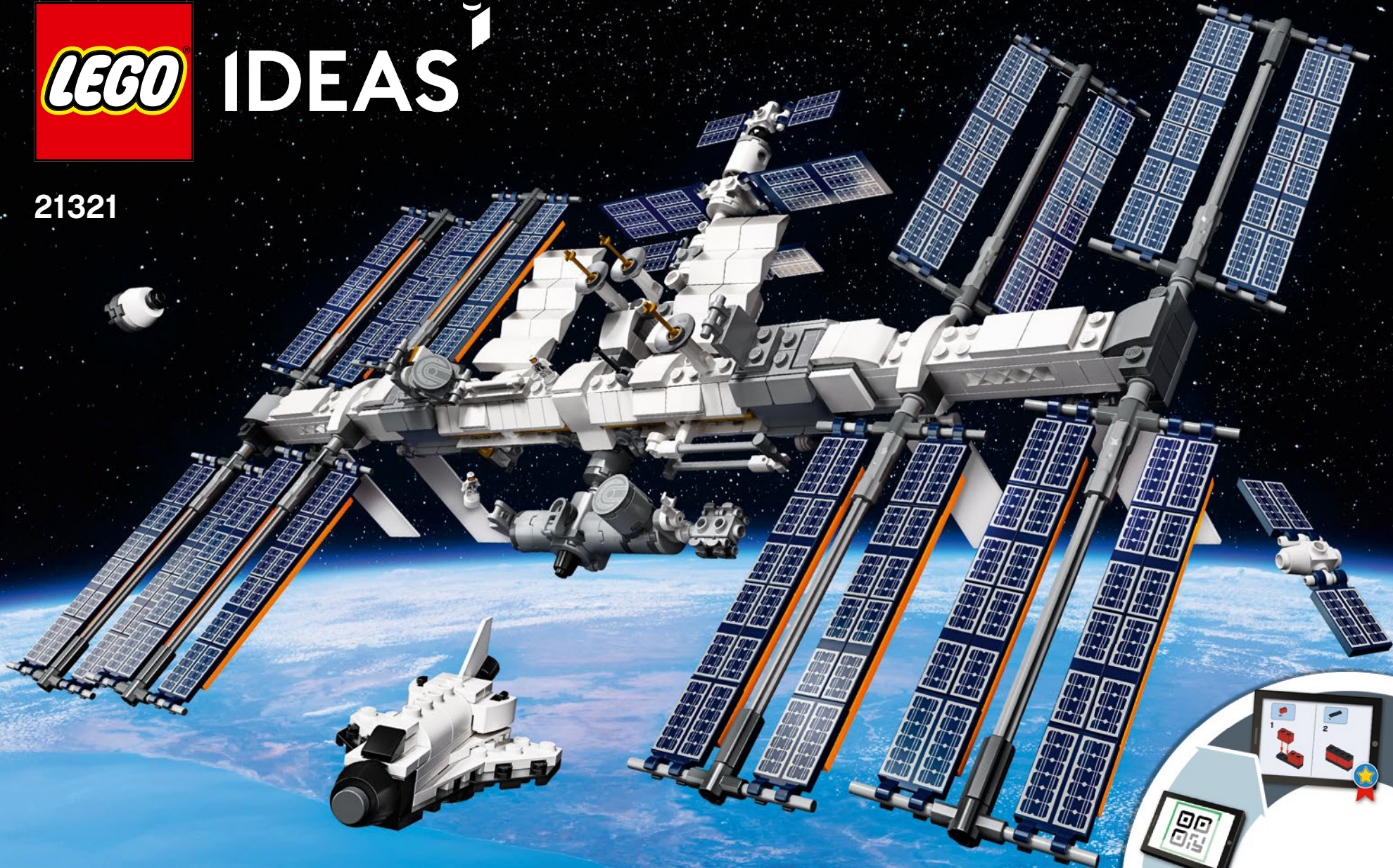

# IDEAS

21321

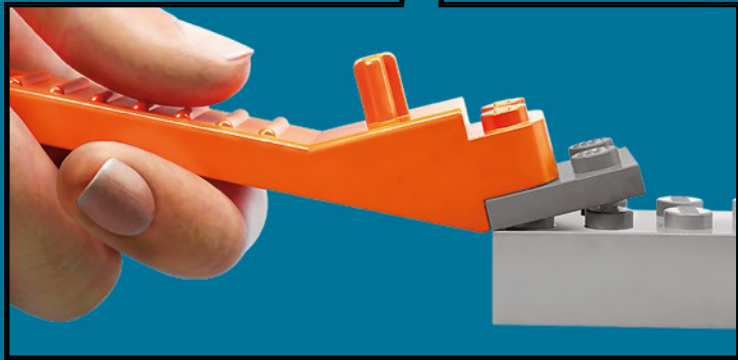

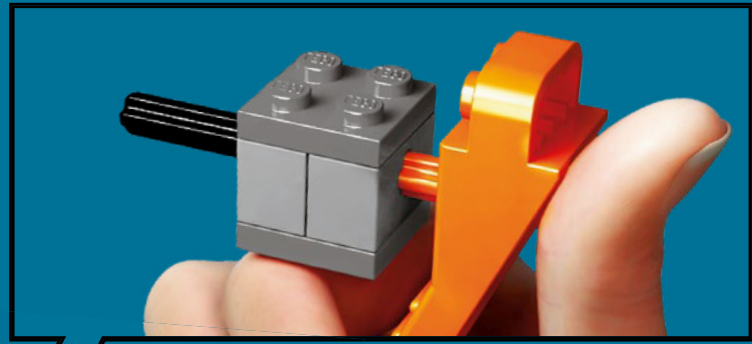
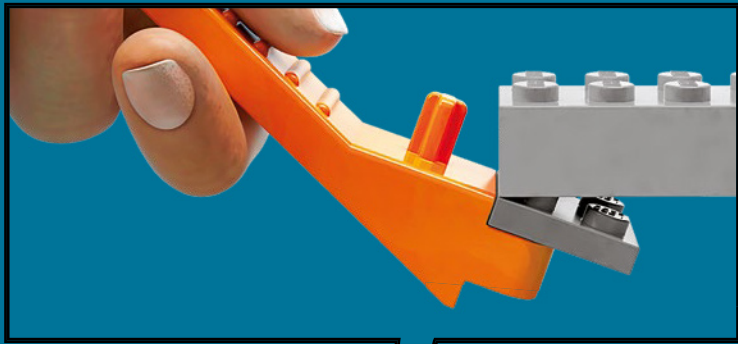

[LEGO.com/brickseparator](https://LEGO.com/brickseparator)



- 1** Scan the code on the front cover  
Scanne den Code auf der Titelseite  
Scanner le code sur la page couverture  
Scansiona il codice sulla copertina  
Escanea el código de la portada  
Faz scan do código na frente da capa  
Olvasd be a borítón látható kódot!  
Noskenē kodu uz priekšējā vāka  
扫描封面上的二维码

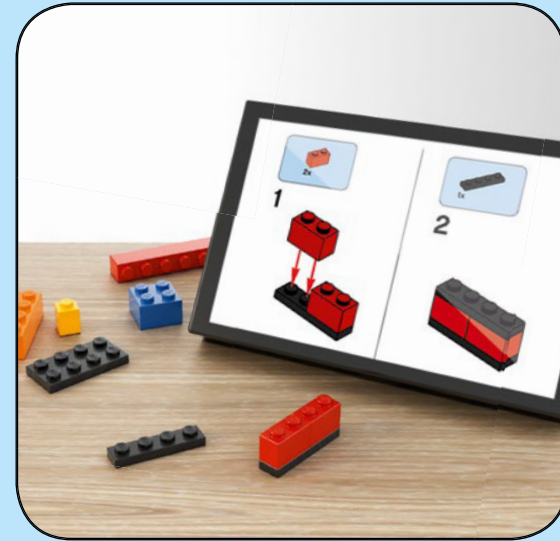

- 2** Get the Building Instructions  
Hol dir die Bauanleitung  
Hol dir die Bauanleitung  
Obtenir les instructions de montage  
Scarica le istruzioni per la costruzione  
Consulta las instrucciones de construcción  
Obtém as Instruções de Construção  
Szerezd be az építési útmutatókat!  
Saņem būvēšanas instrukcijas  
获取拼搭说明

[LEGO.com/apps](https://www.lego.com/apps)

Check for compatibility  
Kompatibilität prüfen  
Vérifier la compatibilité  
Controlla la compatibilità  
Comprueba tu compatibilidad

Verificar a compatibilidade  
Ellenőrizd a kompatibilitást  
Pārbaudīt saderību  
检查兼容性



## Many nations. Shared intentions.

It is truly astounding to think that nearly 16 times a day, the International Space Station orbits Earth on a continuous path of discovery. The space station is a truly international collaboration between five space agencies: NASA (United States), Roscosmos (Russia), JAXA (Japan), ESA (Europe), and CSA (Canada). Utilizing their technological strengths, the participating countries work together under the umbrella of the International Space Station program to achieve common goals that benefit all humankind.

### **Benefits**

The 15 nations involved provide global leadership to advance human exploration, enable scientific research that benefits humanity, and establish a robust low-Earth orbit economy. In parallel to achieving these goals, the partnership also utilizes the space station's unique platform to provide science, technology, engineering, and mathematics (STEM) resources to educate the next generation of leaders and space explorers.





### **Research in Space**

What happens onboard this space station is also astonishing. The station has maintained a continuous human presence in space since November 2000. The astronauts onboard have performed thousands of investigations dedicated to areas of earth and space science, biology, human physiology, physical sciences and technology demonstrations. As NASA states "The International Space Station is a state-of-the-art microgravity laboratory that is unlocking discoveries not possible on Earth and helping us push further into deep space." Research on this immense orbiting laboratory, the largest spacecraft ever built, is investigating how we can send humans farther into space to the Moon and Mars to explore the frontiers of knowledge.



*Christoph Ruge, Fan Designer*

## Meet the Fan Designer Christoph Ruge

"In 2014, I got the idea to model the International Space Station using the LEGO® Digital Designer. Since I didn't have the bricks to build it myself, I thought it would be cool if the LEGO Group would do that instead!

Once it was ready, I set up an entry on LEGO Ideas. The project was well appreciated in the community and had a good start. Nevertheless, it was a long way to reach 10,000 votes. That gave me time to build other space-related models and continue my research about the station itself. So, I refined my model over and over again.

In the end it looked nothing like the first version I posted. I continued and didn't stop, even after the project finally reached the goal and got reviewed by the LEGO Group.

All in all, I had worked for more than three years on the first model and probably knew everything about the space station at that time. This research and knowledge became very handy when the Women of NASA (21312) set came onto the market. That was the moment I got the idea to do another version of the space station in the same scale as the shuttle included in this set. So, I built a new model and set it up on LEGO Ideas.

Again, it took a while to gather support and reach the review phase. Again, it got there. And again, it was rejected.

But then, I got news that my earlier model had passed the special anniversary review to celebrate the 10th anniversary of LEGO Ideas and that there would be a fan vote to determine which model would be built! That was very exciting.

I can be very resourceful in terms of being patient and waiting for something when I think it is a good idea... but I can be impatient as well. I think it is worth fighting for your dreams!"



"I was overwhelmed when I got the news! Since the fan vote was a blind vote, I was only able to imagine how my chances were progressing. I felt sorry for the other three contestants; I would have loved to see Stitch produced as well! All in all, it felt quite unreal."



LEGO® designers Samuel Johnson, Crystal Fontan and Corvin Alexander Stichert were the team who helped take the already awesome ISS design to the finish line: refining the design, working on the graphics and ensuring that the original design met the LEGO requirements for stability and quality.



## More than a decade of amazing LEGO® Ideas!

The bubbling hive of creativity that is LEGO® Ideas turned ten years old at the end of 2018. Originally called LEGO CUUSOO, this creativity crowdsourcing concept has evolved and expanded over the years, finding new ways of collaborating with the many talented and passionate LEGO fans around the world.

Along LEGO Ideas' journey we have encountered many incredible stories while working with amazing LEGO fans, that have resulted in the launch of some of the most unique LEGO sets ever produced.

For the 10-year anniversary review, we dug into the LEGO Ideas archive of unlaunched 10K product ideas to rediscover concepts that still had the potential of becoming an official LEGO Ideas set. We then involved the LEGO Ideas Community in a special vote to make the final choice.

We're proud to present the winner: this brilliant replica of the International Space Station, the largest human-made structure that exists off the Earth.

Enjoy and keep creating!



© 2020 Mojang AB and Mojang Synergies AB. MINECRAFT is a trademark or registered trademark of Mojang Synergies AB.

Back to the Future Films are trademarks and copyrights of Universal Studios and U-Drive Joint Venture. Licensed by Universal Studios Licensing LLC. All Rights Reserved.



© 2014 Columbia Pictures Industries, Inc. All rights reserved.

THE BIG BANG THEORY and all related characters and elements are trademarks of and © Warner Bros. Entertainment Inc.



WB SHIELD: TM & © Warner Bros. Entertainment Inc.

© Disney/Pixar

BBC, DOCTOR WHO (word marks, logos and devices), TARDIS, DALEKS, CYBERMAN and K-9 (word marks and devices) are trademarks of the British Broadcasting Corporation and are used under license. BBC logo © BBC 1996. Doctor Who logo © BBC 2009. Dalek image © BBC/Terry Nation 1963. Cyberman image © BBC/Kit Pedler/Gerry Davis 1966. K-9 image © BBC/Bob Baker/Dave Martin 1977.

BBC

© 2016 Subafilms Ltd. A Yellow Submarine™ product. ™ Trade Mark of Subafilms Ltd © 1968. Authorised Beatles™ merchandise.

Produced under license of Caterham Cars Ltd. The CATERHAM logo, name SEVEN and the 7 device are trademarks used with the approval of the owner; Caterham Cars Lt.

ADVENTURE TIME, CARTOON NETWORK, the logos, and all related characters and elements are trademarks of and © Cartoon Network.

TM & © World Events Productions, Ltd. Under license to Classic Media, LLC.

© Disney





## LEGO® Ideas and Space

The concept of space is one that has a universally fascinating appeal to LEGO® brick fans, and people of all ages worldwide, which is why there have already been some truly iconic LEGO Ideas sets based around the theme.

The International Space Station (ISS) is an amazing addition to this category of LEGO Ideas sets. Check out some of the earlier models and be prepared to be spaced out!

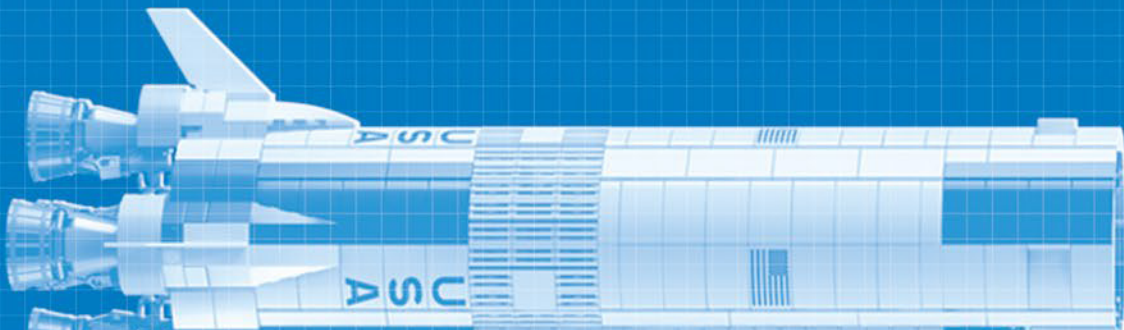

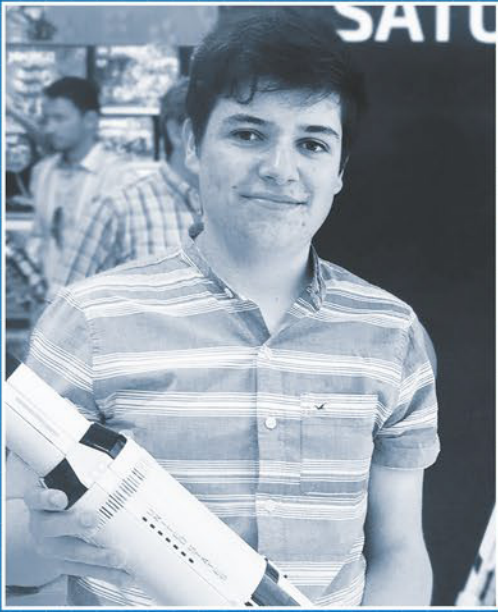

*Felix Stiessen, Co-Fan Designer*

### **NASA Apollo Saturn V**

At a mind-blowing 3+ feet high, this majestic model was packed with details and features. These included the three rocket stages, as well as the lunar lander and orbiter, all of which really do justice to the ground-breaking space mission of the Moon landing. A great job done by Valerie Roche and Felix Stiessen, the Co-Fan designers of the model.

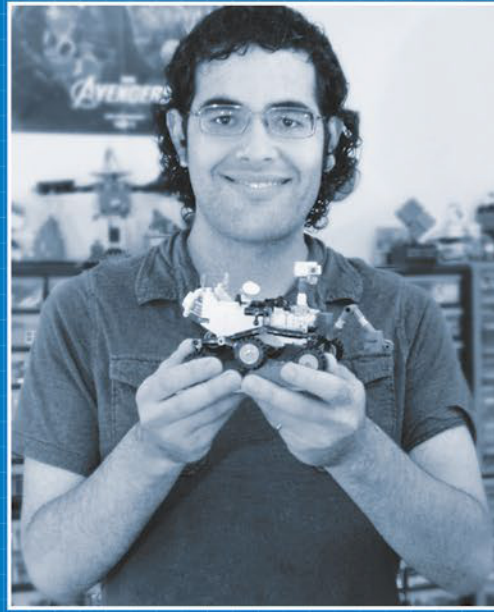

*Stephen Pakbaz, Fan Designer*

### **NASA Mars Science Laboratory Curiosity Rover**

Designed by real Curiosity Rover engineer, Stephen Pakbaz, this little LEGO® brick buggy represents all the innovation and expertise that was packed into the advanced mobile laboratory that had a key role in the history of space exploration.



*Maia Weinstock, Fan Designer*

### **Women of NASA**

A tribute to some of the most ground-breaking women in science, technology, engineering and mathematics (STEM), this set honored the work of four female space pioneers: astronomer and educator Nancy Grace Roman, computer scientist and entrepreneur Margaret Hamilton, astronaut, physicist and entrepreneur Sally Ride and astronaut, physician and engineer Mae Jemison.

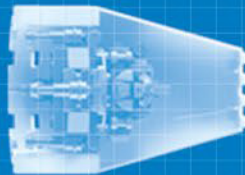

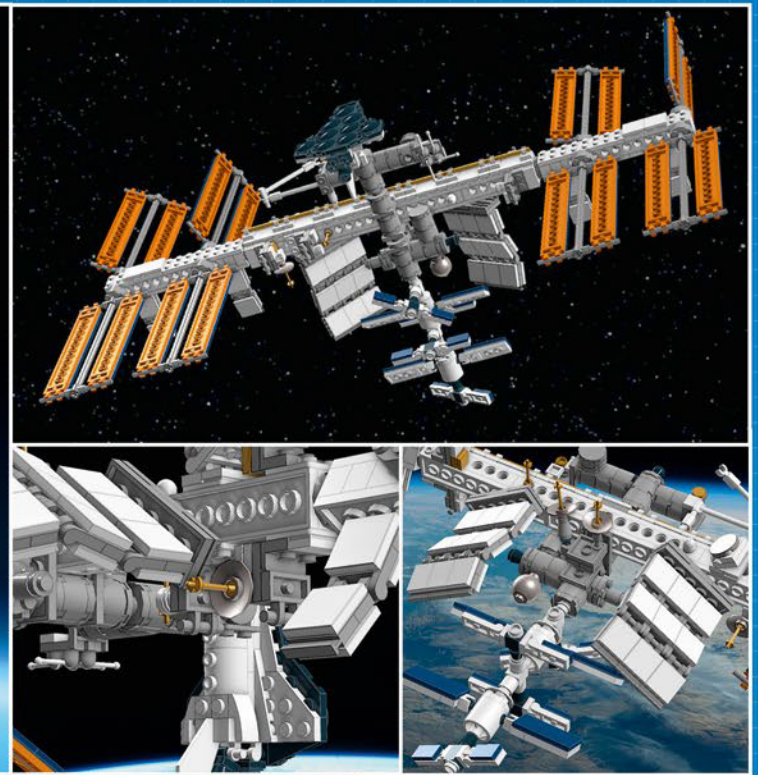
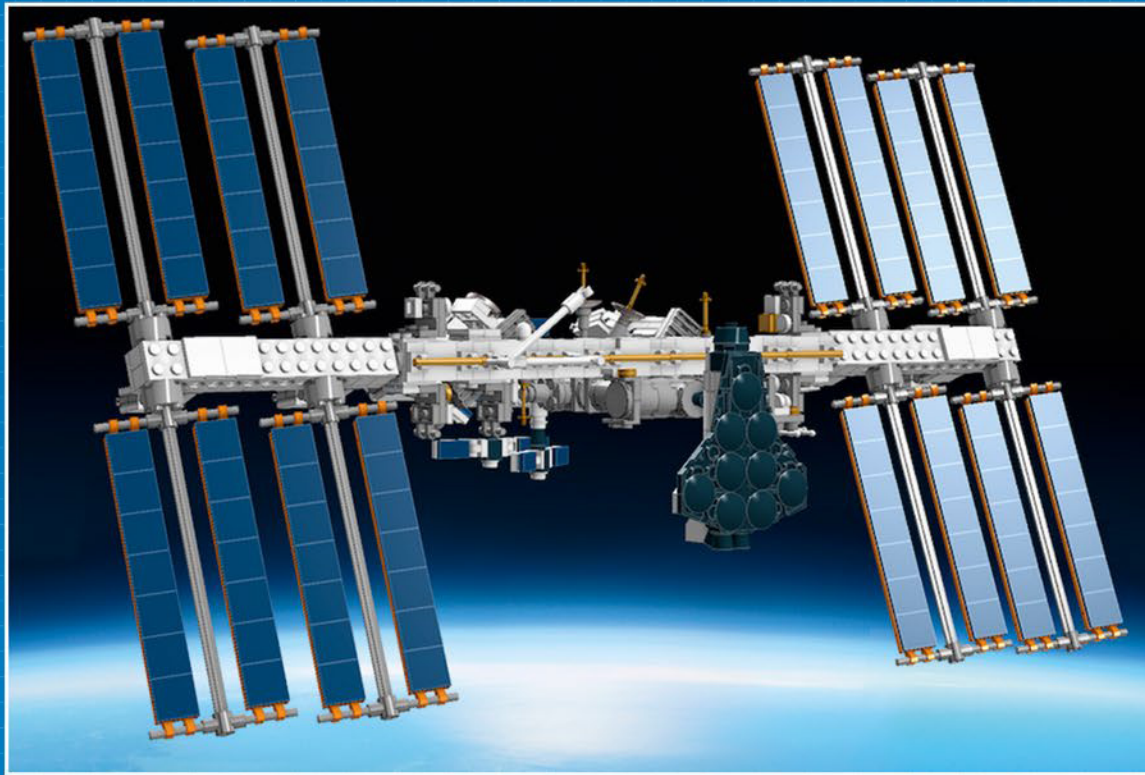

## The 10 Year Anniversary Special Review

The International Space Station was chosen as the winning LEGO® Ideas set via a slightly different selection process than the normal LEGO Ideas sets...

“To celebrate 10 years of crowdsourcing and collaboration between LEGO Ideas (called LEGO CUUSOO until 2014) and LEGO fans around the world, we decided to dive into the archives of LEGO Ideas projects that had gathered 10,000 supporters but hadn’t made it into production. There were over 130 projects which met that criteria and that we believed could still make great LEGO Ideas products, as circumstances around their initial rejection had changed.”



Hasan Jensen,  
Engagement Manager

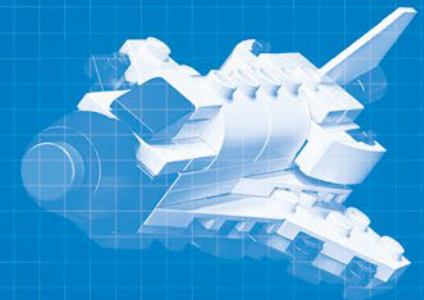

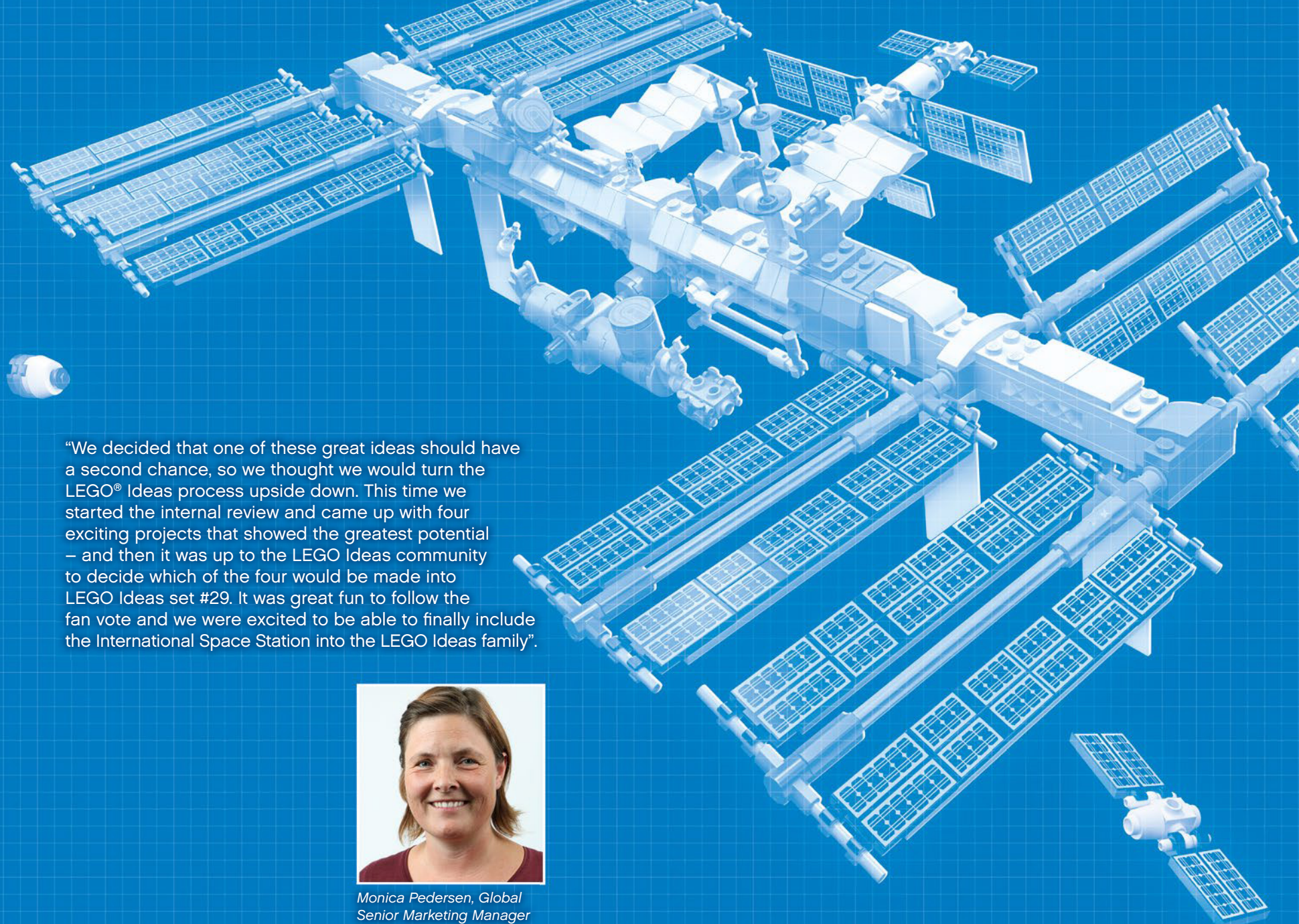

“We decided that one of these great ideas should have a second chance, so we thought we would turn the LEGO® Ideas process upside down. This time we started the internal review and came up with four exciting projects that showed the greatest potential – and then it was up to the LEGO Ideas community to decide which of the four would be made into LEGO Ideas set #29. It was great fun to follow the fan vote and we were excited to be able to finally include the International Space Station into the LEGO Ideas family”.



*Monica Pedersen, Global Senior Marketing Manager*



## Plusieurs nations. Les mêmes intentions.

Il est vraiment incroyable de penser que près de 16 fois par jour, la Station spatiale internationale orbite autour de la Terre sur un chemin continu de découverte. La station spatiale est une collaboration internationale entre cinq agences spatiales : NASA (États-Unis), Roscosmos (Russie), JAXA (Japon), ESA (Europe) et ASC (Canada). Unissant leurs forces technologiques, les pays participants collaborent dans le cadre du programme de la Station spatiale internationale pour atteindre des objectifs communs qui profitent à toute l'humanité.

### Avantages

Les 15 pays concernés assurent un leadership mondial pour faire progresser l'exploration humaine, favoriser la recherche scientifique qui profite à l'humanité et établir une économie solide en orbite terrestre basse. Parallèlement à la réalisation de ces objectifs, le partenariat utilise également la plate-forme unique de la station spatiale pour fournir des ressources en matière de science, technologie, ingénierie et mathématiques (STIM) pour éduquer la prochaine génération de leaders et d'explorateurs de l'espace.

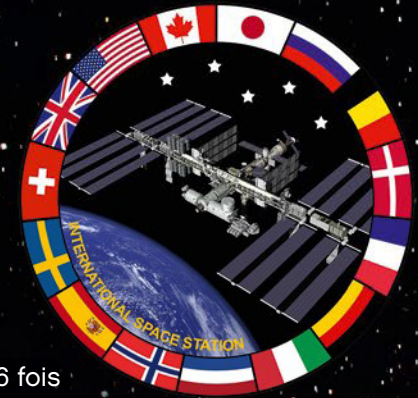



### **La recherche dans l'espace**

Ce qui se passe à bord de cette station spatiale est également étonnant. La station maintient une présence humaine continue dans l'espace depuis novembre 2000. Les astronautes à bord ont effectué des milliers d'études consacrées aux domaines des sciences de la Terre et de l'espace, de la biologie, de la physiologie humaine, des sciences physiques et des démonstrations technologiques. Comme l'affirme la NASA : « La Station spatiale internationale est un laboratoire de microgravité de pointe qui permet des découvertes impossibles sur Terre et qui nous aide à aller plus loin dans l'espace lointain. » La recherche effectuée dans cet immense laboratoire en orbite, le plus grand vaisseau spatial jamais construit, étudie comment nous pouvons envoyer des humains plus loin dans l'espace, vers la Lune et Mars, pour explorer les frontières de la connaissance.

# Rencontre avec le concepteur amateur Christoph Ruge

« En 2014, j'ai eu l'idée de modéliser la Station spatiale internationale à l'aide du logiciel LEGO® Digital Designer. Comme je n'avais pas les briques pour construire le modèle moi-même, je me suis dit qu'il serait bien que le Groupe LEGO le fasse à ma place !

Une fois mon projet terminé, je l'ai présenté sur LEGO Ideas. Il a été bien apprécié dans la communauté et a connu un bon début. Néanmoins, il restait beaucoup de chemin à faire pour atteindre les 10 000 votes. Cela m'a donné le temps de construire d'autres modèles sur le thème de l'espace et de poursuivre mes recherches sur la station spatiale. J'ai donc peaufiné mon modèle encore et encore.

En fin de compte, il ne ressemblait plus du tout à la première version que j'avais proposée. J'ai continué et je ne me suis pas arrêté, même lorsque le projet a finalement atteint l'objectif et a été examiné par le Groupe LEGO.

Dans l'ensemble, j'avais travaillé pendant plus de trois ans sur le premier modèle, et je savais probablement tout sur la station spatiale à cette époque. Cette recherche et ces connaissances sont devenues très utiles lorsque l'ensemble Les femmes de la NASA (21312) est arrivé sur le marché. C'est à ce moment que j'ai eu l'idée de faire une autre version de la station spatiale à la même échelle que la navette incluse dans cet ensemble. J'ai donc construit un nouveau modèle que j'ai proposé sur LEGO Ideas.

Encore une fois, il a fallu un certain temps pour que le modèle recueille des appuis et atteigne la phase d'examen. Mais il l'a atteint encore une fois. Et encore une fois, il a été rejeté.

J'ai alors appris que mon modèle précédent avait passé l'examen spécial pour célébrer le 10<sup>e</sup> anniversaire de LEGO Ideas et qu'il y aurait un vote des fans pour déterminer quel modèle serait construit ! C'était très excitant.

Je peux être très patient pour attendre quelque chose quand je pense que c'est une bonne idée... mais je peux aussi être impatient. Je pense qu'il vaut la peine de se battre pour ses rêves ! »



Christoph Ruge, Concepteur Amateur





« J'ai été bouleversé quand j'ai appris la nouvelle ! Comme le vote des fans était un vote à l'aveugle, je ne pouvais qu'imaginer comment mes chances progressaient. J'étais désolé pour les trois autres candidats; j'aurais aimé que Stitch soit produit aussi ! Dans l'ensemble, tout semblait irréel. »



Les concepteurs LEGO® Samuel Johnson, Crystal Fontan et Corvin Alexander Stichert formaient l'équipe qui a aidé à finaliser la conception de la SSI déjà impressionnante. Ils ont affiné la conception, travaillé sur le graphisme et fait en sorte que le concept original respecte les exigences de LEGO en matière de stabilité et de qualité.

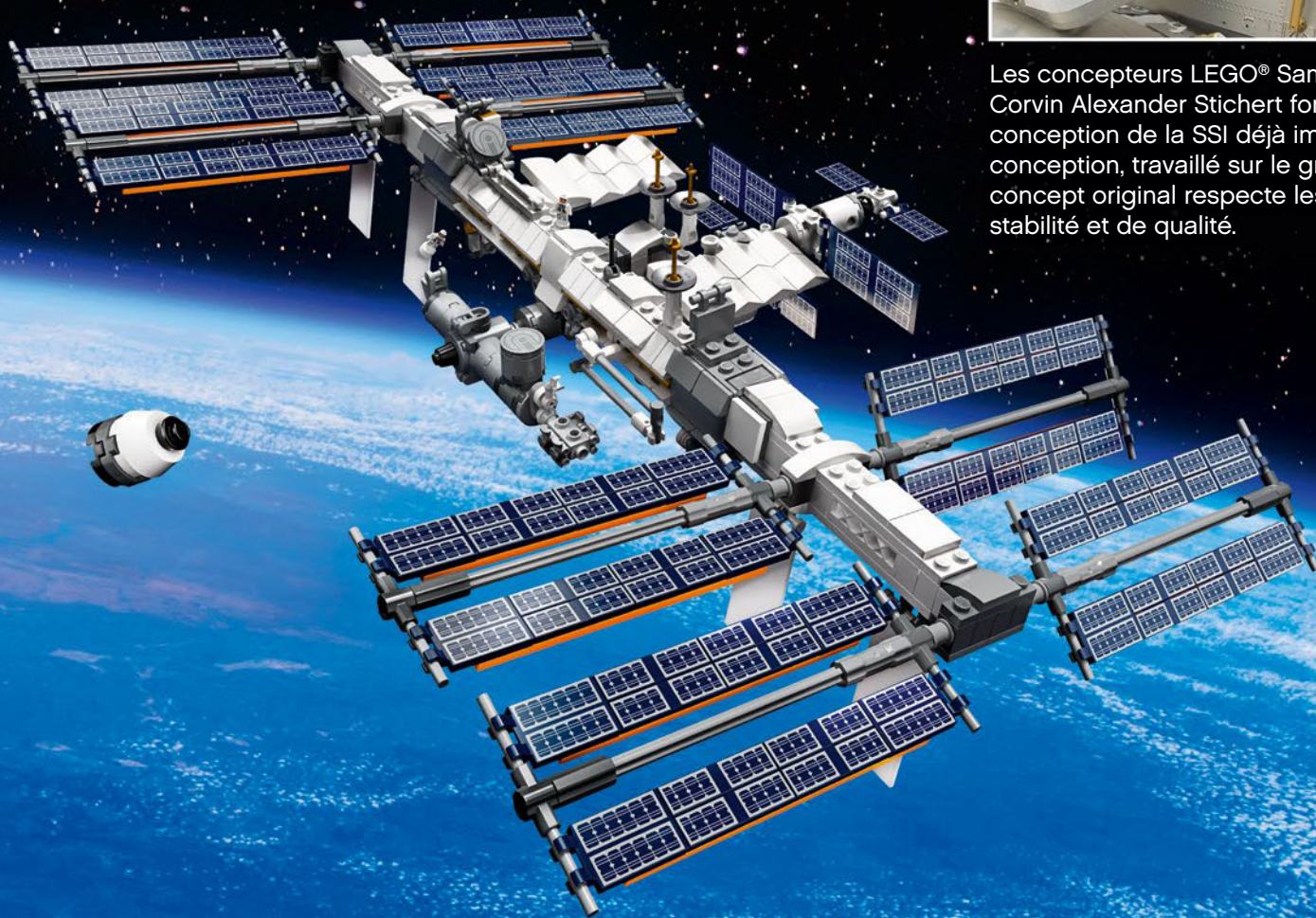



## Plus d'une décennie d'idées incroyables avec LEGO® Ideas !

LEGO® Ideas, une véritable ruche débordante de créativité, a eu dix ans à la fin de 2018. Initialement appelé LEGO CUUSOO, ce concept de participation ouverte a évolué et s'est développé au fil des années, trouvant de nouvelles façons de collaborer avec les nombreux fans de LEGO talentueux et passionnés dans le monde entier.

Tout au long du parcours de LEGO Ideas, nous avons vécu de nombreuses histoires incroyables en travaillant avec des fans de LEGO fantastiques. Certains projets ont abouti au lancement des ensembles LEGO les plus uniques jamais produits.

Pour l'examen organisé en l'honneur du 10<sup>e</sup> anniversaire de LEGO Ideas, nous avons creusé dans les archives d'idées de produits qui avaient obtenu 10 000 votes sans être choisies, afin de redécouvrir des concepts qui avaient toujours le potentiel de devenir des ensembles officiels de LEGO Ideas. Nous avons ensuite convié la communauté LEGO Ideas à un vote spécial pour déterminer le choix final.

Nous sommes fiers de vous présenter le modèle gagnant : cette formidable réplique de la Station spatiale internationale, la plus grande structure artificielle en orbite terrestre.

Amusez-vous et continuez à créer !

© 2020 Mojang AB and Mojang Synergies AB. MINECRAFT is a trademark or registered trademark of Mojang Synergies AB.

Back to the Future Films are trademarks and copyrights of Universal Studios and U-Drive Joint Venture. Licensed by Universal Studios Licensing LLC. All Rights Reserved.



© 2014 Columbia Pictures Industries, Inc. All rights reserved.

THE BIG BANG THEORY and all related characters and elements are trademarks of and © Warner Bros. Entertainment Inc.



WB SHIELD: TM & © Warner Bros. Entertainment Inc.

© Disney/Pixar

BBC, DOCTOR WHO (word marks, logos and devices), TARDIS, DALEKS, CYBERMAN and K-9 (word marks and devices) are trademarks of the British Broadcasting Corporation and are used under license. BBC logo © BBC 1996. Doctor Who logo © BBC 2009. Dalek image © BBC/Terry Nation 1963. Cyberman image © BBC/Kit Pedler/Gerry Davis 1966. K-9 image © BBC/Bob Baker/Dave Martin 1977.

BBC

© 2016 Subafilms Ltd. A Yellow Submarine™ product. ™ Trade Mark of Subafilms Ltd © 1968. Authorised Beatles™ merchandise.

Produced under license of Caterham Cars Ltd. The CATERHAM logo, name SEVEN and the 7 device are trademarks used with the approval of the owner; Caterham Cars Lt.

ADVENTURE TIME, CARTOON NETWORK, the logos, and all related characters and elements are trademarks of and © Cartoon Network.

TM & © World Events Productions, Ltd. Under license to Classic Media, LLC.

© Disney





## LEGO® Ideas et l'espace

Le concept de l'espace exerce un attrait universellement fascinant pour les fans des briques LEGO® et les gens de tous âges dans le monde entier, c'est pourquoi il y a déjà eu quelques ensembles LEGO Ideas vraiment emblématiques basés sur ce thème.

La Station spatiale internationale (SSI) est un excellent ajout à cette catégorie d'ensembles LEGO Ideas. Découvrez quelques-uns des modèles précédents et préparez-vous à être impressionné !

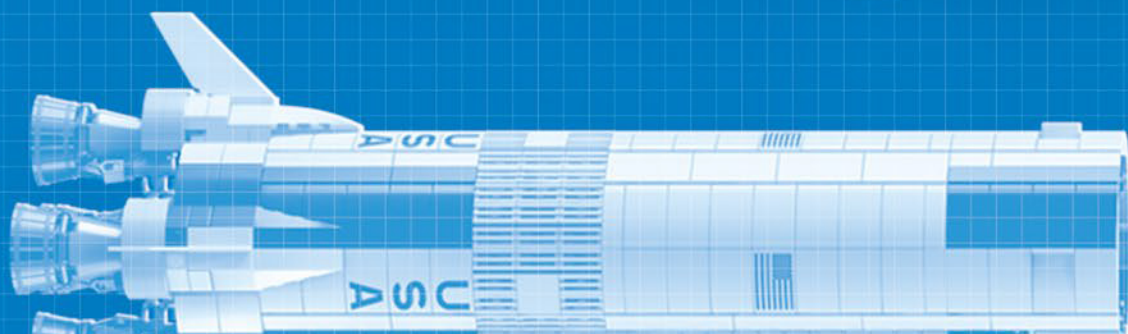

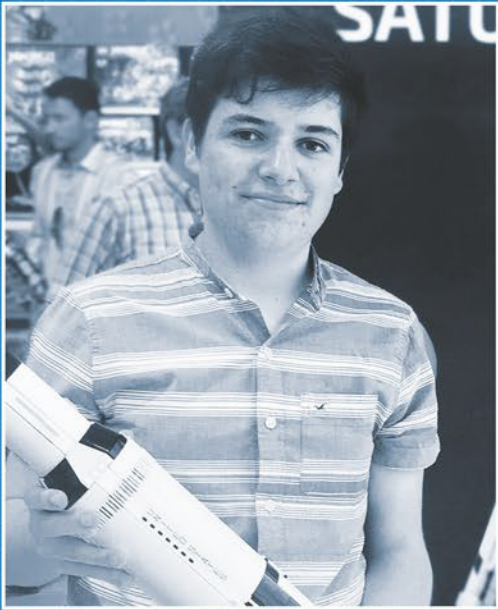

*Felix Stiessen, co-concepteur amateur*

### **NASA Apollo Saturn V**

Avec une hauteur époustouflante de plus de 90 cm, ce modèle majestueux comporte une foule de détails et de fonctionnalités. Il comprend notamment les trois étages de la fusée, ainsi que le module lunaire et l'orbiteur. Tous ces éléments constituent un superbe hommage à la mission spatiale révolutionnaire d'atterrissage sur la Lune. Valerie Roche et Felix Stiessen, les co-concepteurs amateurs du modèle, ont fait un excellent travail.

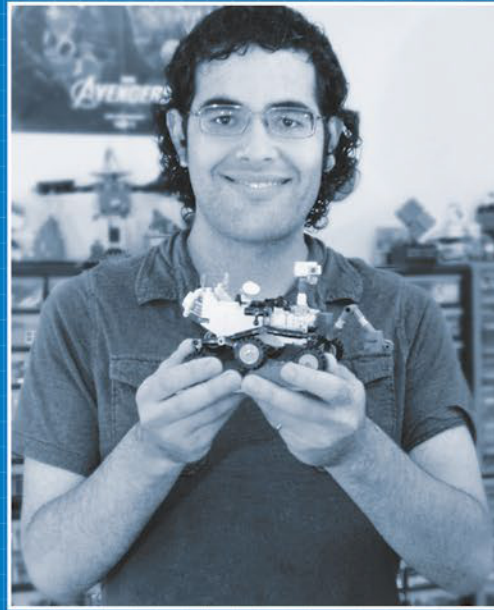

*Stephen Pakbaz, concepteur amateur*

### **Le rover Curiosity du laboratoire scientifique pour Mars de la NASA**

Conçu par l'un des ingénieurs du véritable rover Curiosity, Stephen Pakbaz, ce petit buggy en briques LEGO® représente toute l'innovation et l'expertise derrière ce laboratoire mobile perfectionné qui a joué un rôle clé dans l'histoire de l'exploration spatiale.



*Maia Weinstock, conceptrice amateur*

### **Les femmes de la NASA**

Cet ensemble est un hommage à quelques-unes des femmes les plus révolutionnaires en science, technologie, ingénierie et mathématiques (STIM). Il honore le travail de quatre pionnières de l'espace : l'astronome et éducatrice Nancy Grace Roman, l'informaticienne et entrepreneure Margaret Hamilton, l'astronaute, physicienne et entrepreneure Sally Ride et l'astronaute, médecin et ingénieure Mae Jemison.

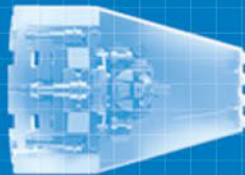

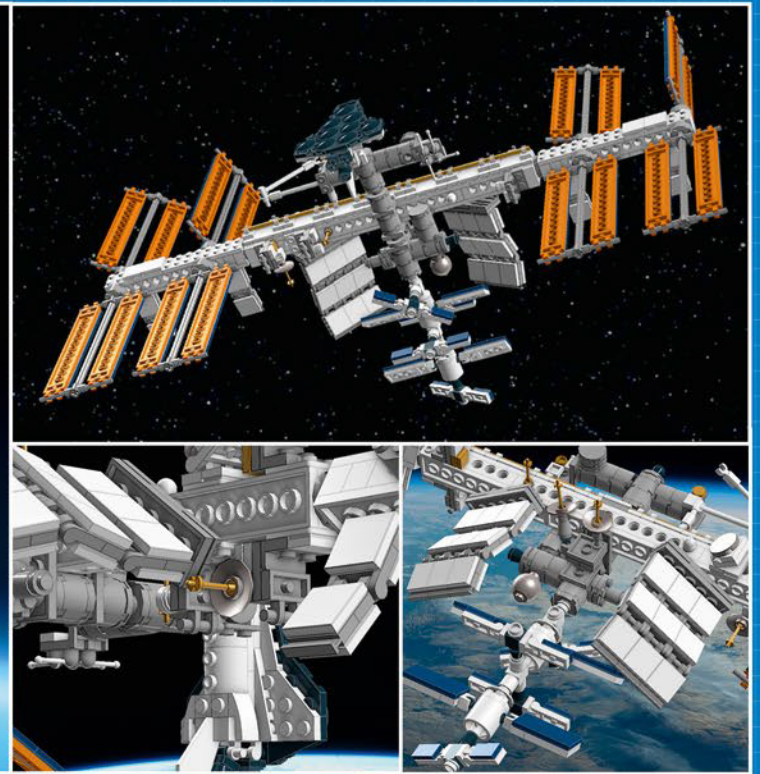
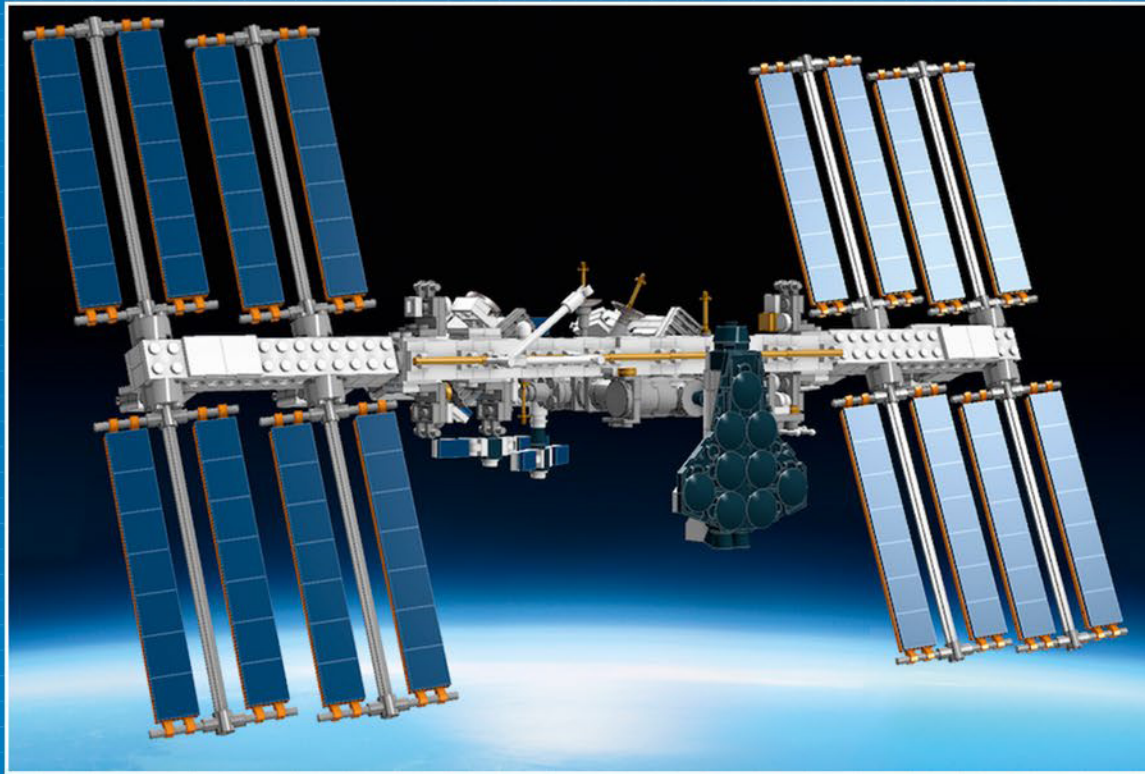

## L'examen spécial du 10<sup>e</sup> anniversaire

La Station spatiale internationale a été choisie comme modèle lauréat de LEGO® Ideas par le biais d'un processus de sélection légèrement différent de celui des autres ensembles LEGO Ideas...

« Pour célébrer les 10 ans de production participative et de collaboration entre LEGO Ideas (appelé LEGO CUUSOO jusqu'en 2014) et les fans de LEGO à travers le monde, nous avons décidé de plonger dans les archives des projets LEGO Ideas qui avaient obtenu 10 000 votes, mais ne s'étaient pas rendus à l'étape de la production. Il y avait plus de 130 projets qui répondaient à ces critères et qui, selon nous, pouvaient encore faire d'excellents produits LEGO Ideas, car les circonstances entourant leur rejet initial avaient changé. »



Hasan Jensen,  
responsable de l'engagement



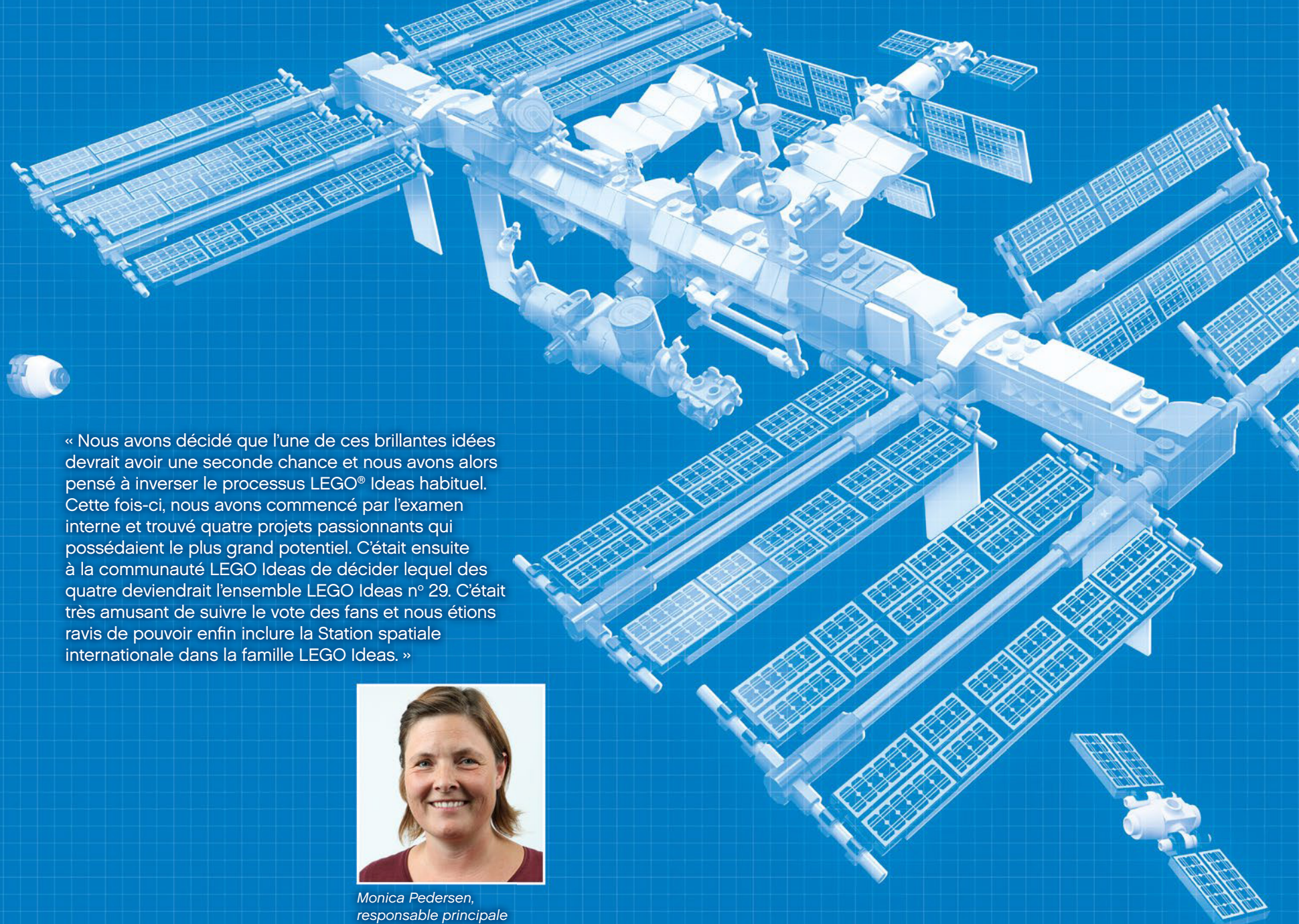

« Nous avons décidé que l'une de ces brillantes idées devrait avoir une seconde chance et nous avons alors pensé à inverser le processus LEGO® Ideas habituel. Cette fois-ci, nous avons commencé par l'examen interne et trouvé quatre projets passionnants qui possédaient le plus grand potentiel. C'était ensuite à la communauté LEGO Ideas de décider lequel des quatre deviendrait l'ensemble LEGO Ideas n° 29. C'était très amusant de suivre le vote des fans et nous étions ravis de pouvoir enfin inclure la Station spatiale internationale dans la famille LEGO Ideas. »



*Monica Pedersen,  
responsable principale  
du marketing mondial*



## Muchas naciones. Propósitos comunes.

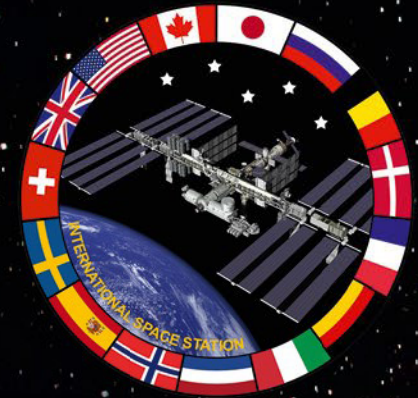

La idea de que la Estación Espacial Internacional complete unas 16 órbitas diarias alrededor de la Tierra en una constante senda de descubrimiento es verdaderamente extraordinaria. Hablamos de una estación espacial fruto de la colaboración internacional entre cinco agencias espaciales: NASA (Estados Unidos), Roscosmos (Rusia), JAXA (Japón), ESA (Europa) y CSA (Canadá). Invirtiendo sus fortalezas tecnológicas, los países participantes trabajan juntos en el marco del programa Estación Espacial Internacional con el objetivo de alcanzar metas comunes que benefician a toda la humanidad.

### Ventajas

Las 15 naciones involucradas aportan liderazgo a nivel internacional para el progreso de la exploración humana, fomentan las investigaciones científicas que benefician a la humanidad y sientan las bases de una economía sólida en torno a la órbita baja del planeta. Paralelamente a la consecución de tales objetivos, la asociación aprovecha la incomparable plataforma que ofrece la estación espacial para crear recursos STEM en los campos de la ciencia, la tecnología, la ingeniería y las matemáticas con el fin de educar a la próxima generación de líderes y exploradores espaciales.





### **Investigar en el espacio**

Lo que sucede a bordo de esta estación espacial es también impresionante. La estación ha mantenido presencia humana constantemente en el espacio desde noviembre de 2000. Los astronautas a bordo han llevado a cabo miles de investigaciones en las áreas de las ciencias terrestres y espaciales, la biología, la fisiología humana, las ciencias físicas y las demostraciones tecnológicas. Tal como afirma la NASA: “La Estación Espacial Internacional es un laboratorio de microgravedad de última generación que está desentrañando misterios imposibles de esclarecer en la Tierra y nos está ayudando a adentrarnos más en el espacio profundo”. Investigar en este inmenso laboratorio en órbita (la nave espacial más grande que se haya construido) es descubrir cómo podemos enviar seres humanos a mayores distancias en el espacio, hasta la Luna y Marte, en busca de las fronteras del conocimiento.



Christoph Ruge, Fan Diseñador

## Conoce a Christoph Ruge, el fan diseñador

“En 2014 se me ocurrió modelar la Estación Espacial Internacional con LEGO® Digital Designer. Como no tenía bricks para construirla yo mismo, ipensé que sería genial que The LEGO Group lo hiciera en mi lugar!

Cuando estuvo lista, preparé mi participación en LEGO Ideas. El proyecto fue recibido positivamente por la comunidad y empezó con el pie derecho. Aun así, el camino hasta los 10.000 votos fue largo. Eso me dio tiempo para construir otros modelos espaciales y continuar investigando sobre la estación. Aproveché para refinar el modelo varias veces.

Al final, no tenía nada que ver con la primera versión que publiqué. Seguí sin detenerme, incluso cuando el proyecto alcanzó por fin la meta y fue revisado por The LEGO Group.

En total, dediqué más de tres años al primer modelo; probablemente para entonces conocía toda la información disponible sobre la estación espacial. Tanta investigación y experiencia resultaron muy útiles cuando salió a la venta el set Mujeres de la NASA (21312). Fue en ese momento cuando tuve la idea de hacer otra versión de la estación espacial a la misma escala que el transbordador que incluye ese set. Así que construí un nuevo modelo y lo publiqué en LEGO Ideas.

Una vez más, tardé un poco en reunir apoyos y llegar a la fase de revisión. Pero volví a lograrlo. Y me lo rechazaron otra vez.

¡Entonces supe que mi anterior modelo había superado la revisión especial por el 10º aniversario de LEGO Ideas y que tendría lugar una votación entre los fans para elegir el modelo que se construiría! Fue muy emocionante.

Puedo ser muy paciente y sé esperar cuando creo que tengo una buena idea..., pero también puedo ser impaciente. ¡Creo que vale la pena luchar por tus sueños!”



“¡Me sentí desbordado cuando recibí la noticia! Como el voto de los fans era secreto, solo podía imaginarme cómo iban avanzando mis posibilidades. Lo sentí por los otros tres participantes: ¡me habría encantado ver también a Stitch convertido en un set! En general, casi no podía creerlo”.



Los diseñadores de LEGO® Samuel Johnson, Crystal Fontan y Corvin Alexander Stichert conformaron el equipo encargado de llevar el ya impresionante diseño de la EEI hasta la línea de meta: lo perfeccionaron, trabajaron en los detalles gráficos y se aseguraron de que el original cumpliera los requisitos de LEGO en cuanto a estabilidad y calidad.



## ¡Más de una década genial con LEGO® Ideas!

La explosiva colmena de ingenio que es LEGO® Ideas cumplió diez años a finales de 2018. Originalmente llamada LEGO CUUSOO, esta plataforma colaborativa de creatividad ha ido evolucionando y expandiéndose a lo largo de los años, encontrando nuevas formas de cooperar con los fans de LEGO más brillantes y apasionados de todo el mundo.

El viaje de LEGO Ideas nos ha permitido conocer historias increíbles al trabajar con los asombrosos fans de LEGO, muchas de las cuales dieron lugar al lanzamiento de algunos de los sets LEGO más singulares que hayamos puesto a la venta.

Para la revisión por el 10º aniversario, nos adentramos en el archivo de LEGO Ideas en busca de propuestas que llegaron a los 10.000 votos, pero no fueron aprobadas, decididos a redescubrir qué prototipos seguían teniendo posibilidades de convertirse en un set LEGO Ideas oficial. Entonces pedimos a los miembros de LEGO Ideas que participaran en una votación especial para tomar la decisión final.

Hoy nos enorgullece presentar el modelo ganador: esta magnífica réplica de la Estación Espacial Internacional (la mayor estructura construida por el hombre que existe fuera de la Tierra).

¡Disfruta y sigue creando!





## LEGO® Ideas y el espacio

El concepto de espacio tiene algo que resulta universalmente fascinante para los fans del brick LEGO® y todas las personas del mundo, independientemente de su edad, razón por la que ya hemos visto pasar varios sets LEGO Ideas verdaderamente representativos en torno a este tema.

La Estación Espacial Internacional (EEI) es una extraordinaria incorporación a esta categoría de sets LEGO Ideas. ¡Dales un vistazo a algunos de los modelos anteriores y prepárate para sentirte fuera de este mundo!

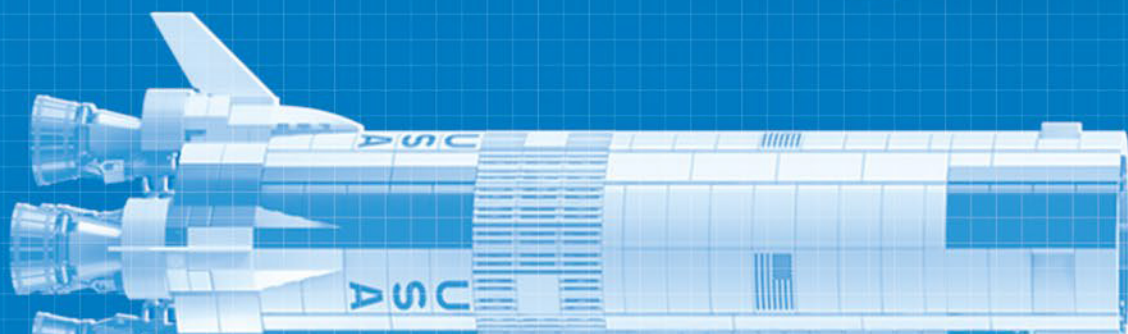

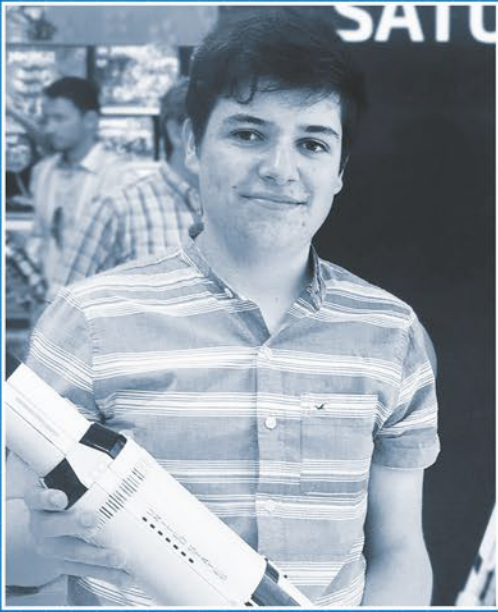

*Felix Stiessen, uno de los fans diseñadores*

### **NASA: Apolo Saturno V**

Con una sorprendente altura aproximada de 1 m, este majestuoso modelo está lleno de detalles y funciones. Incluye tres etapas de propulsión, así como el módulo y el orbitador lunar, todo lo cual hace verdadera justicia a la revolucionaria misión espacial que nos permitió llegar hasta la Luna. Un excelente trabajo de Valerie Roche y Felix Stiessen, los fans que diseñaron el modelo.

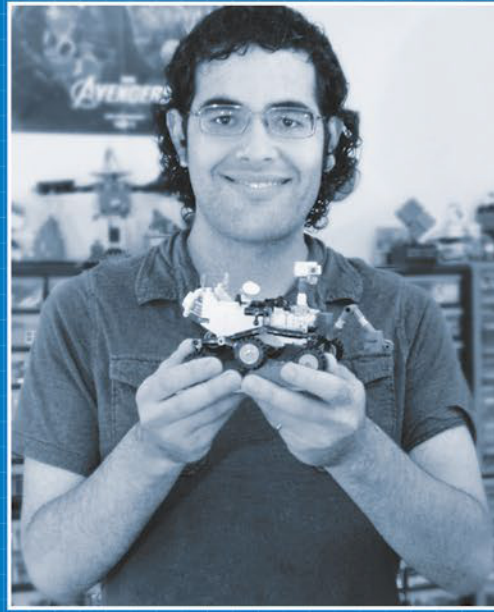

*Stephen Pakbaz, fan diseñador*

### **Róver Curiosity del Laboratorio Científico de Marte de la NASA**

Diseñado por Stephen Pakbaz, ingeniero del róver Curiosity en la vida real, este pequeño vehículo de bricks LEGO® representa la innovación y los conocimientos técnicos que encerraba el avanzado laboratorio móvil, cuyo papel fue clave en la historia de la exploración espacial.



*Maia Weinstock, fan diseñadora*

### **Mujeres de la NASA**

Un homenaje a varias de las mujeres más sobresalientes en los campos de la ciencia, la tecnología, la ingeniería y las matemáticas (las conocidas como “áreas STEM”), este set reconoce la labor de cuatro pioneras del espacio: la astrónoma y educadora Nancy Grace Roman; la científica de computadoras y emprendedora Margaret Hamilton; la astronauta, médica y emprendedora Sally Ride; y la astronauta, médica e ingeniera Mae Jemison.

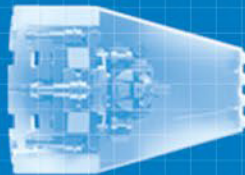

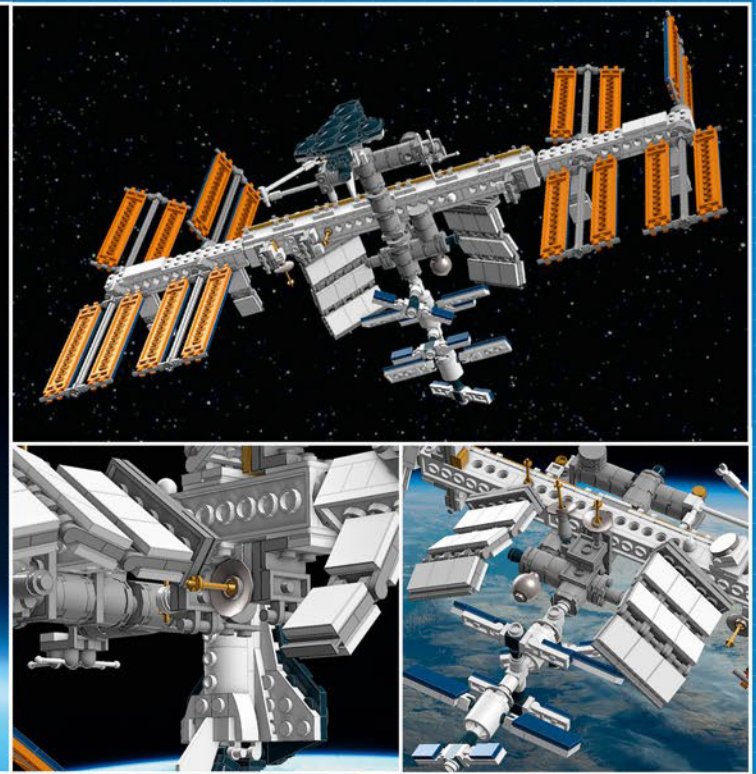
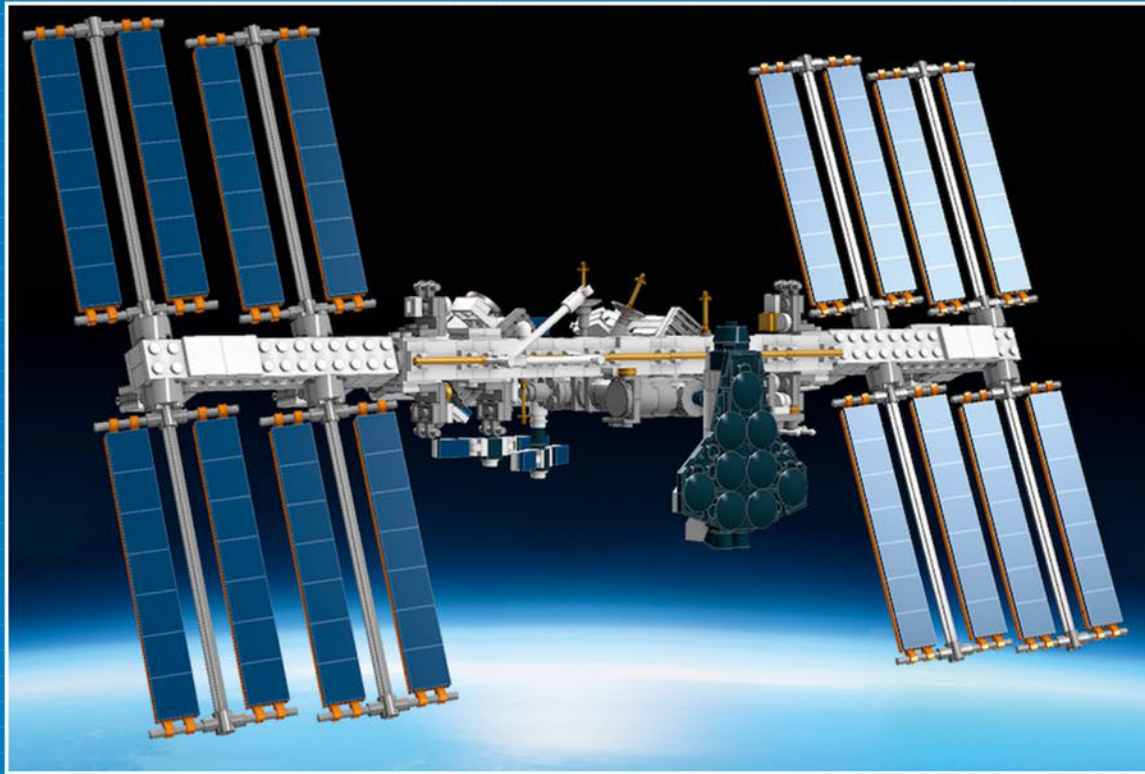

## Revisión especial por el 10° aniversario

La Estación Espacial Internacional fue elegida set LEGO® Ideas ganador mediante un proceso de selección ligeramente diferente al que atraviesan habitualmente los sets LEGO Ideas...

“Para celebrar los 10 años de trabajo conjunto entre LEGO Ideas (que se conoció como LEGO CUUSOO hasta 2014) y los fans de LEGO de todo el mundo, decidimos adentrarnos en el archivo de LEGO Ideas en busca de proyectos que hubieran reunido 10.000 votos, pero no hubieran llegado a convertirse en productos. Encontramos unos 130 proyectos que, cumpliendo esas condiciones, hoy serían estupendos productos LEGO Ideas a nuestro parecer, pues las circunstancias que condujeron a su rechazo original habían cambiado”.



Hasan Jensen,  
jefe de relaciones

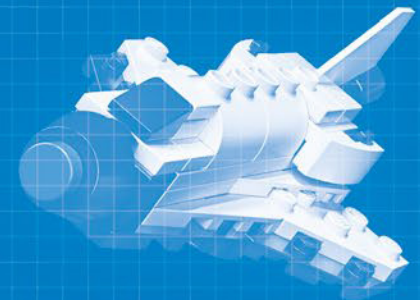



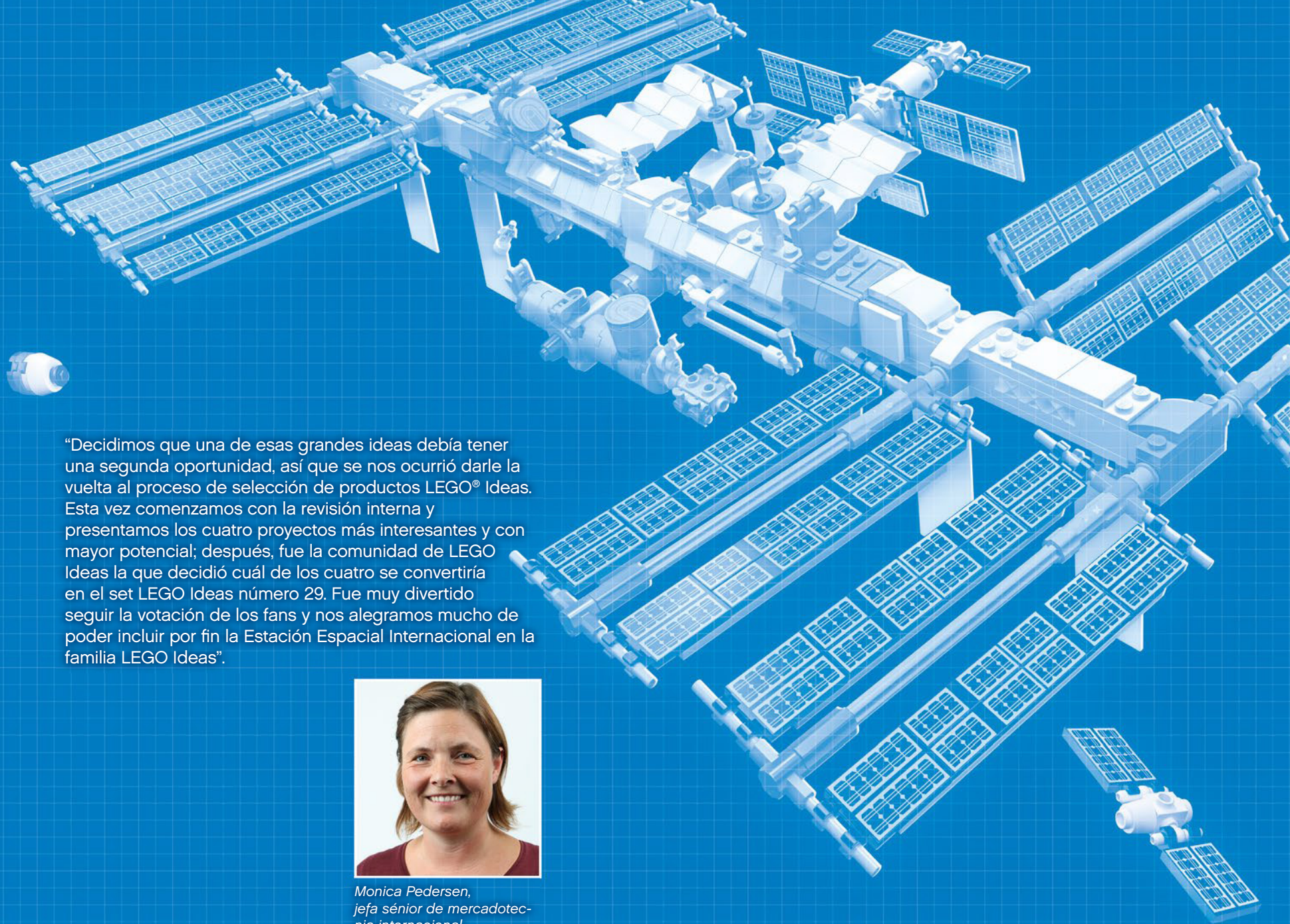

“Decidimos que una de esas grandes ideas debía tener una segunda oportunidad, así que se nos ocurrió darle la vuelta al proceso de selección de productos LEGO® Ideas. Esta vez comenzamos con la revisión interna y presentamos los cuatro proyectos más interesantes y con mayor potencial; después, fue la comunidad de LEGO Ideas la que decidió cuál de los cuatro se convertiría en el set LEGO Ideas número 29. Fue muy divertido seguir la votación de los fans y nos alegramos mucho de poder incluir por fin la Estación Espacial Internacional en la familia LEGO Ideas”.



*Monica Pedersen,  
jefa sénior de mercadotec-  
nia internacional*

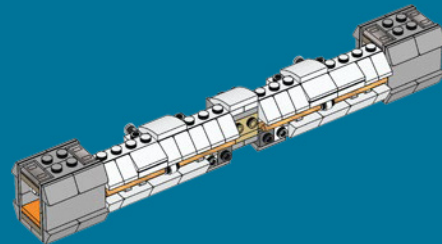
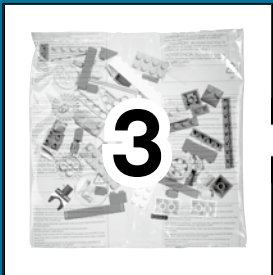
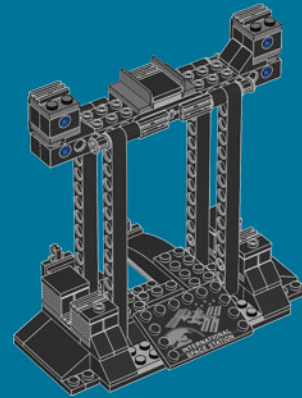
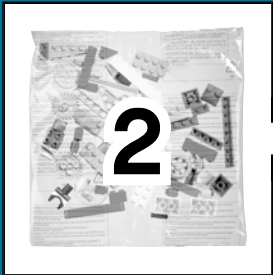
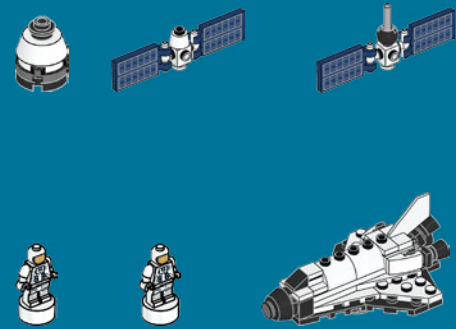

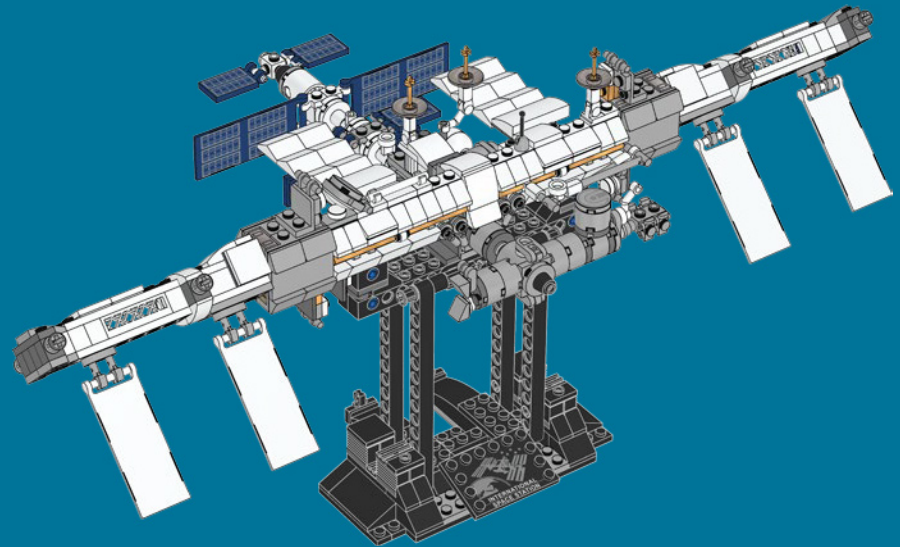
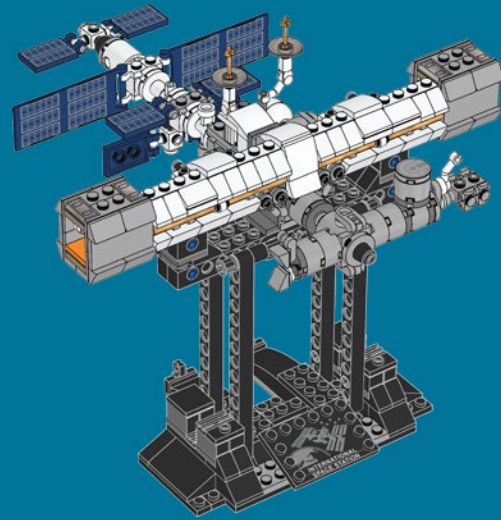
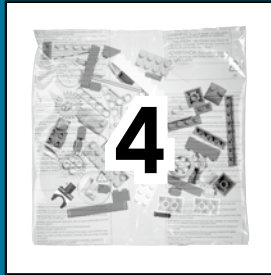

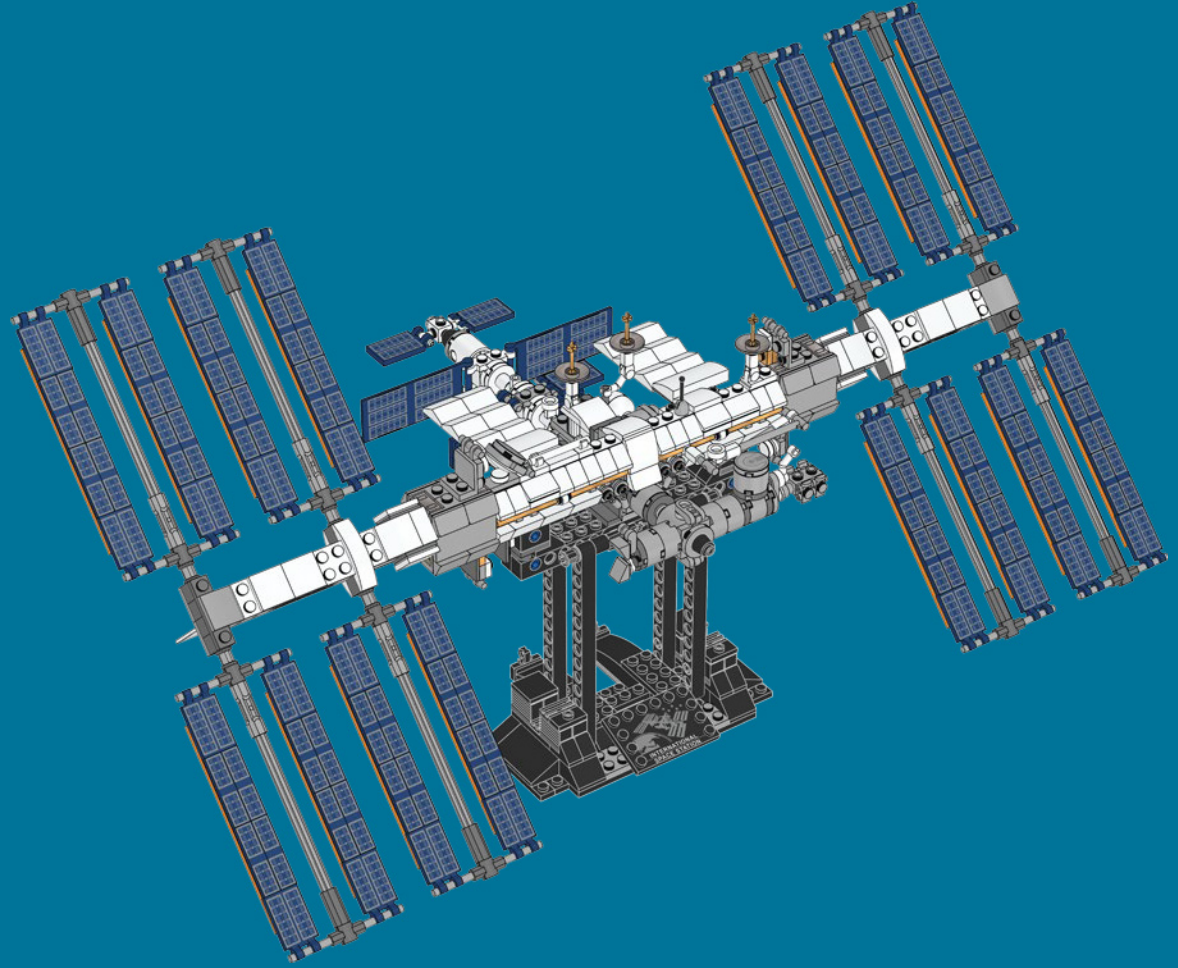
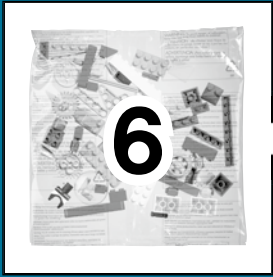

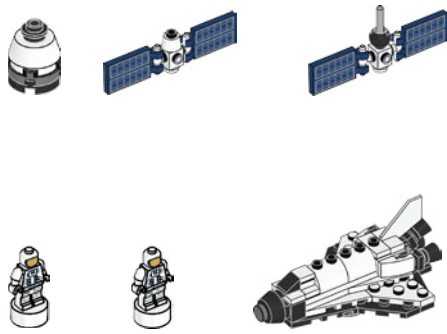
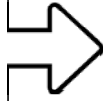

2x



1x



1x



1x



1x

1

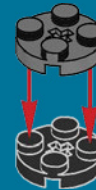

2



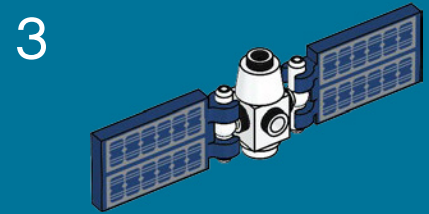
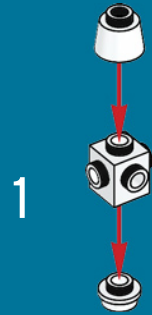
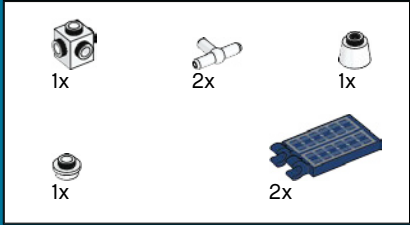

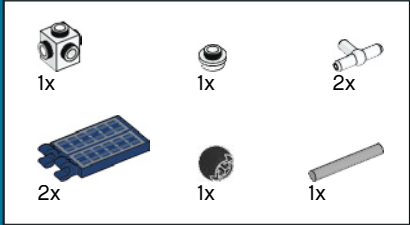

1

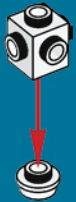

2

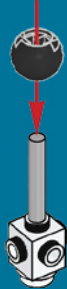

3



4

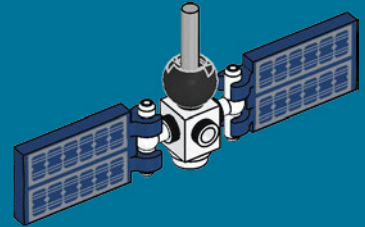

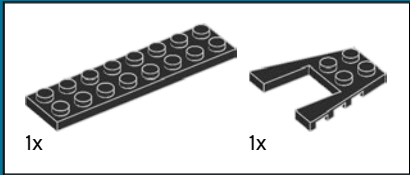

1

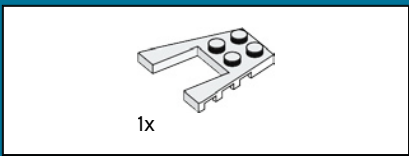
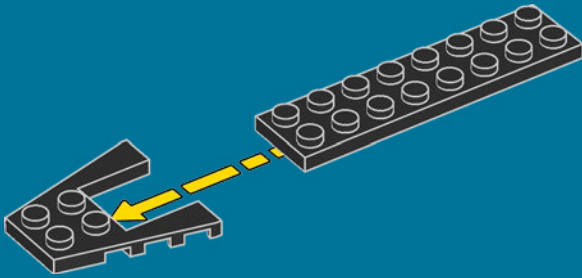

2

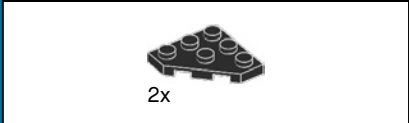
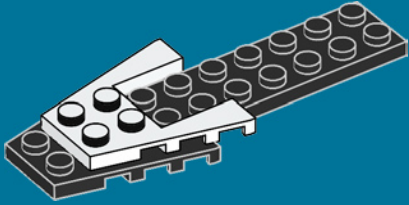

3

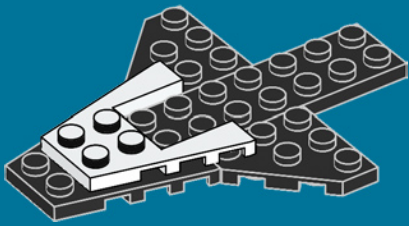



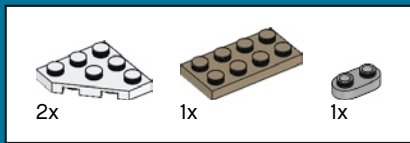

4

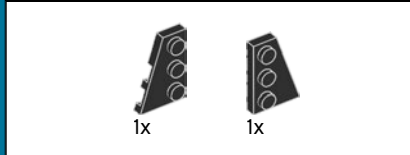
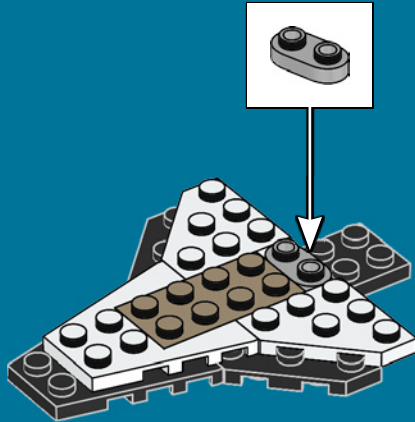

5

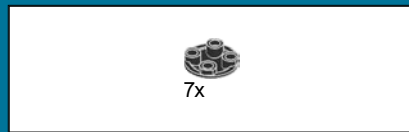
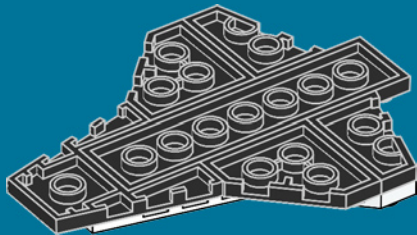

6

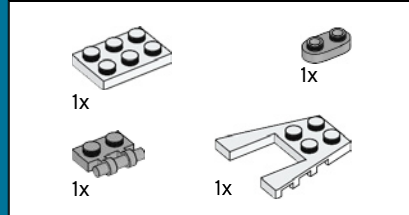
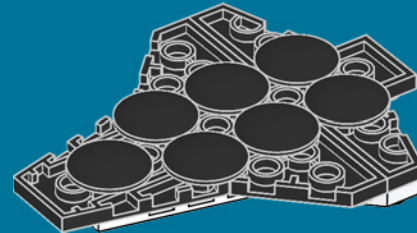

7

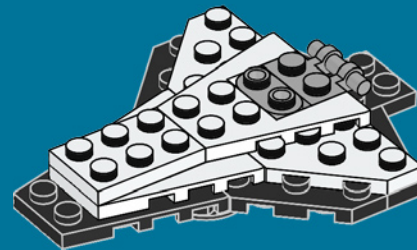

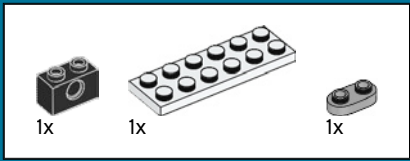

8

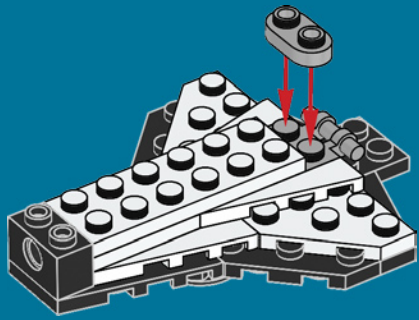

9

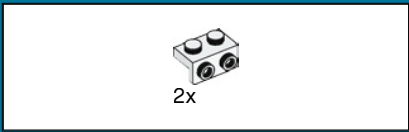
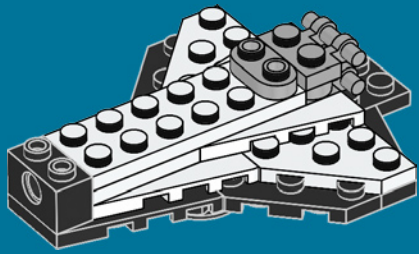

10

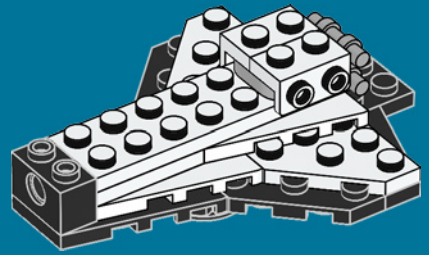

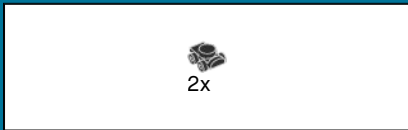

11

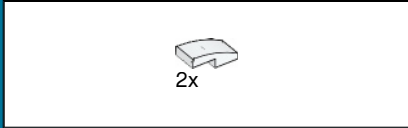
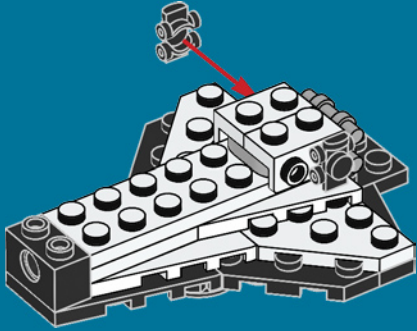

12

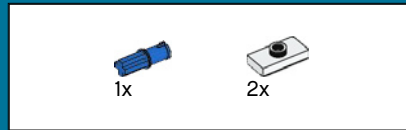
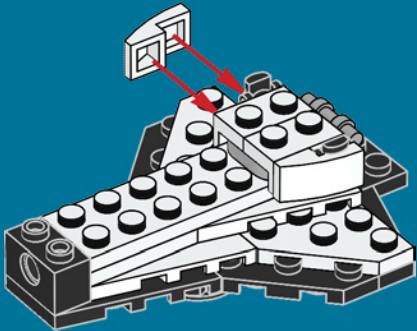

13

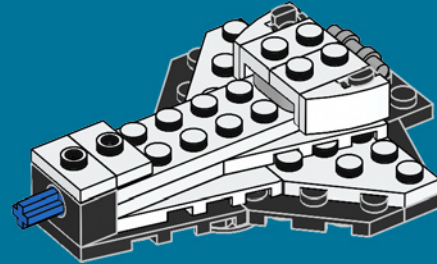

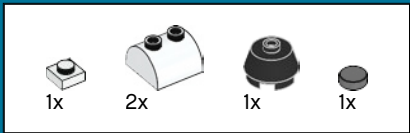

14

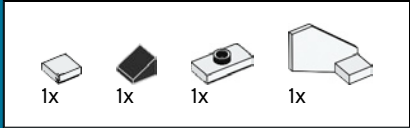
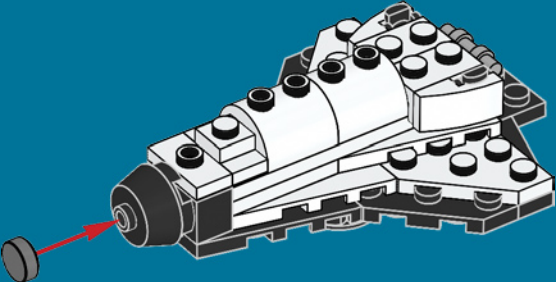

15

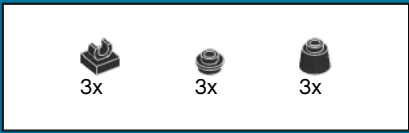
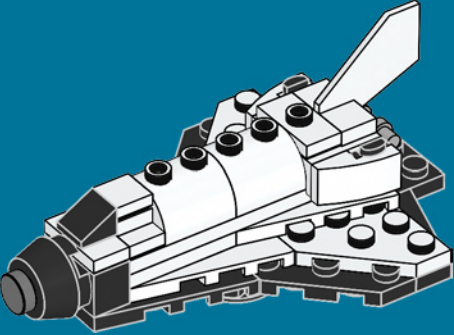

16

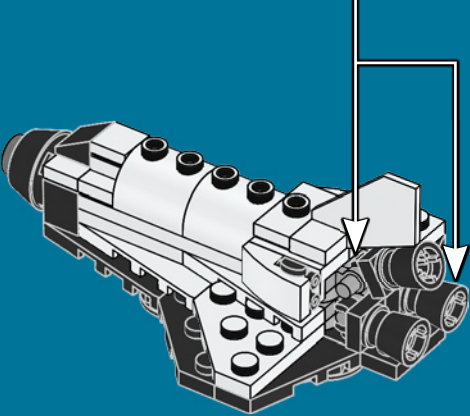
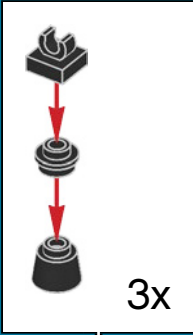

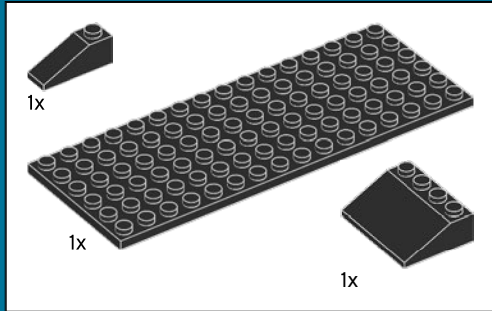
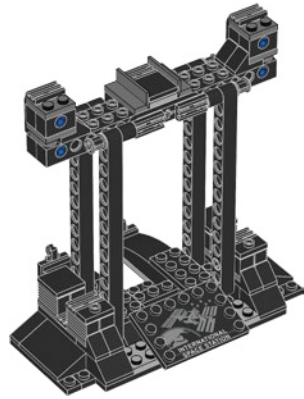

1

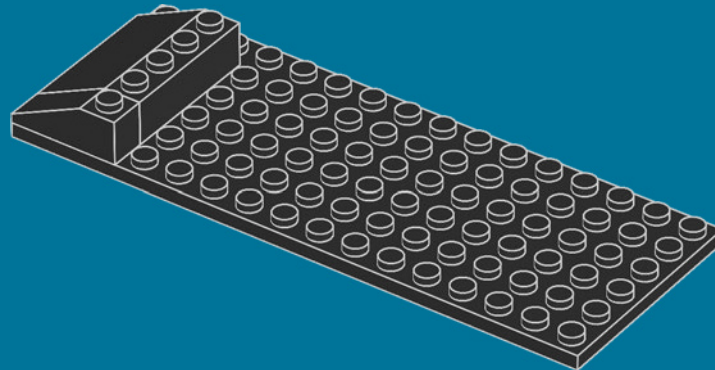

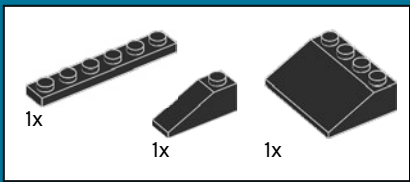

2

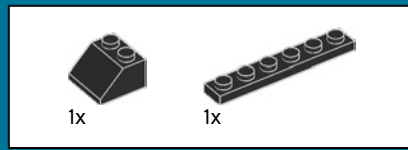
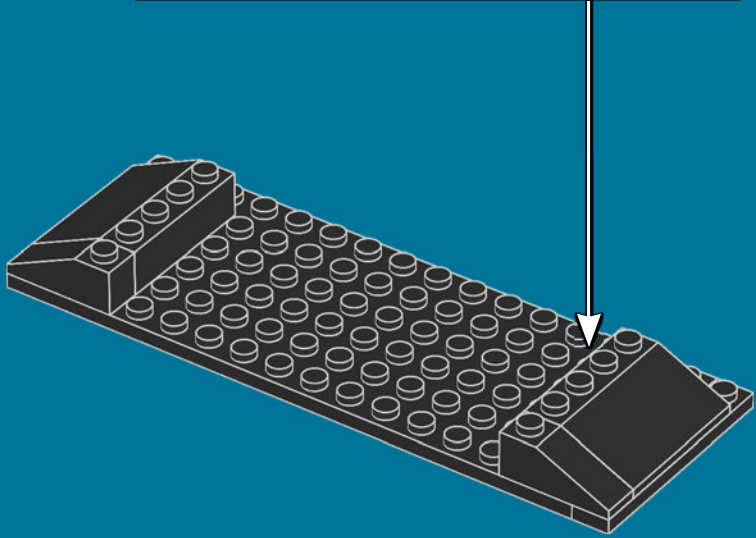
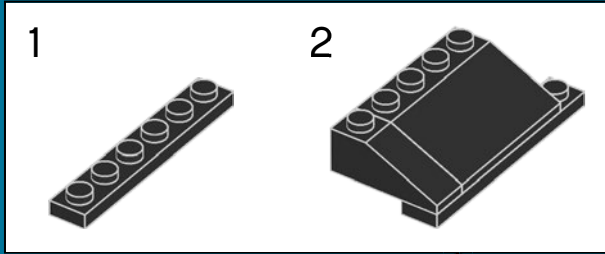

3

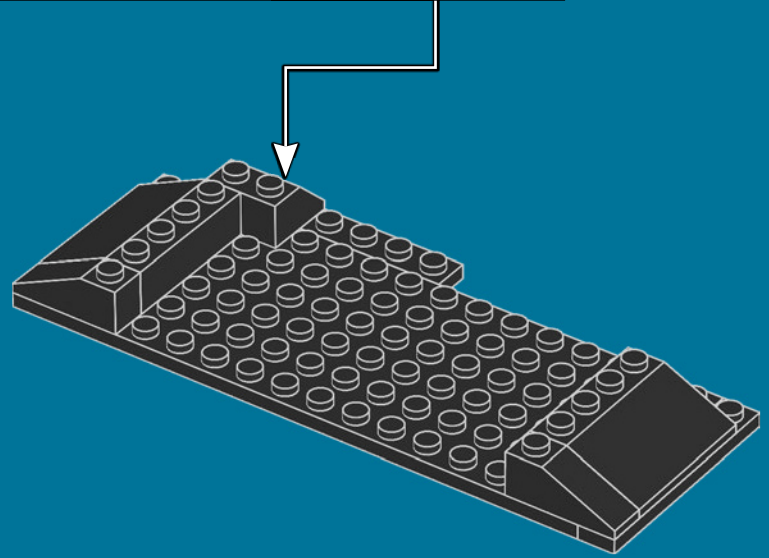
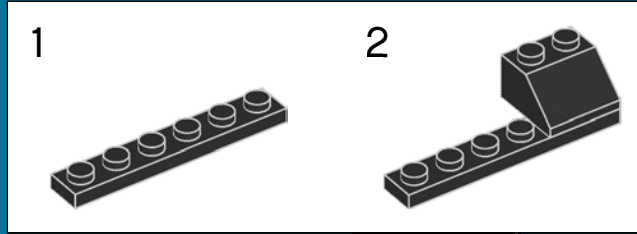

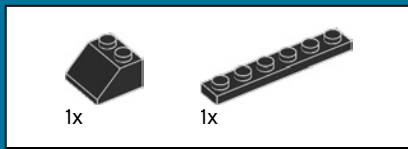

4

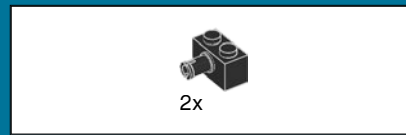
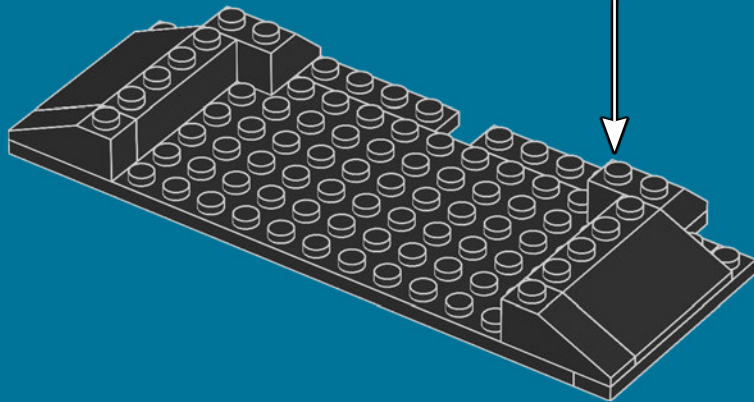
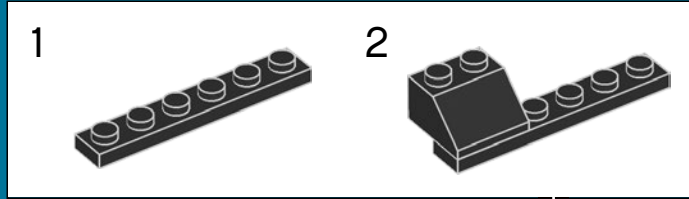

5

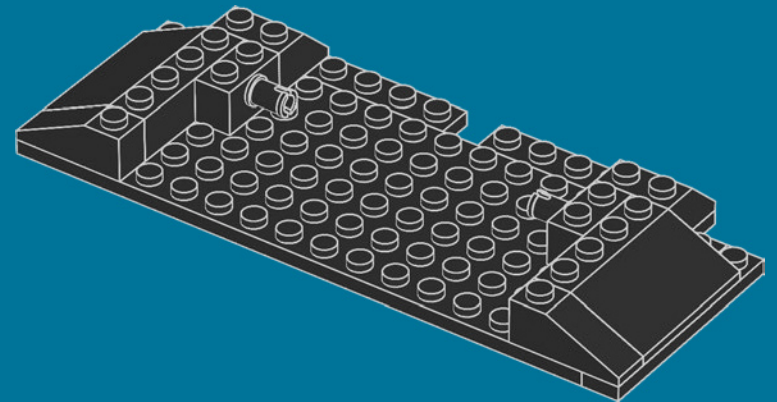

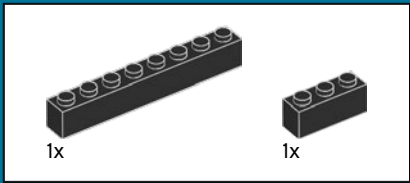

6

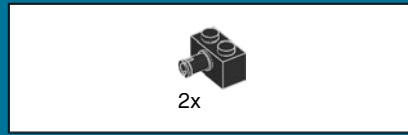
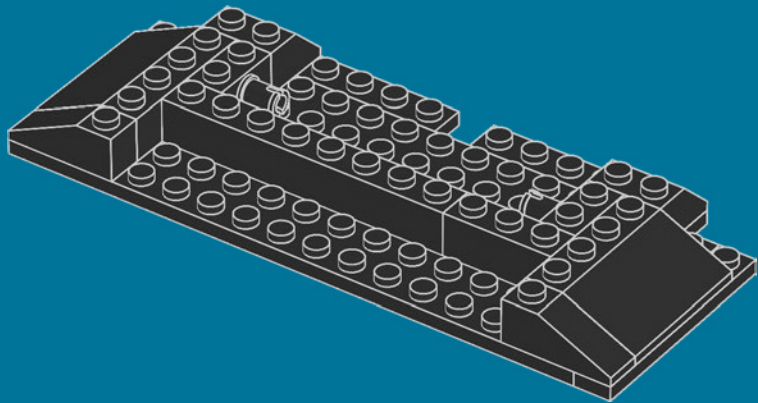

7

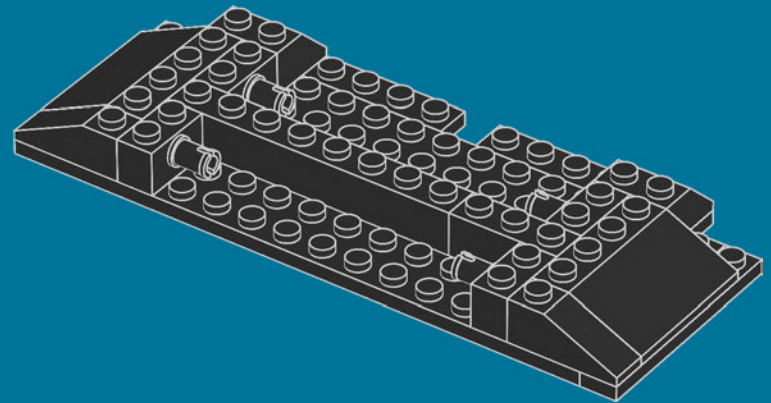



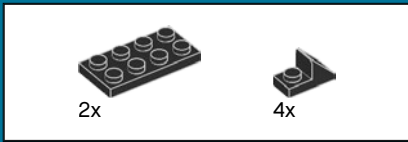

8

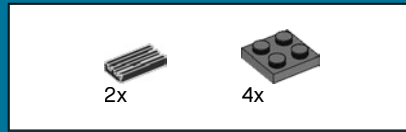
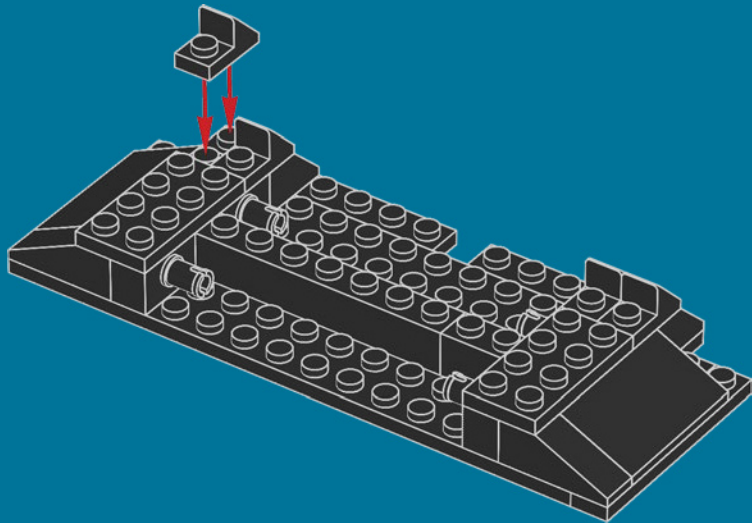

9

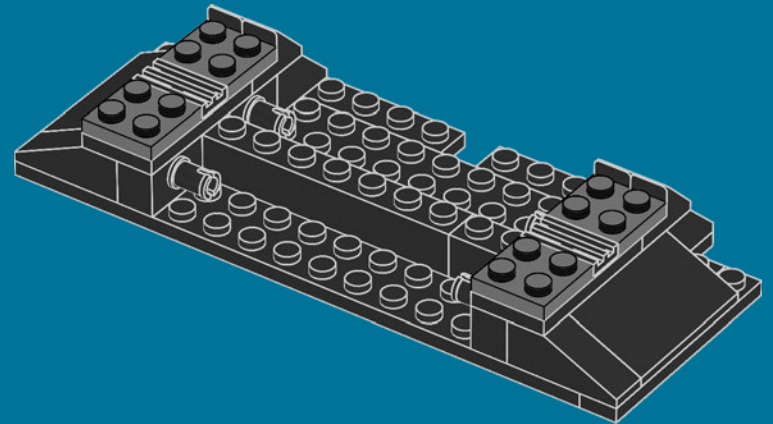



4x



4x

10

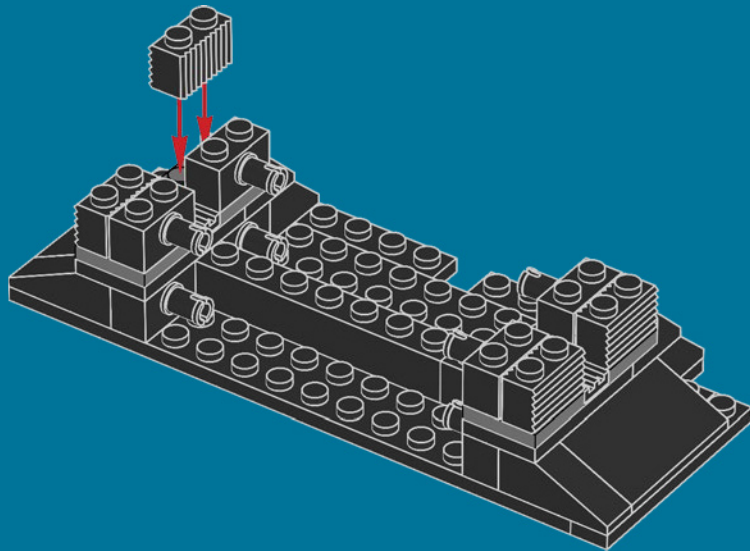

2x



2x



2x

11

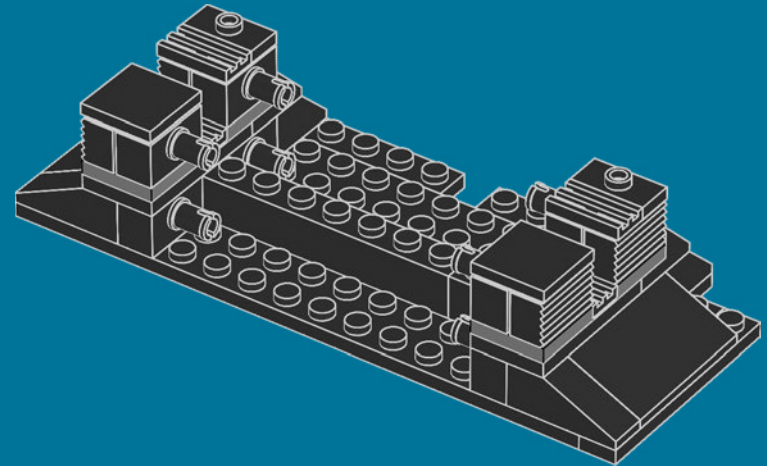

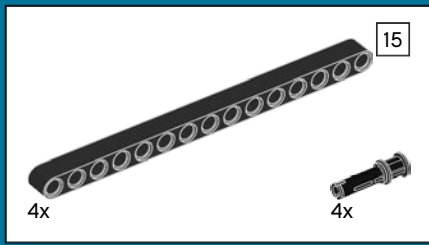

12

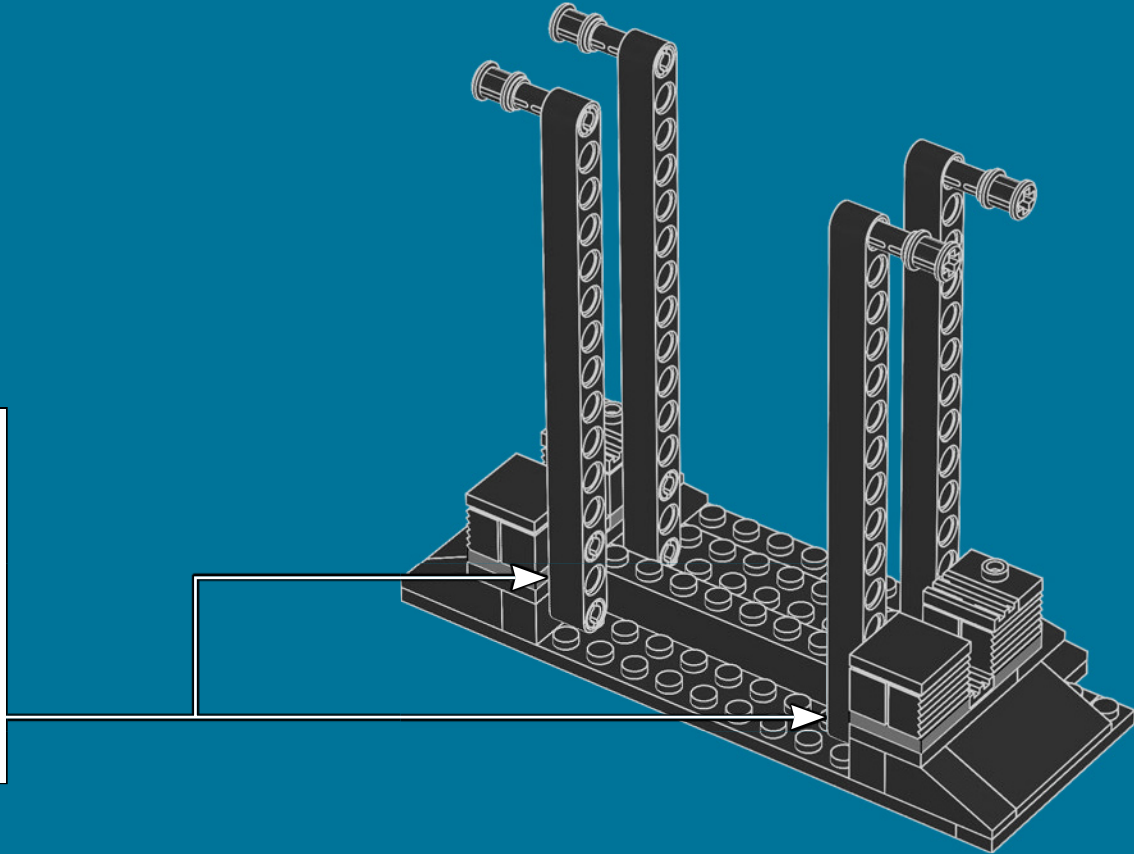
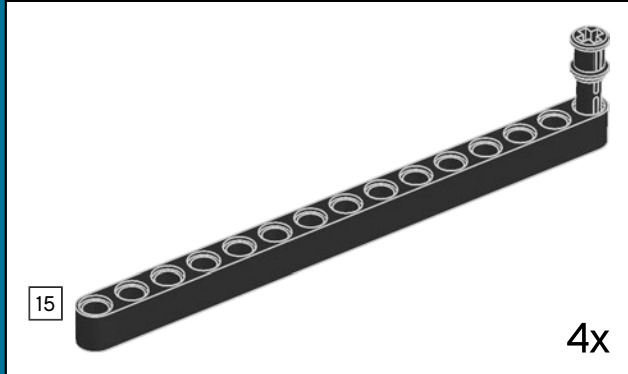

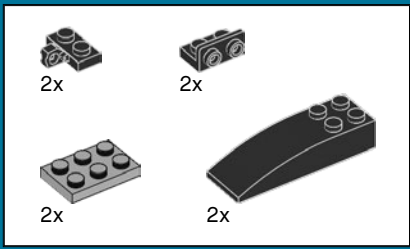

13

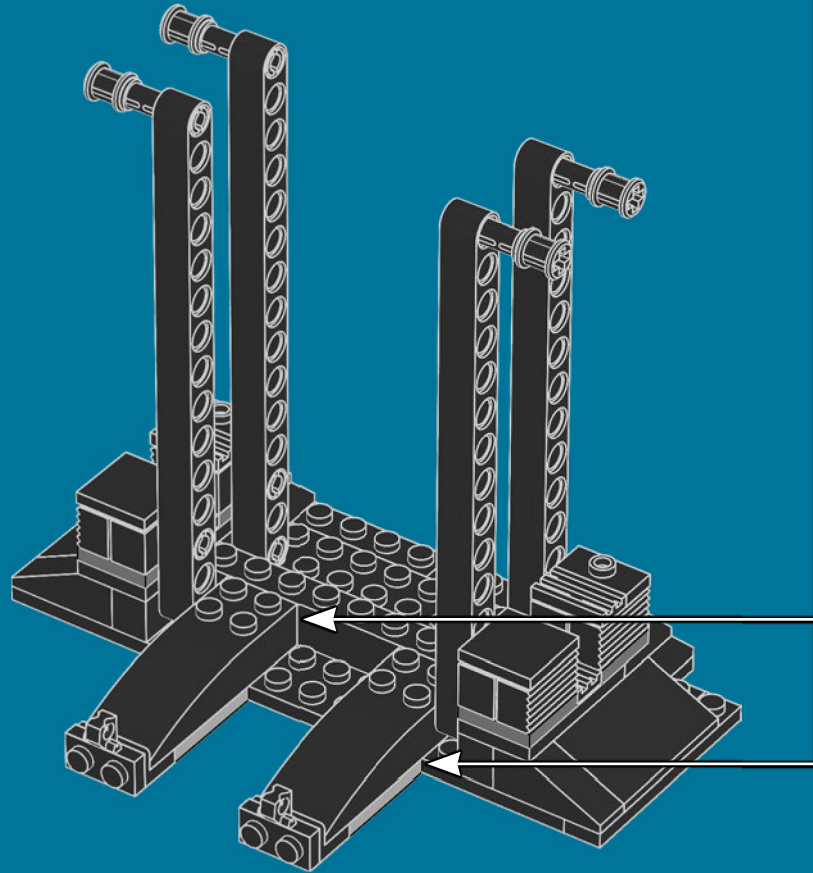
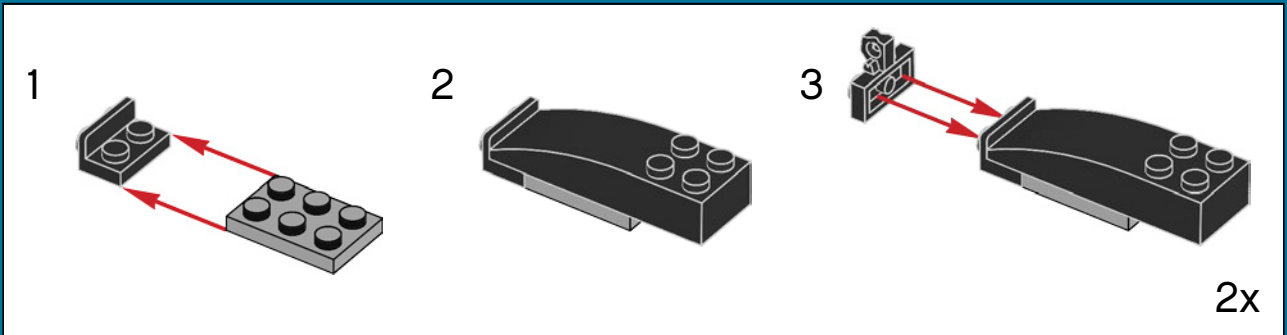

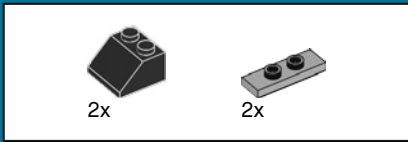

14

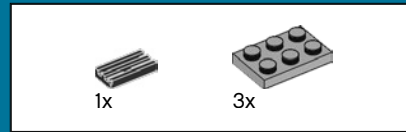
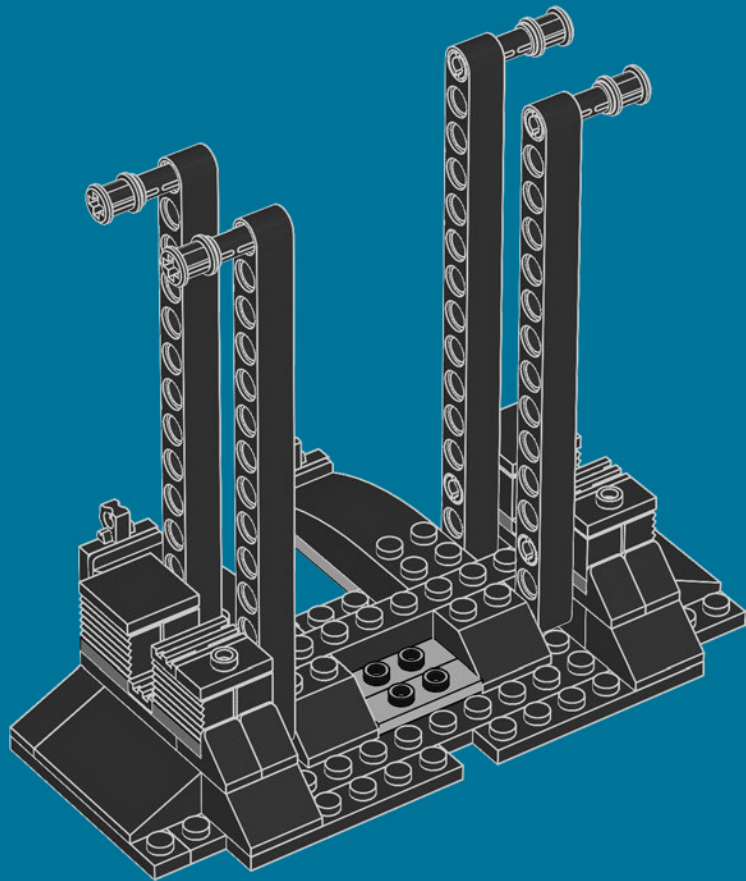

15

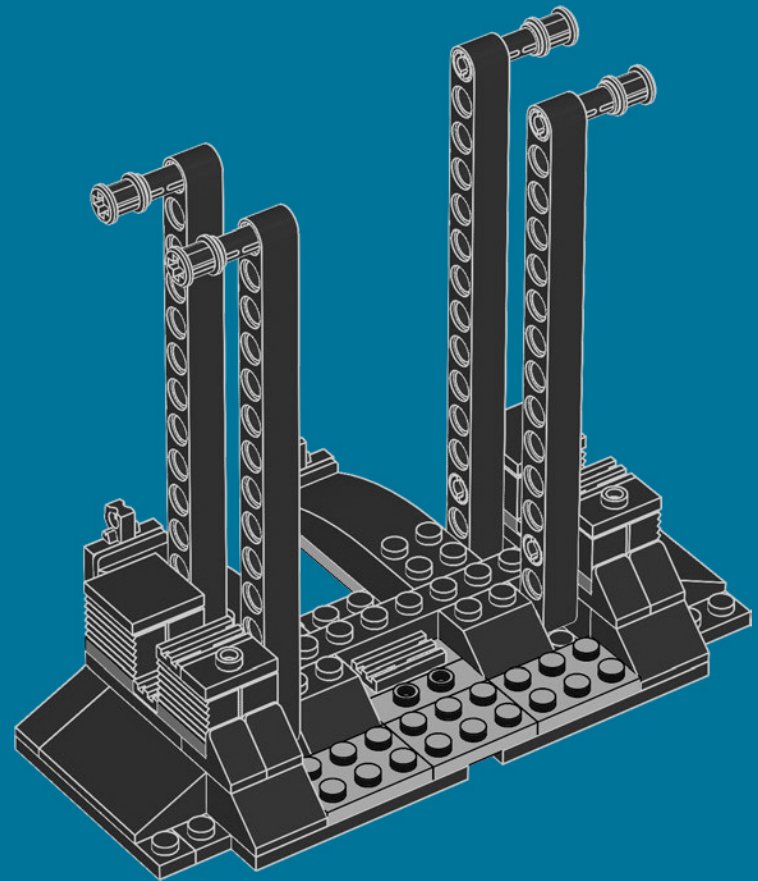



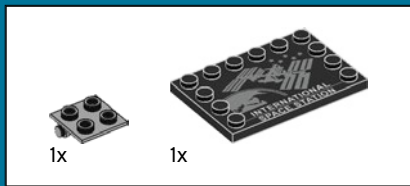

17

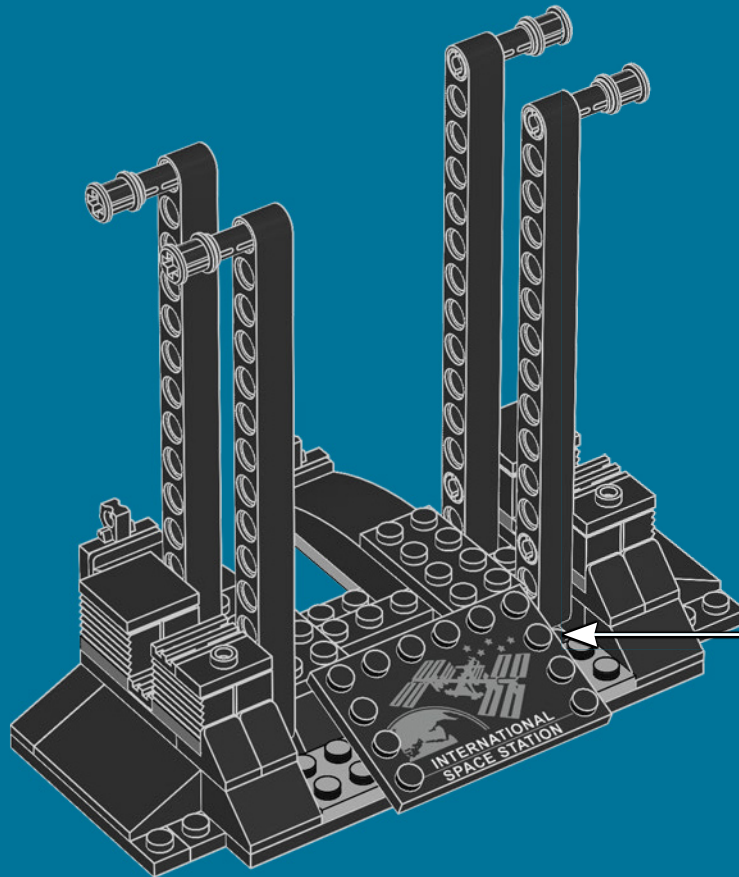
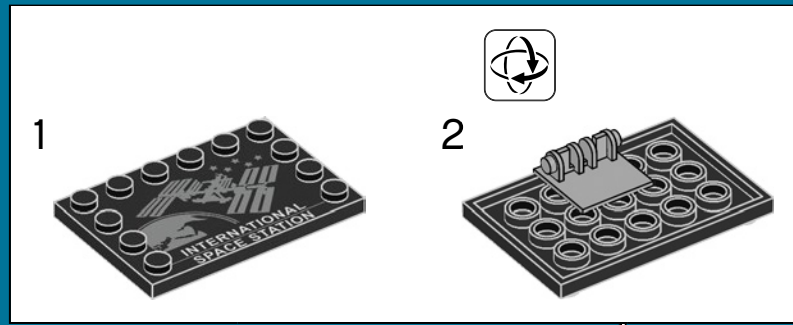

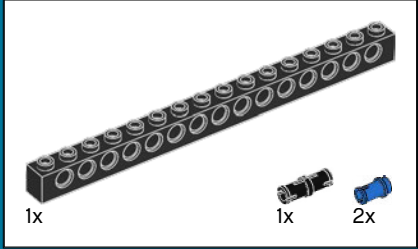
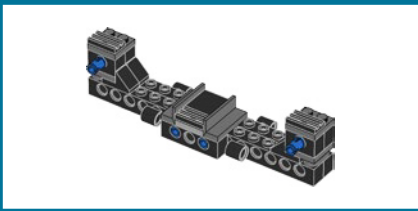

18

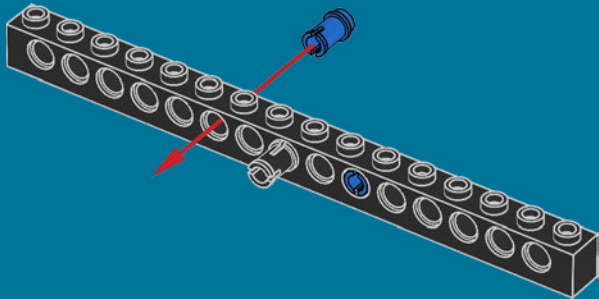

19

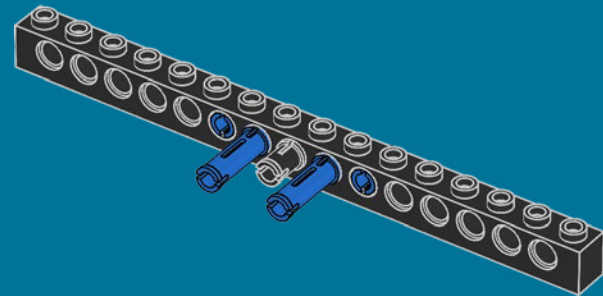



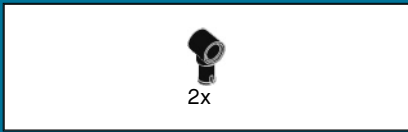

20

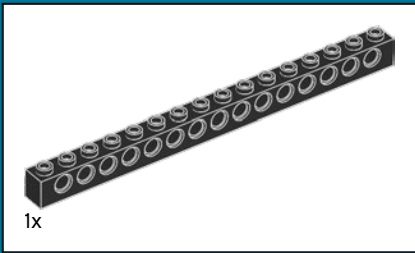
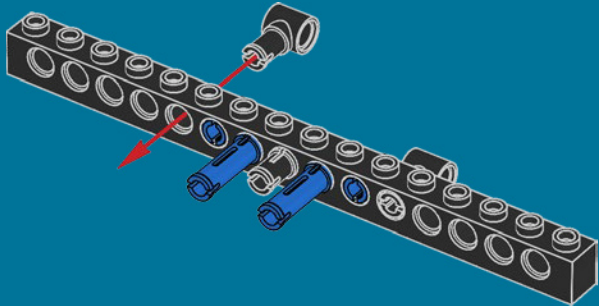

21

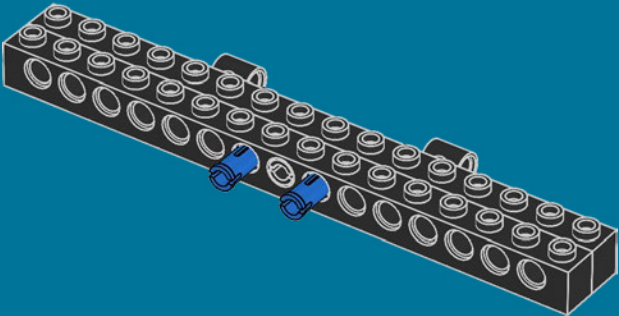

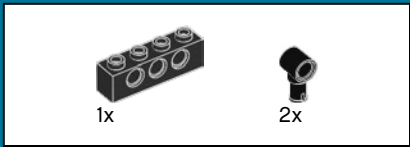

22

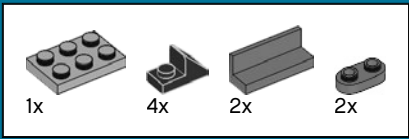
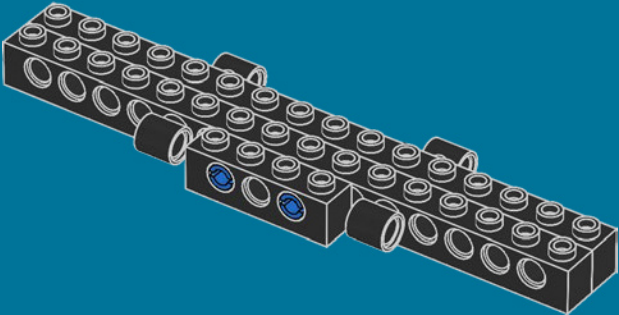

23

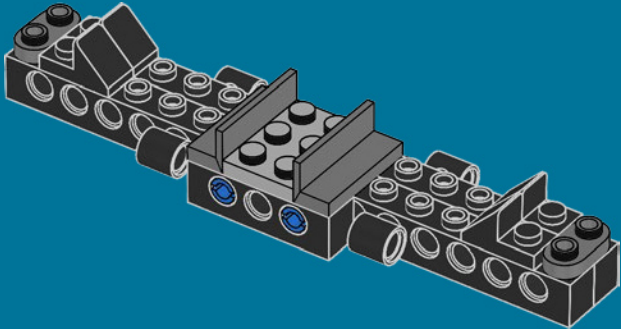



24

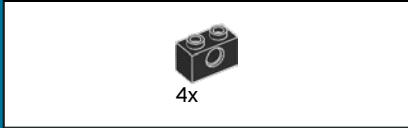
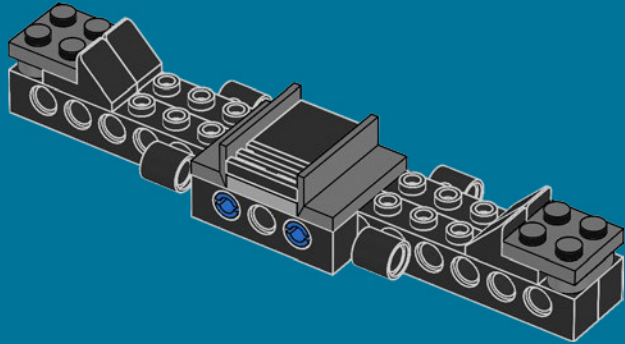

25

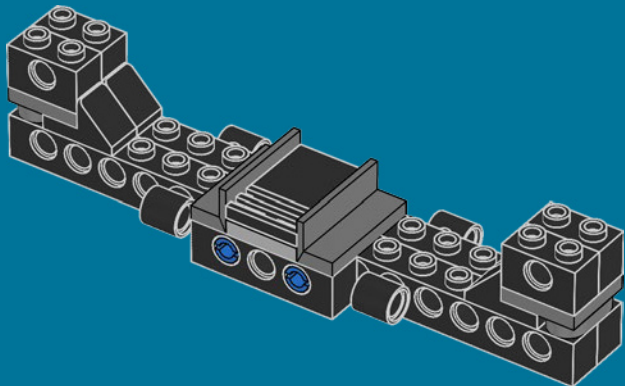

26

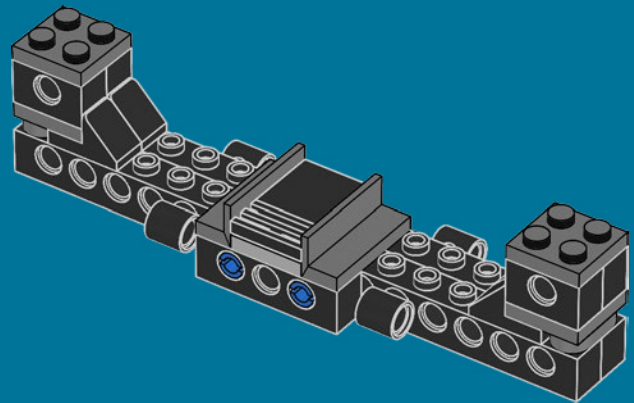

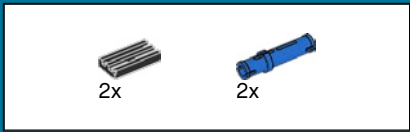

27

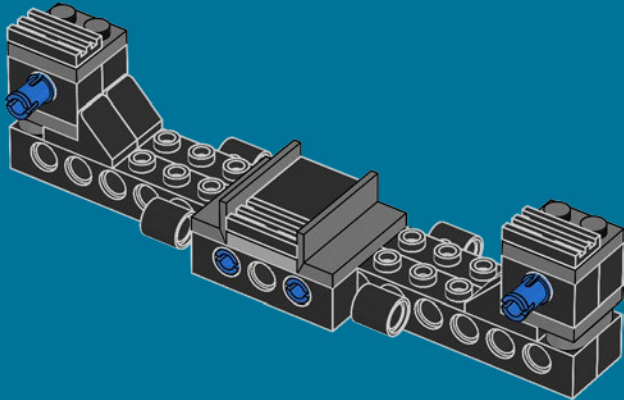

28

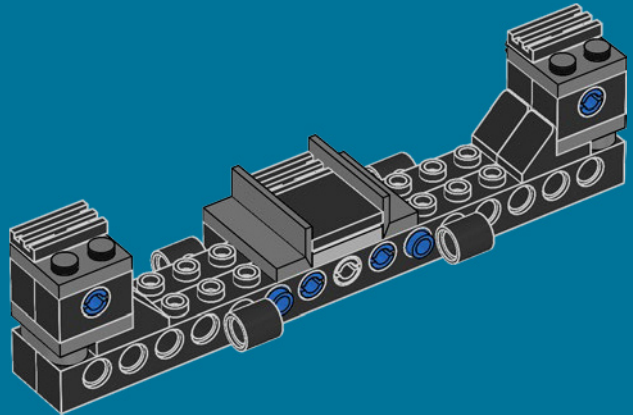

29

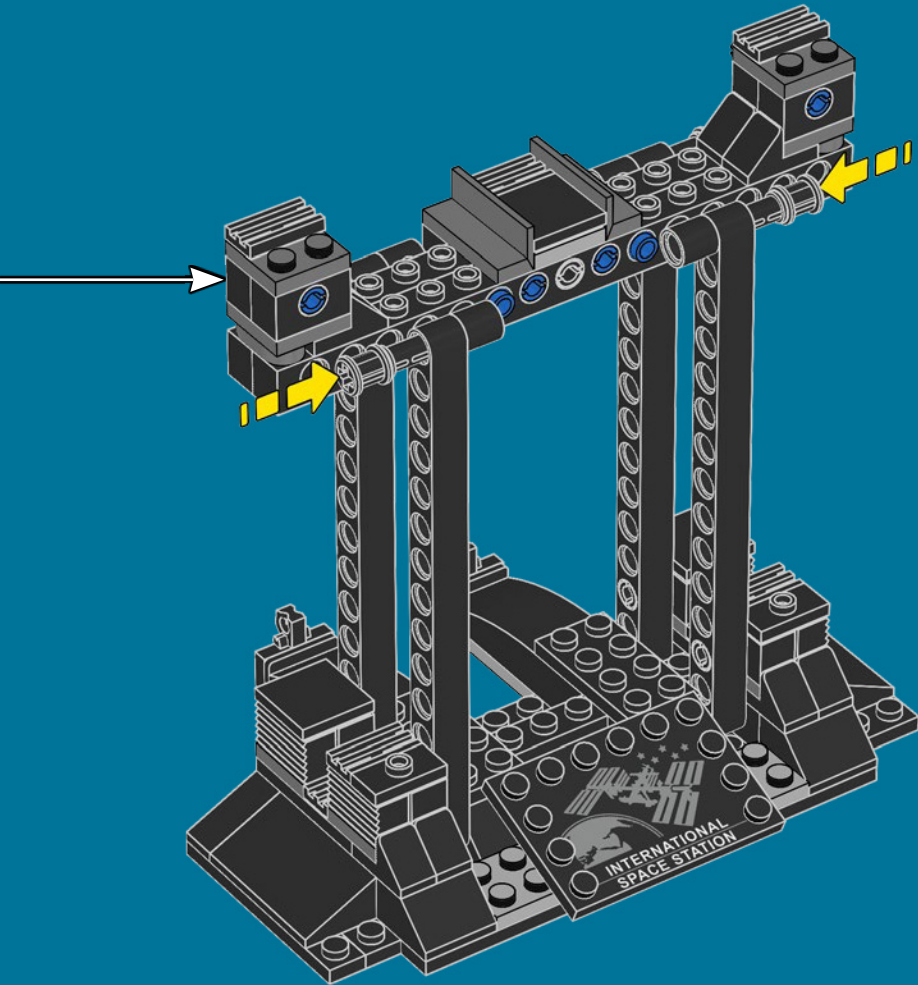

30

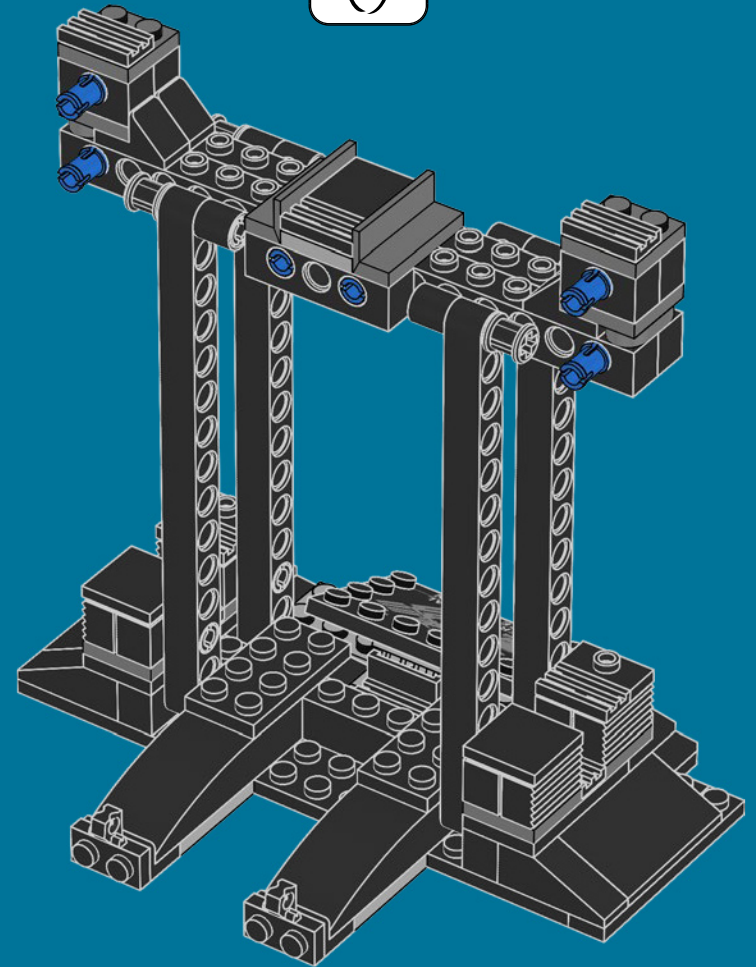
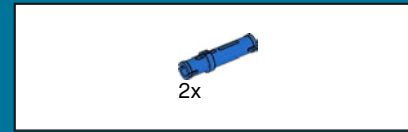

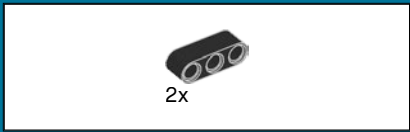

31

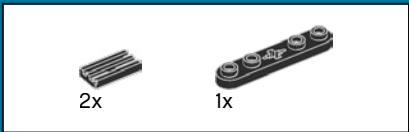
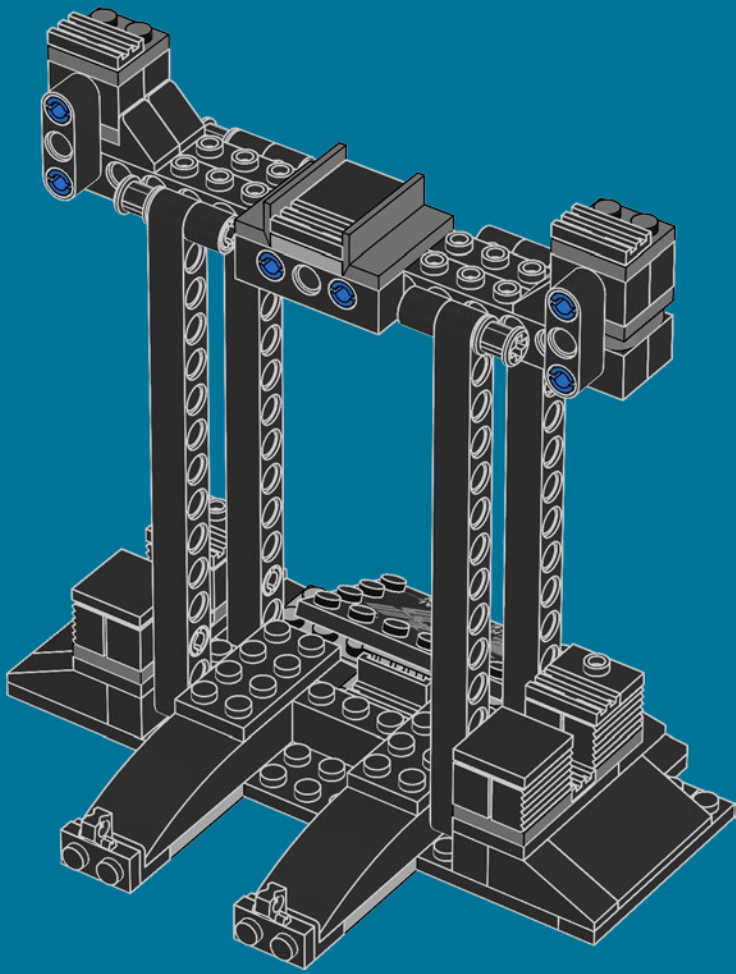

32

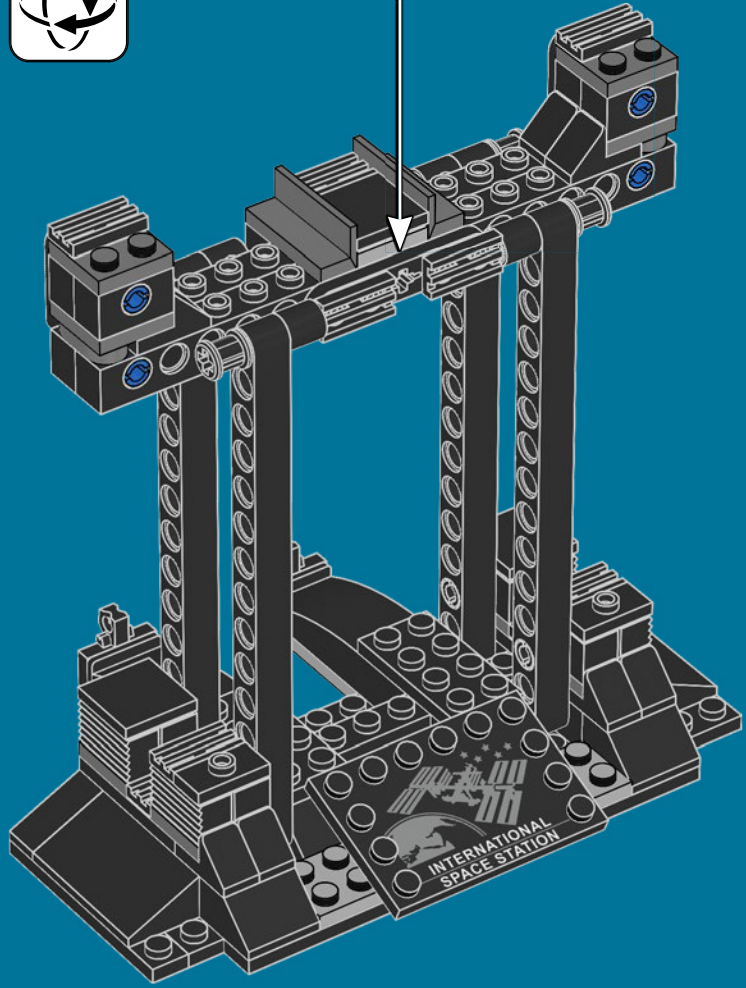
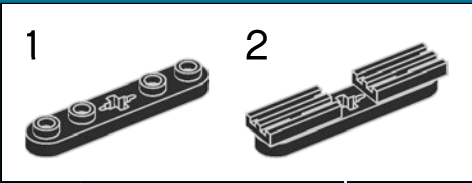

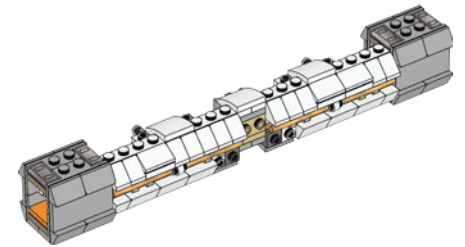
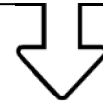
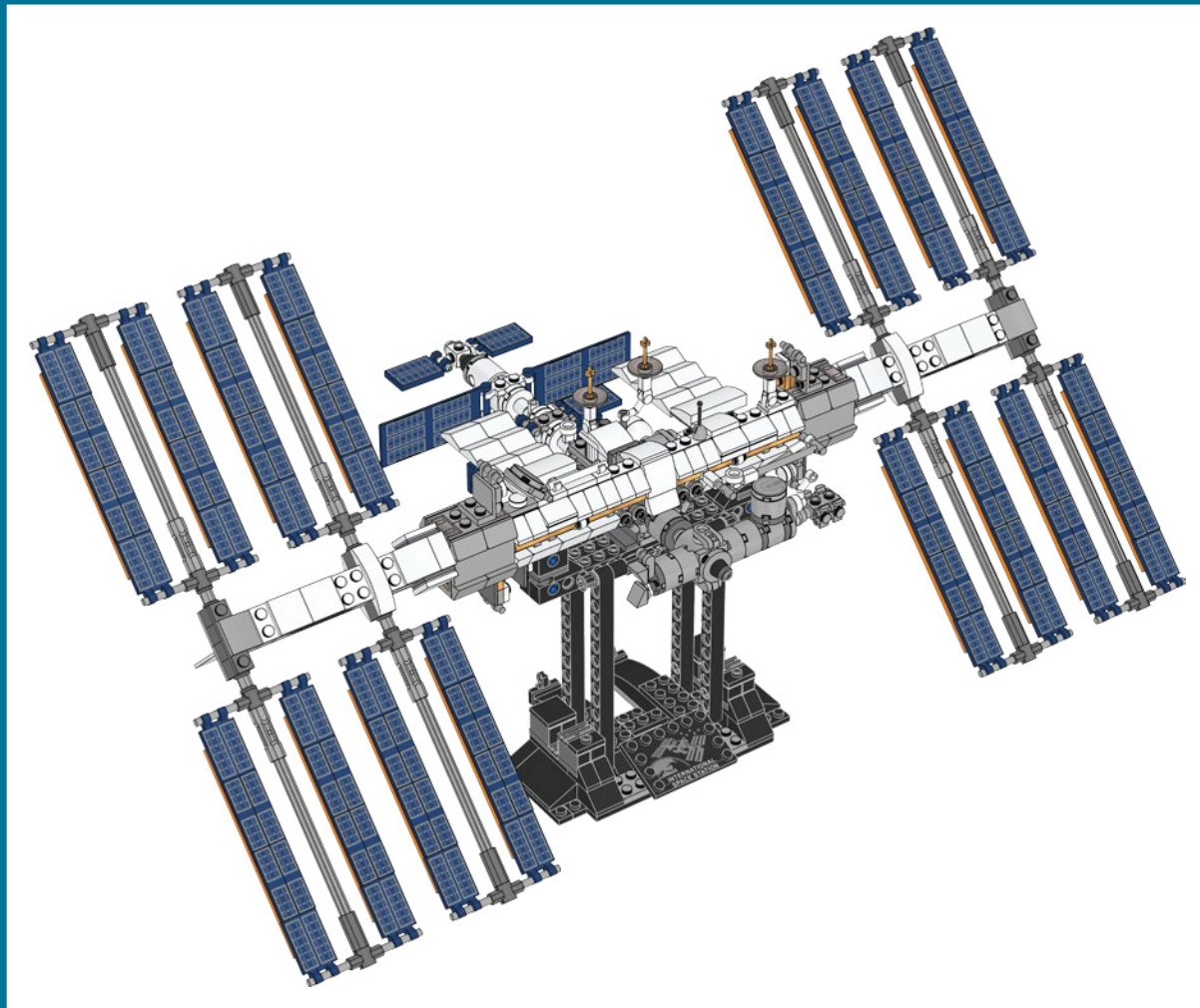

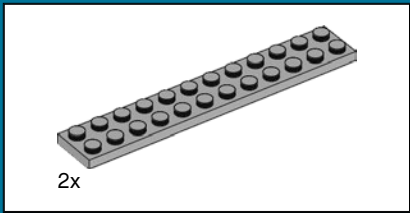

1

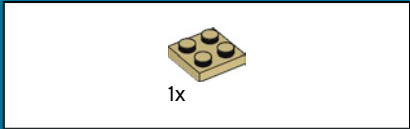
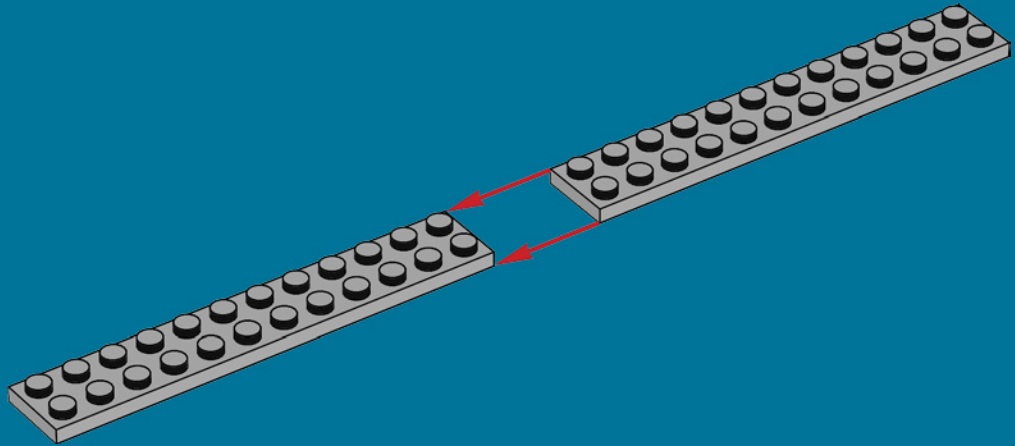

2

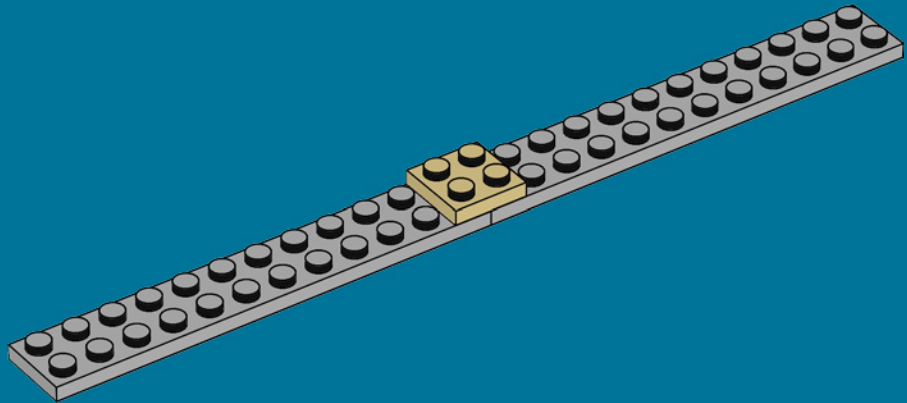



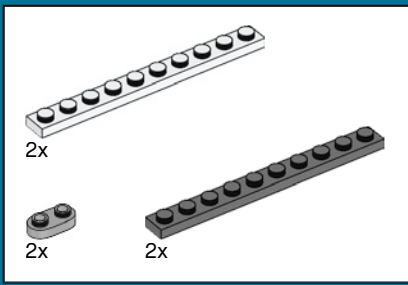

3

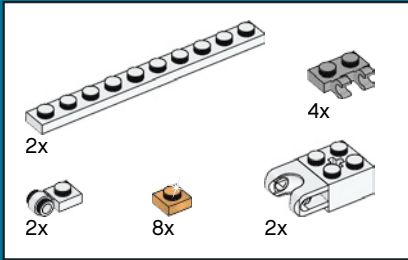
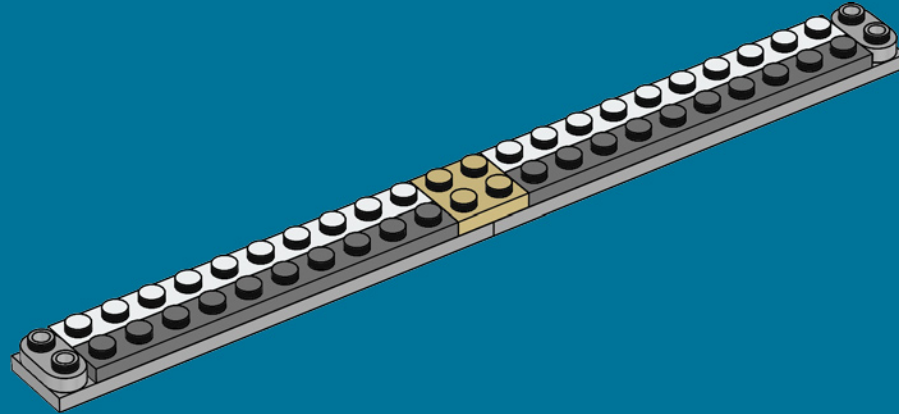

4

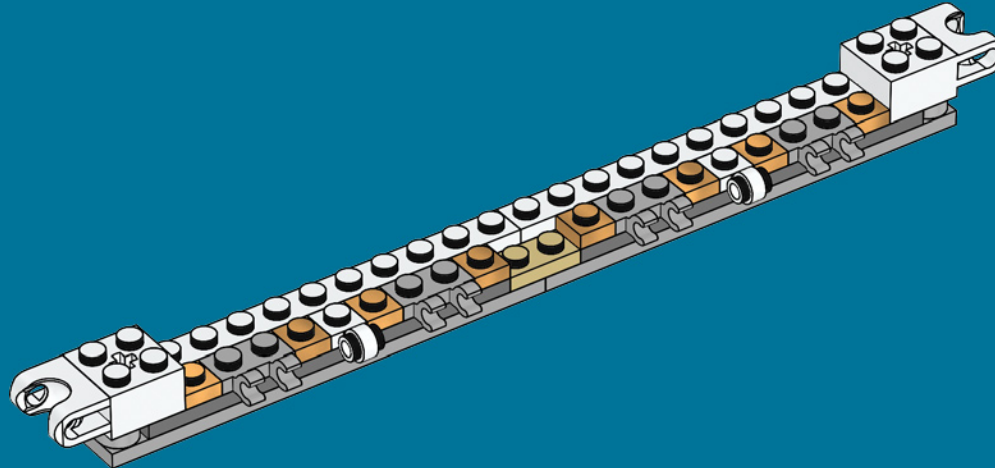

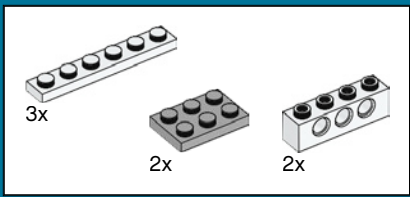

5

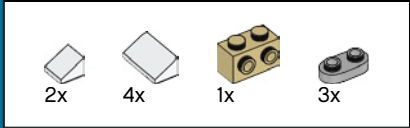
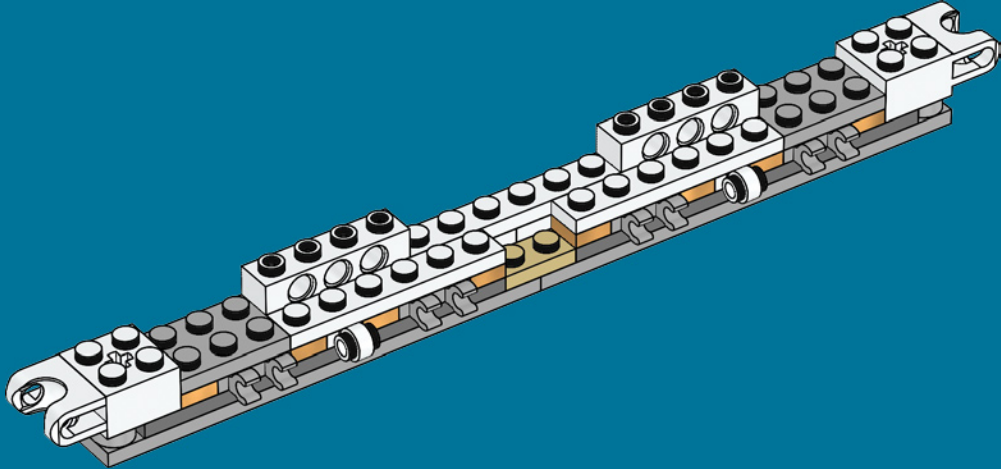

6

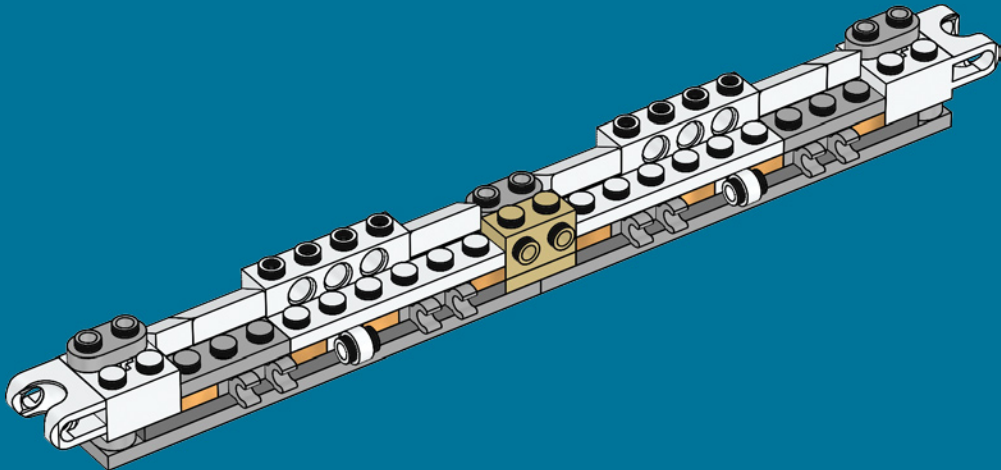

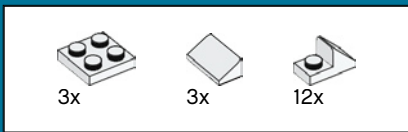

7

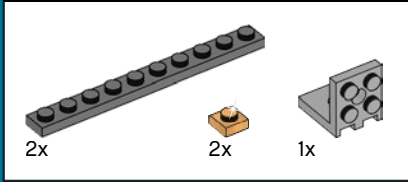
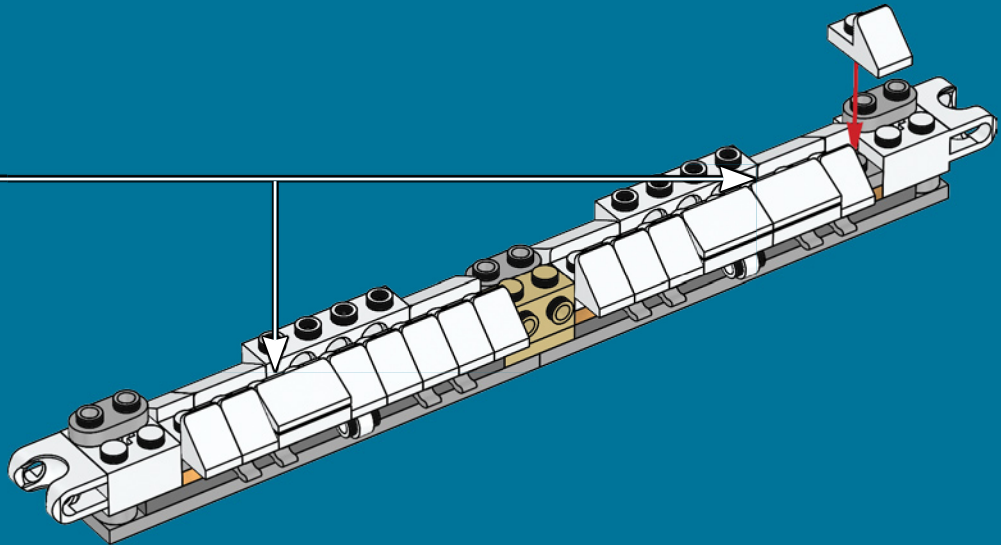
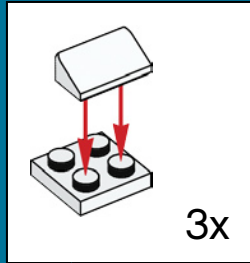

8

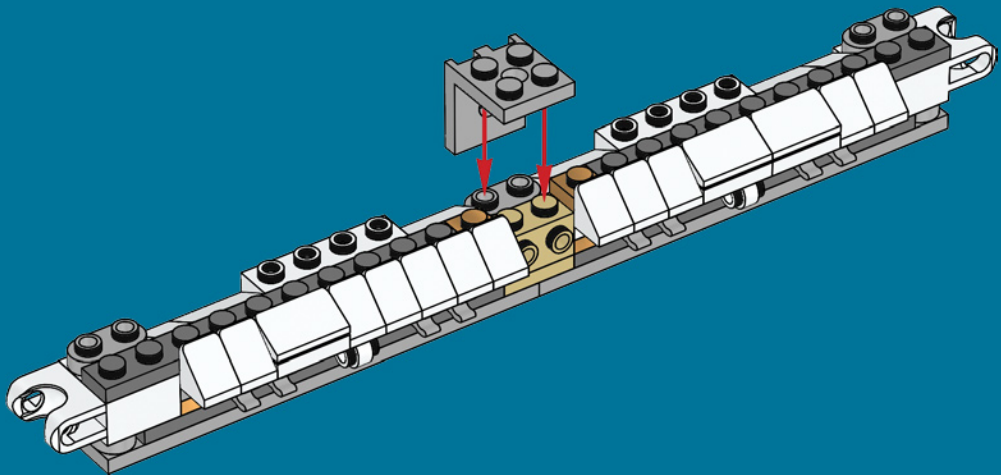

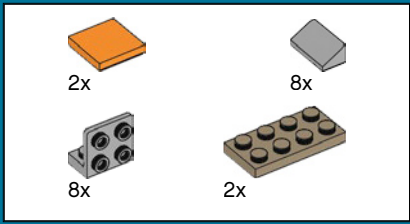

9

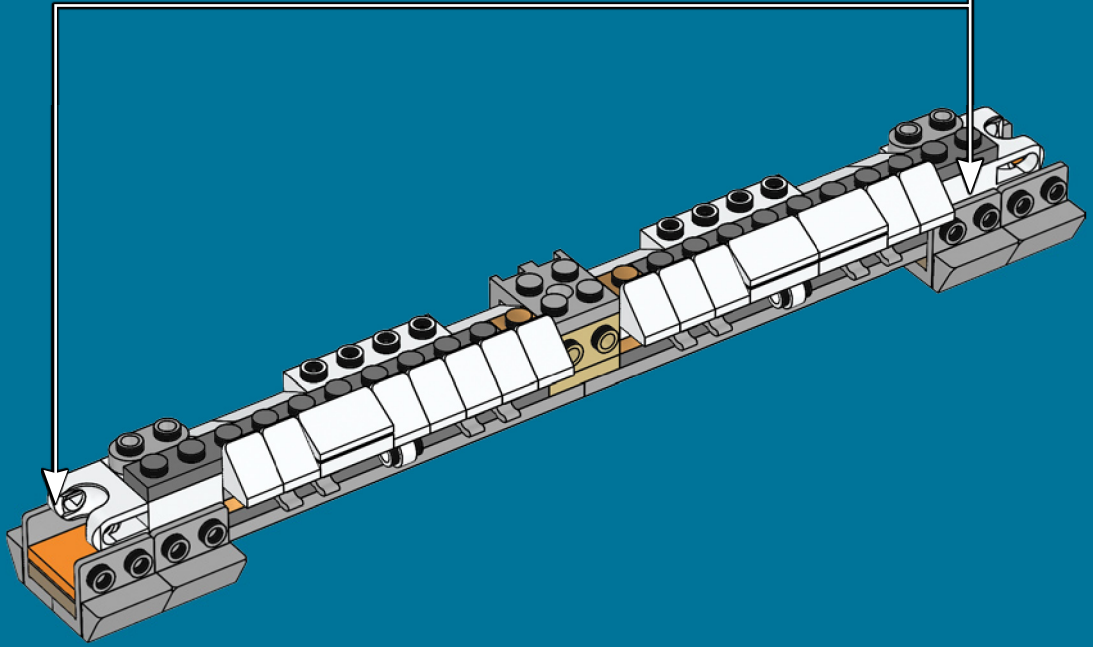
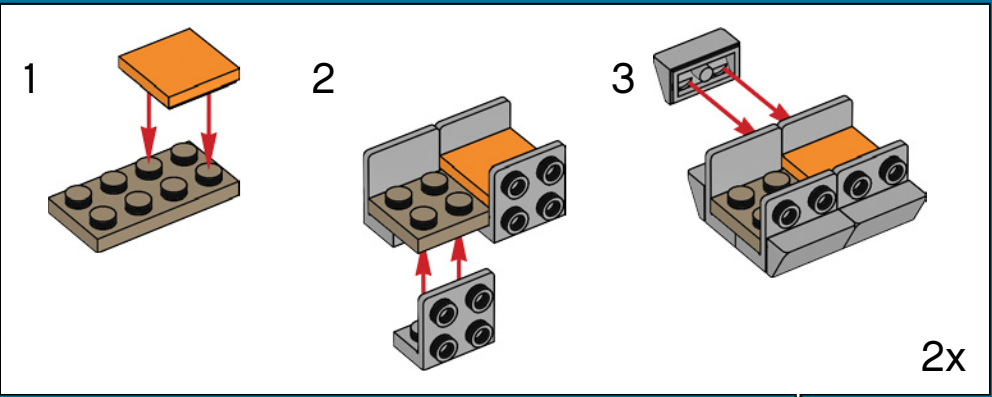

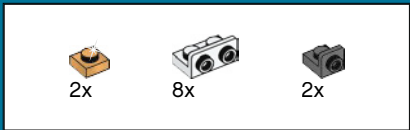

10

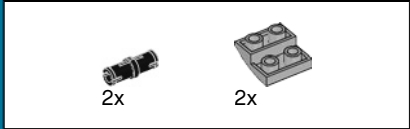
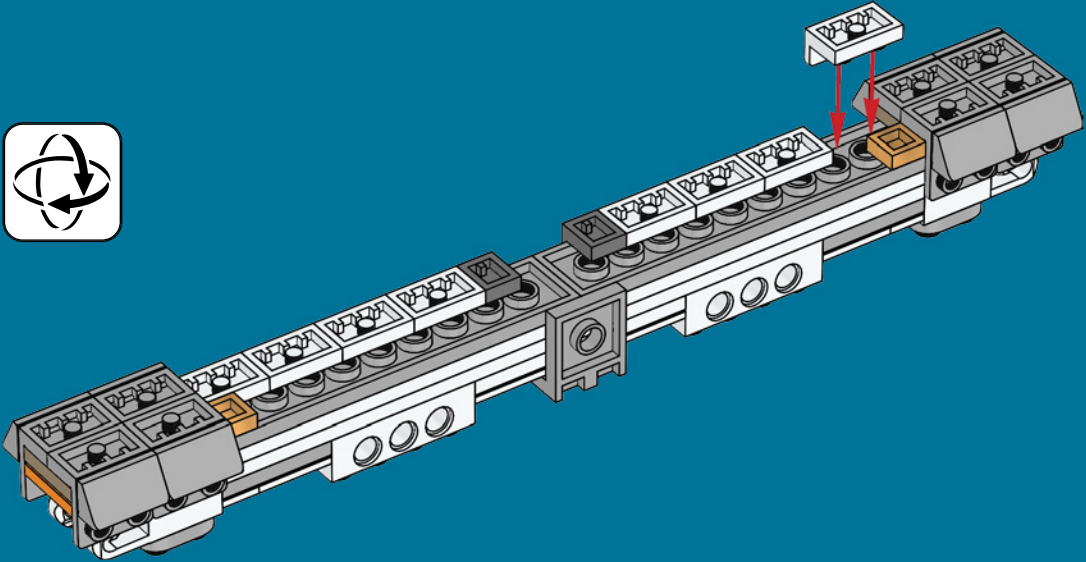

11

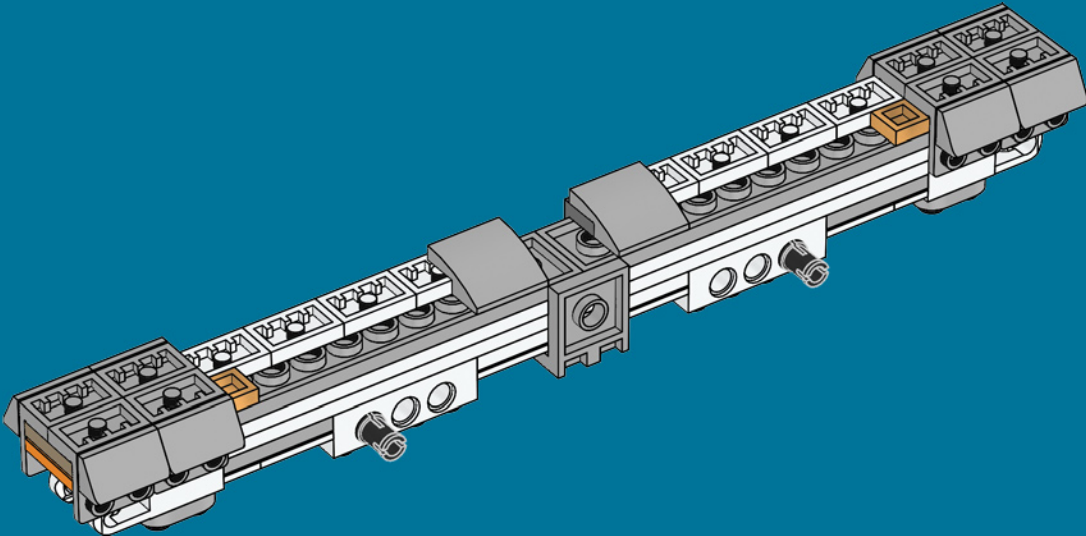

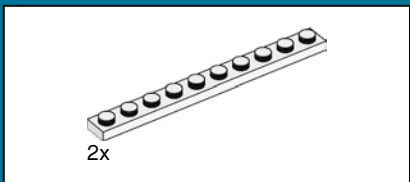

12

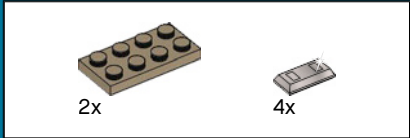
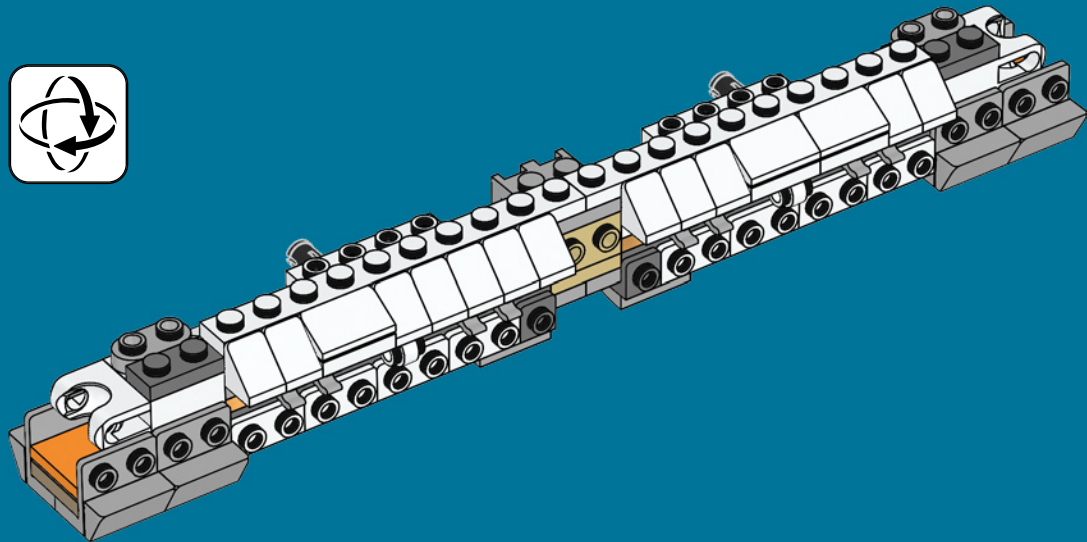

13

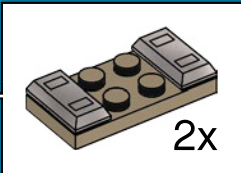
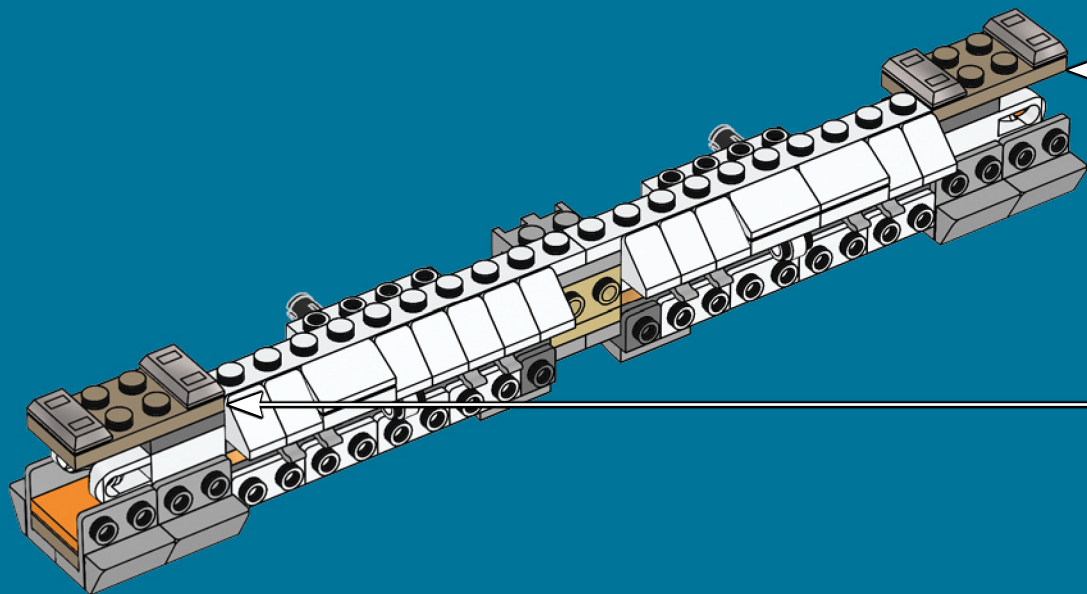

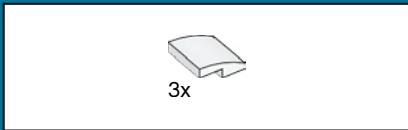

14

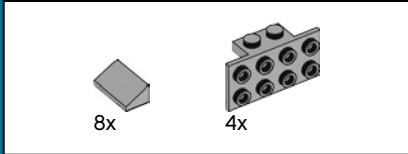
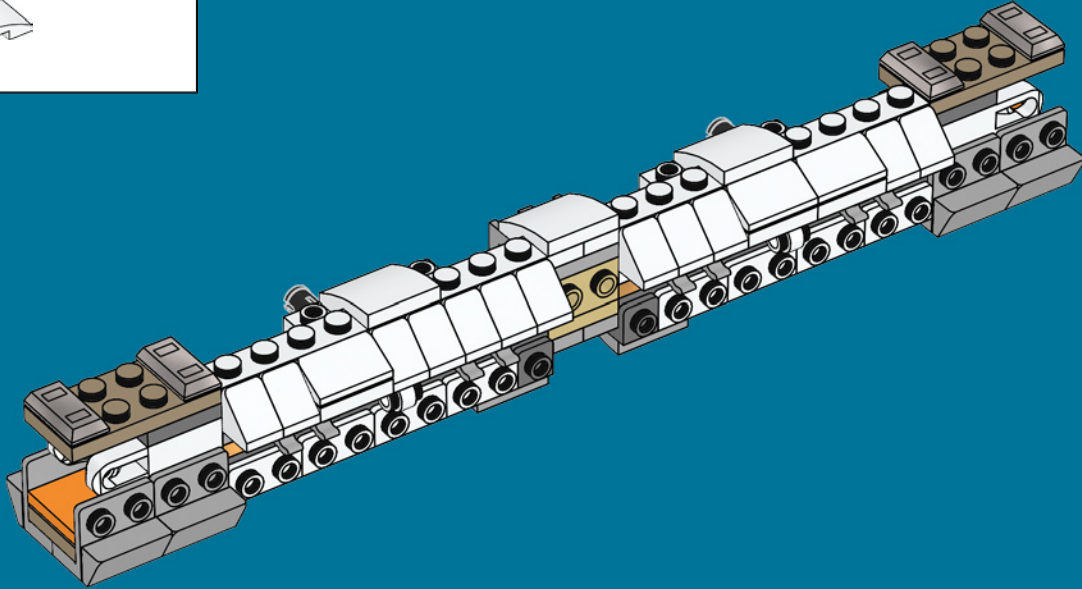

15

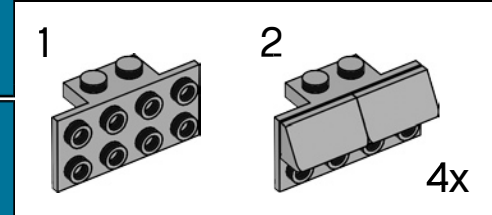
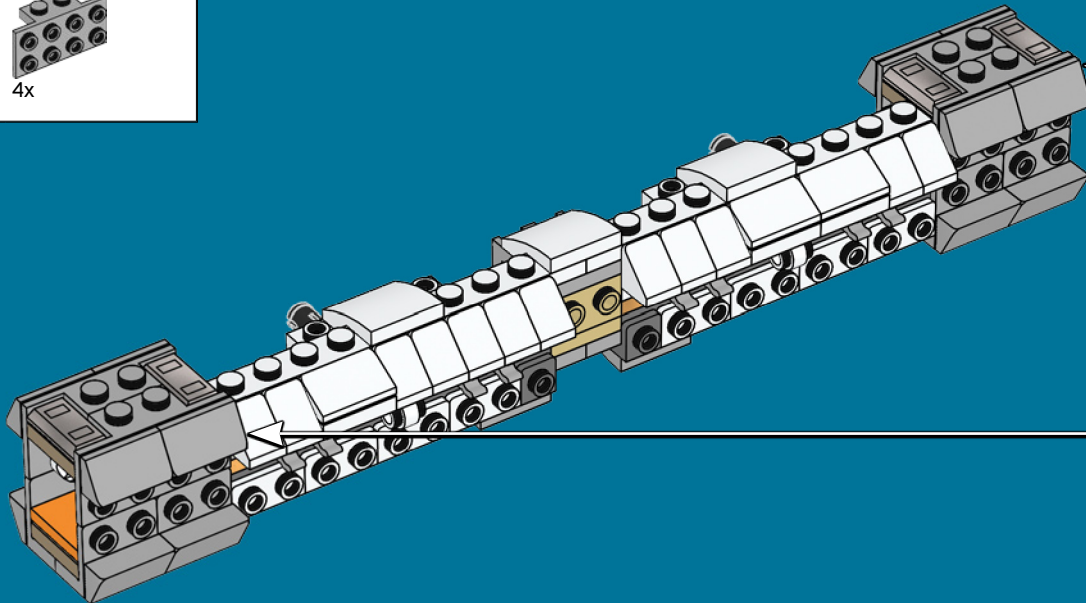

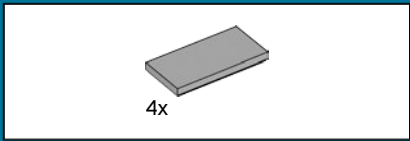

16

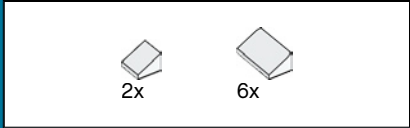
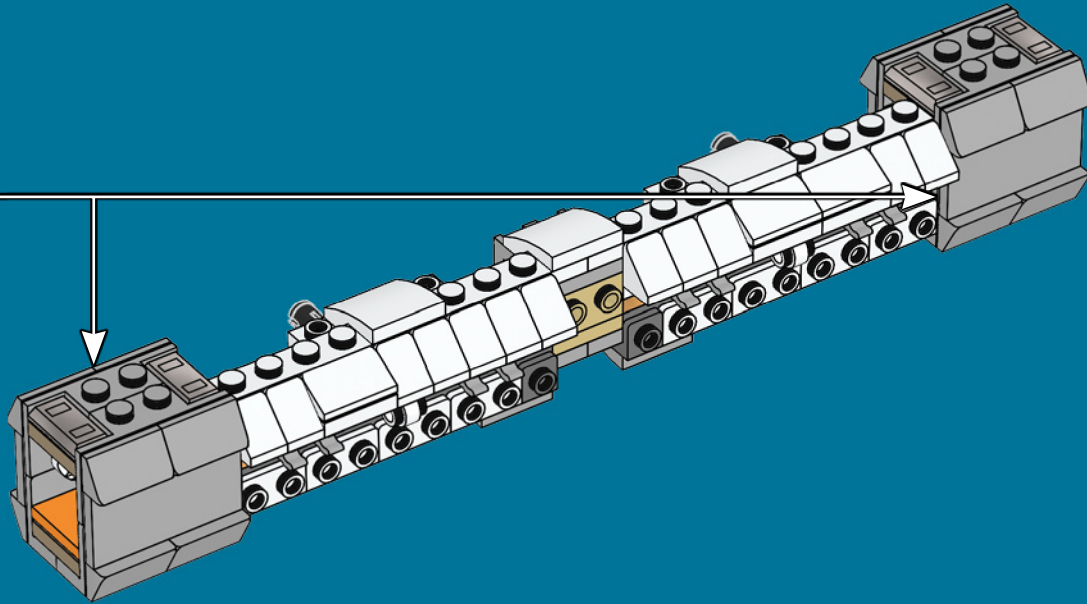
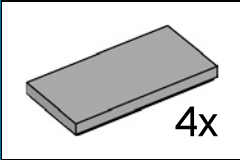

17

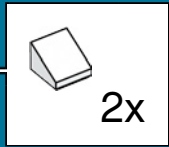
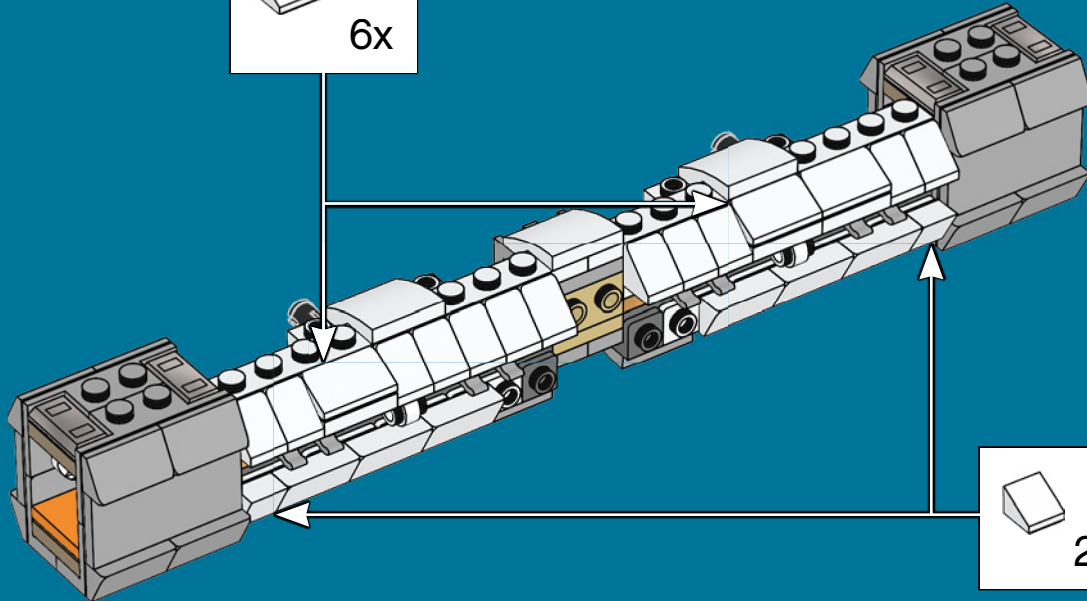
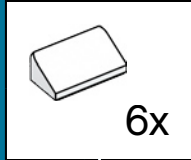



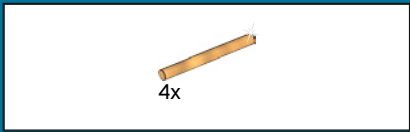

18

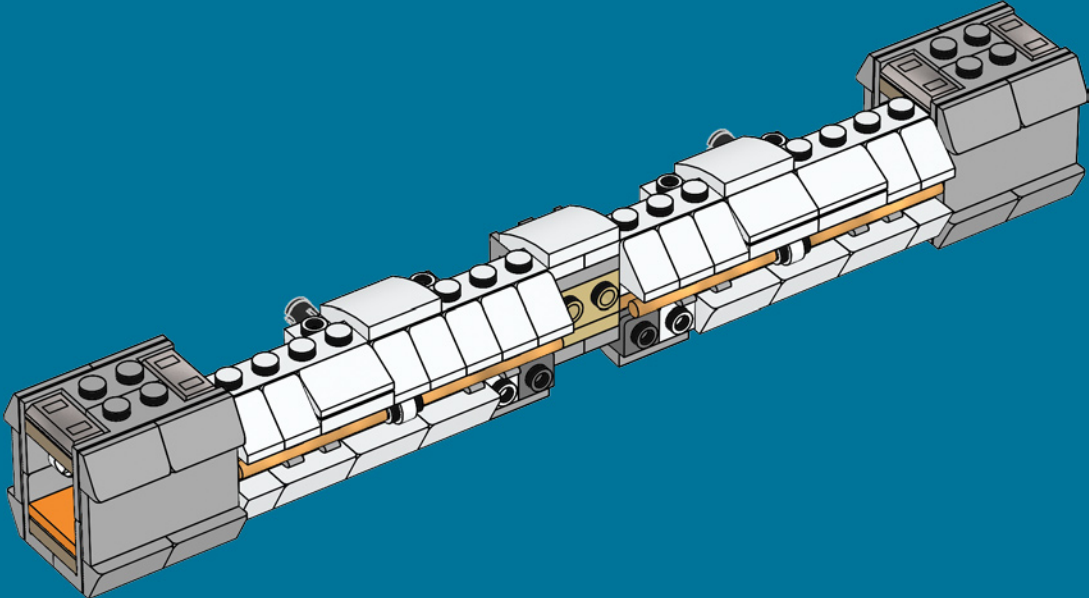

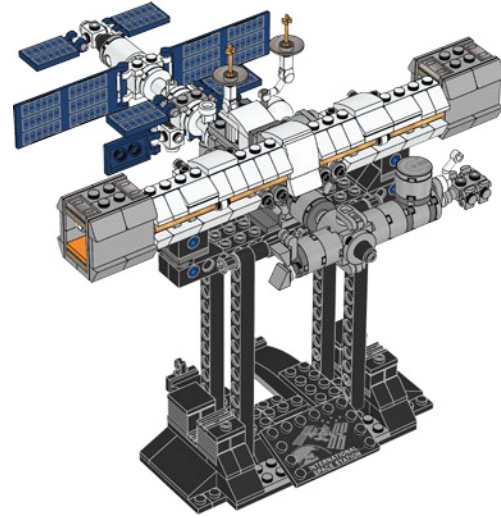
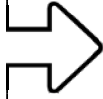

4x

19

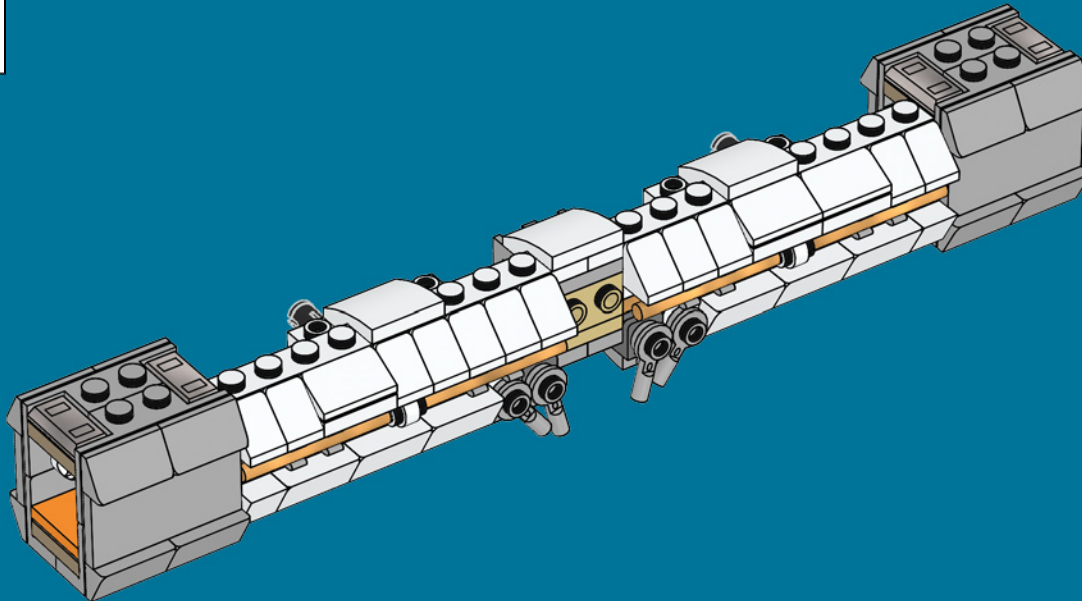

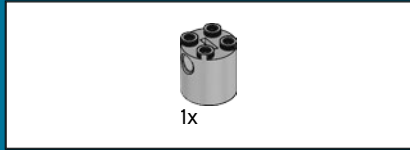
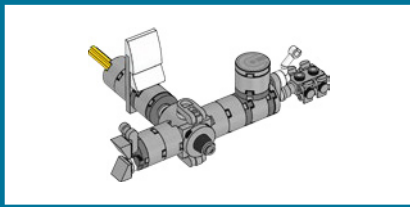

20

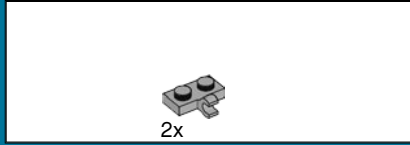

21

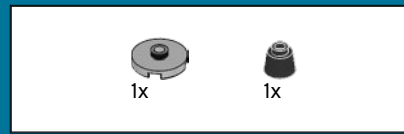
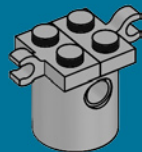

22

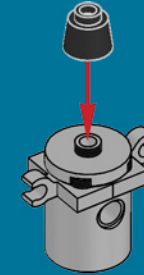

23

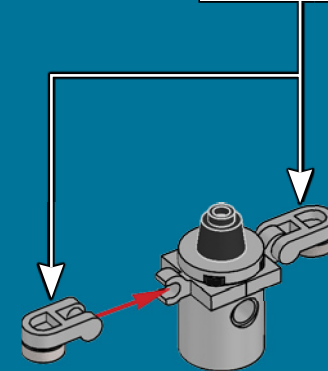
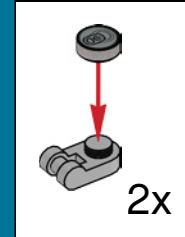

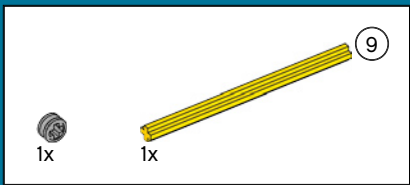

24

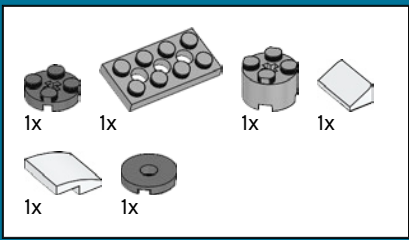
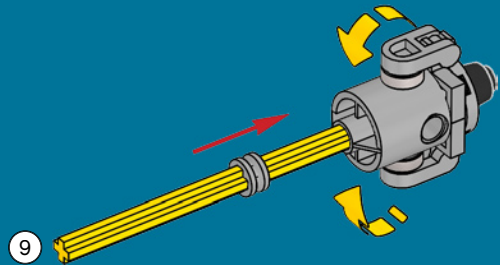

25

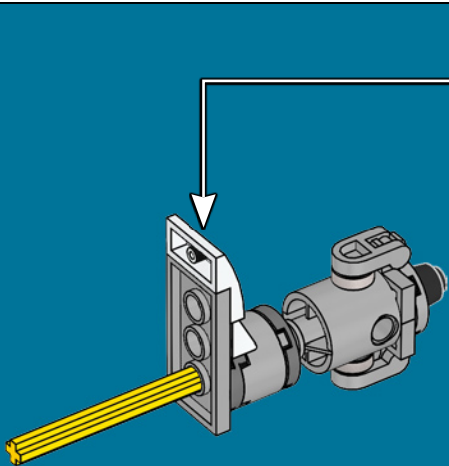
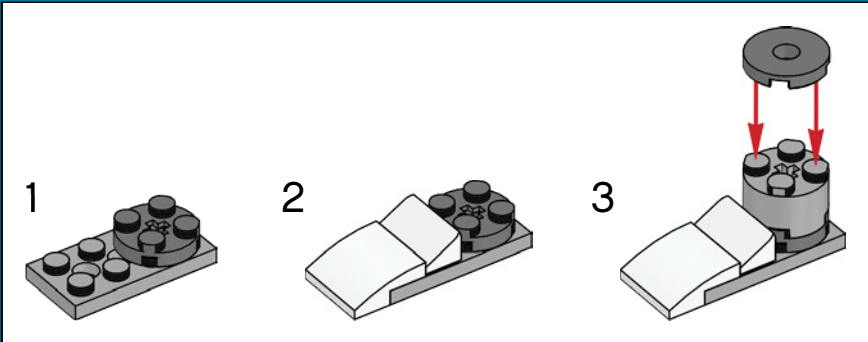



2x

26

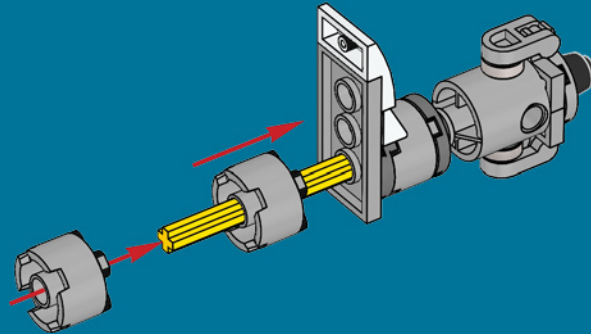

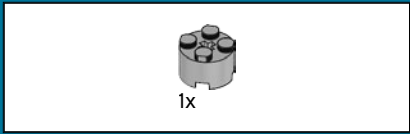
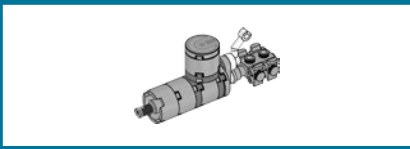

27

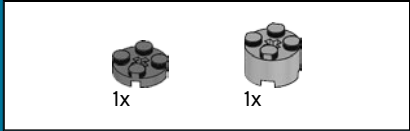

28

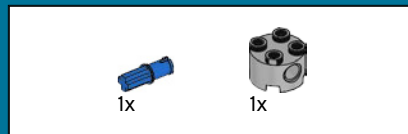

29

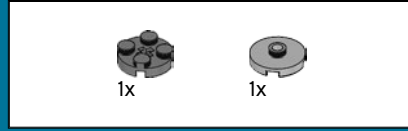
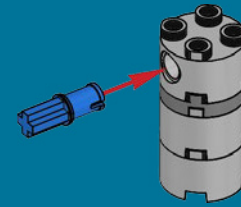

30

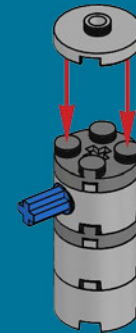



31

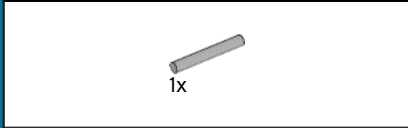
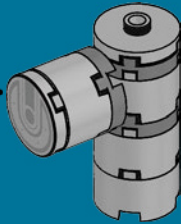
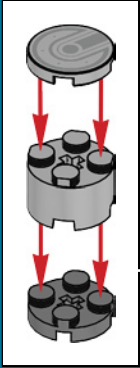

32

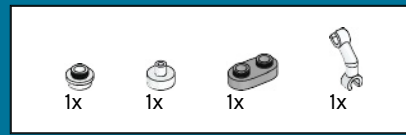
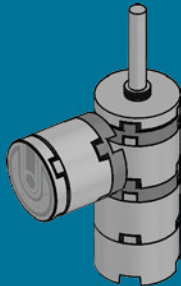

33

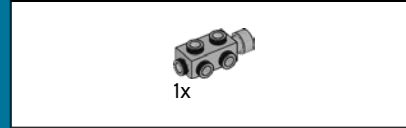
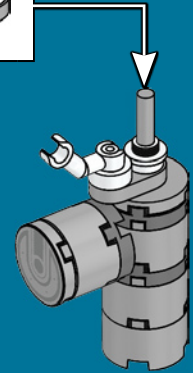

34

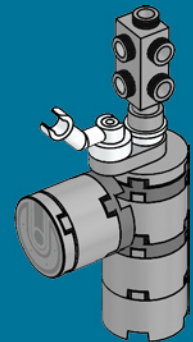



4x

35

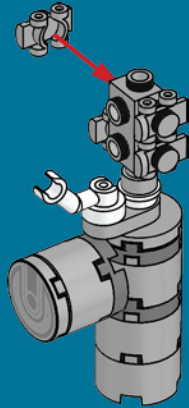

1x

36

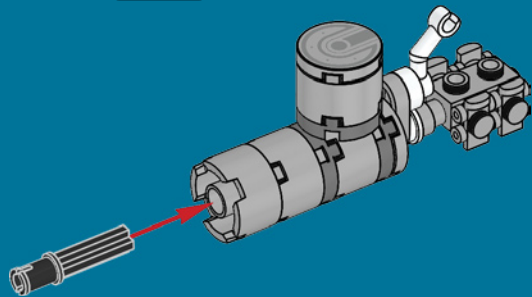

37

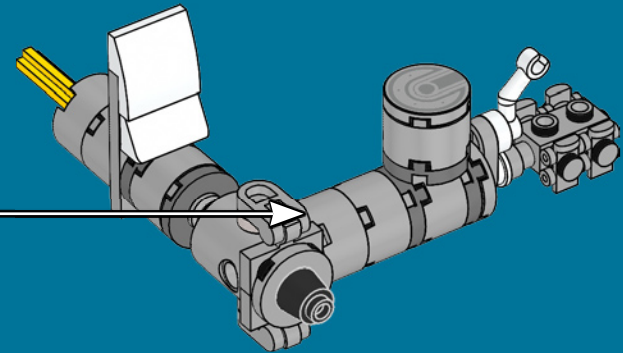



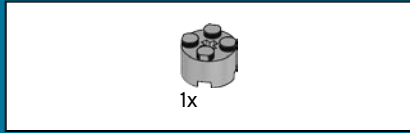
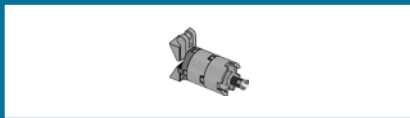

38

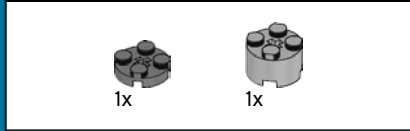
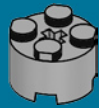

39

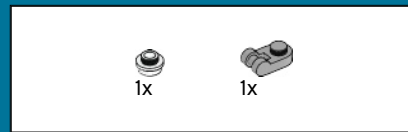
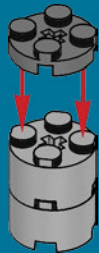

40

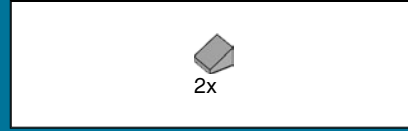
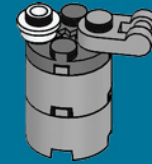

41





42

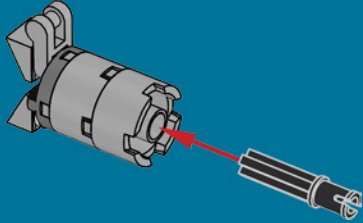

43

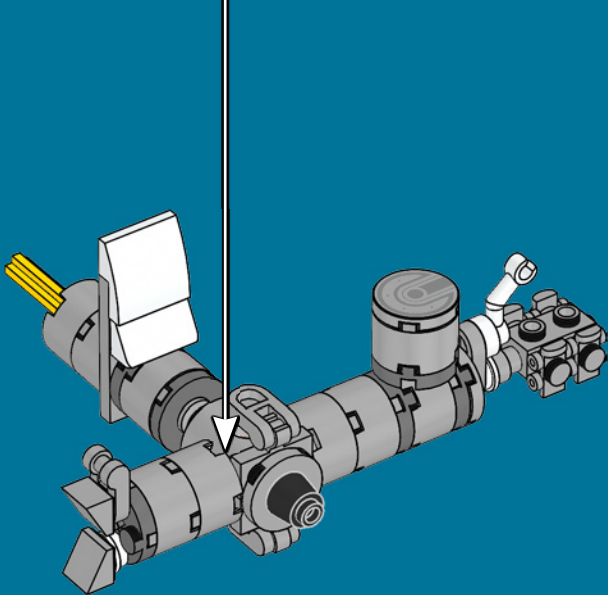

44

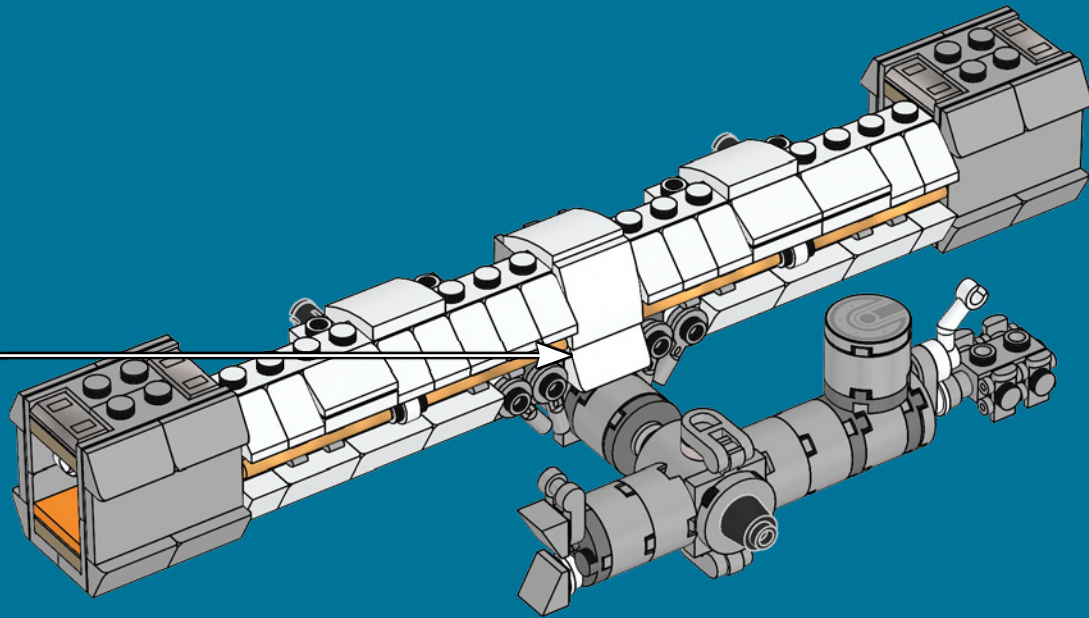

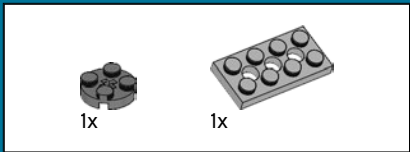

45

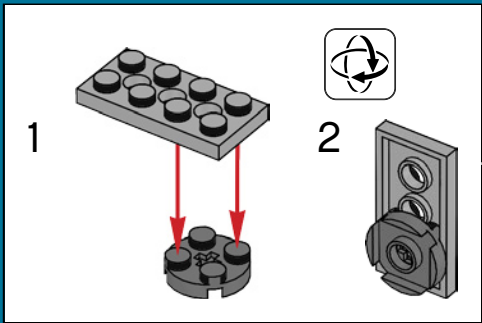
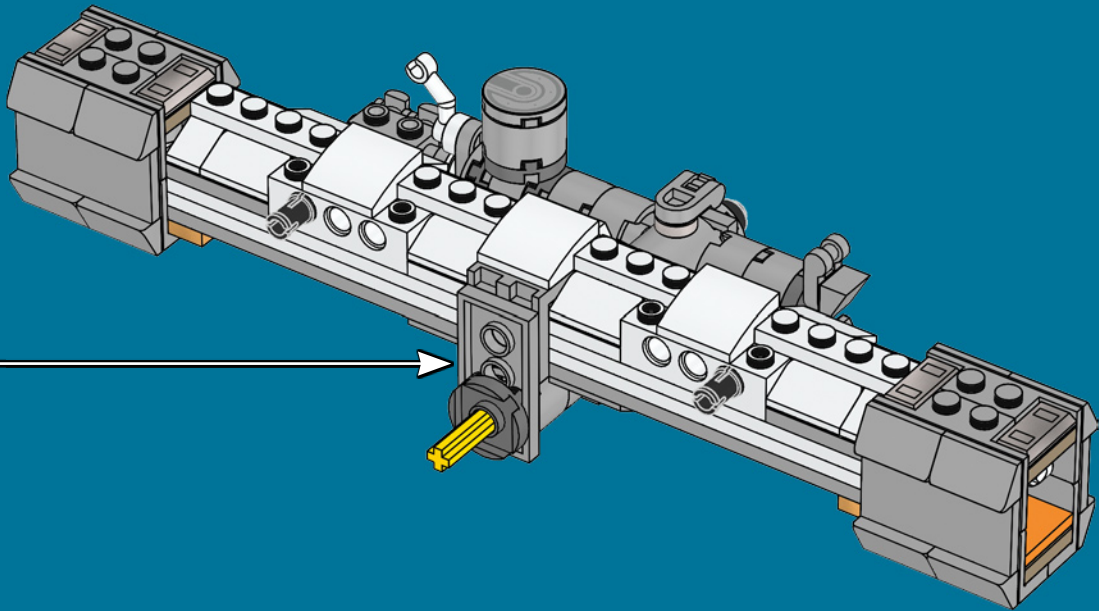

46

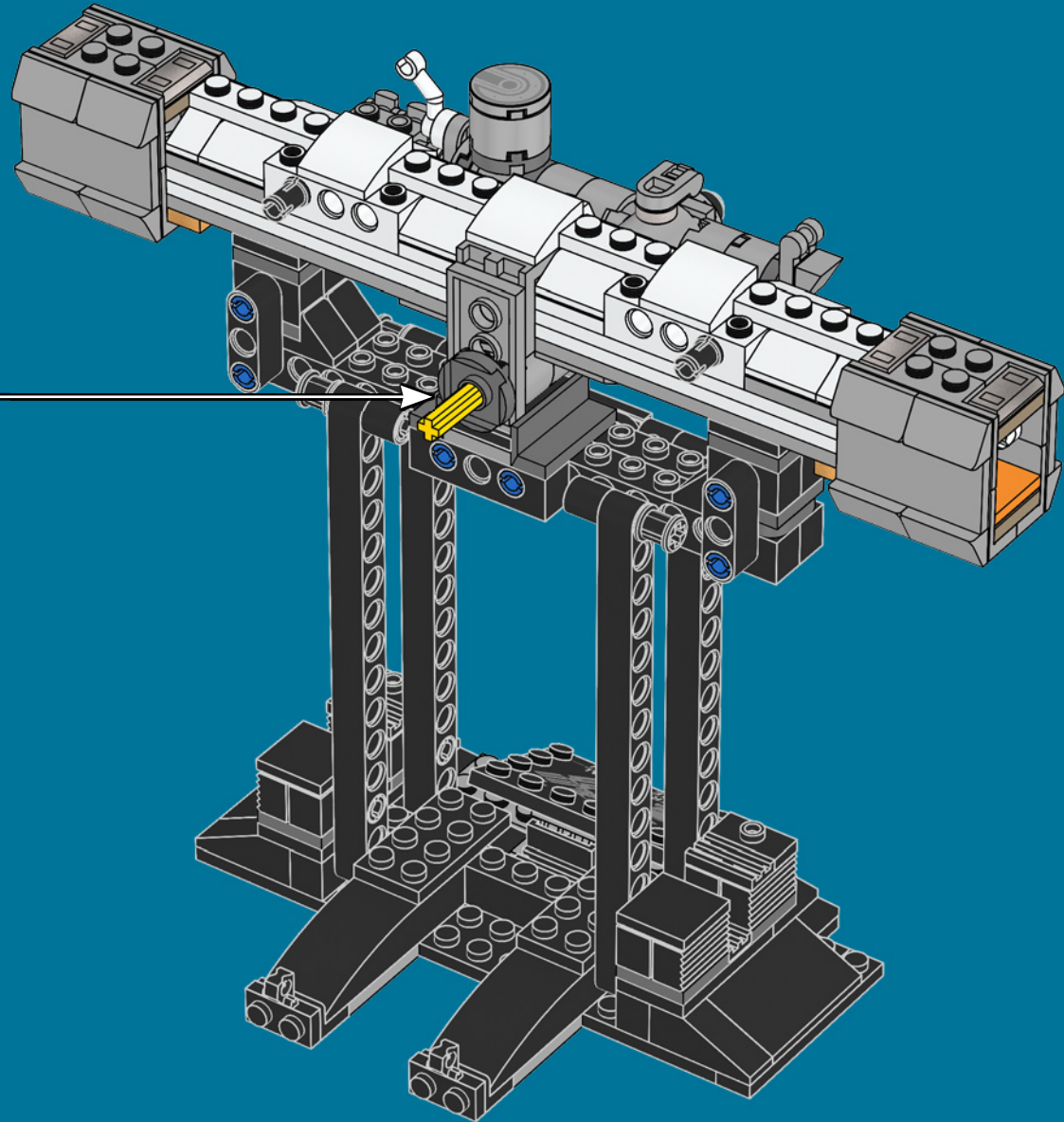

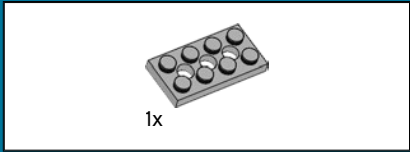
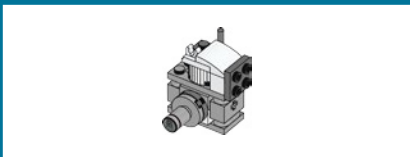

1x

47

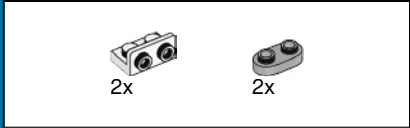
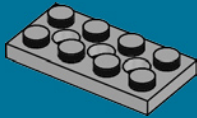

2x

2x

48

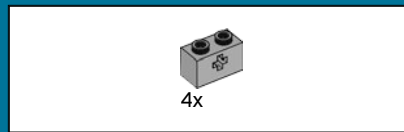
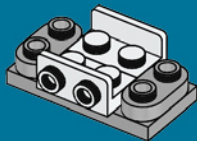

4x

49

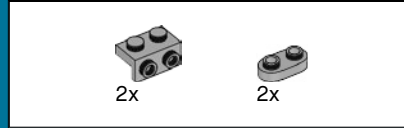
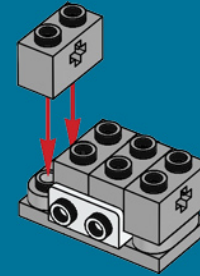

2x

2x

50

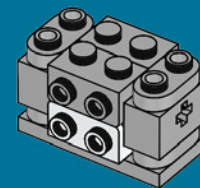

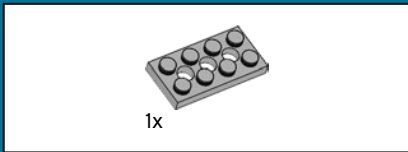

51

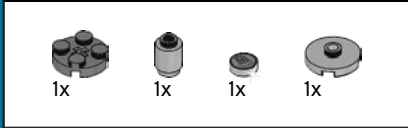
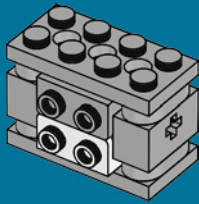

52

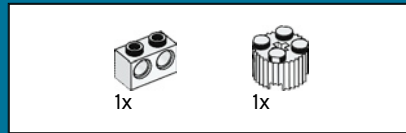
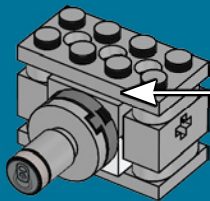
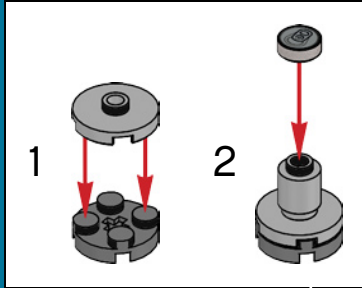

53

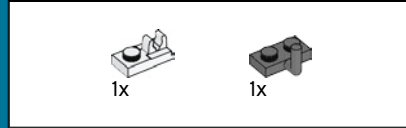
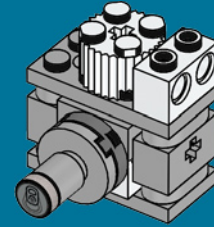

54

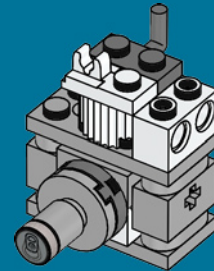

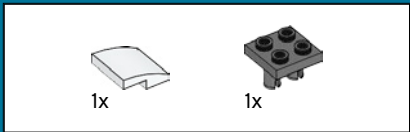

55

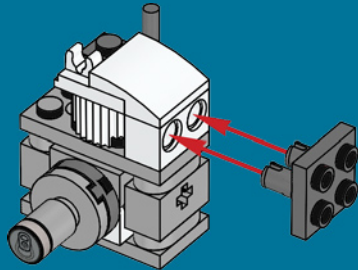

56

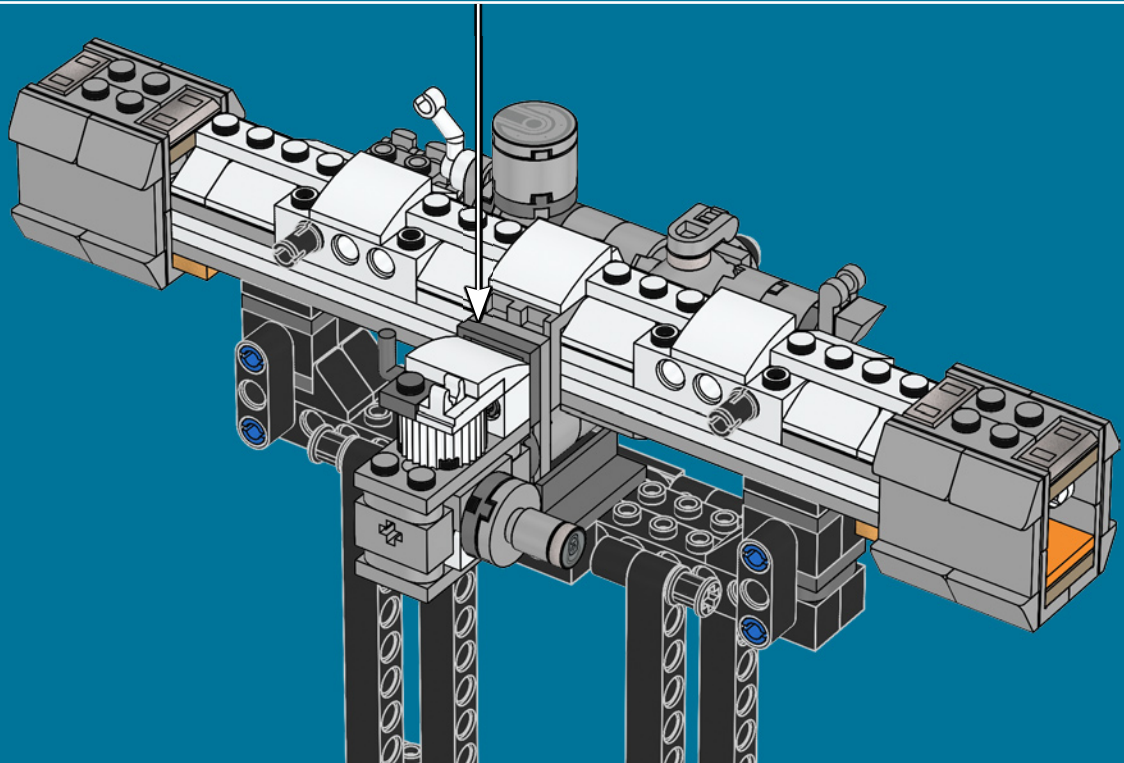



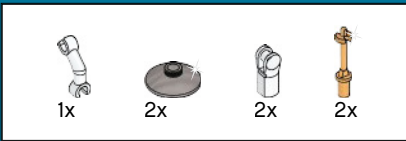

57

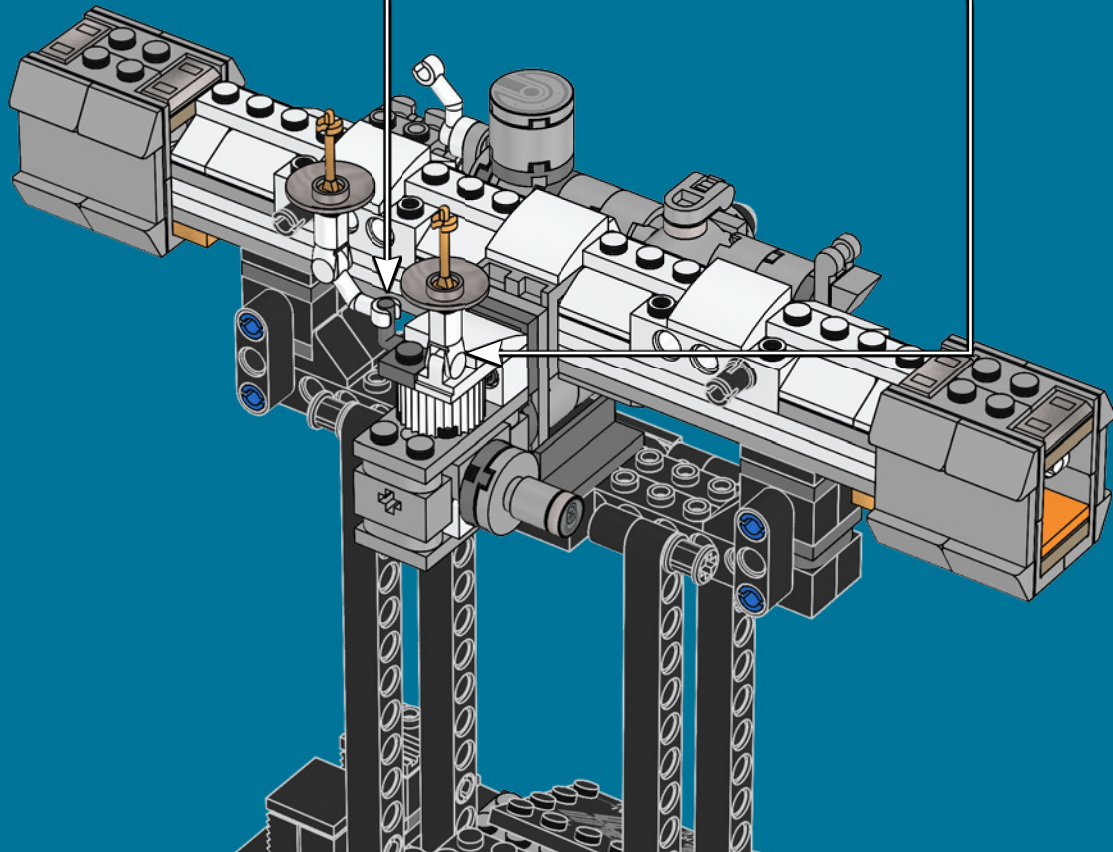
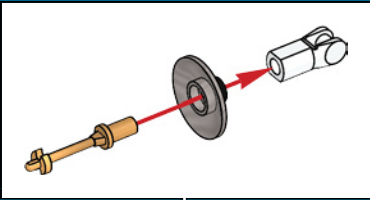
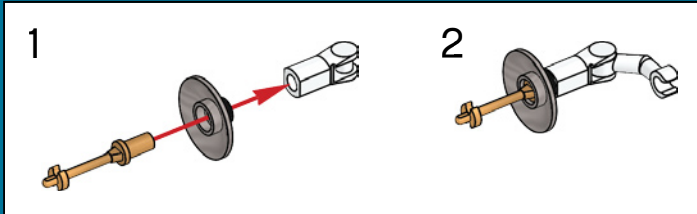

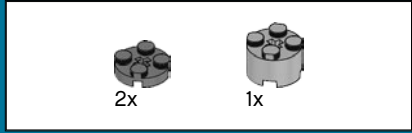

58

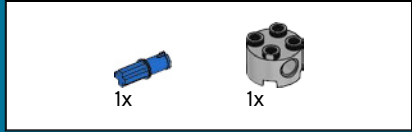
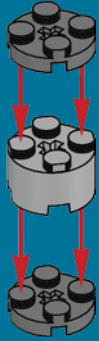

59

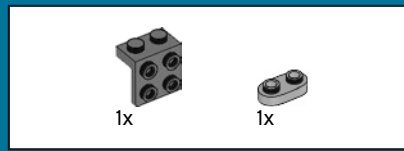
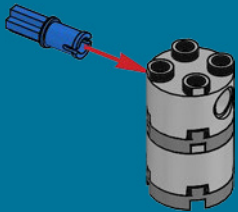

60

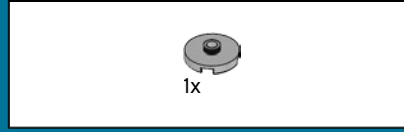
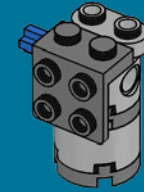

61

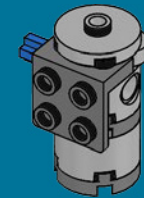

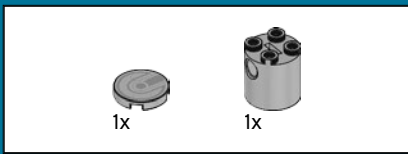

62

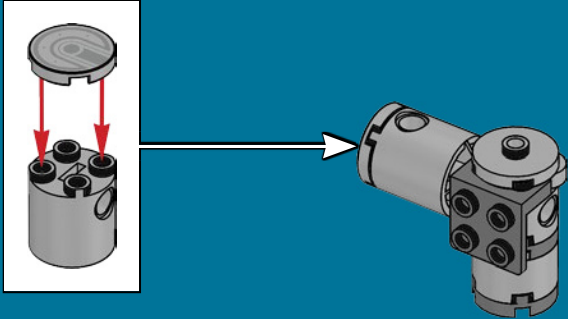

63

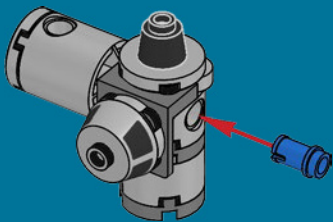

64

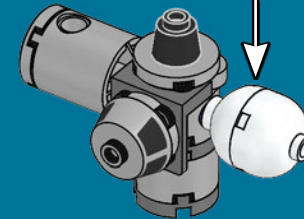
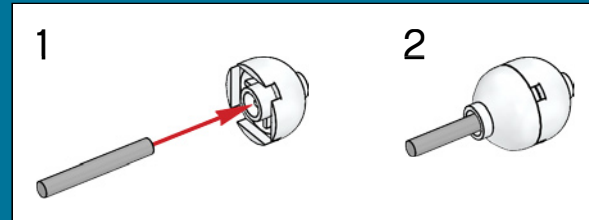

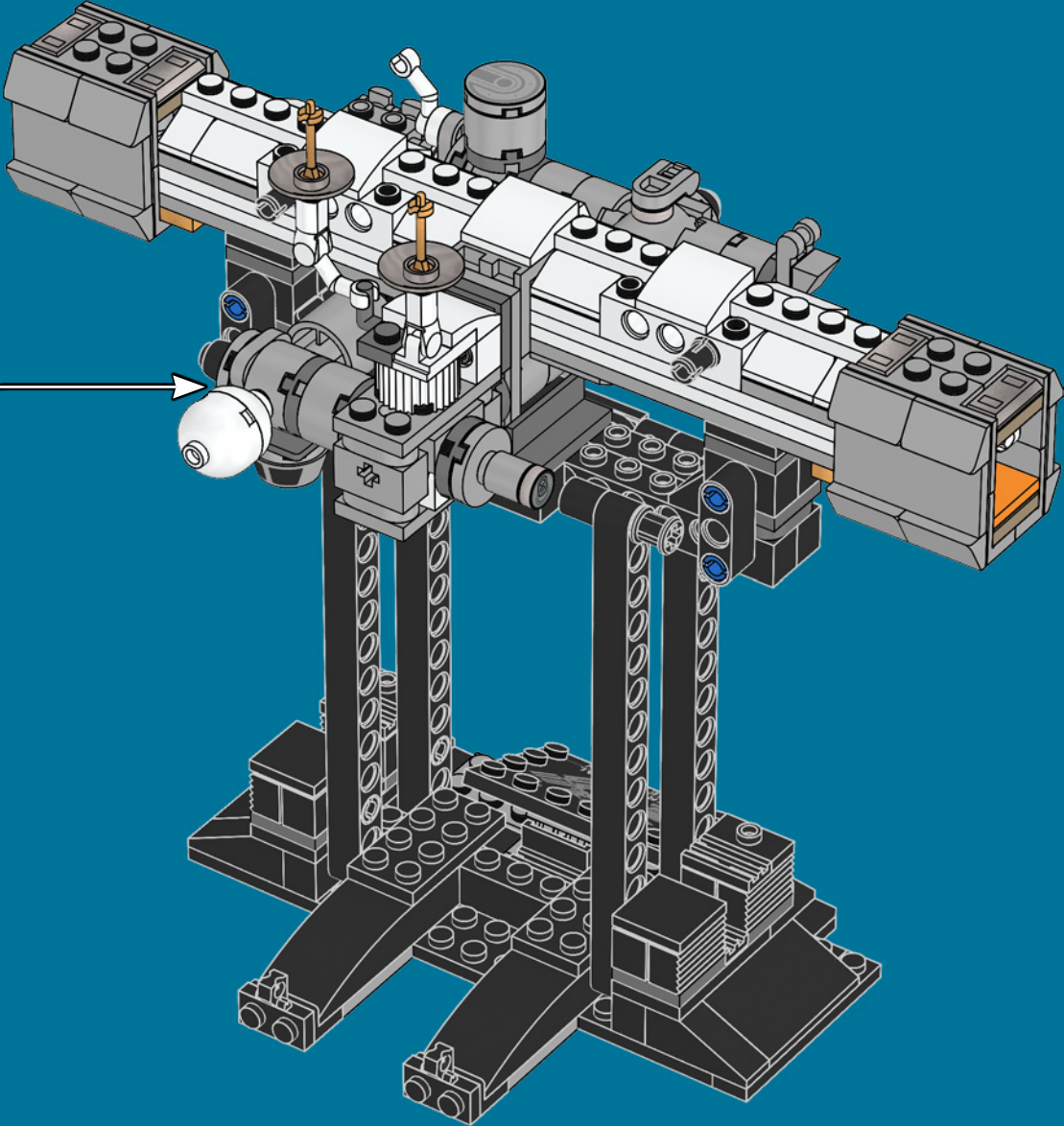

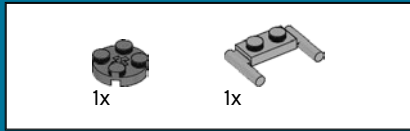

66

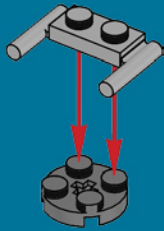

67

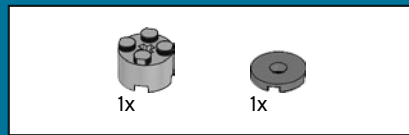

68

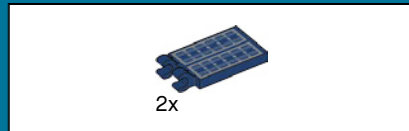
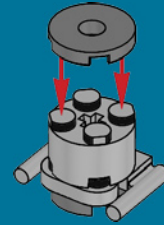

69

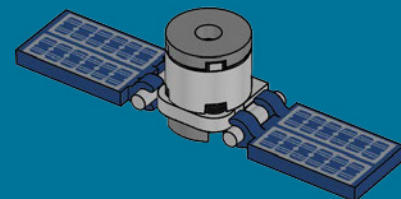

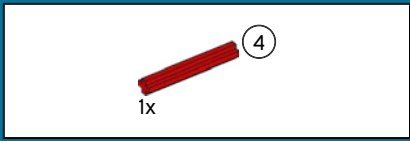

70

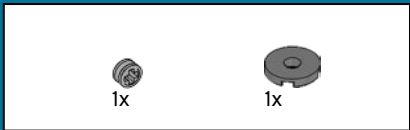
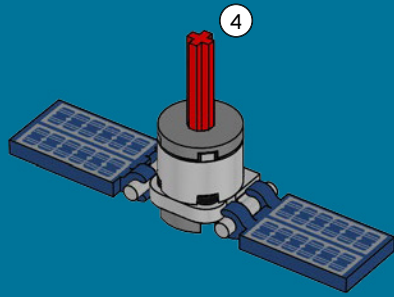

71

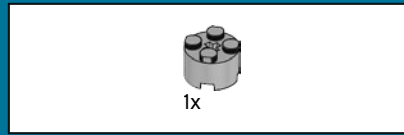
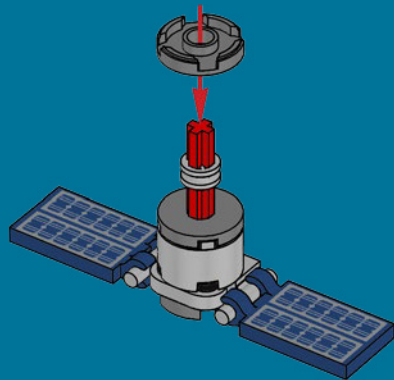

72

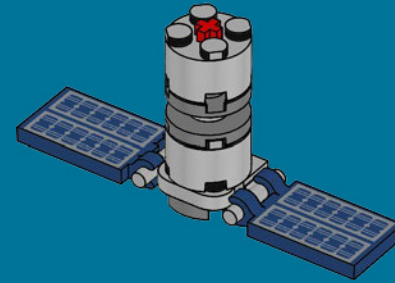

73

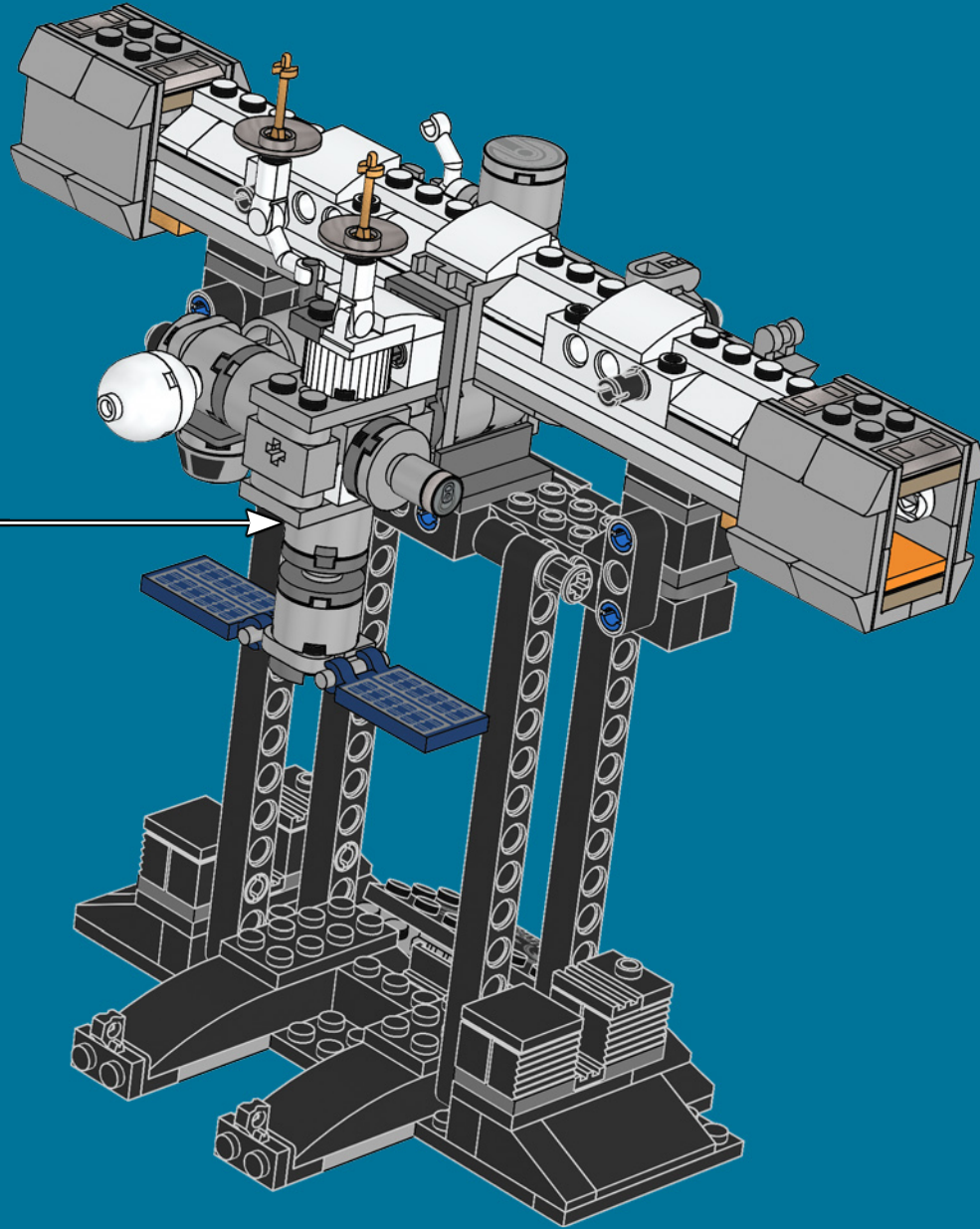

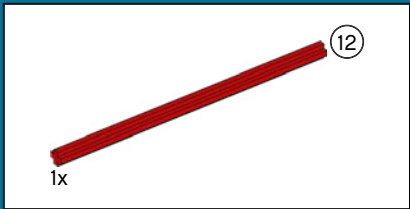

74

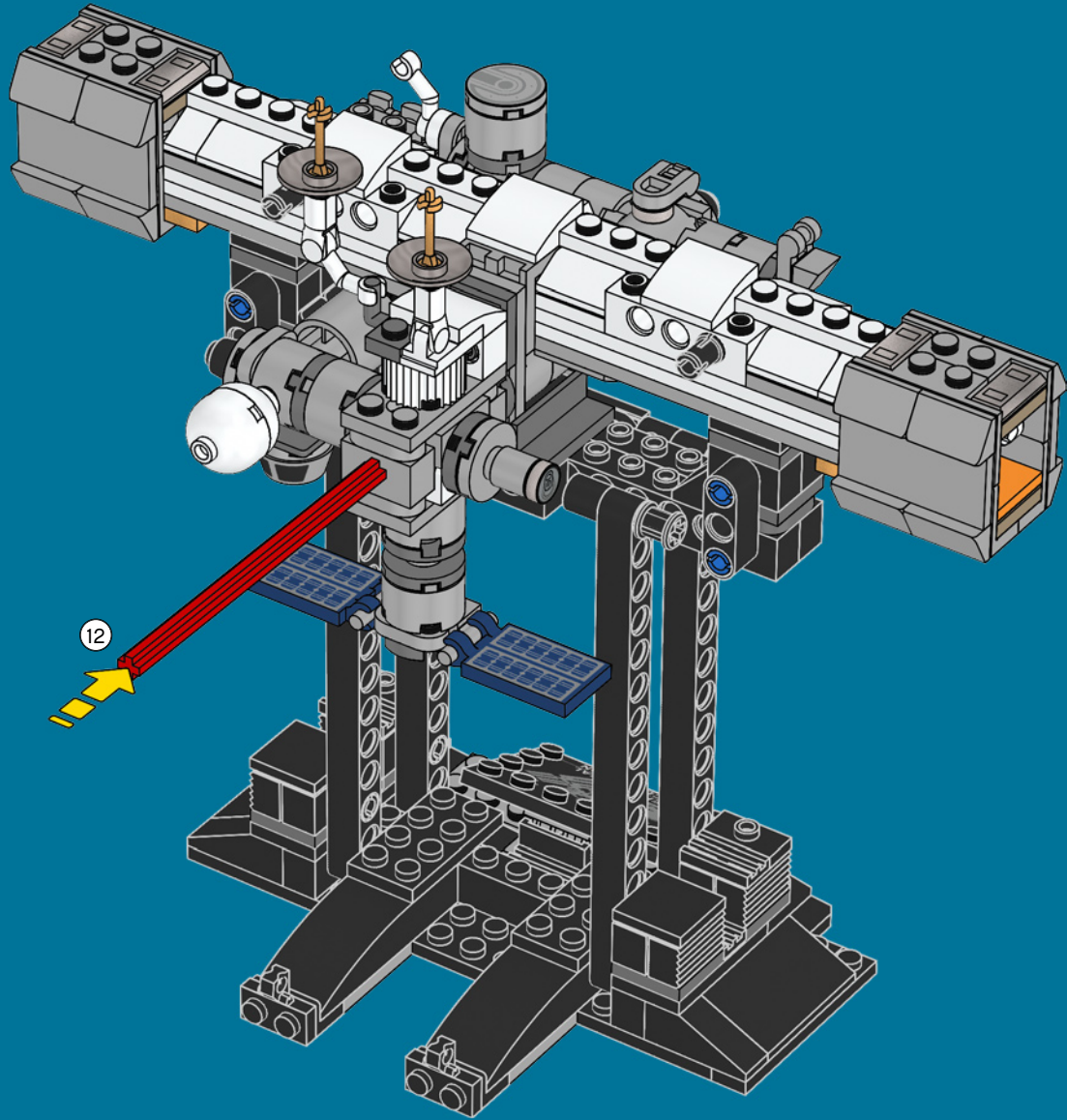



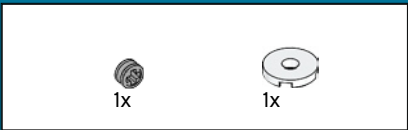

75

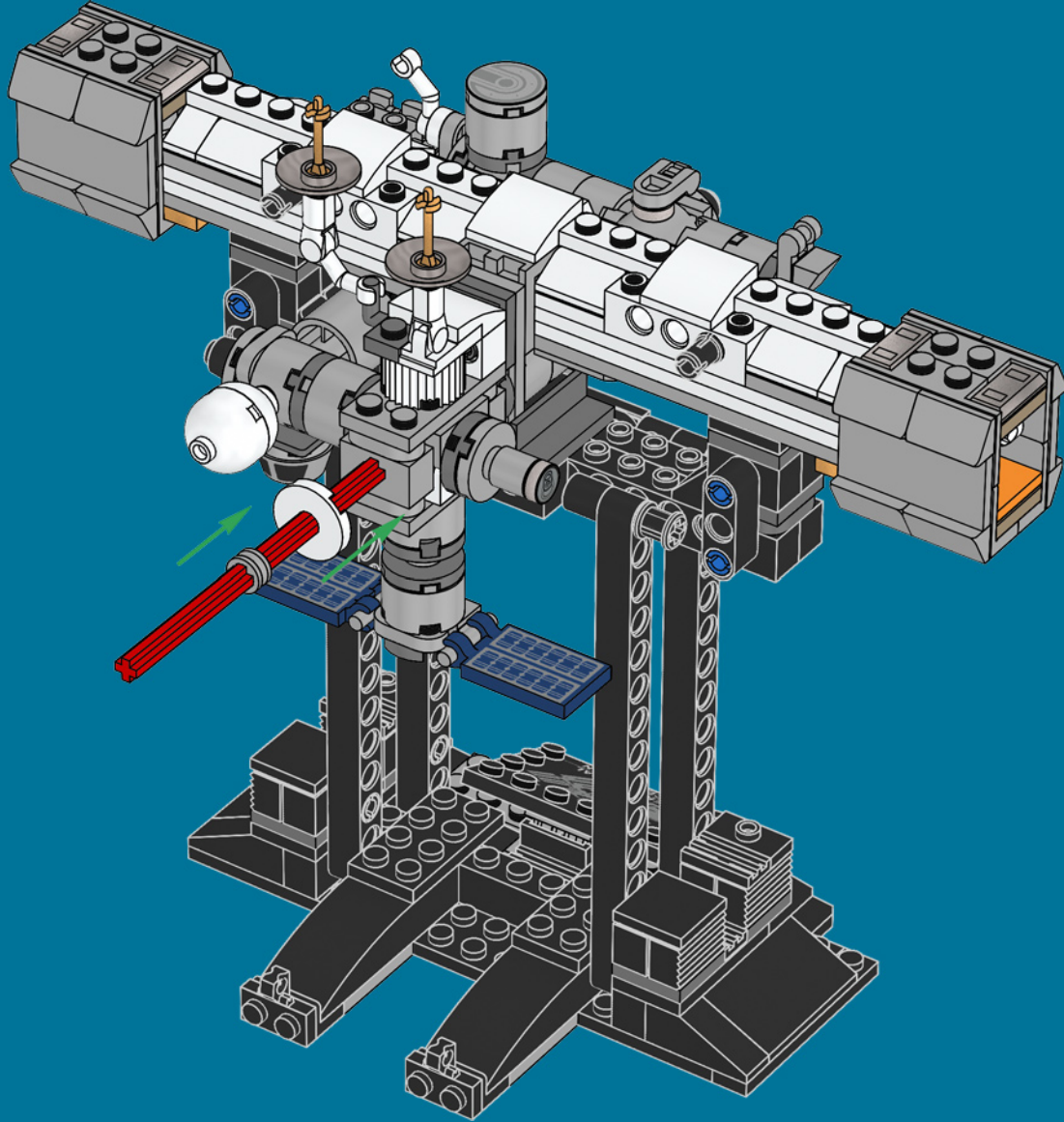

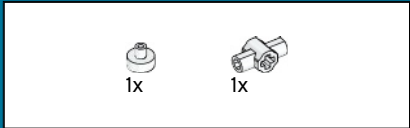

76

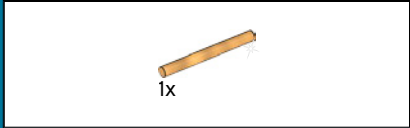
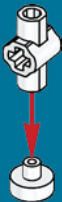

77



78



79





80

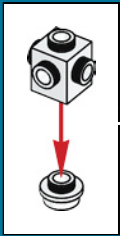

81

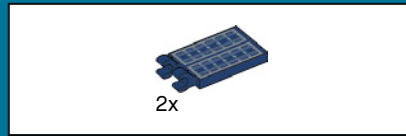

82

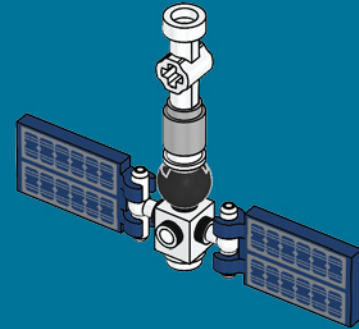

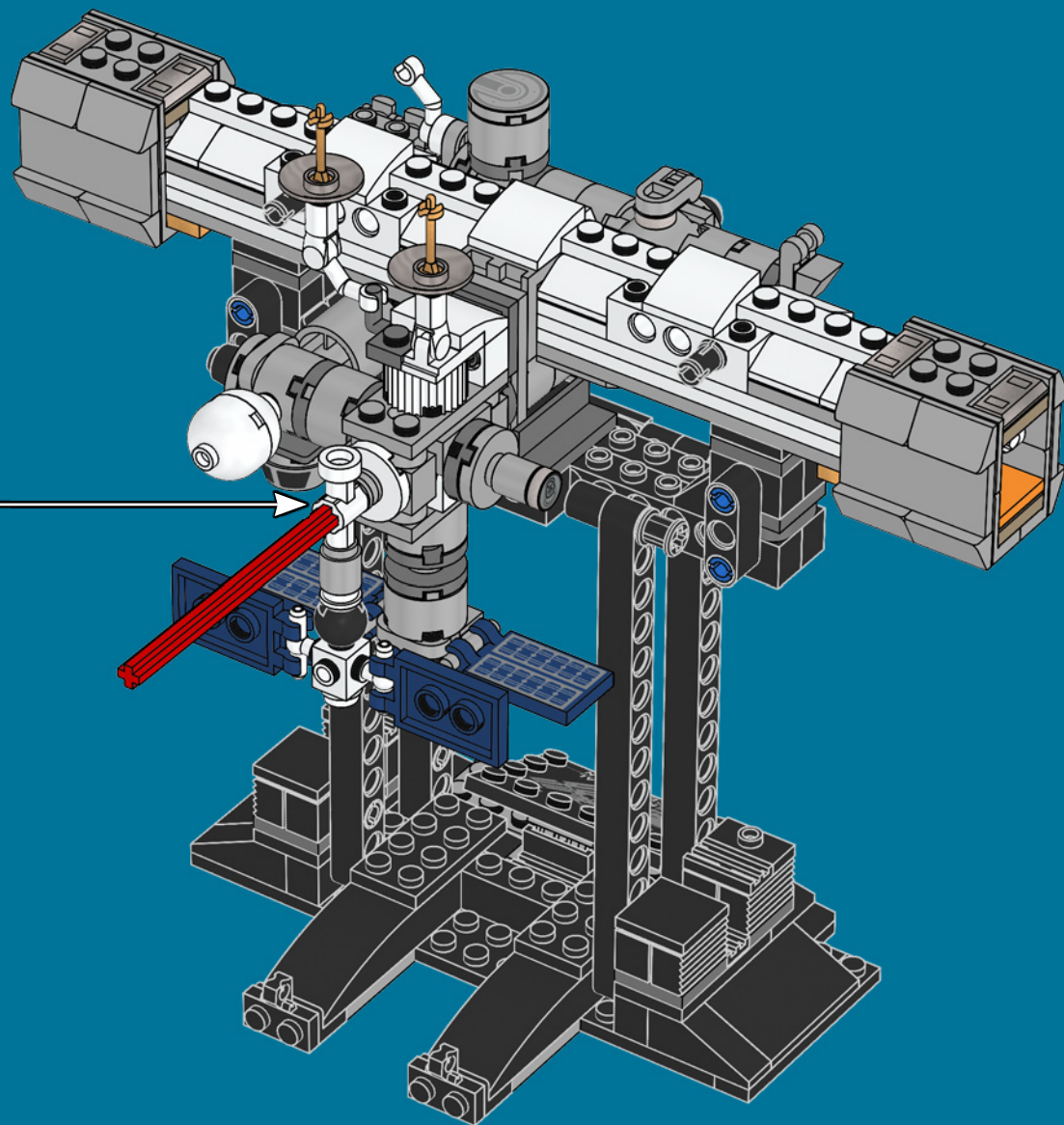



84

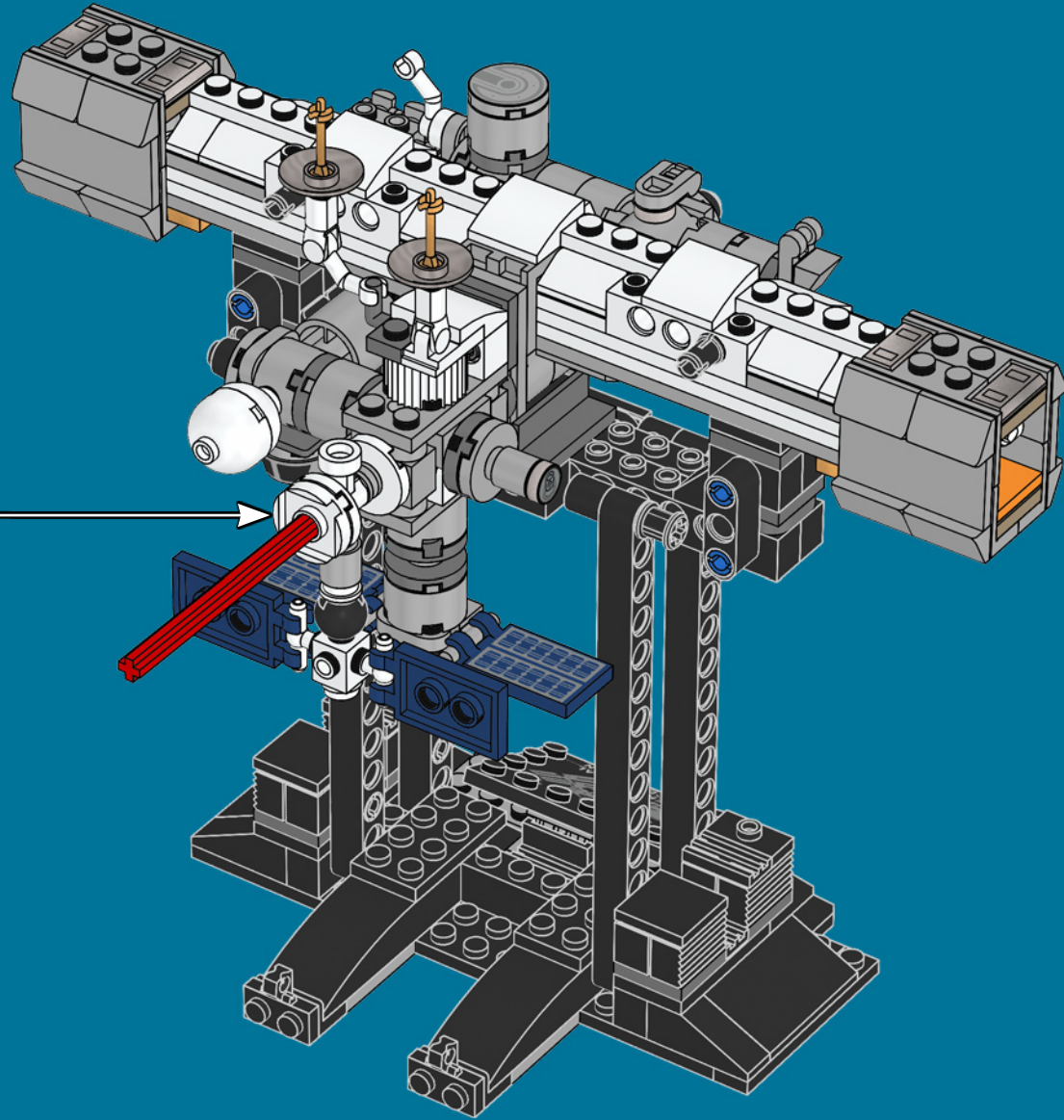
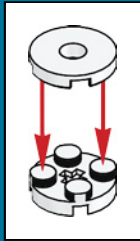

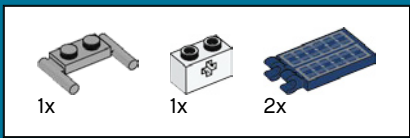

85

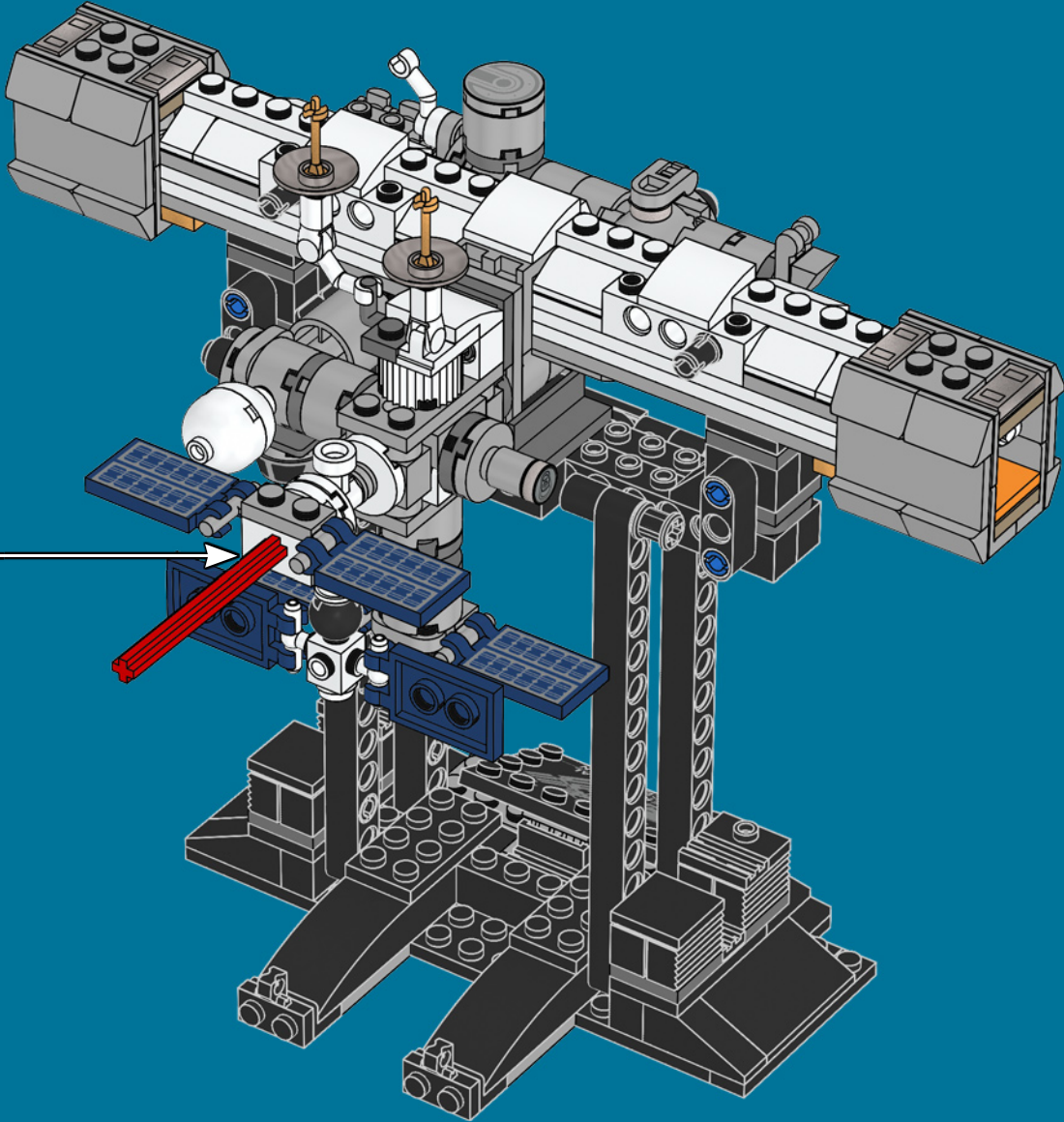
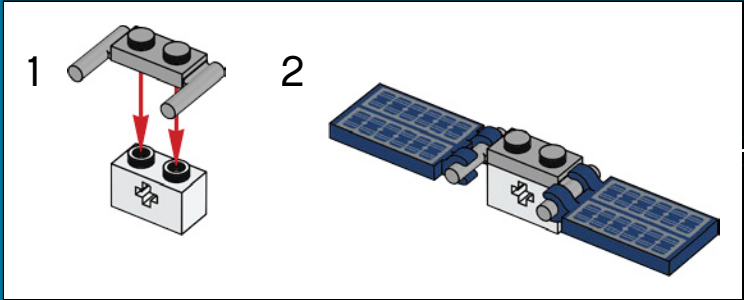



1x



1x

86

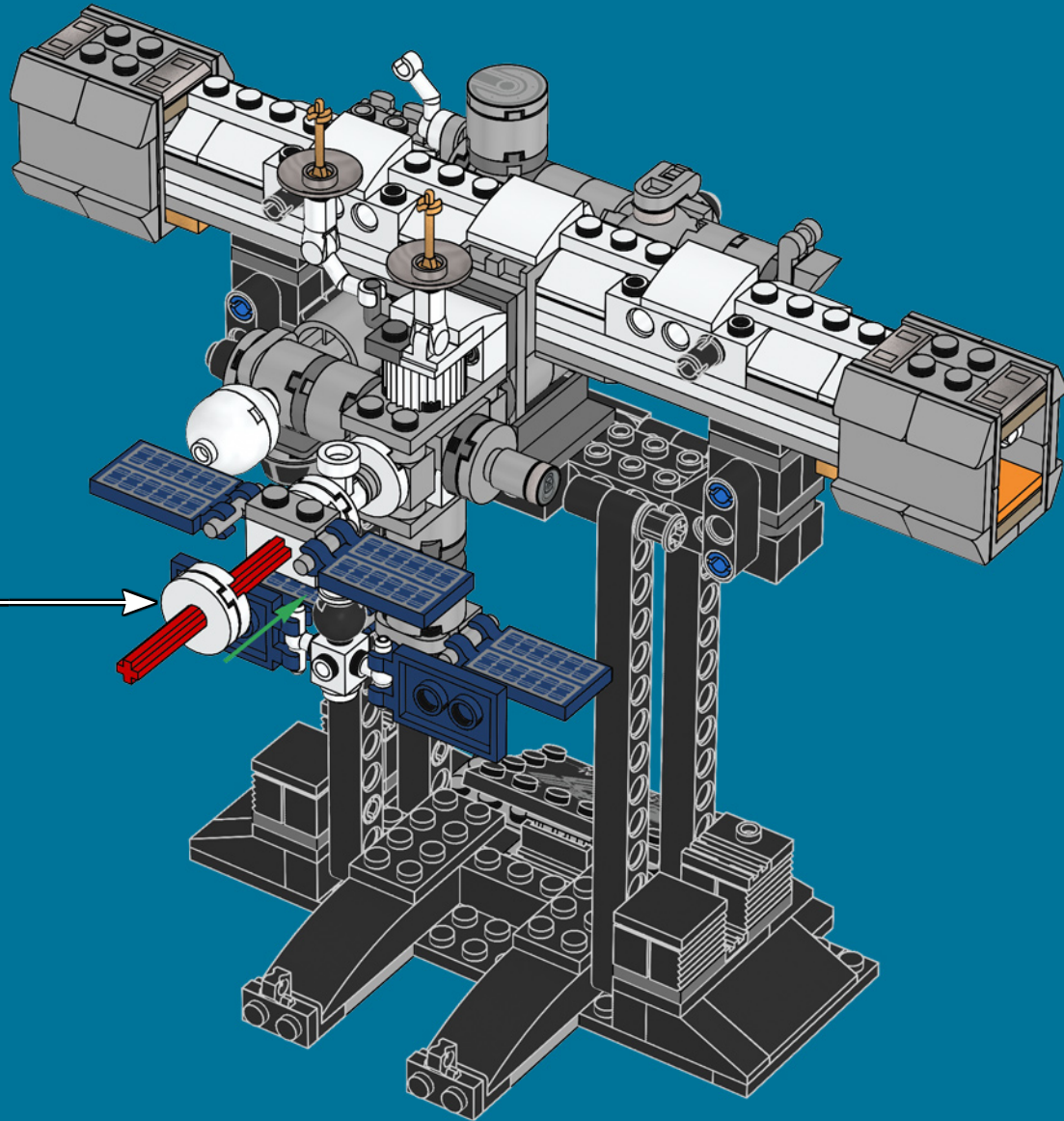
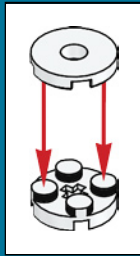

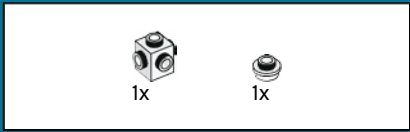

87

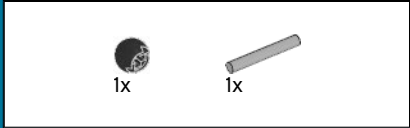
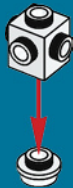

88

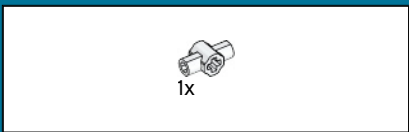
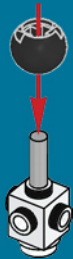

89

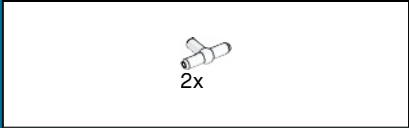

90





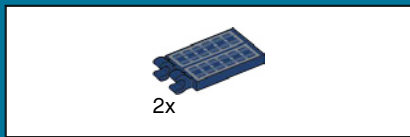

91

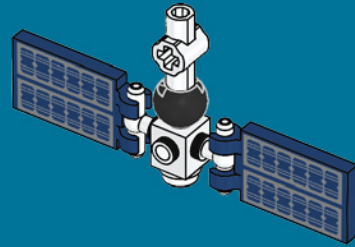

92

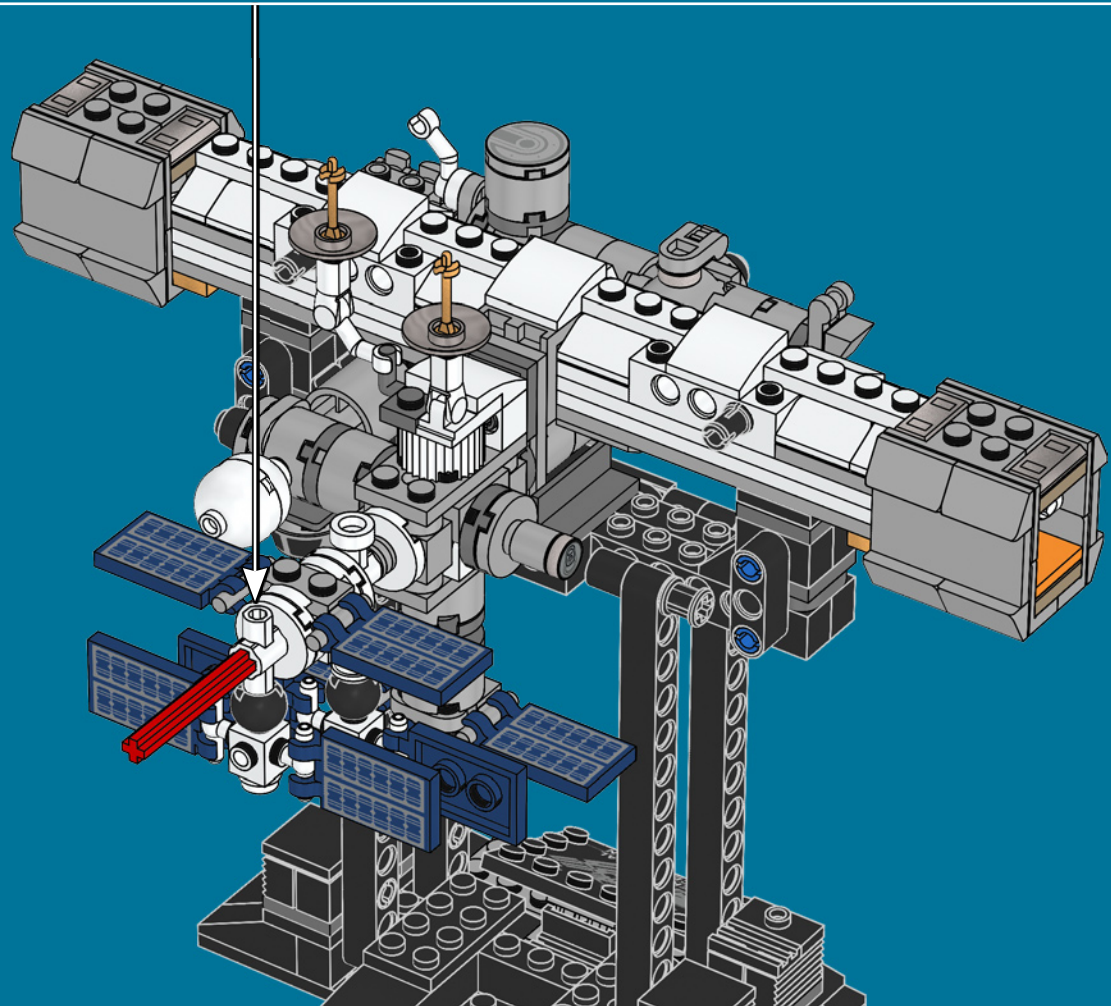



1x



1x



1x

93

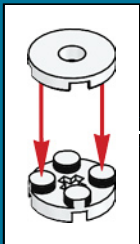
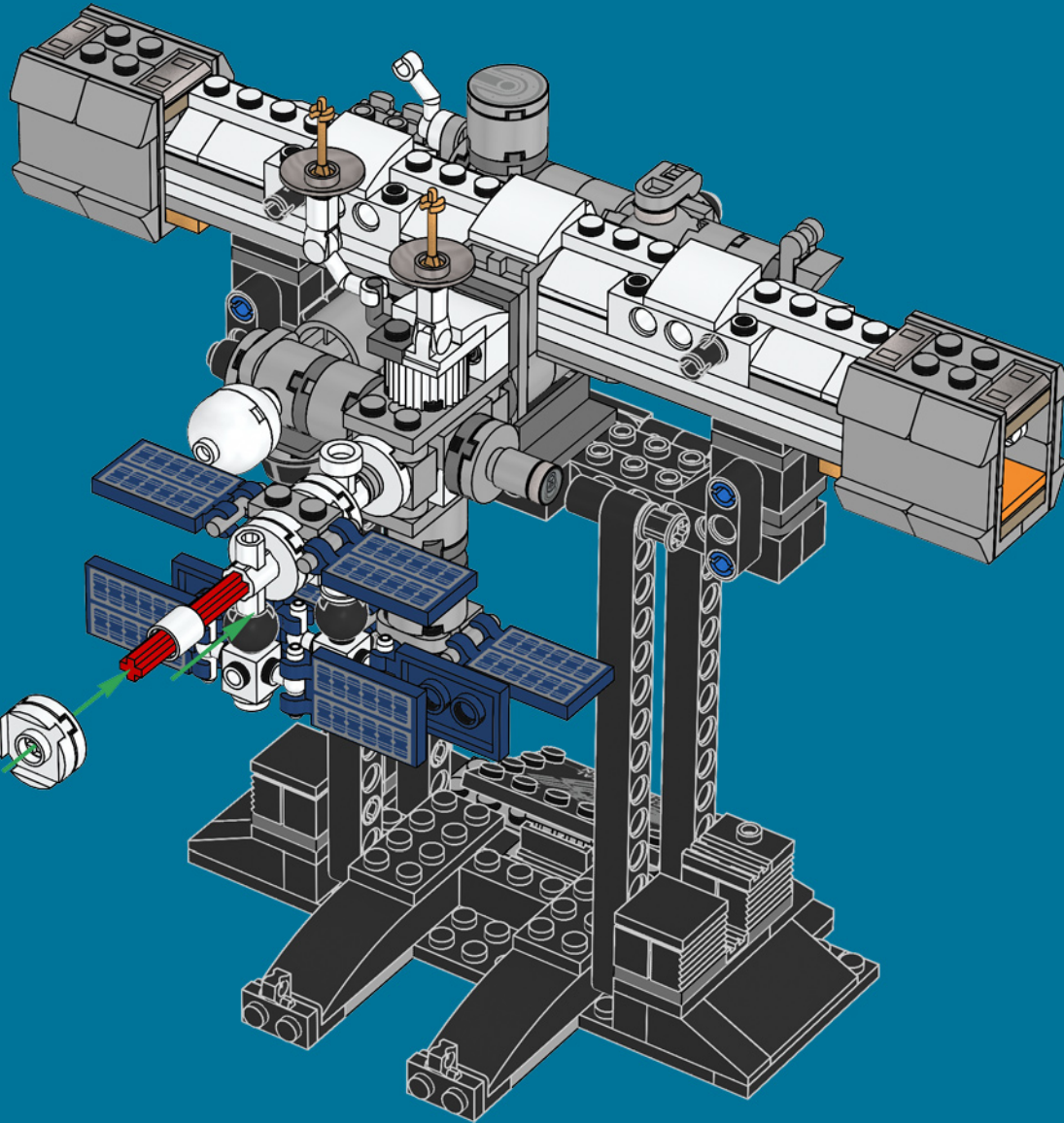

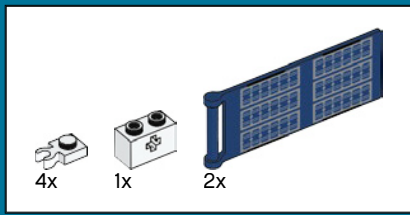

94

1



2

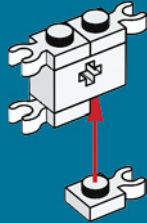

3

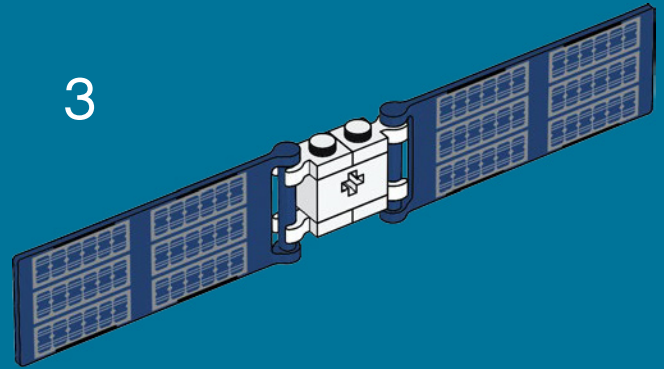

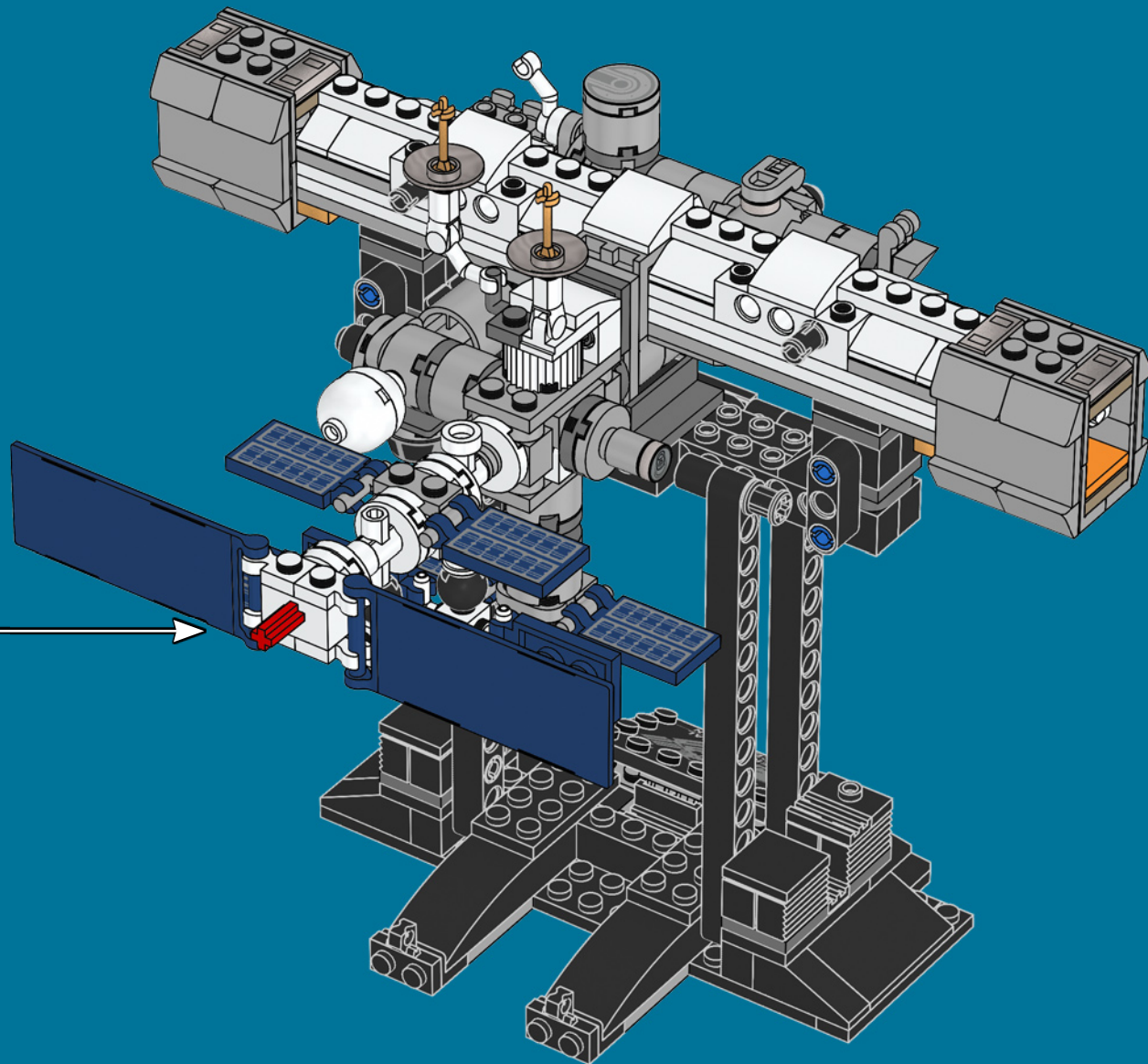

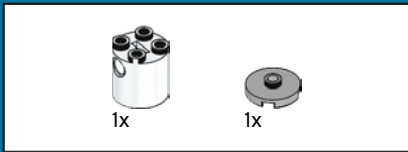

95

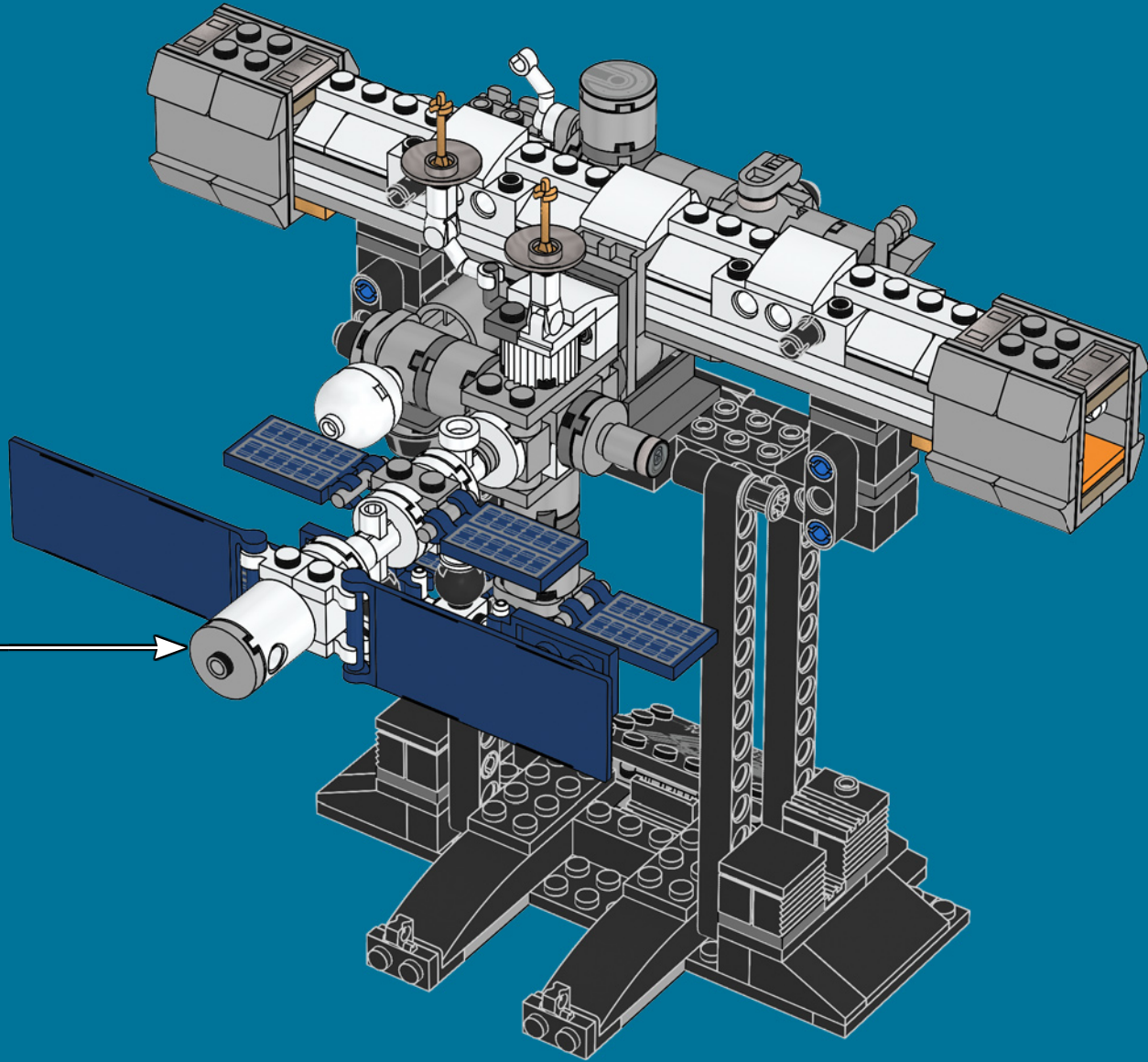
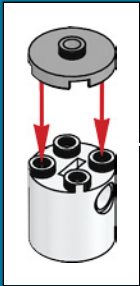



96

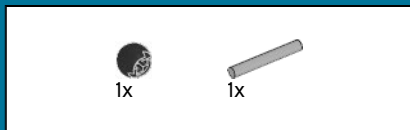
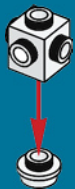

97

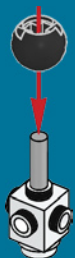

98

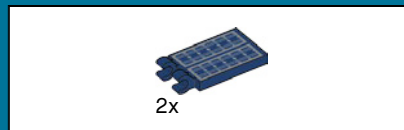

99

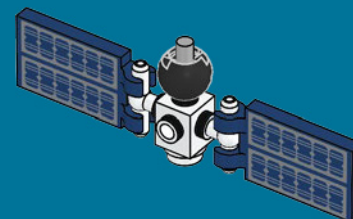

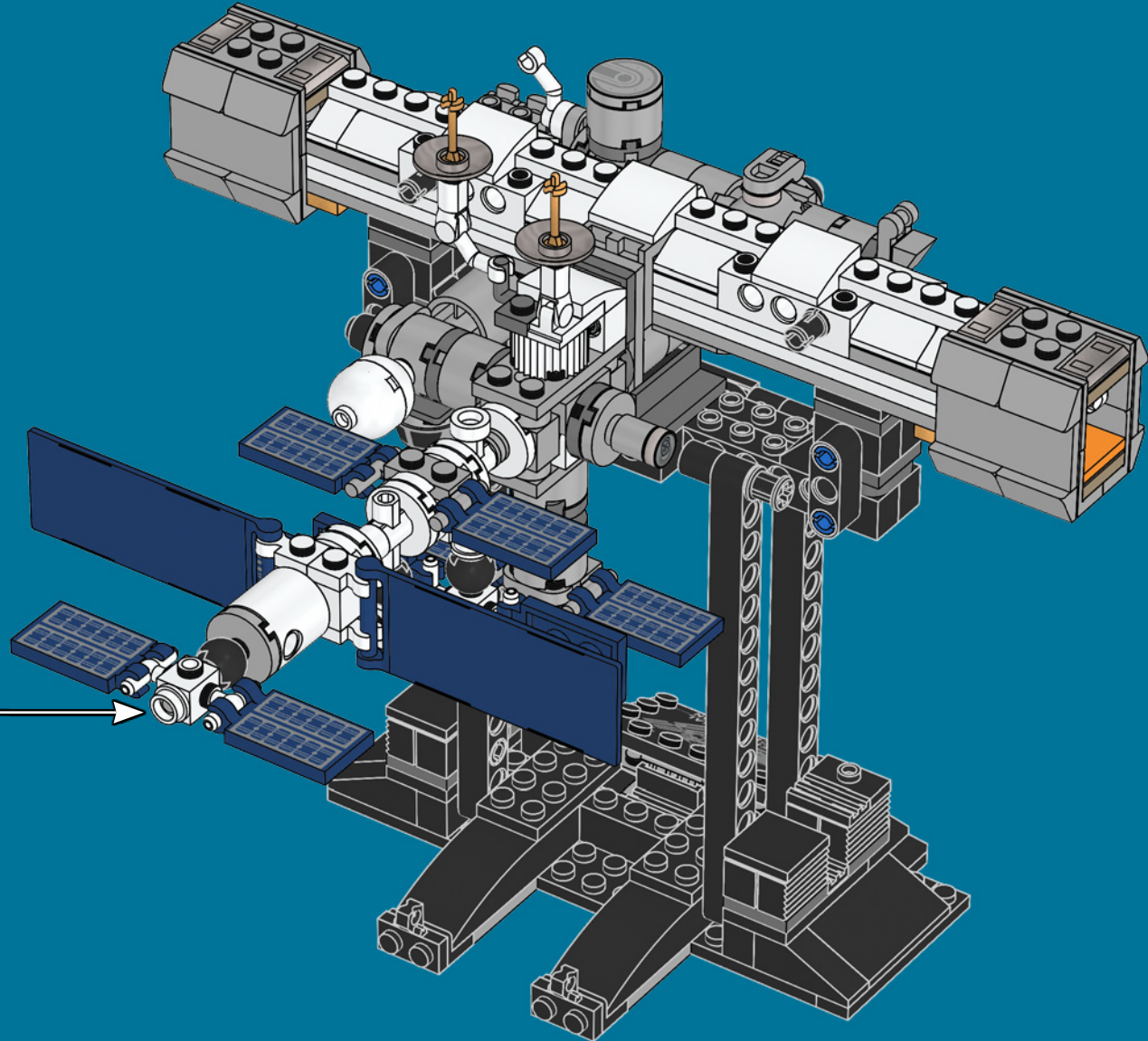

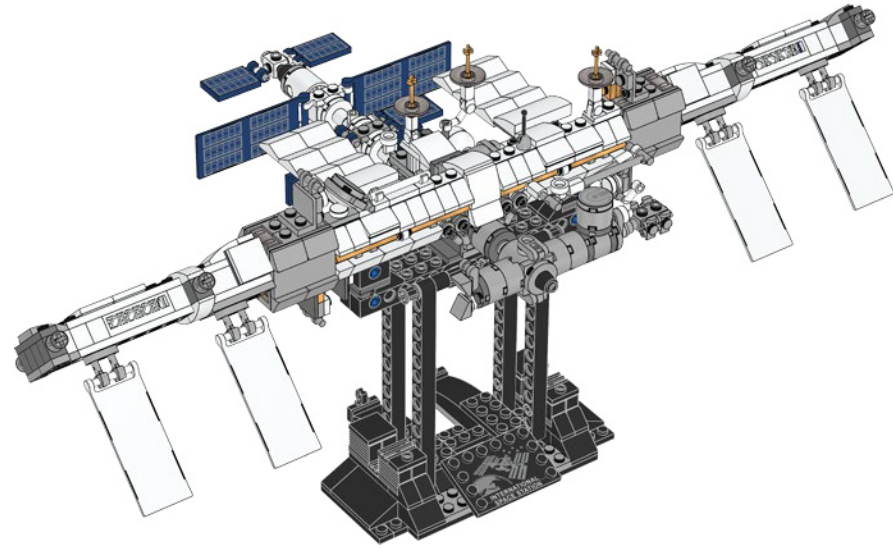
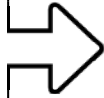

2x



1x

101



4x

102

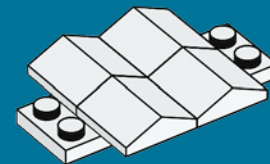



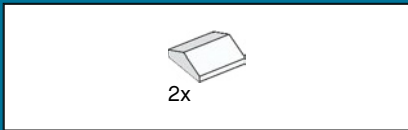

103

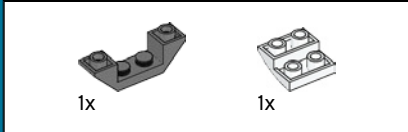
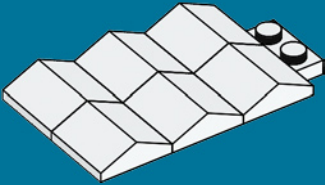

104

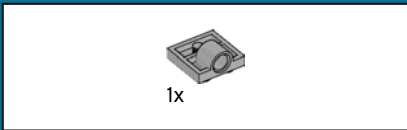
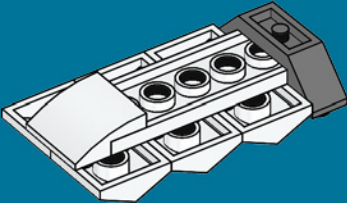

105

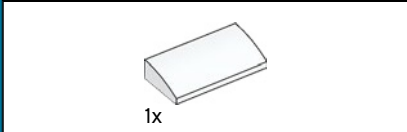
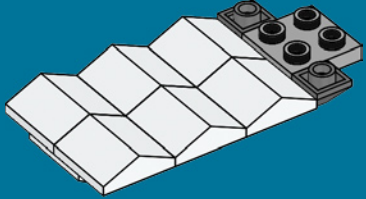

106

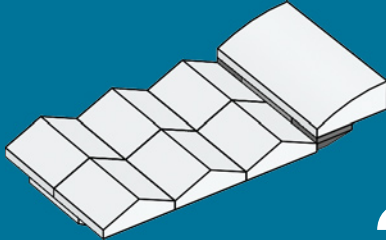

2x

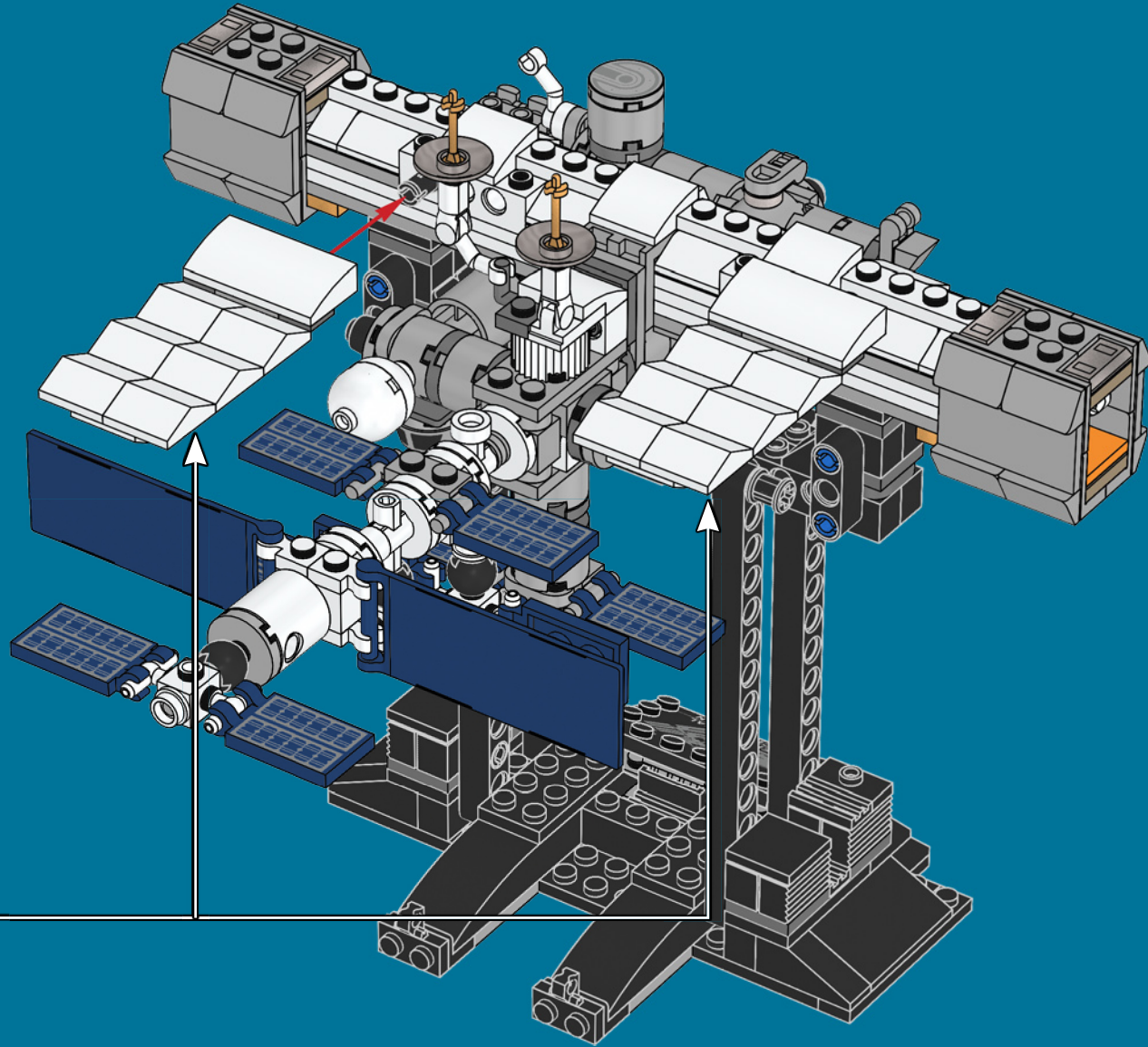



1x



1x

108

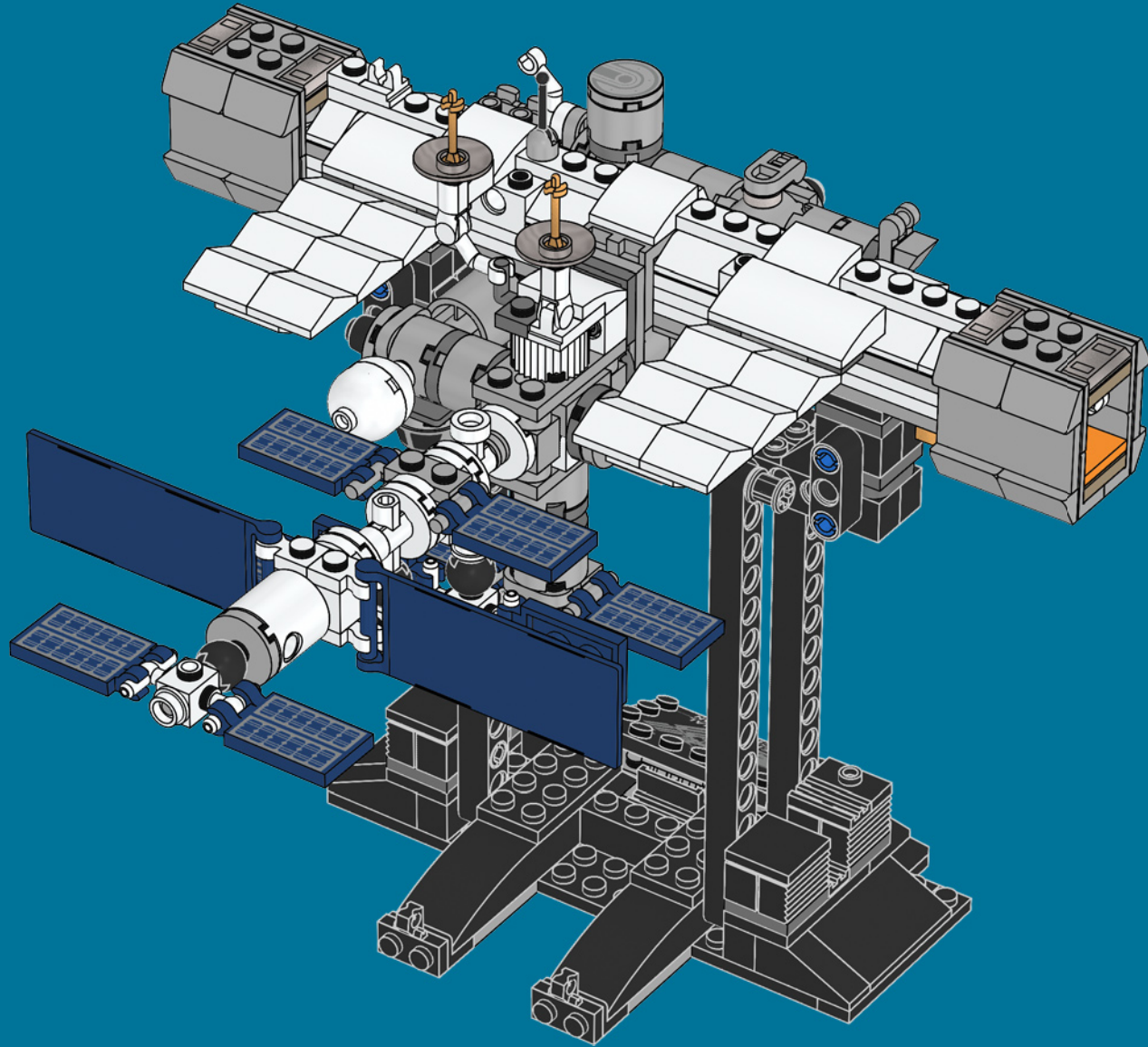

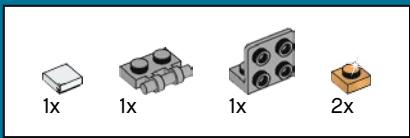

109

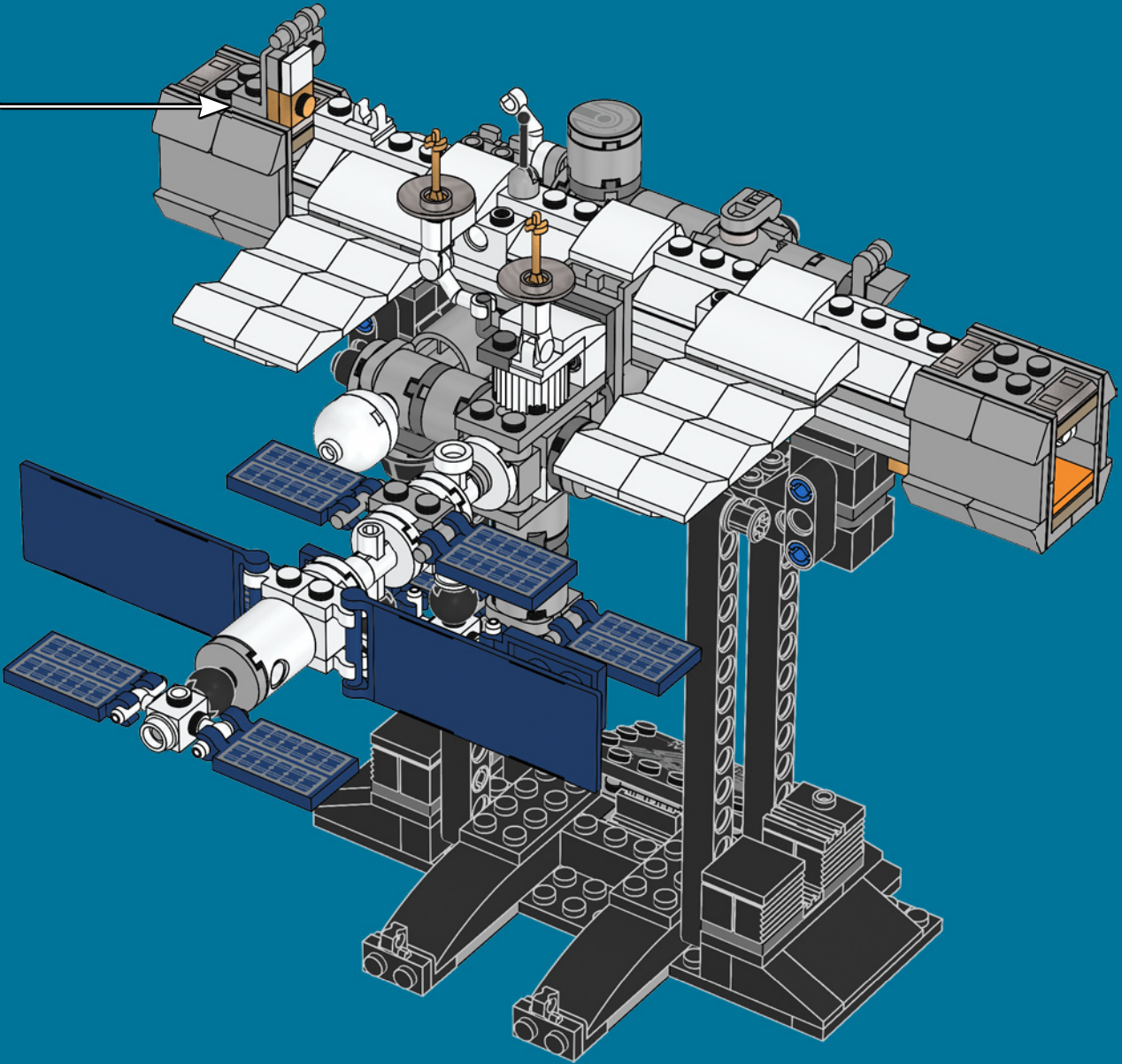
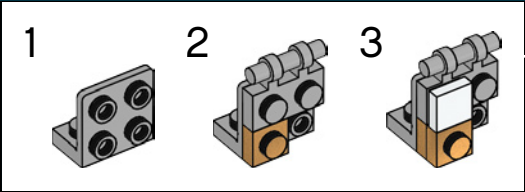

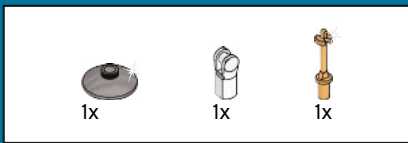

110

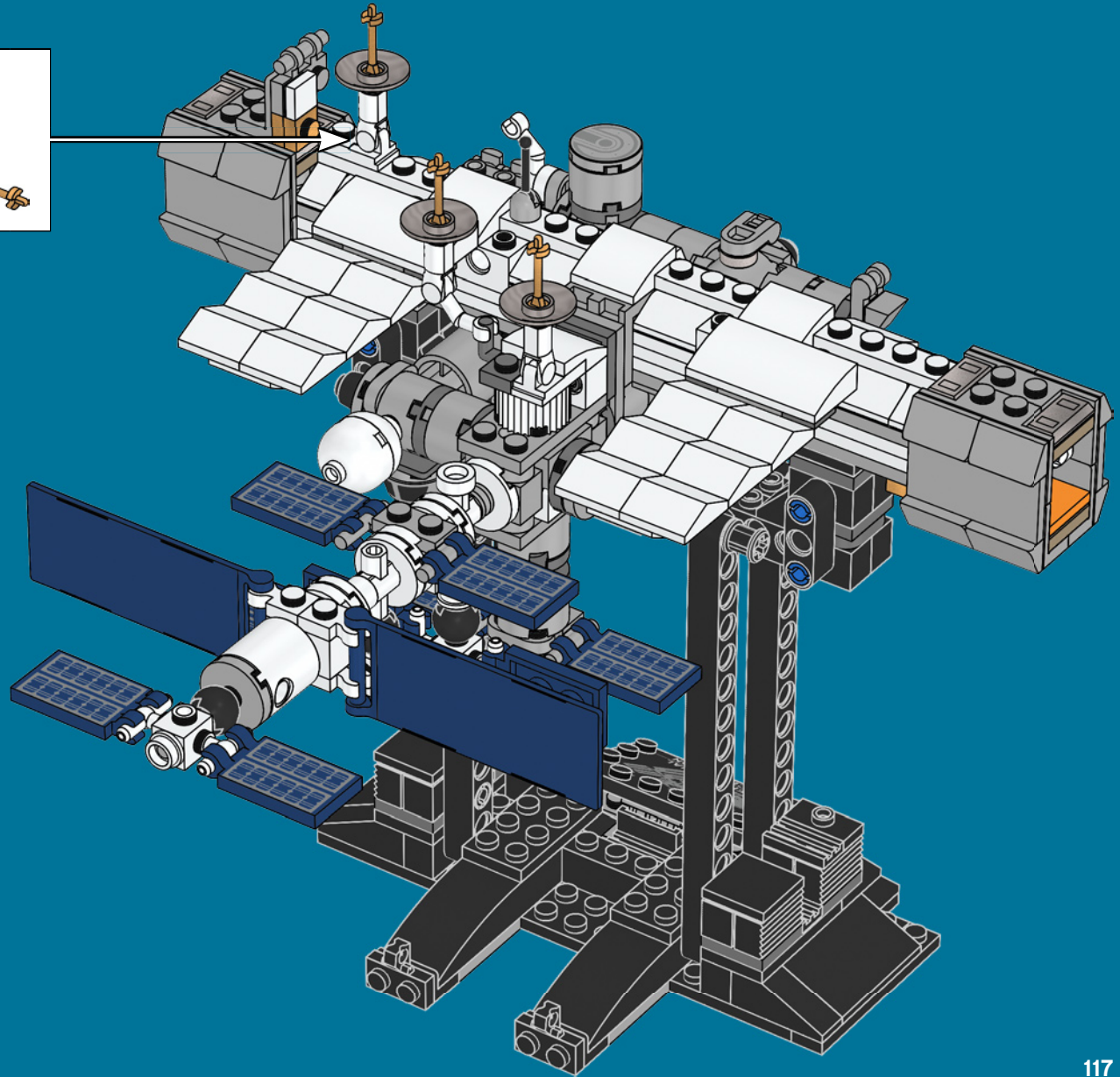
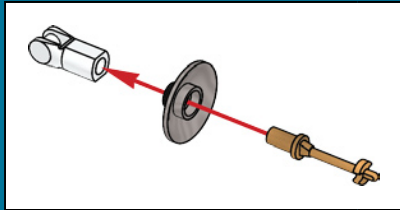



3x



1x



1x

111

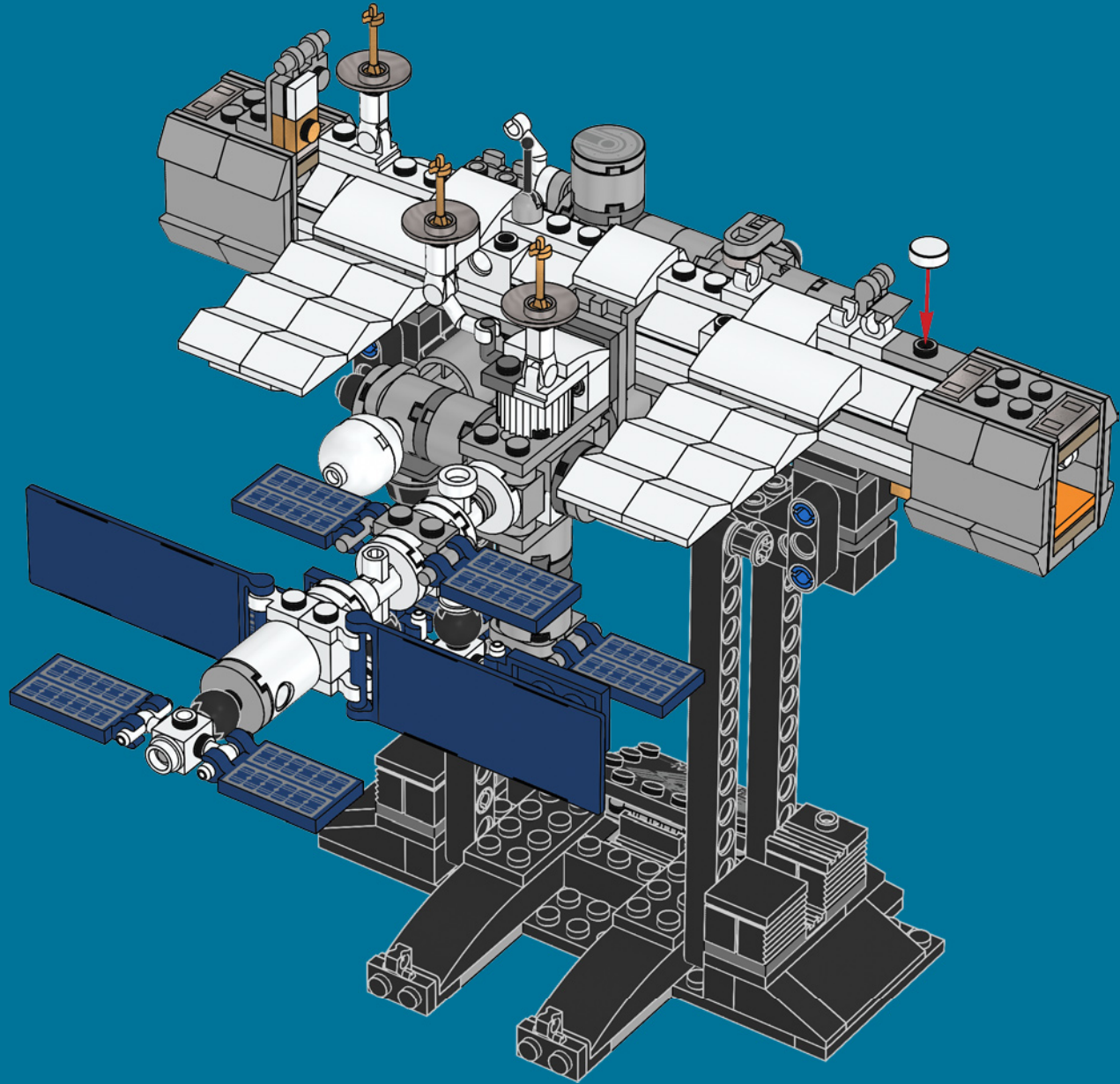

118

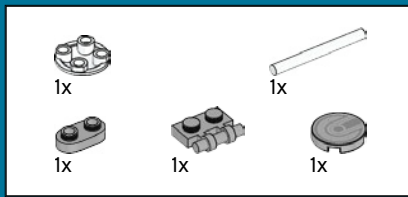

112

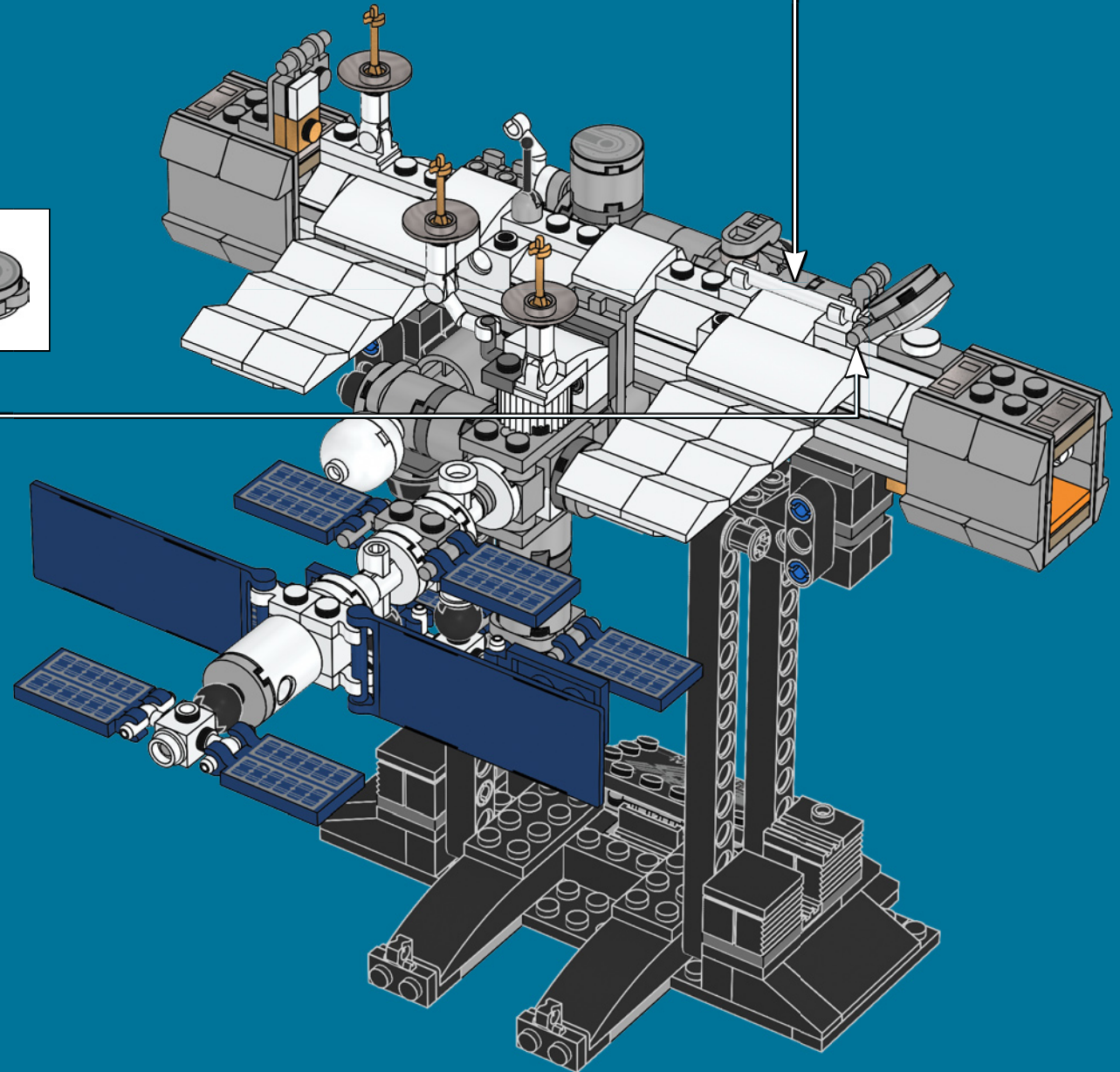
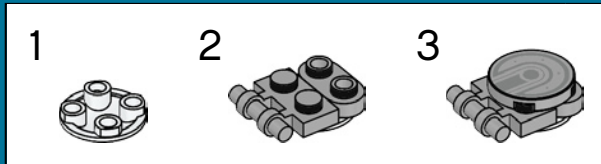

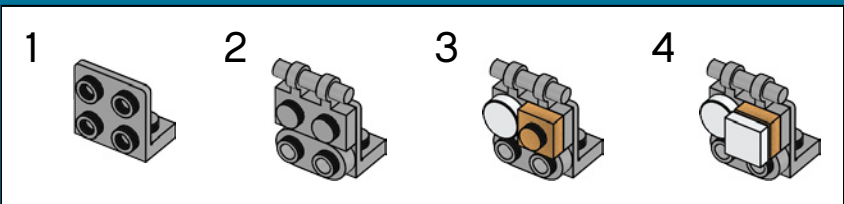
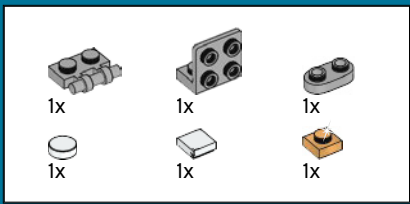

113

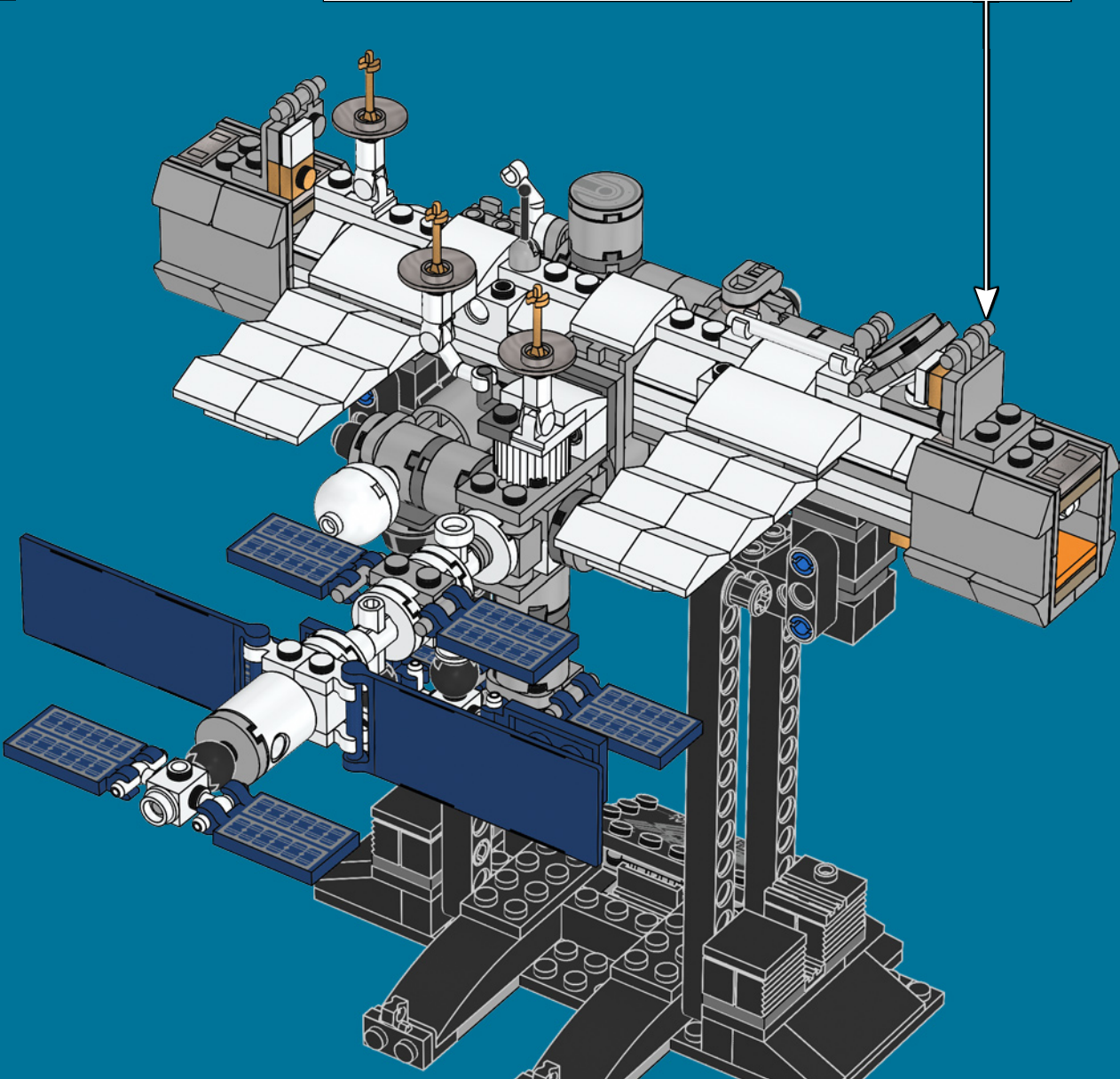



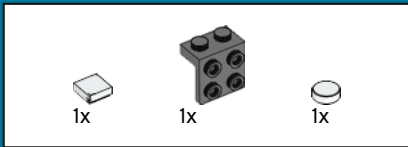

114

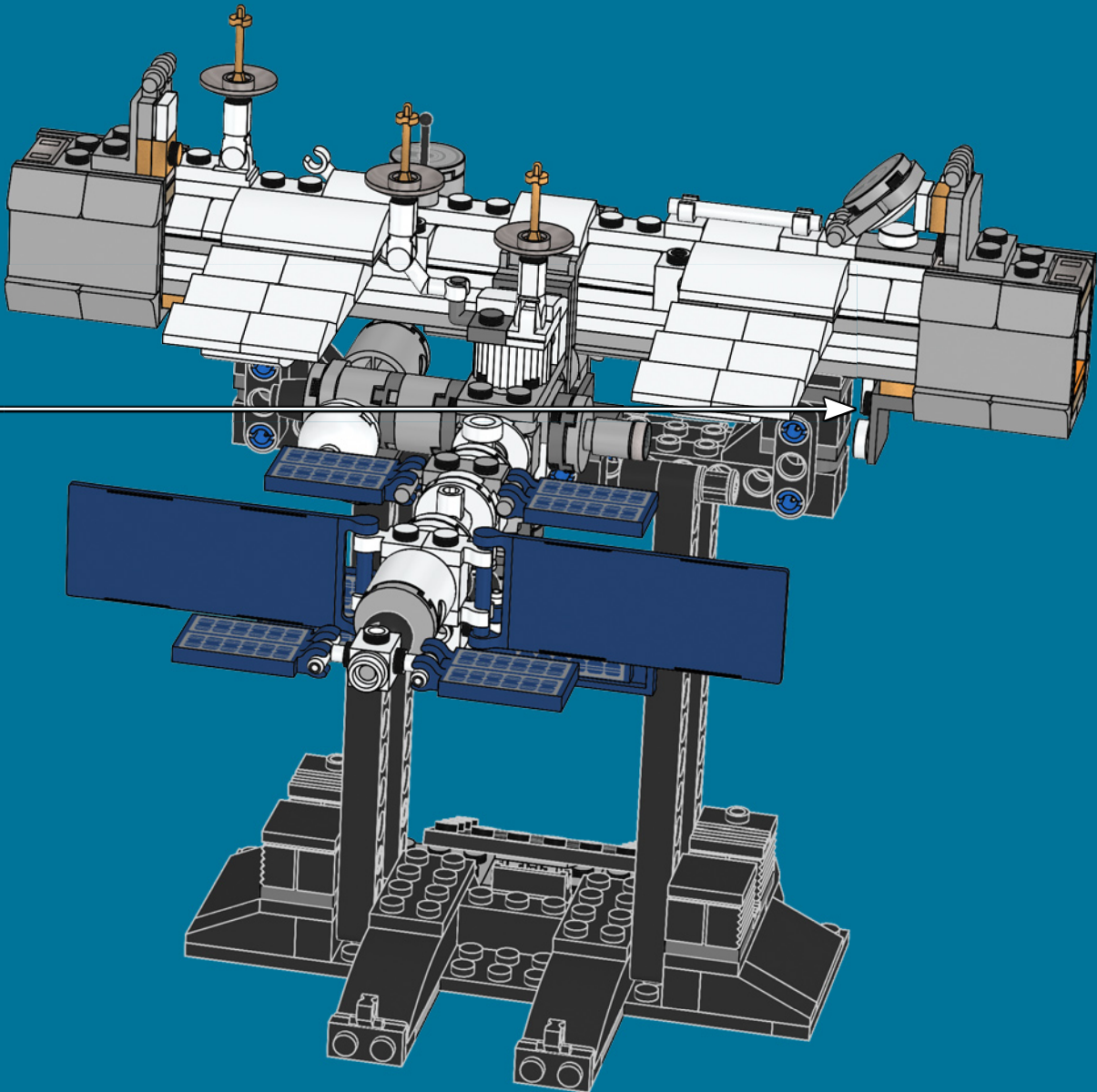
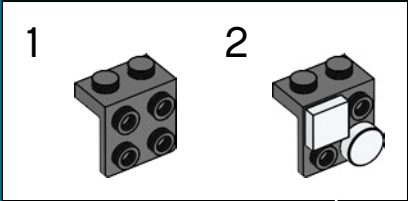

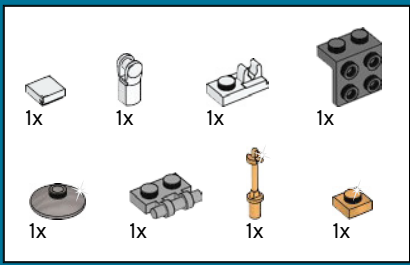

115

1

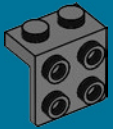

2

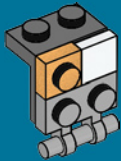

3

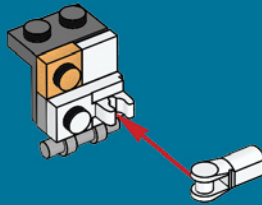

4

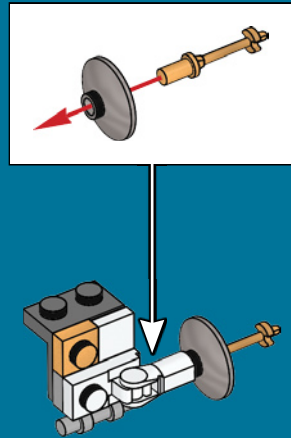

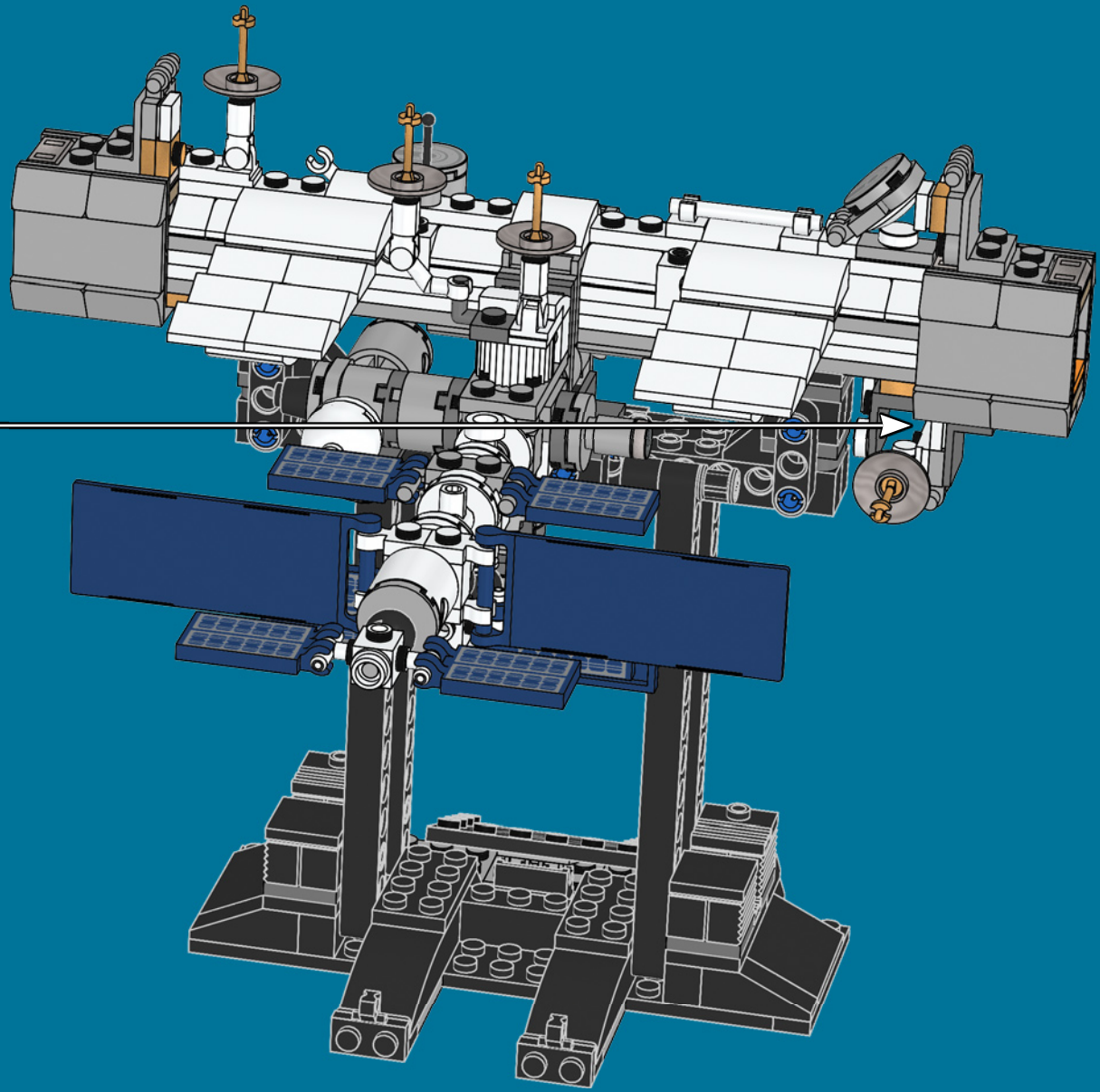

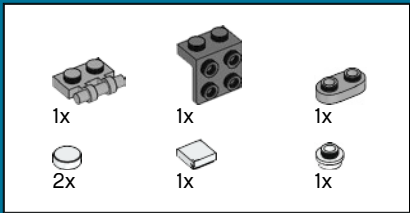

116

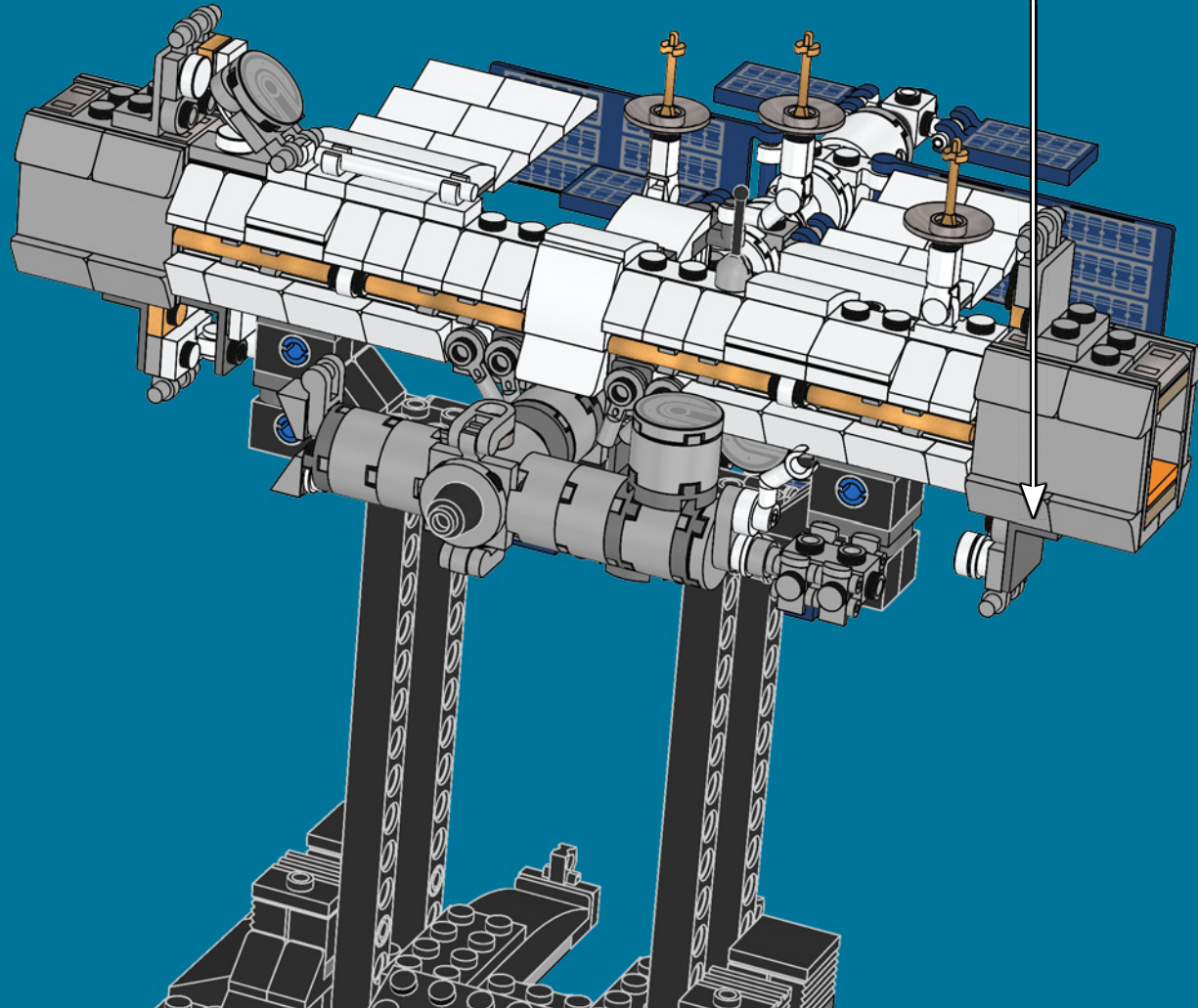
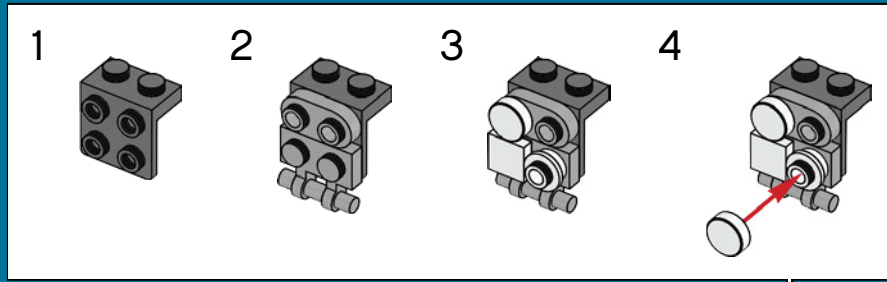

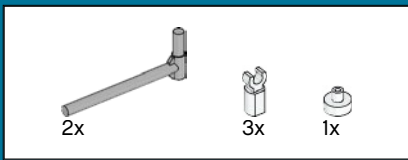

117

1

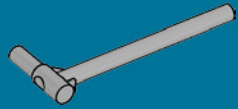

2

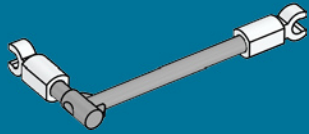

3

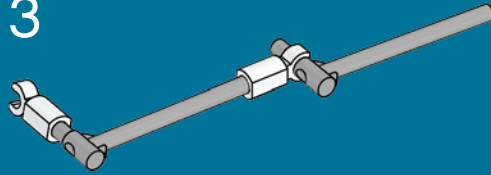

4

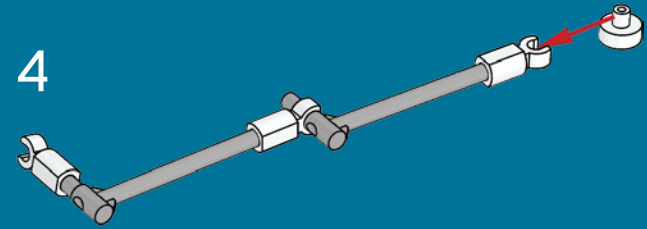

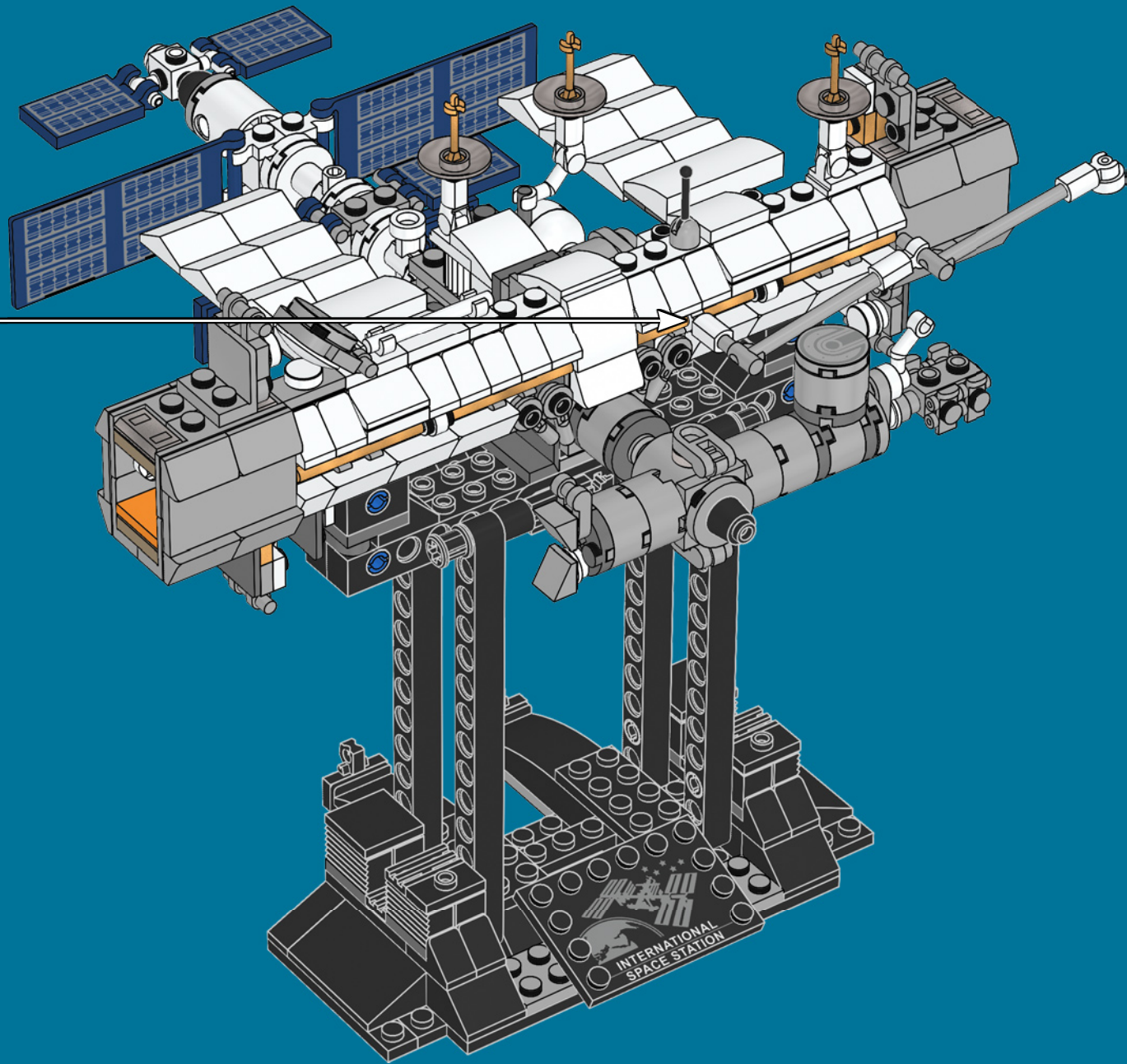

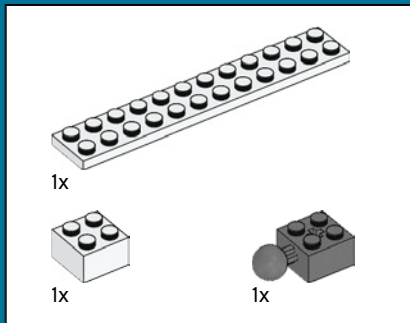
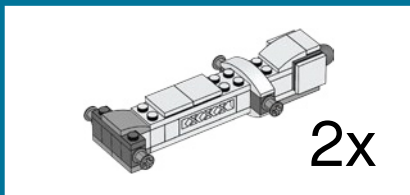

118

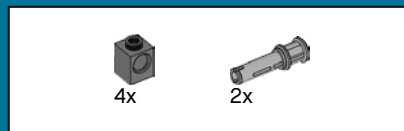
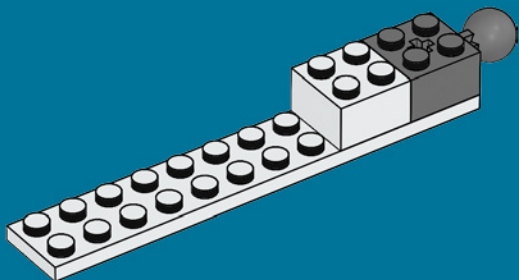

119

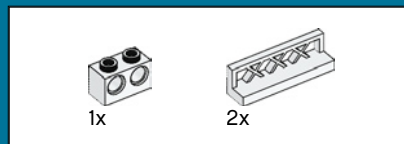
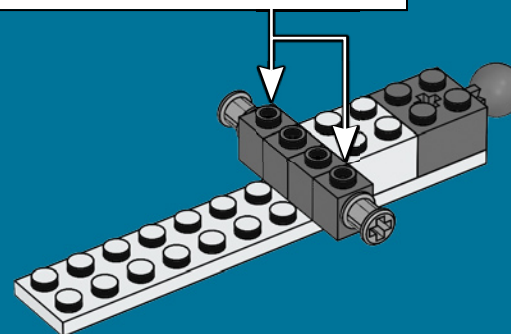
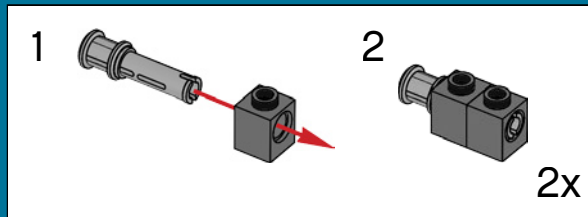

120

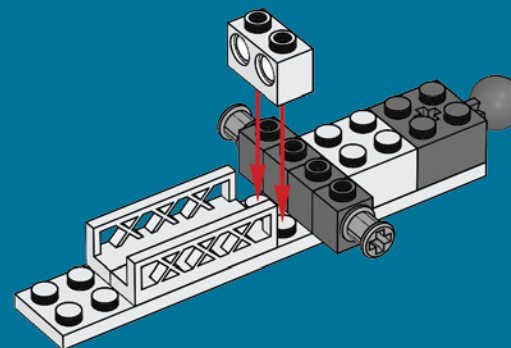



121

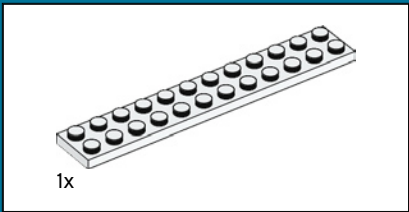
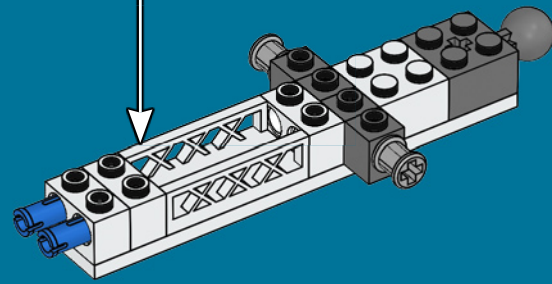
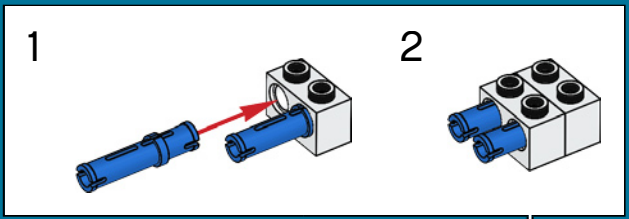

122

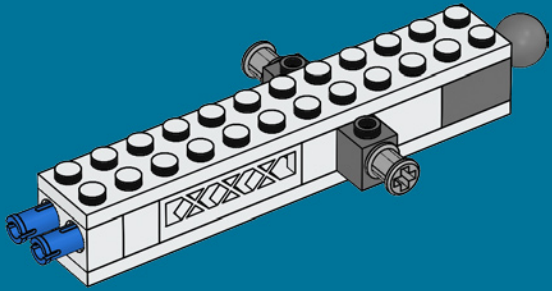



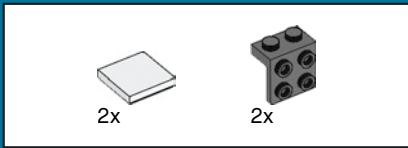

123

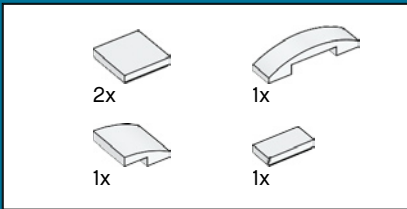
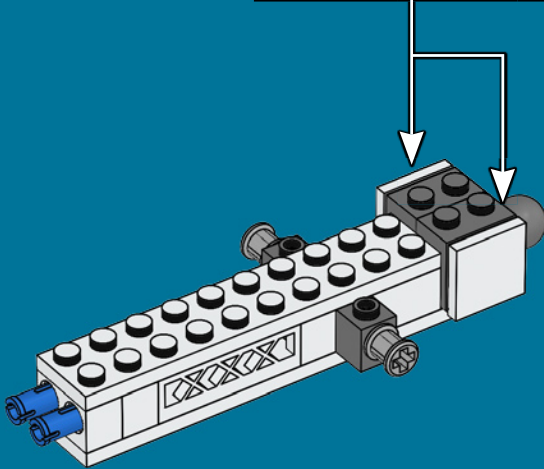
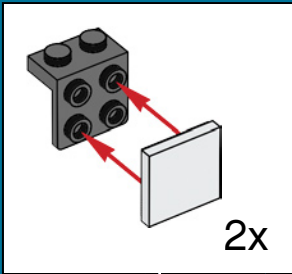

124

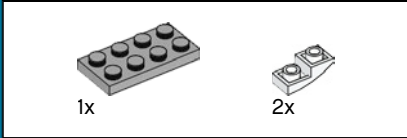
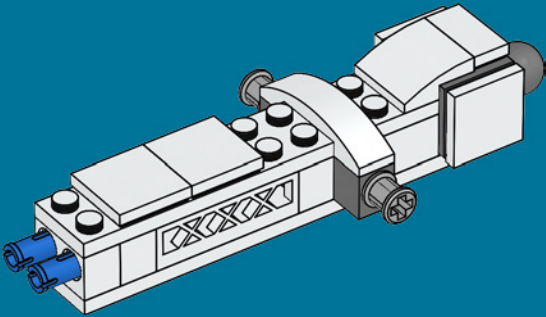

125

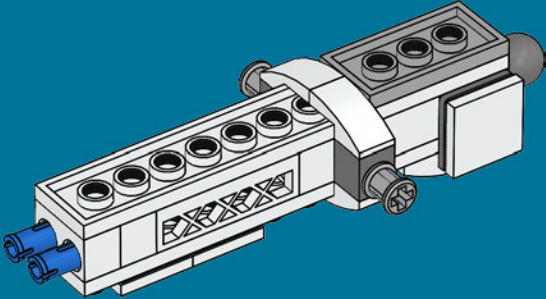

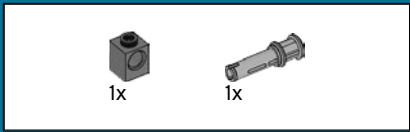

126

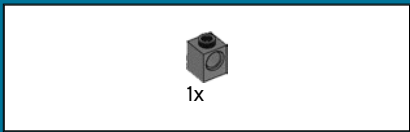
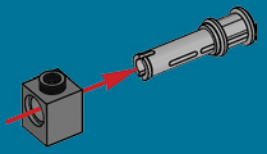

127

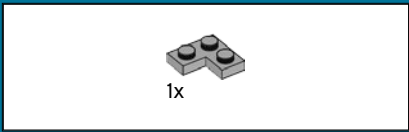
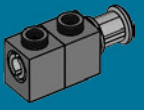

128

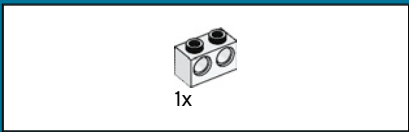
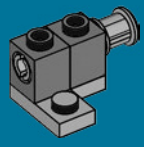

129

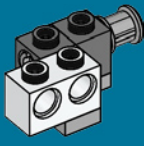

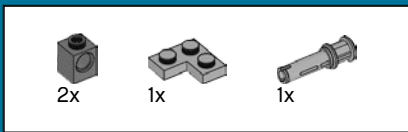

130

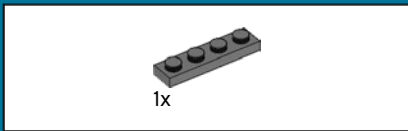
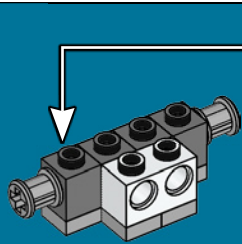
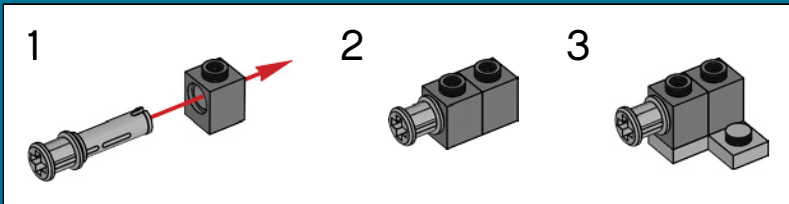

131

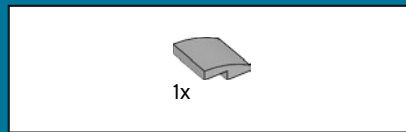
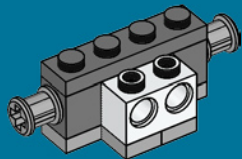

132

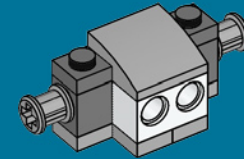

133

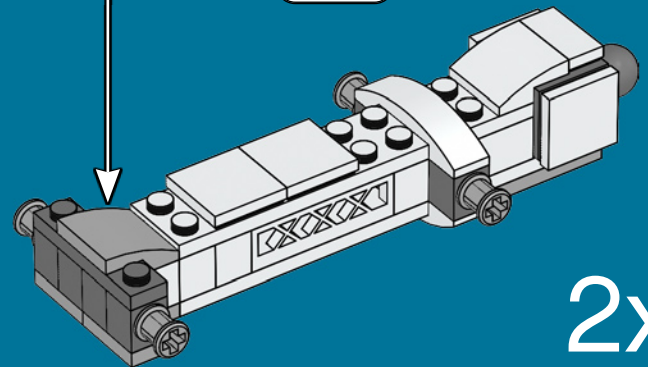

2x

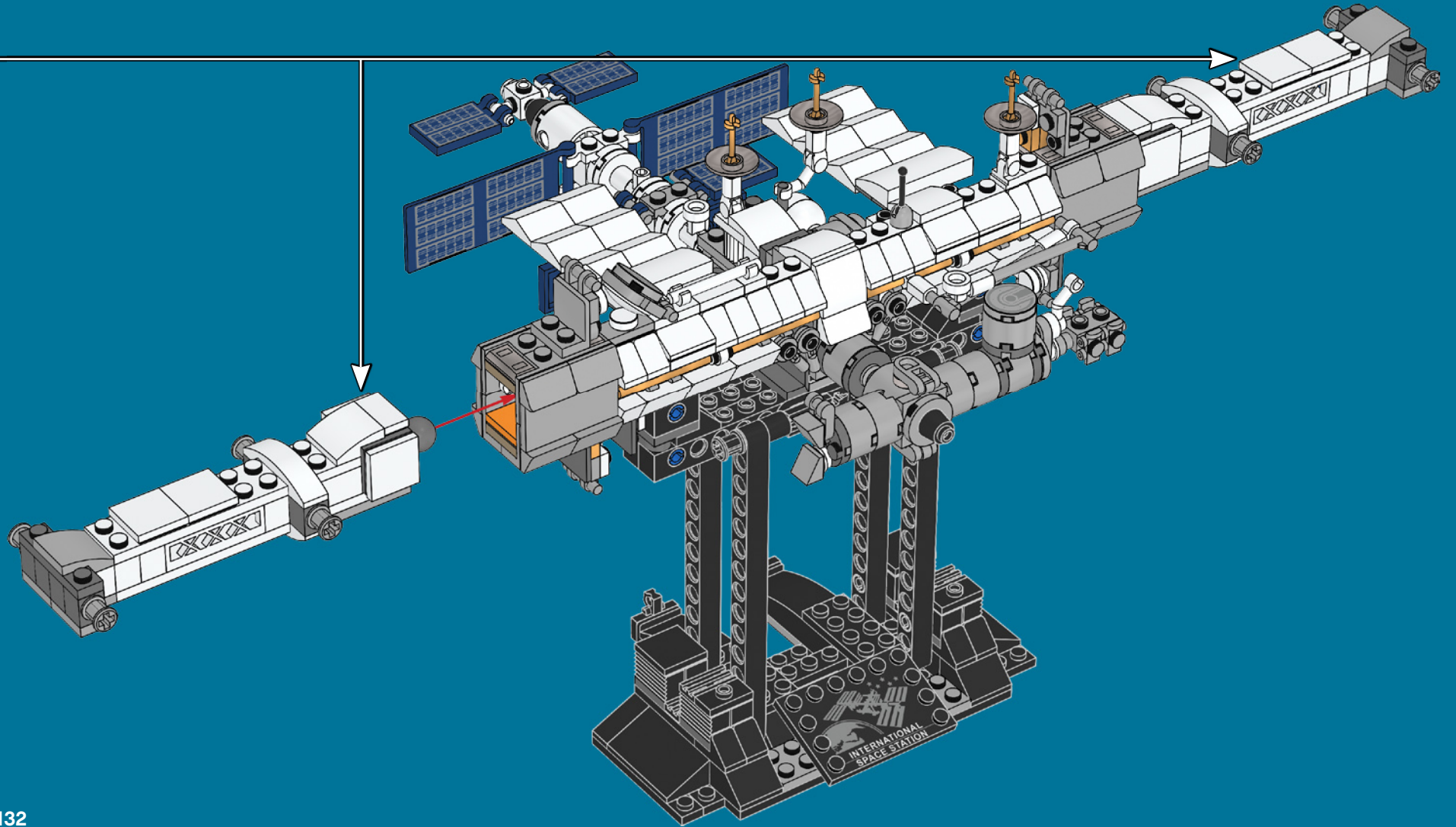



4x

135

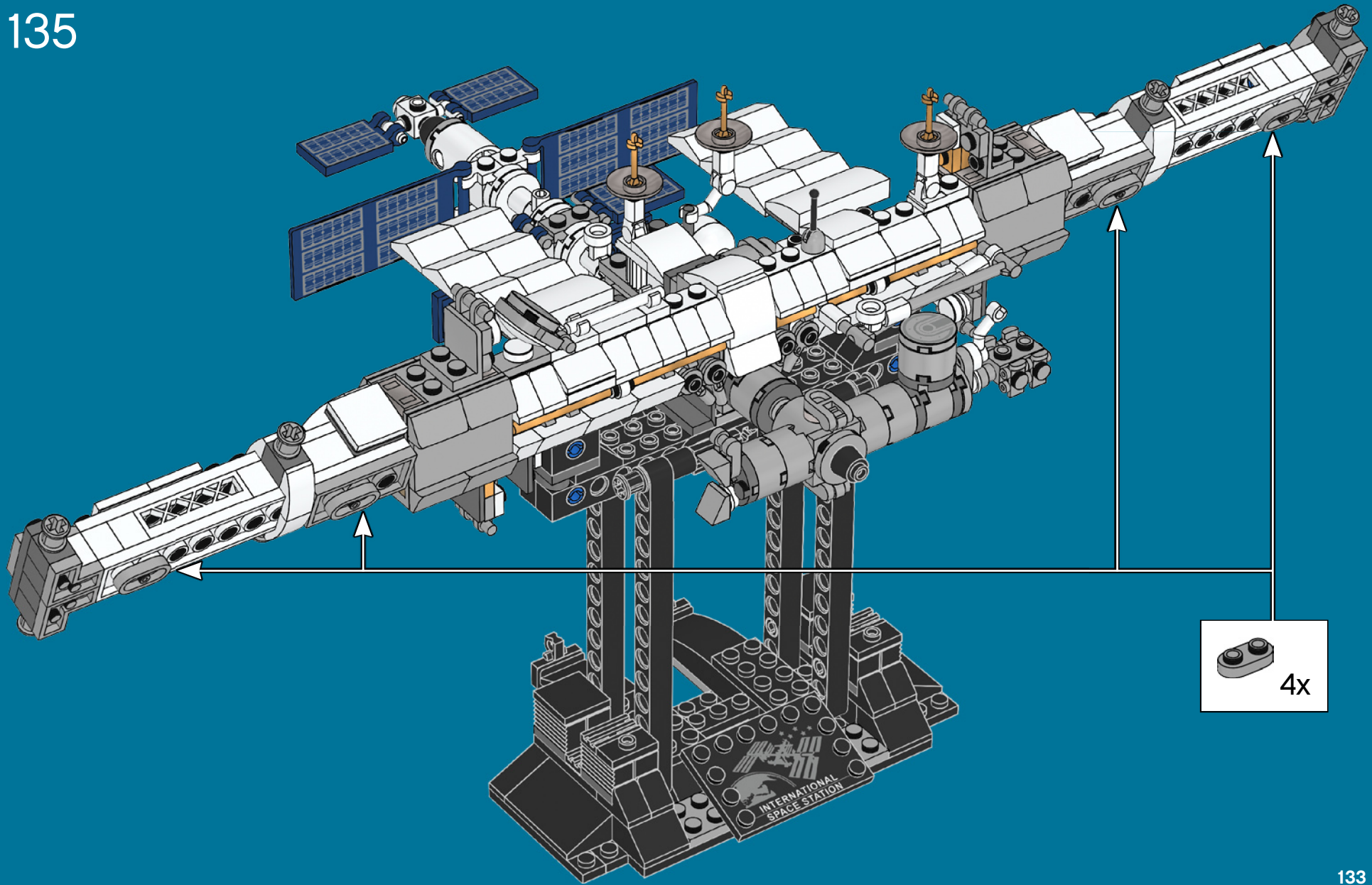

4x



8x

136

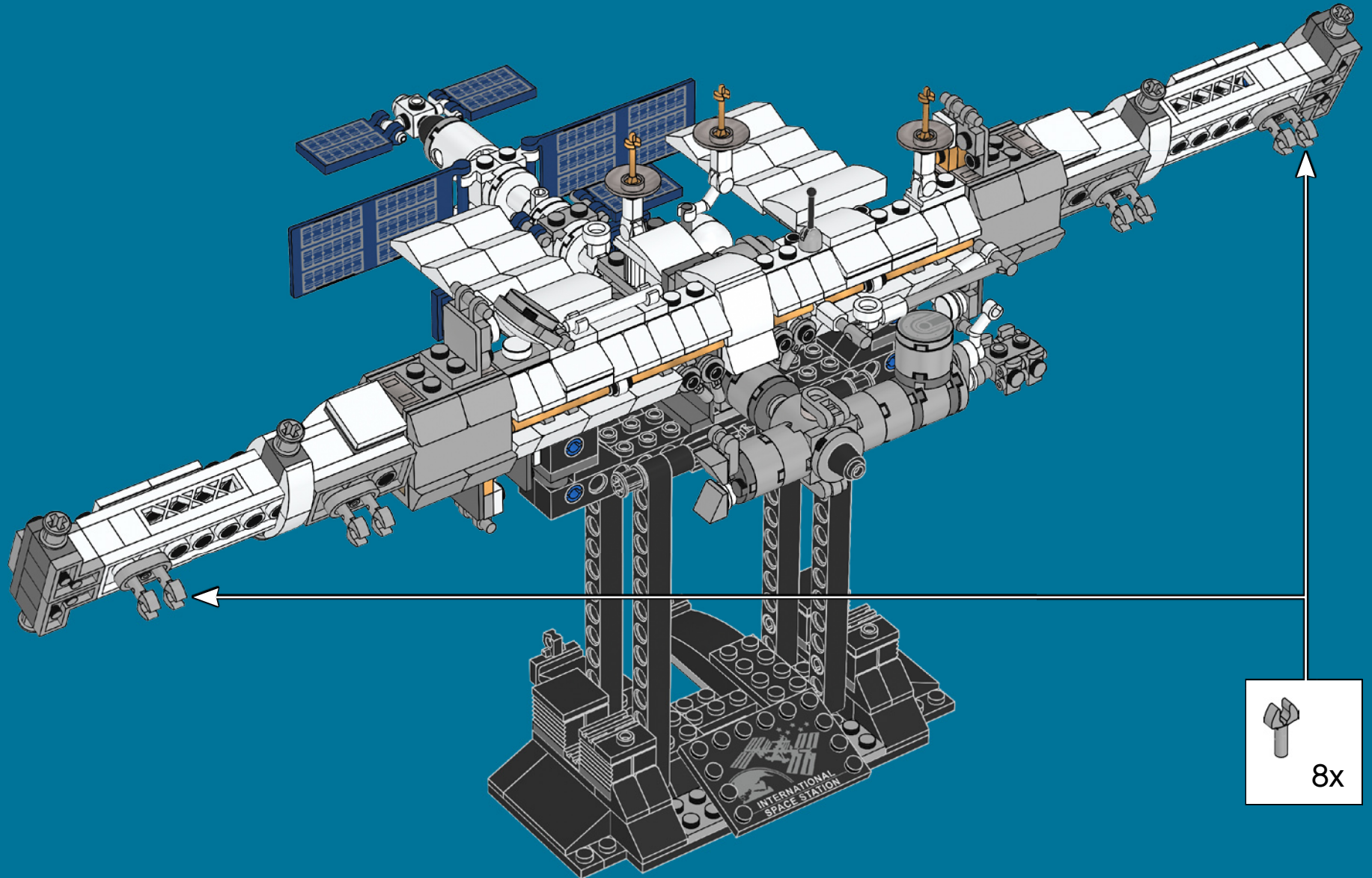

8x

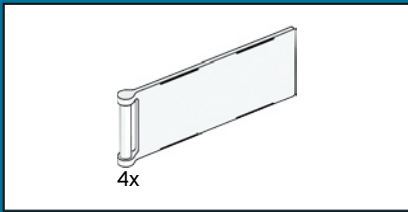

137

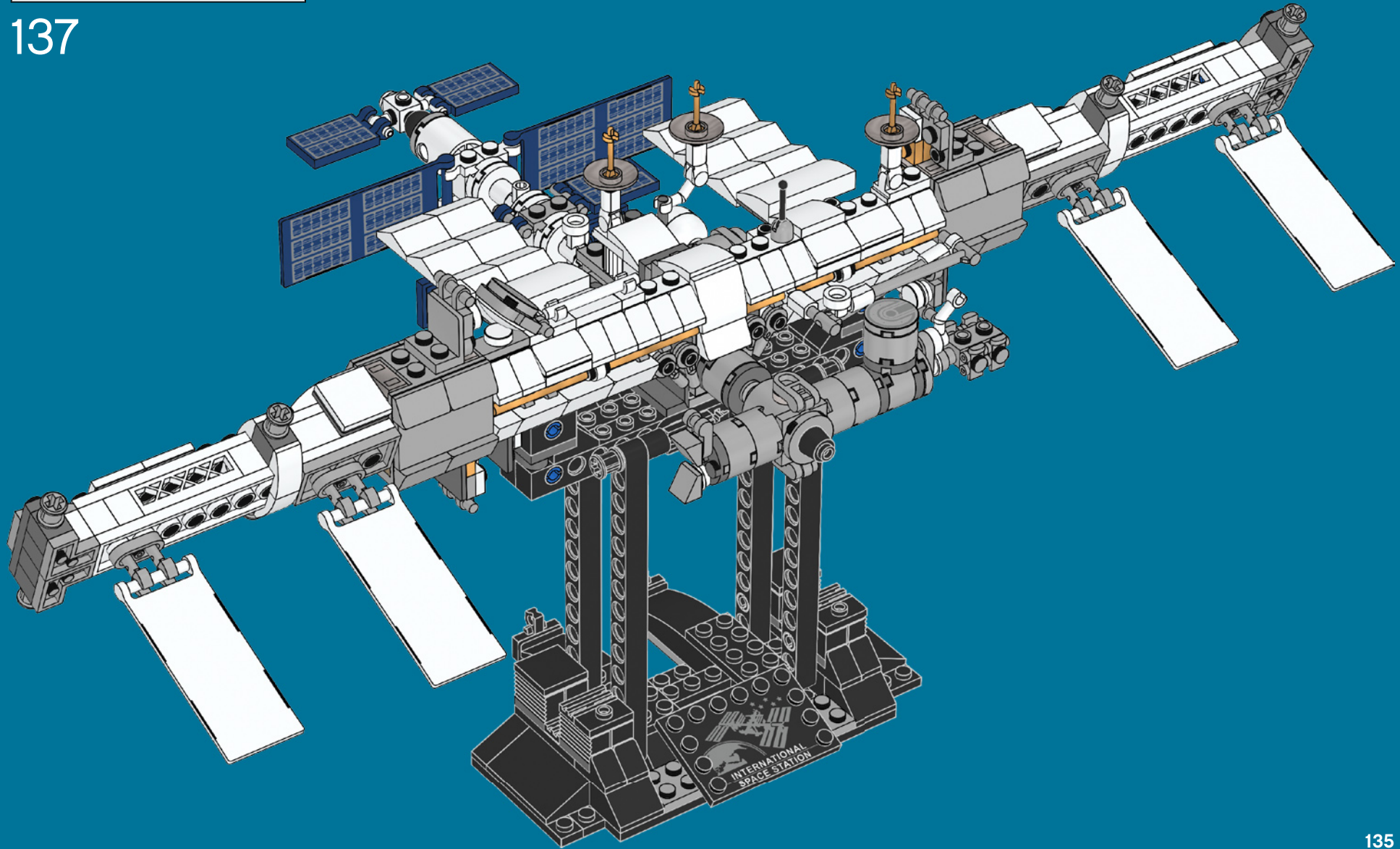

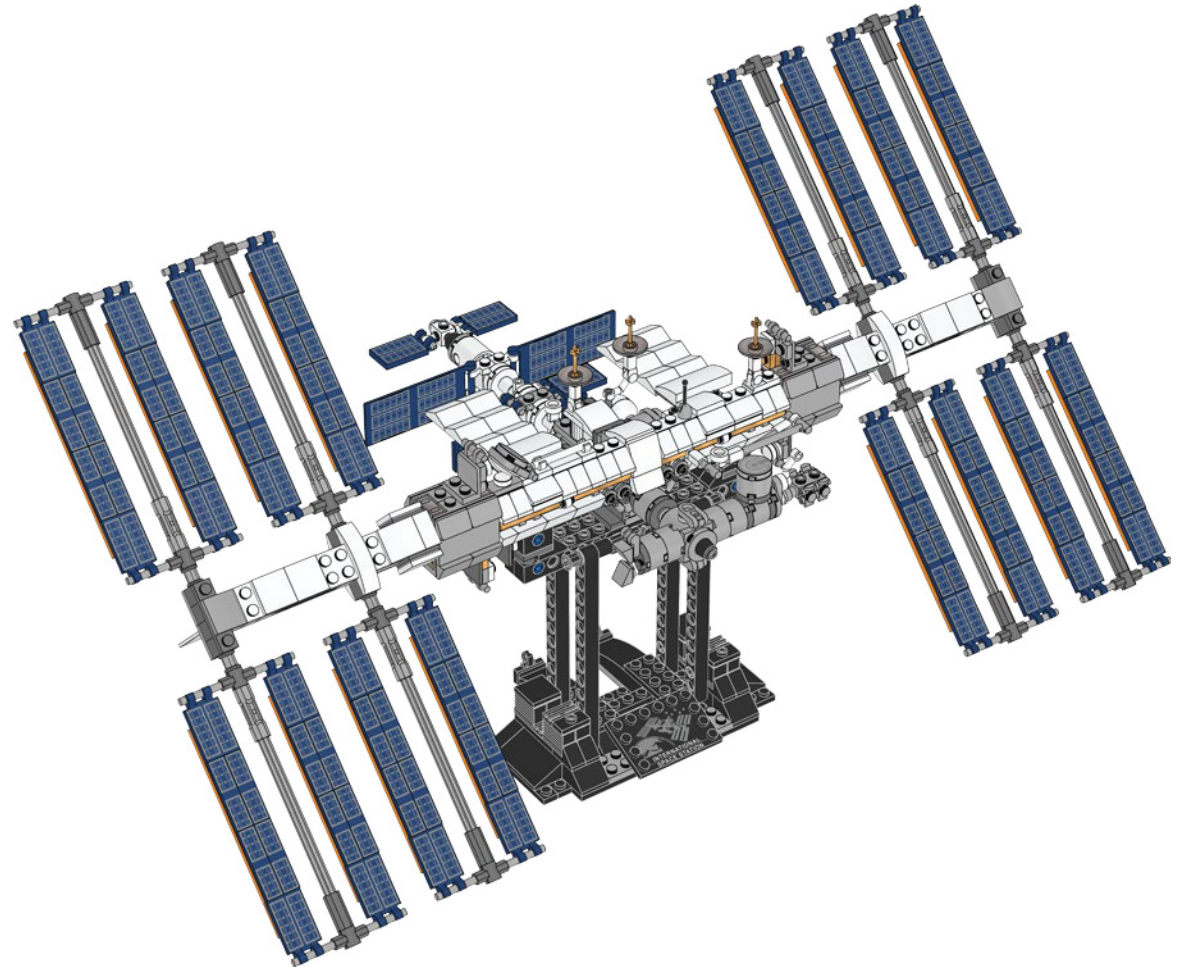



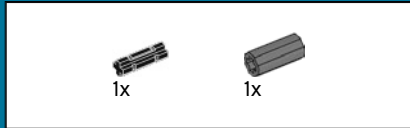

138

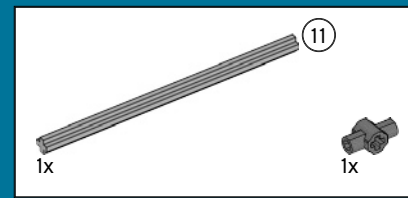
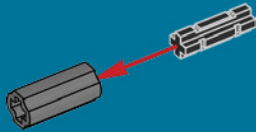

139

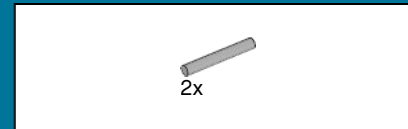
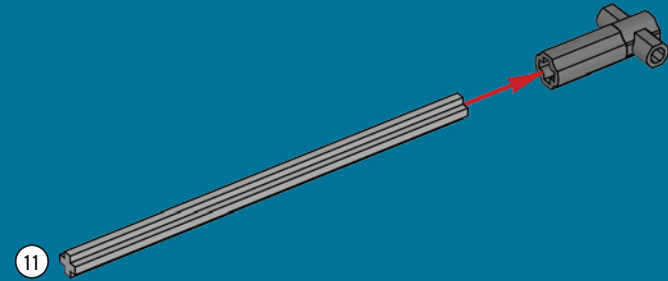

140

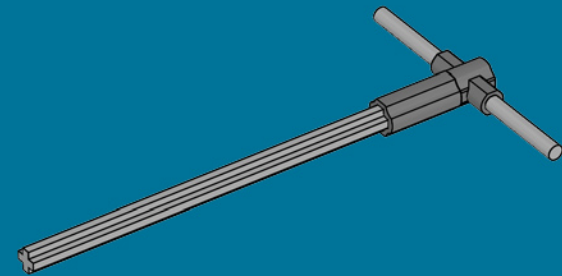

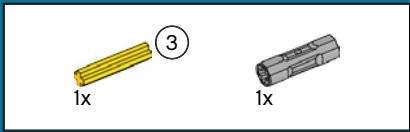

141

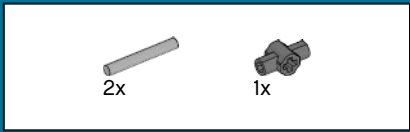
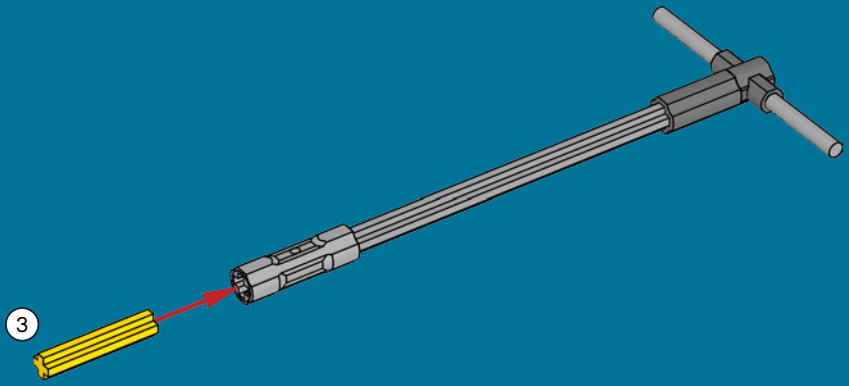

142

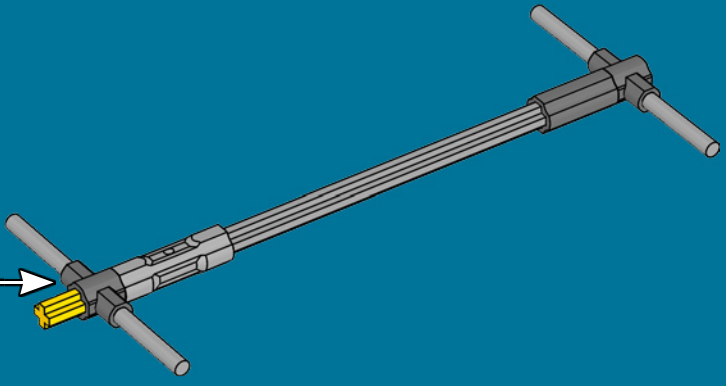
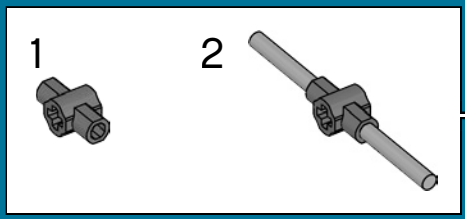

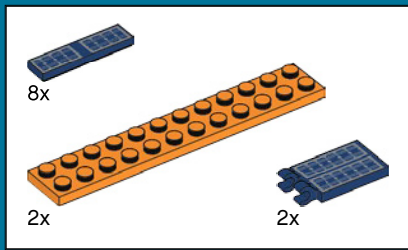

143

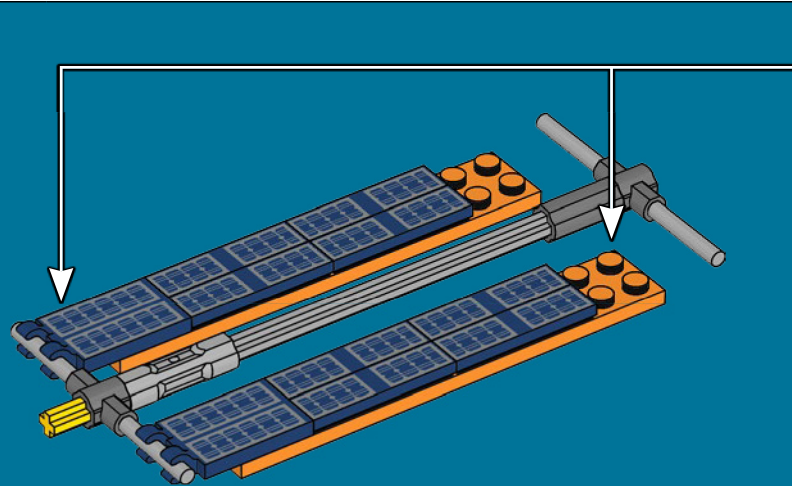
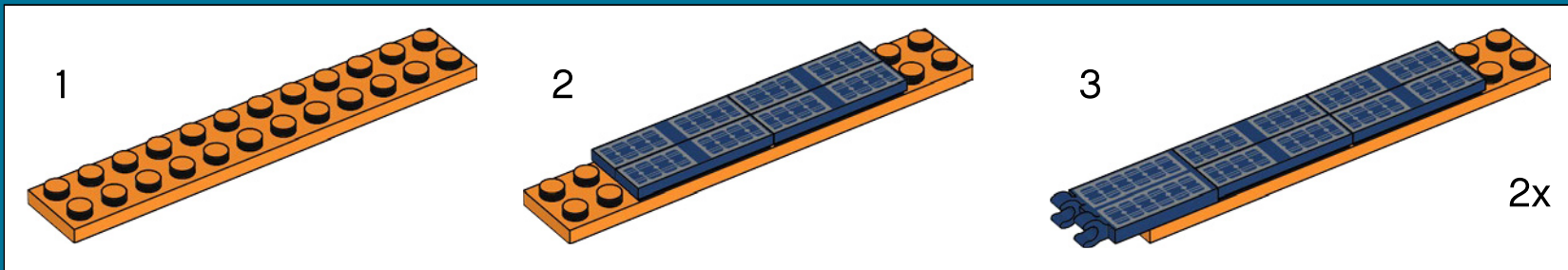

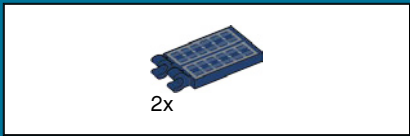

144

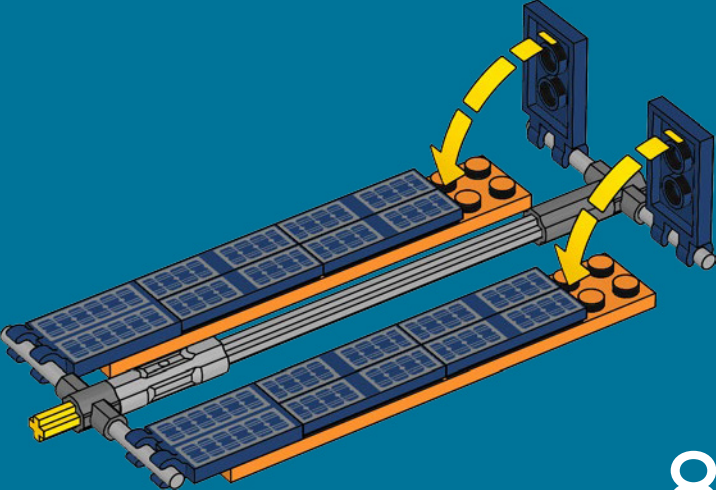

8x

145

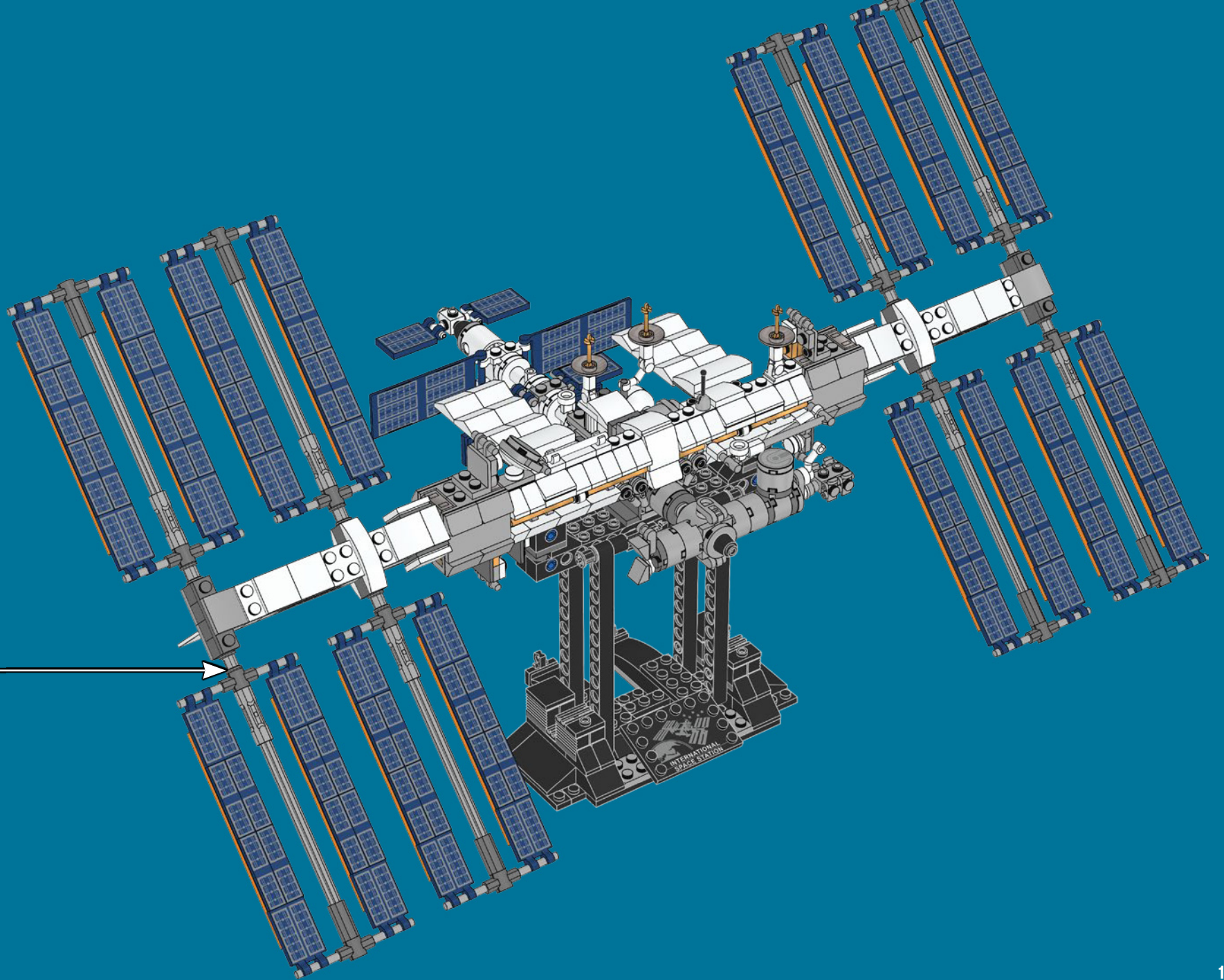

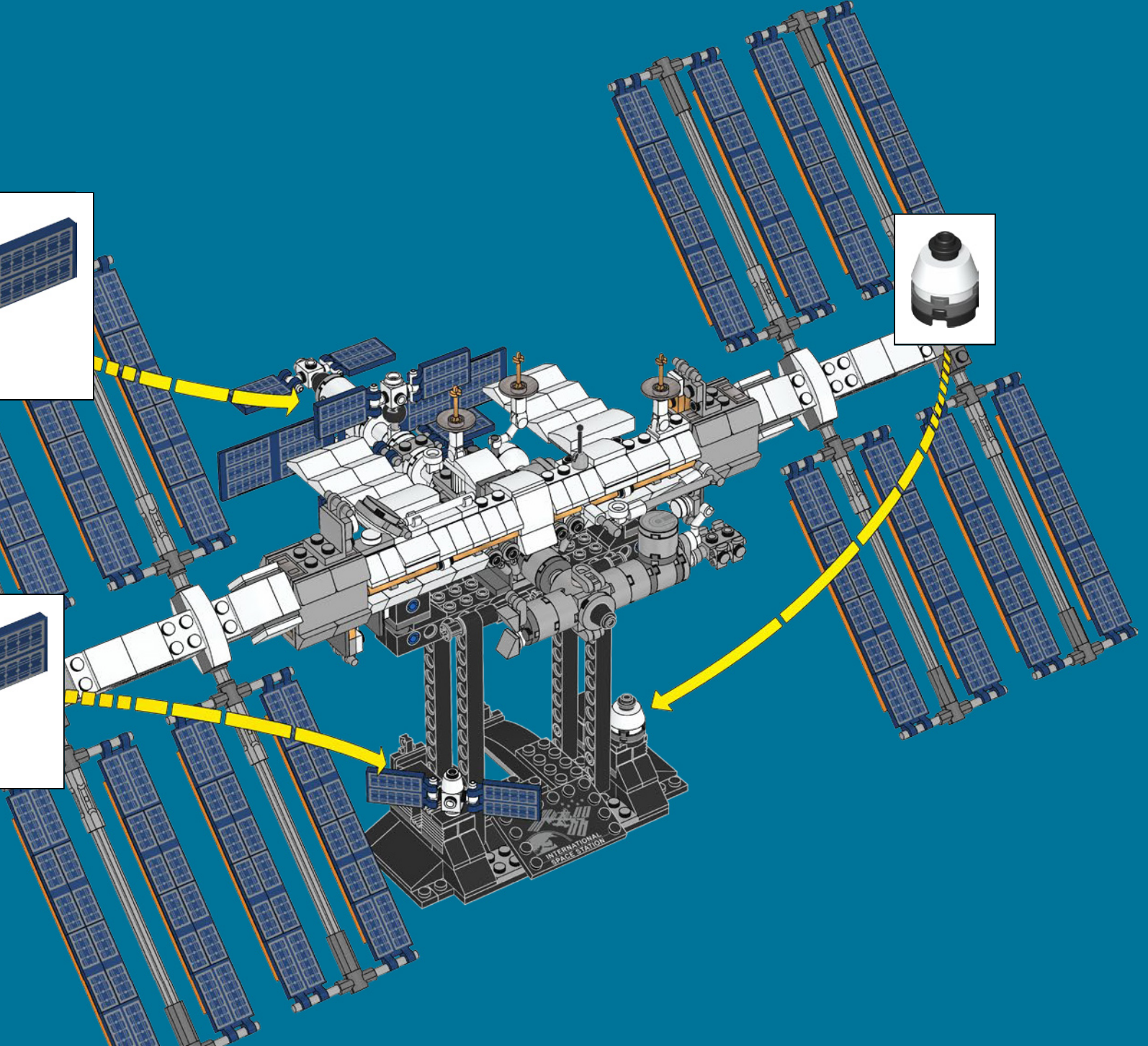
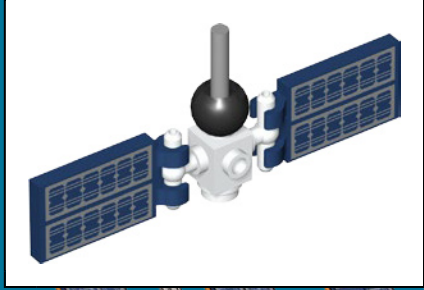

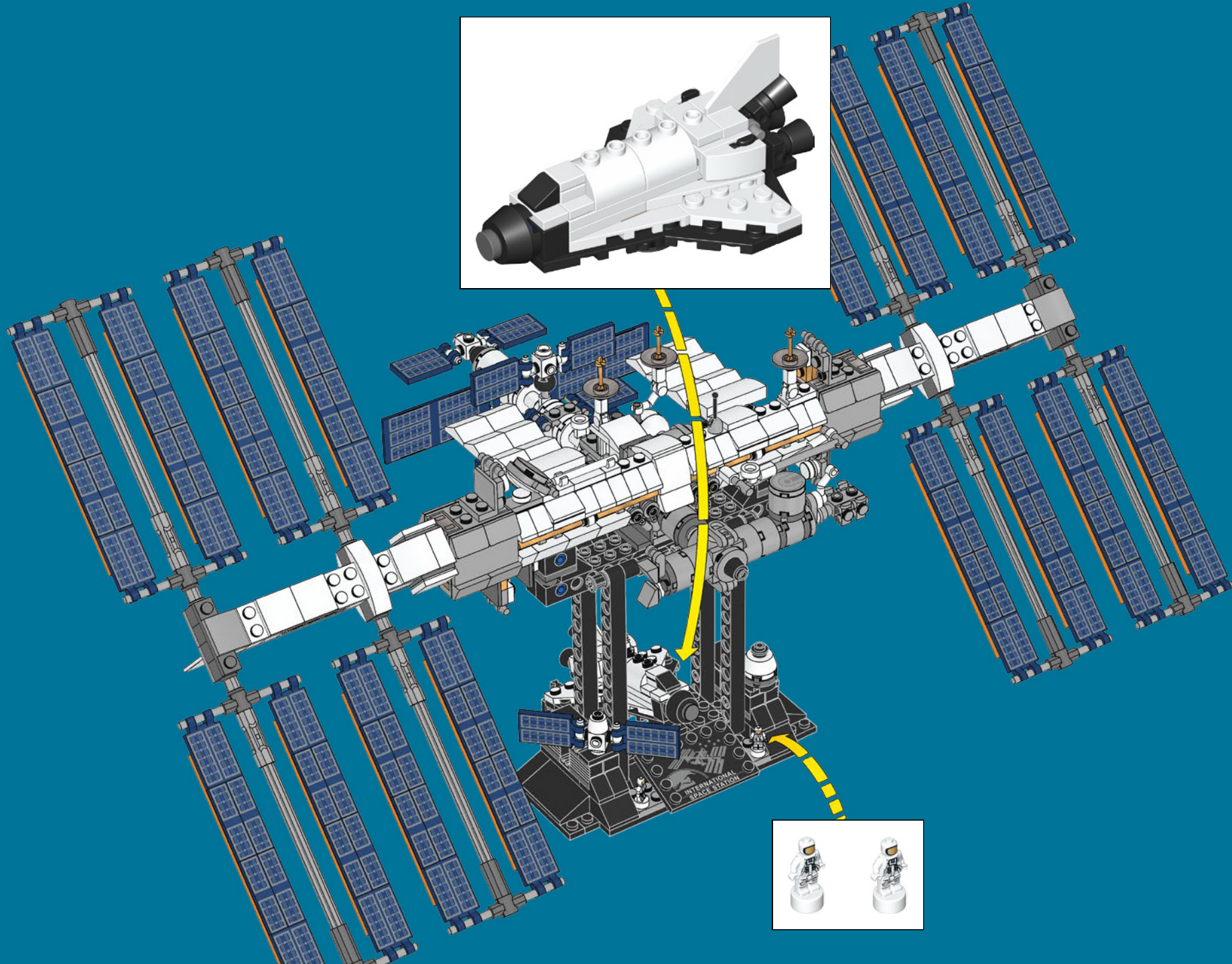



# IDEAS

GATHER SUPPORT  
OBTIENS DE L'APPUI  
OBTÉN APOYOS



SHARE YOUR IDEA  
PARTAGE TON IDÉE  
COMPARTE TU IDEA

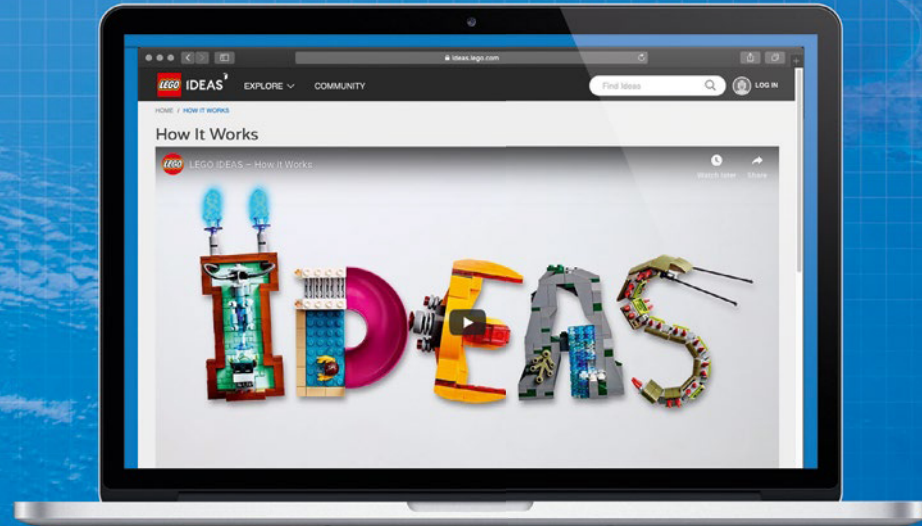



NEW LEGO® PRODUCT  
NOUVEAU PRODUIT LEGO®  
NUEVO PRODUCTO LEGO®



LEGO® REVIEW  
EXAMEN LEGO®  
REVISIÓN DE LEGO®



[LEGO.com/ideas](https://www.lego.com/ideas)



FRIENDS and all related characters and elements © & ™ Warner Bros. Entertainment Inc. WB SHIELD: TM & © WBEI. (s19)





Customer Service  
 Kundenservice  
 Service Consommateurs  
 Servicio Al Consumidor  
 LEGO.com/service or dial



: 00800 5346 5555  
 : 1-800-422-5346



## Do you like this LEGO® Ideas set?

The LEGO Group would like your opinion on the new product you have just purchased. Your feedback will help shape the future development of this product series.

Please visit:

[LEGO.com/productfeedback](https://www.lego.com/productfeedback)

By completing our short feedback survey, you will be automatically entered into a drawing to win a LEGO® prize.

Terms & Conditions apply.

## Aimez-vous cet ensemble LEGO® Ideas ?

Le Groupe LEGO aimerait connaître votre opinion sur le produit que vous venez d'acheter. Vos commentaires nous aideront à concevoir les futurs produits de cette gamme.

Veuillez visiter :

[LEGO.com/productfeedback](https://www.lego.com/productfeedback)

En remplissant ce court sondage sur le produit, vous serez automatiquement inscrit à un tirage au sort pour gagner un prix LEGO®.

Des conditions s'appliquent.



## ¿Te gusta este set LEGO® Ideas?

The LEGO Group quiere conocer tu opinión acerca del nuevo producto que acabas de comprar. Tus comentarios nos ayudarán a dar forma a los futuros productos de esta serie.

Visita:

[LEGO.com/productfeedback](https://www.lego.com/productfeedback)

Al contestar este breve cuestionario de opinión, participarás automáticamente en el sorteo de un producto LEGO®.

Sujeto a términos y condiciones.