



# The Beatles Yellow Submarine

21306



[LEGO.com/ideas](https://www.lego.com/ideas)

When the spectacular Yellow Submarine debuted in 1968, it was instantly recognized as a landmark film that took animation beyond anything seen before. Together with LEGO®

fan designer Kevin Szeto, we are proud to present our version of the iconic submersible as our 15<sup>th</sup> product in the LEGO Ideas series.



John



Paul



George



Ringo



Jeremy

# The story behind the story



The Yellow Submarine began its voyage when the producers of the American animated Beatles TV series approached The Beatles with an idea for a full-length feature. From the very beginning, the filmmakers wanted the feature to have a fresh, highly stylized look inspired by the modern art styles of the time.

The animated film they created was a fantasy tale full of adventure, music and colorful characters. On one side stands the evil Chief Blue Meanie, his henchman Max and the Blue Meanie Army that also includes the Apple Bonkers, Evil Clowns and Snapping Turks. On the other, John, Paul, George and Ringo come

together with the strange, riddle-speaking Jeremy Hillary Boob, Ph. D and the old sailor, Captain Fred.

At the center of the adventure is the remarkable Yellow Submarine, the magical craft that carries the Beatles beneath the waves from Liverpool, across wondrous seas to the shores of Pepperland.

When the film premiered in London on July 17<sup>th</sup> 1968, the colorful, visual feast was met with widespread critical acclaim and is still seen as a groundbreaking piece of animation almost half a century later.

Lors de sa parution en 1968, le spectaculaire « Yellow Submarine » fut immédiatement reconnu comme un film décisif qui fit entrer l'animation dans une nouvelle dimension. En collaboration

avec le fan designer LEGO® Kevin Szeto, nous sommes fiers de présenter notre version du célèbre sous-marin comme 15<sup>e</sup> produit de la série LEGO Ideas.



John



Paul



George



Ringo



Jeremy



# L'histoire derrière l'histoire



Le « Yellow Submarine » a commencé son voyage lorsque les producteurs de la série télévisée d'animation américaine sur les Beatles contactèrent ceux-ci pour leur proposer une idée de long métrage. Dès le début, les réalisateurs voulaient que le film ait une allure originale et hautement stylisée, inspirée par les styles d'art moderne de l'époque.

Le film d'animation qu'ils ont créé est une histoire fantastique pleine d'aventure, de musique et de personnages hauts en couleur. D'un côté se tiennent le maléfique Chief Blue Meanie, son homme de main Max et l'armée de Blue Meanies qui inclut aussi les Apple Bonkers, les Evil Clowns et les Snapping

Turks. De l'autre côté il y a John, Paul, George et Ringo, qui se réunissent avec l'étrange conteur d'énigmes Jeremy Hillary Boob, Ph. D, et le vieux marin, Captain Fred.

Au cœur de l'aventure se trouve le remarquable sous-marin jaune, le vaisseau magique qui transporte les Beatles sous les vagues depuis Liverpool vers les côtes de Pepperland, dans des mers merveilleuses.

Lorsque le film sortit à Londres le 17 juillet 1968, cette fête visuelle et colorée fut encensée par la critique et est toujours considérée comme un film d'animation révolutionnaire presque un demi-siècle plus tard.

Cuando se estrenó Yellow Submarine en 1968, la espectacular película fue instantáneamente reconocida como un hito cinematográfico que había llevado la animación más allá de lo que nadie había visto hasta entonces.

En colaboración con Kevin Szeto, fan de LEGO® y diseñador aficionado, nos complace presentarles nuestra versión del emblemático submarino, que constituye el 15º producto como parte de la colección LEGO Ideas.



John



Paul



George



Ringo



Jeremy

# La historia detrás de la historia



El popular Submarino Amarillo comenzó su viaje cuando los productores de la serie animada para televisión de los Beatles lo visitaron con una idea para un largometraje. Desde el principio, los responsables del proyecto querían que el título tuviera un aspecto fresco y un estilo peculiar inspirado en el arte moderno de la época.

La película animada que crearon fue una historia fantástica llena de aventuras, música y llamativos personajes. Por un lado está Chief Blue Meanie, su esbirro Max y el ejército de Blue Meanies, que incluía a los Apple Bonkers, los Evil Clowns y los Snapping Turks. Por el otro tenemos a John, Paul, George y Ringo, que se reúnen con el extraño y enigmático

Jeremy Hillary Boob, Ph. D, y Captain Fred, un viejo marinero.

En el centro de la aventura se sitúa el célebre Submarino Amarillo, un artefacto mágico que transporta a los Beatles bajo las olas desde Liverpool, a través de mares maravillosos, hasta las costas de Pepperland.

La película se estrenó en Londres el 17 de julio de 1968. El festival de efectos visuales y colores fue ampliamente aclamado por la crítica y todavía hoy, casi medio siglo después, se considera una revolucionaria obra de animación.

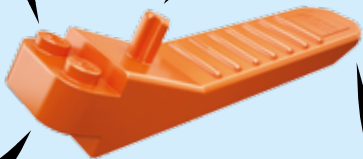
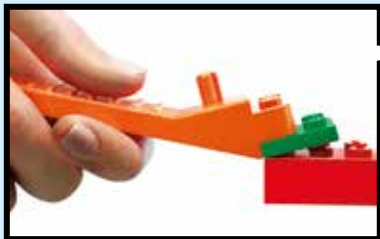

[LEGO.com/brickseparator](https://LEGO.com/brickseparator)

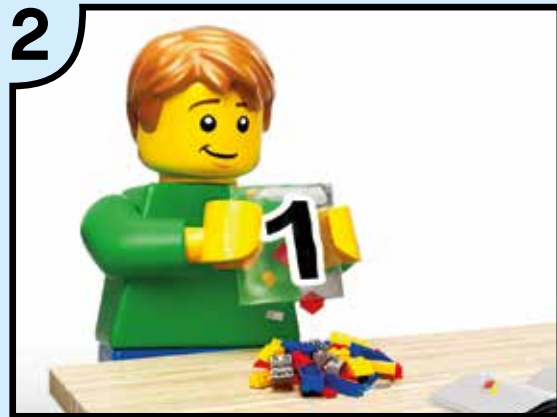

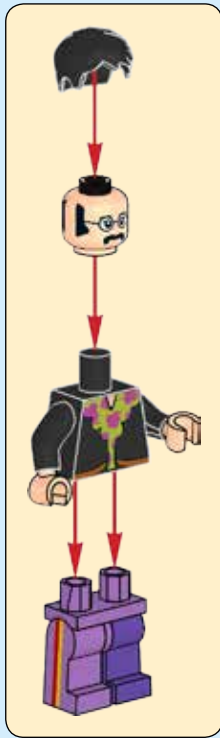



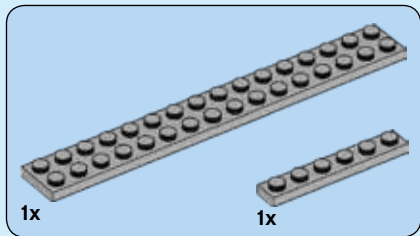

**1**

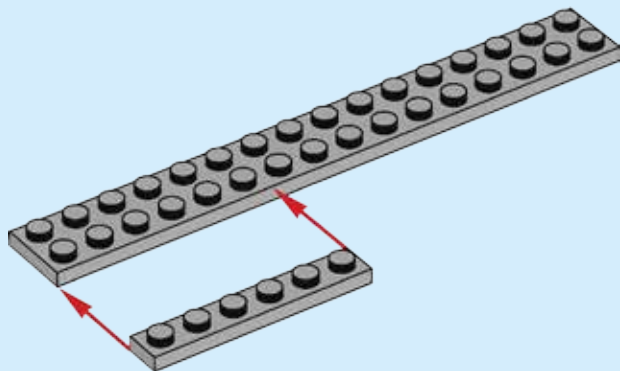



4x

2

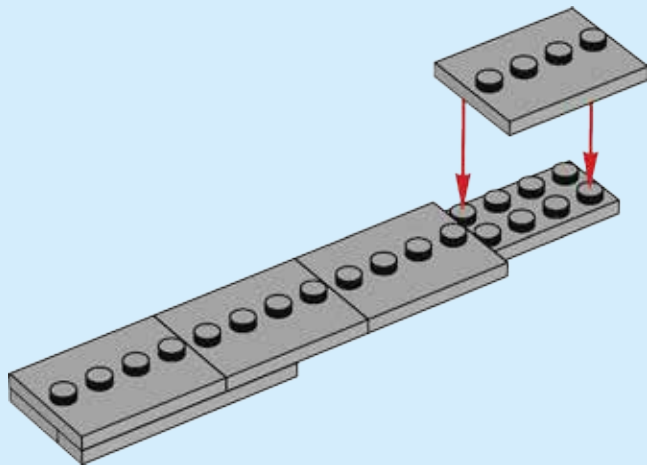

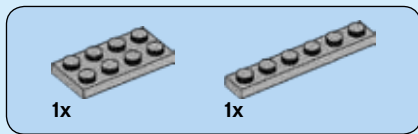

**3**

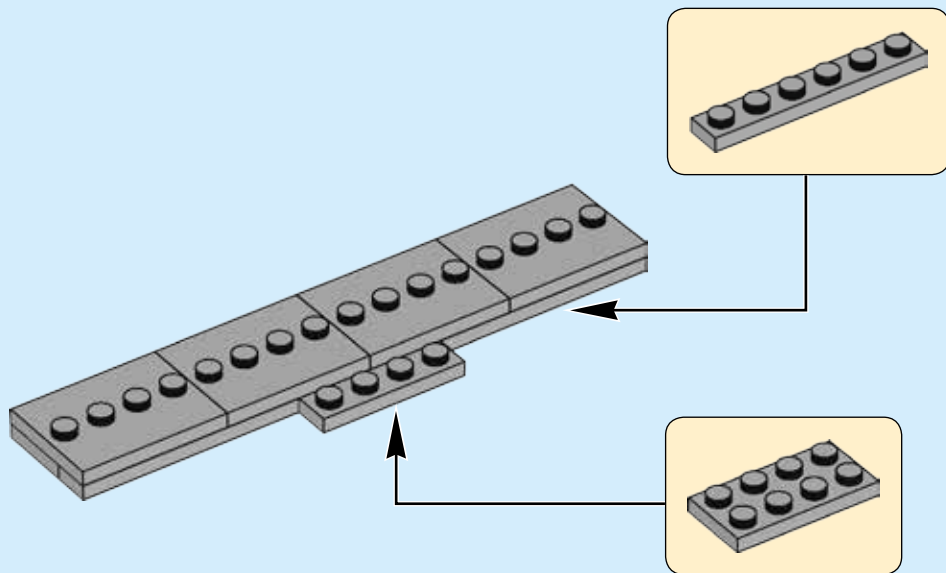



2x



2x

4

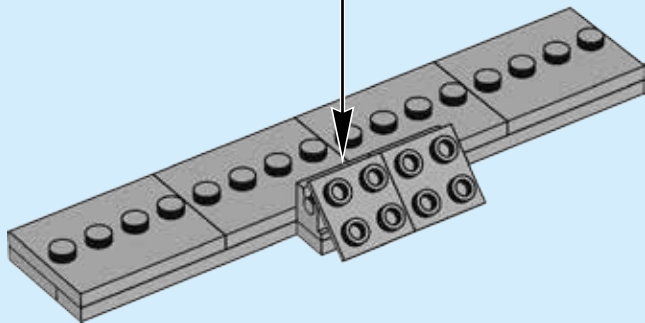
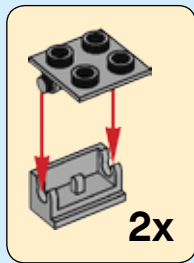



5

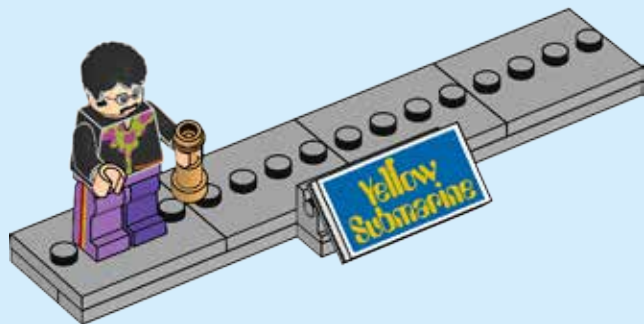

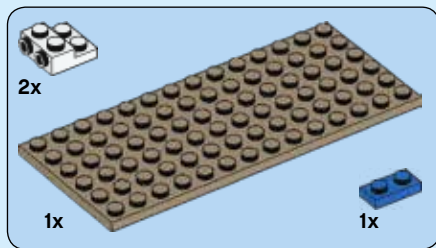
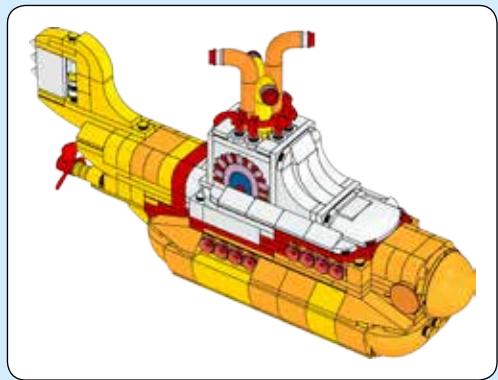

1

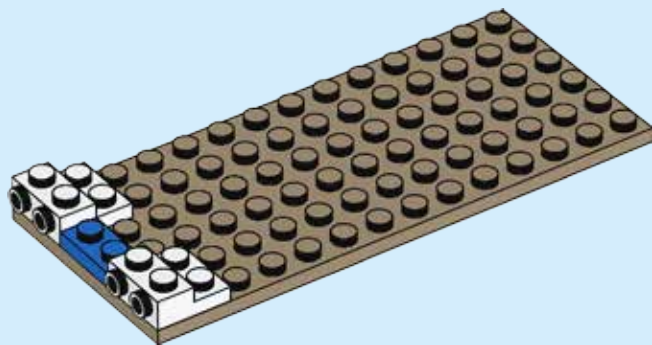





1x



10x

2

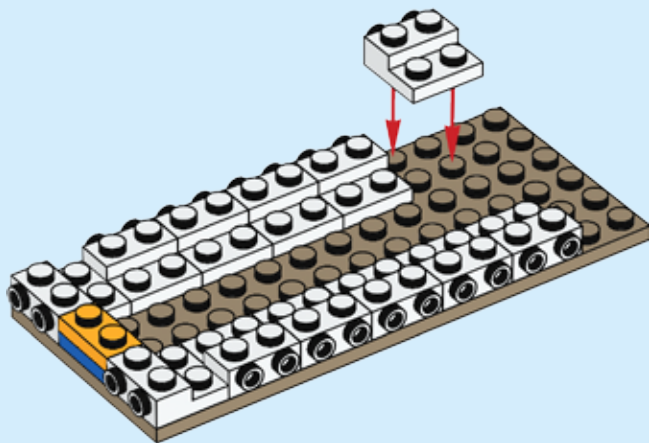



2x

3

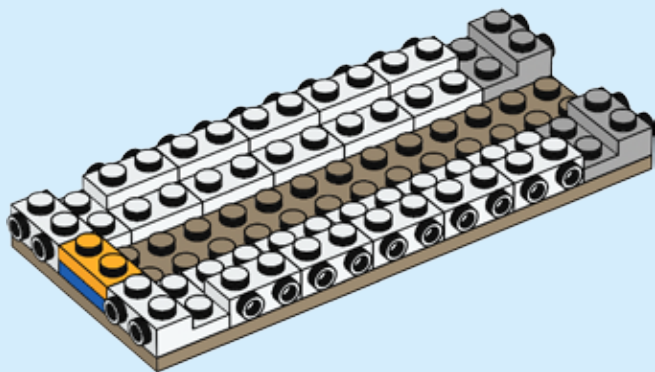



4x

4

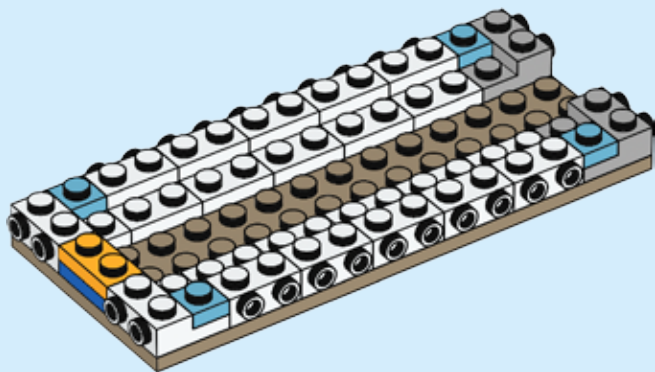

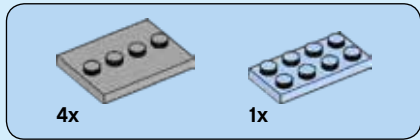

5

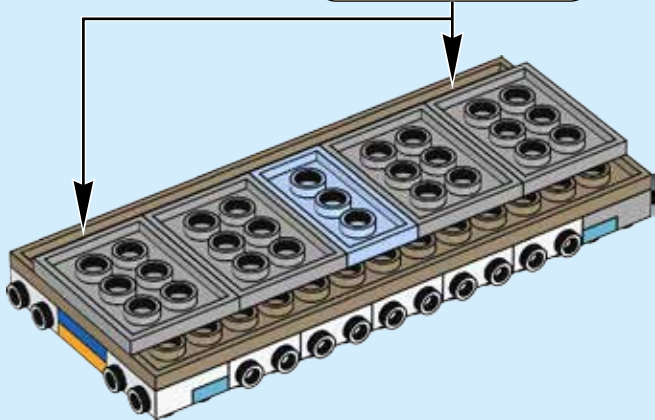
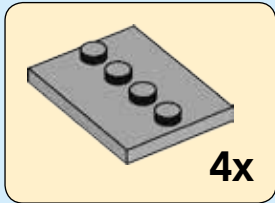
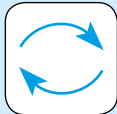



6

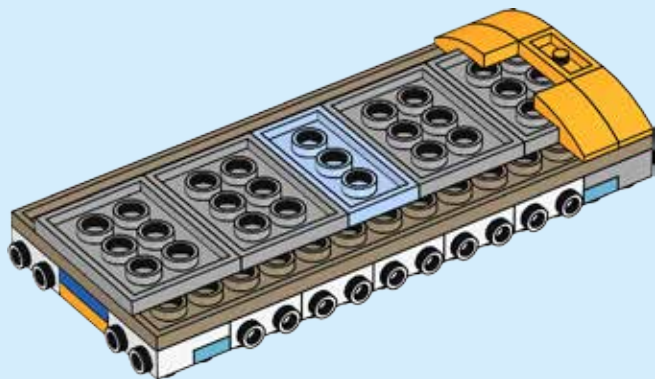



7

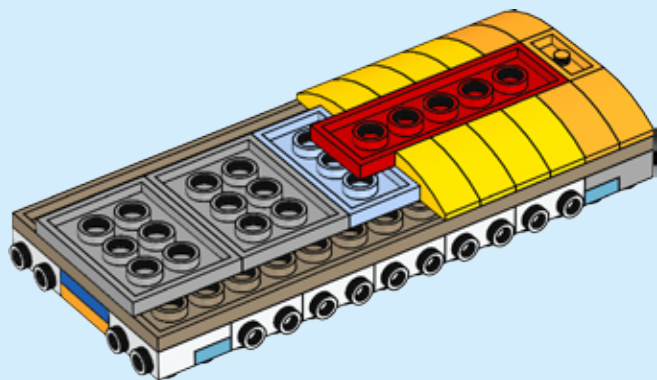





8

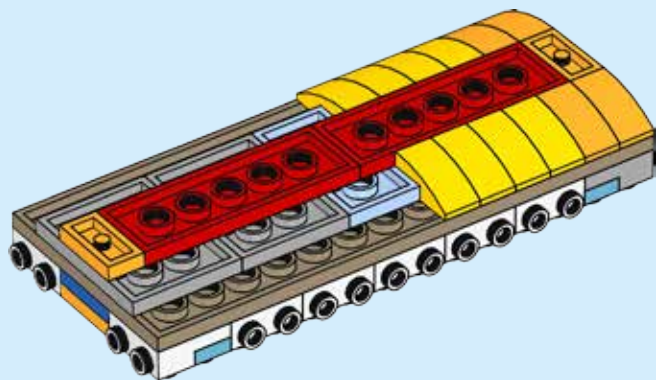



16x

9

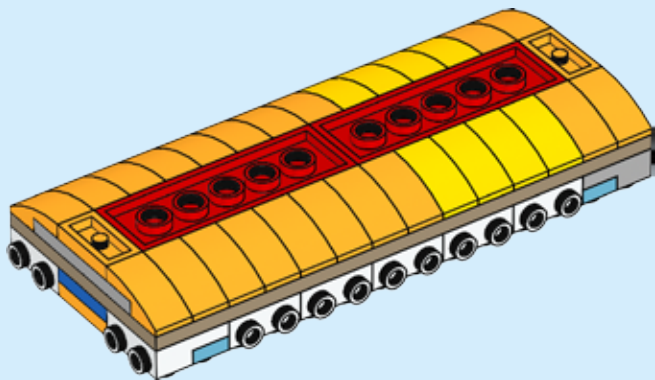



10

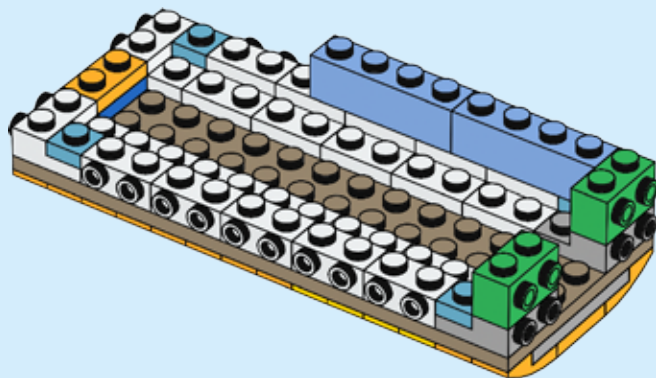
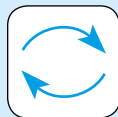



11

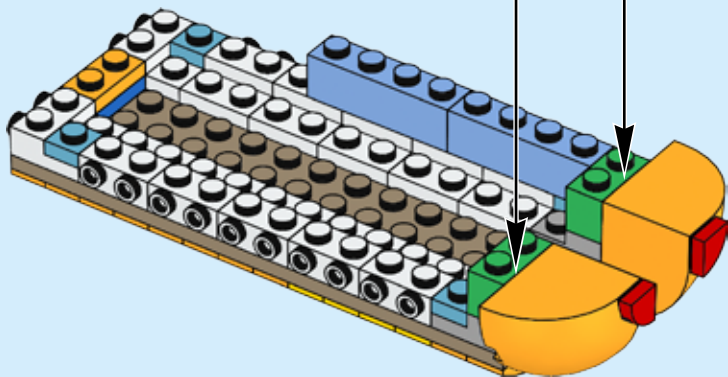
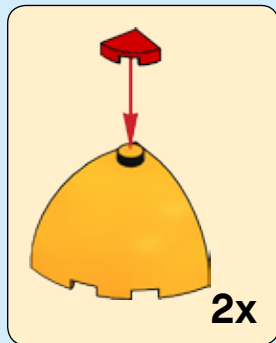



12

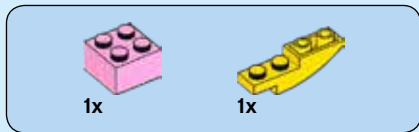
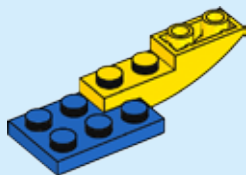

13

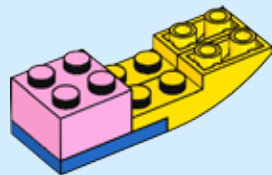



2x

14

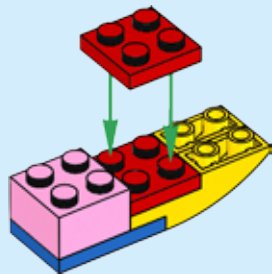

1x

15

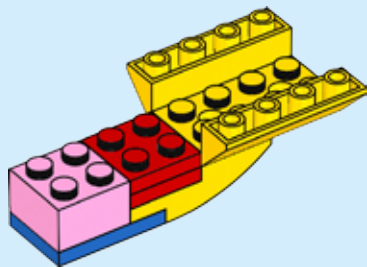



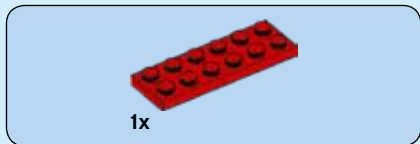

16

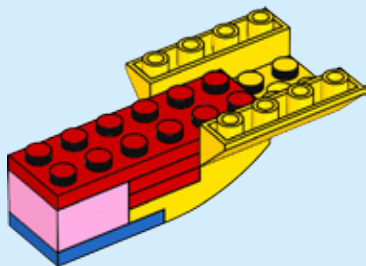

17

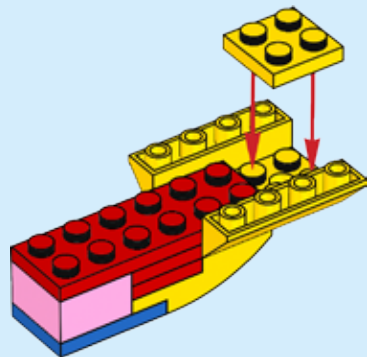

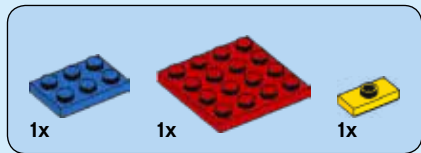

18

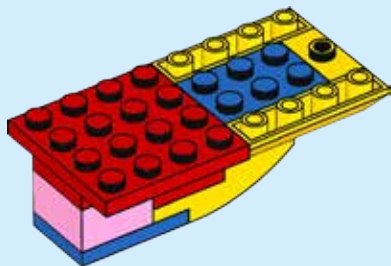

30



19

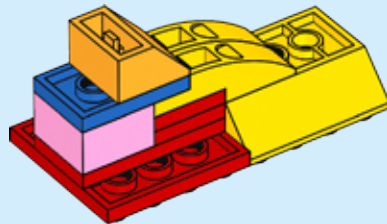
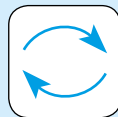

20

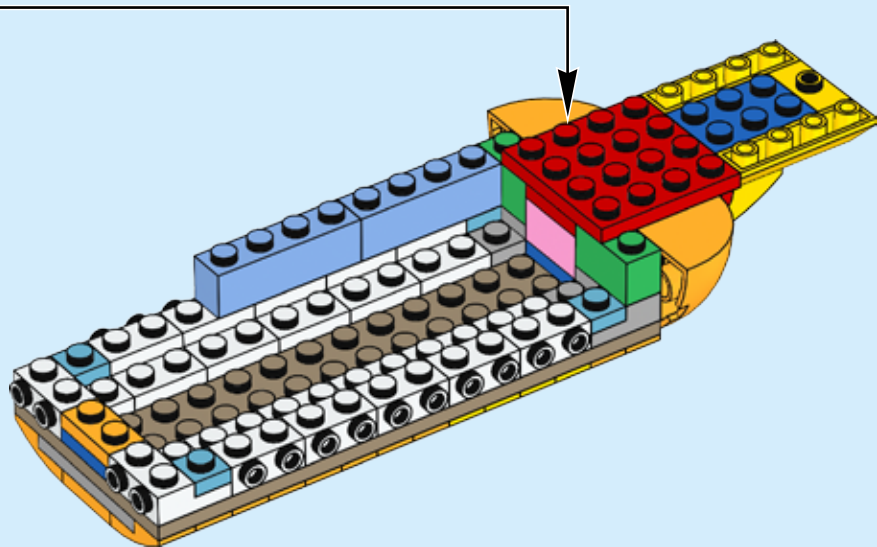

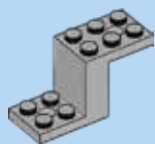

1x

21

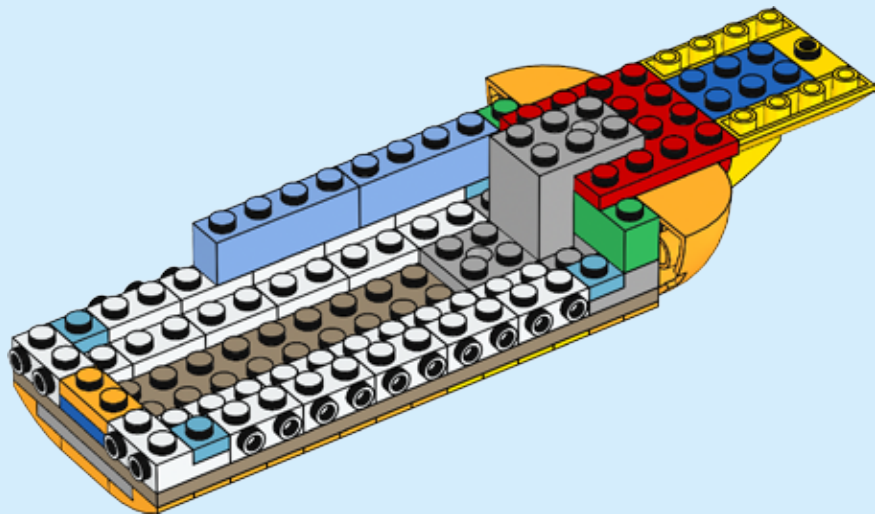

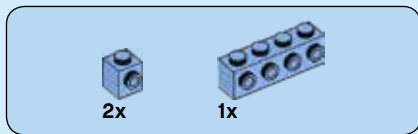

22

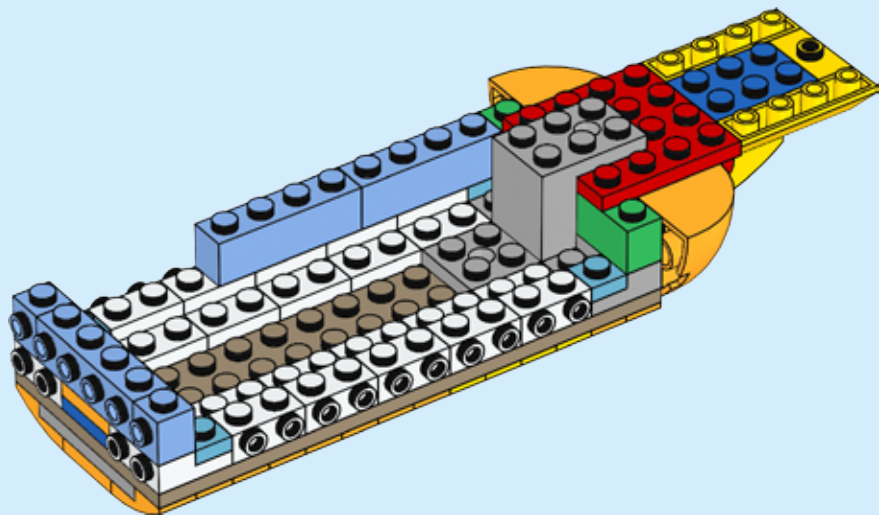



2x



1x

# 23

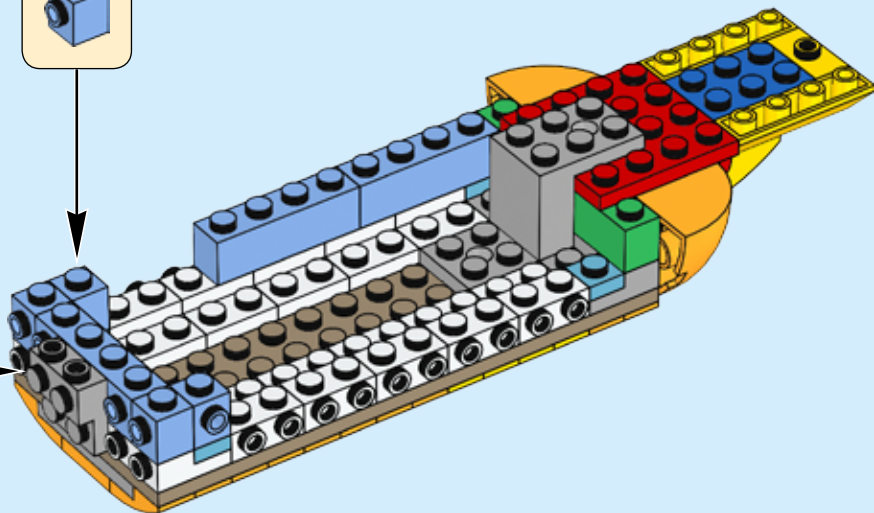



24

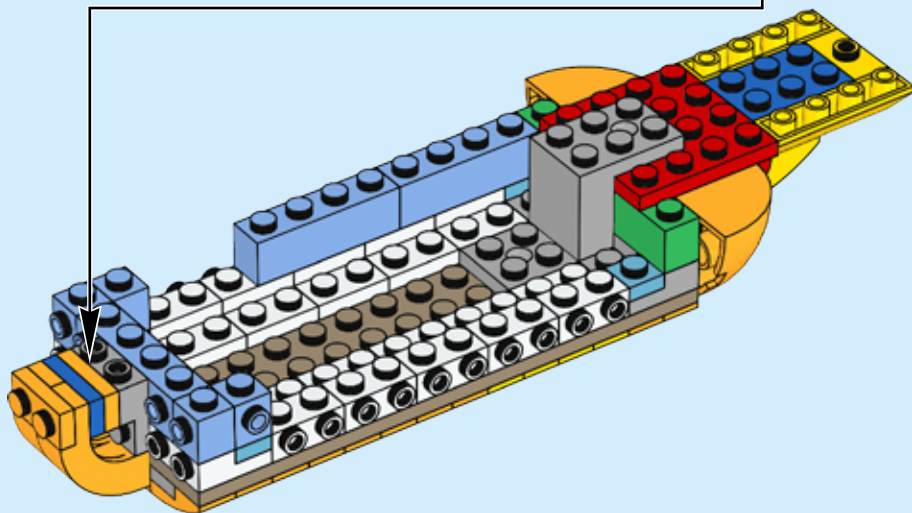
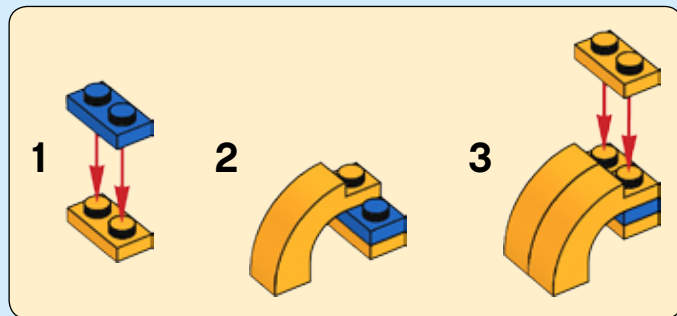



2x

25

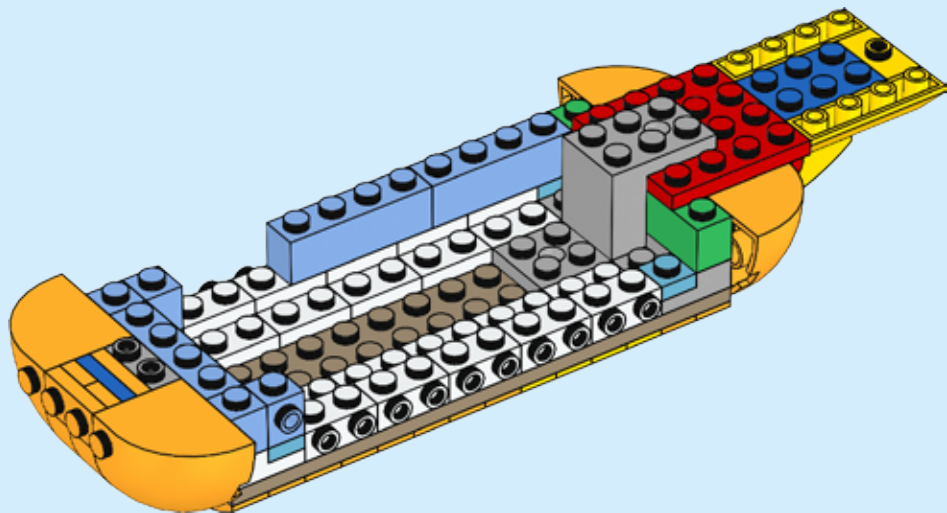





2x

26

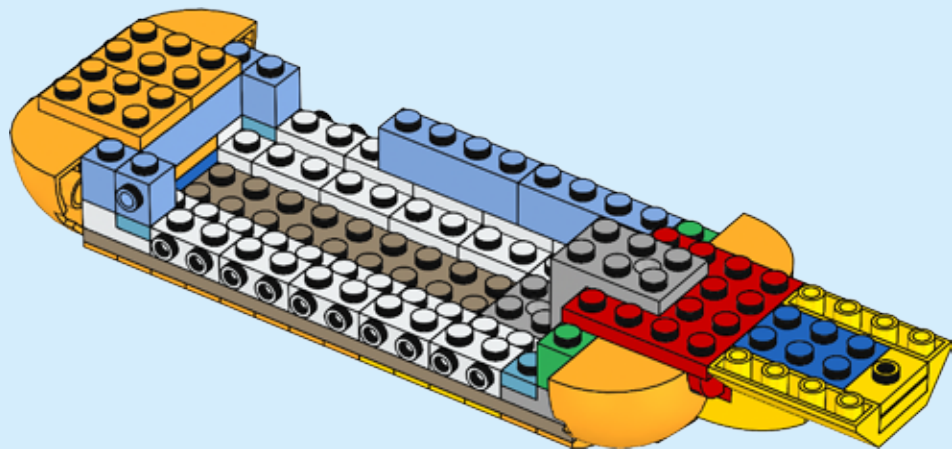

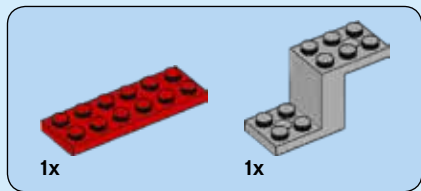

27

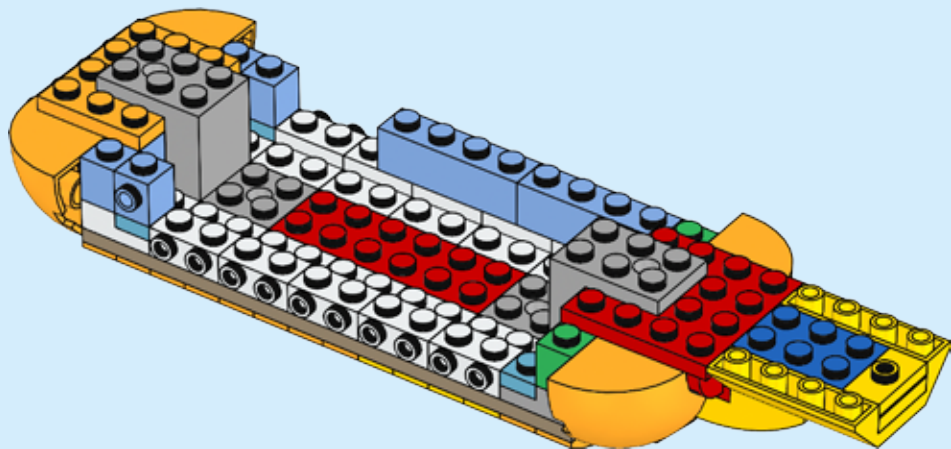

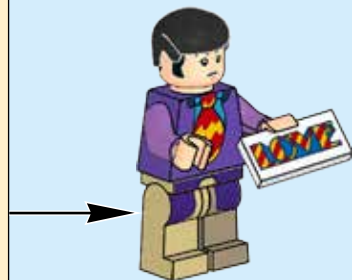
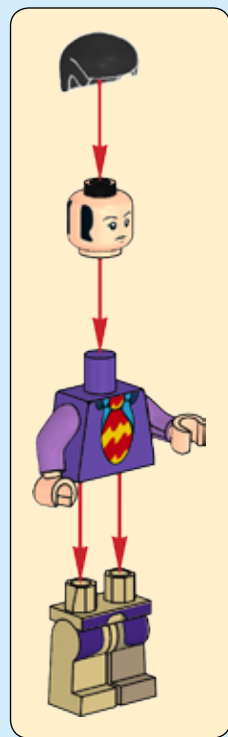
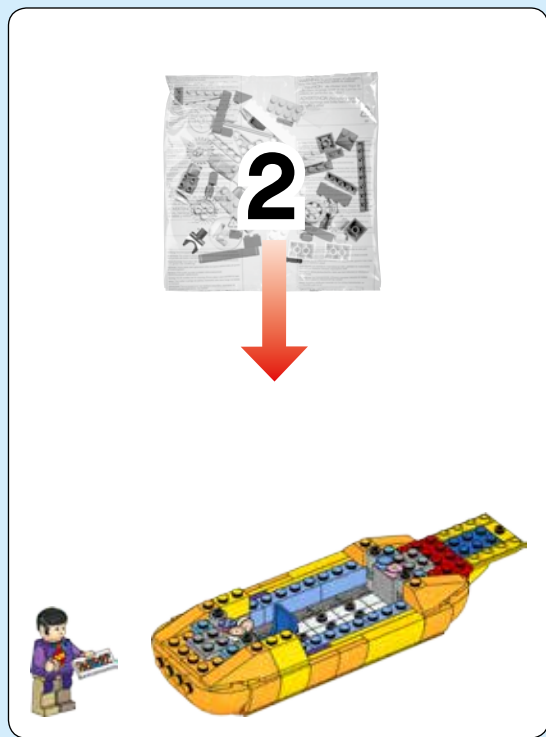



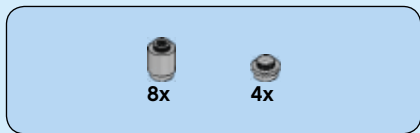

28

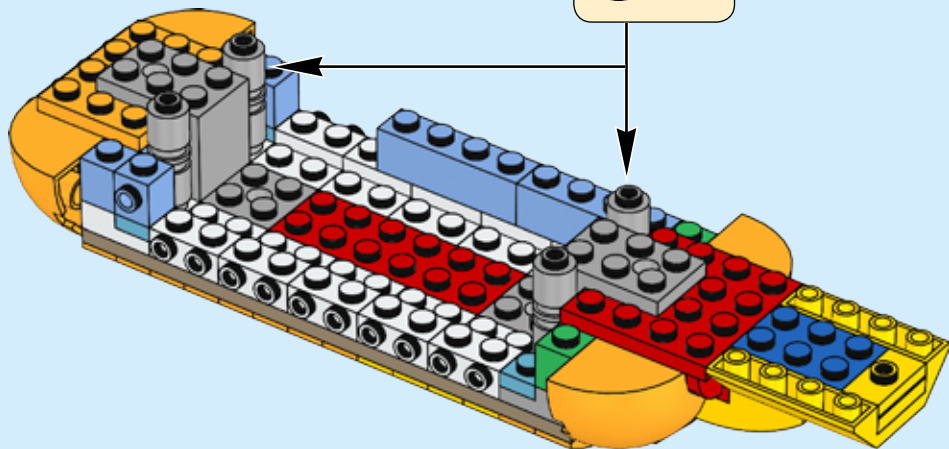
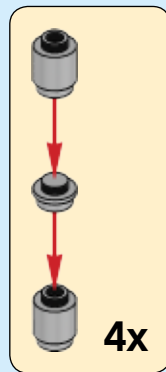



10x

29

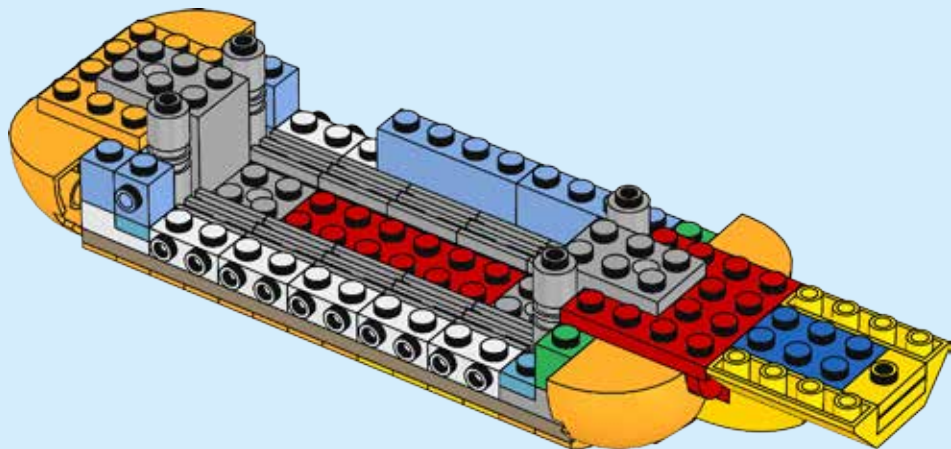

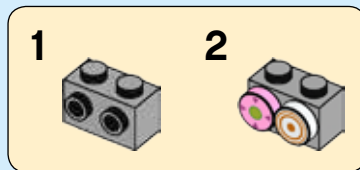
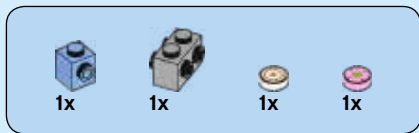

30

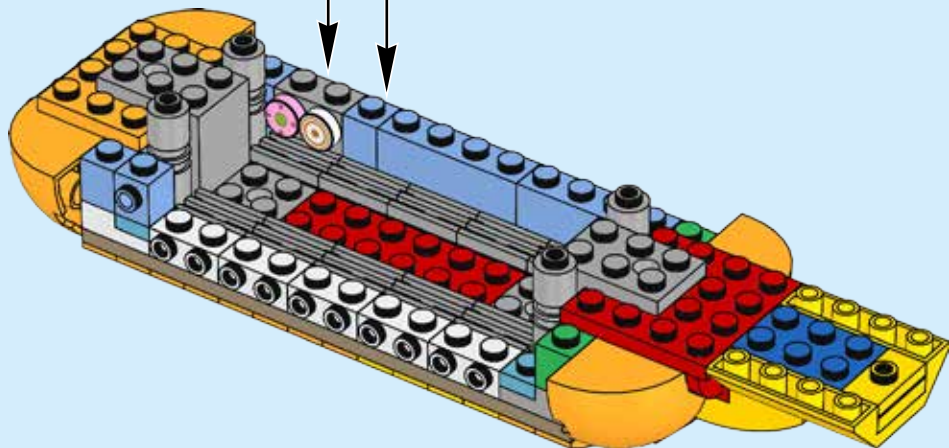
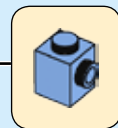



2x



6x

# 31



2x

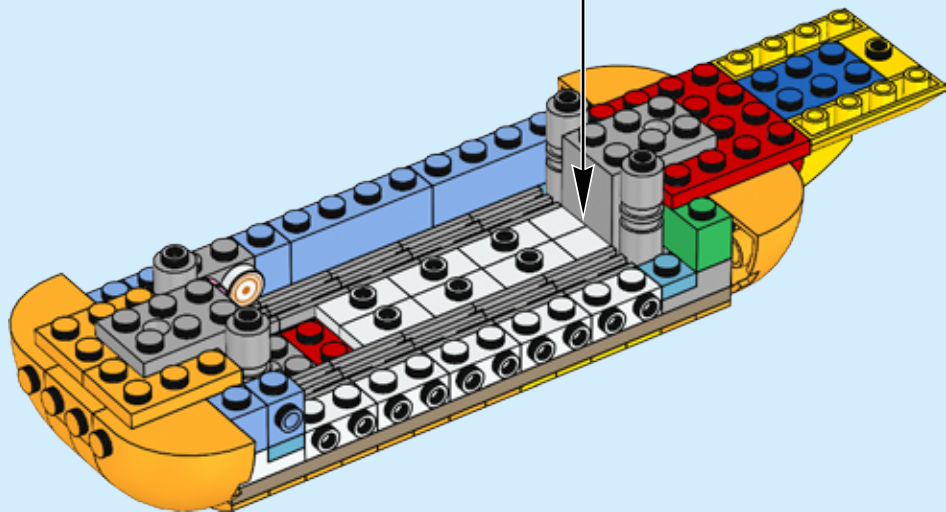





32

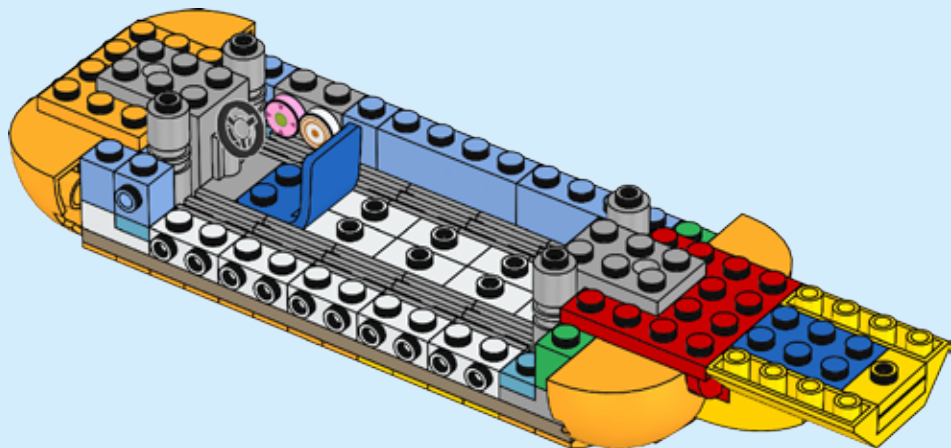



1x



2x

# 33

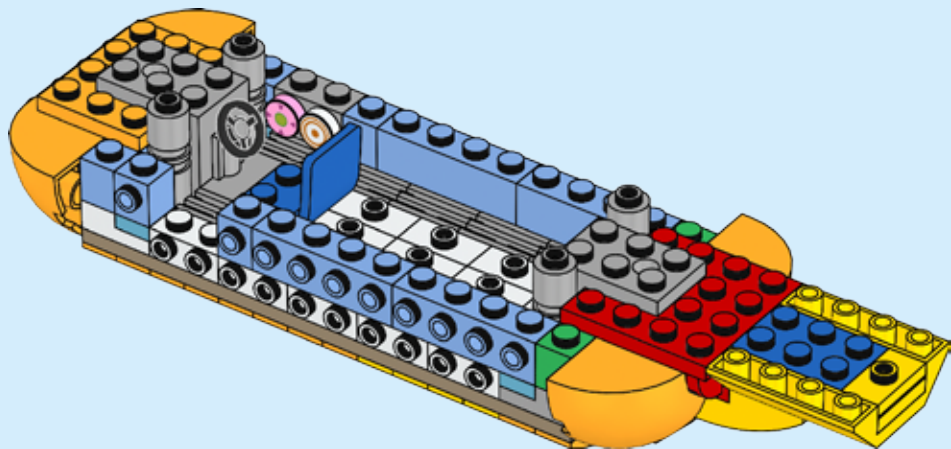

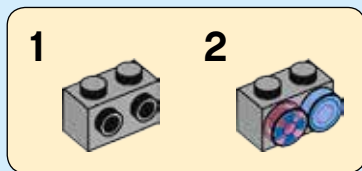
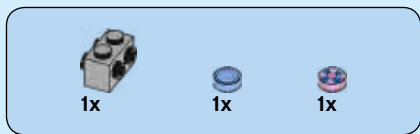

34

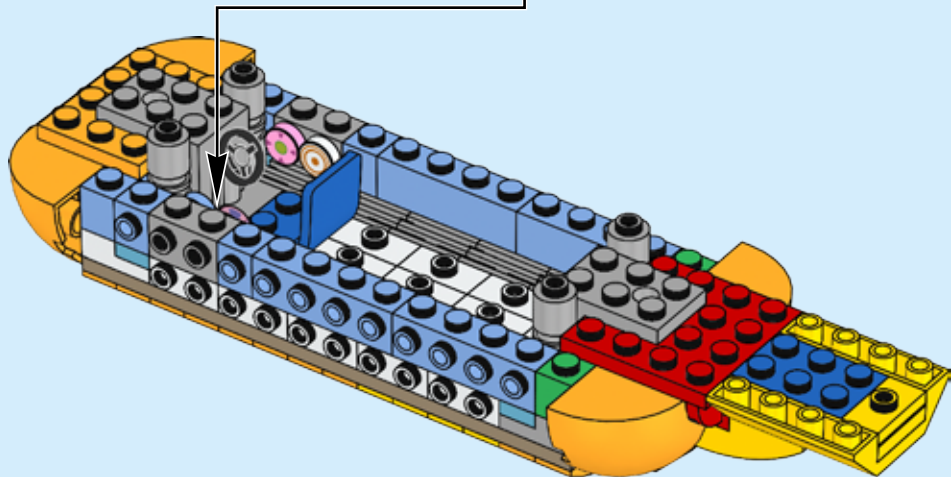

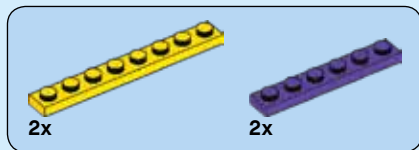

35

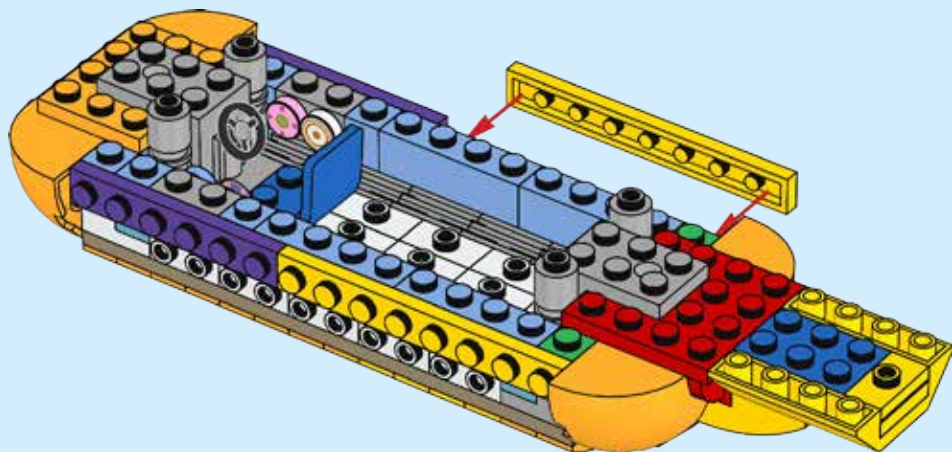



36

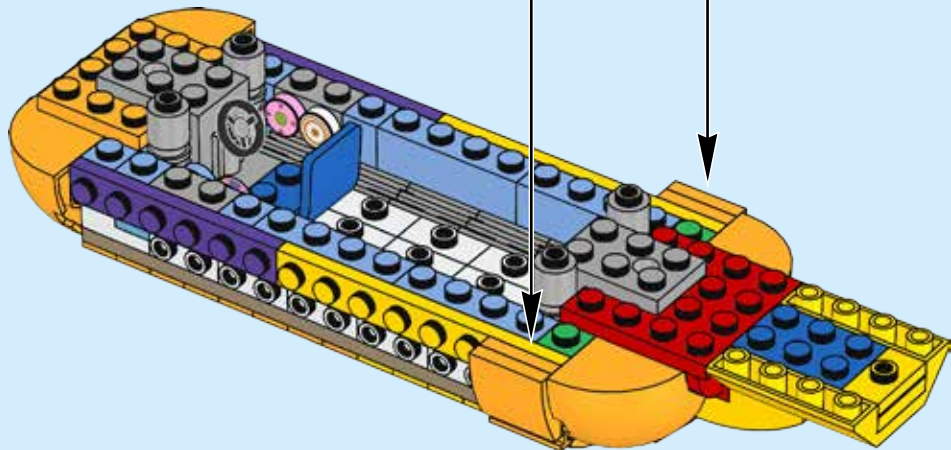
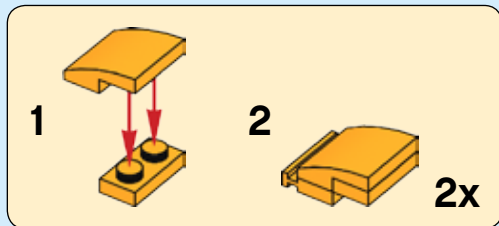

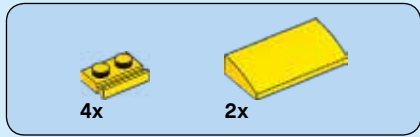

37

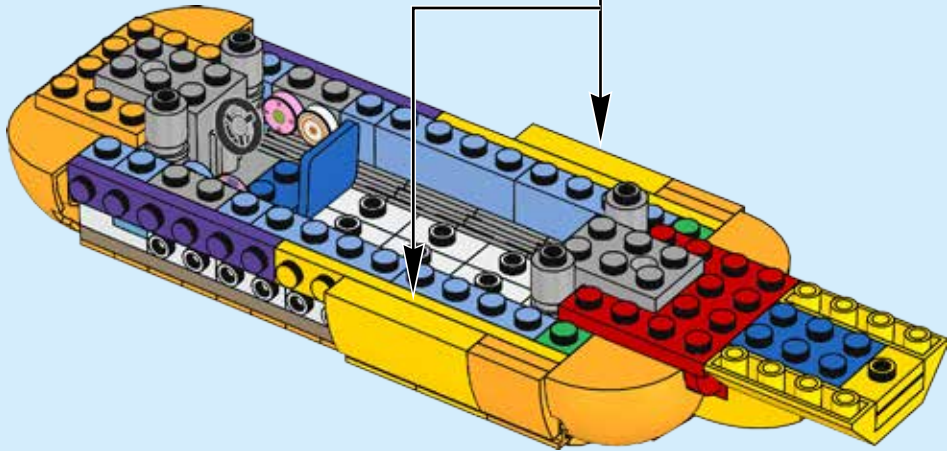
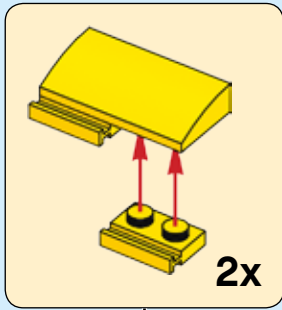

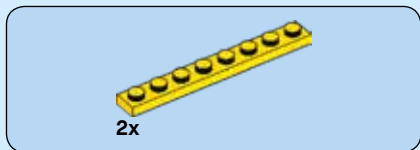

38

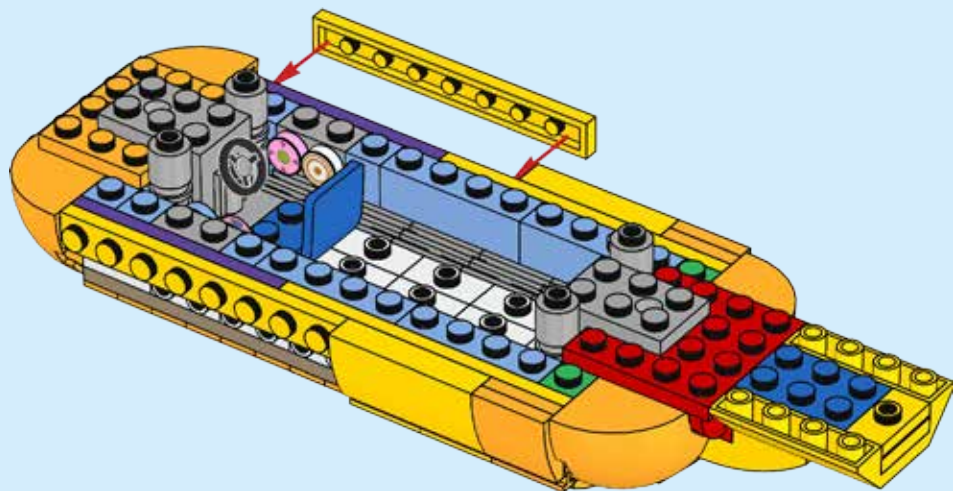

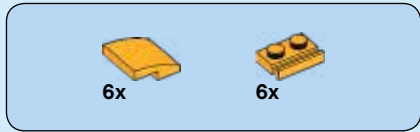

39

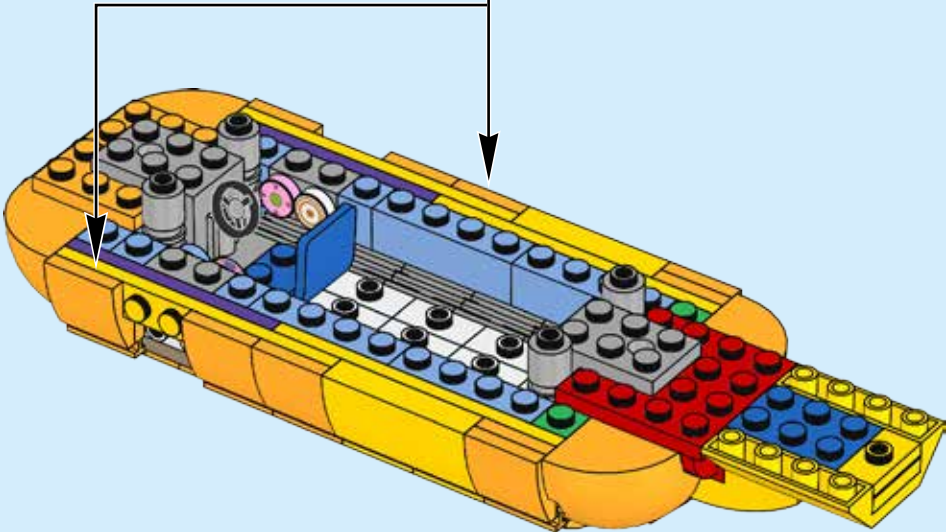
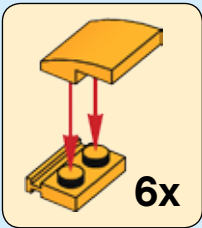



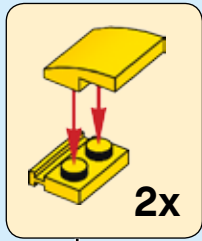
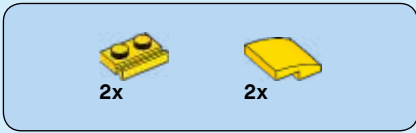

40

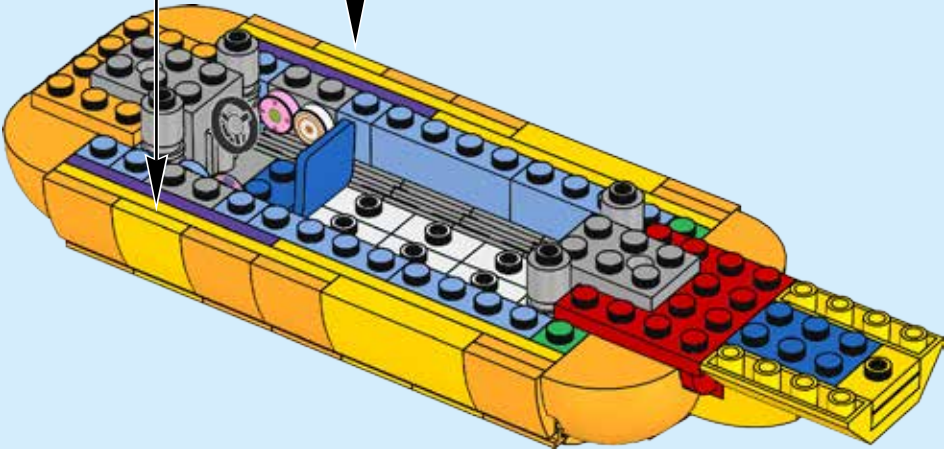

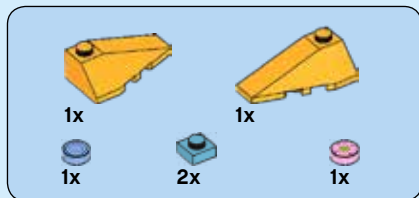

41

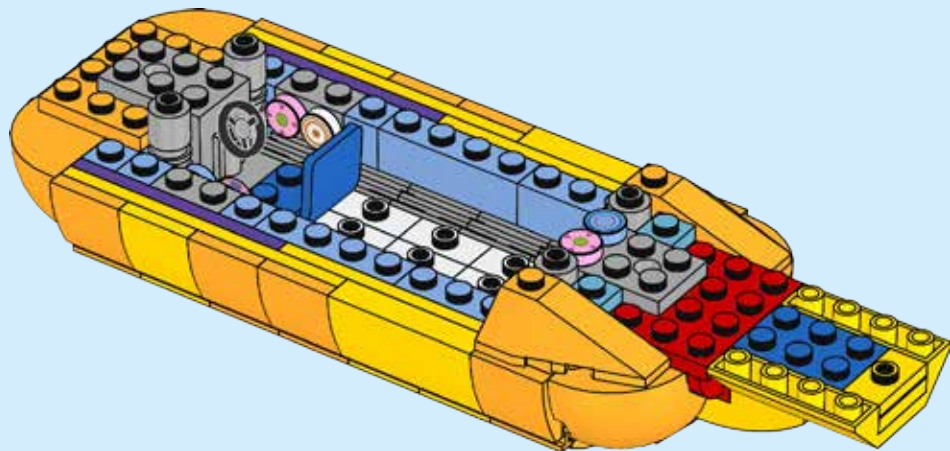



2x



1x



1x

# 42

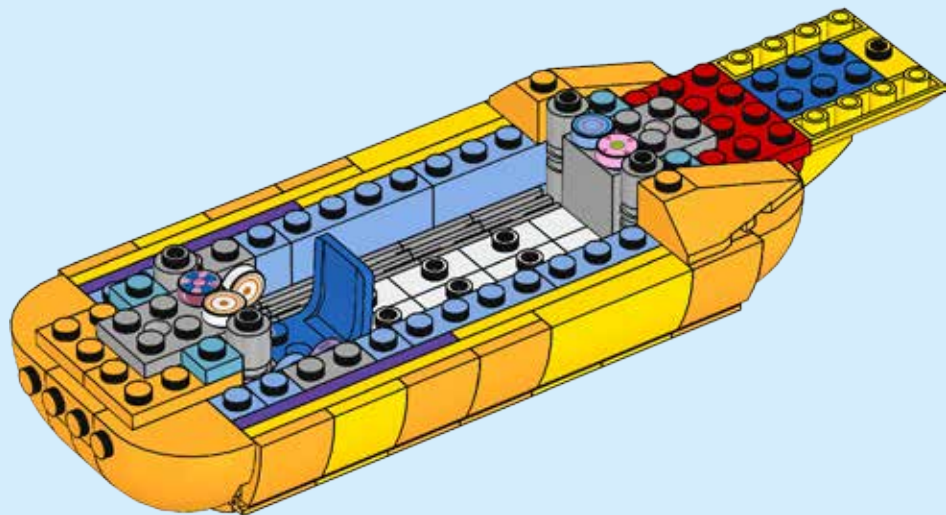

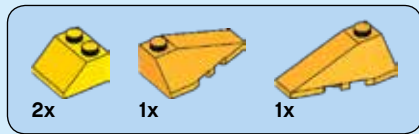

43

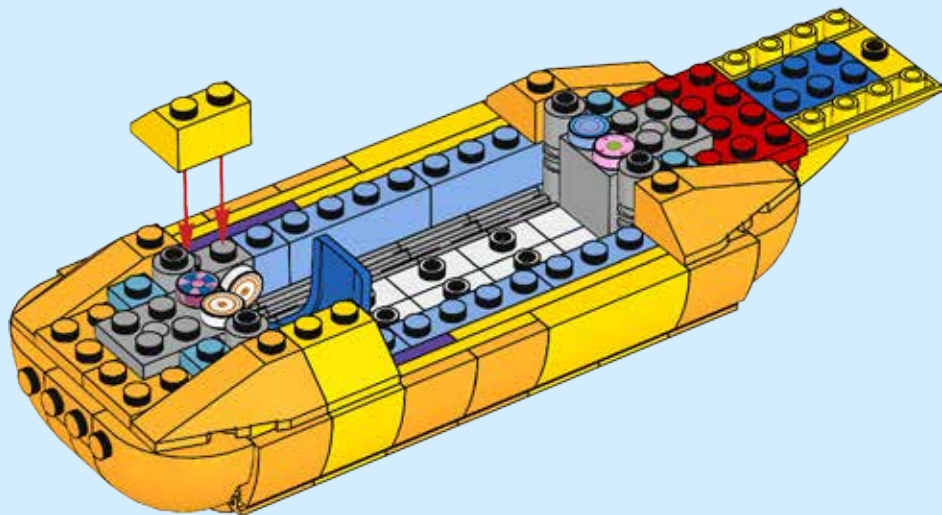

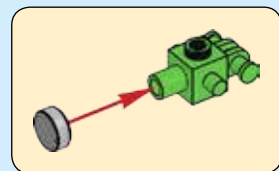
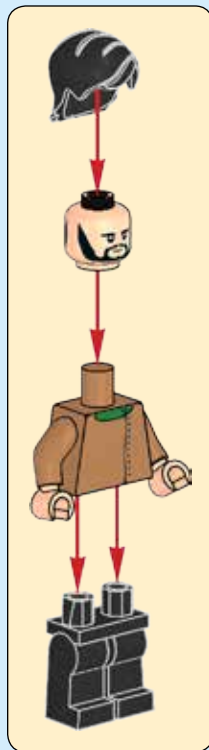





44

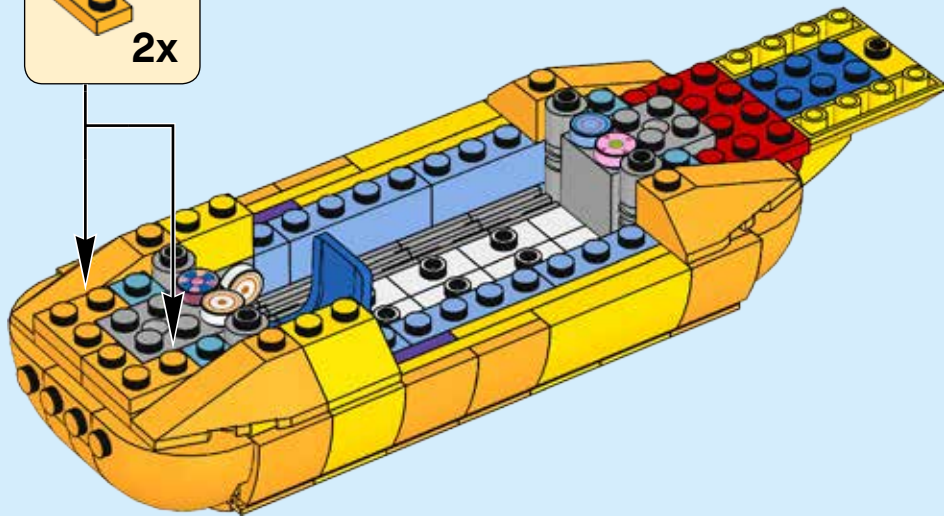



2x

45

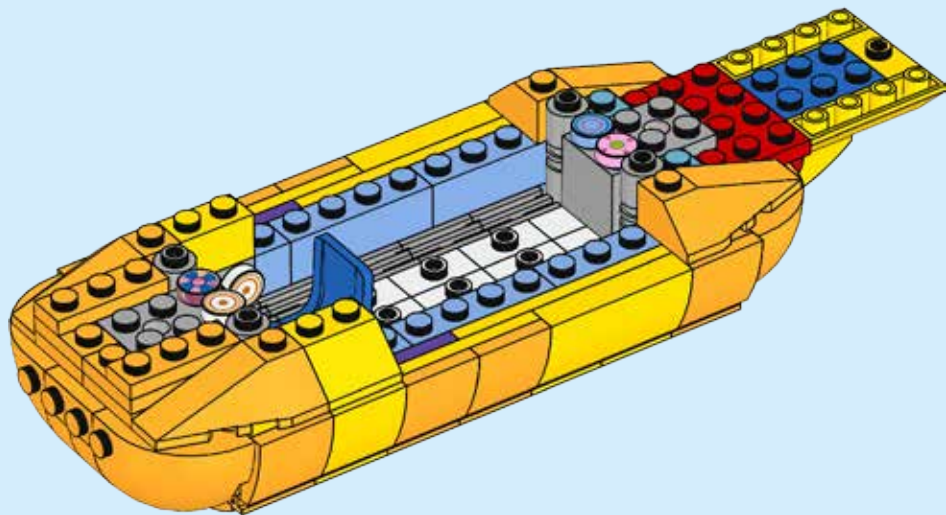





46

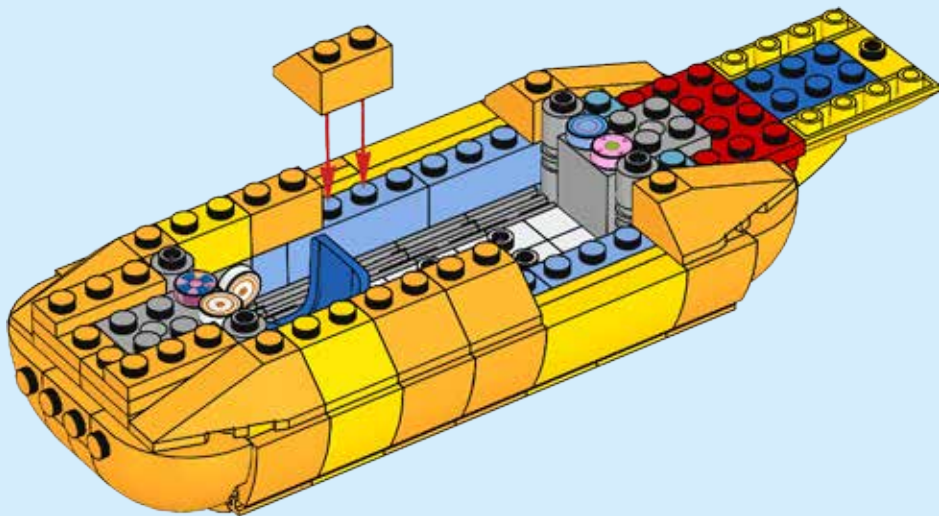



47

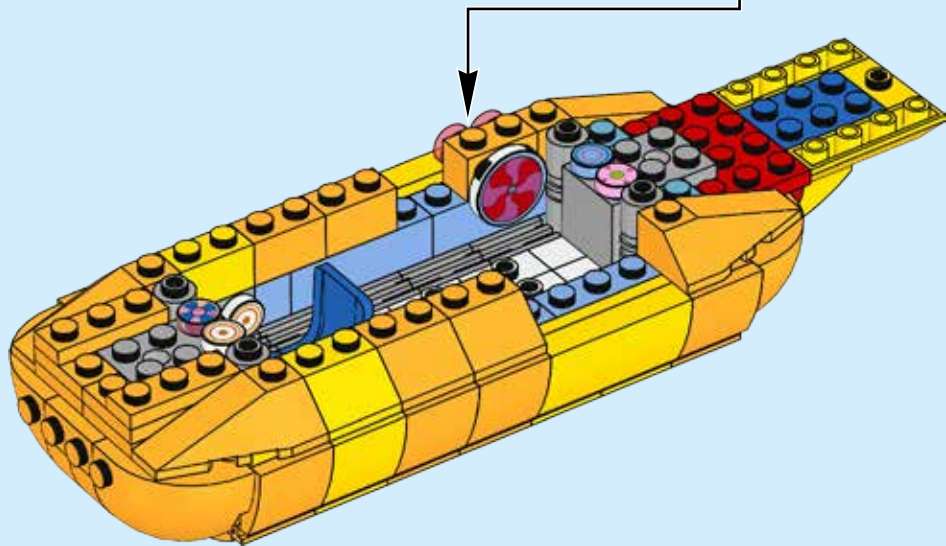



48

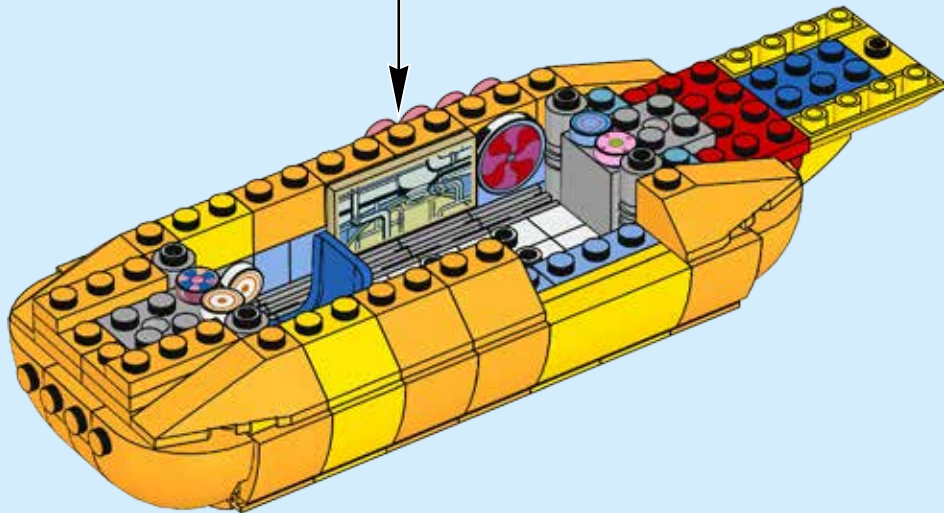
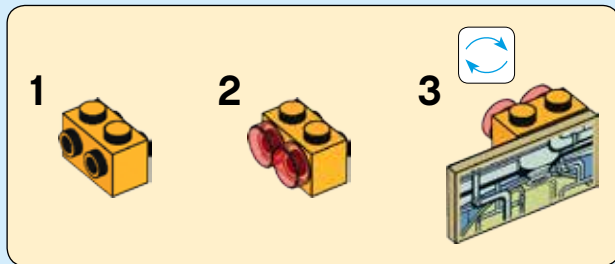



49

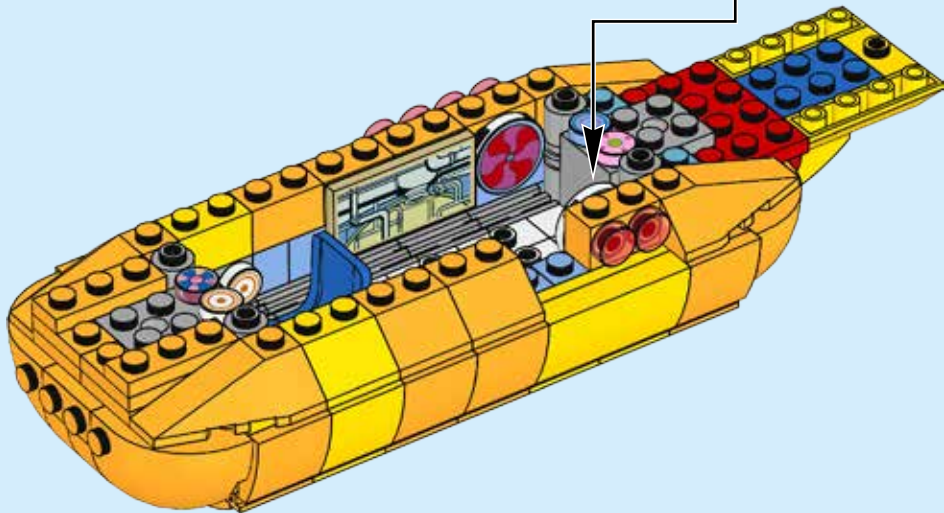



50

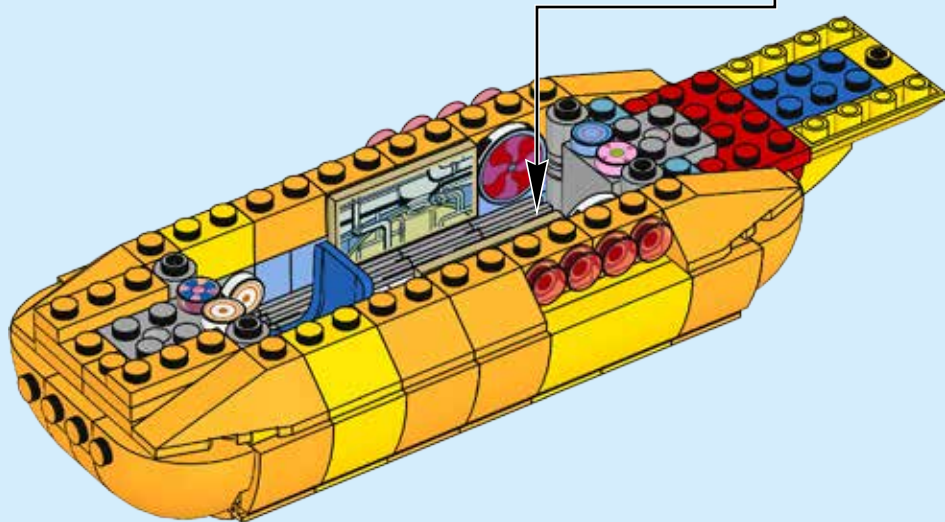
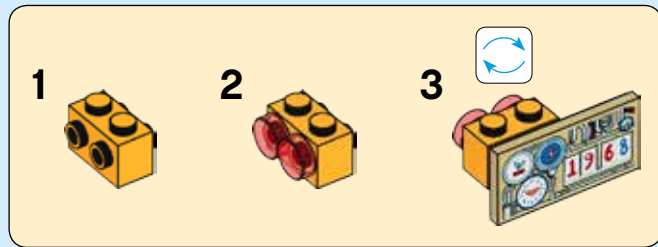

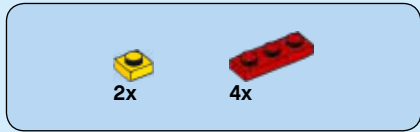

51

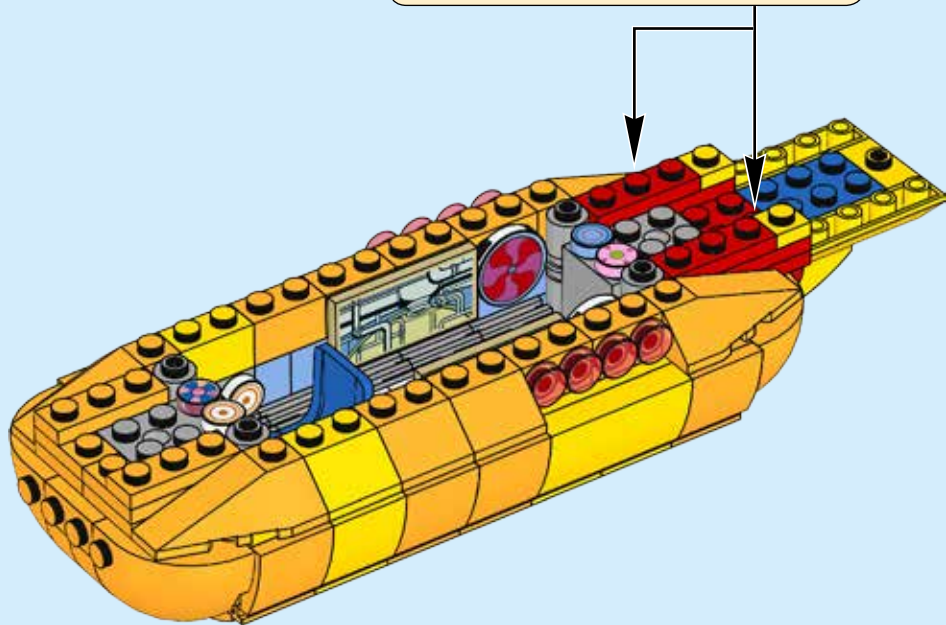
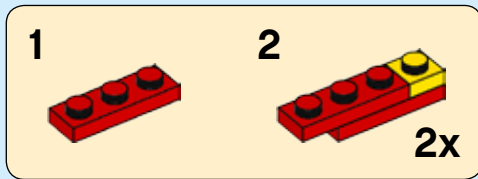



2x



2x

# 52

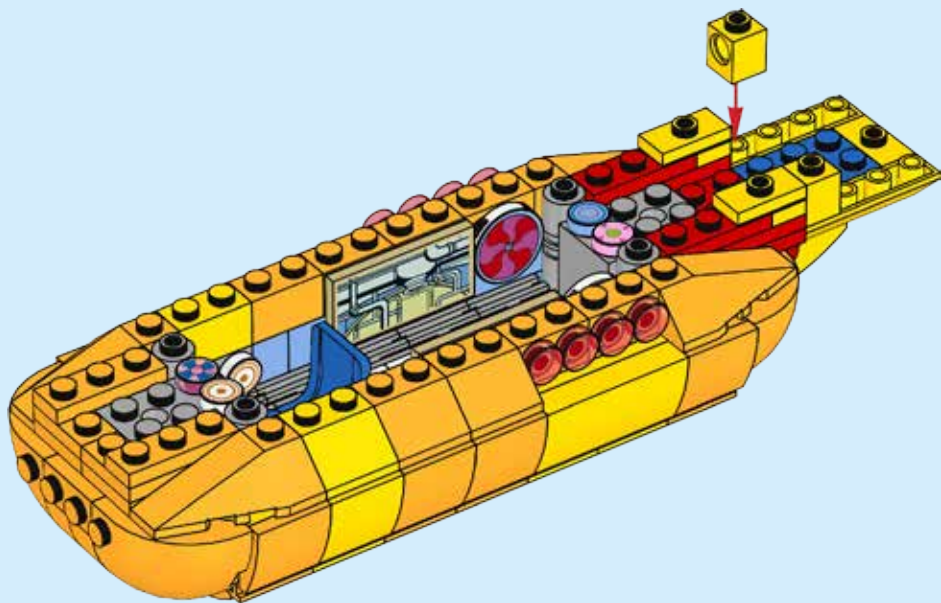





53

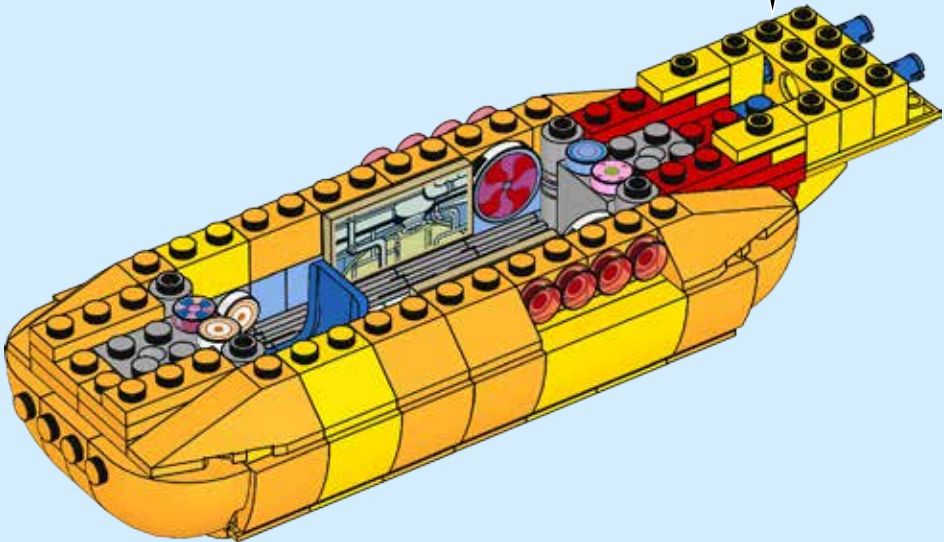
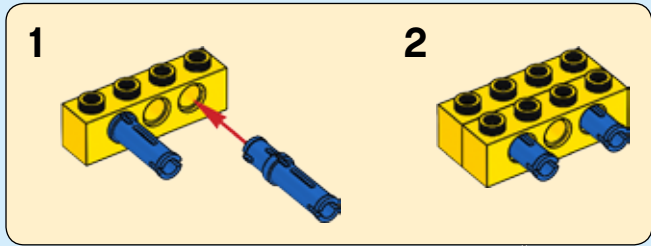



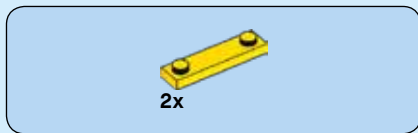

54

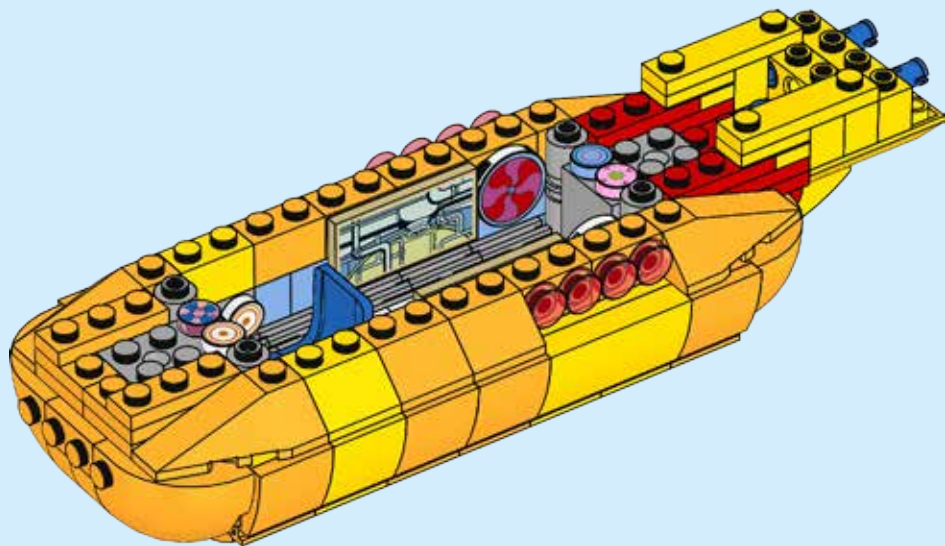



2x

55

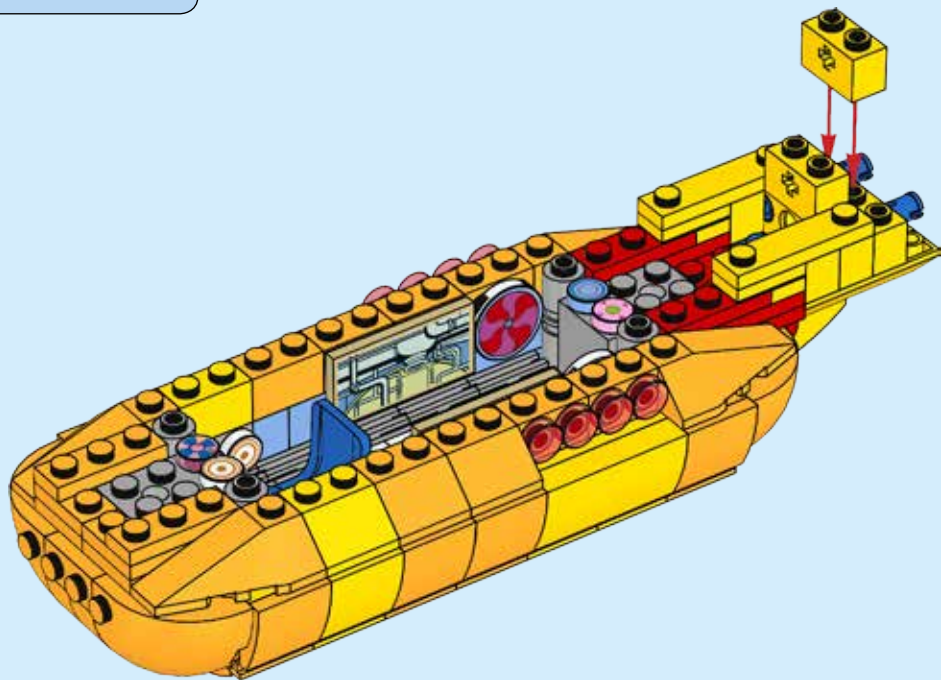



56

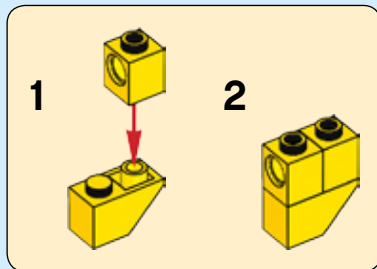

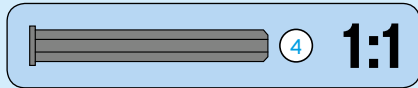
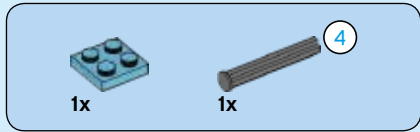

57

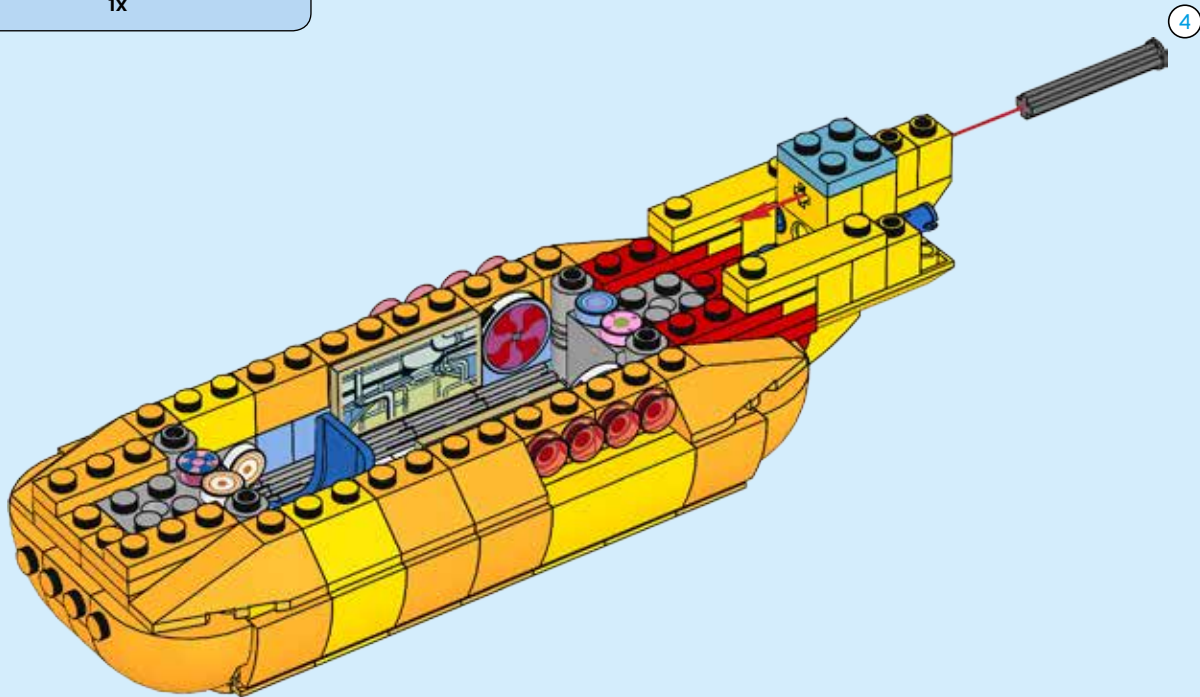

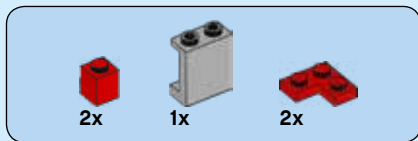

58

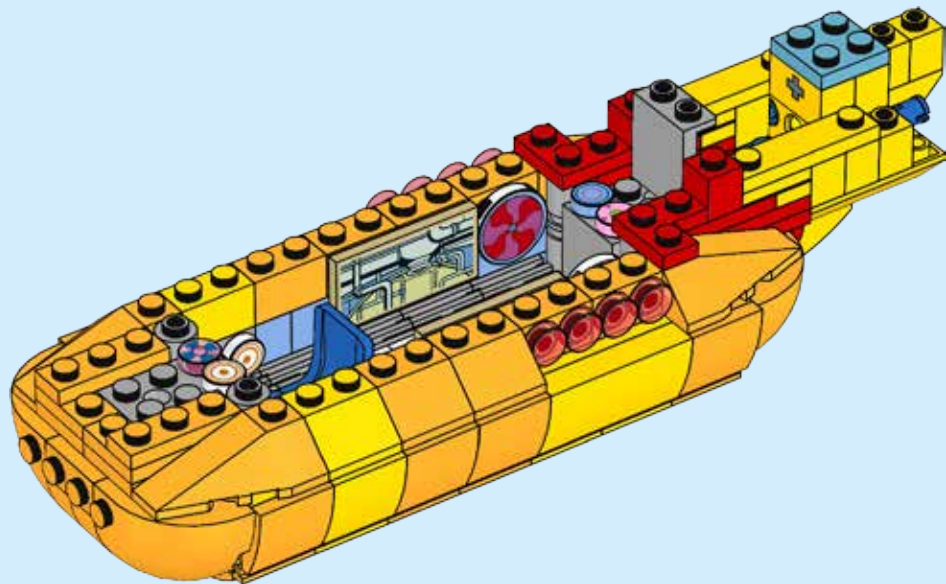



4x

59



2x

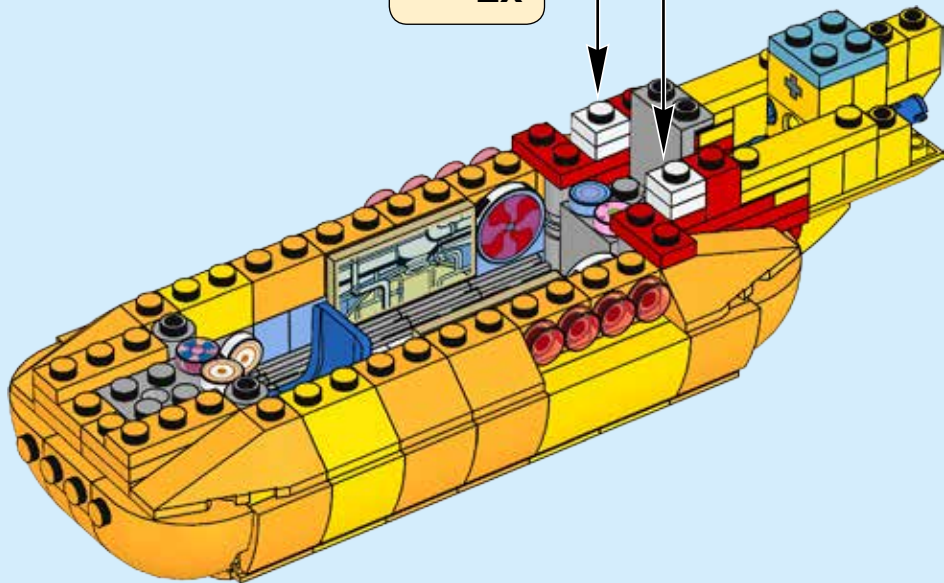

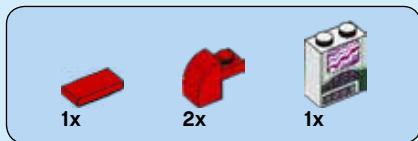

60

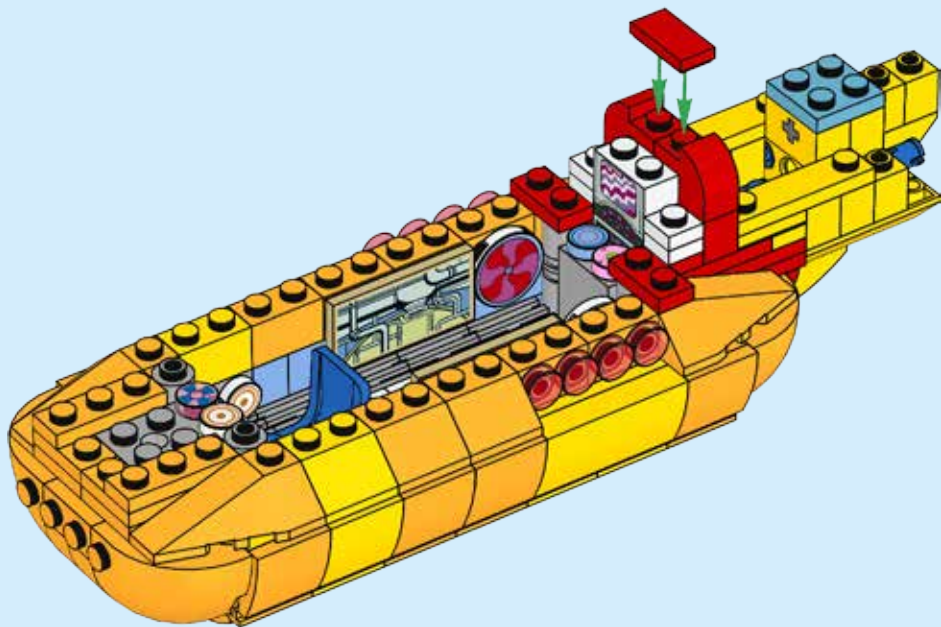





1x



2x

61

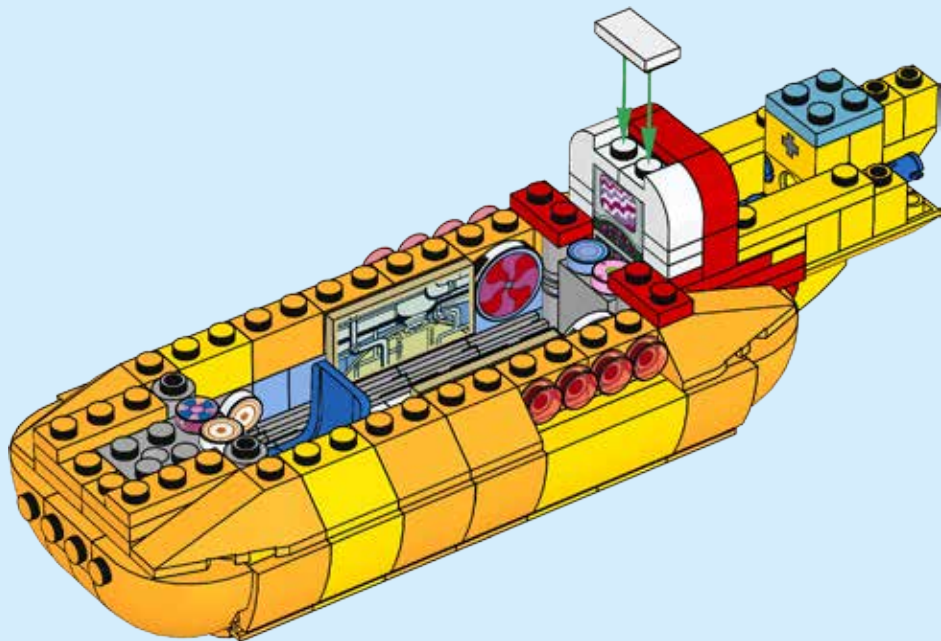



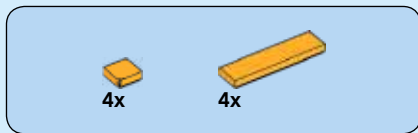

62

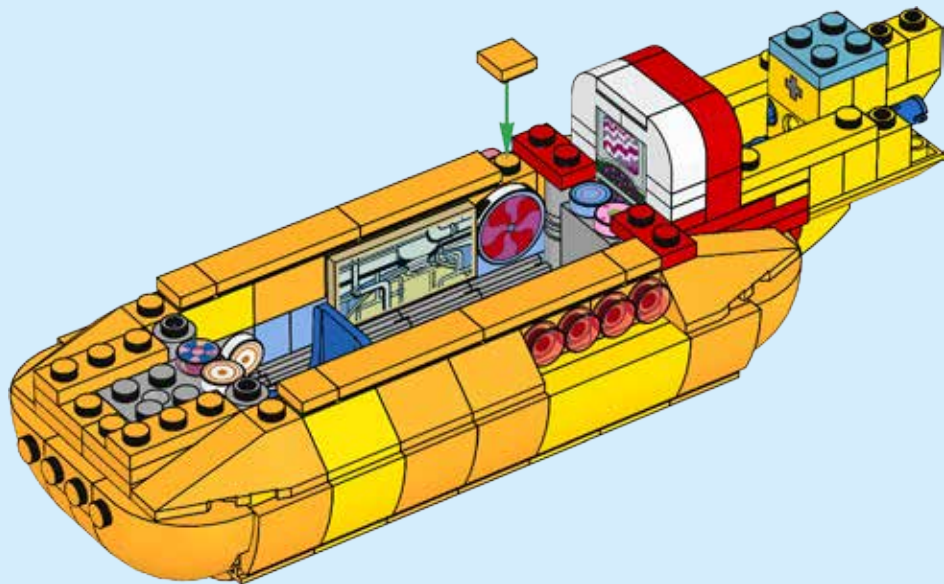



2x



2x

63

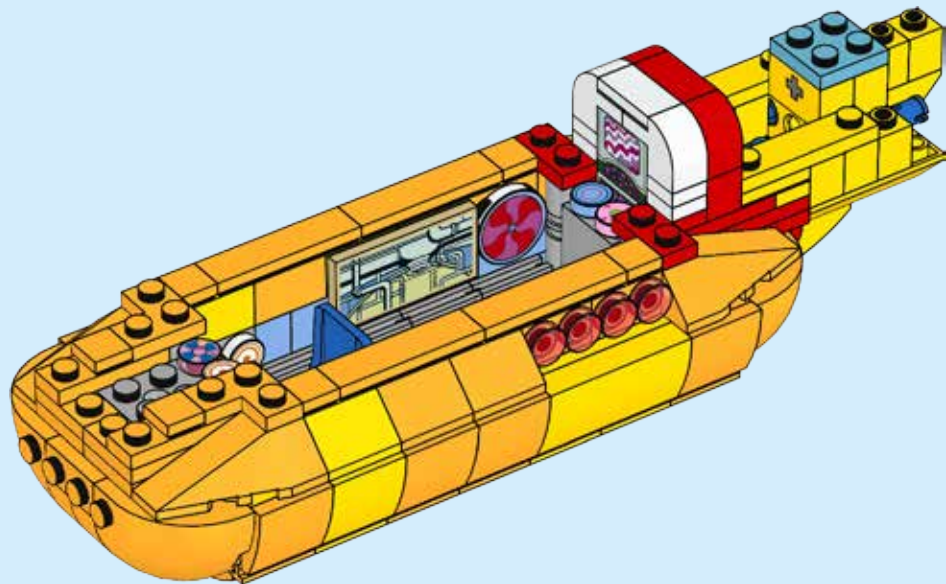

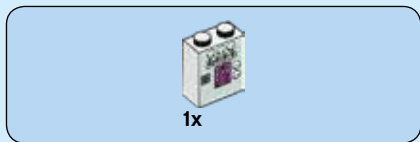

64

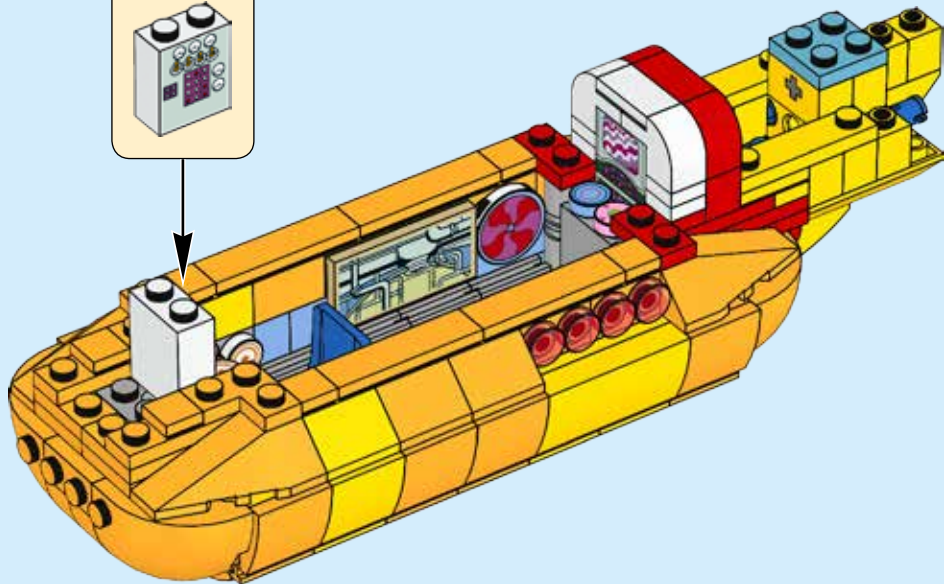
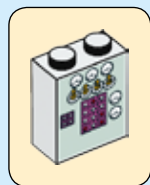



4x



1x

# 65

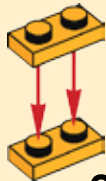

2x

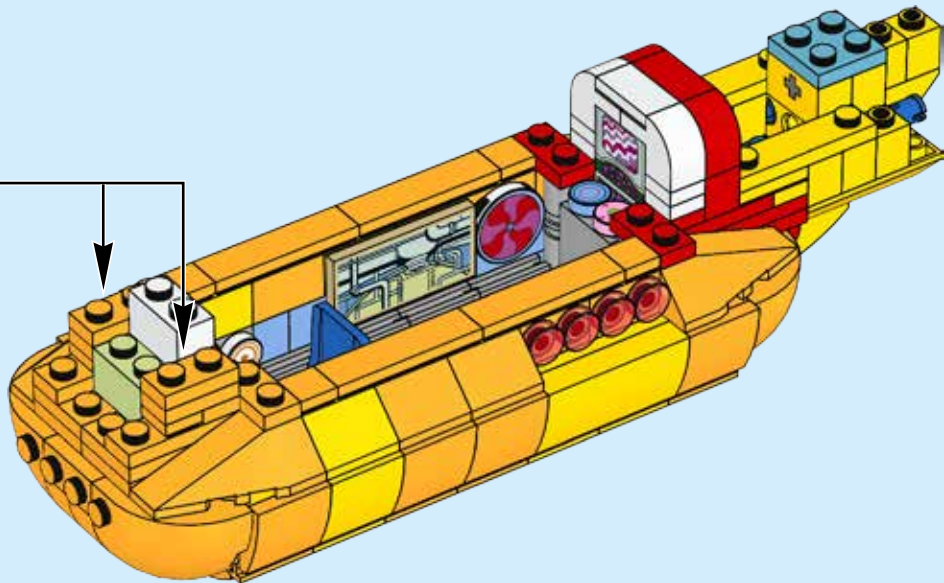



2x



1x

# 66

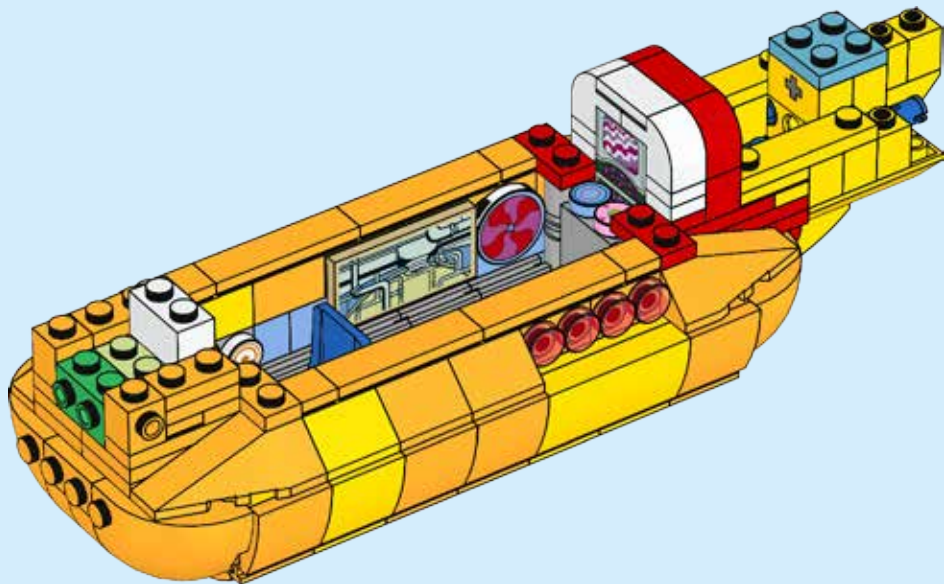

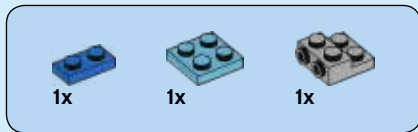

67

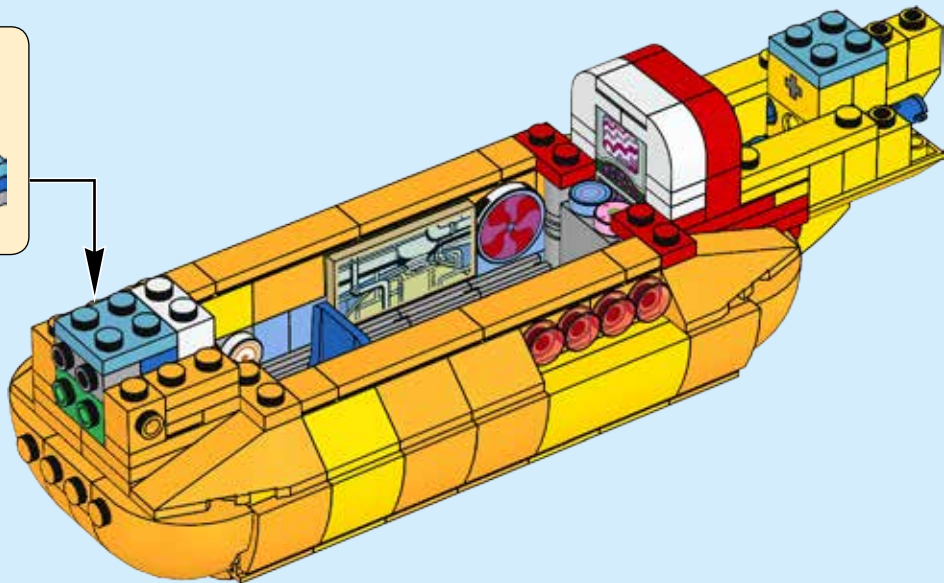
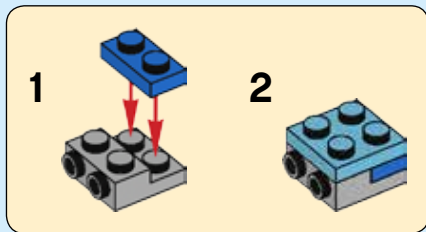



6x

68

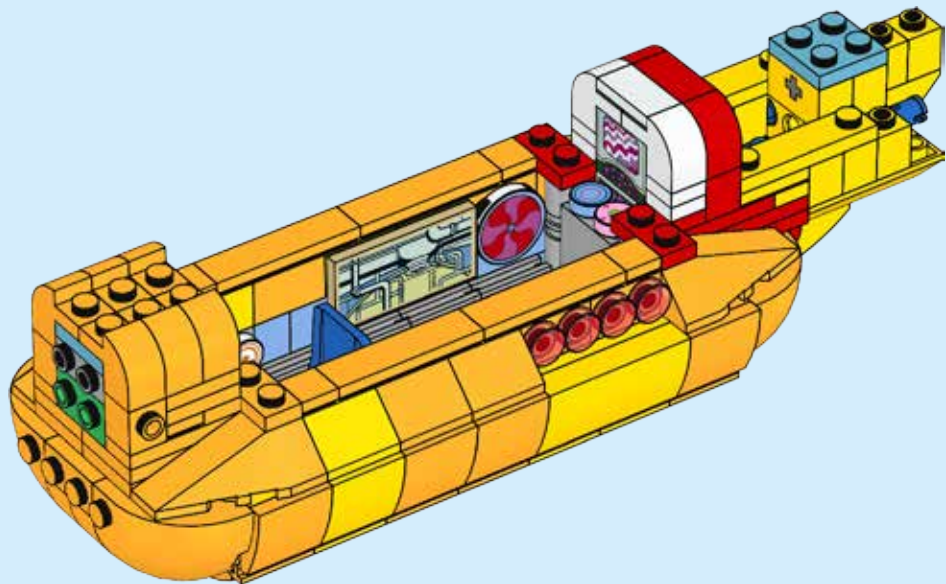





1x



1x

69

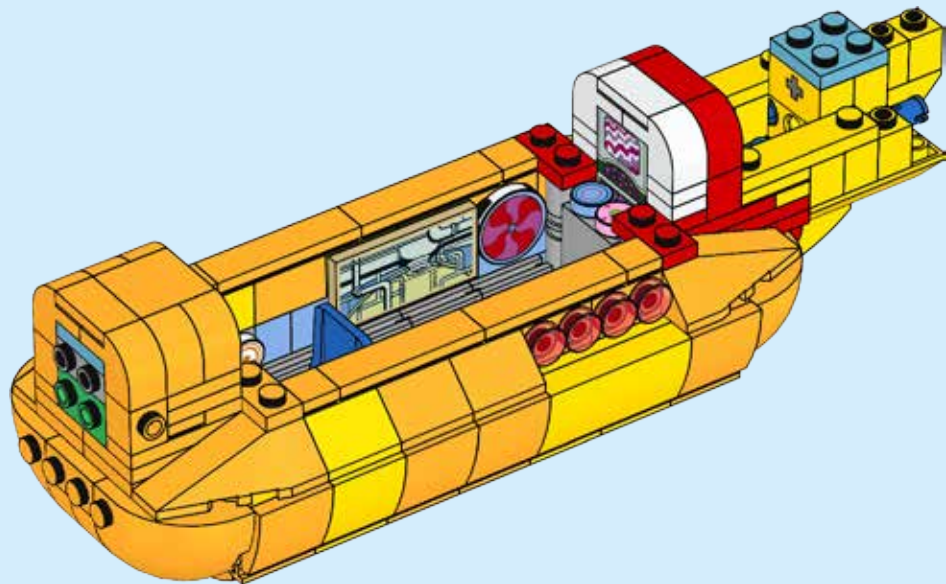



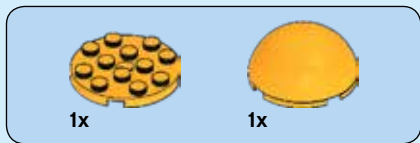

70

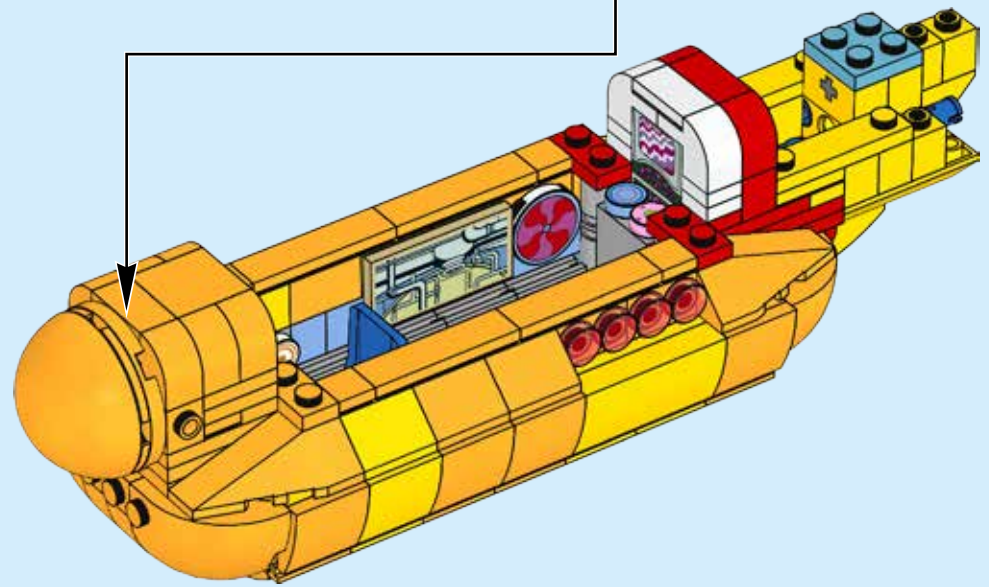



2x

71

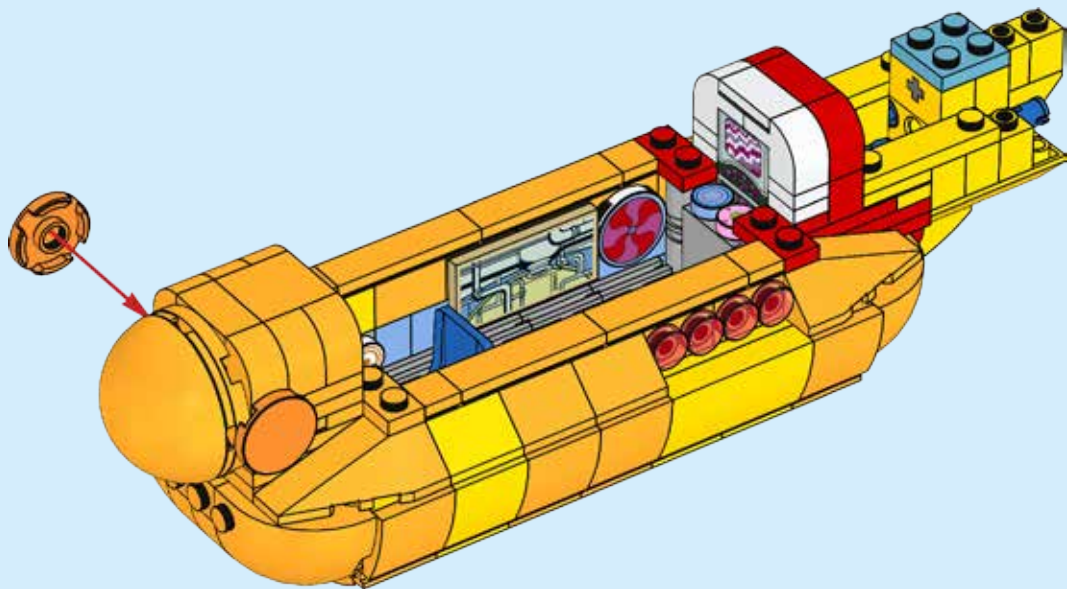

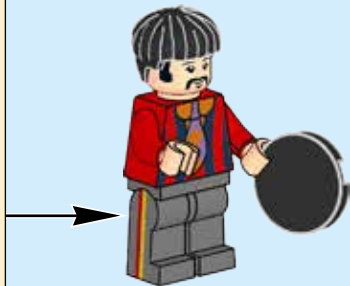
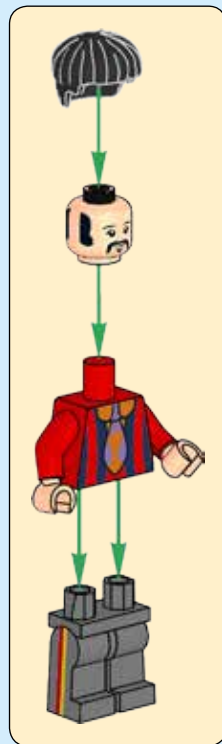
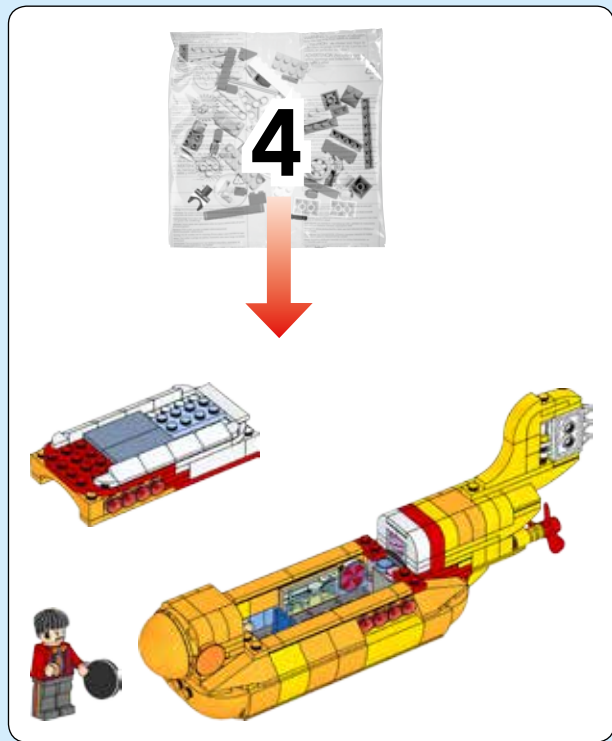

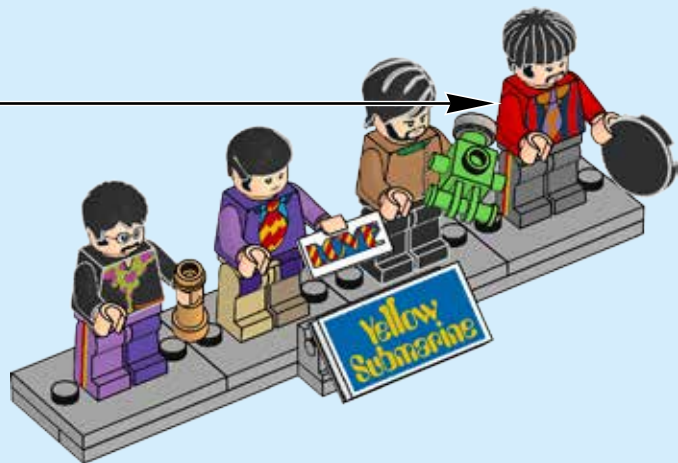

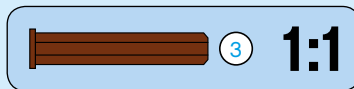
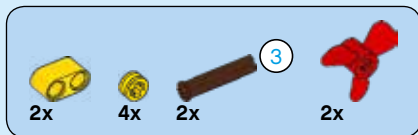

72

1

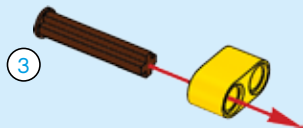

2

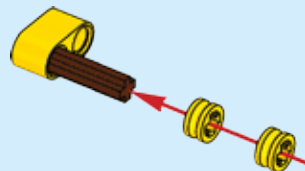

3

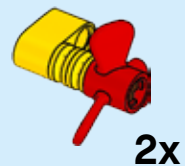

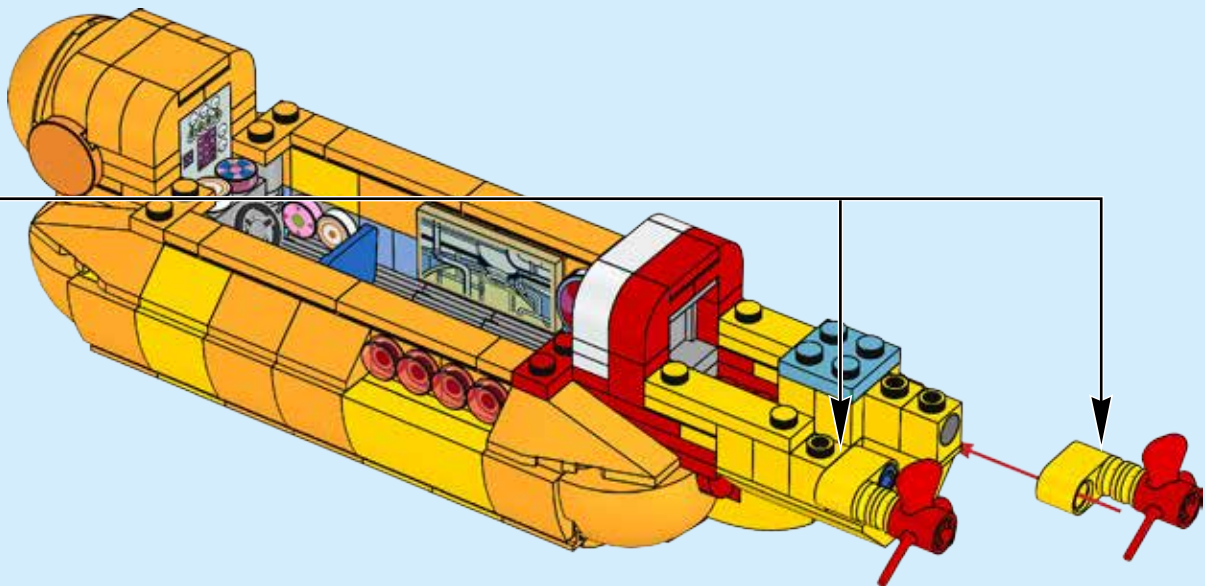



73

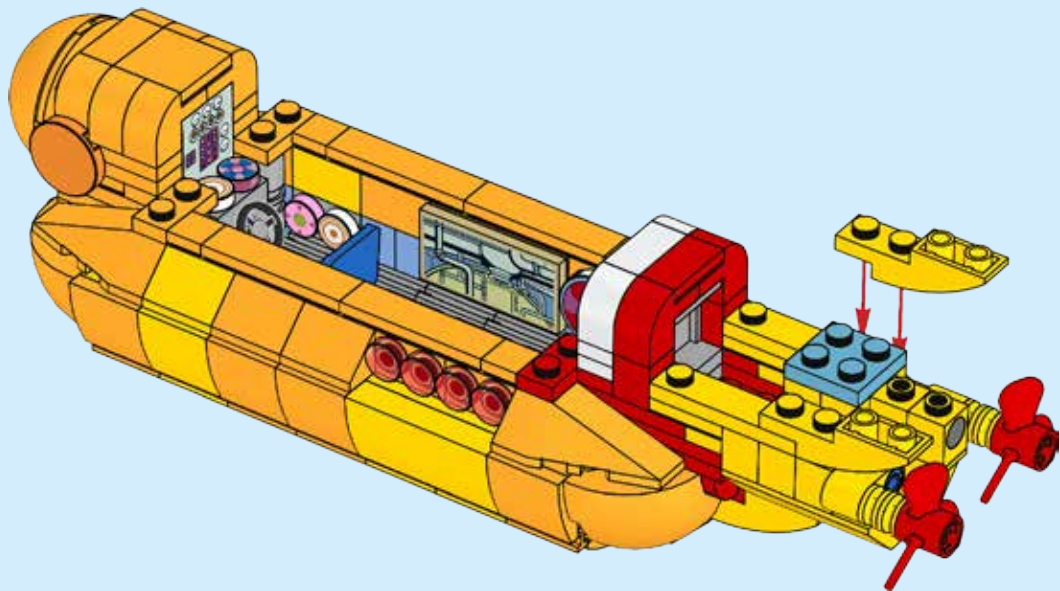



4x

74

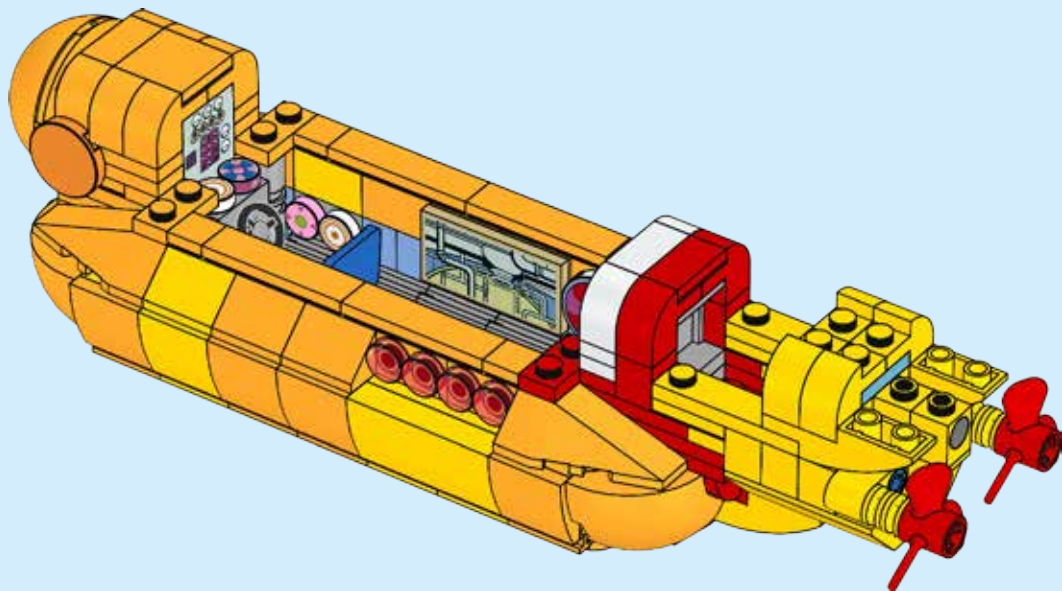





2x

75

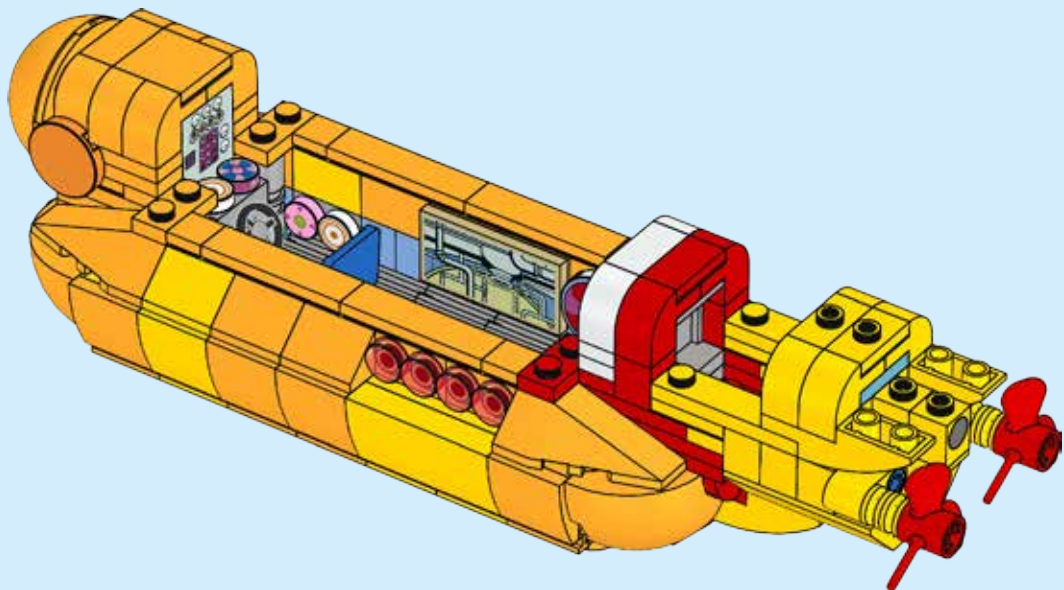

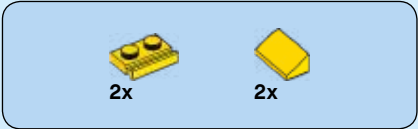

76

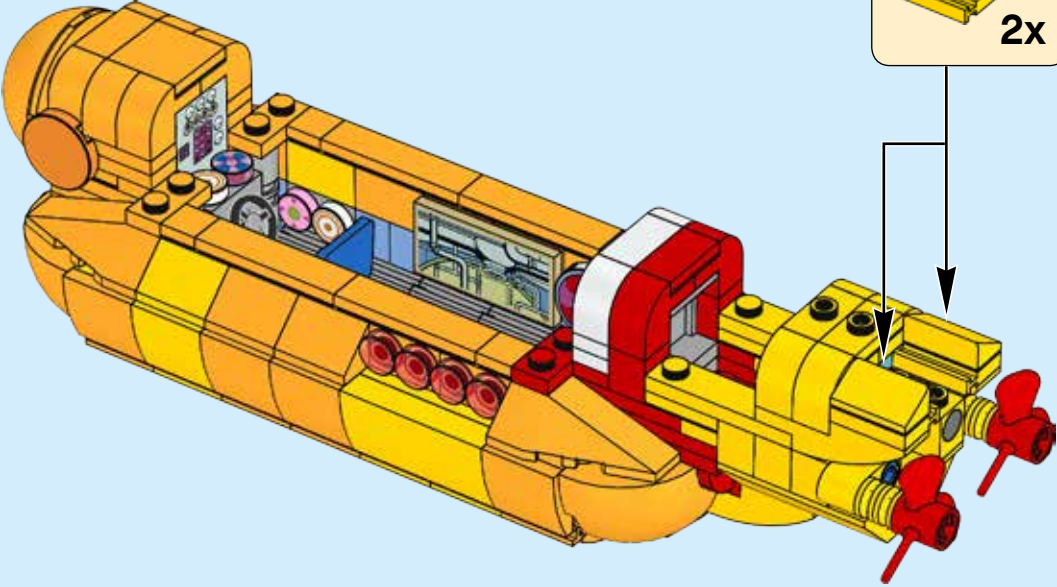
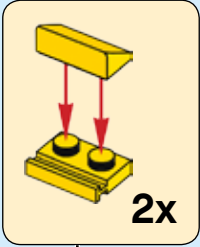

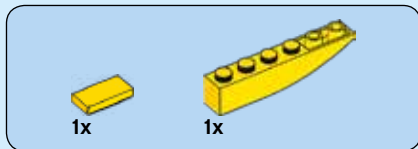

77

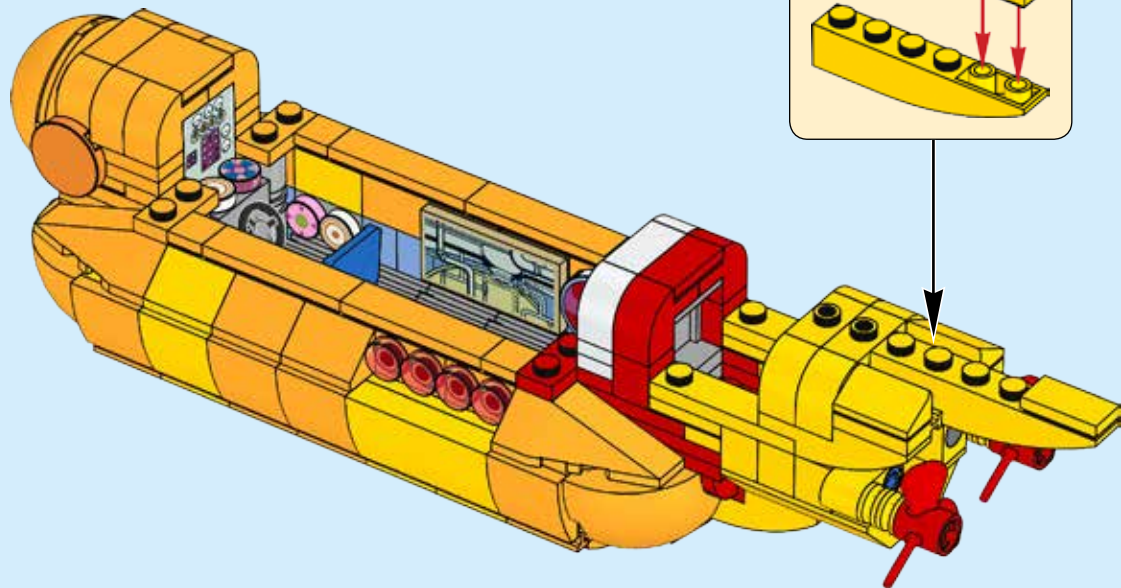

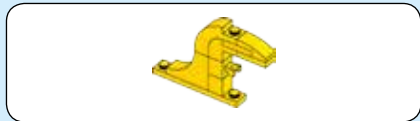

78

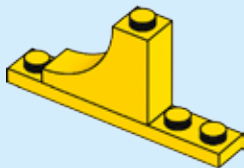

79

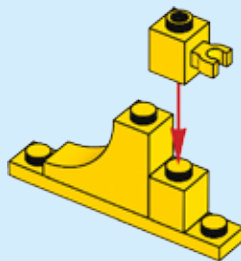

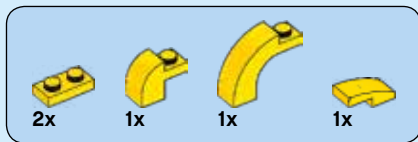

80

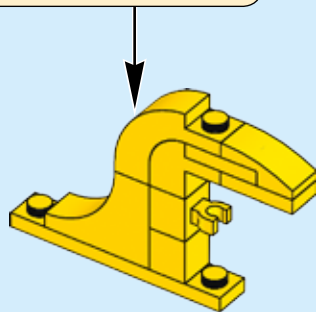
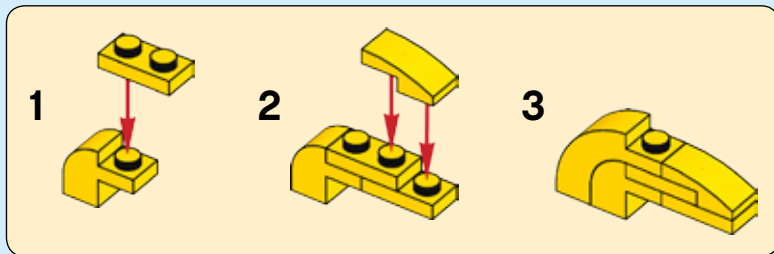

81

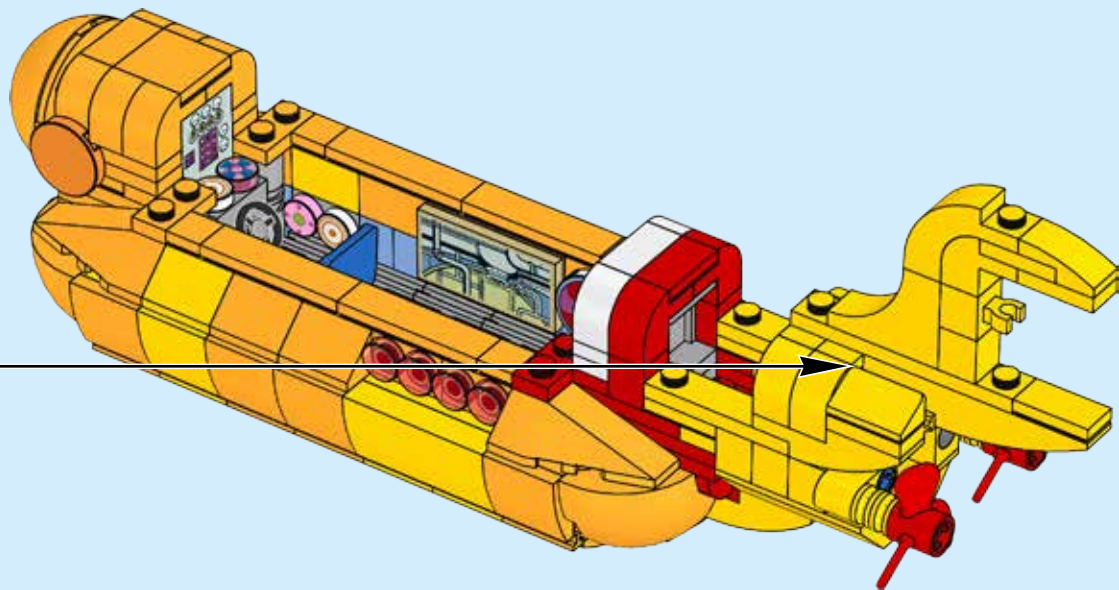

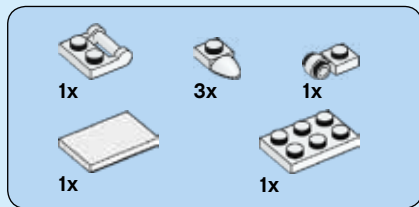

82

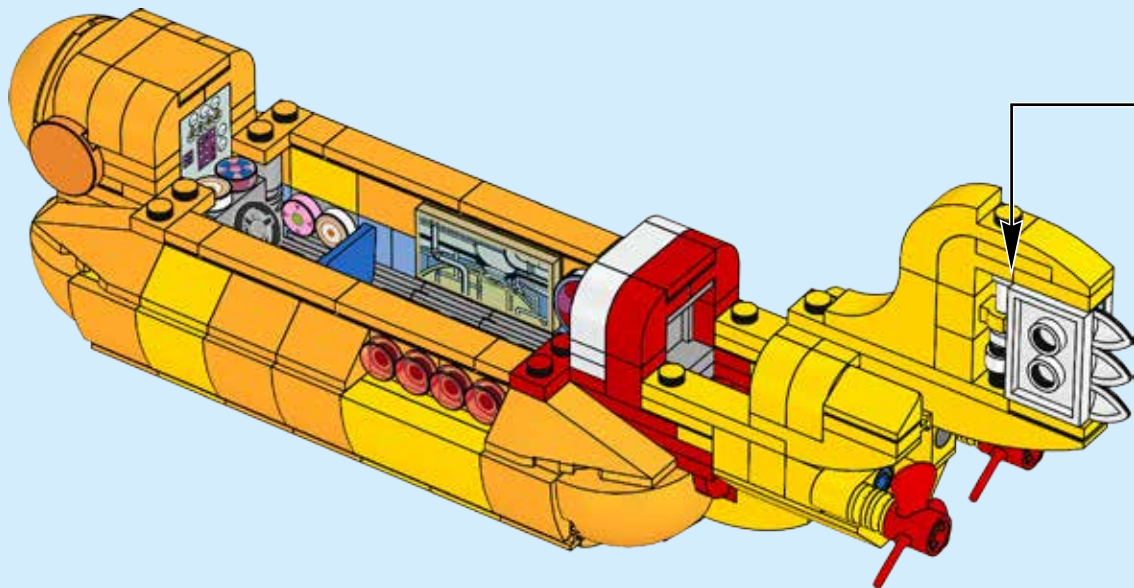
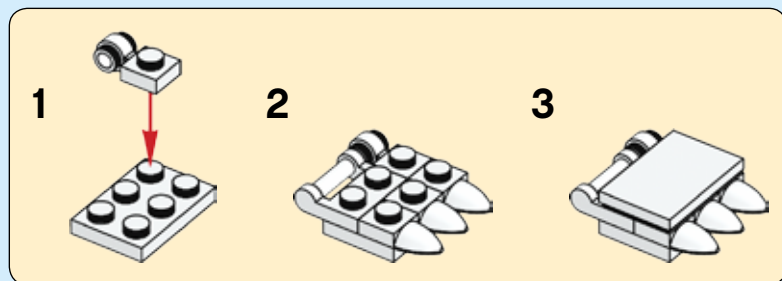



1x



2x



2x



2x



1x



4x

# 83

1

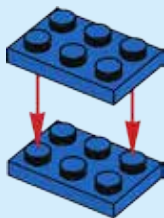

2



3

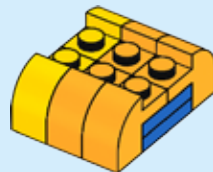



4

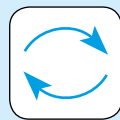
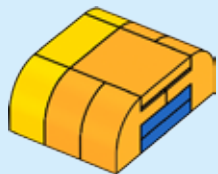

5

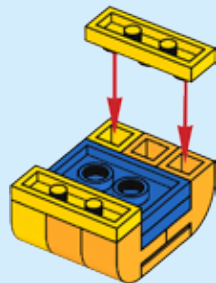

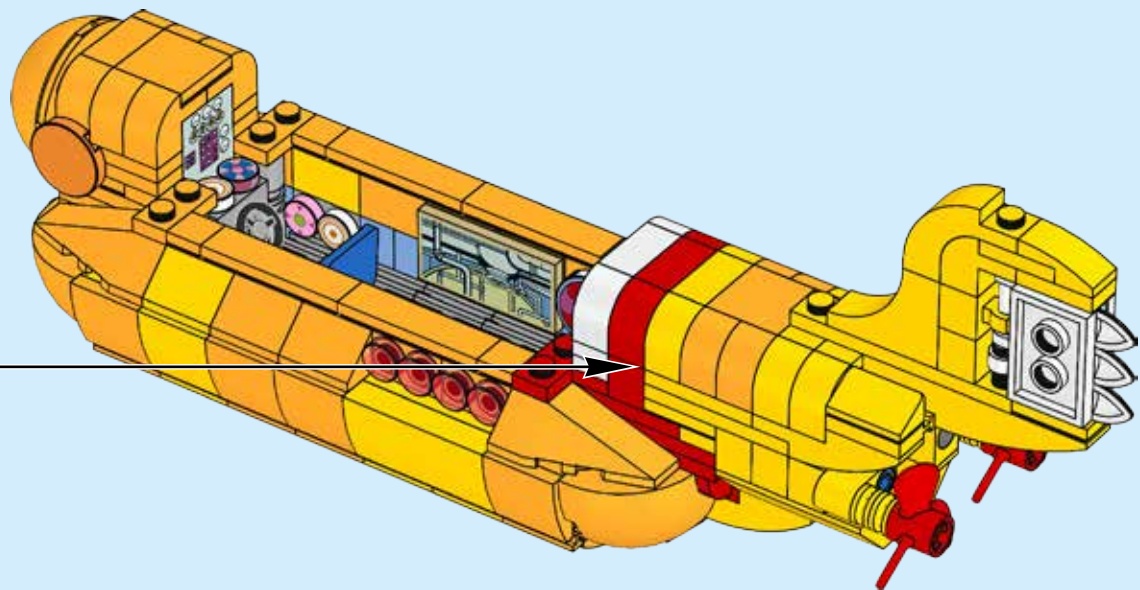

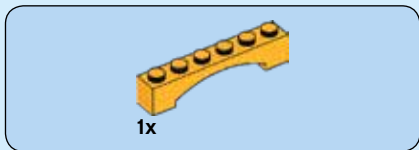

84

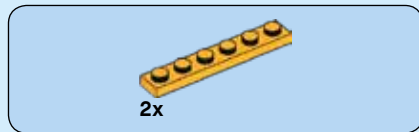
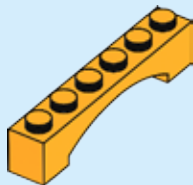

85

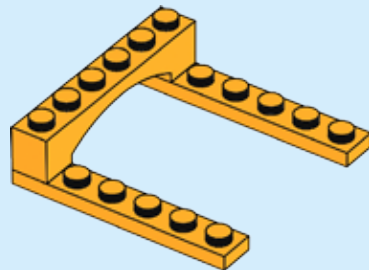

8x

4x

# 86

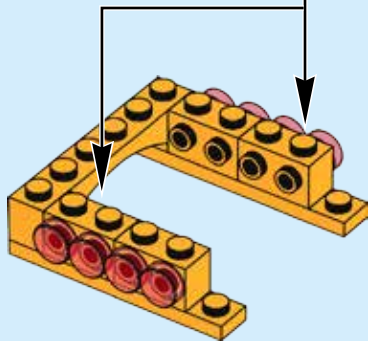

1x

# 87

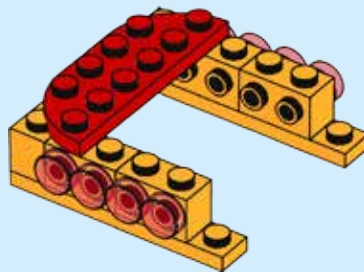
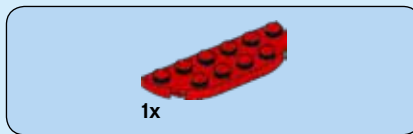

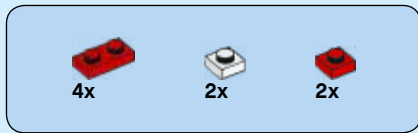

88

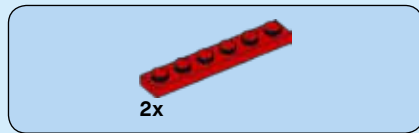
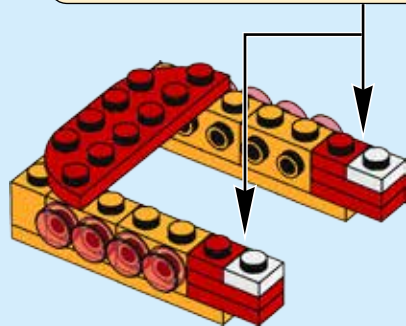
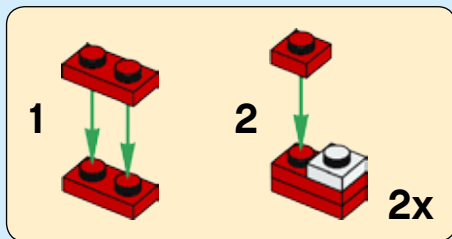

89

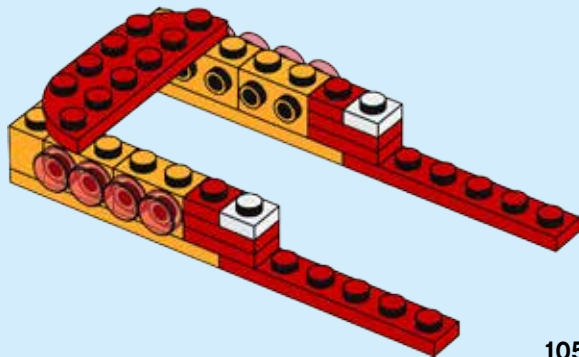

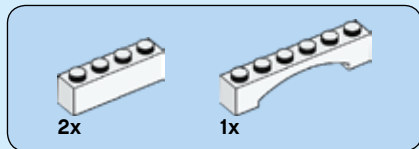

90

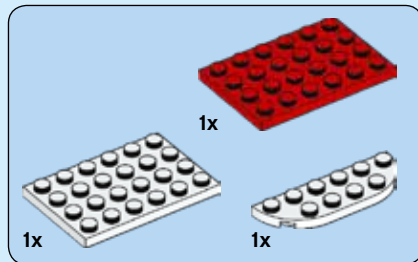
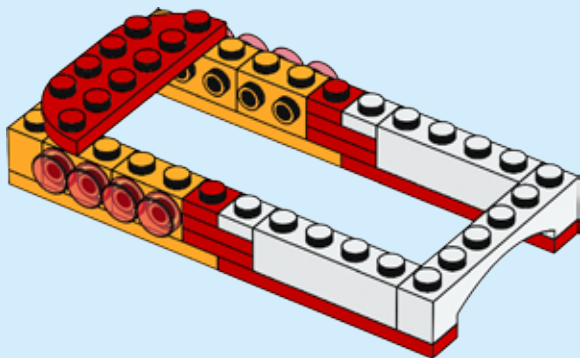

91

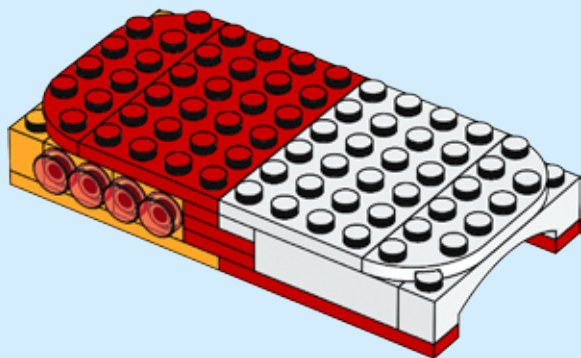

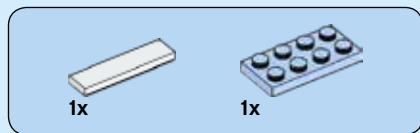

92

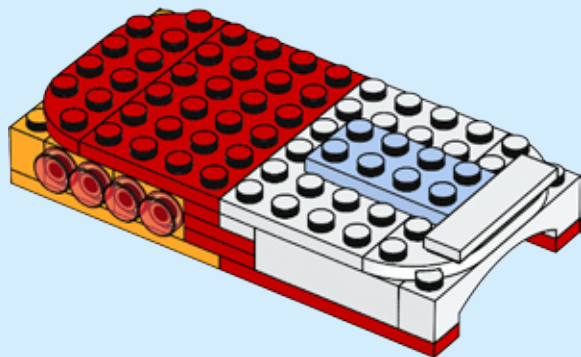

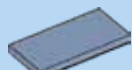

2x

# 93

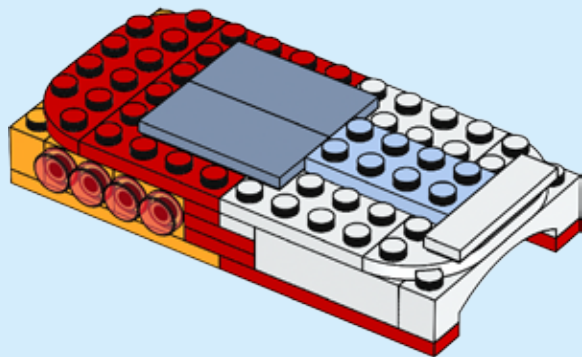

8x



4x

# 94

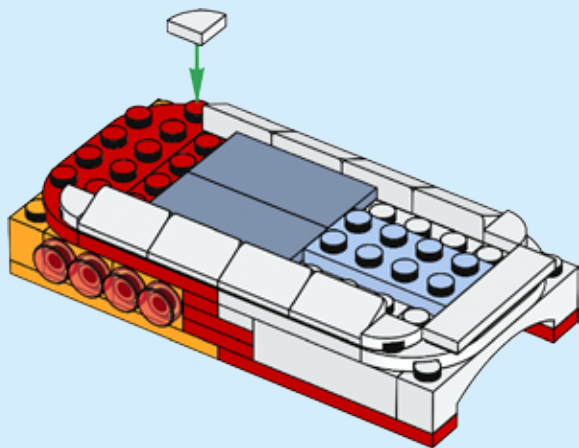



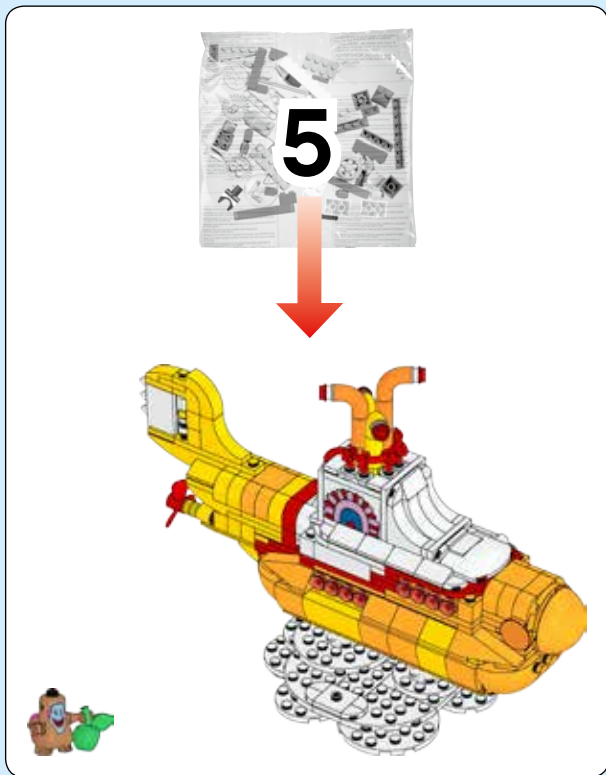



2x

95

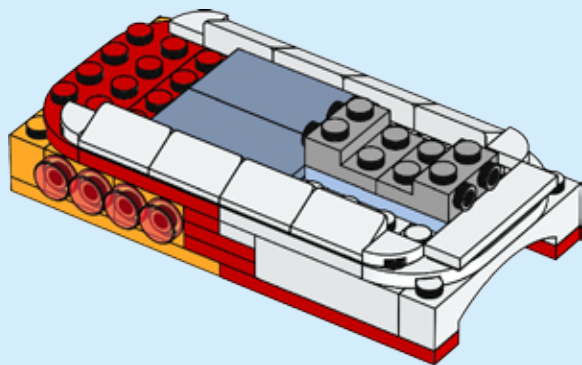

2x

96

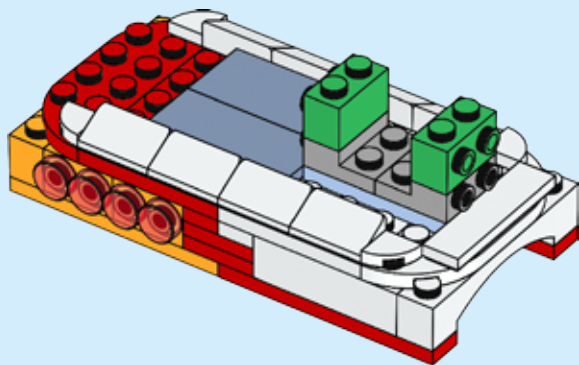



97

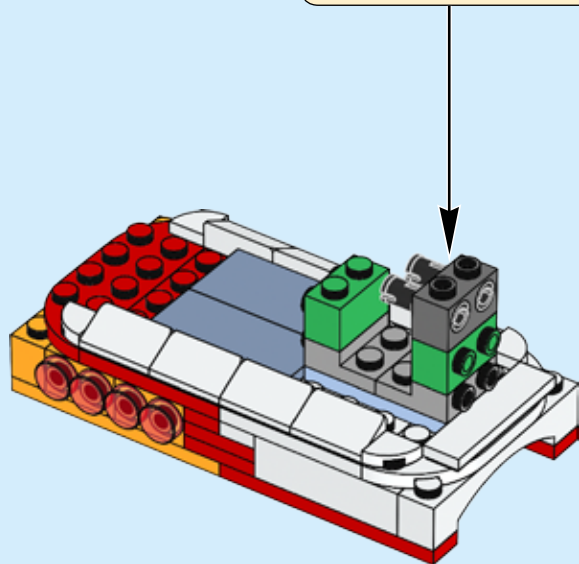
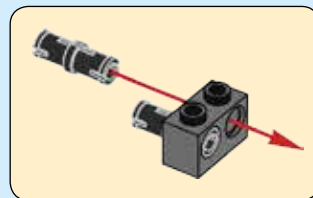

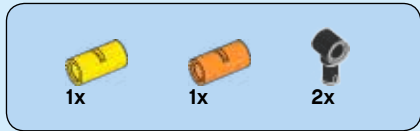

98

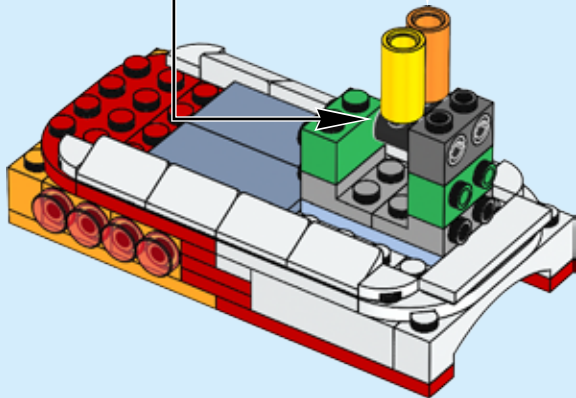
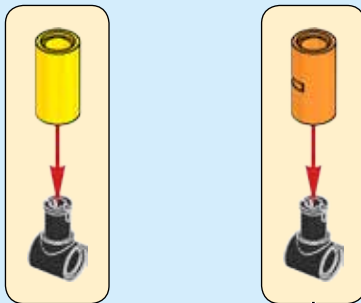



99

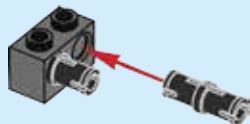

100

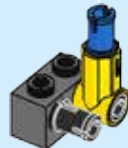
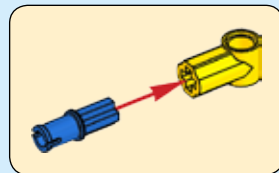



1x



1x

# 101

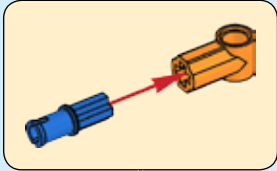

1x



1x

# 102

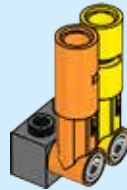

103

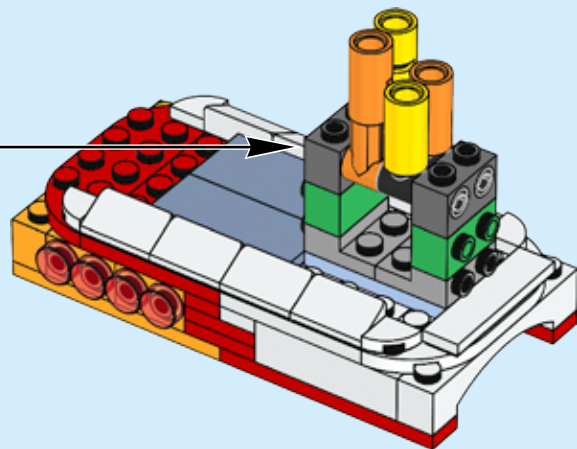

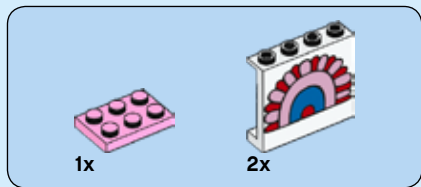

104

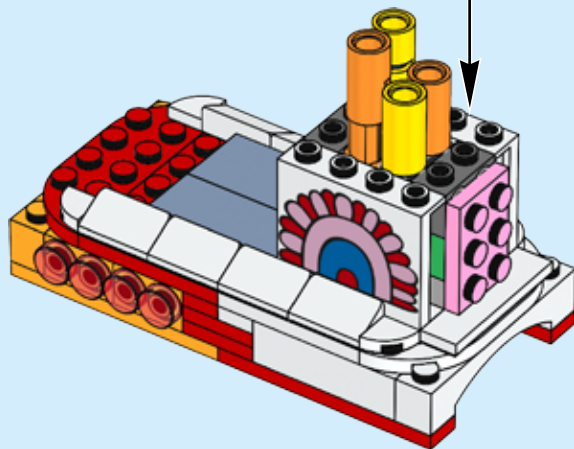
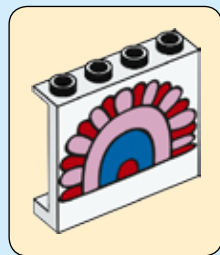



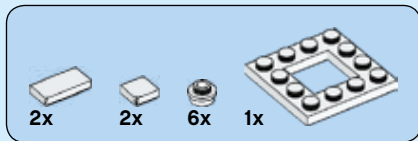

105

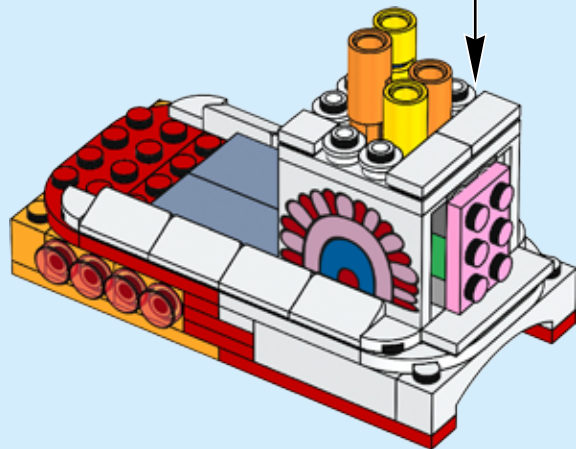
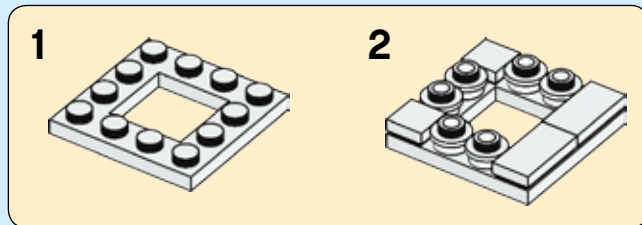

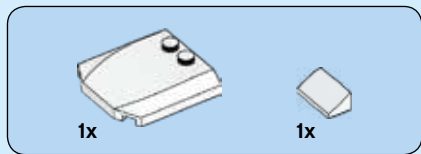

106

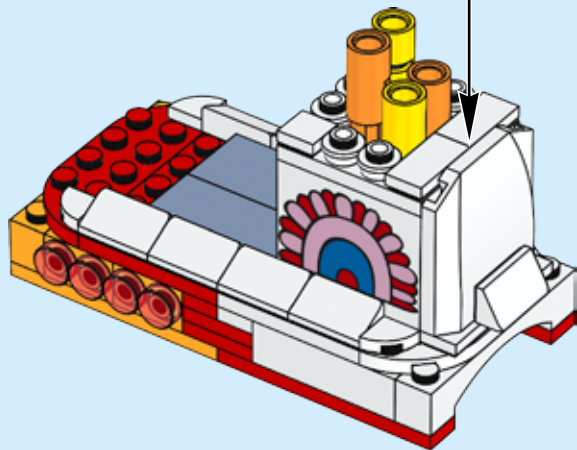
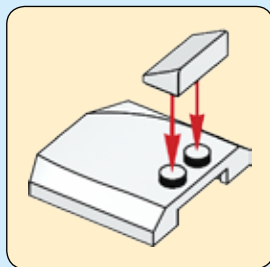



6x

# 107

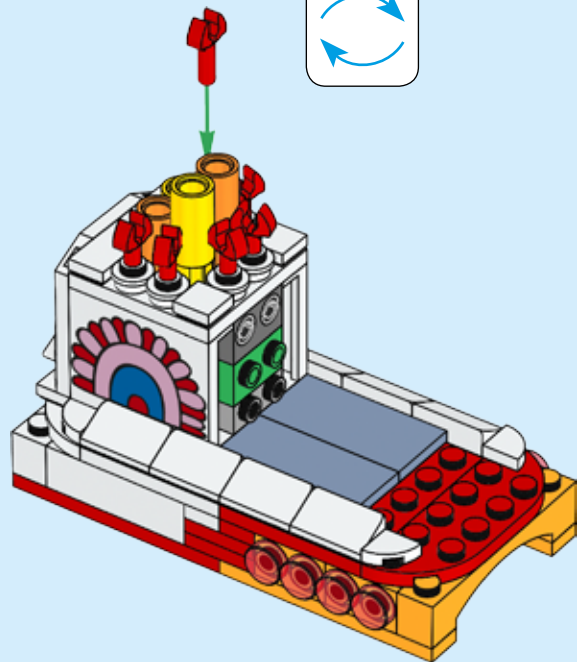
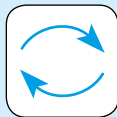

4x

# 108

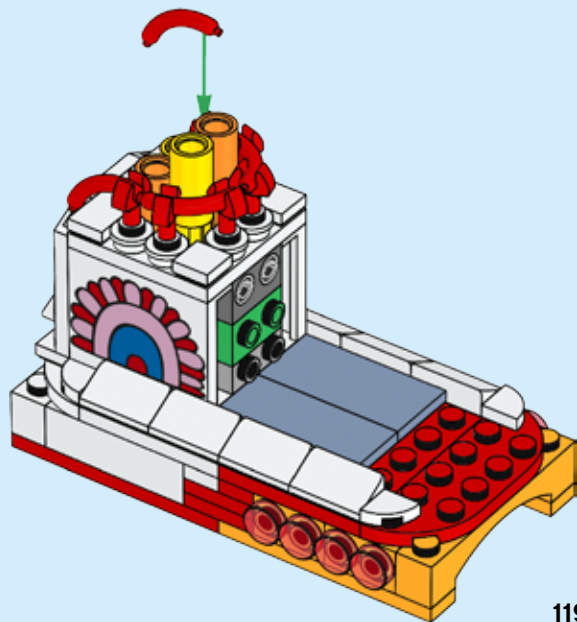

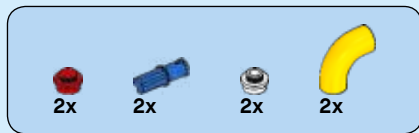

109

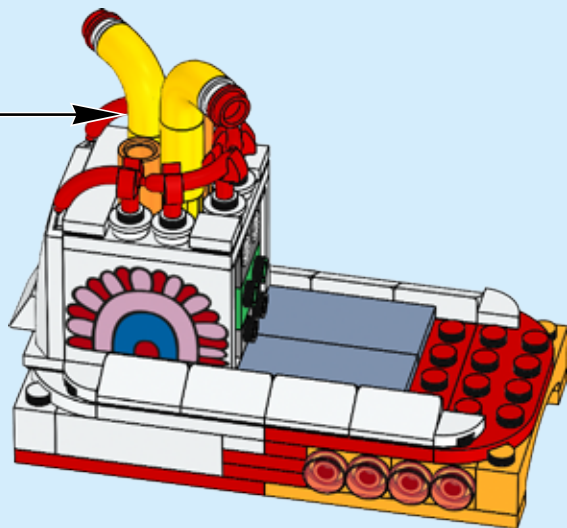
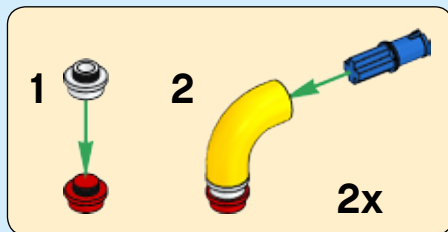

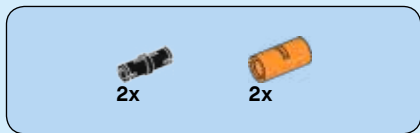

110

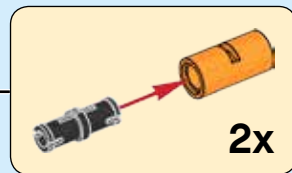

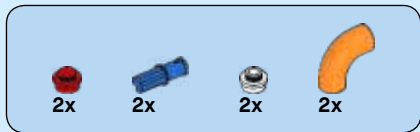

111

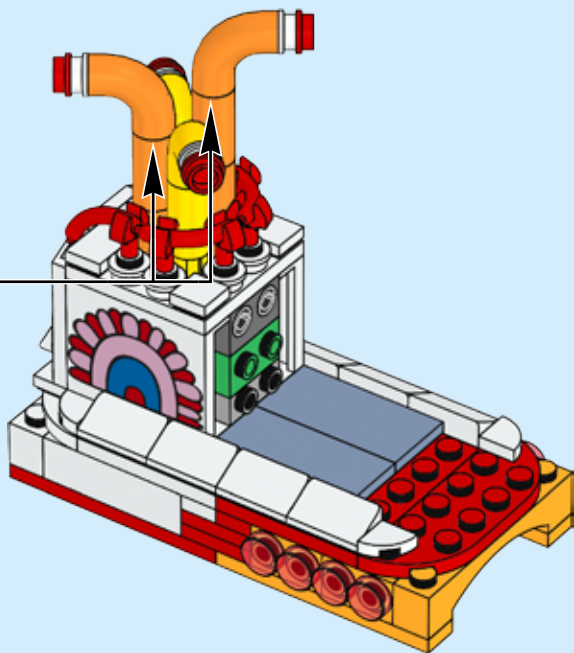
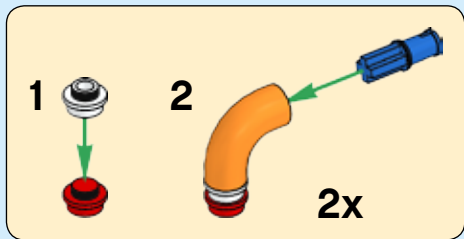

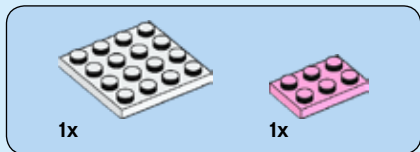
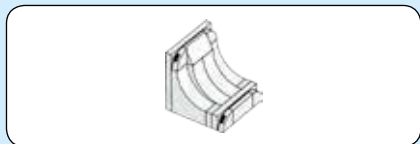

**112**

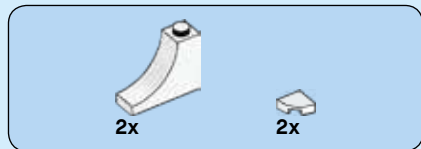
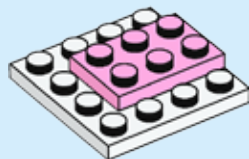

**113**

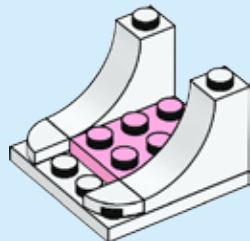

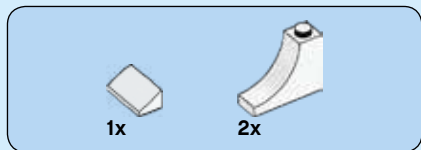

114

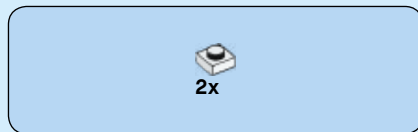
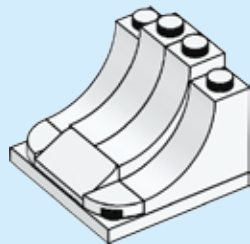

115

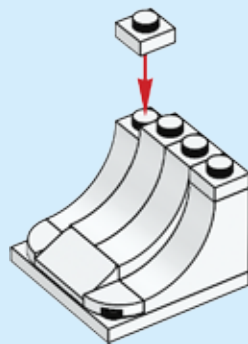



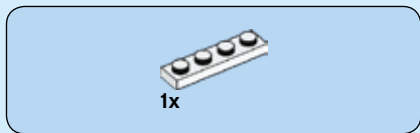

116

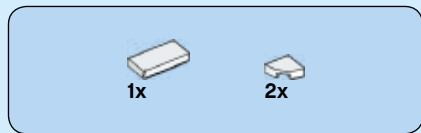
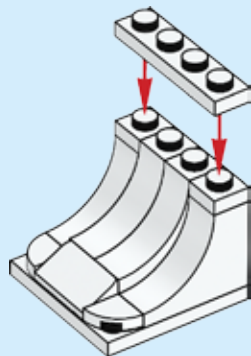

117

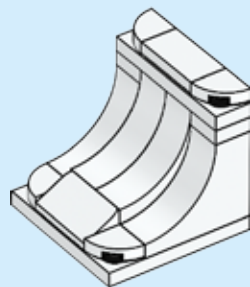

118

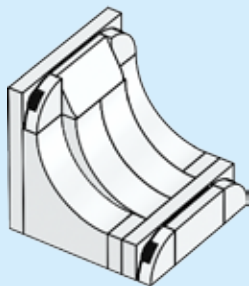
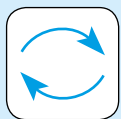

119

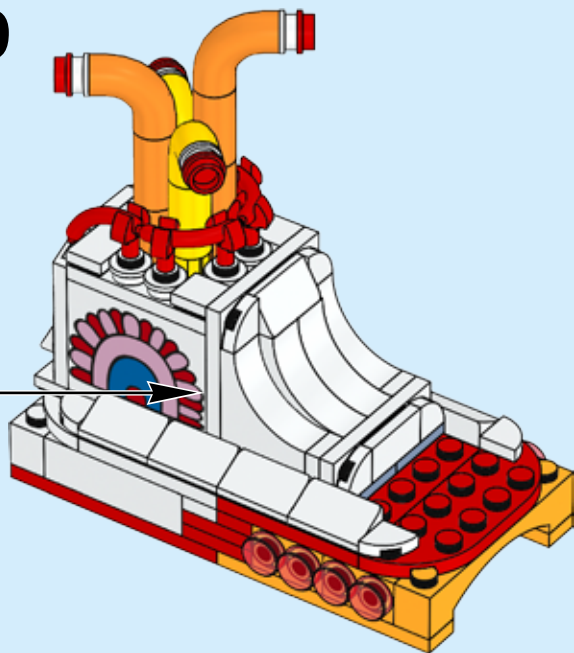



120

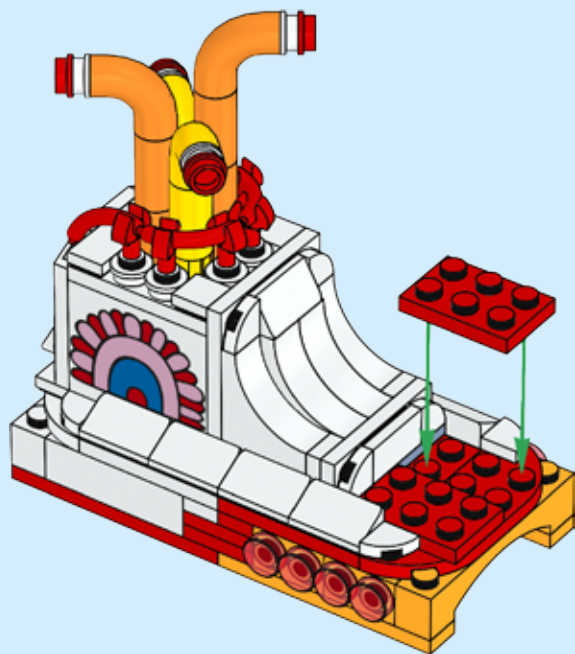

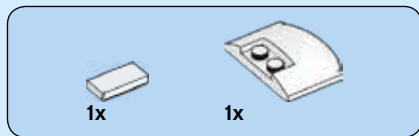

121

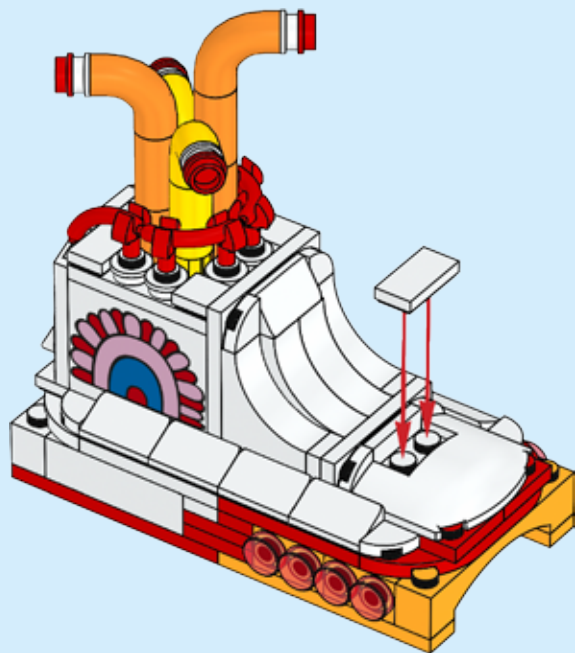

122

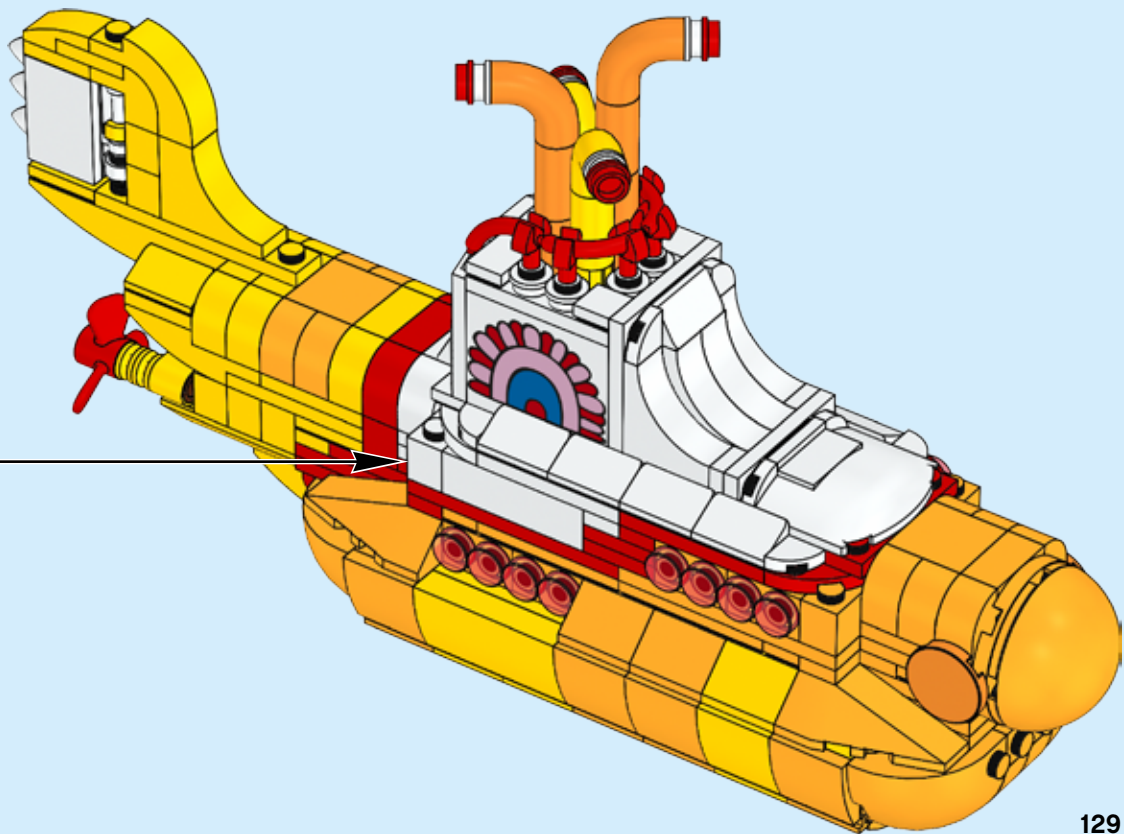

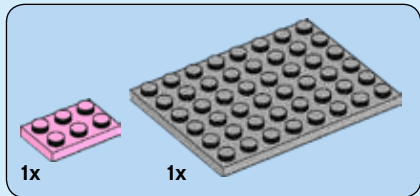
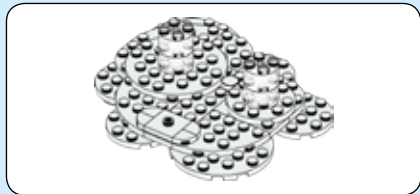

123

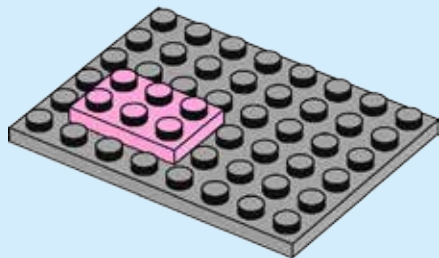

124

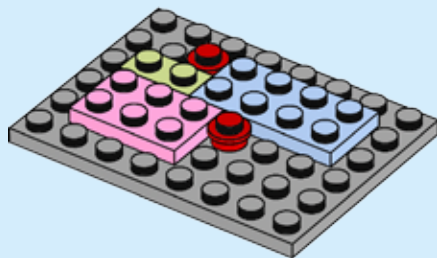

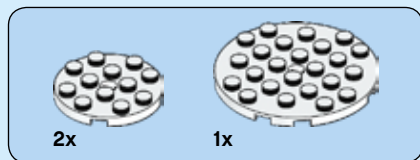

125

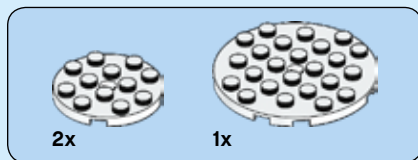
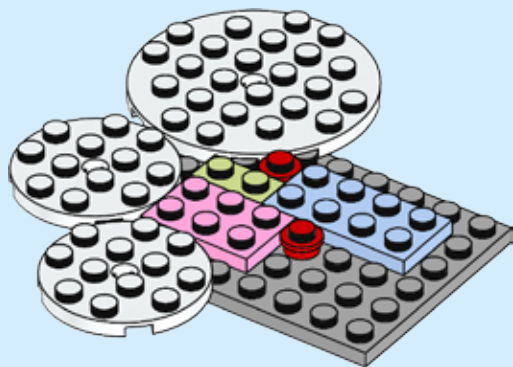

126

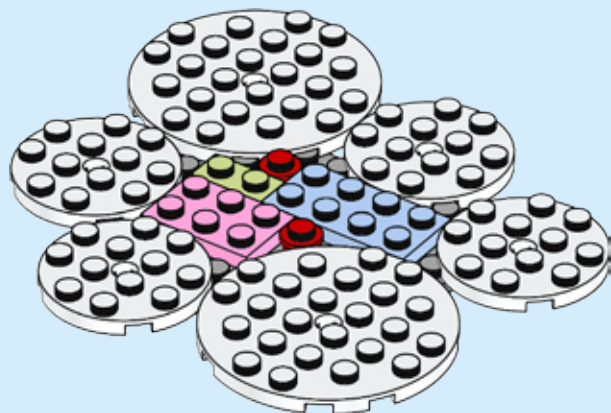



7x

127

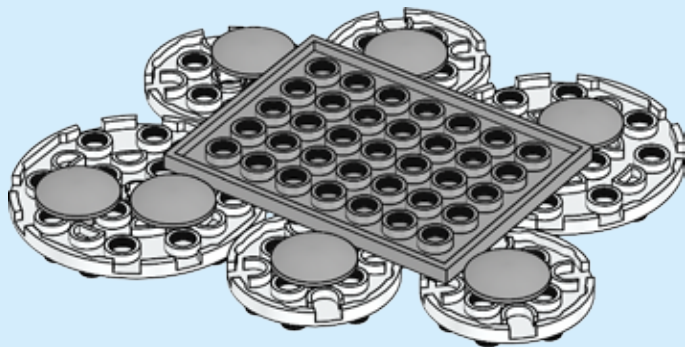
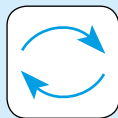



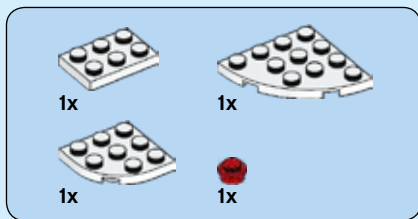

128

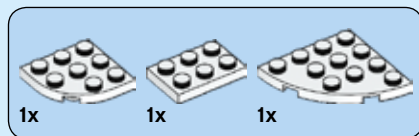
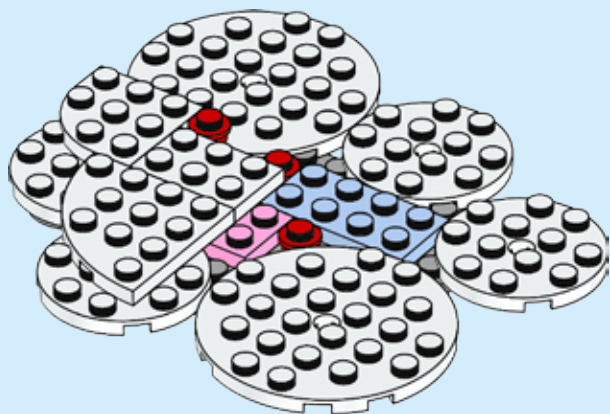
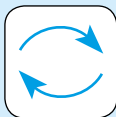

129

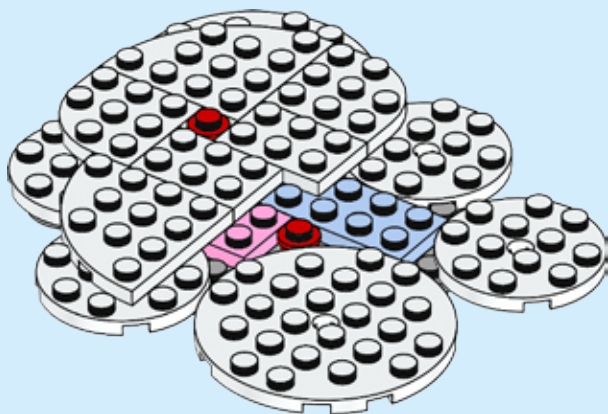

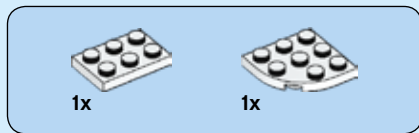

130

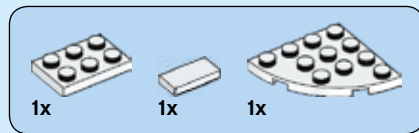
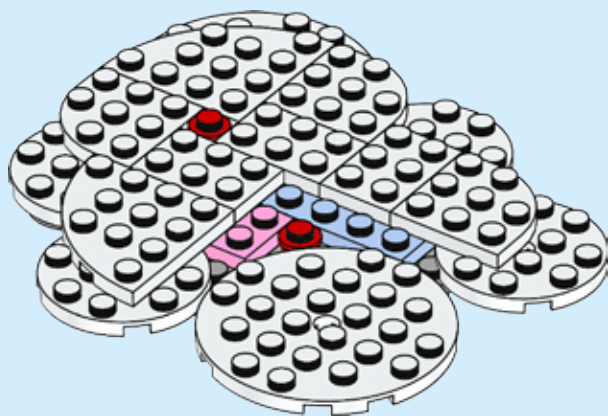

131

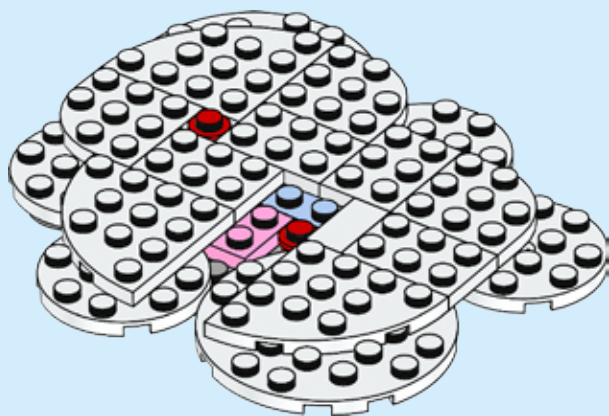



# 132

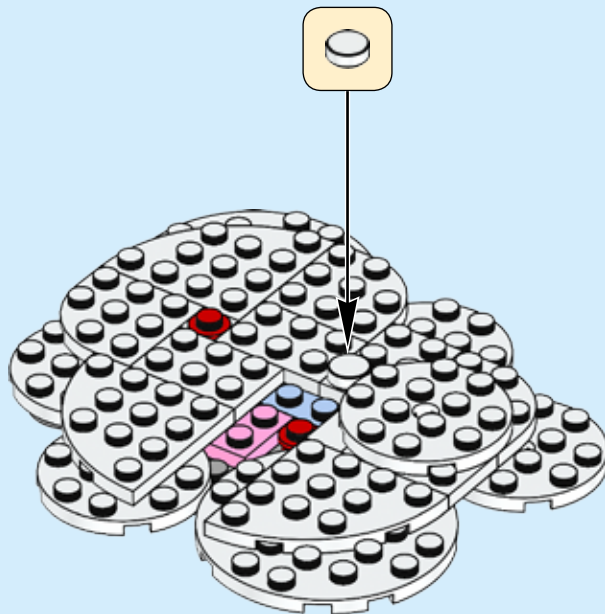

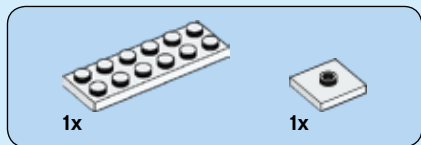

133

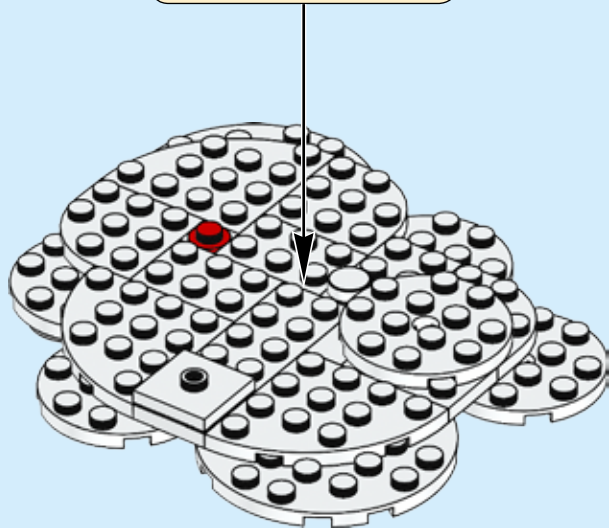
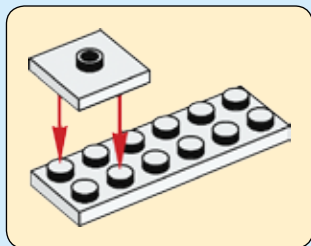

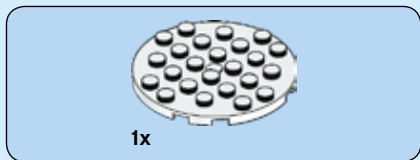

134

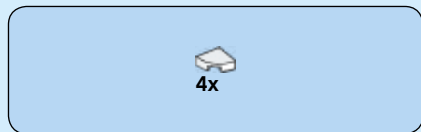
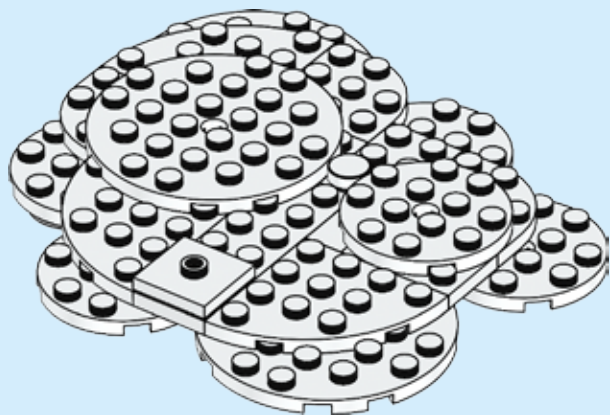

135

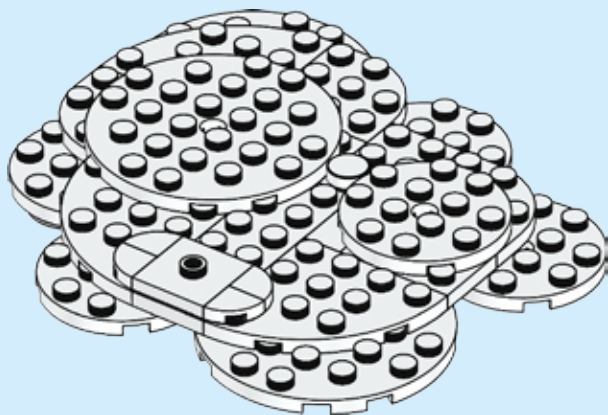



4x

136



2x

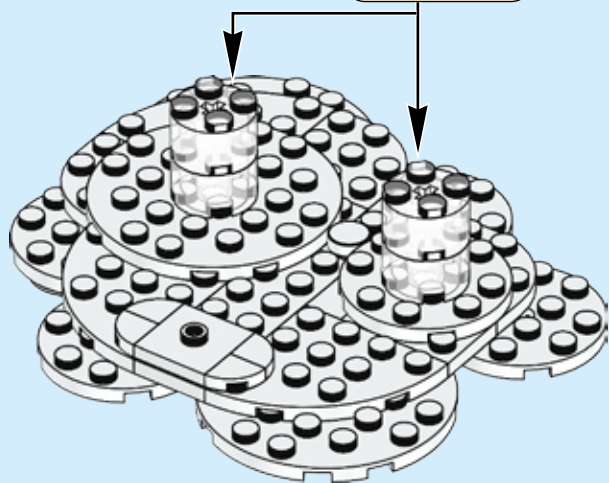

137

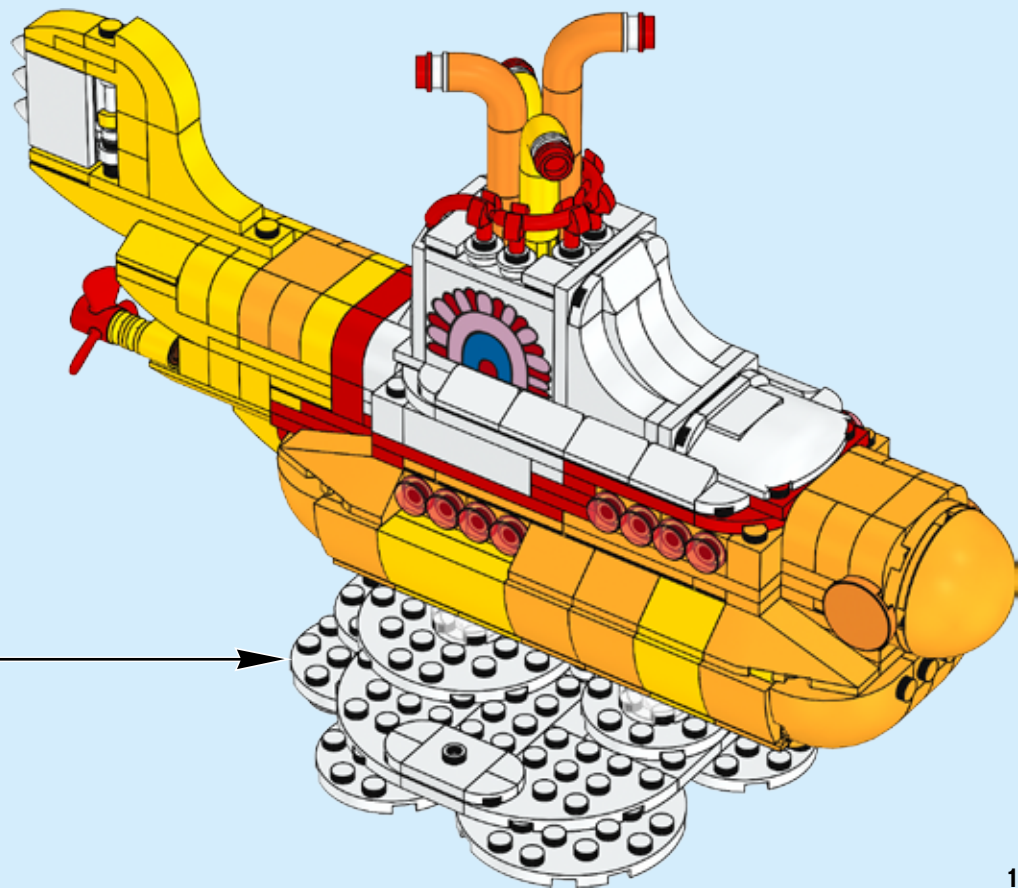

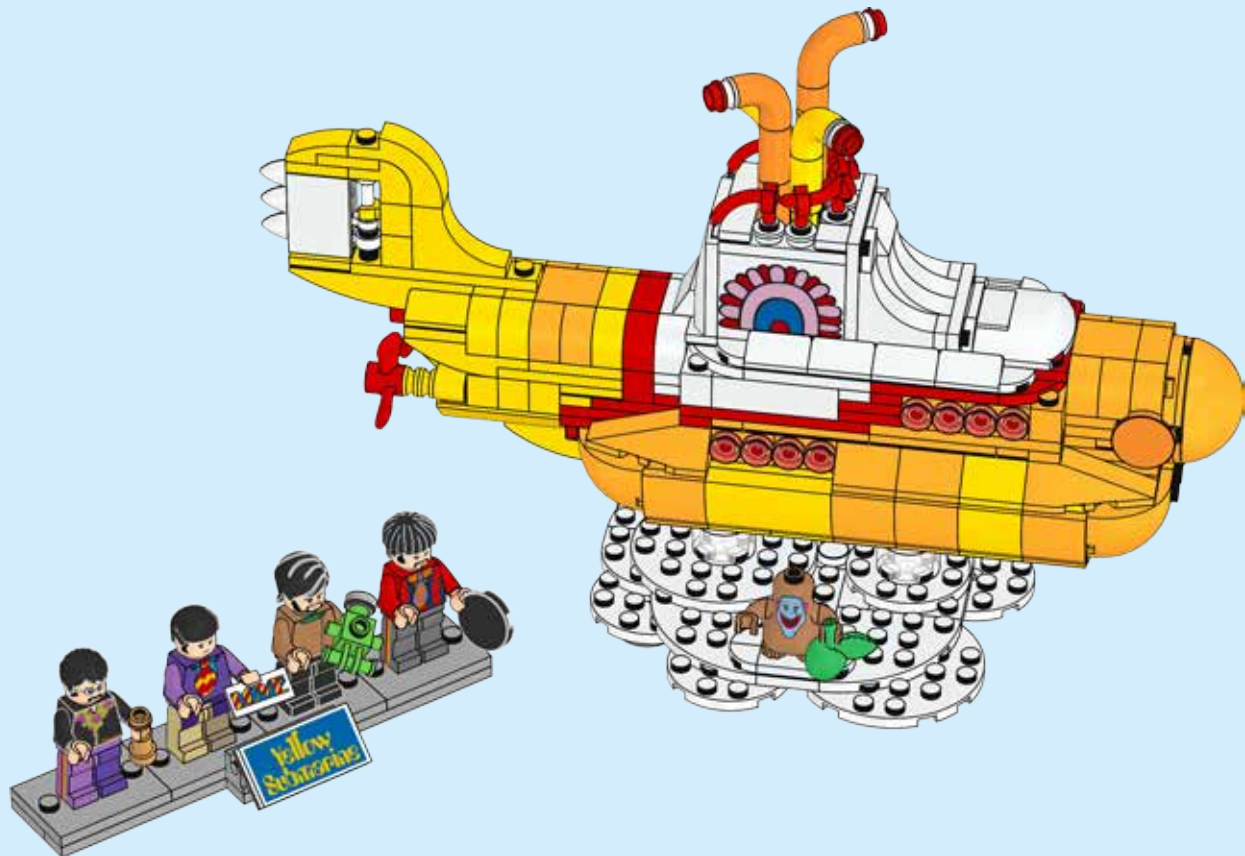



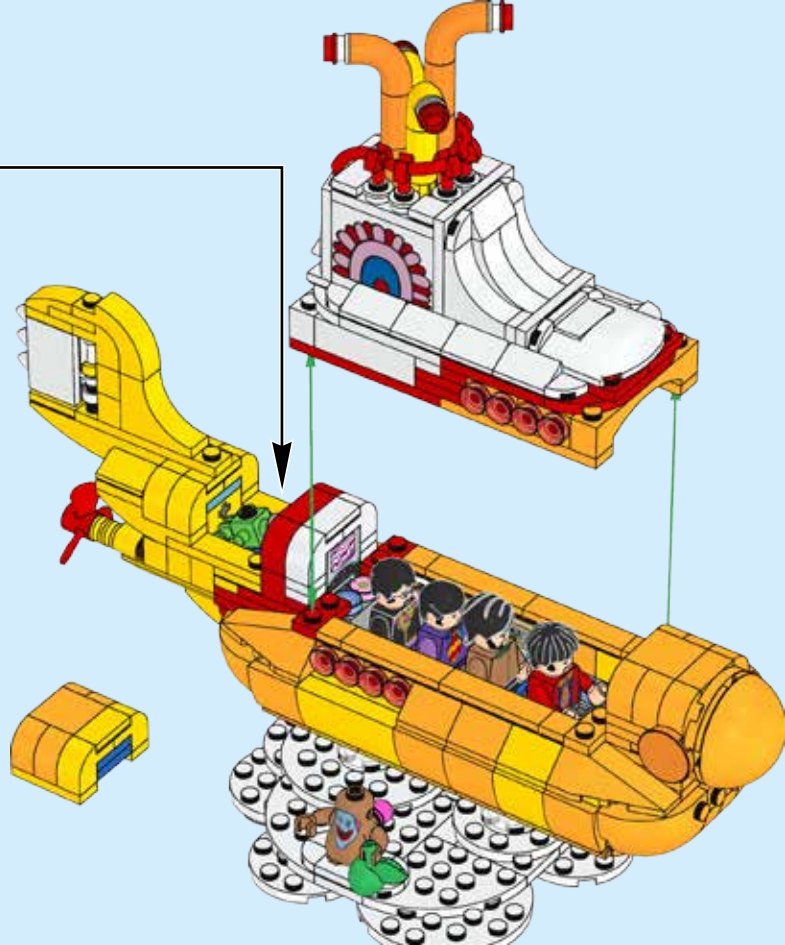

## A word from the fan designer

Designing the Yellow Submarine allowed Kevin Szeto to indulge two of his passions: The Beatles and designing with LEGO® bricks.

“As an amateur musician and songwriter, I have always been drawn to the music of the Beatles. The Yellow Submarine is bright, fun, and colorful,

which also makes it a good subject to translate into LEGO form.”

“I completed the main structure of the Yellow Submarine over one weekend, but I probably spent another half dozen weeknights tweaking details here and there. I would estimate I spent about 25 - 30 hours designing and building the initial model.”

“When the model hit 10,000 supporters on LEGO Ideas, I was, of course, totally ecstatic. To be just one of the thousands of contributors to this platform has been a fun and rewarding experience.”



Kevin Szeto  
Fan Designer



## LEGO® designer

LEGO® Designer Justin Ramsden was also a fan of the movie and was delighted to be a part of this LEGO Ideas project.

“I watched the film when I was younger and was really inspired by how it oozed so much imagination – comparable to how I view LEGO elements. I’m also a massive fan of The Beatles, having grown up with their music all my life, so to see The Beatles in LEGO form is a dream come true.”

“Kevin did a great job with his model, and many of the ideas and details could be used in the final set, but as a LEGO designer I had to ensure that the final version offered an enjoyable and stable LEGO building experience.”

“There are many new elements included within the model (and old elements in new colors); two of my favorites are the 2x3 tile and the ¼ circle tile. As a LEGO designer I’ve wanted these elements for ages, so I’m pleased to finally get my hands on them!”

Justin Ramsden  
LEGO Designer



# Un mot du fan designer

Concevoir le « Yellow Submarine » a permis à Kevin Szeto de combiner deux de ses passions : les Beatles et la création avec les briques LEGO®.

« En tant que musicien et auteur-compositeur amateur, j'ai toujours été attiré par la musique des Beatles. Le sous-marin jaune est amusant

et coloré, ce qui en fait aussi un bon sujet à transposer sous forme LEGO. »

« J'ai complété la structure principale du sous-marin jaune au cours d'un week-end, mais j'ai probablement passé six autres soirées à peaufiner les détails ici et là. Je pense que j'ai passé environ de 25 à 30 heures pour concevoir et construire le modèle initial. »

« Lorsque le modèle a obtenu l'appui de 10 000 personnes sur LEGO Ideas, j'étais, bien sûr, fou de joie. Être l'un des milliers de contributeurs sur cette plateforme a été une expérience amusante et gratifiante. »



Kevin Szeto  
Fan designer



## Le designer LEGO®

Le designer LEGO® Justin Ramsden est aussi un fan du film et était ravi de faire partie de ce projet LEGO Ideas.

« J'ai vu le film quand j'étais plus jeune et j'ai été vraiment inspiré par la façon dont il faisait preuve de tellement d'imagination, comparable à la façon dont je vois les éléments LEGO. Je suis aussi un grand fan des Beatles, ayant grandi avec leur musique toute ma vie, donc de voir les Beatles sous forme LEGO est un rêve devenu réalité. »

« Kevin a fait un travail formidable avec ce modèle et nombre des idées et détails auraient pu être utilisés dans l'ensemble final, mais en tant que designer LEGO, je devais m'assurer que la version finale offrait une expérience de construction LEGO agréable et stable. »

« Il y a de nombreux nouveaux éléments inclus dans le modèle (et d'anciens éléments dans de nouvelles couleurs); deux de mes préférés sont la plaque 2x3 et la plaque de quart de cercle. En tant que designer LEGO, je voulais ces éléments depuis très longtemps, je suis donc ravi de mettre finalement la main dessus ! »

Justin Ramsden  
*Designer LEGO*



## En palabras del fan diseñador

Diseñar el Submarino Amarillo permitió a Kevin Szeto dedicarse a dos de sus pasiones: los Beatles y diseñar con bricks LEGO®.

«Como músico y cantautor aficionado, siempre he sentido una particular atracción por la música de los Beatles. El Submarino Amarillo

es brillante, divertido y colorido, lo cual invita a convertirlo en un modelo LEGO».

«Completé la estructura principal del Submarino Amarillo en un fin de semana, pero puede que pasara otras seis noches ajustando detalles aquí y allá. Debí de dedicar unas 25-30 horas al diseño y la construcción del modelo inicial».

«Cuando el modelo alcanzó los 10.000 apoyos en LEGO Ideas, me emocioné, lógicamente. Sólo ser uno de los miles de miembros que colaboran en la plataforma ya fue una experiencia divertida y gratificante».



Kevin Szeto  
Fan diseñador



## El diseñador de LEGO®

Justin Ramsden, diseñador de LEGO®, también era fan de la película y disfrutó formando parte de este proyecto LEGO Ideas.

«Vi la película cuando era joven y me llamó mucho la atención la cantidad de imaginación que se había depositado en ella. Casi tanta como la que me inspiran hoy los elementos LEGO. Soy también un gran fan de los Beatles y crecí escuchando su música, así que tener la oportunidad de verlos en formato LEGO es un sueño hecho realidad para mí».

«Kevin hizo un gran trabajo con su modelo y muchas de las ideas y detalles sobrevivieron hasta el set definitivo. Como diseñador de LEGO, mi labor consistió en garantizar que la versión final ofreciese una experiencia de construcción LEGO estable y que se pudiera disfrutar».

«El modelo incluye muchos elementos nuevos, y también algunos antiguos en nuevos colores. Dos de mis favoritos son la placa 2x3 y la placa circular de ¼. Como diseñador de LEGO, hacía mucho tiempo que quería que se hicieran esos elementos. ¡Por fin los tengo en mis manos!»

Justin Ramsden  
Diseñador de LEGO





1x 6175984	1x 6174934	1x 4243812	1x 379501	2x 6174891	2x 609121	2x 366621	4x 4143346	4x 654124	2x 6132263	2x 302324
1x 6175982	6x 6051511	1x 6167450	1x 6018101	1x 6174910	2x 302421	2x 302421	2x 6135494	2x 4233484	2x 362324	5x 6092583
2x 301001	6x 306901	1x 6182017	5x 4515347	1x 6174902	4x 302321	4x 302321	1x 6175899	2x 4550348	1x 4652261	2x 306924
10x 4547489	2x 6177074	3x 4224792	3x 4550745	1x 6175422	1x 306921	1x 306921	1x 6175321	1x 366524	1x 302224	1x 302224
2x 609101	1x 6174728	1x 6126046	1x 6147792	1x 6175422	2x 242021	2x 242021	6x 4121715	1x 6173894	1x 6029947	1x 6029947
4x 6110019	2x 609101	5x 302101	3x 4178429	1x 4243814	2x 302221	2x 302221	2x 6073231	4x 6146298	2x 6079007	2x 6079007
4x 6110019	1x 6156667	1x 4632566	3x 4178429	1x 302221	3x 302323	3x 302323	1x 6070695	1x 4187122	2x 6173898	2x 6173898
8x 302401	1x 243101	1x 4222017	3x 6109817	1x 303221	4x 302123	4x 302123	1x 9339	2x 4188357	4x 4239601	4x 4239601
4x 307001	1x 371001	12x 6046979	1x 303201	4x 379521	1x 407923	1x 407923	1x 6175970	2x 302424	1x 6175158	1x 4107066
1x 4193068	1x 4646844	10x 4547649	1x 4193068	4x 379521	7x 614121	7x 614121	1x 390126	1x 4515354	1x 6097644	2x 4526983
1x 6108802	2x 6170390	2x 4514553	1x 6108802	2x 300521	2x 4514553	2x 4514553	1x 4526110	1x 300524	2x 370124	8x 4141630





**Customer Service**  
**Kundenservice**  
**Service Consommateurs**  
**Servicio Al Consumidor**

[LEGO.com/service](http://LEGO.com/service) or dial



: 00800 5346 5555  
 : 1-800-422-5346

SHARE YOUR IDEA  
PARTAGE TON IDÉE  
COMPARTE TU IDEA



LEGO® REVIEW  
EXAMEN LEGO®  
REVISIÓN DE LEGO®



GATHER SUPPORT  
OBTIENS DE L'APPUI  
OBTÉN APOYOS



NEW LEGO® PRODUCT  
NOUVEAU PRODUIT LEGO®  
NUEVO PRODUCTO LEGO®



[LEGO.COM/IDEAS](https://www.lego.com/ideas)

# Do you like this LEGO® Ideas set?

The LEGO Group would like your opinion on the new product you have just purchased. Your feedback will help shape the future development of this product series. Please visit:

[LEGO.com/productsurvey](https://www.lego.com/productsurvey)

By completing our short feedback survey, you will be automatically entered into a drawing to win a LEGO® prize.

See website for official rules and details. Open to all countries where not prohibited.

## Aimez-vous cet ensemble LEGO® Ideas ?

Le Groupe LEGO aimerait connaître votre opinion sur le produit que vous venez d'acheter. Vos commentaires nous aideront à concevoir les futurs produits de cette gamme. Veuillez visiter :

[LEGO.fr/productsurvey](https://www.lego.fr/productsurvey)

En remplissant ce court sondage sur le produit, vous serez automatiquement inscrit à un tirage au sort pour gagner un prix LEGO®. Consultez le site Web pour obtenir le règlement officiel et les détails. Ouvert à tous les résidents des pays autorisés.

LEGO and the LEGO logo are trademarks of the/son des marques de commerce du/son marcas registradas de LEGO Group. ©2016 The LEGO Group.

©2016 Apple Corps Ltd. All rights reserved. A Beatles™ product licensed by Apple Corps Ltd.



## ¿Te gusta este set LEGO® Ideas?

The LEGO Group quiere conocer tu opinión acerca del nuevo producto que acabas de comprar. Tus comentarios nos ayudarán a dar forma a los futuros productos de esta serie. Visita:

[LEGO.com/productsurvey](https://www.lego.com/productsurvey)

Al contestar este breve cuestionario de opinión, participarás automáticamente en el sorteo de un producto LEGO®.

Consulta las reglas oficiales y demás información en el sitio web. Válido en todos los países en los que esta actividad no esté prohibida.

"Beatles" is a trademark of Apple Corps Ltd. "Apple" and the Apple logo are exclusively licensed to Apple Corps Ltd.

©2016 Subafilms Ltd. A Yellow Submarine™ product. ™ Trade Mark of Subafilms Ltd ©1968. Authorised Beatles™ merchandise.