



21305

MAZE



THE LEGO® MAZE

LEGO® Maze reinvents the classic ball and labyrinth game, adding a twist of creative LEGO building to the fun.

Built entirely from LEGO elements, the LEGO Maze consists of a base frame and a simple tip-and-tilt mechanism made up of LEGO beams and axles. You turn the wheels to move the maze up and down or from side to side, guiding the ball away from the traps.

Challenge your family and friends and see who navigates past the obstacles fastest. Once you've mastered the two maze designs included with the set, you will find lots of inspiration to start creating your own mazes using the bricks included or any of your own LEGO elements.

You decide how simple or challenging the maze should be. Add extra traps or more walls, or use different colored elements. The interchangeable maze system means you can easily swap maze plates without rebuilding the entire game.

The set also includes a removable container to

store the balls and a travel lock that keeps everything in place when you are carrying or storing the game.

Build up your gaming skills and enjoy hours of challenging and creative fun with this latest creation from LEGO Ideas.

["The possibilities seem almost limitless."]

*Jason Allemann
LEGO MAZE Designer*

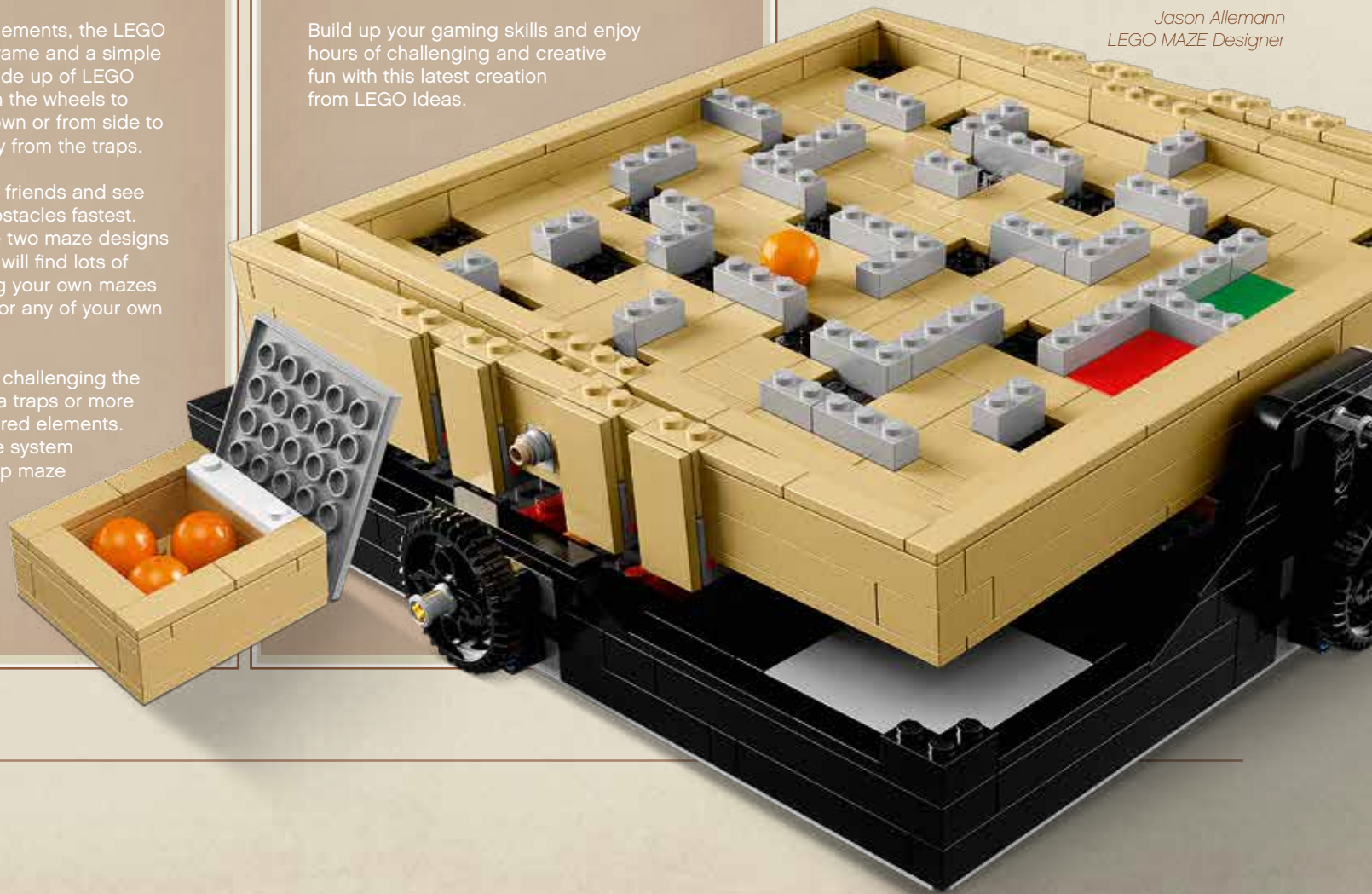

THE DESIGNER

Jason Allemann,
LEGO® fan and designer
of the LEGO Maze

“Growing up I was always fascinated with how things worked. I have never actually owned one of those original wooden mazes, but I would always be drawn to them whenever visiting someone who had one.

“After building a few small mazes it didn't take long before I was building larger mazes to run a LEGO® soccer ball through. I originally tried to recreate the wooden version of the labyrinth maze as faithfully as possible, but it quickly became apparent that this wasn't practical.

“I decided to decrease the size of the maze and eliminate the holes. By having the ball fall into depressions, the maze could be built using fewer larger plates.

“One of the limitations of the original wooden toy is that it is always the same. There is no way to make it more or less difficult, or modify the maze to have a different play experience. As I was designing this model I really wanted to embrace the customization that having it built out of LEGO pieces would allow.

“Not only can people modify the difficulty of the mazes to gradually increase their skill, but they can create mazes that follow specific patterns, themed mazes, mazes with multiple pathways to the finish. The possibilities seem almost limitless.”

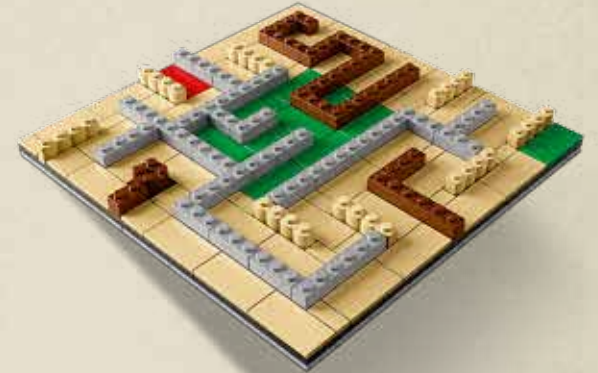

LE LABYRINTHE LEGO®

Le labyrinthe LEGO® réinvente le jeu classique de boule et de labyrinthe, en ajoutant une note de construction créative LEGO.

Construit entièrement à partir d'éléments LEGO, le labyrinthe LEGO comprend un cadre de base et un simple mécanisme de bascule et d'inclinaison composé de poutres et d'axes LEGO. Tourne les roues pour déplacer le labyrinthe verticalement ou latéralement, en guidant la boule pour éviter les pièges.

Lance un défi à ta famille et à tes amis et découvre qui franchira les obstacles le plus vite. Une fois que tu auras maîtrisé les deux modèles de labyrinthe inclus avec l'ensemble, tu trouveras de nombreuses idées pour commencer à créer tes propres labyrinthes en utilisant les briques incluses ou tes propres éléments LEGO.

À toi de décider si le labyrinthe sera simple ou compliqué. Tu peux ajouter des pièges ou des murs supplémentaires, ou bien utiliser des éléments de différentes couleurs. Le système de labyrinthe interchangeable

signifie que tu peux facilement échanger les plaques du labyrinthe sans reconstruire tout le jeu.

Cet ensemble inclut aussi un compartiment amovible pour ranger les boules et un verrou qui maintient tout bien en place quand tu transportes ou ranges le jeu.

Prépare-toi à faire preuve d'adresse pour des heures d'amusement stimulant et créatif avec ce nouvel ensemble de LEGO Ideas.

[« Les possibilités semblent pratiquement illimitées. »]

*Jason Allemann
Designer du labyrinthe LEGO*

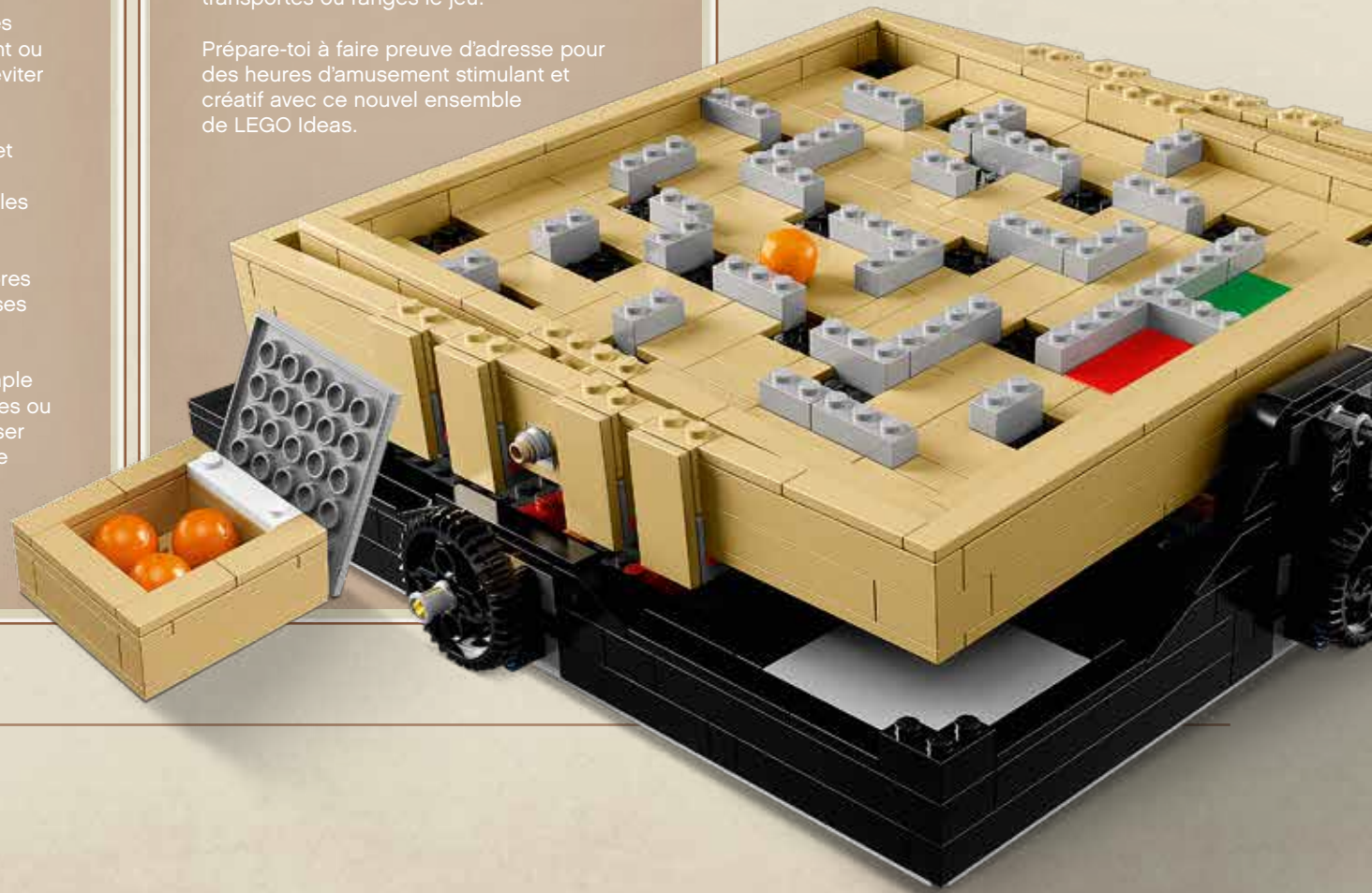

LE DESIGNER

Jason Allemann Fan LEGO® et designer du labyrinthe LEGO

« En grandissant, j'ai toujours été fasciné par la façon dont les choses fonctionnaient. Je n'ai en fait jamais eu l'un de ces labyrinthes en bois, mais ils m'ont toujours attiré quand je rendais visite à quelqu'un qui en avait un.

Après avoir construit quelques petits labyrinthes, je me suis rapidement mis à construire des labyrinthes plus grands pour y faire passer un ballon de soccer LEGO®. J'ai essayé à l'origine de recréer la version en bois du labyrinthe aussi fidèlement que possible, mais il est rapidement devenu évident que cela n'était pas réalisable.

J'ai décidé de réduire la taille du labyrinthe et d'éliminer les trous. En faisant tomber la boule dans des creux, le labyrinthe pouvait être construit en utilisant moins de grandes plaques.

L'une des limitations du jouet d'origine en bois est qu'il ne change jamais. Il n'y a aucun moyen de le rendre plus ou moins difficile ou de modifier le labyrinthe pour avoir une expérience de jeu différente. En concevant ce modèle, je voulais vraiment tirer parti de la personnalisation que la construction en pièces LEGO pouvait permettre.

Les gens peuvent non seulement modifier la difficulté des labyrinthes pour augmenter graduellement leur habileté, mais aussi créer des labyrinthes avec des motifs spécifiques, des thématiques ou de multiples chemins possibles vers l'arrivée. Les possibilités semblent pratiquement illimitées. »

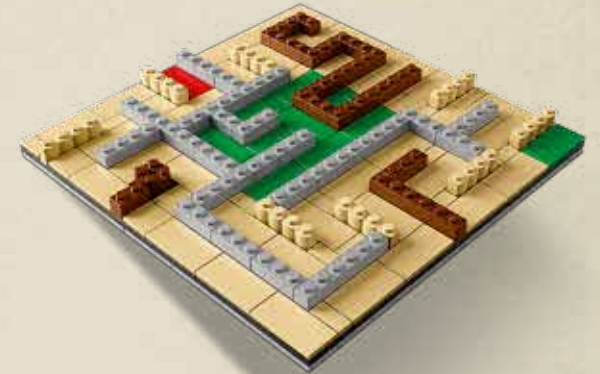

EL LABERINTO LEGO®

El Laberinto LEGO® reinventa el clásico juego de la bola en el laberinto, aportando un toque de creatividad a través de la construcción con LEGO.

Construido íntegramente con elementos LEGO, el Laberinto LEGO se compone de una base y un sencillo mecanismo de inclinación basado en ejes y barras LEGO. Debes girar las ruedas para mover el laberinto hacia arriba, hacia abajo y hacia los lados, guiando la bola para mantenerla alejada de las trampas.

Desafía a tus familiares y amigos para descubrir quién es capaz de superar los obstáculos más rápido. Cuando seas capaz de atravesar con facilidad los dos laberintos incluidos, usa la imaginación para inventar otros empleando los bricks que contiene el set o tu propia colección de elementos LEGO.

Tú decides lo sencillo o complejo que debe ser el laberinto. Agrega más trampas o murallas, o usa elementos de diferentes colores. El sistema de intercambio de

laberintos te permite cambiar las bases sin reconstruir el juego entero.

El set incluye también una caja desmontable para guardar las bolas y un cierre de viaje que lo mantendrá todo en su sitio cuando quieras transportar el juego o guardarlo.

Pon a prueba tu habilidad y disfruta durante horas de divertidos y creativos desafíos con la última creación de LEGO Ideas.

[«Las posibilidades son casi infinitas».]

*Jason Allemann
Diseñador del Laberinto LEGO*

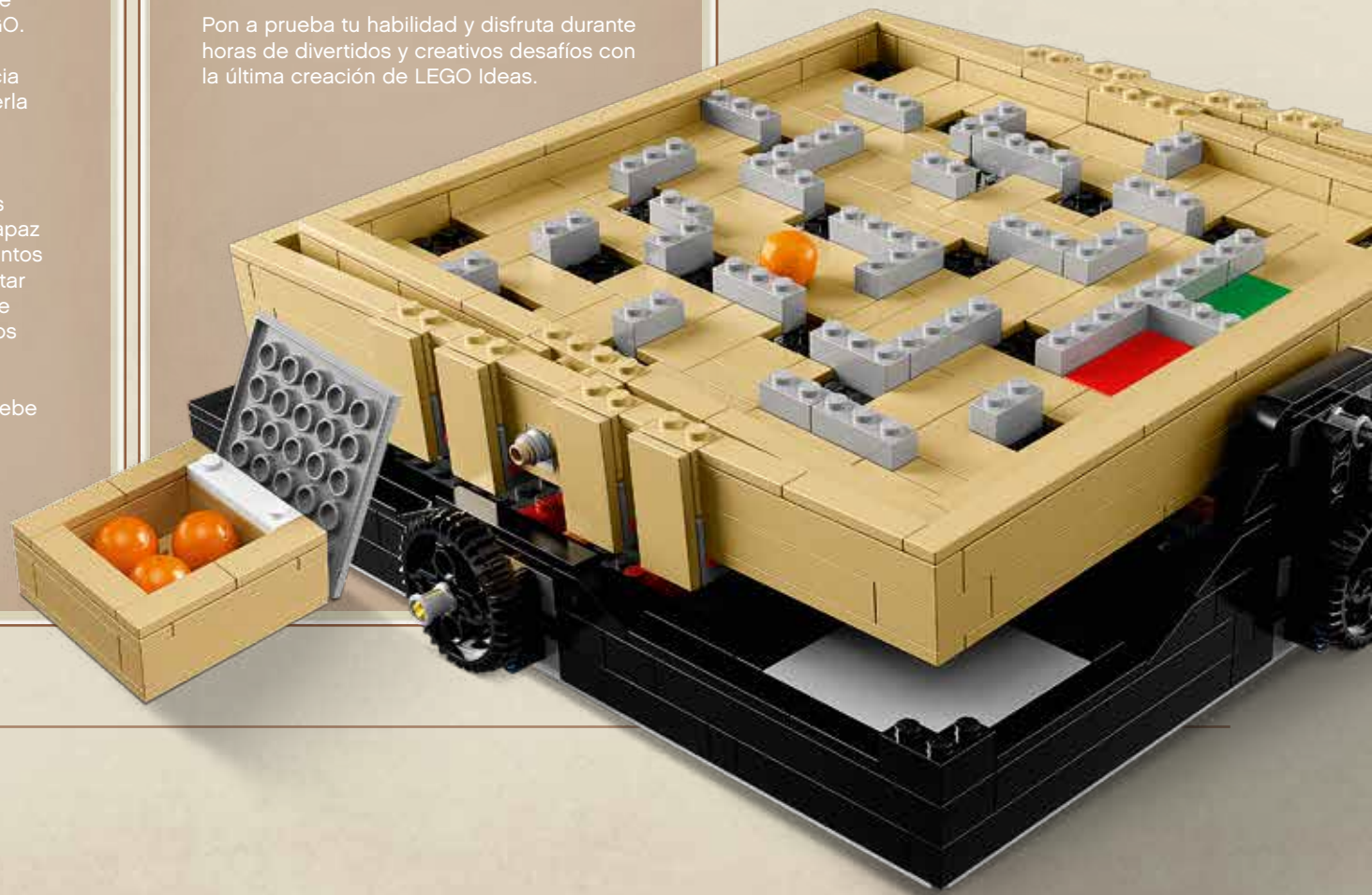

EL DISEÑADOR

Jason Allemann,
fan de LEGO® y diseñador
del Laberinto LEGO

«Cuando era niño, me fascinaba descubrir cómo funcionaban las cosas. En realidad, nunca llegué a tener uno de esos laberintos de madera, pero siempre sentía interés cuando visitaba a alguien que tenía uno».

«Poco después de construir un par de laberintos pequeños, decidí construir otros más grandes que pudiera atravesar con un balón de fútbol LEGO®. Al principio intenté recrear la versión de madera del laberinto con la máxima fidelidad, pero enseguida descubrí que no resultaba nada práctico».

«Entonces decidí reducir el tamaño del laberinto y eliminar los agujeros. Al hacer caer la bola en huecos de poca profundidad, era posible construir el laberinto con menos placas grandes».

«Una de las limitaciones del juguete de madera original era que no se podía cambiar. No había manera de hacerlo más o menos difícil, o modificarlo para disfrutar de una experiencia de juego diferente. Al diseñar este modelo, quise sacar el máximo partido de las posibilidades de personalización que proporcionan los elementos LEGO».

«La gente no sólo puede modificar la dificultad de los laberintos para practicar gradualmente, sino también crear laberintos en función de patrones específicos, laberintos temáticos y laberintos que permitan llegar al final de distintas formas. Las posibilidades son casi infinitas».

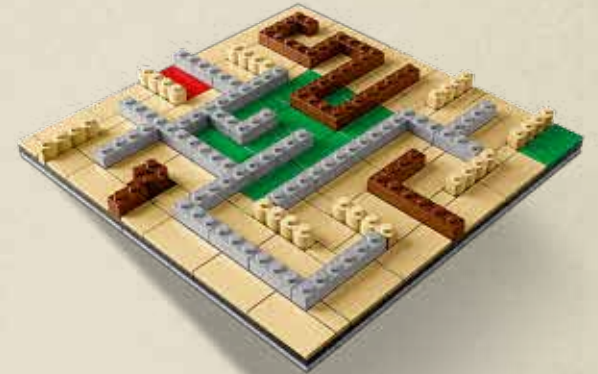

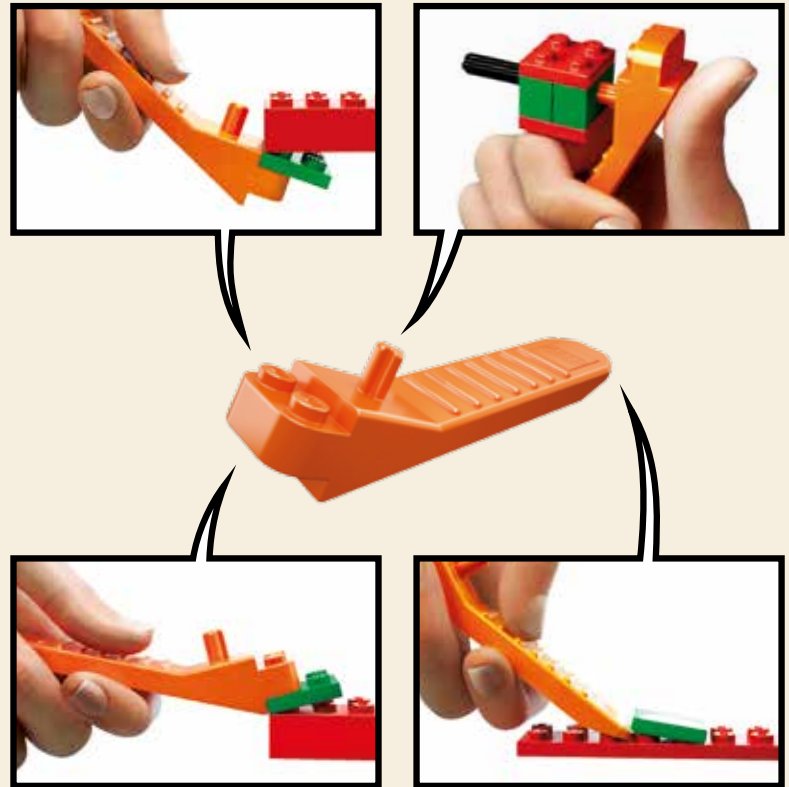

LEGO.com/brickseparator

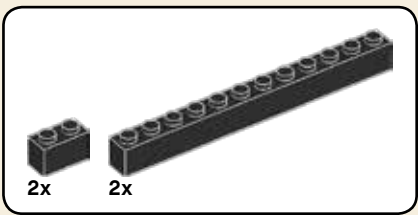

1

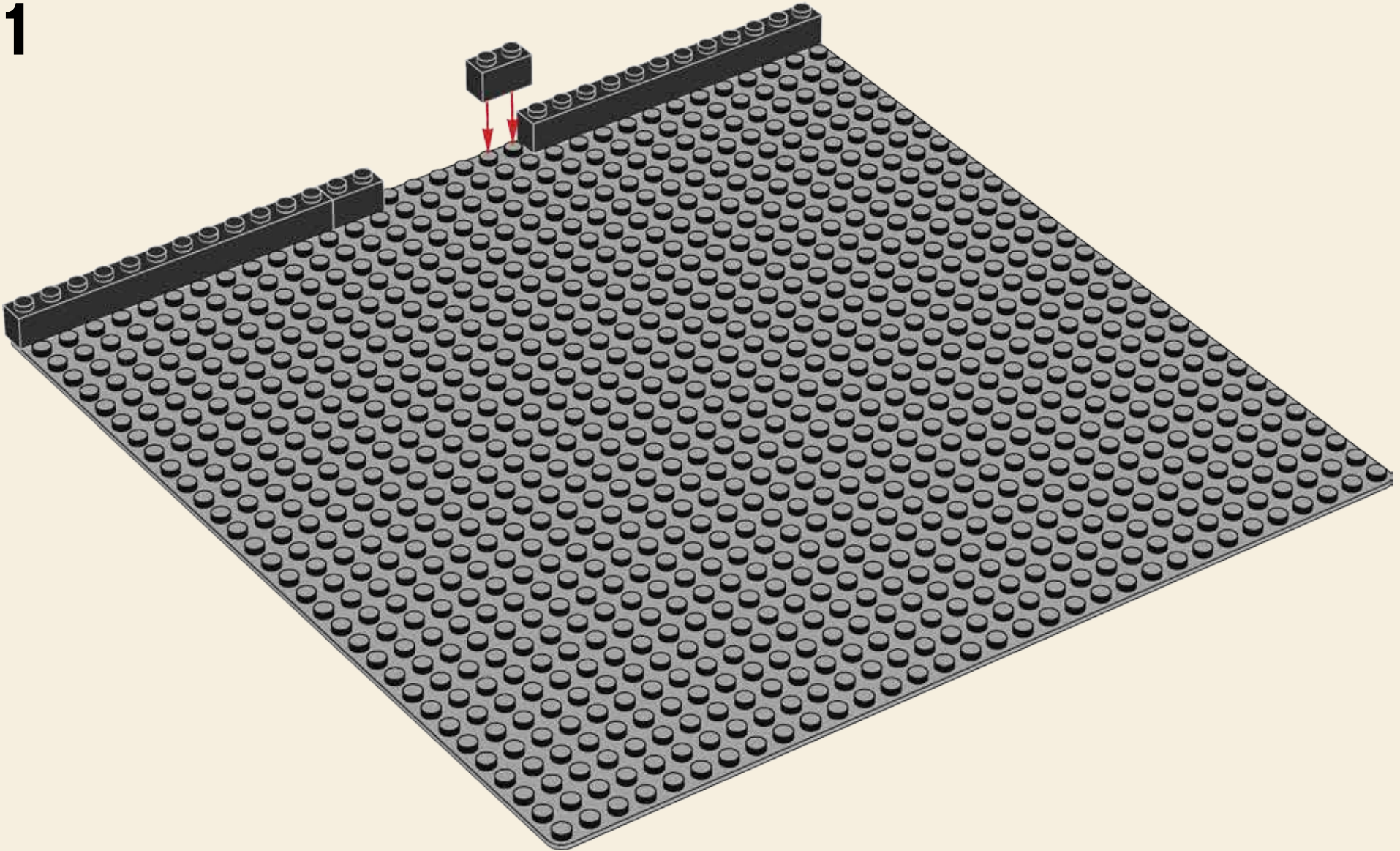

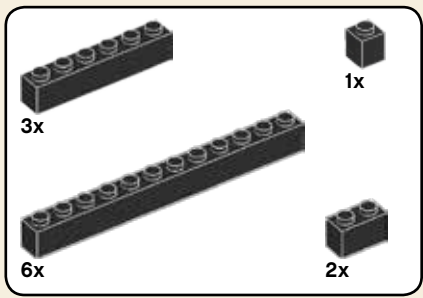

2

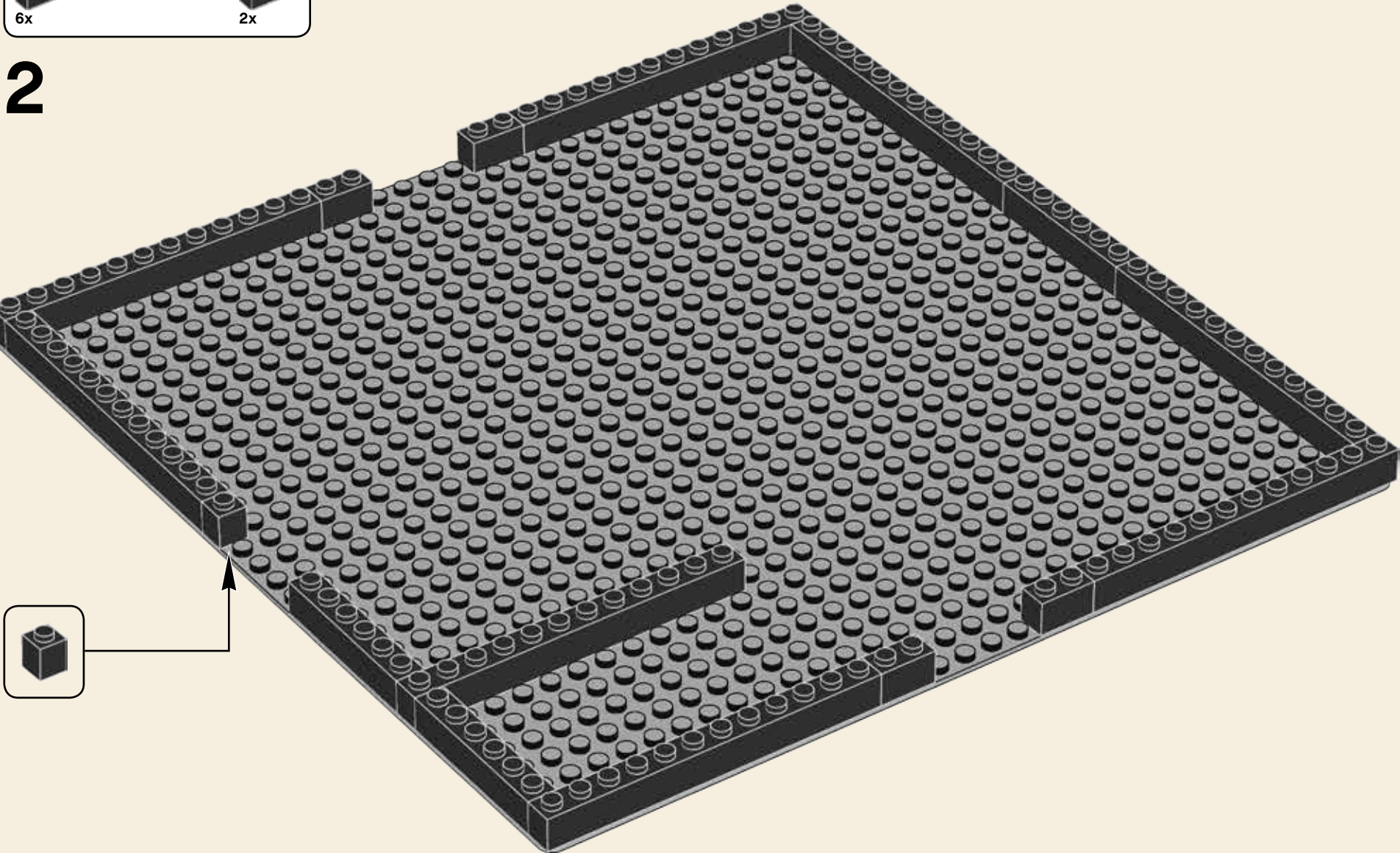

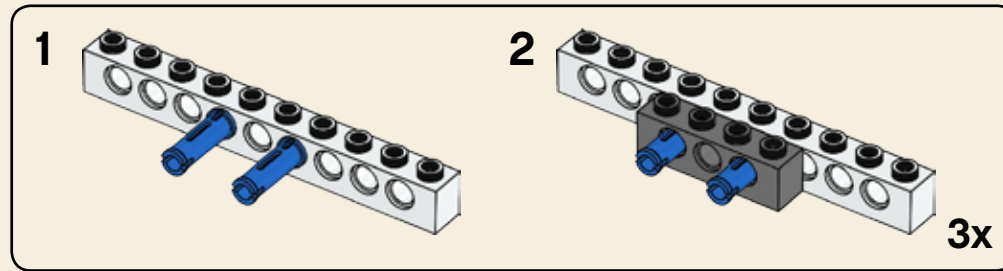
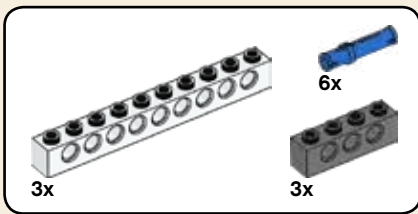

3

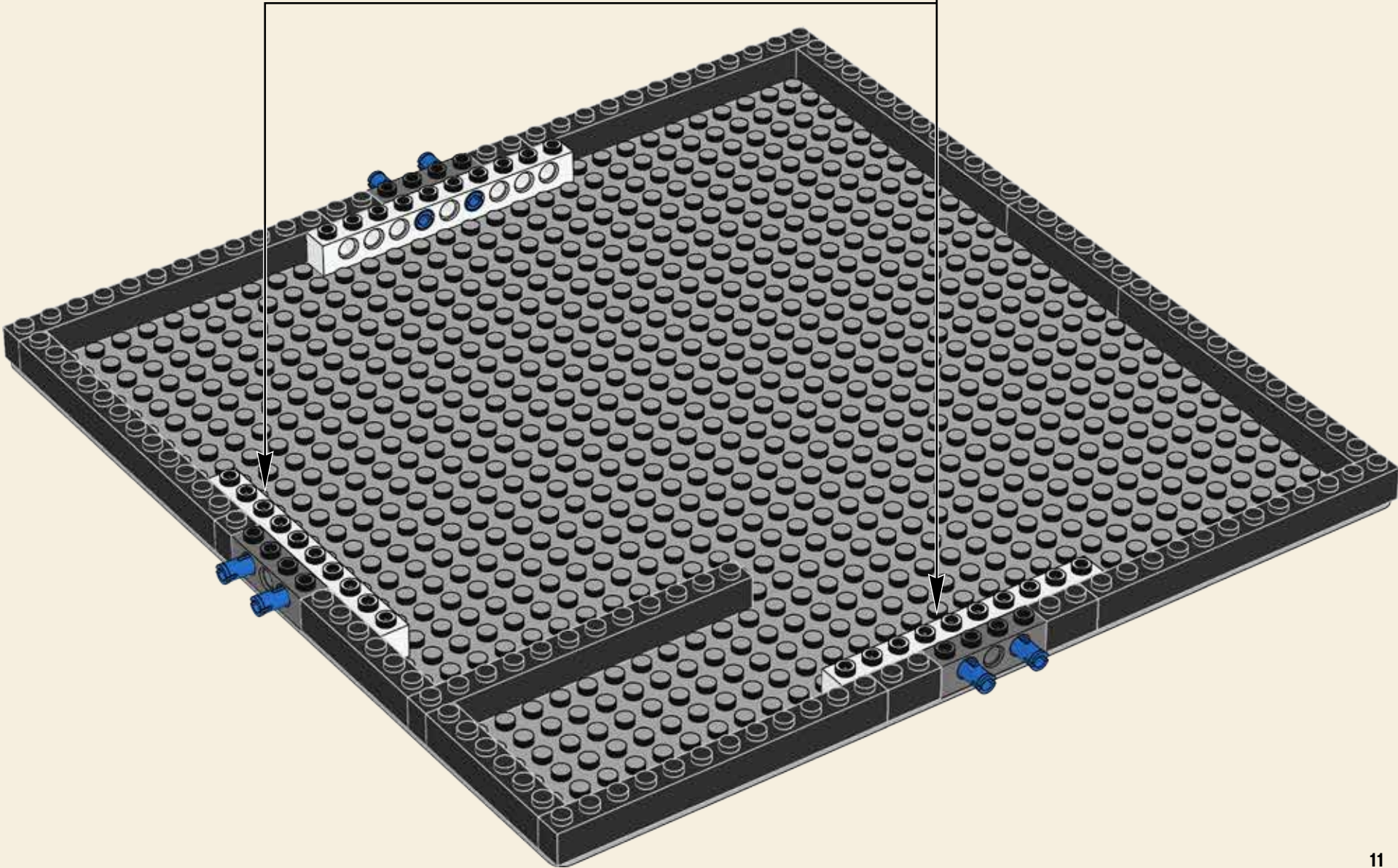

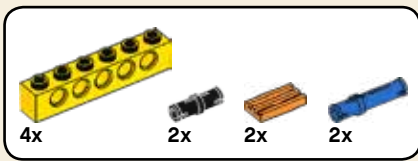

5

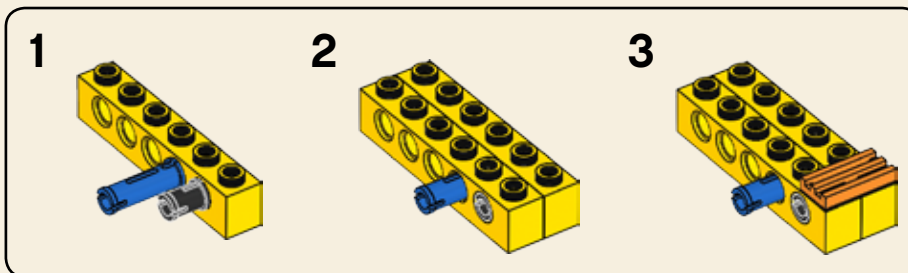
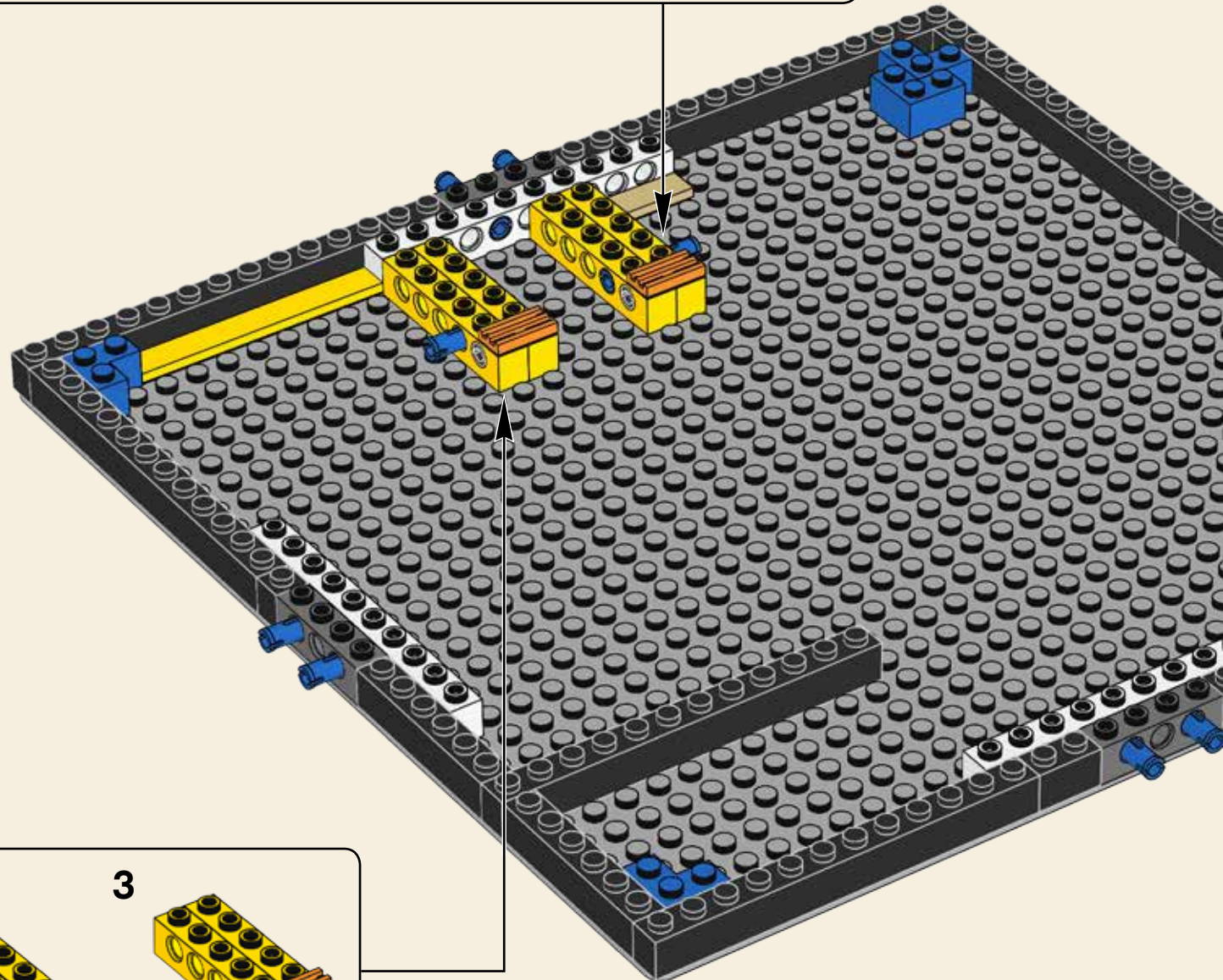
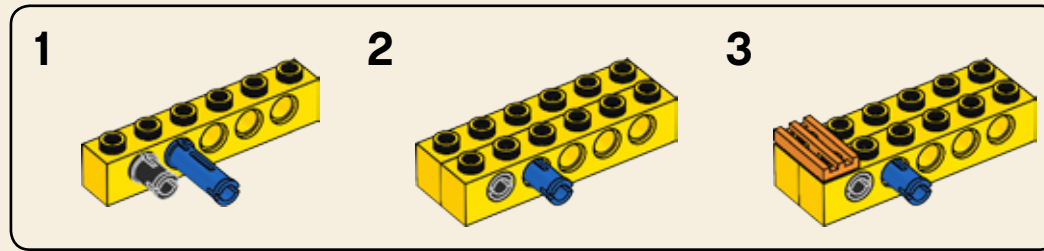

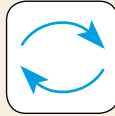
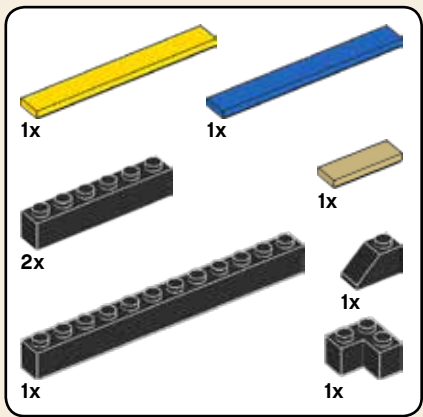

6

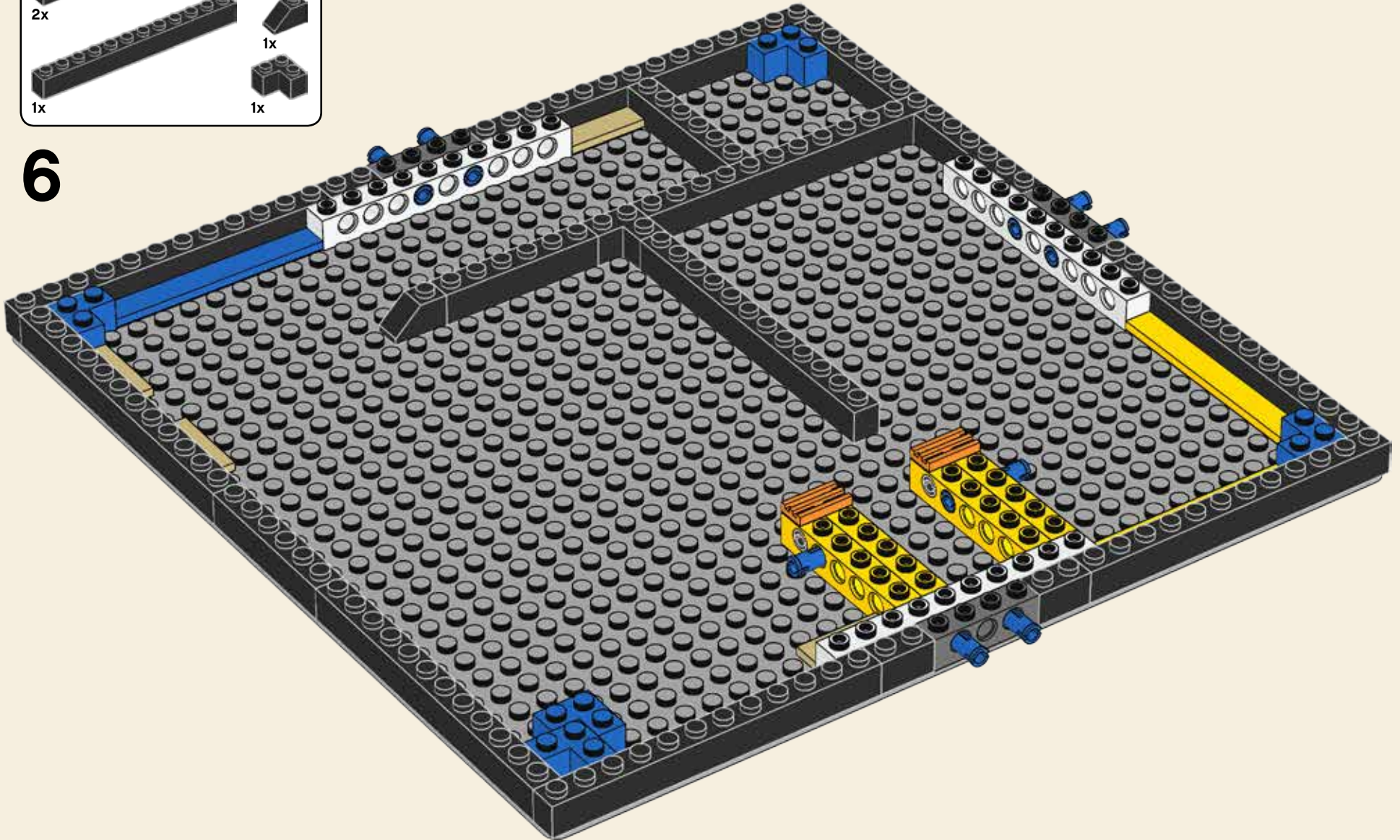

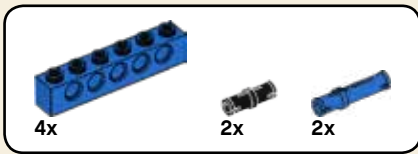

7

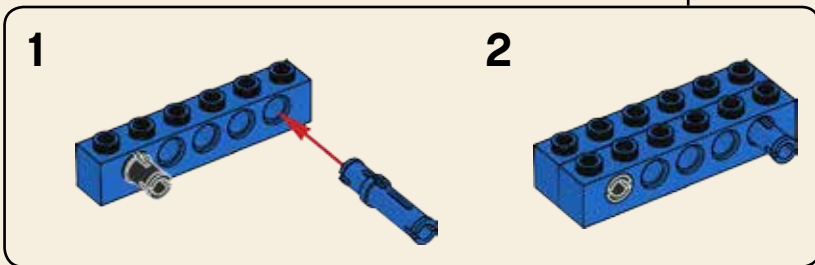
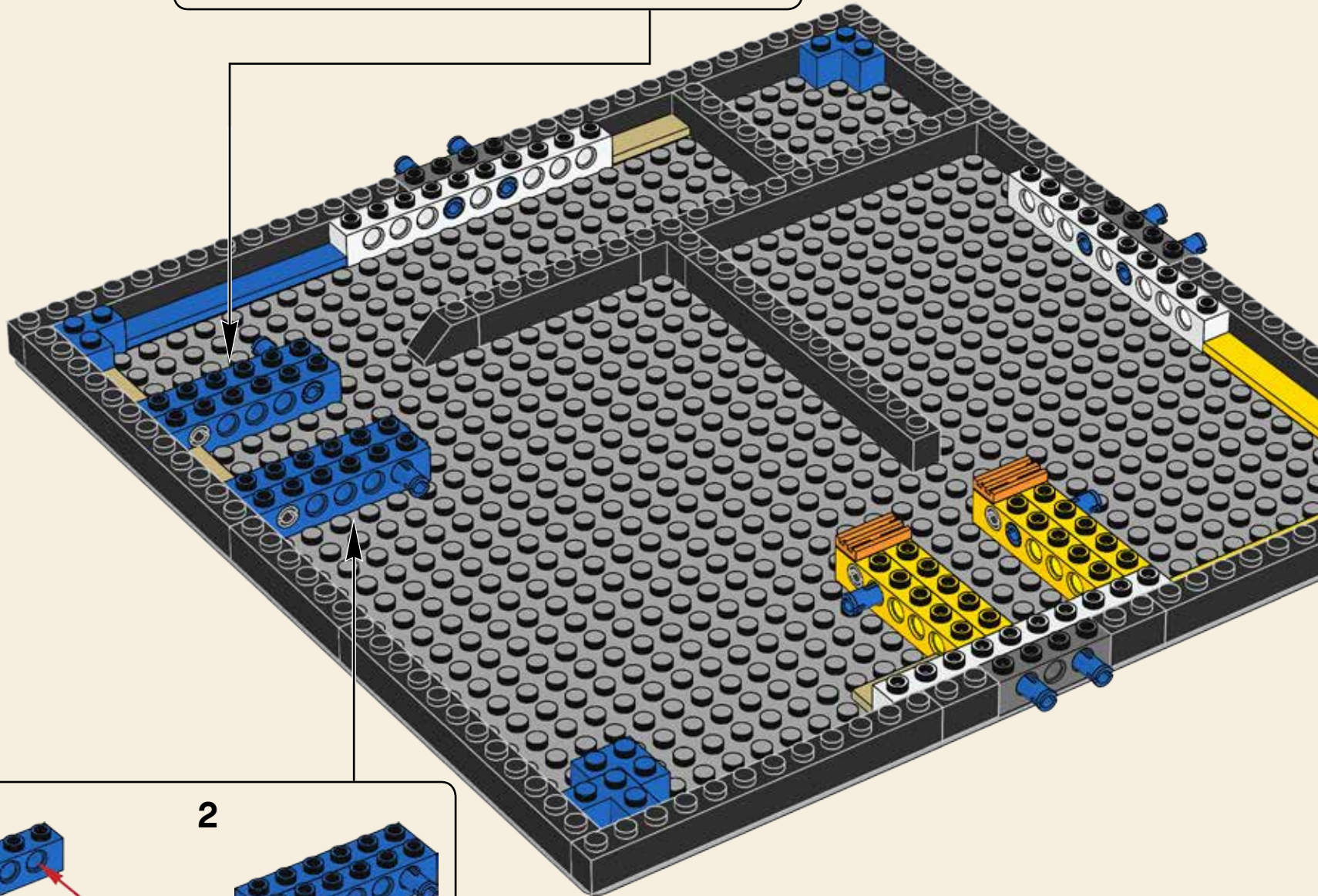
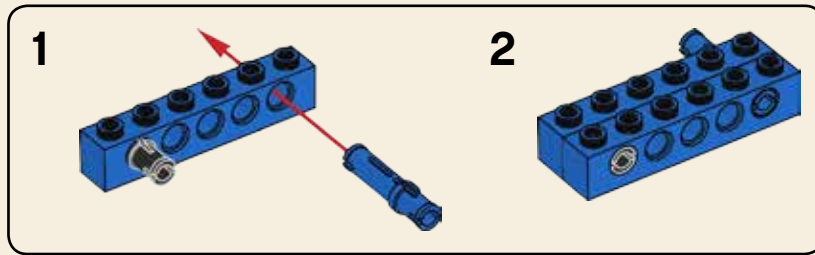

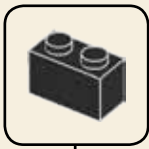
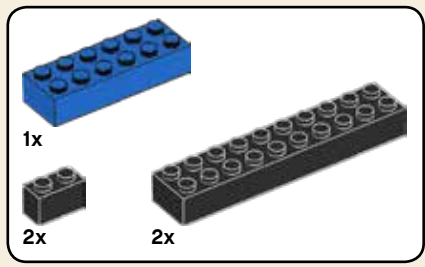

8

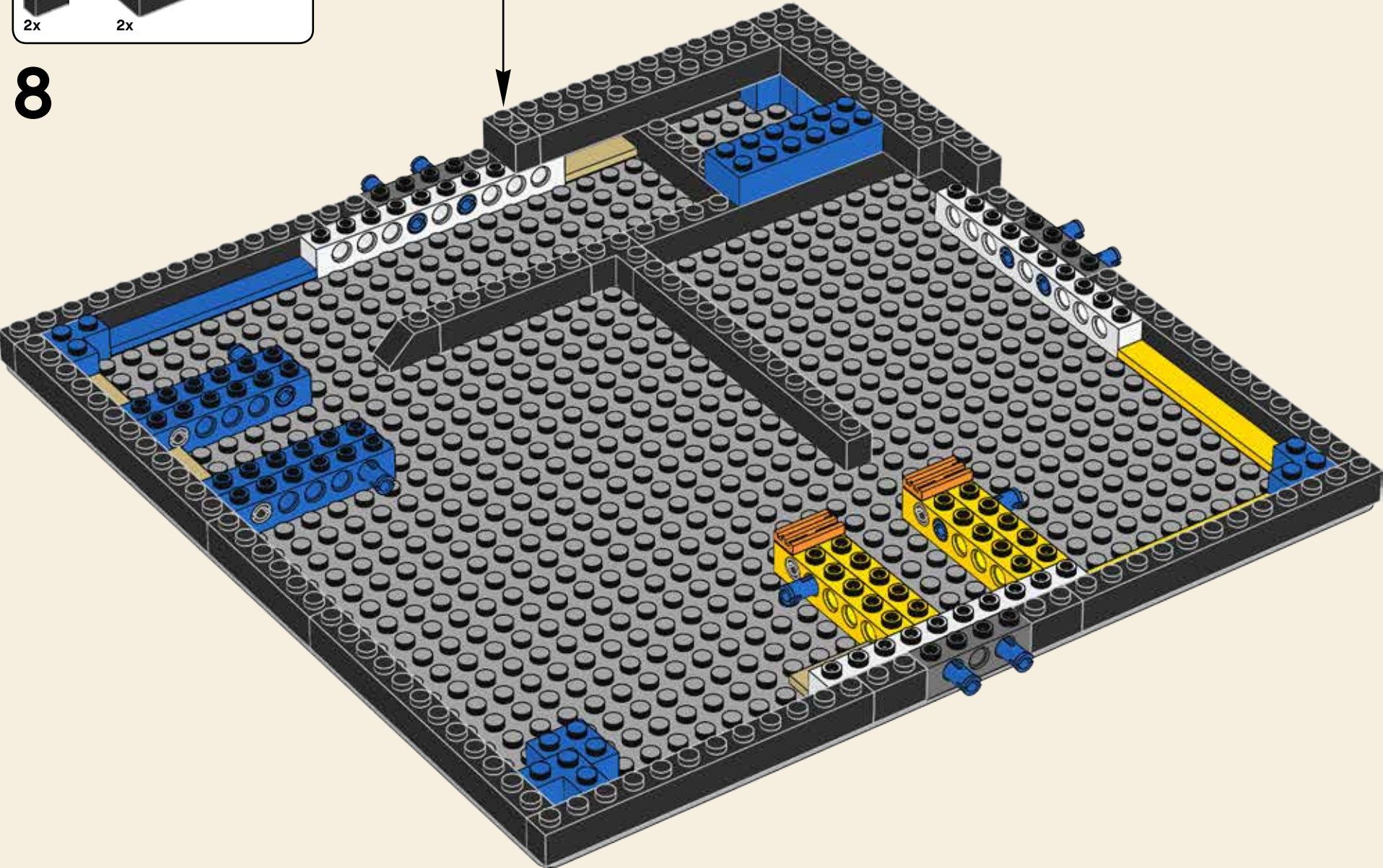

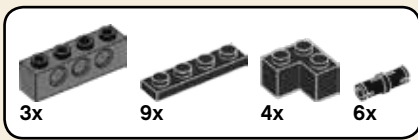

9

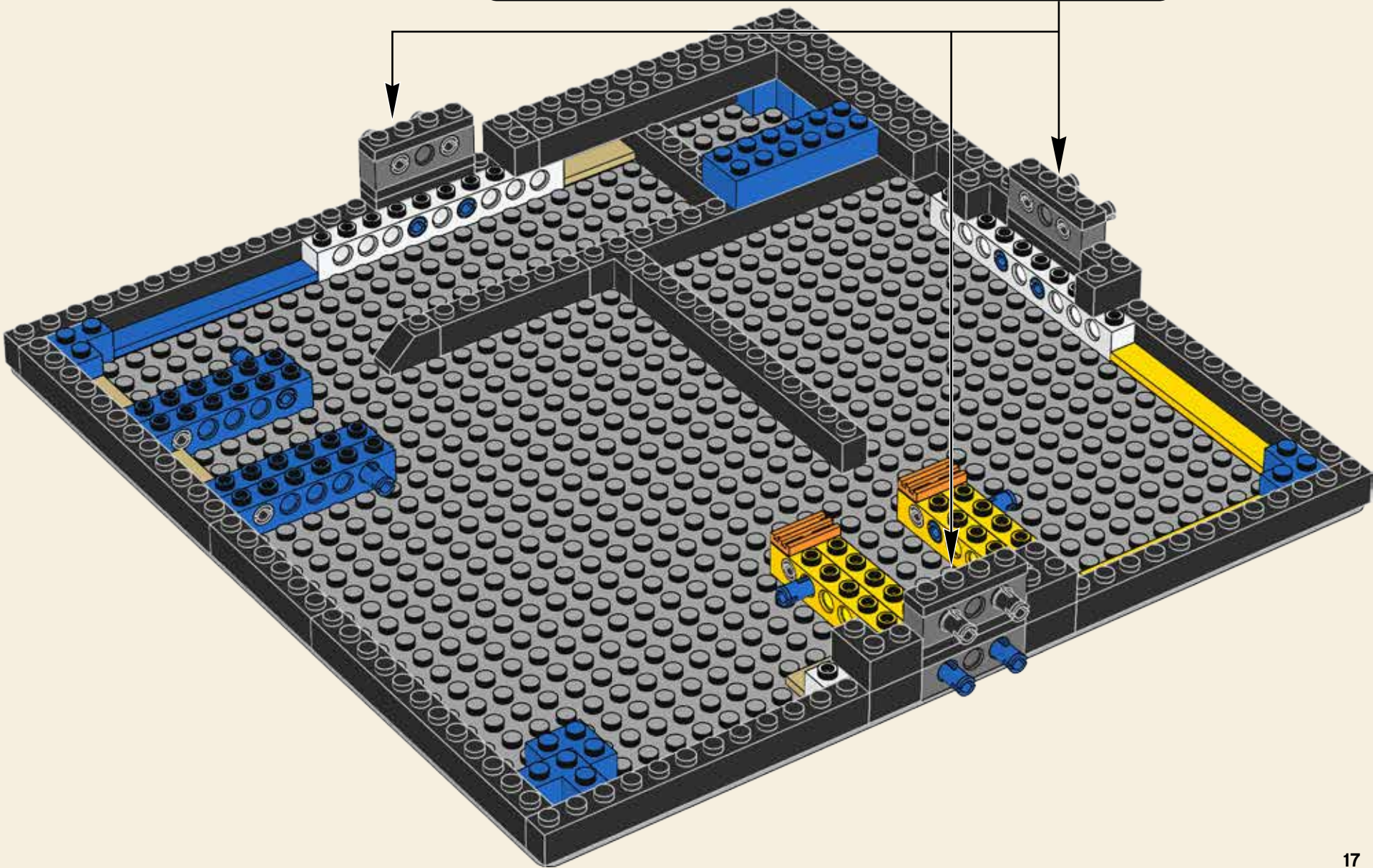
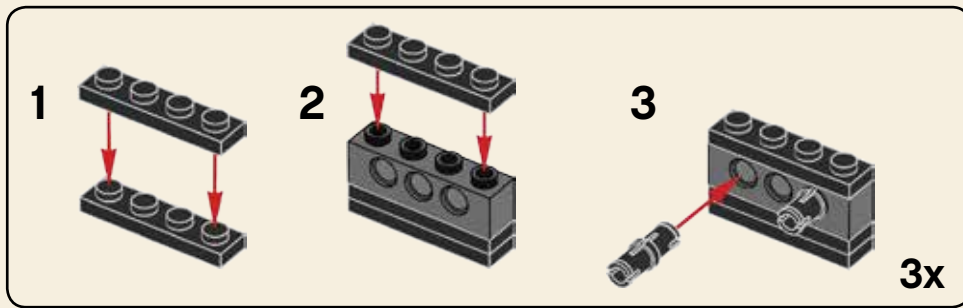

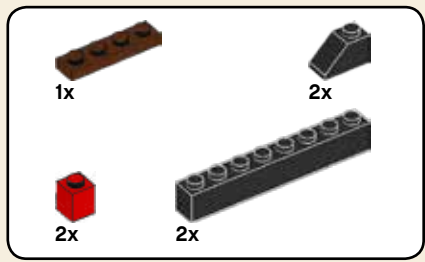

10



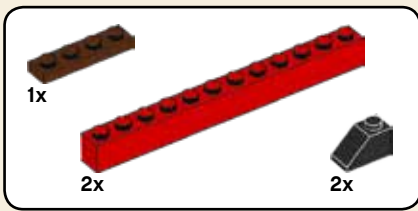

11

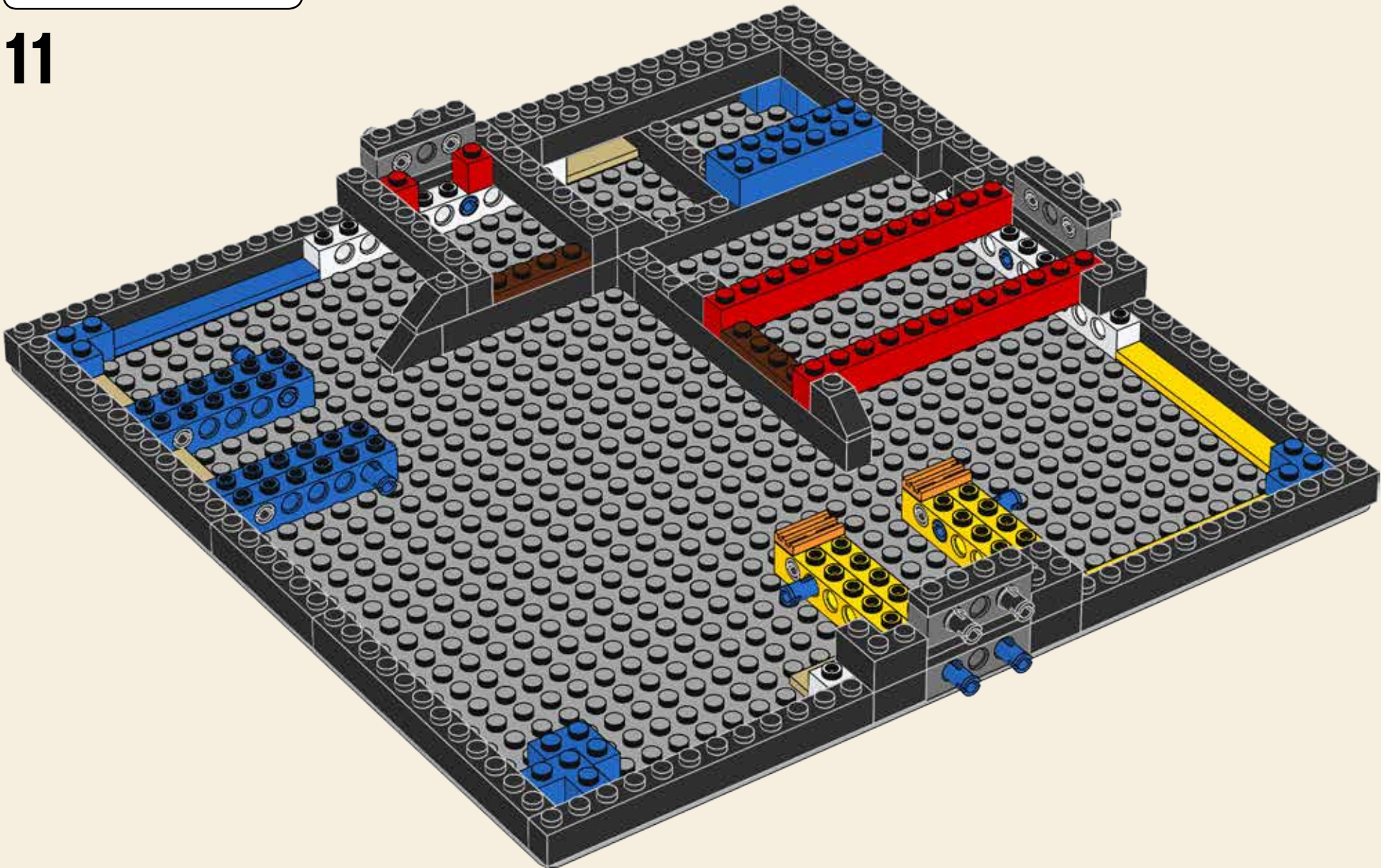

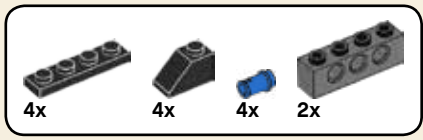

12

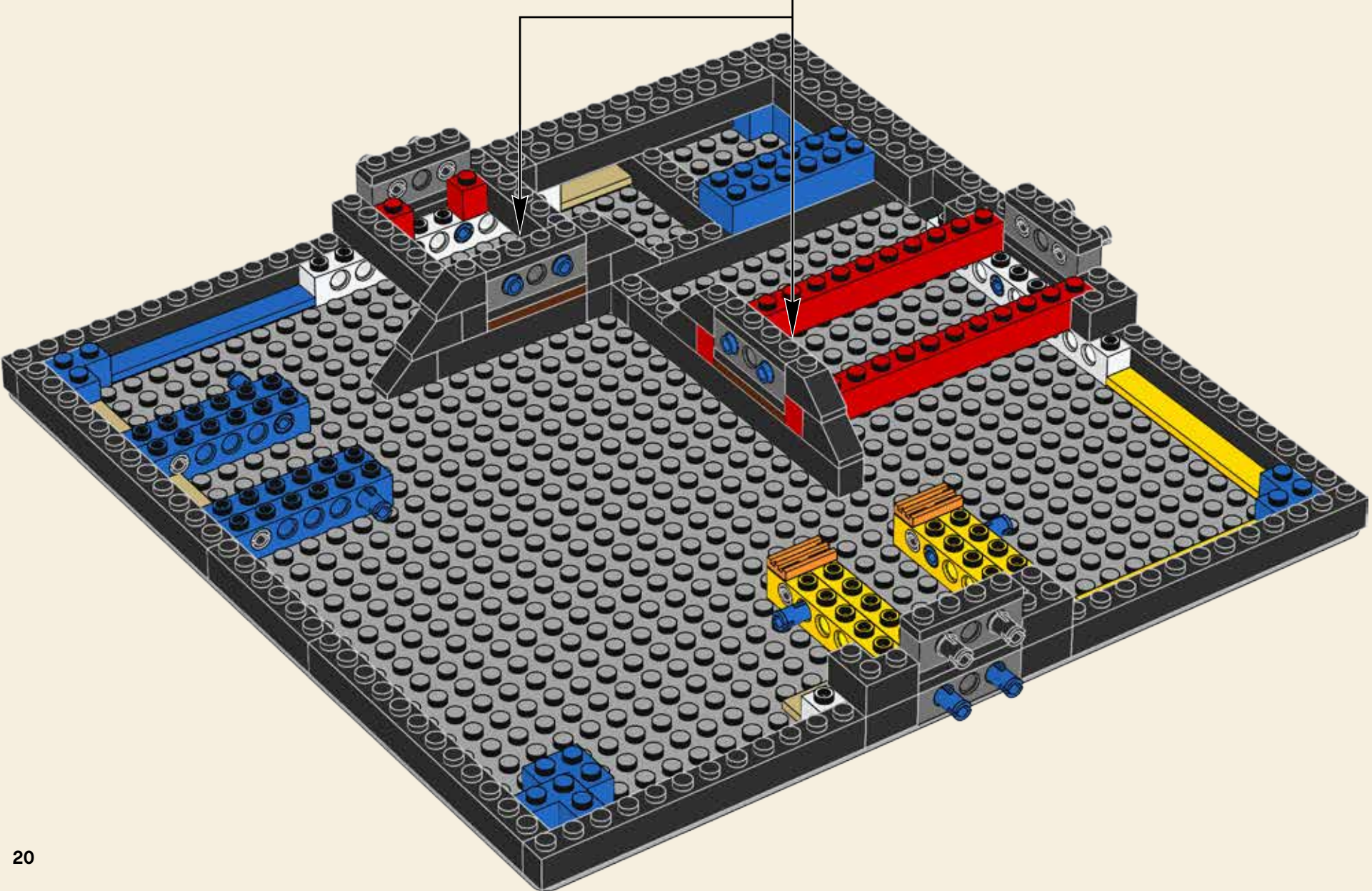
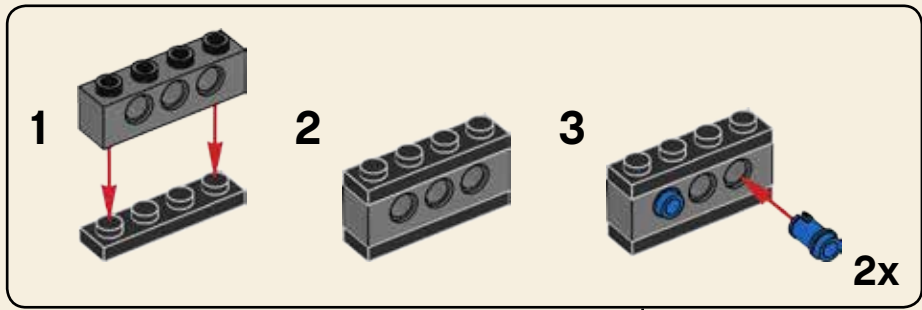

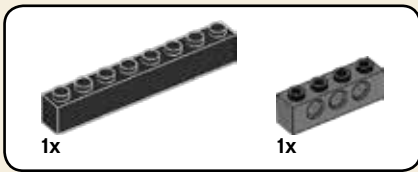

13

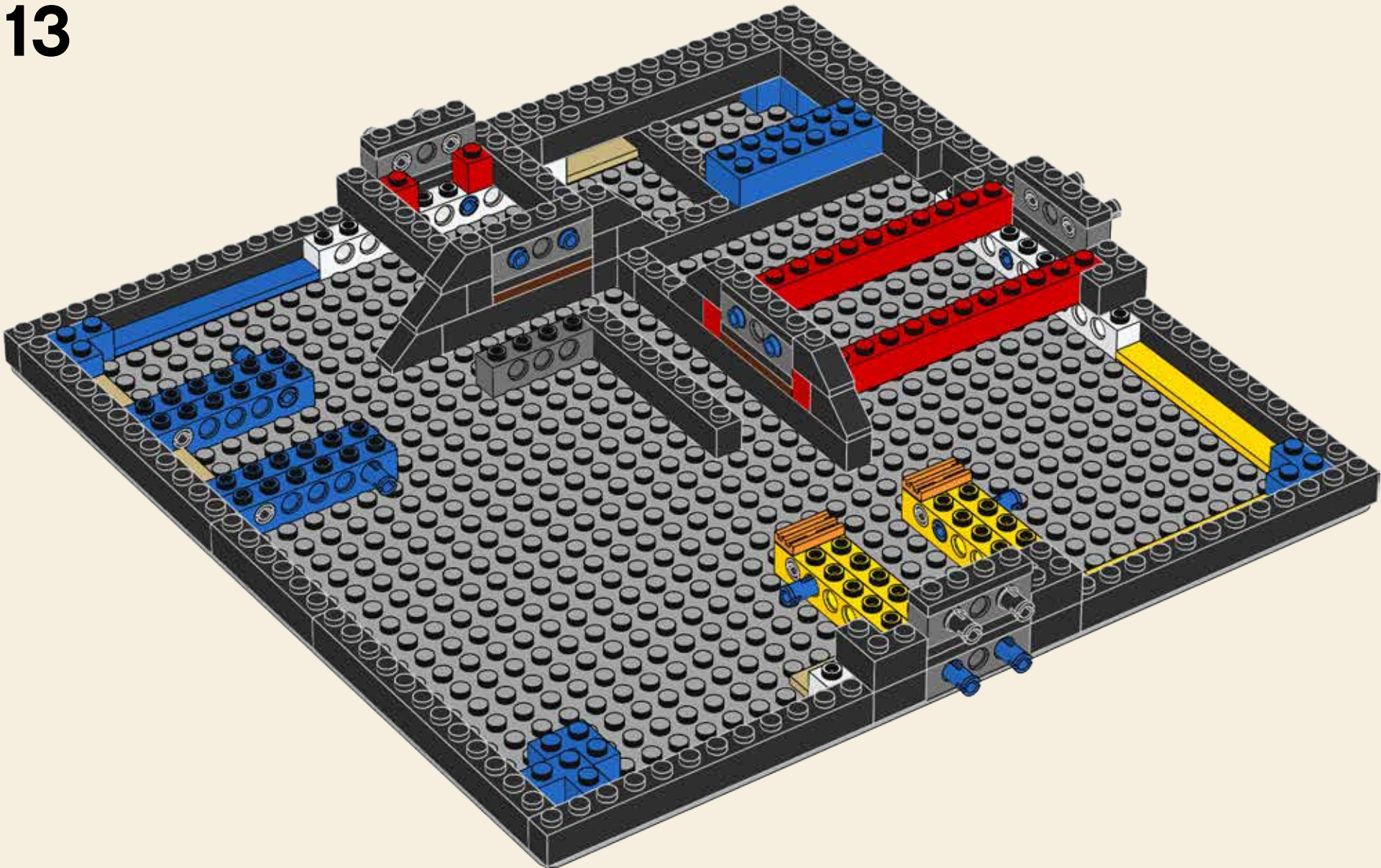

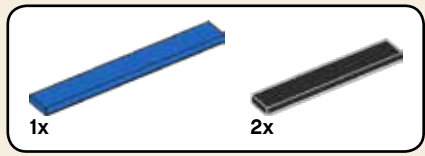

14

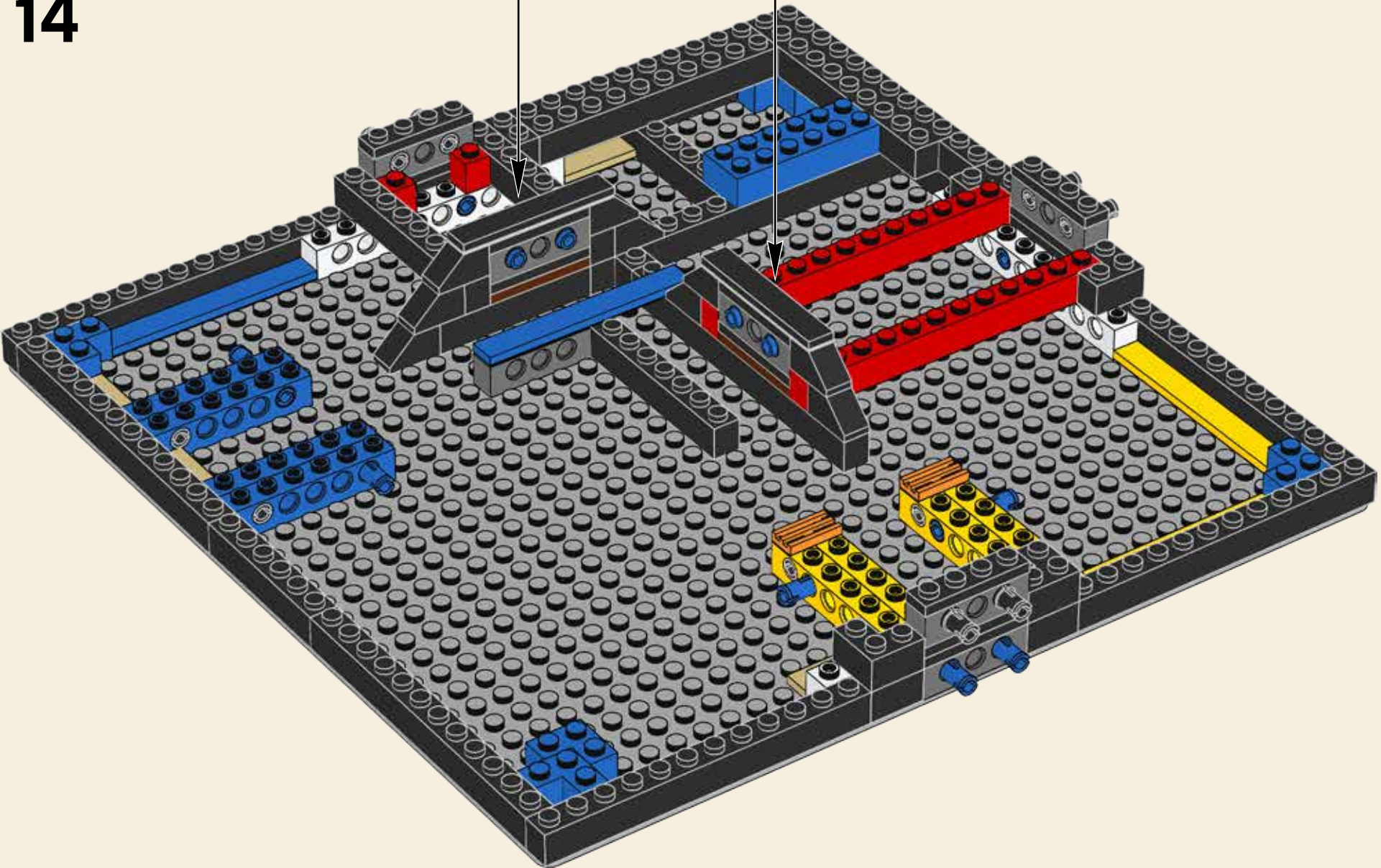

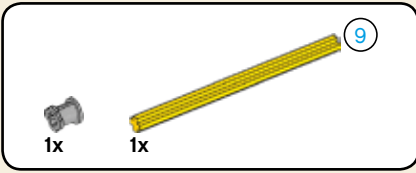
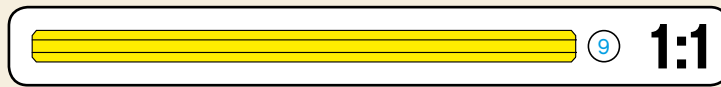
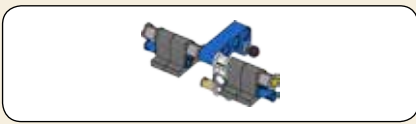

15

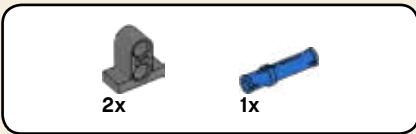
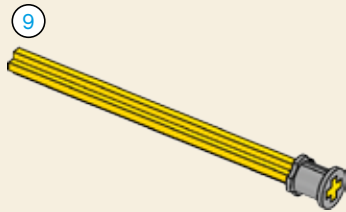

16

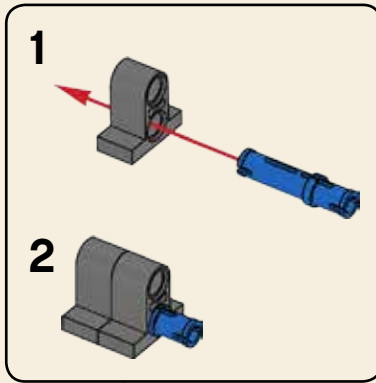

2

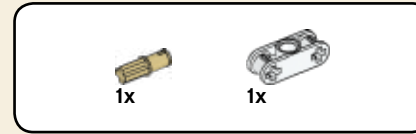
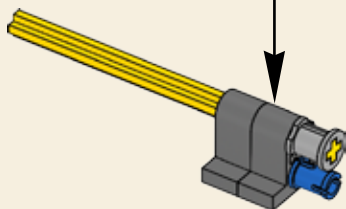
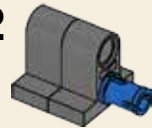

17

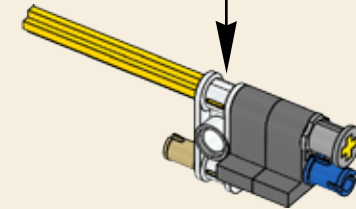
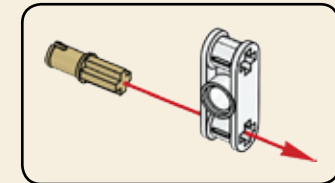

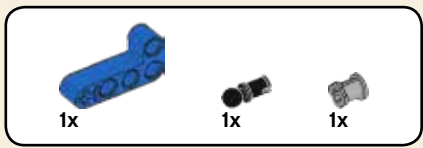

18

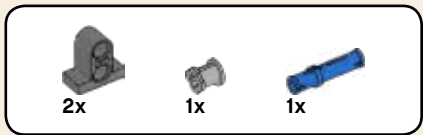
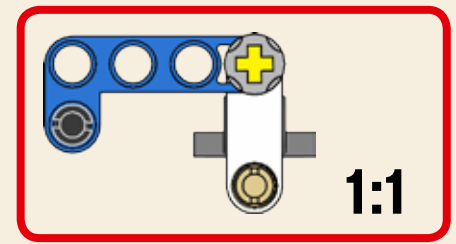
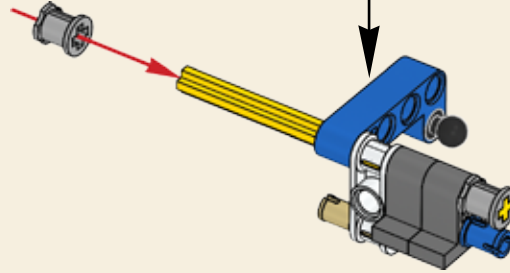
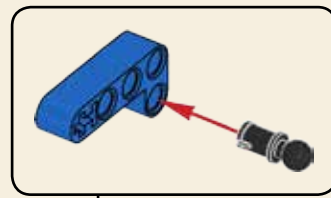

19

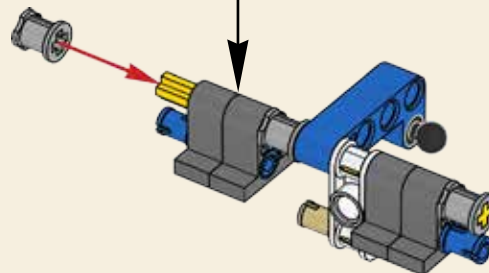
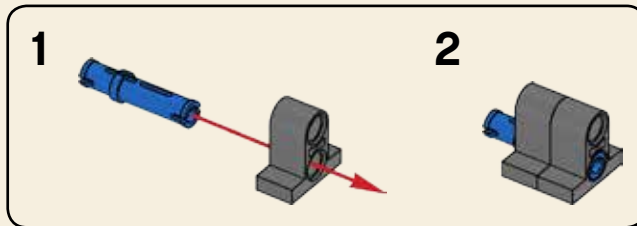

20

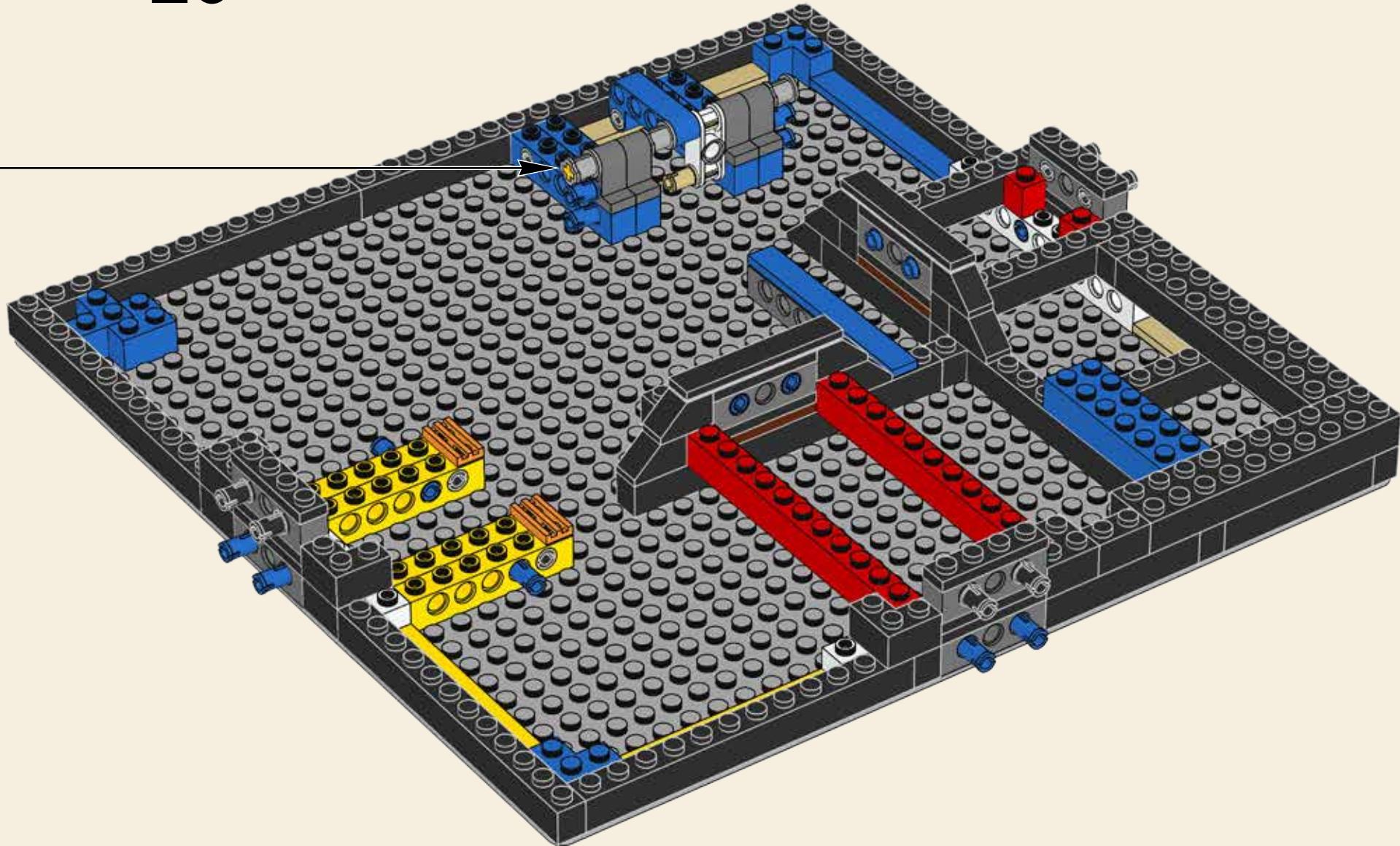
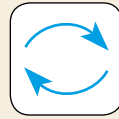

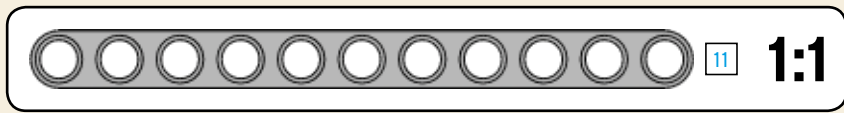
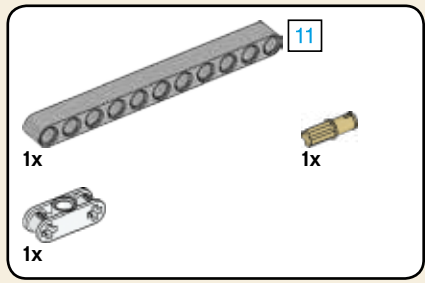

21

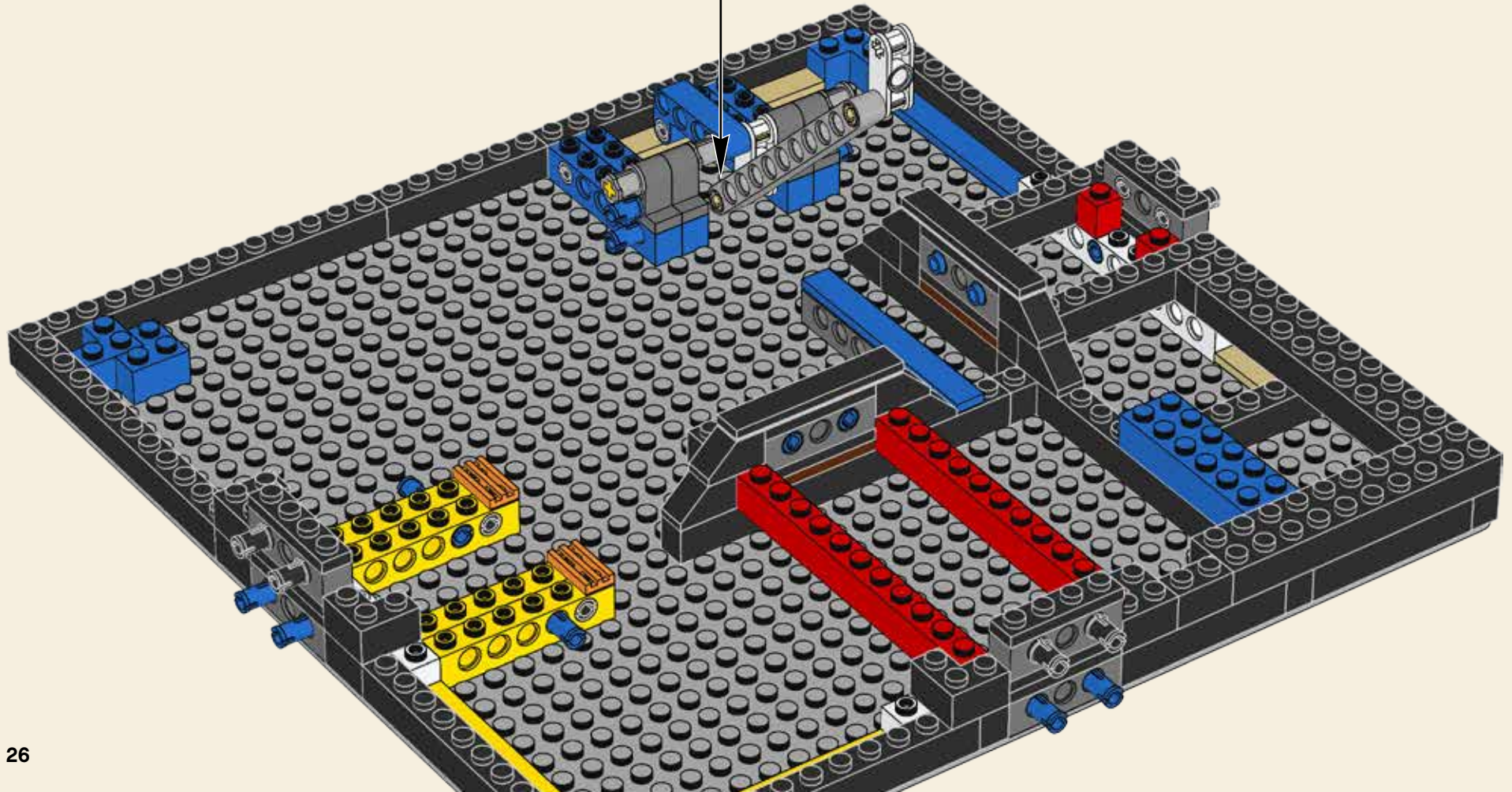
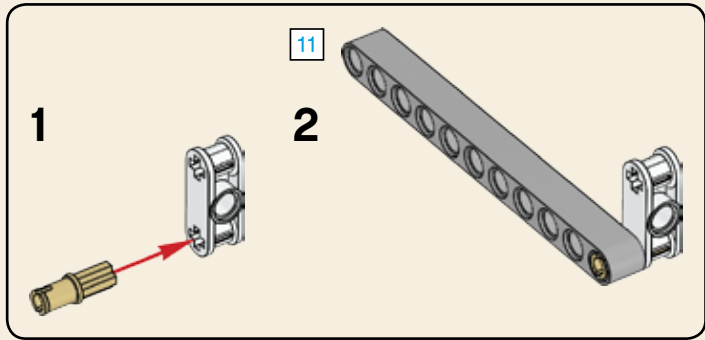

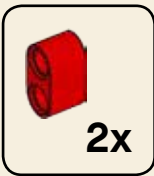

22

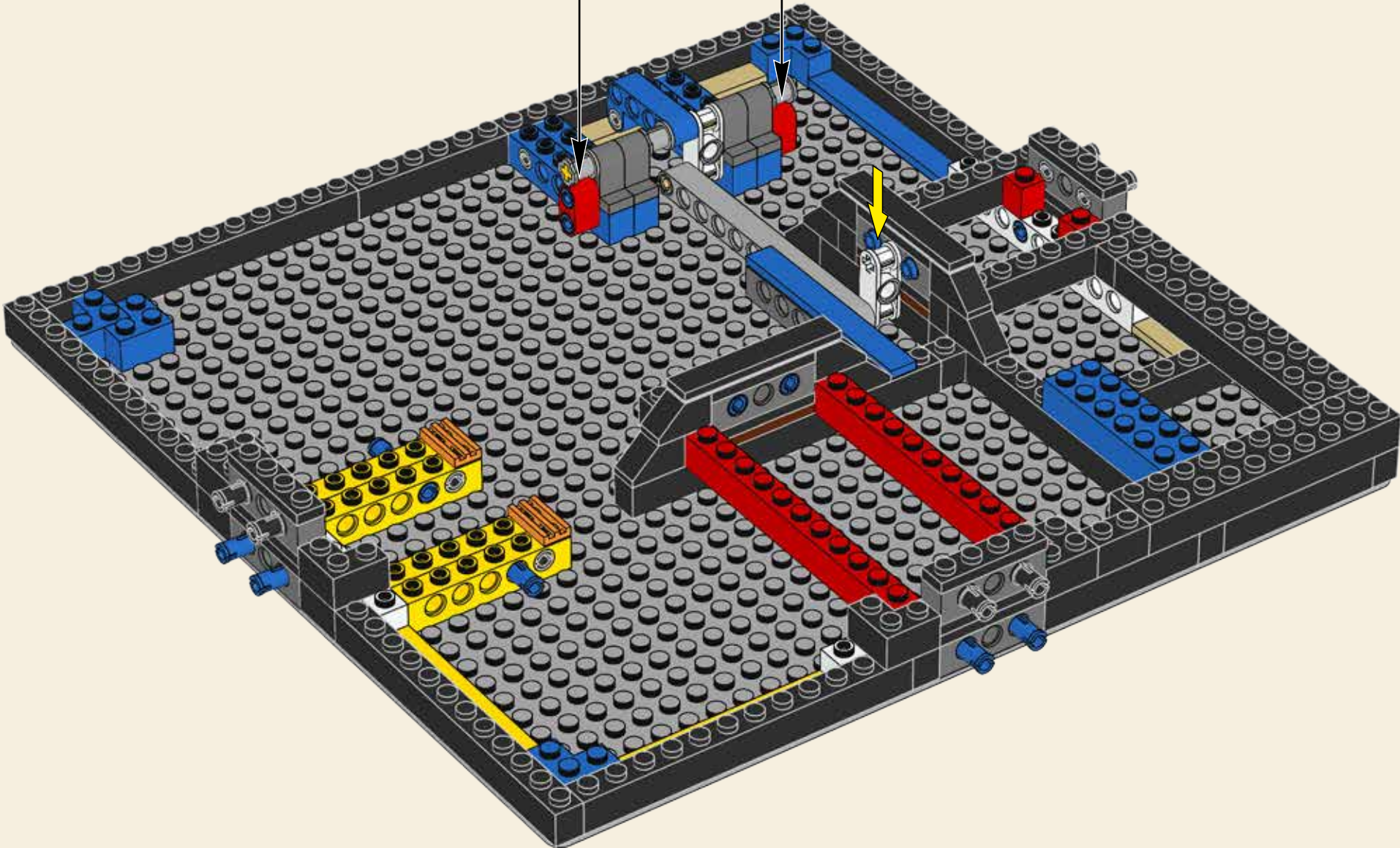

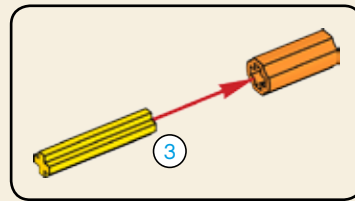
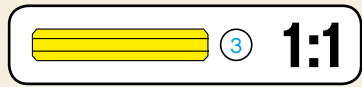
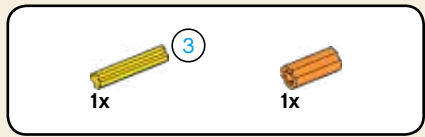

23

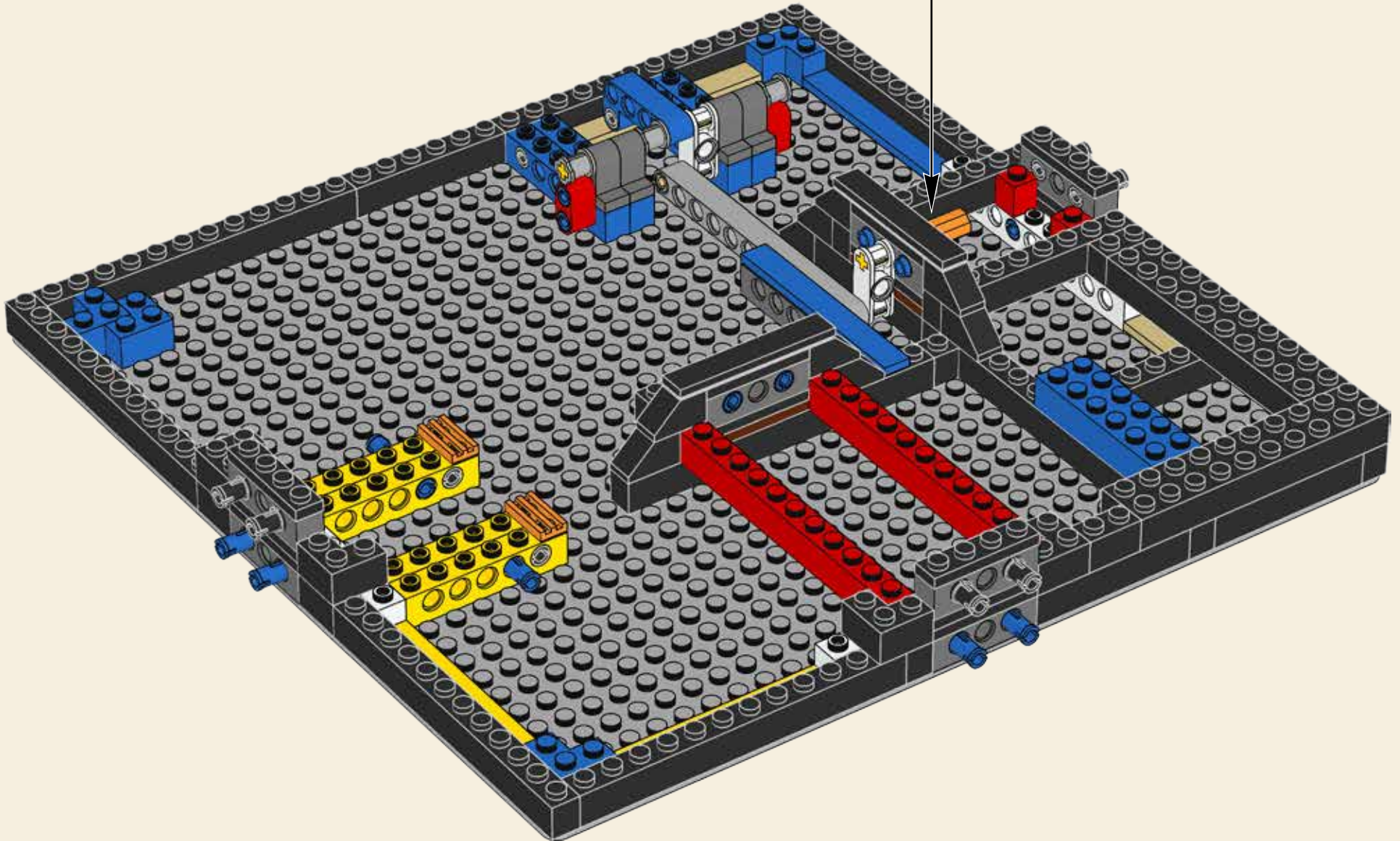

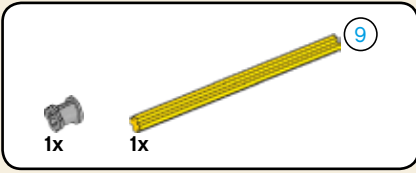
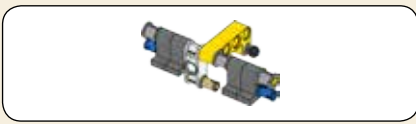

24

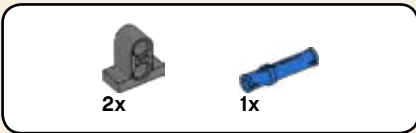
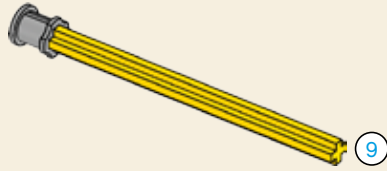

25

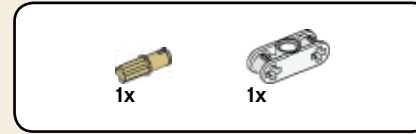
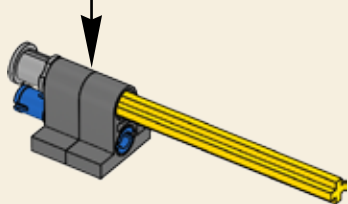
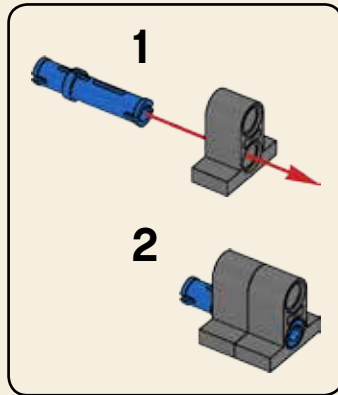

26

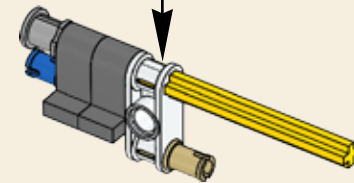
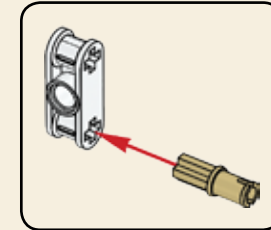

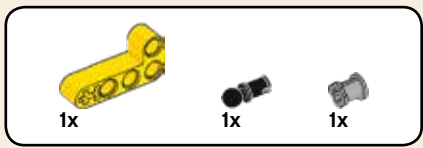

27

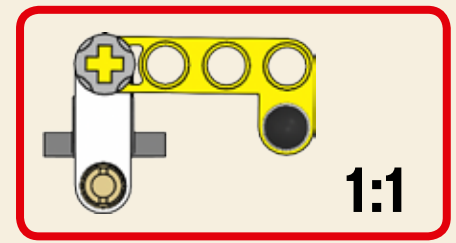
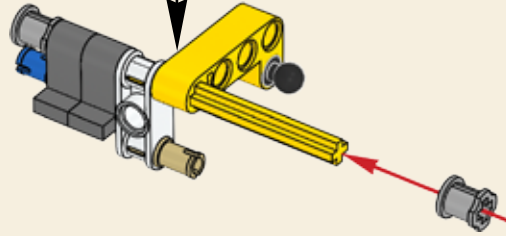
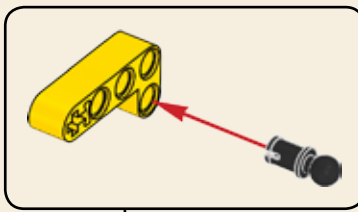

28

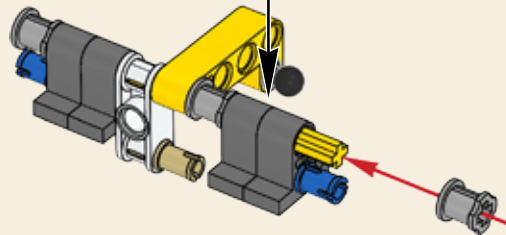
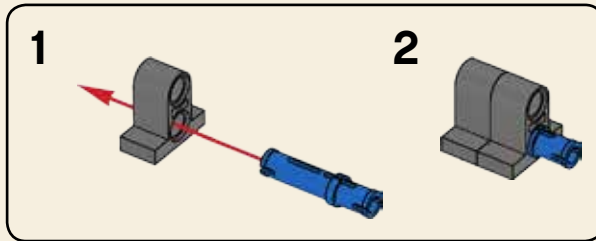

29

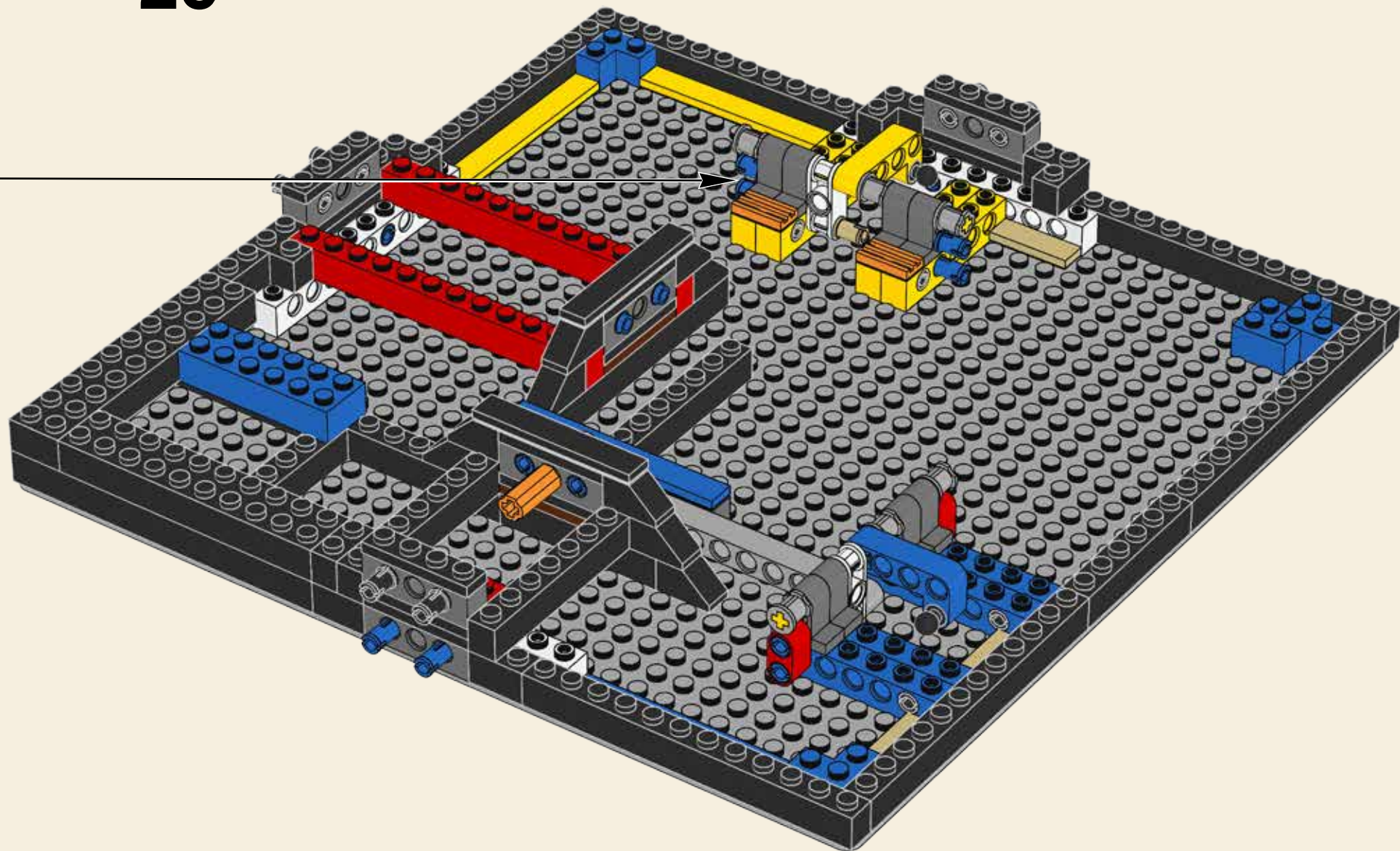
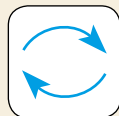

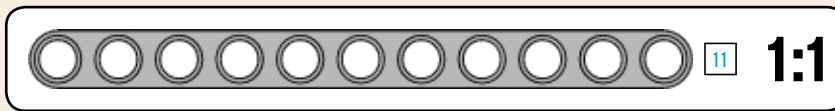
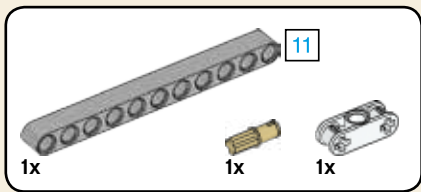

30

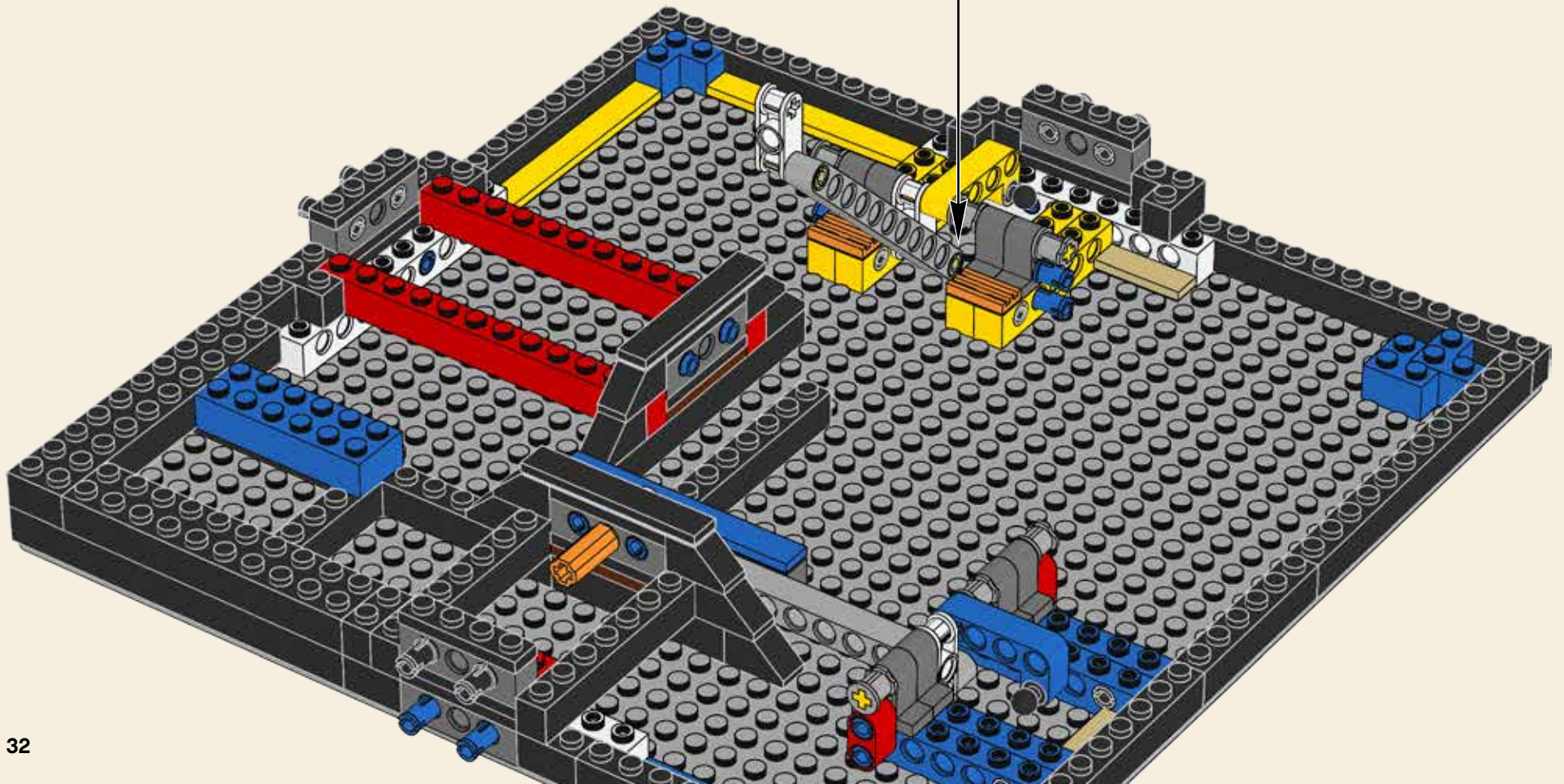
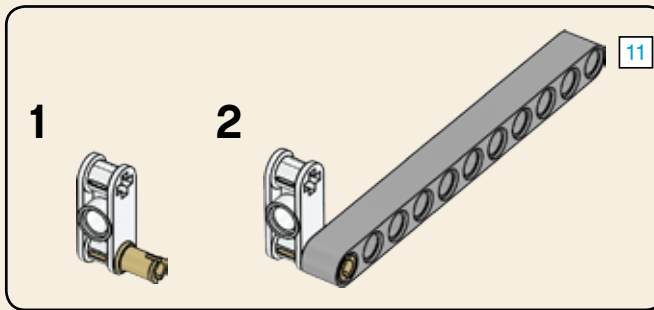



31

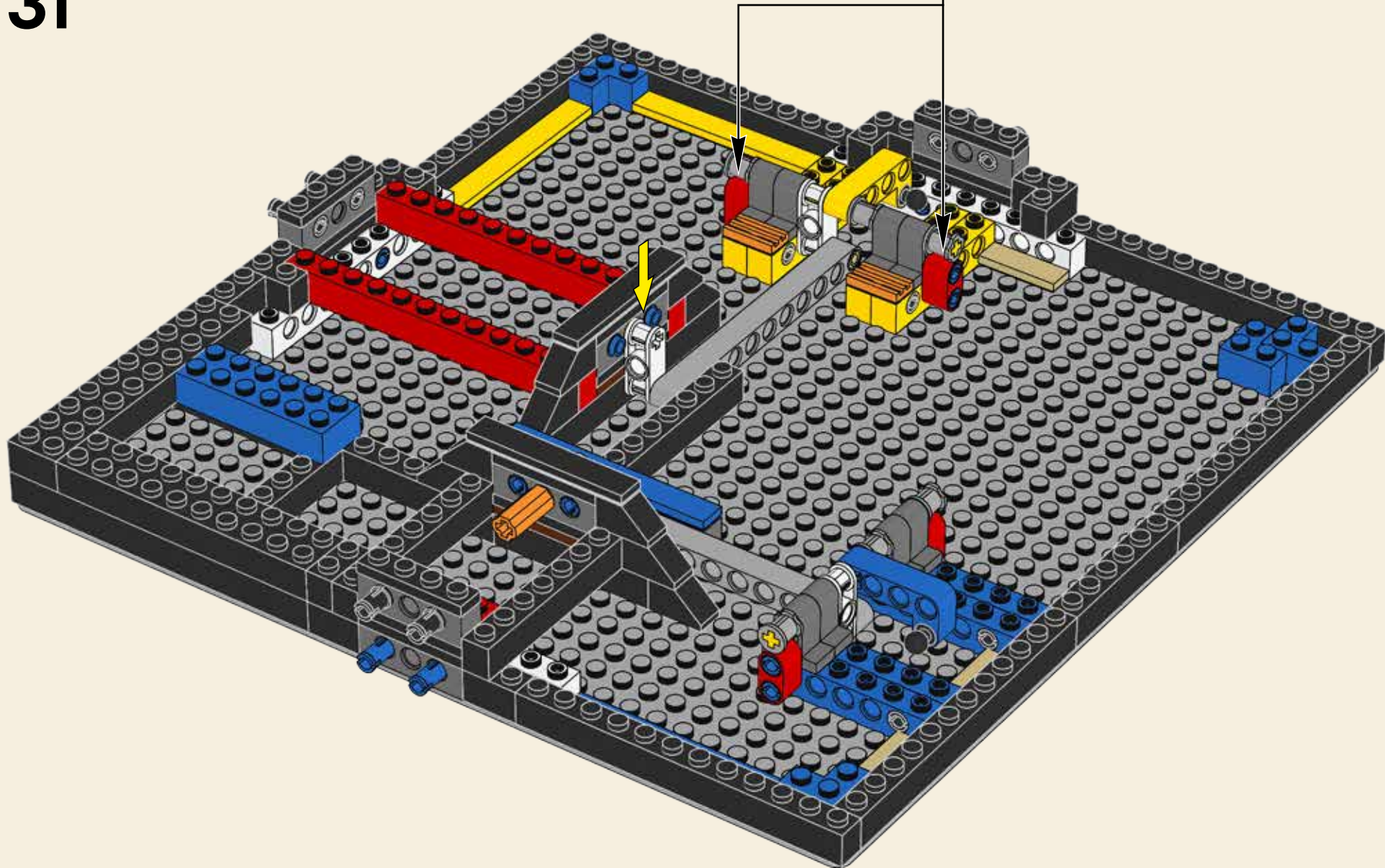
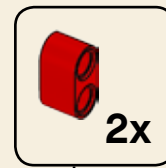

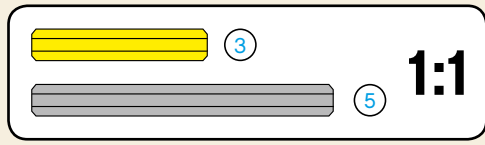
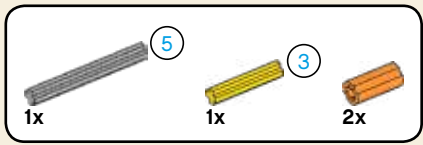

32

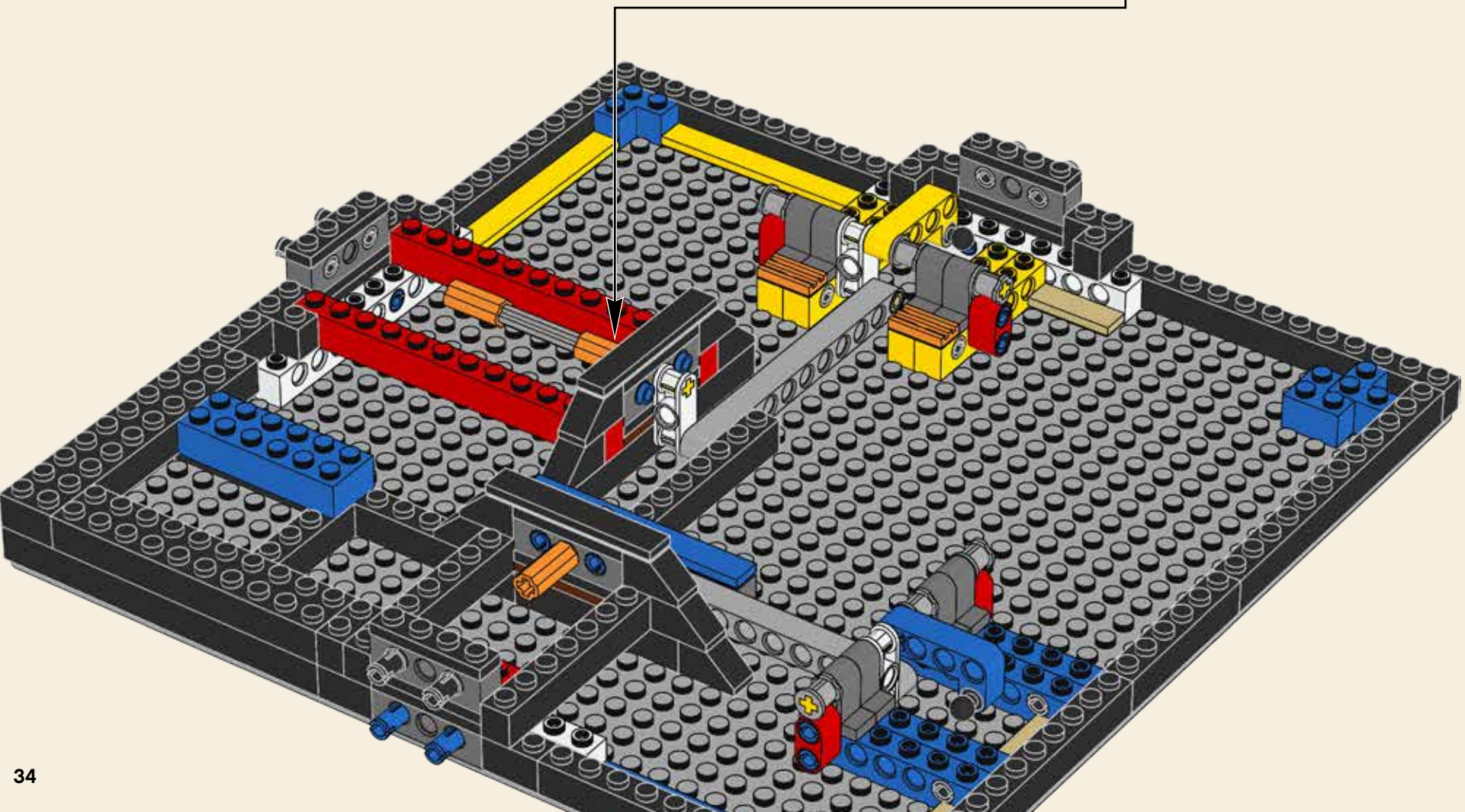
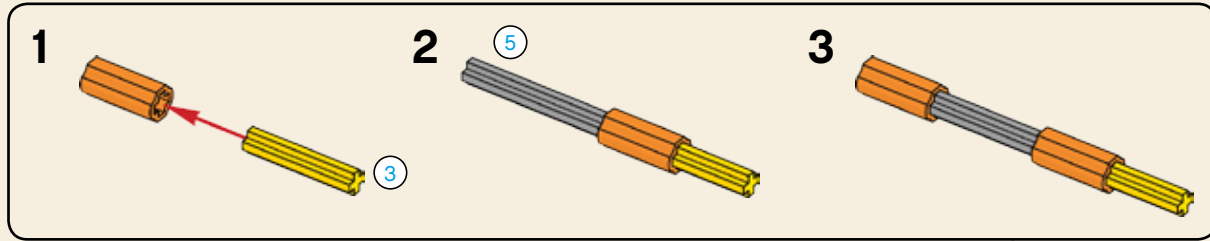

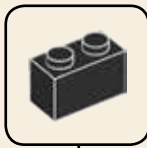
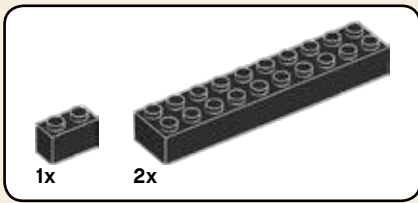

33

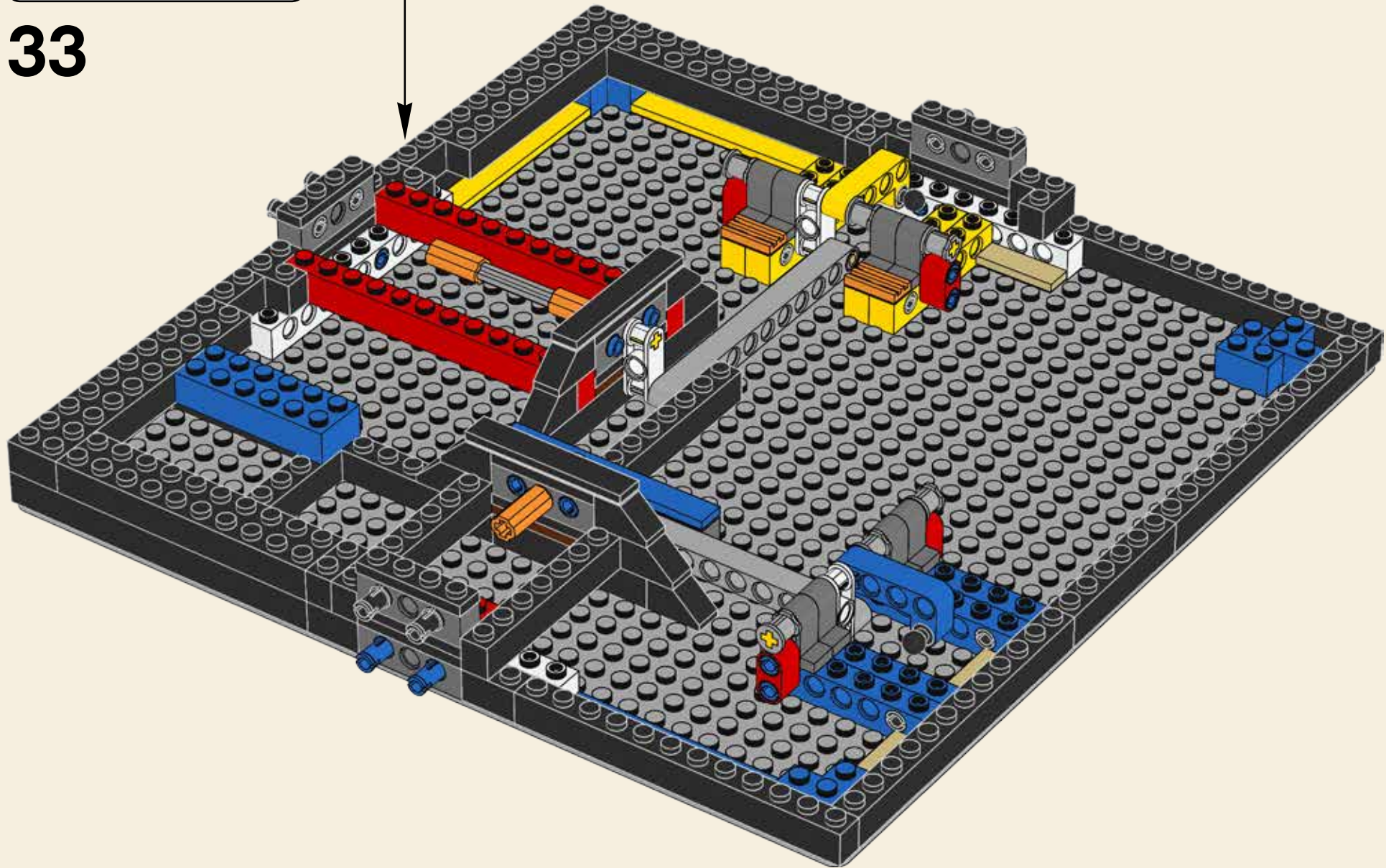

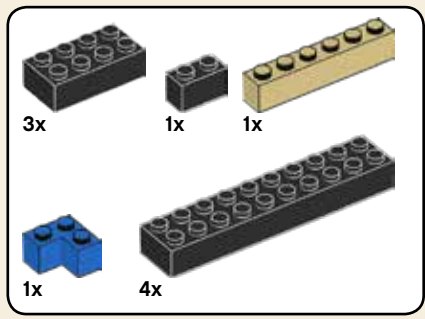

34

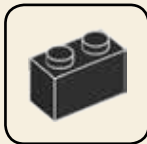
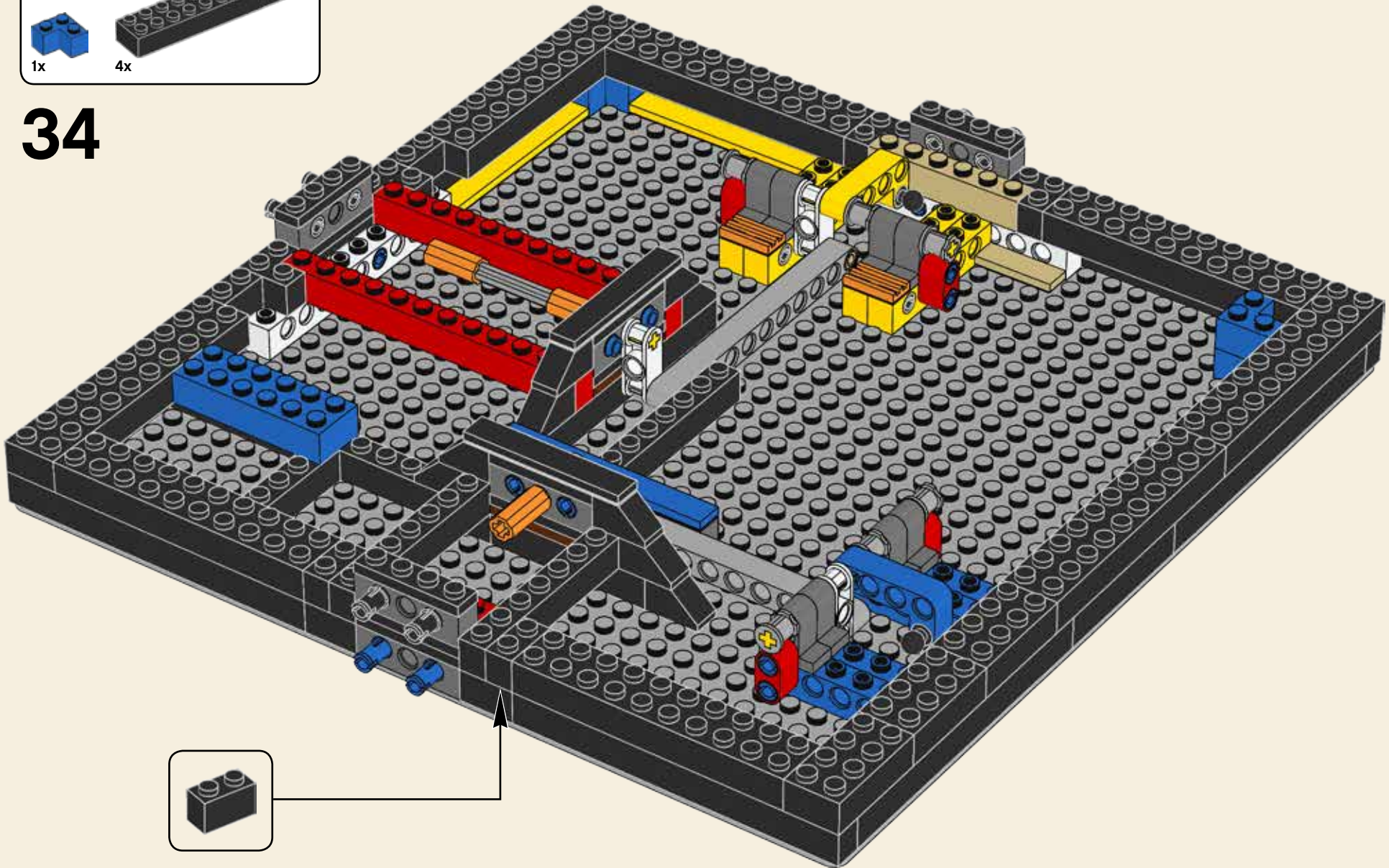

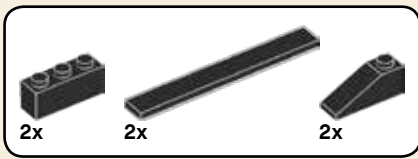

35

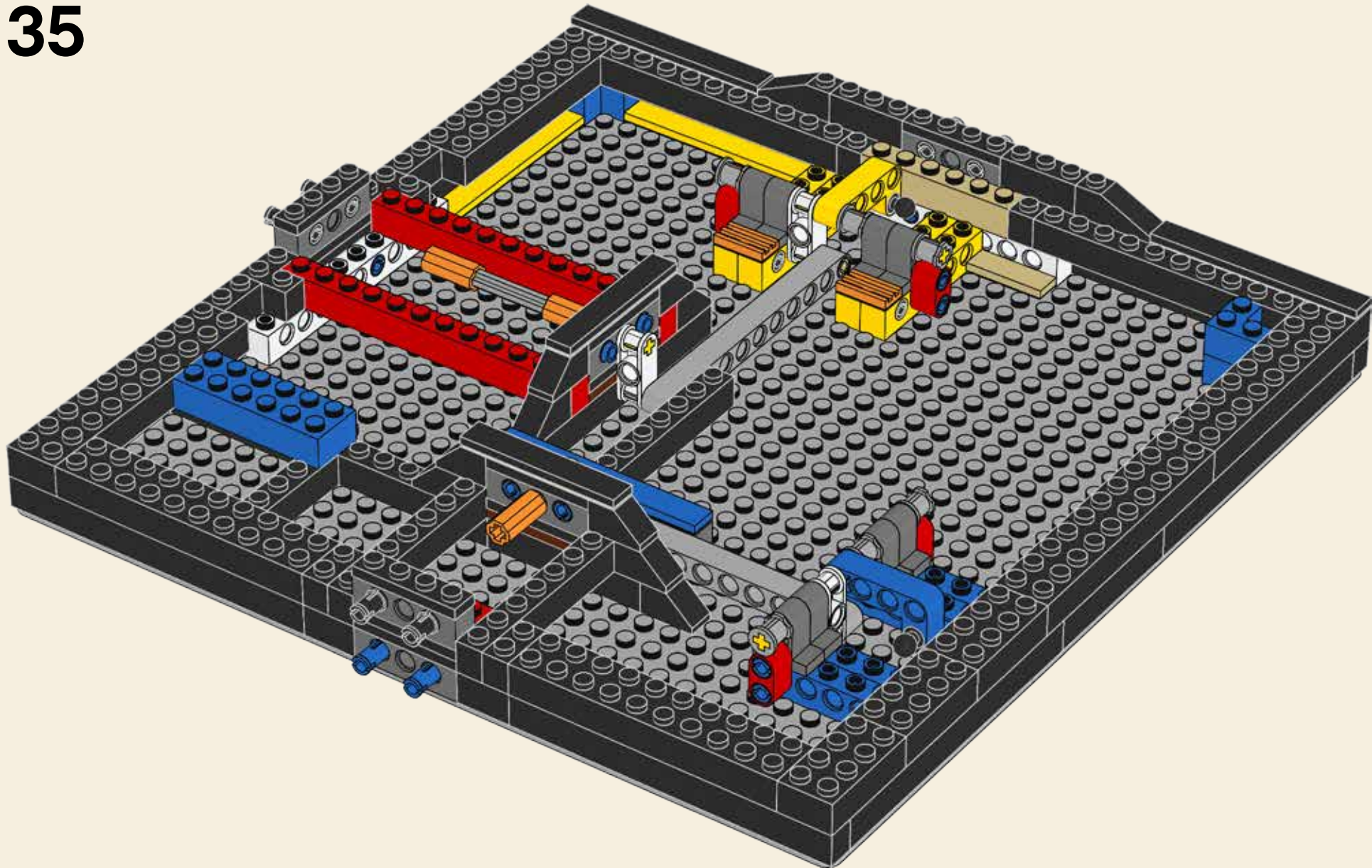

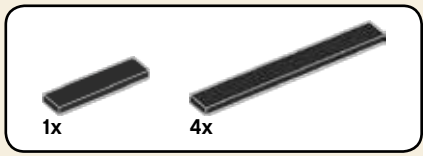

36

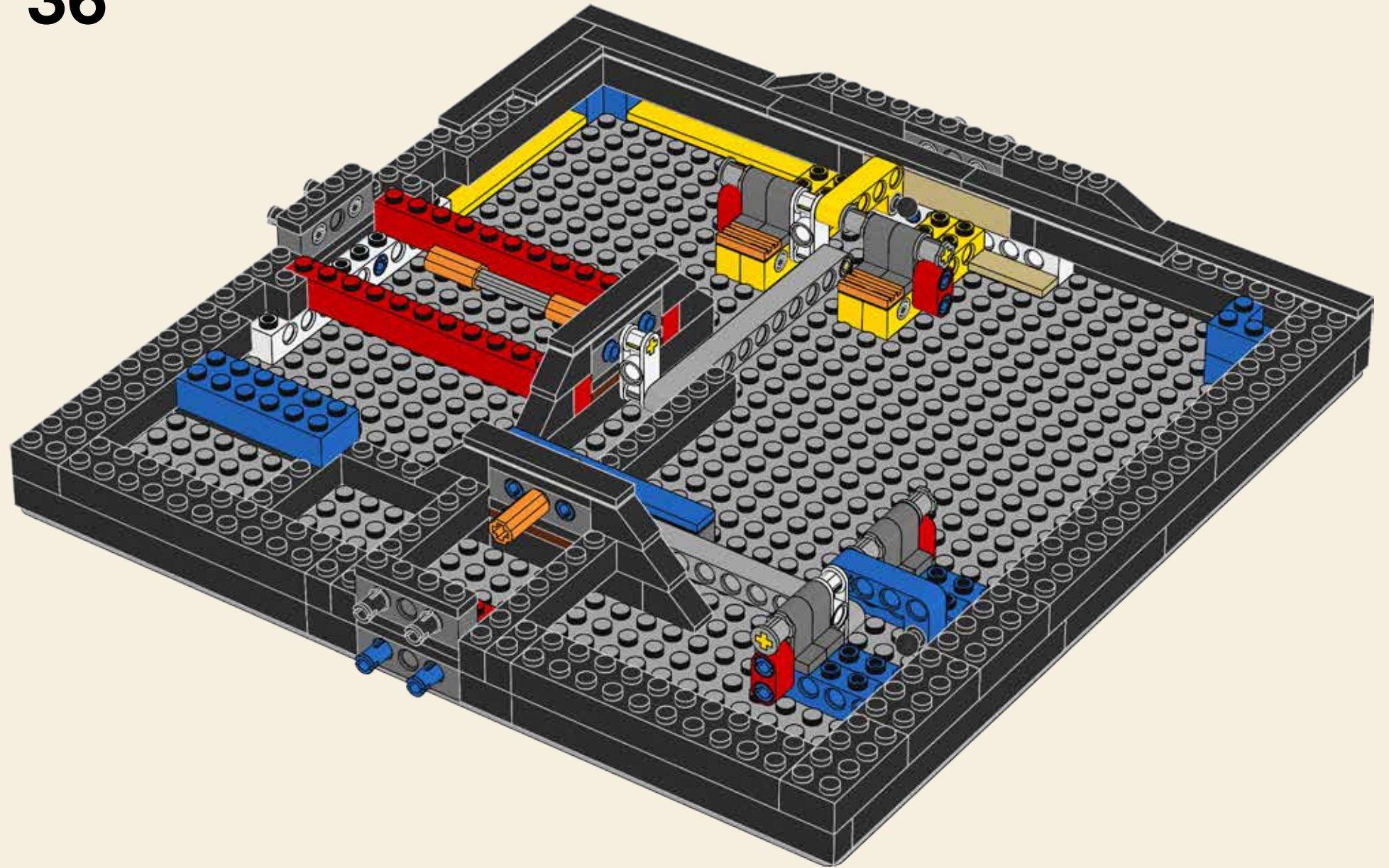

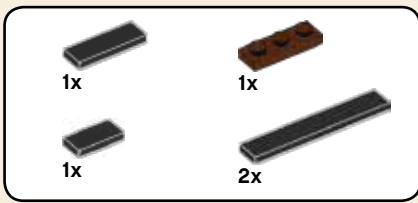

37

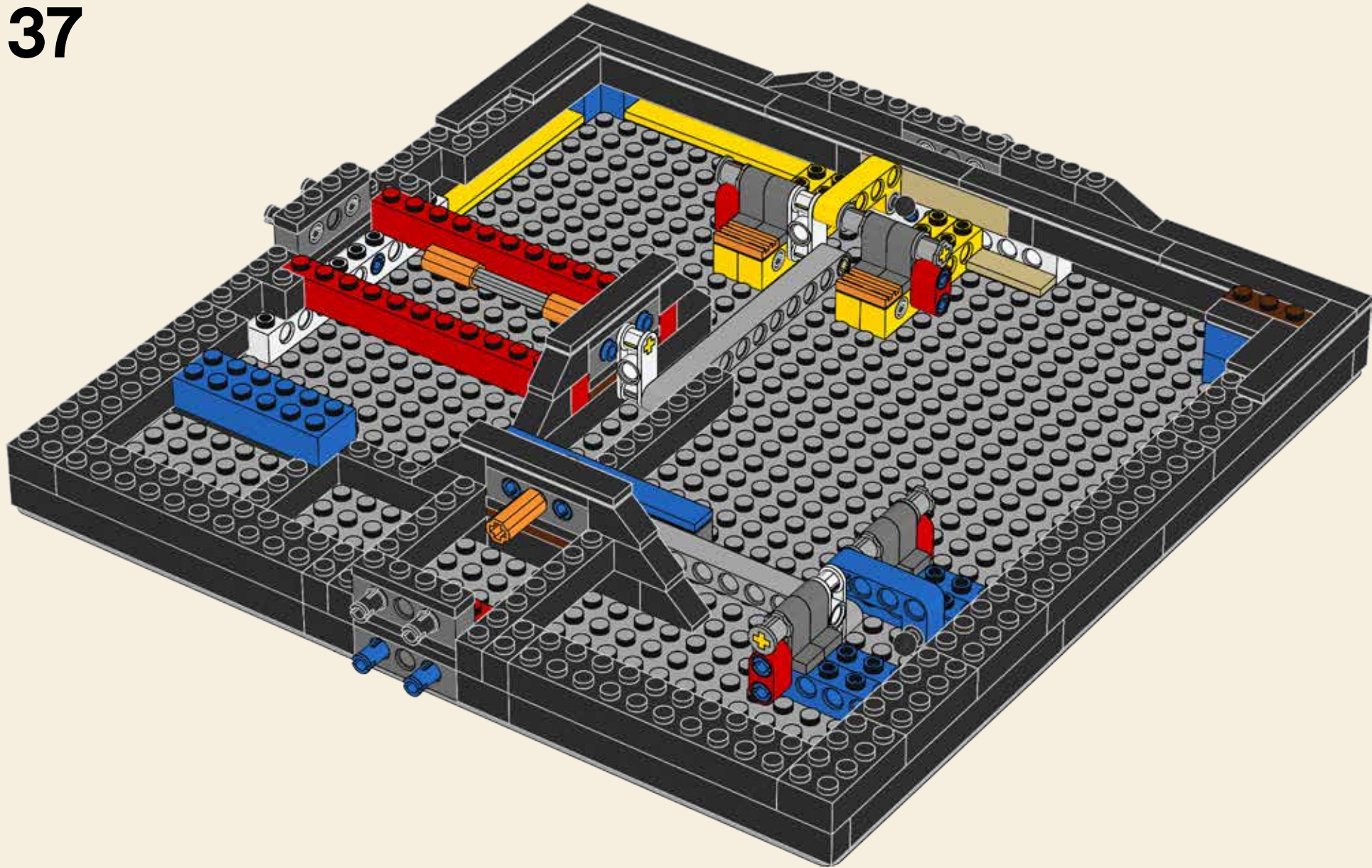



38

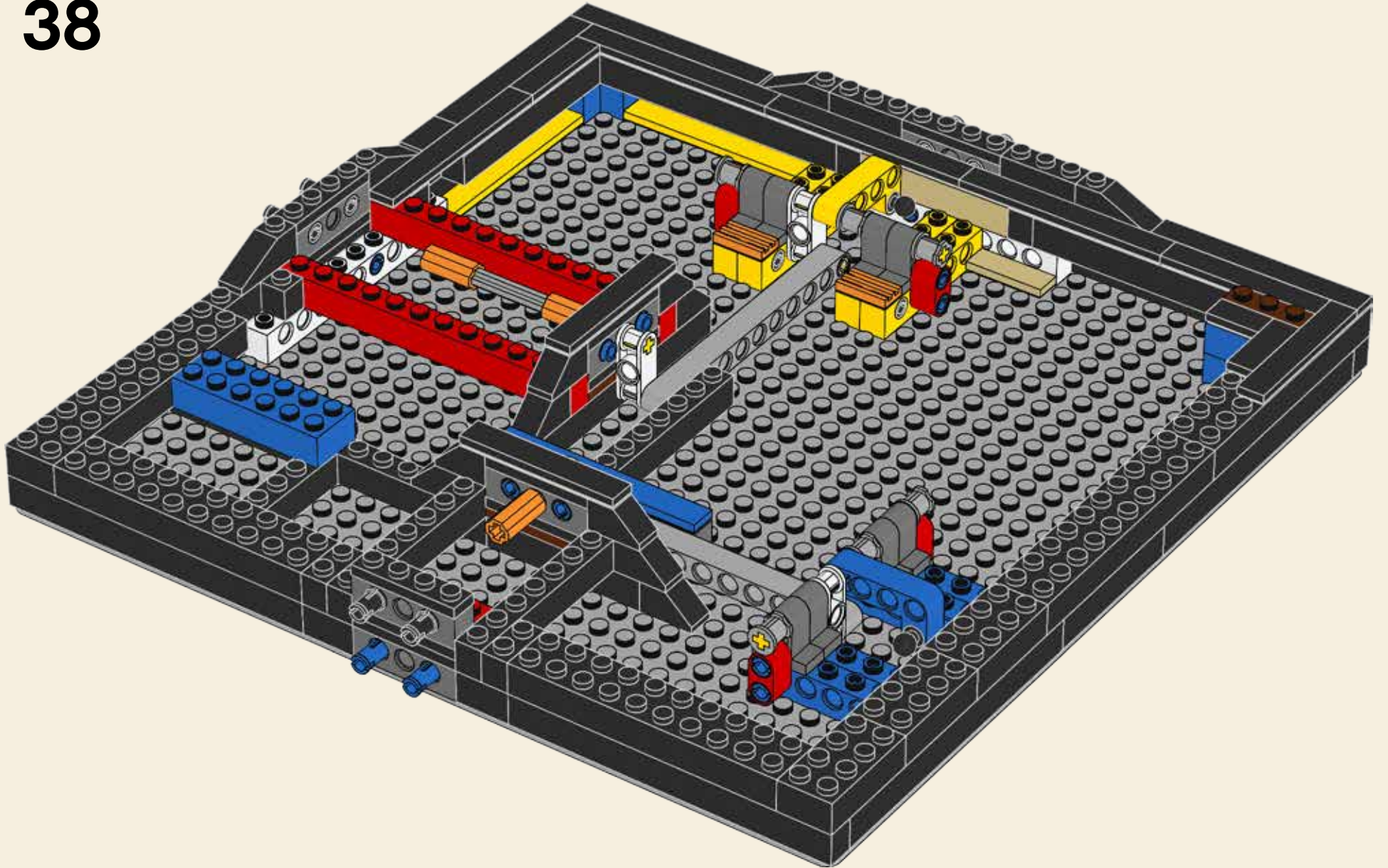

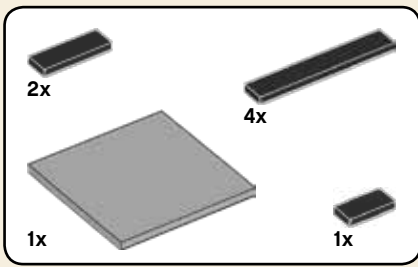

39

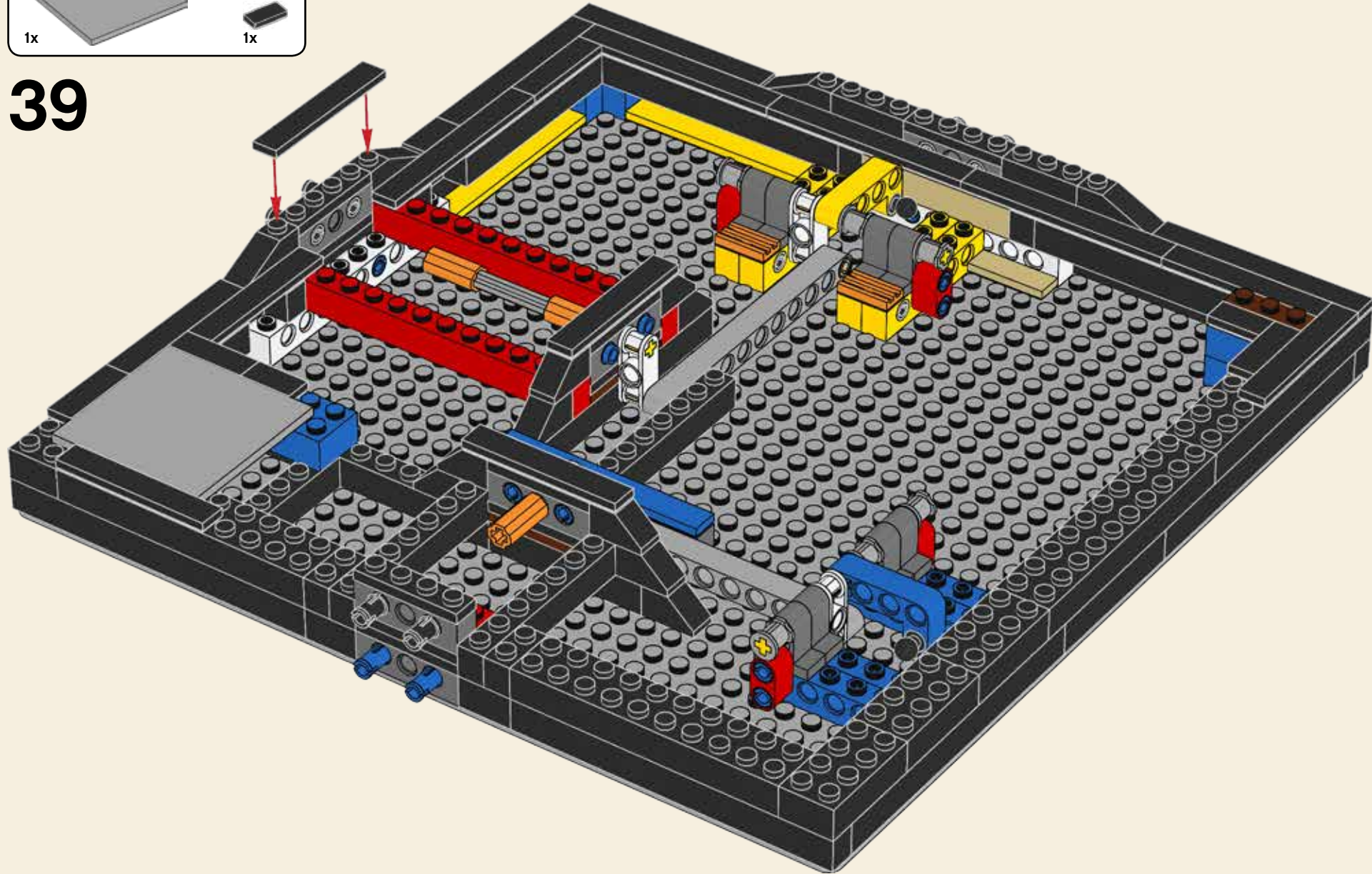

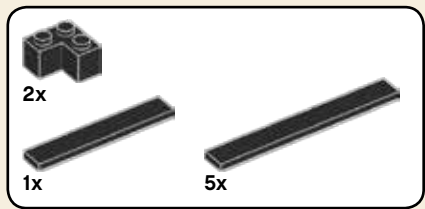

40

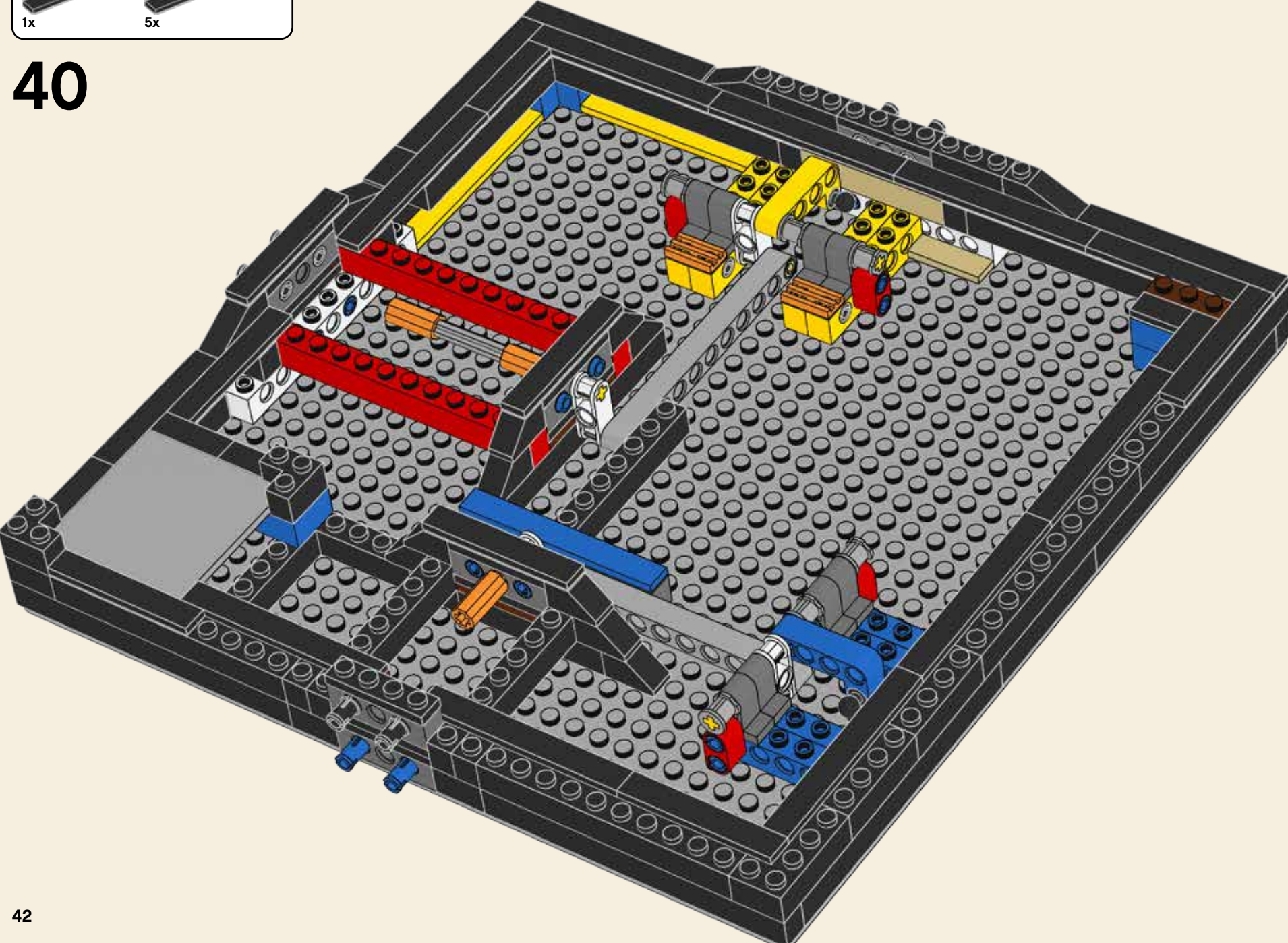



41

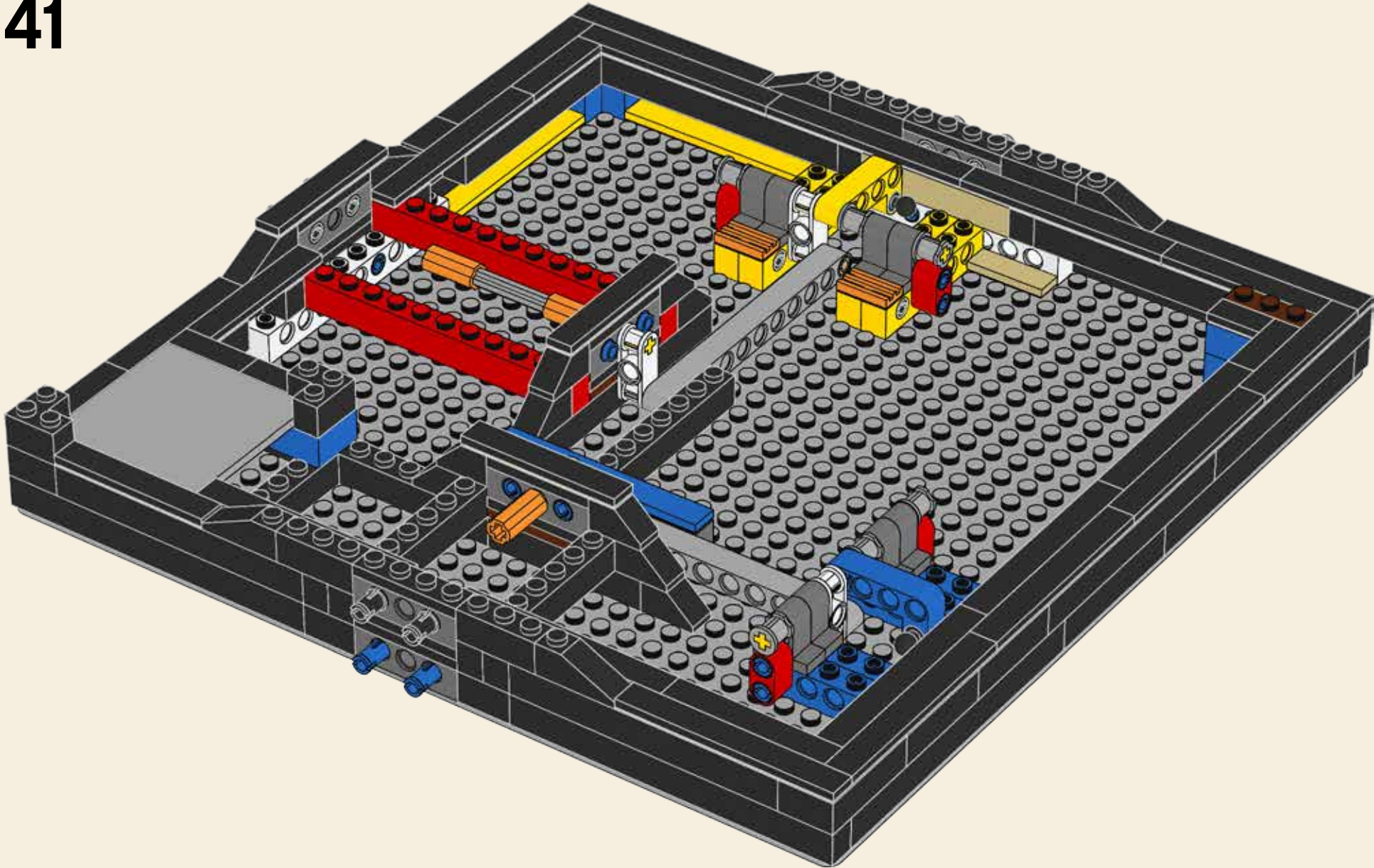

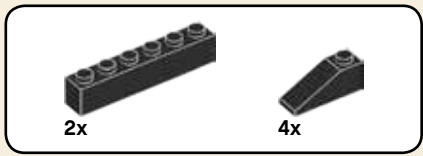

42

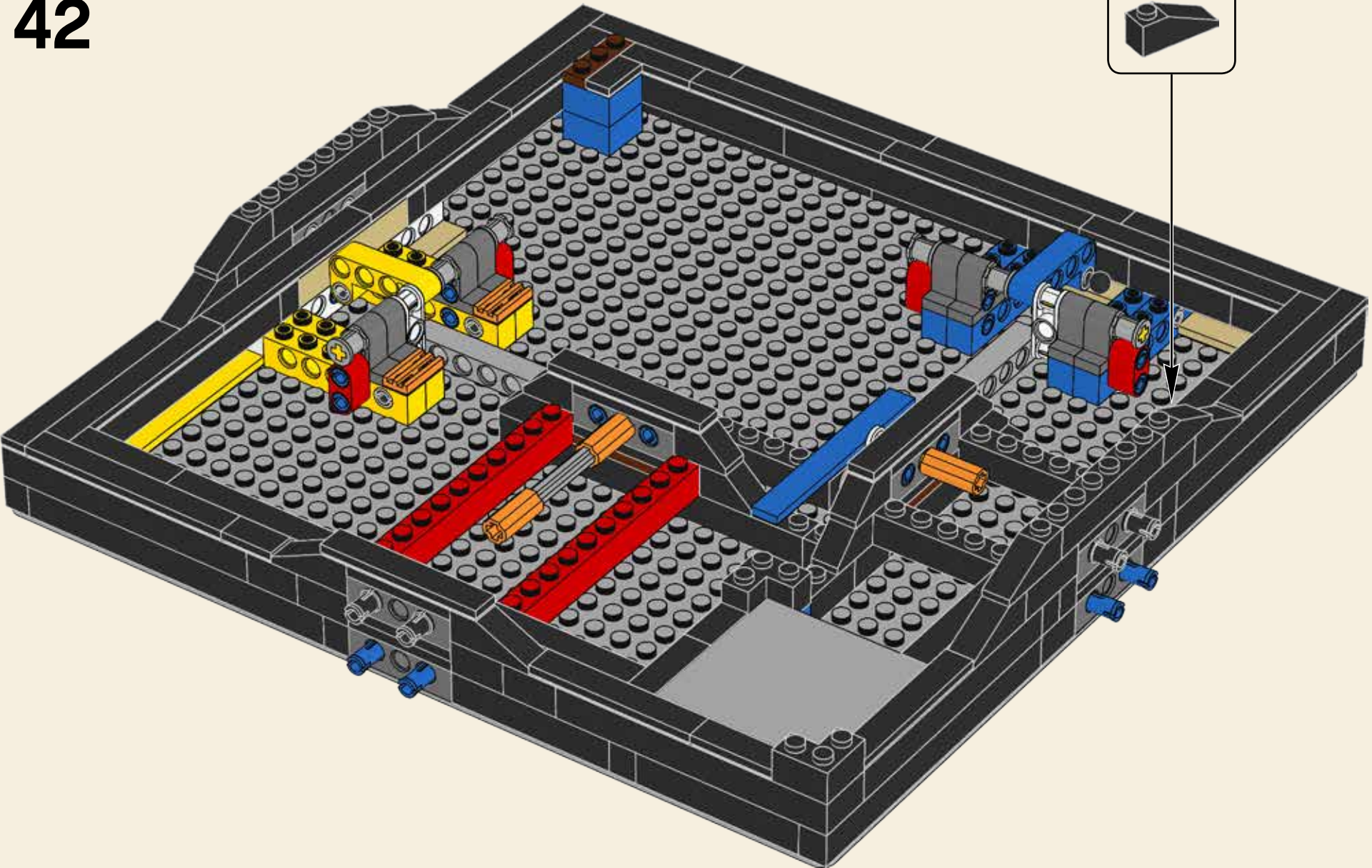
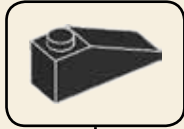



43

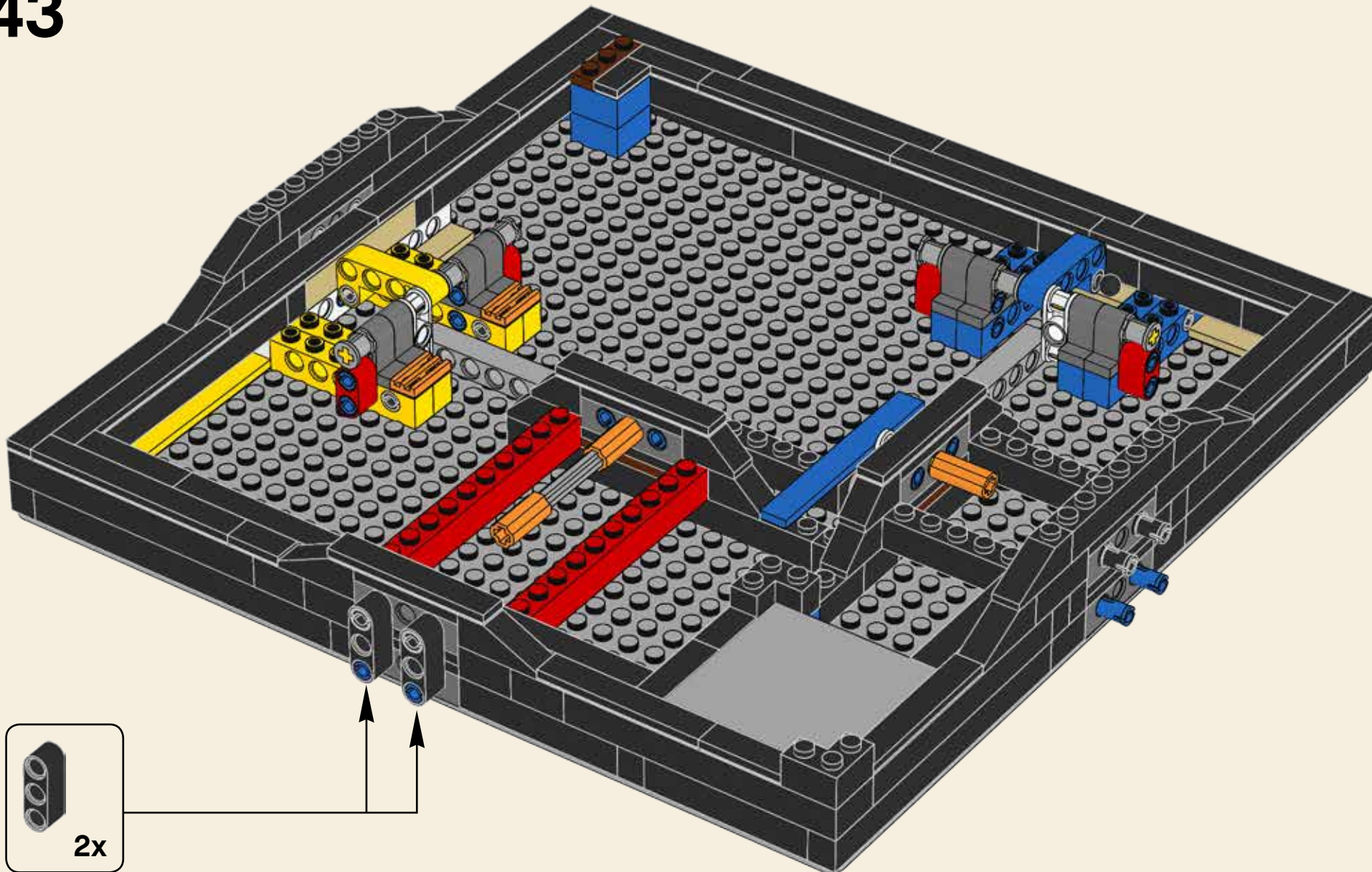

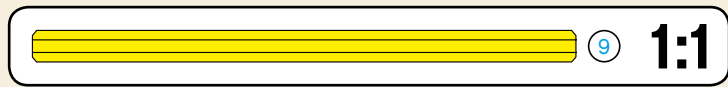
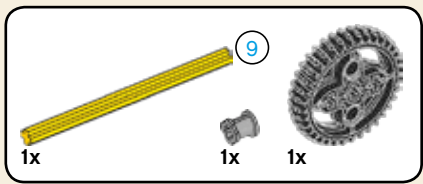

44

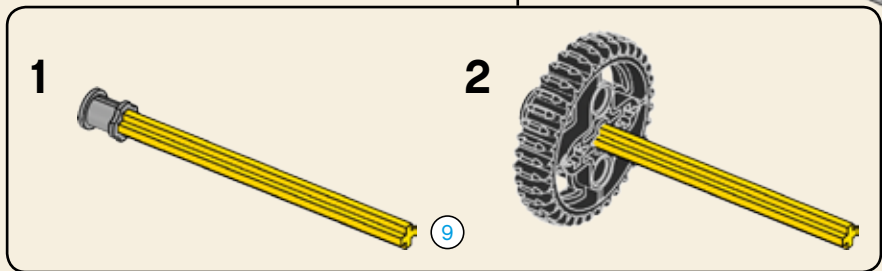
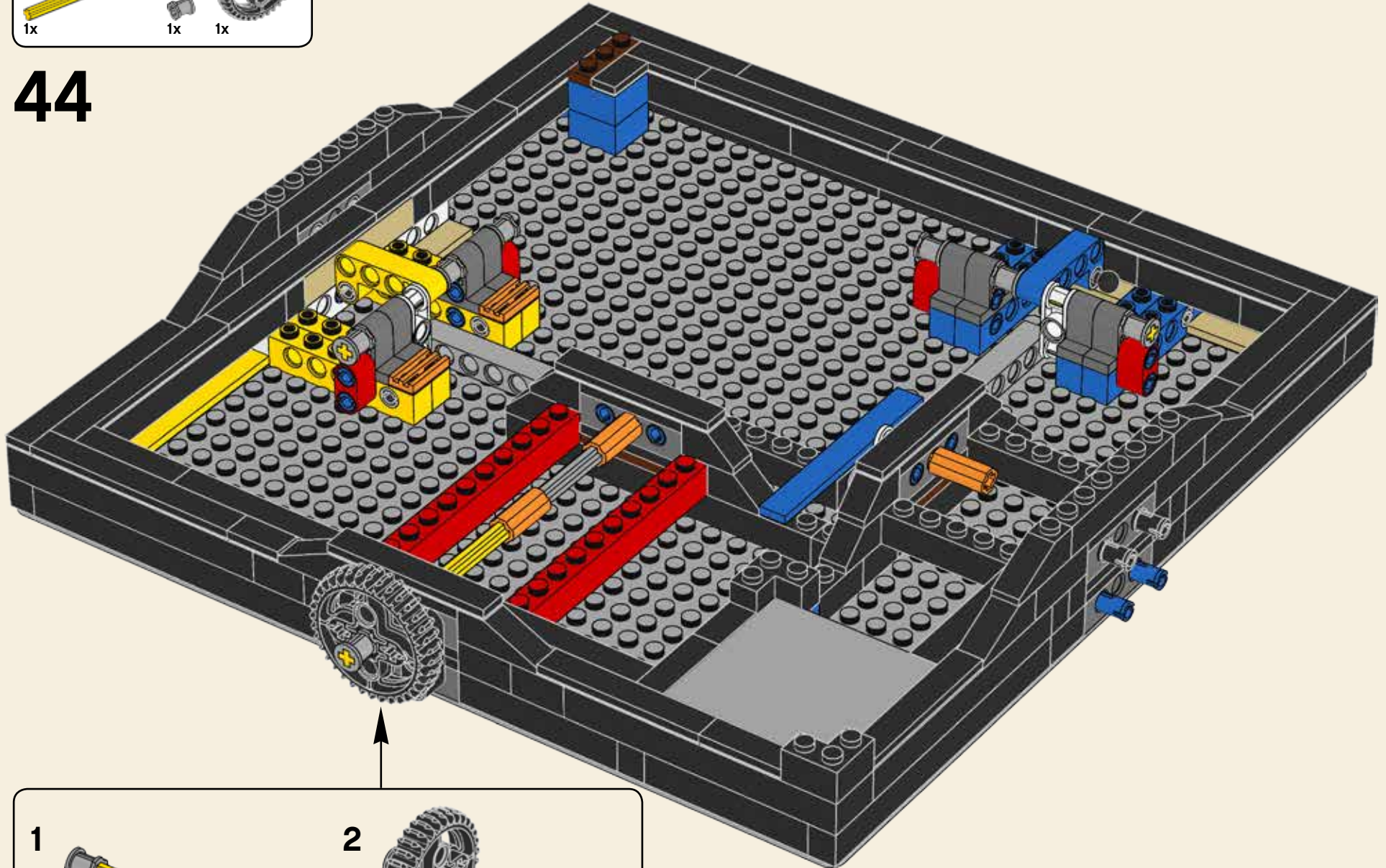

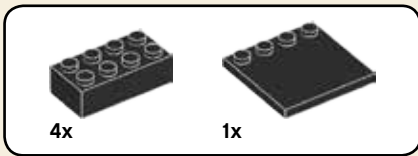

45

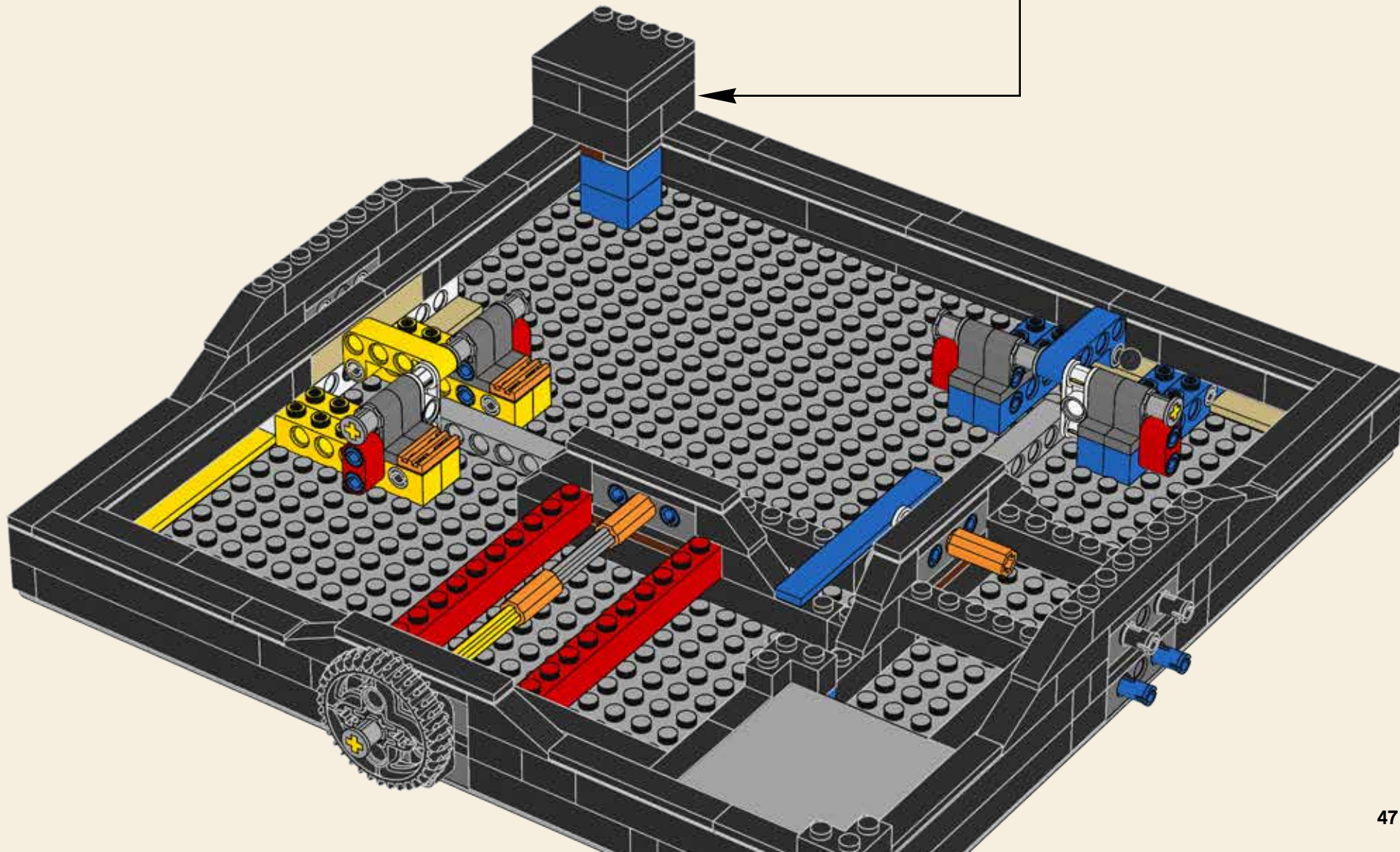
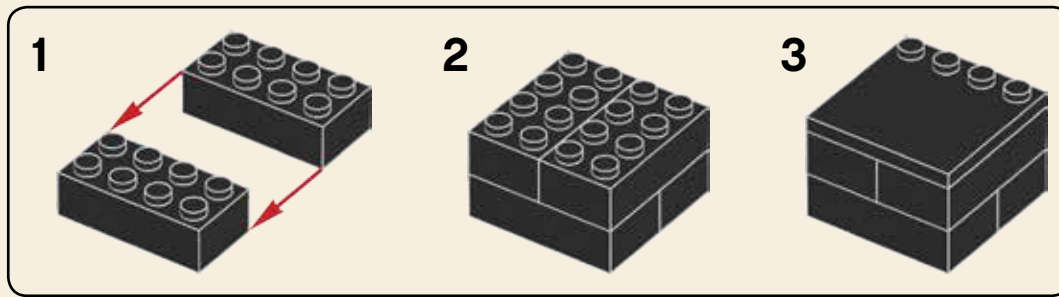

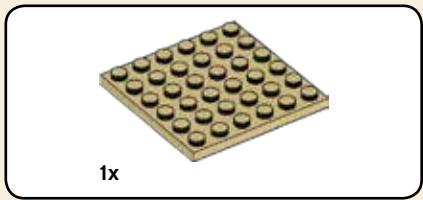

46

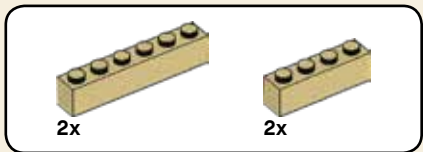
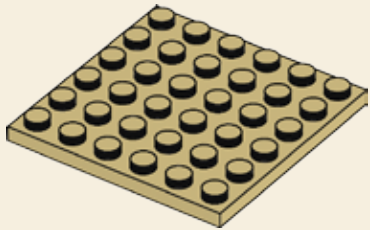

47

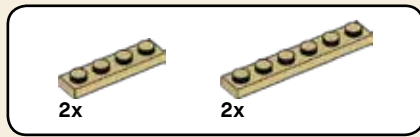
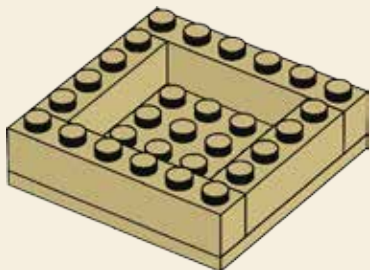

48

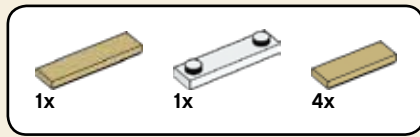
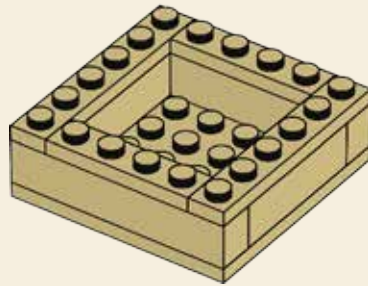

49

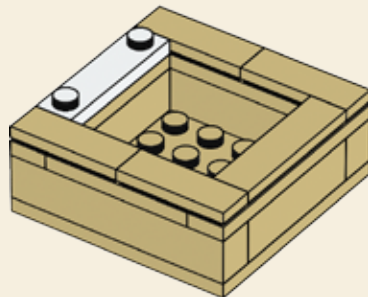

50

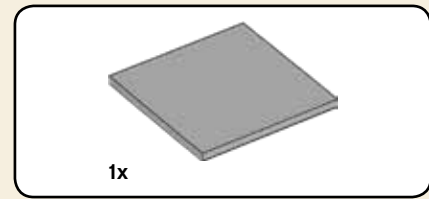
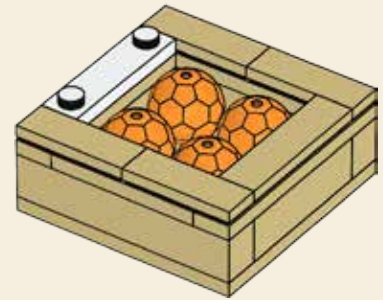

51

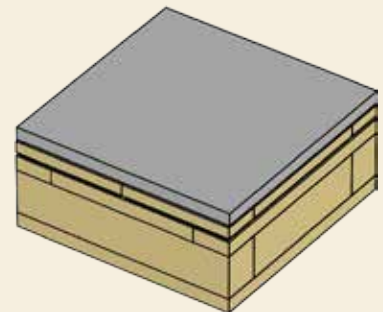

52

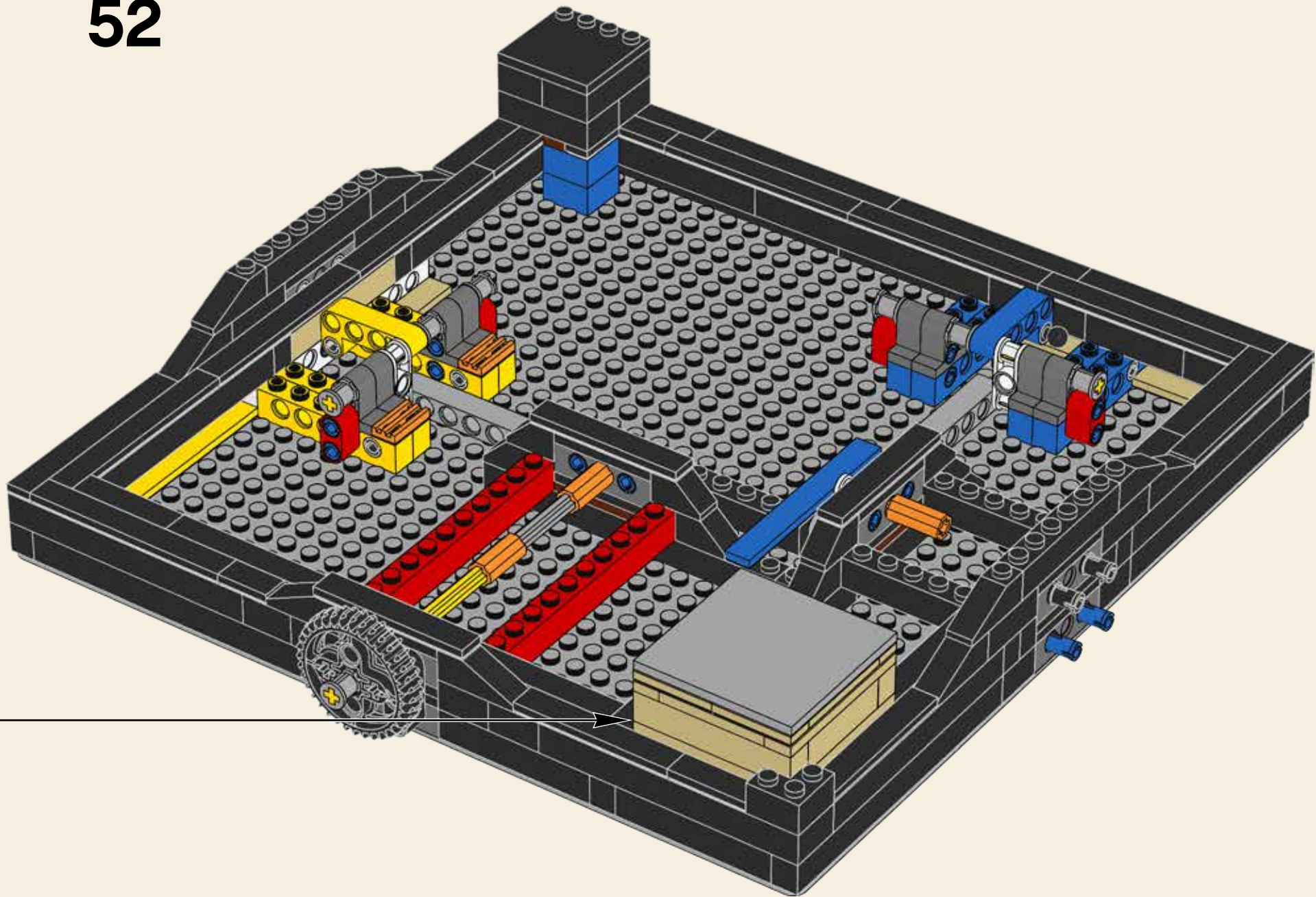

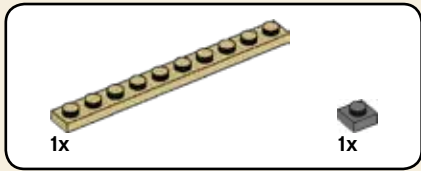
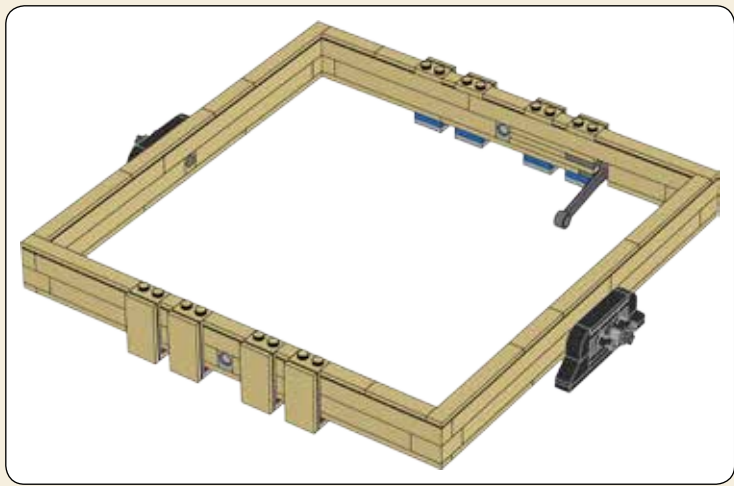

53

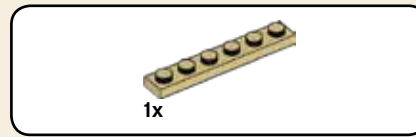
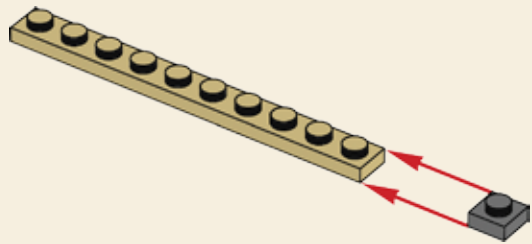

54

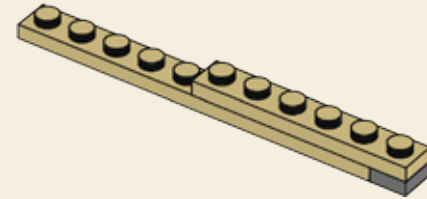

55

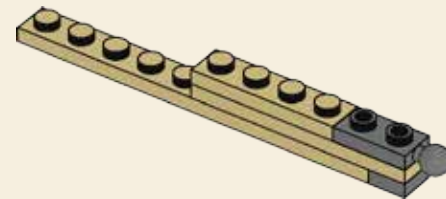

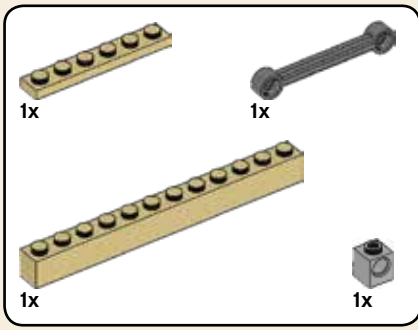

56

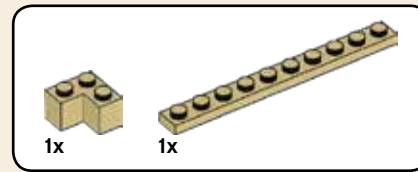
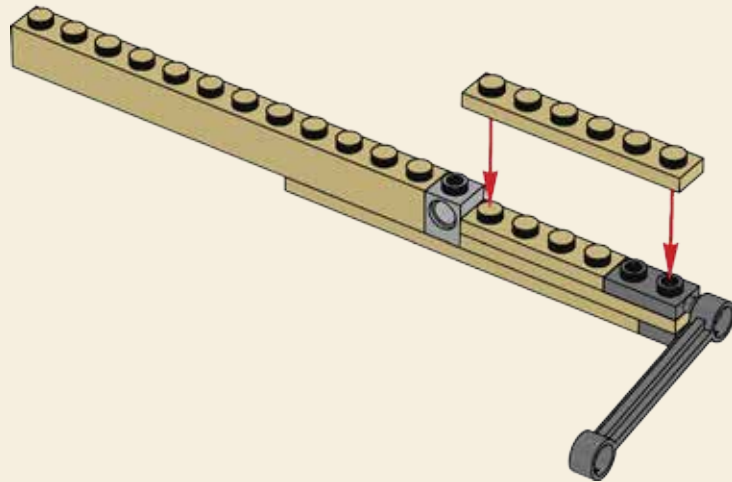

57

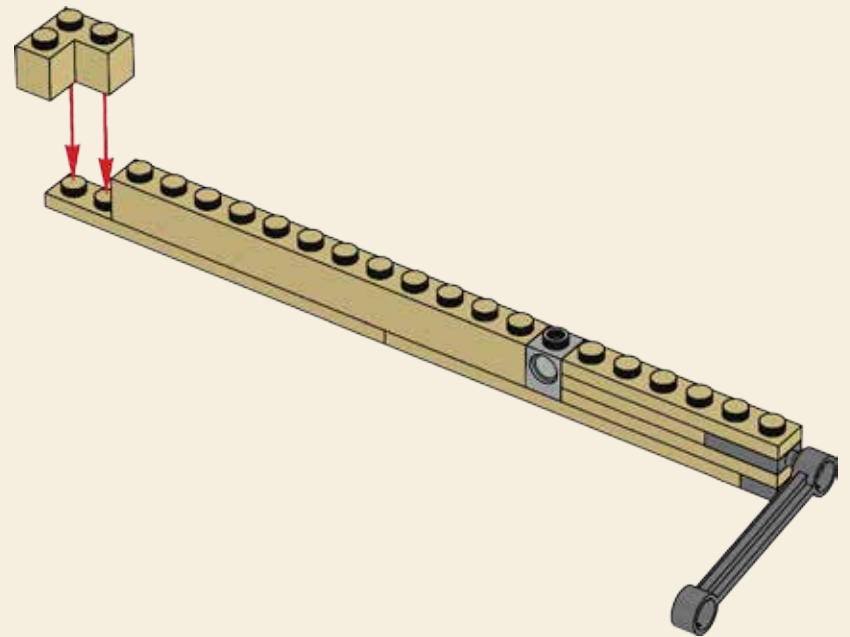

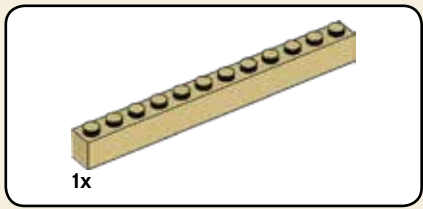

58

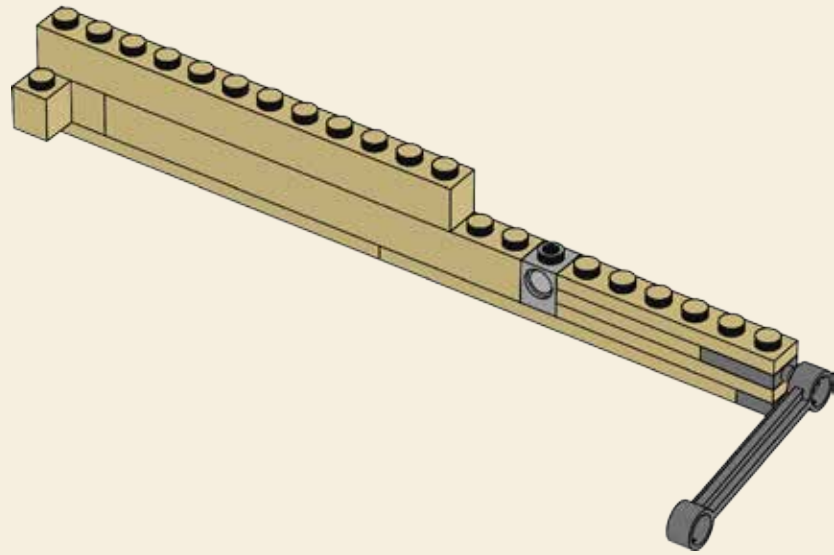

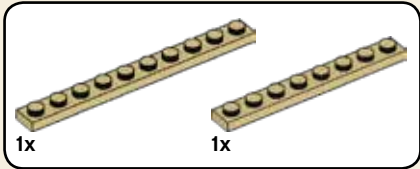
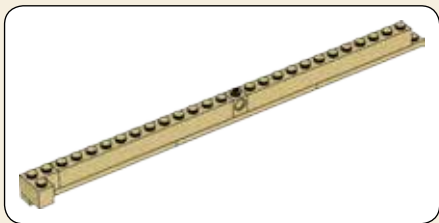

59

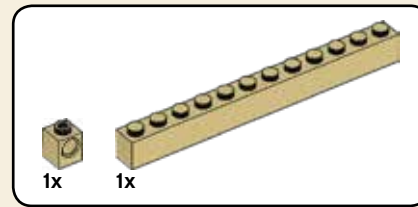
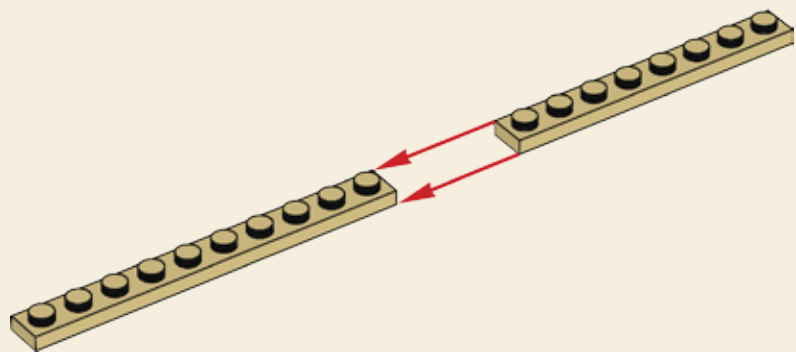

60

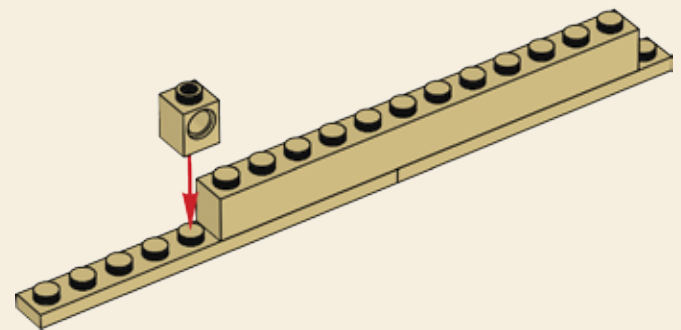

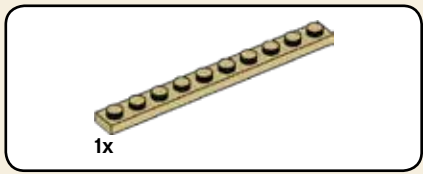

61

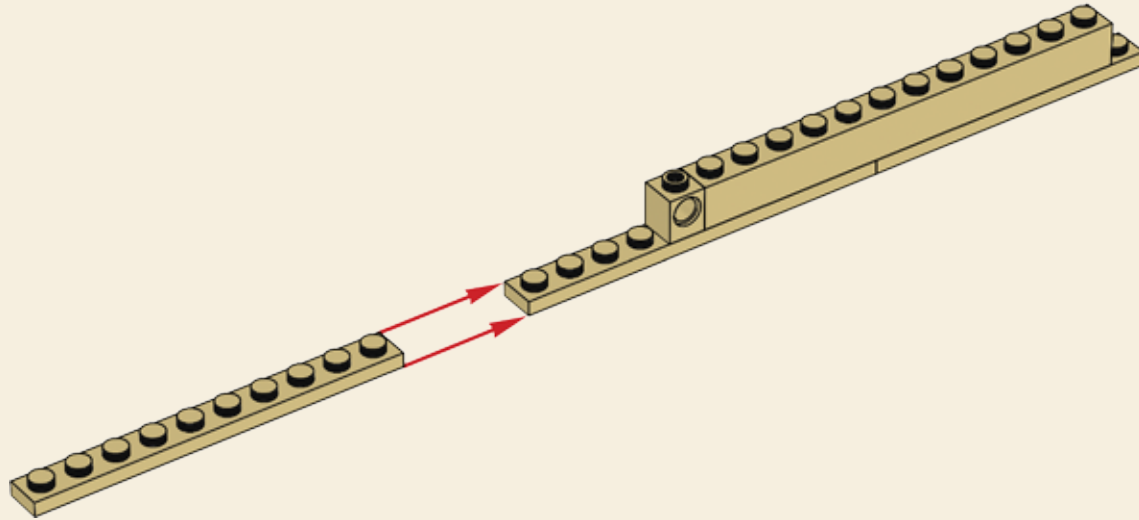

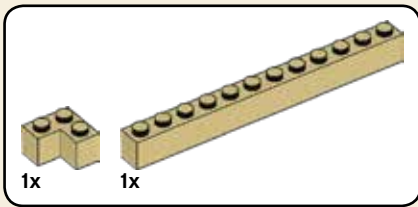

62

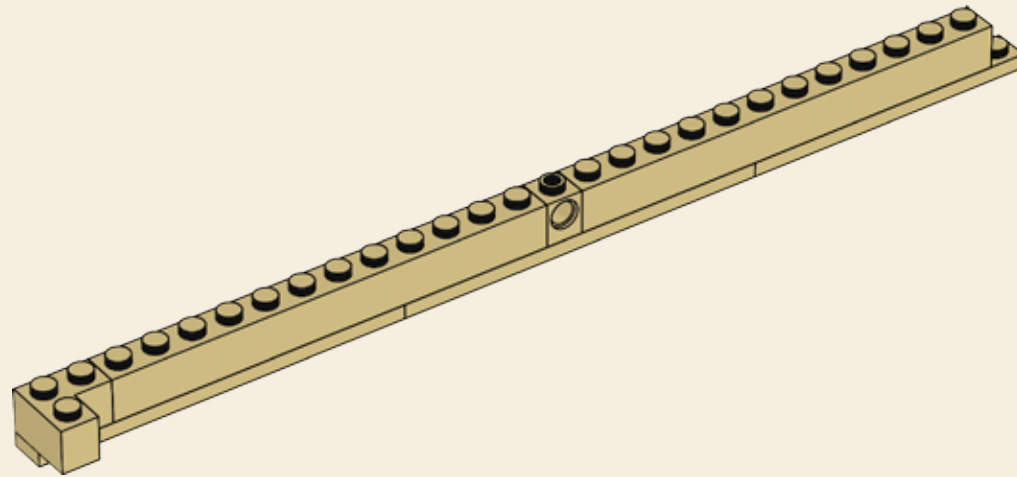

63

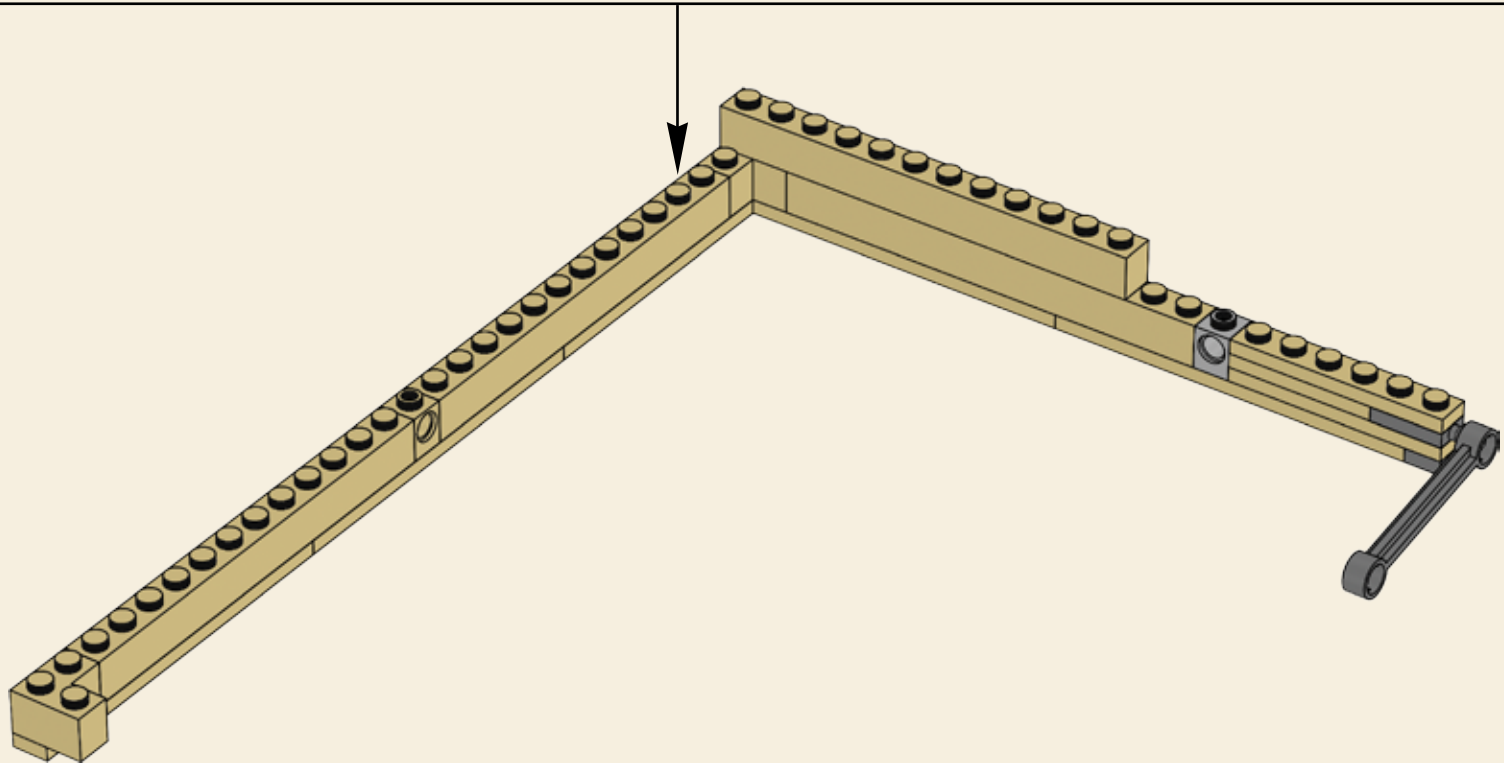

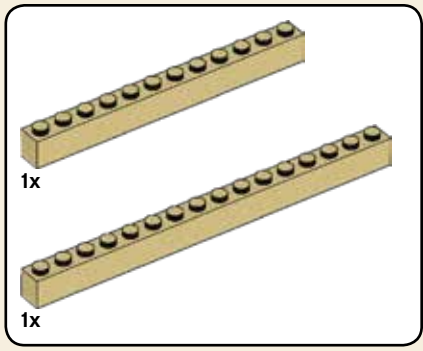

64

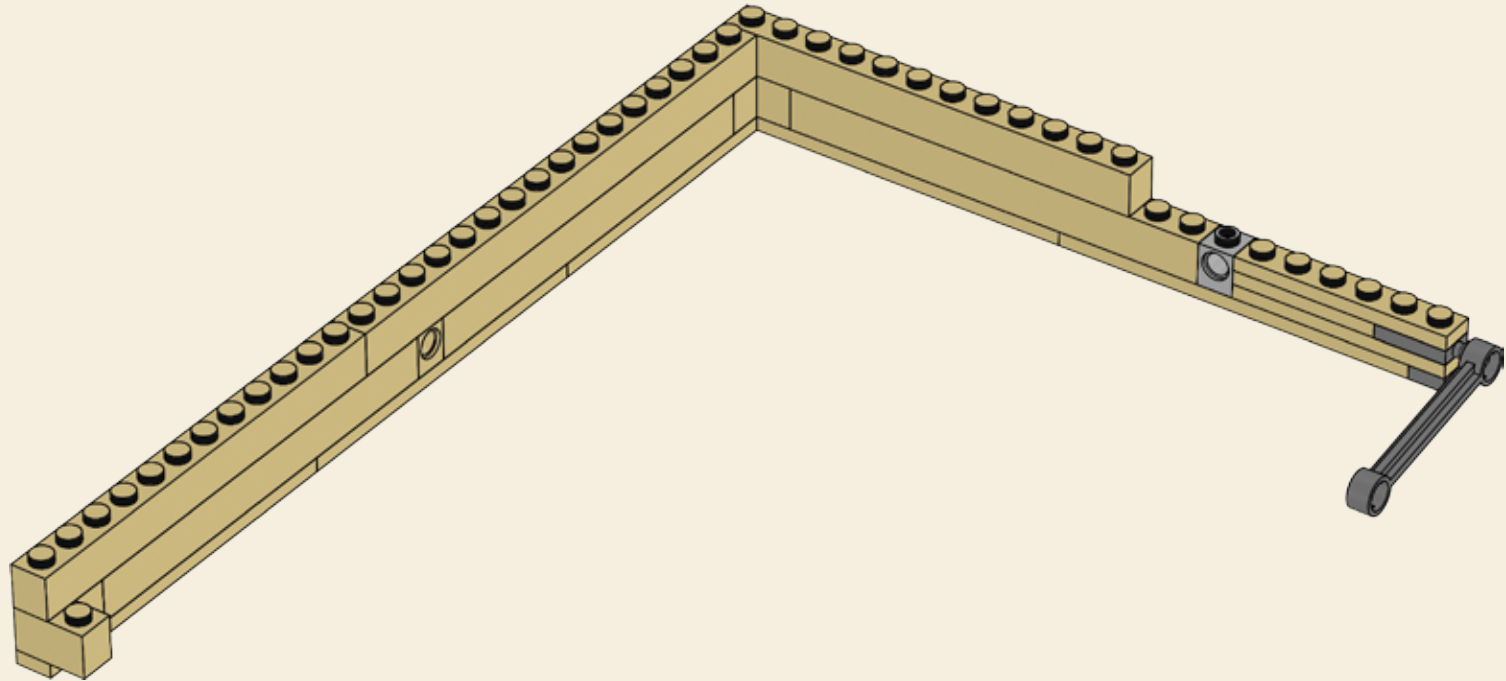

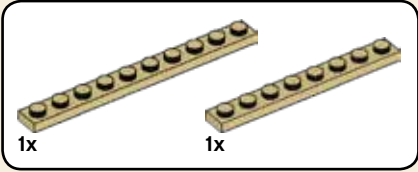
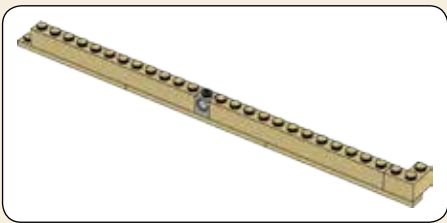

65

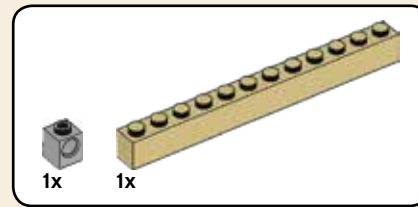
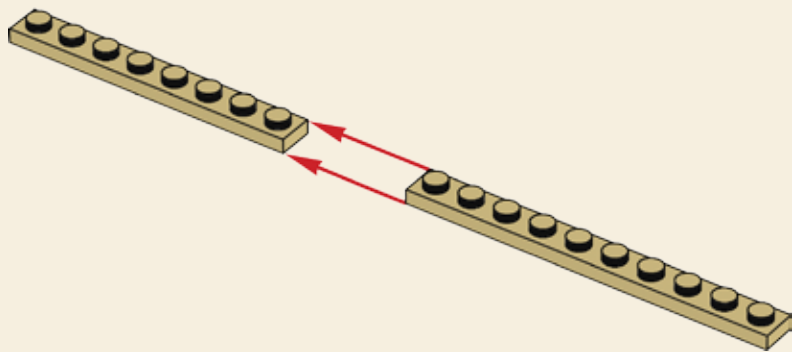

66

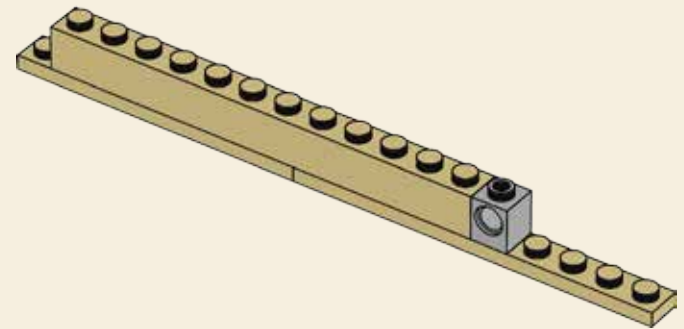

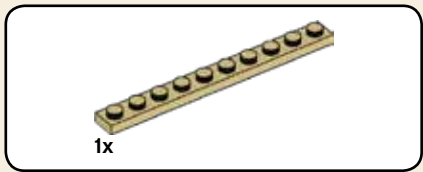

67

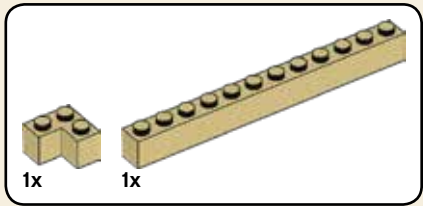
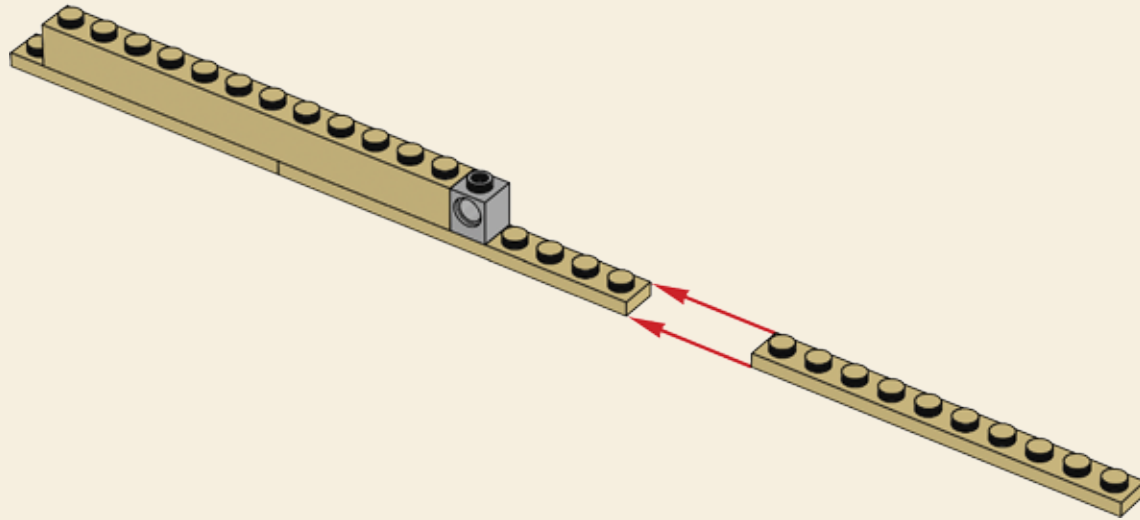

68

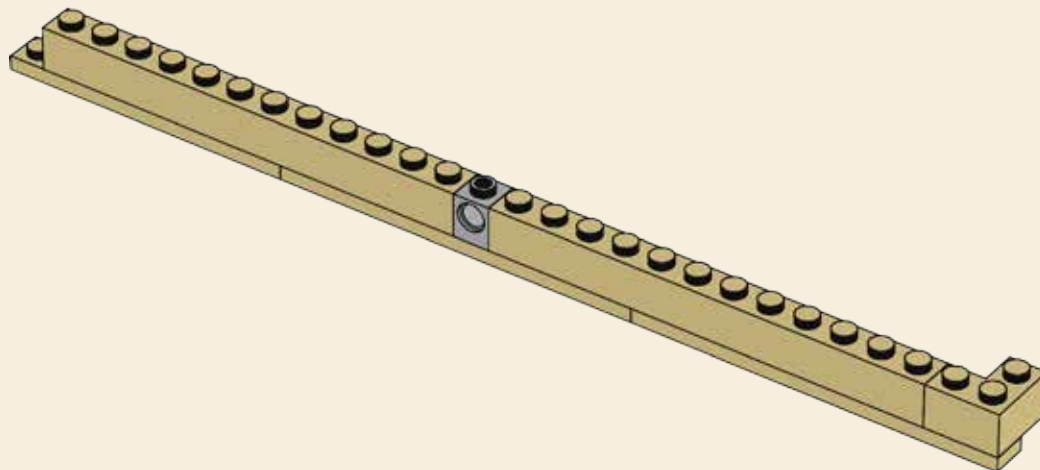

69

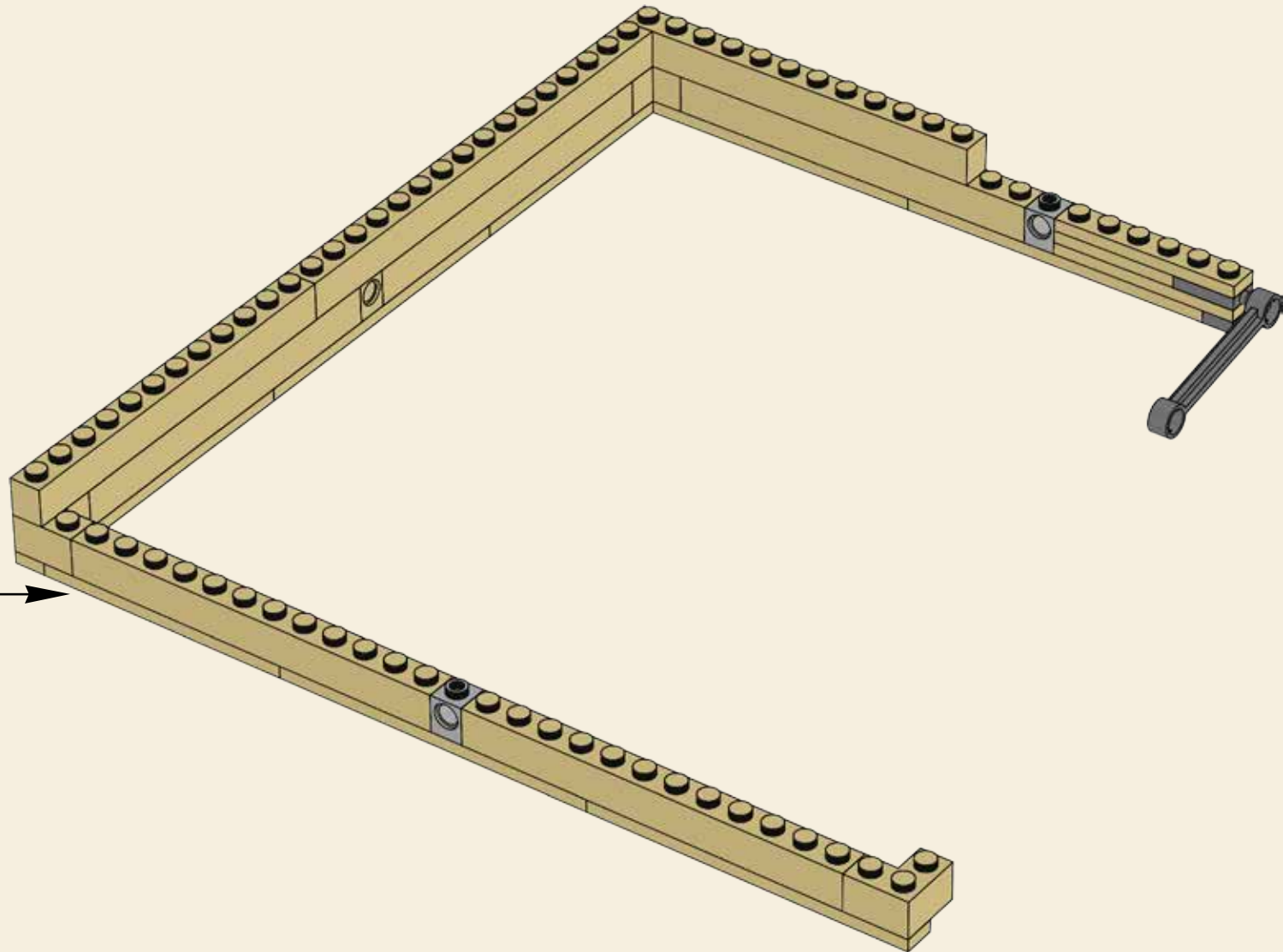

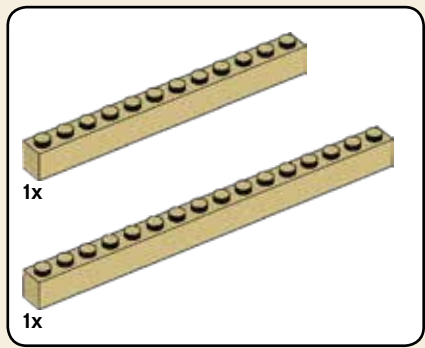

70

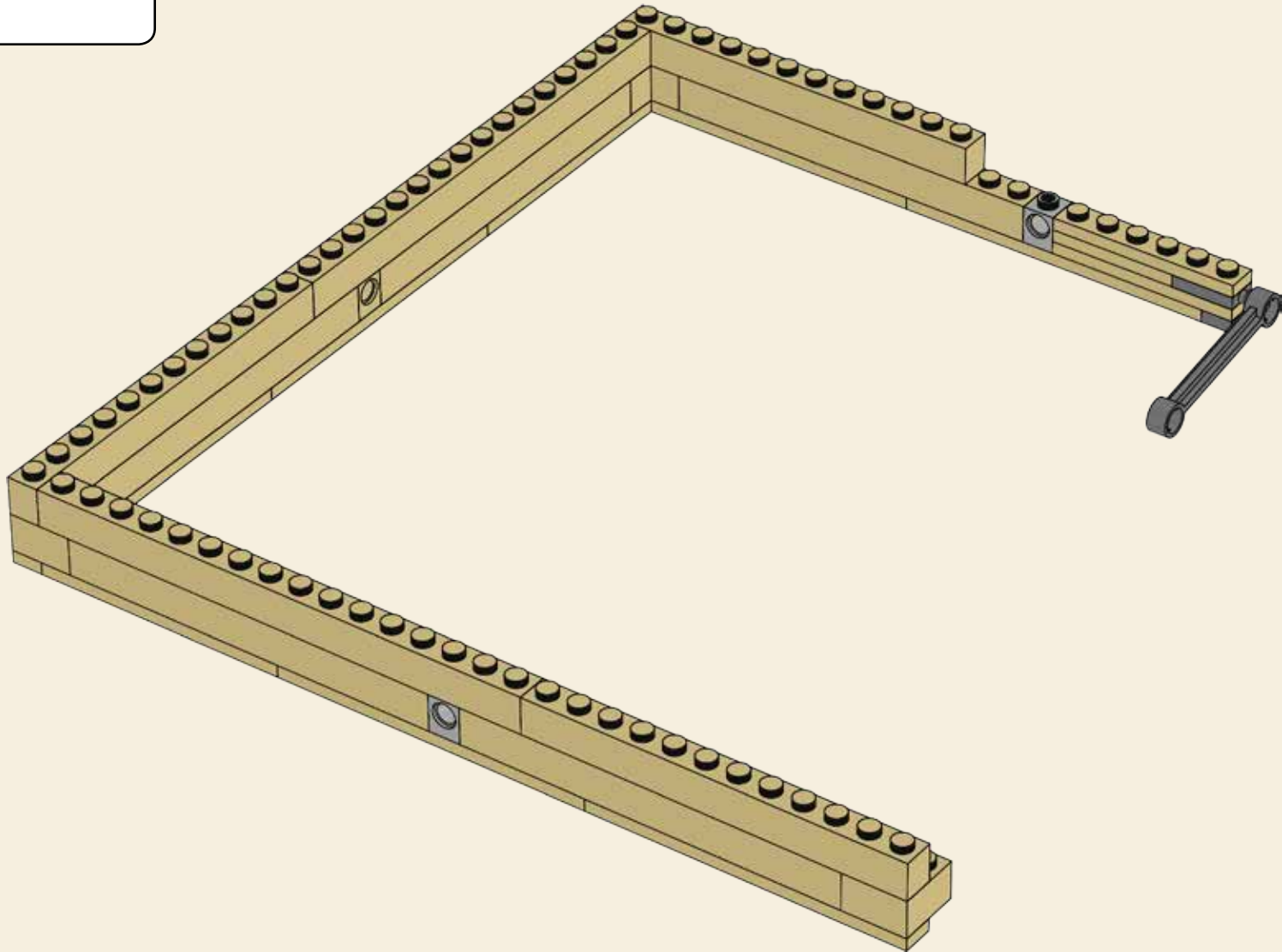

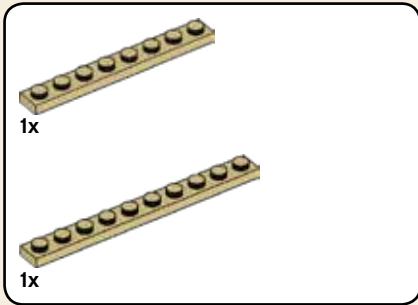
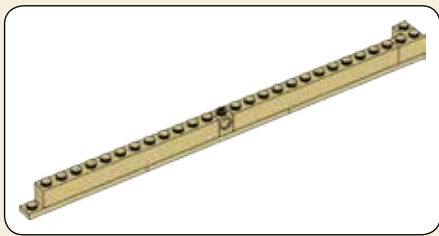

71

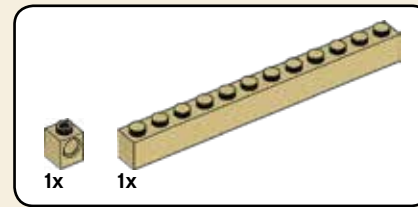
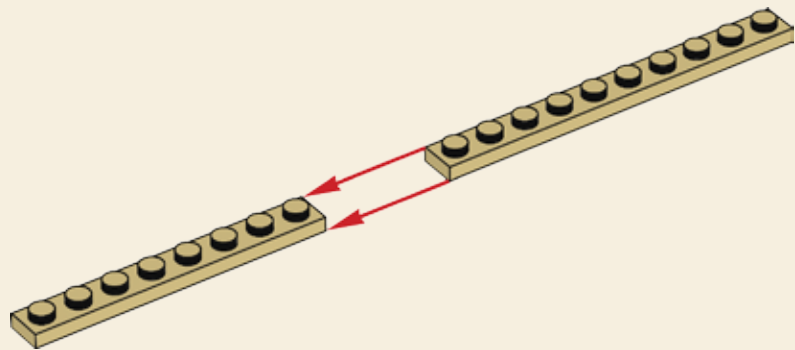

72

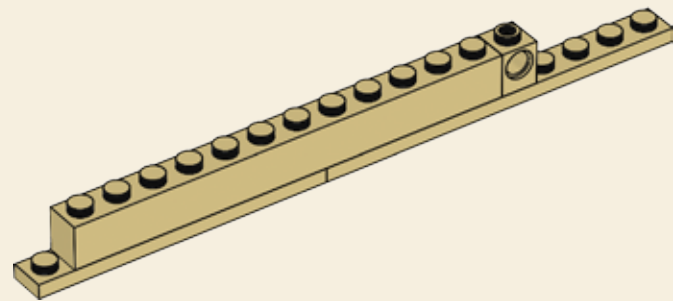

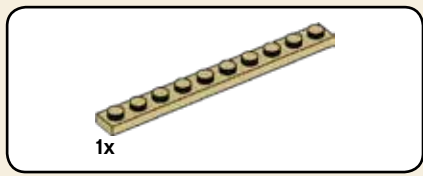

73

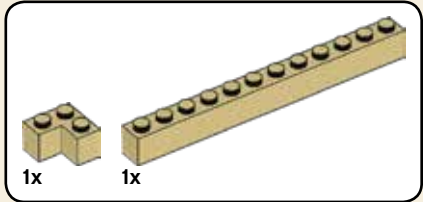
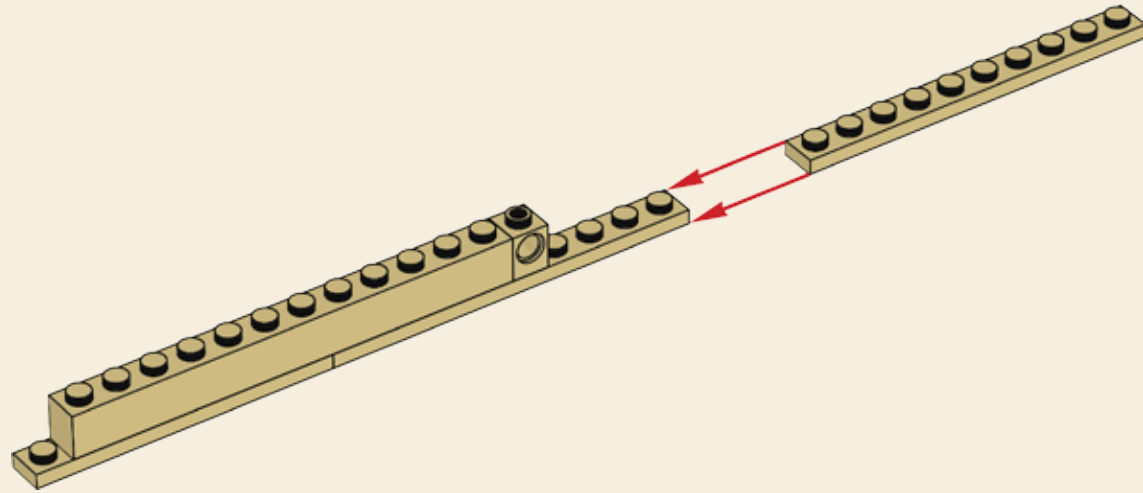

74

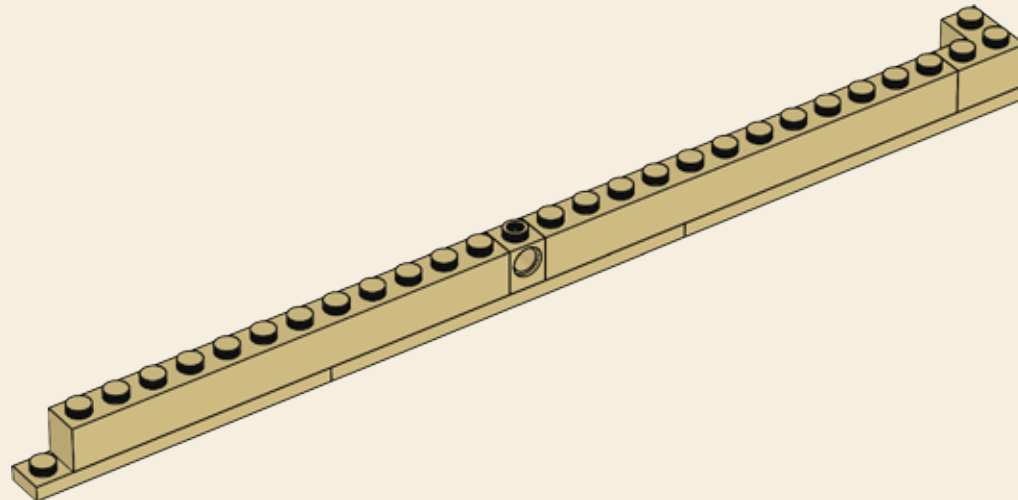

75

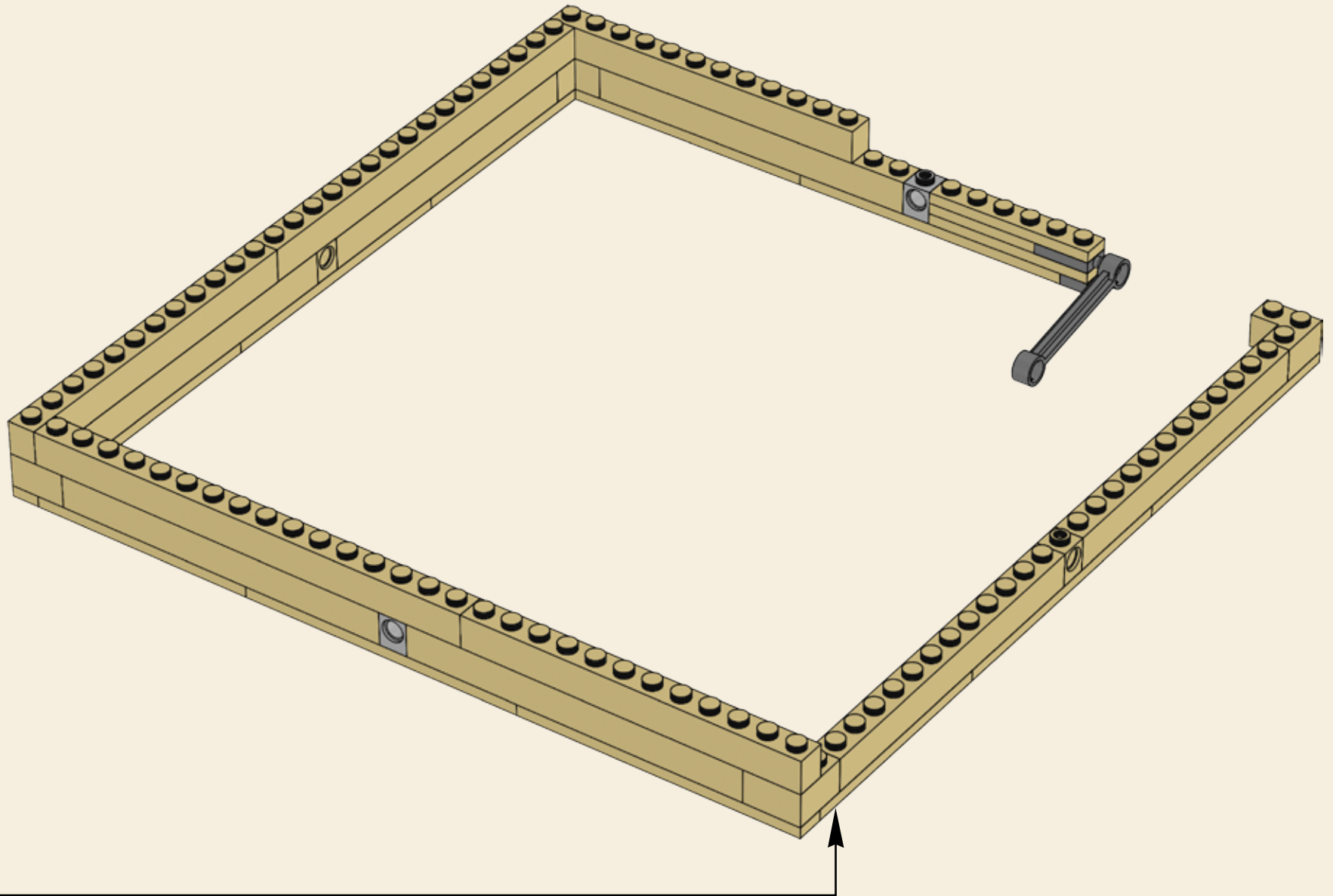

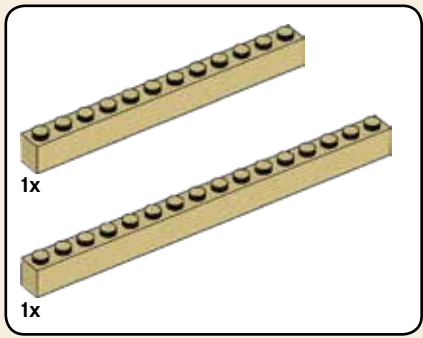

76

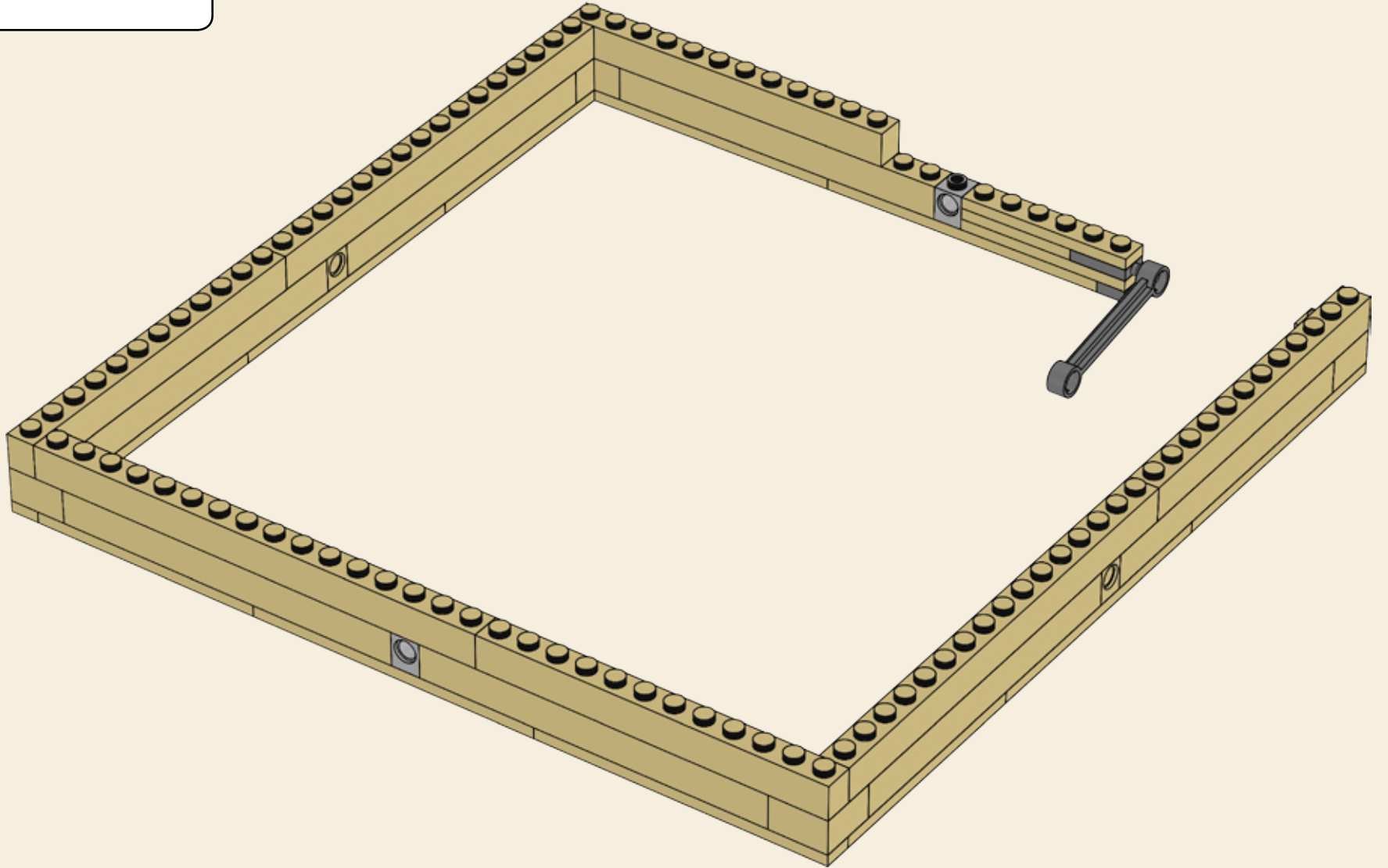

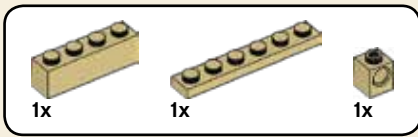

77

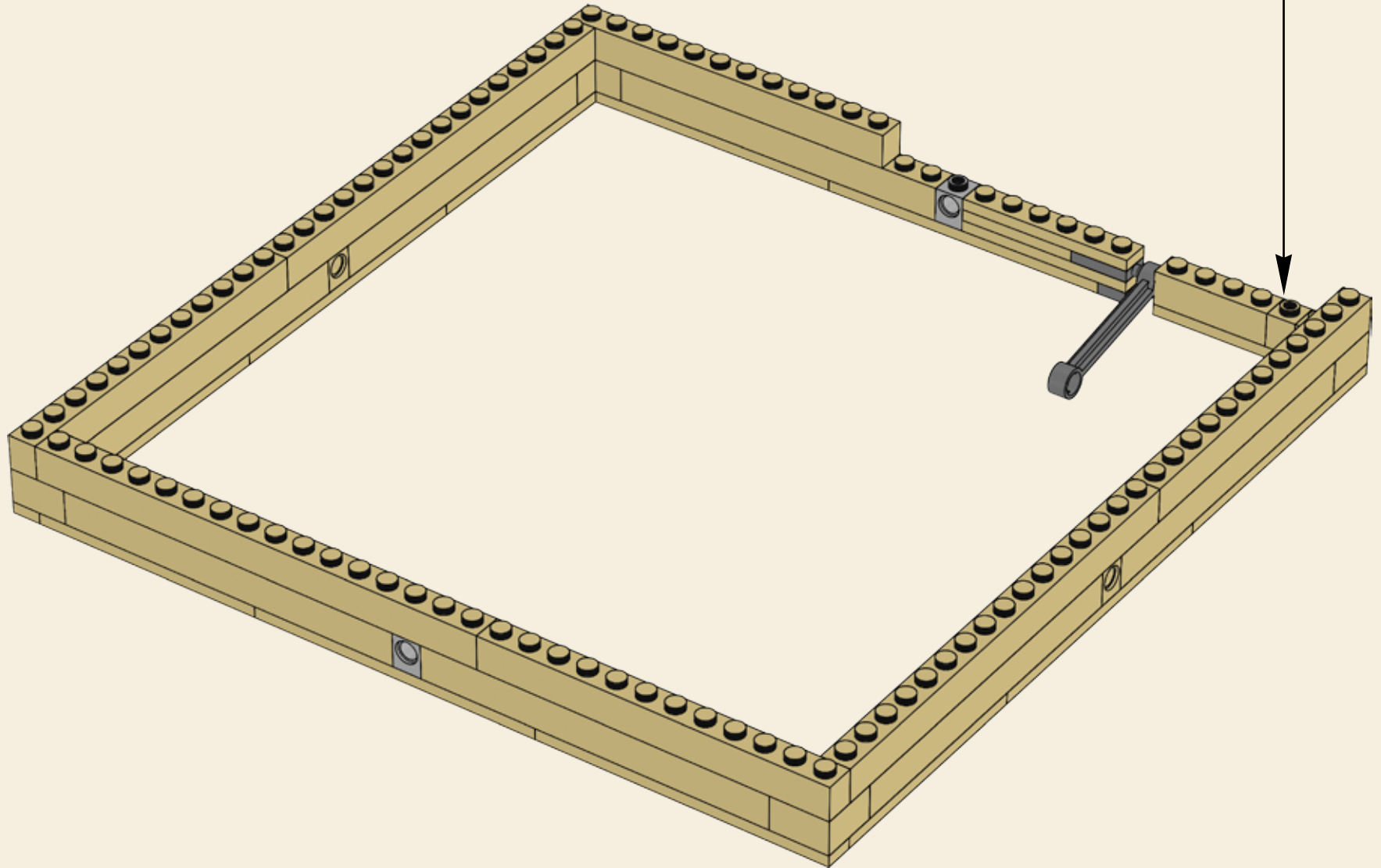
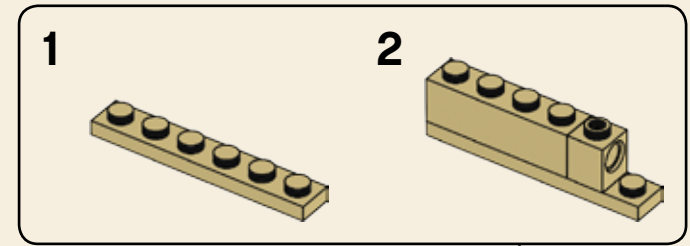

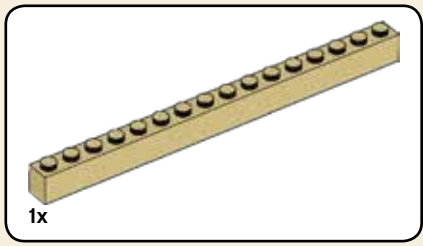

78

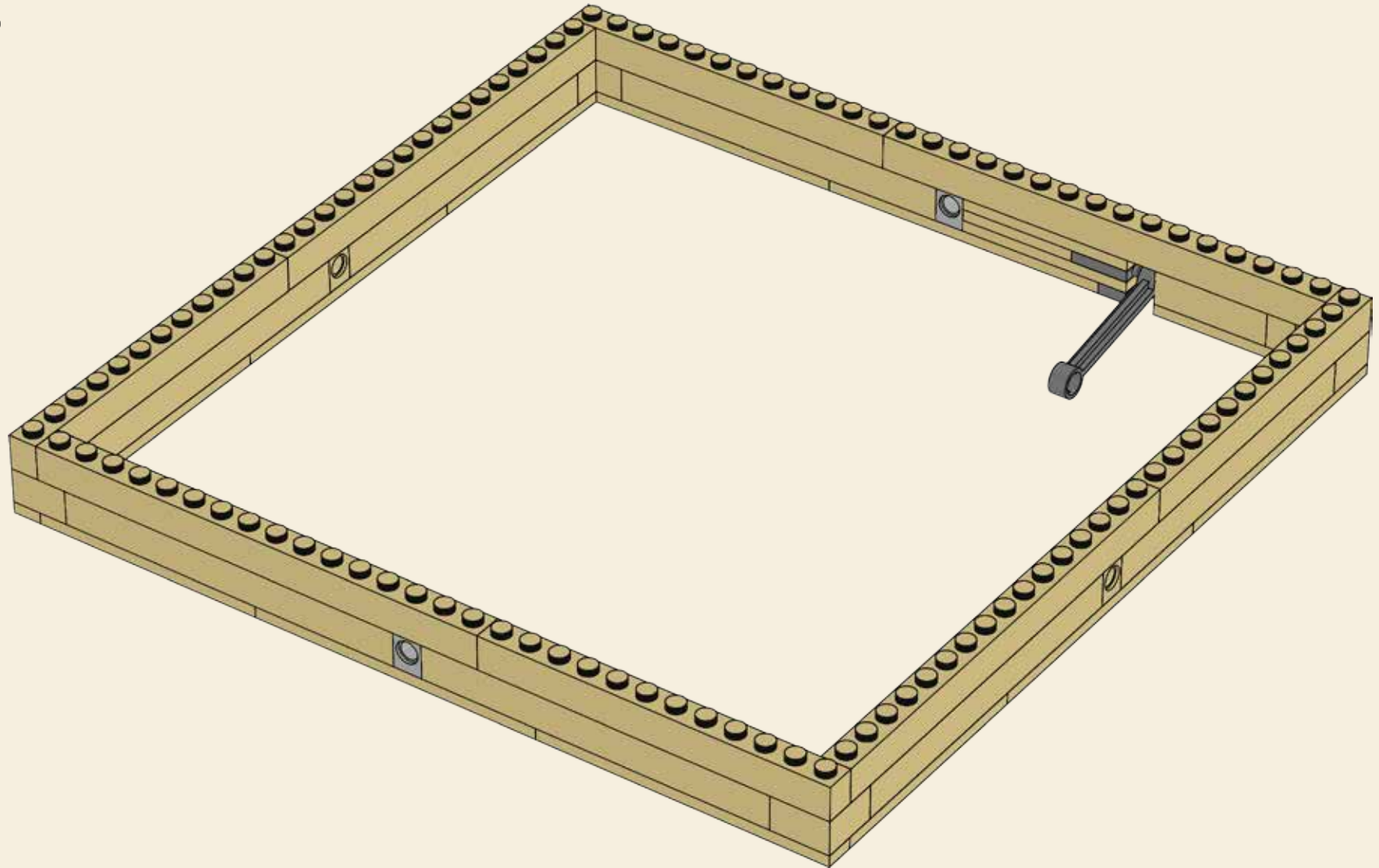

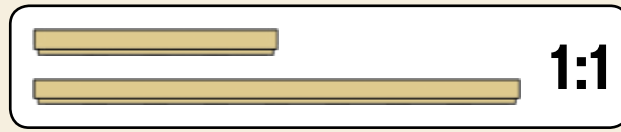
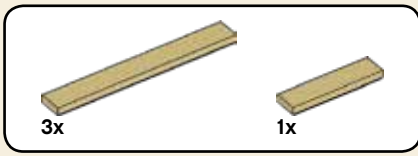

79

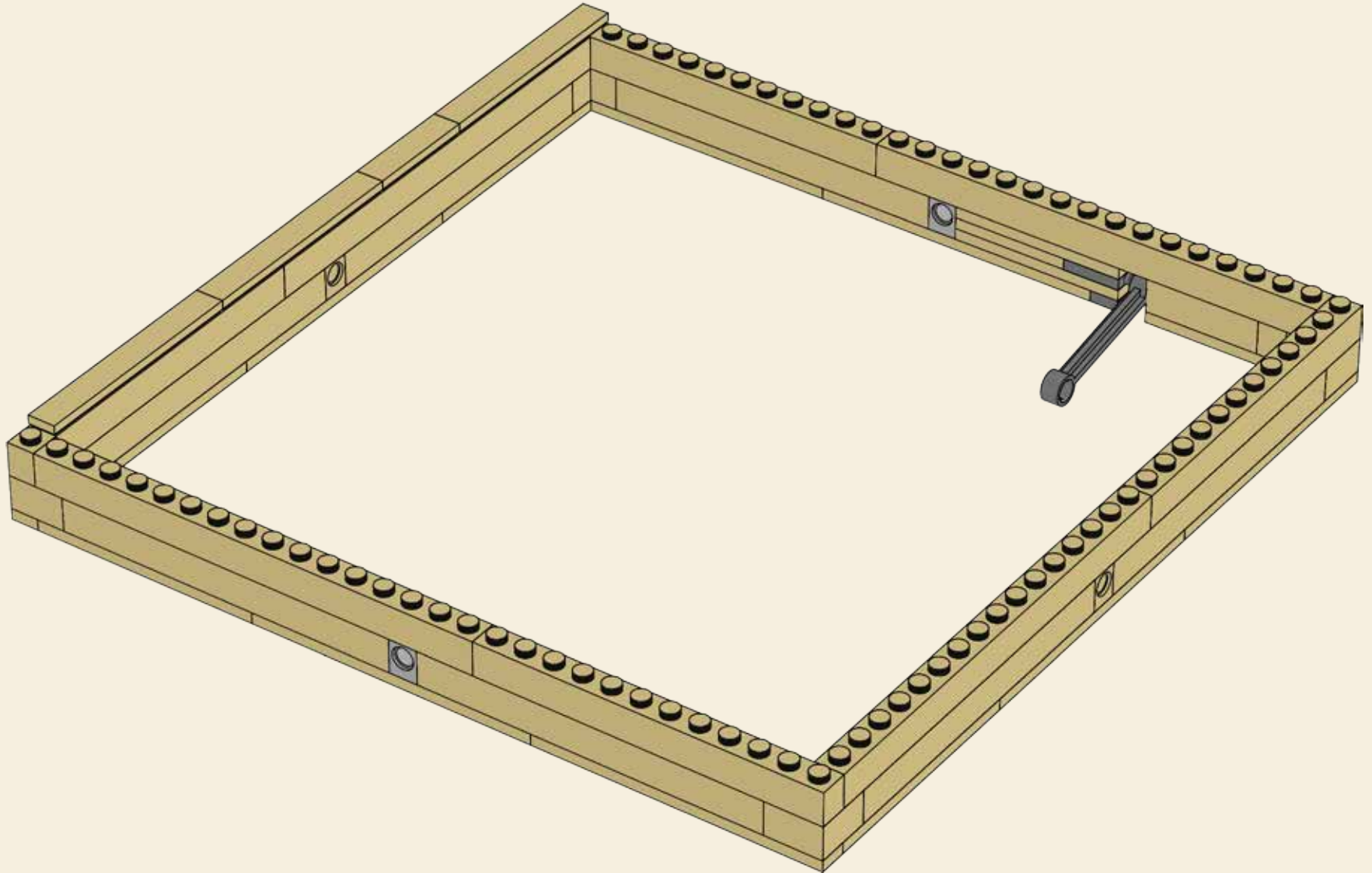

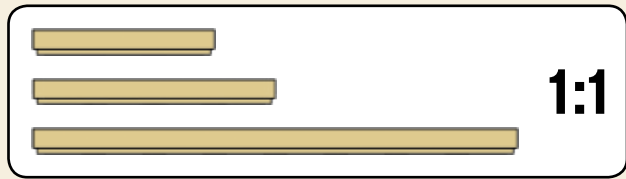
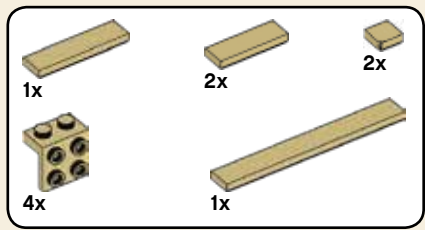

80

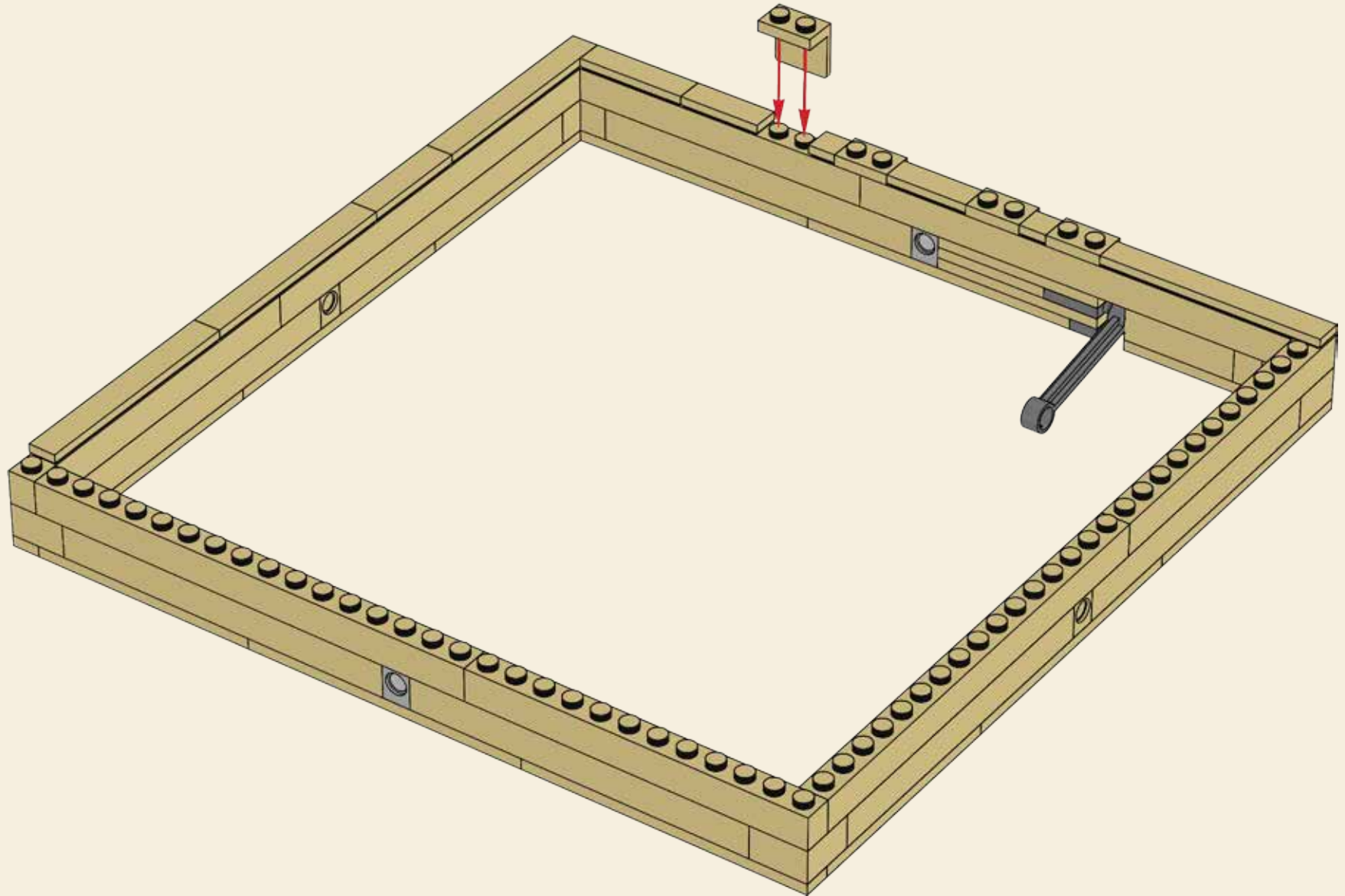

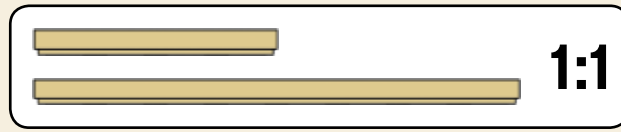
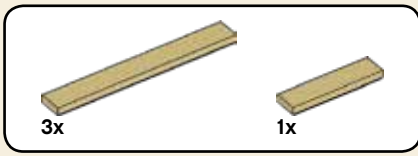

81

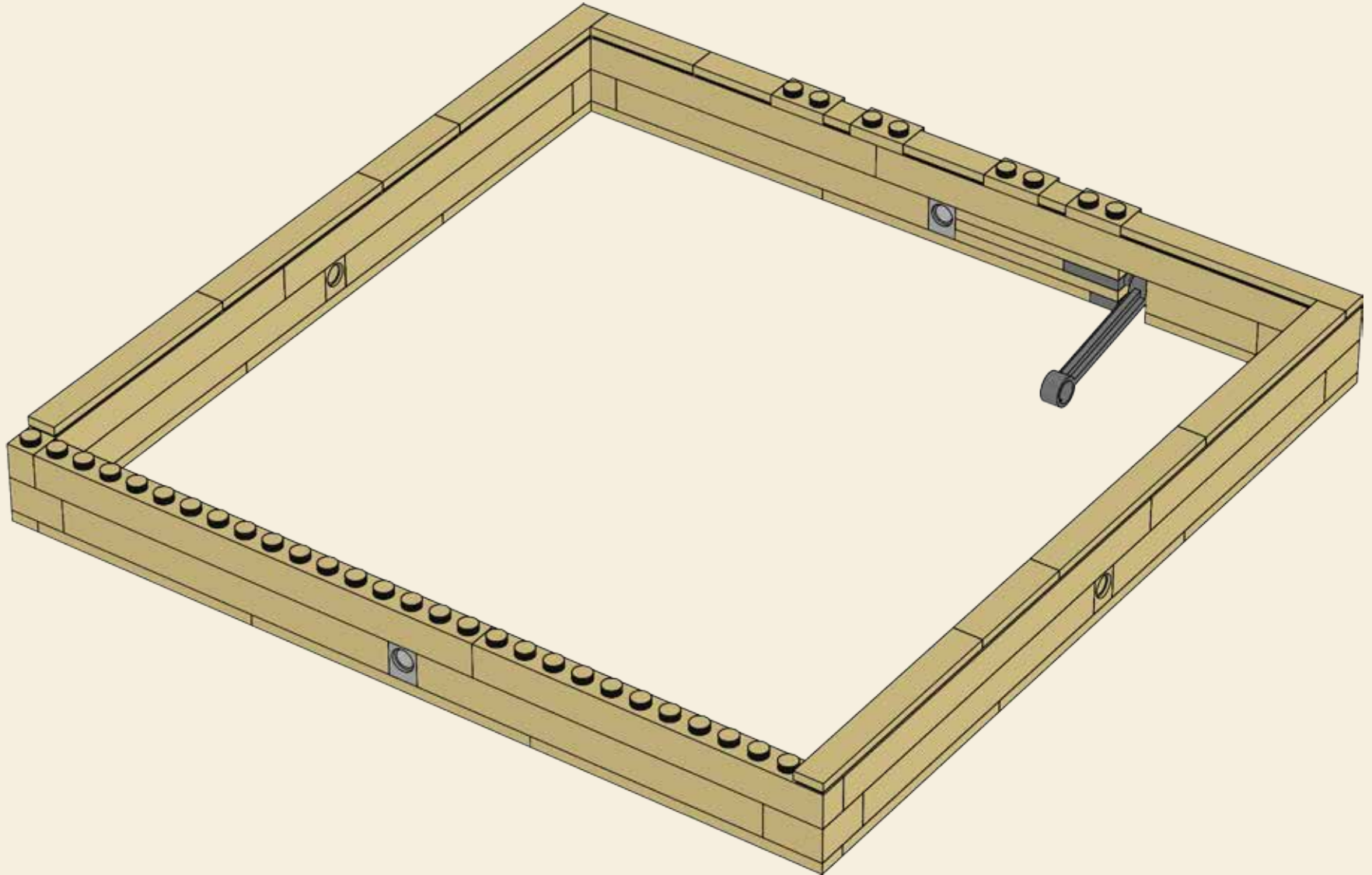

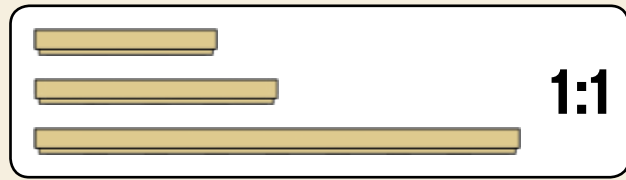
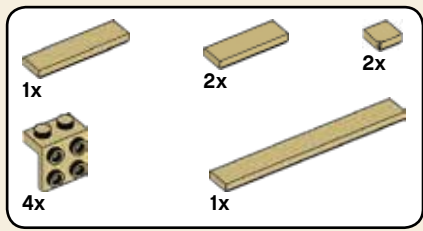

82

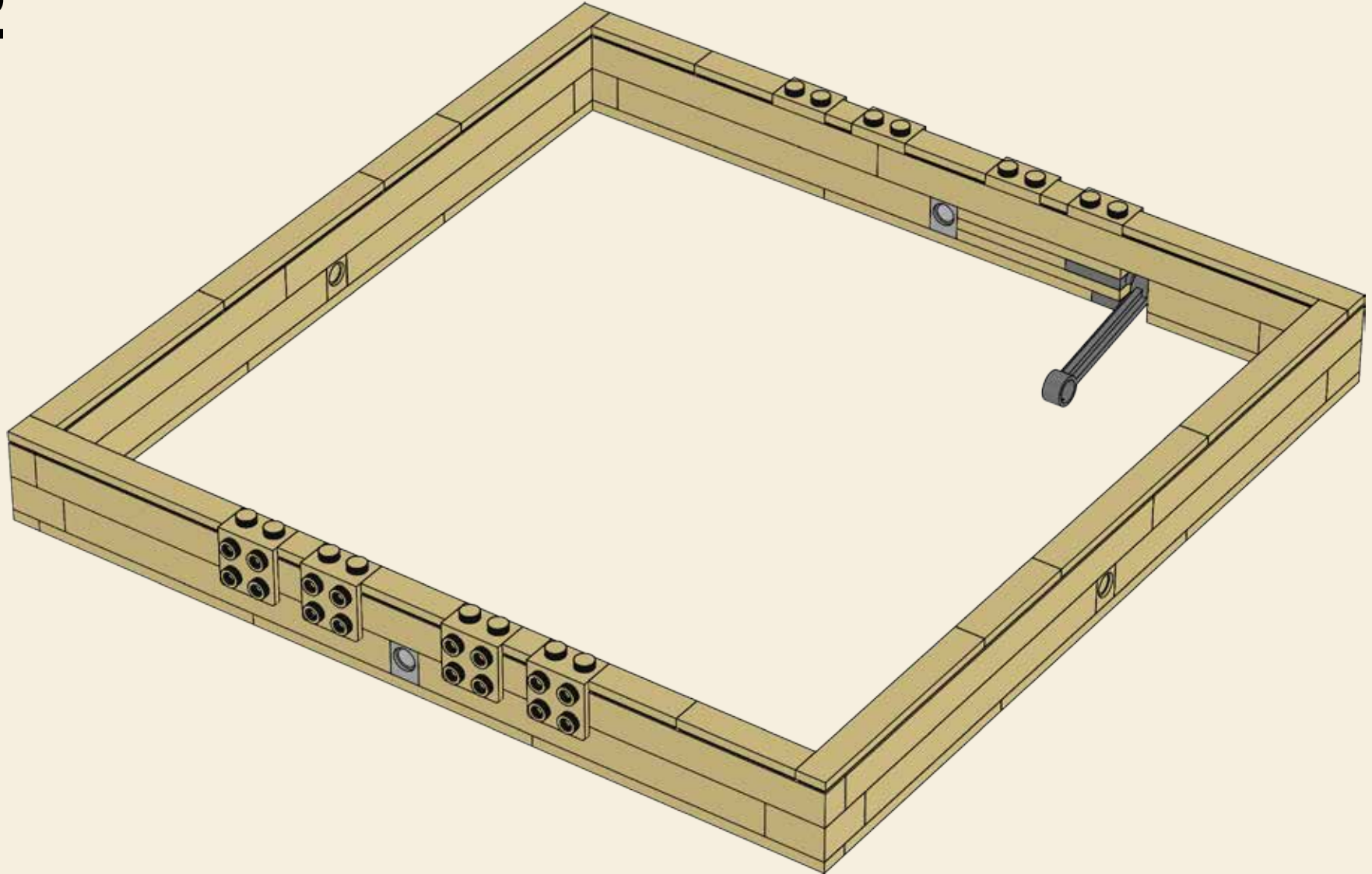

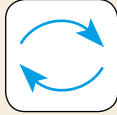
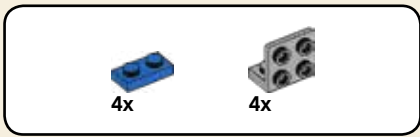

83

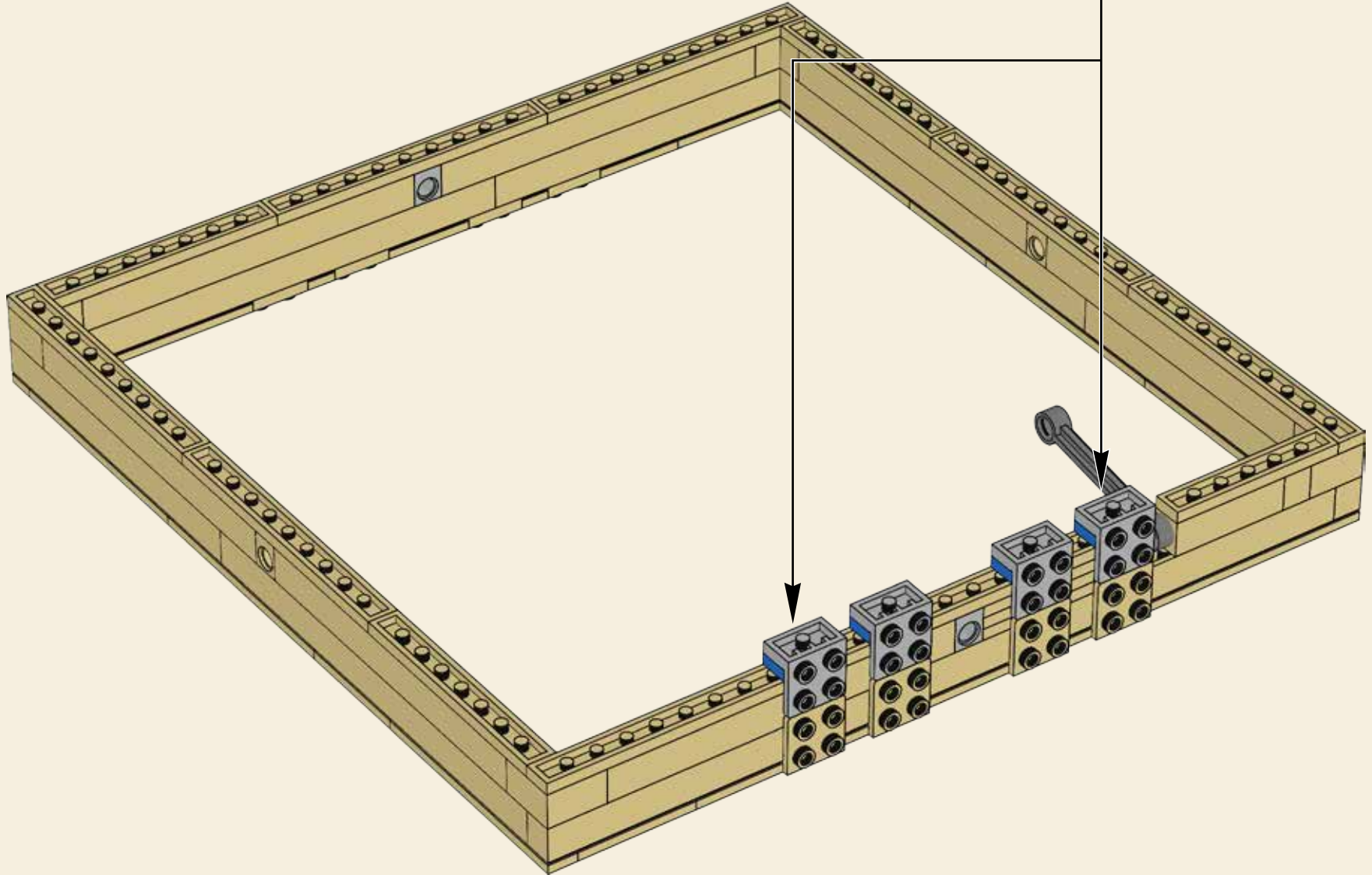
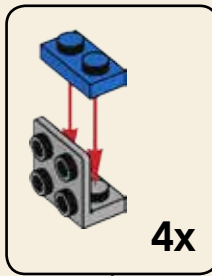

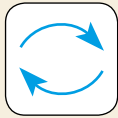
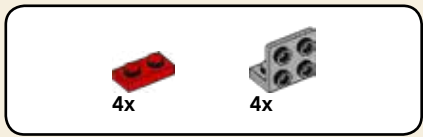

84

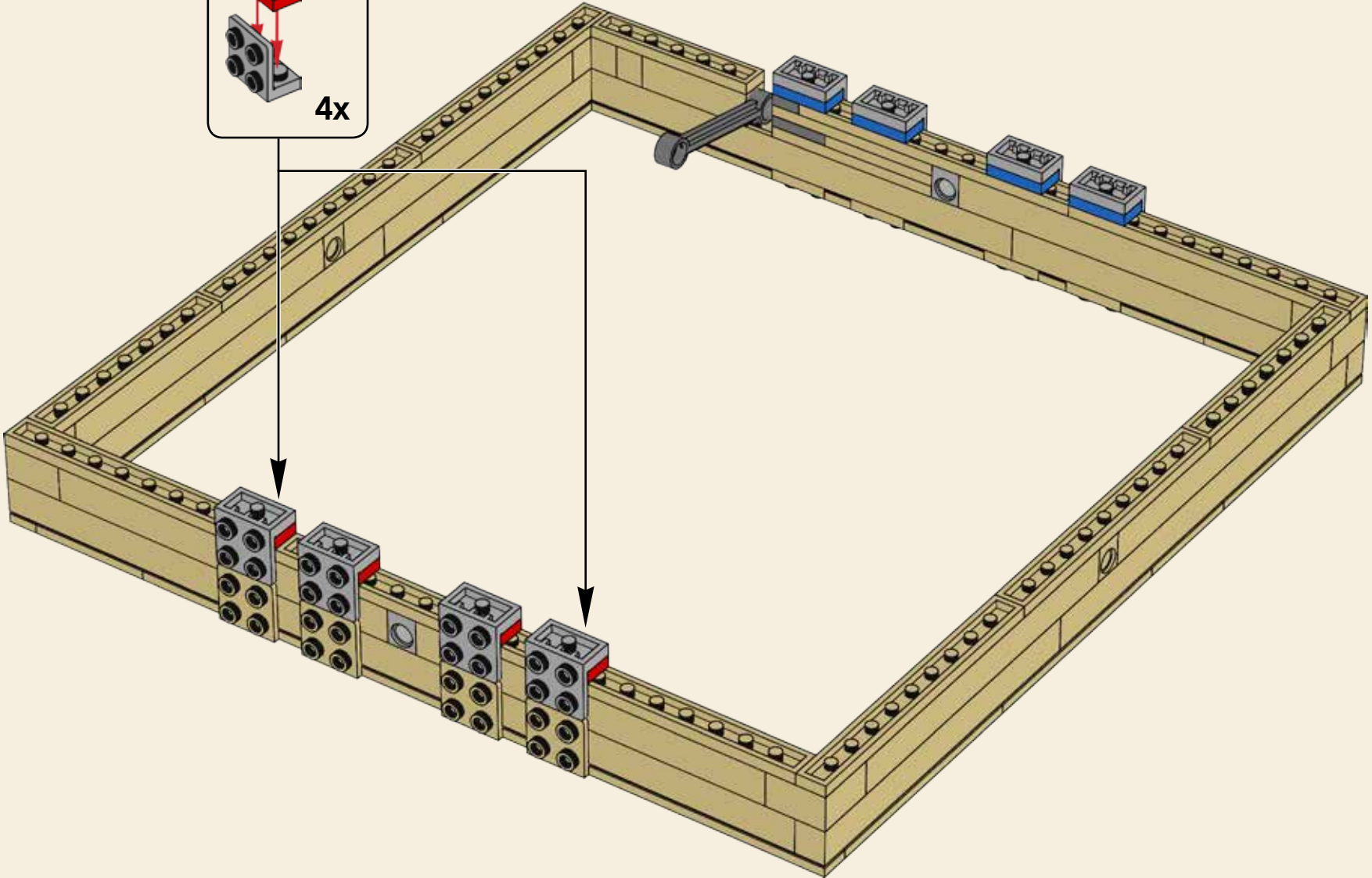
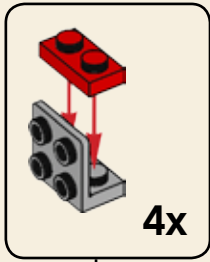

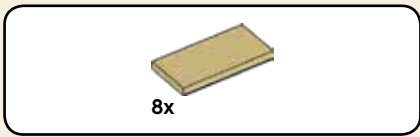

85

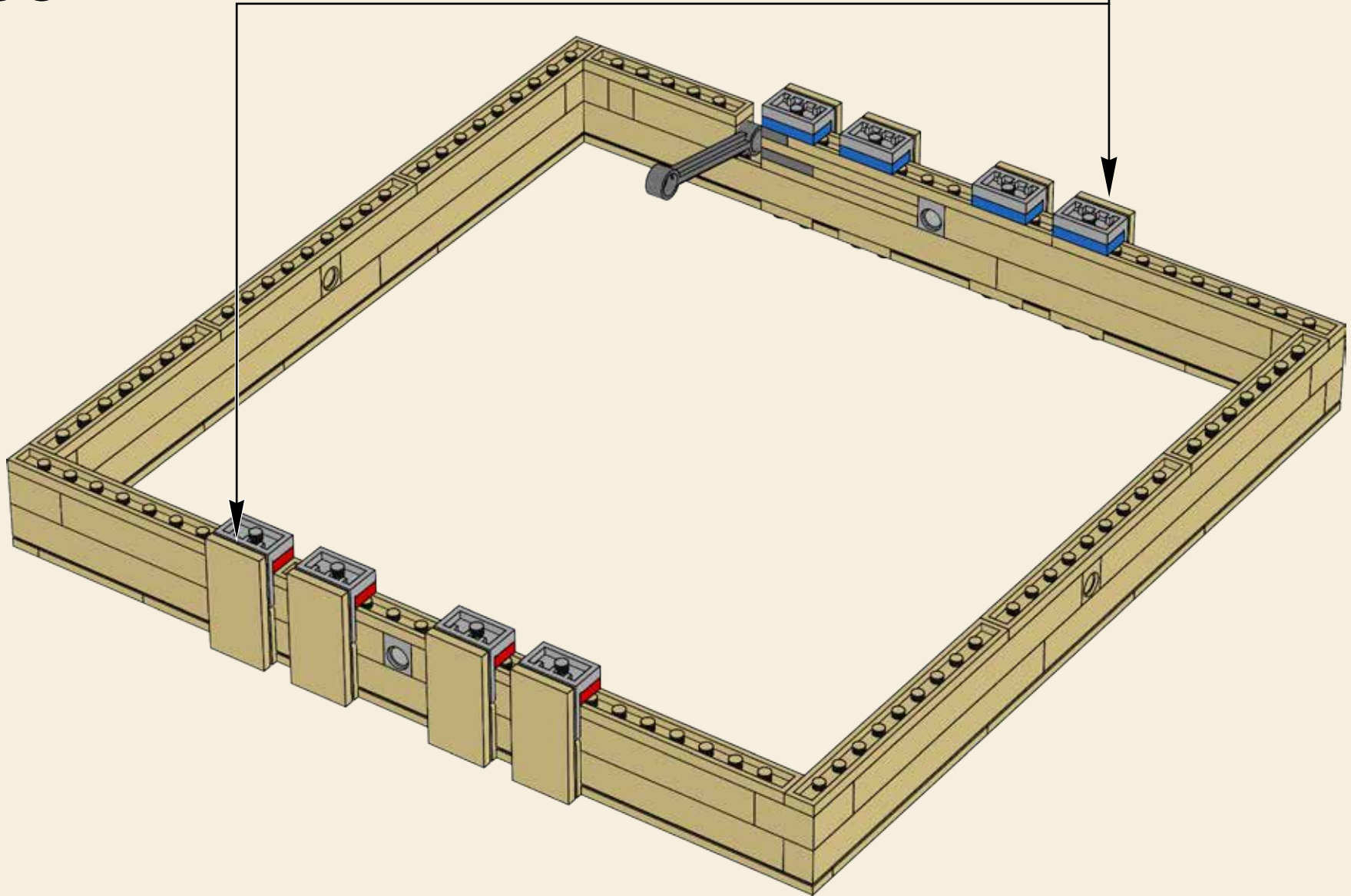
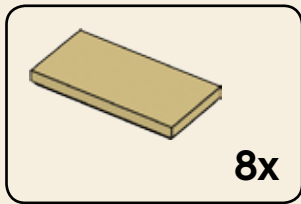

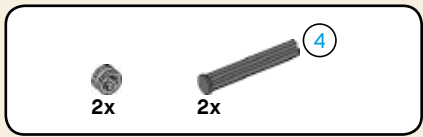

86

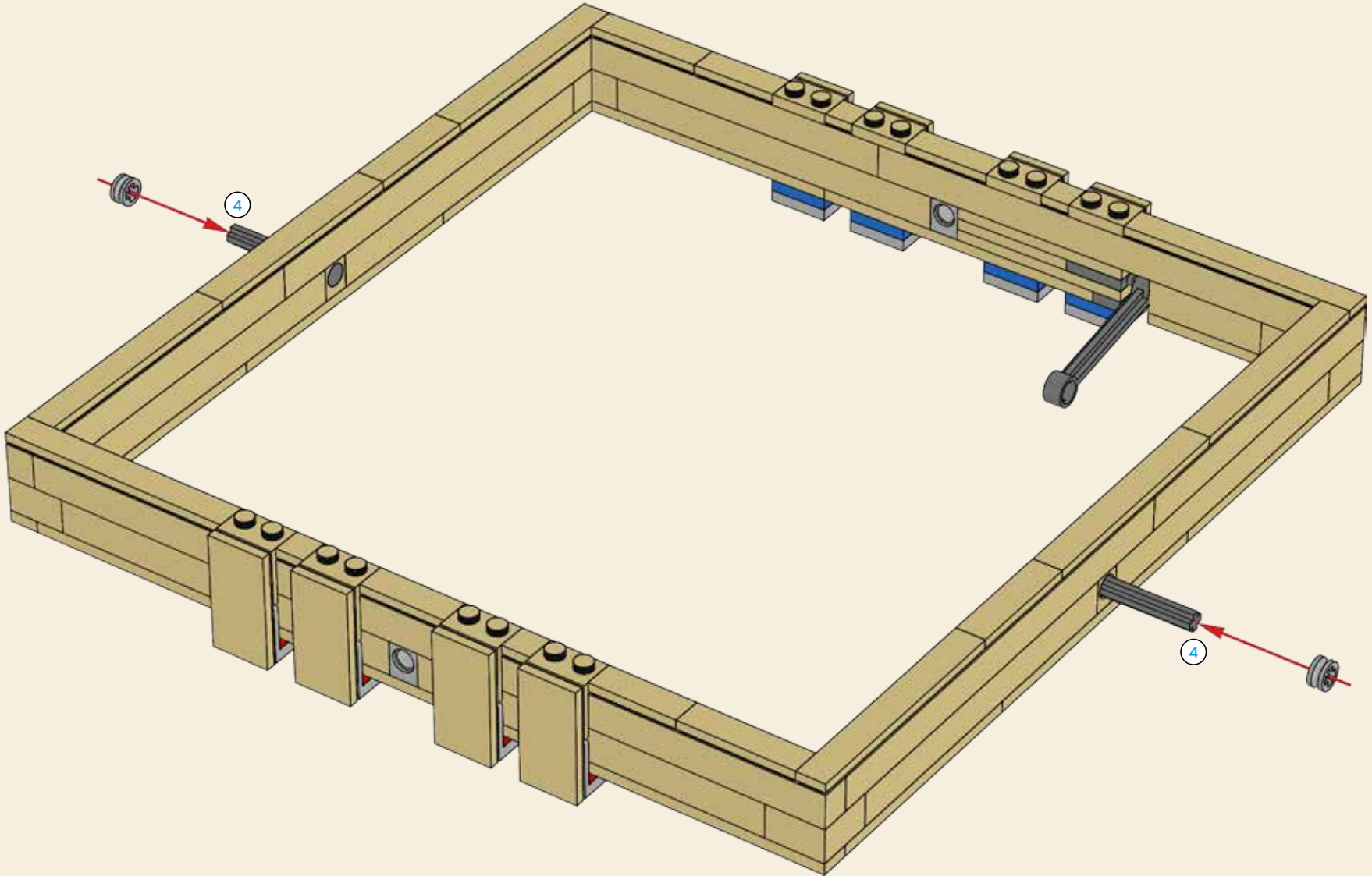

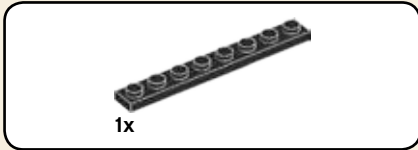
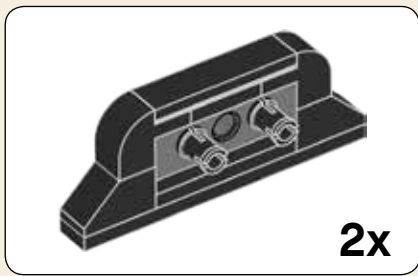

87

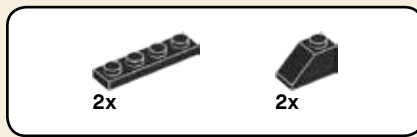

88

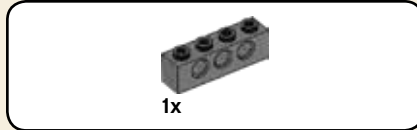
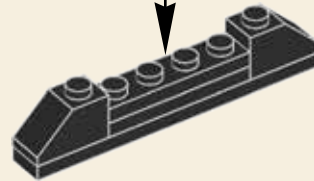
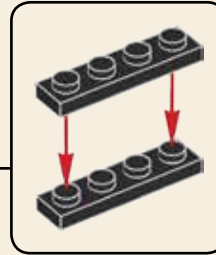

89

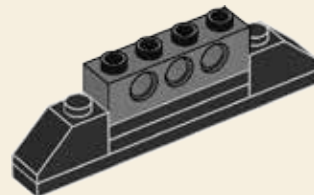

90

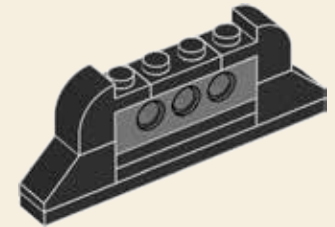

91

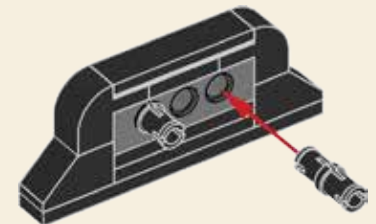

2x



2x

92

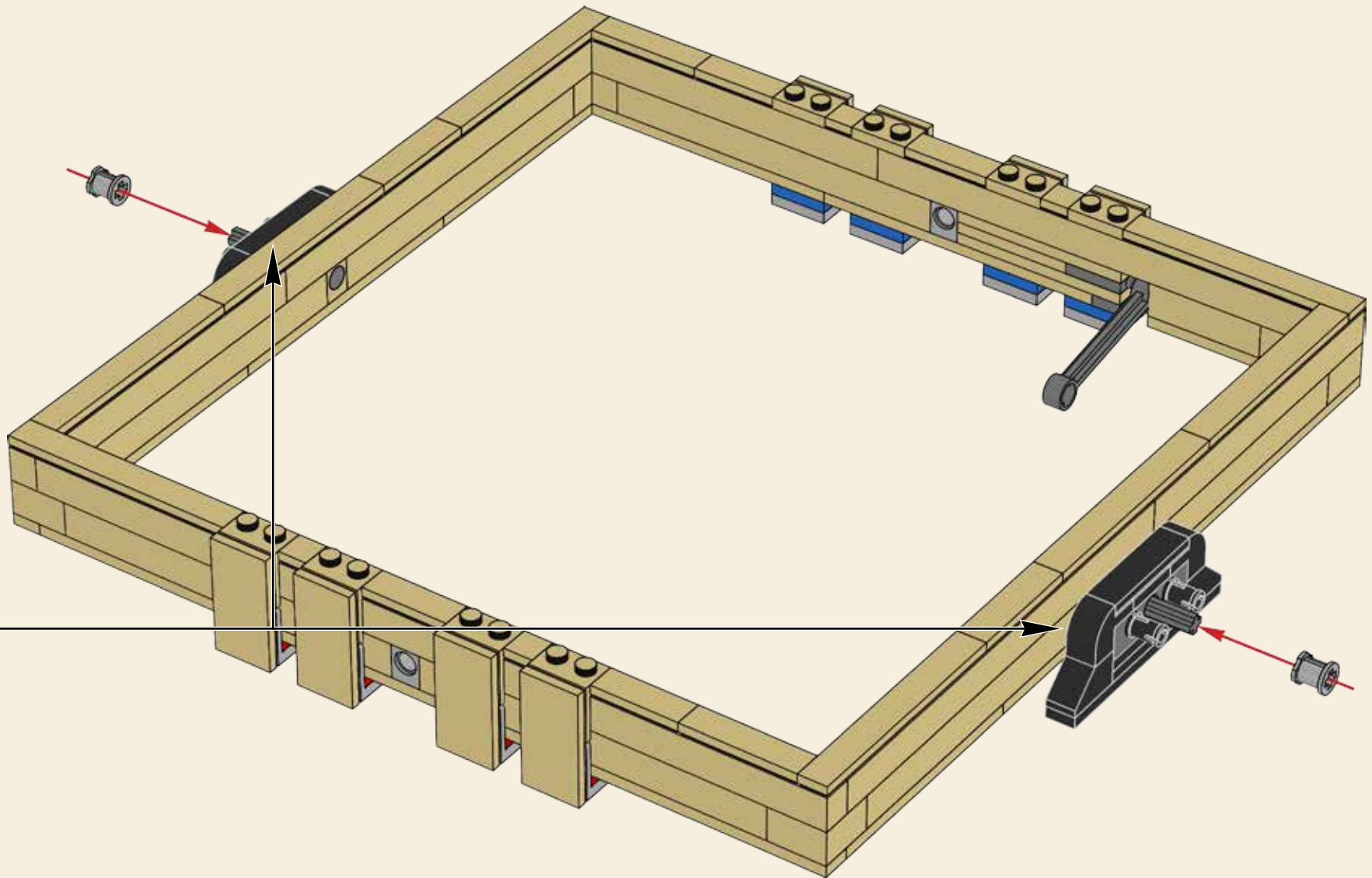

93

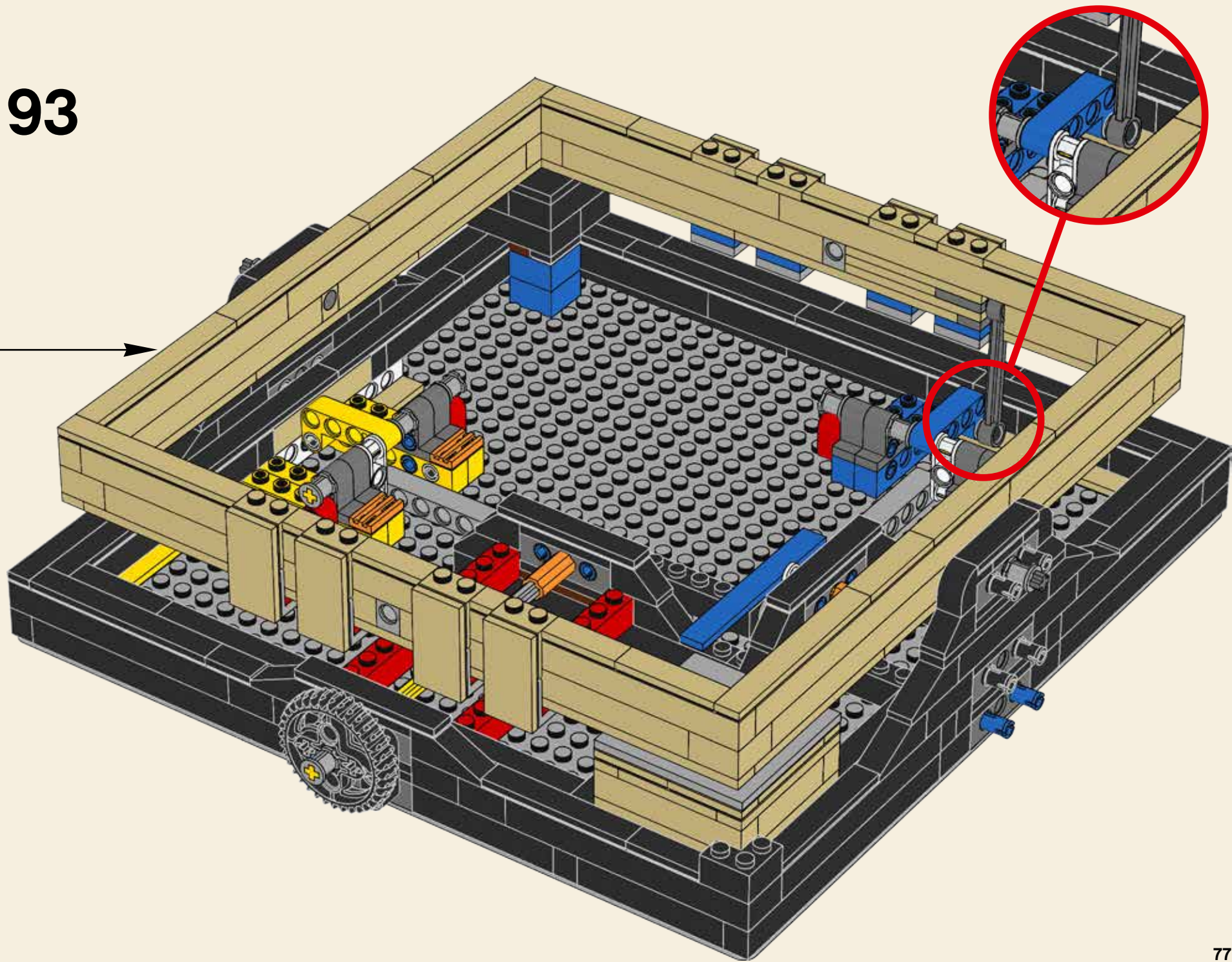

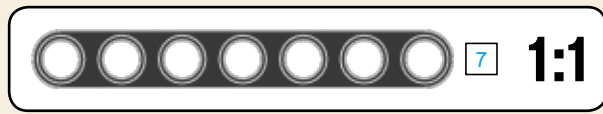
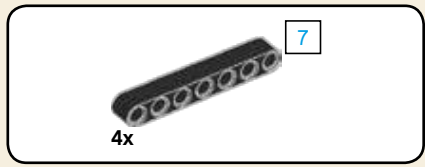

94

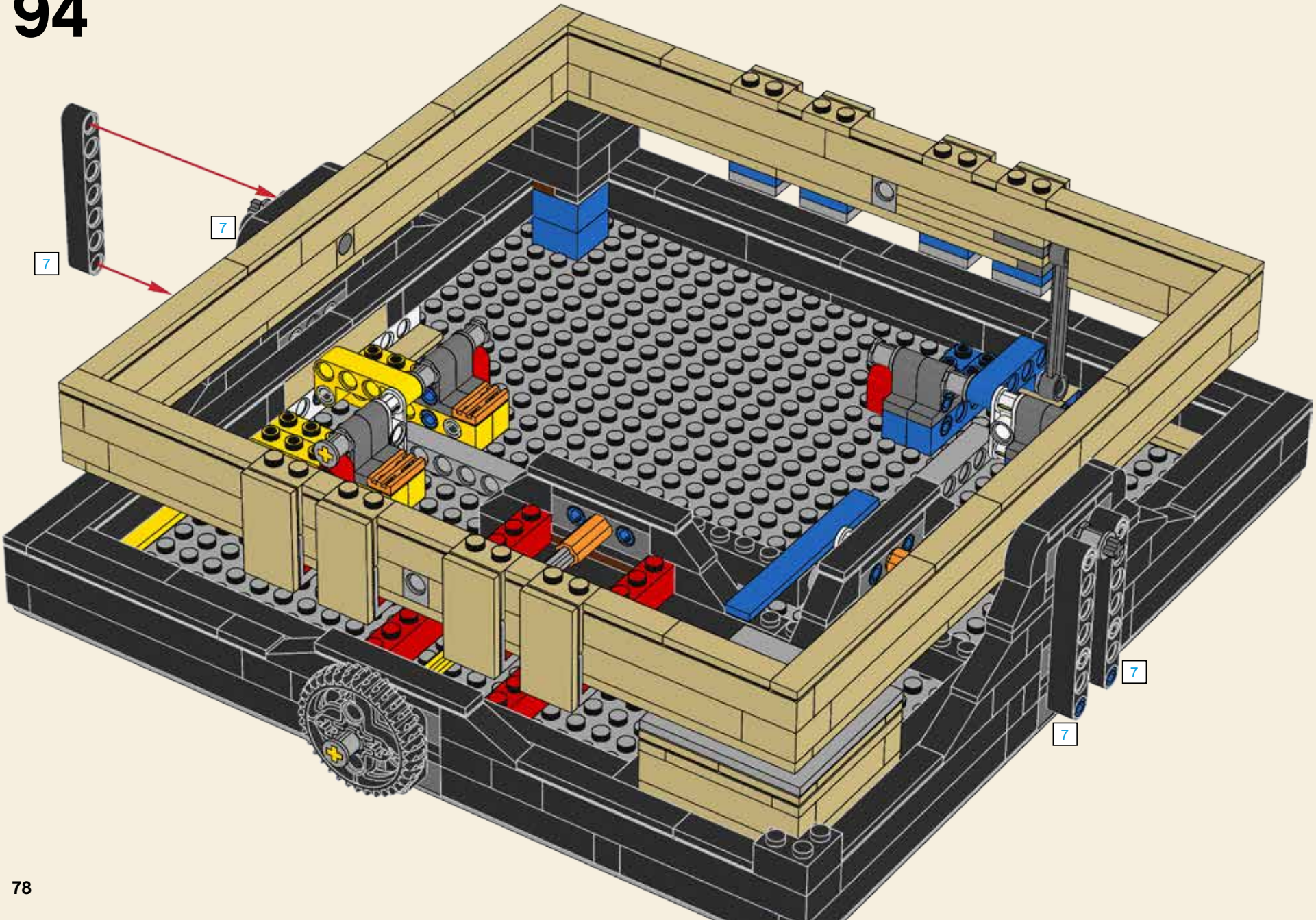

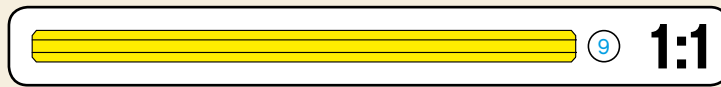
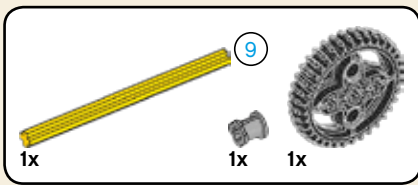

95

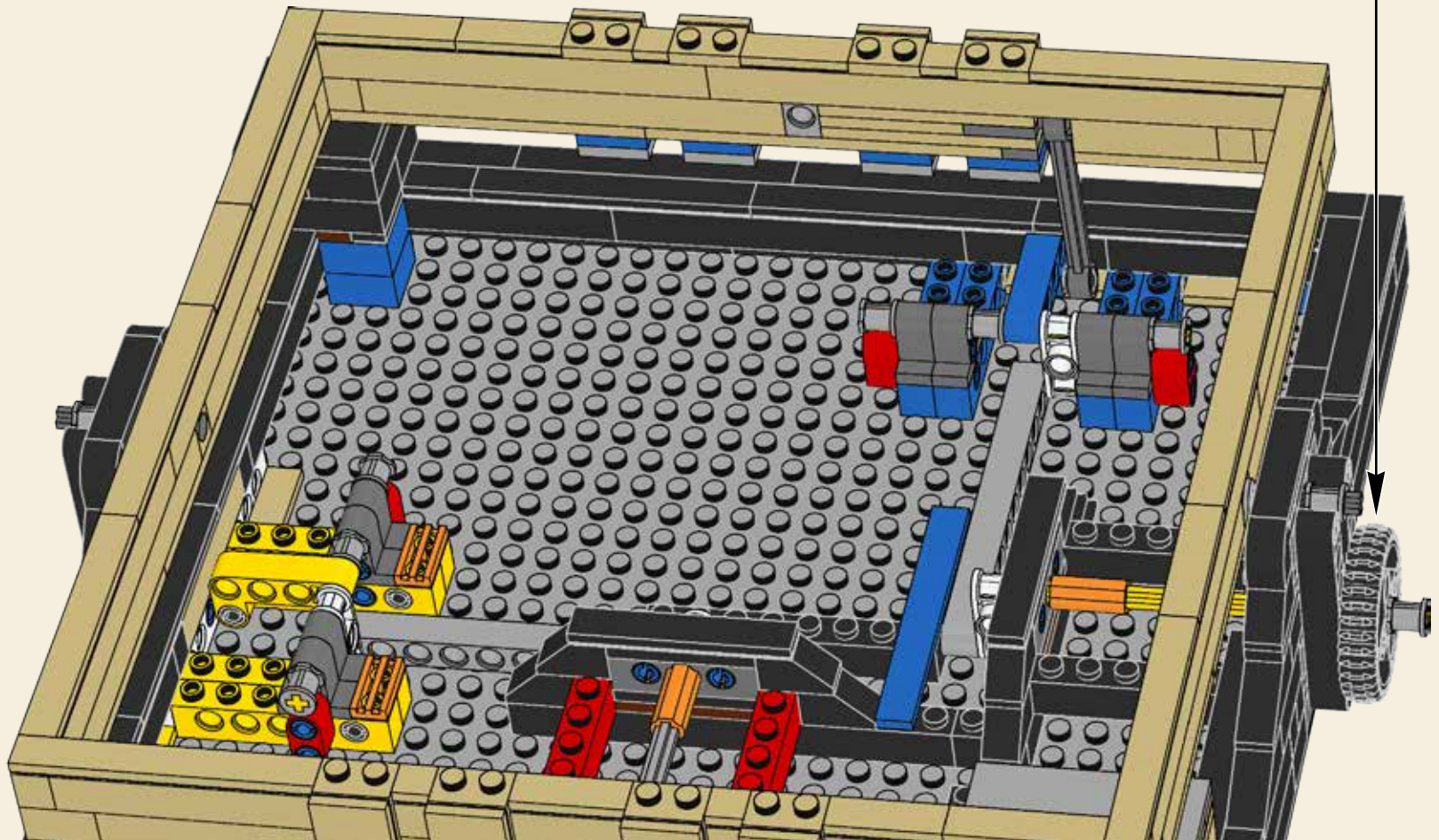
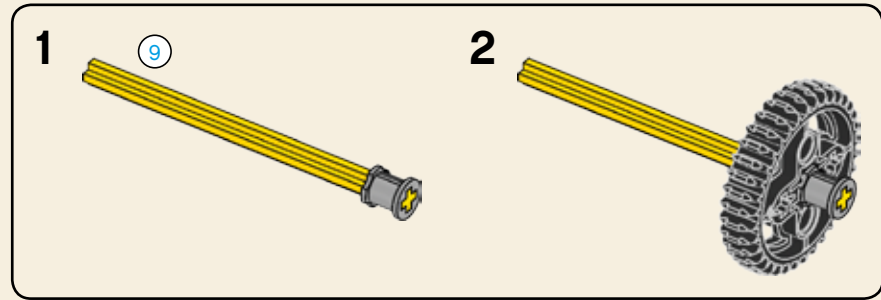

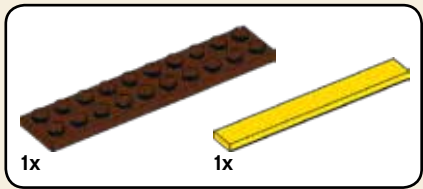
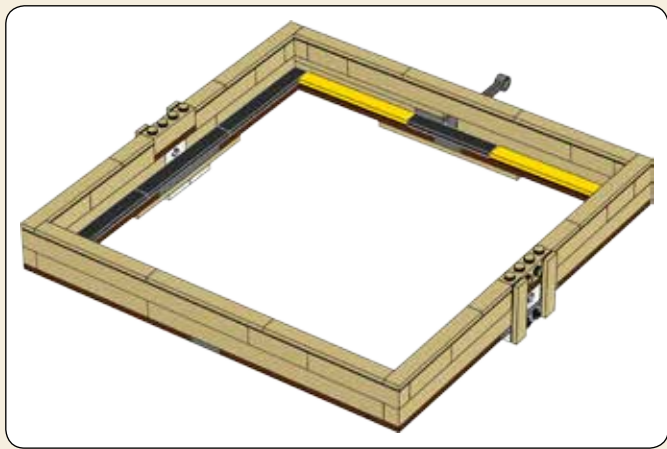

96

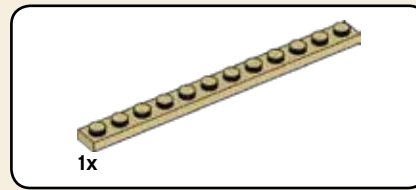
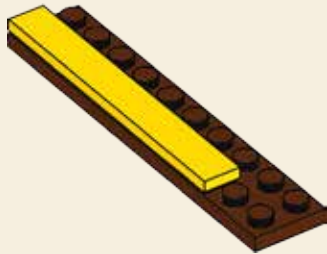

97

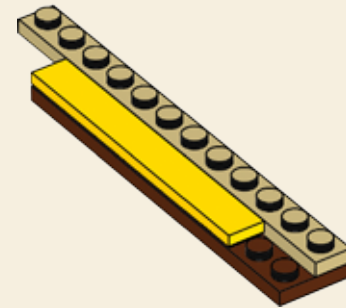

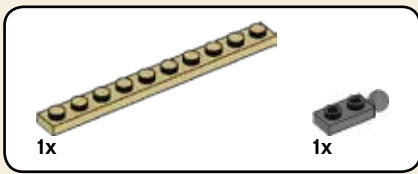

98

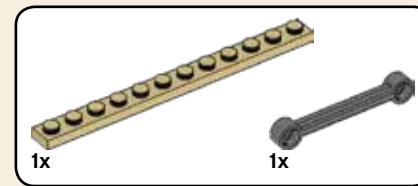
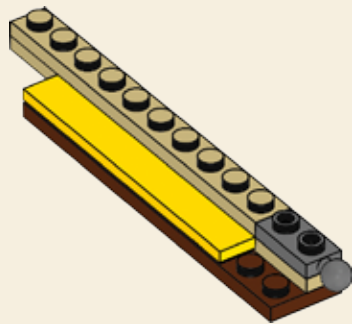

99

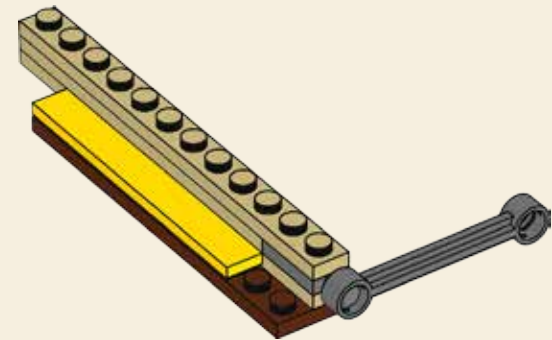

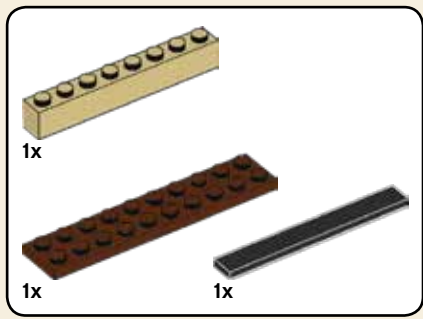

100

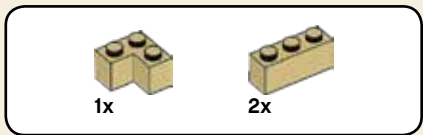
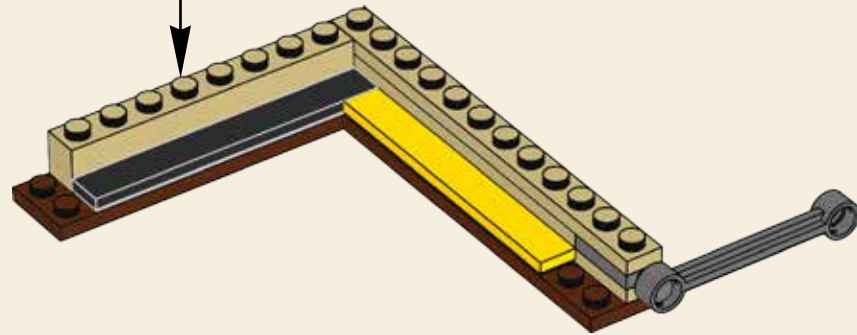
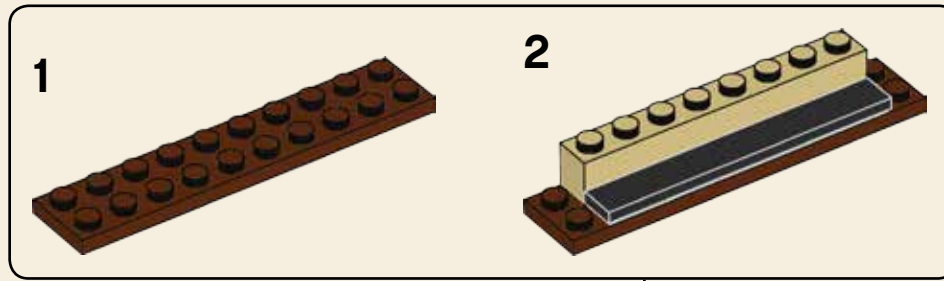

101

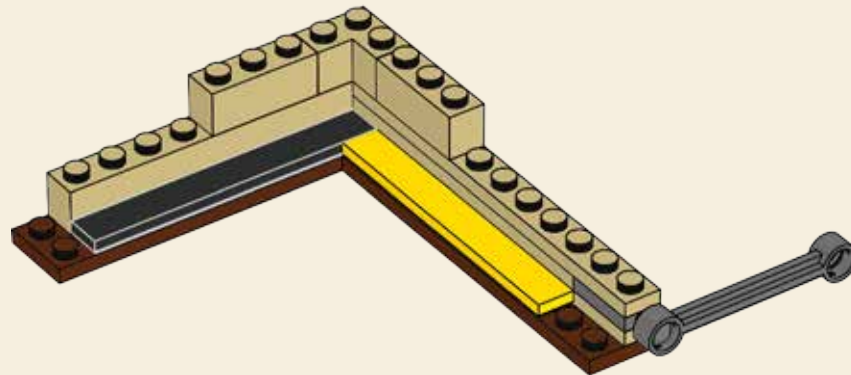

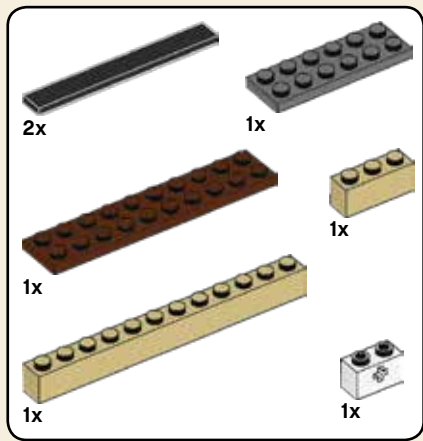

102

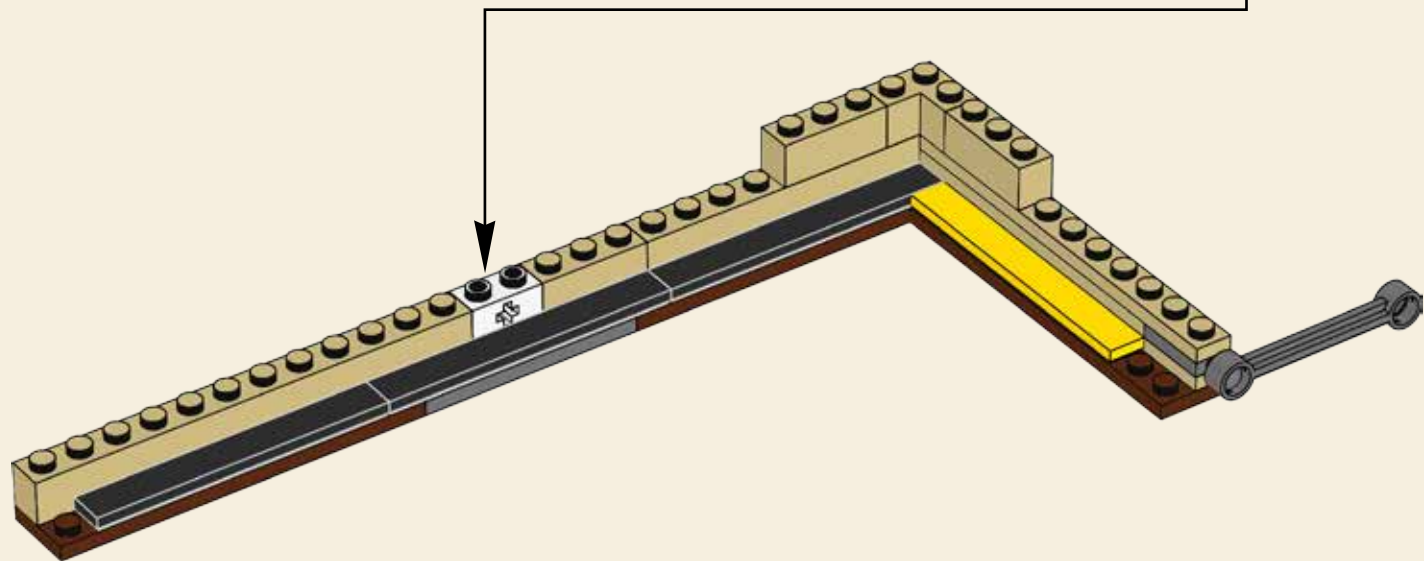
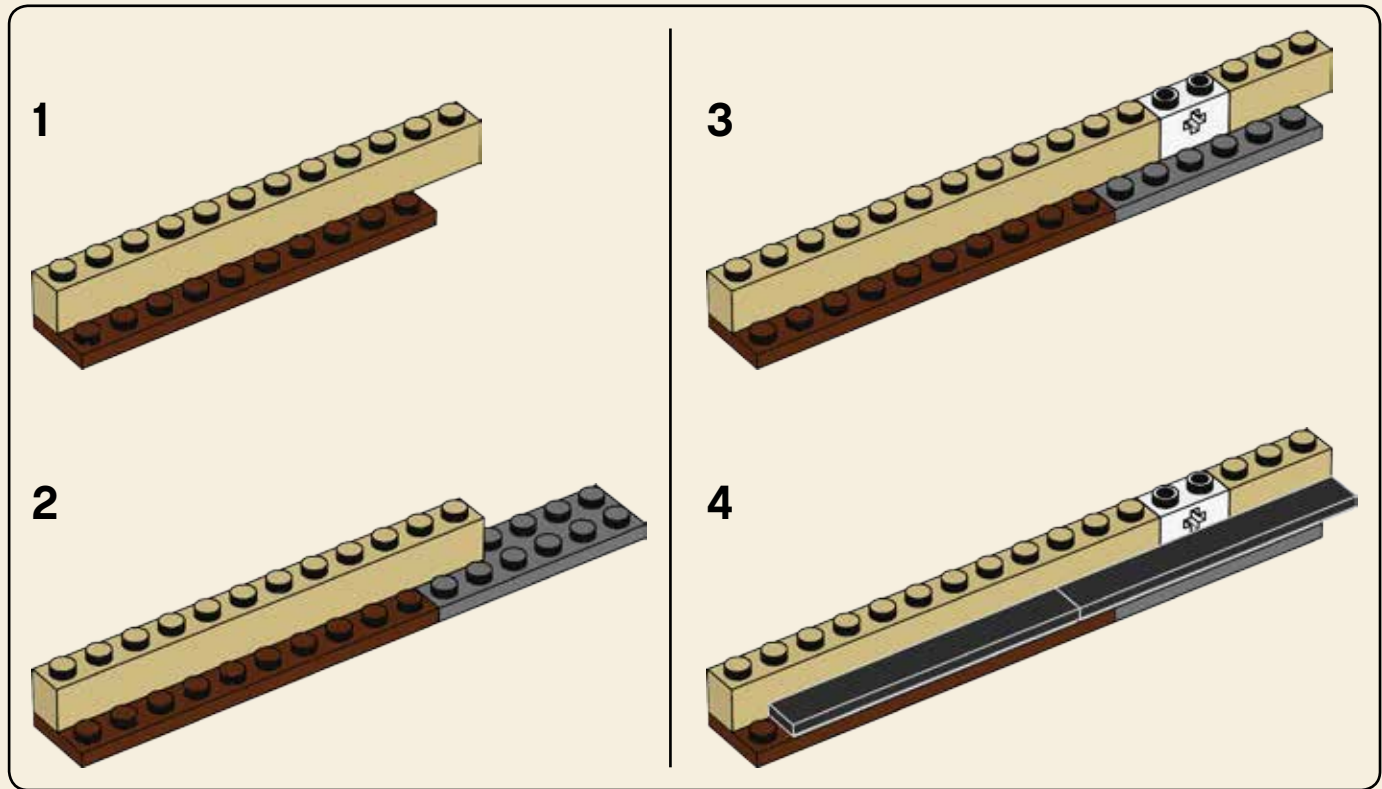

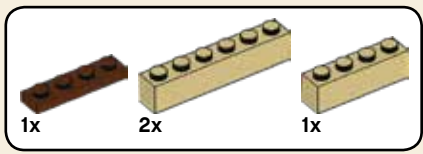

103

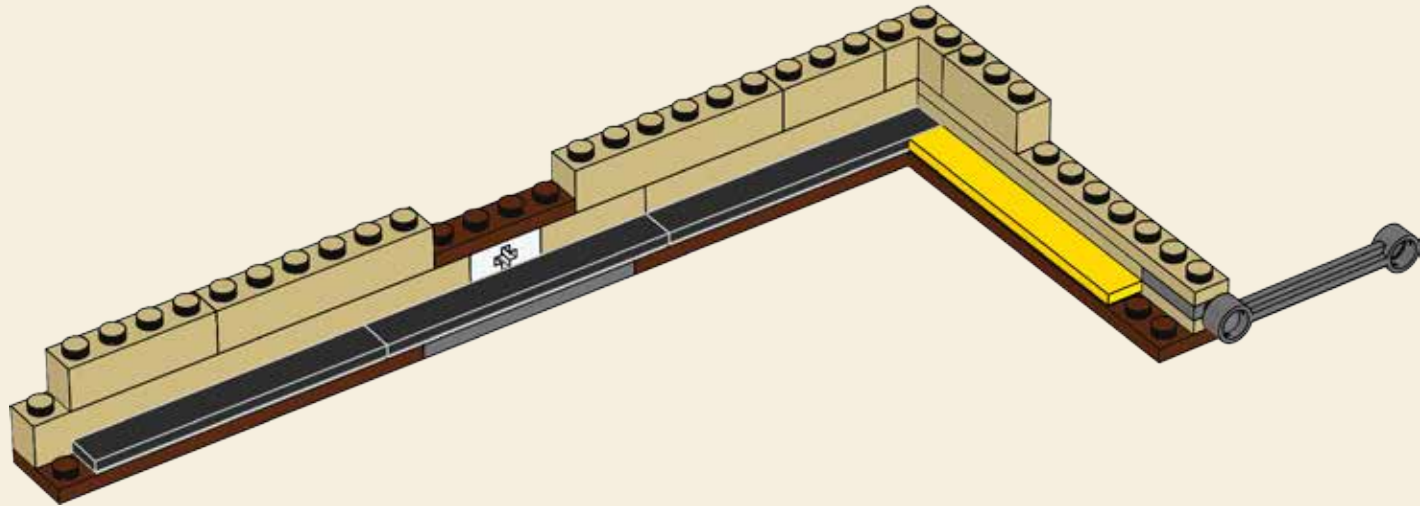

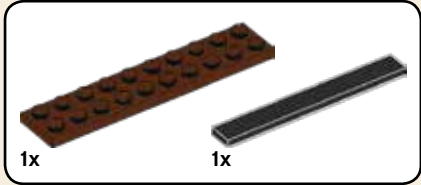
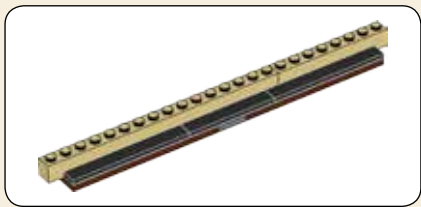

104

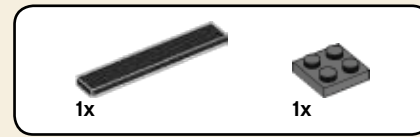

105

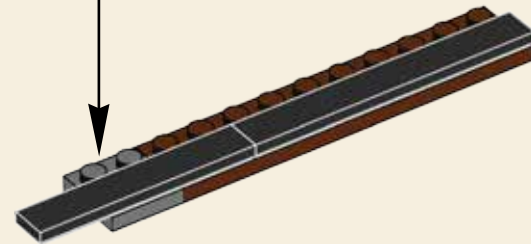
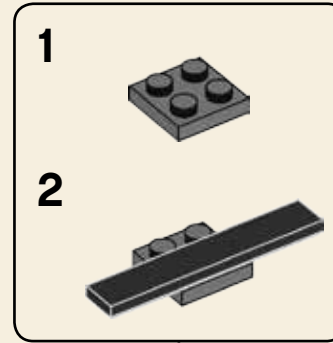

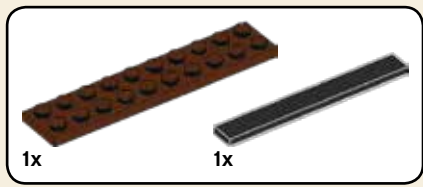

106

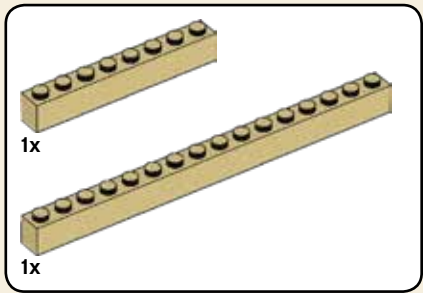
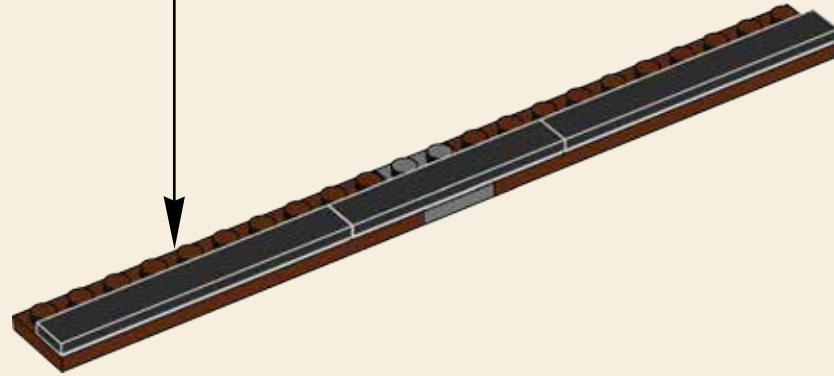
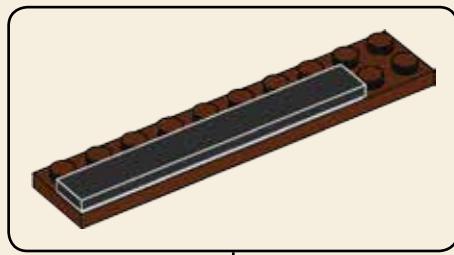

107

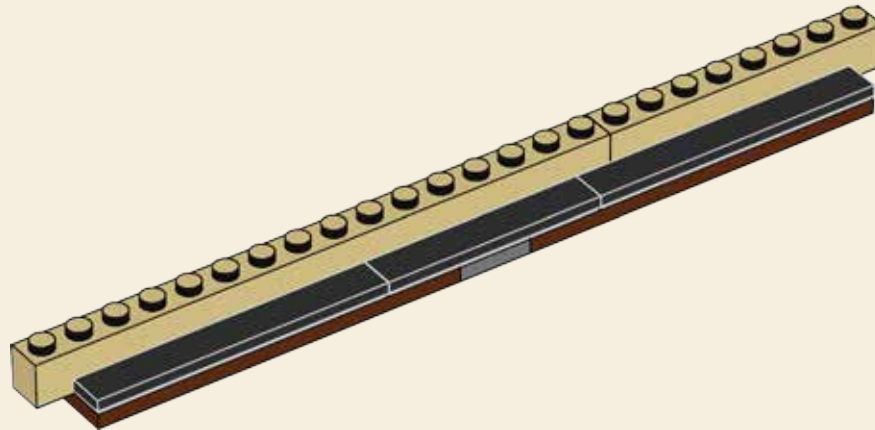

108

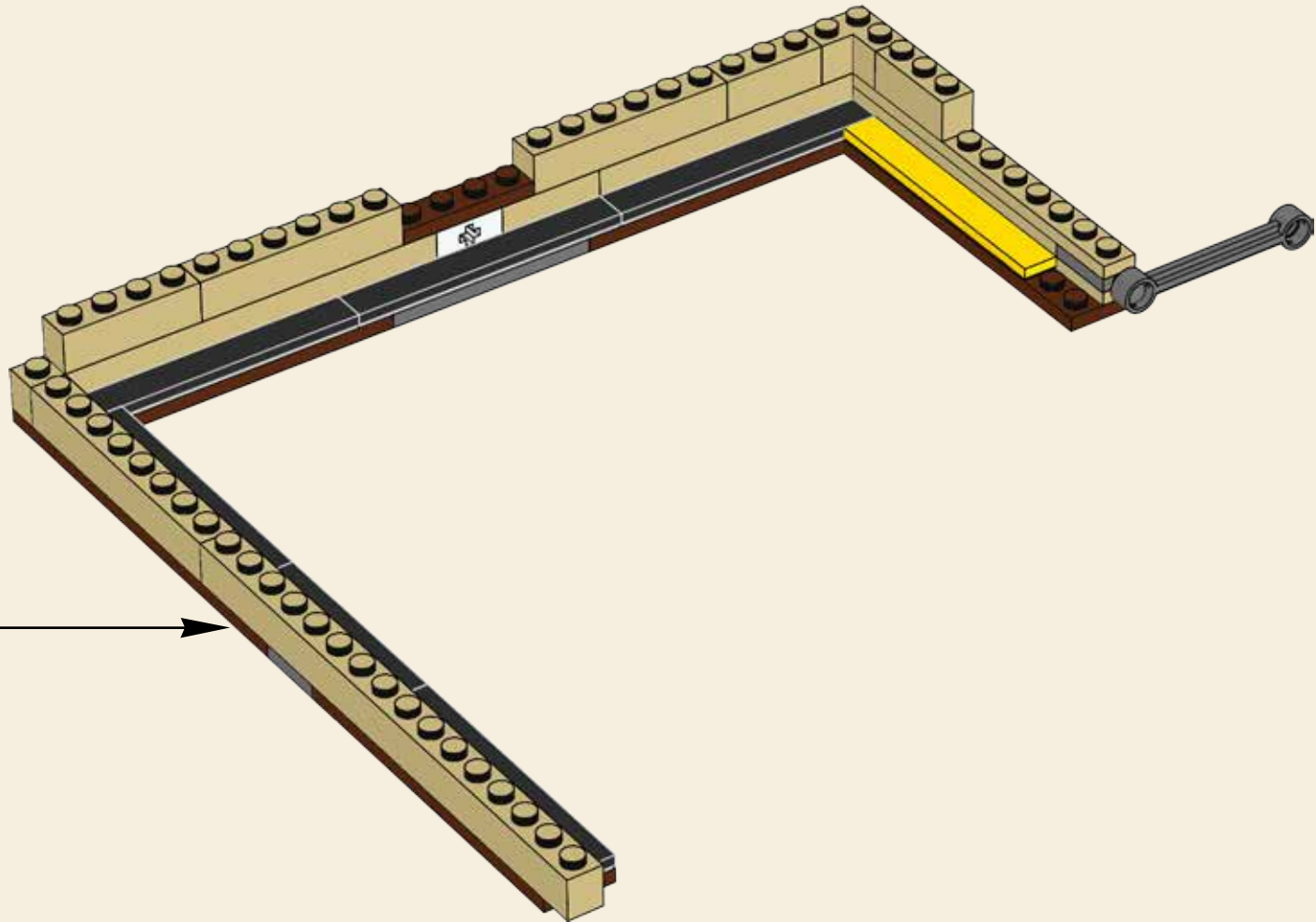

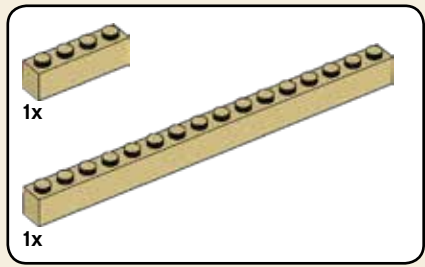

109

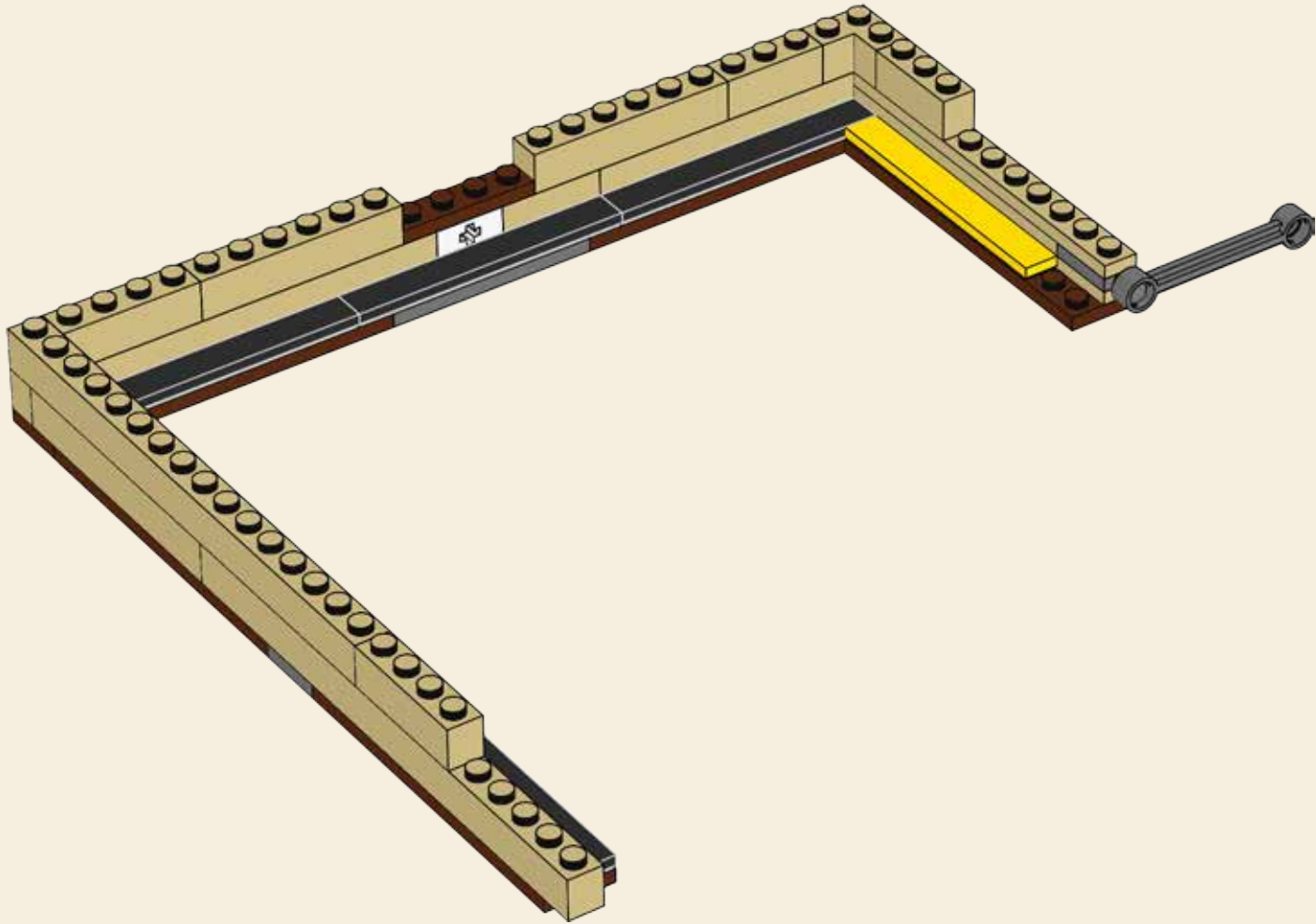

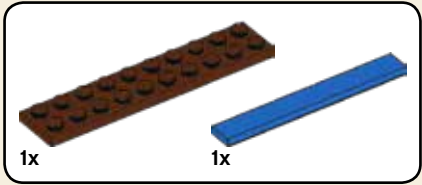
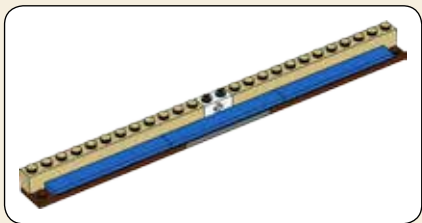

110

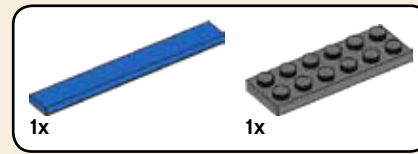

111

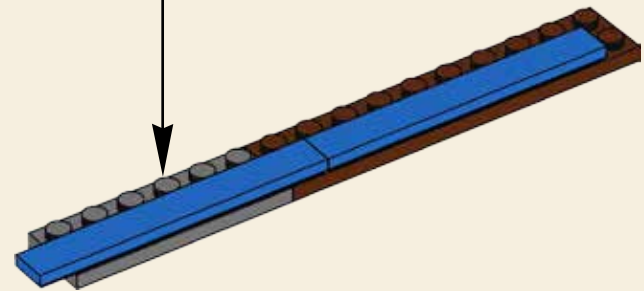
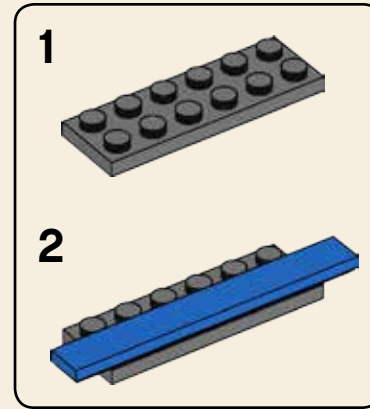

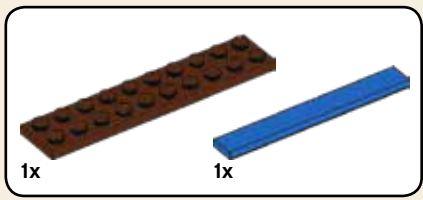

112

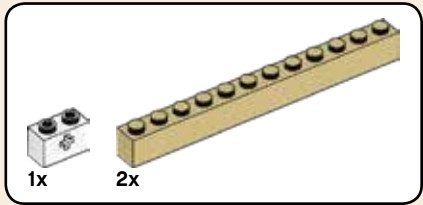
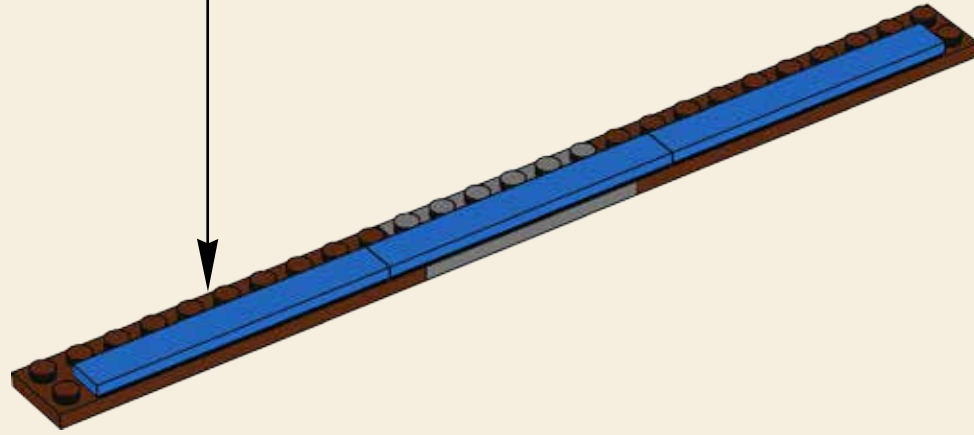
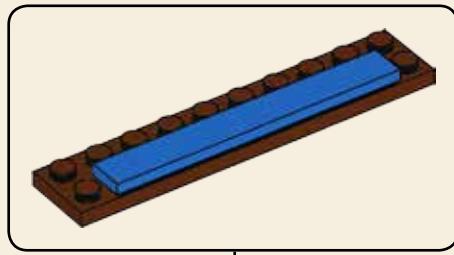

113

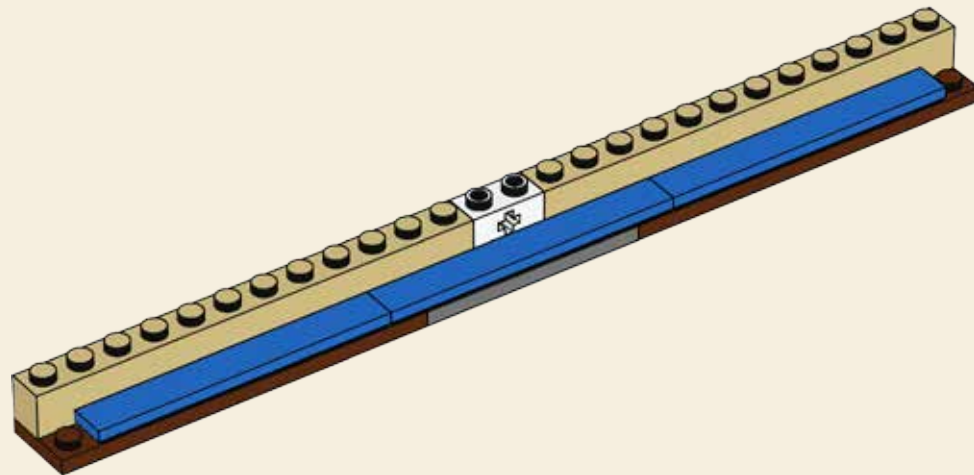

114

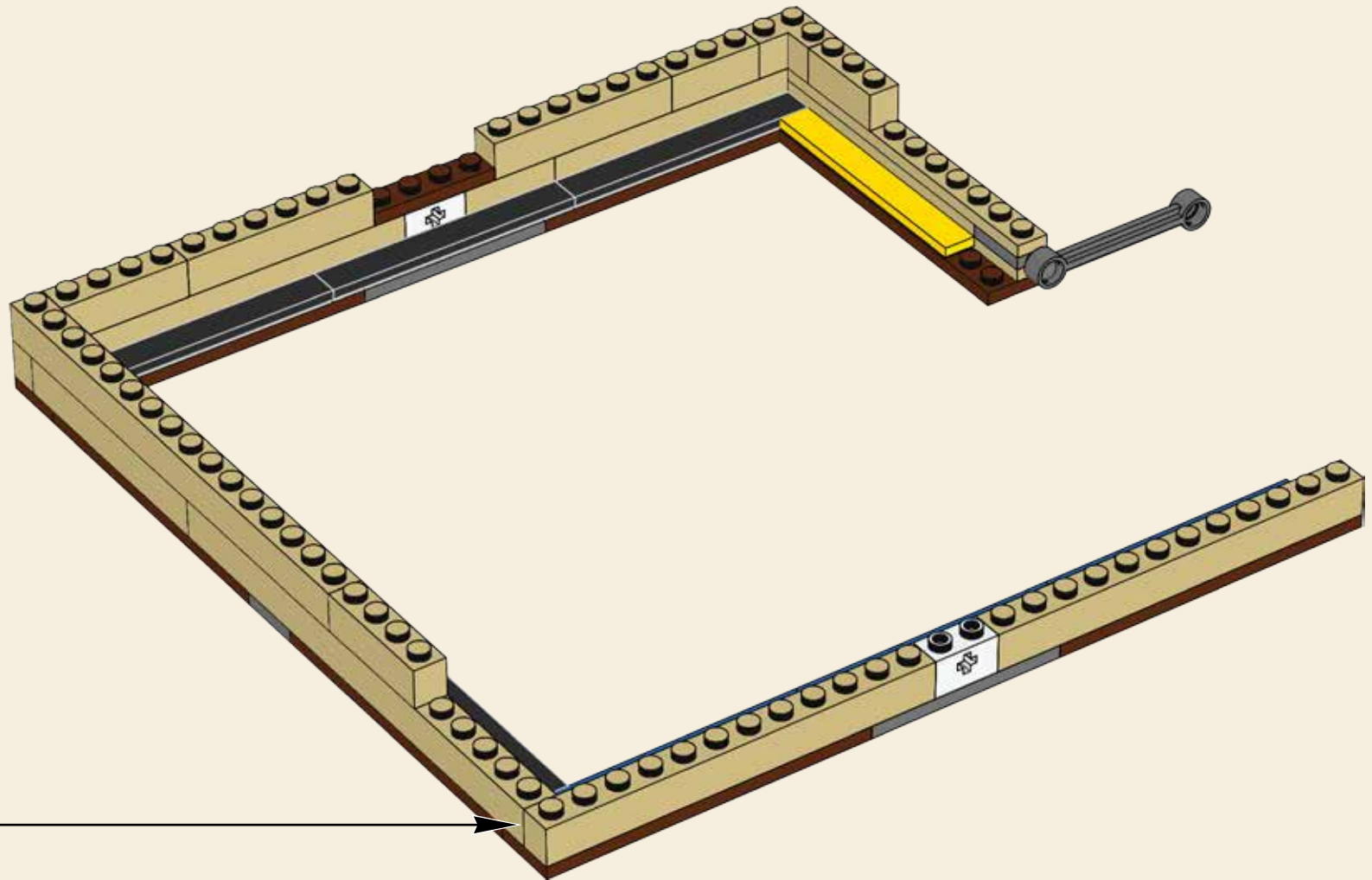

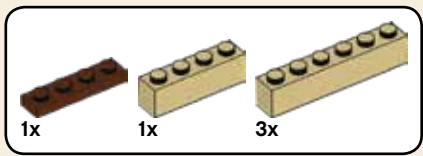

115

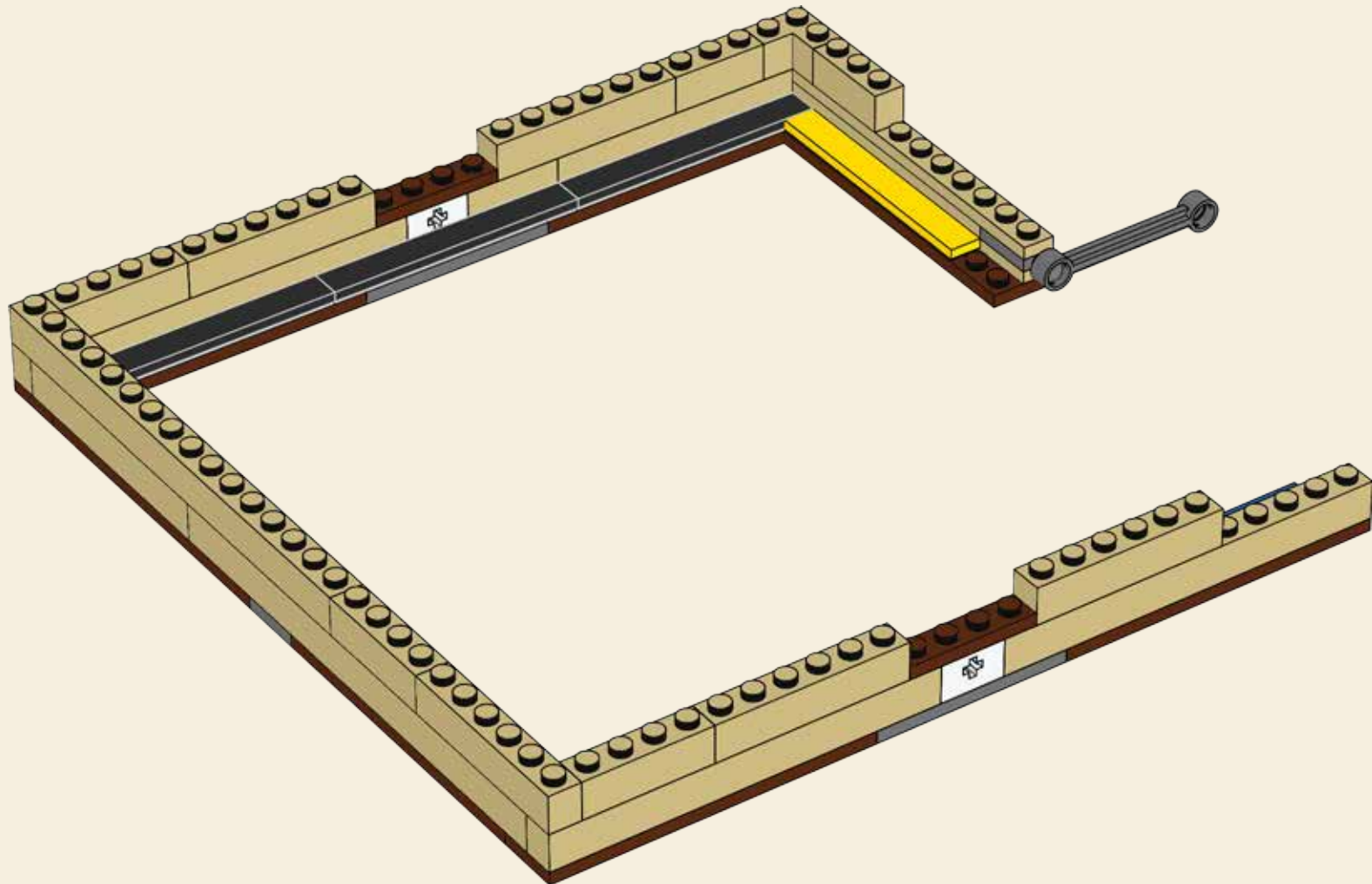

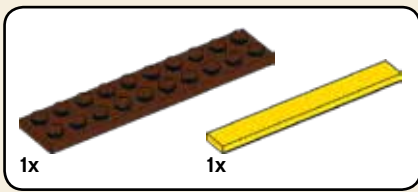

116

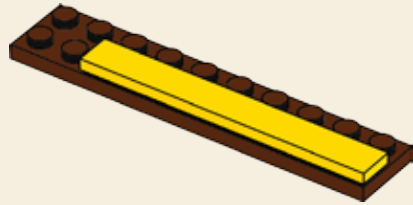

117

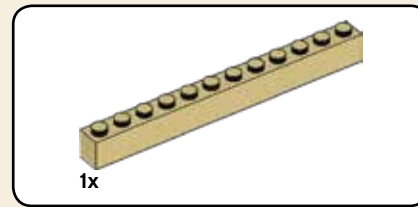
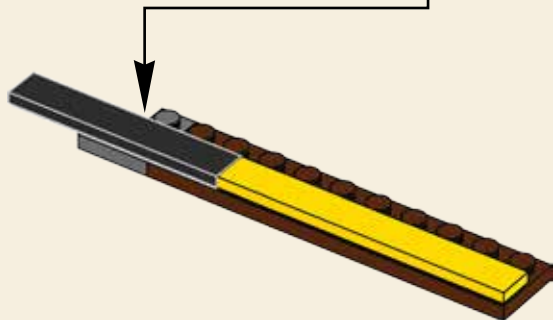
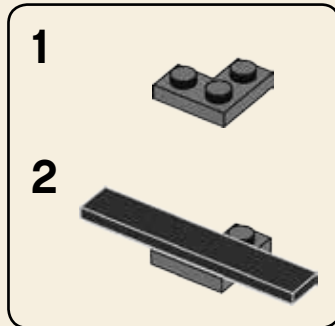

118

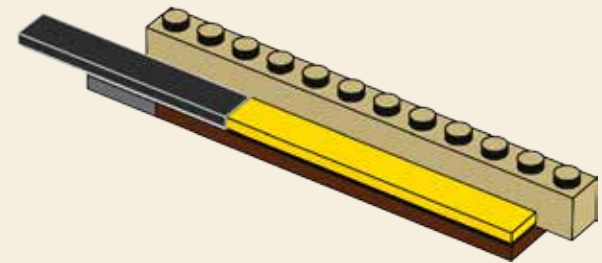

119

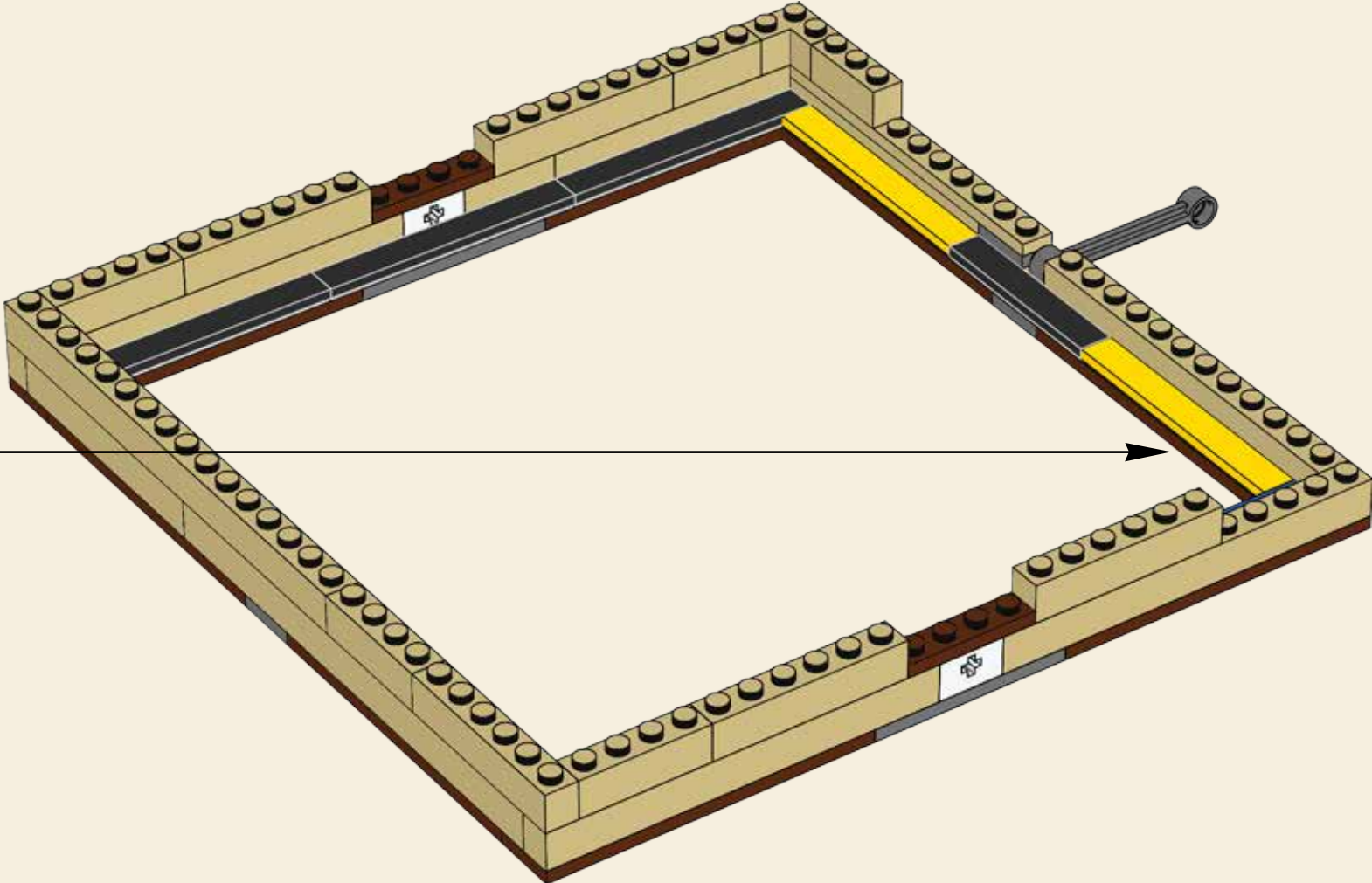

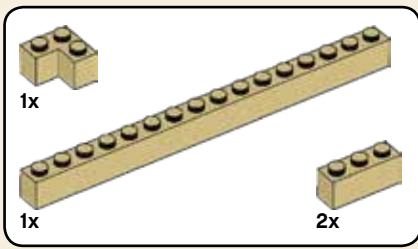

120

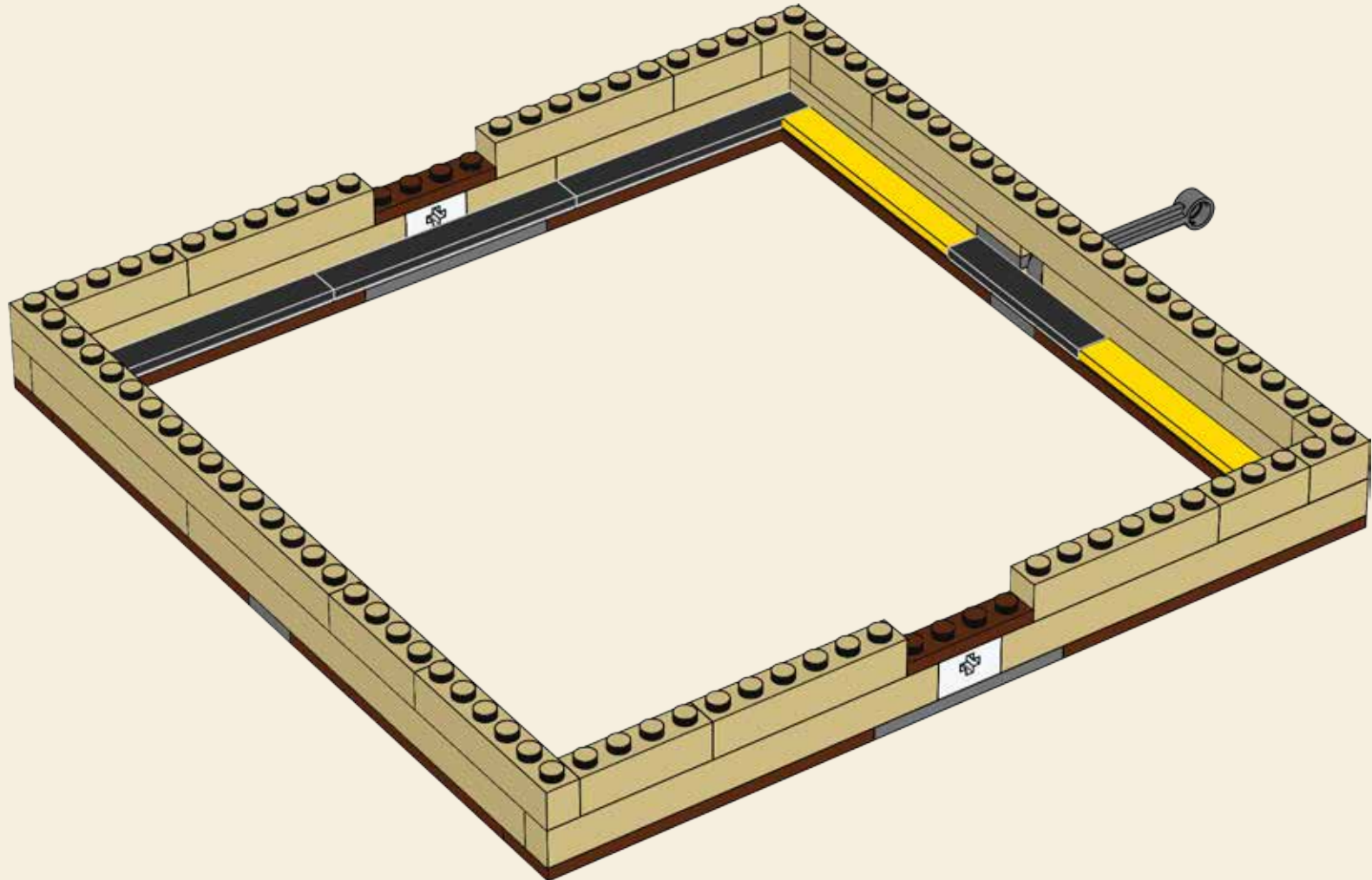

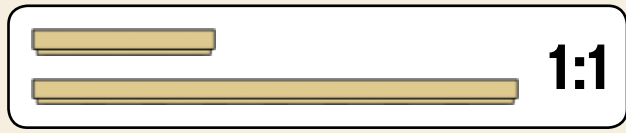
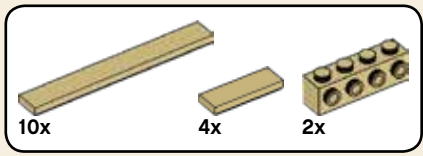

121

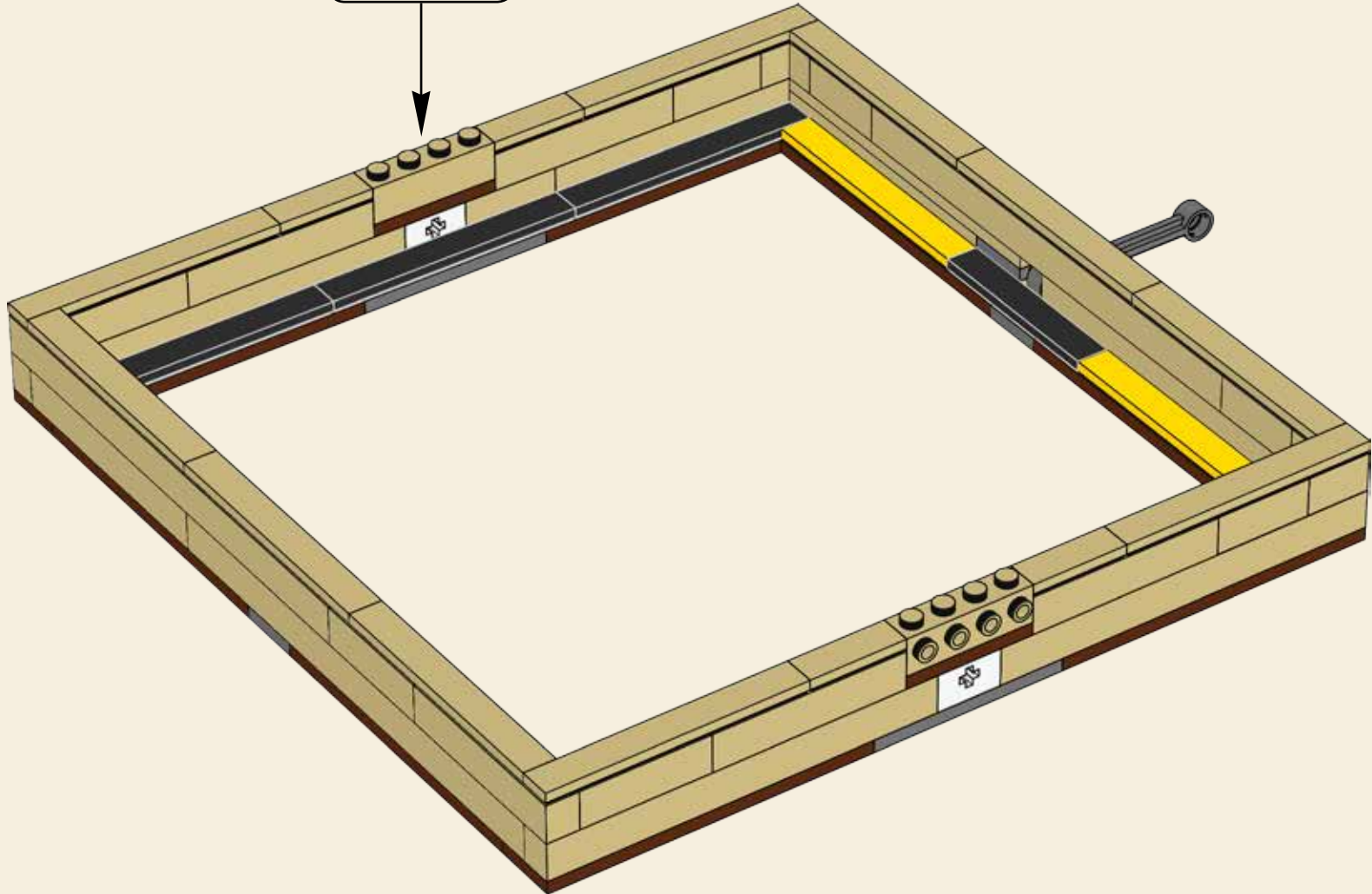
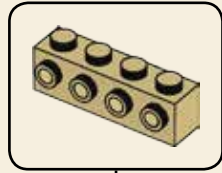

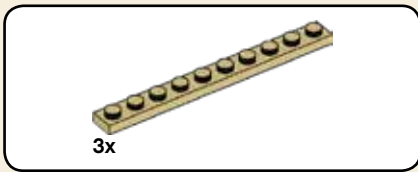

122

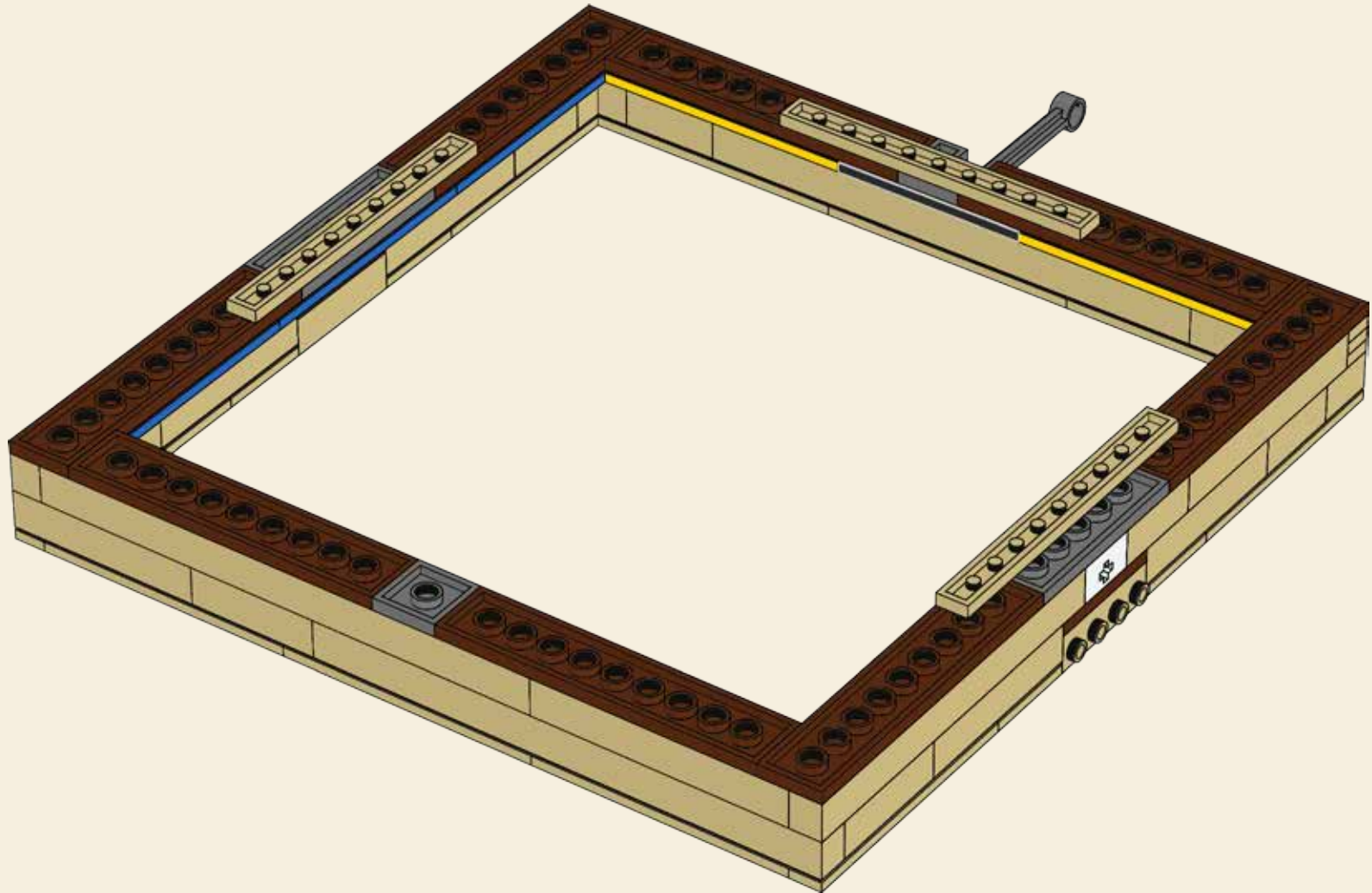
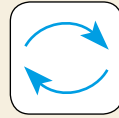



4x

123

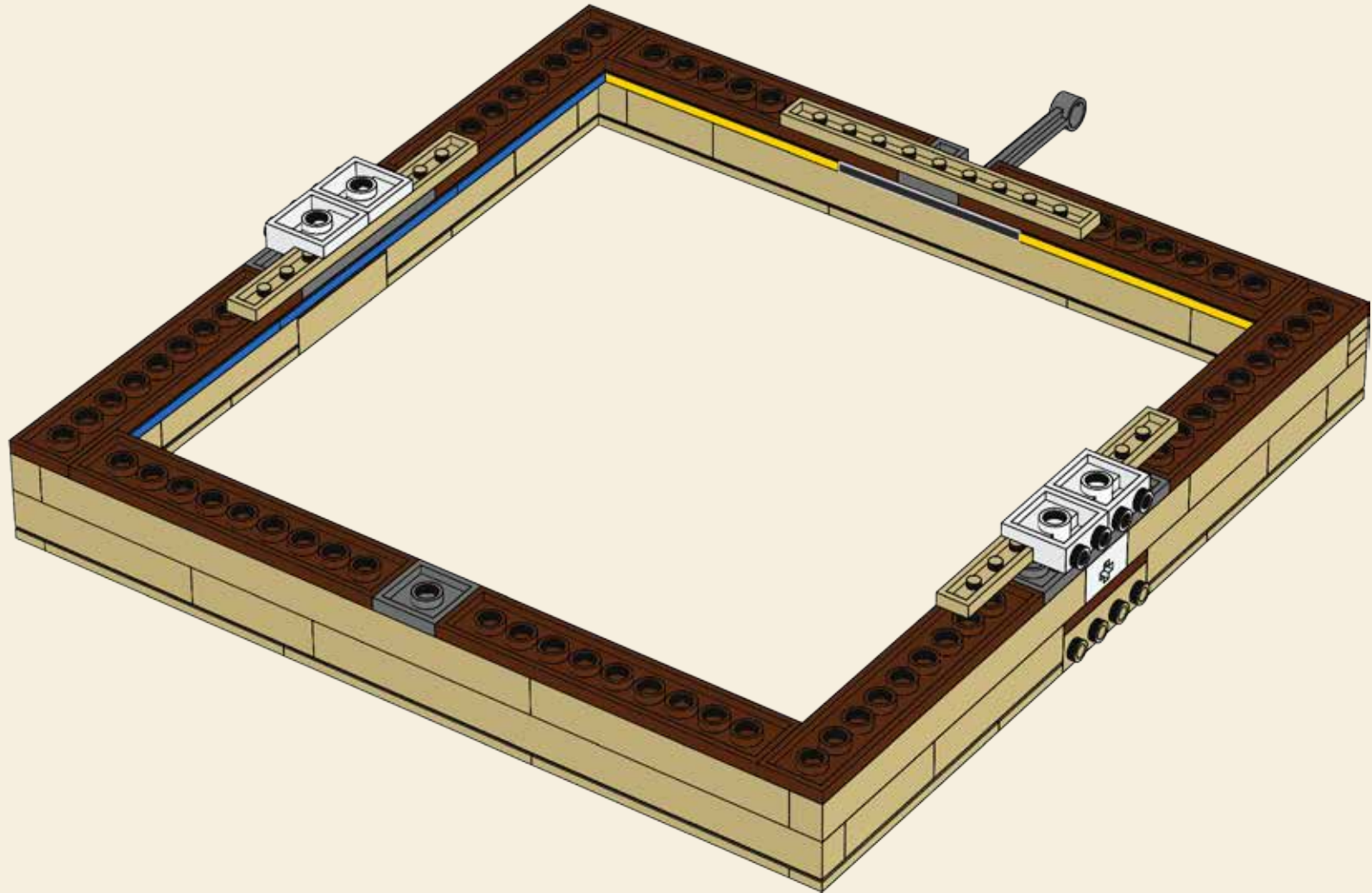

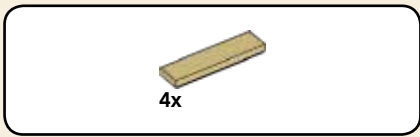

124

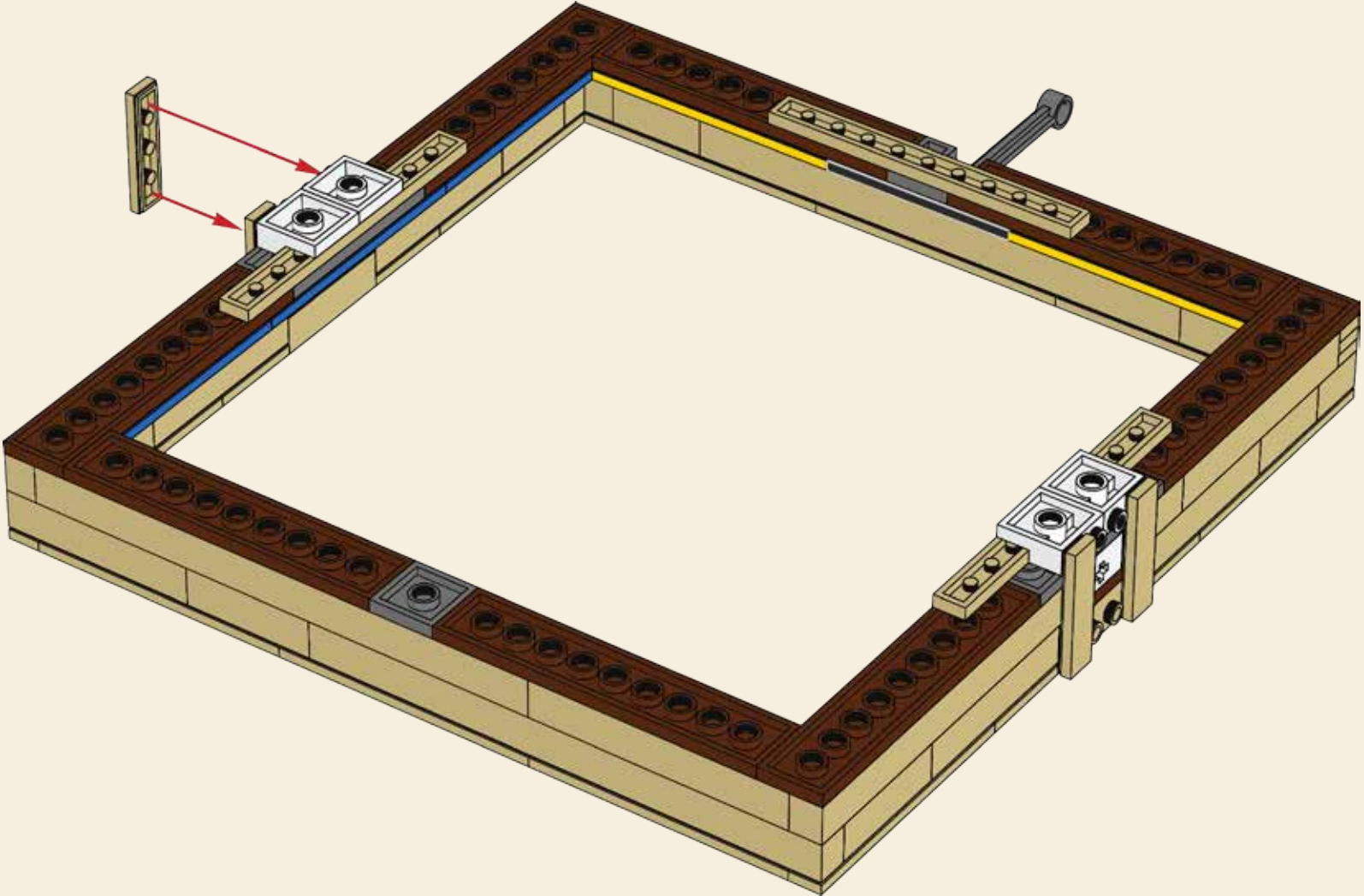

125

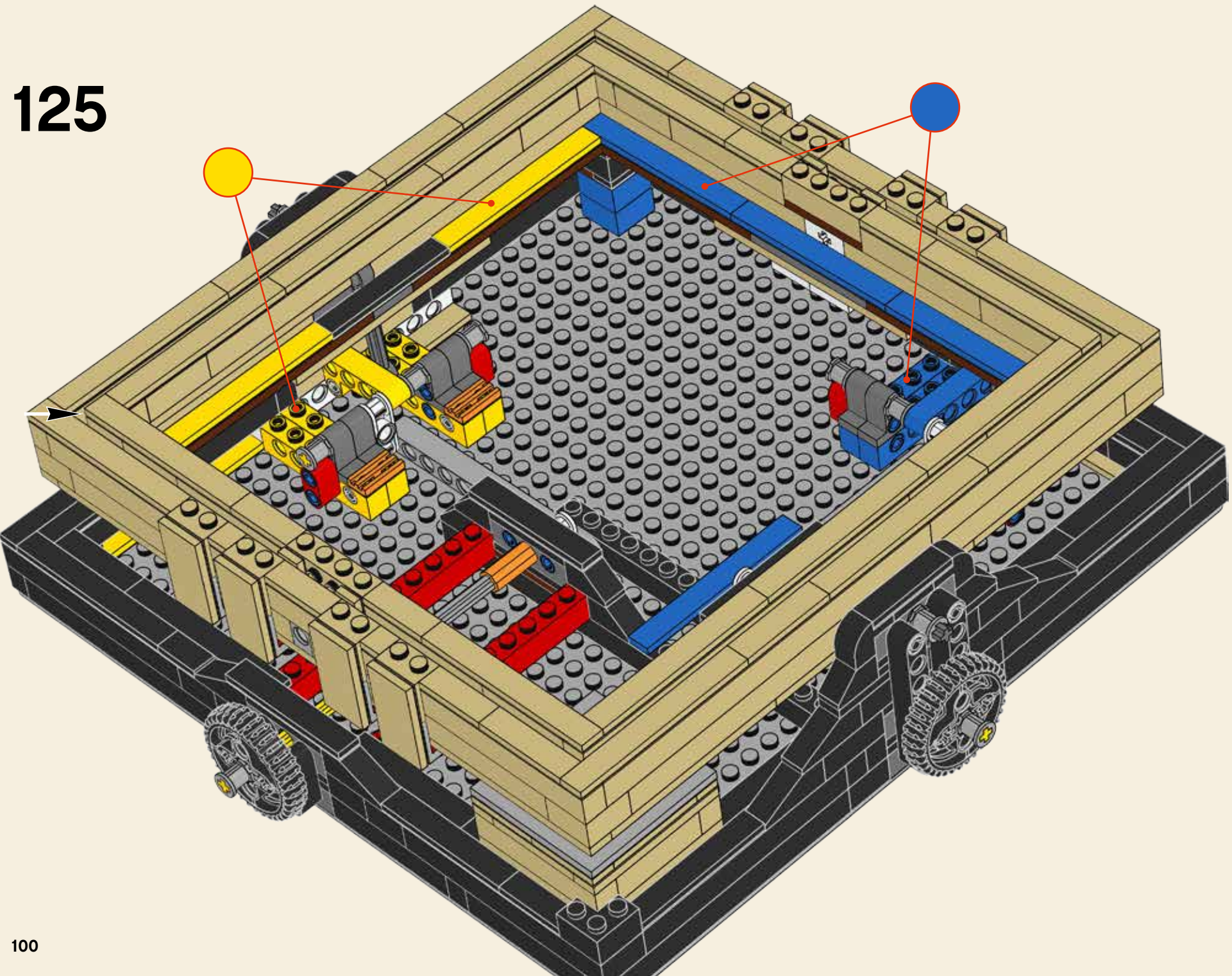

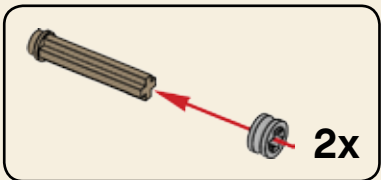
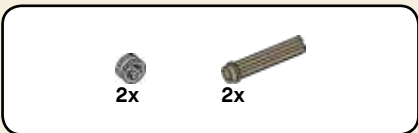

126

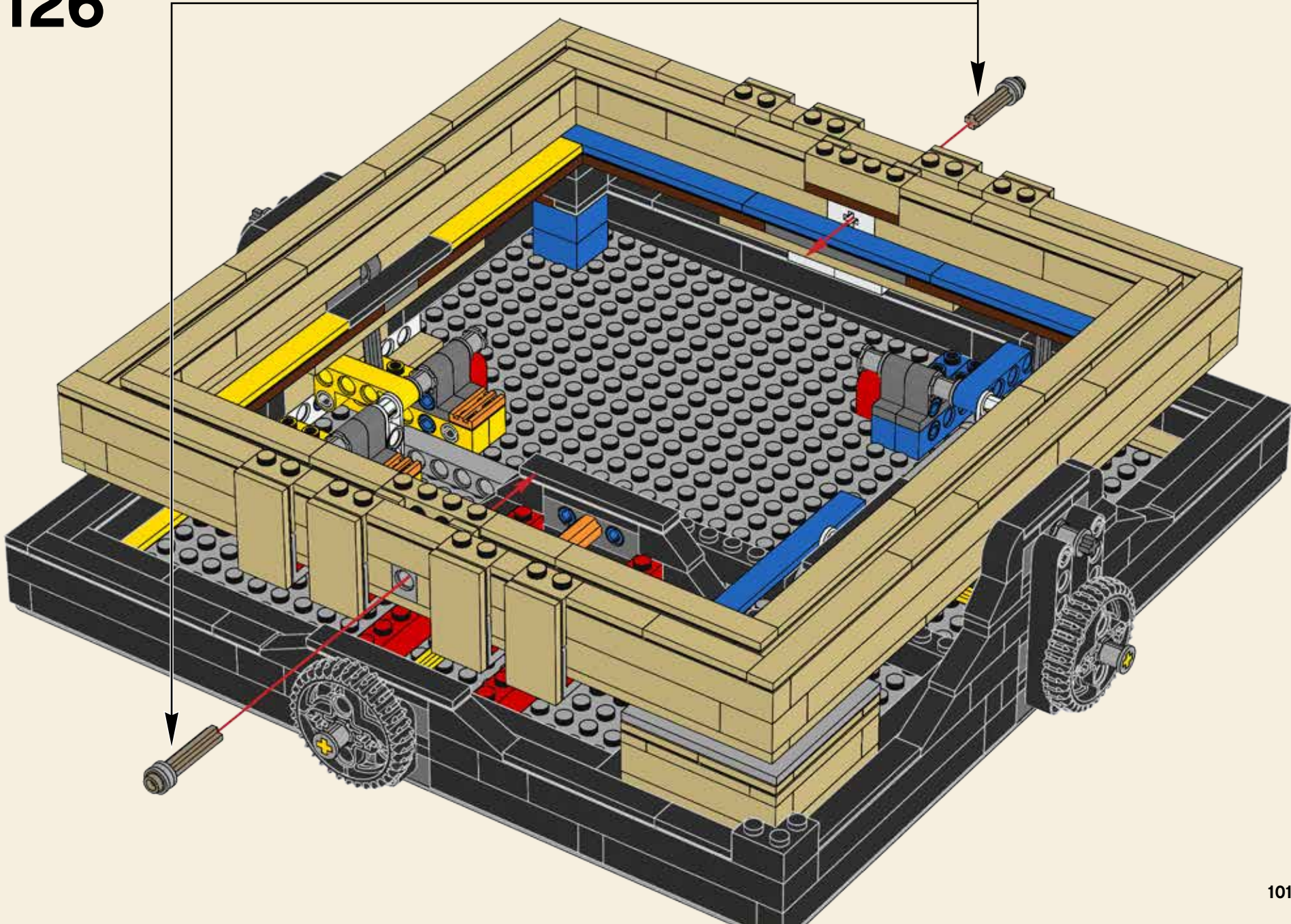

127

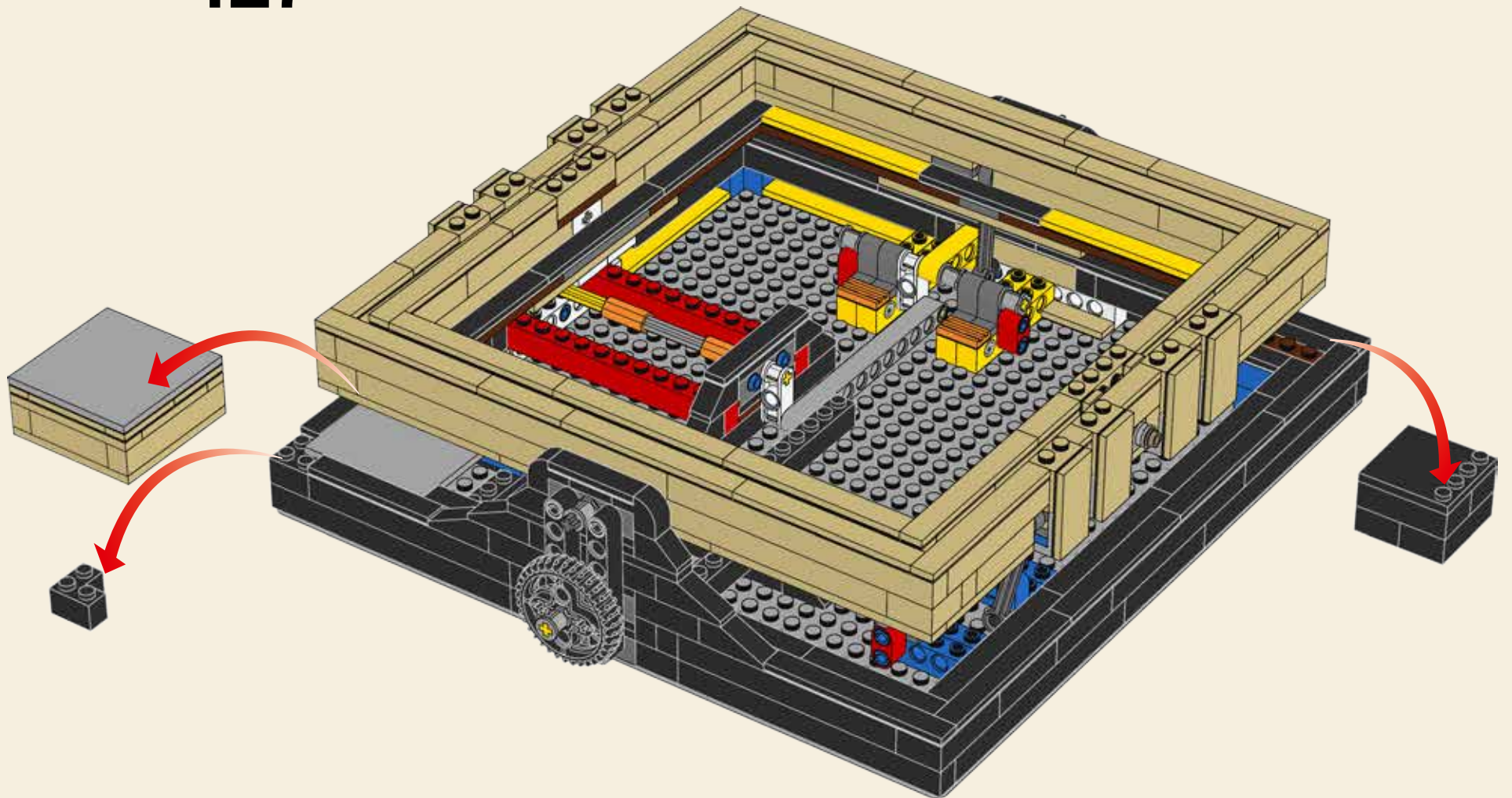

128

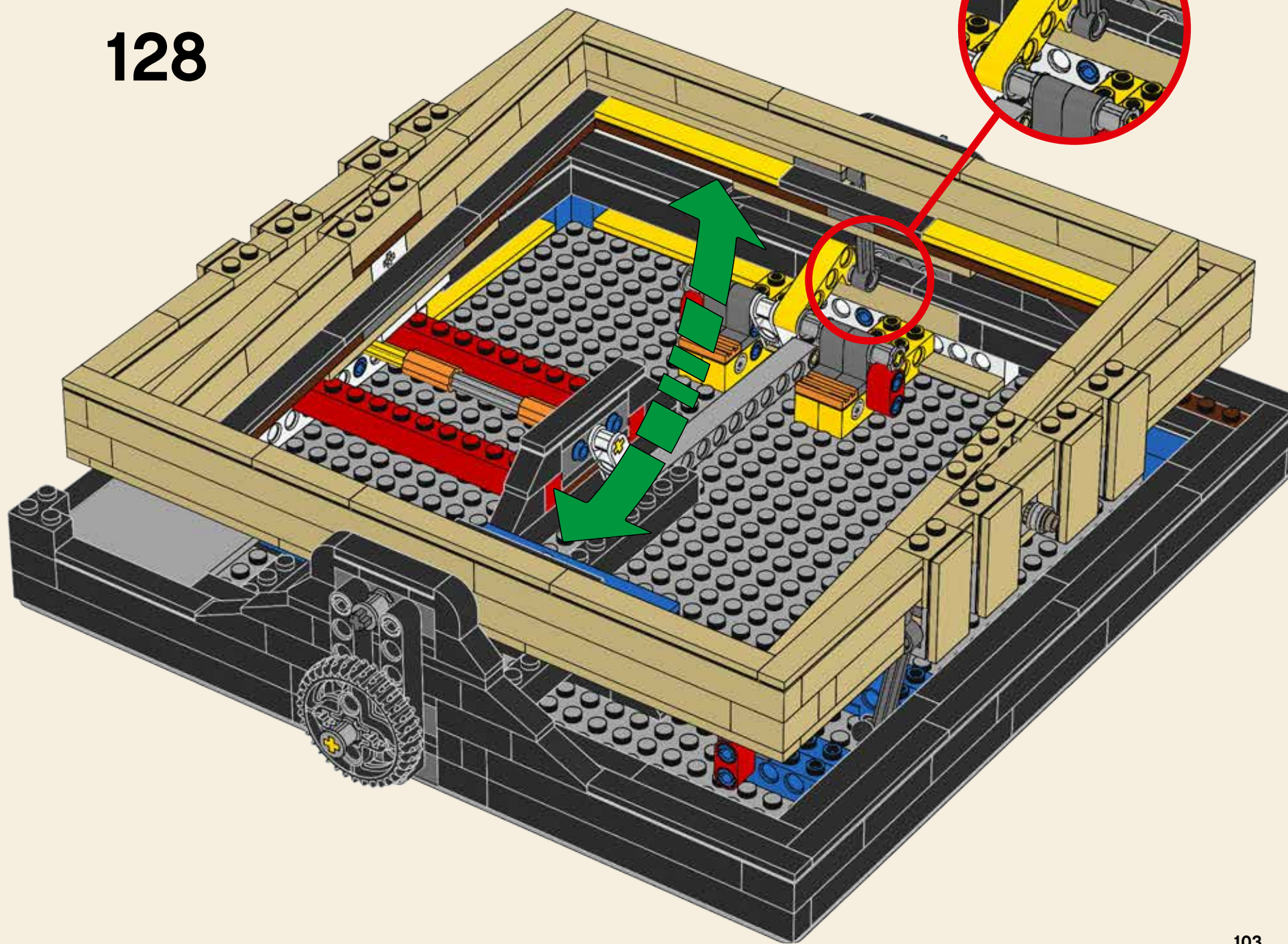

129

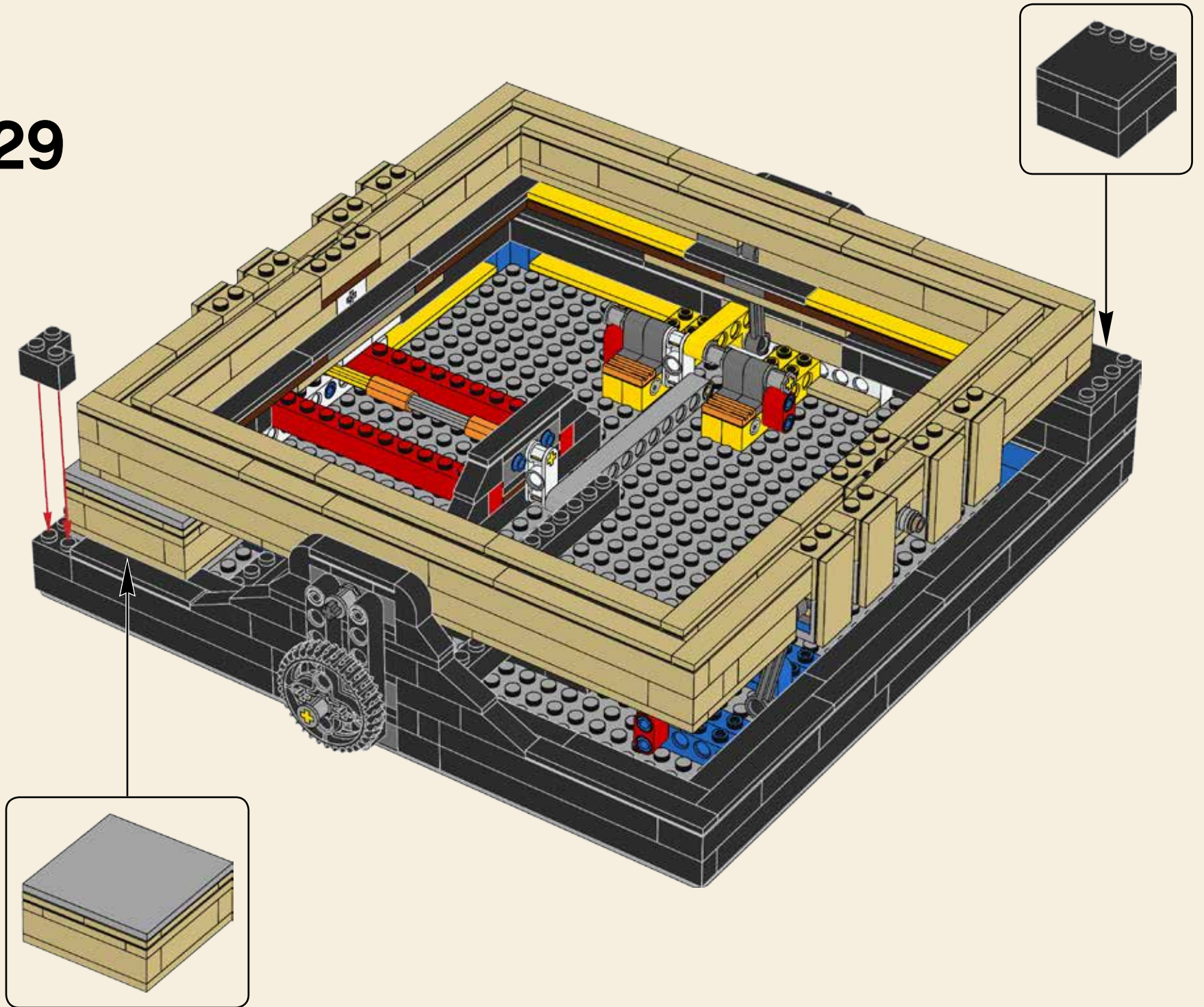

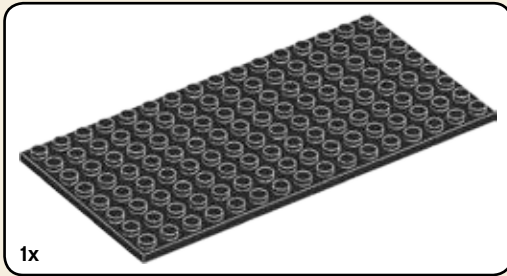
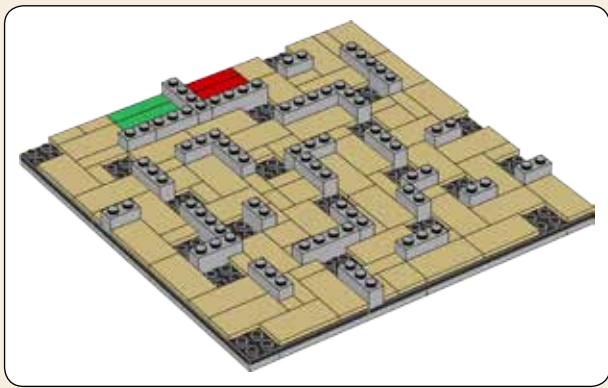

1x

130

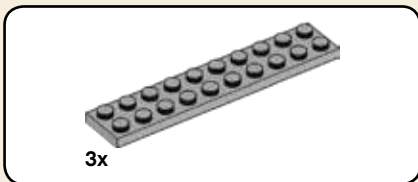
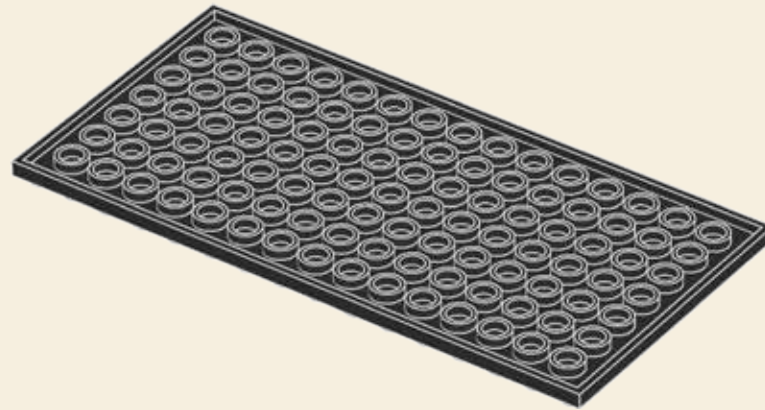

3x

131

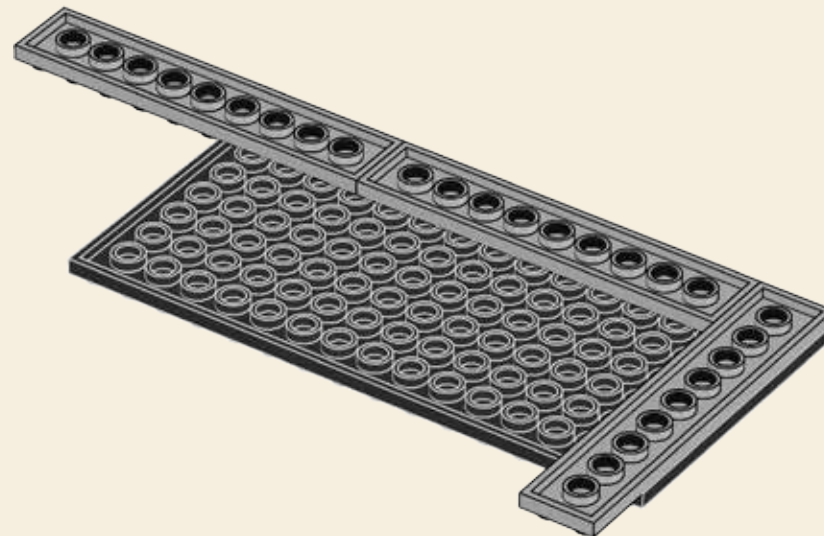

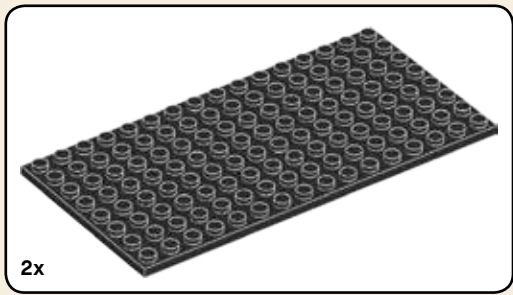

132

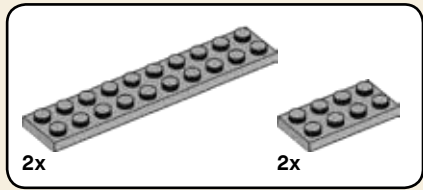
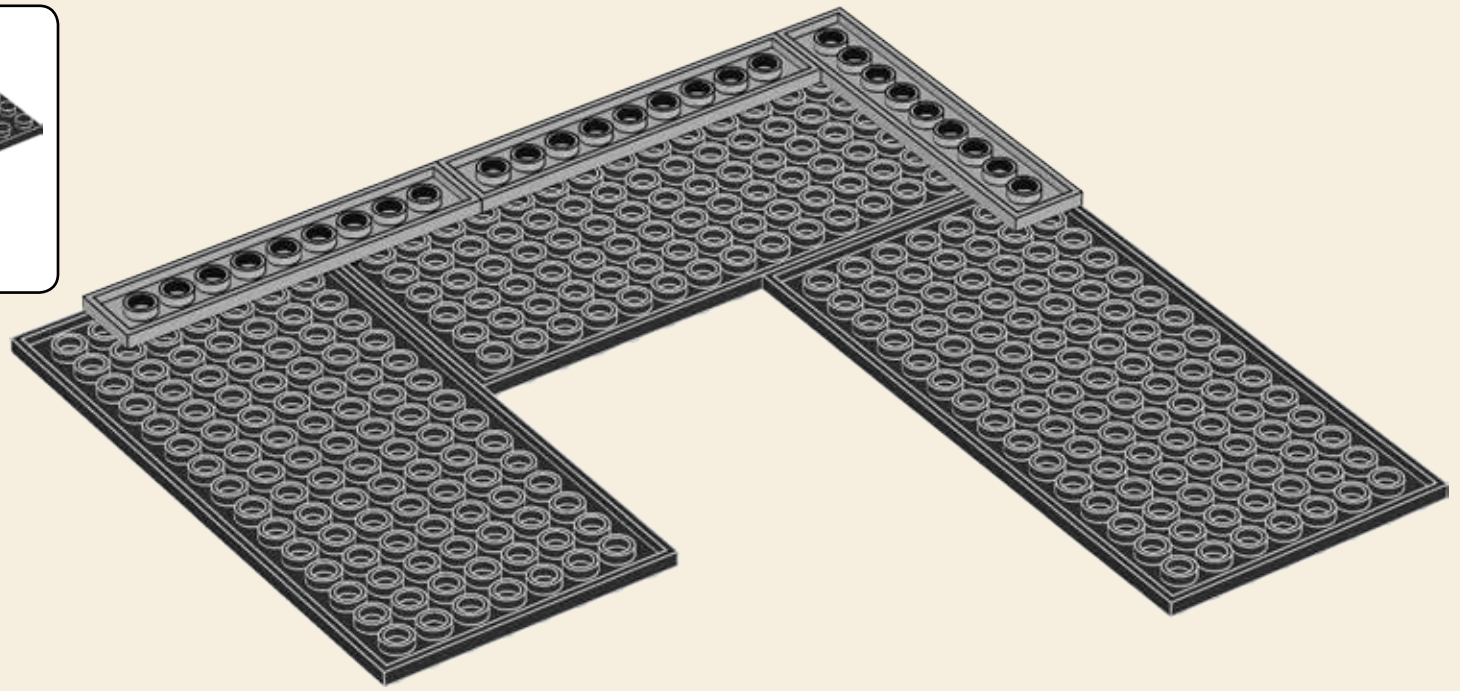

133

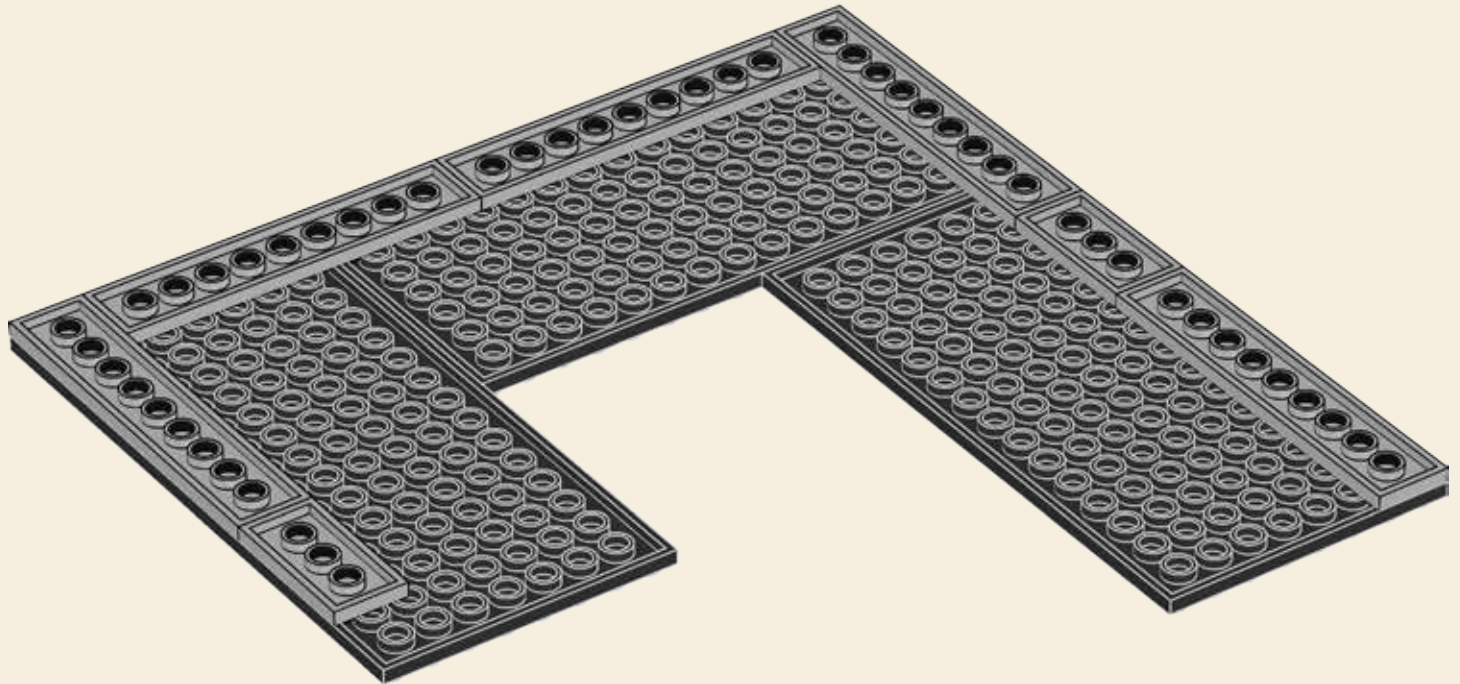

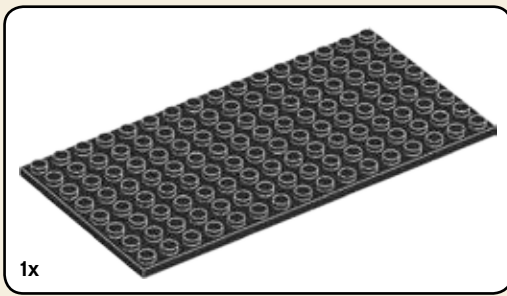

134

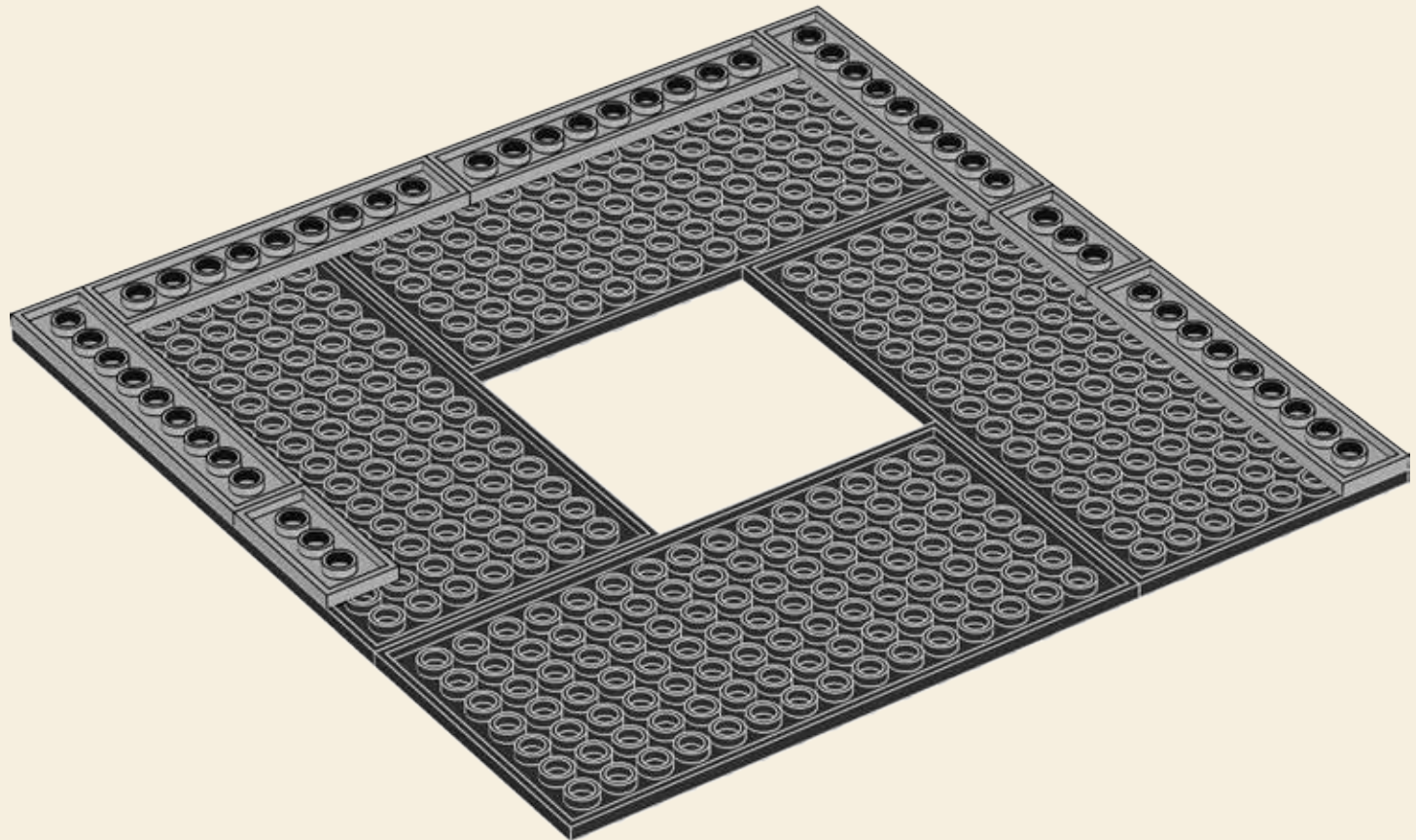

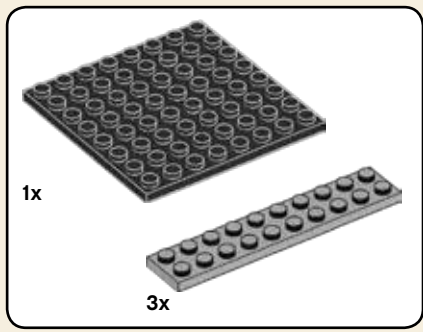

135

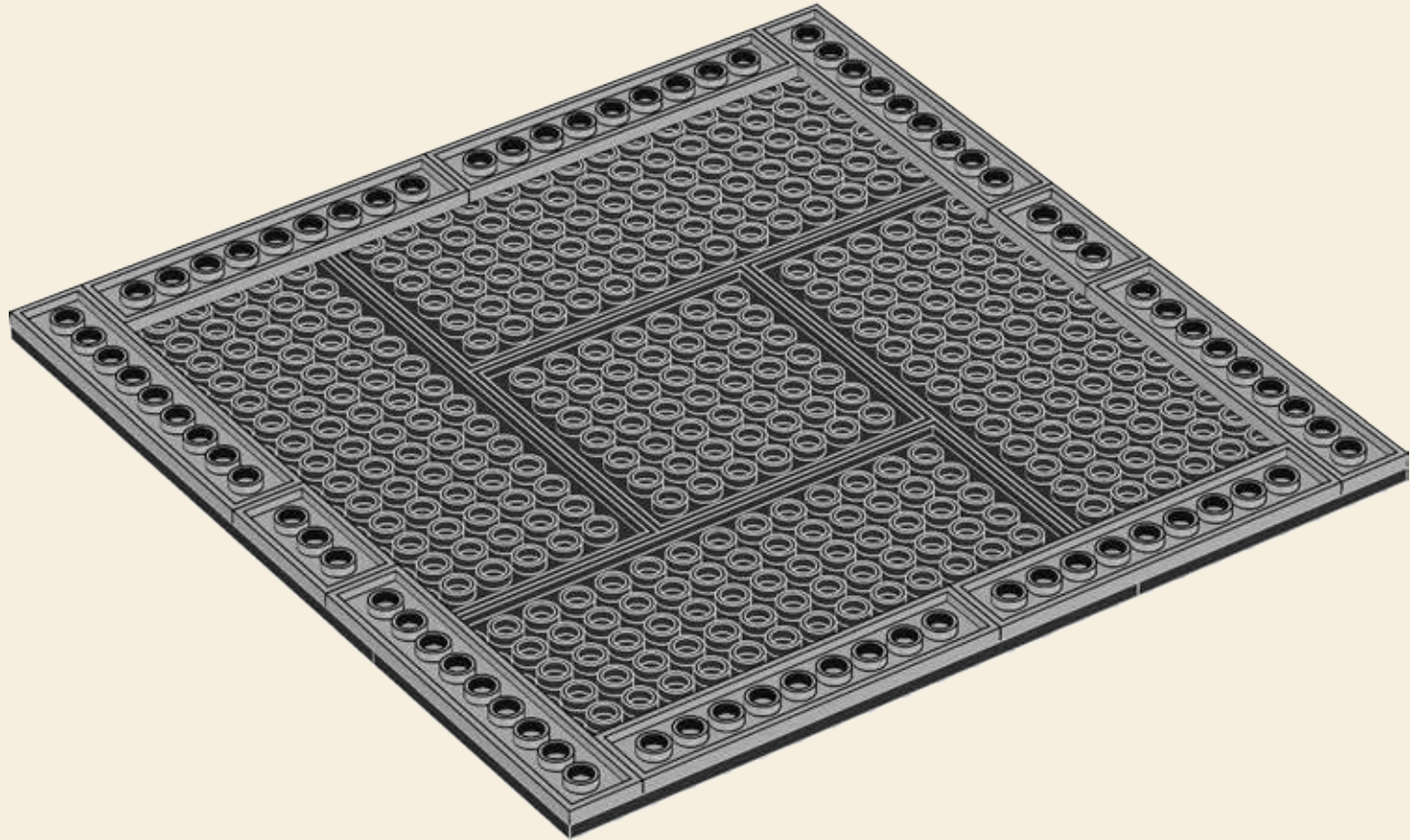

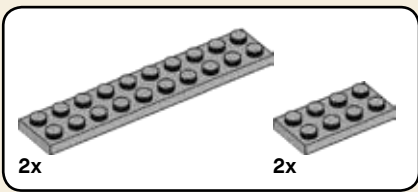

136

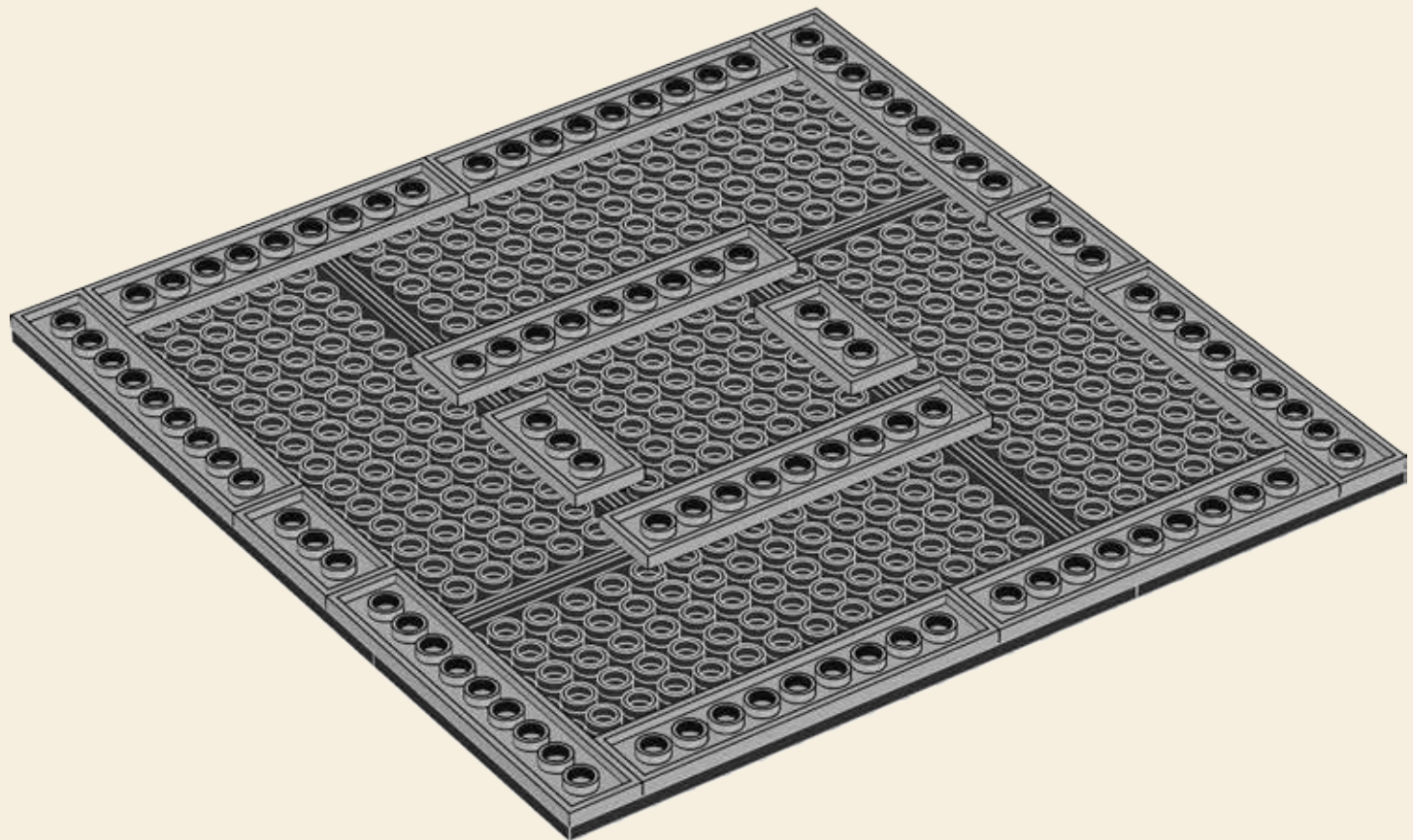

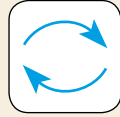
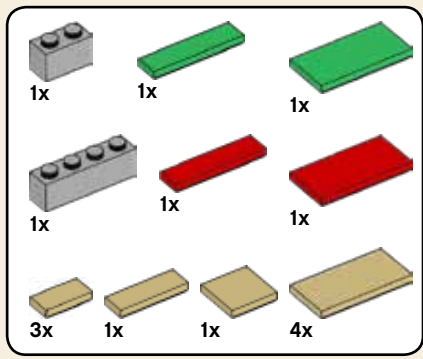

137

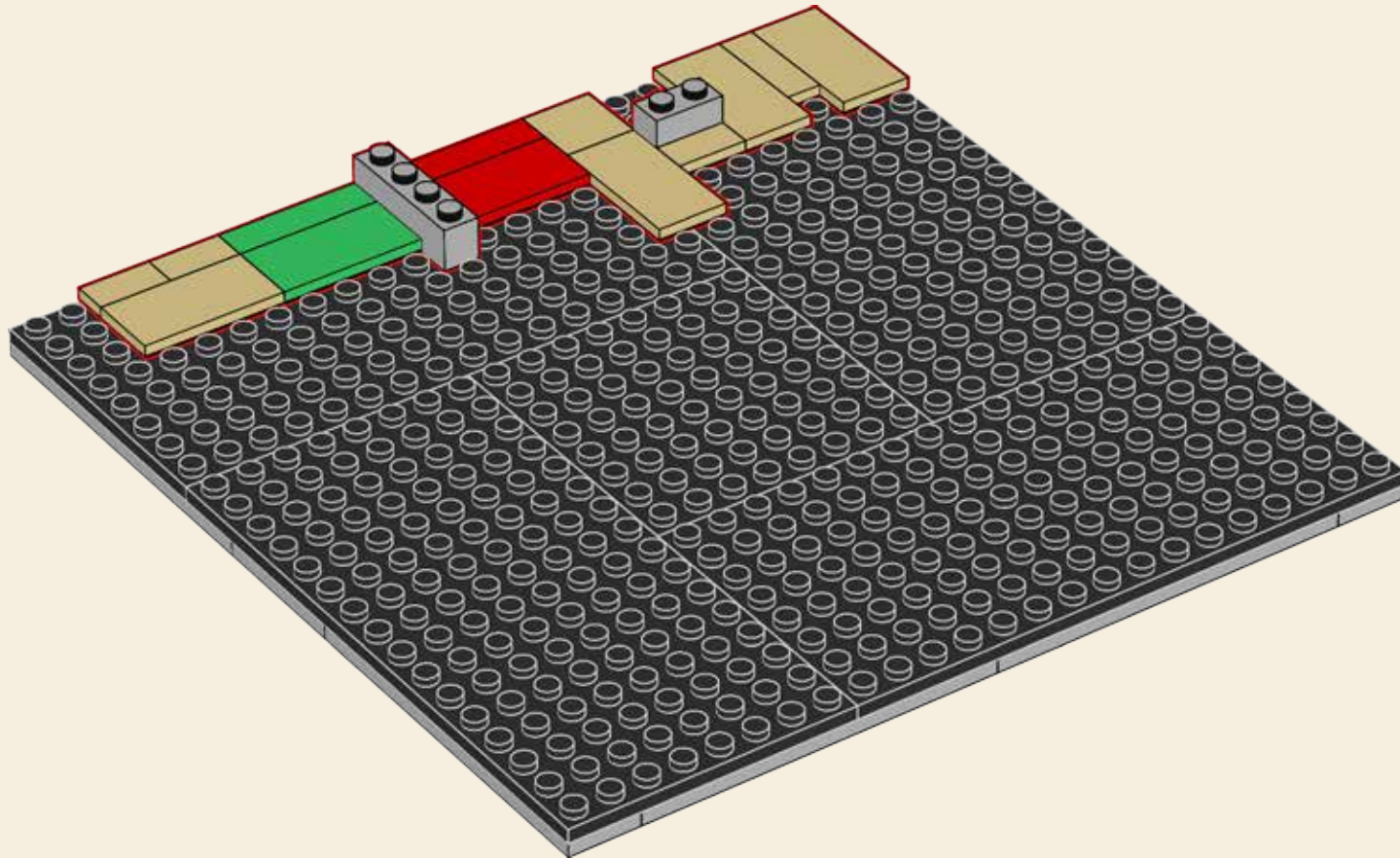

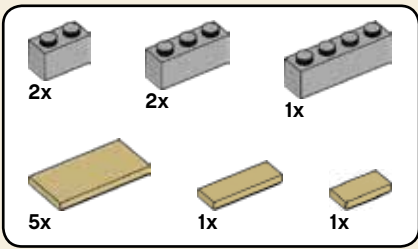

138

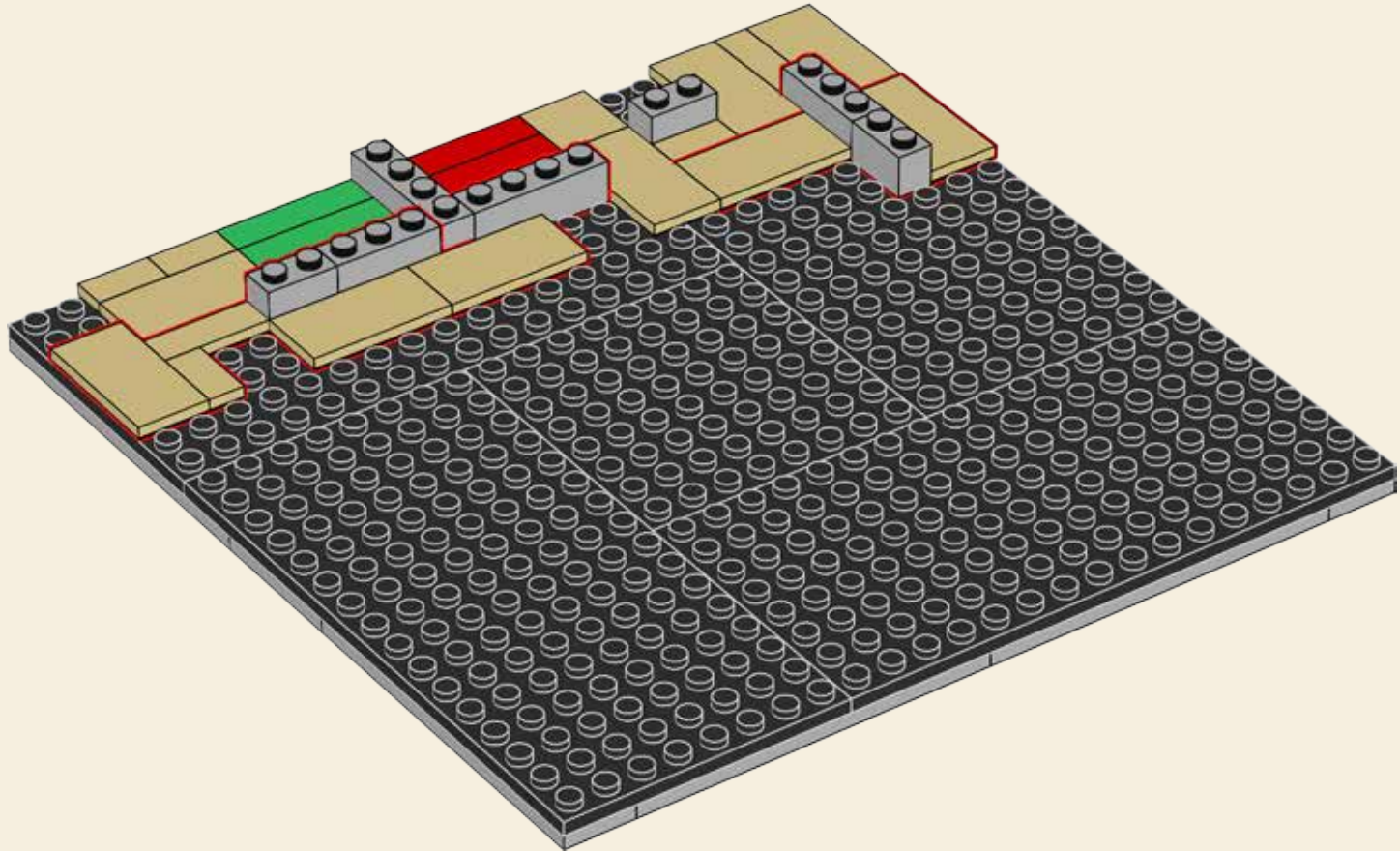

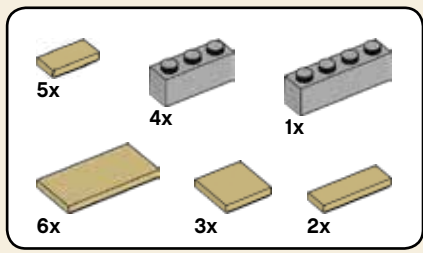

139

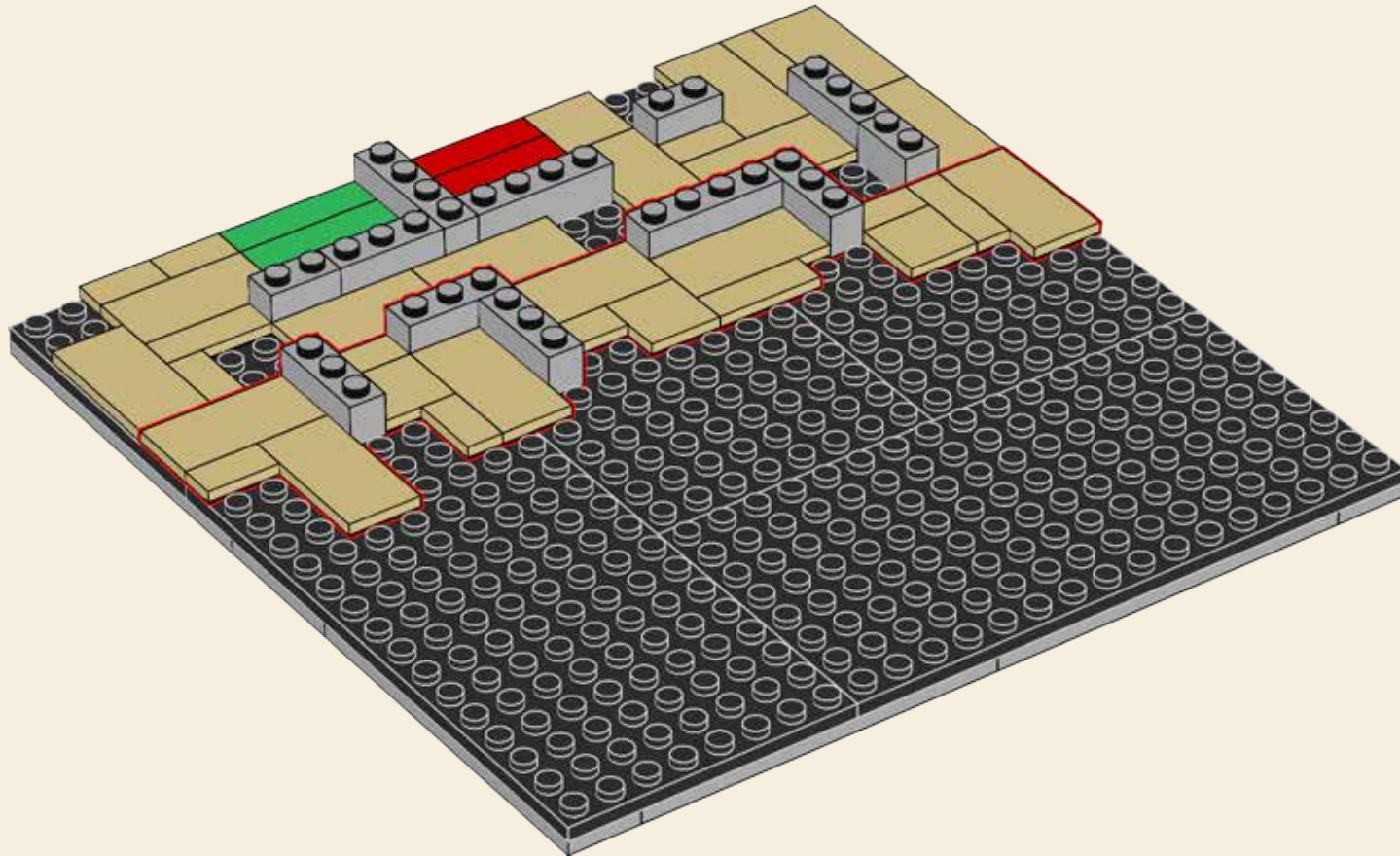

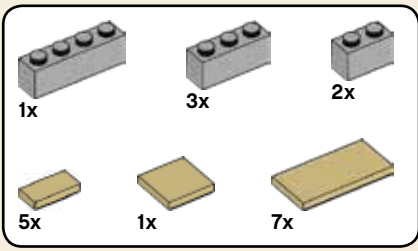

140

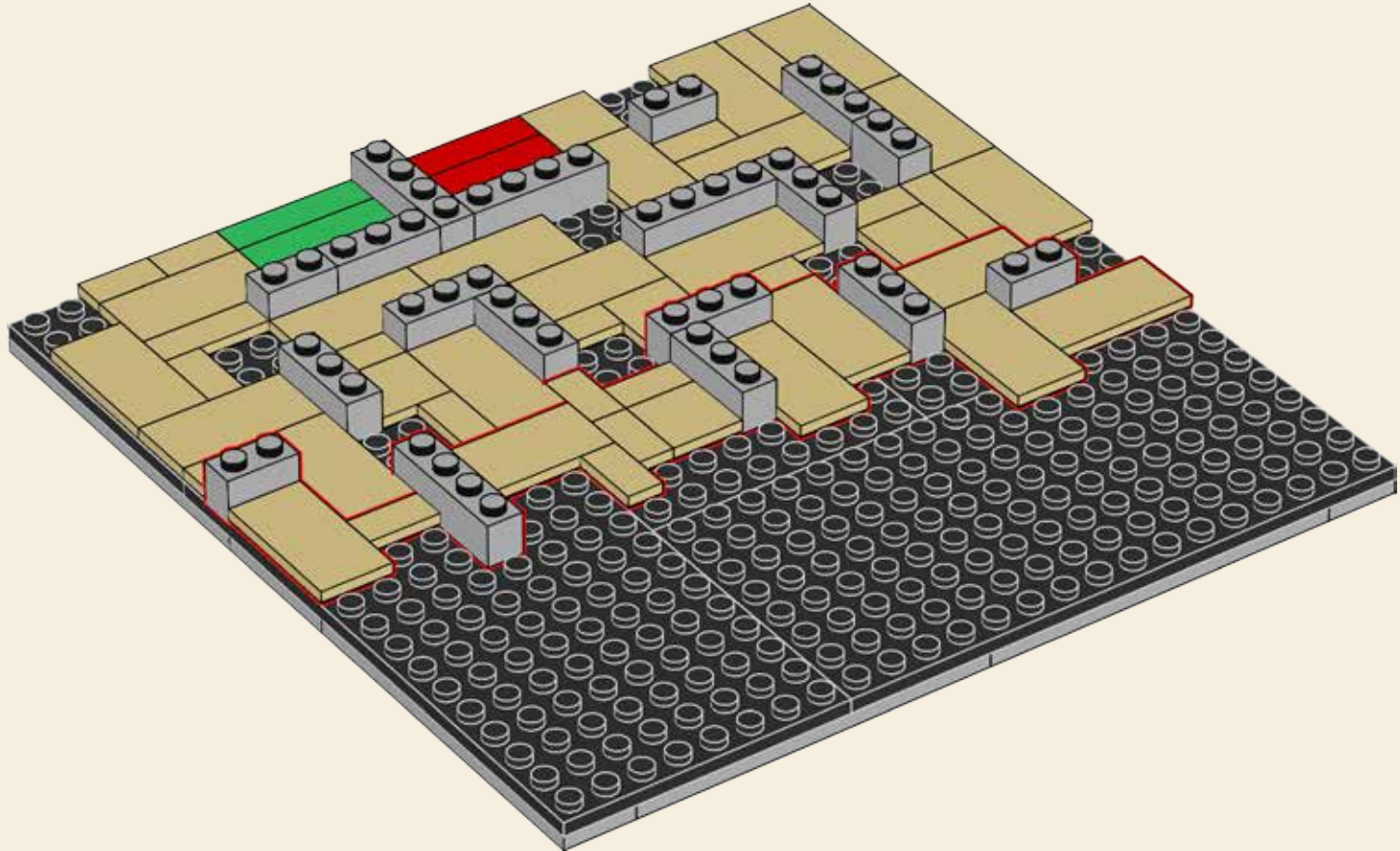

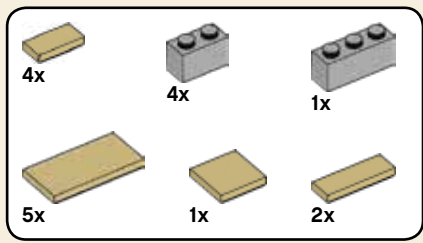

141

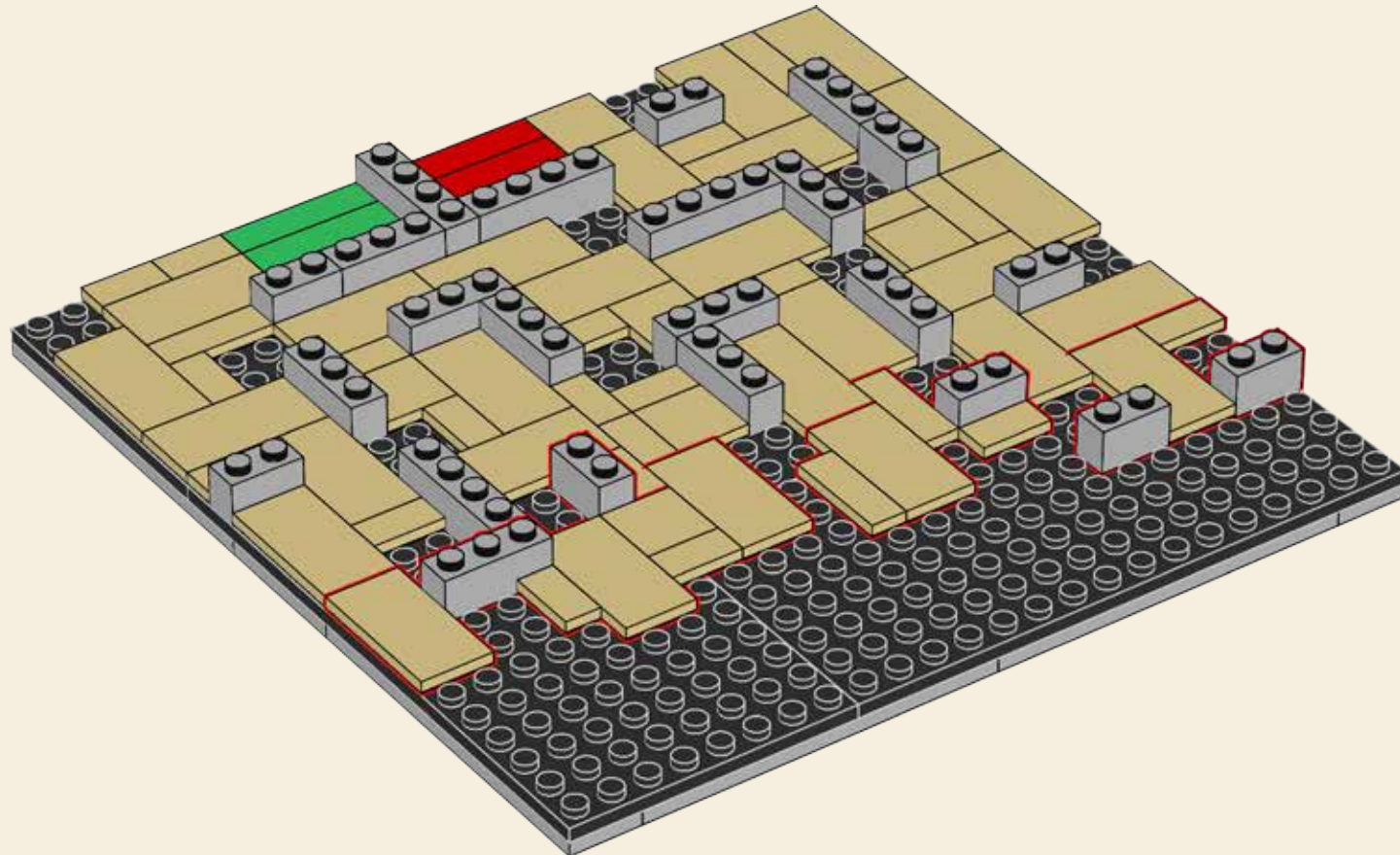

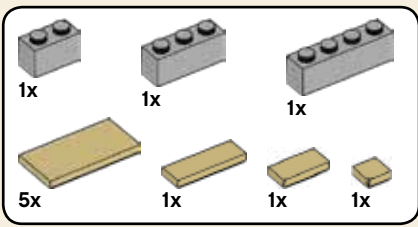

142

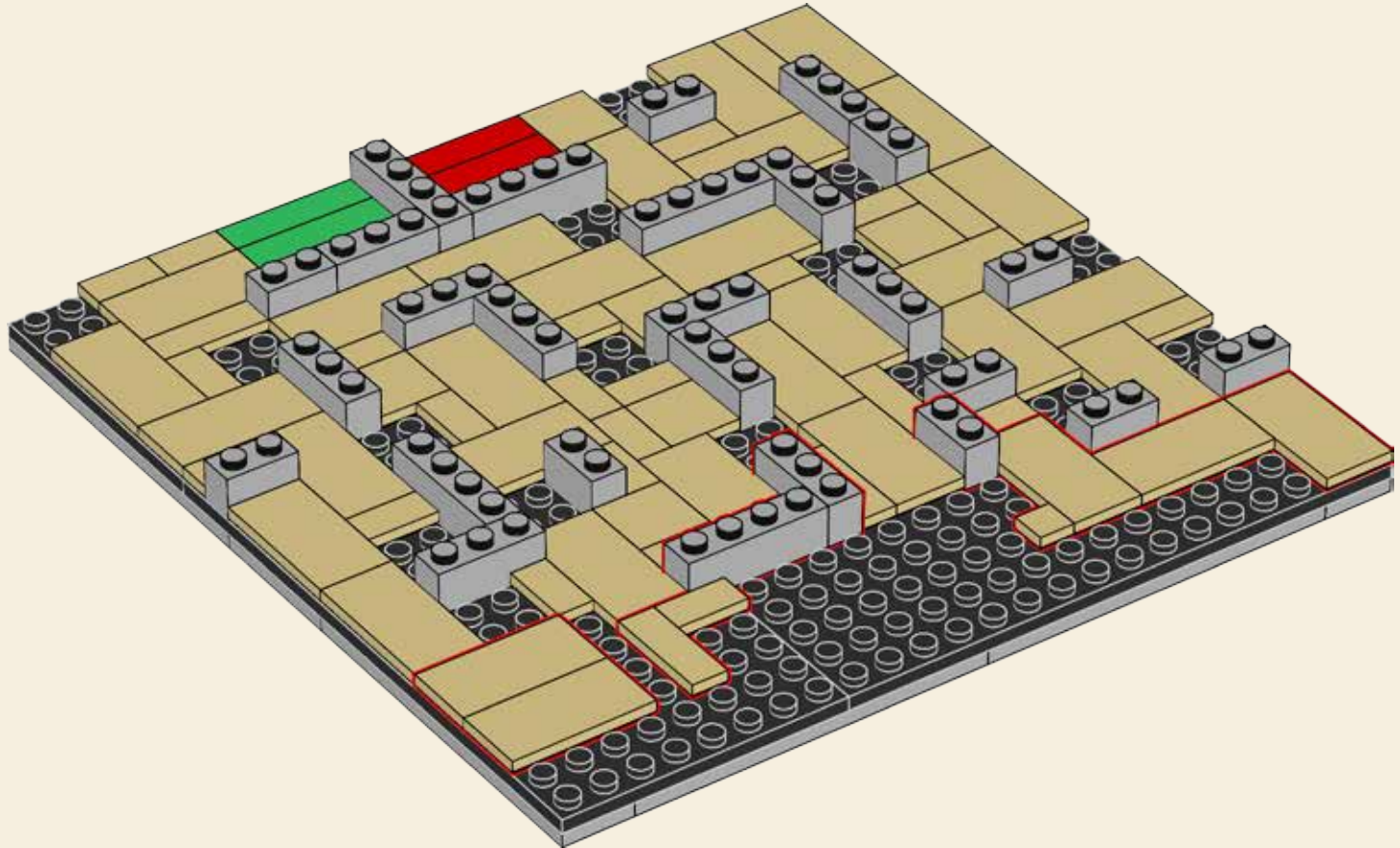

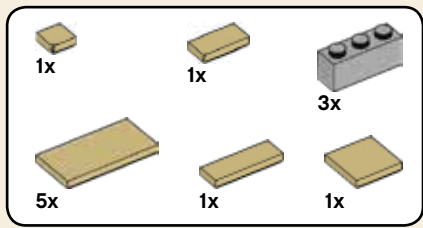

143

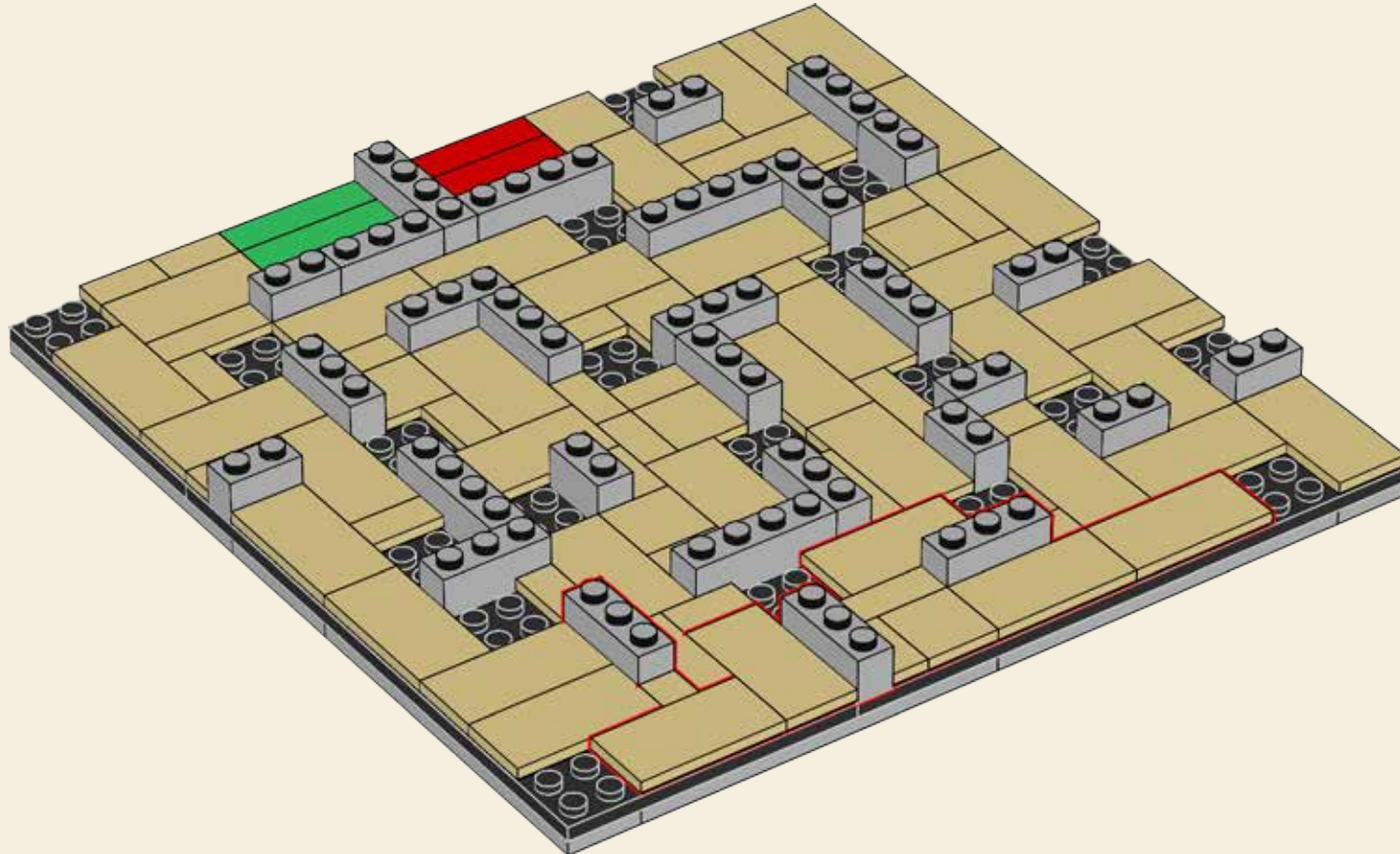

144

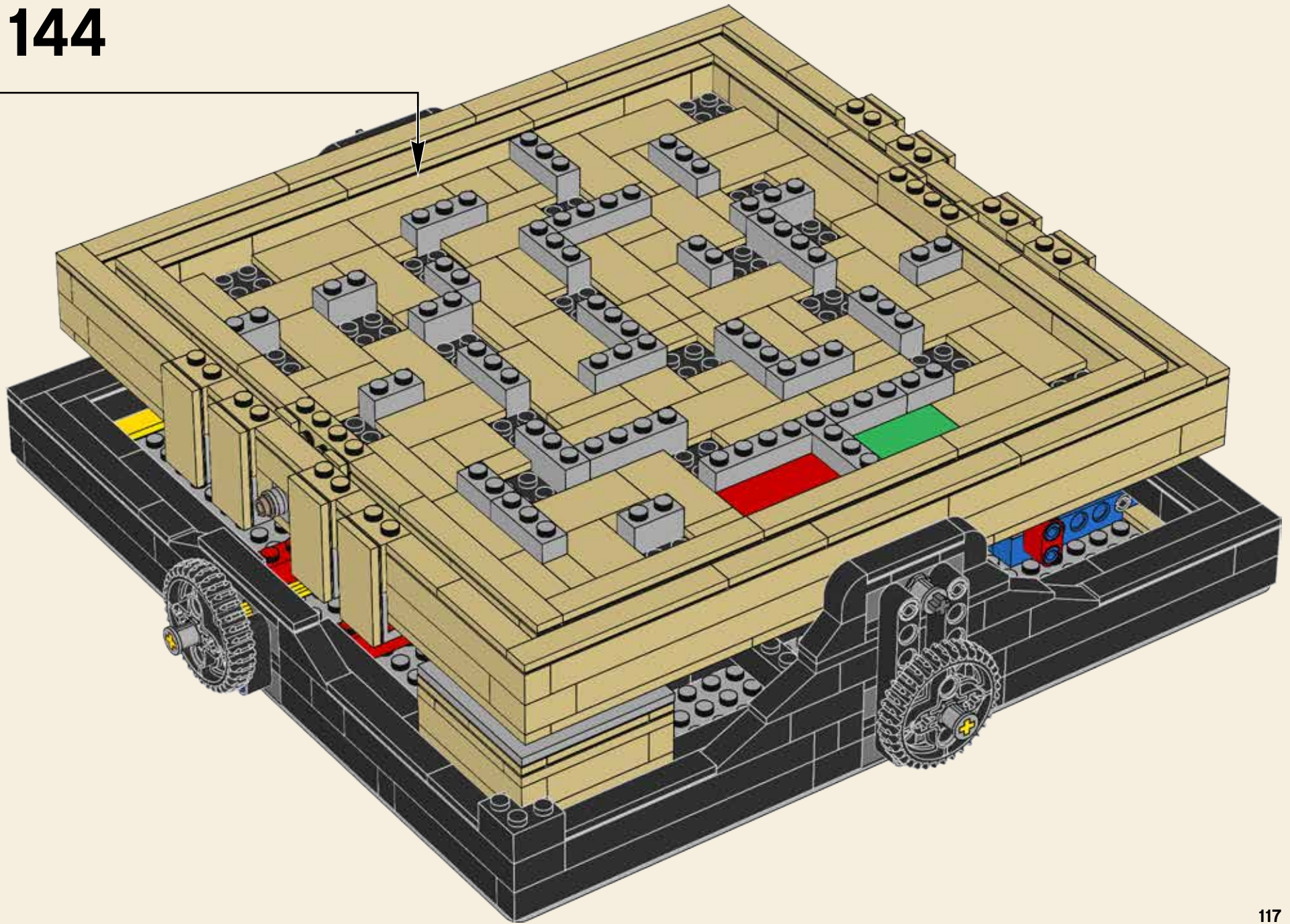

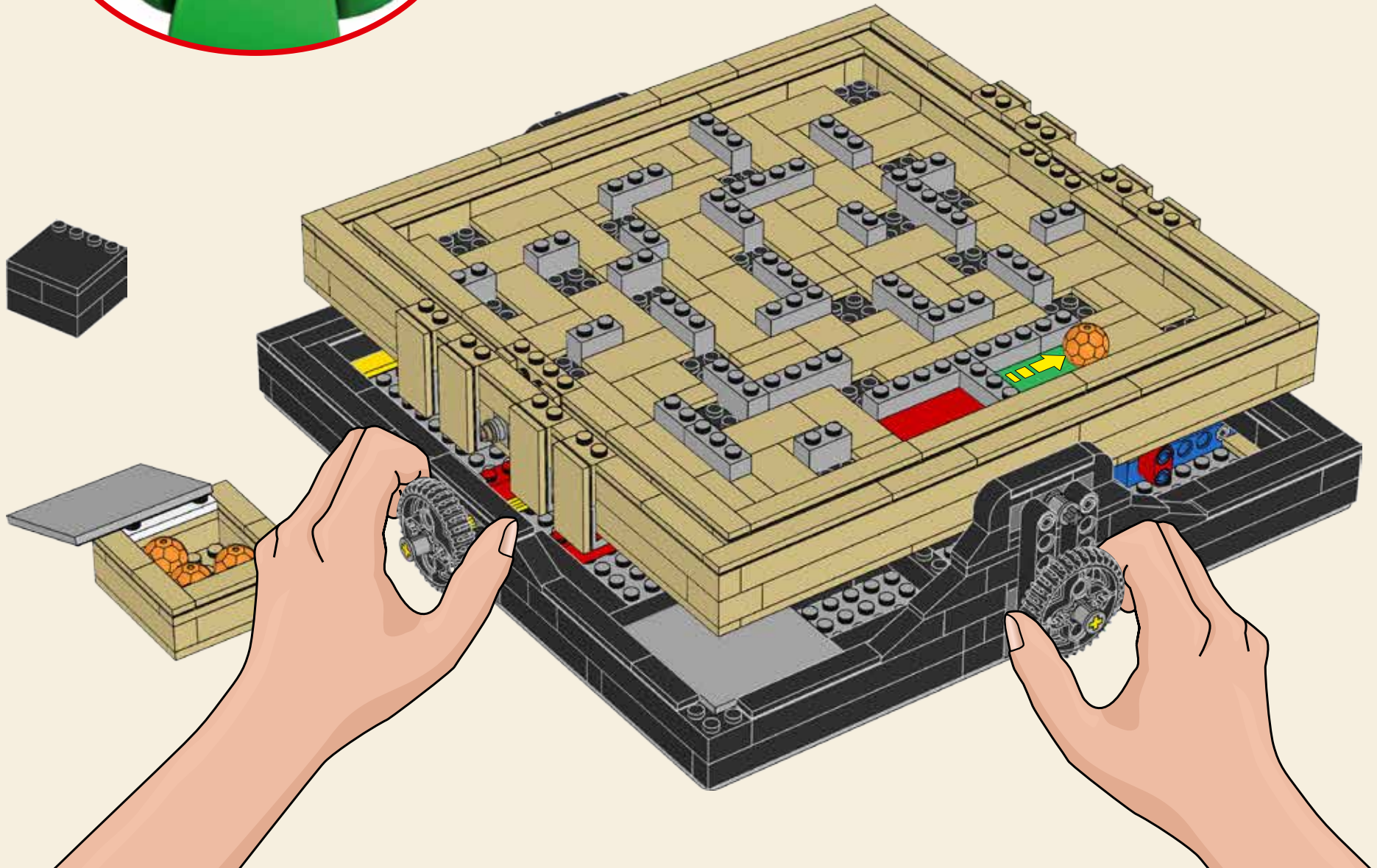

1

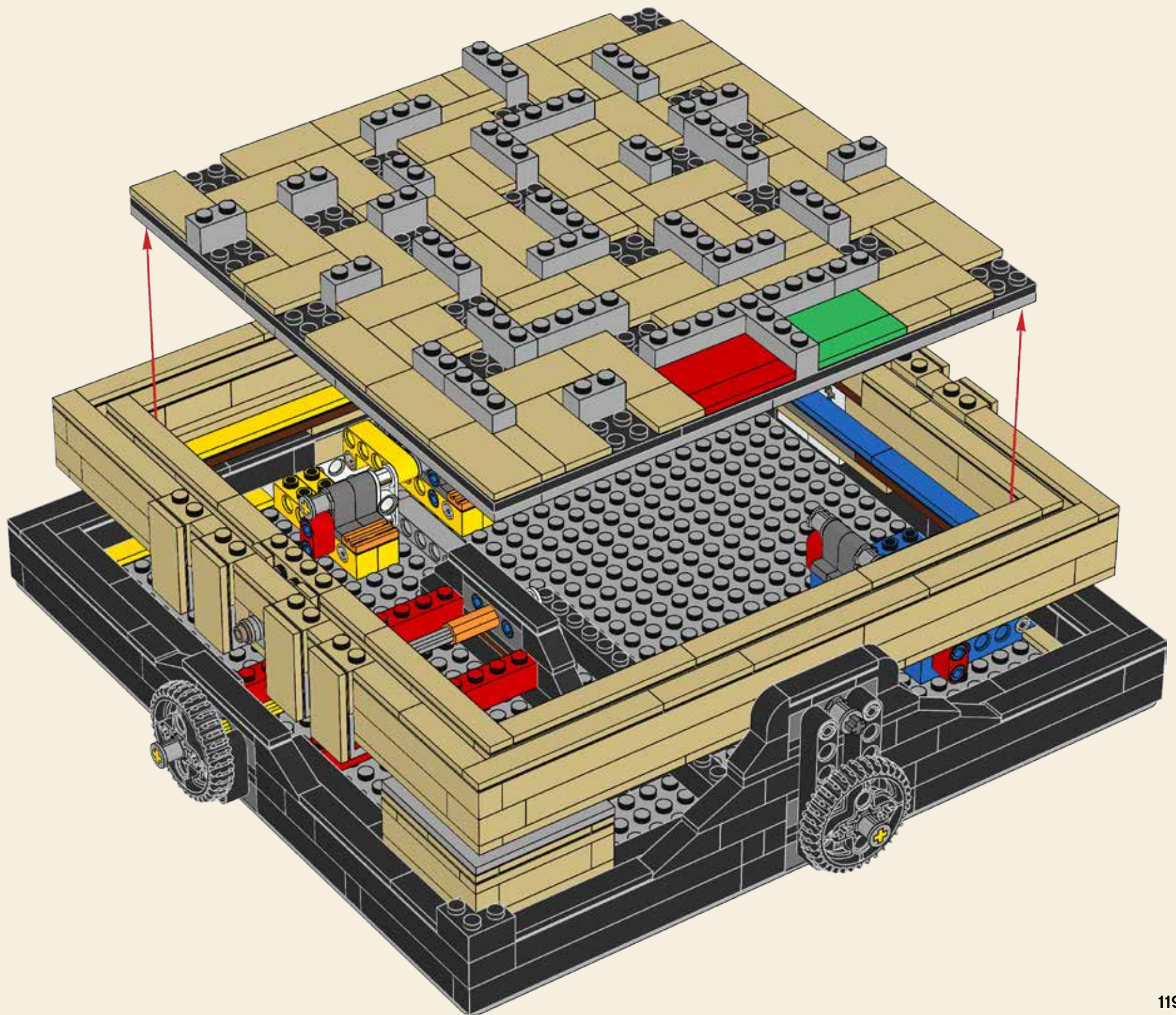

2

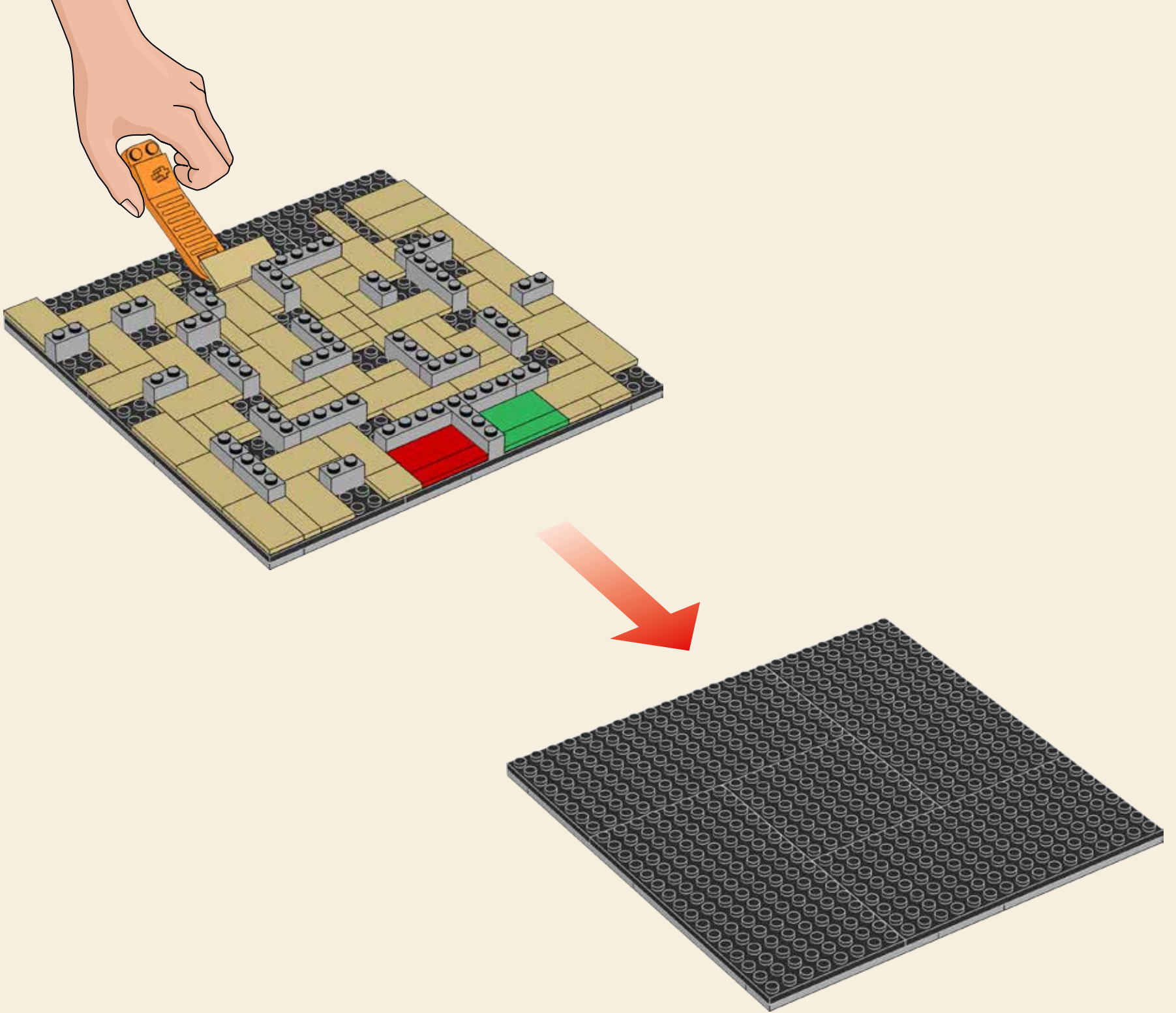

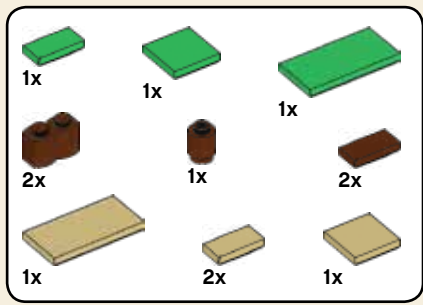

4

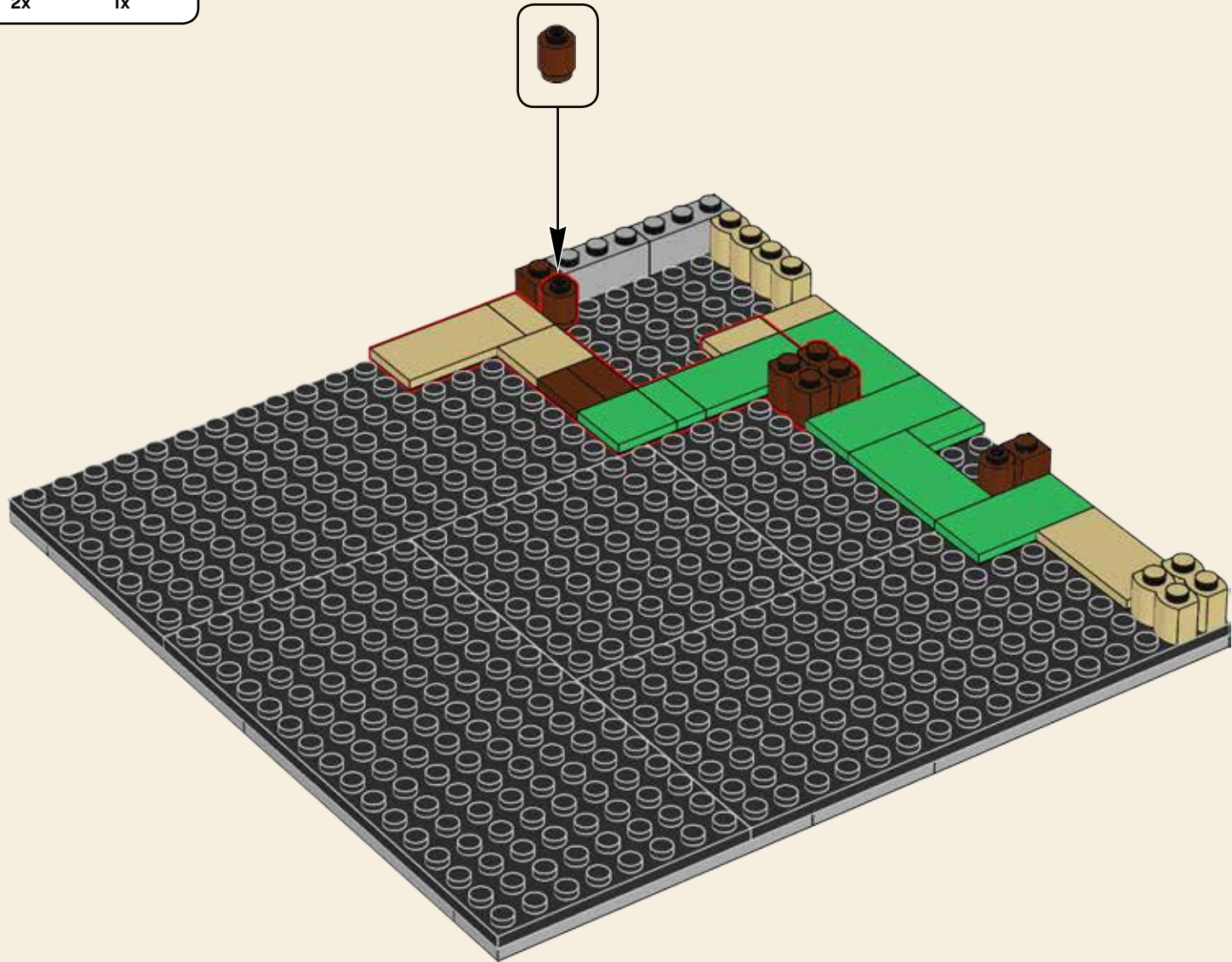

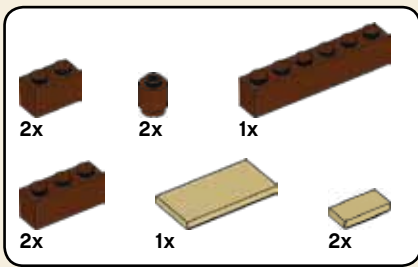

5

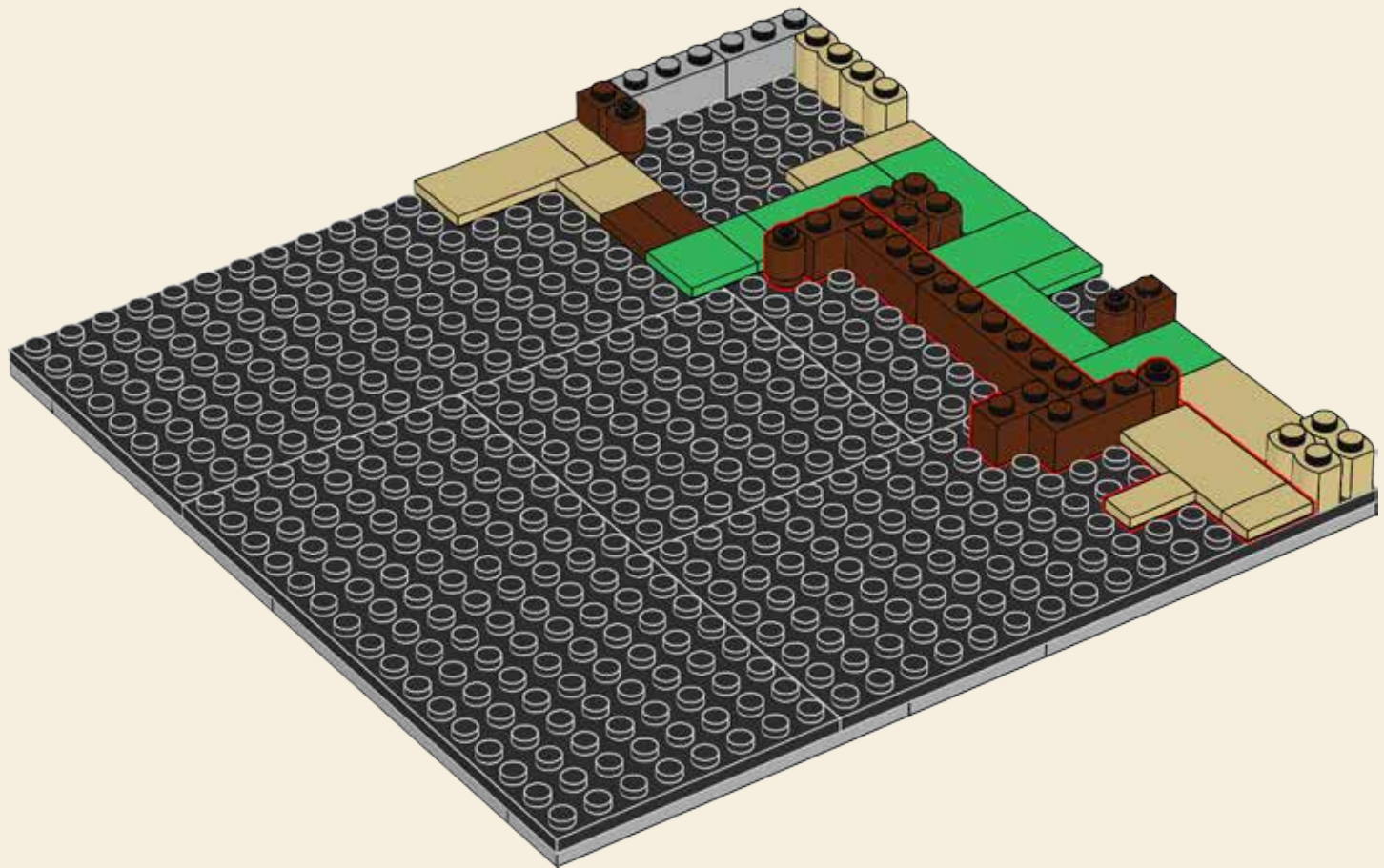

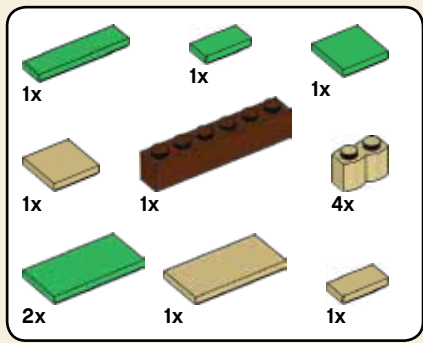

6

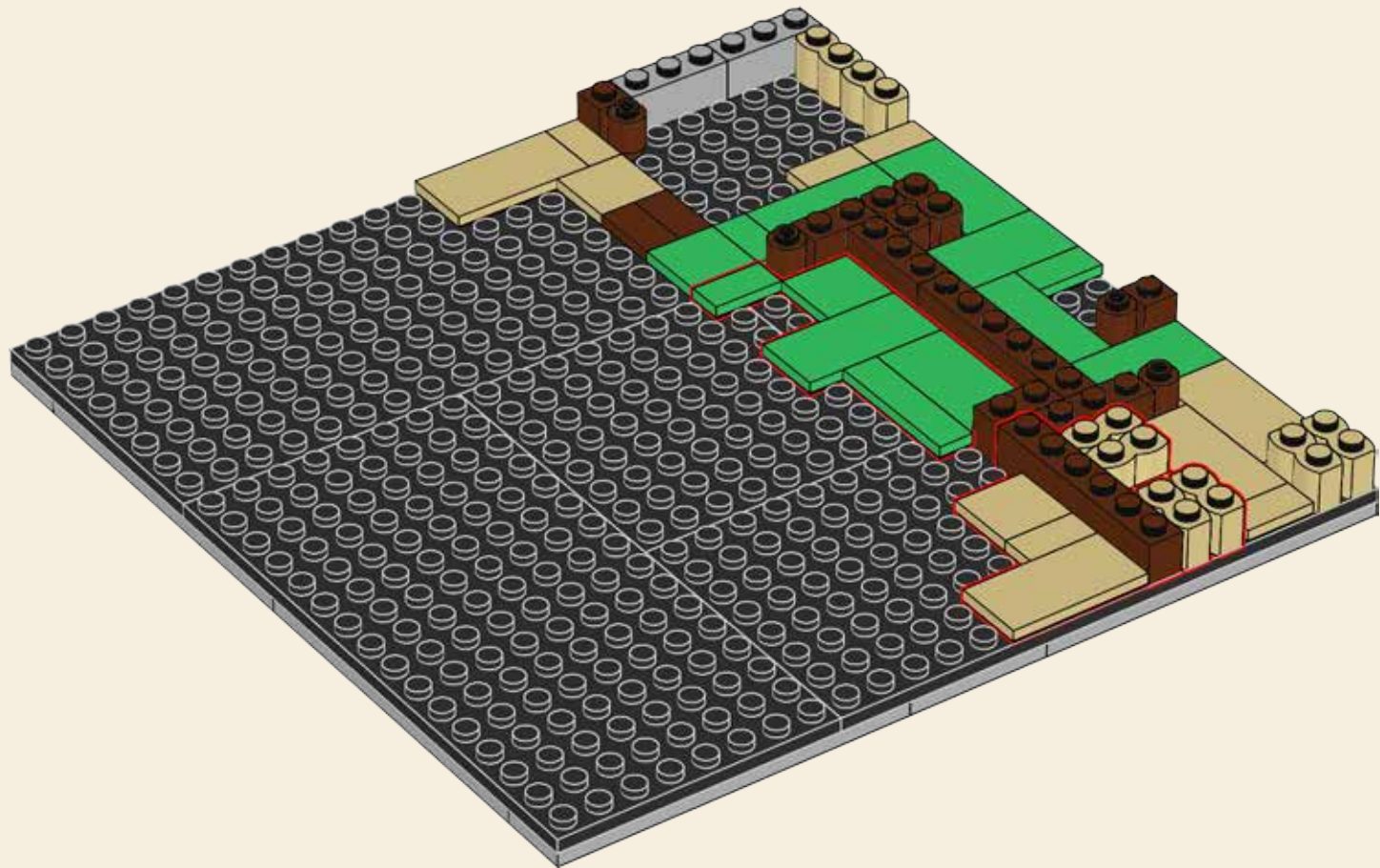

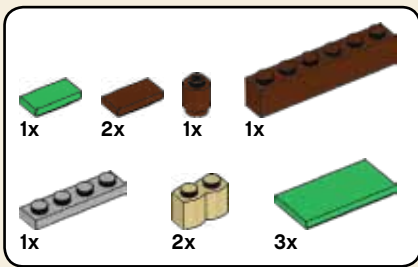

7

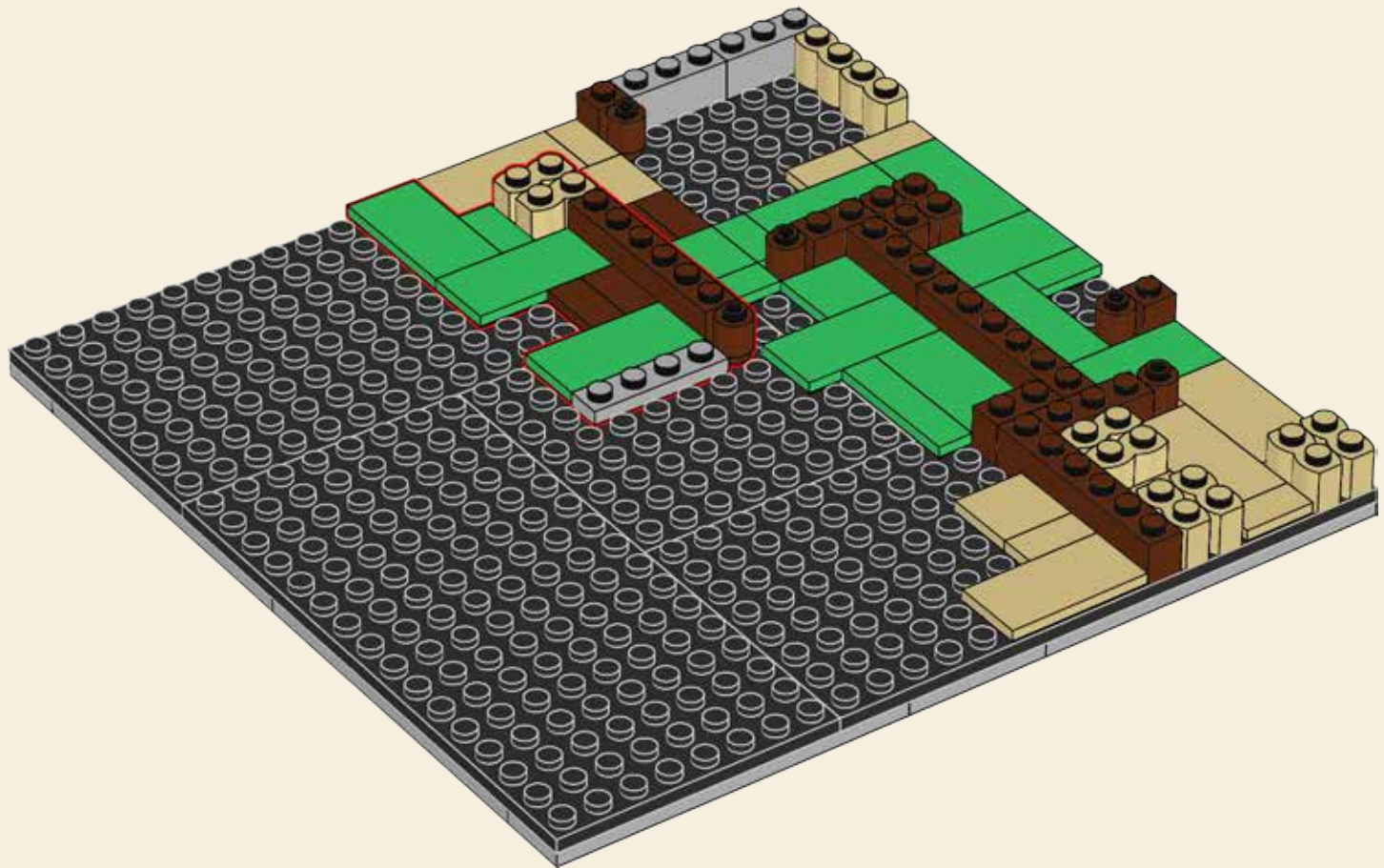

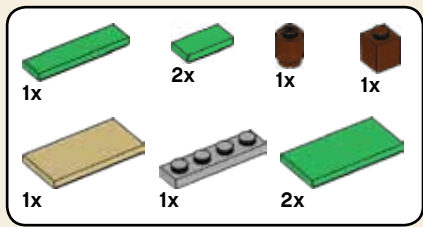

8

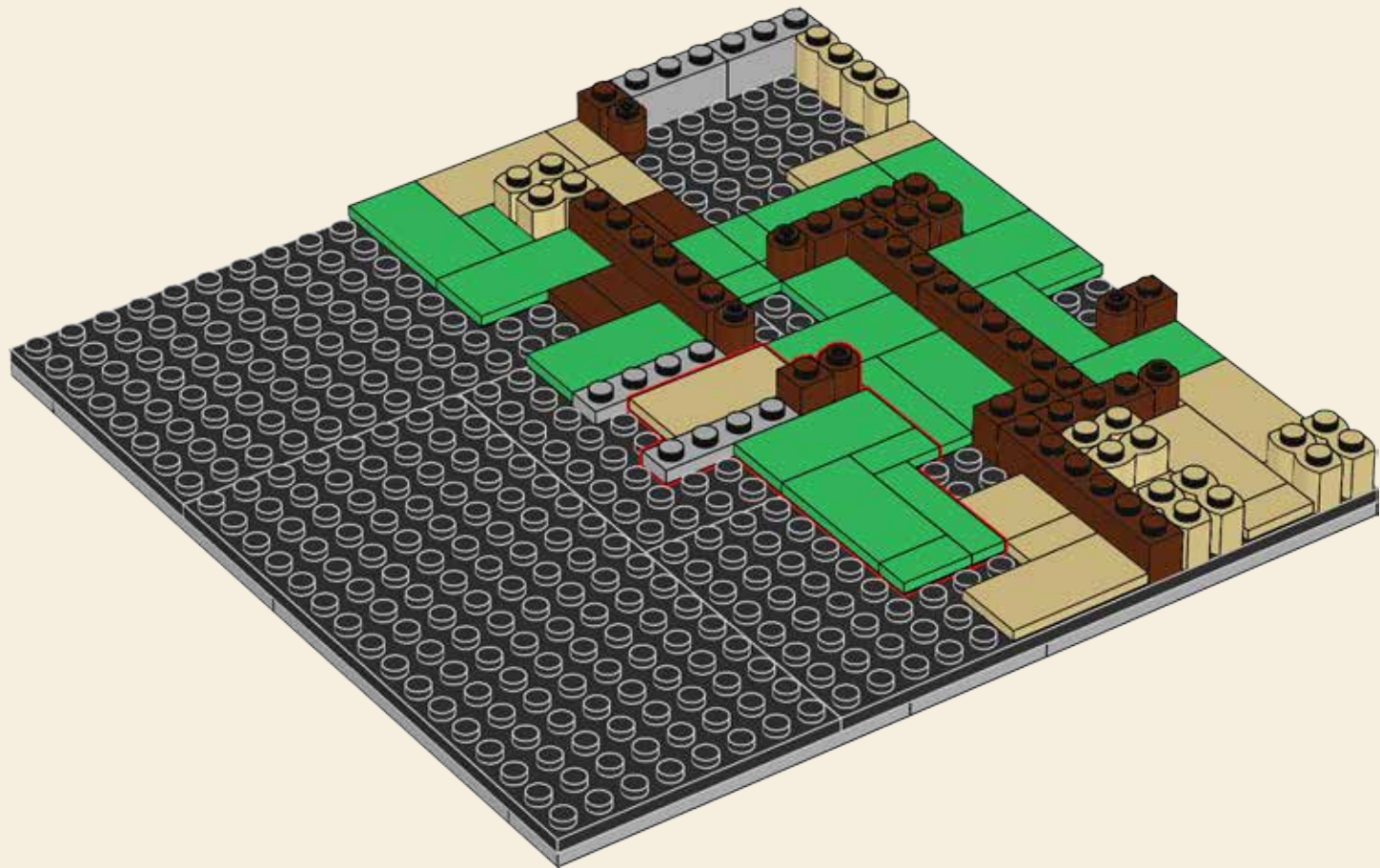

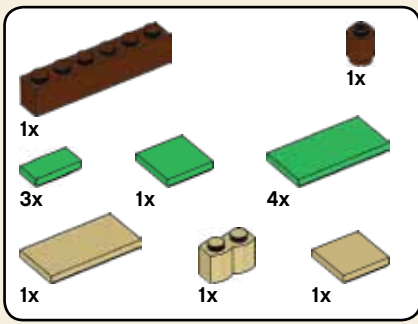

9

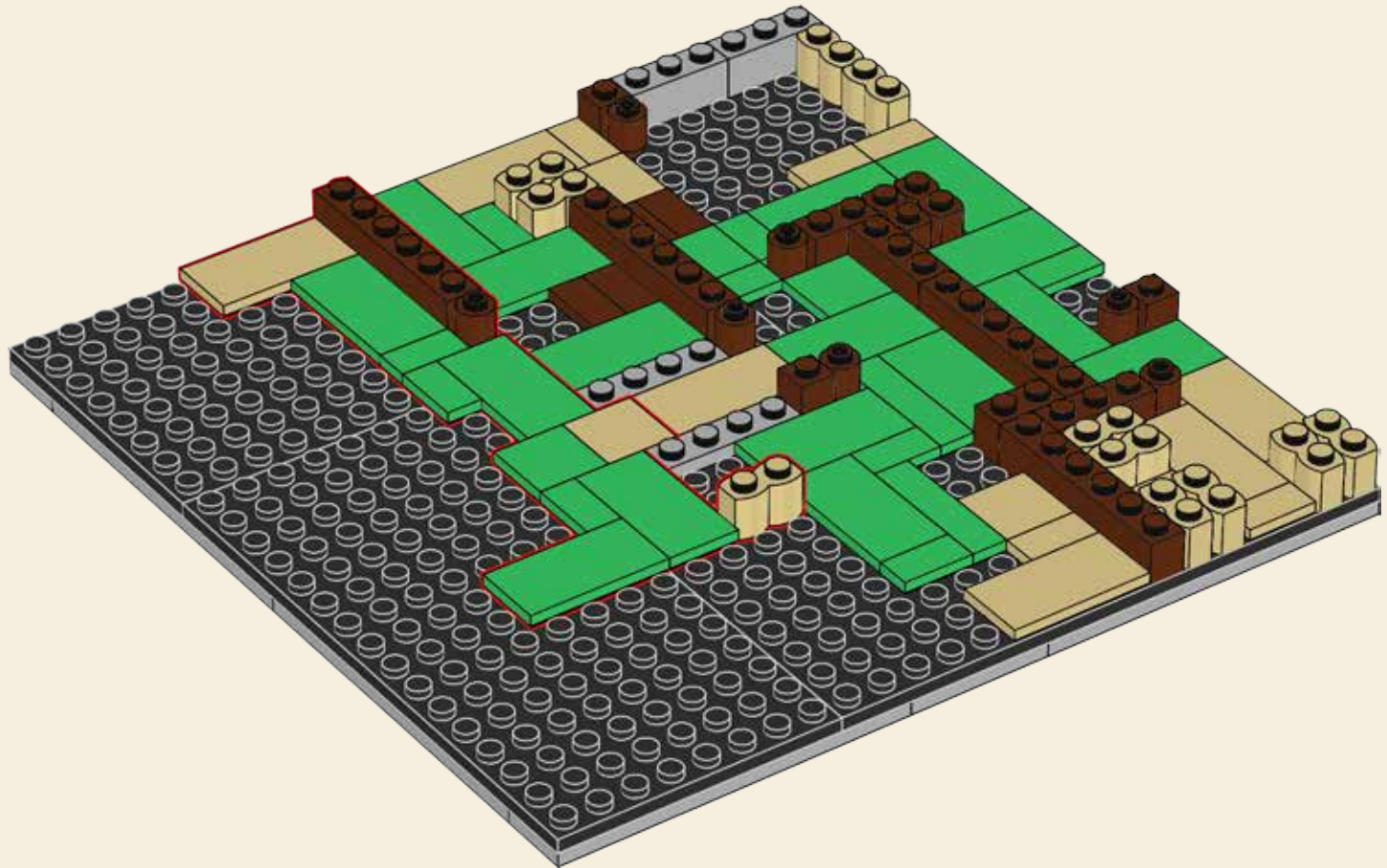

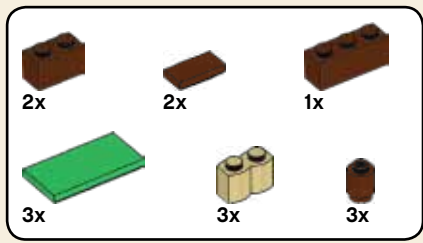

10

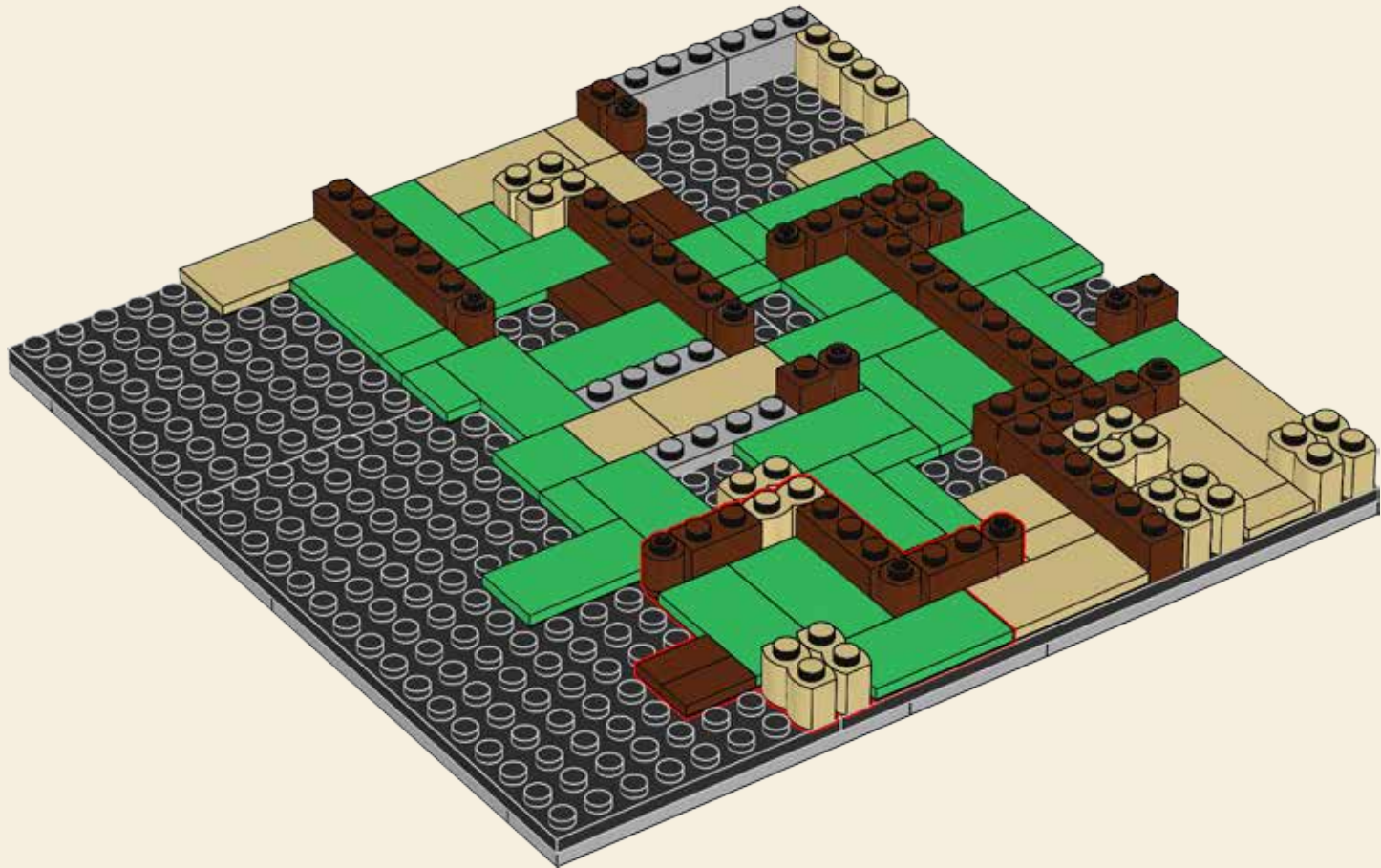

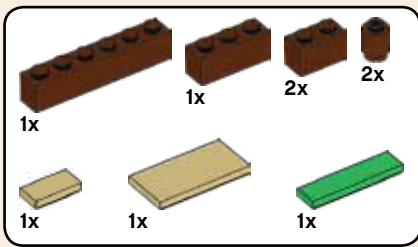

11

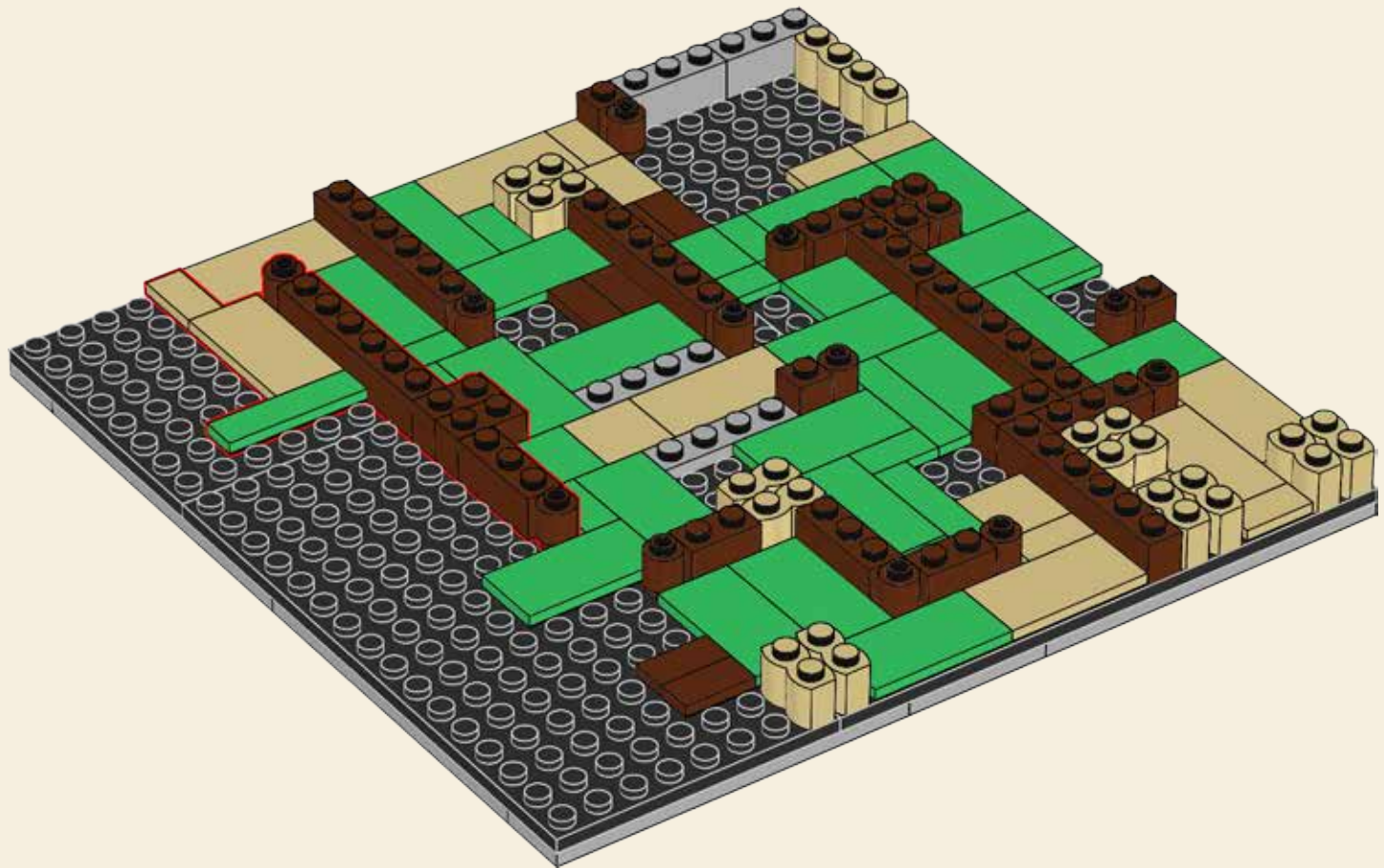

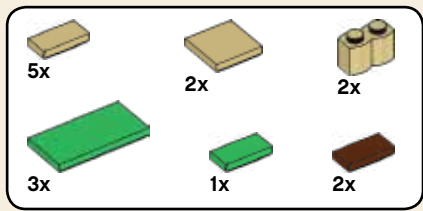

12

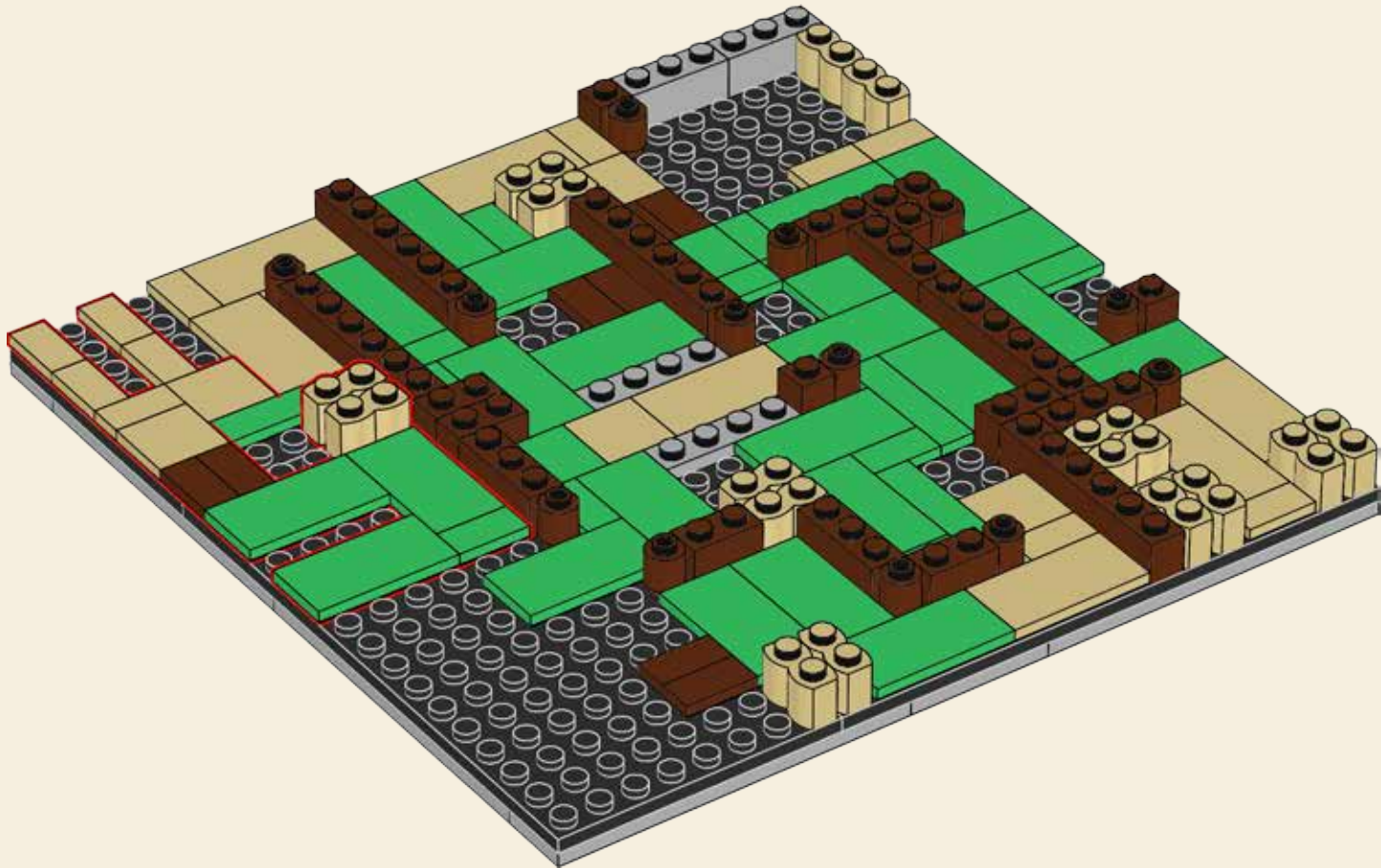

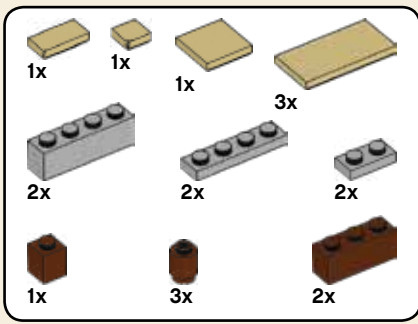

13

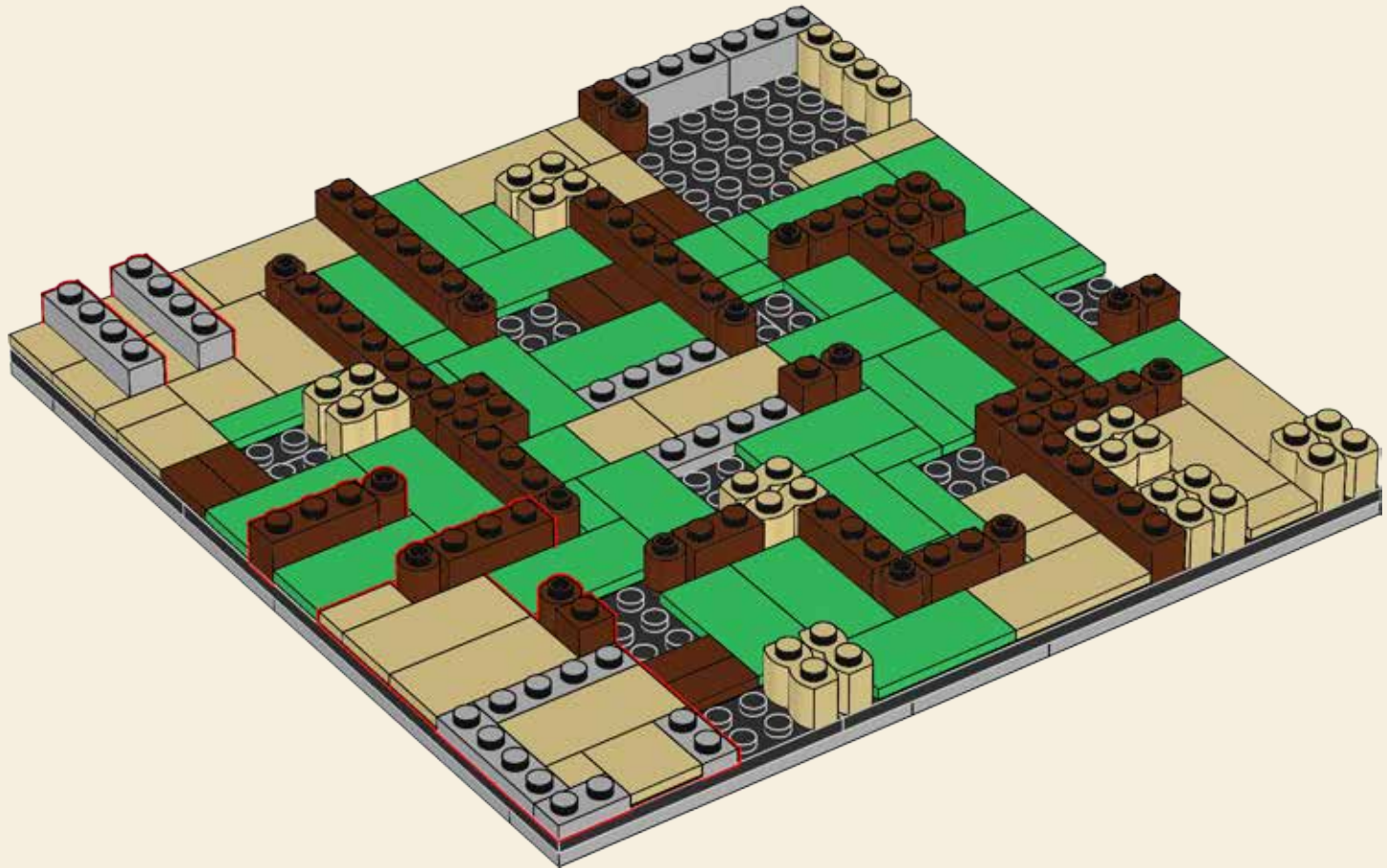

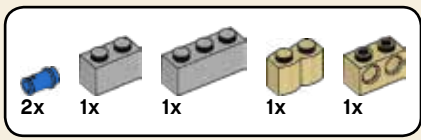

14

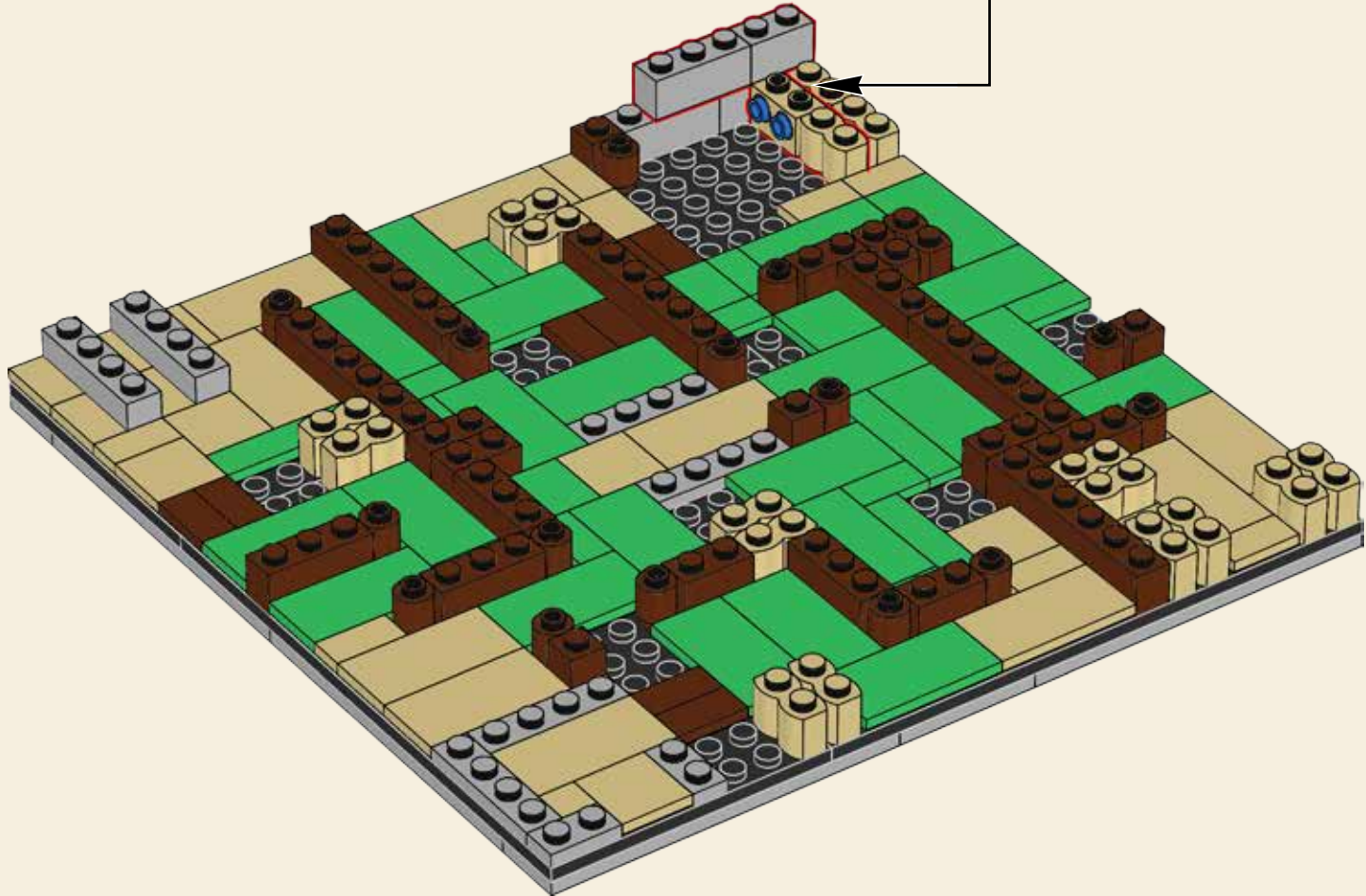
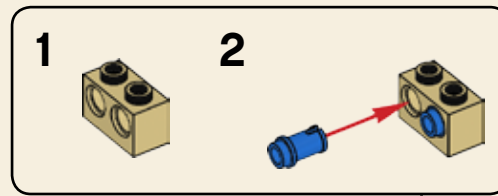



15

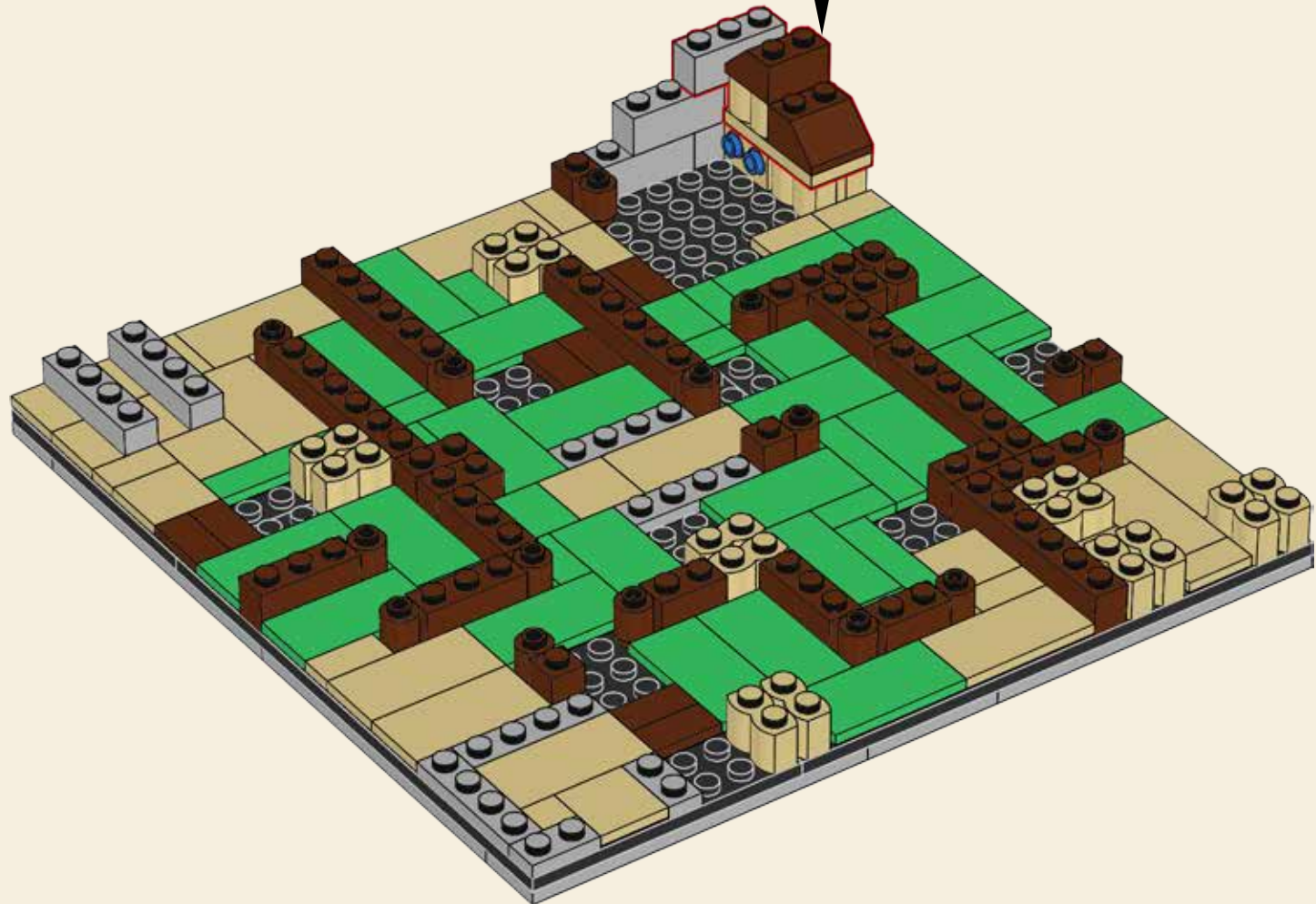
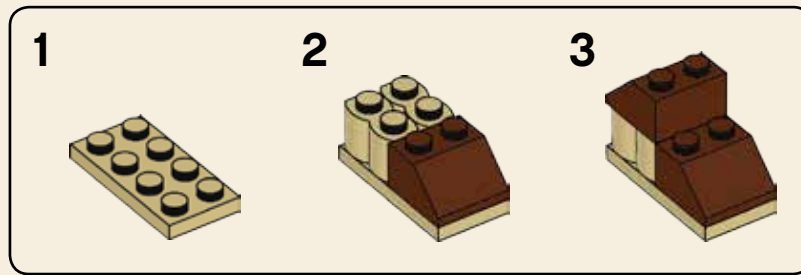

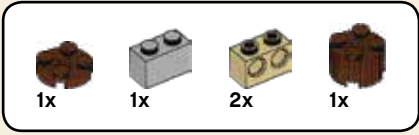

16

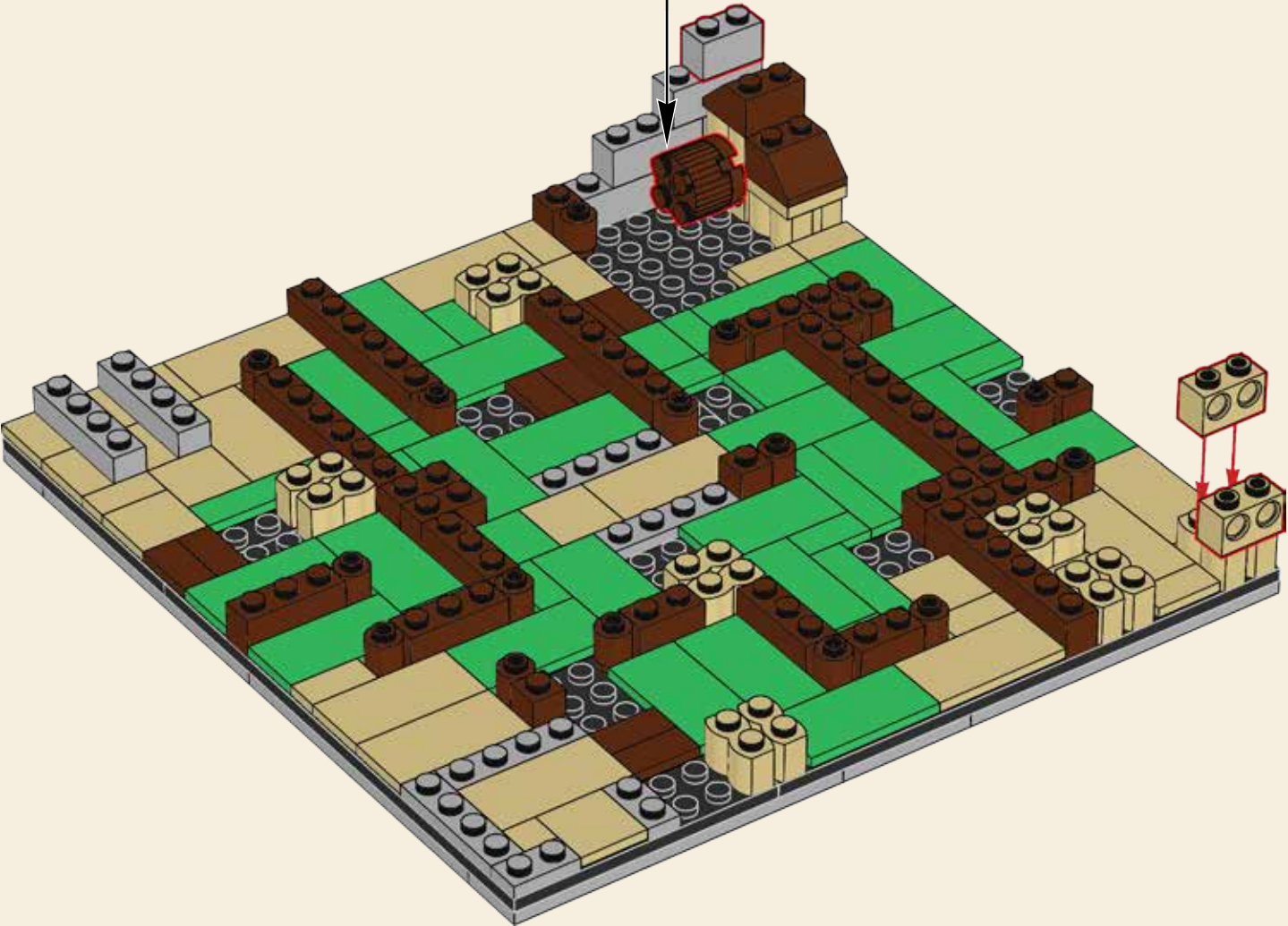



17

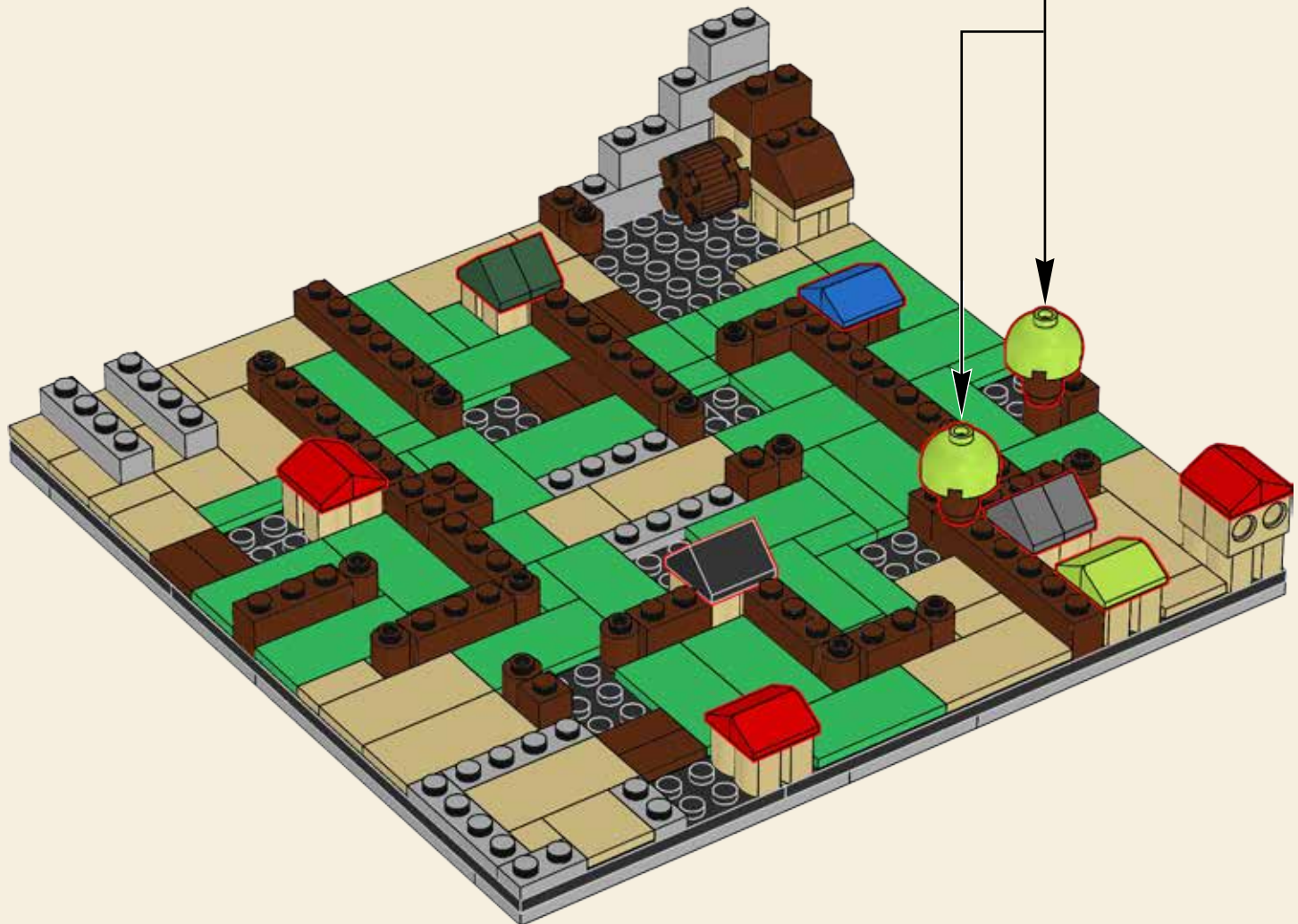
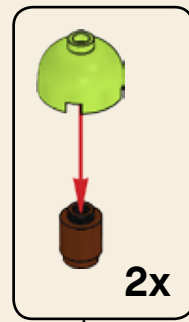

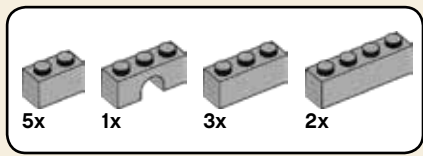

18

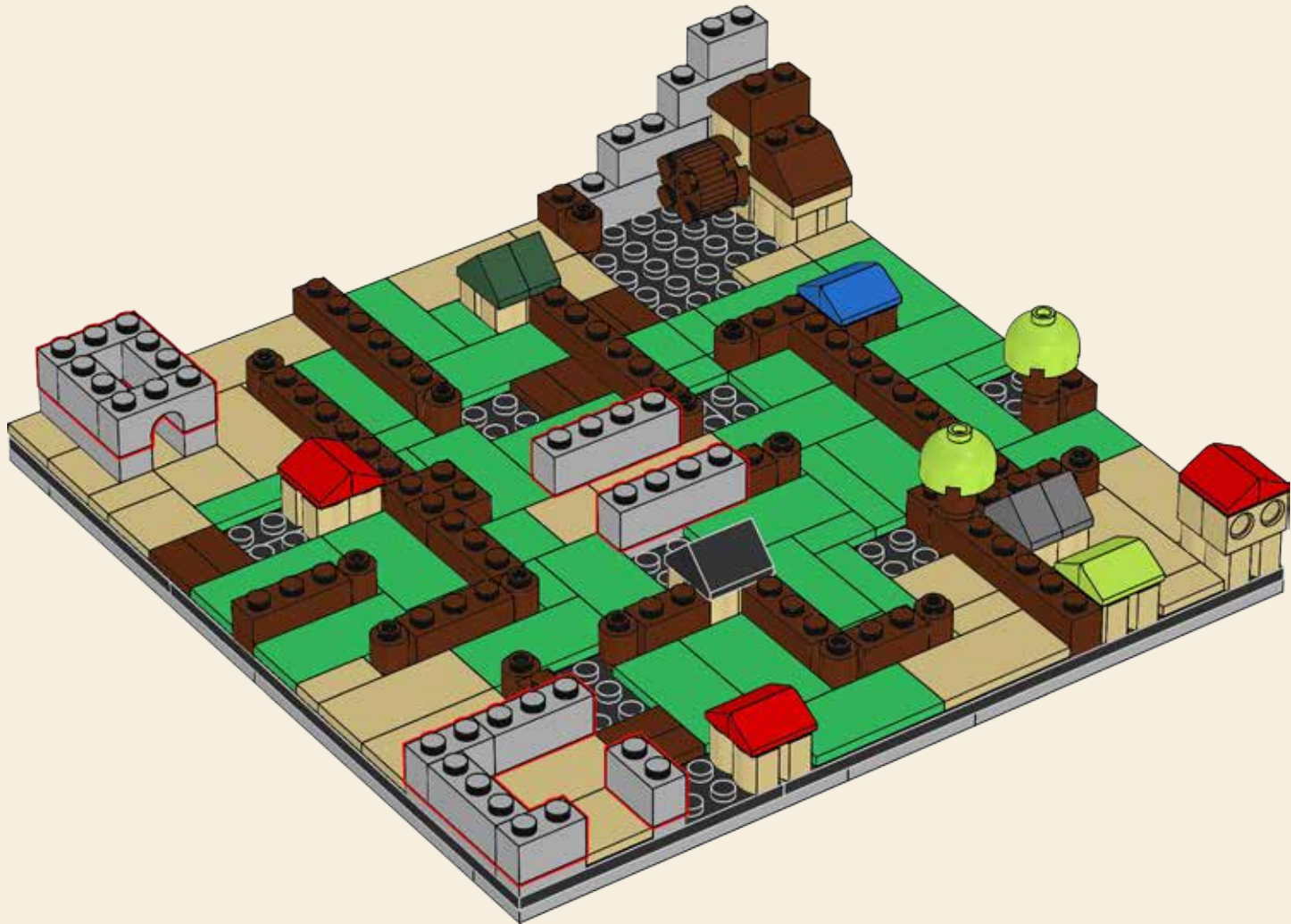

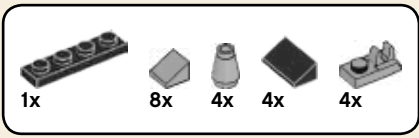

20

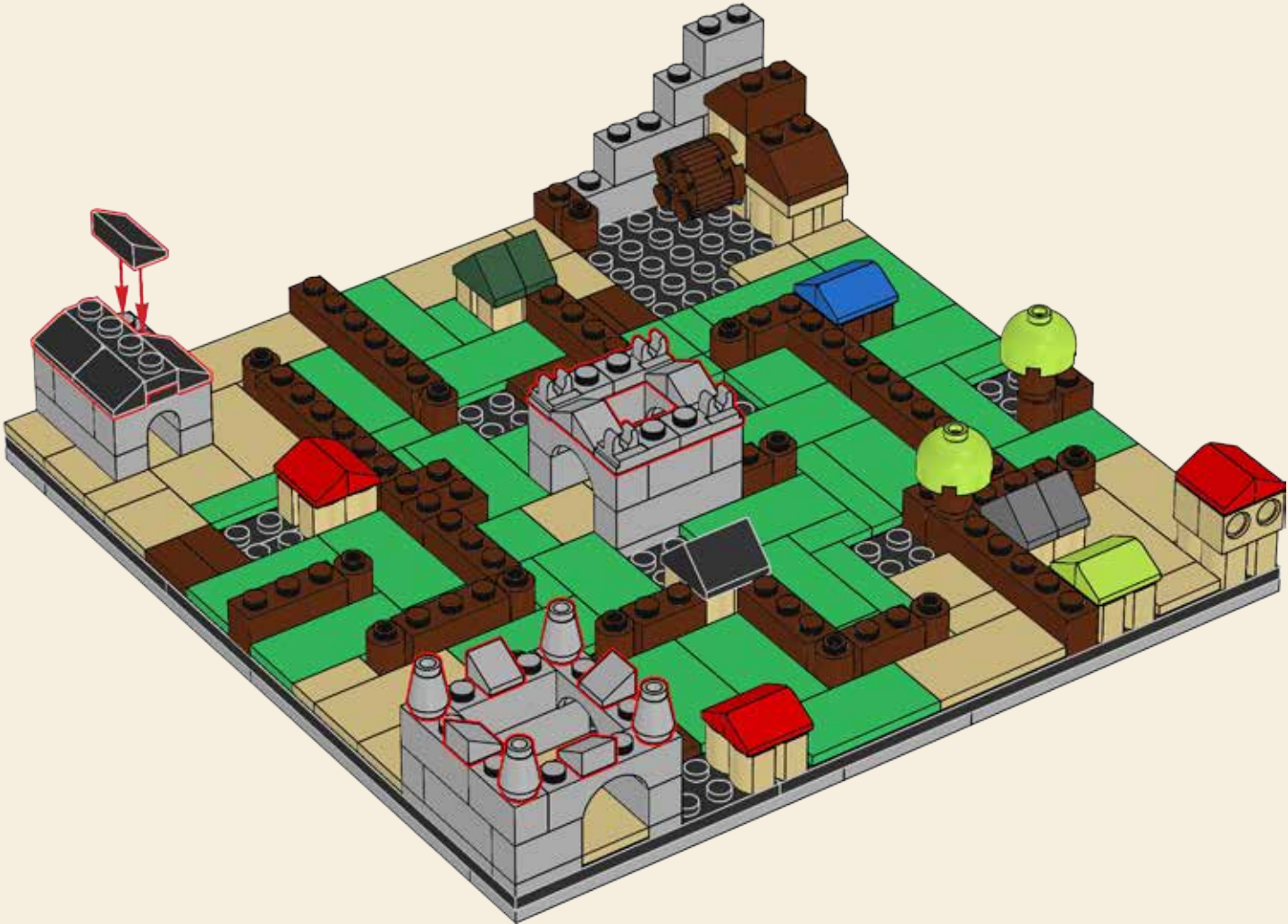

21

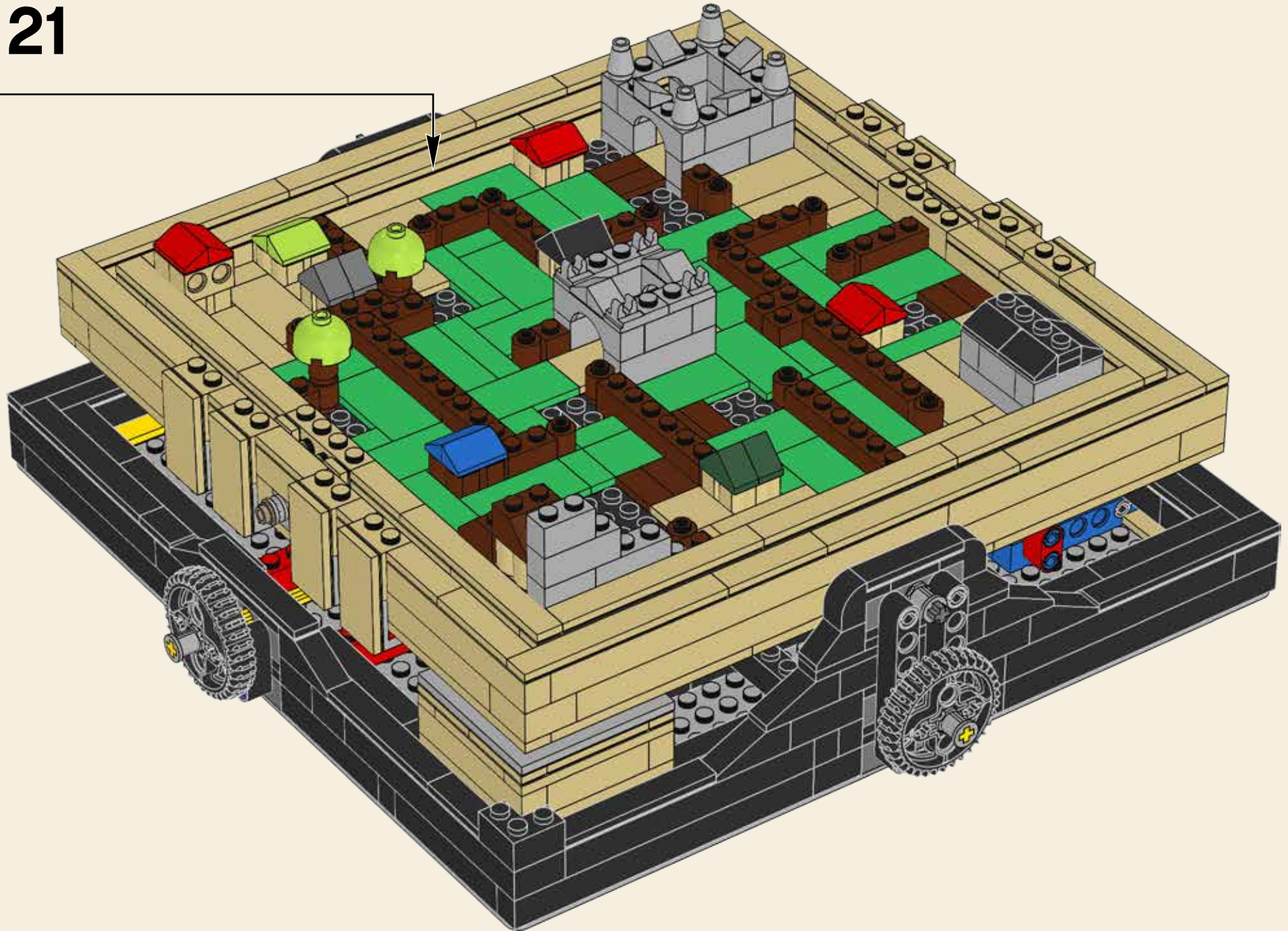

ADD SOME CREATIVITY OF YOUR OWN...

Once you have conquered the two maze designs included with the set you can start designing your own customized mazes. Jason Allemann has created additional mazes here to inspire you.

Just remember to build evenly over the entire base plate and make sure your creation is not too heavy (otherwise it can be hard to control the tip-and-tilt function).

Visit LEGO.com/ideas to see more inspirational maze suggestions.

AJOUTE TA PROPRE TOUCHE DE CRÉATIVITÉ...

Une fois que tu maîtrises les deux modèles de labyrinthe inclus avec l'ensemble, tu peux commencer à créer tes propres labyrinthes personnalisés. Jason Allemann a créé ici d'autres labyrinthes pour te donner des idées.

Souviens-toi de construire de façon égale sur la totalité de la plaque de base et assure-toi que ta création n'est pas trop lourde (sinon il risque d'être difficile de contrôler la fonction de bascule et d'inclinaison).

Rends-toi sur LEGO.com/ideas pour découvrir d'autres idées de labyrinthe.

AÑADE TU PROPIO TOQUE DE CREATIVIDAD...

Cuando hayas conquistado los dos laberintos incluidos con el set, podrás comenzar a diseñar los tuyos. Jason Allemann ha creado algunos laberintos más para inspirarte.

Sólo tienes que construir uniformemente por toda la base y asegurarte de que tu creación no sea demasiado pesada (de lo contrario, puede ser difícil controlar el laberinto).

Visita LEGO.com/ideas y descubre nuevas ideas para crear tus laberintos.

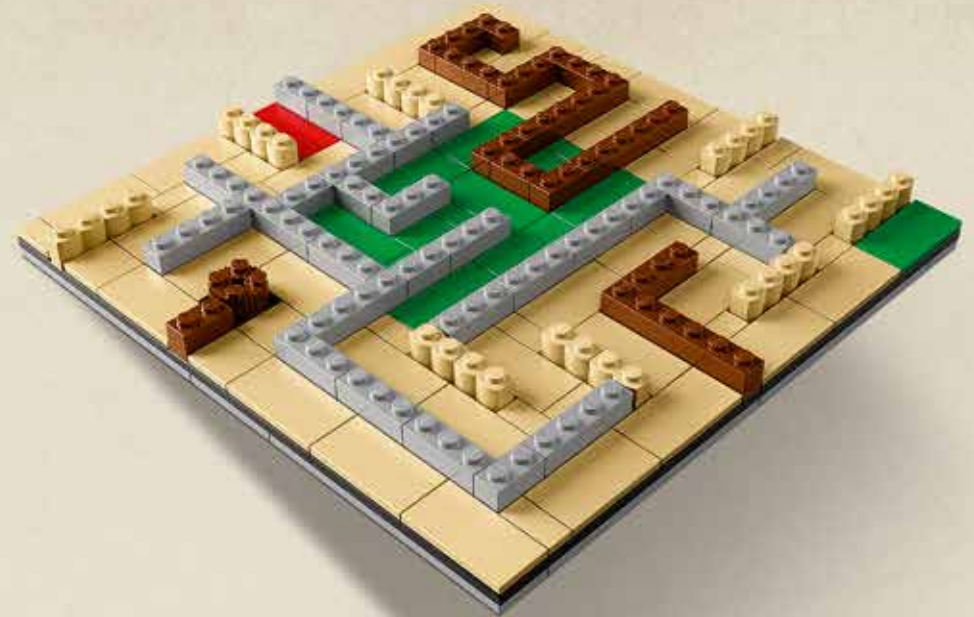

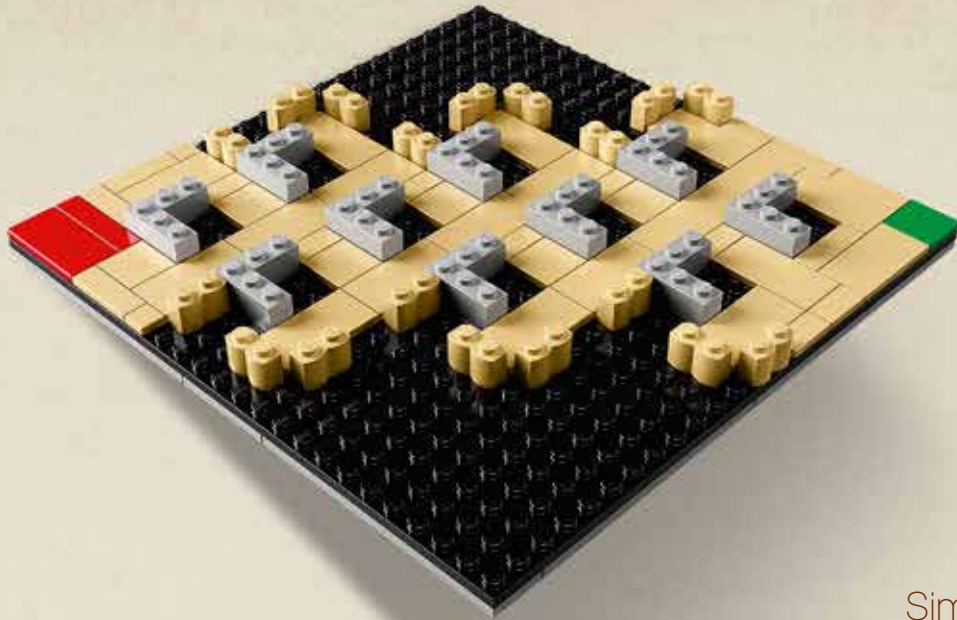

Simple Level
Niveau simple
Nivel sencillo

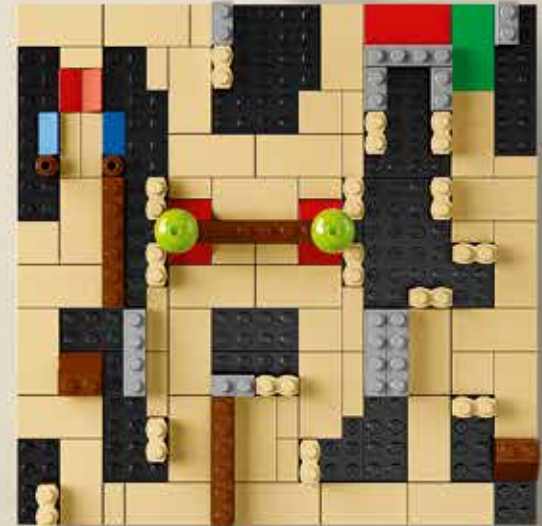
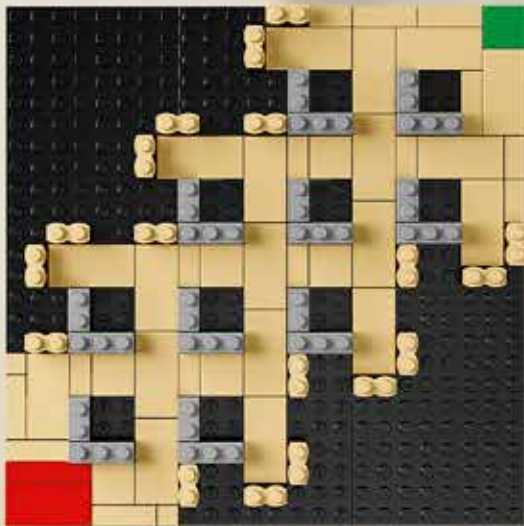

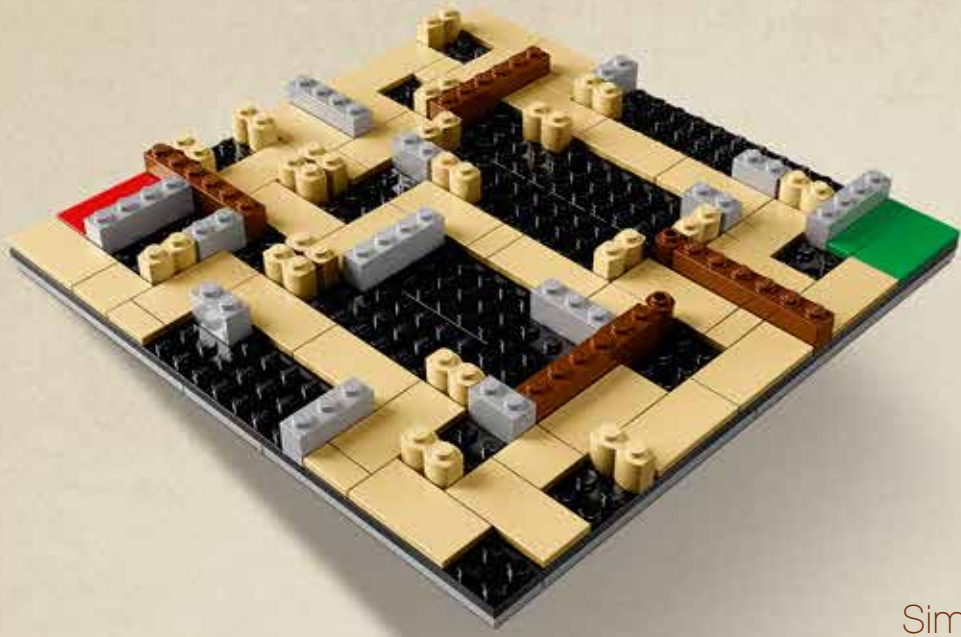

Simple Level
Niveau simple
Nivel sencillo

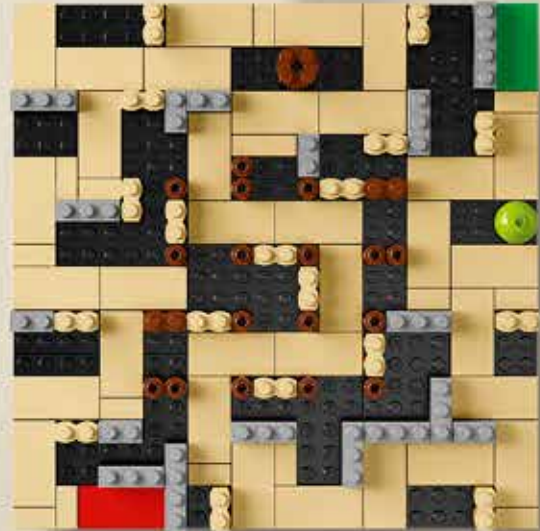
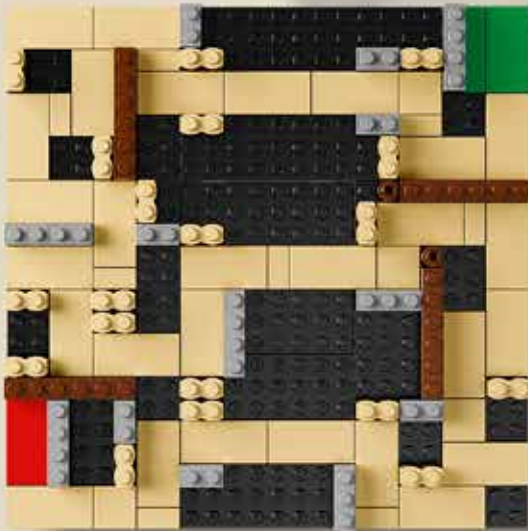

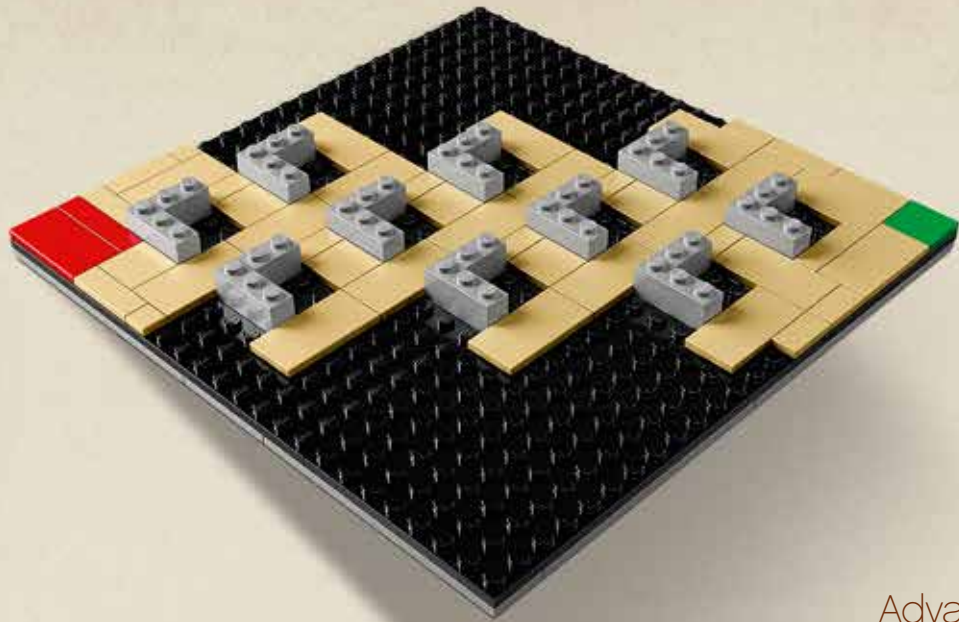

Advanced Level
Niveau avancé
Nivel avanzado

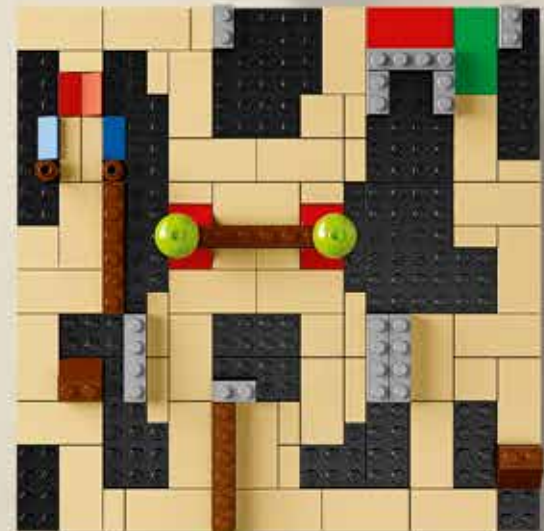
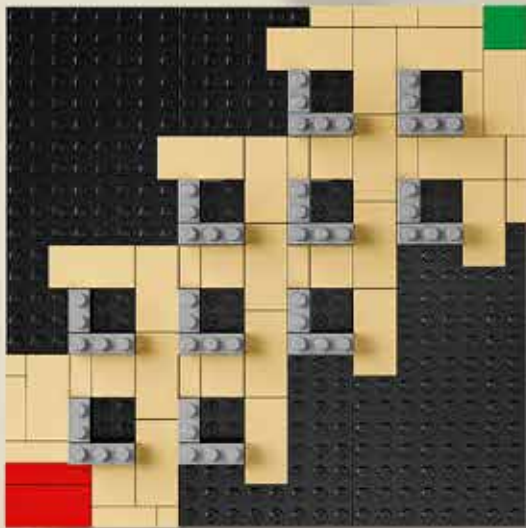

A WHOLE UNIVERSE OF INNOVATIVE LEGO® IDEAS

Do you have an exciting idea for a LEGO® model? Then why not make it into a LEGO Ideas project? You can share your product concept on ideas.LEGO.com and see what other people think about it.

If your project gains 10,000 supporters, it will automatically qualify for the quarterly LEGO Review. This is where we take an in-depth look at the most popular projects and carefully evaluate them to discover the idea with the most potential. If your project makes it through the review, it will become an official LEGO product.

There are tens of thousands of active members, and thousands of product ideas on LEGO Ideas – several of which have become hit LEGO sets! So take a look, sign up, and support your favorite ideas, or even better: upload your own!



[LEGO.com/ideas](https://www.lego.com/ideas)

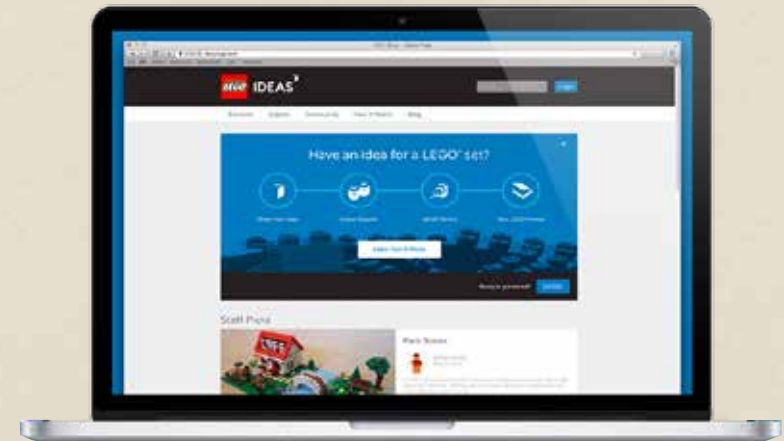

TOUT UN UNIVERS D'IDÉES LEGO® NOVATRICES

As-tu une idée de modèle LEGO® passionnante ? Alors pourquoi ne pas en faire un projet LEGO Ideas ? Tu peux partager ton concept de produit sur ideas.LEGO.com et voir ce que les autres en pensent.

Si ton projet obtient l'appui de 10 000 personnes, il sera automatiquement qualifié pour l'examen LEGO trimestriel. Cet examen nous permet d'étudier en profondeur les projets les plus populaires et de les évaluer attentivement pour découvrir les idées ayant le plus grand potentiel. Si ton projet passe l'examen, il deviendra alors un produit LEGO officiel.

Il y a des dizaines de milliers de membres actifs et des milliers d'idées de produits sur LEGO Ideas, et plusieurs d'entre elles sont devenues des ensembles LEGO très populaires ! Alors va regarder, inscris-toi et soutiens tes idées préférées. Ou mieux encore : télécharge ton propre projet !



[LEGO.com/ideas](https://www.lego.com/ideas)

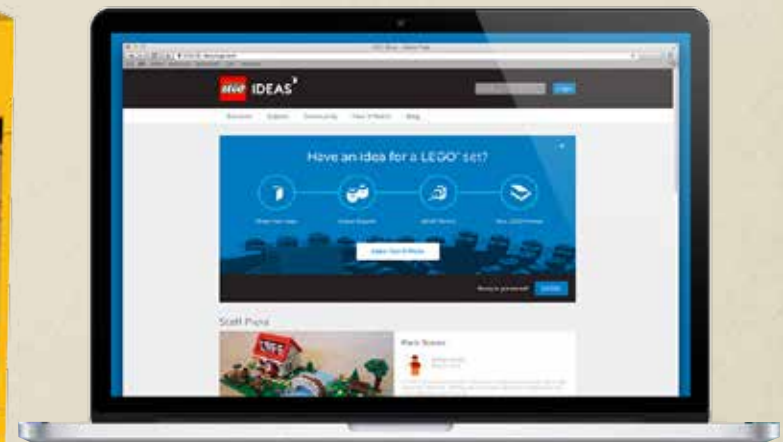

TODO UN UNIVERSO DE INNOVADORAS IDEAS LEGO®

¿Tienes una buena idea para un modelo LEGO®? ¿Por qué no convertirla en un proyecto LEGO Ideas? Puedes compartir tu idea en ideas.LEGO.com y ver lo que los demás piensan de ella.

Si tu proyecto consigue 10.000 votos, se clasificará automáticamente para la revisión trimestral de LEGO. Es entonces cuando daremos un vistazo a los proyectos más populares y los evaluaremos detenidamente para determinar qué idea tiene más potencial. Si tu proyecto supera la revisión, se convertirá en un producto LEGO oficial.

Hay decenas de miles de miembros activos y miles de ideas en LEGO Ideas (varias de las cuales ya se han convertido en sets LEGO de gran éxito). Ven a dar un vistazo, regístrate y apoya tus ideas favoritas. O aún mejor: ¡envía la tuya!



[LEGO.com/ideas](https://www.lego.com/ideas)

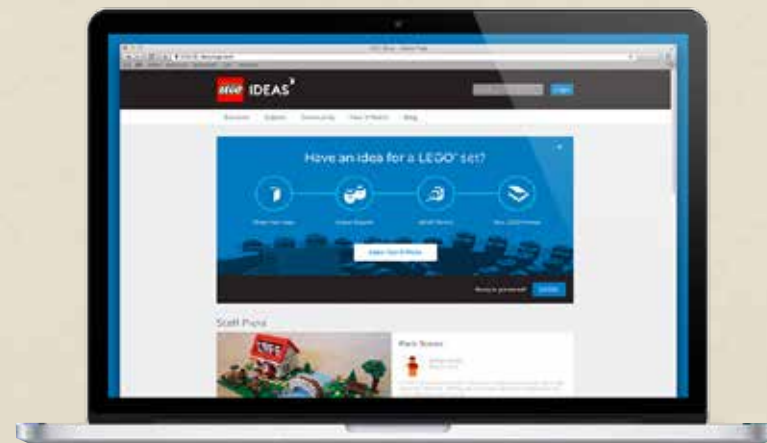

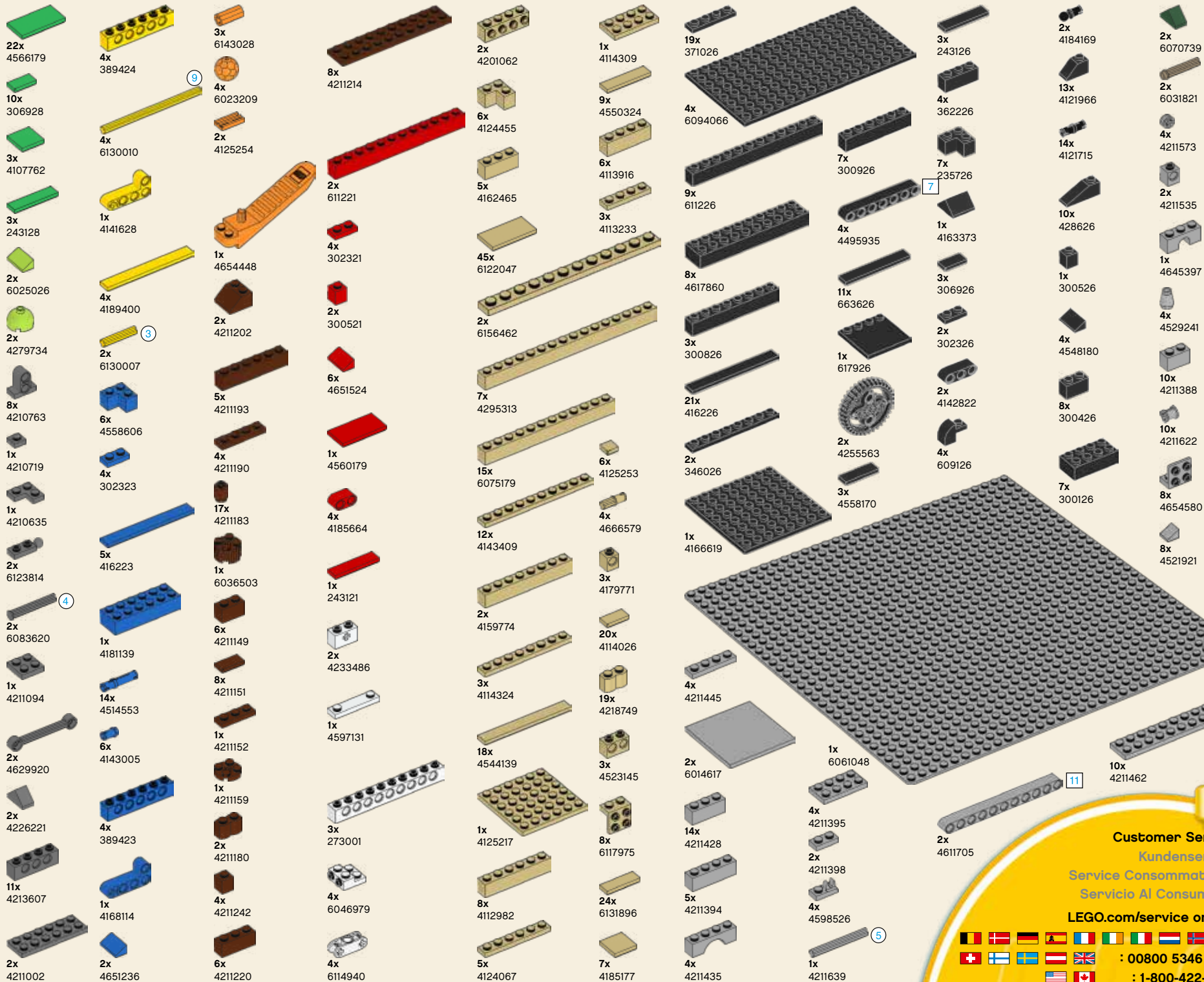

Customer Service
 Kundenservice
 Service Consommateurs
 Servicio Al Consumidor
 LEGO.com/service or dial

 : 00800 5346 5555
 : 1-800-422-5346