



# MINECRAFT

21127





1

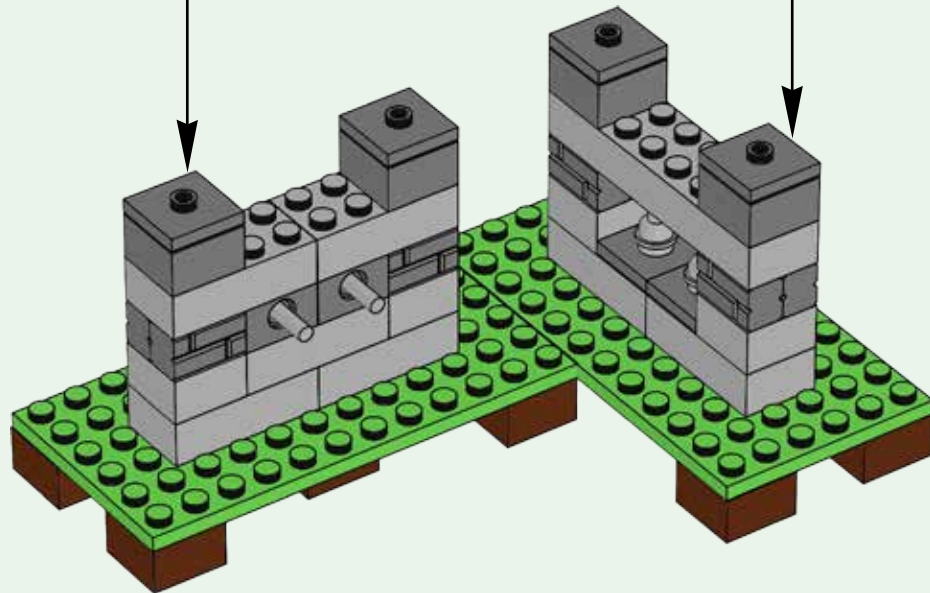
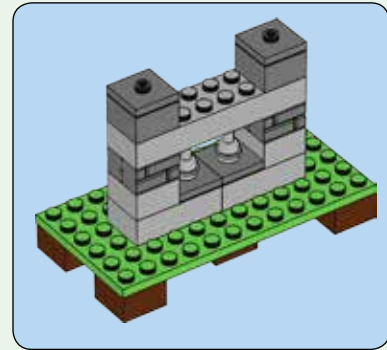
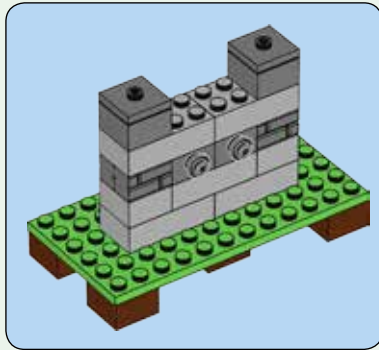

2



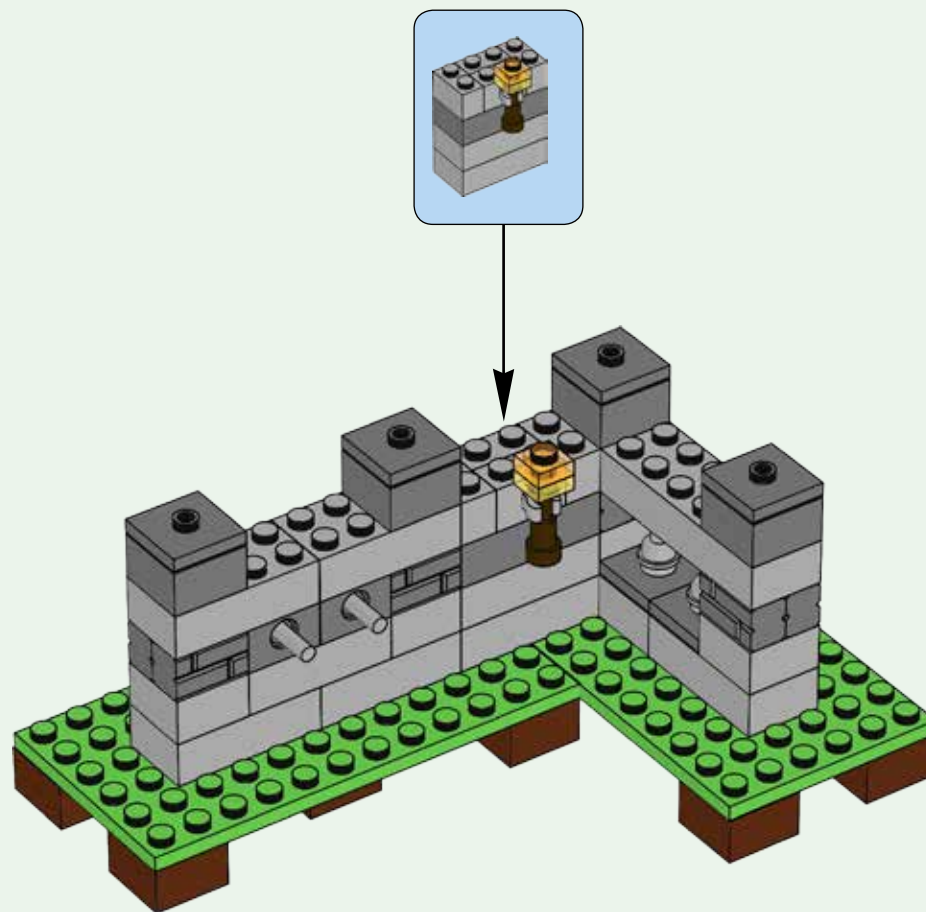

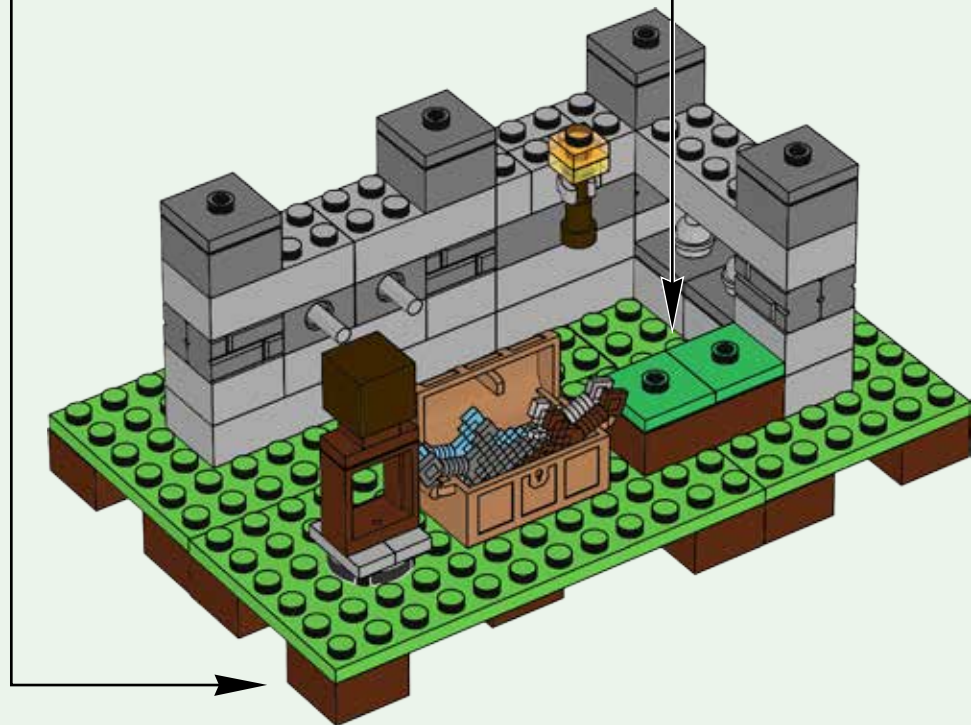
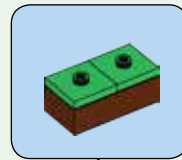
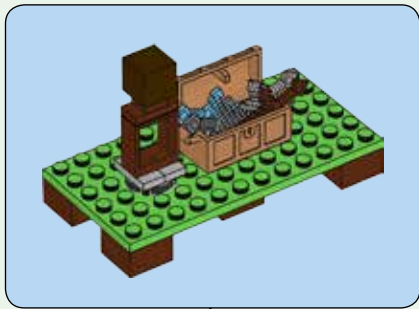

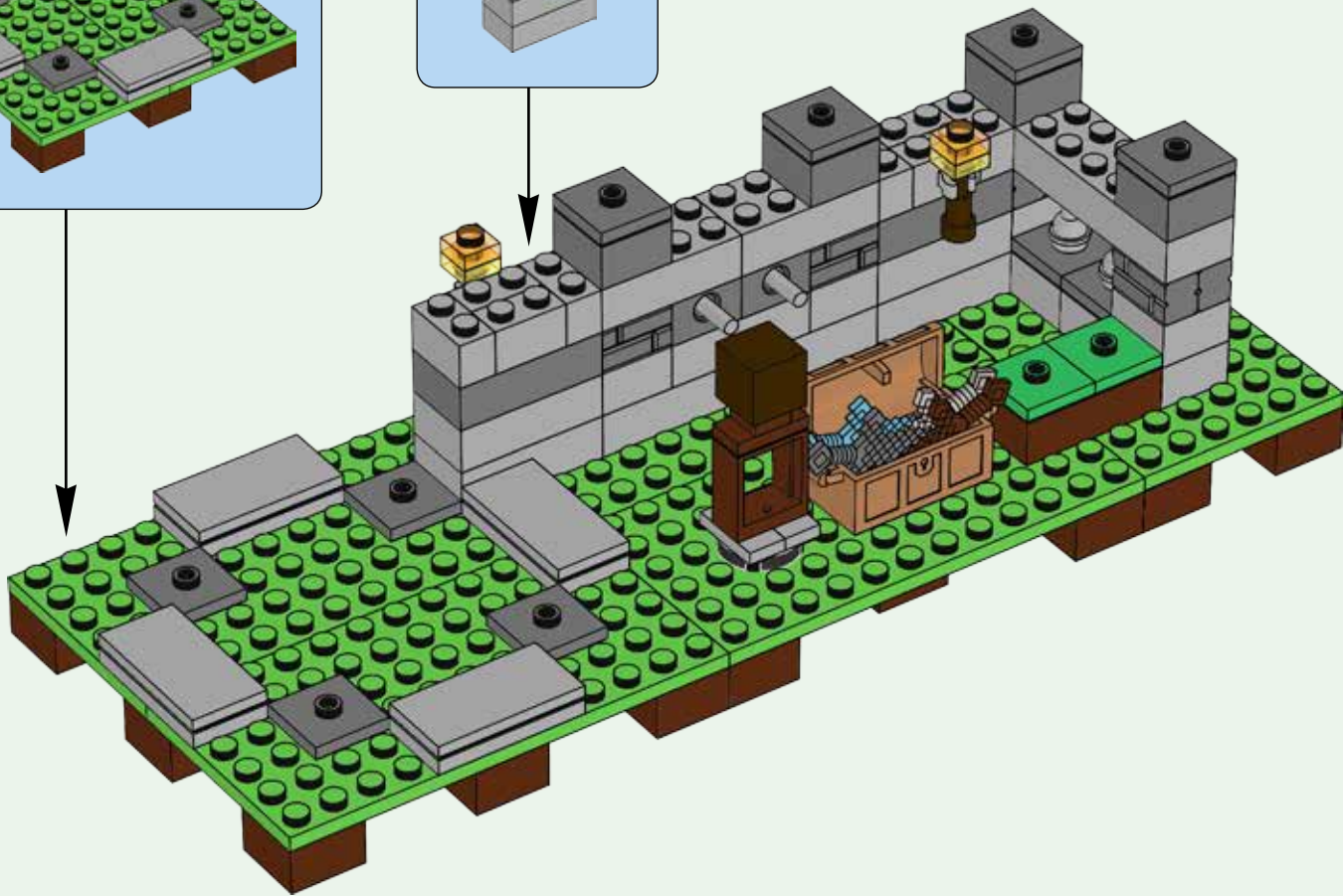
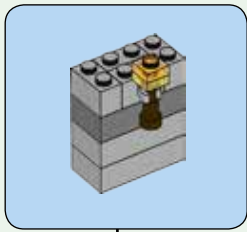
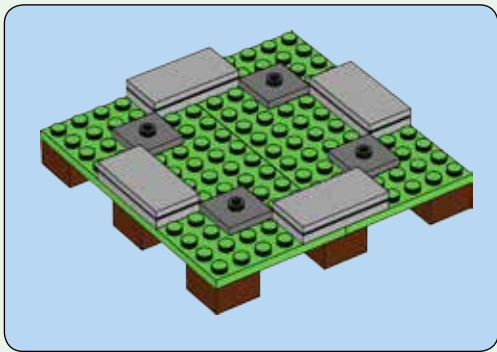

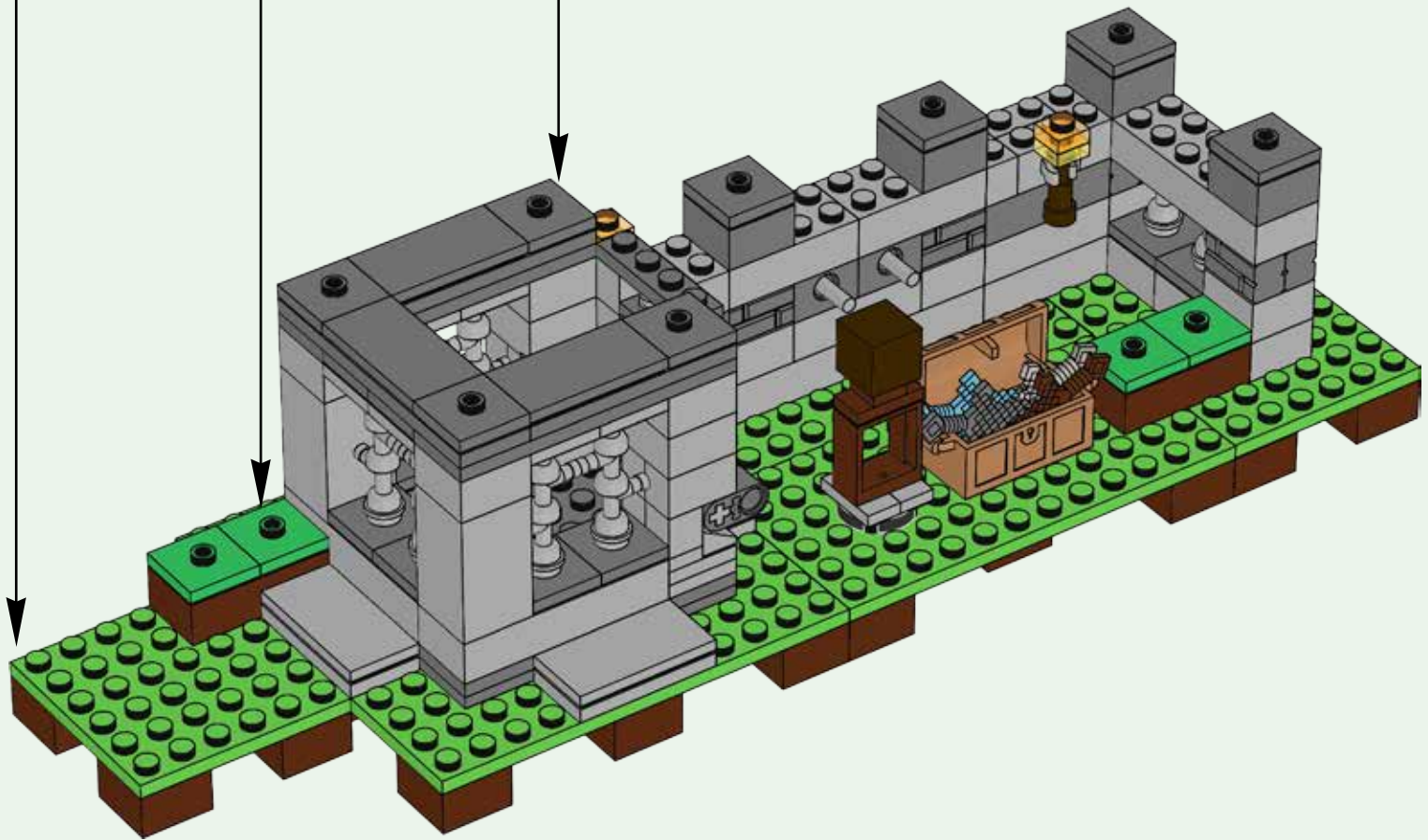
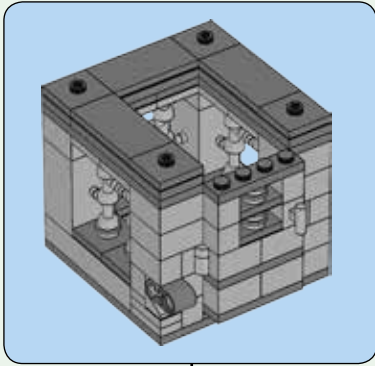
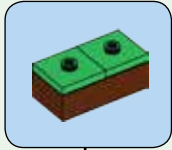
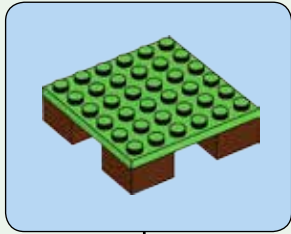



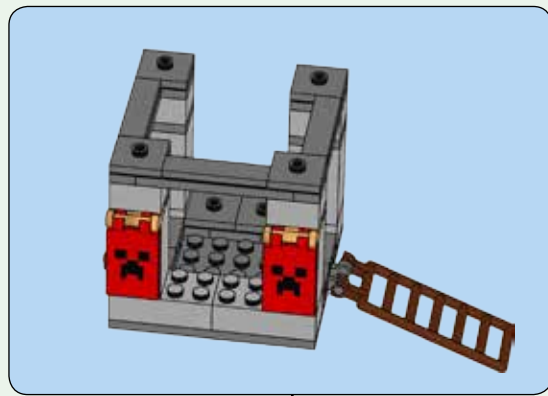

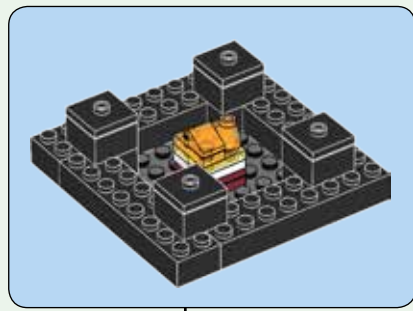
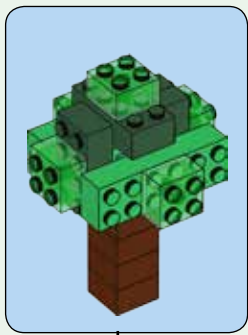





2

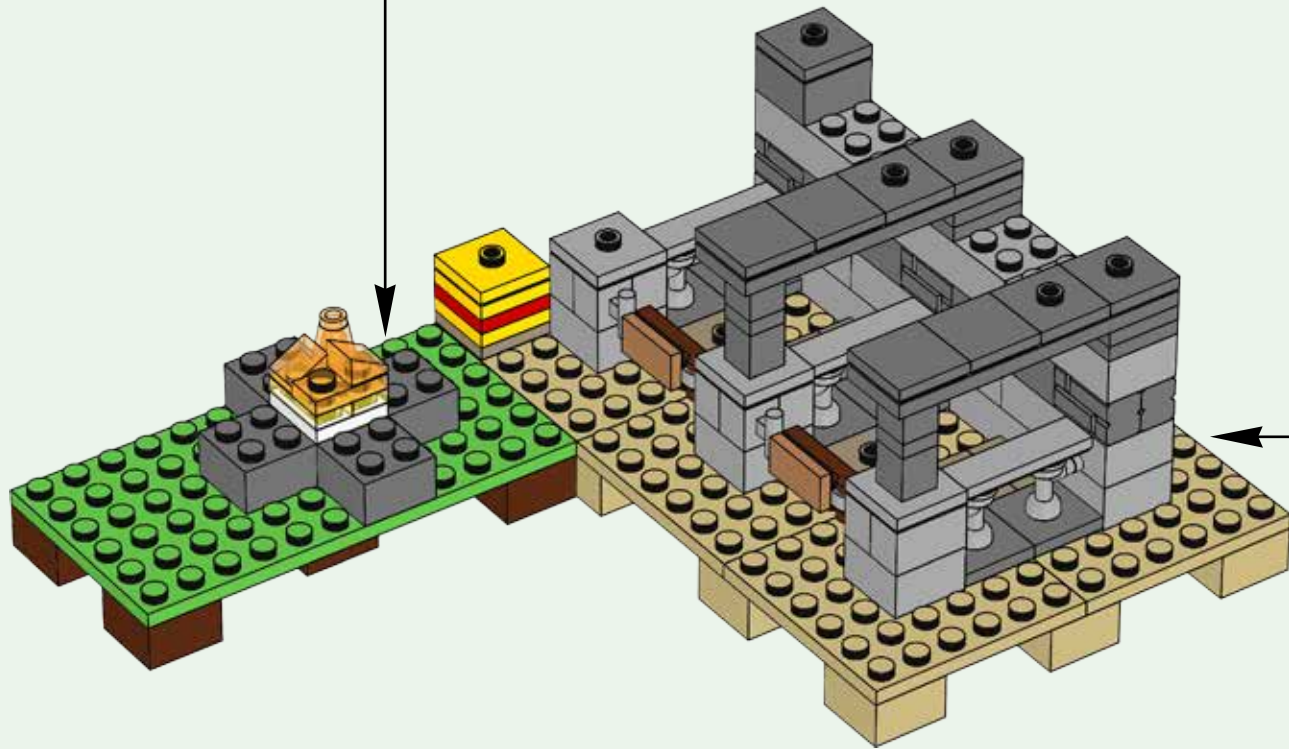
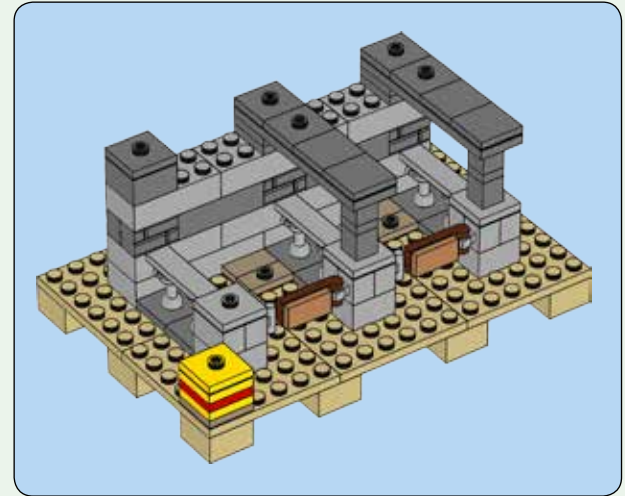
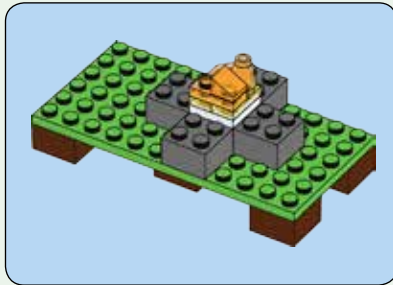

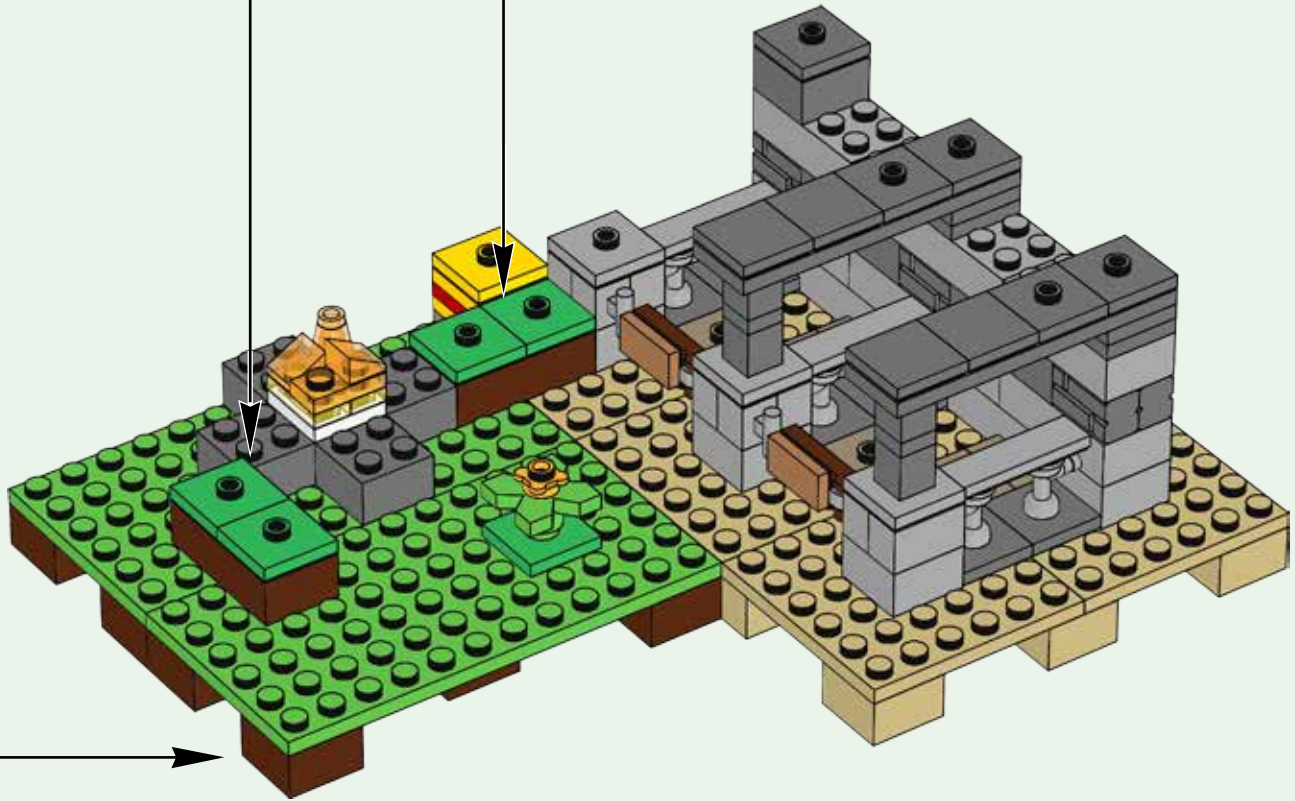
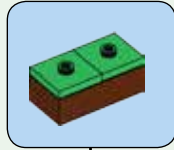
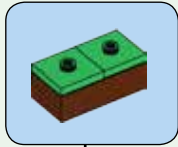
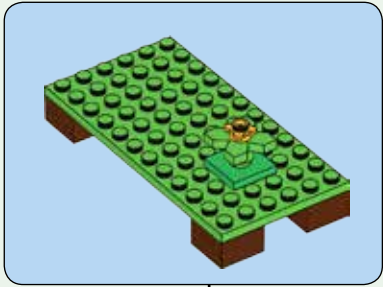

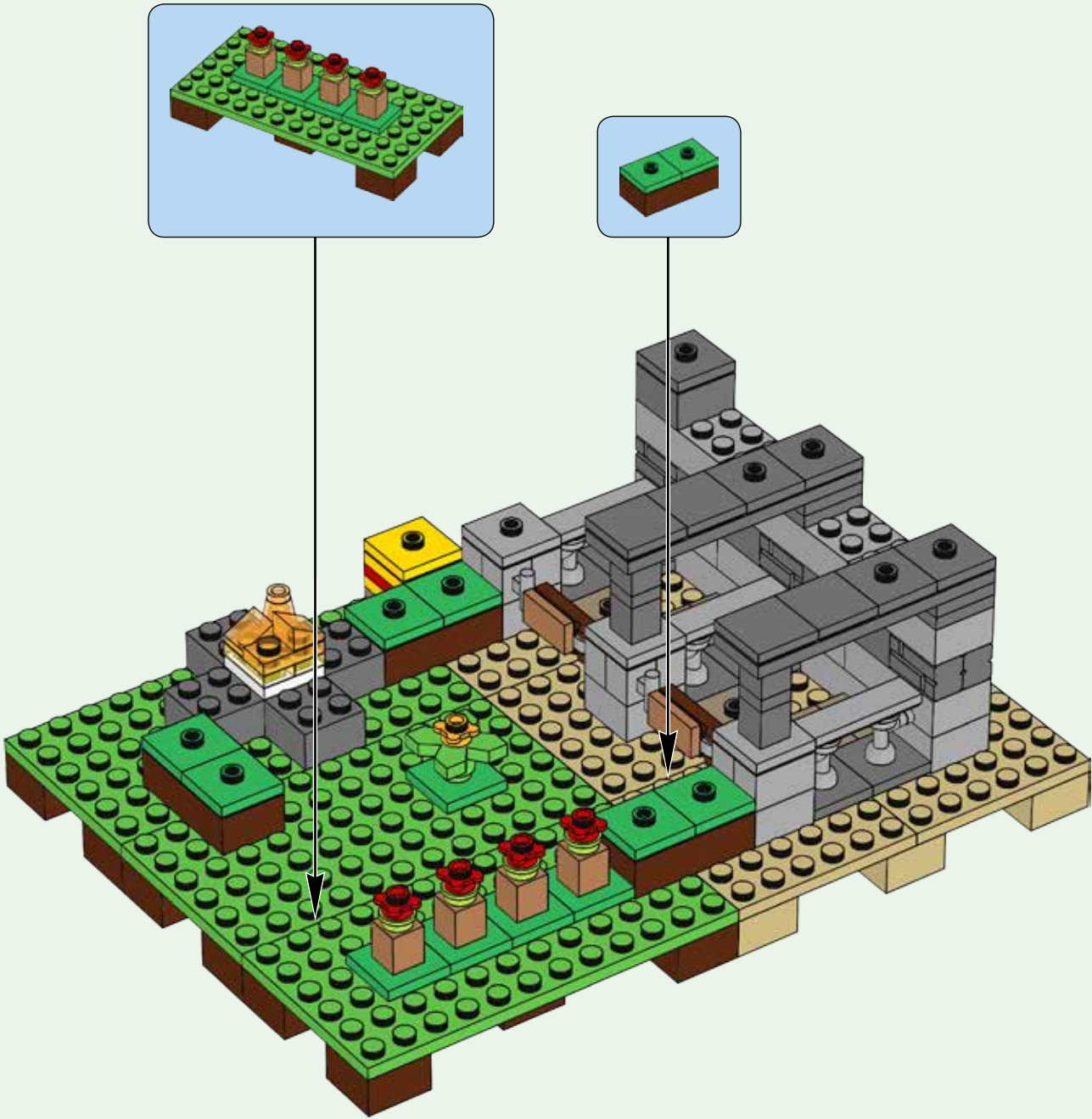



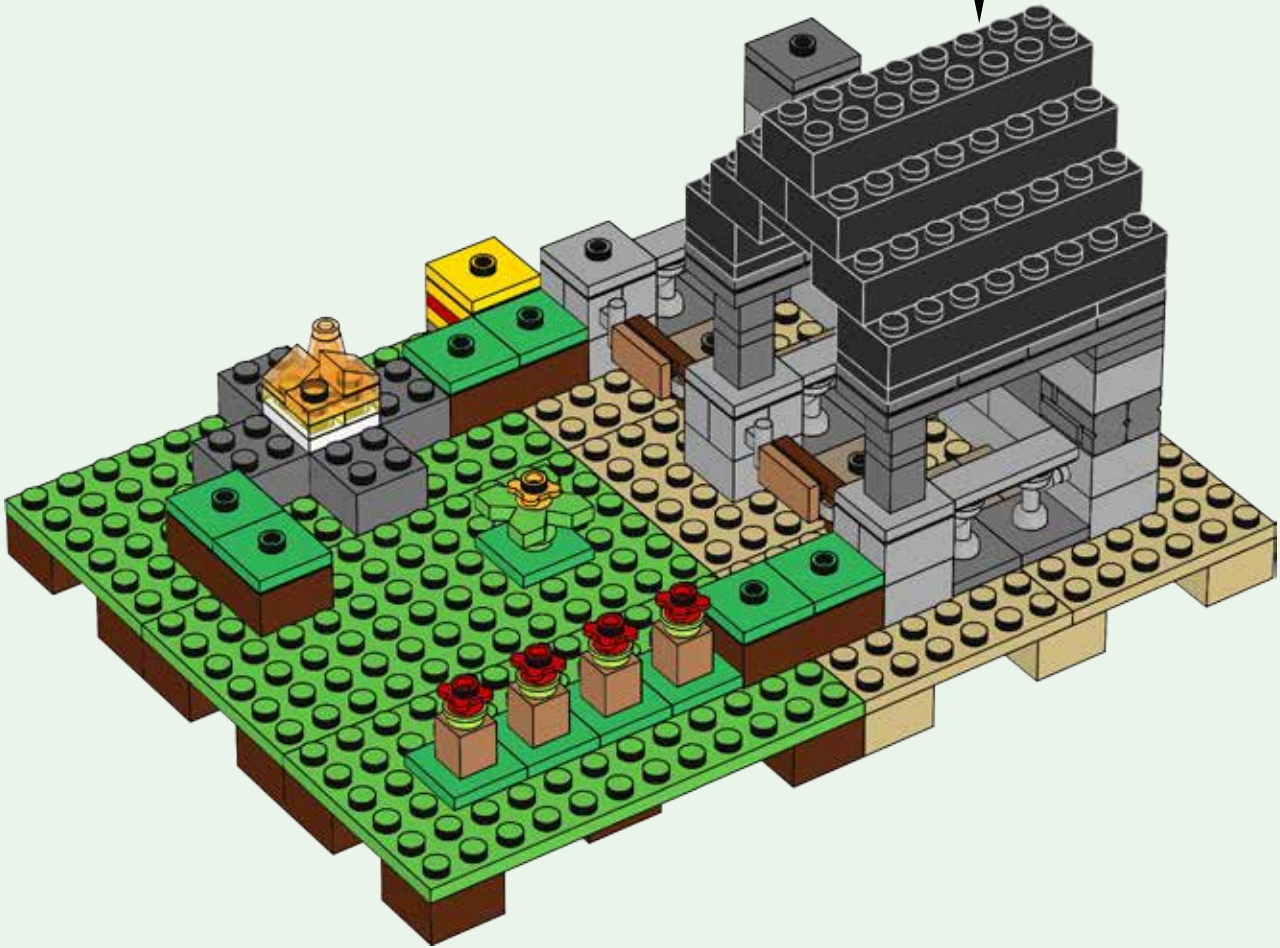
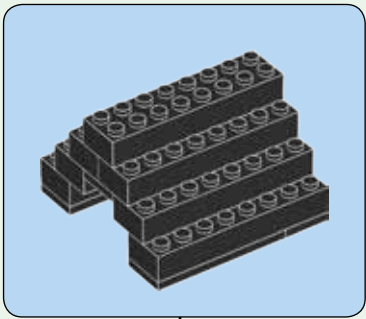



3

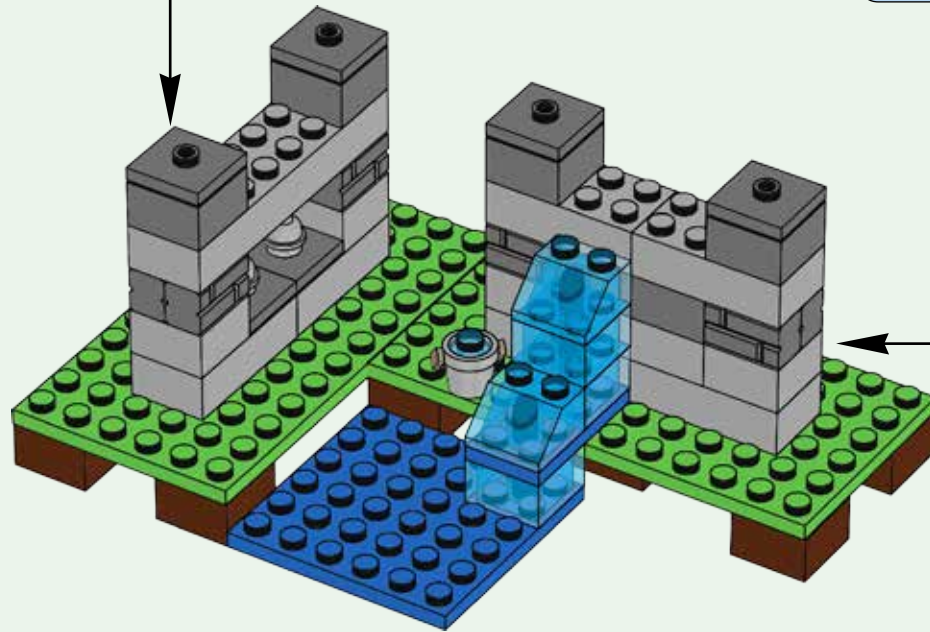
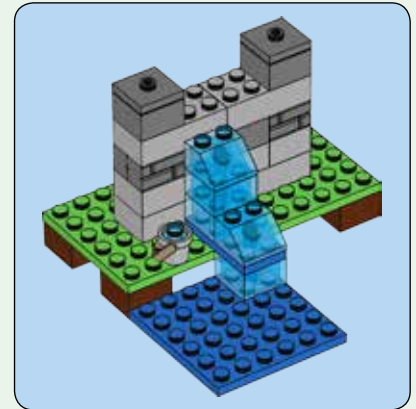
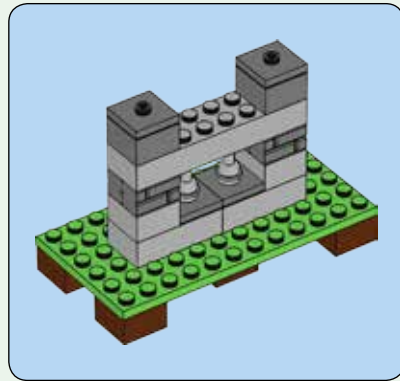

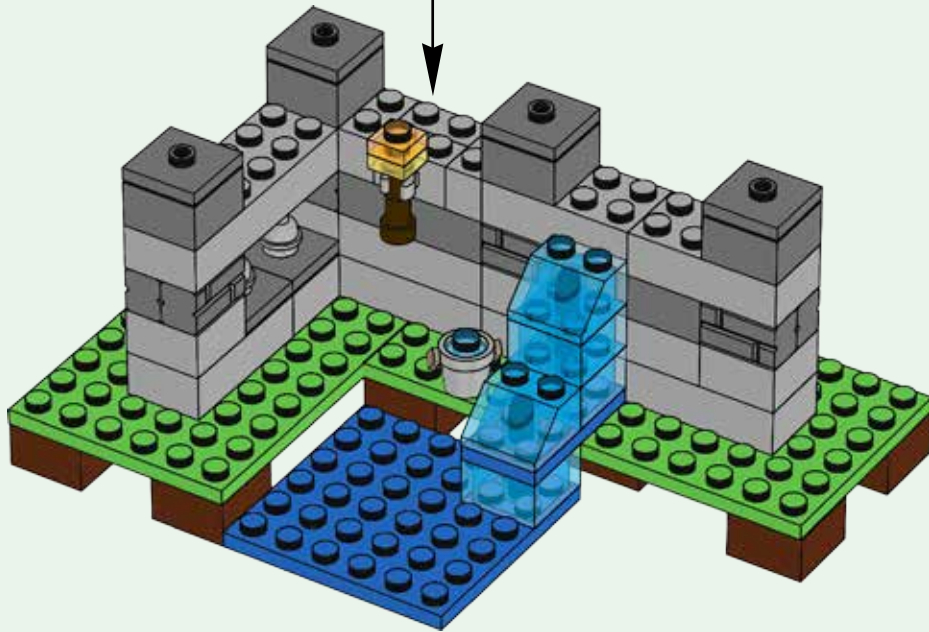
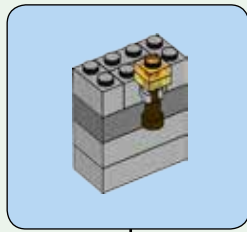



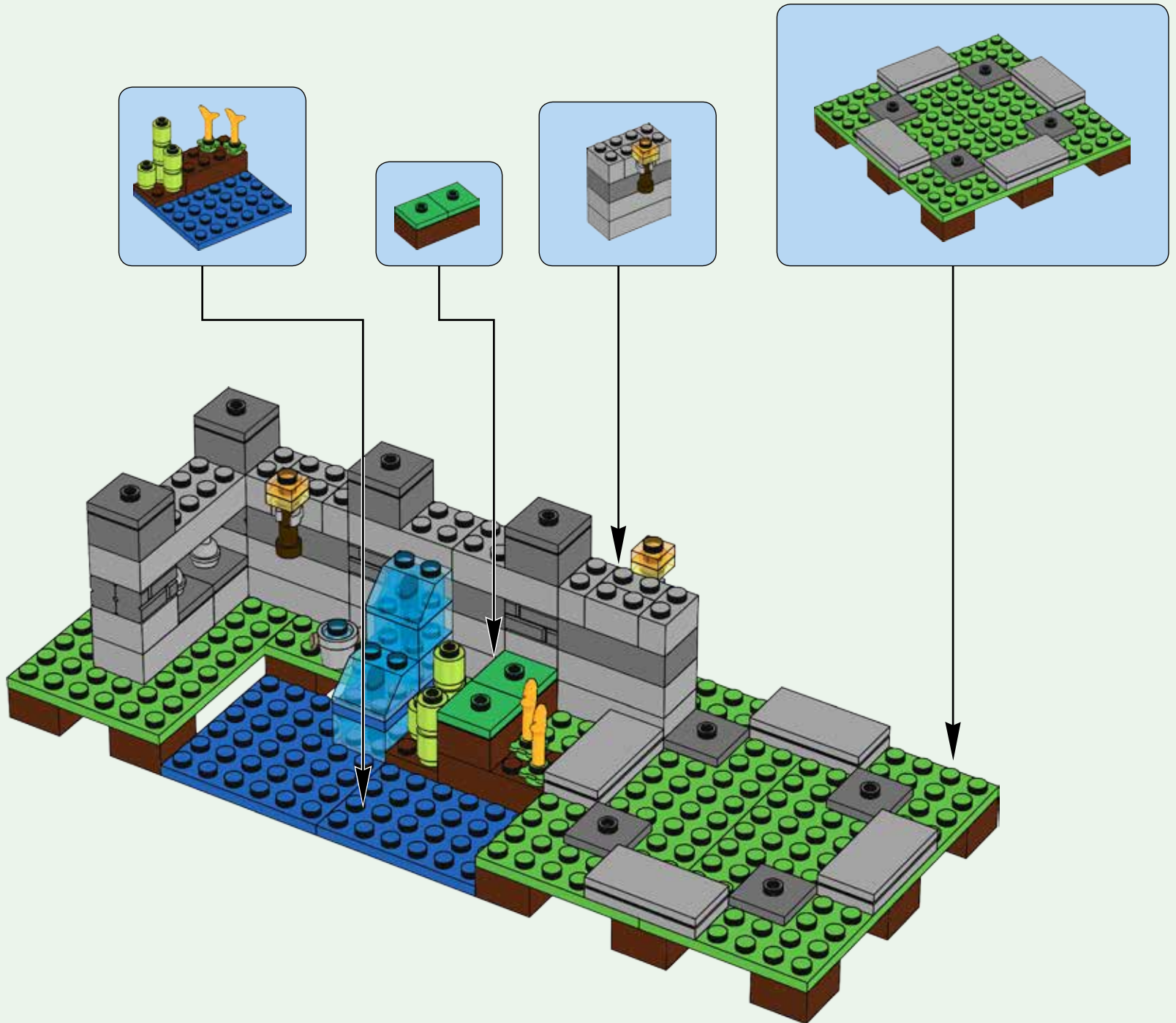

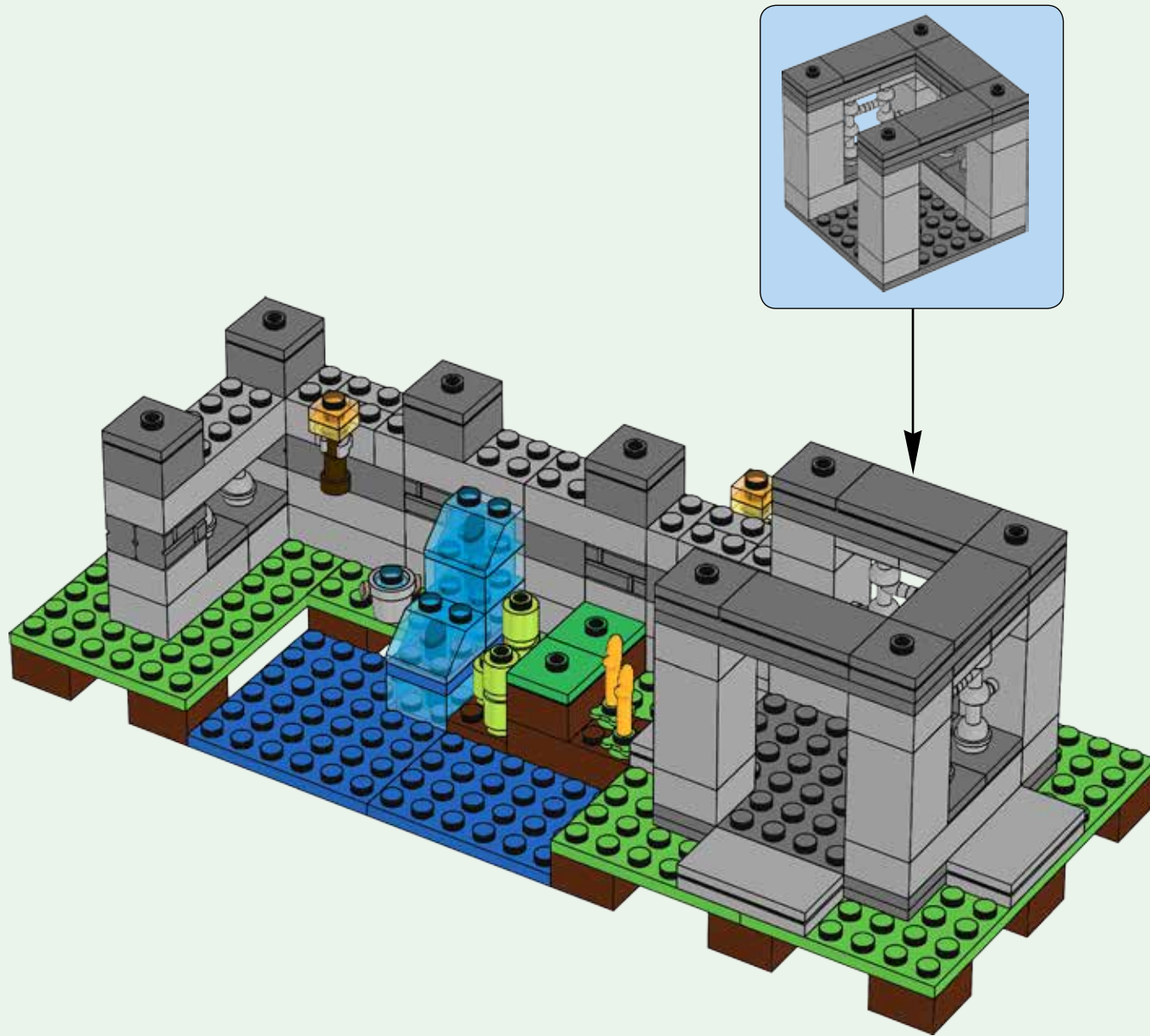

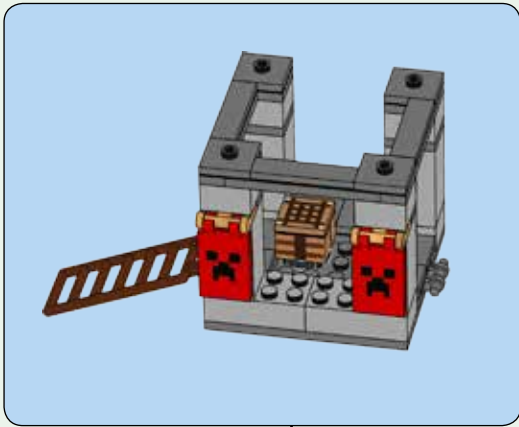



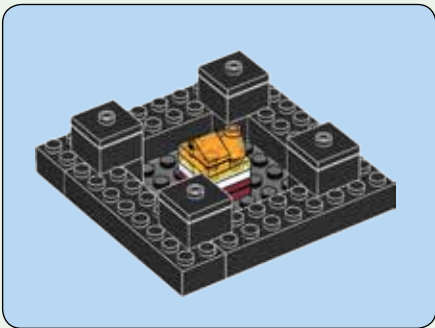

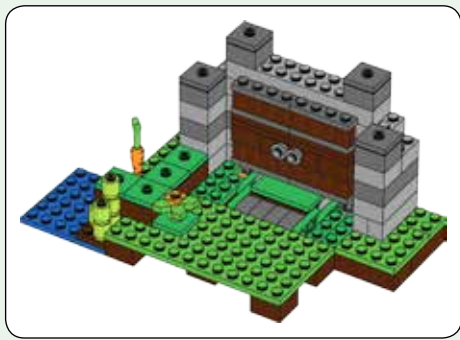

4

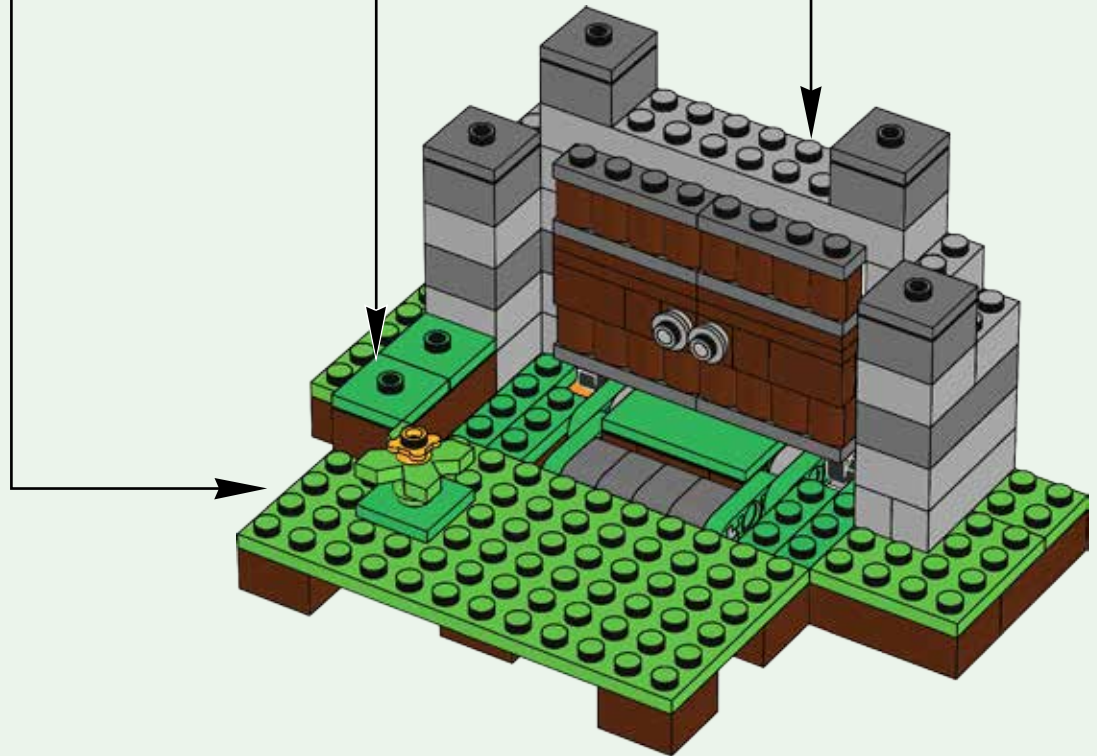
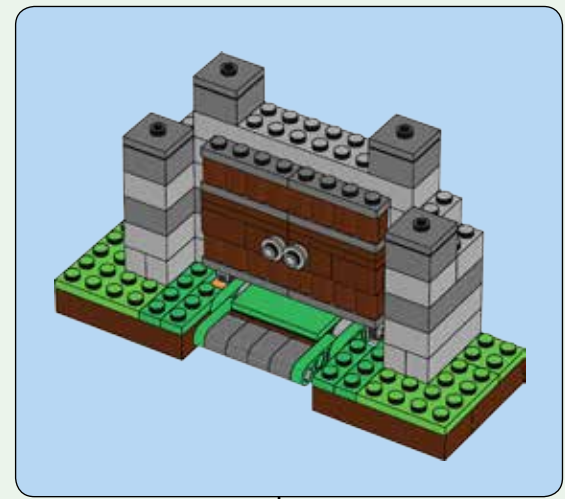
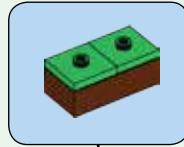
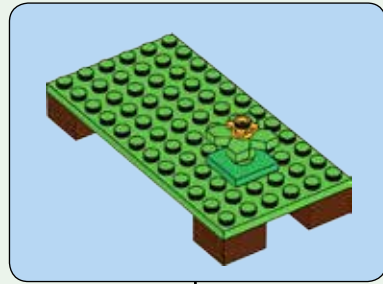

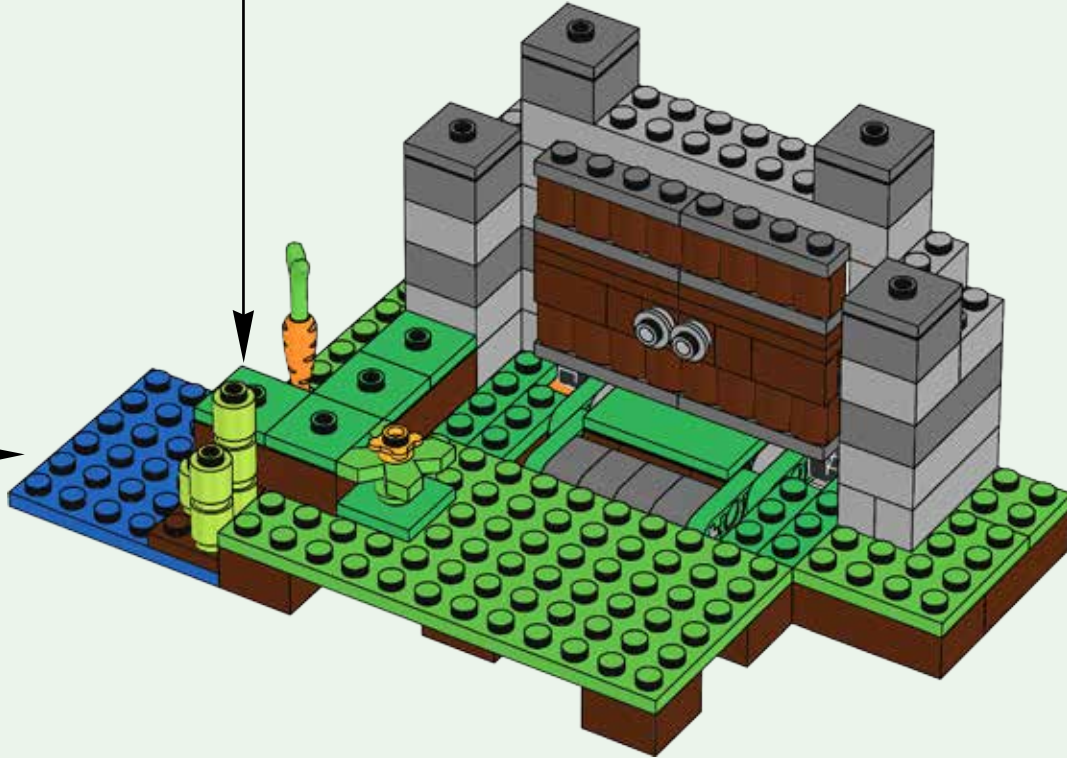
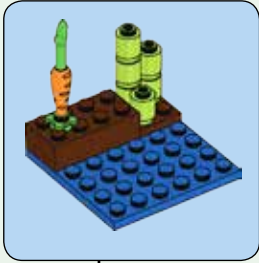



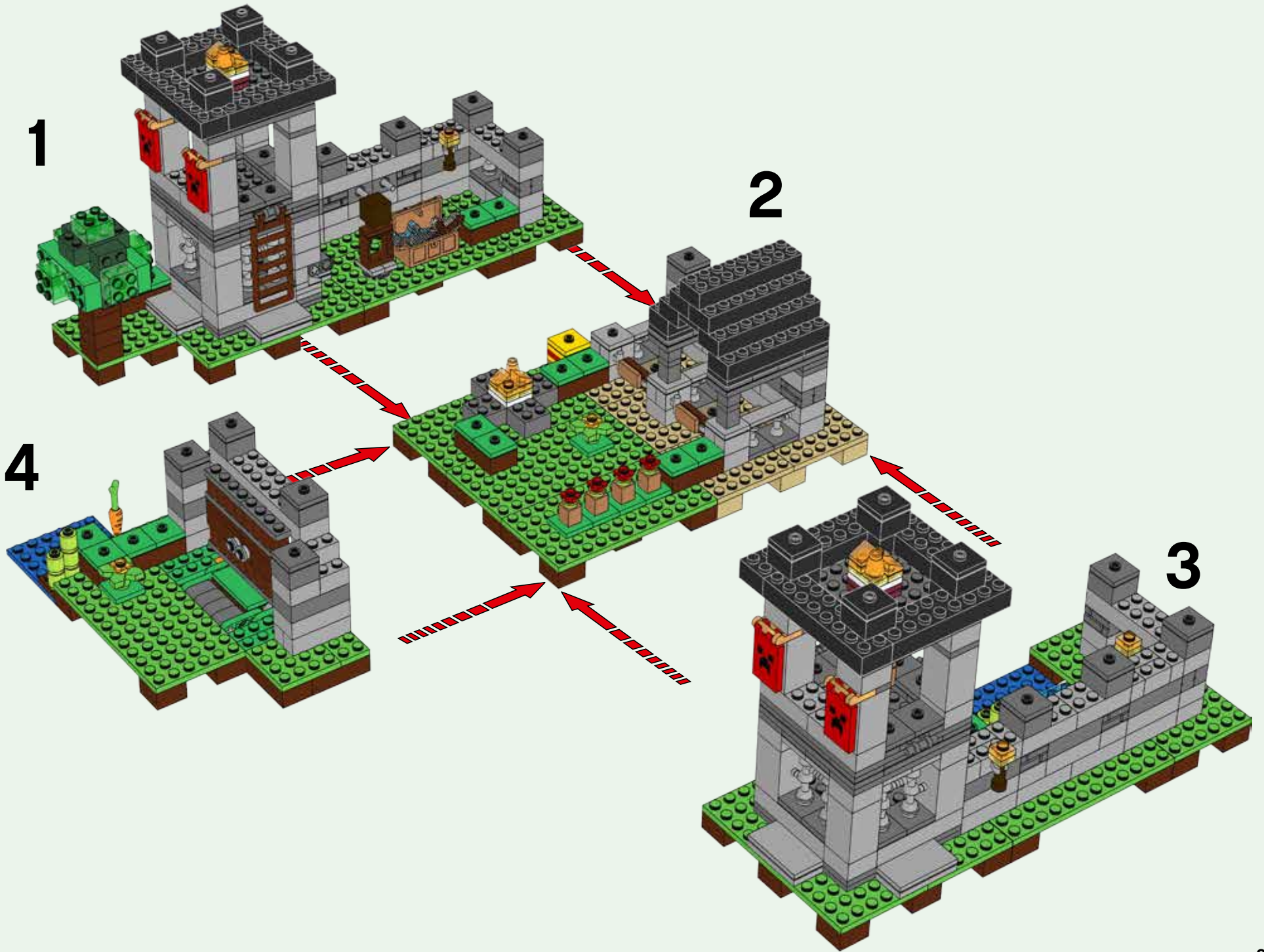







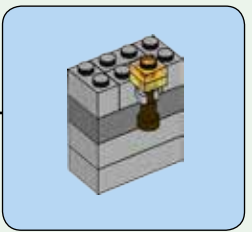
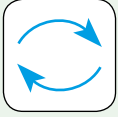



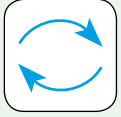

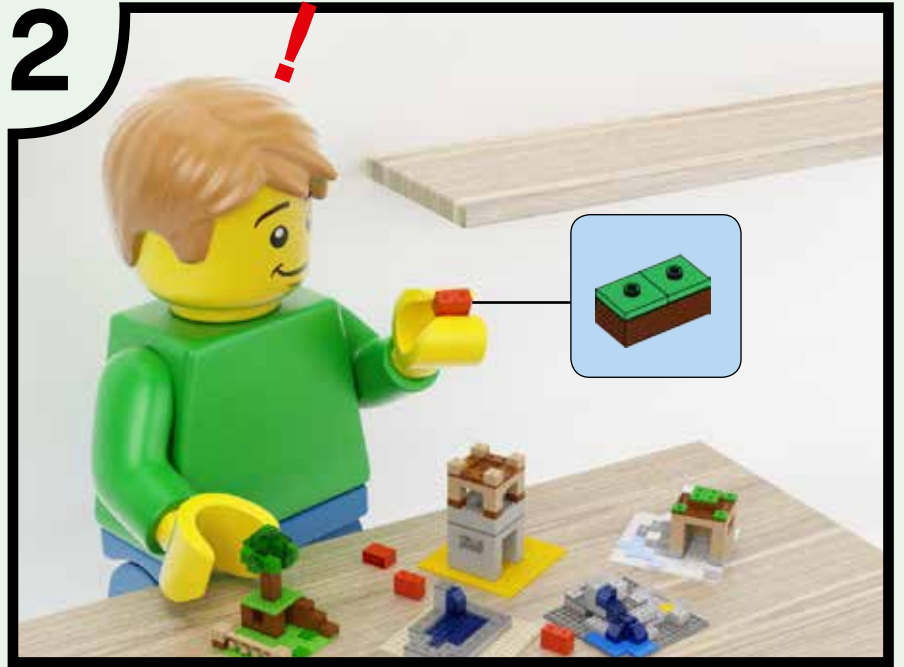
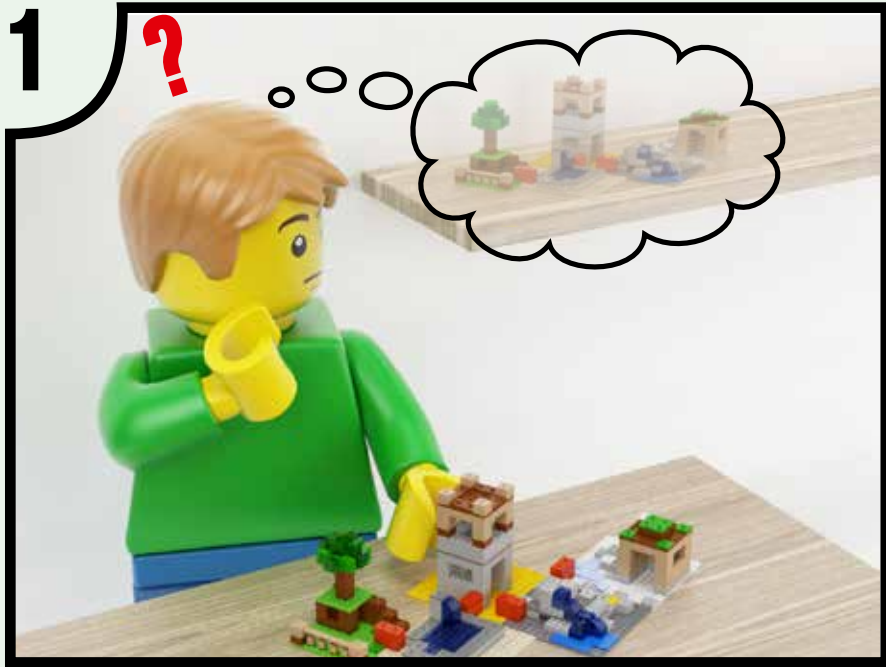



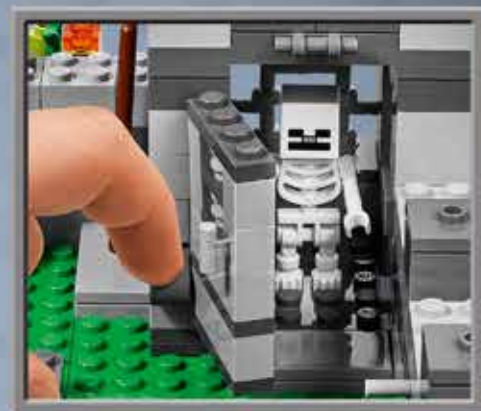

21127





21123



21128



21124



21125



21126





# See more and share your creations on [LEGO.com/minecraft](http://LEGO.com/minecraft)



LEGO and the LEGO logo are trademarks of the LEGO Group. ©2016 The LEGO Group.  
© 2016 Mojang AB and Mojang Synergies AB. MINECRAFT is a trademark or registered trademark of Mojang Synergies AB.  
6163750