

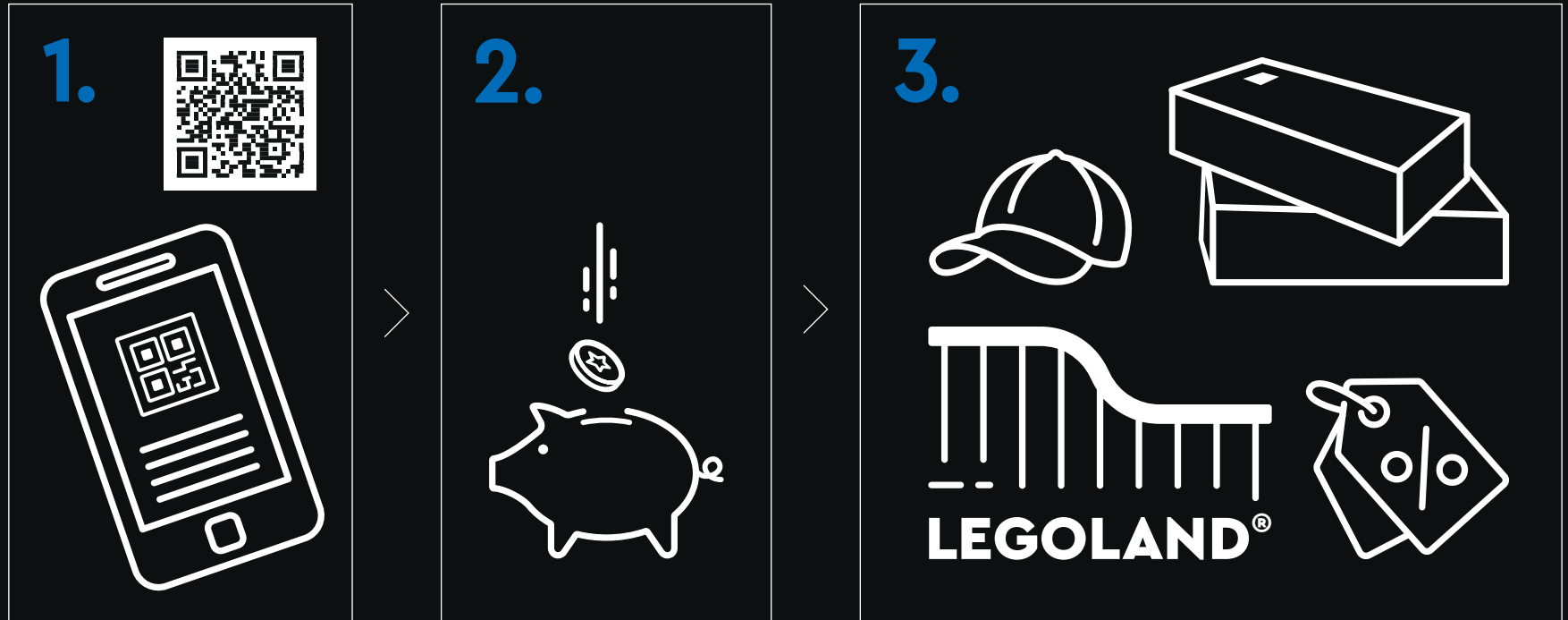



LEGO.com/sustainable-packaging

LEGO® VIP



1. Sign up **2.** Earn points for purchases **3.** Redeem points for rewards, experiences, discounts & more | **1.** Melde dich an **2.** Sammle Punkte bei jedem Kauf **3.** Löse die Punkte für Belohnungen, Erlebnisse, Rabatte und Ähnliches ein | **1.** Inscrivez-vous **2.** Gagnez des points lors de vos achats **3.** Échangez vos points contre des récompenses, des expériences, des remises et bien plus encore | **1.** Iscriviti **2.** Guadagna punti con i tuoi acquisti **3.** Riscatta punti per premi, esperienze, sconti e altro ancora | **1.** Regístrate **2.** Gana puntos por tus compras **3.** Canjea puntos por recompensas, experiencias, descuentos y mucho más | **1.** Registe-se **2.** Ganhe pontos em compras **3.** Troque os pontos para prémios, experiências, descontos e muito mais | **1.** 注册 **2.** 购物赚积分 **3.** 用积分兑换奖励、体验、折扣等 | **1.** Zarejestruj się **2.** Zdobywaj punkty za zakupy **3.** Wymieniaj punkty na rabaty, przygody i inne nagrody | **1.** Zaregistrujte se **2.** Sbírejte body za nákupy **3.** Vyměňujte body za odměny, zážitky, slevy a spoustu dalšího | **1.** Zaregistrujte se **2.** Získavajte body za nákupy **3.** Uplatnite si body a získajte odmeny, rôzne zážitky, zľavy a ešte viac | **1.** Regisztrálj **2.** Szerezz pontokat minden vásárlással **3.** Váltsd be pontjaidat jutalmakra, élményekre, kedvezményekre és egyebekre | **1.** Înscric-te **2.** Câștigă puncte pentru achiziții **3.** Valorifică puncte pentru recompense, experiențe, reduceri și multe altele | **1.** Регистрируйте се **2.** Получайте точки за покупки **3.** Используйте точки за награды, услуги, отстъпки и т.н. | **1.** Reģistrējies **2.** Pelni punktus par pirkumiem **3.** Izmanto punktus, lai saņemtu balvas, izklaides iespējas, atlaides un daudz ko citu | **1.** Registreeru **2.** Teeni ostude eest punkte **3.** Lunasta punktide eest preemiad, elamused, allahindlused ja muu | **1.** Užsiregistruokite **2.** Pelnykite taškų už pirkinius **3.** Panaudokite taškus atlygiui, funkcijoms, nuolaidoms ir ne tik





姫路城

姫路城/白鹭城

令人叹为观止的姫路城雄伟壮观，俯瞰着日本城市姫路，是名列联合国教科文组织世界遗产名录的建筑瑰宝。这座城堡始建于 1333 年，时值日本内战即将结束。几个世纪以来，它经历了多次改造。1600 年，开始对姫路城进行大规模重建，建成后的结构一直完整地保存到今天。这座城堡最初由封建统治者管理和维护，后来由日本政府开展此工作。错综复杂的路径宛若迷宫，曾经是为了迷惑和困住敌人，而现在成为了游客的一段有趣旅程。白鹭城历经战争、地震、火灾和平时时期，成为日本文化无言的纪念碑。可以在拼搭过程中探索主天守阁的复杂细节和这座城堡的历史。

CHRIS MCVEIGH
乐高®高级设计师

向受人尊崇的地标致敬

🍷 “2023 年是姬路城列入联合国教科文组织世界遗产名录 30 周年，但其建筑结构 and 历史仍然是一个谜。我们将主天守阁作为关注点，并利用比例使其脱颖而出。如果你参观过这座城堡，那么你可能会辨识出一些内部细节，但如果你没有亲眼见过它，我们希望它能激发你的想象力和好奇心。”





沿着错综复杂的路径、坡道和楼梯穿过城堡。



视觉错觉

● 姬路城的屋顶采用互锁的黑色矩形瓦片和半圆形瓦片。数层白色粘土作为瓦片的衬里，使屋顶呈现高对比度的网状外观。但在远处，网格图案变为灰色。此套装中的屋顶瓦片采用深石灰色，以反映瓦片的老化。



可以在模型拼搭完成后查看其内部

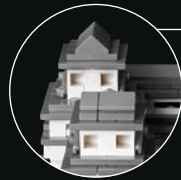

这些塔的结构各不相同——
甚至高度也不同。



不规则的角度在整座城堡和墙
壁中占主导地位。

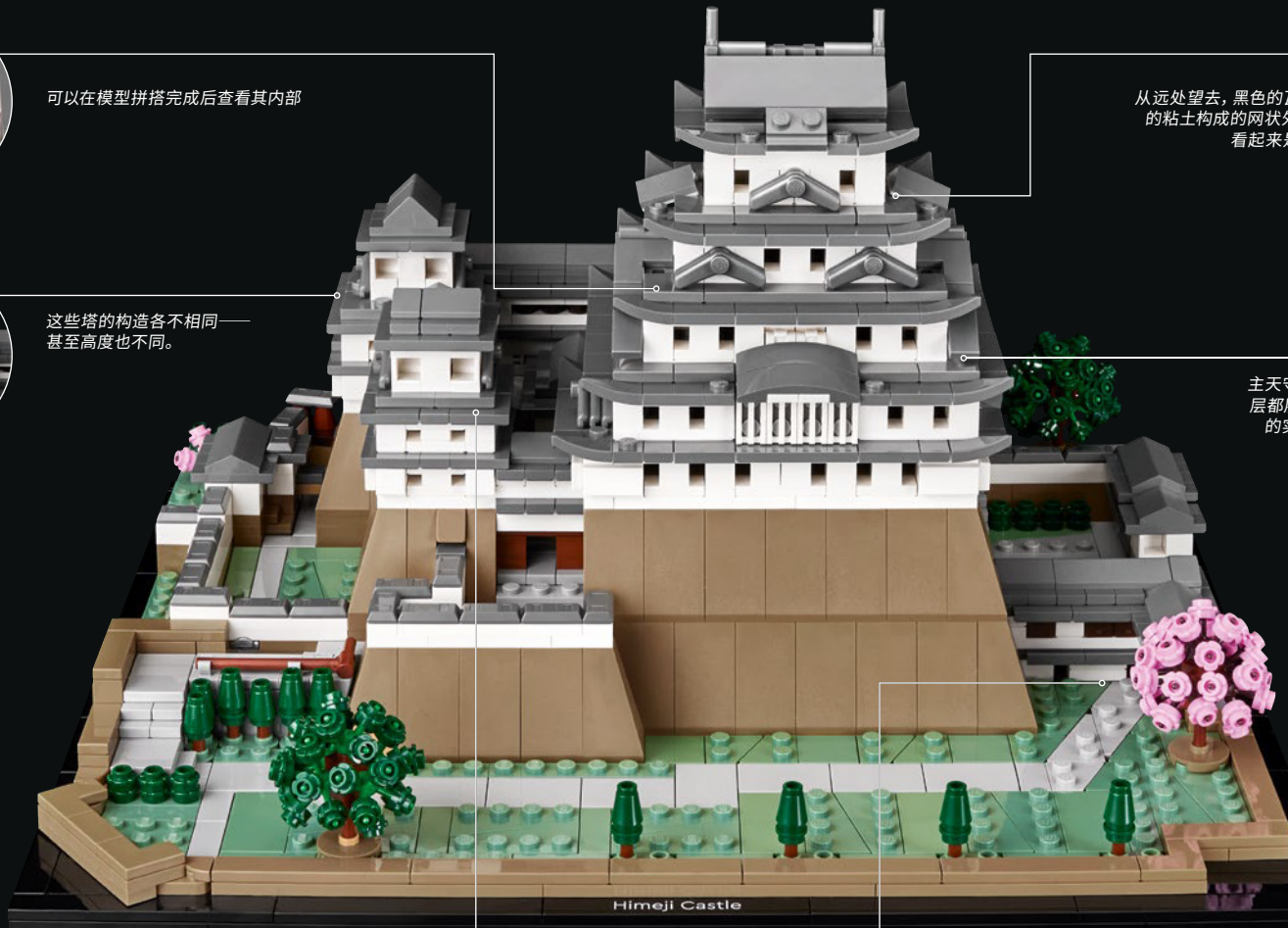

从远处望去，黑色的瓦片和白色的
粘土构成的网状外形使屋顶
看起来是灰色的。

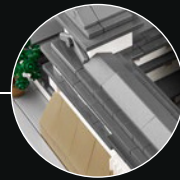
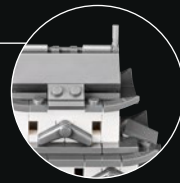

主天守阁的每一
层都展现了城堡
的实际结构。



可以用粉色的花朵或绿
色的叶子装饰樱花树

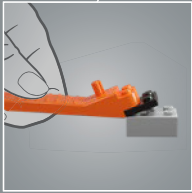
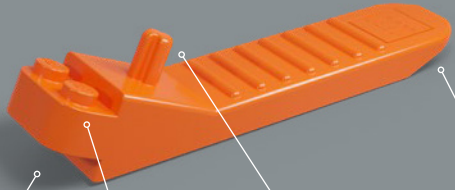

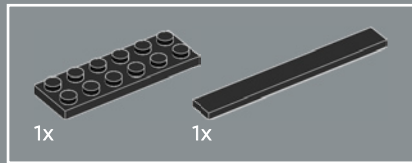

1

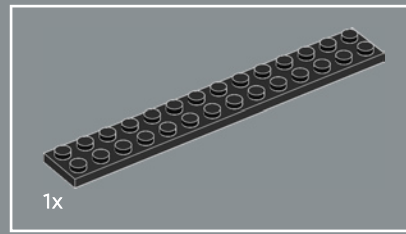
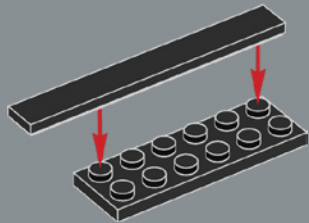

2

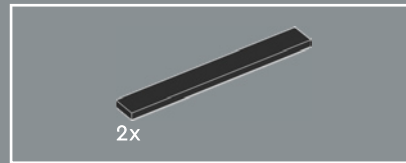
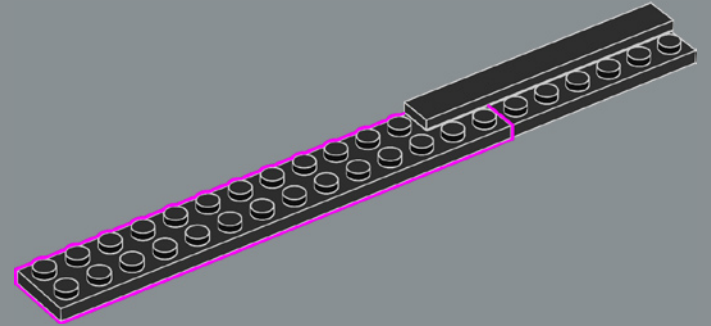

3

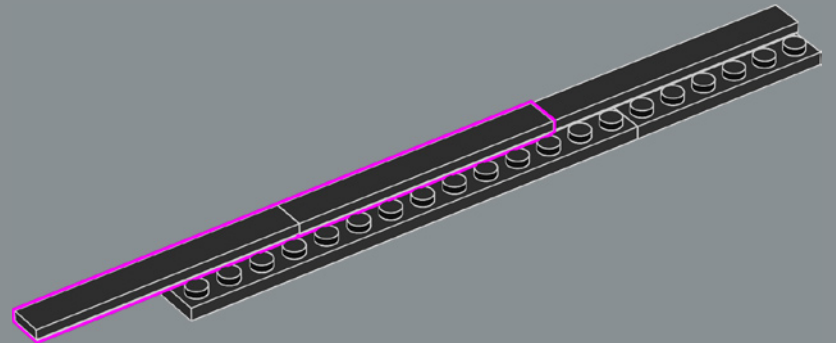

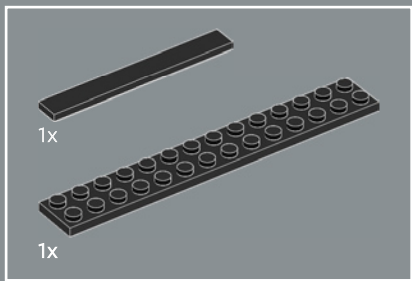

4

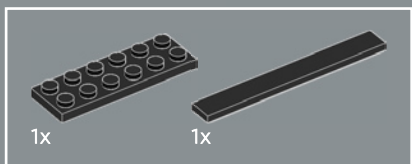
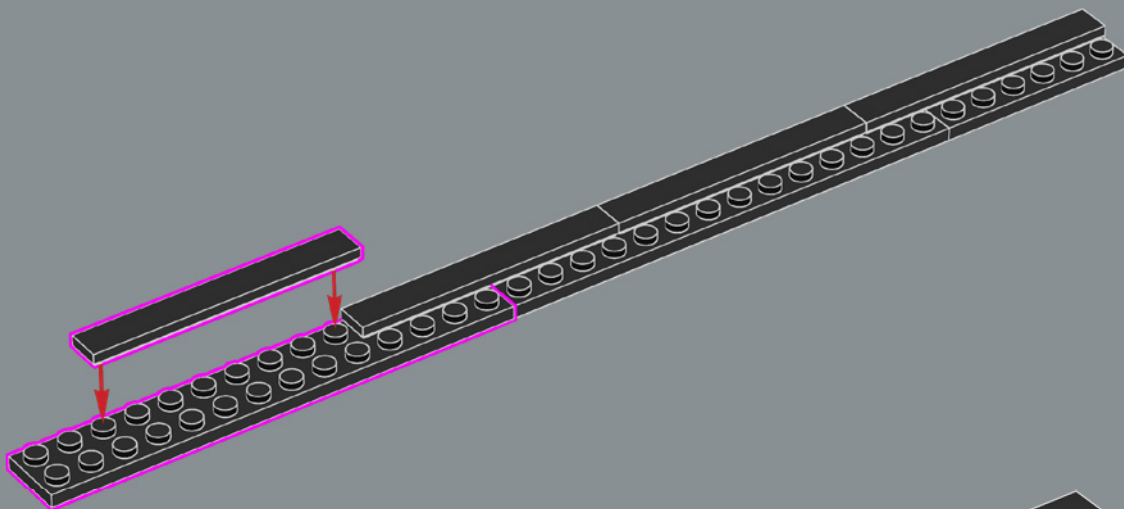

5

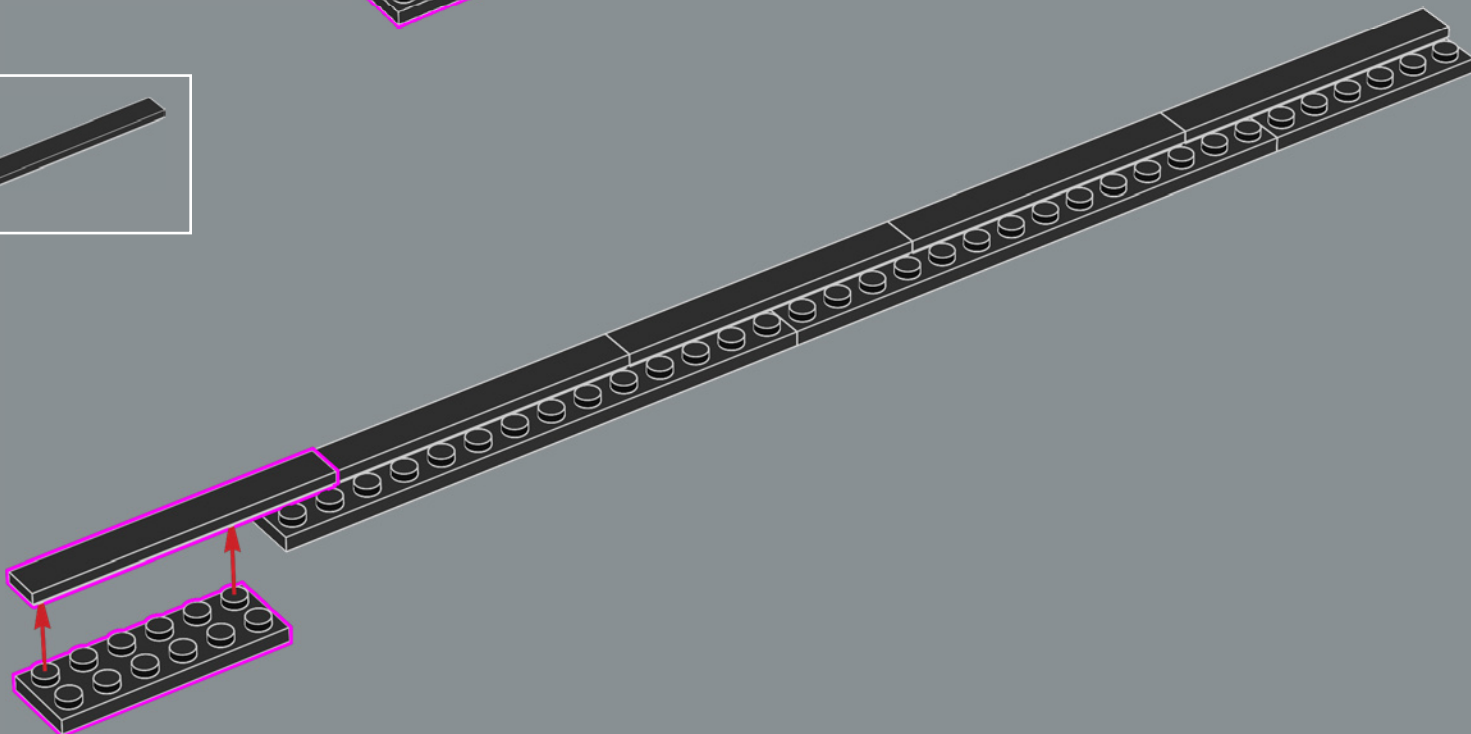

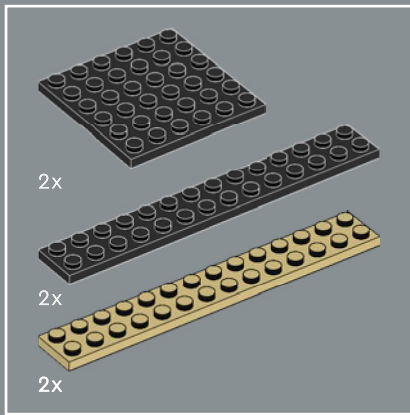

6

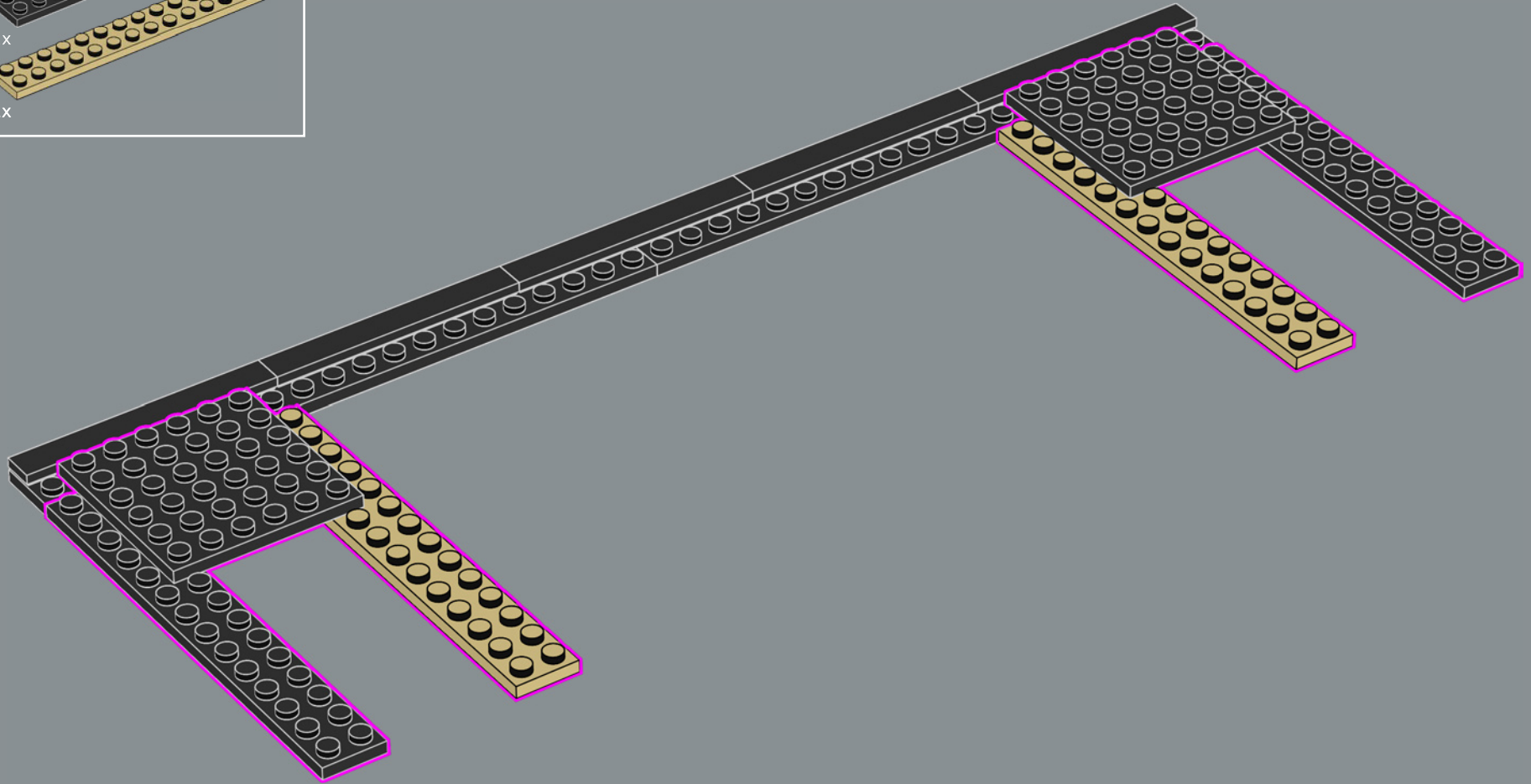

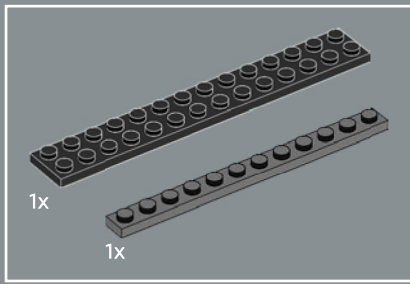

8

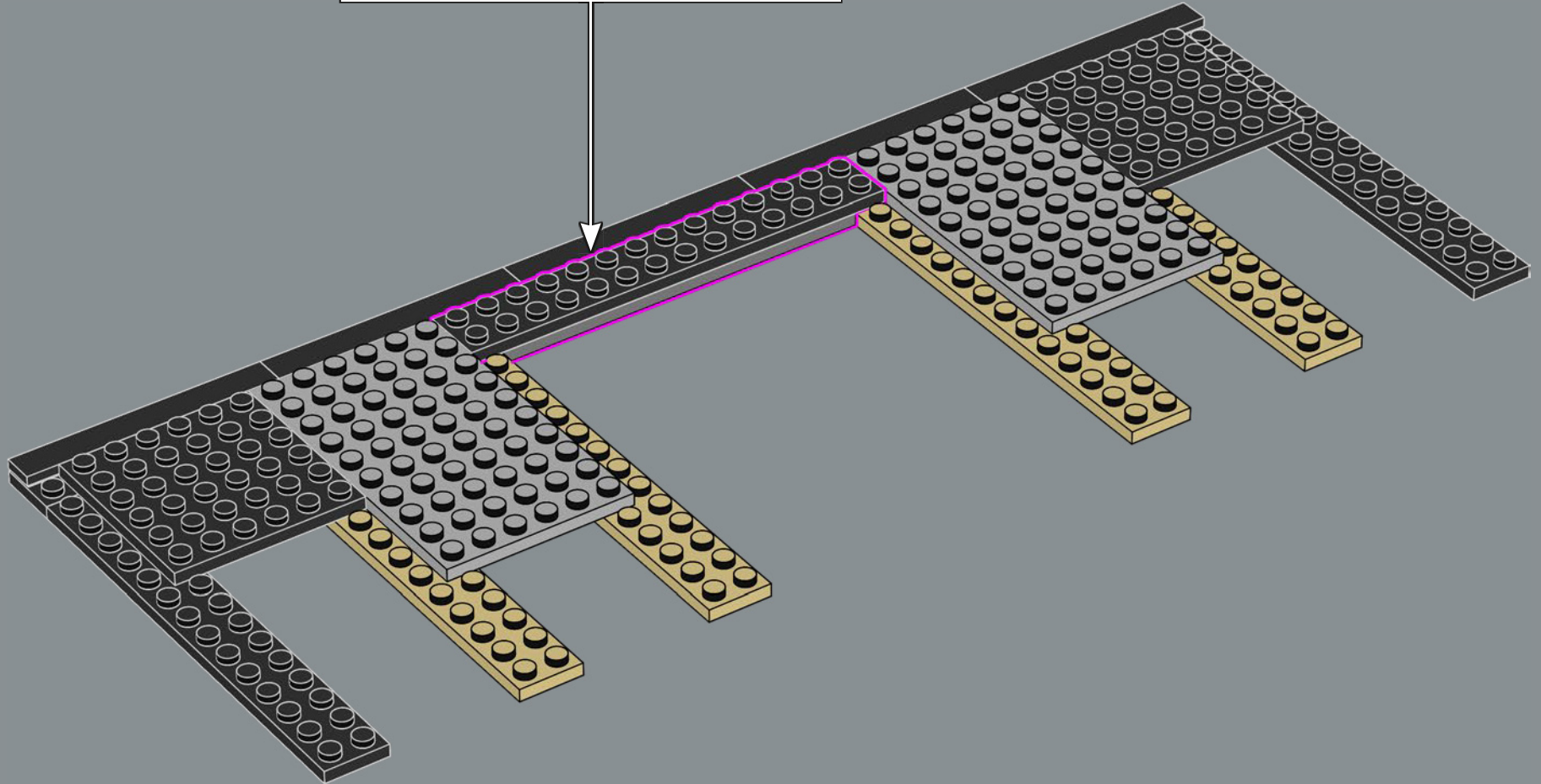
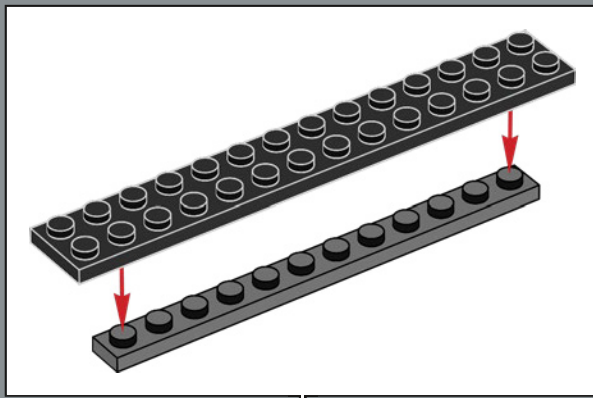

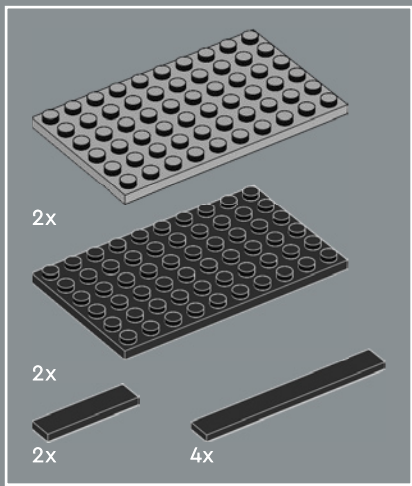

9

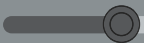
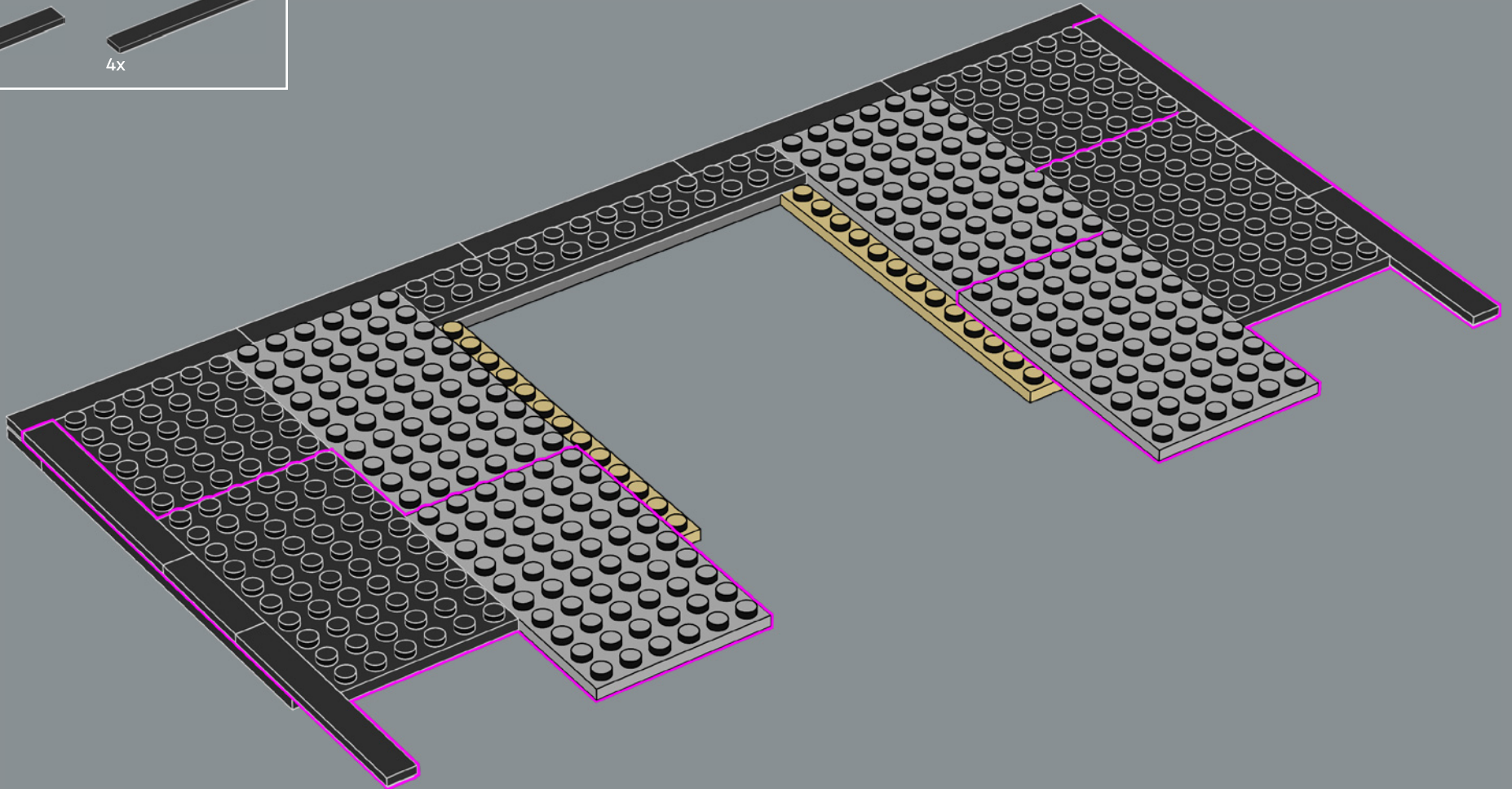

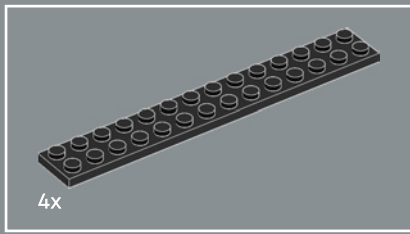

10

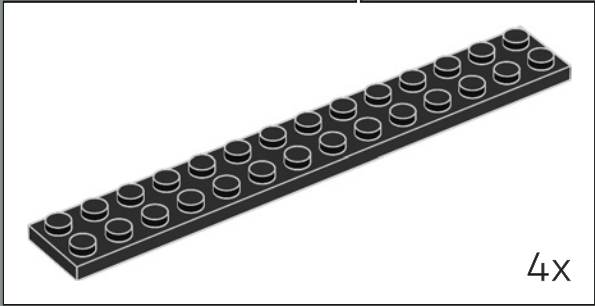
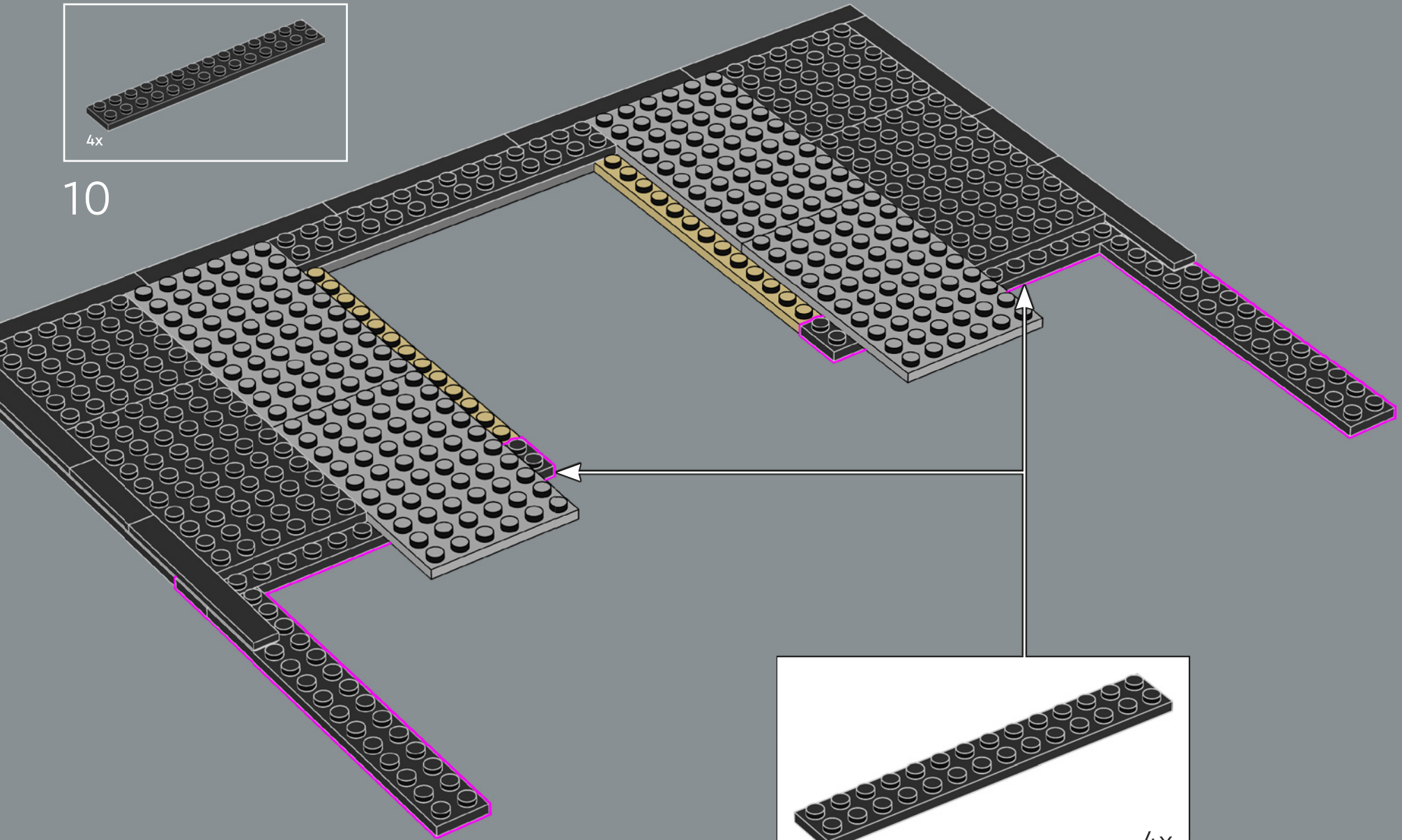

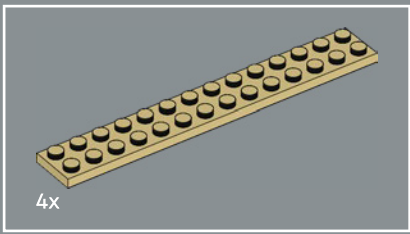

11

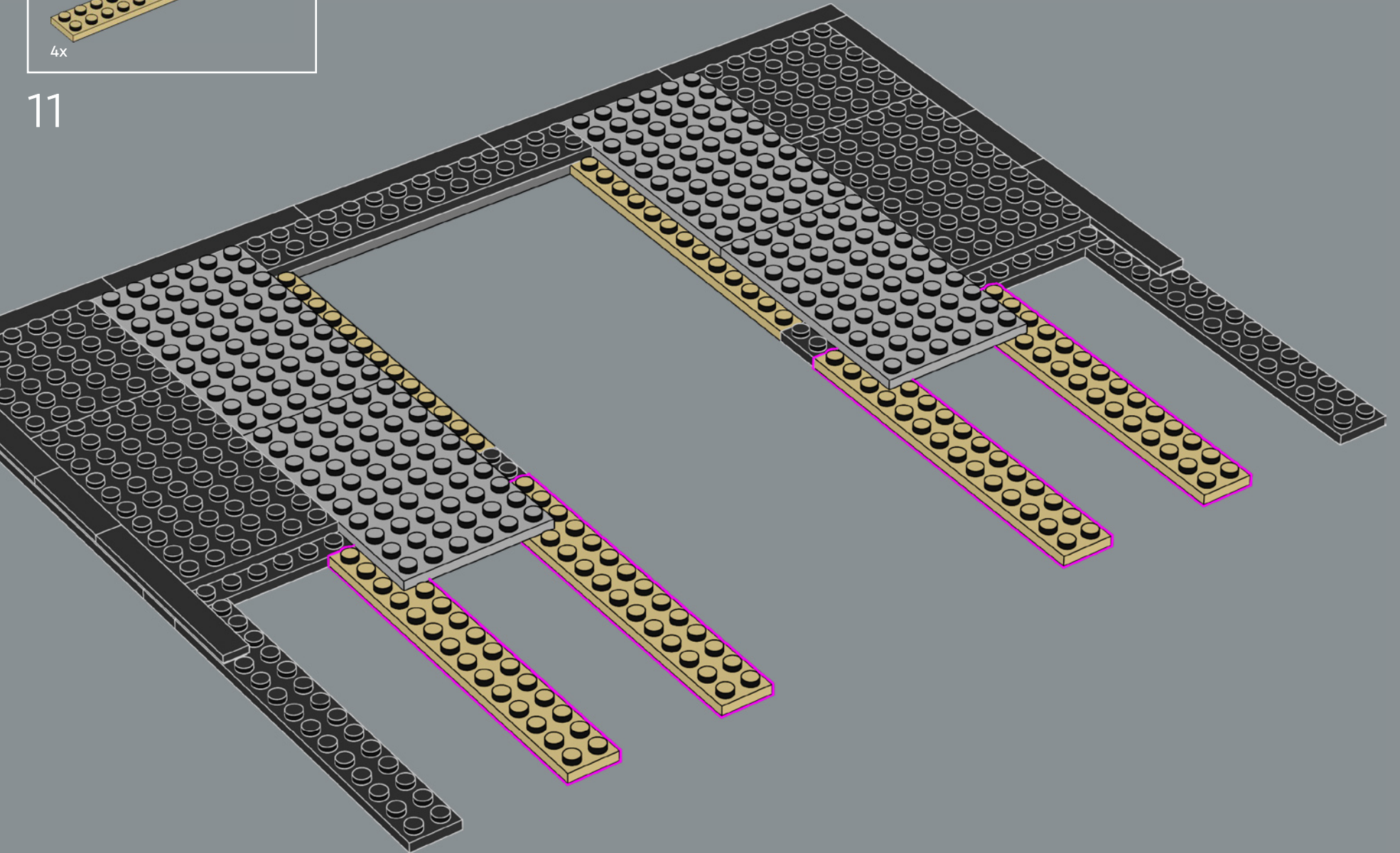

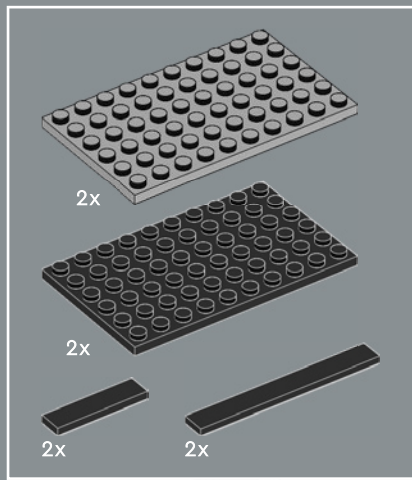

12

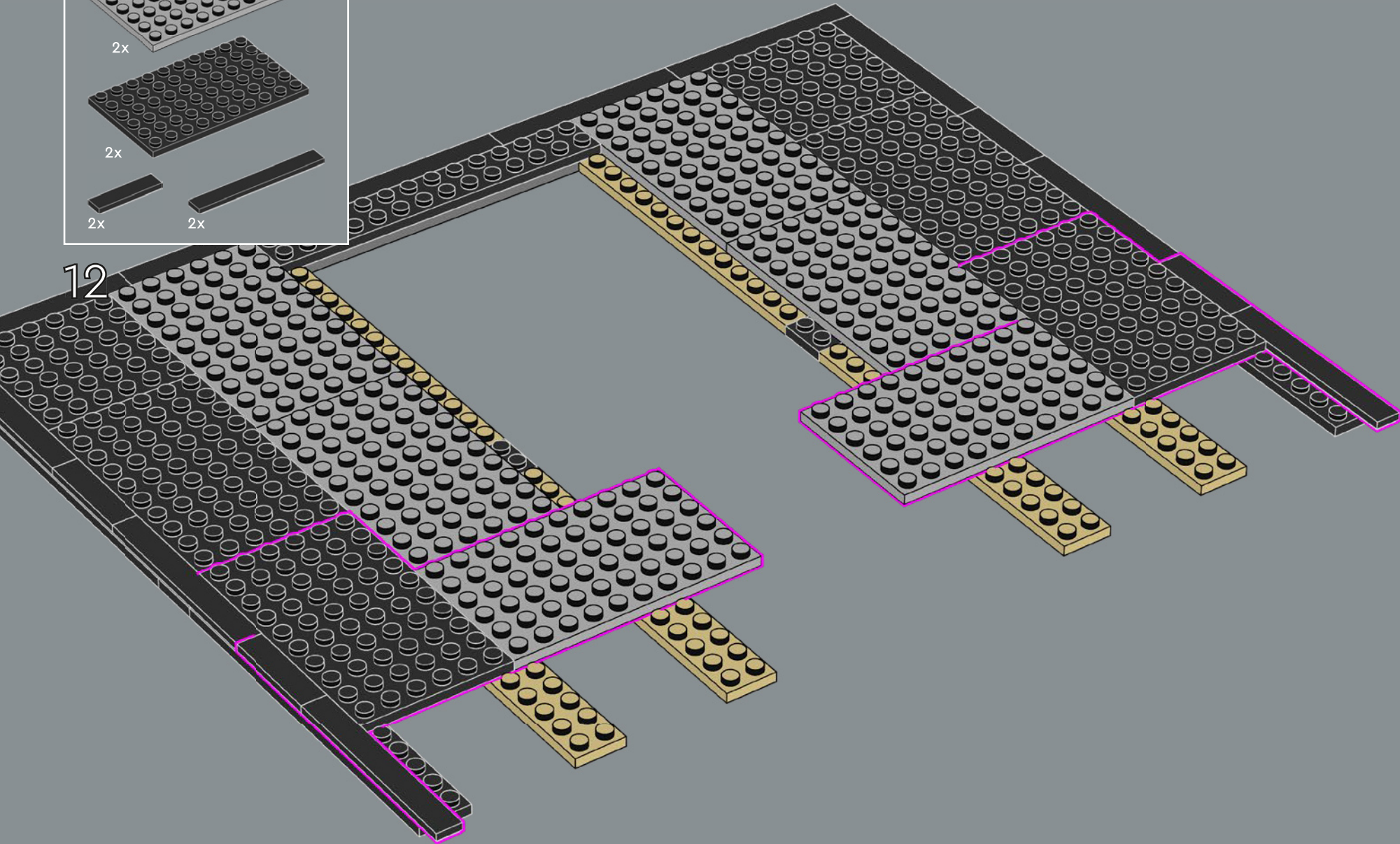

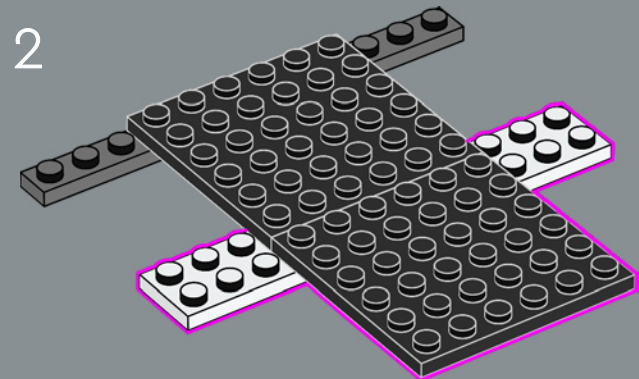
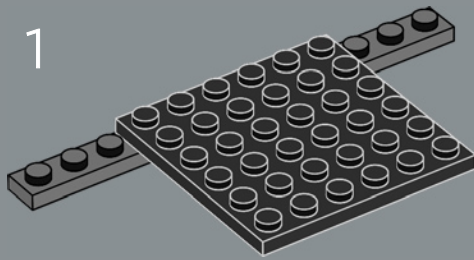
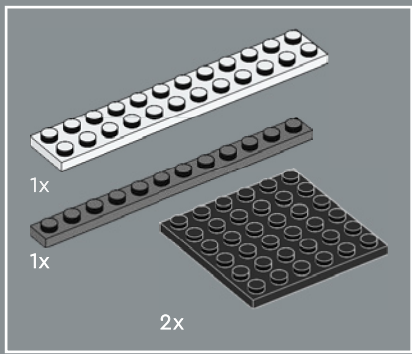

13

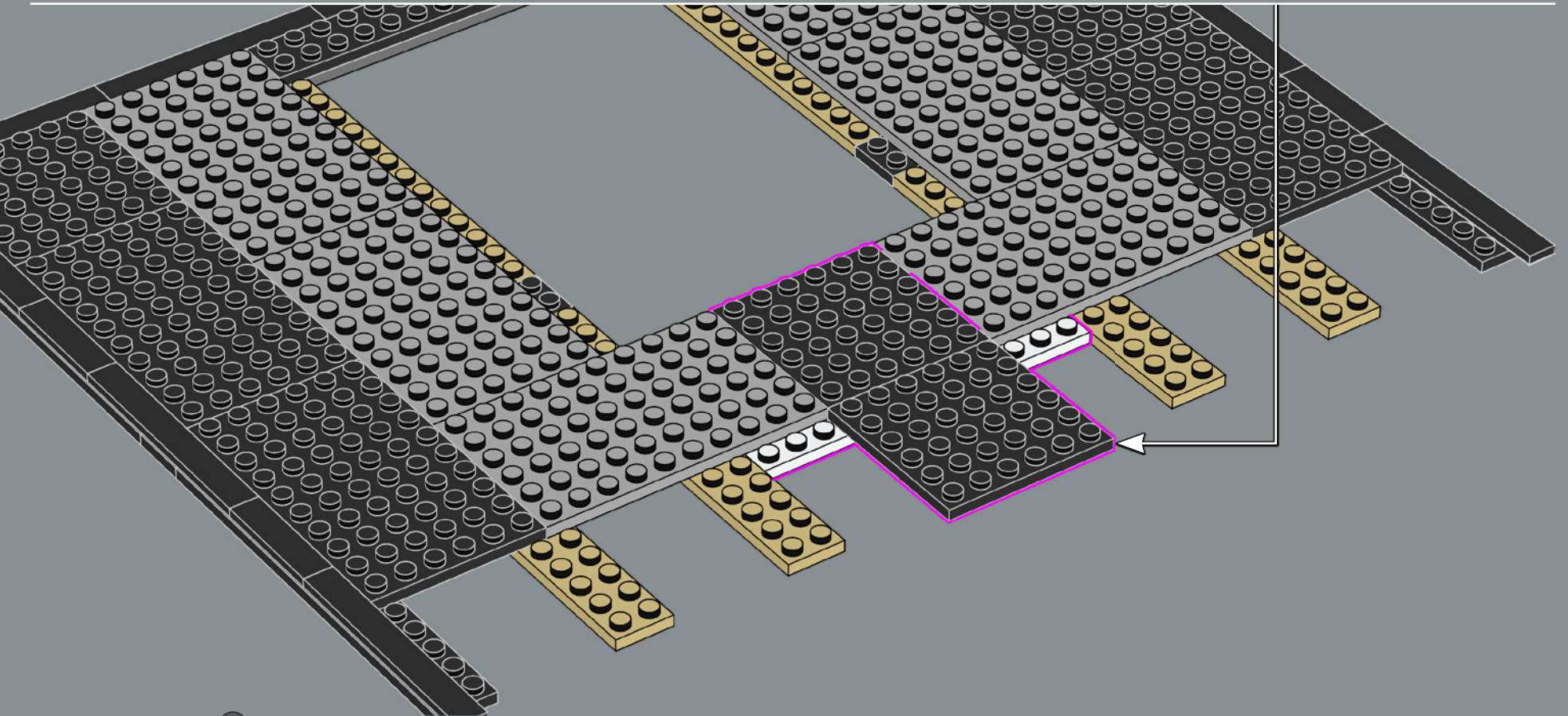

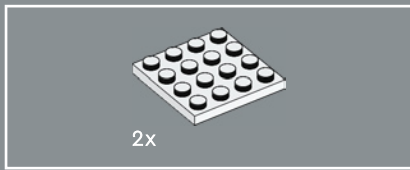

14

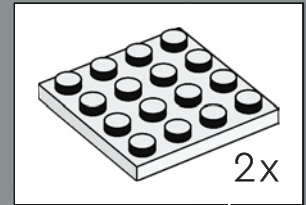
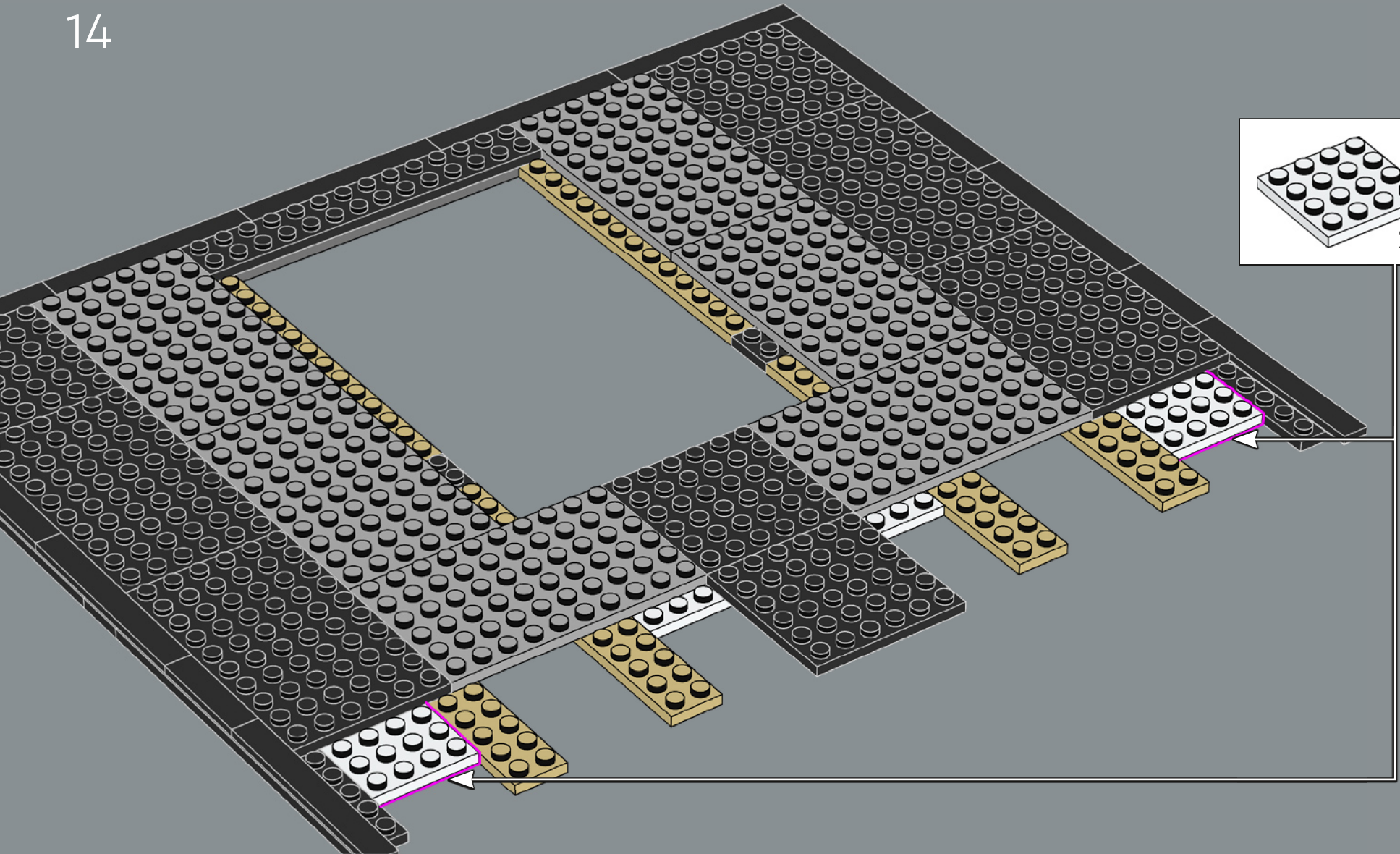

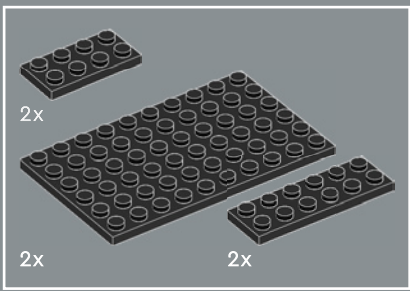

15

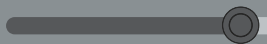
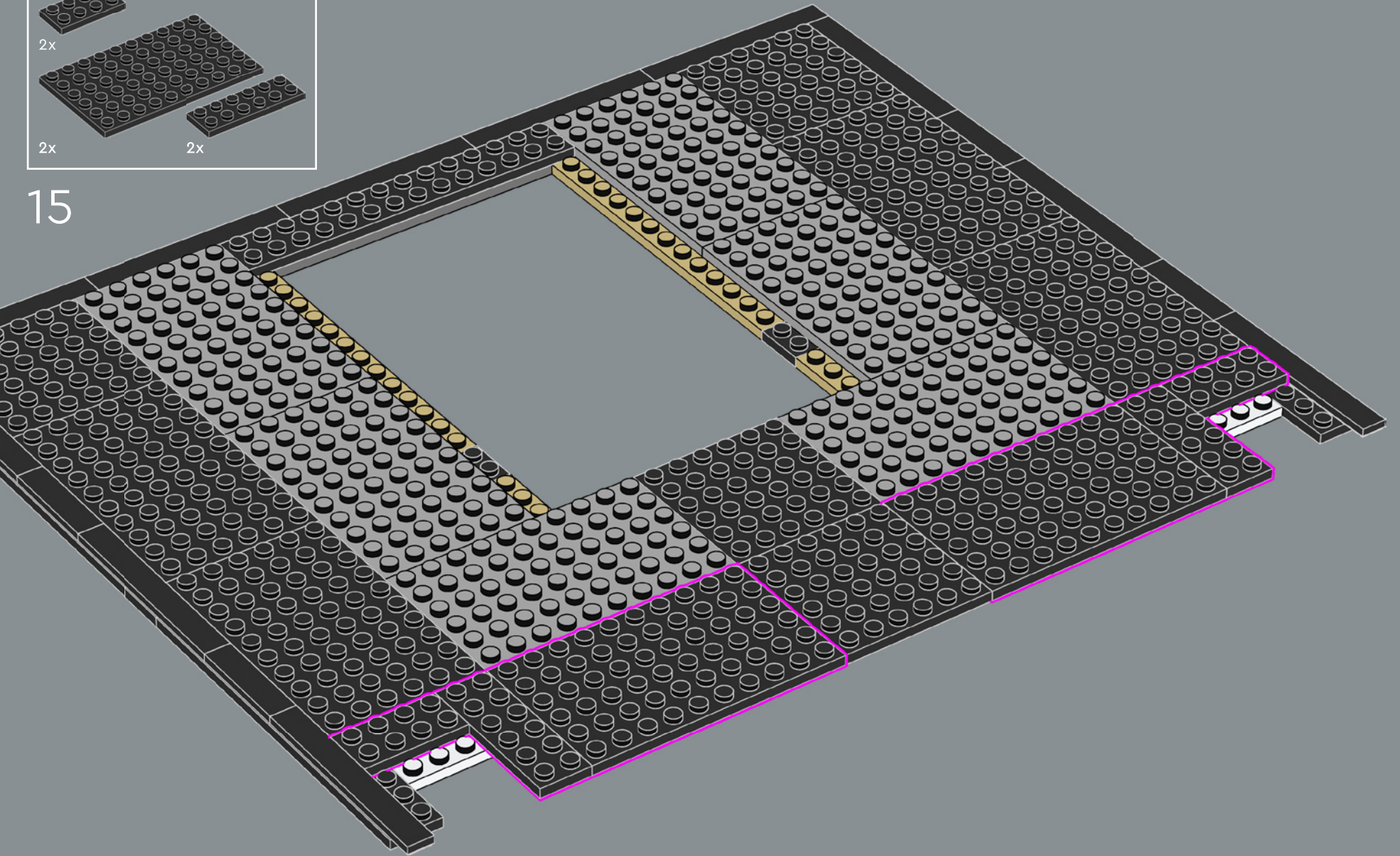

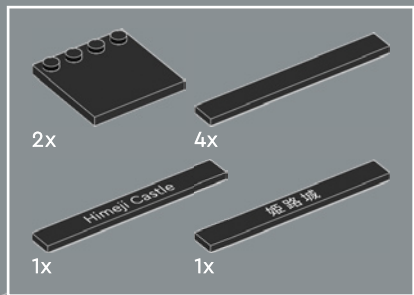

17

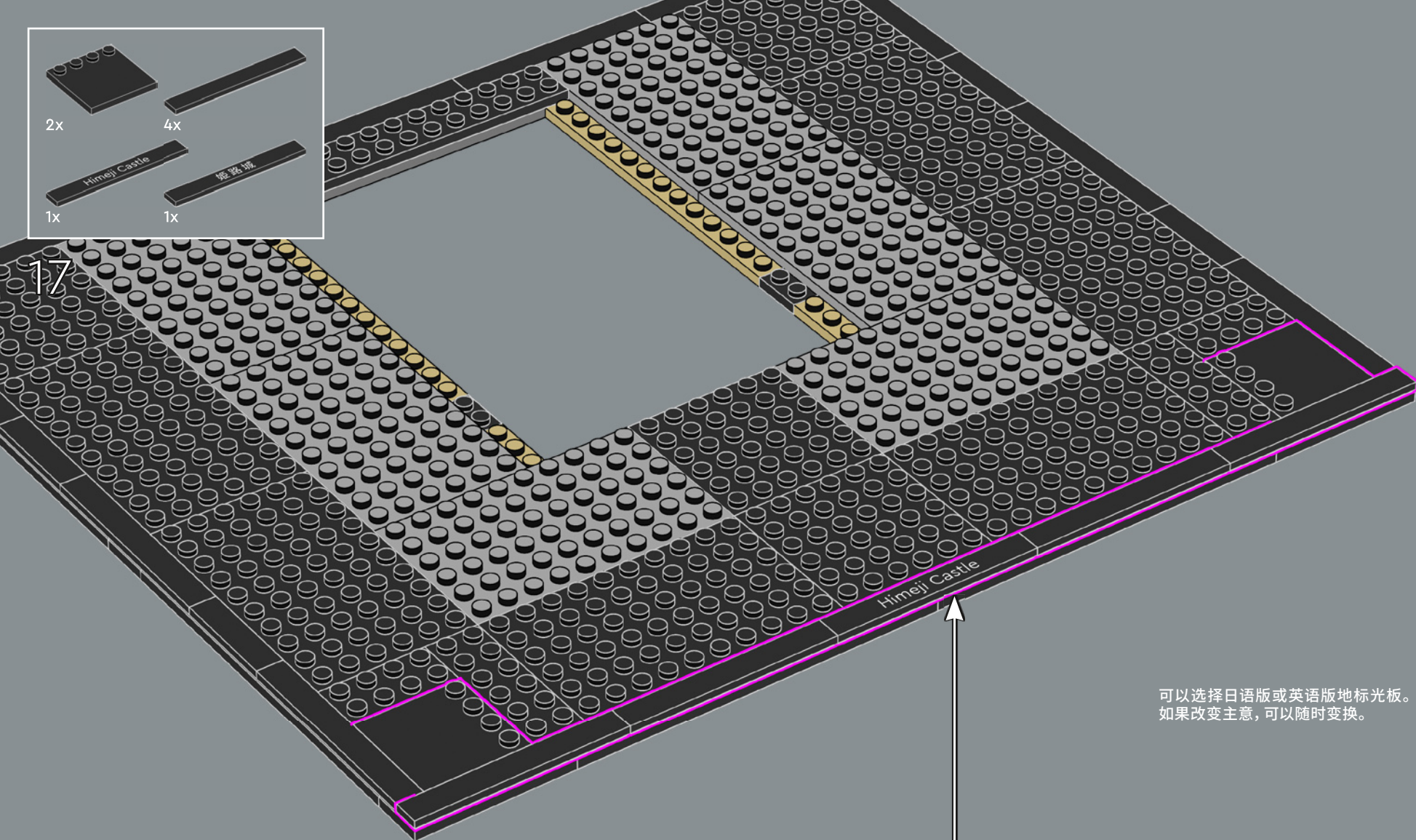

可以选择日语版或英语版地标光板。
如果改变主意,可以随时变换。

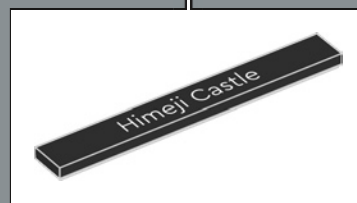

1993年，姬路城被列入联合国教科文组织世界遗产名录，以纪念该地标建筑的杰出设计，其代表了日本木制城堡建筑的顶峰。

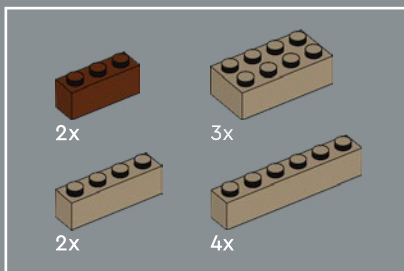

18

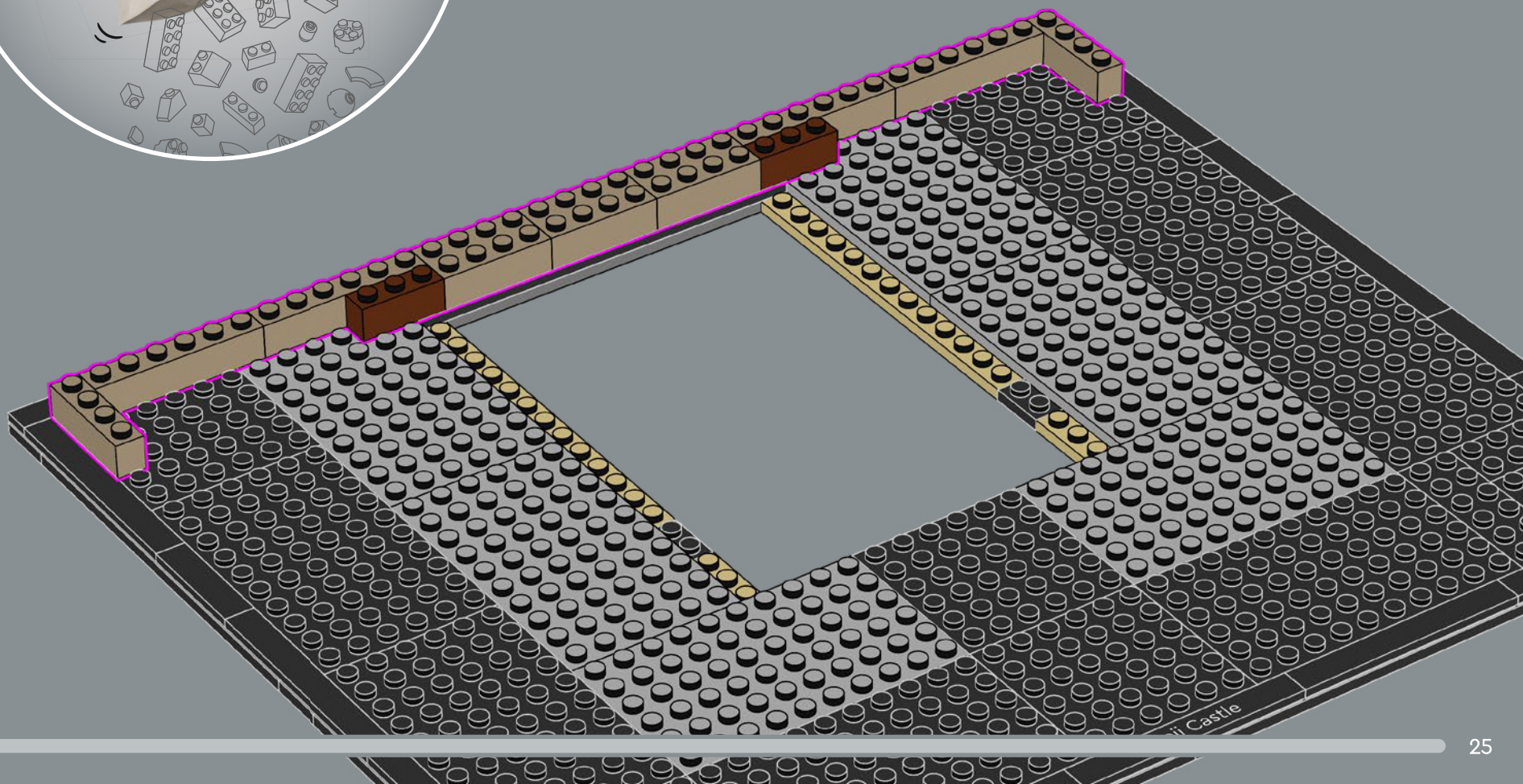

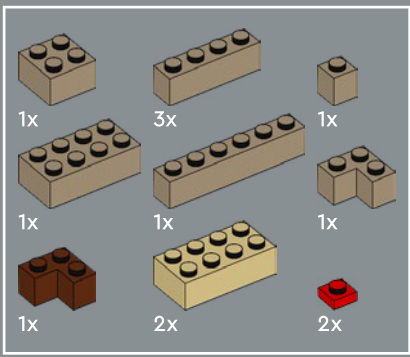

19

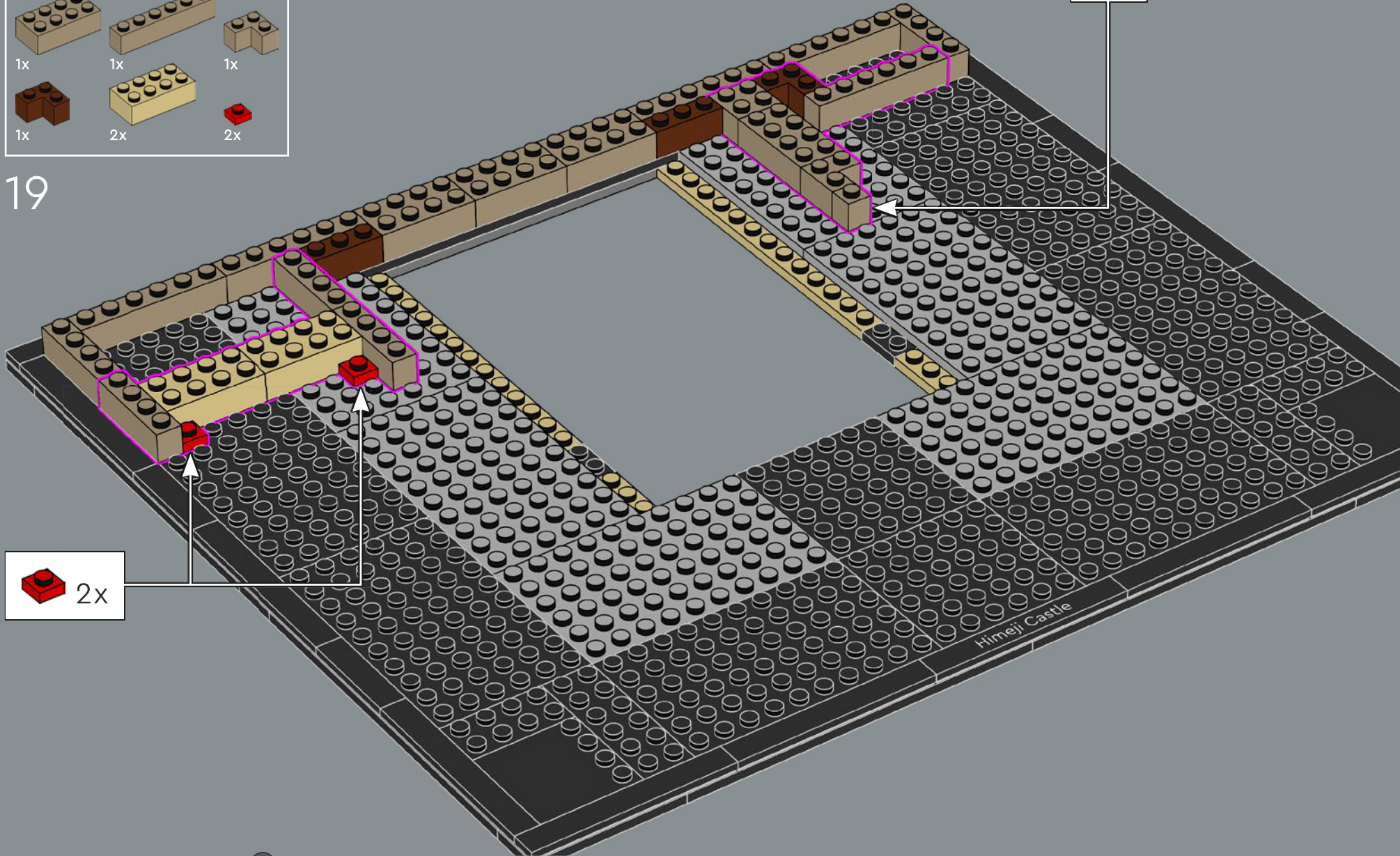

Himeji Castle

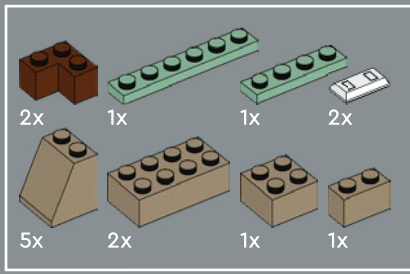

20

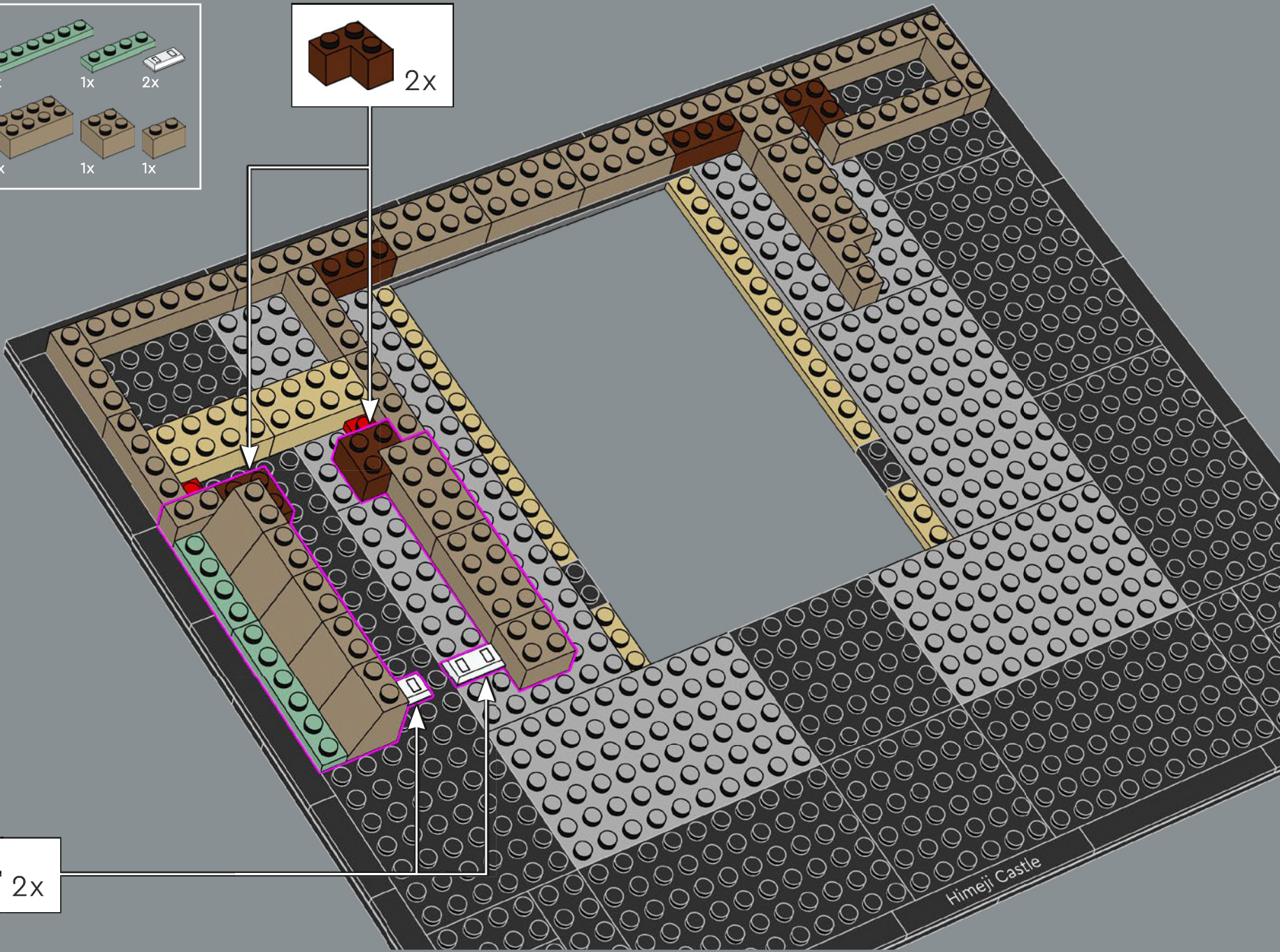

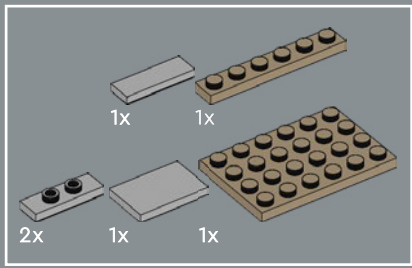



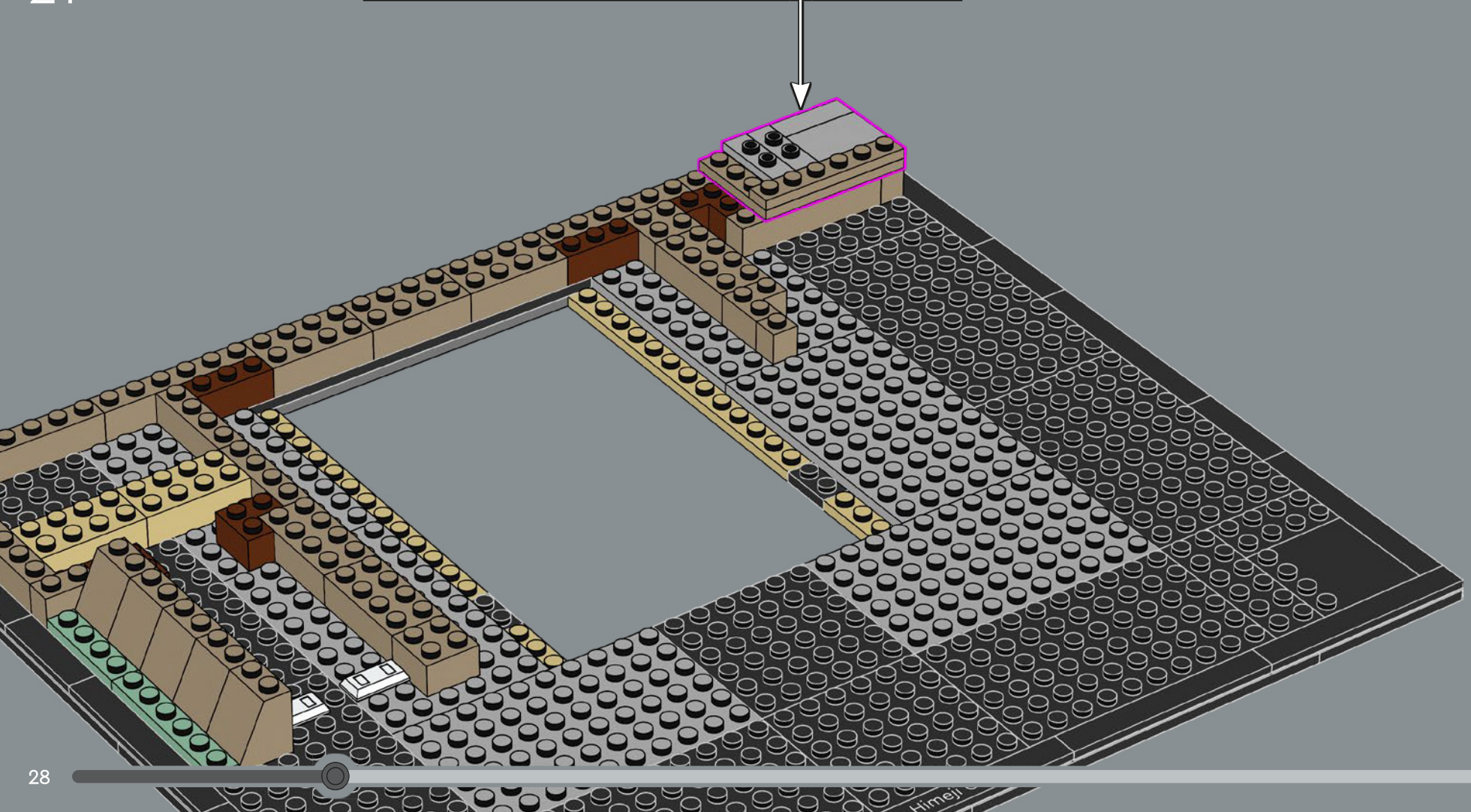
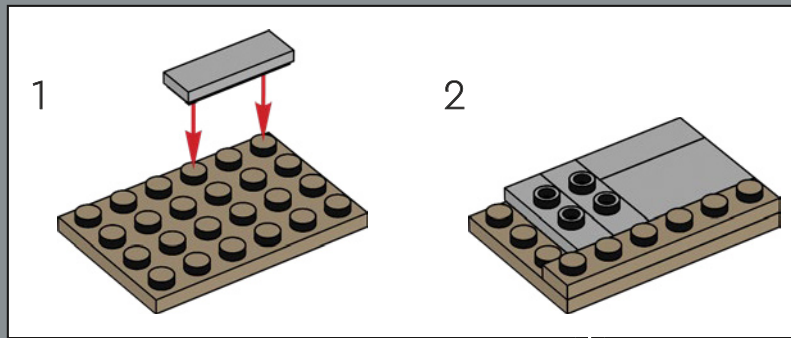

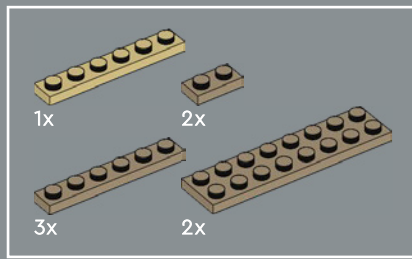

21

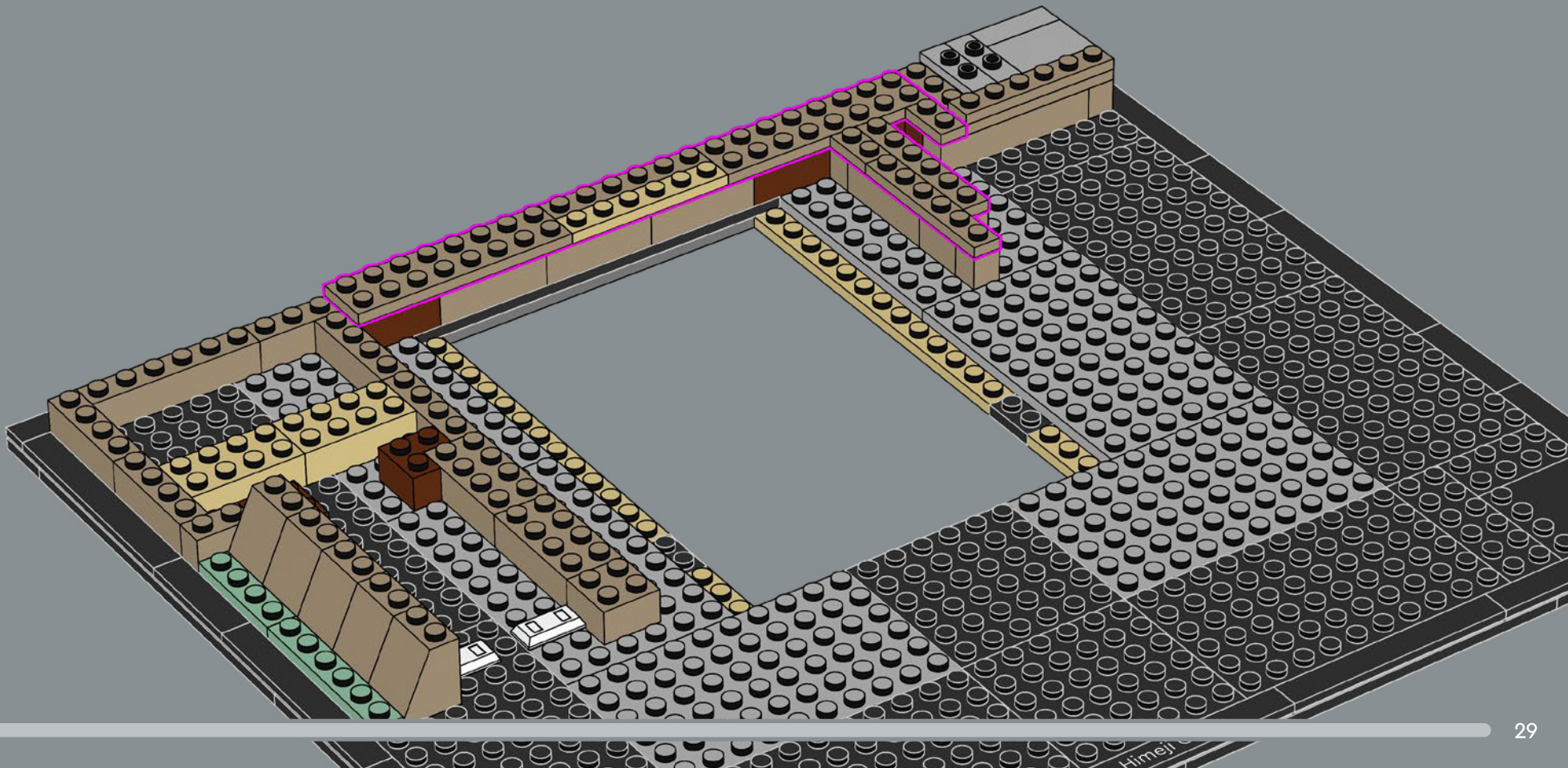



22



- 1x 
- 1x 
- 2x 
- 2x 
- 1x 

23

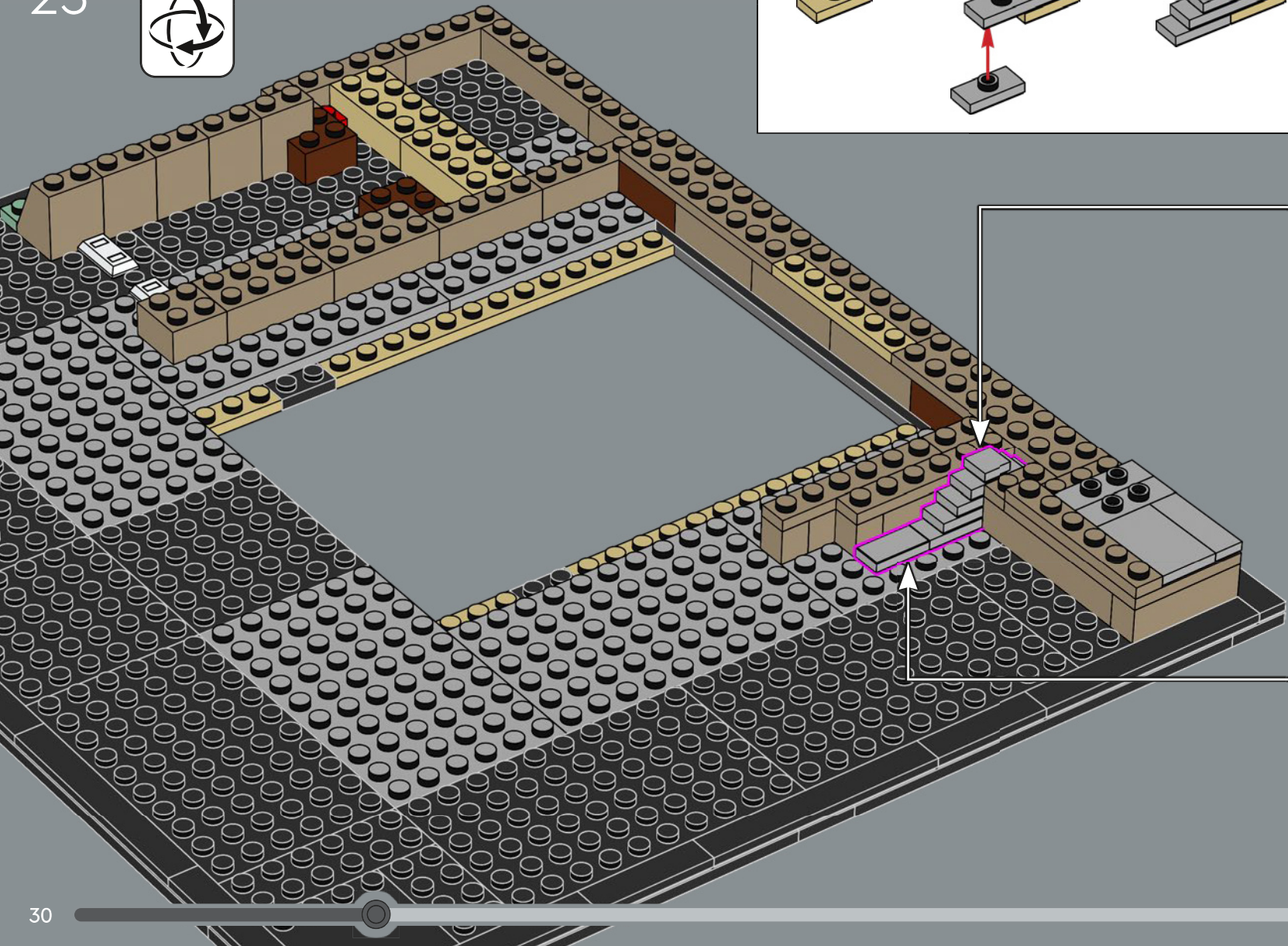
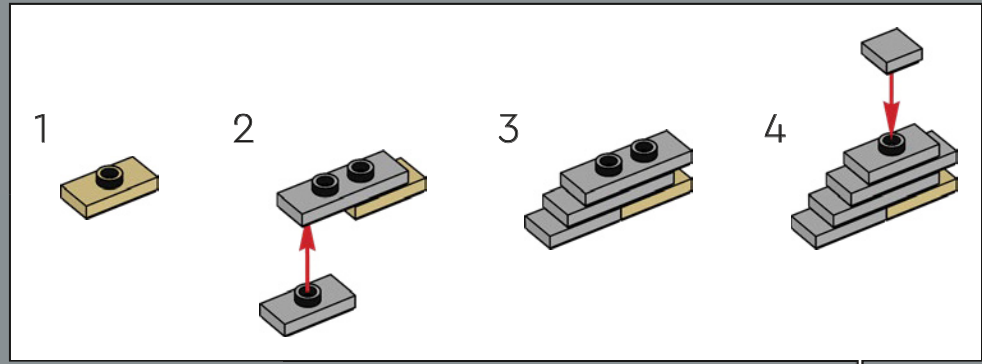

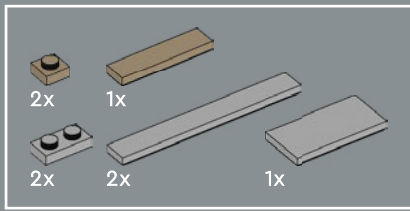

24

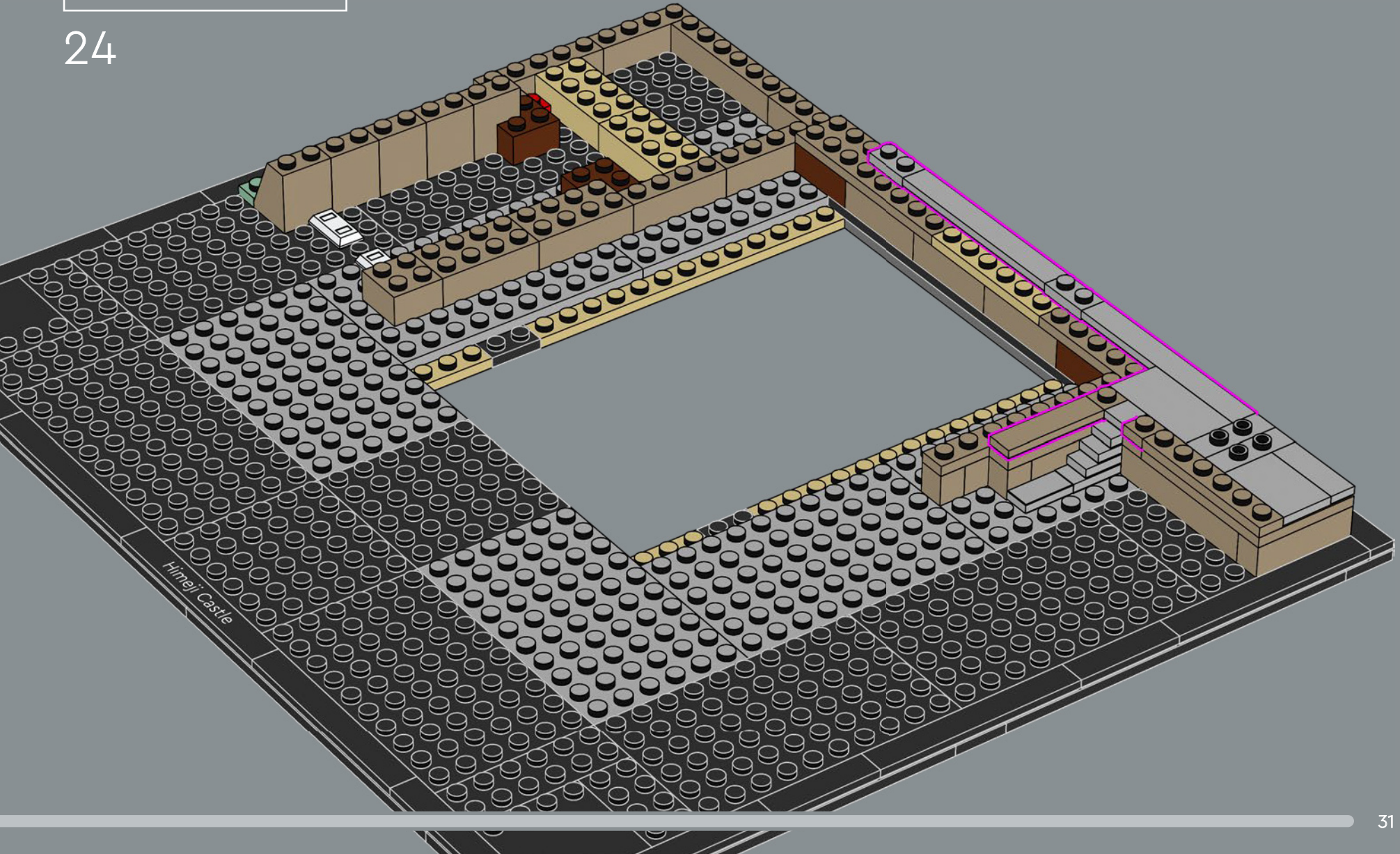

1x  4x  1x 

25

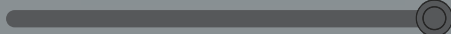
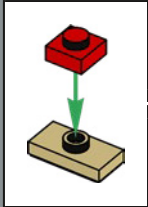
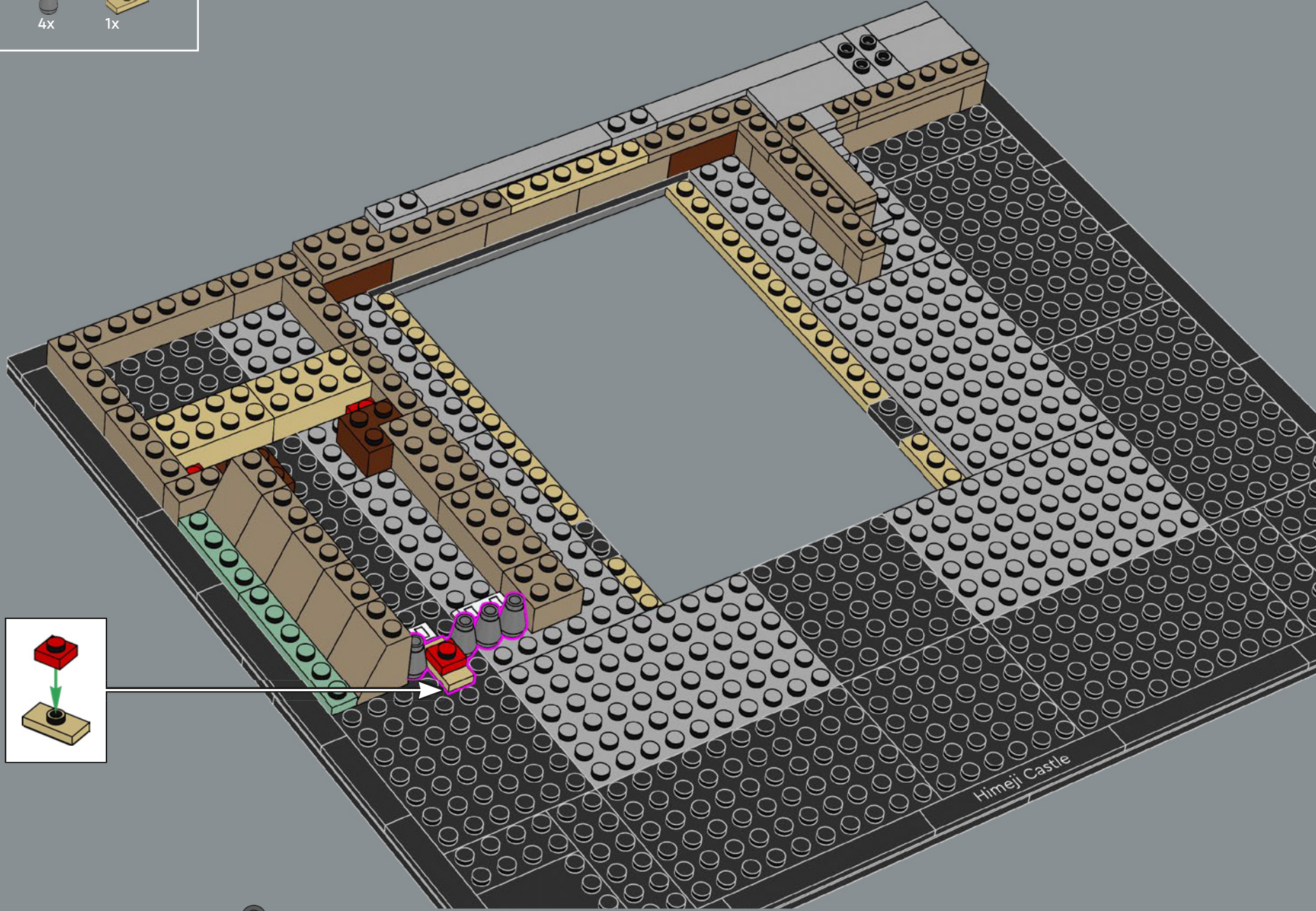

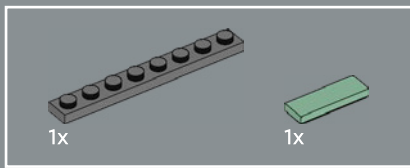

26

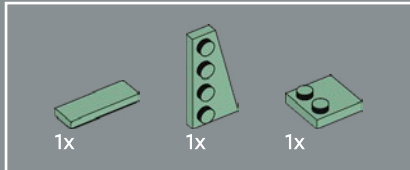
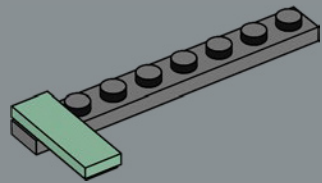

27

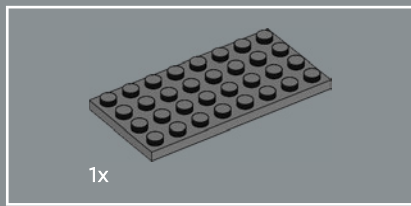
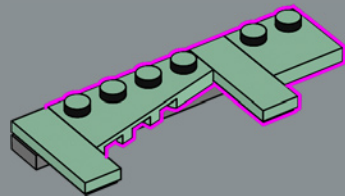

28

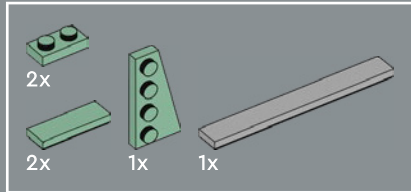
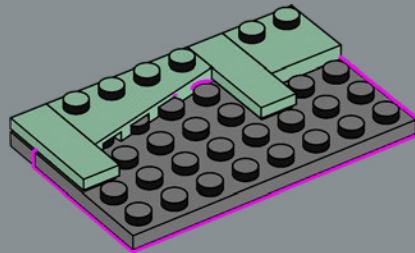

29

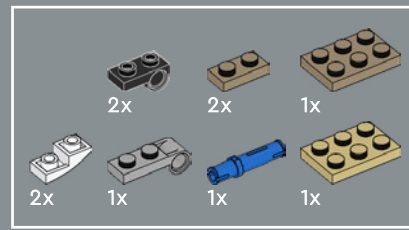
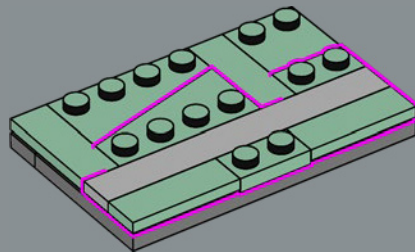

30

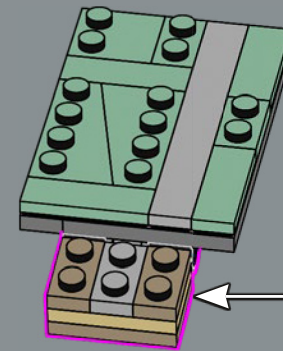
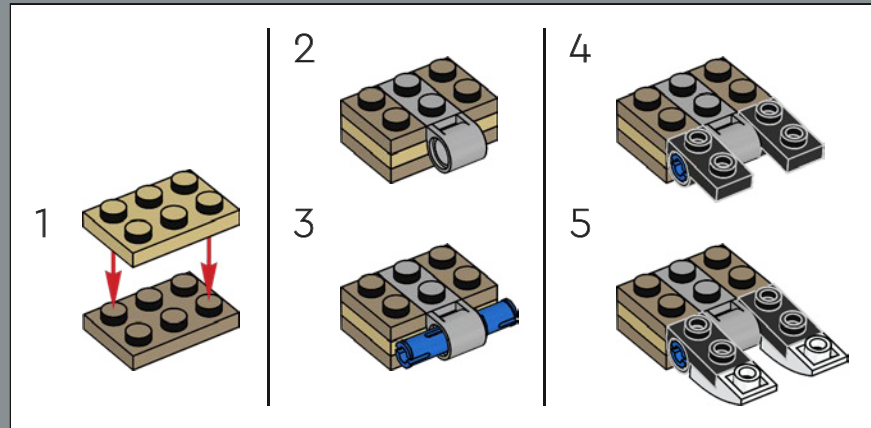

31

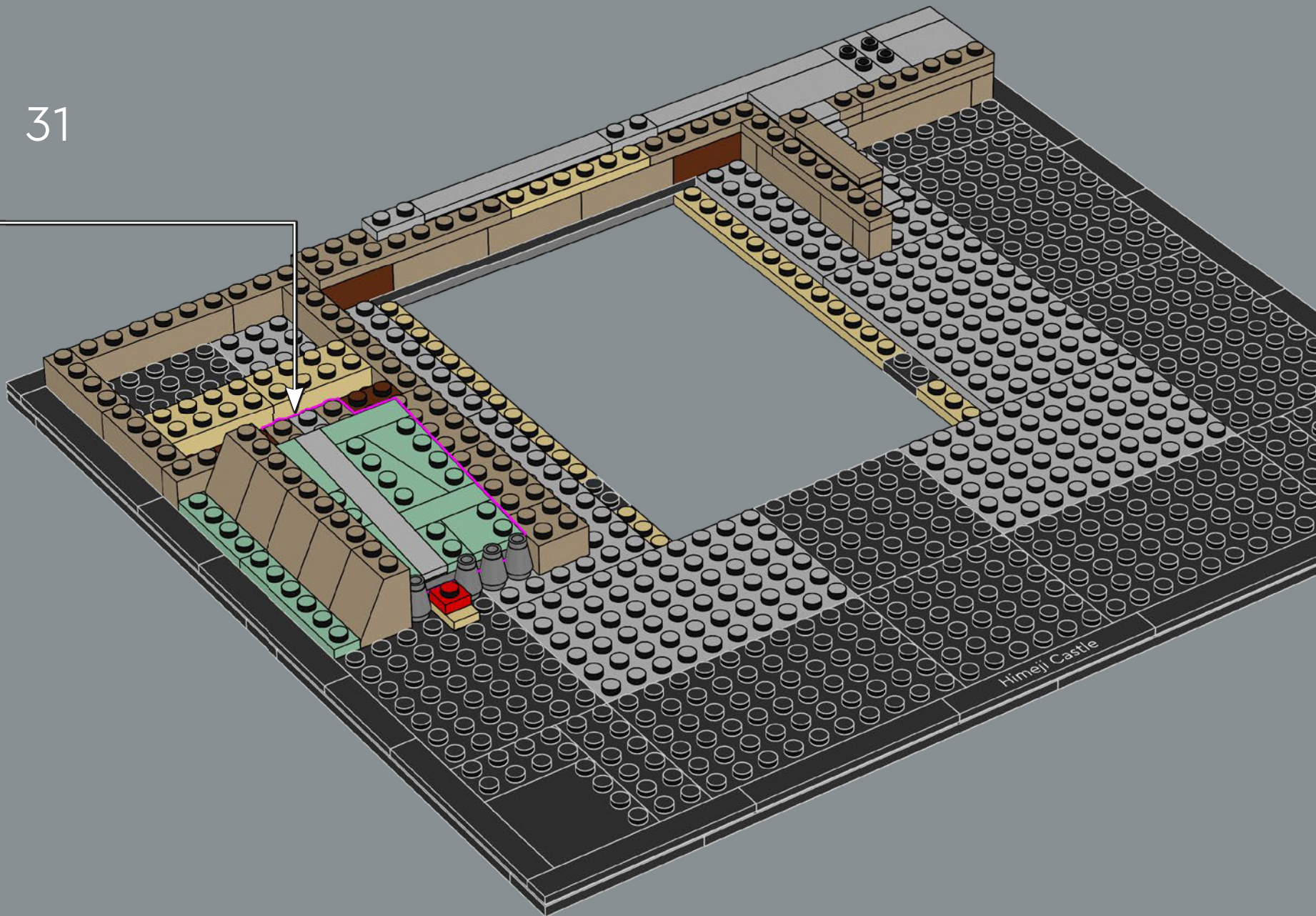

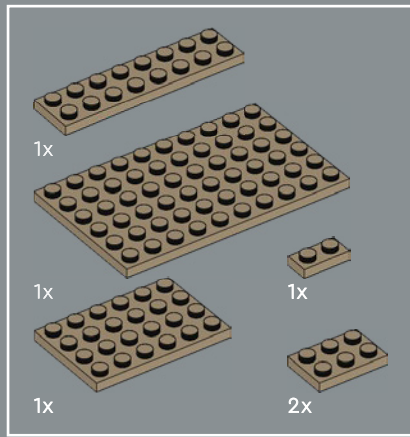

32

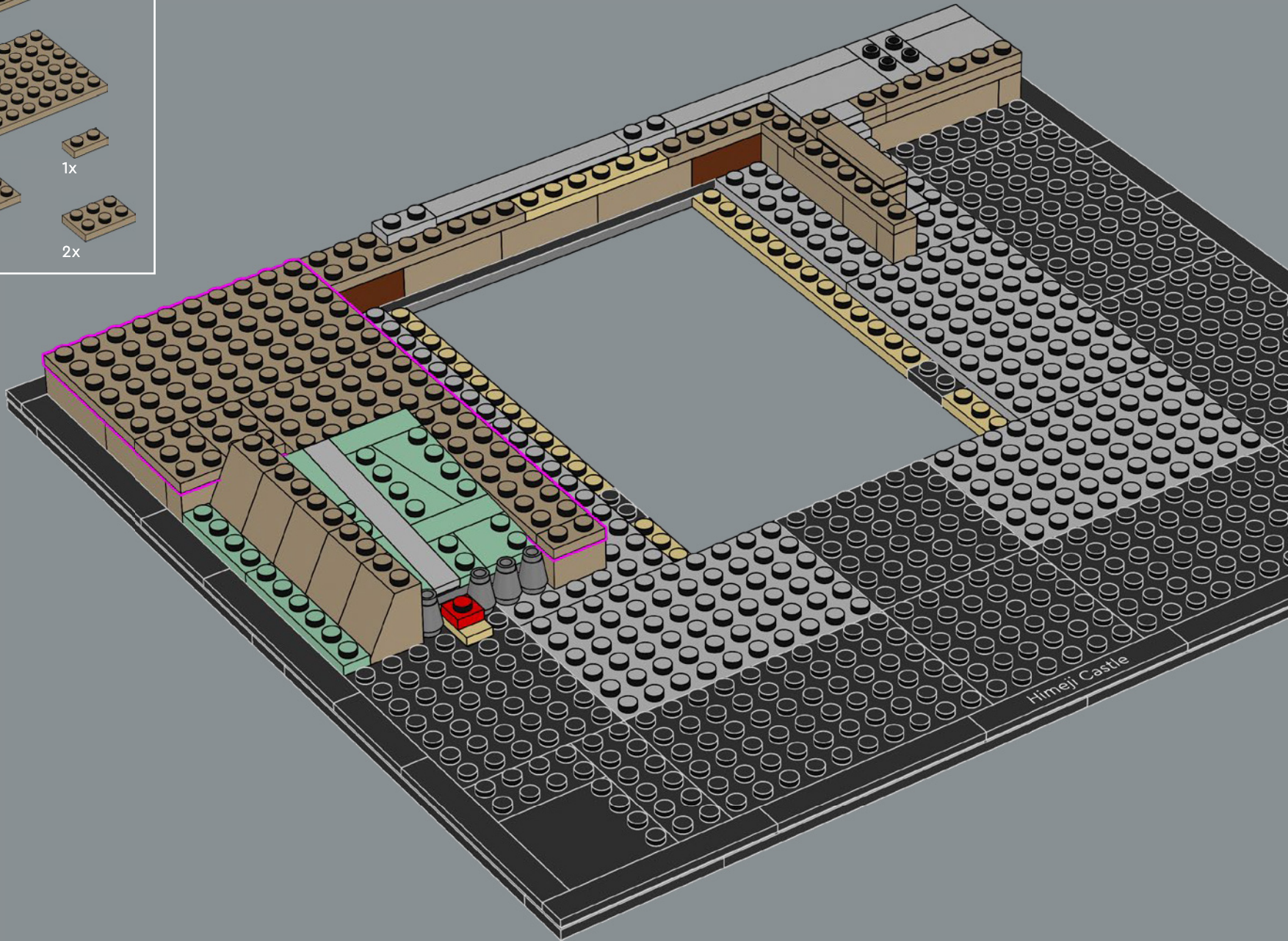

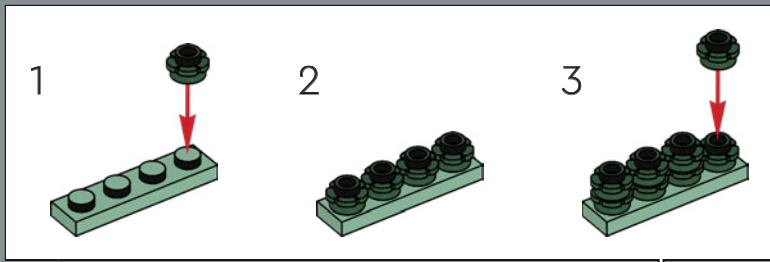
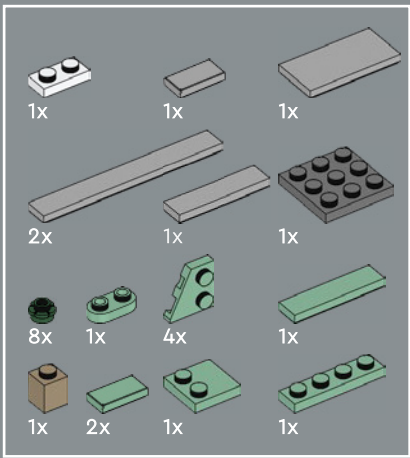

33

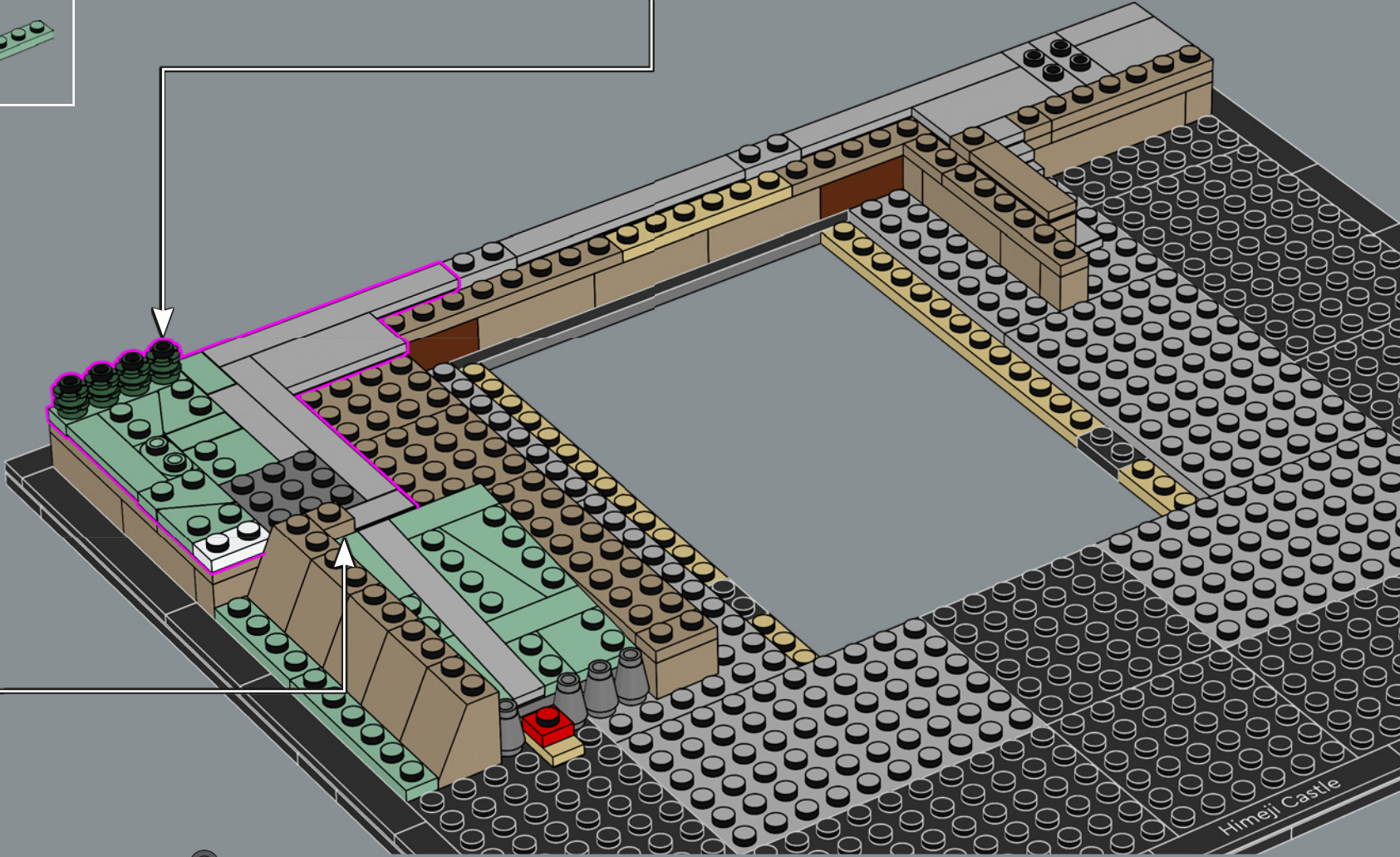

Himeiji Castle

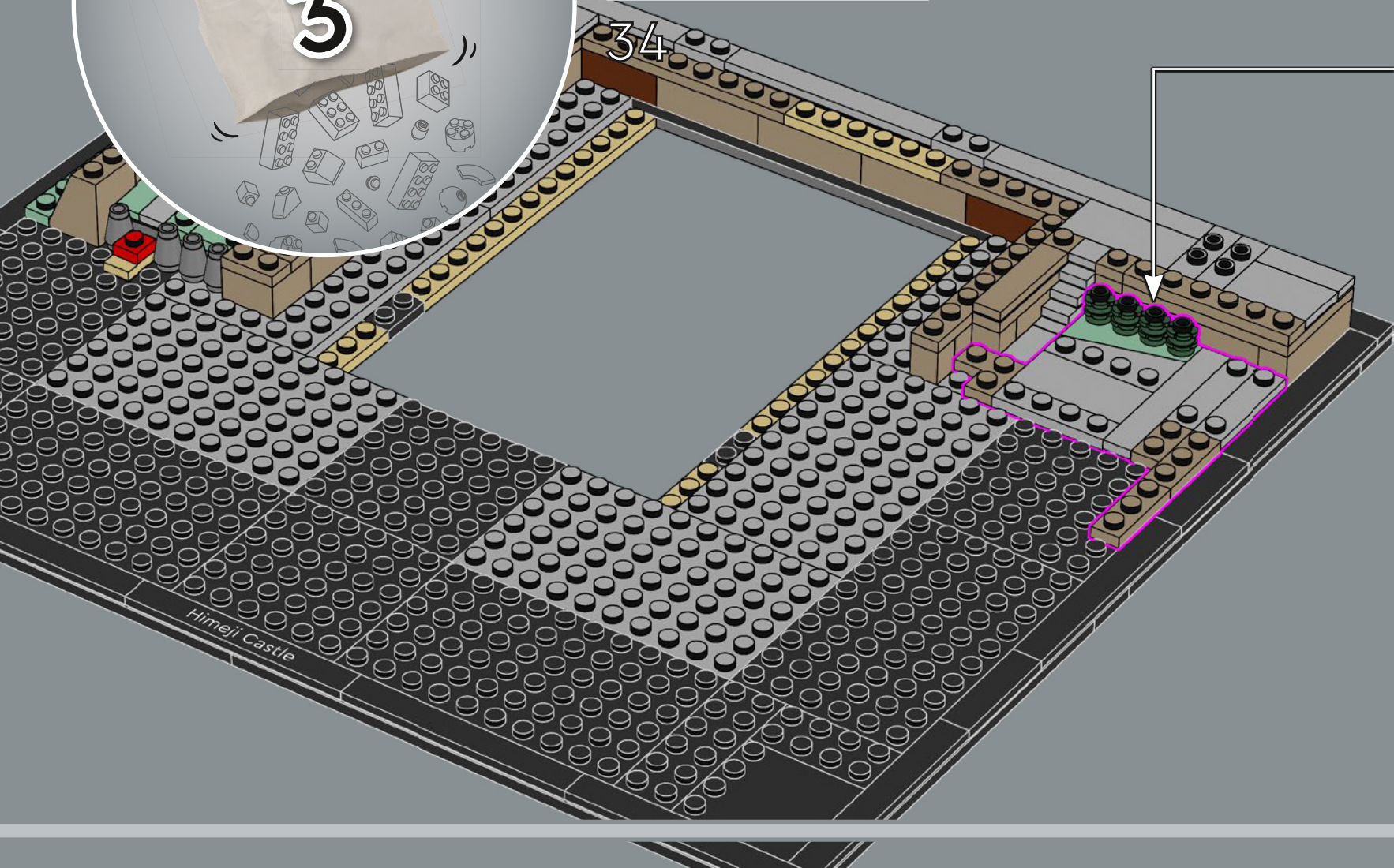
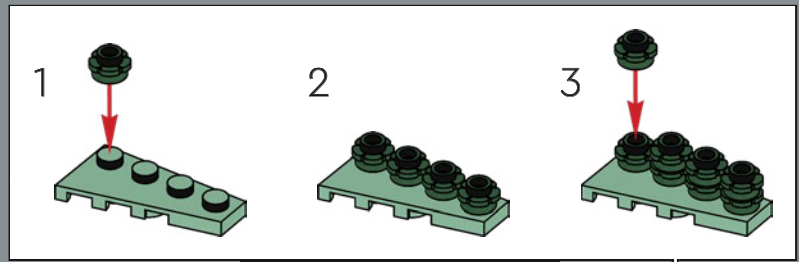
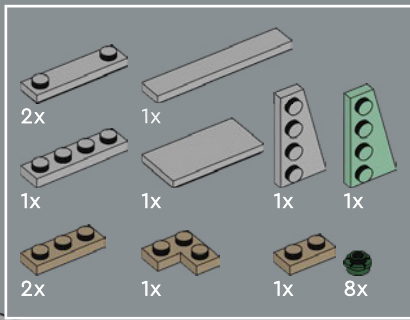

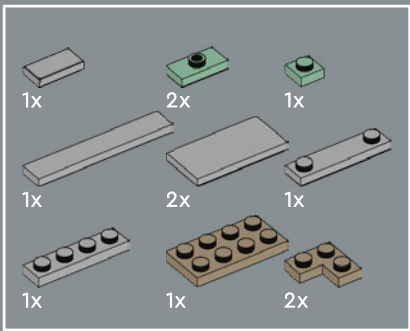

35

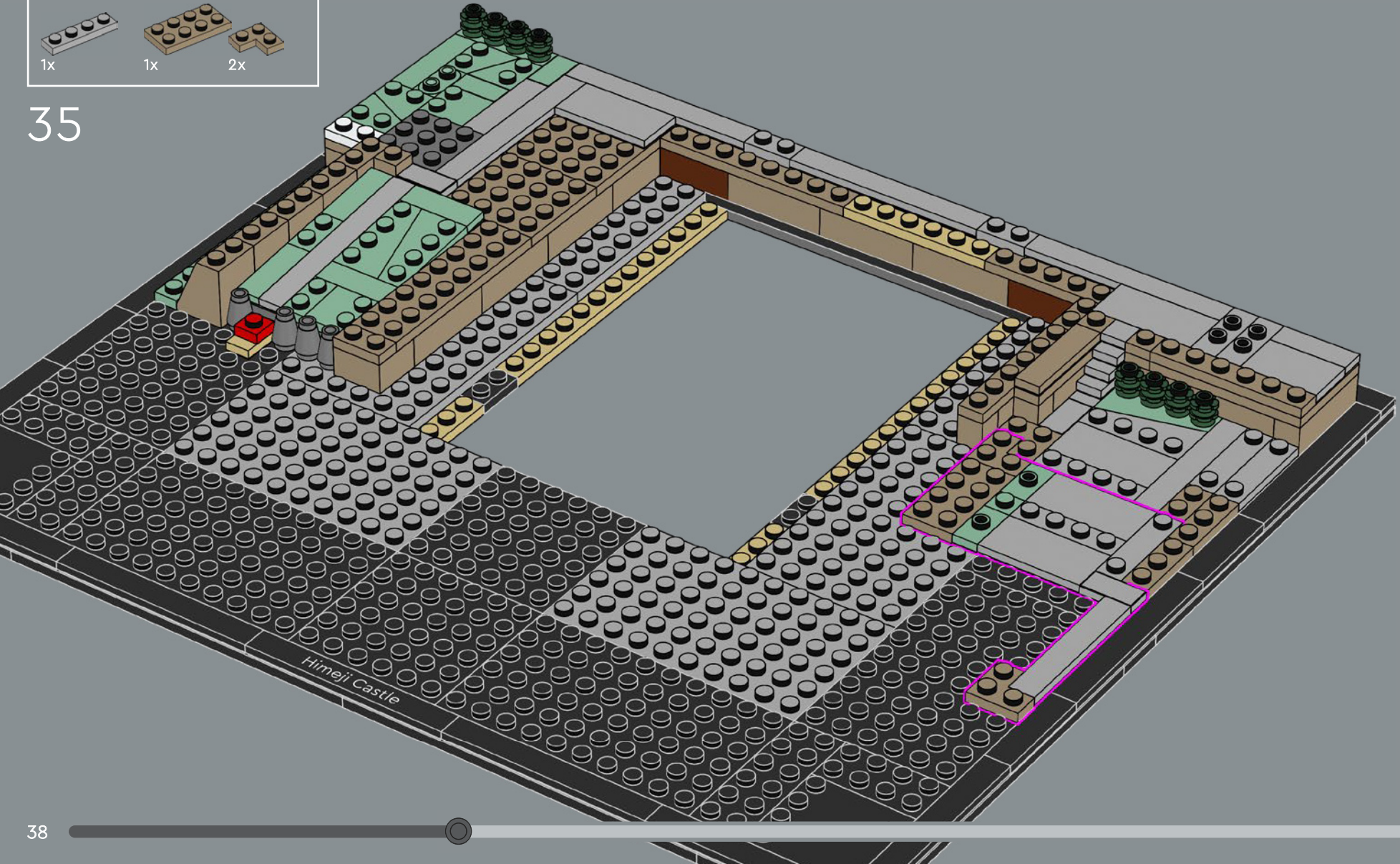

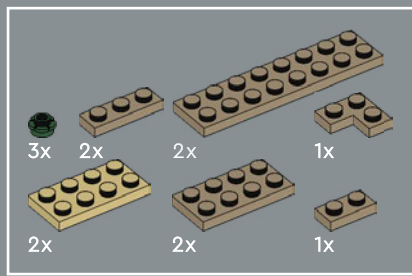

36

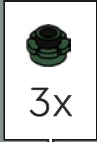
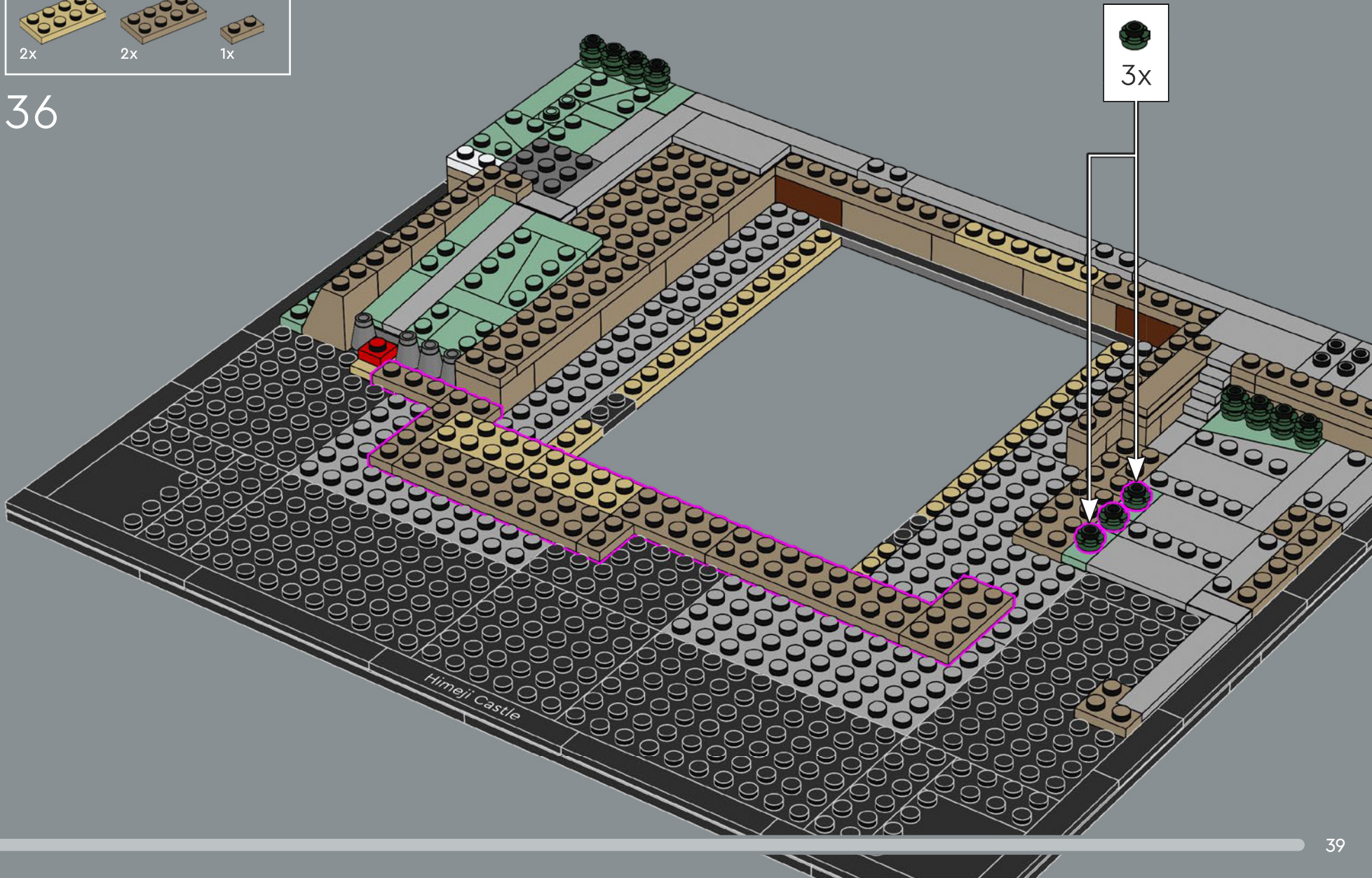

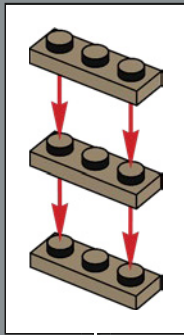
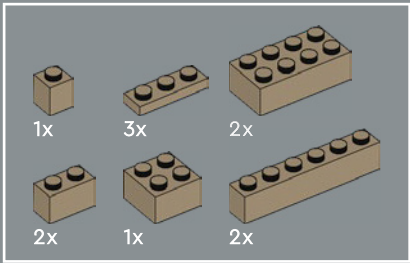

37

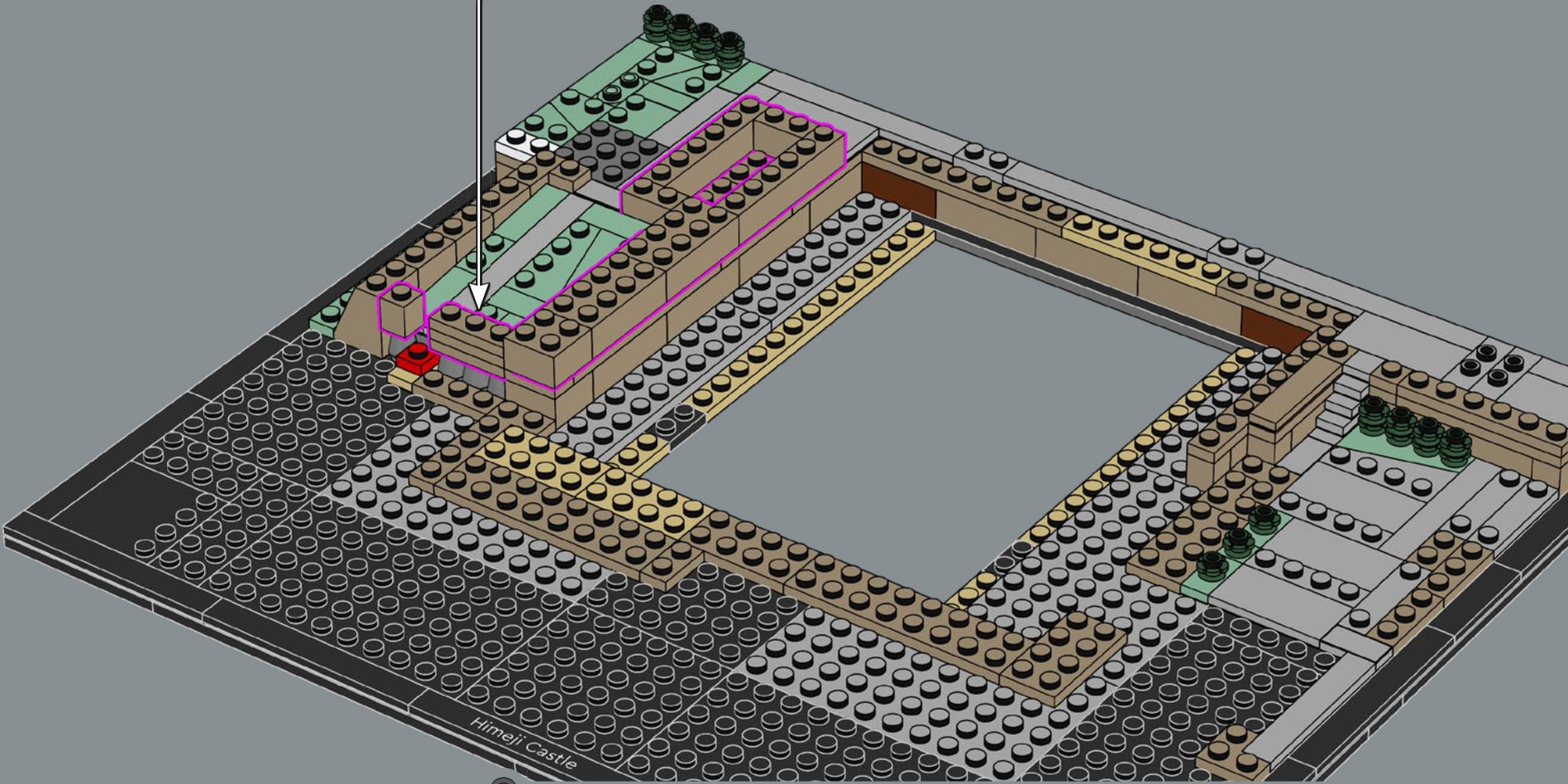

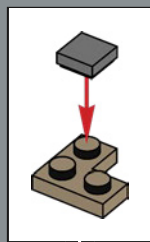
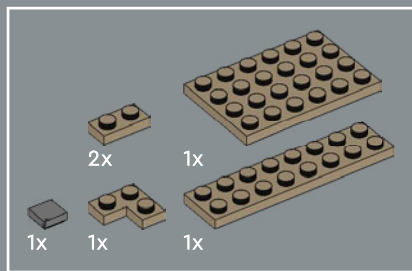

38

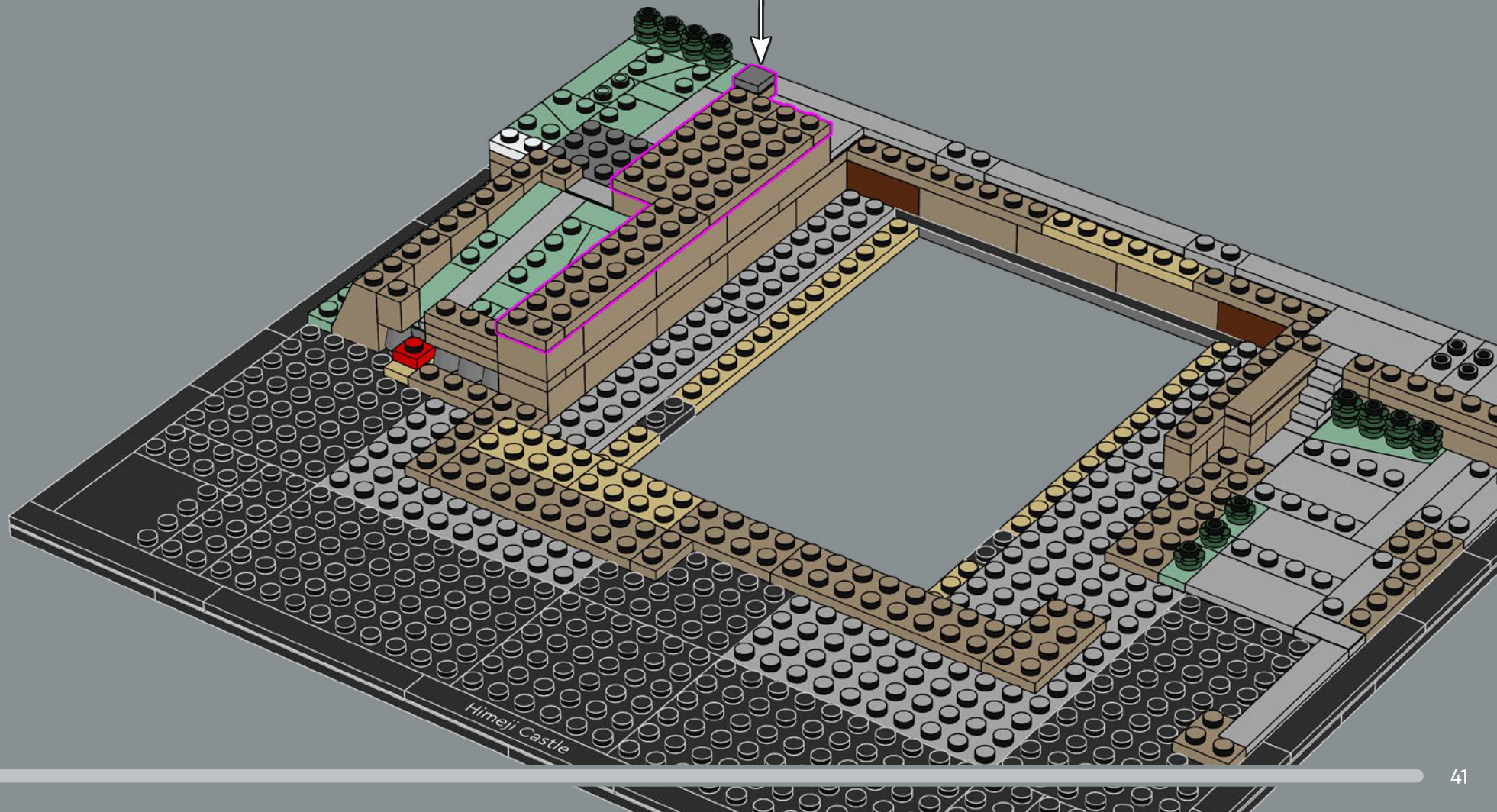

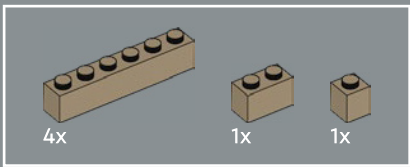

39

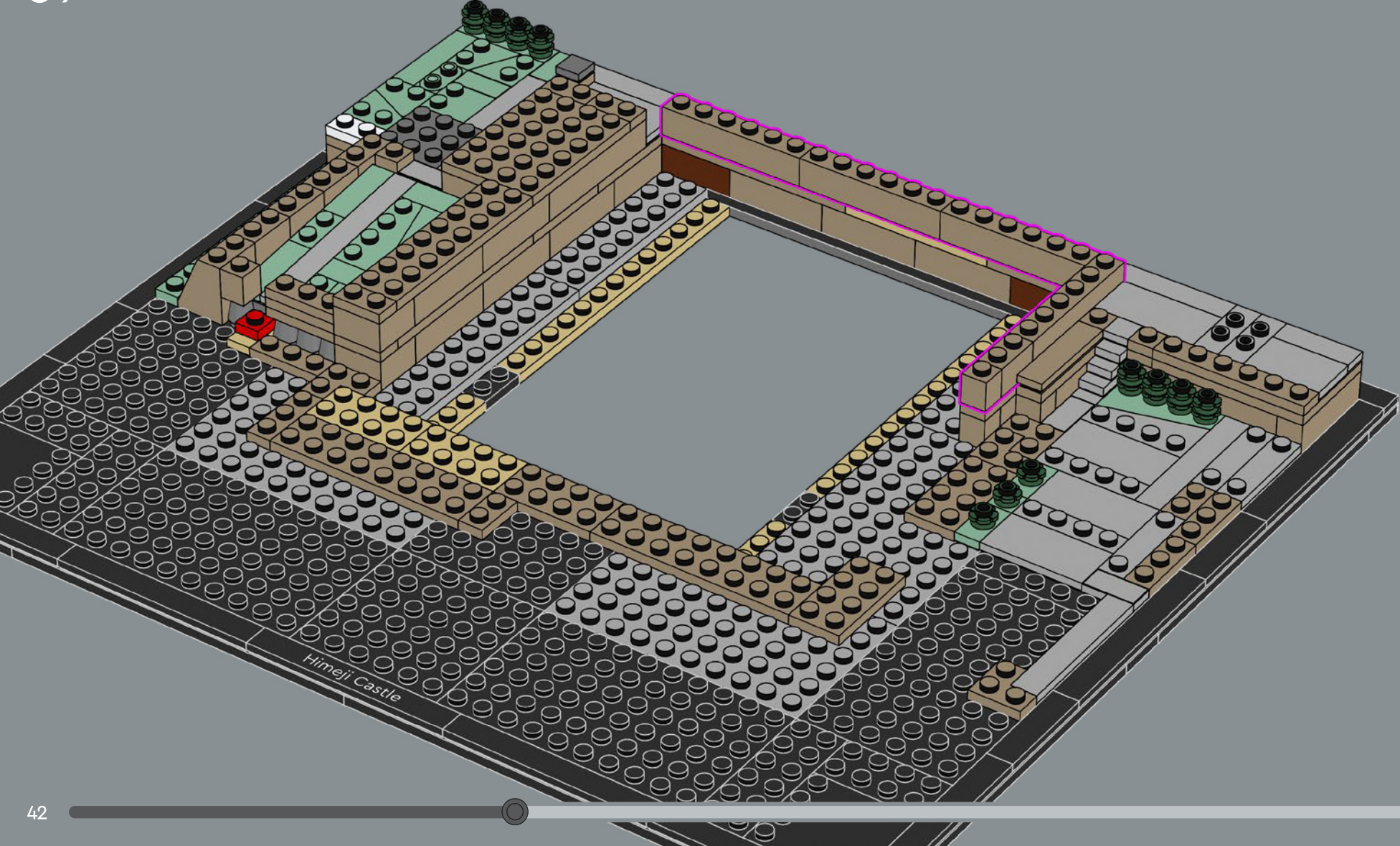

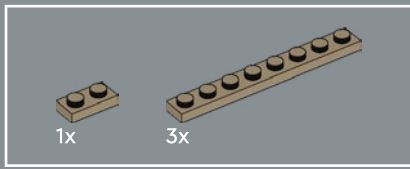

40

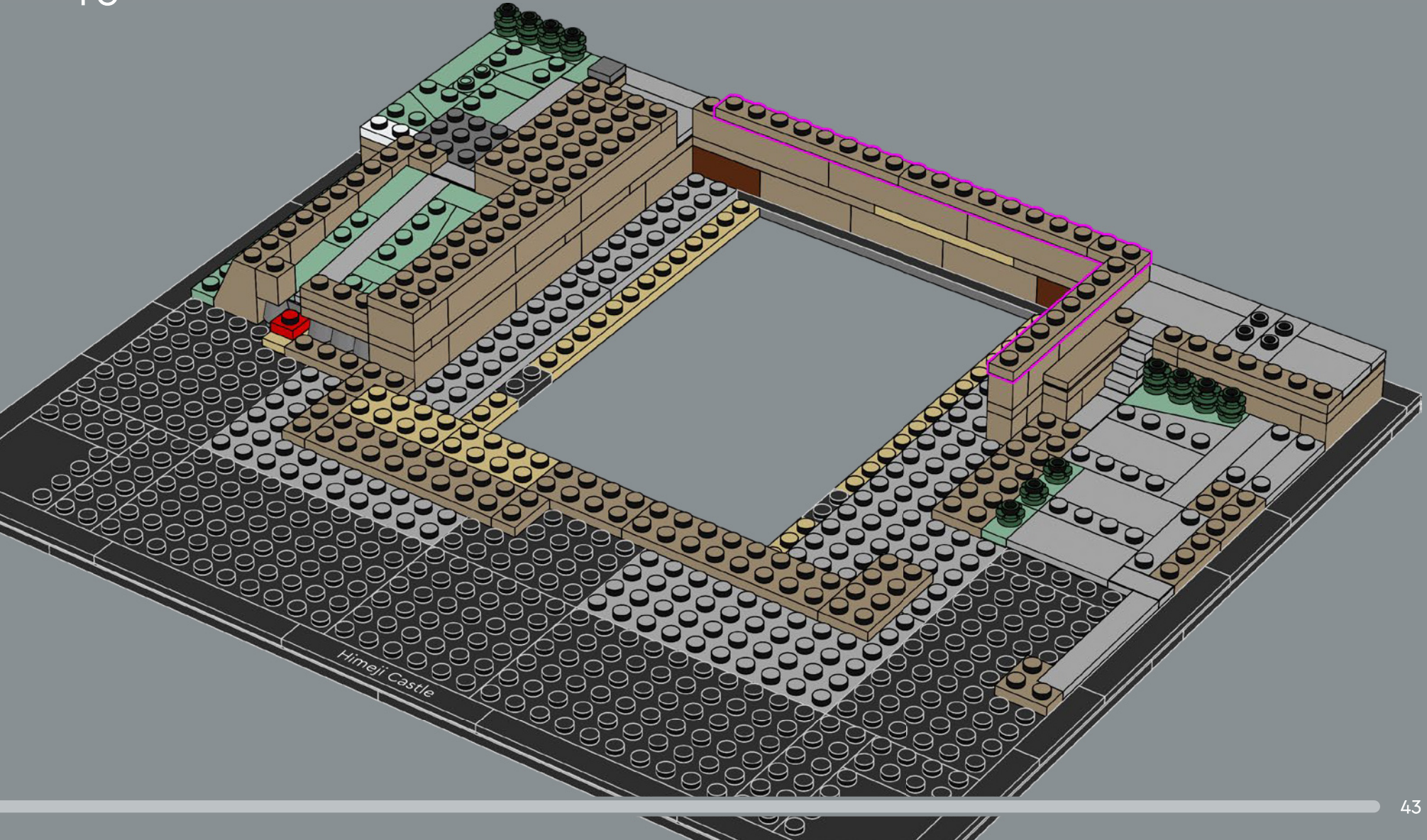

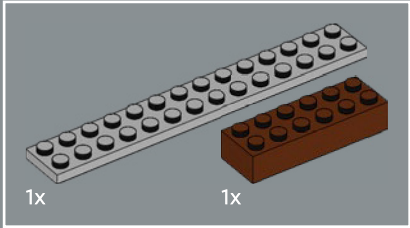
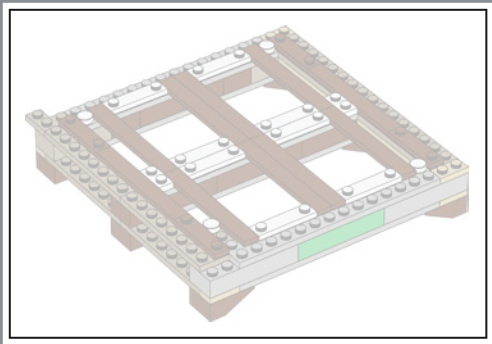

41

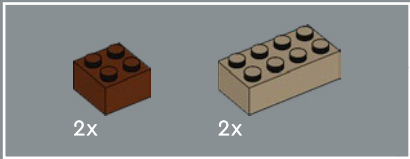
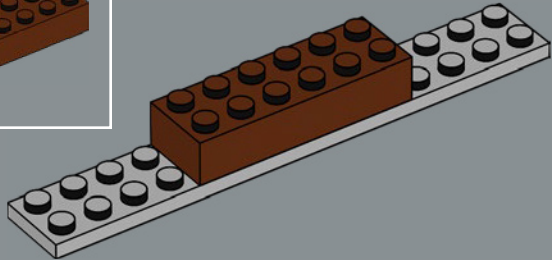

42

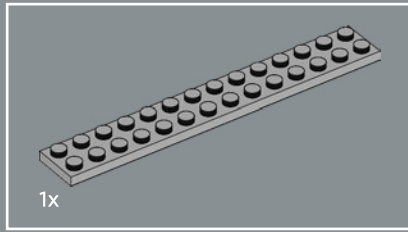
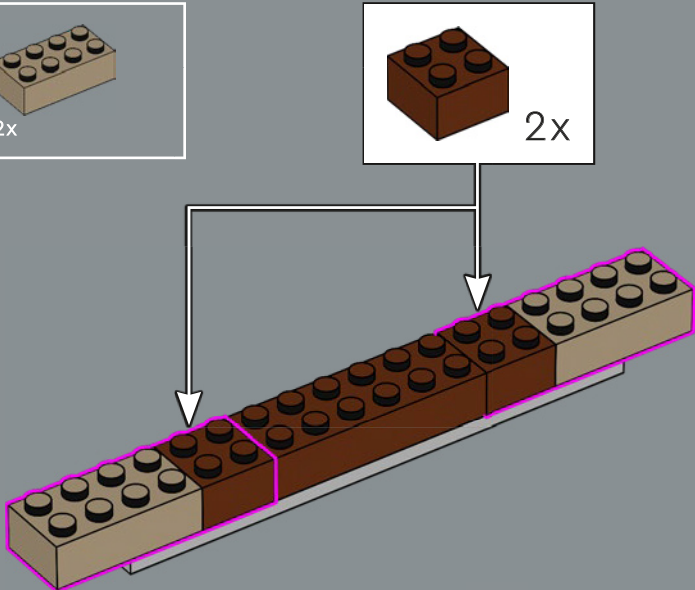

43

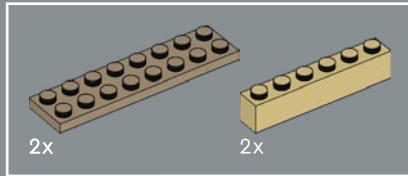
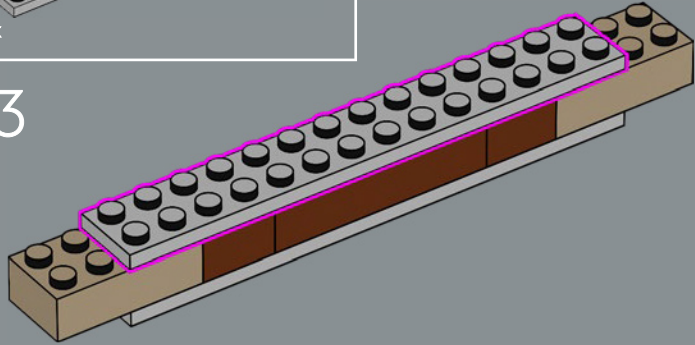

44

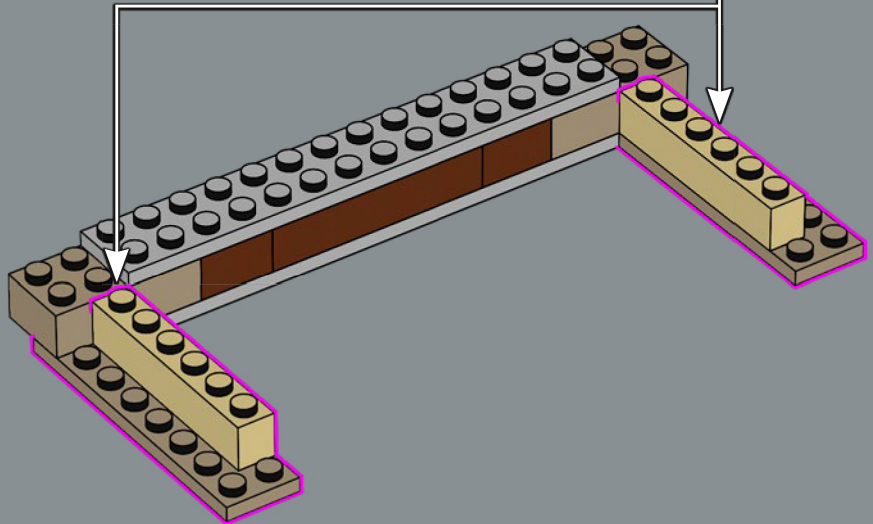
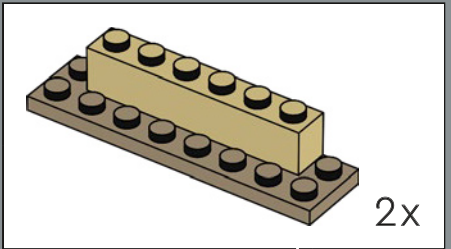

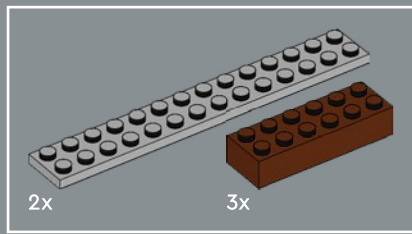

45

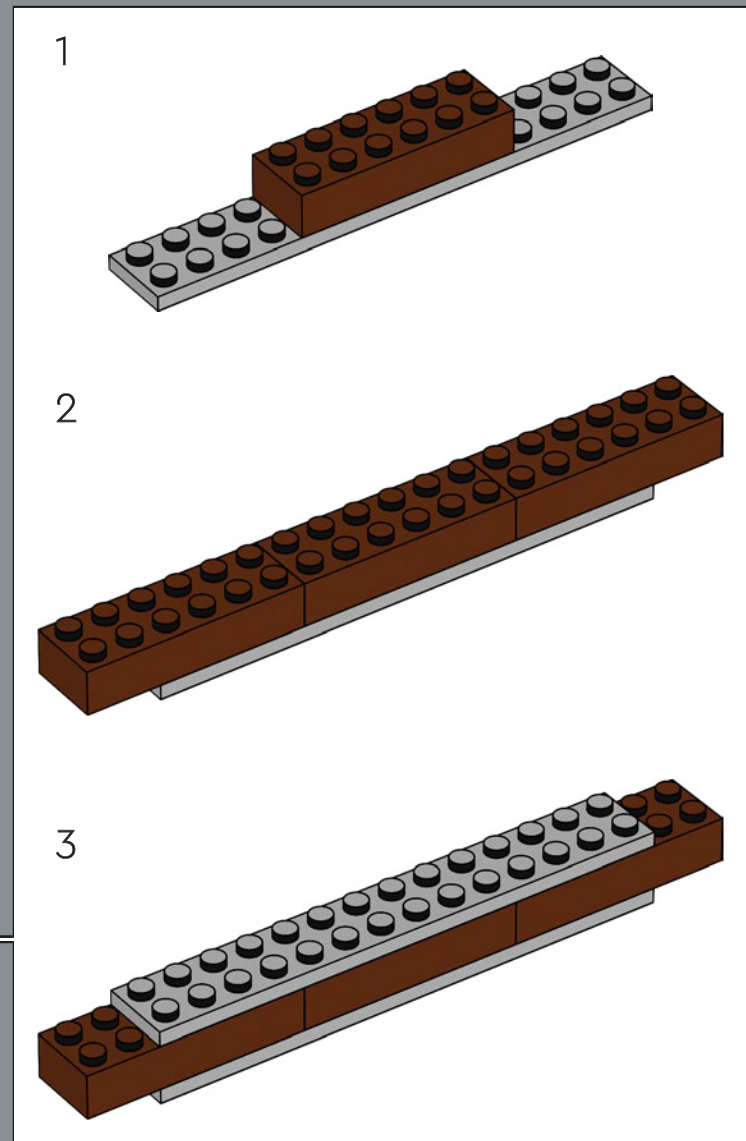
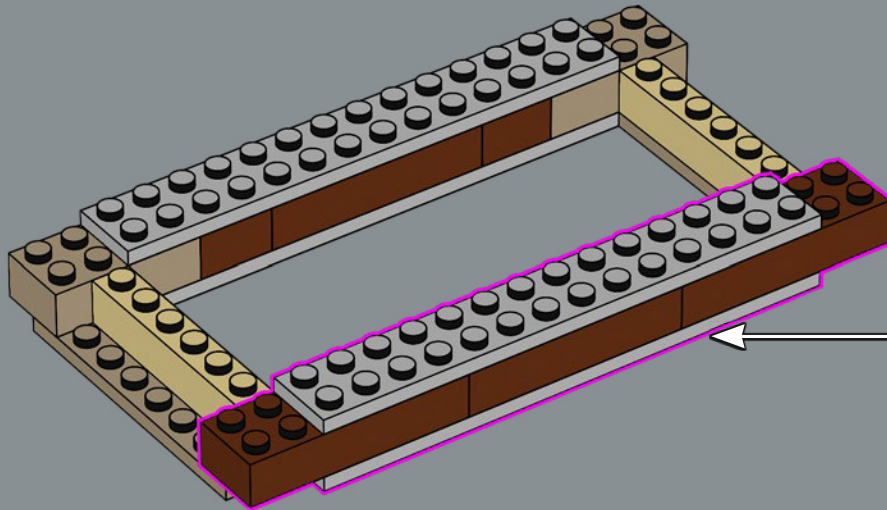

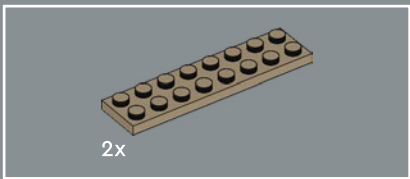

46

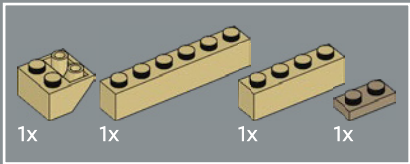
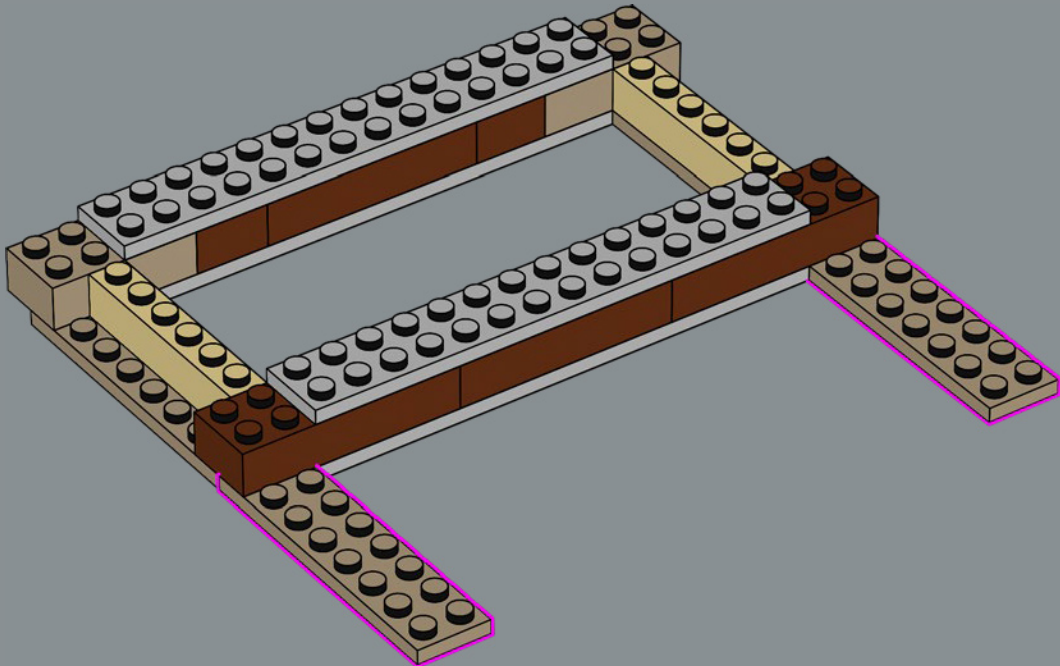

47

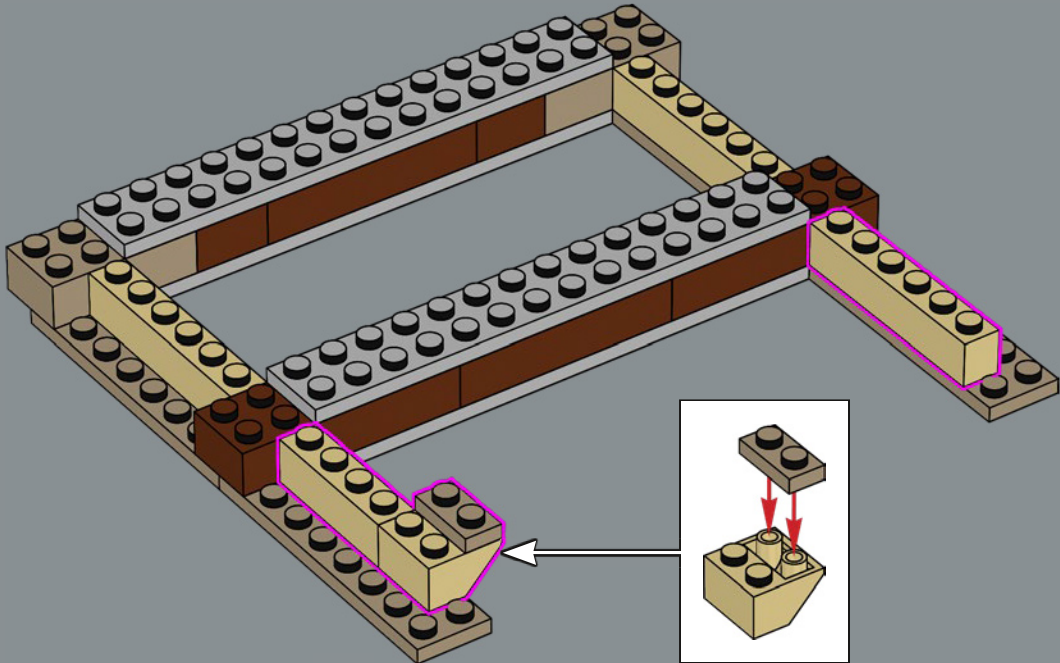

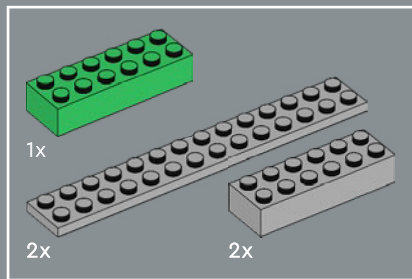

48

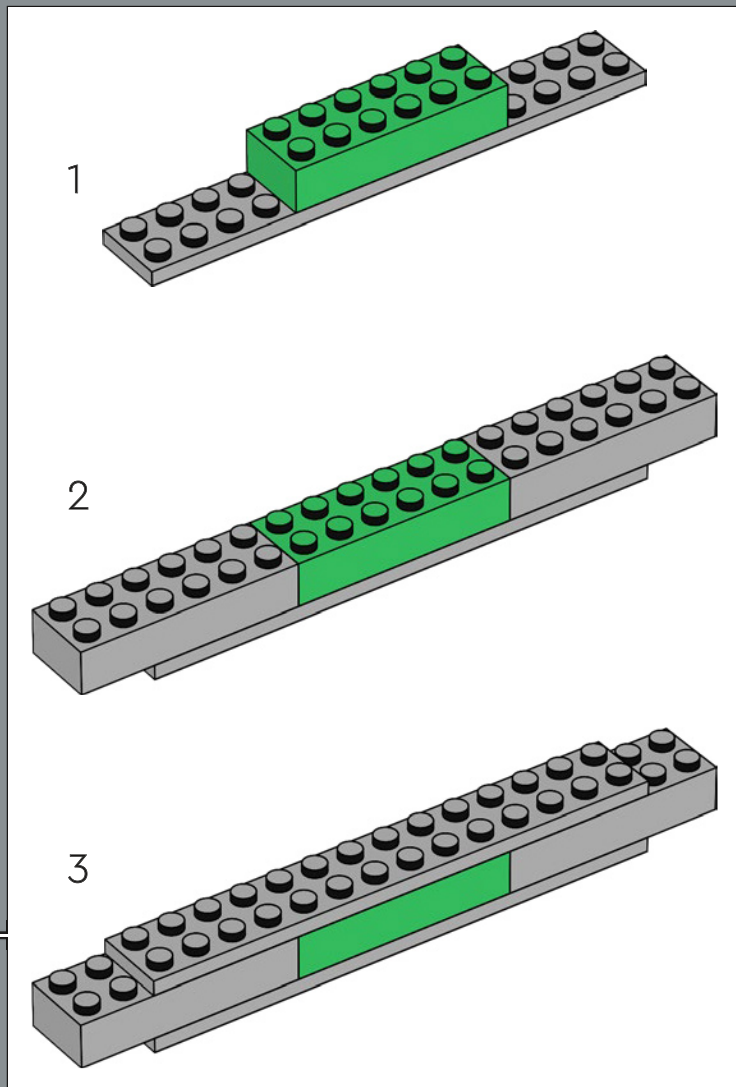
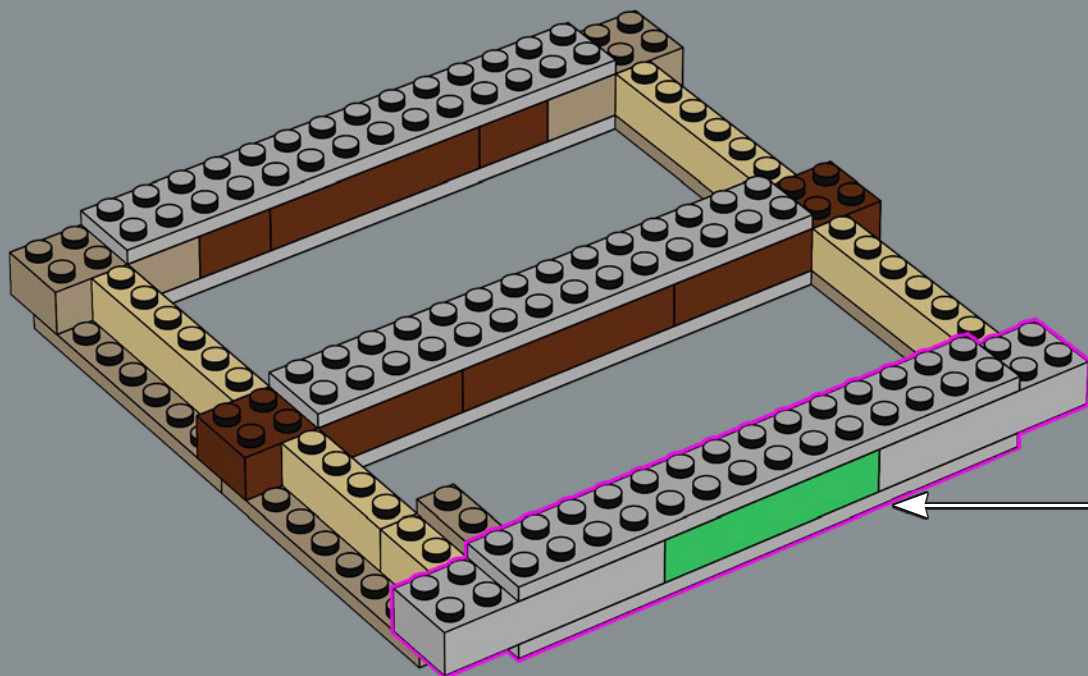

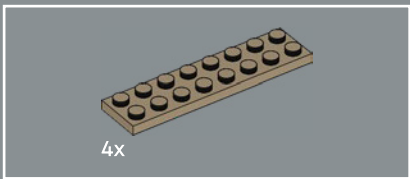

49

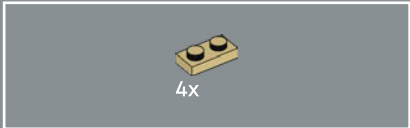
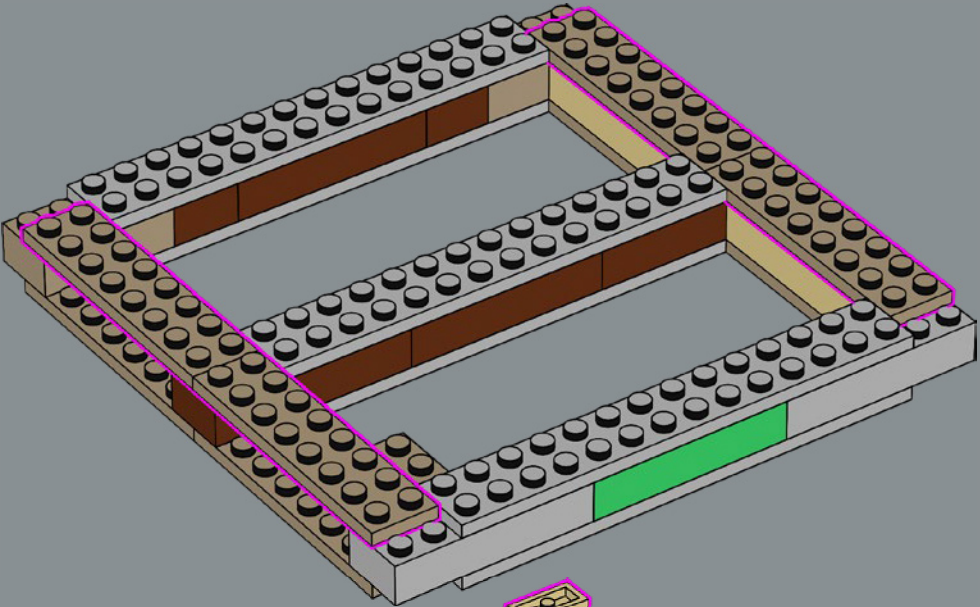

50

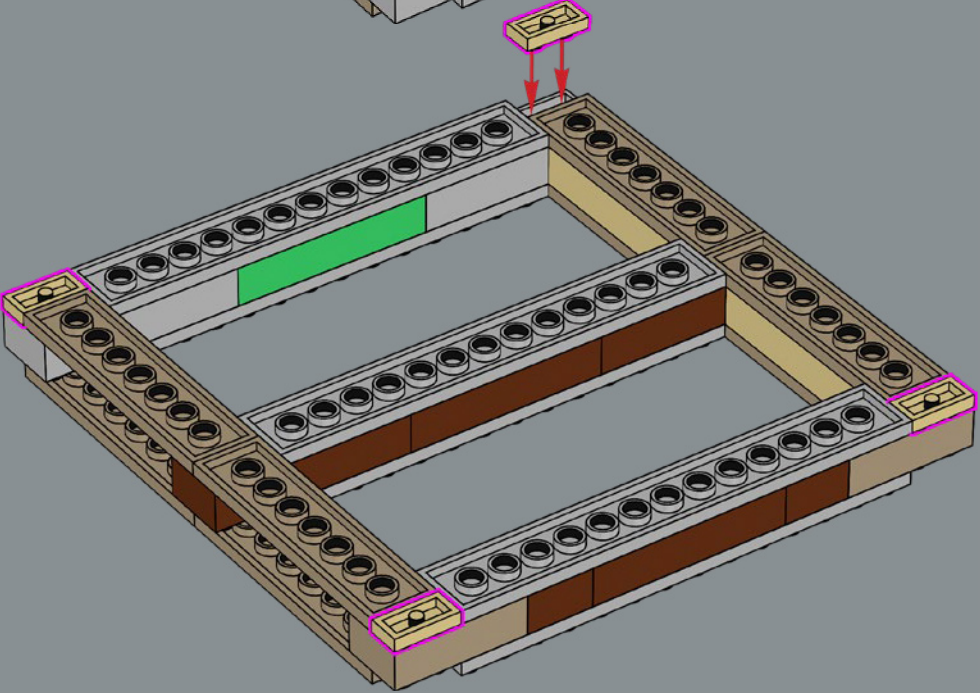



51

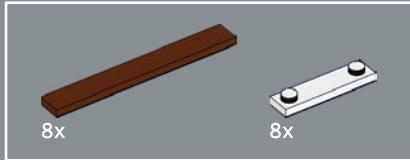
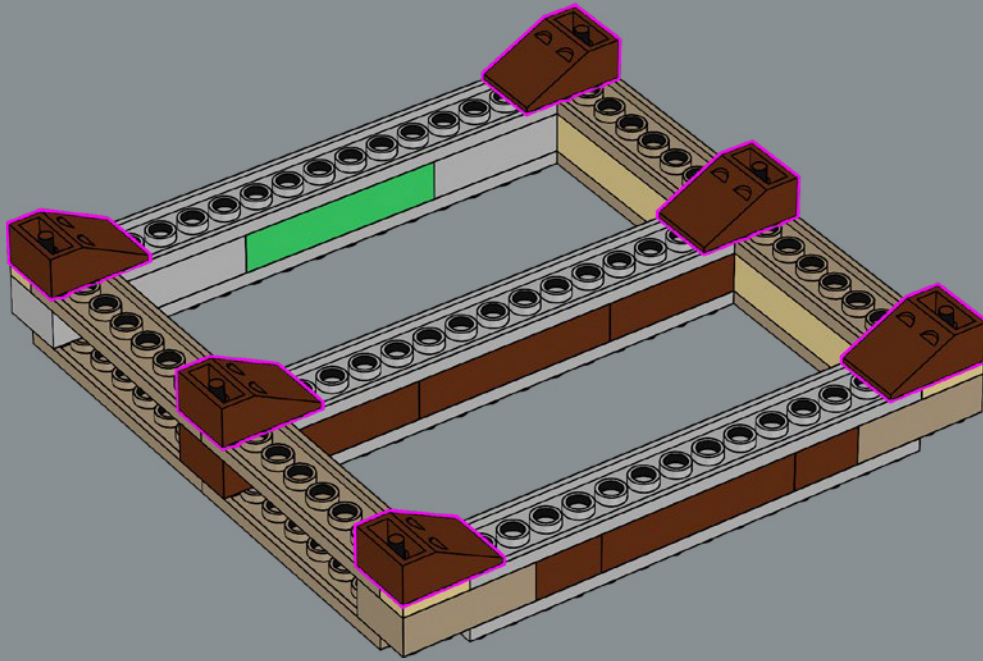

52

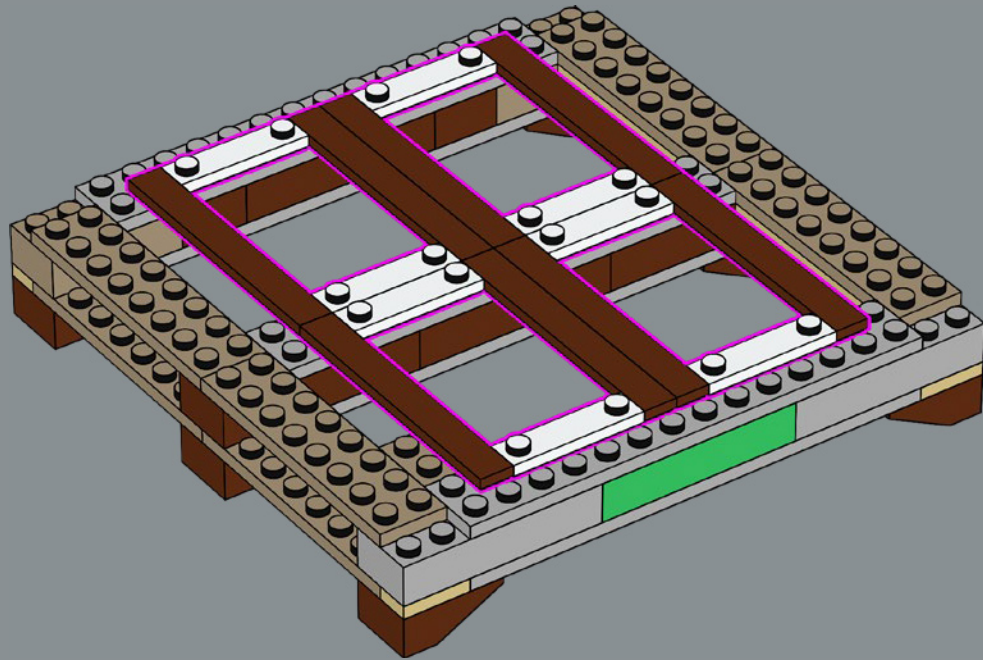

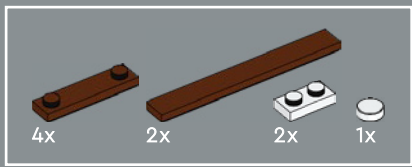

53

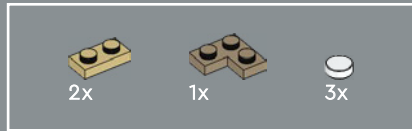
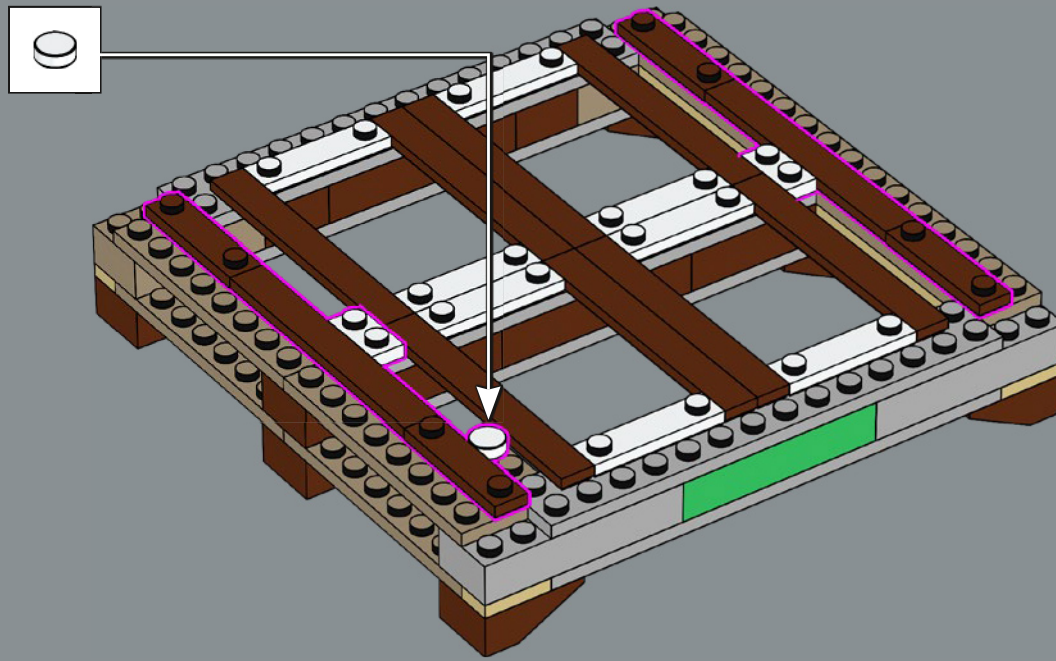

54

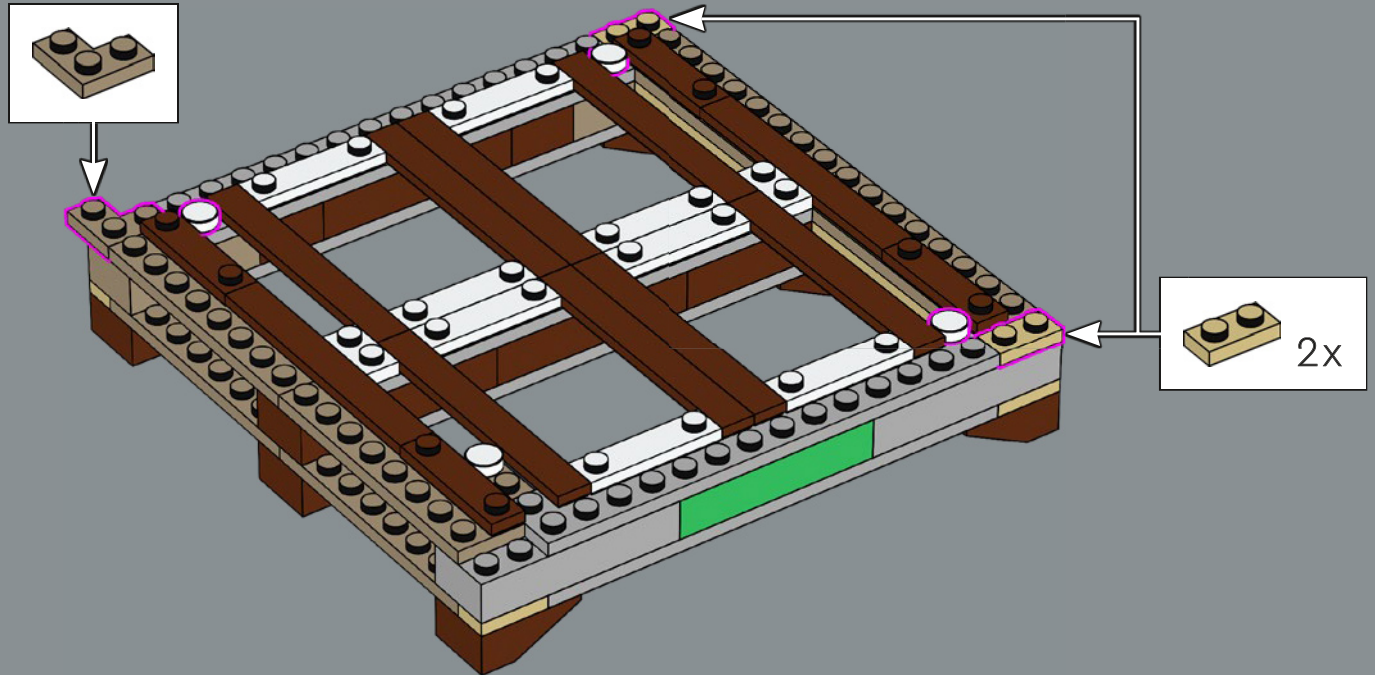

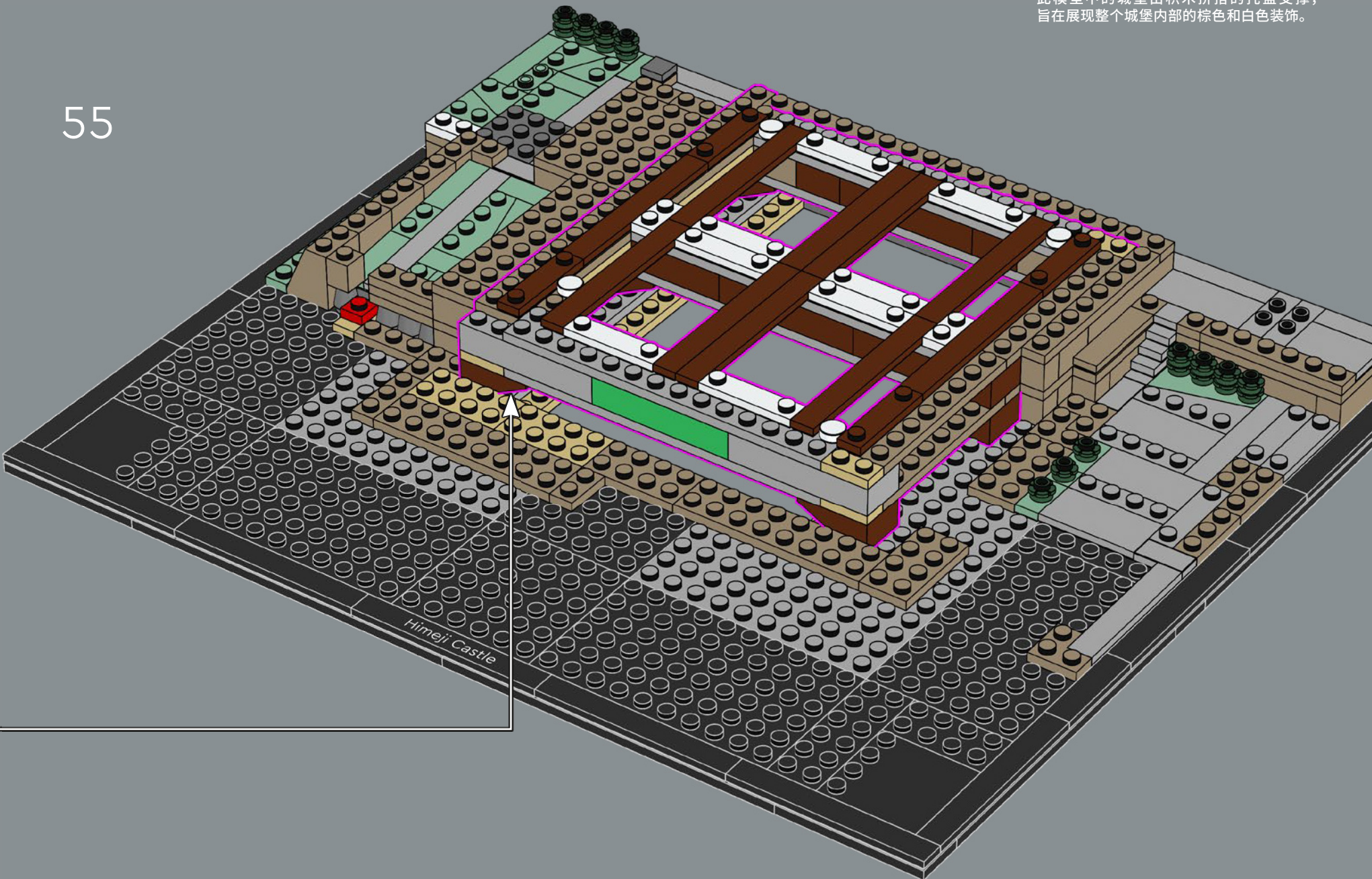

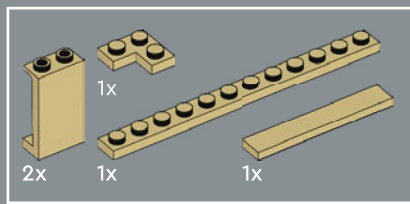

56

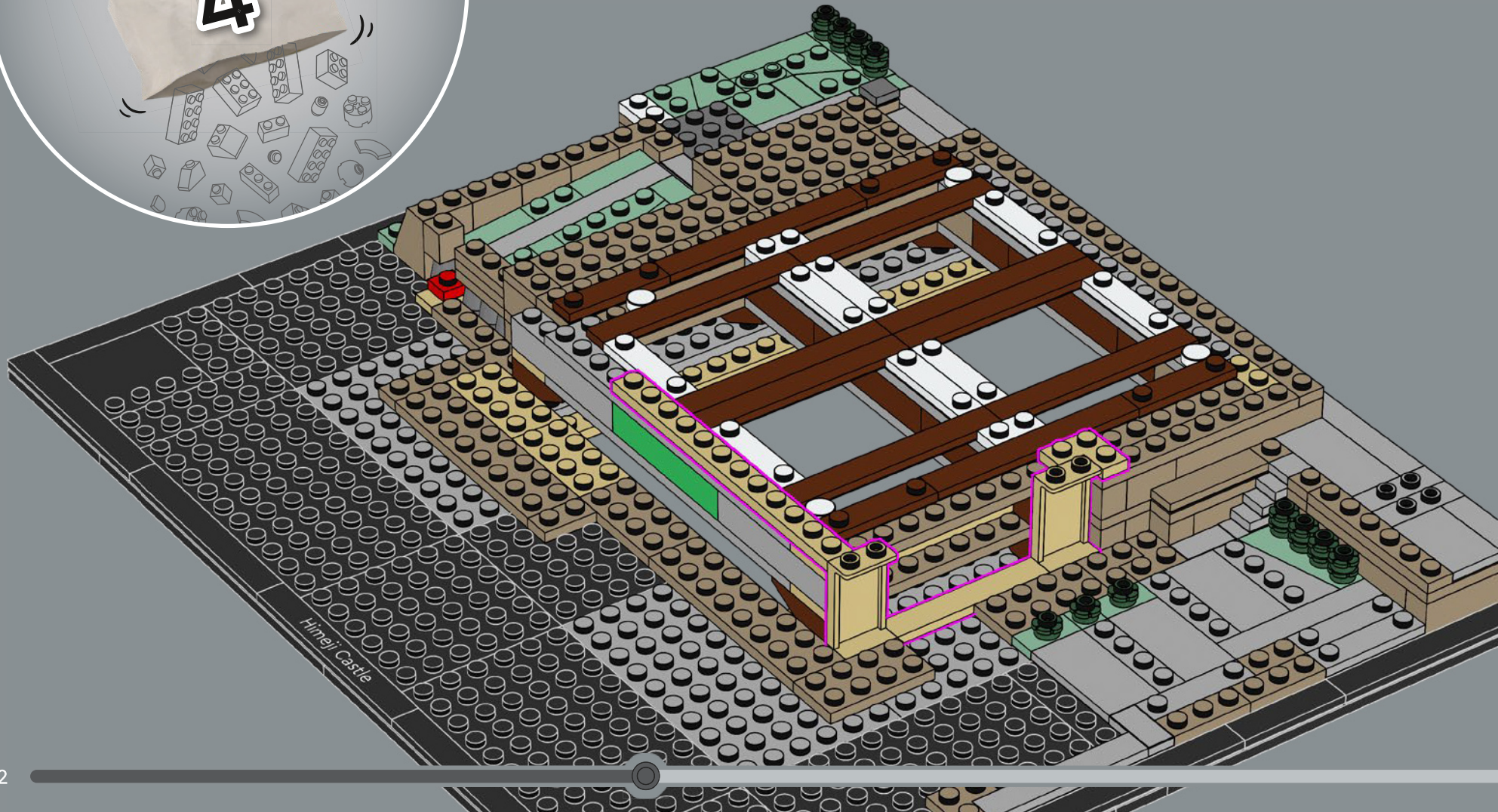

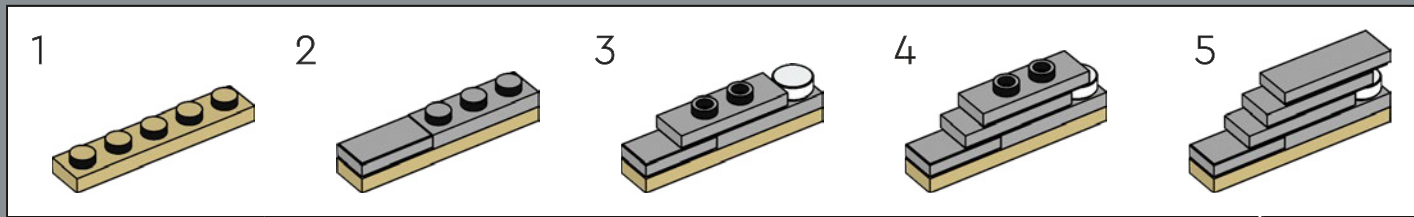
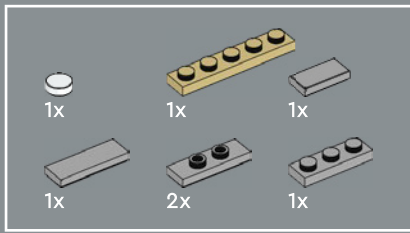

57

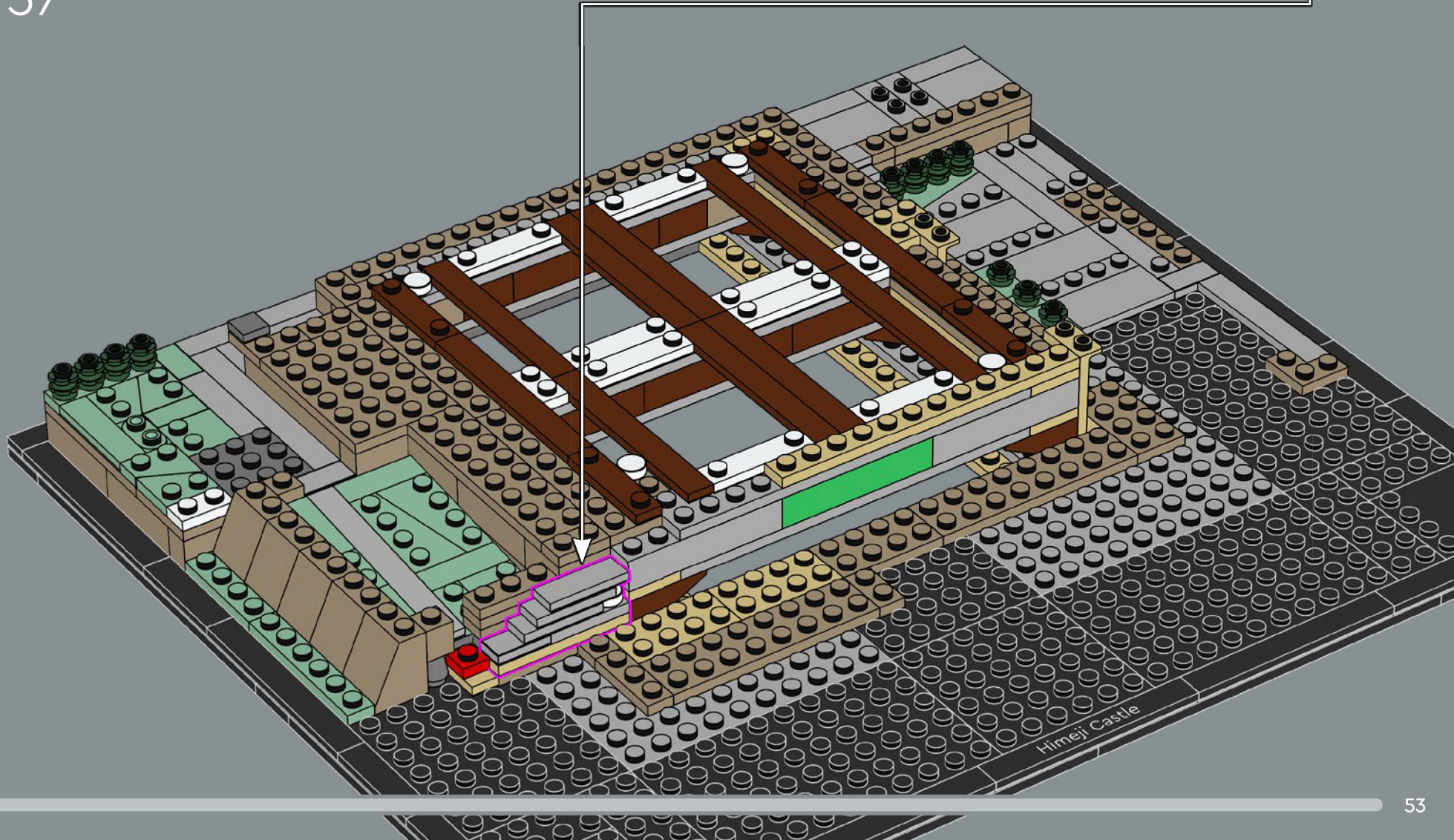

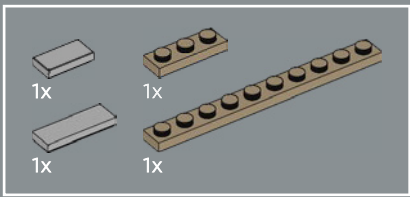

58

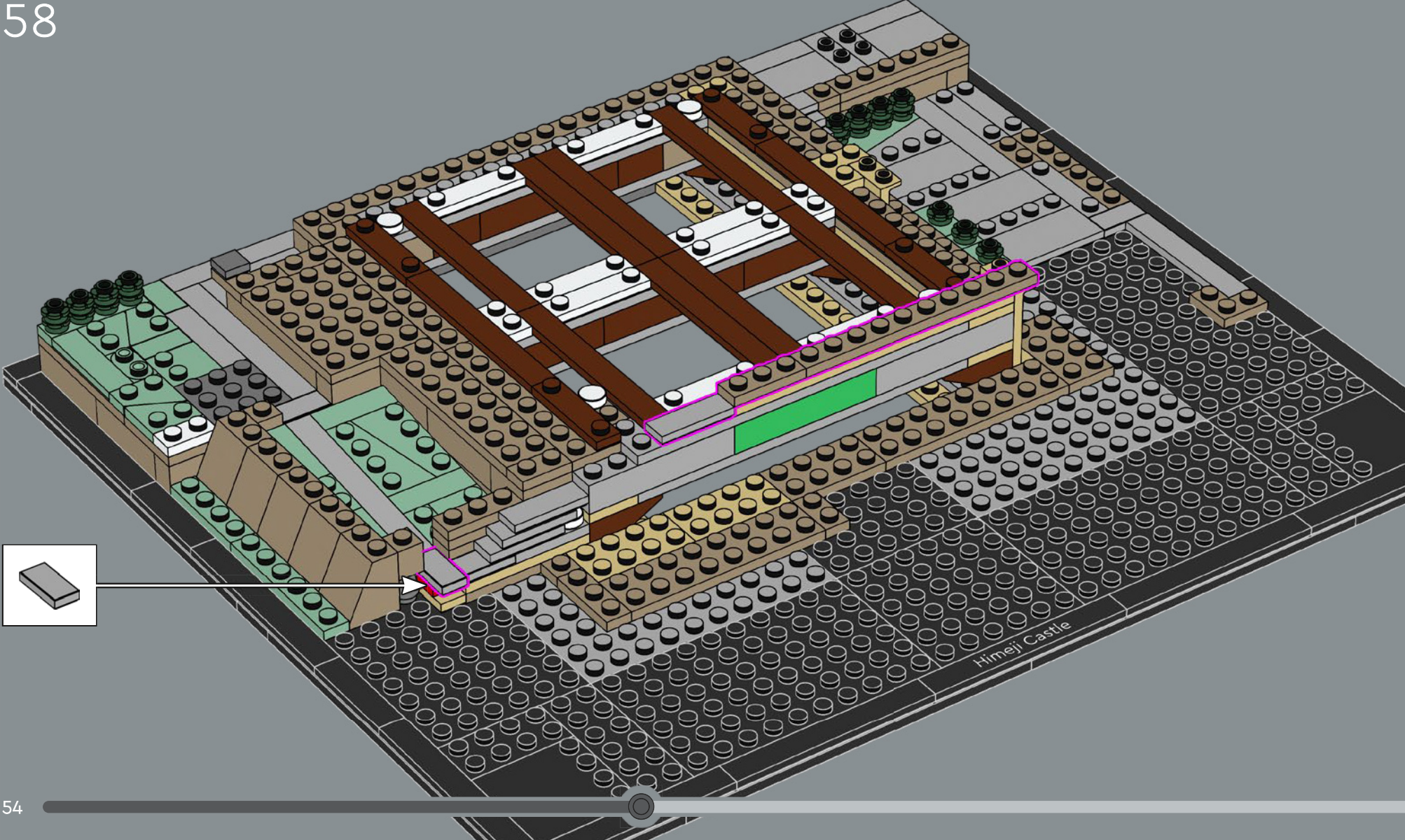

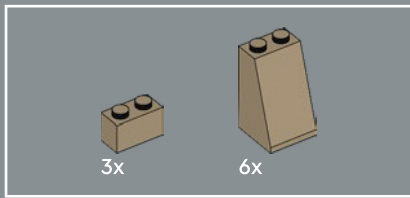

59

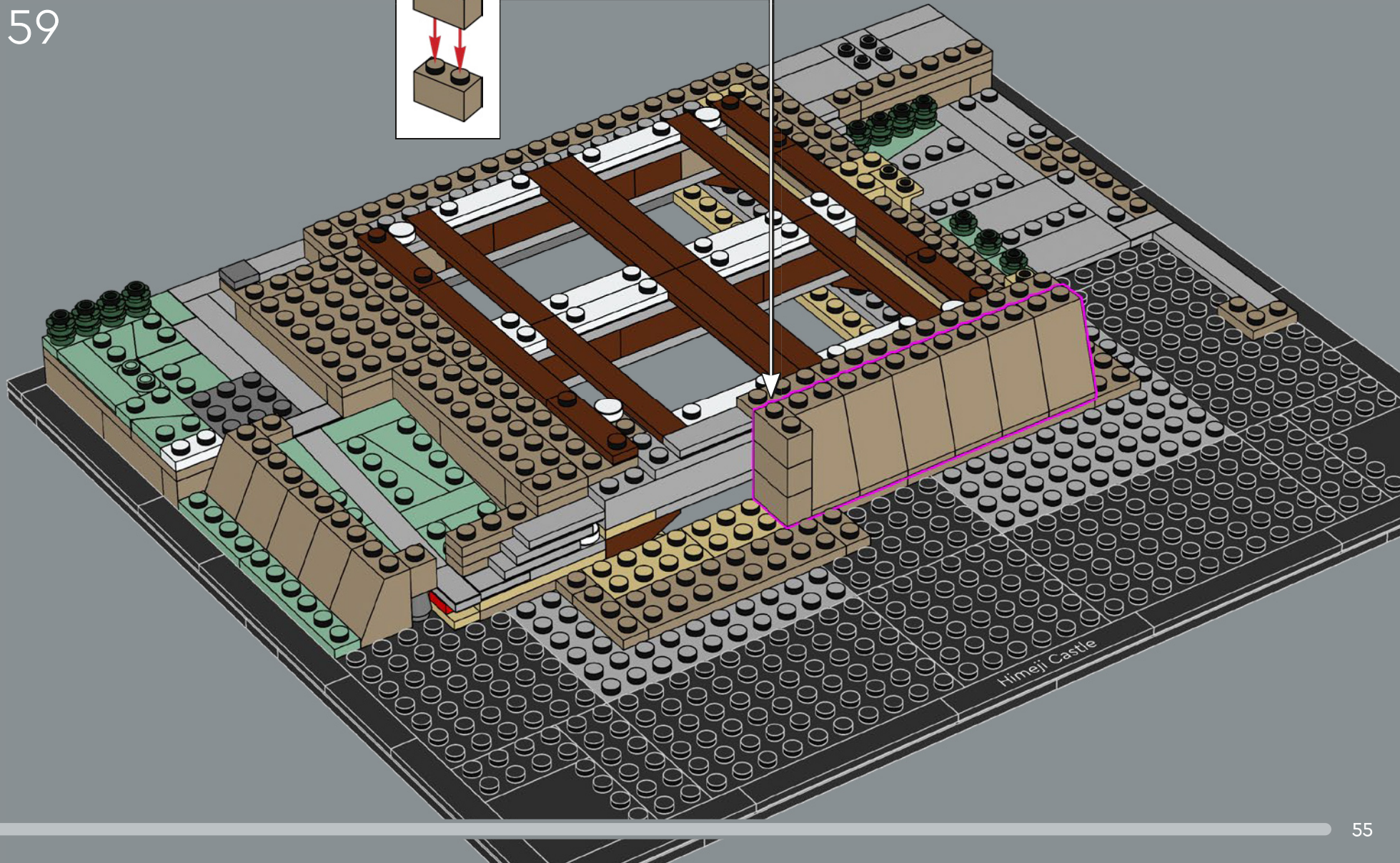
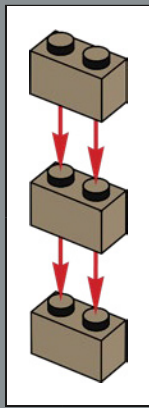

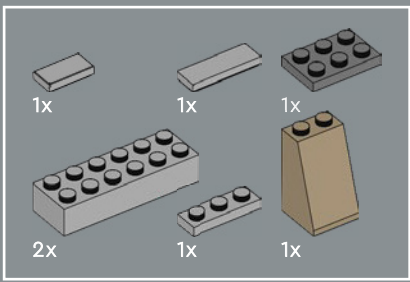

60

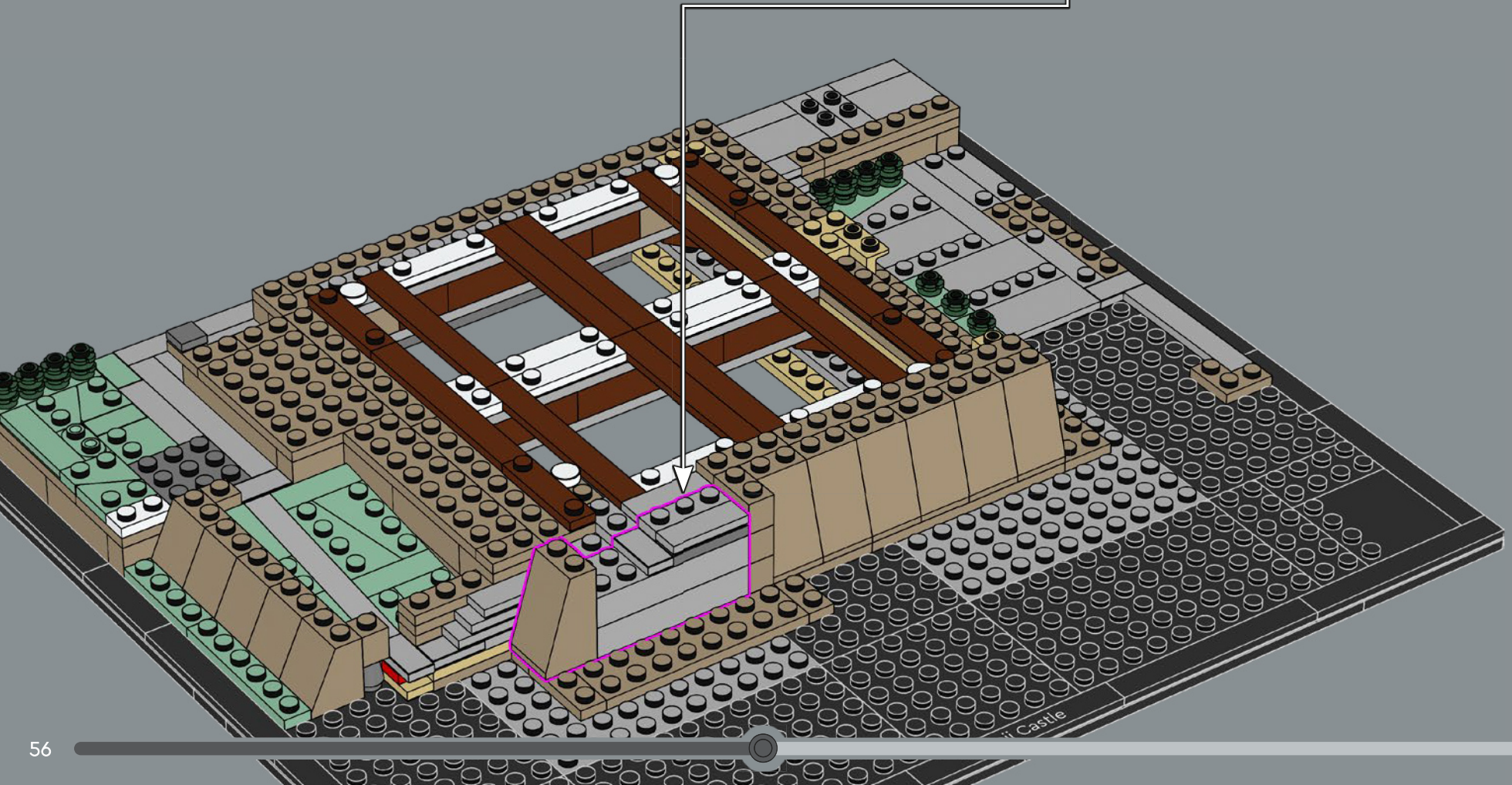
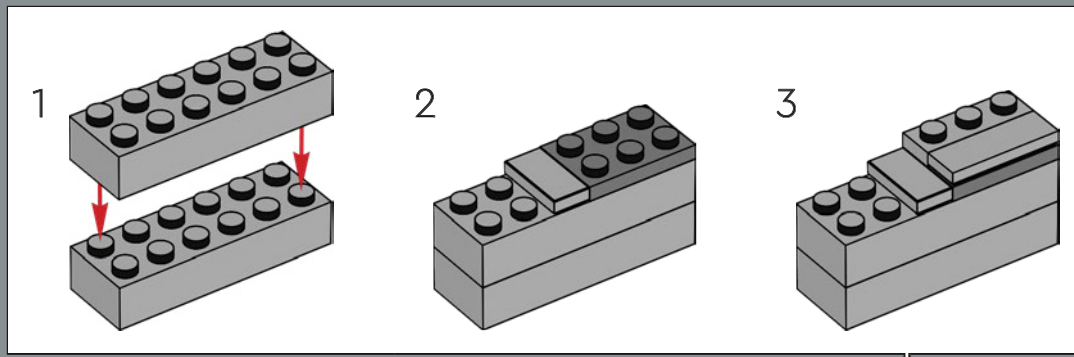

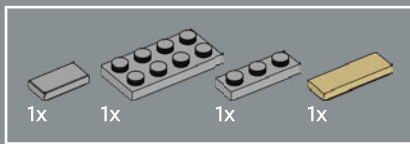

61

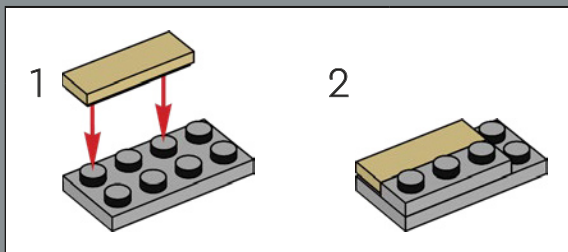
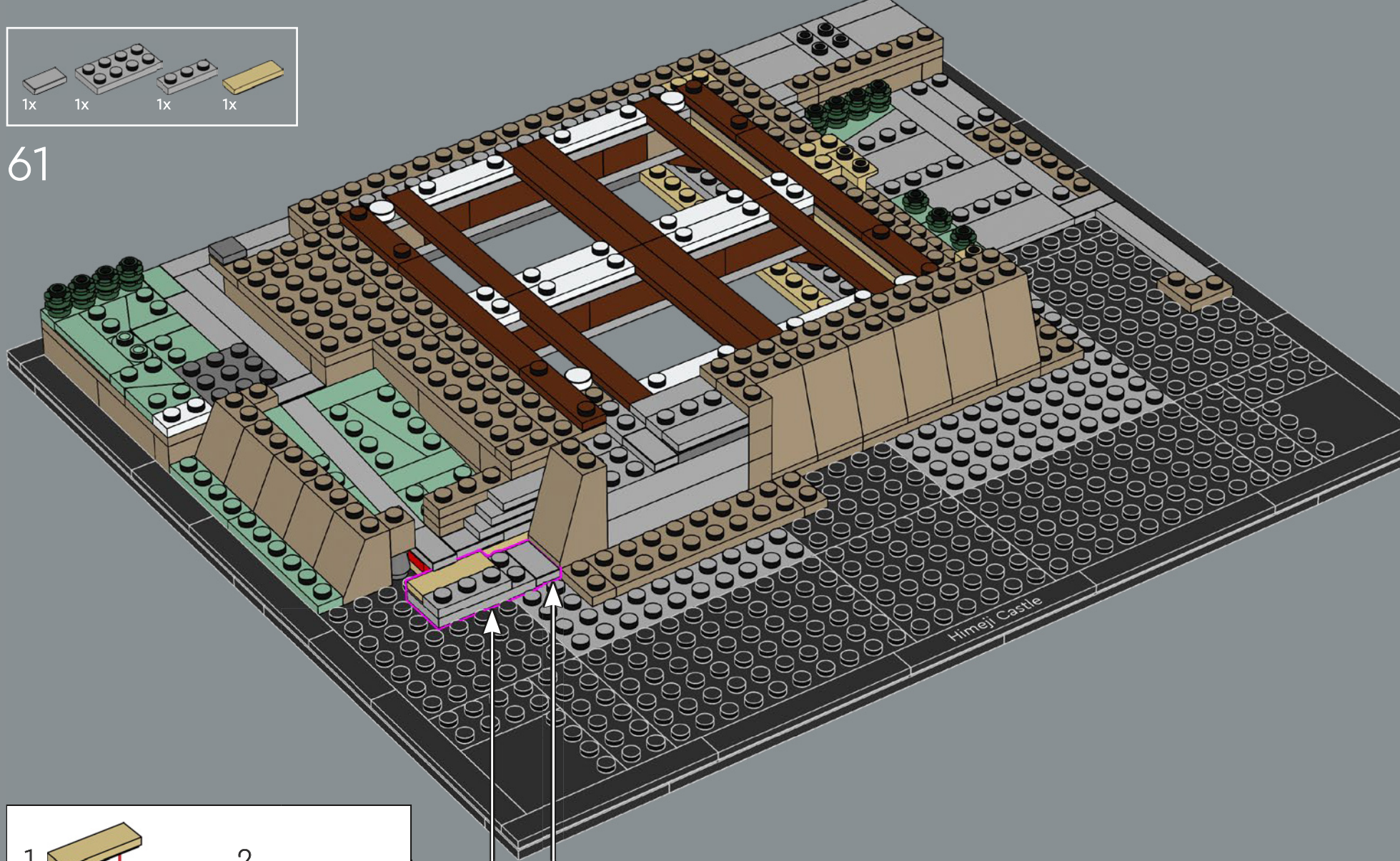

2

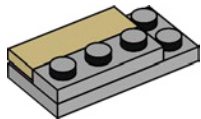

Himeji Castle

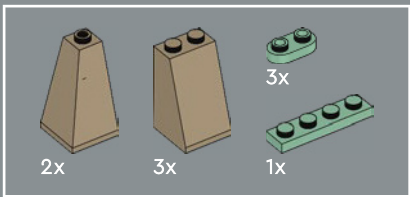

62

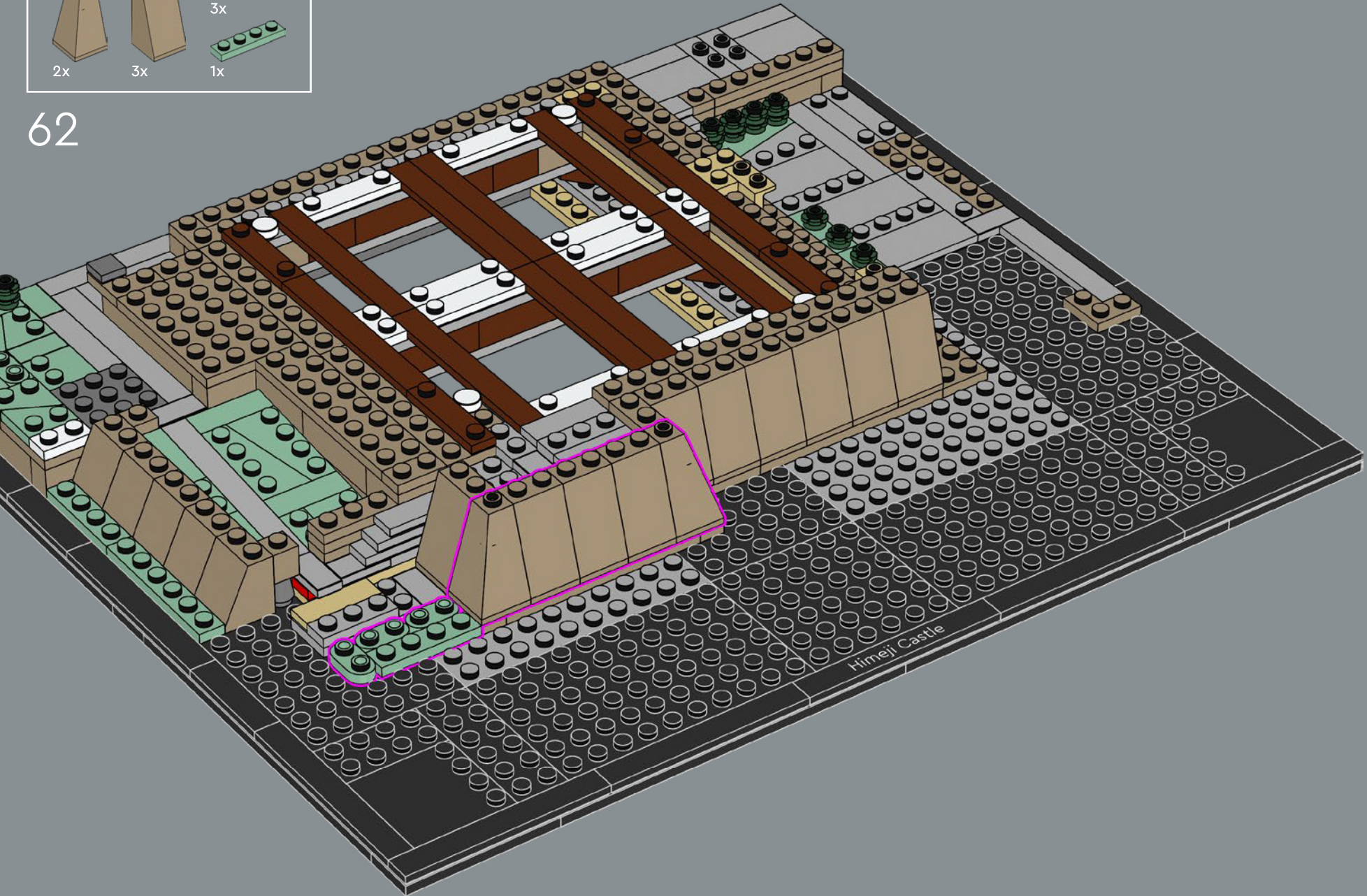

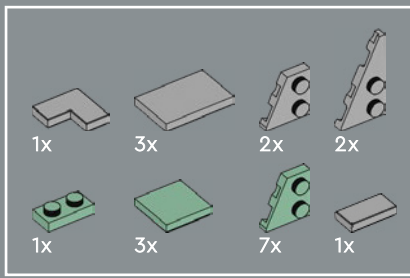

63

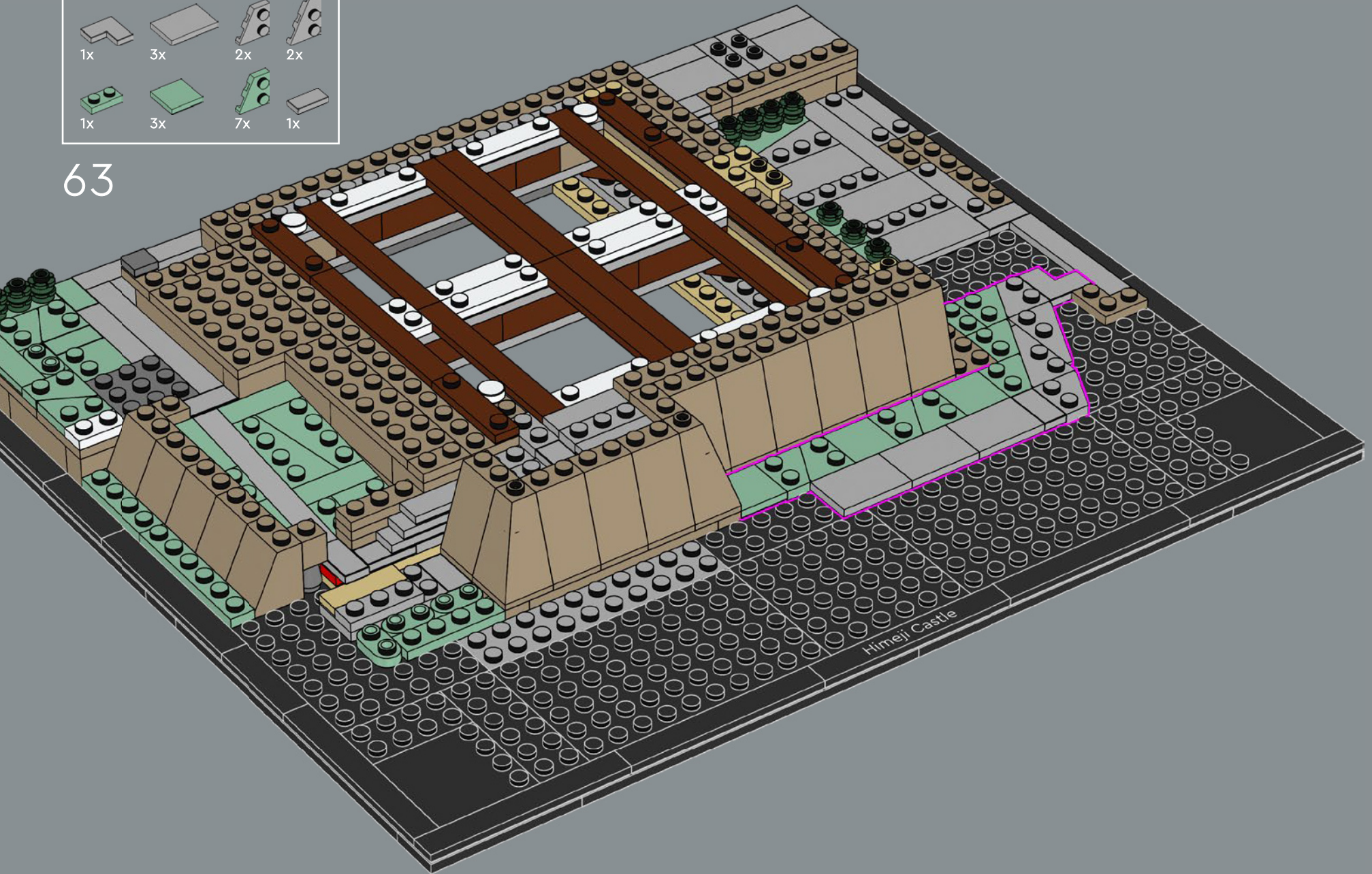

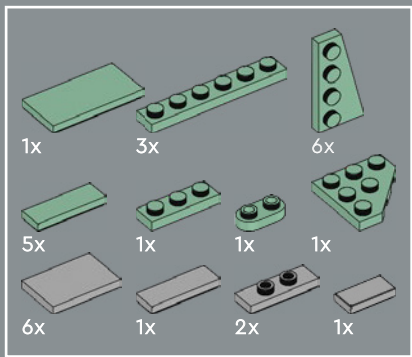

64

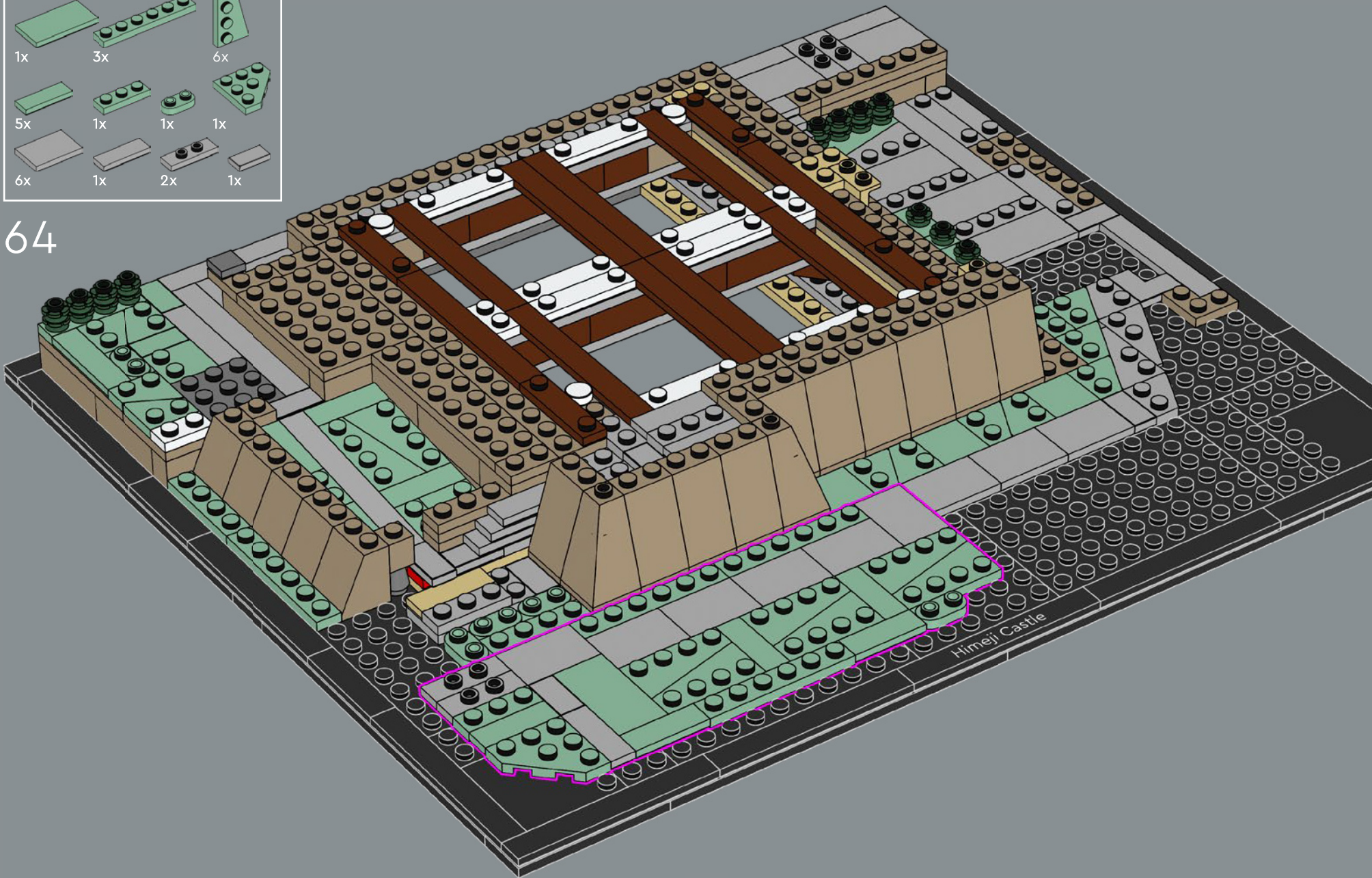

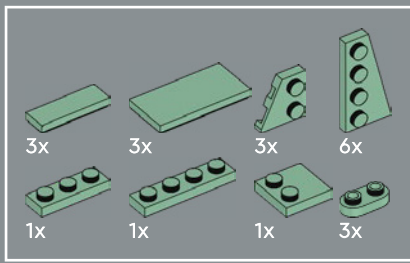

65

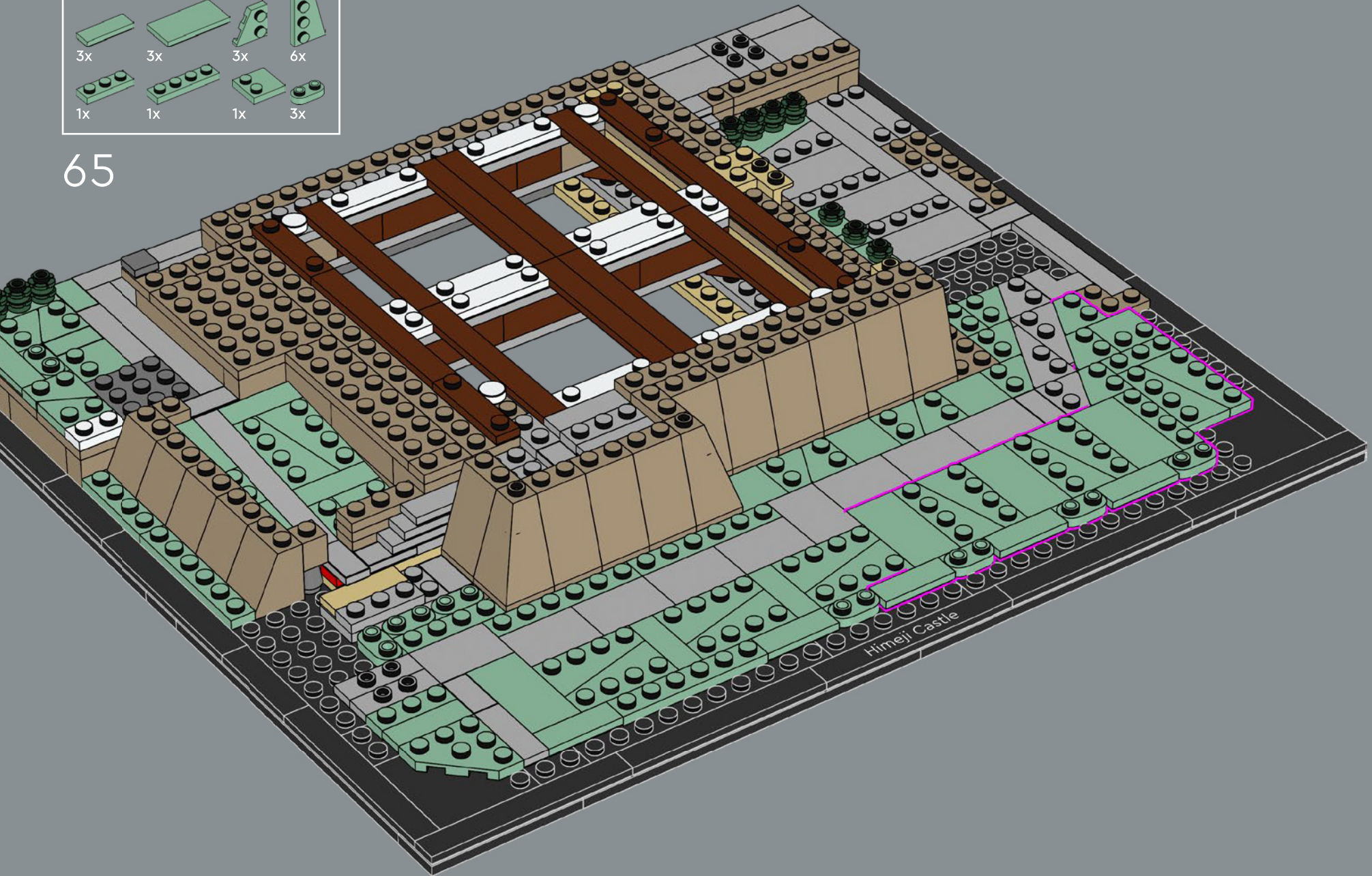

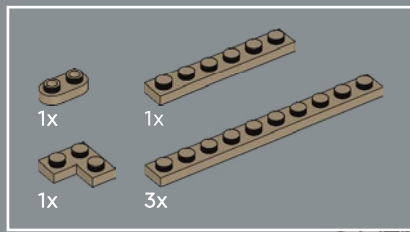

66

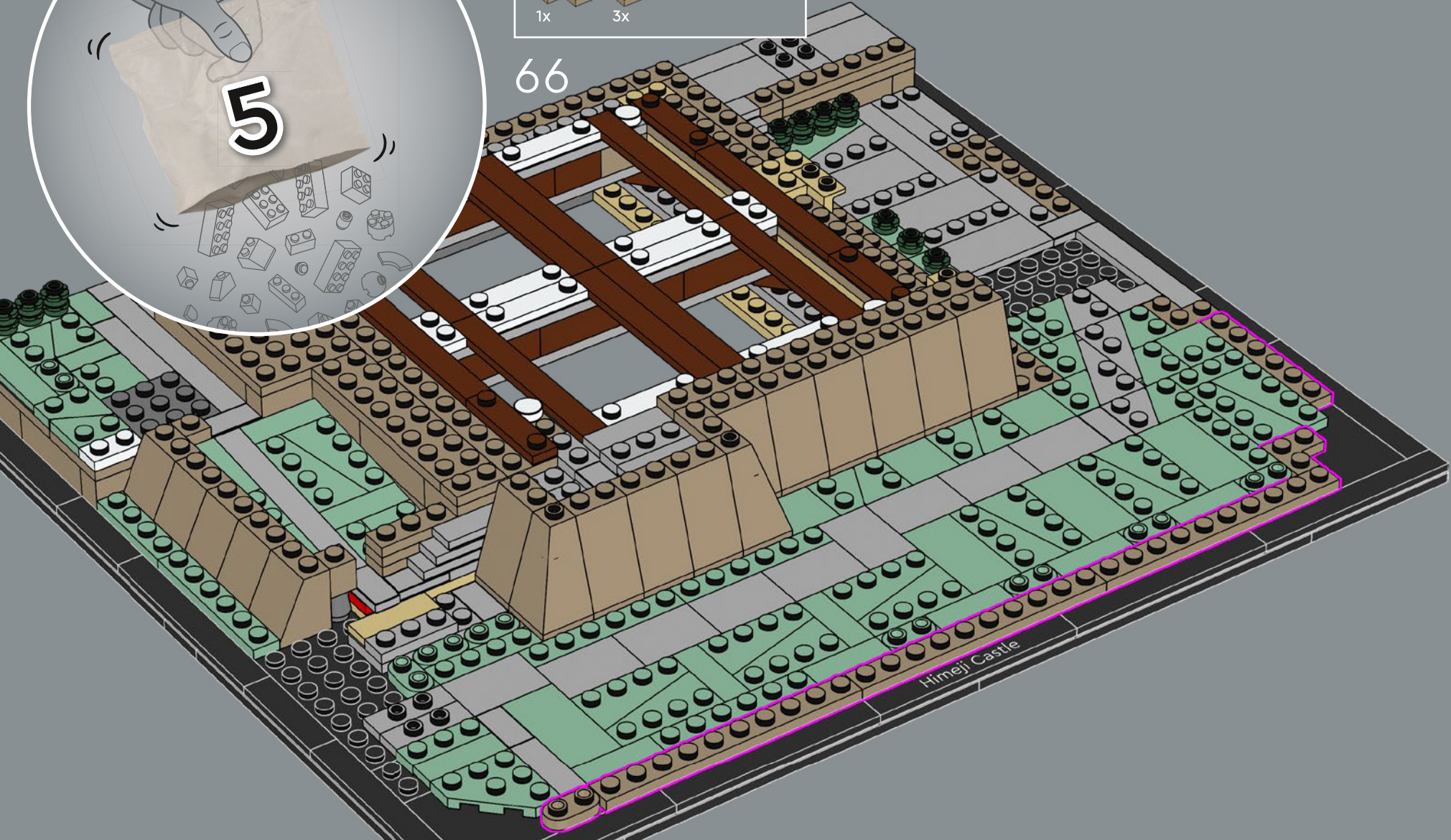

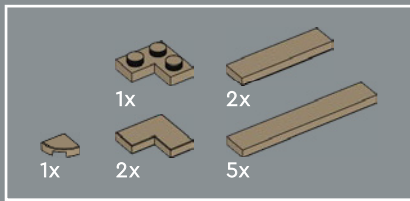

67

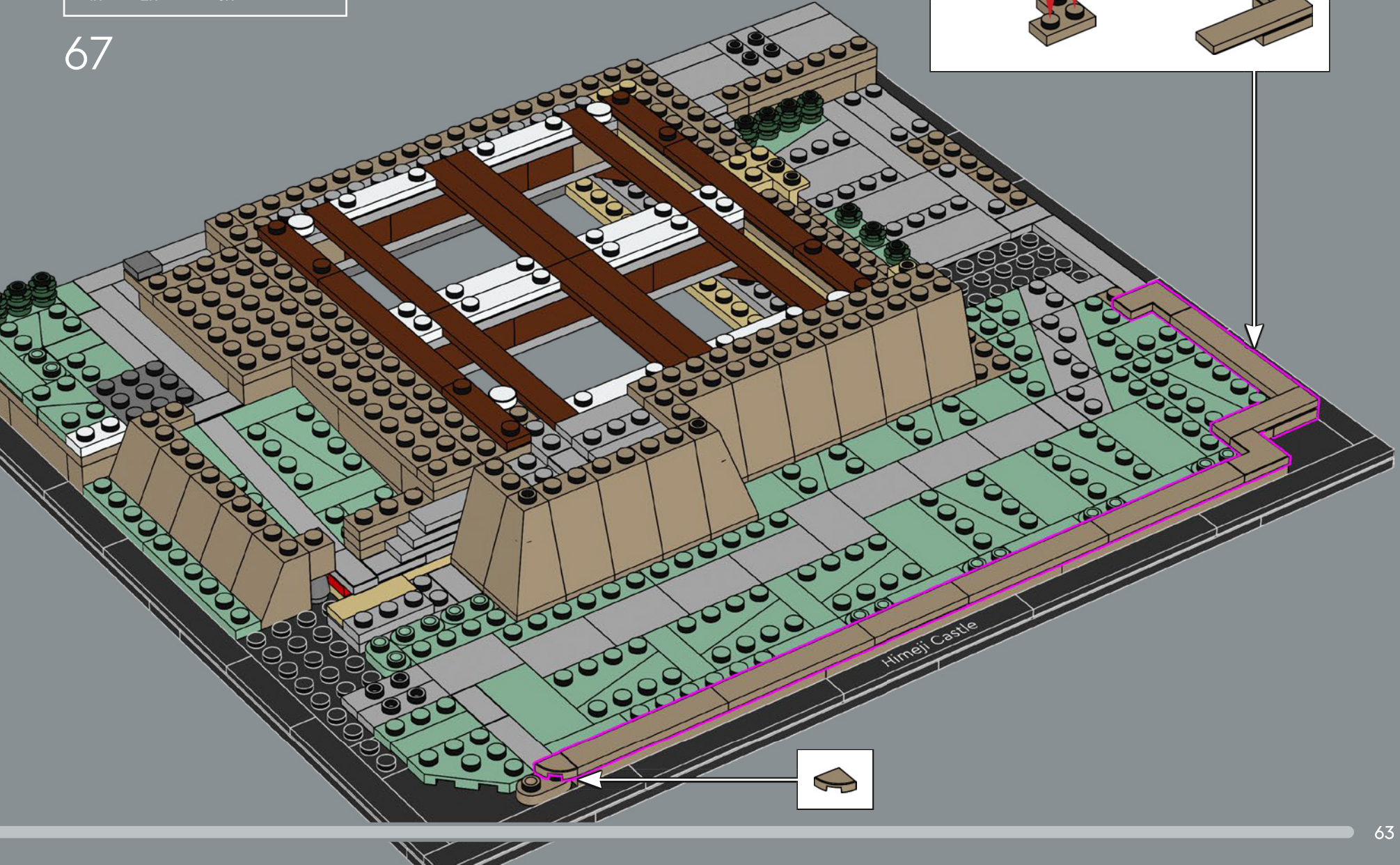
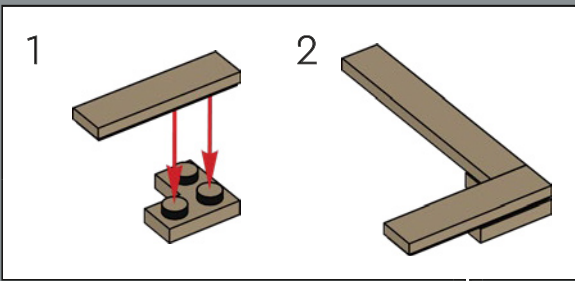

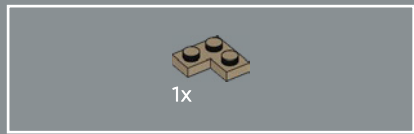

68

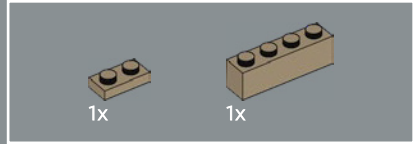
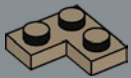

69

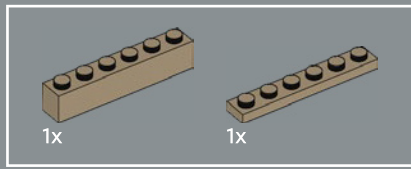
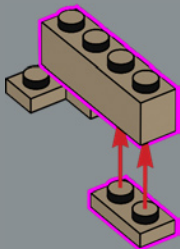

70

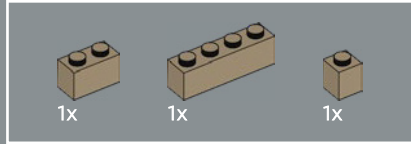
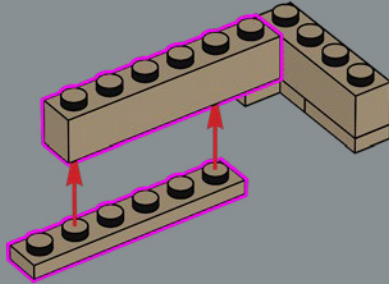

71

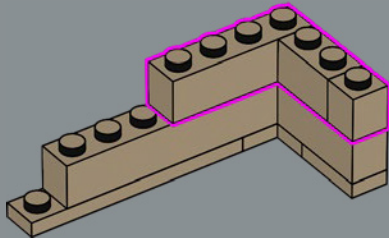

72

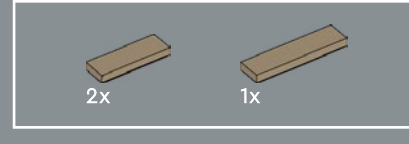
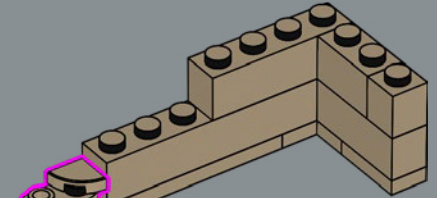
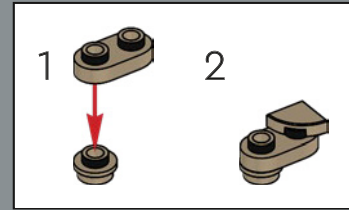

73

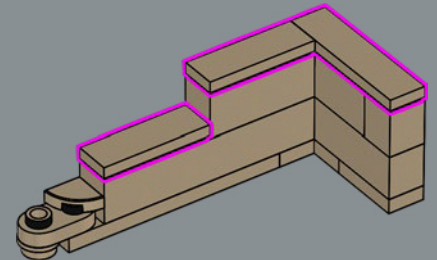

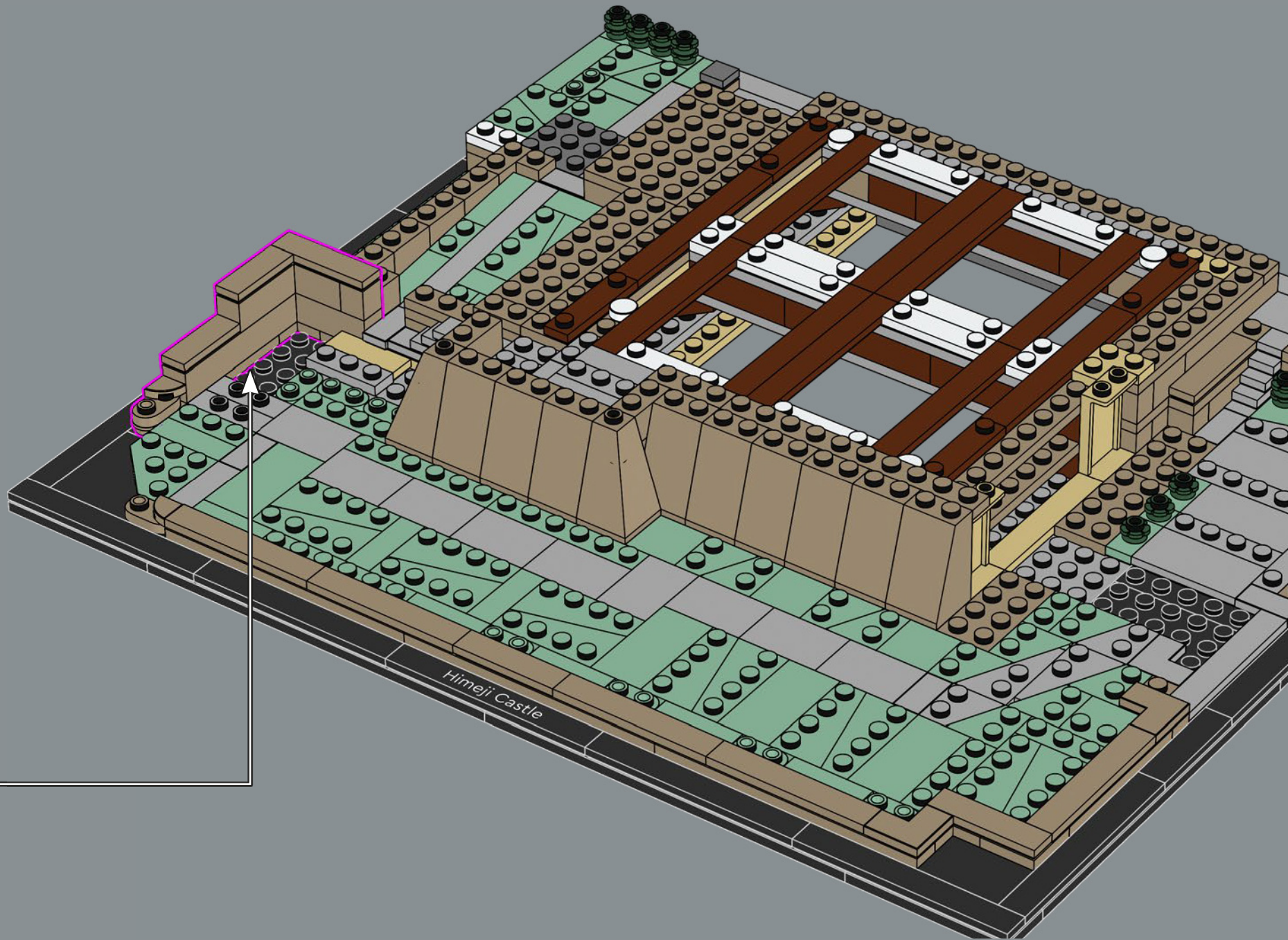

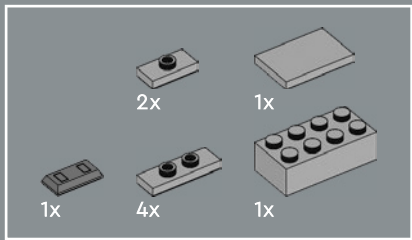

75

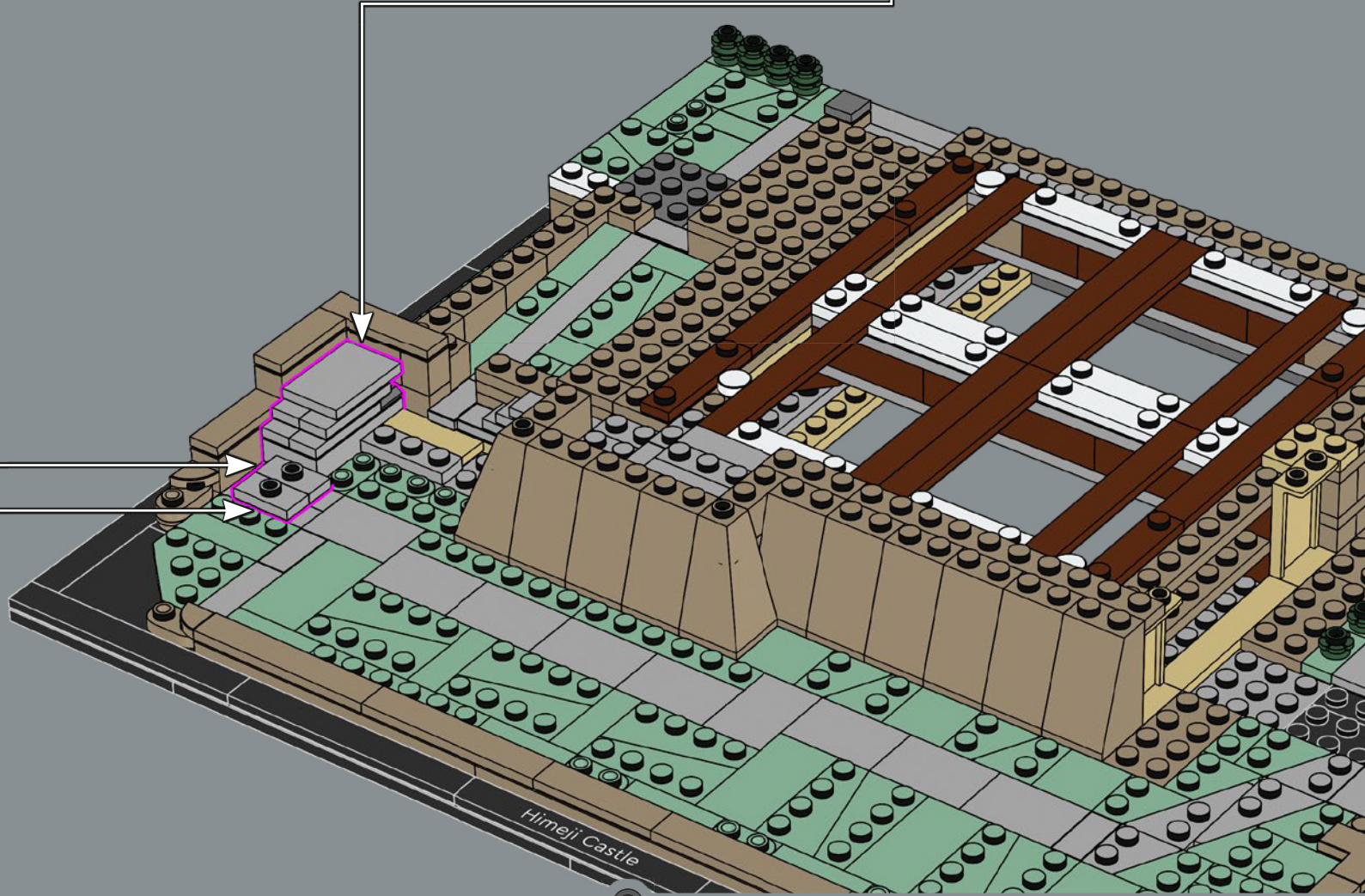
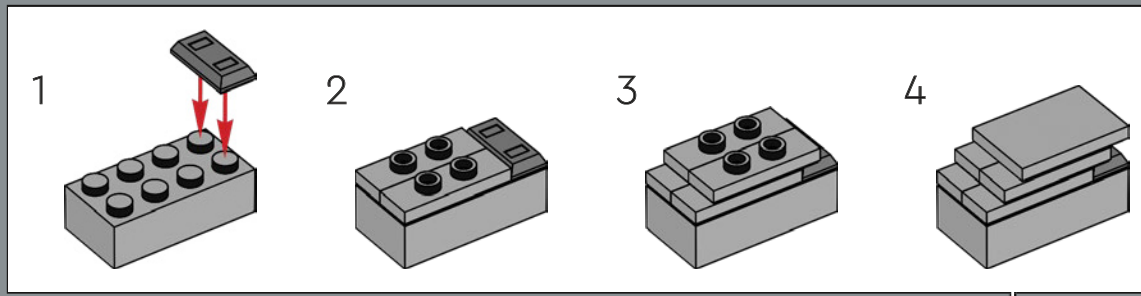

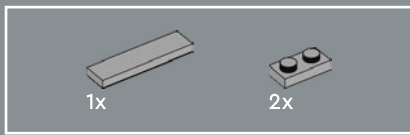

76

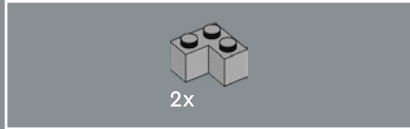
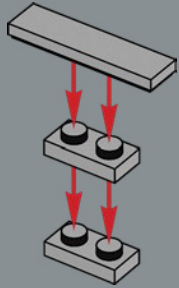

77

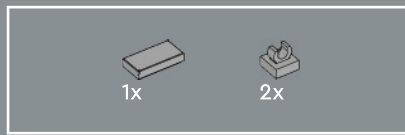
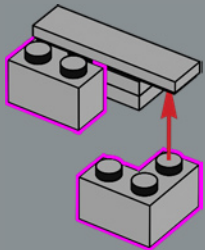

78

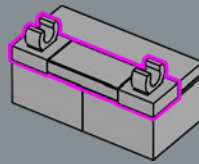

79

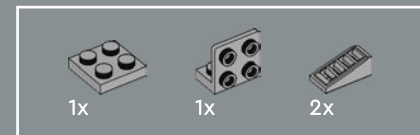
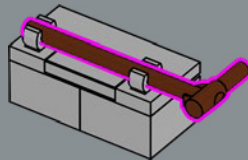

80

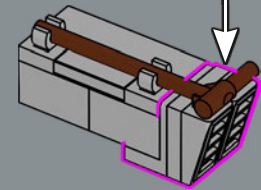
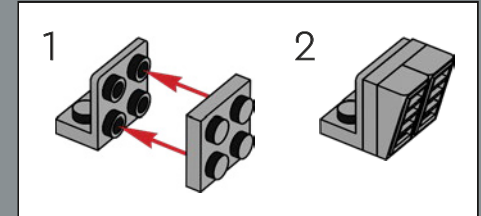

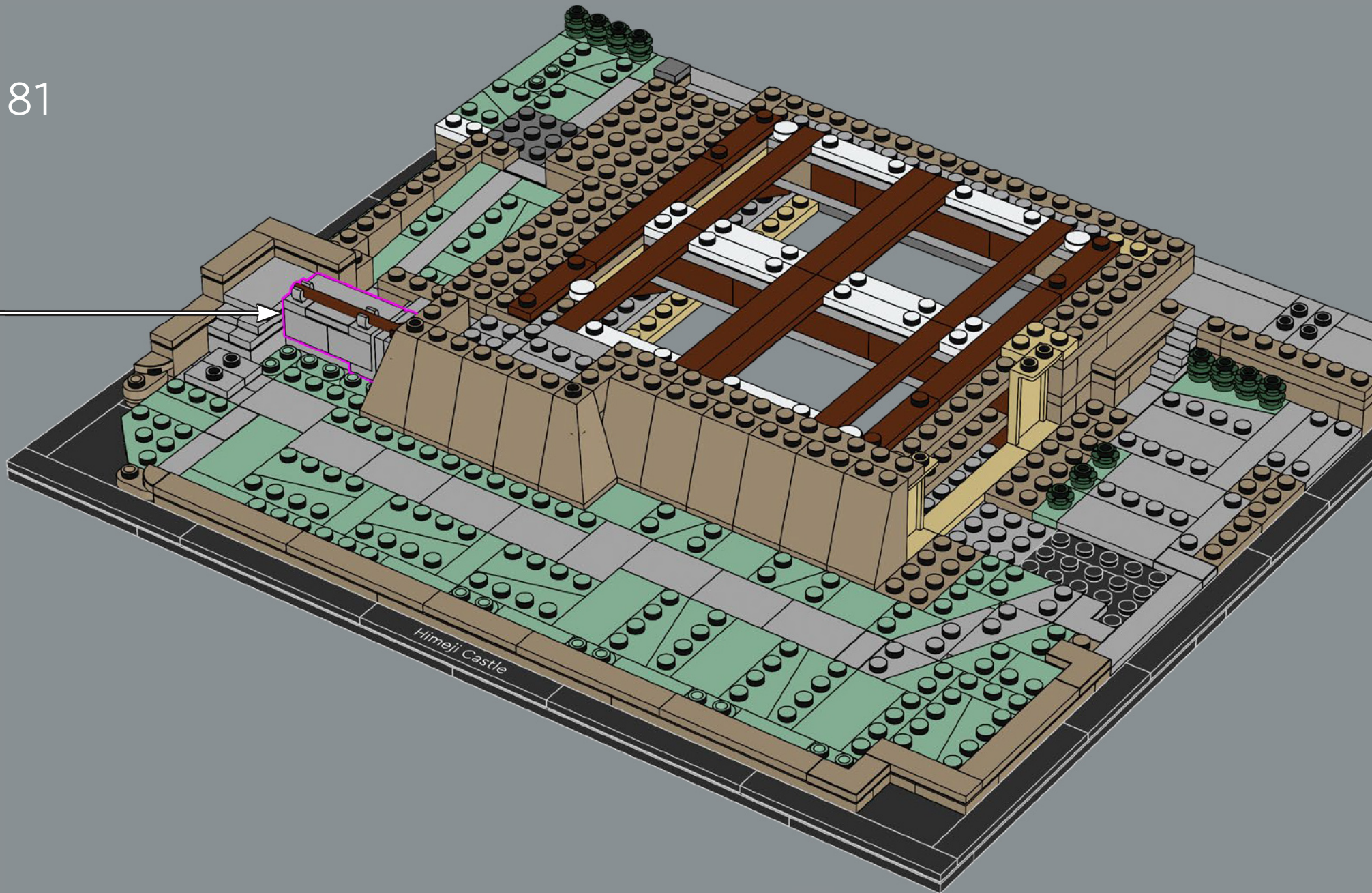

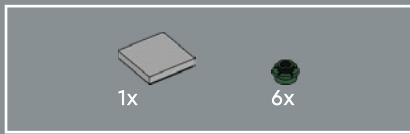

82

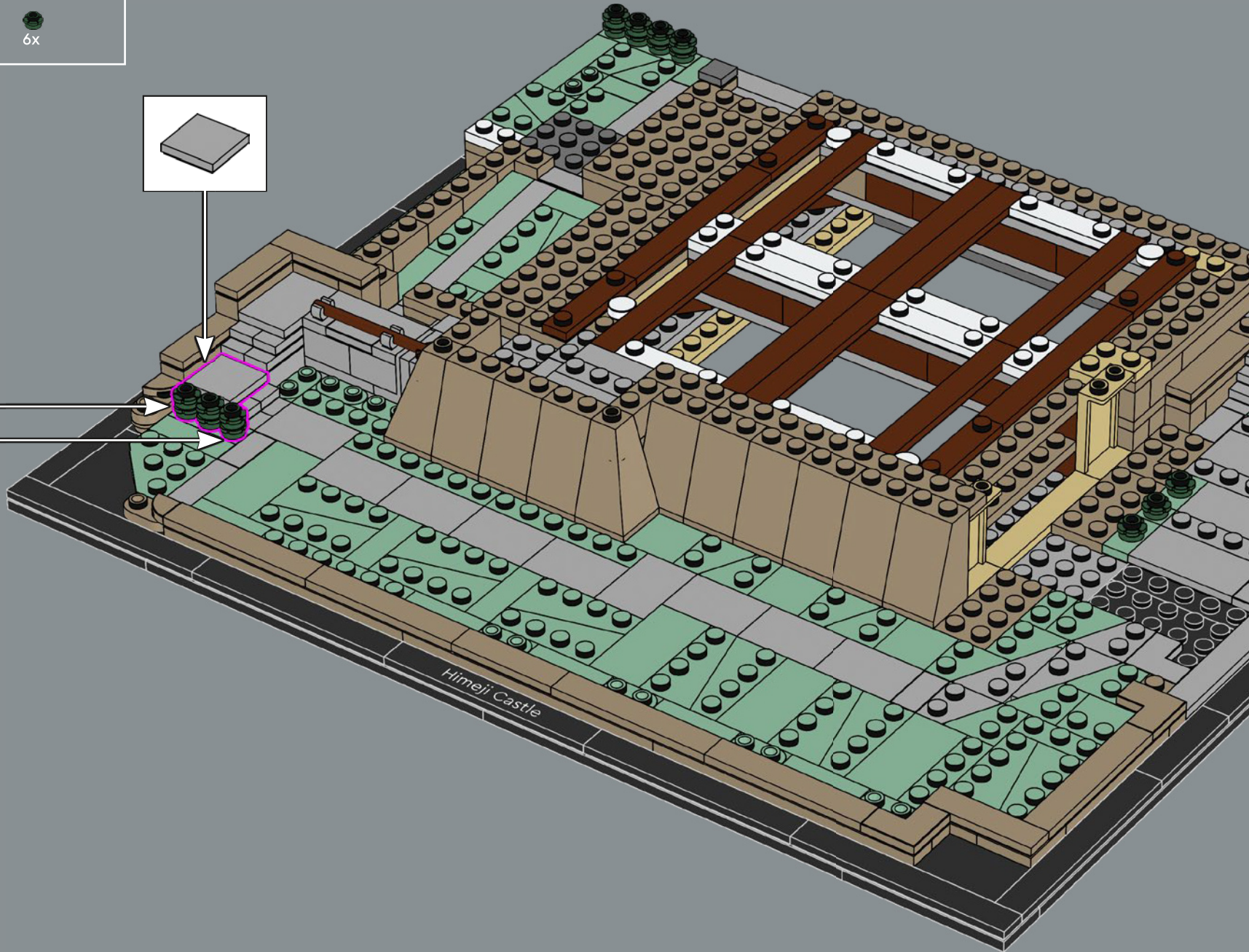
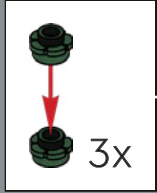

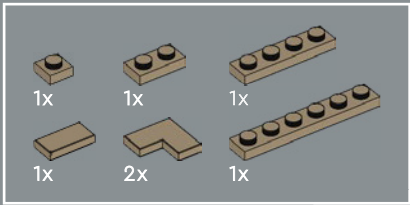

83

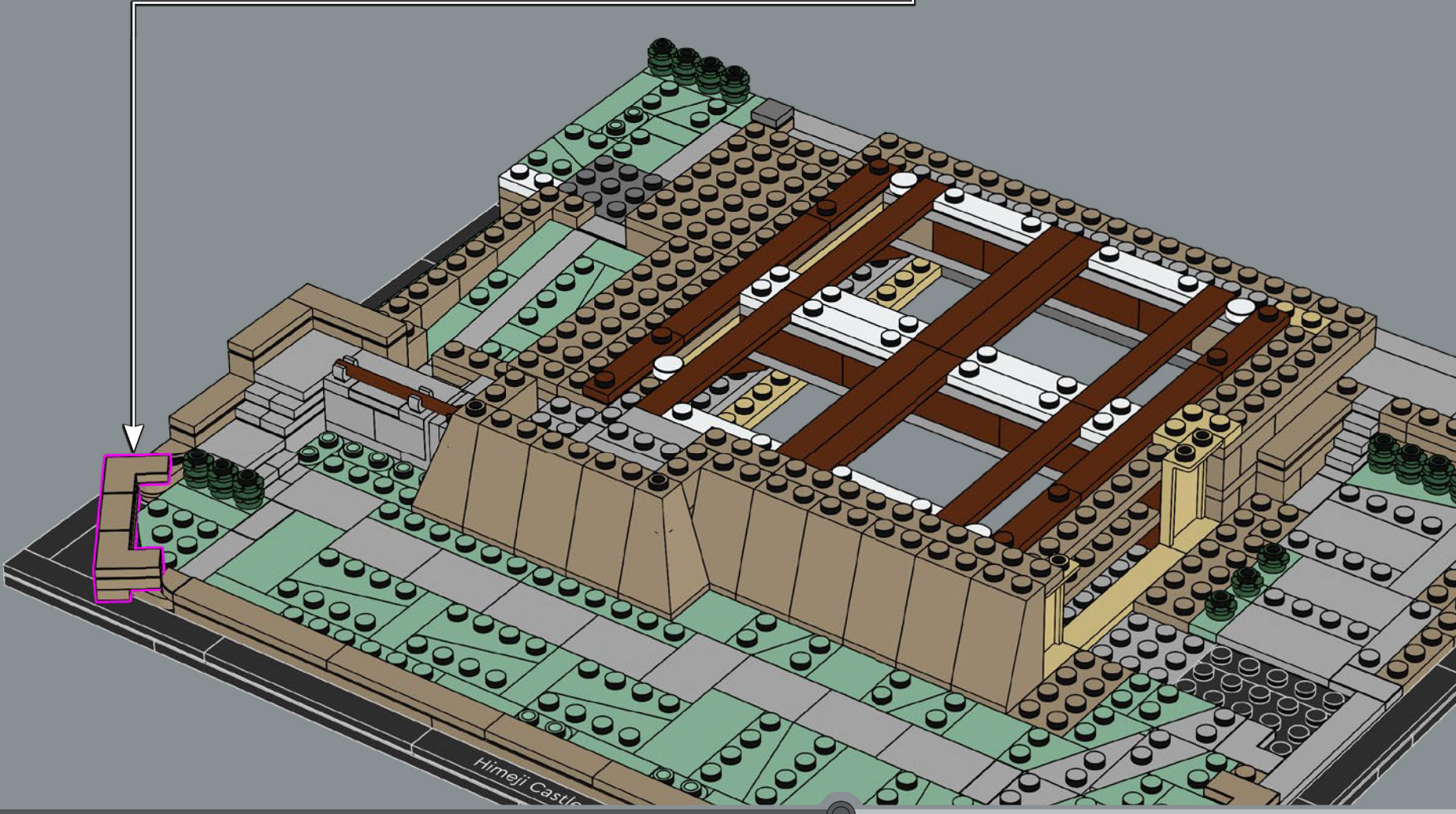
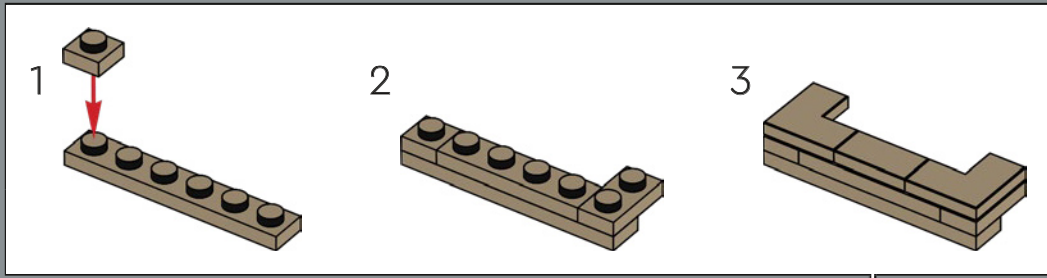

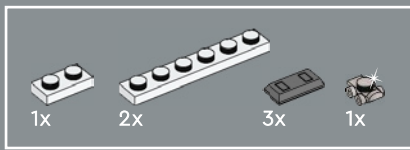

84

1

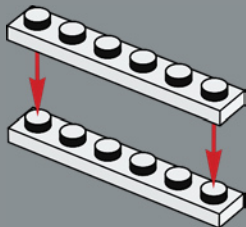

2

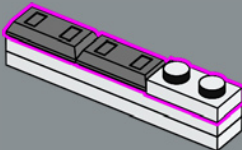

3

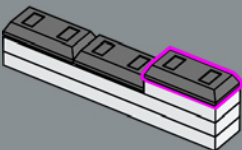

4



1:1

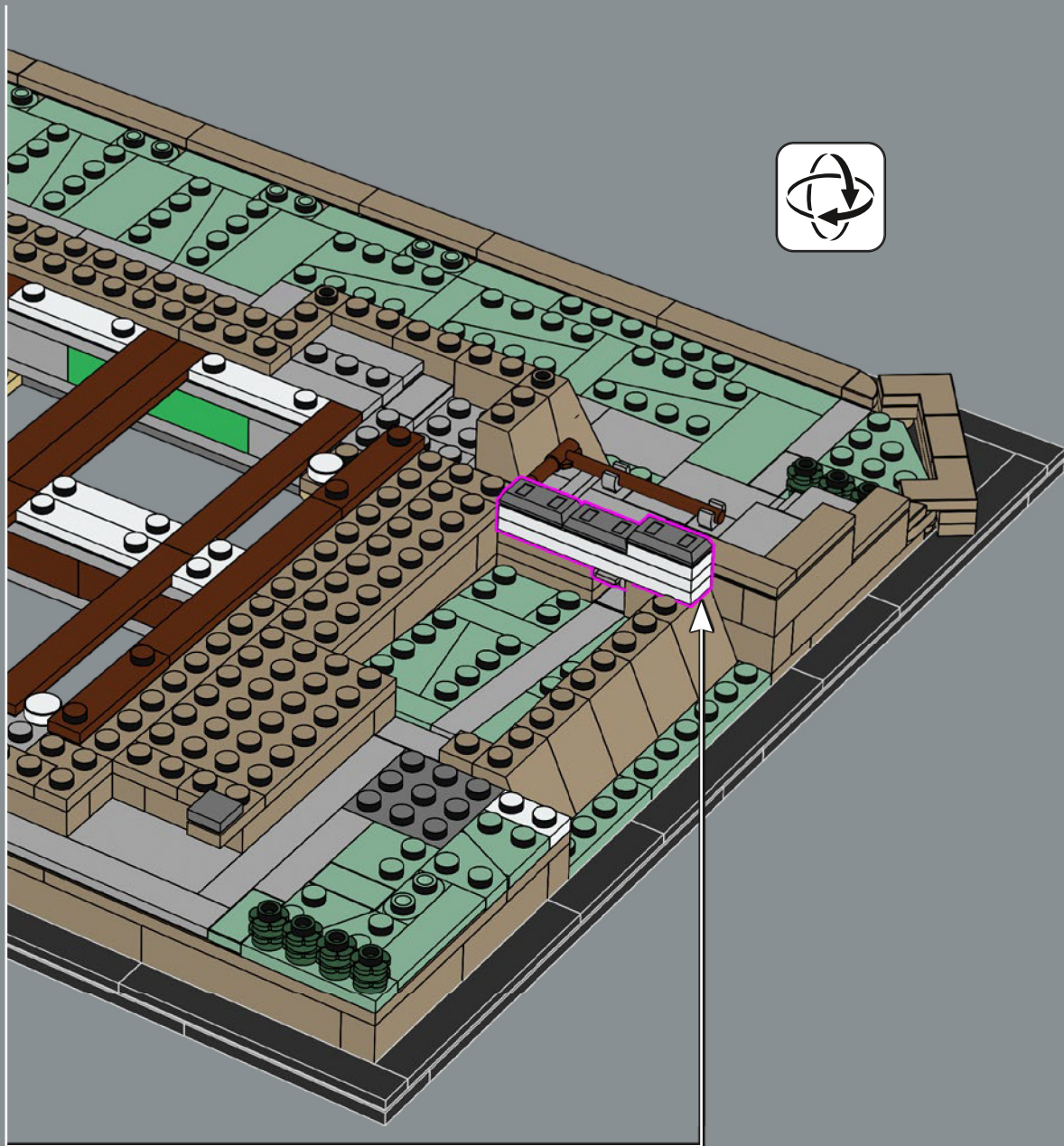

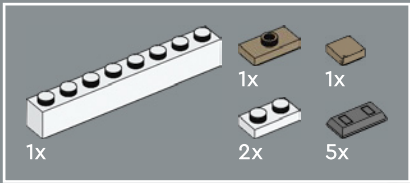

85

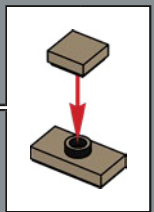
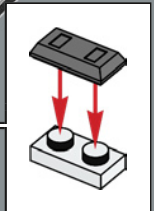
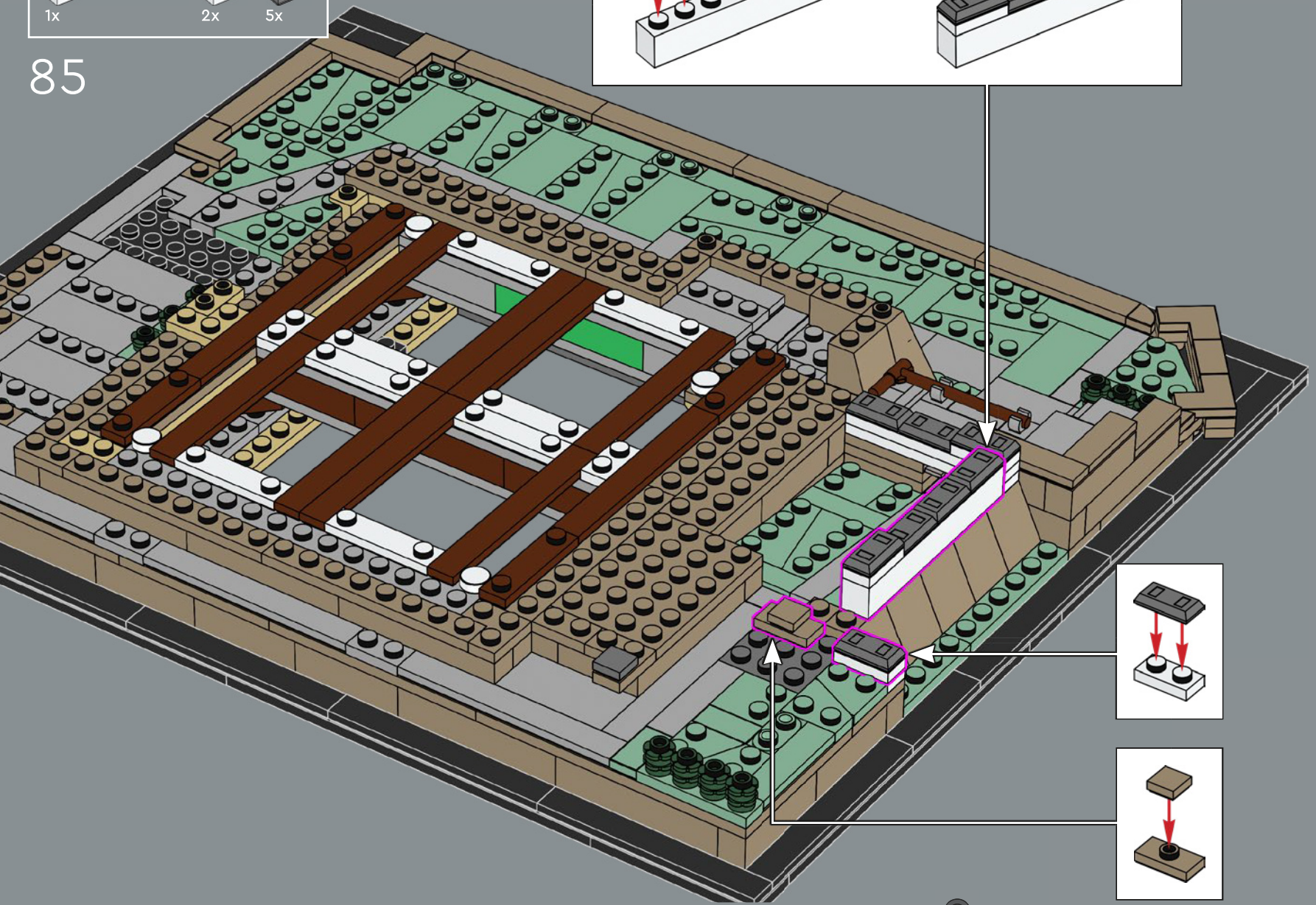
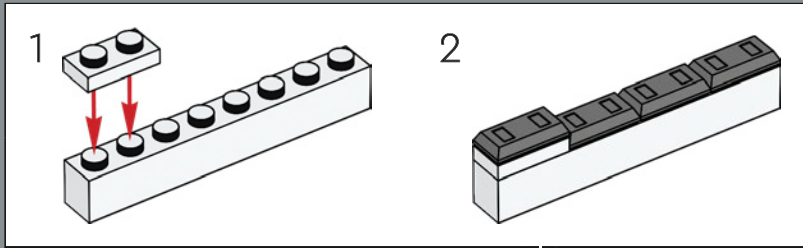

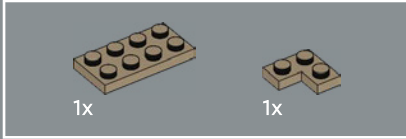
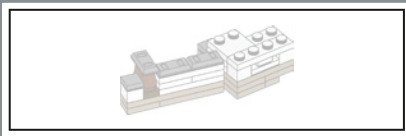

86

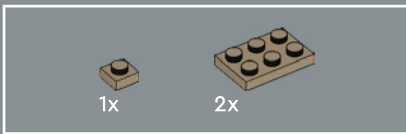
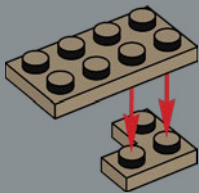

87

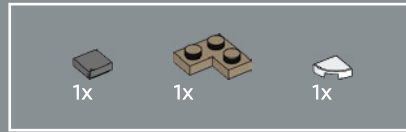
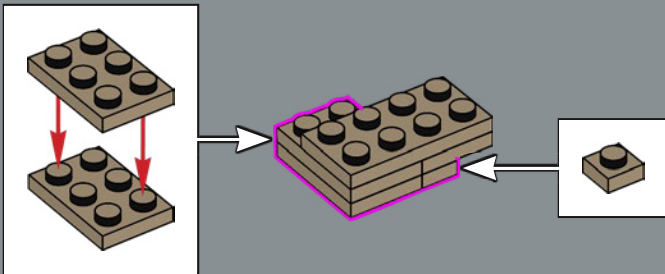

88

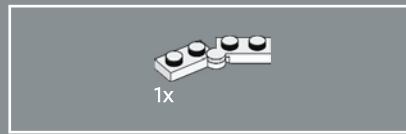
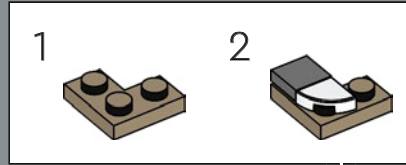

89

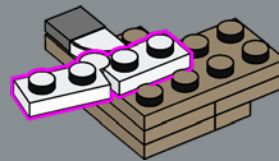

90

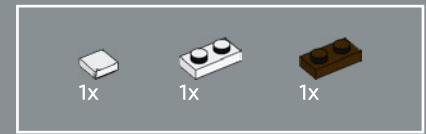
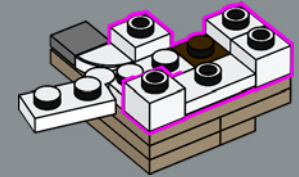

91

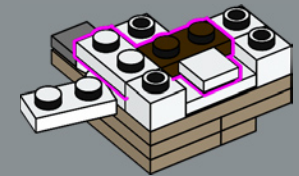

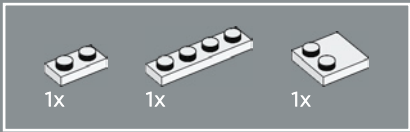

92

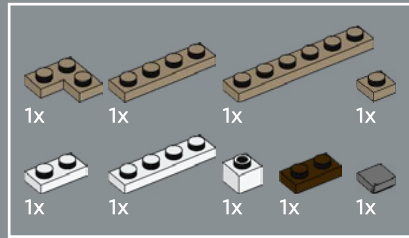
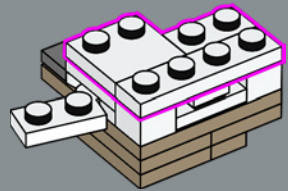

93

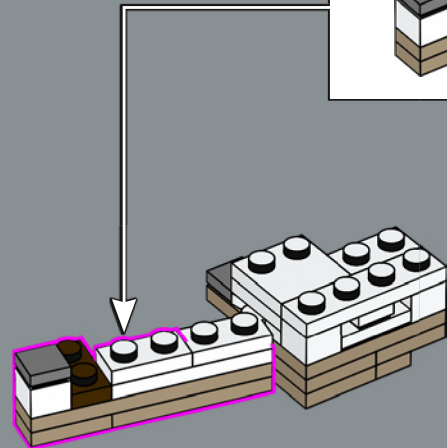
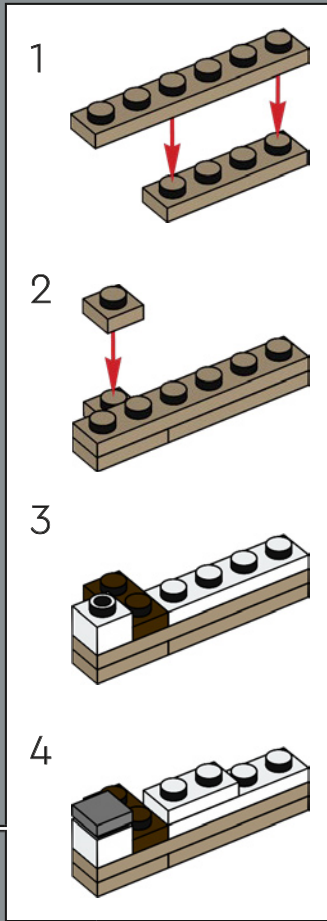

94

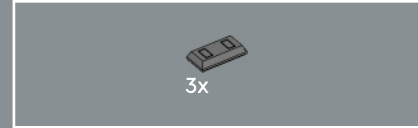
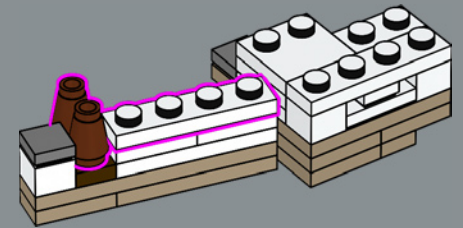

95

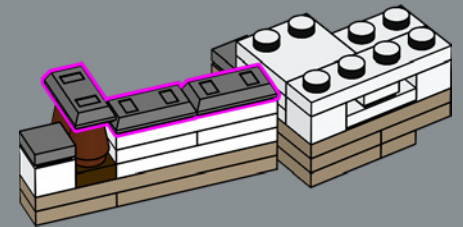

令城堡中建筑如此有趣的一个特征是：
许多墙壁、塔楼和路径以不规则的角度布置。

96

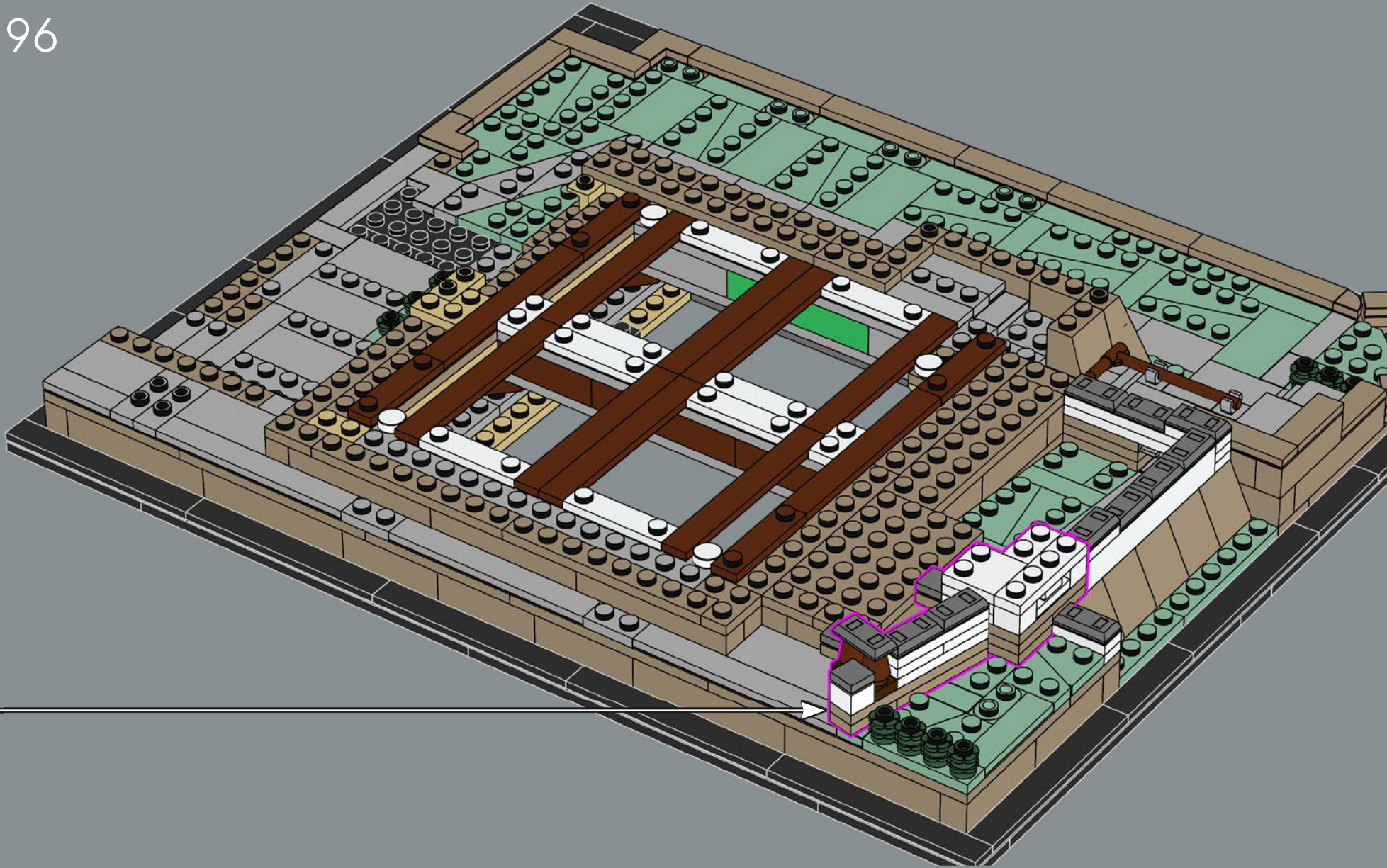

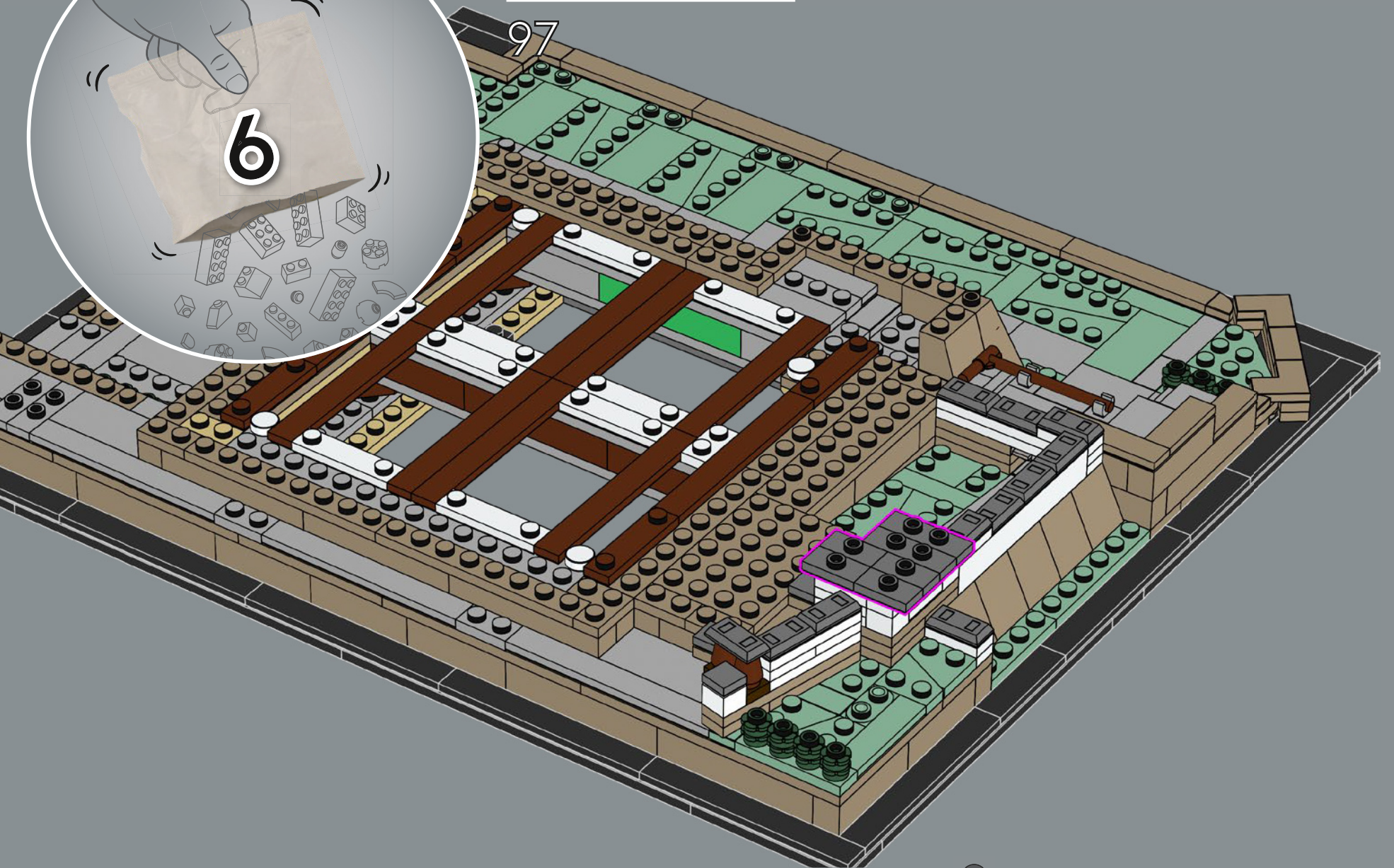
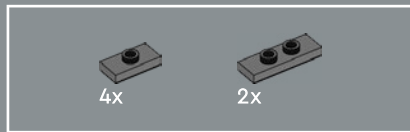

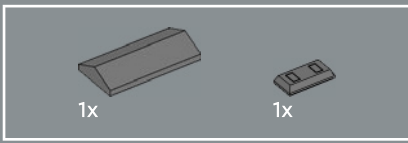

98

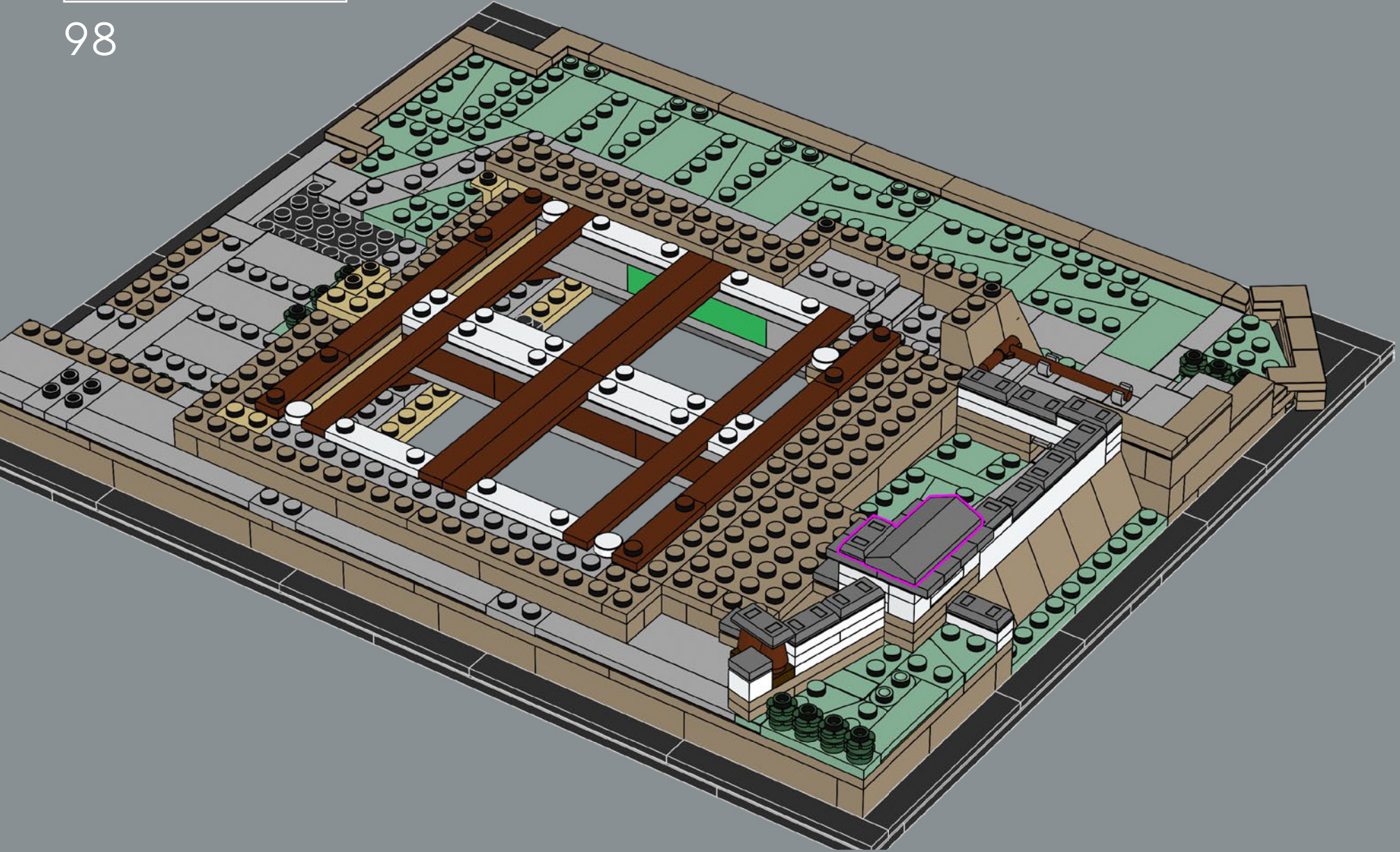

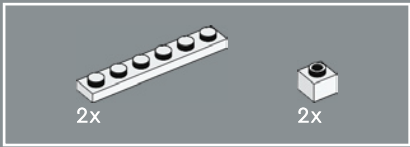

99

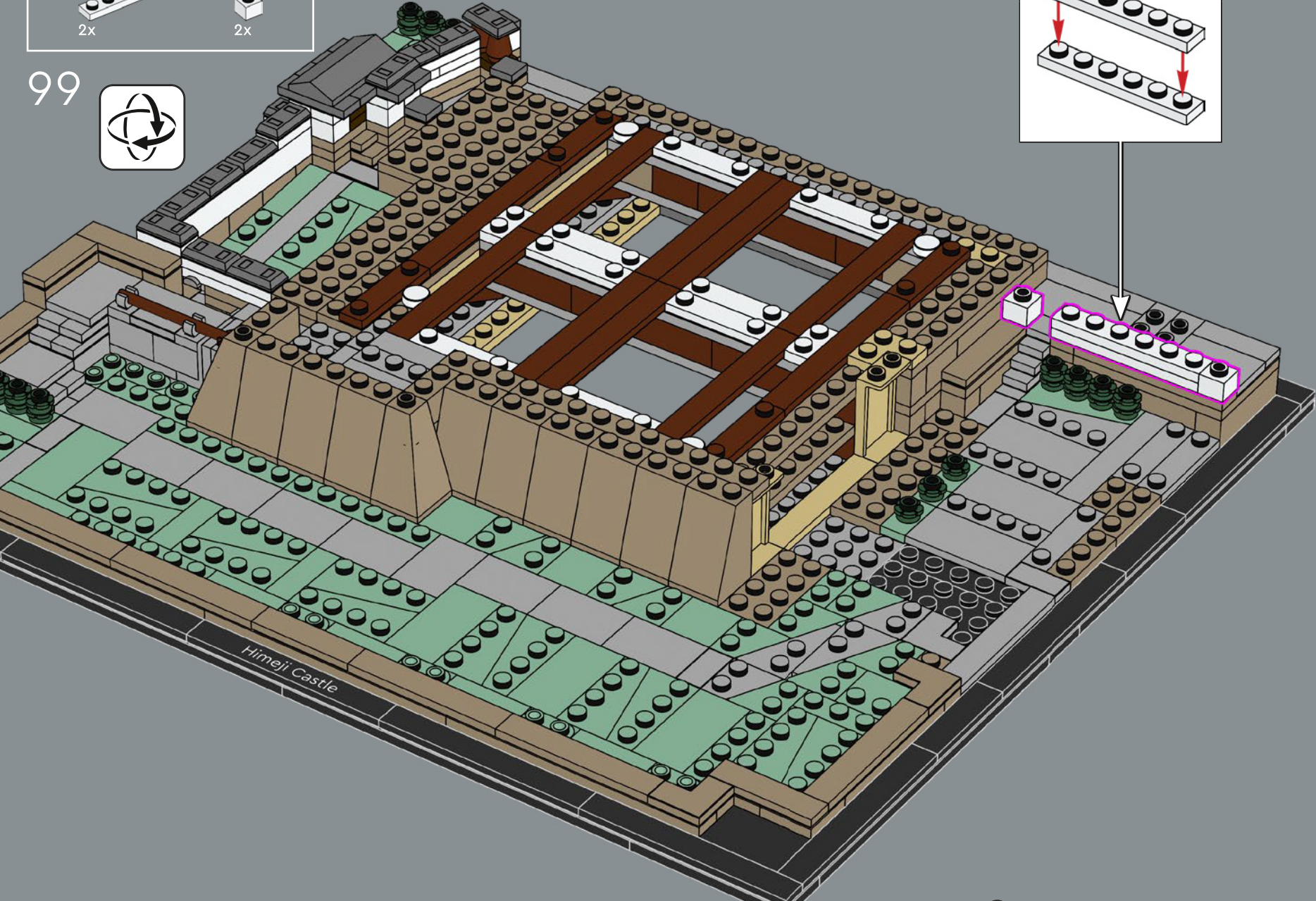
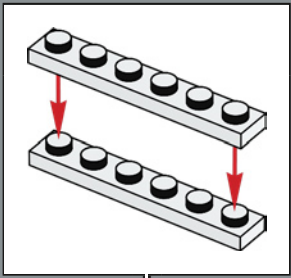

Himeji Castle



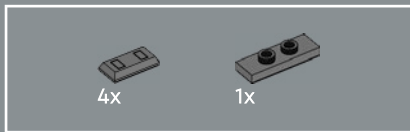

100

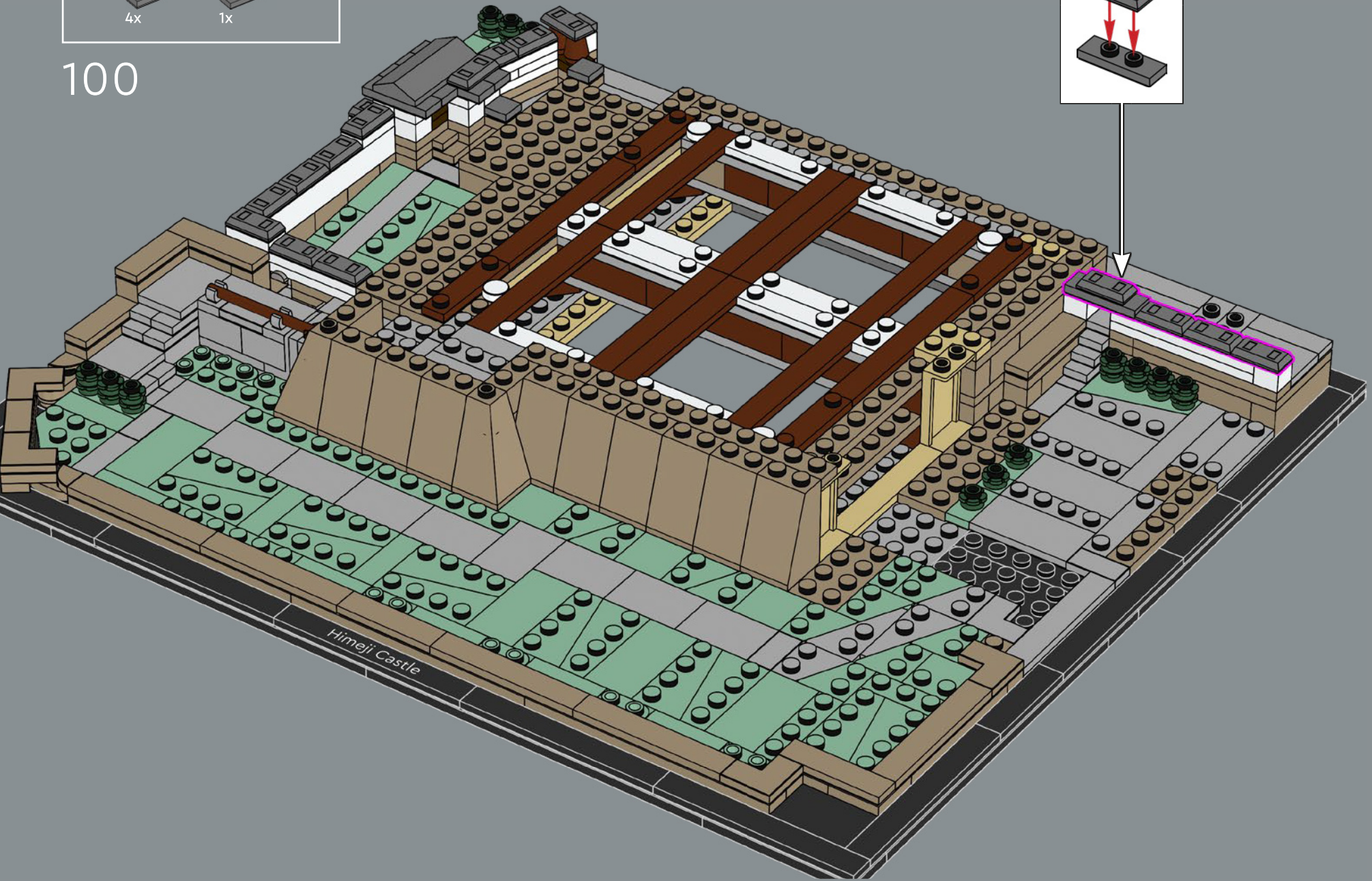
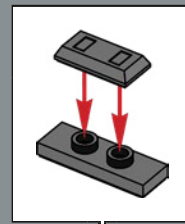

Himeji Castle

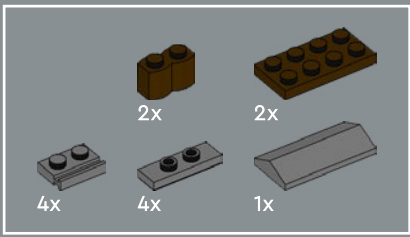

101

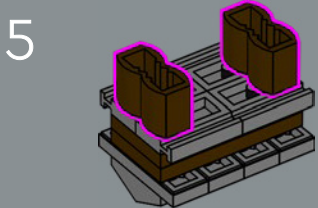
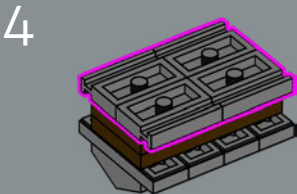
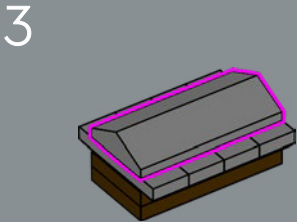
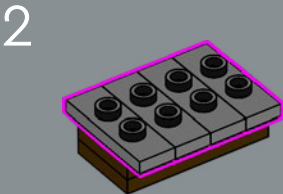
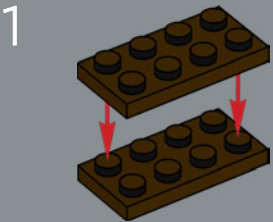

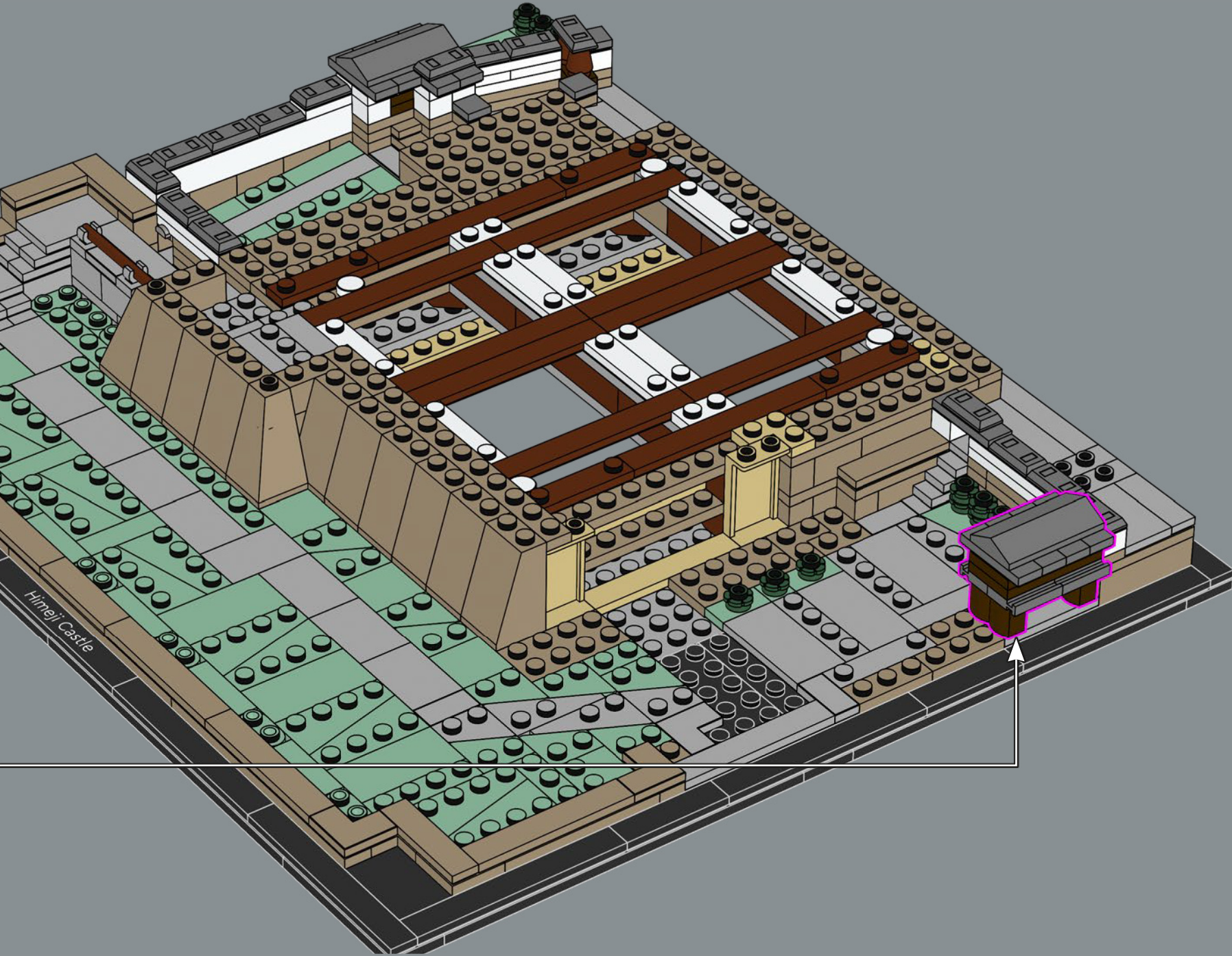

Himeji Castle

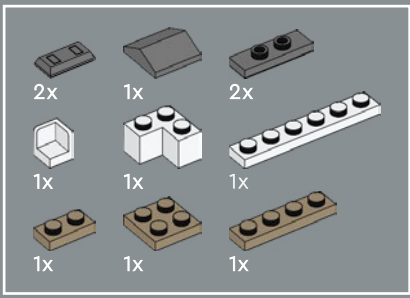

102

1

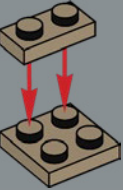

2

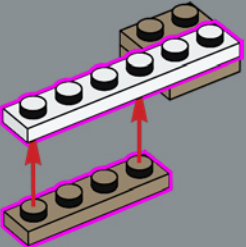

3

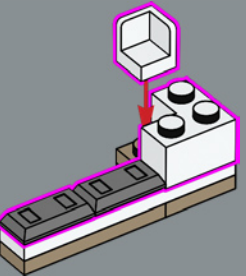

4

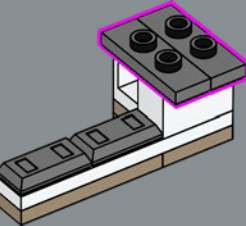

5

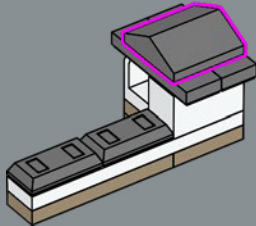

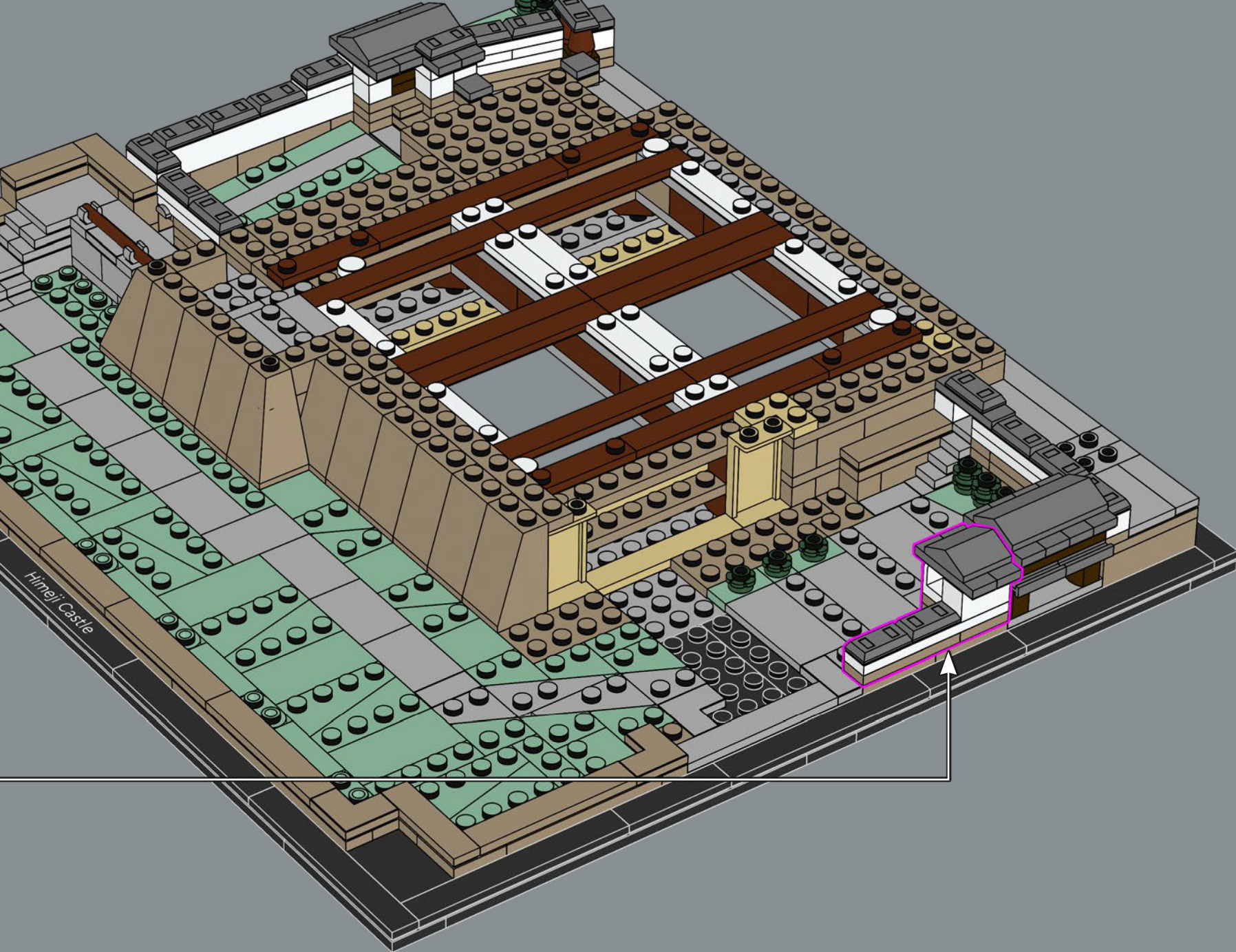

		
1x	2x	1x

103

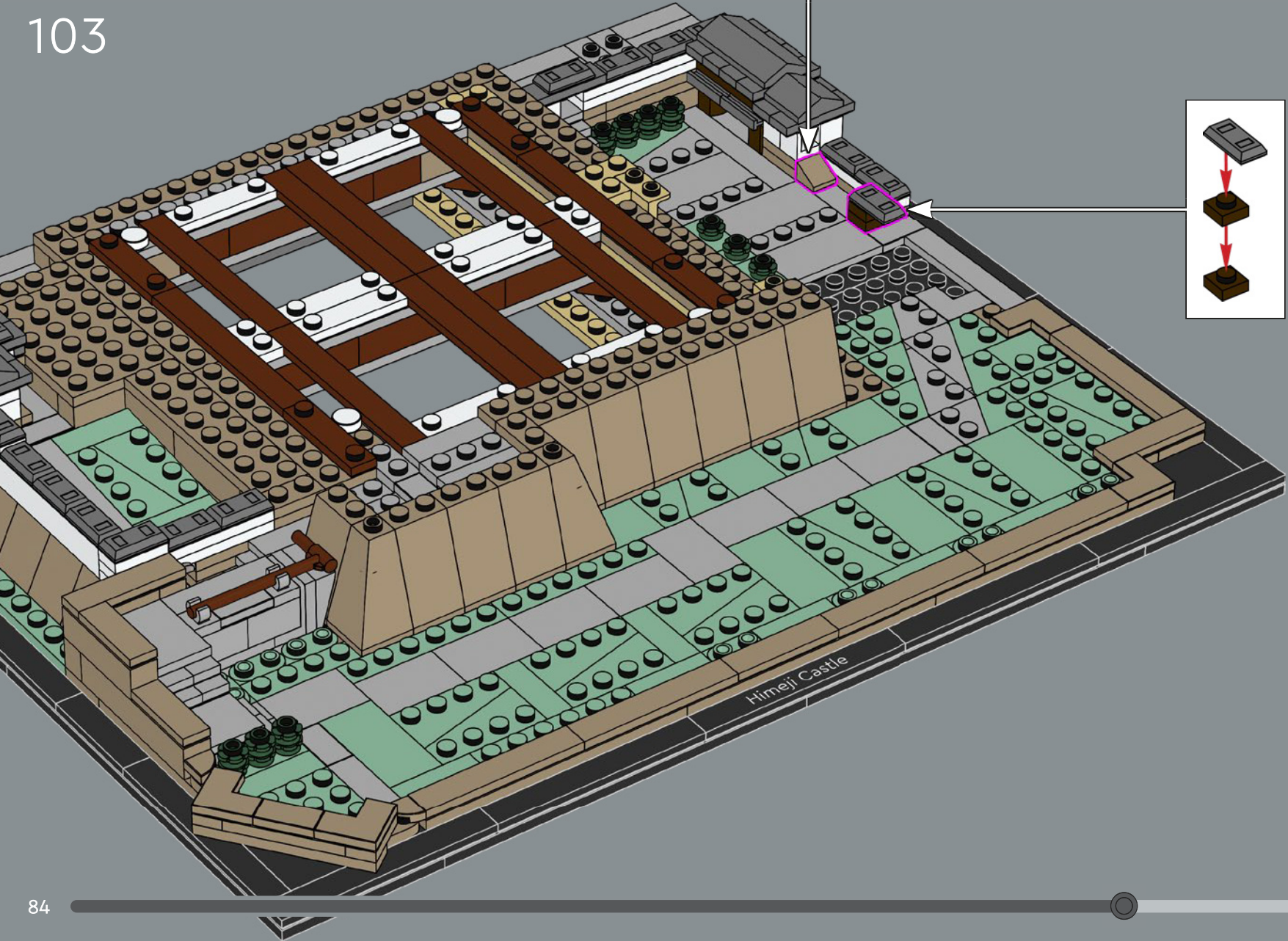
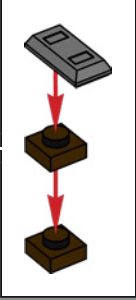

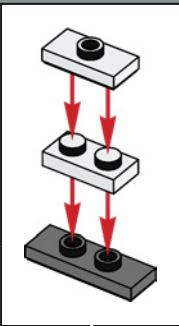
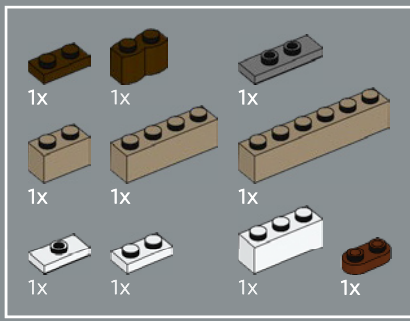

104

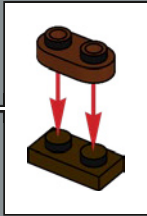
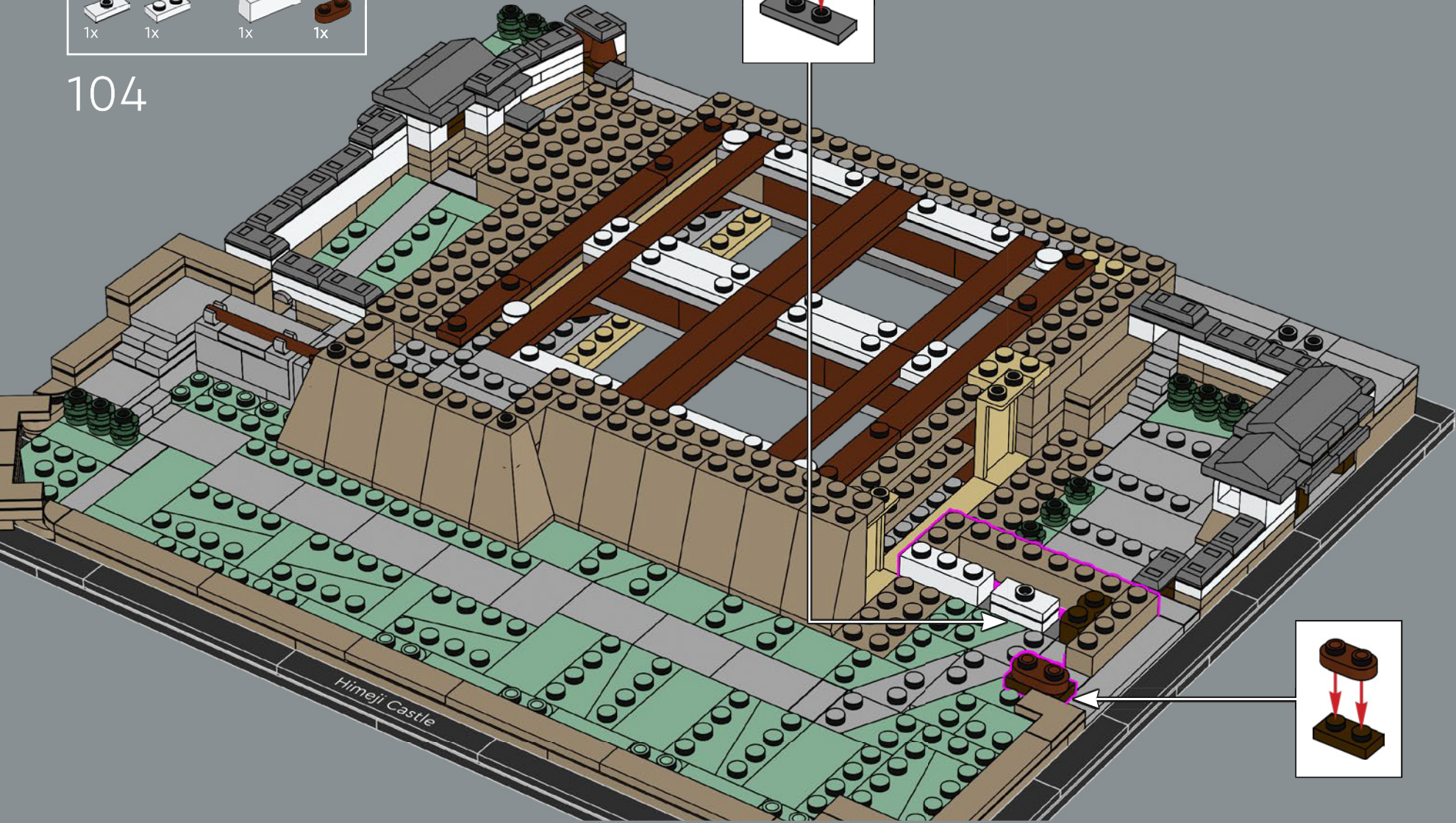

Himeji Castle

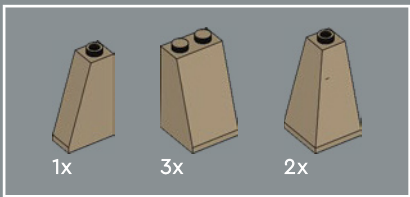

105

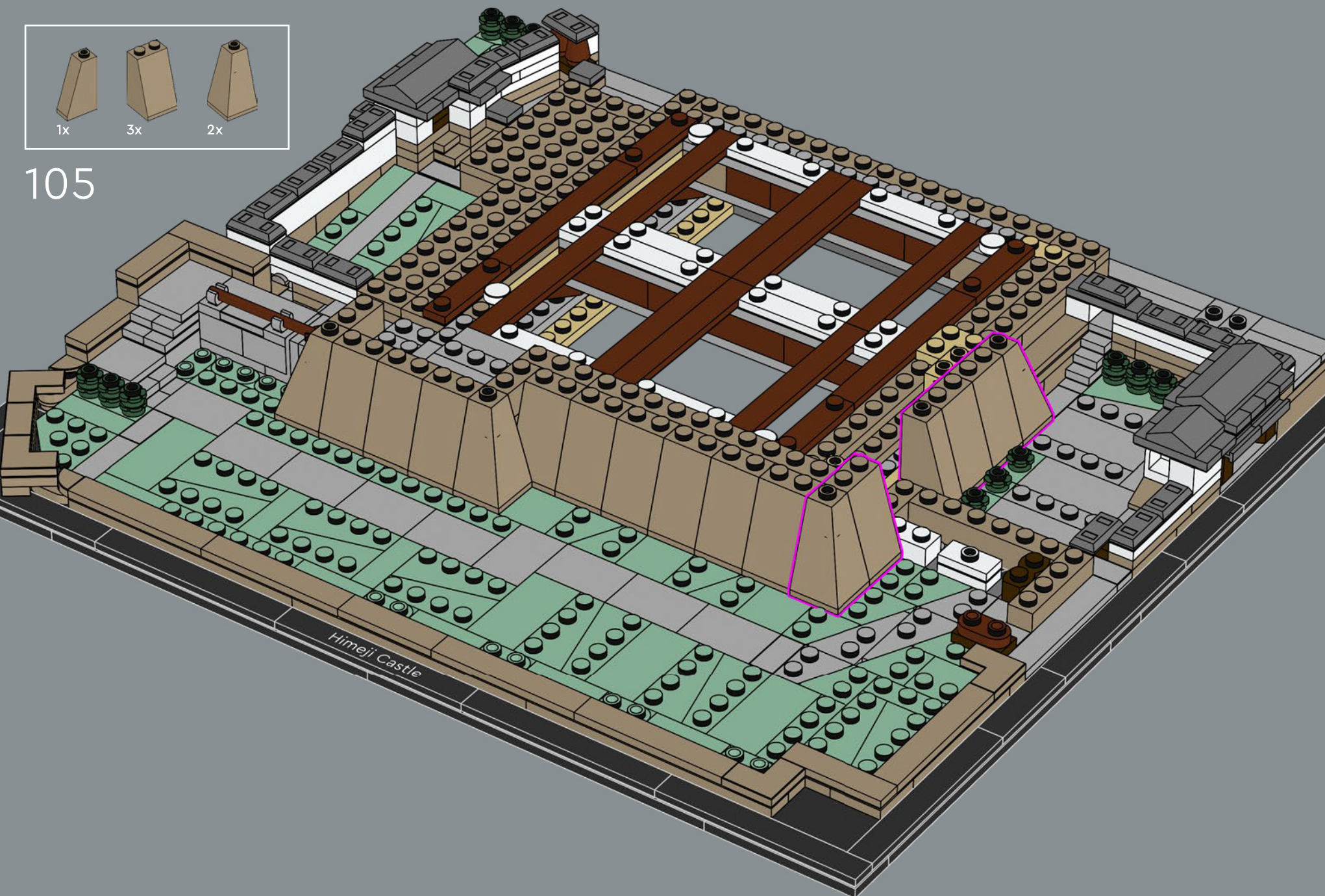

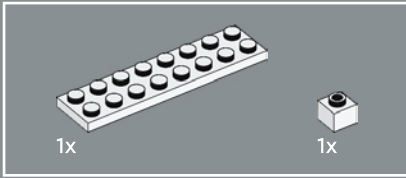
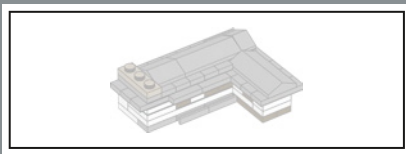

106

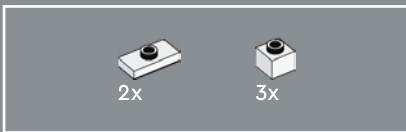
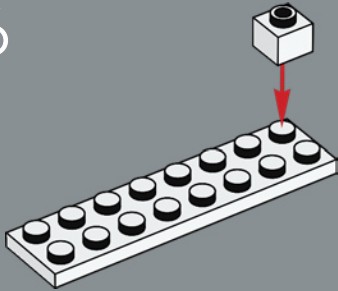

107

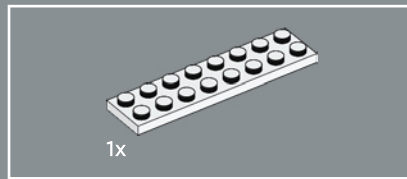
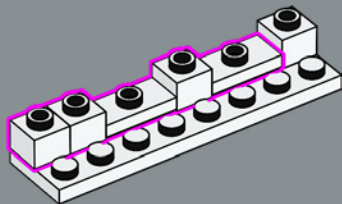

108

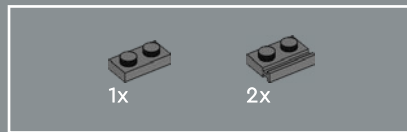
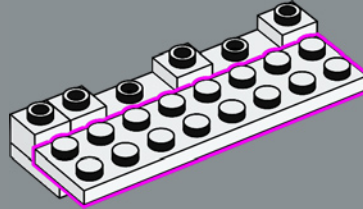

109

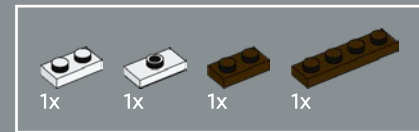
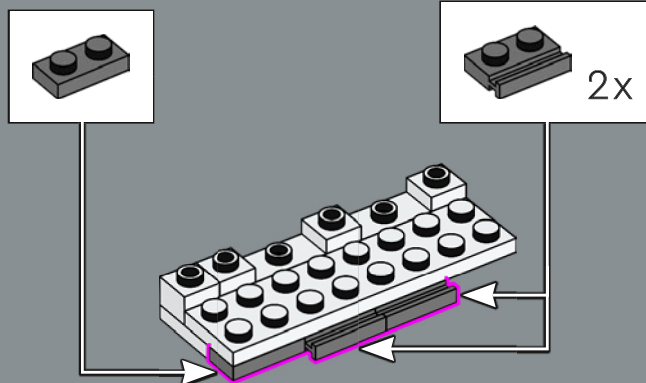

110

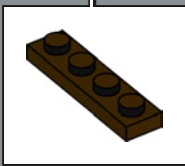
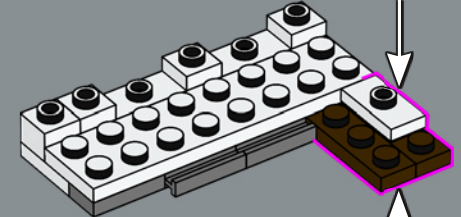
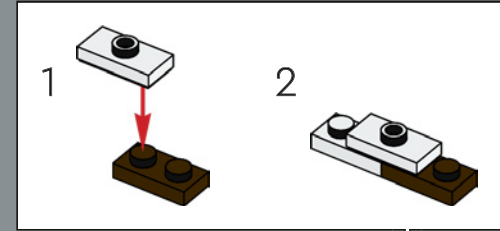

111

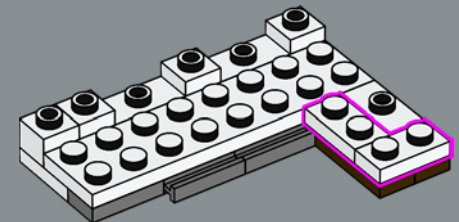

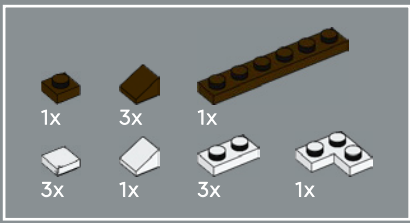

112

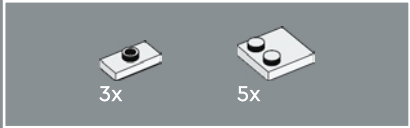
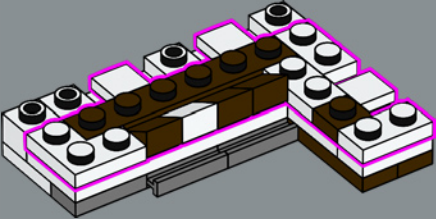

113

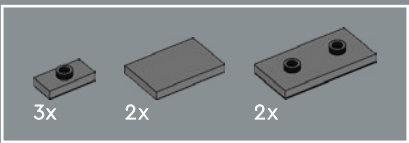
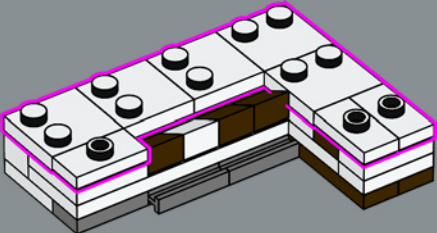

114

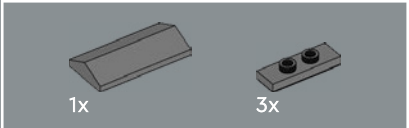
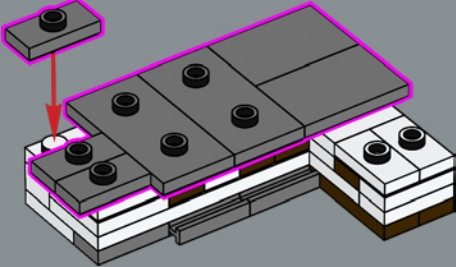

115

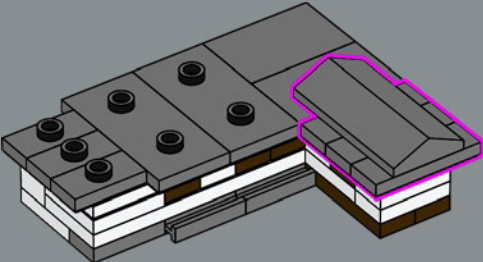
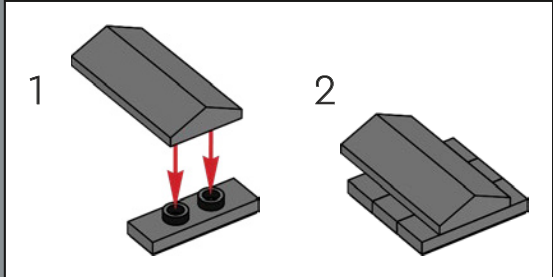

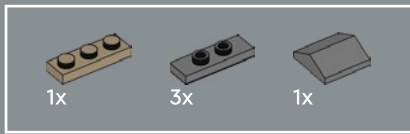

116

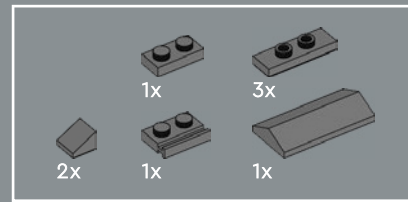
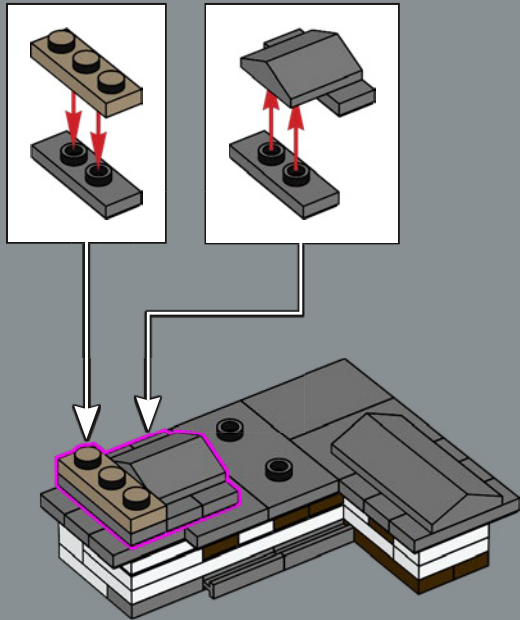

117

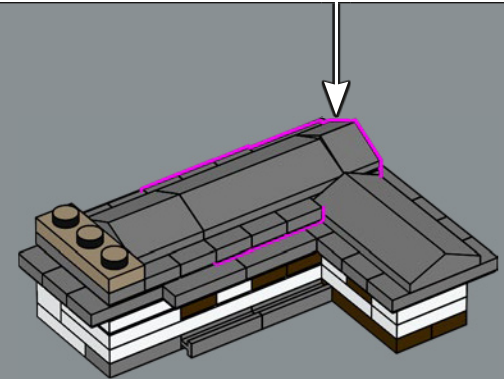
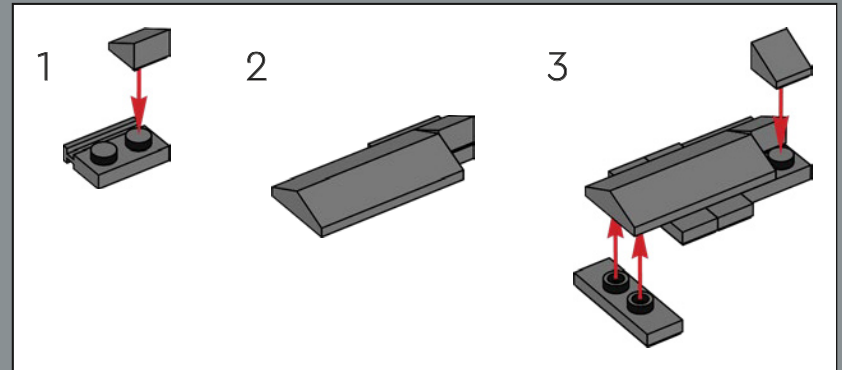

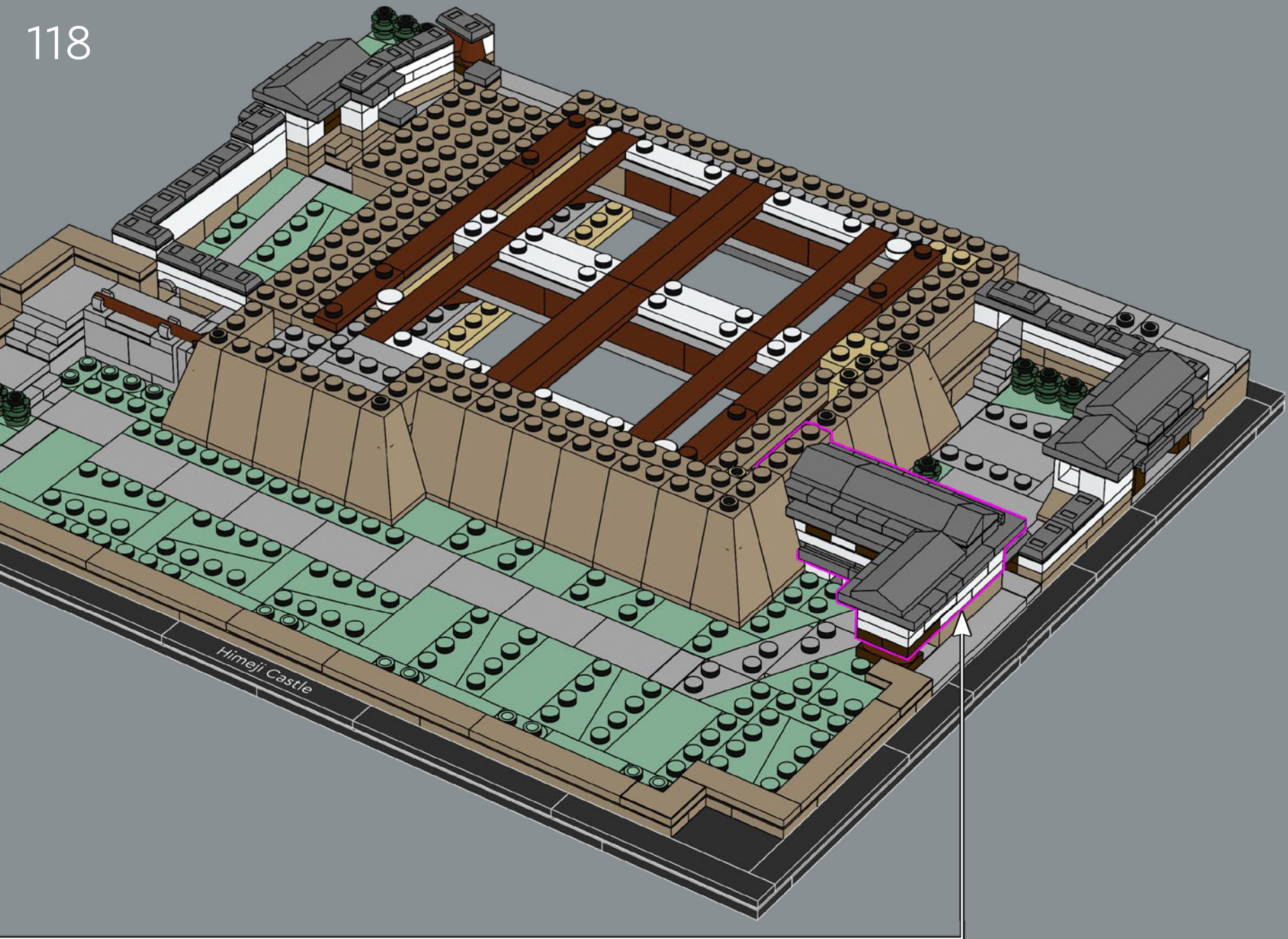

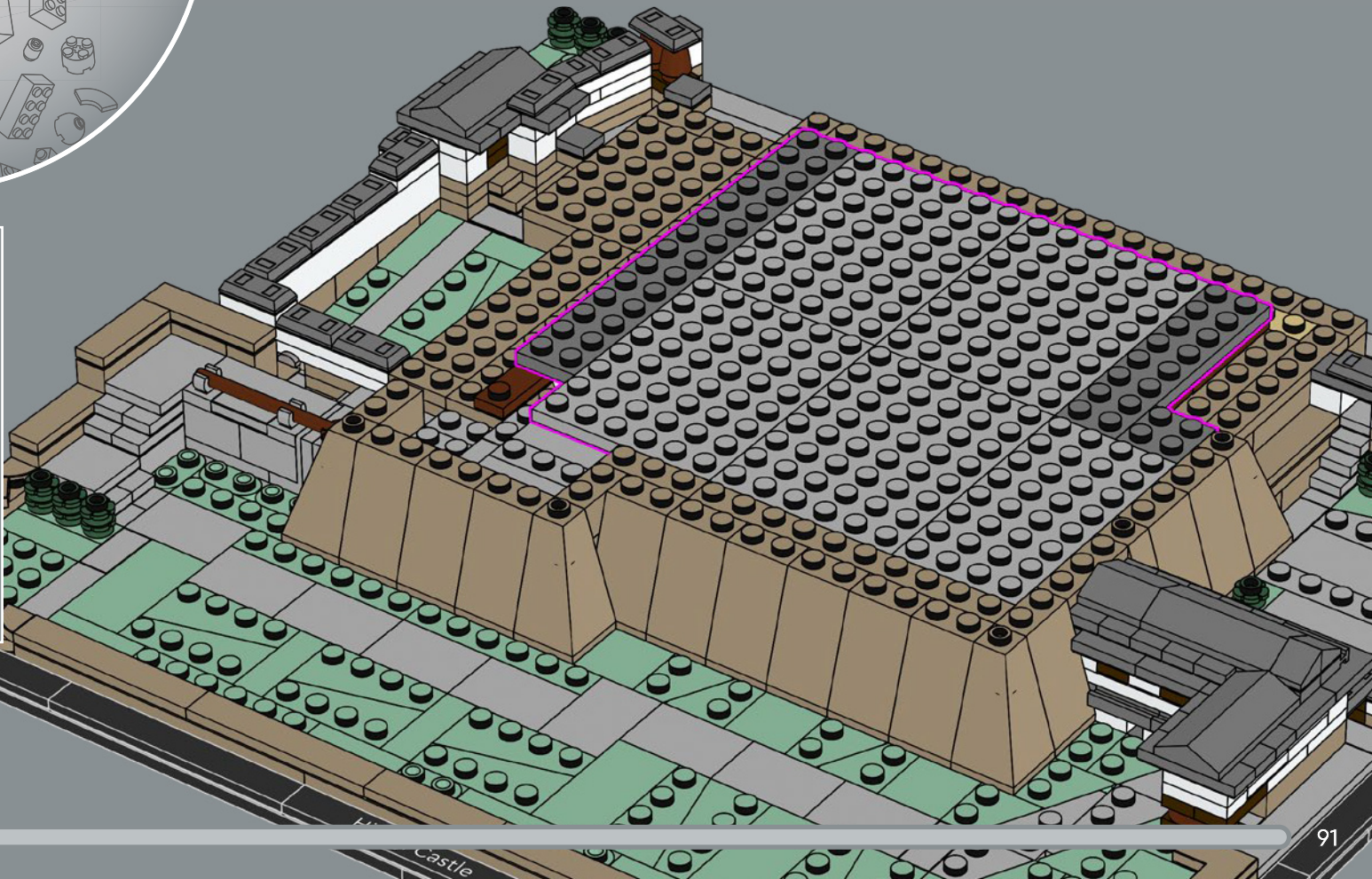
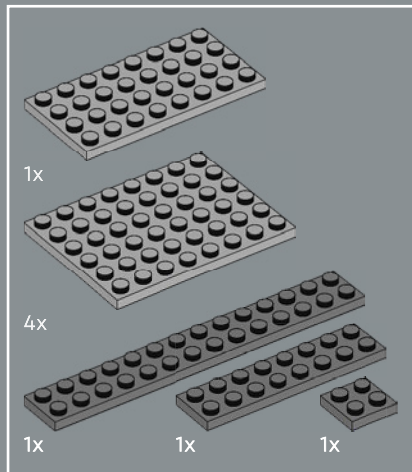

119

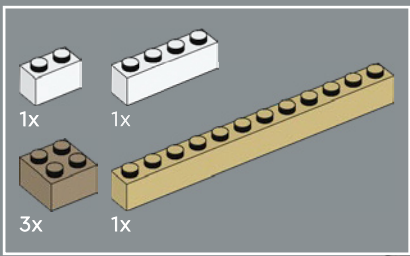

120

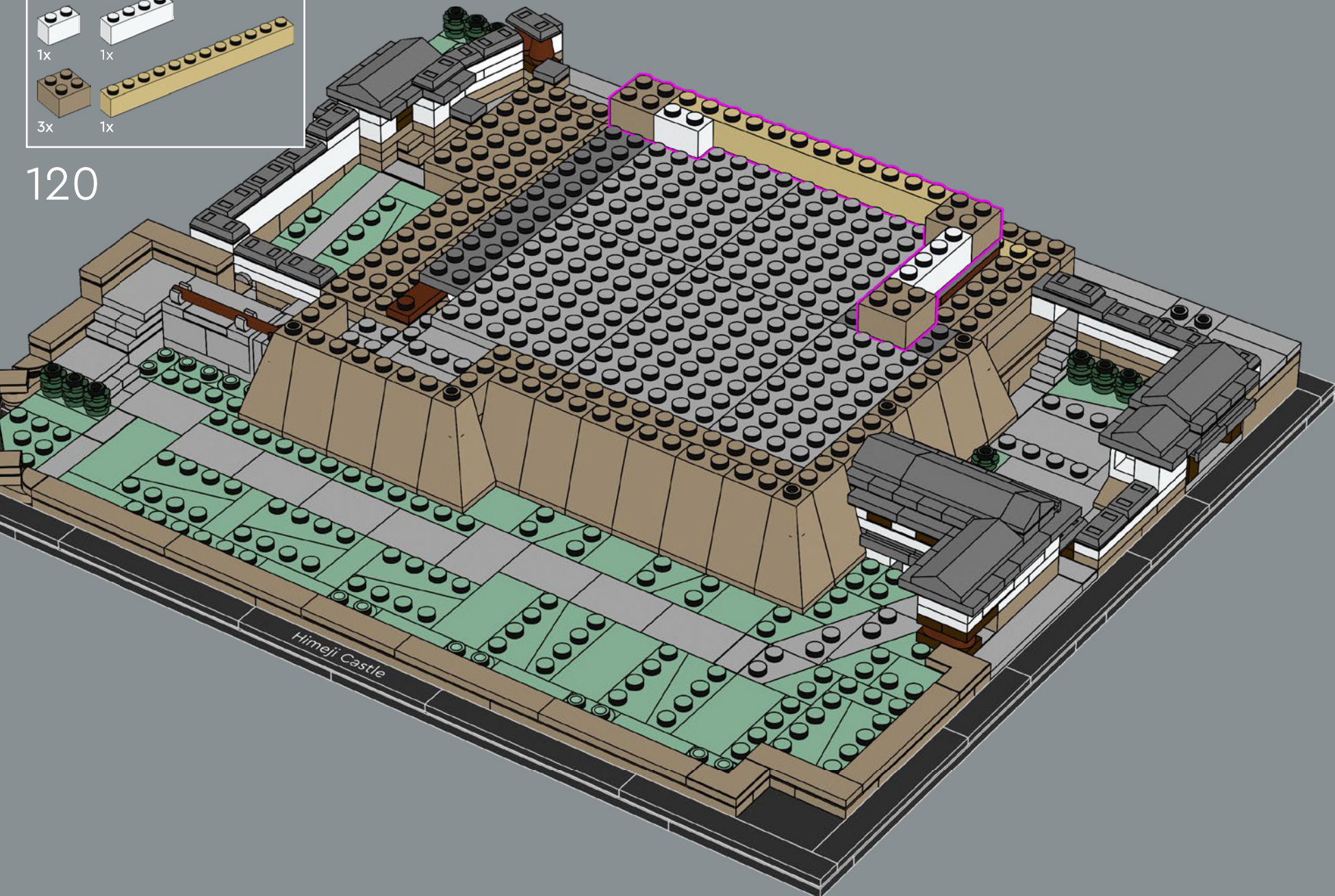

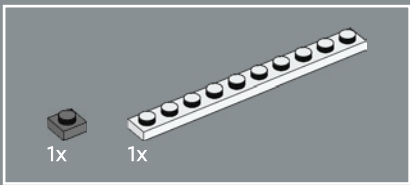

122

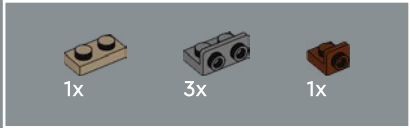
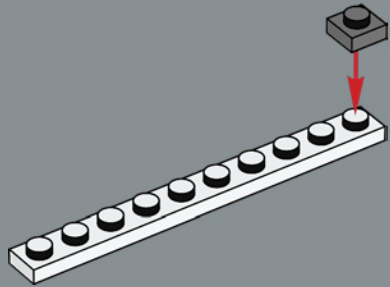

123

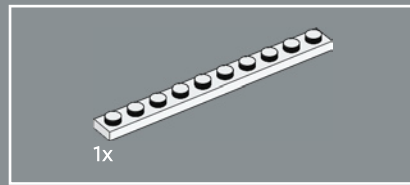
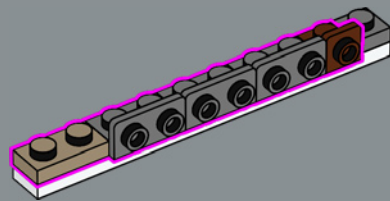

124

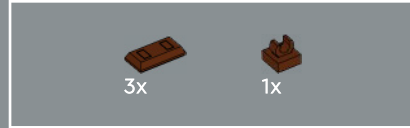
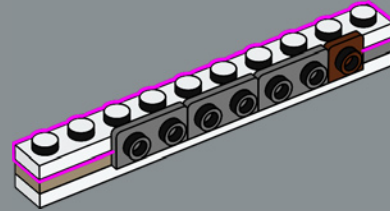

125

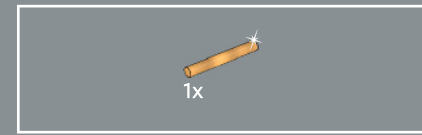
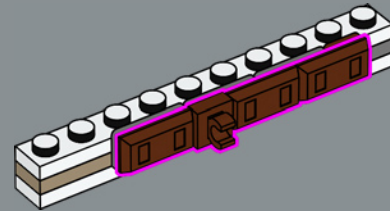

126

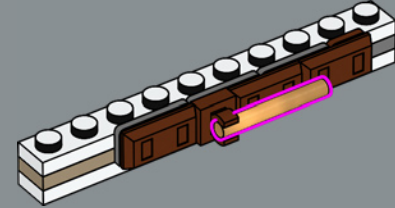

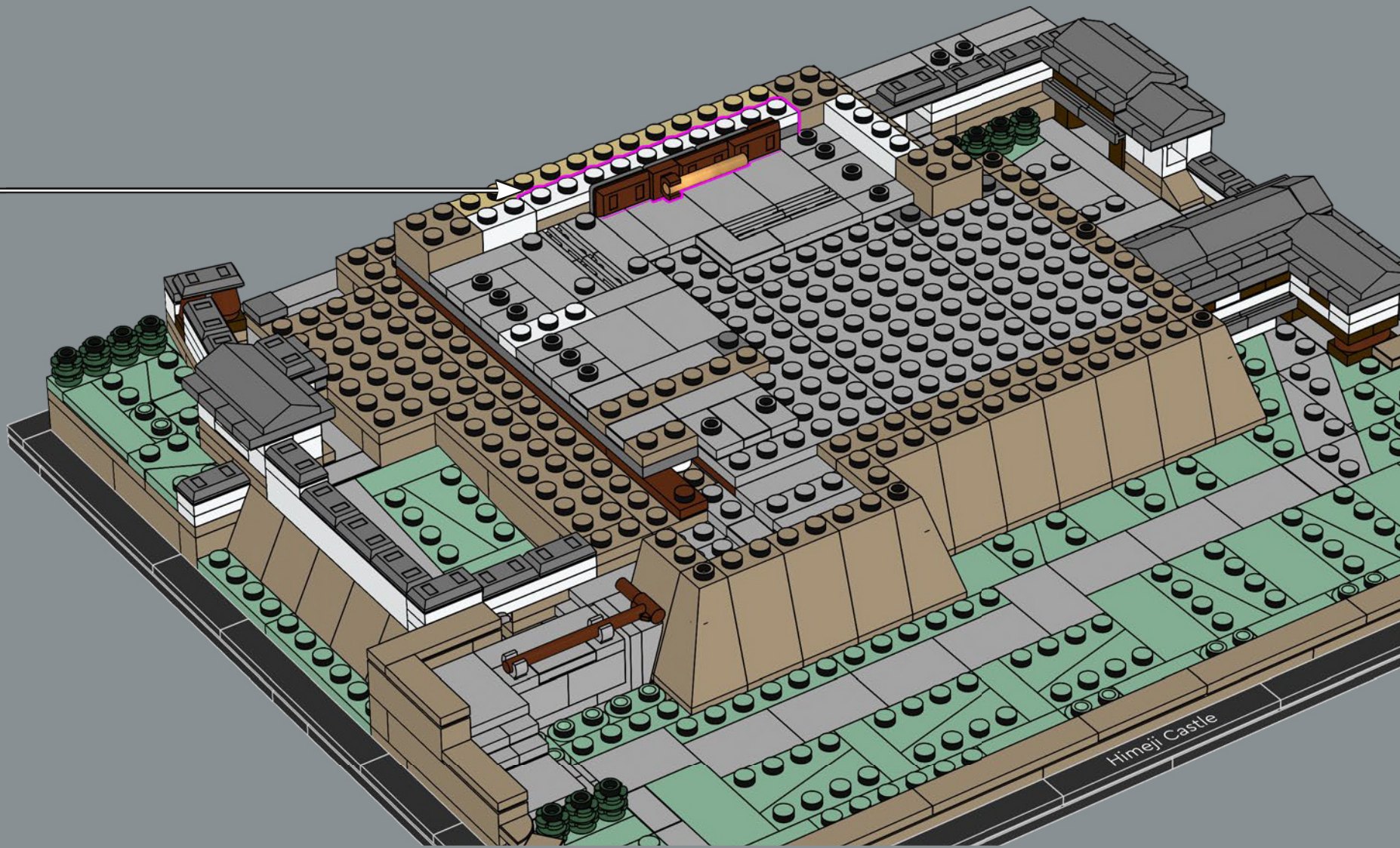

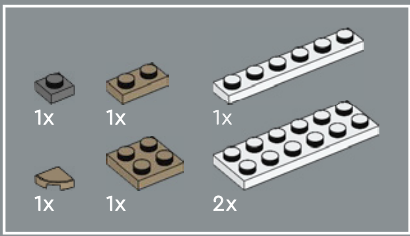

128

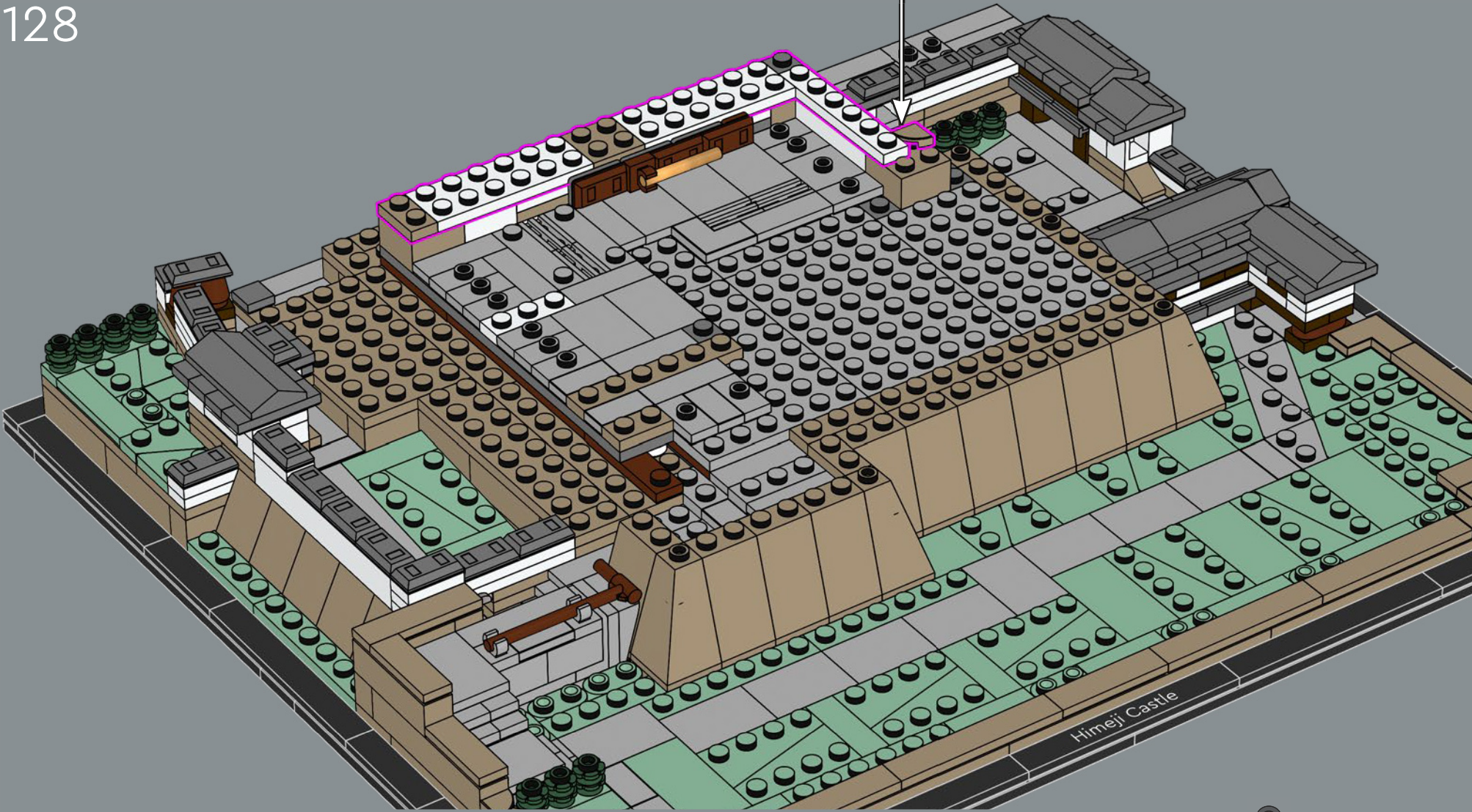

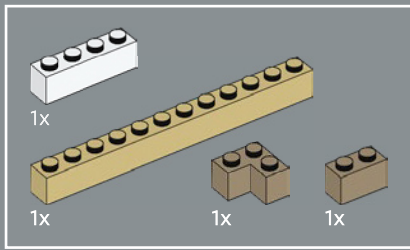

129

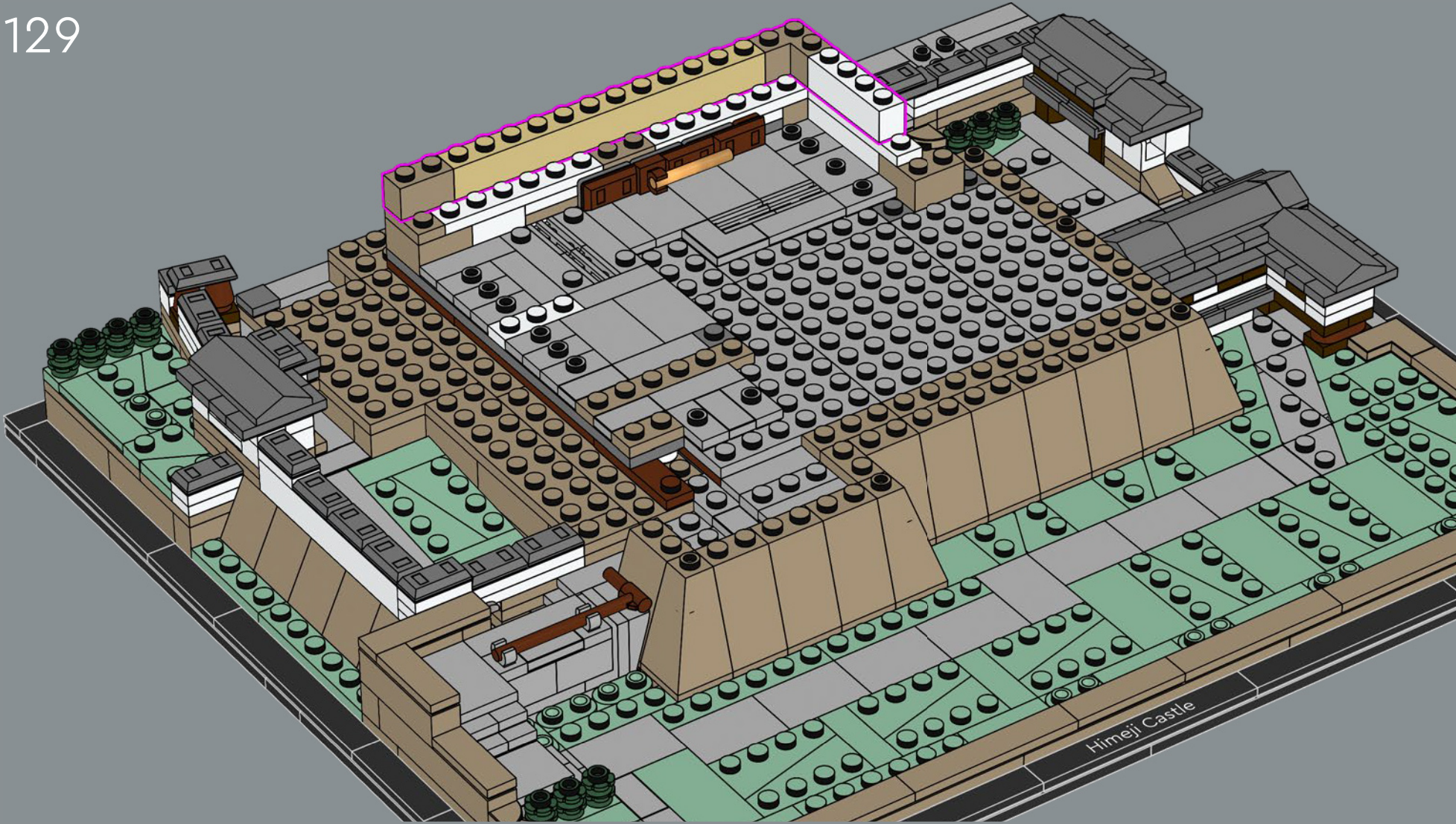

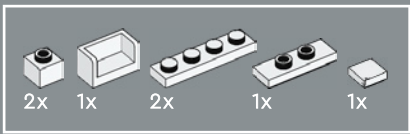

130

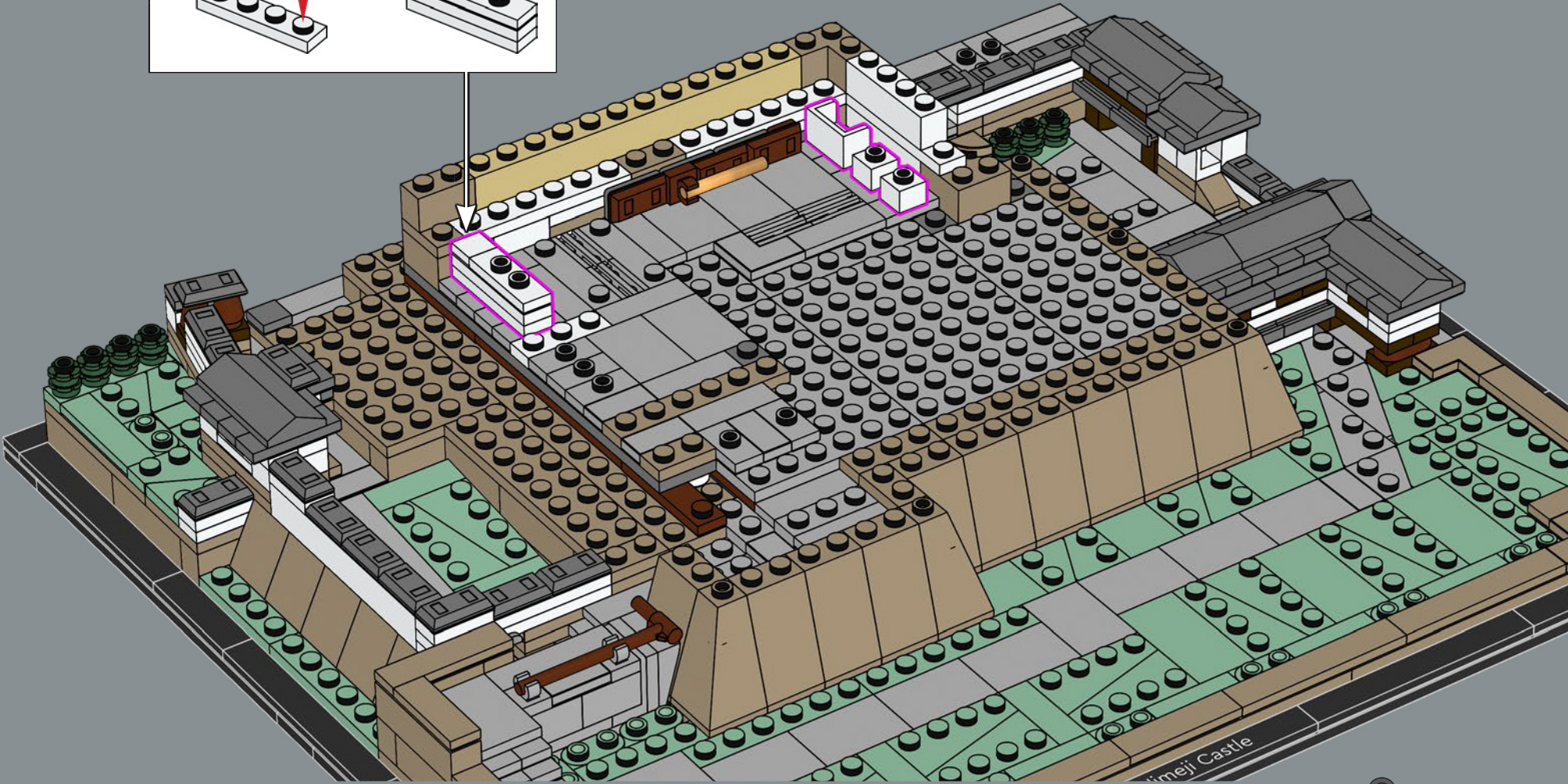
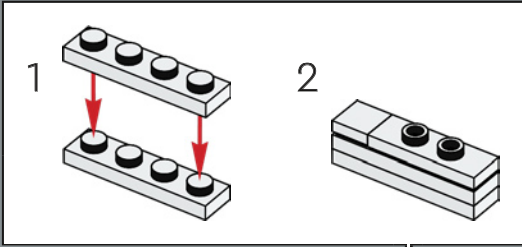

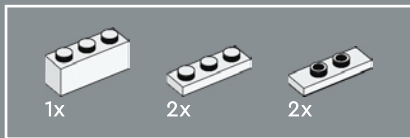

131

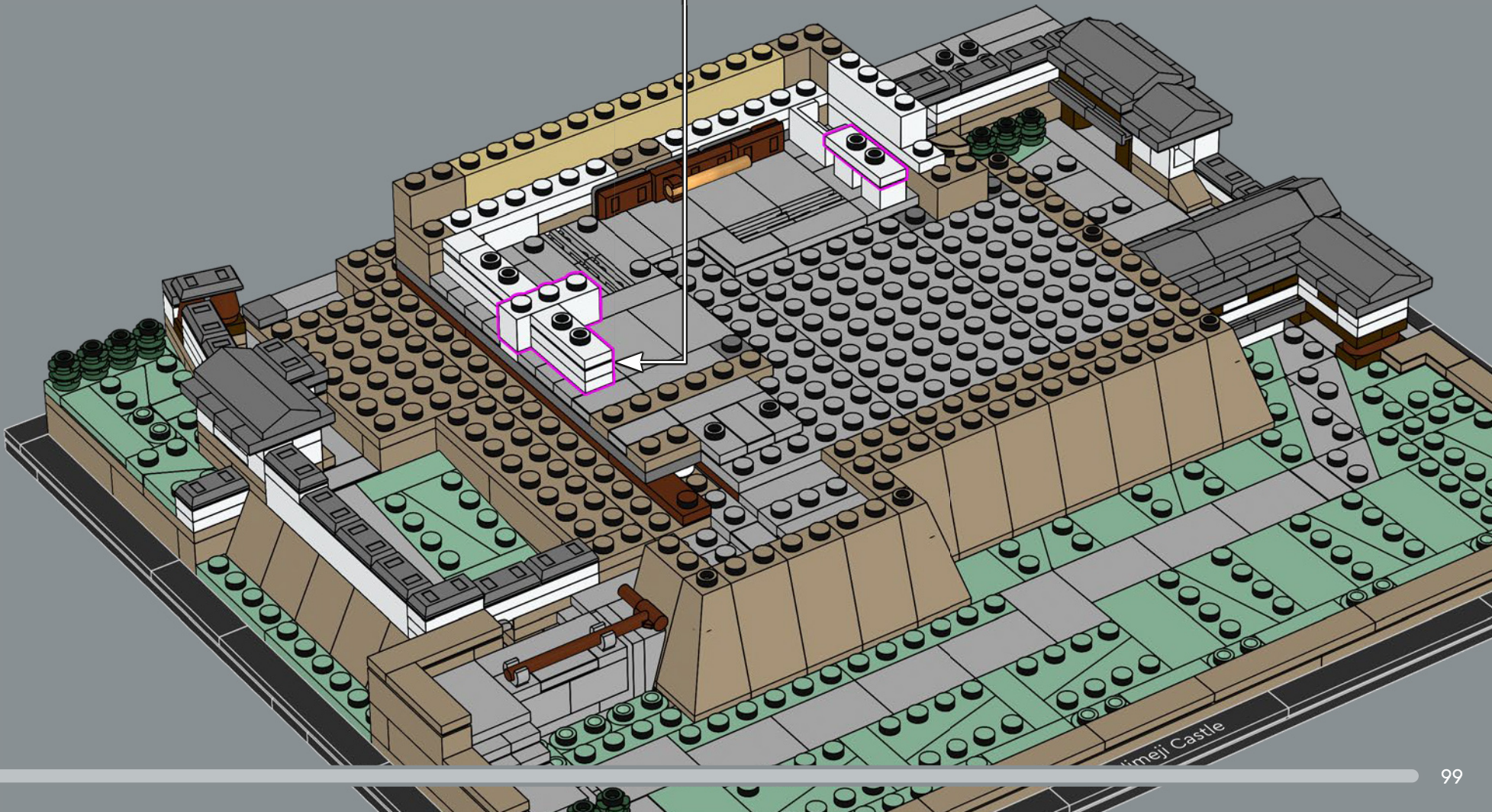
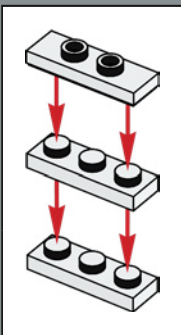

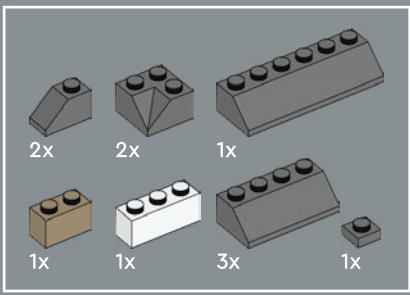

132

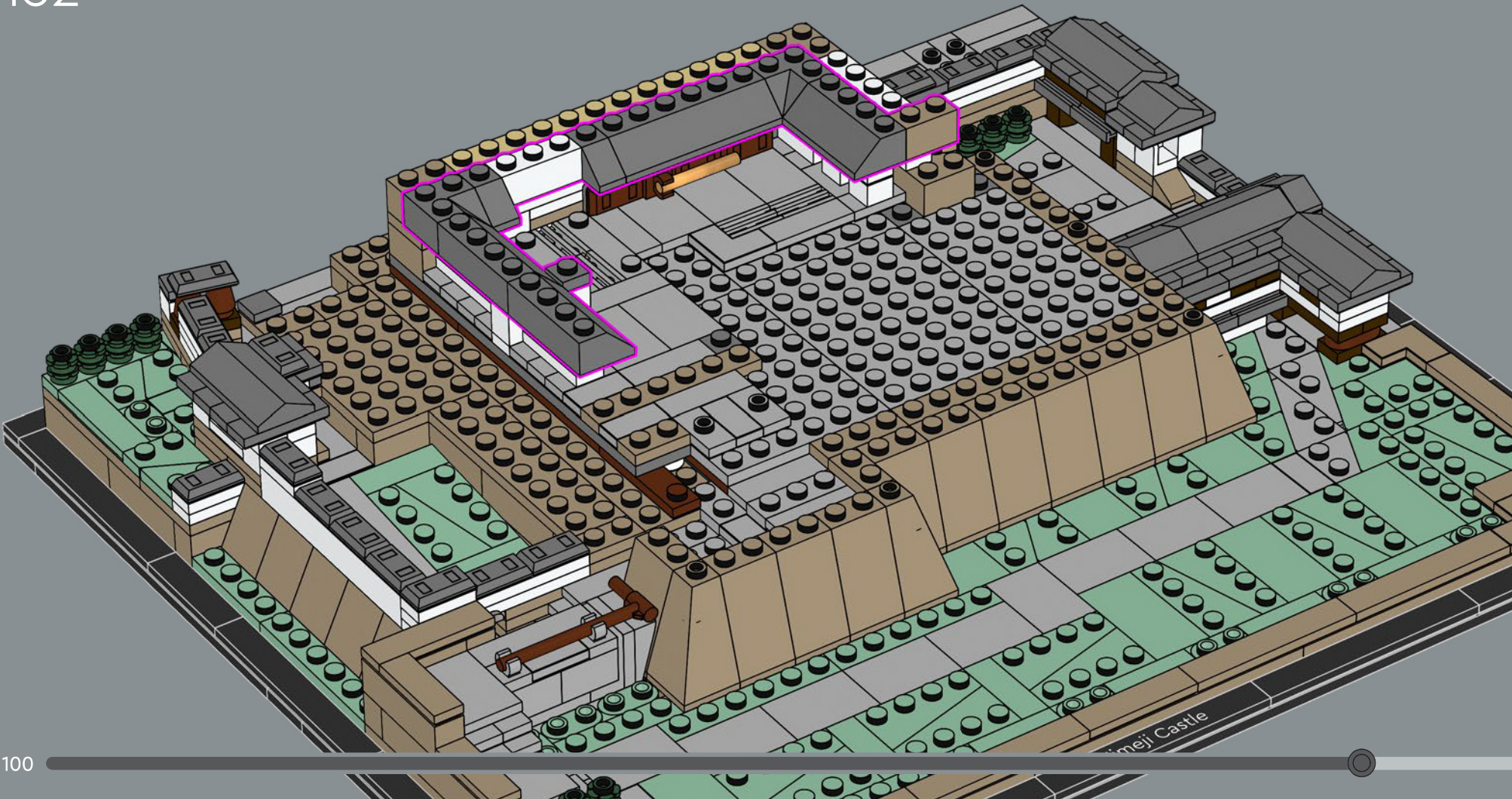

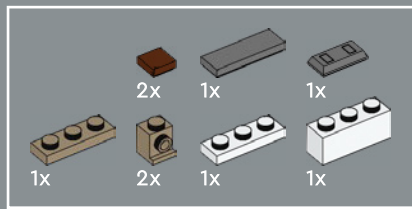

133

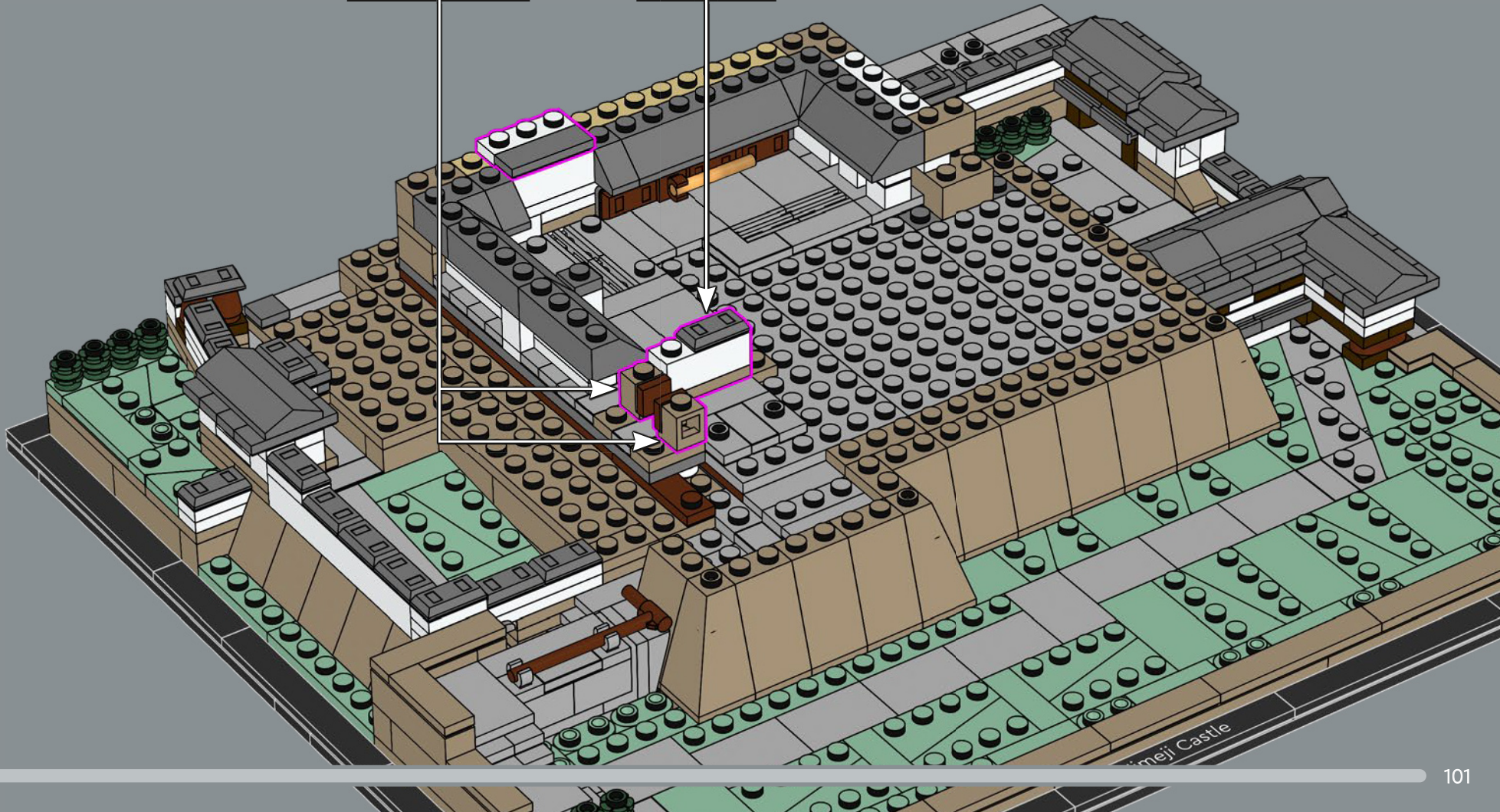
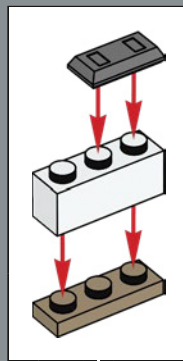
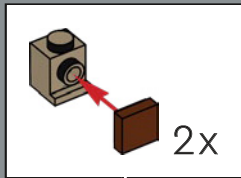

Meiji Castle

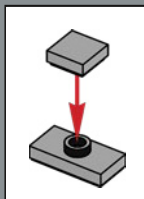
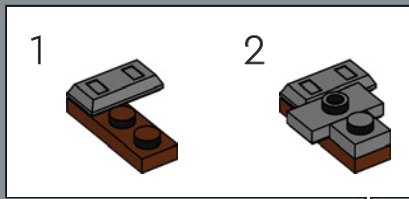
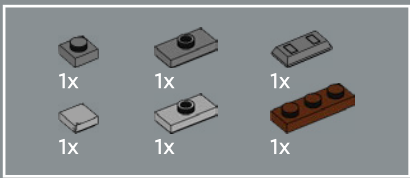

134

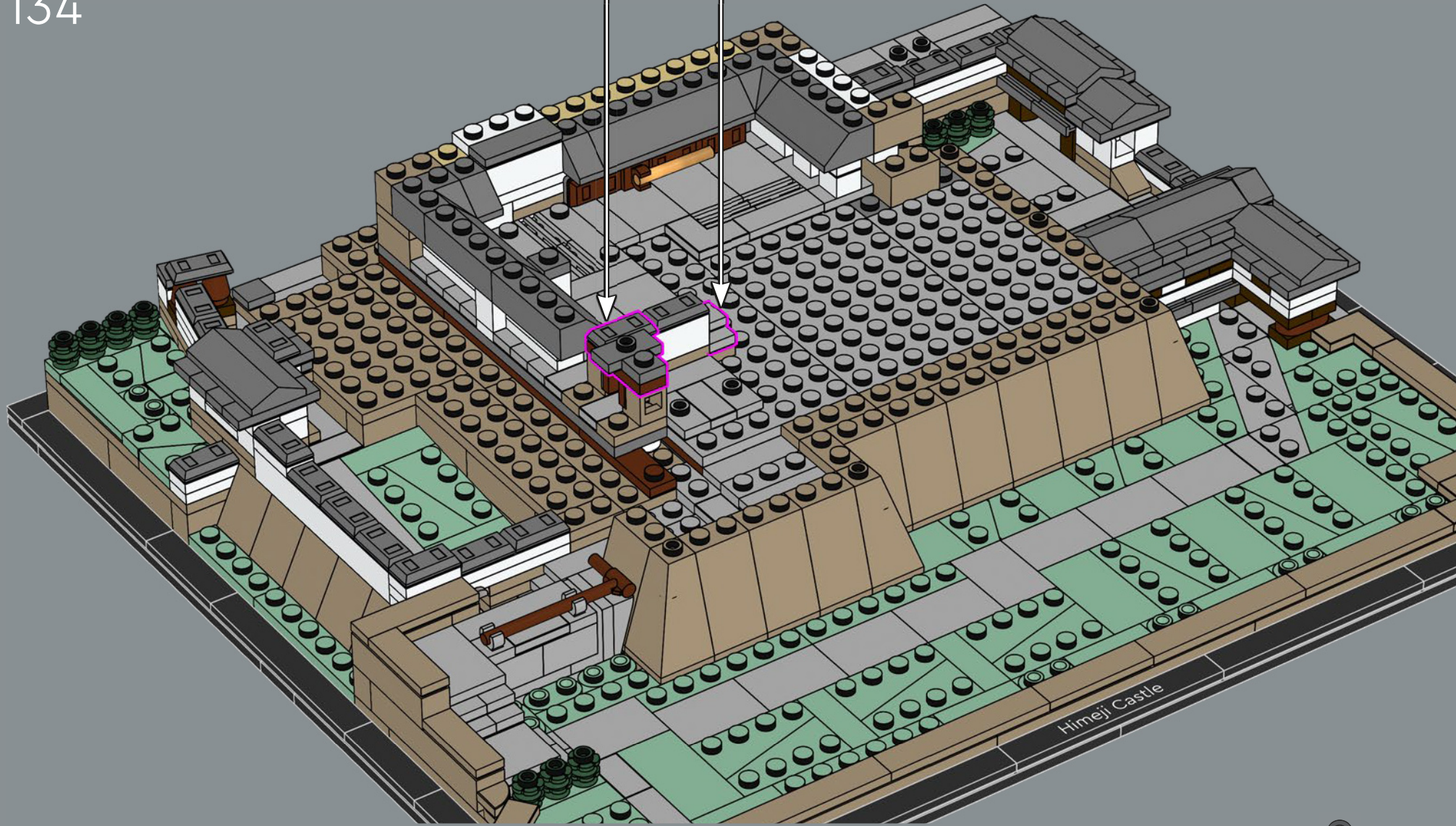

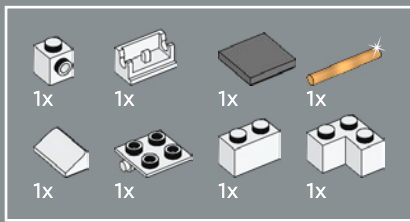

135

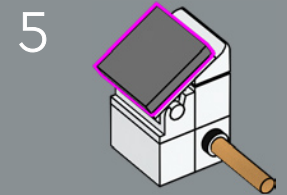
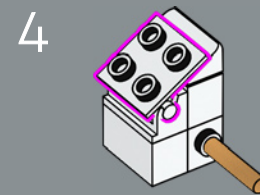
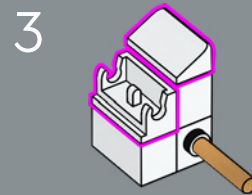
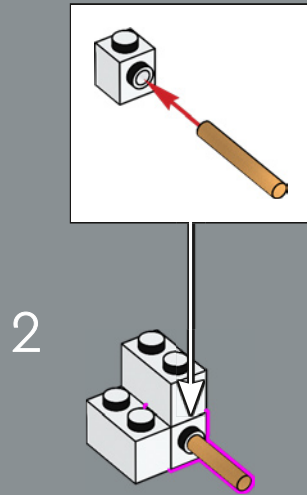
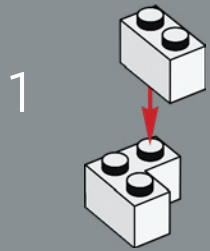

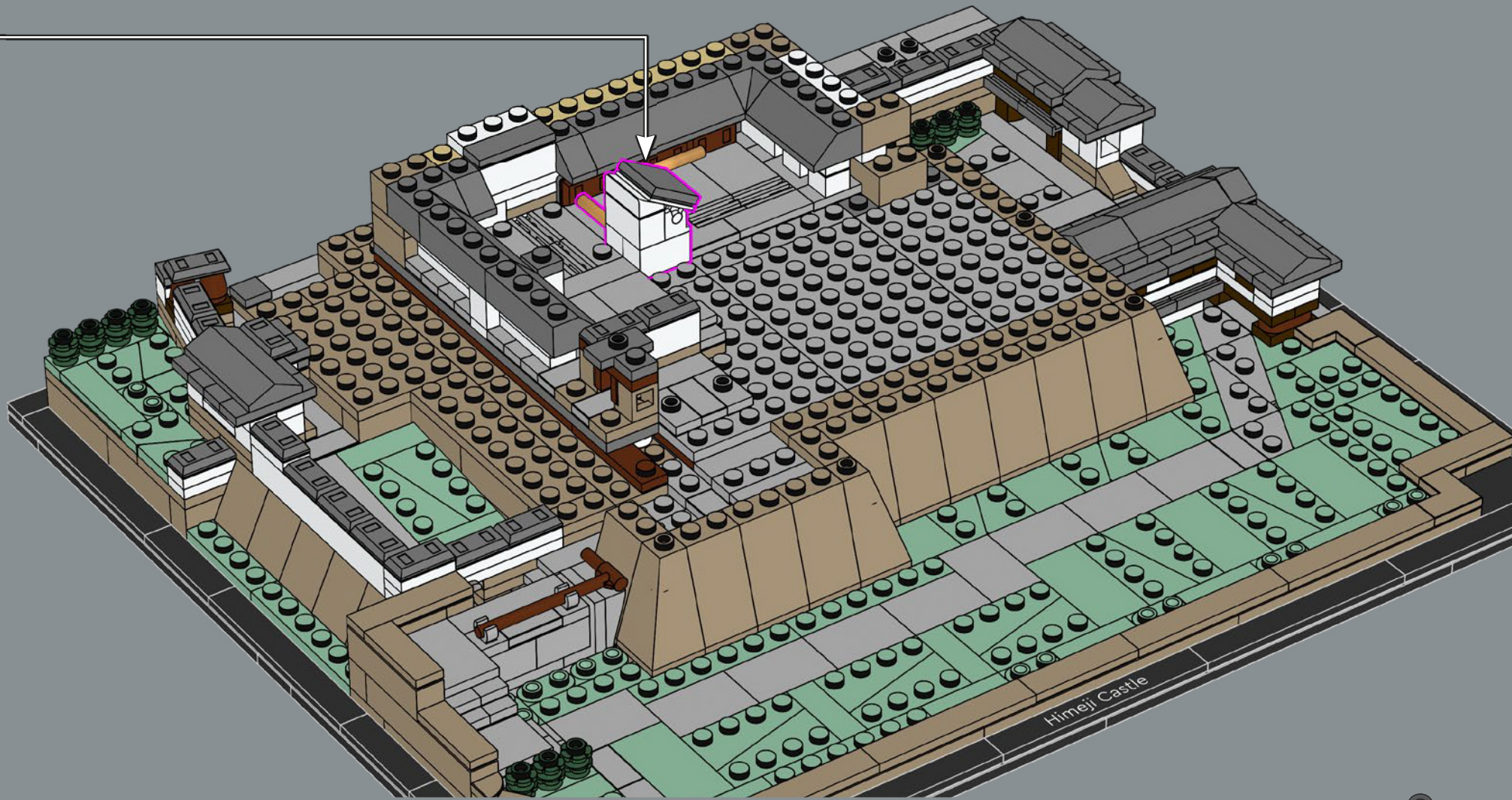

Himeji Castle



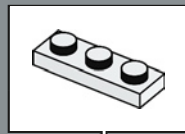
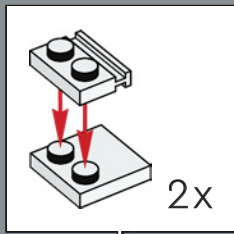
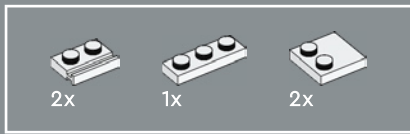

136



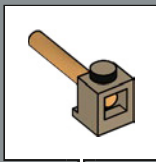
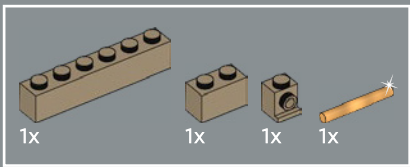

137

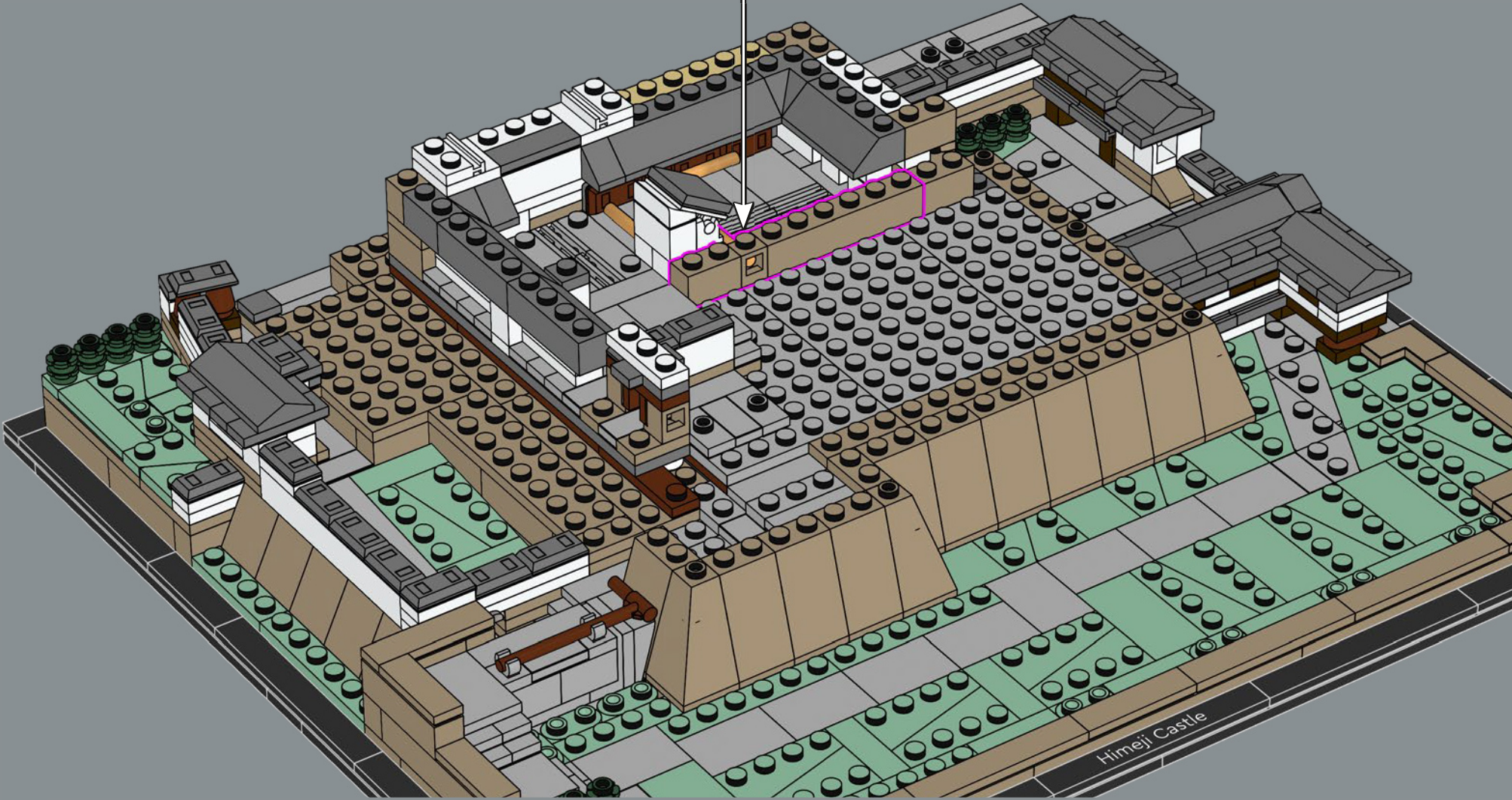

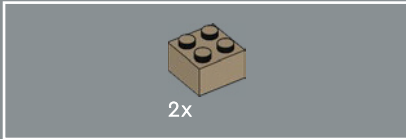
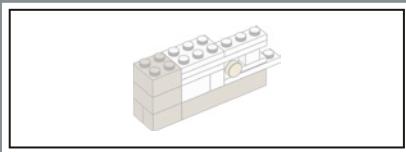

138

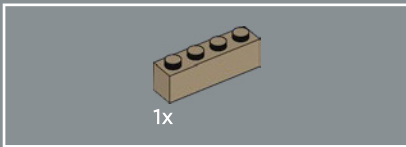
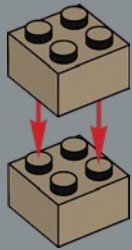

139

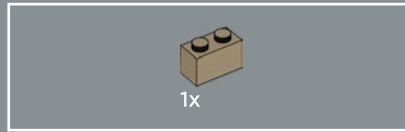
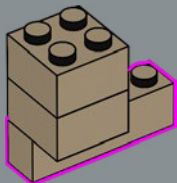

140

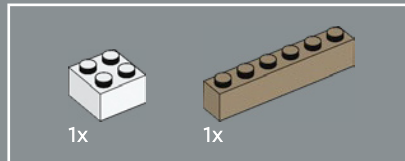
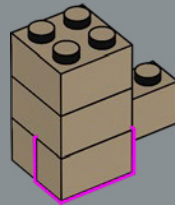

141

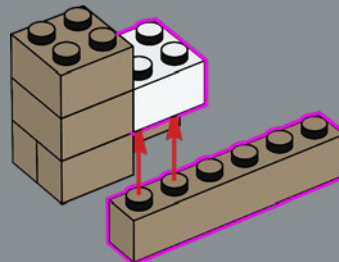

142

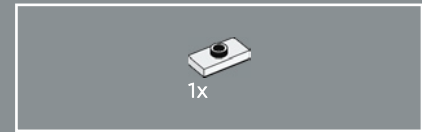
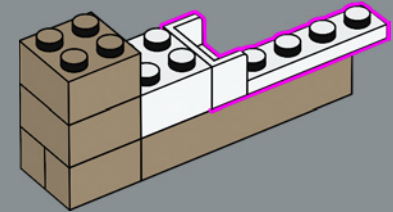

143

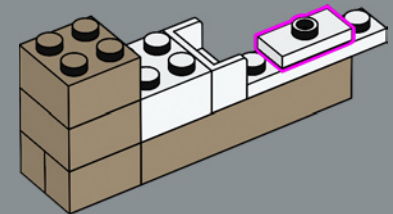

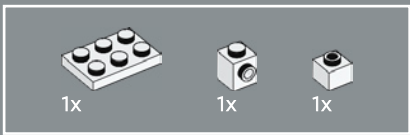

144

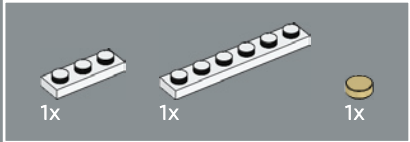
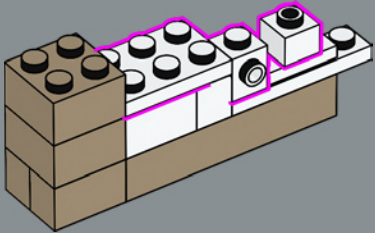

145

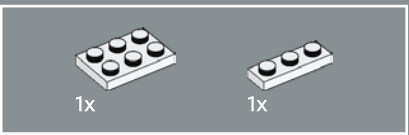
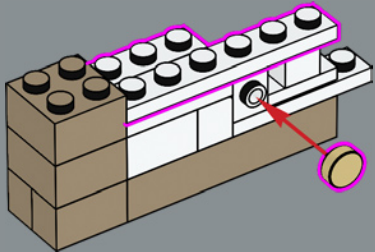

146

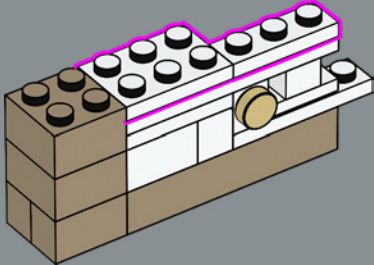

147

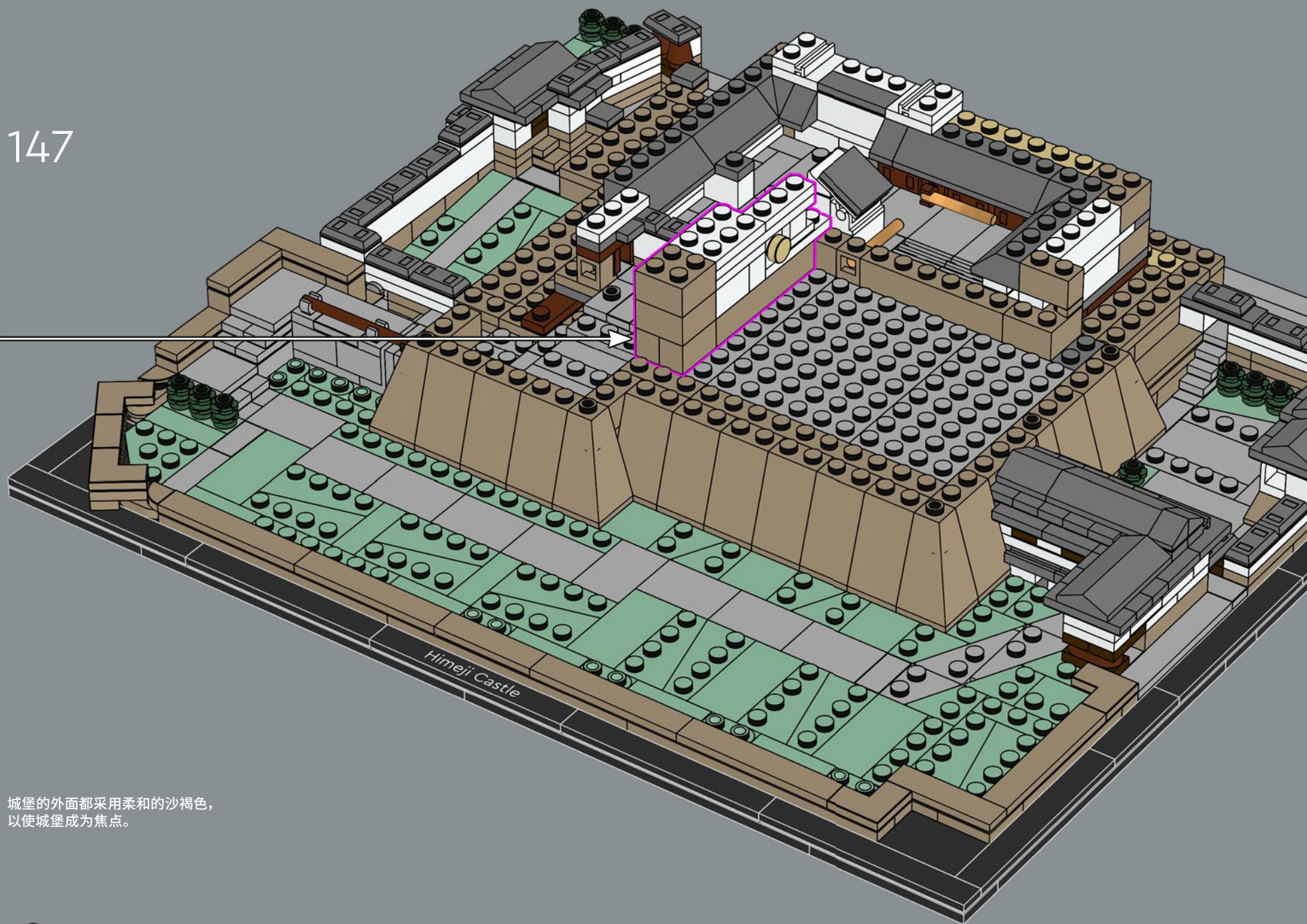

城堡的外面都采用柔和的沙褐色，
以使城堡成为焦点。

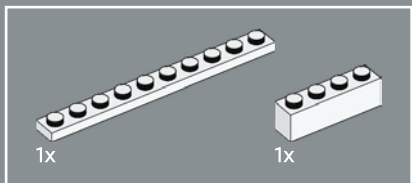

148

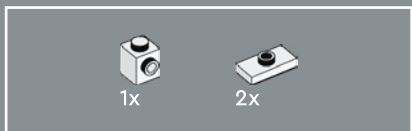
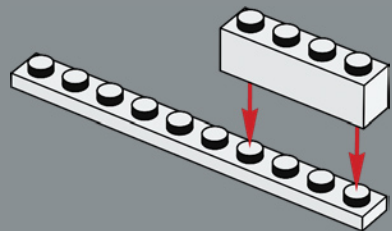

149

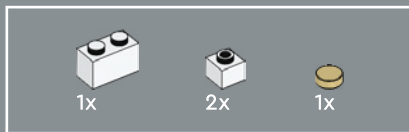
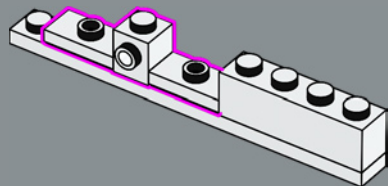

150

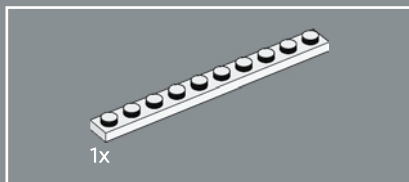
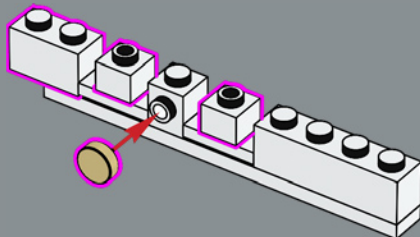

151

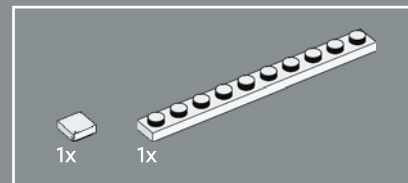
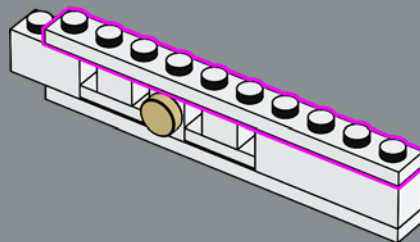

152

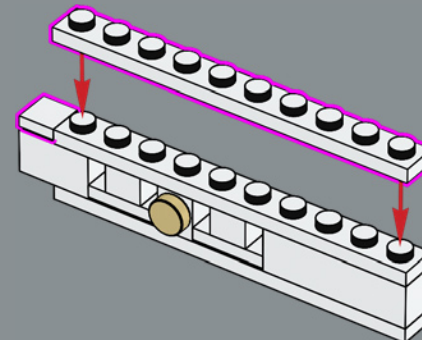

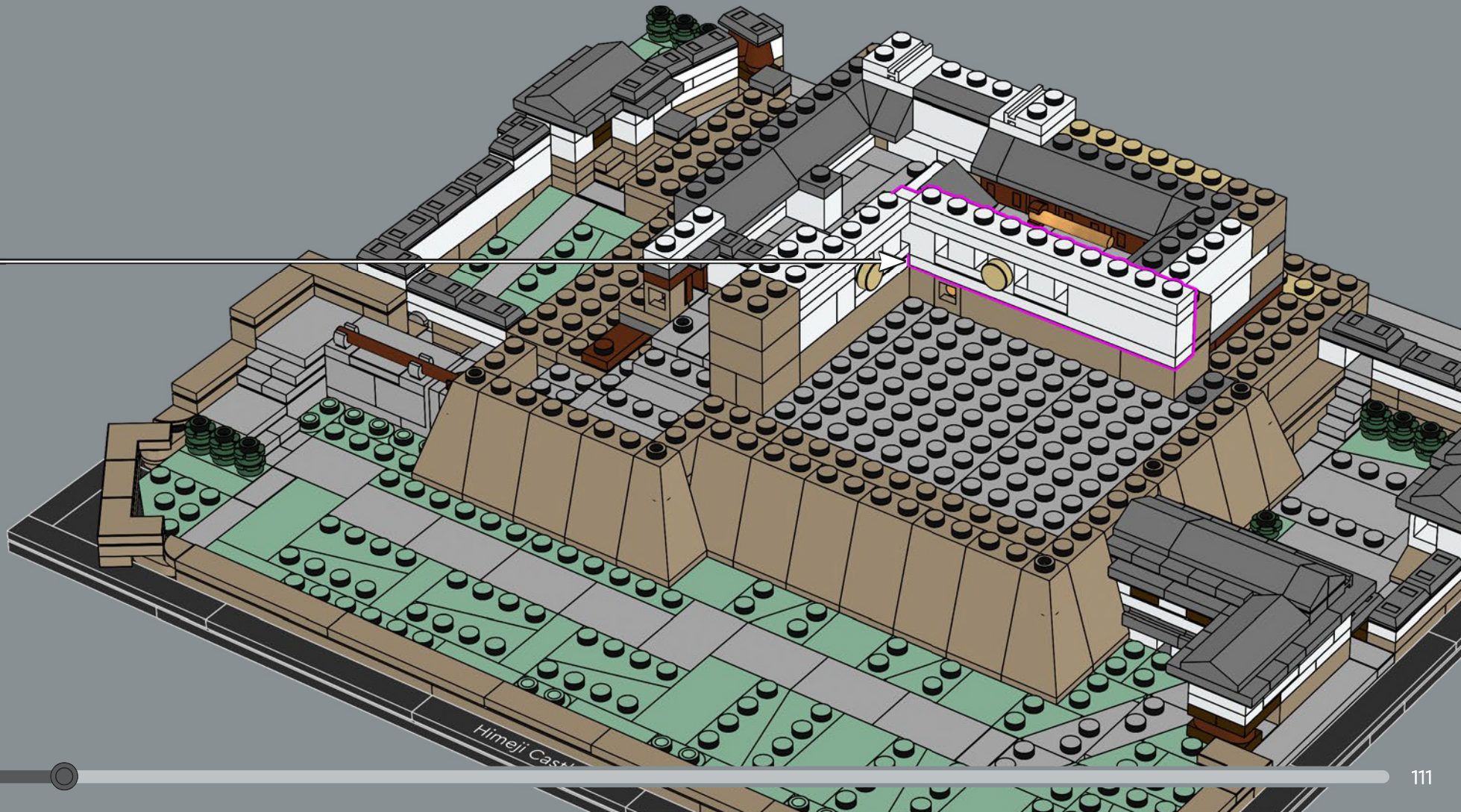

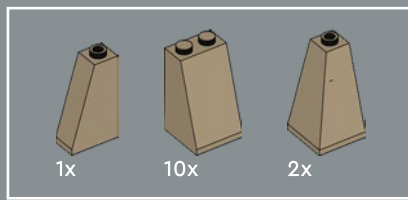

154

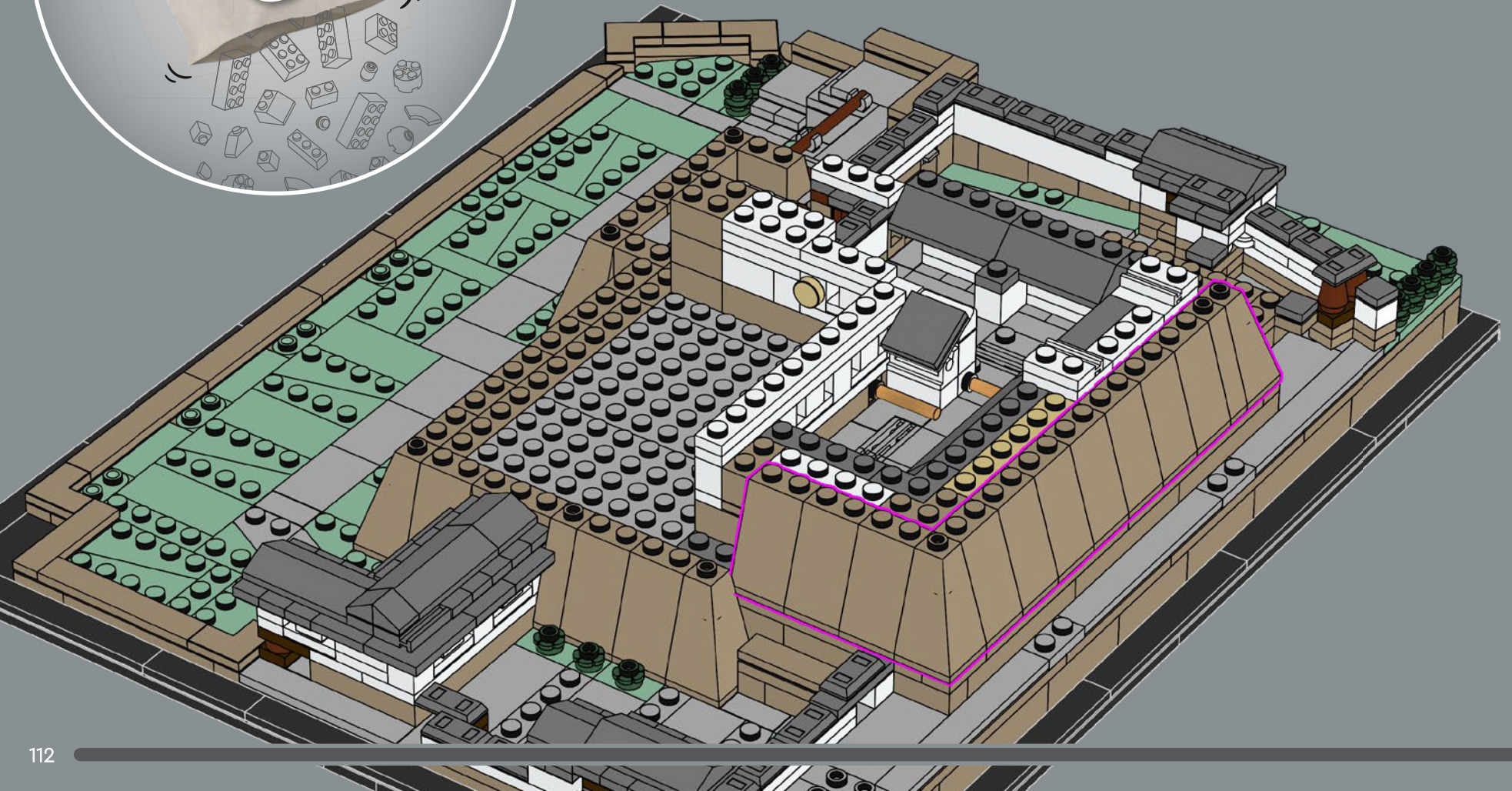

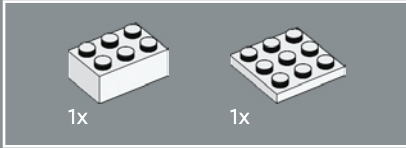

155

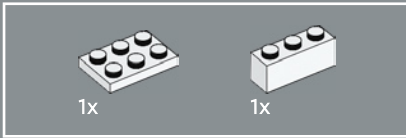
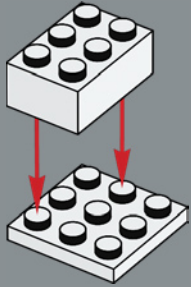

156

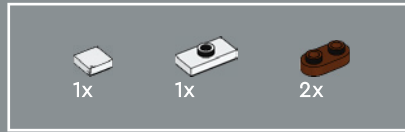
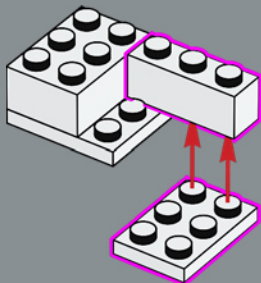

157

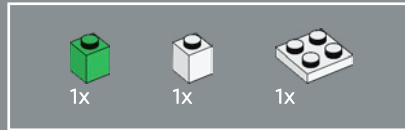
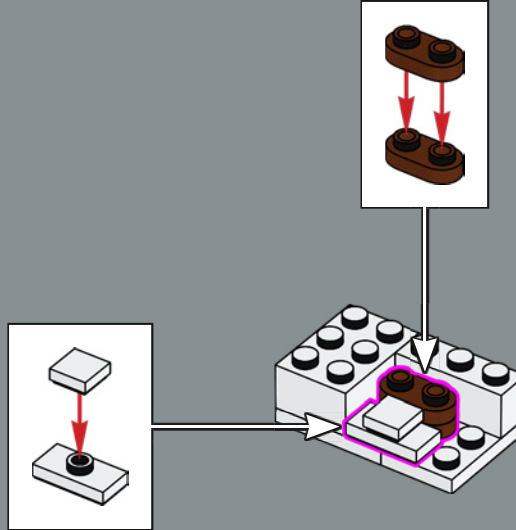

158

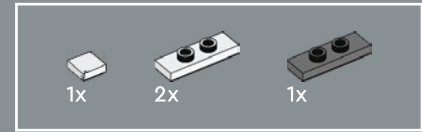
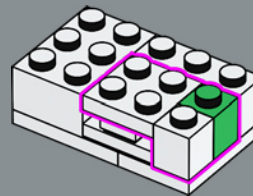

159

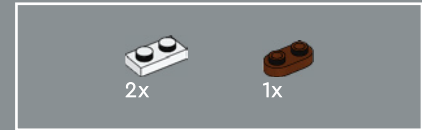
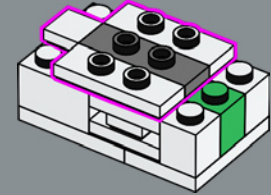

160

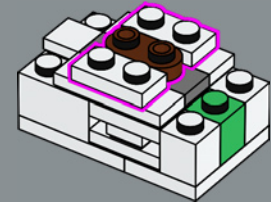

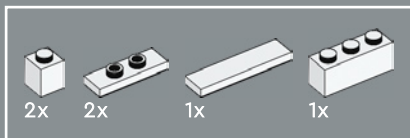

161

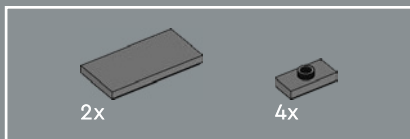
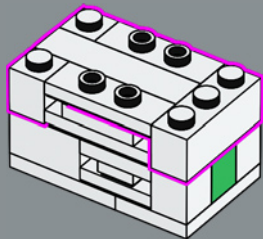

162

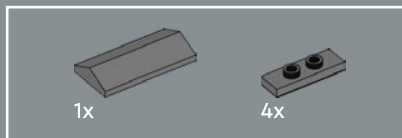
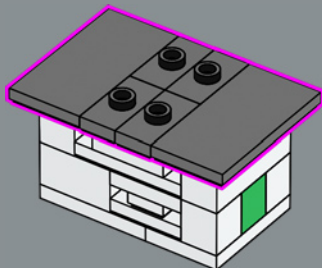

163

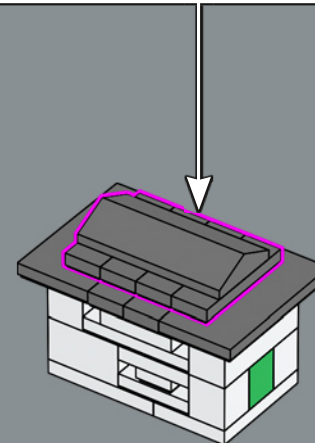
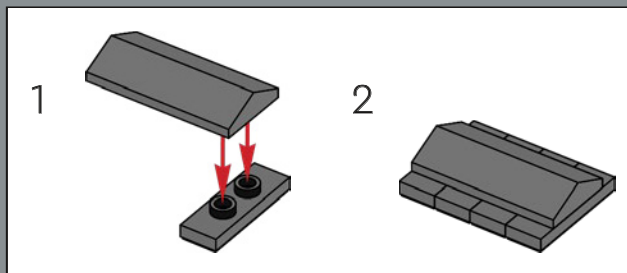

164

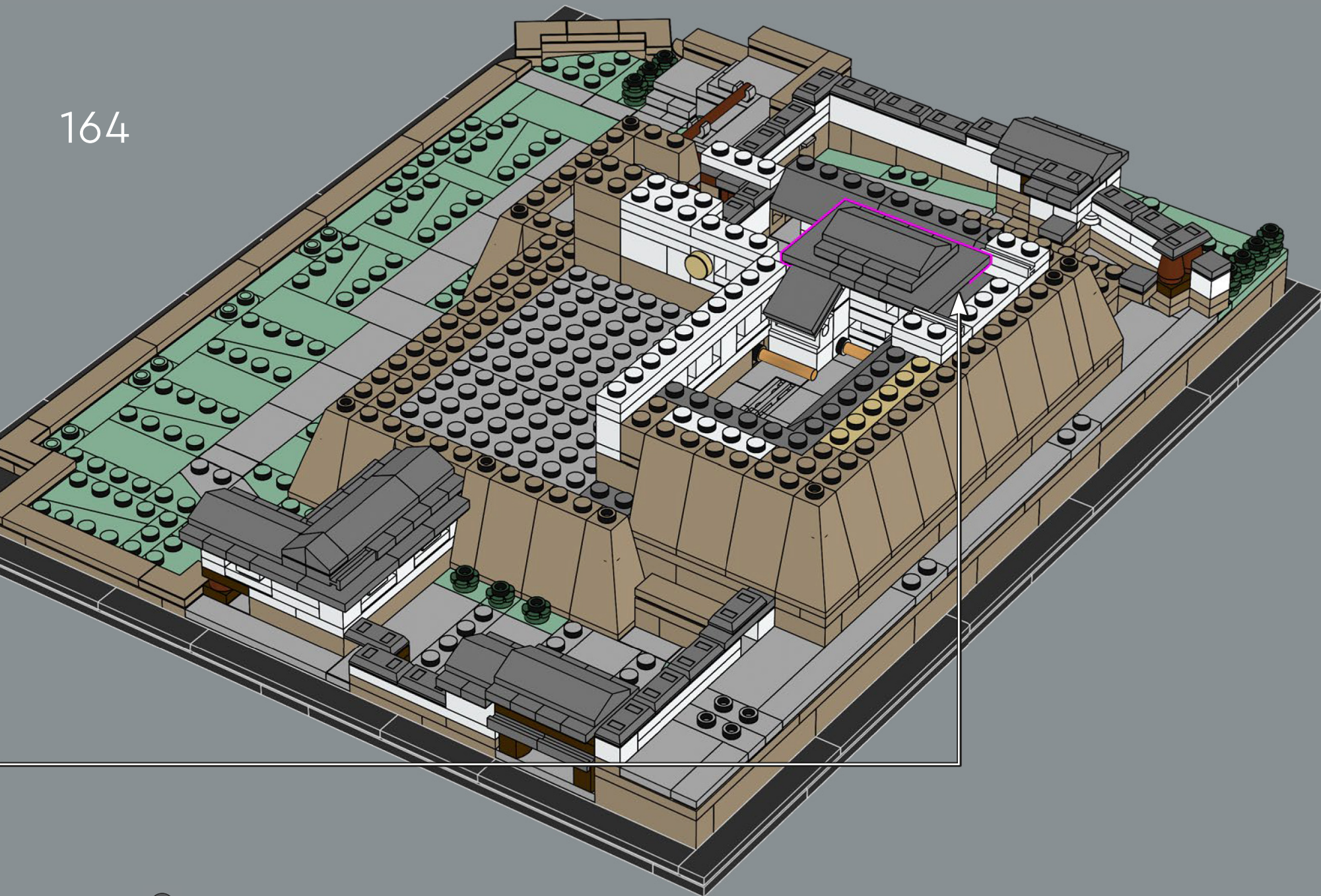

169

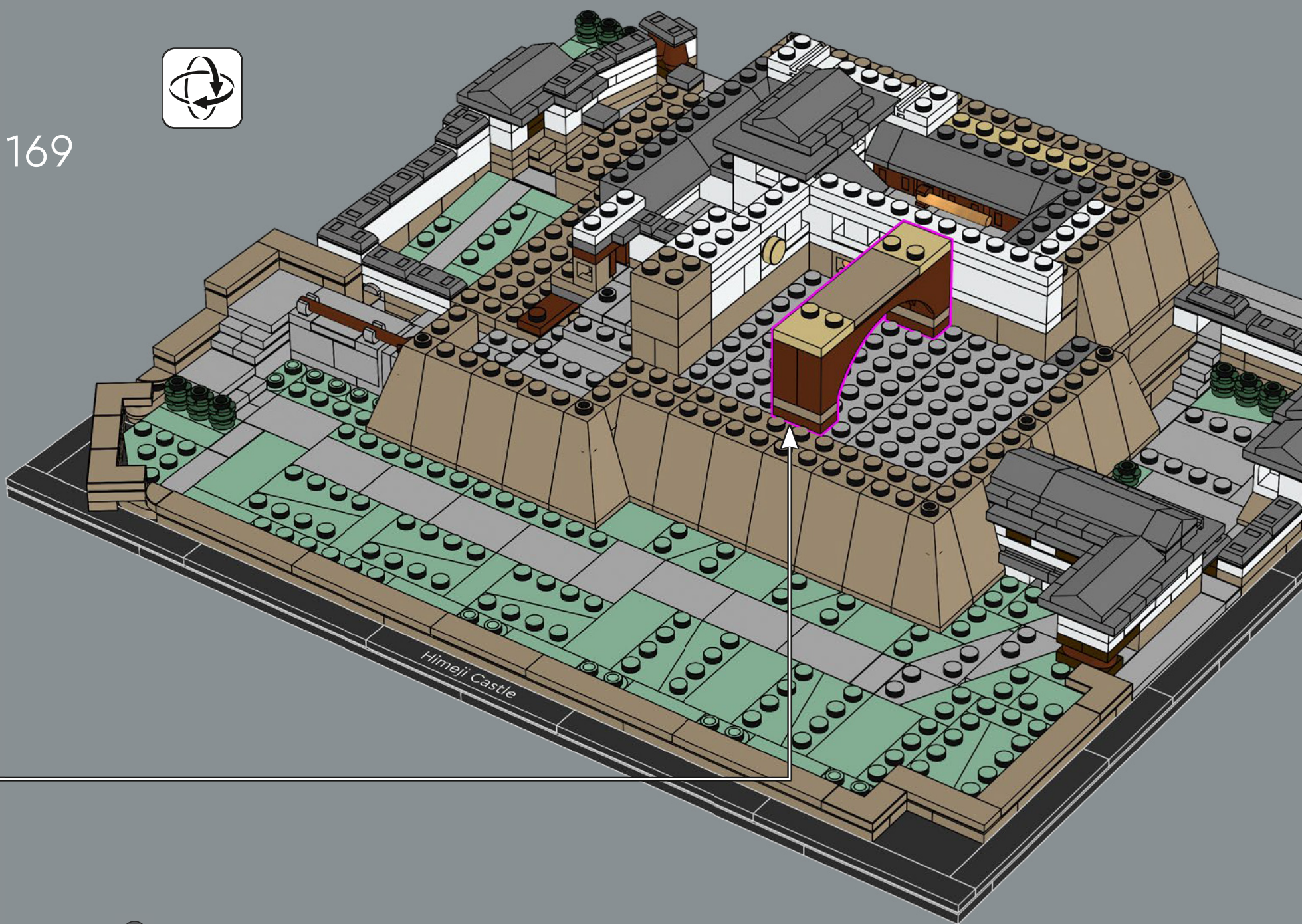

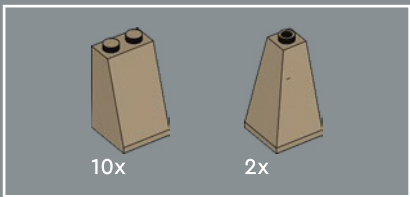

170

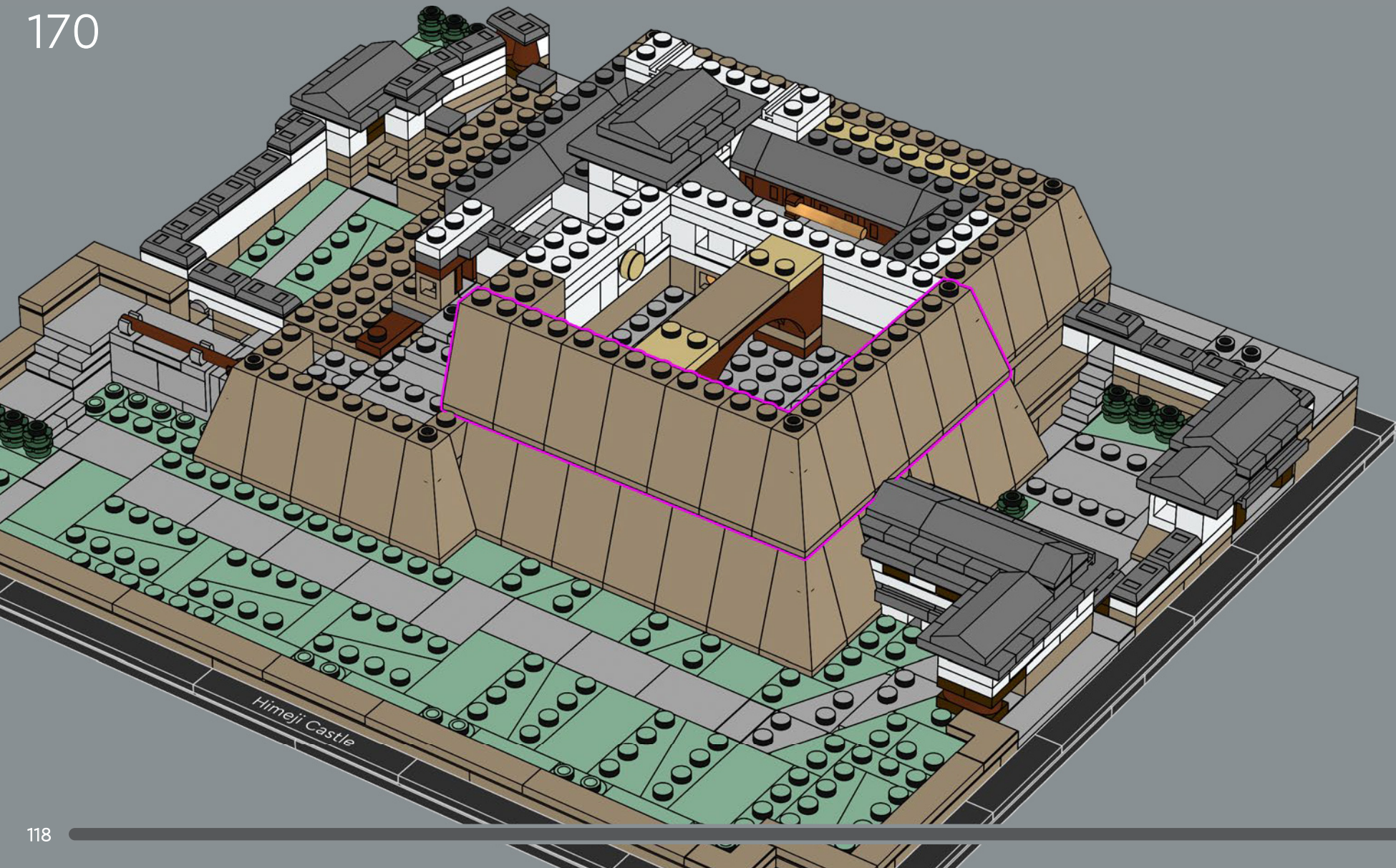

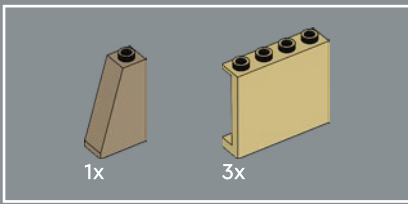

171



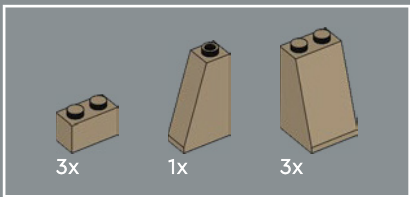

172

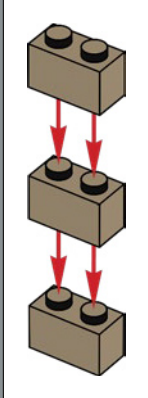

Himeji Castle

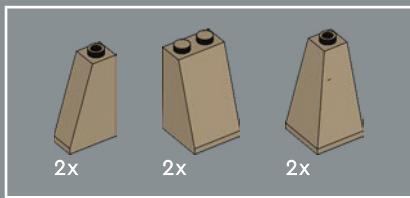

173



Himeji Castle

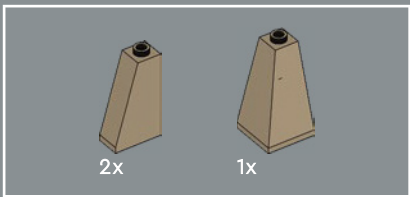

174

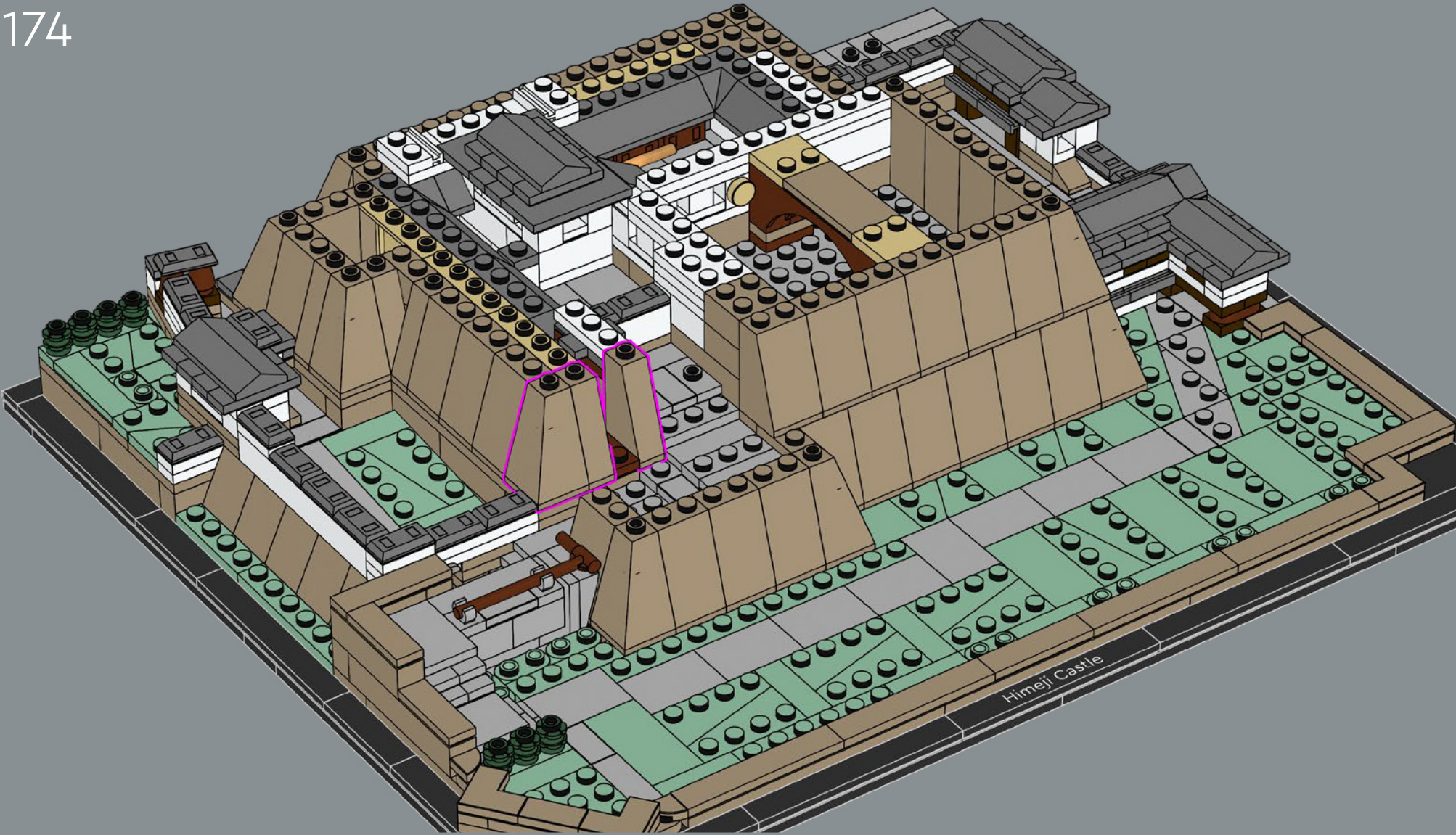

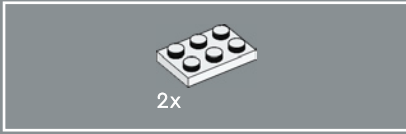
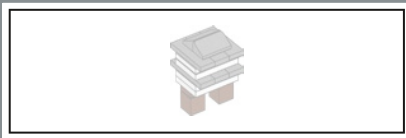

175

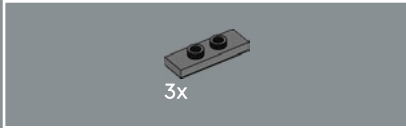
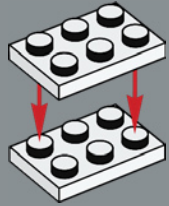

176

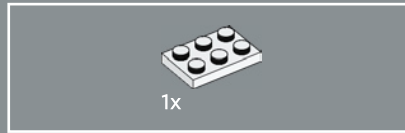
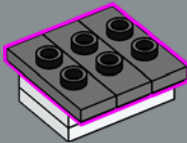

177

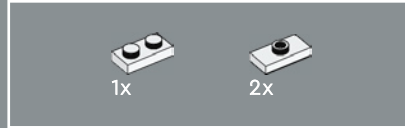
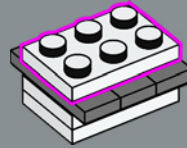

178

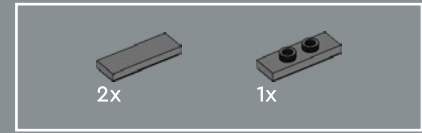
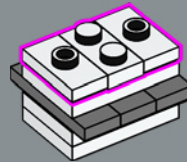

179

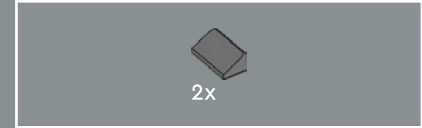
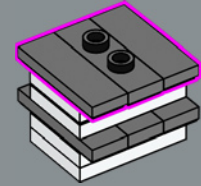

180

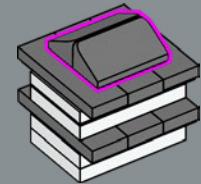

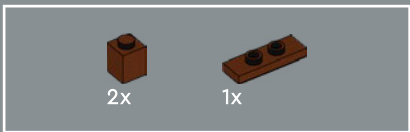

181

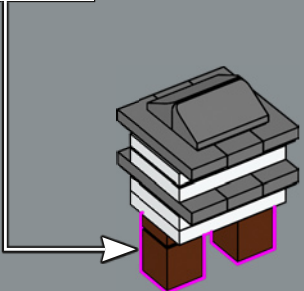
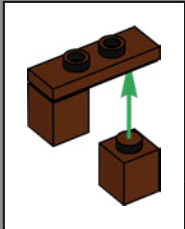

182



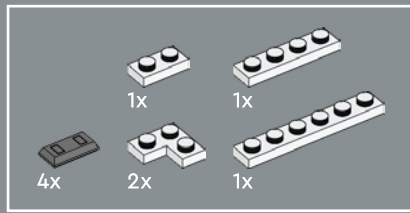

183

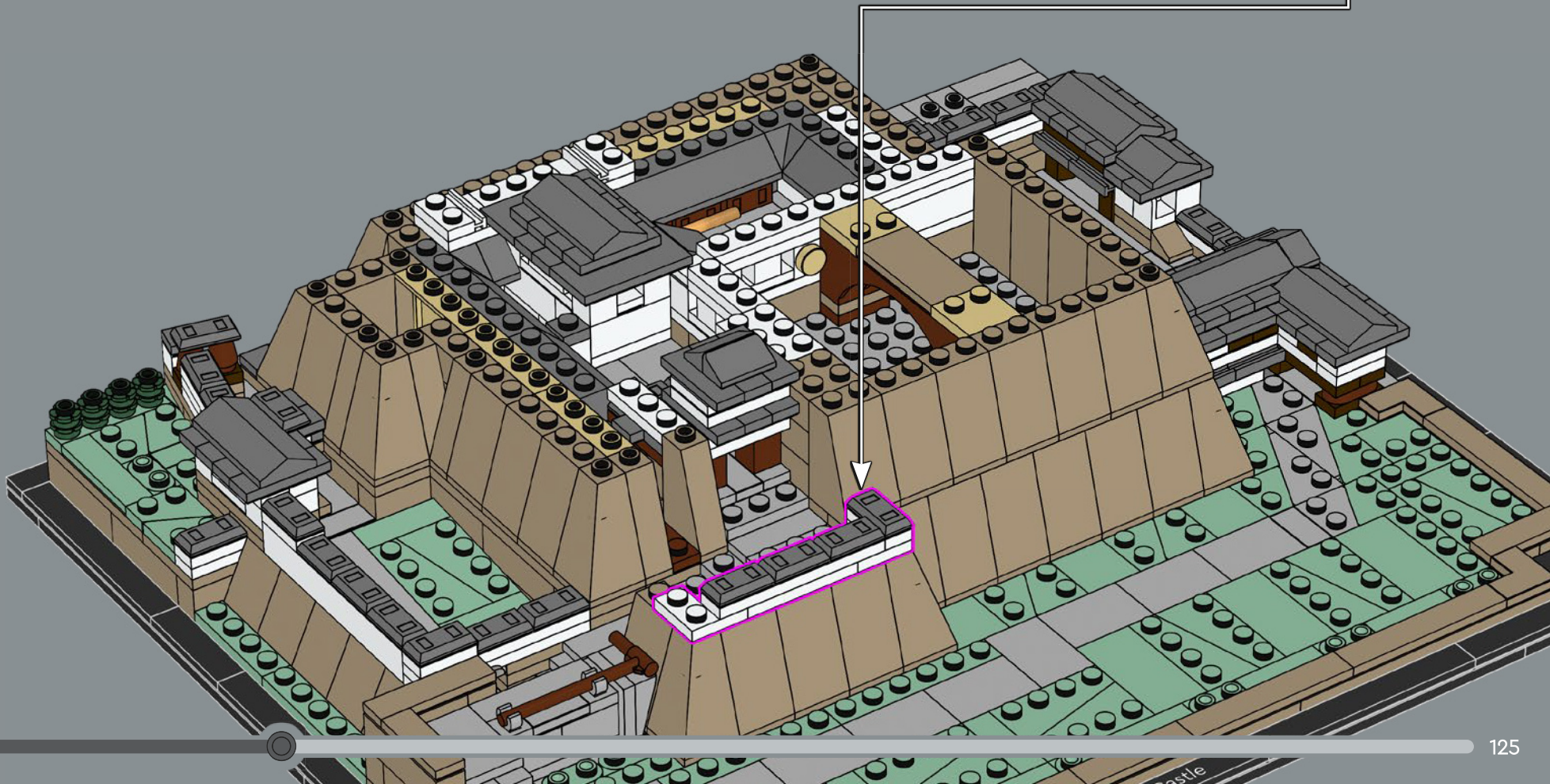
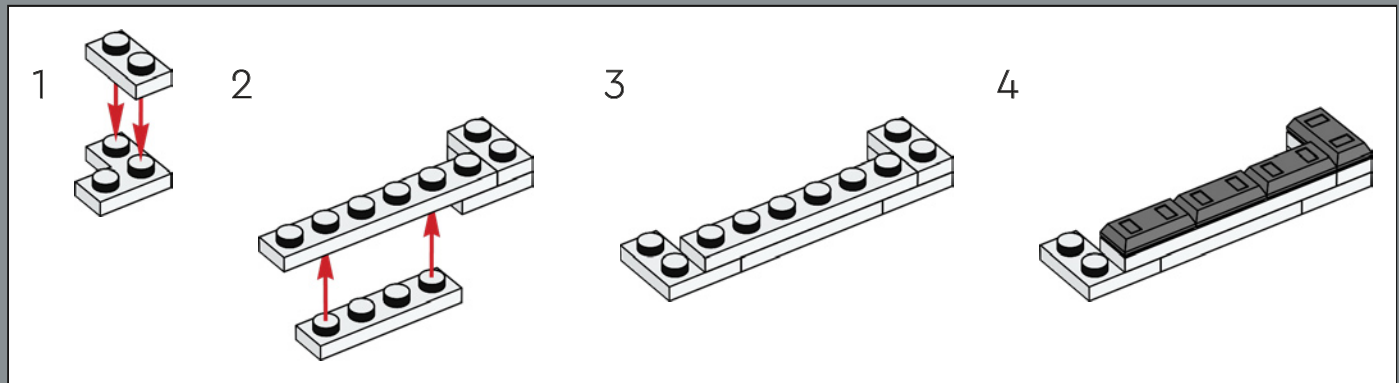

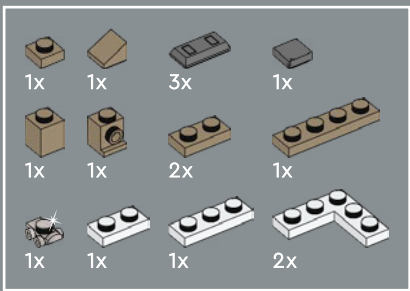

184

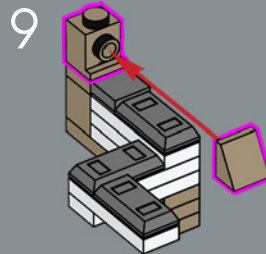
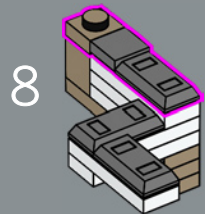
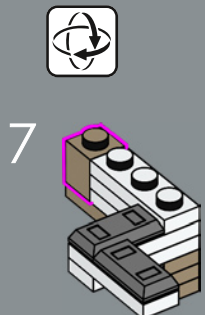
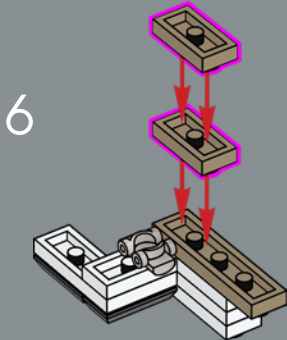
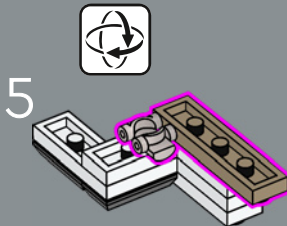
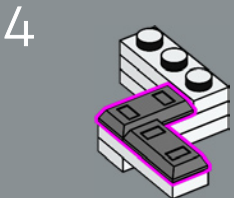
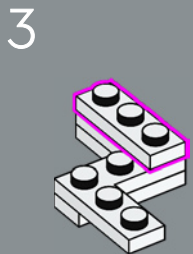
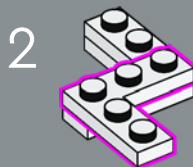
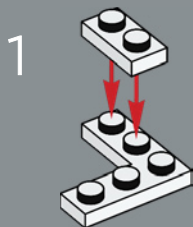

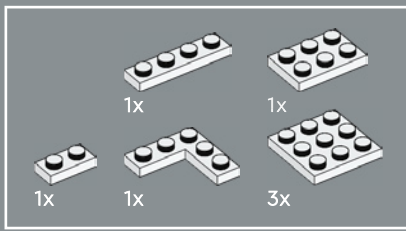

185

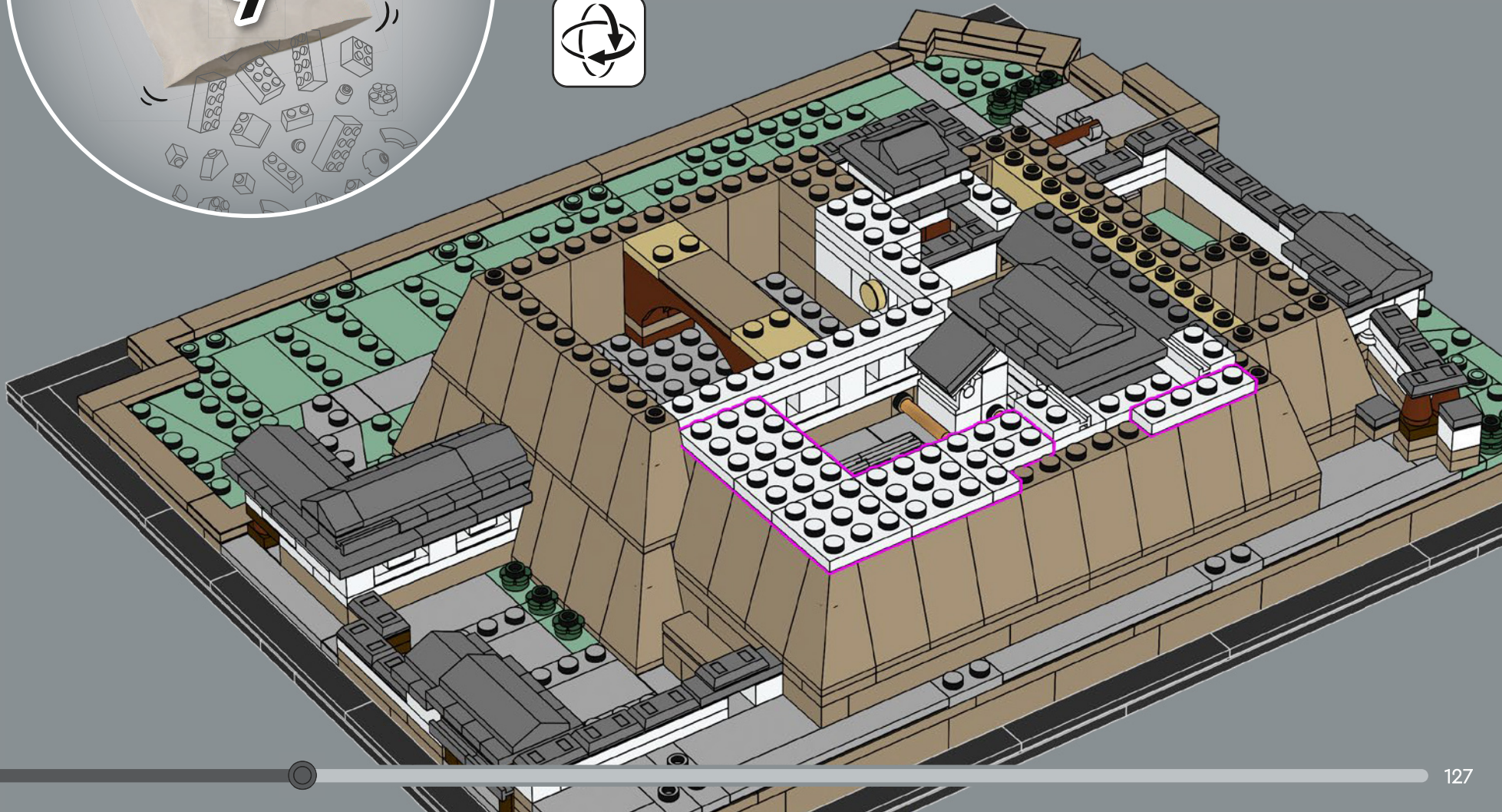

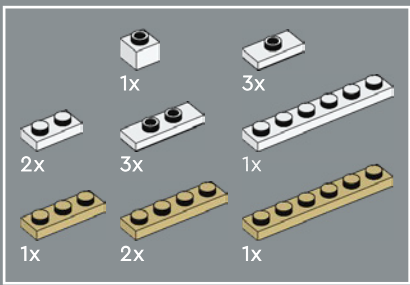

186

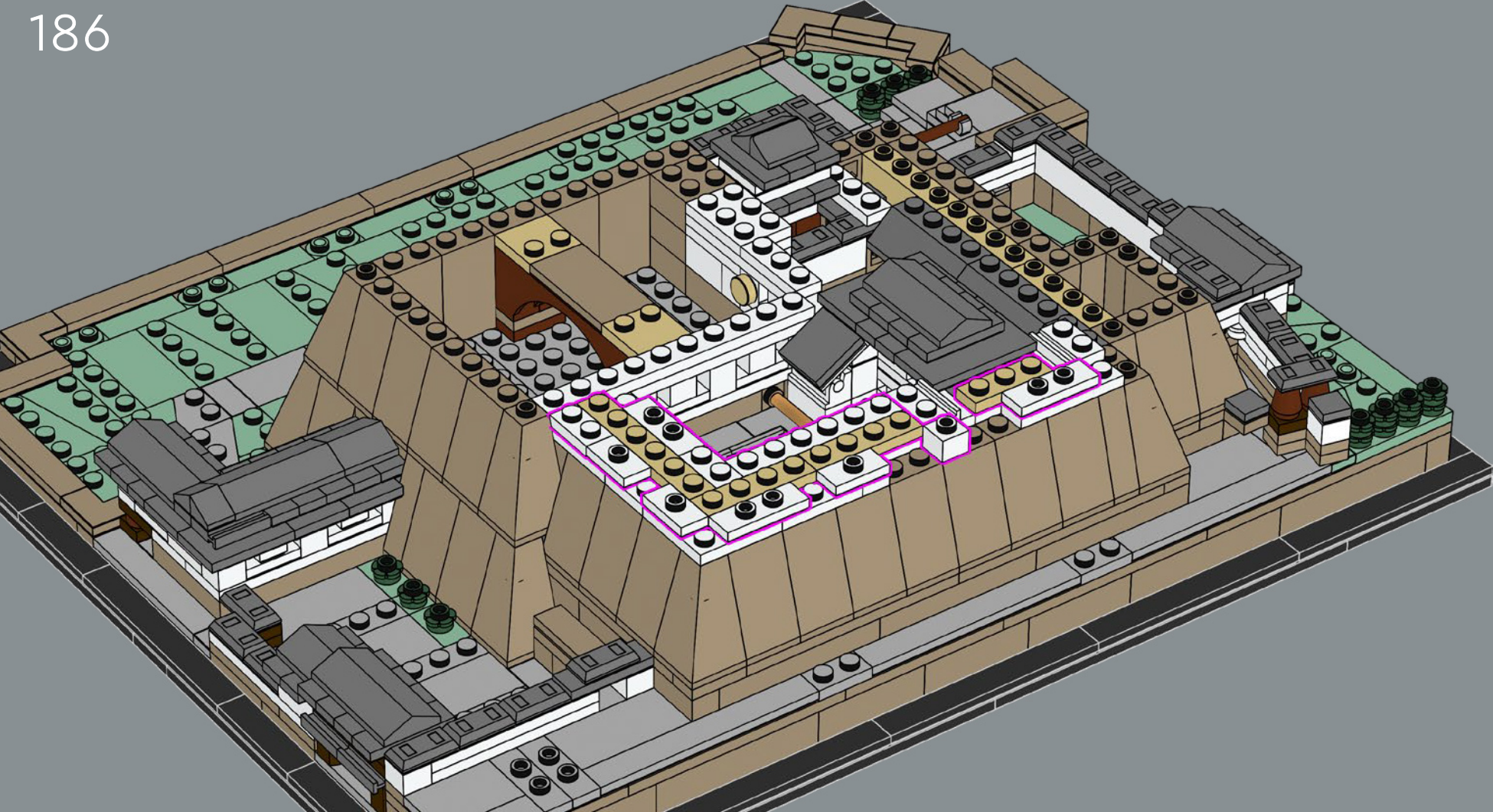

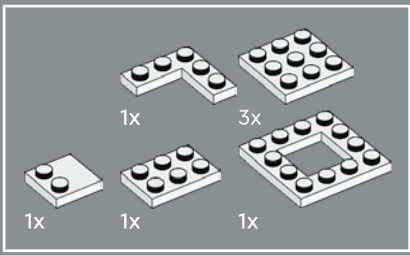

188

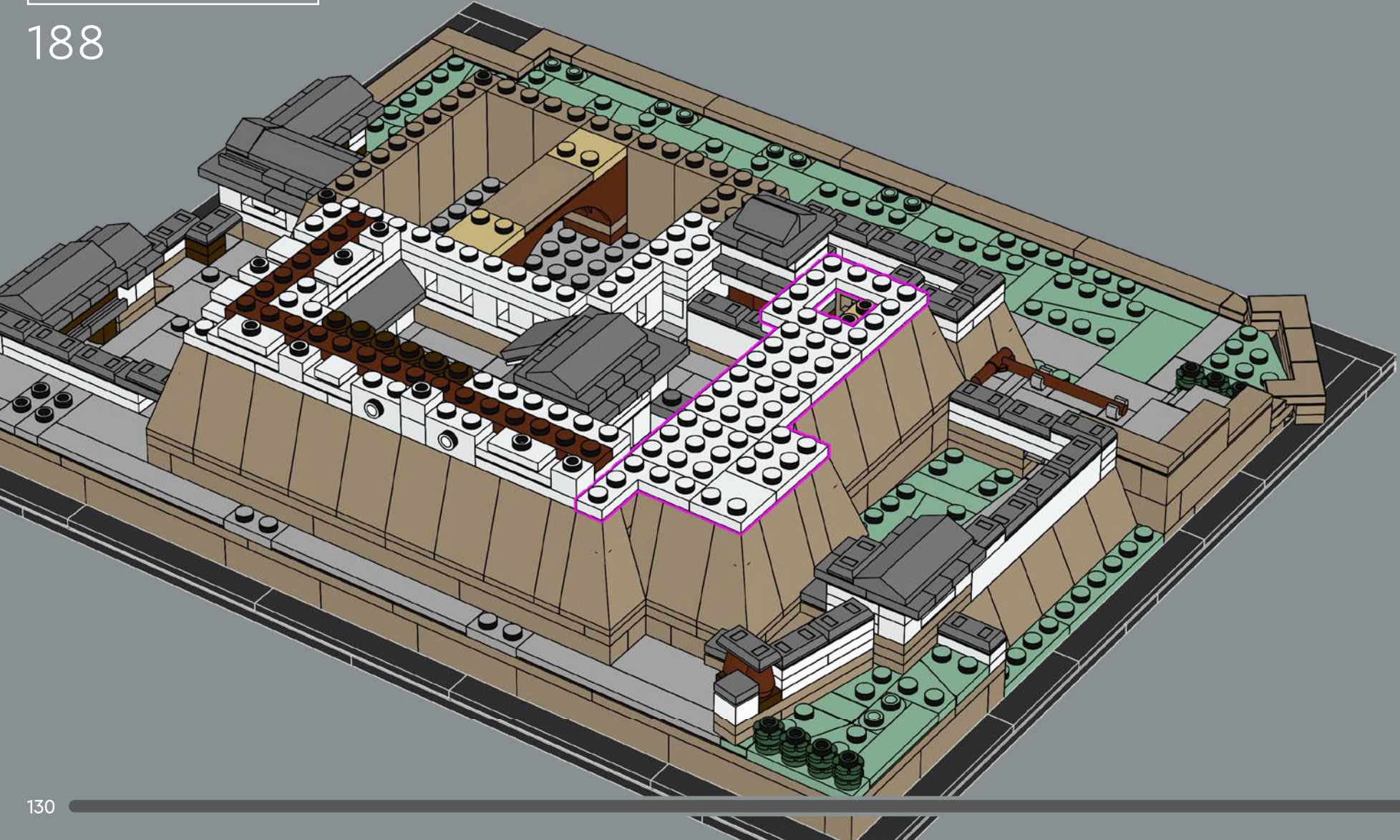

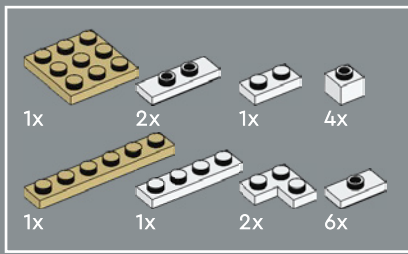

189



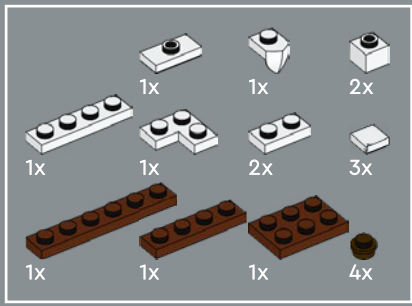

190



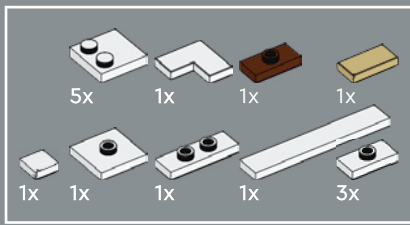

191

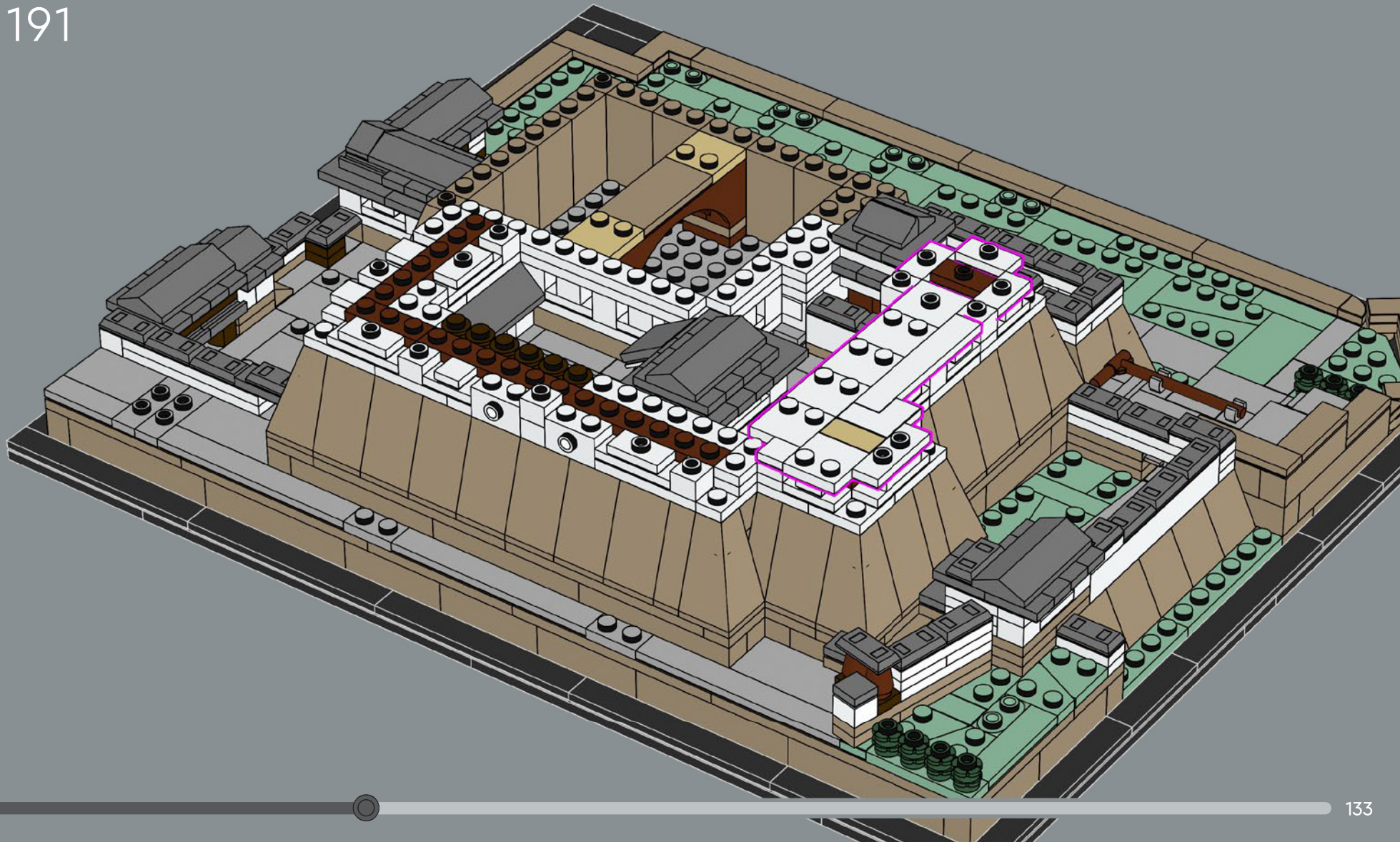

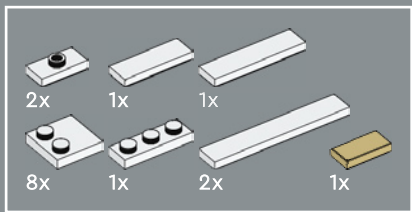

192

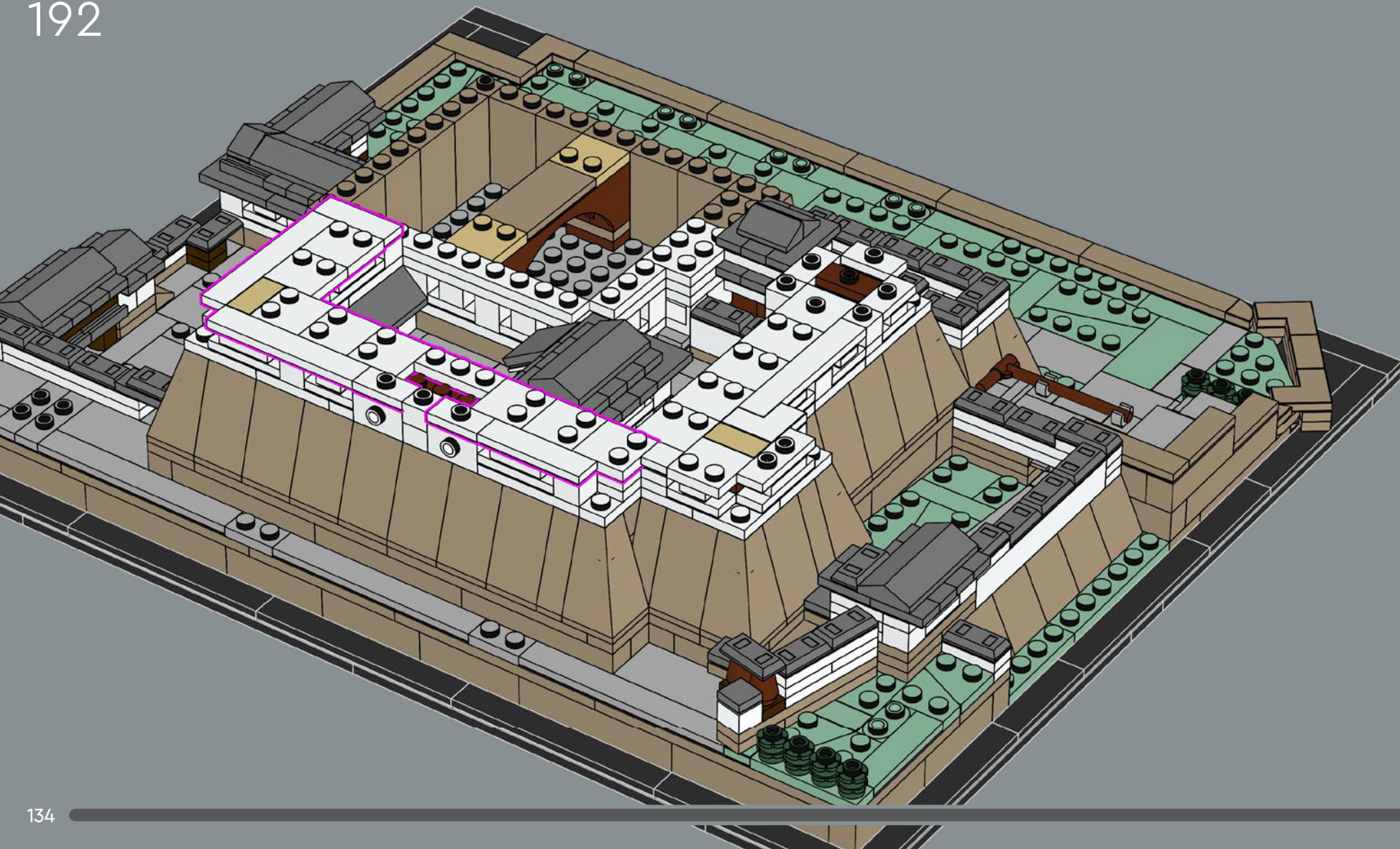

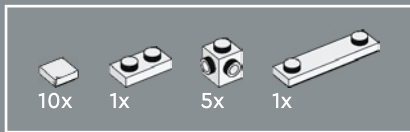

193

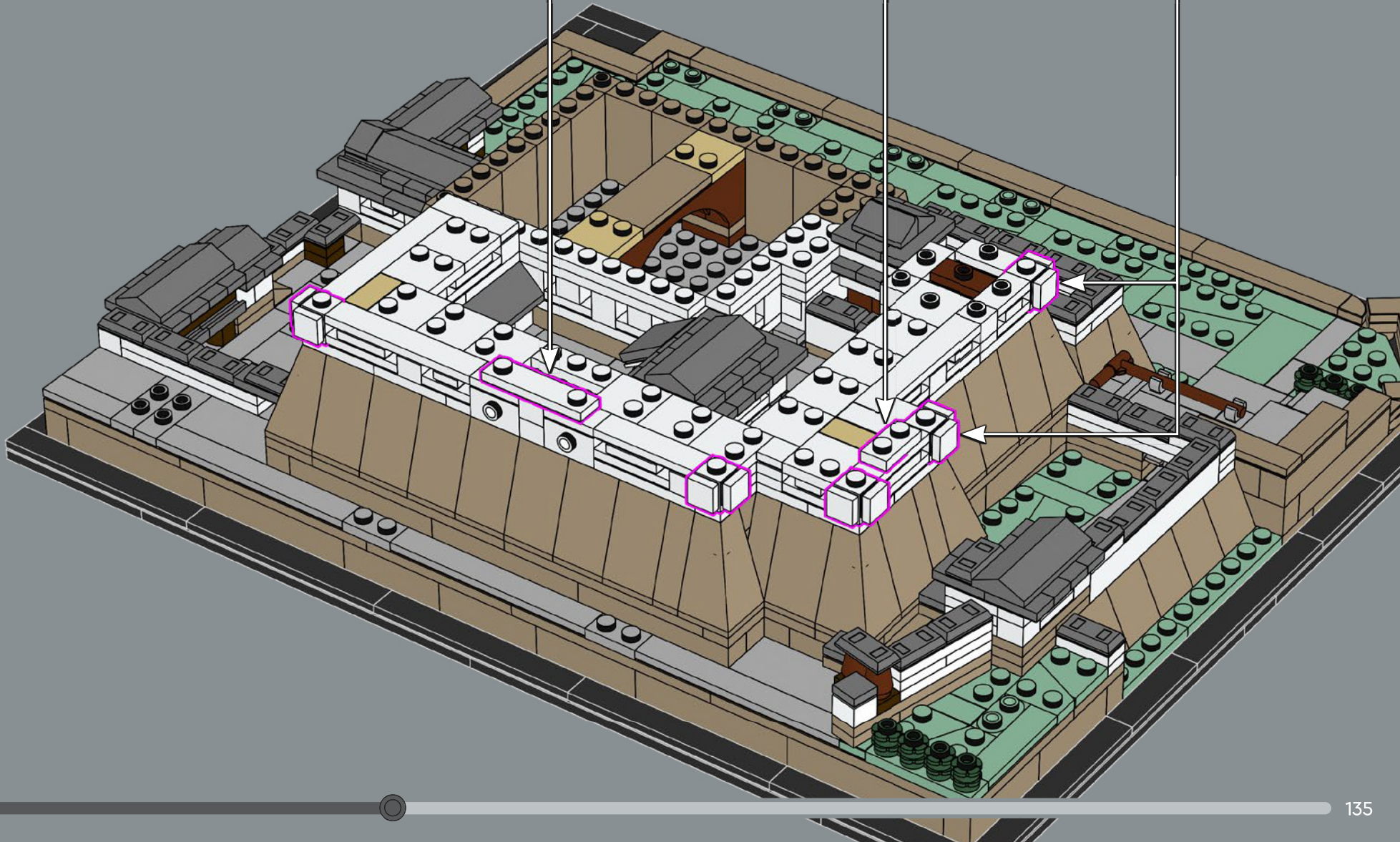
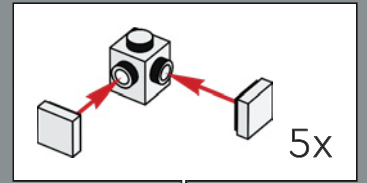
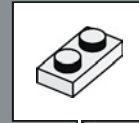
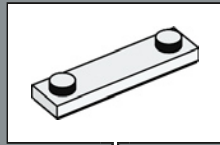

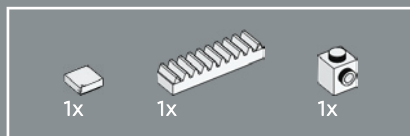

194

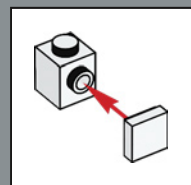
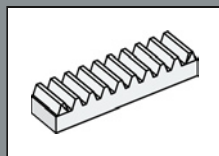

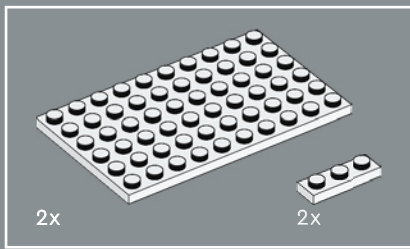

195



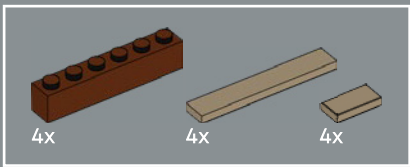

196

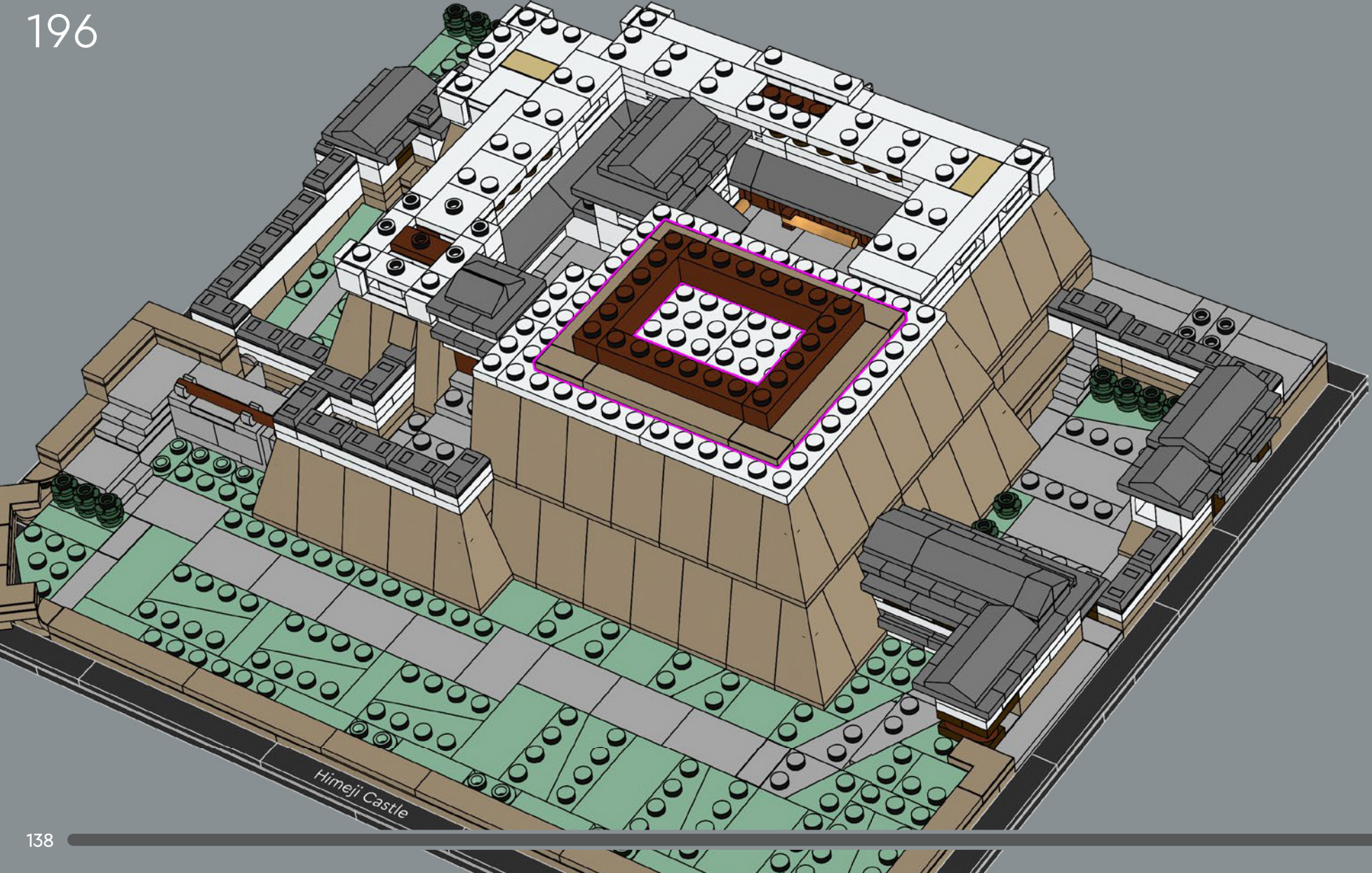

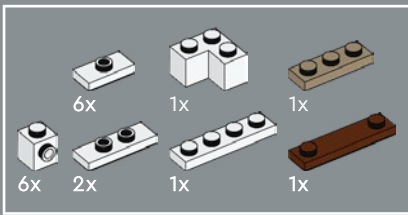

197

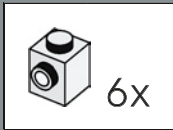
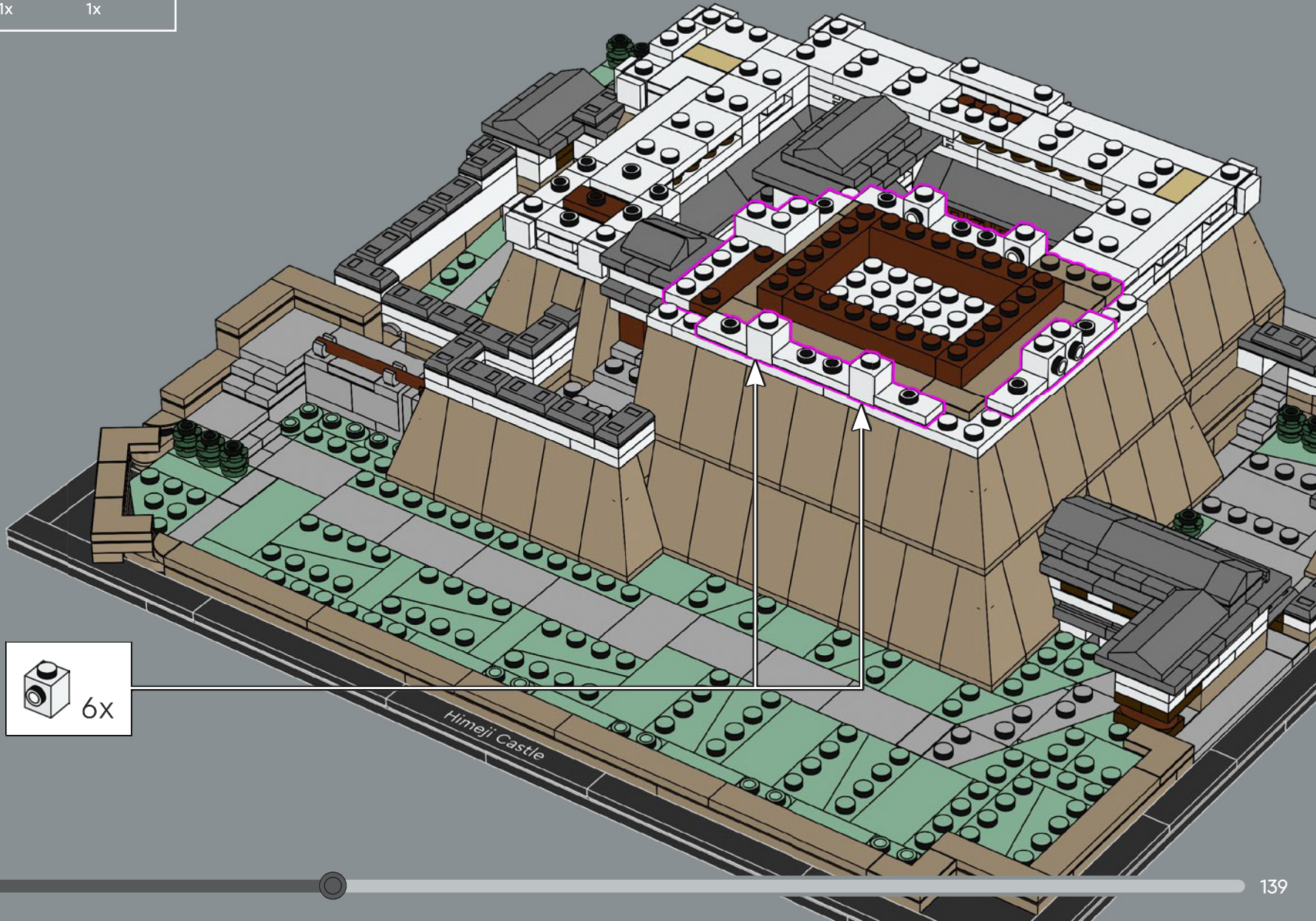

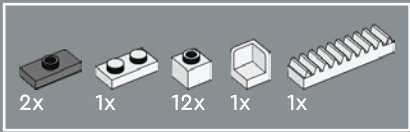

198

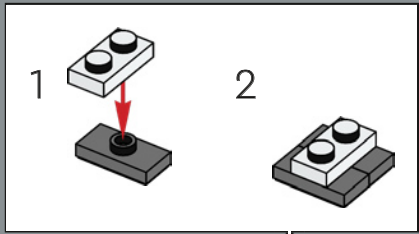

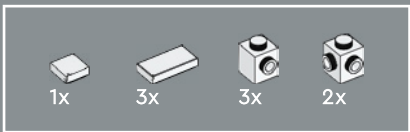

199

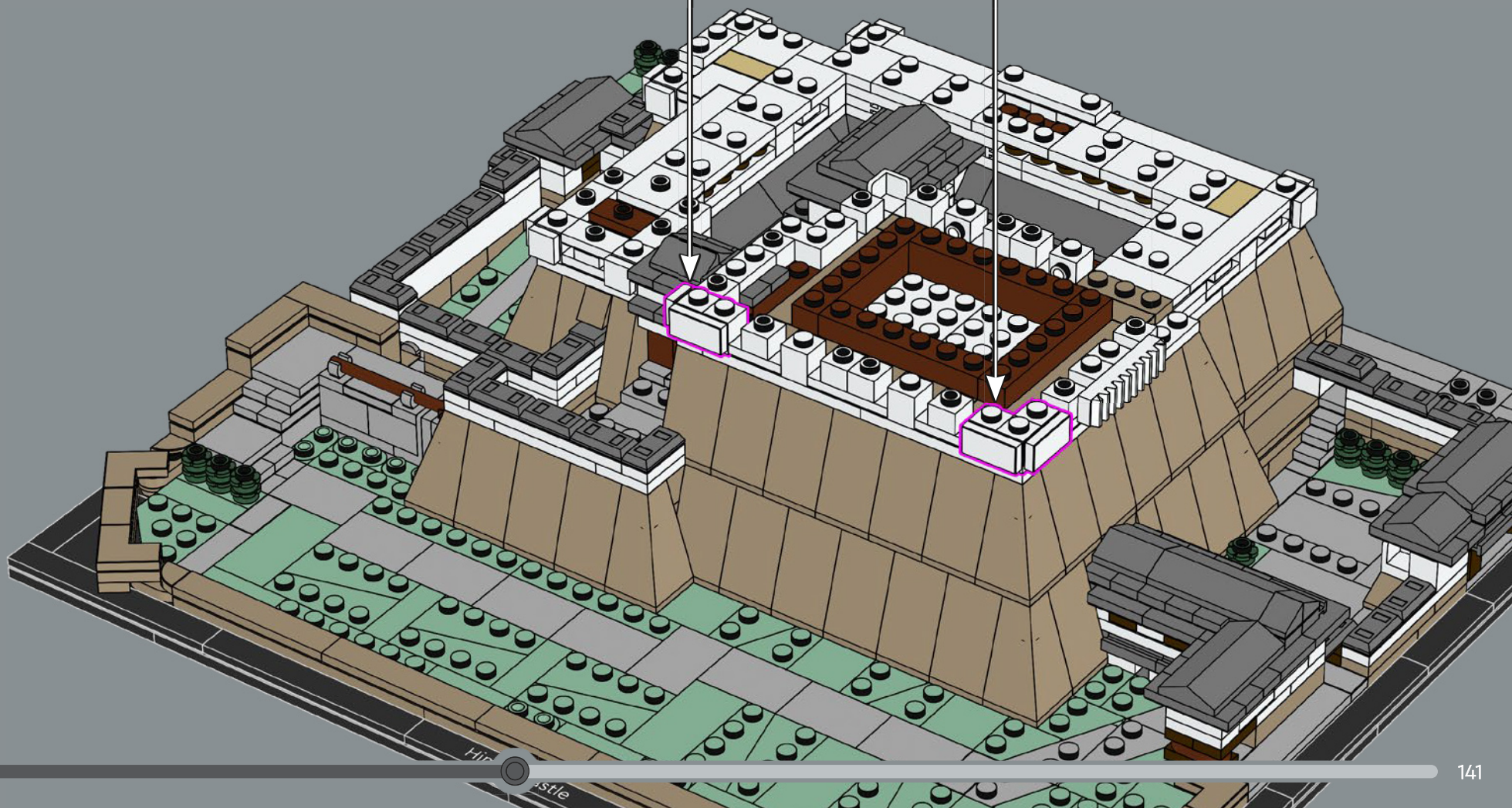
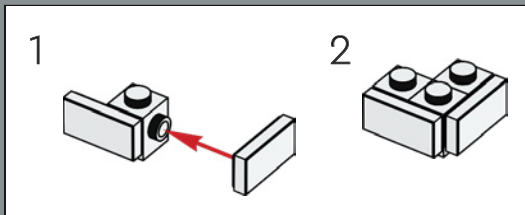
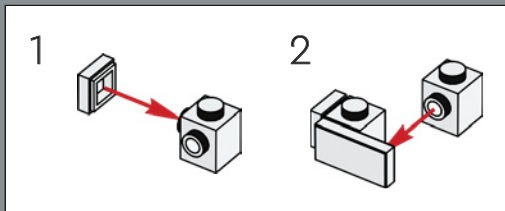

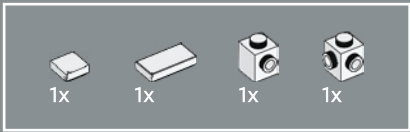

200

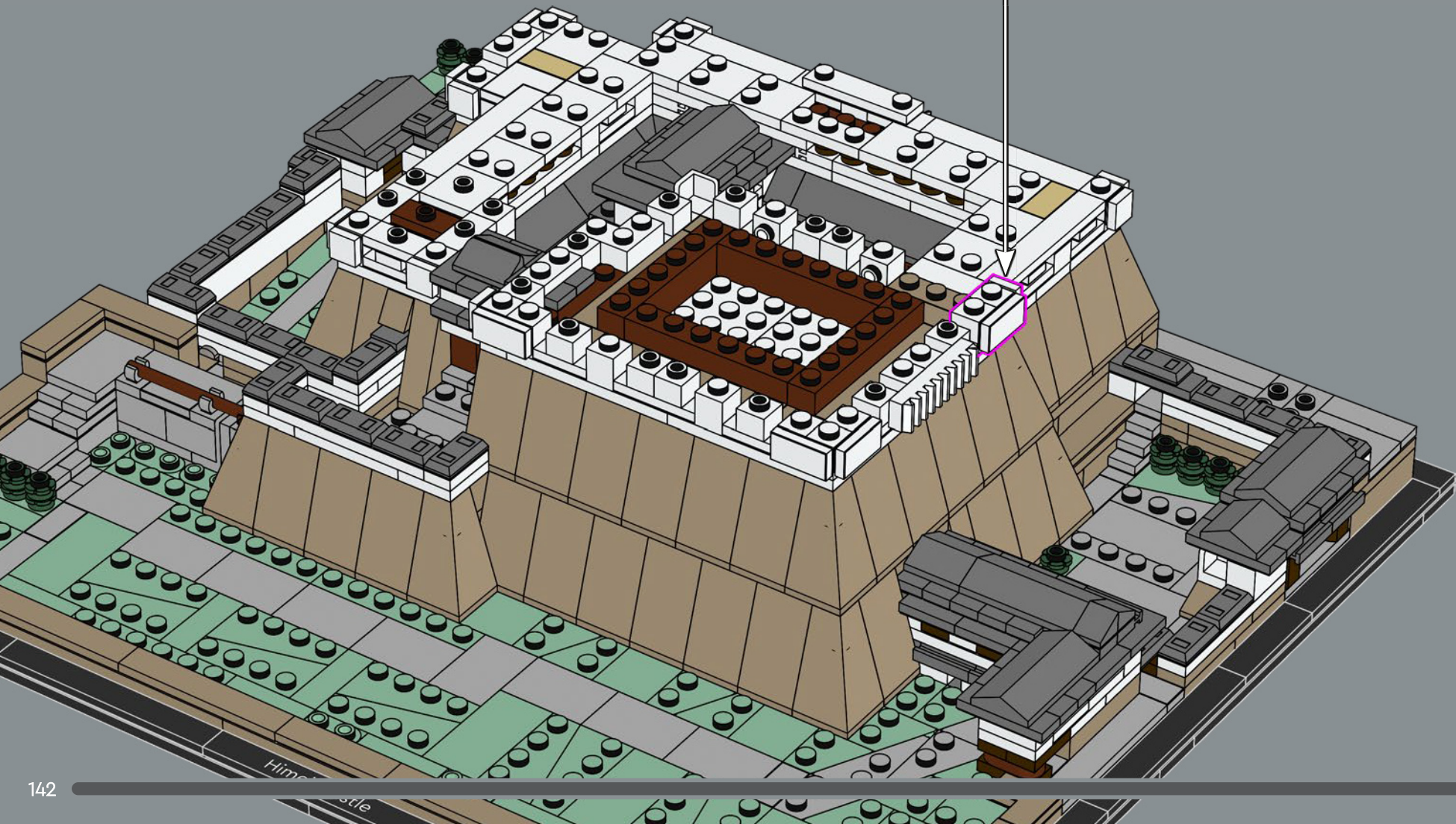
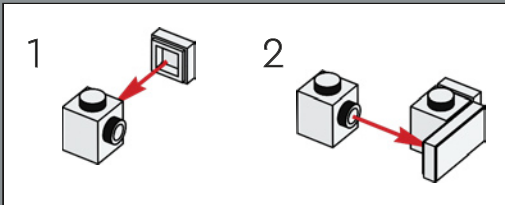

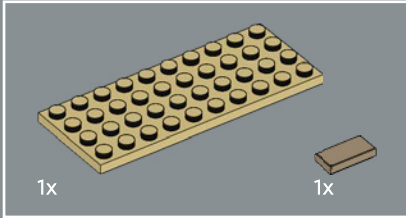
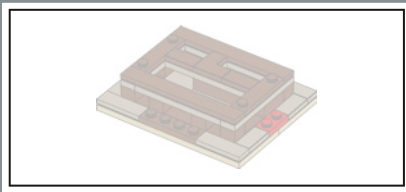

201

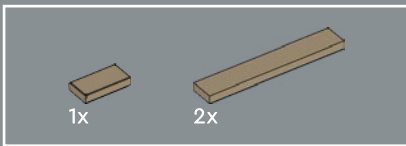
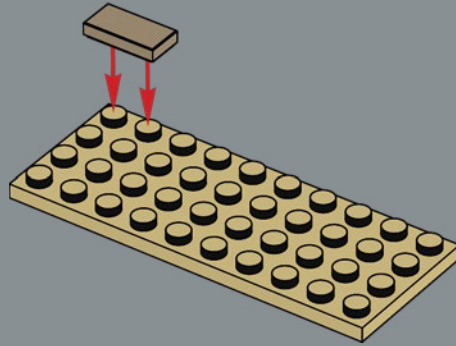

202

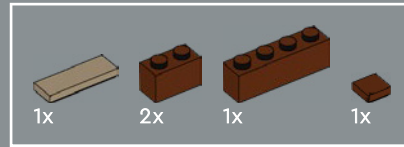
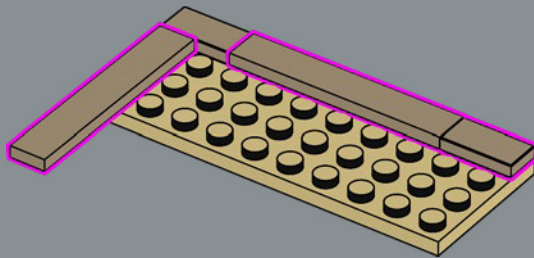

203

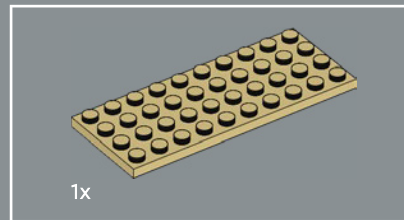
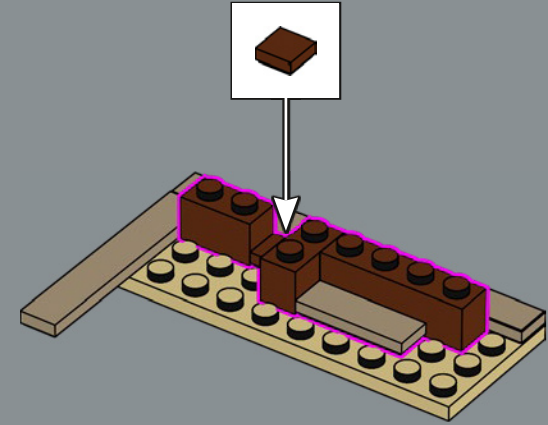

204

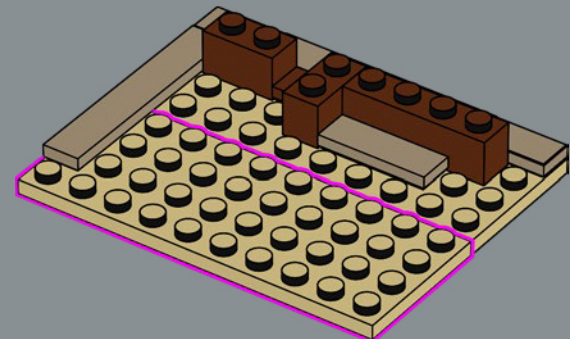

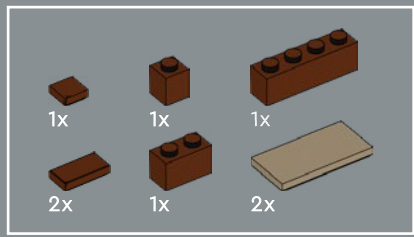

205

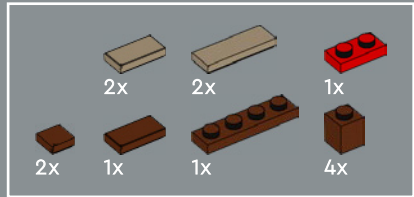
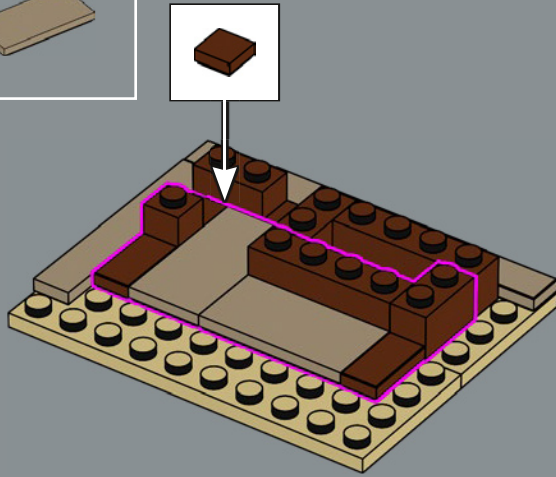

206

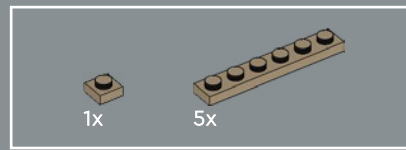
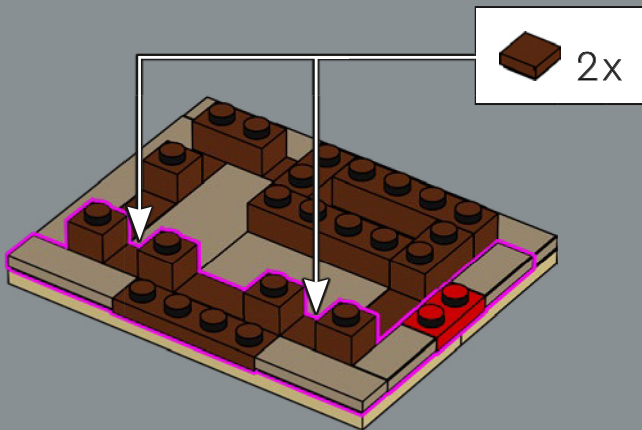

207

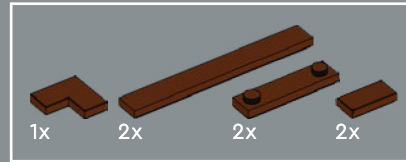
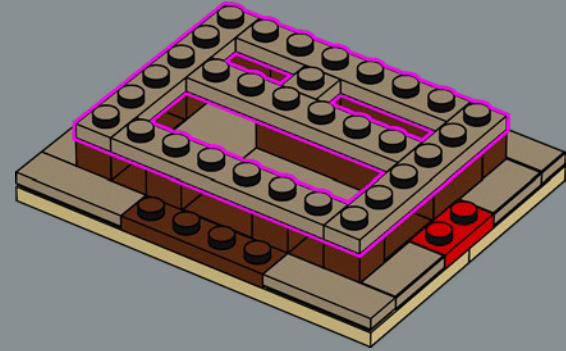

208

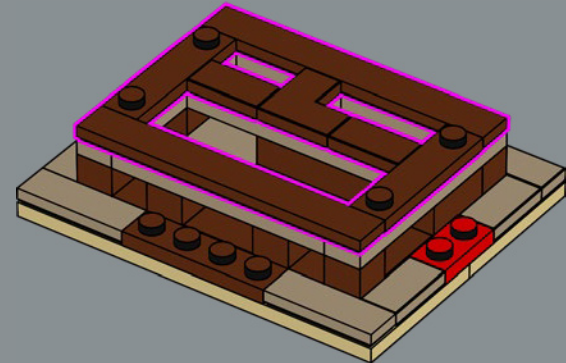

209

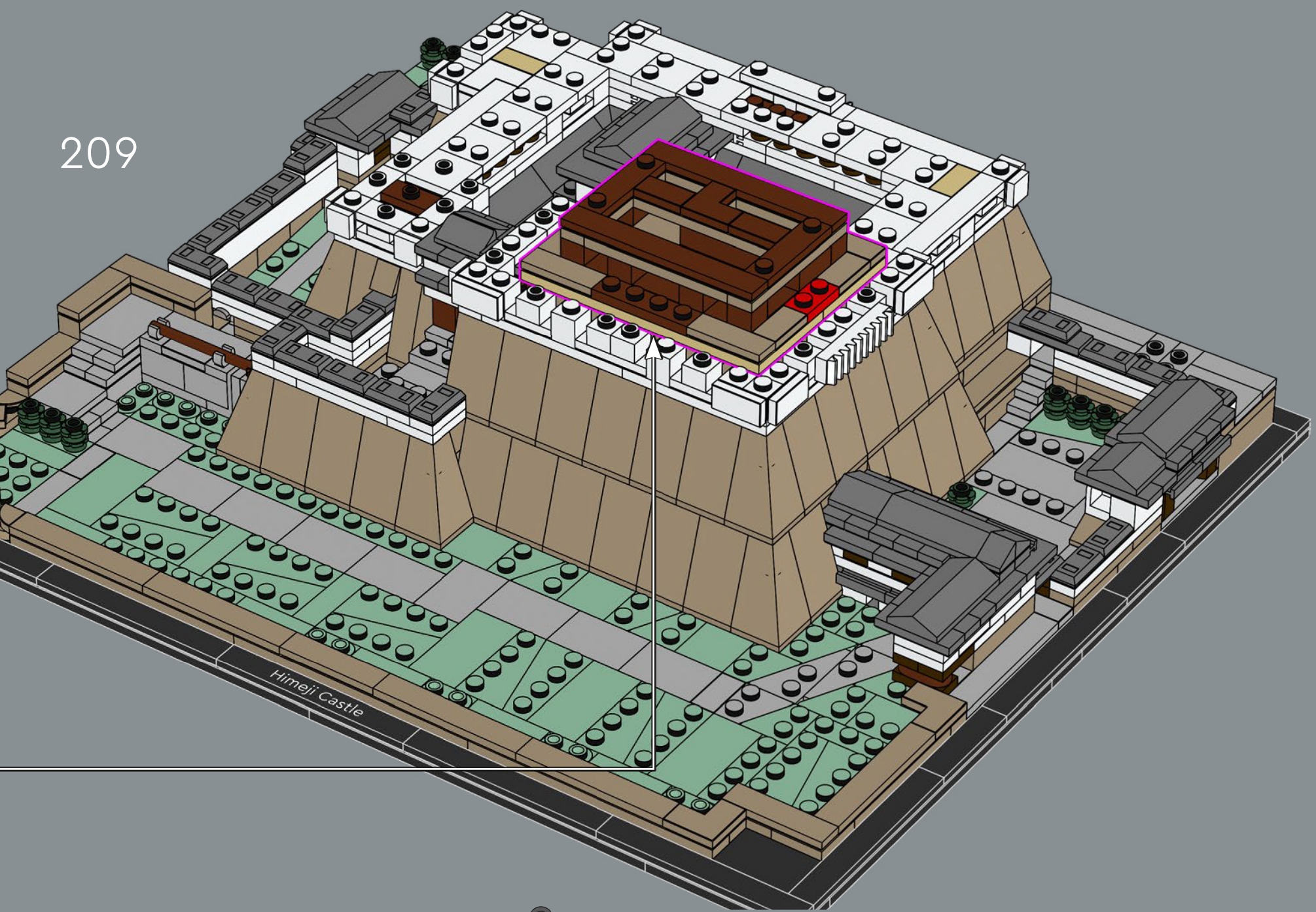

Himeji Castle

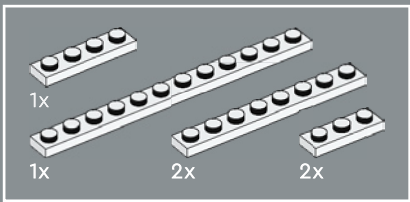

210

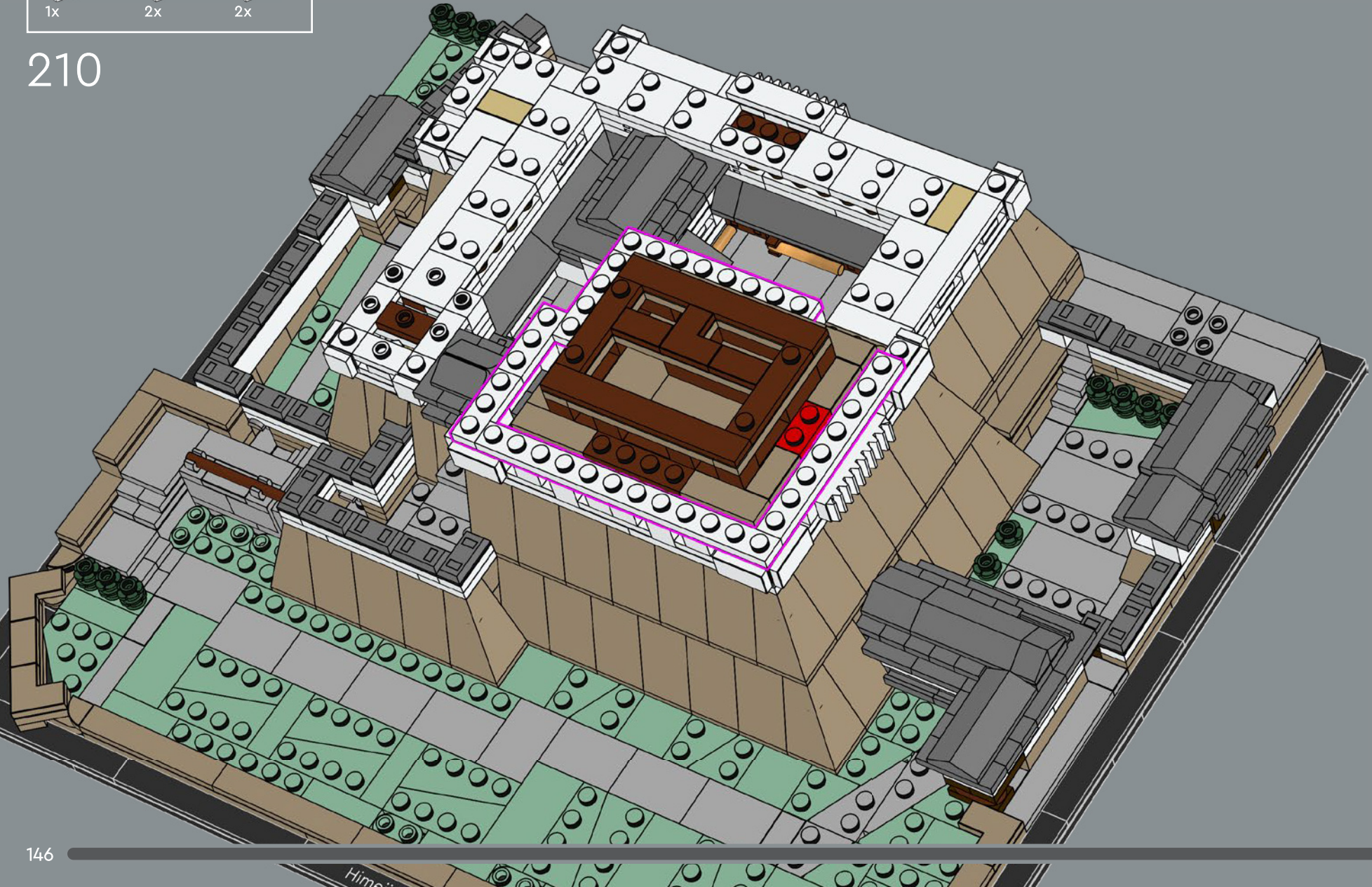

虽然在这款套装中我们不得不遵循 90 度或其它可控角度的设计，但我们保留了一些不对称的线条来纪念原始城堡。

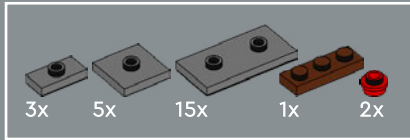

211

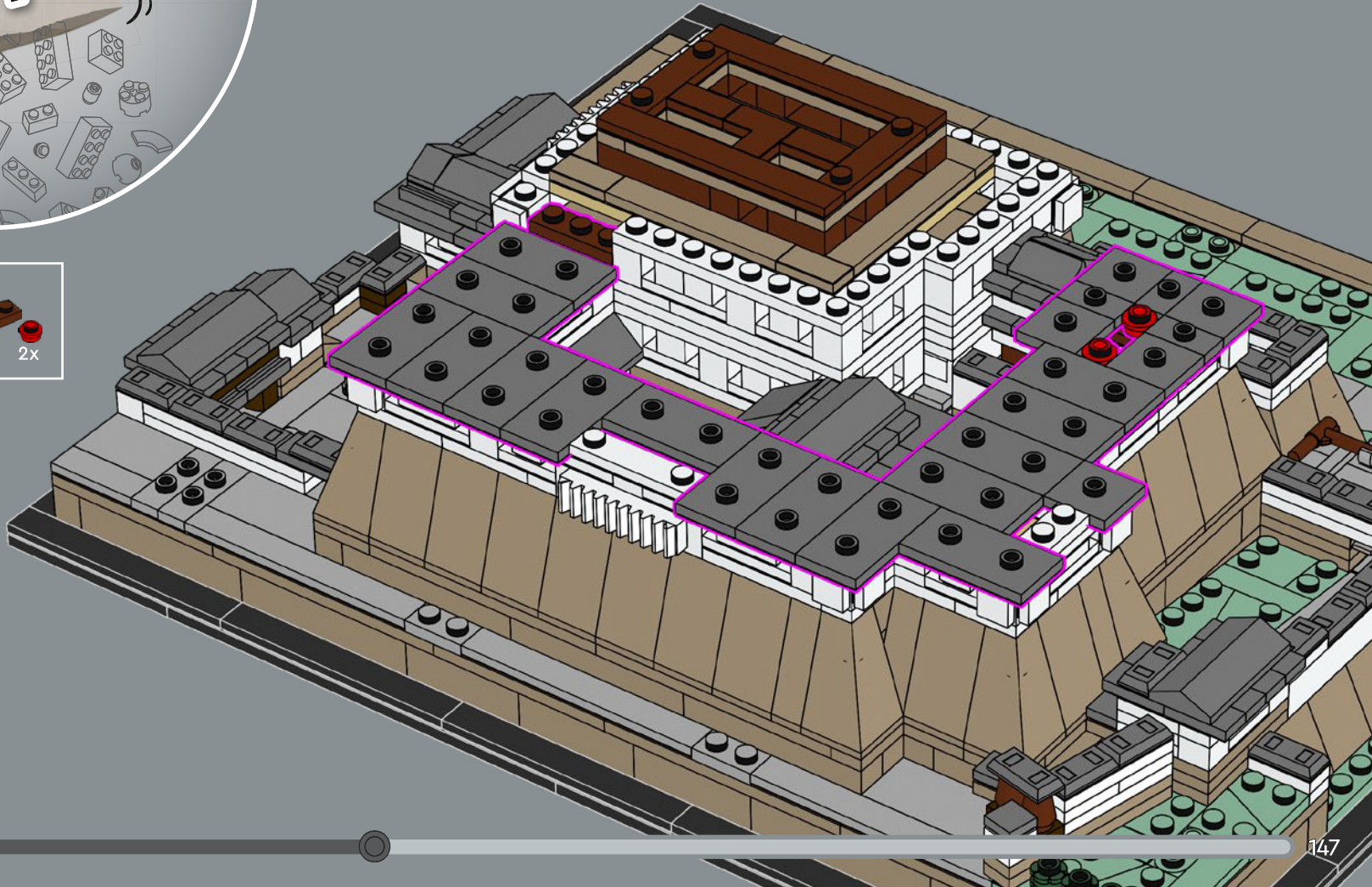

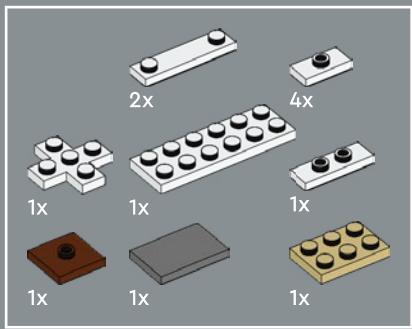

212

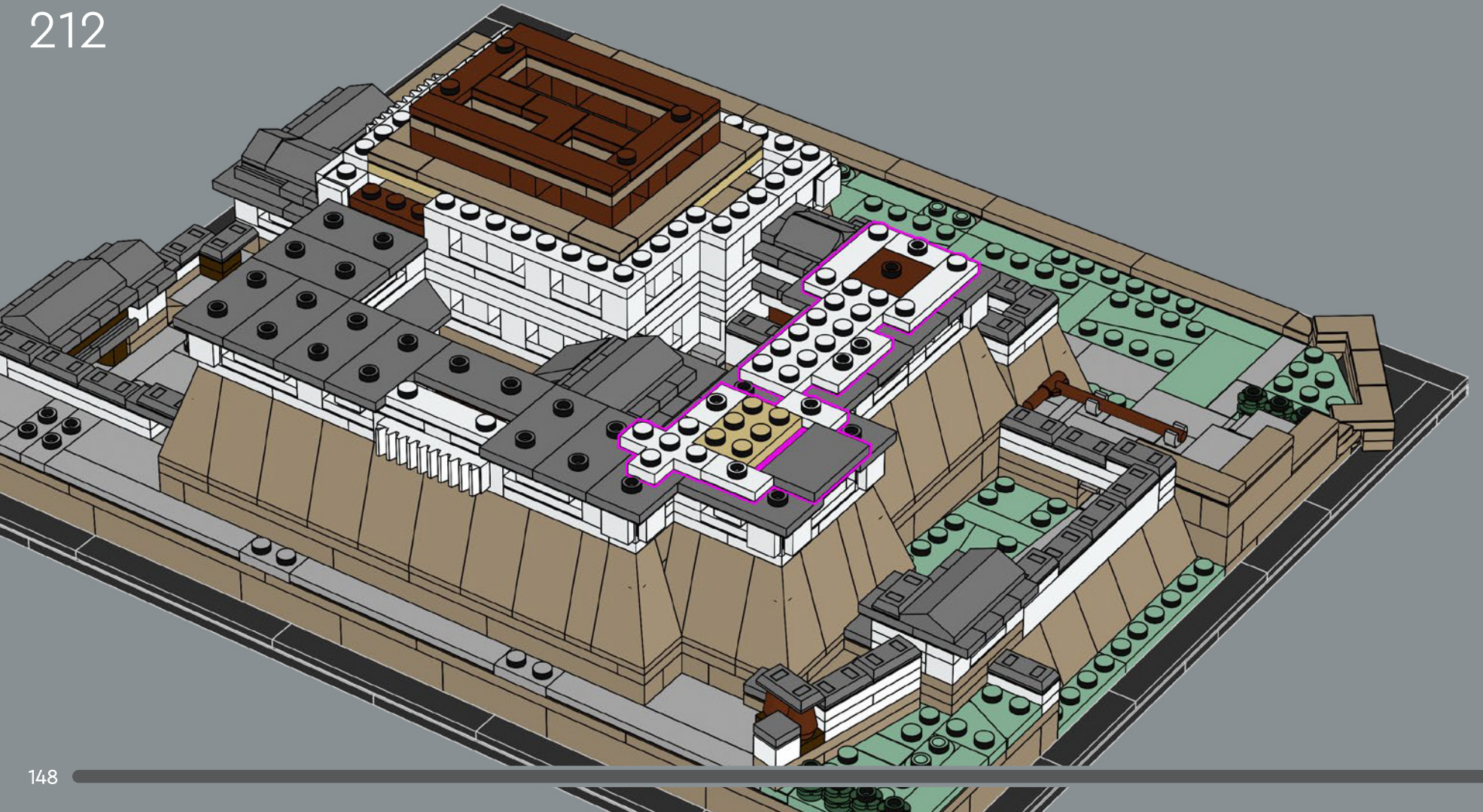

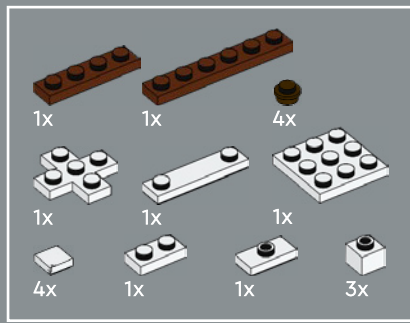

213

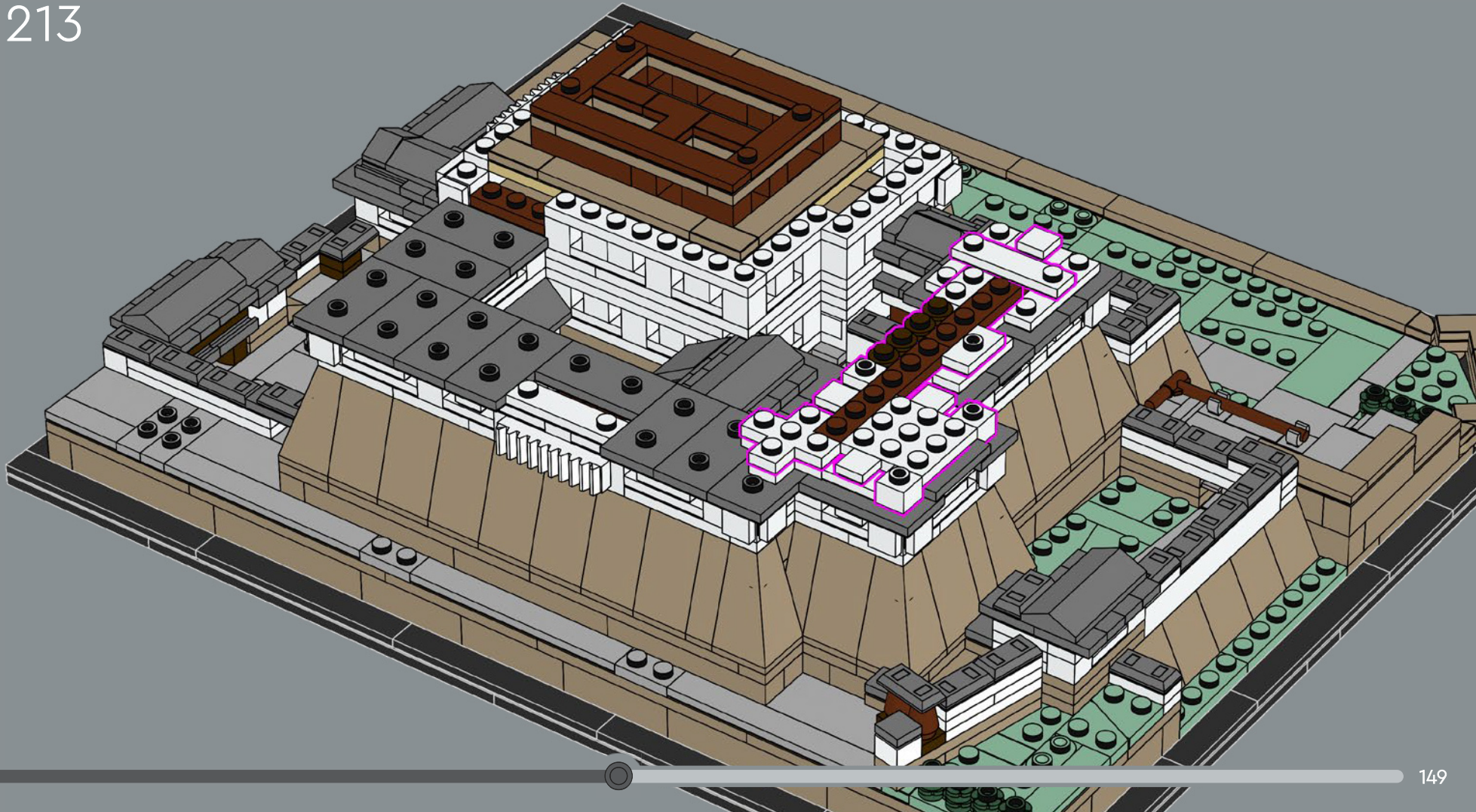

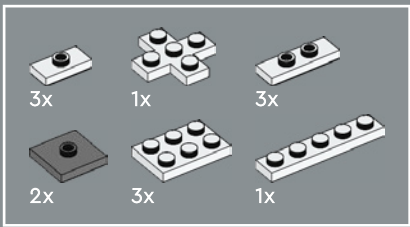

214

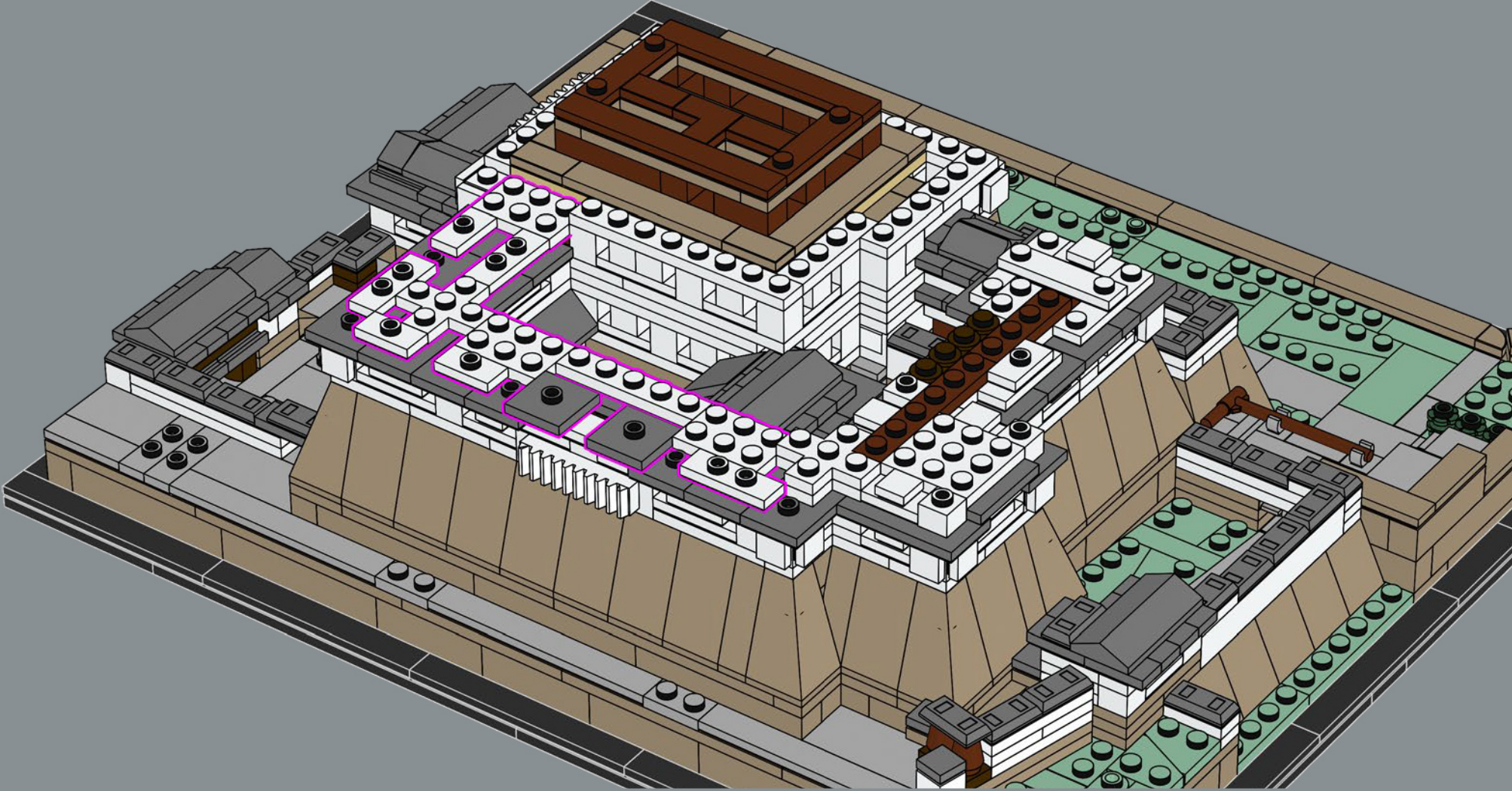

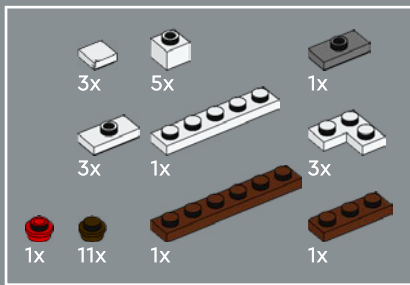

215

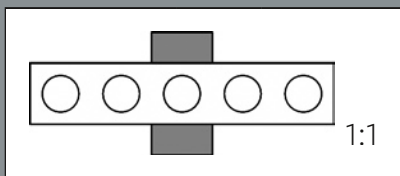
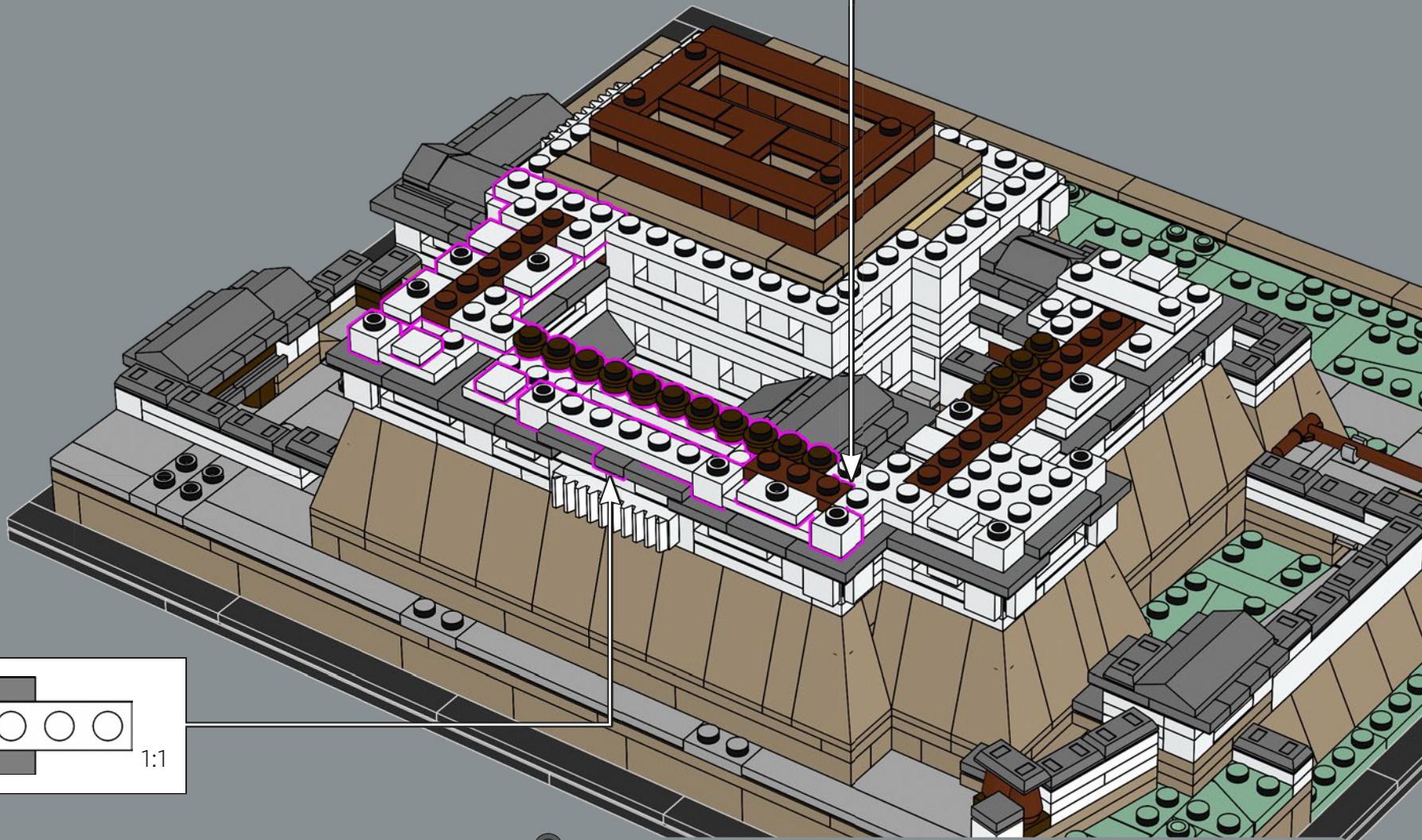
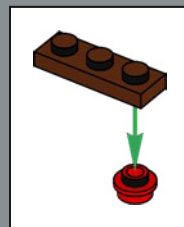

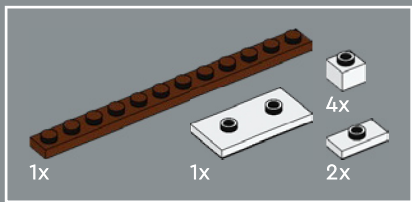

216

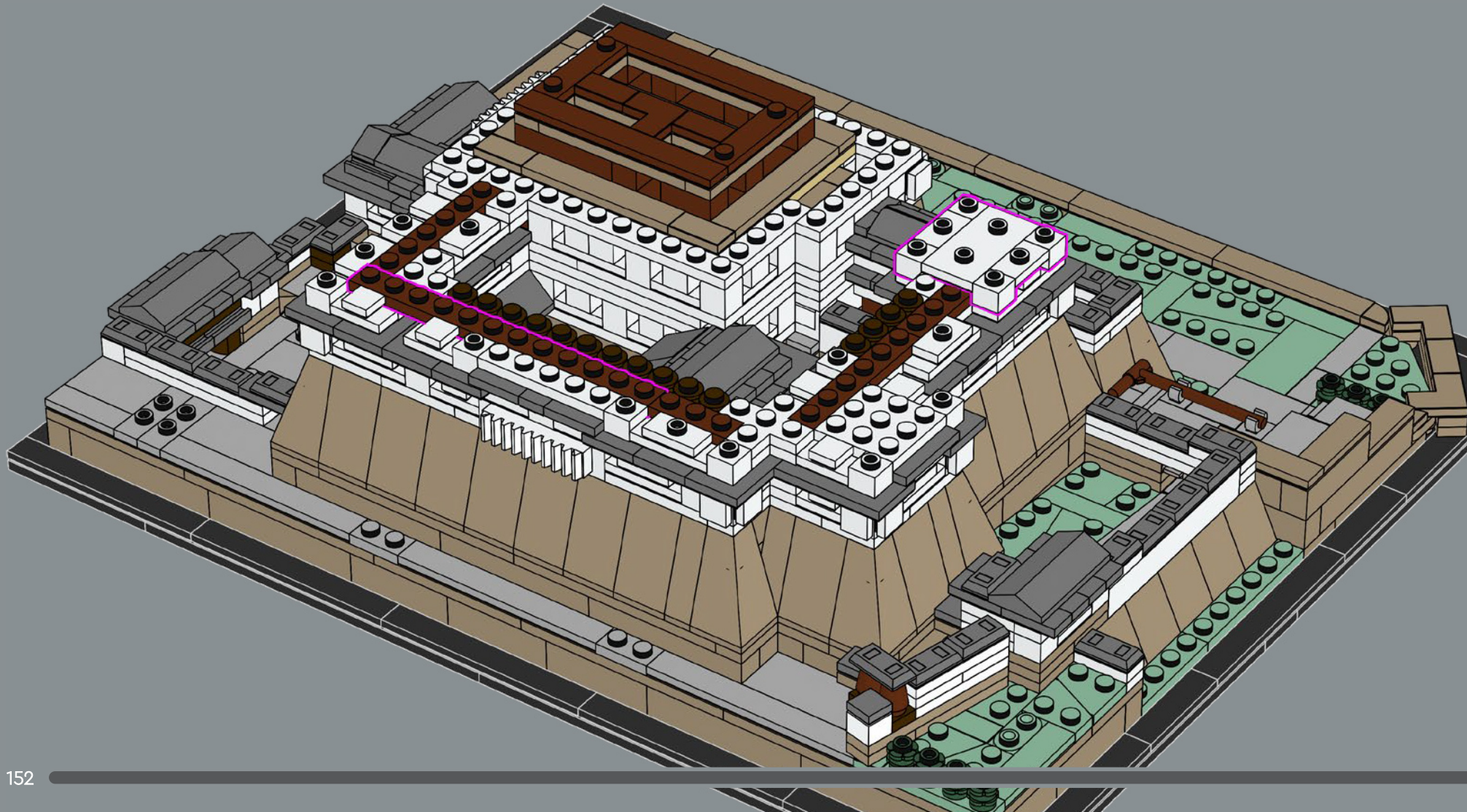

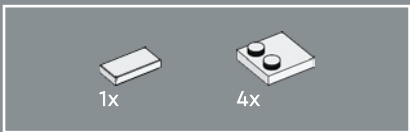

217

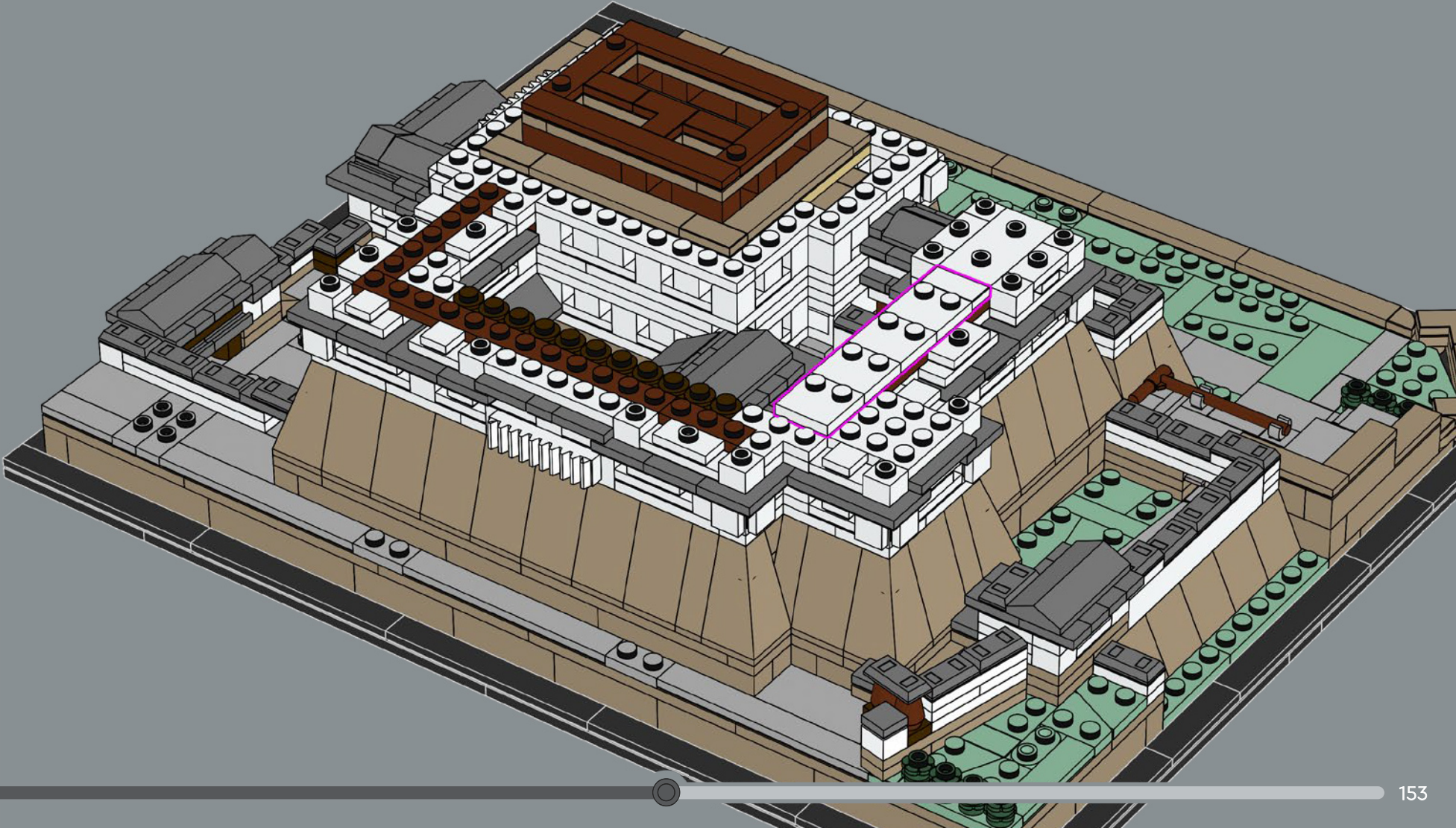

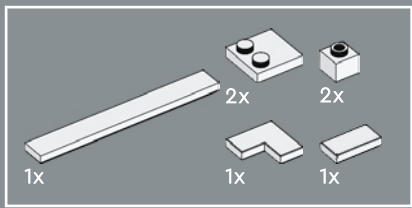

218

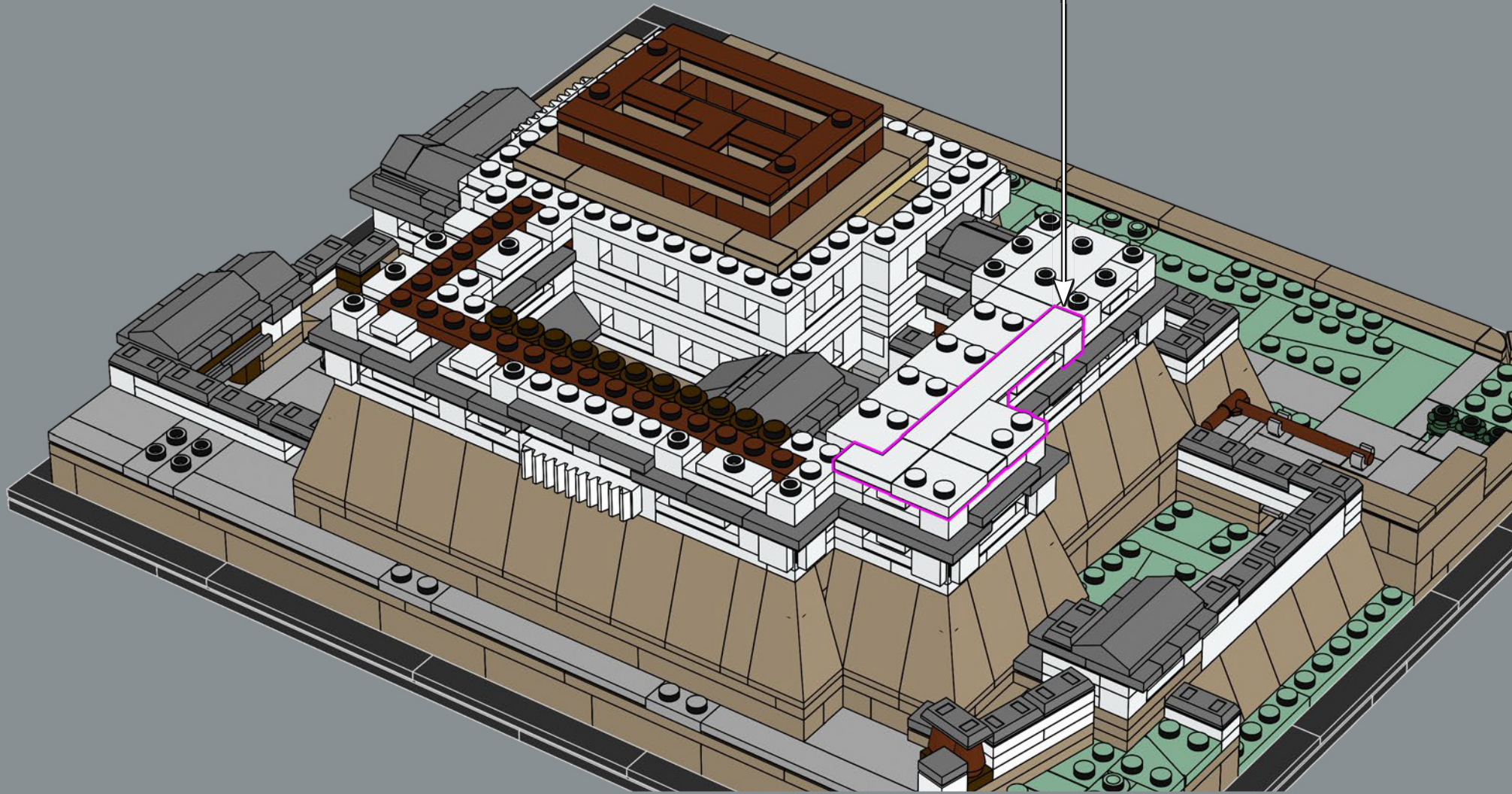
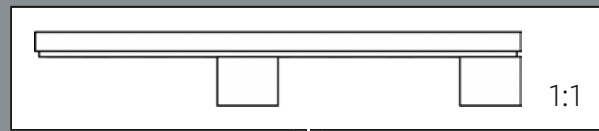

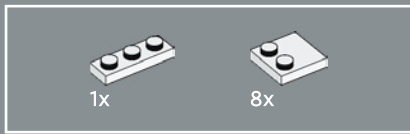

219

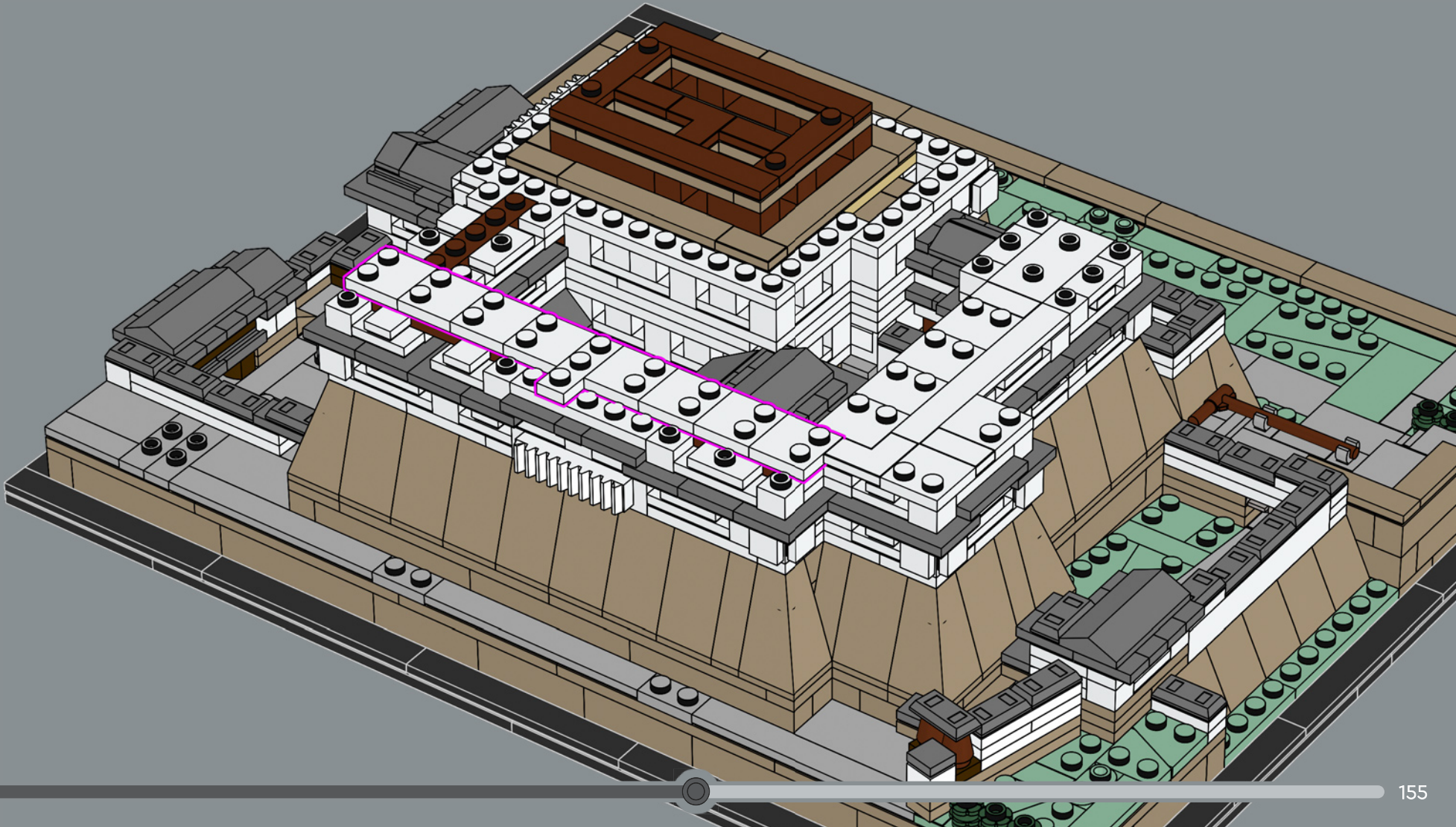

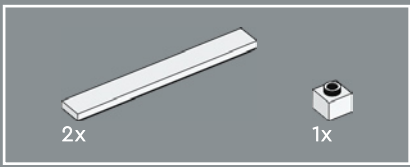

220

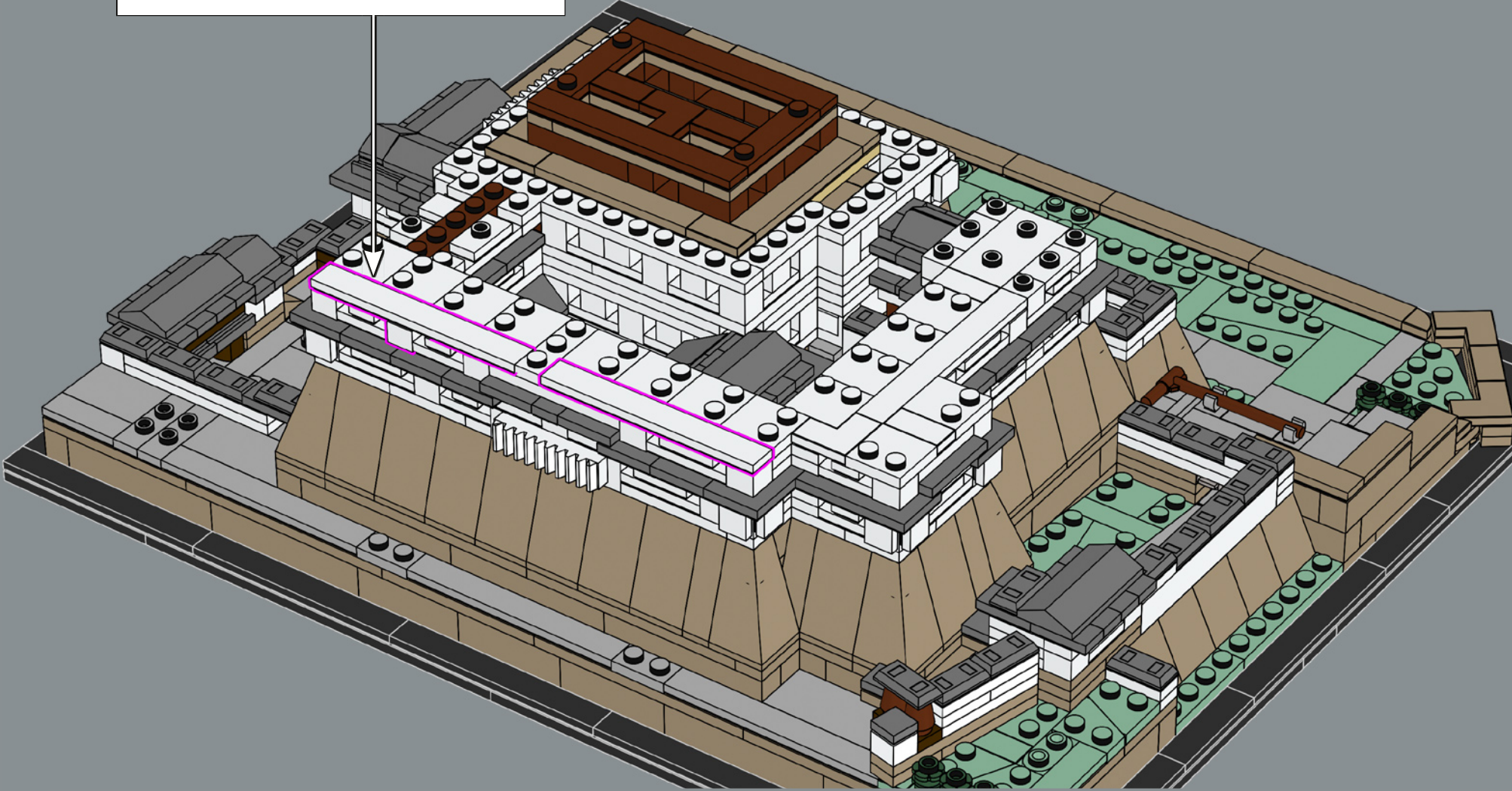
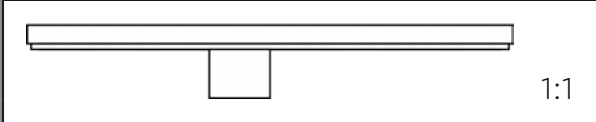

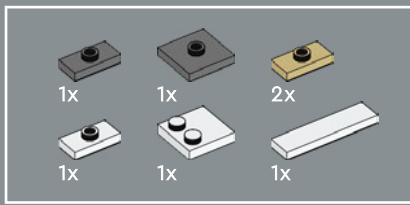

221

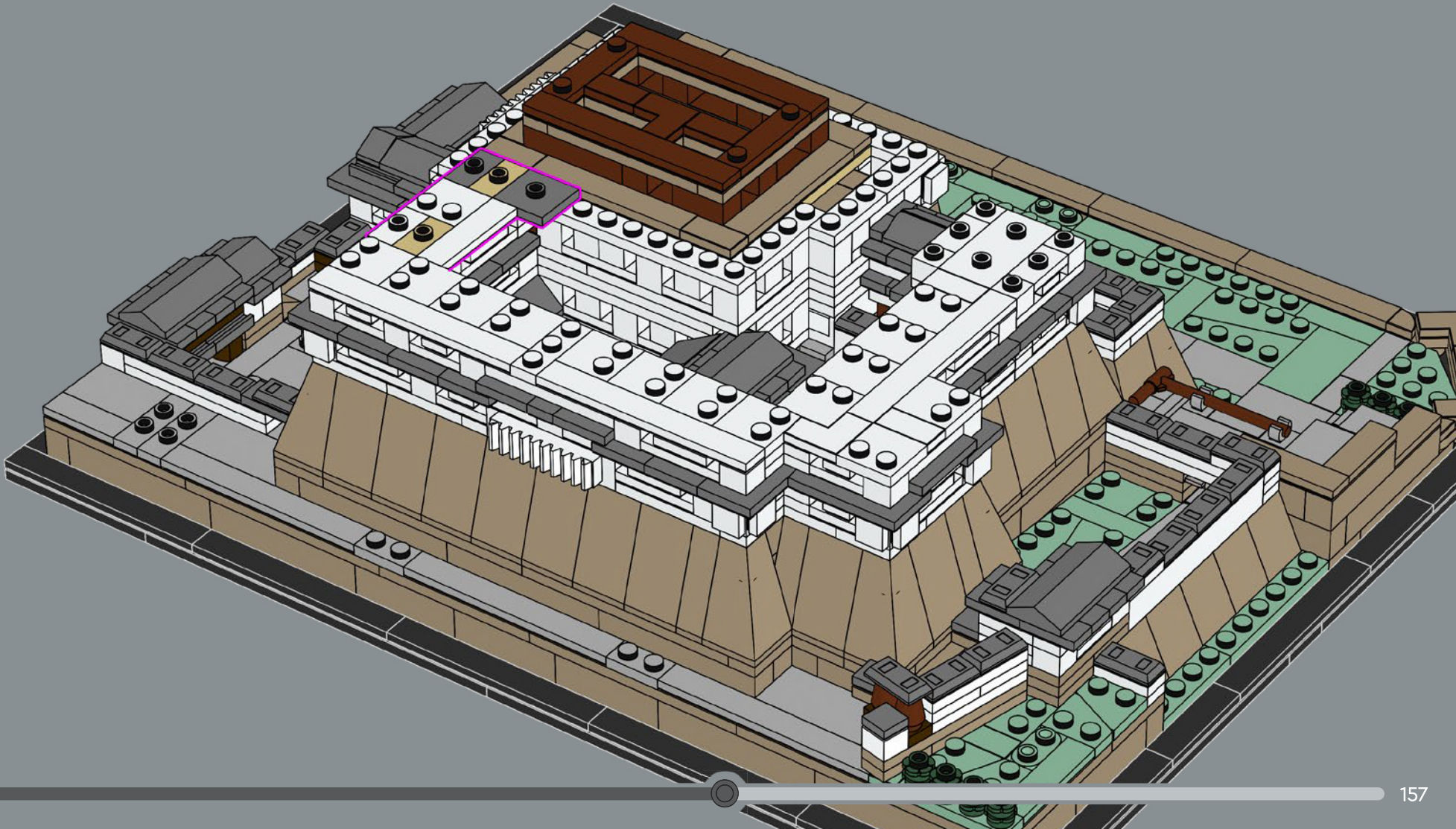

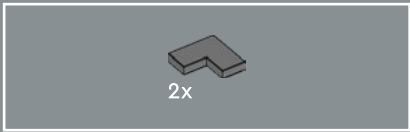

222

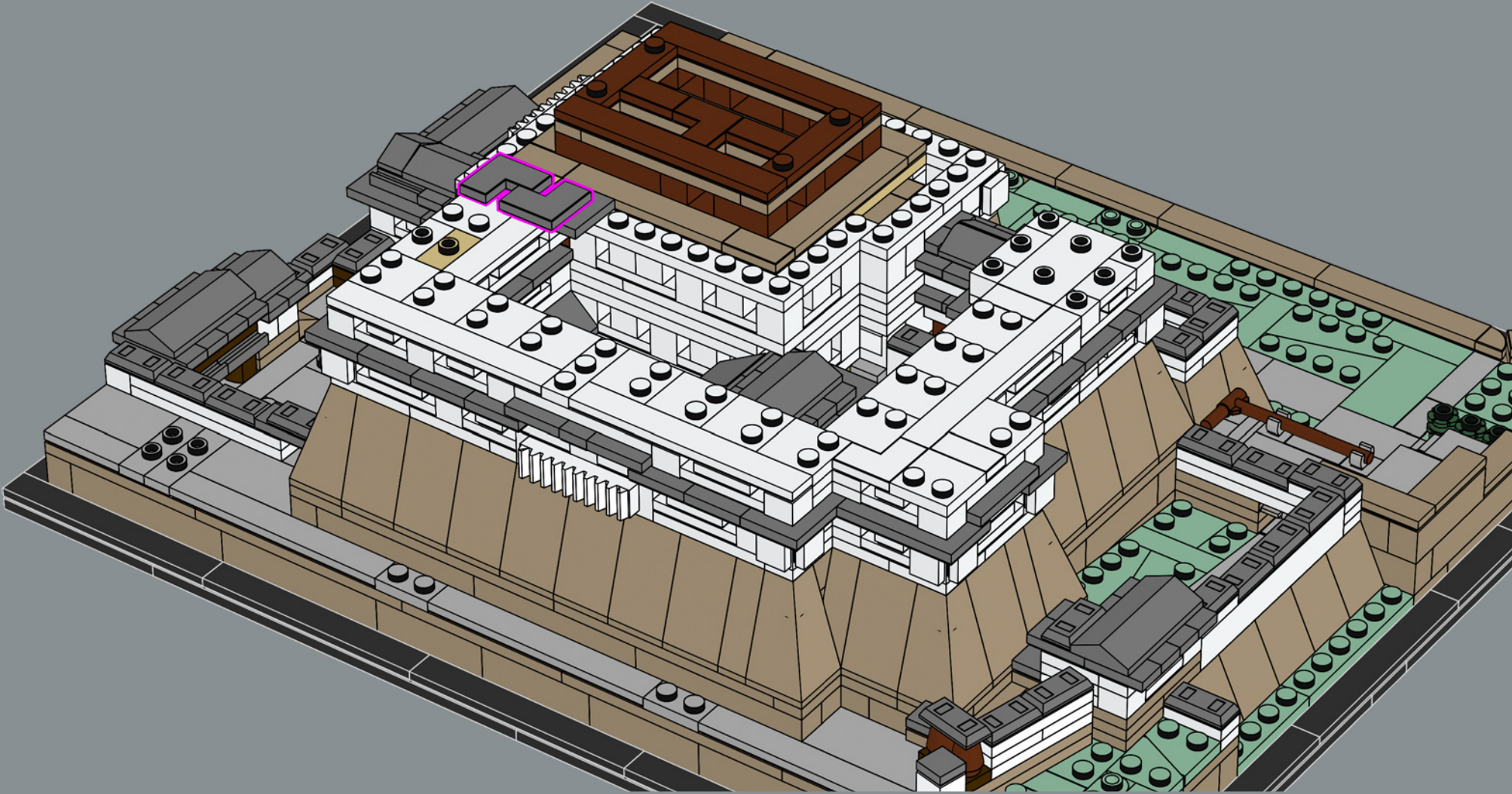

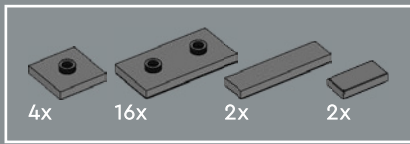

223

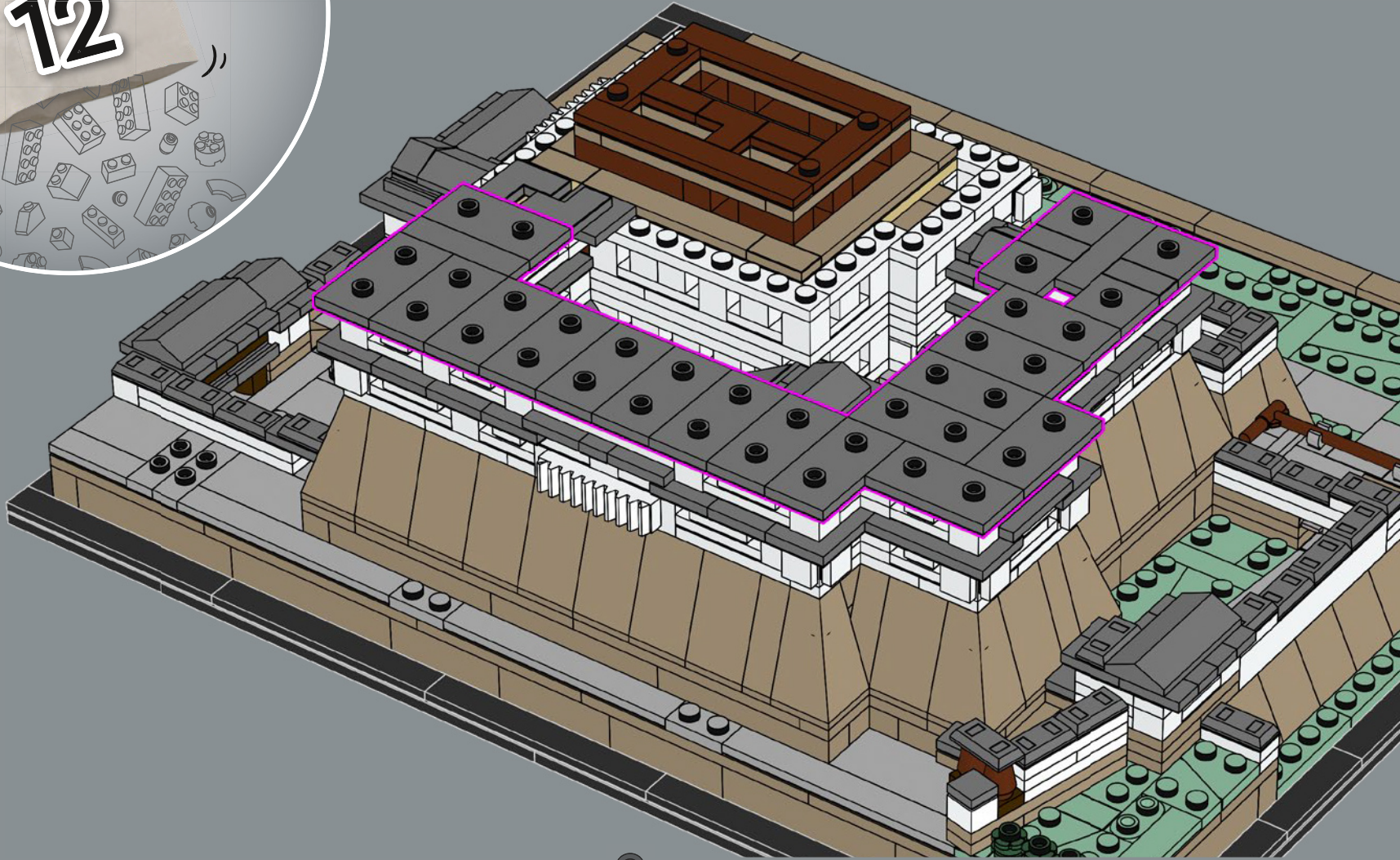

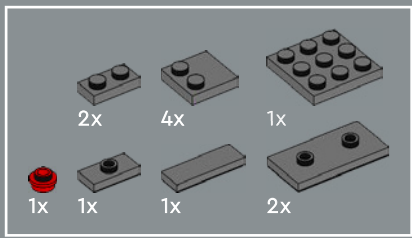

224

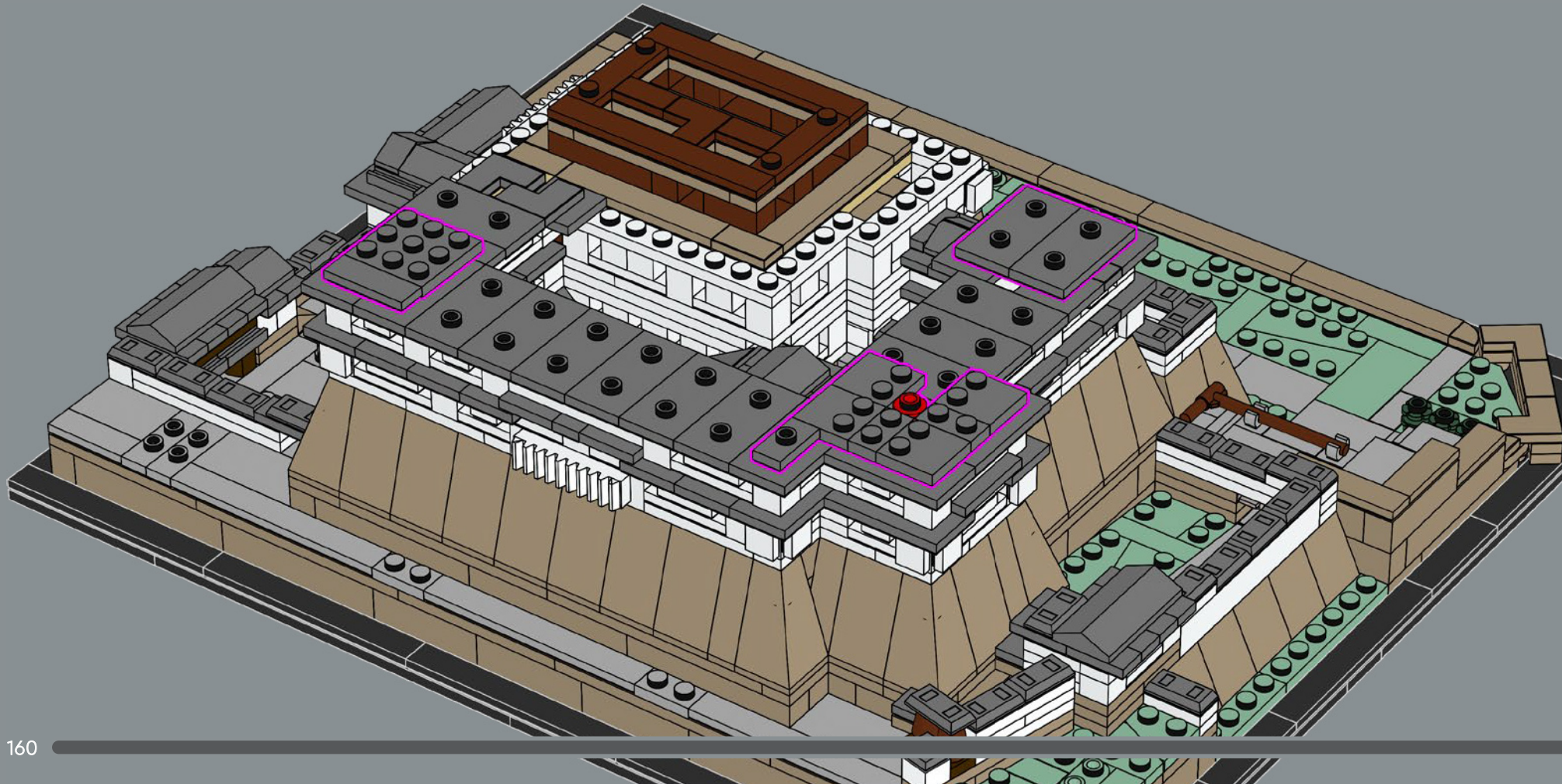

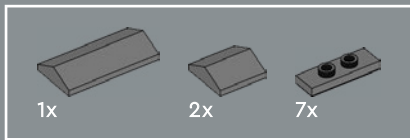

225

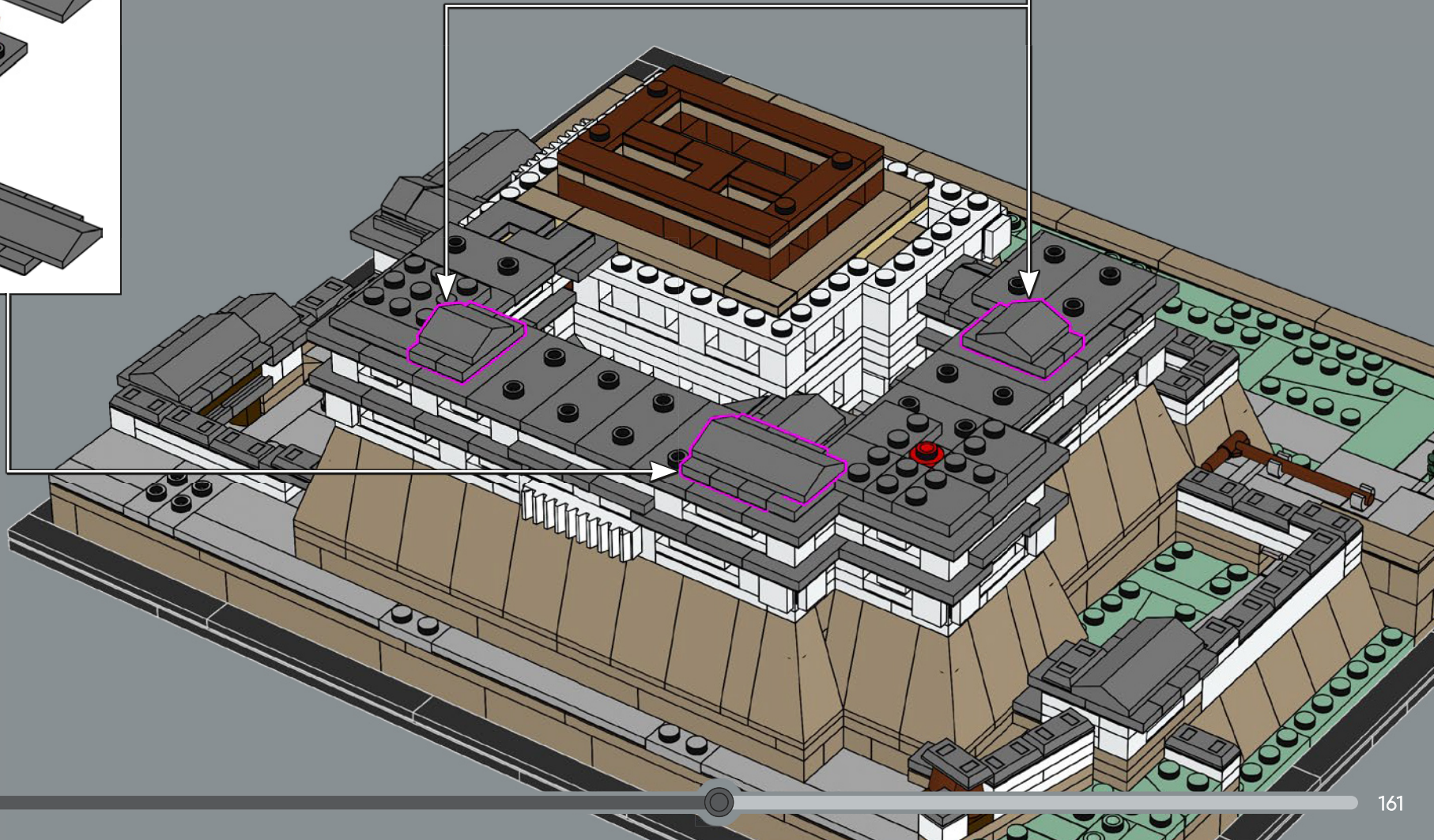
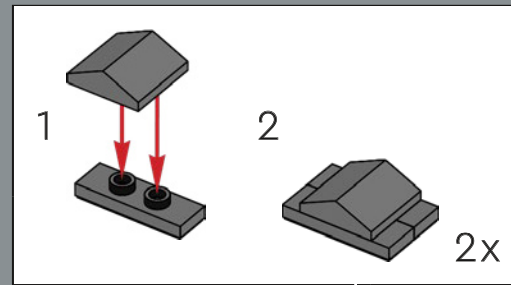
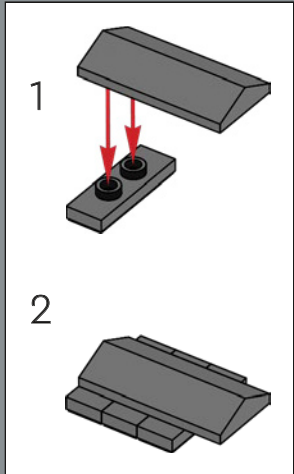

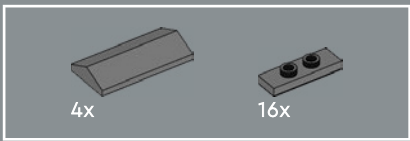

226

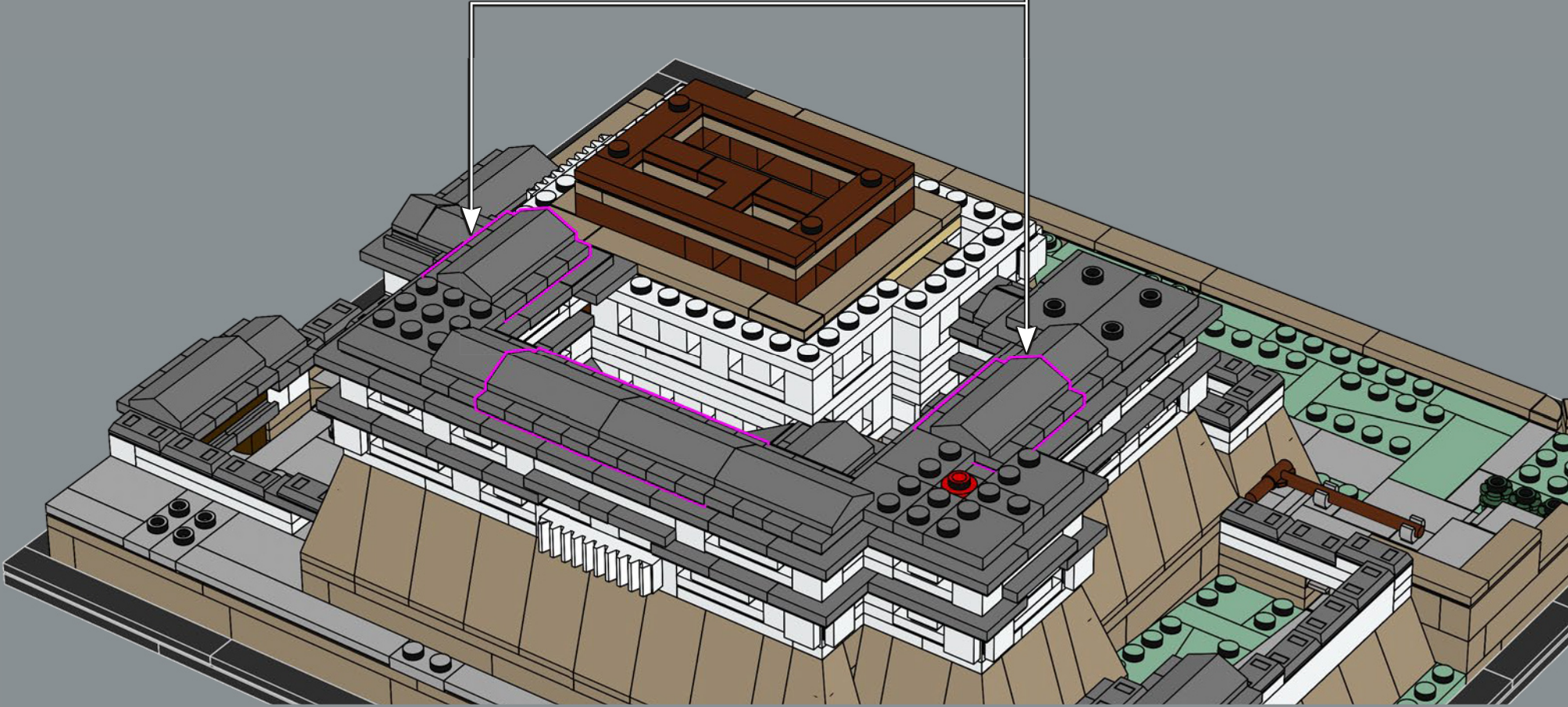
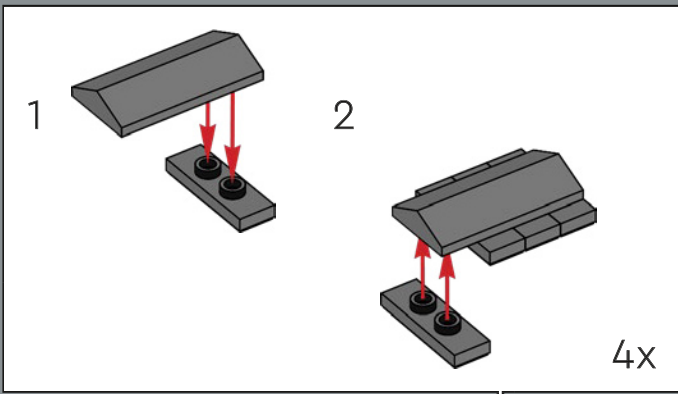

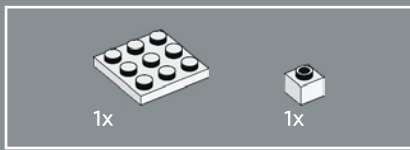

227

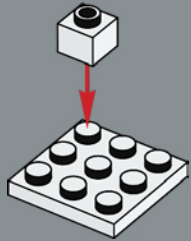

228

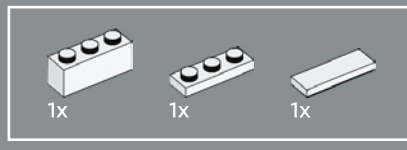
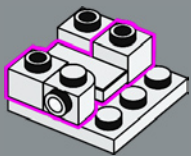

229

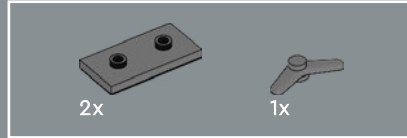
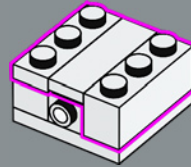

230

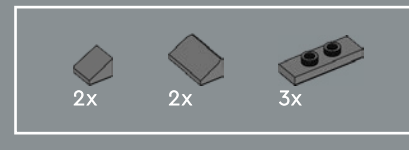
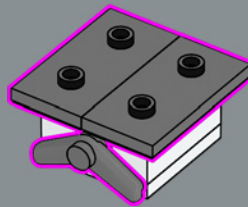

231

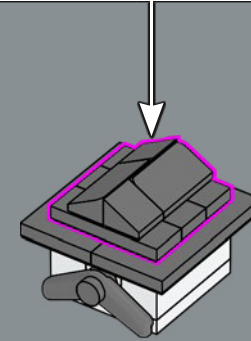
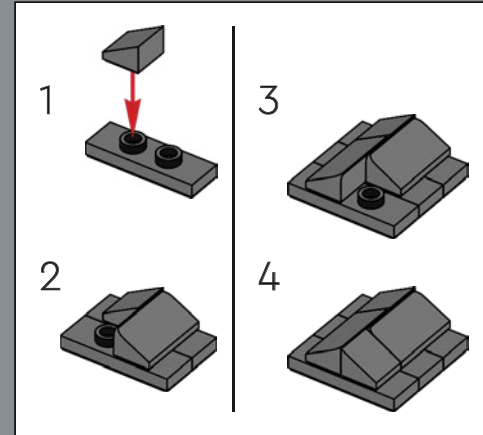

由于多年暴露于外界，屋顶上的白色粘土开始变脏，慢慢改变了屋顶的外观和颜色。

232

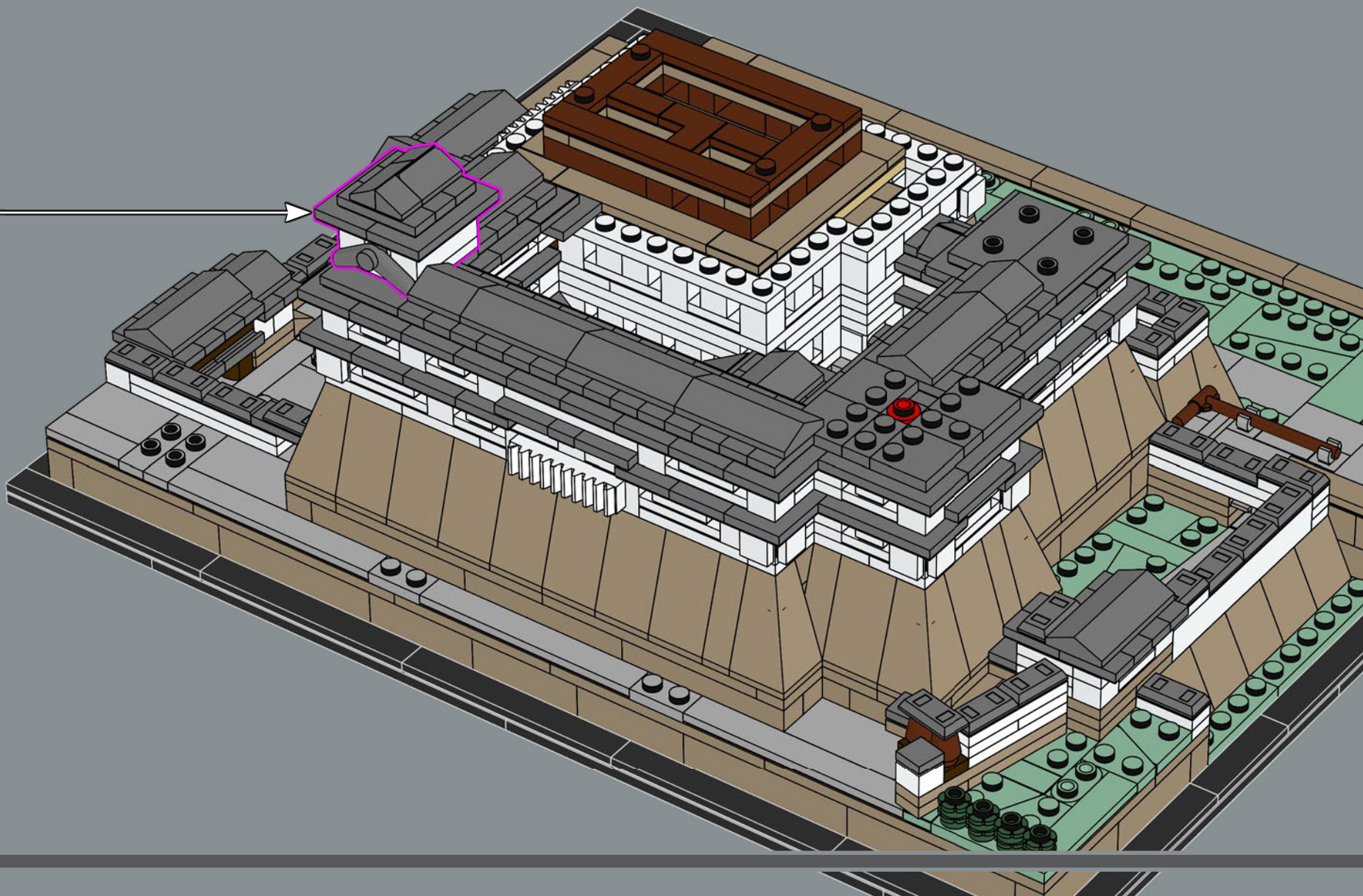

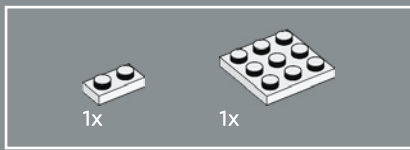

233

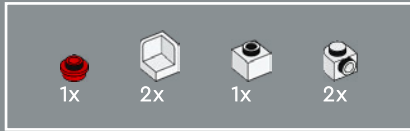
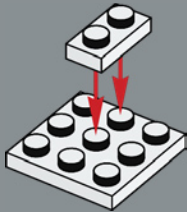

234

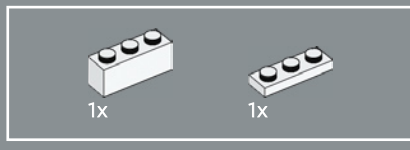
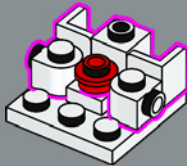

235

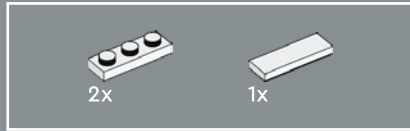
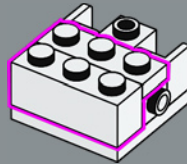

236

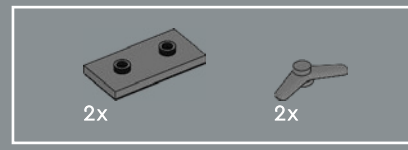
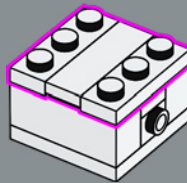

237

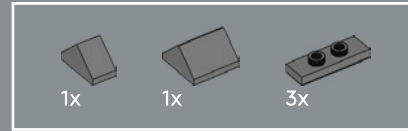
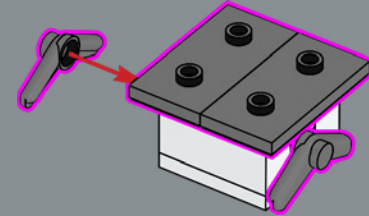

238

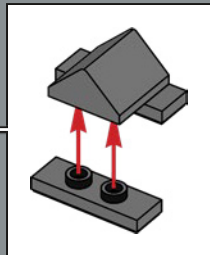
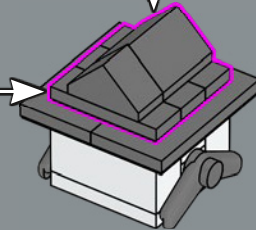
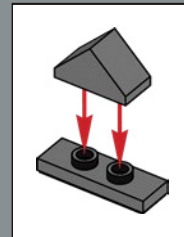

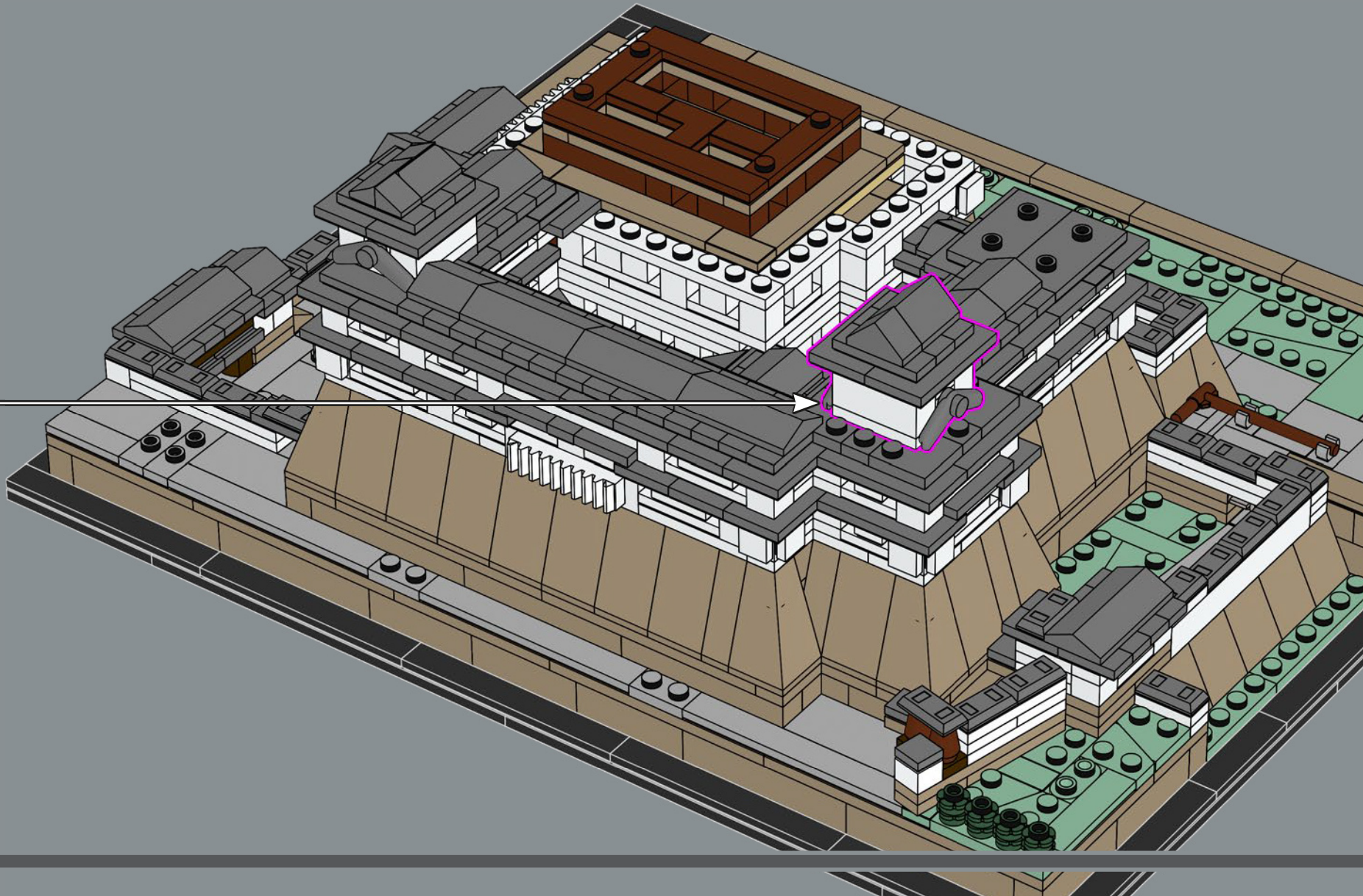



240

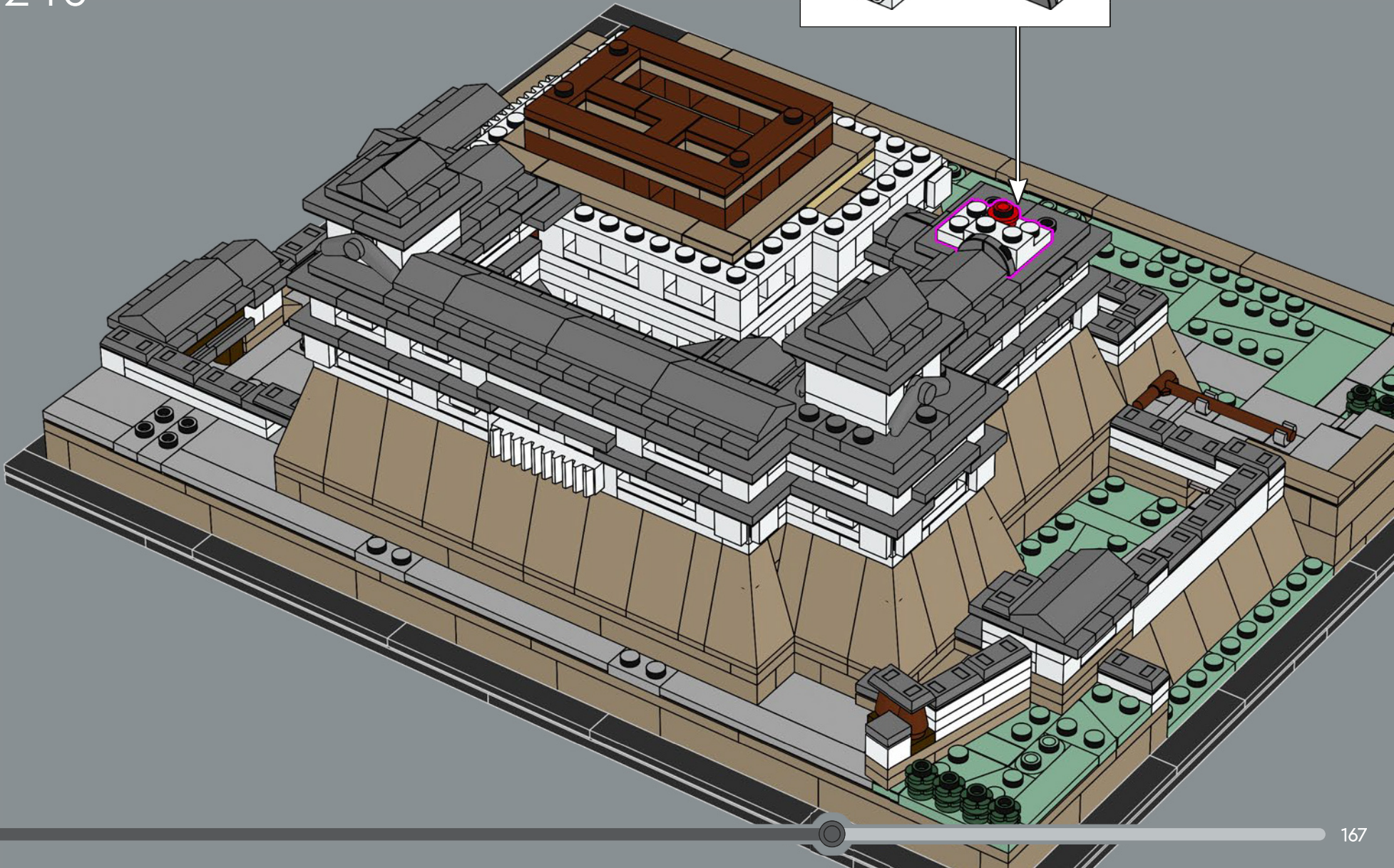
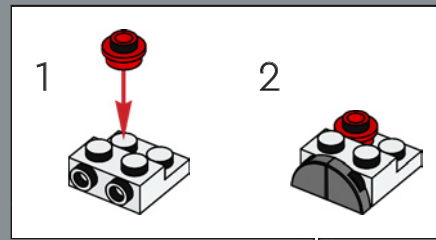

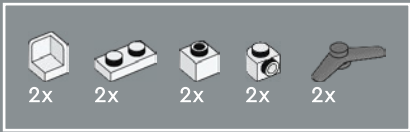

241

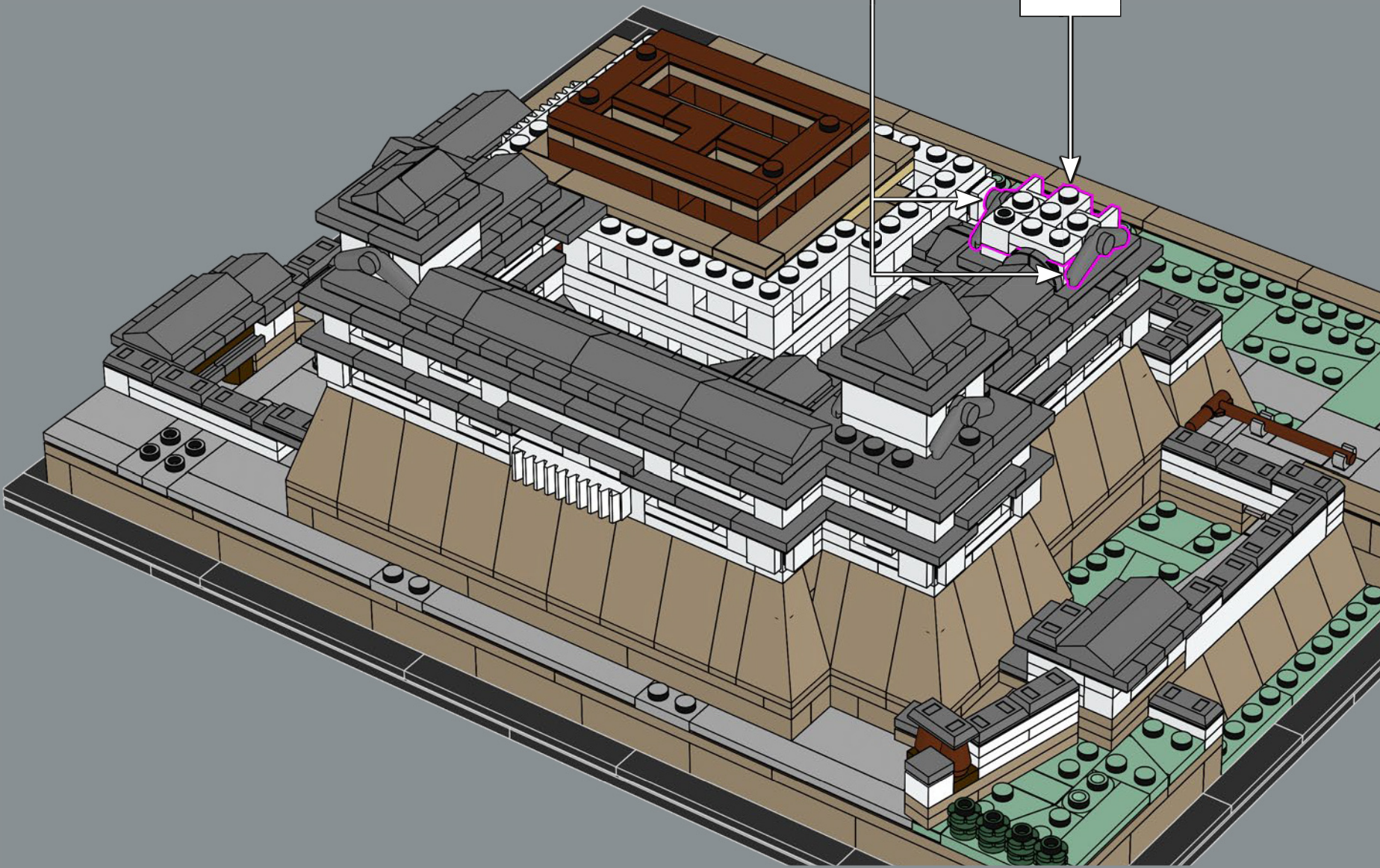
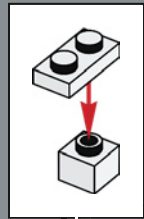
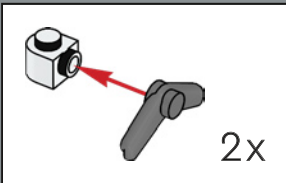

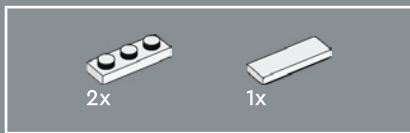

242

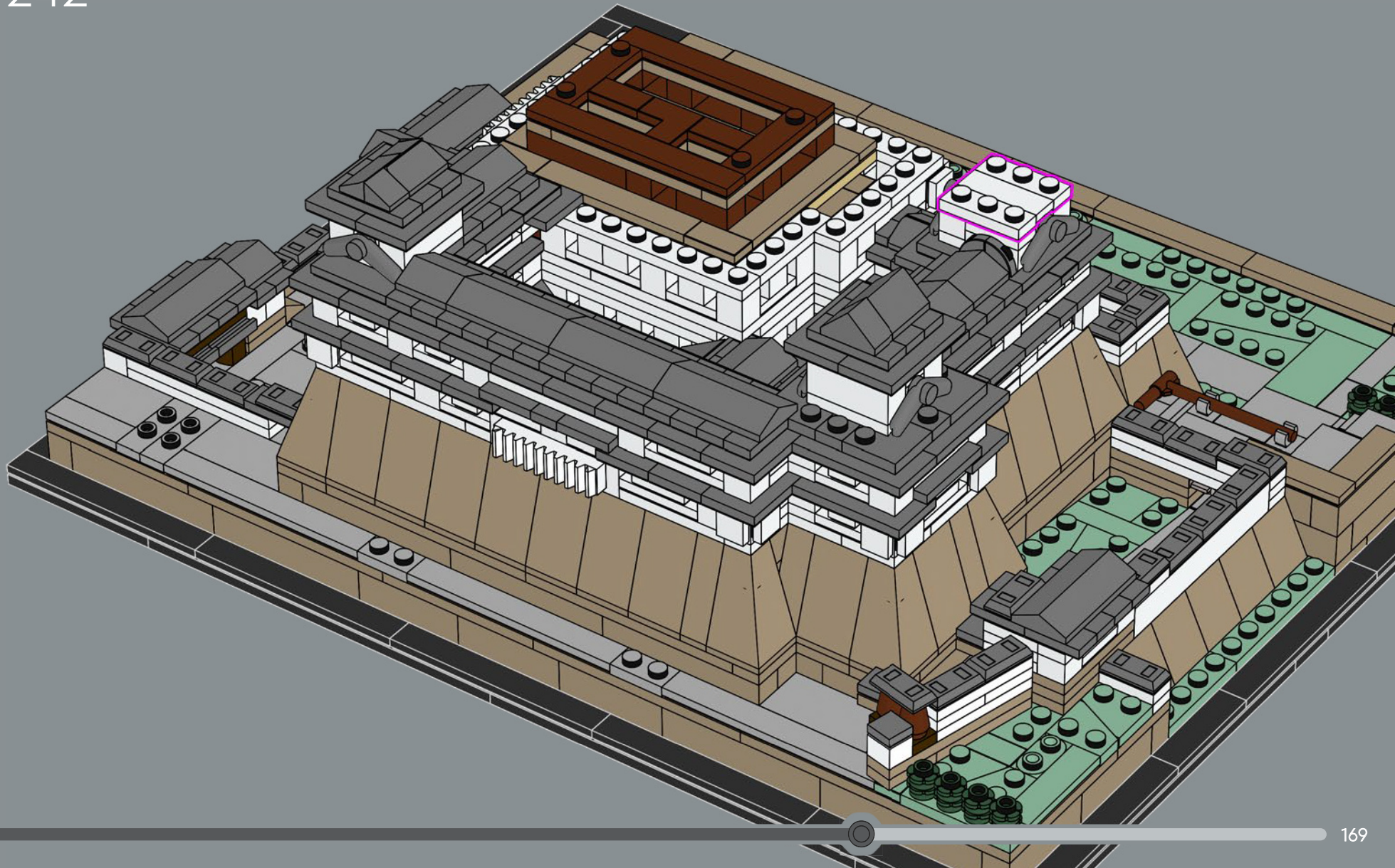

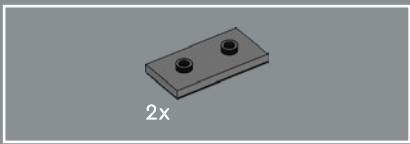

243

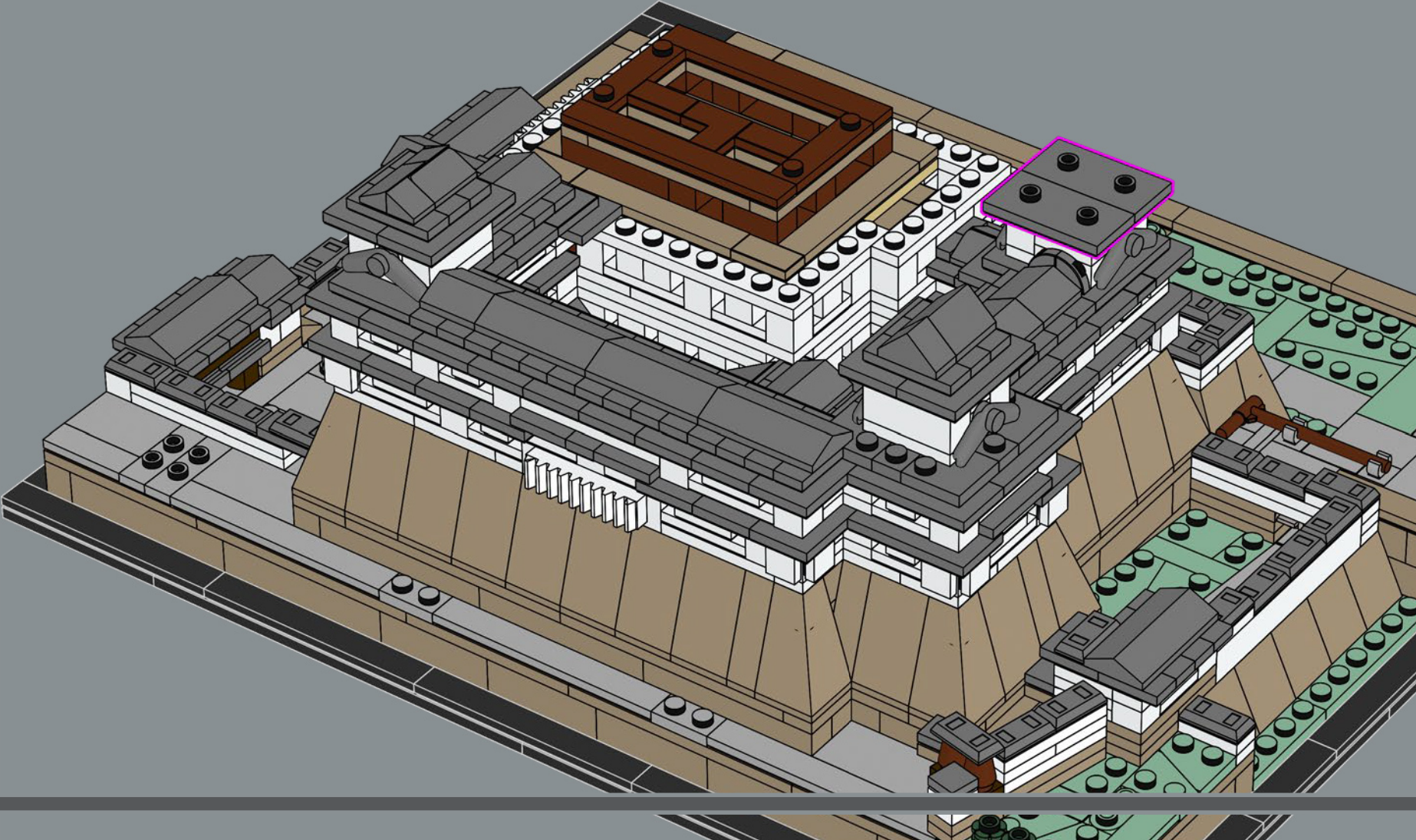

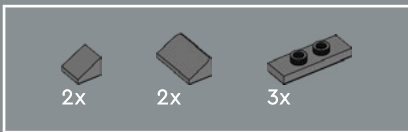

244

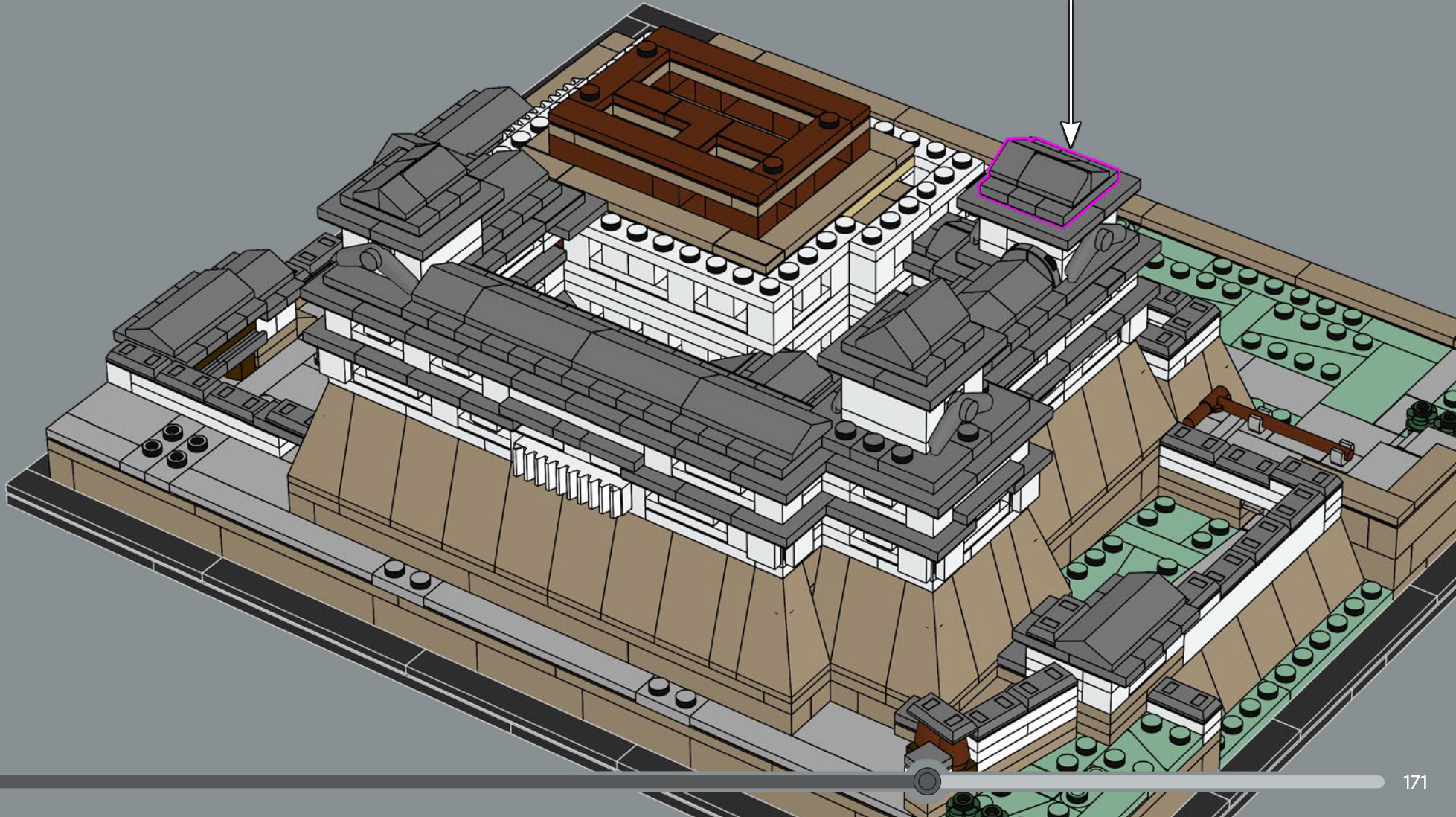
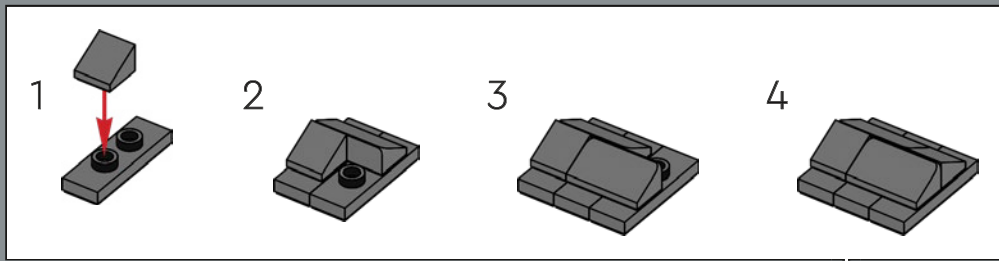

这款全新的弓形 2x2 角组件是第二件获准用于乐高®建筑系列套装的新组件。第一件是一个类似的 3x3 组件，出现在罗宾别墅 Robie House 21010 (2011 年) 中。

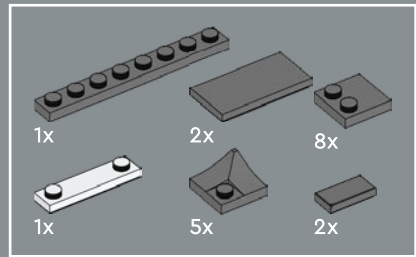

245

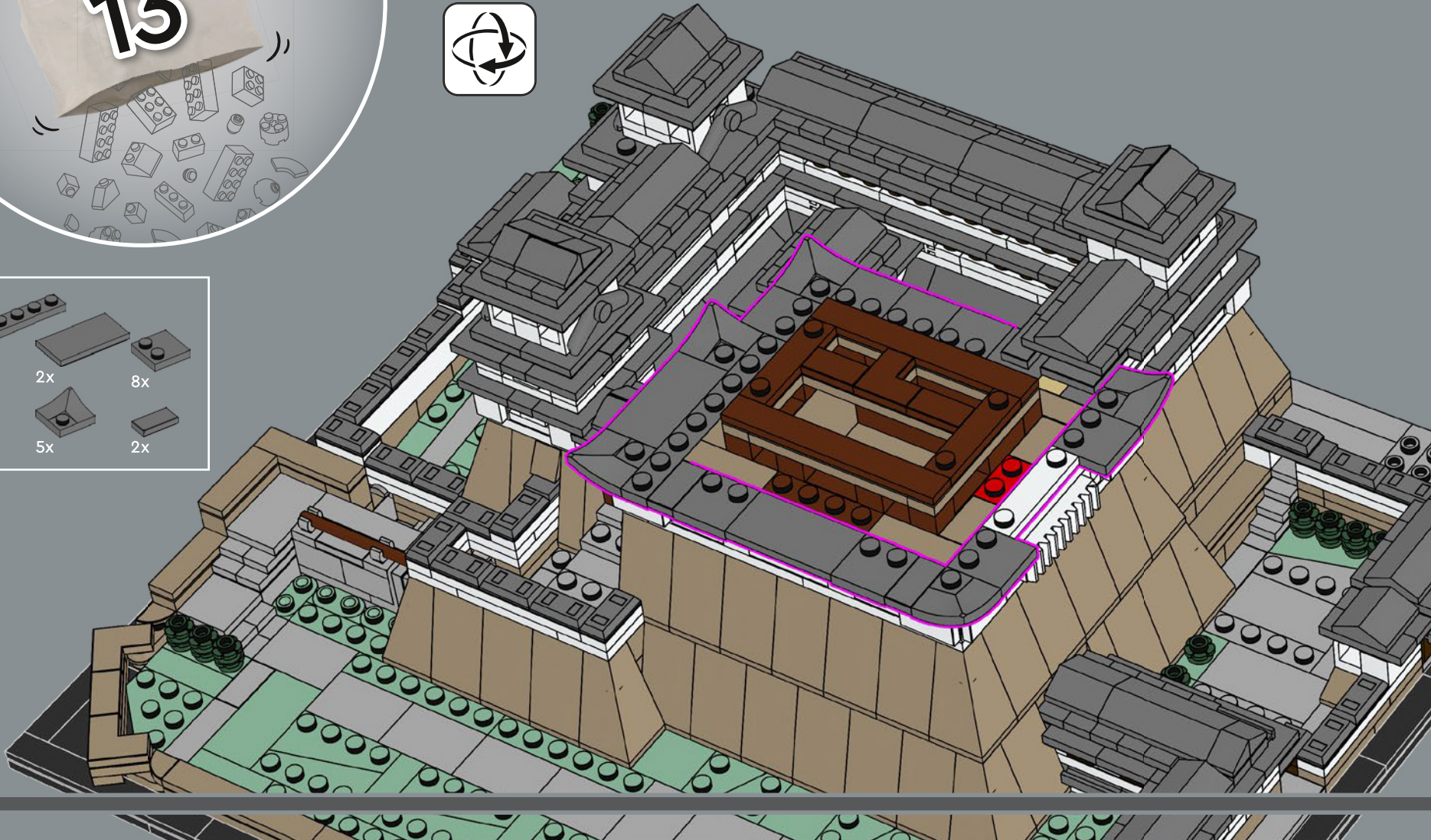

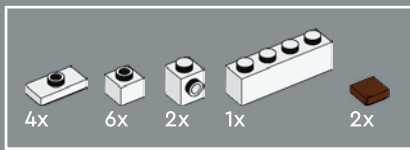

246

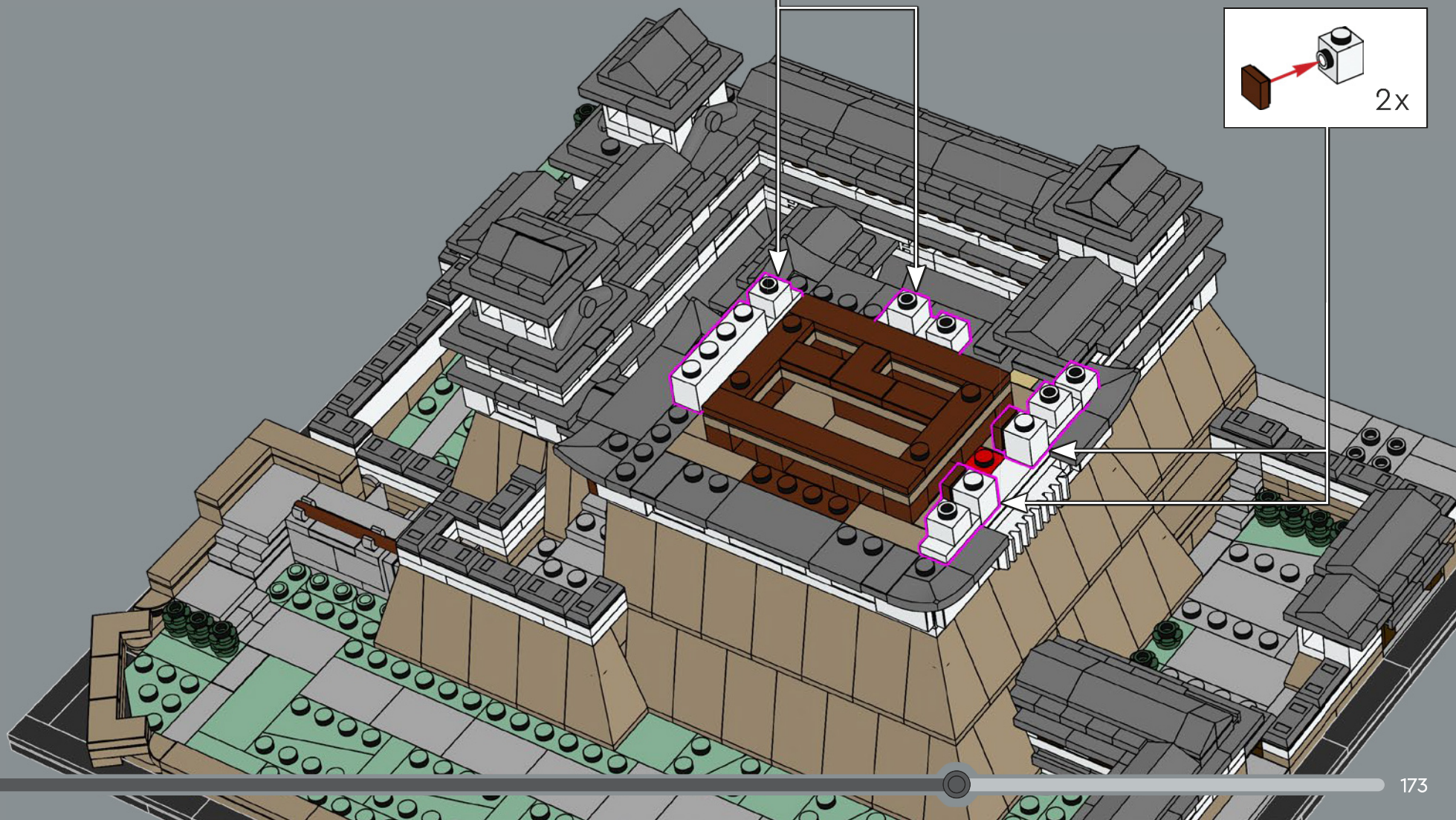
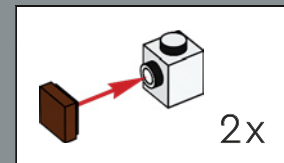
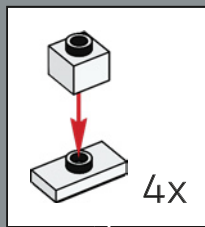

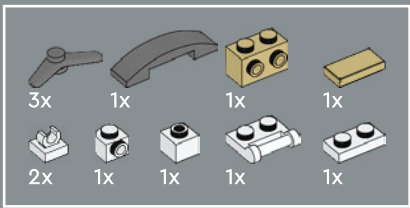

247

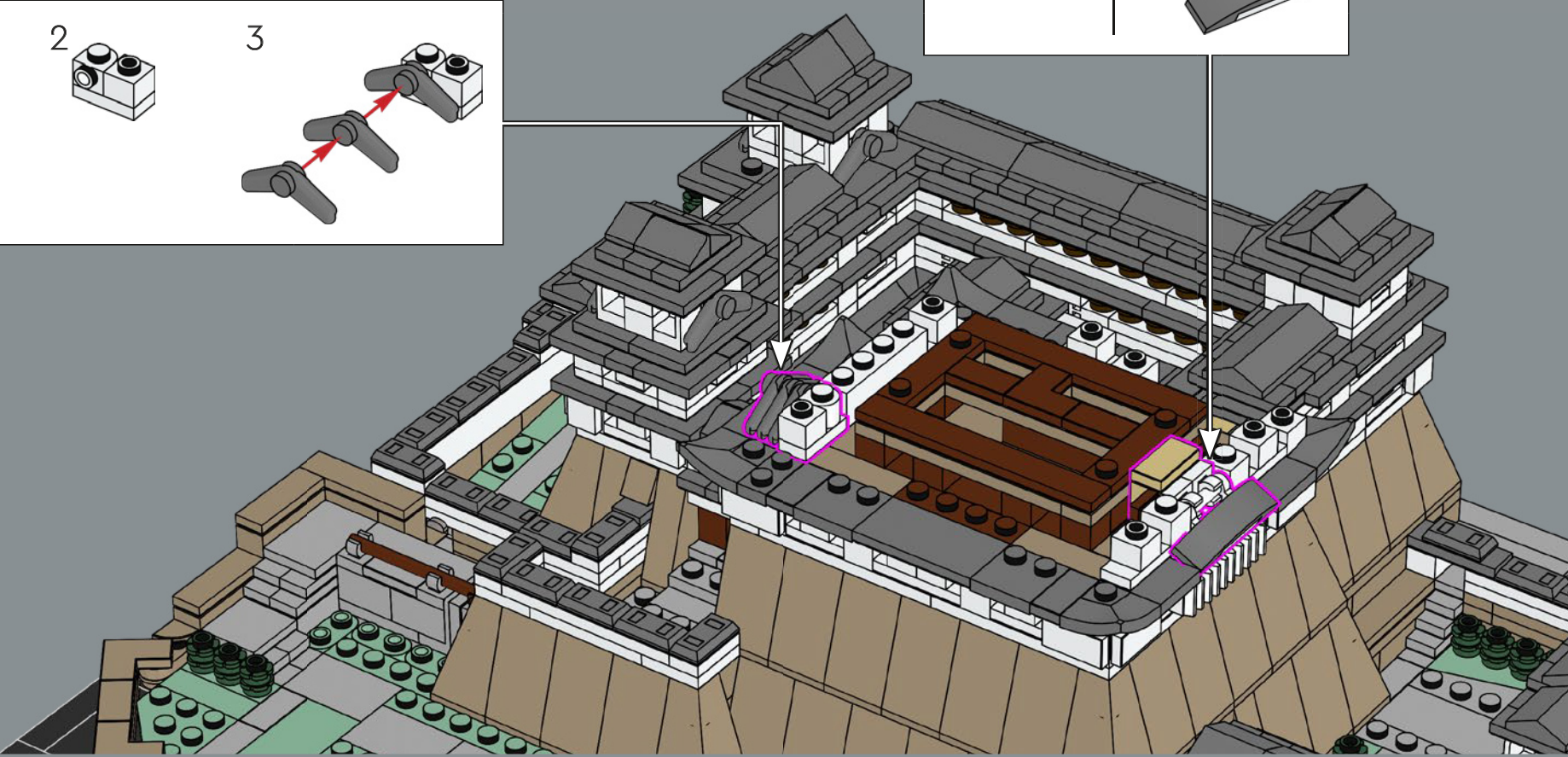
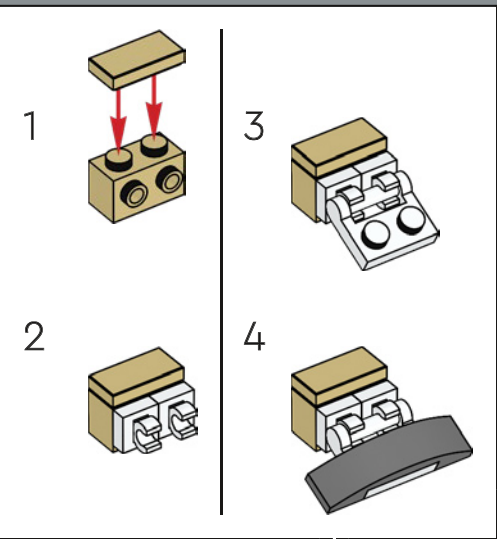
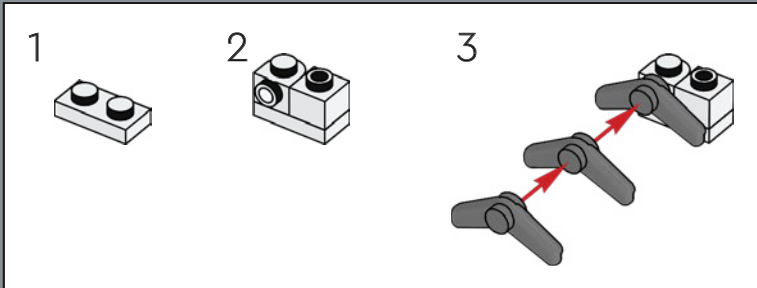

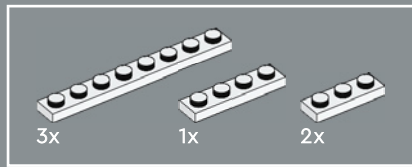

248

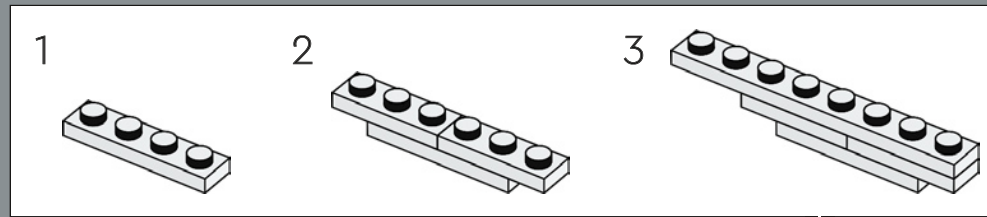

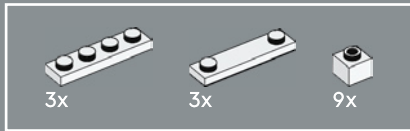
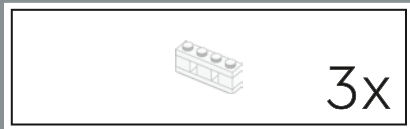

249

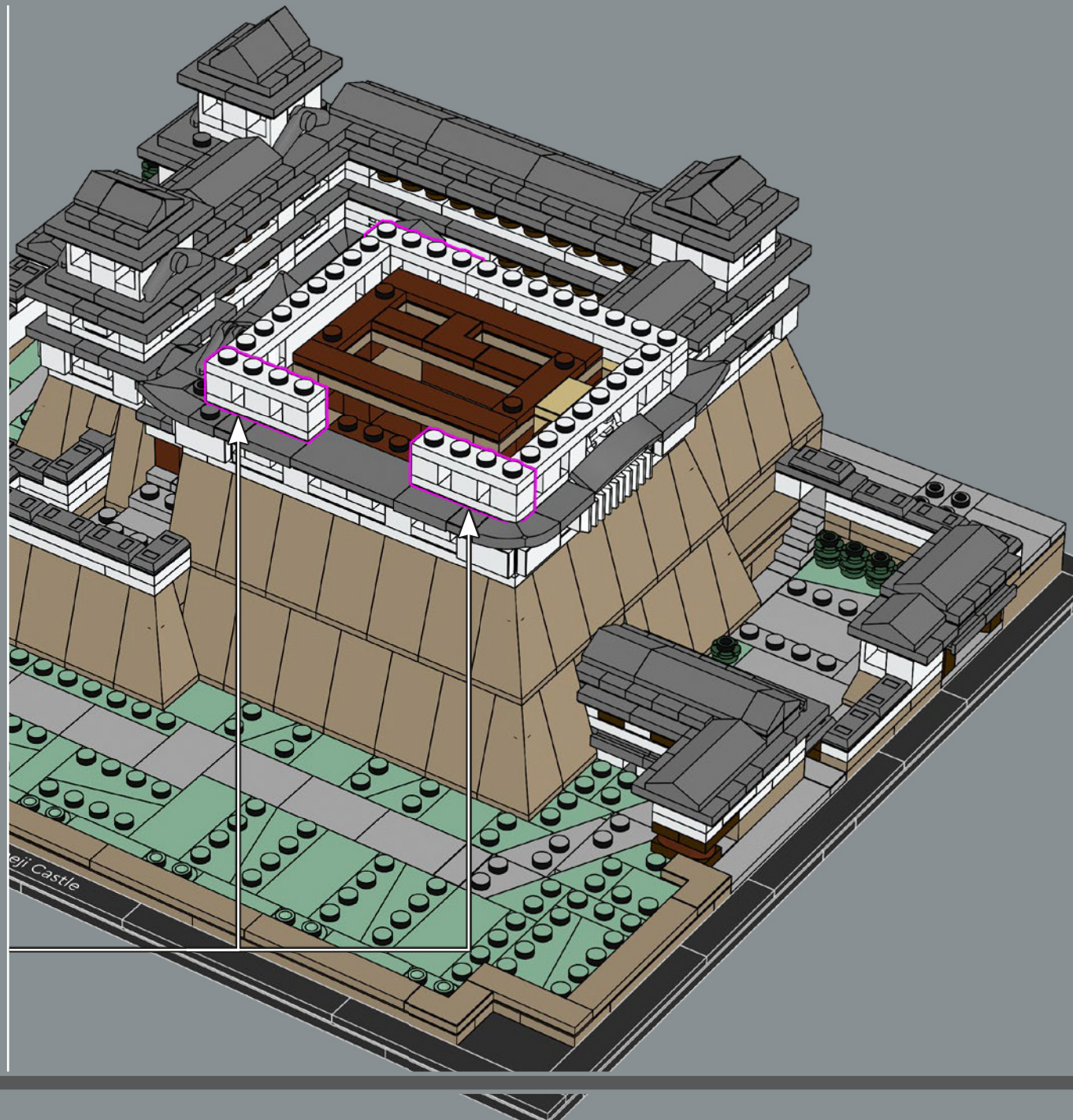
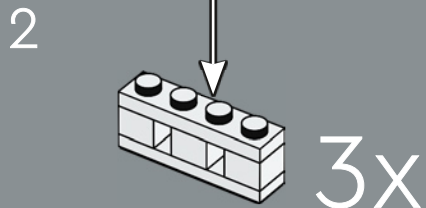
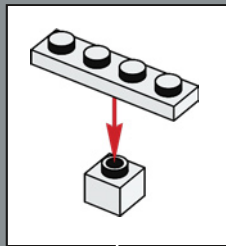
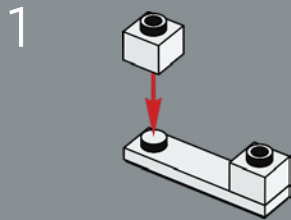

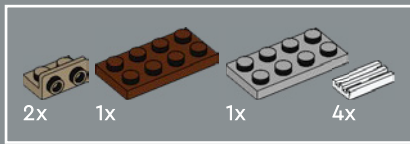

250

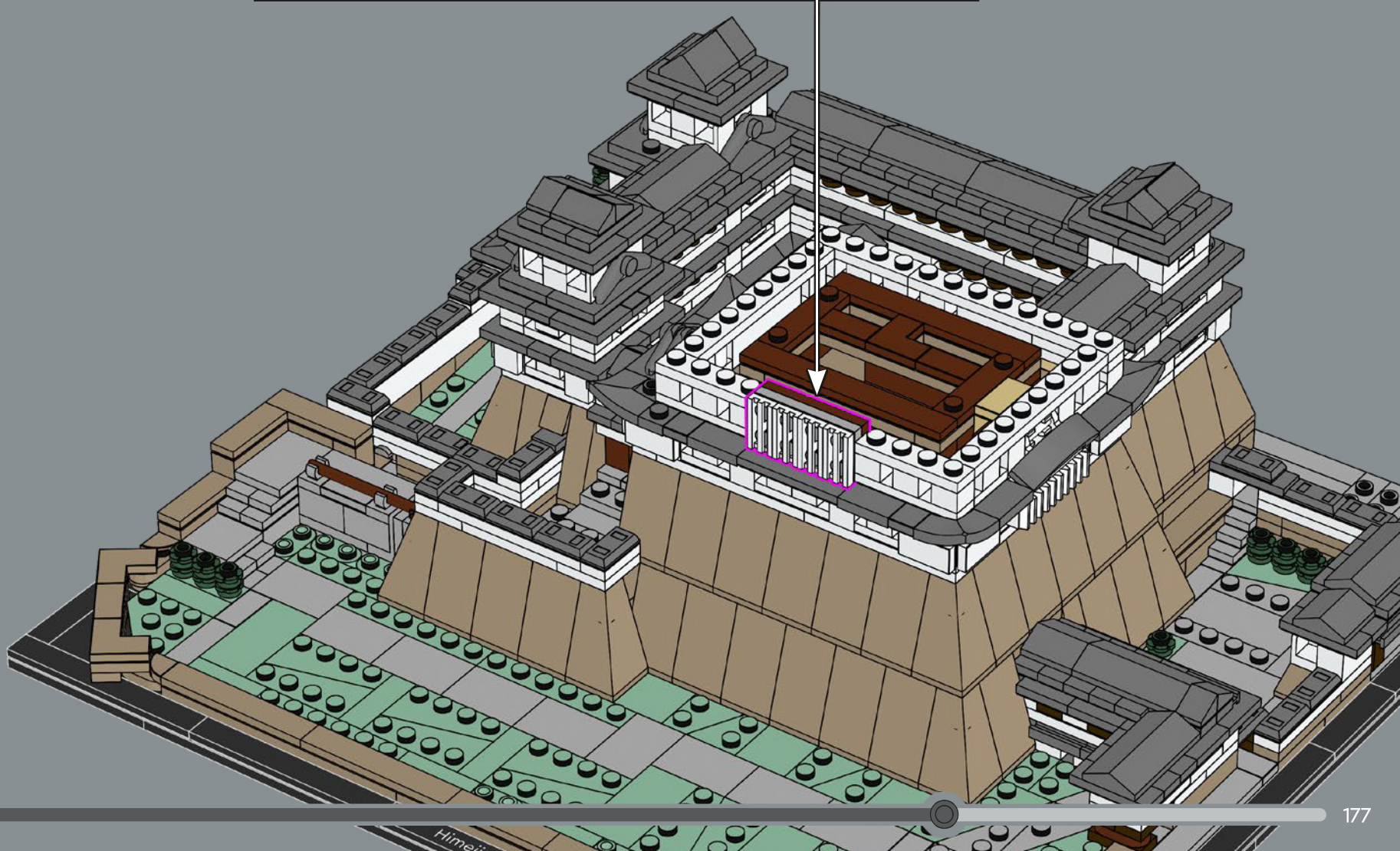
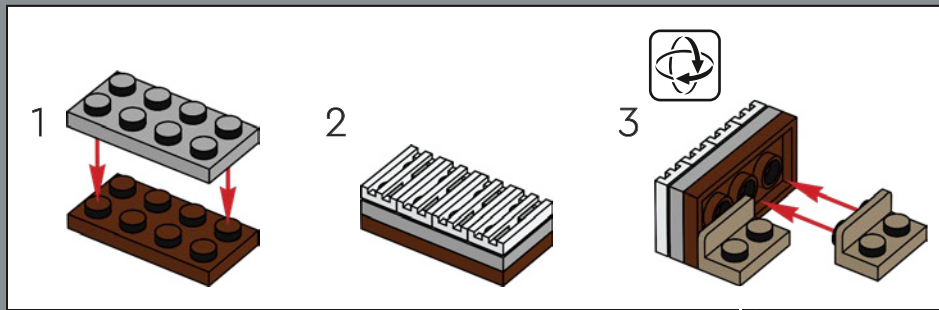

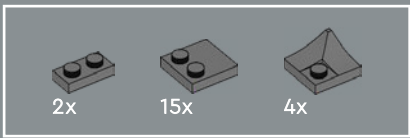

251



可以移除建筑的顶部，显露出内部的一部分，其中包括大部分空置的会议厅，以展示此建筑在 2009-2015 年翻新期间的样子。

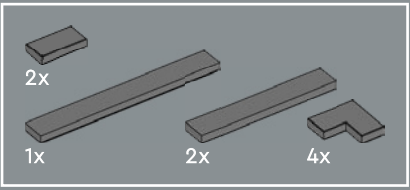

252

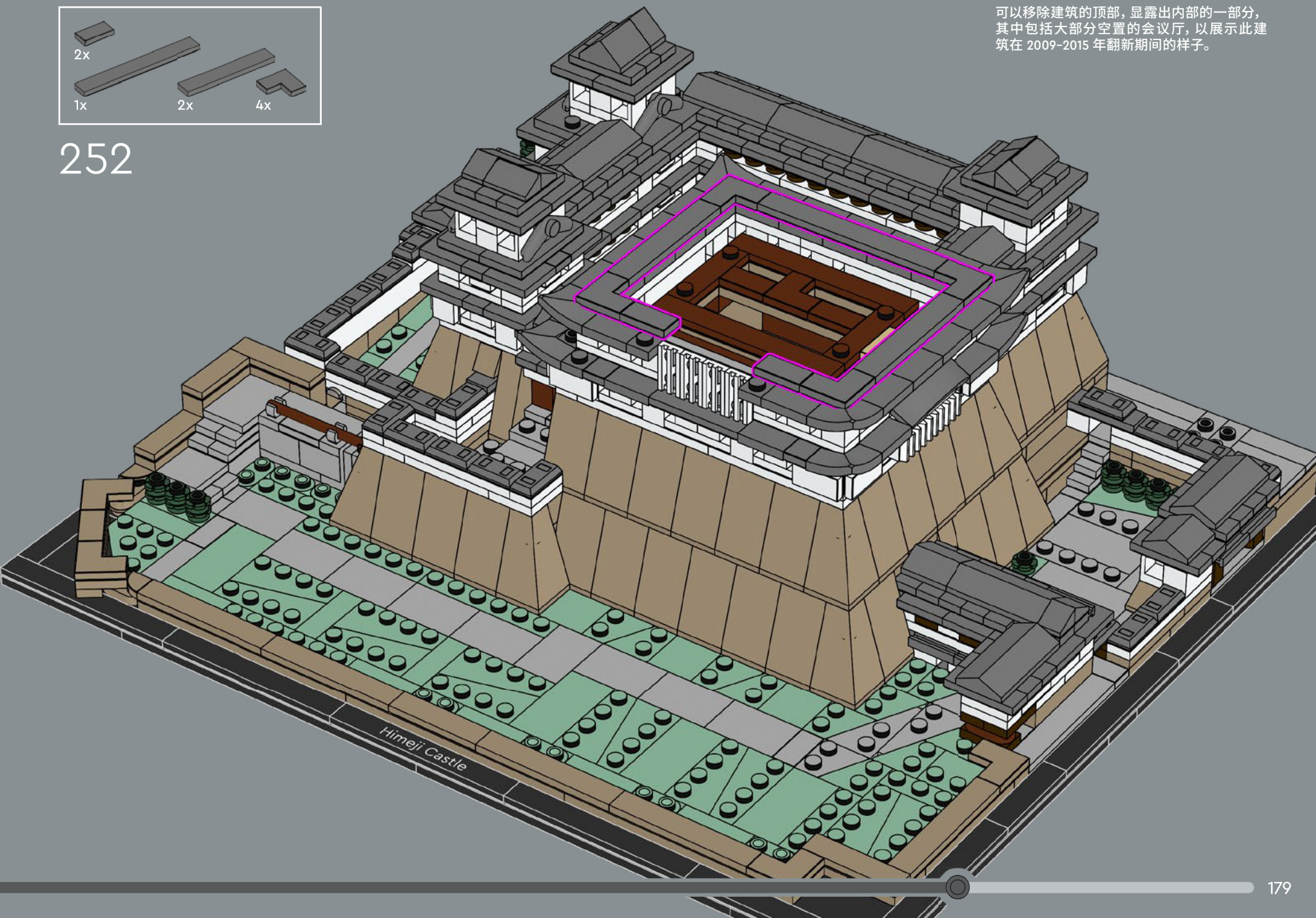

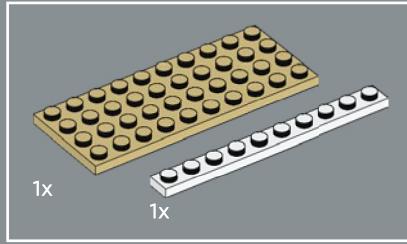
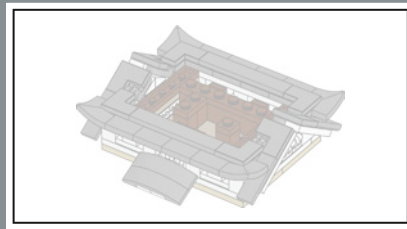

253

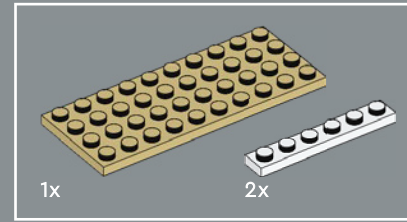
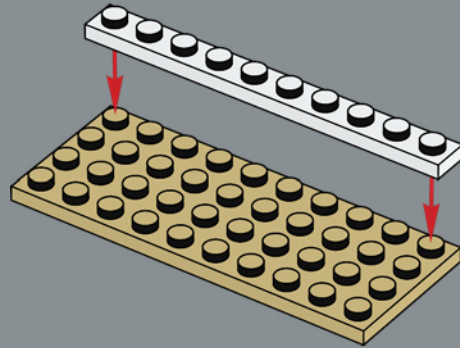

254

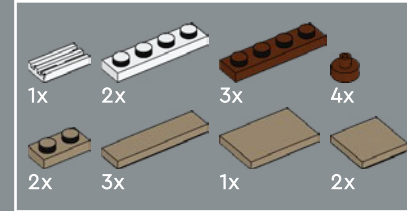
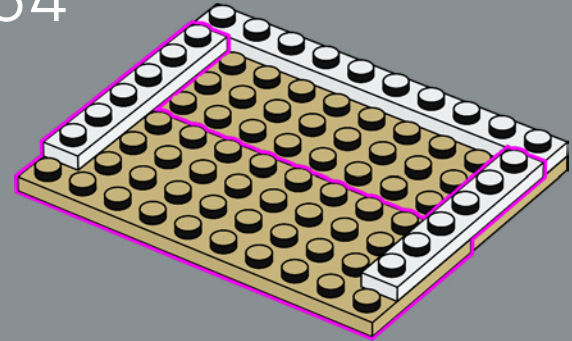

255

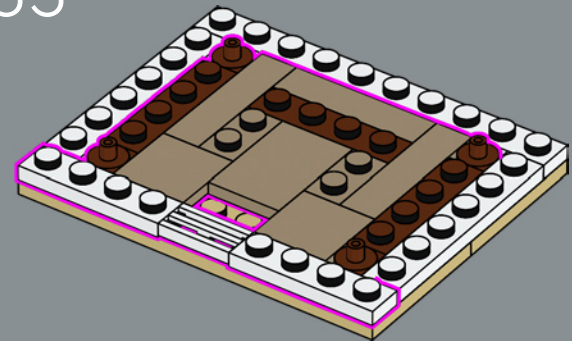

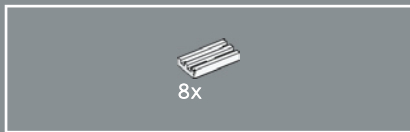

256

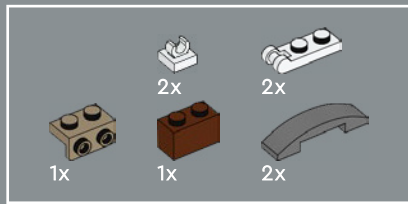
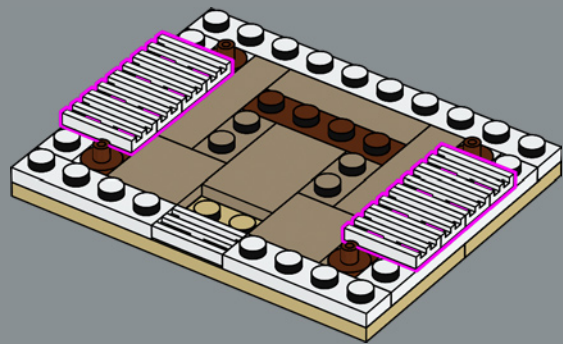

257

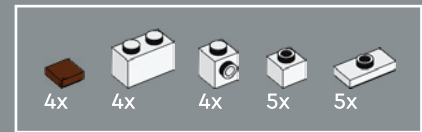
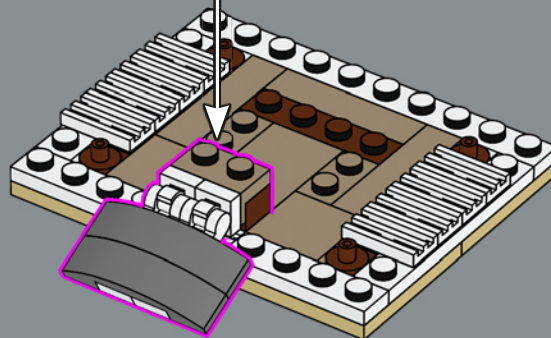
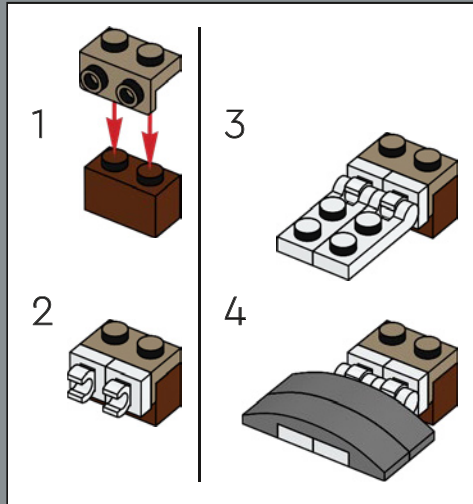

258

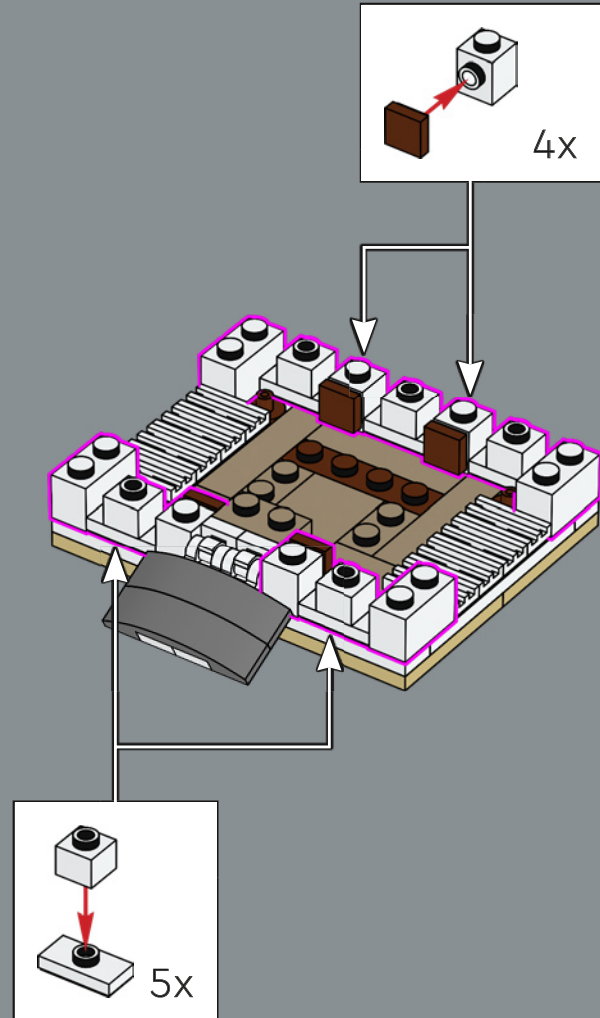

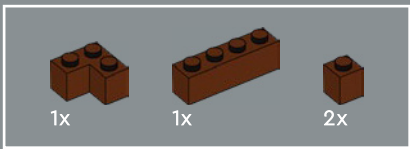

259

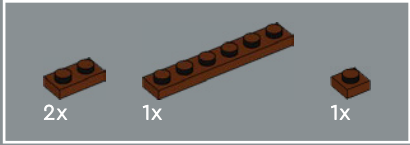
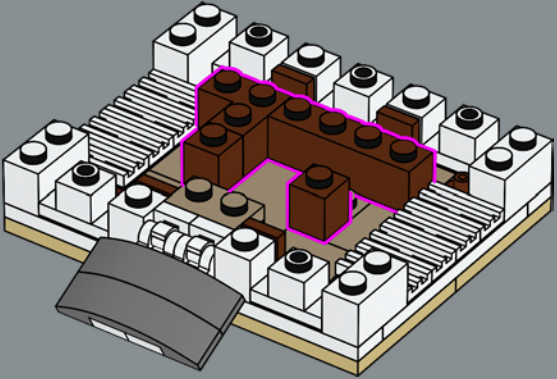

260

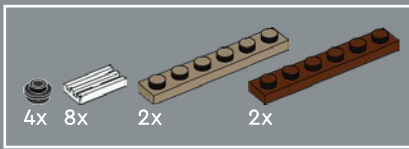
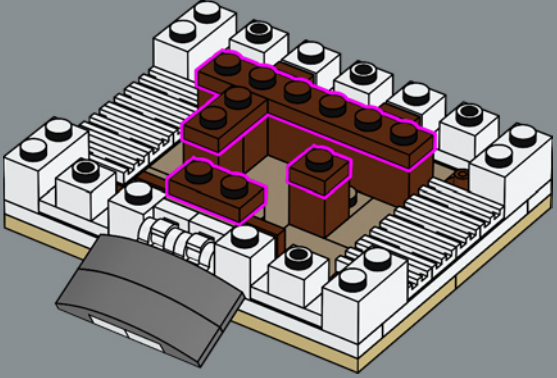

261

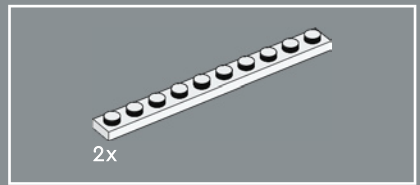
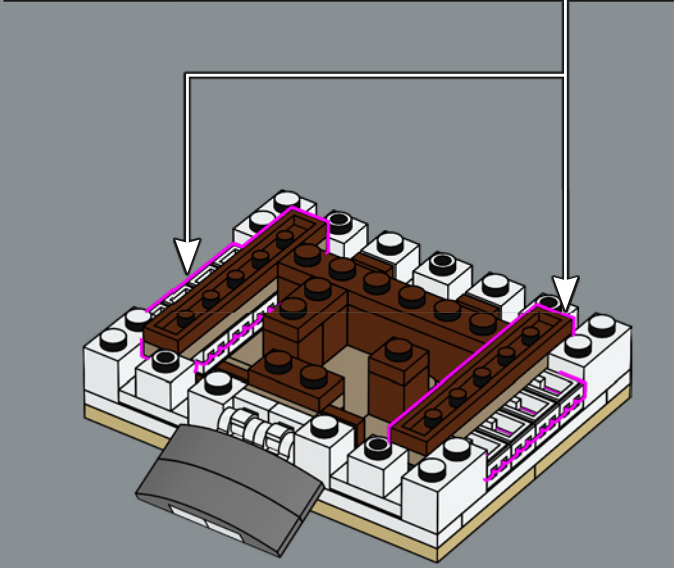
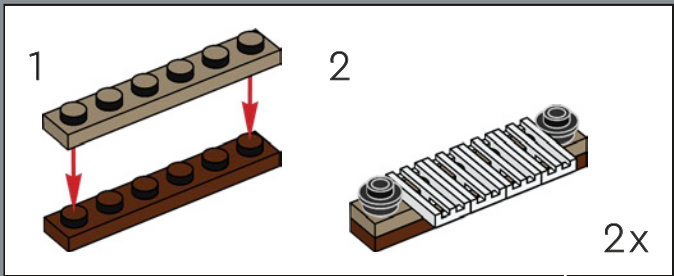

262

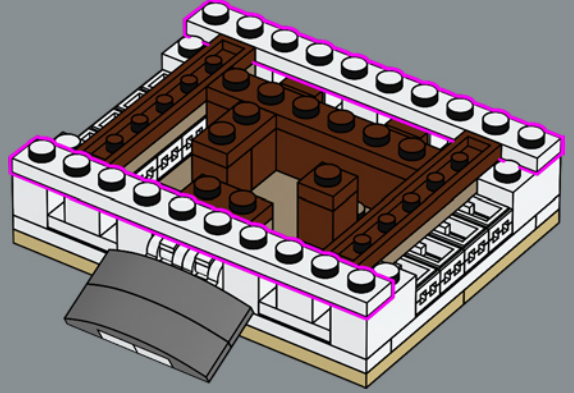

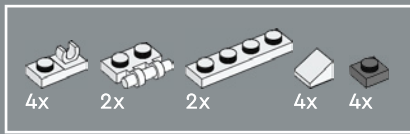

263

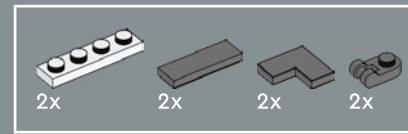
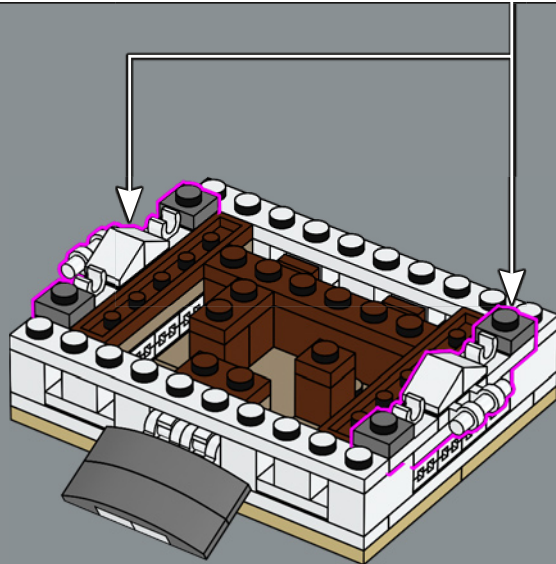
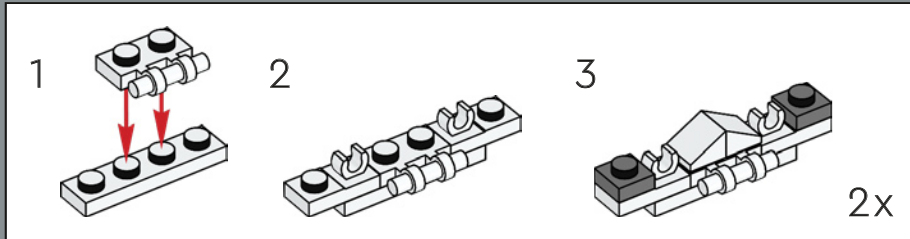

264

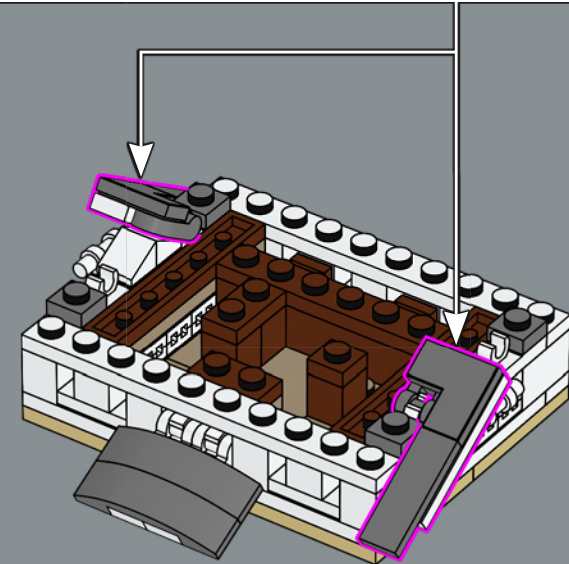
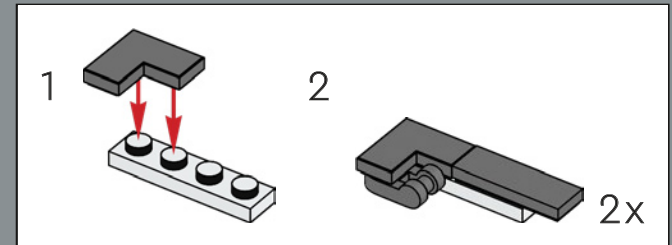

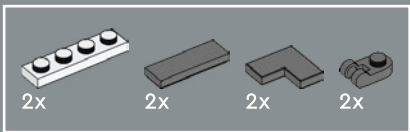

城堡主天守阁的每一层都拥有独特的布局, 借鉴了原始城堡的平面图。

265

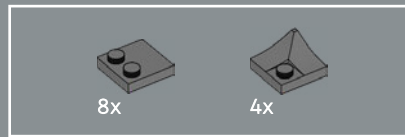
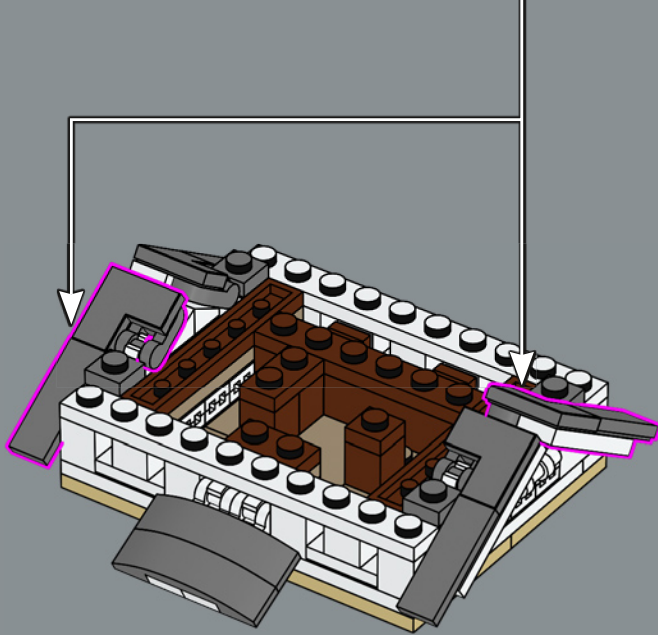
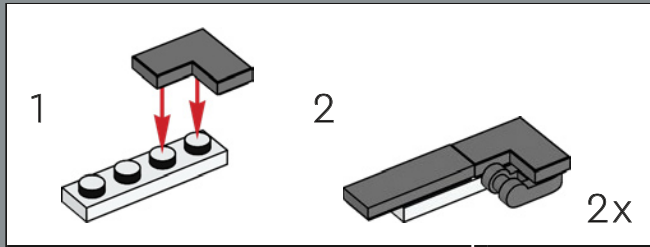

266

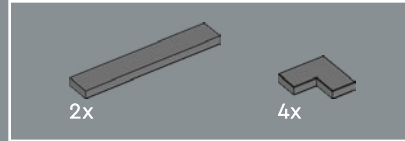
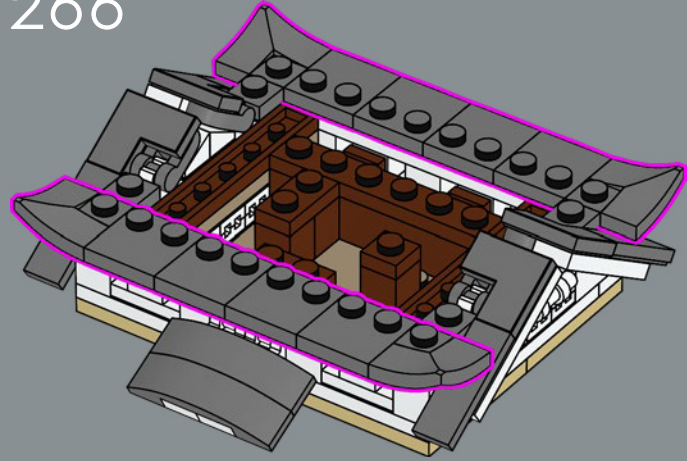

267

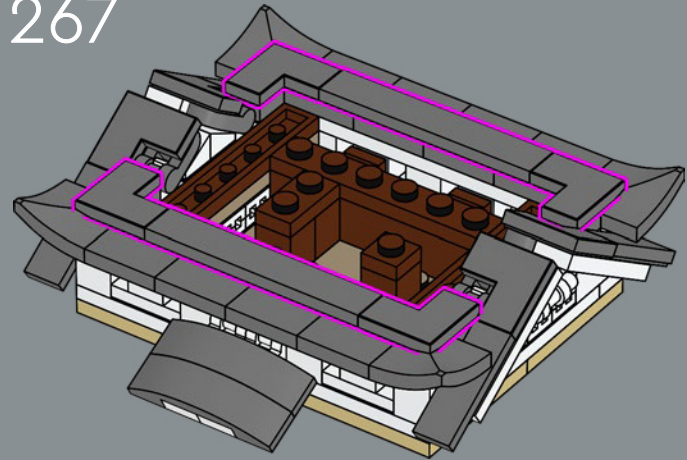

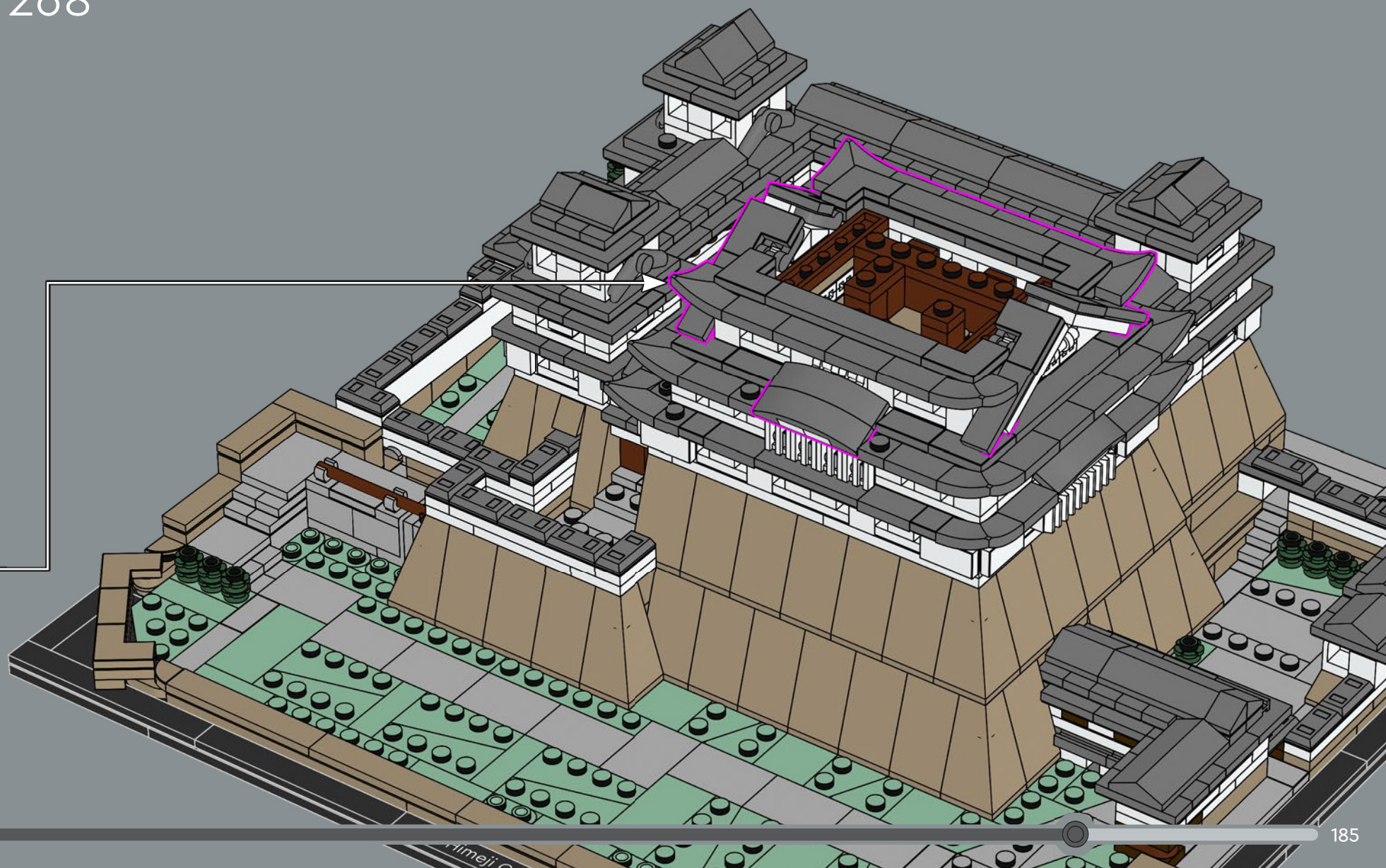

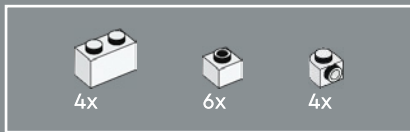

272

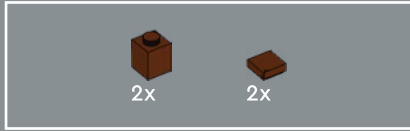
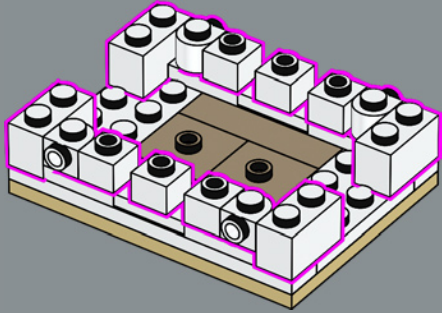

273

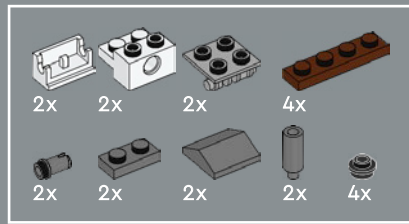
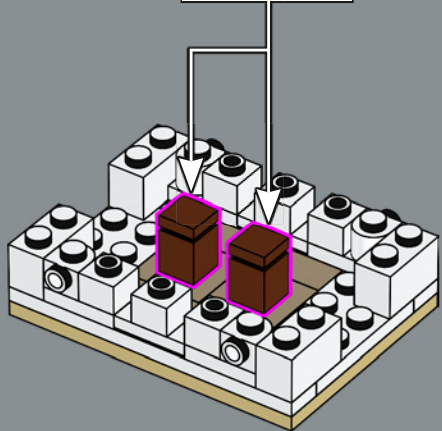
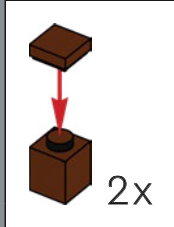

274

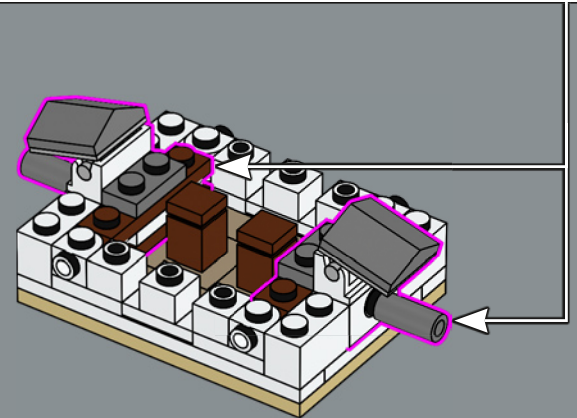
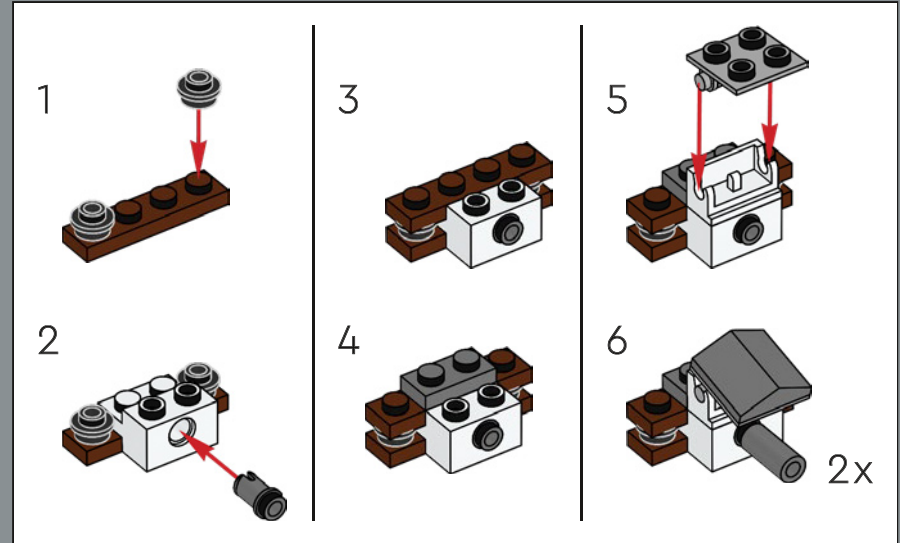

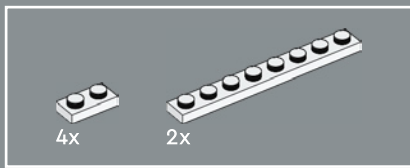

275

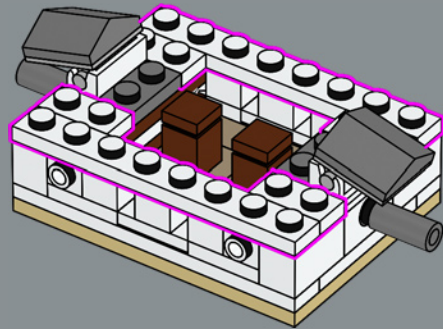

276

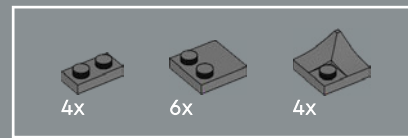
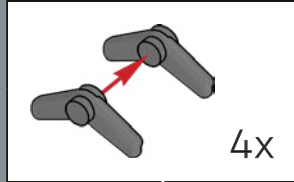
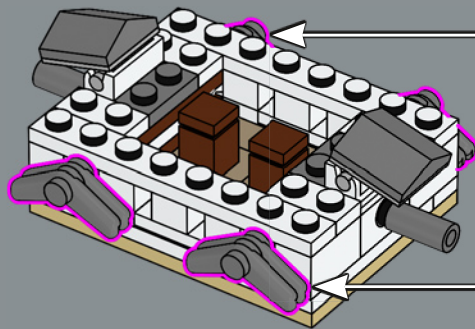

277

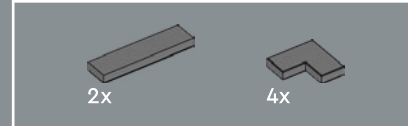
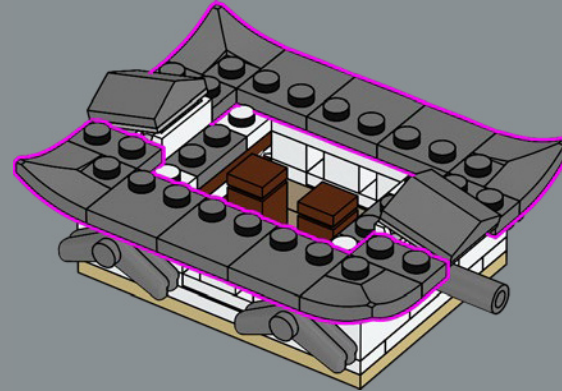

278

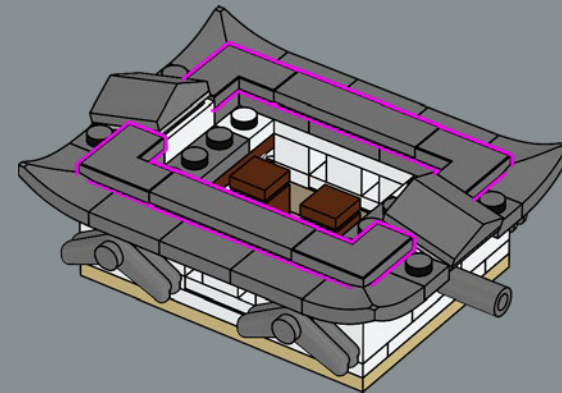

279

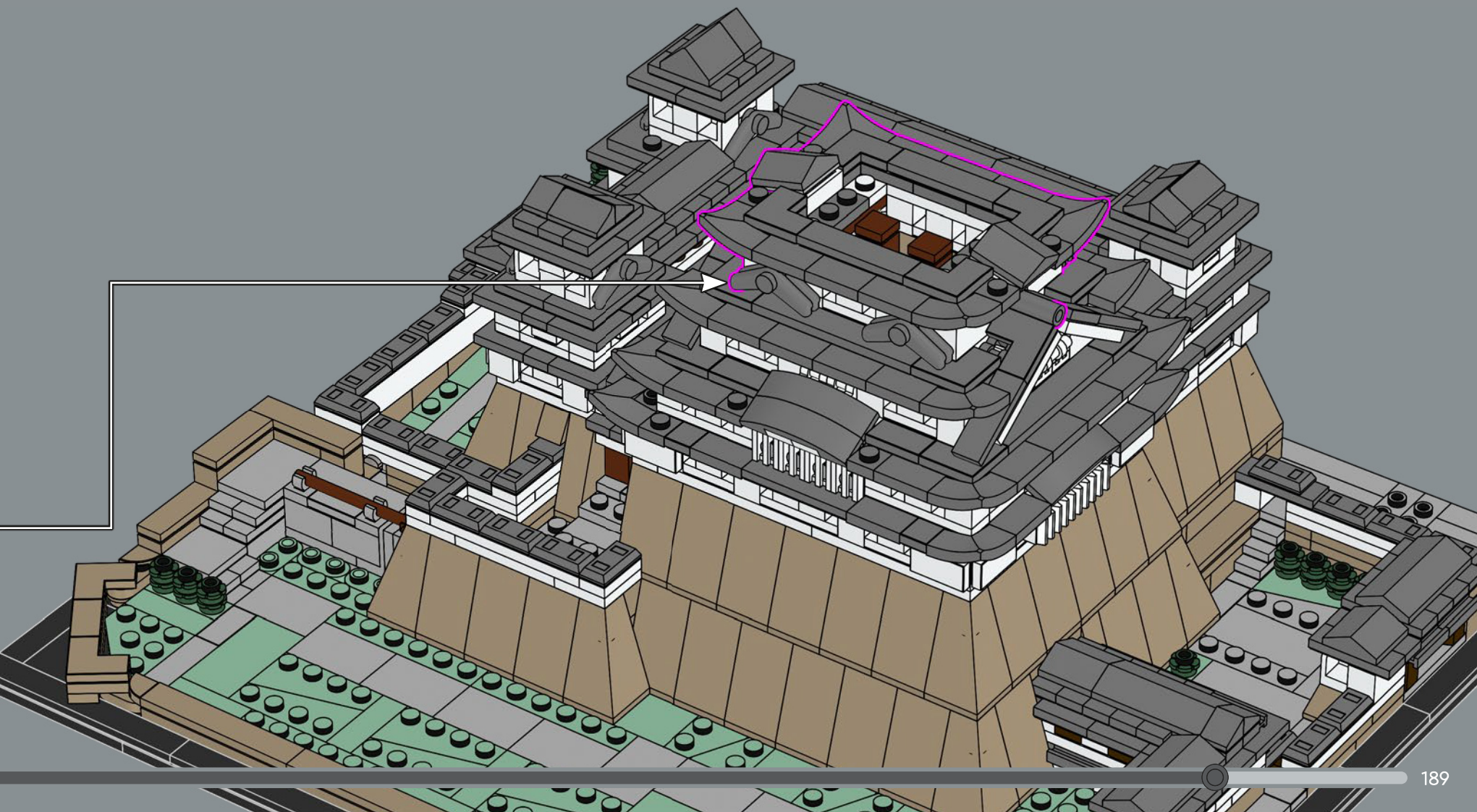

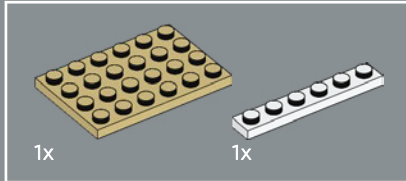
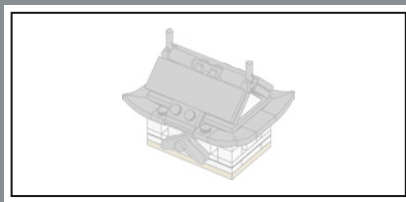

280

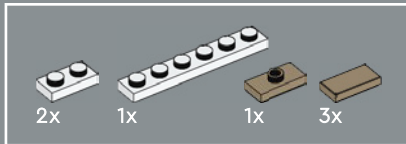
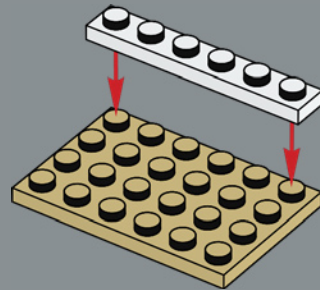

281

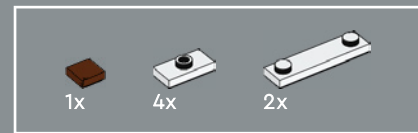
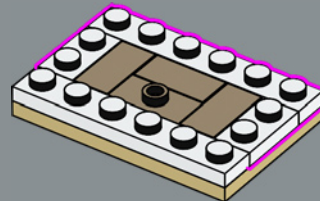

282

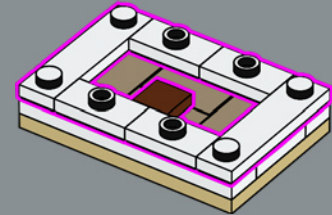

283

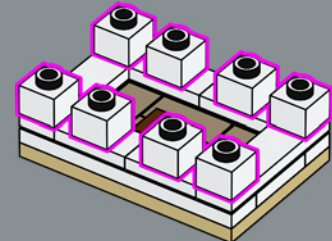

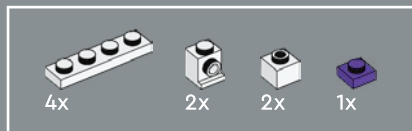

主天守阁顶层房间的紫色 1x1 光板代表了
这个城堡房间内遮盖着紫色帷幔的小型木制神龛。

284

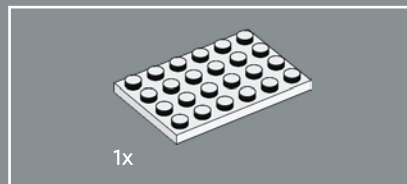
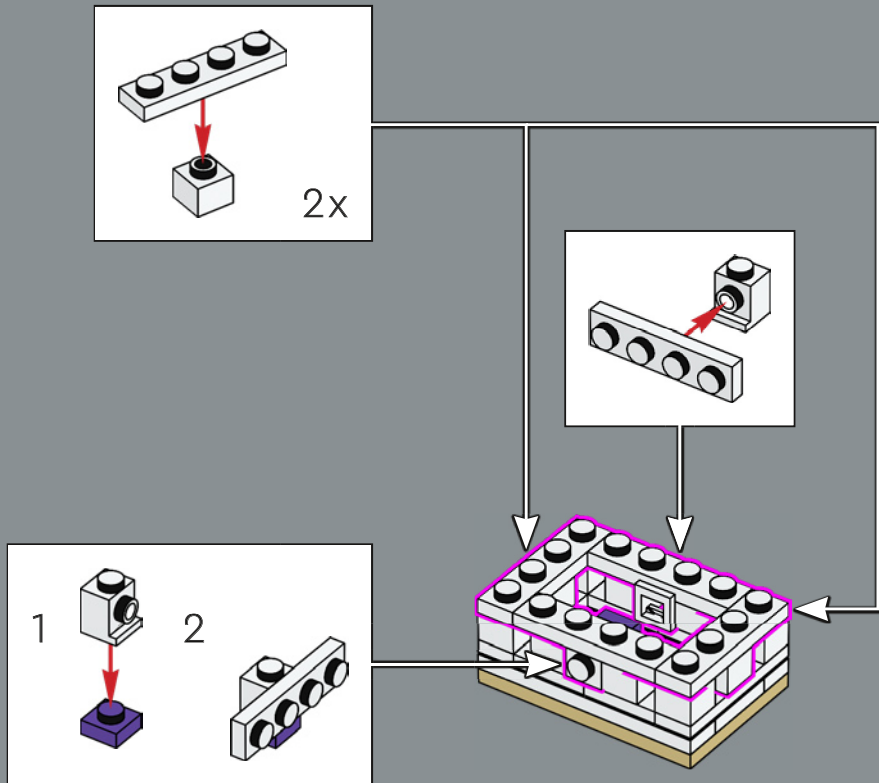

285

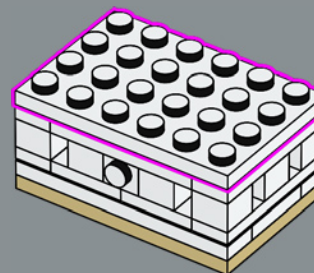

286

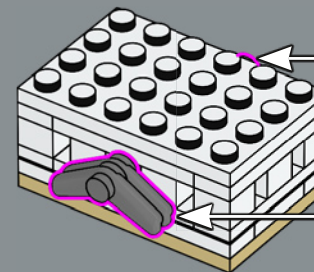
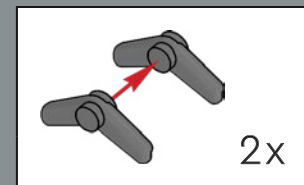

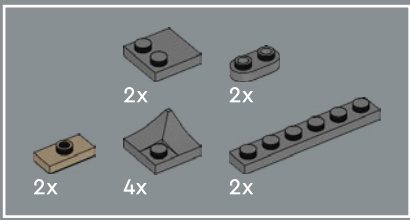

287

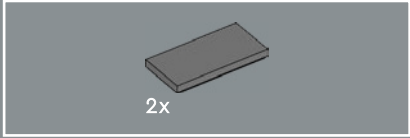
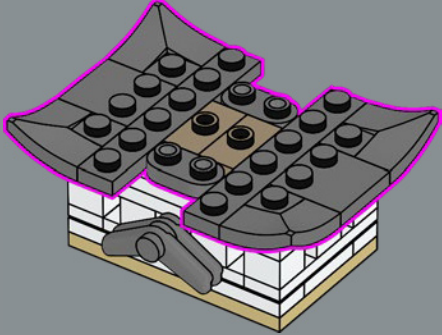

288

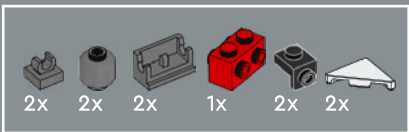
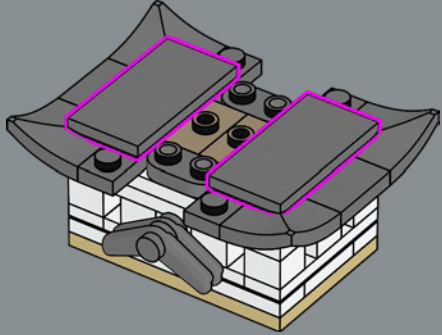

289

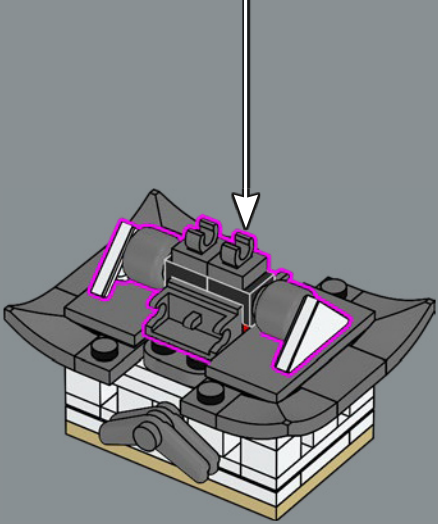
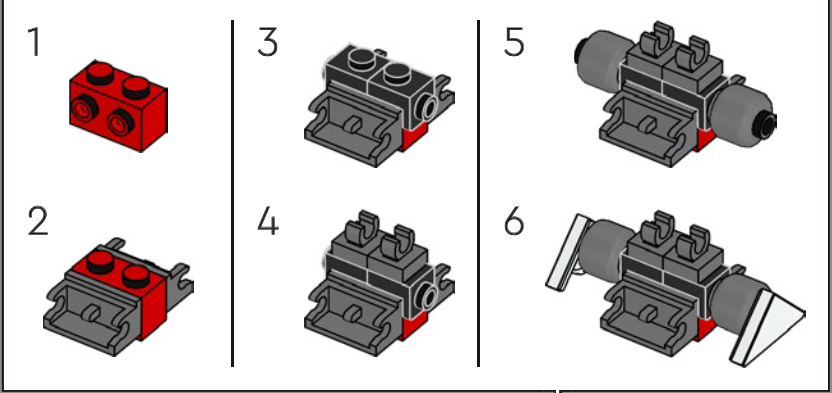

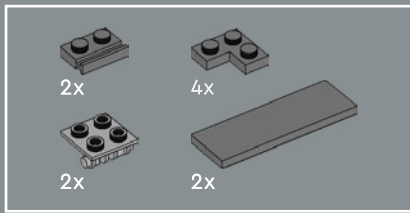

290

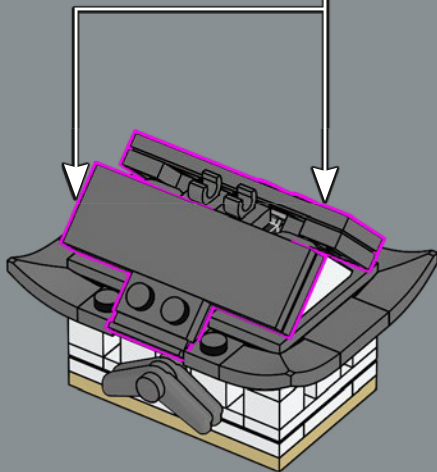
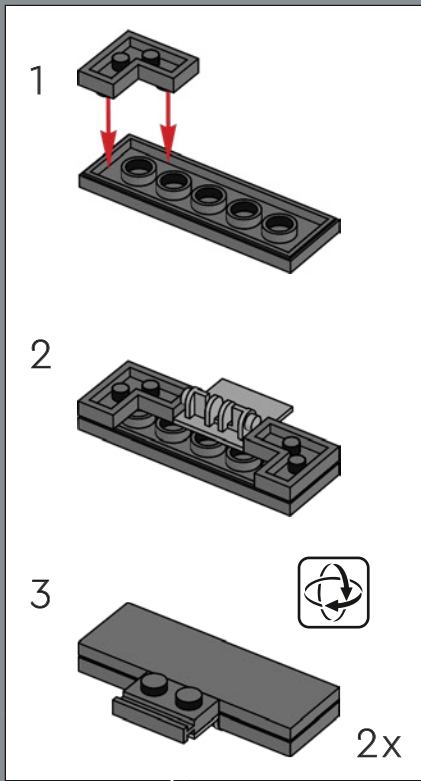

291

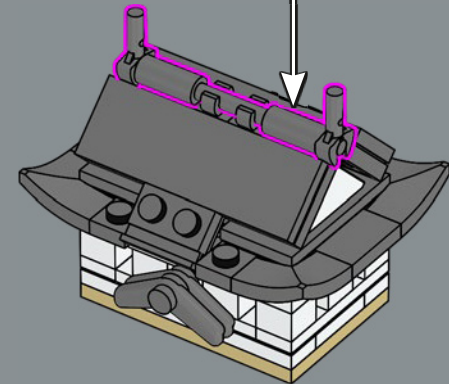
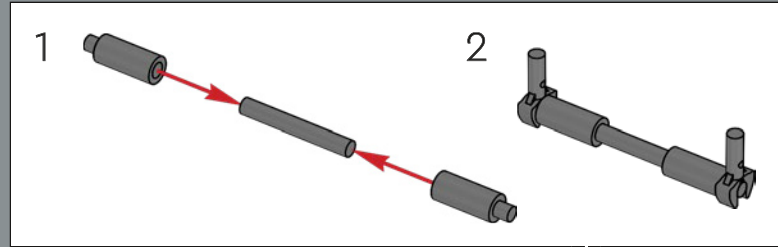

在 2009-2015 年翻新期间更换了主天守阁屋顶的瓦片。
新式瓦片更薄更轻，每块瓦片减轻了 0.75 公斤，整个屋顶
比之前轻超过 45 吨！

292

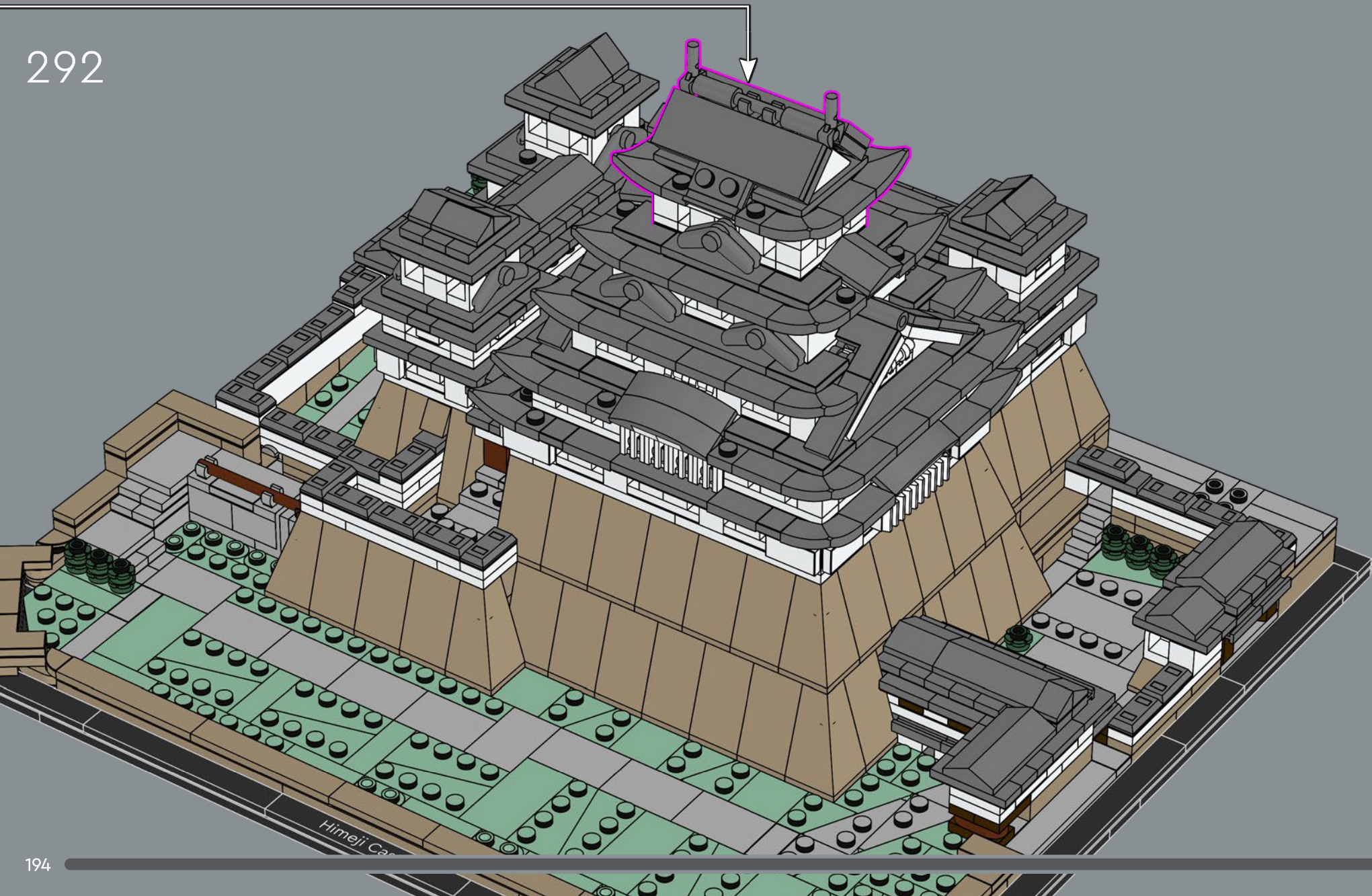

3x

3x

293

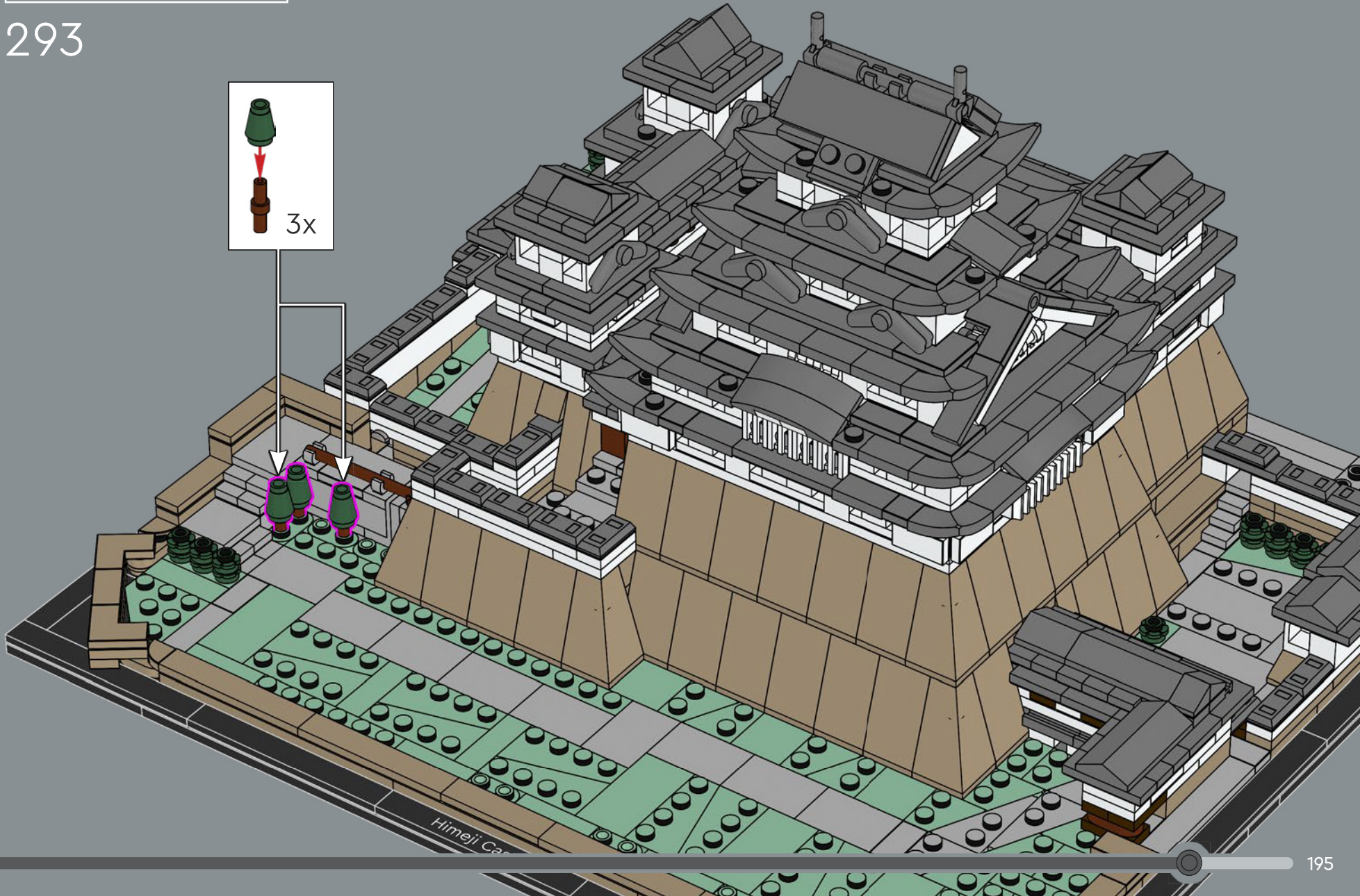
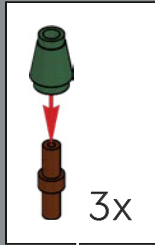



294

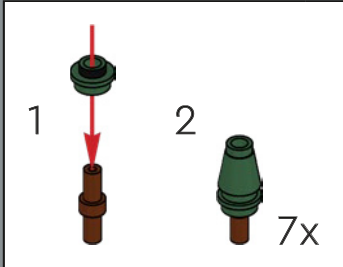

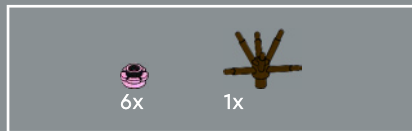

295

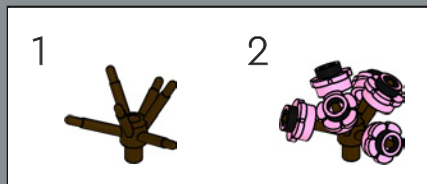

3x

296

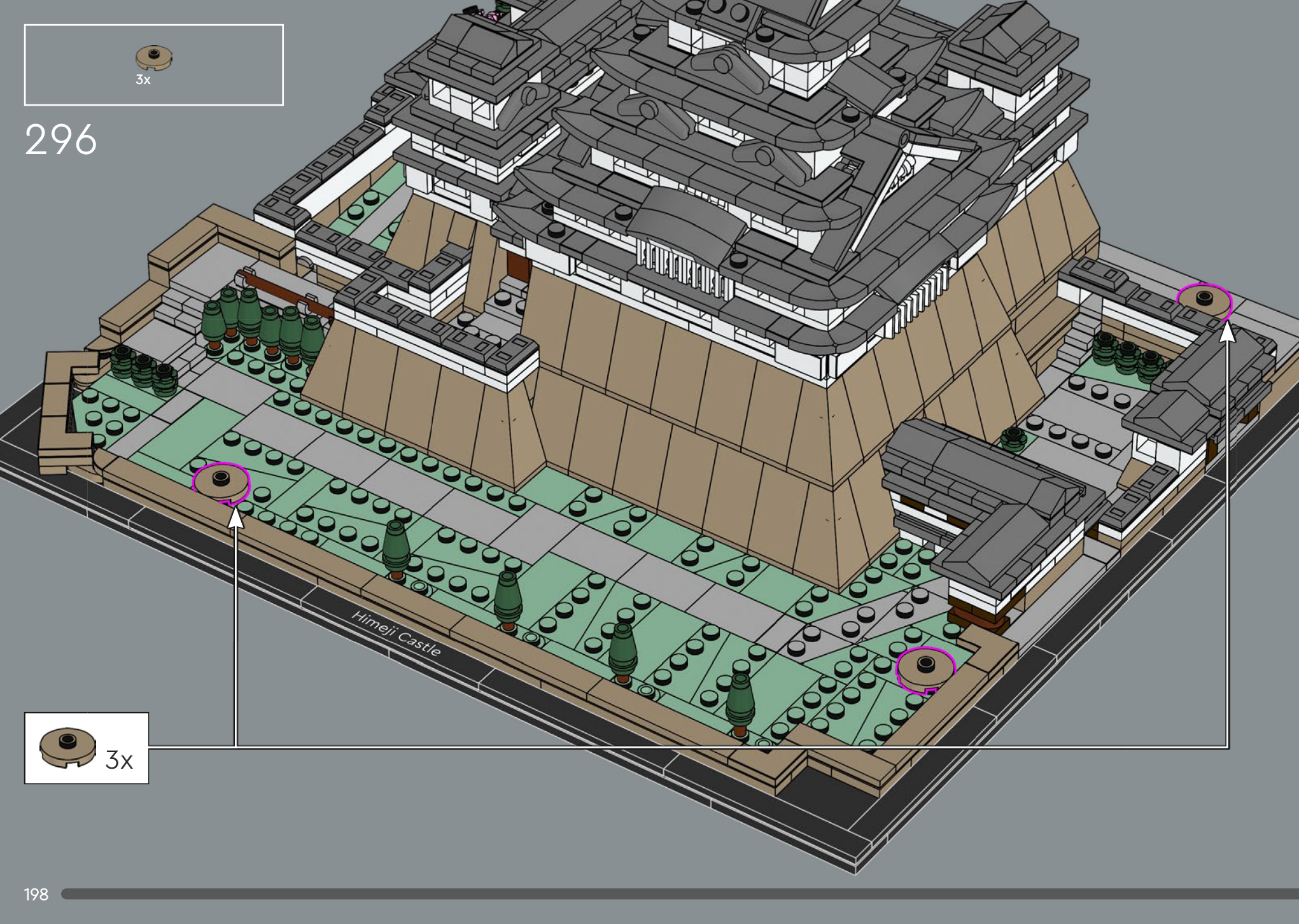

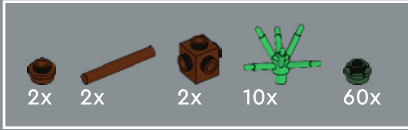
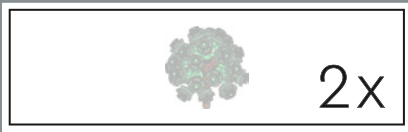

297

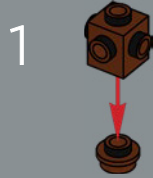
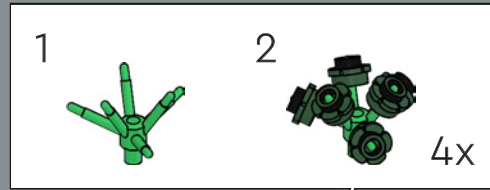
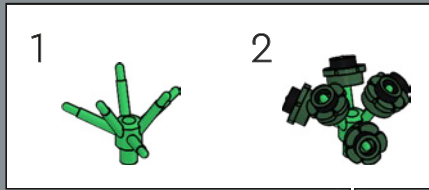



298

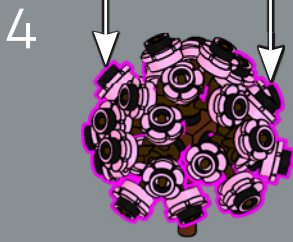
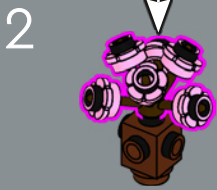
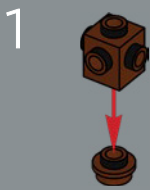
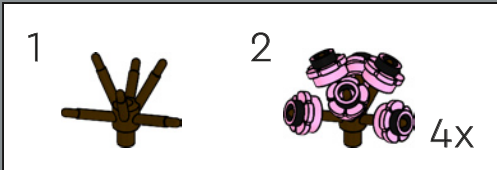
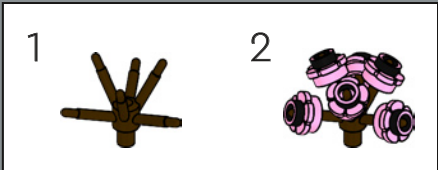



Himeji Castle



299

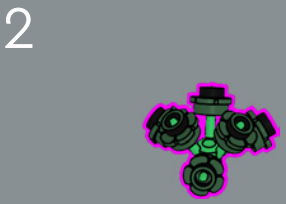
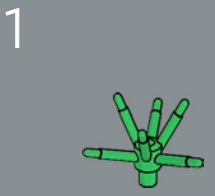
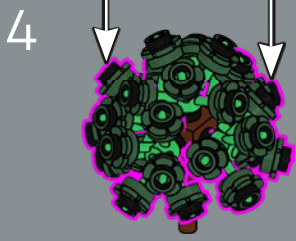
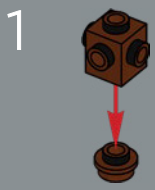
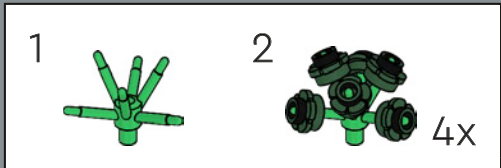
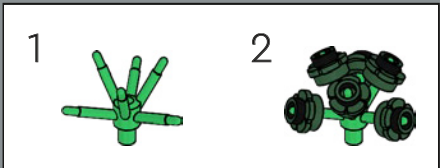

姬路城也被称为白鹭城，因为它像展翅欲飞的白鹭。

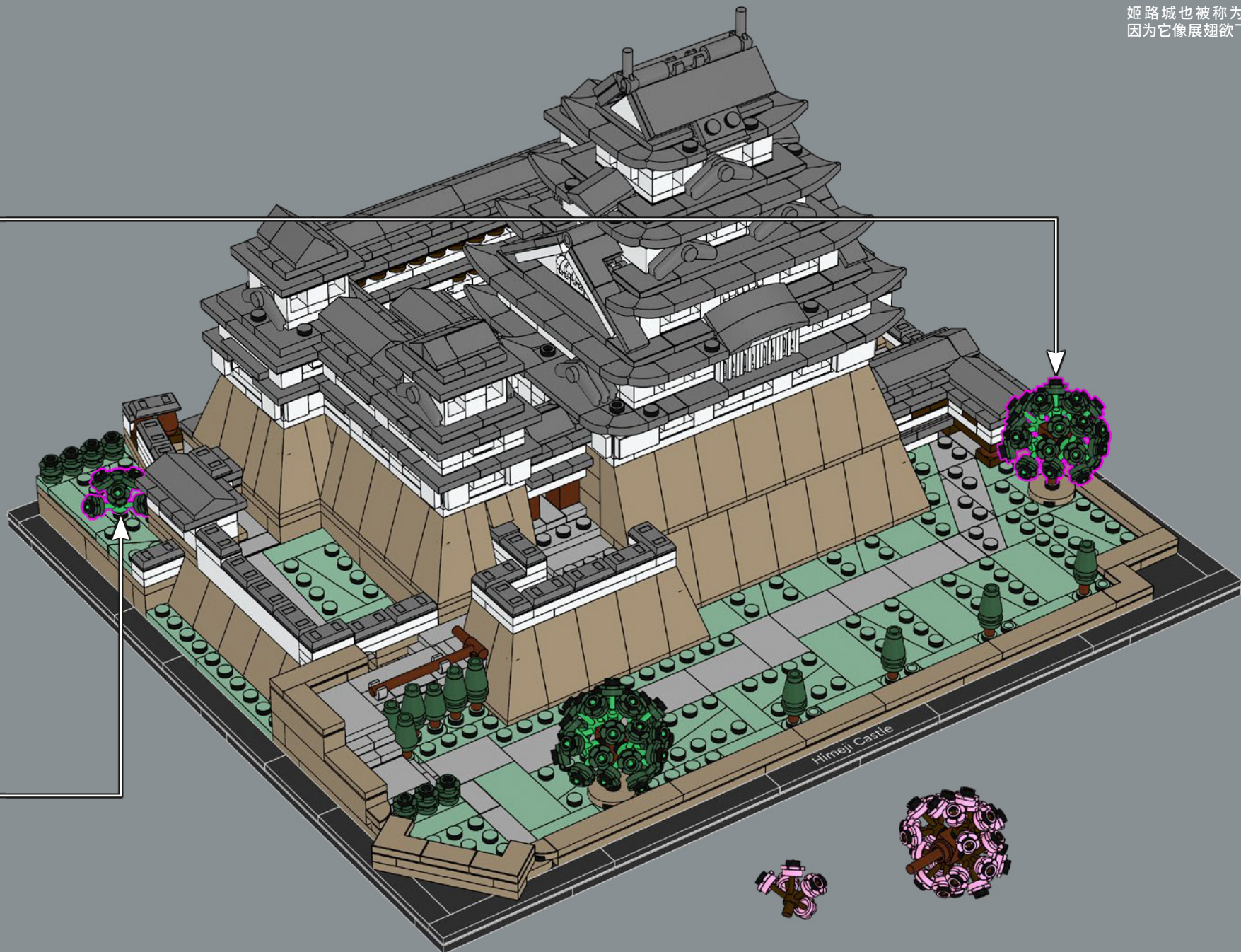

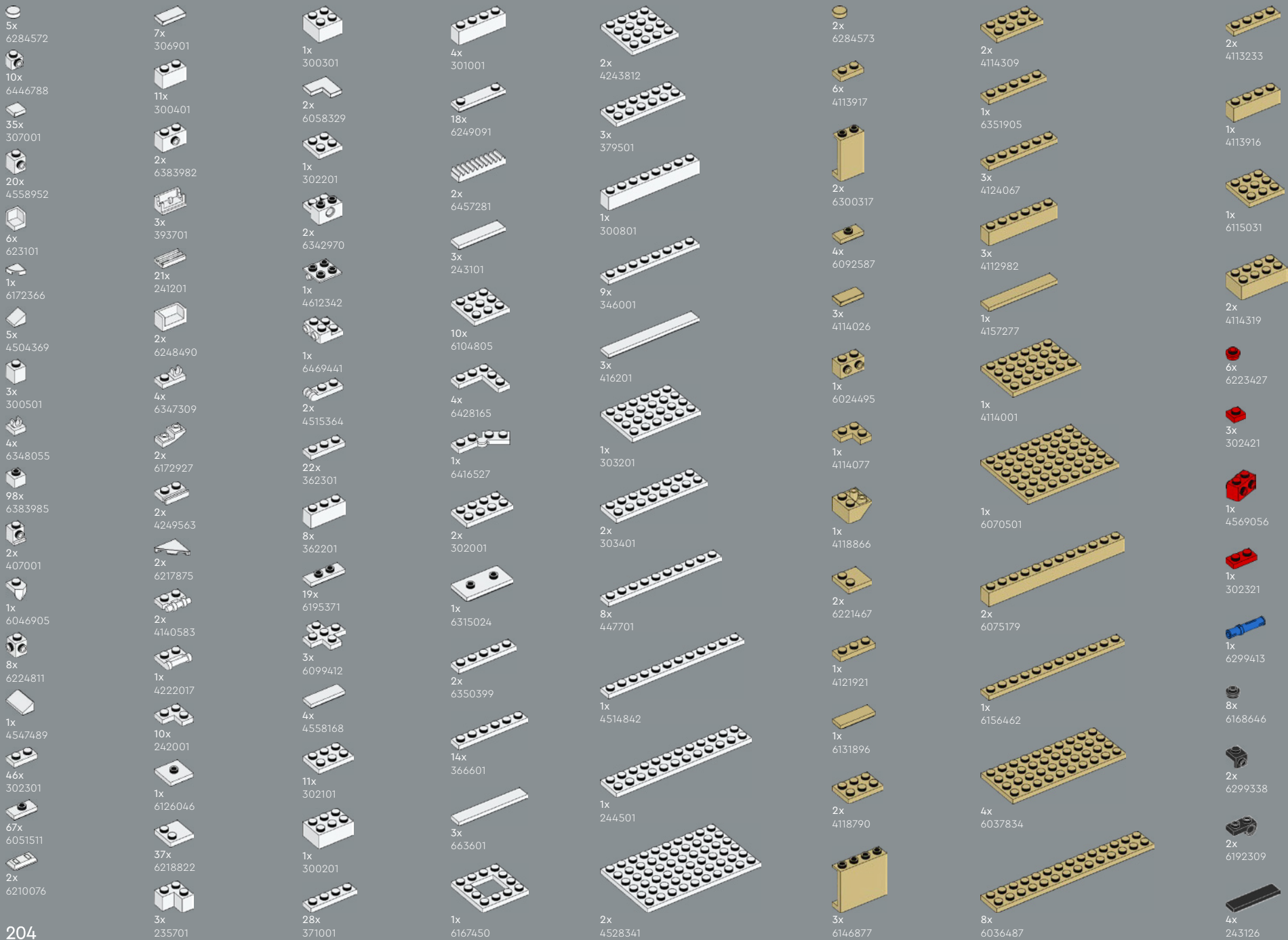



- 1x 6126082
- 1x 4211397
- 2x 4211349
- 1x 4211413
- 4x 4211881
- 1x 6438836
- 12x 4558169
- 12x 6211969
- 3x 4211429
- 16x 6171894
- 2x 4211356
- 5x 6257593
- 2x 4211445
- 5x 4560183
- 2x 4211395
- 1x 4211385
- 2x 4211549
- 4x 4211795
- 5x 4211481

- 1x 4211407
- 4x 4211408
- 6x 4211405
- 6x 4662161
- 4x 6058221
- 6x 6452882
- 1x 6252667
- 2x 6226792
- 1x 6223039
- 36x 6212501
- 4x 6388120
- 4x 4529240
- 2x 6439040
- 1x 4211407
- 4x 4211408
- 6x 4211405
- 4x 6058221
- 6x 6452882
- 1x 6252667
- 2x 6226792
- 1x 6223039
- 36x 6212501
- 4x 6388120
- 4x 4529240
- 2x 6439040

- 2x 6192569
- 2x 6395635
- 4x 4210848
- 9x 4210719
- 2x 6344022
- 6x 4504378
- 2x 6199549
- 2x 6221607
- 4x 6388119
- 1x 4226221
- 6x 4567887
- 29x 6331866
- 20x 6092572
- 12x 4211063
- 6x 4211052
- 2x 4211066
- 2x 4211135

- 3x 6000606
- 9x 4543086
- 20x 6446785
- 1x 6310596
- 12x 6126083
- 6x 6446786
- 1x 4211094
- 43x 6309059
- 2x 4210702
- 18x 6247784
- 1x 6232193
- 21x 6447212
- 4x 4210635
- 1x 4211055
- 60x 6343852
- 8x 4568734

- 1x 4211043
- 3x 6187008
- 4x 4211053
- 3x 4648256
- 2x 6039176
- 41x 6307616
- 6x 4560184
- 3x 4211127
- 10x 6189120
- 4x 4210651
- 2x 4211056
- 2x 6321746
- 1x 6230281

- 2x 4210998
- 1x 4211008
- 1x 4210997
- 1x 4211061
- 2x 6133611
- 1x 6000970
- 1x 6231376
- 2x 6215447
- 3x 6093529
- 25x 6315780
- 3x 6259071
- 4x 6194729
- 3x 4519970



[LEGO.com/service](https://www.LEGO.com/service)



YOU COULD WIN



YOU COULD WIN

Your feedback will help shape the future development of this product series.

Visit:

DU KÖNNTEST GEWINNEN

Dein Feedback trägt zur Weiterentwicklung dieser Produktreihe bei.

Geh auf:

VOUS POURRIEZ GAGNER

Vos commentaires nous aideront à concevoir les futurs produits de cette gamme.

Visitez :

POTRESTI VINCERE TU

La tua opinione ci aiuterà a migliorare la creazione futura di questa linea di prodotti.

Visita:

PUEDES GANAR

Tu opinión contribuirá al futuro de esta serie de productos.

Visita:

轻松获奖

您的反馈将有助于我们在今后改进本产品系列。

请访问:

[LEGO.com/productfeedback](https://www.lego.com/productfeedback)

You also have the chance to win a LEGO® set.

Terms and conditions apply.*

Außerdem hast du die Chance, ein LEGO® Set zu gewinnen.

Es gelten die Teilnahmebedingungen.*

Vous pourriez également gagner un ensemble LEGO®.

Des conditions s'appliquent.*

Hai anche la possibilità di vincere un set LEGO®.

Termini e condizioni sono applicabili.*

También tienes la oportunidad de ganar un set LEGO®.

Aplican términos y condiciones.*

您还有机会赢取乐高®套装。

条款和条件适用。*

*[LEGO.com/productfeedback-terms](https://www.lego.com/productfeedback-terms)

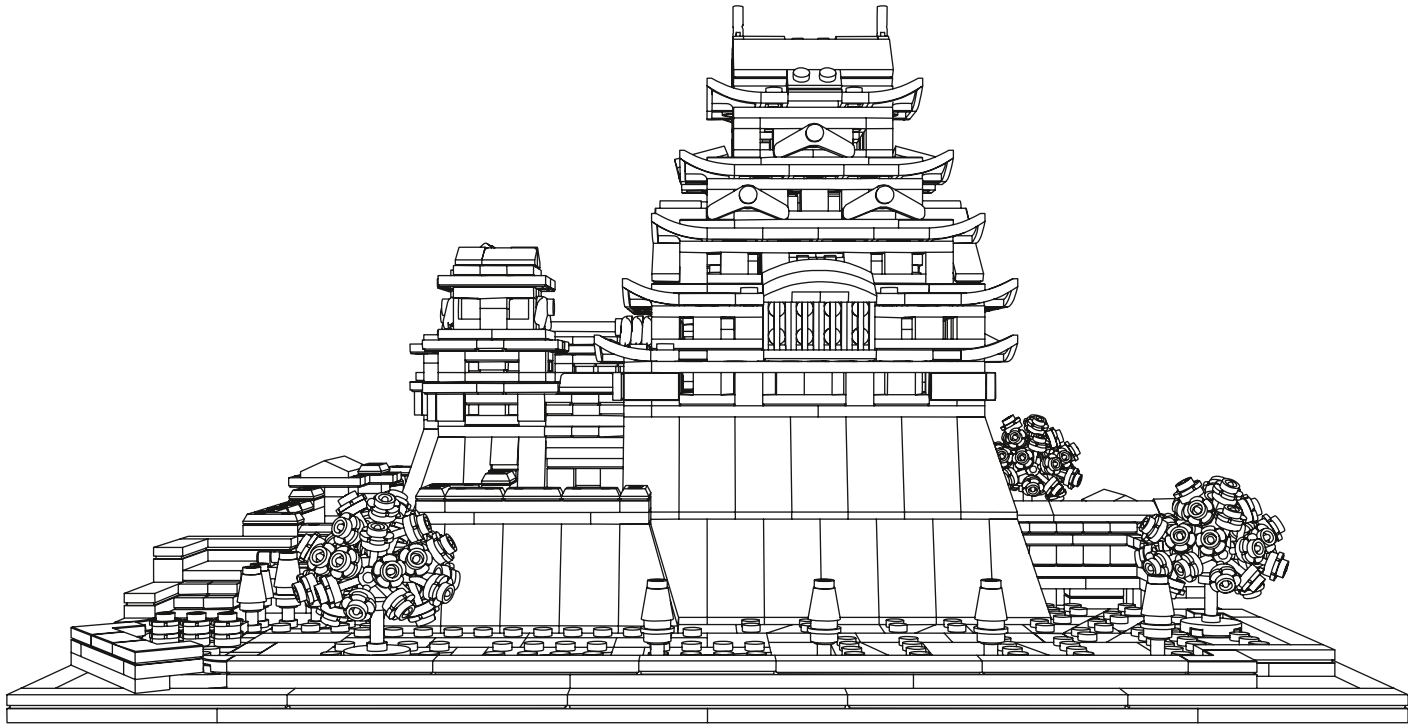

LEGO and the LEGO logo are trademarks of the LEGO Group. ©2023 The LEGO Group.

Adam Reed Tucker is the co-developer of the LEGO® Architecture product line.