



THE WHITE HOUSE

WASHINGTON D.C., USA



LA MAISON-BLANCHE

WASHINGTON D.C., ÉTATS-UNIS

LA CASA BLANCA

WASHINGTON D. C., EE. UU.



Architecture



The White House

La Maison-Blanche

La Casa Blanca

The White House is an enduring symbol of the United States and one of the most famous buildings in the world. Every president since John Adams has occupied the White House and countless leaders and dignitaries have been entertained within its walls. It's a place where many momentous decisions have been taken and where history continues to unfold.

La Maison-Blanche est un symbole durable des États-Unis et l'un des bâtiments les plus célèbres au monde. Chaque président depuis John Adams a occupé la Maison-Blanche, sans compter les innombrables dirigeants et dignitaires qui y ont été reçus. C'est là où de nombreuses décisions capitales ont été prises et où l'histoire se poursuit.

La Casa Blanca es un símbolo histórico de los Estados Unidos y uno de los edificios más famosos del mundo. Desde John Adams, todos los presidentes han vivido en la Casa Blanca y sus muros han recibido a un sinfín de líderes y dignatarios. Es un lugar en el que se han tomado numerosas decisiones de gran trascendencia y en el que la historia continúa desarrollándose.



James Hoban's White House design.
Wikimedia Commons

Conception de la Maison-Blanche par James Hoban. Wikimedia Commons

El diseño de James Hoban para la Casa Blanca. Wikimedia Commons

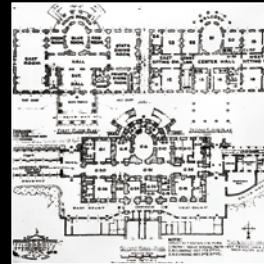

Lorenzo Winslow's 1948 plan for changes. White House Museum
Plan de Lorenzo Winslow pour les modifications en 1948. Musée de la Maison-Blanche

El plan de renovación de Lorenzo Winslow, de 1948. Museo de la Casa Blanca

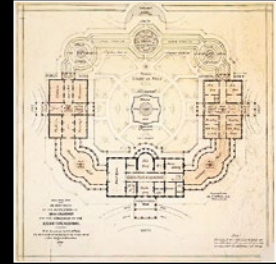

Alterations to the Executive Mansion. Library of Congress, Prints & Photographs Division

Modifications du manoir exécutif. Bibliothèque du Congrès, Service des images et des photographies

Cambios en la mansión presidencial. Biblioteca del Congreso (Departamento de Impresiones y Fotografías)



The History

L'histoire

La historia

The first president, George Washington, selected the site in 1791 and a competition design submitted by Irish-born architect James Hoban was chosen a year later. During the War of 1812, the British set fire to The White House and James Hoban was appointed to rebuild it. Completed once again in 1817, there have been countless renovations and additions since.

Le premier président, George Washington, a choisi le site en 1791. Un plan présenté par l'architecte d'origine irlandaise James Hoban dans le cadre d'un concours a été sélectionné un an plus tard. Pendant la guerre de 1812, les Britanniques ont mis le feu à la Maison-Blanche, et James Hoban a été chargé de la reconstruire. Achevée une fois de plus en 1817, la Maison-Blanche a depuis subi d'innombrables rénovations et ajouts.

George Washington, el primer presidente, escogió el lugar en 1791. Un año después, se eligió por concurso el diseño del arquitecto irlandés James Hoban. Durante la guerra de 1812, los británicos incendiaron la Casa Blanca y James Hoban fue el encargado de reconstruirla. Terminada de nuevo en 1817, ha atravesado incontables reformas y ampliaciones desde entonces.



James Hoban

The White House Historical Association (White House Collection)
Association historique de la Maison-Blanche (collection de la Maison-Blanche)
Asociación Histórica de la Casa Blanca (colección de la Casa Blanca)



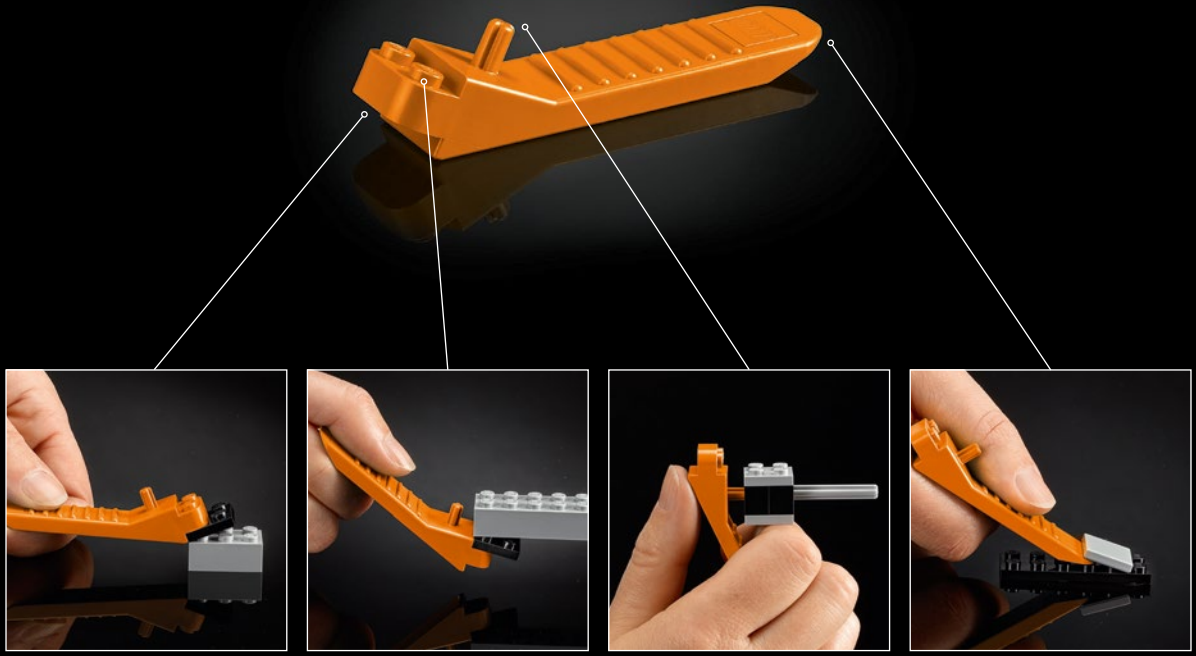

LEGO.com/brickseparator

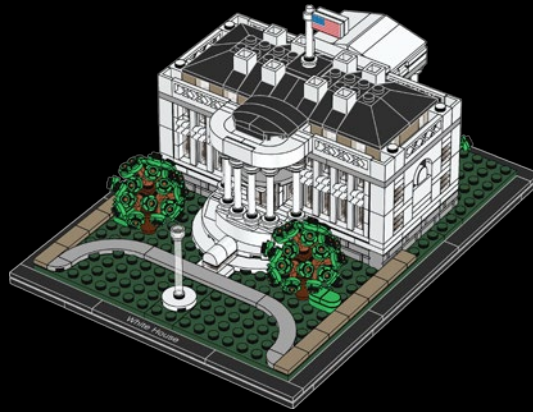









A Grand Mansion

Un grand manoir

Una gran mansión

The White House is a grand mansion in the neoclassical Federal style with details that echo classical Greek architecture. The style shares its name with the Federal Period in American history, a time when the founding generation of the young Republic consciously chose to associate the nation with the ancient democracies of Greece and the republican values of Rome.

La Maison-Blanche est un grand manoir de style fédéral néo-classique agrémenté de détails qui rappellent l'architecture grecque classique. Le style tient son nom de la période fédérale de l'histoire américaine, une époque où la génération fondatrice de la jeune République a délibérément choisi d'associer la nation aux anciennes démocraties de la Grèce et aux valeurs républicaines de Rome.

La Casa Blanca es una gran mansión de estilo neoclásico federal con detalles que recuerdan a la arquitectura clásica griega. El nombre del estilo se asocia al Período Federal de la historia americana, una época en la que la generación fundadora de la joven república eligió conscientemente vincular la nación a las antiguas democracias griegas y los valores republicanos de Roma.

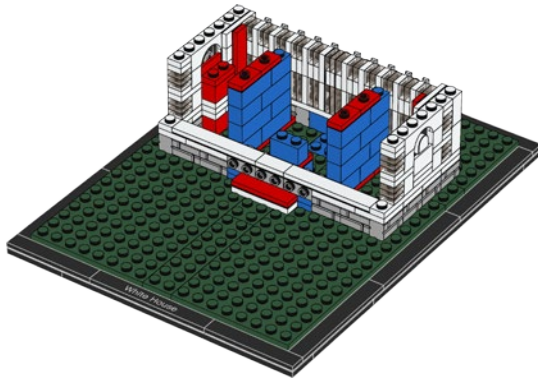
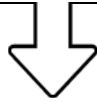

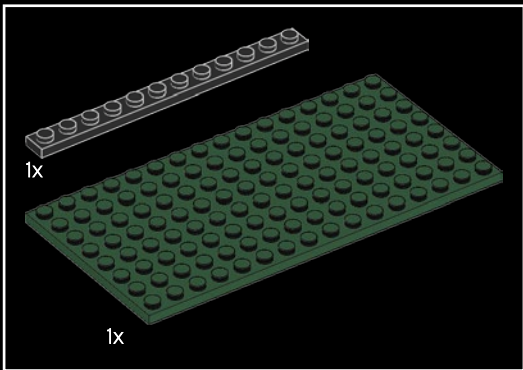
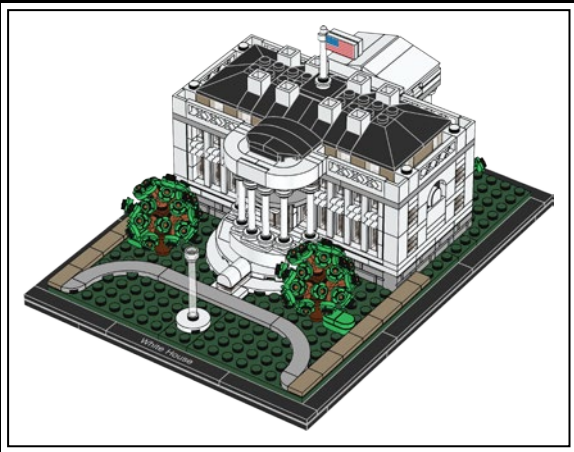

1

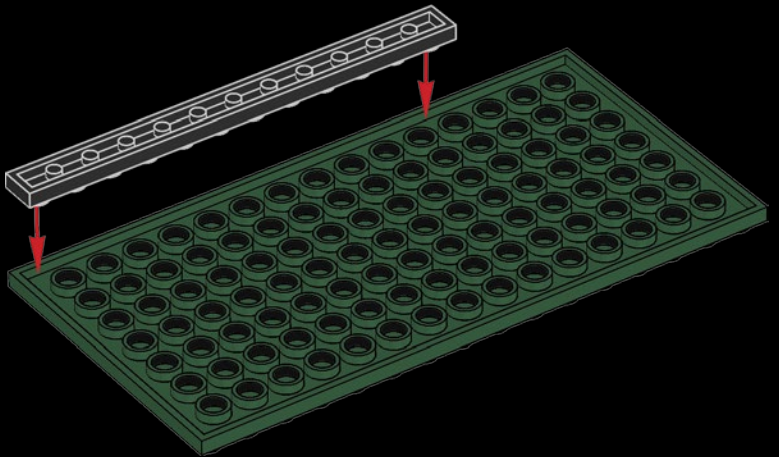

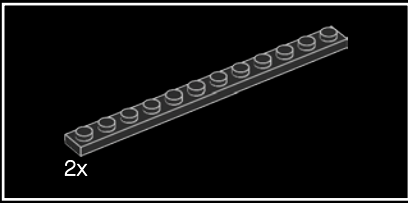

2

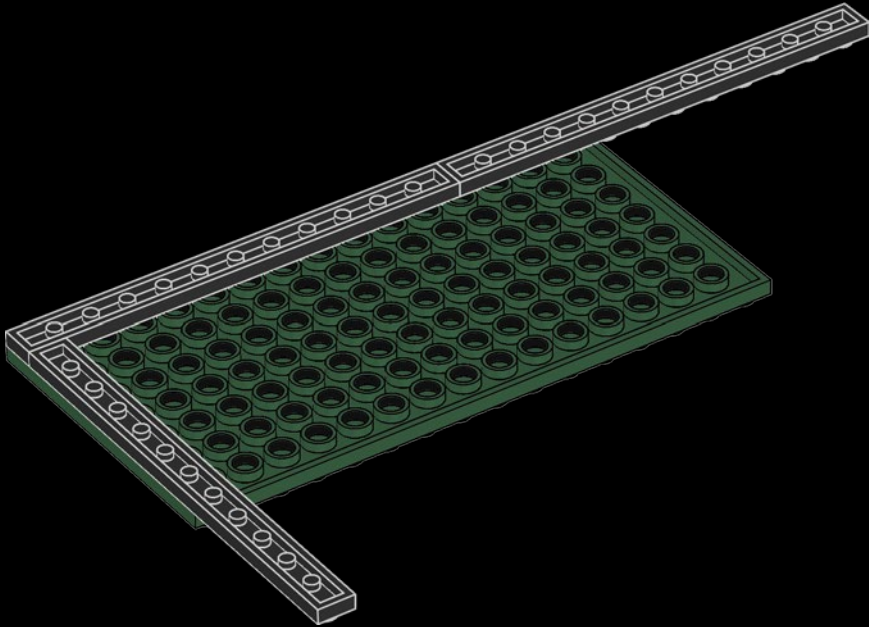

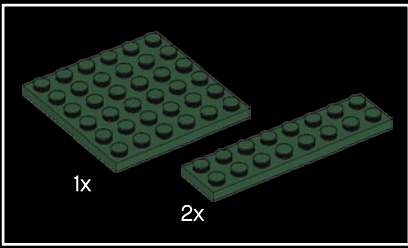

3

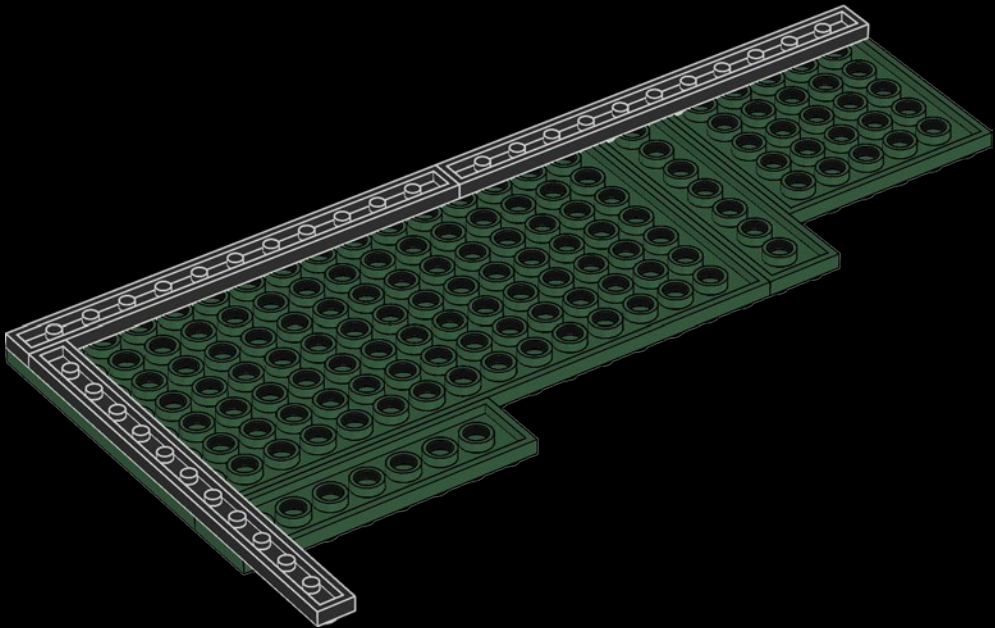

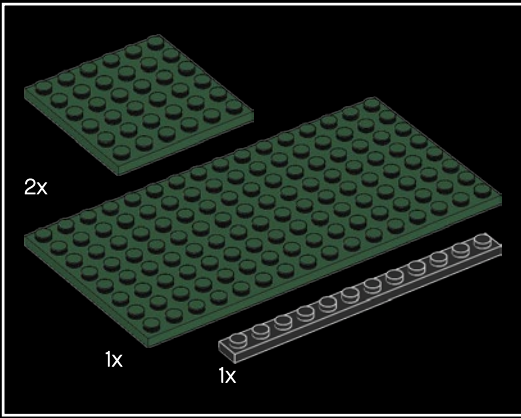

4

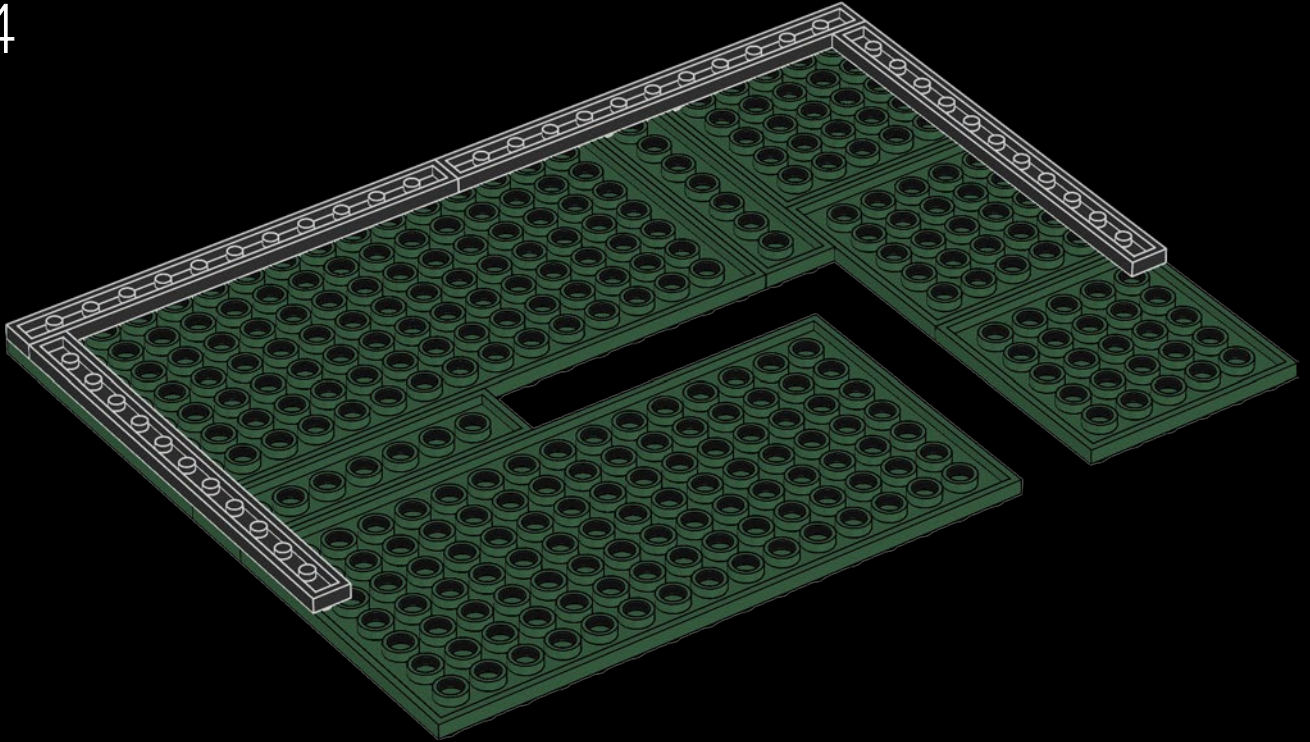

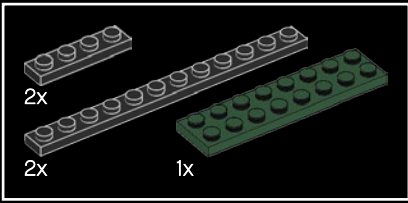

5

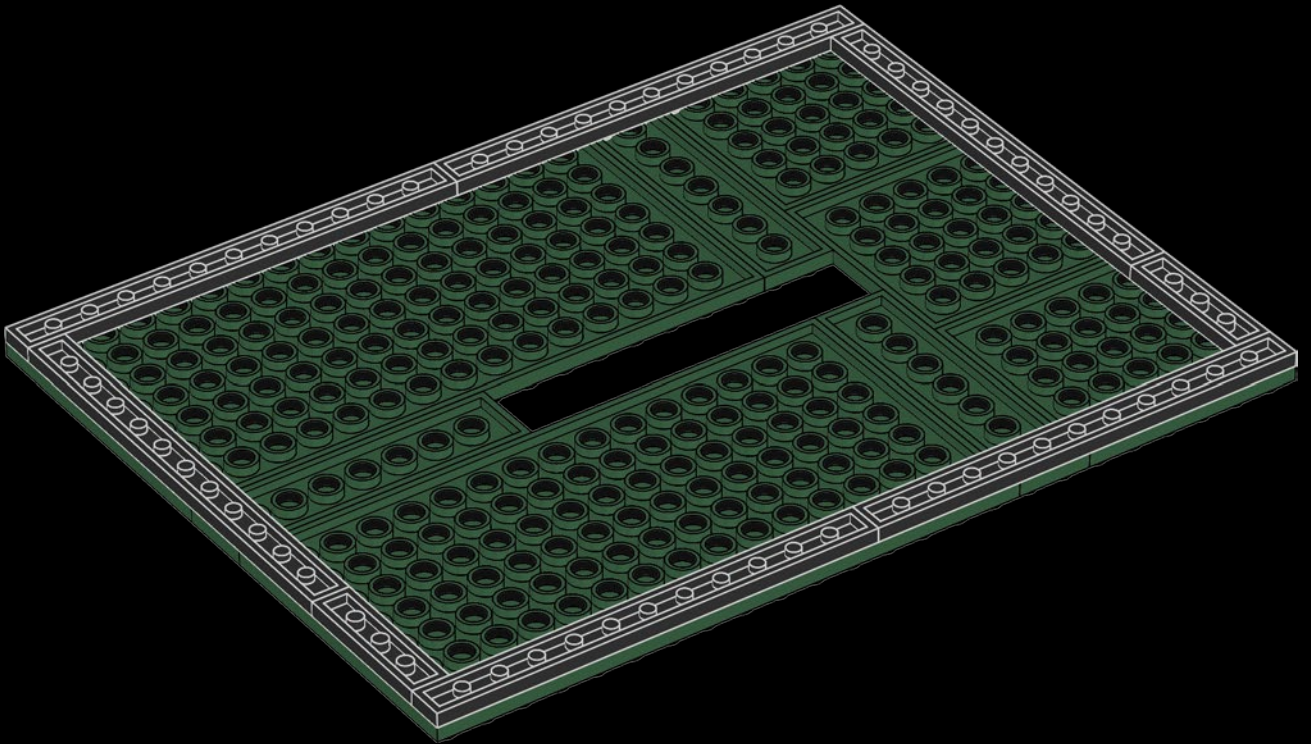

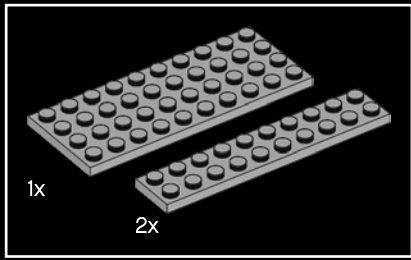

6

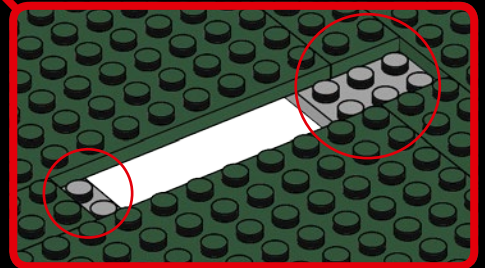
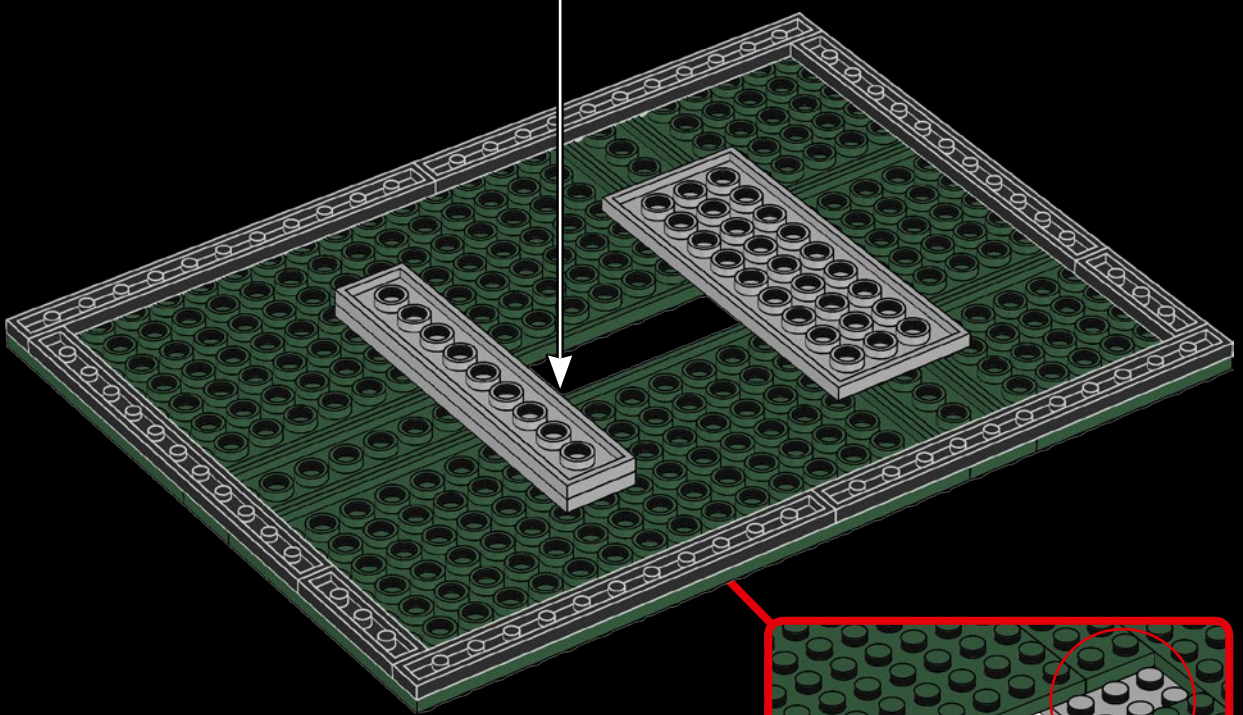
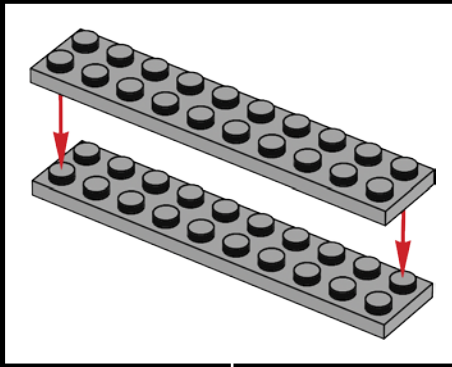

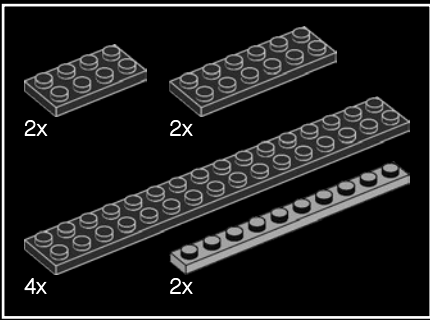

7

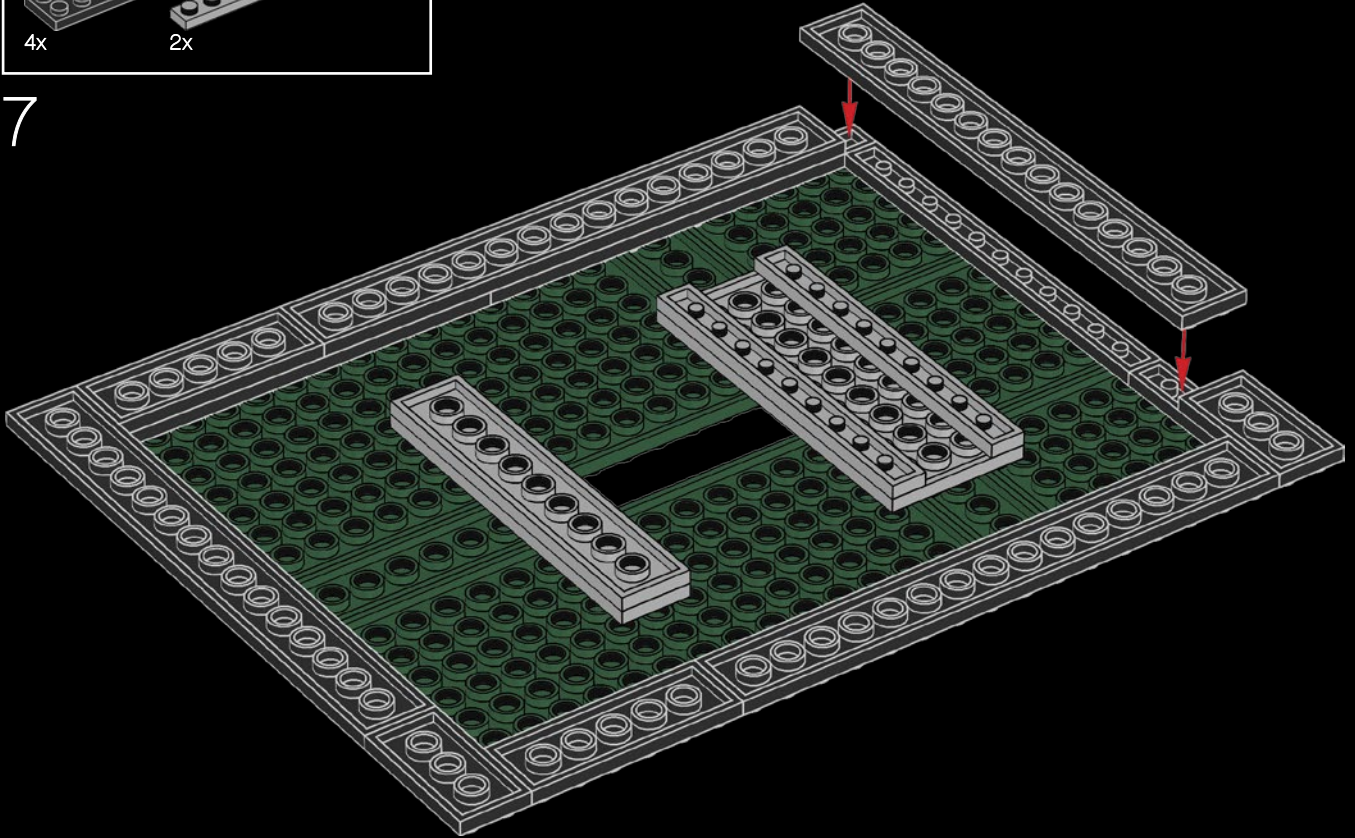

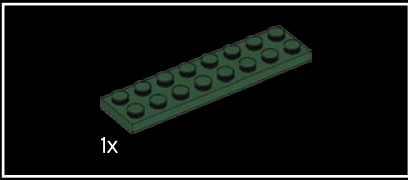

8

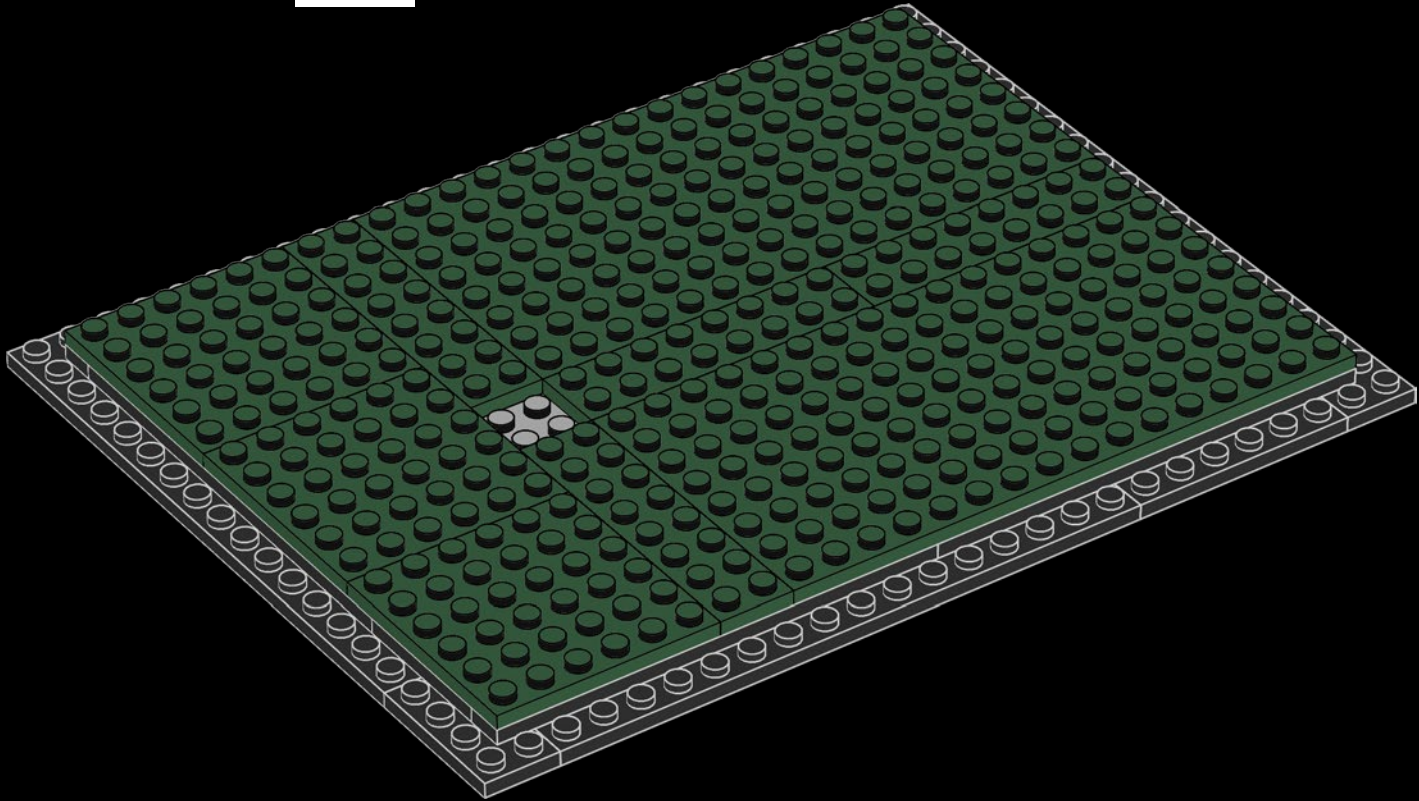

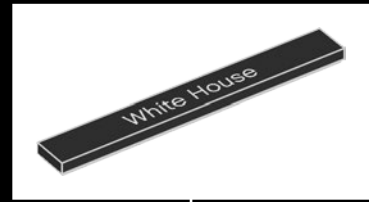
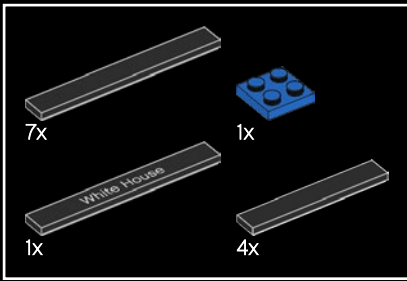

9

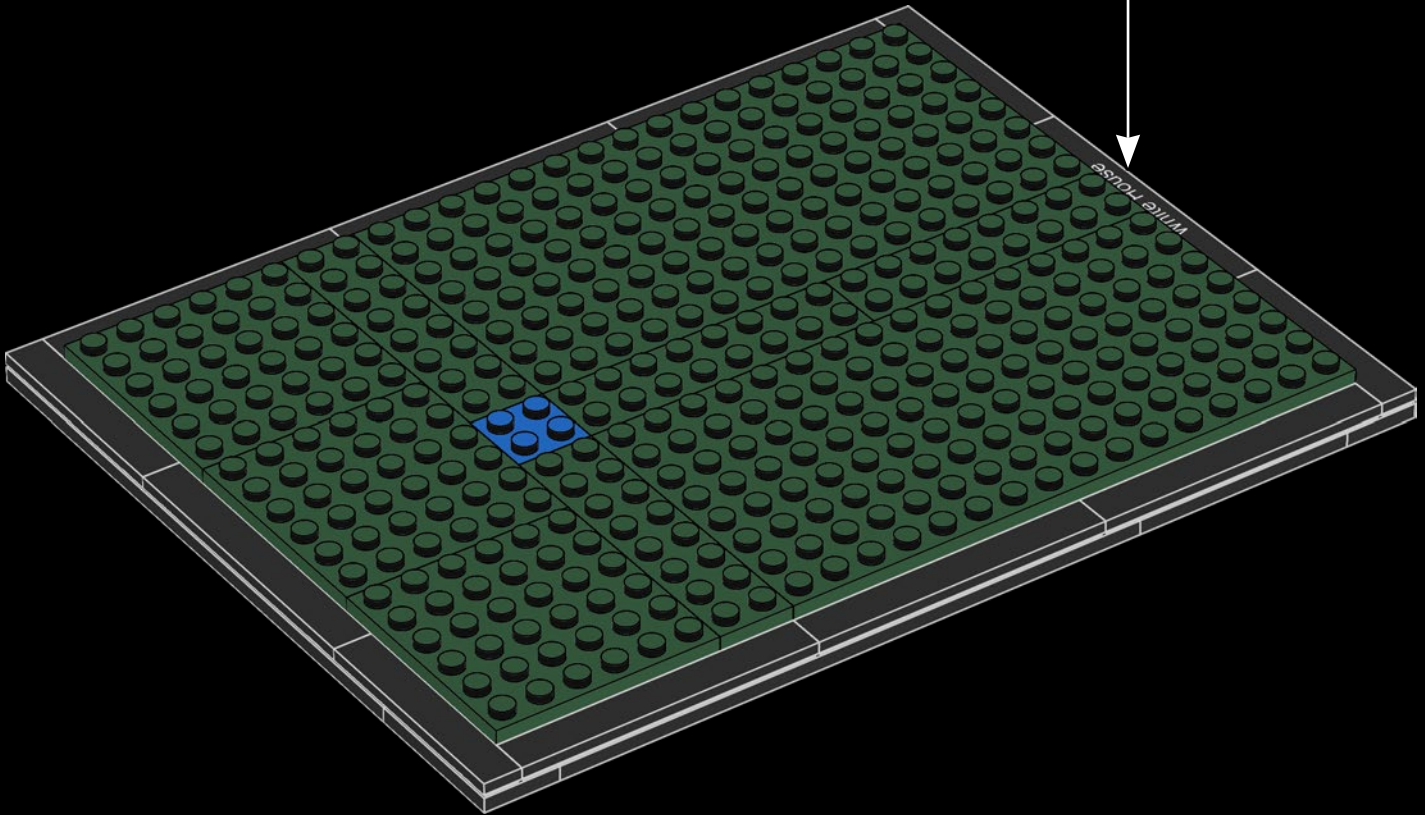

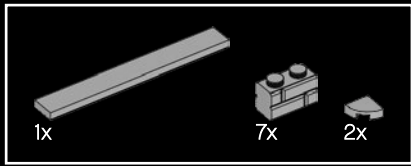

10

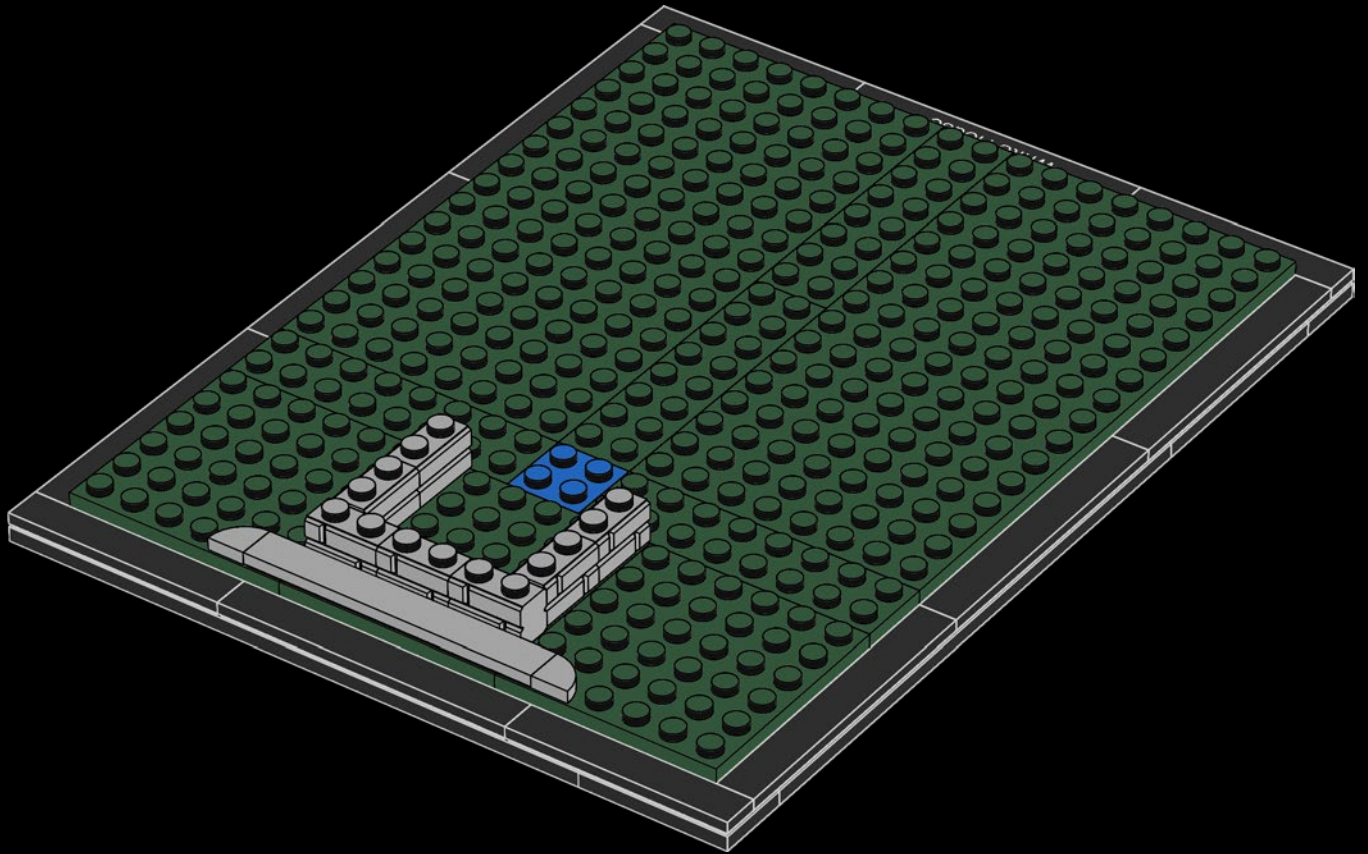

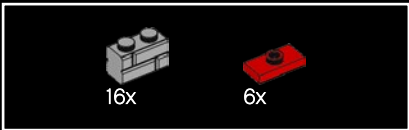

The White House sits at 1600 Pennsylvania Avenue in Washington D.C., the capital city of the United States

La Maison-Blanche est située au 1600 Pennsylvania Avenue à Washington D.C., la capitale des États-Unis

La Casa Blanca se encuentra en el número 1600 de la avenida Pennsylvania, en Washington D. C., capital de los Estados Unidos.

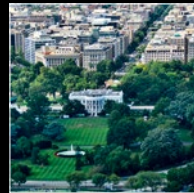

11

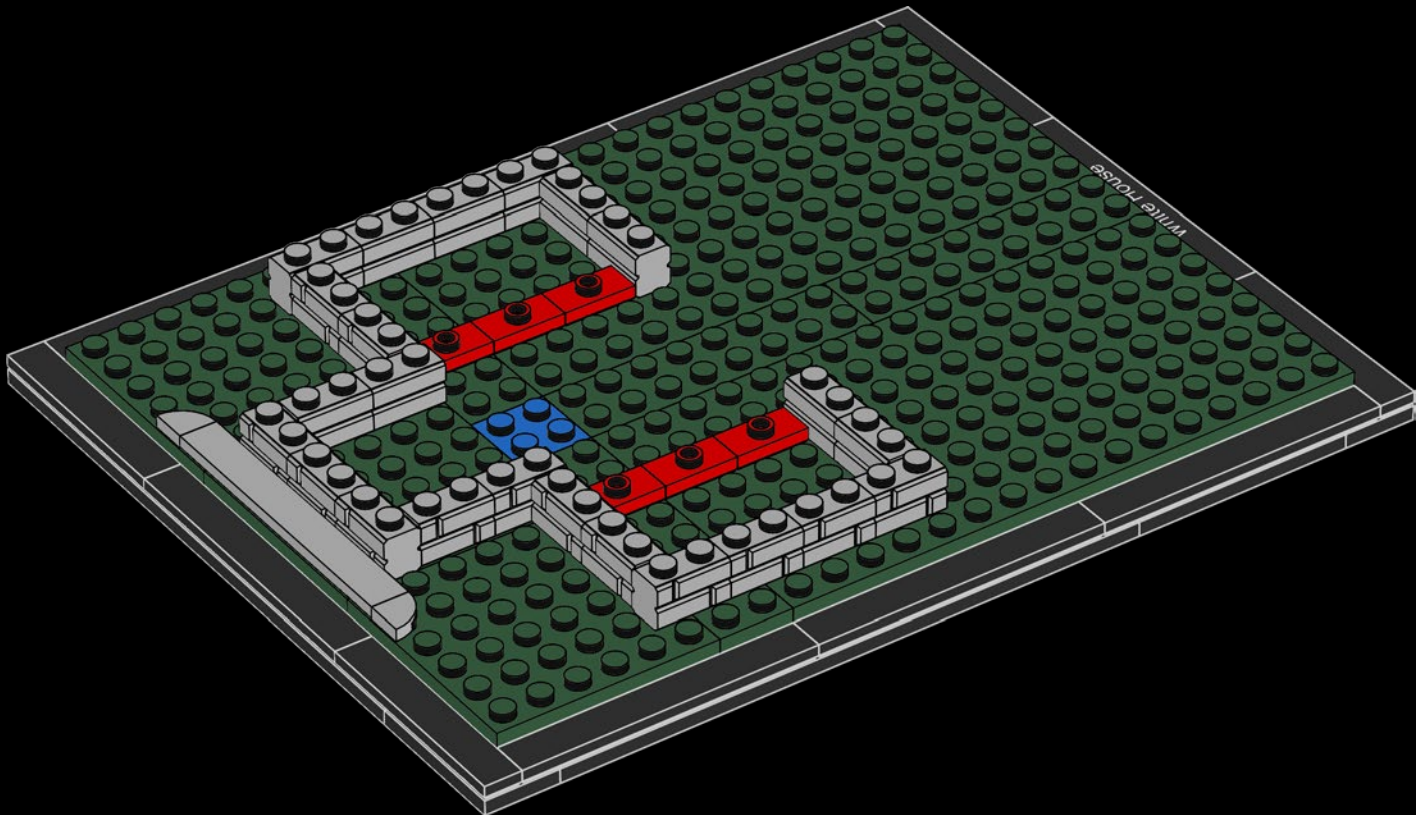

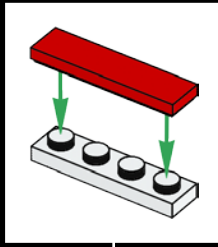
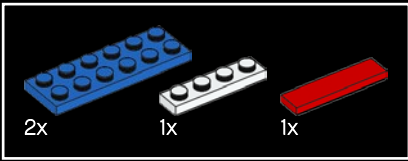

12

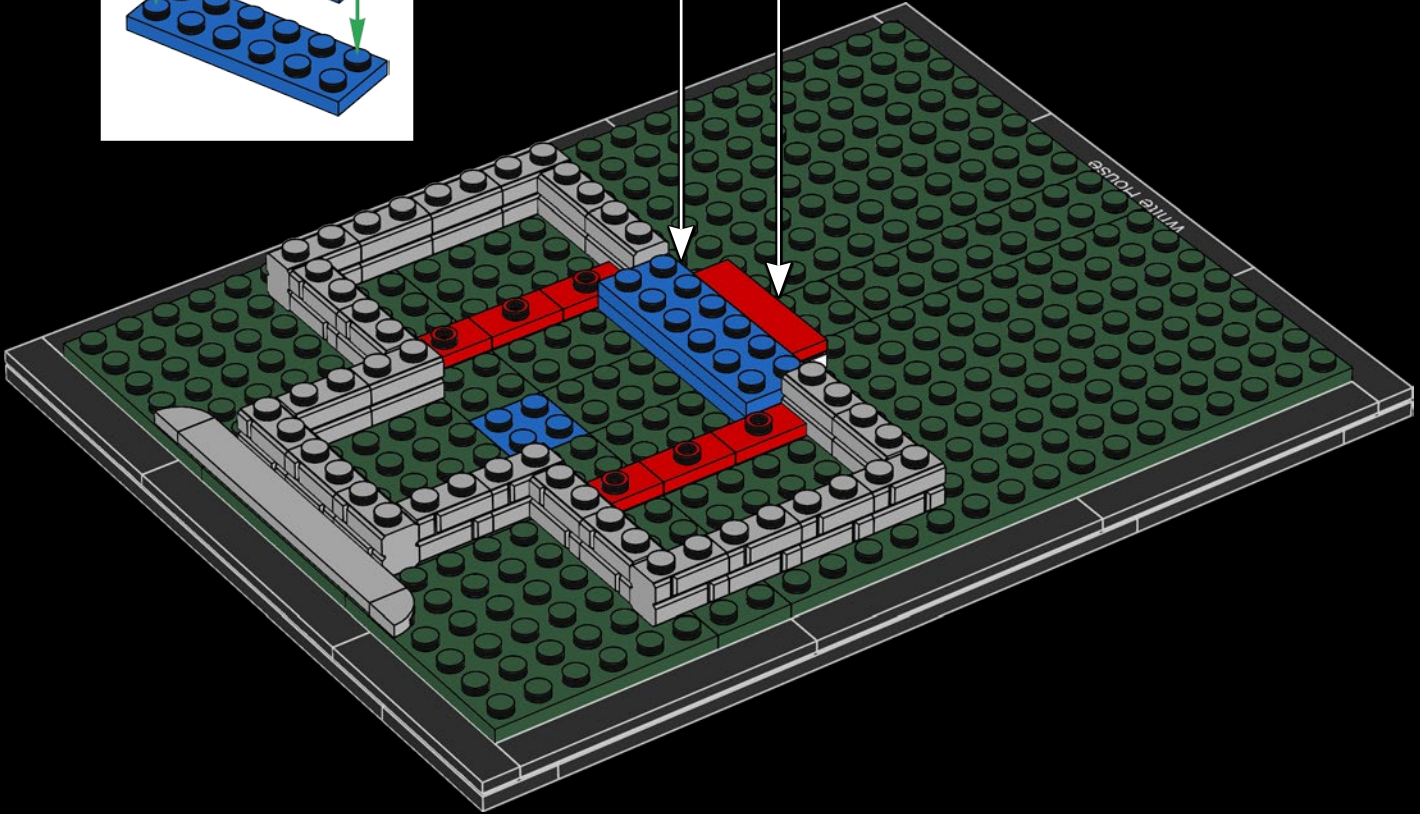
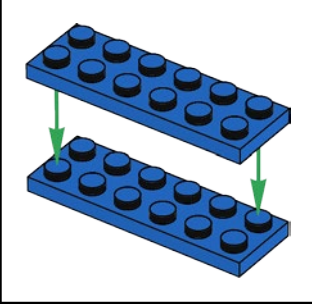

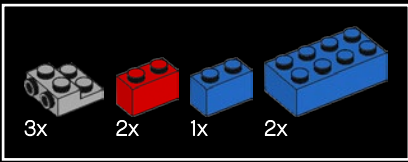

13

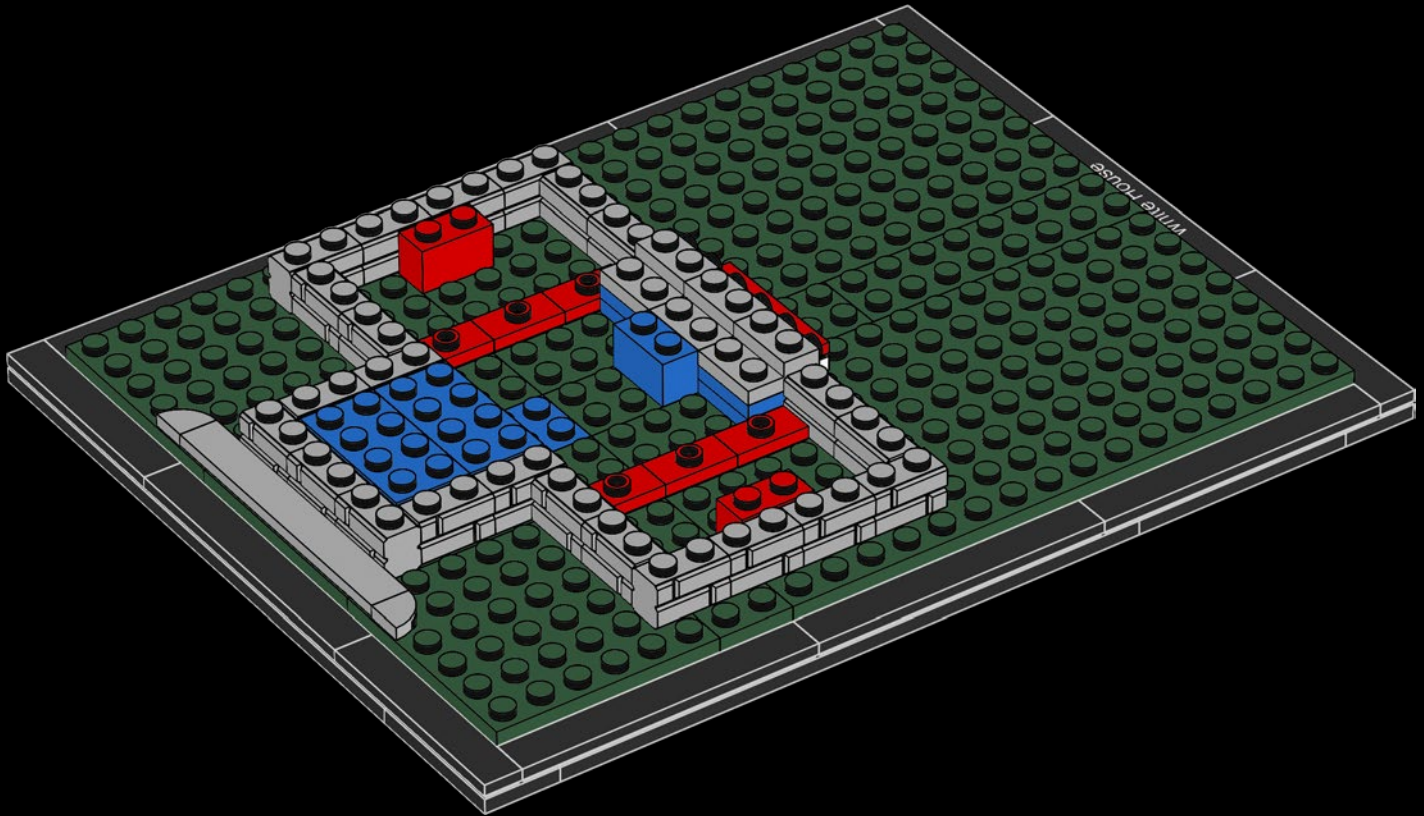

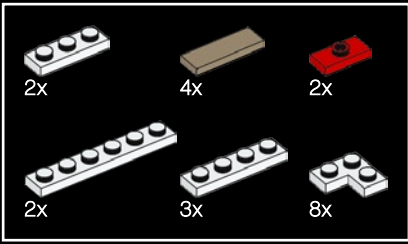

14

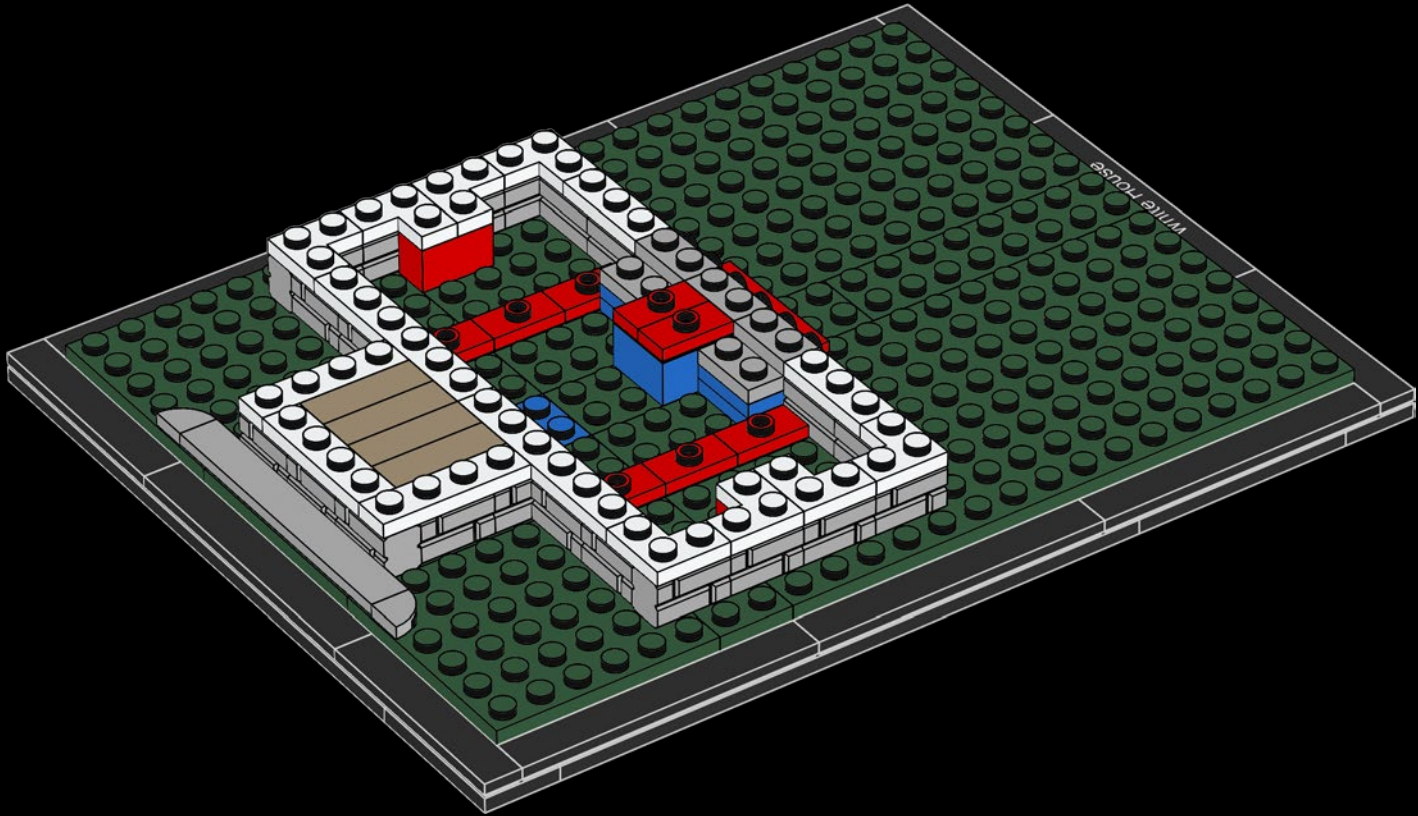

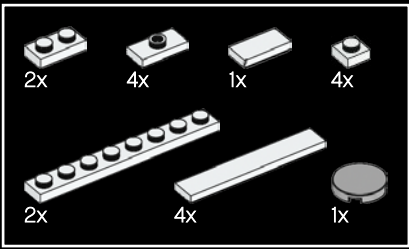

15

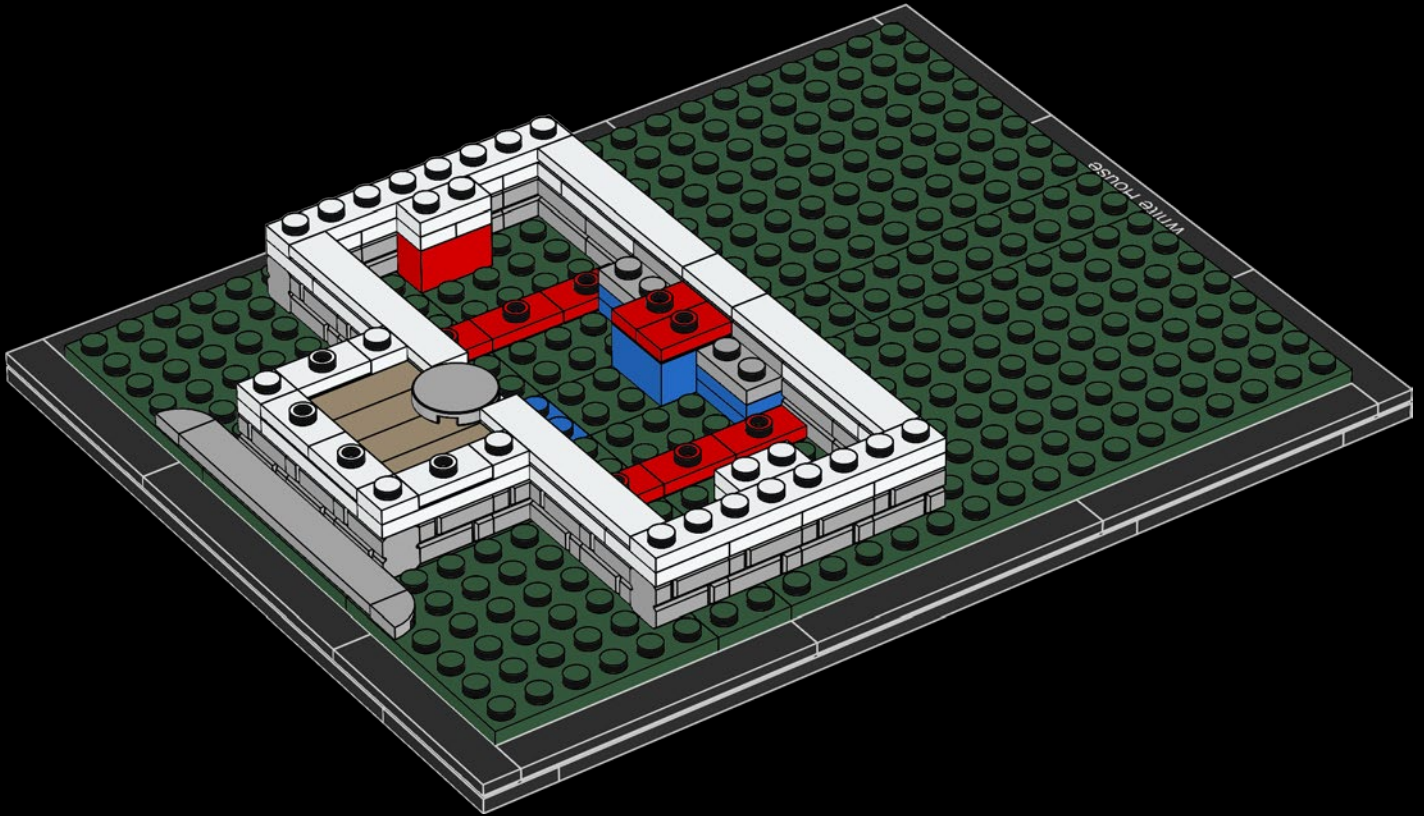

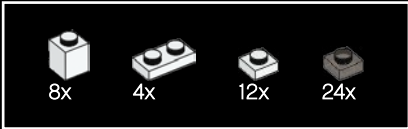
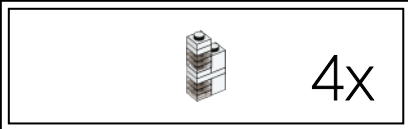

16

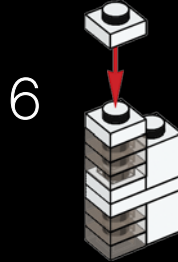
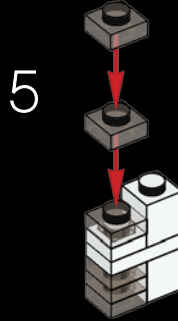
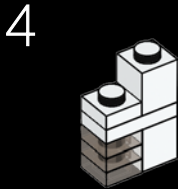
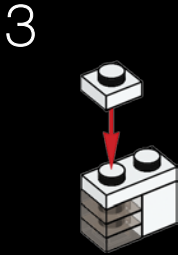
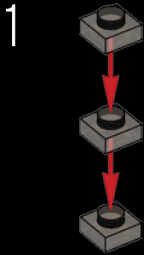

4x

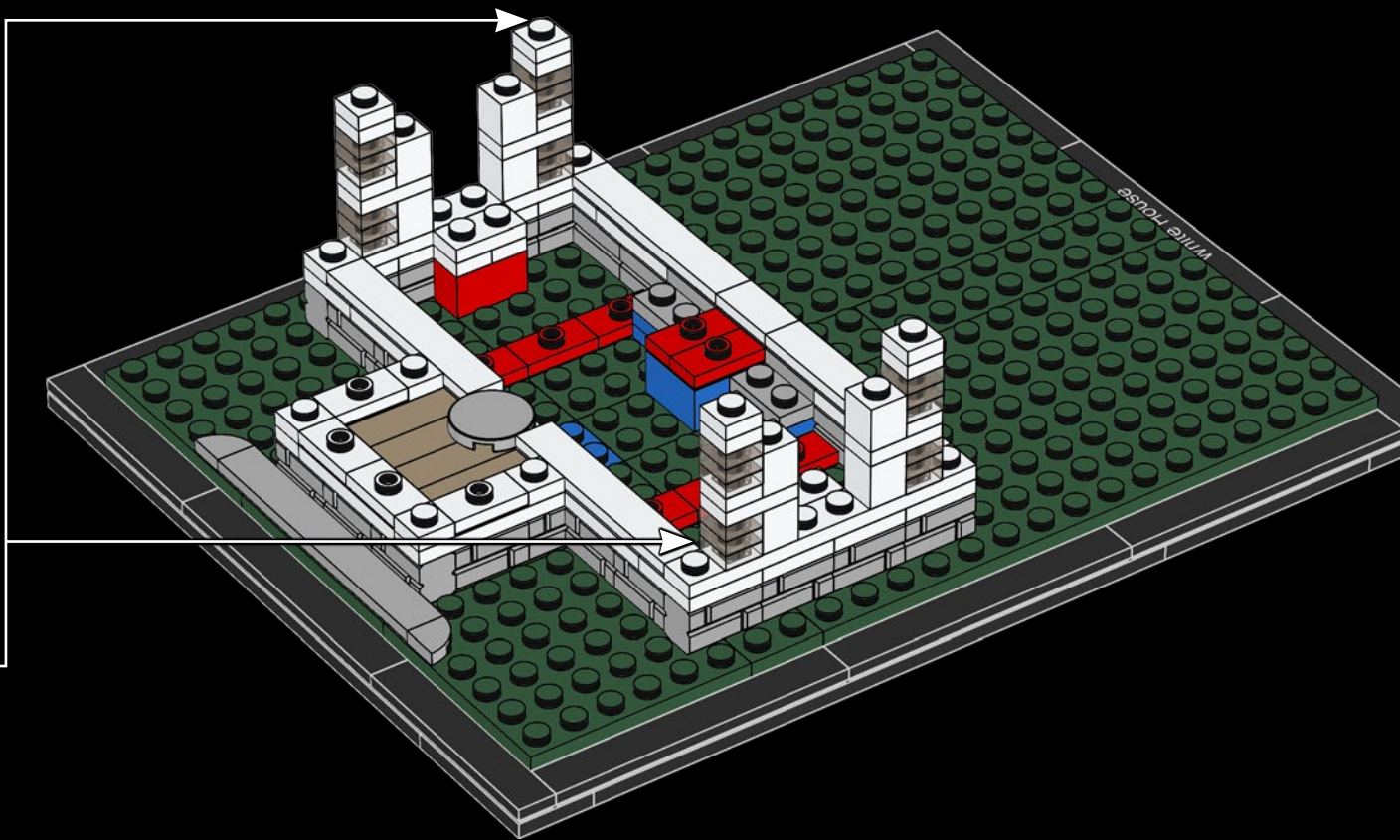

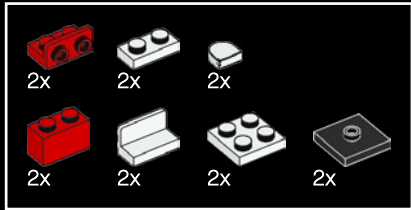

17

1



2



3

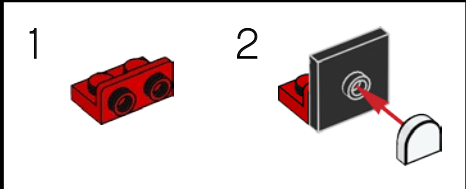

4



2x

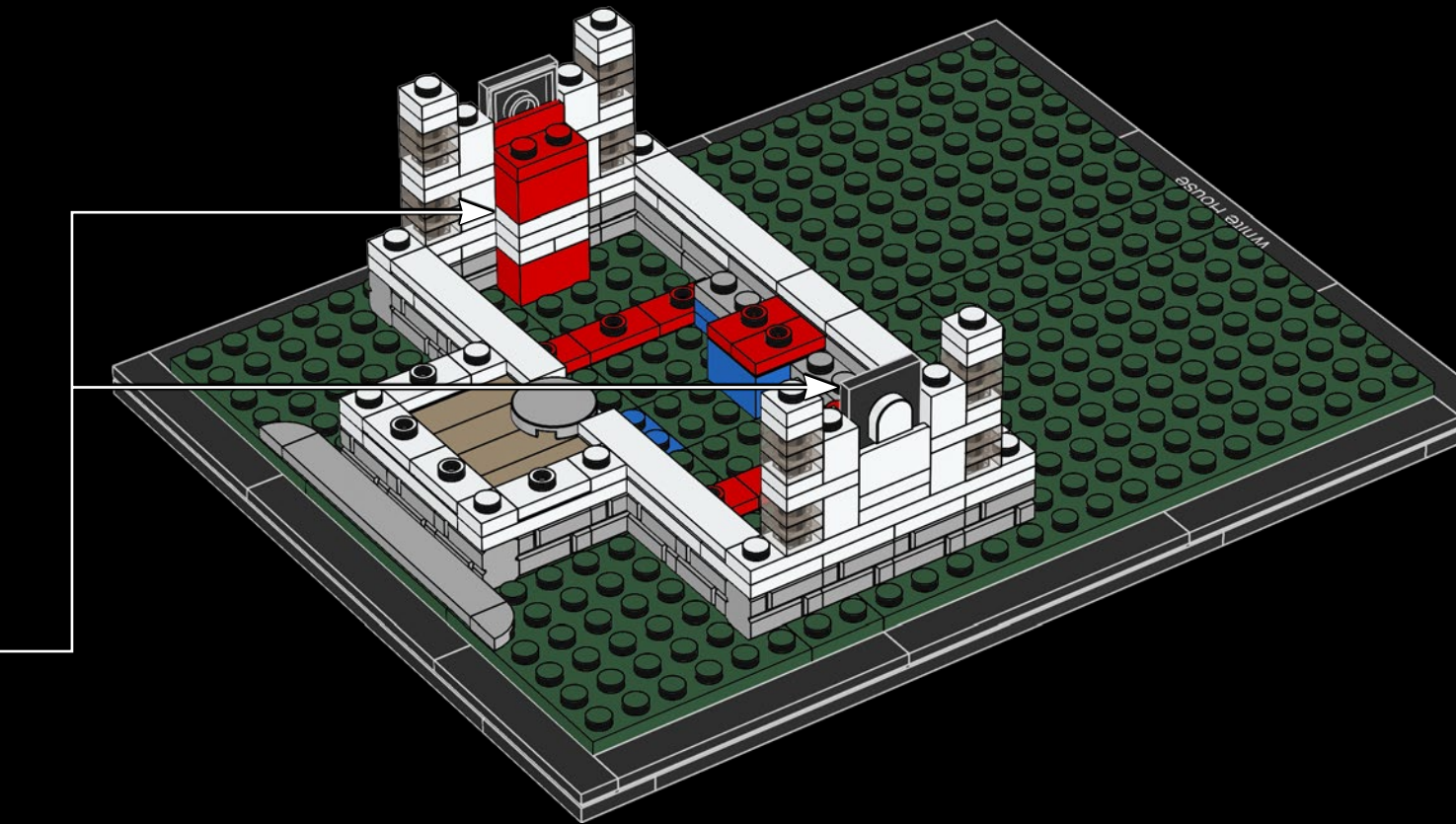

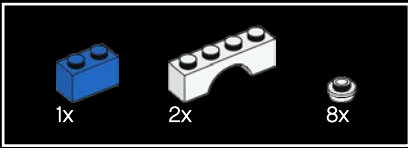

18

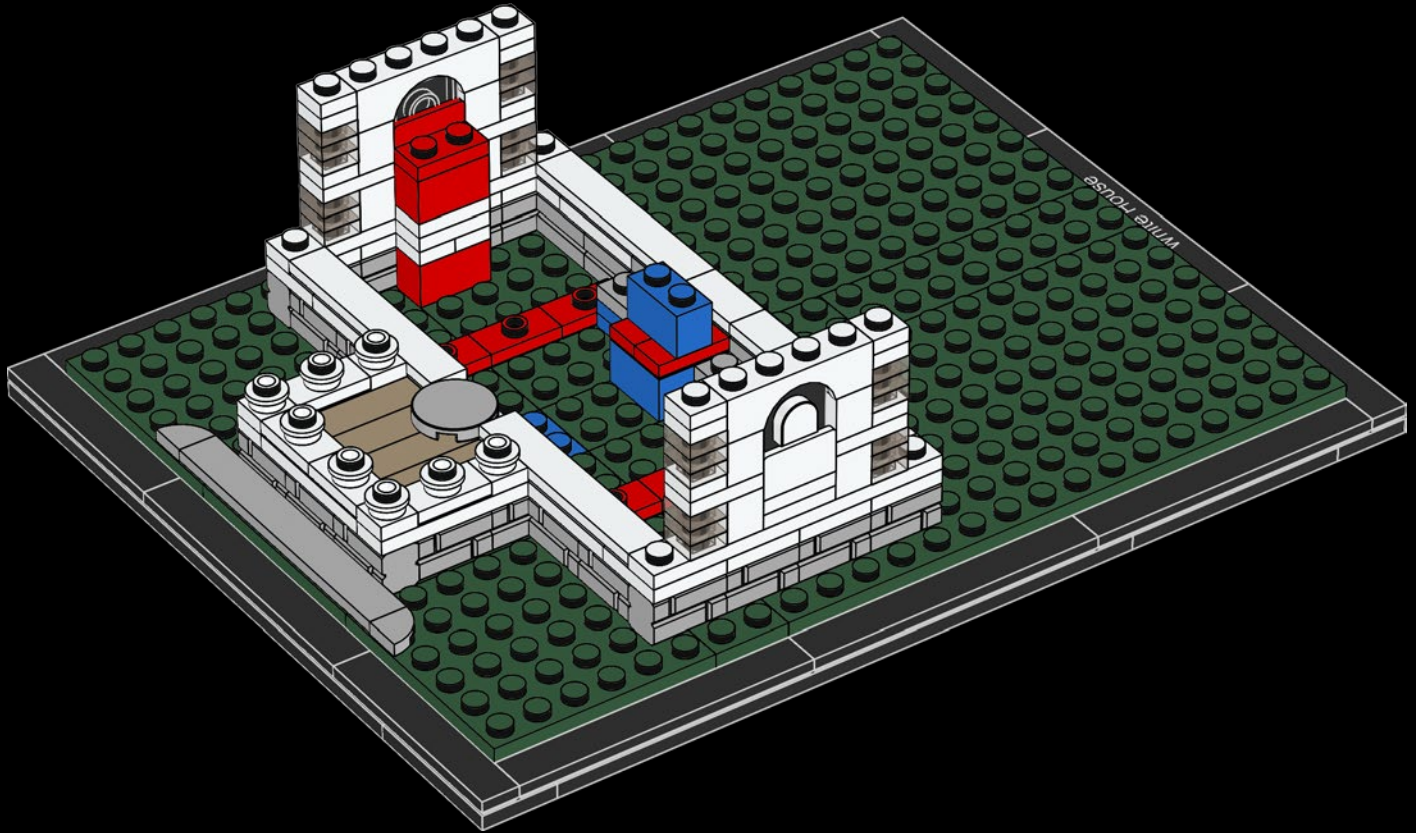

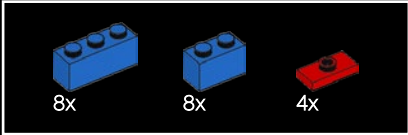
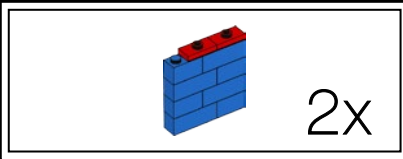

19

1

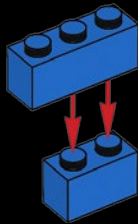

2

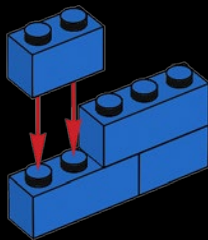

3

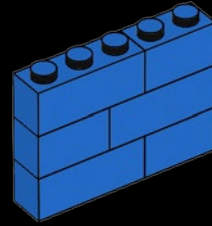

4

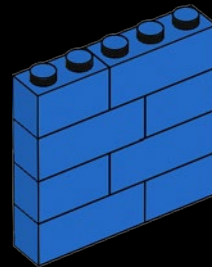

5

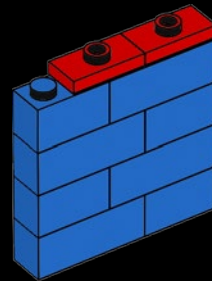

2x

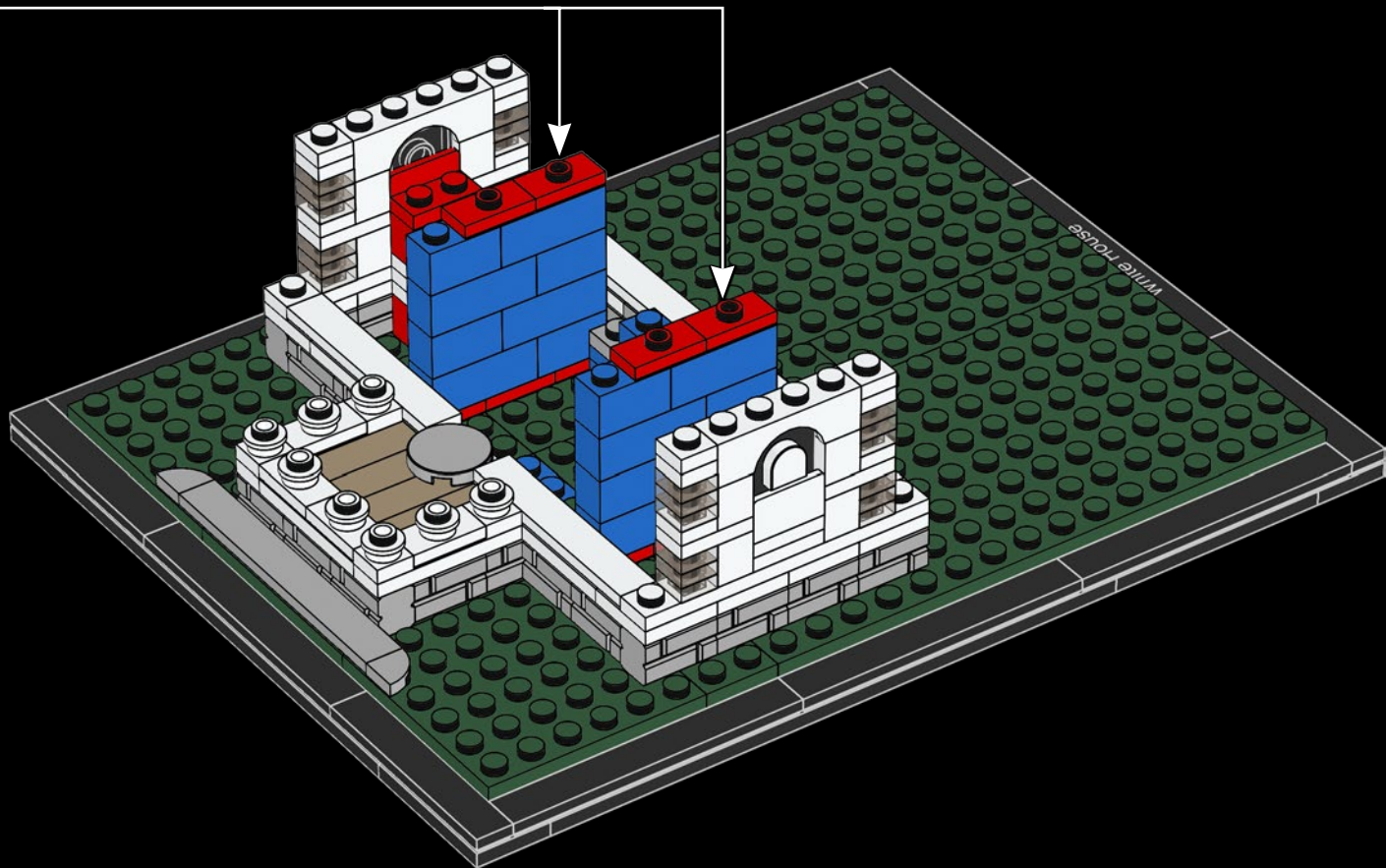

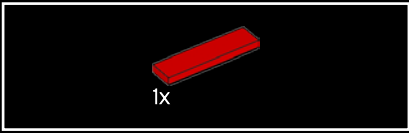
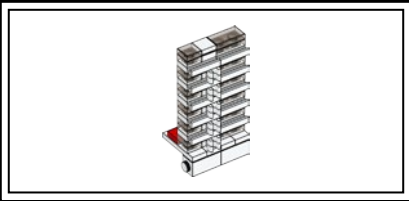

20

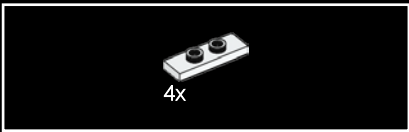

21



22

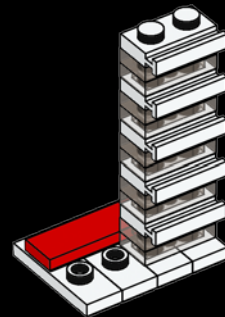
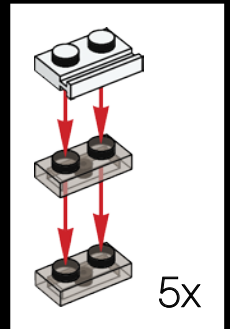



23

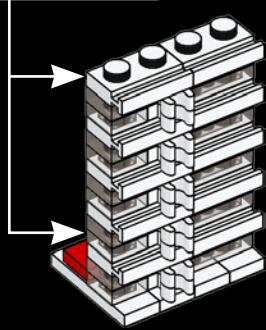
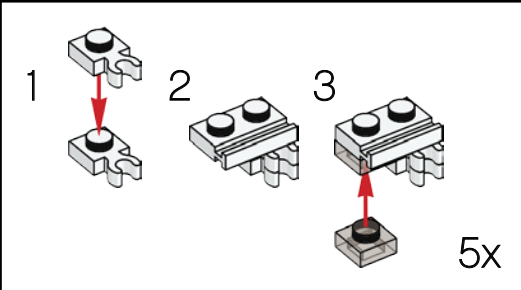

24

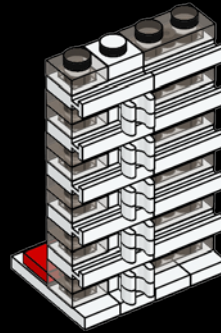



25

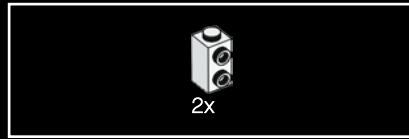
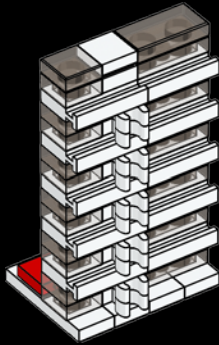

26

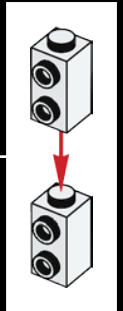
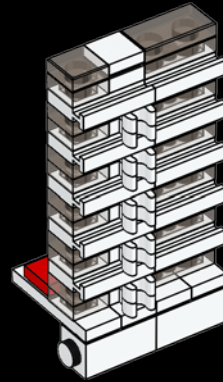

27

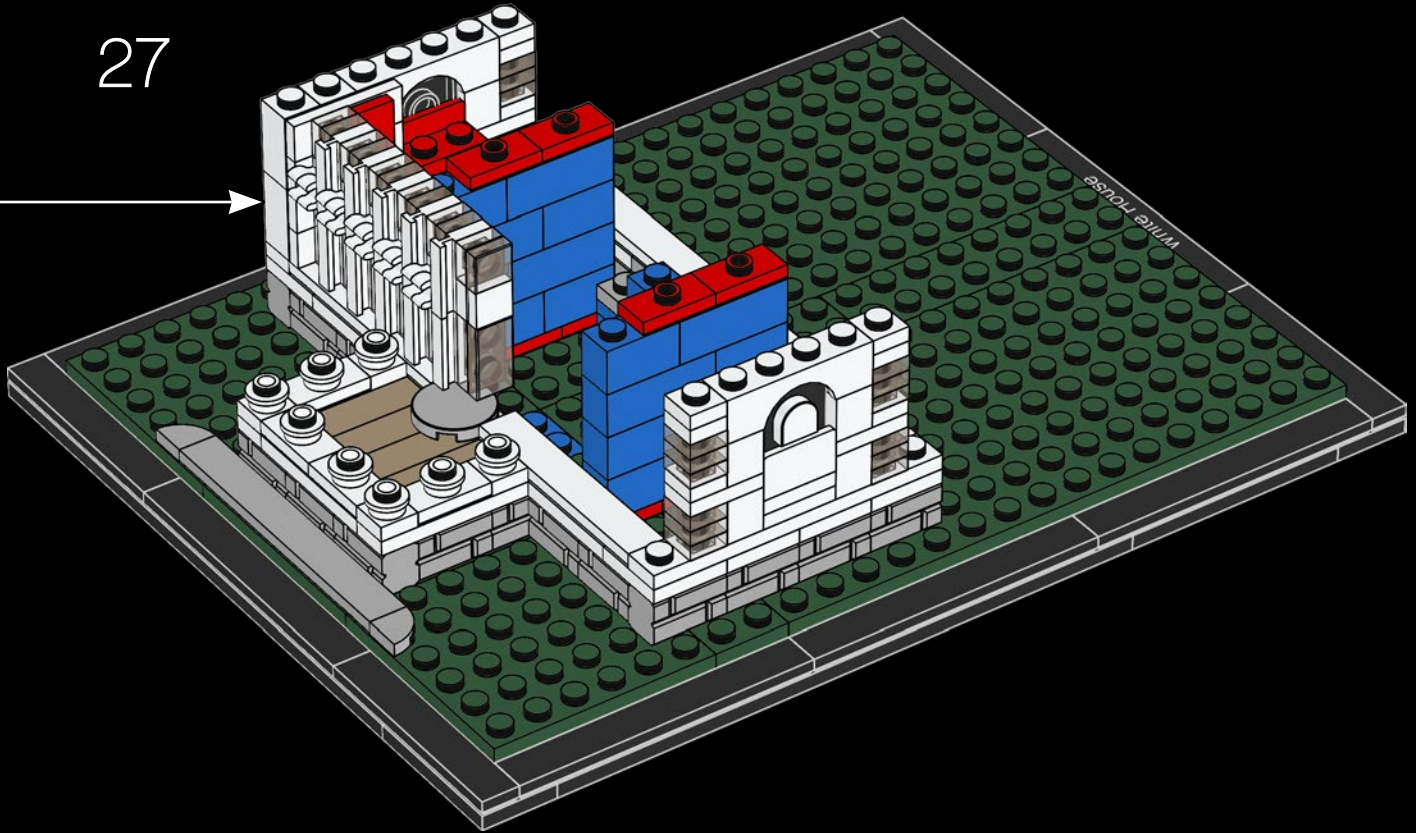

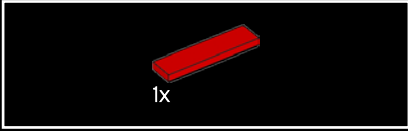
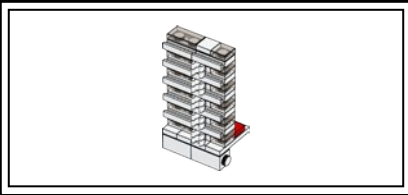

28

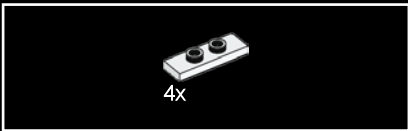

29

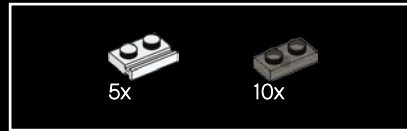

30

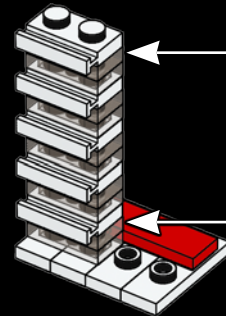
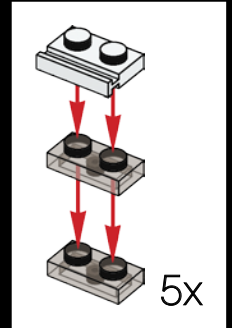



31

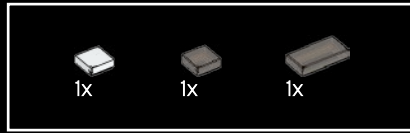
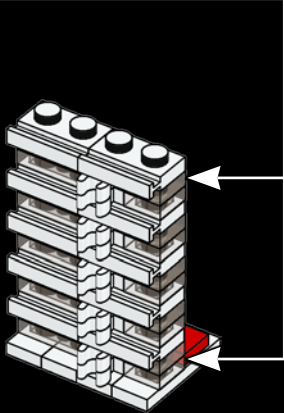
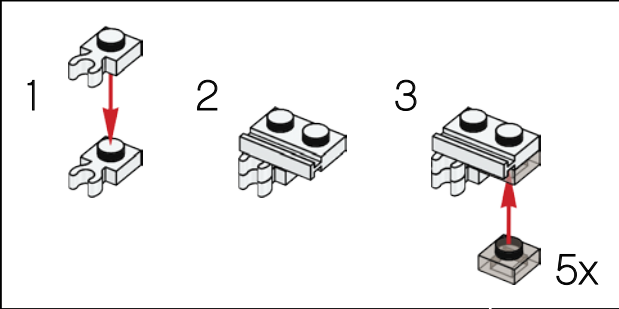

32

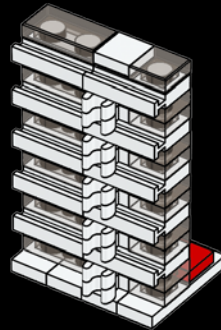

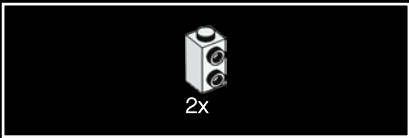

33

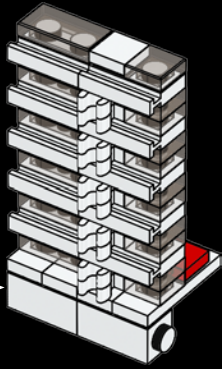
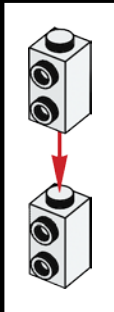

34

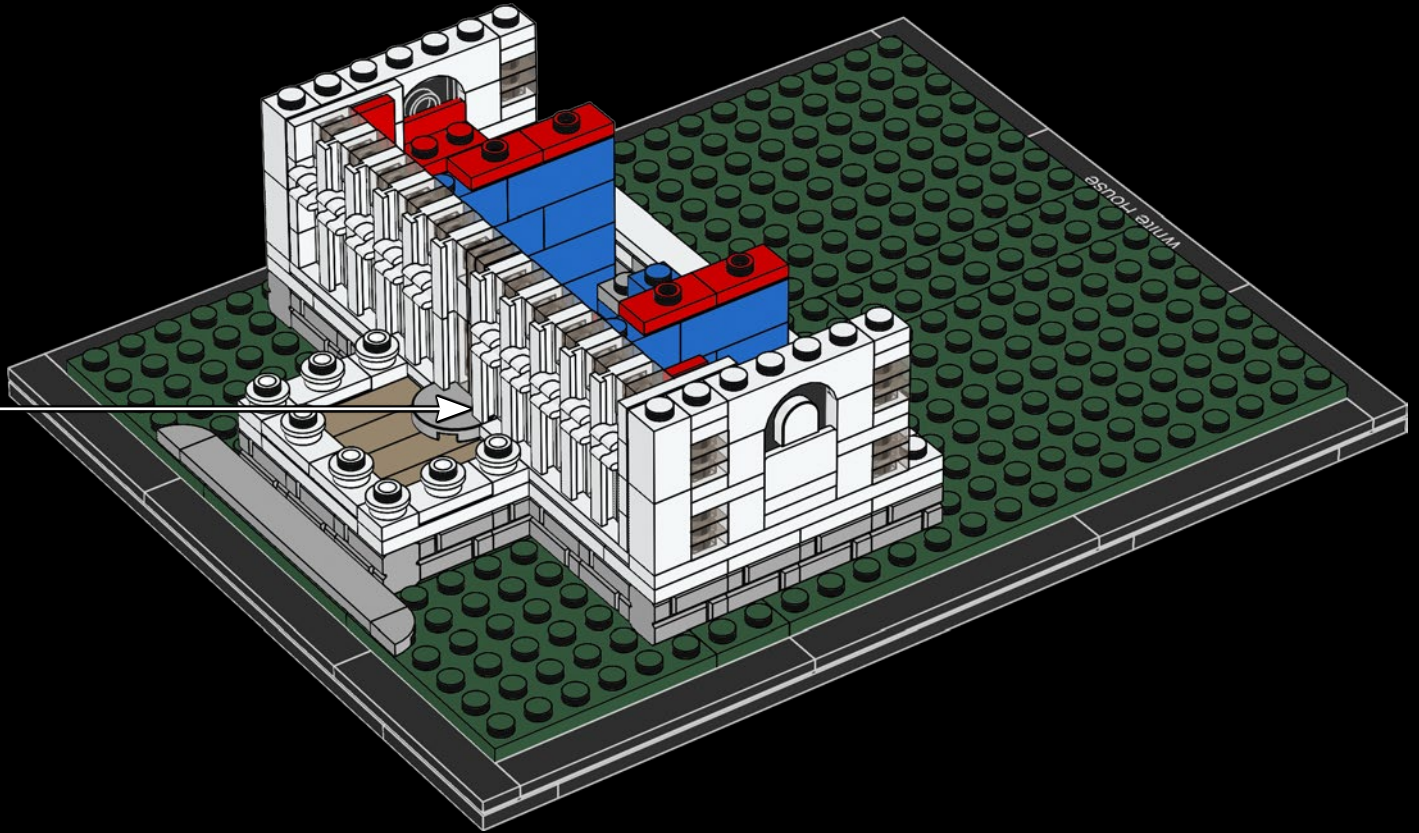

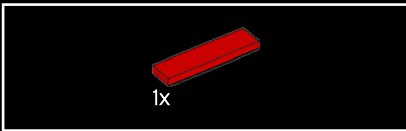
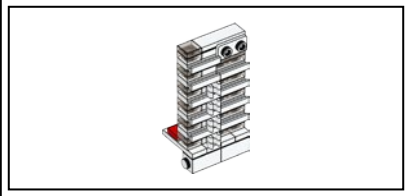
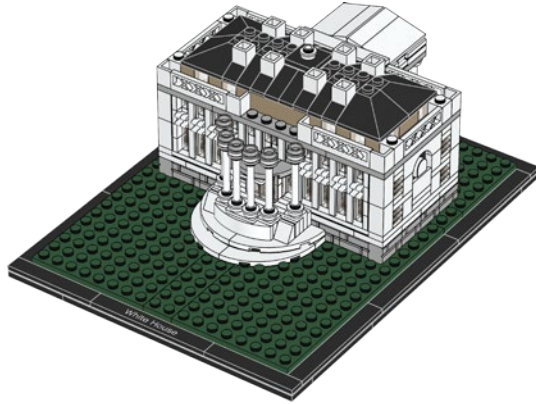
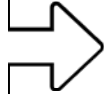
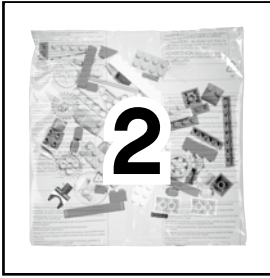

35

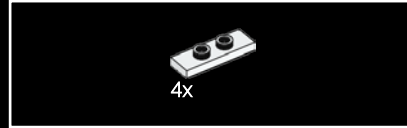

36





37

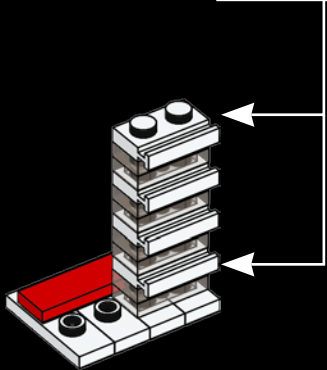
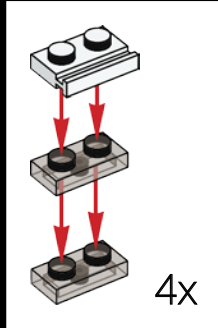

38

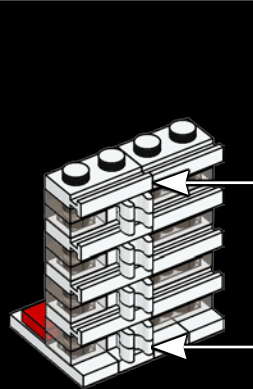
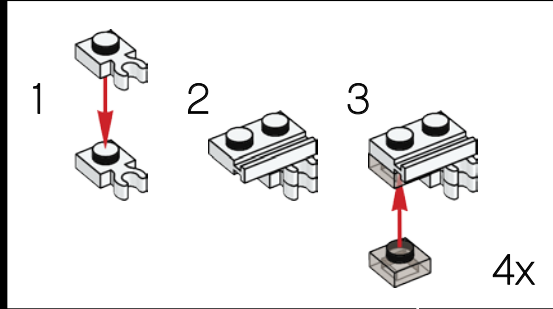



39

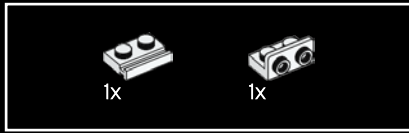
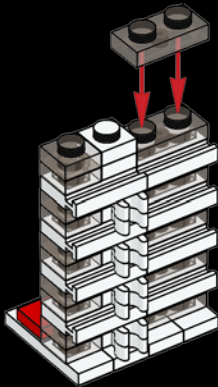

40

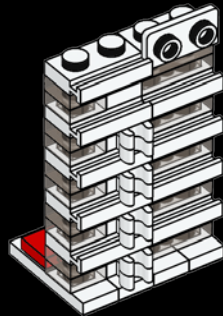

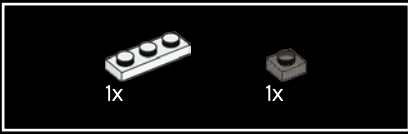

41

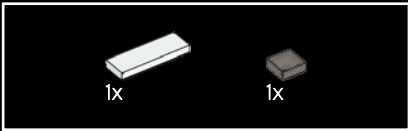
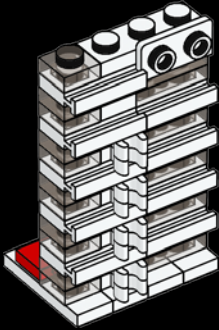

42

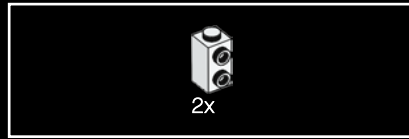
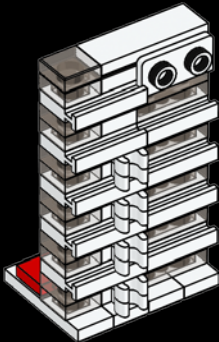

43

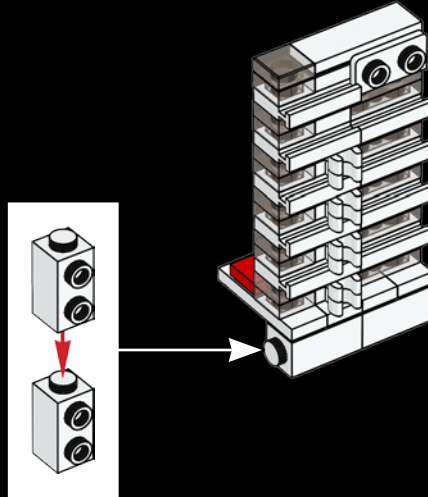

44

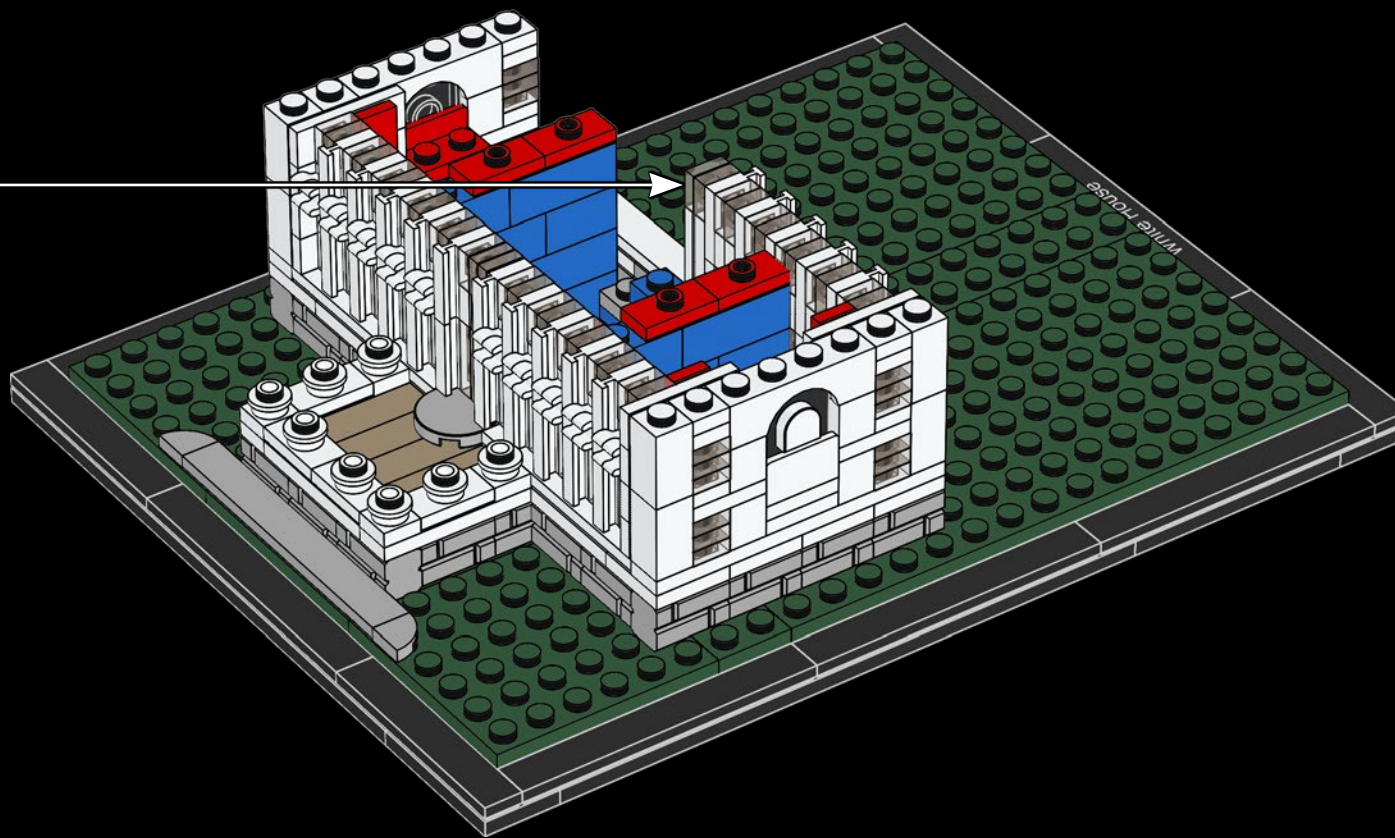

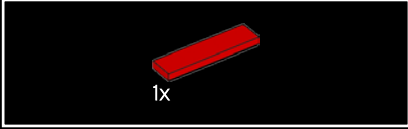
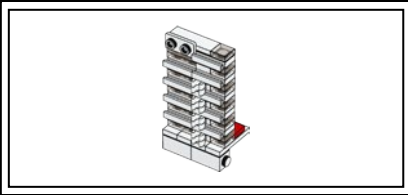

1x

45

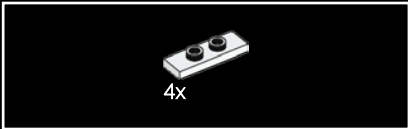

4x

46



4x

8x

47

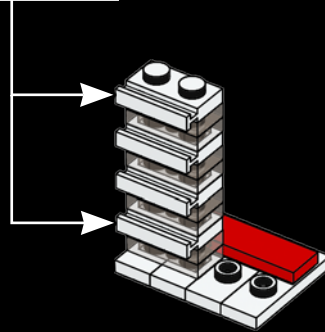
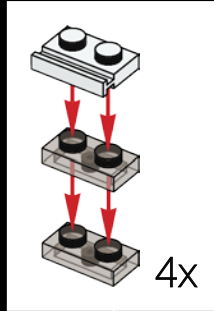



48

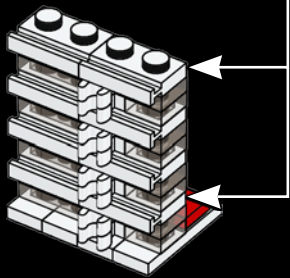
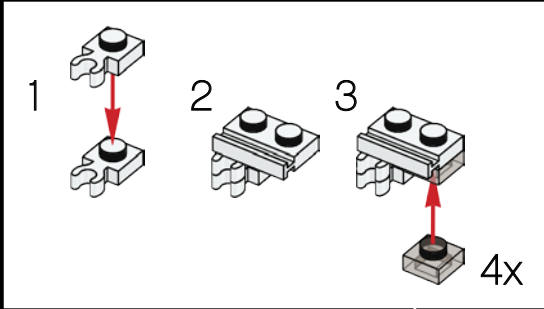

49

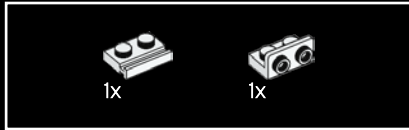
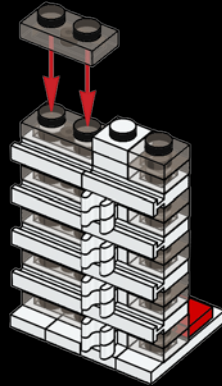

50

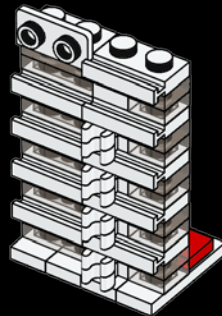

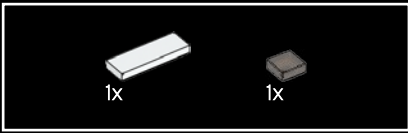

51

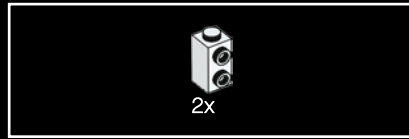
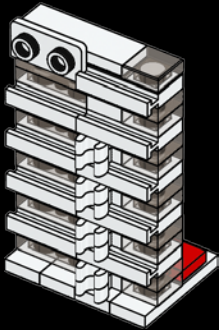

52

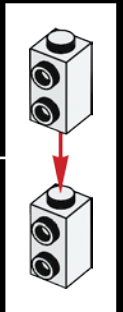
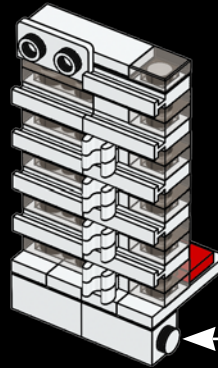

53

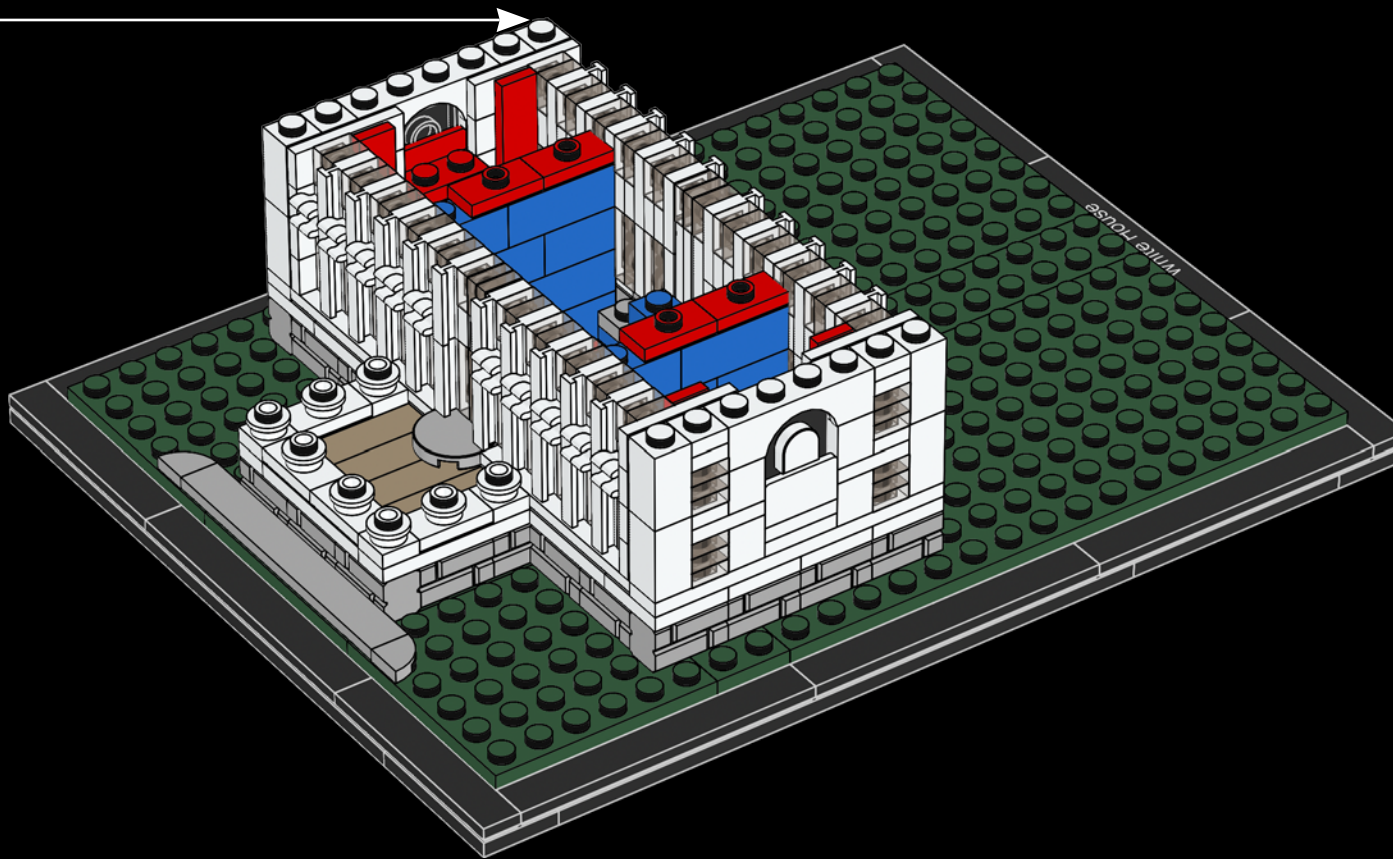

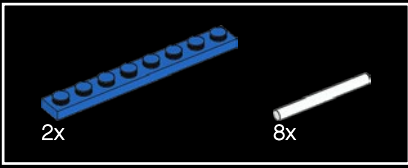

54

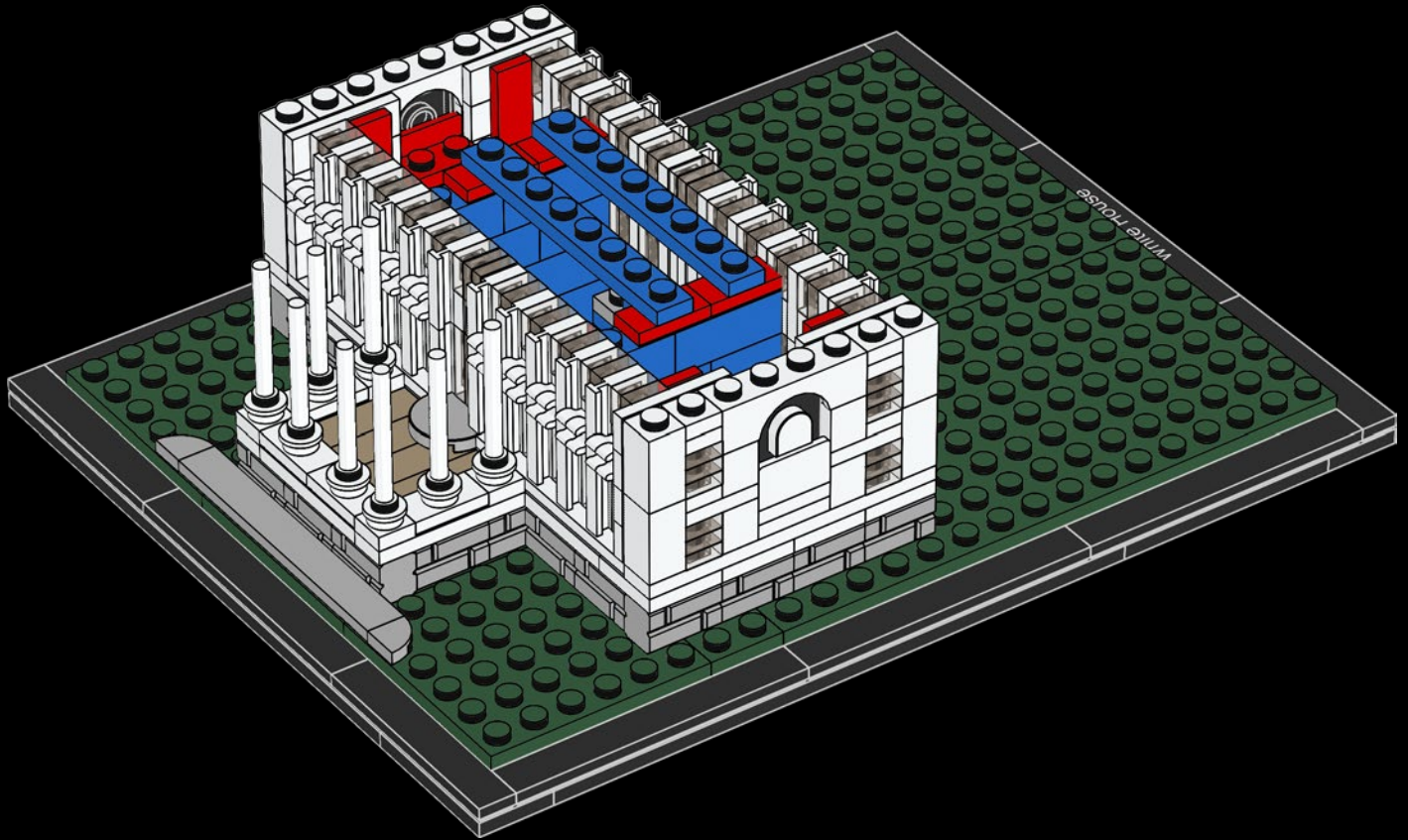

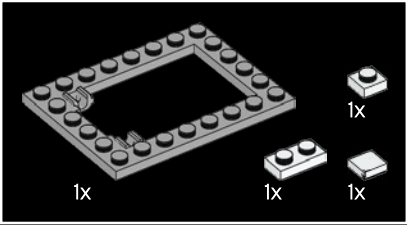
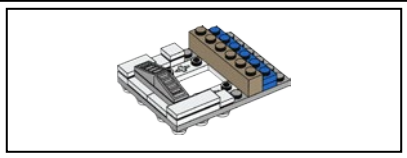

55

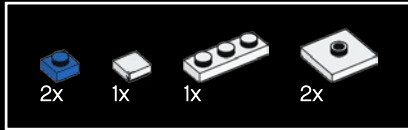
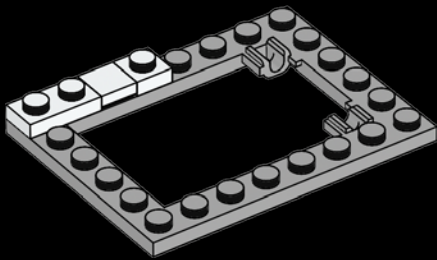

56

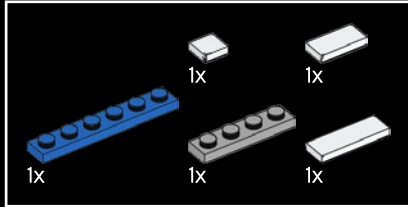
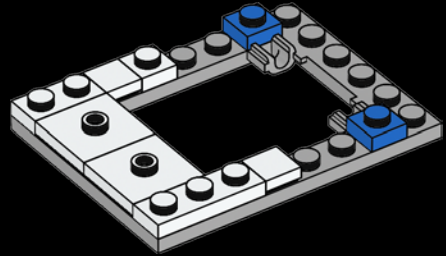

57

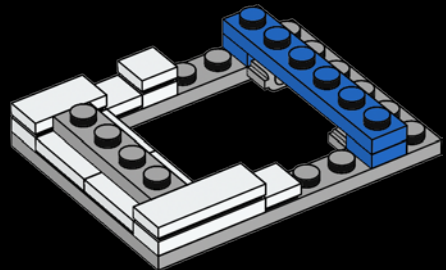

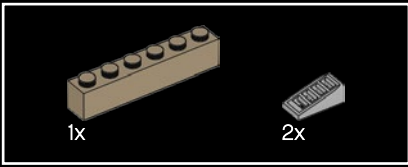

58

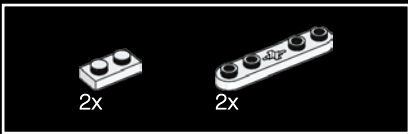
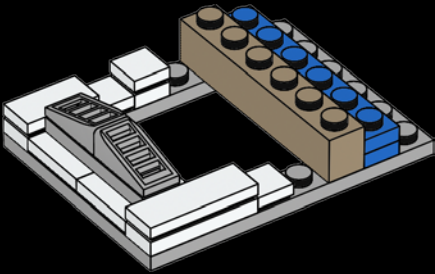

59

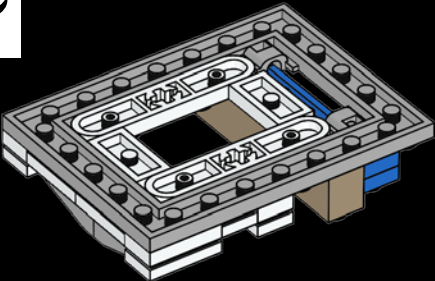
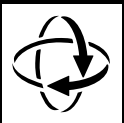

54



60

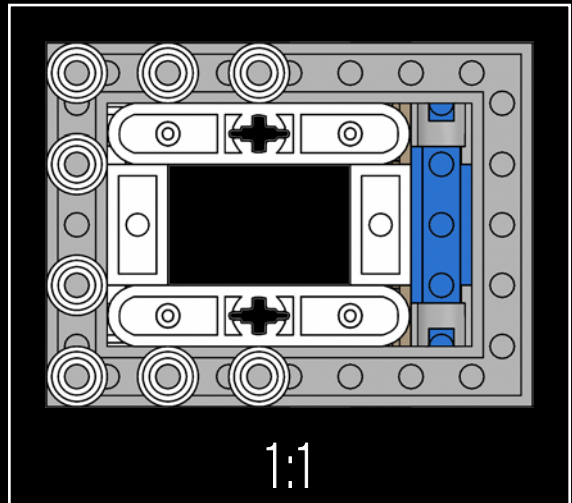
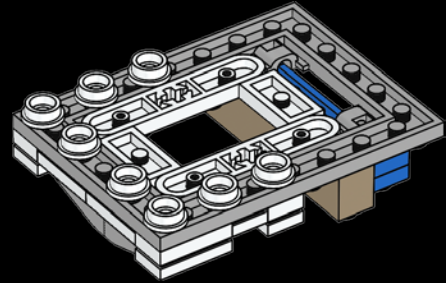

61

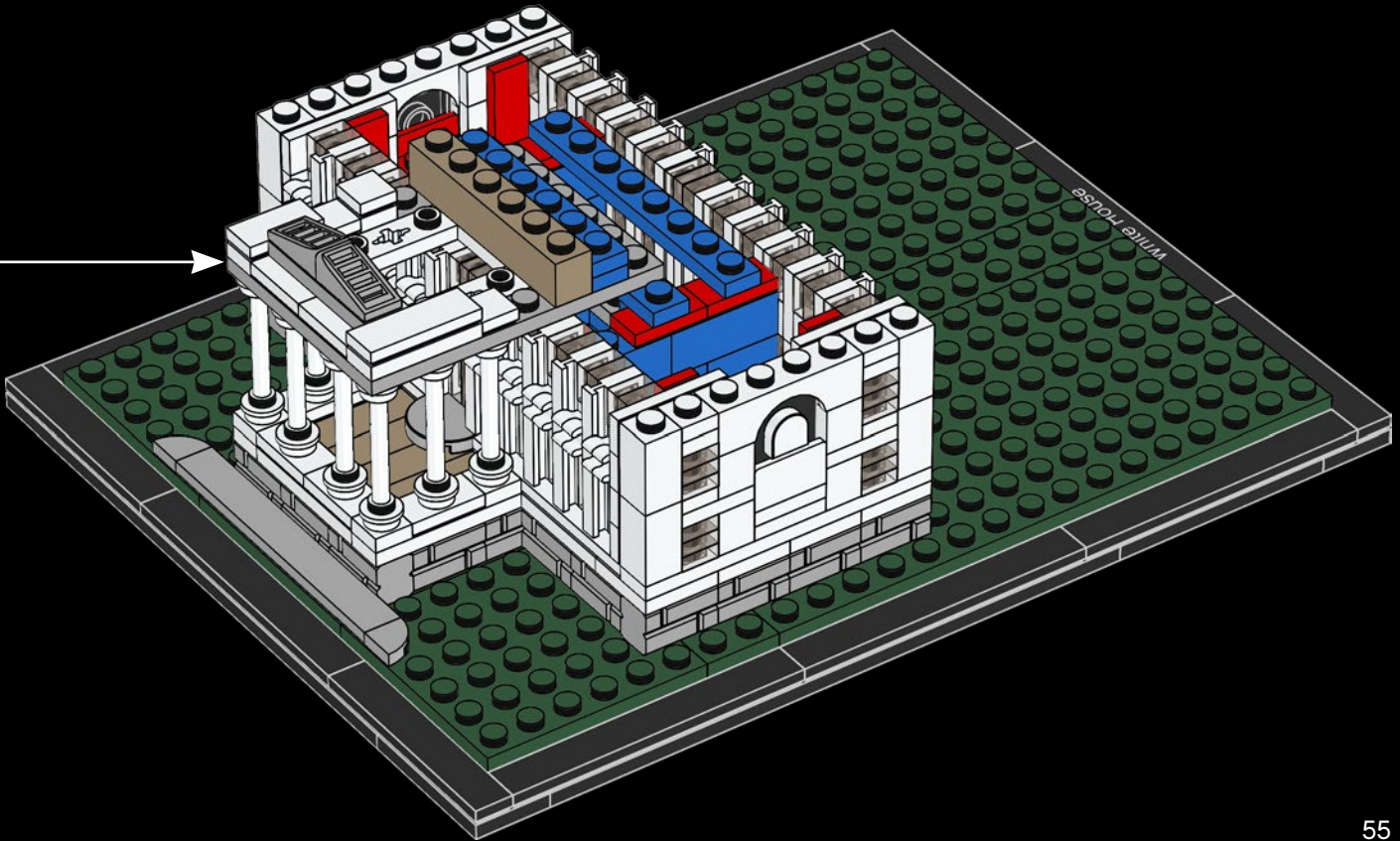

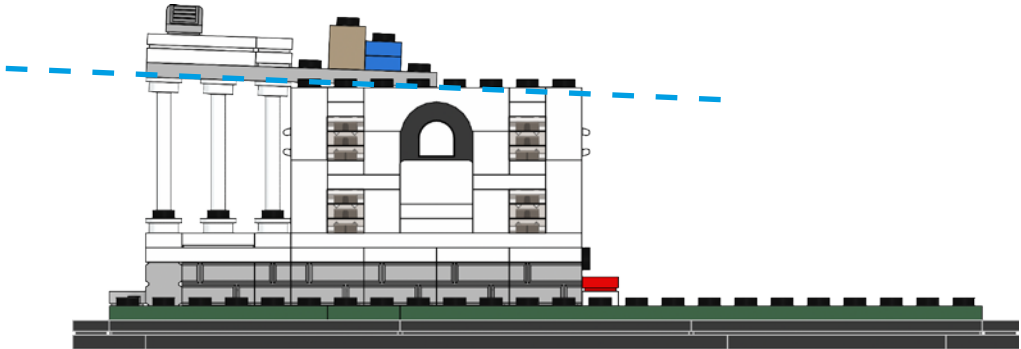
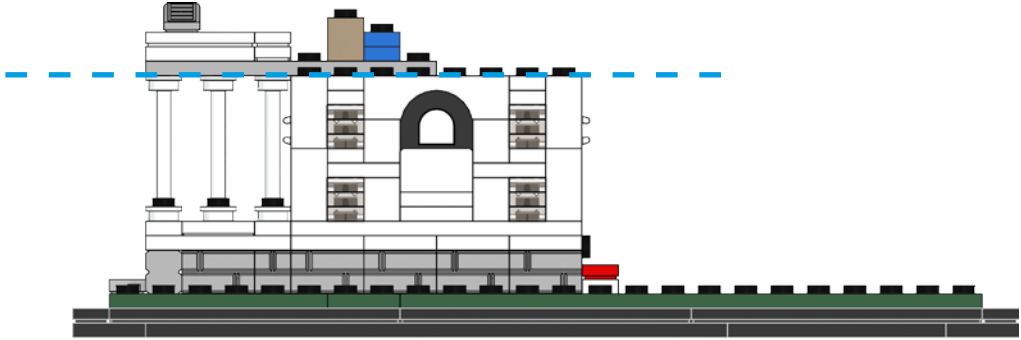

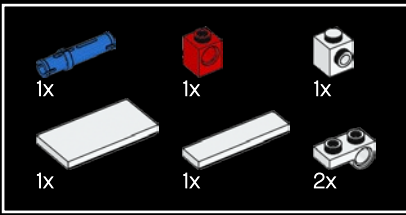

62

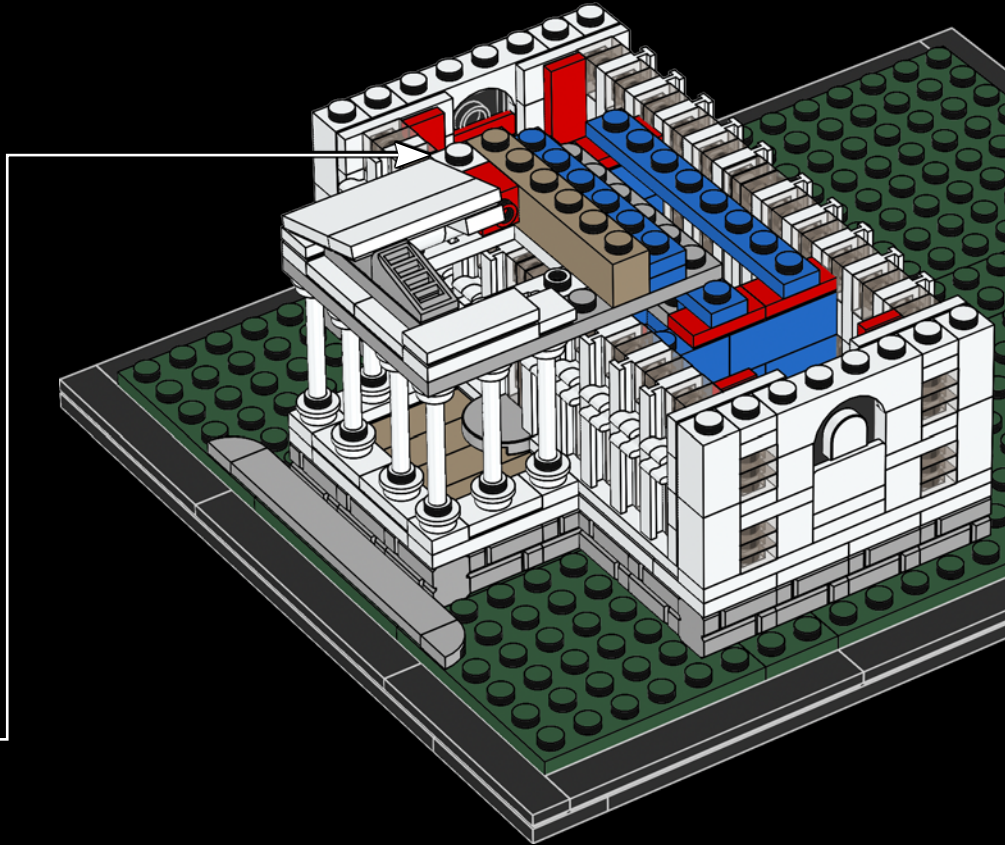
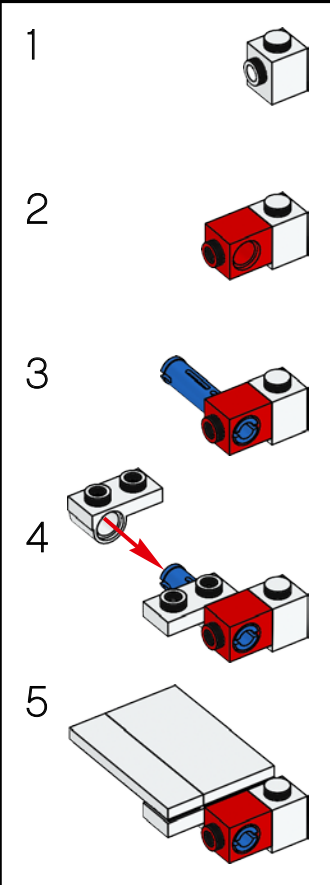

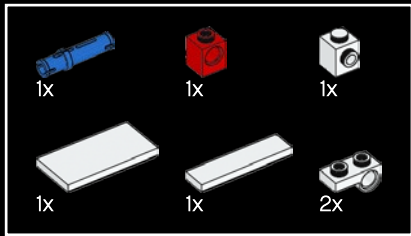

63

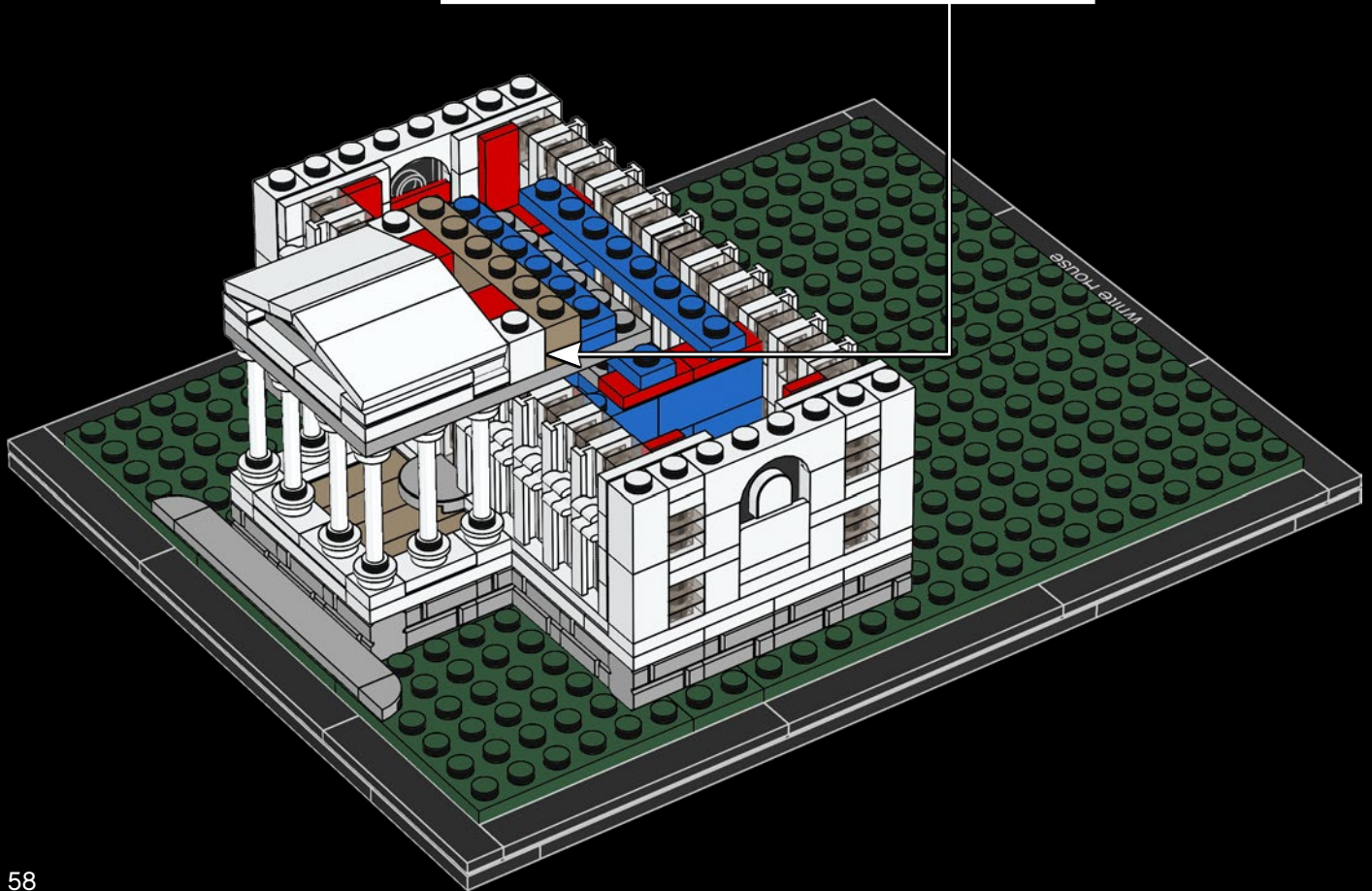
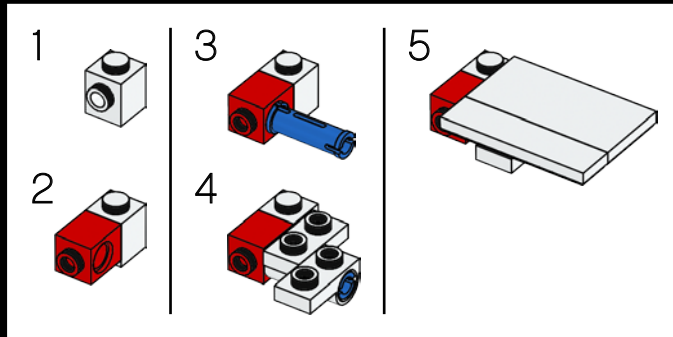

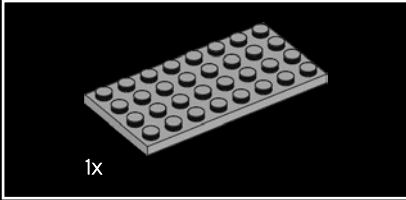
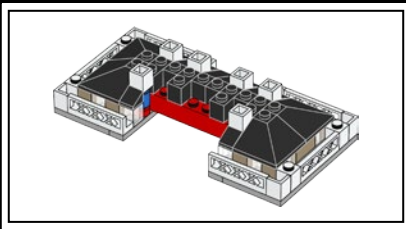

64

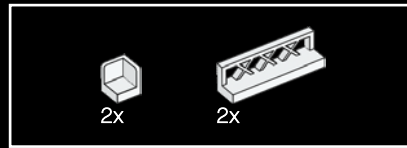
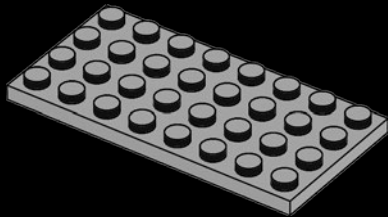

65

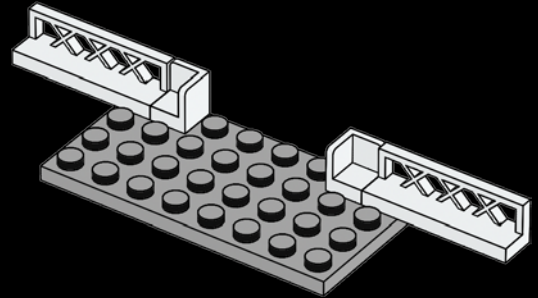

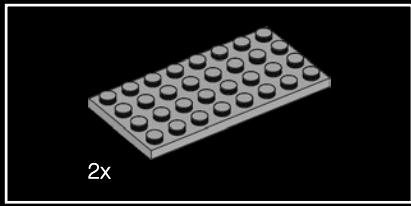

66

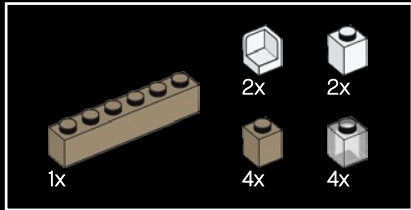
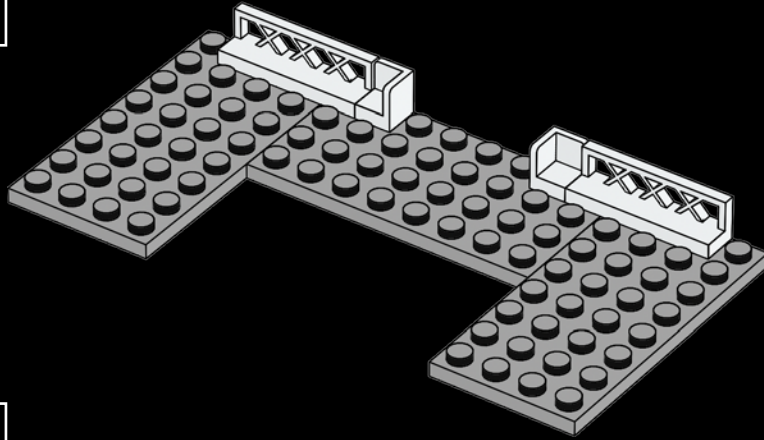

67

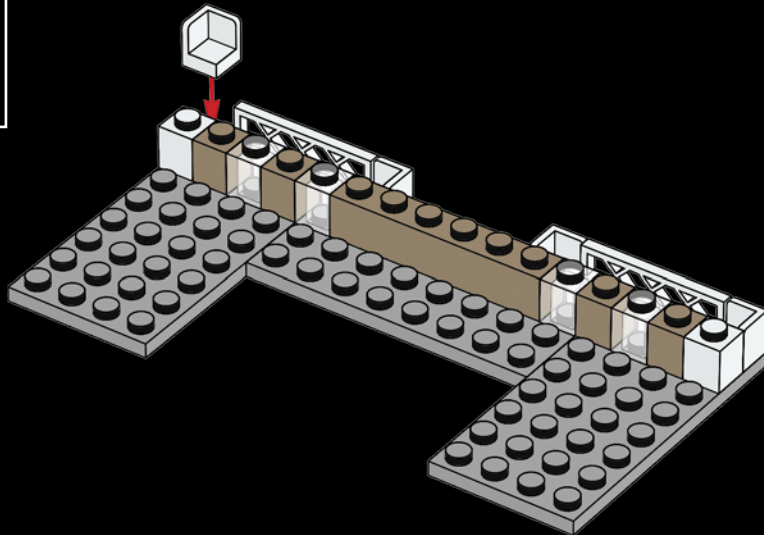

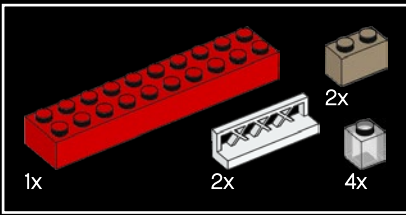

68

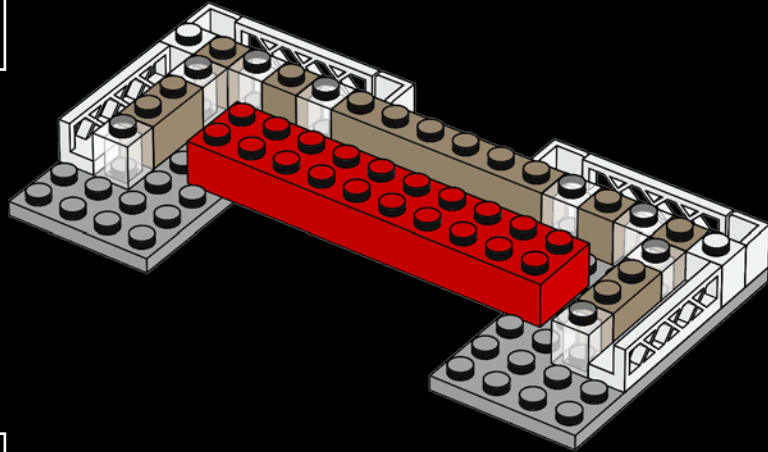

69

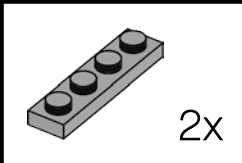
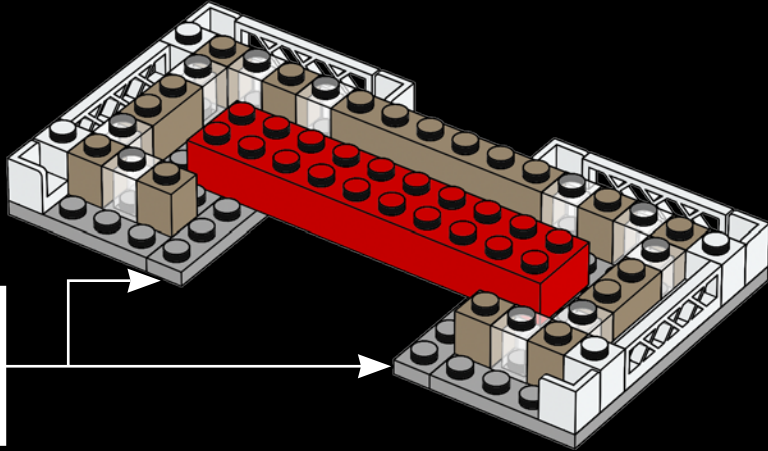

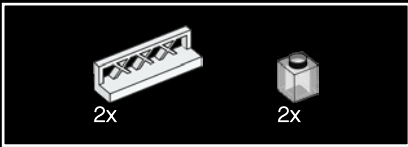

70

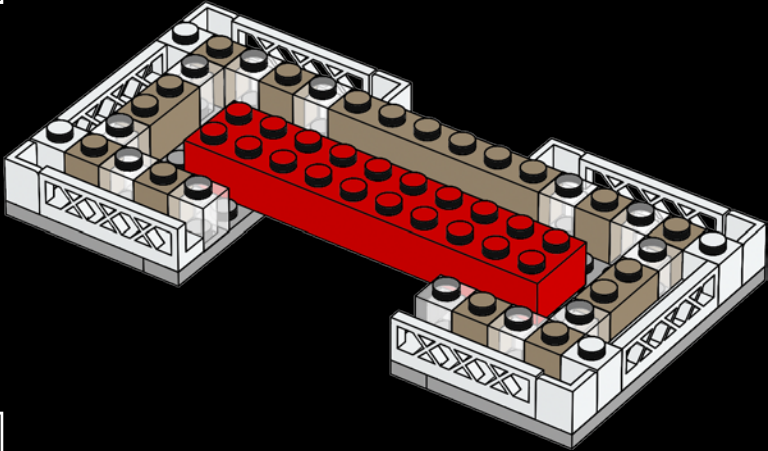

71

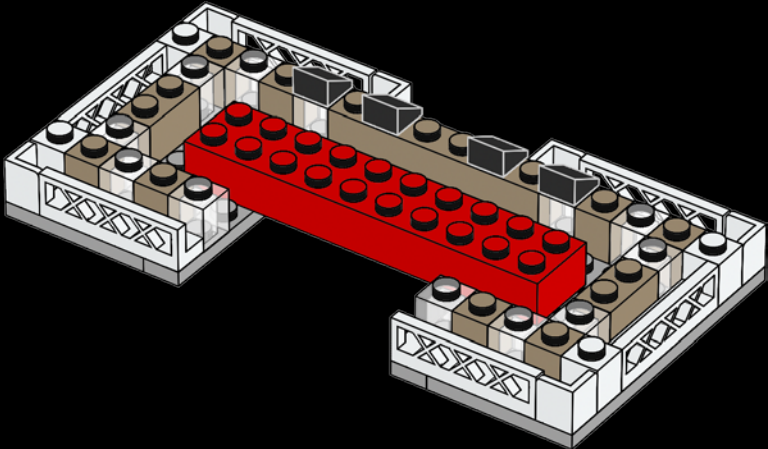

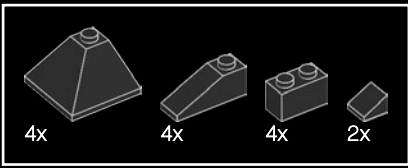

72

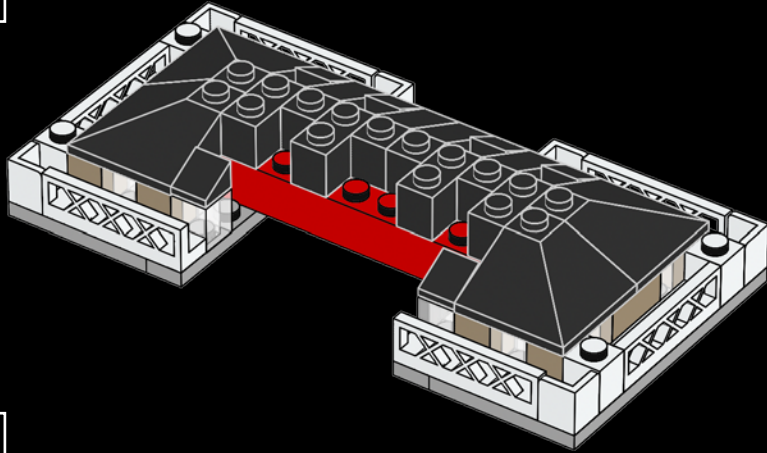

73

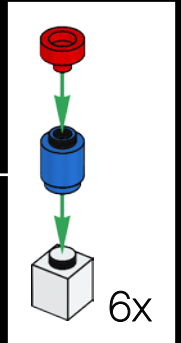
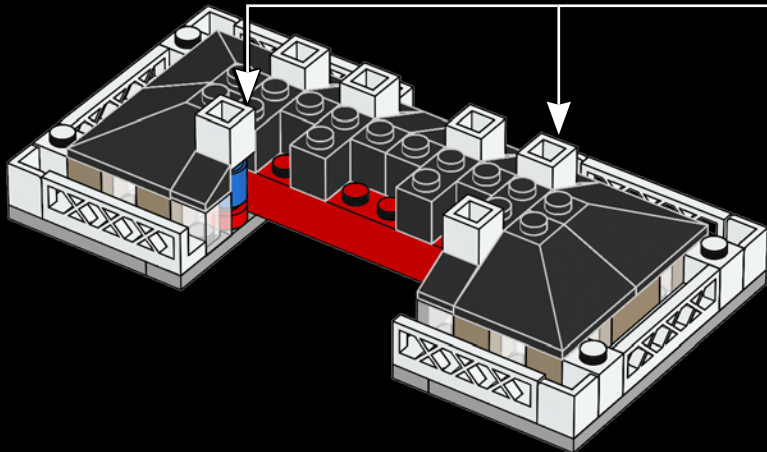

The White House has 6 floors – 2 basements,
2 public floors and 2 floors for the First Family

La Maison-Blanche compte six étages : deux sous-sols,
deux étages publics et deux étages pour
la première famille

La Casa Blanca tiene seis pisos: dos sótanos, dos pisos
públicos y dos pisos para la primera familia.

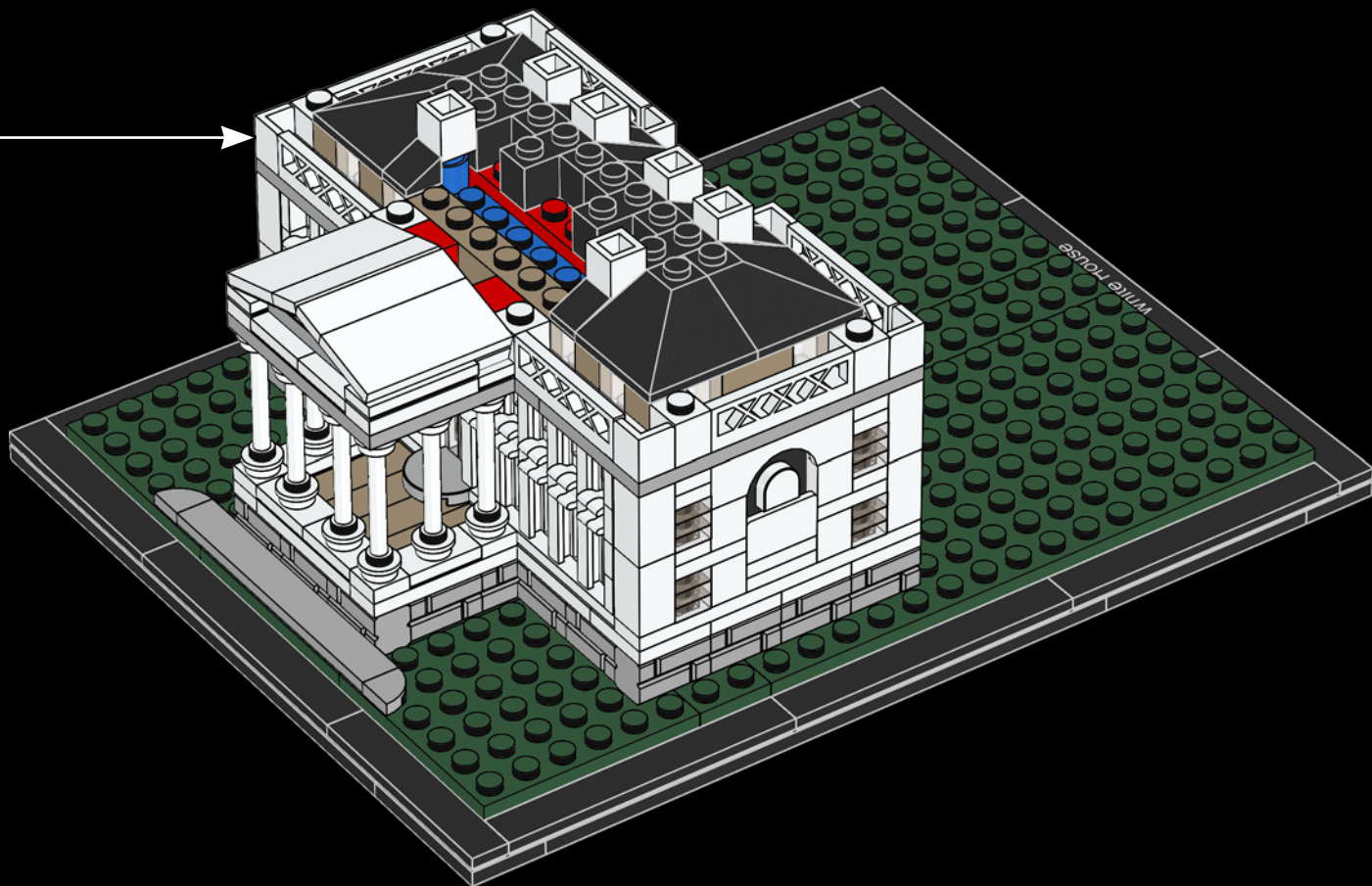
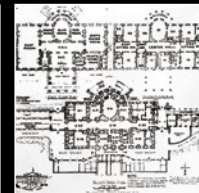

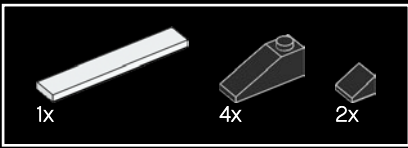

75

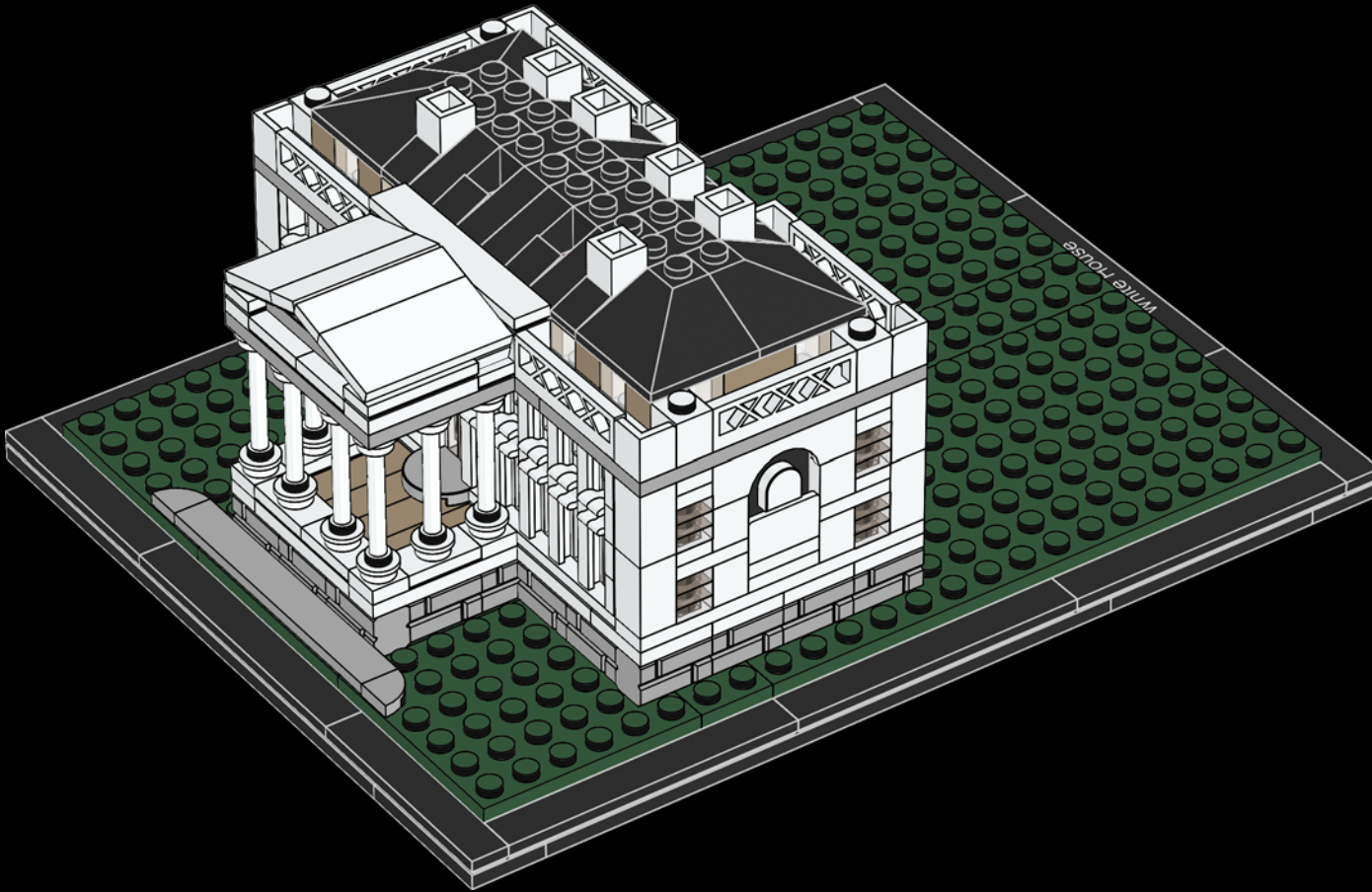

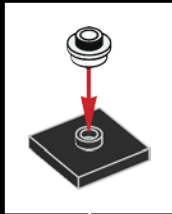
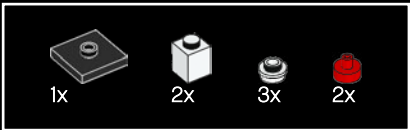

76

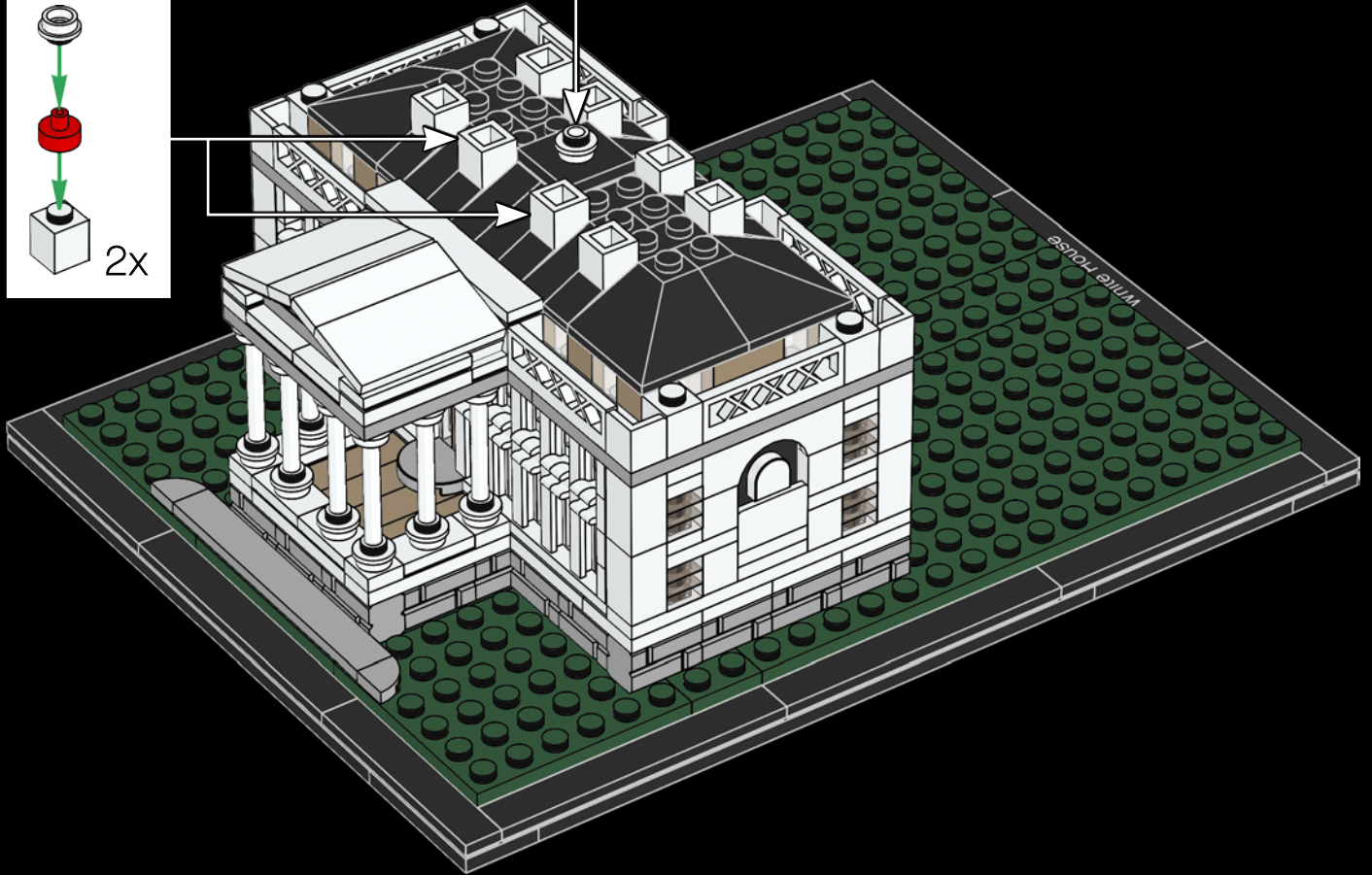
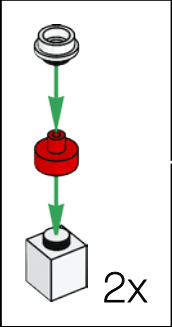

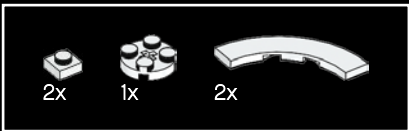

77

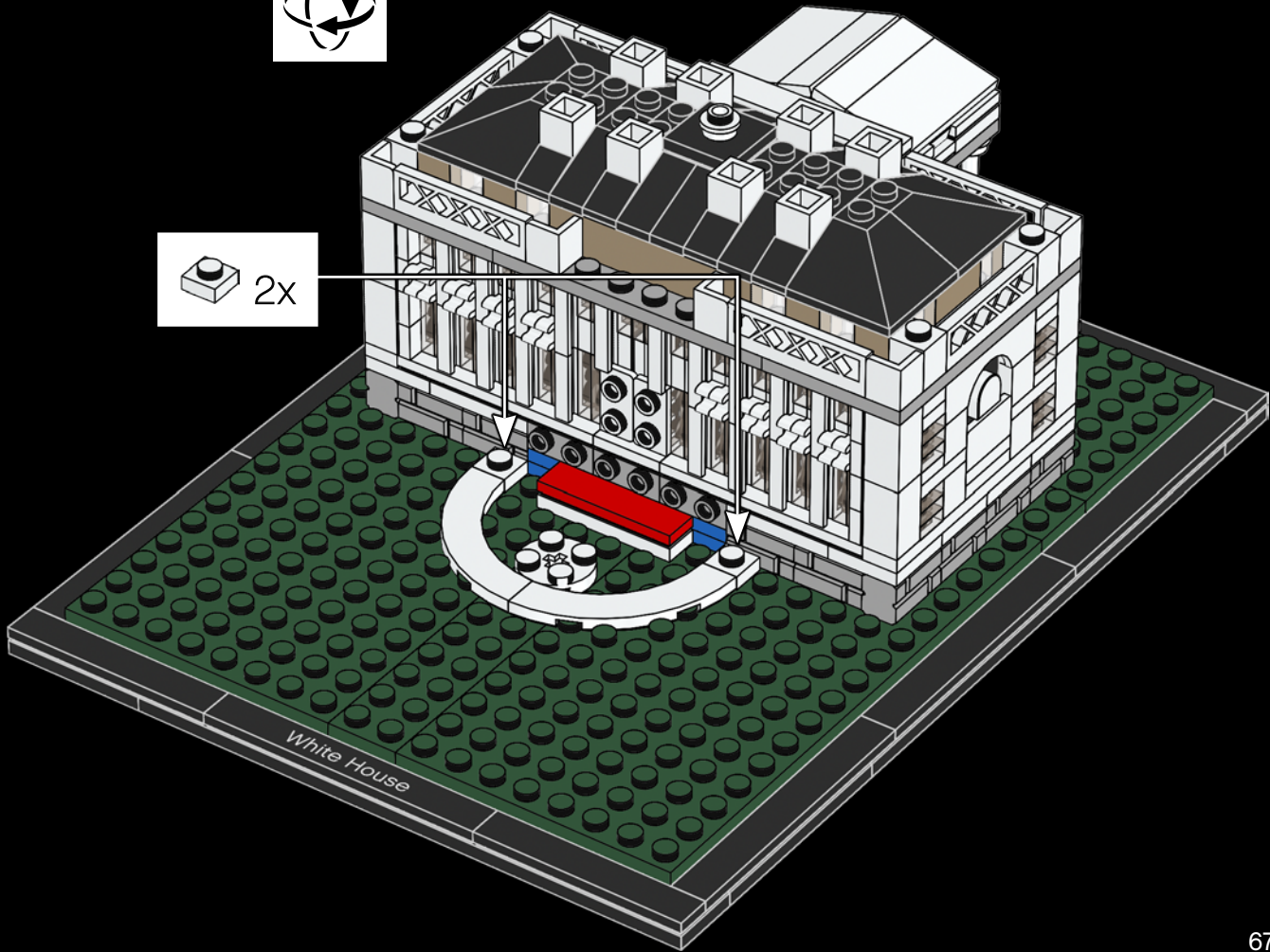

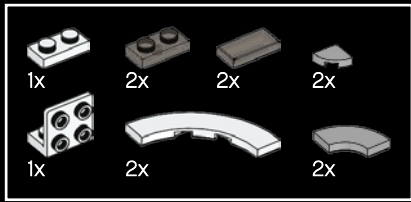

78

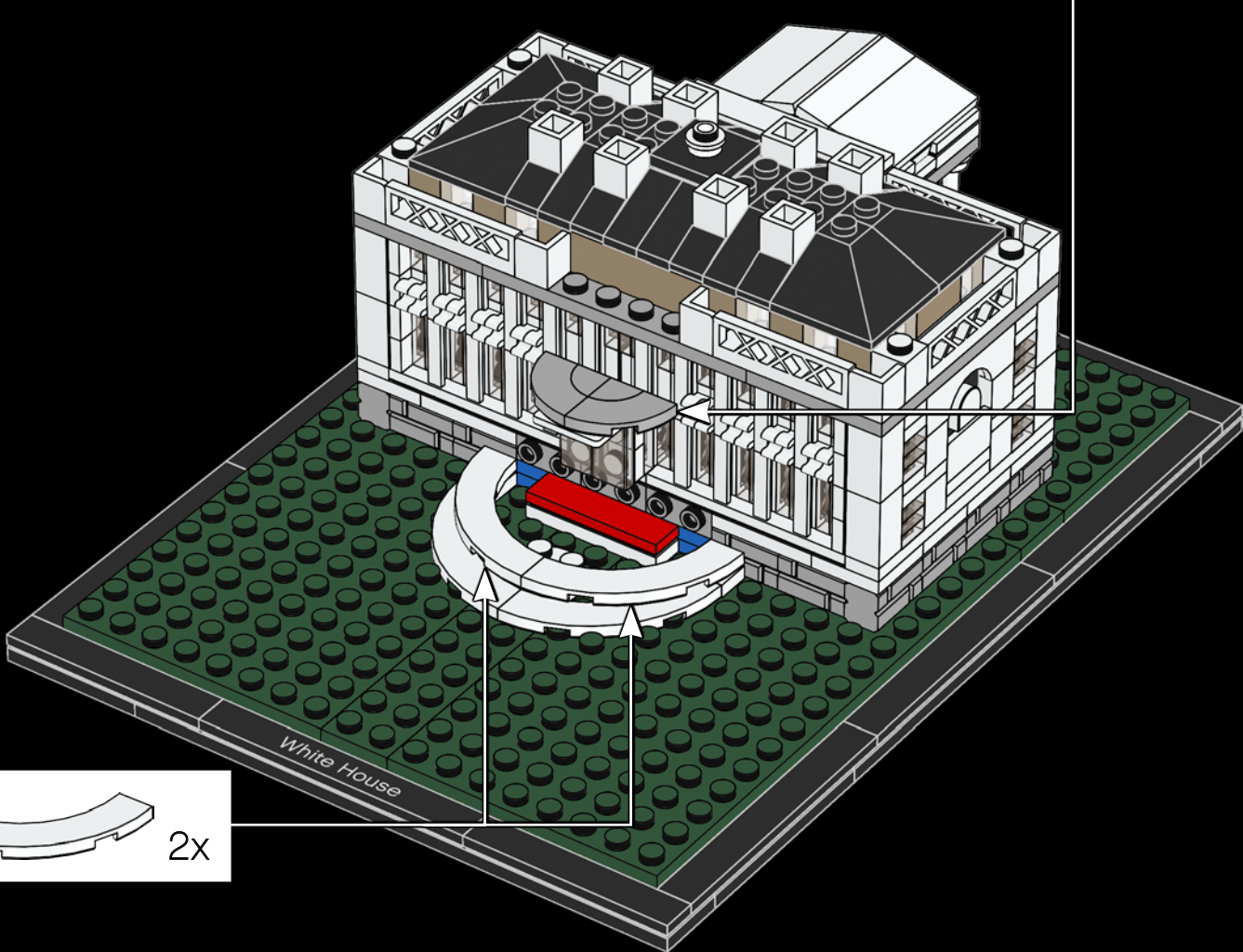
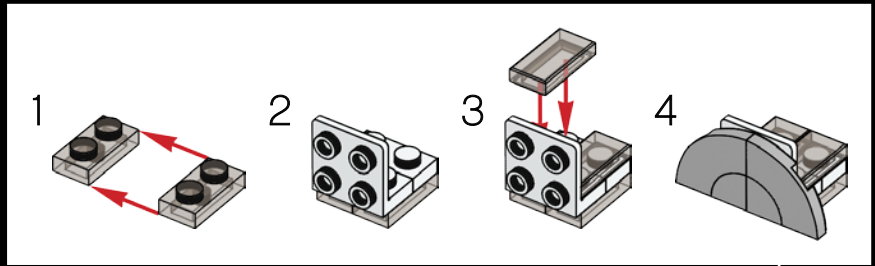

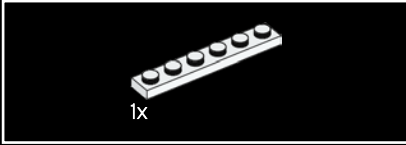
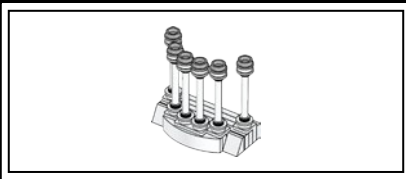

1x

79

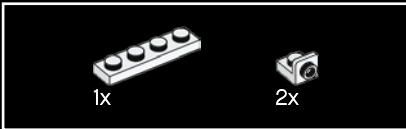

1x

2x

80

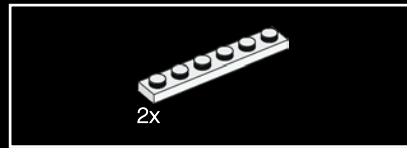
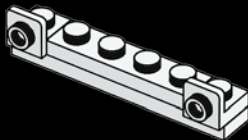

2x

81

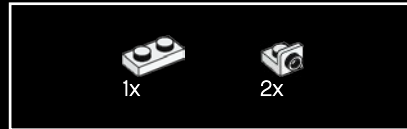
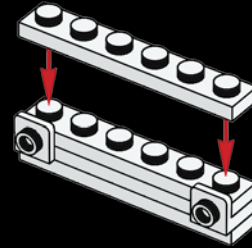

1x

2x

82

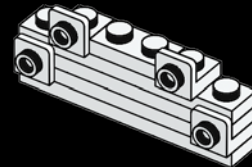

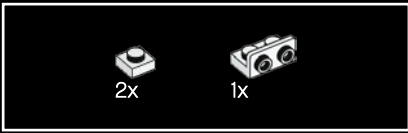

83

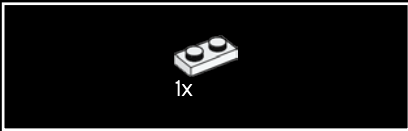
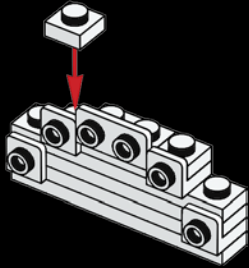

84

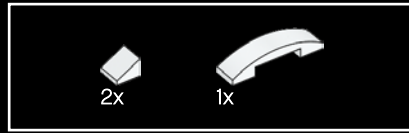
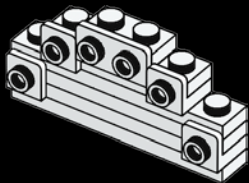

85

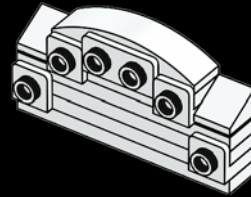

86

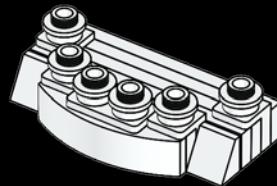



87

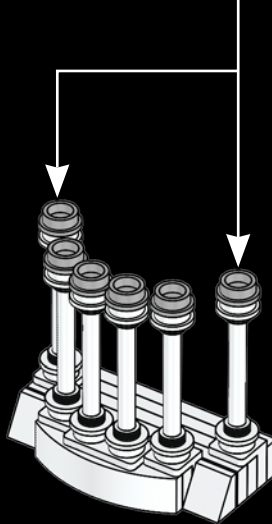
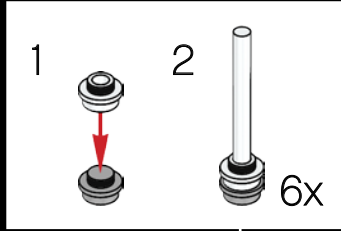

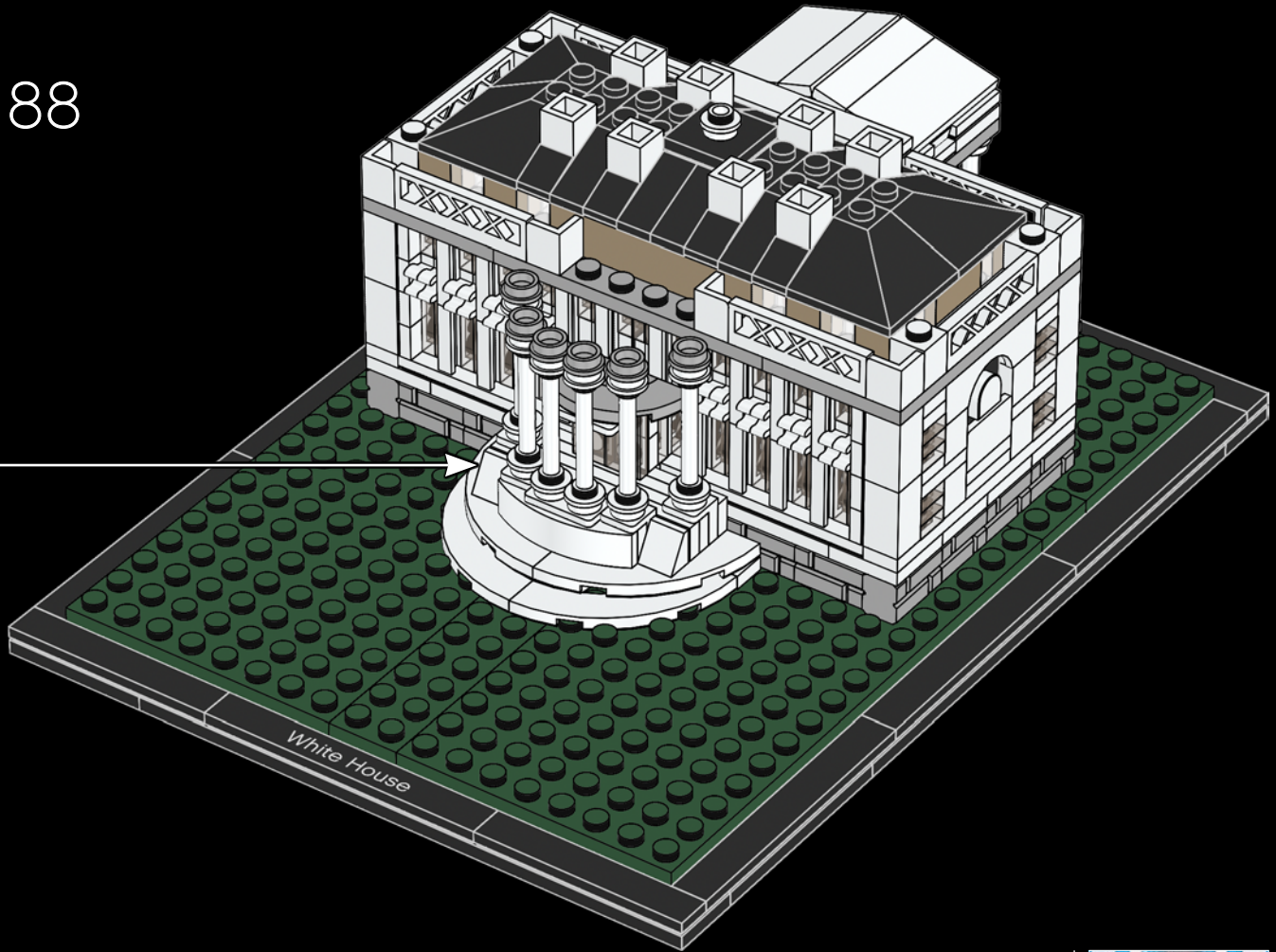

White House

There are 412 doors, 147 windows, 28 fireplaces,
8 staircases and 3 elevators in the building
Le bâtiment comprend 412 portes, 147 fenêtres,
28 foyers, 8 escaliers et 3 ascenseurs

El edificio contiene 412 puertas, 147 ventanas,
28 chimeneas, 8 escaleras y 3 elevadores.

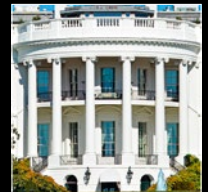

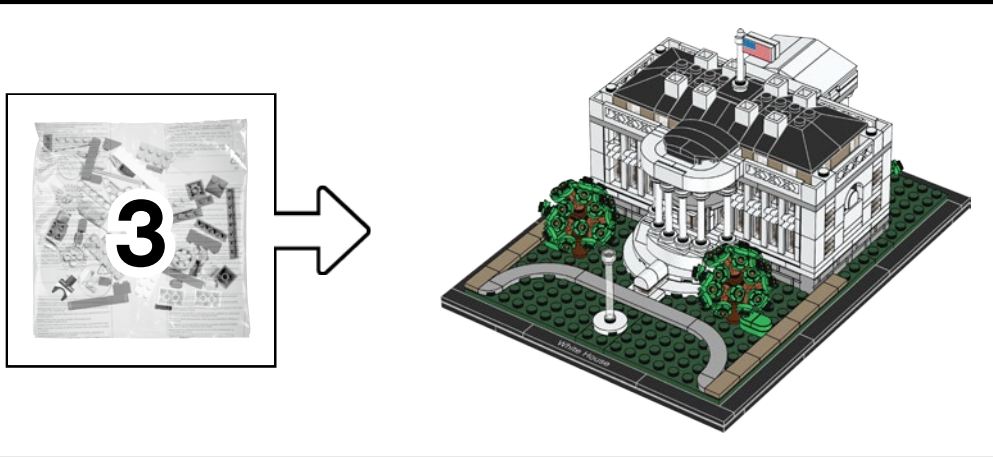

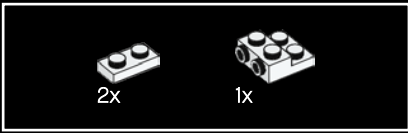

89

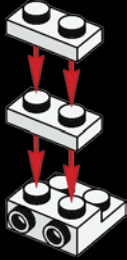

90

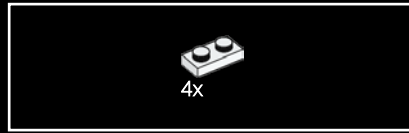
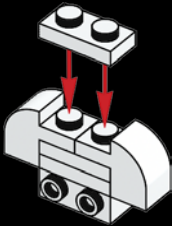

91

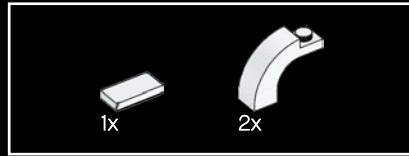
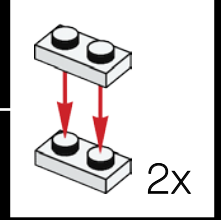
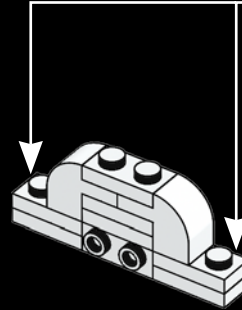

92

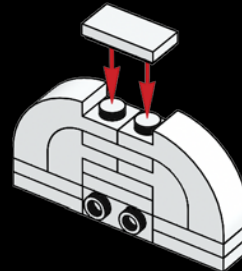

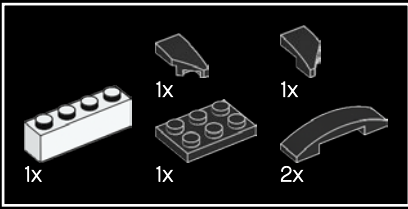

93

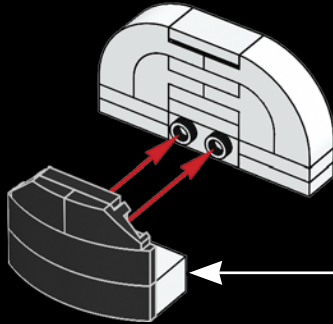
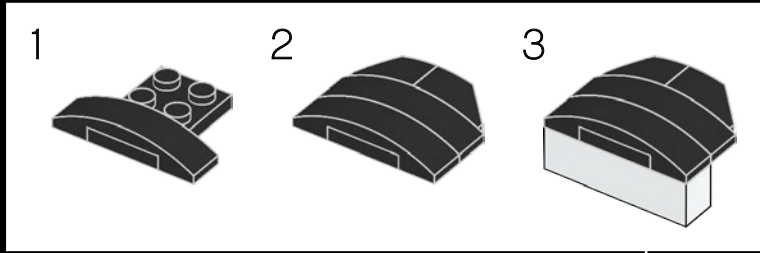

94

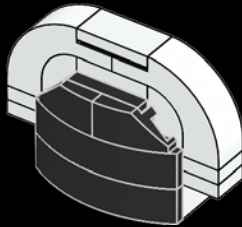

There are 132 rooms, 35 bathrooms and 6 levels in the official Residence

La résidence officielle compte 132 pièces, 35 salles de bain et 6 étages

La residencia oficial cuenta con 132 habitaciones, 35 baños y 6 pisos.

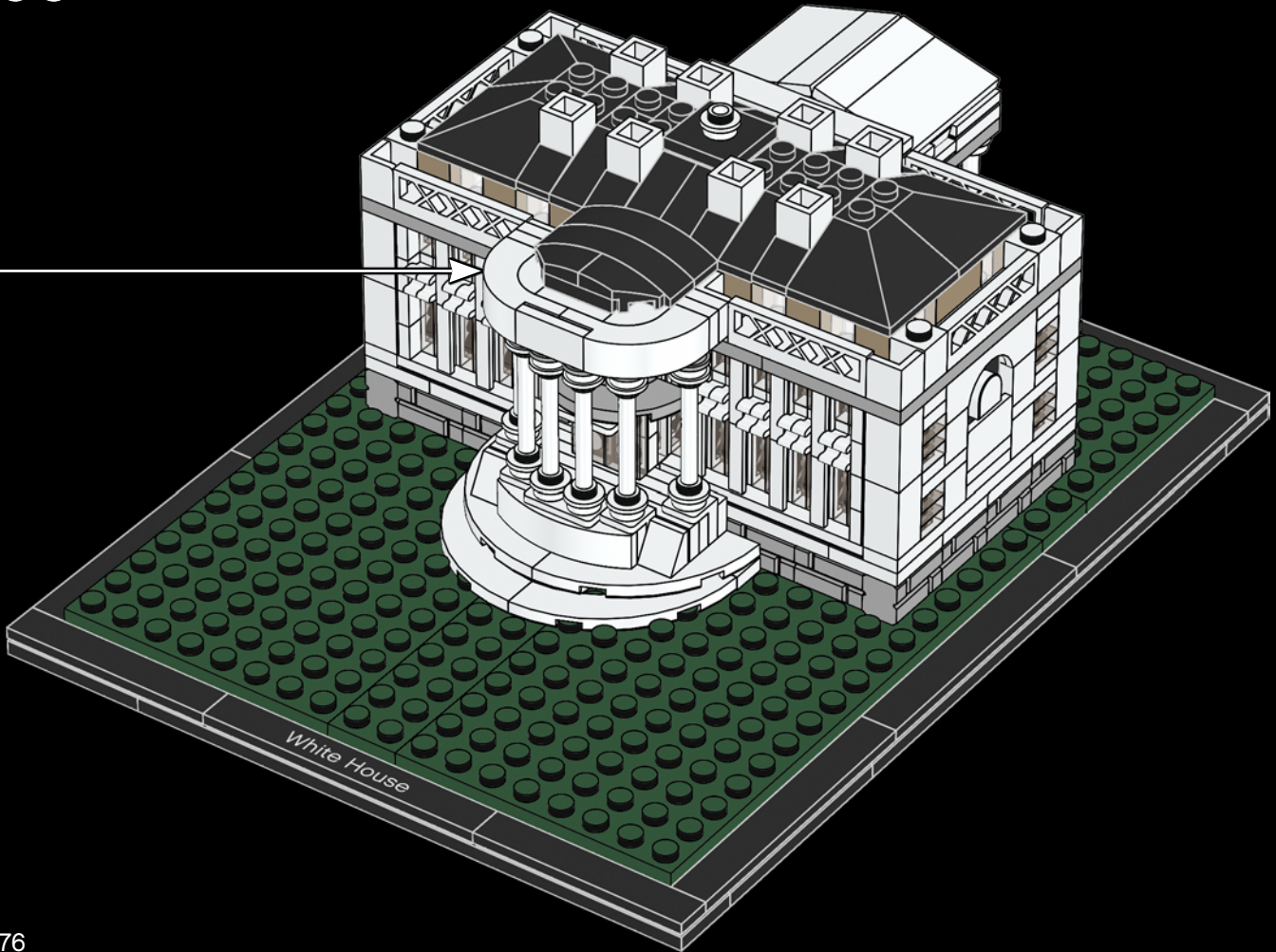

White House

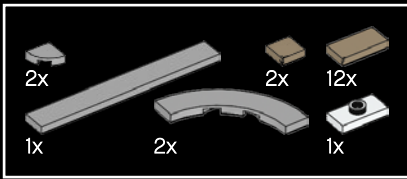

96

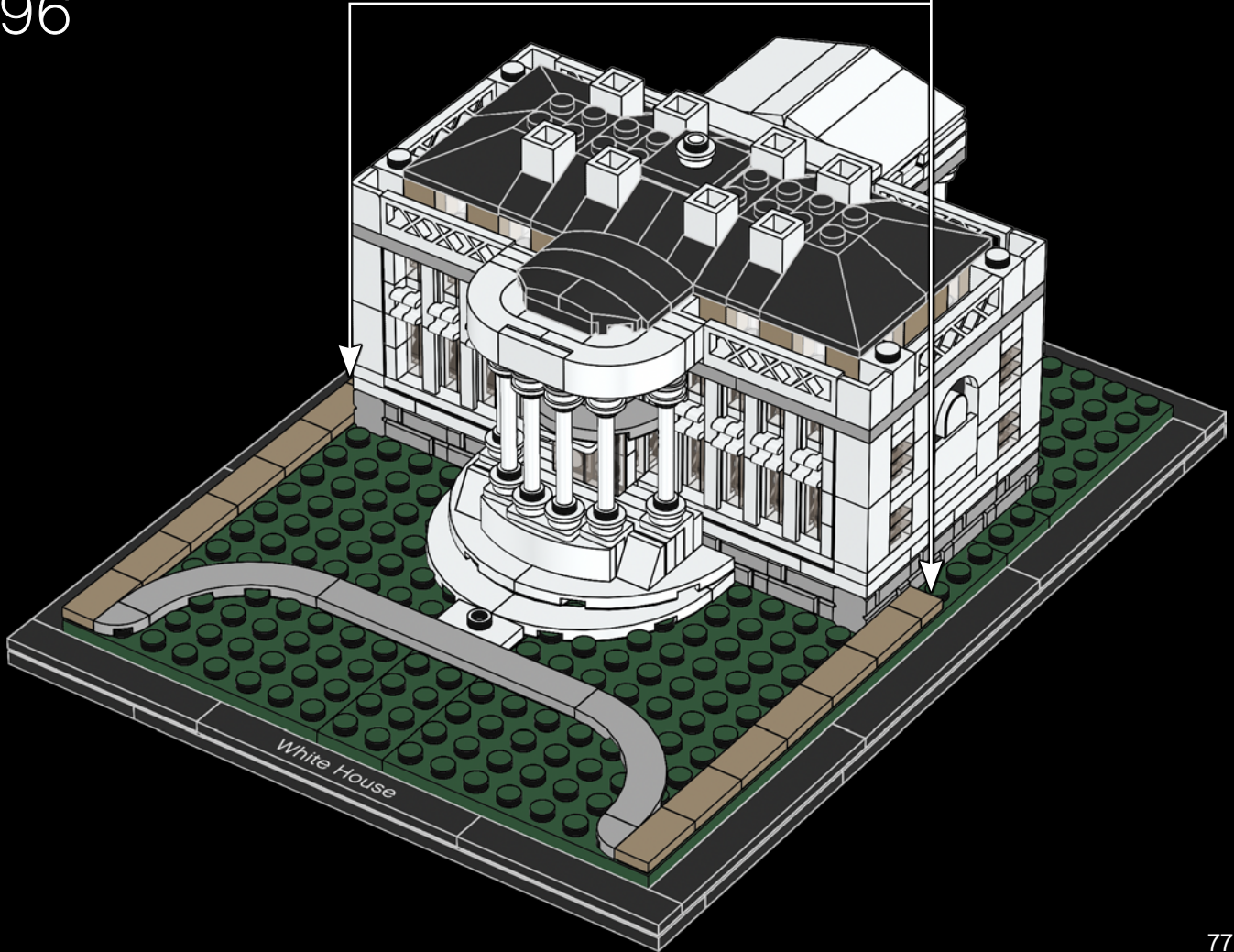
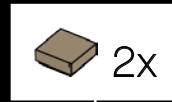

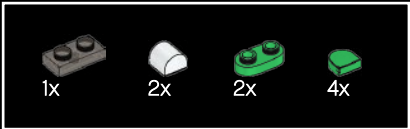

97

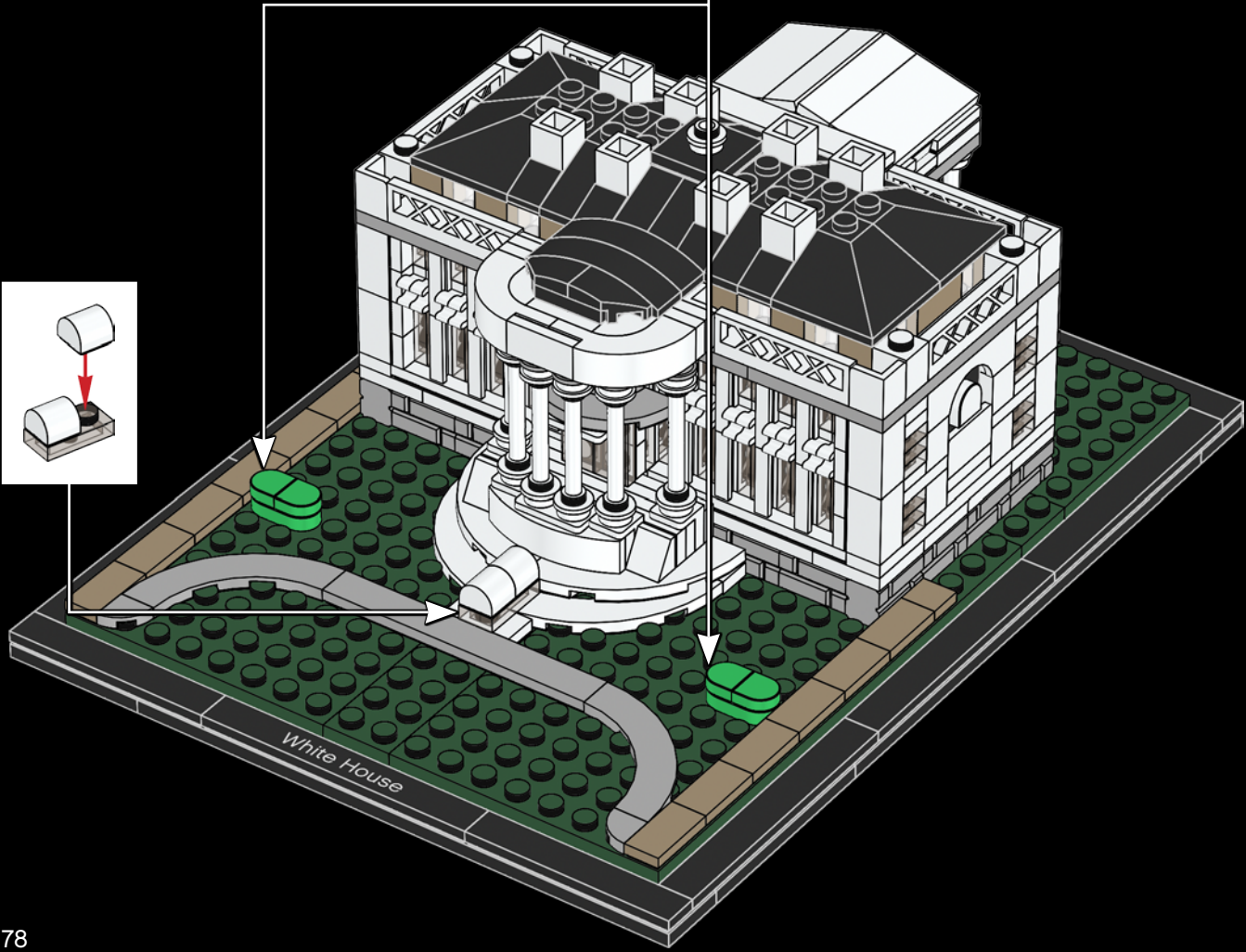
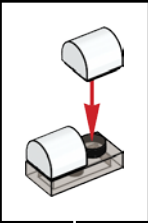
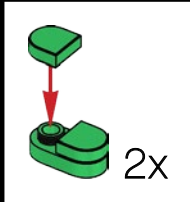

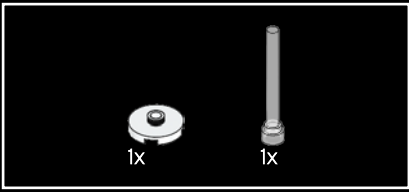

98

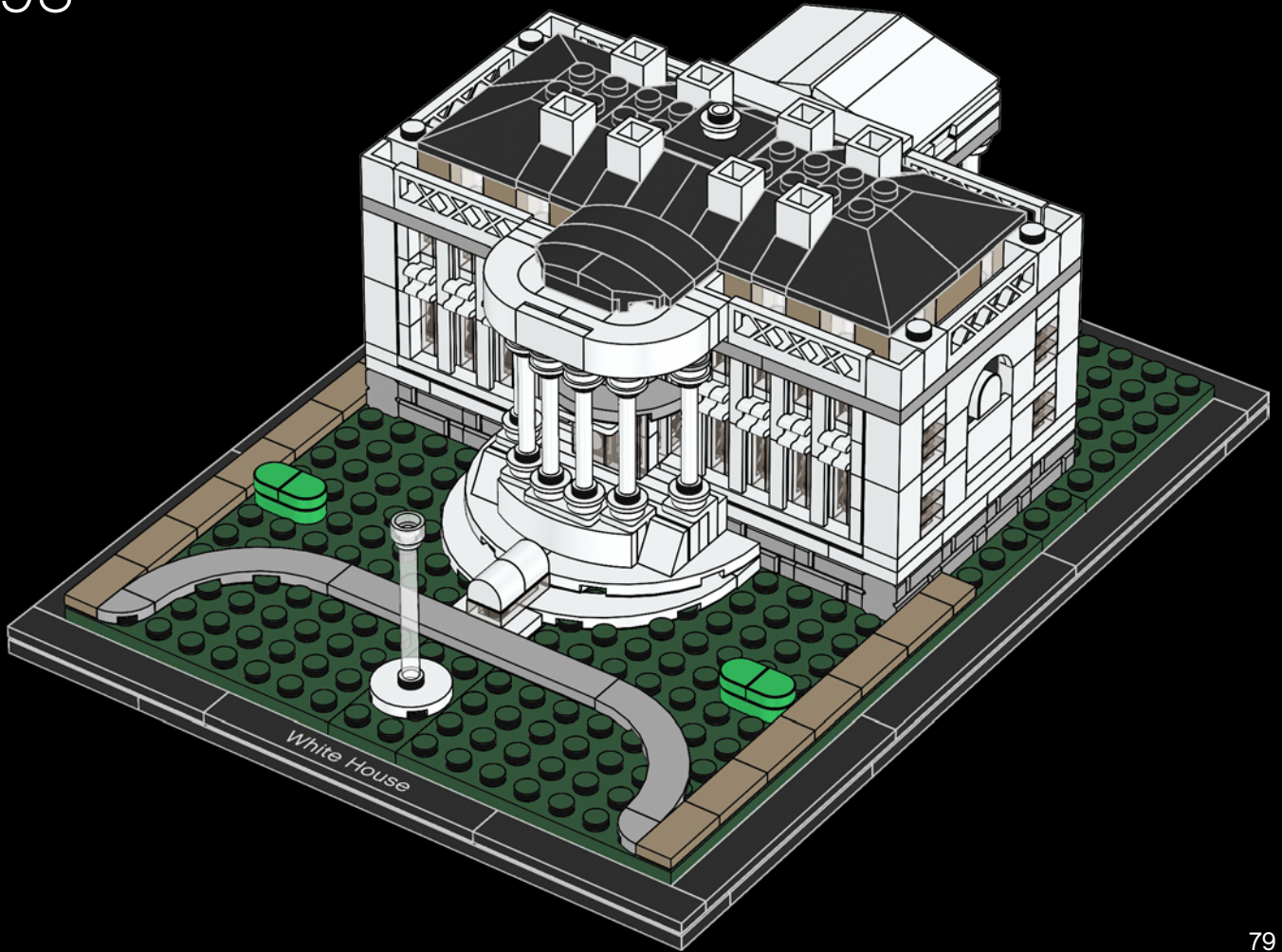



99

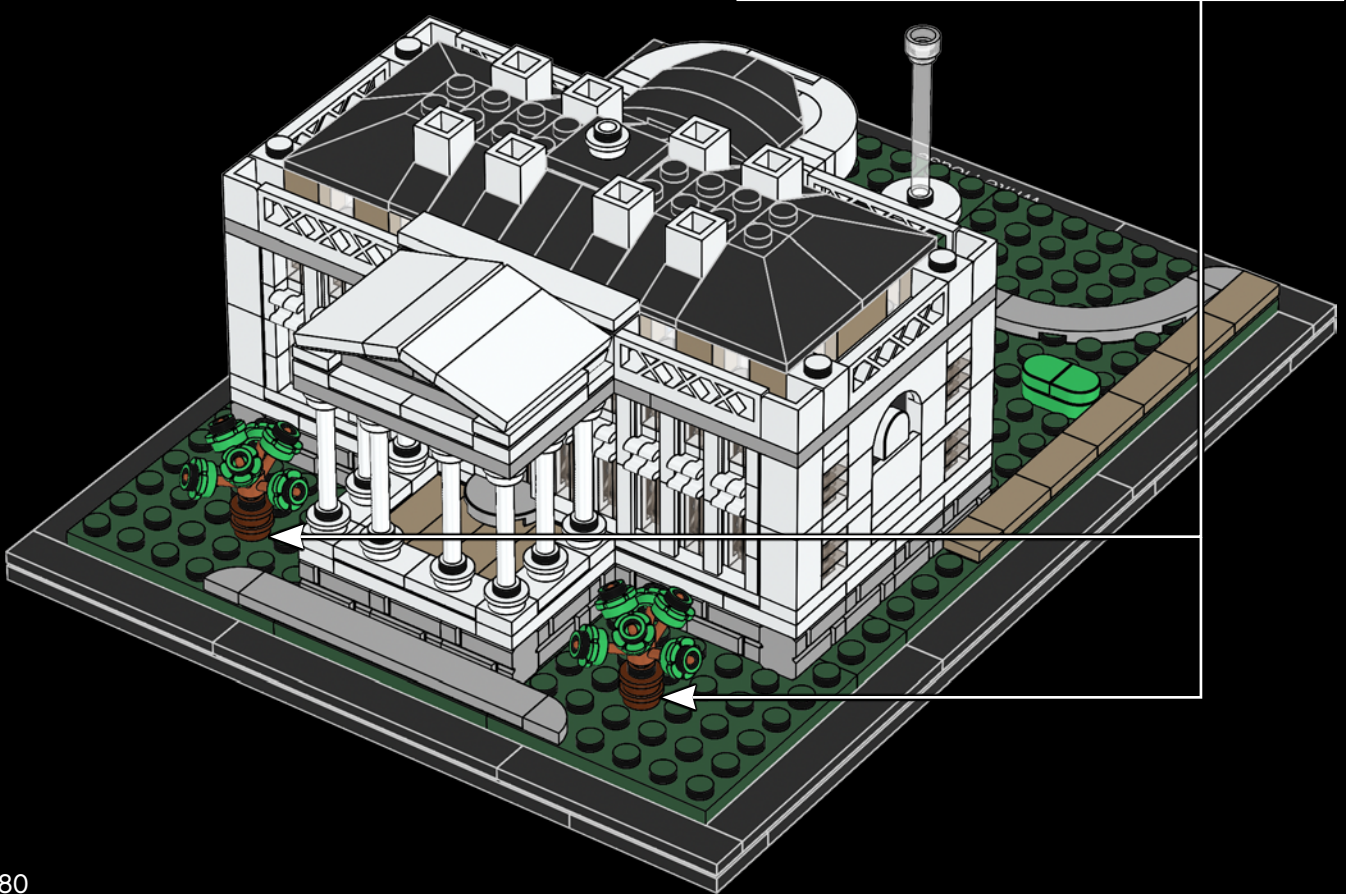

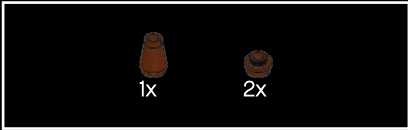

100



101



102

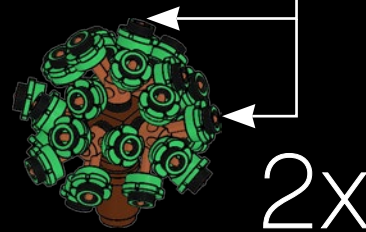
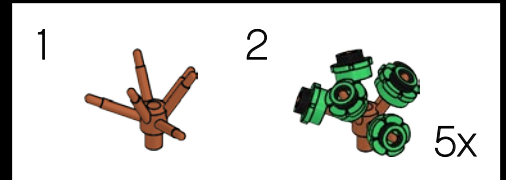

103

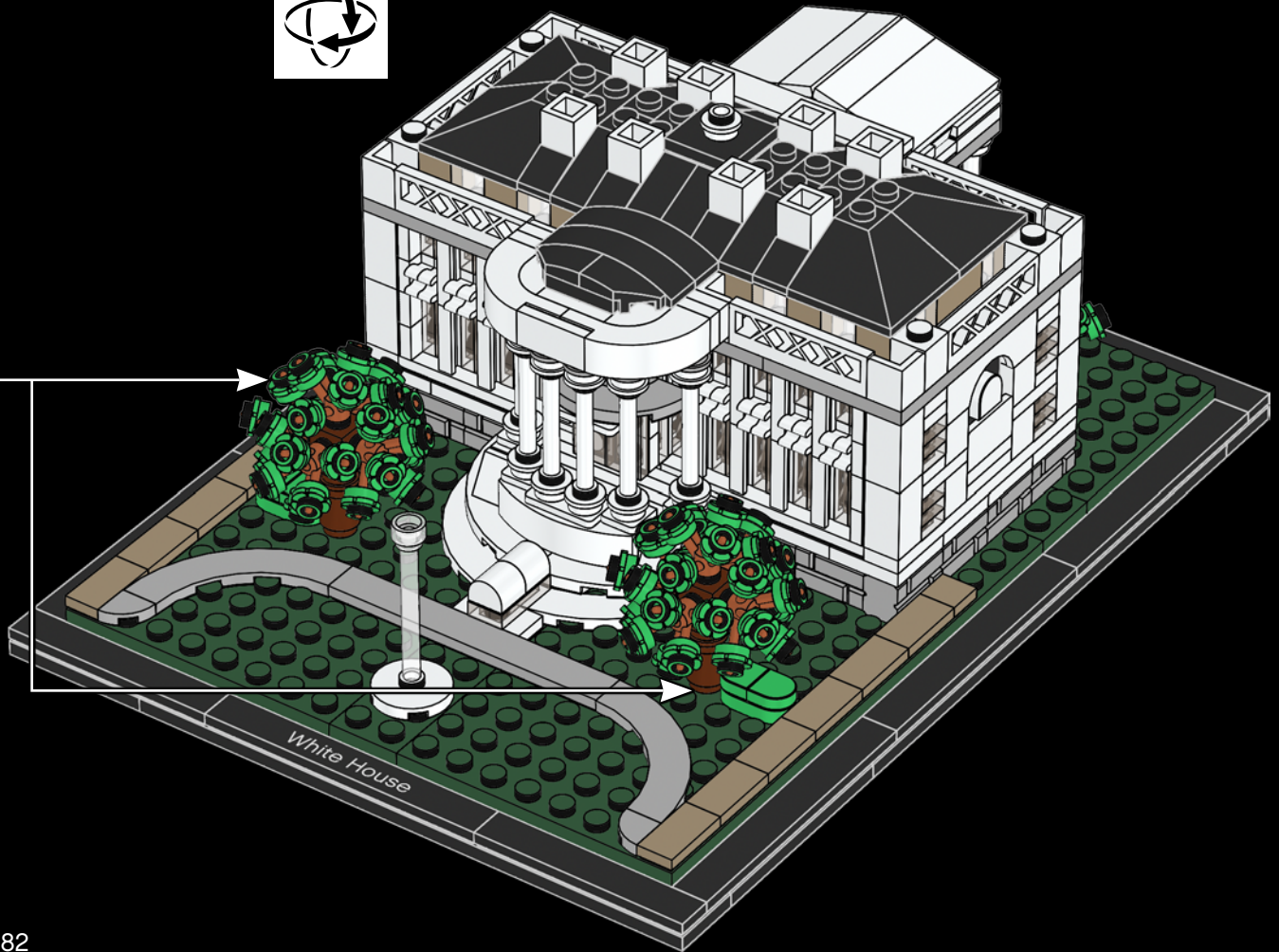

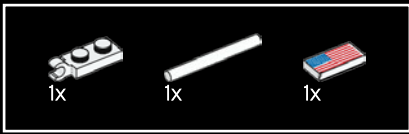

104

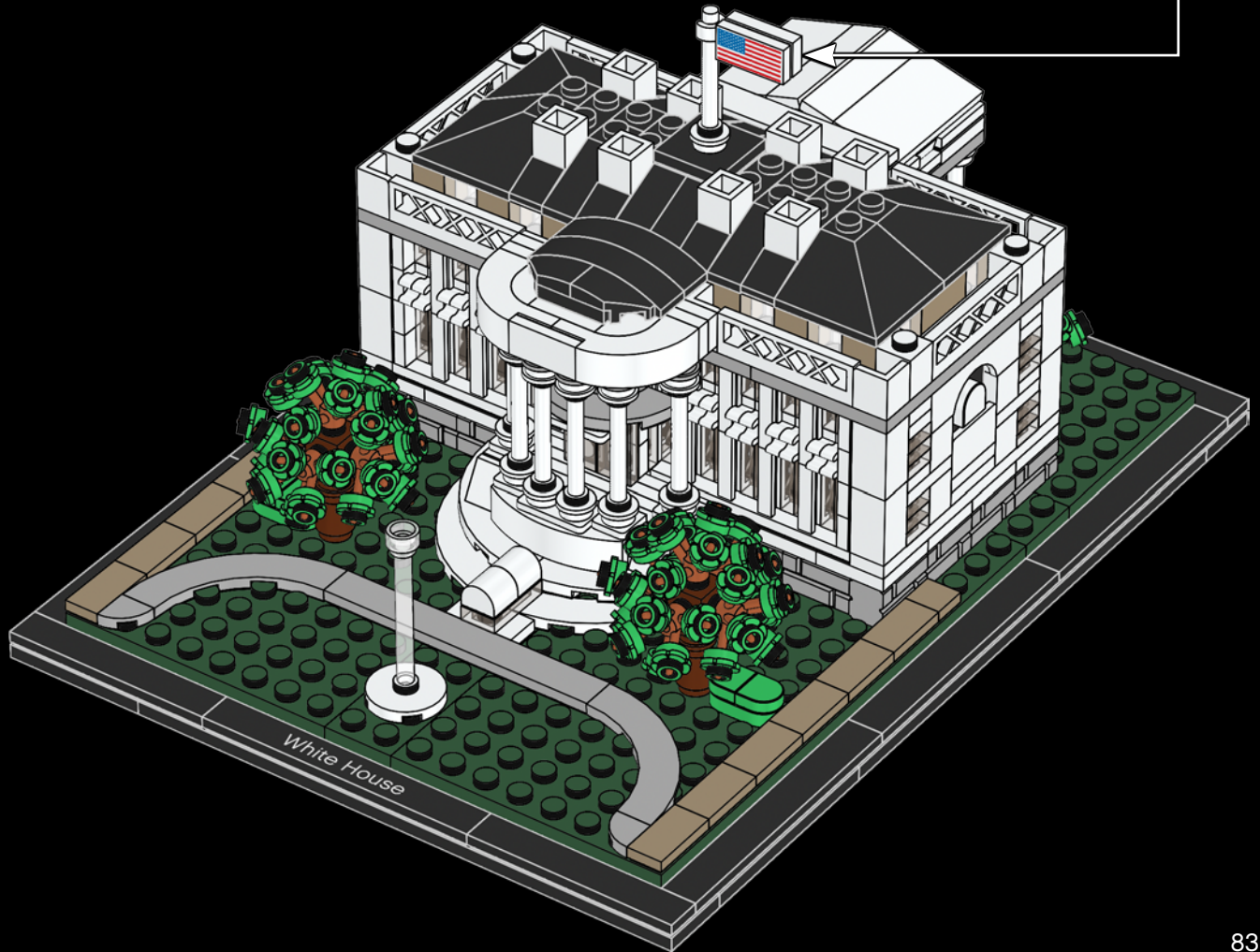
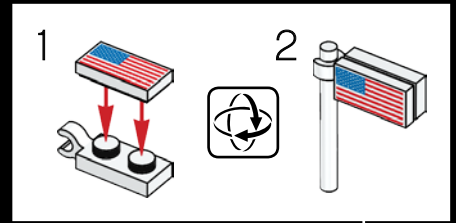



The East Wing

L'aile est

El ala este

The original East Wing was completed in 1902 and served mainly as an entrance for formal visitors during large social gatherings. The building we see today was added in 1942, primarily to cover the construction of an underground shelter and emergency operations center for Franklin D. Roosevelt. Traditionally the East Wing now serves as office space for the first lady and her staff.

L'aile est originale a été achevée en 1902 et servait principalement d'entrée aux visiteurs officiels lors de grands rassemblements mondains. Le bâtiment que nous voyons aujourd'hui a été ajouté en 1942, essentiellement pour couvrir la construction d'un abri souterrain et d'un centre d'opérations d'urgence pour Franklin D. Roosevelt. Traditionnellement, l'aile est sert aujourd'hui de bureaux pour la première dame et son personnel.

El ala este original se concluyó en 1902 y solía usarse principalmente como entrada para visitantes formales durante las grandes reuniones sociales. El edificio que hoy podemos ver fue construido en 1942 y su función básica era cubrir un refugio subterráneo y un centro de operaciones de emergencia para Franklin D. Roosevelt. Tradicionalmente, el ala este sirve ahora como espacio de oficinas para la primera dama y su personal.



The East Wing of the White House in 1992
L'aile est de la Maison-Blanche en 1992
El ala este de la Casa Blanca en 1992

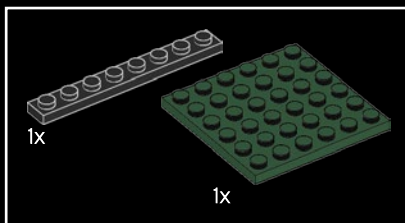
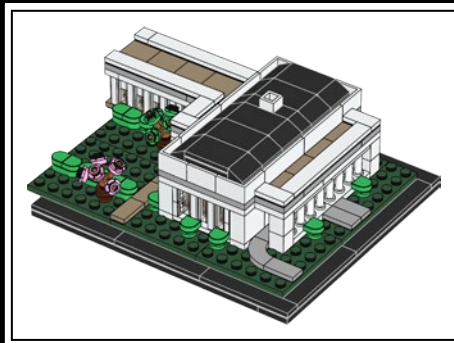

105

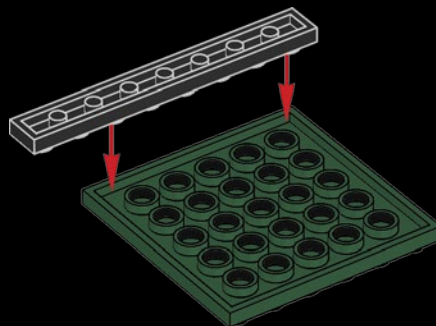
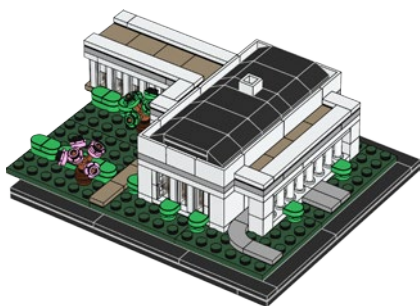

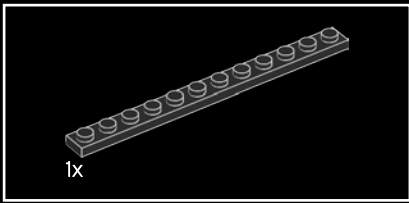

106

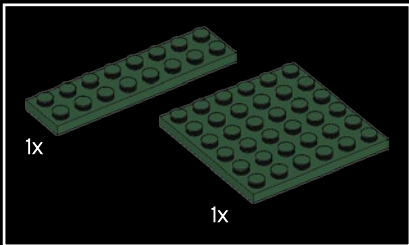
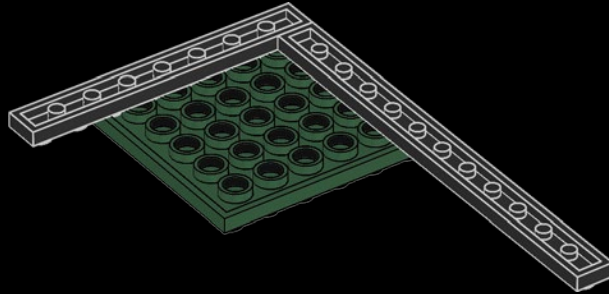

107

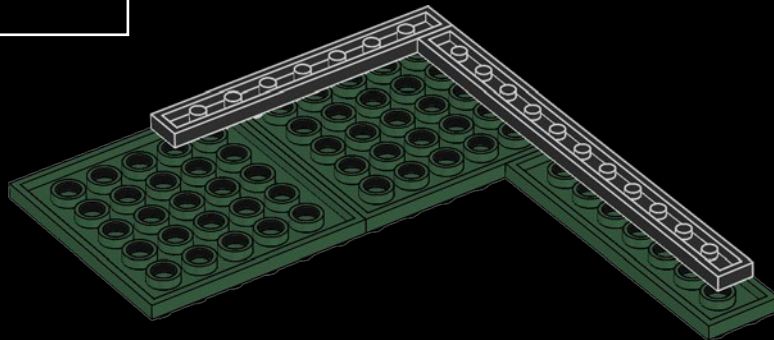

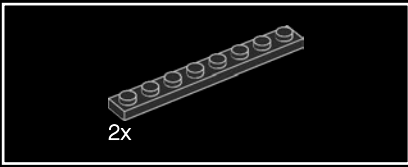

108

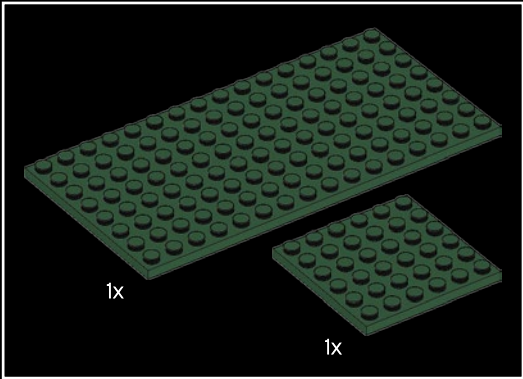
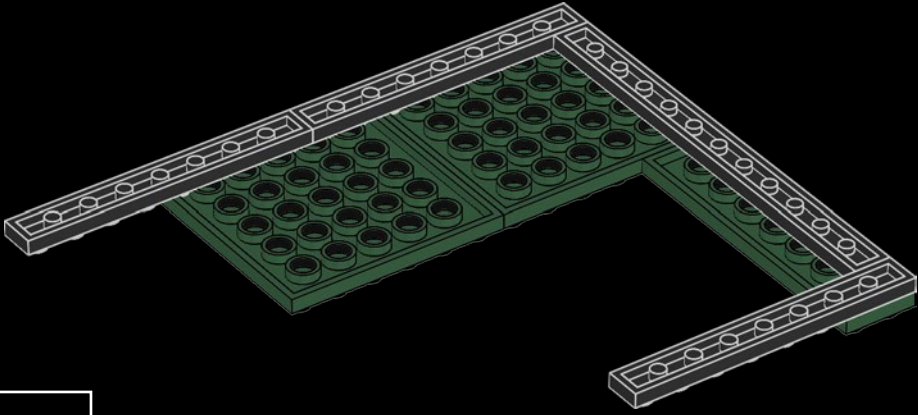

109

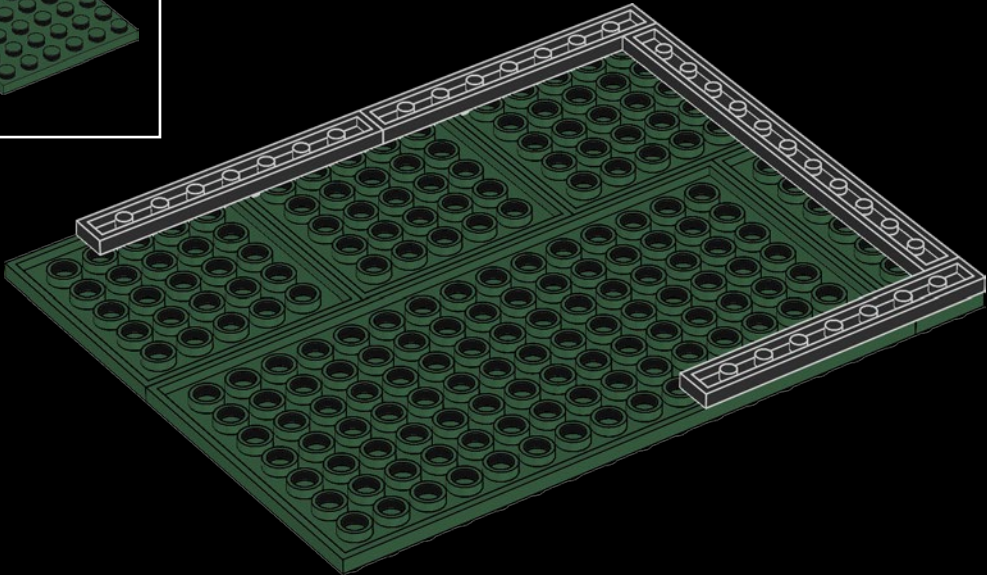

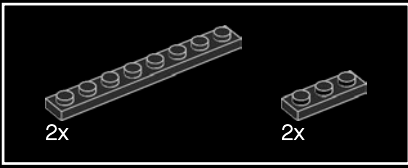

110

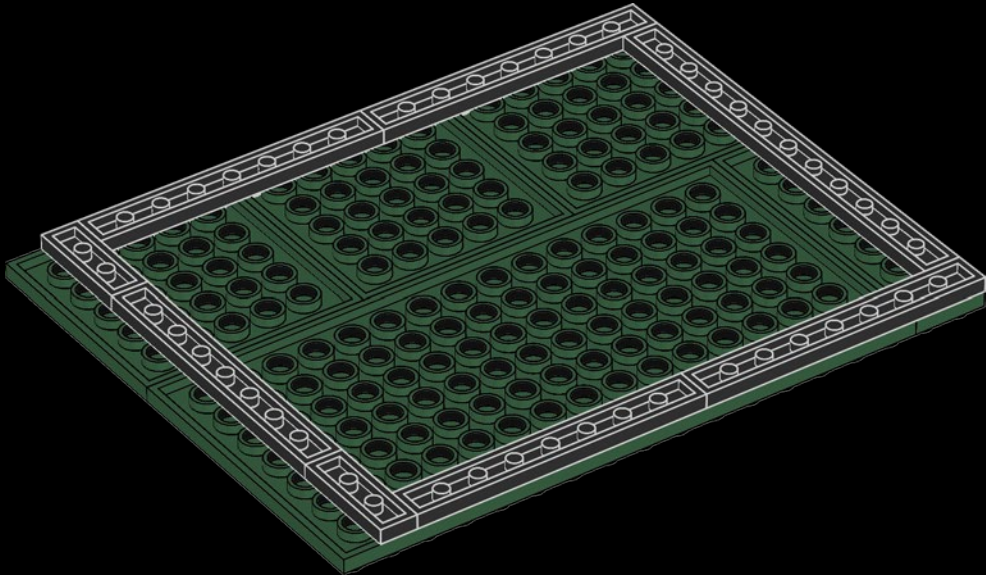

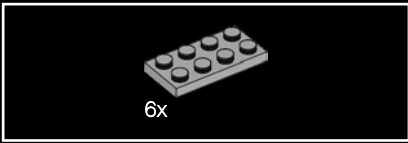

111

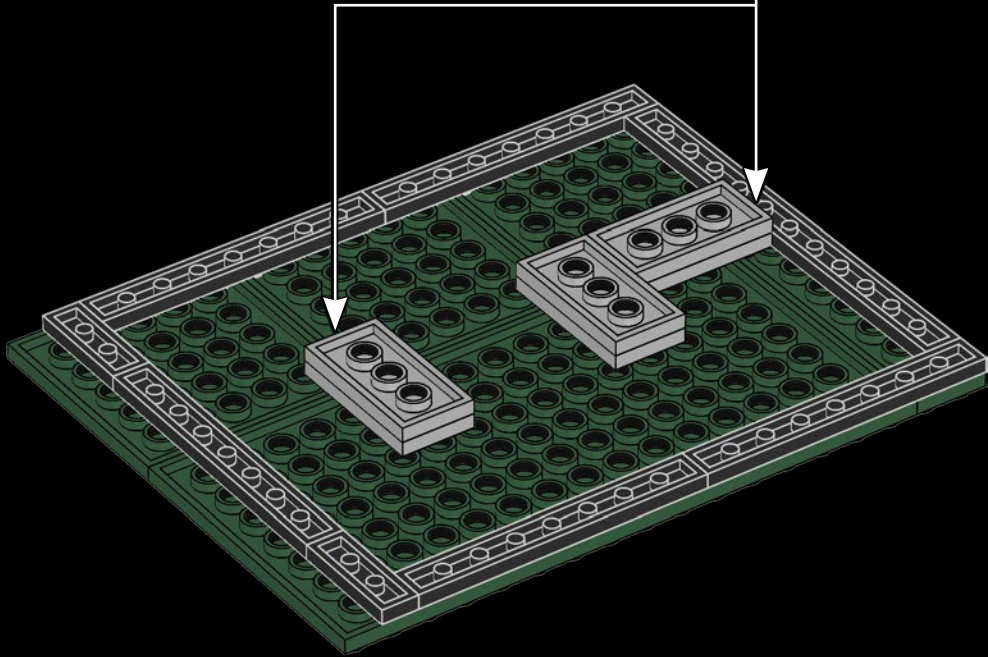
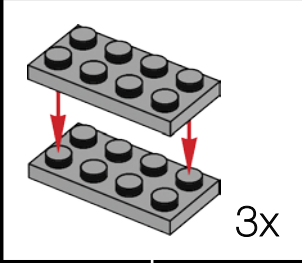

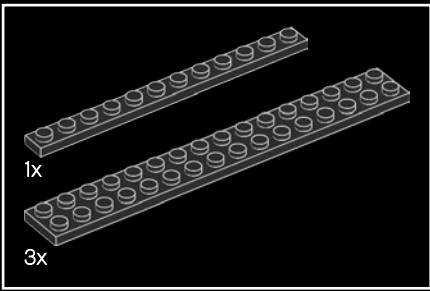

112

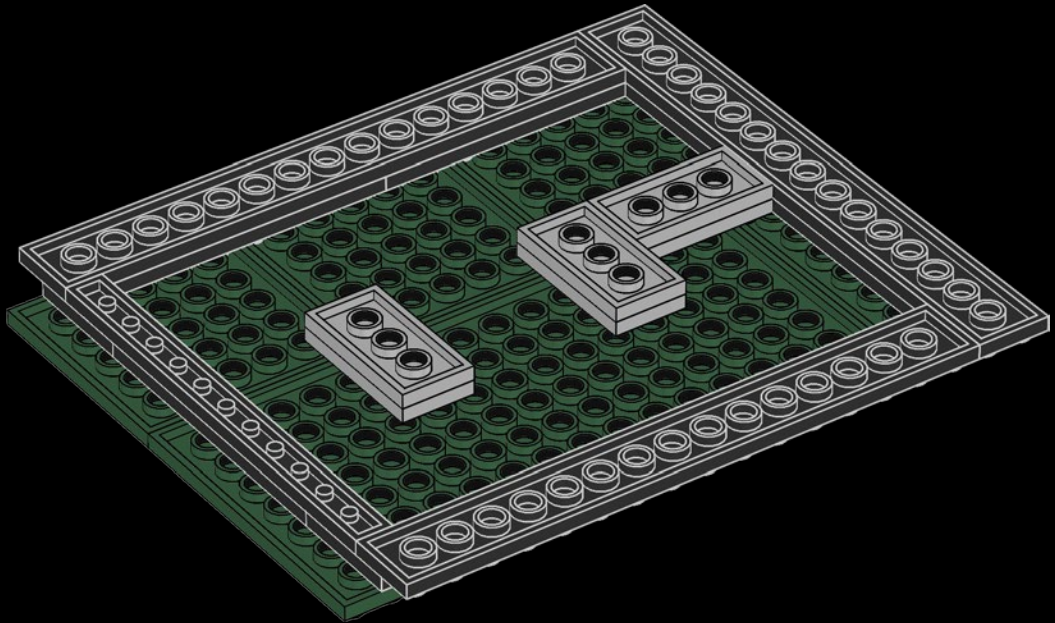

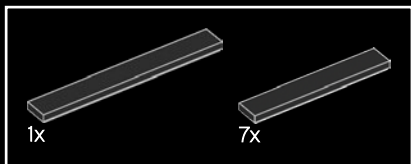

113

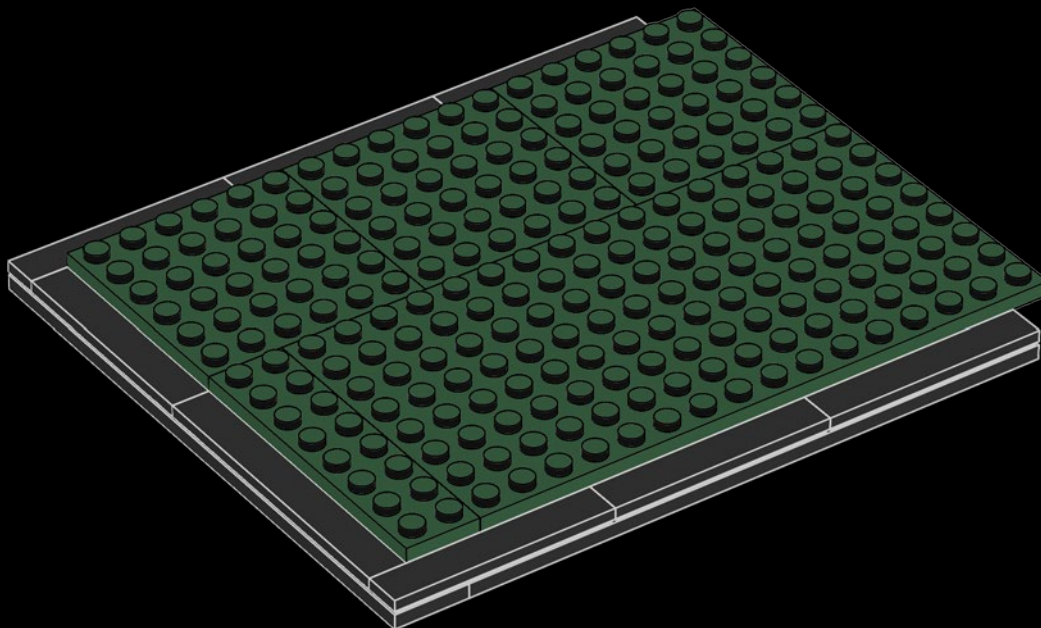

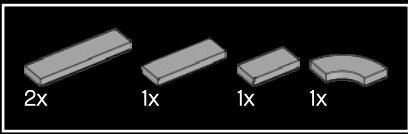

114

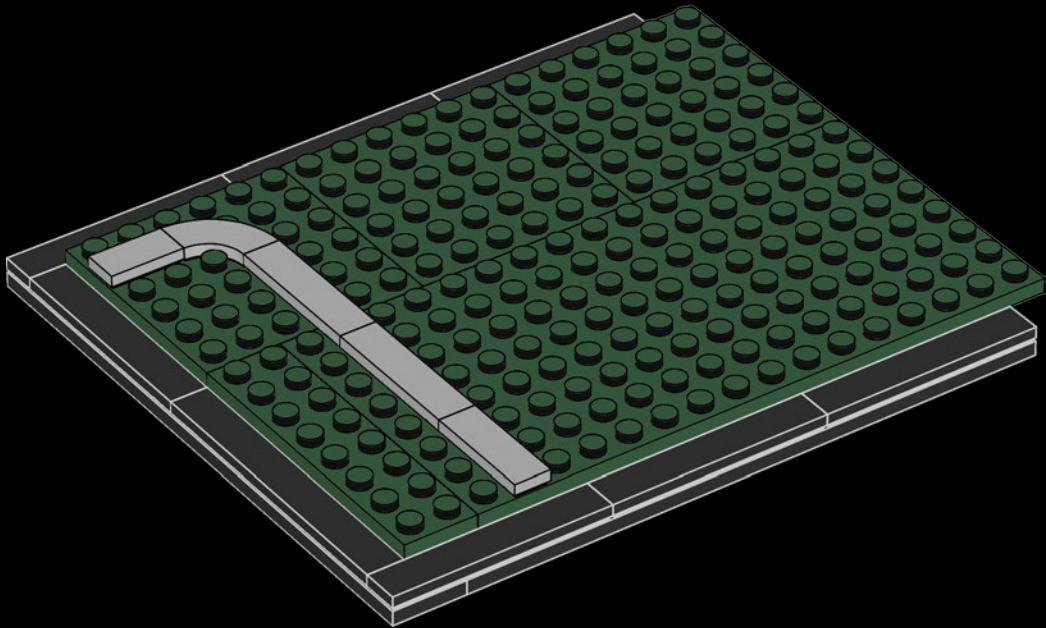

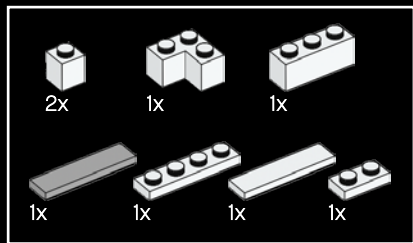

115

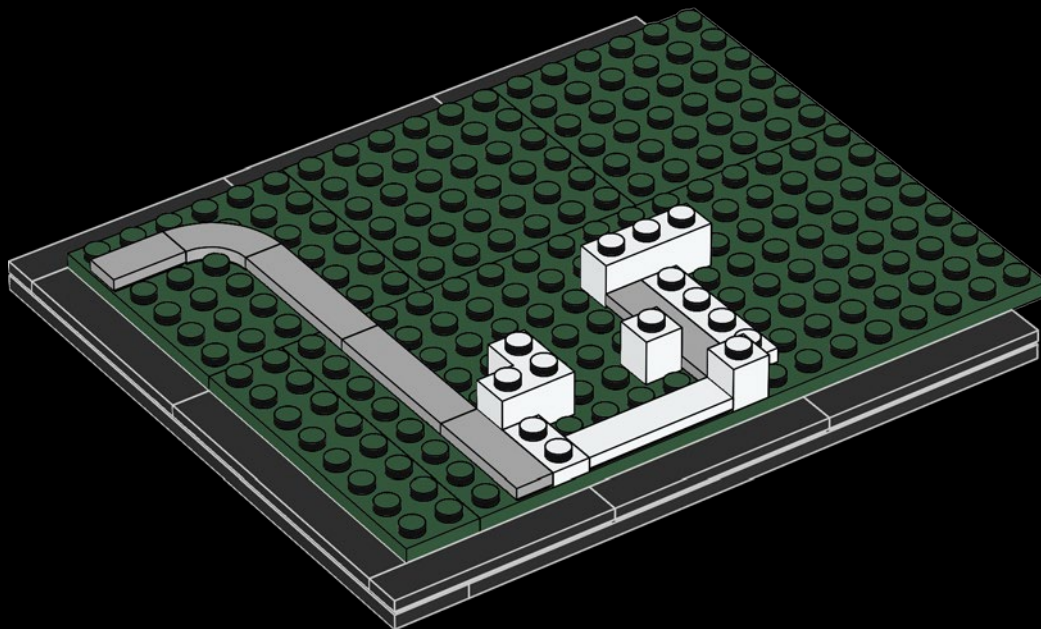

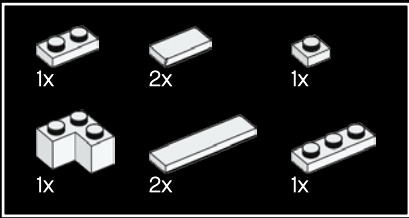

116

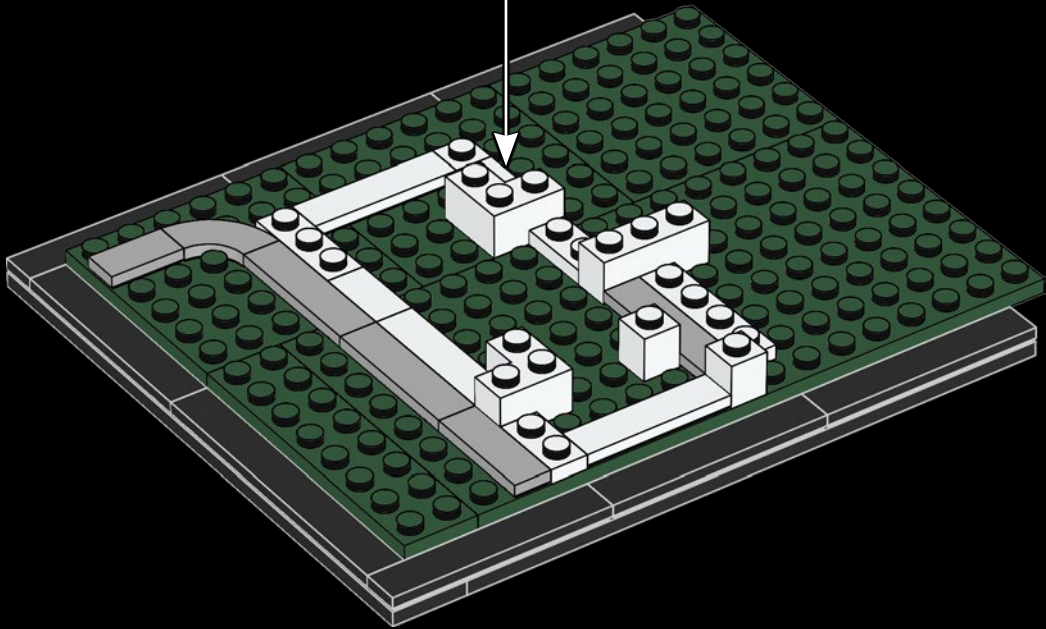
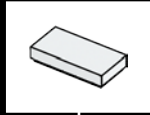

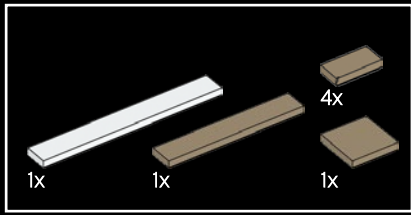

117

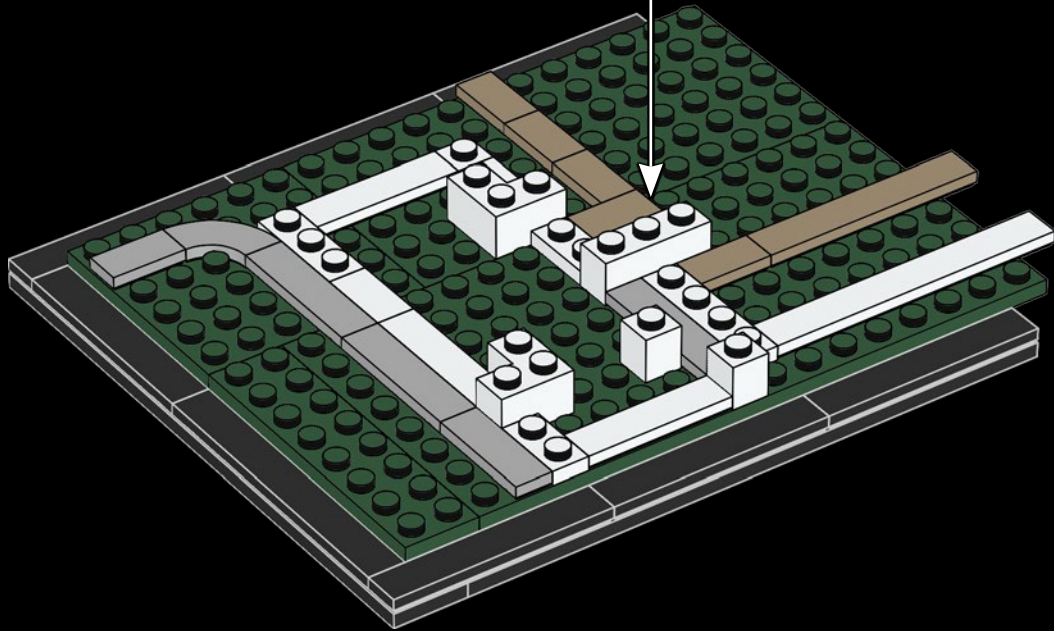
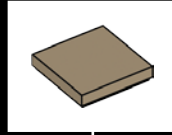

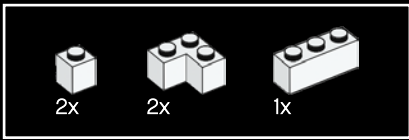

118

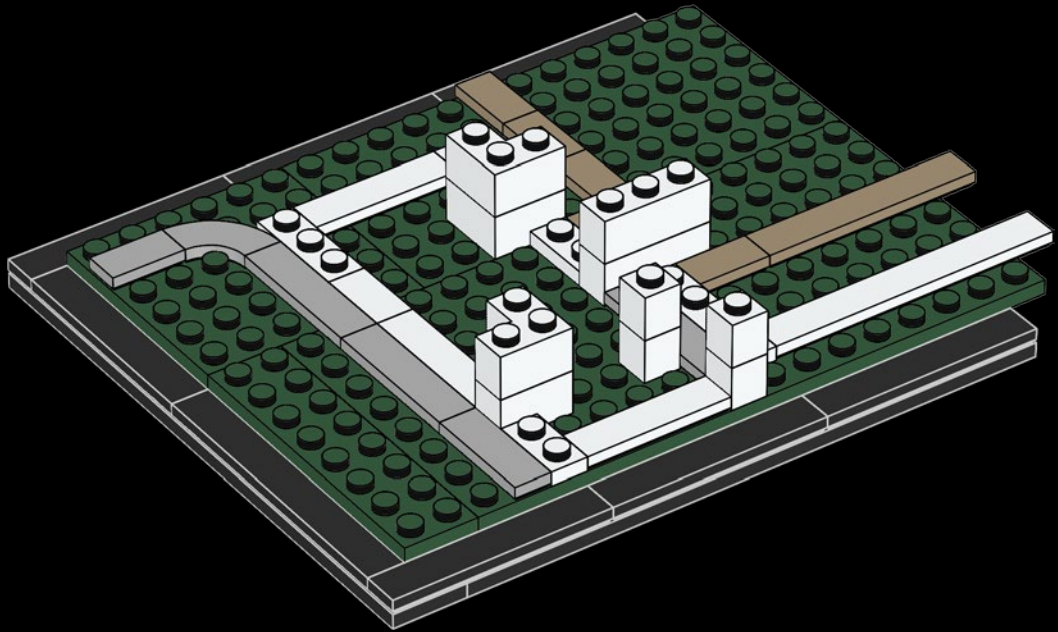

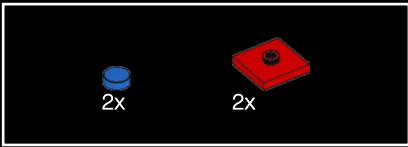

119

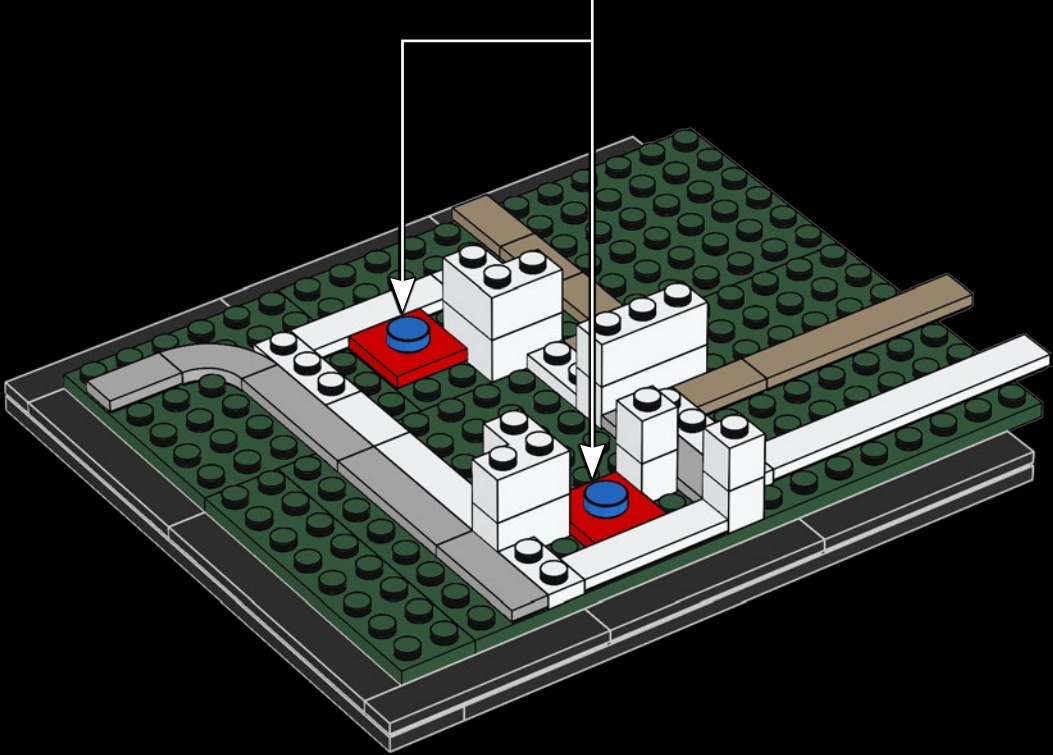
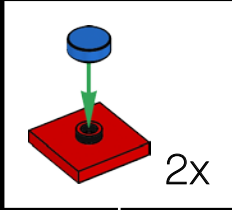



120

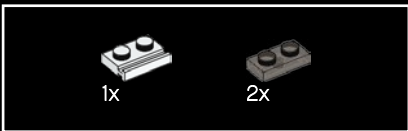
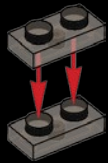

121

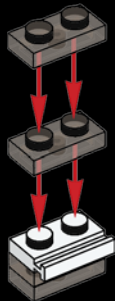

122

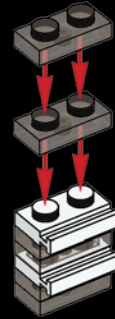

123



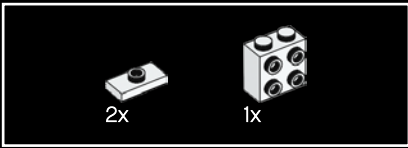

124

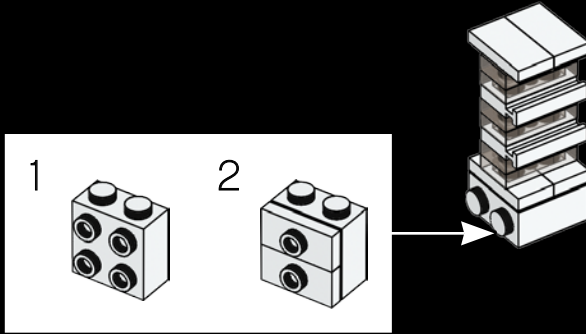

125

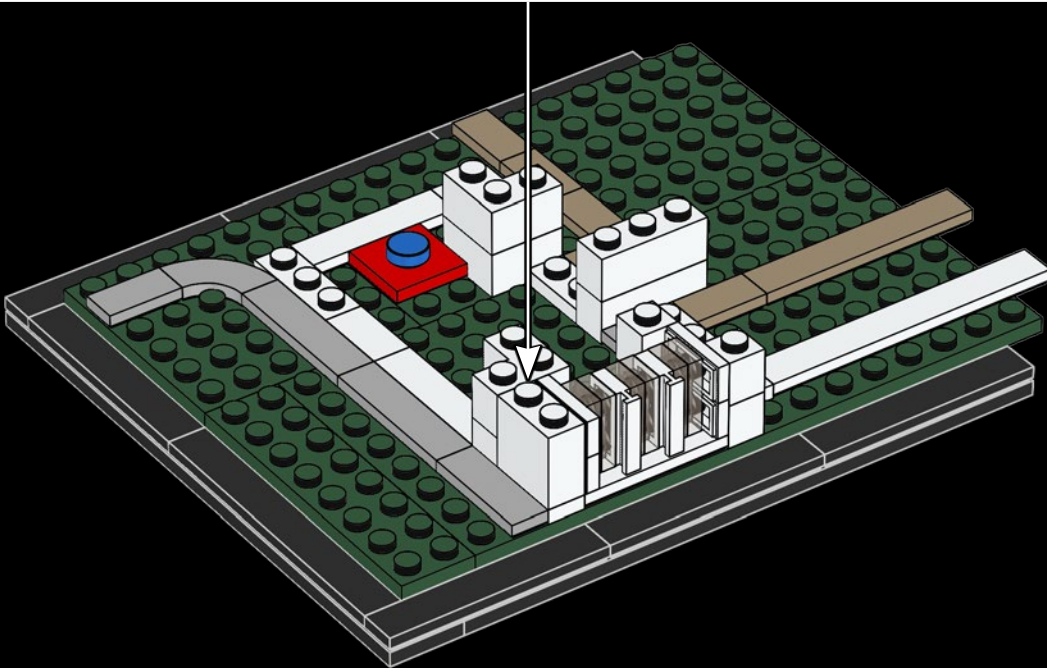

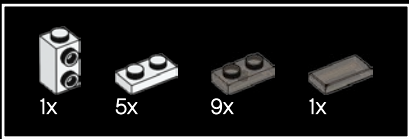

126

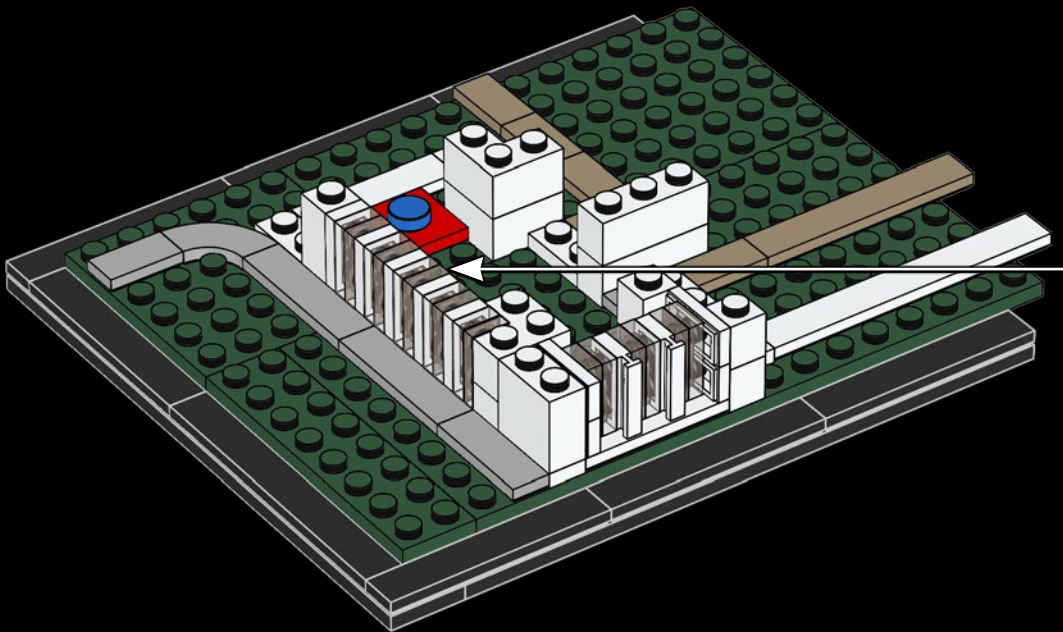
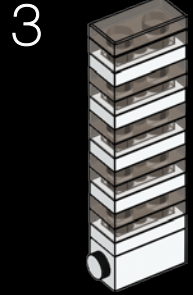
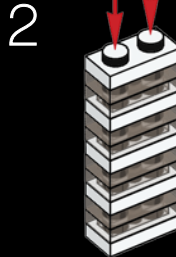
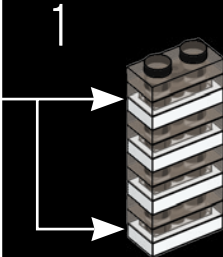
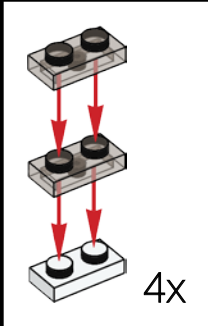



127

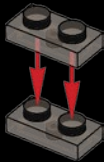

128

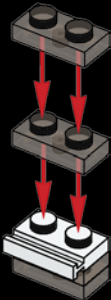

129

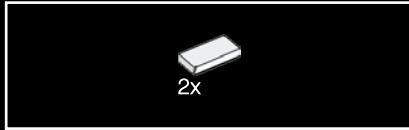

130

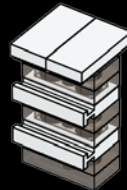

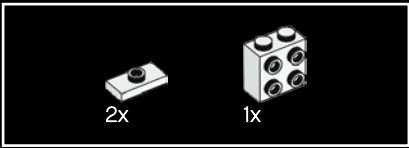

131

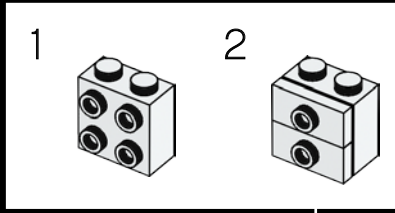

132

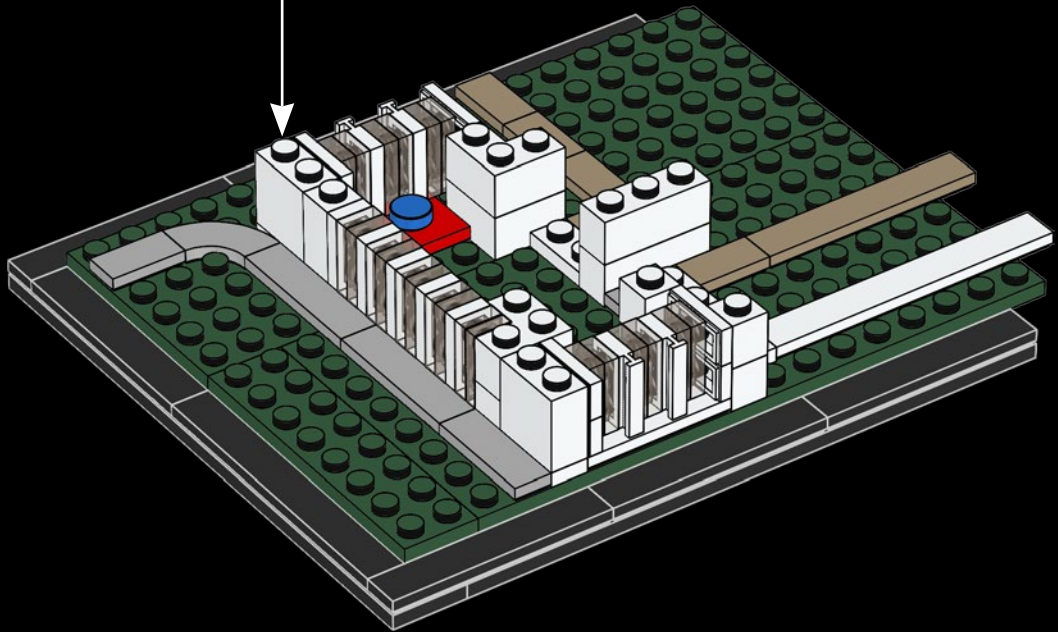

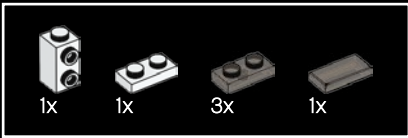

133

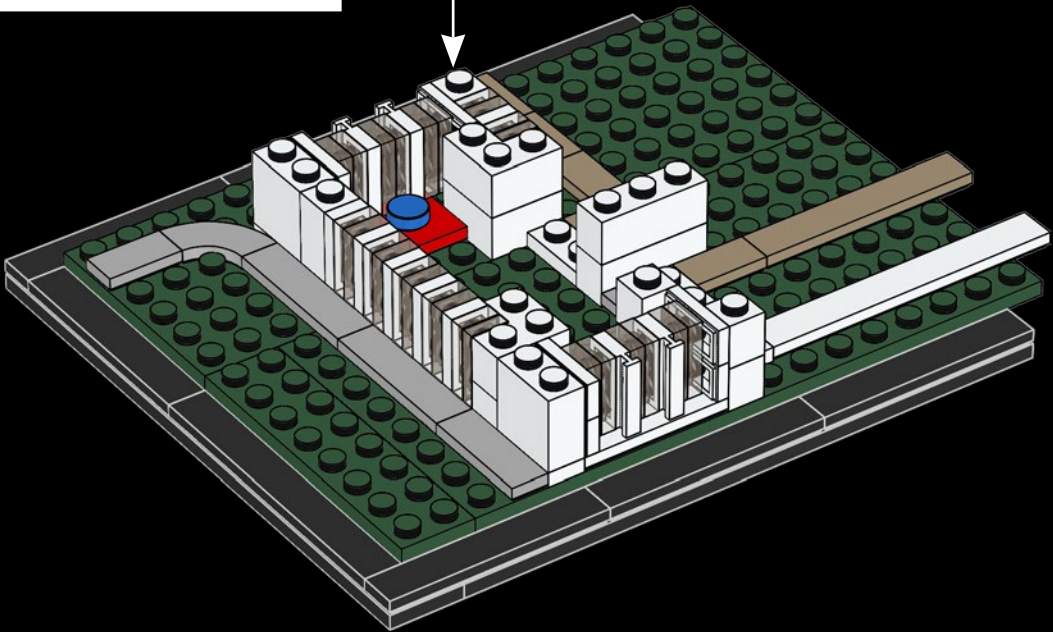
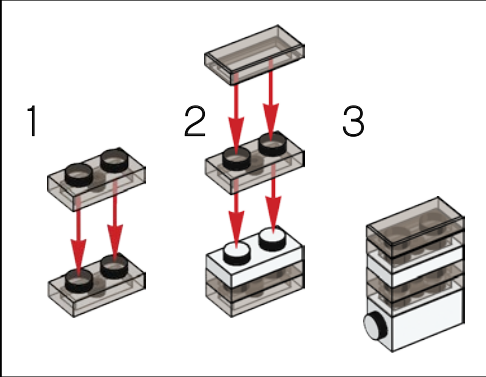

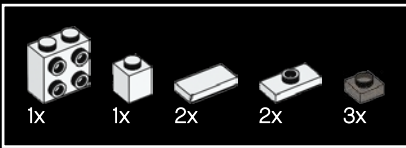

134

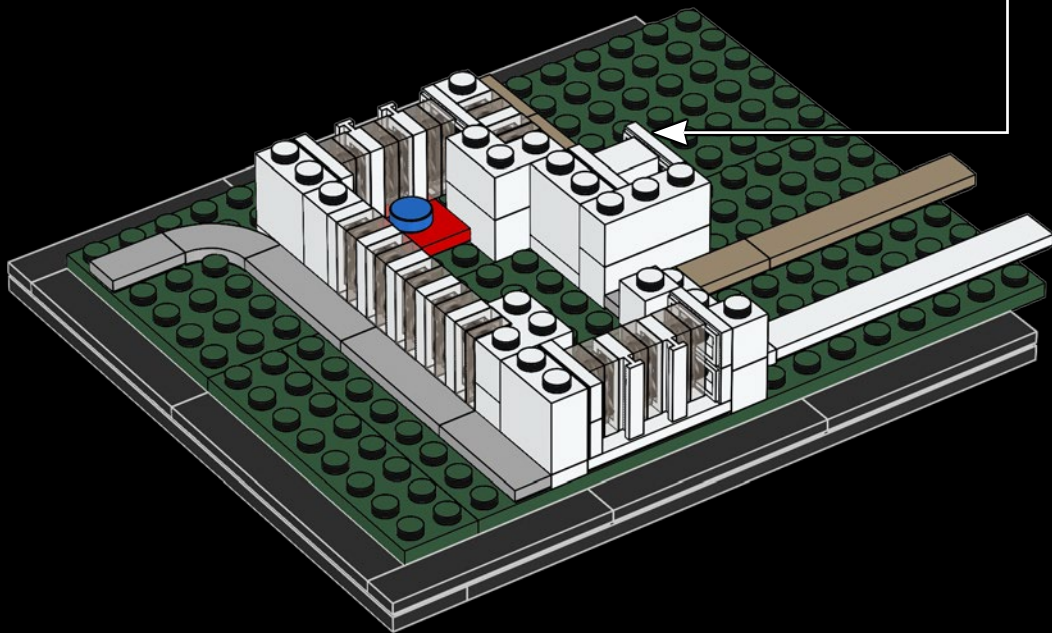
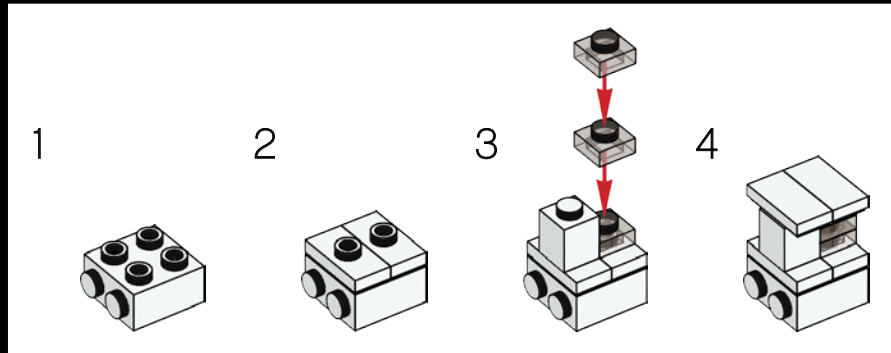

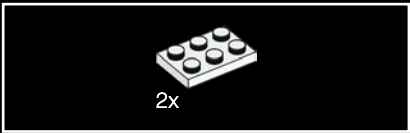

135

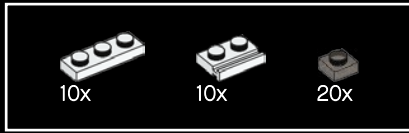
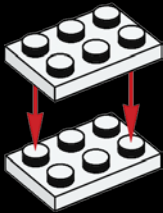

136

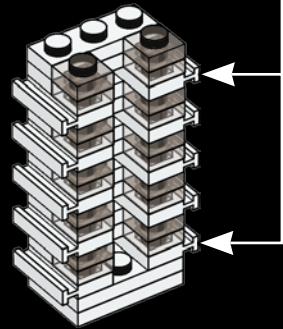
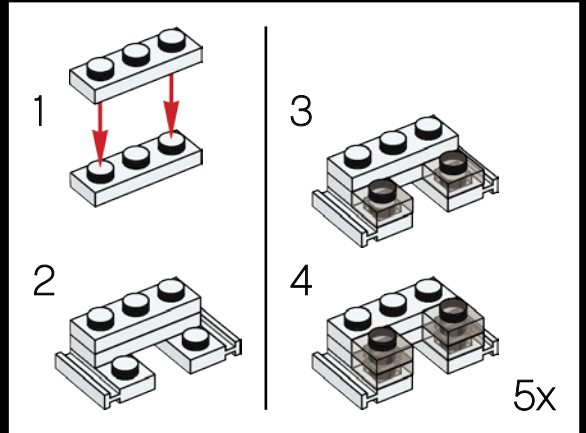

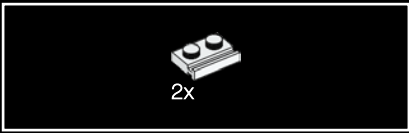

137

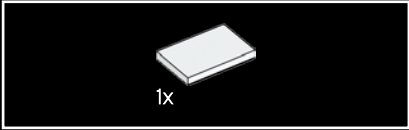
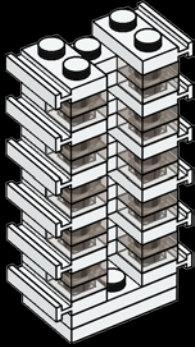

138

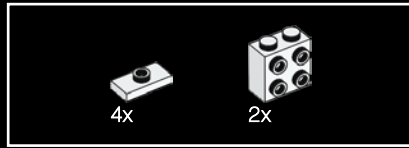

139

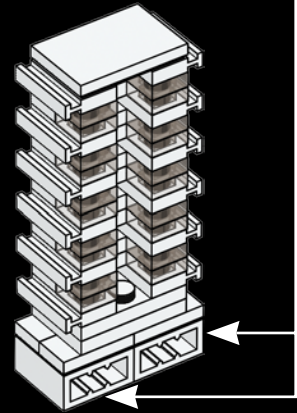
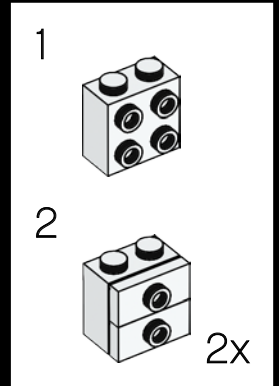

140

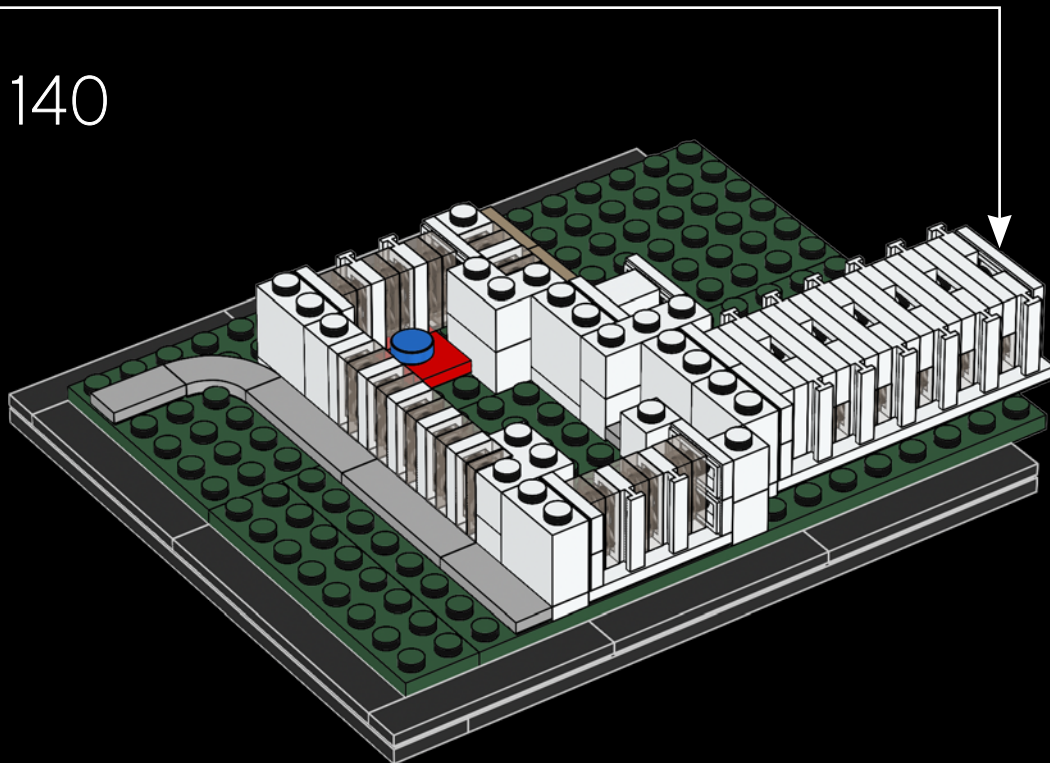

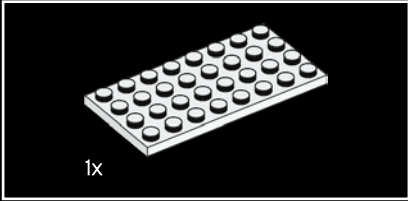
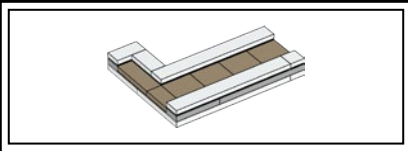

141

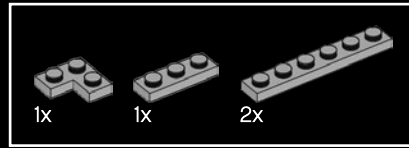
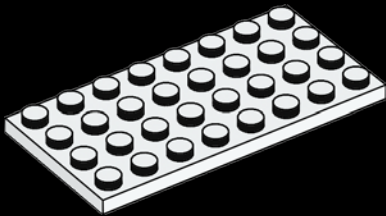

142

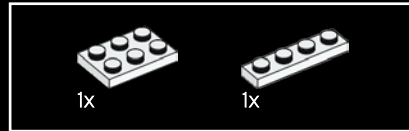
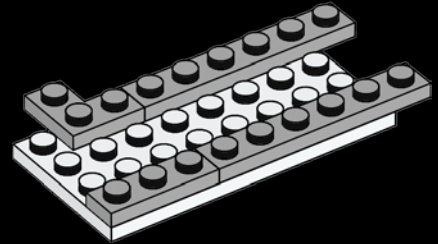

143

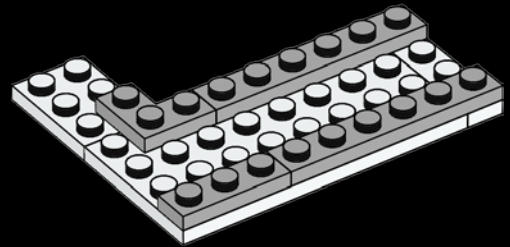

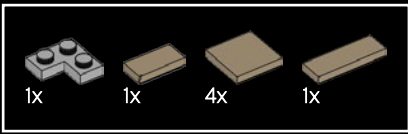

144

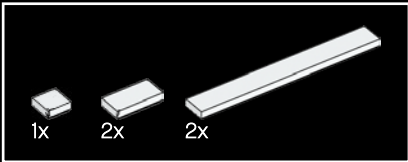
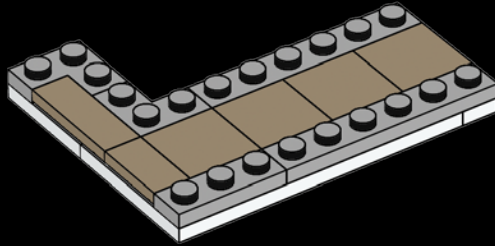

145

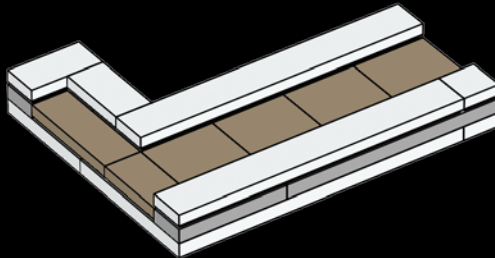

146

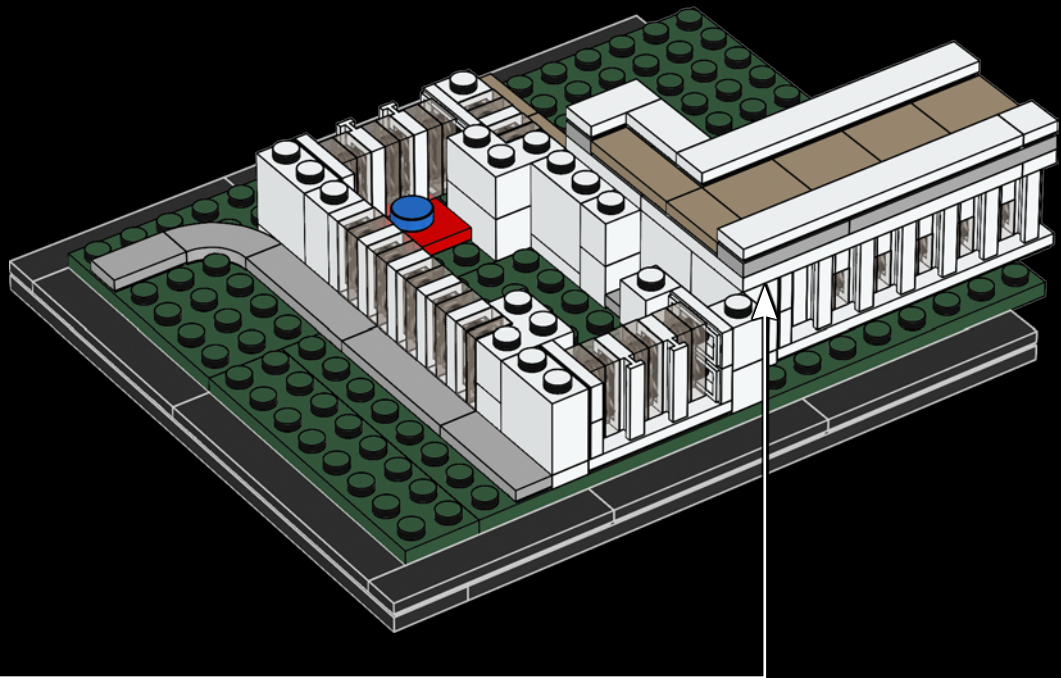

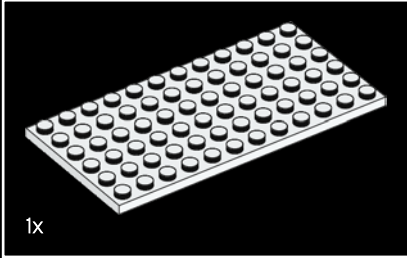
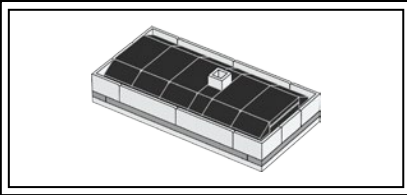

147

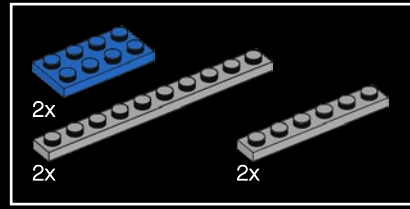
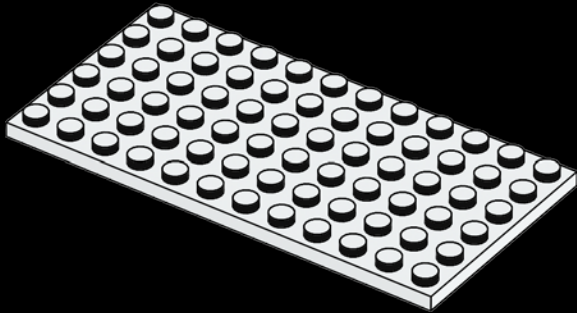

148

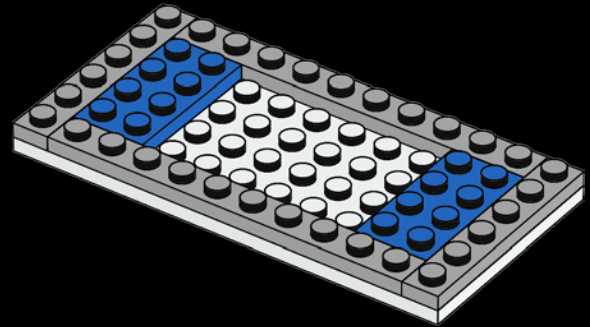

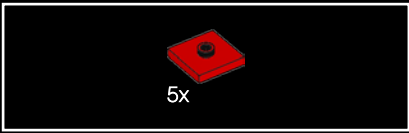

149

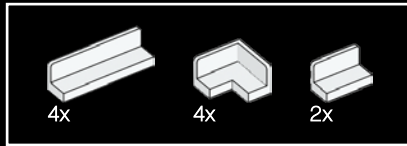
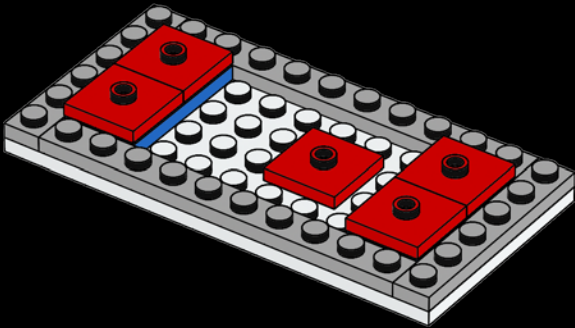

150

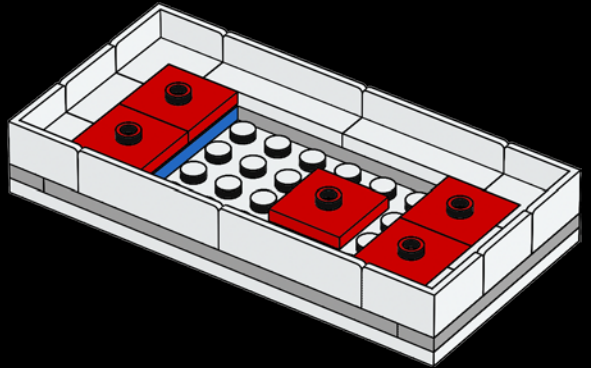



151

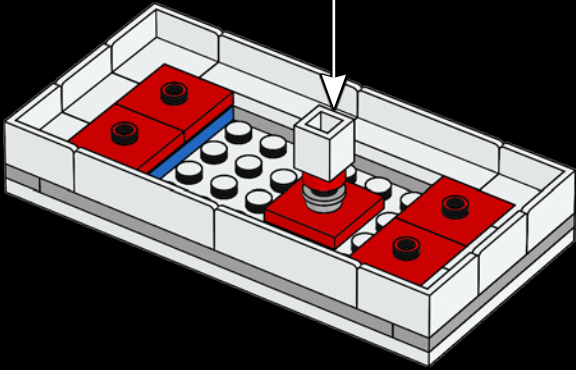
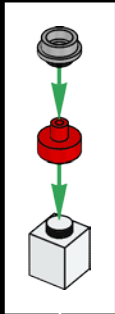

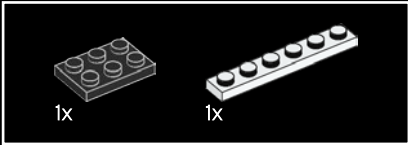
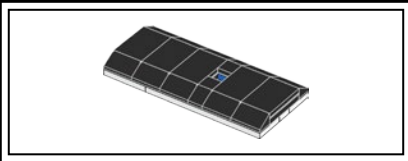

152

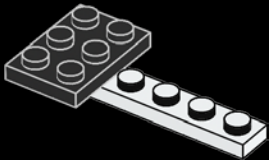

153

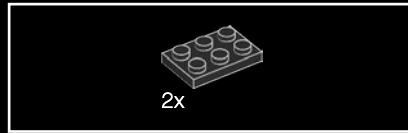
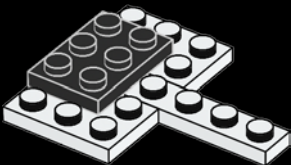

154

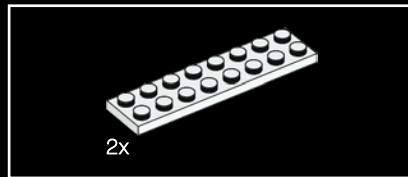
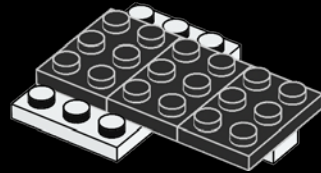

155

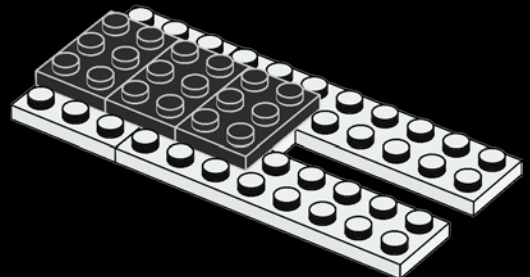

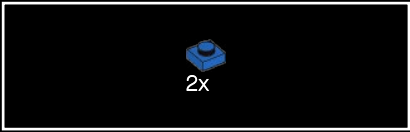

156

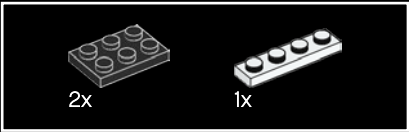
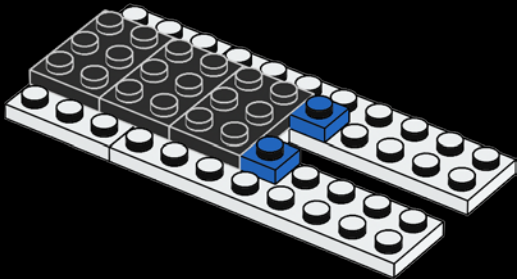

157

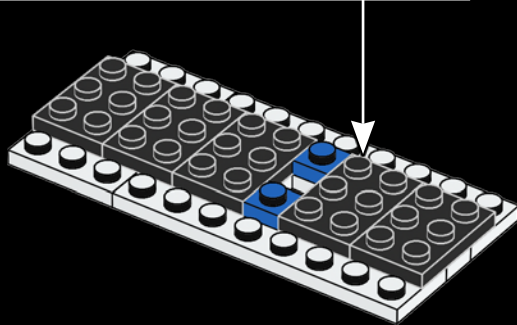
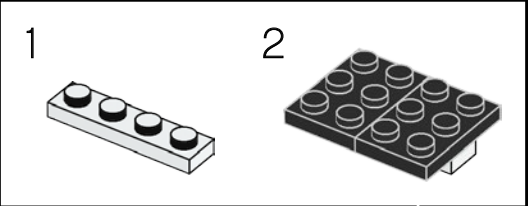

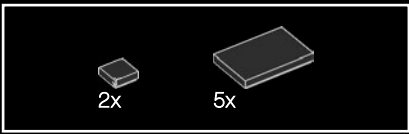

158

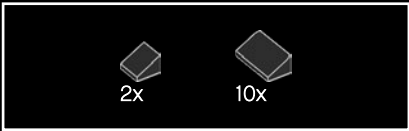
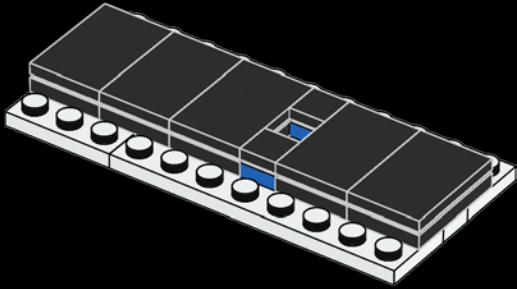

159

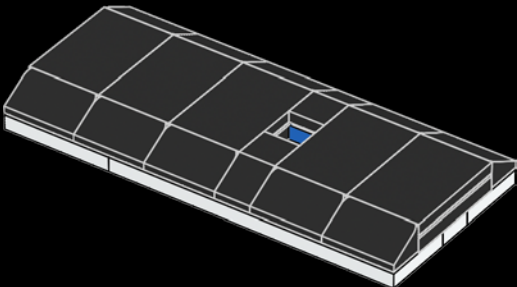

160

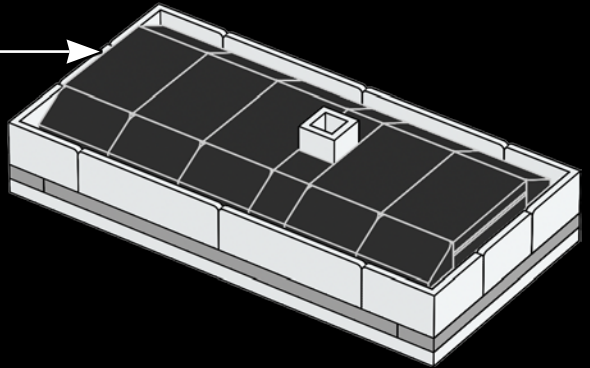

161

The White House requires 570 gallons (2157 liters)
of paint to cover its outside surface

Il faut 2 157 litres de peinture pour couvrir la
surface extérieure de la Maison-Blanche

Cubrir la superficie exterior de la Casa Blanca
requiere 2157 l de pintura.

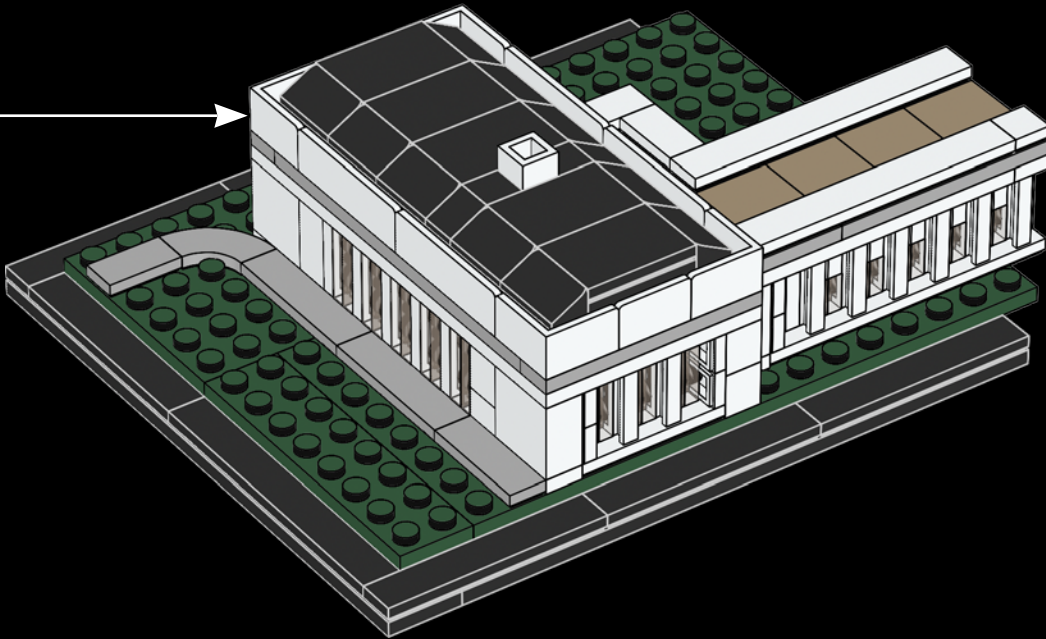



162

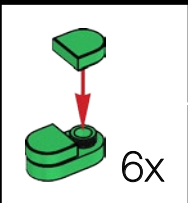
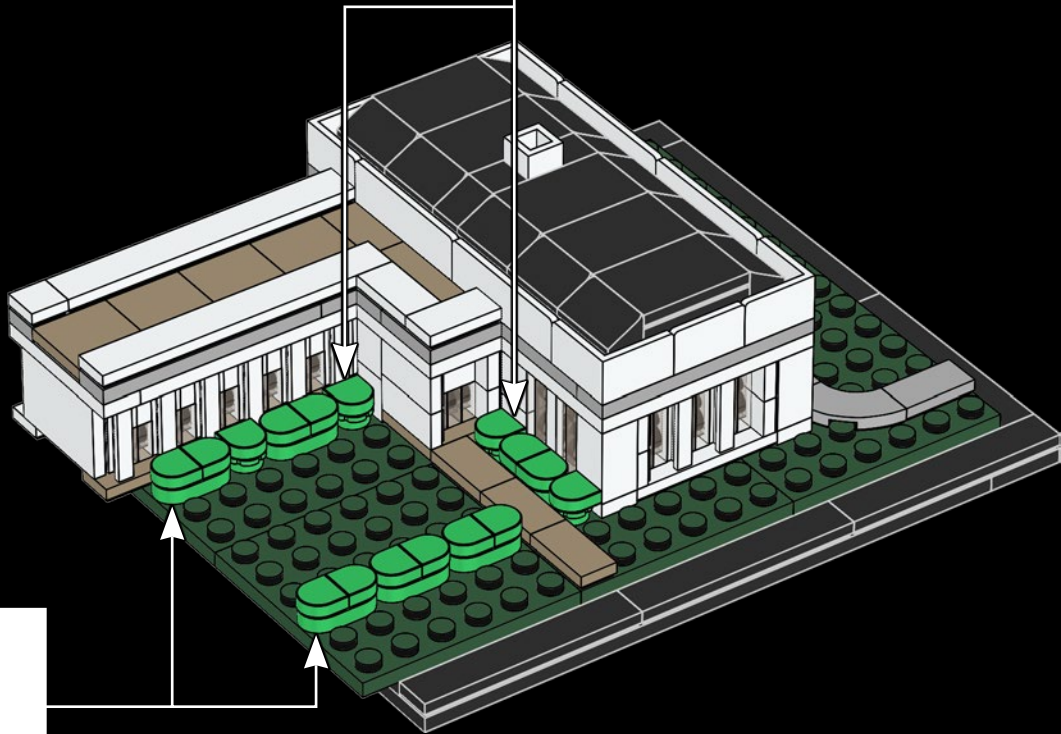
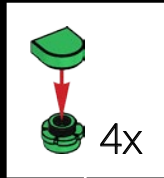



163

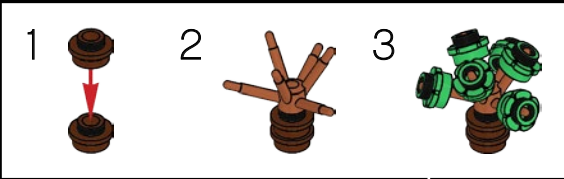

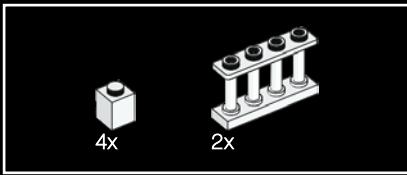

164

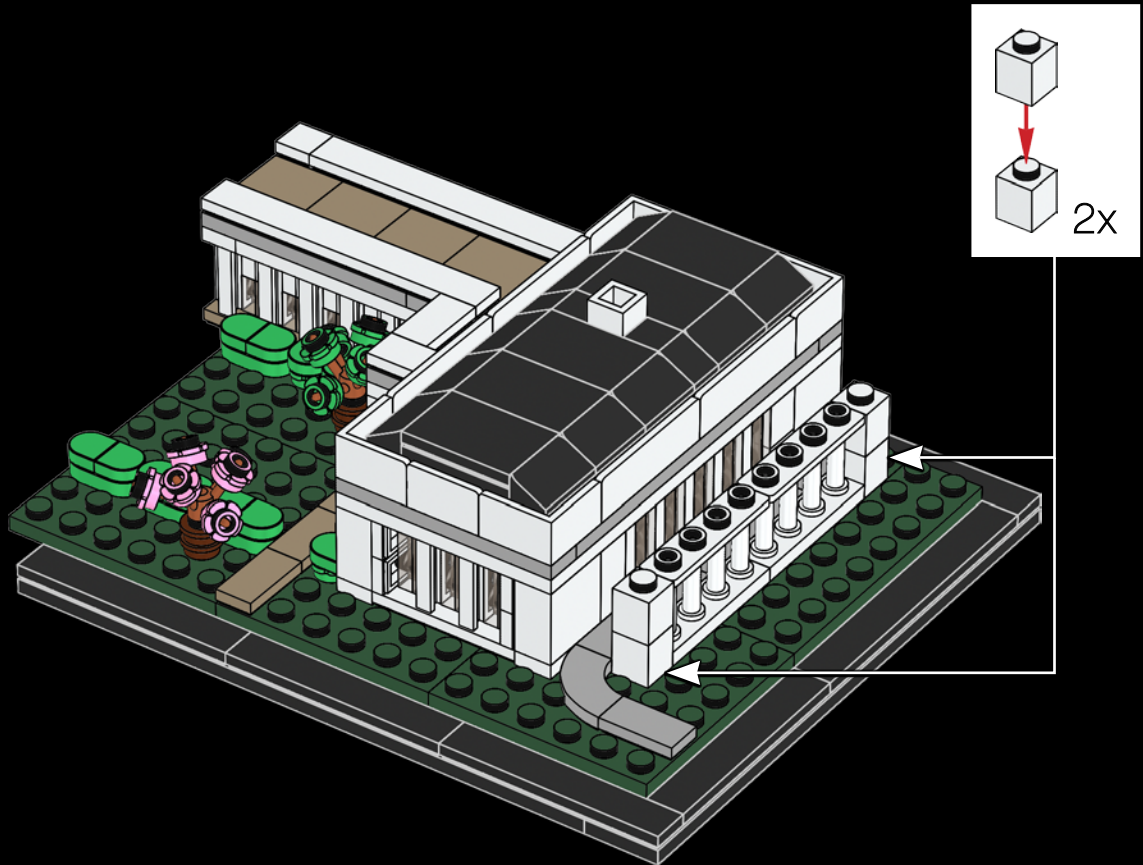

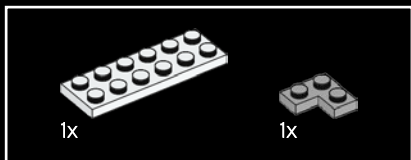

165

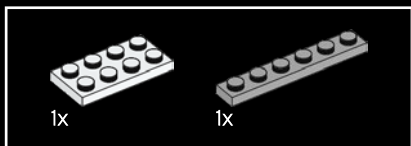
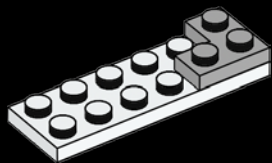

166

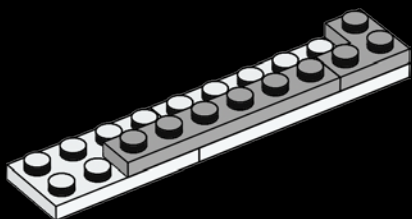

167

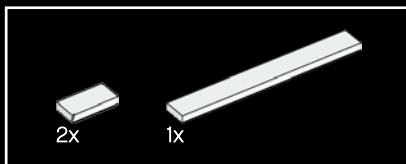
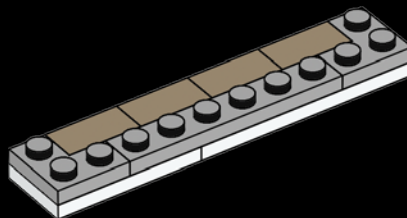

168

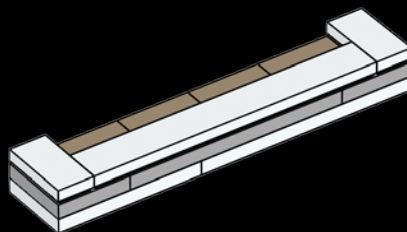

169

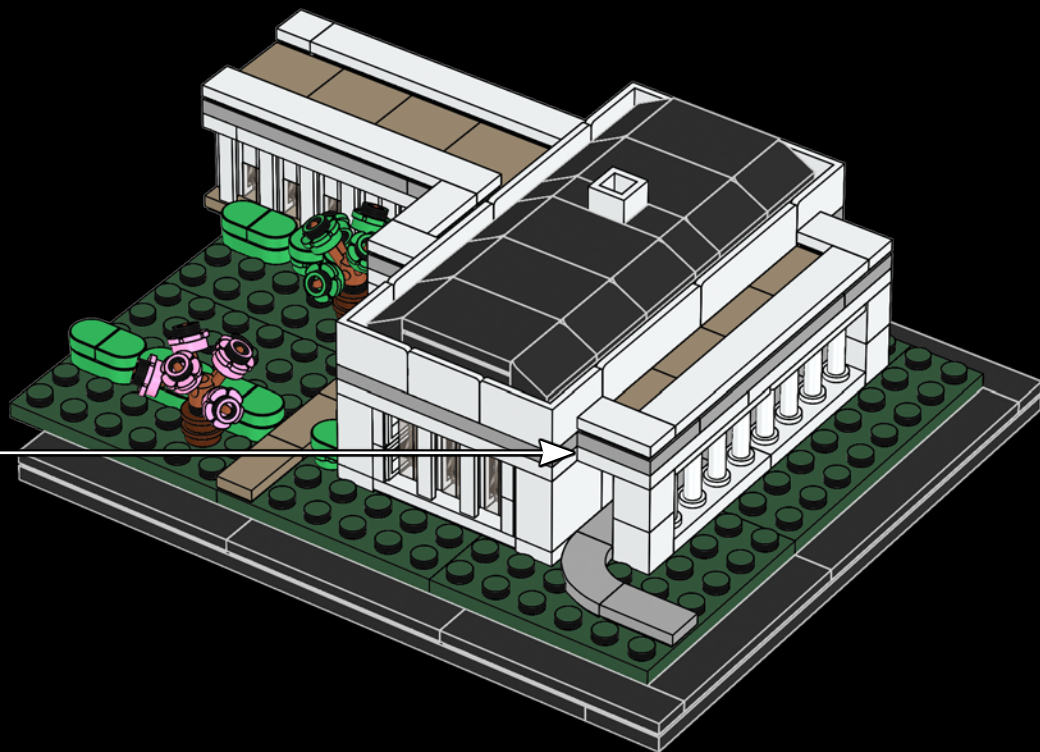



170

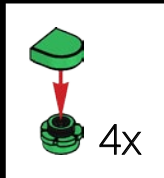
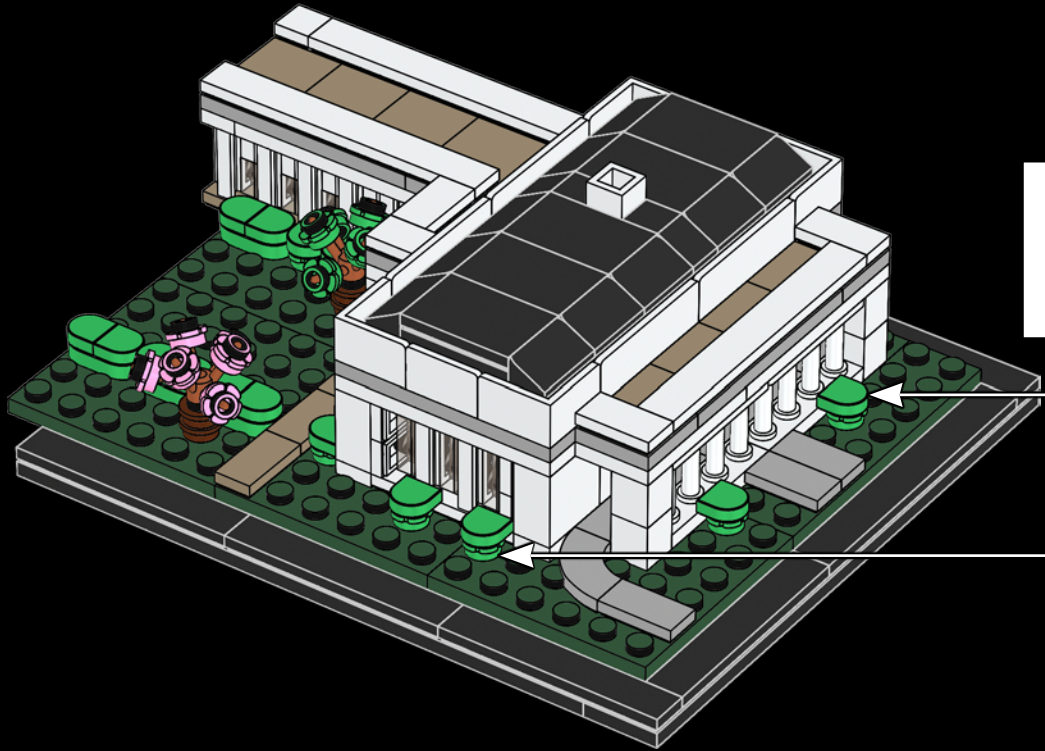

171

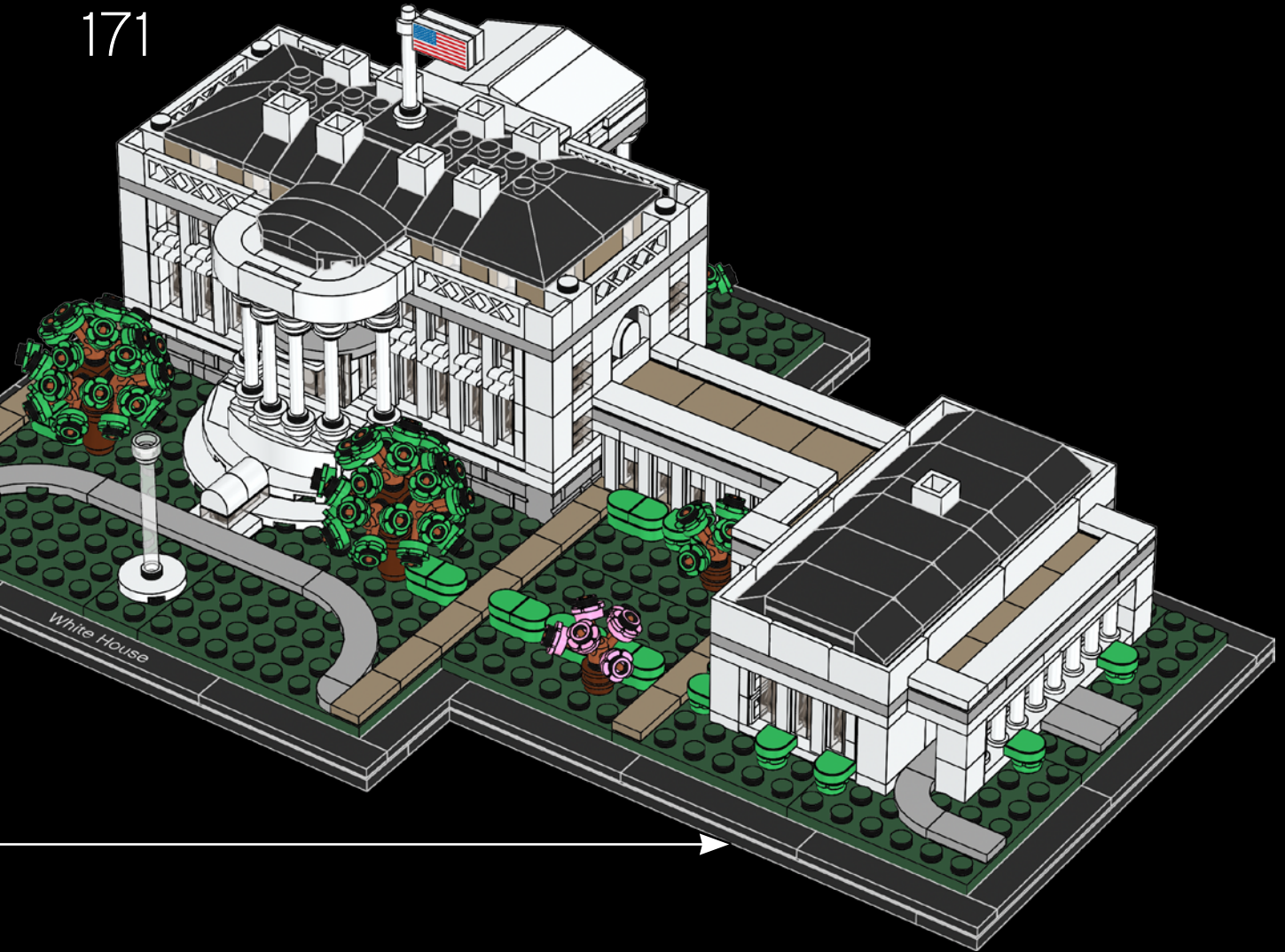

The West Wing

L'aile ouest

El ala oeste

It was Thomas Jefferson who first proposed adding one-story extensions east and west of the presidential mansion. A century later William Howard Taft officially moved the president's working room to the West Wing, creating the Oval Office we know today. It's from here the president addresses the American public on TV and where he confers with staff and visiting heads of state.

C'est Thomas Jefferson qui a été le premier à proposer d'ajouter des annexes d'un étage à l'est et à l'ouest du manoir présidentiel. Un siècle plus tard, William Howard Taft a officiellement déplacé la salle de travail du président à l'aile ouest, créant le Bureau ovale que nous connaissons aujourd'hui. C'est de là que le président s'adresse au public américain à la télévision et où il s'entretient avec le personnel et les chefs d'État en visite.

Fue Thomas Jefferson quien propuso por primera vez incorporar extensiones de un piso al este y al oeste de la mansión presidencial. Un siglo después, William Howard Taft trasladó oficialmente la sala de trabajo del presidente al ala oeste, creando el despacho oval tal como lo conocemos hoy. Es desde aquí desde donde el presidente se dirige al pueblo estadounidense por televisión; también es donde se reúne con el personal y las visitas de estado.



Windows of the Oval Office, the office of the US President, in the West Wing of the White House

Fenêtres du Bureau ovale, le bureau du président américain, dans l'aile ouest de la Maison-Blanche

Ventanas del despacho oval, la oficina del presidente de los Estados Unidos, en el ala oeste de la Casa Blanca



White House and the Executive Offices of the newly renovated West Wing. Feb. 8, 1938.

La Maison-Blanche et les bureaux exécutifs de l'aile ouest récemment rénovée. Le 8 février 1938.

La Casa Blanca y las oficinas ejecutivas de la recién renovada ala oeste. 8 de febrero de 1938



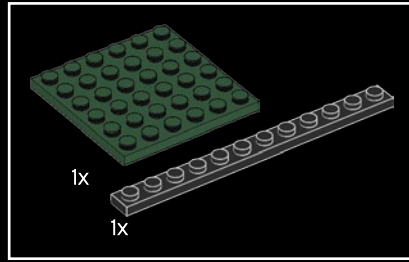
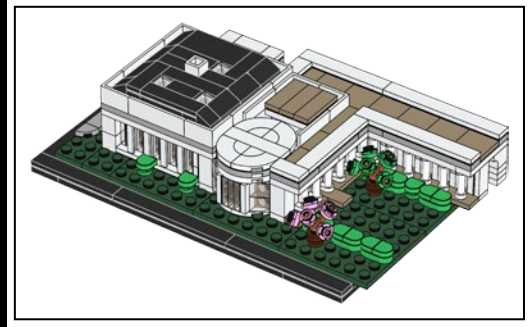
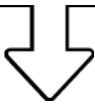

172



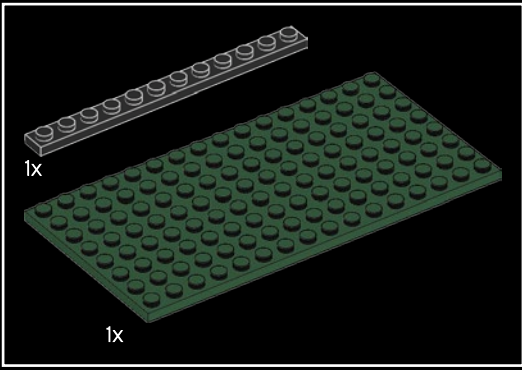

173

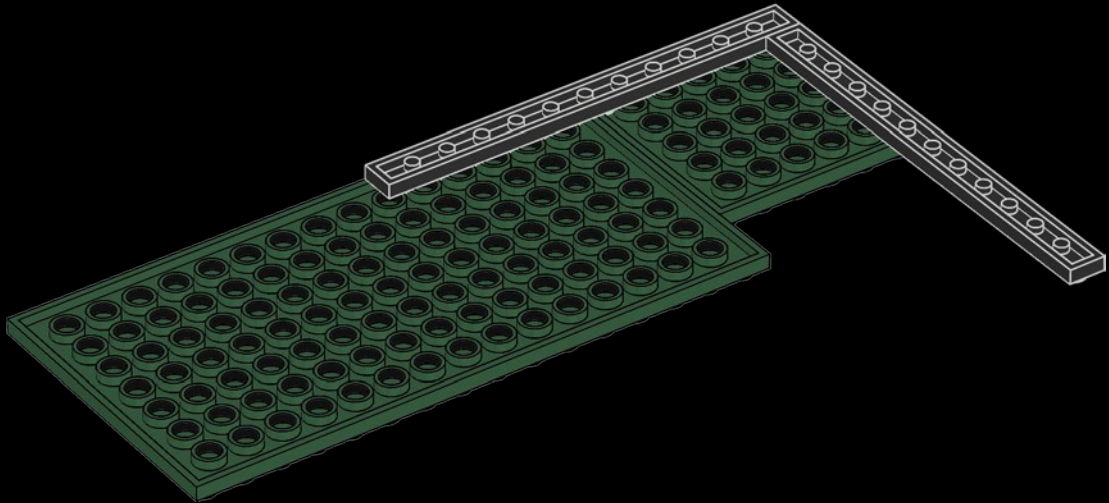

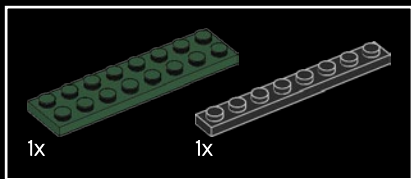

174

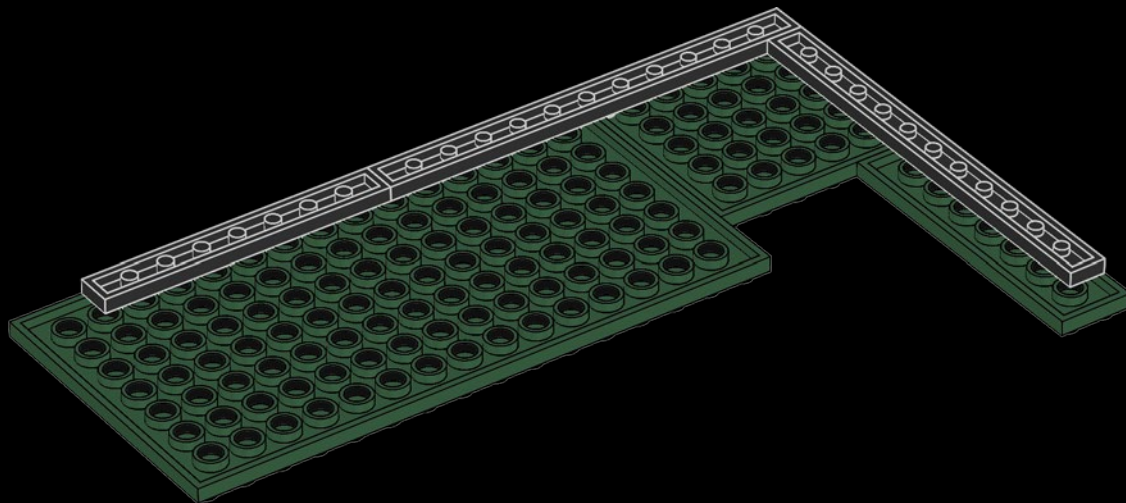

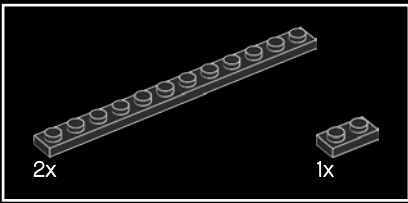

175

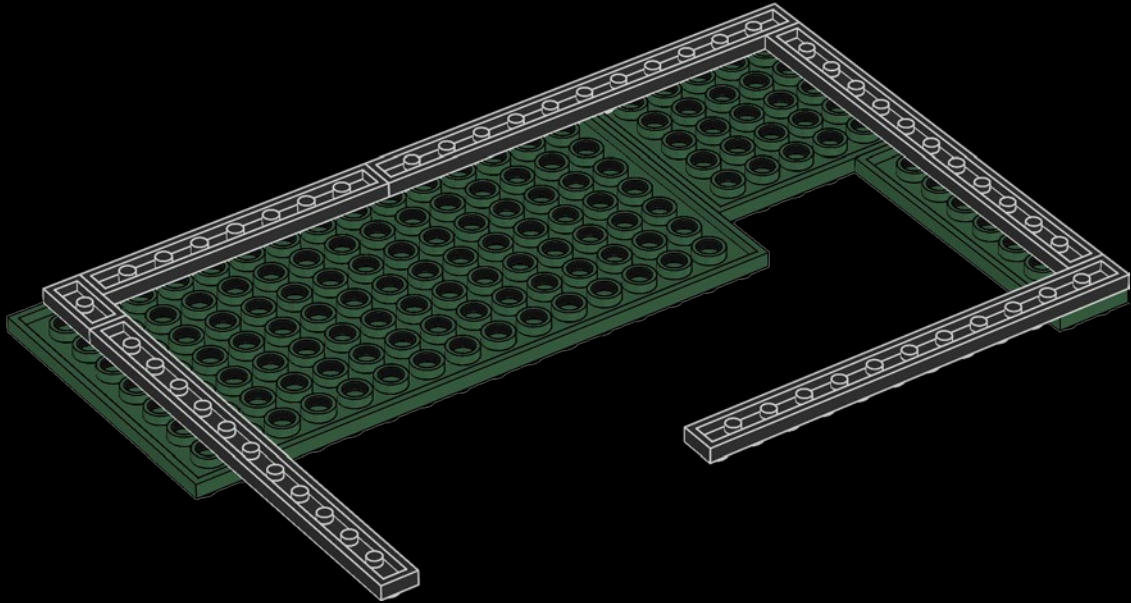

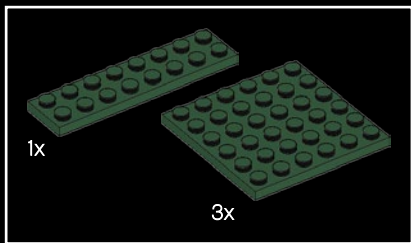

176

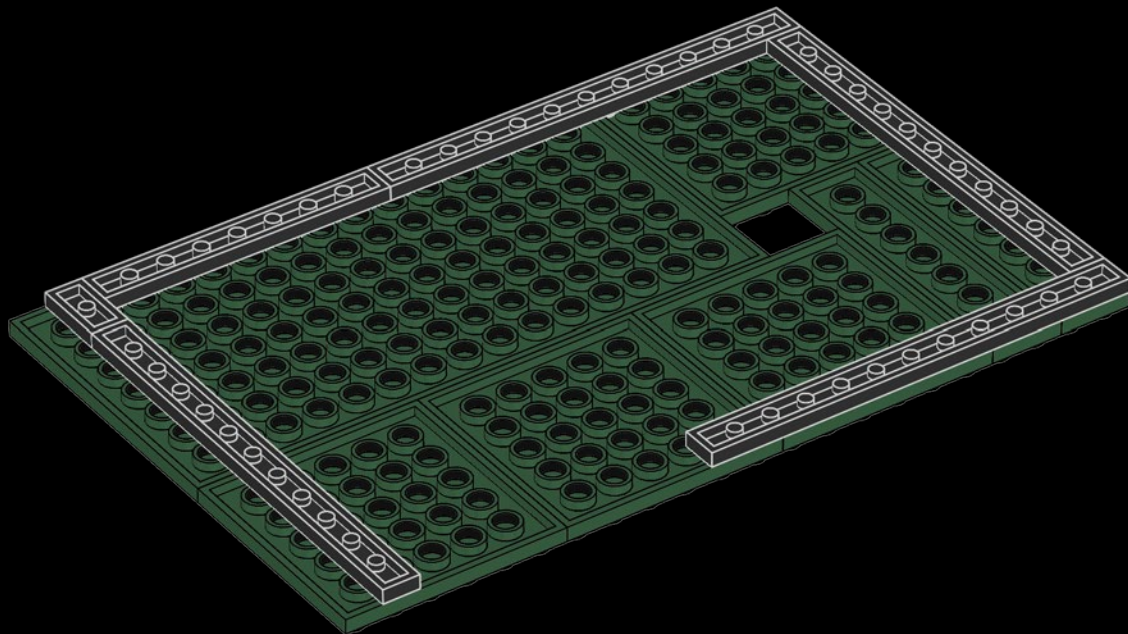

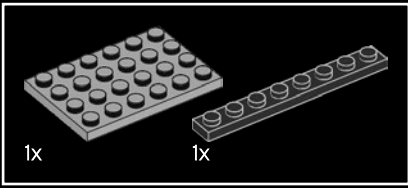

177

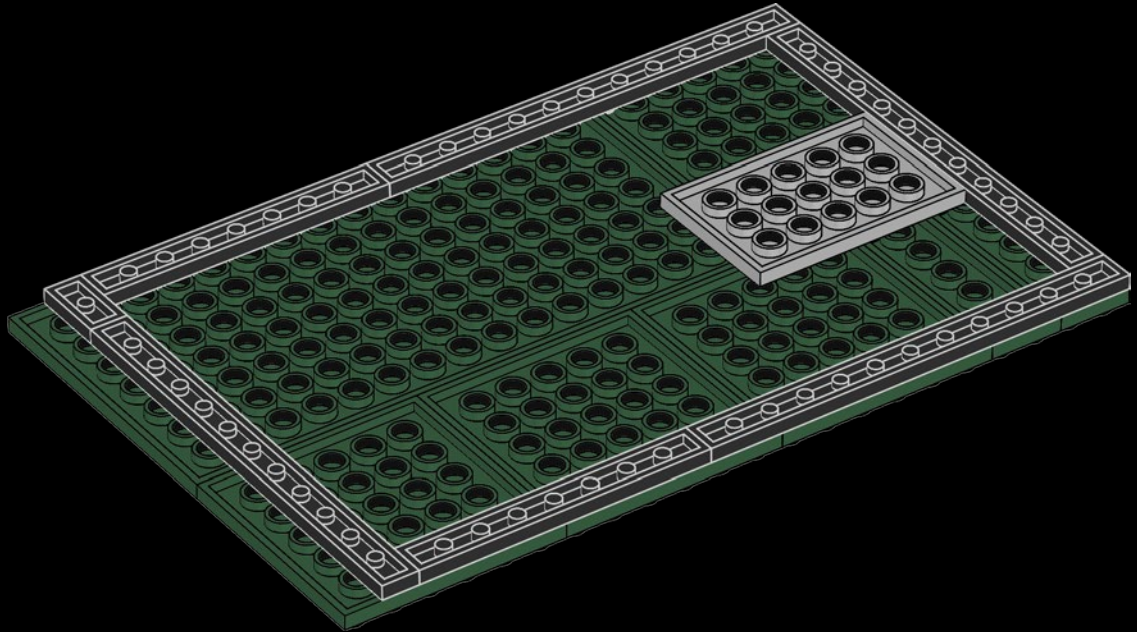

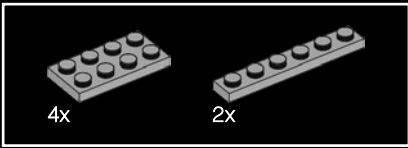

178

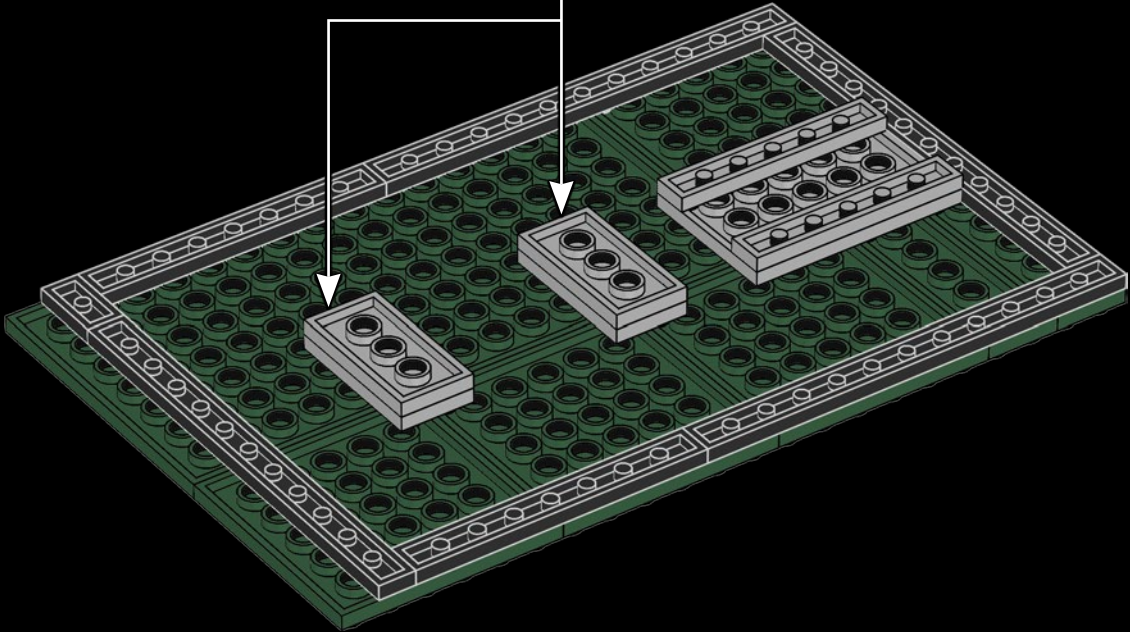
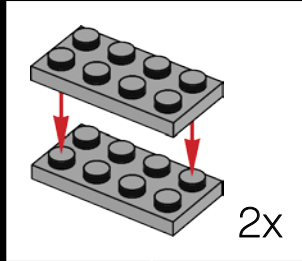

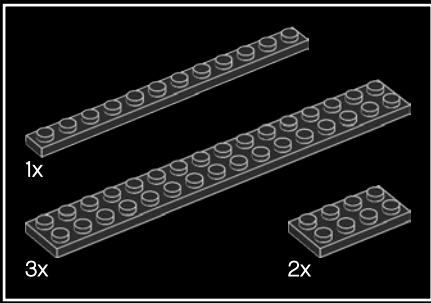

179

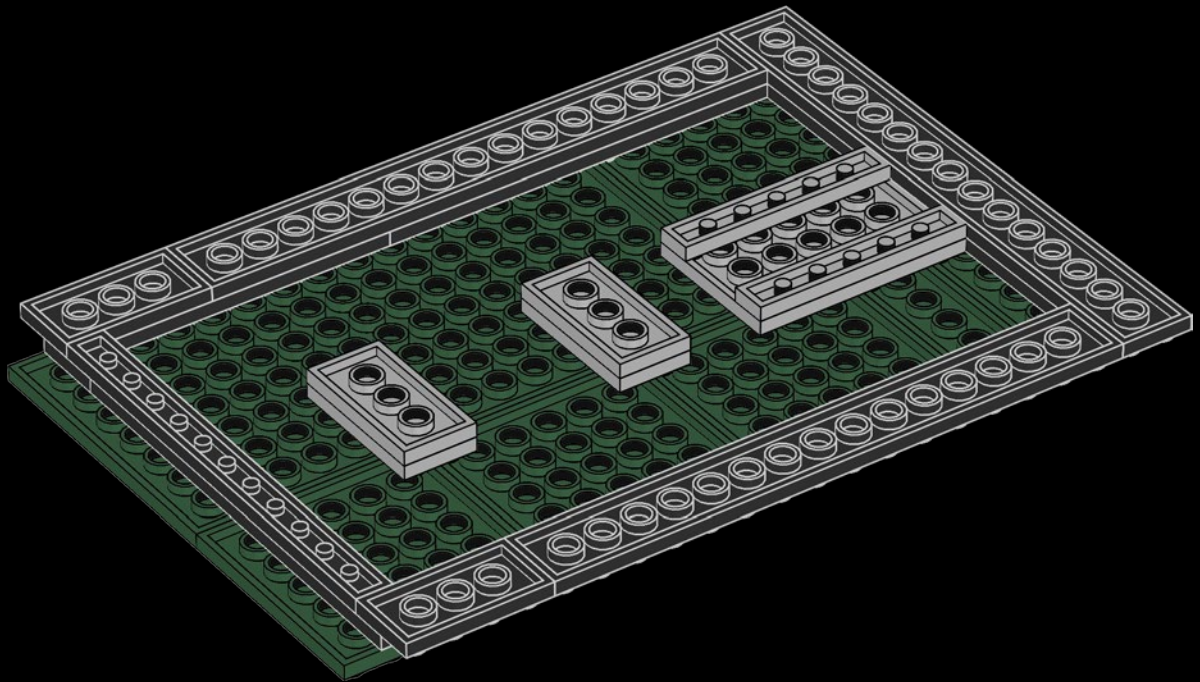

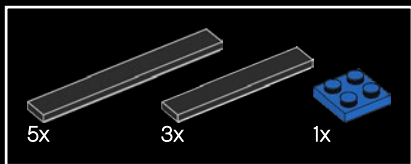

180

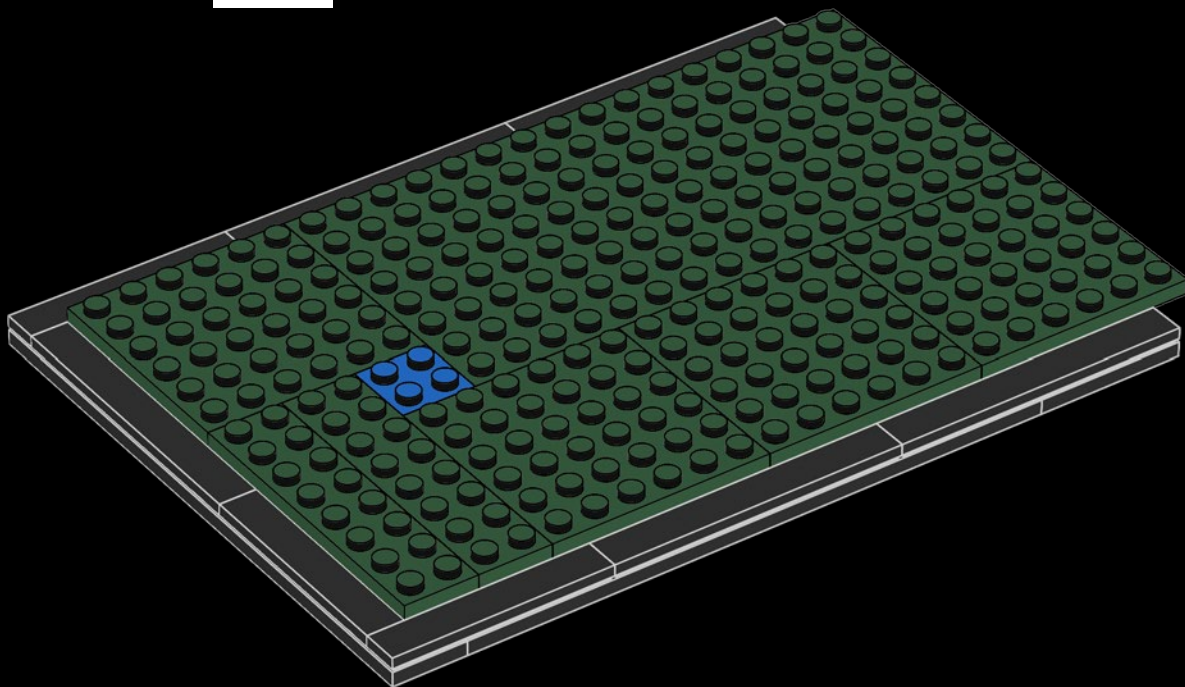

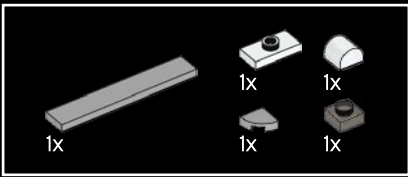

181

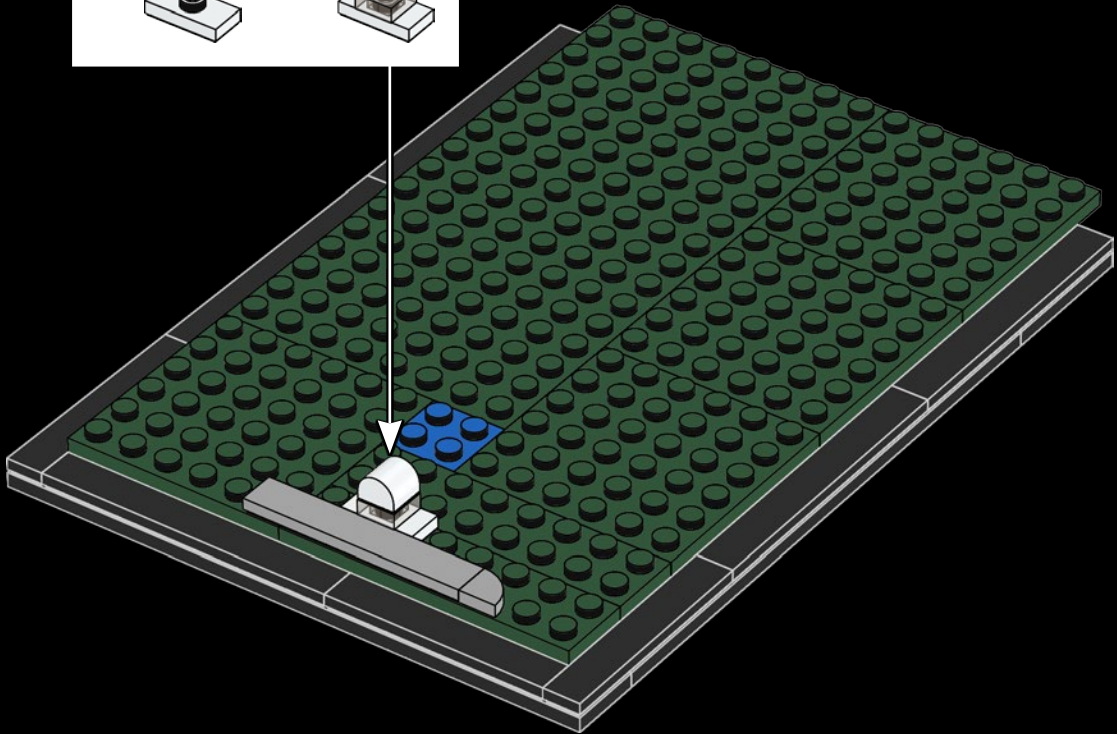
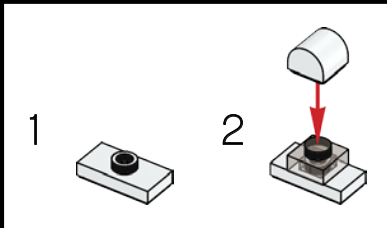

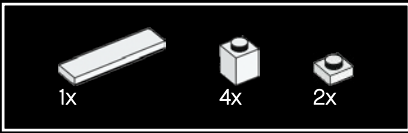

182

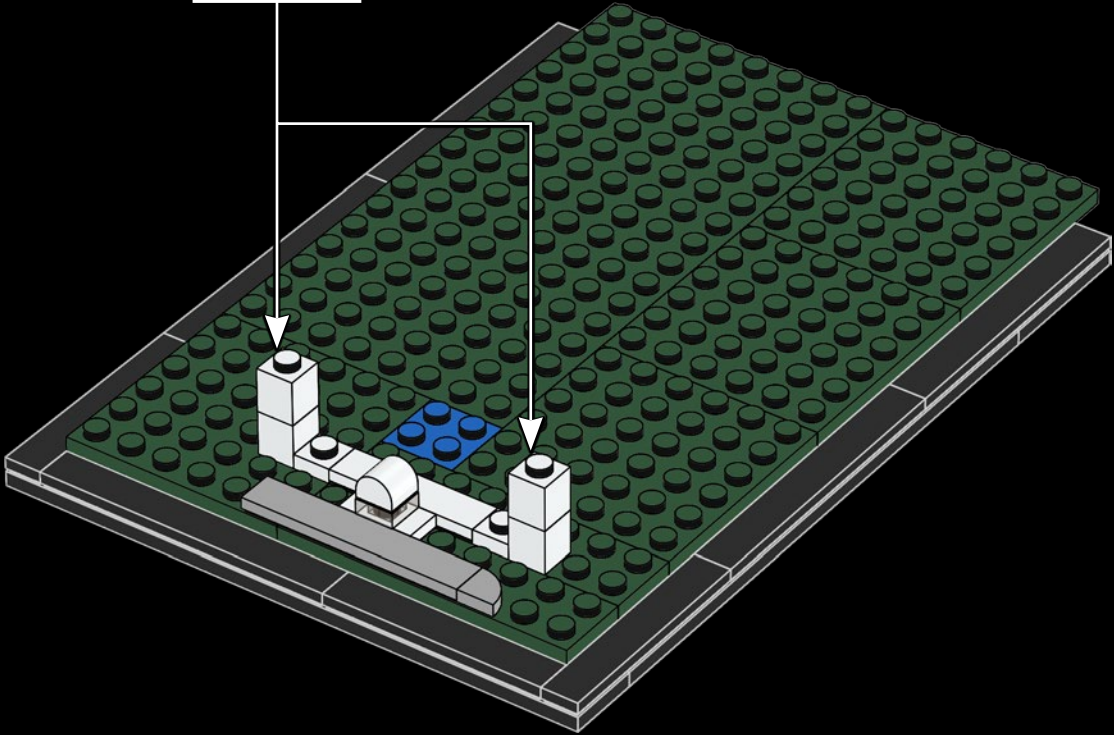
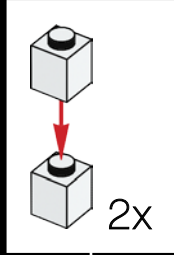

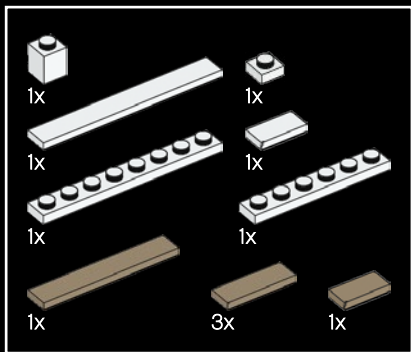

184

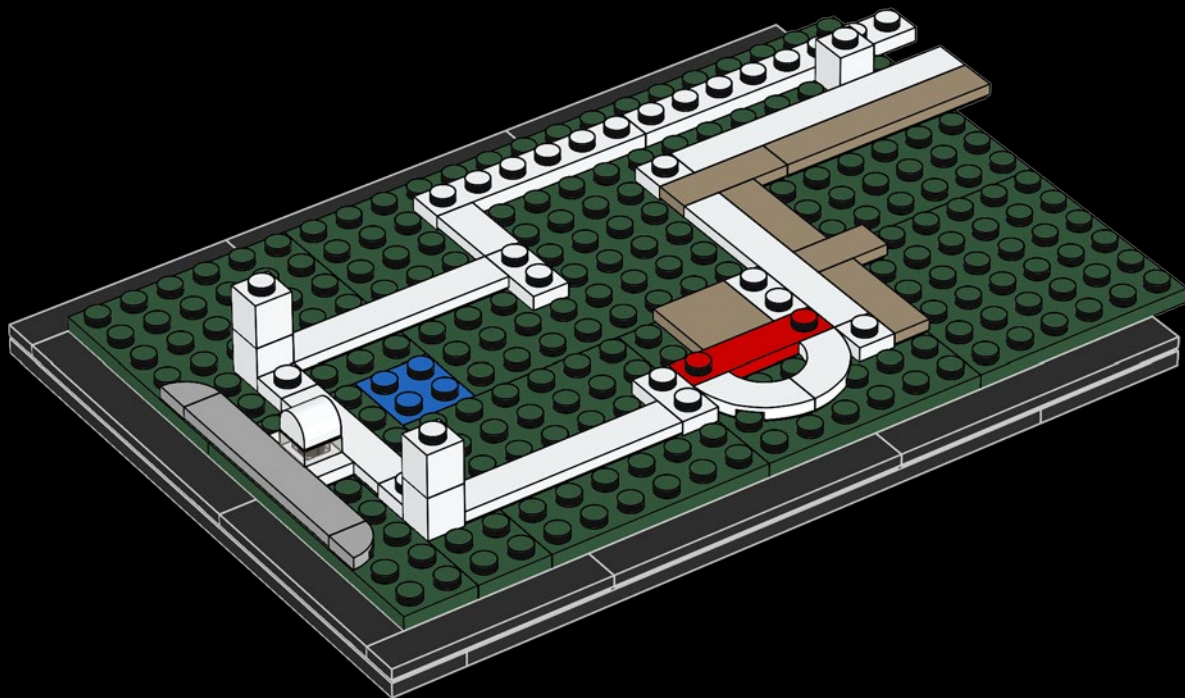



14x

185



7x

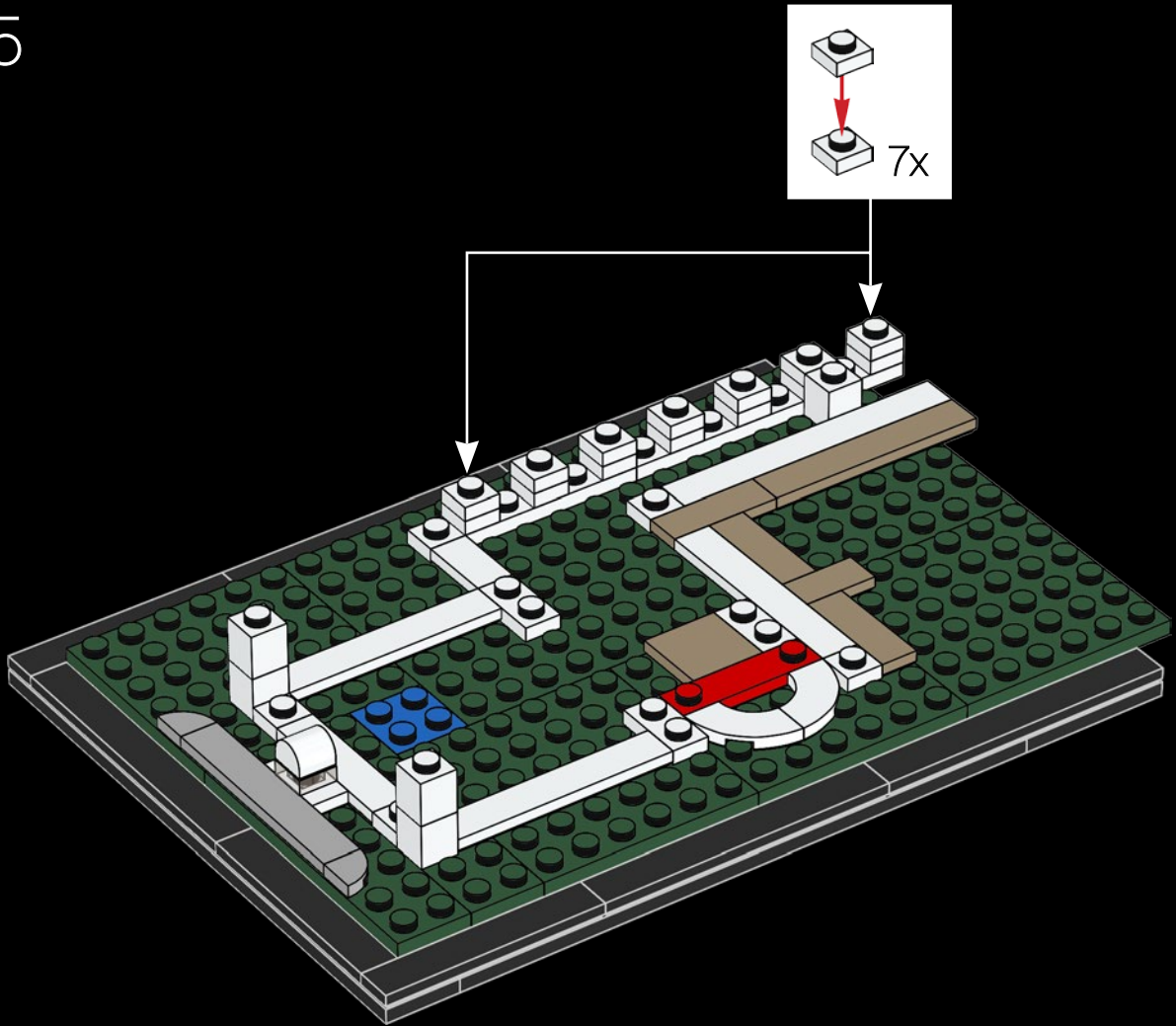



186

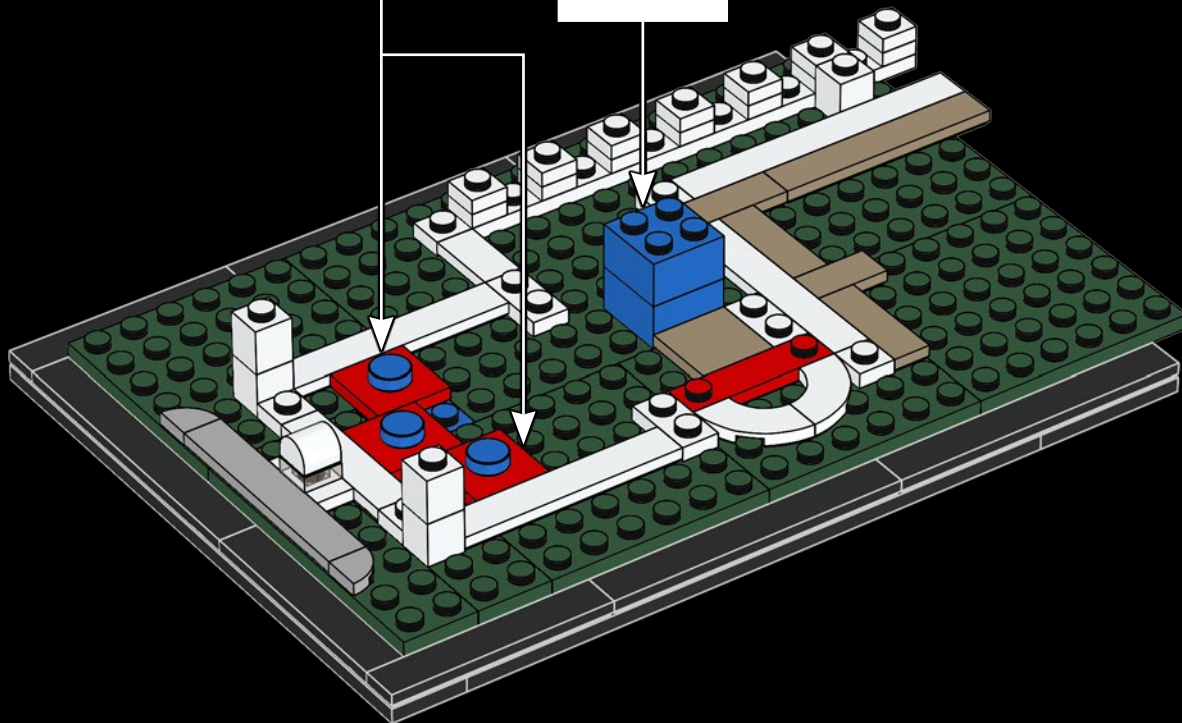
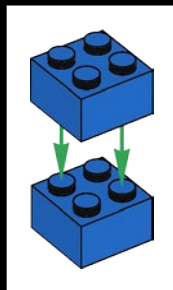
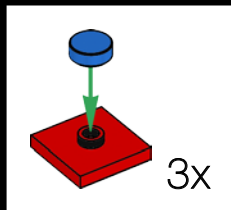



187

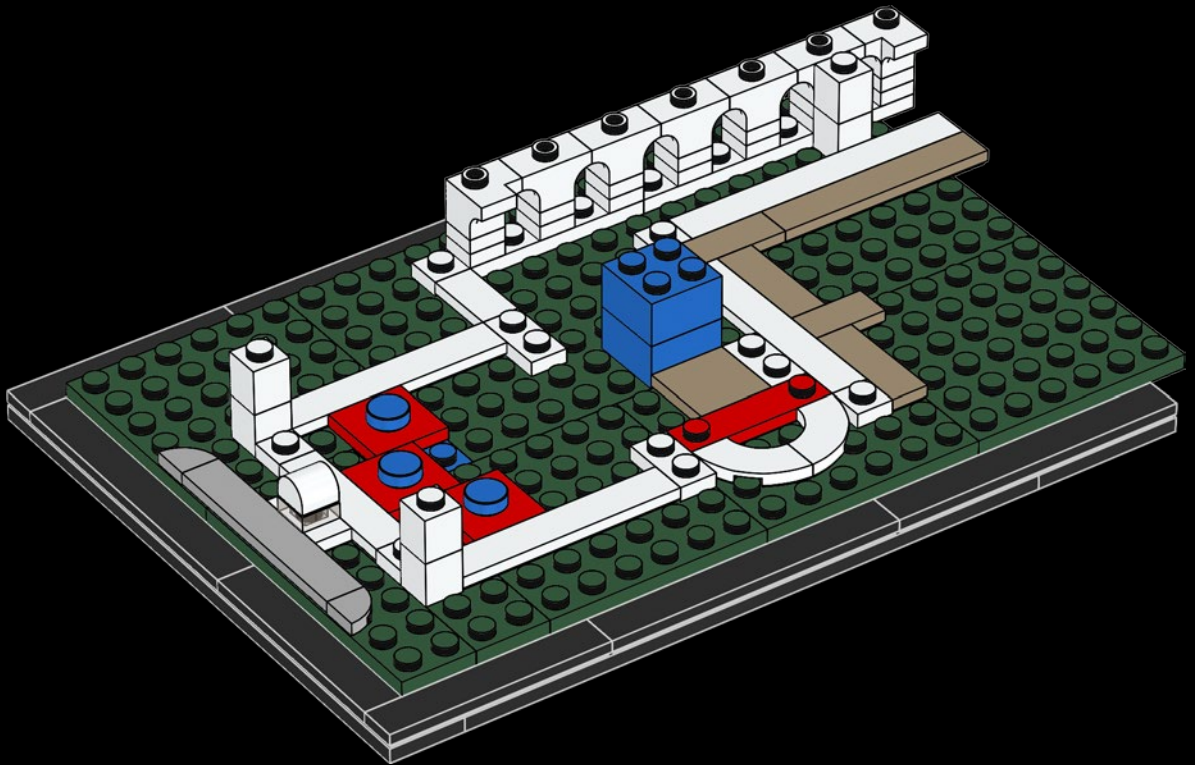



188

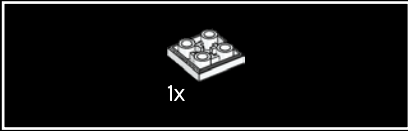
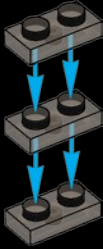

189

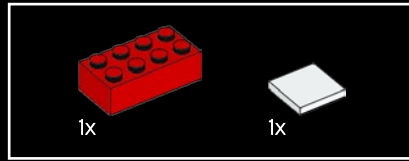
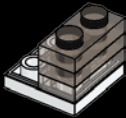

190

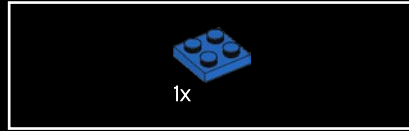
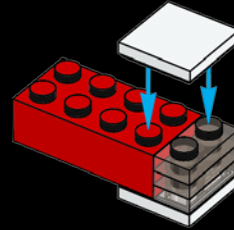

191

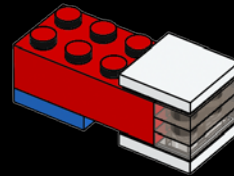

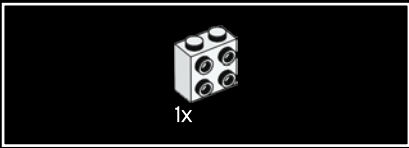

192

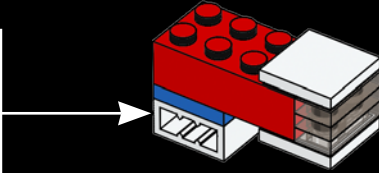
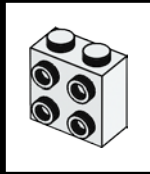

193

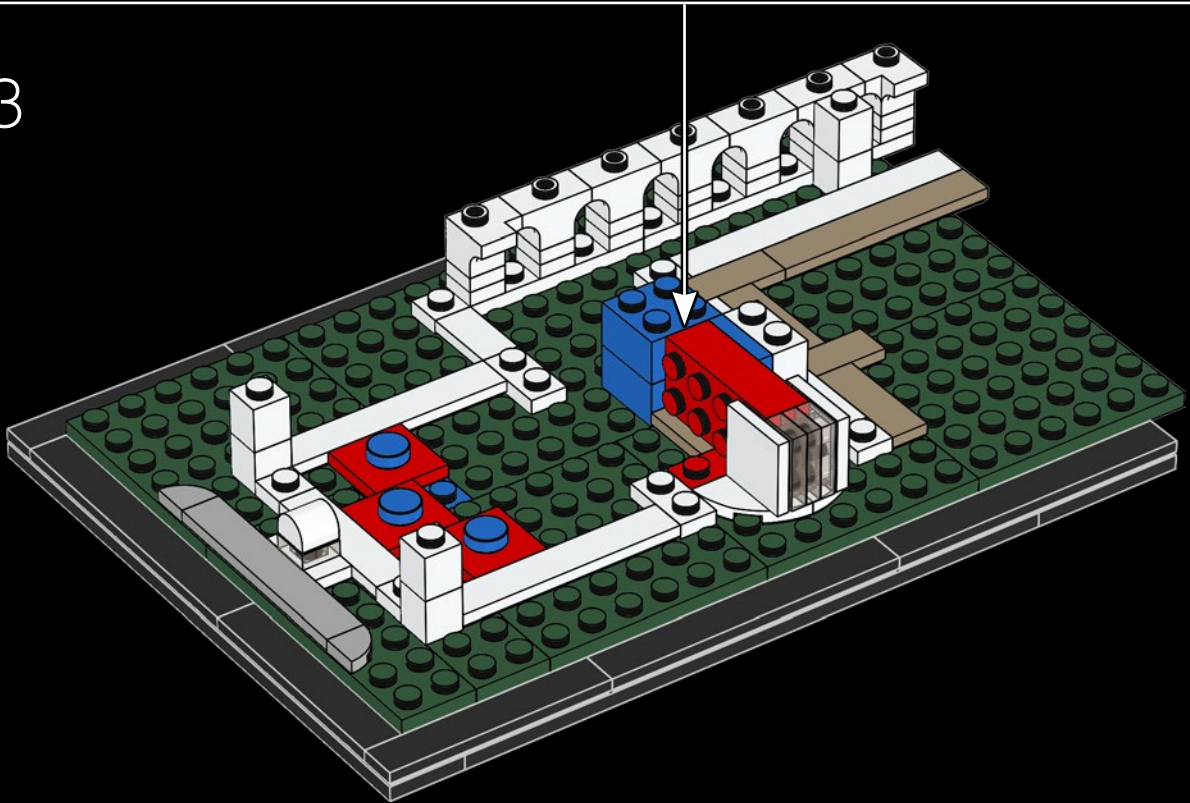

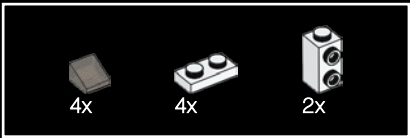

194

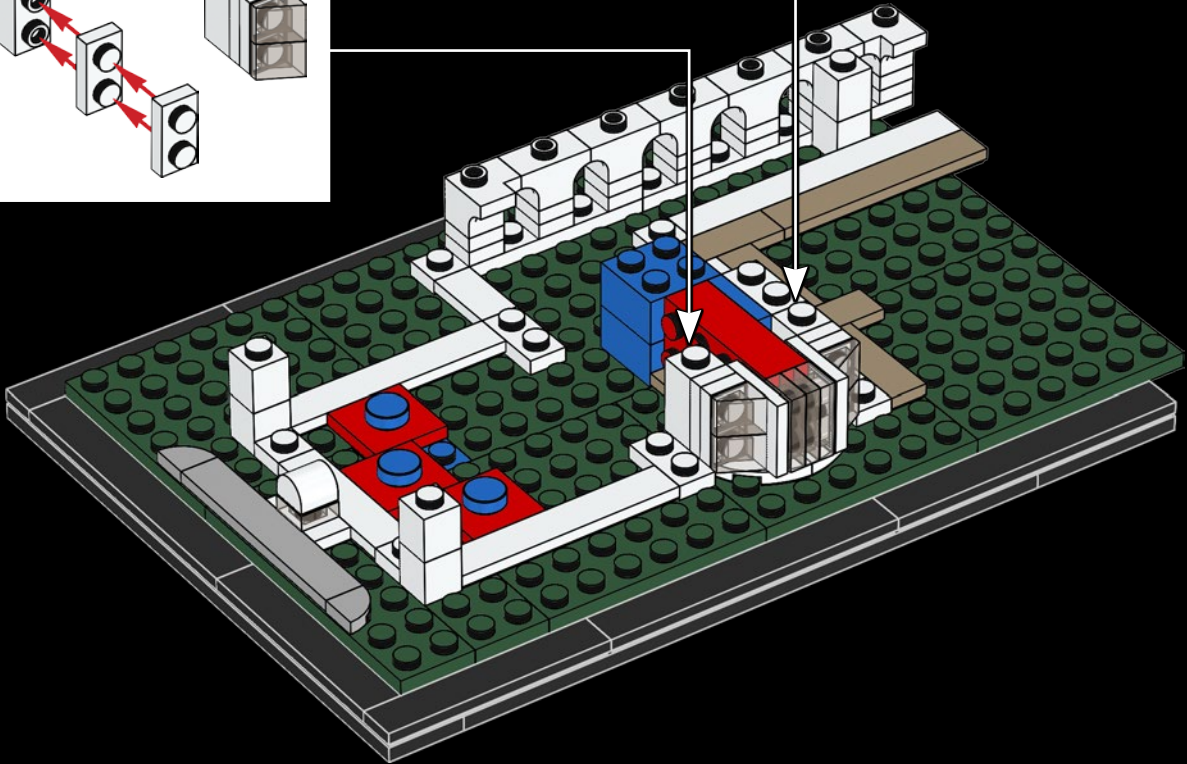
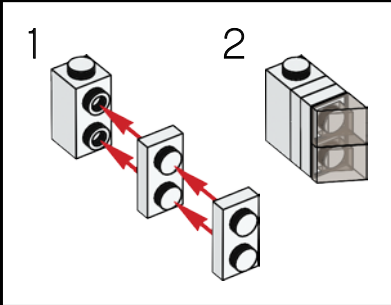
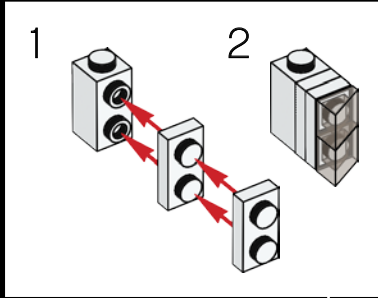

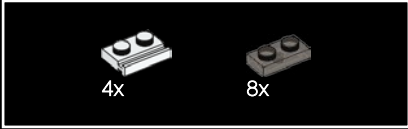

195

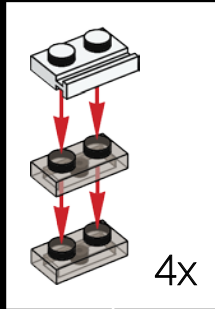

196



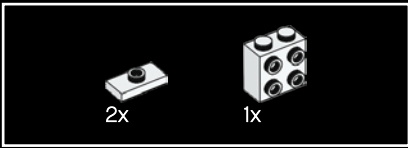

197

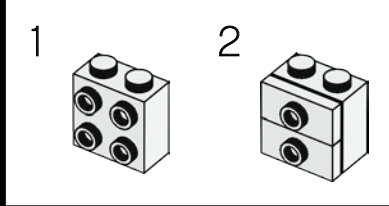

198

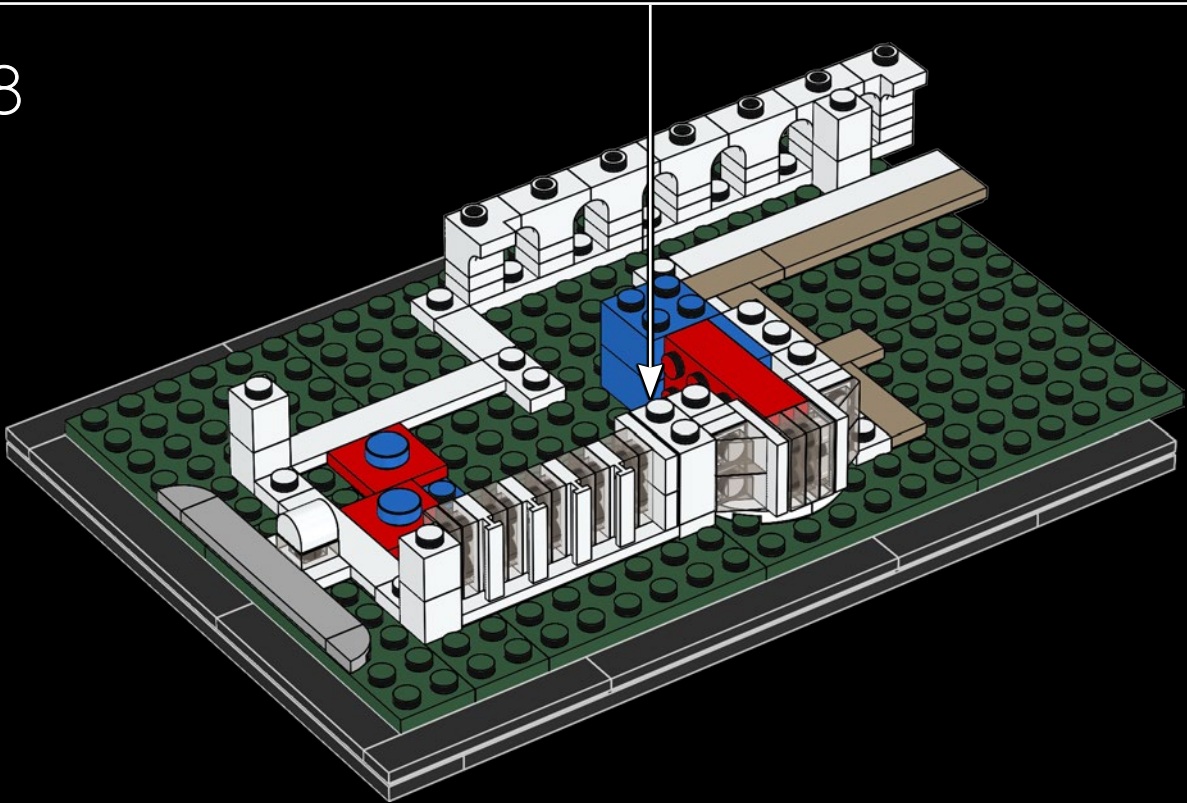

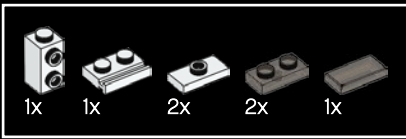

199

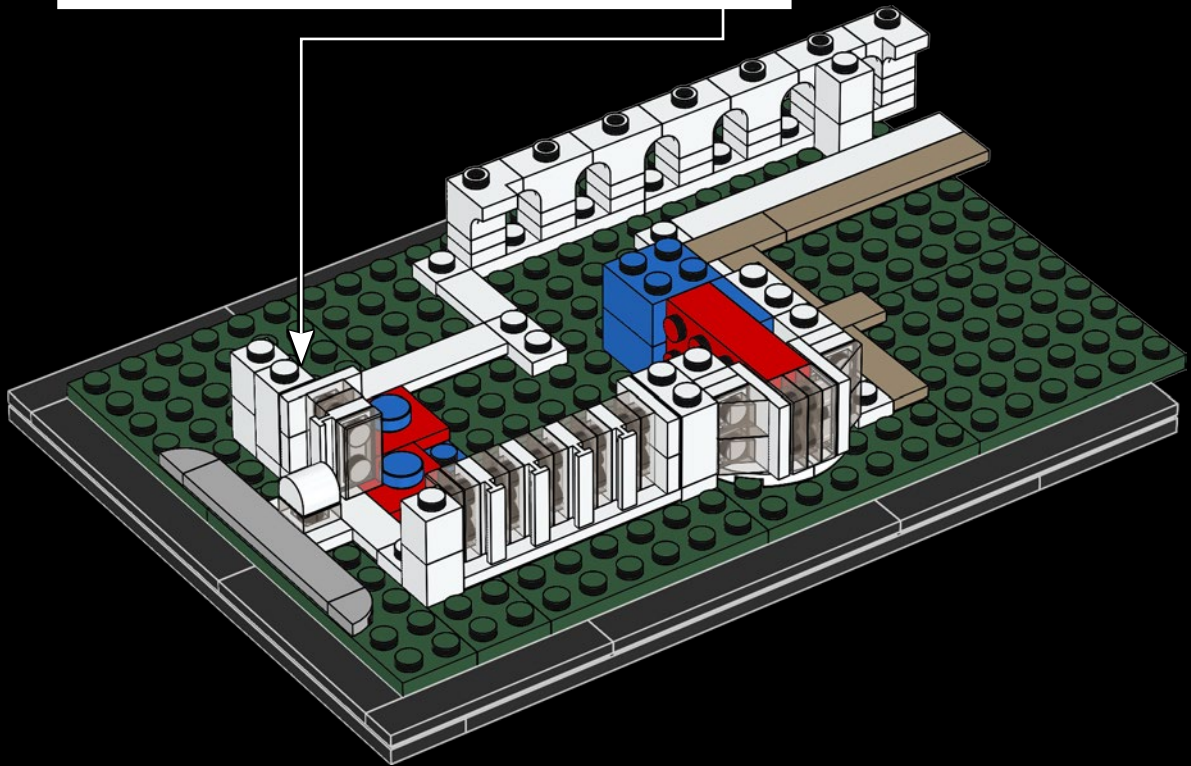
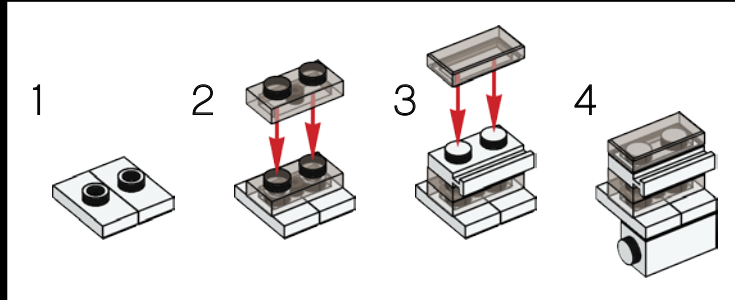

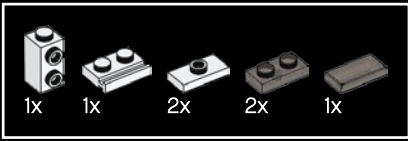

200

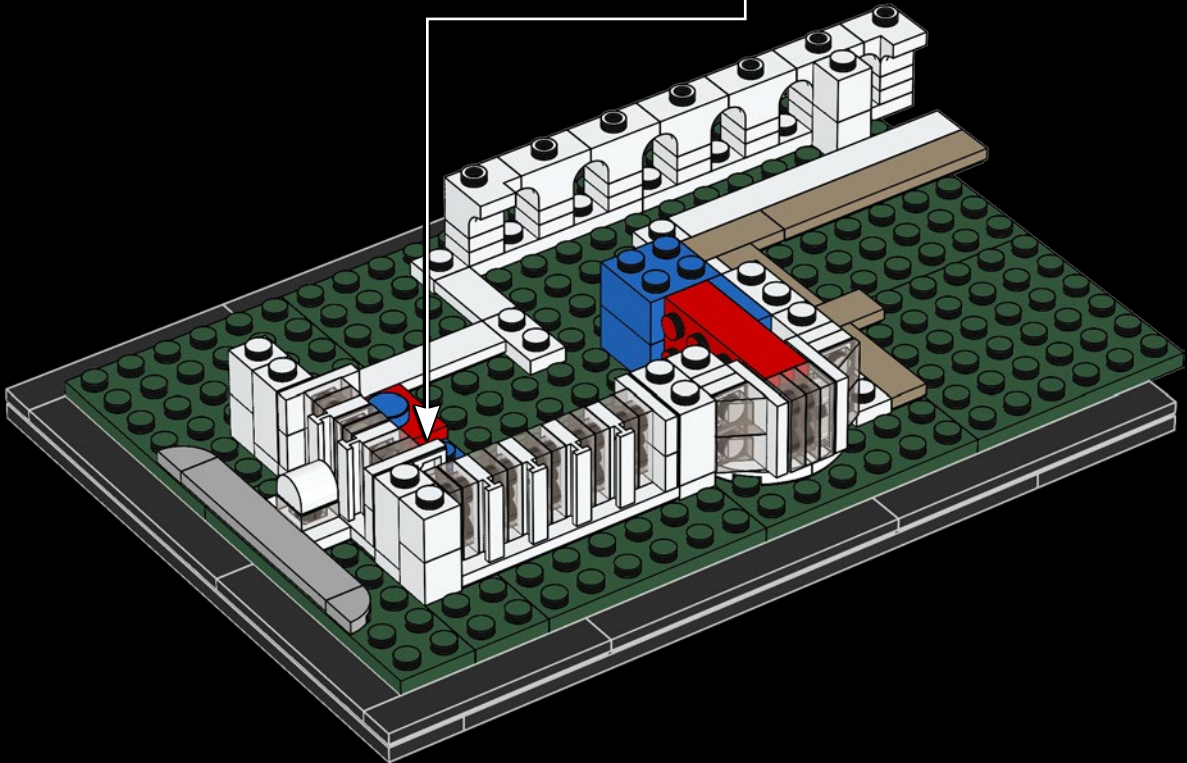
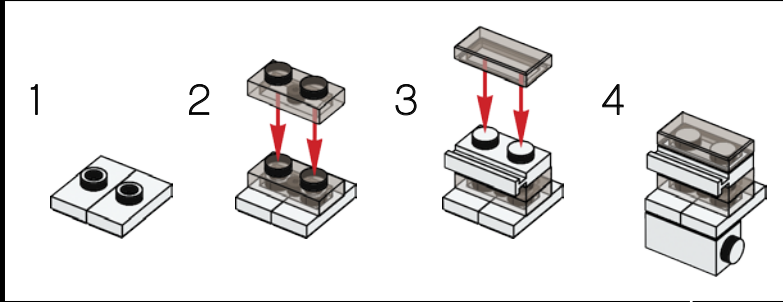



201

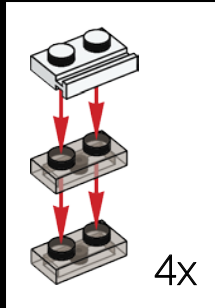

202



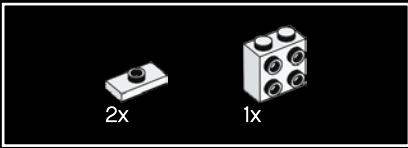

203

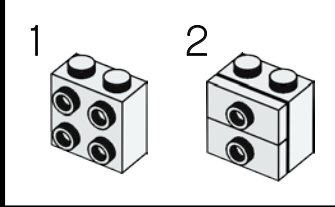

204

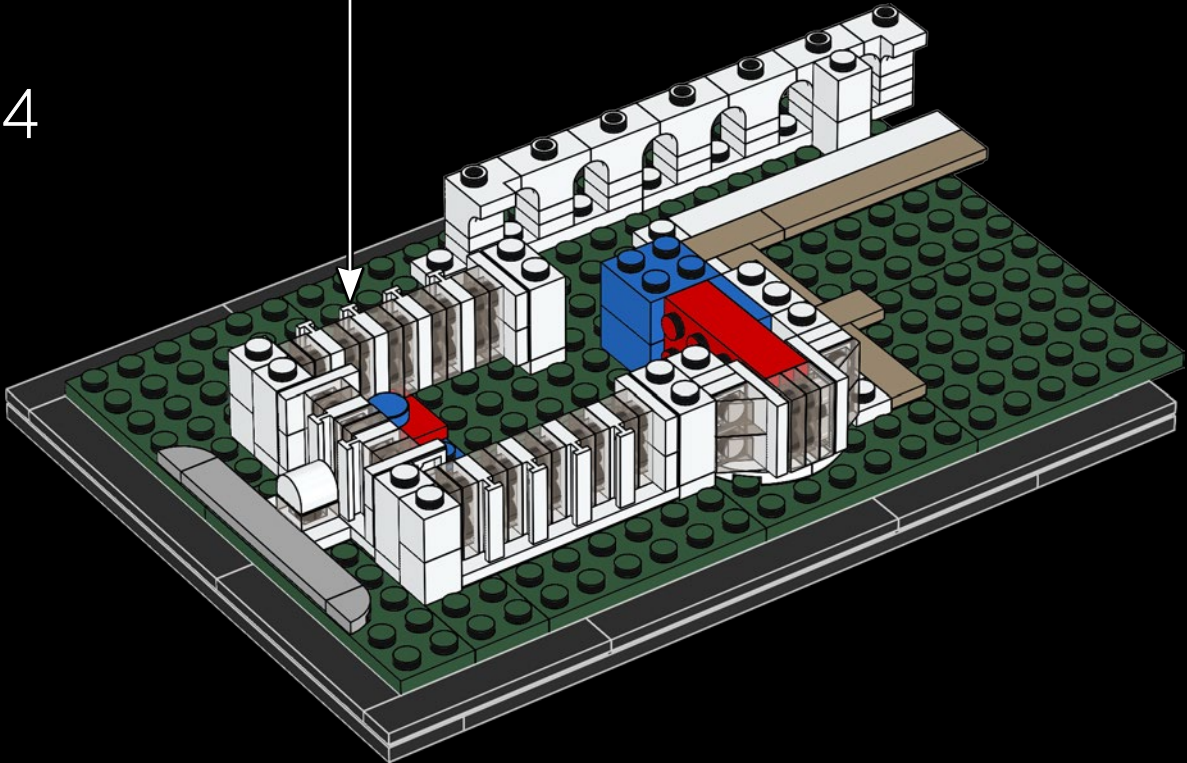

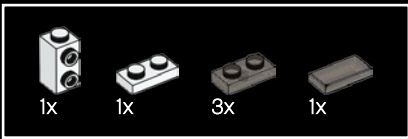

205

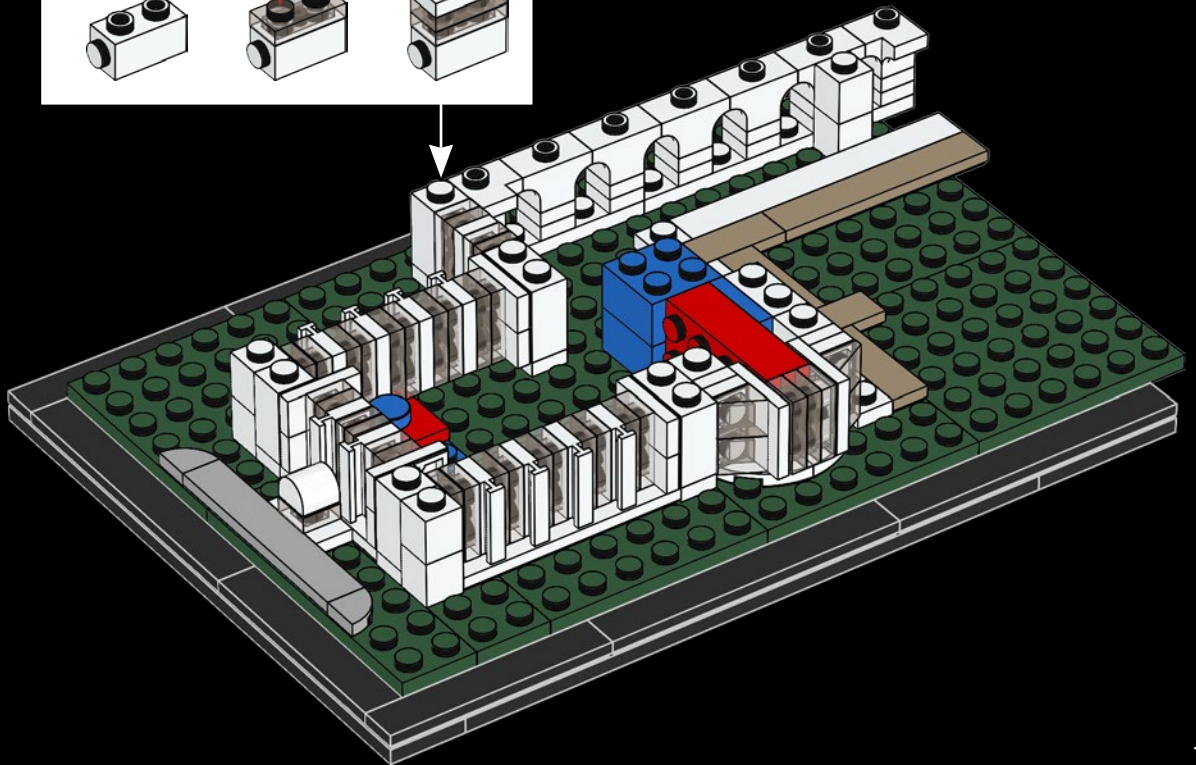
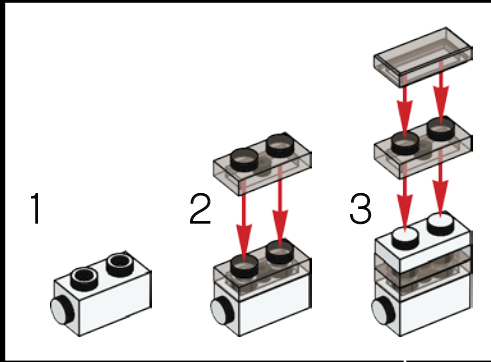



206

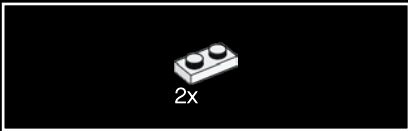
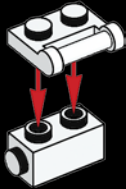

207

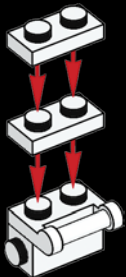

208

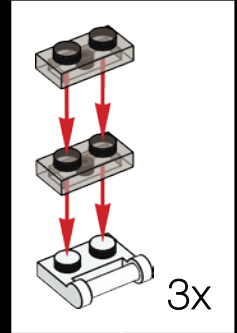

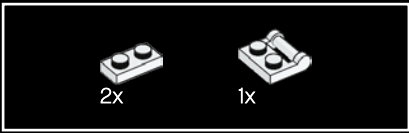

209

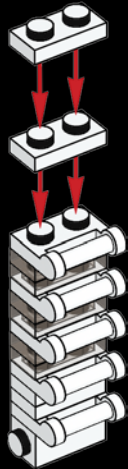

210



The White House receives approximately
6,000 visitors a day
La Maison-Blanche accueille environ
6 000 visiteurs par jour
La Casa Blanca recibe unos
6000 visitantes al día.



211

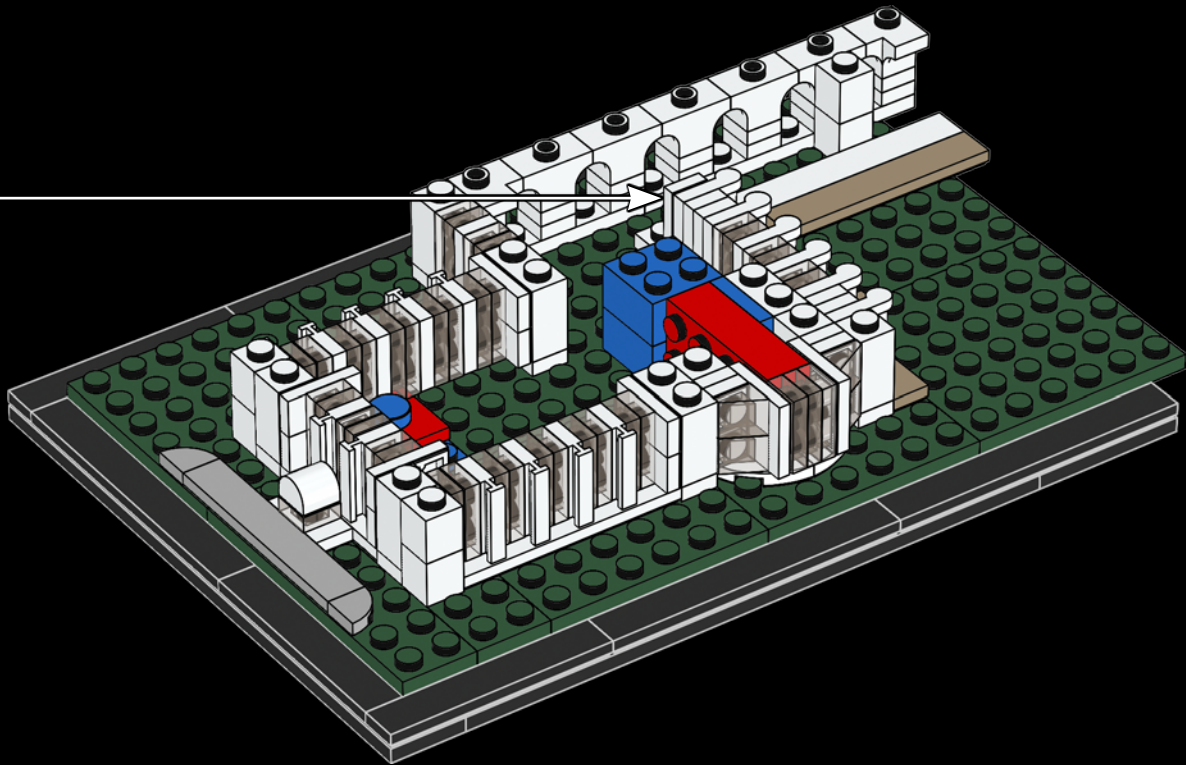

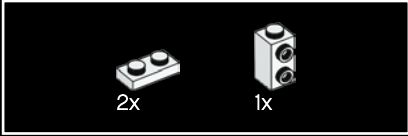
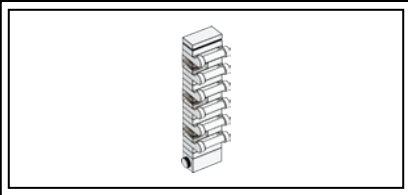

212

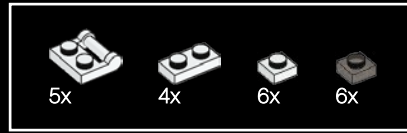
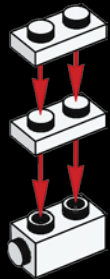

213

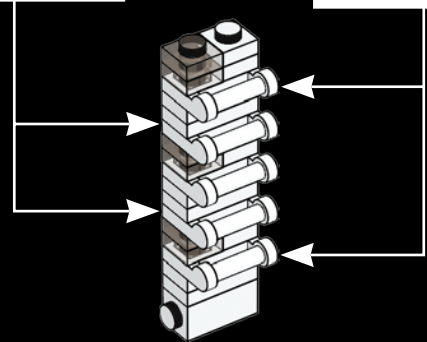
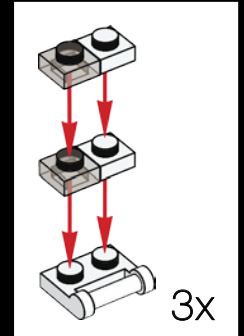
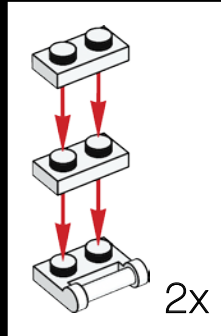

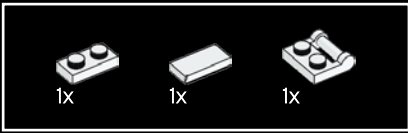

214

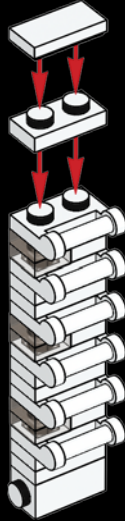

215

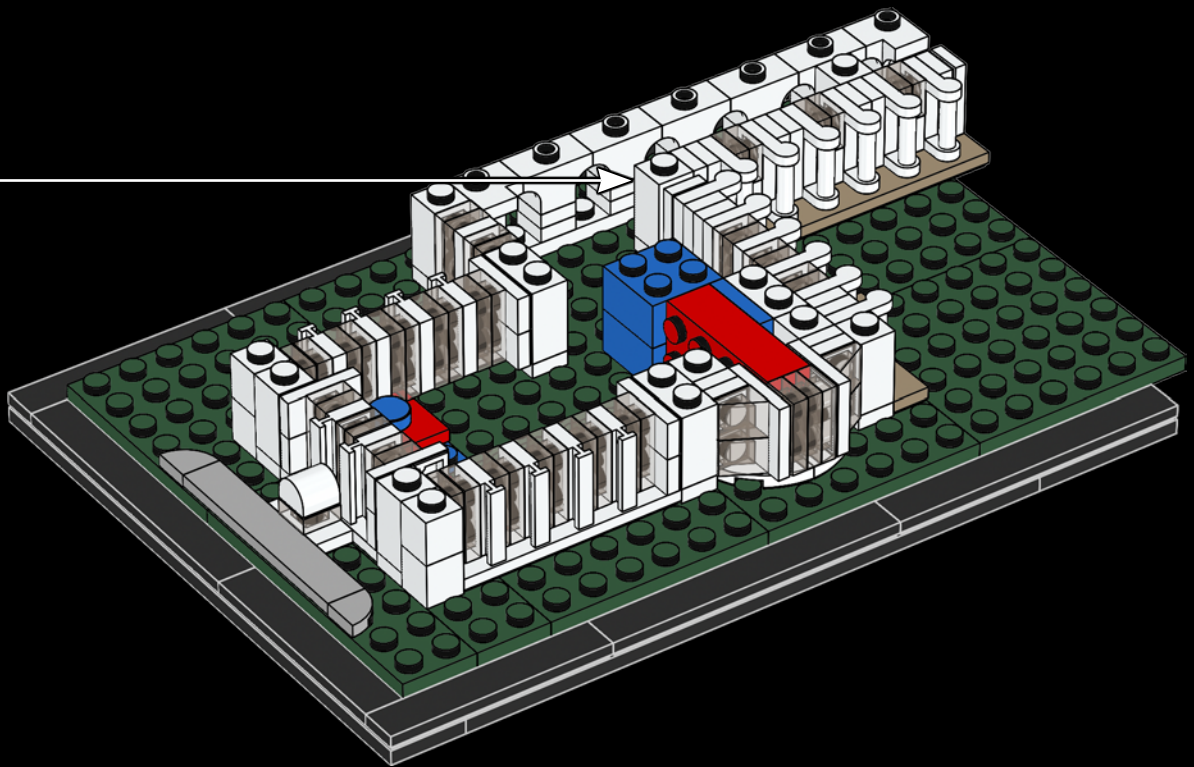

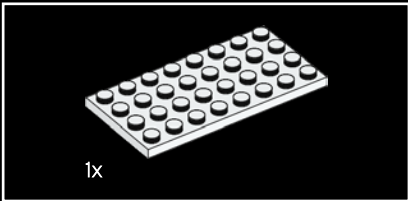
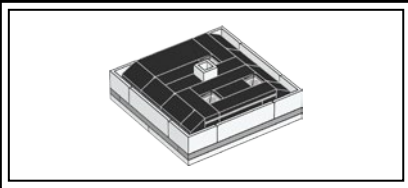

216

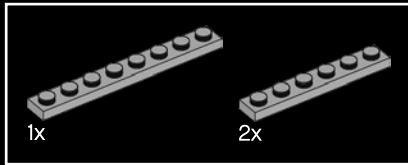
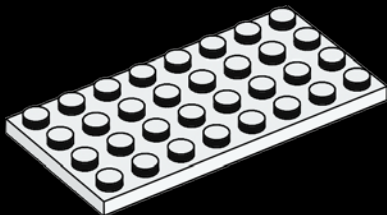

217

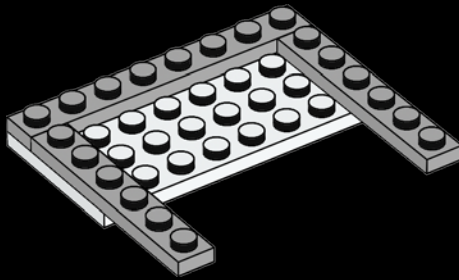

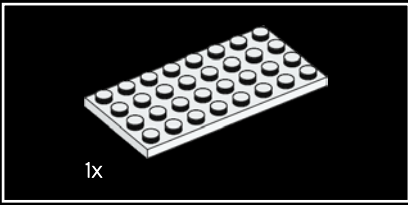

218

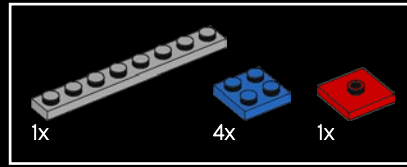
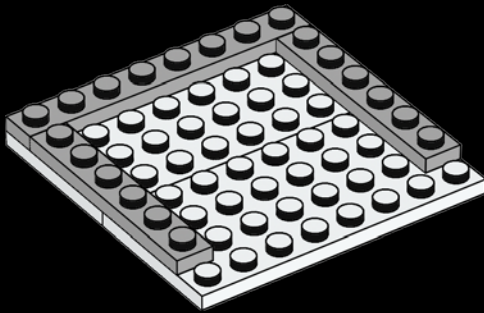

219

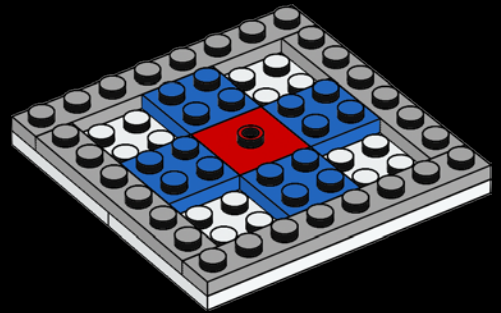

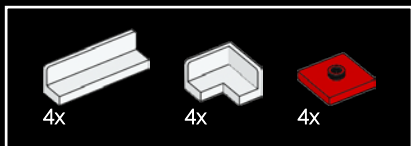

220

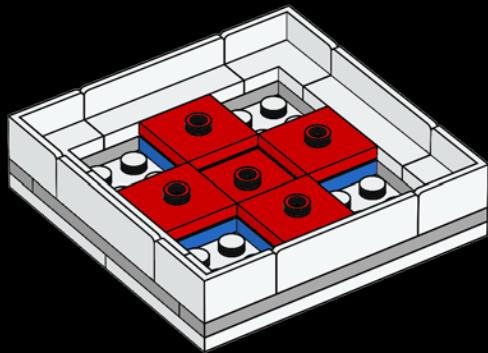

221

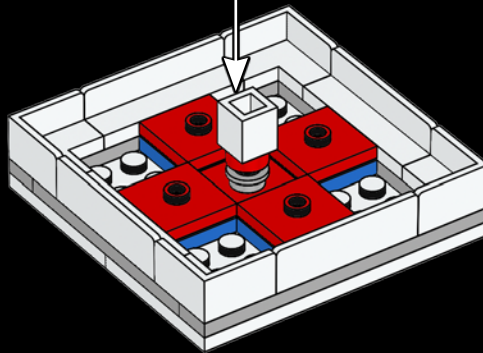
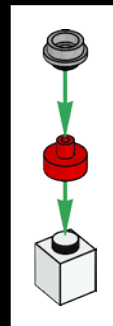

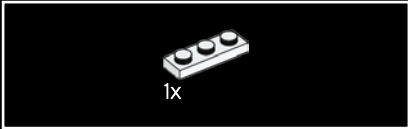
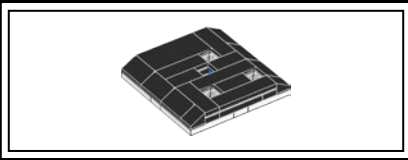

222

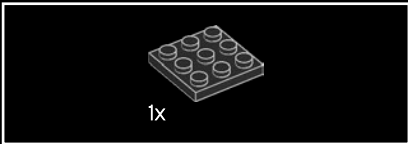

223

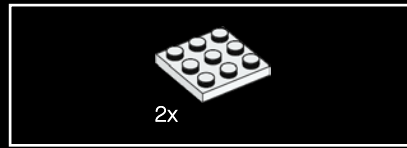

224

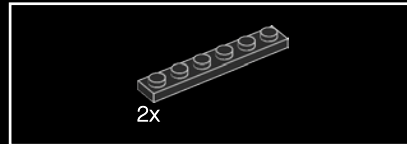
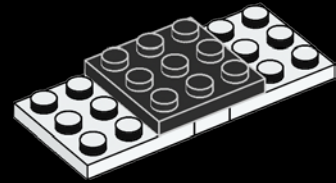

225

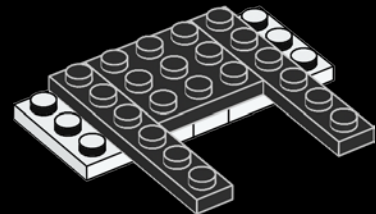

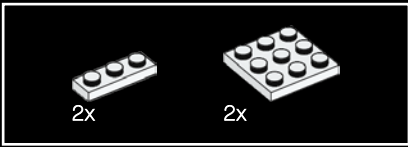

226

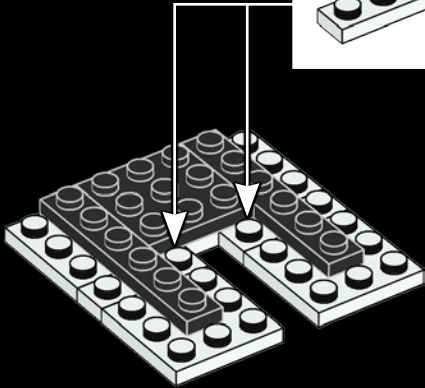
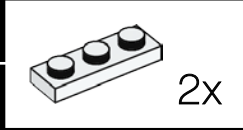

227

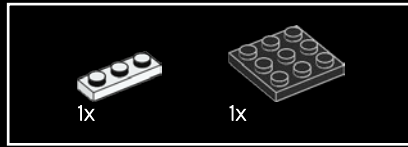
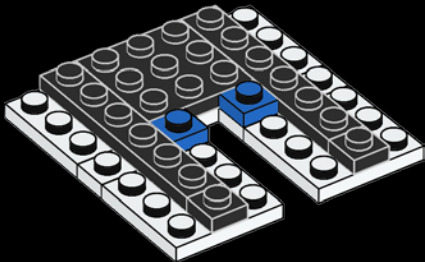

228

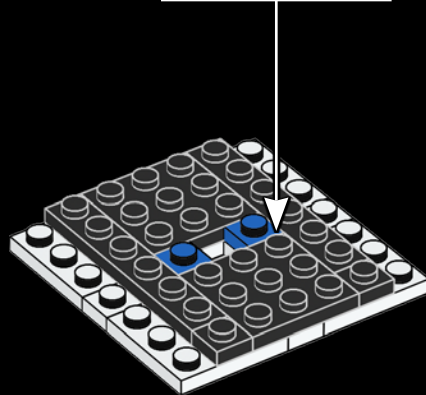
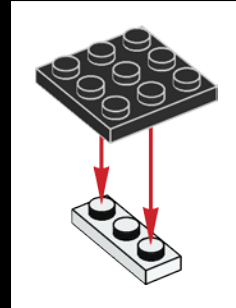

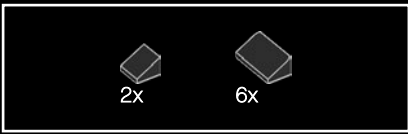

229

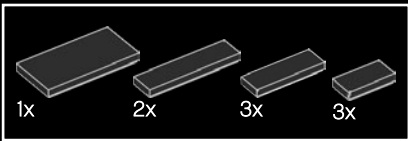
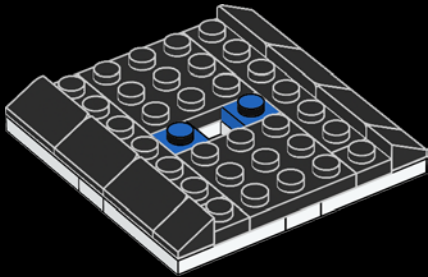

230

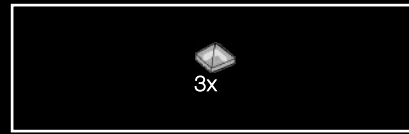
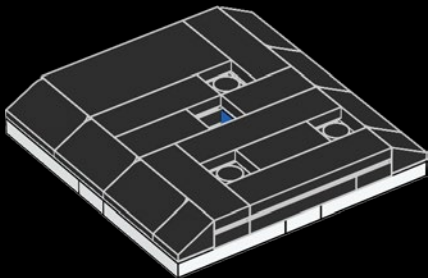

231

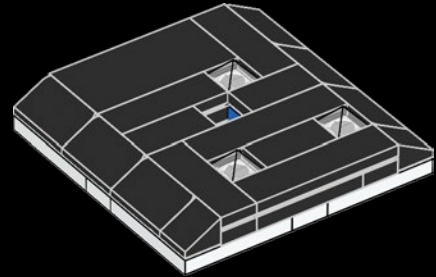

232

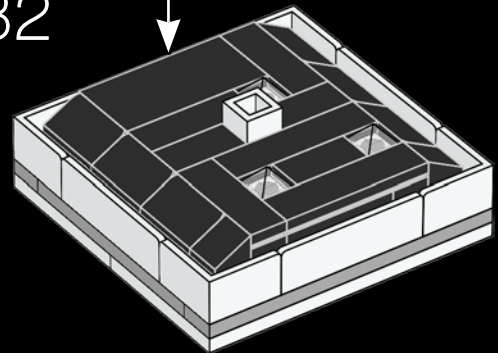

233

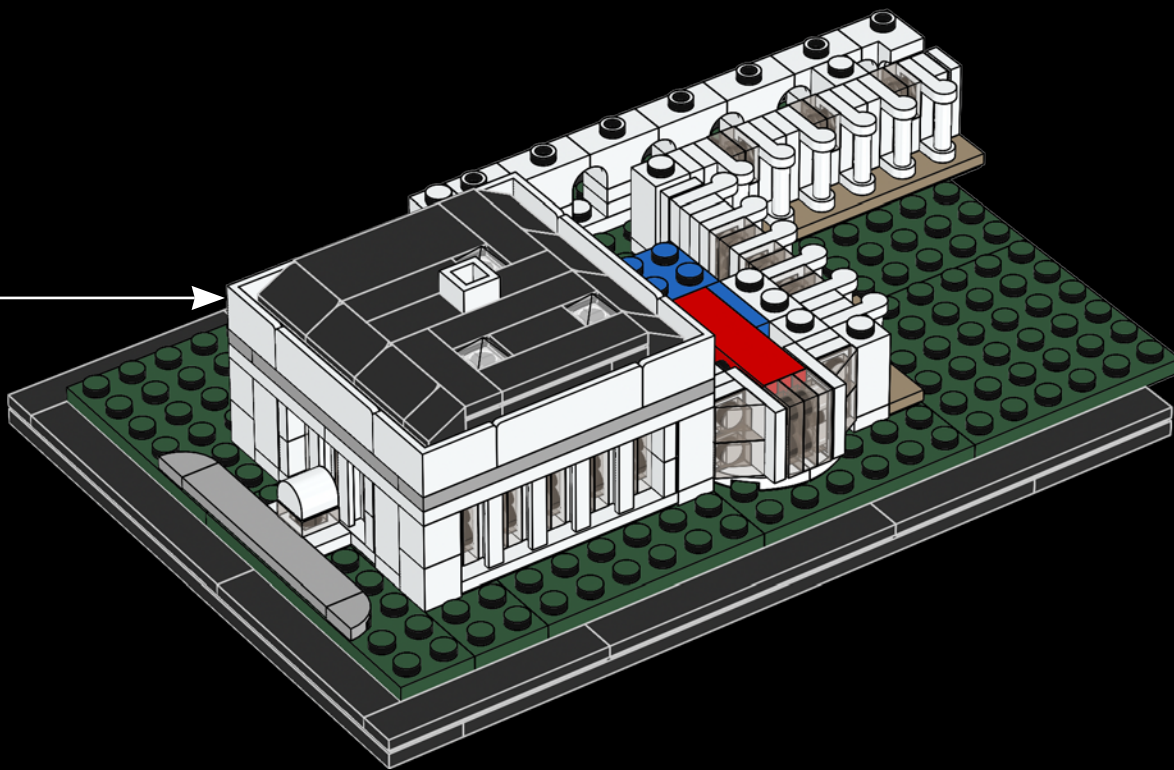

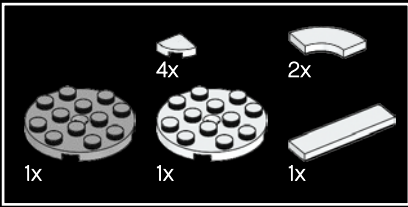

234

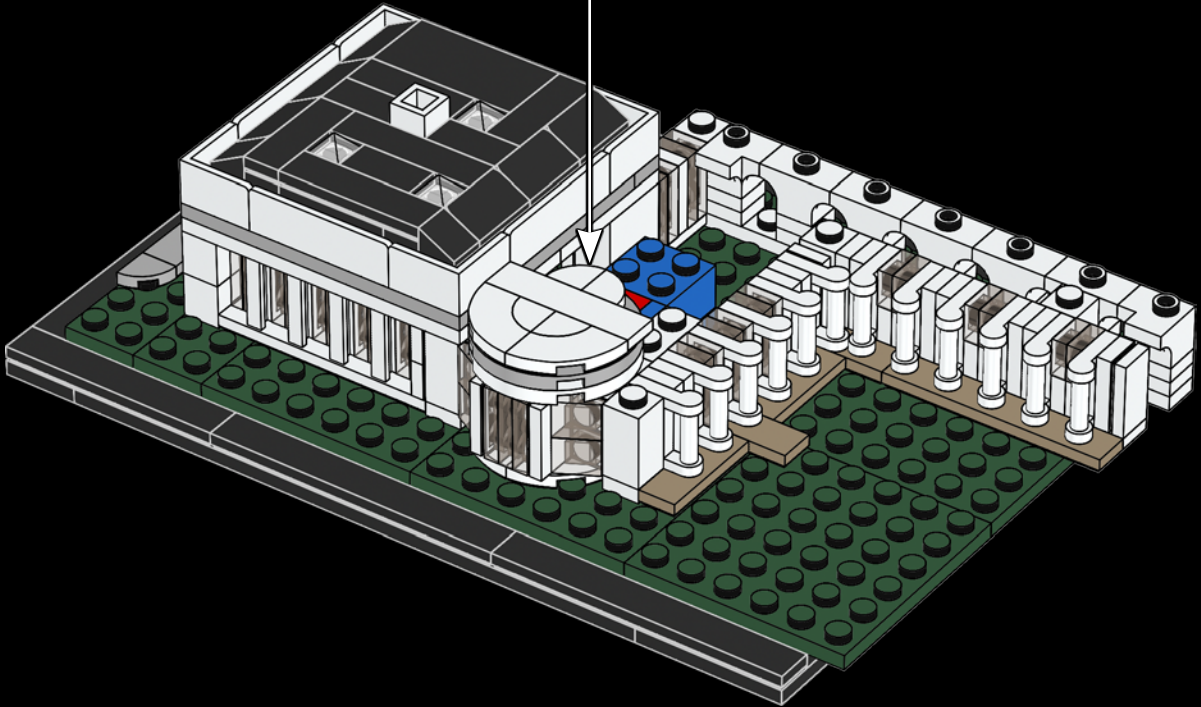
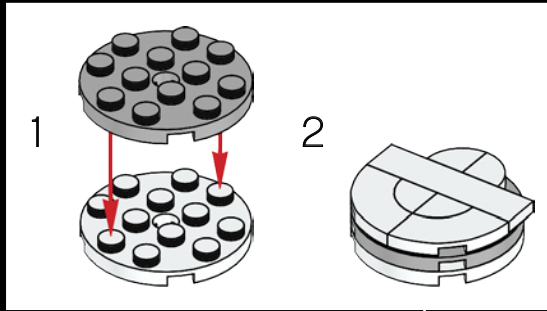

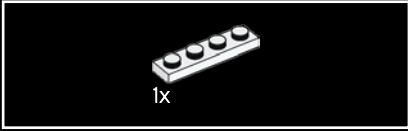
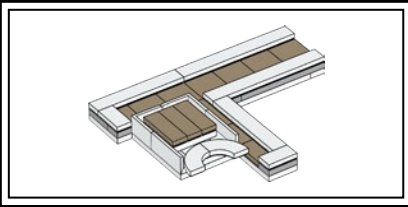

235

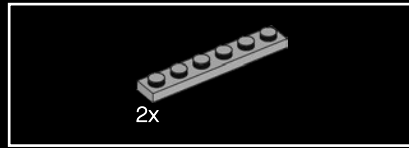

236

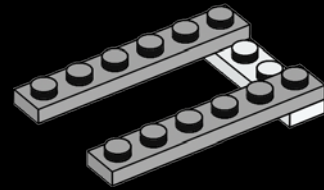

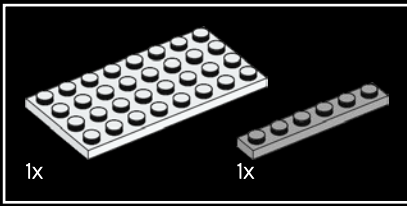

237

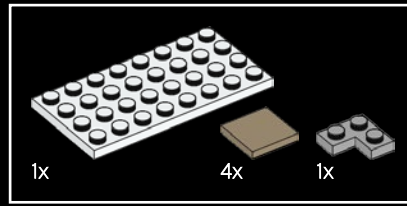
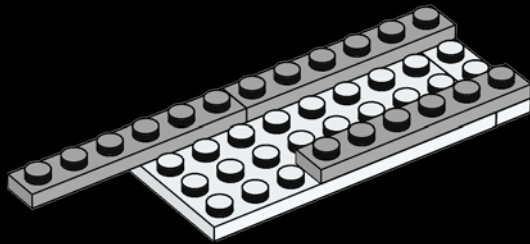

238

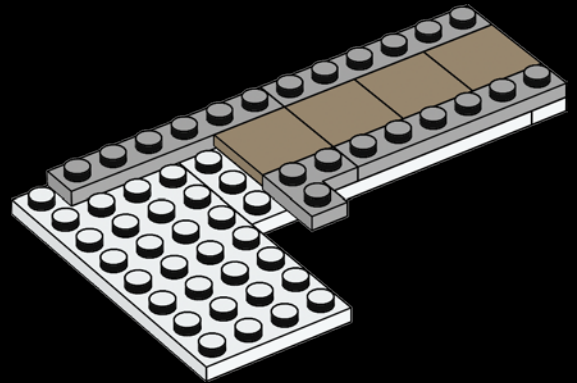

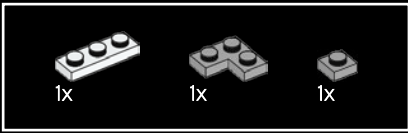

239

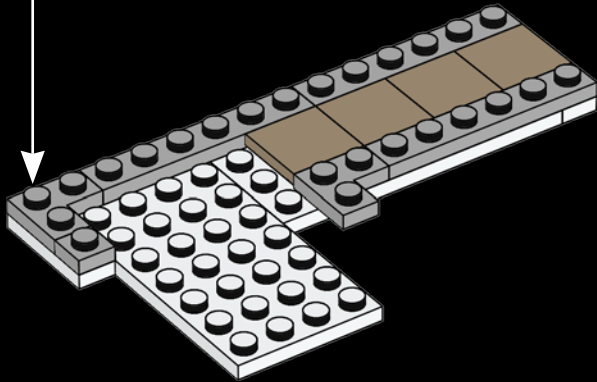
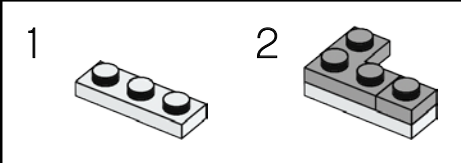

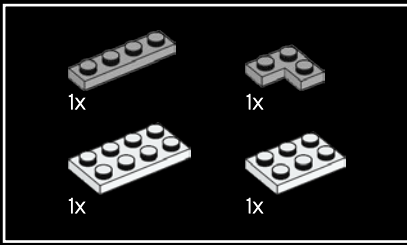

240

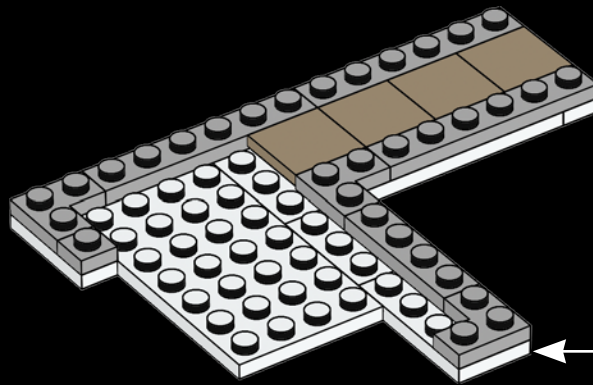
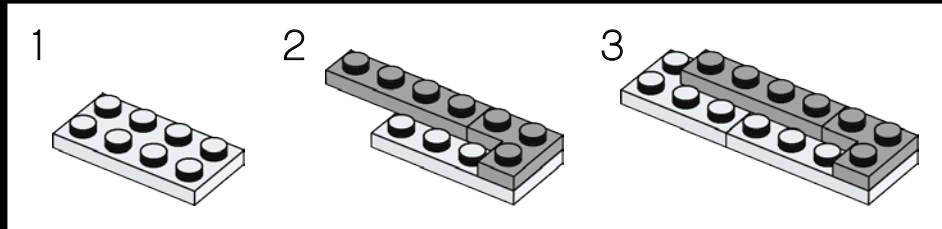

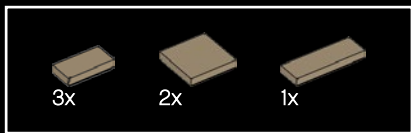

241

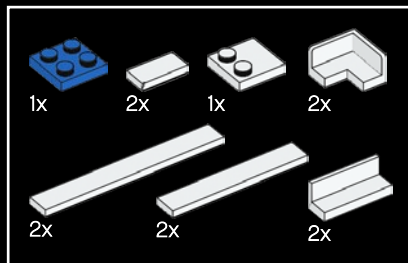
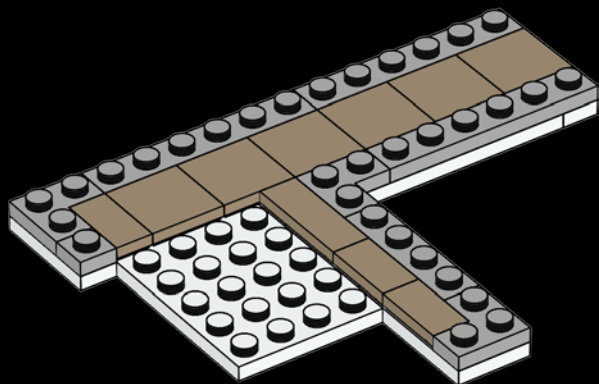

242

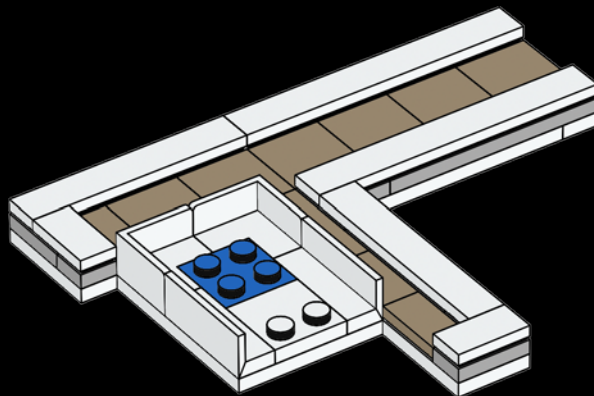

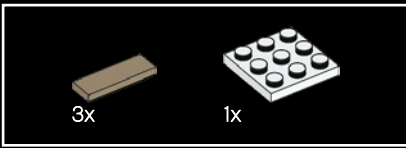

243

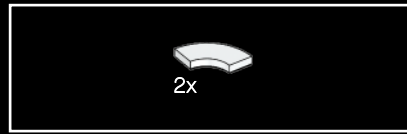
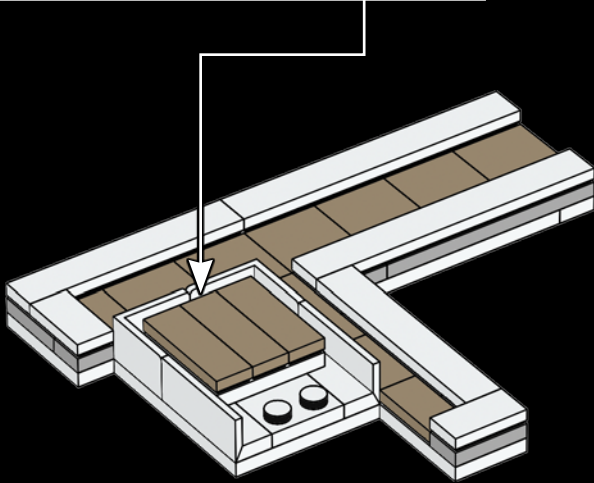
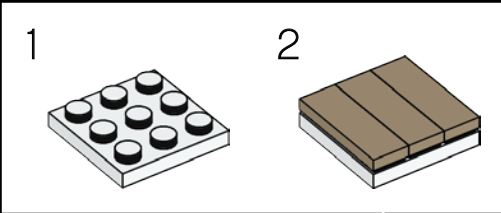

244

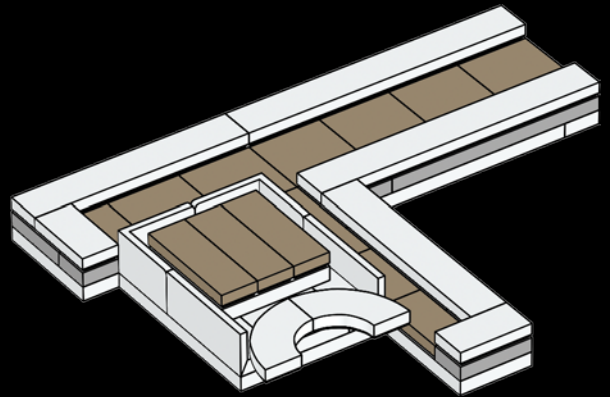

245

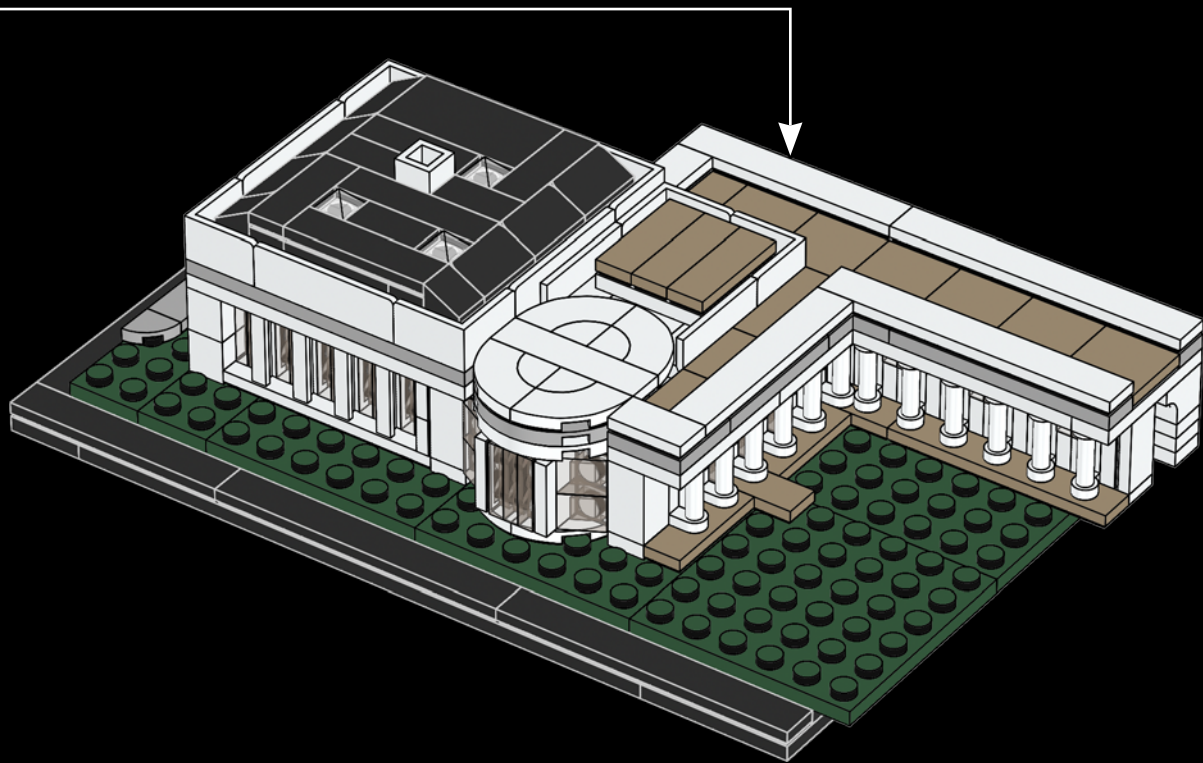

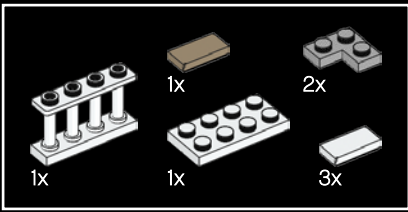

246

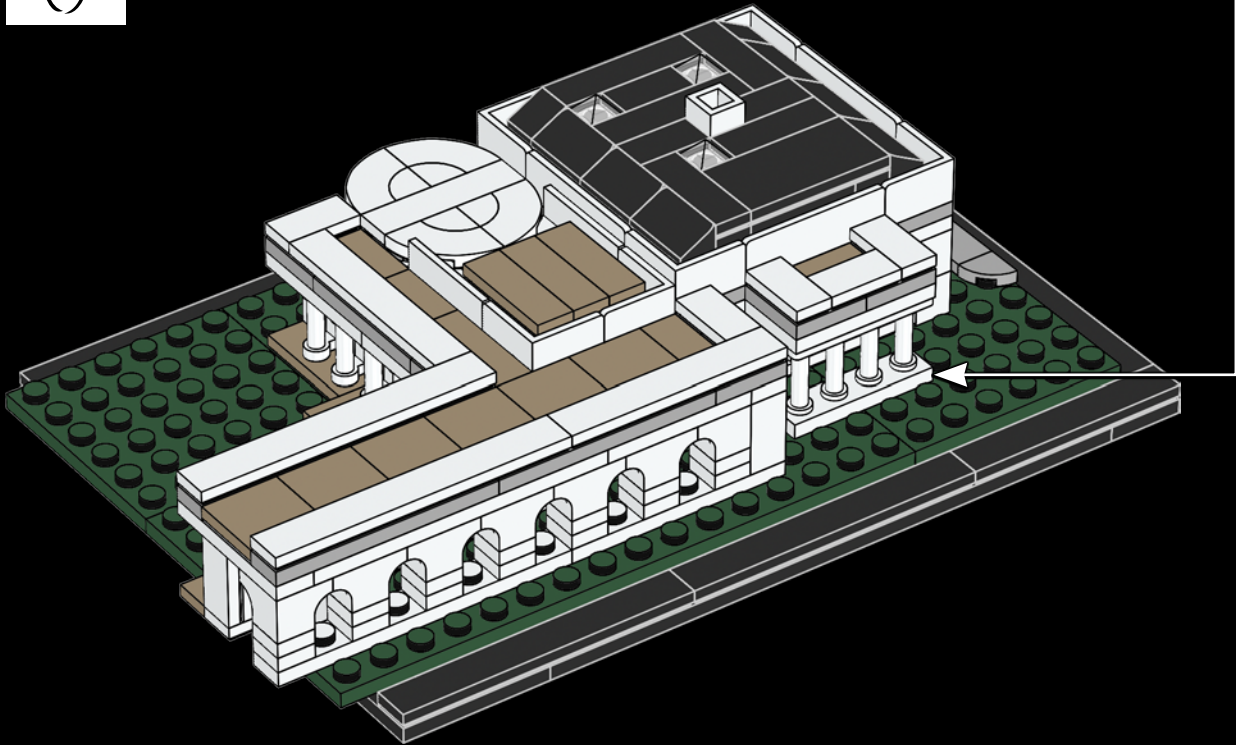
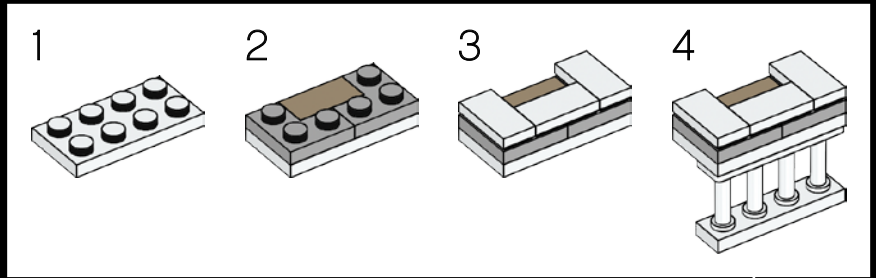
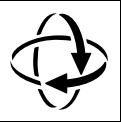



247

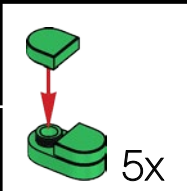
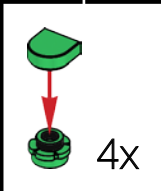
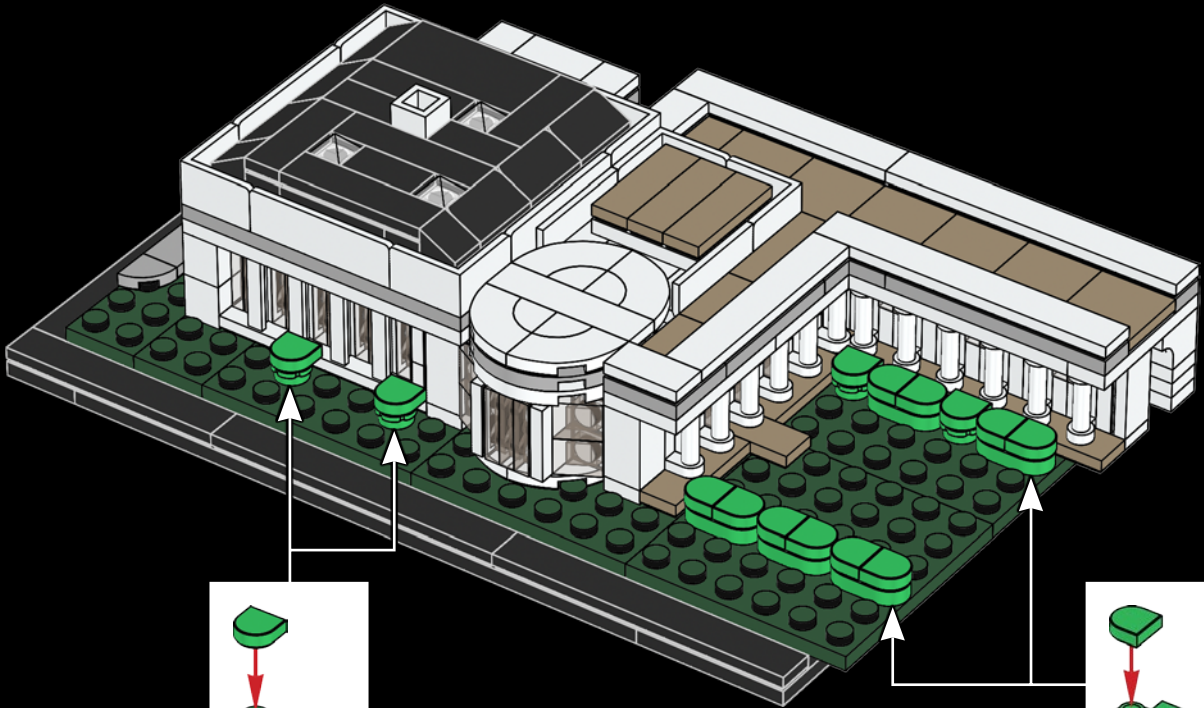



248

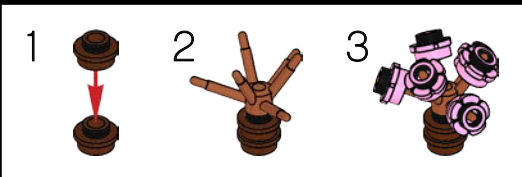
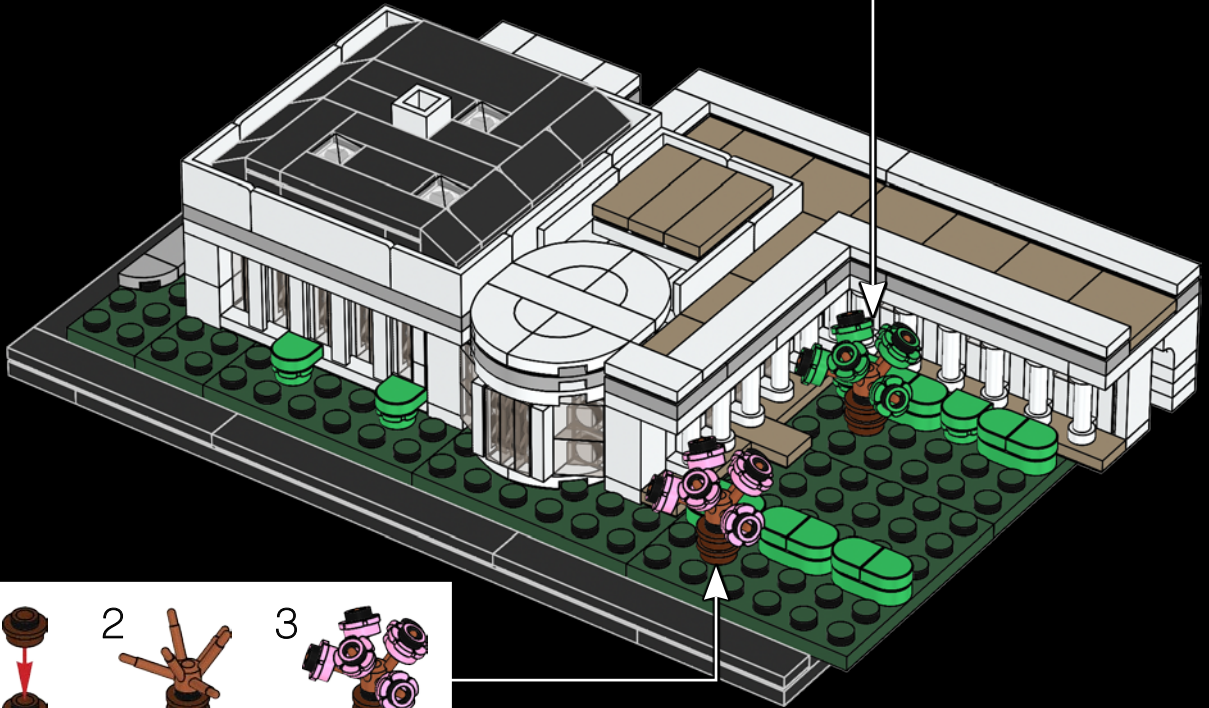
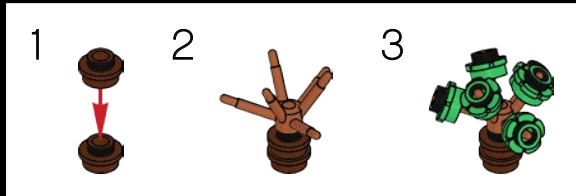

249



President Theodore Roosevelt officially gave the White House its current name in 1901

En 1901, le président Theodore Roosevelt a officiellement donné à la Maison-Blanche son nom actuel

La Casa Blanca fue bautizada oficialmente con este nombre por el presidente Theodore Roosevelt en 1901.

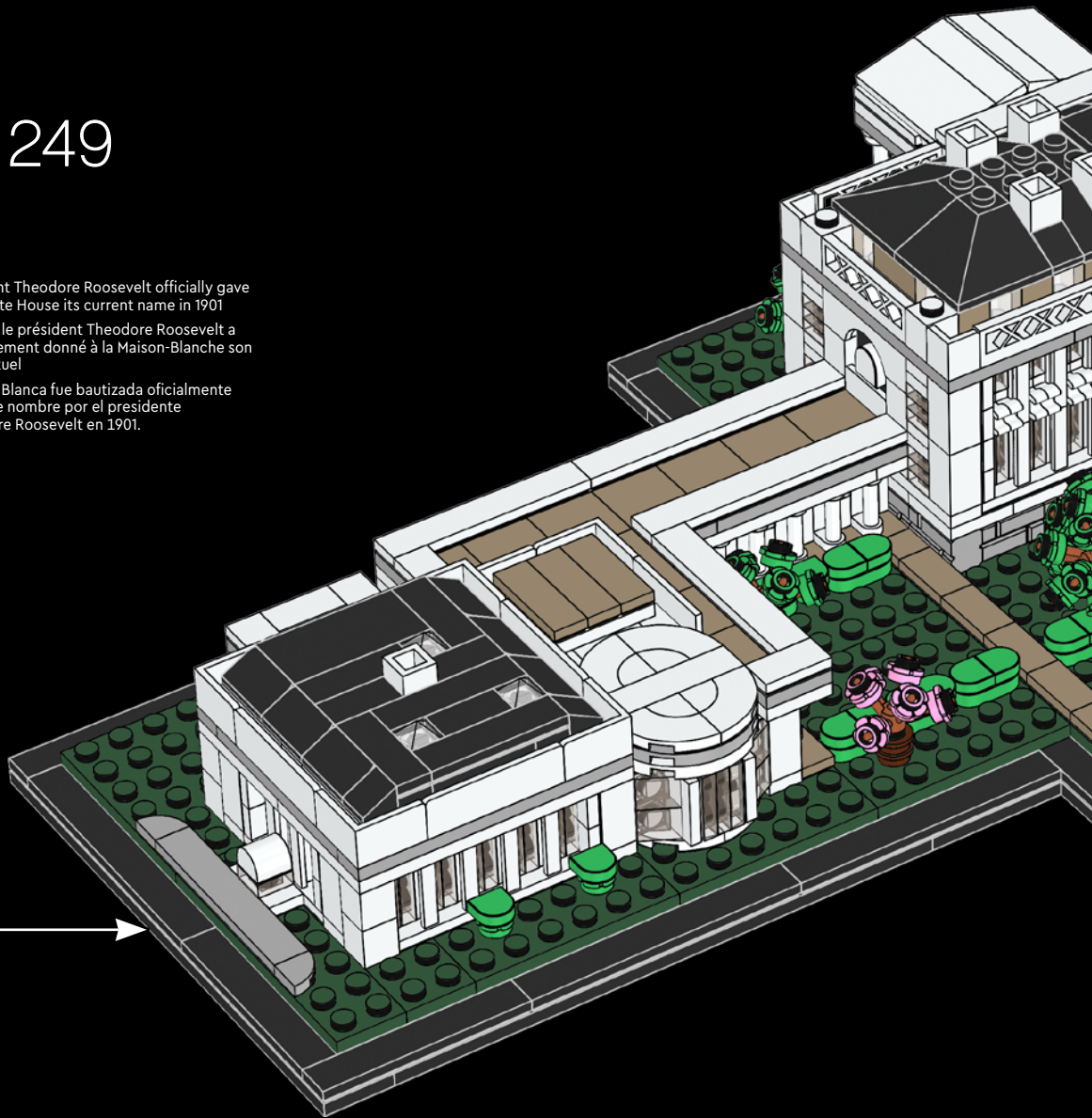



Celebrate the world of architecture and collect all the models
Célébrez le monde de l'architecture et collectionnez tous les modèles
Celebra el mundo de la arquitectura y colecciona todos los modelos

21045
Trafalgar Square



21042
Statue of Liberty
La statue de la Liberté
Estatua de la Libertad



21046
Empire State Building
L'Empire State Building



21028
New York City
New York
Nueva York



21039
Shanghai
Shanghai



21043
San Francisco



21052
Dubai
Dubai
Dubai

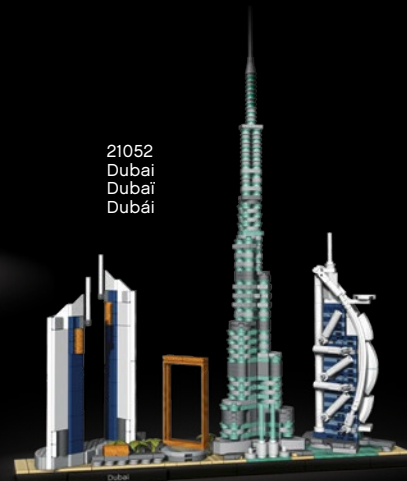

21044
Paris
Paris



21051
Tokyo
Tokyo



21034
London
Londres



The Transamerica Pyramid Building is a registered service mark of Transamerica Corporation and is being used with permission.

© Pyramide du Louvre, architecte I. M. Pei, musée du Louvre.

© TOKYO-SKYTREE

東京スカイツリー®/东京晴空塔®/TOKYO SKYTREE

© Jumeirah International LLC





LEGO® Architecture

The LEGO® Architecture series creatively captures the essence of many of the world's most iconic landmarks while giving you an enjoyable and engaging LEGO building experience.

Whether your interest is in travel, design, history or architecture, these sets are a physical memento of a great trip abroad, a famous building you know well, or a city you still dream of visiting.

Every LEGO Architecture set is designed to be displayed. Much more than just a photo, building and displaying your model on your desk, in the bookcase or on the shelf, lets you be transported every time you admire the view.

La série LEGO® Architecture capture l'essence de nombreux monuments parmi les plus célèbres du monde tout en vous offrant une expérience agréable et stimulante de construction LEGO.

Que votre intérêt porte sur les voyages, le design, l'histoire ou l'architecture, ces ensembles constituent un souvenir tangible d'un voyage mémorable, d'un célèbre bâtiment que vous connaissez bien ou d'une ville que vous rêvez de visiter.

Chaque ensemble LEGO Architecture est conçu pour être exposé. Construire votre modèle et l'exposer sur votre bureau, une bibliothèque ou une tablette vous fera voyager à chaque coup d'œil, bien plus qu'une simple photo ne pourrait le faire.

La línea LEGO® Architecture captura con creatividad la esencia de muchos de los monumentos más populares del mundo y pone a tu alcance una experiencia de construcción gratificante y cautivadora con el sello característico de LEGO.

Ya sea que sientas atracción por los viajes, el diseño, la historia o la arquitectura, estos sets expresan físicamente tus recuerdos de aquel fantástico viaje al extranjero, ese famoso edificio que conoces tan bien o la ciudad que sueñas con visitar algún día.

Todos los sets LEGO Architecture están diseñados para decorar. Mucho más que una simple fotografía, construir y exhibir un modelo en tu escritorio, un librero o una repisa te traslada a otro lugar al admirar las vistas.

Follow us on

Suivez-nous sur



Síguenos en

Adam Reed Tucker is the co-developer of the LEGO Architecture product line.

Adam Reed Tucker est le codéveloppeur de la gamme de produits LEGO Architecture.

Adam Reed Tucker es el codesarrollador de la línea de productos LEGO Architecture.

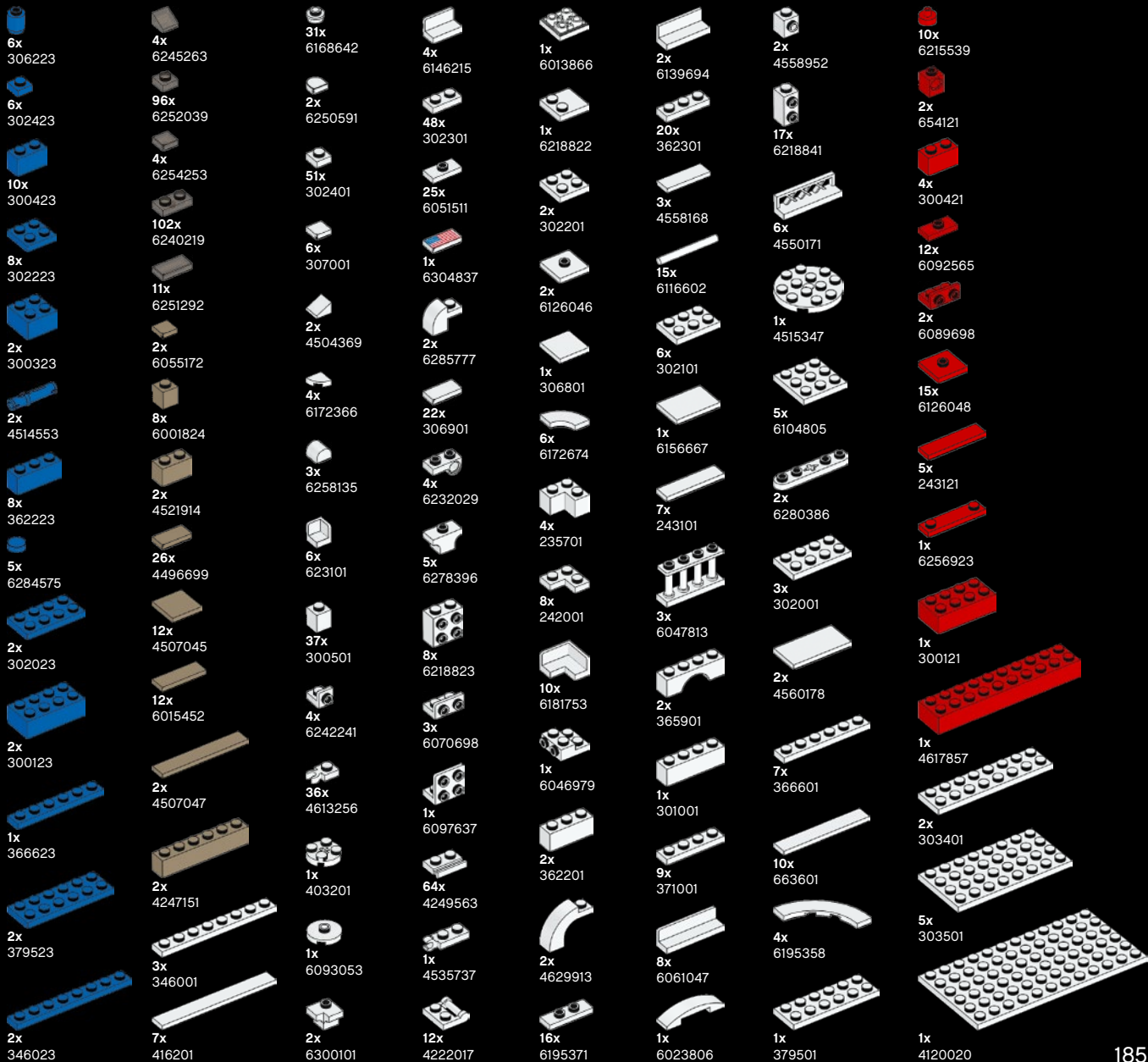



Customer Service
Kundenservice
Service Consommateurs
Servicio Al Consumidor
LEGO.com/service or dial



00800 5346 5555 :
 1-800-422-5346 :



FEEDBACK AND WIN

FEEDBACK AND WIN

Your feedback will help shape the future development of this product series.

Please visit:

FEEDBACK UND GEWINNEN

Dein Feedback trägt zur Weiterentwicklung dieser Produktreihe bei.

Geh auf:

COMMENTEZ ET GAGNEZ

Vos commentaires nous aideront à concevoir les futurs produits de cette gamme.

Rendez-vous sur :

COMENTA Y GANA

Tu opinión nos ayudará a dar forma al desarrollo de esta serie de productos en el futuro.

Visita:

反馈有奖

您的反馈将有助于我们在今后改进本系列产品。

请访问：

[LEGO.com/productfeedback](https://www.lego.com/productfeedback)

By completing, you will automatically enter a drawing to win a LEGO® set.

Terms & Conditions apply.

Durch Ausfüllen nimmst du automatisch an der Verlosung eines LEGO® Preises teil.

Es gelten die Teilnahmebedingungen.

En envoyant vos commentaires, vous serez automatiquement inscrit(e) à un tirage au sort qui vous permettra de remporter un prix LEGO®.

Offre soumise à conditions.

Al contestar, participarás automáticamente en el sorteo y podrás ganar un set LEGO®.

Sujeto a Términos y Condiciones.

完成我们的反馈调查，即可自动进入抽奖环节，赢取乐高®套装。

适用《条款和条件》。

References/Références/Referencias

Text/Texte/Texto
www.whitehouse.gov
www.whitehousehistory.org

Images/Imágenes
@ Shutterstock

LEGO and the LEGO logo are trademarks of the/son des marques de commerce du/son marcas registradas de LEGO Group. ©2020 The LEGO Group.



Follow LEGO® Architecture on
Suivez LEGO® Architecture sur
Sigue a LEGO® Architecture en





Architecture^o

