



# CLASSIC

10712



 [LEGO.com/classic](https://www.lego.com/classic)



**WARNING:**  
CHOKING HAZARD.  
Small parts. Not for  
children under 3 years.





**AVERTISSEMENT : RISQUE D'ÉTOUFFEMENT.**

Contient des petites pièces. Ne convient pas aux enfants de moins de 3 ans.



**ADVERTENCIA: PELIGRO DE ASFIXIA.**

No recomendado para niños menores de 3 años. Contiene piezas pequeñas.

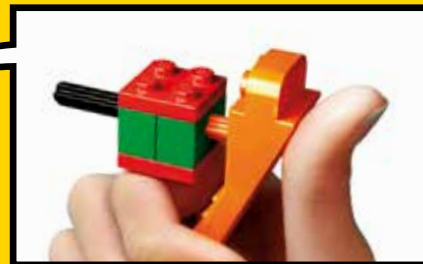



Easy Building  
Construction facile  
Construcción fácil



Medium Building  
Construction intermédiaire  
Construcción intermedia



Advanced Building  
Construction avancée  
Construcción avanzada



p./pag.

6

p./pag.

18



p./pag.  
26



p./pag.  
48



p./pag.  
40



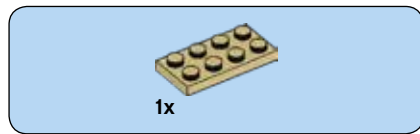

1

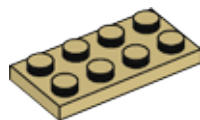



2x

2

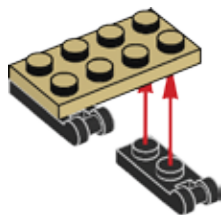

1x

3

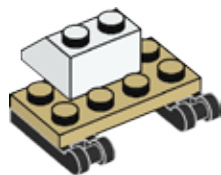

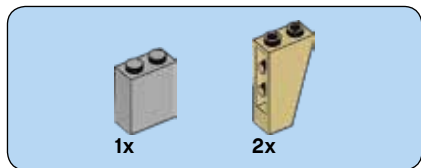

4

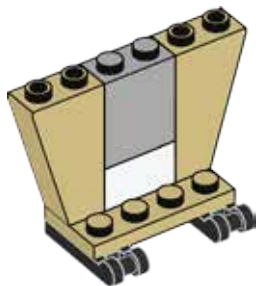



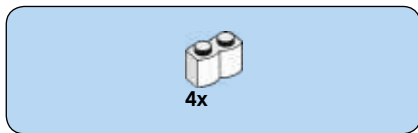

5

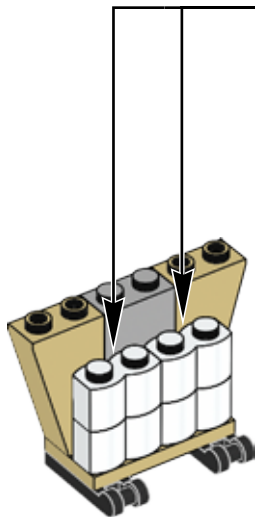
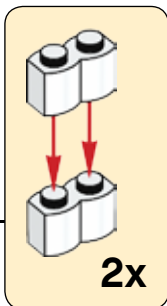

6

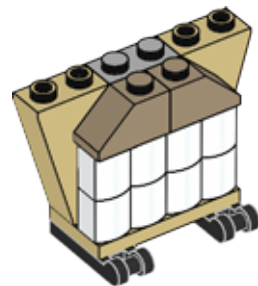



1x



2x

7

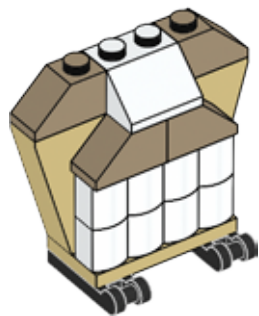



2x



1x

8

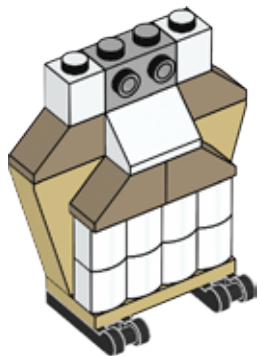

1x



1x

9

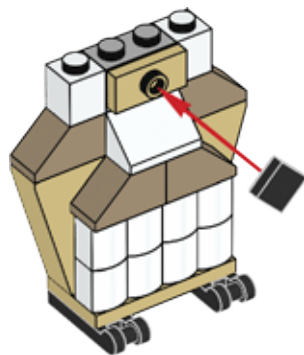



1x

10





2x

11

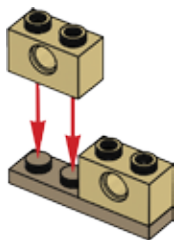

1x

12

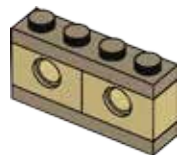



1x



1x

# 13

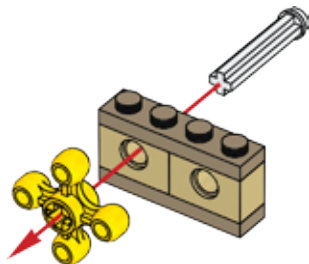

14



1x



1x

# 14

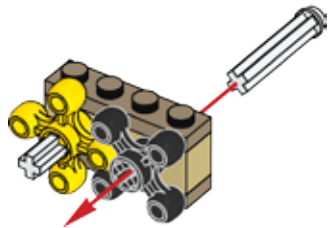

1x

# 15

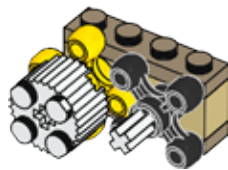

16

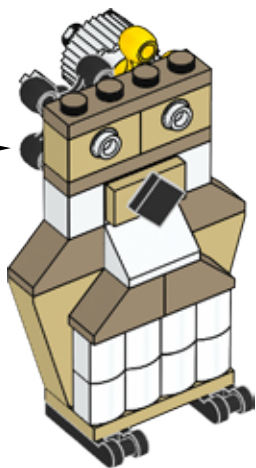





2x



2x

17

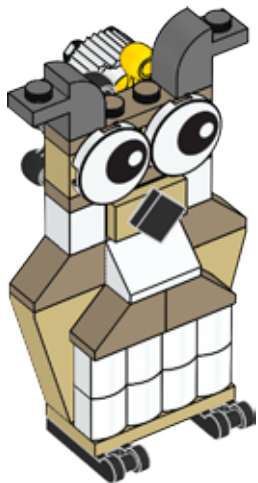

LEGO.com/classic

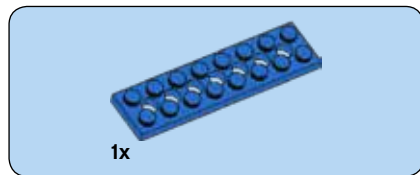

1

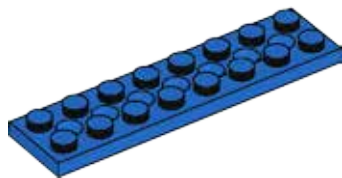



3x

2

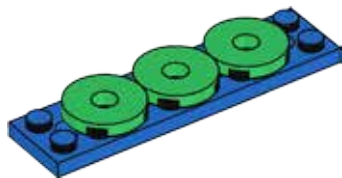

2x

3

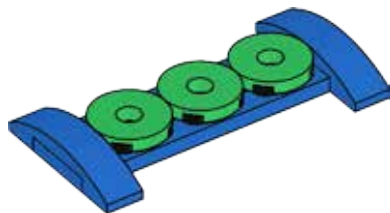

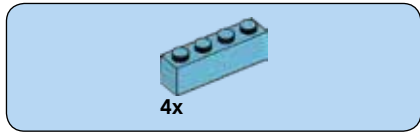

4

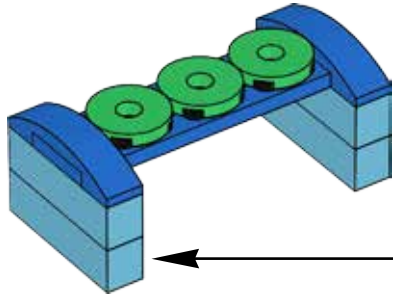
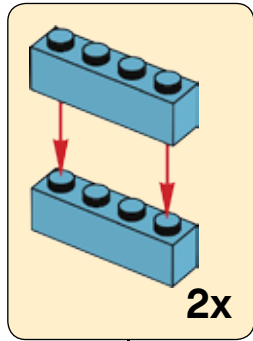

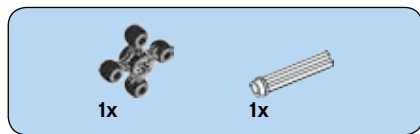

5

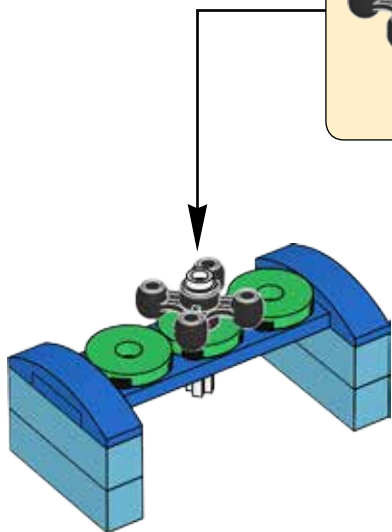
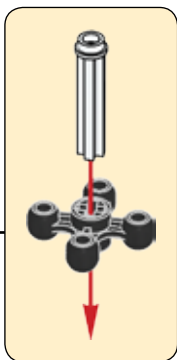

6

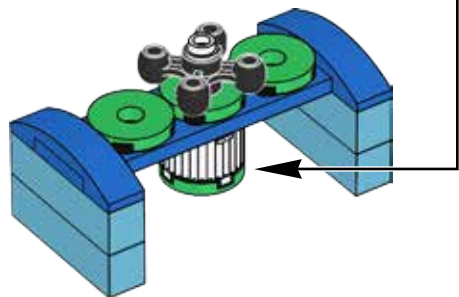
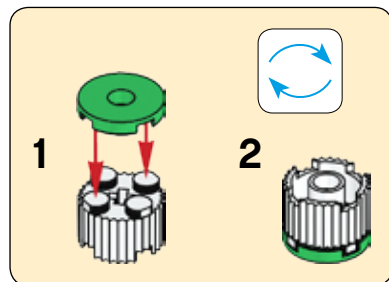



7

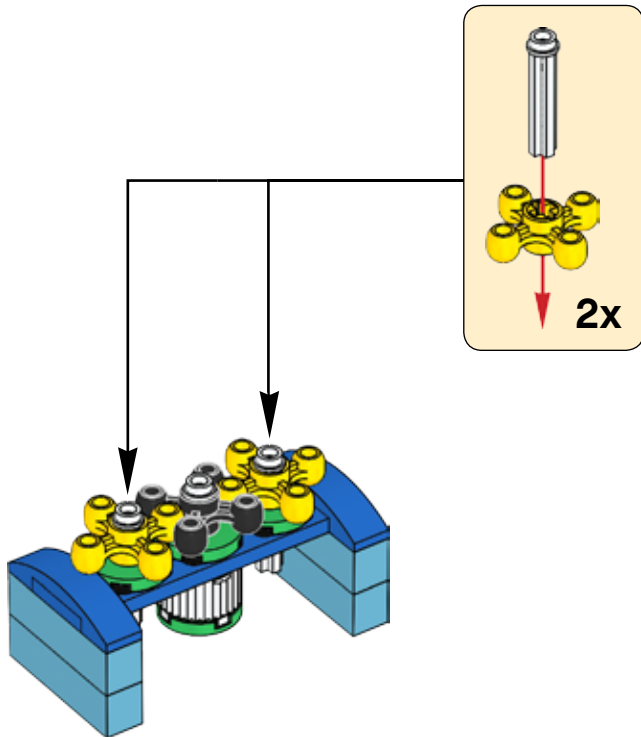



3x

8

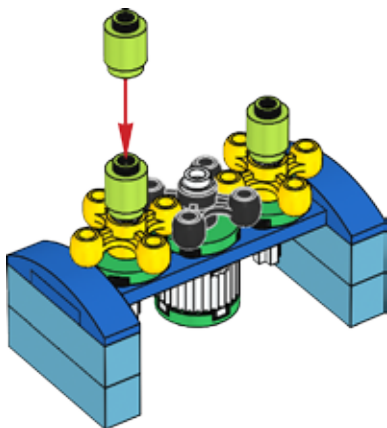

1x



2x

9

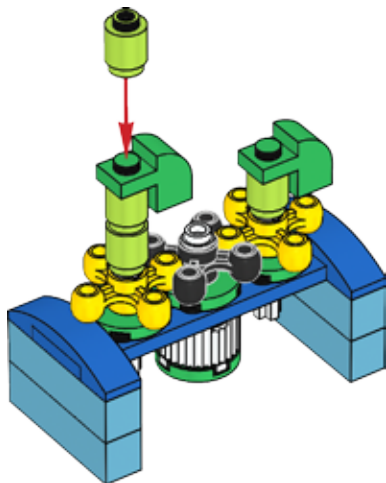



2x

10

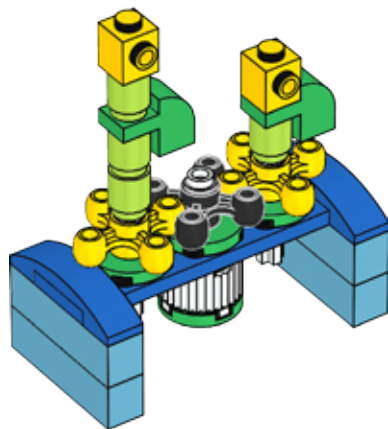



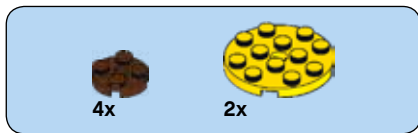

11

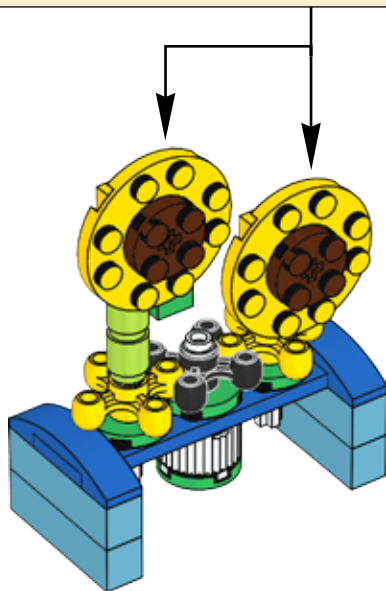
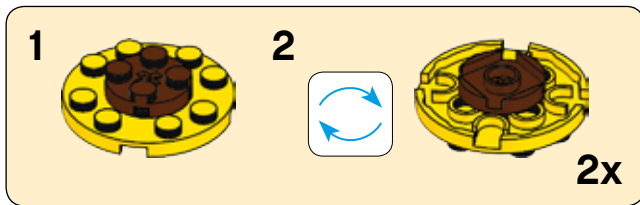

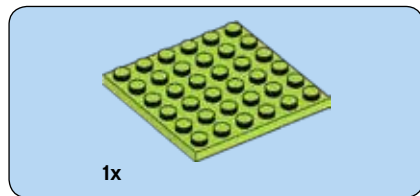

1





1x

2

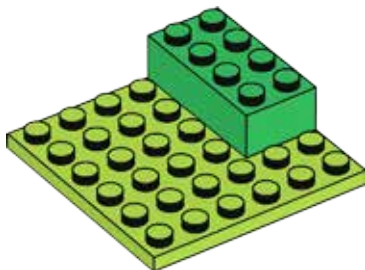



2x

3

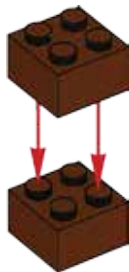

2x

4





5



6

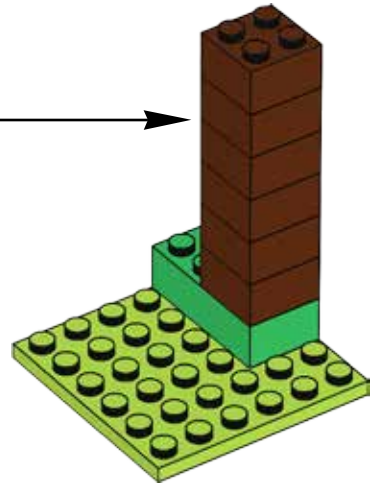

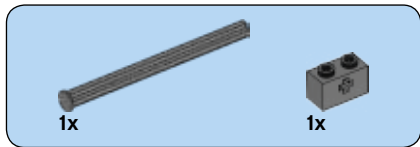
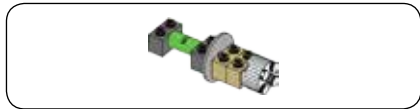

7

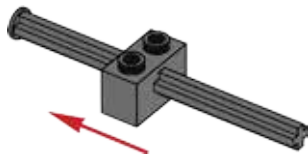



8

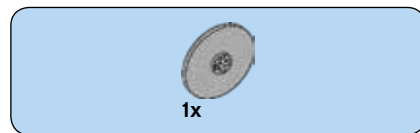
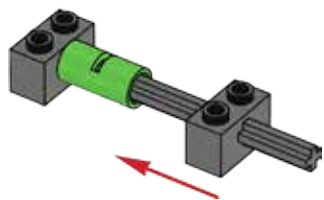

9

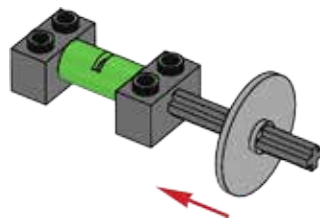



2x

10

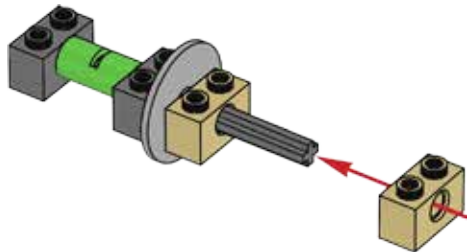





1x

11

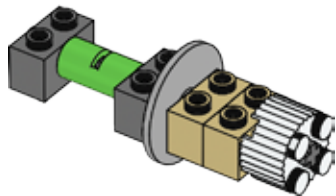

12

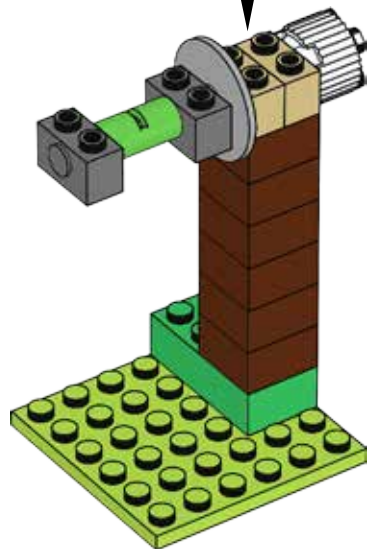





1x



1x

# 14



1x



1x

# 15

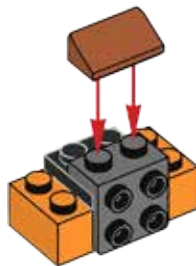



2x



1x

# 16

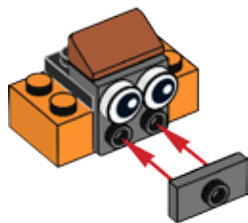

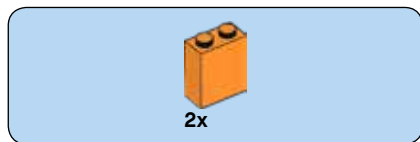

17

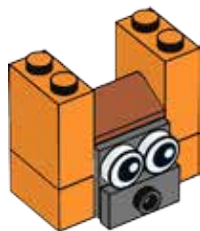

18

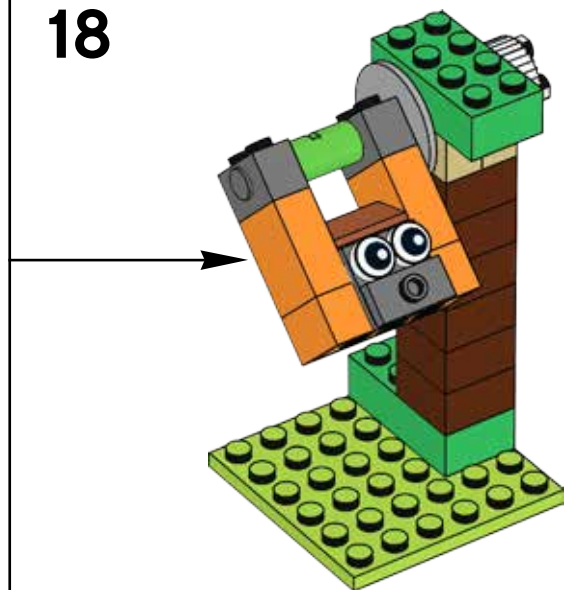

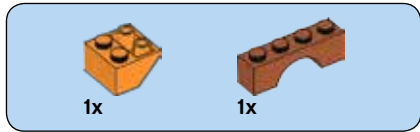

19

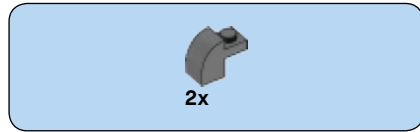
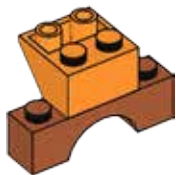

20

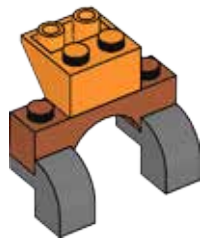

21

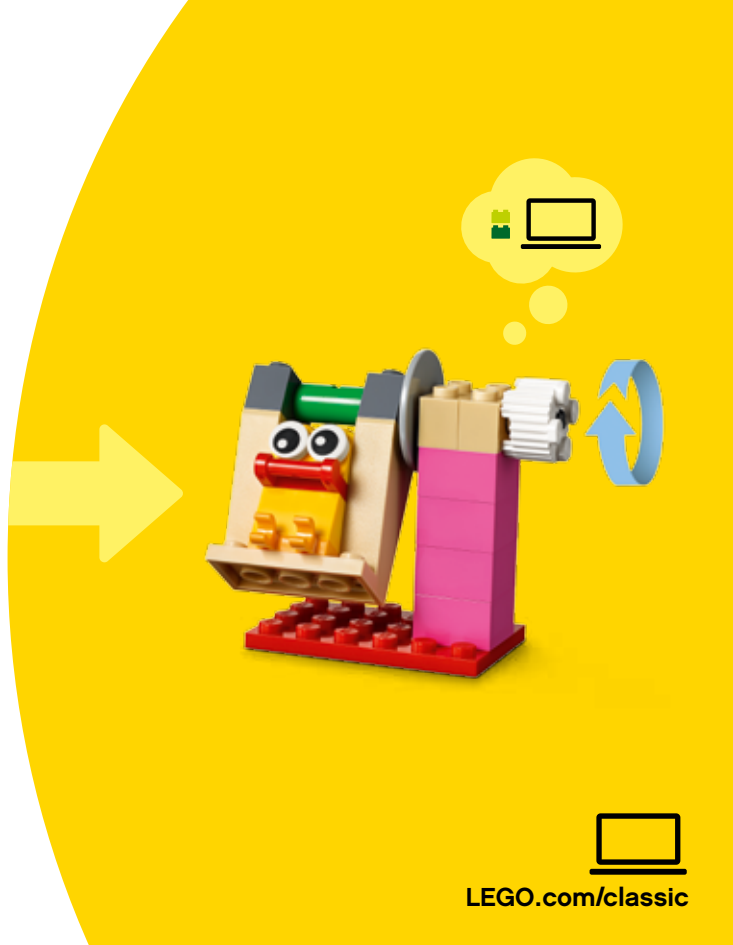
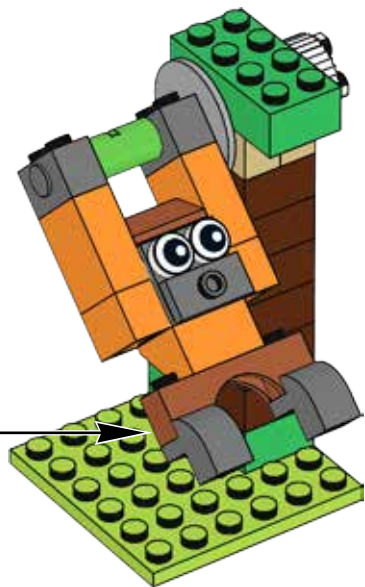

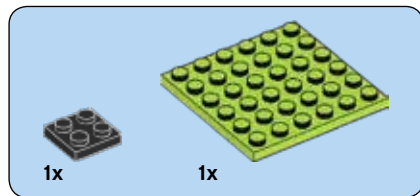

1

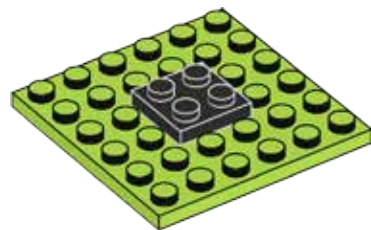





2

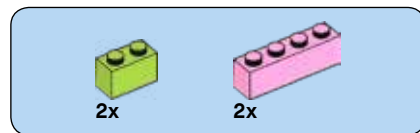
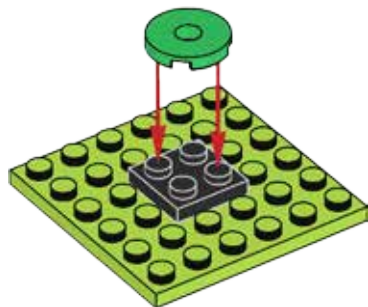

3

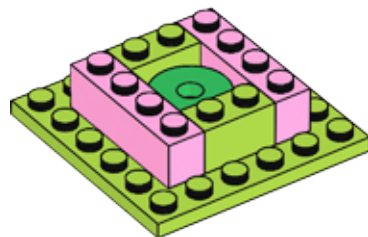

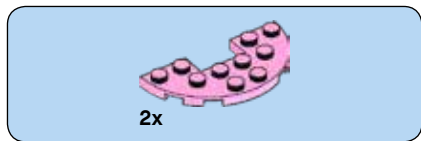

4

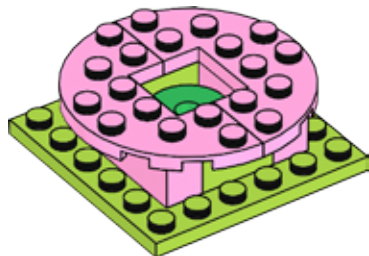

5

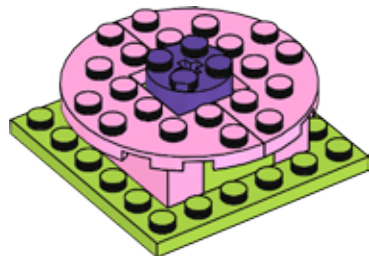

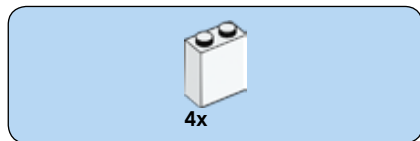

6

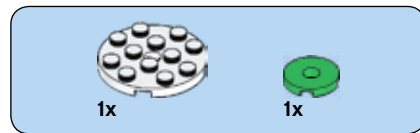
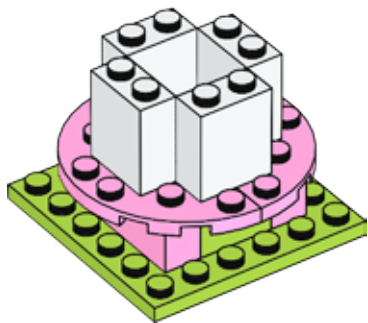

7

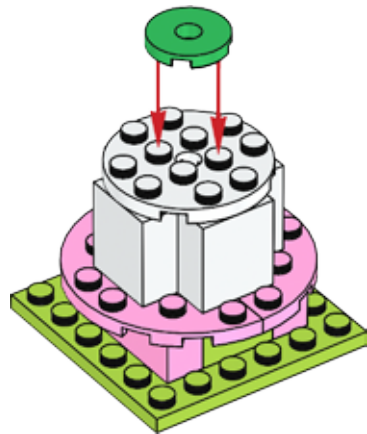

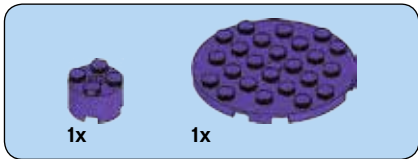

8



9





4x



4x

# 10



4x



4x

# 11

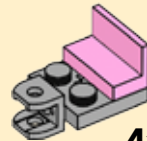

4x

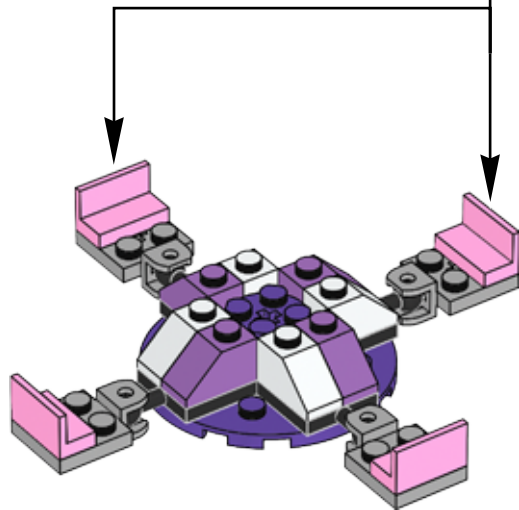

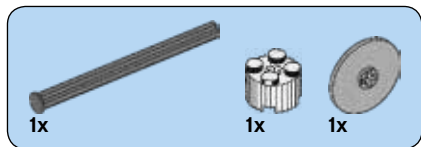

12

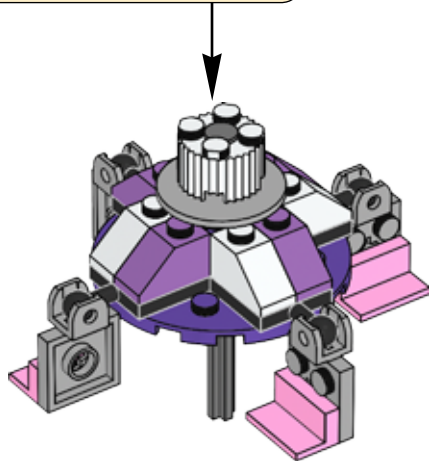
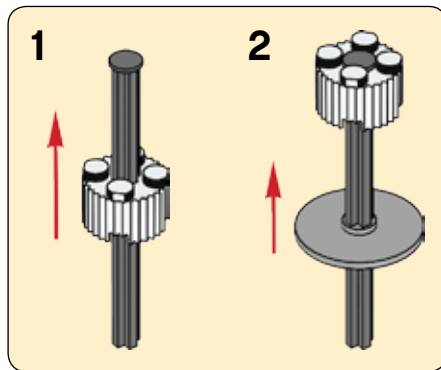

13

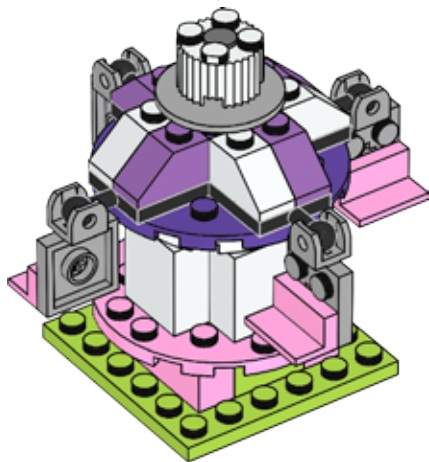



1





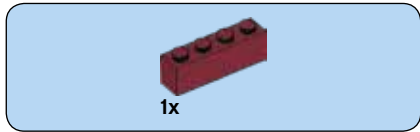

2

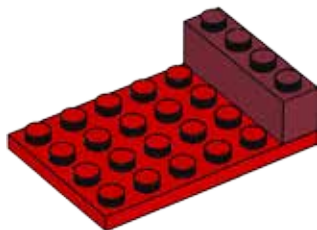

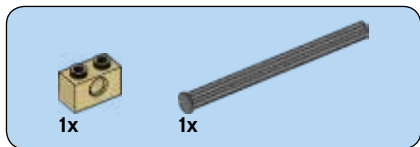
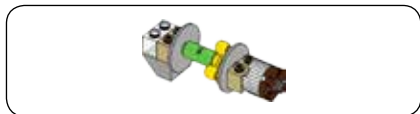

3

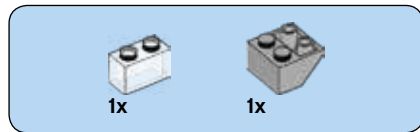
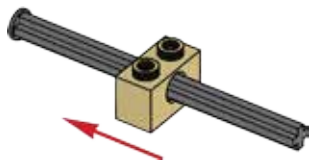

4

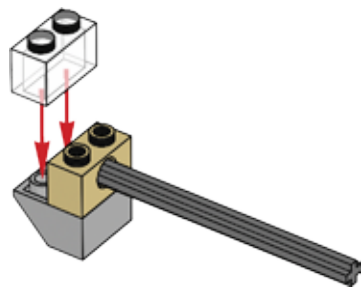

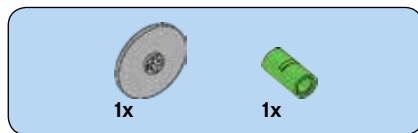

5

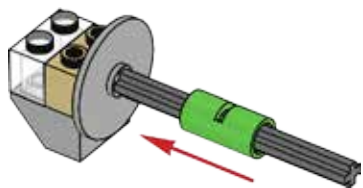

6

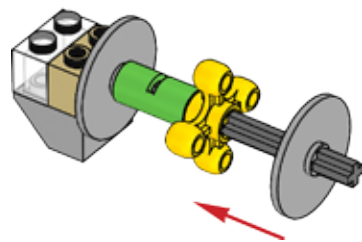



1x



1x

7

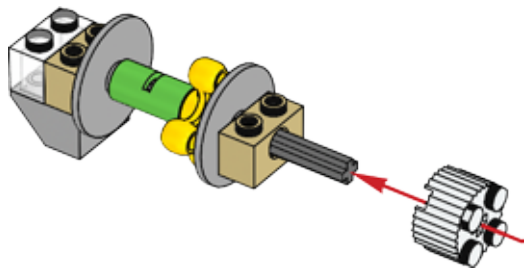

1x

8

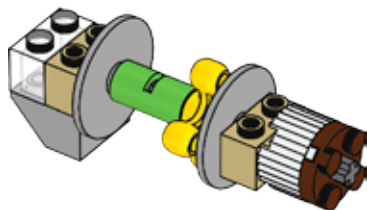

9

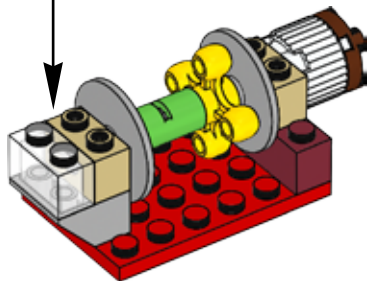

2x



1x

10

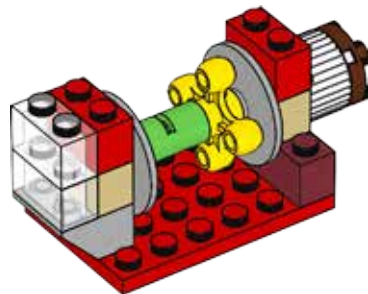

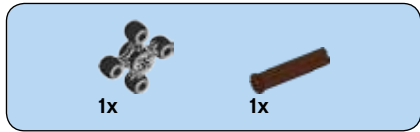

11

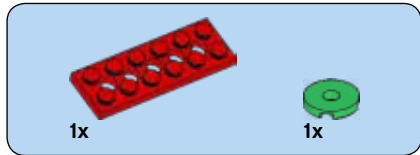

12

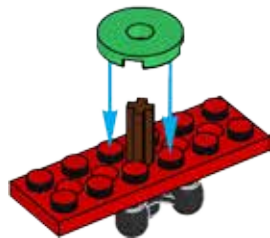



1x

13

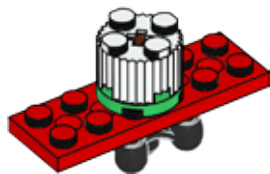

14

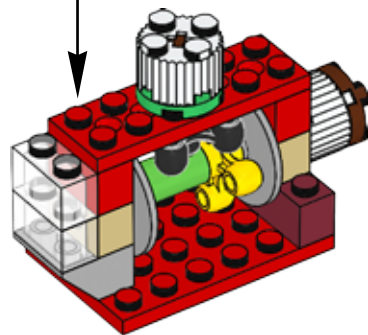

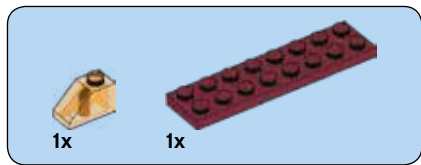

15

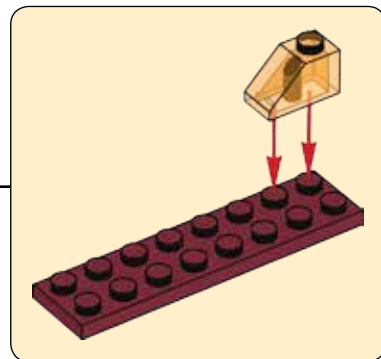
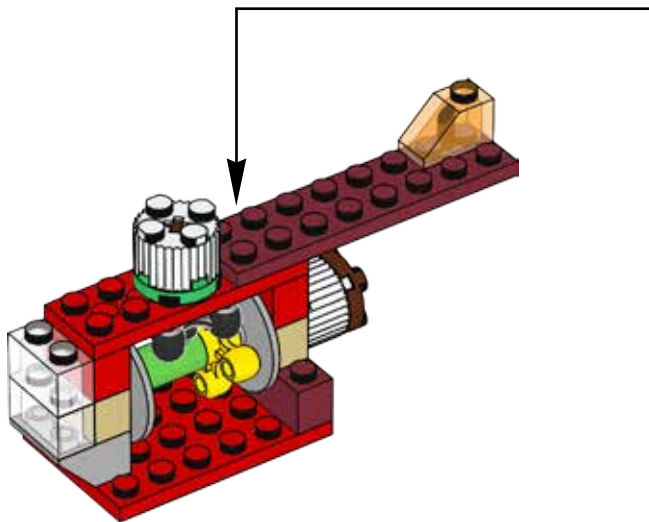





2x

16

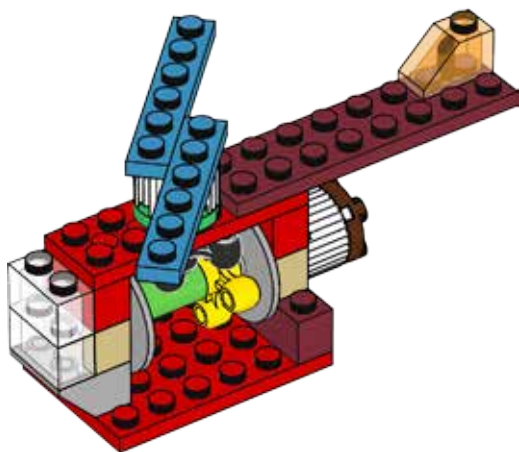

2x

17

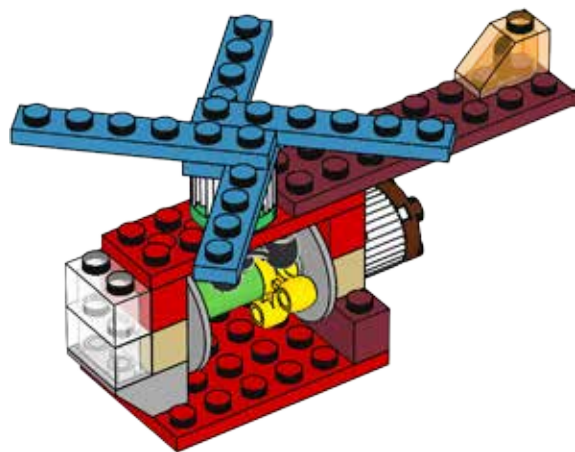



1x

18

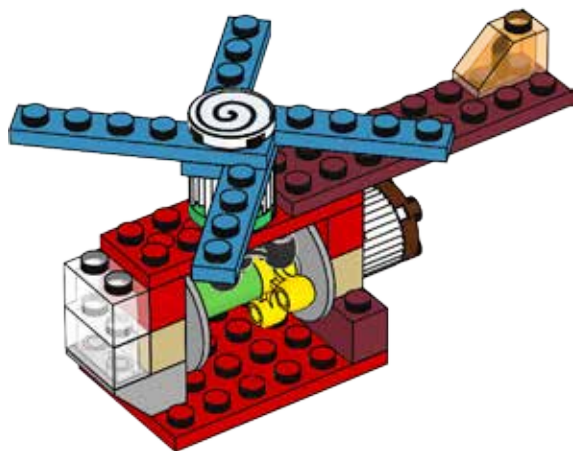

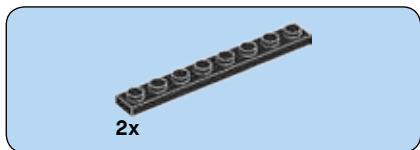
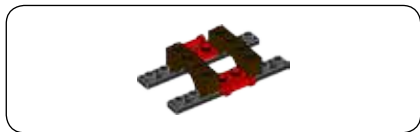

19

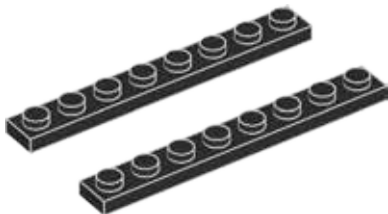

20

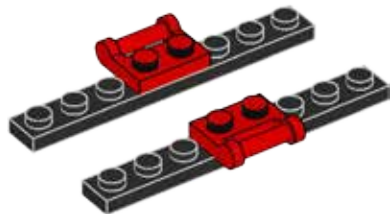



2x

21

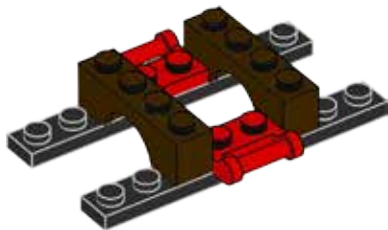

22

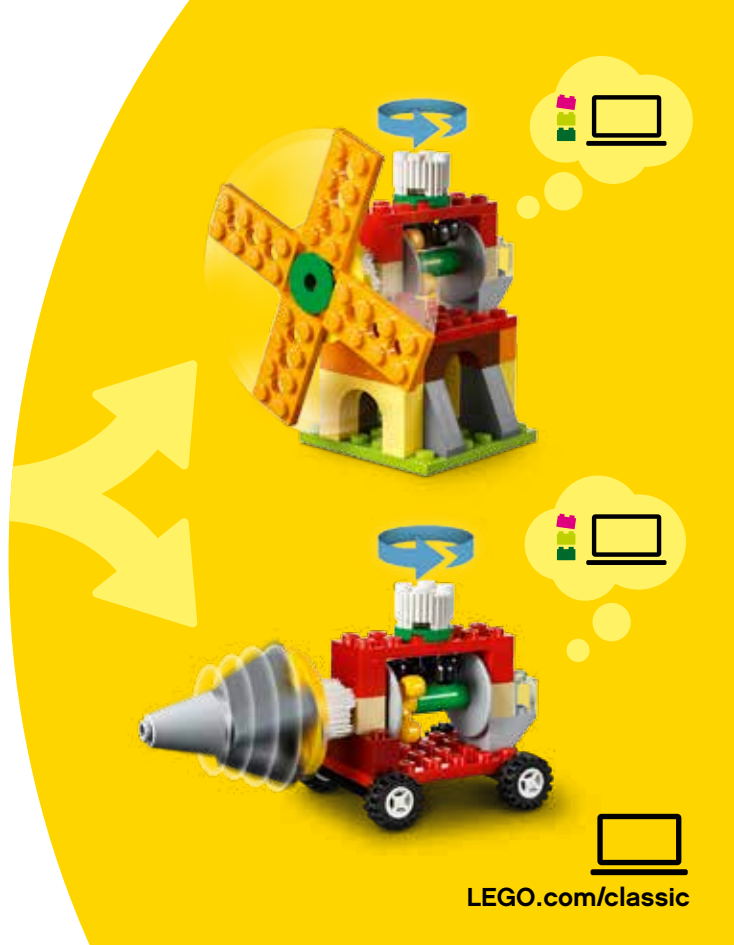
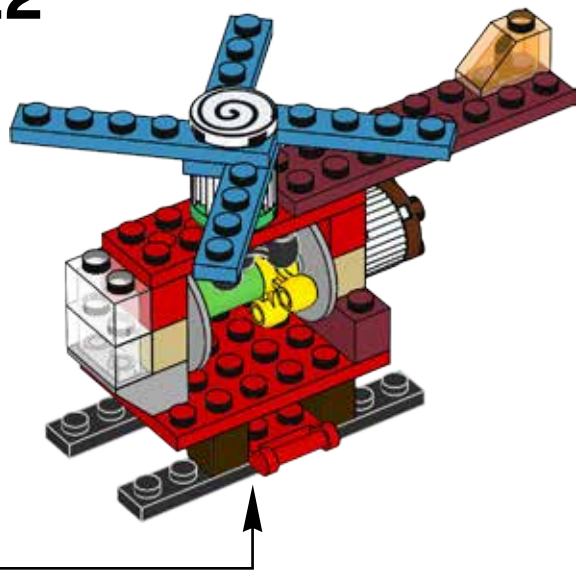

What will you build for Mr. Stareyes' adventures?  
Que vas-tu construire pour les aventures de M. Rêvétoilé ?  
¿Qué construirás para las aventuras del Sr. Ojos de Estrella?





10698



10696



10700



10714



10713



10701



# CITY



60170



60171



60172



60173



60174



60176







# CREATOR

# 3 IN 1



31075

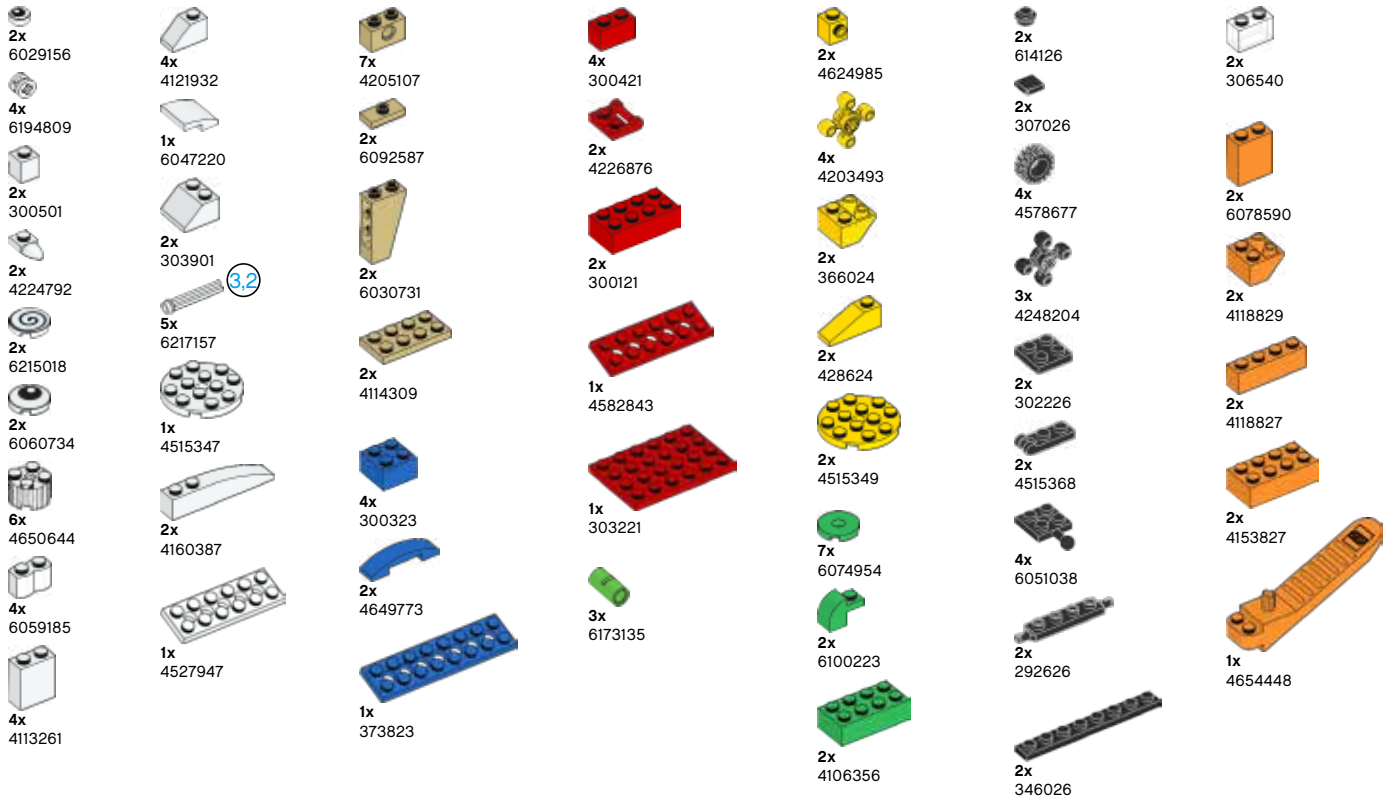

4x  
4530678

2x  
4626904

2x  
6052777

1x  
6152321

4x  
4212454

2x  
4164022

2x  
4234716

2x  
4525858

2x  
6188477

2x  
6212897

2x  
6022650

2x  
6093459

4x  
6132408

1x  
6057616

2x  
6015344

2x  
4211564

2x  
4211614

4x  
4667578

4x  
4530469

1x  
4211436

2x  
6178919

4x  
4210797

4x  
6013658

2x  
6092572

1x  
6117972

3x  
4499858

4x  
4517992

5x  
4211159

6x  
4211210

2x  
6135494

4x  
6146231

2x  
4518890

2x  
6133060

2x  
6036232

1x  
6102580

2x  
4622176

1x  
6216908

2x  
4623775

2x  
6004943

4x  
6151657

4x  
6036238

4x  
6022005

3

8

**Customer Service**  
Kundenservice  
Service Consommateurs  
Servicio Al Consumidor

[LEGO.com/service](http://LEGO.com/service) or dial



: 00800 5346 5555

: 1-800-422-5346

# WIN

GO TO [WWW.LEGO.COM/PRODUCTFEEDBACK](http://WWW.LEGO.COM/PRODUCTFEEDBACK) AND  
GIVE US YOUR SHORT **FEEDBACK** ABOUT THIS  
LEGO® SET FOR A CHANCE TO WIN  
A COOL LEGO PRIZE.

Terms & Conditions apply

## LEGO.com/productfeedback



### GEWINNE

Erzähle uns auf  
[www.LEGO.com/productfeedback](http://www.LEGO.com/productfeedback)

etwas über die Erfahrungen, die du mit  
diesem LEGO® Set gemacht hast, und  
sichere dir die Chance auf einen coolen  
LEGO Preis!

Es gelten die Teilnahmebedingungen

### GAGNE

Rends-toi sur  
[www.LEGO.com/productfeedback](http://www.LEGO.com/productfeedback)

et donne-nous quelques commentaires sur  
ce produit LEGO® pour avoir une chance  
de gagner un prix LEGO !

Voir Conditions Générales

### GANAN

Visita  
[www.LEGO.com/productfeedback](http://www.LEGO.com/productfeedback)

y envíanos tu opinión acerca de este set  
LEGO®. ¡Participarás en el sorteo de un  
premio LEGO!

Términos y Condiciones aplicables

### 获取奖品

登录  
[www.LEGO.com/productfeedback](http://www.LEGO.com/productfeedback)

给出关于此乐高®套装的简短反馈，  
就有机会获得炫酷乐高奖品

《条款及条件》适用

LEGO and the LEGO logo are trademarks of the/son des marques de commerce du/son marcas registradas de LEGO Group. ©2018 The LEGO Group.

6225660