



JUNIORS



10686





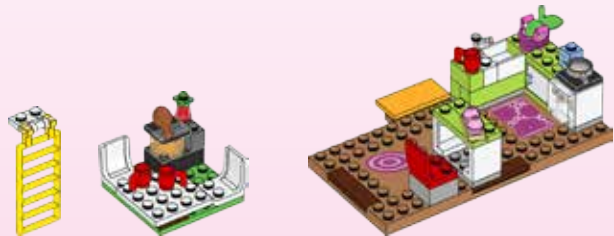
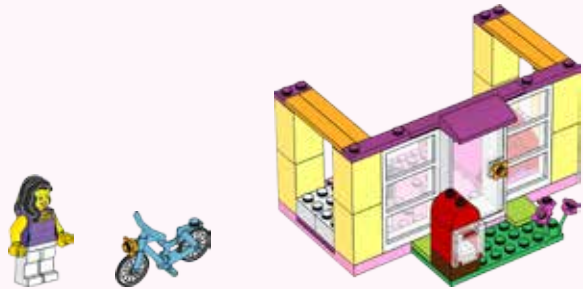



1



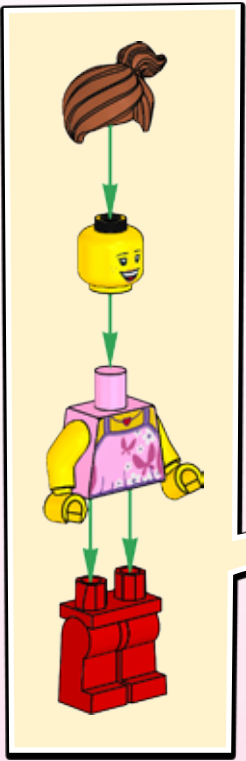



1x



1x



1x

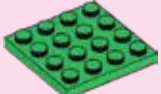

1x



1



2

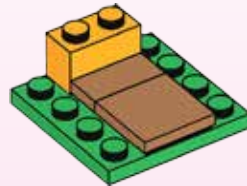



2x



1x

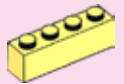

2x

3

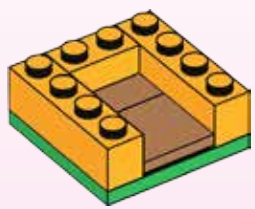

4

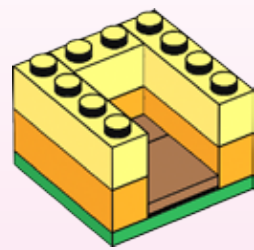



1x



2x

5

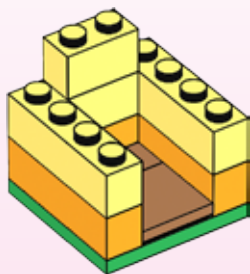

6

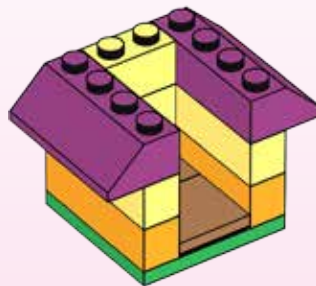

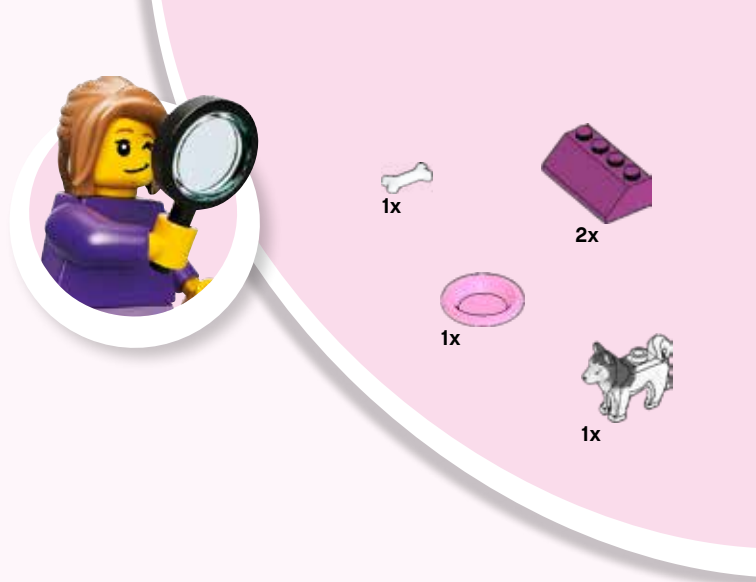

7

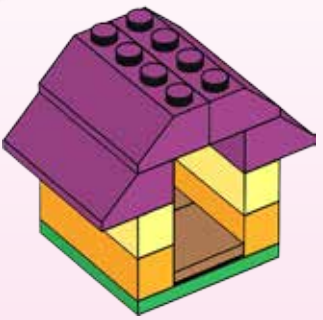

8





1x



1x



1

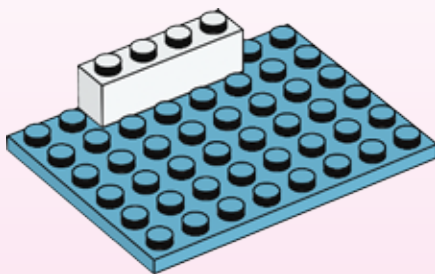



2

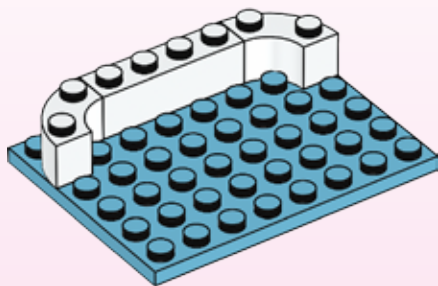

3

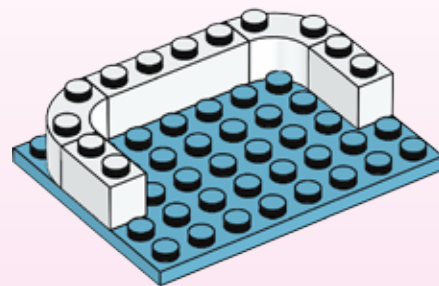

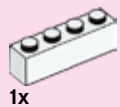

4

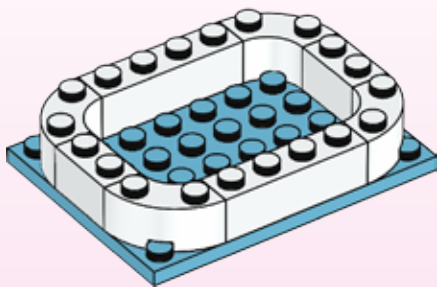



1x



1x



1x



1x

5

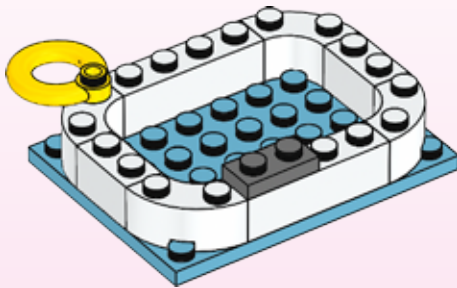

6

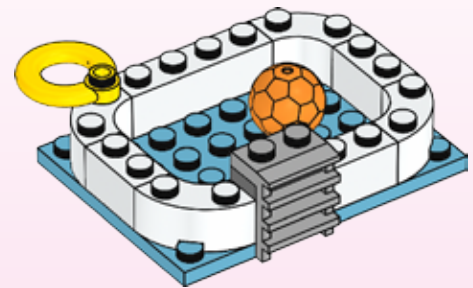





1x



2x



1x



1x



1x



1x



1x

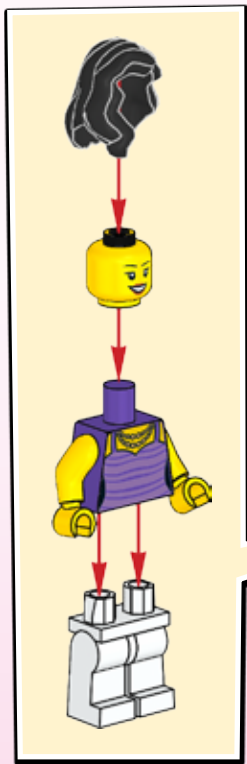

1

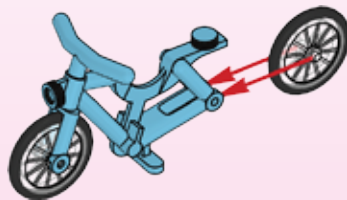

2

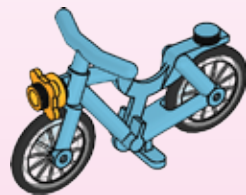



2x



1x

1

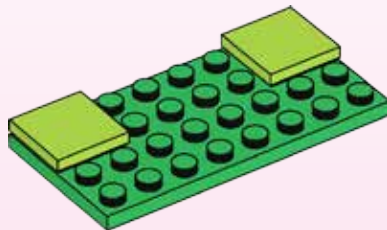

2

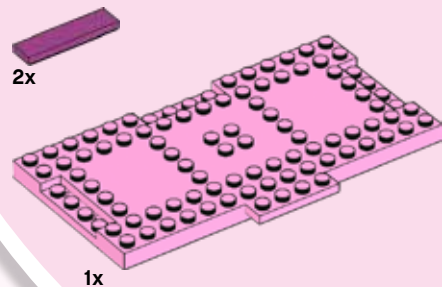
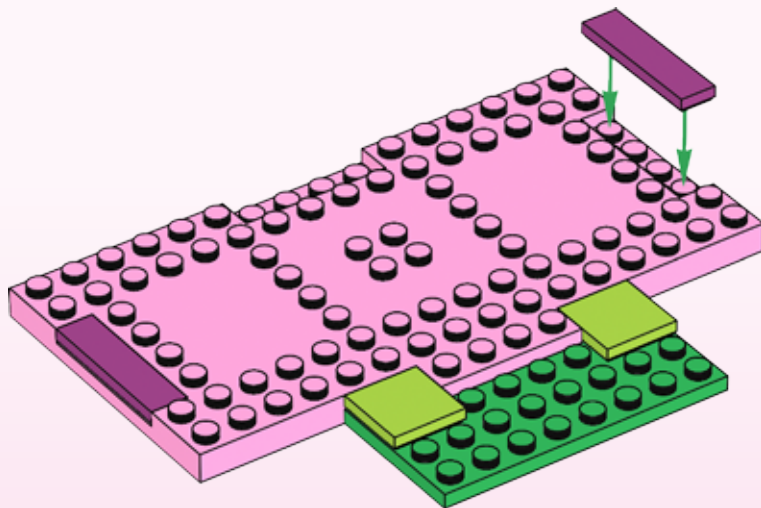

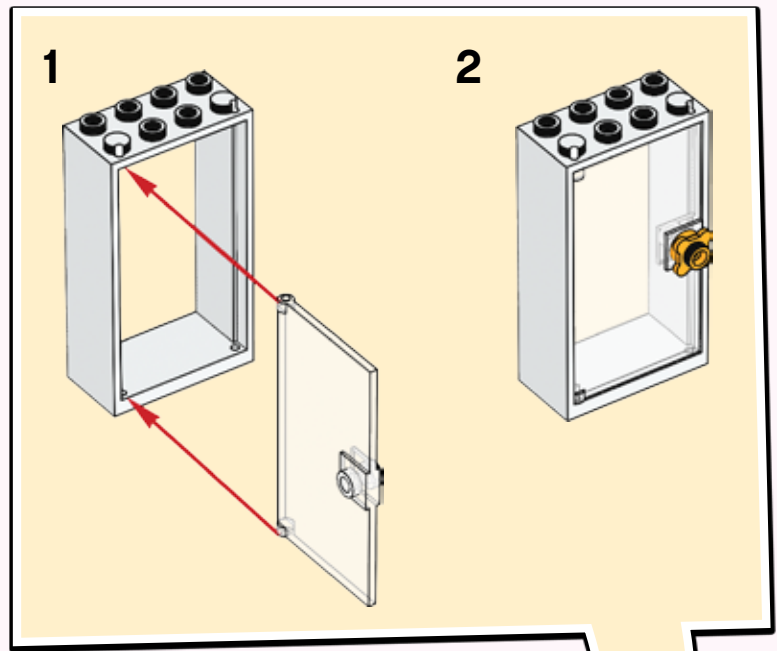
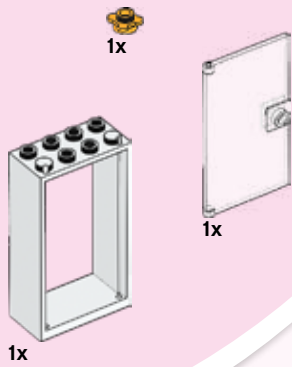

3

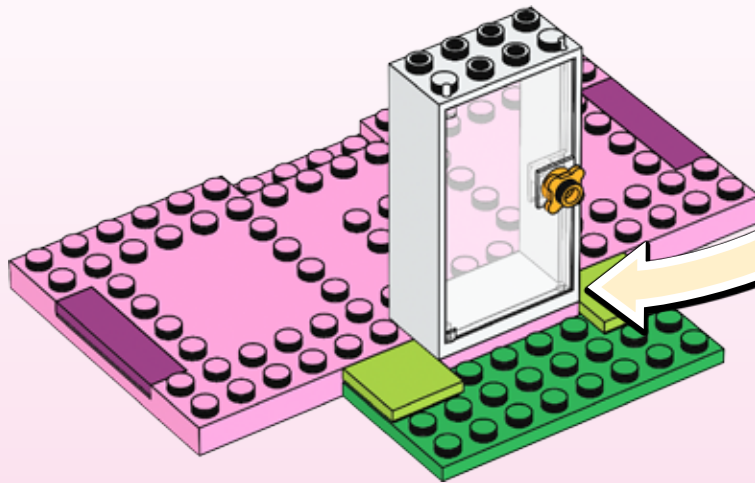

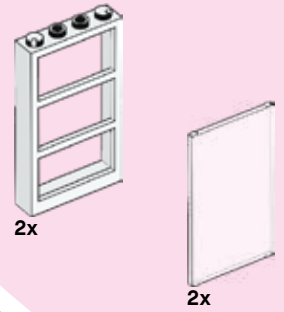
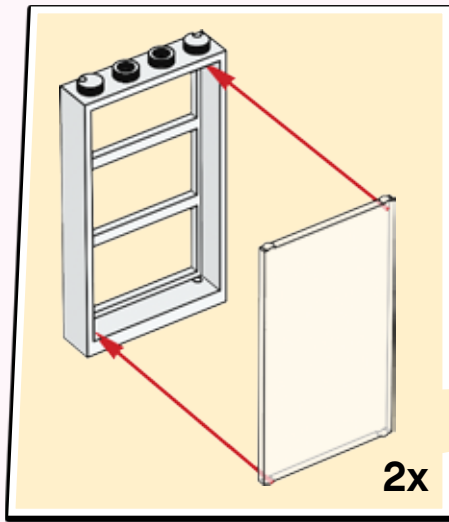

4

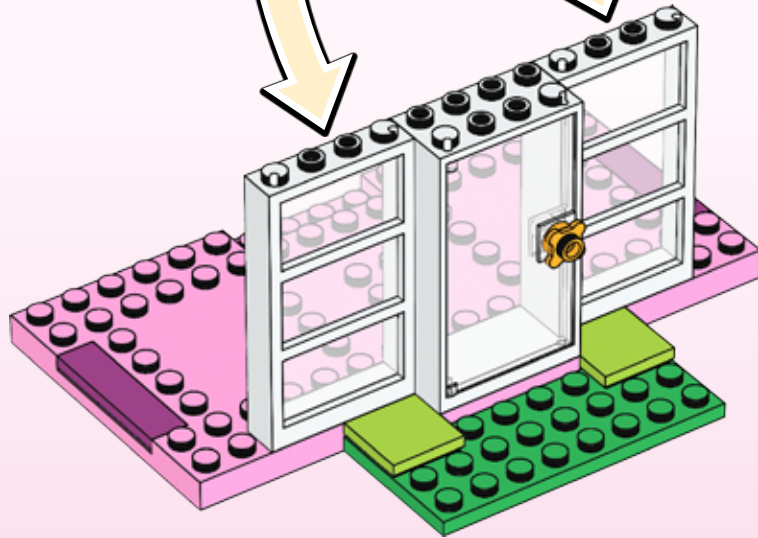



4x

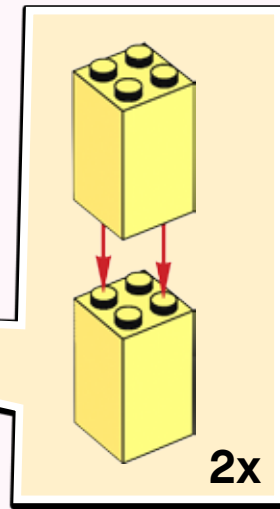

2x

5

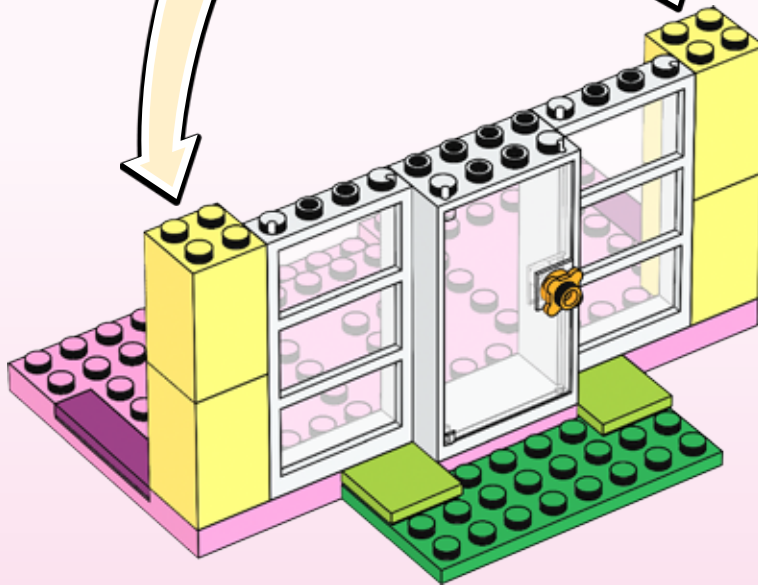

6

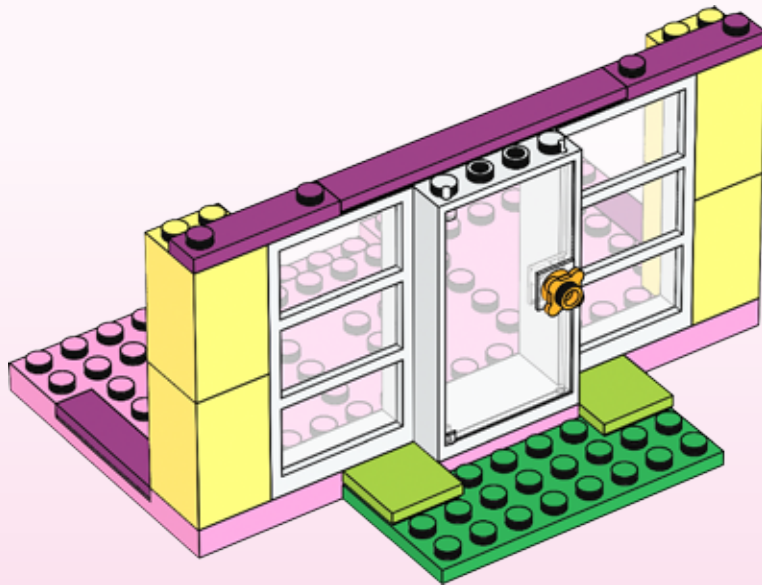



3x



7

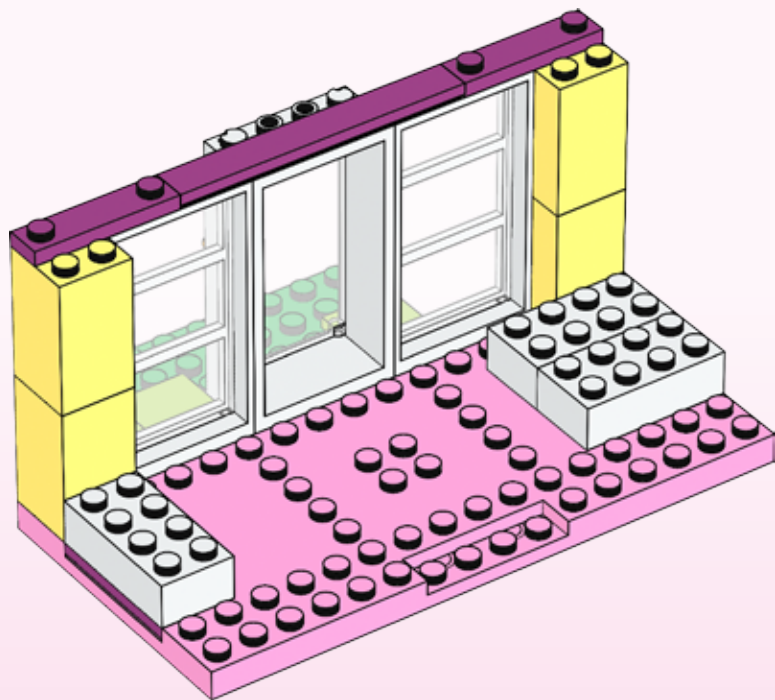

8

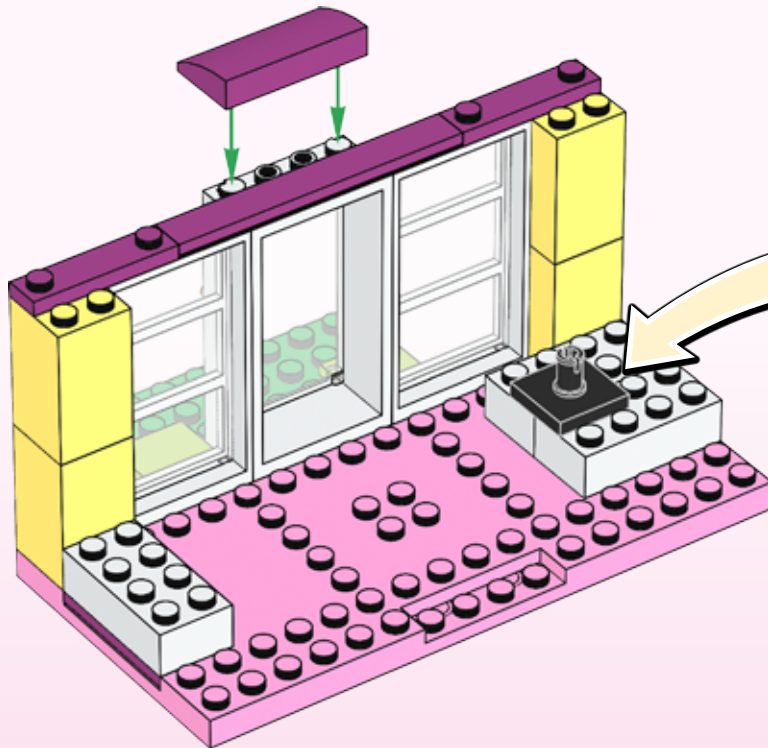

1x



1x

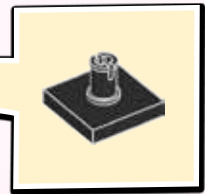



1x



1x

1



2



9





2x



1x



2x

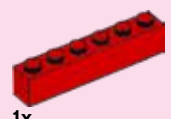

1x

1

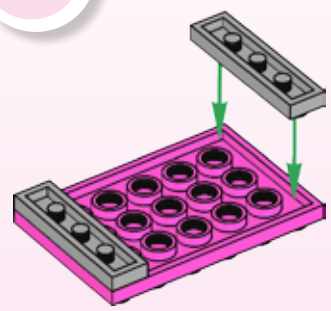

2

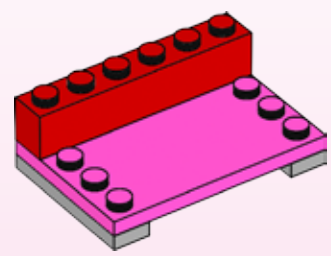
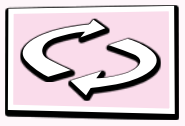

3

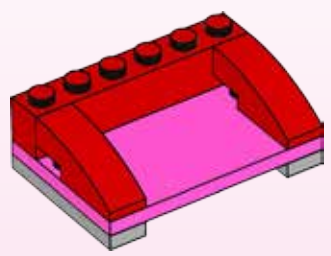

1x

2x

4

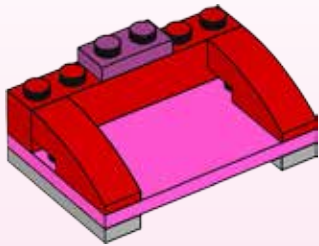

5

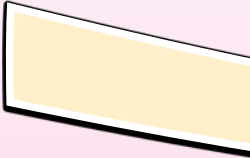
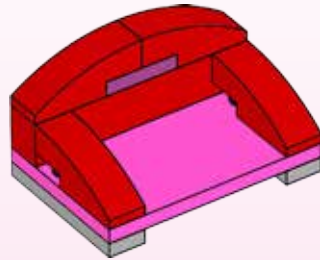

10

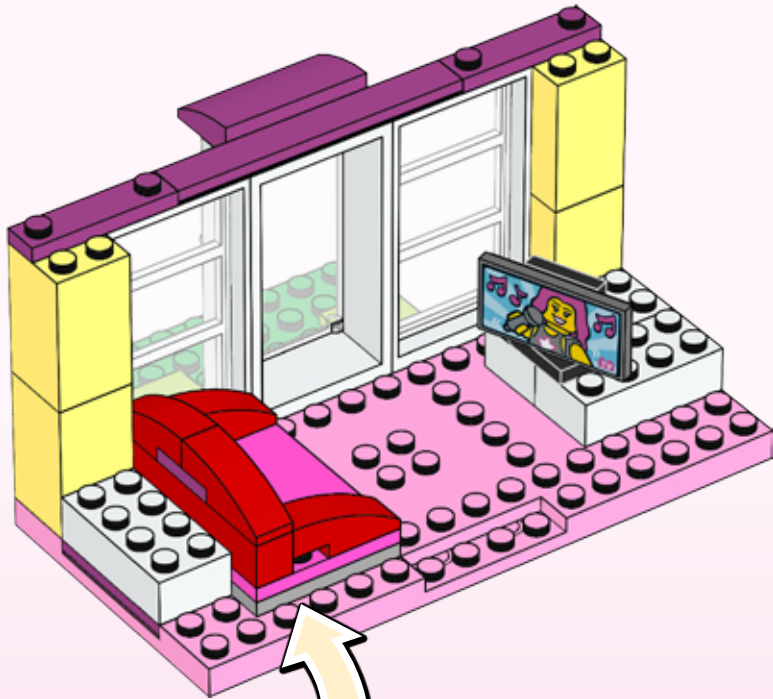



4x



2x

11

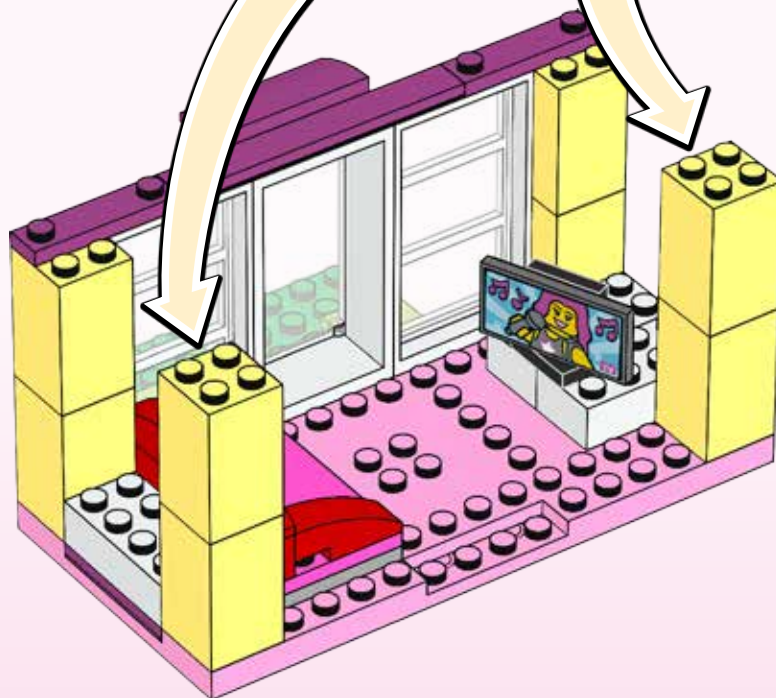

12

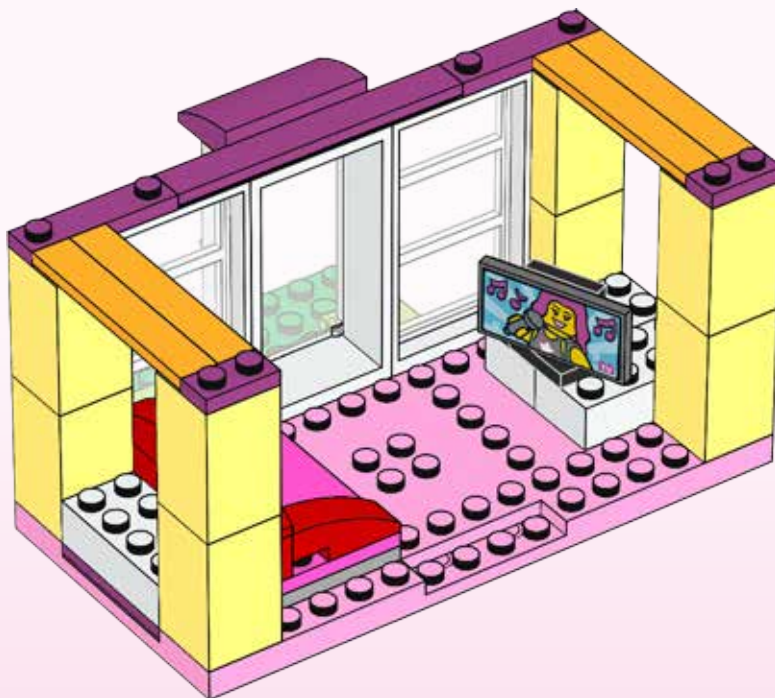

2x

4x

3x

1x

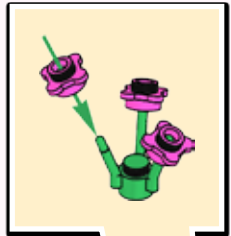

13

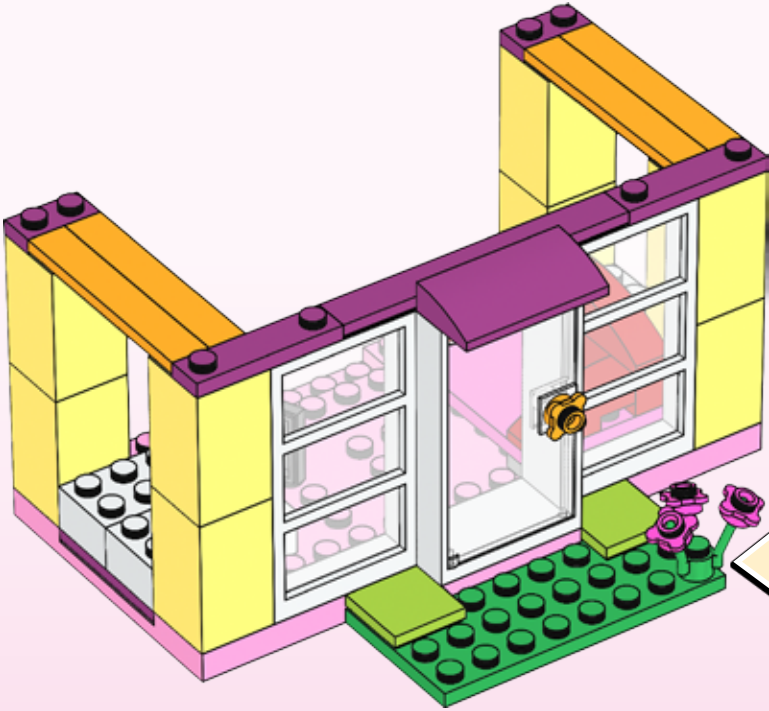

1



2



3

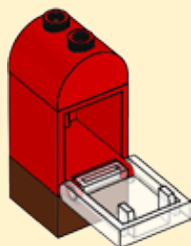

4

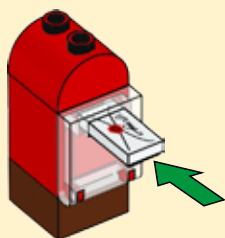

- 1x 
- 1x 
- 1x 
- 1x 
- 1x 

14



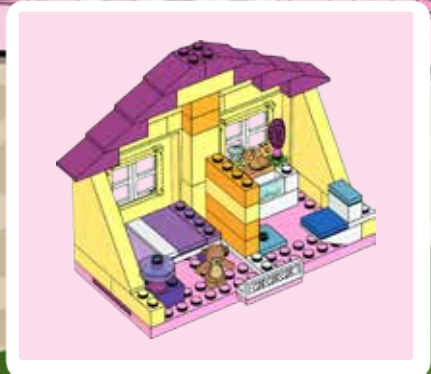

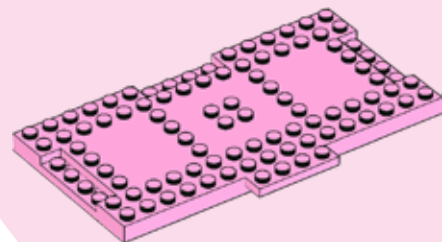

1x



3x

1

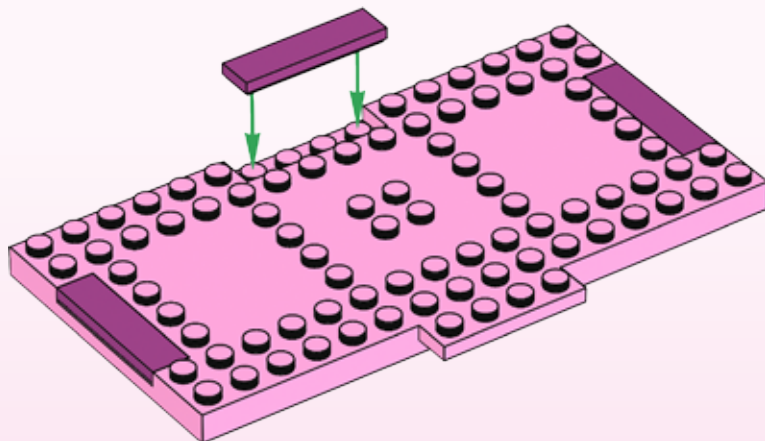

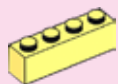

4x

2

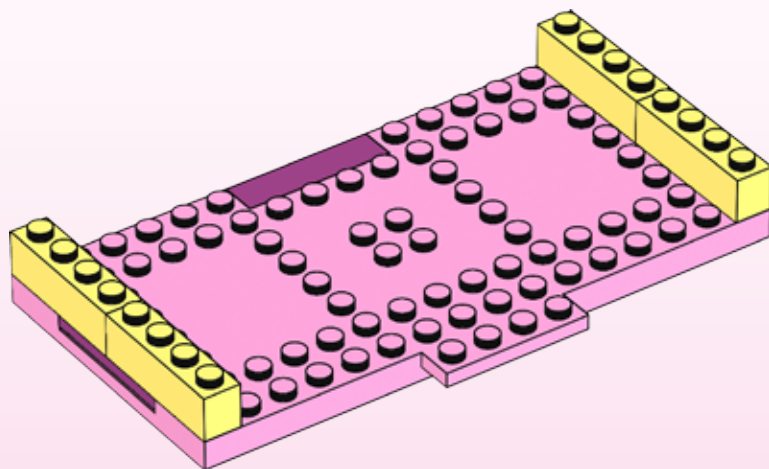

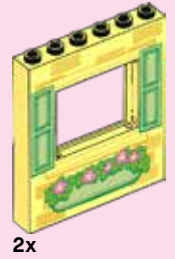
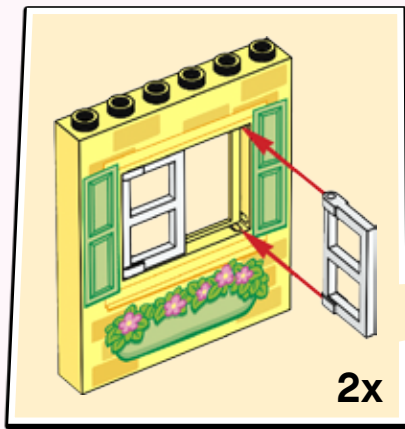

3

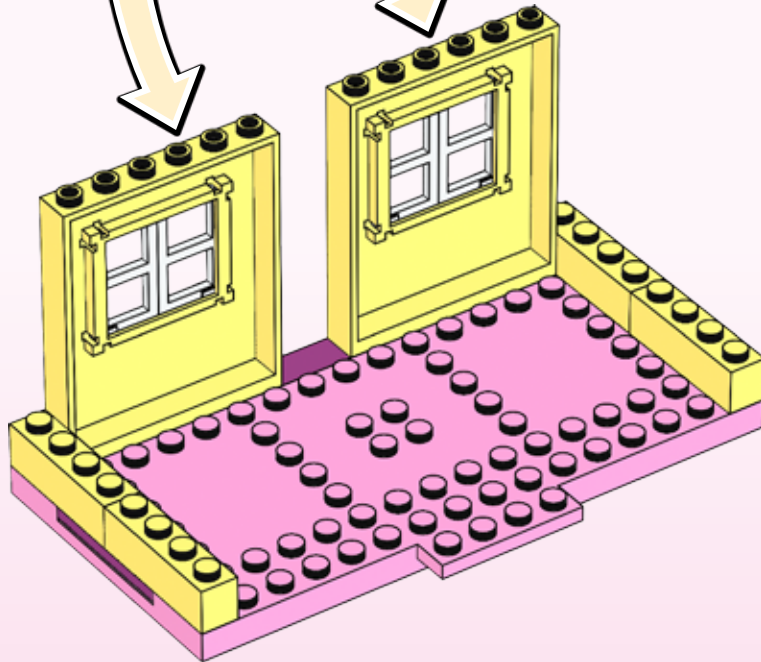



2x

4

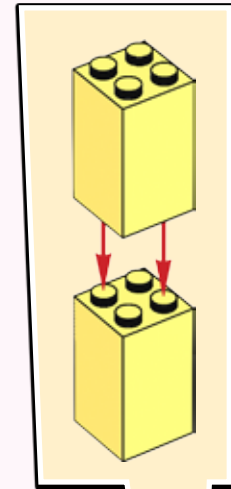
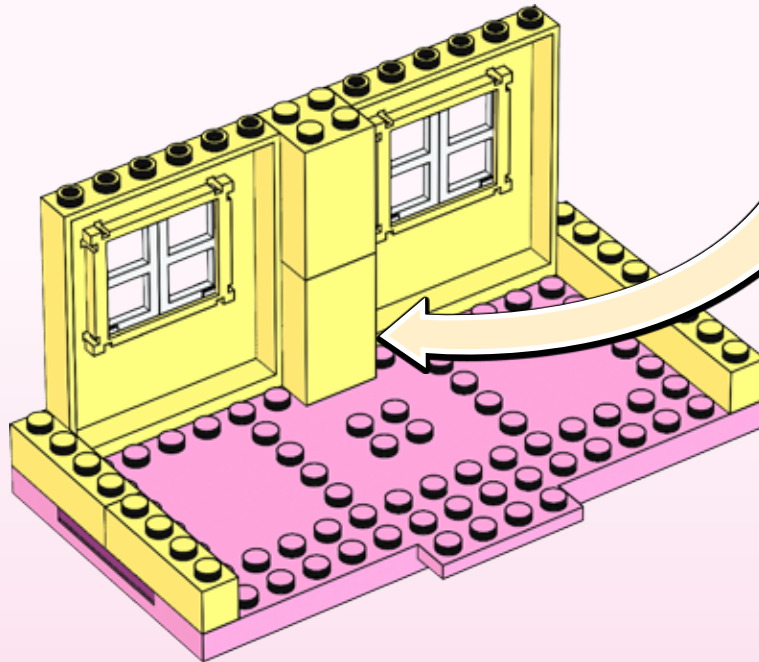

5

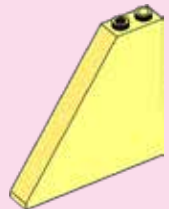
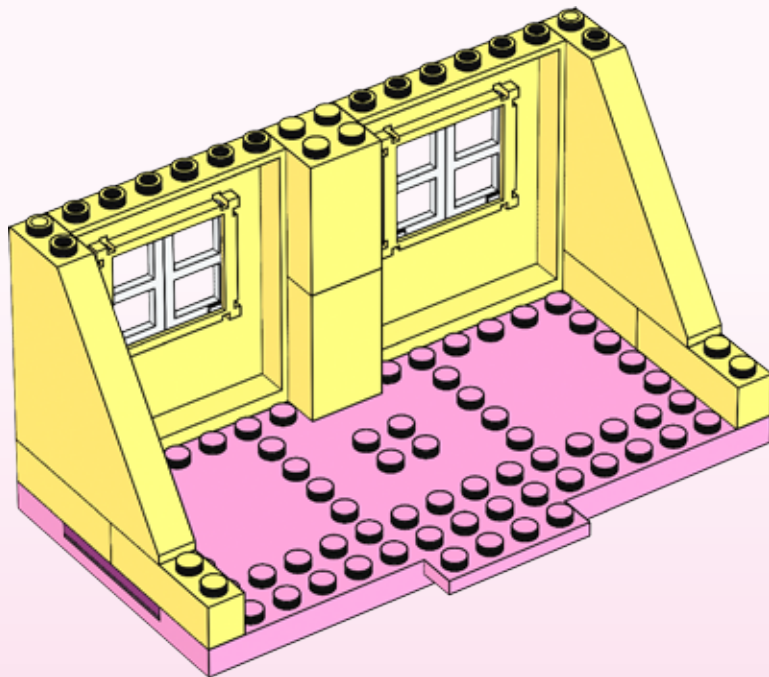

2x



3x

6

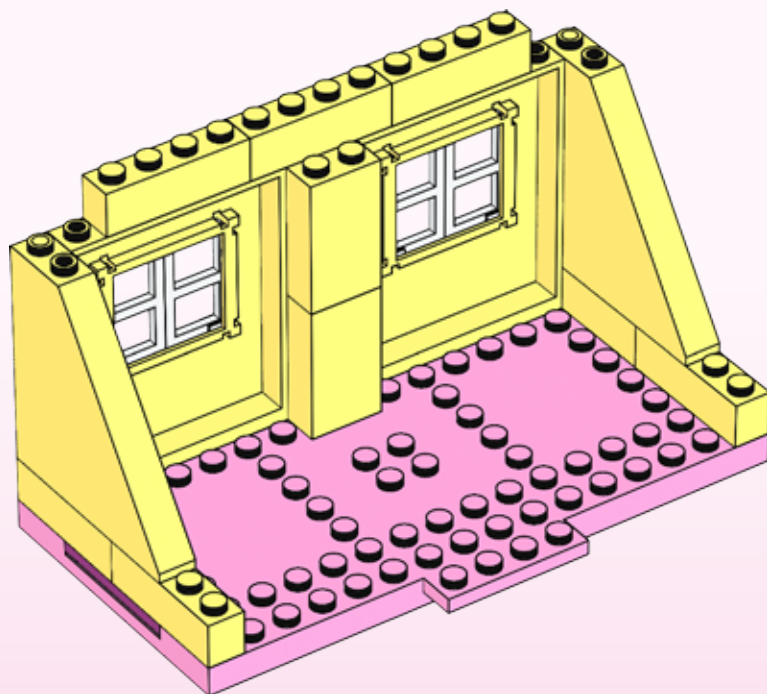

7

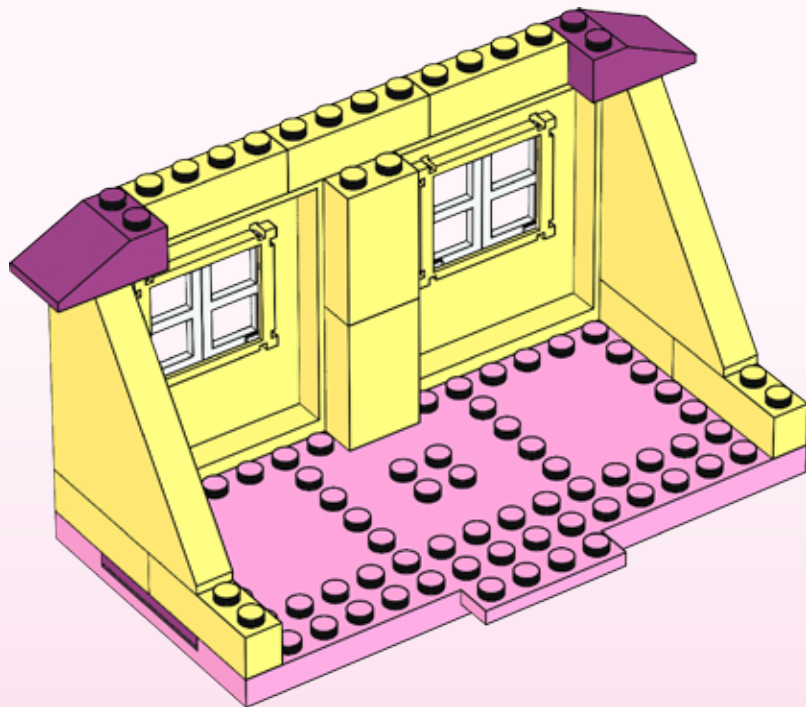

2x

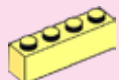

2x



2x

8

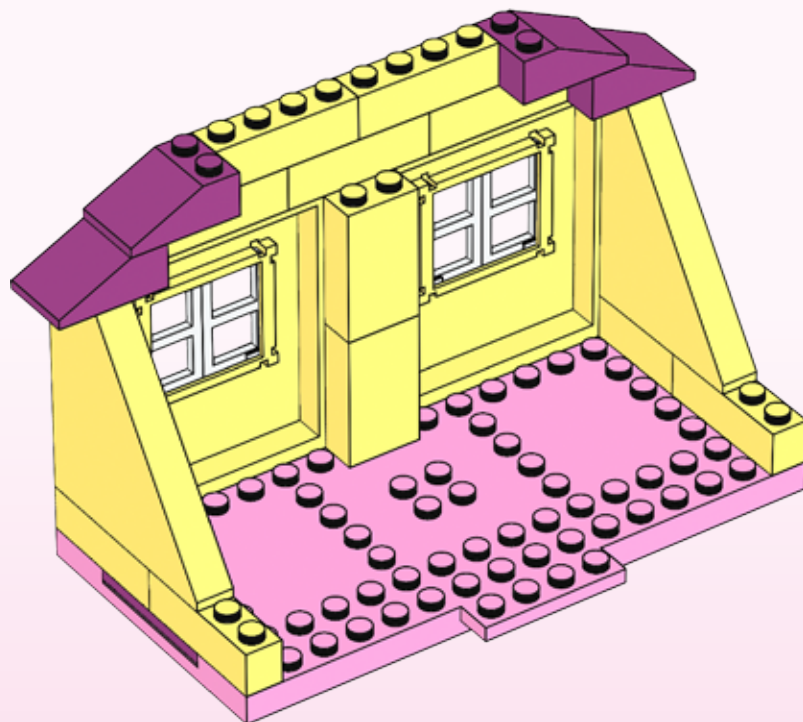



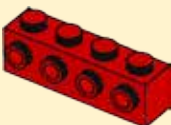

1

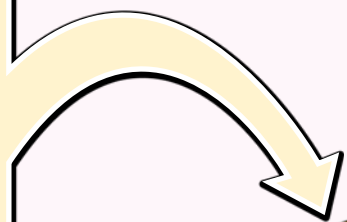

2



9

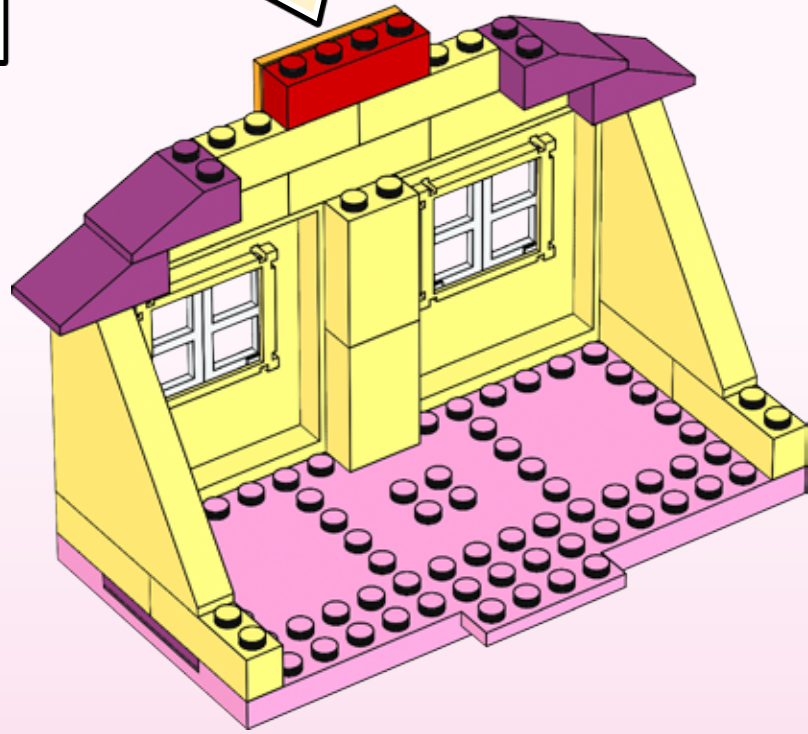

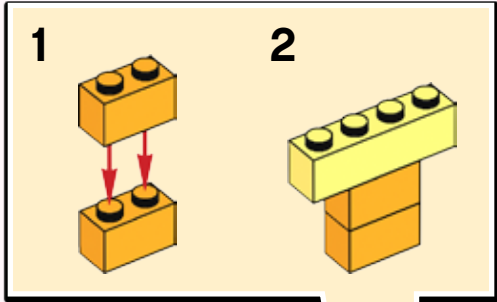
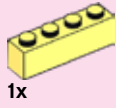

10

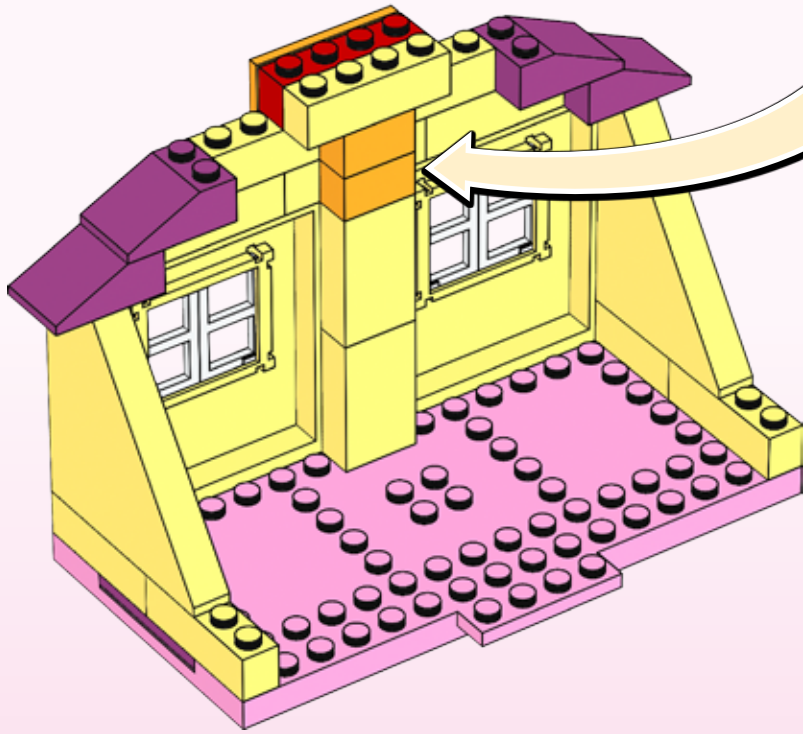

11

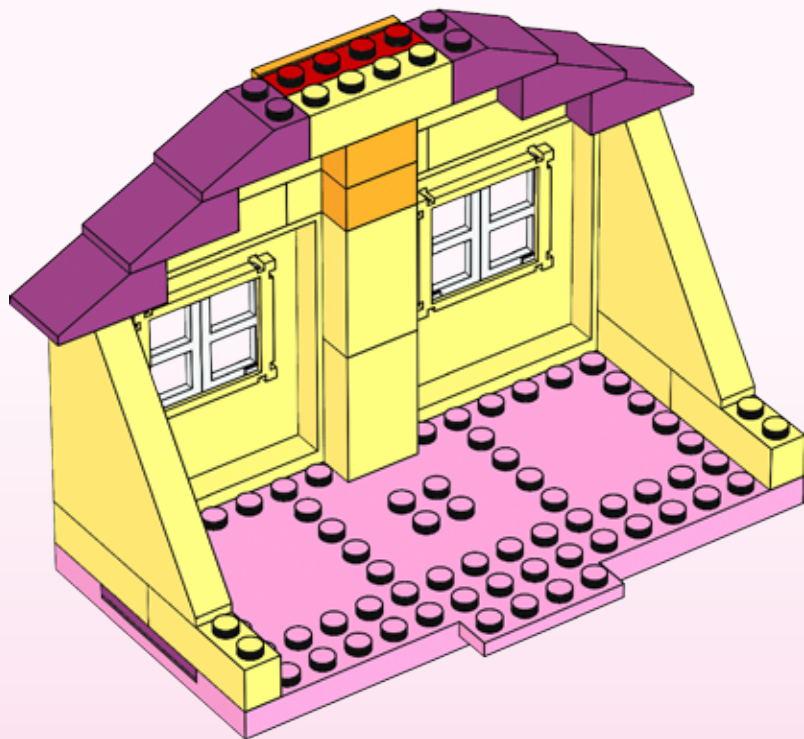

2x



2x

12

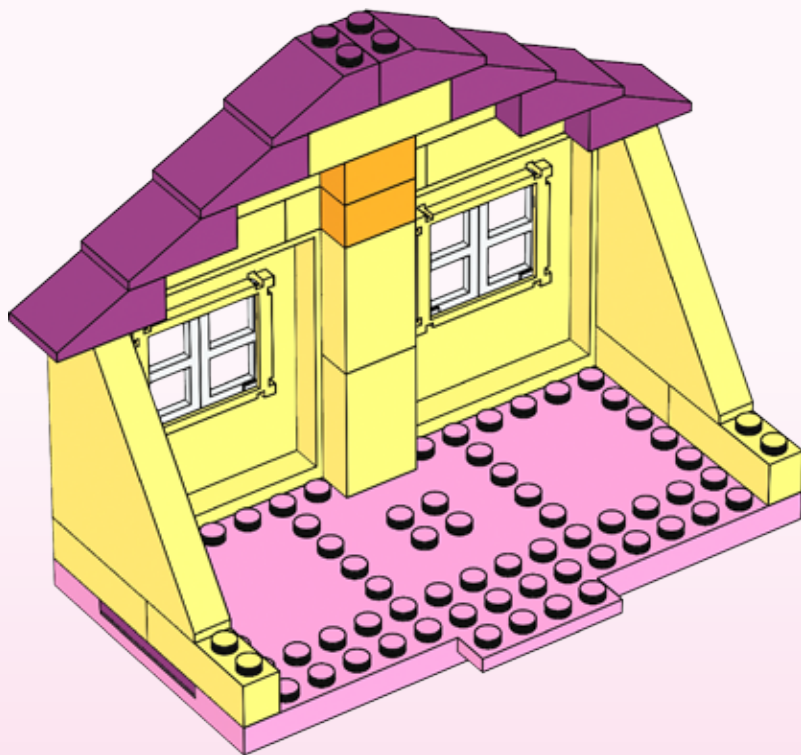

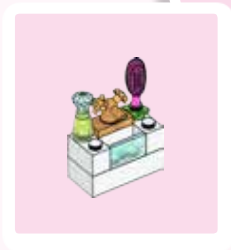

3x



1x



1x

1

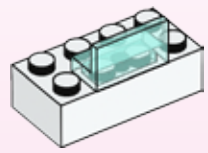

2

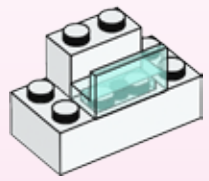

3

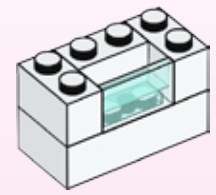

1x



1x



1x



1x



1x



4



5



6



13

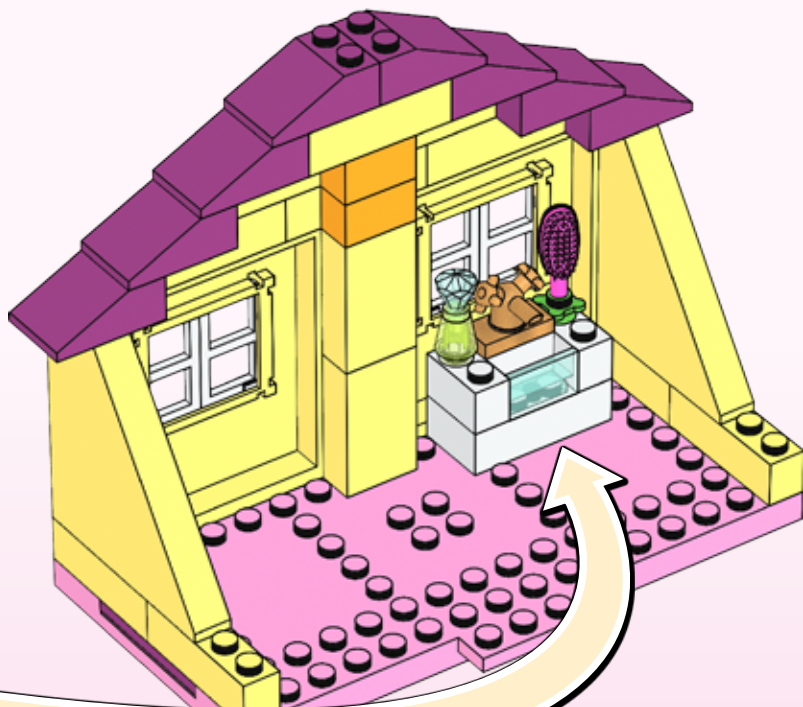



1x



1x

14



15

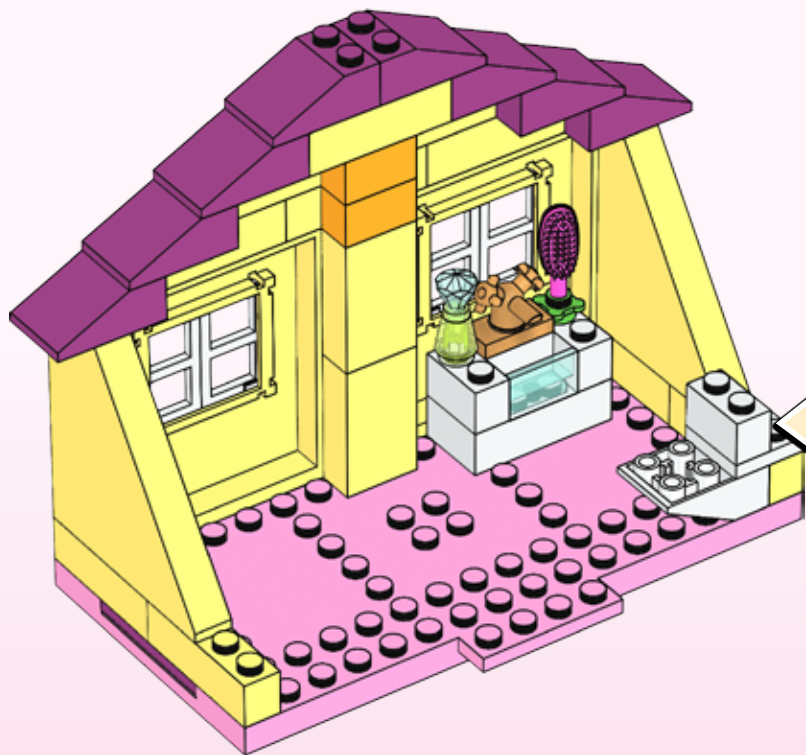

1x

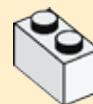



1x



1x

16

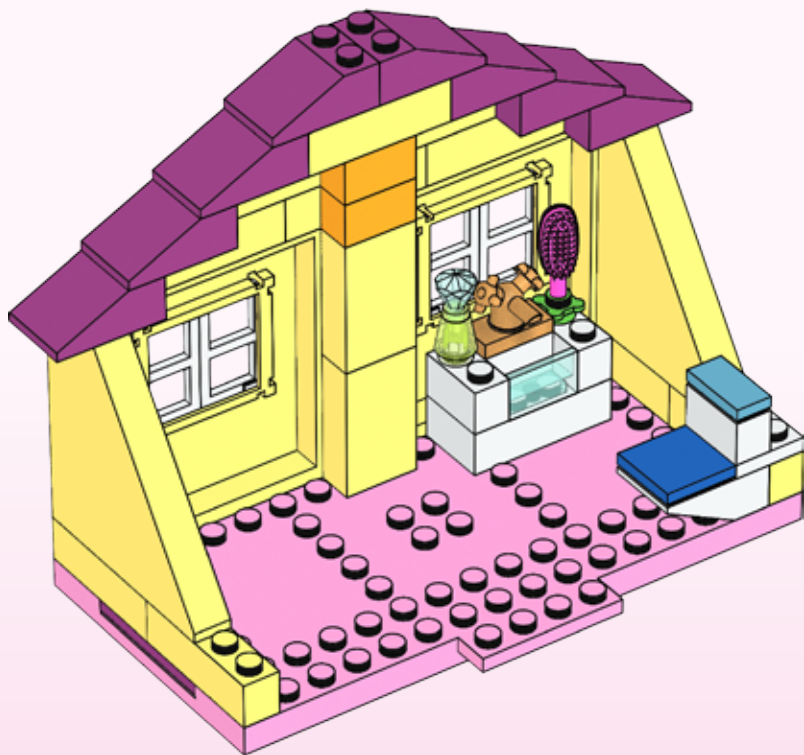



17





2x



1x



1x

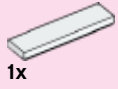

1x



1x



1x

18

1

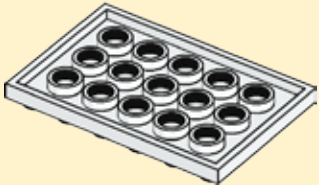

2

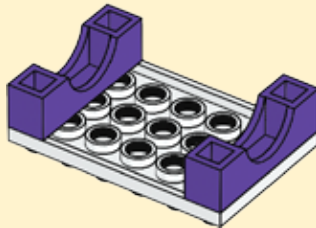

3

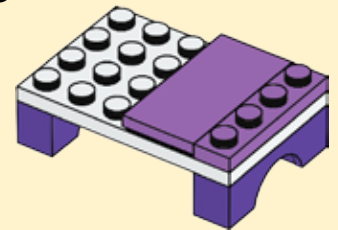

4

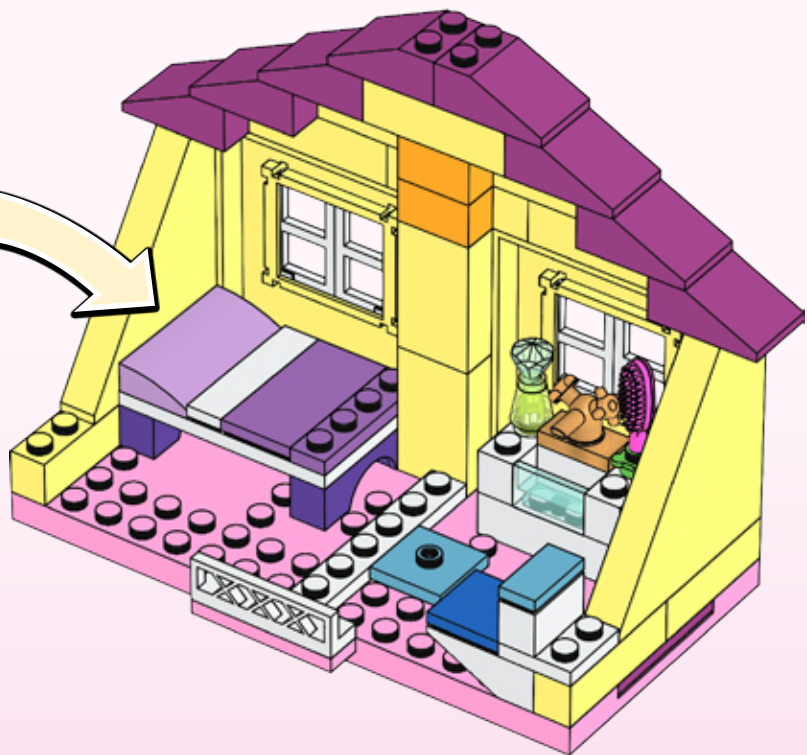
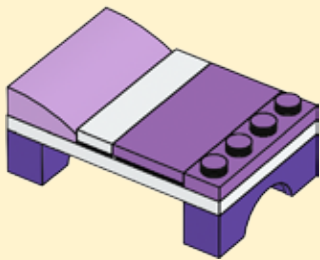



19



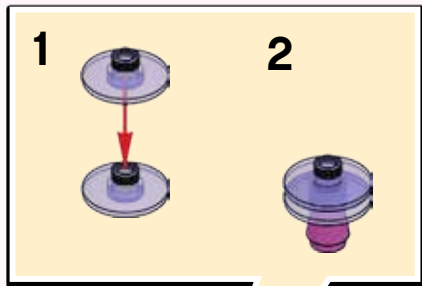

1x

2x

20

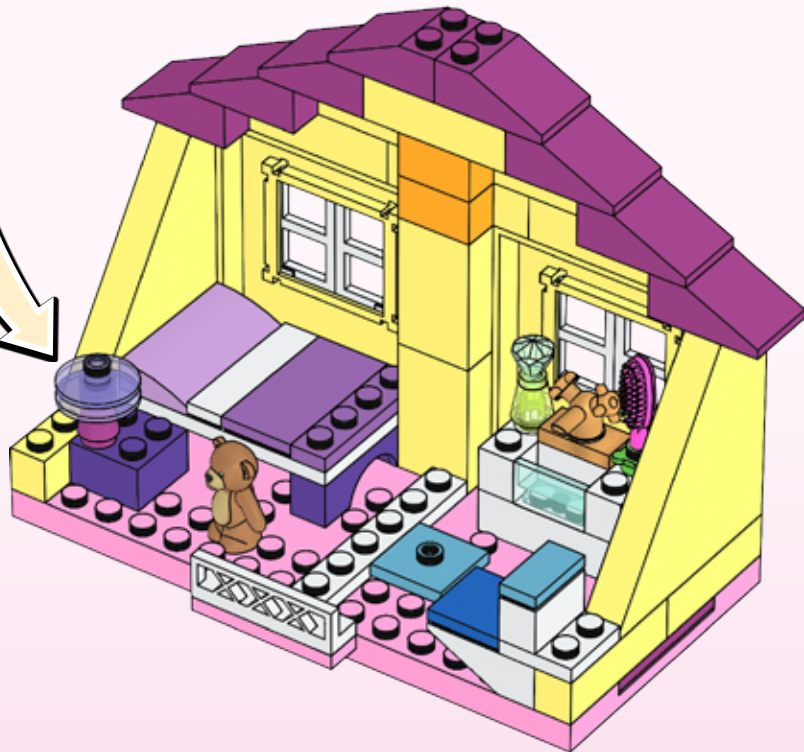



1x



3x

21

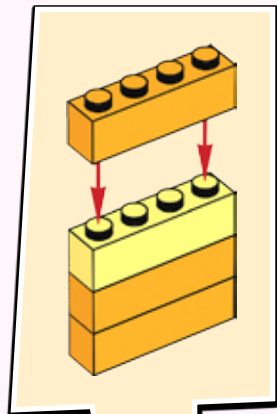
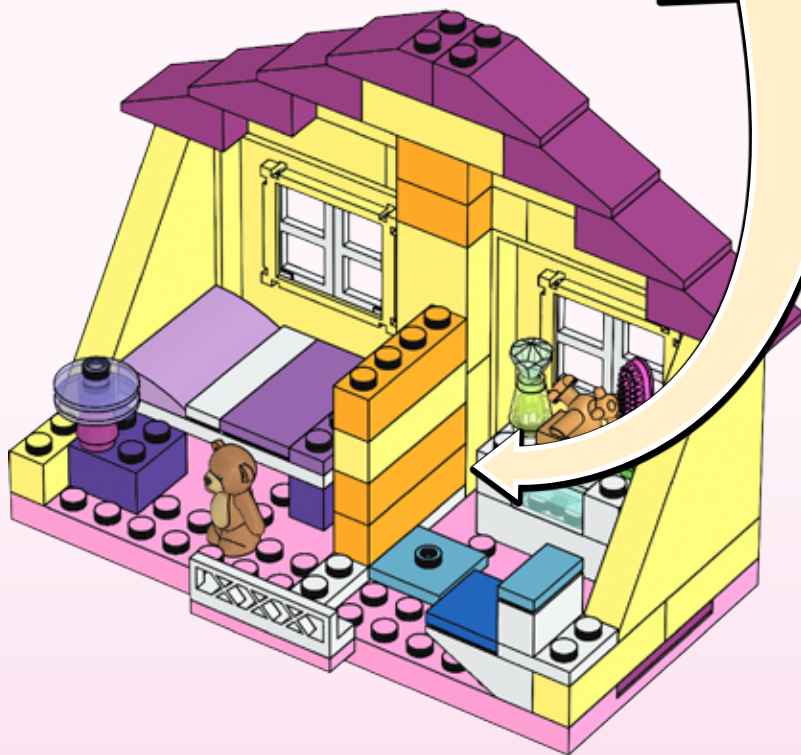

22

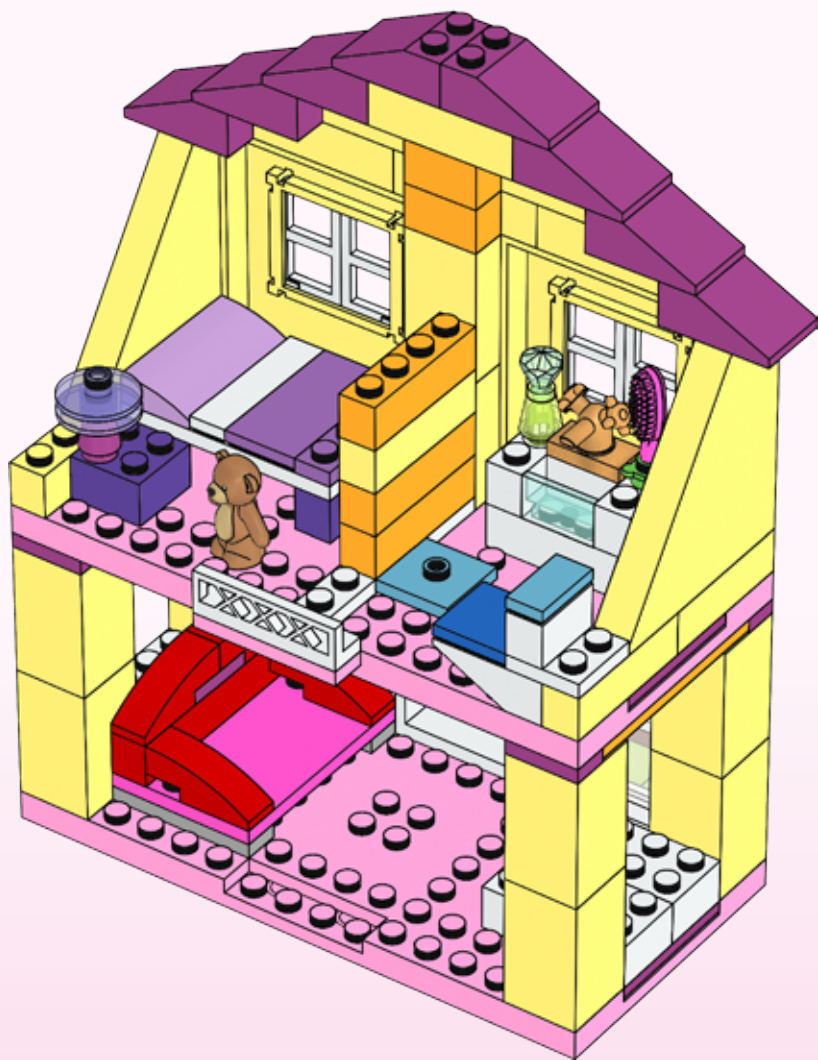



23

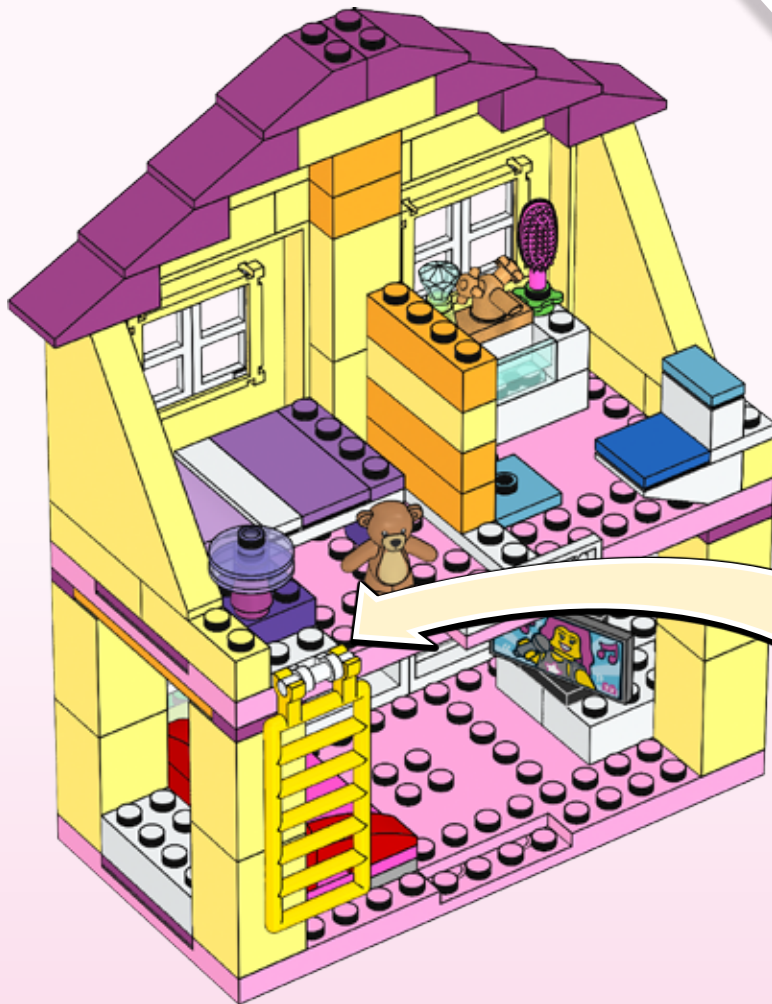

1x

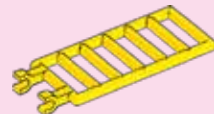

1x

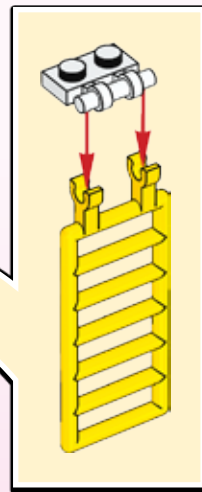



1x

24



25



1x

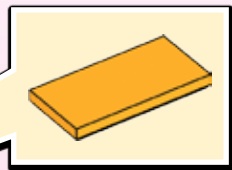



3x

26



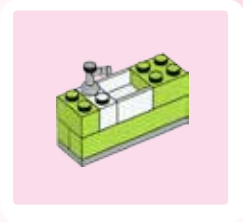

1x

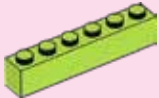

2x

1

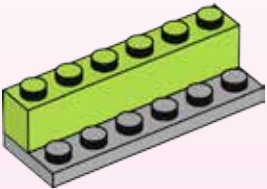

2

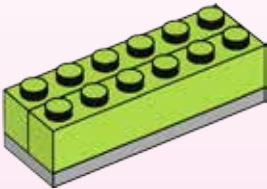



1x



1x



1x



2x



1x

3

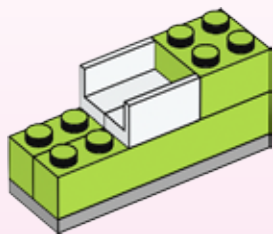

4

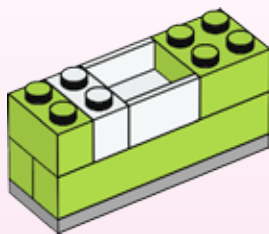

5

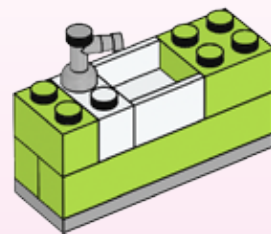

27





1x



1x



1x



1x

28



1



2



29





1x



1x



1x



1x



1x



1x

30

1



2



3

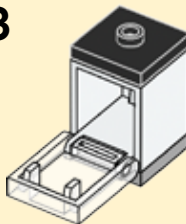

4

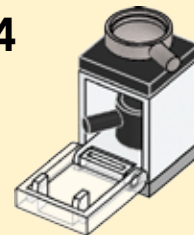

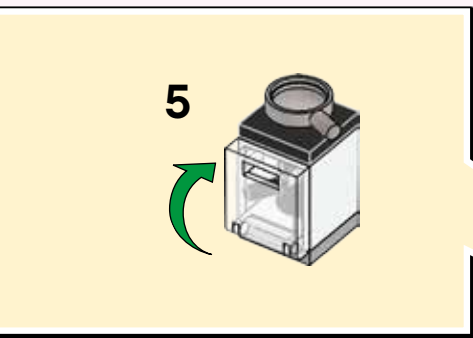



1x



2x



2x



2x



1x

31

1

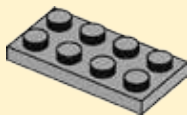

2

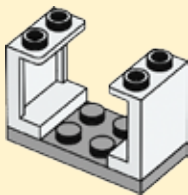

3

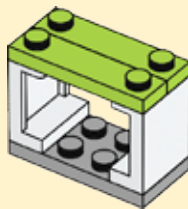

1



2



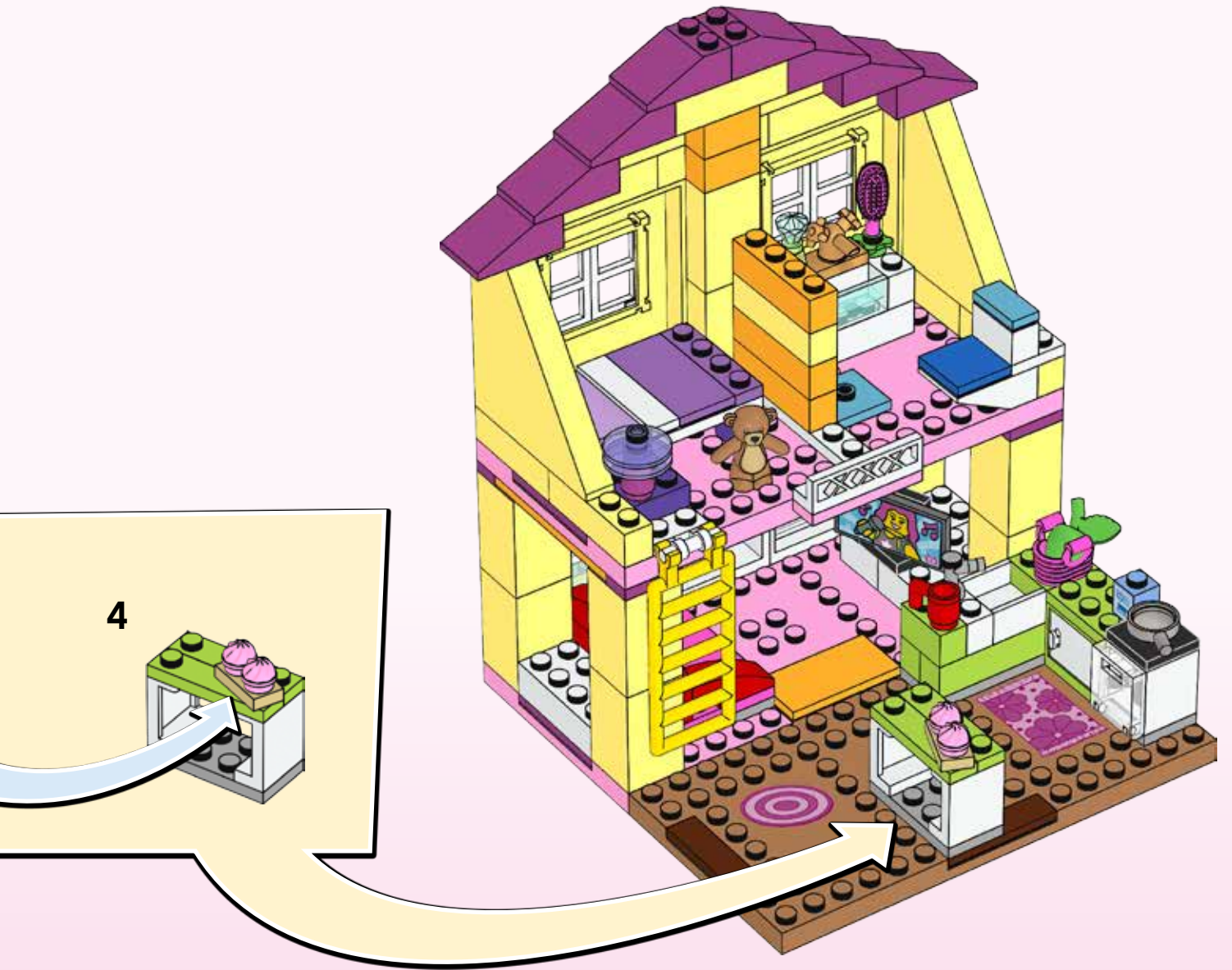



1x



1x

32

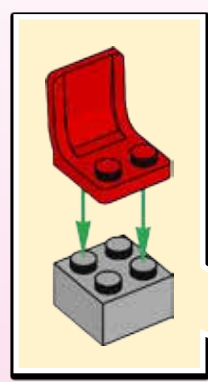



1x



1x



1x



1x

1

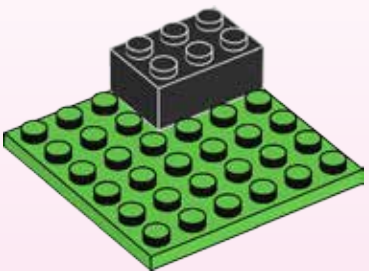

2

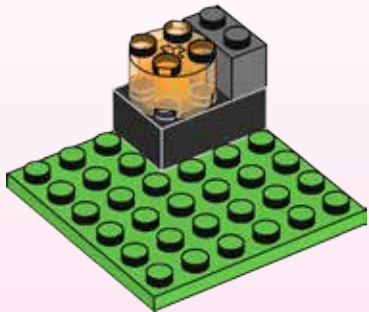



3

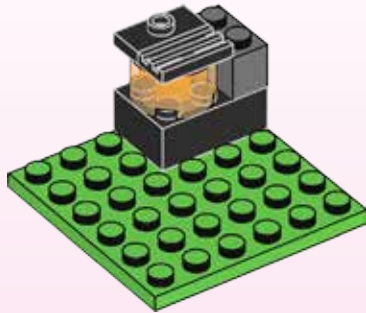

4

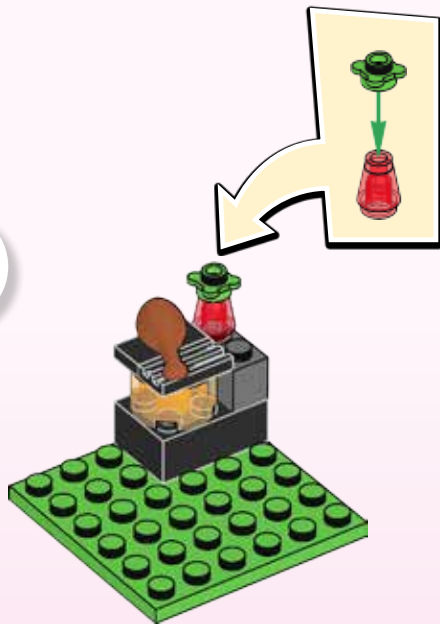

5

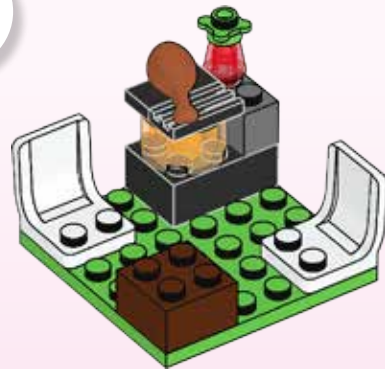



6

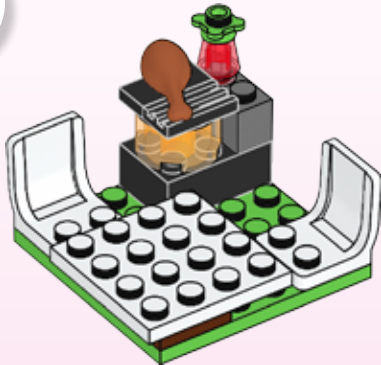

7

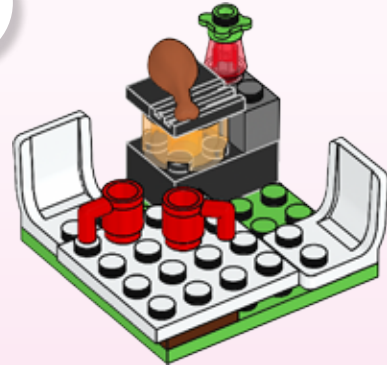

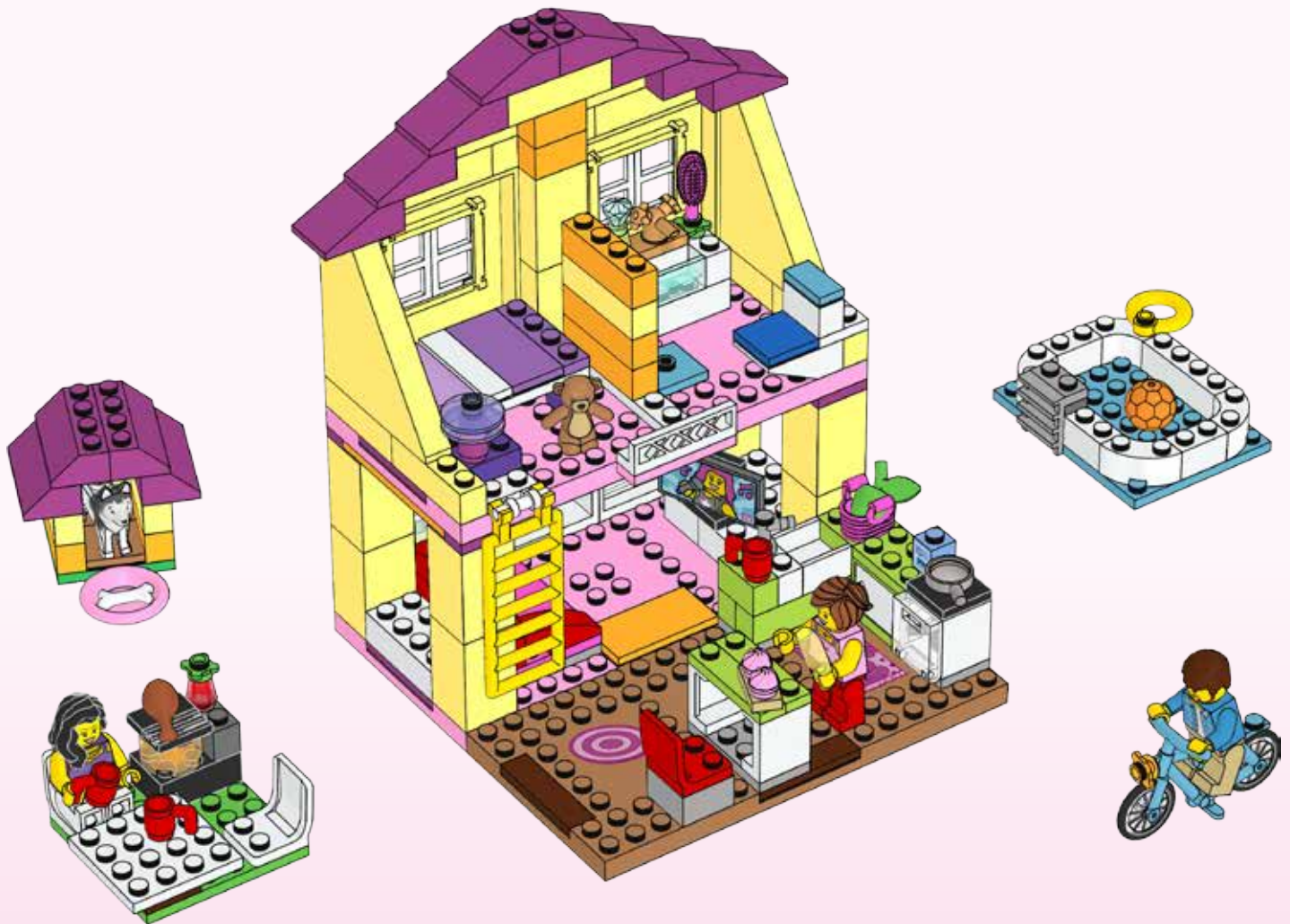



7x
300401



2x
301001



4x
300101



4x
4567449



1x
4500469



1x
302201



1x
243101



1x
366601



1x
4243812



1x
303201



1x
4119410



1x
4140583



4x
4520842



2x
4585458



2x
486501

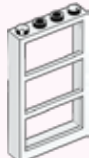

2x
4507543

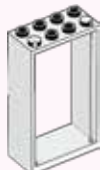

1x
4528140



1x
4261470



2x
407901



1x
434501



1x
4550171



1x
9327



1x
4600294



1x
6076467



1x
300921



1x
4157223



1x
4521852



4x
4251162



1x
407921



1x
4261628



1x
9342



3x
389921



1x
300226



1x
6092585



1x
241226



1x
4565323



1x
6061032



1x
4258354



1x
4610232



1x
452926



1x
4113917



1x
4107623



1x
6070784



1x
6116616



1x
4651443



1x
4578503



1x
4527354



1x
306823



1x
4243821



1x
4277361



1x
374128



1x
6004650



2x
4619599



1x
4107050



1x
6122201



1x
4278013



2x
4622574



2x
4639698



1x
4521504



2x
4219773



1x
4544720



1x
6066124



1x
4119482



1x
4568173



1x
4619596



1x
6023209



1x
4164022



1x
4220632



2x
4537919



2x
4518611



1x
6013530



2x
6058127



1x
4625623



1x
6003007



8x
4599547



4x
4518889



1x
6070762



3x
6103415

5x
6078305

2x
6115085

1x
6099347

2x
6097512

1x
6061560

3x
6003003

5x
6003004

1x
4621543

1x
6116536

4x
4654129

2x
4624184

2x
4211210

3x
4211194

1x
4622483

1x
4211387

1x
4211397

2x
4599498

1x
4211395

1x
4211452

1x
4211503

1x
4603503

1x
4211088

1x
4211063

1x
6118957

1x
6024672

3x
4216479

1x
6097446

1x
6096094

2x
6022083

10x
6109695

13x
6036232

2x
6109768

2x
6116532

1x
6116640

1x
4618629

2x
6060795

2x
6109774

1x
4653960

2x
6112854

1x
6116697

1x
6044591

1x
6053084

1x
6021997

1x
6102990

1x
6055832

1x
4624615

1x
6116690

1x
4649741

1x
6003008

1x
4620433

1x
6097036

1x
4619524

1x
4651902

1x
6037655



1x
6116512

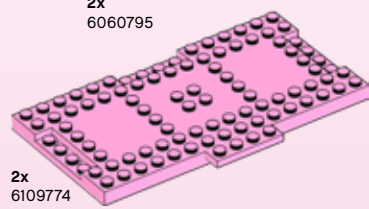

2x
6109774



Customer Service
Kundenservice
Service Consommateurs
Servicio Al Consumidor
LEGO.com/service or dial

: 00800 5346 5555
: 1-800-422-5346



JUNIORS



10674



10667



10673



10668



Ready for more? build and play

- Bereit für mehr? Bauen und Spielen
- Encore plus de jeu ? construis et joue
- ¿Estás preparado? ¡Más construcción y más juegos!
- Estás pronto para más? constrói e brinca
- Készen állsz MEG TÖBB építésre és játékra?
- 想要更多么? 拼砌和玩耍



Friends

5-12



JUNIORS

4-7



... with LEGO® Friends
in Heartlake City



LEGO.com/Juniors



App
Aplicação
Alkalmazás
应用程序



Games
Spiele
Jeux
Jogos
Játékok
游戏



Models
Modelle
Modèles
Modelos
Modell
模型

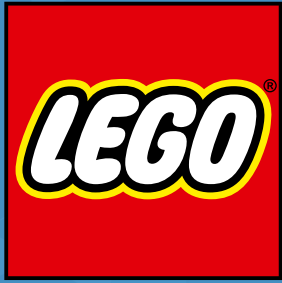

club™

