



TROCKENPFLANZEN

☐ Trockenpflanzen oder Wüstenpflanzen zählen zu den widerstandsfähigsten Pflanzenarten. Sie haben sich zu Gewächsen entwickelt, die in Klimazonen mit heftigen Winden, sengender Hitze und nur äußerst sporadischen Niederschlägen überleben. Üblicherweise speichern sie die geringen Feuchtigkeitsmengen, die sie irgendwie aufnehmen können, in rundlichen Knollen, um lange Dürreperioden zu überstehen. Leuchtende Blüten locken Bestäuber an, was ihnen einen Vorteil gegenüber konkurrierenden Pflanzen in ihrem Umfeld verschafft.



(Dudleya brittonii)

DUDLEYA BRITTONII

Eine in Baja California (Mexiko) heimische Sukkulente.



(Opuntia humifusa)

FEIGENKAKTUS

Ein im Osten der USA und im nordöstlichen Mexiko beheimateter Kaktus.



*(Mammillaria crinita
f. zeilmanniana)*

MAMMILARIA CRINITA

Dieses Kakteengewächs ist in Mexiko, dem Südwesten der USA, der Karibik und Südamerika heimisch.



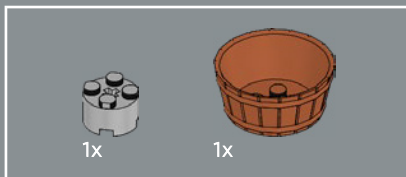

1

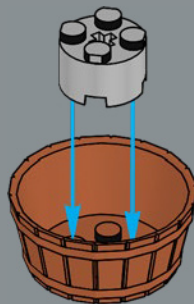



2

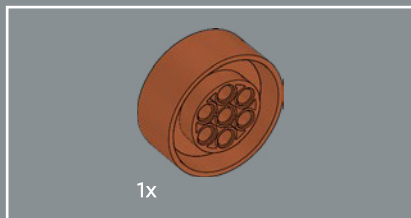
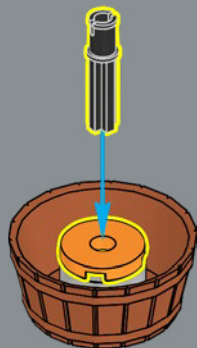

3

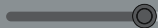
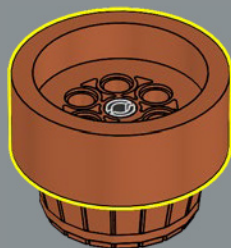



4

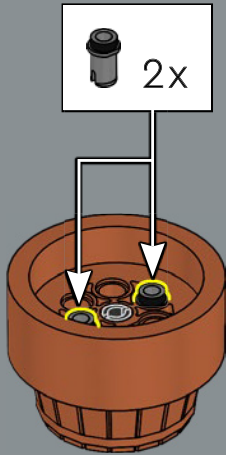

5

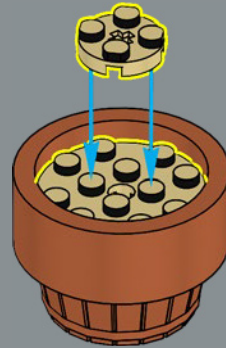



4x

6

Die farbenfrohe Sukkulente wurde nach Nathaniel Lord Britton benannt. Dieser amerikanische Botaniker war der Erste, der *Dudleya* als eigene Pflanzengattung einstuft.

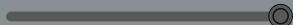
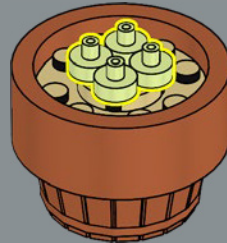



Um die dornigen Blätter mit einem schönen Farbverlauf darzustellen, haben wir die 1x1 Platte mit Zahn in einer neuen Farbe hinzugefügt. Falls du bei dir zu Hause LEGO® Tiere hältst, könntest du ihnen jetzt wunderschöne hellviolette Zähne verpassen.

7

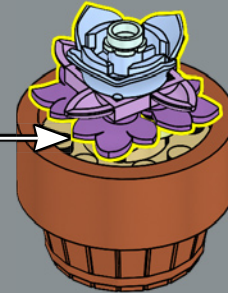
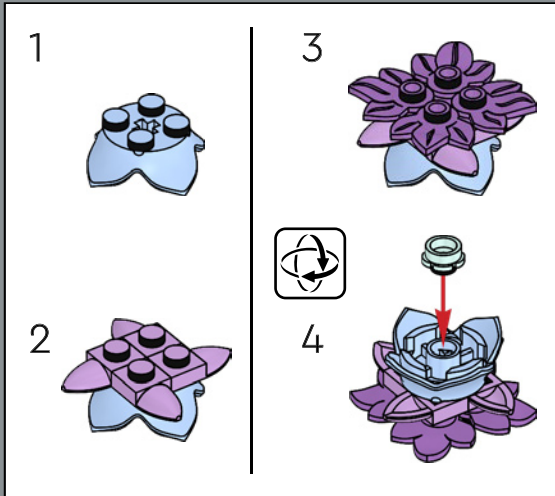

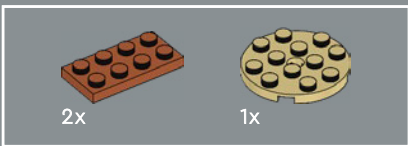
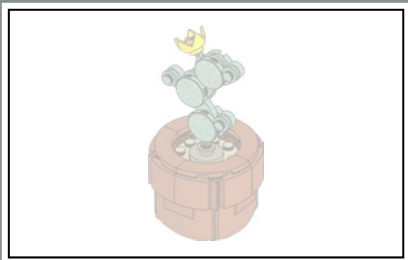

1

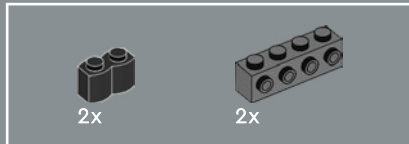
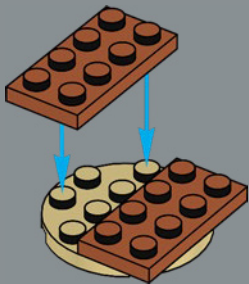

2

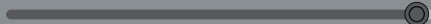
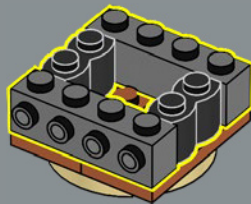

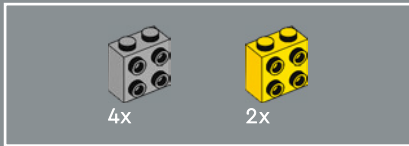

3

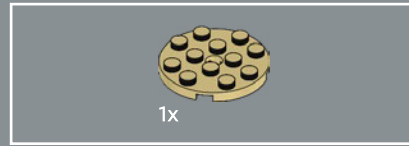
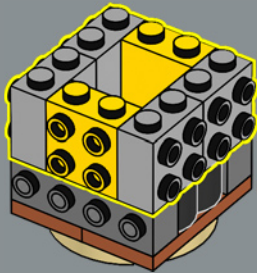

4

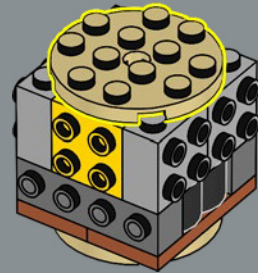

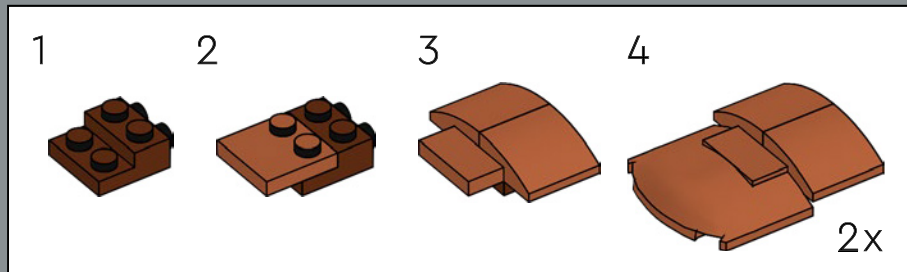
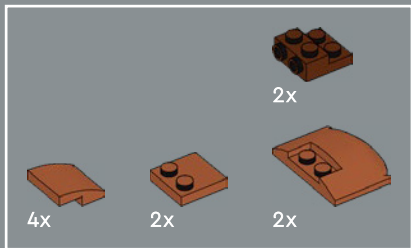

5

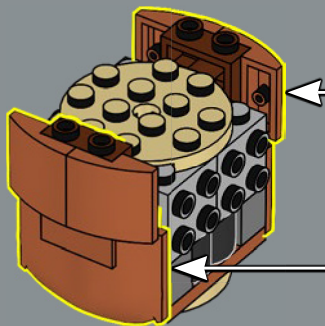

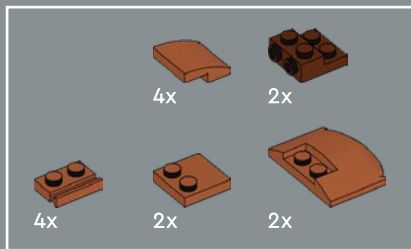

6

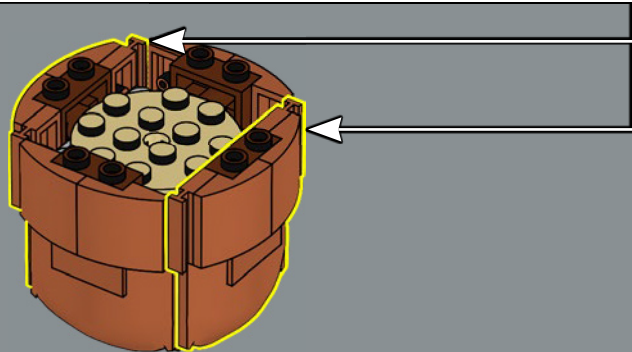
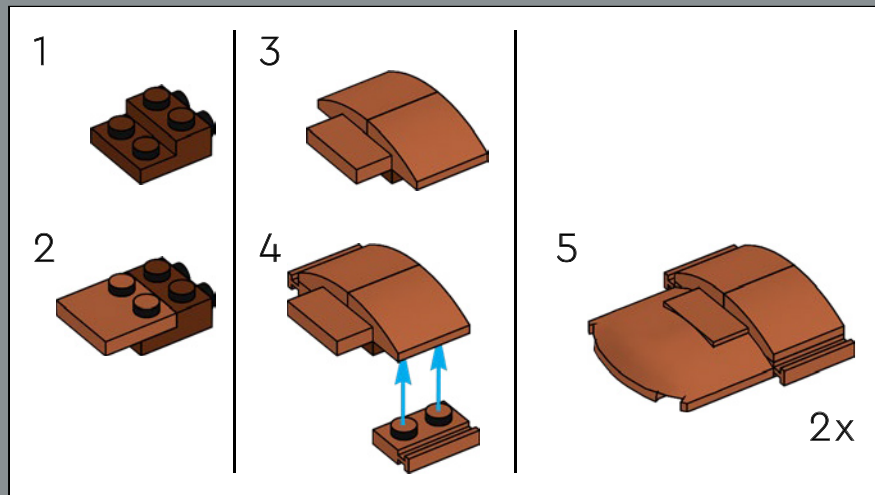

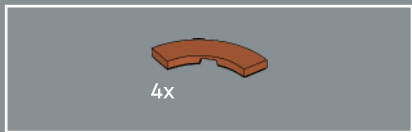

7

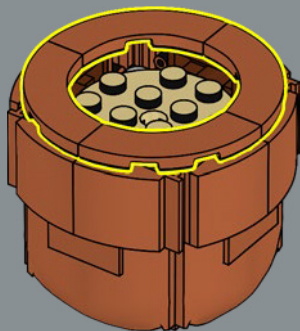

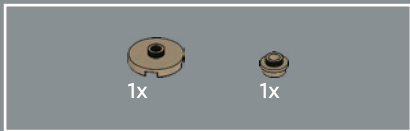

8

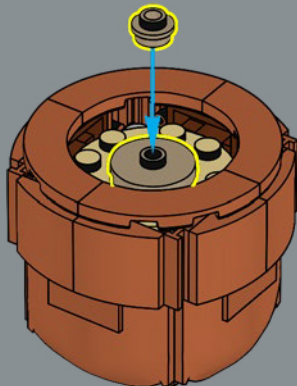

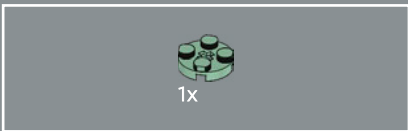
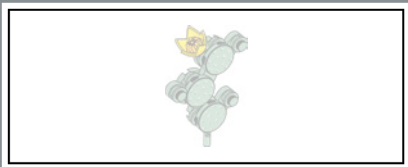

9

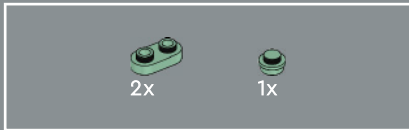

10

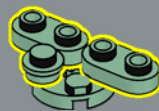

11

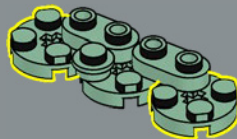

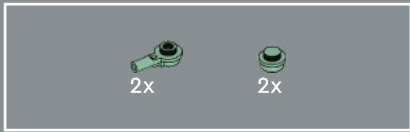

12

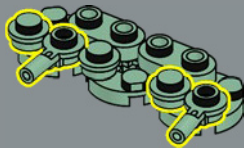

13

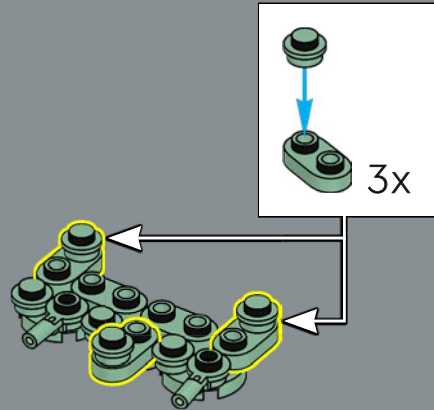



14

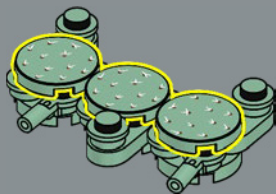

Die runden LEGO® 2x2 Kacheln in einem neuen Sandgrünton sind mit Stacheln bedruckt, um den dornigen Look des Feigenkaktus nachzubilden.

15

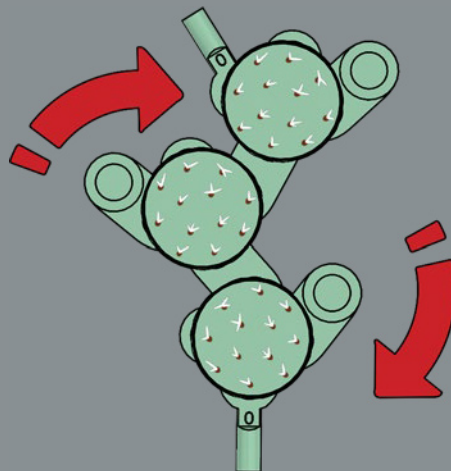

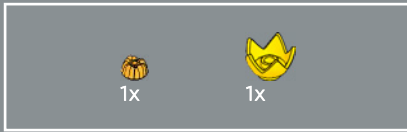

16

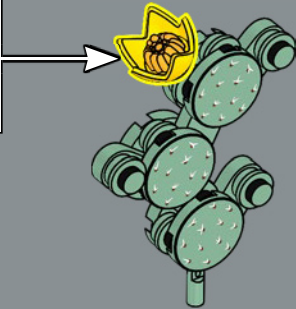

17

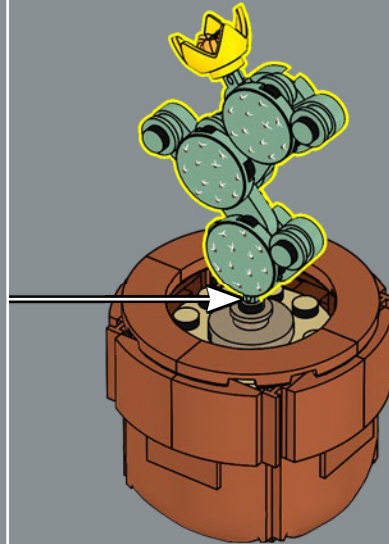

Wusstest du, dass man die Früchte des Feigenkaktus essen kann? Und die großen grünen „Polster“ sind ebenfalls genießbar. Man sollte aber vor dem Verzehr unbedingt die Stacheln entfernen!

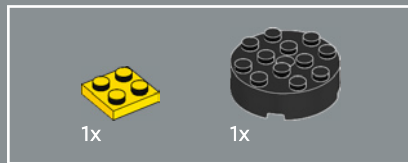
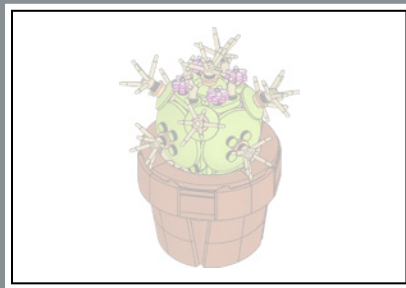

1

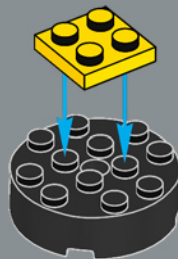

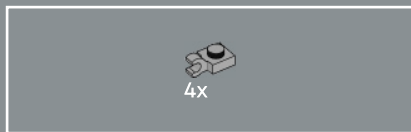

2

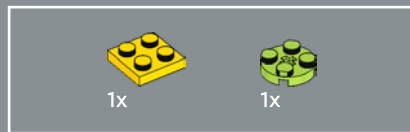
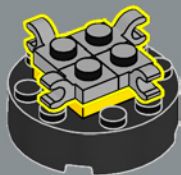

3

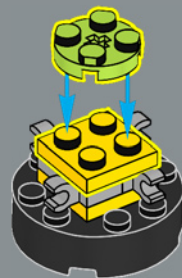



4



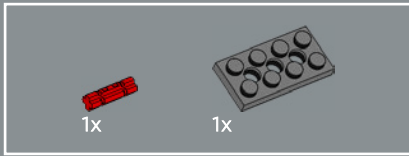

5

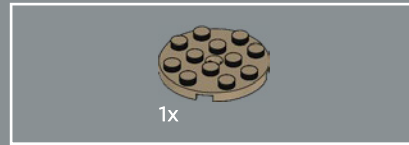
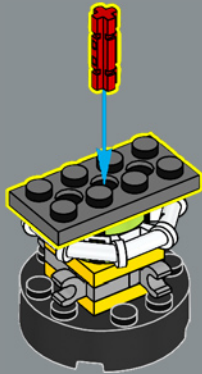

6

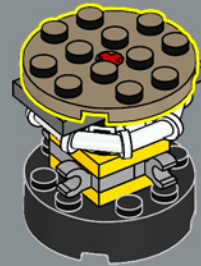

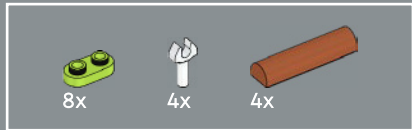

7

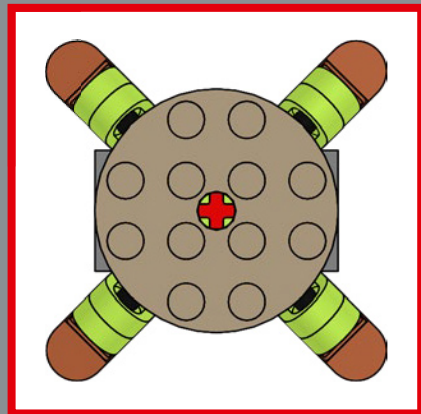
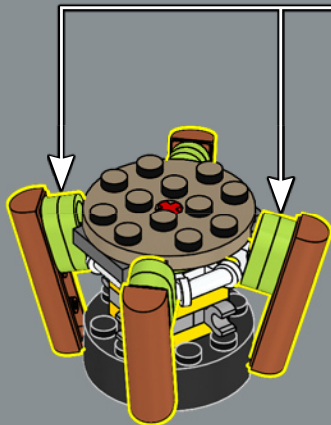
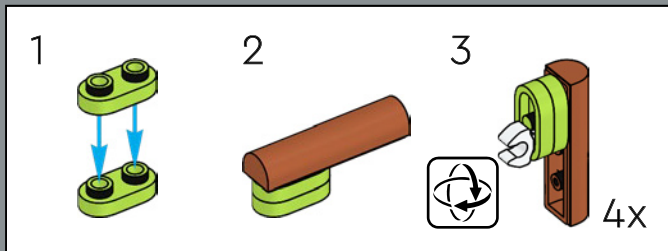

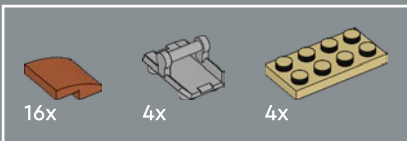

8

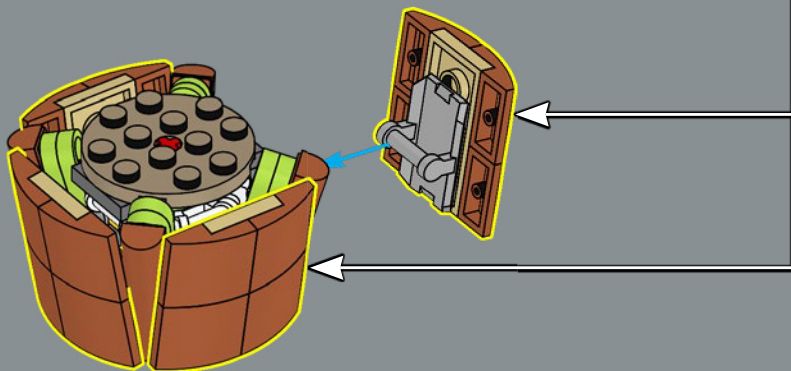
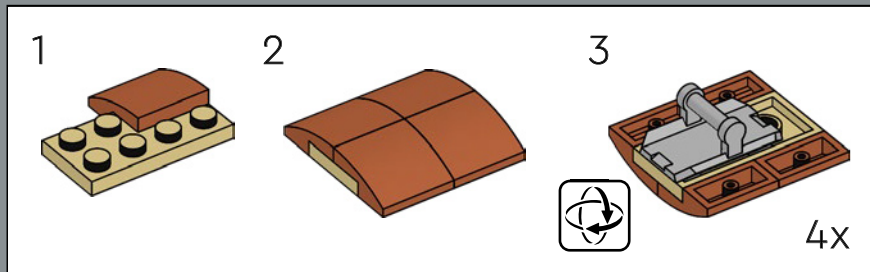

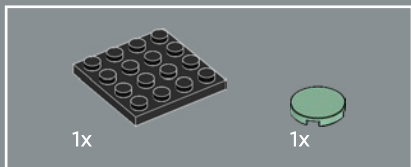
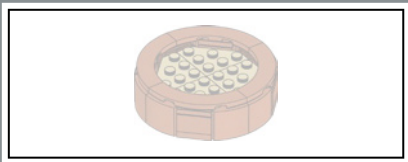

9

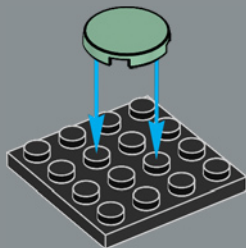

10

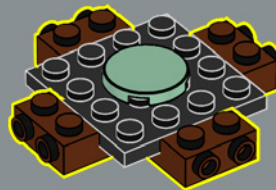



4x

11

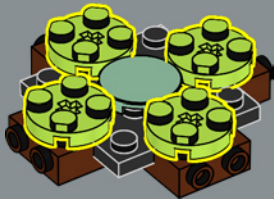

4x

12

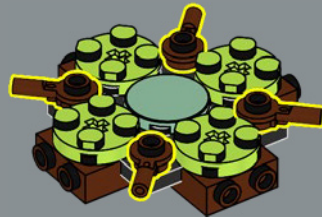

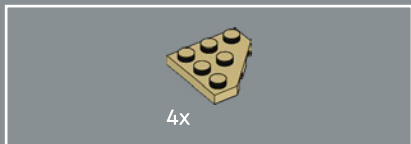

13

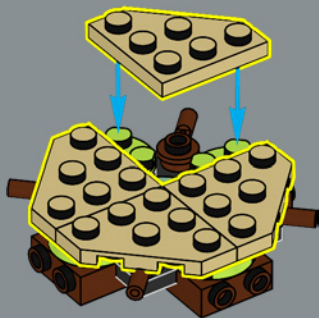

14

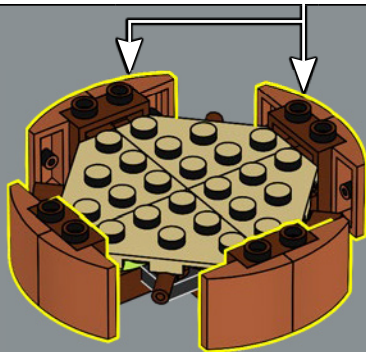
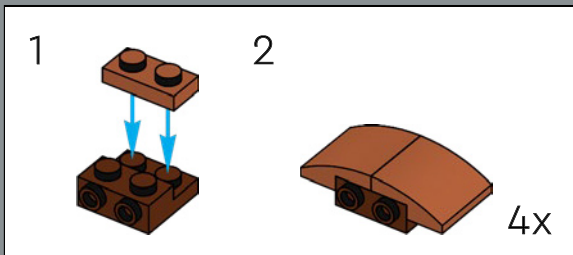

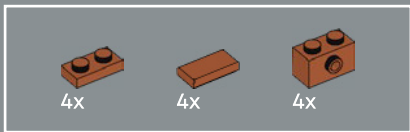

15

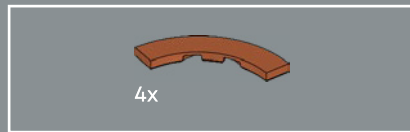
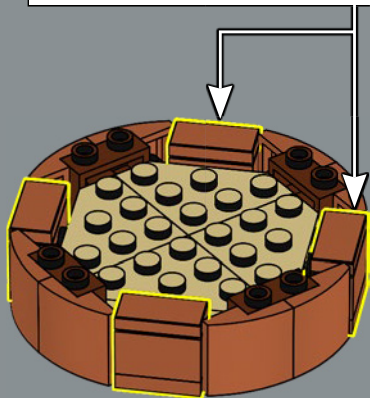
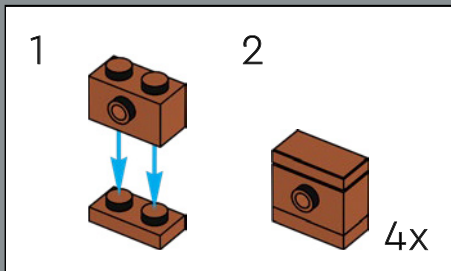

16

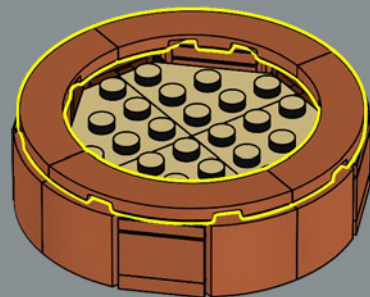

17

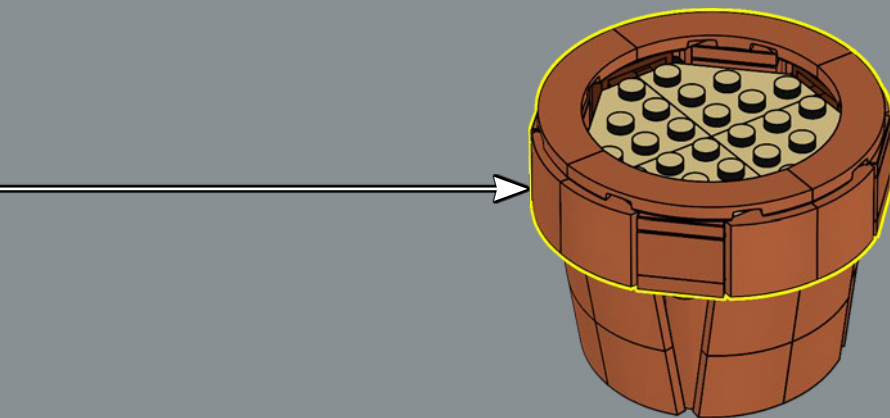

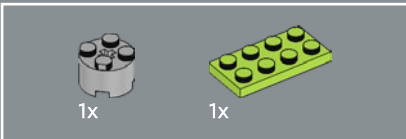
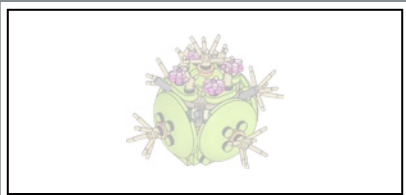

18

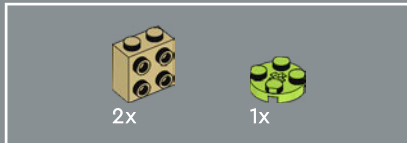
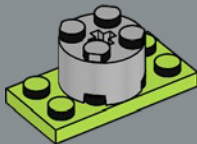

19

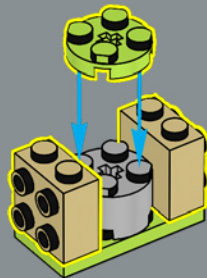



20

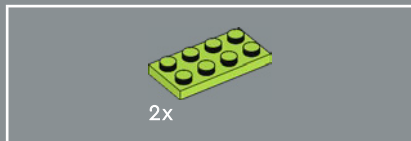
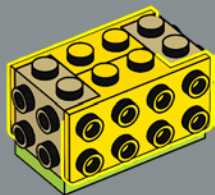

21

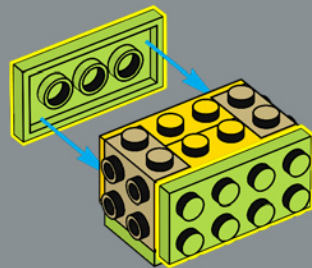



22

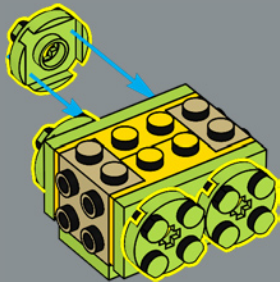

23

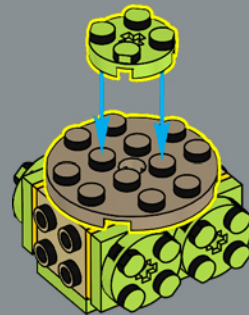



8x

24

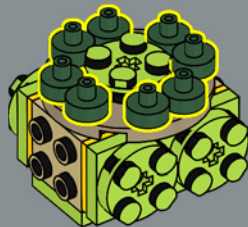



25

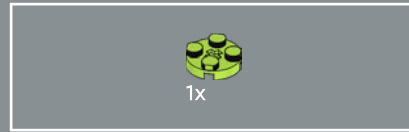
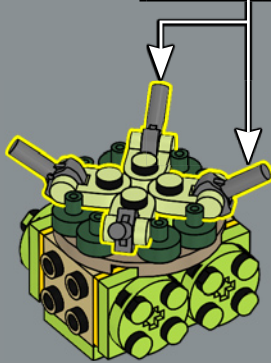
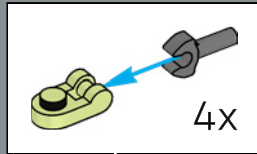

26

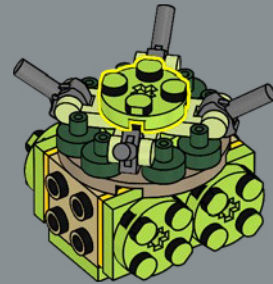

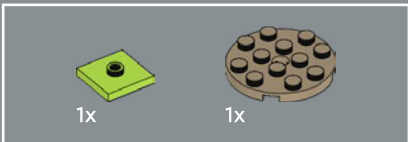

27

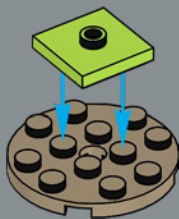

28

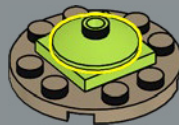



1x



4x

29

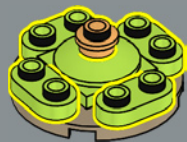

4x

30

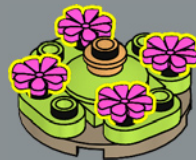



31



32





33



34

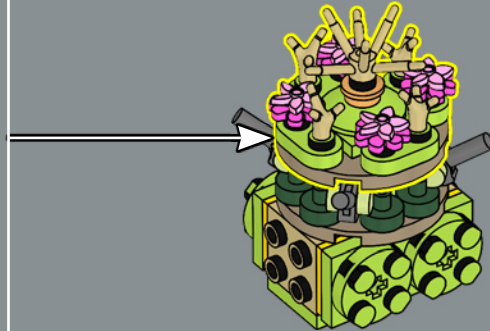

An einigen Kakteengewächsen der Gattung *Mammillaria crinita* wachsen wunderschöne Blütenkronen in leuchtenden Farben.

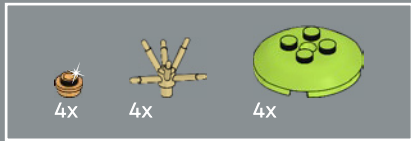

35

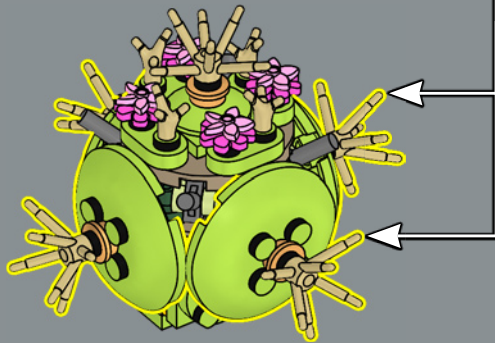
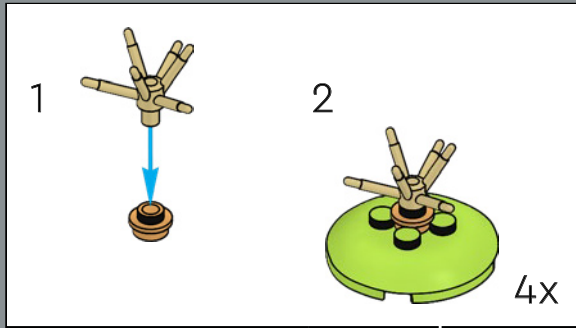

36

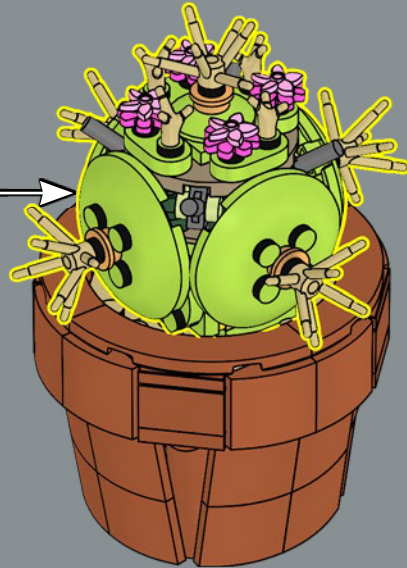

Mammillaria crinata f. zeilmanniana wurde zwar in den späten 1920er-Jahren zum ersten Mal katalogisiert, blieb aber zunächst weitgehend unbekannt. 1988 wurde sie dann in einen bestimmten Gebiet in einer Schlucht in Mexiko wiederentdeckt.

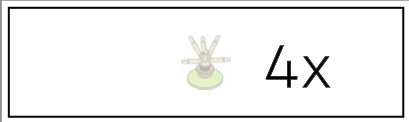

37

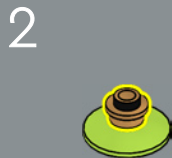
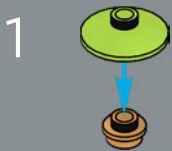

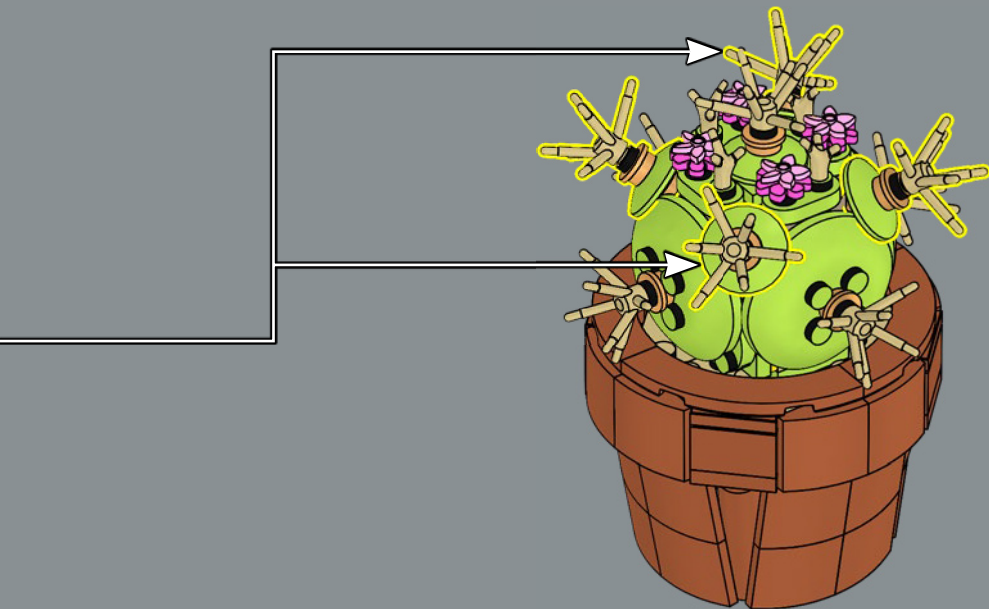

12x
6439046

3x
6302268

8x
6210269

2x
6468074

6x
4644456

1x
6074954

3x
6009016

12x
4114309

3x
4142865

1x
6170487

3x
6089119

2x
6399780

4x
6324176

1x
6449709

1x
6132541

1x
6168644

3x
4558957

2x
302228

13x
4140562

2x
6439048

1x
6102138

1x
6365630

3x
4243819

4x
6451597

2x
6214334

4x
6368619

2x
6135130

2x
6313592

5x
6382575

4x
6328327

10x
6463564

4x
6348058

4x
6370686

2x
302224

10x
6210271

4x
6468078

4x
4208072

2x
6400110

2x
302221

2x
6118828

2x
6253140

8x
6400649



2x
6138624



2x
4119479



3x
6161772



24x
4570877



12x
6468067



12x
4614158



12x
6228839



96x
6104344



12x
6394948



12x
6439724



12x
6468066



12x
6468071



3x
6462459



6x
4535928



3x
6462460



12x
6468069



4x
6240030



1x
6147052

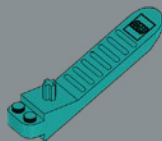

1x
6254100



6x
6211875



13x
6264062



2x
6190251



4x
6468391



13x
6314224



2x
6438450



5x
6121816



2x
6468075



1x
6056291



4x
6468077



3x
4537936



2x
6143445



13x
6300322



5x
6132767

2x
6092591

4x
6038637

6x
6232138

13x
6190252



8x
6454462

5x
6397157

8x
6392975

6x
6403175

5x
6303004

2x
6357616

3x
6468072

3x
6467694

3x
6223237

8x
6468343

4x
6360079

1x
6448317

1x
6456642

1x
4211183

3x
6133765

20x
6306775

6x
6102360

1x
6349130

36x
6470170

1x
6313506

4x
6075207

1x
6170468

12x
6335378

4x
4211526

12x
6123809

12x
6195471

1x
6420921

4x
6439040

7x
6395635

6x
4210725

3x
4227398

1x
6230582

4x
6206151

4x
6096990

3x
6468345

8x
6426463

6x
6468346

5x
6005030

1x
6251854

4x
6210460

4x
6468342

1x
6275487

4x
6223506

12x
6468504

4x
6468079

 [LEGO.com/service](https://www.LEGO.com/service)



YOU COULD WIN



YOU COULD WIN

Your feedback will help shape the future development of this product series.

Visit:

DU KÖNNTEST GEWINNEN

Dein Feedback trägt zur Weiterentwicklung dieser Produktreihe bei.

Geh auf:

VOUS POURRIEZ GAGNER

Vos commentaires nous aideront à concevoir les futurs produits de cette gamme.

Visitez :

POTRESTI VINCERE TU

La tua opinione ci aiuterà a migliorare la creazione futura di questa linea di prodotti.

Visita:

PUEDES GANAR

Tu opinión contribuirá al futuro de esta serie de productos.

Visita:

轻松获奖

您的反馈将有助于我们在今后改进本产品系列。

请访问：

LEGO.com/productfeedback

You also have the chance to win a LEGO® set.

Terms and conditions apply.*

Außerdem hast du die Chance, ein LEGO® Set zu gewinnen.

Es gelten die Teilnahmebedingungen.*

Vous pourriez également gagner un ensemble LEGO®.

Des conditions s'appliquent.*

Hai anche la possibilità di vincere un set LEGO®.

Termini e condizioni sono applicabili.*

También tienes la oportunidad de ganar un set LEGO®.

Aplican términos y condiciones.*

您还有机会赢取乐高®套装。

条款和条件适用。*

*LEGO.com/productfeedback-terms



LEGO and the LEGO logo are trademarks of the LEGO Group. ©2024 The LEGO Group.