

2

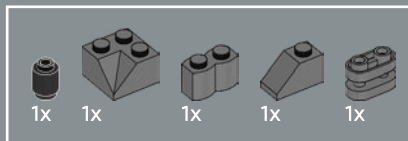

3

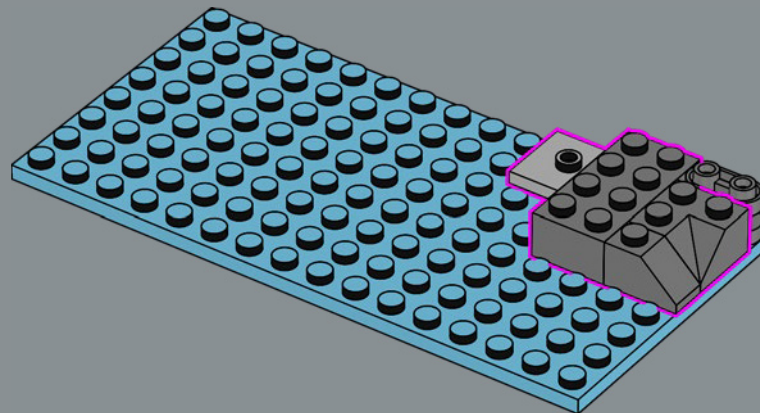

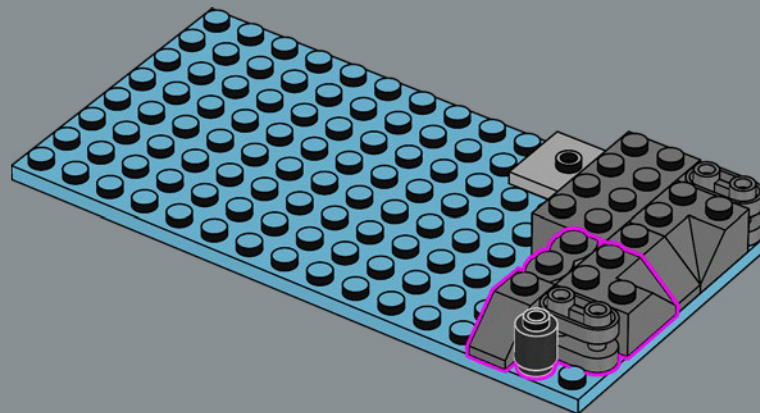
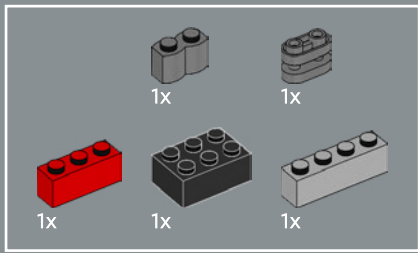

4

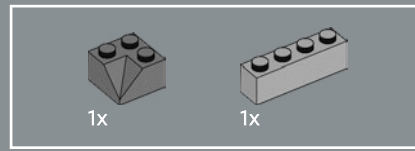
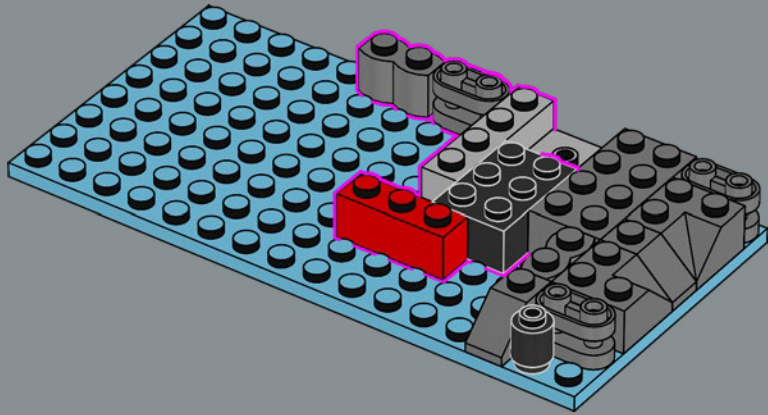

5

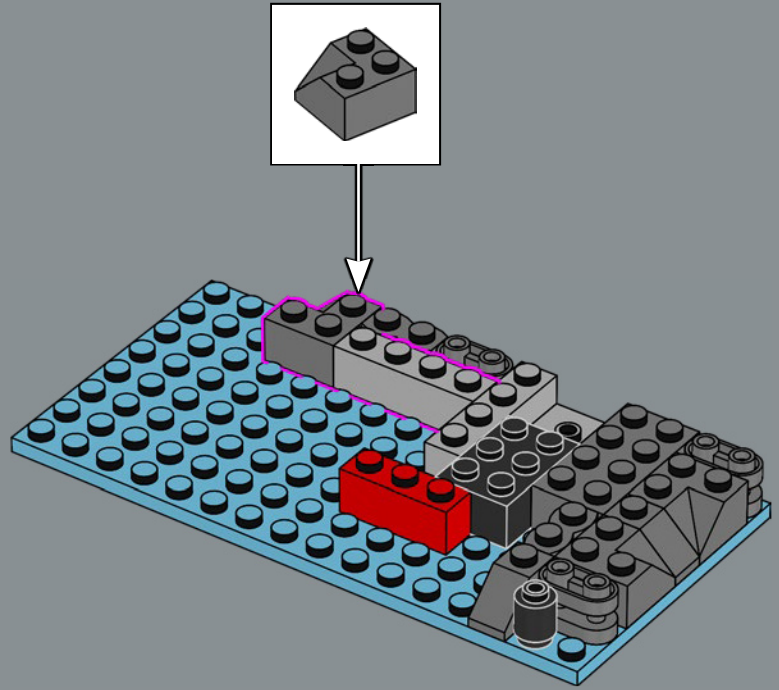

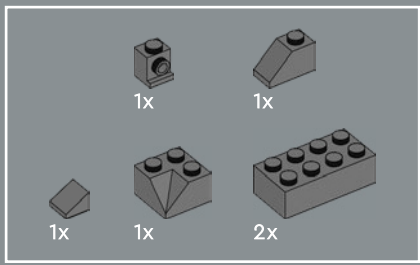

6

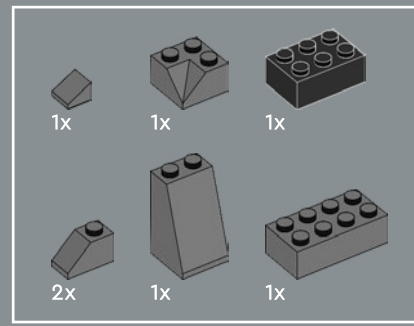
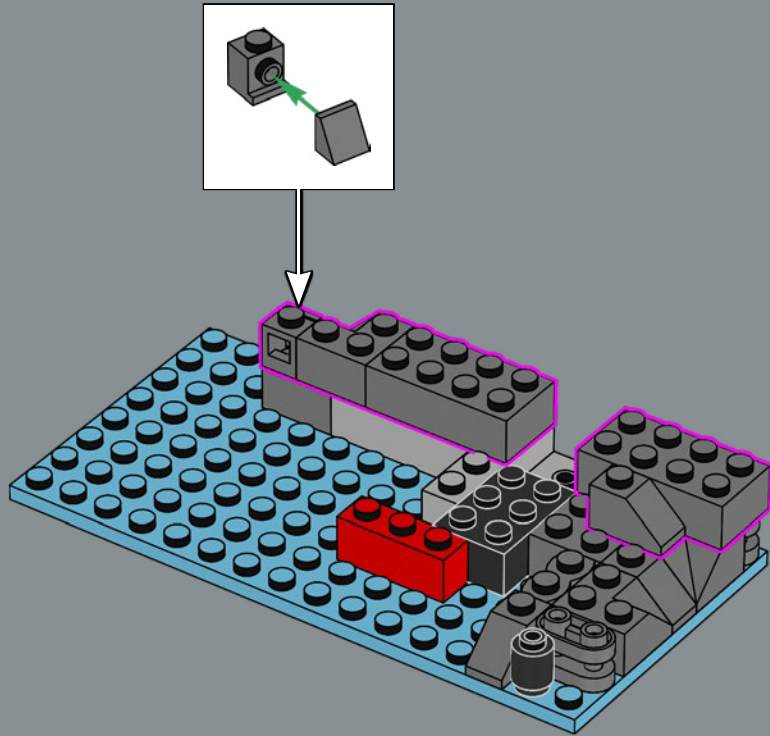

7

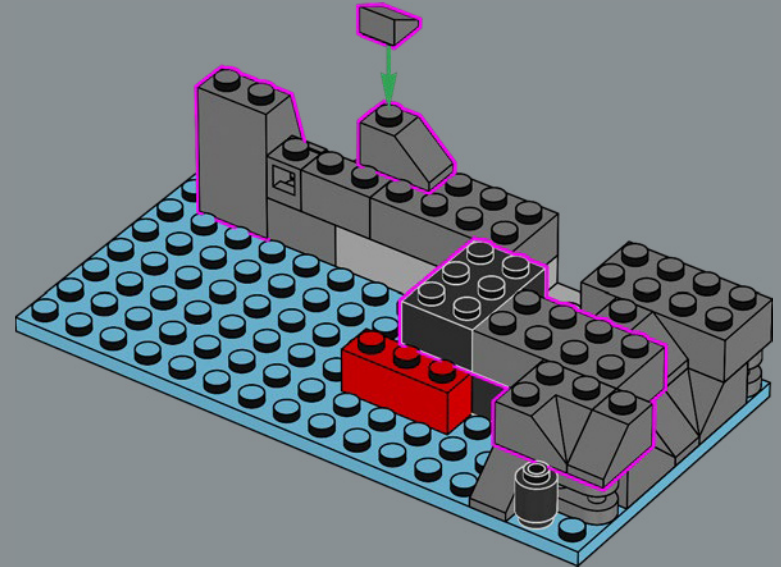

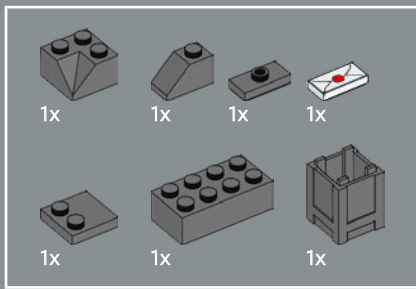

8

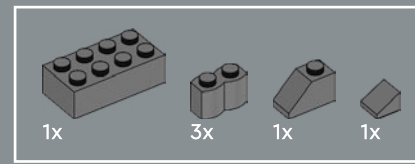
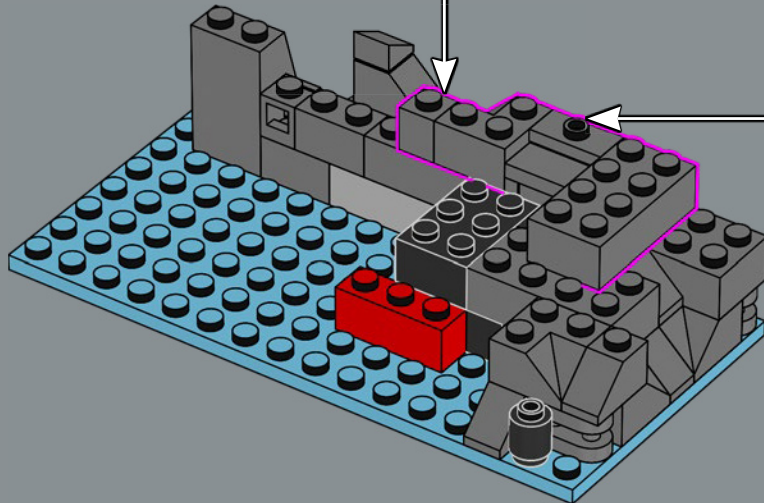
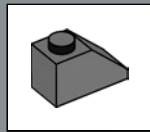
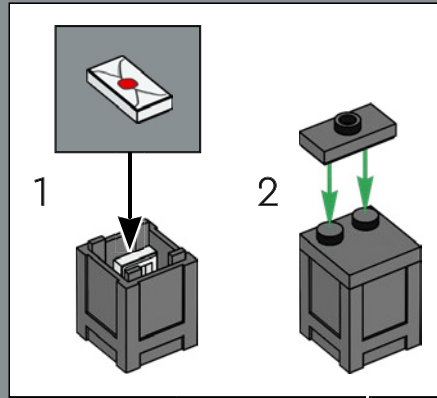

9

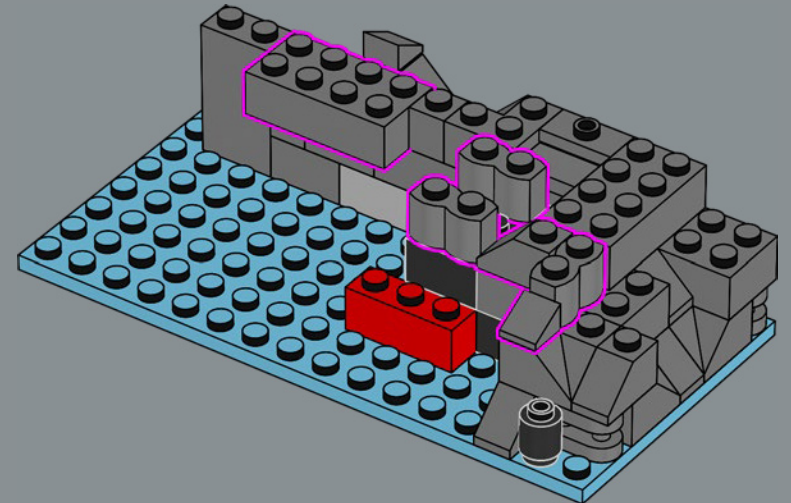

A hidden letter? Whom could it be from?  
Who can solve this mystery?

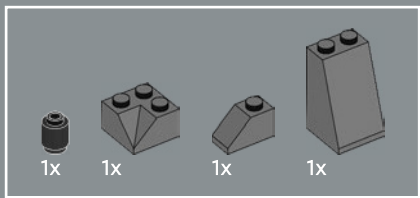

10

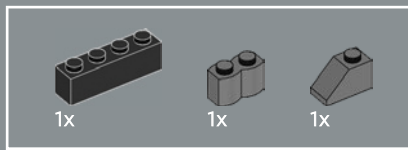
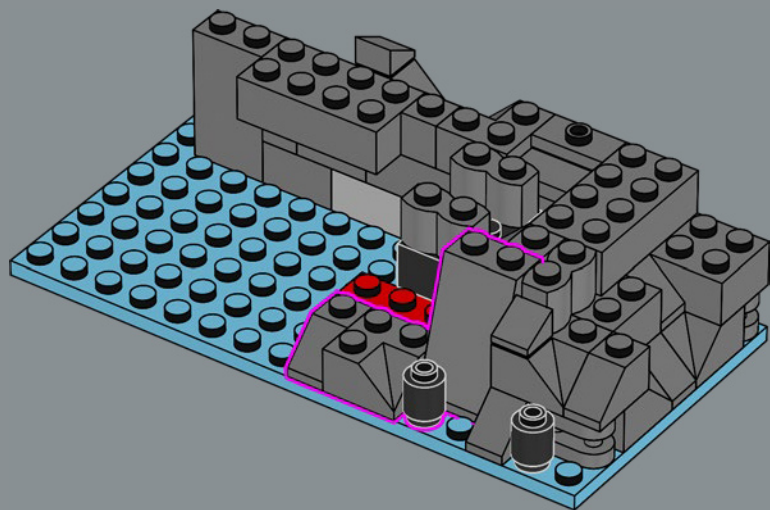

11

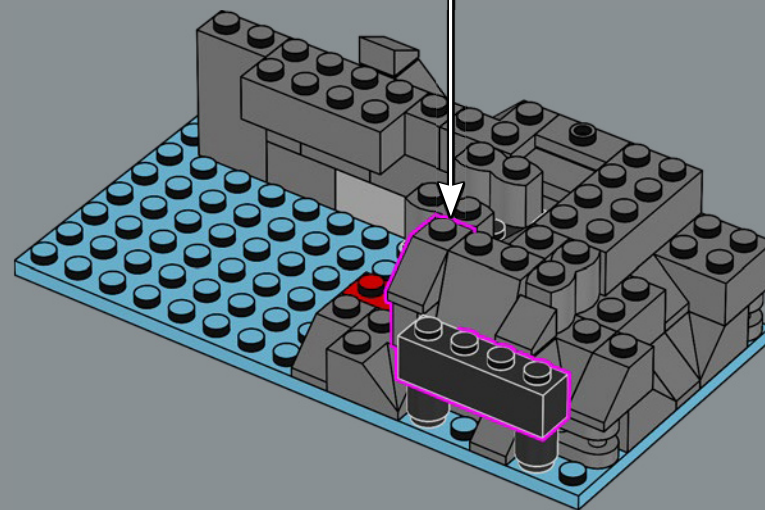
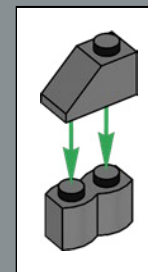



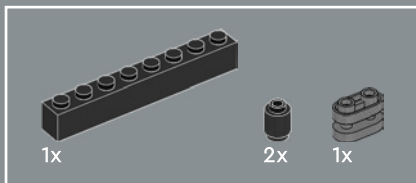

12

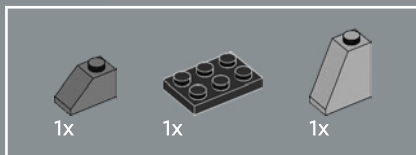
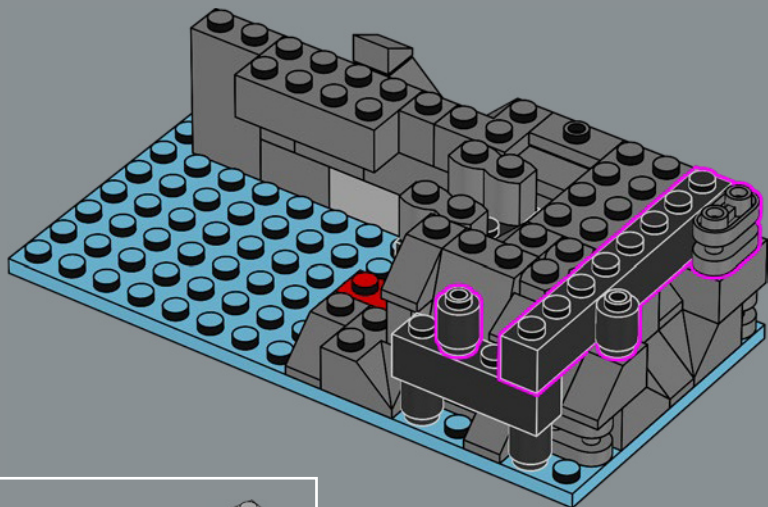

13

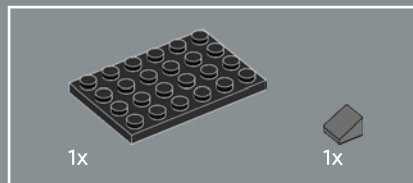
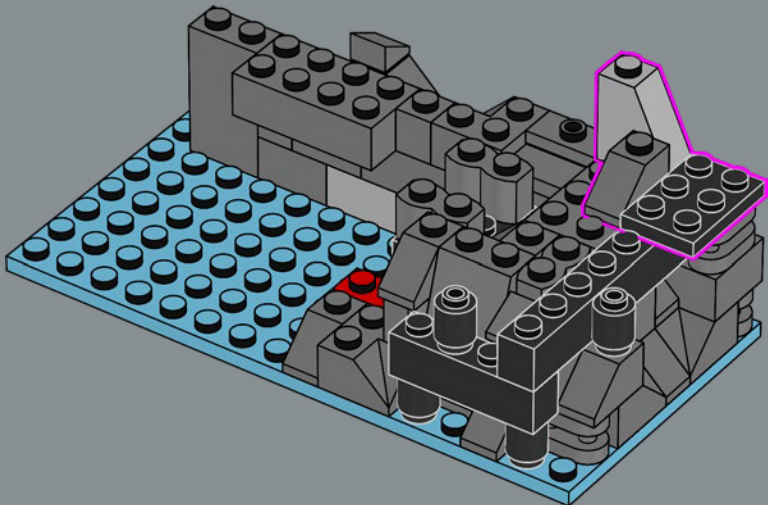

14

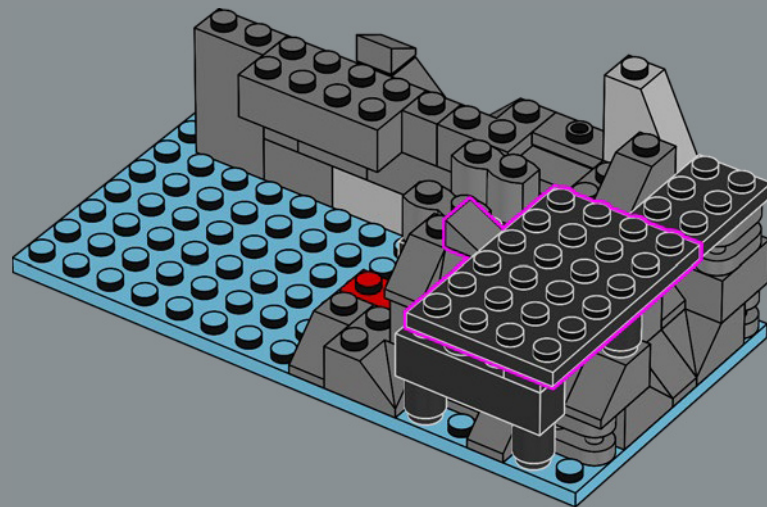

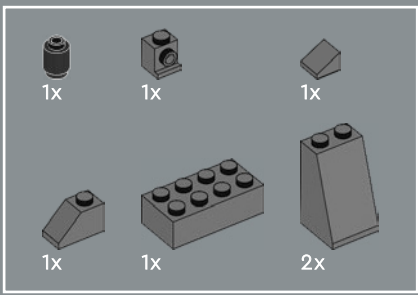

15

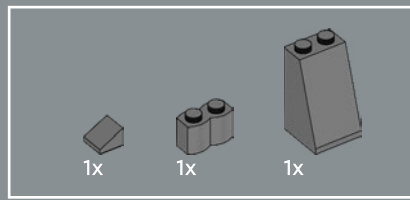
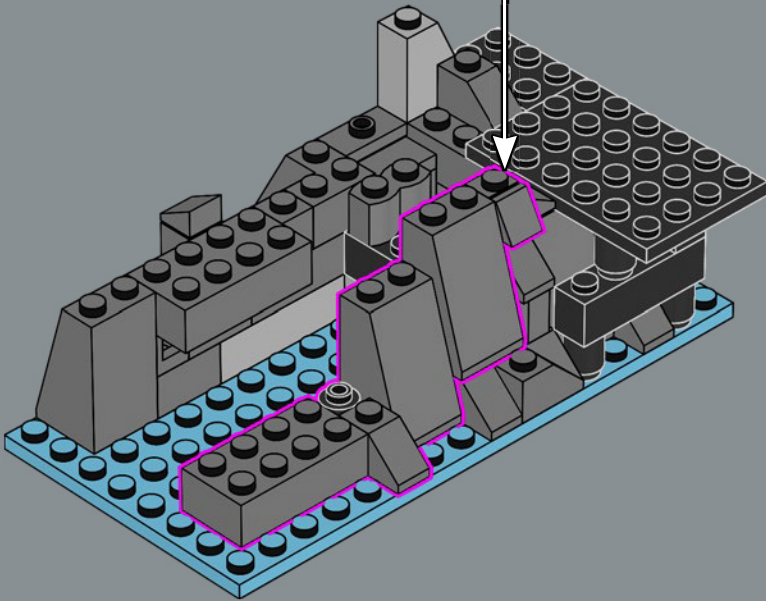
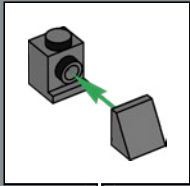

16

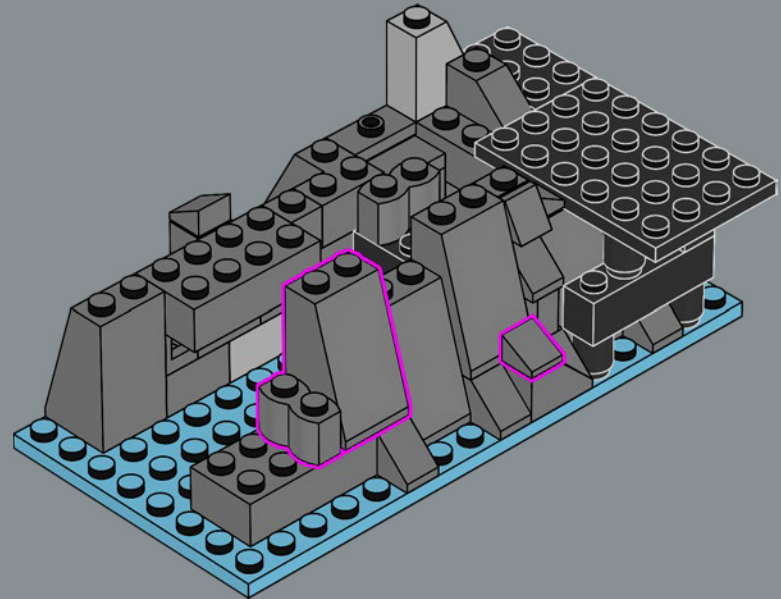

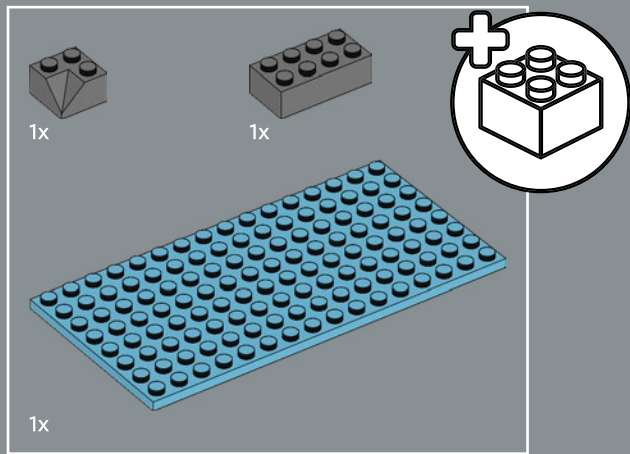

17

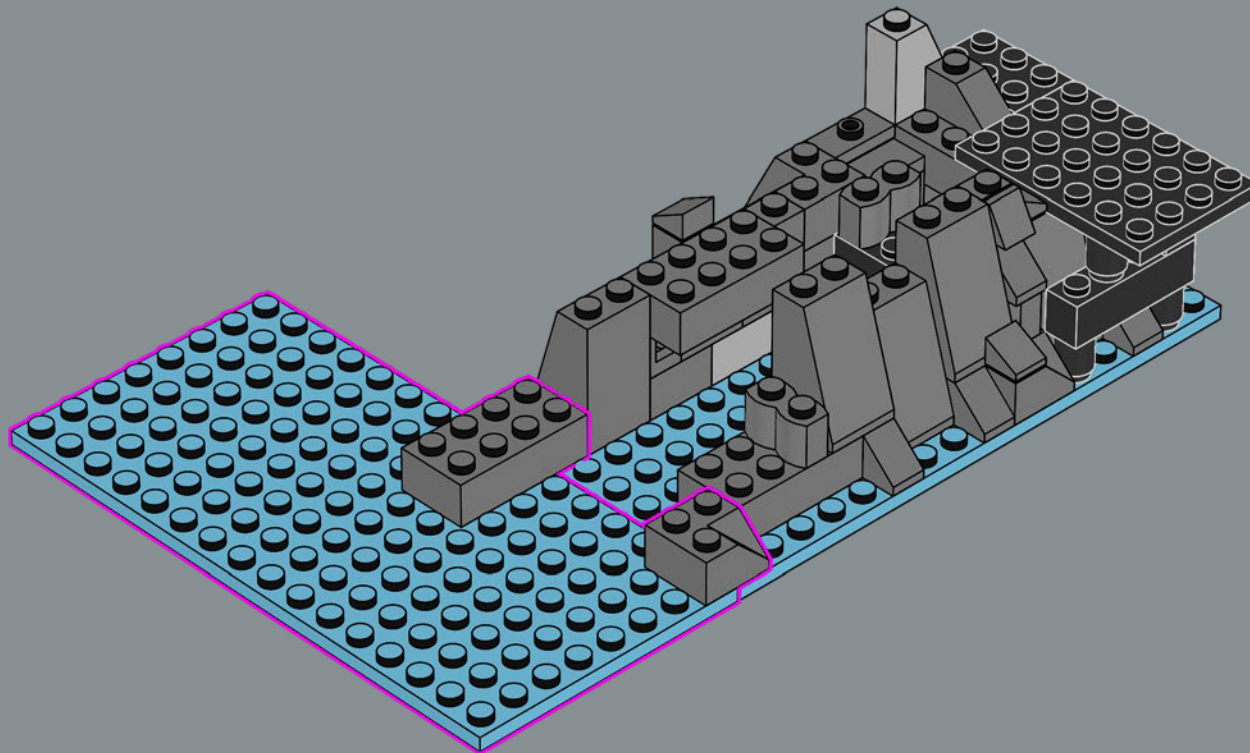

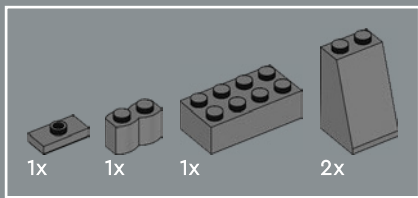

18

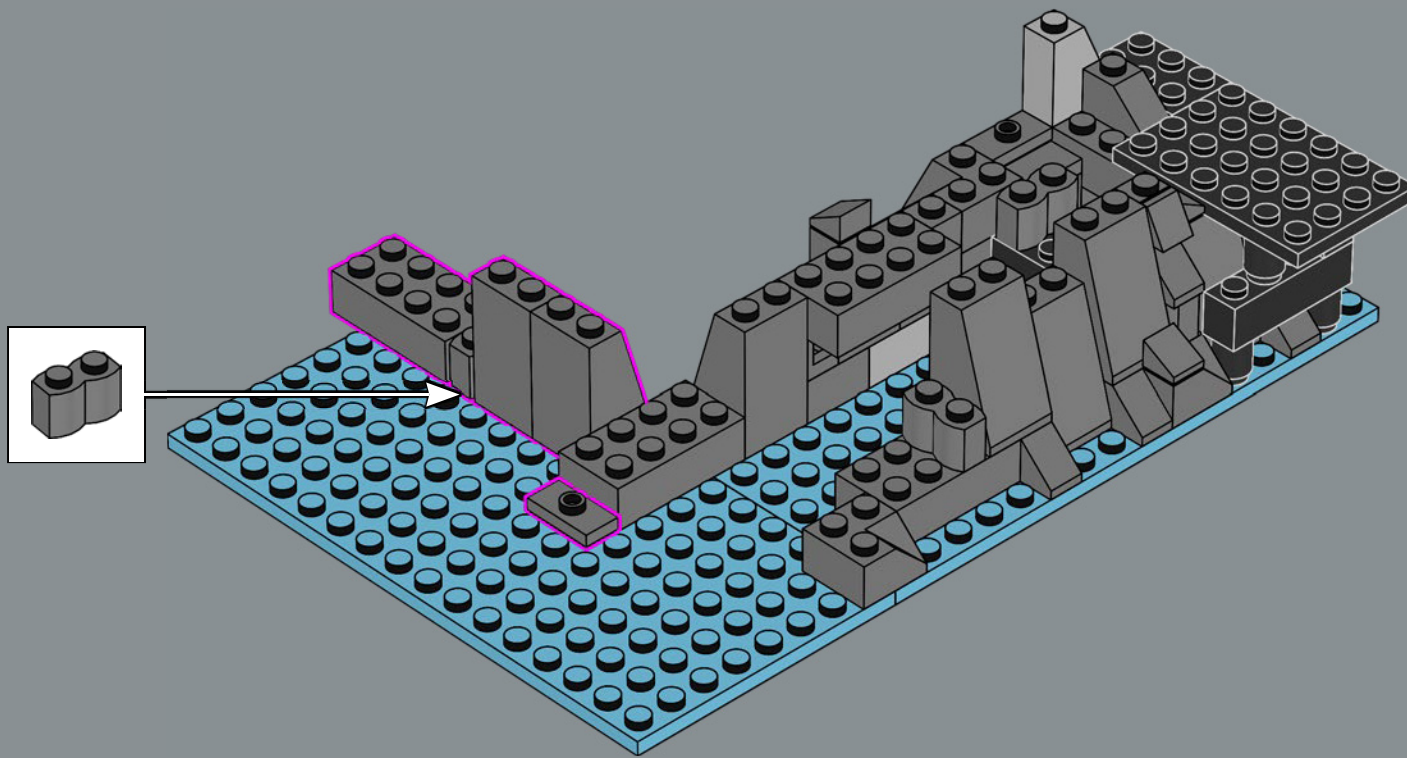

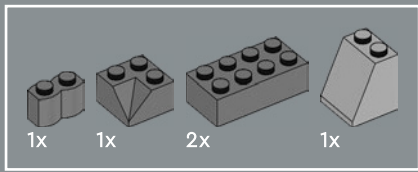

19

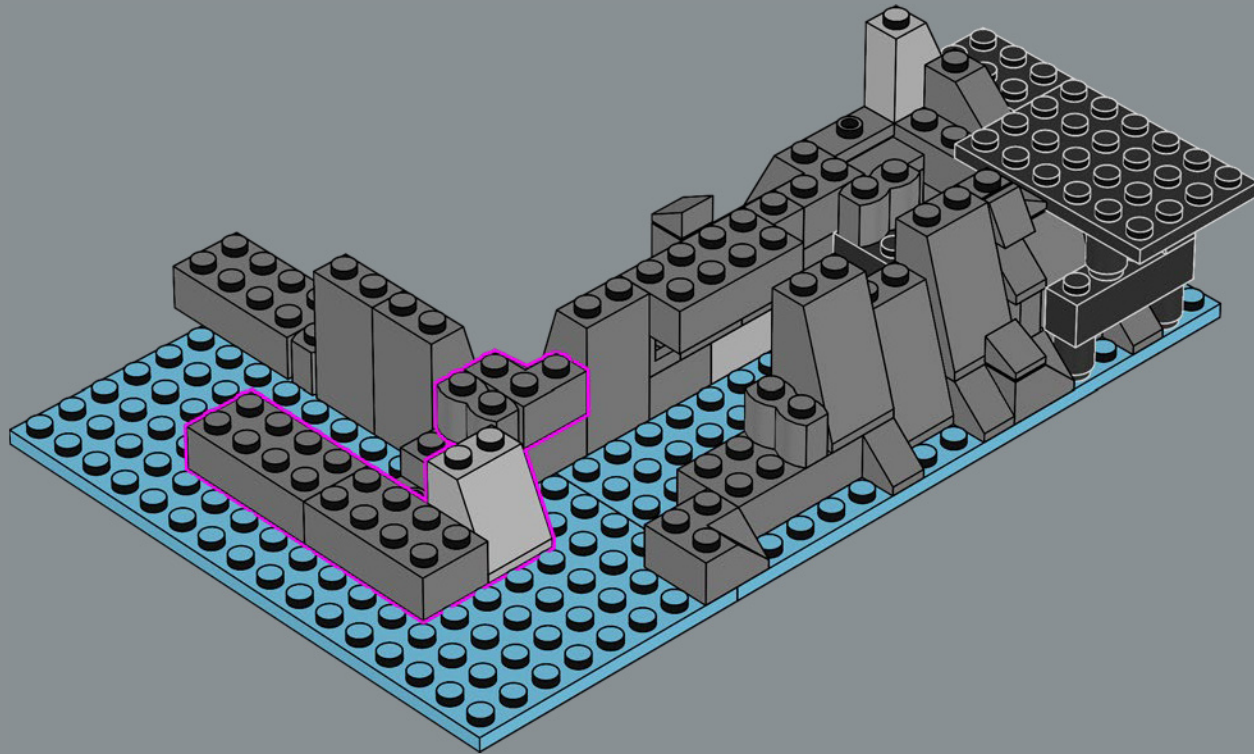

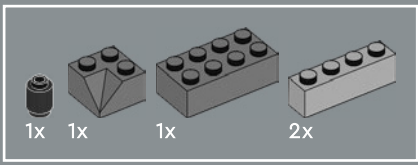

20

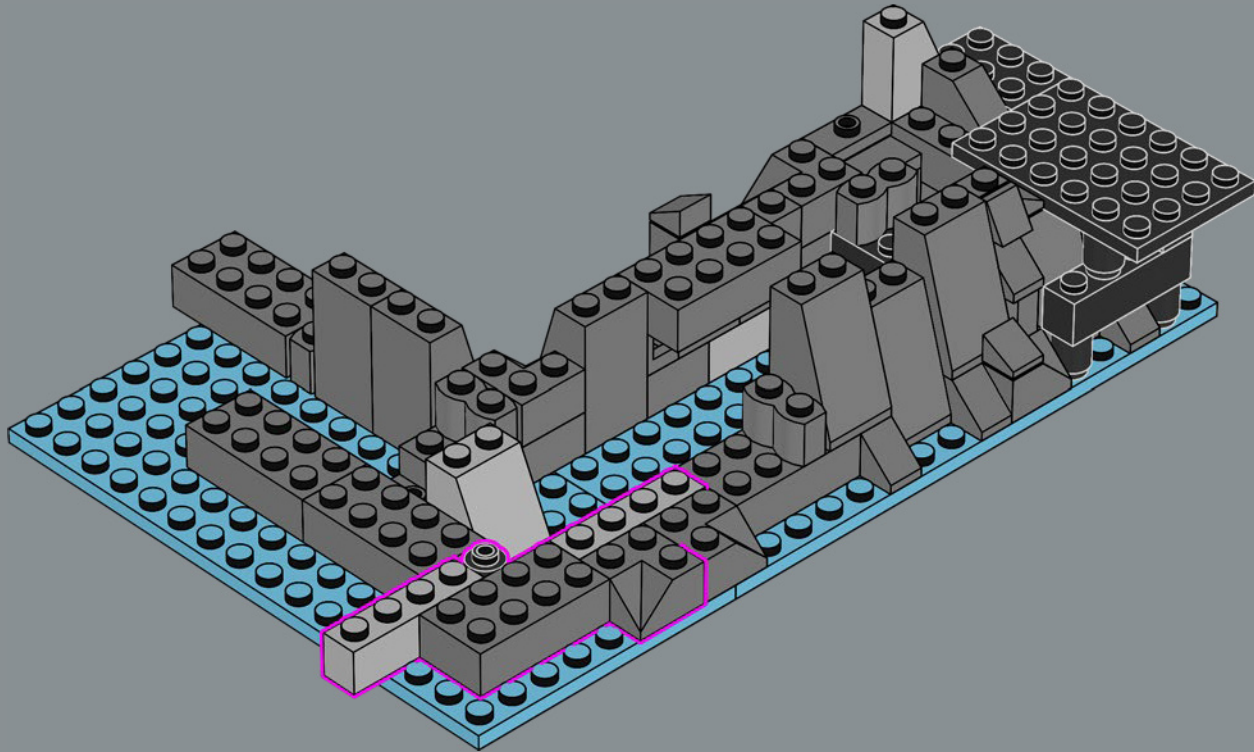

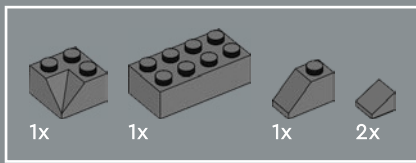

21

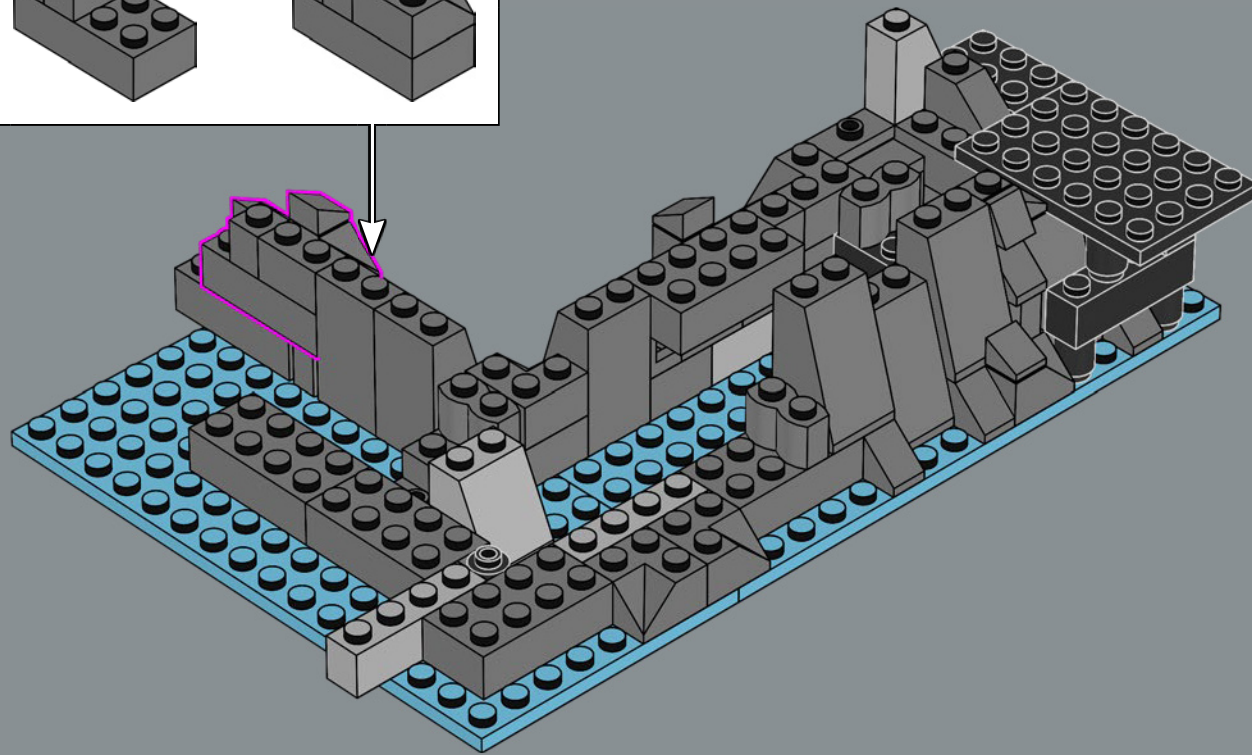
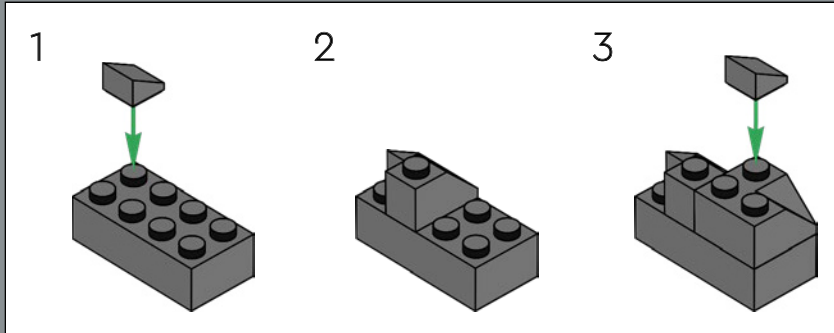





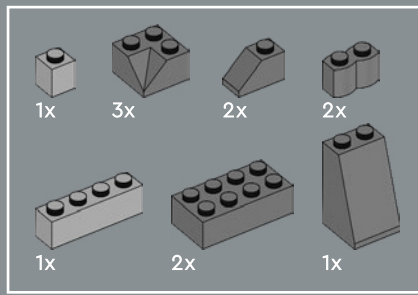

23

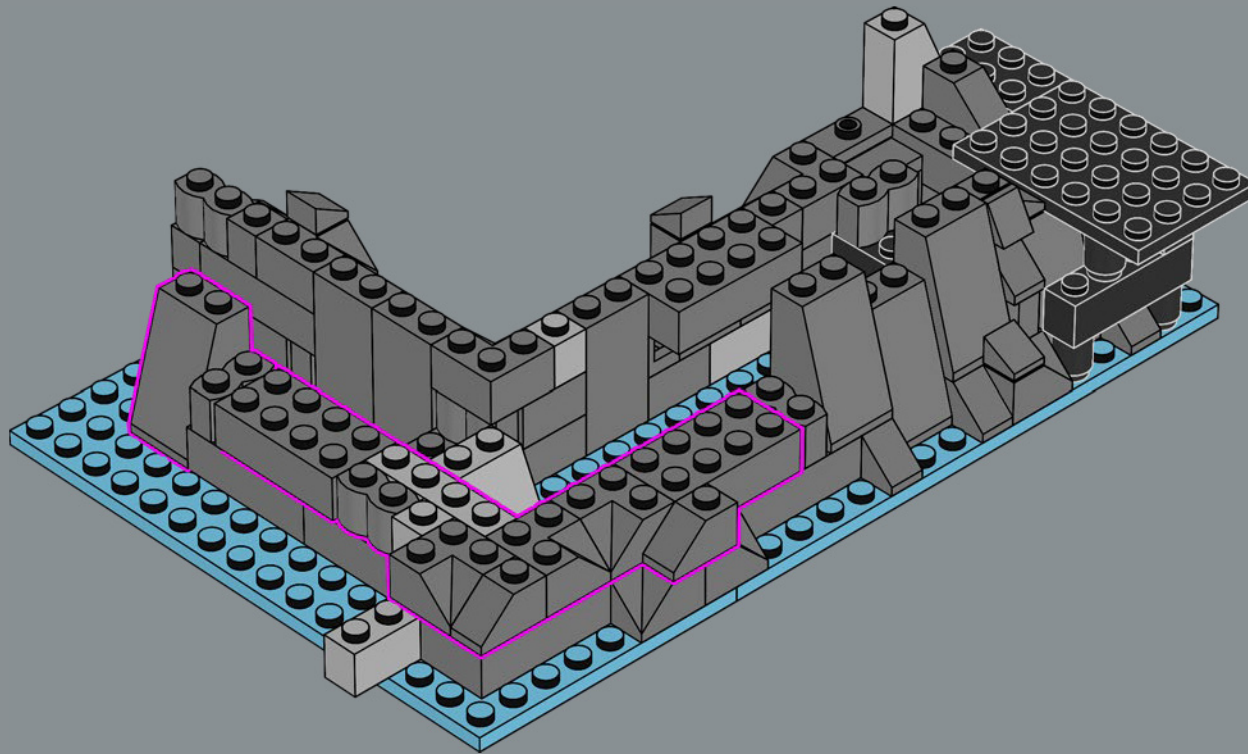

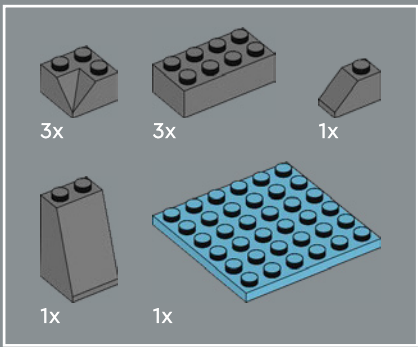

24

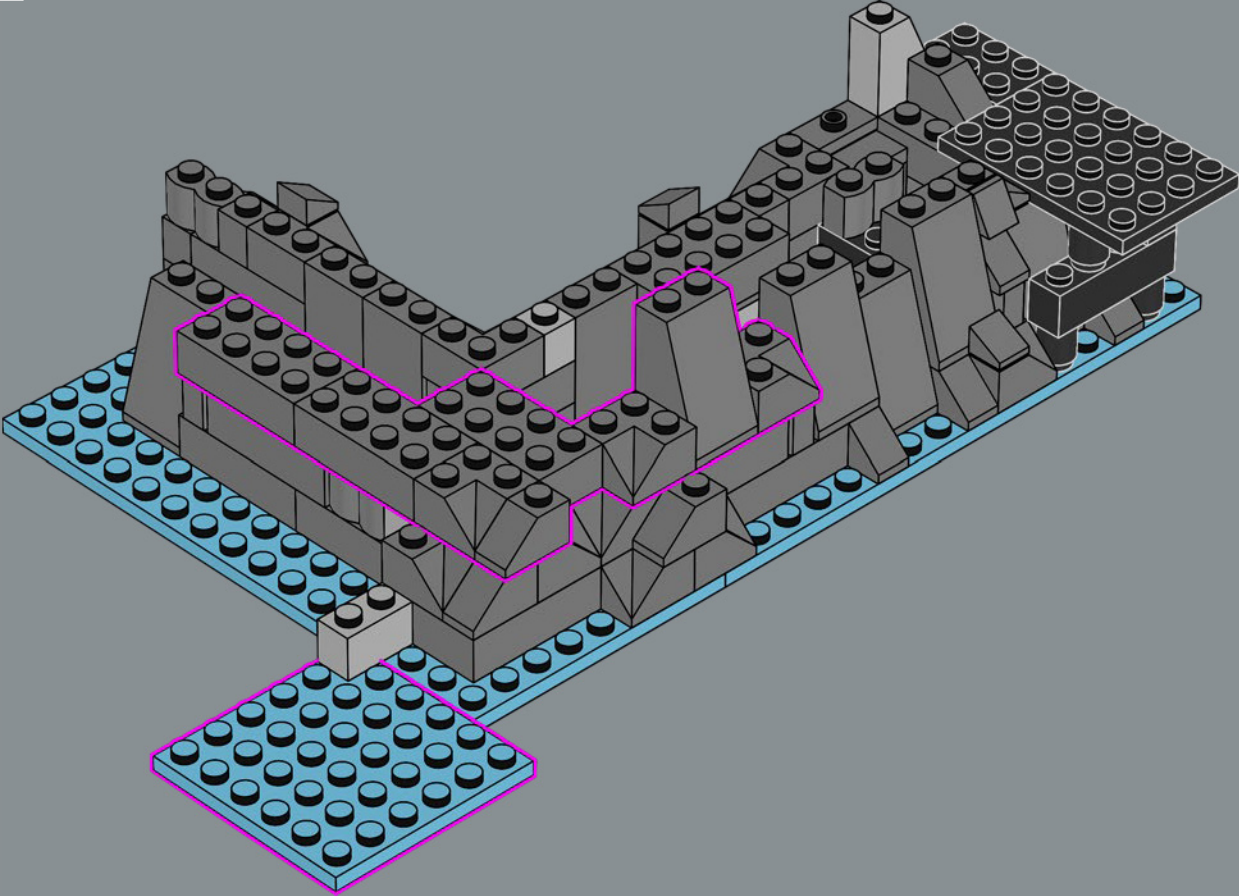

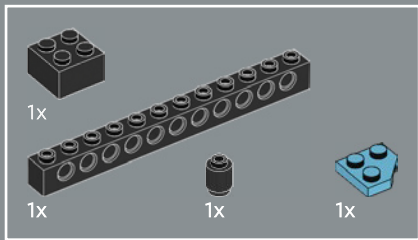

25

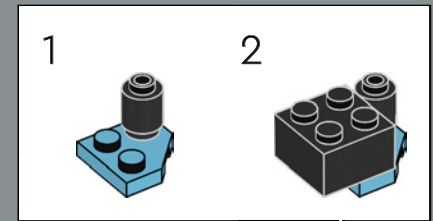
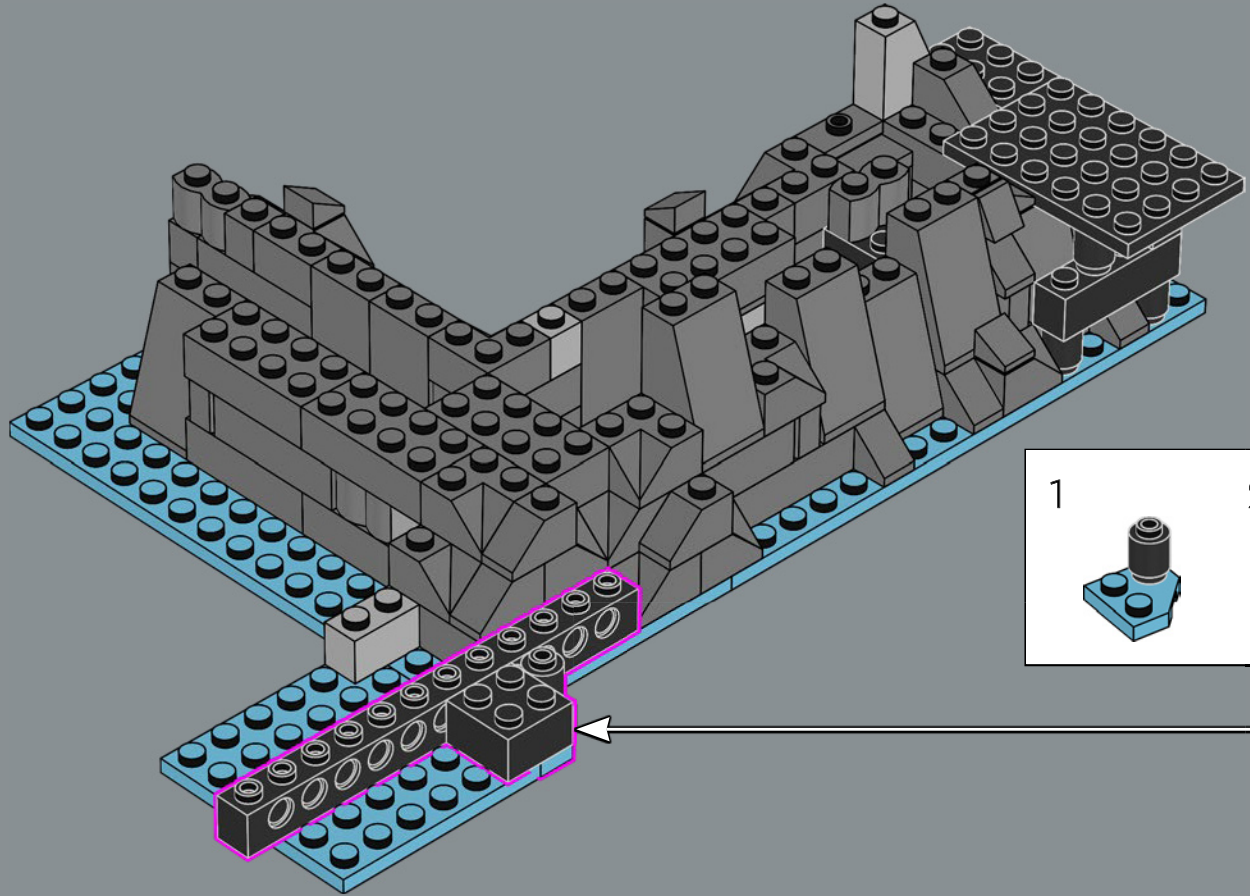

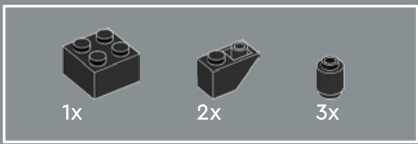

26

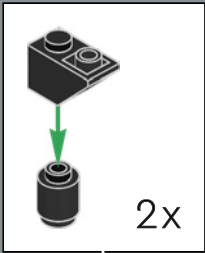
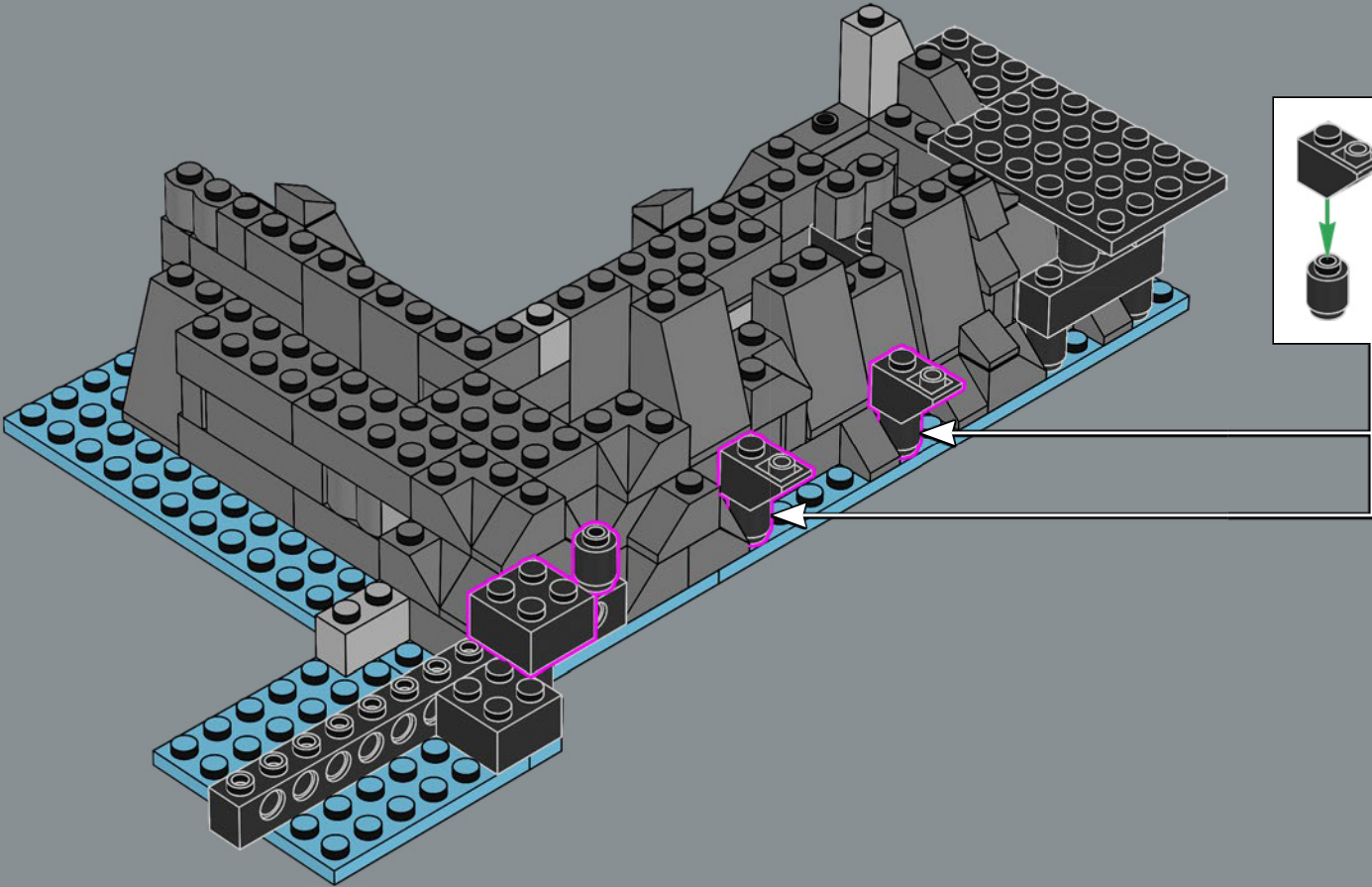

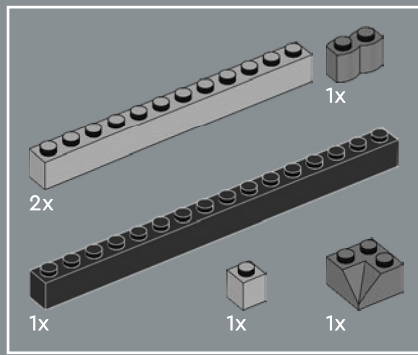

27

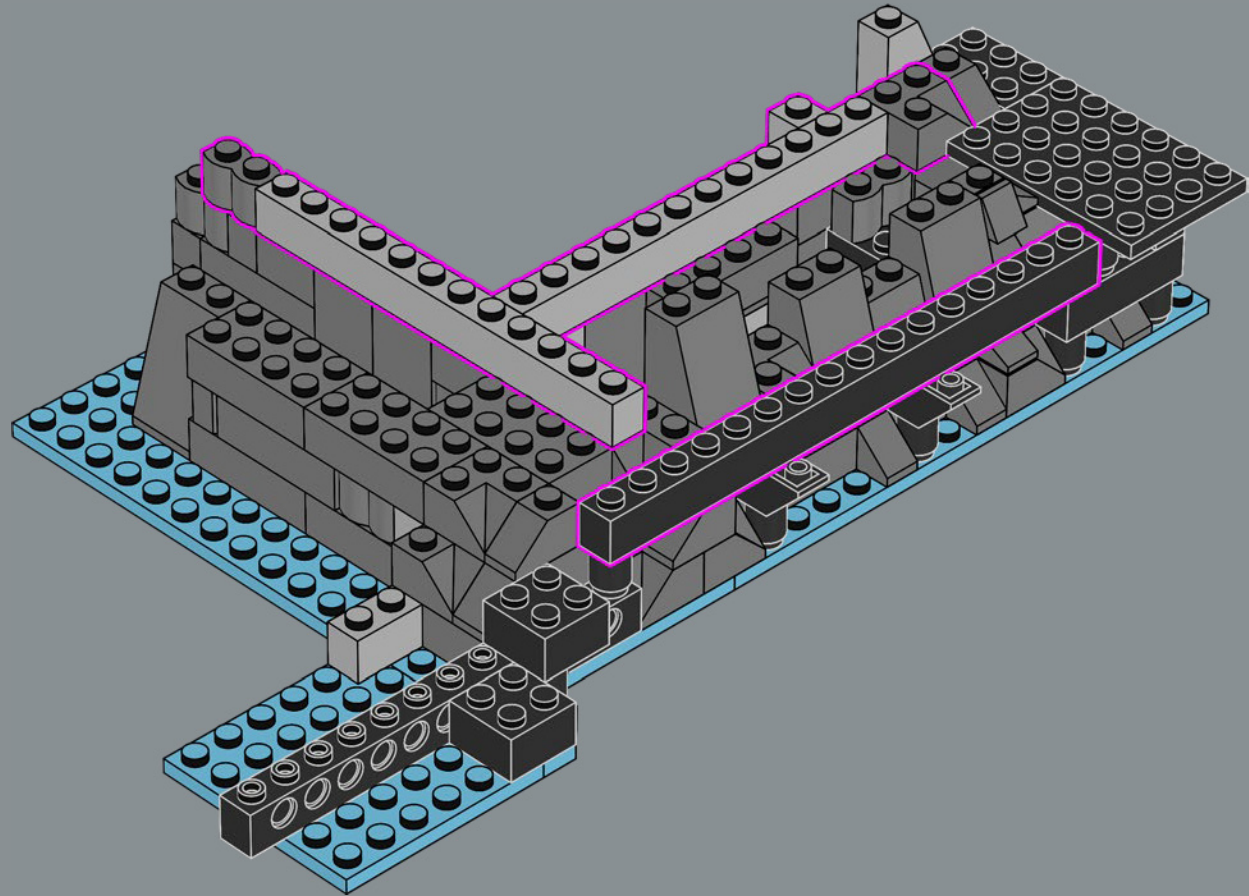

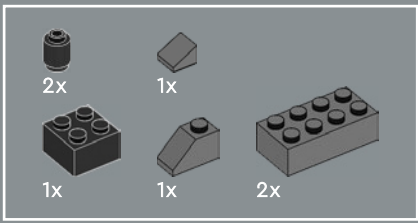

28

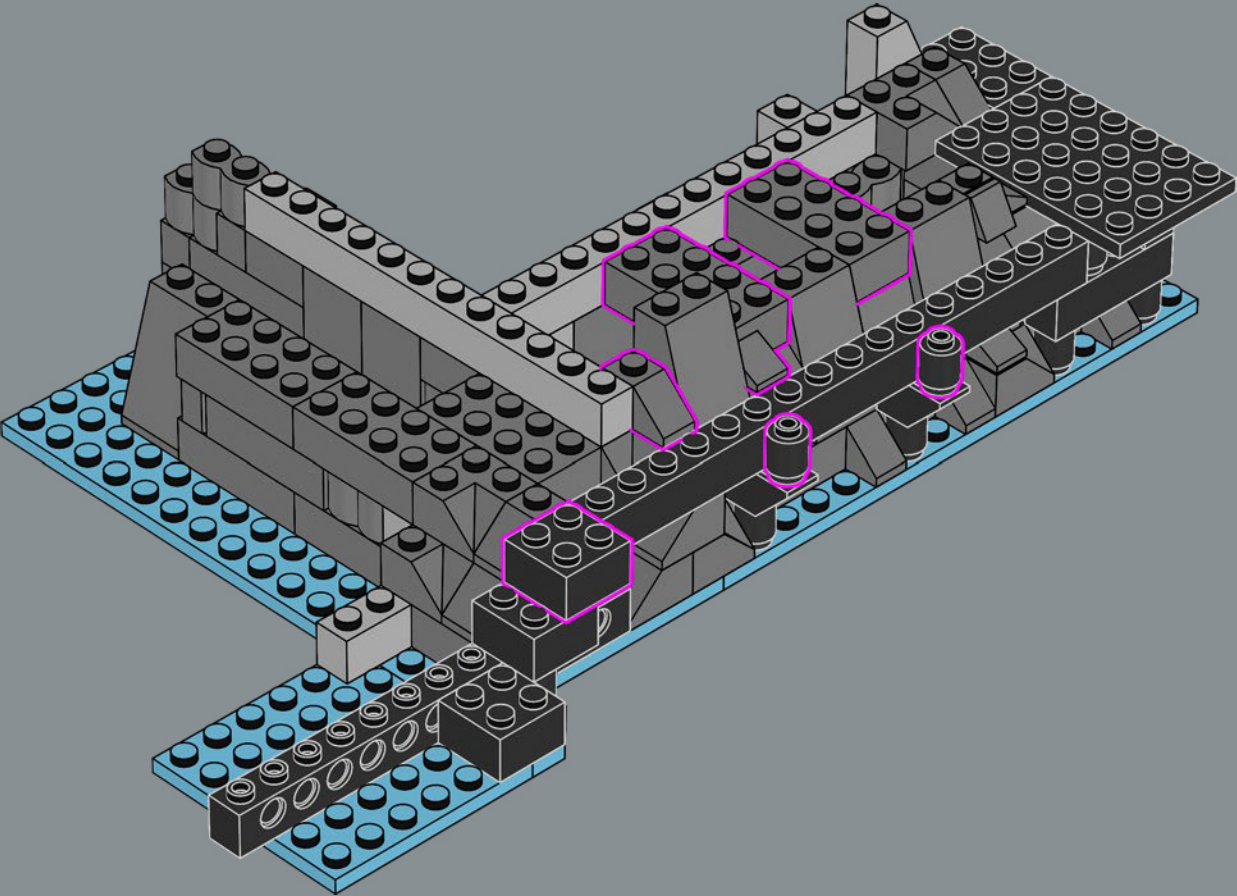

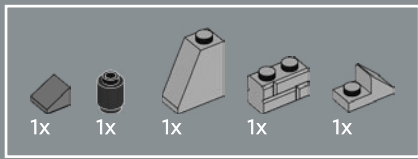

29

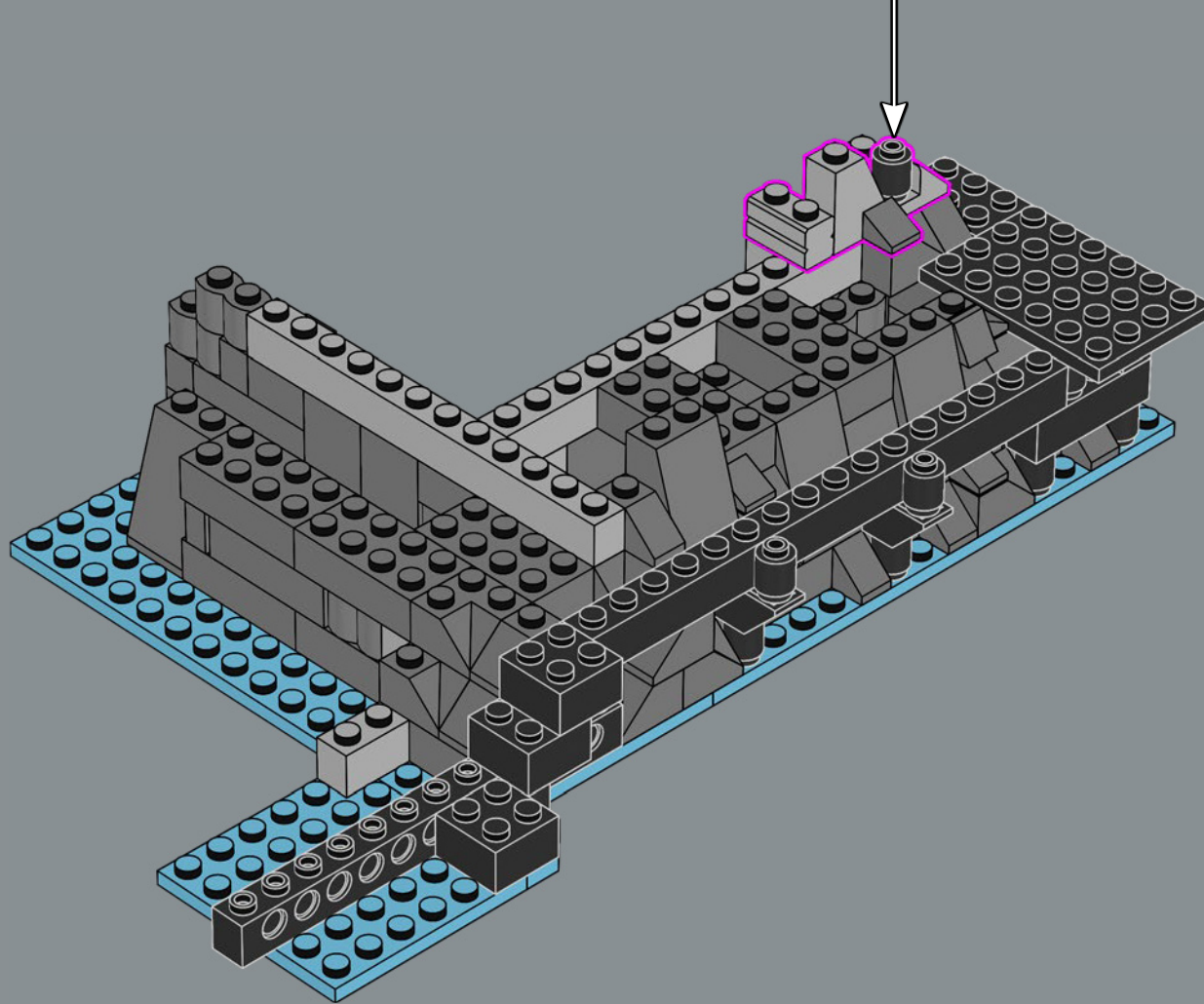
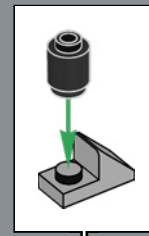

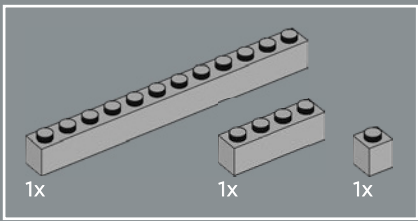

30

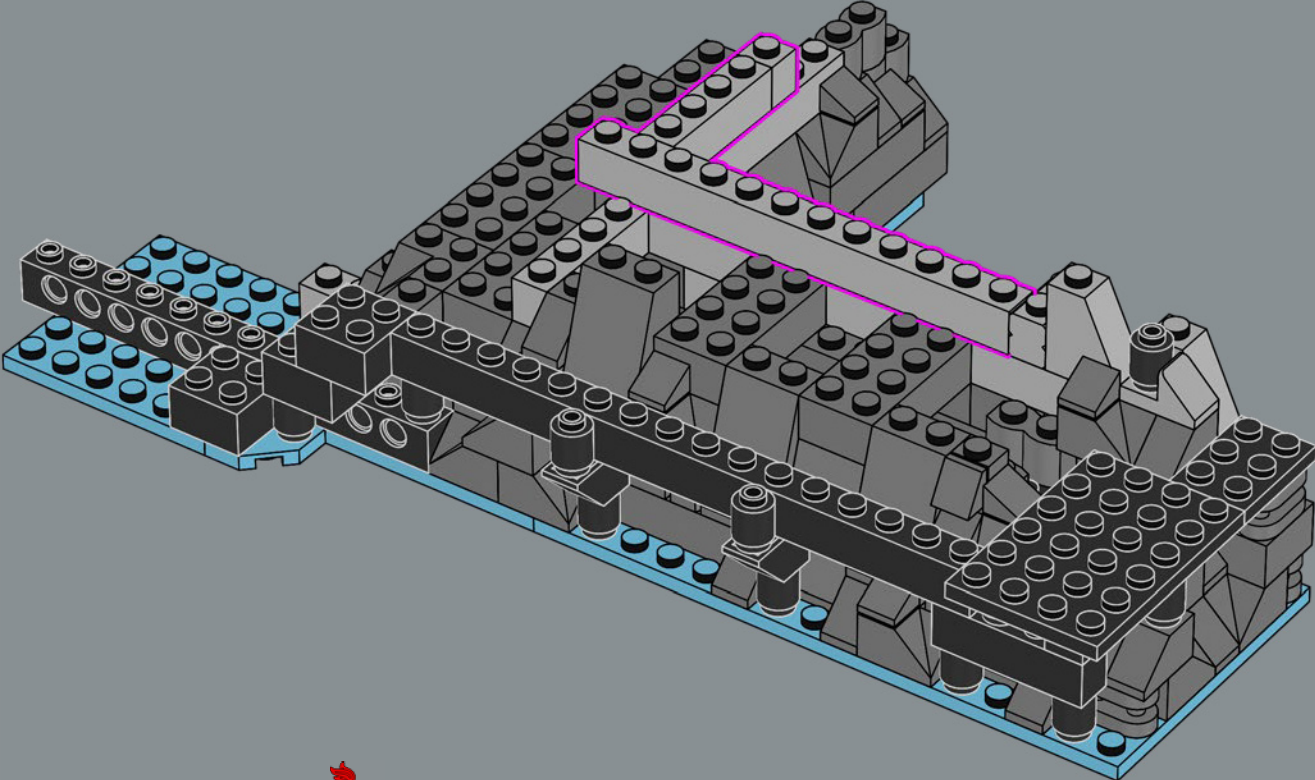



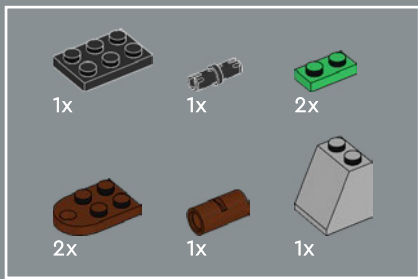

31

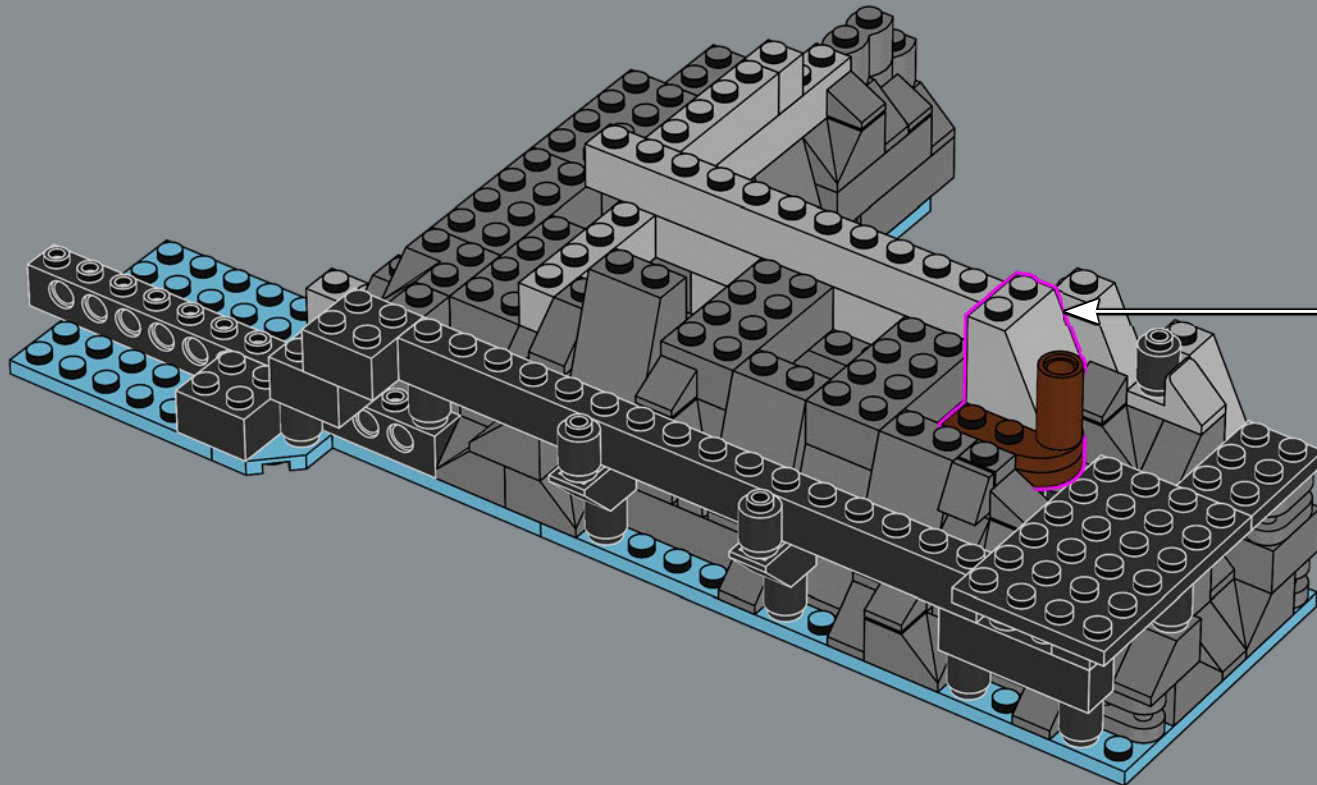
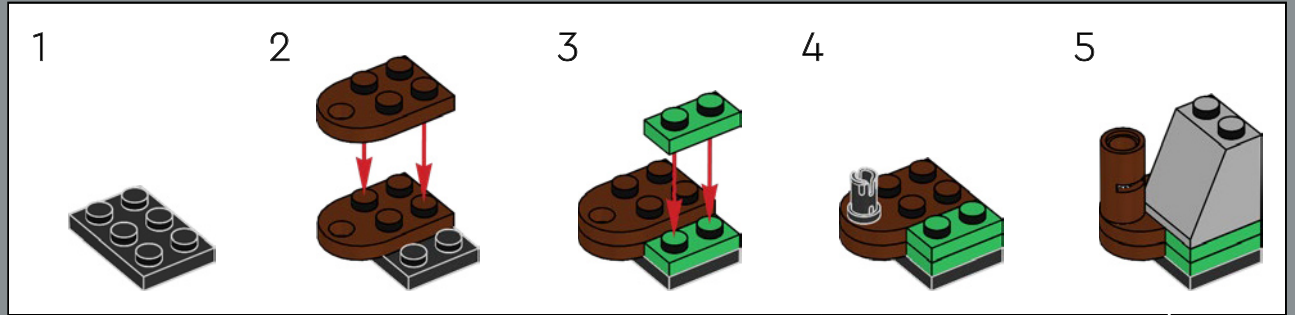

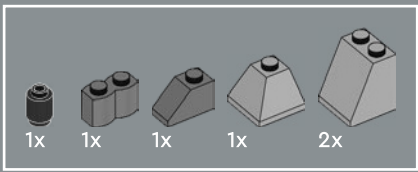

32

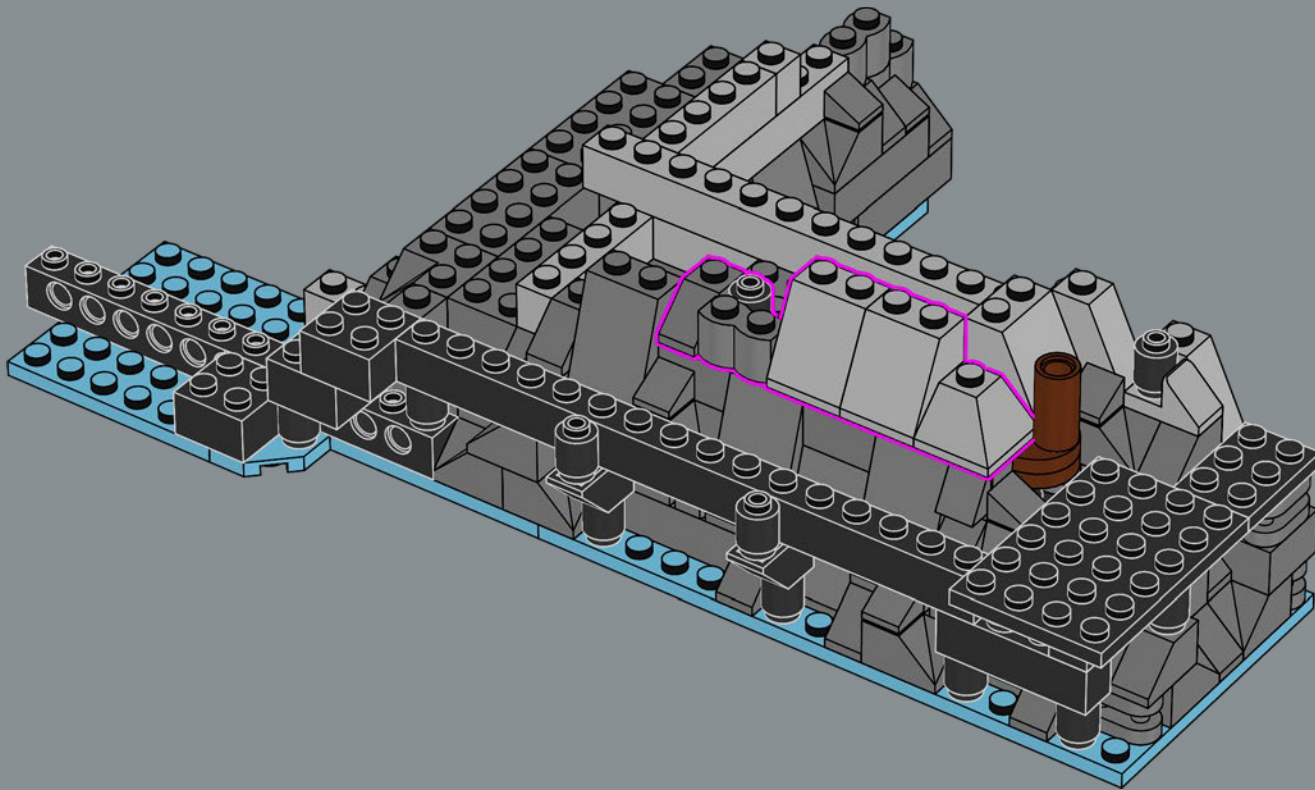

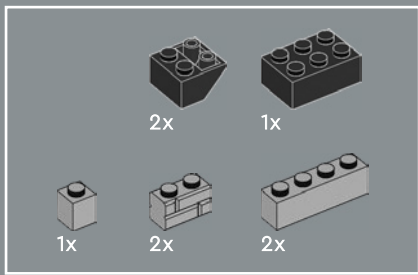

33

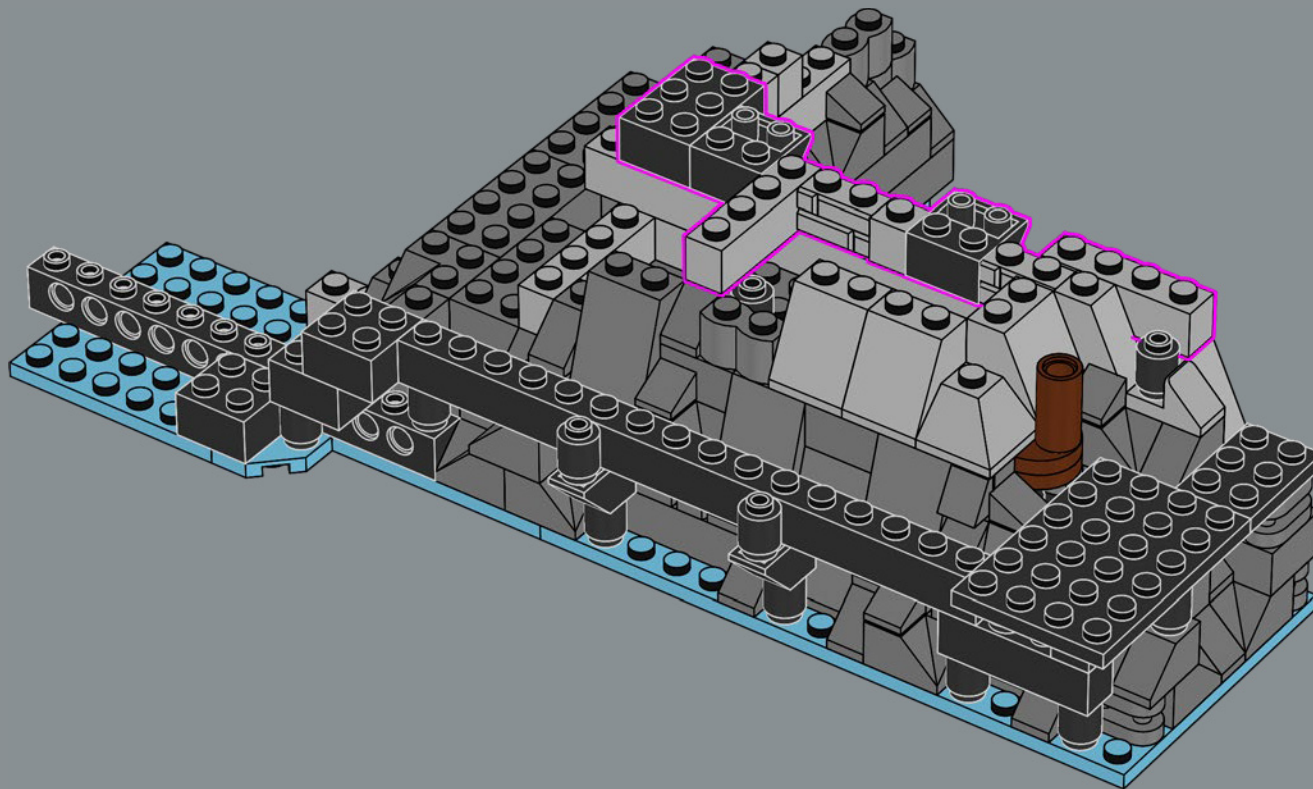

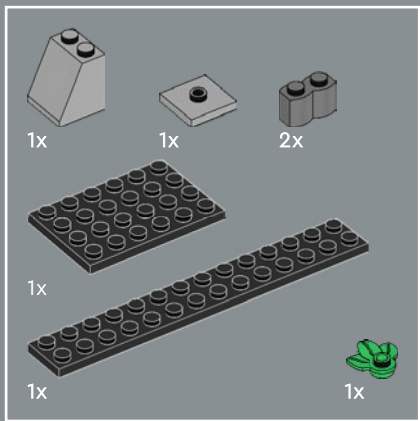

34

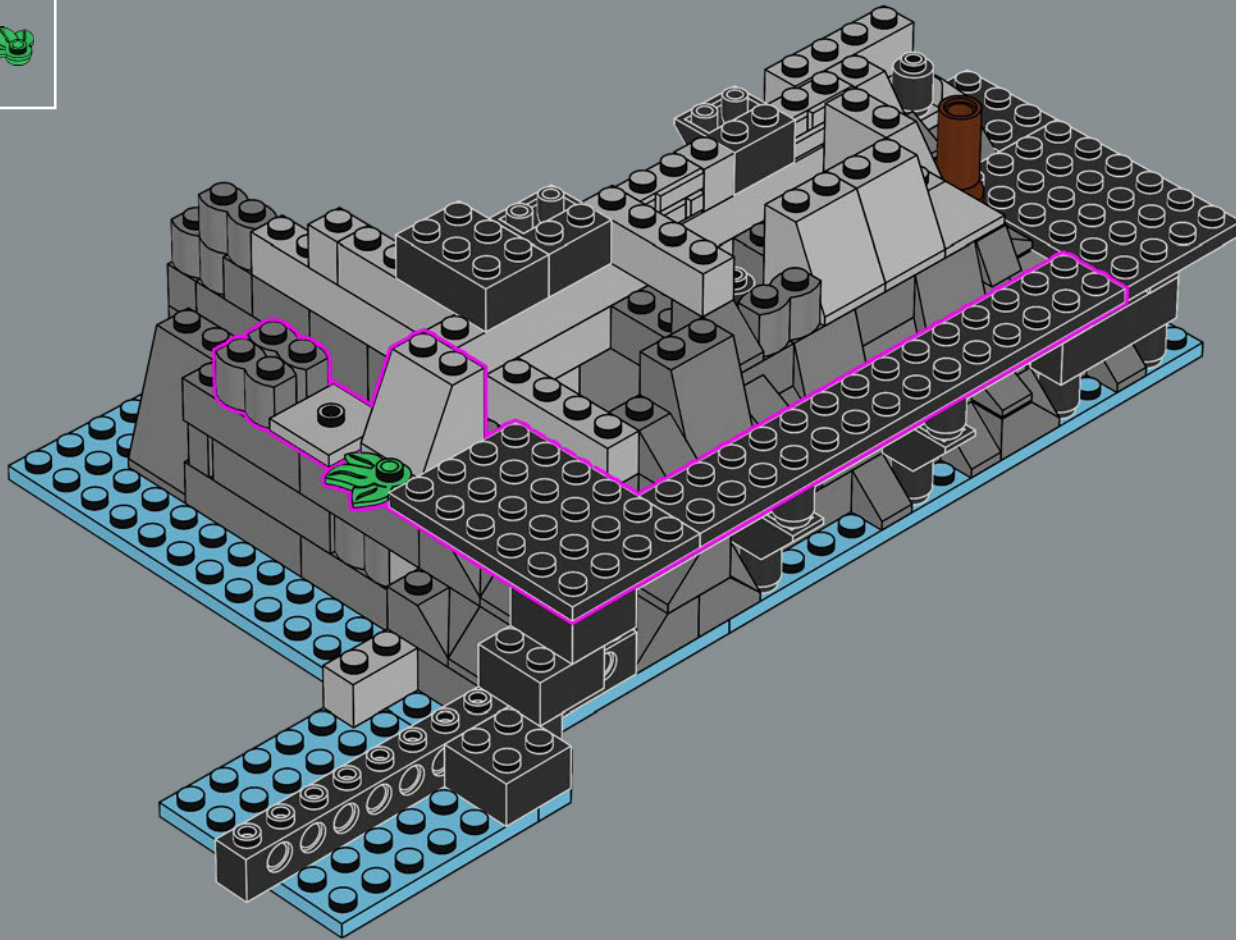

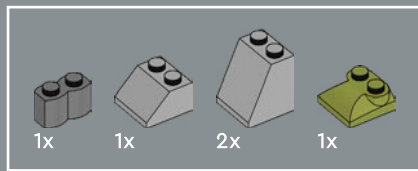

35

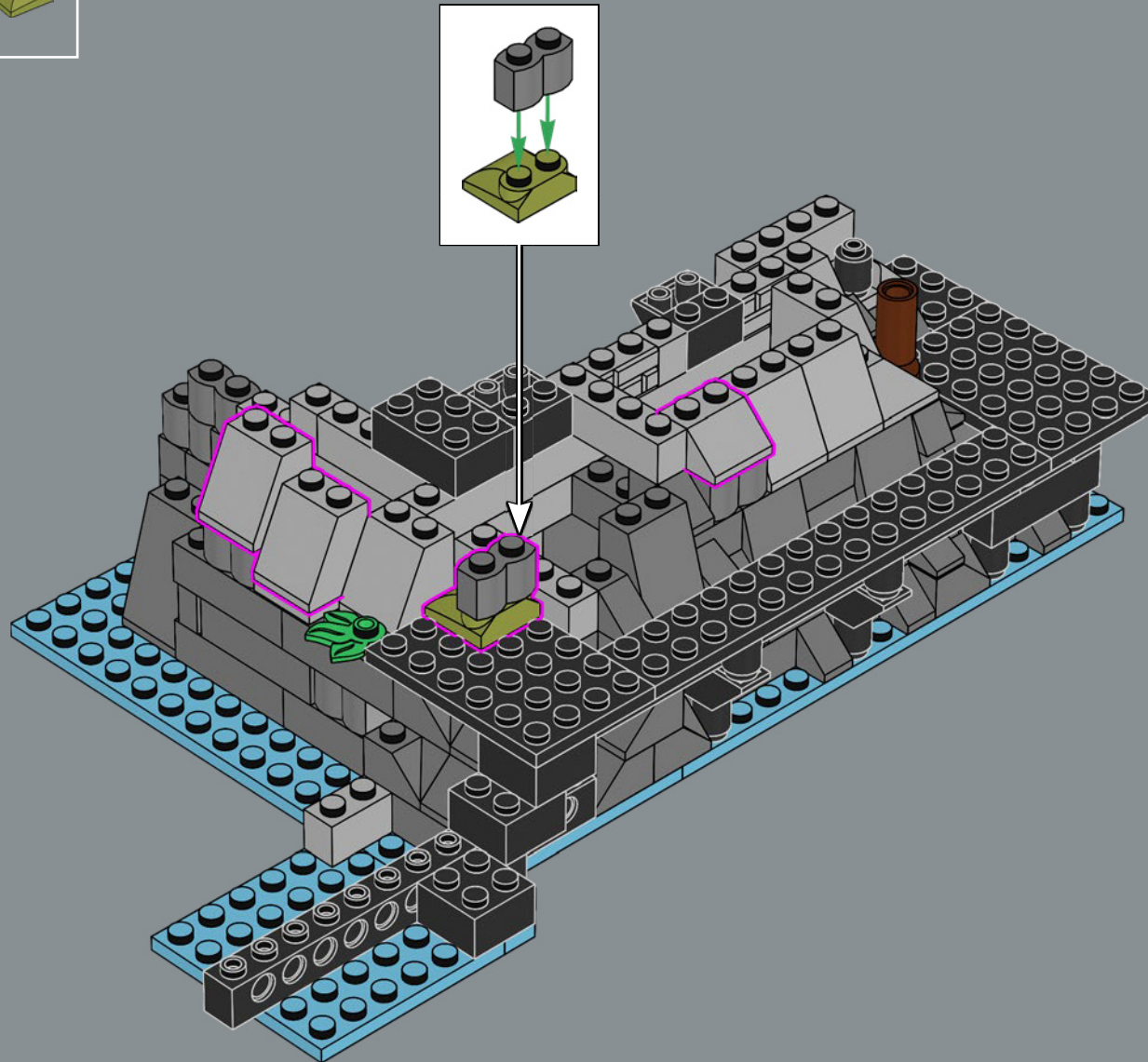

- 4x 
- 1x 
- 1x 

36

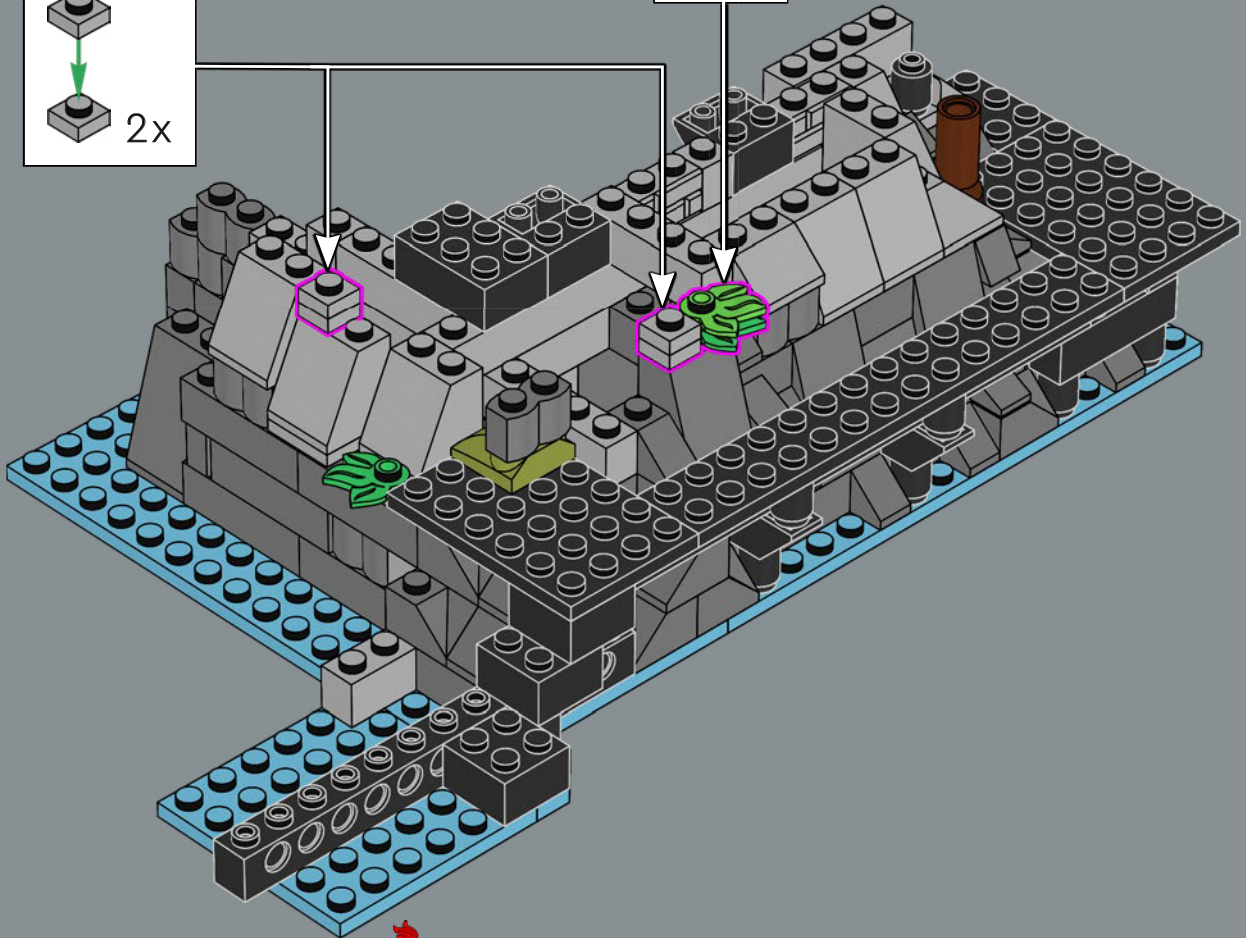
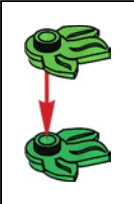
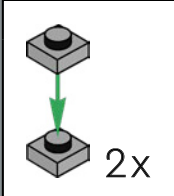

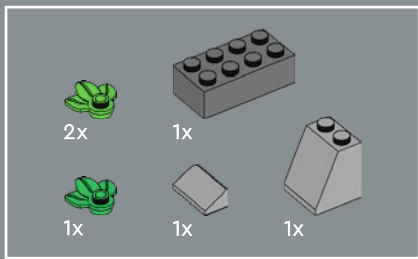

37

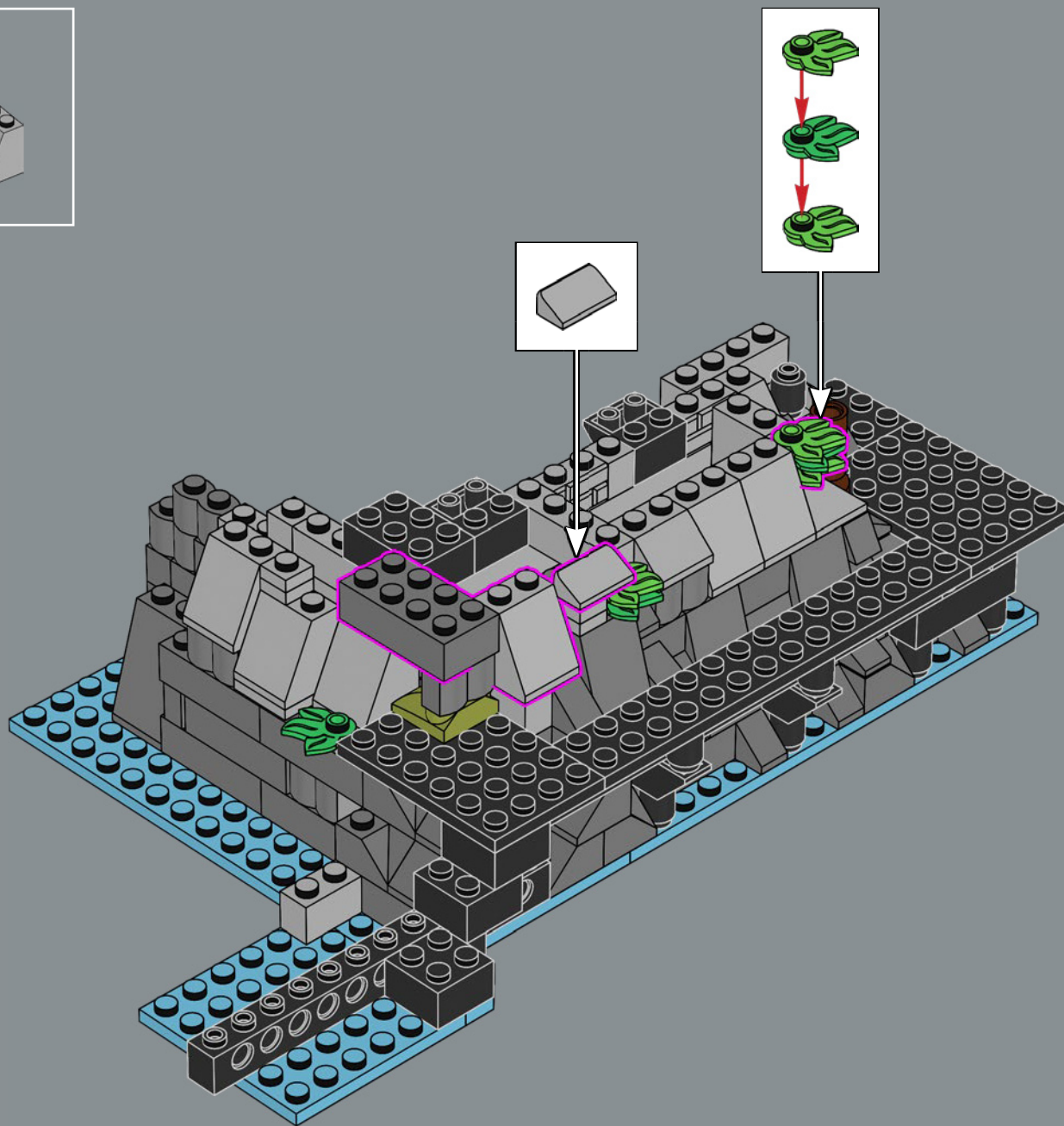

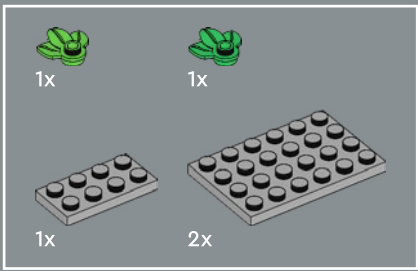

38

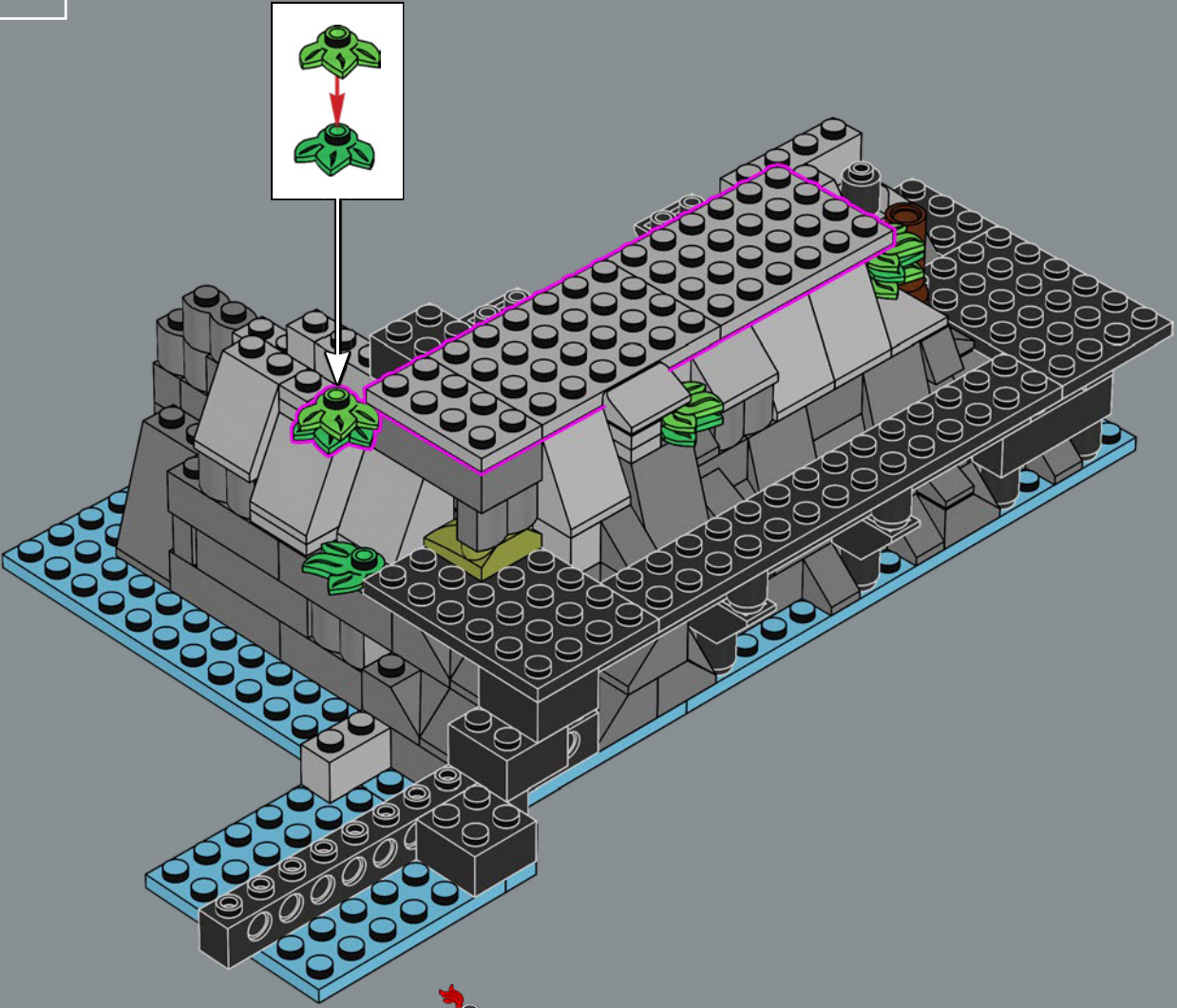



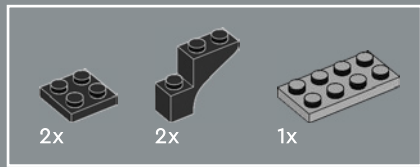

39

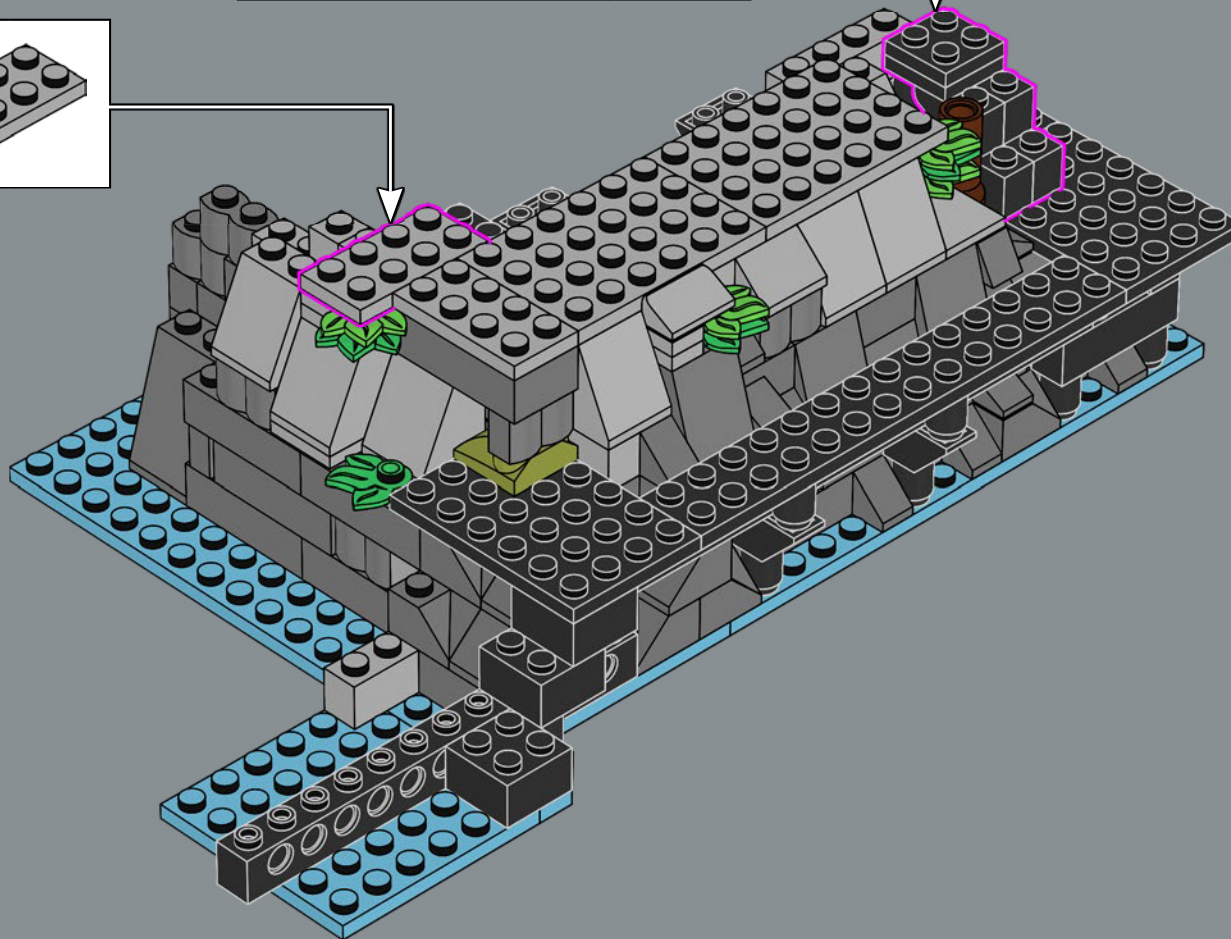
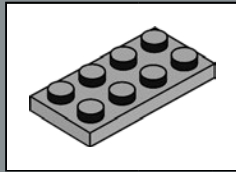
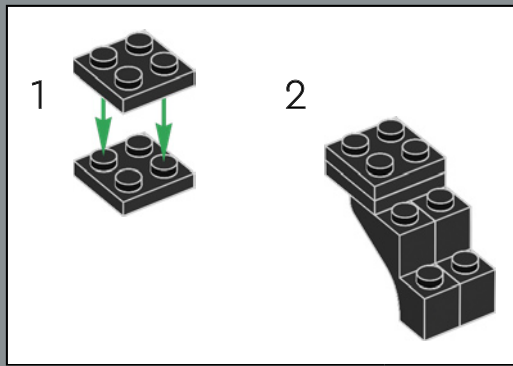

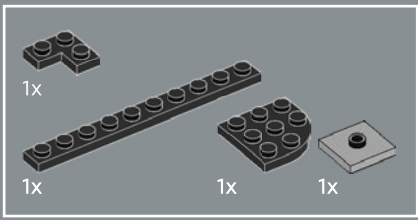

40

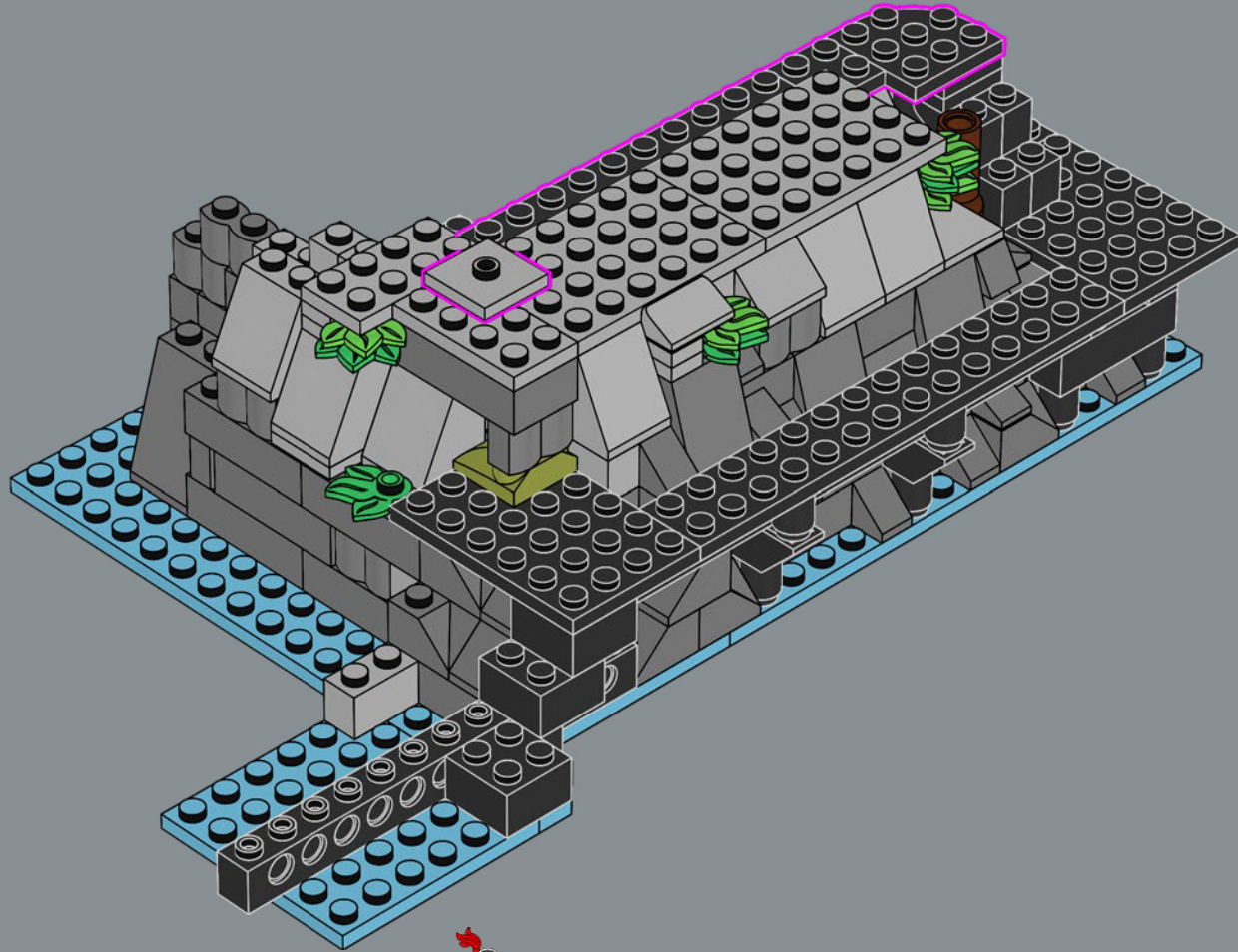

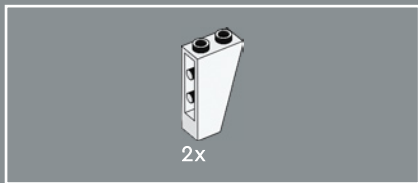

41

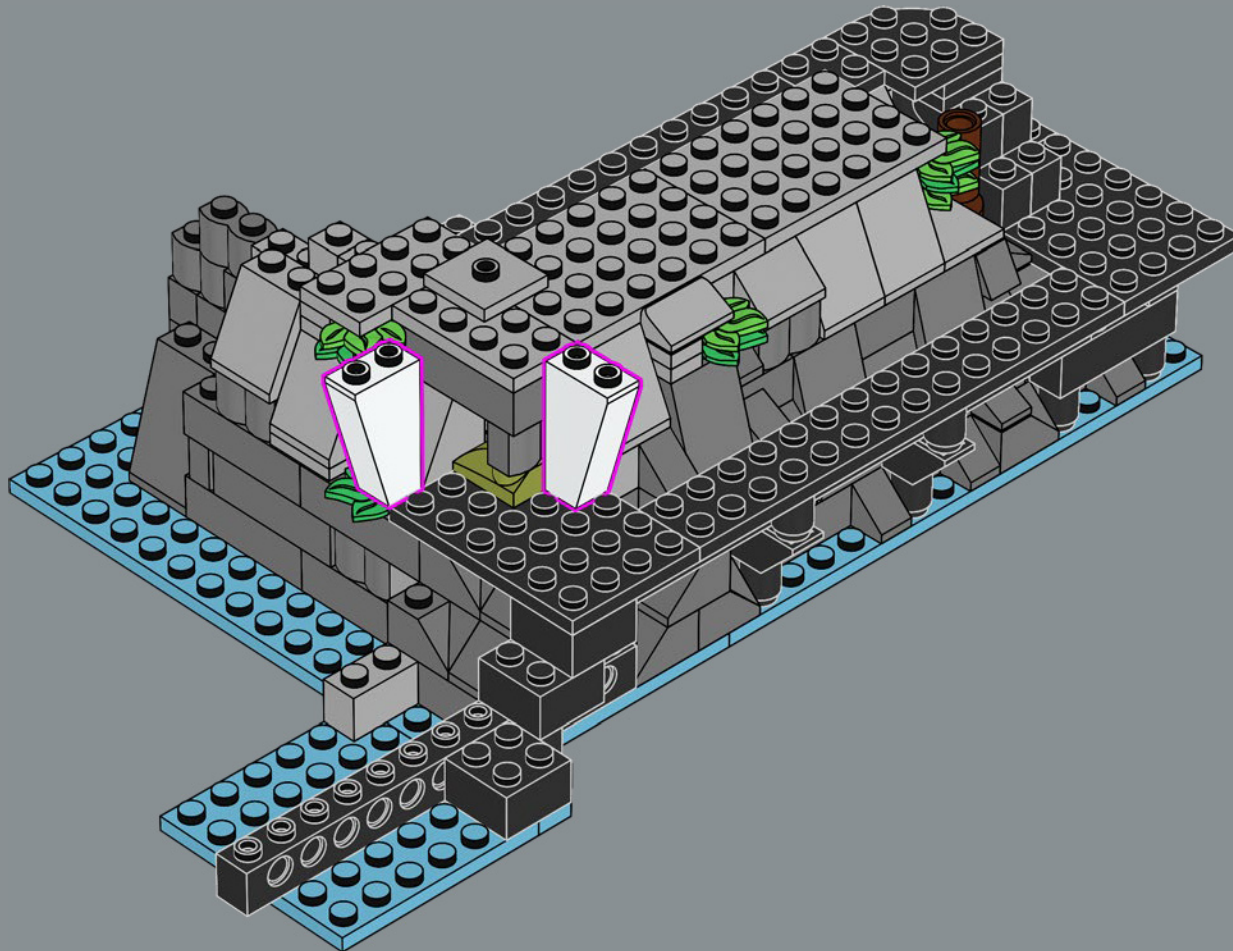

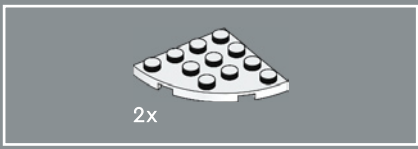

42

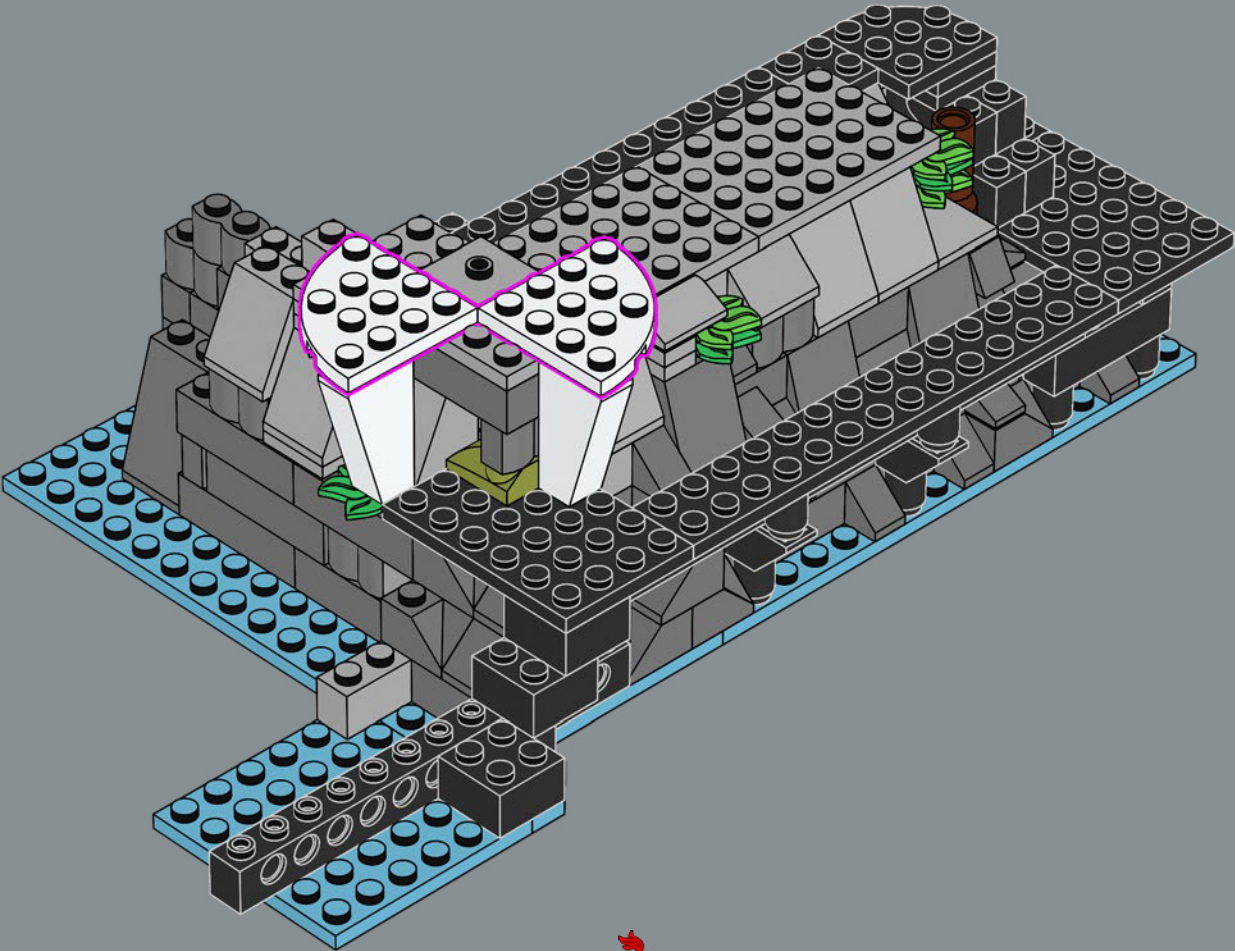

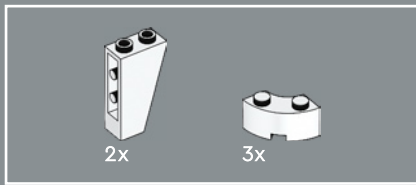

43

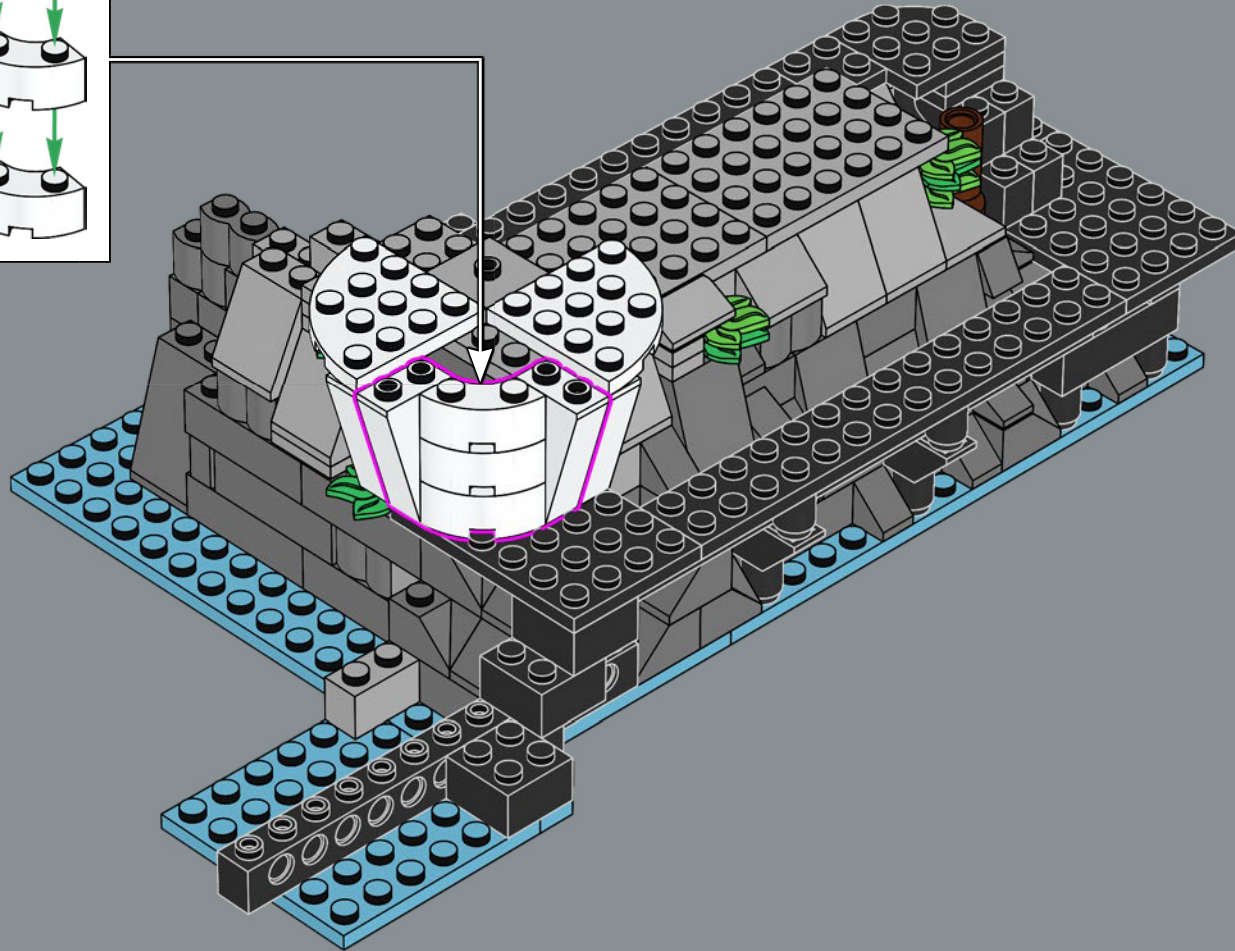
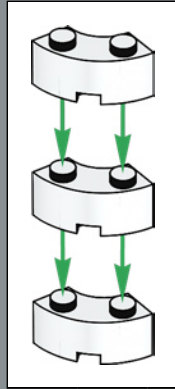



44

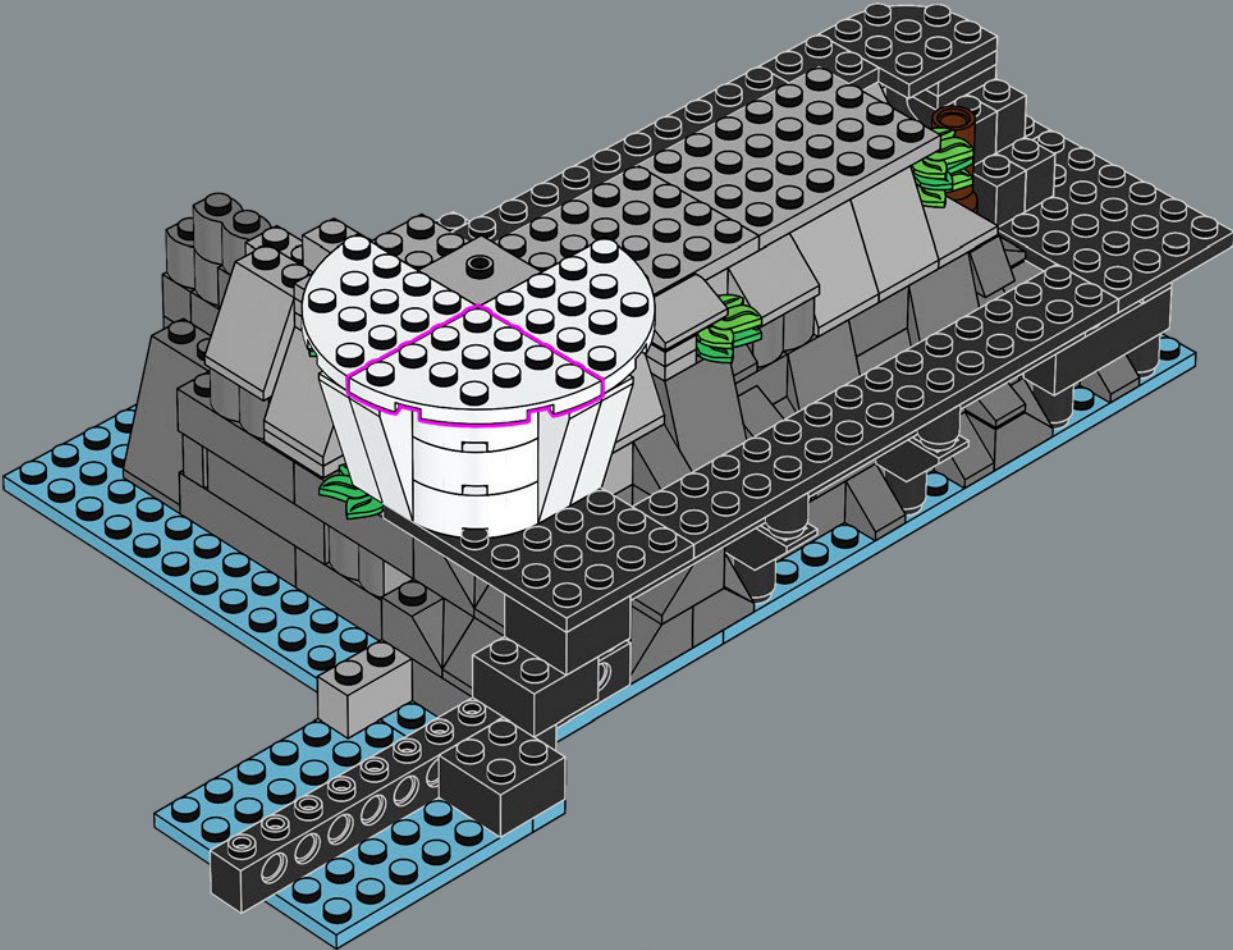

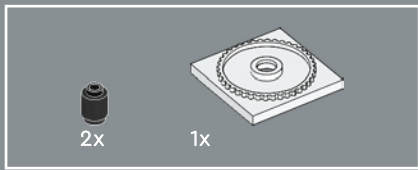

45

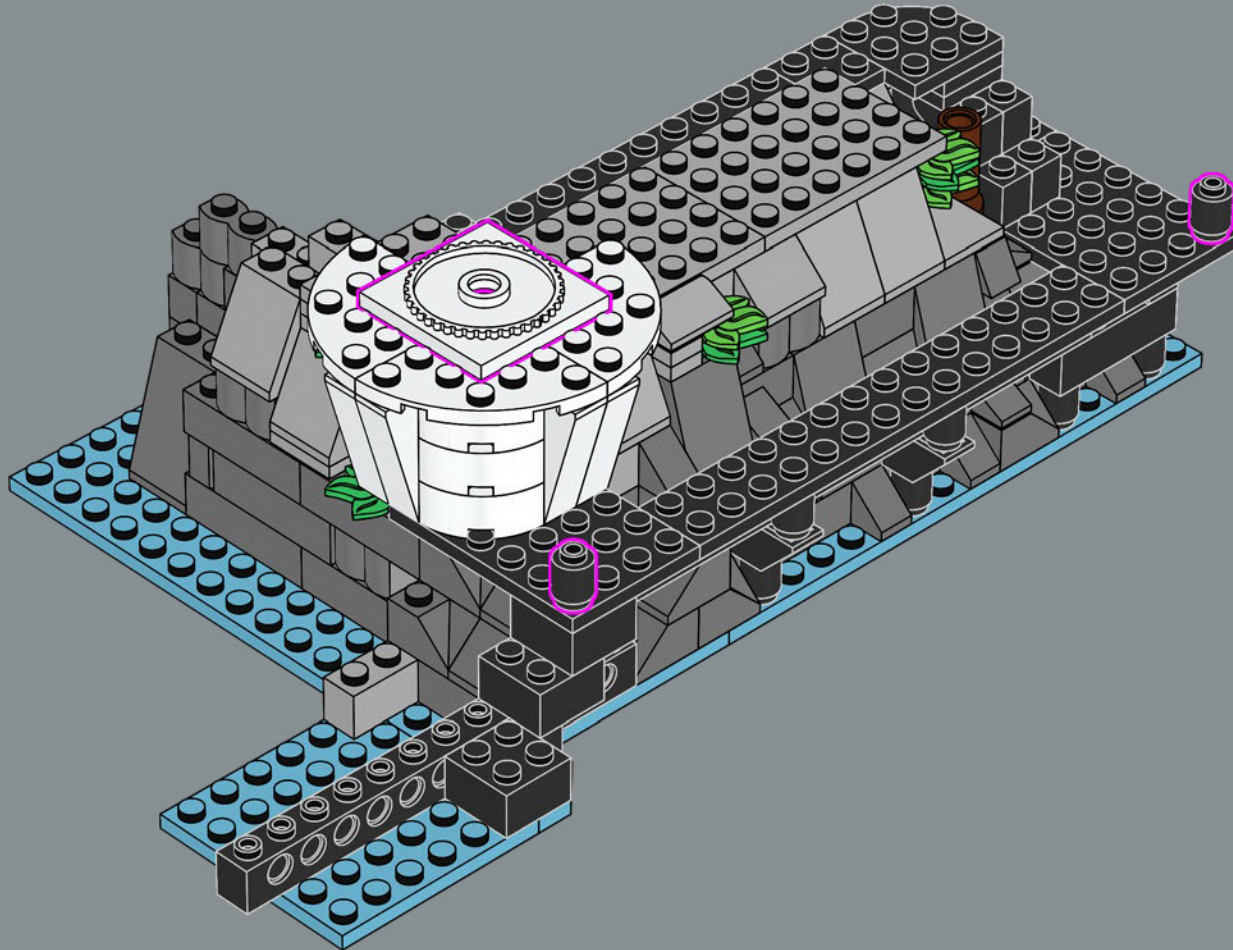

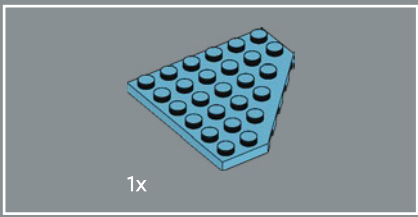

46

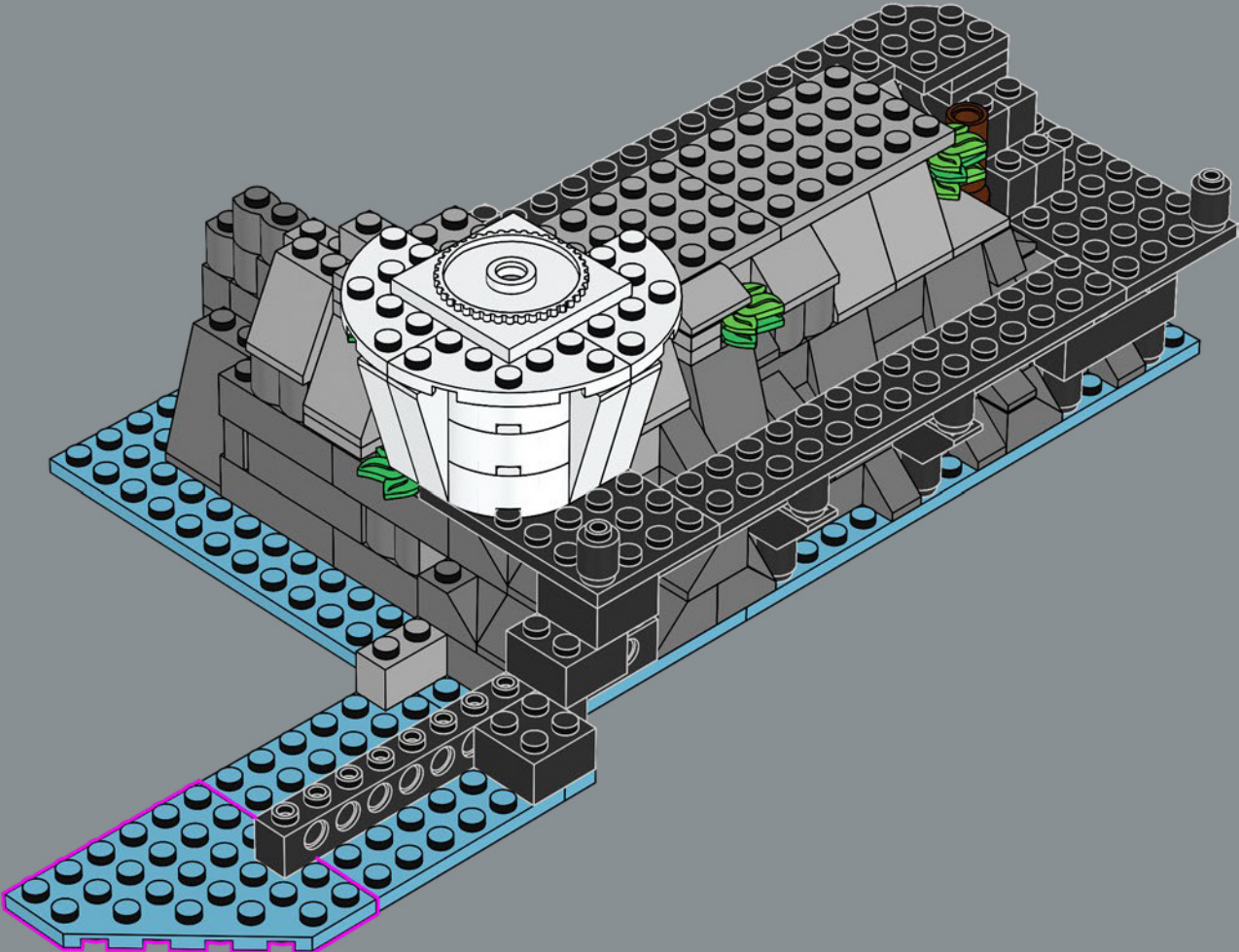



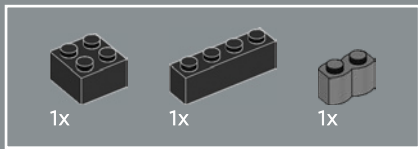

47

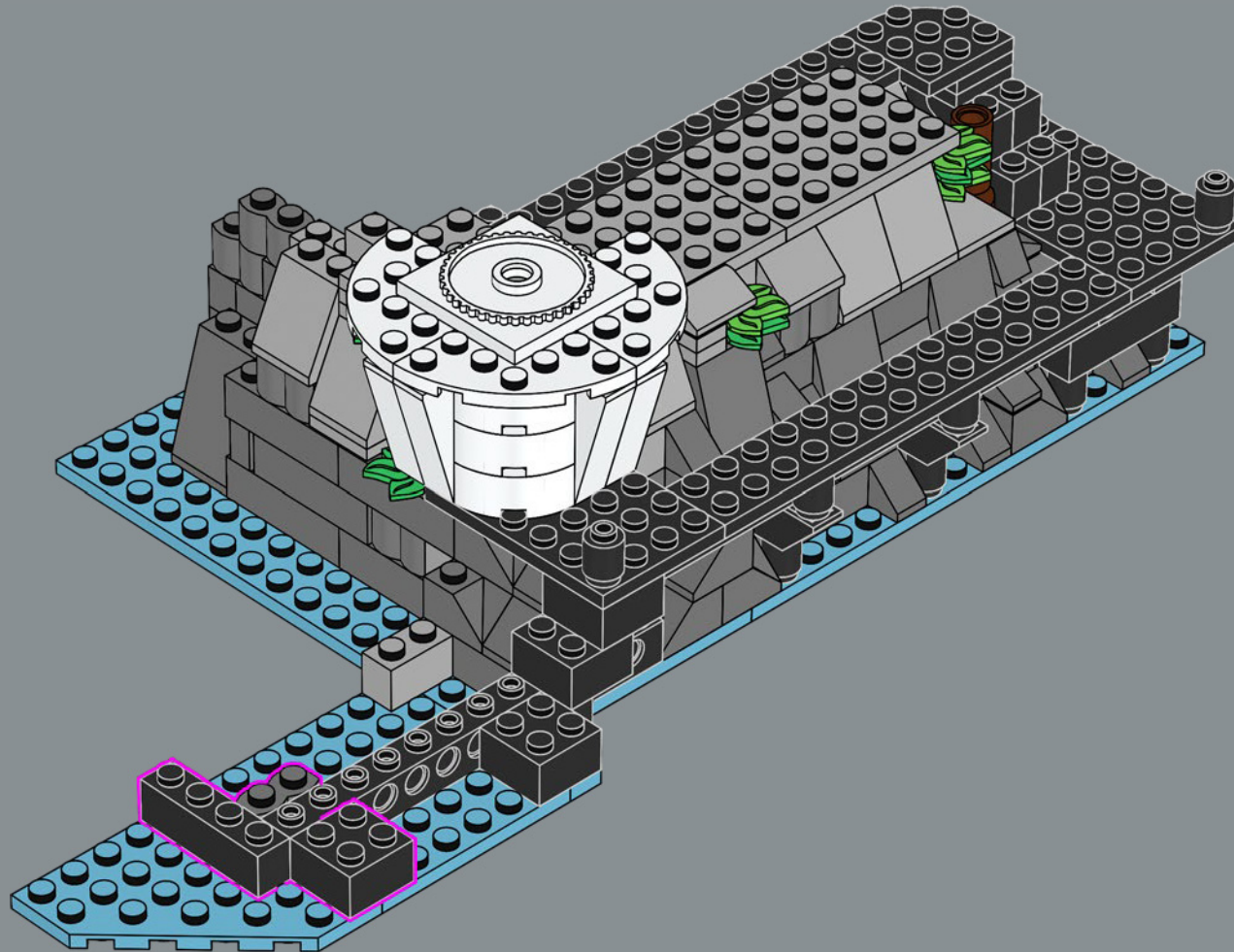

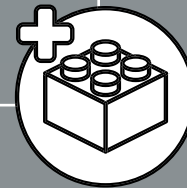
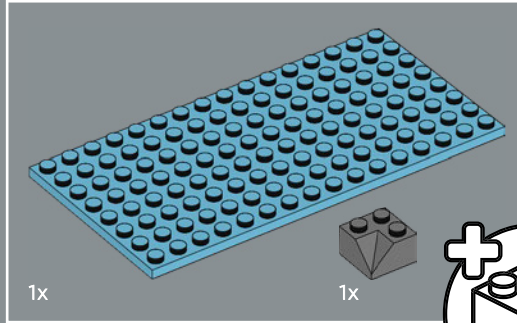
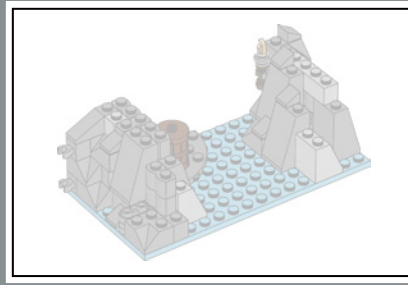
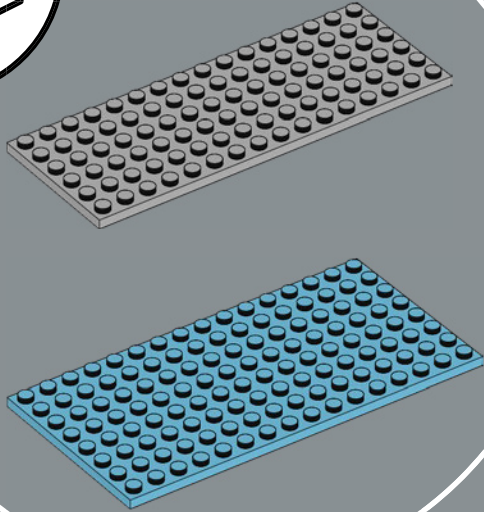
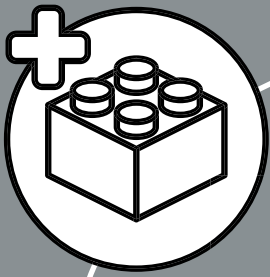

48

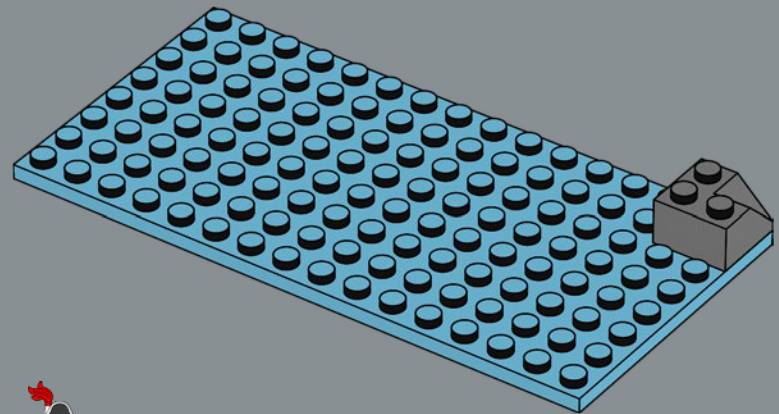



49

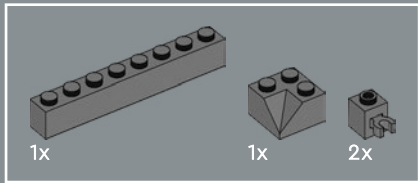
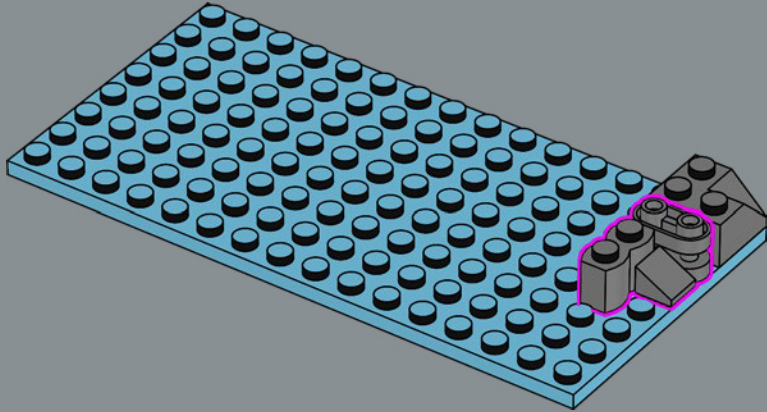

50

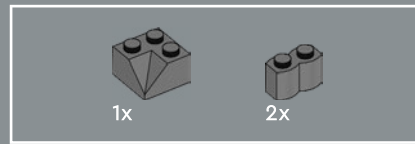
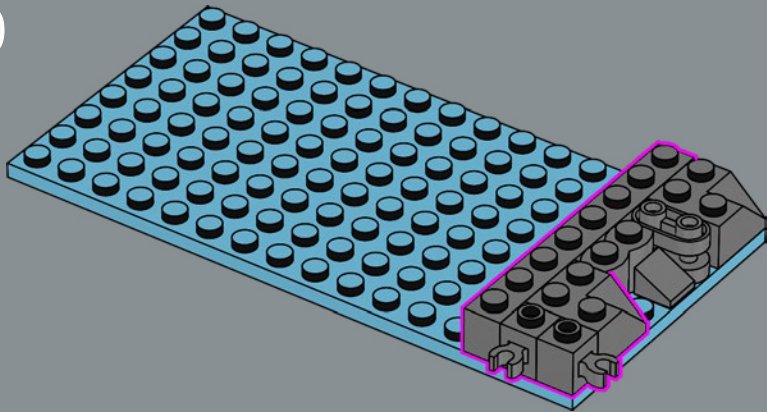

51

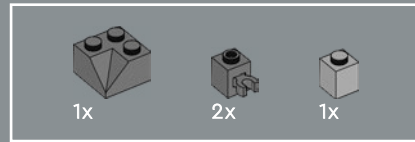
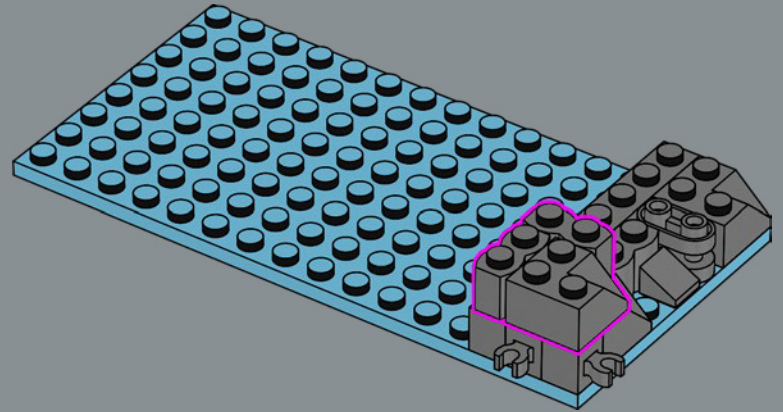

52

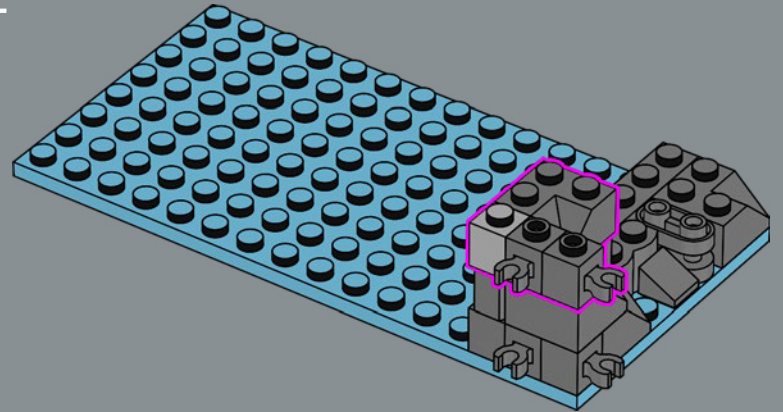

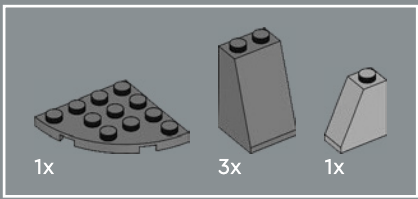

53

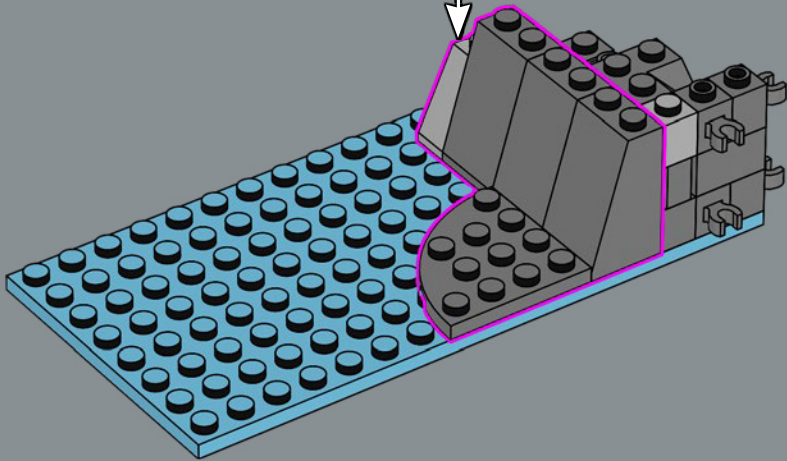
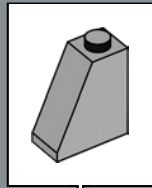

54

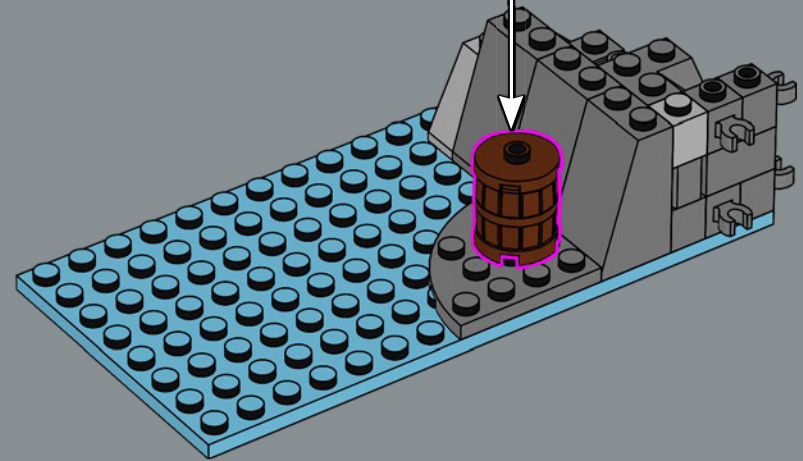
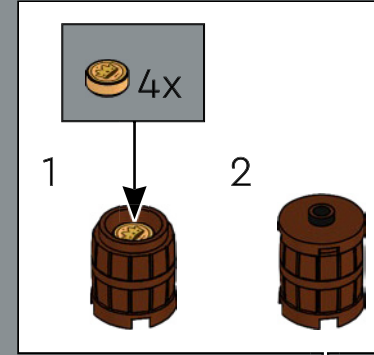

Gold doubloons are safely stored where no one can find them.



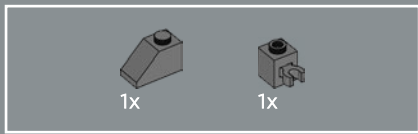

55

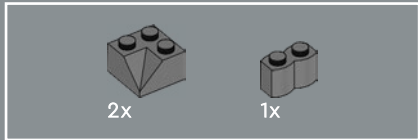
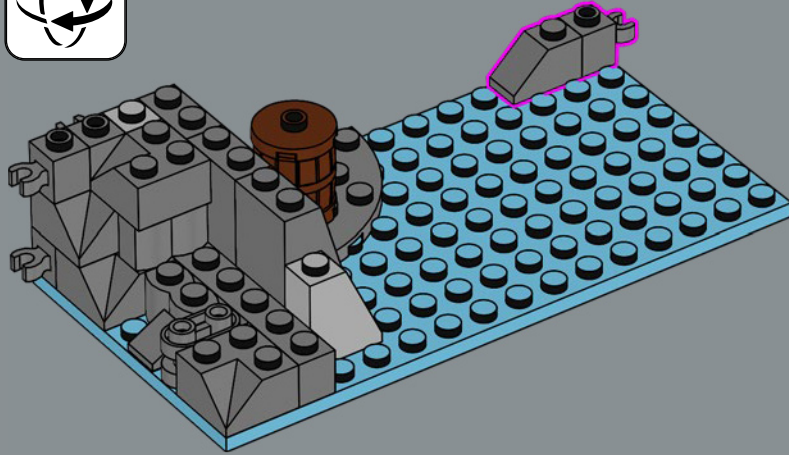

56

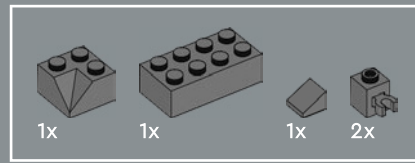
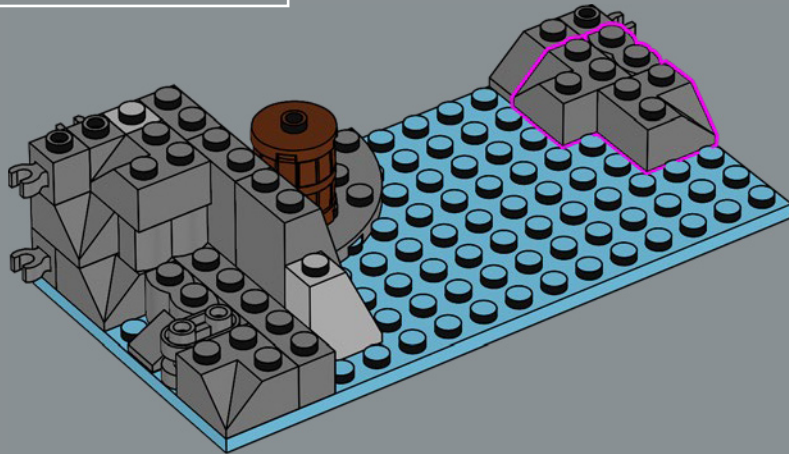

57

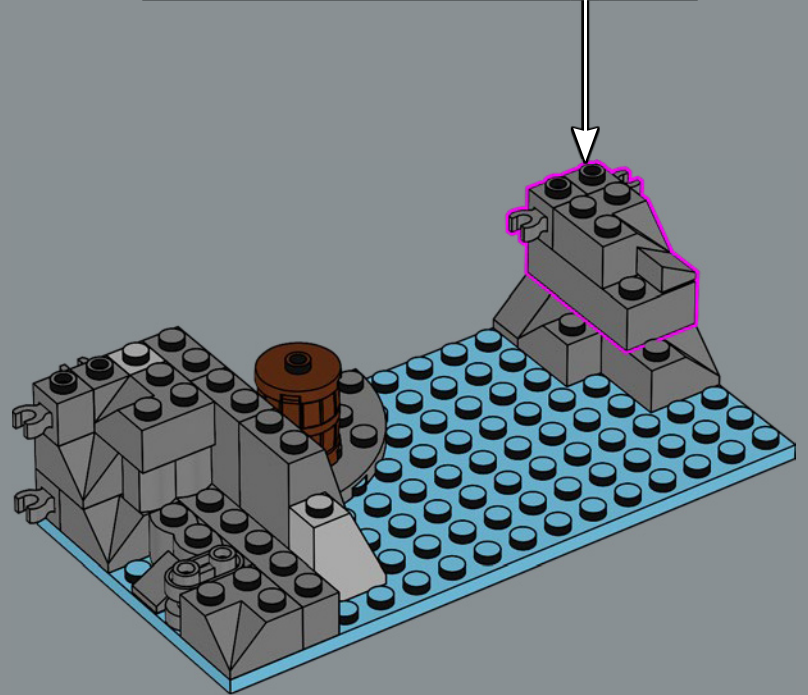
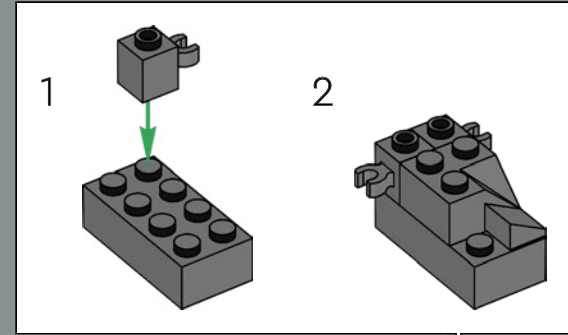

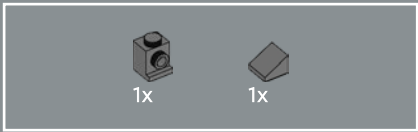

58

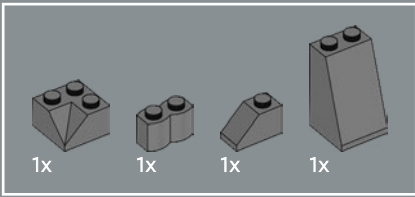
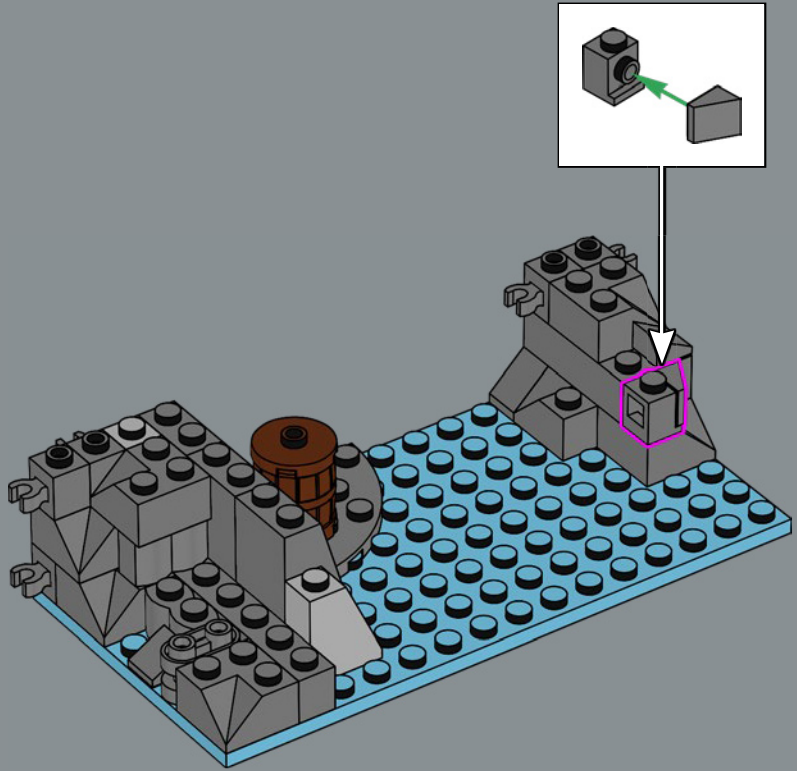
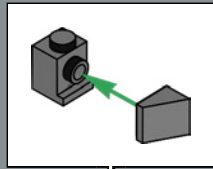

59

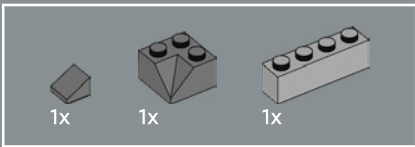
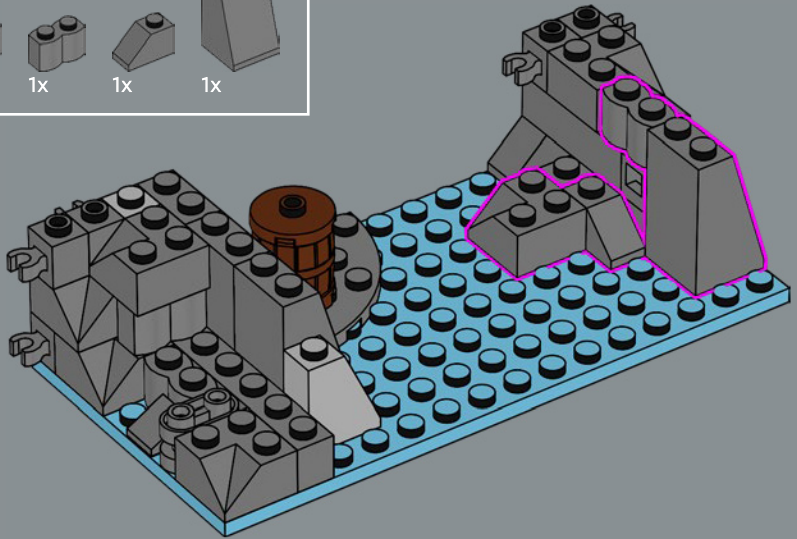

60

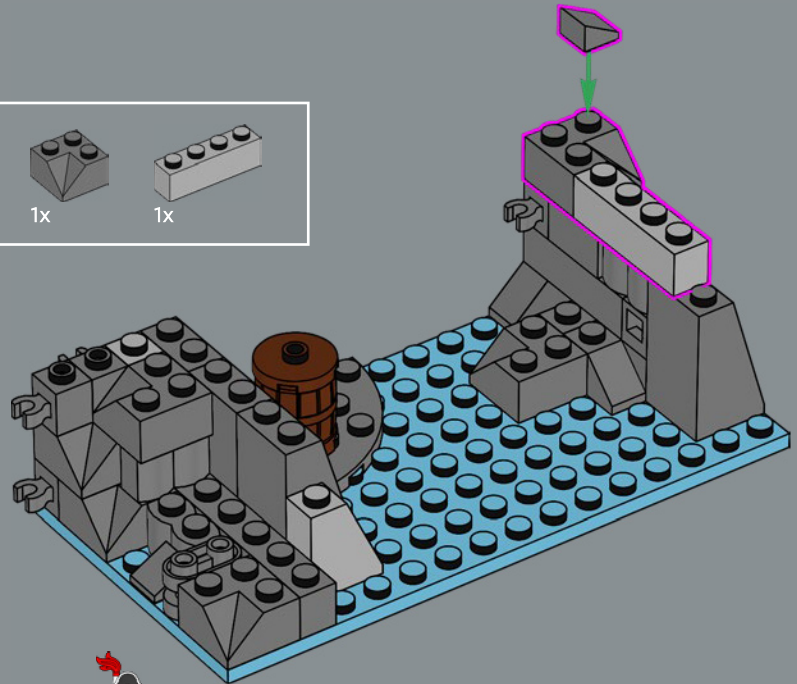

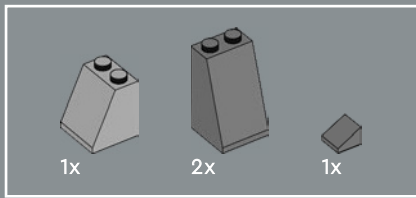

61

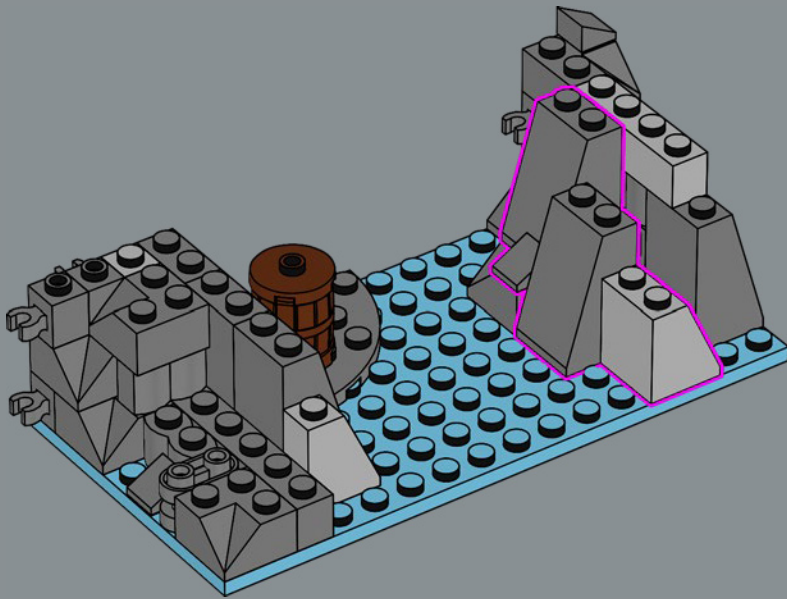

62

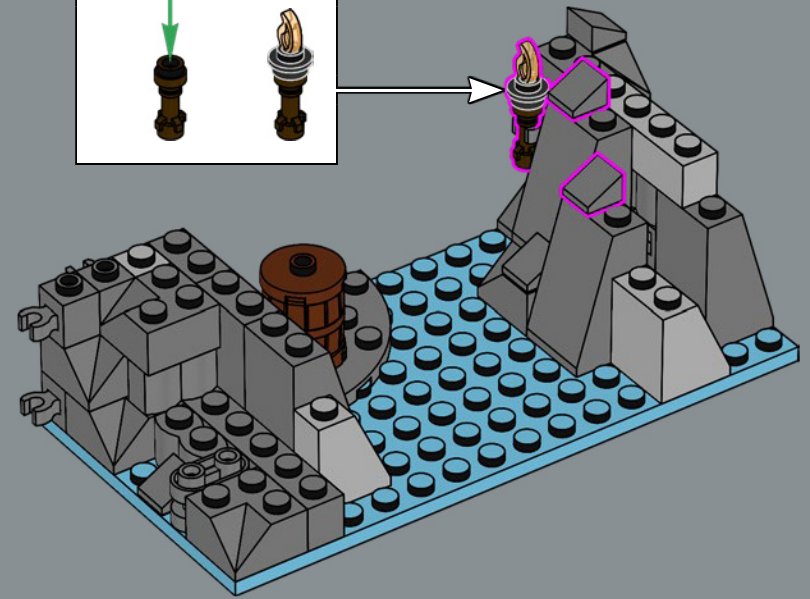
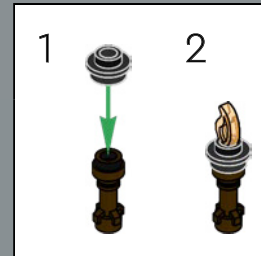

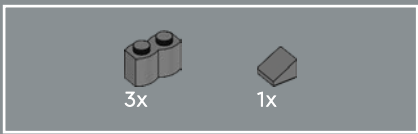

63

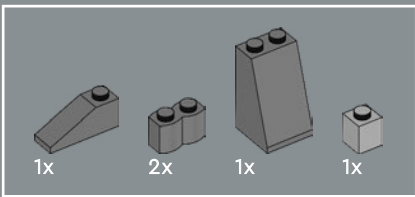
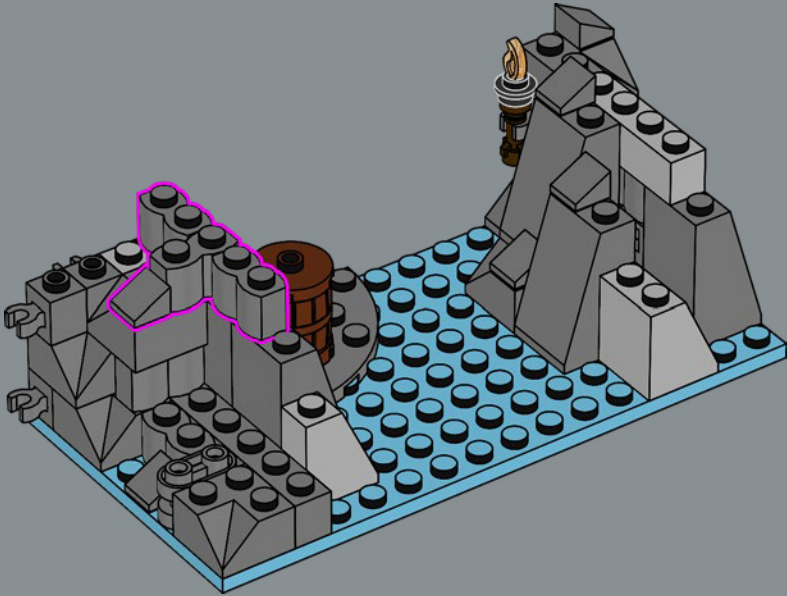

64

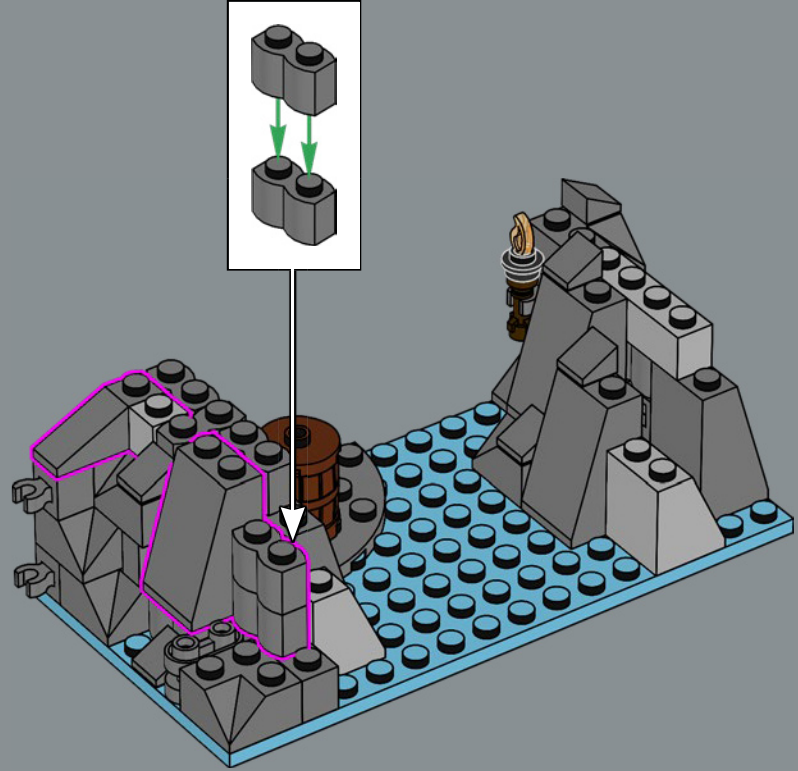



65

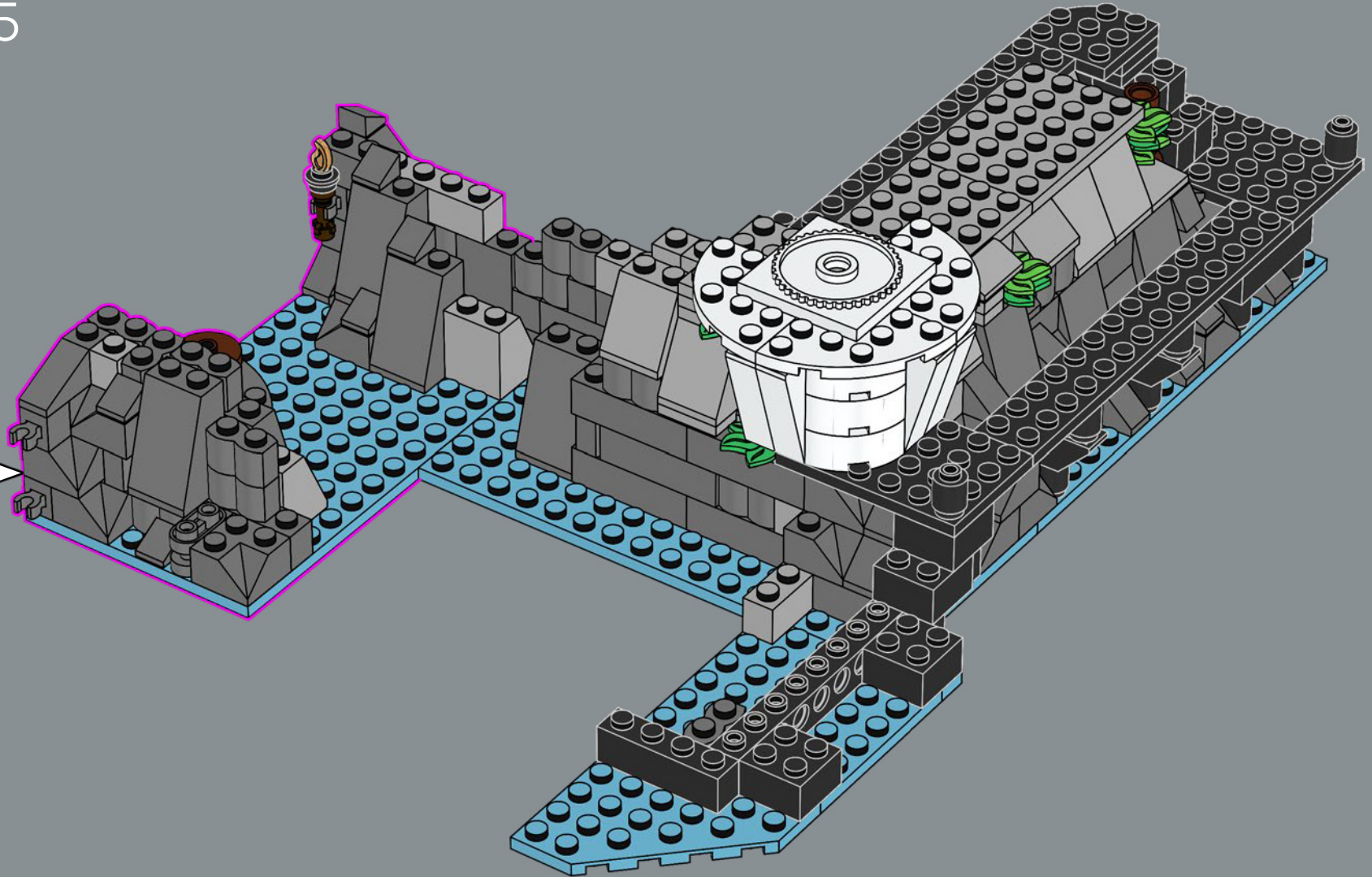

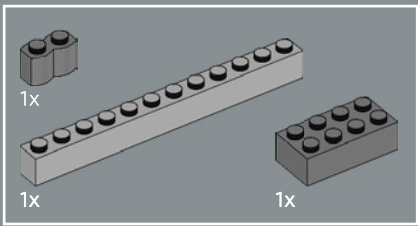

66

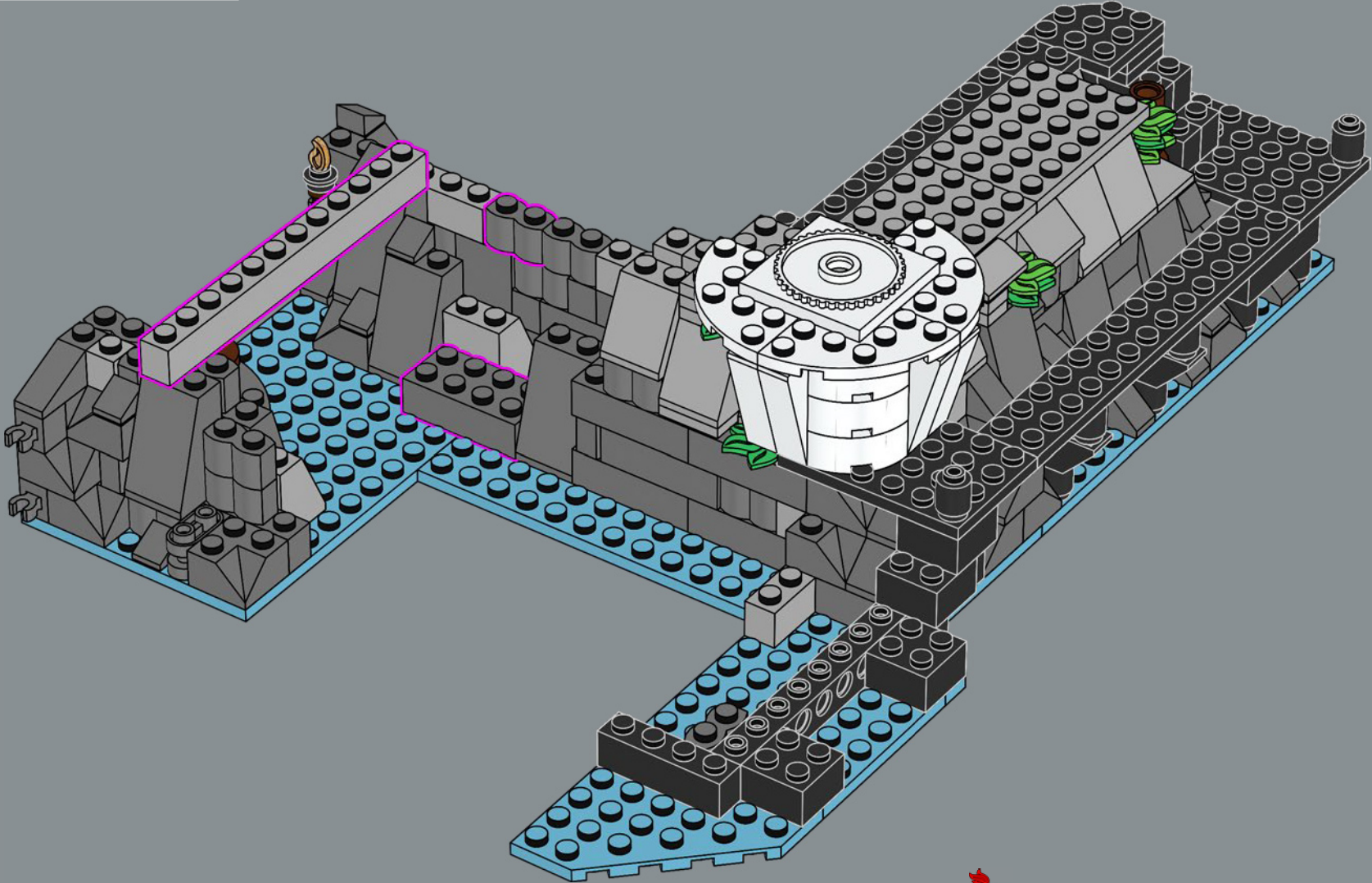

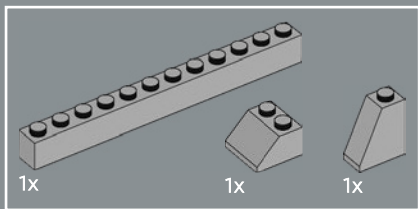

67

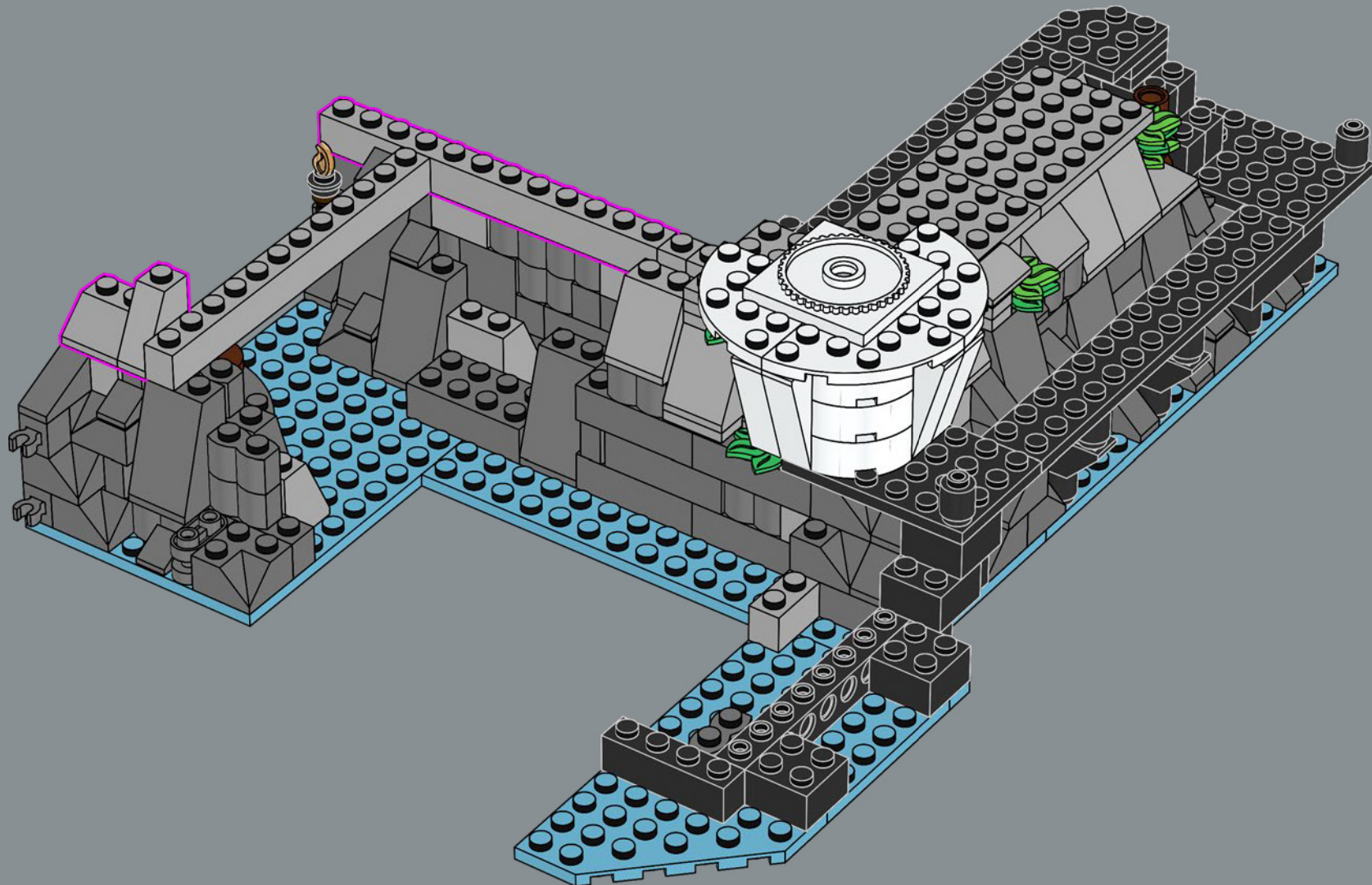

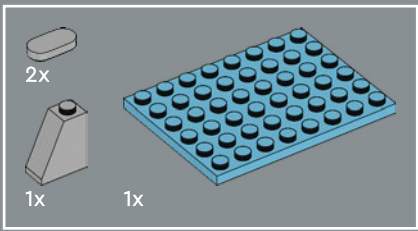

68

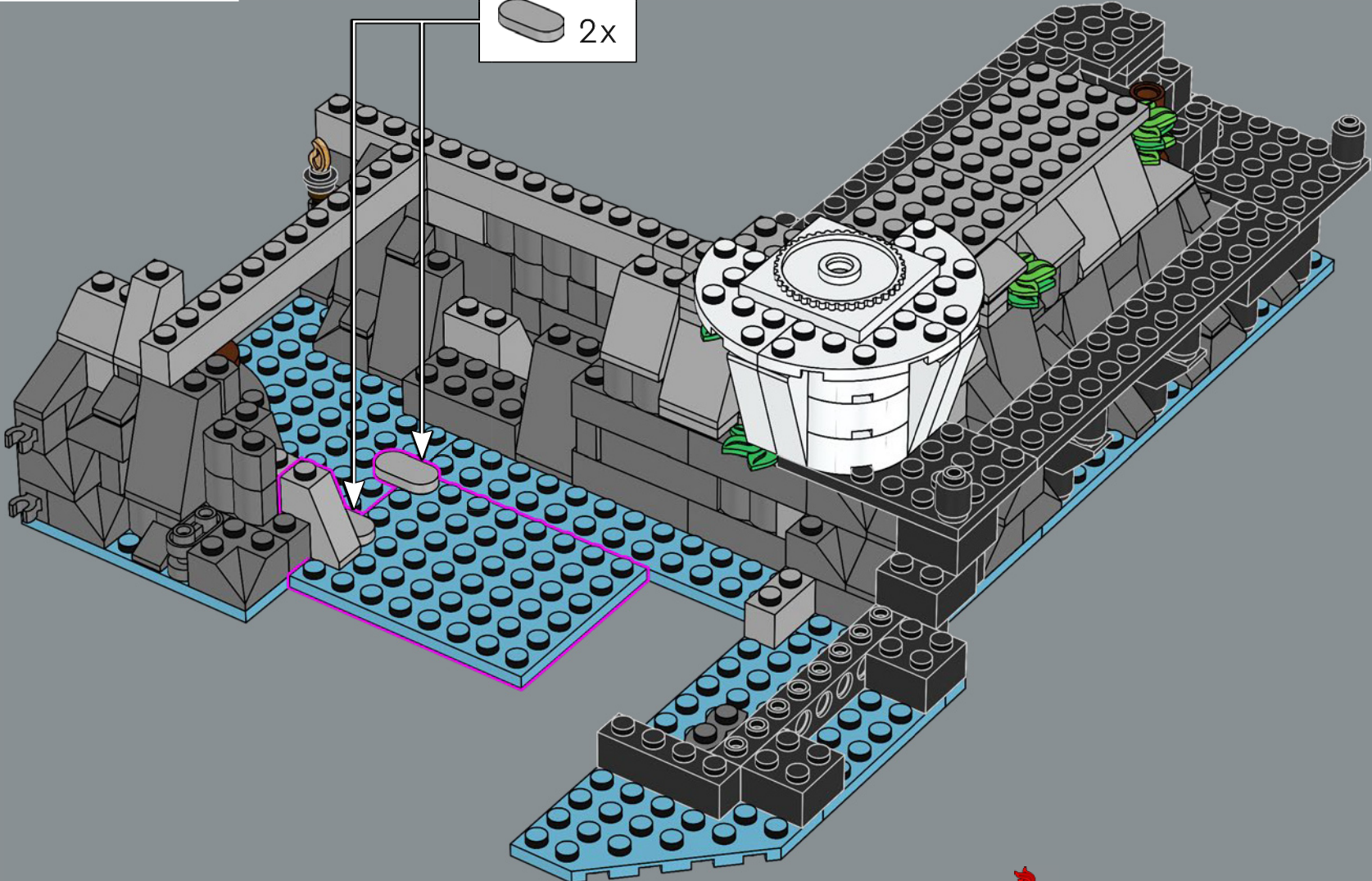

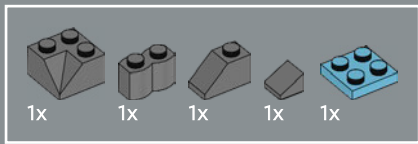

69

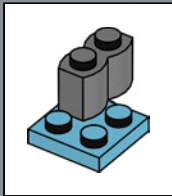
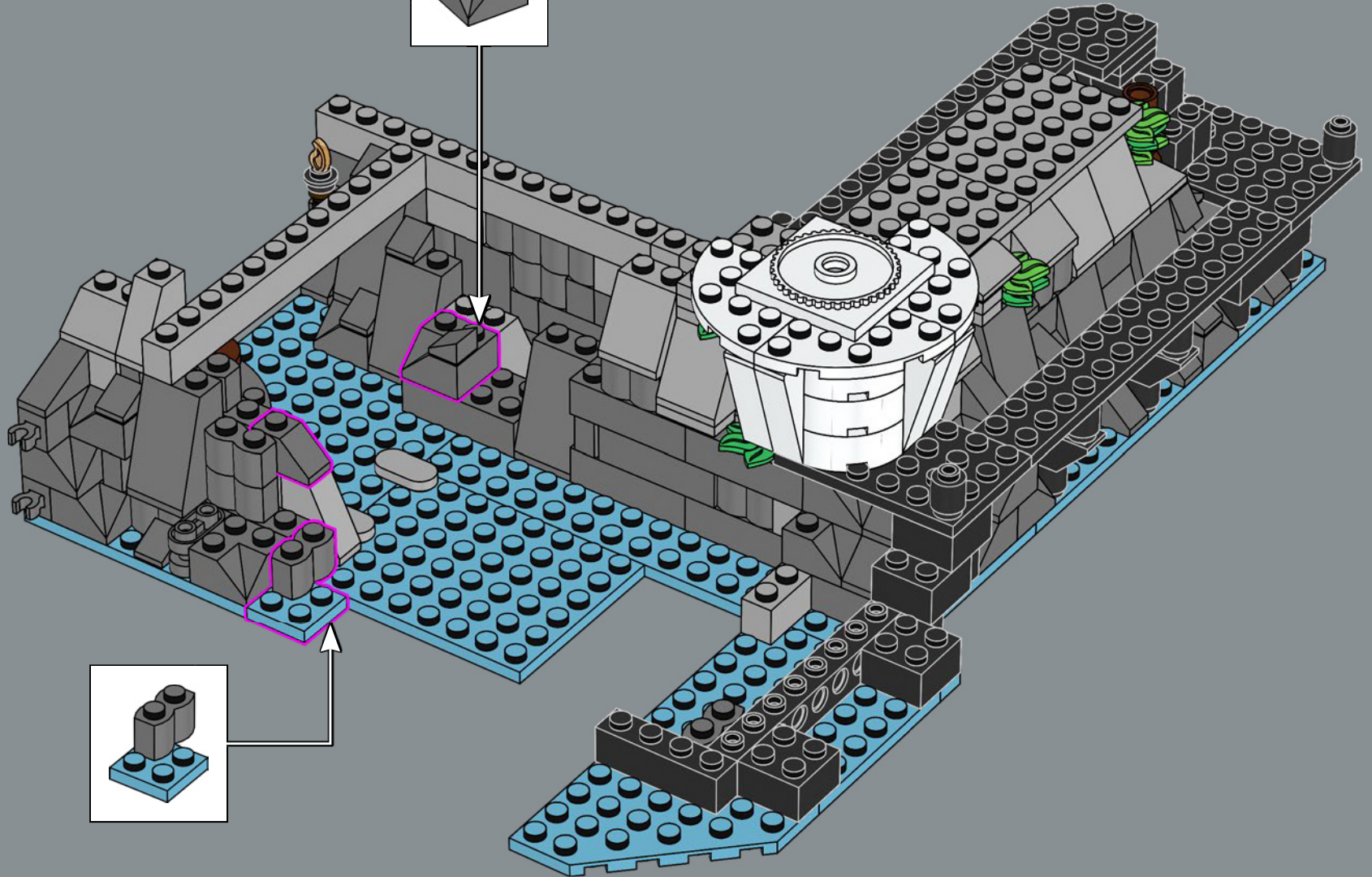
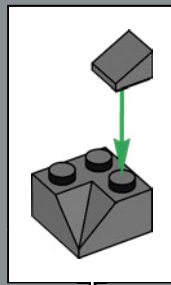

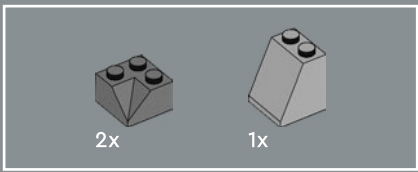

70

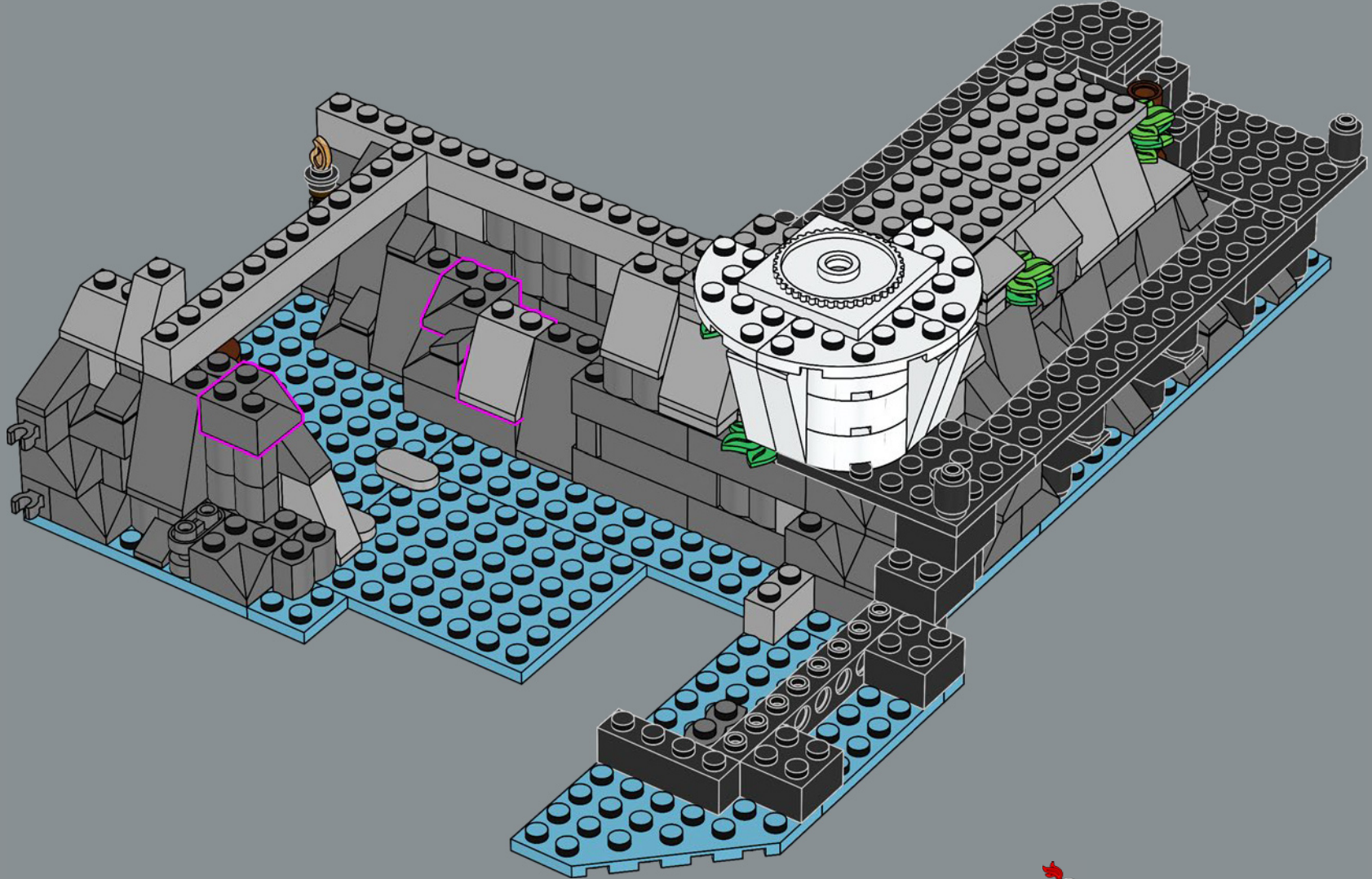

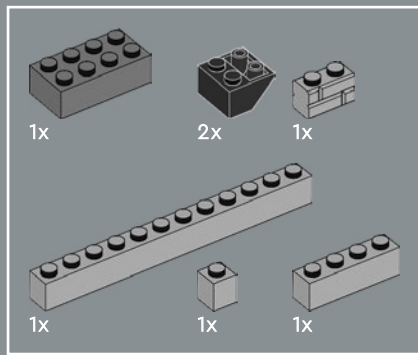

71

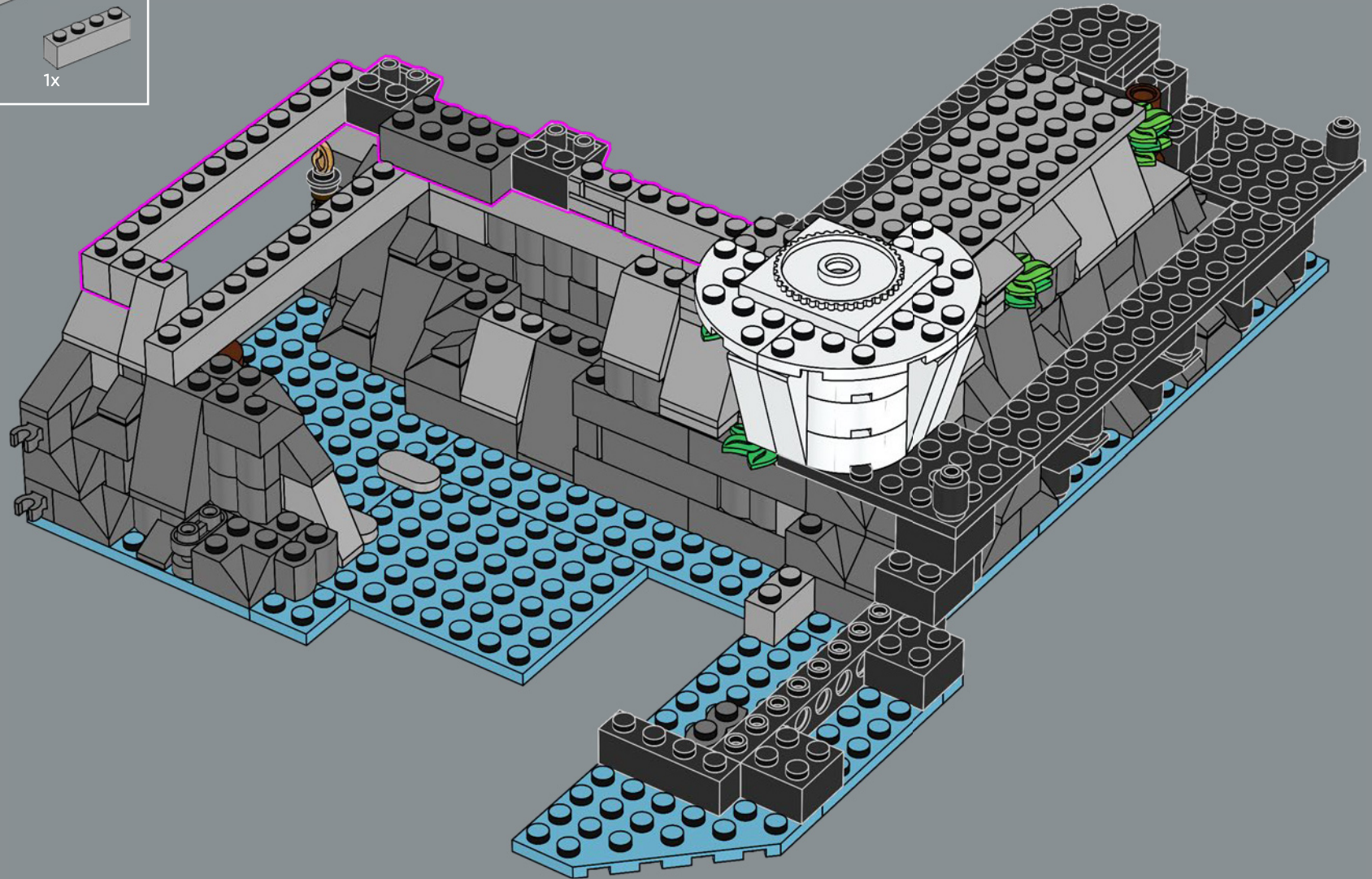

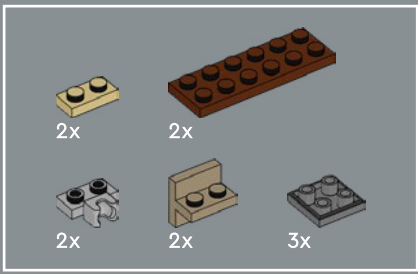

72

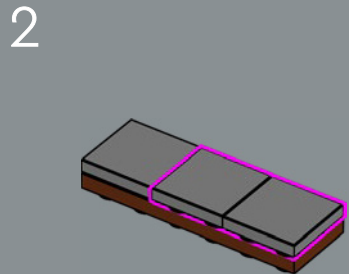
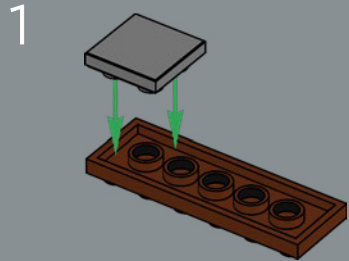

3

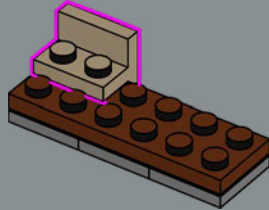

4

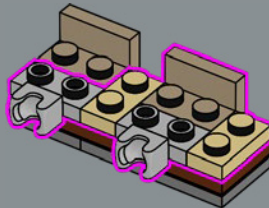

5

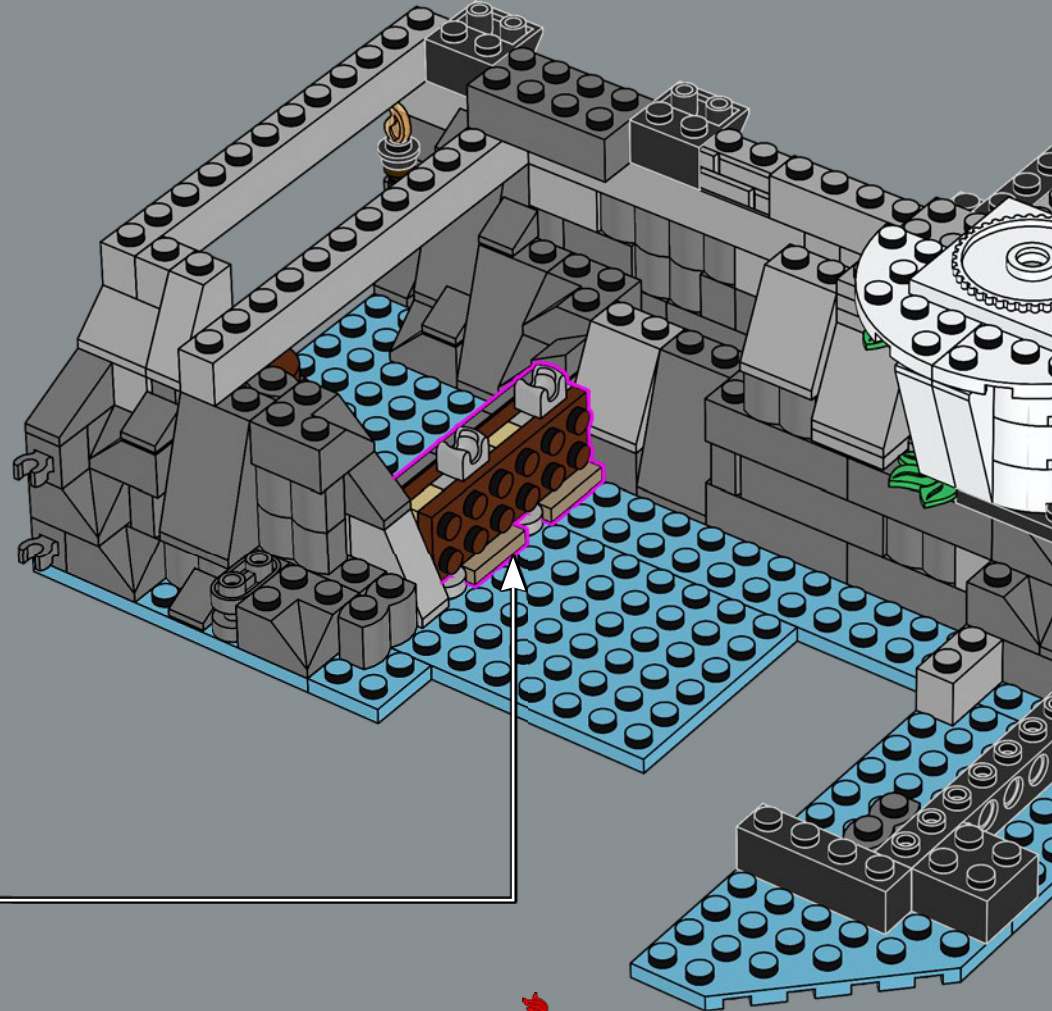
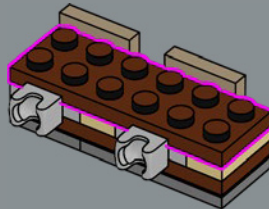



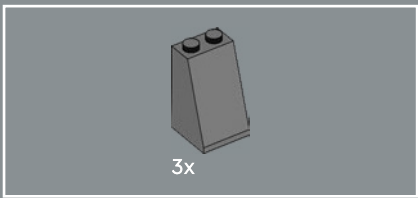

73

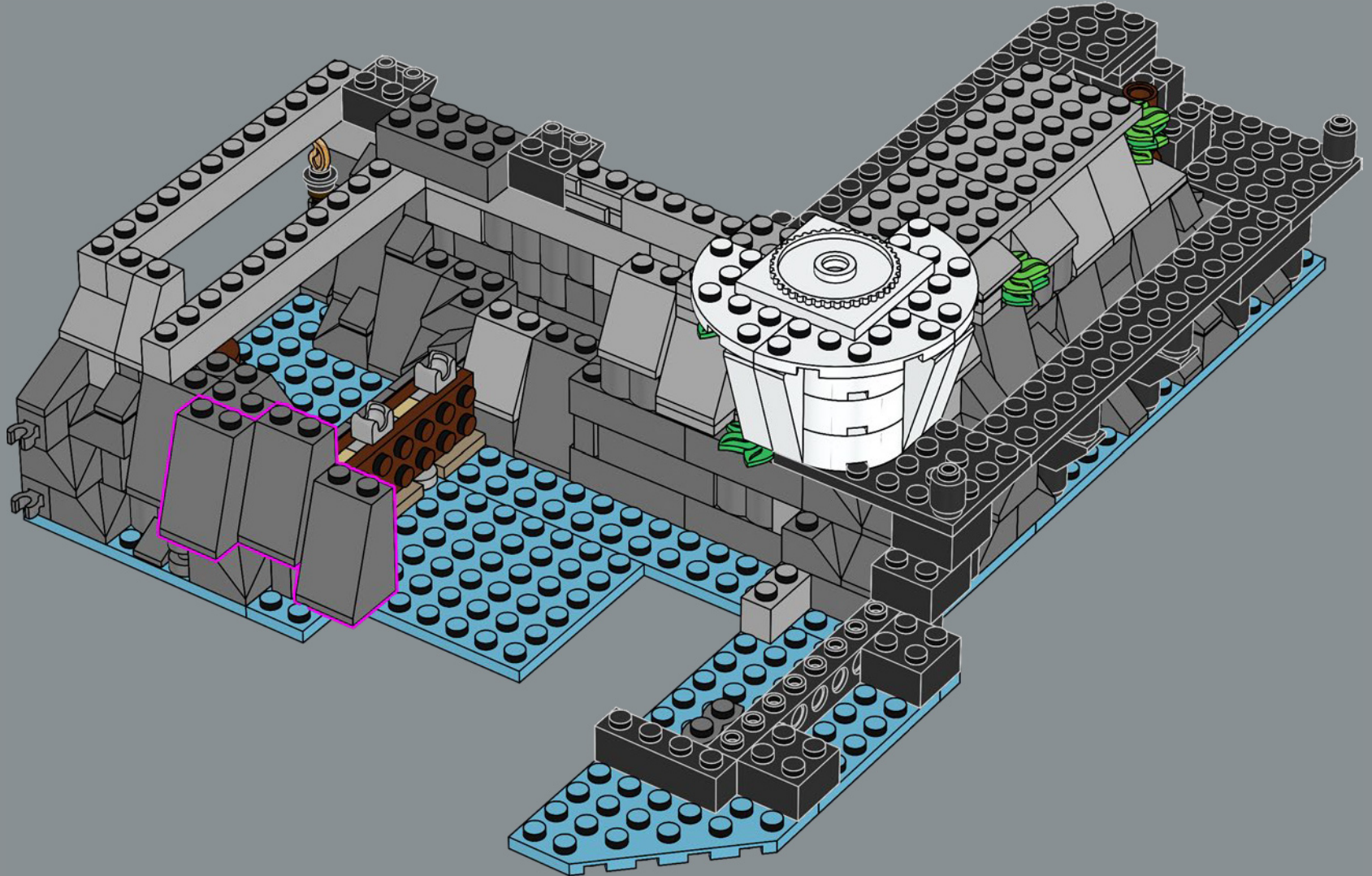

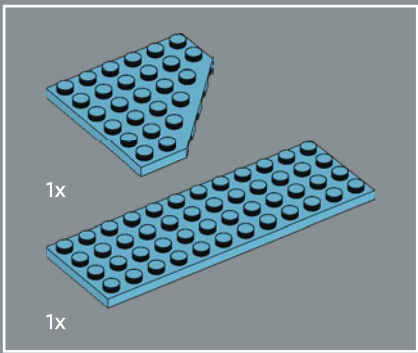

74

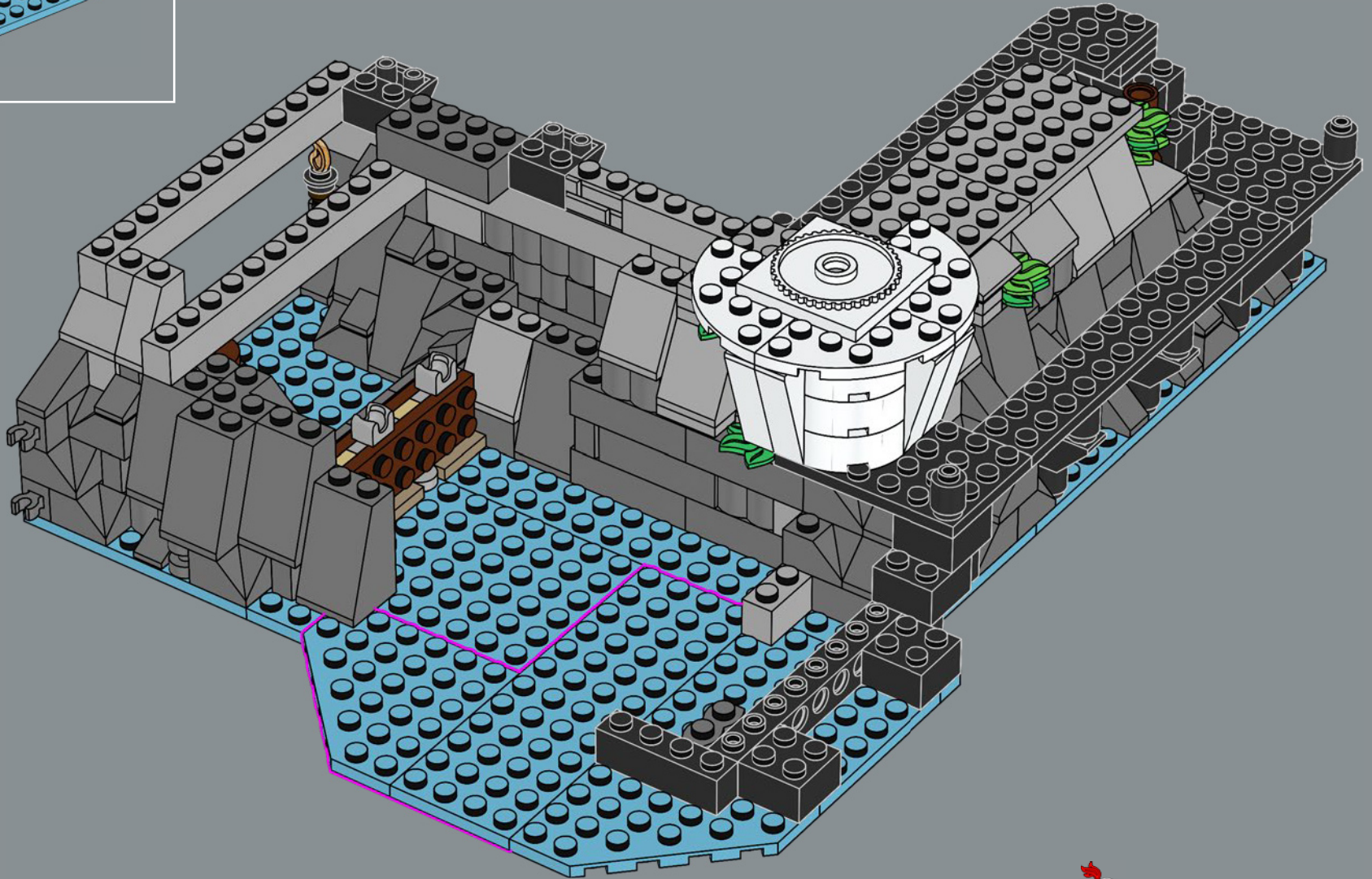

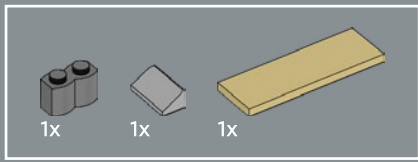

75

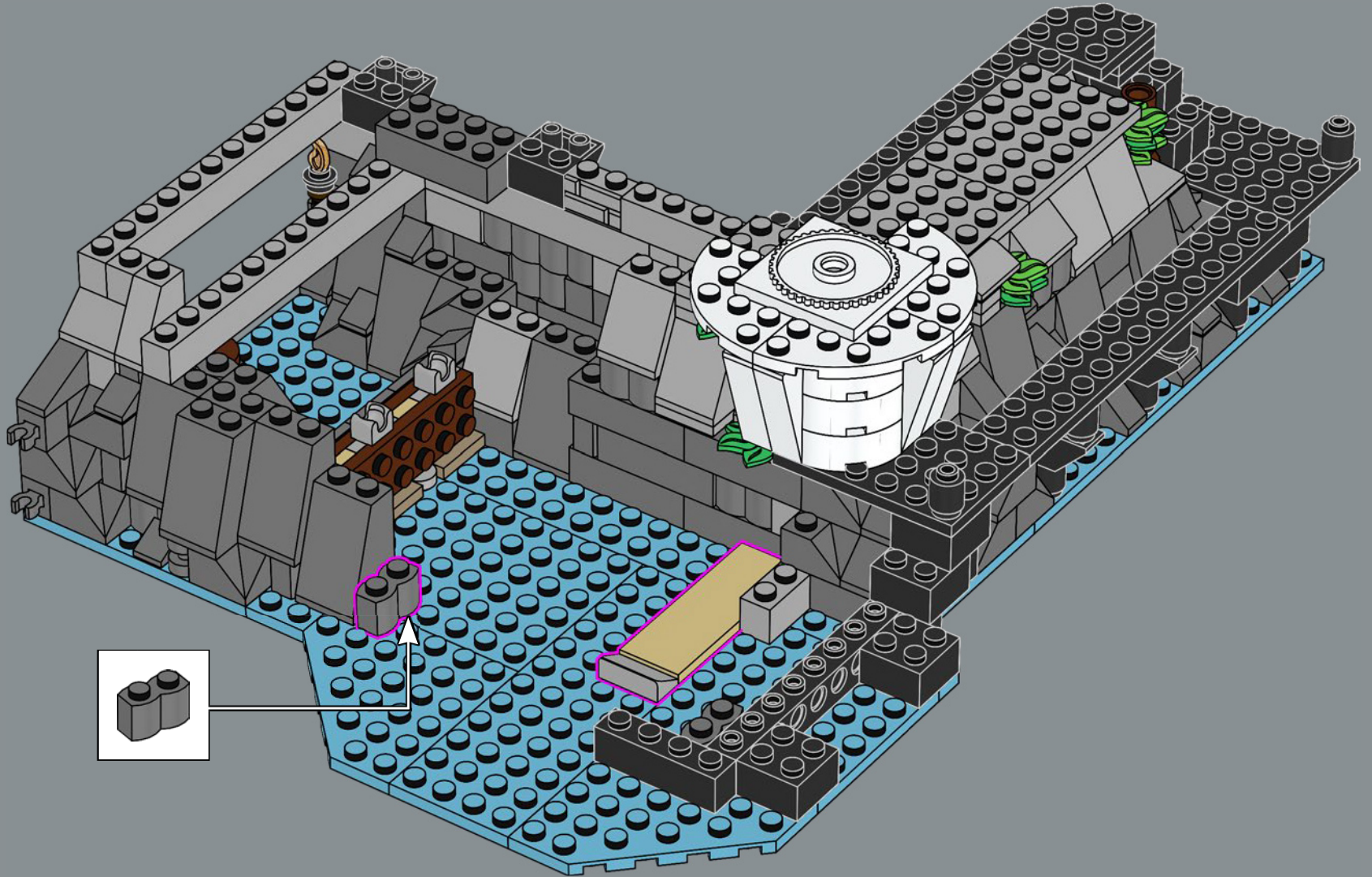

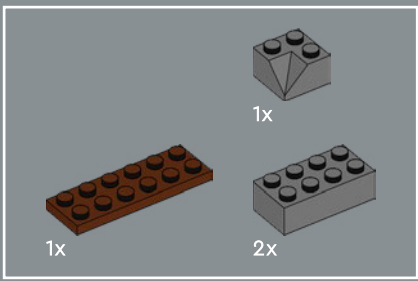

76

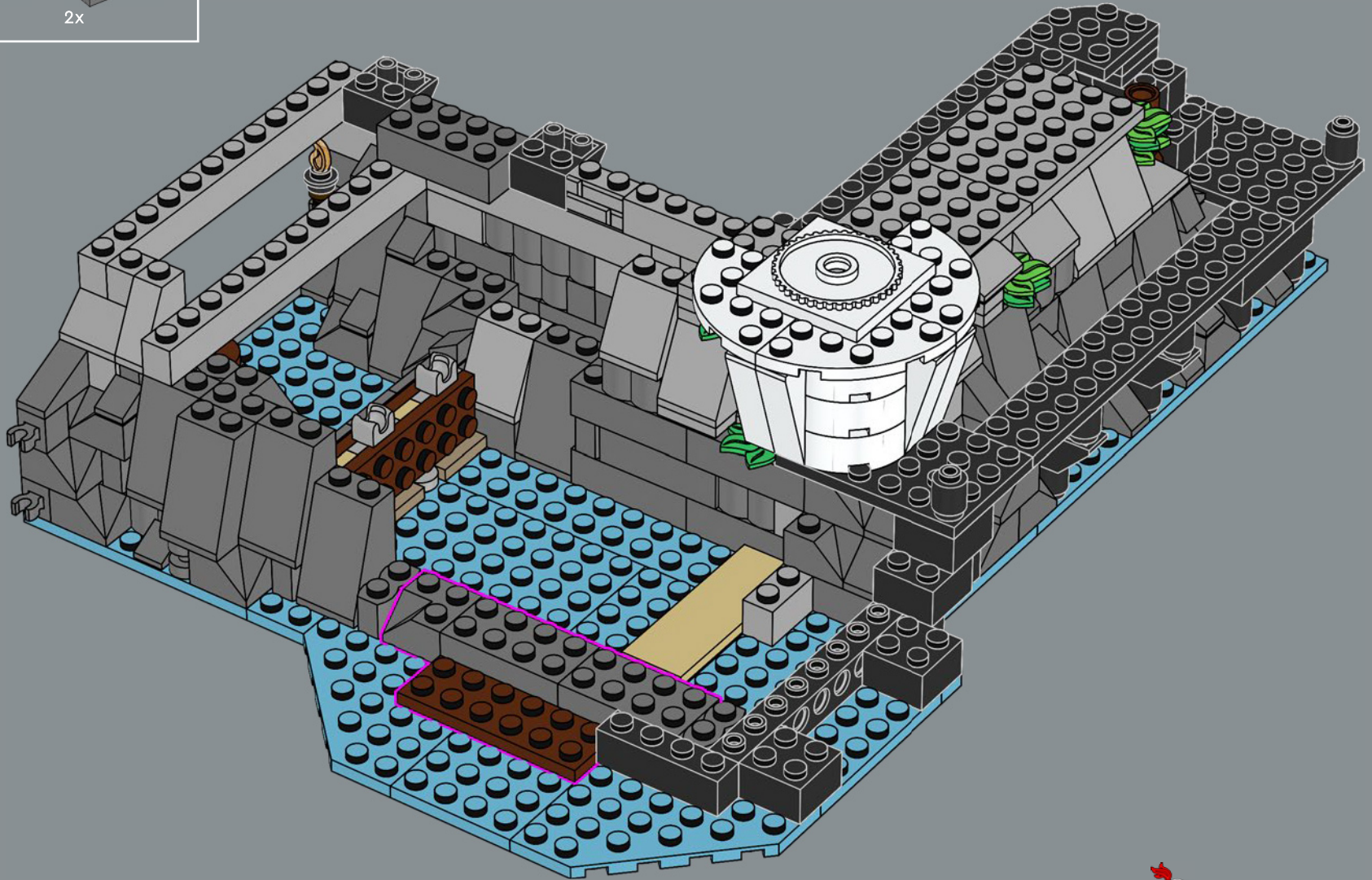

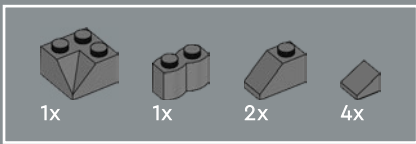

77

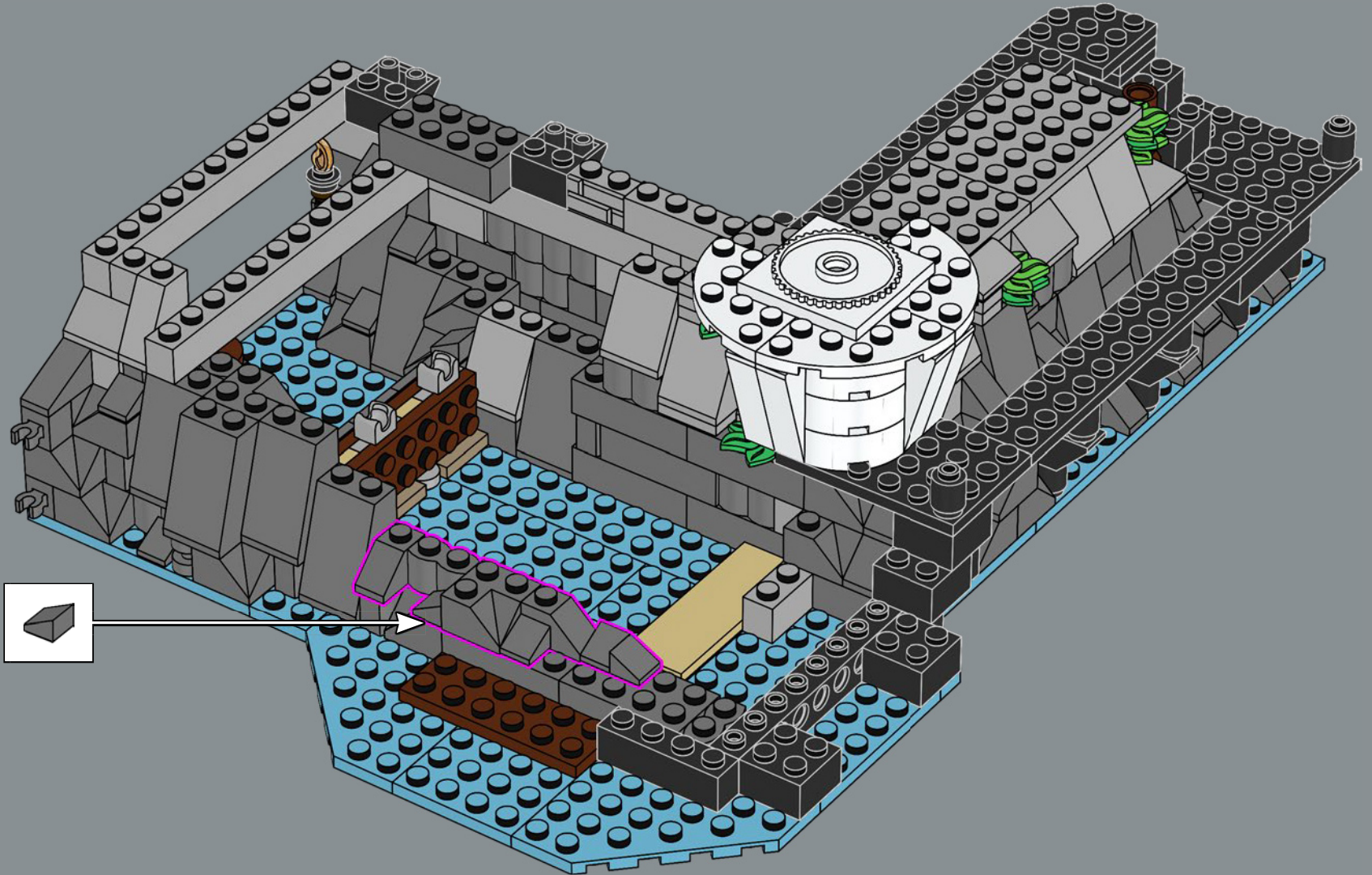

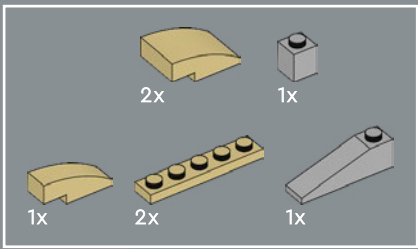

78

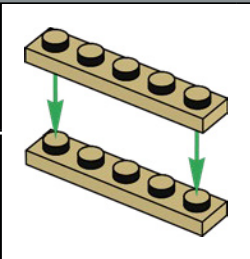
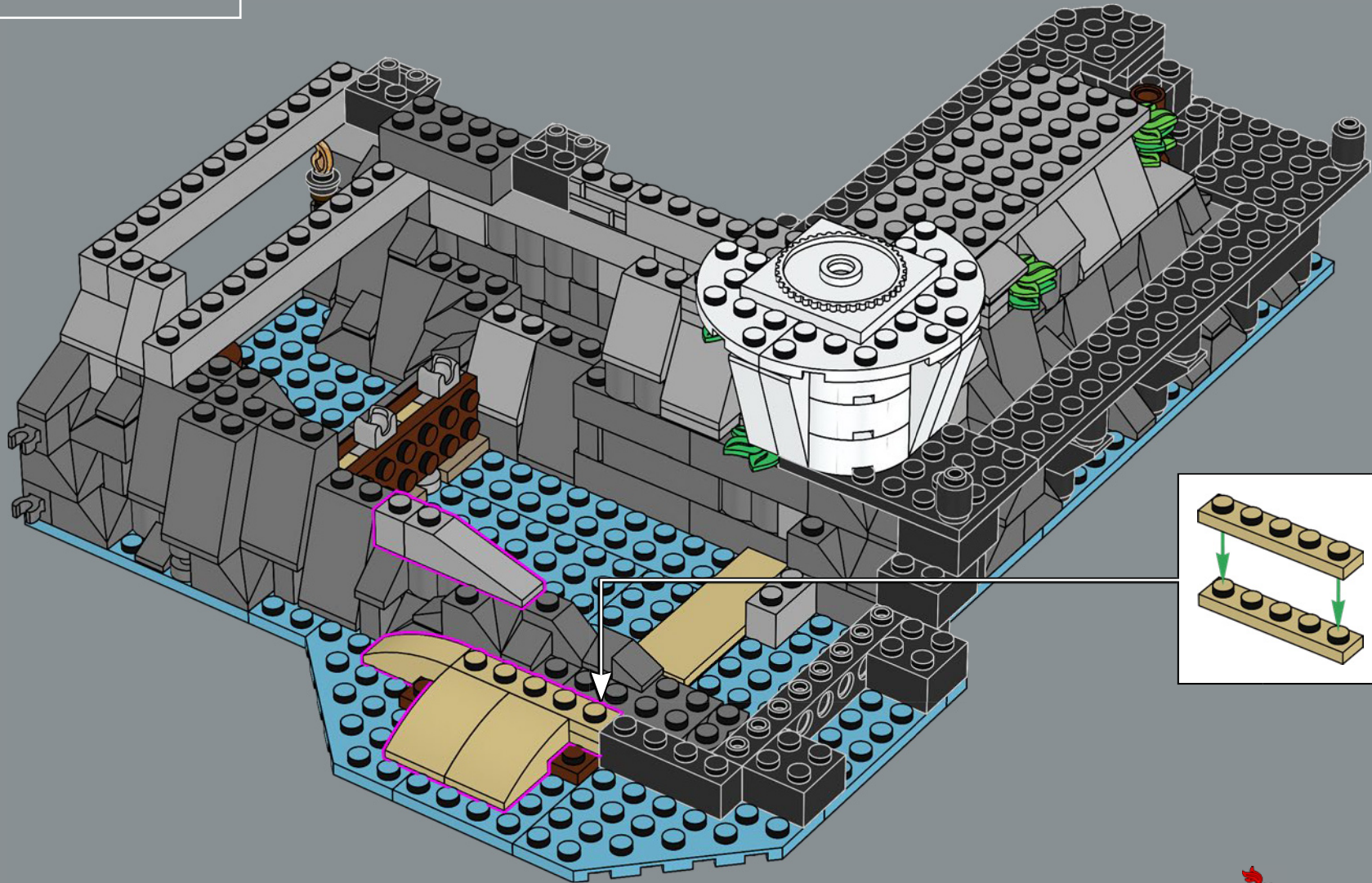

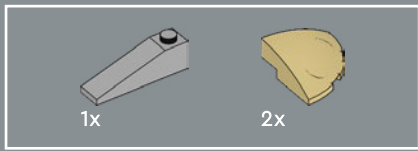

79

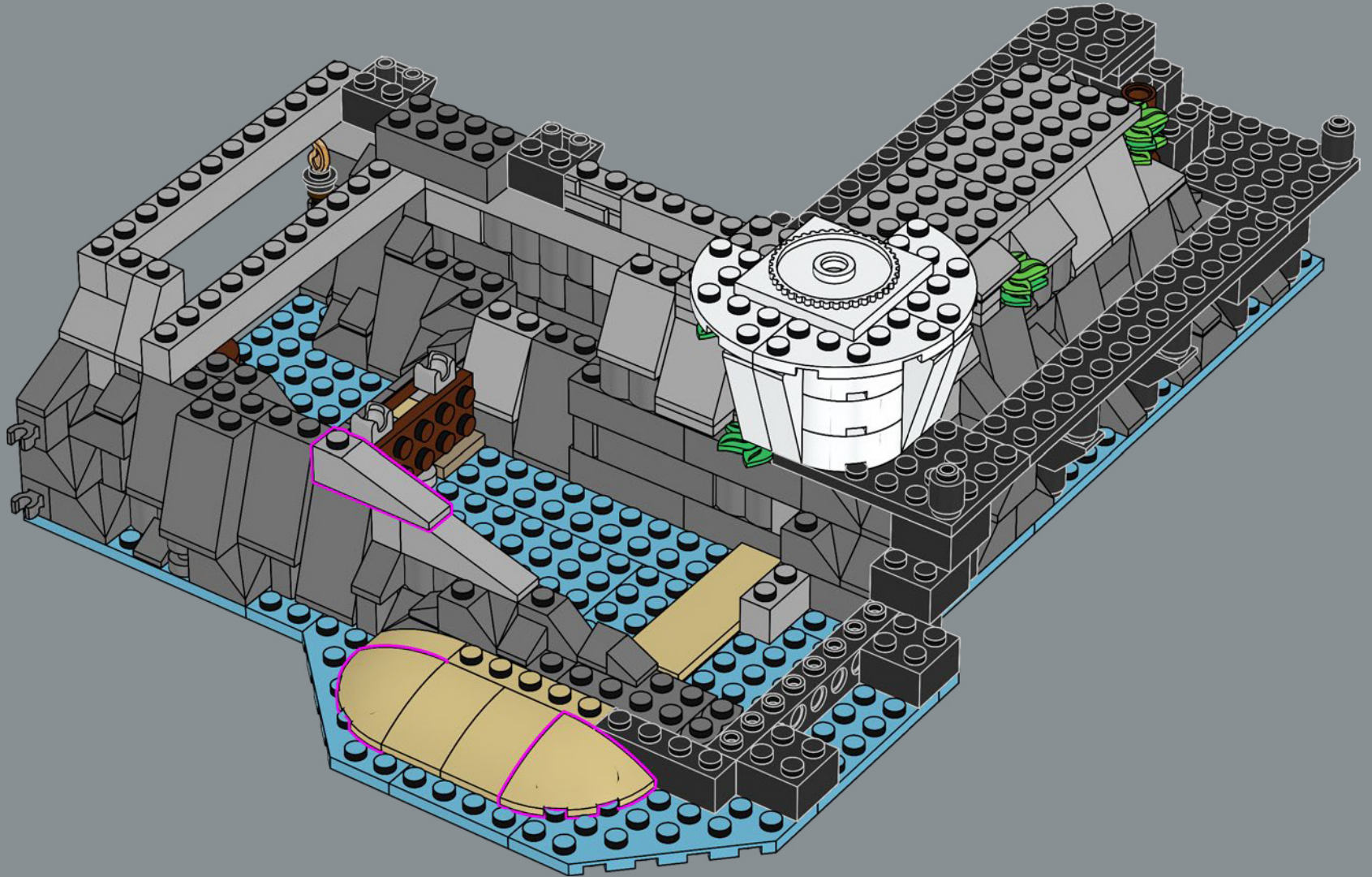

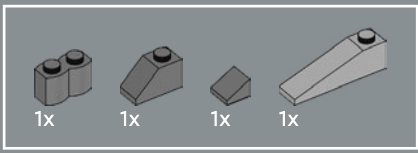

80

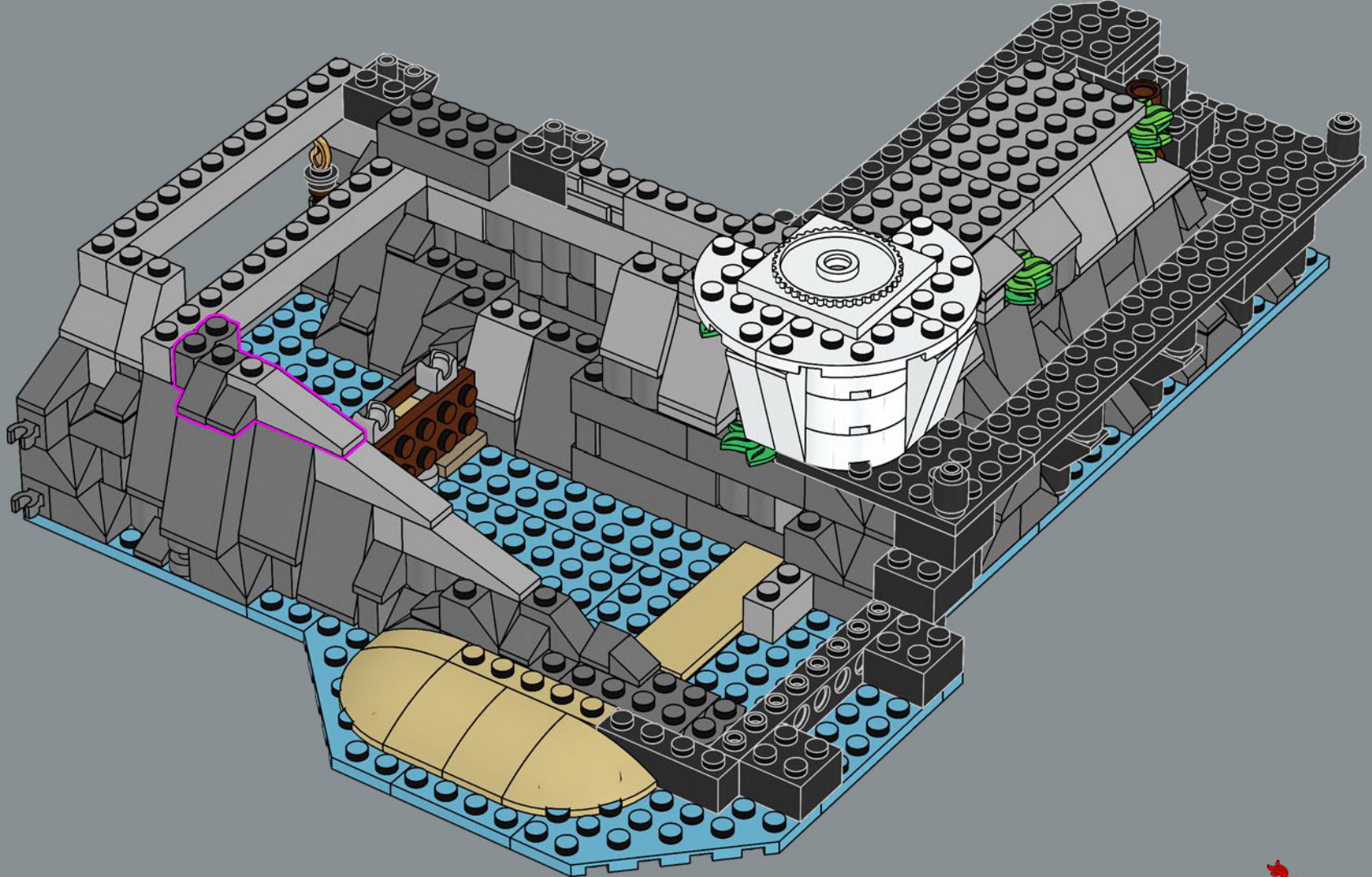



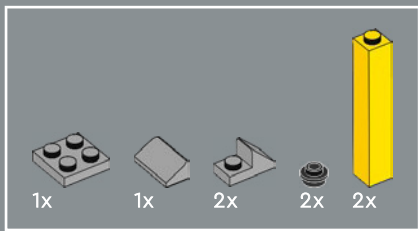

81

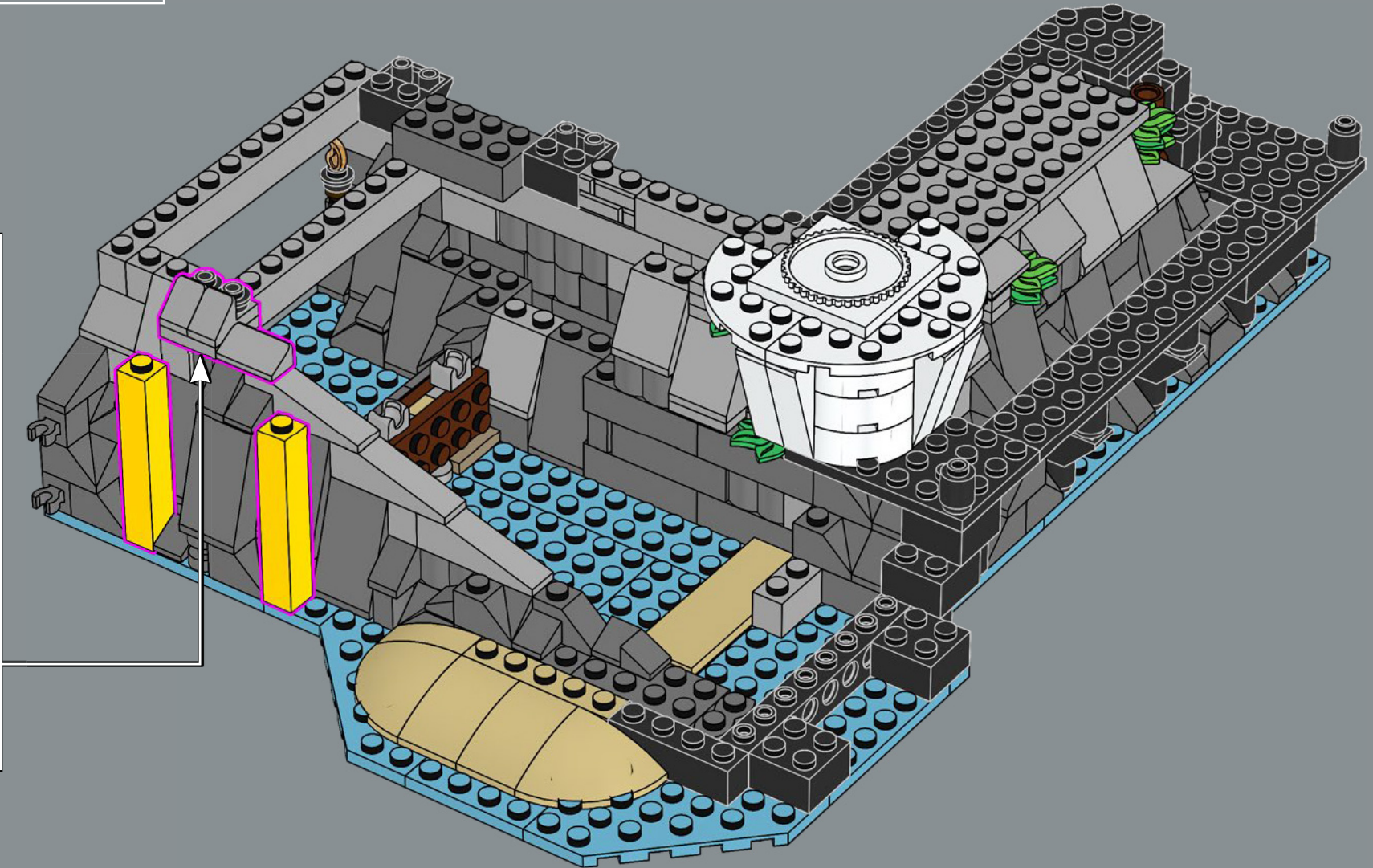
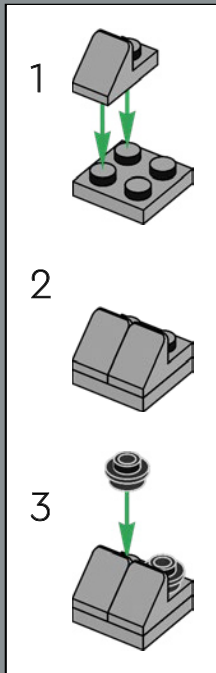

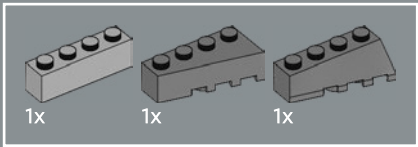

82

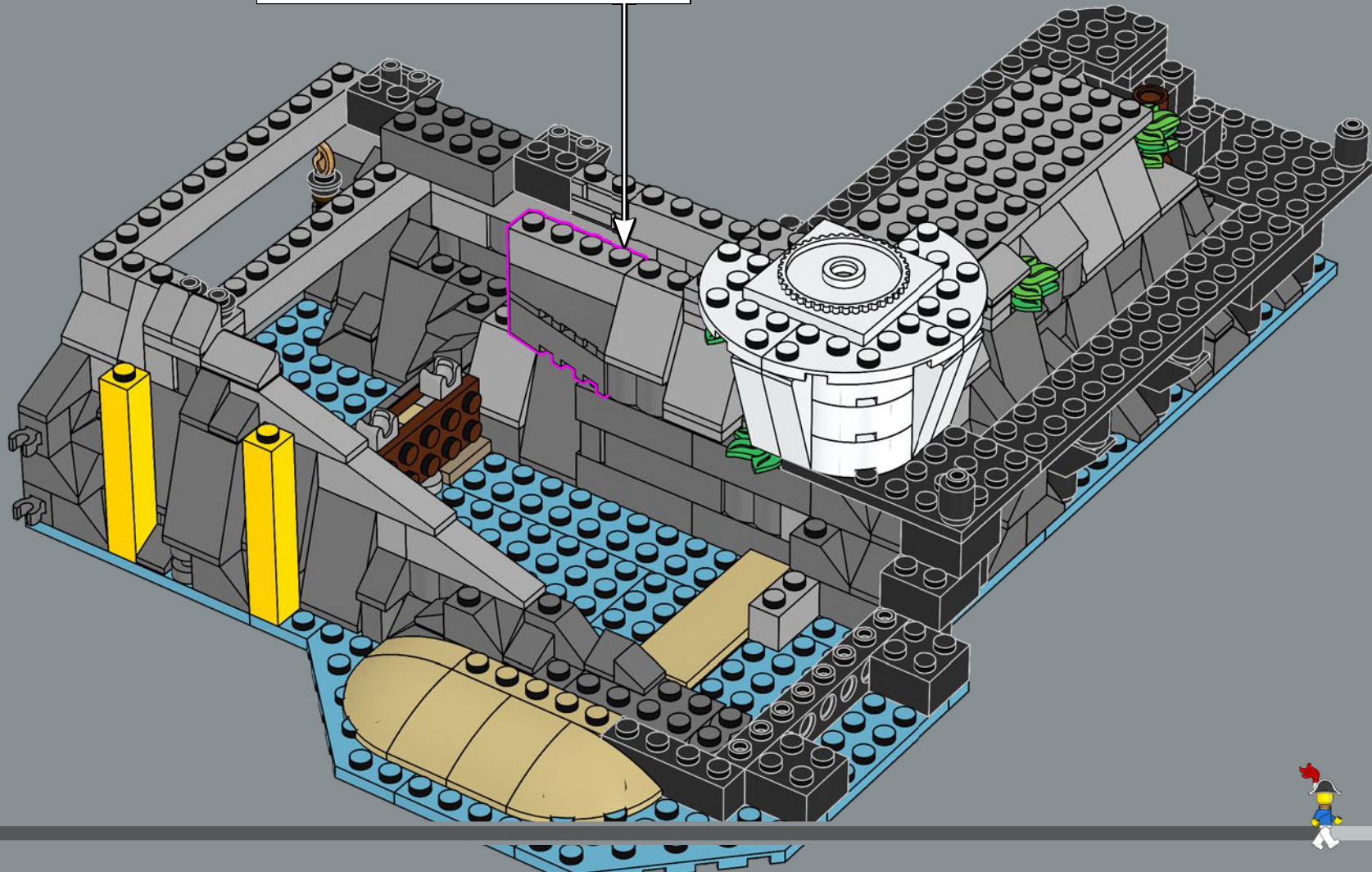
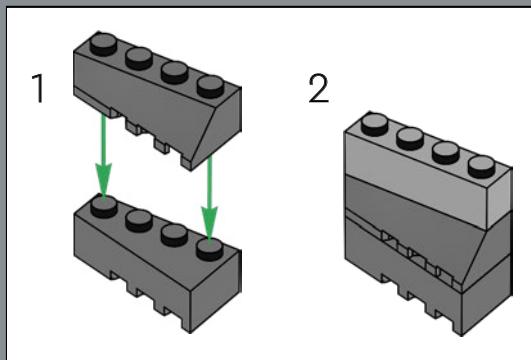

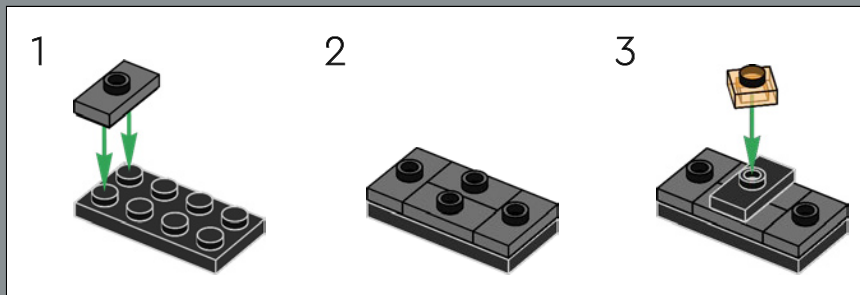
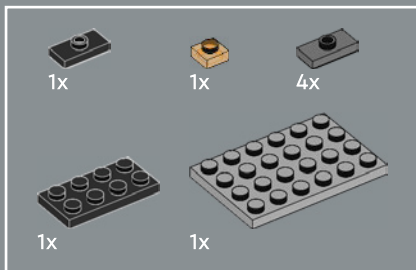

83

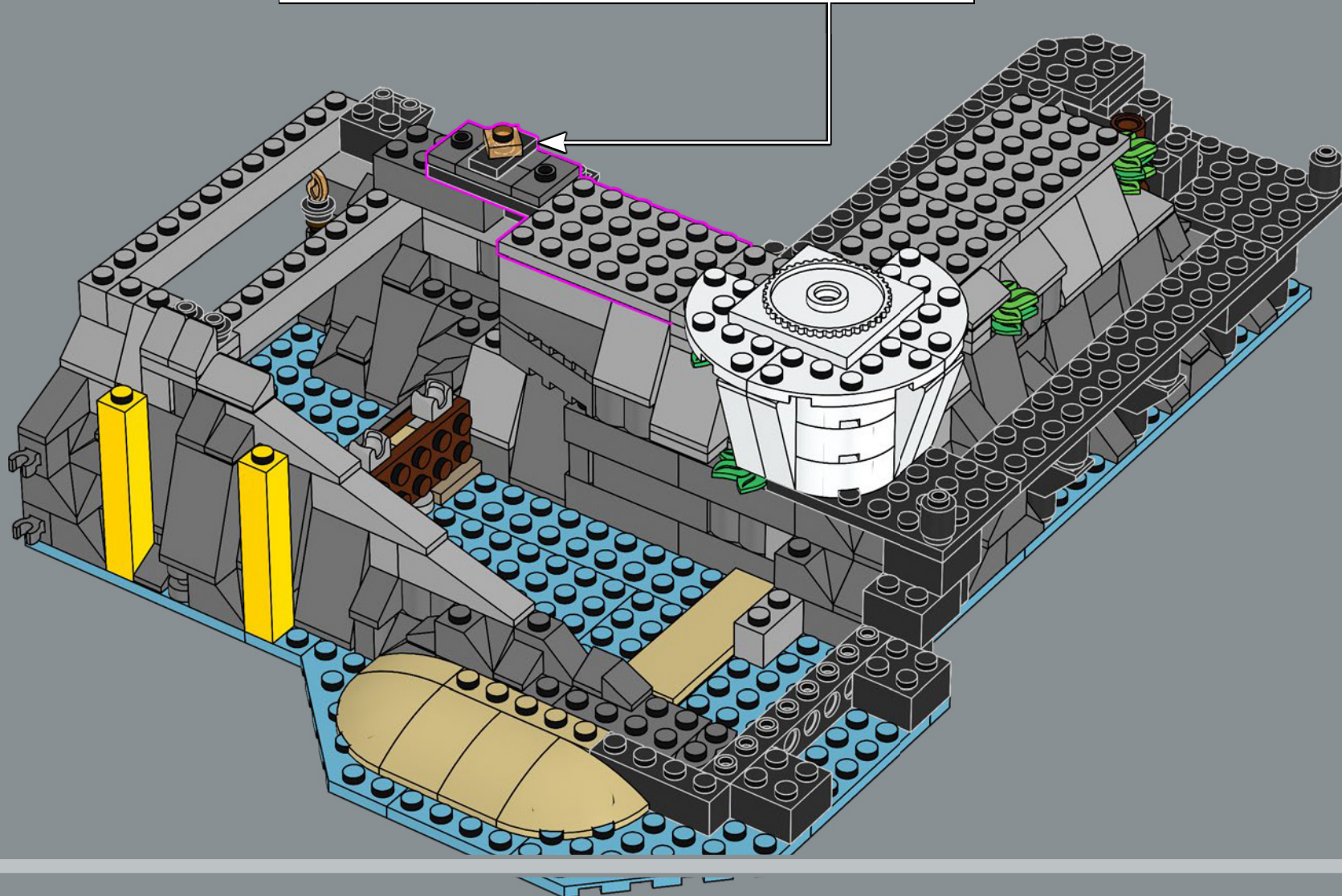

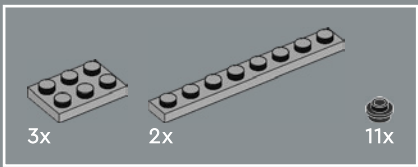

84

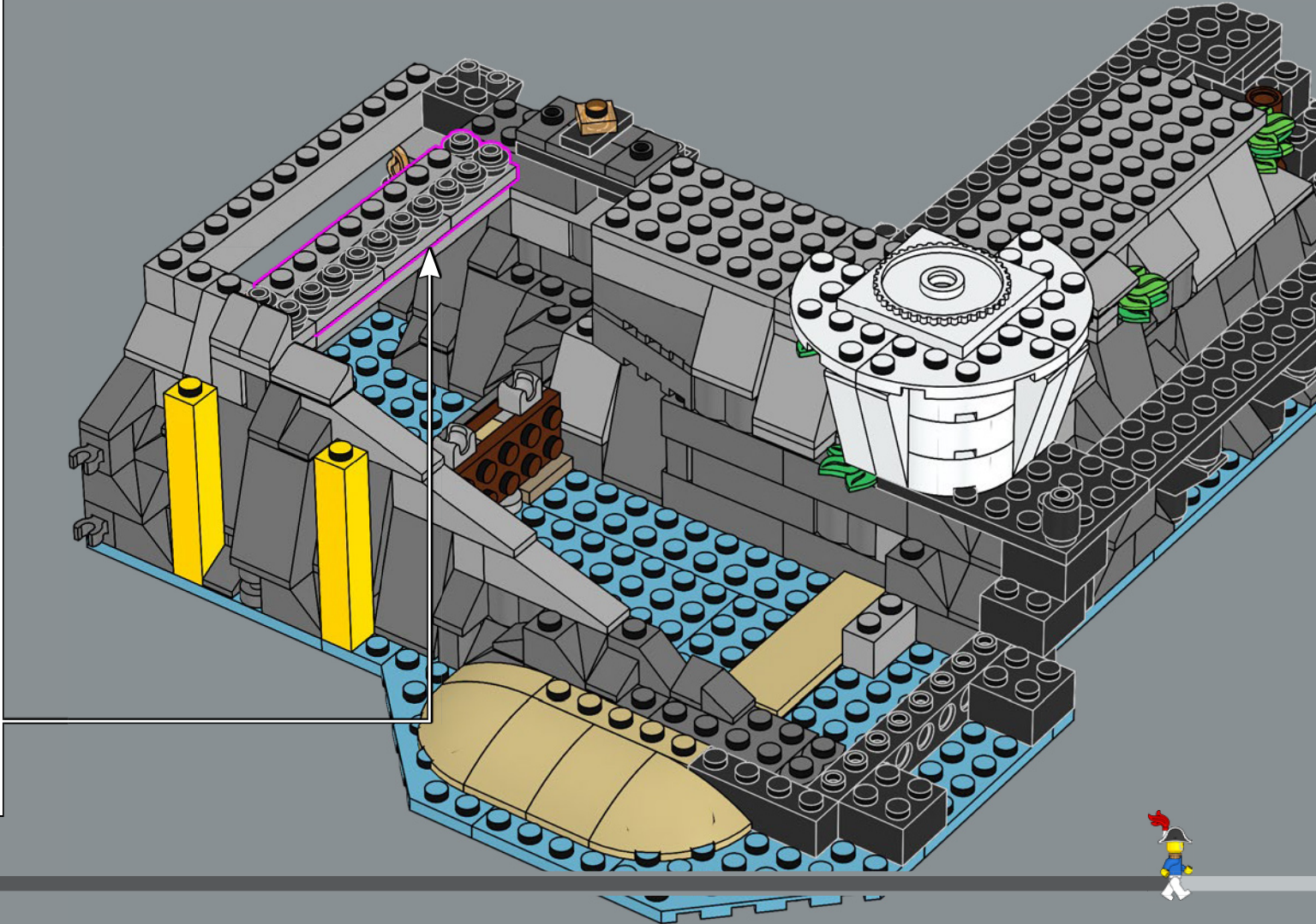
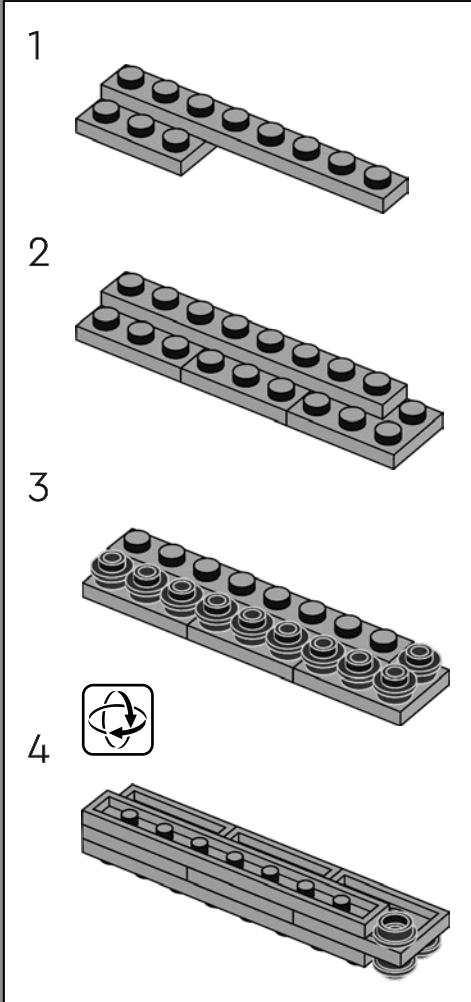

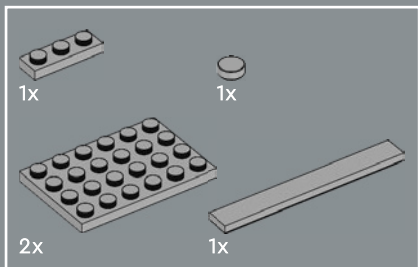

85

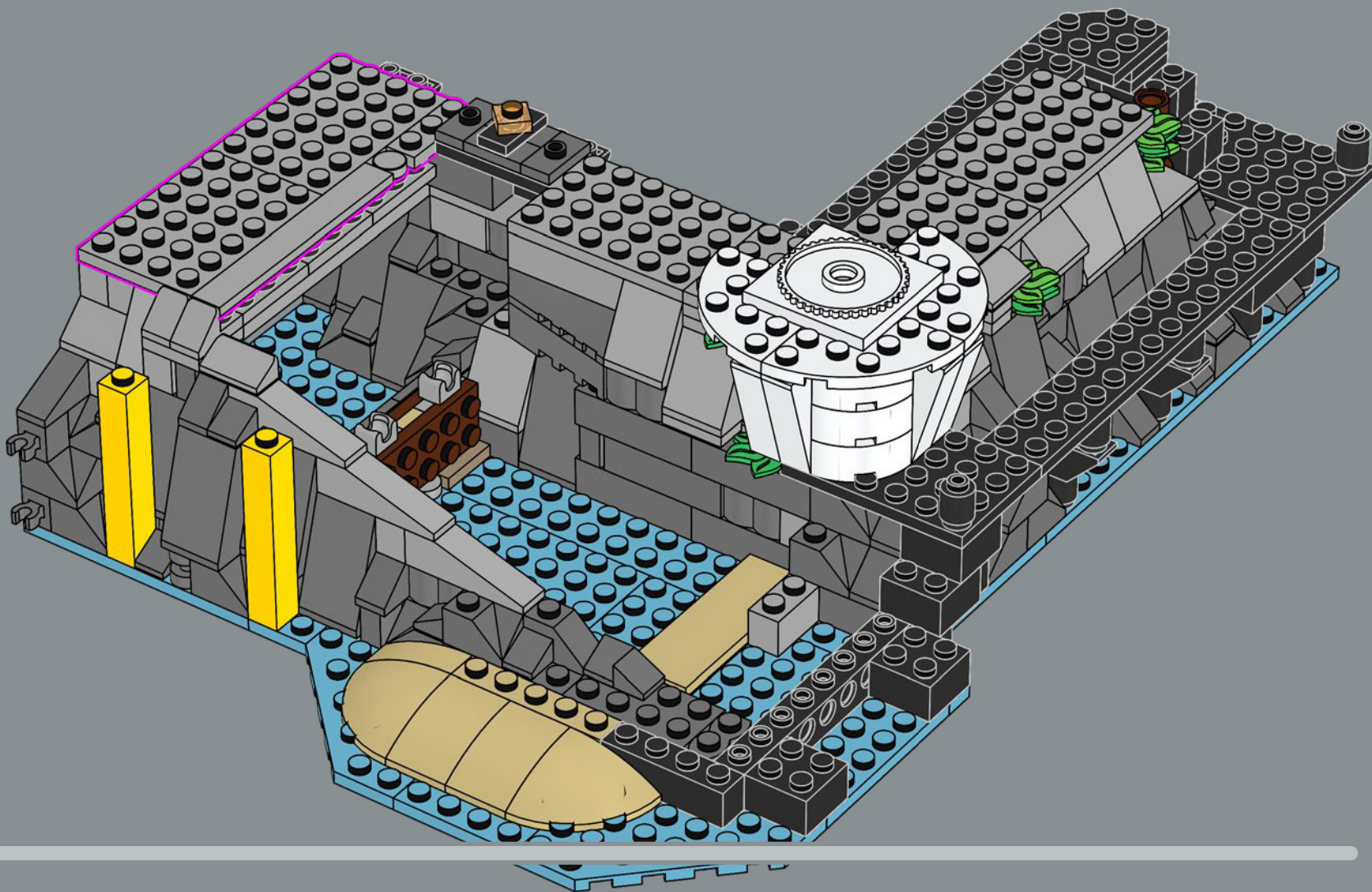

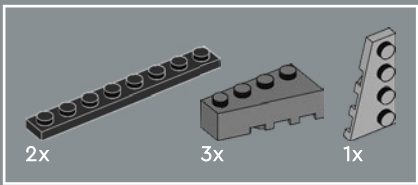

86

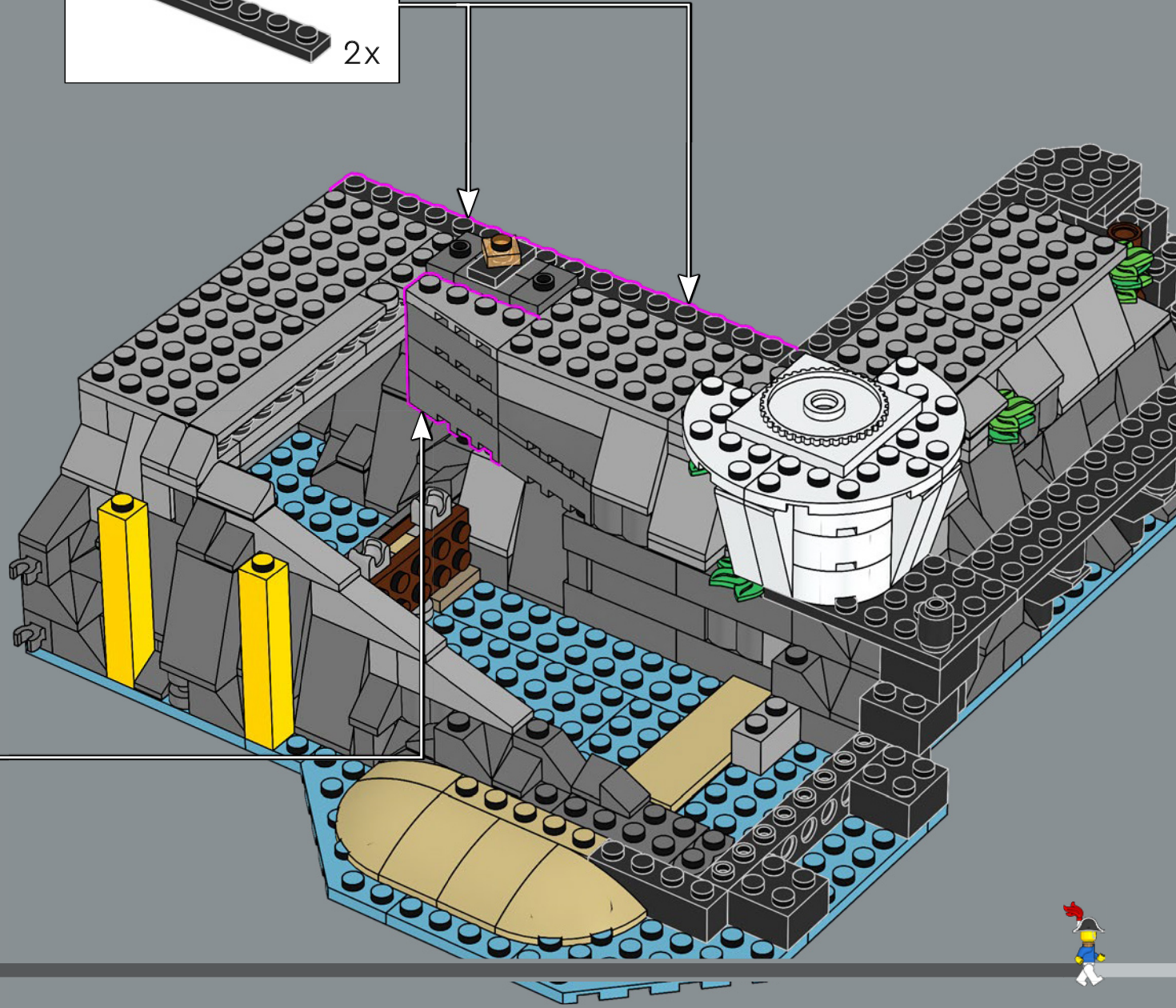
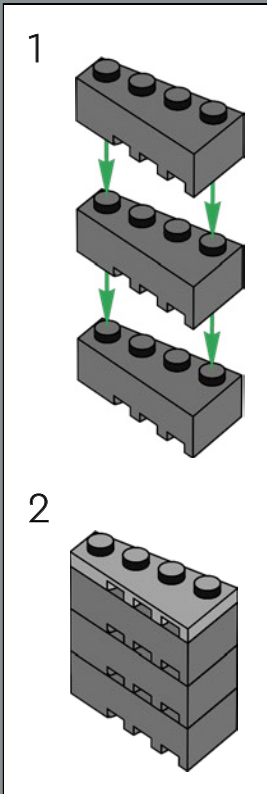
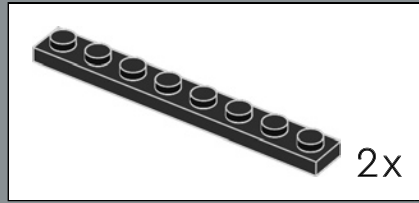

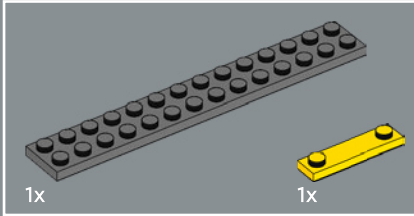
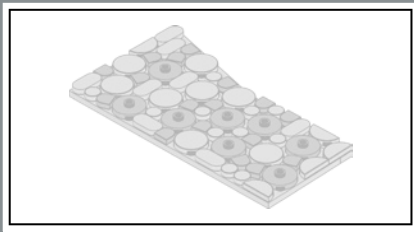

87

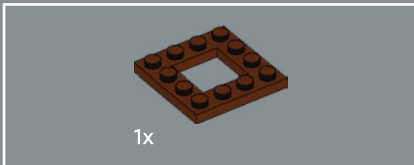
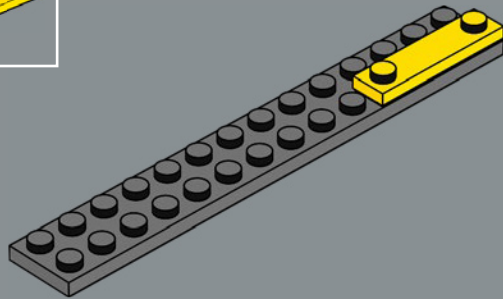

88

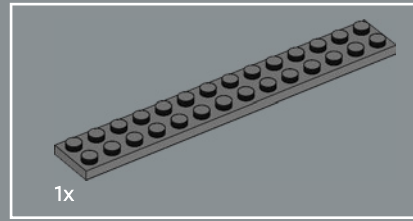
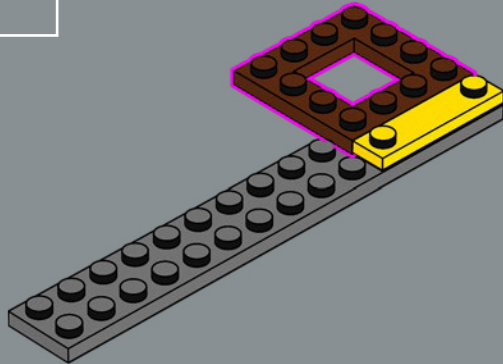

89

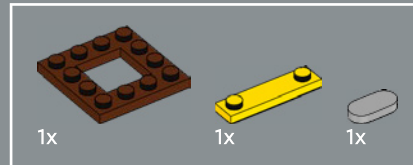
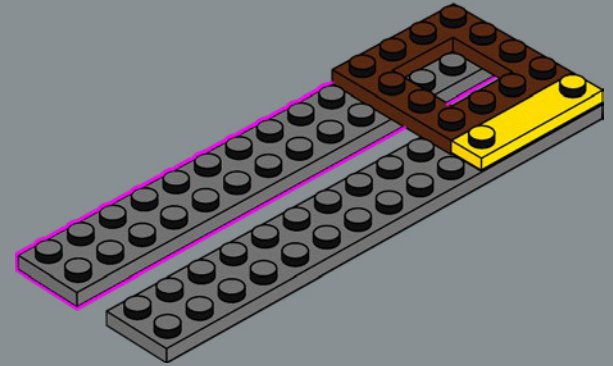

90

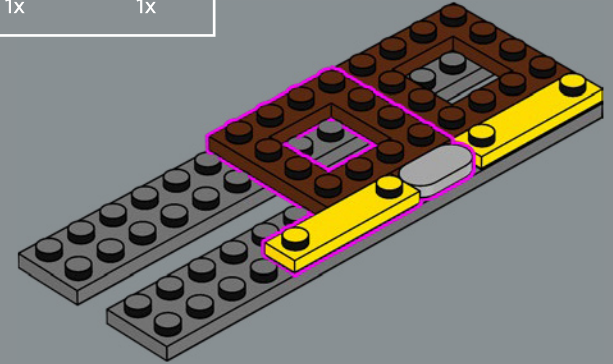

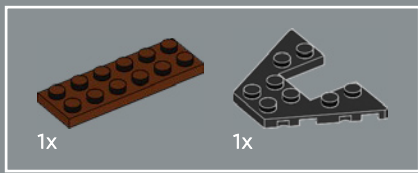

91

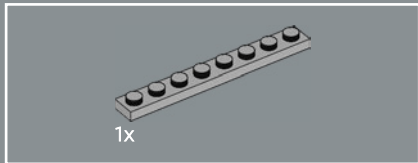
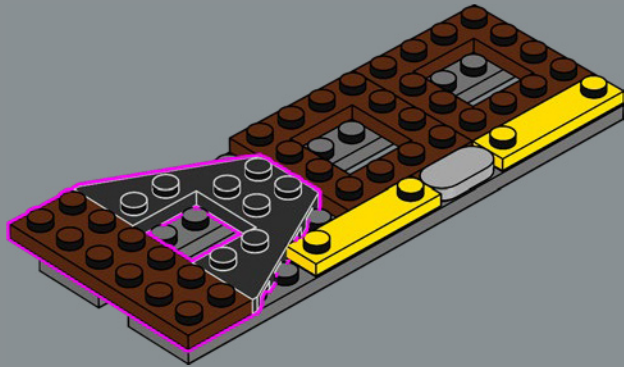

92

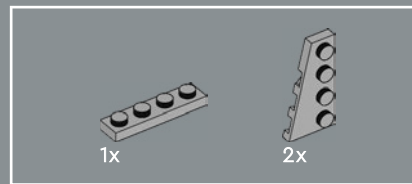
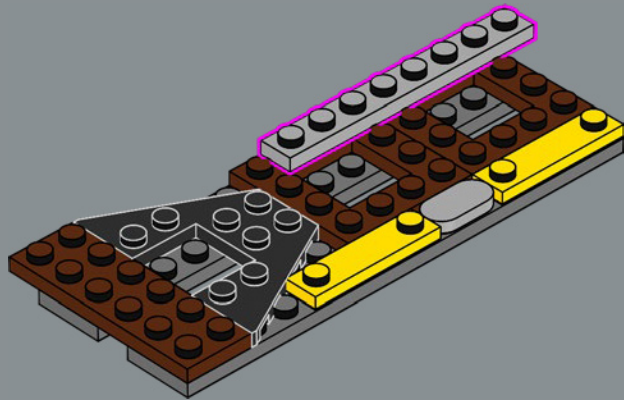

93

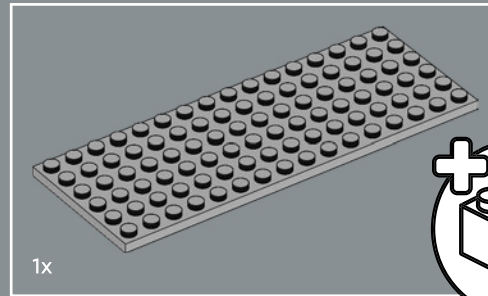
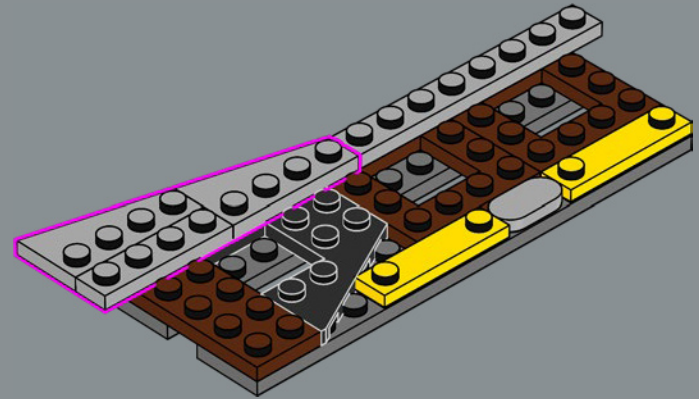

94

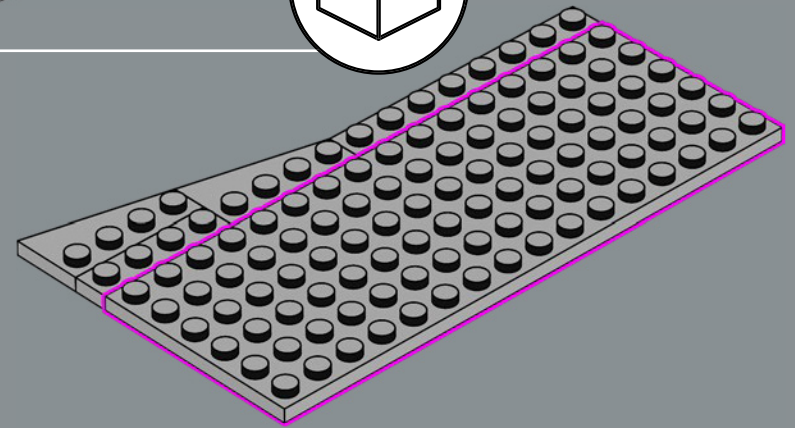



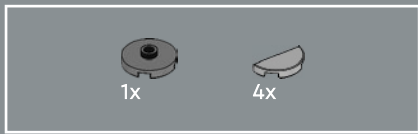

95

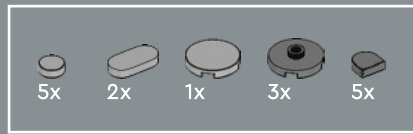
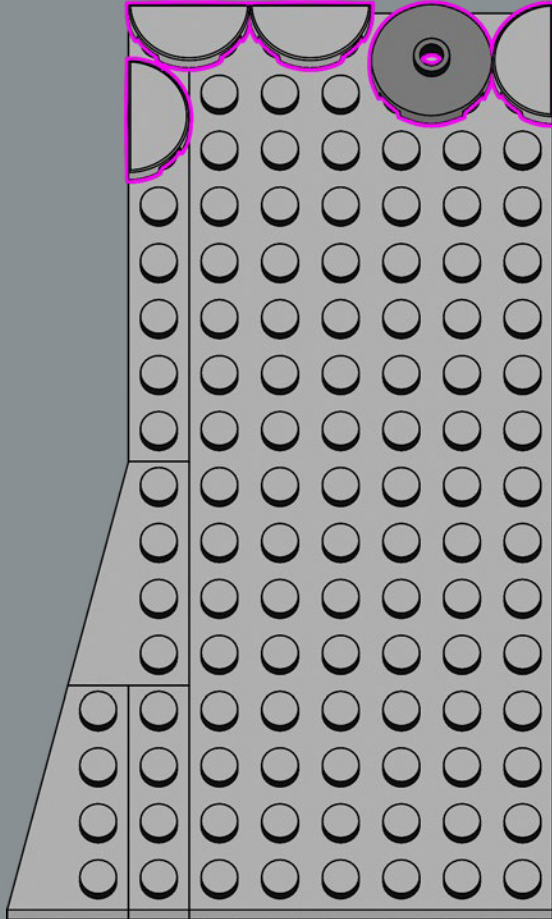

96

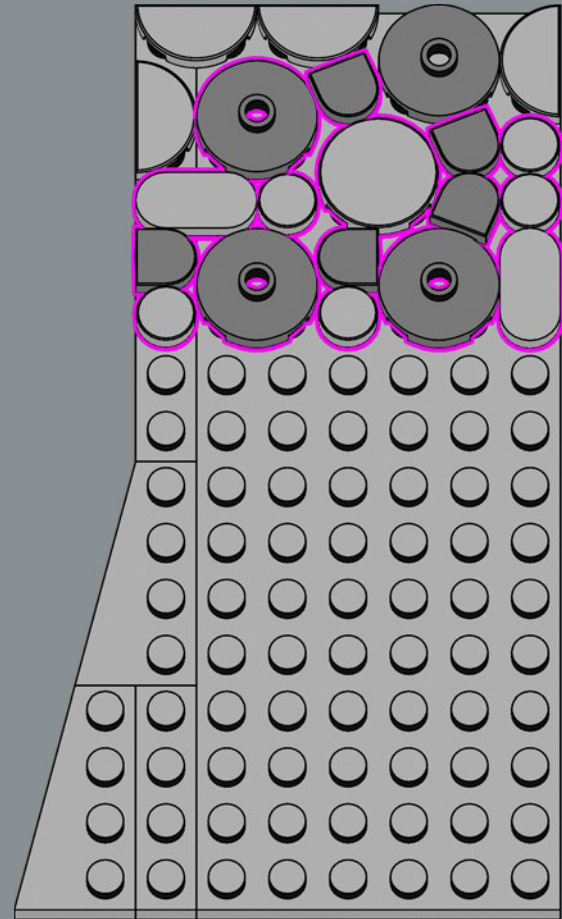

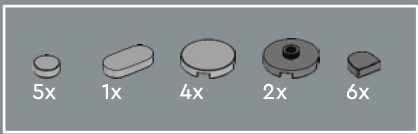

97

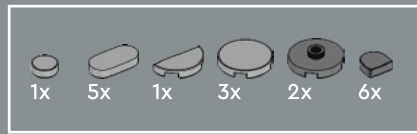
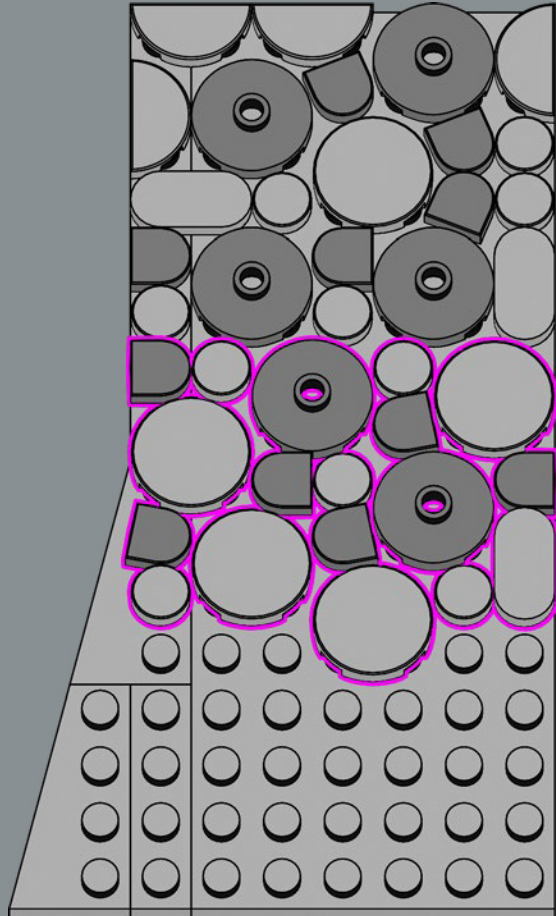

98

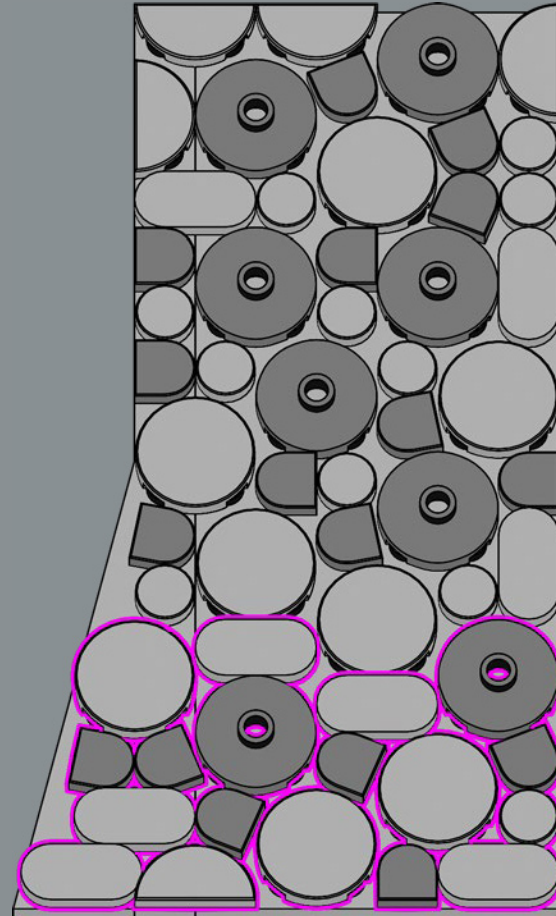

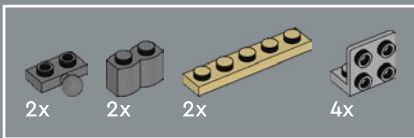

99

1

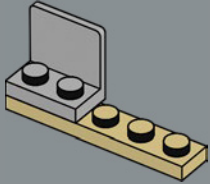

2

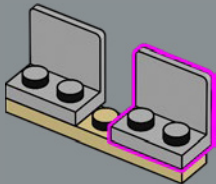

3

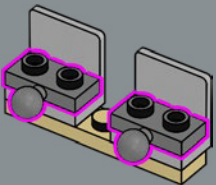

4

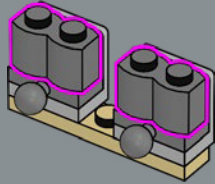

5

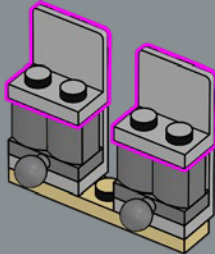

6

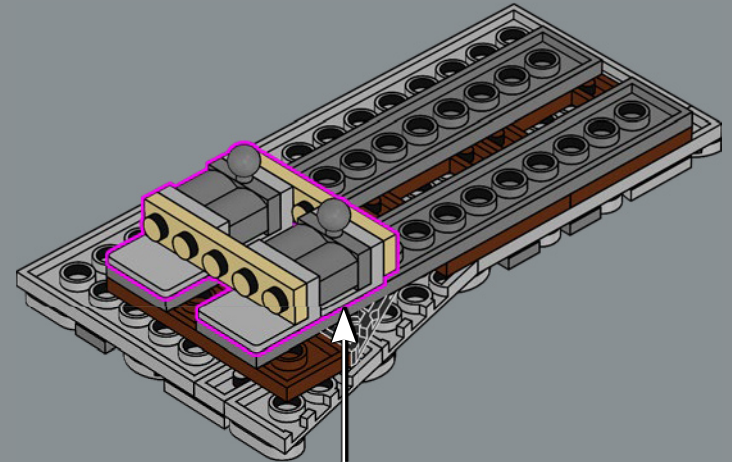
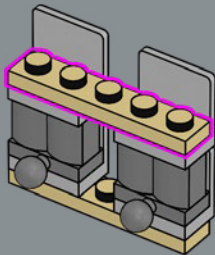



The original printed ramp has been repaved with cobblestones.

100

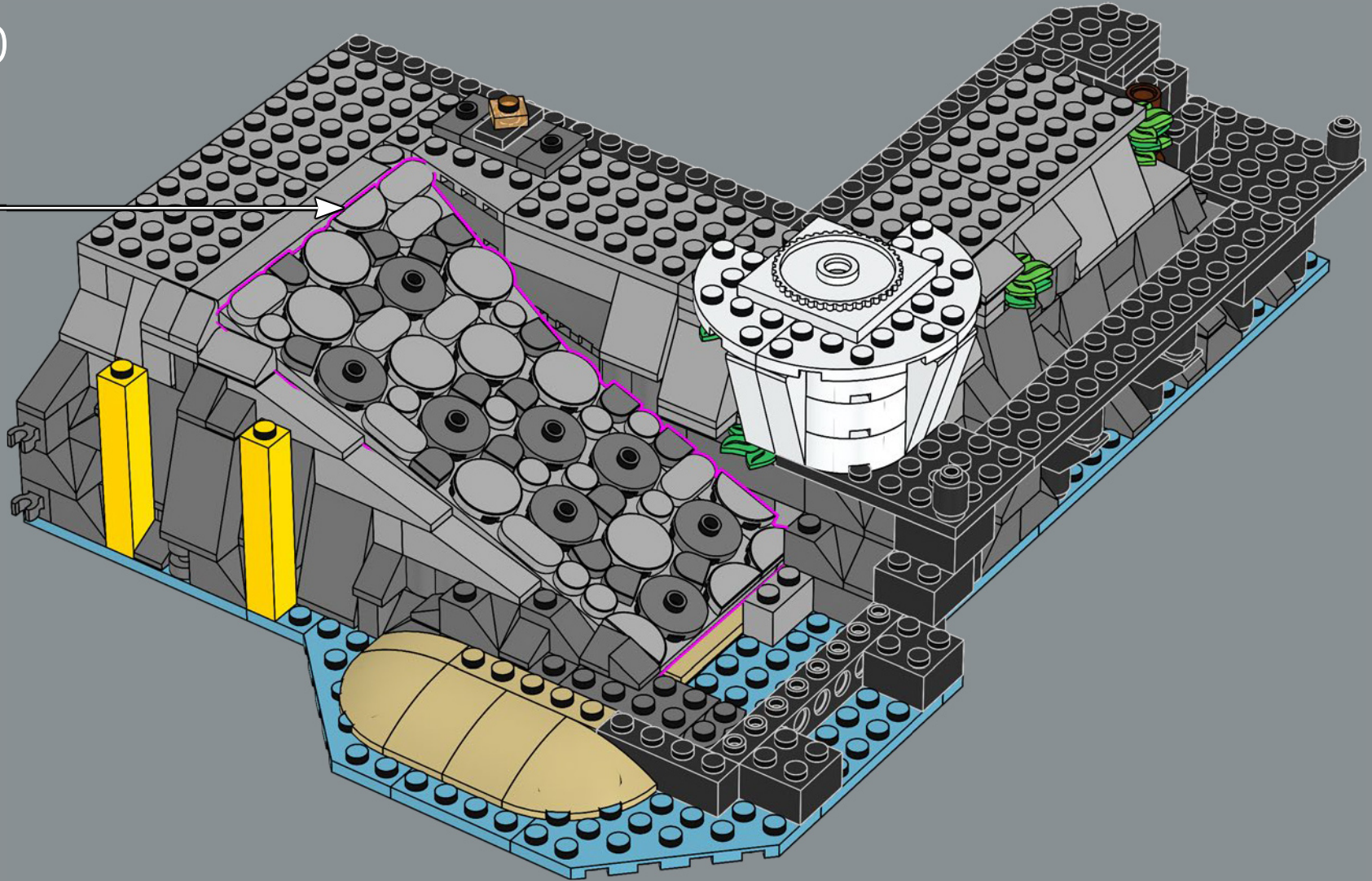
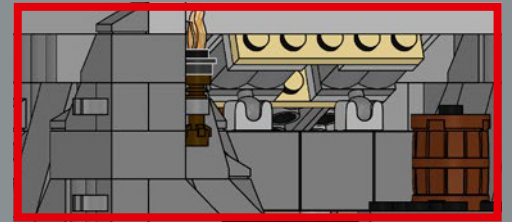

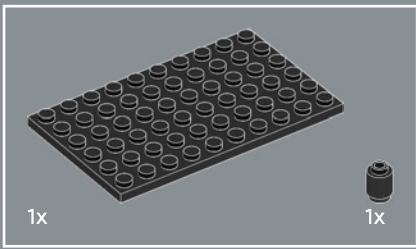

101

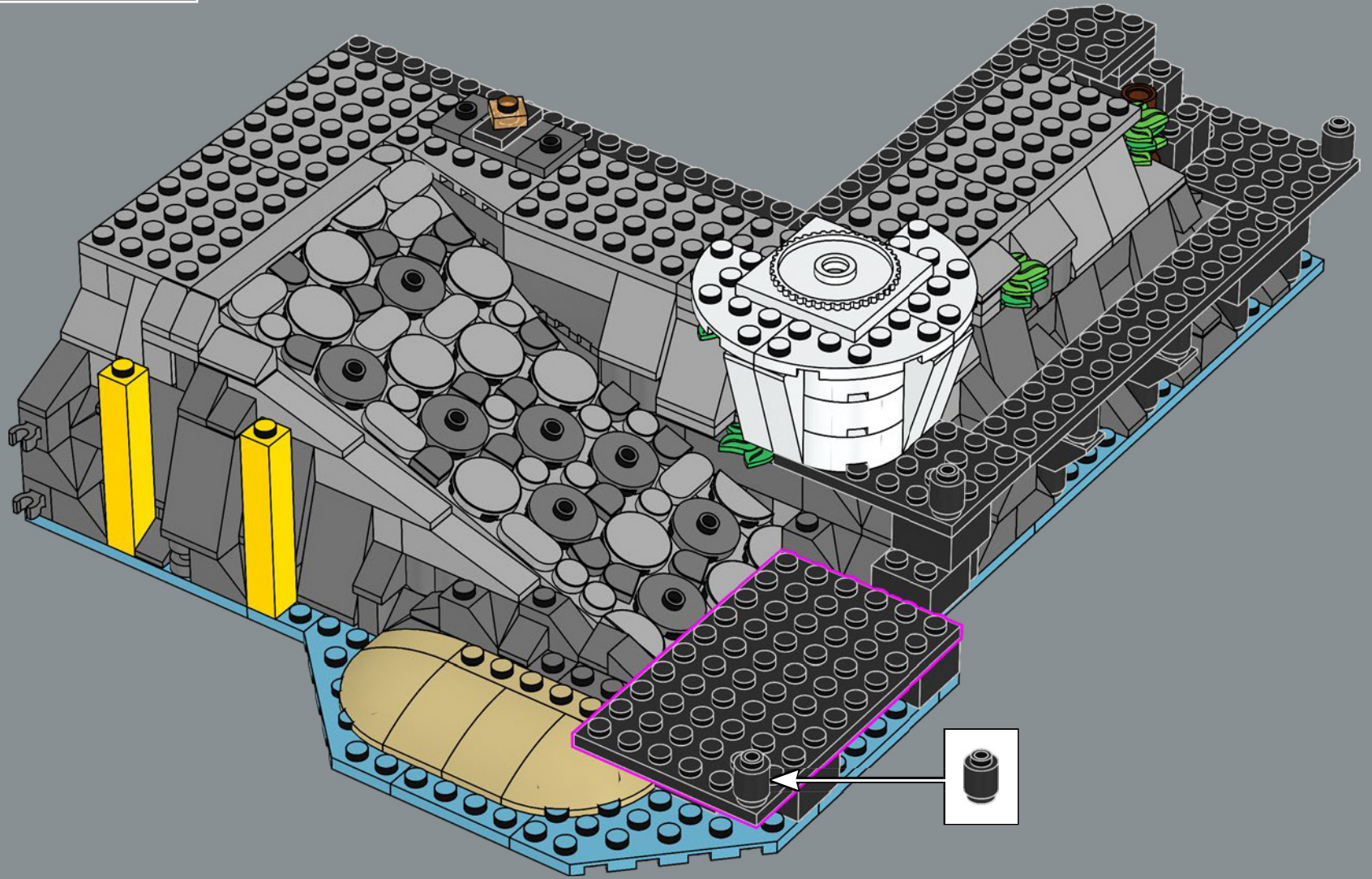

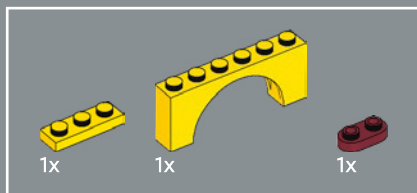

102

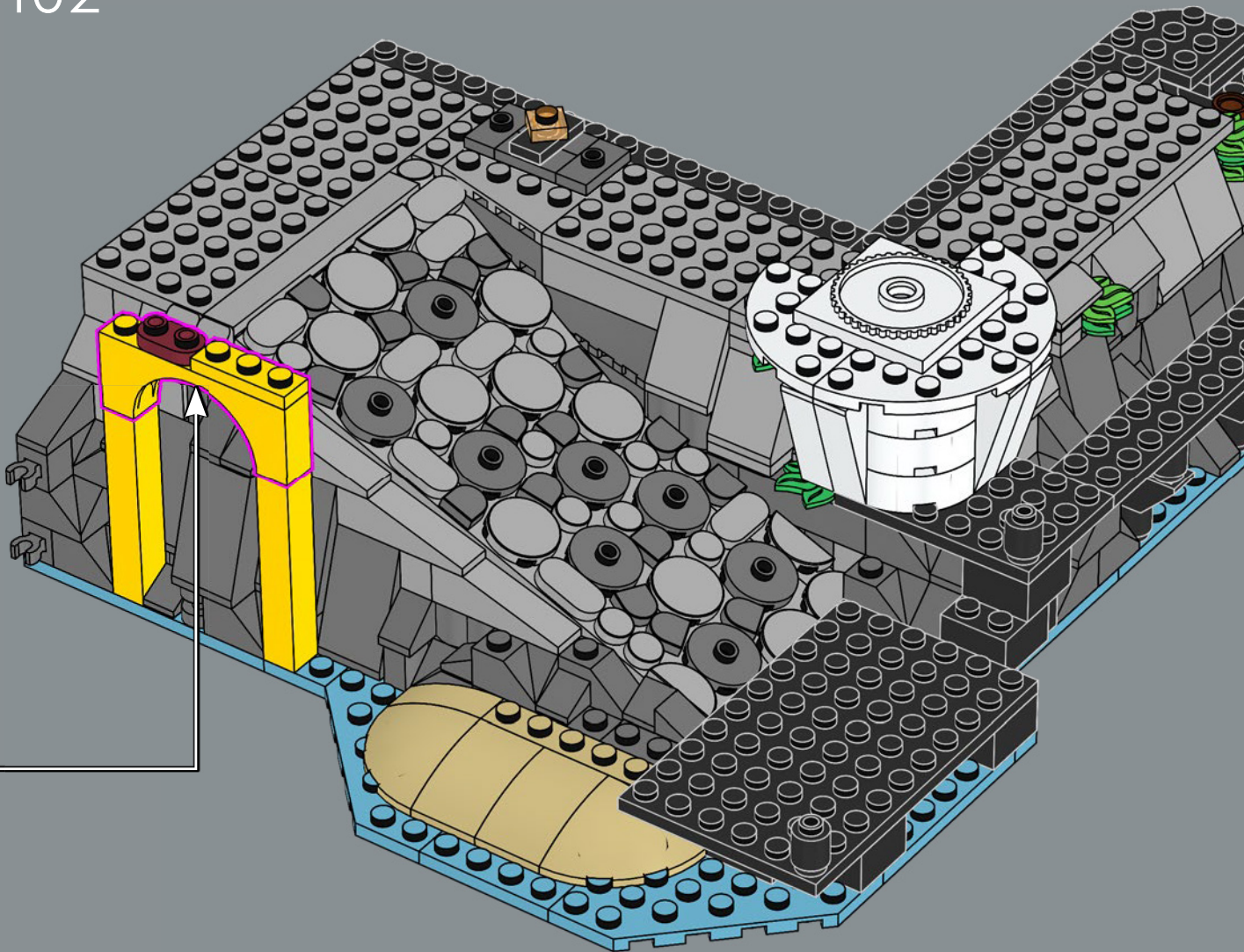
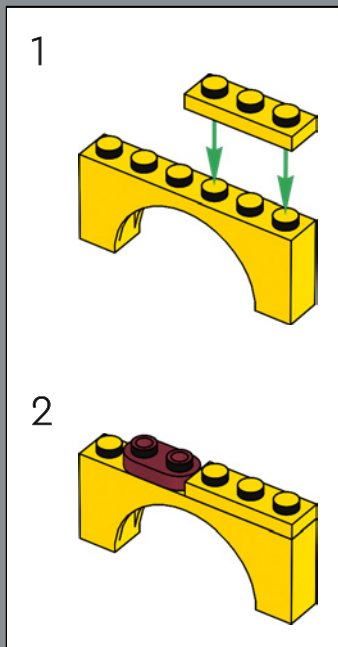

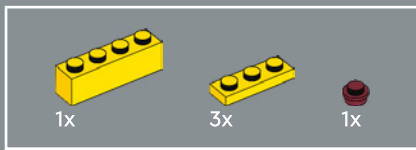

103

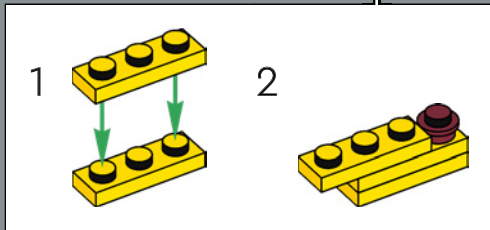
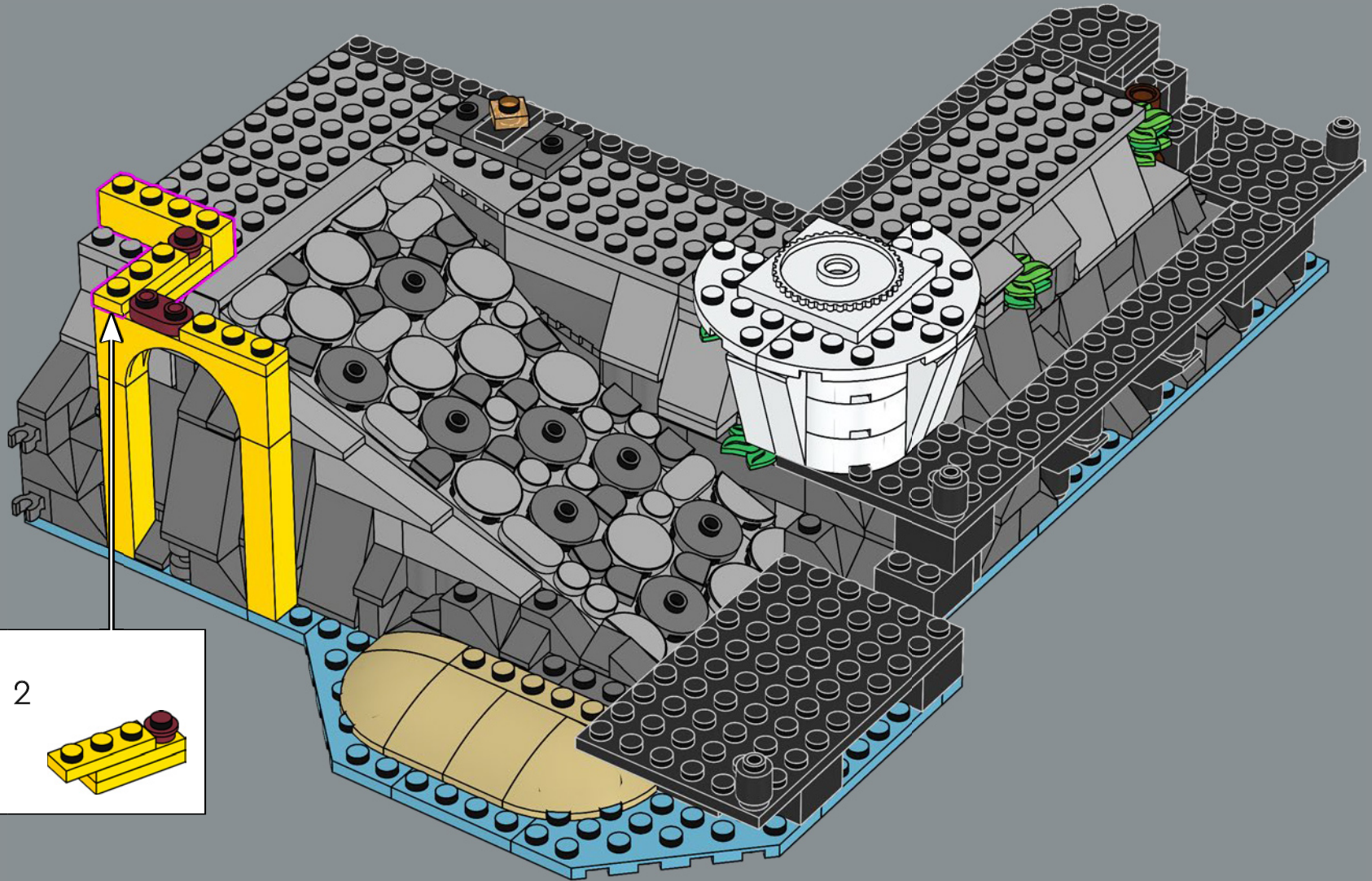

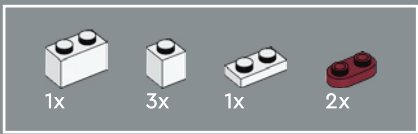

104

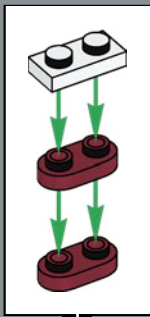



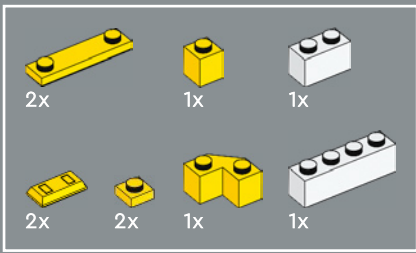

105

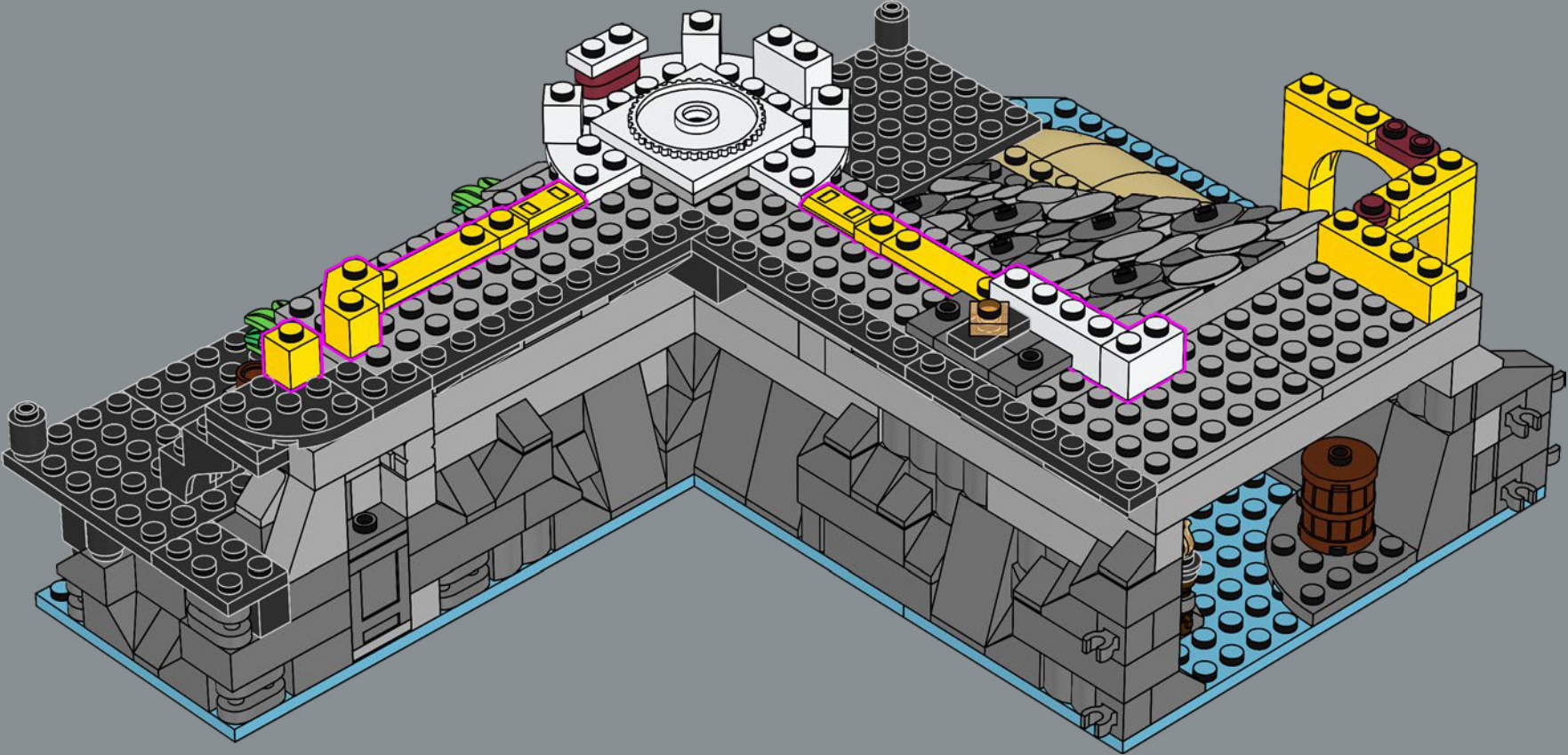

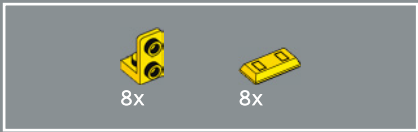

106

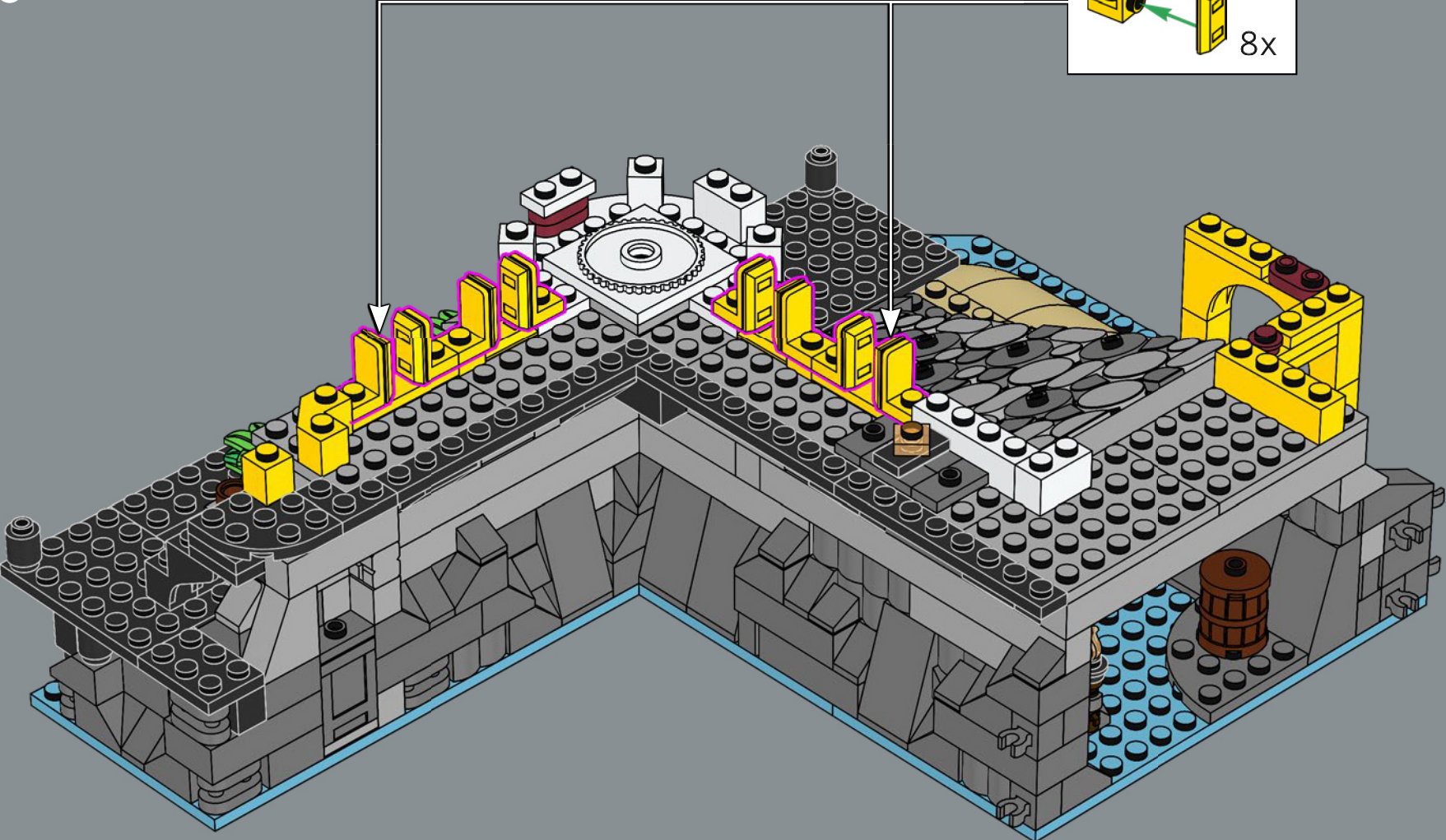
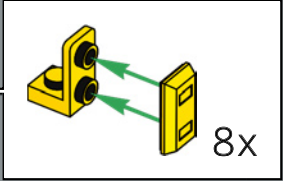

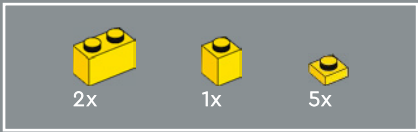

107

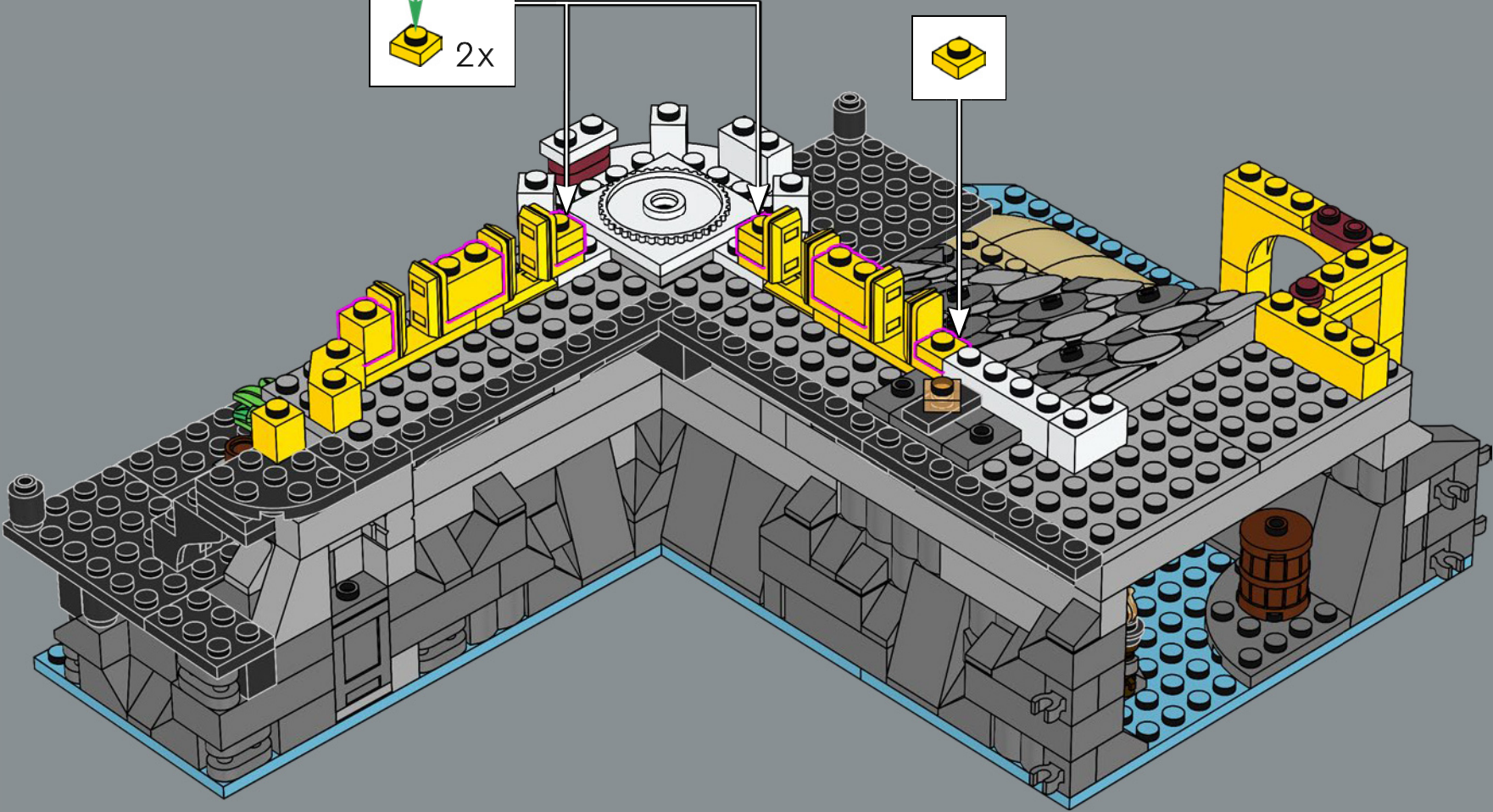
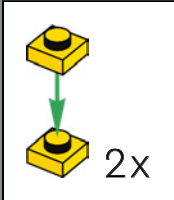



108

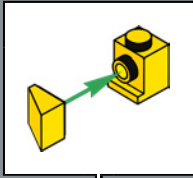
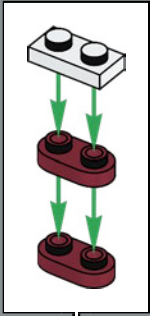

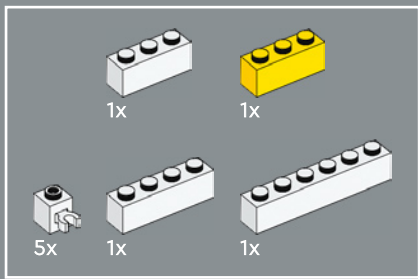

109

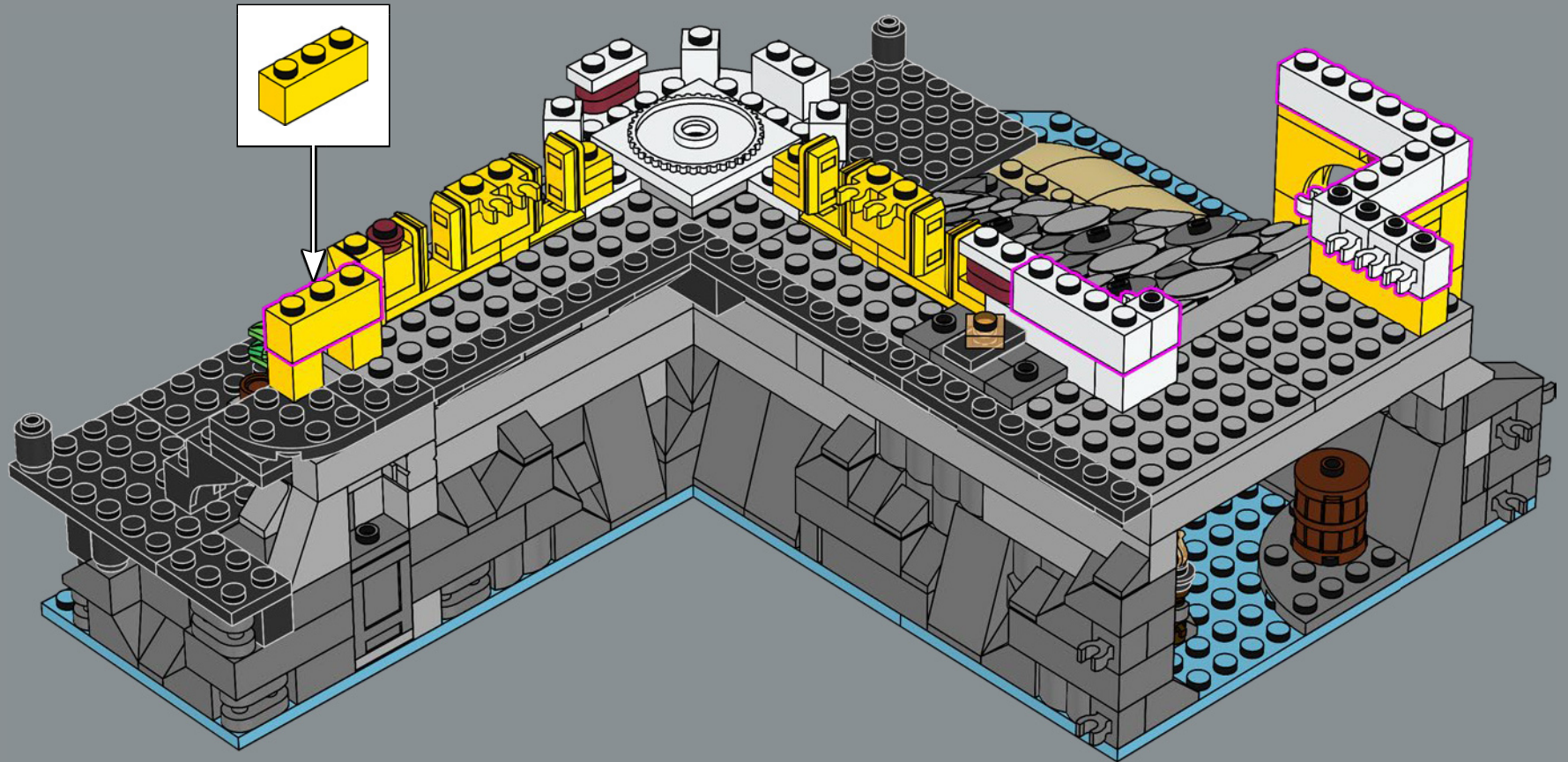

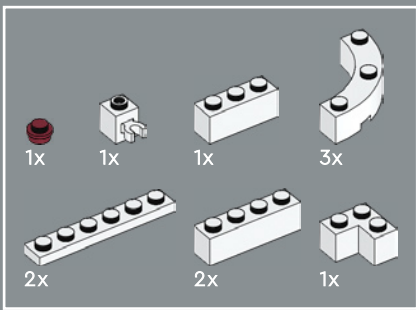

110

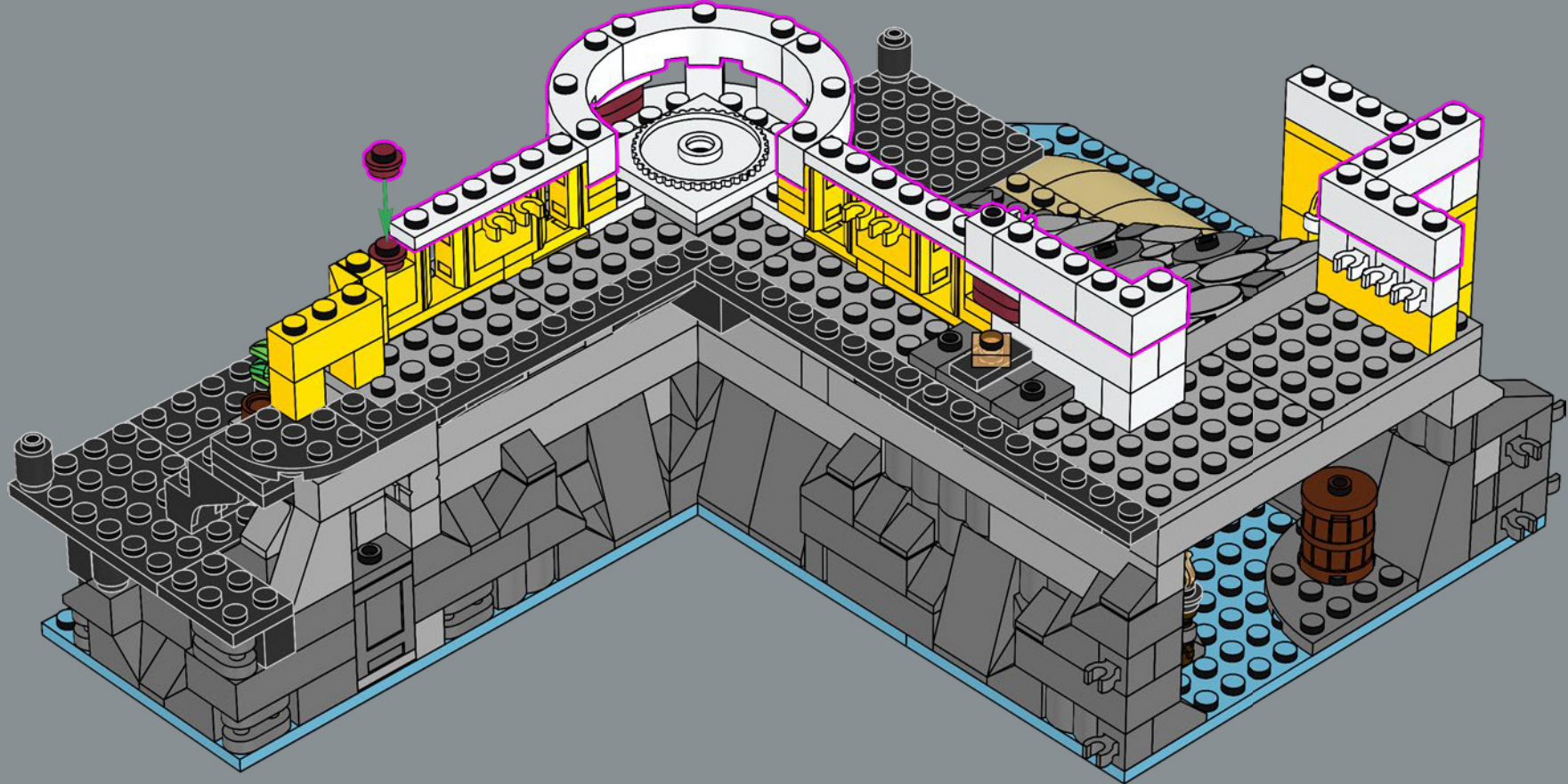

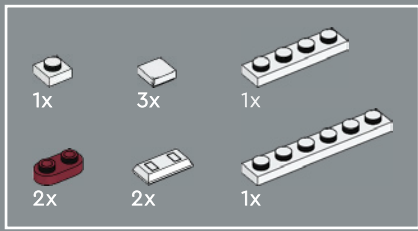

111

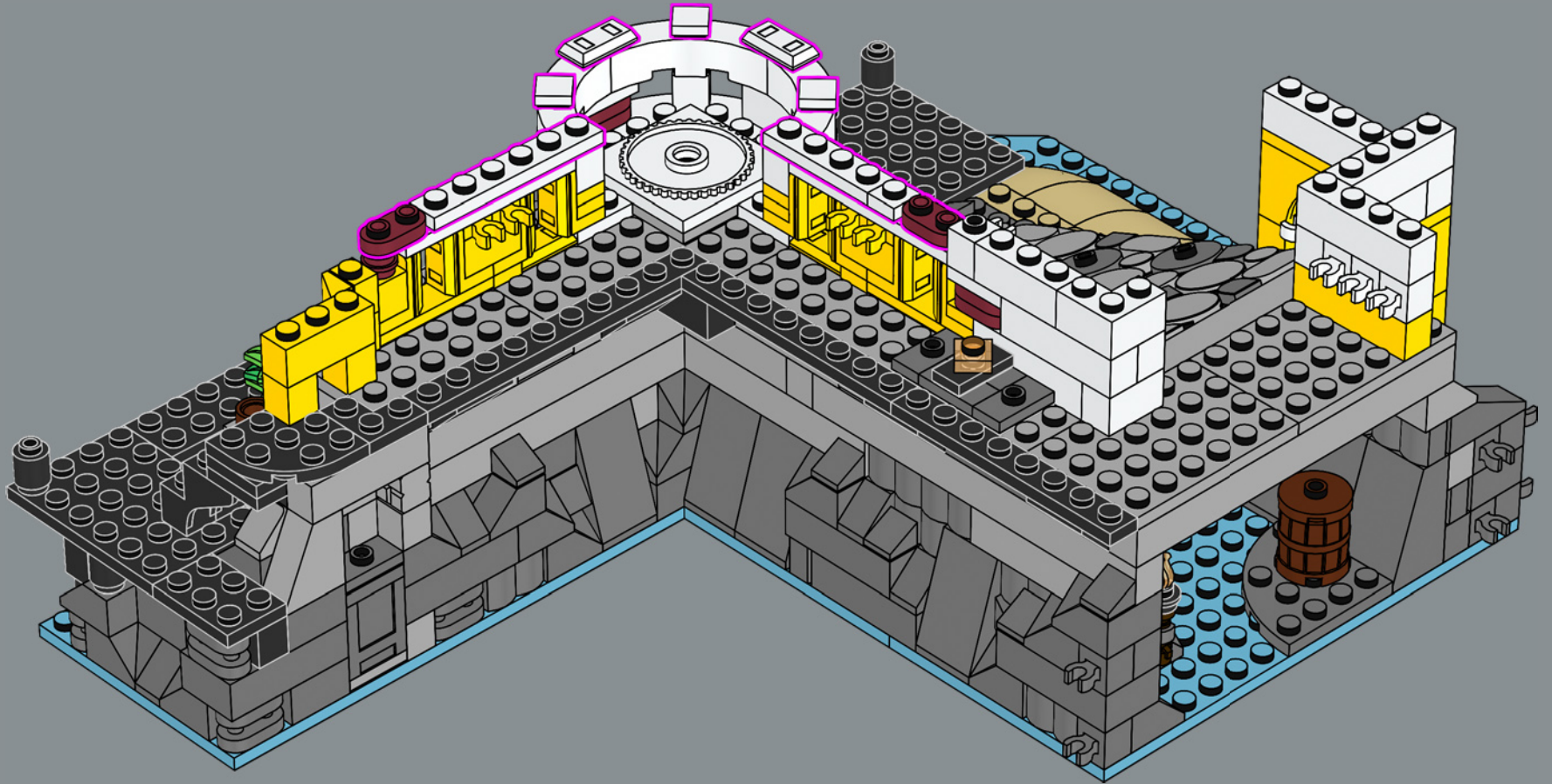

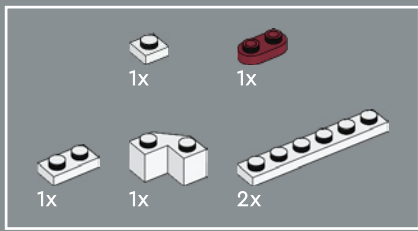

112

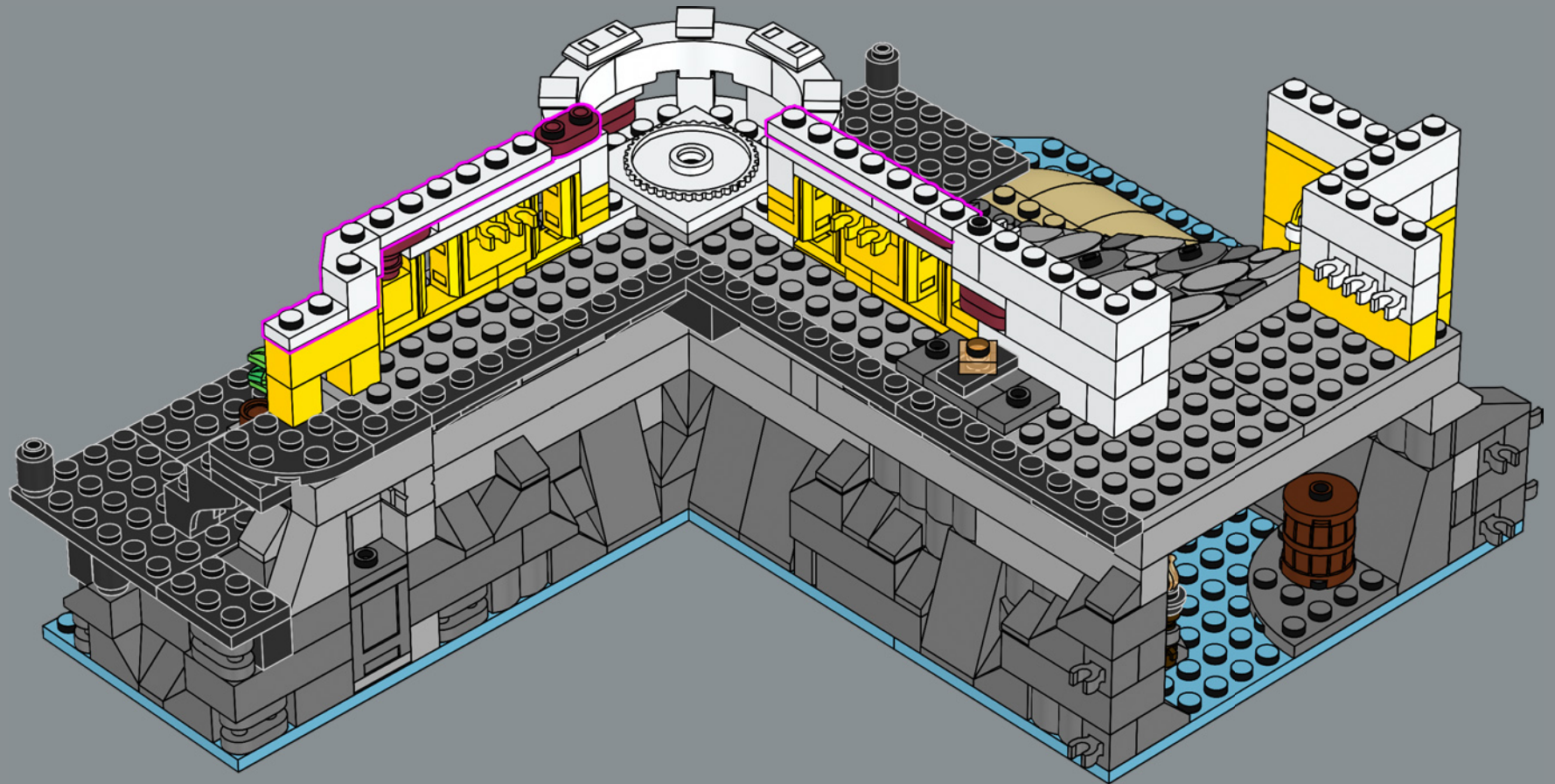



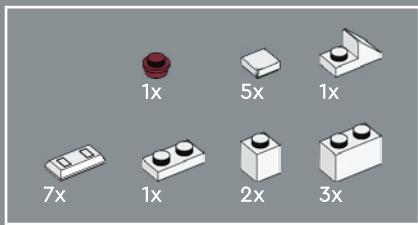

113

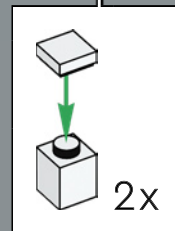
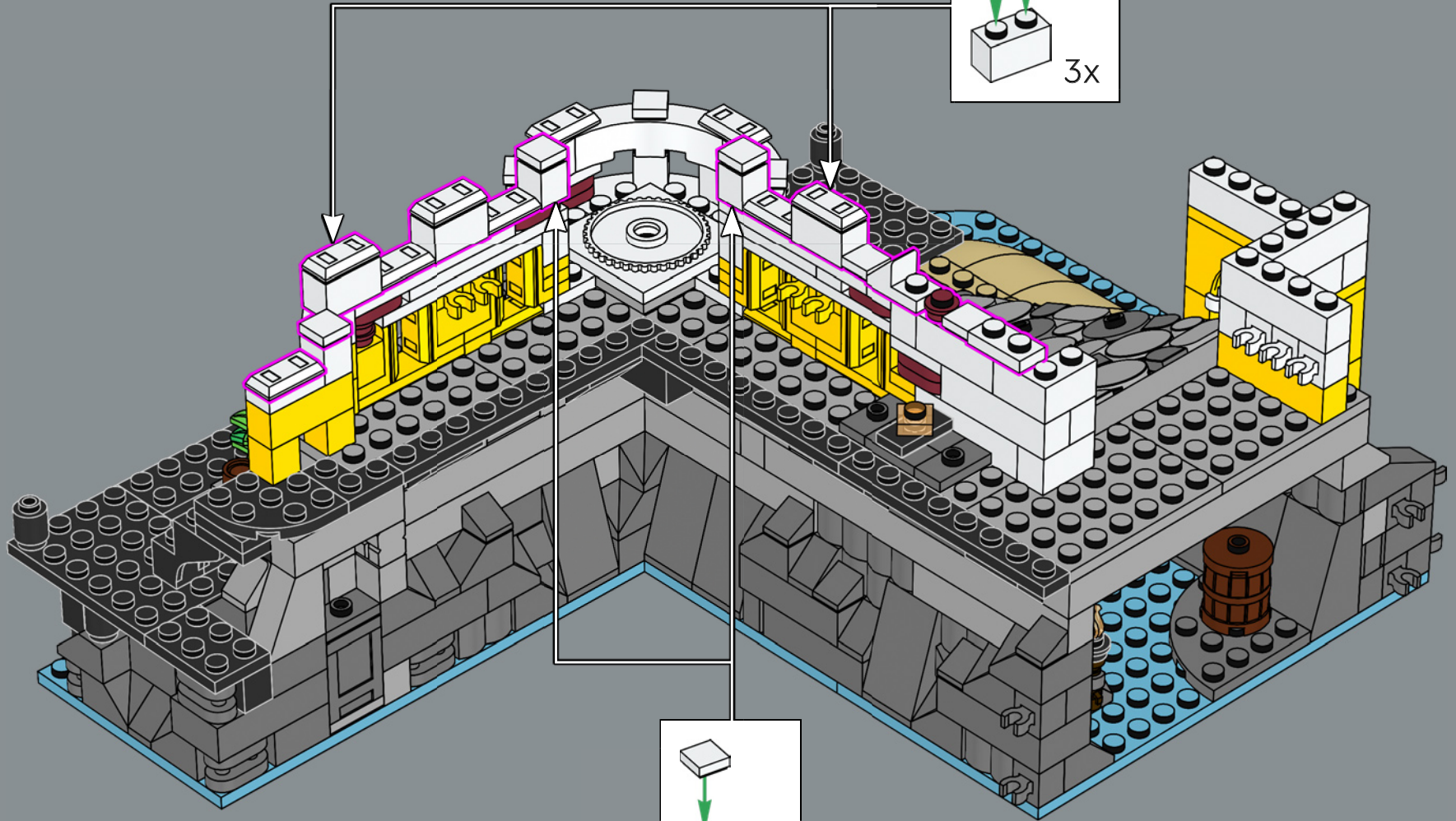
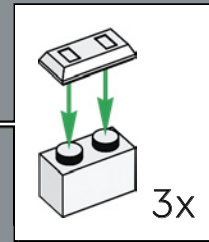

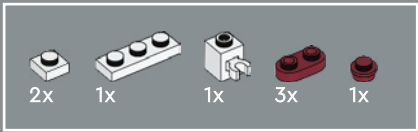

114

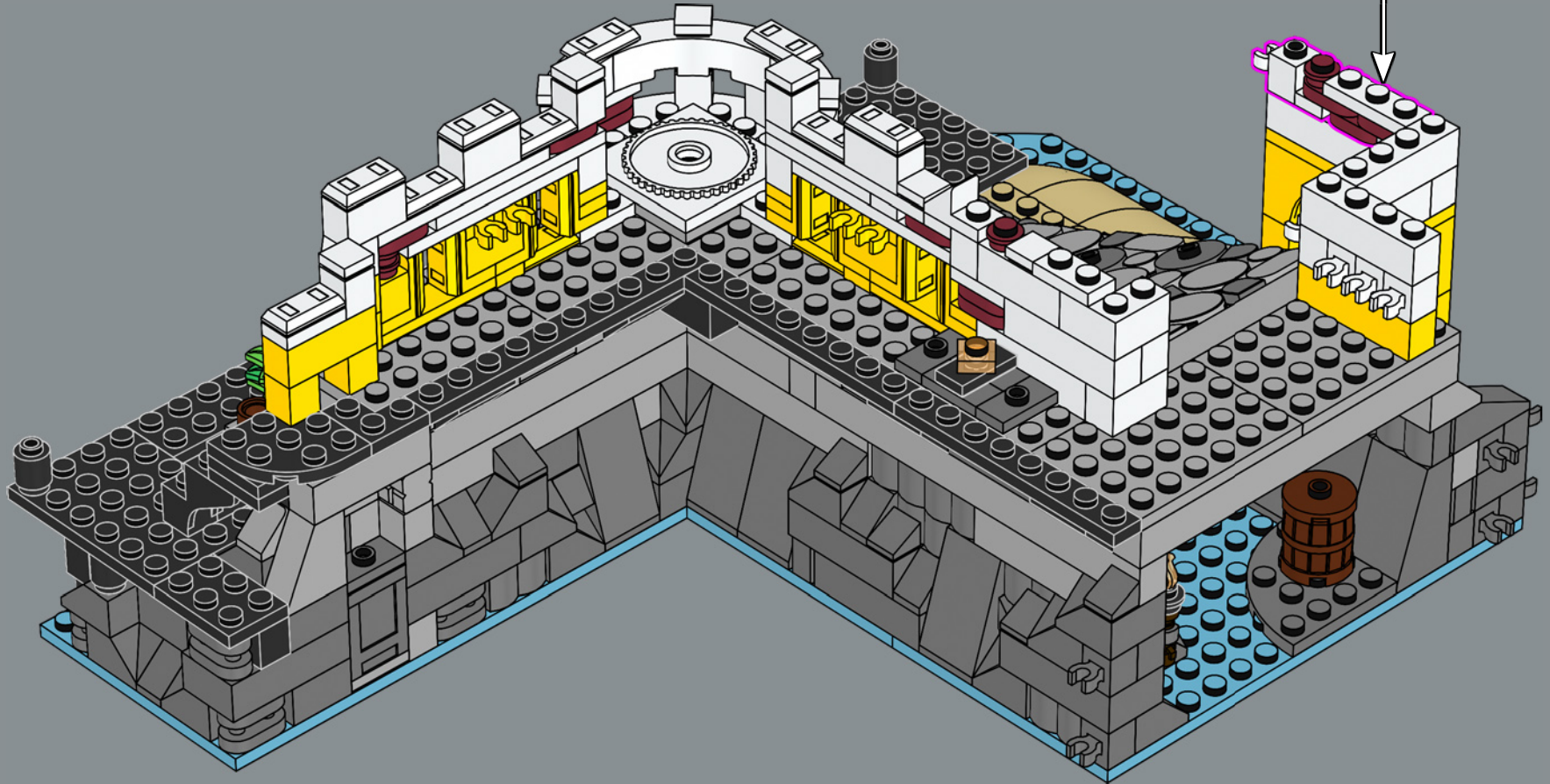
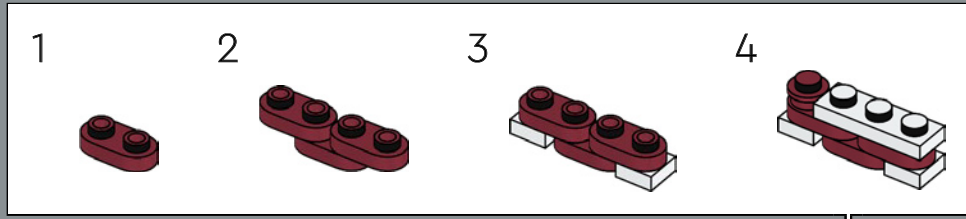

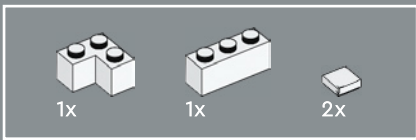

115

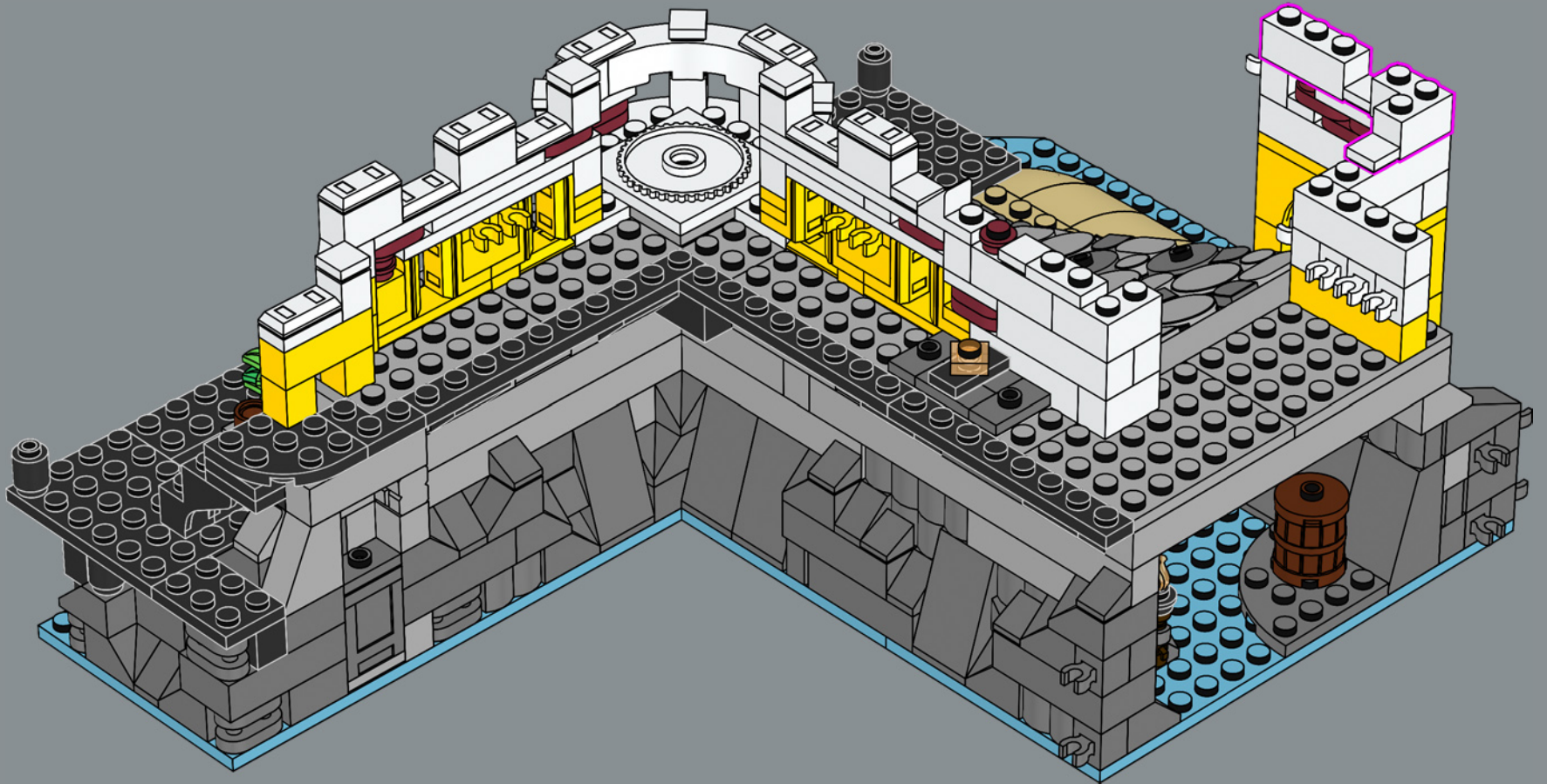

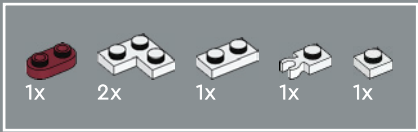

116

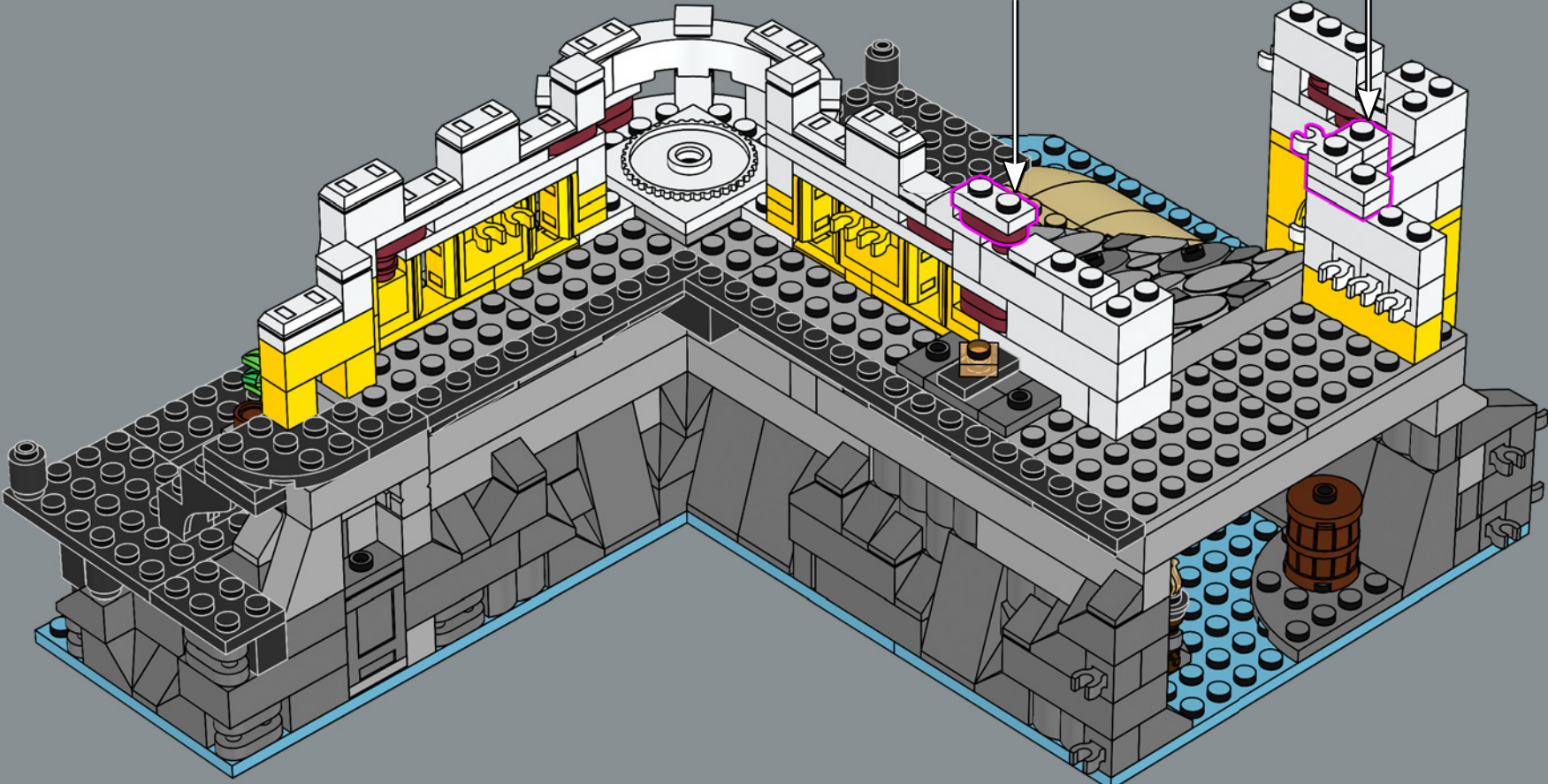
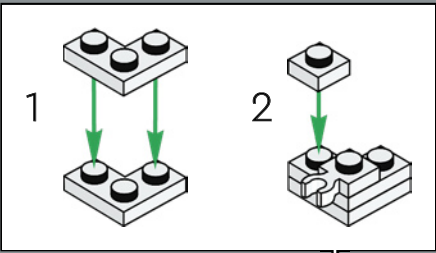
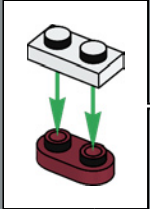



117

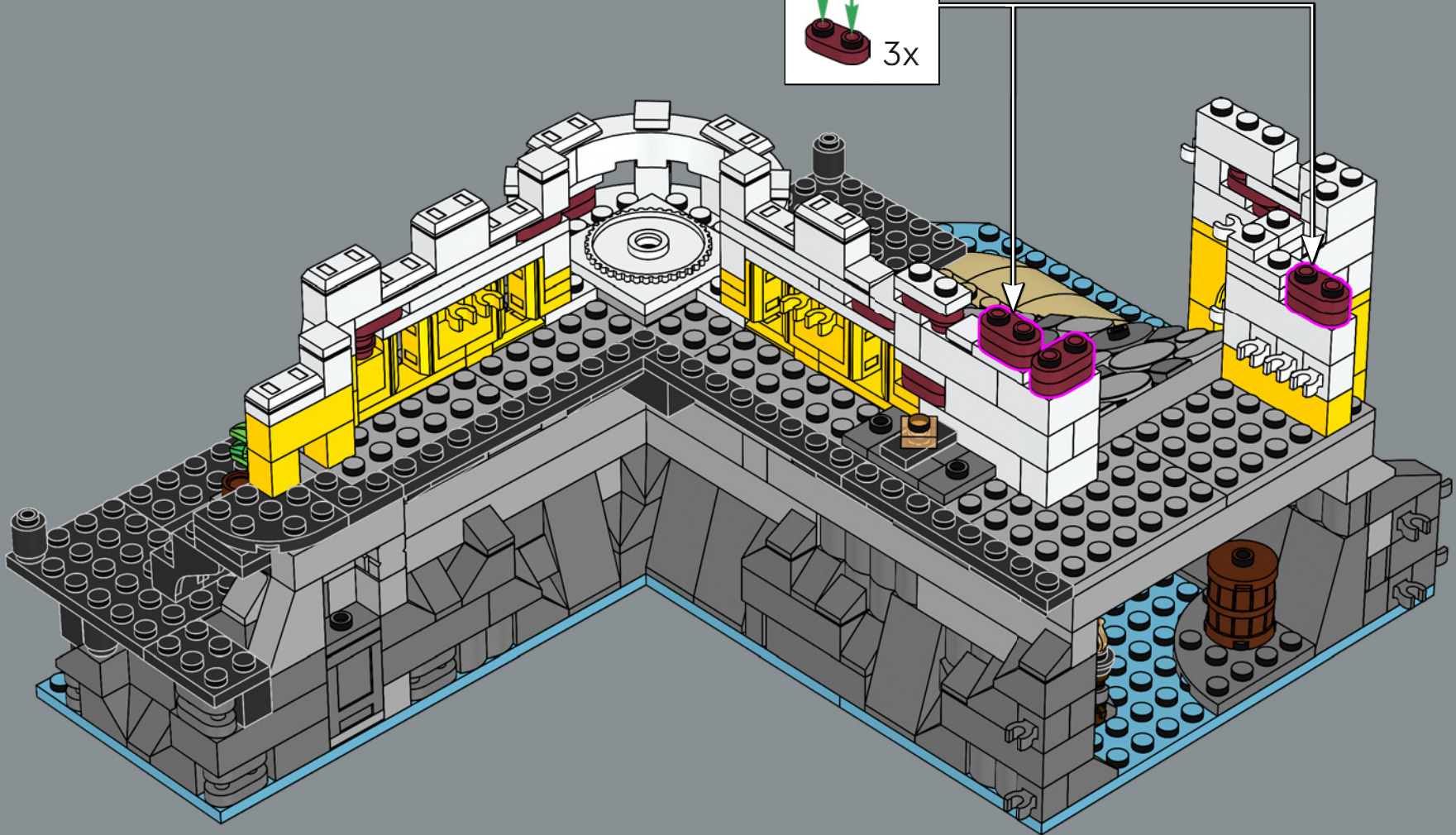
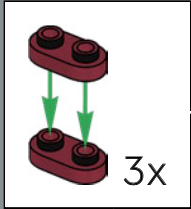

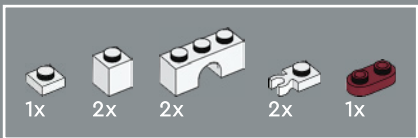

118

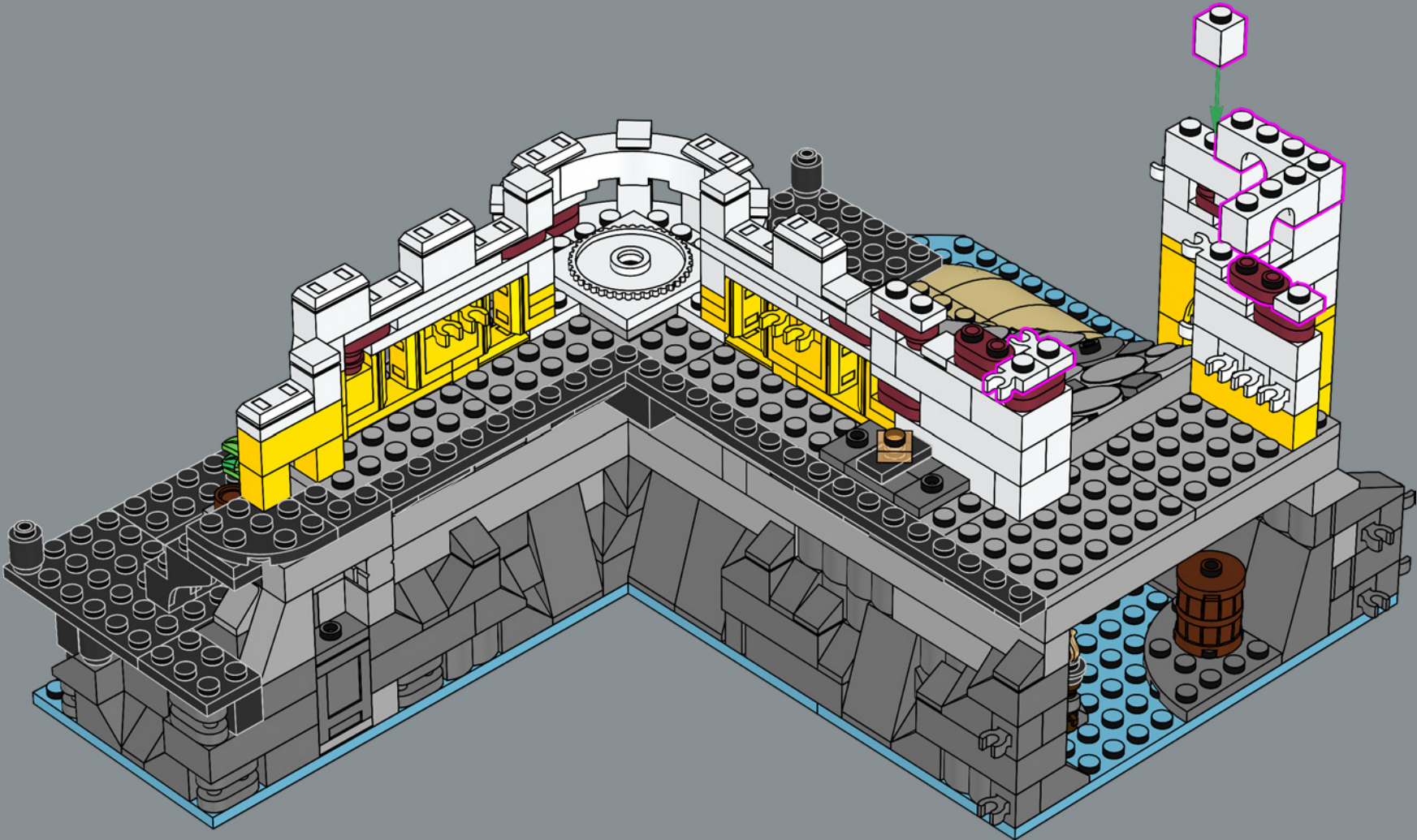

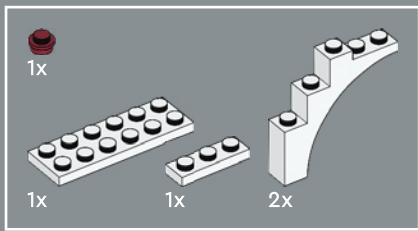

119

1

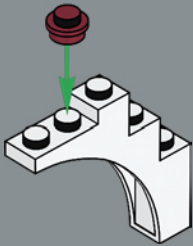

2

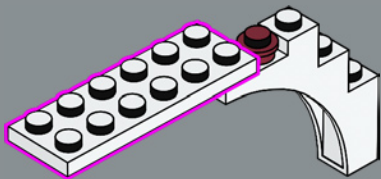

3

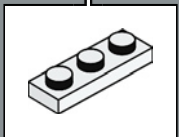
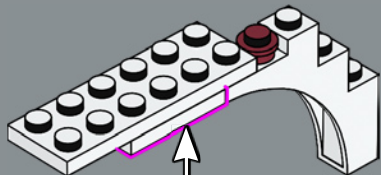

4

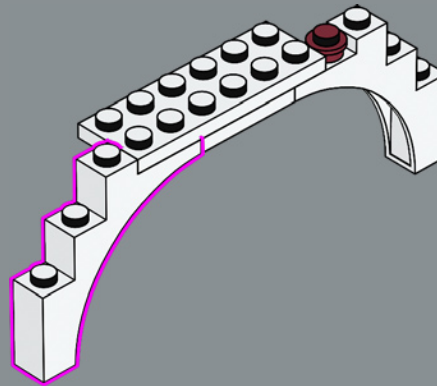

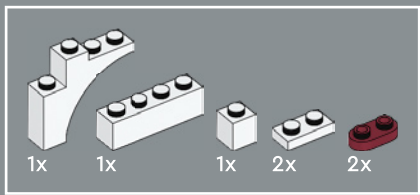

120

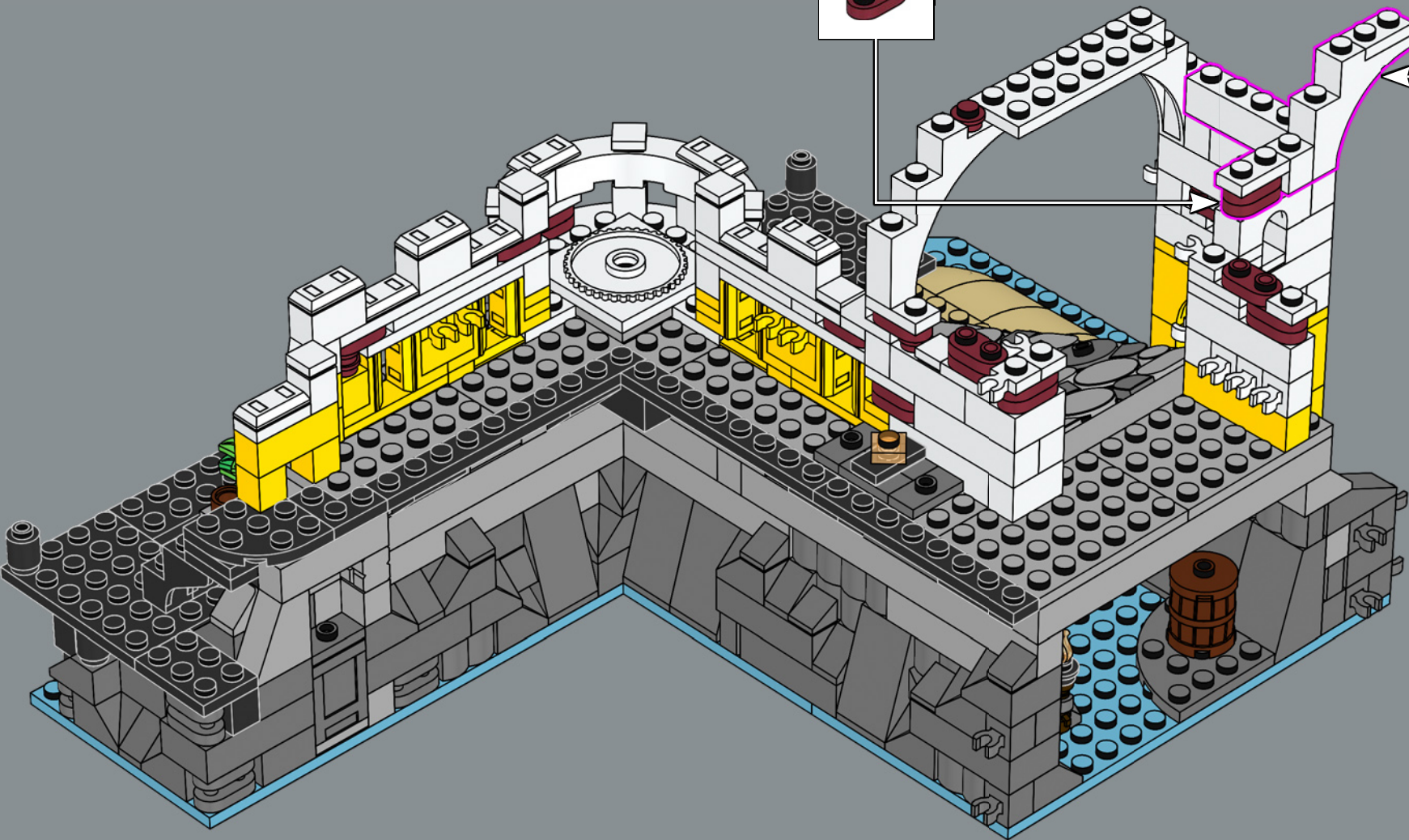
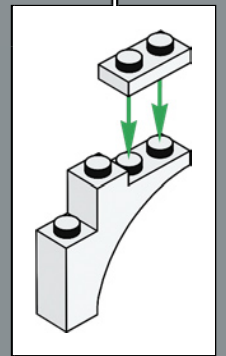
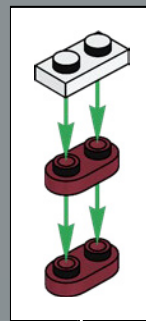



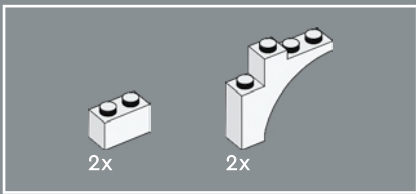

121

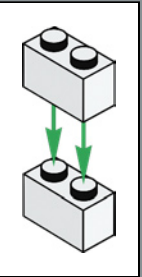
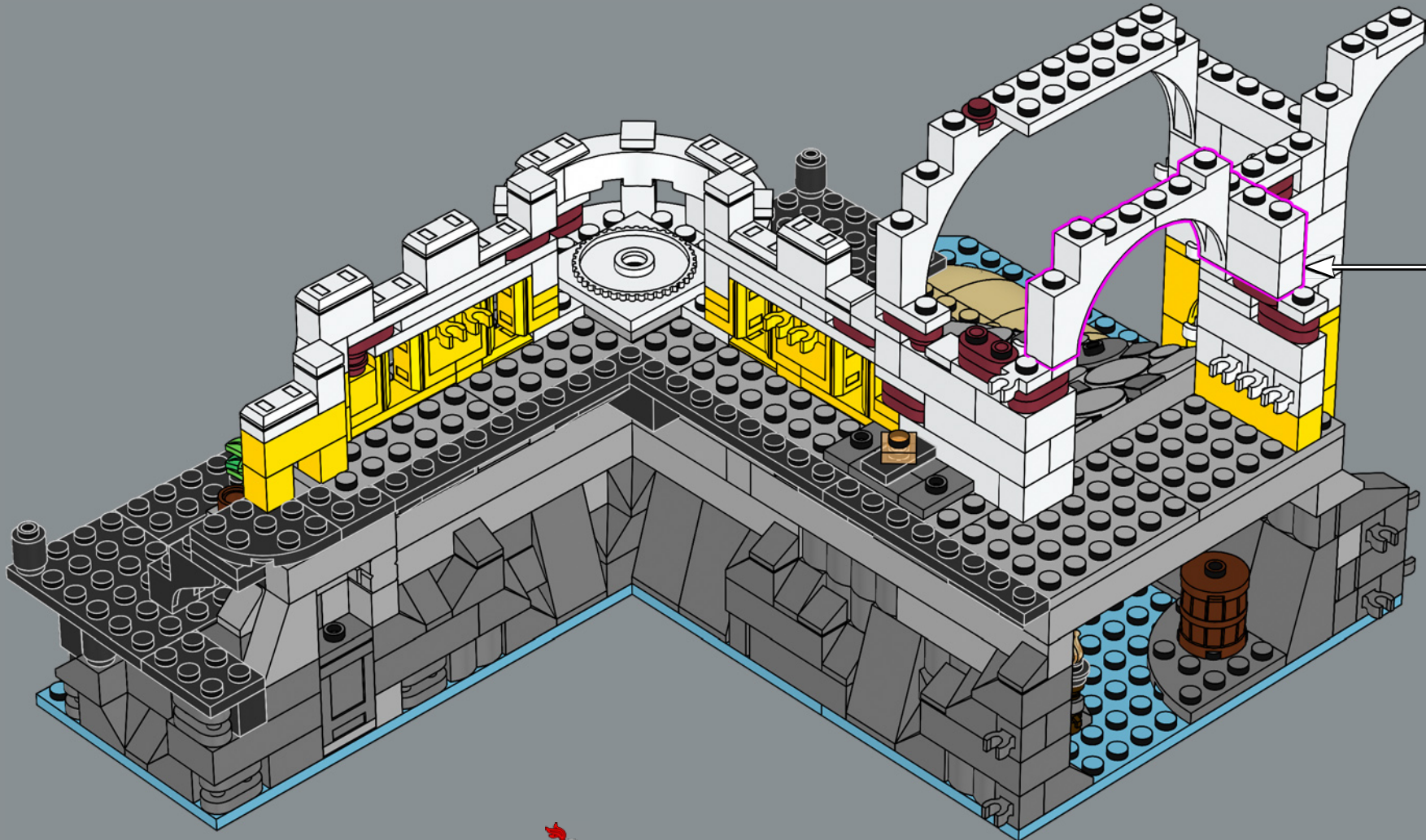

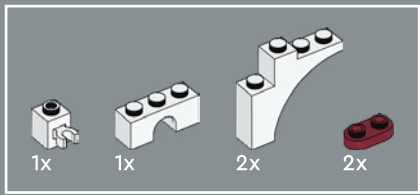

122

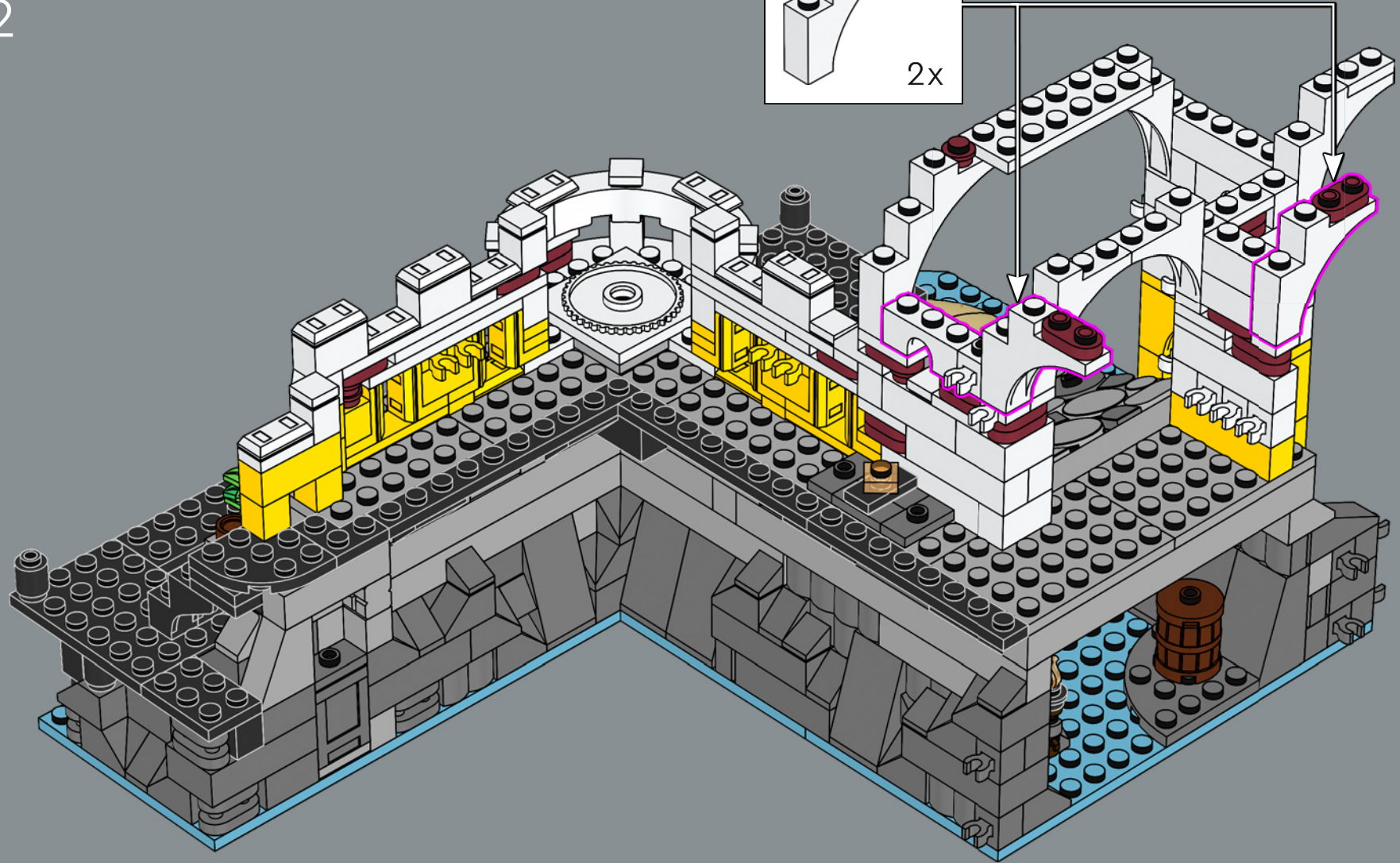
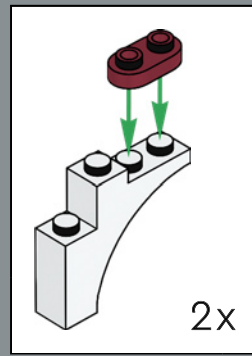



123

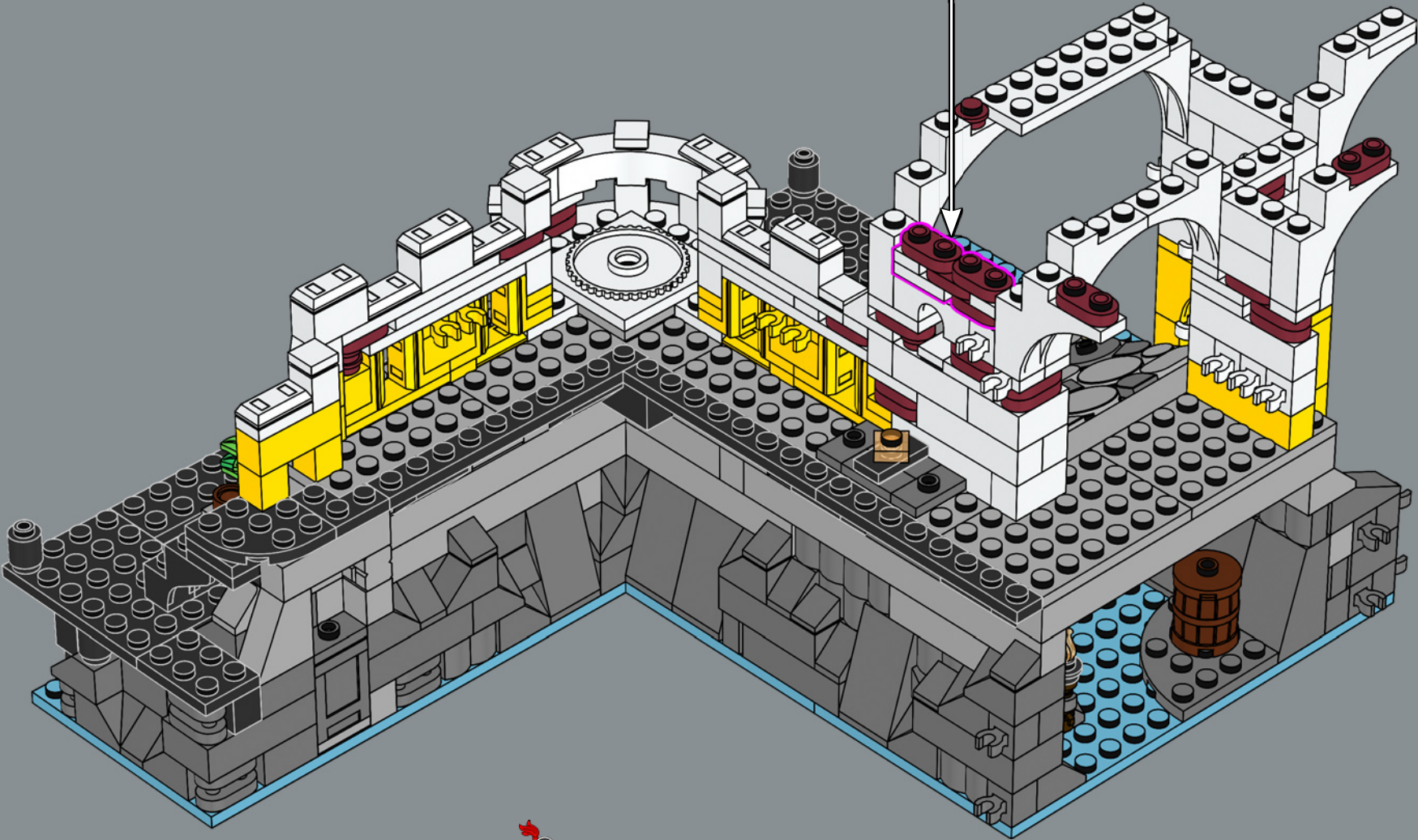
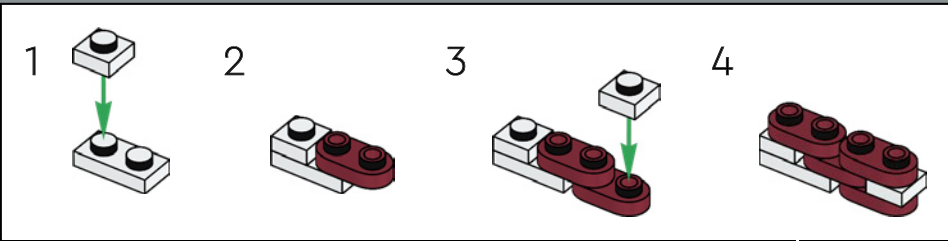

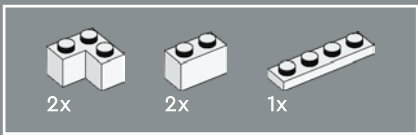

124

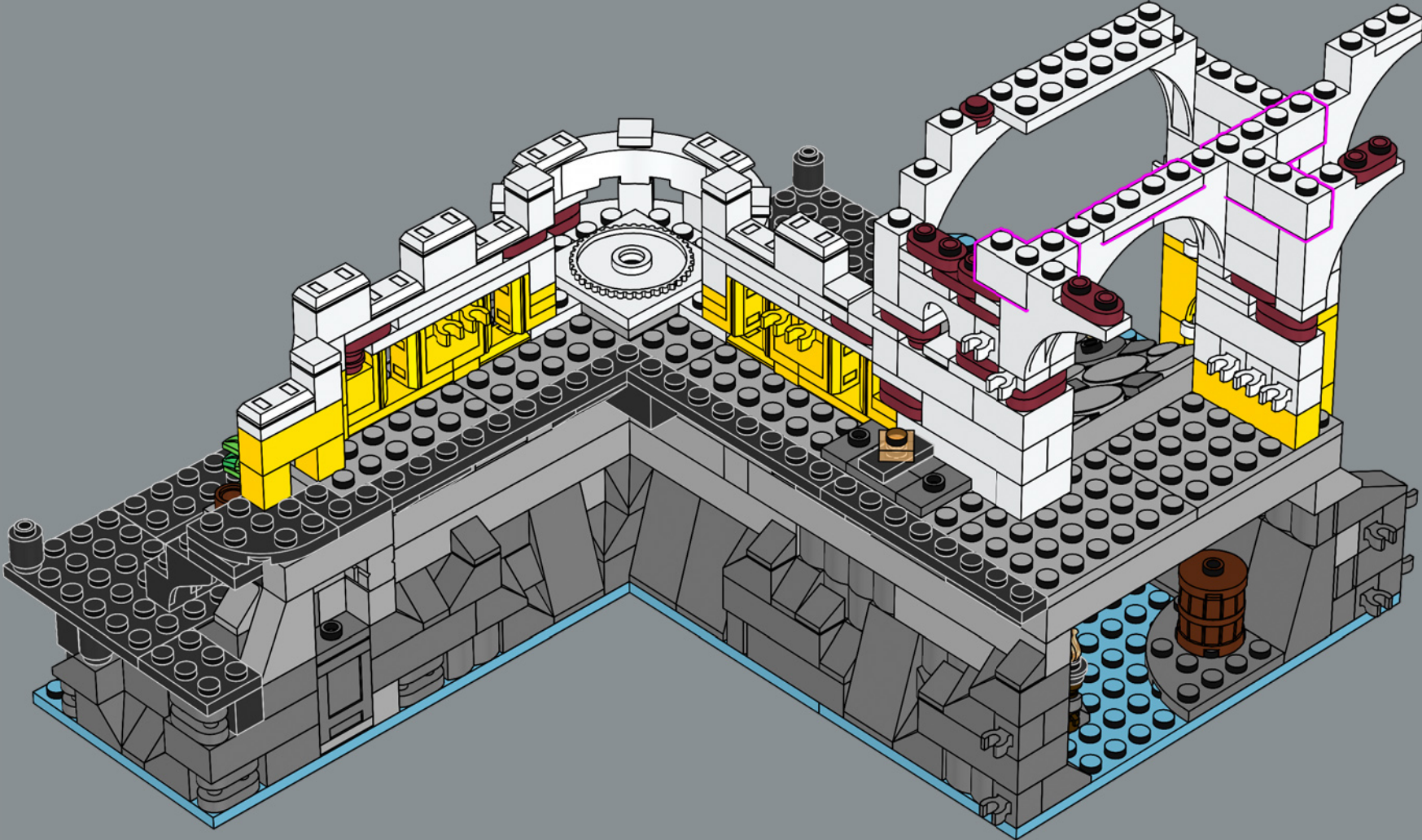

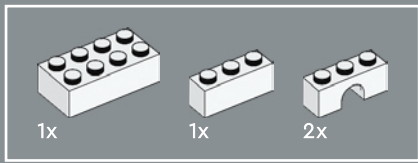

125

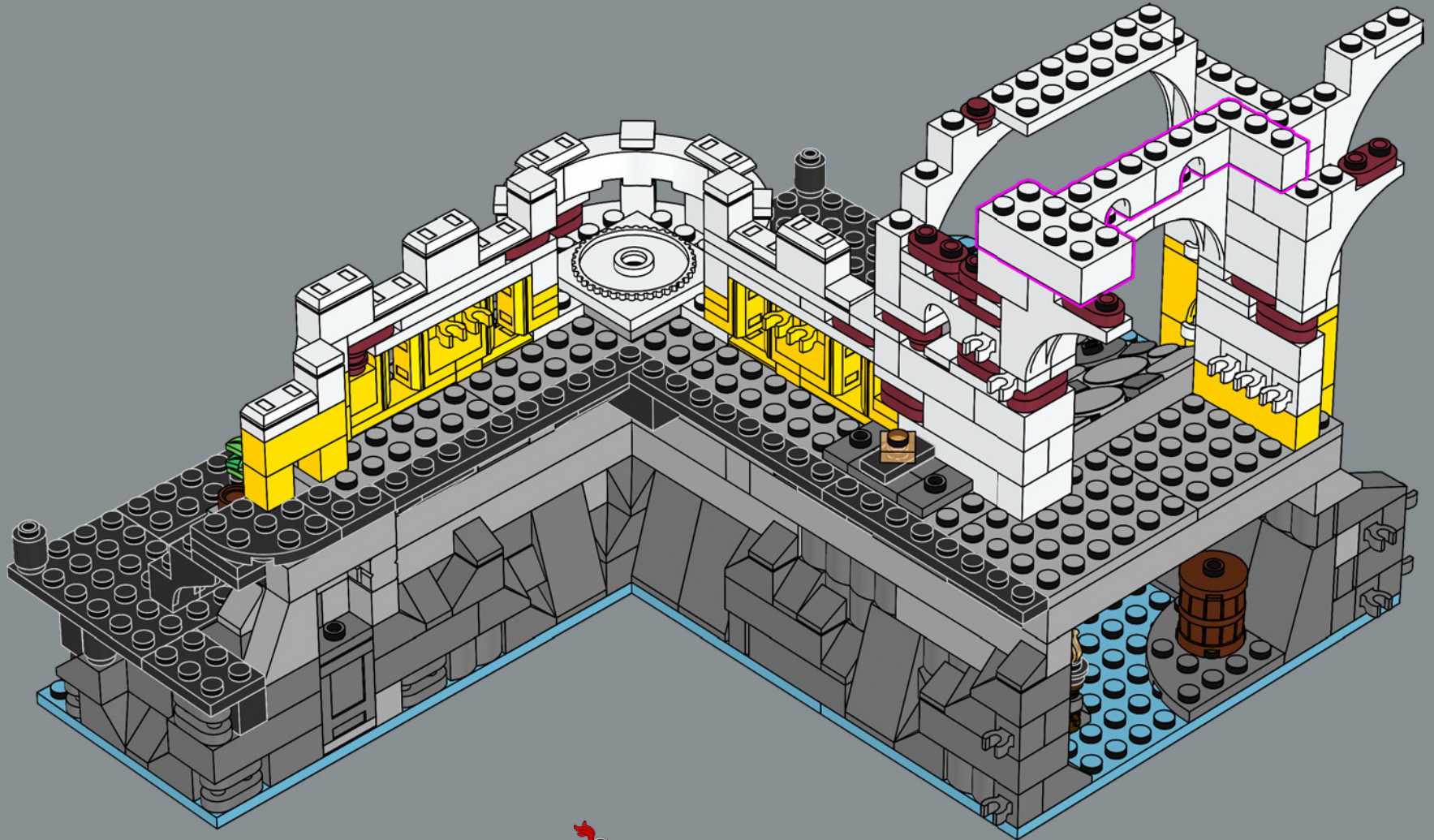

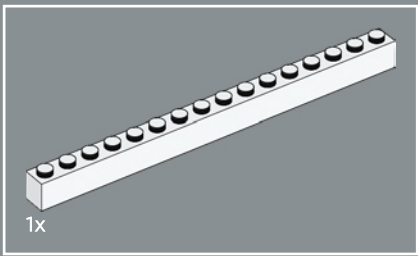

126

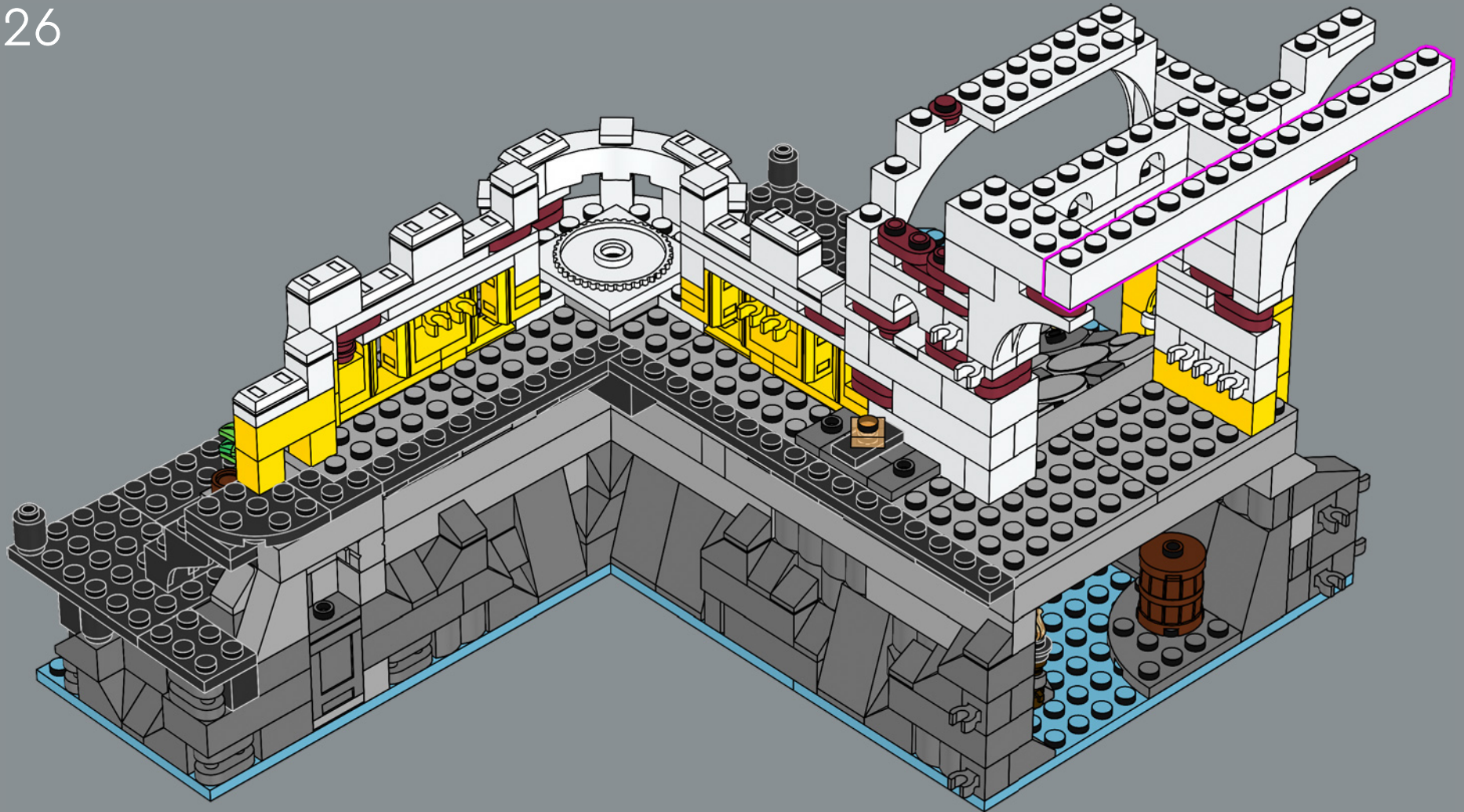

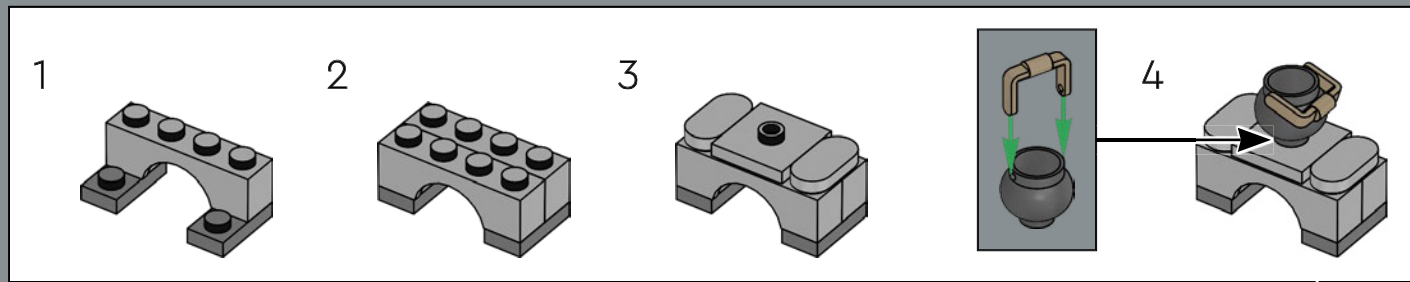
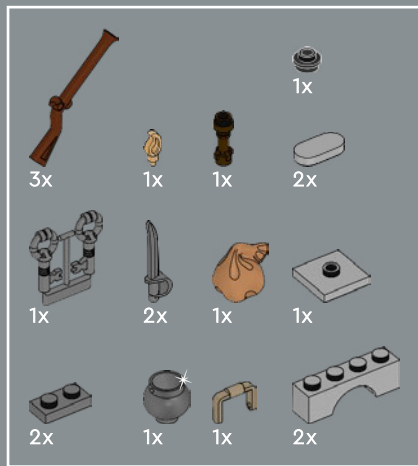

127



Sailors, pirates and guards all have to eat!  
What's cooking? Fish? Coconuts? Plantains?

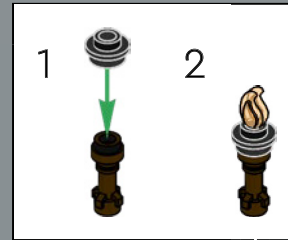

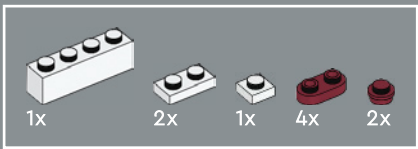

128

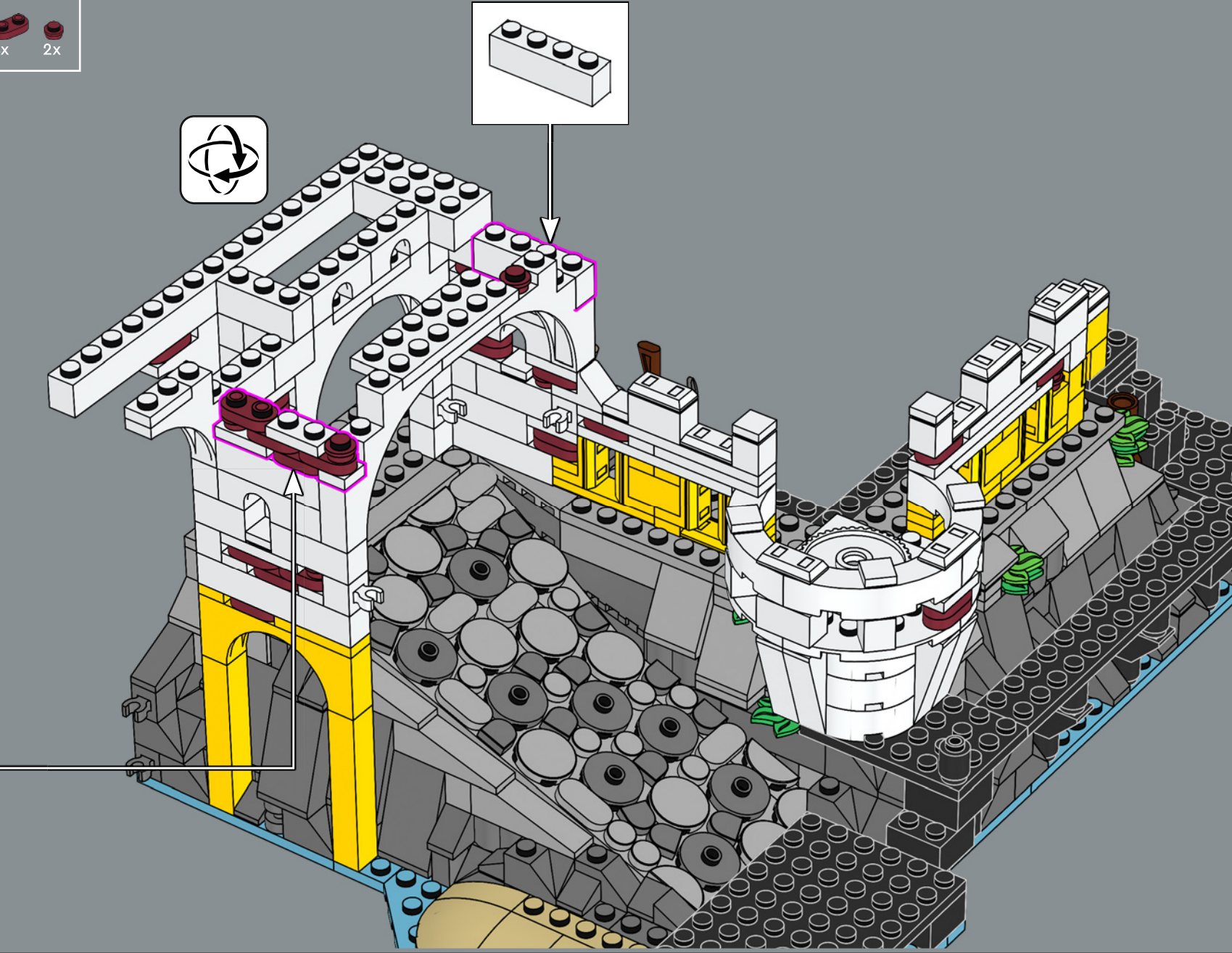
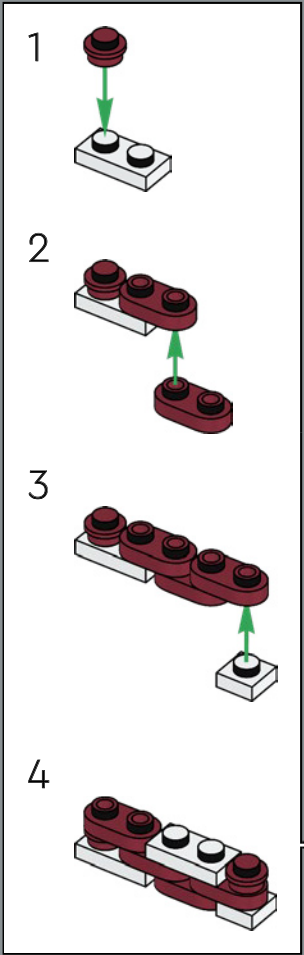
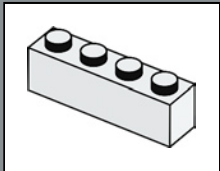



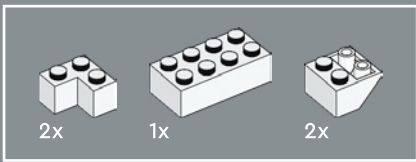

129

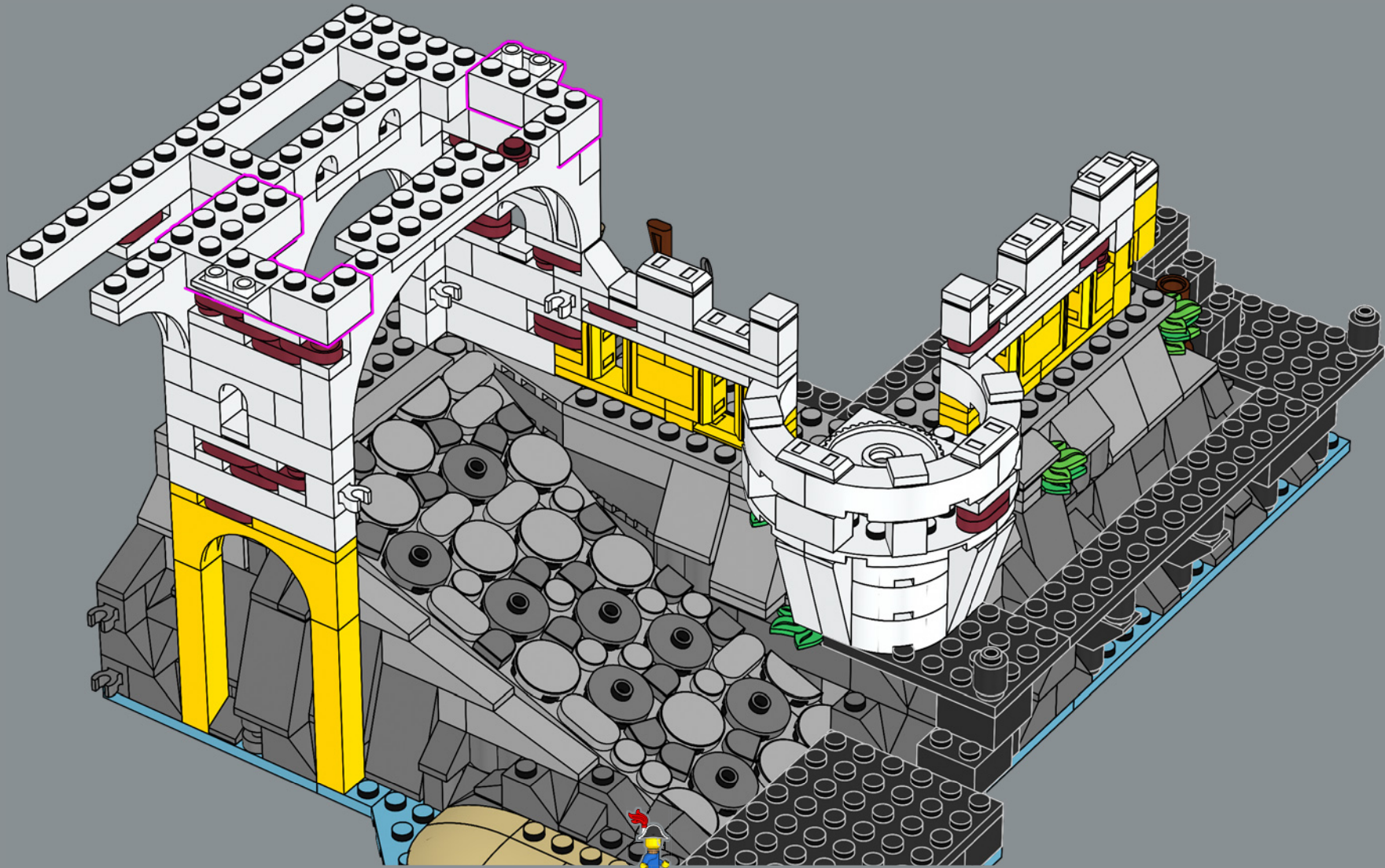

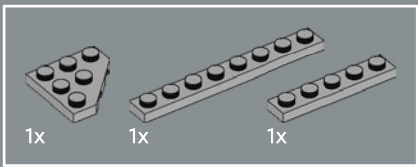

130

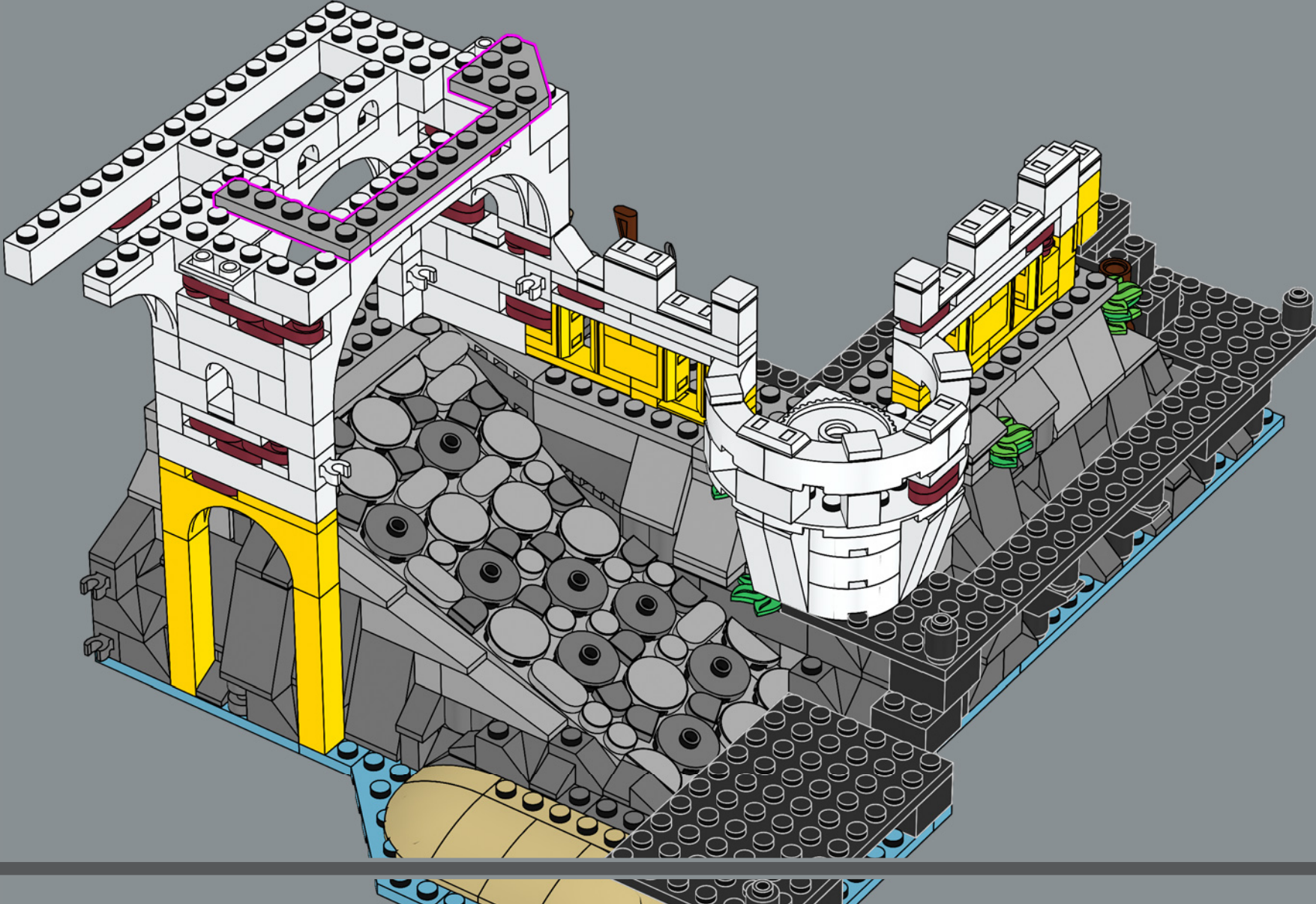

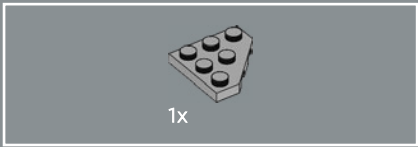

131

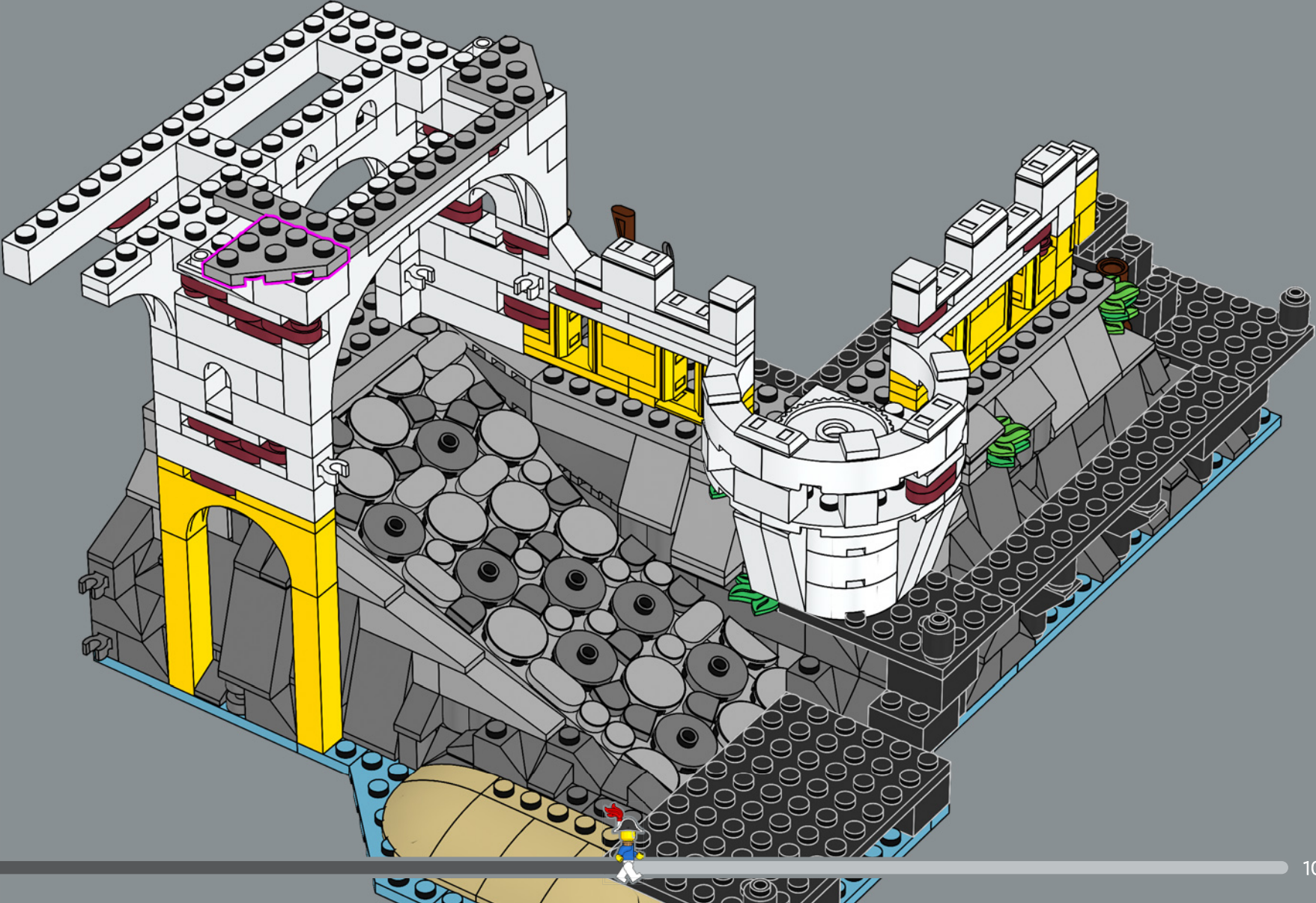

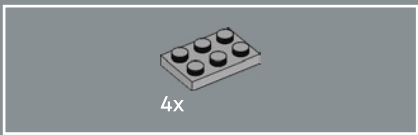

132

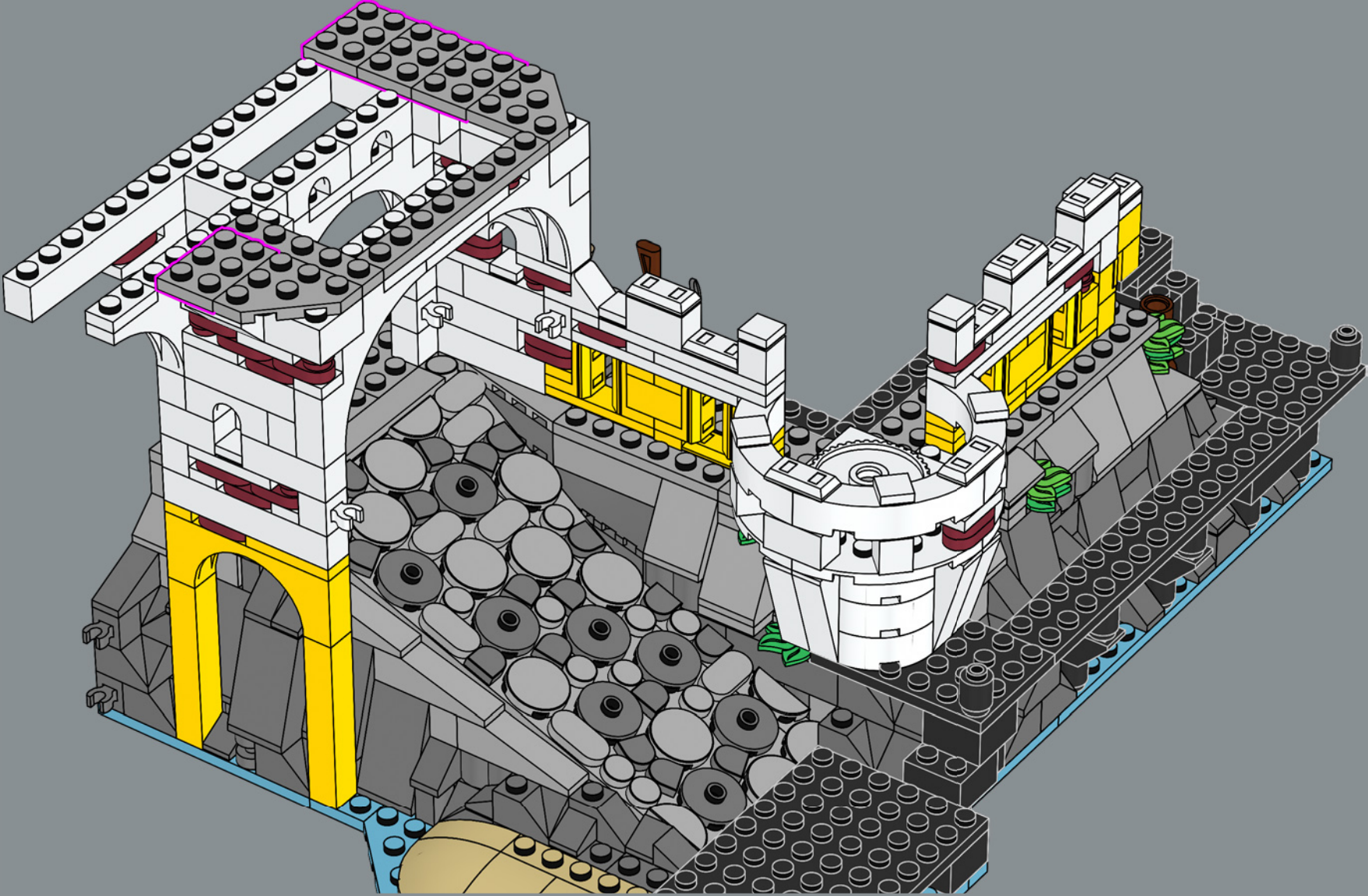

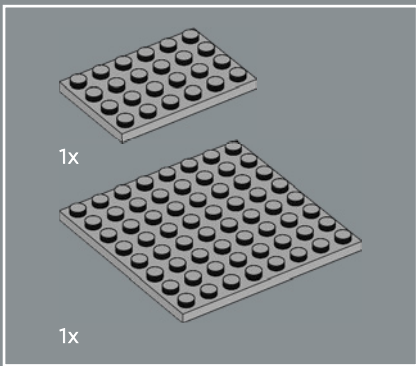

133

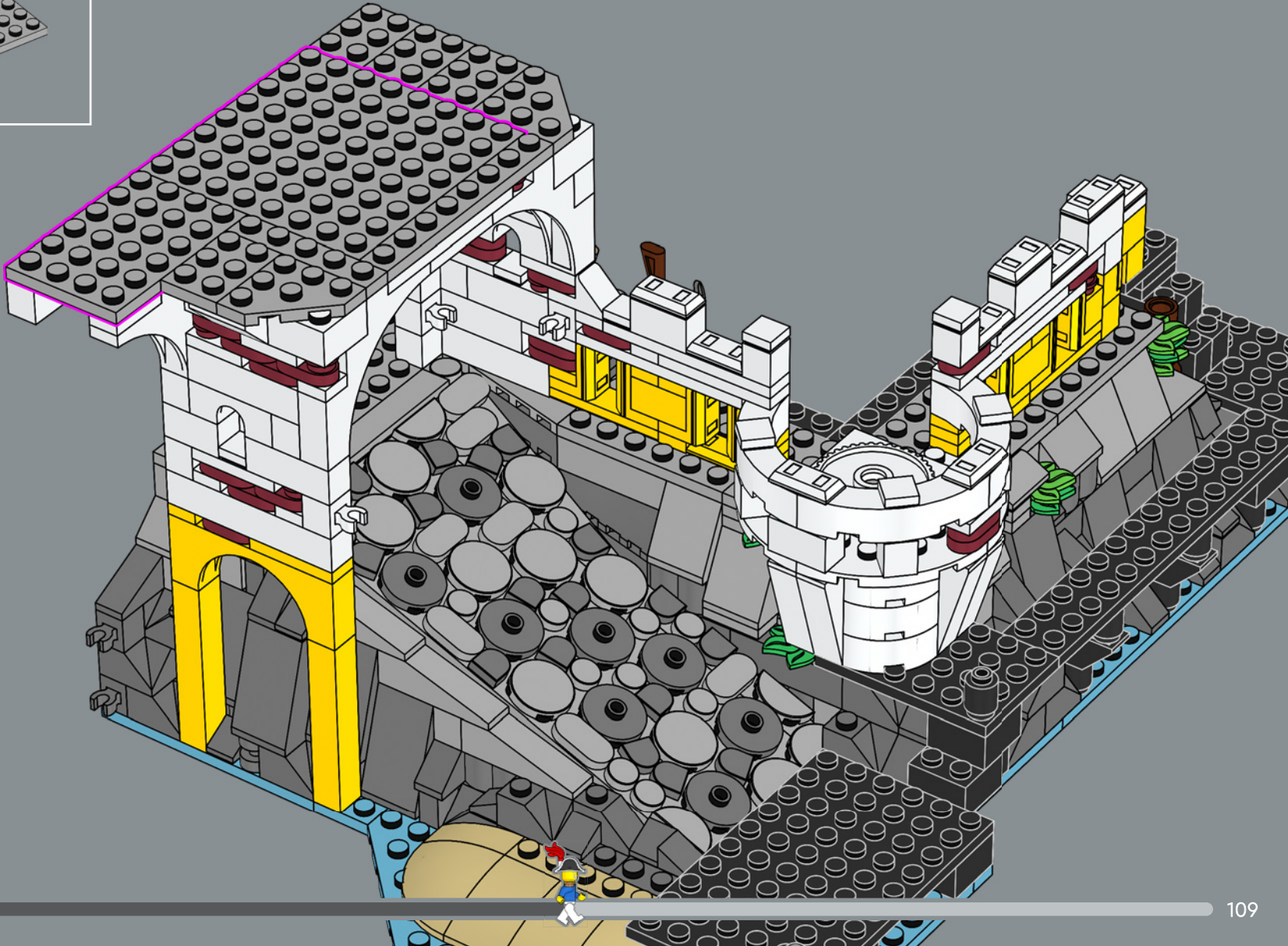

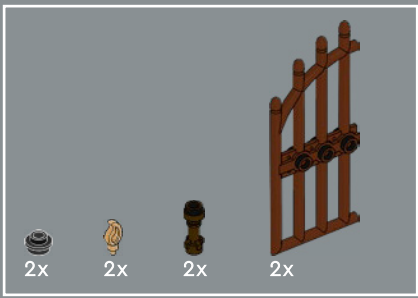

134

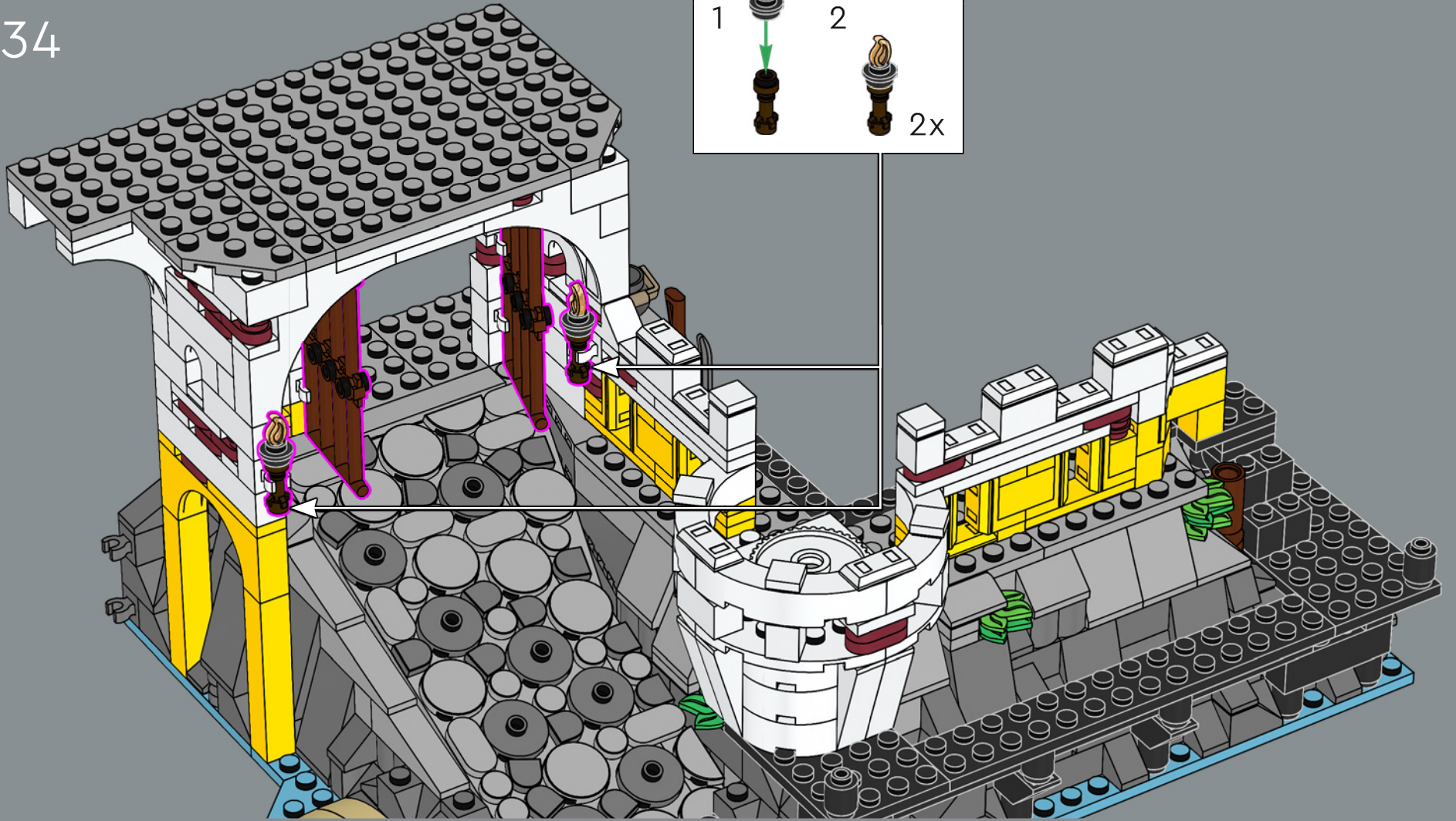
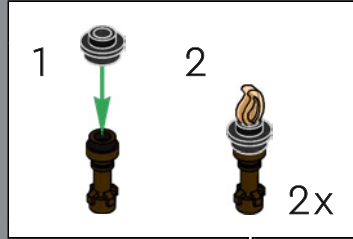

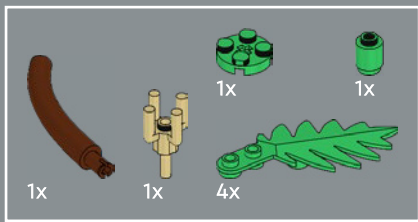

135

1

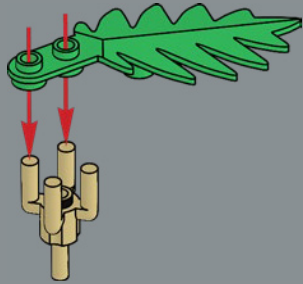

2

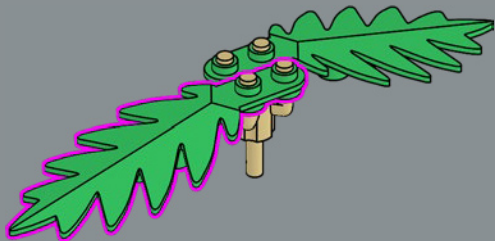

3



4



5



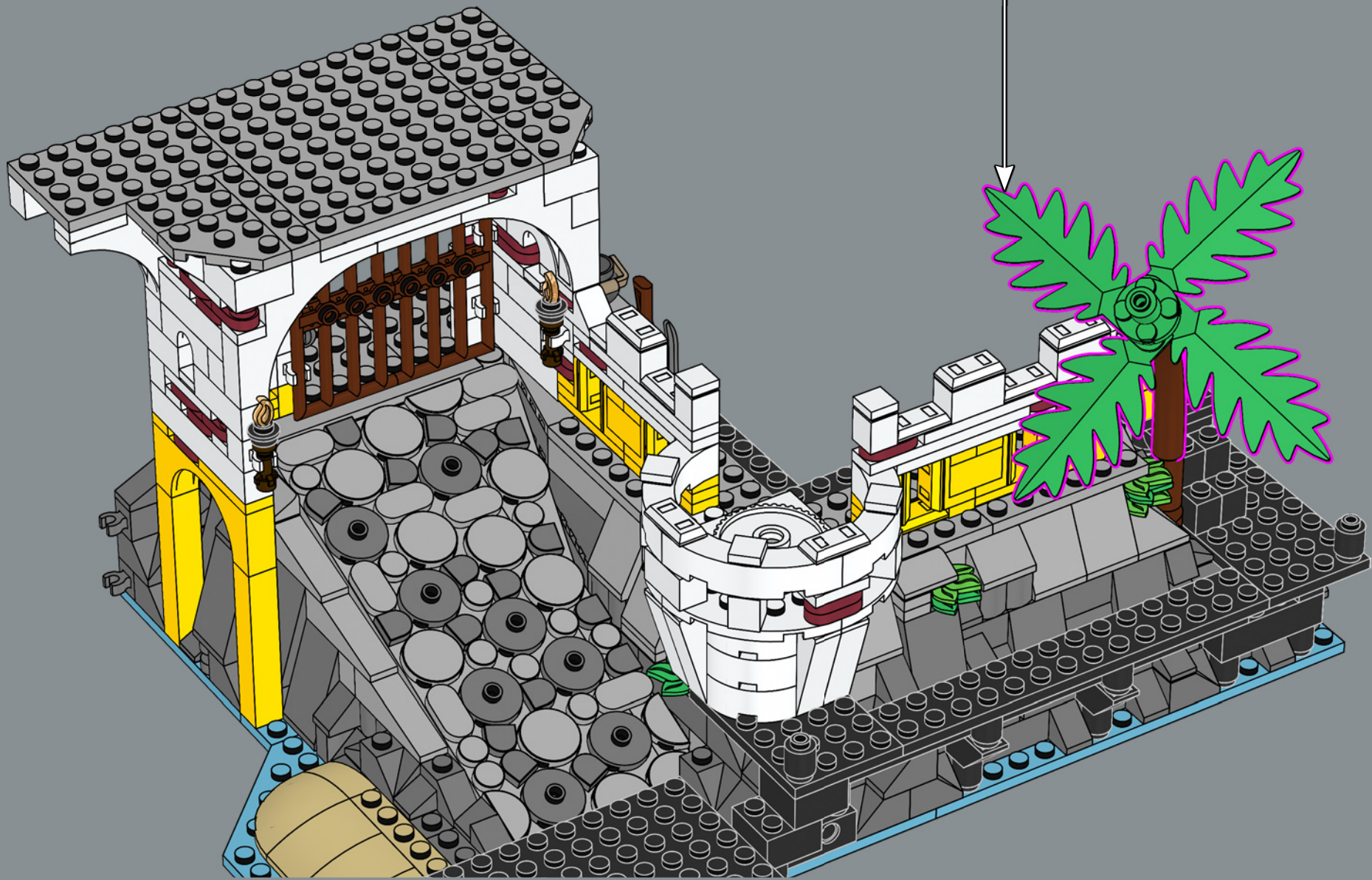



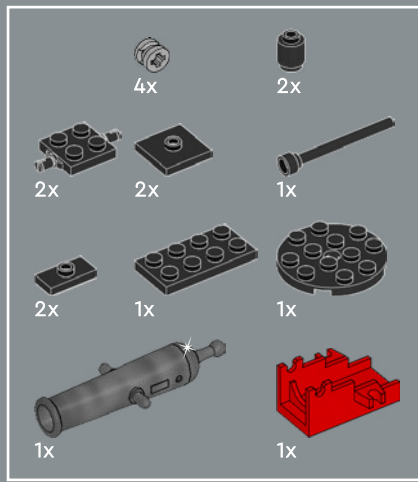

136

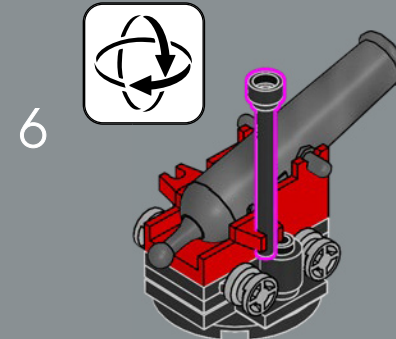
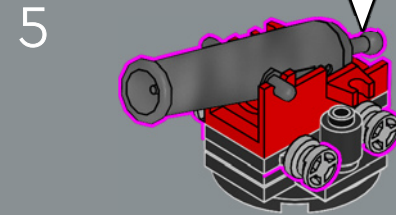
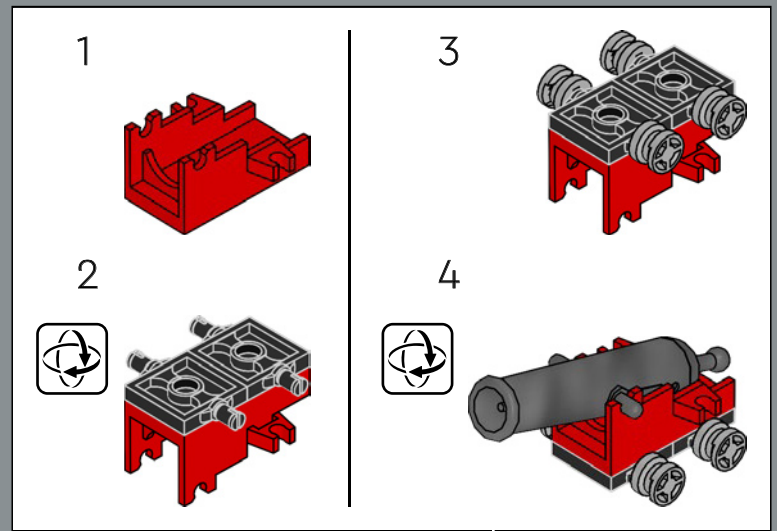
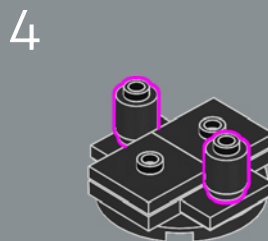
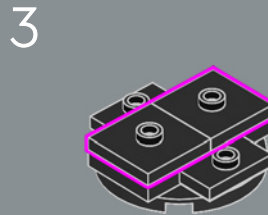
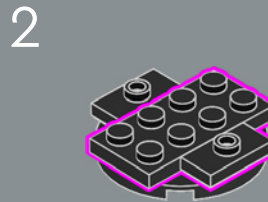
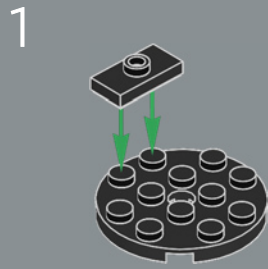

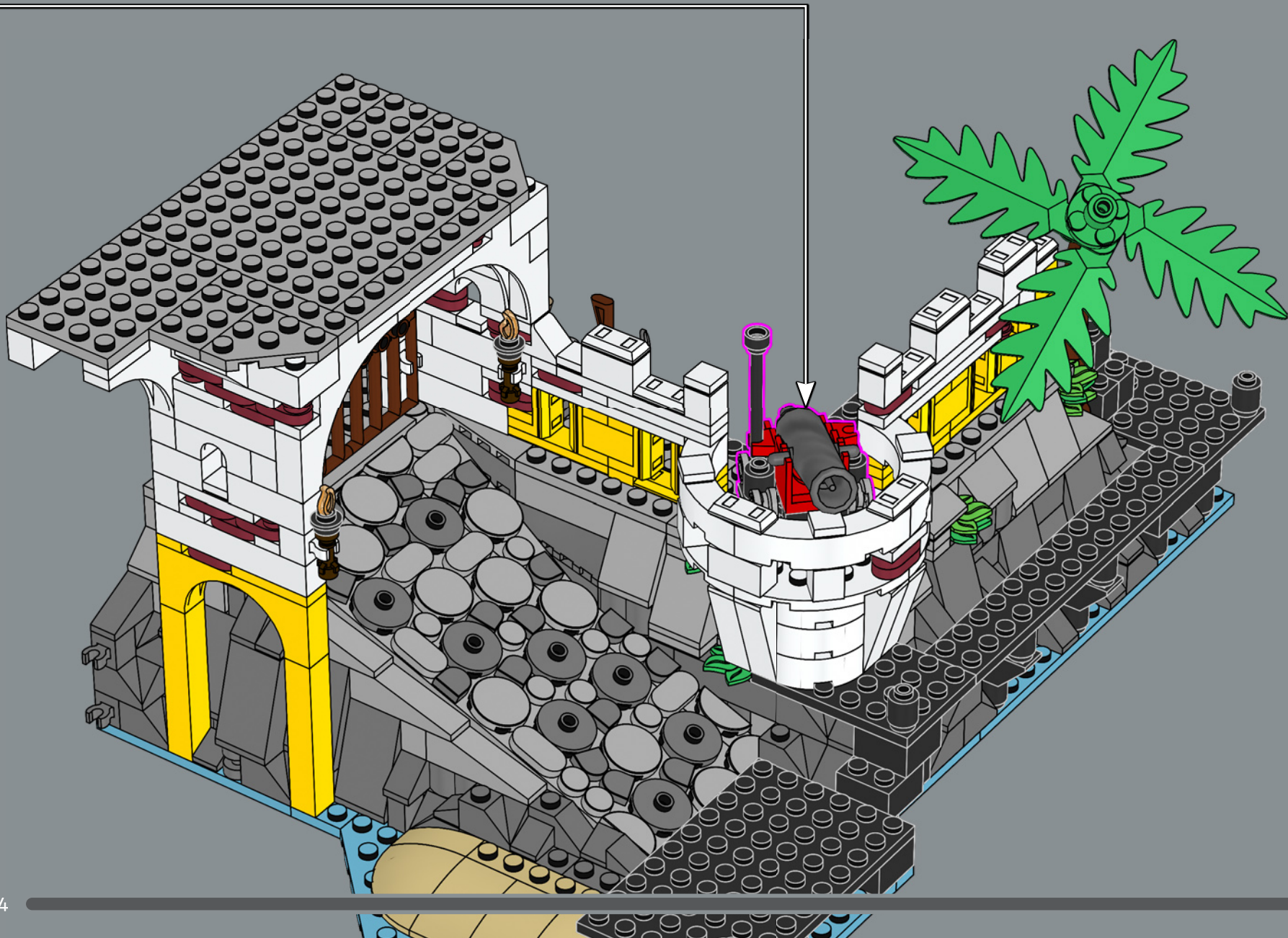

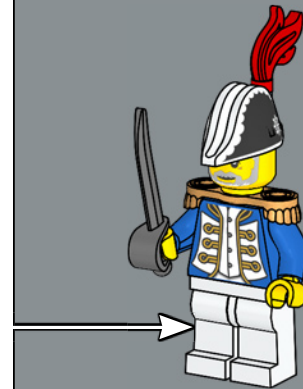
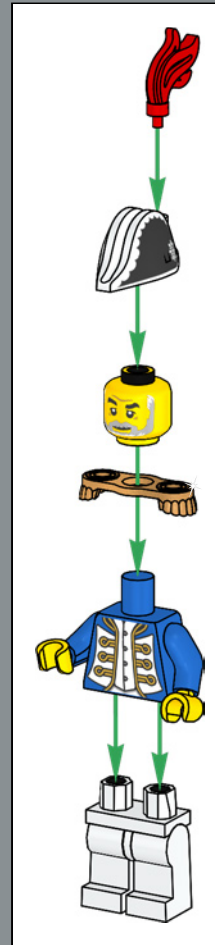

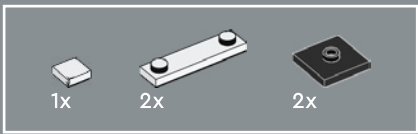

137

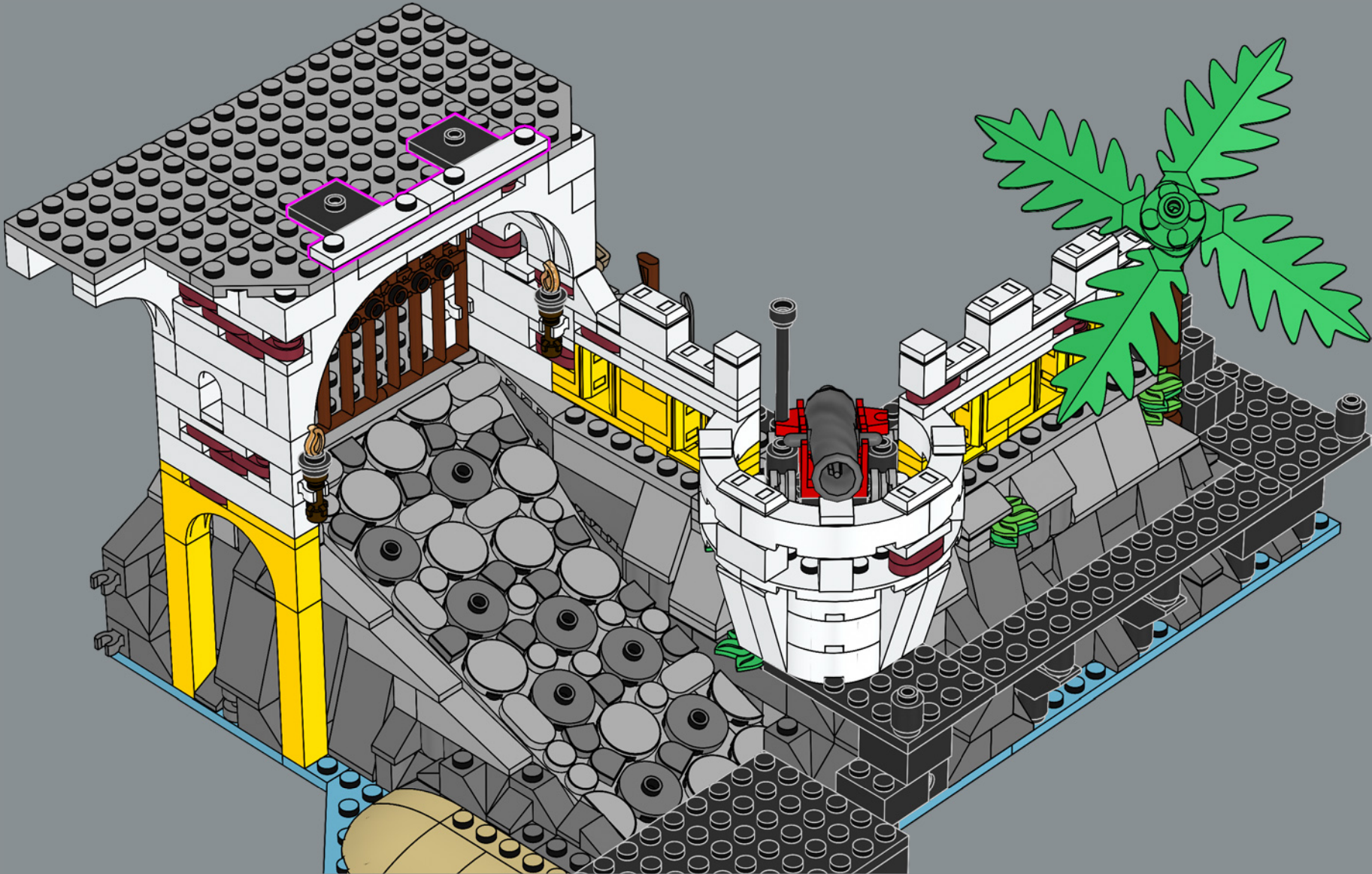

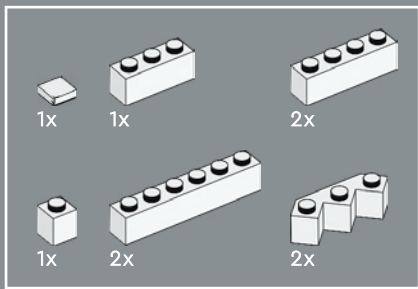

138



1x 5x 1x



139



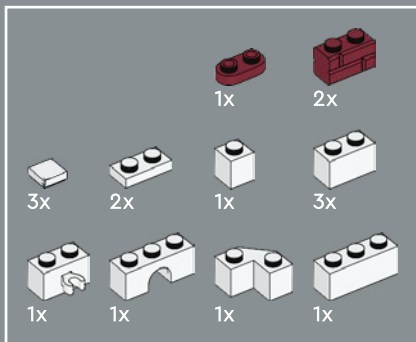

140

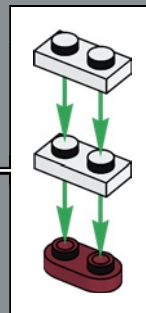

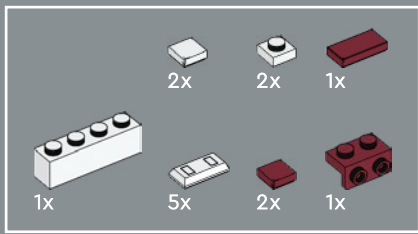

141

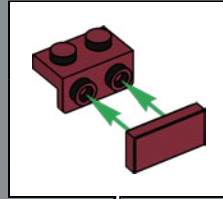



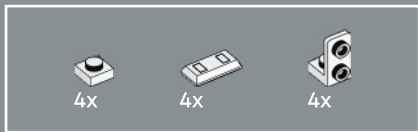

142

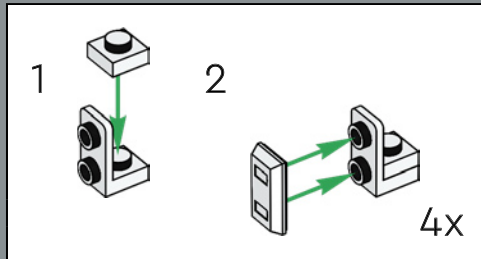

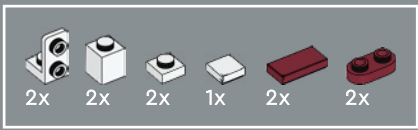

143

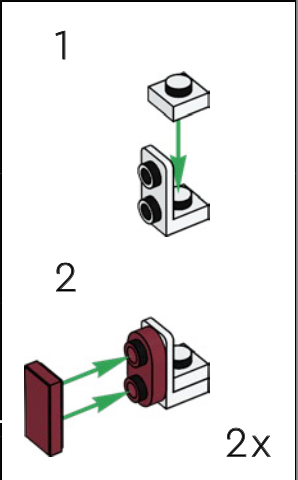

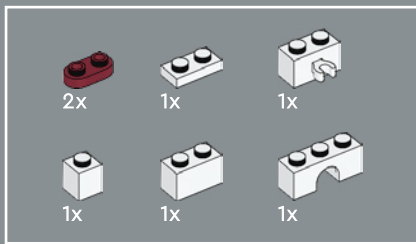

144



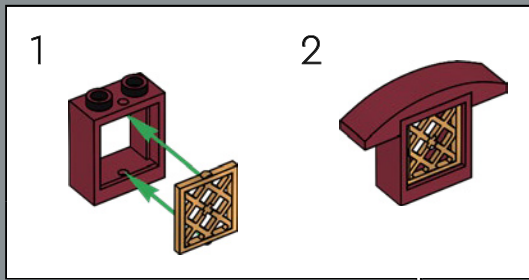
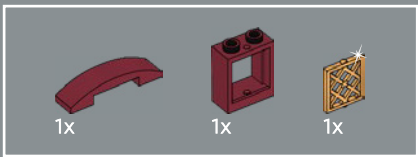

145



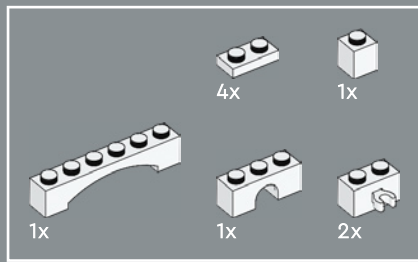

146

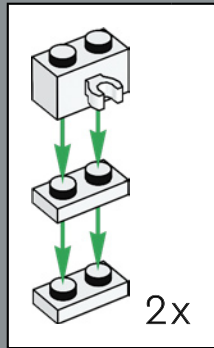

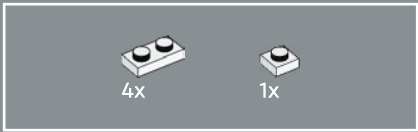

147



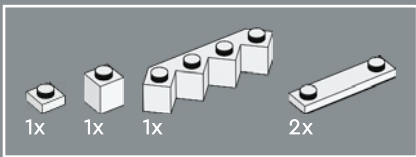

148

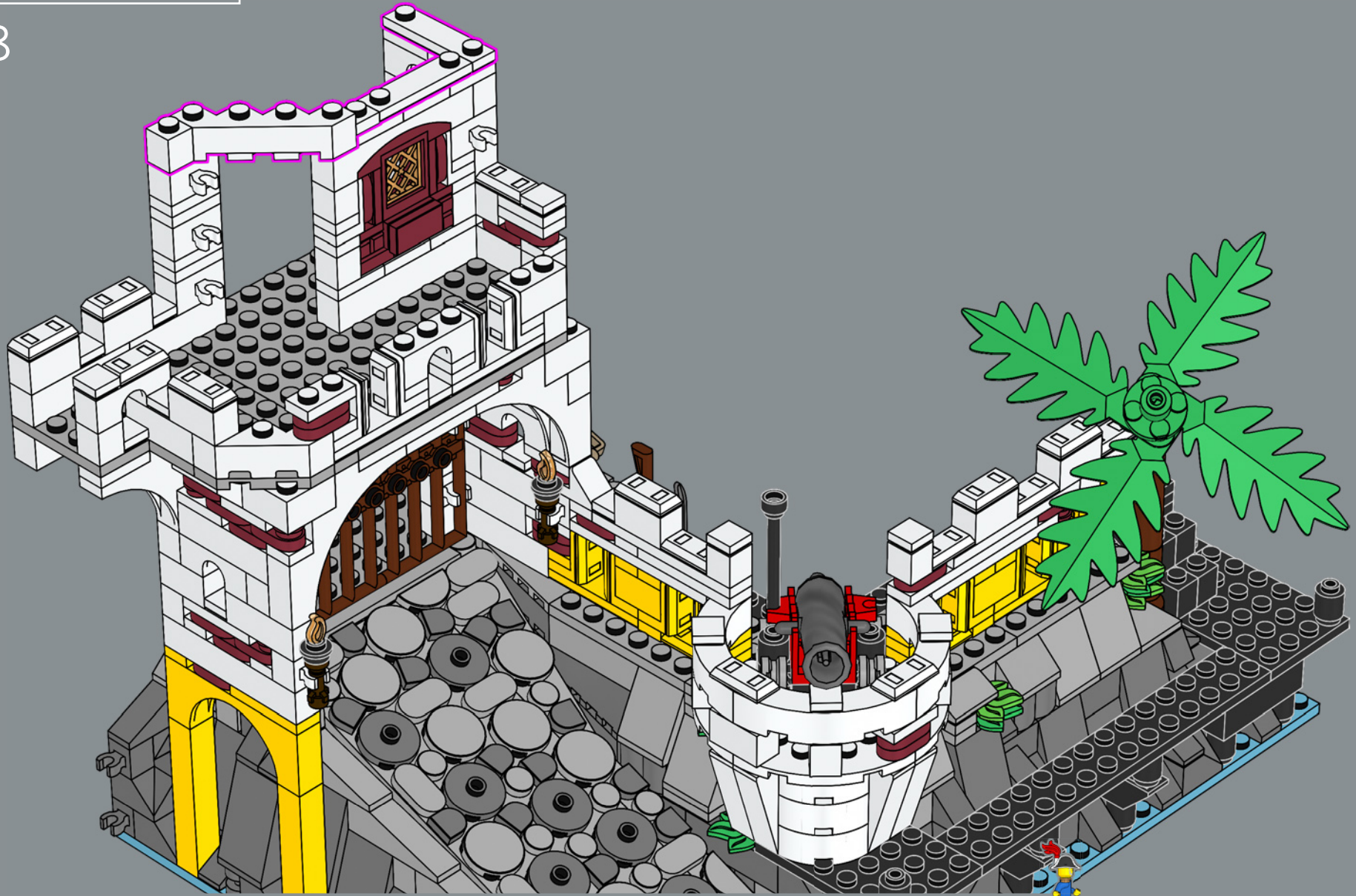

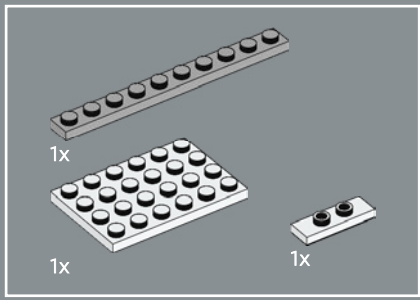

149

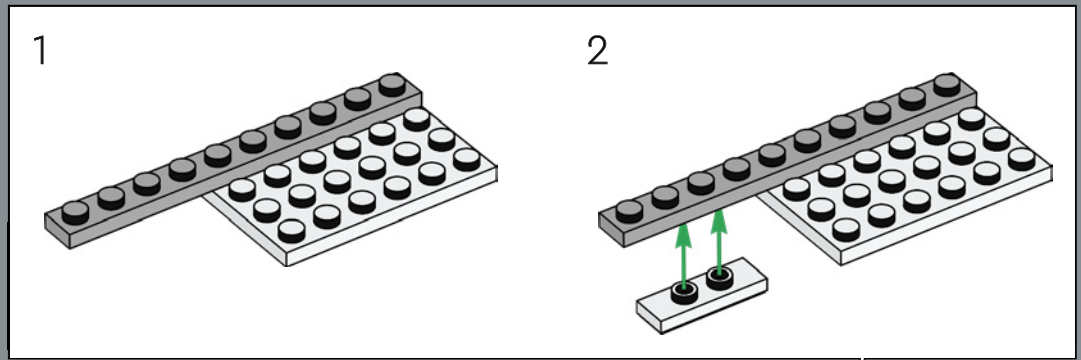



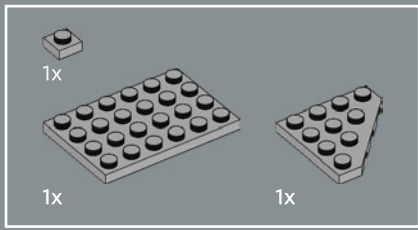

150



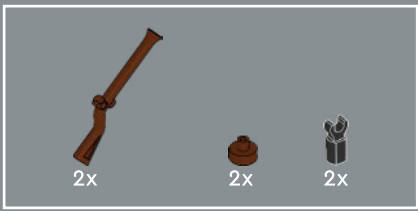

151

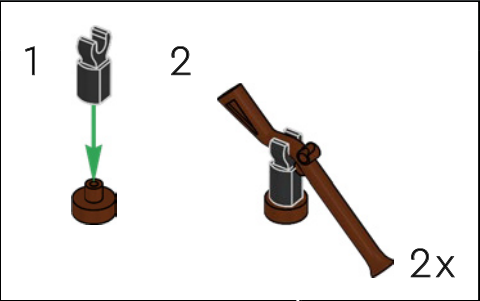

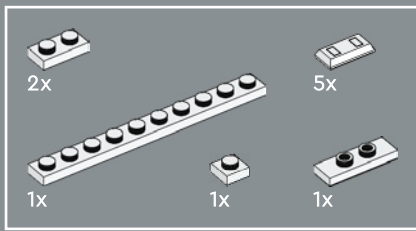

152

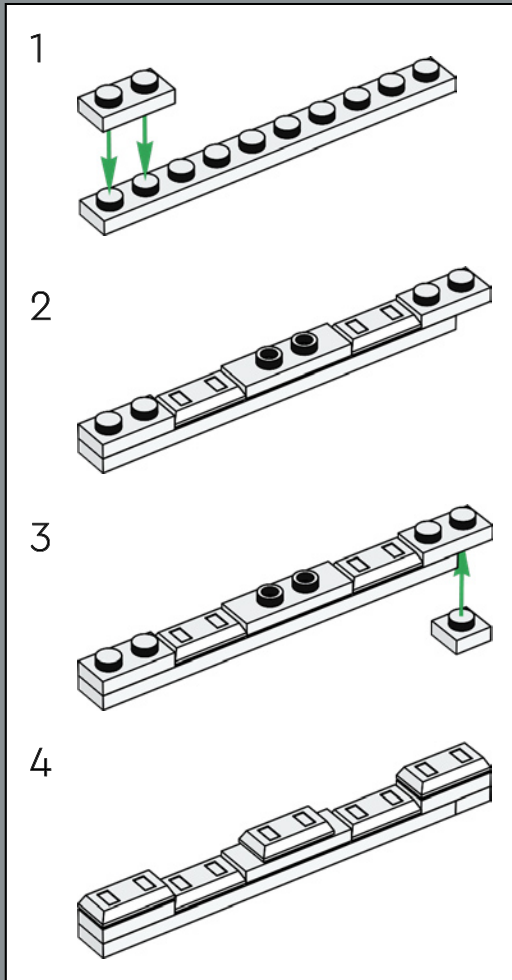

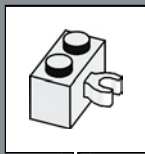
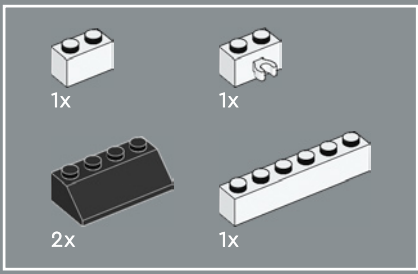

153



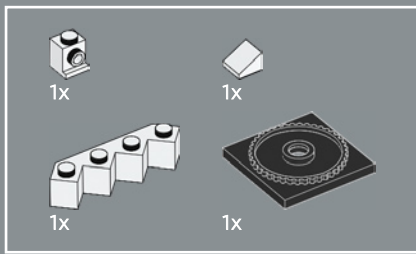

154



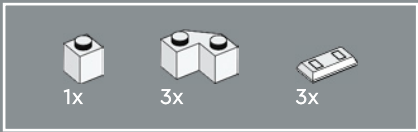

155





156



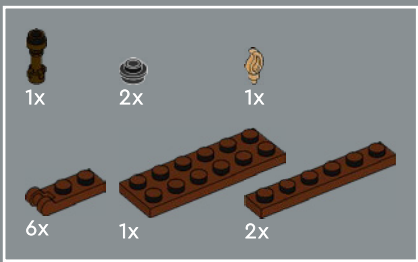

157

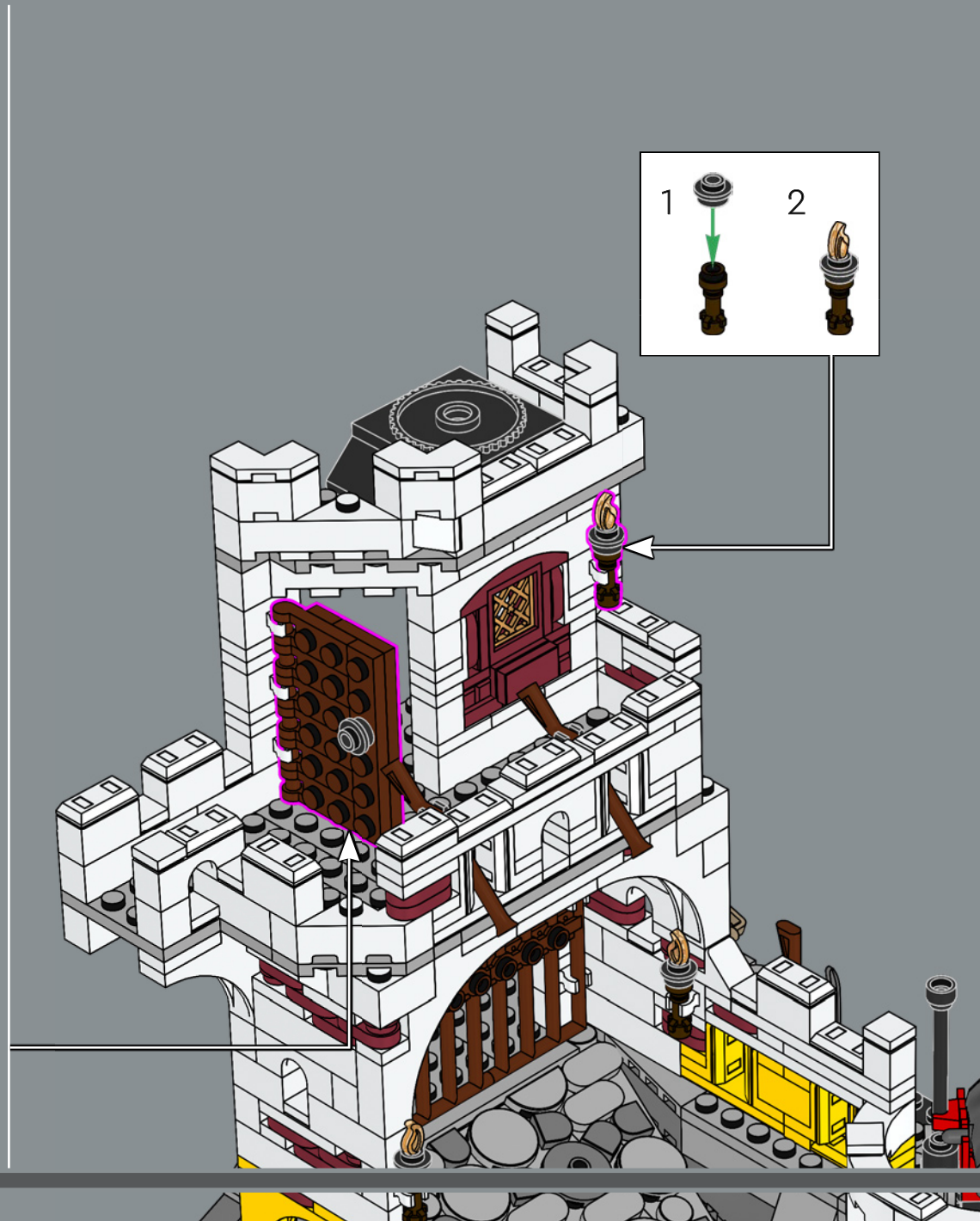
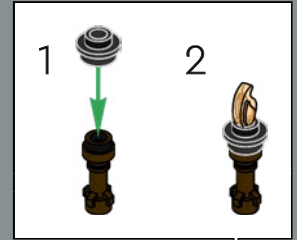
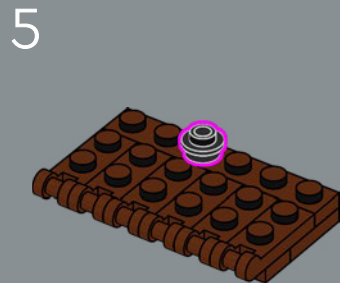
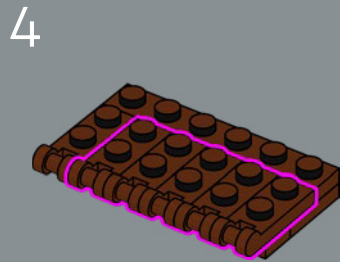
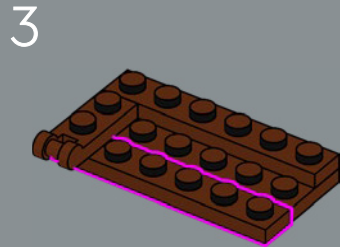
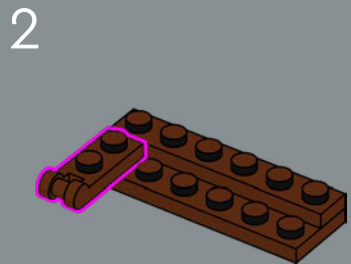
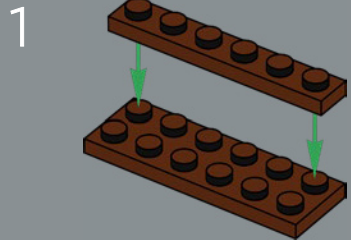





The governor's office holds his most prized possessions and important documents.

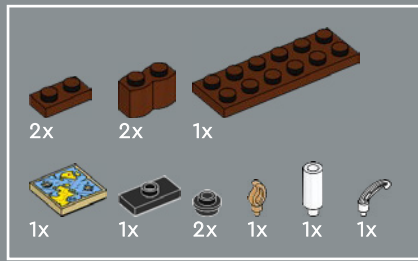

3

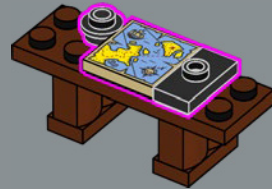

158

1

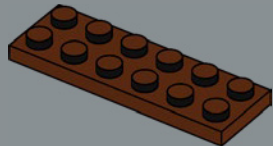

4

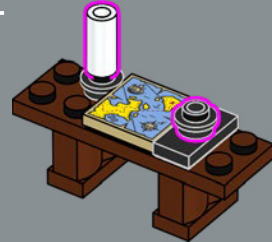

2

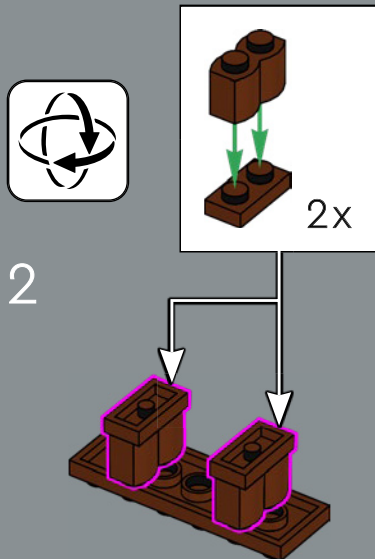

5



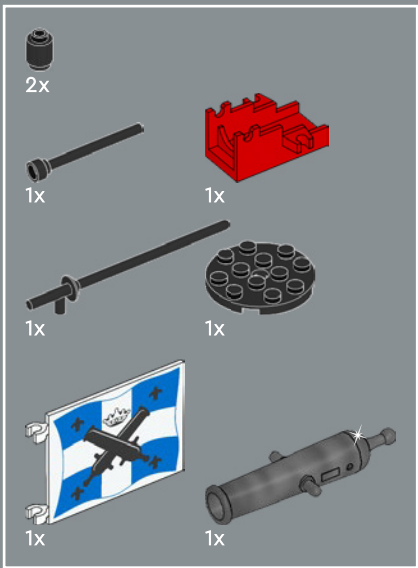

159

1



2

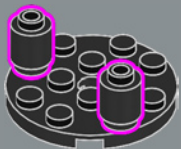

3

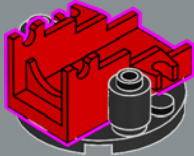

4

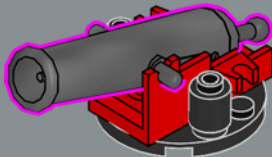

5

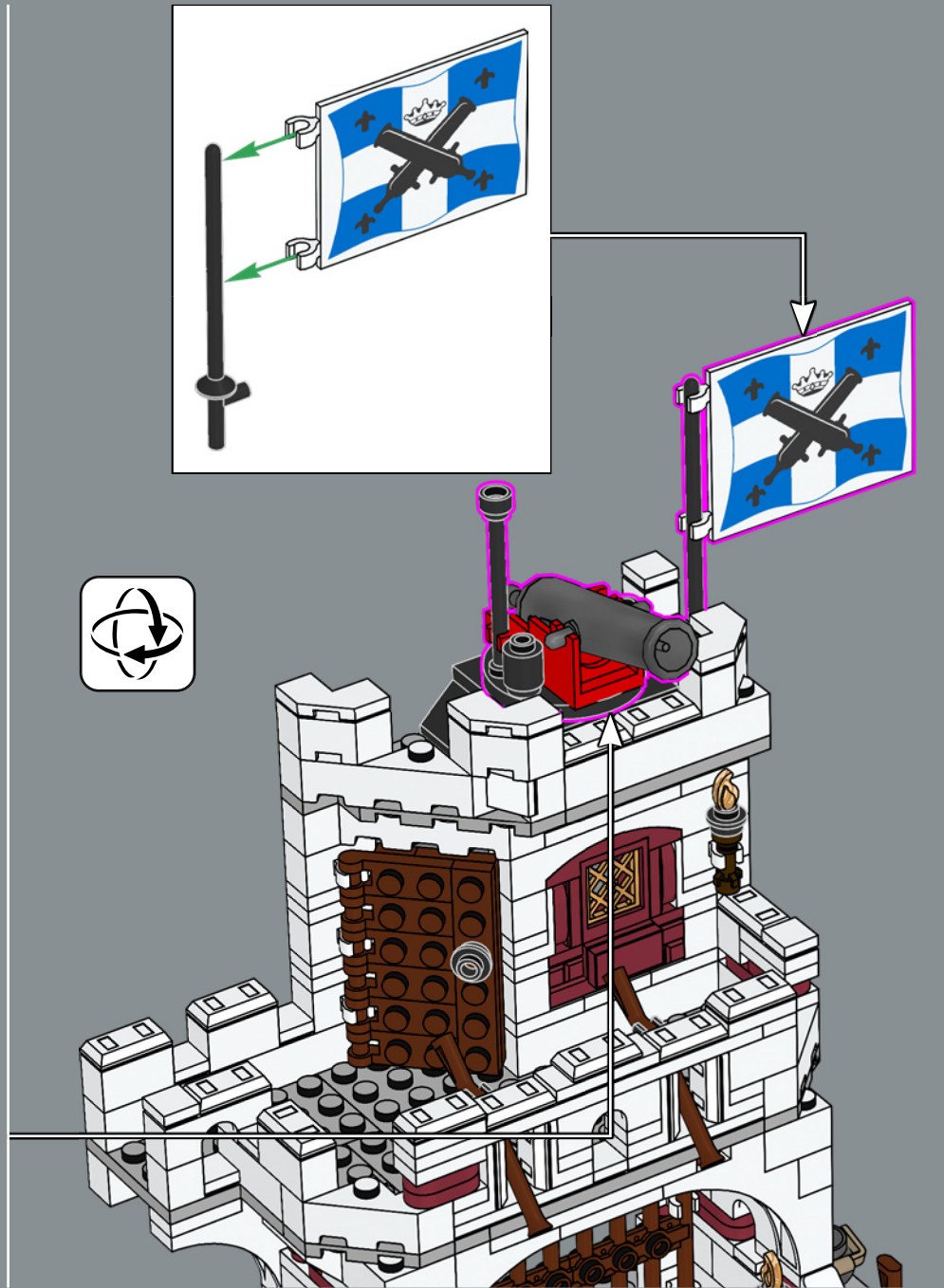
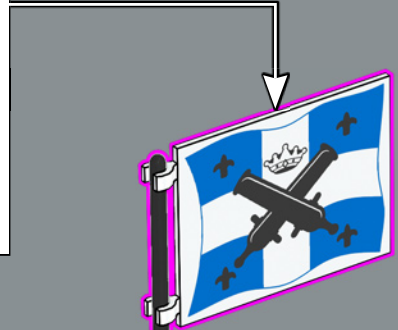
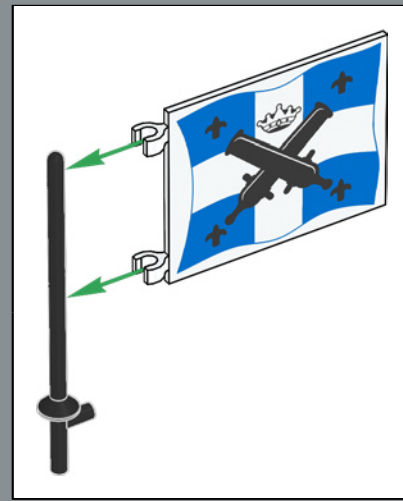
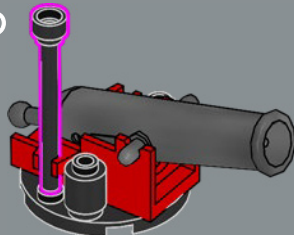





LEGO and the LEGO logo are trademarks of the LEGO Group.  
©2023 The LEGO Group.

6467654