

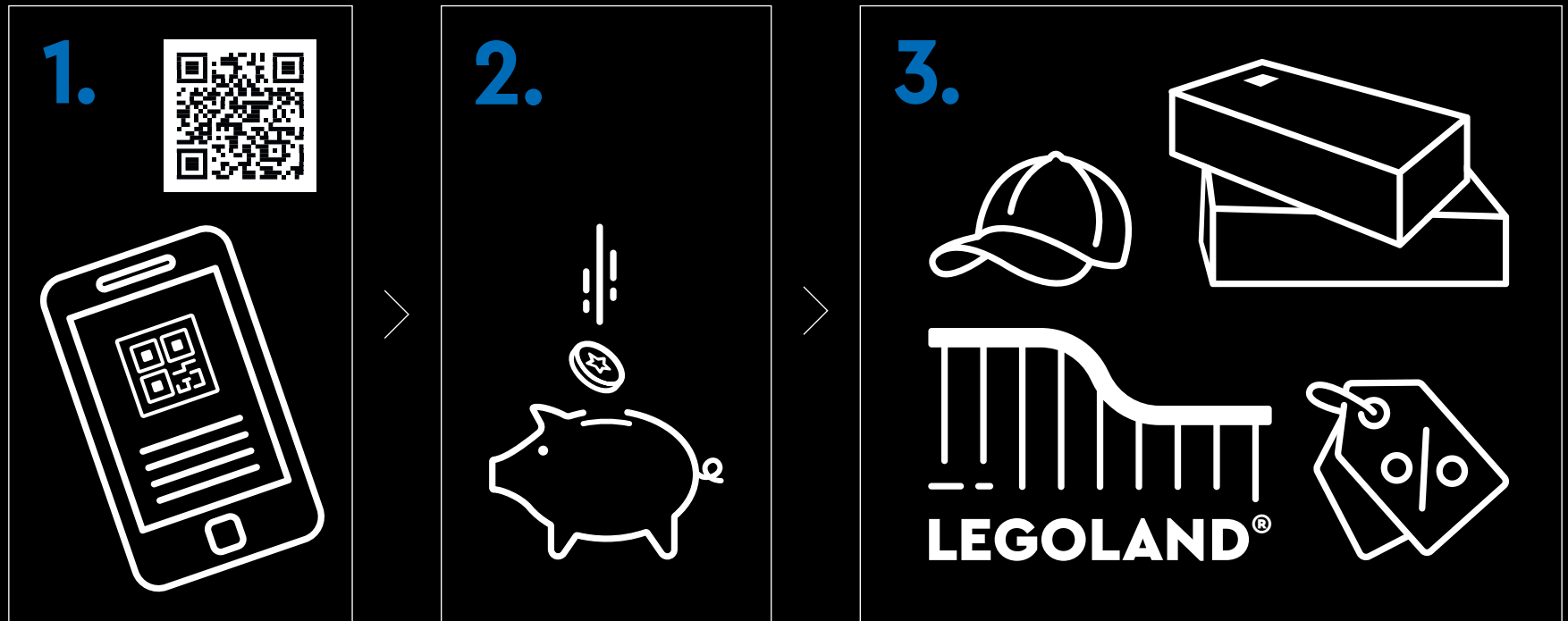



[LEGO.com/sustainable-packaging](https://LEGO.com/sustainable-packaging)

# LEGO® VIP



**1.** Sign up **2.** Earn points for purchases **3.** Redeem points for rewards, experiences, discounts & more | **1.** Melde dich an **2.** Sammle Punkte bei jedem Kauf **3.** Löse die Punkte für Belohnungen, Erlebnisse, Rabatte und Ähnliches ein | **1.** Inscrivez-vous **2.** Gagnez des points lors de vos achats **3.** Échangez vos points contre des récompenses, des expériences, des remises et bien plus encore | **1.** Iscriviti **2.** Guadagna punti con i tuoi acquisti **3.** Riscatta punti per premi, esperienze, sconti e altro ancora | **1.** Regístrate **2.** Gana puntos por tus compras **3.** Canjea puntos por recompensas, experiencias, descuentos y mucho más | **1.** Registe-se **2.** Ganhe pontos em compras **3.** Troque os pontos para prémios, experiências, descontos e muito mais | **1.** 注册 **2.** 购物赚积分 **3.** 用积分兑换奖励、体验、折扣等 | **1.** Zarejestruj się **2.** Zdobywaj punkty za zakupy **3.** Wymieniaj punkty na rabaty, przygody i inne nagrody | **1.** Zaregistrujte se **2.** Sbírejte body za nákupy **3.** Vyměňujte body za odměny, zážitky, slevy a spoustu dalšího | **1.** Zaregistrujte se **2.** Získavajte body za nákupy **3.** Uplatnite si body a získajte odmeny, rôzne zážitky, zľavy a ešte viac | **1.** Regisztrálj **2.** Szerezz pontokat minden vásárlással **3.** Váltsd be pontjaidat jutalmakra, élményekre, kedvezményekre és egyebekre | **1.** Înscric-te **2.** Câștigă puncte pentru achiziții **3.** Valorifică puncte pentru recompense, experiențe, reduceri și multe altele | **1.** Регистрируйте се **2.** Получайте точки за покупки **3.** Используйте точки за награды, услуги, отстъпки и т.н. | **1.** Reģistrējies **2.** Pelni punktus par pirkumiem **3.** Izmanto punktus, lai saņemtu balvas, izklaides iespējas, atlaides un daudz ko citu | **1.** Registreeru **2.** Teeni ostude eest punkte **3.** Lunasta punktide eest preemiad, elamused, allahindlused ja muu | **1.** Užsiregistruokite **2.** Pelnykite taškų už pirkinius **3.** Panaudokite taškus atlygiui, funkcijoms, nuolaidoms ir ne tik





## 欢迎来到幽谷

在《王者归来》上映20年后，波澜壮阔的《指环王》三部曲仍然是我们这个时代最耀眼的电影艺术作品之一。你怎么可能只选择一个喜爱的场景或时刻？在最黑暗的时期，精灵族的壮美家园幽谷是一个宁静、繁荣的天堂，可以带来康复、希望、冷静坚定的信念和联合。在此处的重要会议上，中土世界的代表们组成了护戒联盟，以摧毁统治他们所有人的至尊魔戒。



乐高®设计师团队

## 乐高®设计师团队

作为全球模型设计师、组件设计师和美术设计师团队的一部分，我们踏上了捕捉幽谷魔力的旅程。我们以电影中的摄影棚蓝图为参考，并发挥了一些艺术自由性，来组合我们最喜欢的细节和功能。这款套装为标志性地地点幽谷（大海以东最后的庇护所）的重现版，包含 6000 块乐高®积木，以乐高小人仔比例细致展现了幽谷，充满令人难忘的故事时刻和深受喜爱的角色。

## 源自《乐高®指环王》的经典场景

我们可以通过 2012-2013 年发布的乐高®指环王系列套装重温一些经典场景，从灰袍甘道夫抵达夏尔到在米那斯提力斯海岸上与亡灵王 (King of the Dead) 的最后一战。



### 9469 甘道夫到来

灰袍甘道夫来到夏尔，庆祝他老朋友比尔博·巴金斯的 111 岁生日。在这里，他遇到了年轻的佛罗多·巴金斯，冒险也就此展开。



### 79006 埃尔隆德会议

中土世界的人民被召唤到幽谷参加埃尔隆德会议。在这里，他们将决定至尊魔戒的命运。



### 9473 莫瑞亚矿区

在令人毛骨悚然的废弃莫瑞亚矿区，英勇的护戒使者在巴林墓中面对邪恶的莫瑞亚半兽人和洞穴巨怪。



### 9474 圣盔谷之战

圣盔谷的围墙堡垒和洛汗人民正遭受萨鲁曼野蛮的强兽人大军的攻击。



### 10237 欧散克塔

这款套装(含 2357 块组件)是其发行时最大的乐高®指环王系列套装,共有六层,包含标志性的小人仔角色和场景。



### 79008 海盗船伏击战

索伦的魔多半兽人准备在海盗船上迎接他们的盟友,结果却对上阿拉贡、吉姆利、莱戈拉斯和亡灵军团。



## 幽谷塔楼

在幽谷逗留期间，比尔博在这座塔楼的办公桌上完成了他的书《There and Back Again》。塔楼底部秘密藏身处的空间足够大，可以隐藏逃犯，或者让至尊魔戒远离窥探。

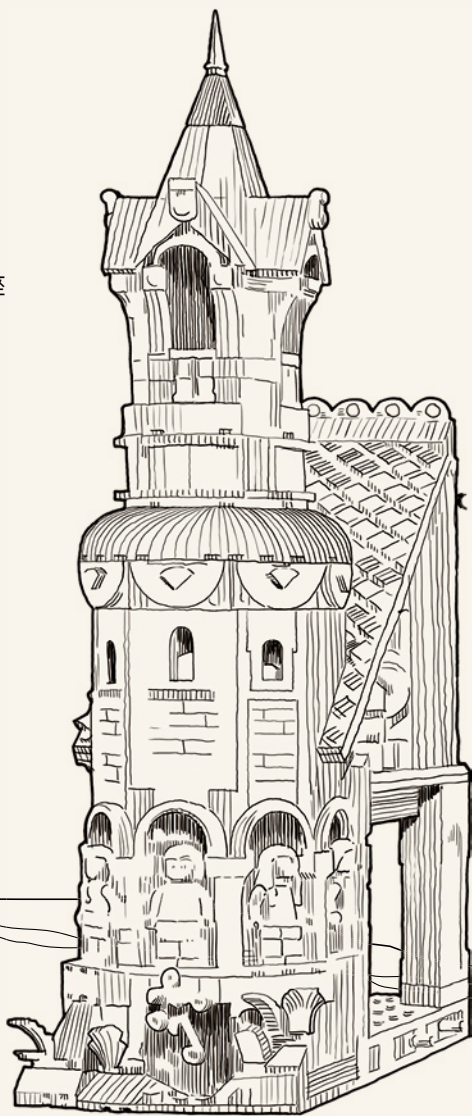

佛罗多拥有双模制腿部，以展示他的赤脚，这是夏尔霍比特人的标志性特征。他还带着至尊魔戒，这枚戒指被带到幽谷，由议会决定它的命运。

佛罗多·巴金斯



比尔博拥有全新的双面头部装饰，包括他试图从佛罗多手中夺走魔戒时短暂显露出的可怕面孔。

比尔博·巴金斯





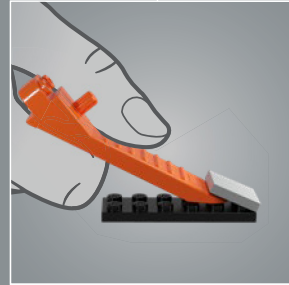
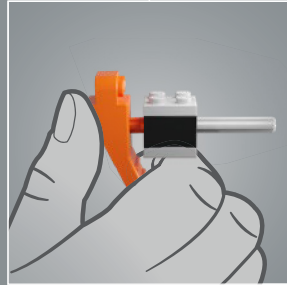
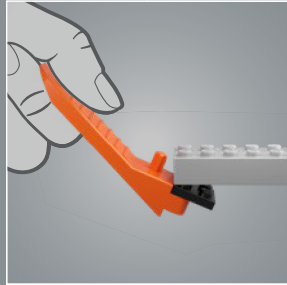
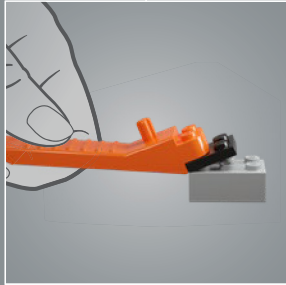
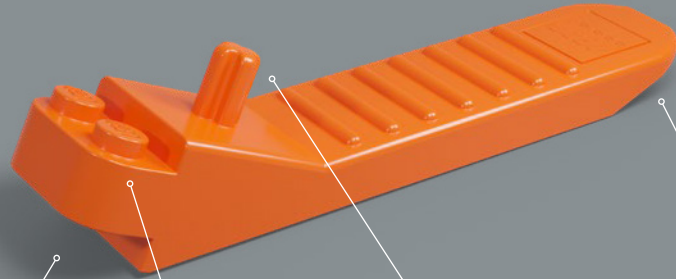

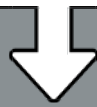

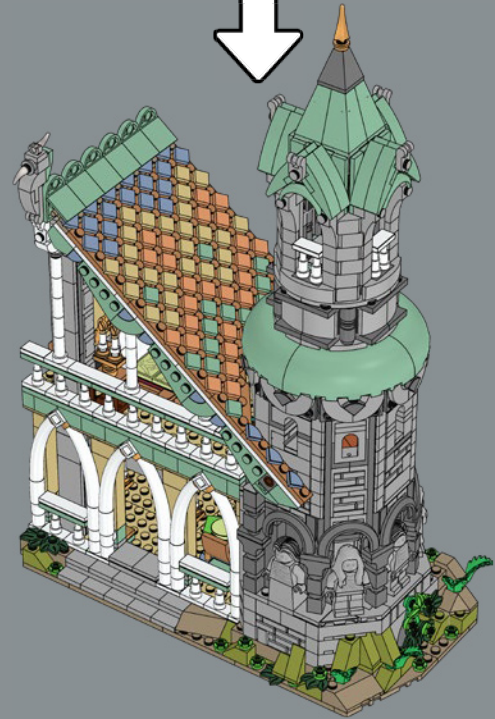

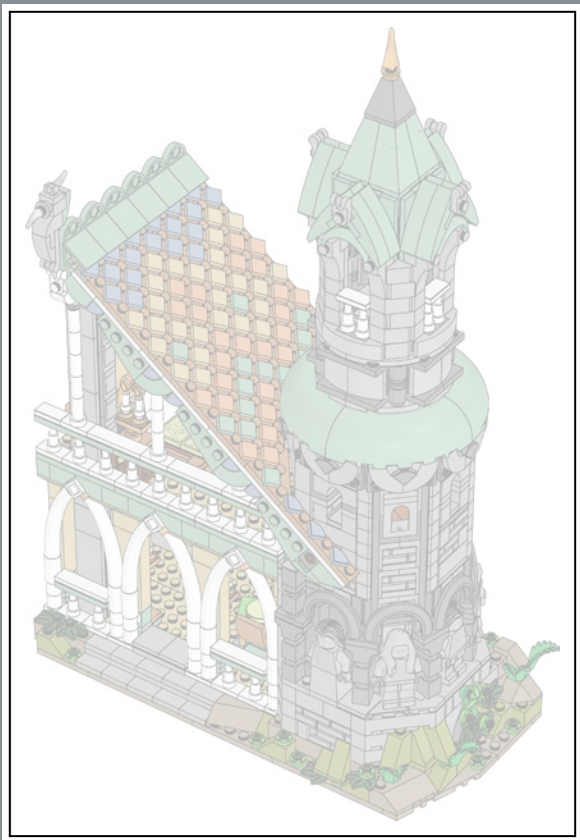

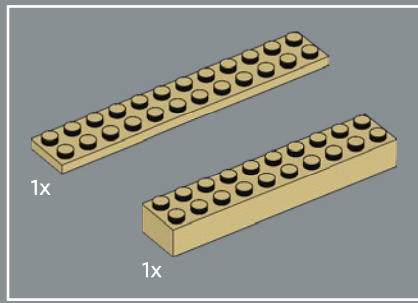

1

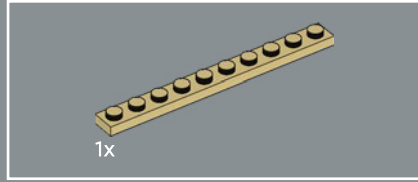
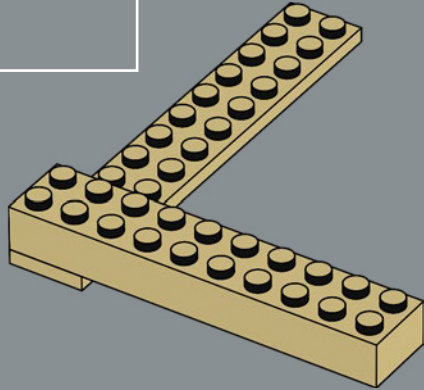

2

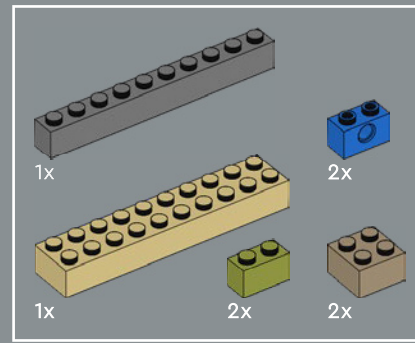
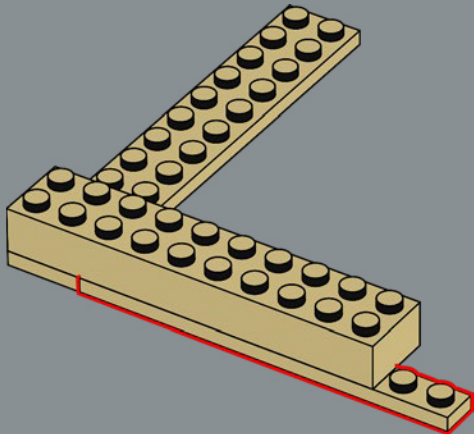

3

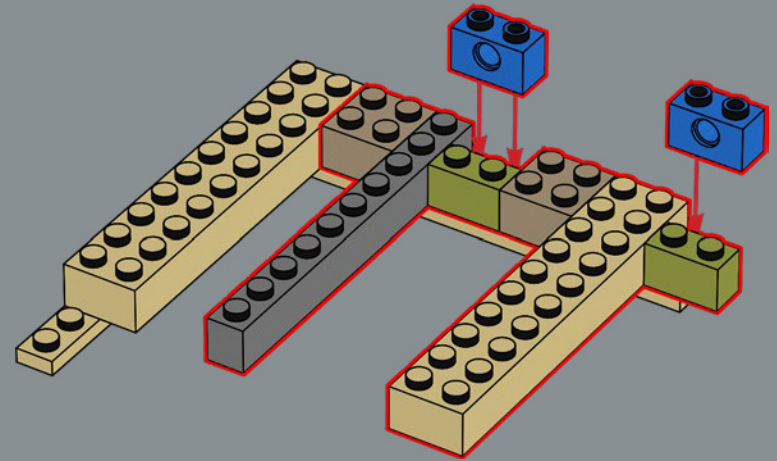

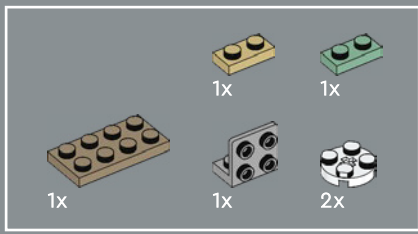

4

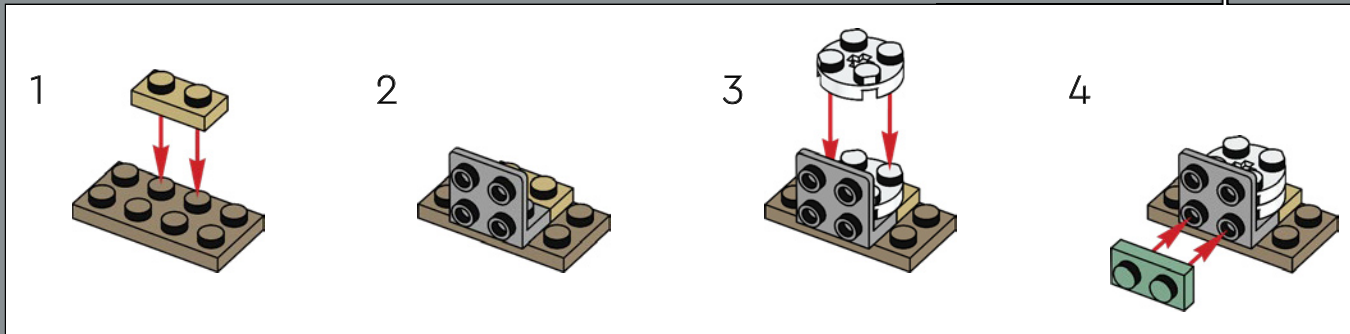
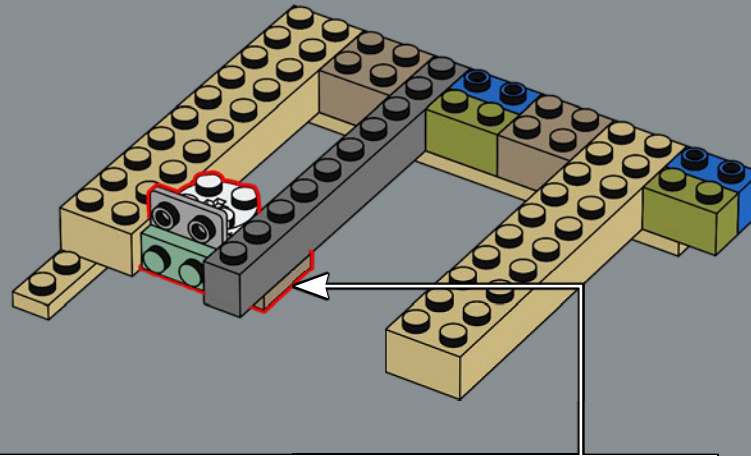

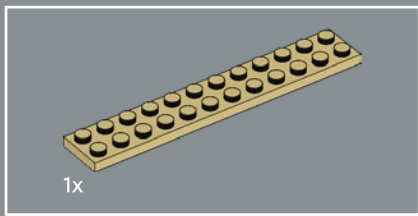

5

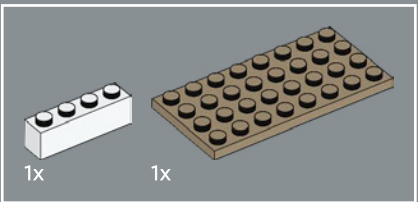
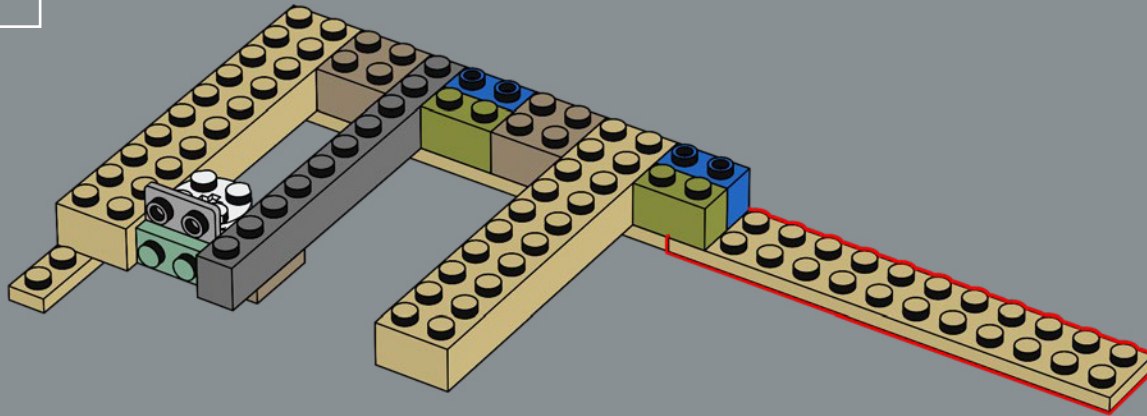

6

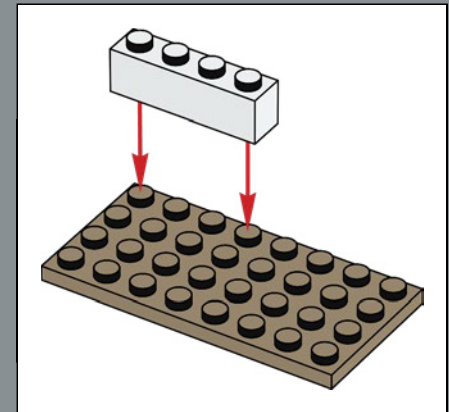
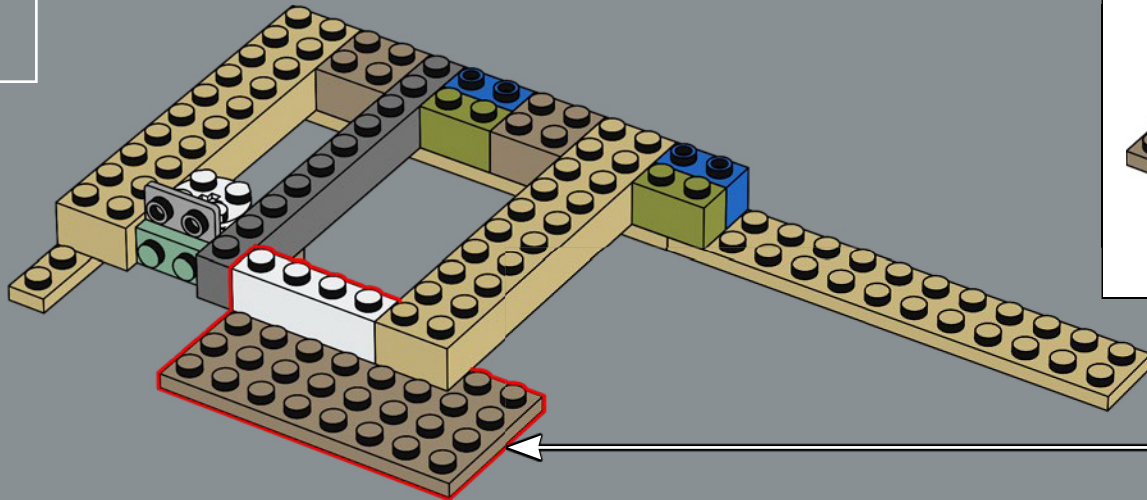

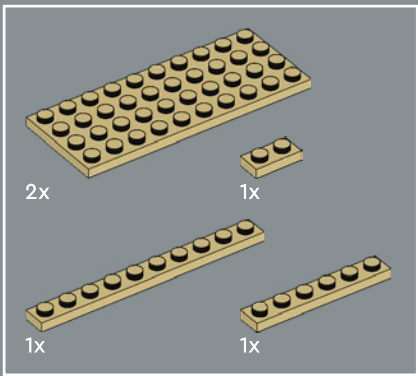

7

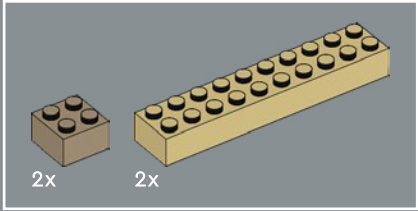
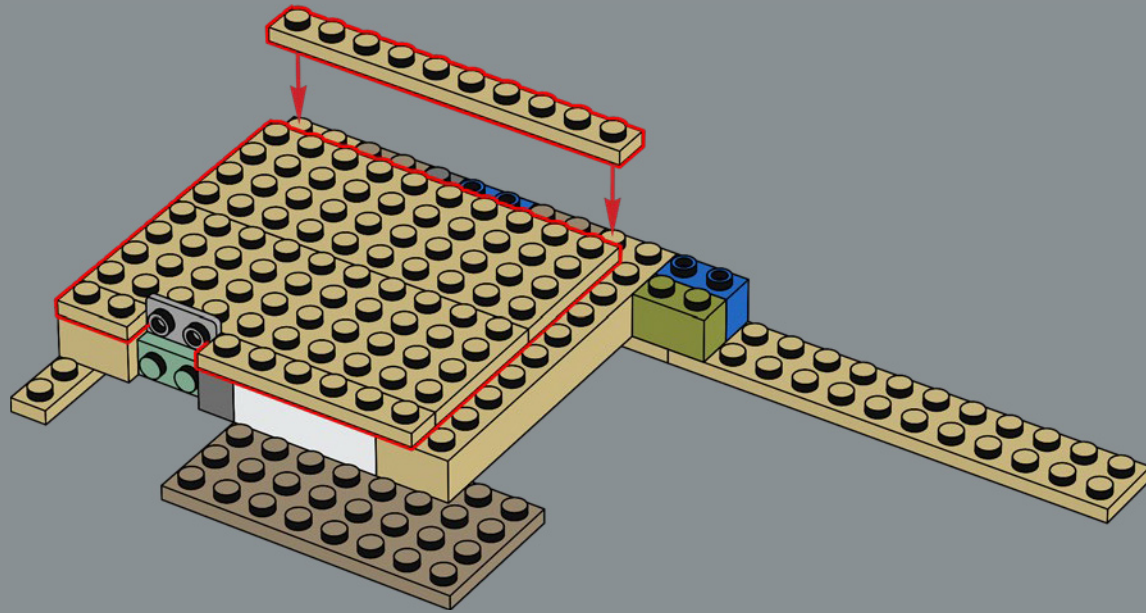

8

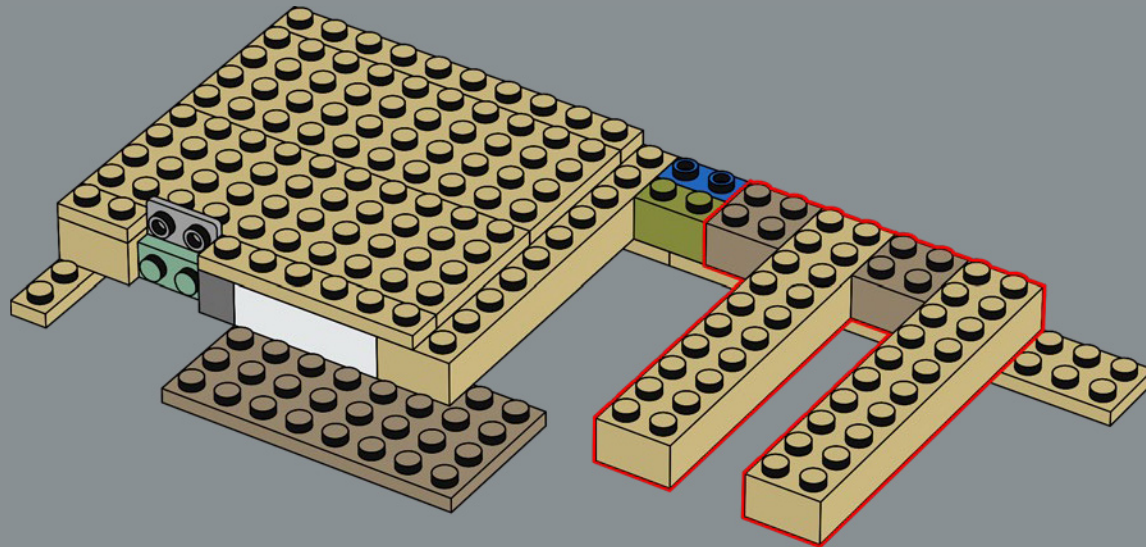



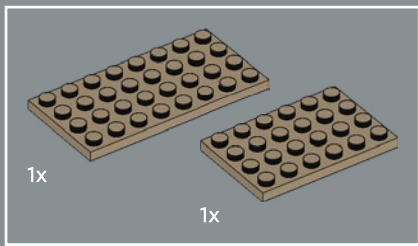

9

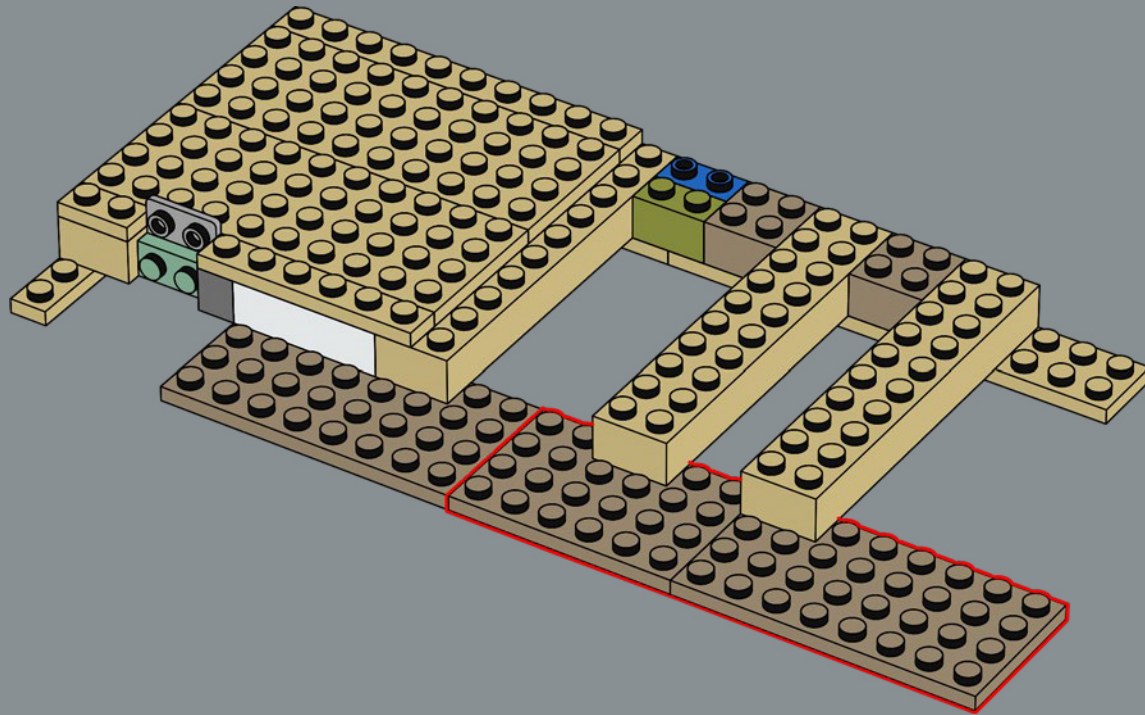

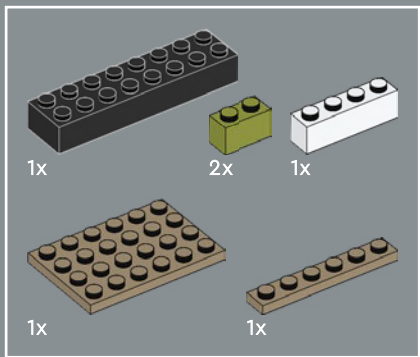

10

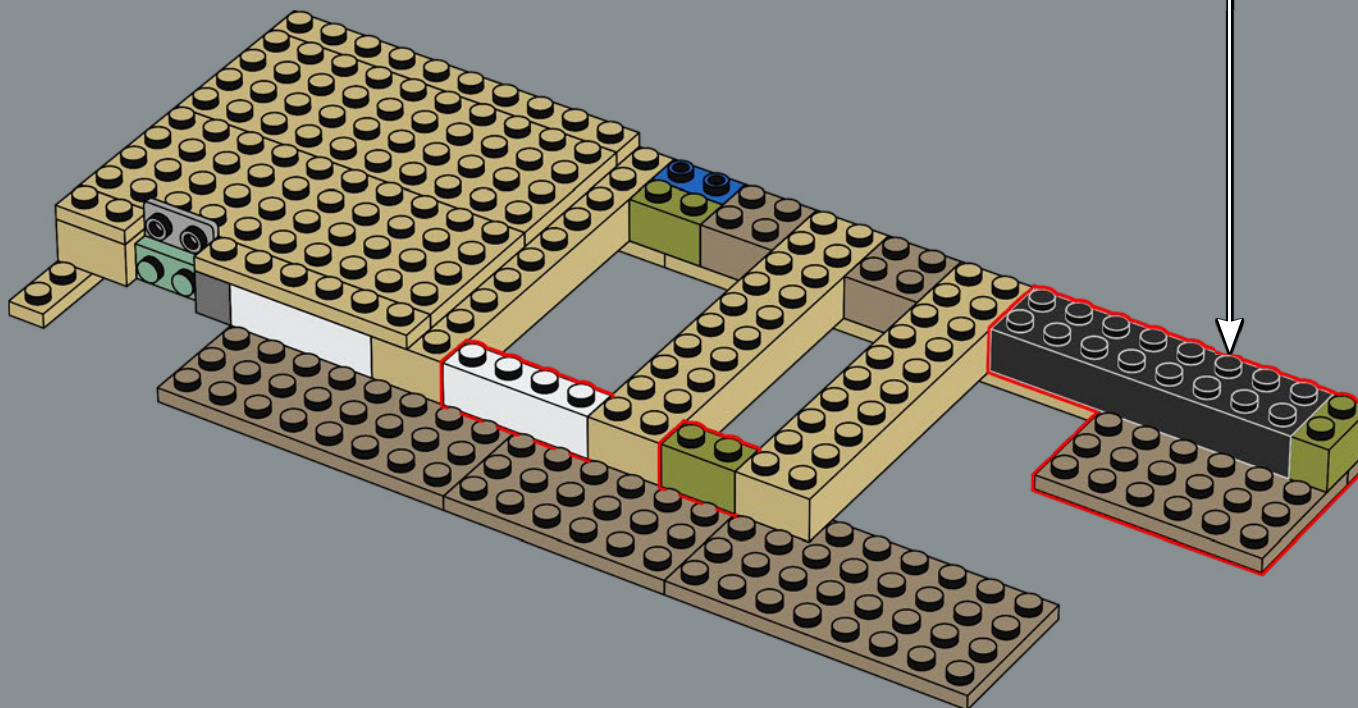
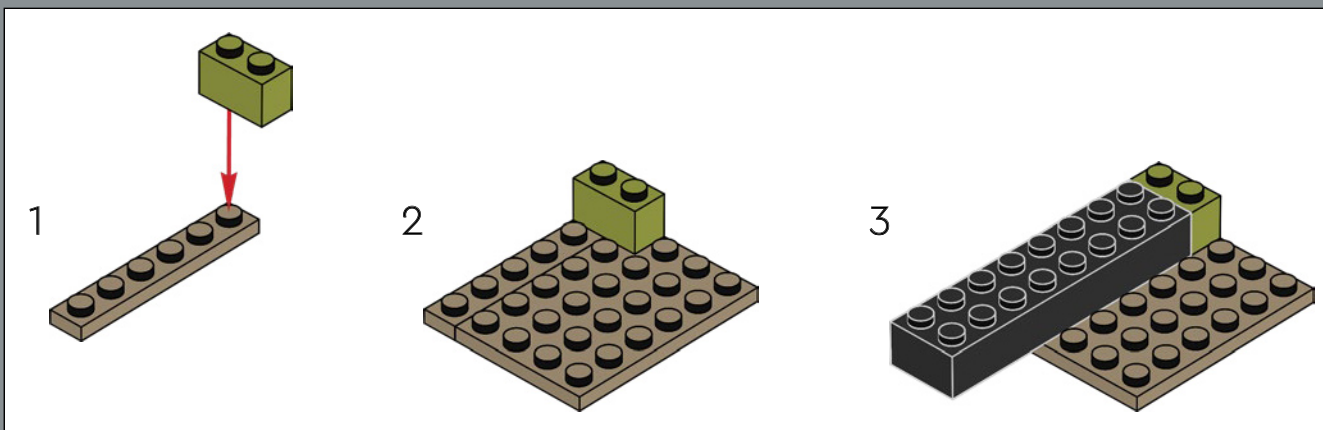

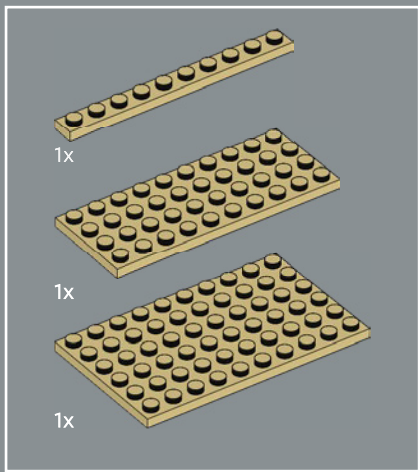

11

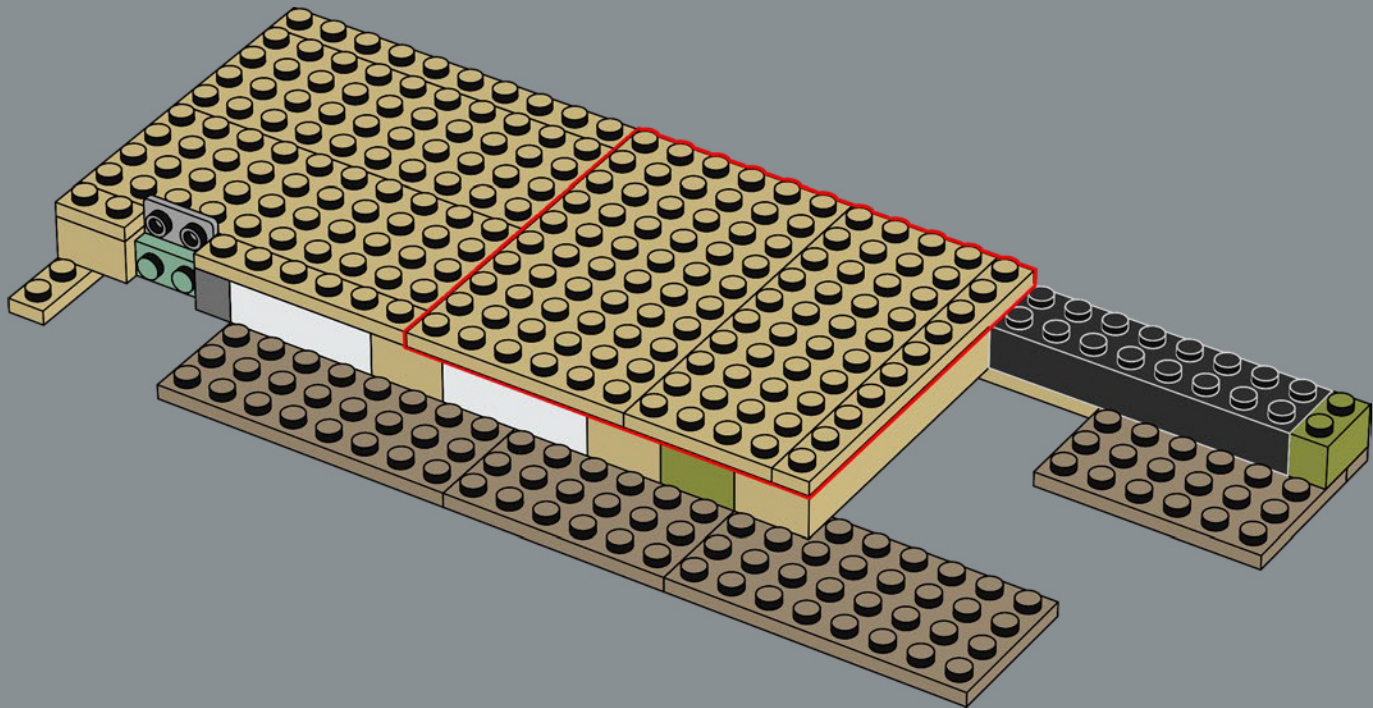

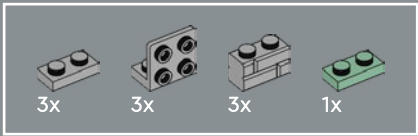

12

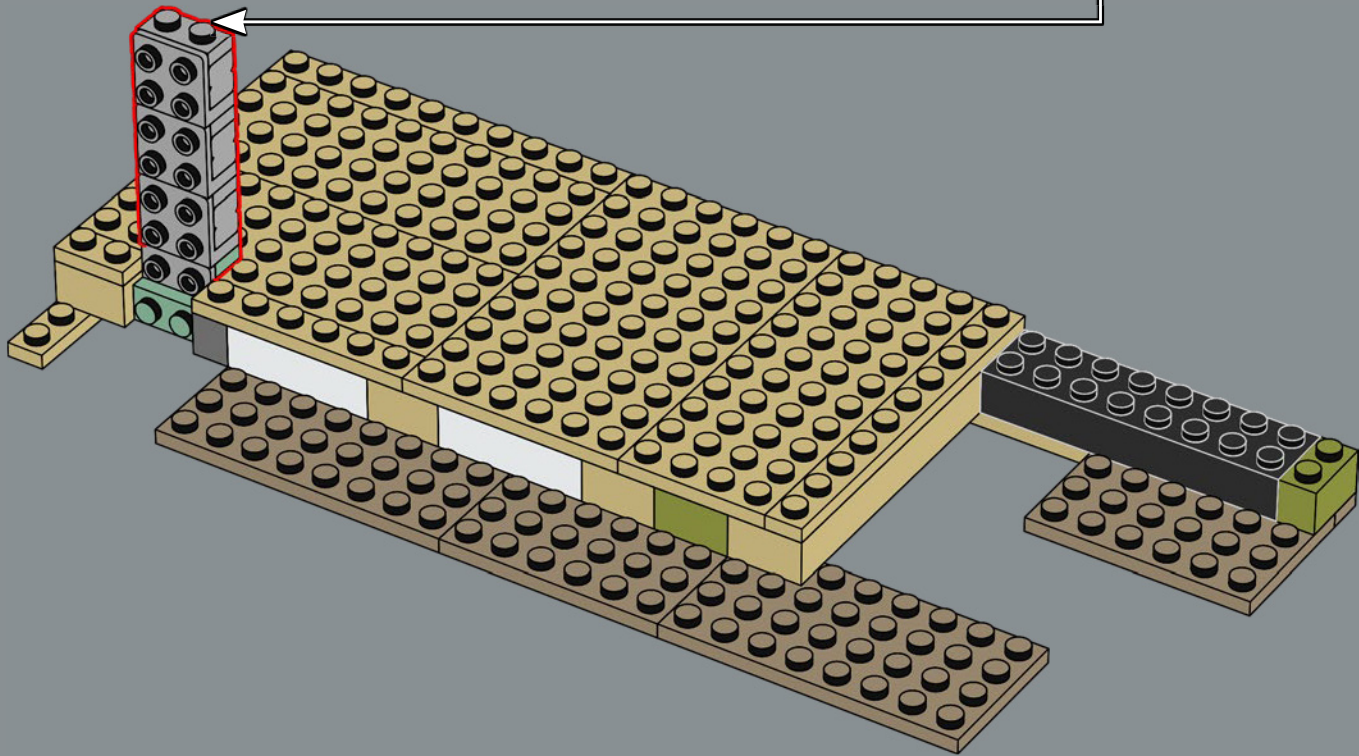
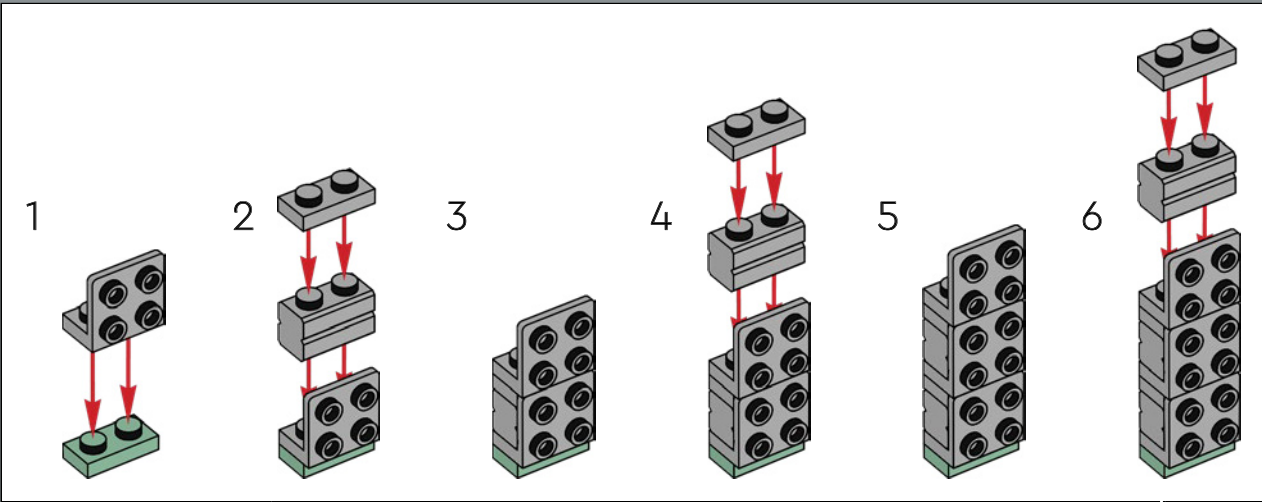

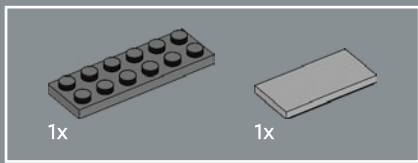

13

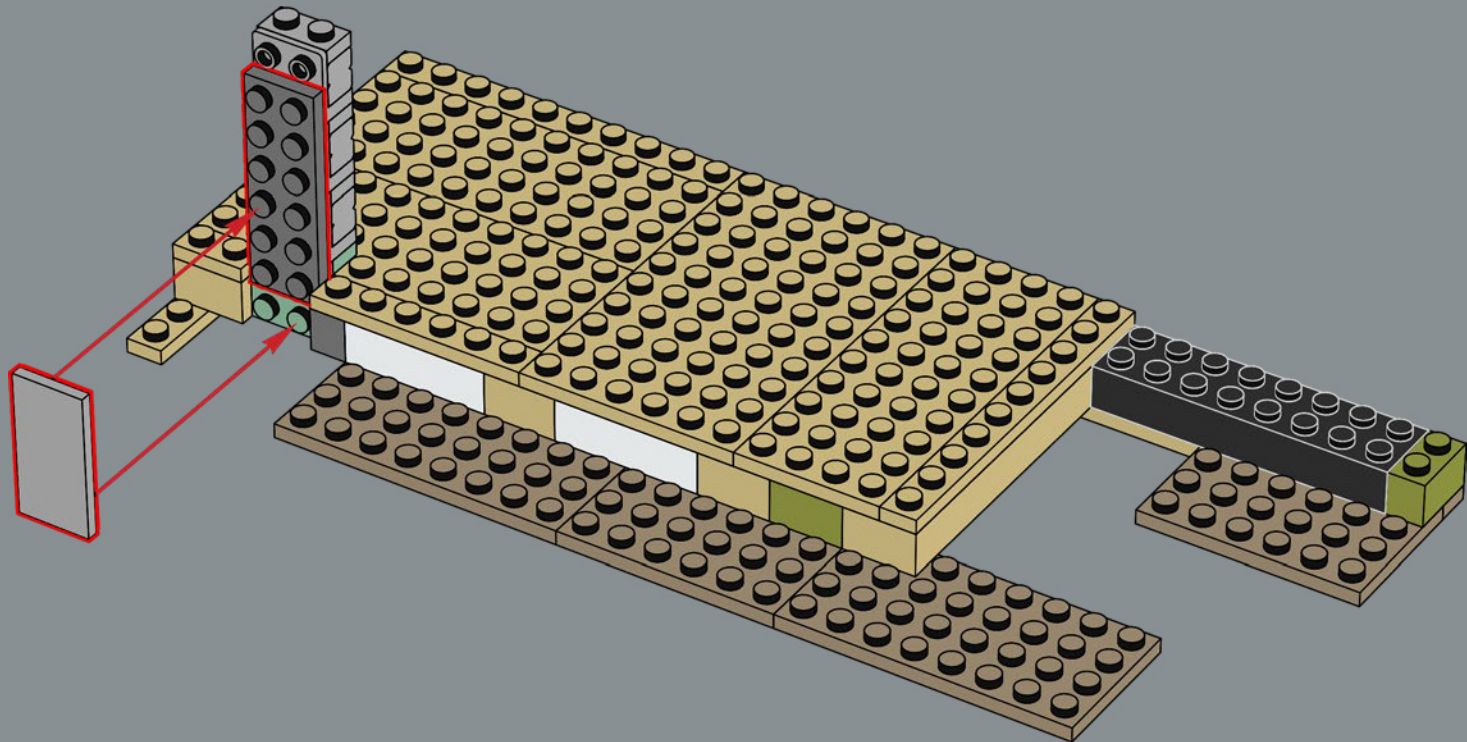

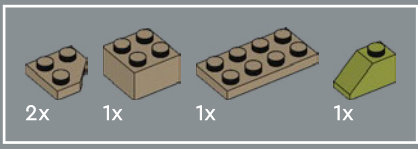

14

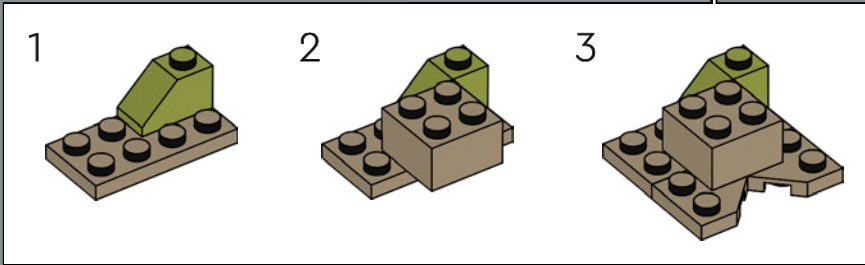
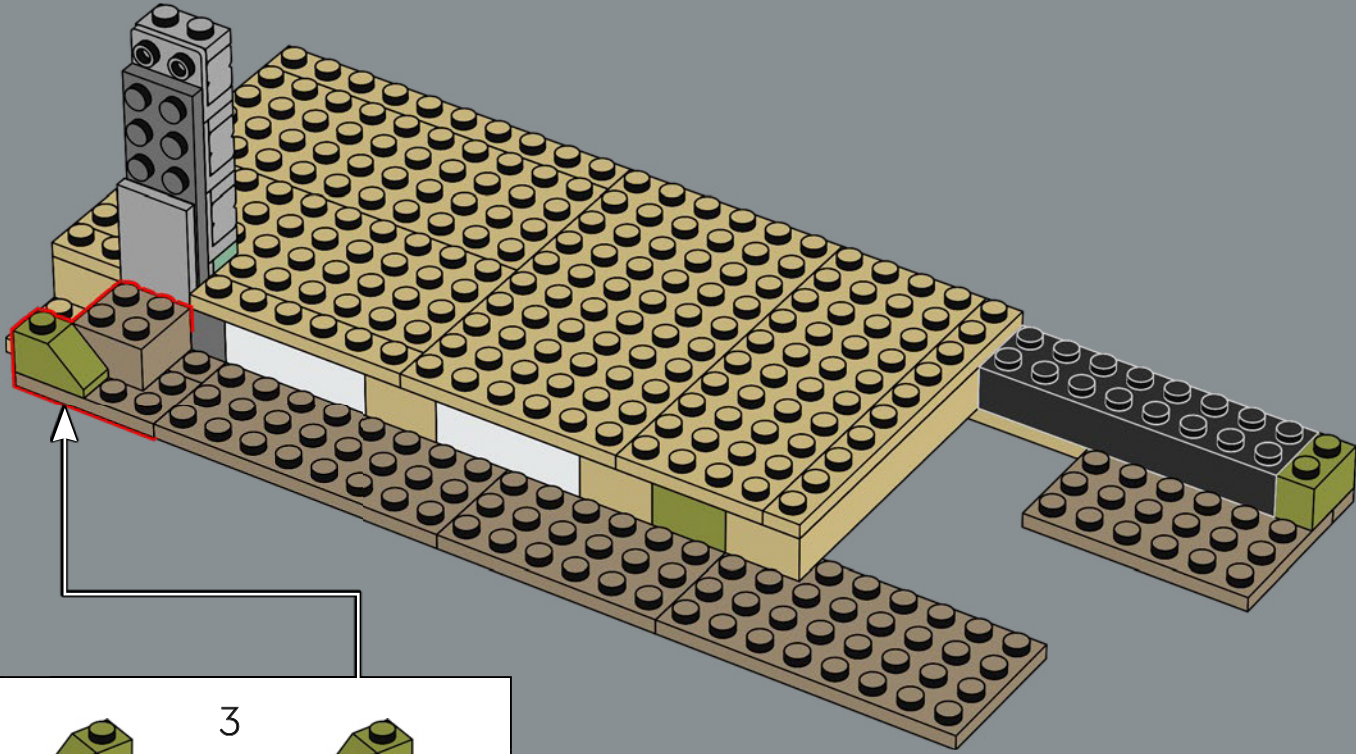



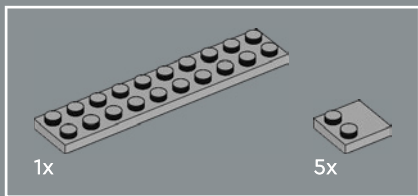

16

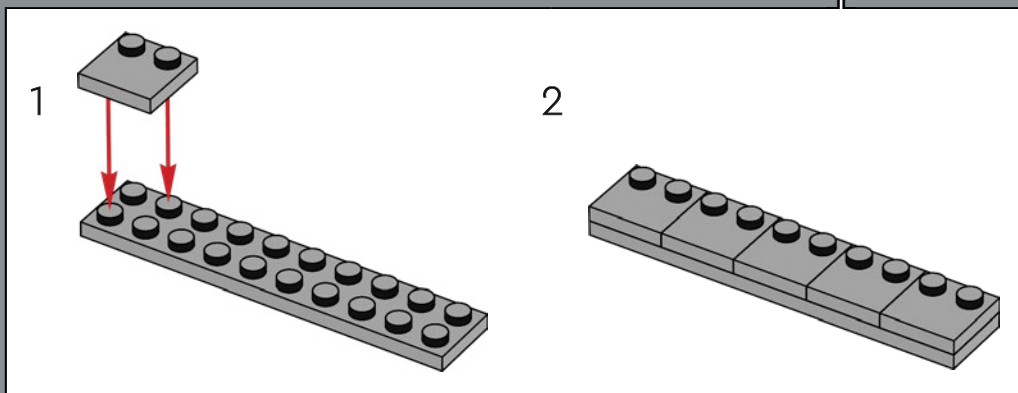
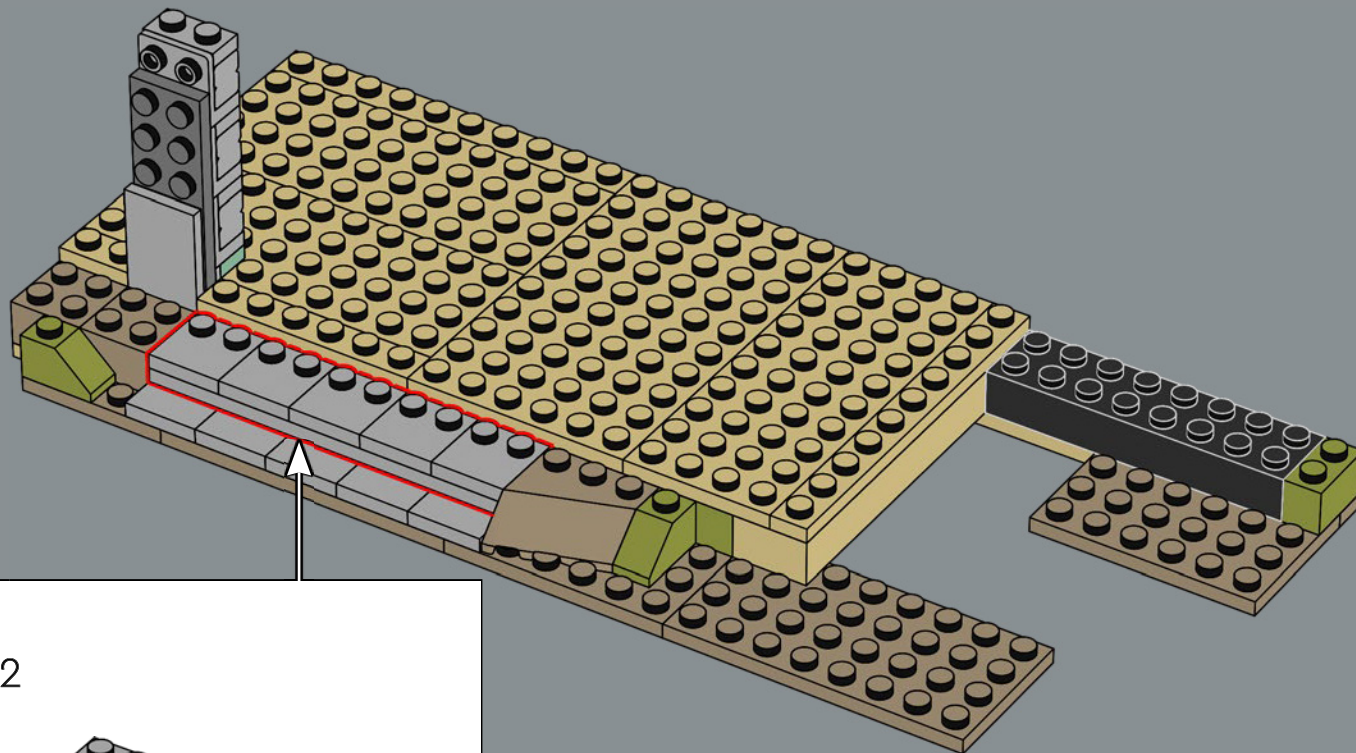



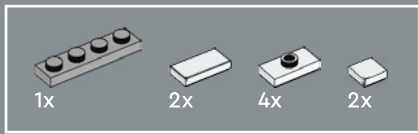

17

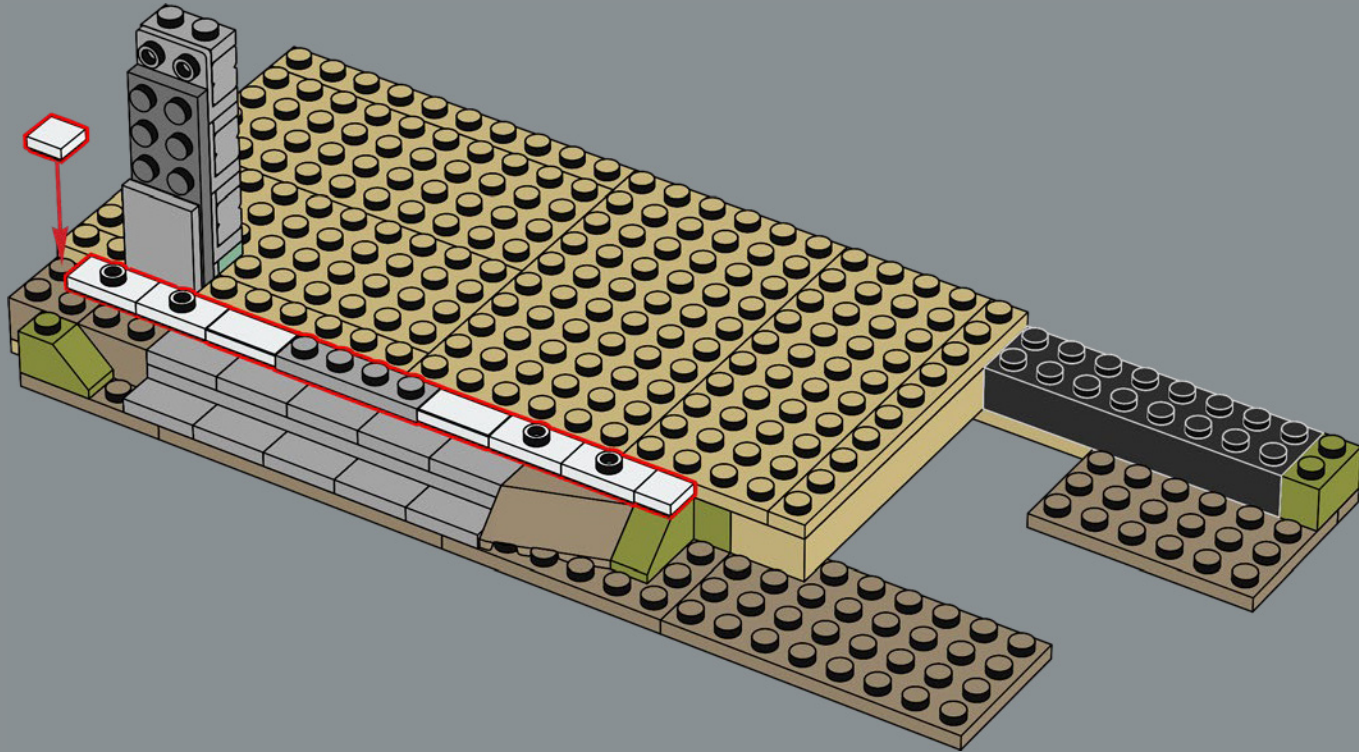

 1x	 2x
--	--

18

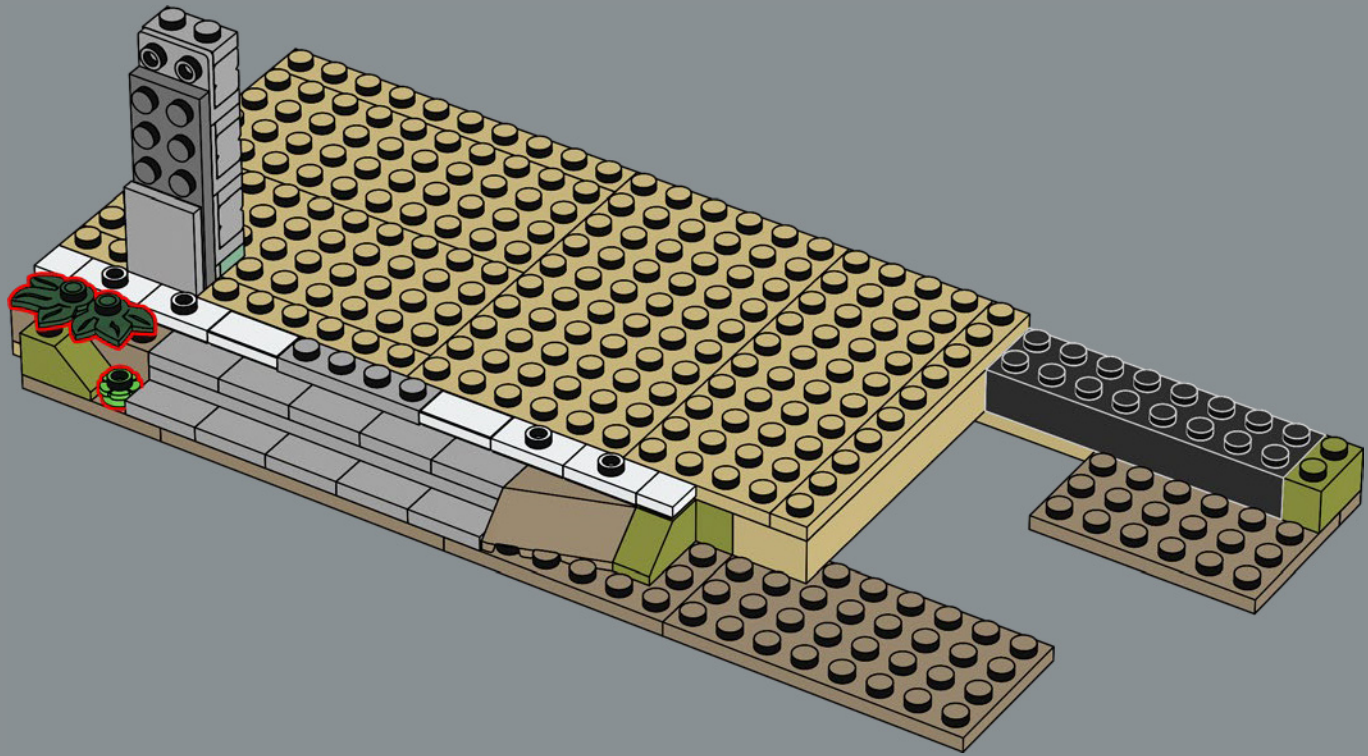

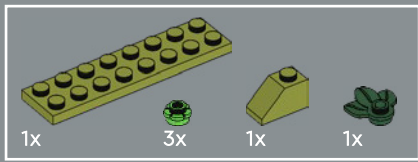

19

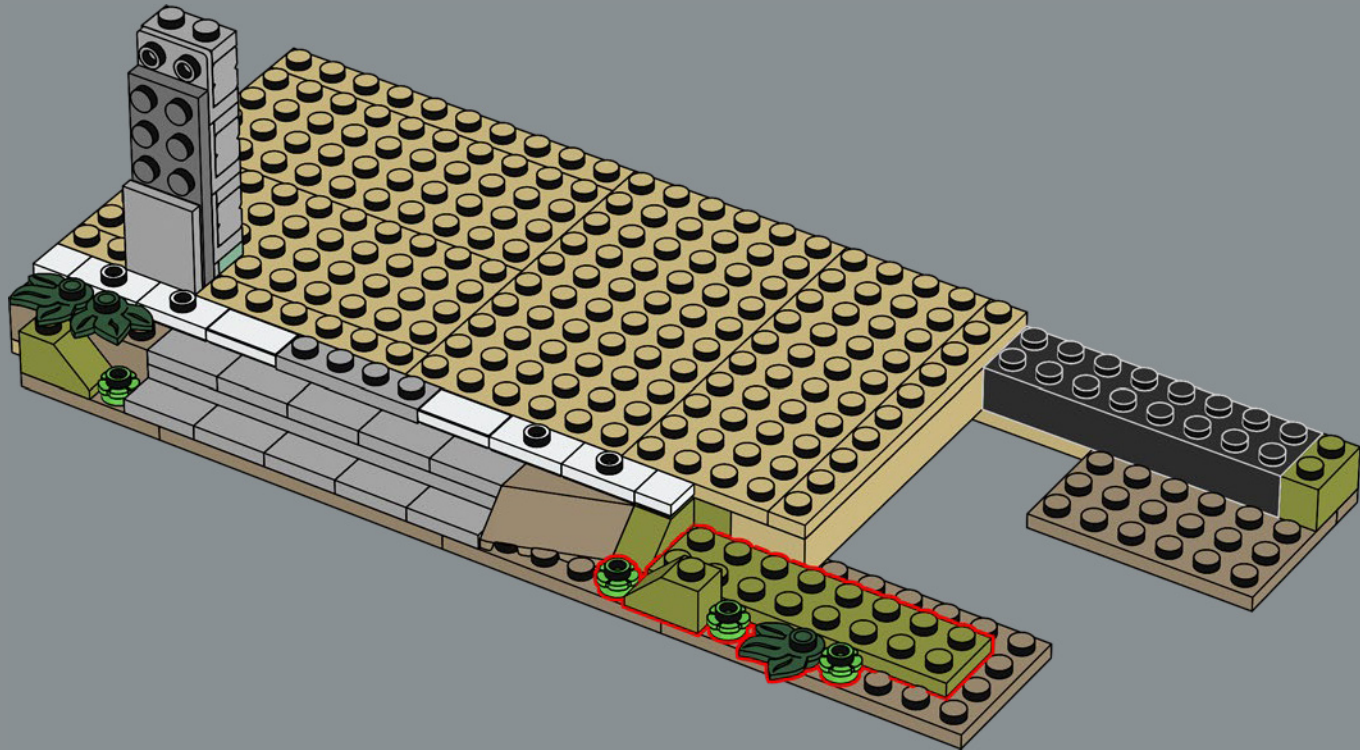

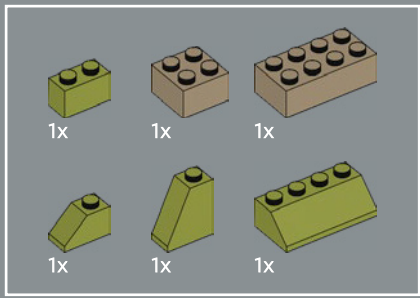

20

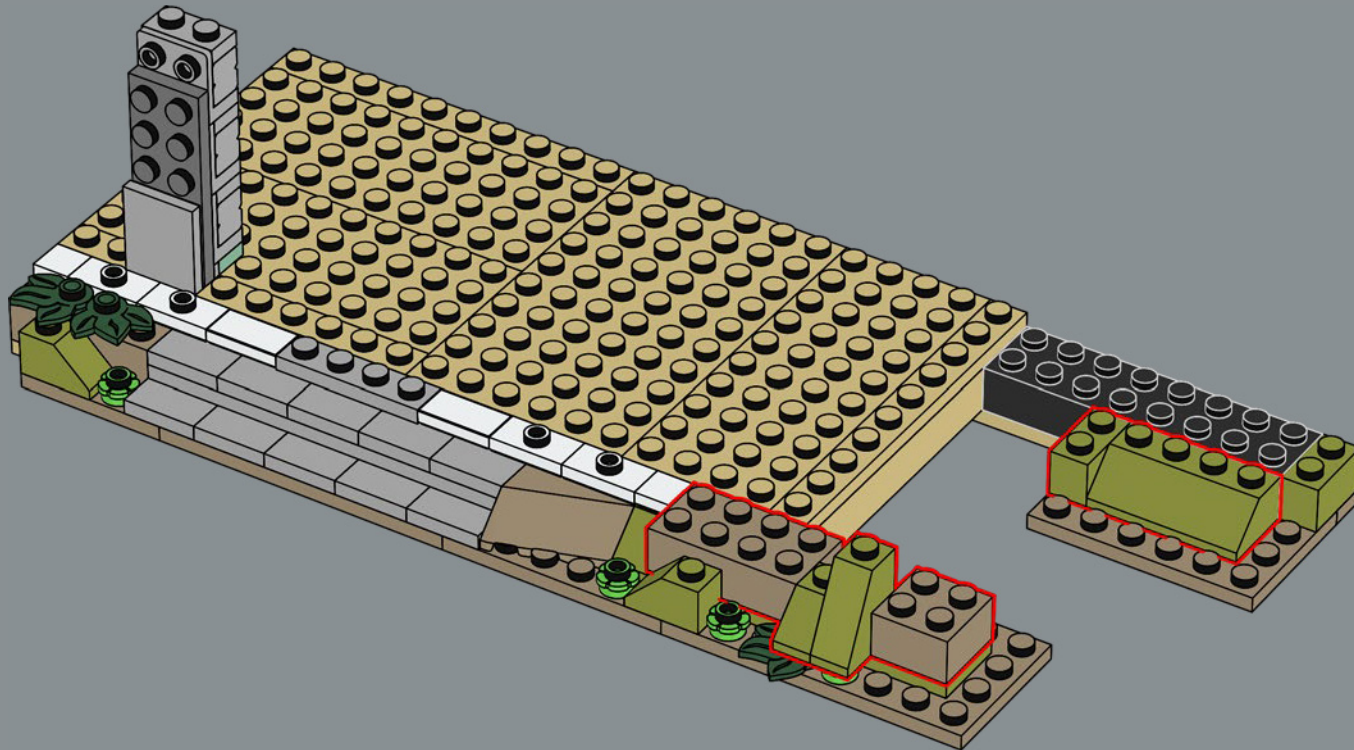

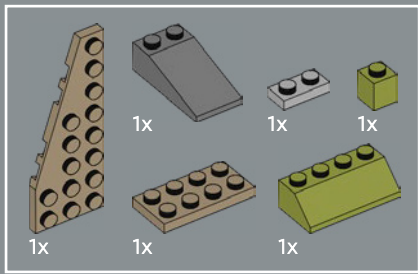

21

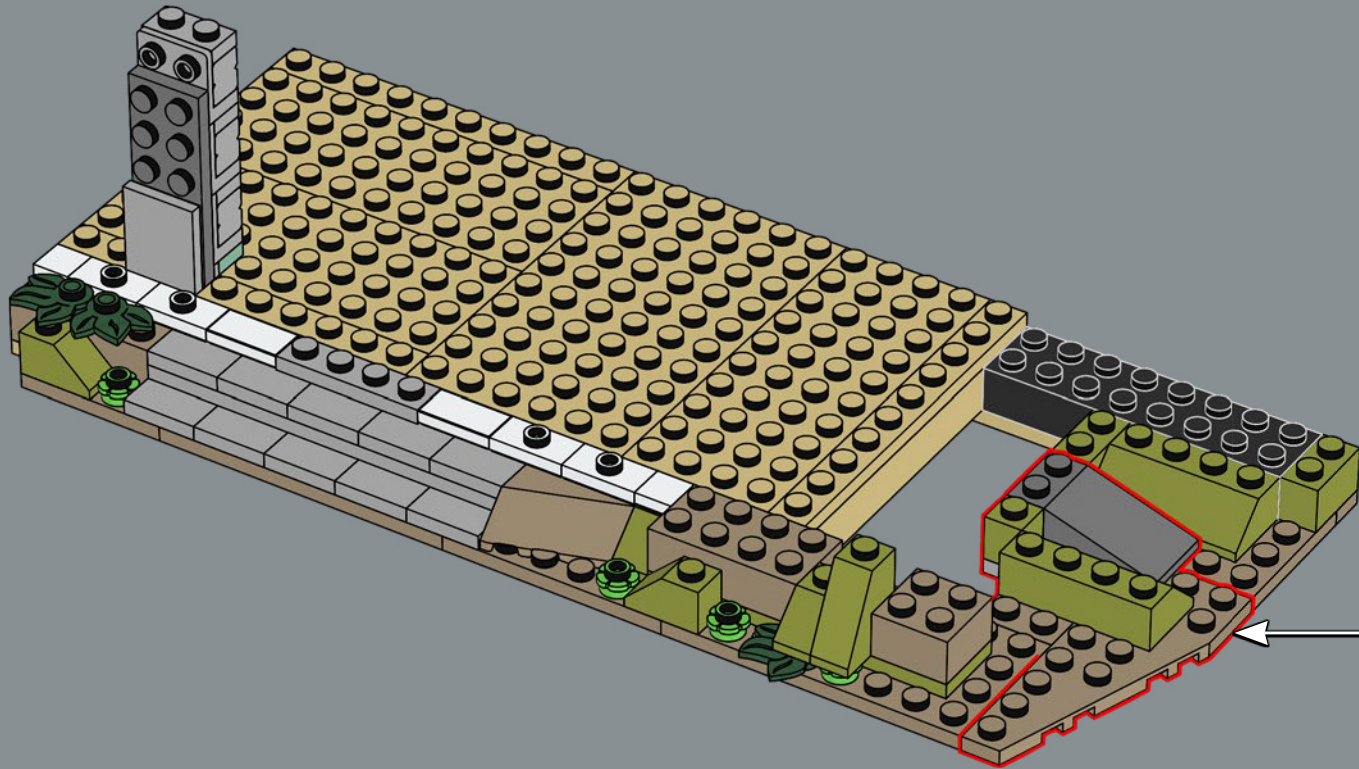
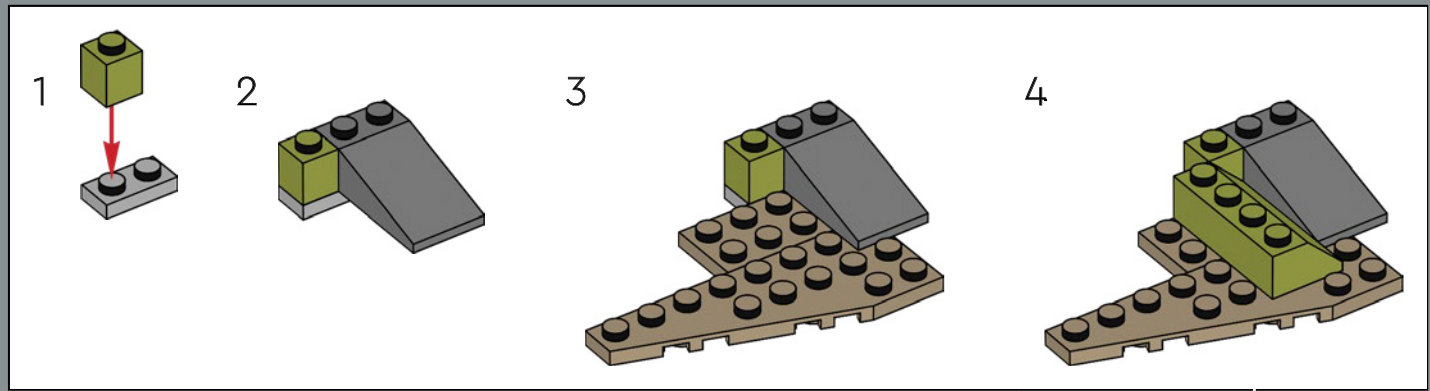

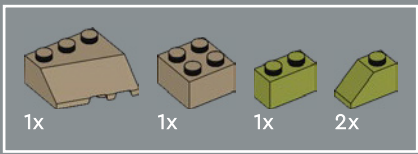

22

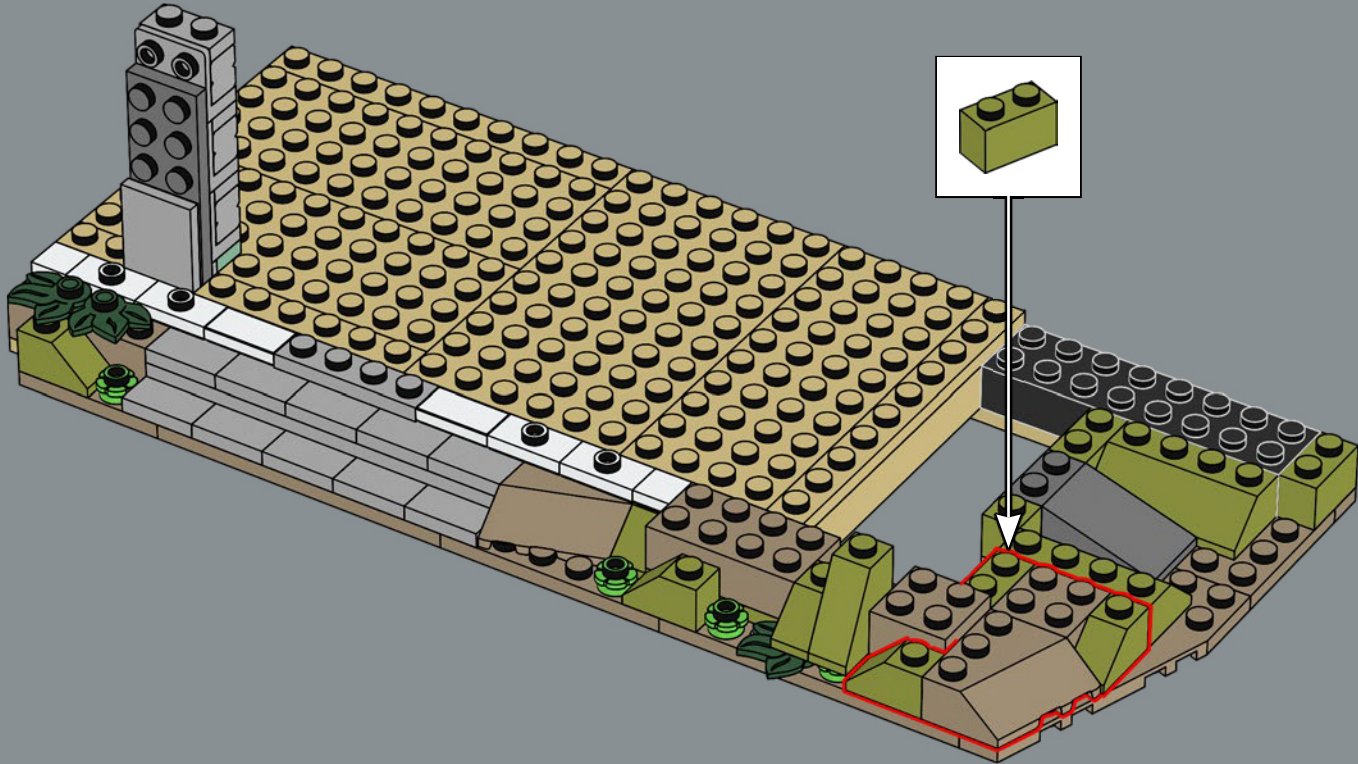

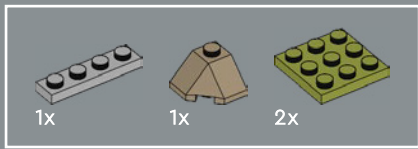

23

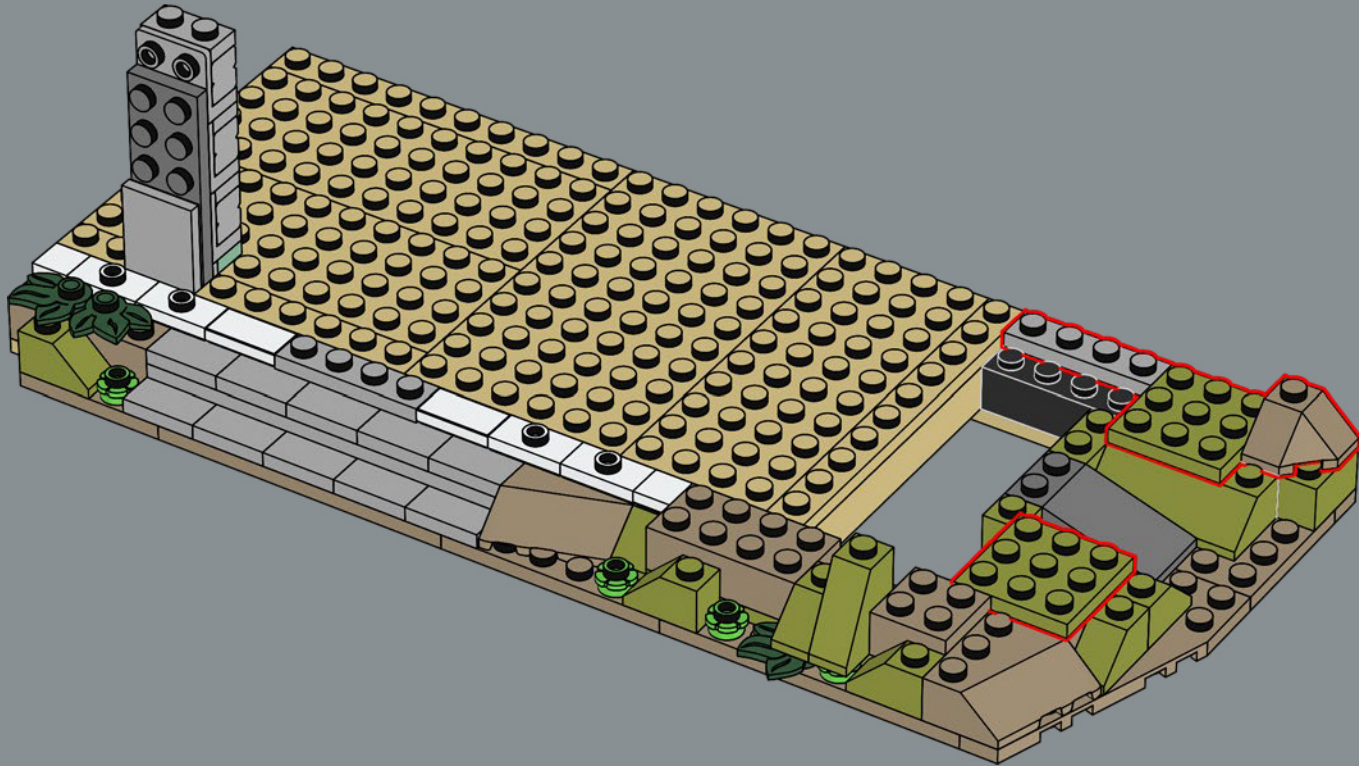

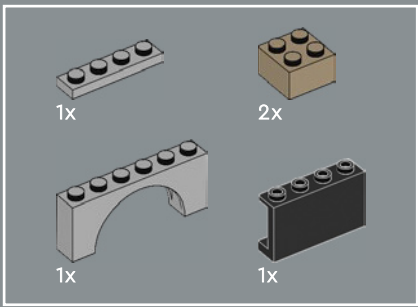

24

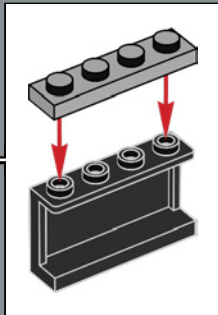
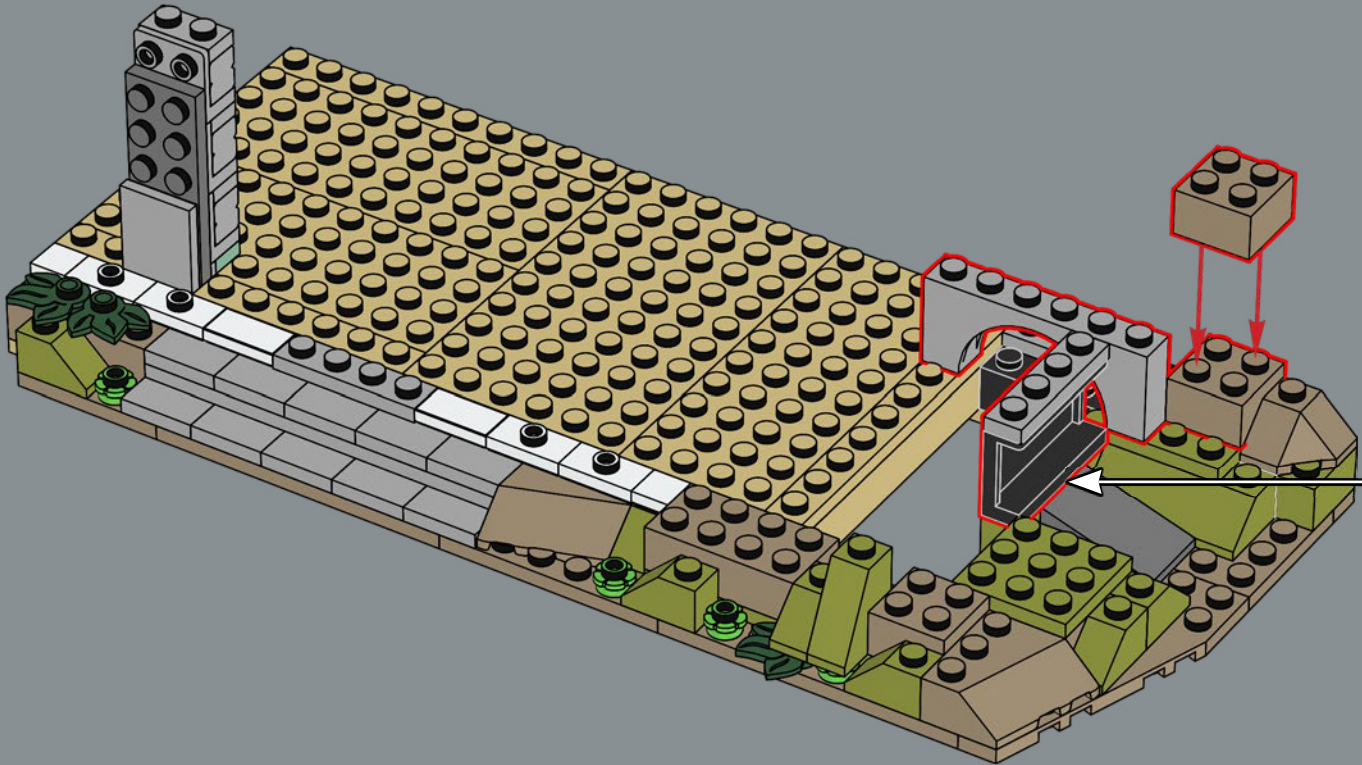



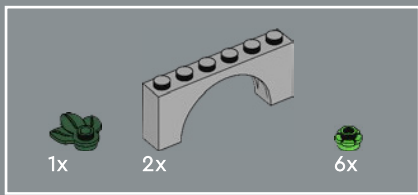

25

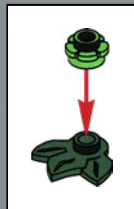
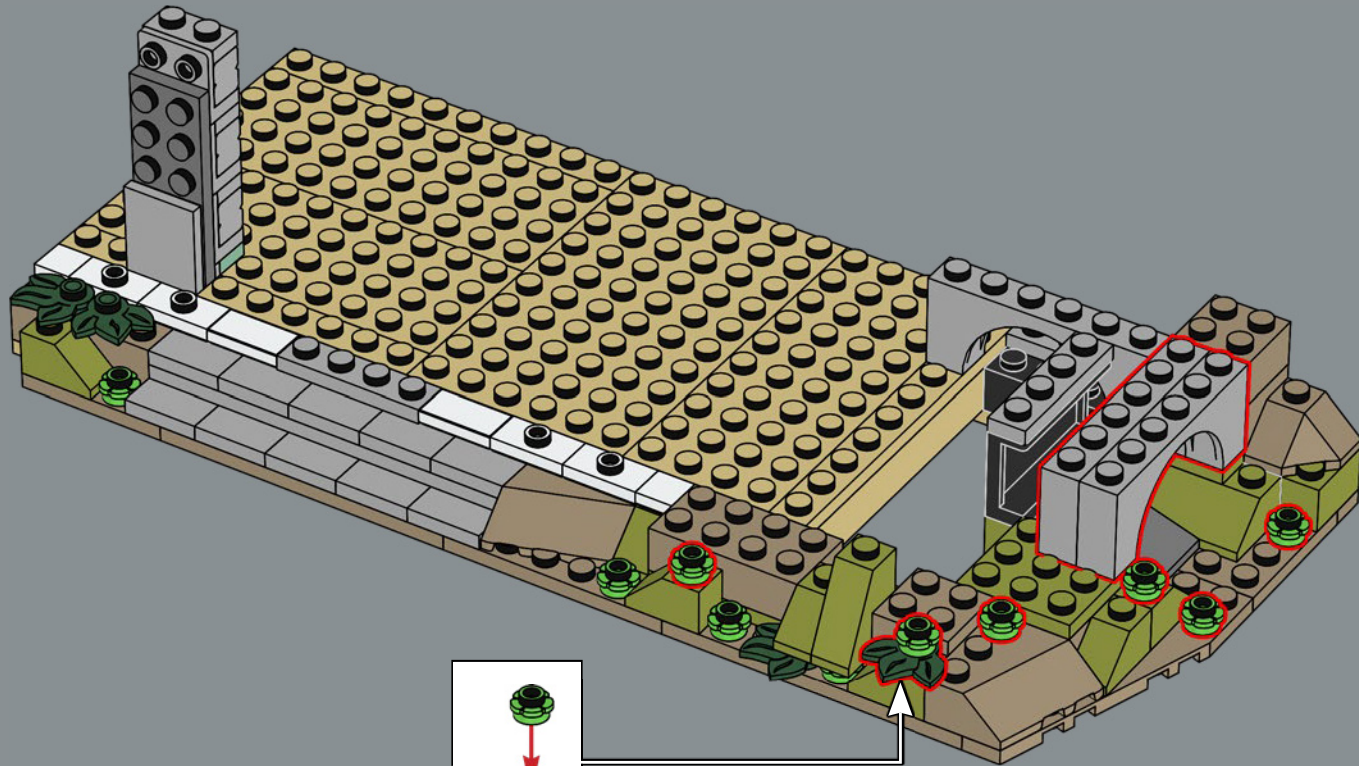

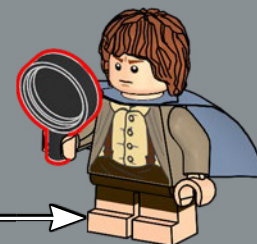
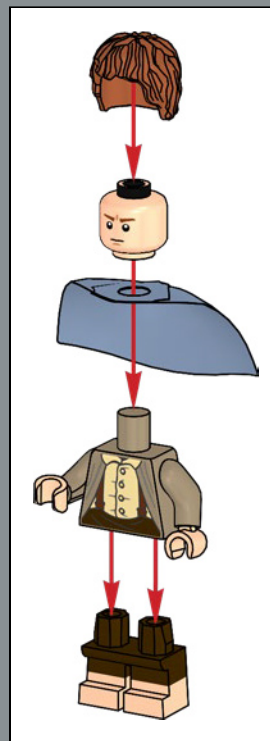
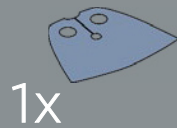
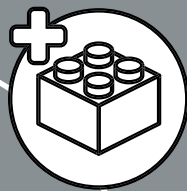

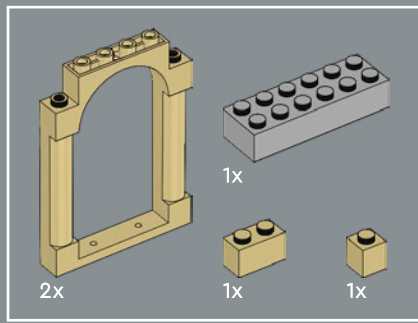

26

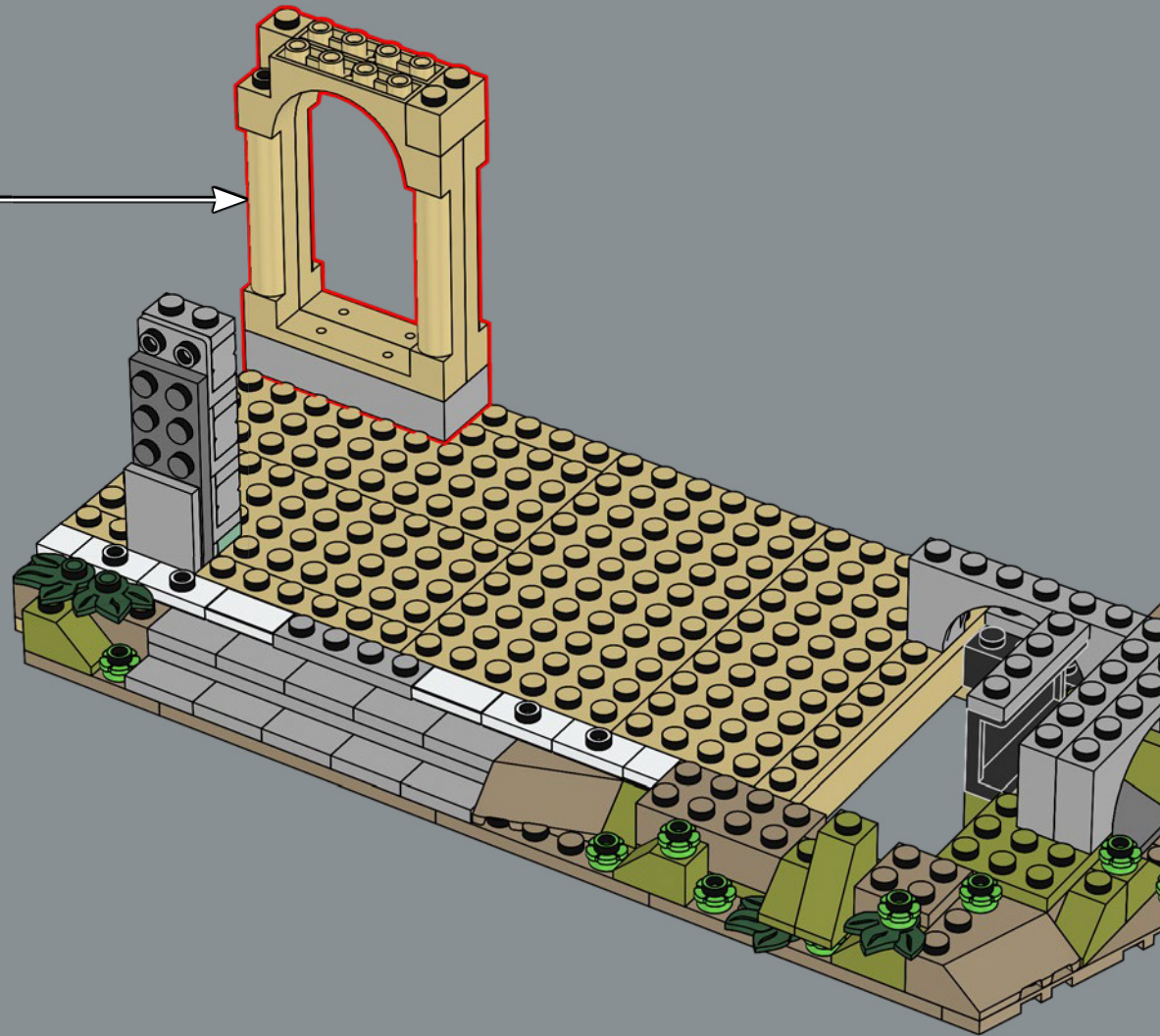
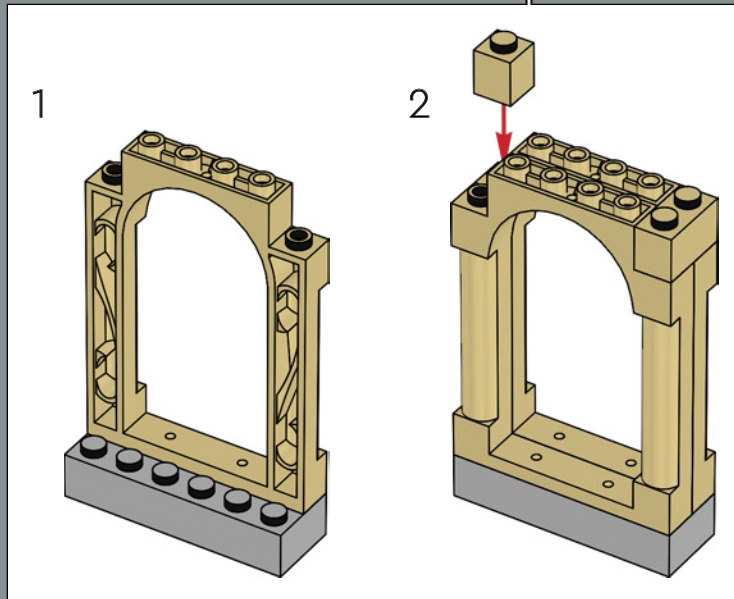

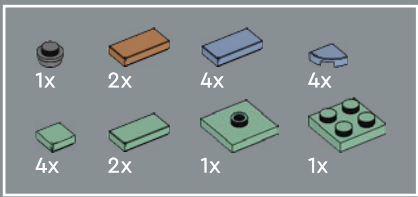

27

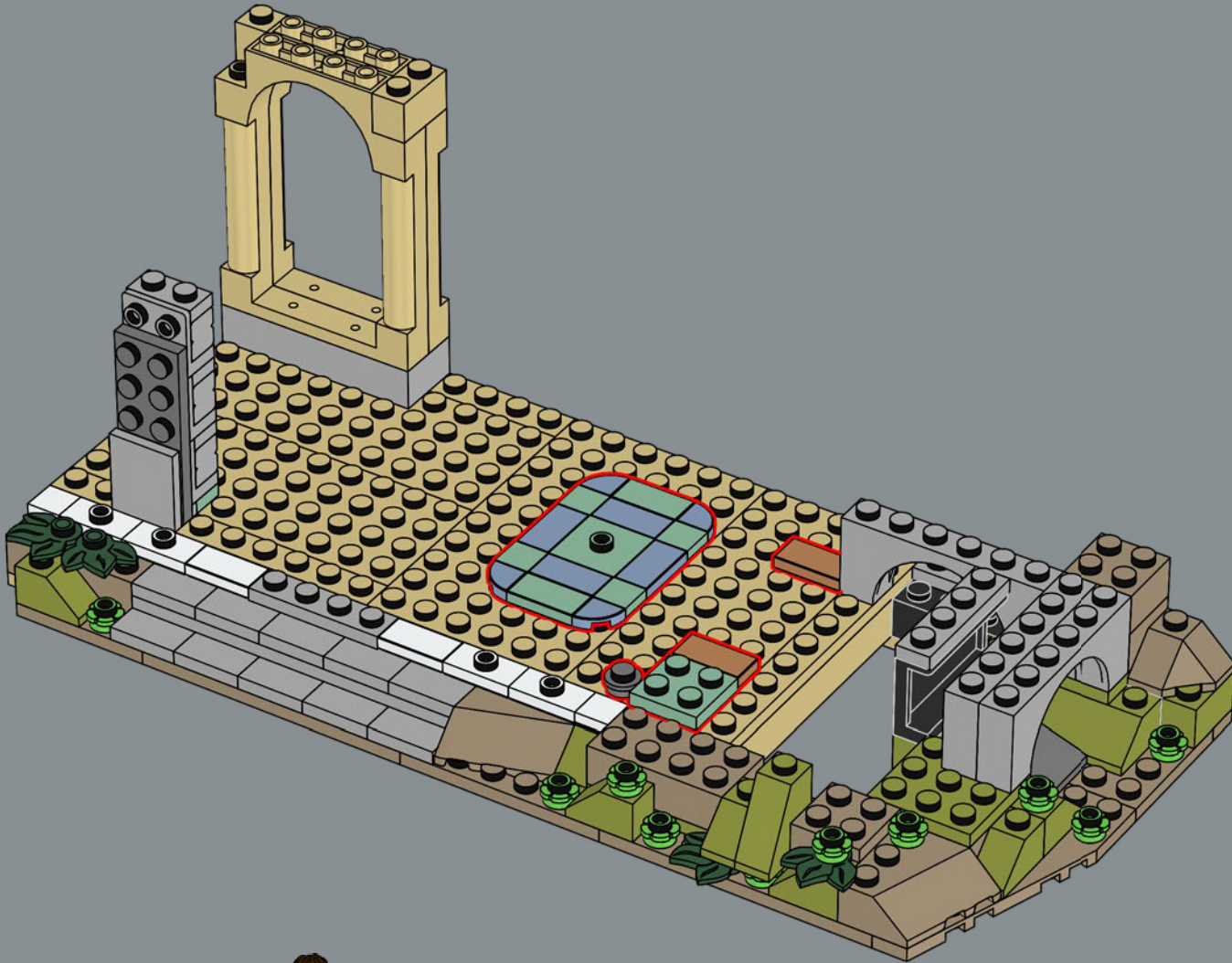

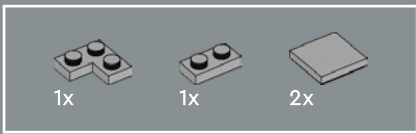

28

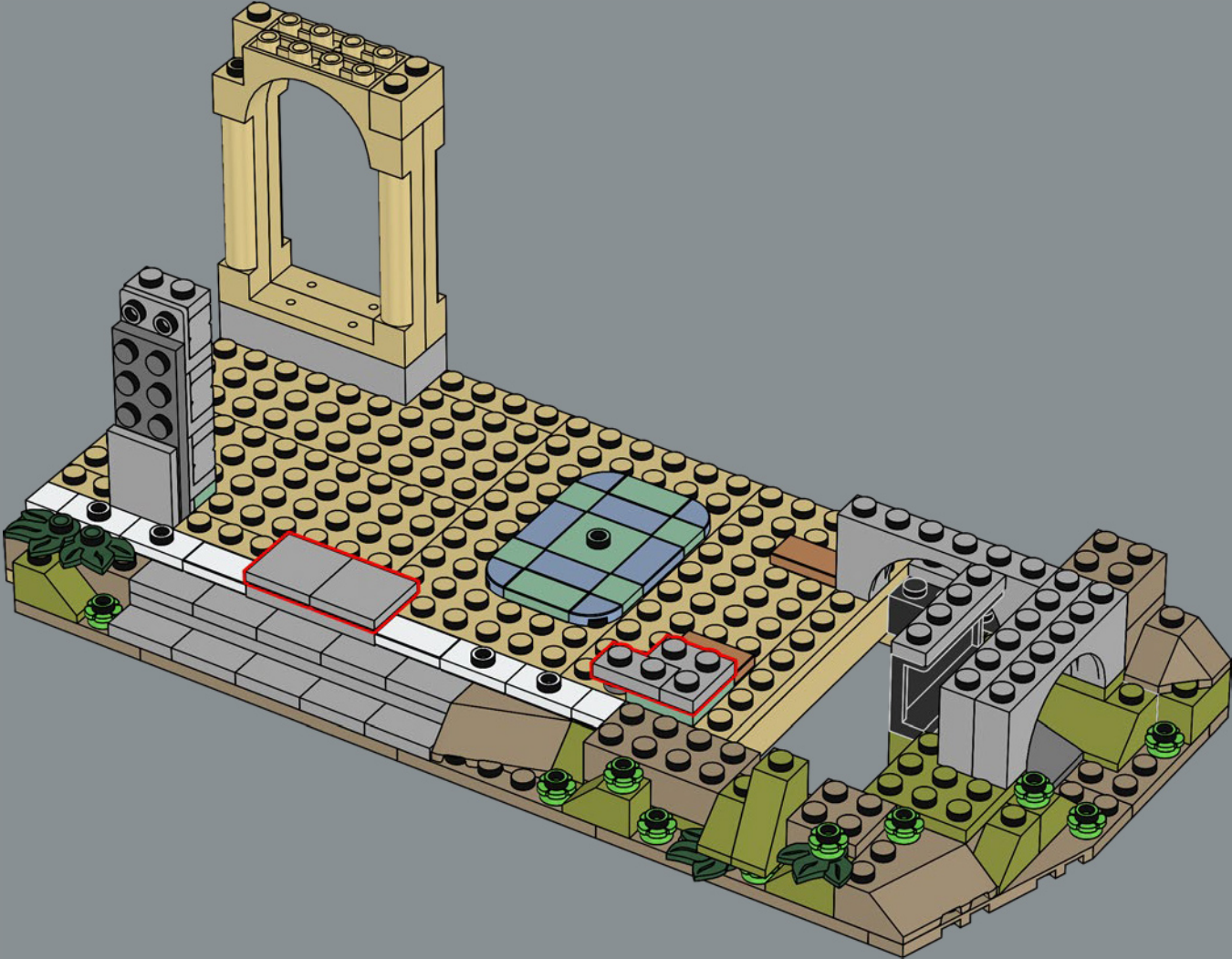



2x

29

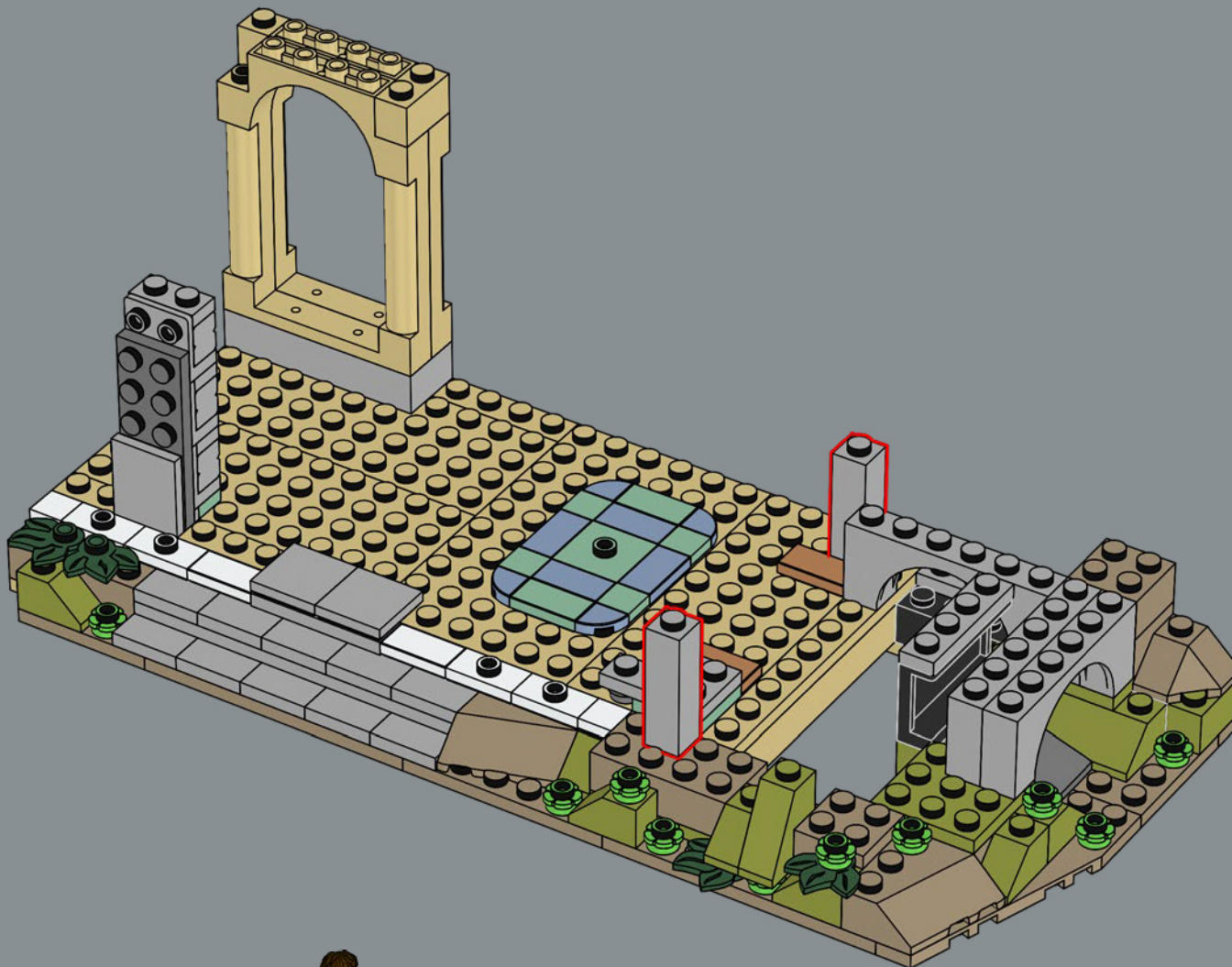



蕨类植物组件是 2023 年推出的新设计。  
这是第一次在此模型中出现, 共包含 34 块同种组件!

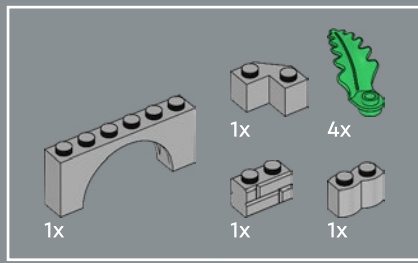

30

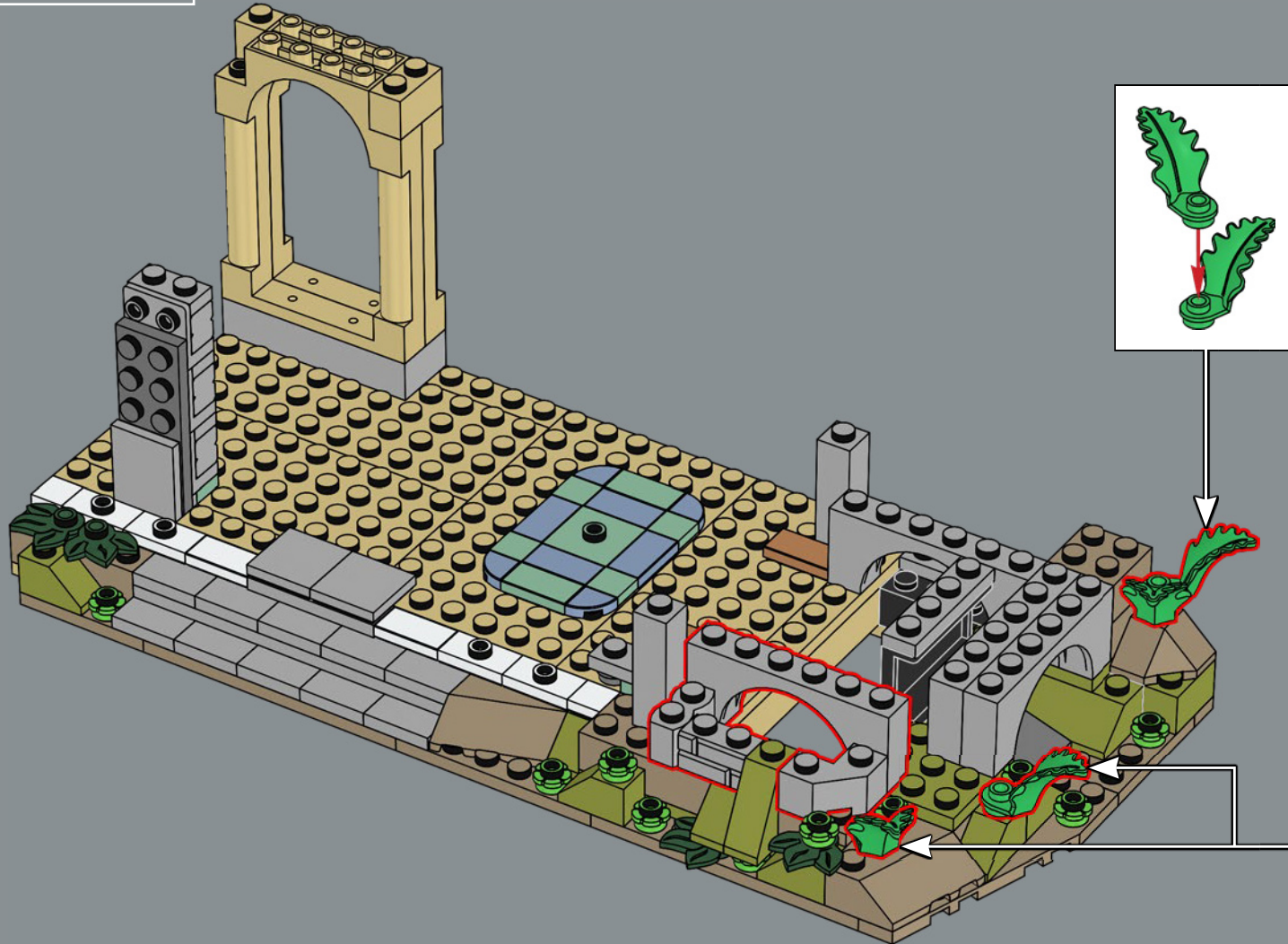

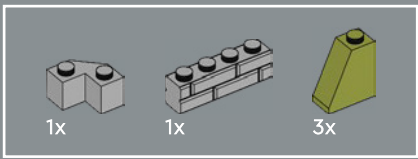

31

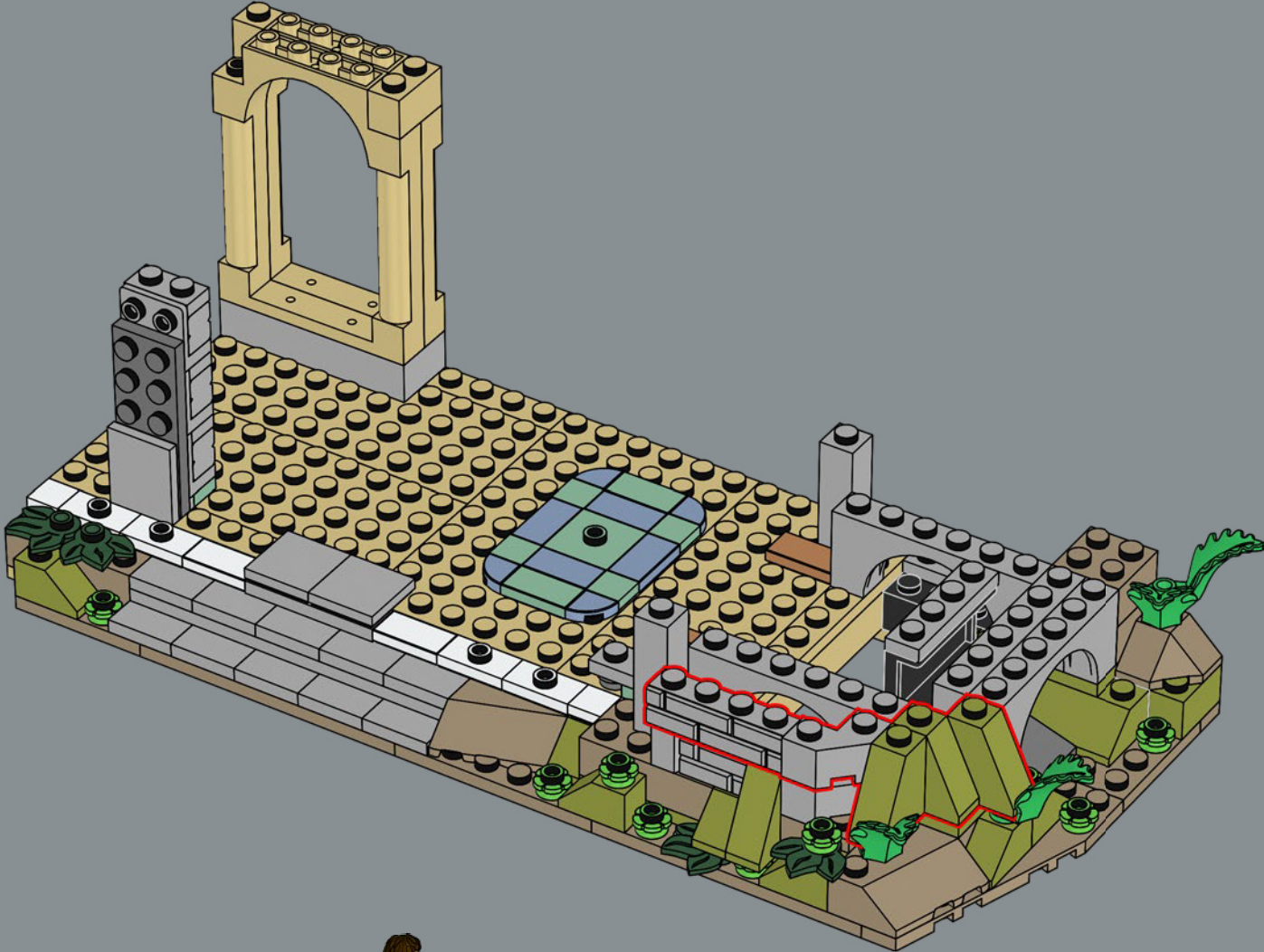



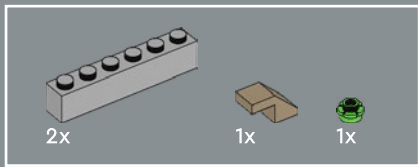

32

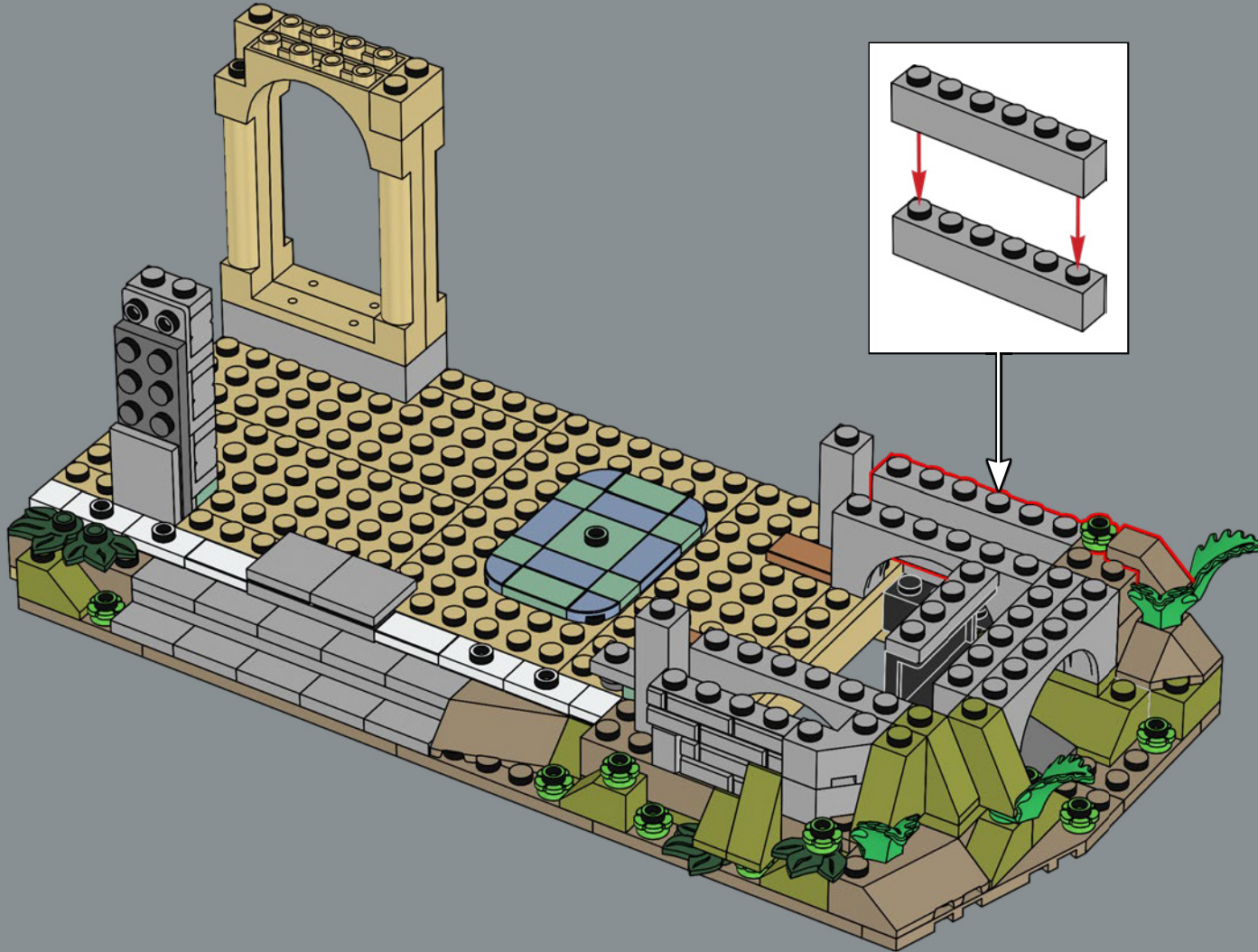

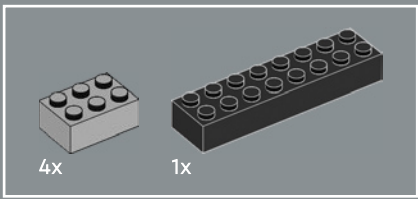

33

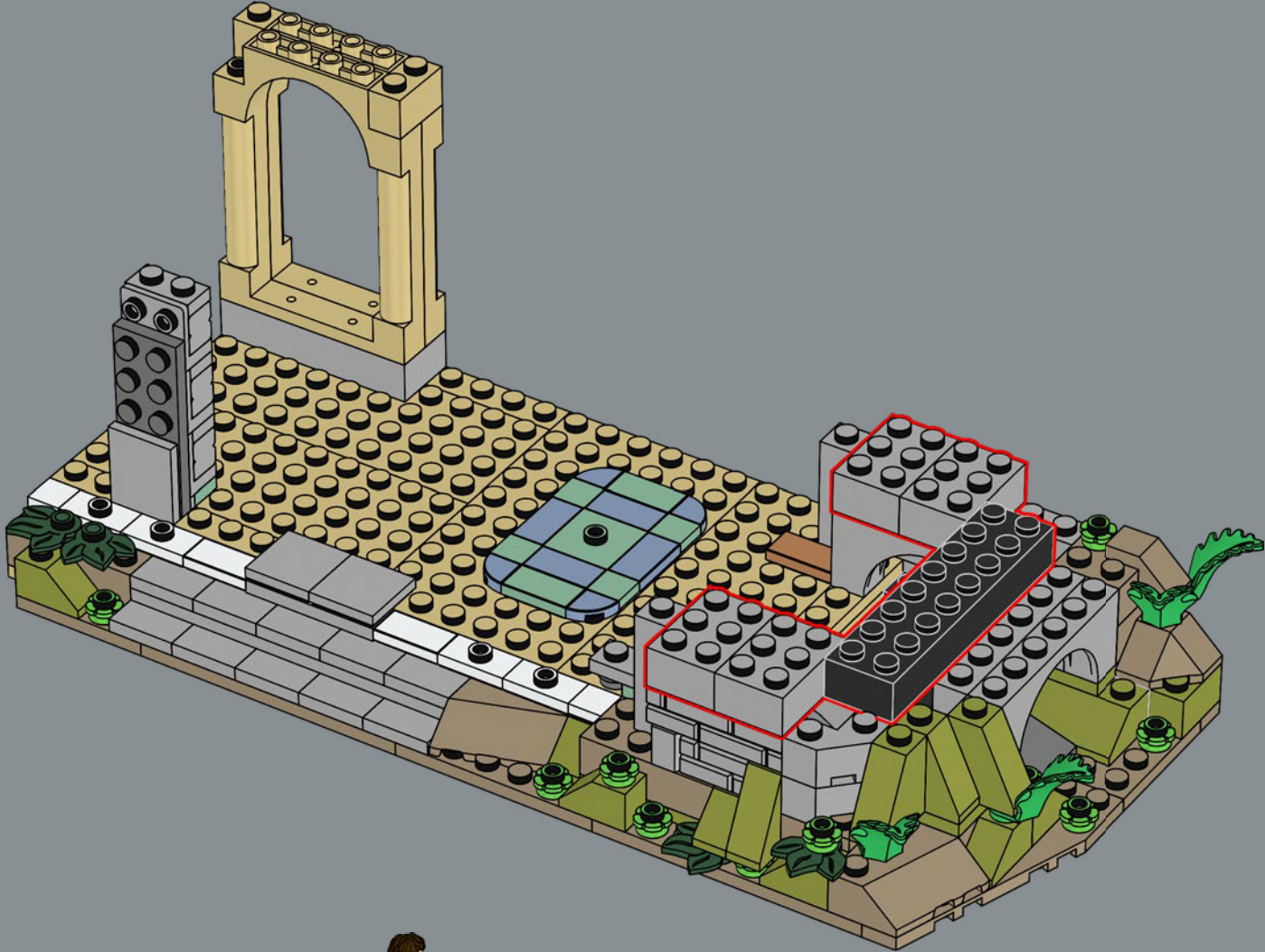

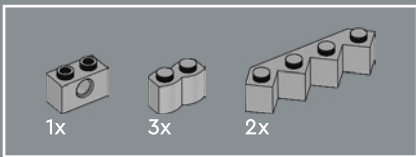

34

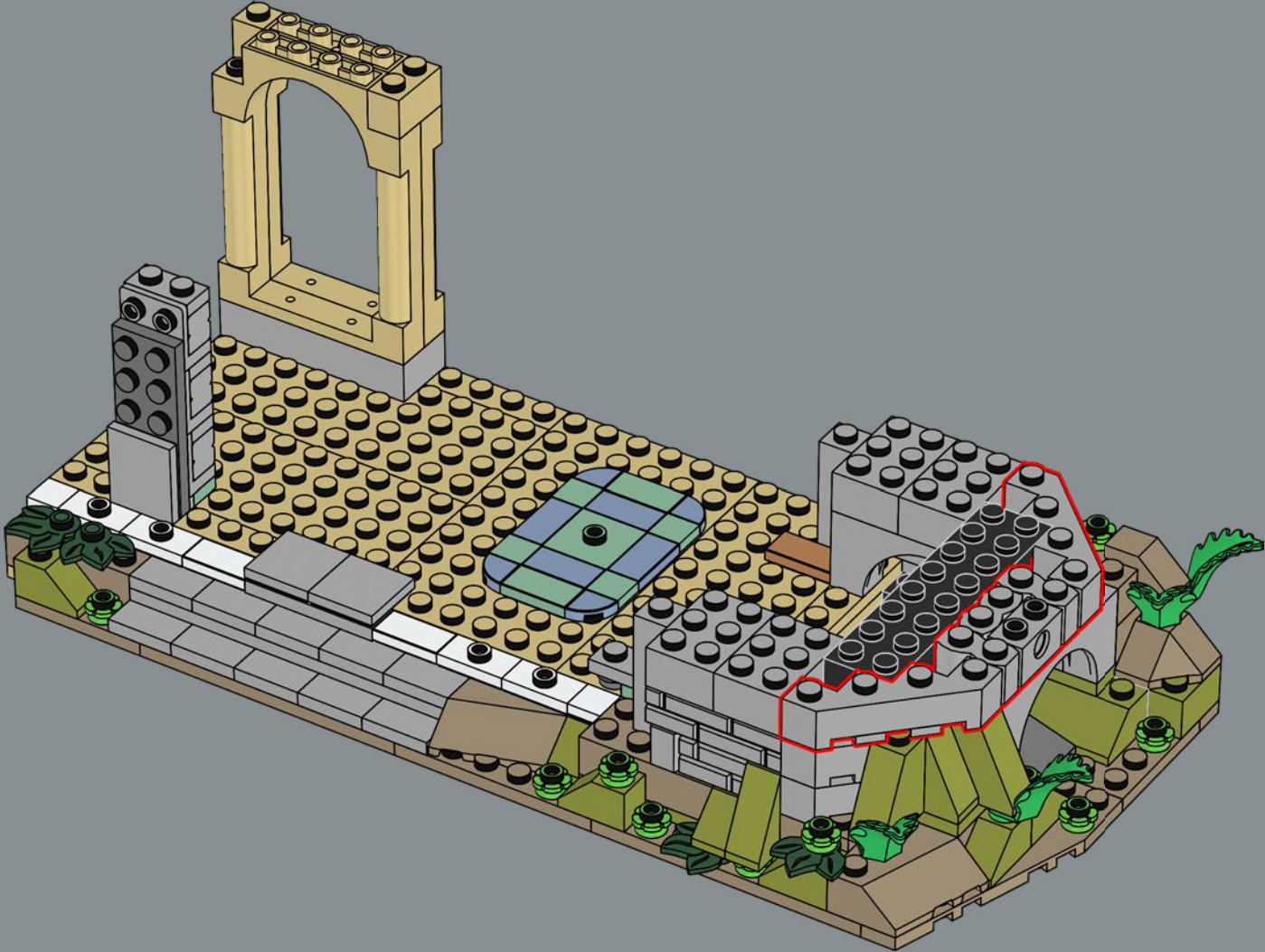

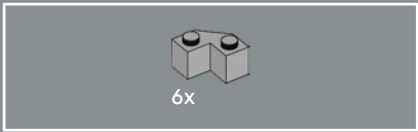

35

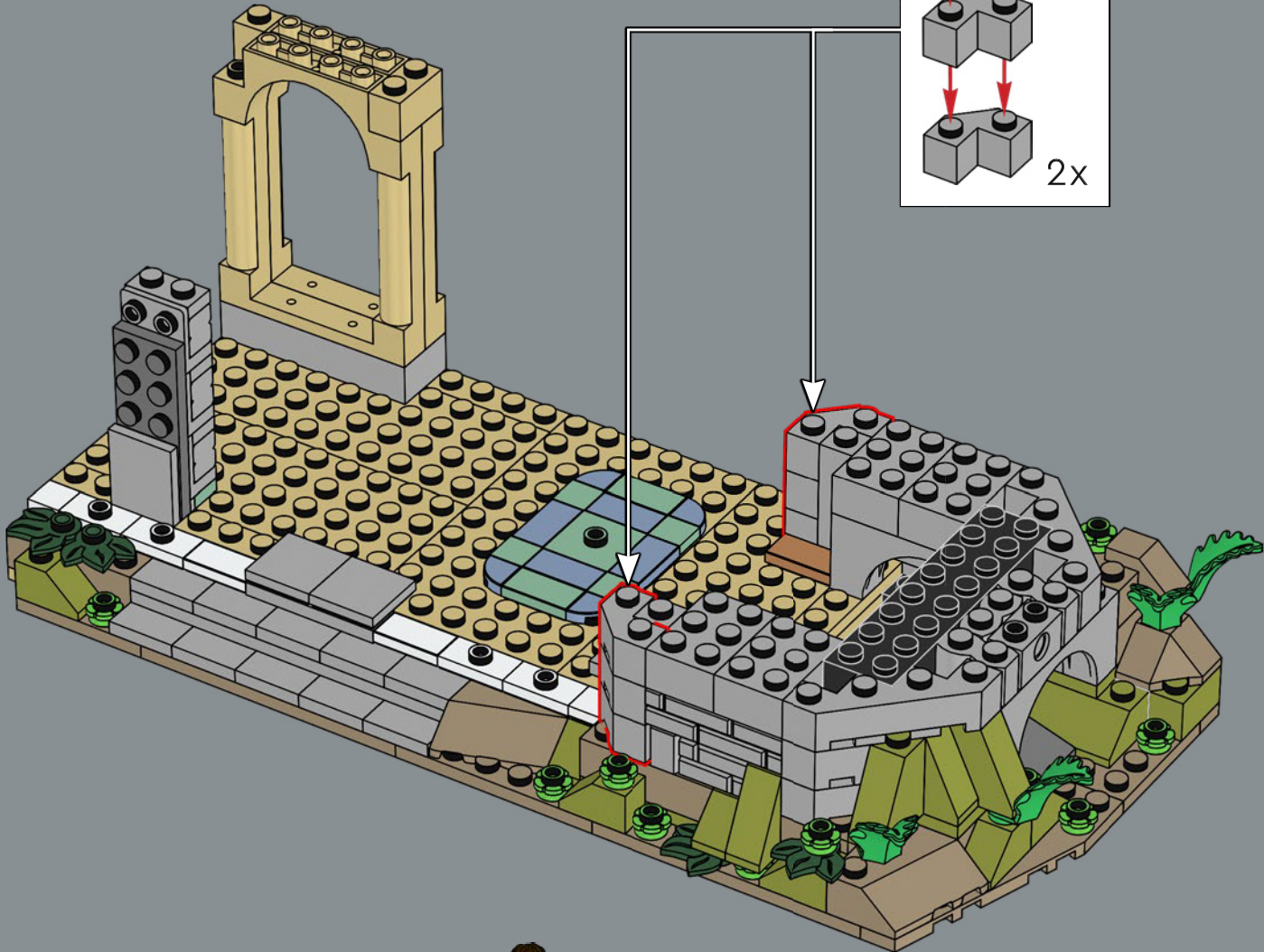
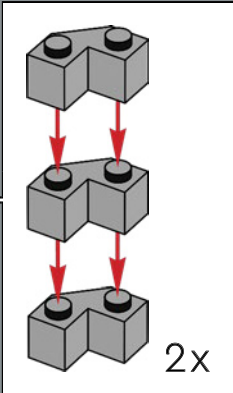

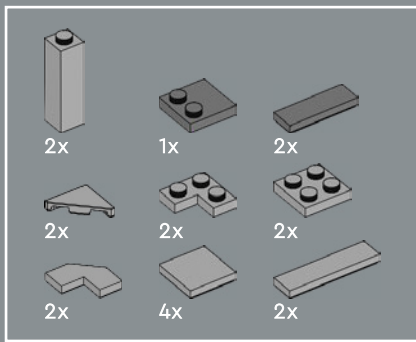

36

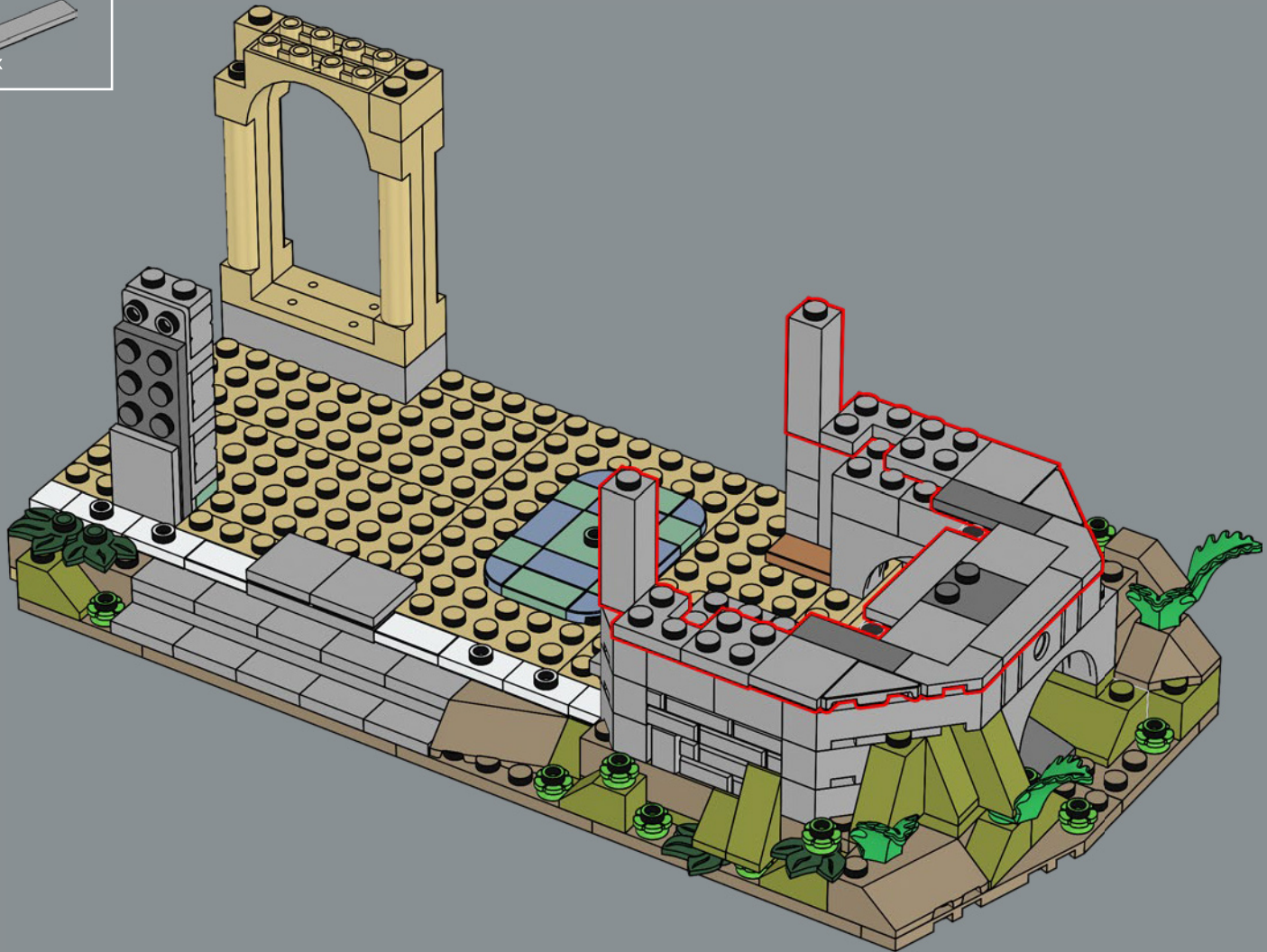

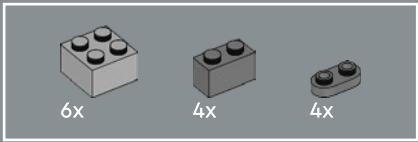

37

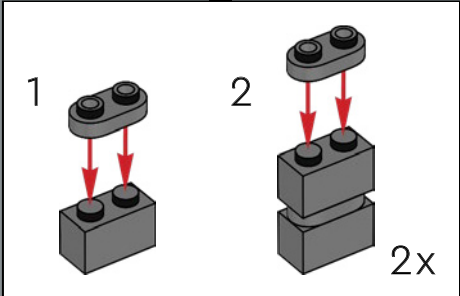
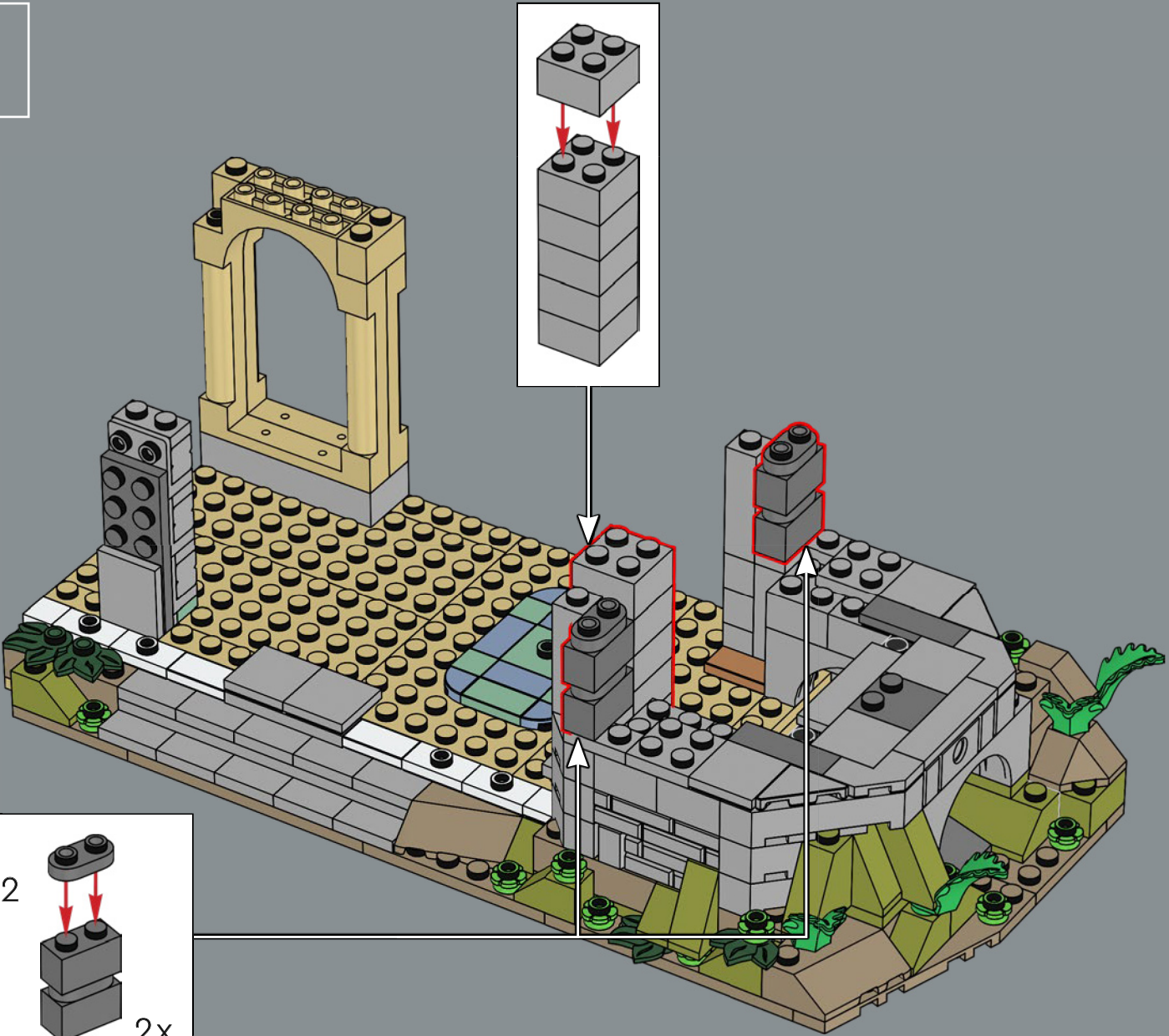

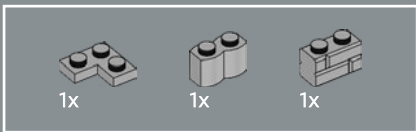

38

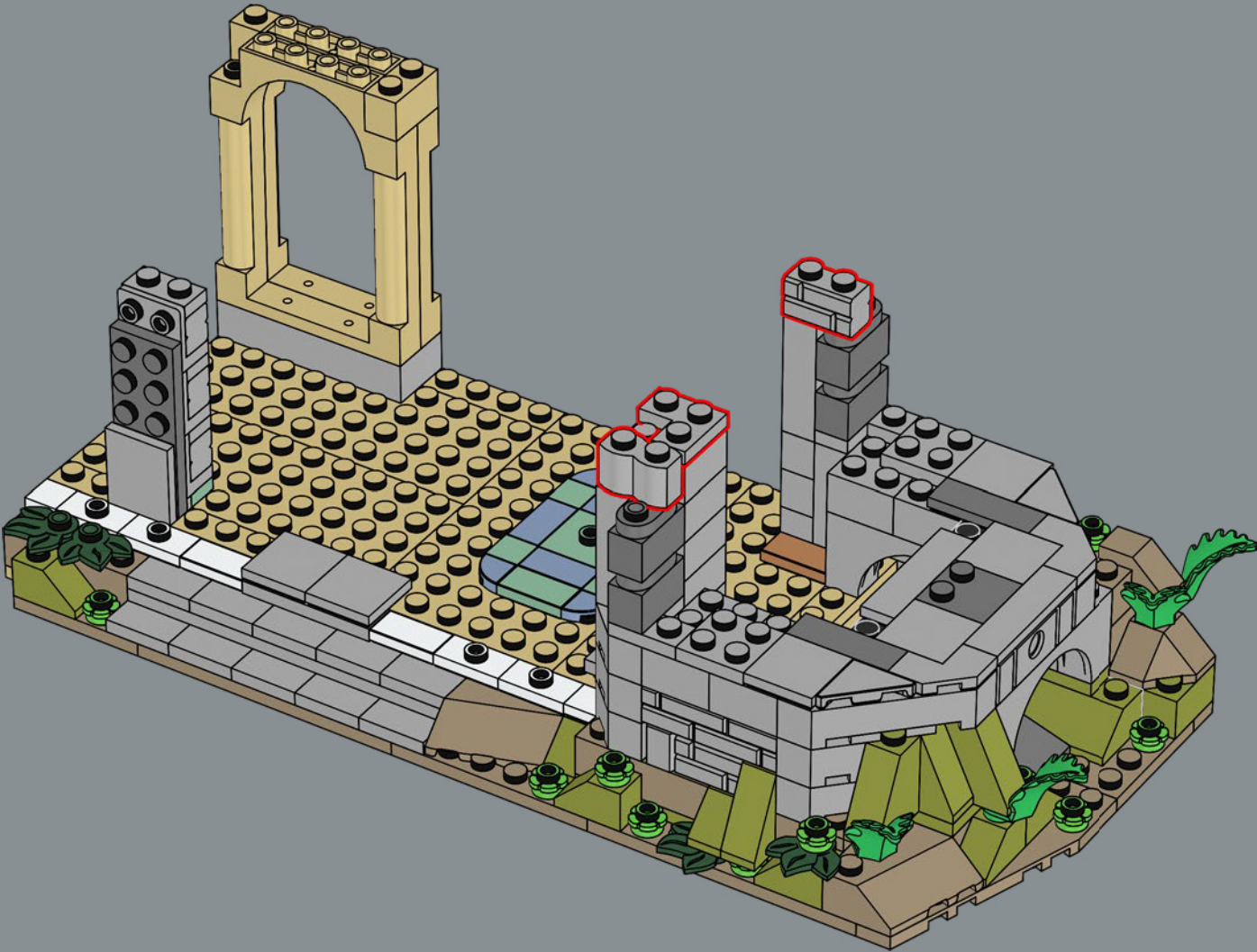



山姆卫斯·詹吉的这个躲藏处是为此模型添加的最终特征之一。



39

1



2



3



4



5





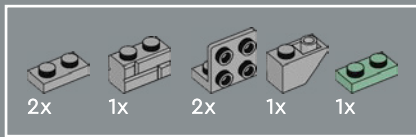

40

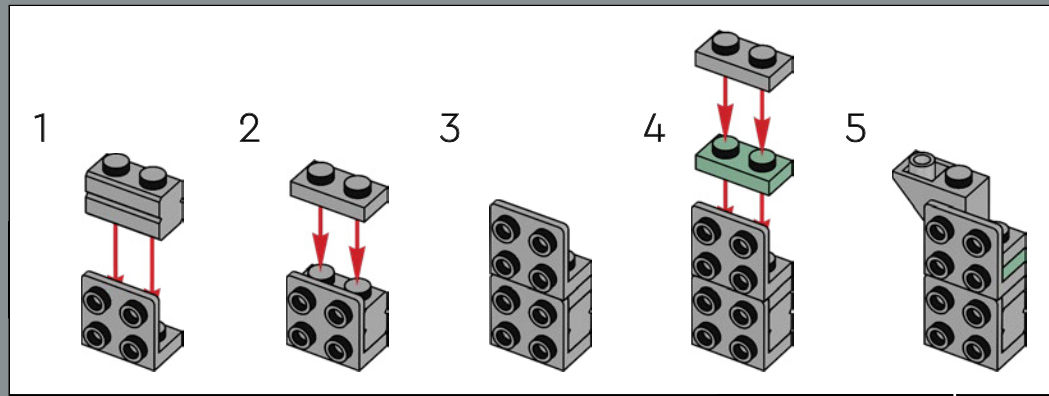
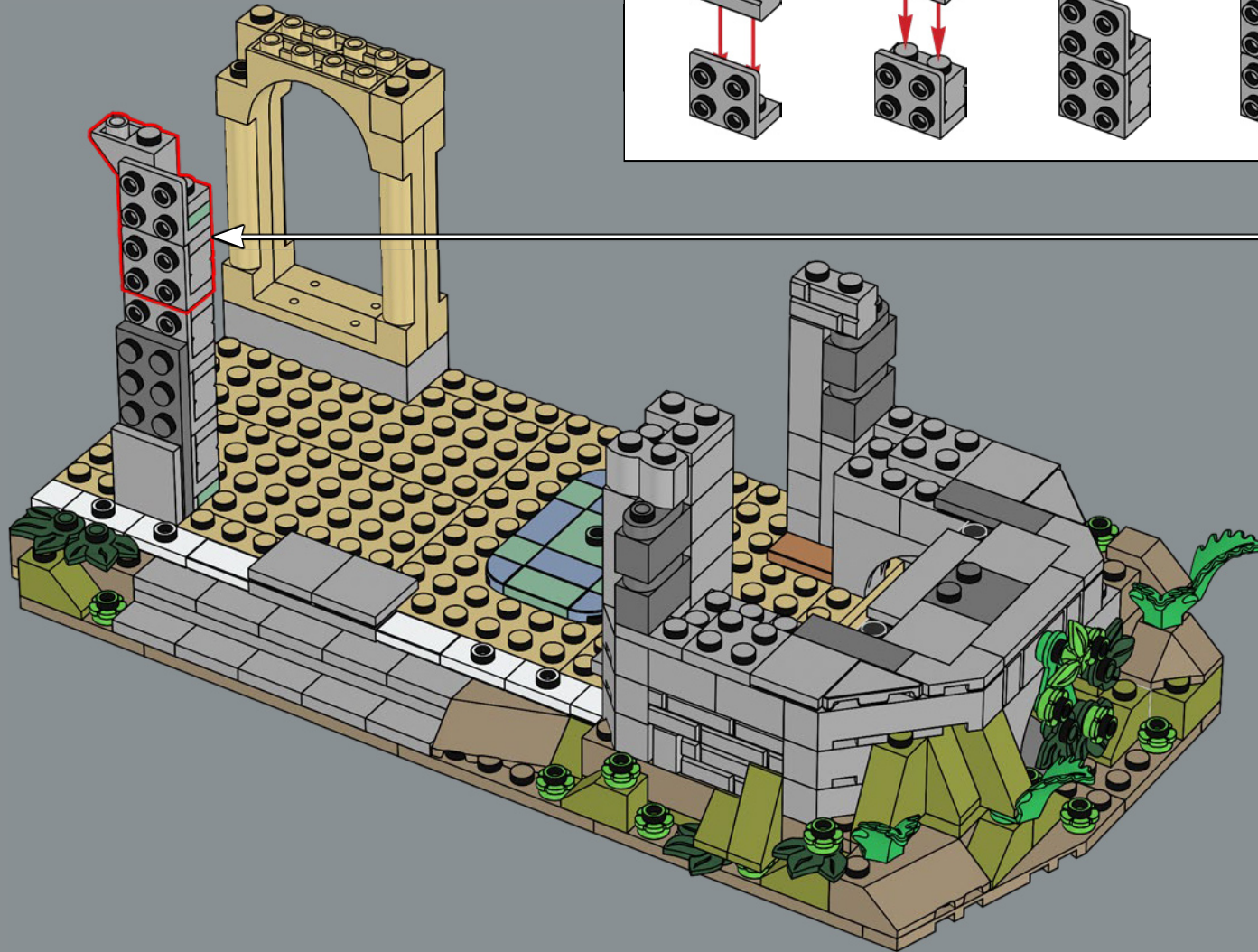

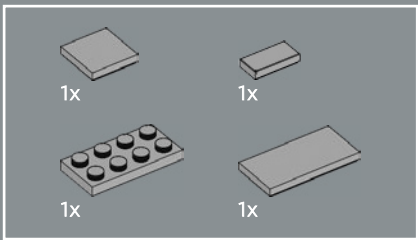

41

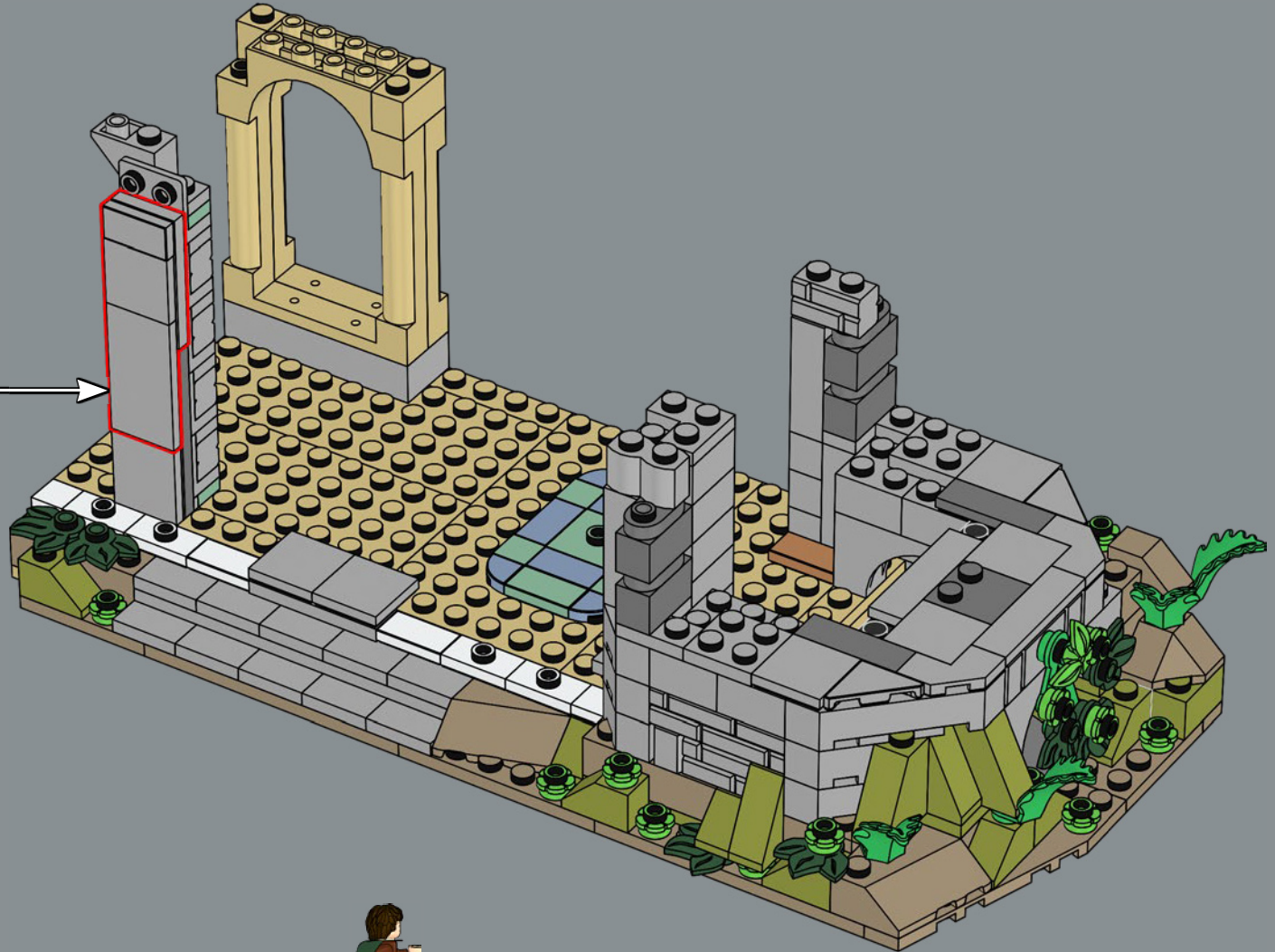
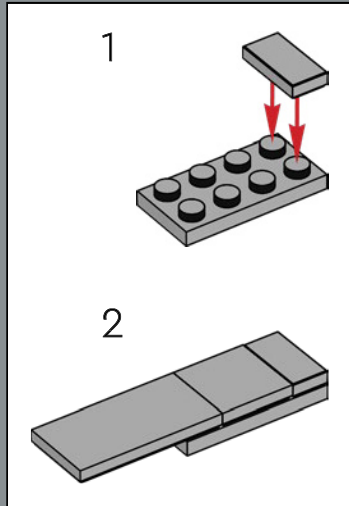

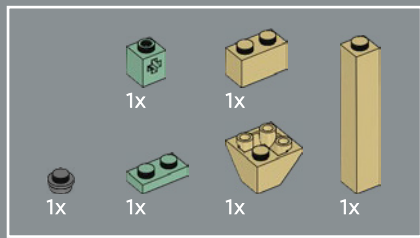

42

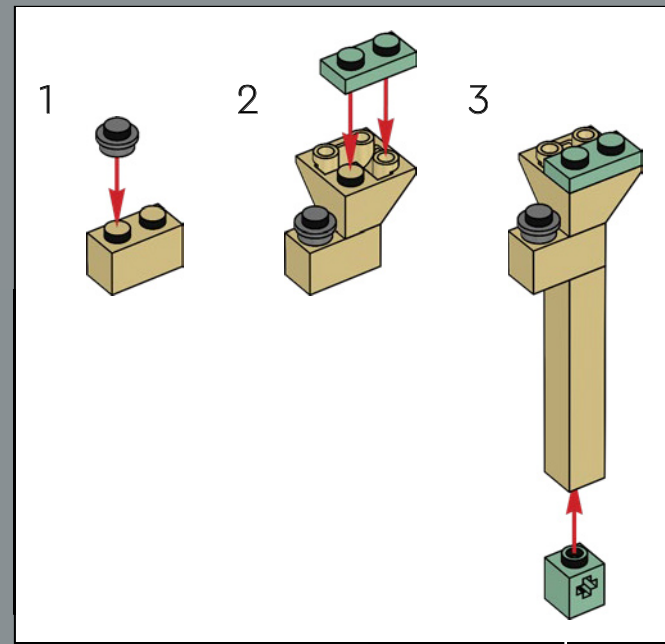
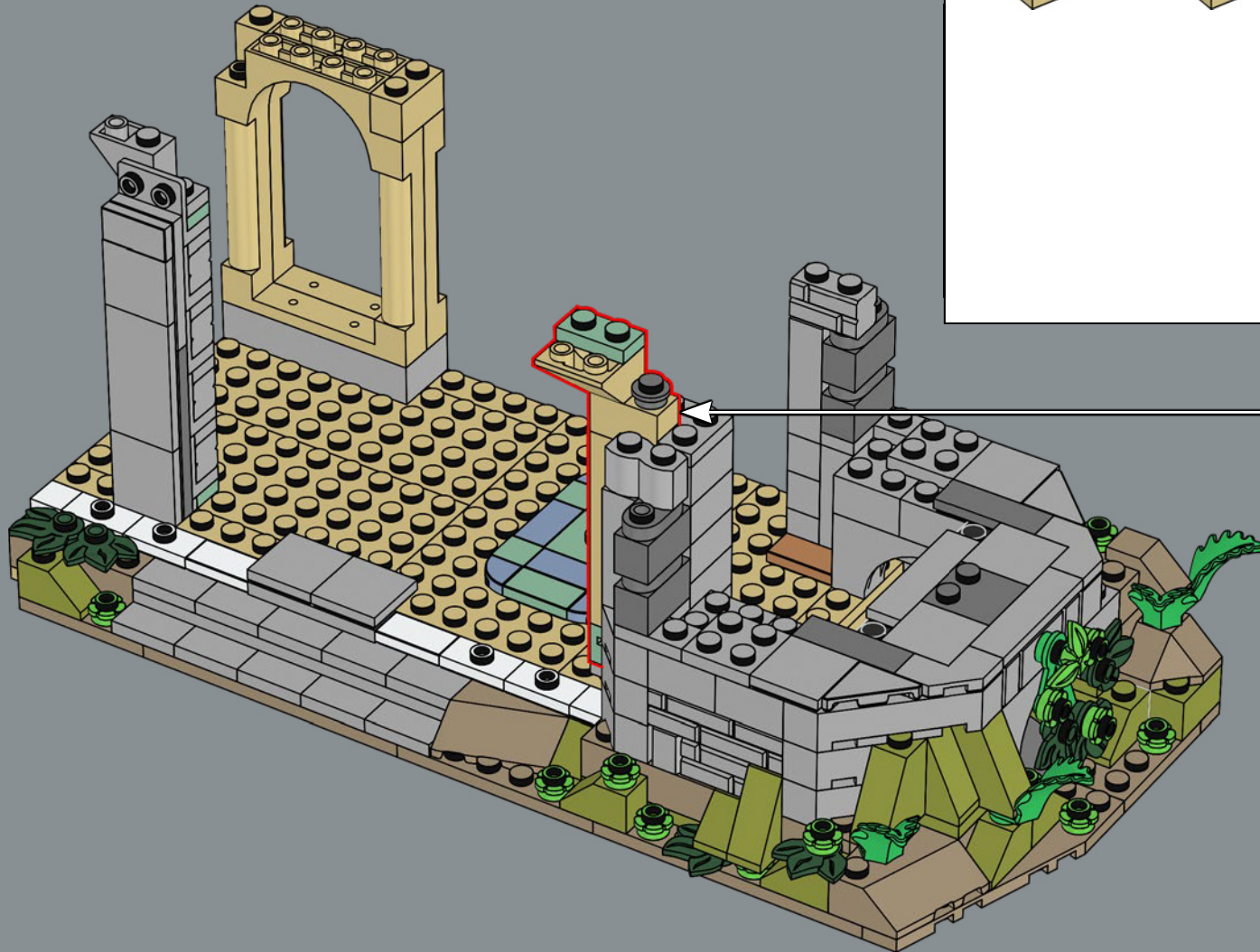

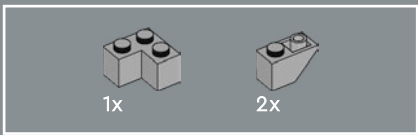

43

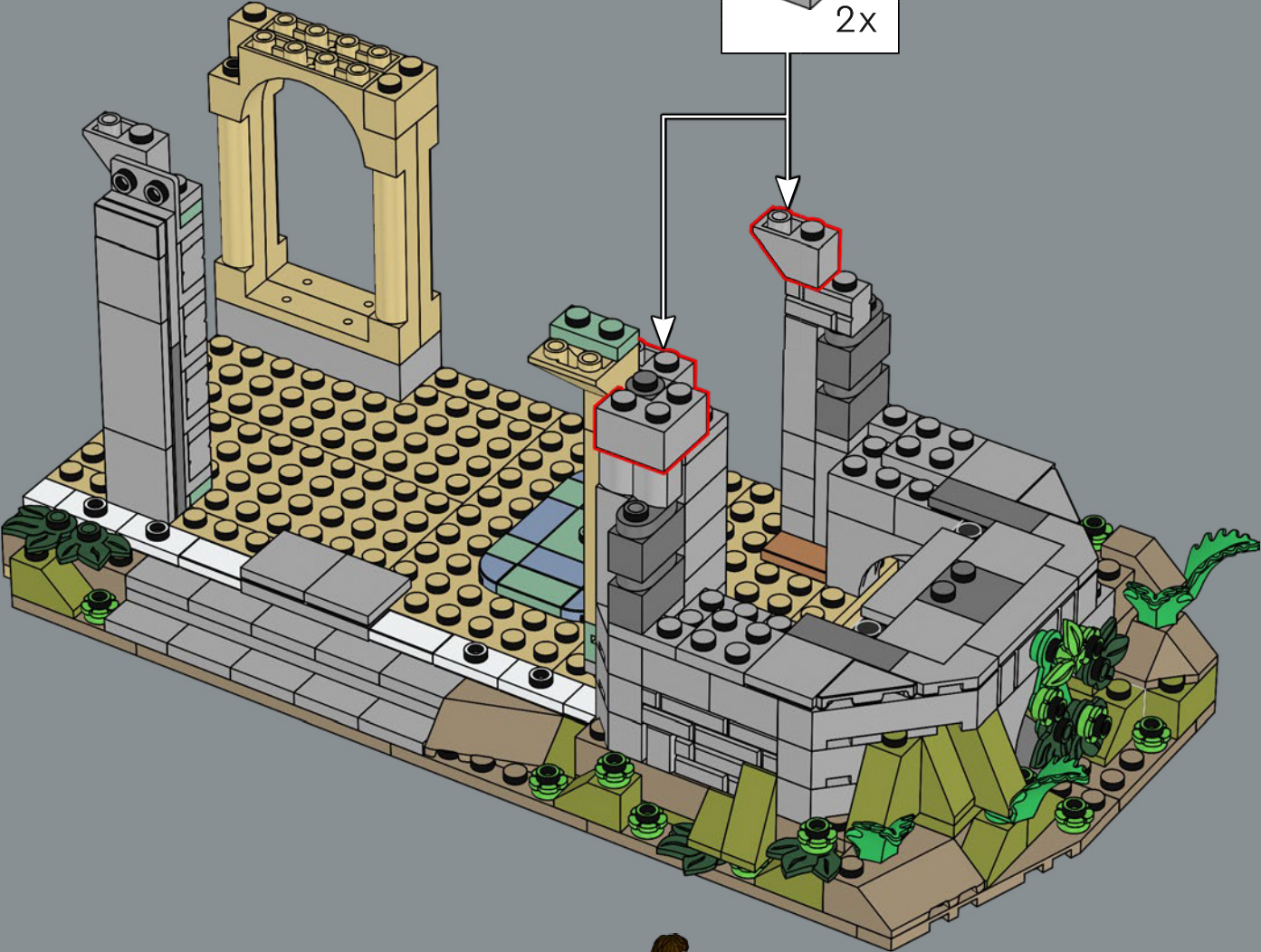
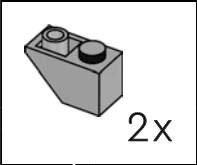

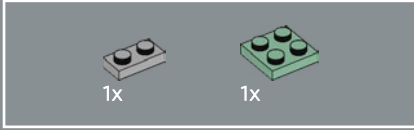
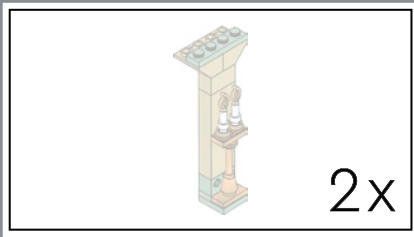

44

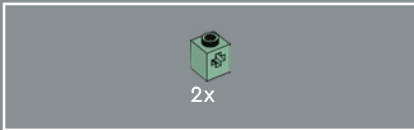
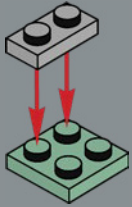

45

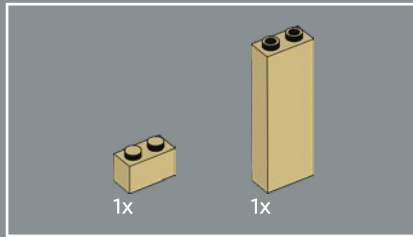
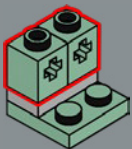

46

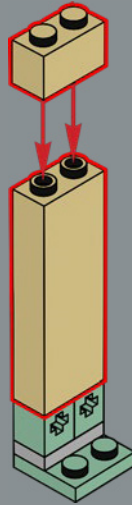

47

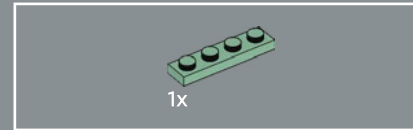
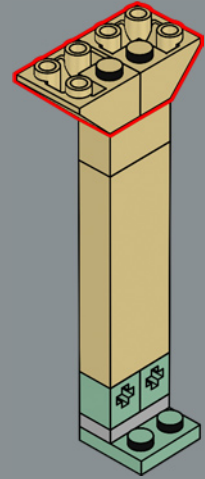

48

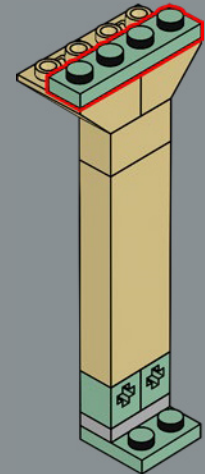

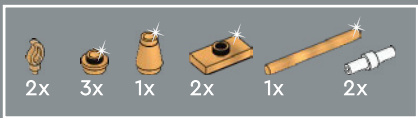

49

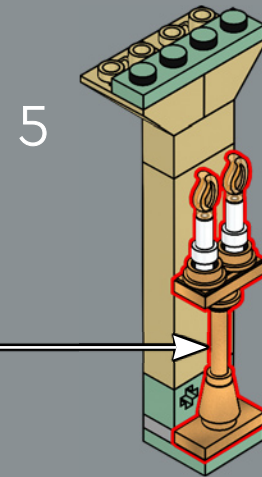
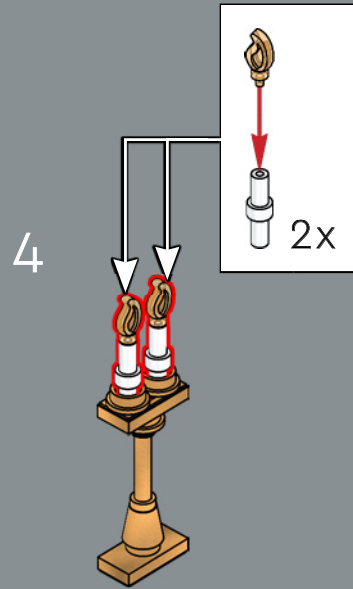
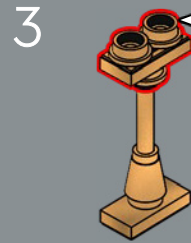
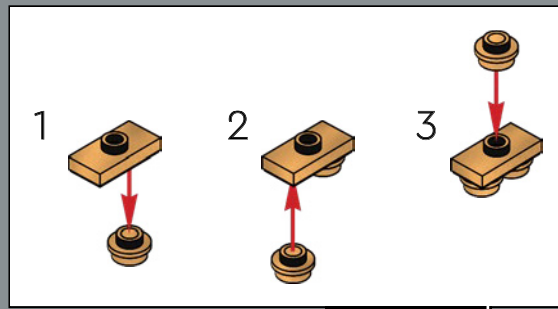
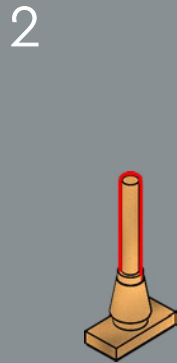
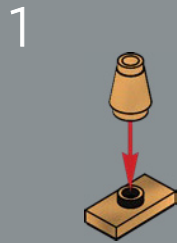

2x



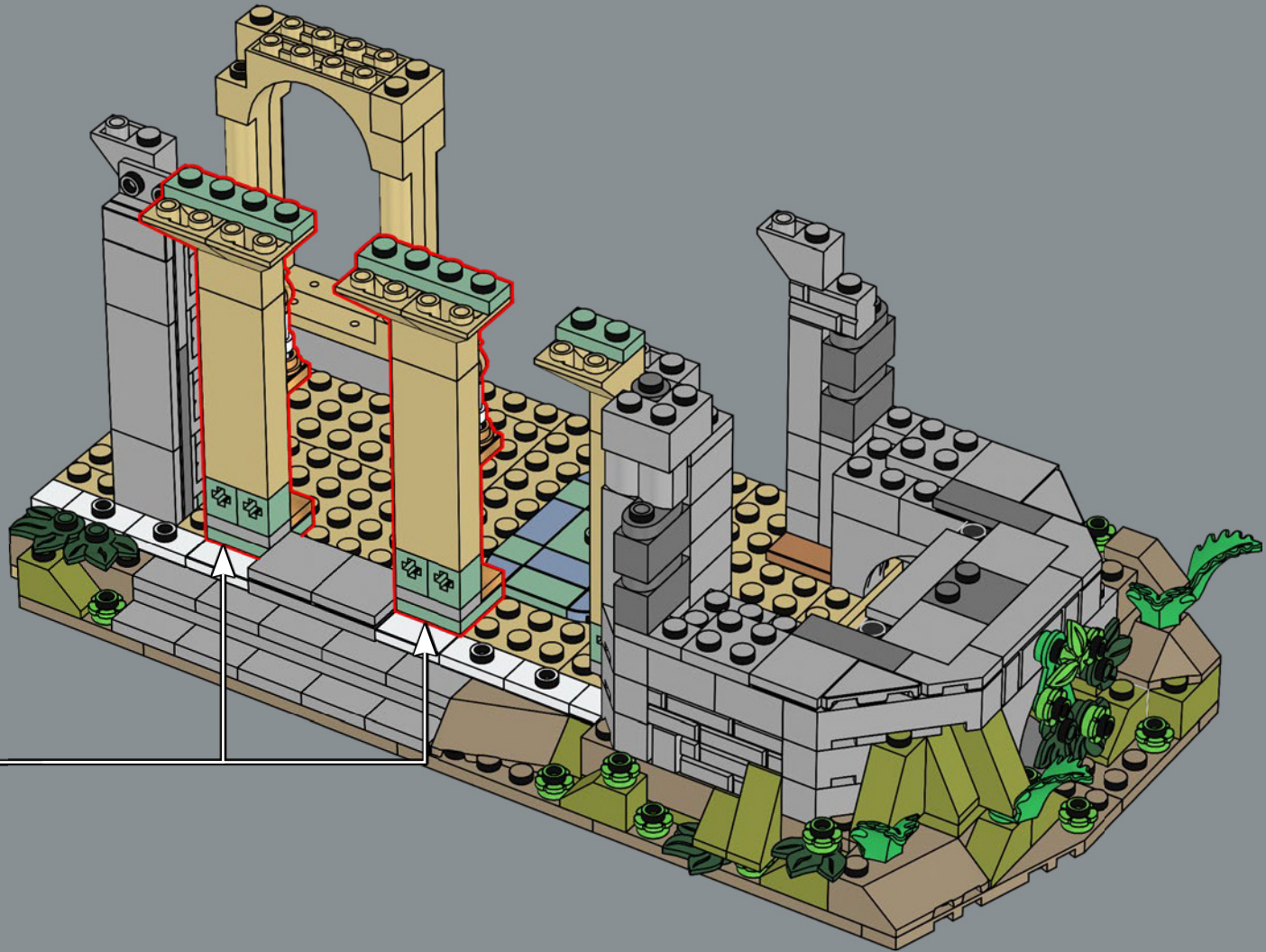

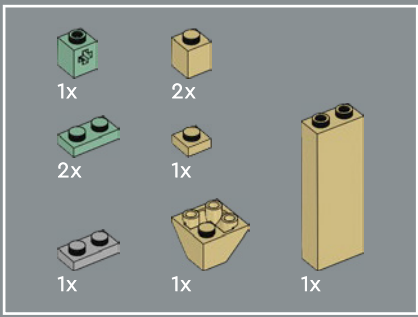

50

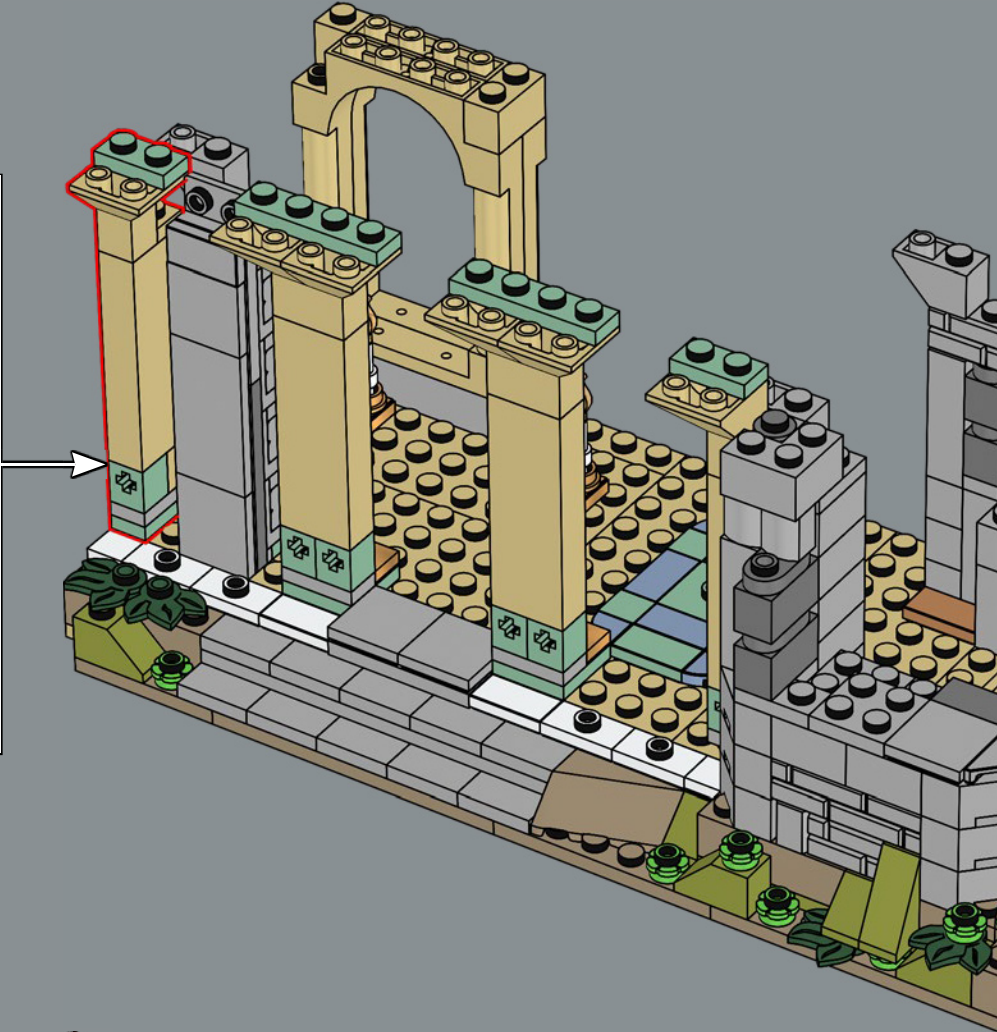
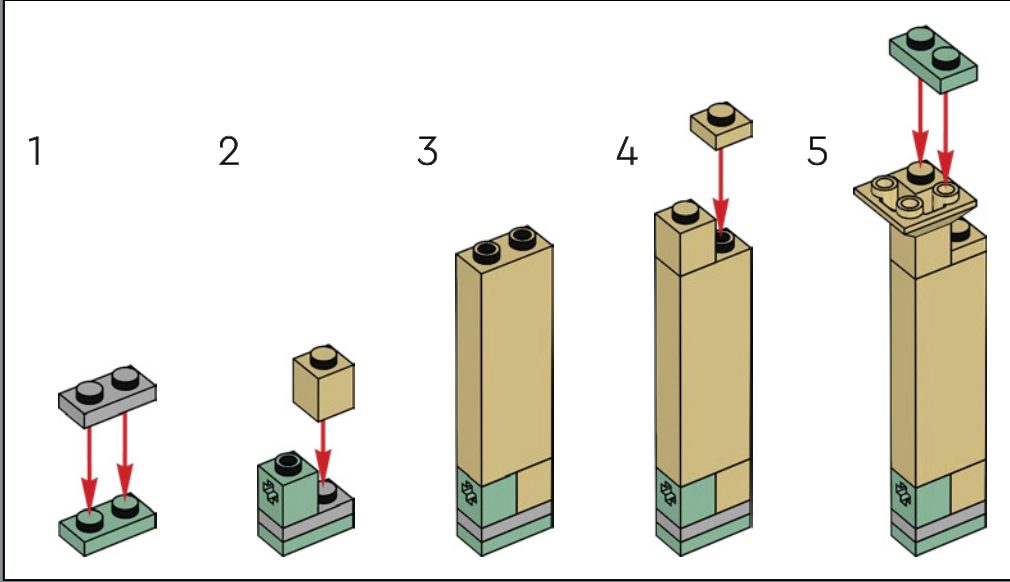



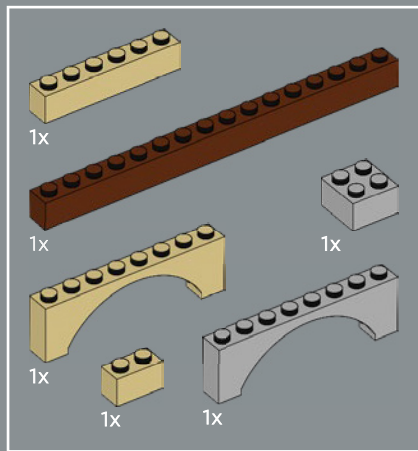

51

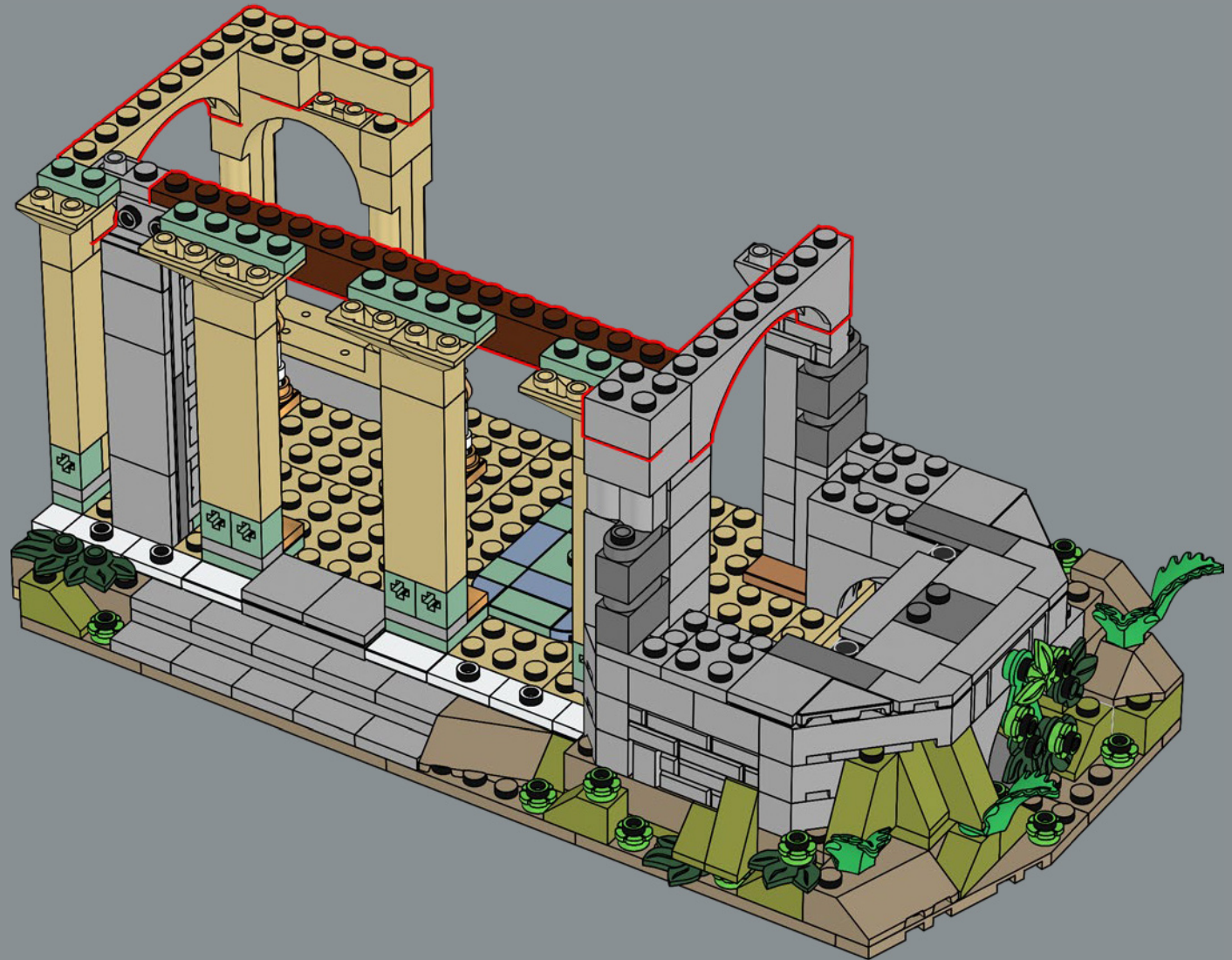

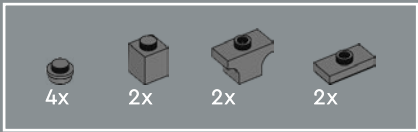

52

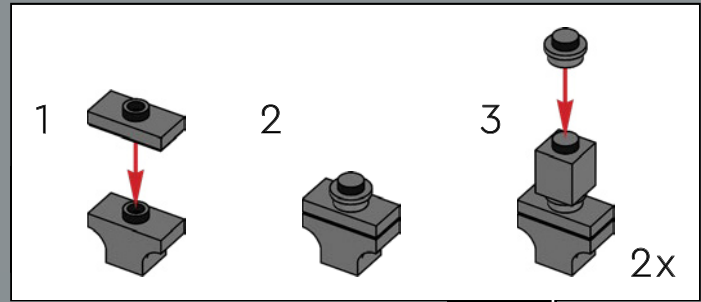
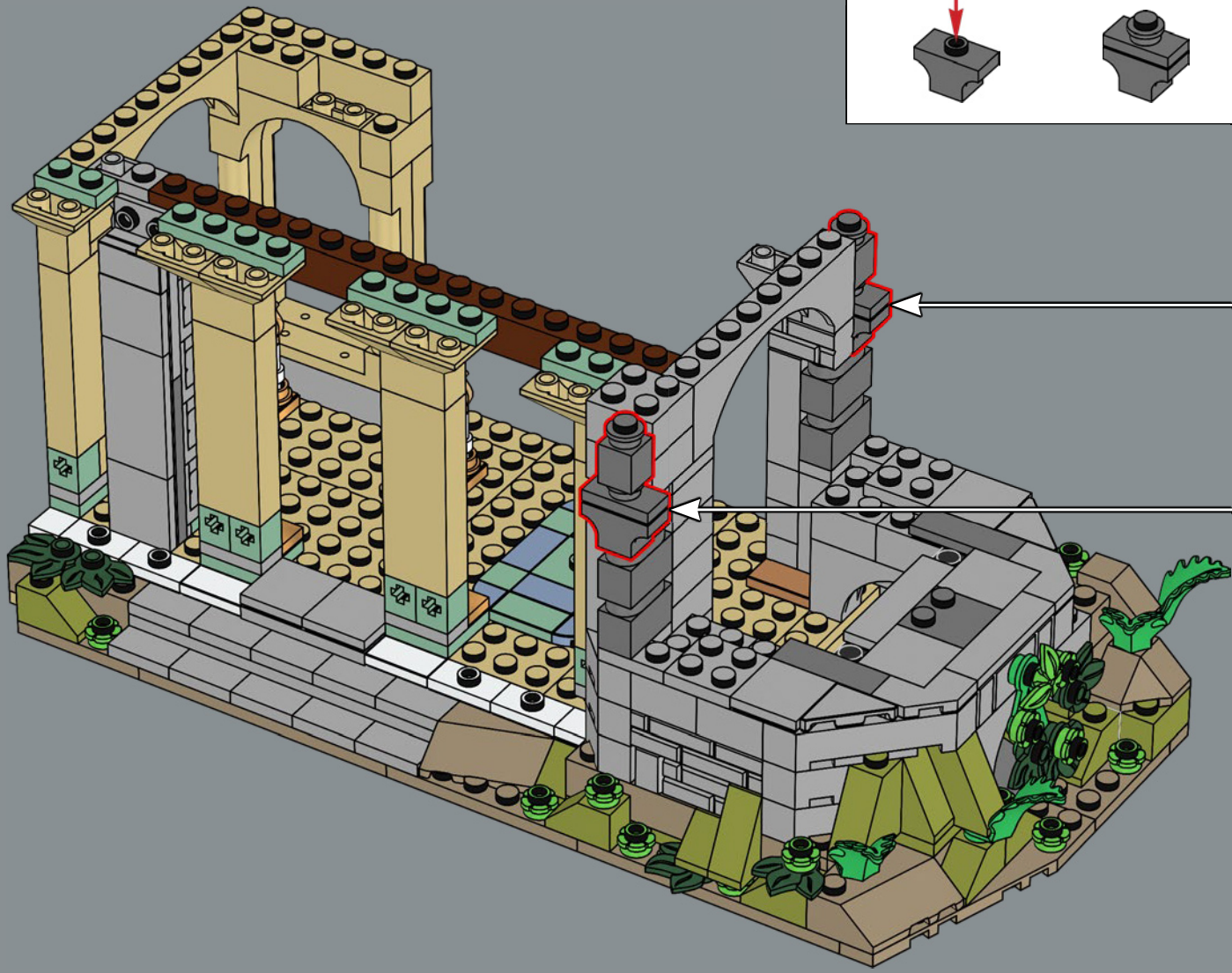

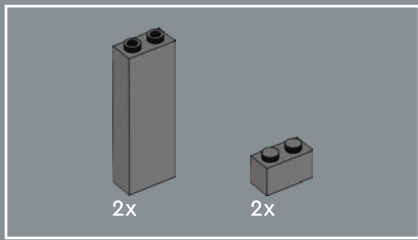

53

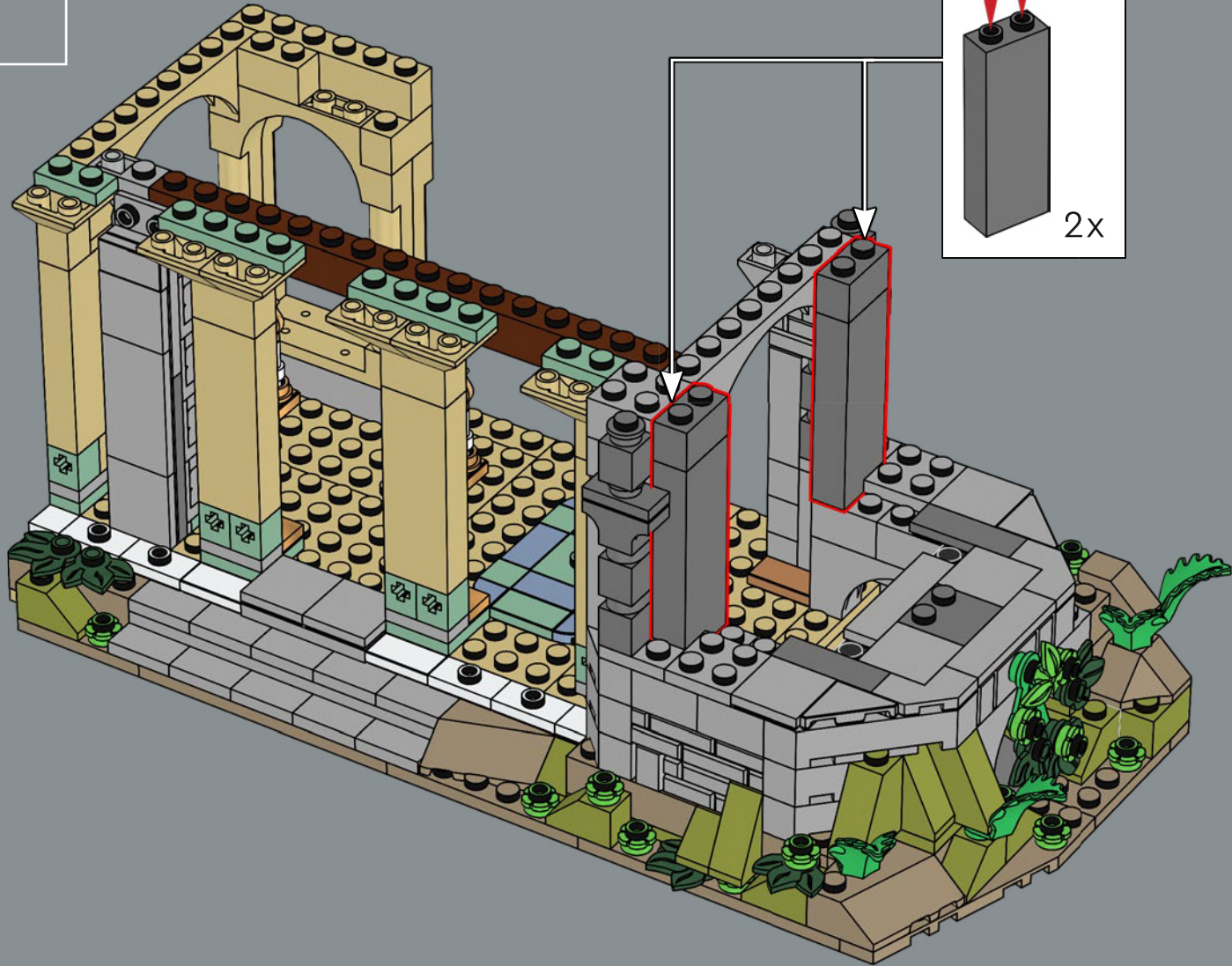



4x

54

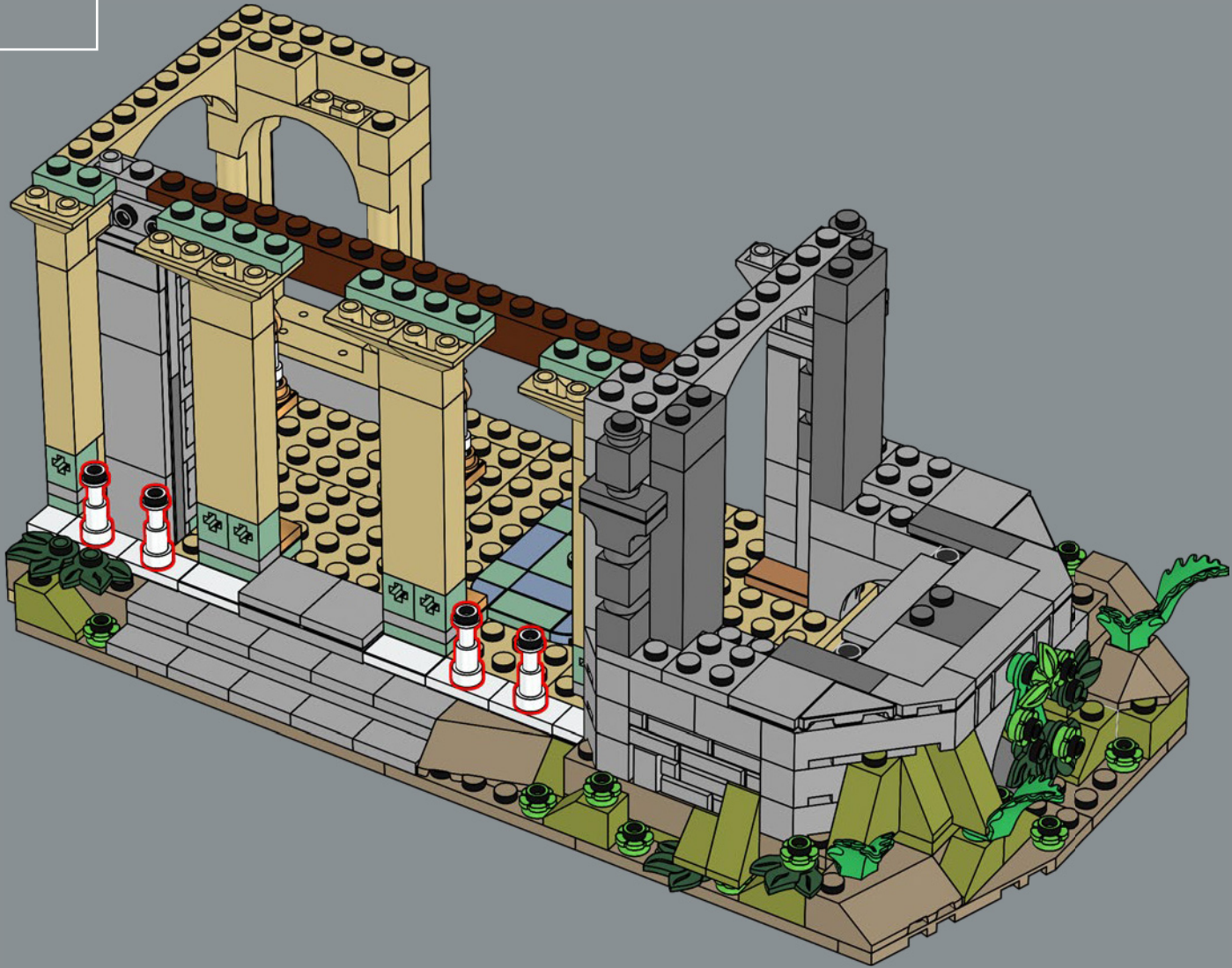

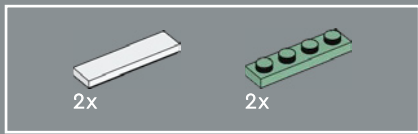

55

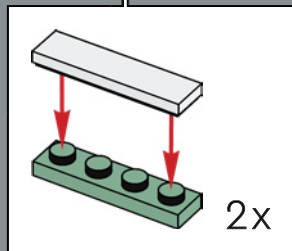
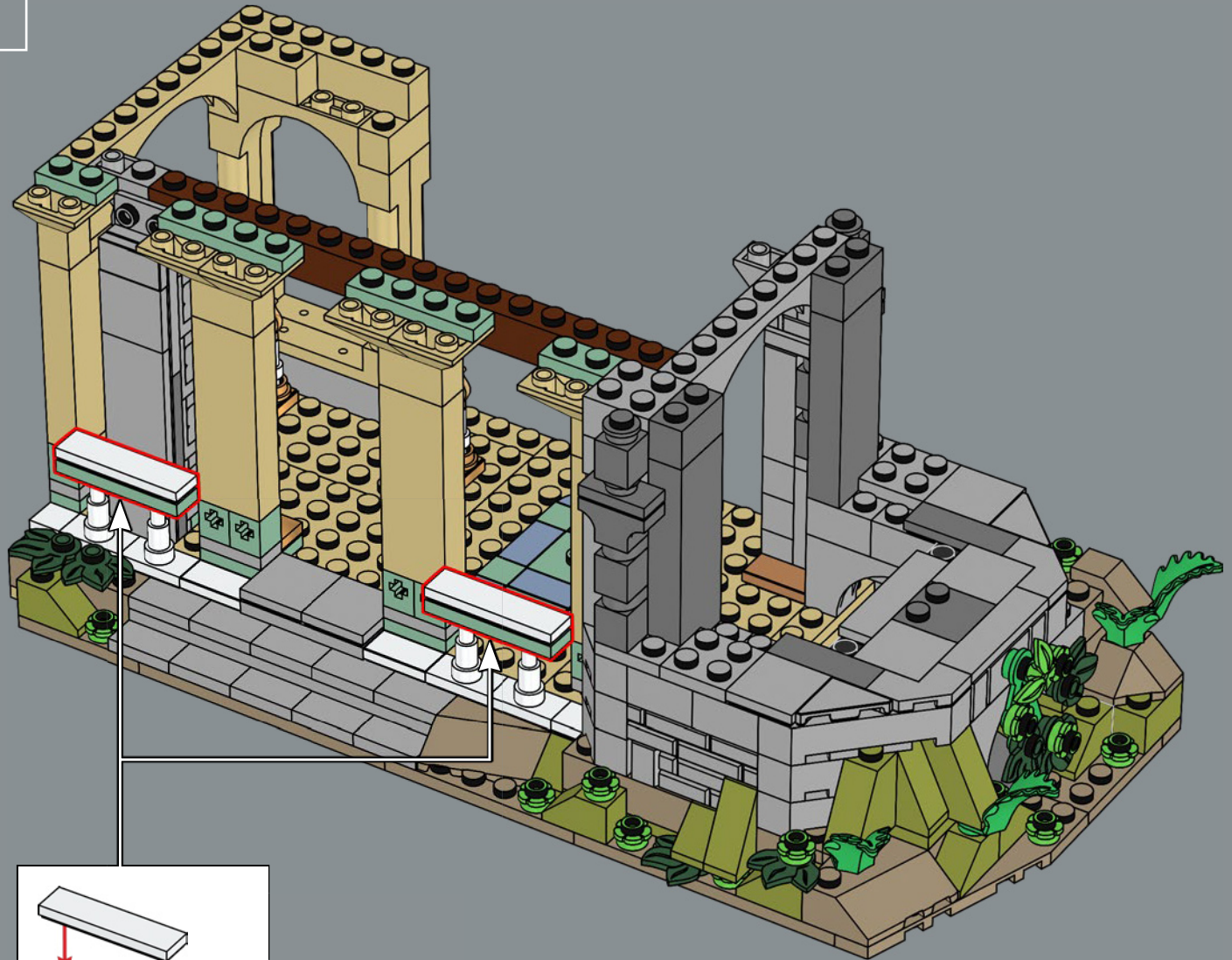

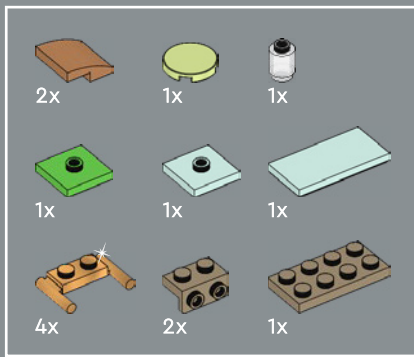

56

1



2

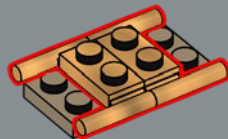

3

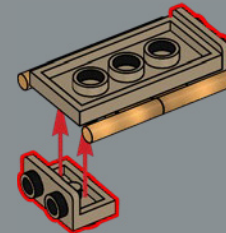

4

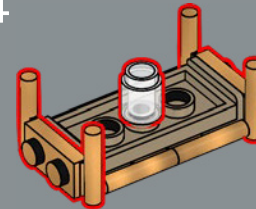

5

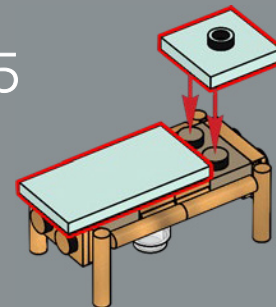

6

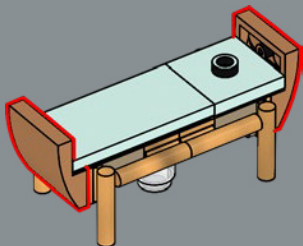

7

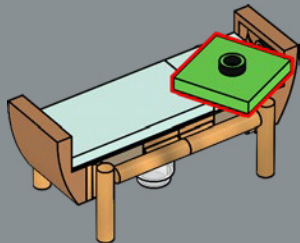

8

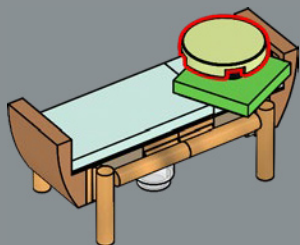

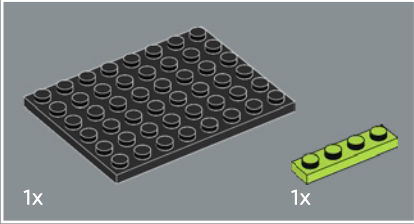
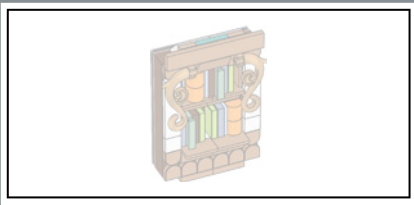

57

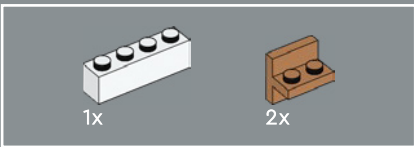
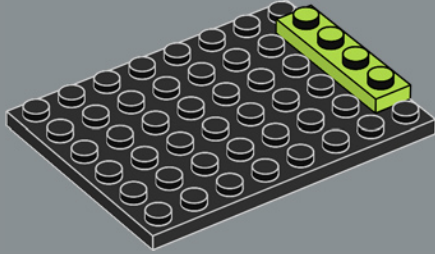

58

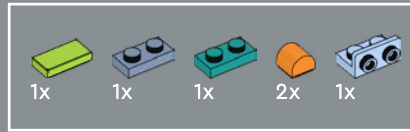
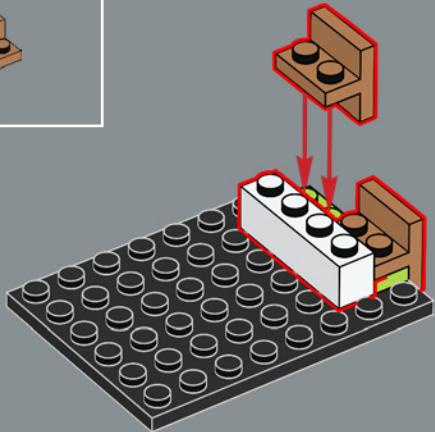

59

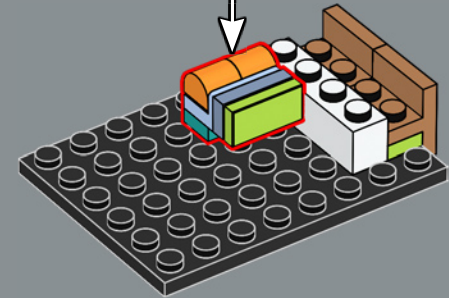
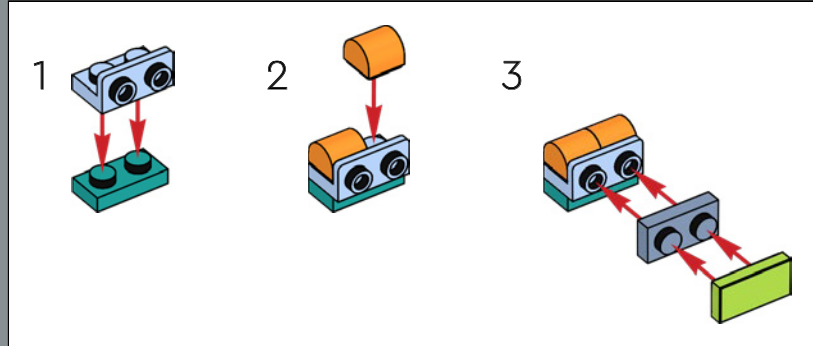



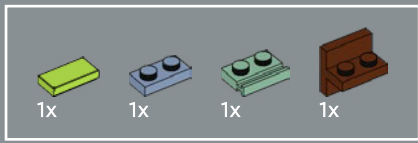

60

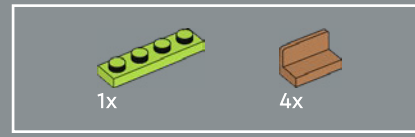
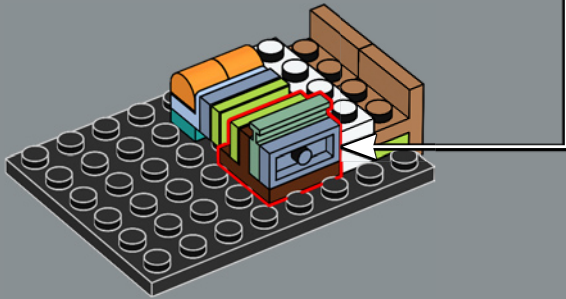
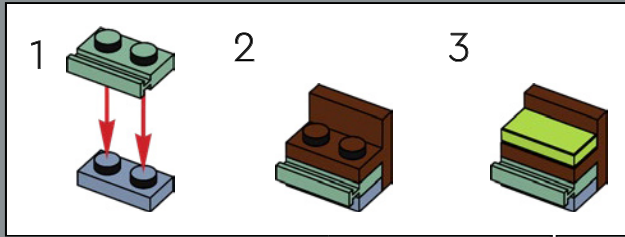

61

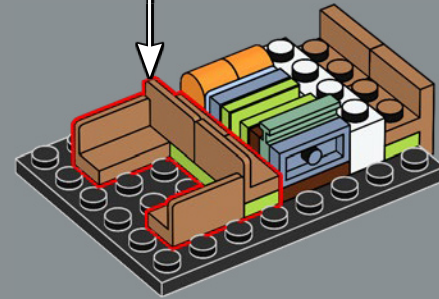
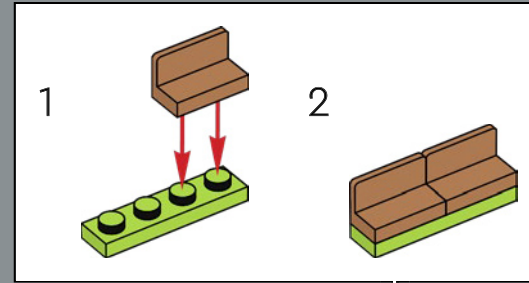

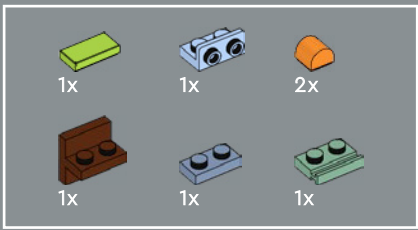

62

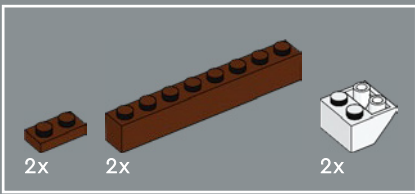
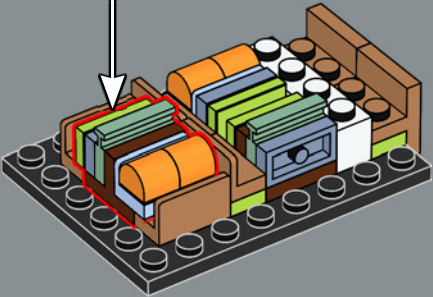
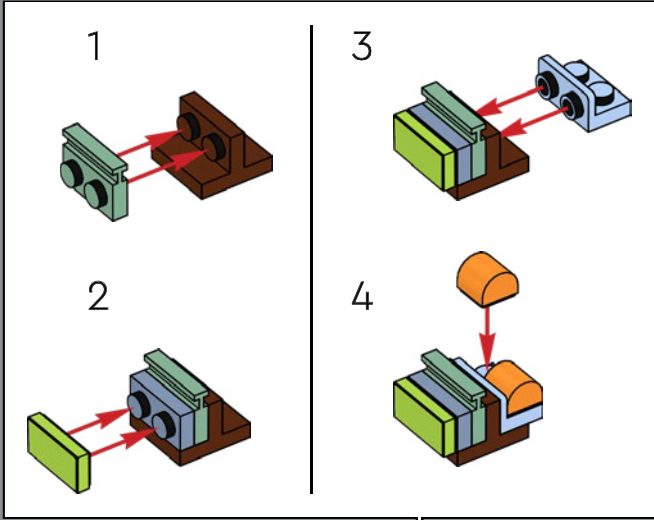

63

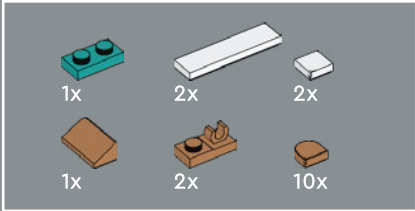
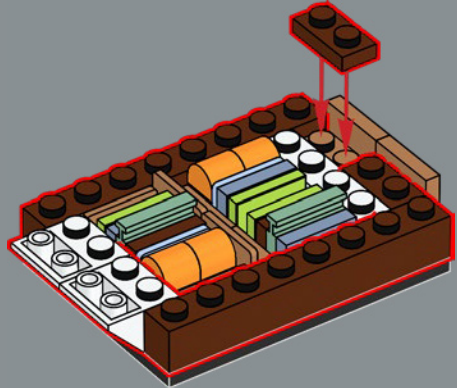

64

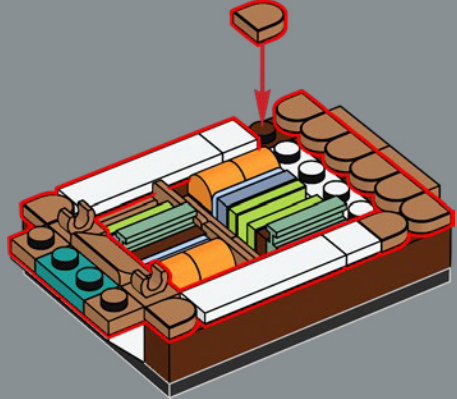

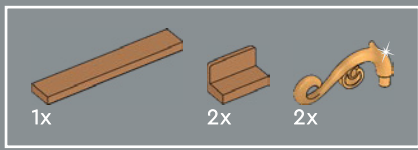

65

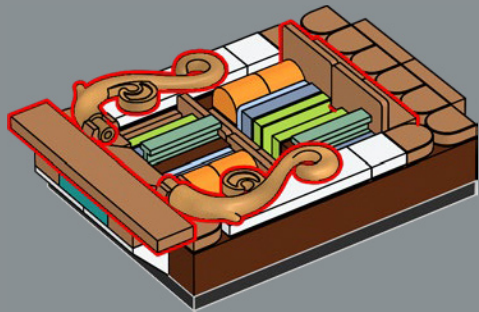

66



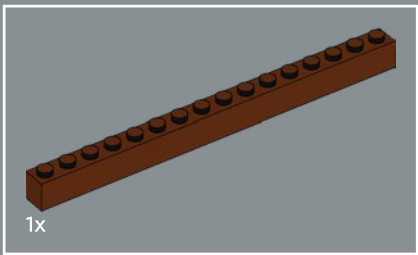

67



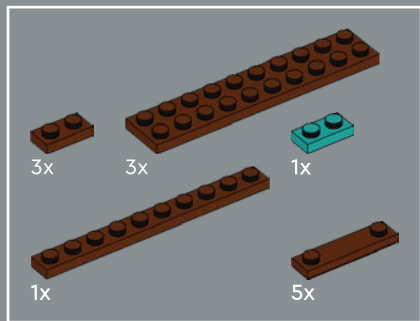

68

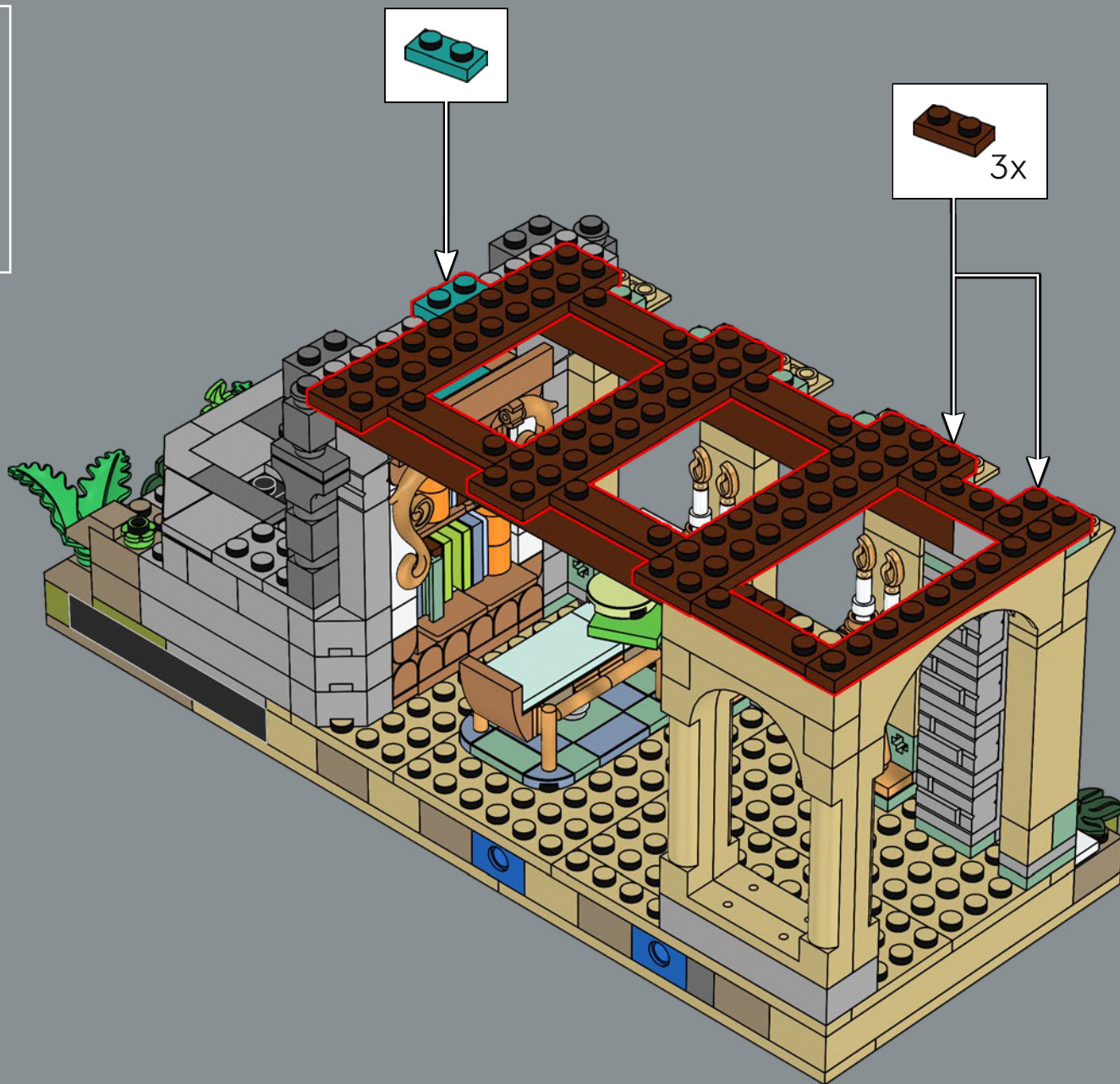

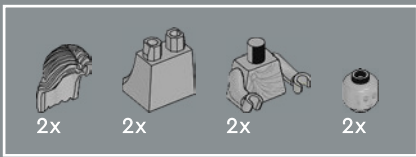

69

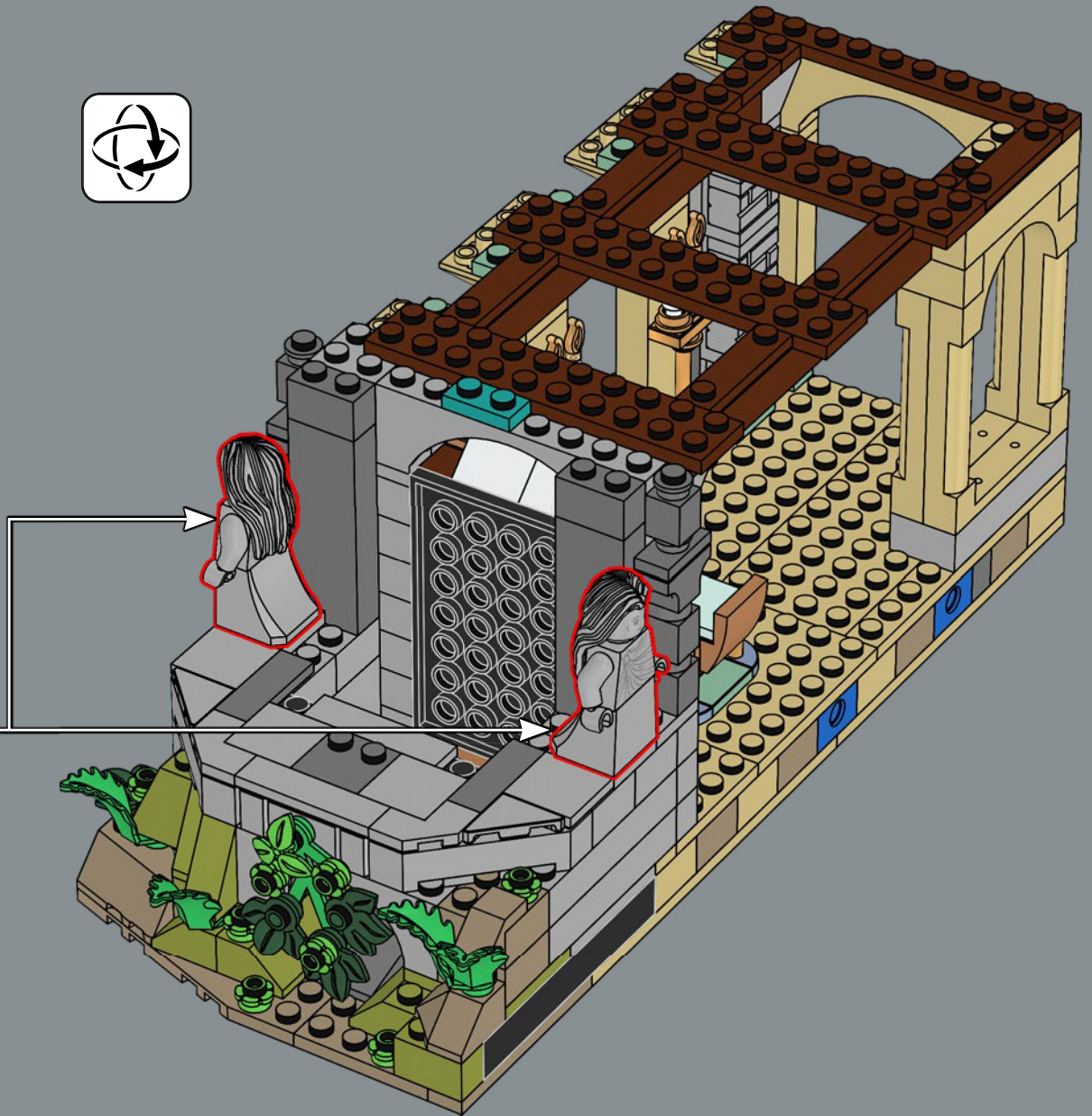
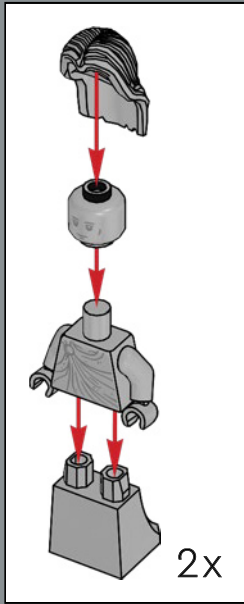

雕像的新头部装饰带有两种截然不同的表情：  
面无表情和凝视！





70

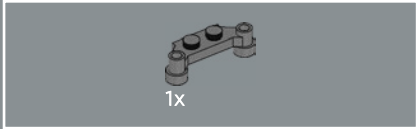
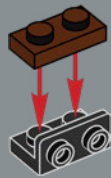

71

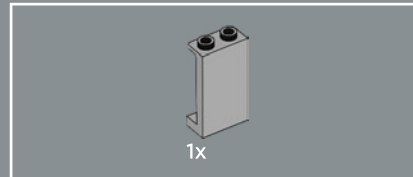
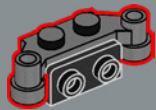

72

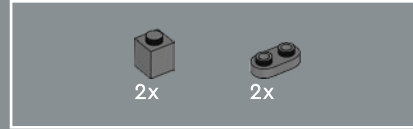
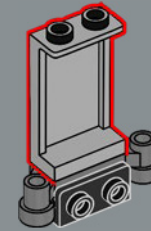

73

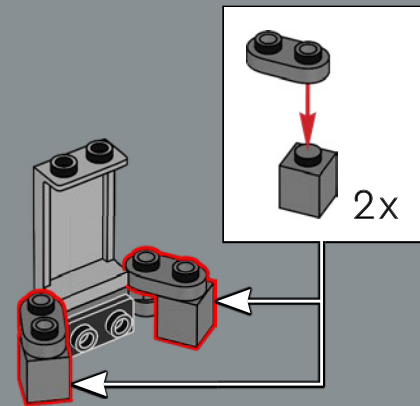



2x

74

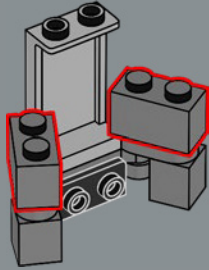

2x

75

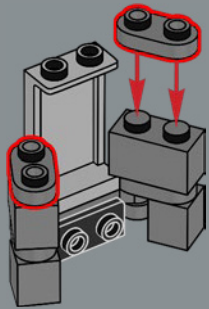

2x



2x

76

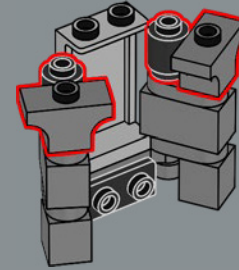

1x

77

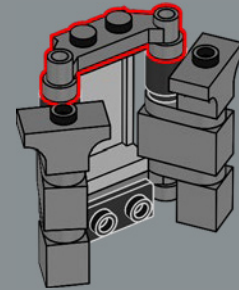



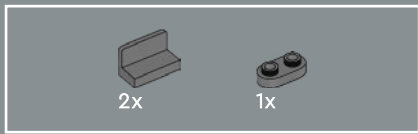

78

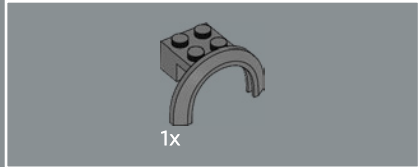
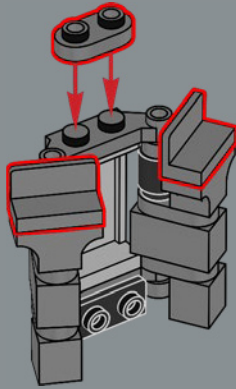

79

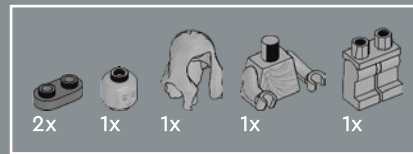
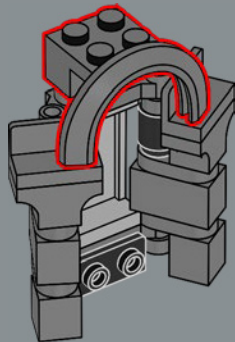

80

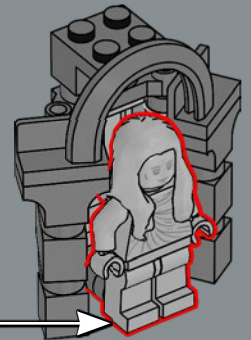
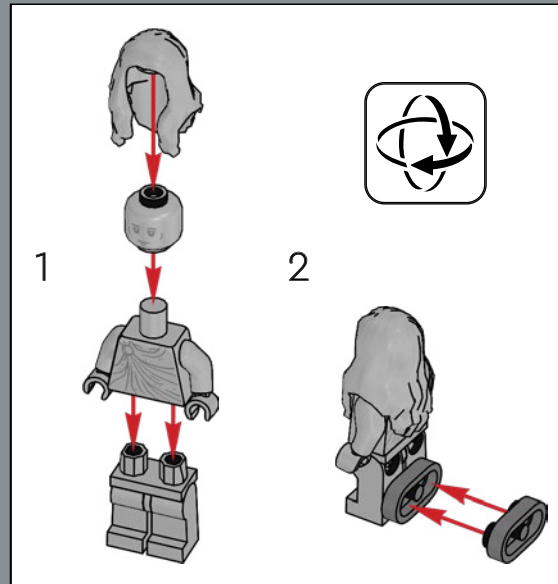



1x

81

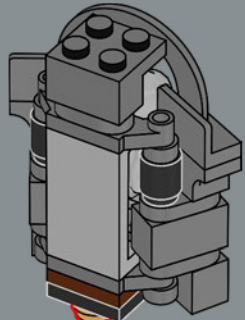

2x



82

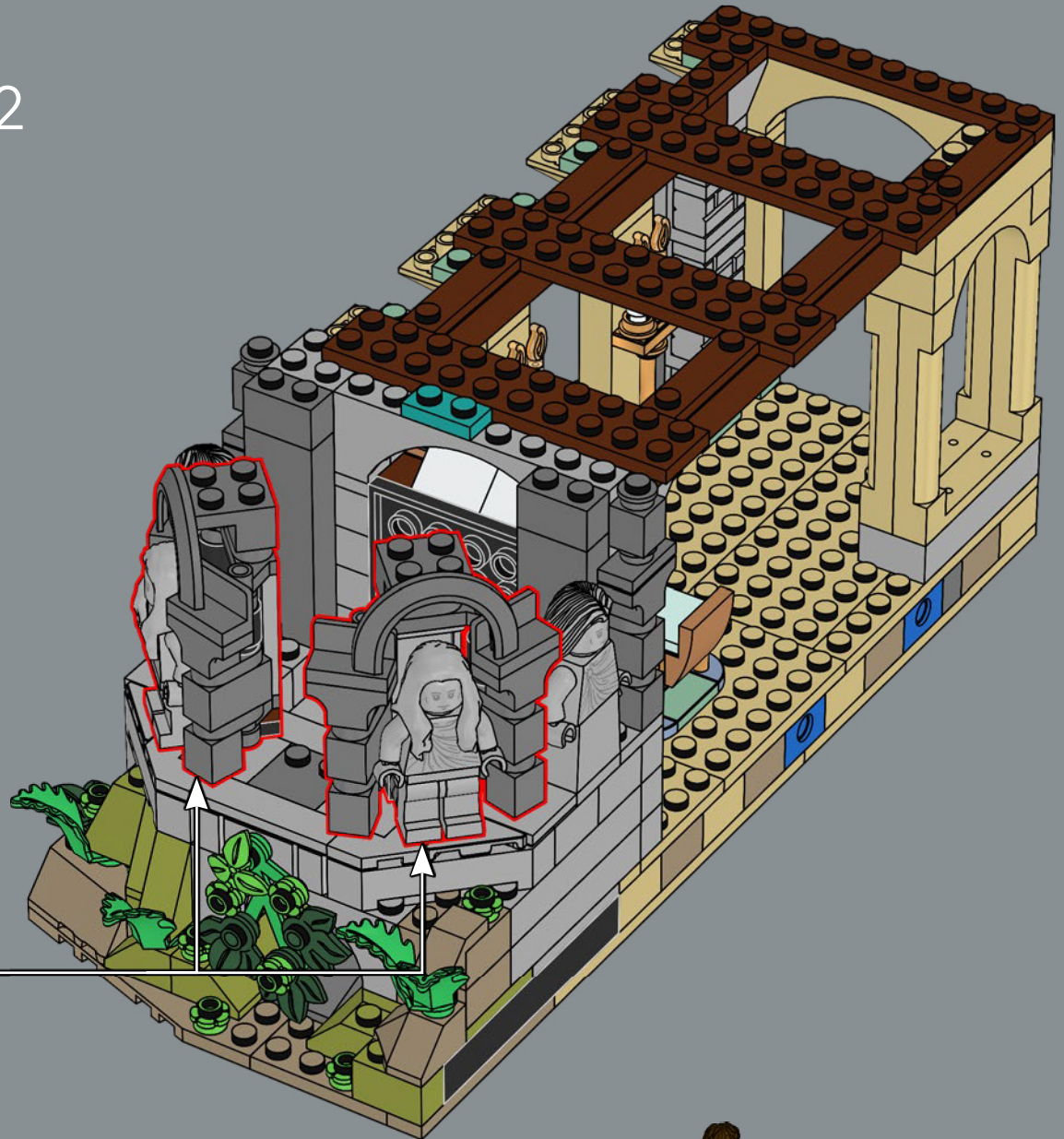

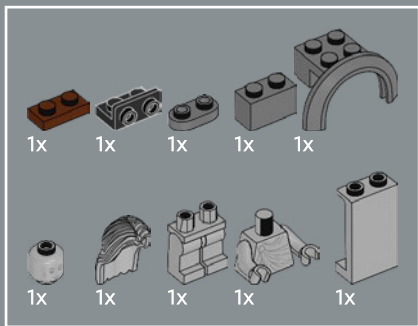

83

1

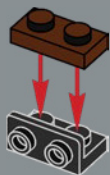

2

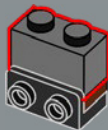

3

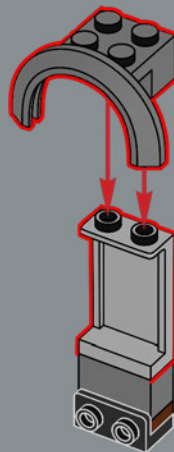

4

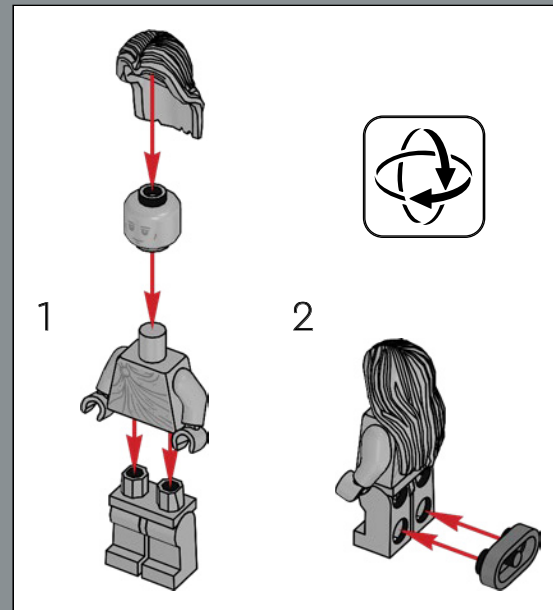

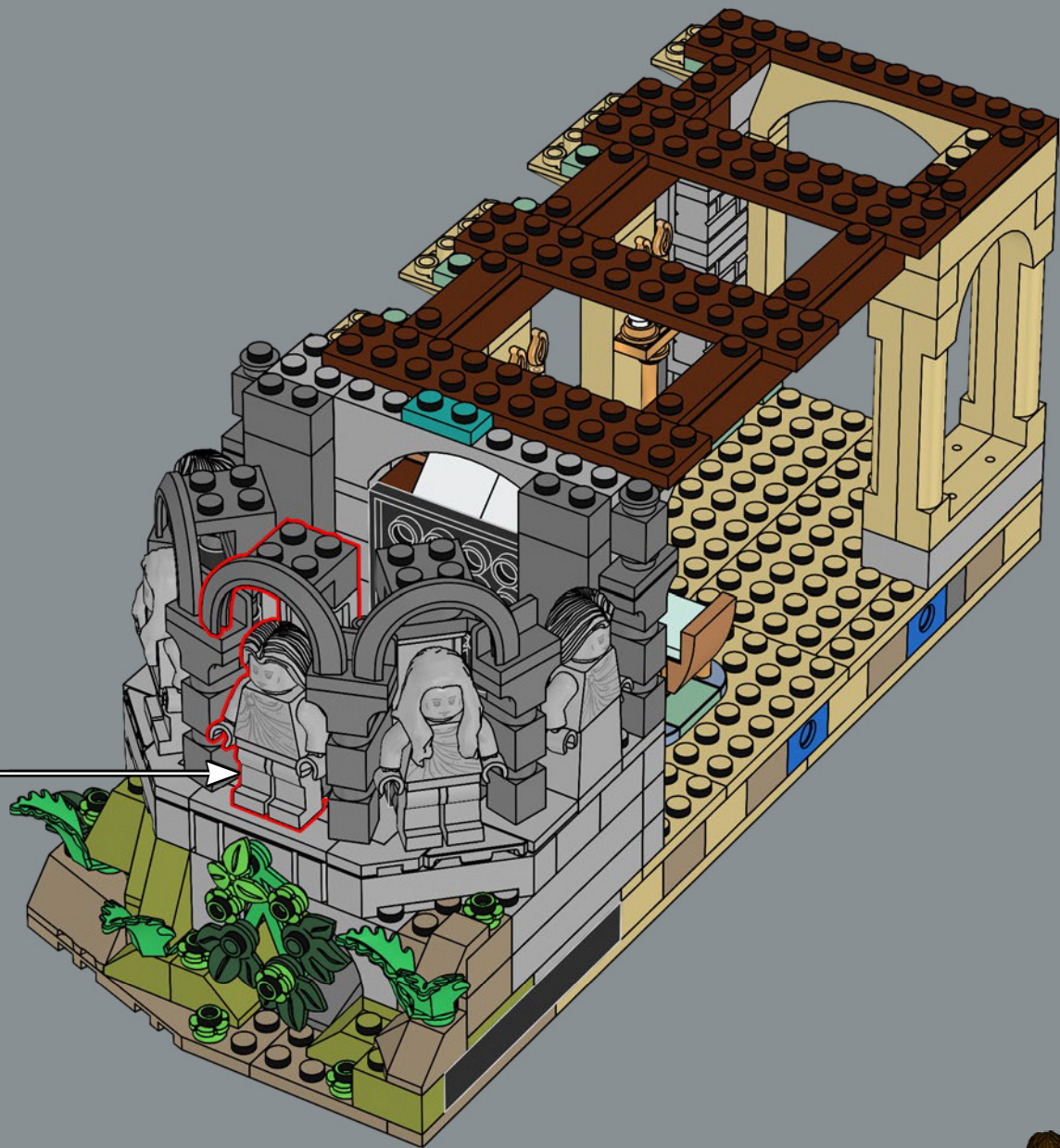

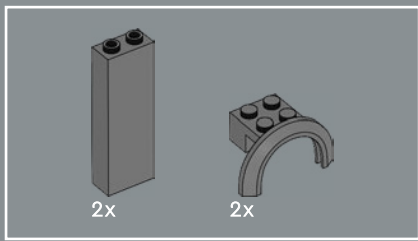

84

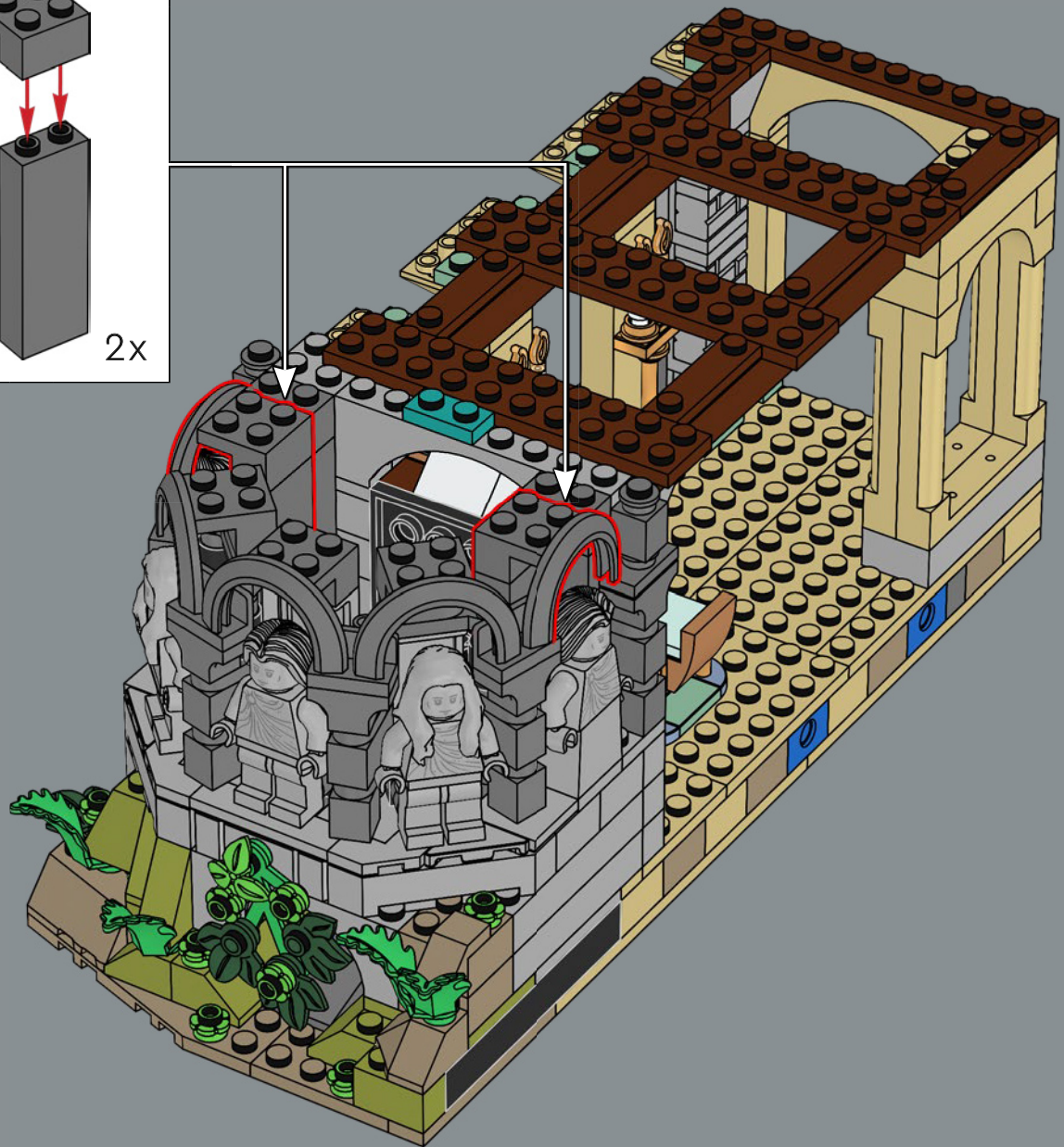
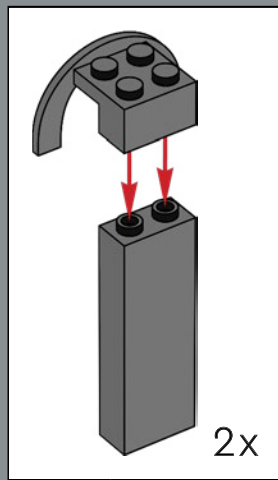

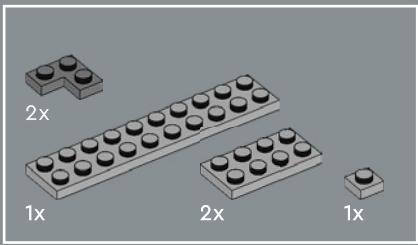

85

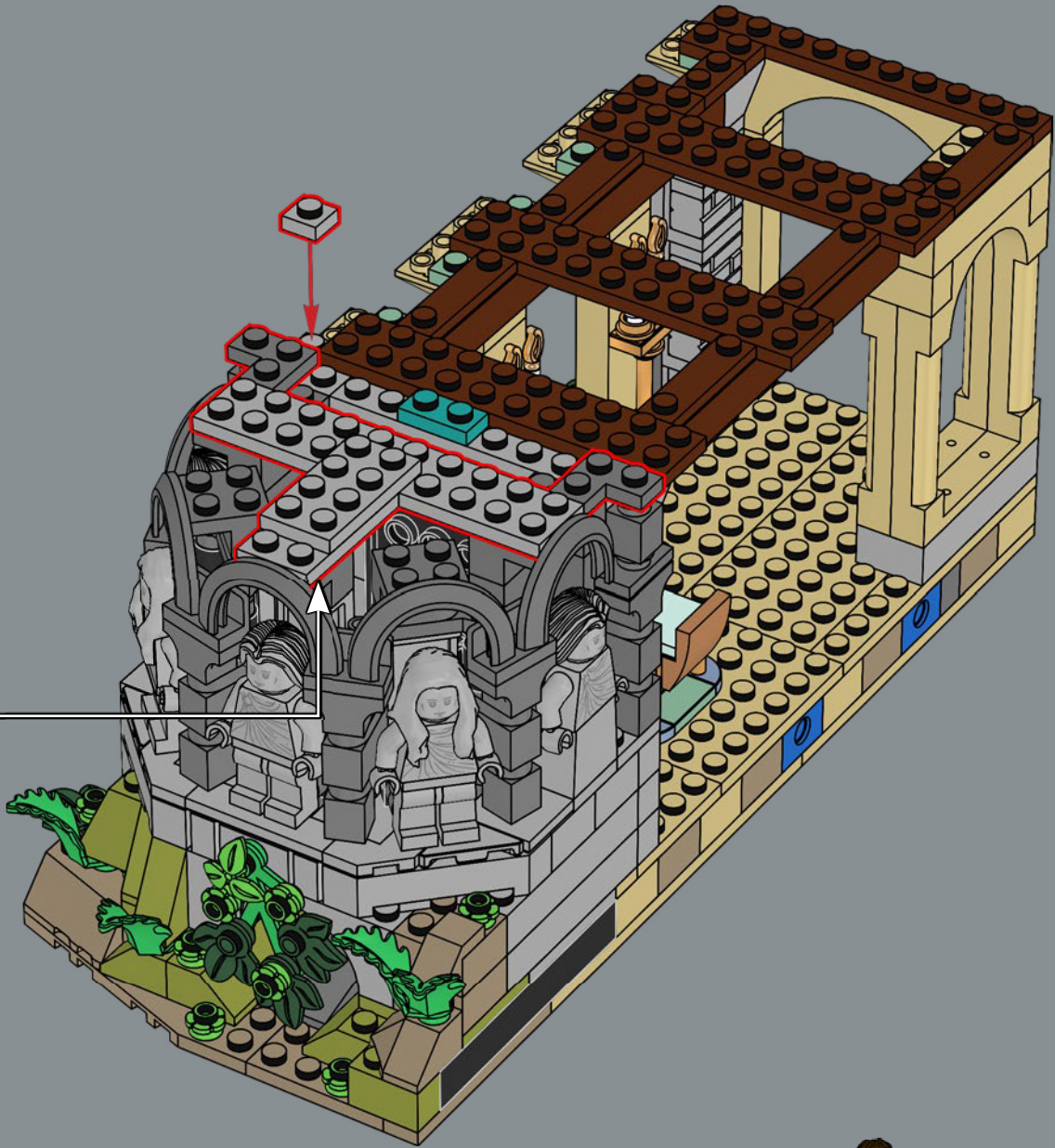
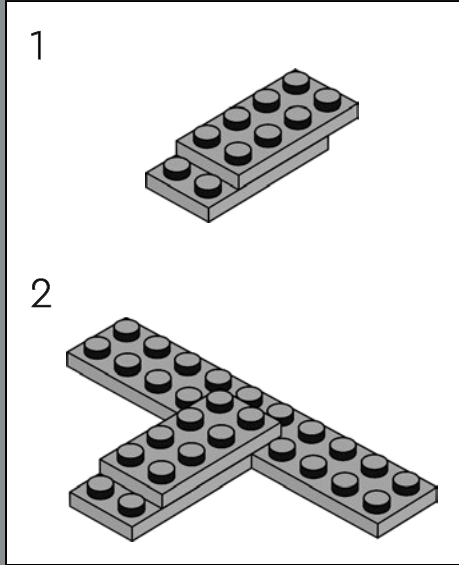

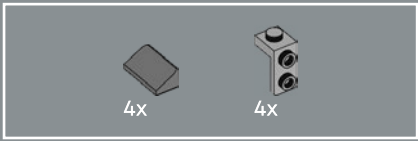

86

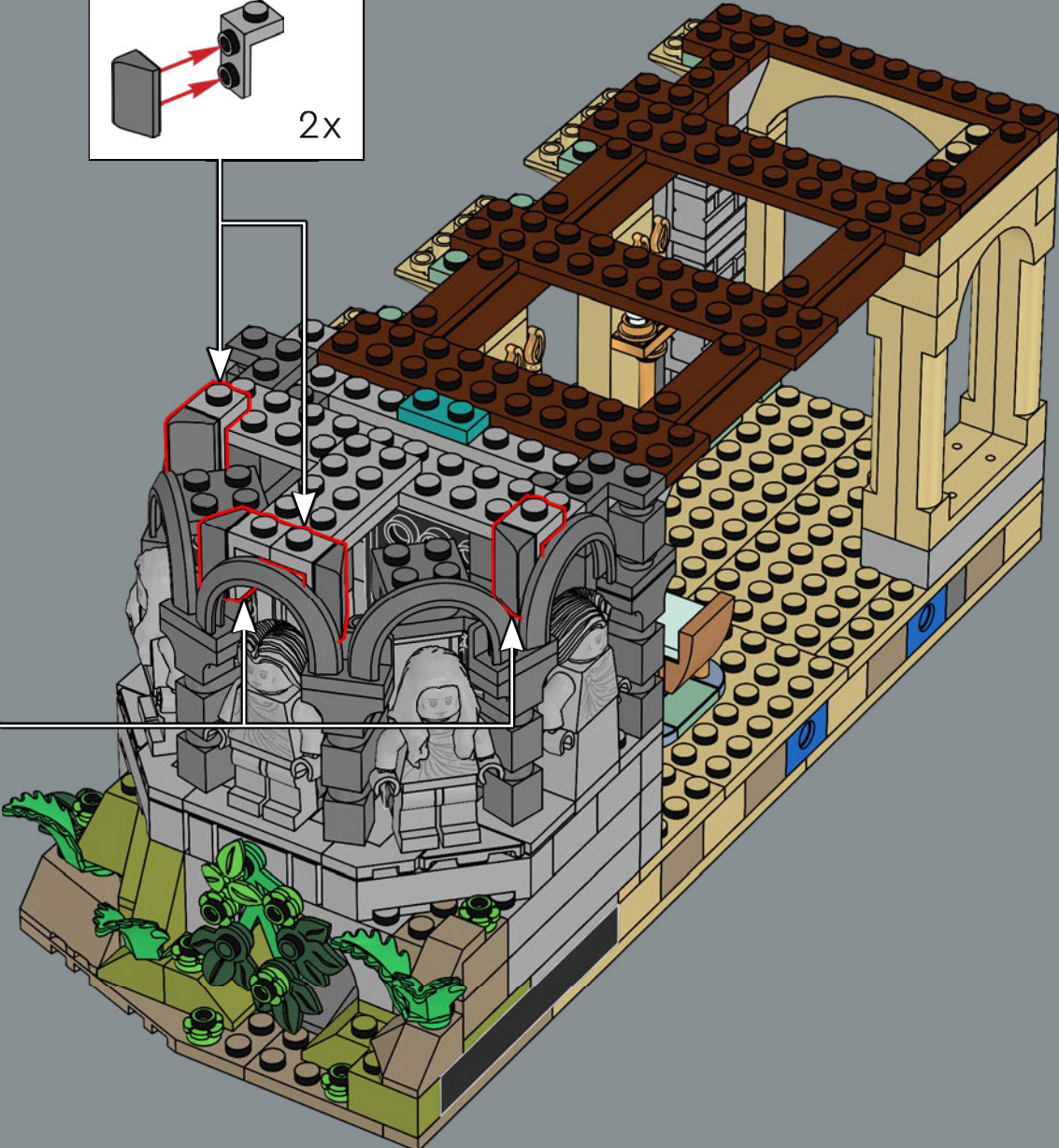
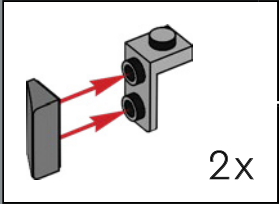
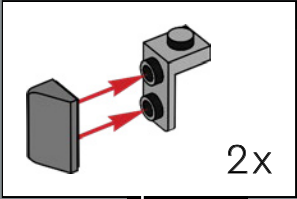

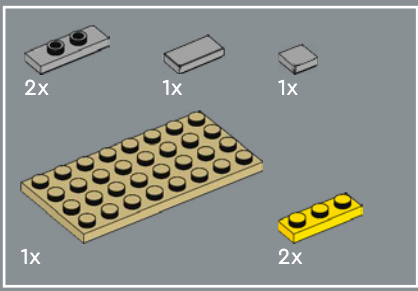

87





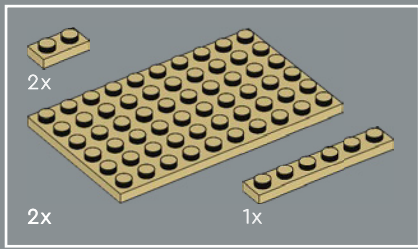

88

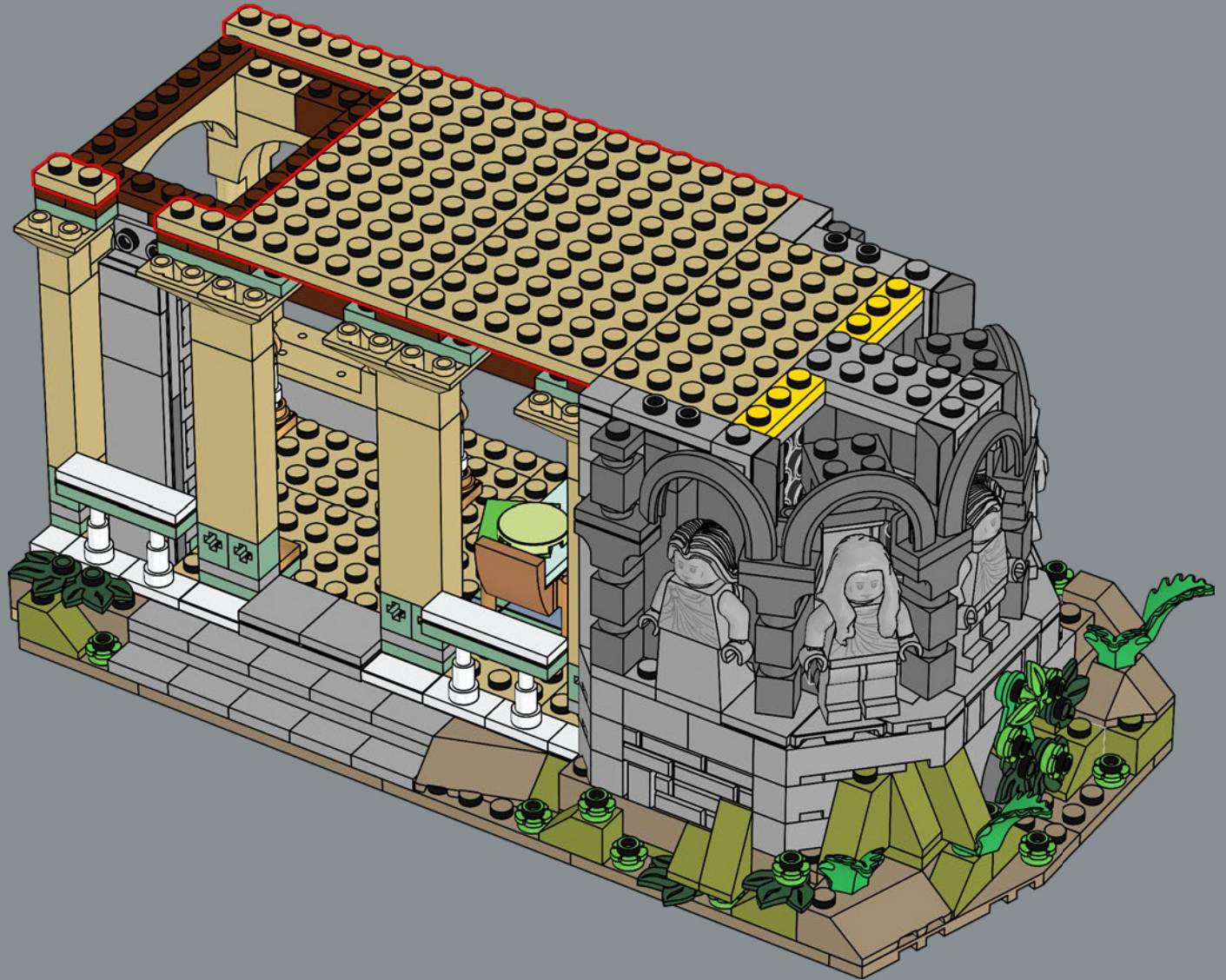

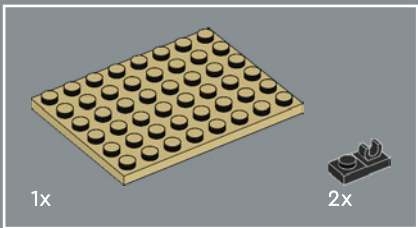
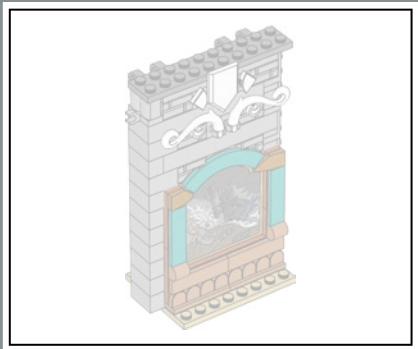

89

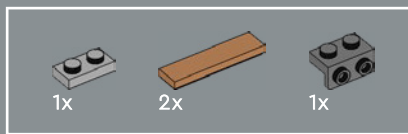
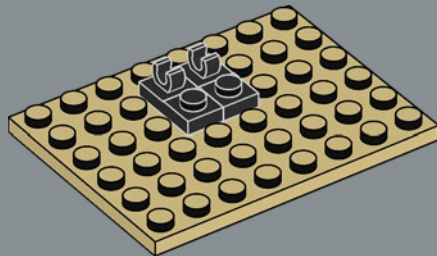

90

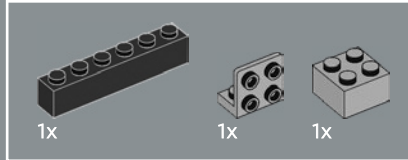
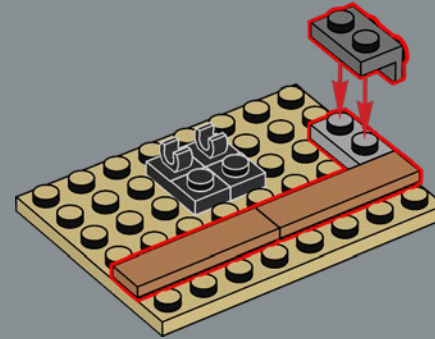

91

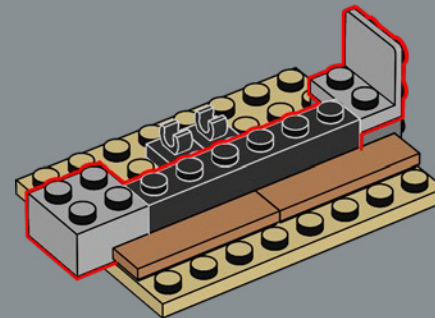

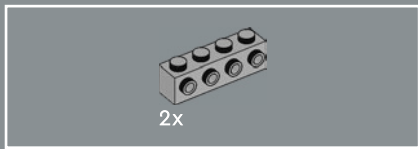

92

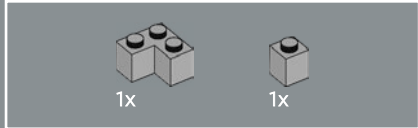
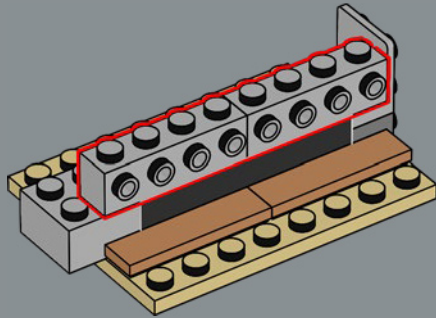

93

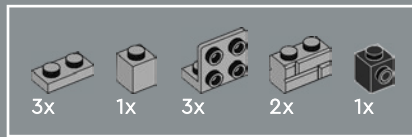
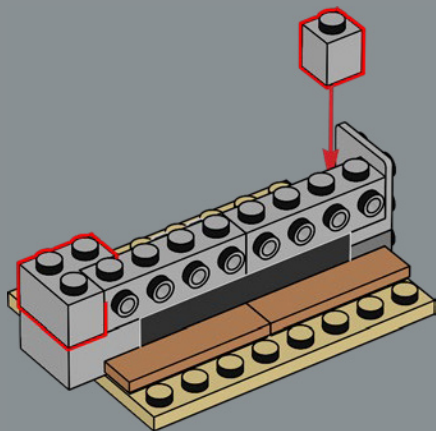

94

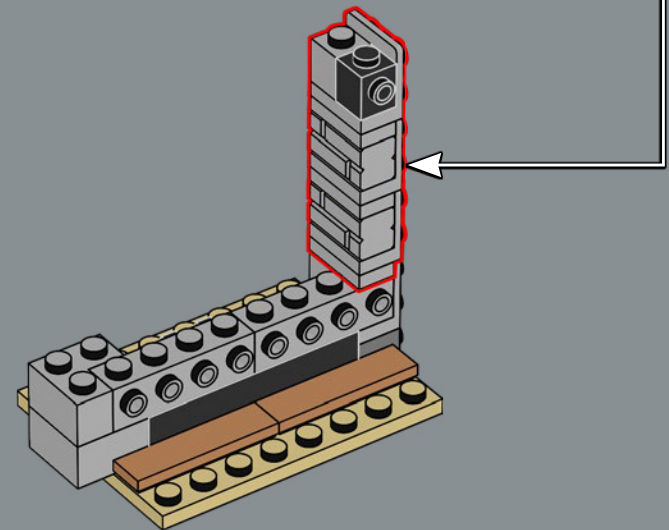
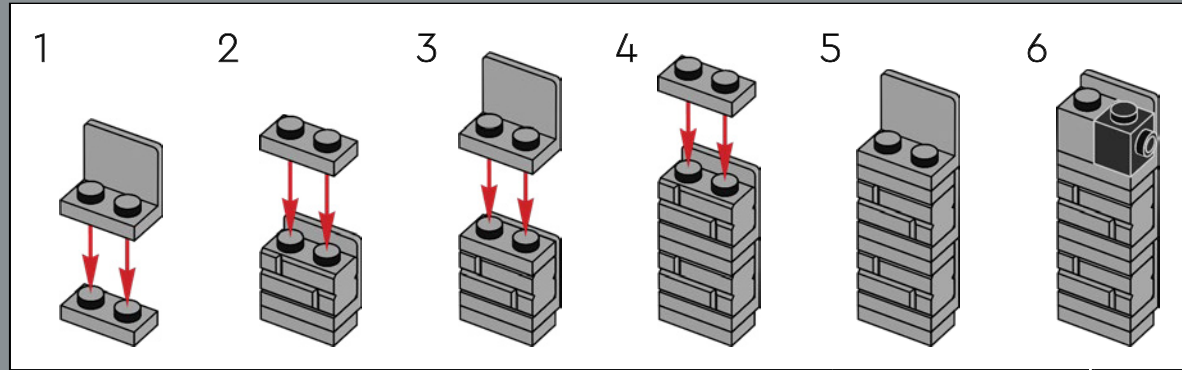

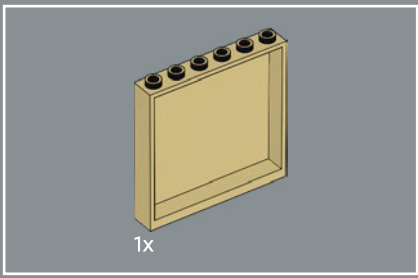

95

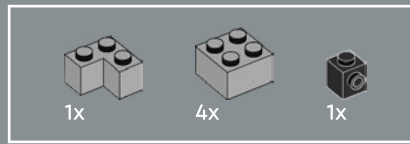
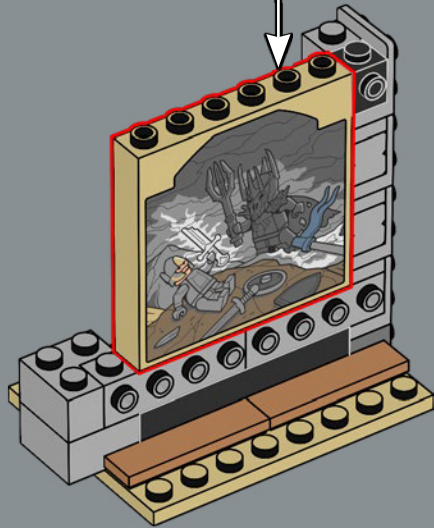
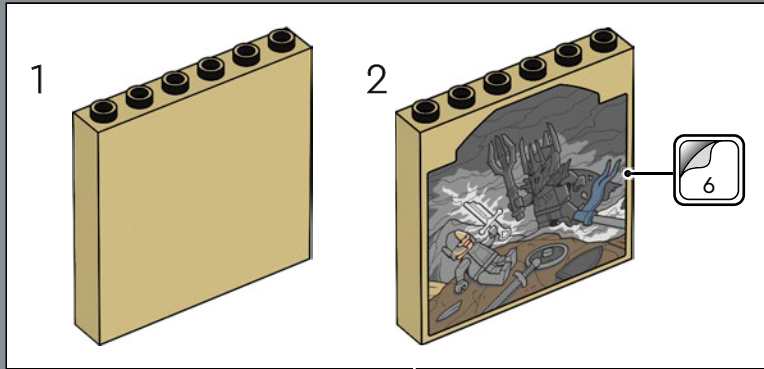

96

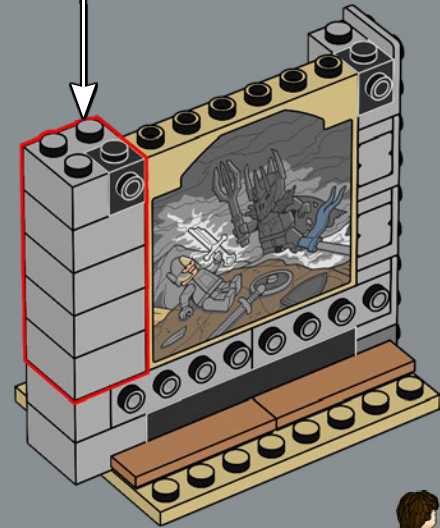
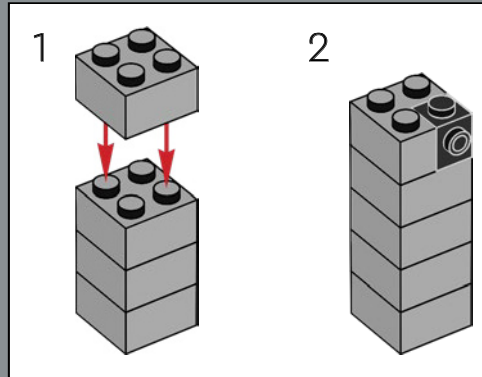

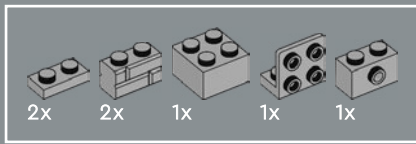

97

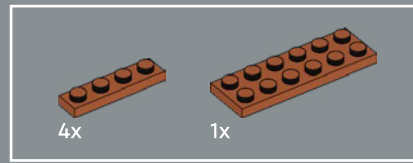
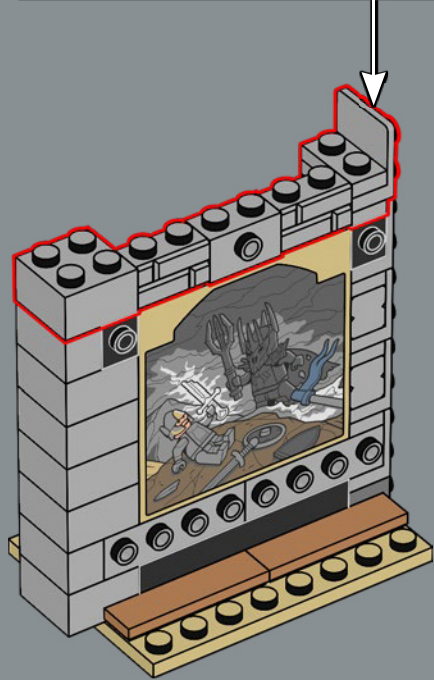
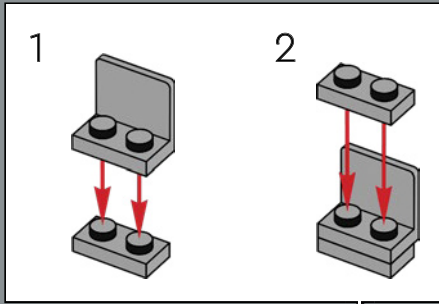

98

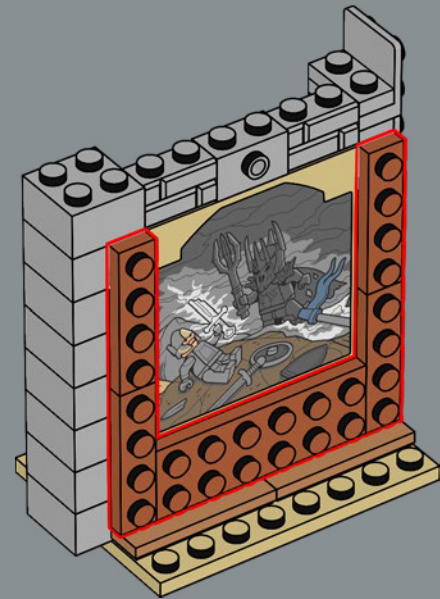



引入乐高®世界的《索伦的毁灭力 (the Destruction of Sauron)》  
采用全新设计的纳熙尔剑柄组件和精美的蓝绿色框架。

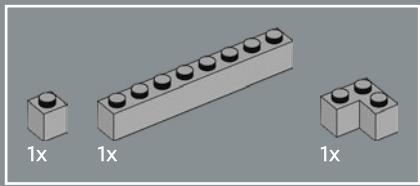

99

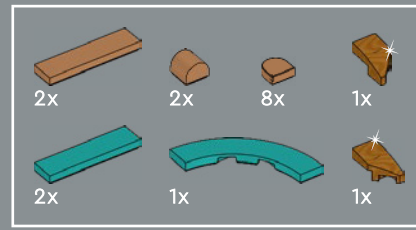
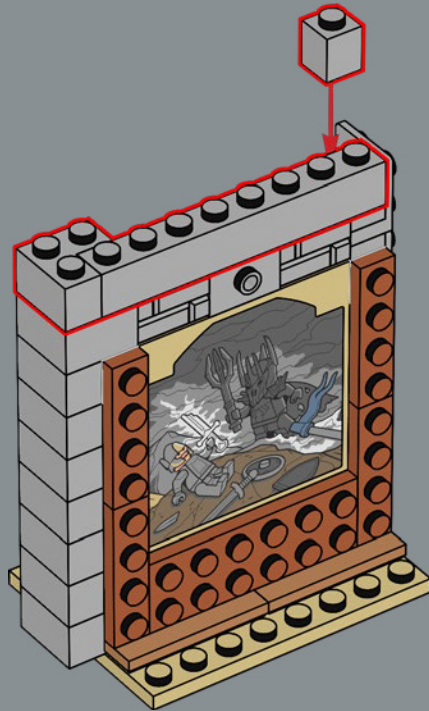

100

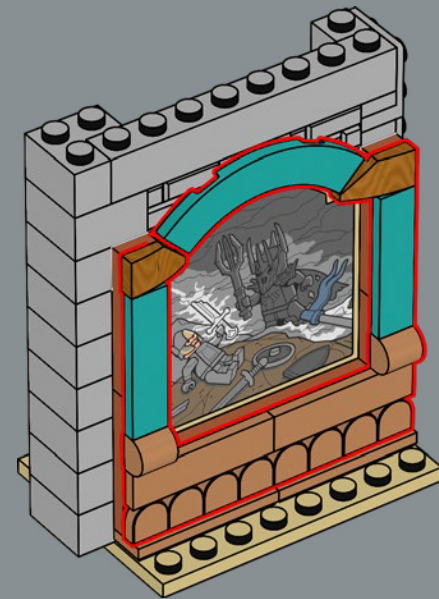

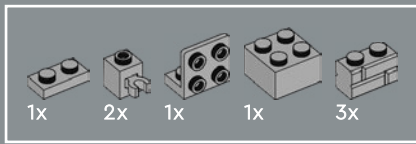

101

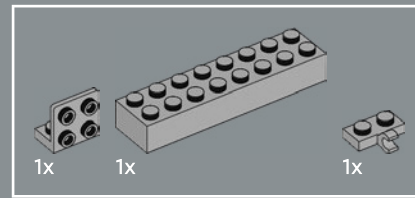
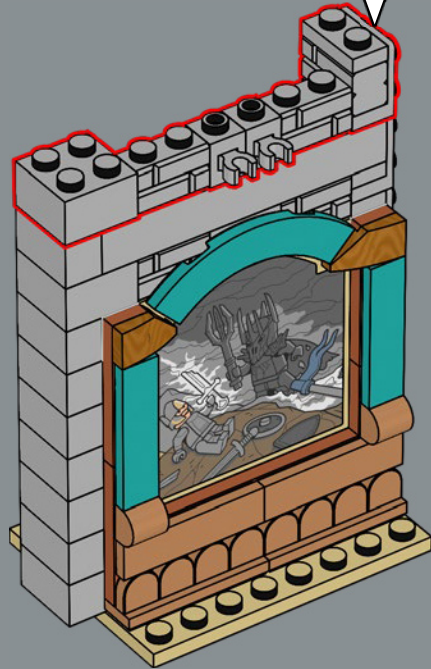
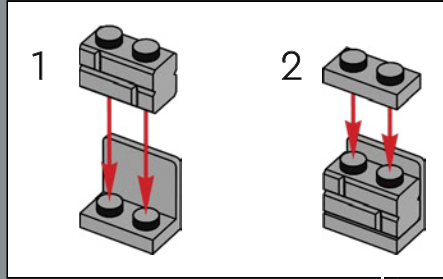

102

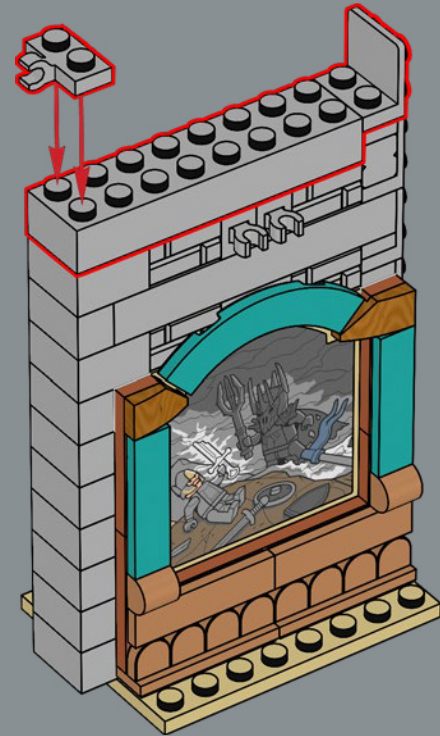

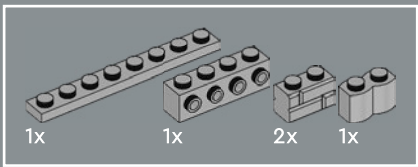

103

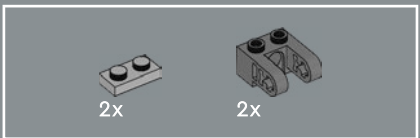
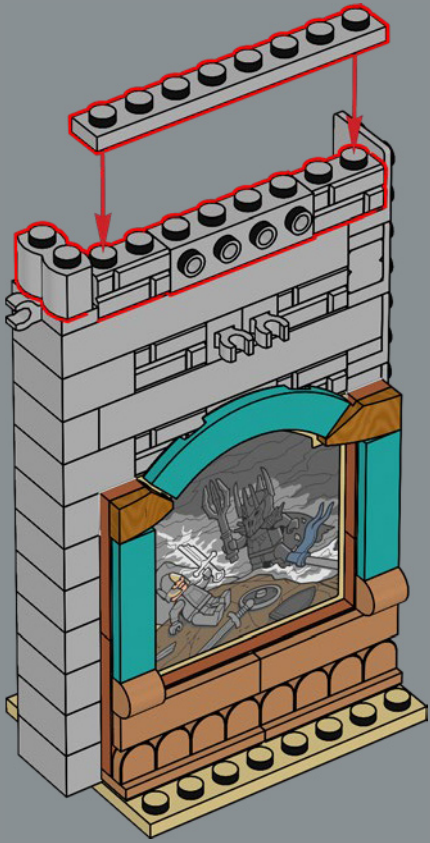

104

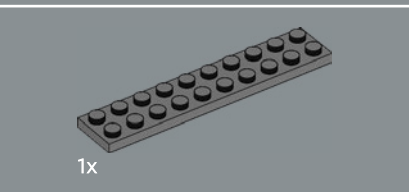
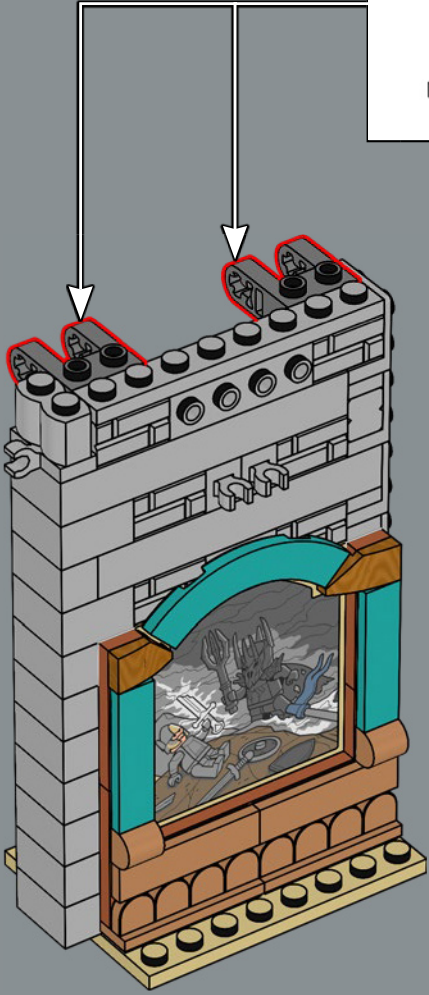
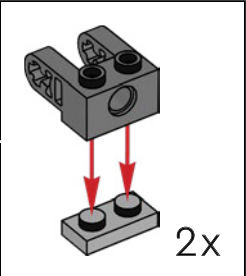

105

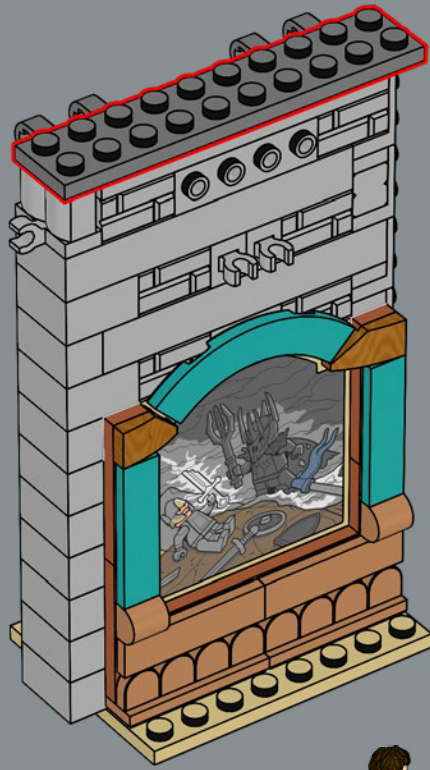





106



107

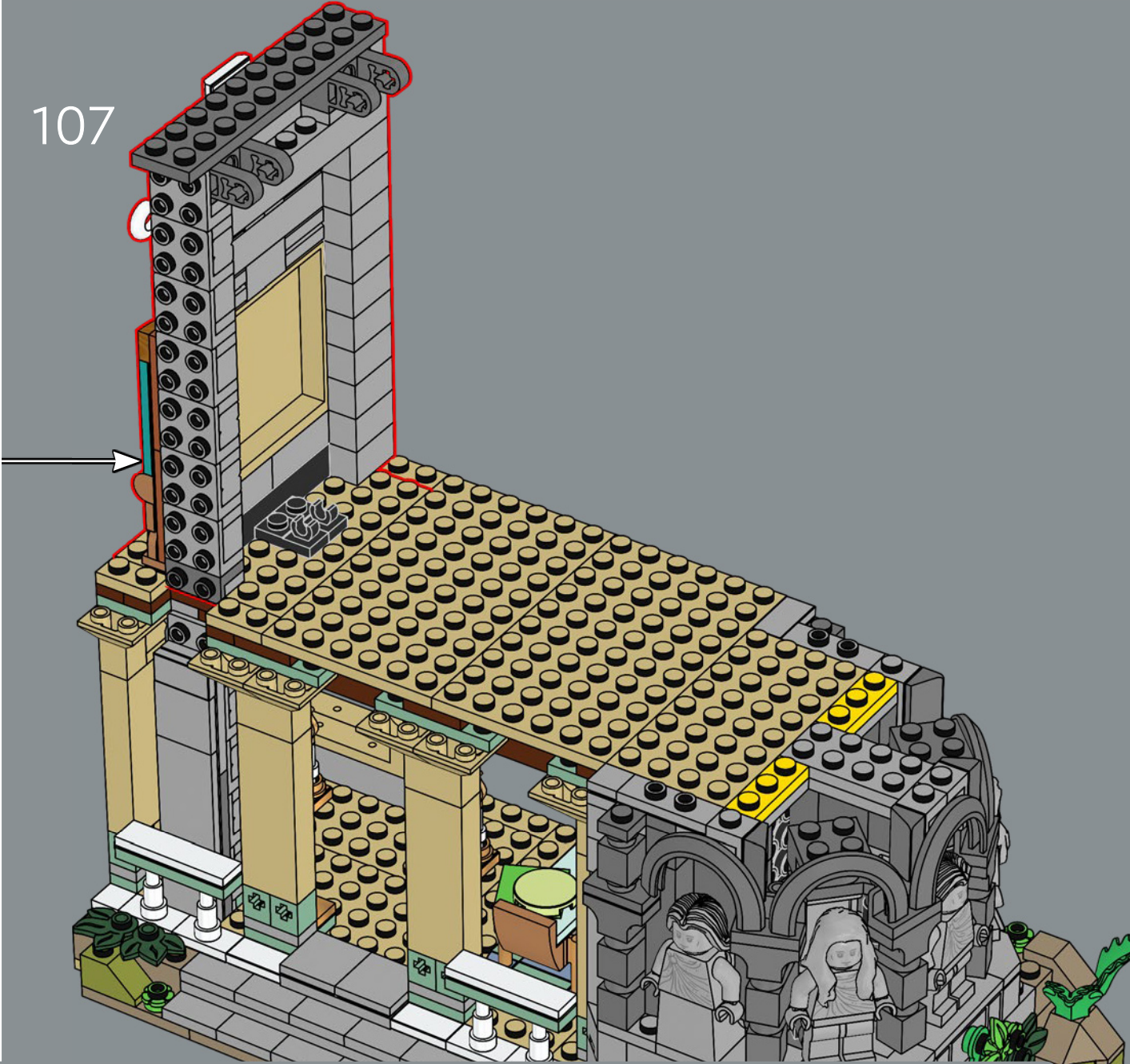

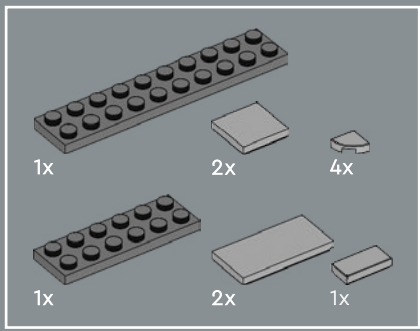

108

1

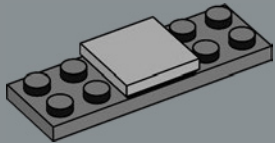

2

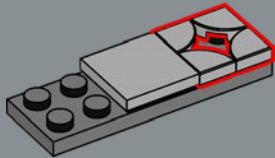

3

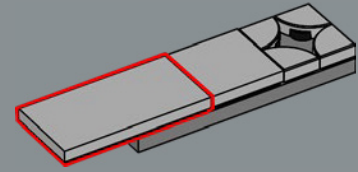

4

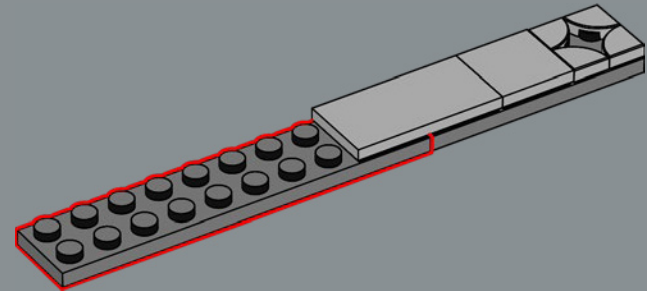

5

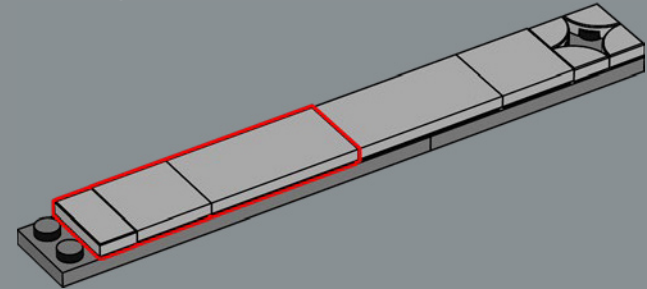

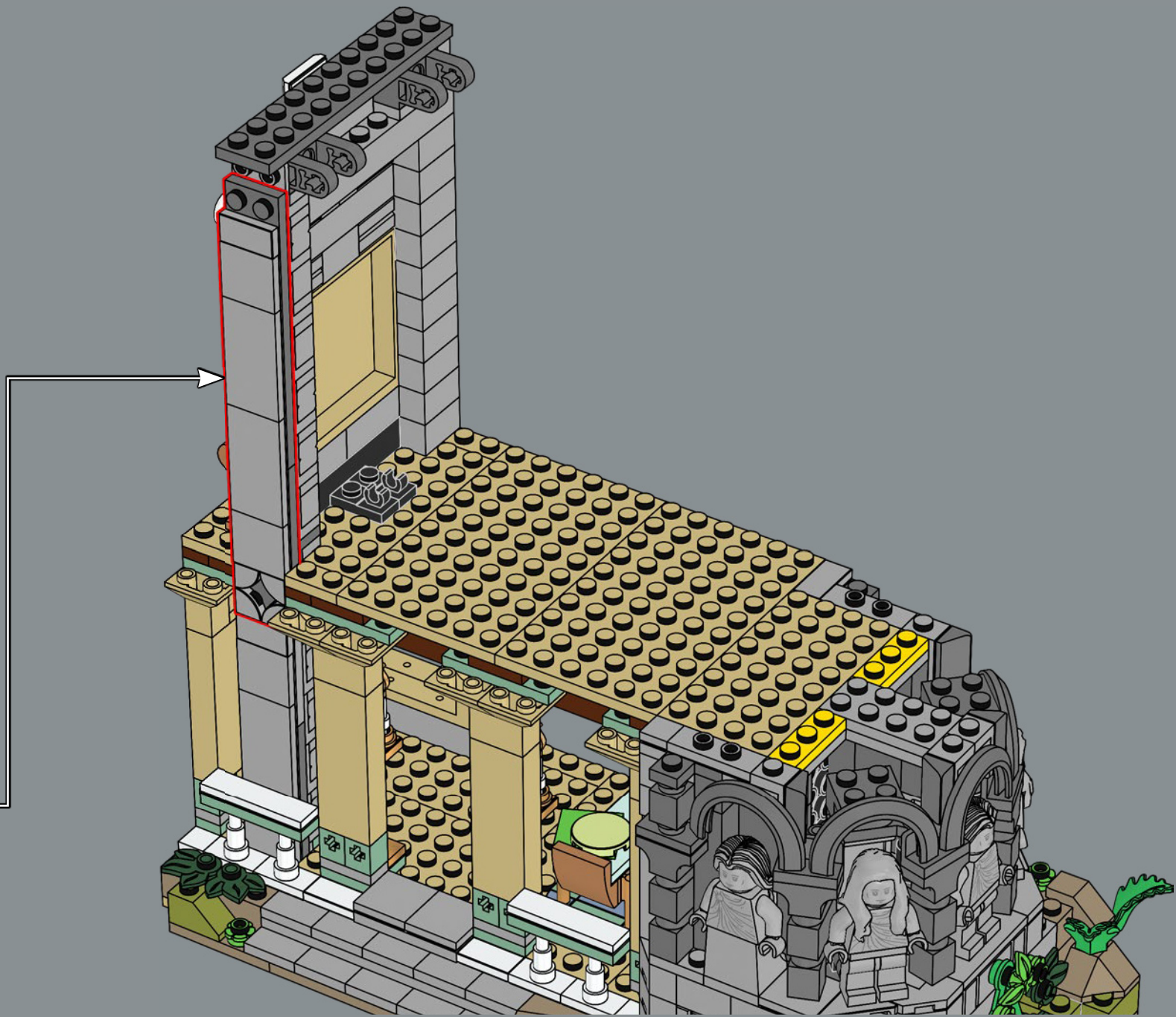

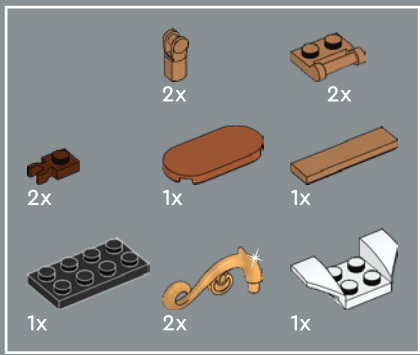

109

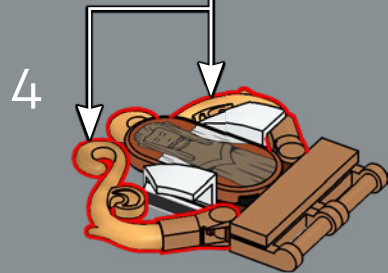
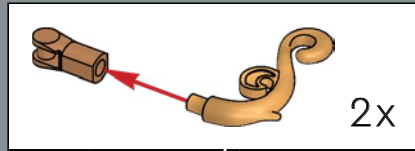
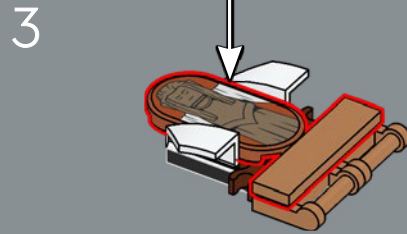
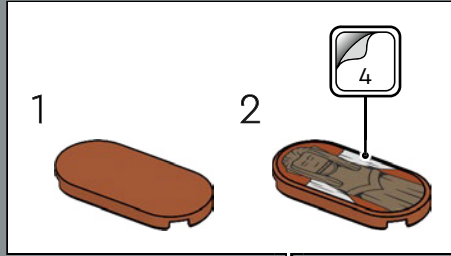
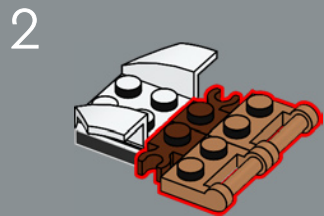
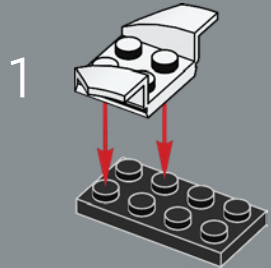

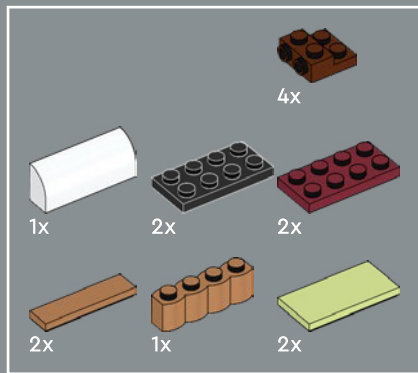

110

1

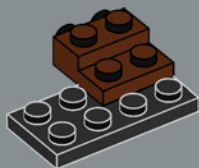

2

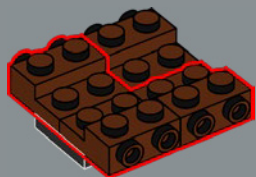

3

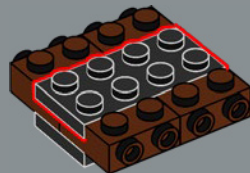

4



5



6

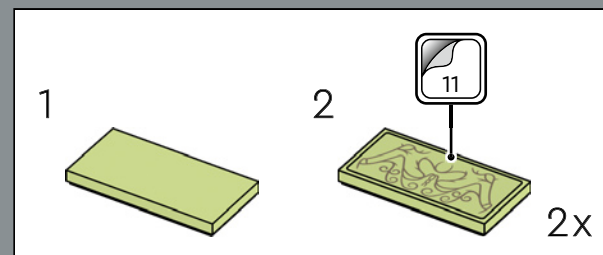
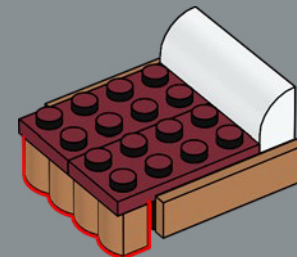

7

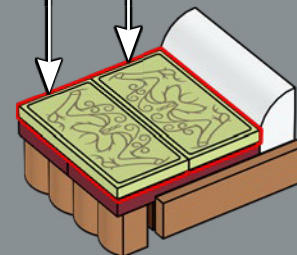





111



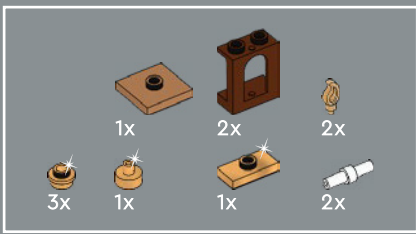

112

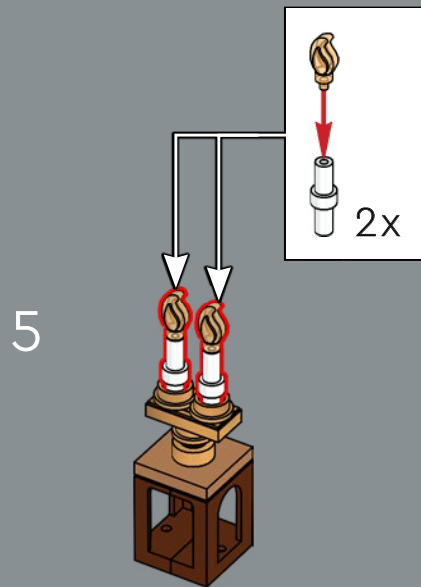
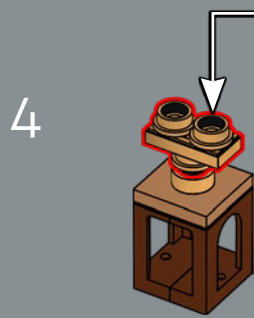
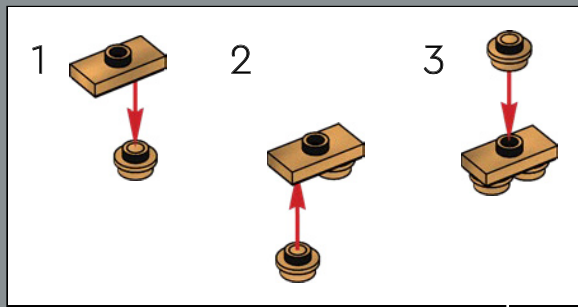
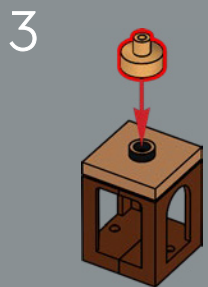
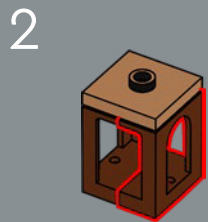
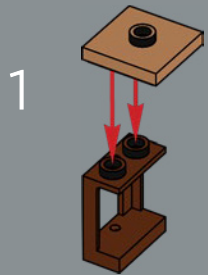



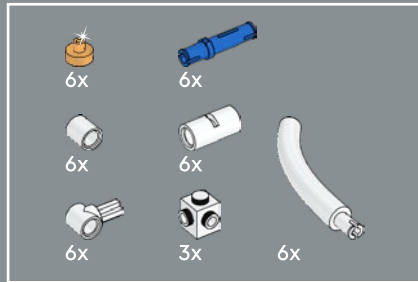
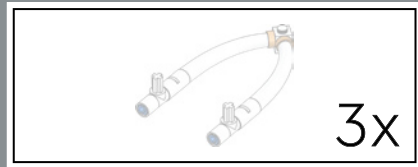

1



2



3

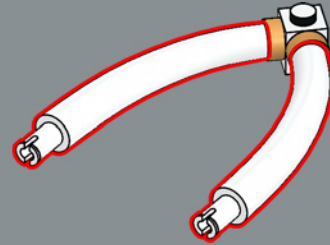

4

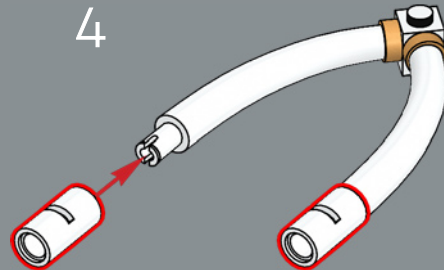

5

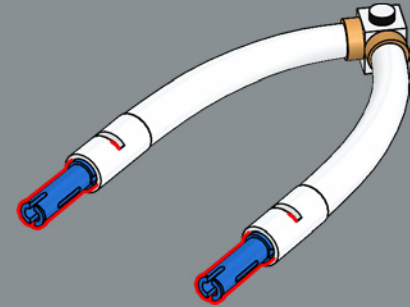

6

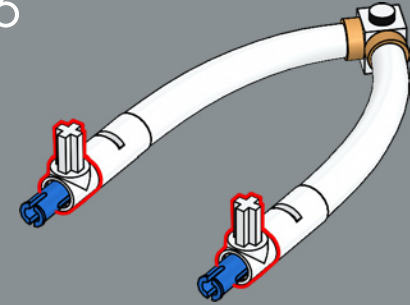

7

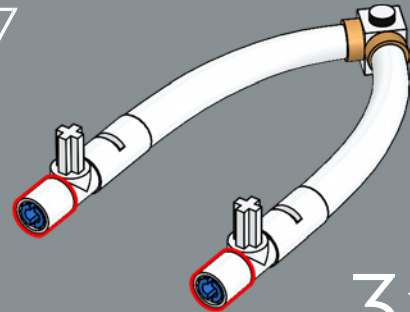

3x

113





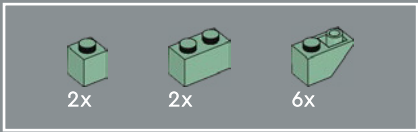

114



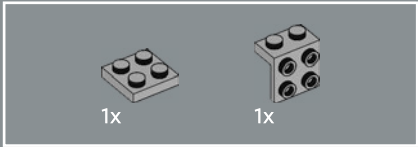
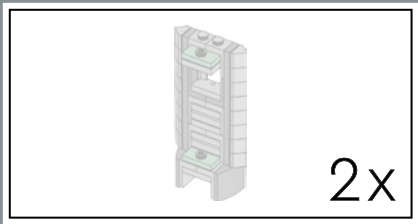

115

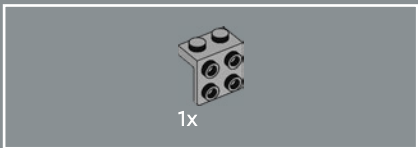
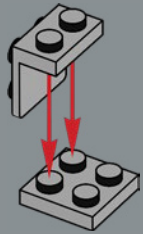

116

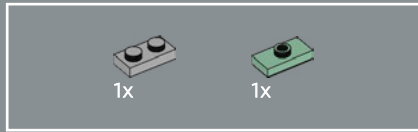
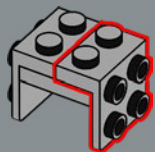

117

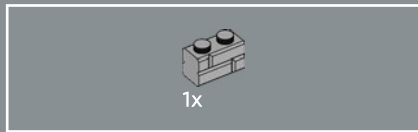
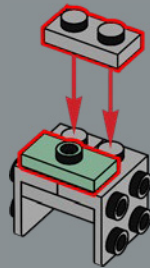

118

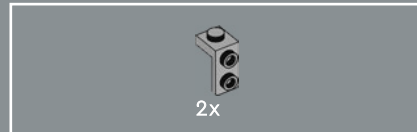
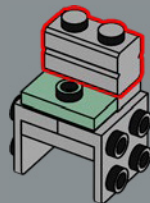

119

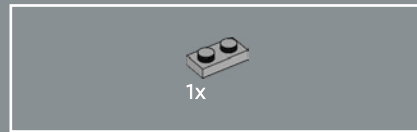
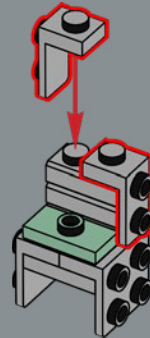

120

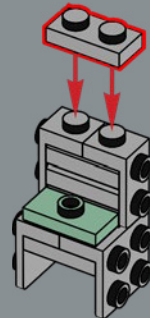

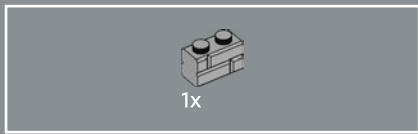

121

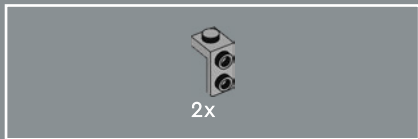
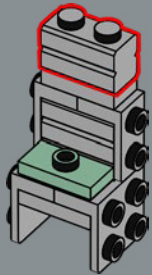

122

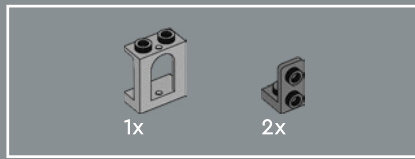
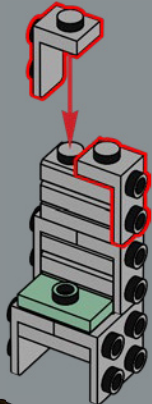

123

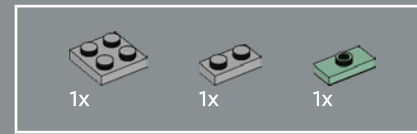
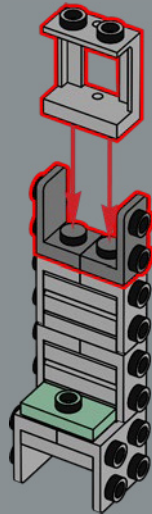

124

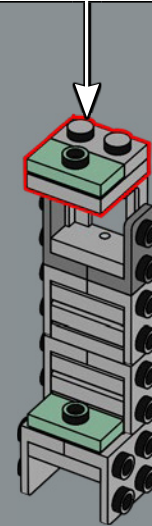
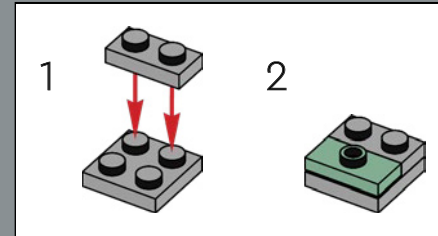



2x

125

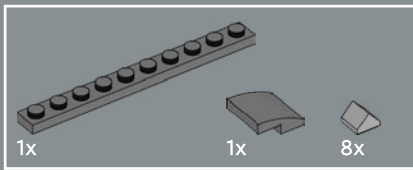
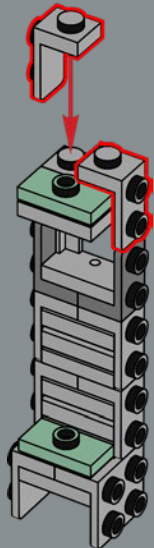

126

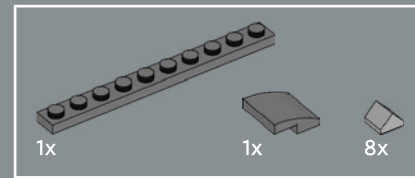
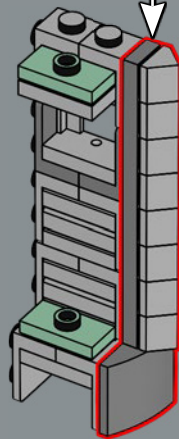
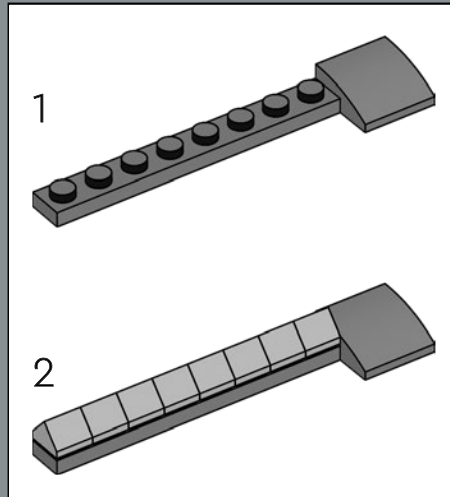

127

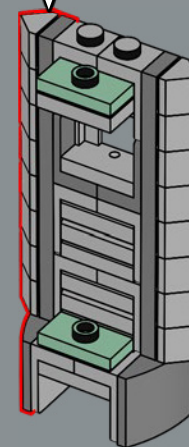
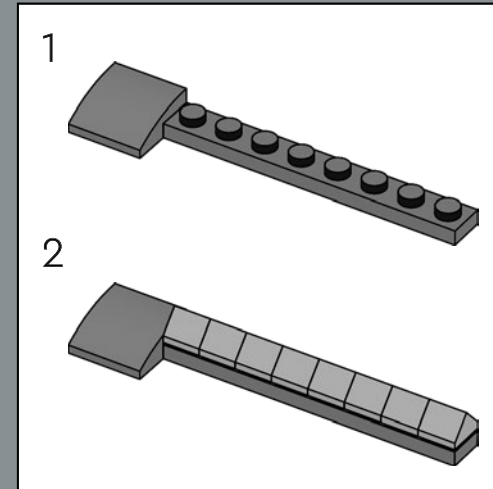

2x

128



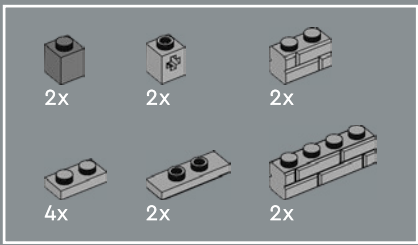

129

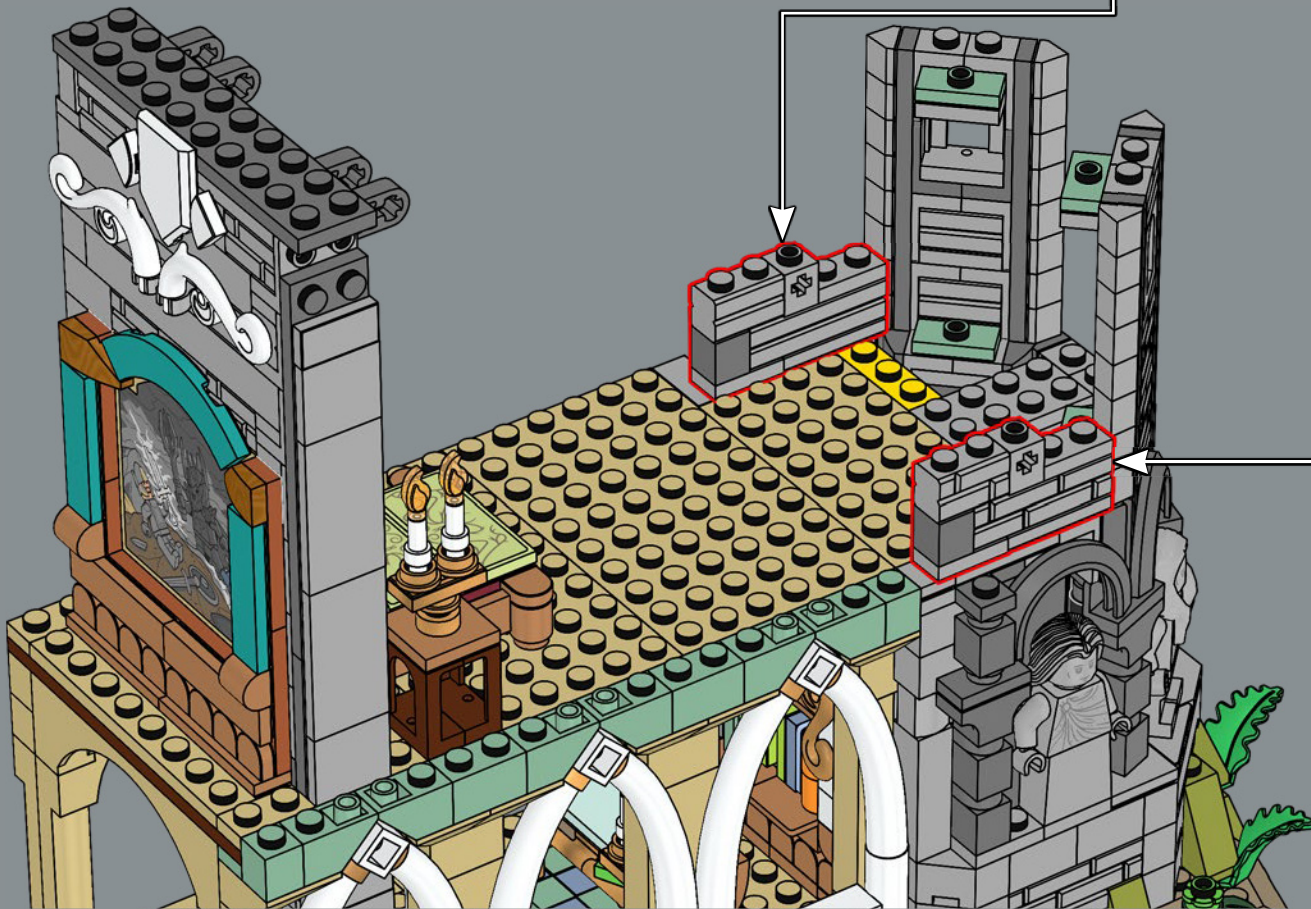
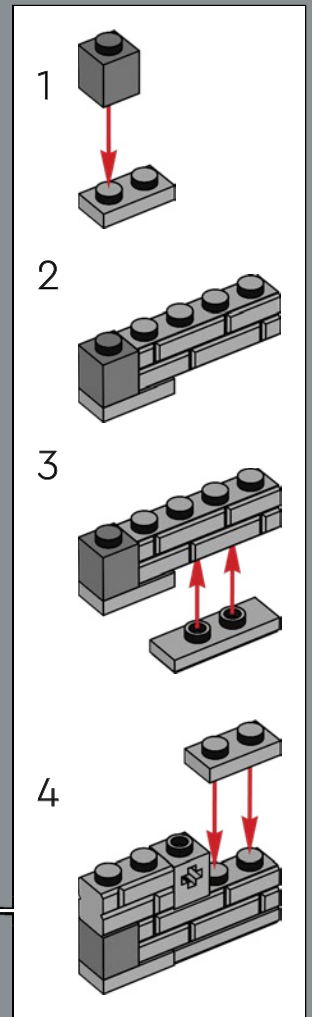
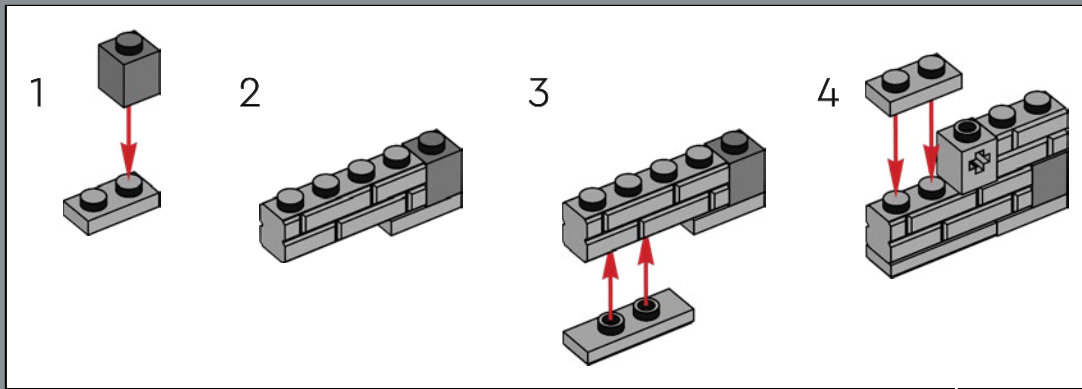



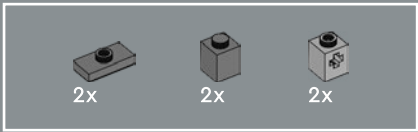

130

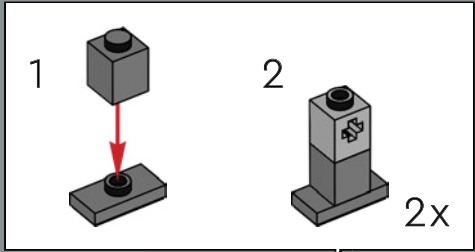

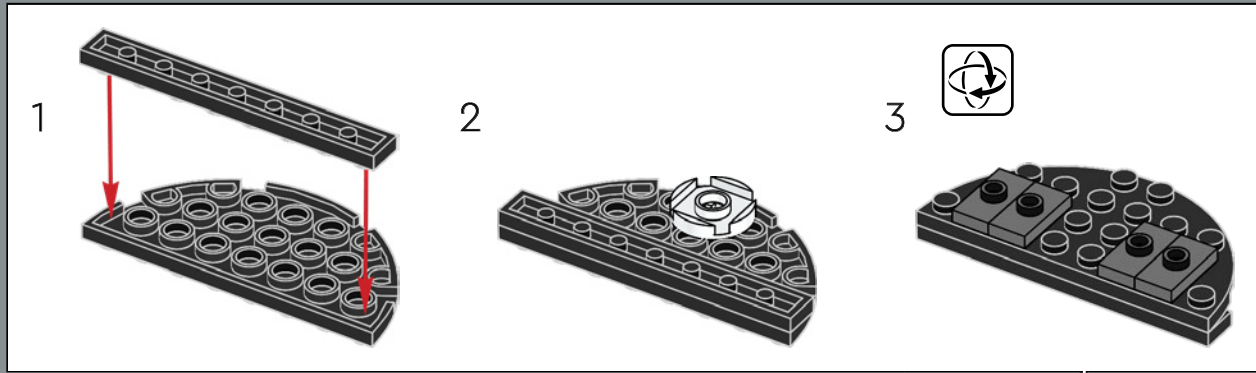
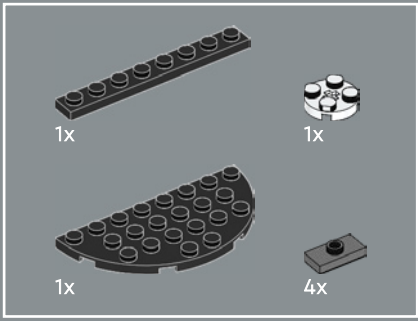

131

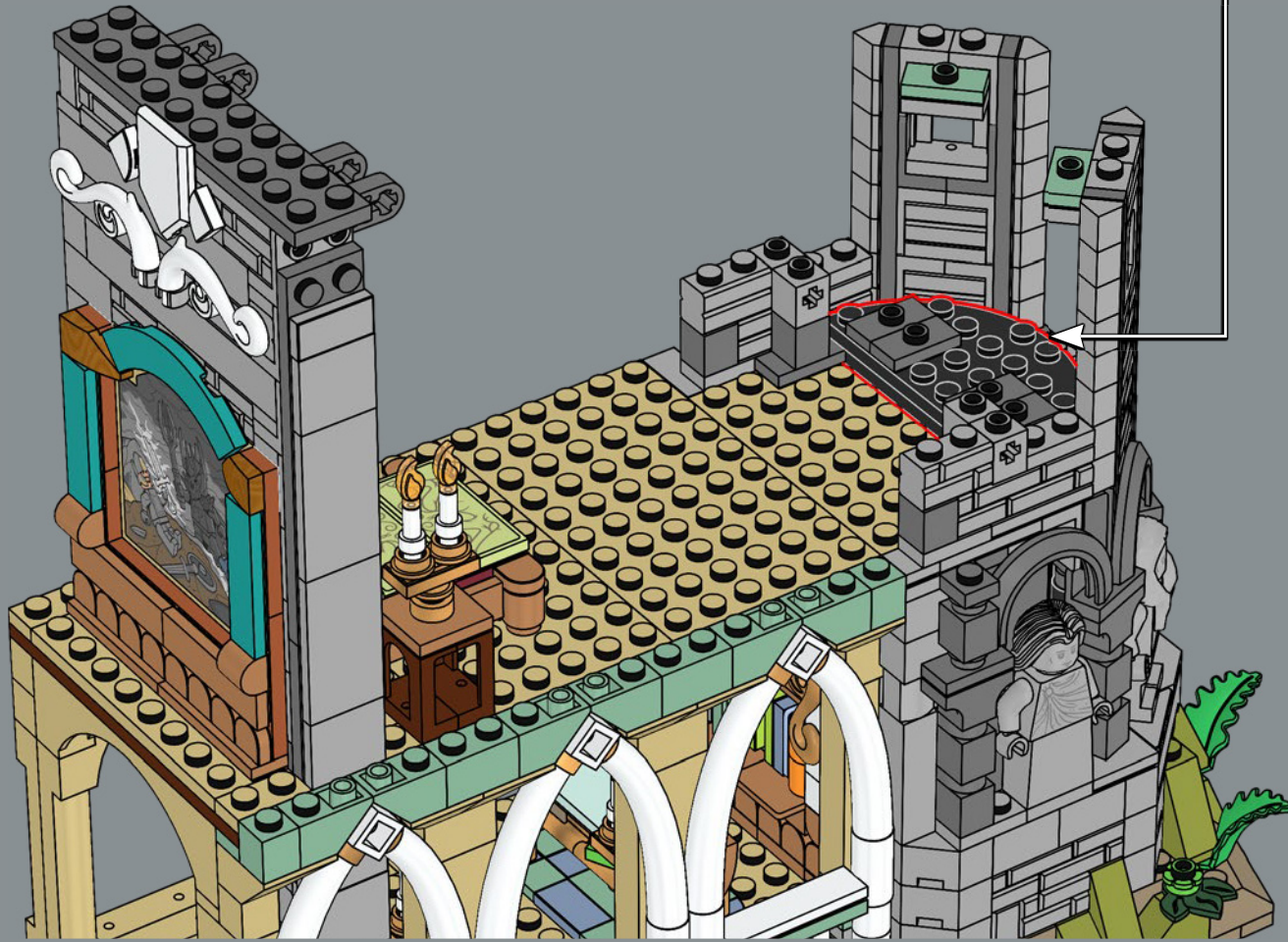

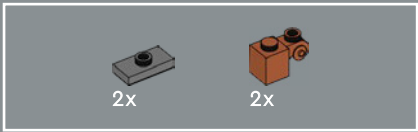

132

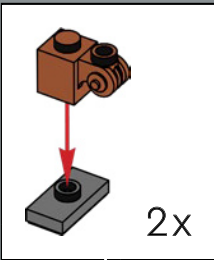

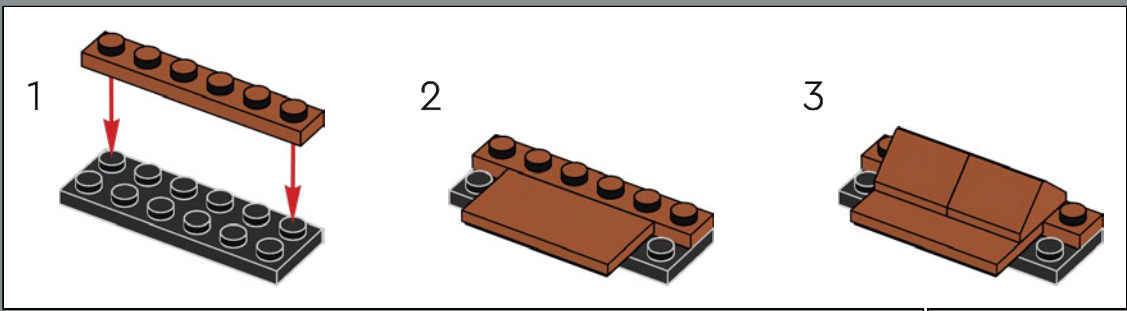
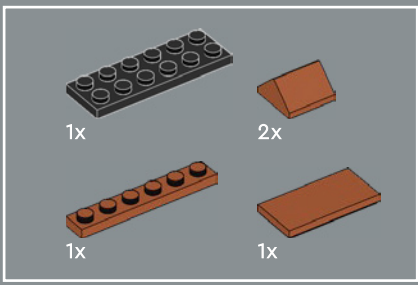

133



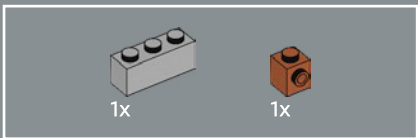

134

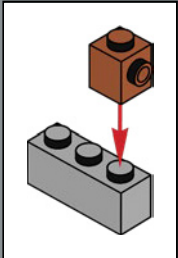



不仅这里是个著书立传的好地方，而且这张桌子还为稍后将要连接的屋顶和塔楼提供了关键的结构稳定性。

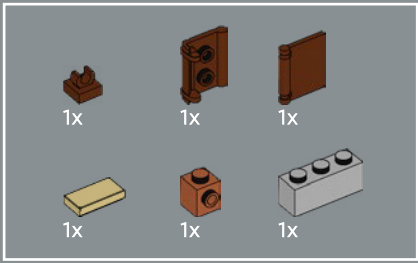

# 135

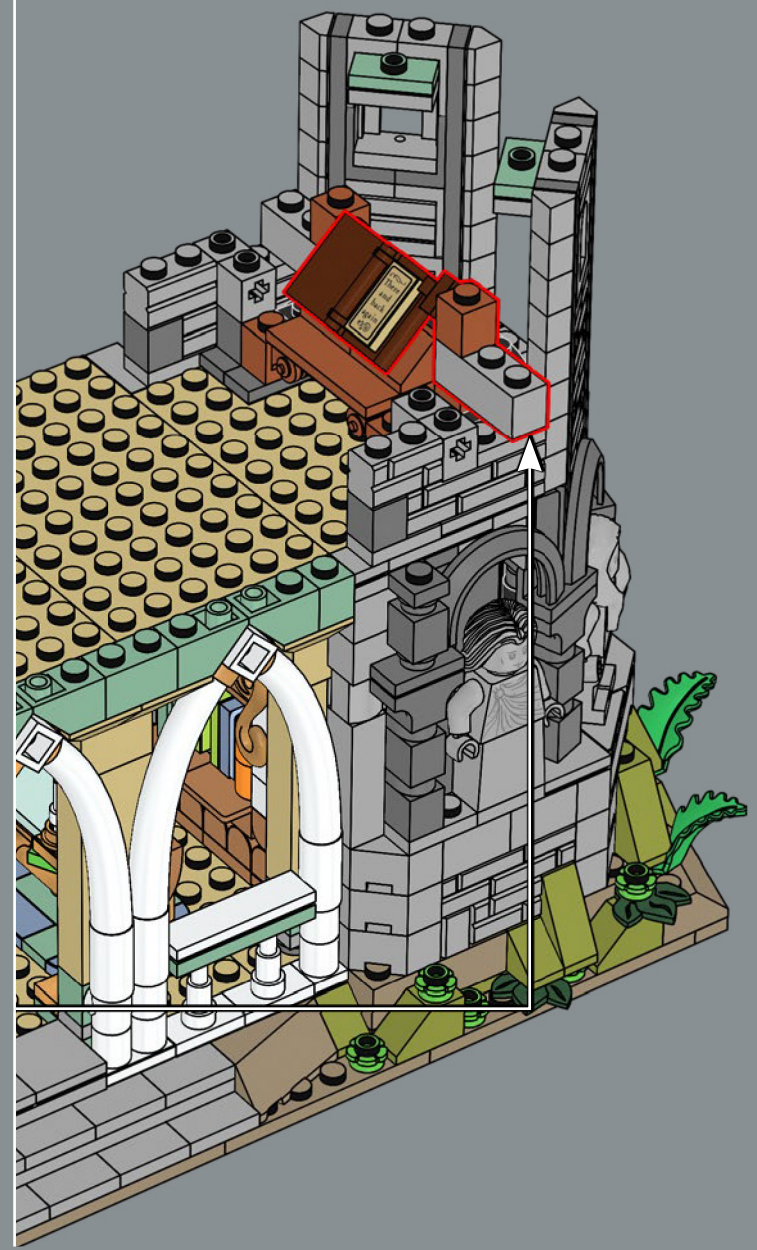
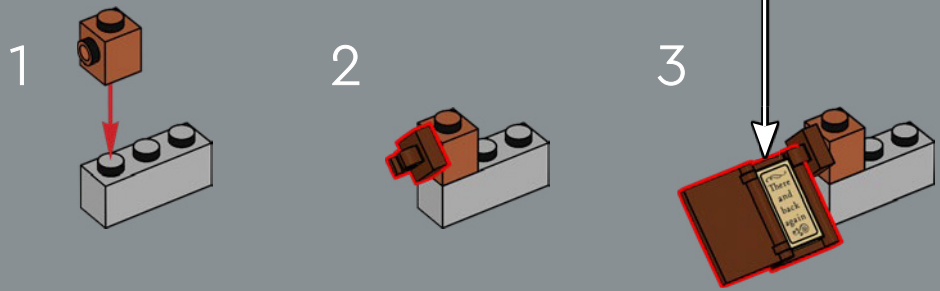
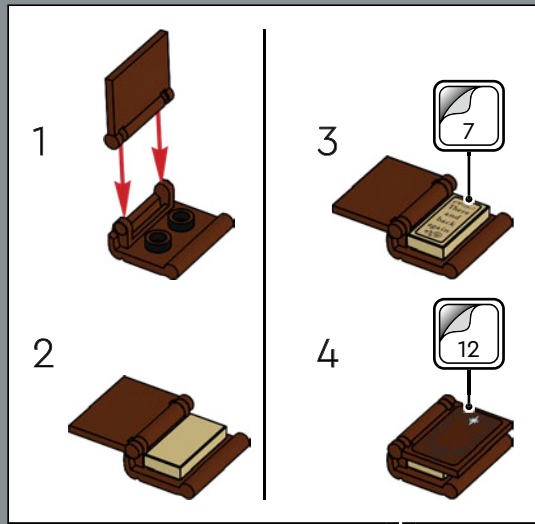

-  2x
-  1x
-  2x
-  1x
-  2x
-  2x
-  1x

136

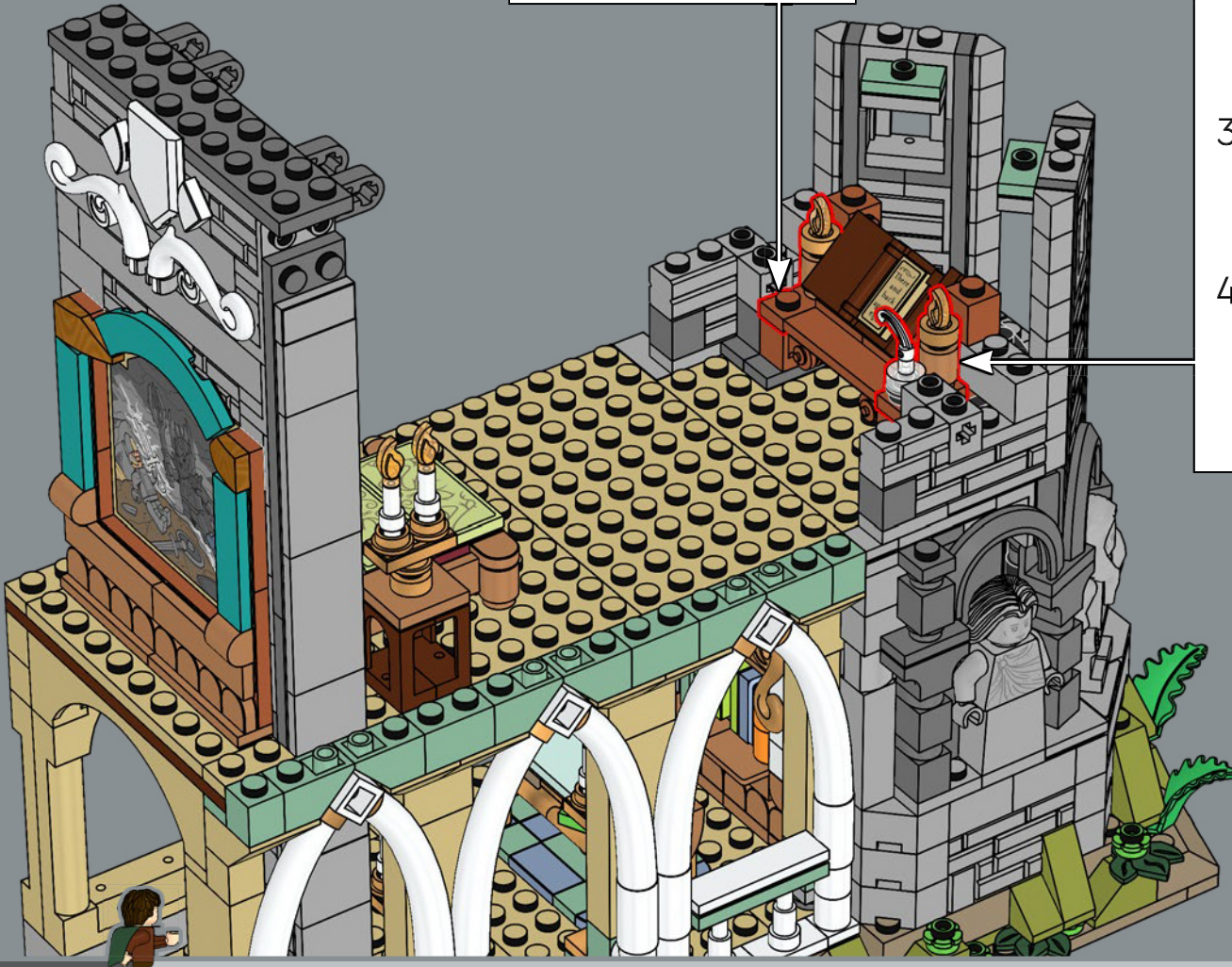
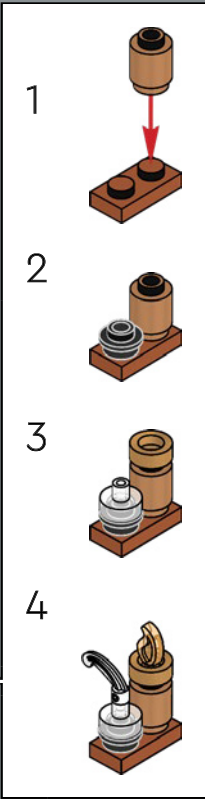
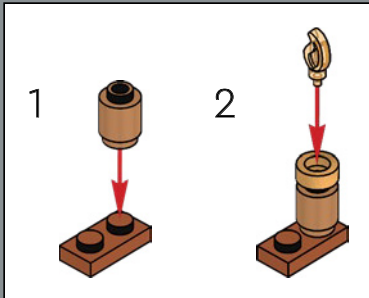

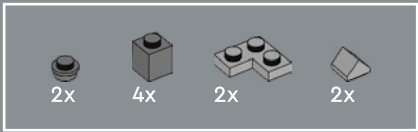

137

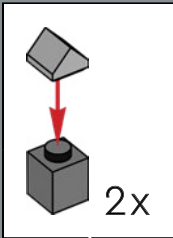





这是我们第一次在乐高®模型中见到超过 111 岁的比尔博。  
千万别让他看到魔戒，否则他可能会有点太兴奋了！

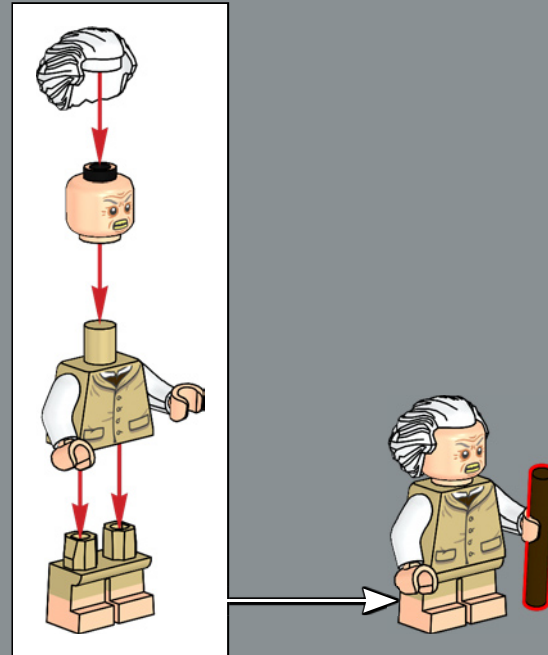

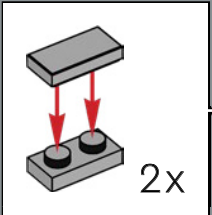
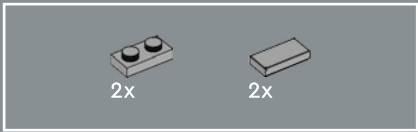

138

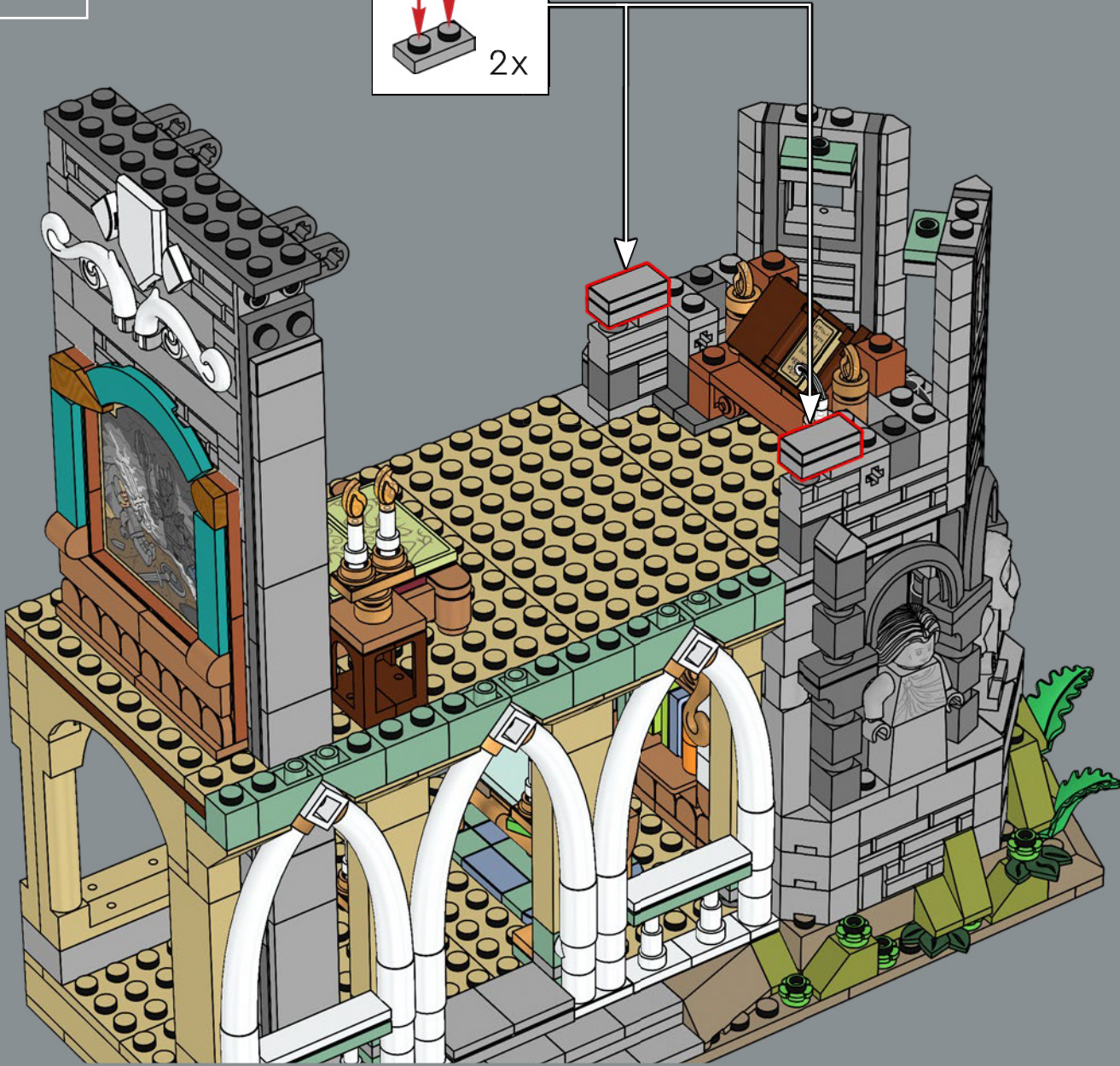

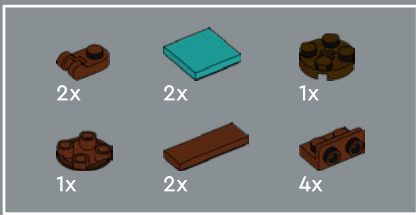

139

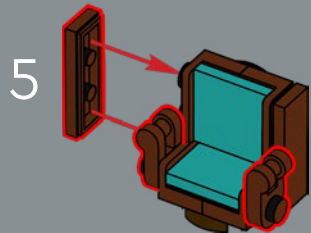
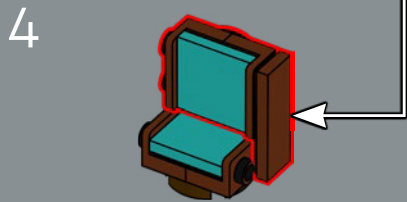
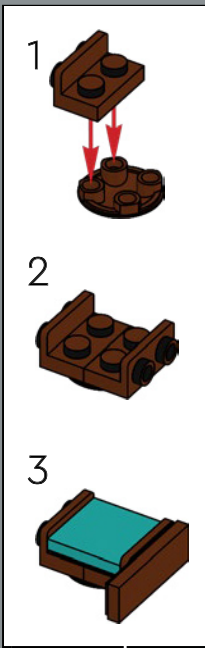
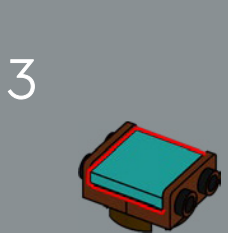
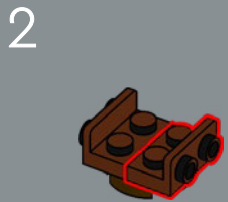
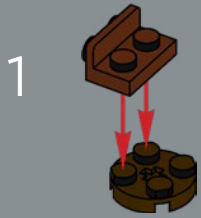

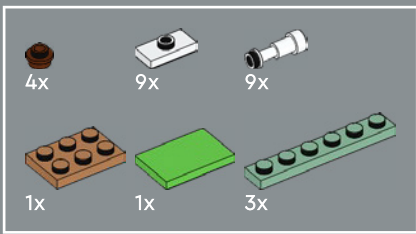

140

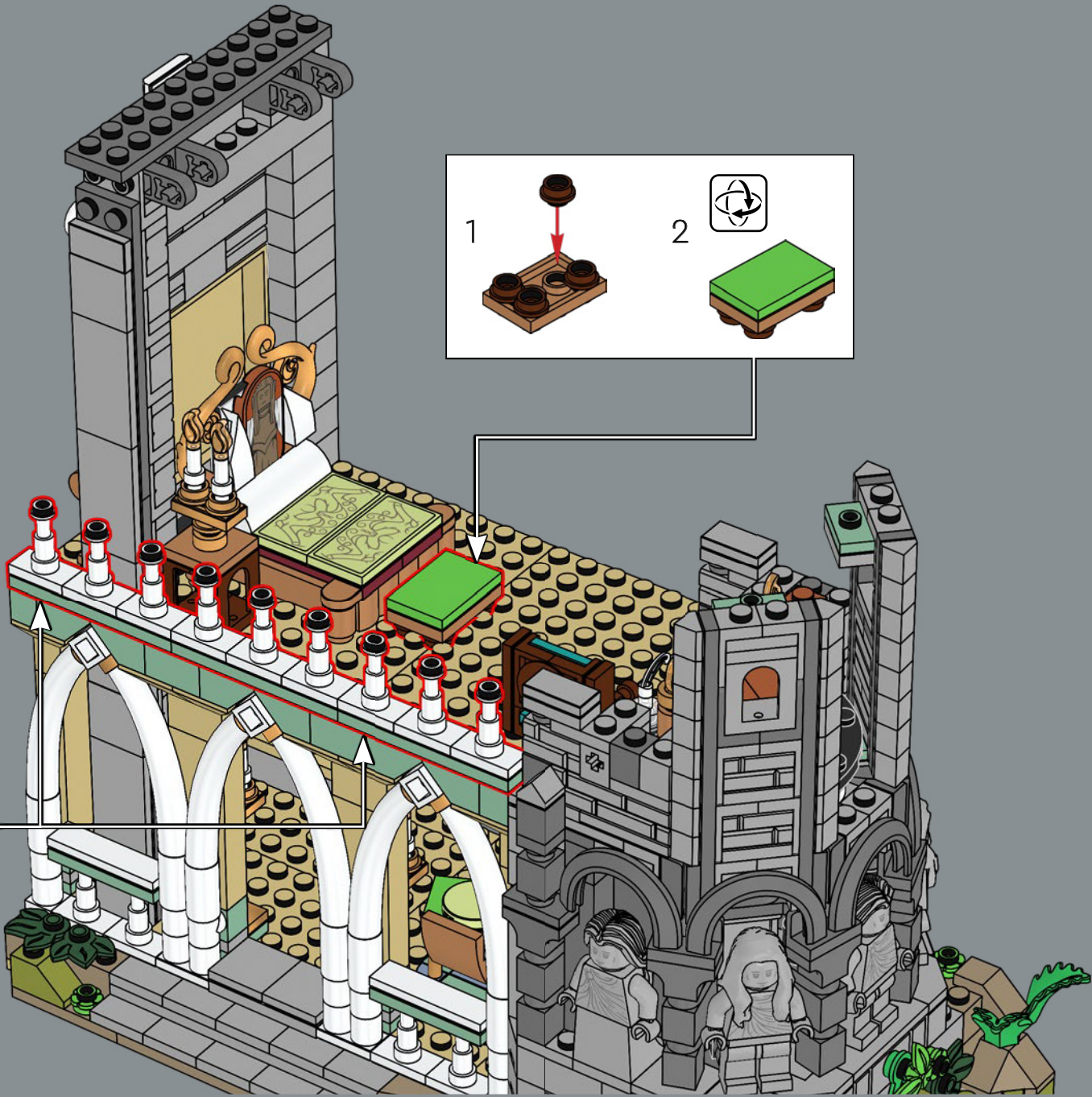
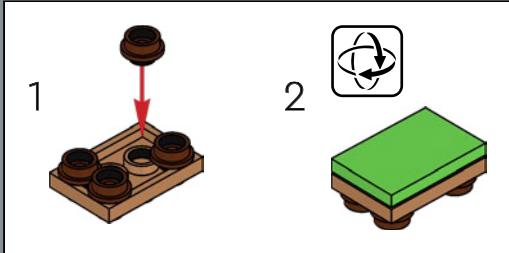
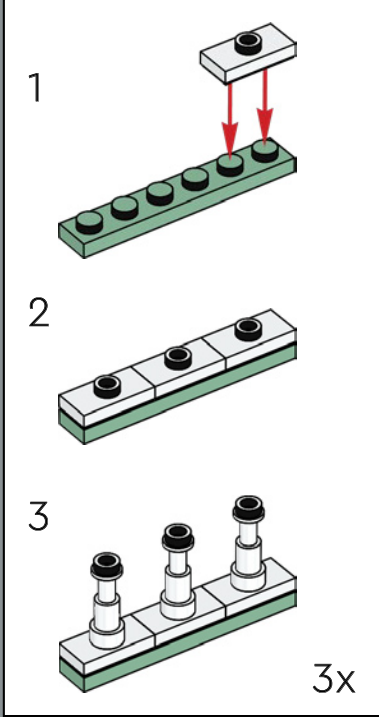

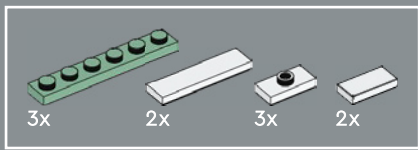

141

1

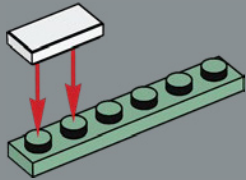

2

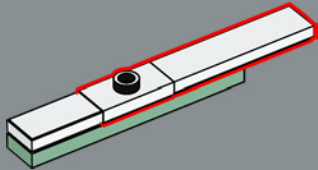

3

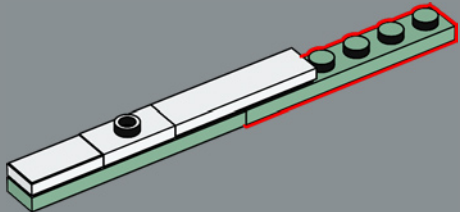

4

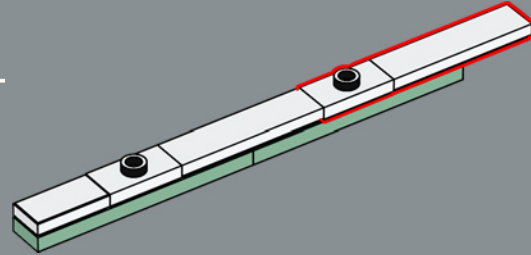

5

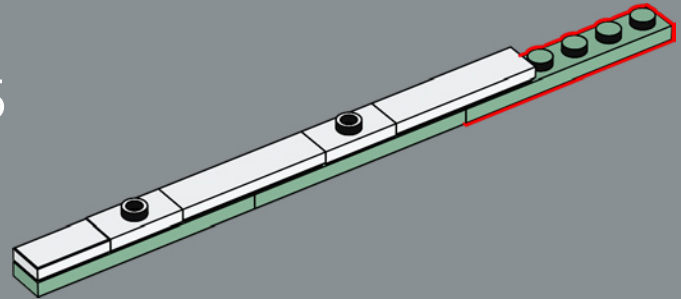

6

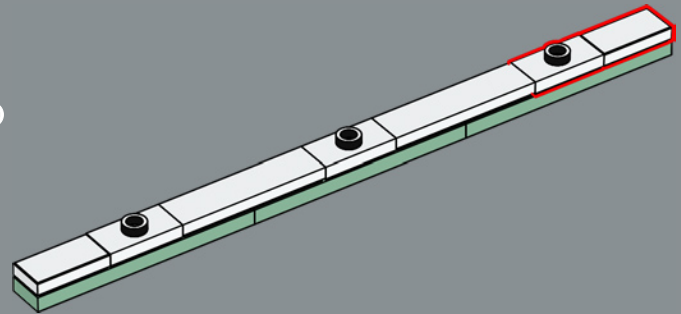



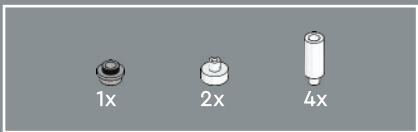

142

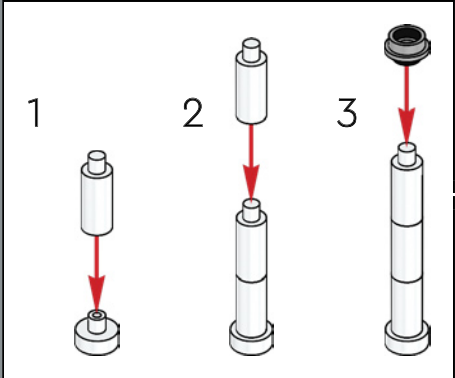

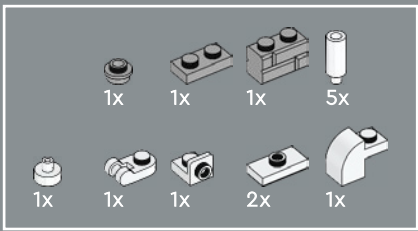

143

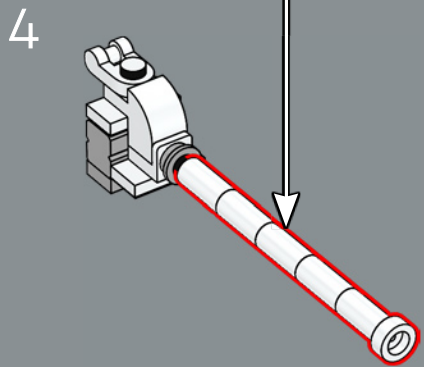
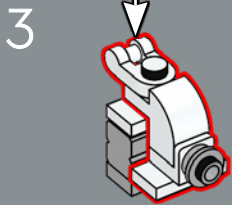
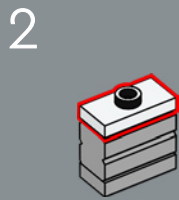
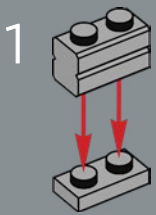
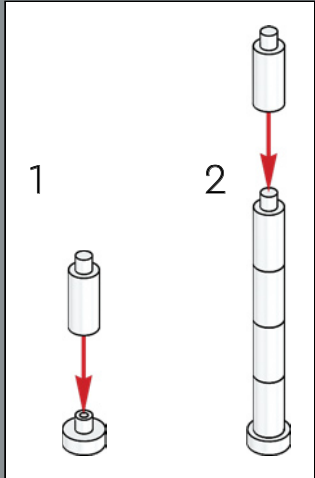
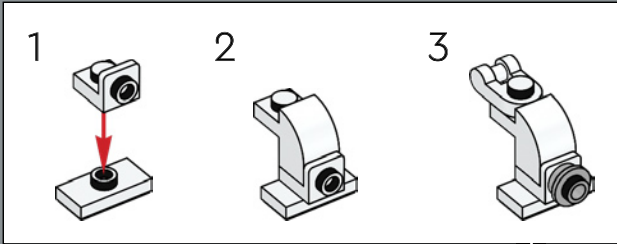





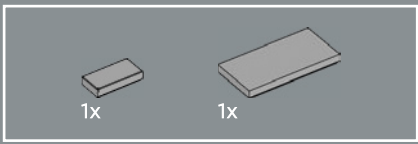

144



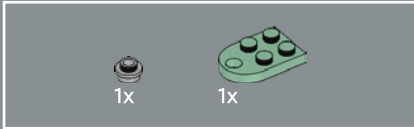
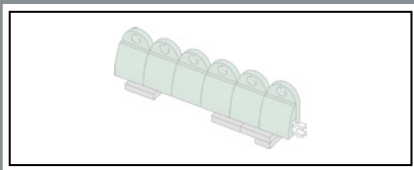

145

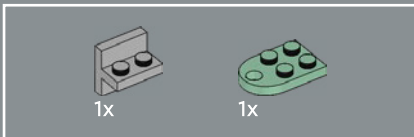
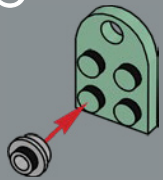

146

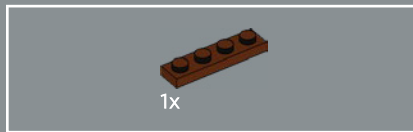
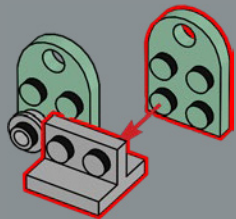

147

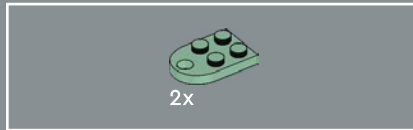
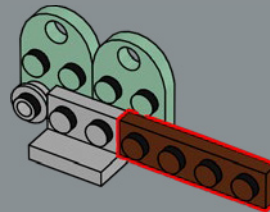

148

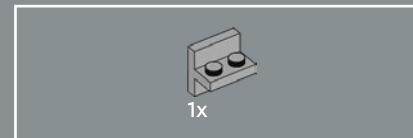
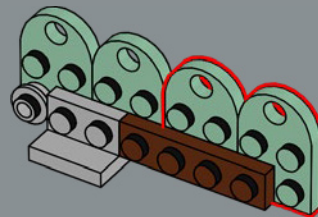

149

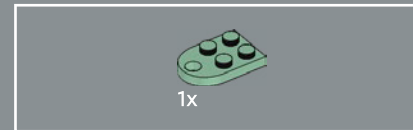
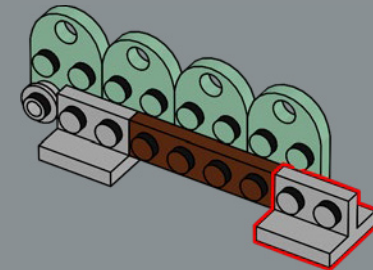

150

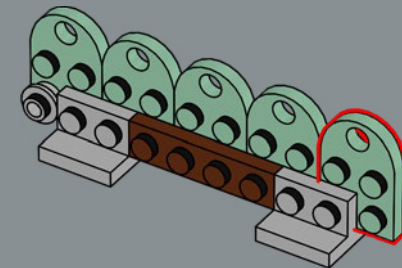

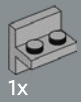

1x

151

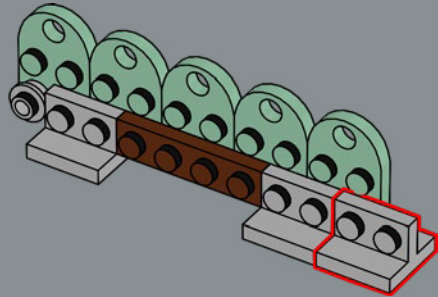

6x

153

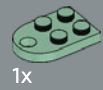
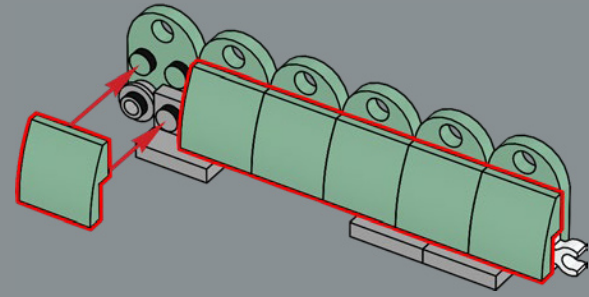

1x



1x

152

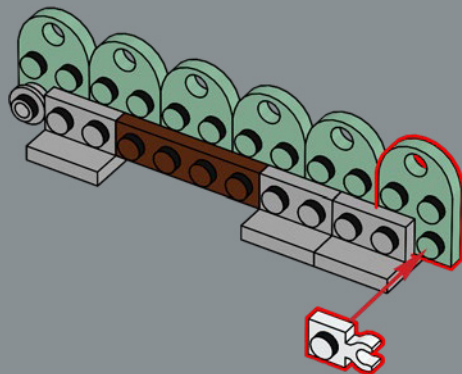

1x

154

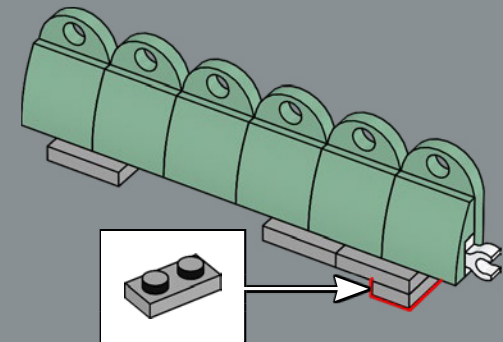

155



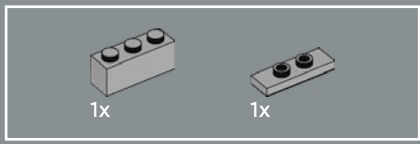

156

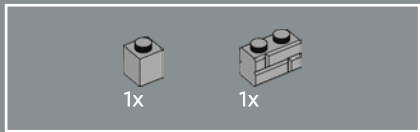
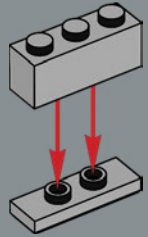

157

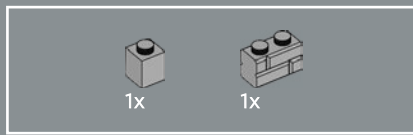
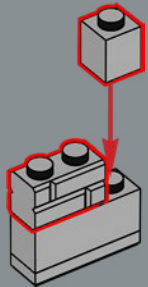

158

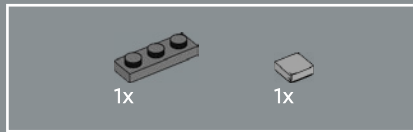
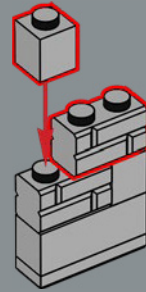

159

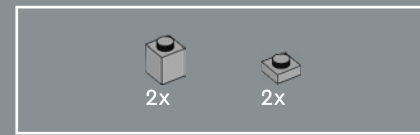
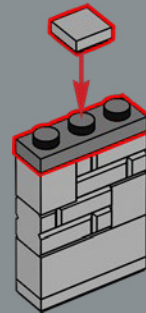

160

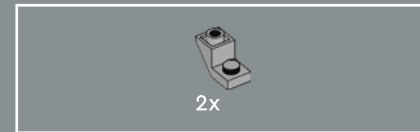
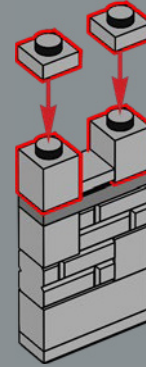

161

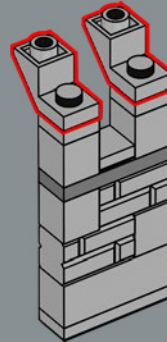

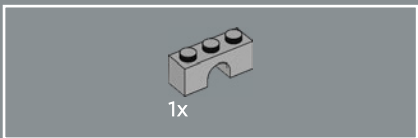

162

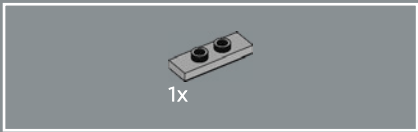
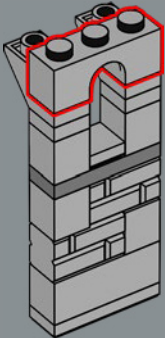

163

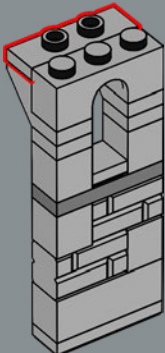

164

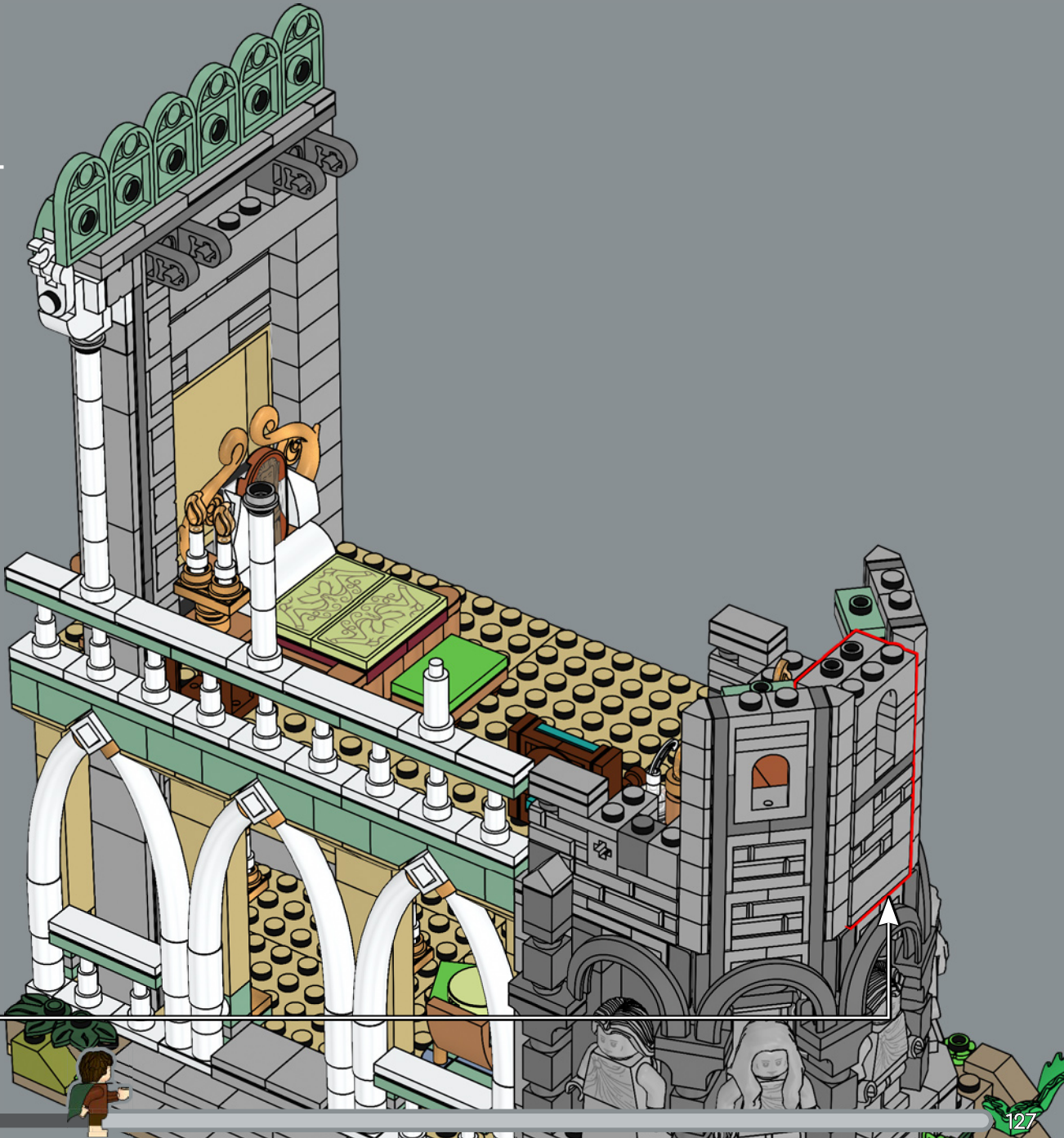

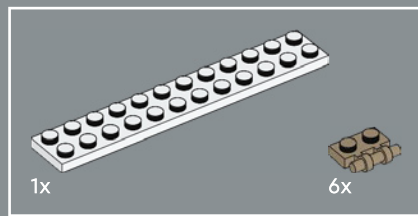

165

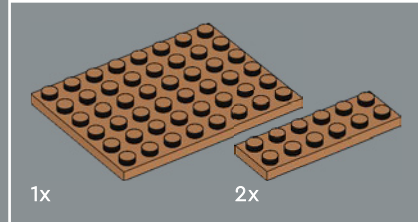
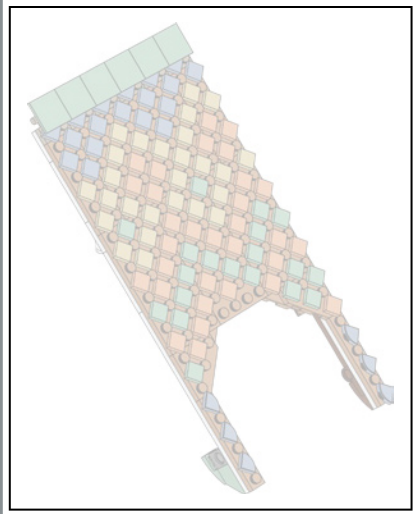
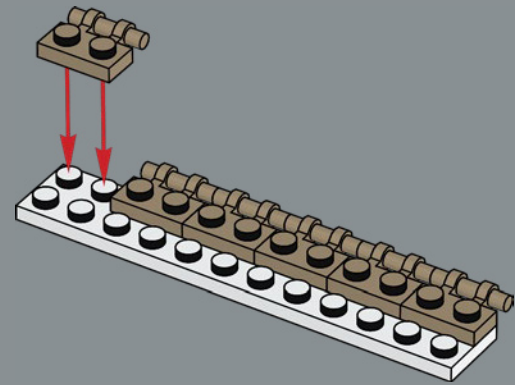

166

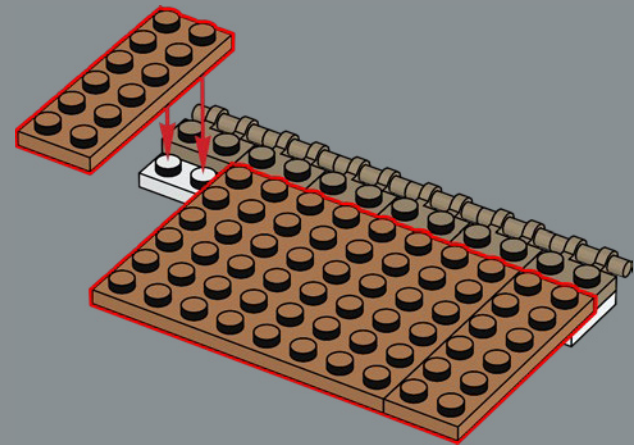



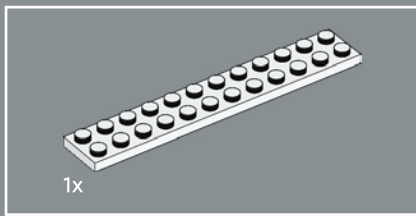

167

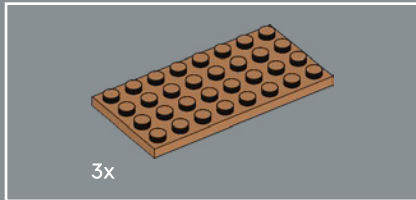
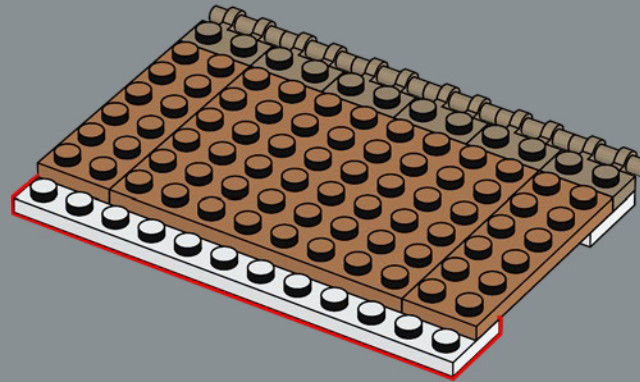

168

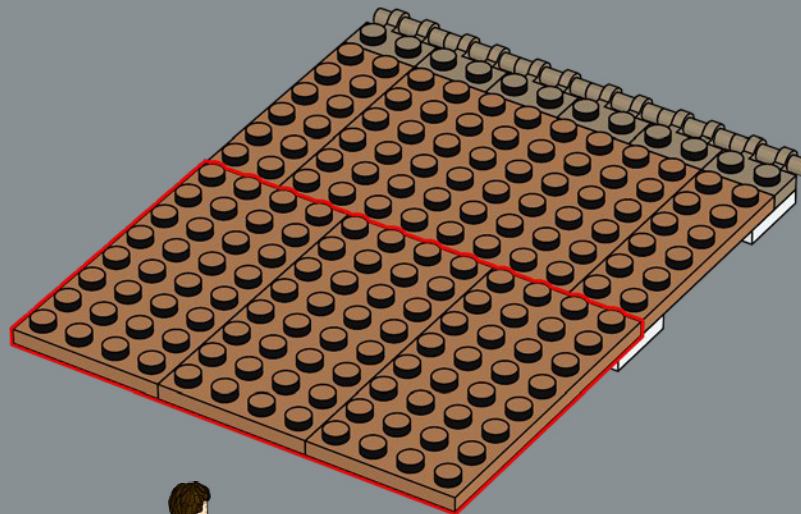

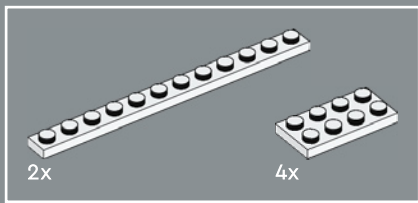

169

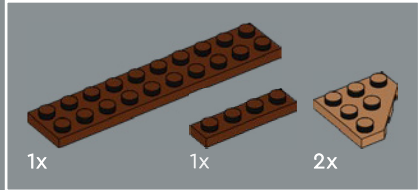
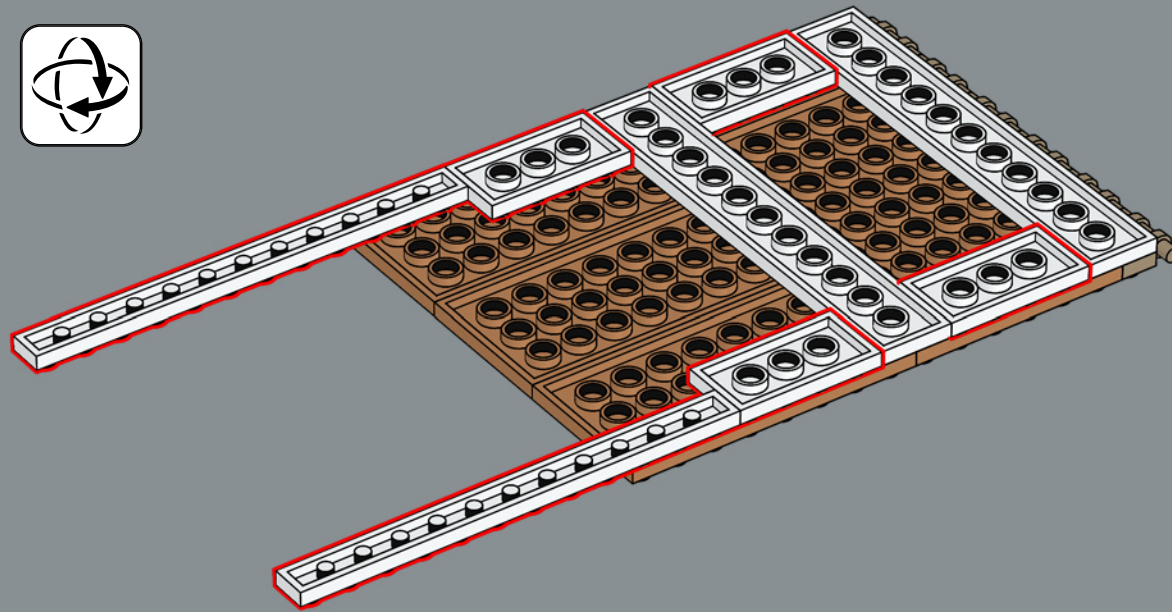

170

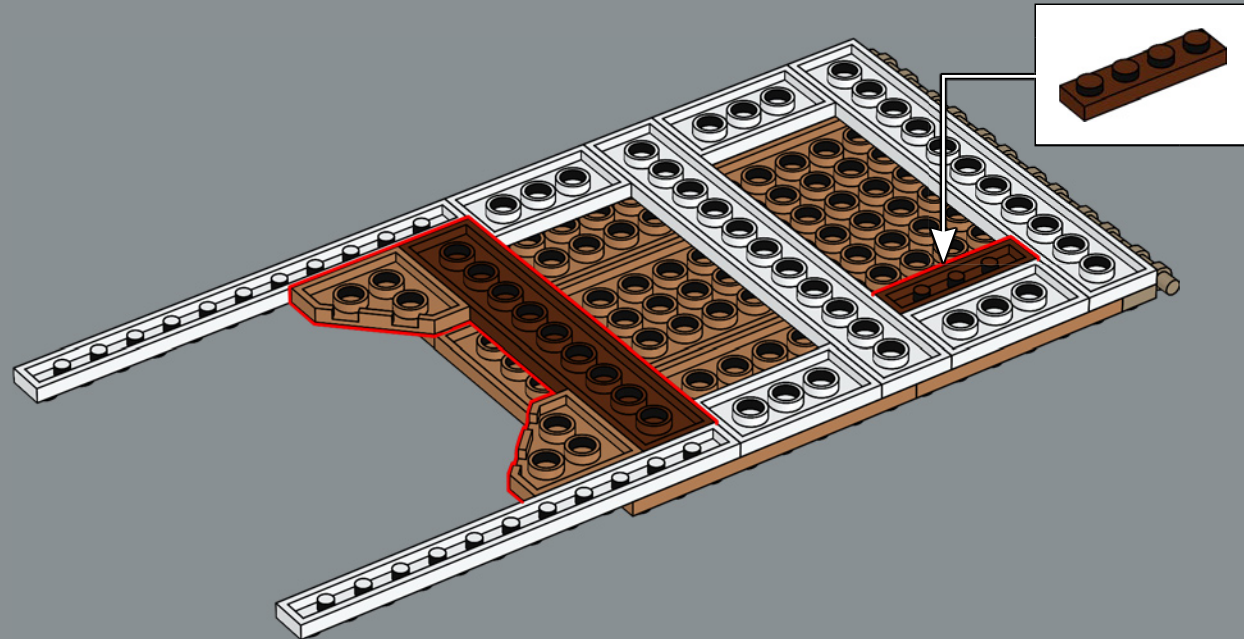

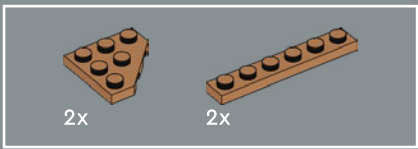

171

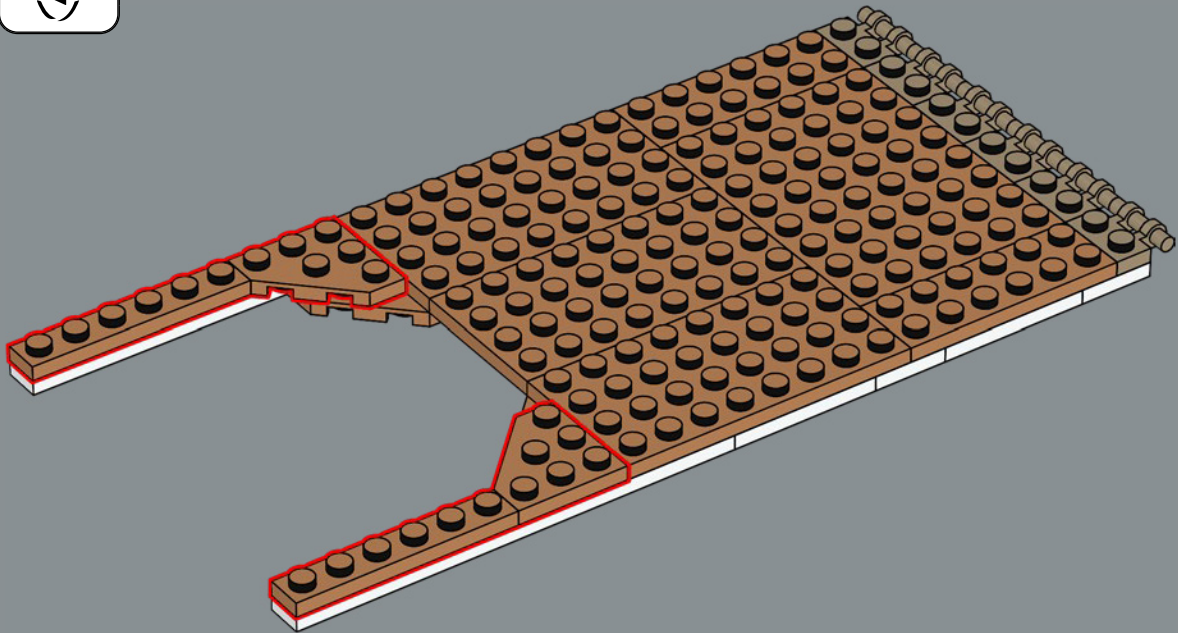



18x



172

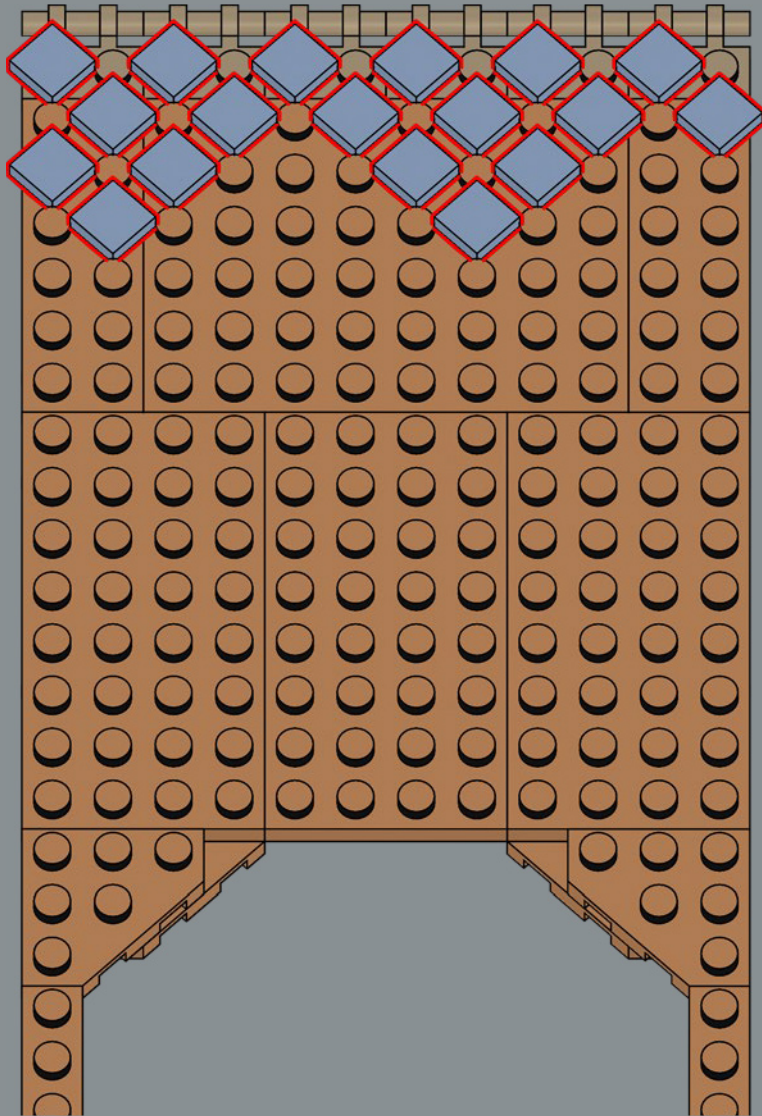

12x



8x

173

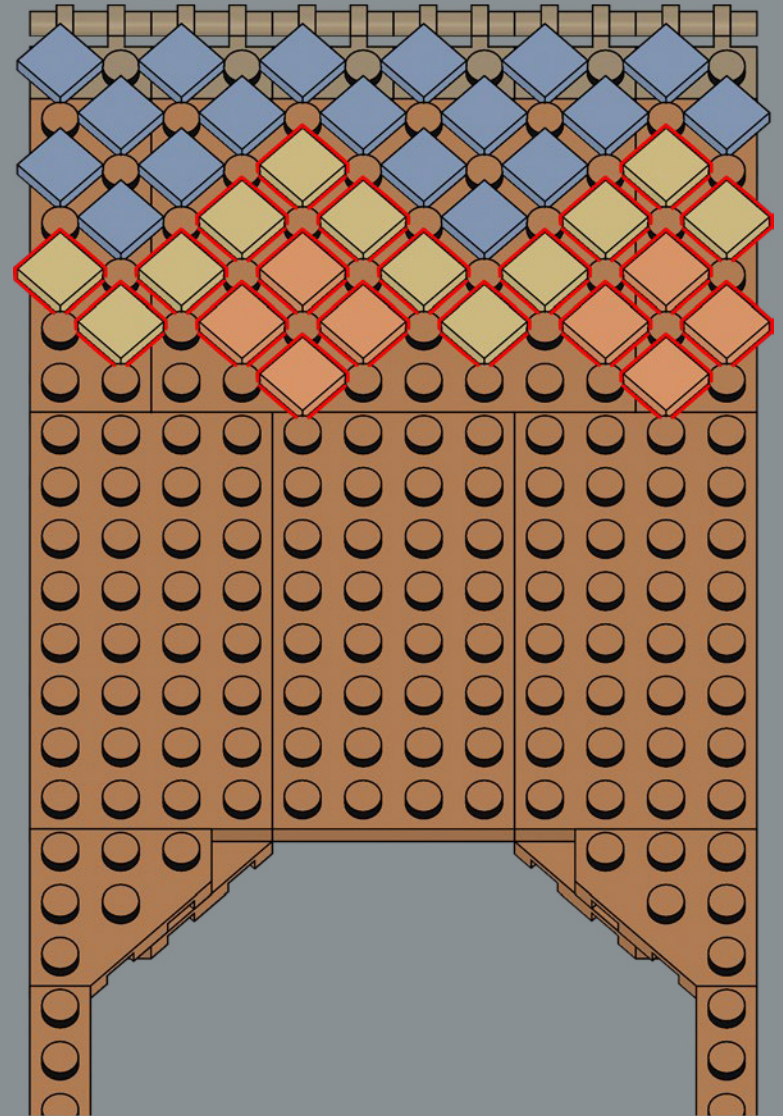

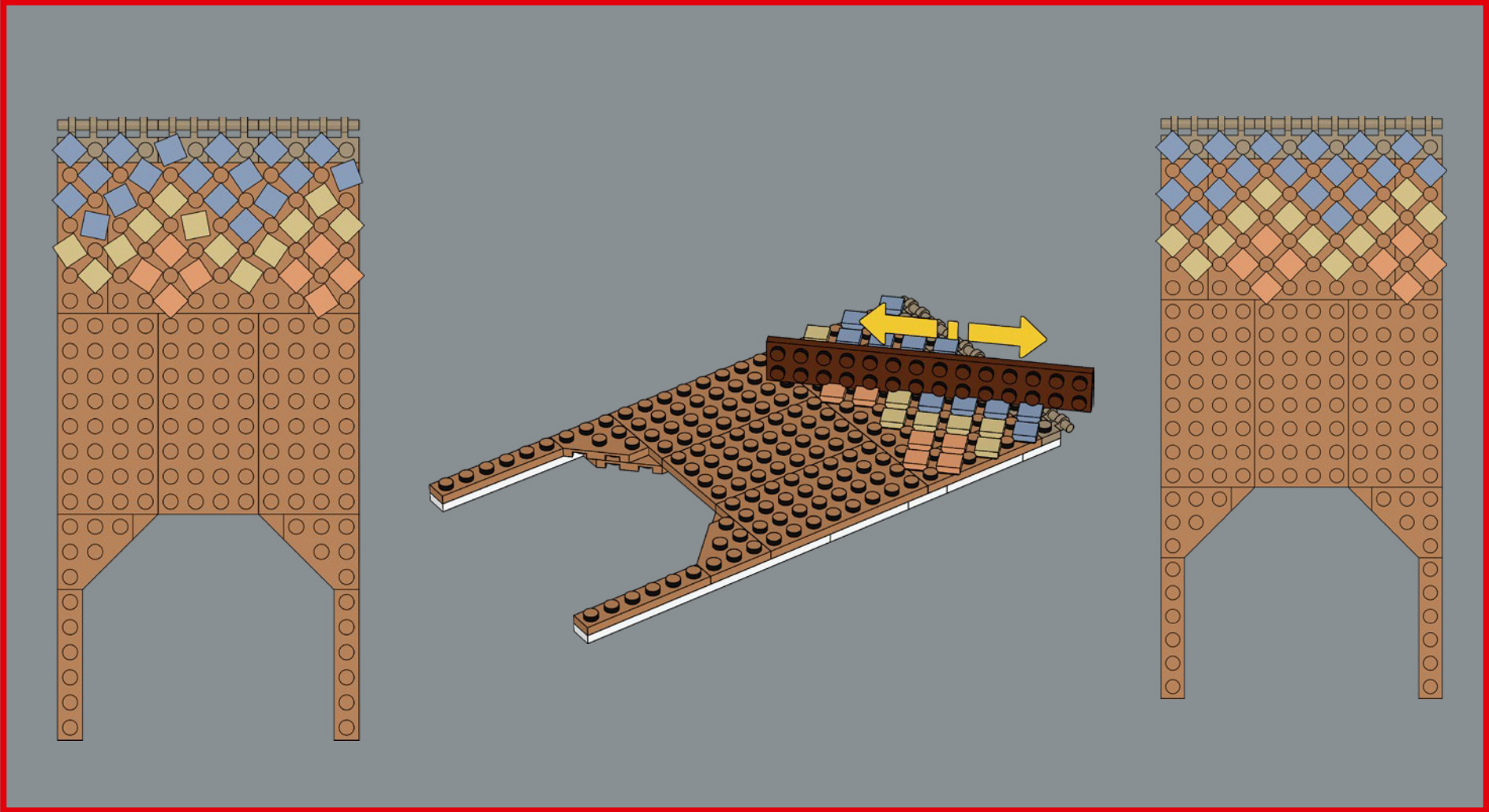



174

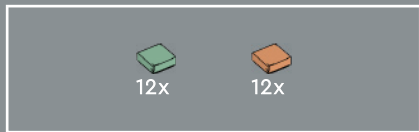
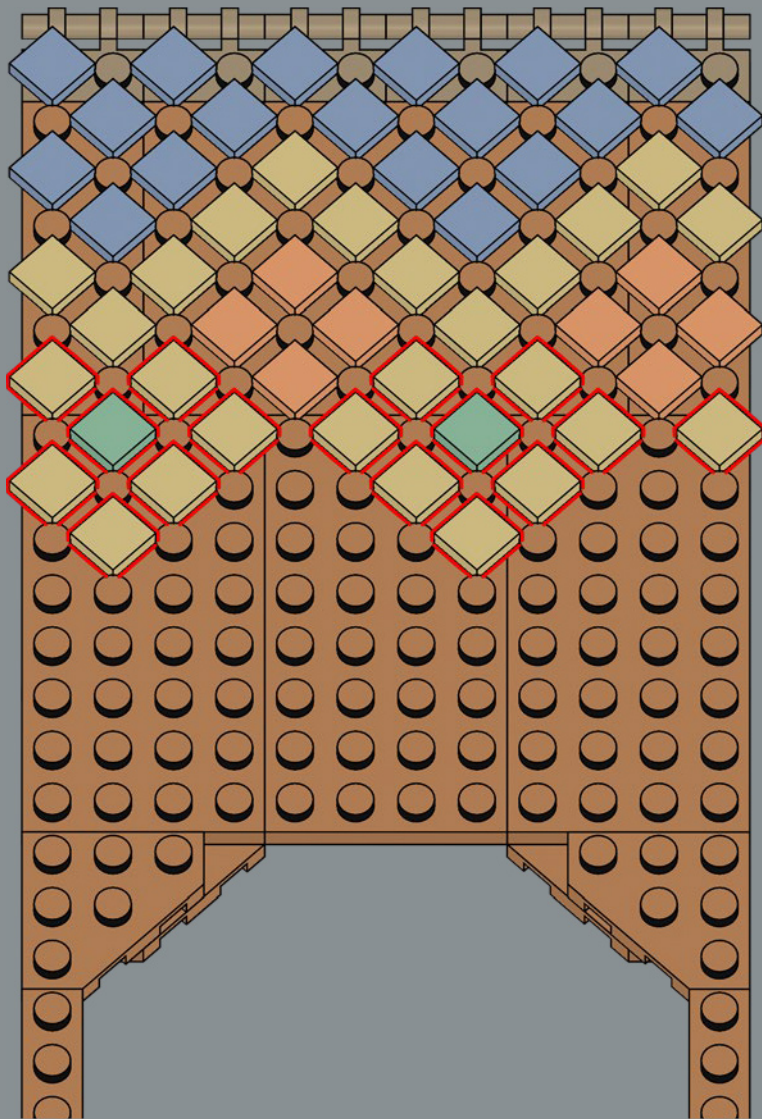

175

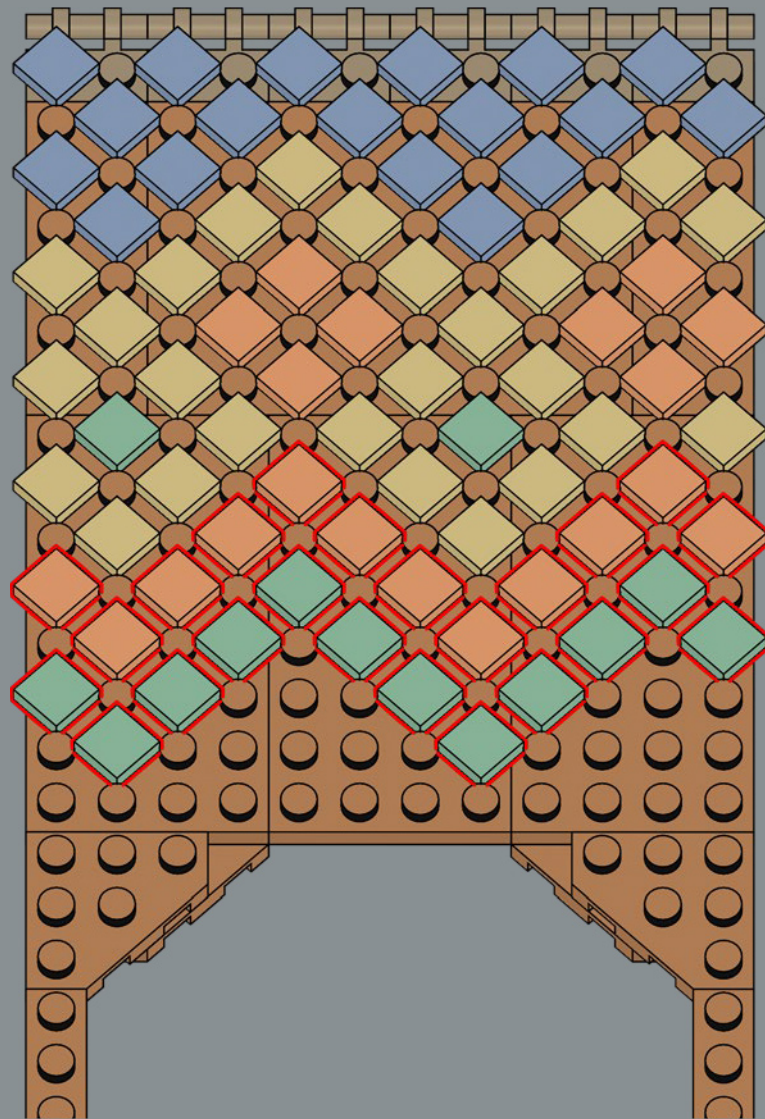



176

屋顶 94 块 1x1 光板中的每一块都应按照 45 度角拼搭。组件就位后，沿凹槽拼搭长板或光板是将它们全部对齐的好方法。

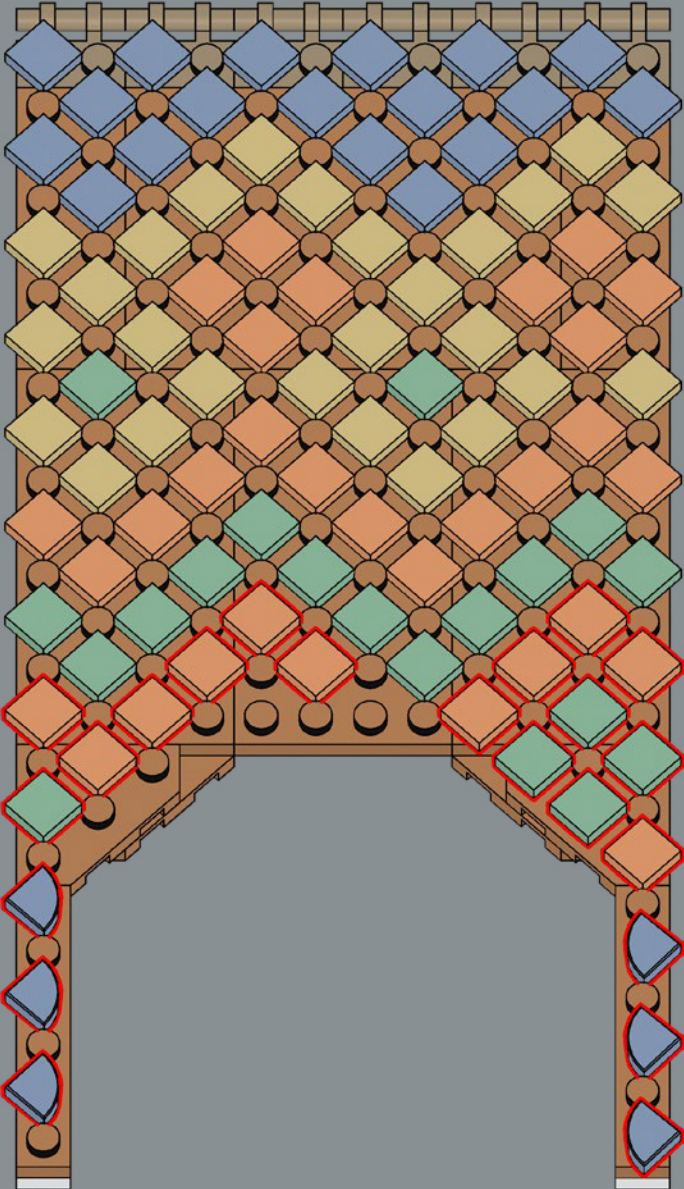



6x

177

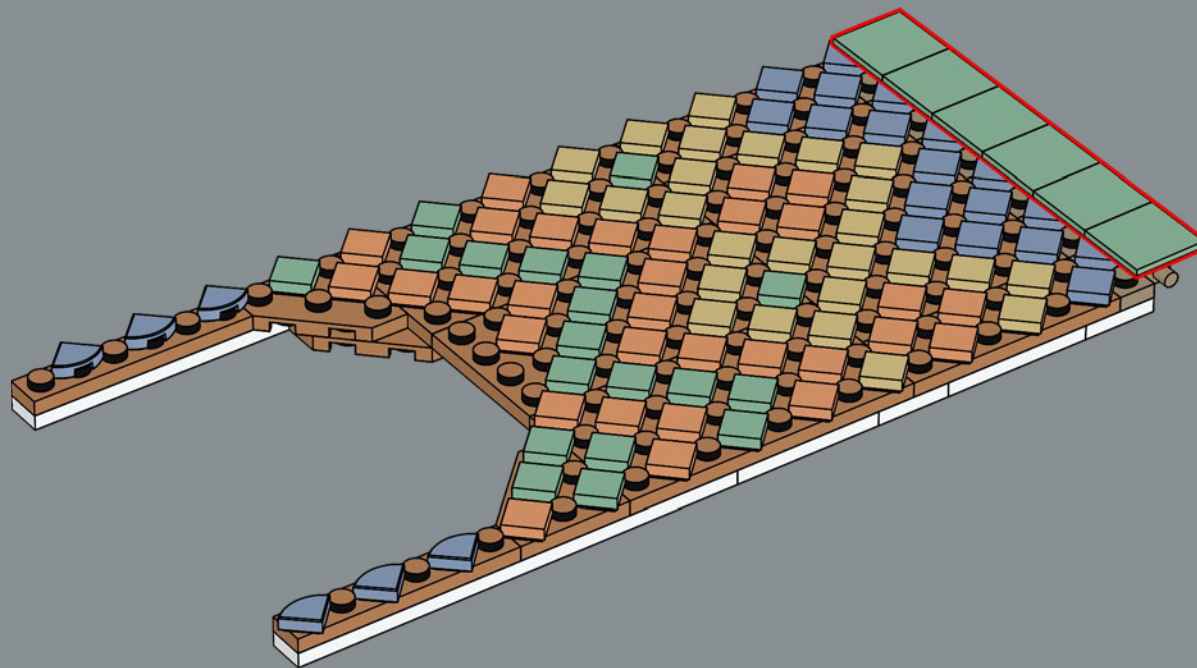



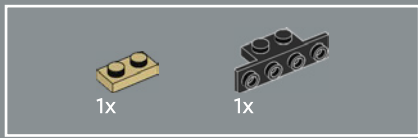

178

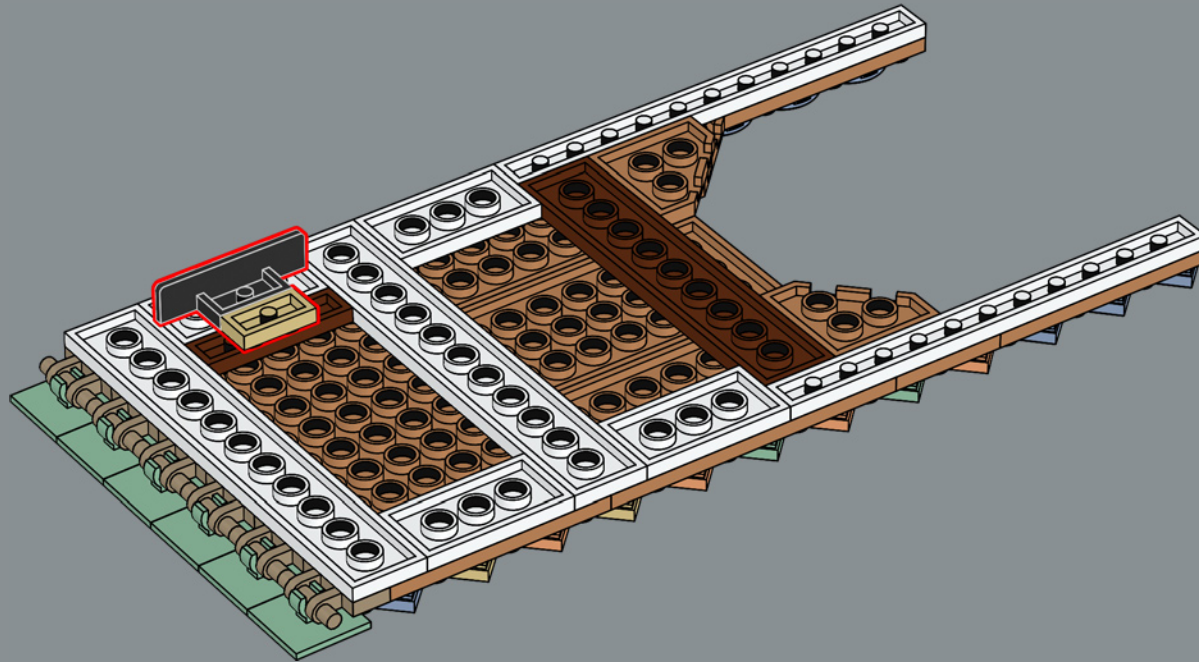



179

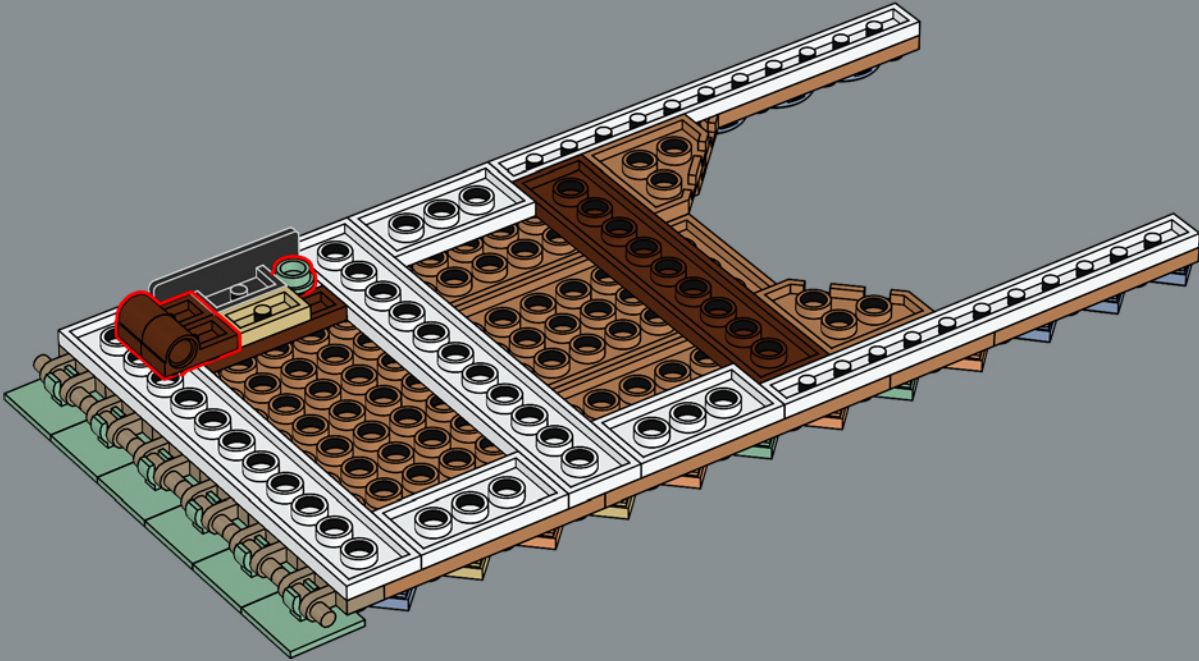

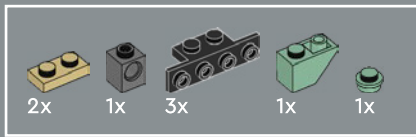

180

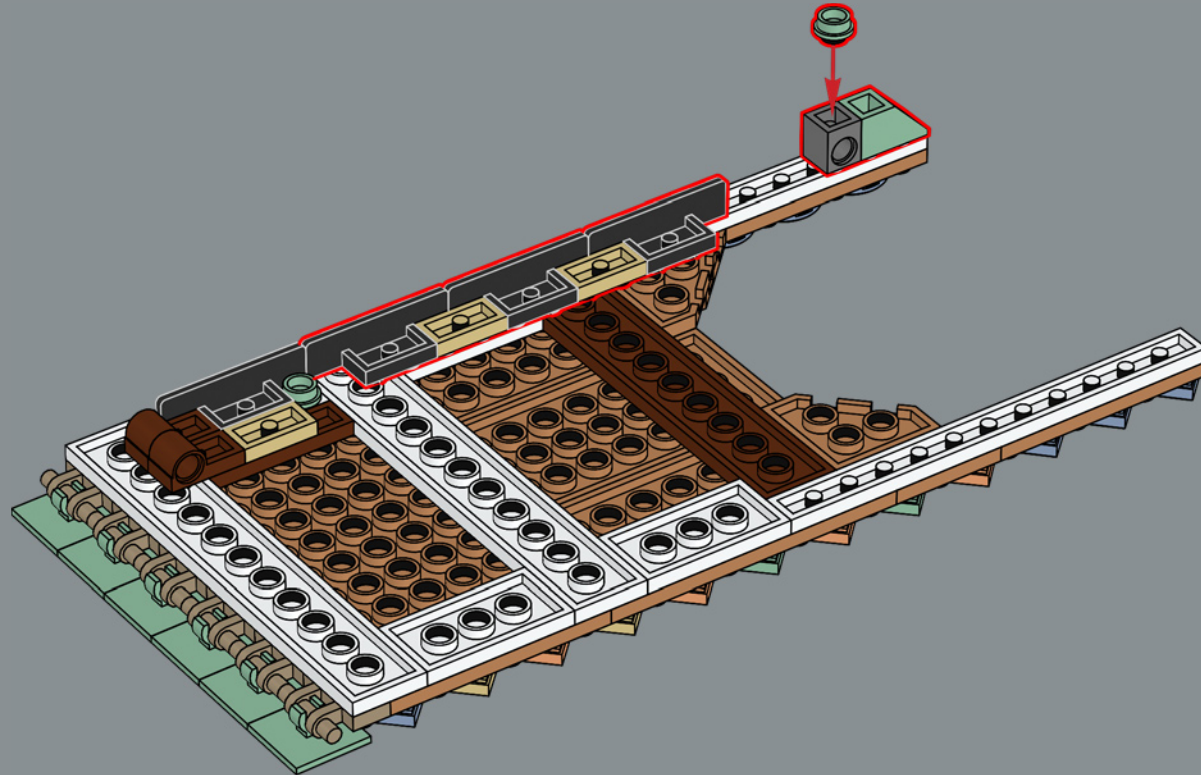

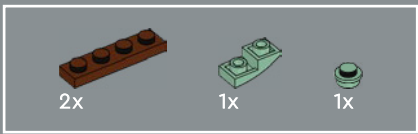

181

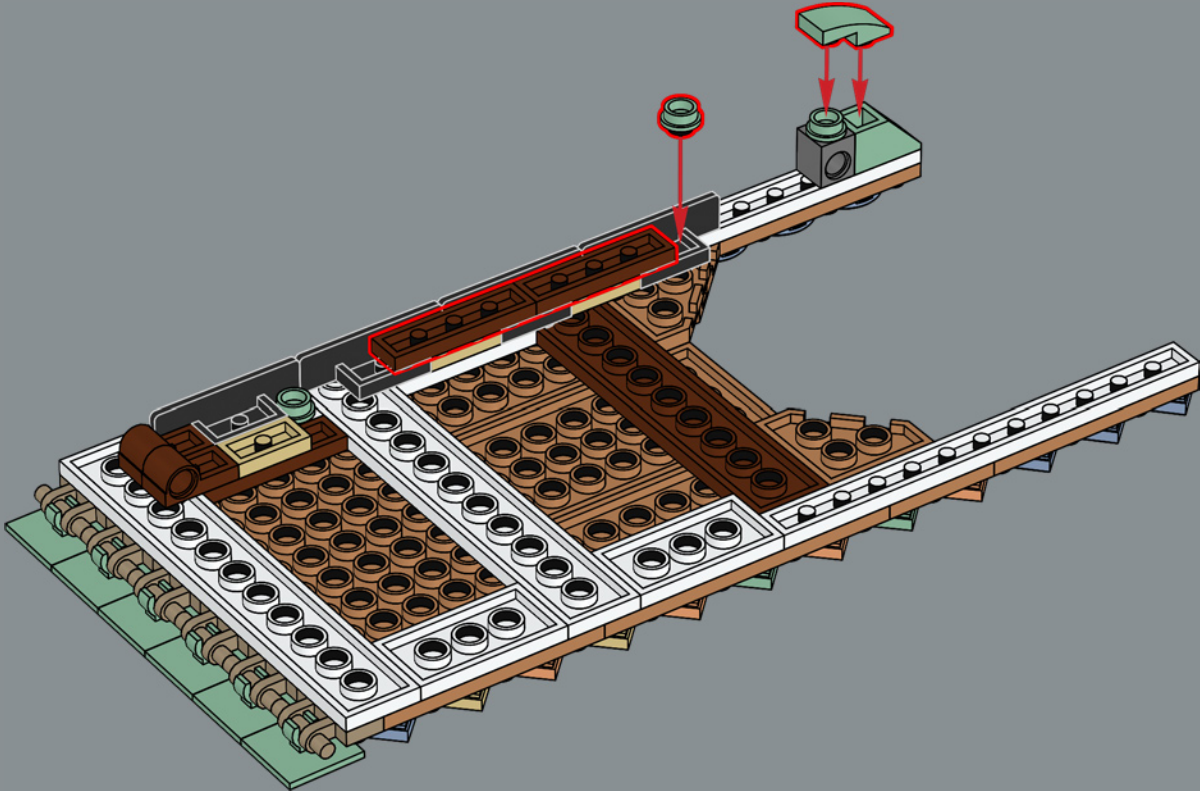

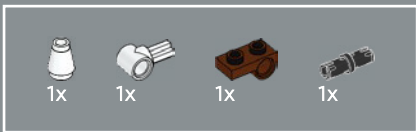

182

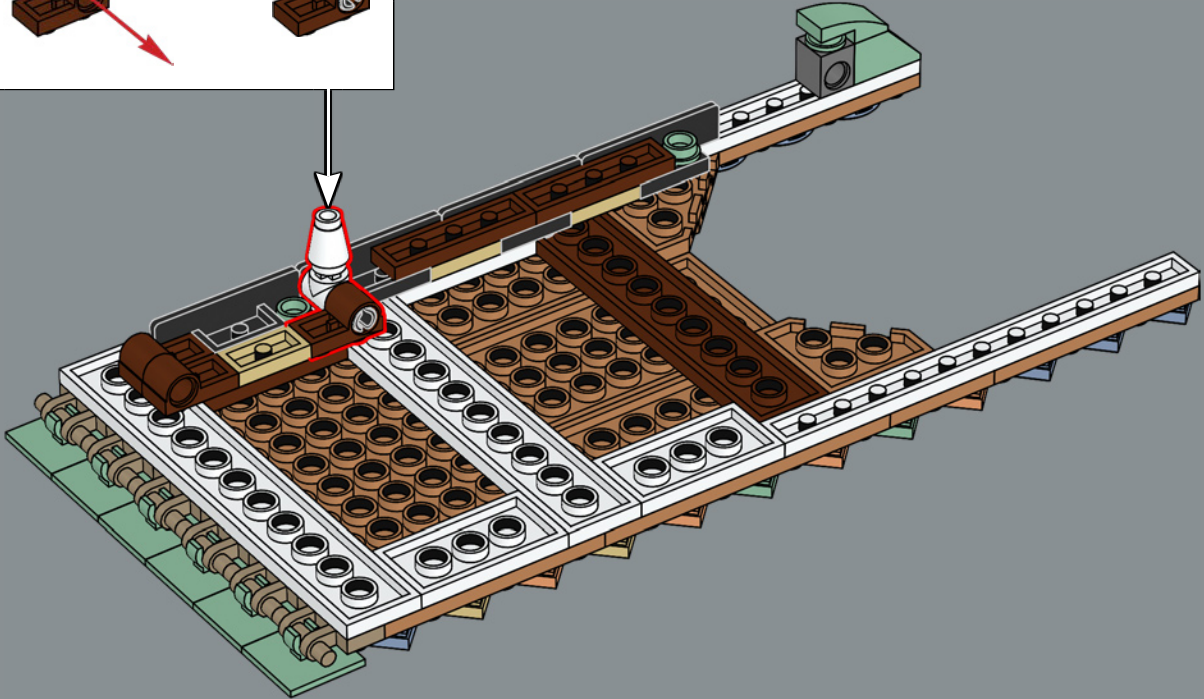
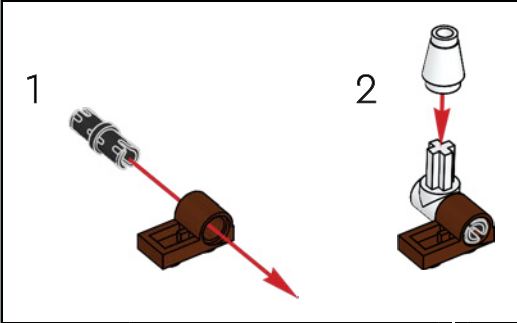

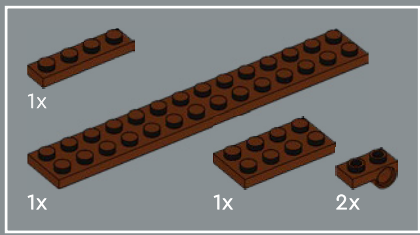

183

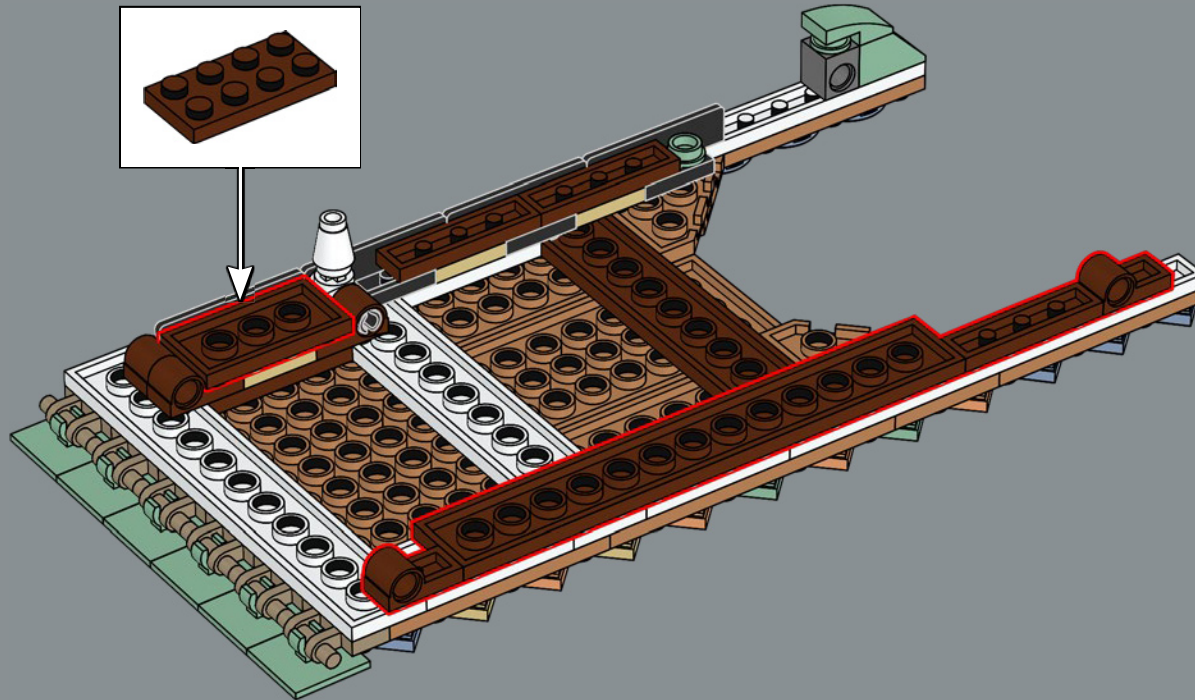

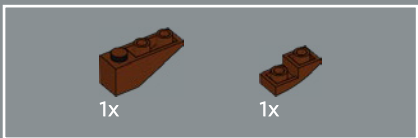

184

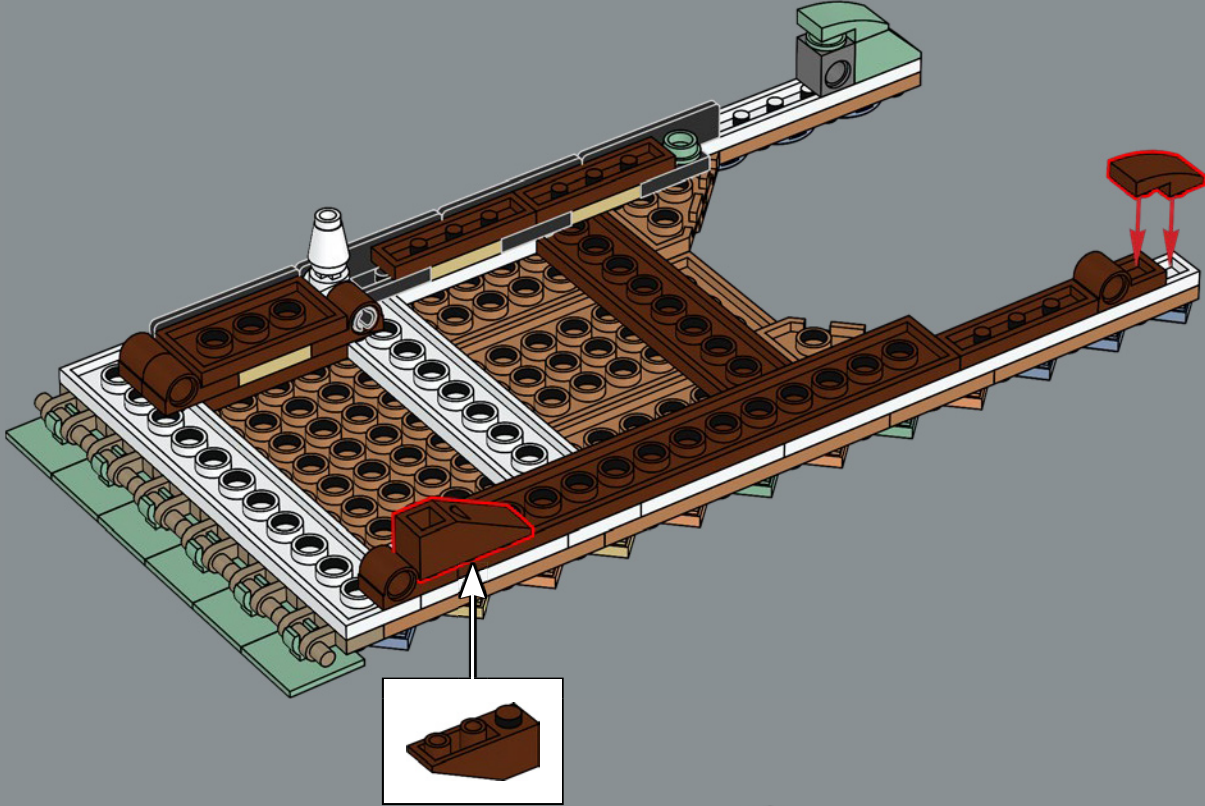

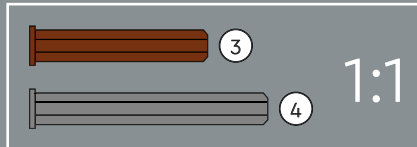
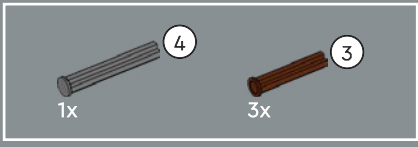

185

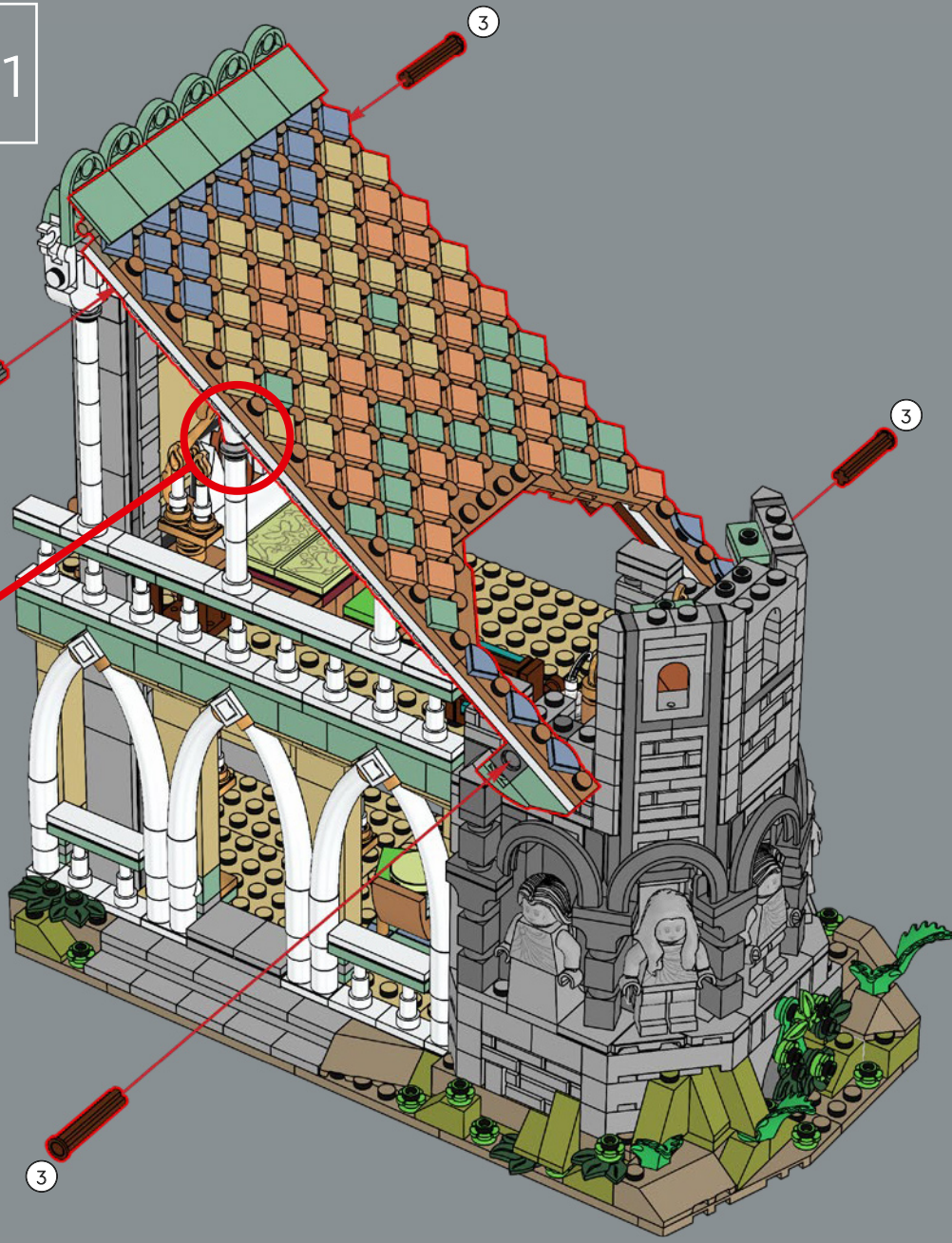
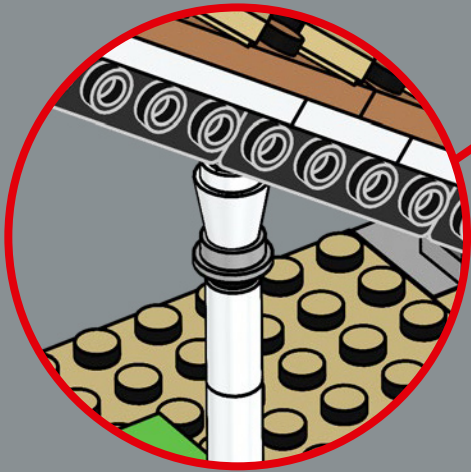
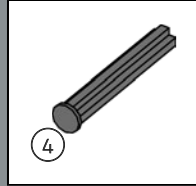



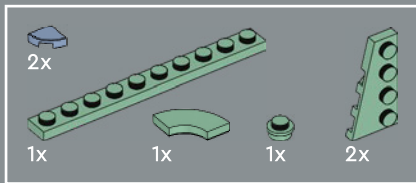

186

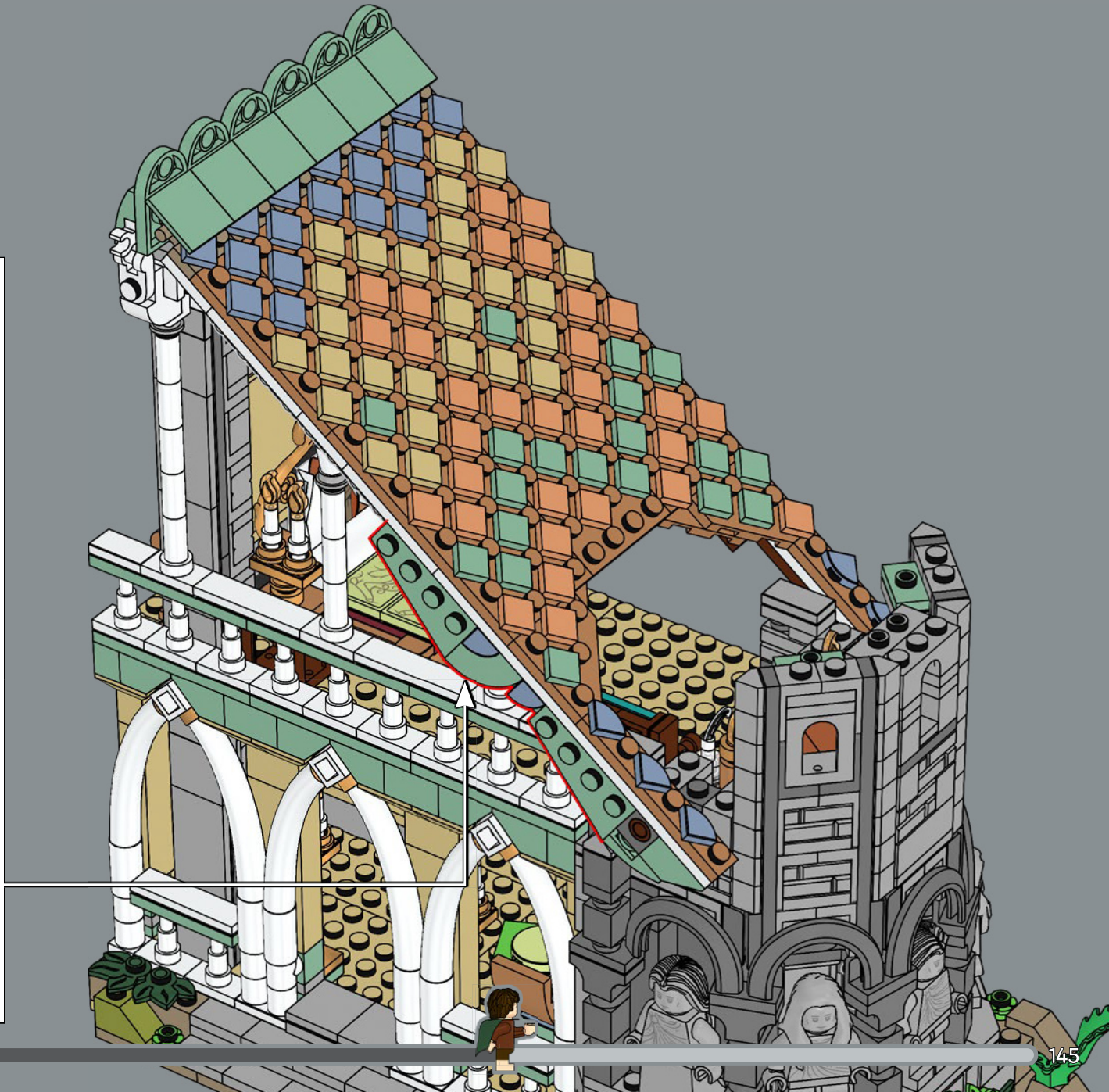
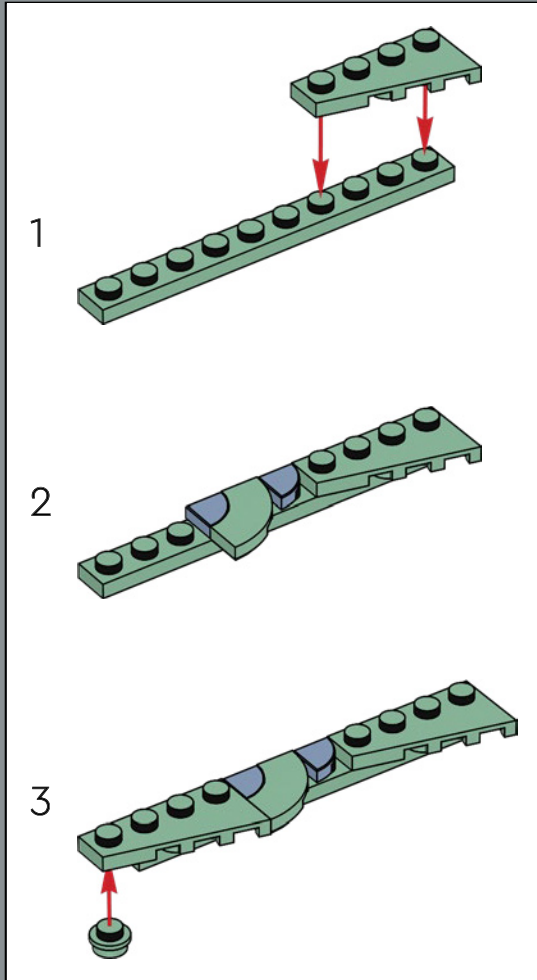

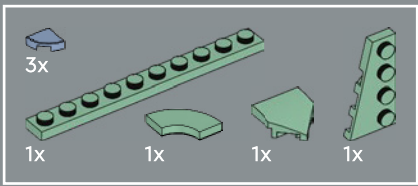

187

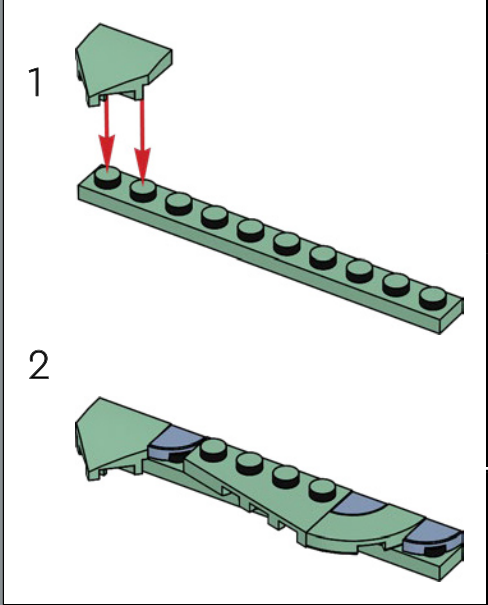

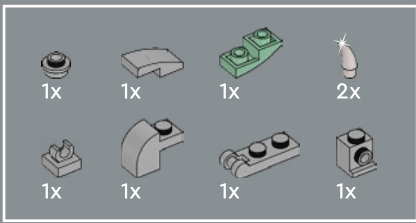

188

1

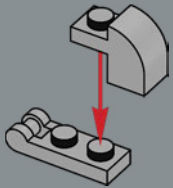

2

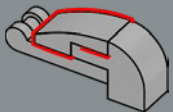

3

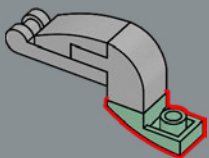

4

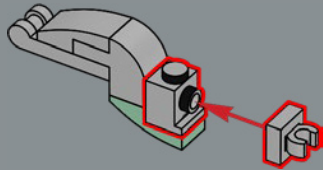

5

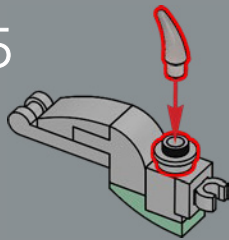

6

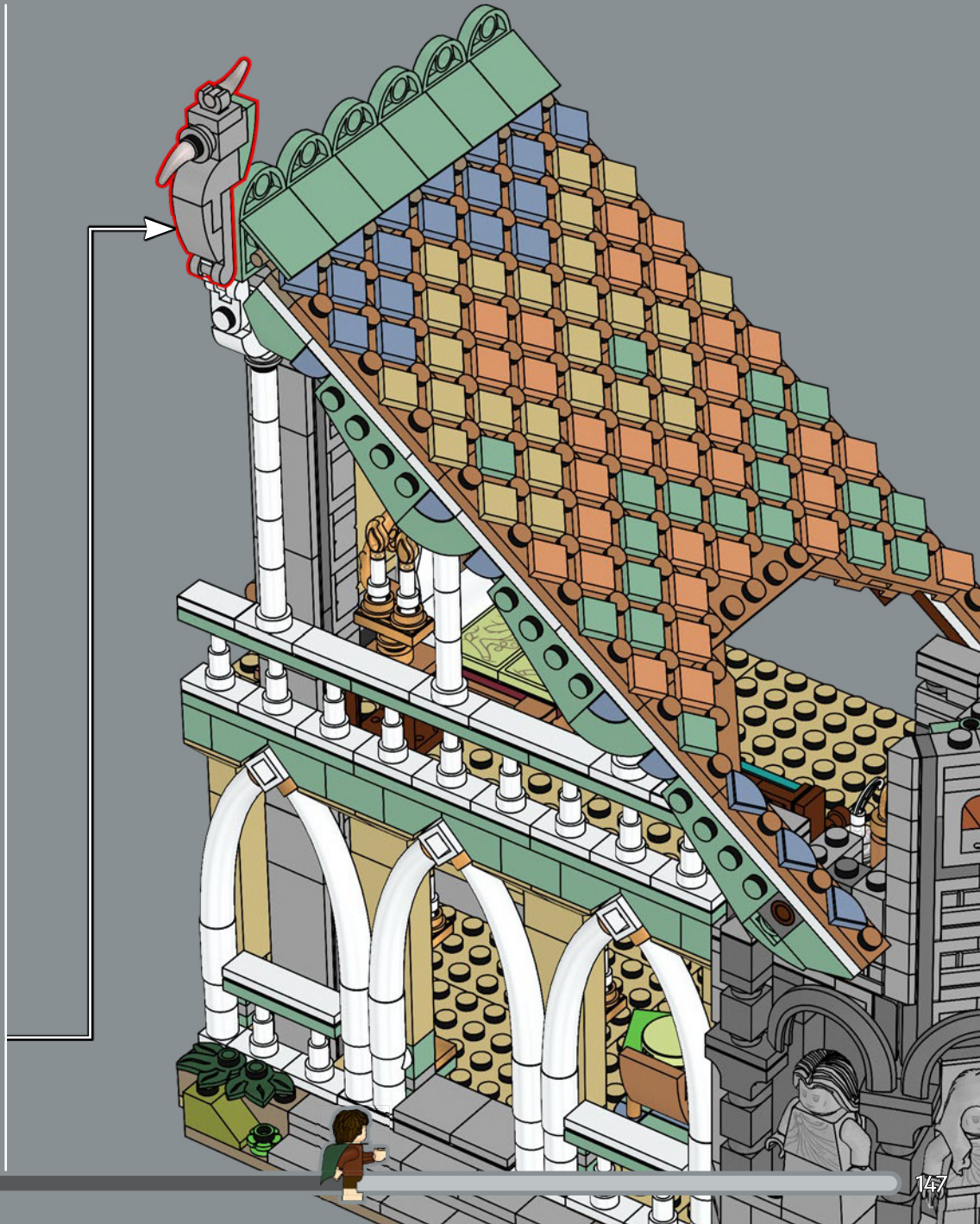
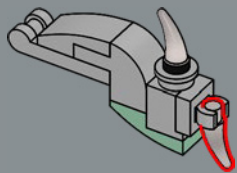

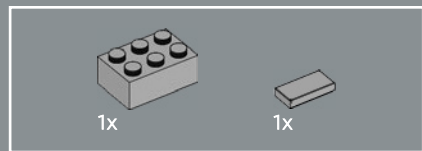

189

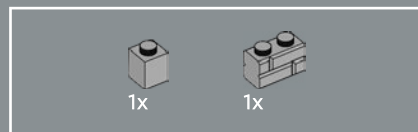
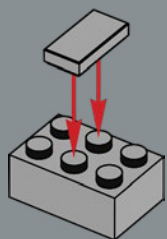

190

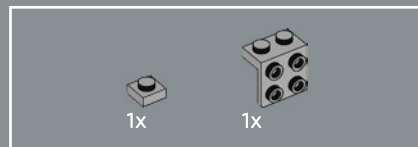
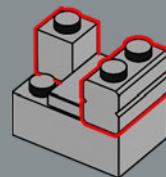

191

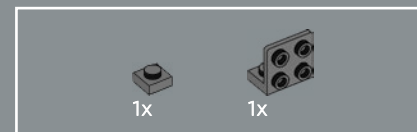
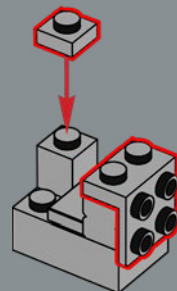

192

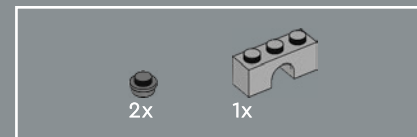
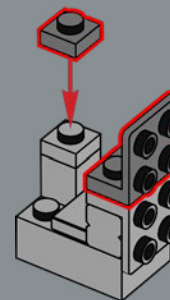

193

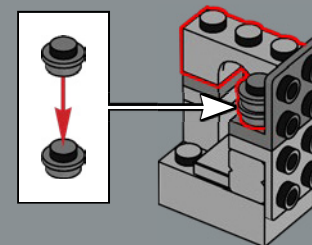

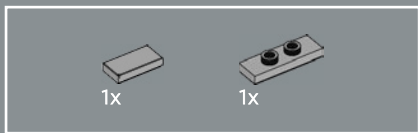

194

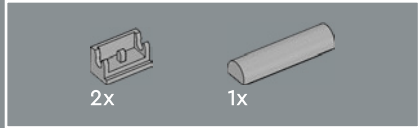
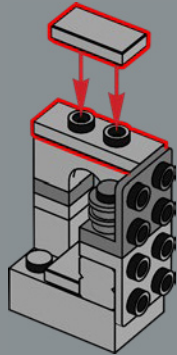

195

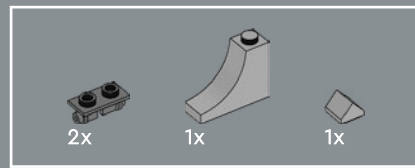
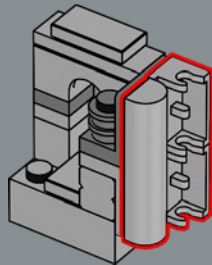

196

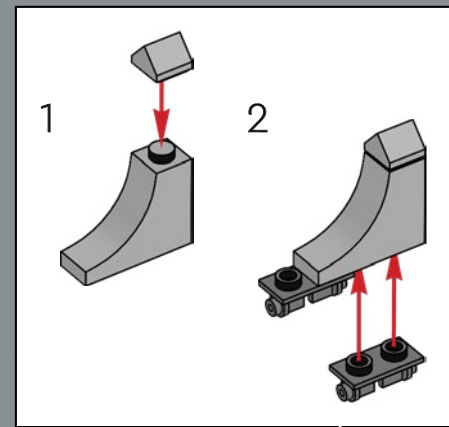
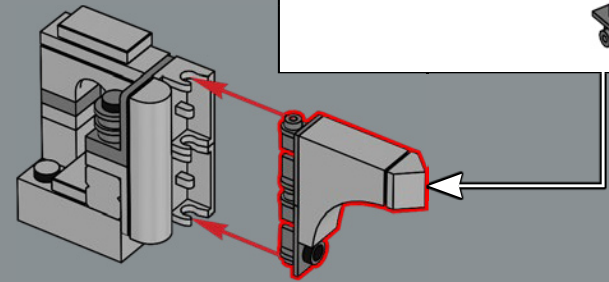

197

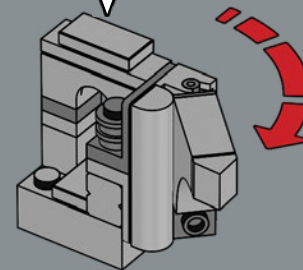

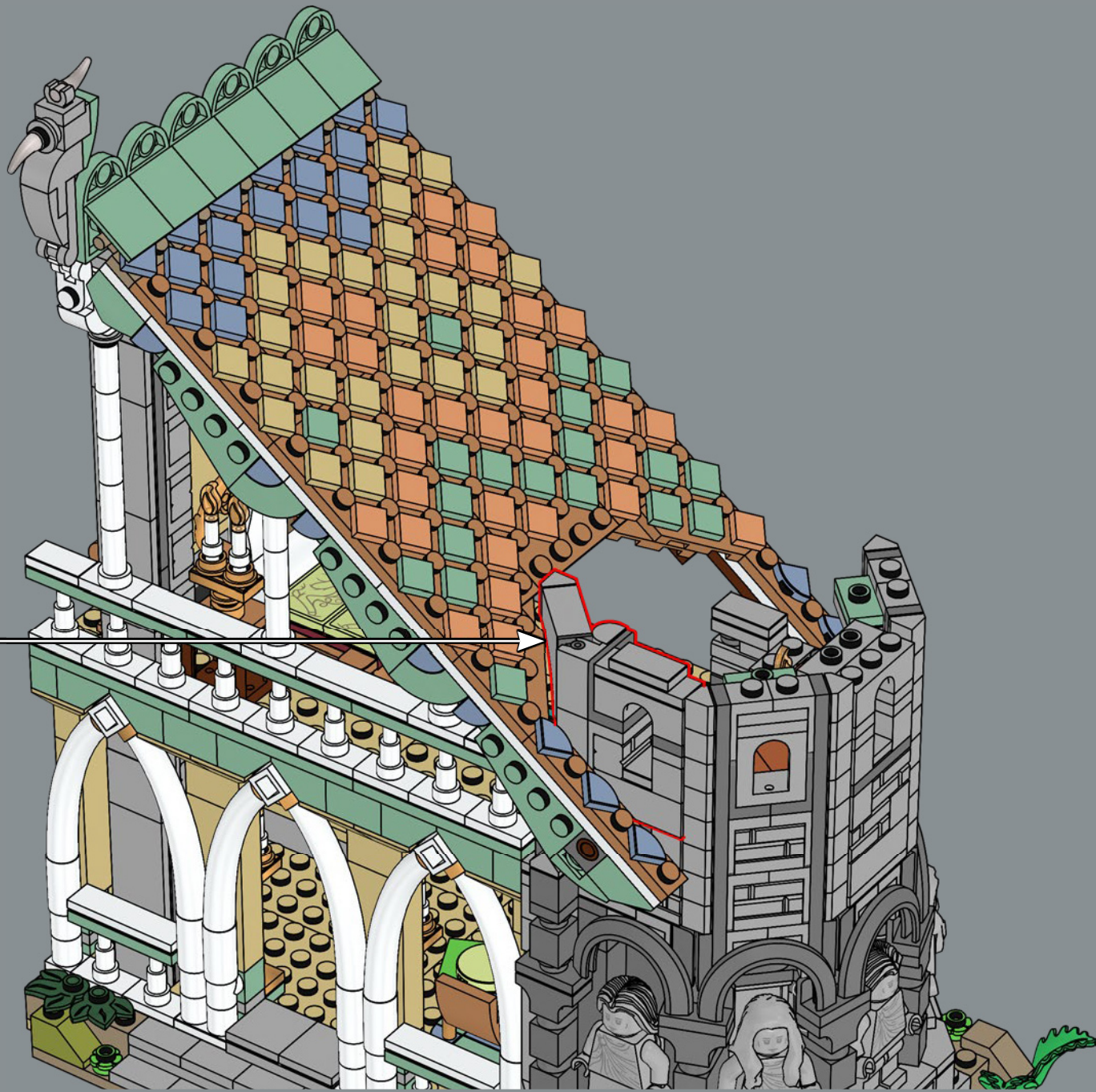

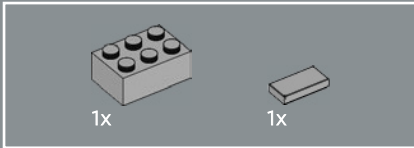
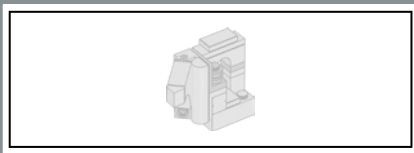

199

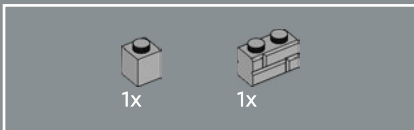
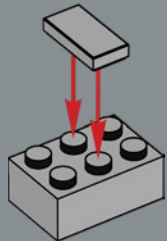

200

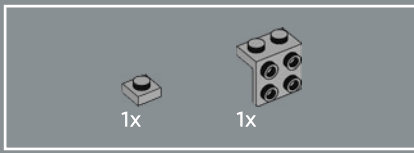
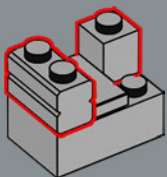

201

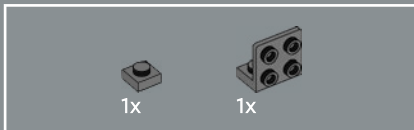
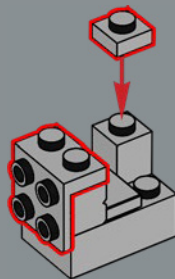

202

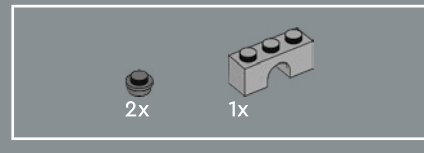
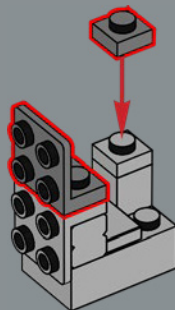

203

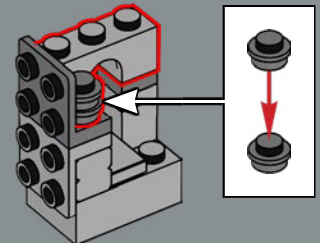

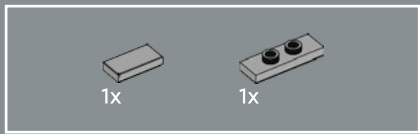

204

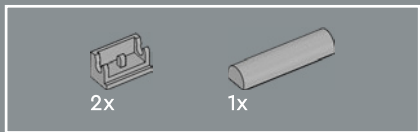
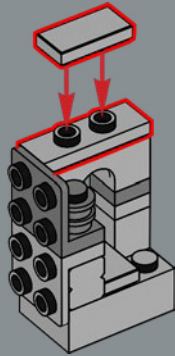

205

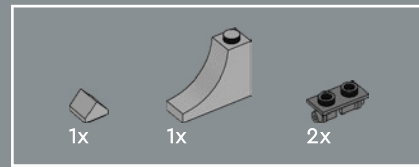
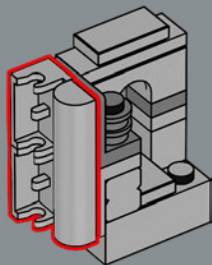

206

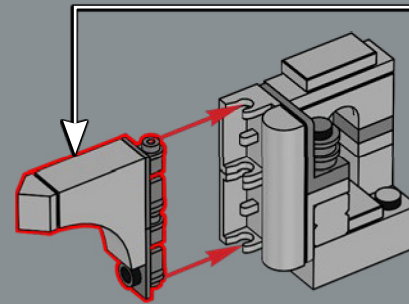
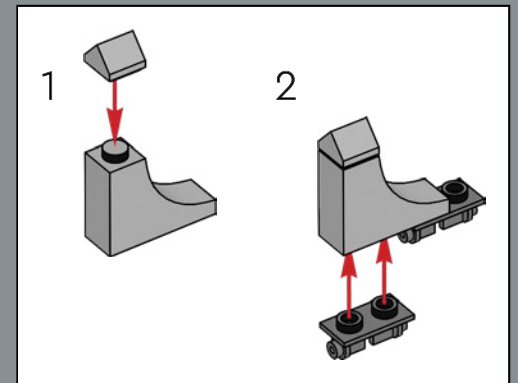

207

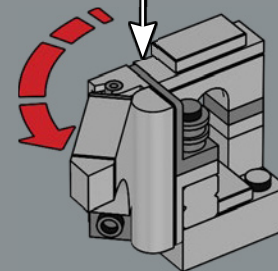



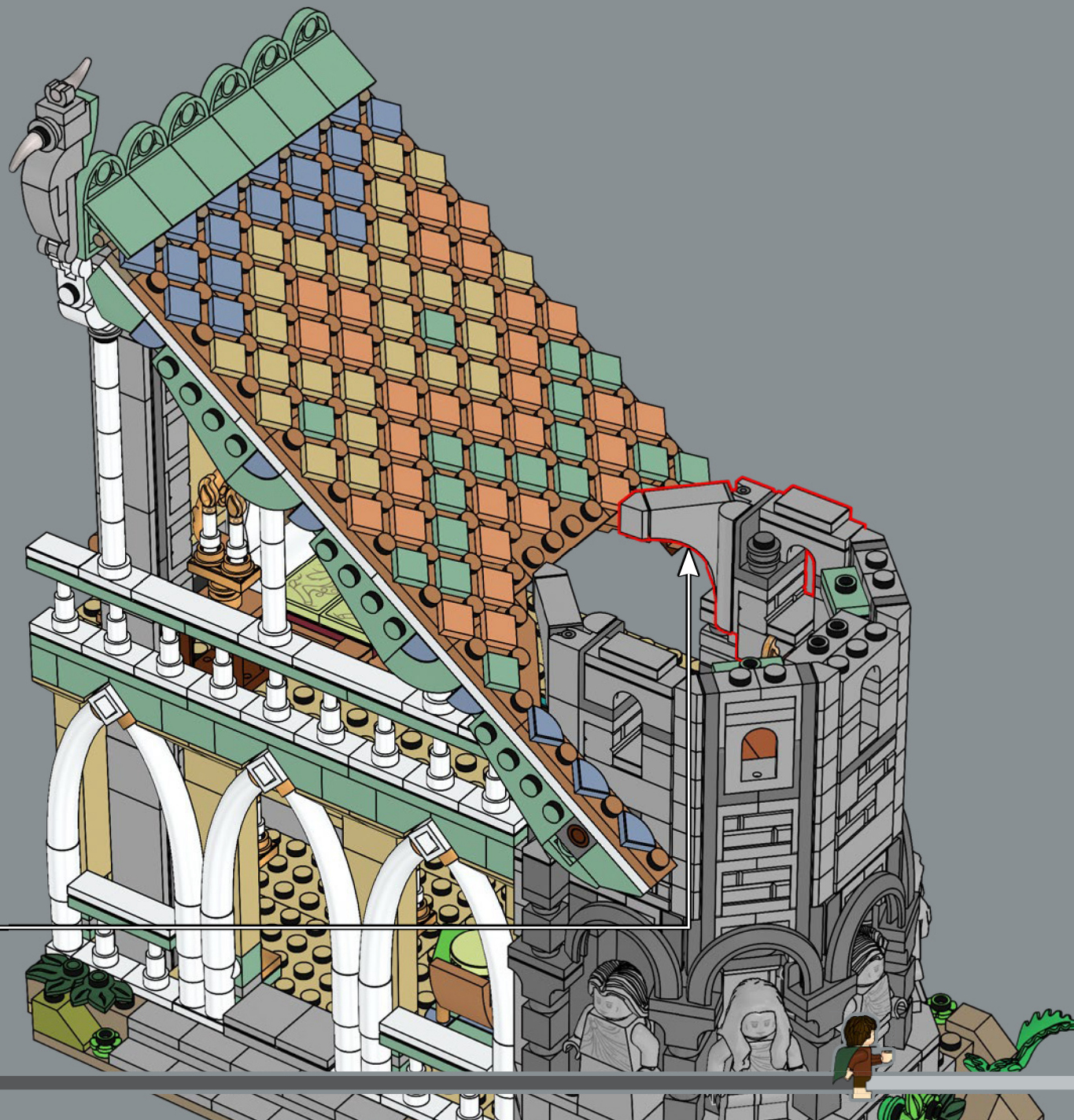

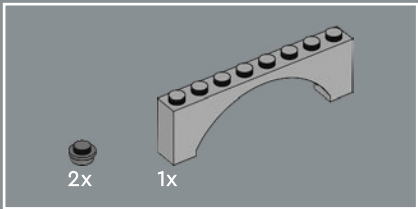

209

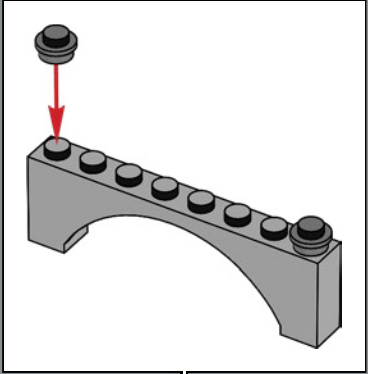
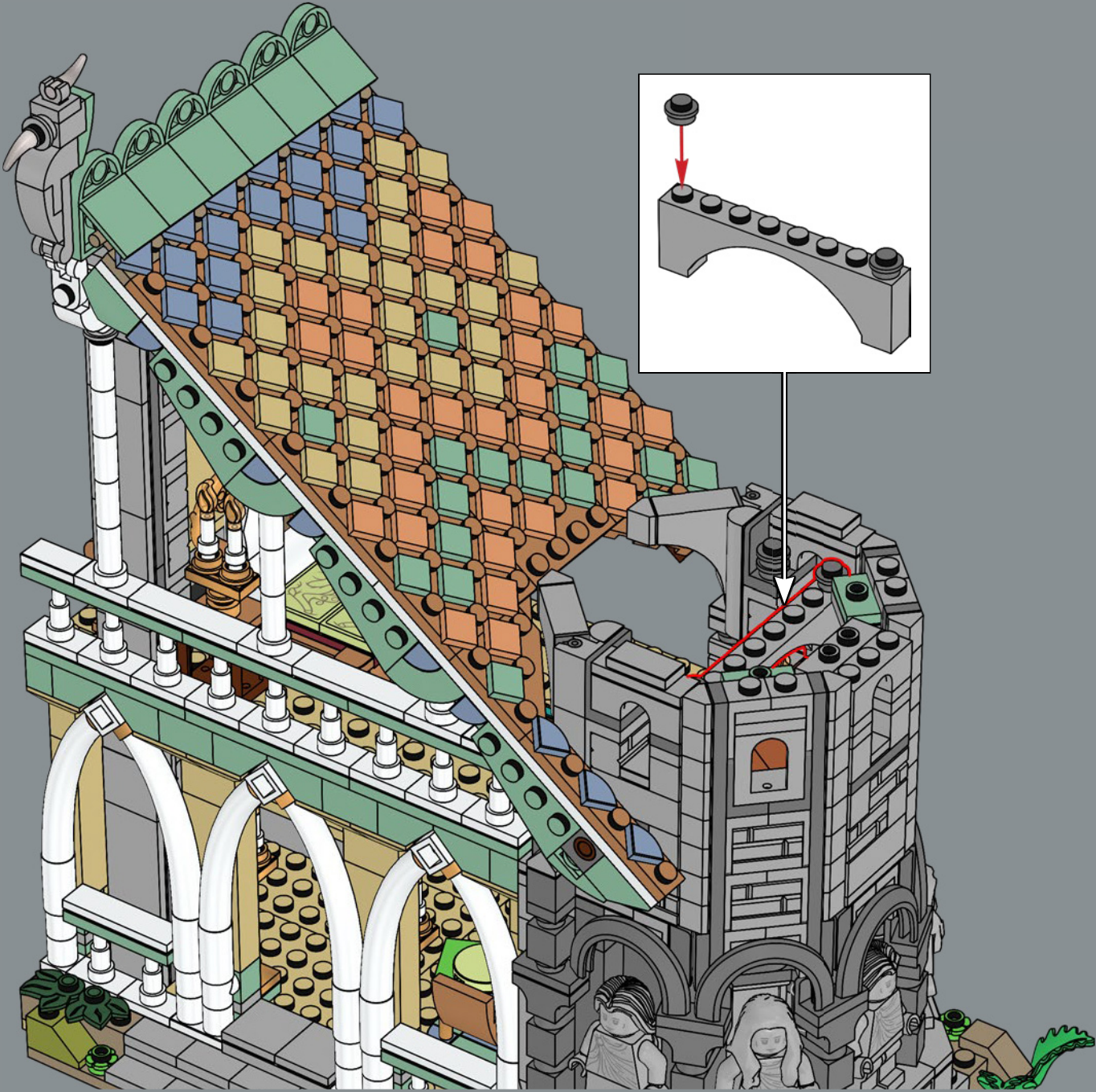

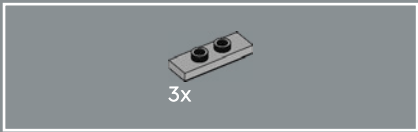

210

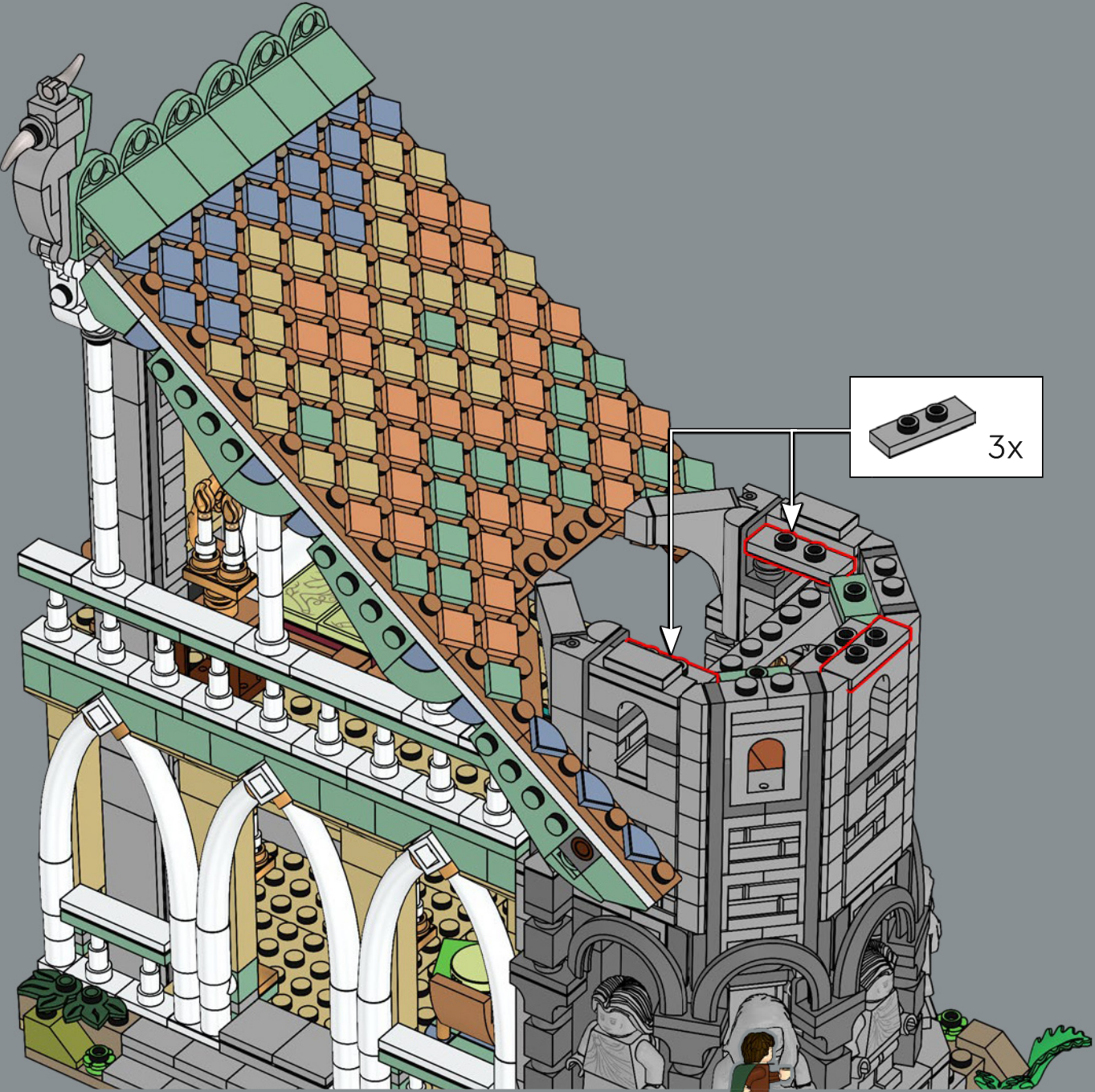



211

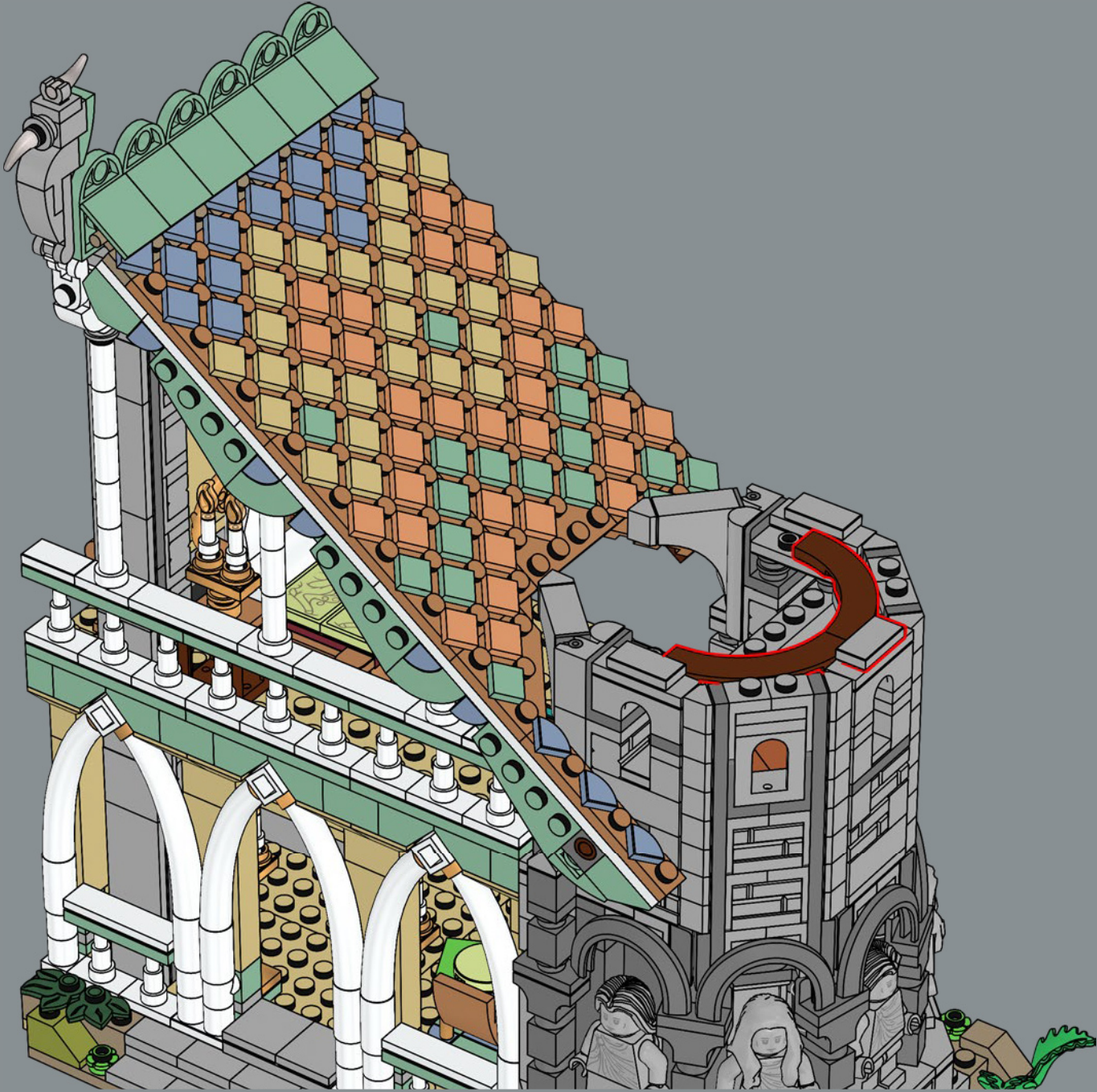

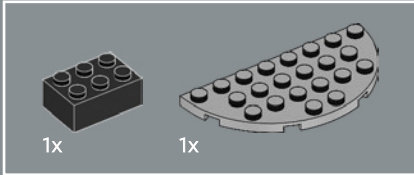
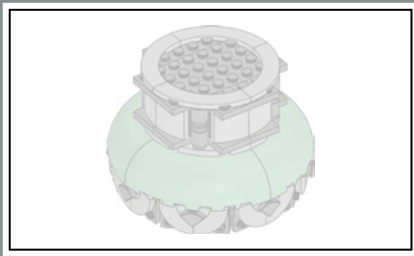

212

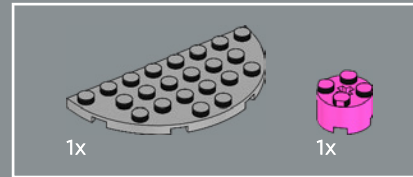
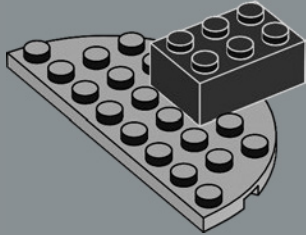

213

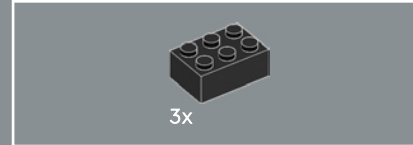
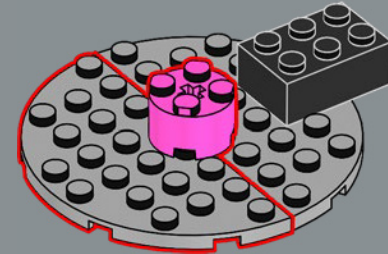

214

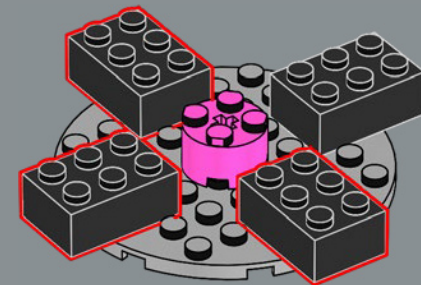

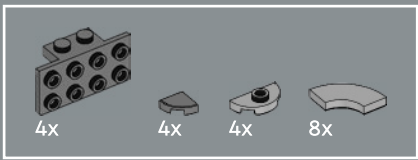

215

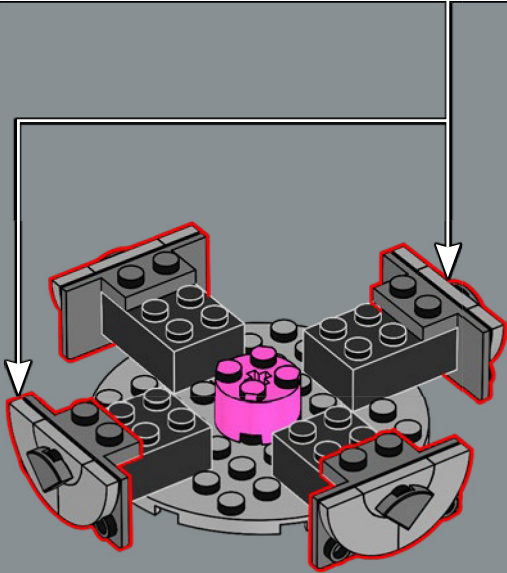
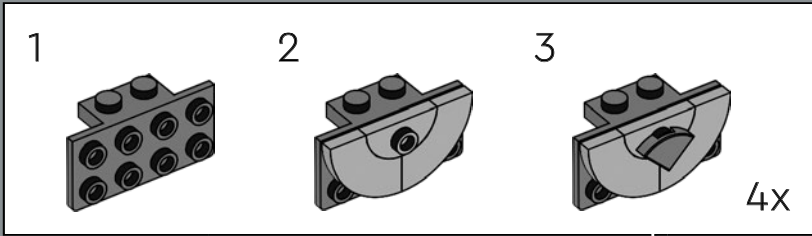

216

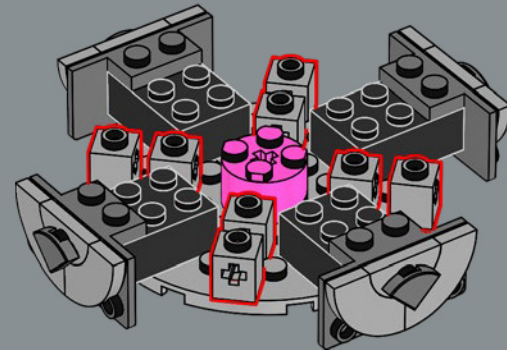

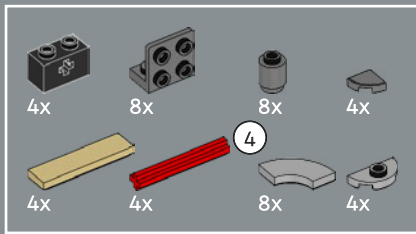

217

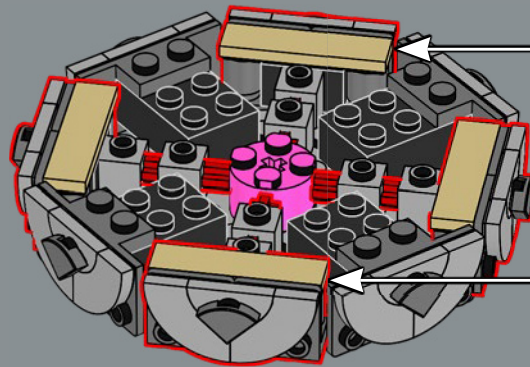
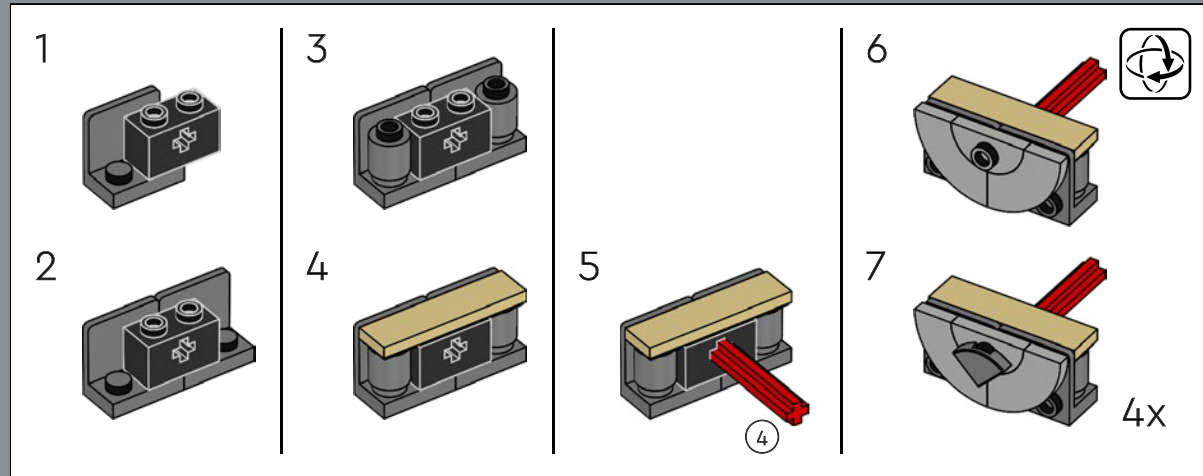

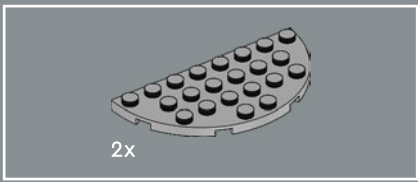

218

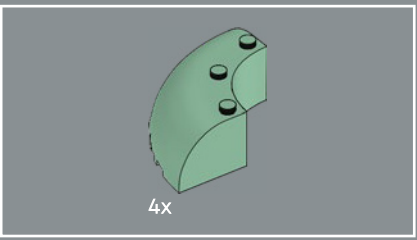
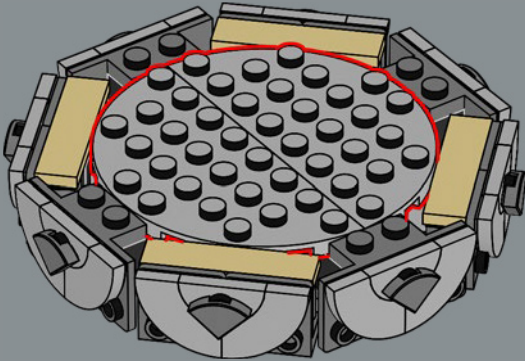

219

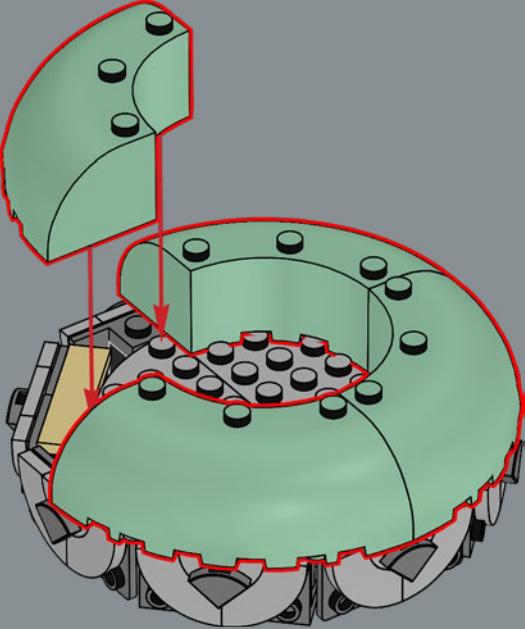



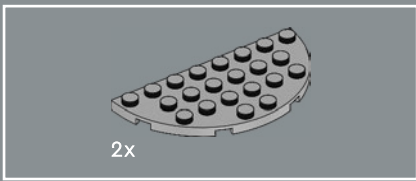

220

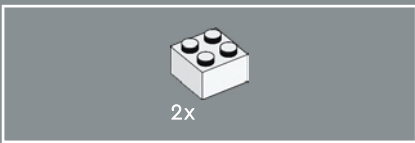
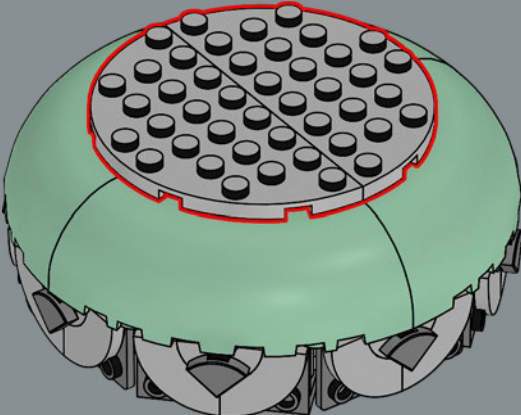

221

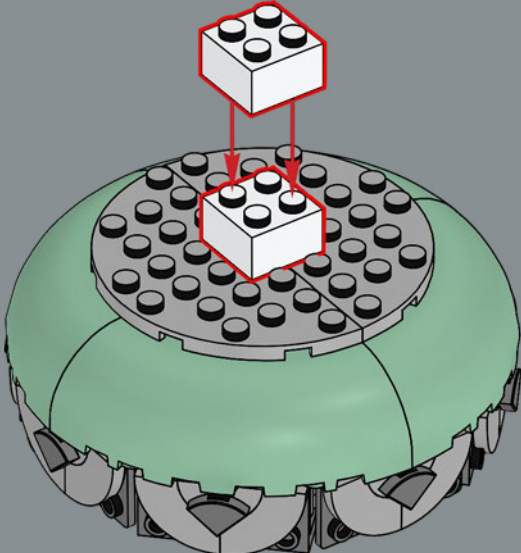

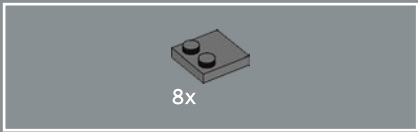

222

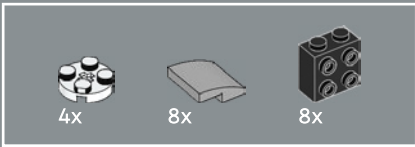
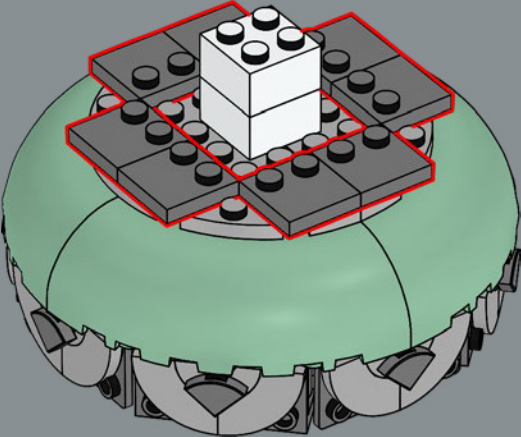

223

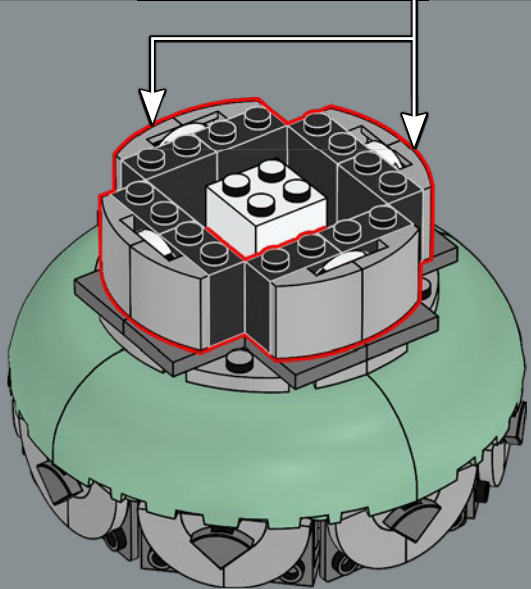
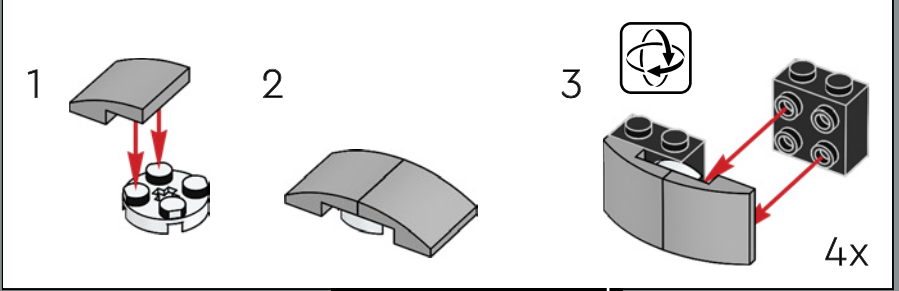

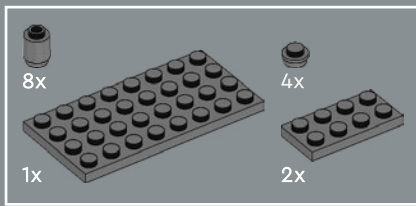

224

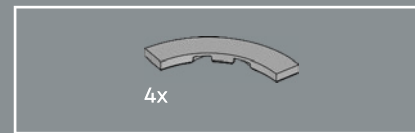
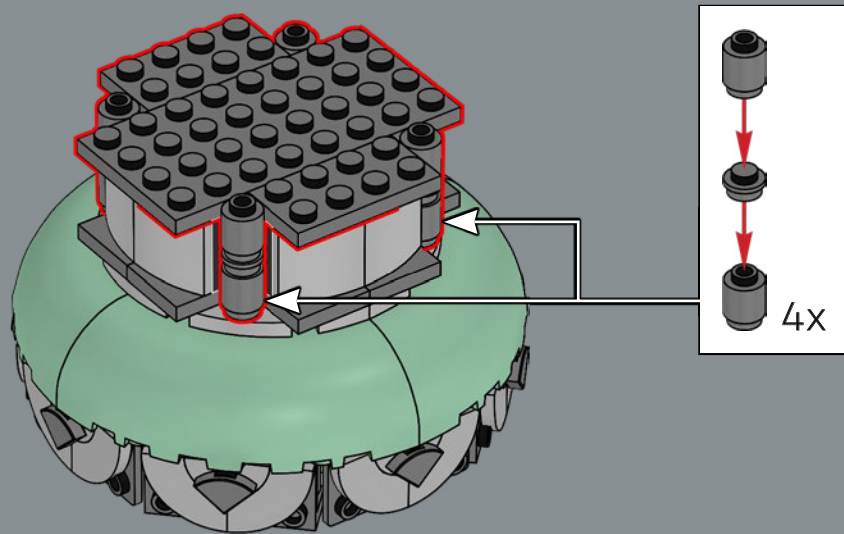

225

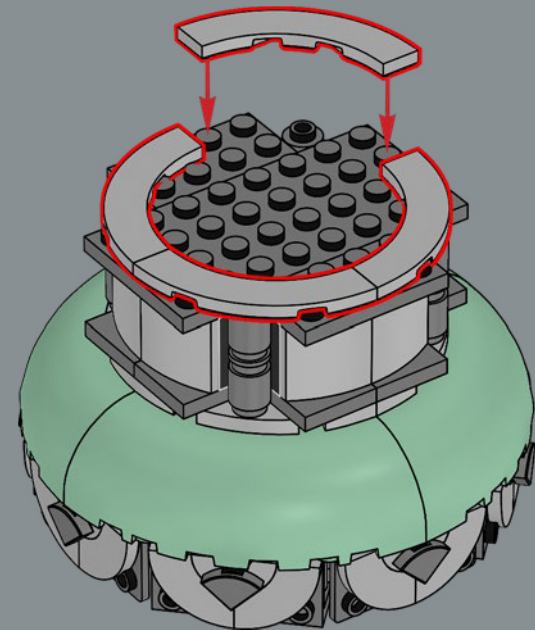



塔顶可以拆卸，以便你查看比尔博的写作进度。

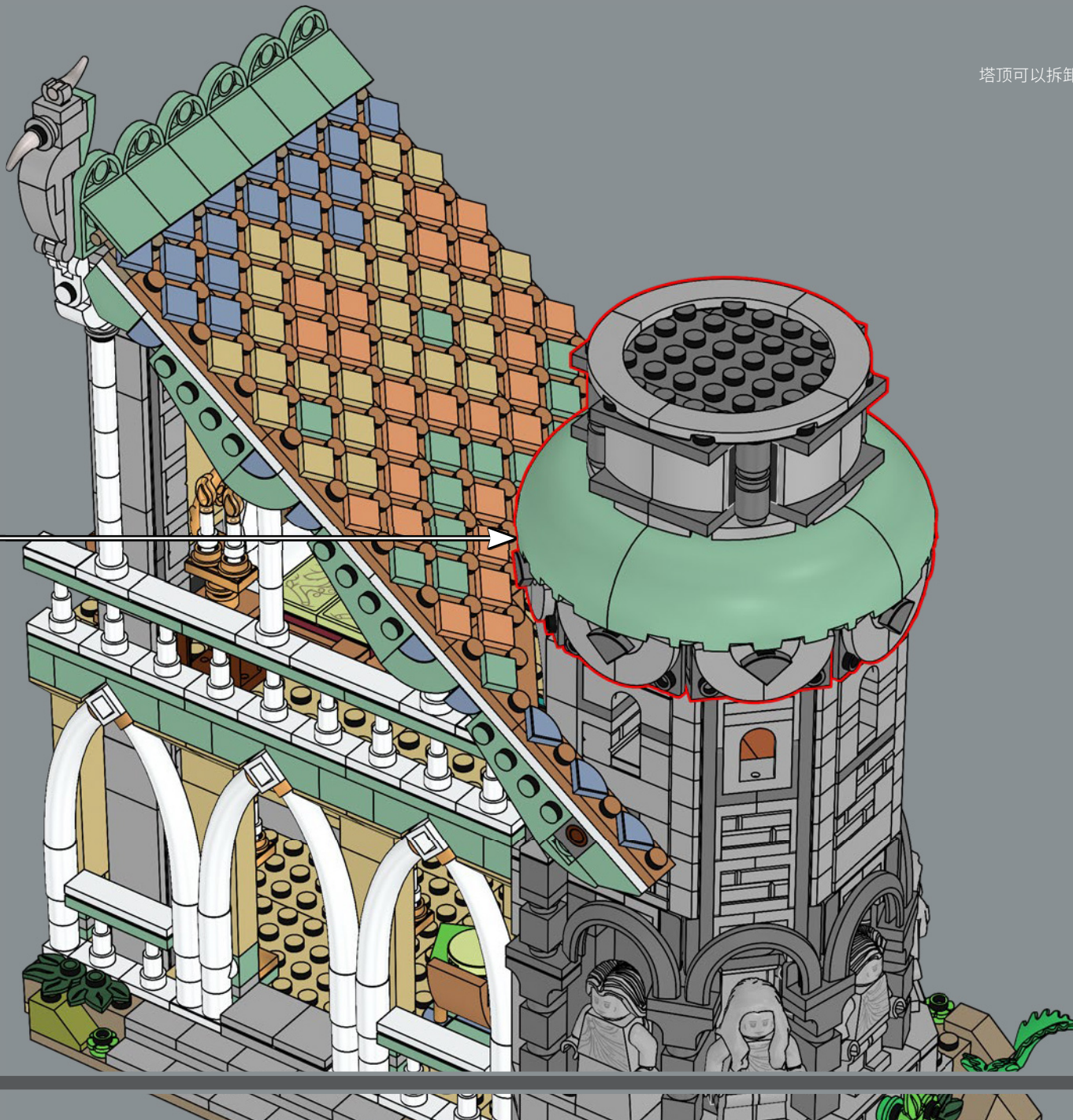

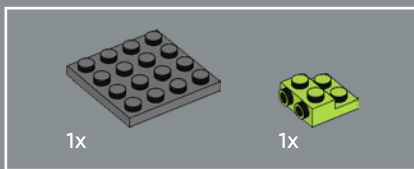

227

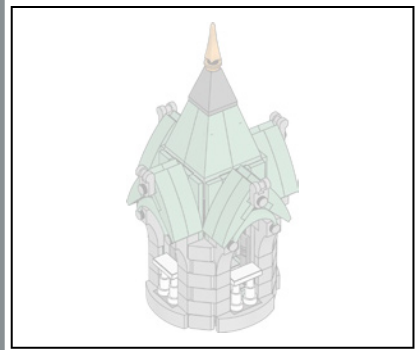
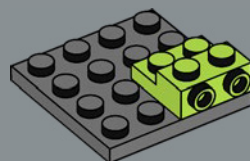

228

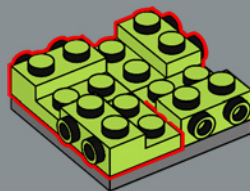

229

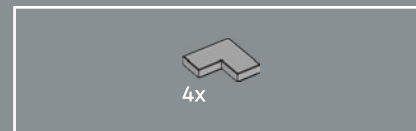
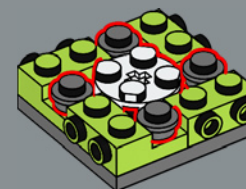

230

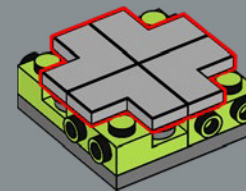



4x

231

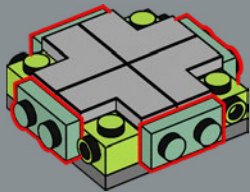

4x



8x



8x



4x

232

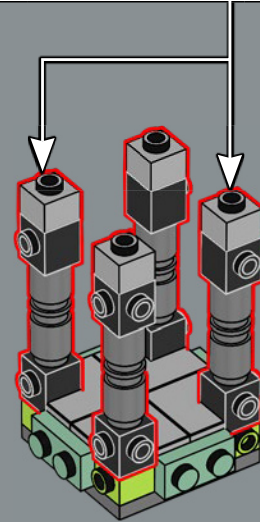
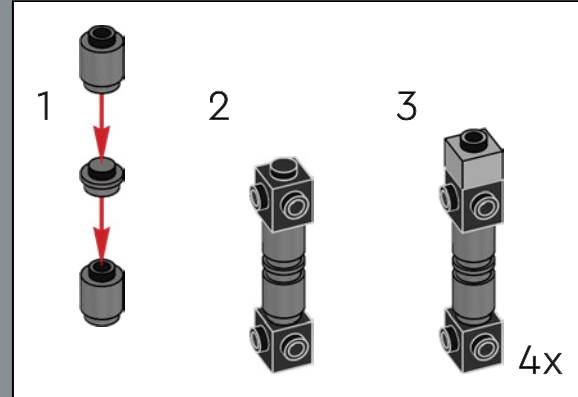

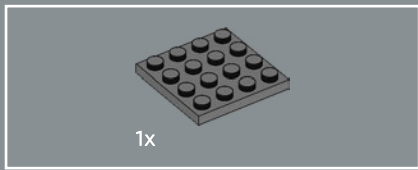

233

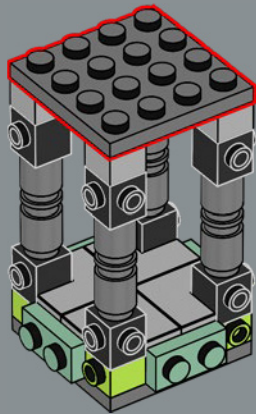

234

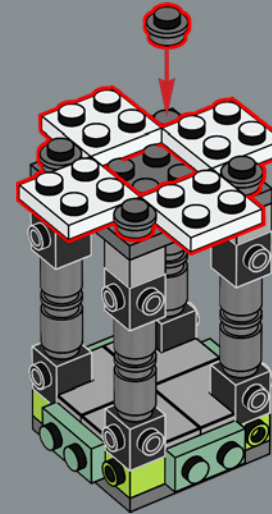

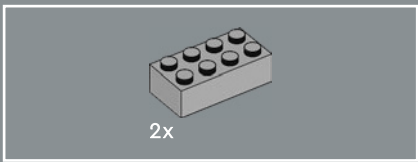

235

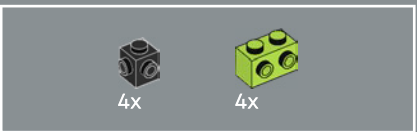
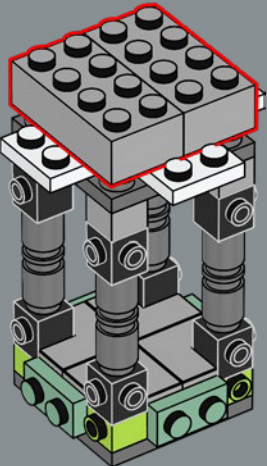

236

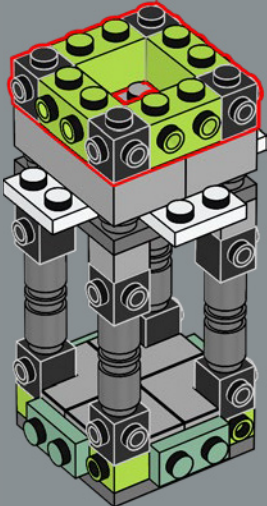



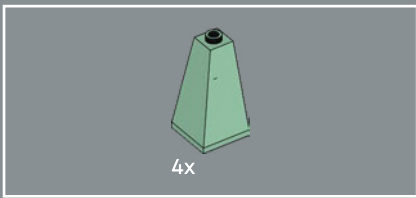

237

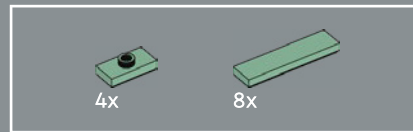
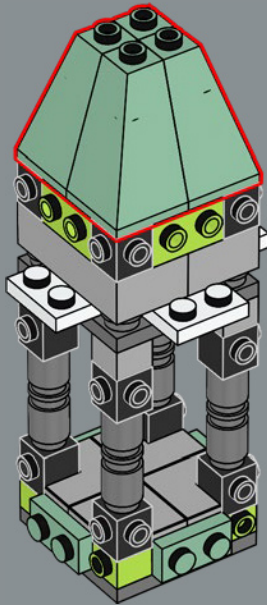

238

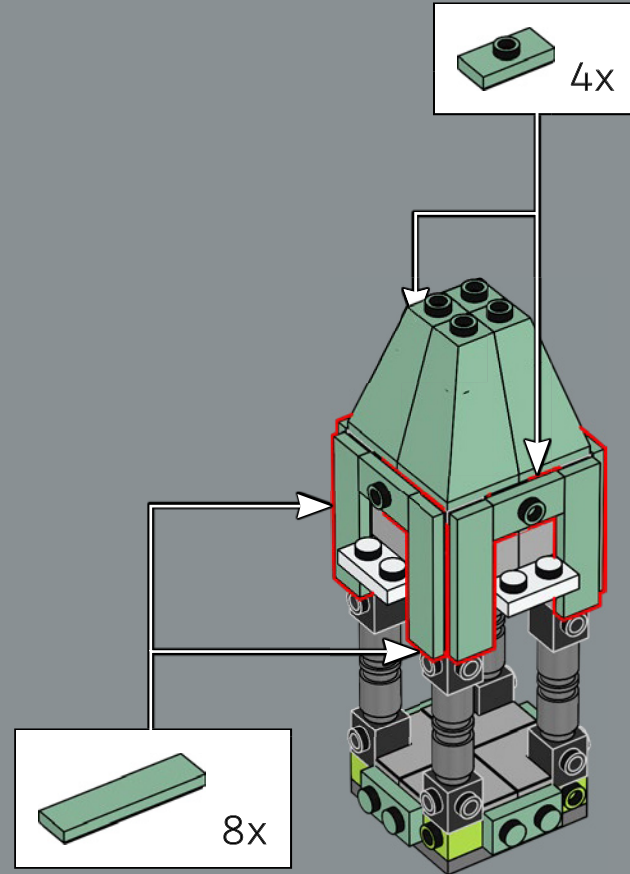

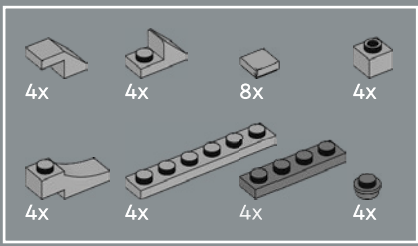

239

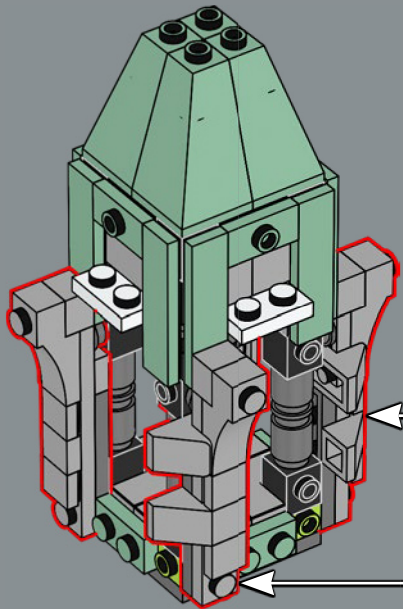
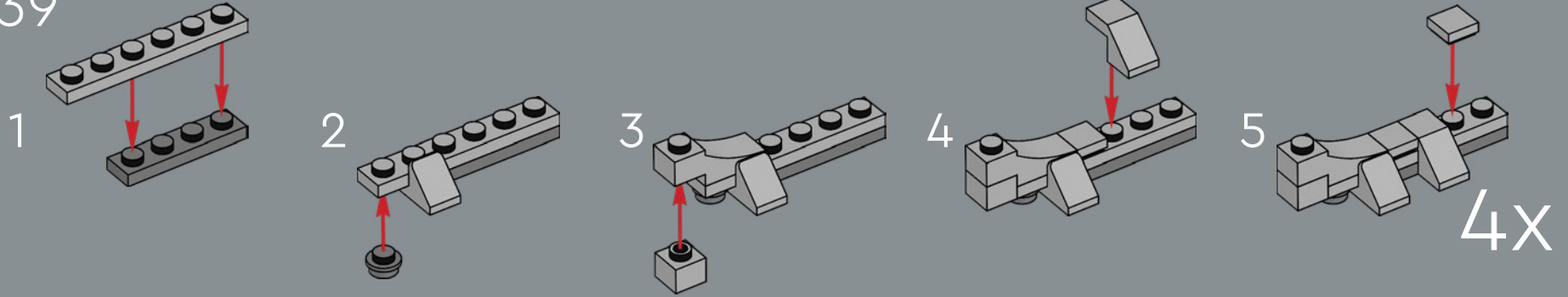

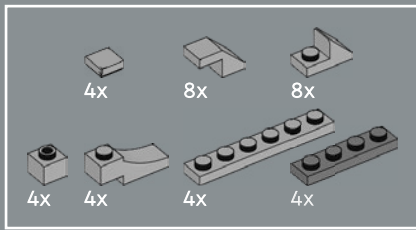

240

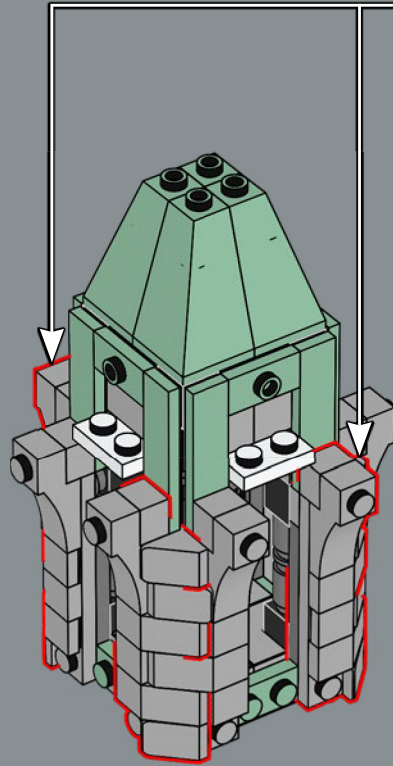
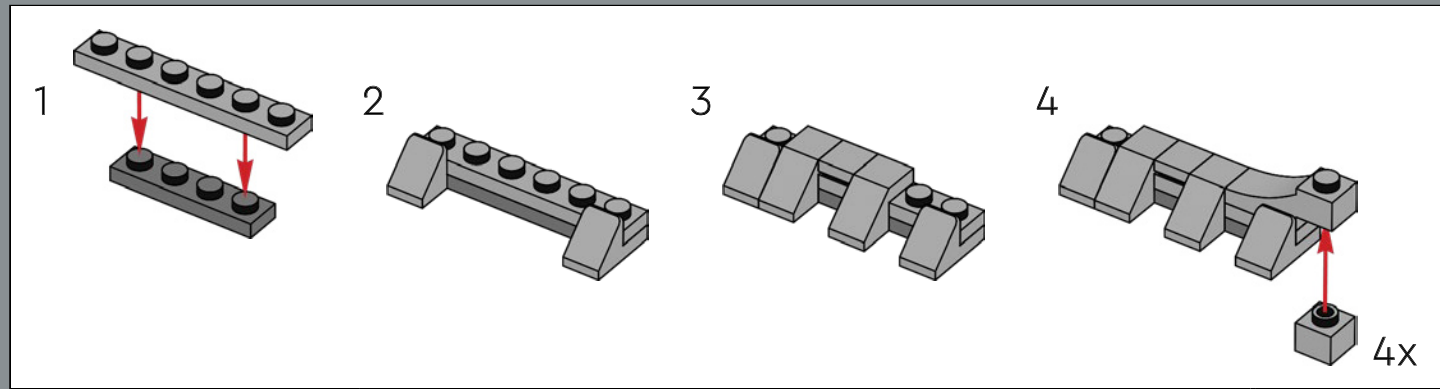

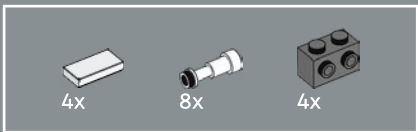

241

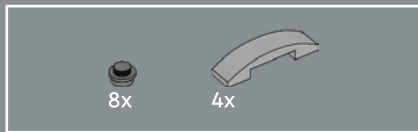
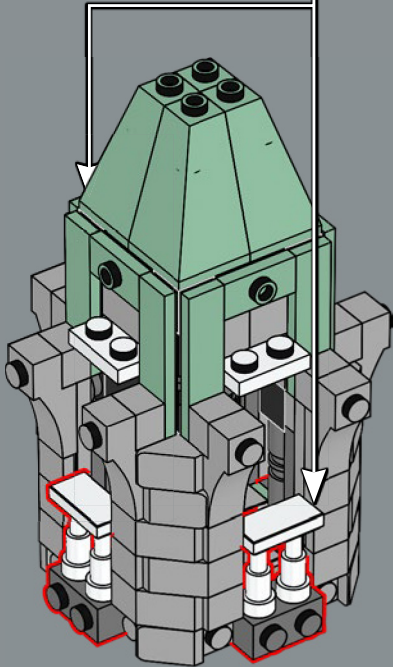
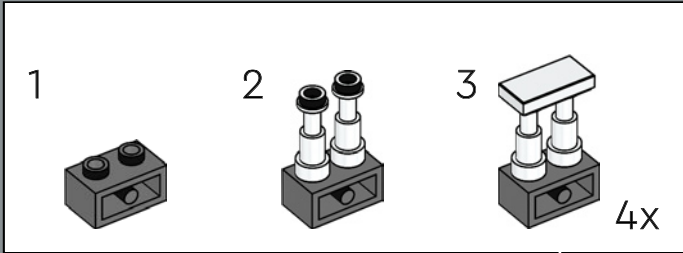

242

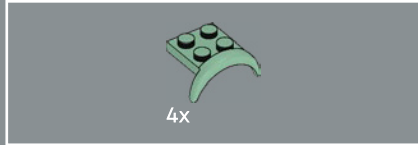
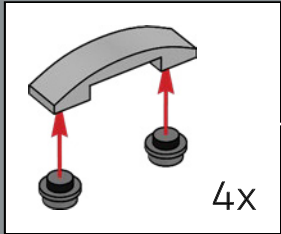

243

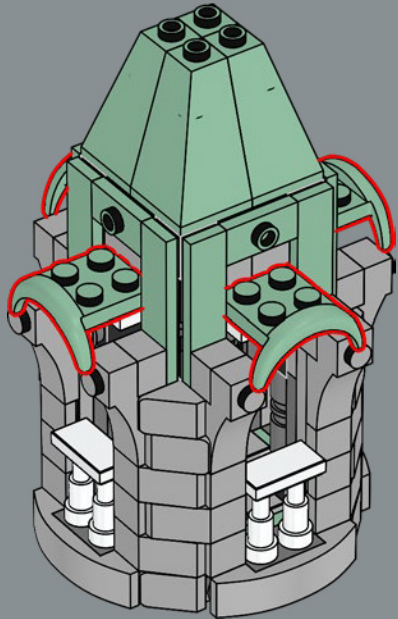
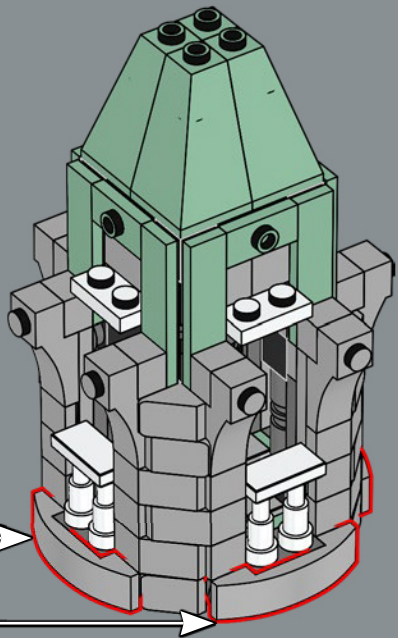

用作窗户拱顶的绿色组件最初是作为汽车的轮拱而开发的。

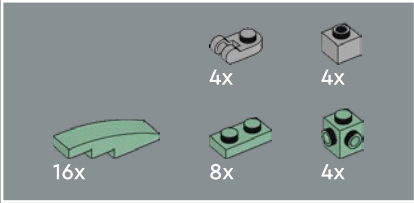

244

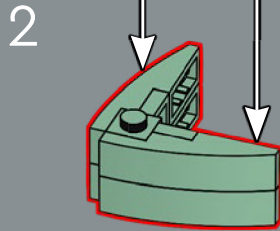
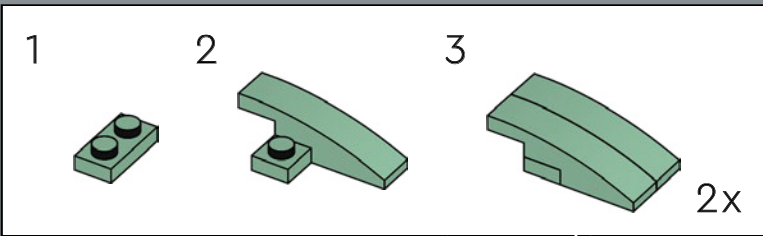
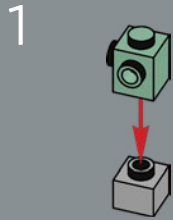

3

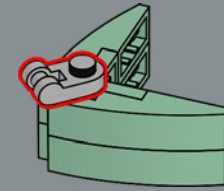

4x

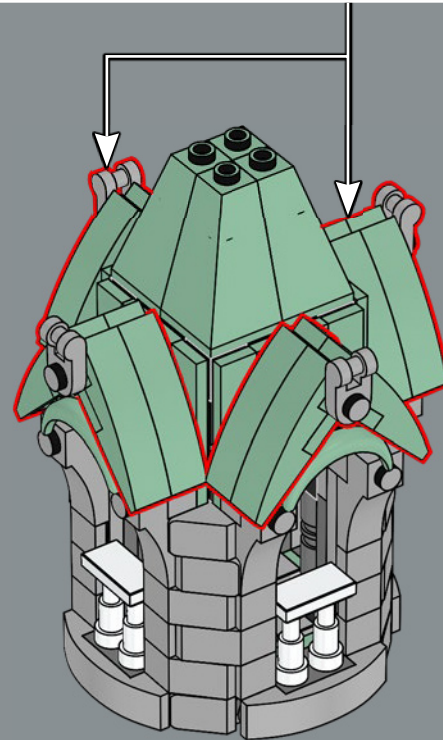



245

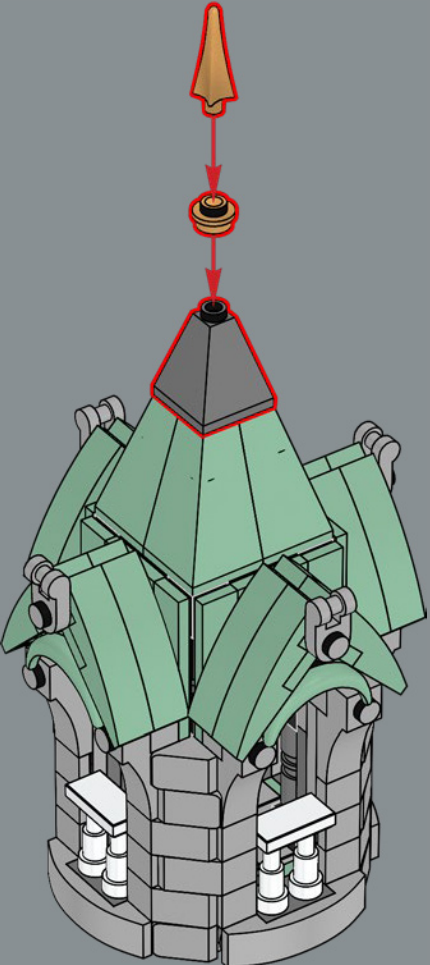

246

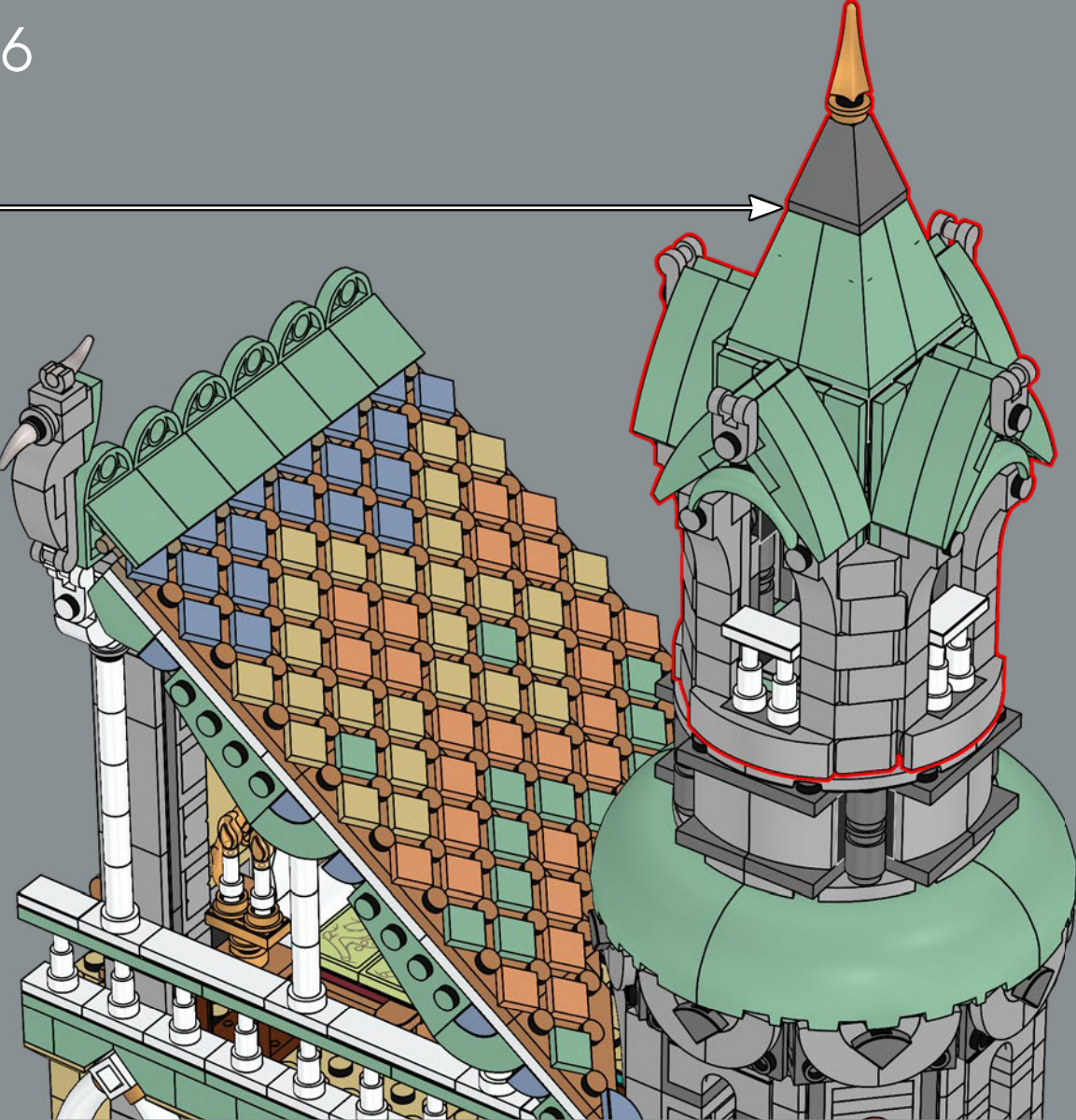

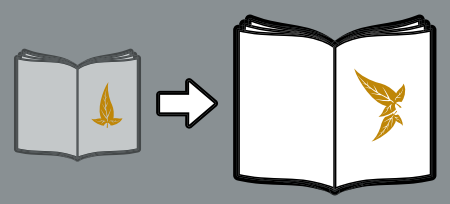

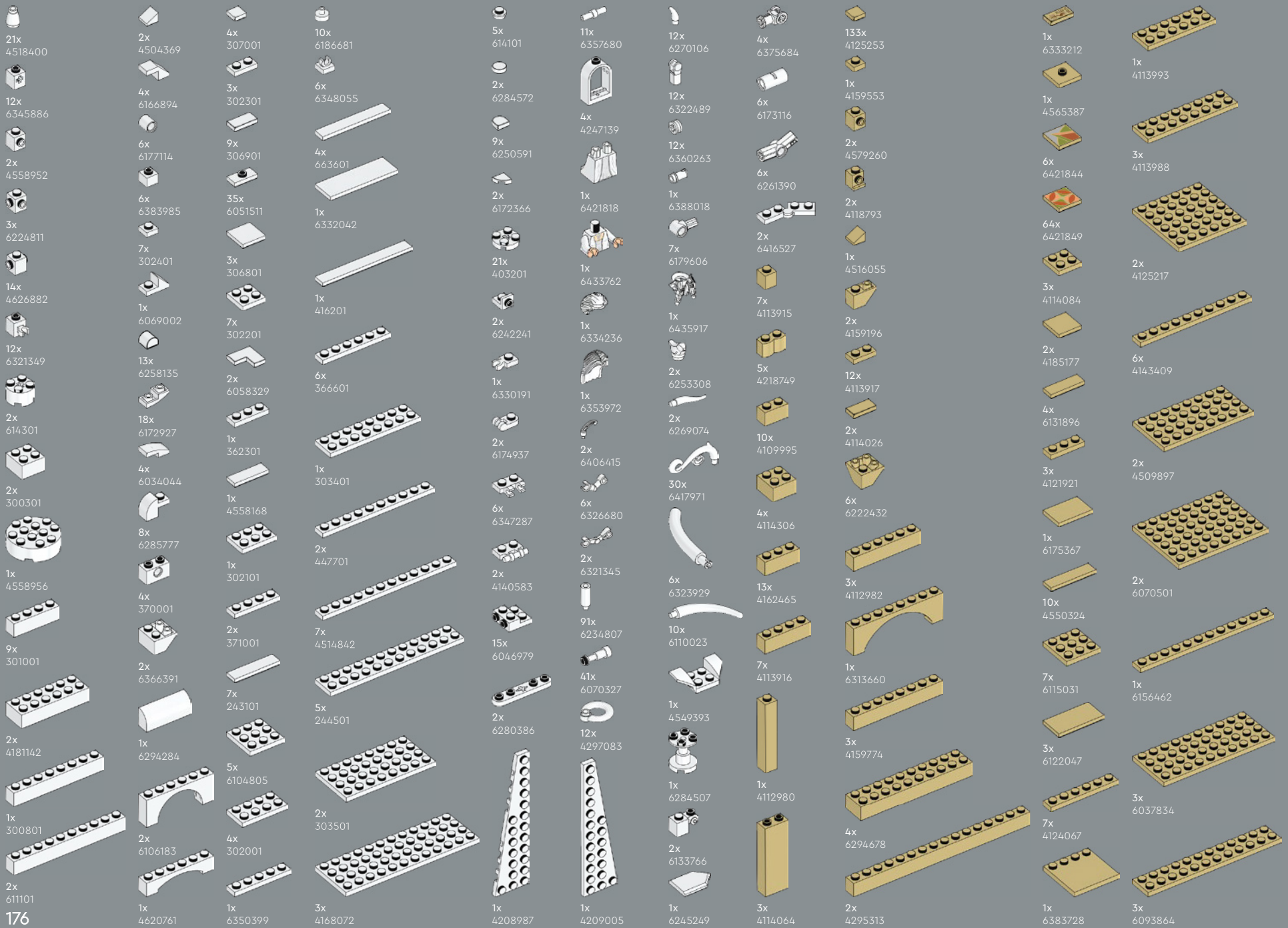



5x 4666579	1x 6310249	3x 6330584	6x 614124	1x 4529236	3x 6186675	1x 6186646	1x 452226	1x 6299492
2x 6145570	1x 6433765	130x 6419170	72x 6286830	4x 306226	1x 6335388	40x 614126	1x 4189009	1x 6321770
1x 6236914	1x 64330418	2x 6330418	1x 346024	1x 4504382	1x 6330189	1x 474026	1x 4189009	1x 6171101
1x 4512688	3x 6429962	2x 614323	2x 6130008	2x 6265091	2x 6347310	2x 6195325	1x 6315887	15x 6229130
1x 4512688	7x 6421843	2x 370023	2x 4558954	4x 6170566	1x 6338799	10x 6052126	3x 6278152	2x 6331100
4x 6273864	1x 306921	2x 302323	2x 6228987	12x 6187572	3x 6020193	1x 452826	5x 6279875	46x 6206150
3x 4624185	2x 6347308	2x 302123	4x 407026	1x 4214559	1x 6016172	6x 4119479	8x 6280097	4x 4119479
4x 6030980	1x 6187620	1x 4206482	2x 6228987	8x 473326	2x 6250020	15x 6182261	6x 4512363	1x 6235080
2x 4611414	1x 6001806	9x 6299413	19x 300226	20x 6275806	2x 6313191	4x 4119479	6x 616604	1x 6235080
	1x 6066342	4x 300823	1x 300926	5x 6138173	7x 346026	1x 6235080	1x 6267045	34x 6411022
	2x 6378120	1x 300823	1x 4181144	4x 6178922	1x 395826	6x 6168620	6x 6168620	16x 6268814
	18x 4142865	1x 300823	9x 6037390	4x 6178922	1x 303626	2x 6280168	2x 6280168	2x 6389695
	1x 6209519	2x 362324	1x 4181144	1x 6039347	1x 615573	1x 4558209	1x 6315573	1x 6406357
	5x 243121	1x 302024	9x 6037390	3x 302026	1x 6283610	1x 6115117	1x 6283610	5x 6395814
	5x 6129995	2x 300224	2x 611226	2x 366626	1x 4517986	4x 6401209	1x 4517986	1x 6293826
		1x 300824		3x 379526	6x 302128	1x 6133200	6x 302128	2x 6266964

5

4





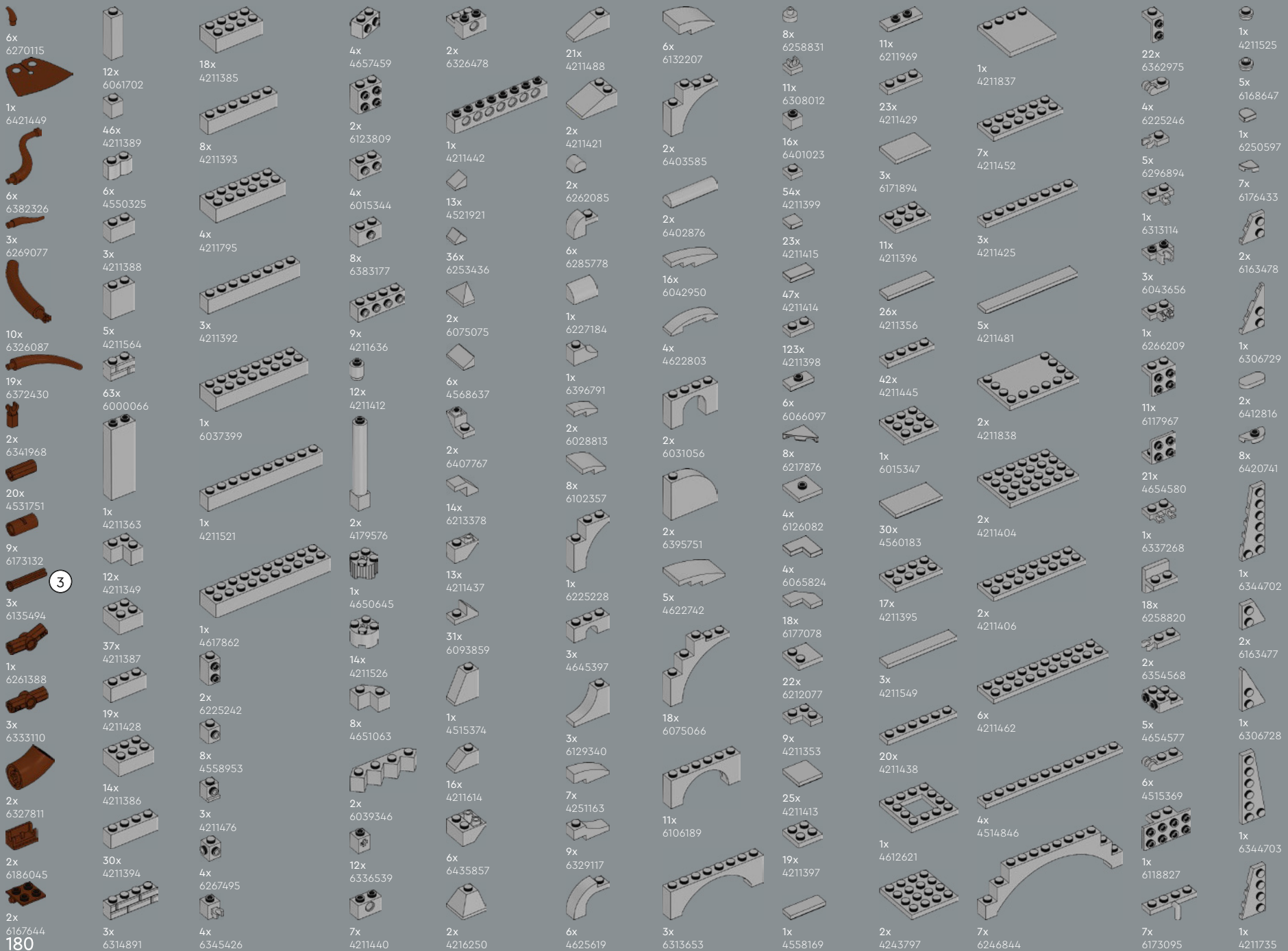

3



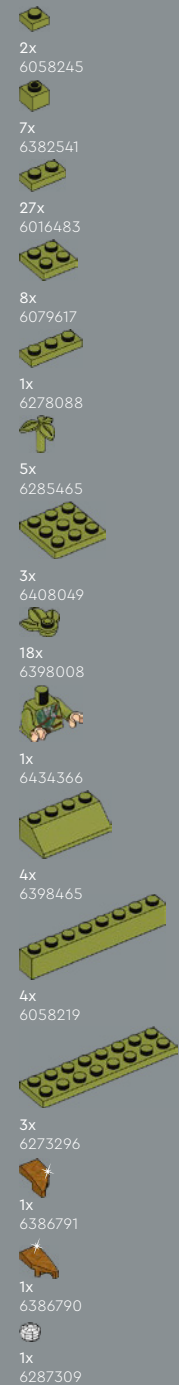
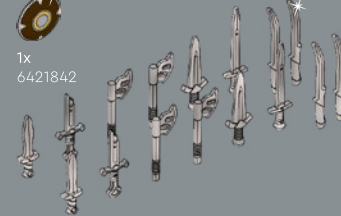
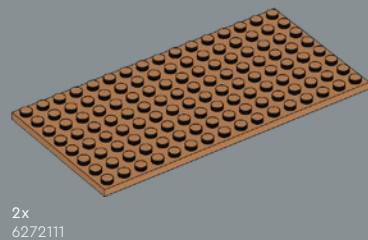

LEGO.com/service



# YOU COULD WIN



## YOU COULD WIN

Your feedback will help shape the future development of this product series.

Visit:

## DU KÖNNTEST GEWINNEN

Dein Feedback trägt zur Weiterentwicklung dieser Produktreihe bei.

Geh auf:

## VOUS POURRIEZ GAGNER

Vos commentaires nous aideront à concevoir les futurs produits de cette gamme.

Visitez :

## POTRESTI VINCERE TU

La tua opinione ci aiuterà a migliorare la creazione futura di questa linea di prodotti.

Visita:

## PUEDES GANAR

Tu opinión contribuirá al futuro de esta serie de productos.

Visita:

## 轻松获奖

您的反馈将有助于我们在今后改进本产品系列。

请访问:

---

**[LEGO.com/productfeedback](https://LEGO.com/productfeedback)**

---

You also have the chance to win a LEGO® set.

Terms and conditions apply.\*

Außerdem hast du die Chance, ein LEGO® Set zu gewinnen.

Es gelten die Teilnahmebedingungen.\*

Vous pourriez également gagner un ensemble LEGO®.

Des conditions s'appliquent.\*

Hai anche la possibilità di vincere un set LEGO®.

Termini e condizioni sono applicabili.\*

También tienes la oportunidad de ganar un set LEGO®.

Aplican términos y condiciones.\*

您还有机会赢取乐高®套装。

条款和条件适用。\*

\*[LEGO.com/productfeedback-terms](https://LEGO.com/productfeedback-terms)

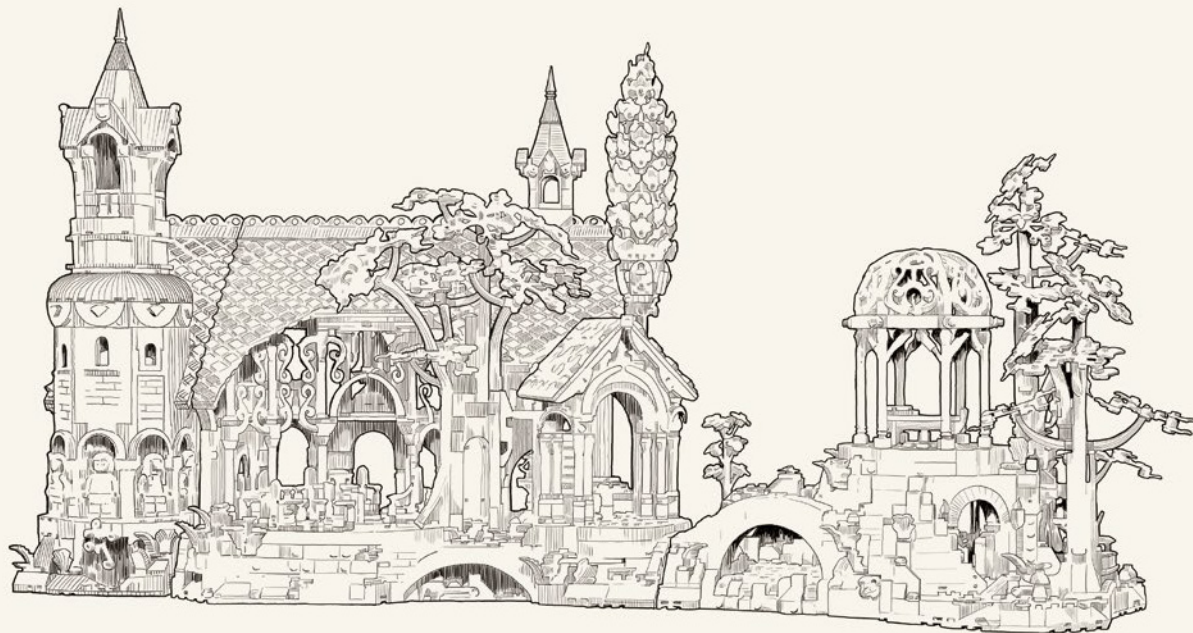

LEGO and the LEGO logo are trademarks of the LEGO Group. ©2023 The LEGO Group.

© 2023 New Line Productions, Inc. All rights reserved. The Lord of the Rings: The Fellowship of the Ring, The Lord of the Rings: The Two Towers, The Lord of the Rings: The Return of the King and the names of the characters, items, events and places therein are trademarks of The Saul Zaentz Company d/b/a Middle-earth Enterprises under license to New Line Productions, Inc. (s23)