

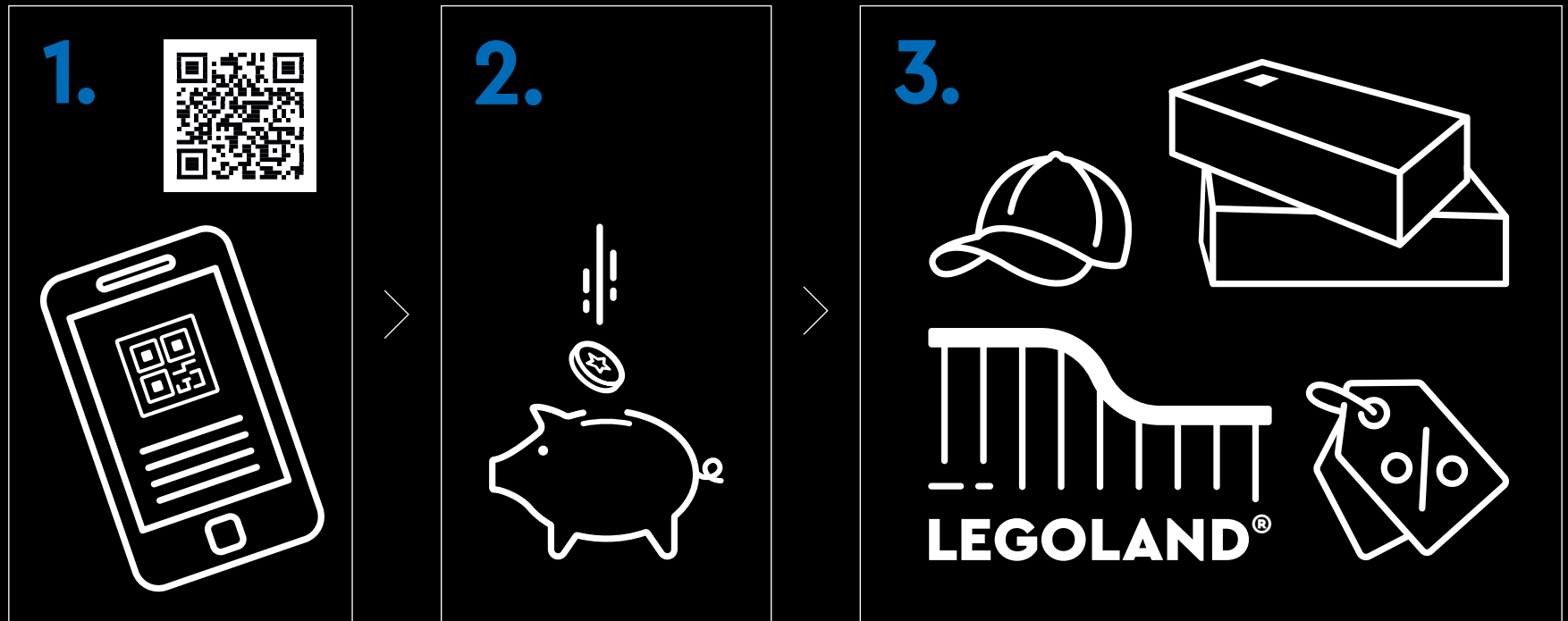



LEGO.com/sustainable-packaging

LEGO® VIP



1. Sign up **2.** Earn points for purchases **3.** Redeem points for rewards, experiences, discounts & more | **1.** Melde dich an **2.** Sammle Punkte bei jedem Kauf **3.** Löse die Punkte für Belohnungen, Erlebnisse, Rabatte und Ähnliches ein | **1.** Inscrivez-vous **2.** Gagnez des points lors de vos achats **3.** Échangez vos points contre des récompenses, des expériences, des remises et bien plus encore | **1.** Iscriviti **2.** Guadagna punti con i tuoi acquisti **3.** Riscatta punti per premi, esperienze, sconti e altro ancora | **1.** Regístrate **2.** Gana puntos por tus compras **3.** Canjea puntos por recompensas, experiencias, descuentos y mucho más | **1.** Registe-se **2.** Ganhe pontos em compras **3.** Troque os pontos para prémios, experiências, descontos e muito mais | **1.** 注册 **2.** 购物赚积分 **3.** 用积分兑换奖励、体验、折扣等 | **1.** Zarejestruj się **2.** Zdobywaj punkty za zakupy **3.** Wymieniaj punkty na rabaty, przygody i inne nagrody | **1.** Zaregistrujte se **2.** Sbírejte body za nákupy **3.** Vyměňujte body za odměny, zážitky, slevy a spoustu dalšího | **1.** Zaregistrujte se **2.** Získavajte body za nákupy **3.** Uplatnite si body a získajte odmeny, rôzne zážitky, zľavy a ešte viac | **1.** Regisztrálj **2.** Szerezz pontokat minden vásárlással **3.** Váltsd be pontjaidat jutalmakra, élményekre, kedvezményekre és egyebekre | **1.** Înscric-te **2.** Câștigă puncte pentru achiziții **3.** Valorifică puncte pentru recompense, experiențe, reduceri și multe altele | **1.** Регистрируйте се **2.** Получайте точки за покупки **3.** Используйте точки за награды, услуги, отстъпки и т.н. | **1.** Reģistrējies **2.** Pelni punktus par pirkumiem **3.** Izmanto punktus, lai saņemtu balvas, izklaides iespējas, atlaides un daudz ko citu | **1.** Registreeru **2.** Teeni ostude eest punkte **3.** Lunasta punktide eest preemiad, elamused, allahindlused ja muu | **1.** Užsiregistruokite **2.** Pelnykite taškus už pirkinius **3.** Panaudokite taškus atlygiui, funkcijoms, nuolaidoms ir ne tik





TE DAMOS LA BIENVENIDA A RIVENDEL

20 años después del lanzamiento de *El retorno del rey*, la espectacular trilogía de *El señor de los anillos* sigue siendo una de las obras más trascendentes del arte cinematográfico de nuestros días. Eso solo hace que decidirte por una escena o momento como tu favorito sea verdaderamente difícil. Incluso en los tiempos más oscuros, Rivendel, el majestuoso hogar de los elfos, es un sereno refugio de sanación, esperanza, reflexión y unificación. En una reunión decisiva celebrada en este lugar, representantes de los pueblos de la Tierra Media conformaron la Comunidad del Anillo con el propósito de destruir el Anillo Único, forjado "para gobernarlos a todos".



La comunidad de diseñadores de LEGO®

UNA COMUNIDAD DE DISEÑADORES DE LEGO®

Como una auténtica comunidad, diseñadores gráficos, de modelos y de elementos de todos los rincones del mundo nos embarcamos en un viaje para capturar la magia de este lugar. Nos basamos en los planos de entorno utilizados en las películas, aunque también nos tomamos algunas libertades artísticas con el fin de combinar nuestras características favoritas. Esta recreación hecha con 6000 ladrillos LEGO® del icónico Imladris, el Último Hogar al Este del Mar, es una detallada porción de Rivendel a escala de minifigura LEGO llena de memorables momentos y entrañables personajes de la historia.



ESCENAS CLÁSICAS DE EL SEÑOR DE LOS ANILLOS, INMORTALIZADAS AL ESTILO LEGO®

Desde la llegada de Gandalf el Gris a la Comarca hasta la batalla final contra el Rey de los Muertos en las riberas de Minas Tirith, revive las inolvidables escenas que reprodujeron los sets LEGO® inspirados en *El señor de los anillos*, lanzados entre 2012 y 2013.



9469 LA LLEGADA DE GANDALF™

Gandalf el Gris viaja hasta la Comarca para celebrar el 111 cumpleaños de su viejo amigo Bilbo Bolsón. Es aquí donde se reúne con el joven Frodo Bolsón, ¡y la aventura comienza!



79006 EL CONCILIO DE ELROND

Los pueblos de la Tierra Media han sido convocados al Concilio de Elrond en Rivendel. Entre todos, aquí determinarán el destino del Anillo Único.



9473 LAS MINAS DE MORIA

La heroica Comunidad del Anillo se enfrenta a malvados orcos de Moria y un gigantesco trol de las cavernas cerca de la tumba de Balin, en las espeluznantes minas abandonadas de Moria.



9474
LA BATALLA DEL
ABISMO DE HELM

La fortaleza amurallada del Abismo de Helm y las gentes de Rohan están bajo el asedio del brutal ejército de guerreros Uruk-hai de Saruman.



10237
LA TORRE DE ORTHANC

El más grande de los sets LEGO® inspirados en El señor de los anillos en el momento de su lanzamiento (con 2357 piezas) tiene un total de seis niveles con montones de personajes en formato de minifigura y escenas representativas de la saga.



79008
EMBOSCADA EN EL BARCO PIRATA

Los orcos de Mordor, comandados por Sauron, se preparan para dar la bienvenida a los aliados que llegan a bordo del barco pirata. ¡Cuál será su sorpresa cuando se den cuenta de que solo encontrarán a Aragorn, Gimli, Legolas y el Ejército de los Muertos!



LA TORRE

Durante su estancia en Rivendel, Bilbo escribe su libro *Partida y regreso* en su escritorio de la torre.

Hay un escondite secreto en la base de la torre, apenas lo suficientemente grande para ocultar a un fugitivo o mantener el Anillo Único alejado de miradas entrometidas.



Frodo tiene piernas moldeadas en dos partes que revelan sus pies descalzos, un rasgo distintivo de los hobbits de la Comarca. Además, lleva consigo el Anillo Único hacia Rivendel para que su destino se decida en el Concilio.

FRODO BOLSÓN



Bilbo cuenta con una novedosa cabeza con 2 lados decorados, uno de los cuales tiene la aterradora expresión que muestra momentáneamente cuando trata de quitarle el anillo a Frodo.

BILBO BOLSÓN



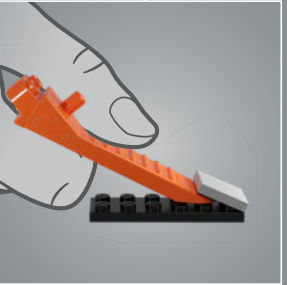
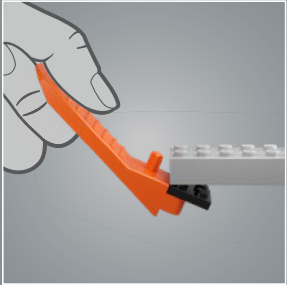
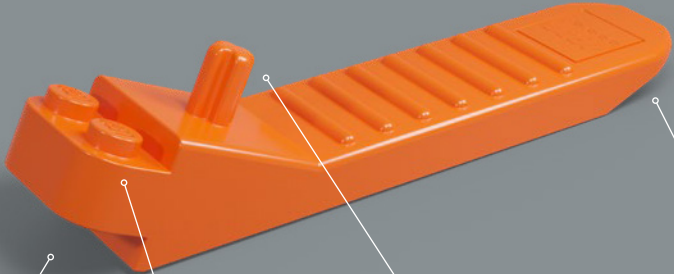

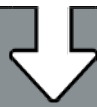

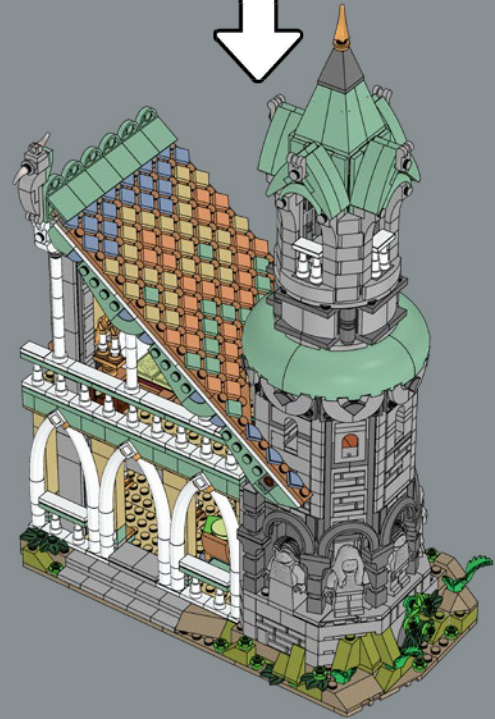



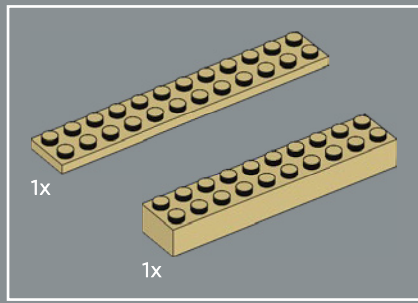

1

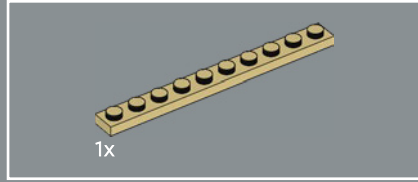
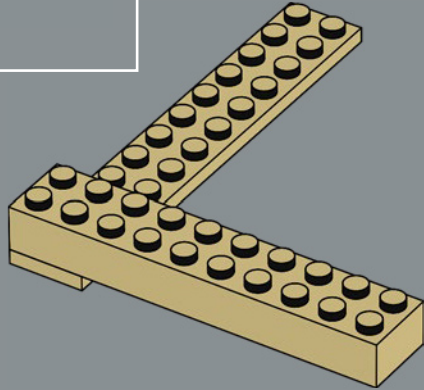

2

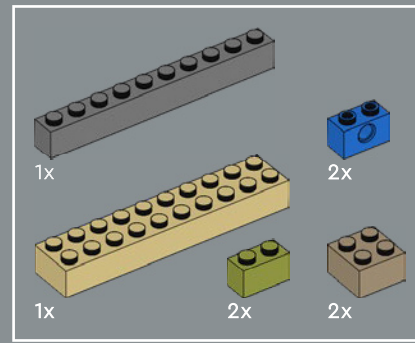
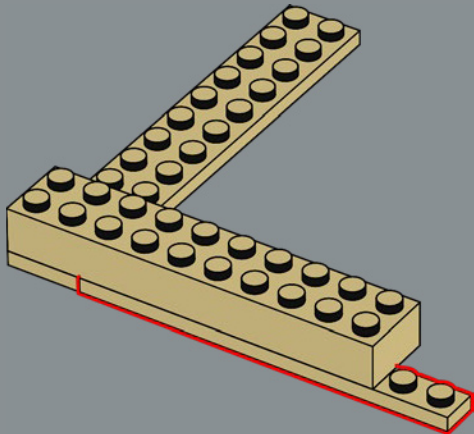

3

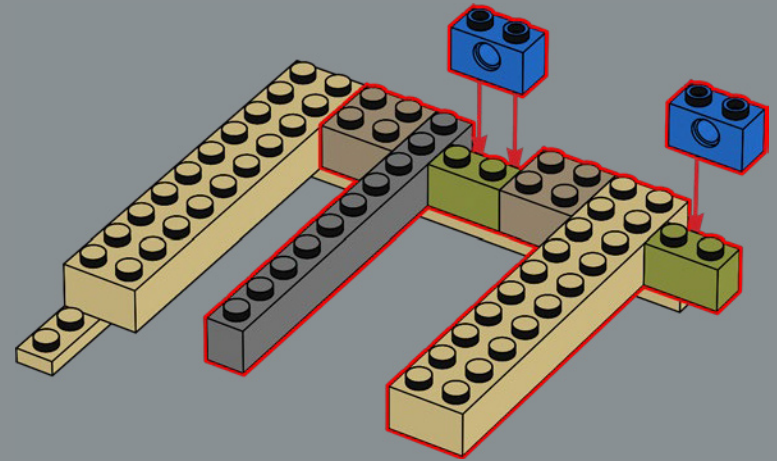

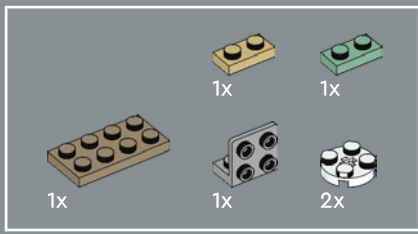

4

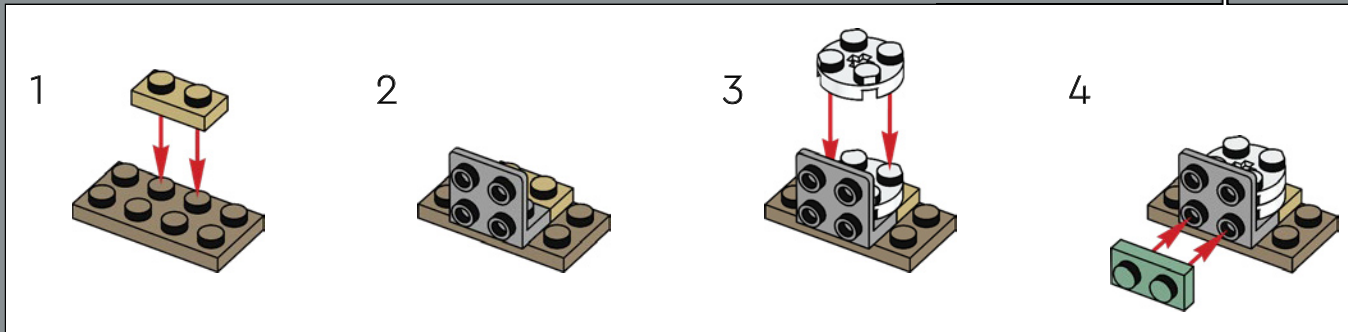
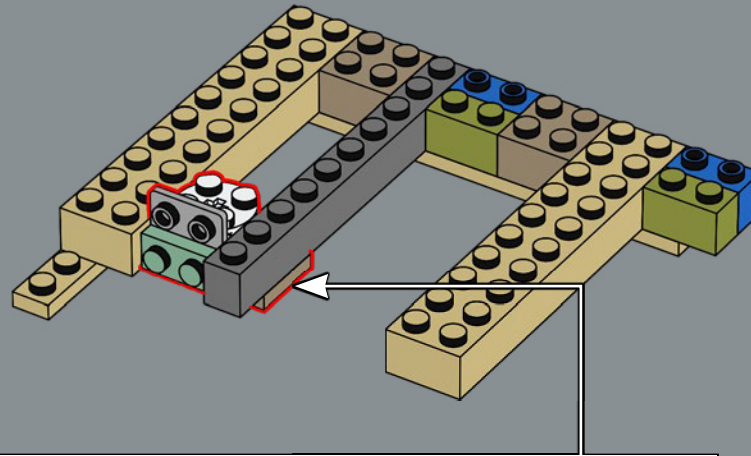

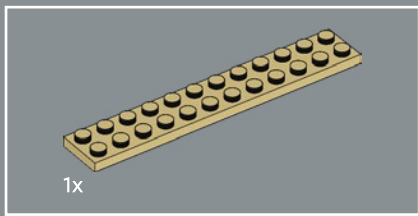

5

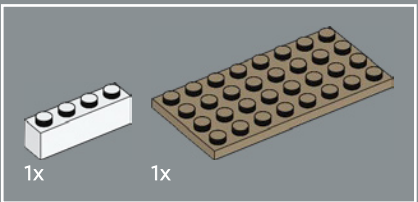
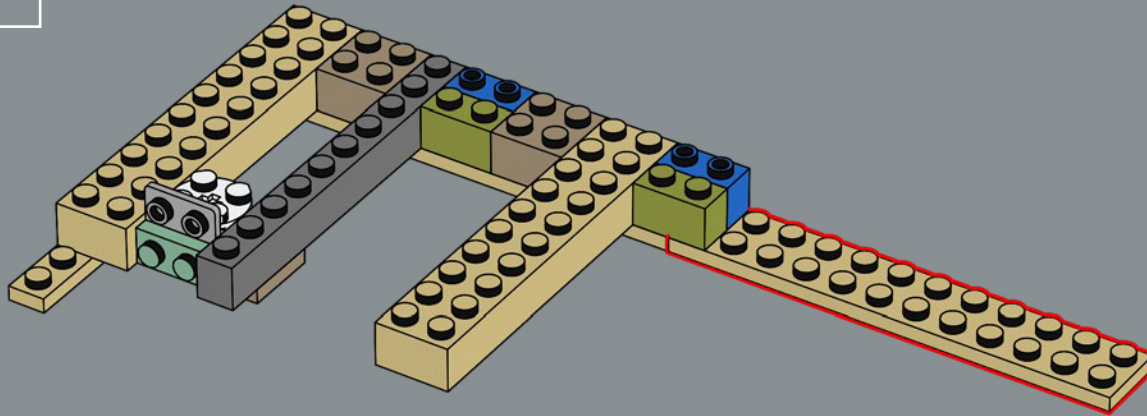

6

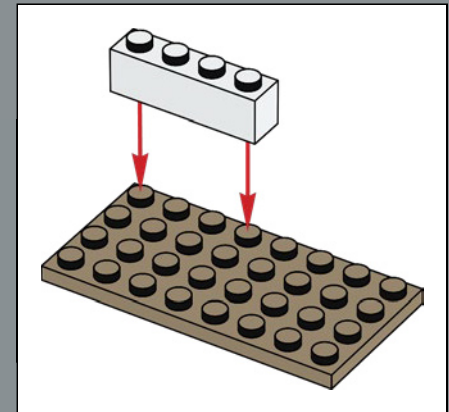
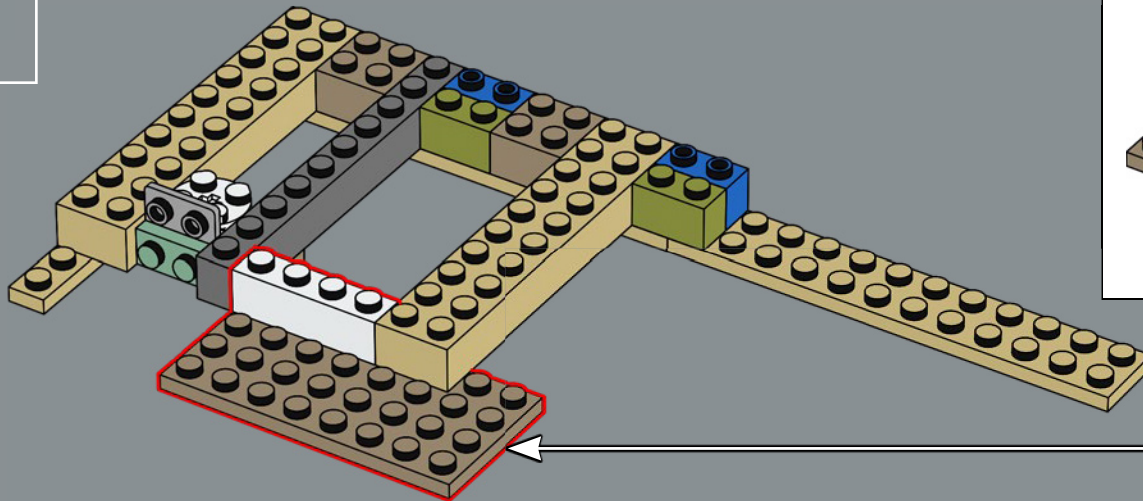

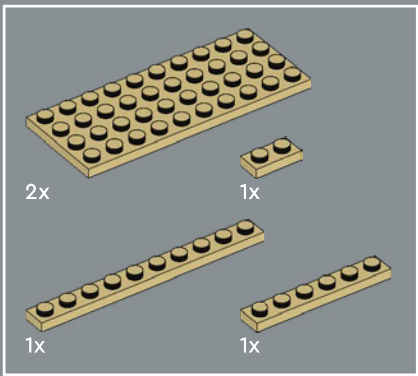

7

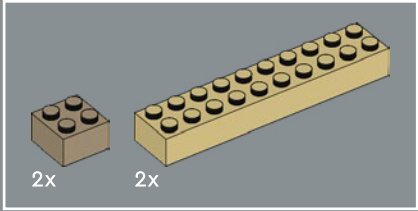
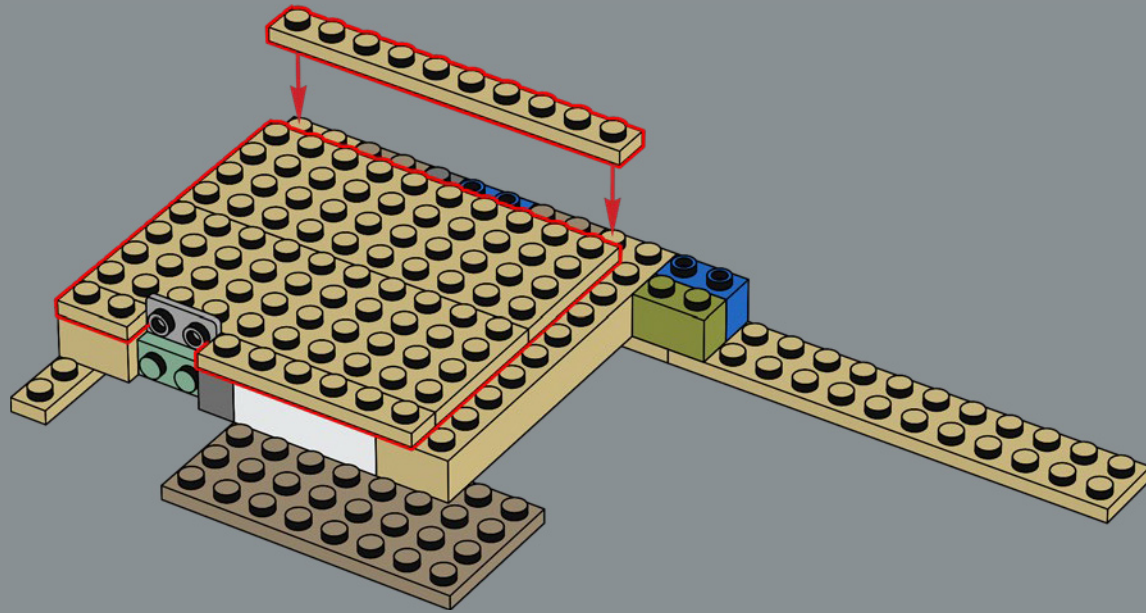

8

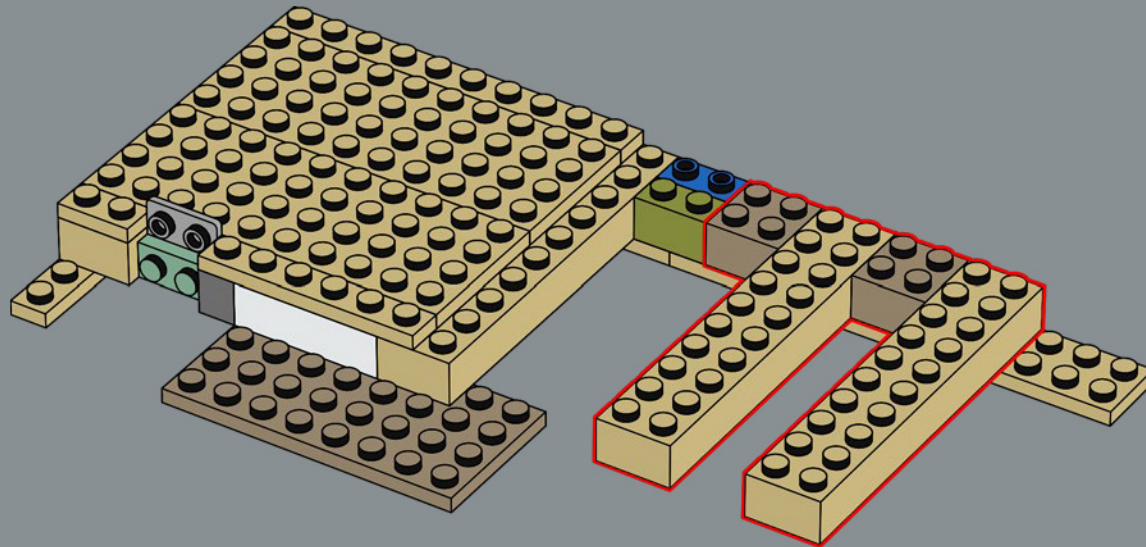

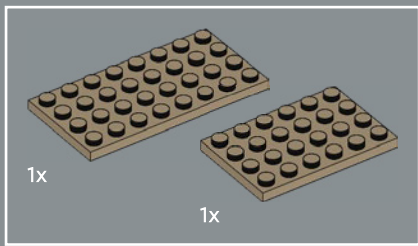

9

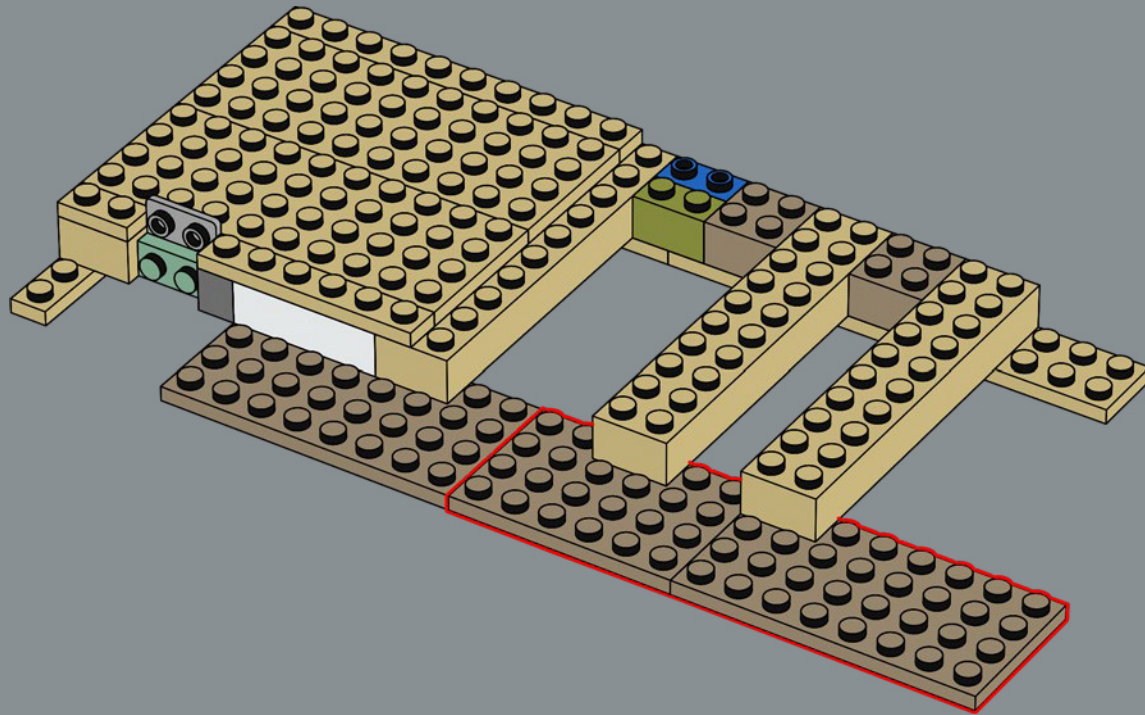

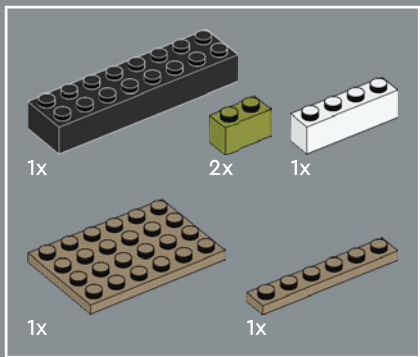

10

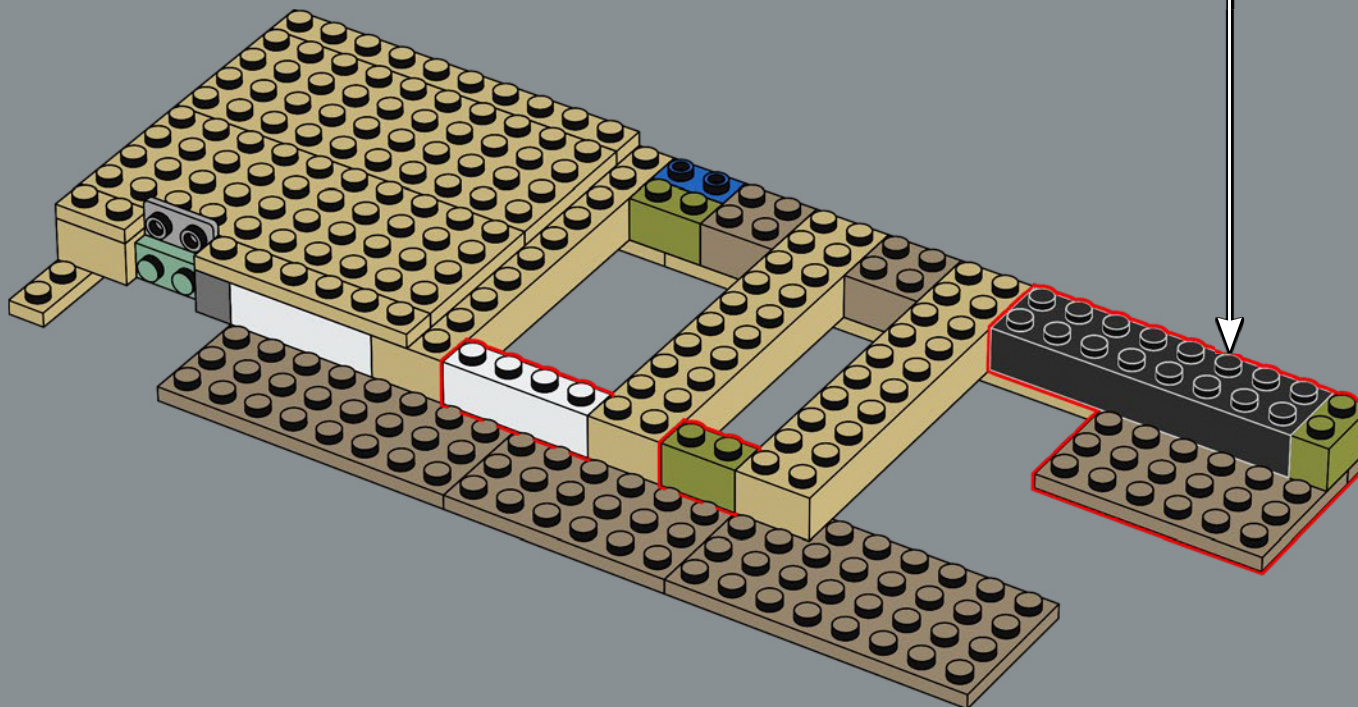
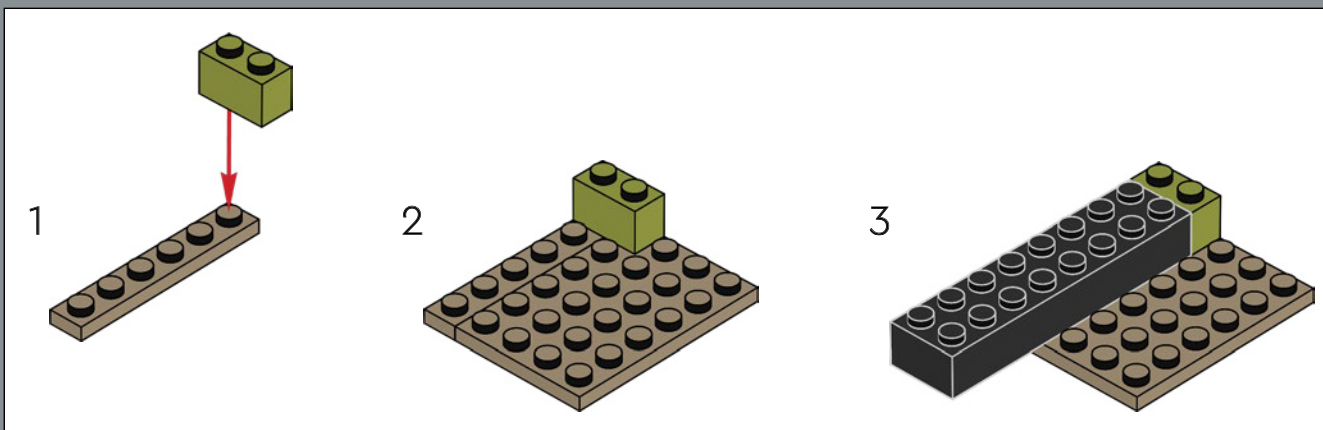

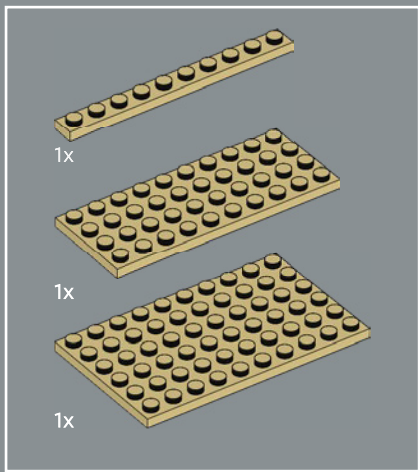

11

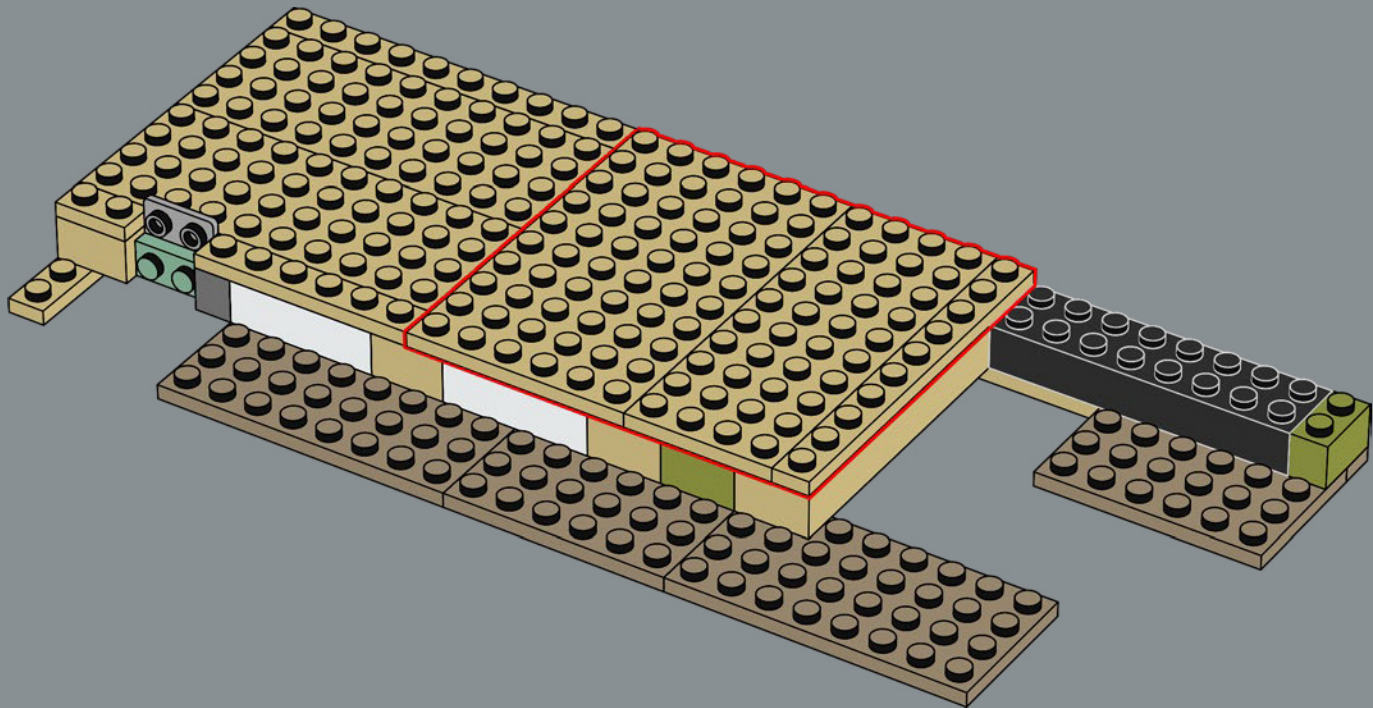

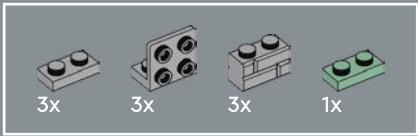

12

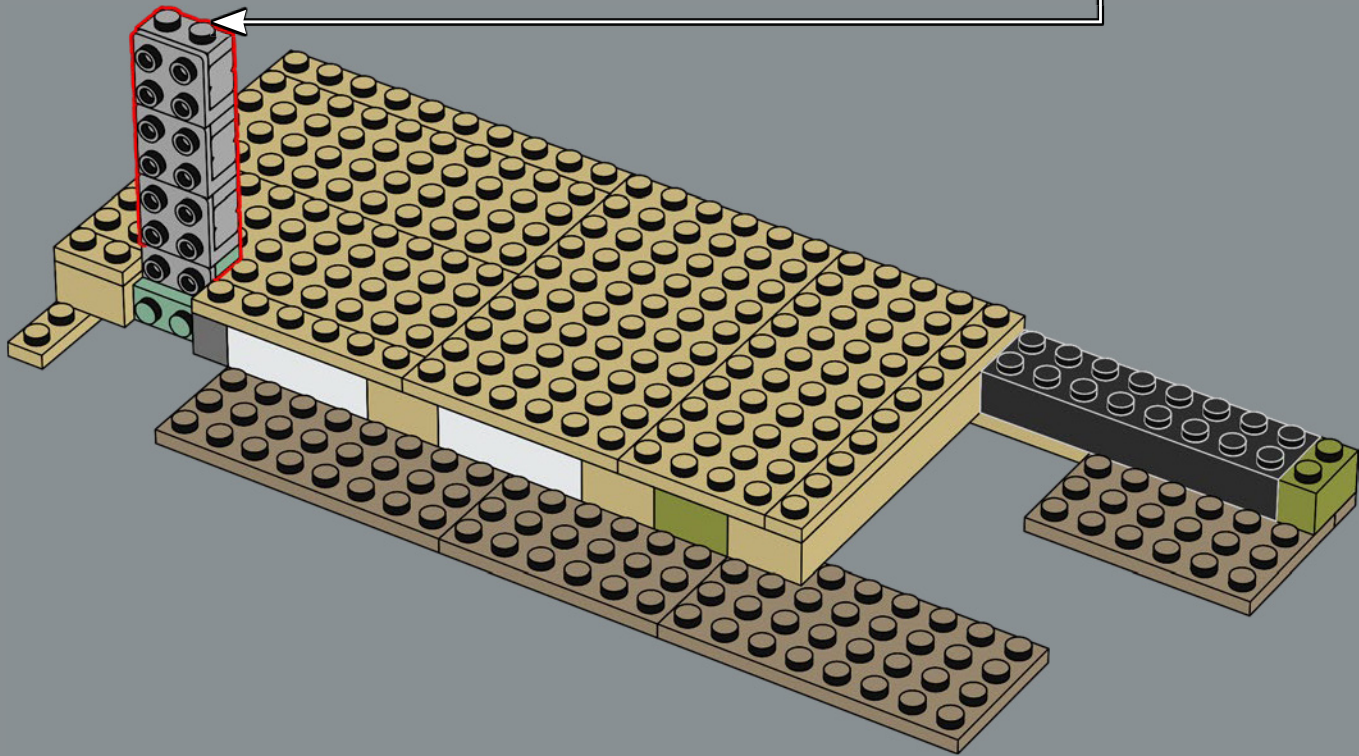
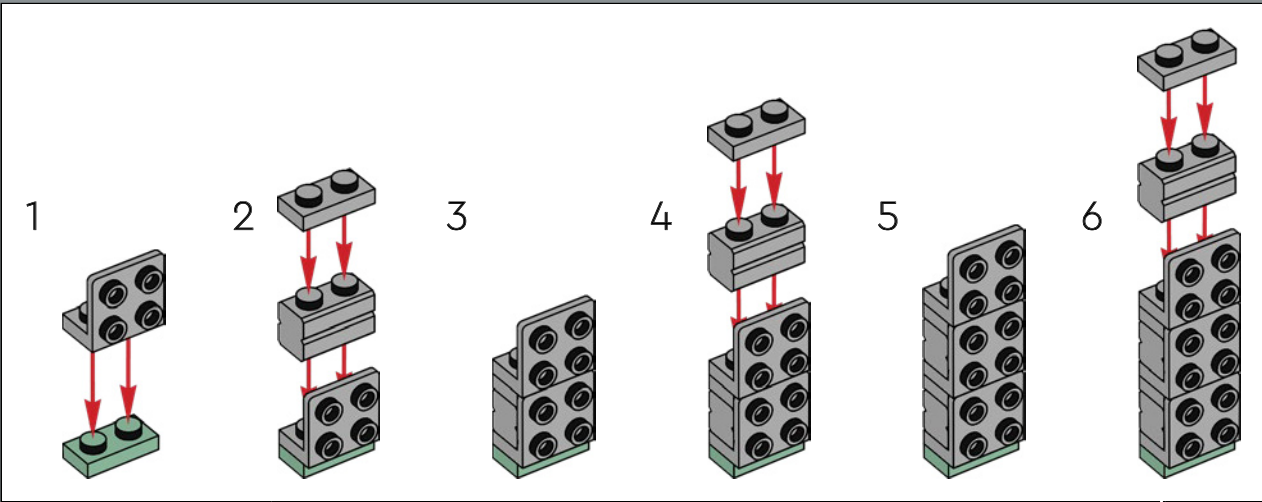

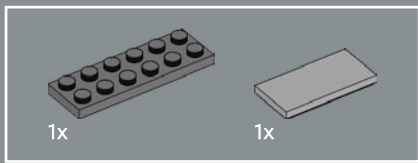

13

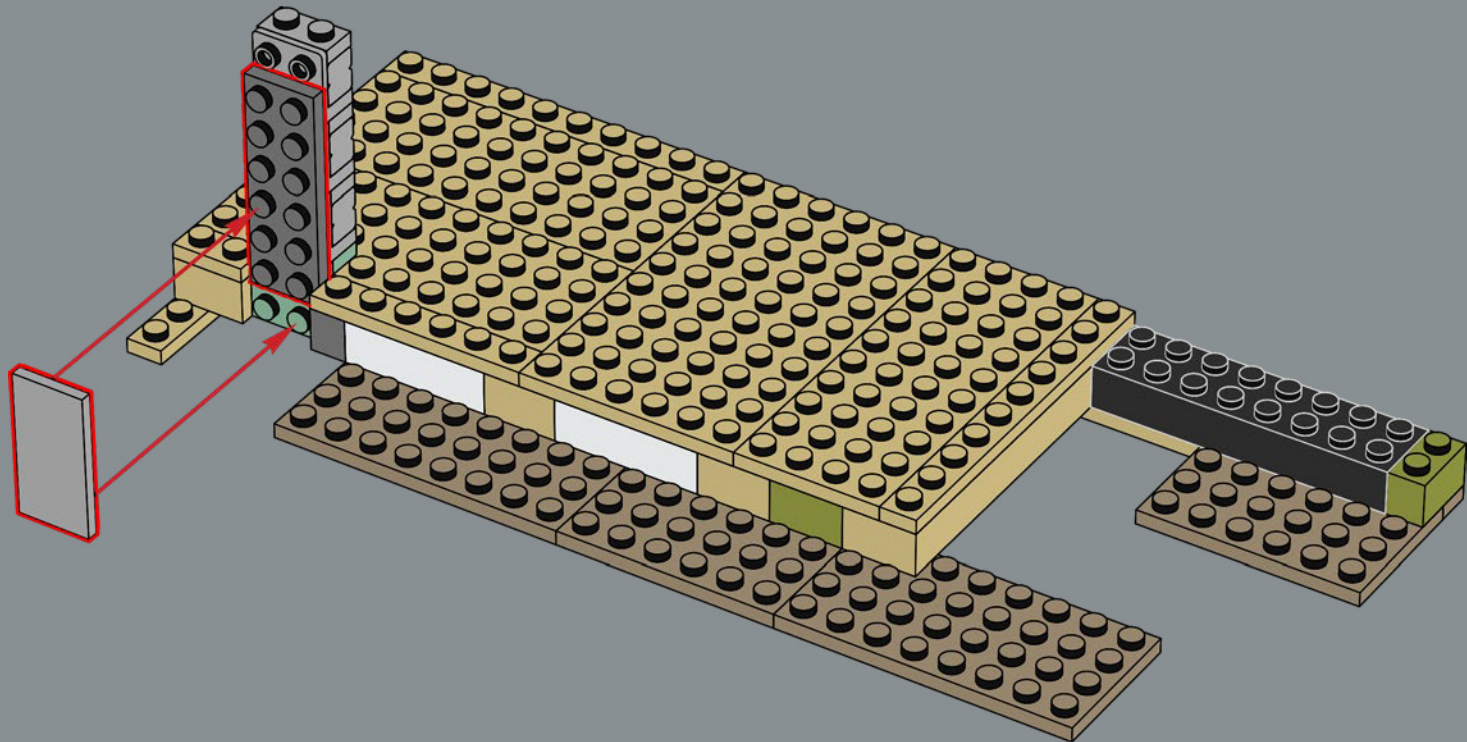

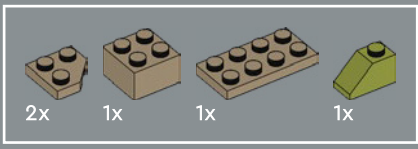

14

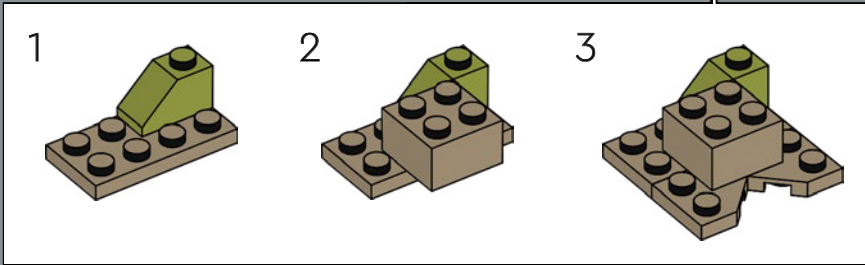
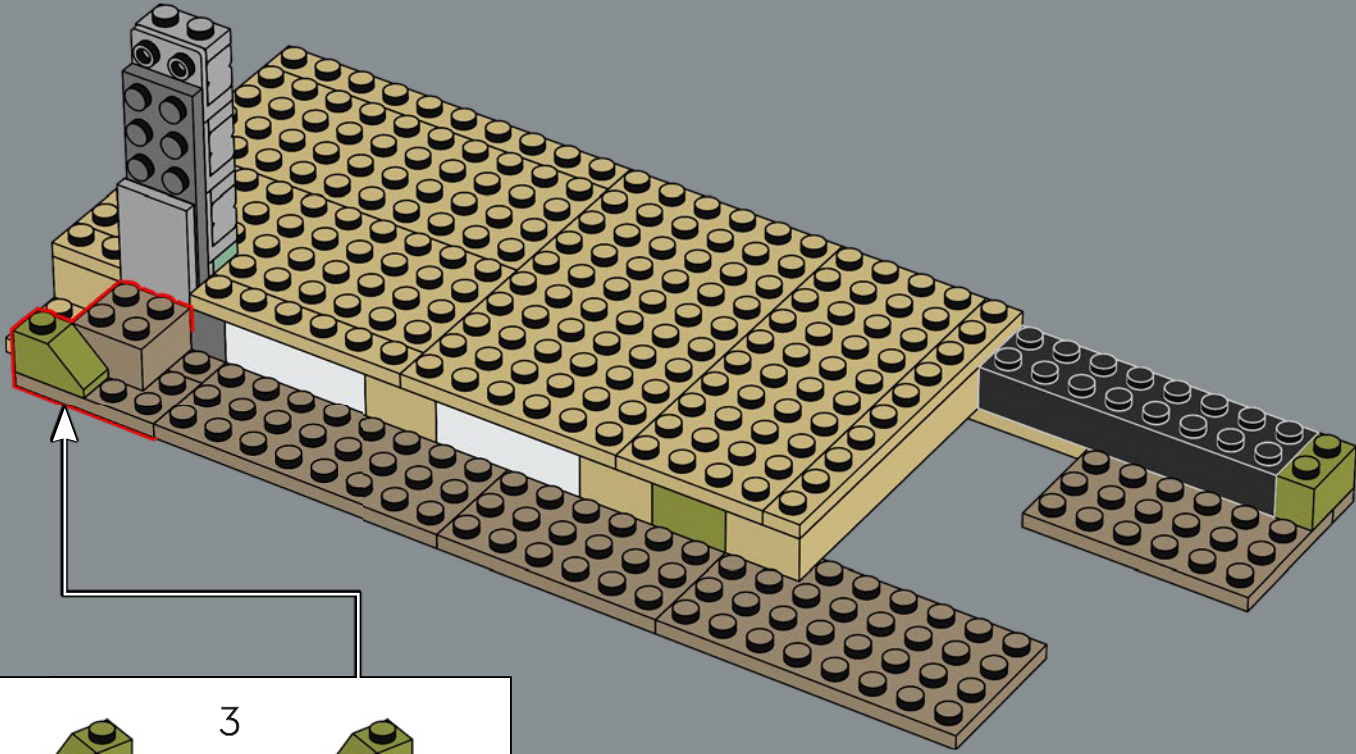

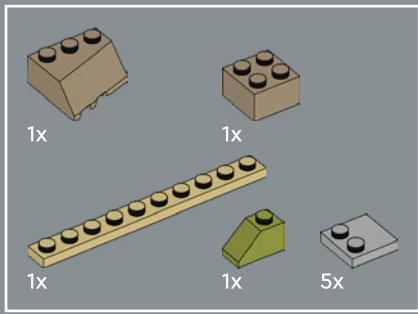

15

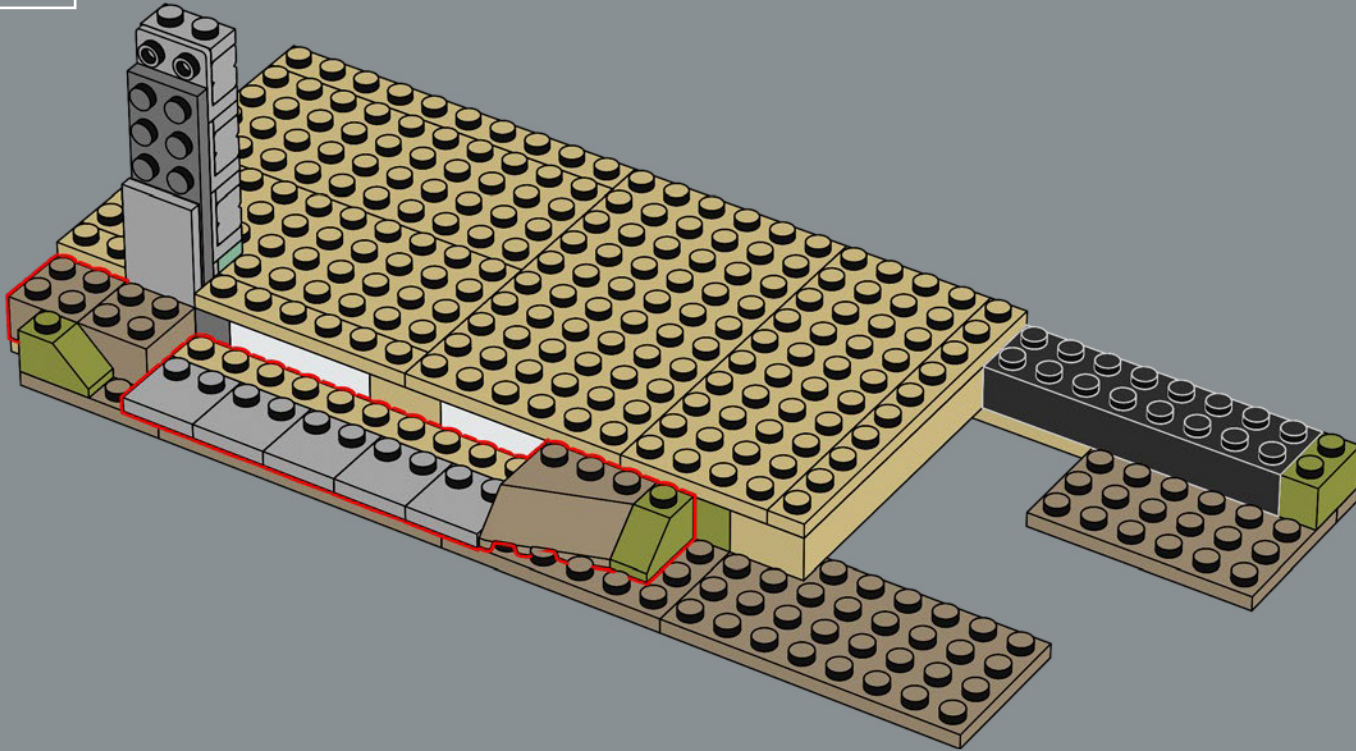

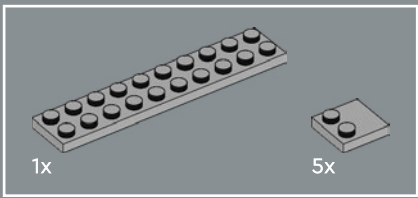

16

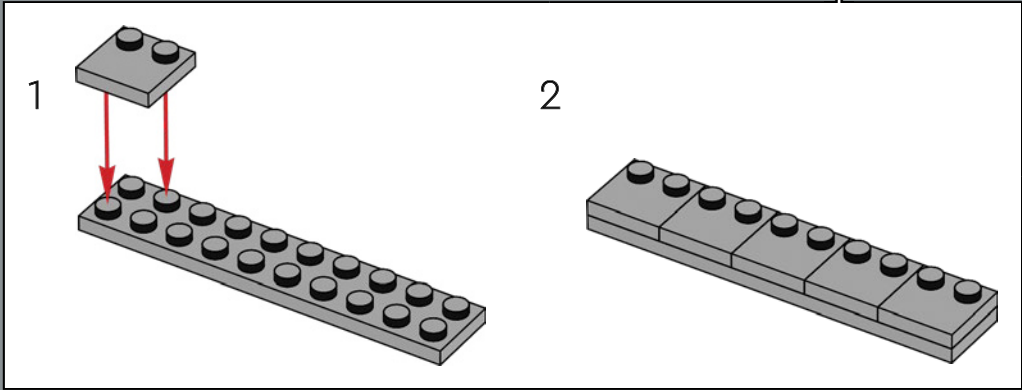
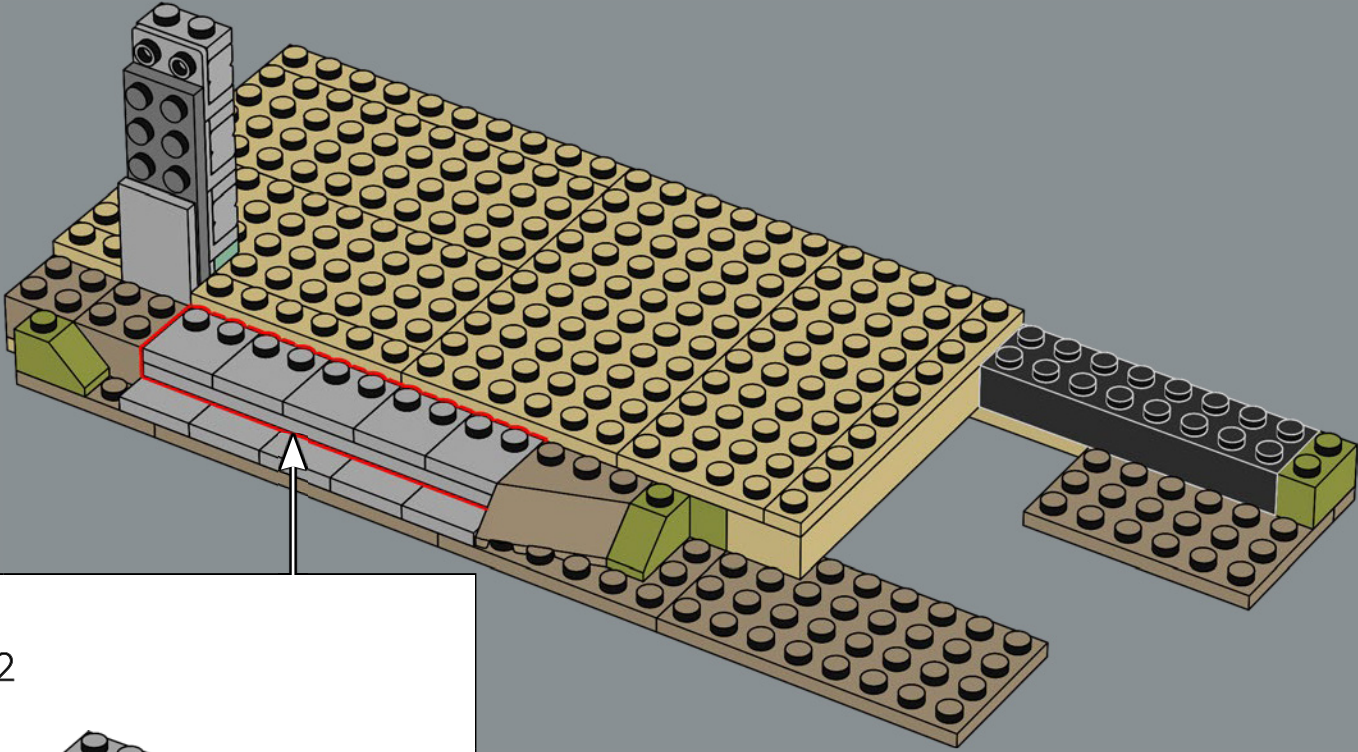

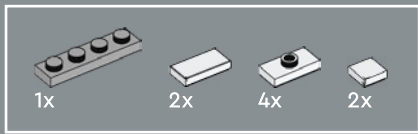

17

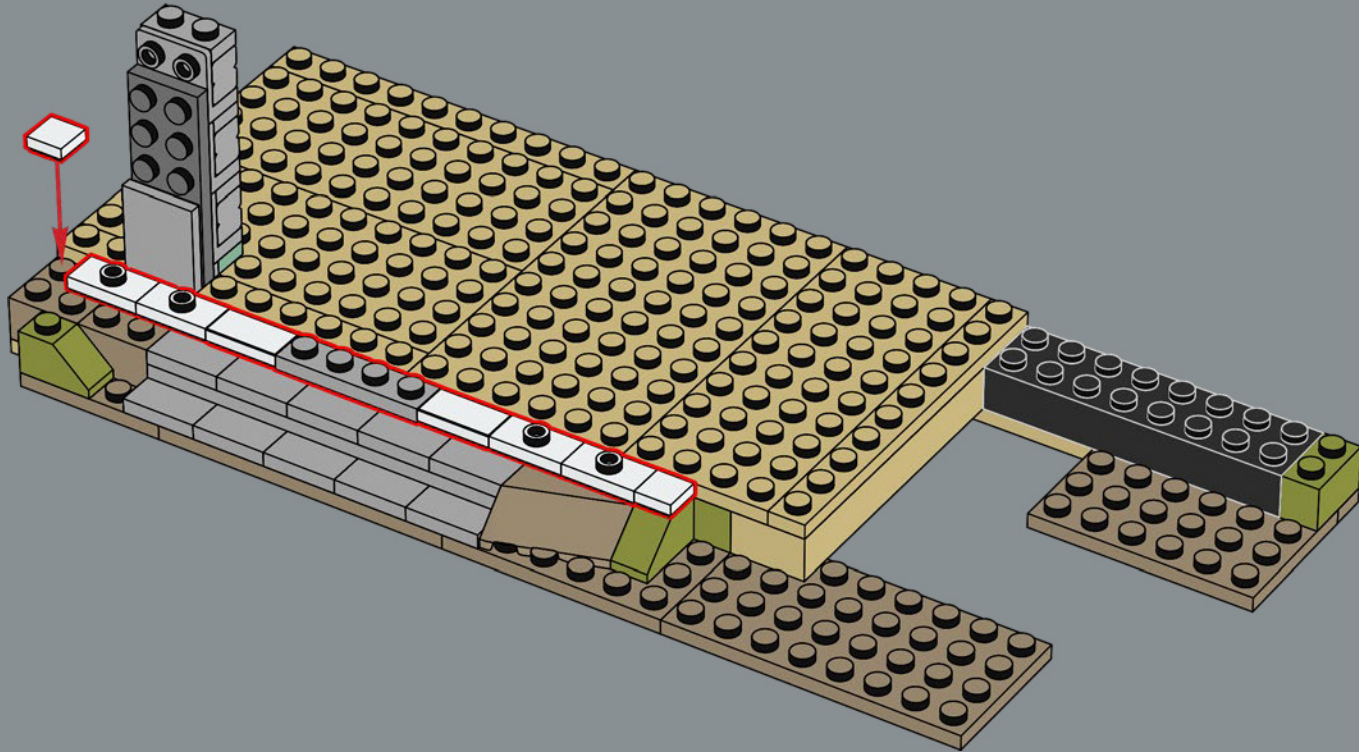

 1x	 2x
--	--

18

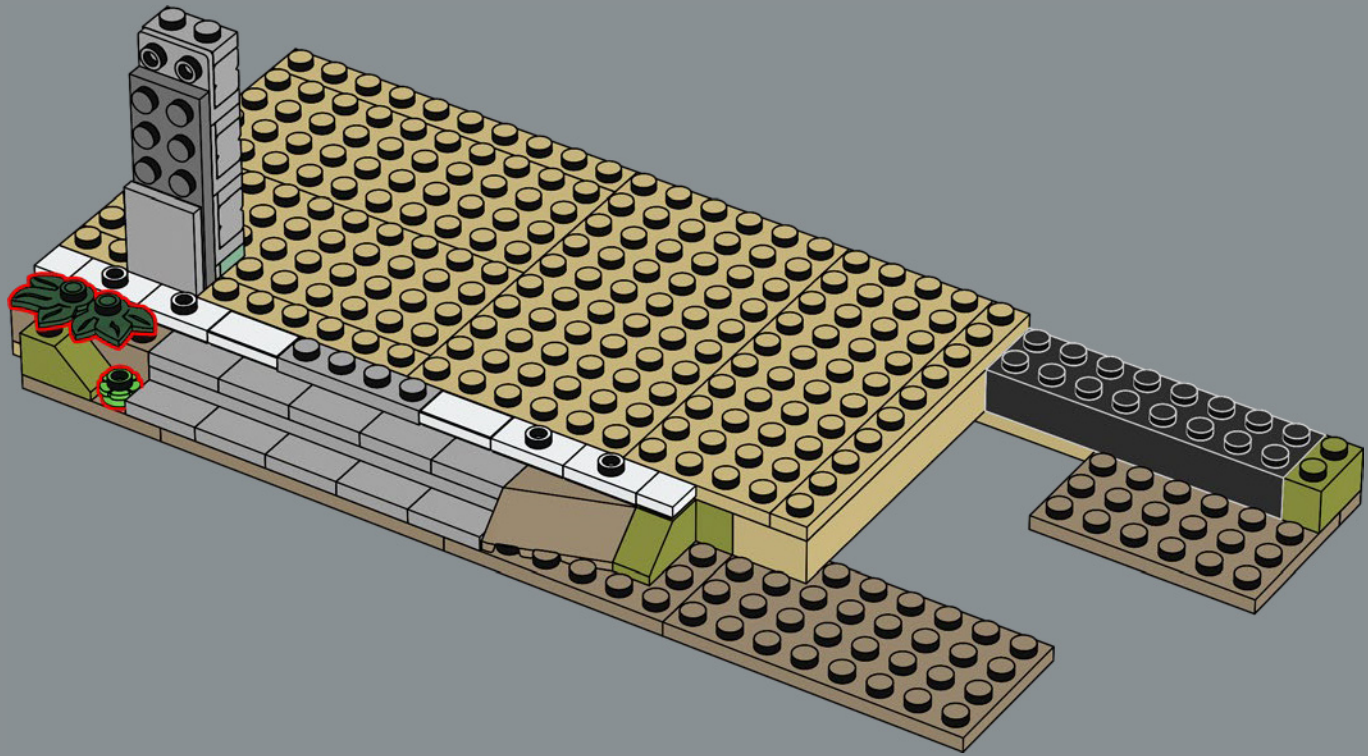

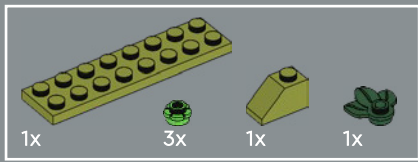

19

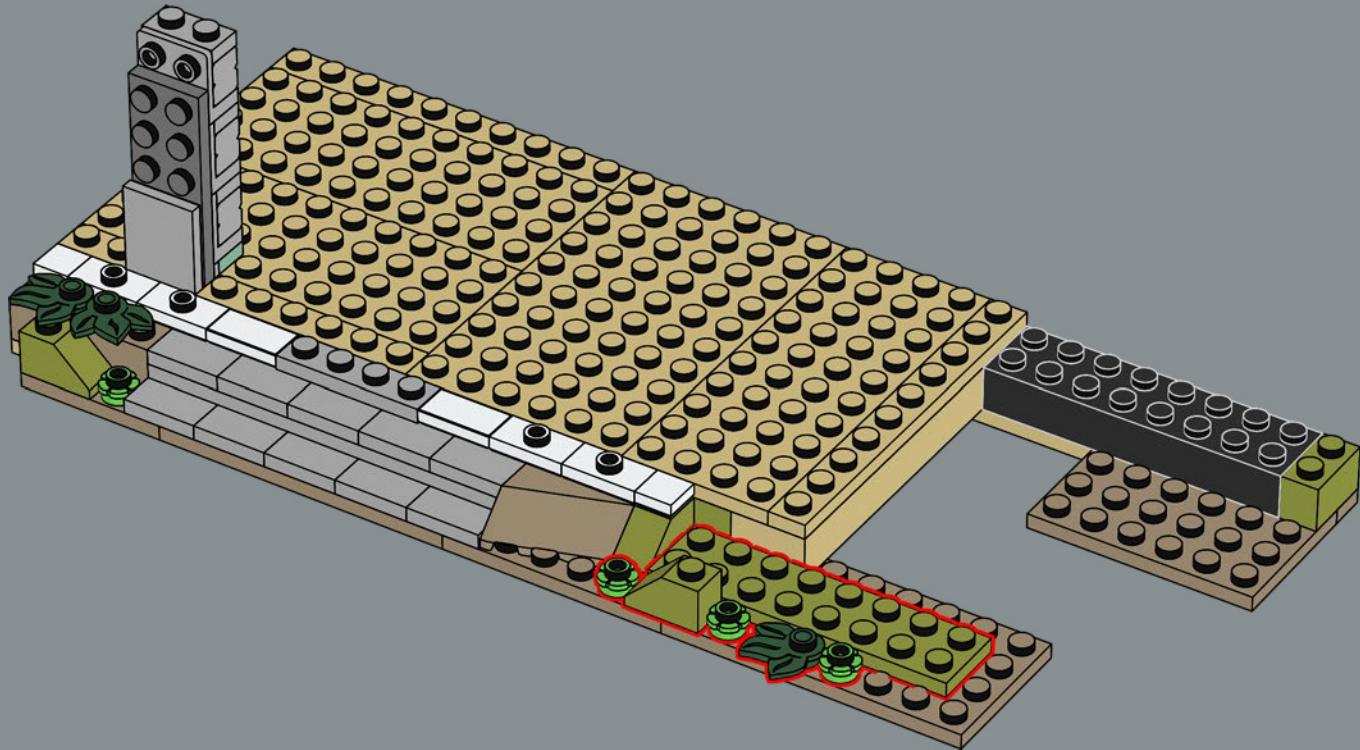

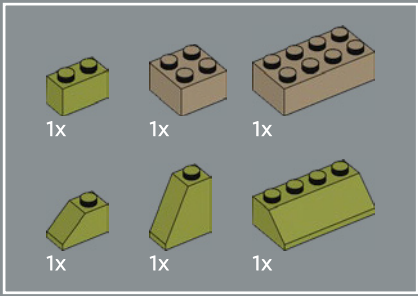

20

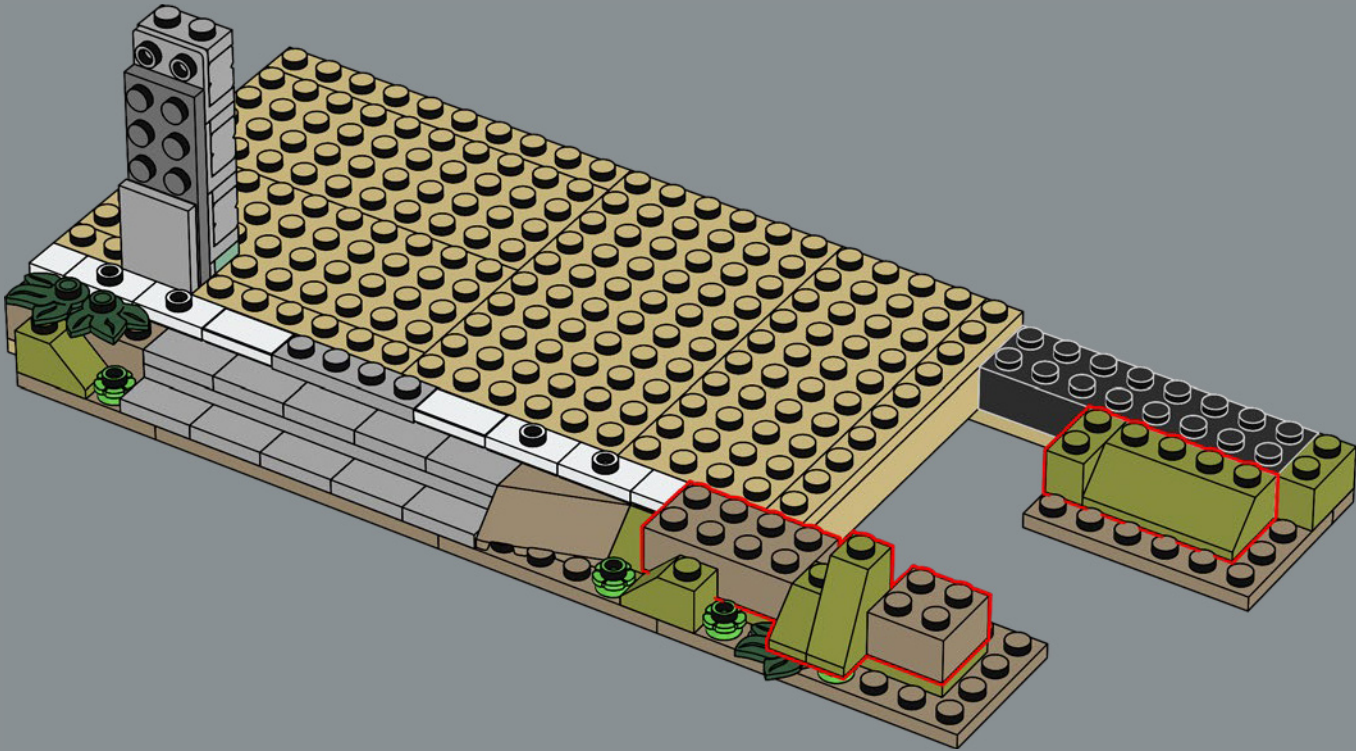

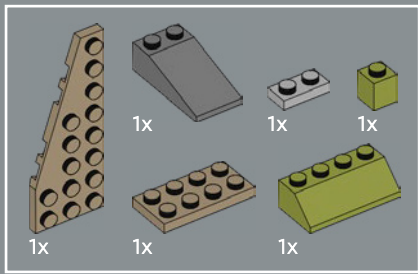

21

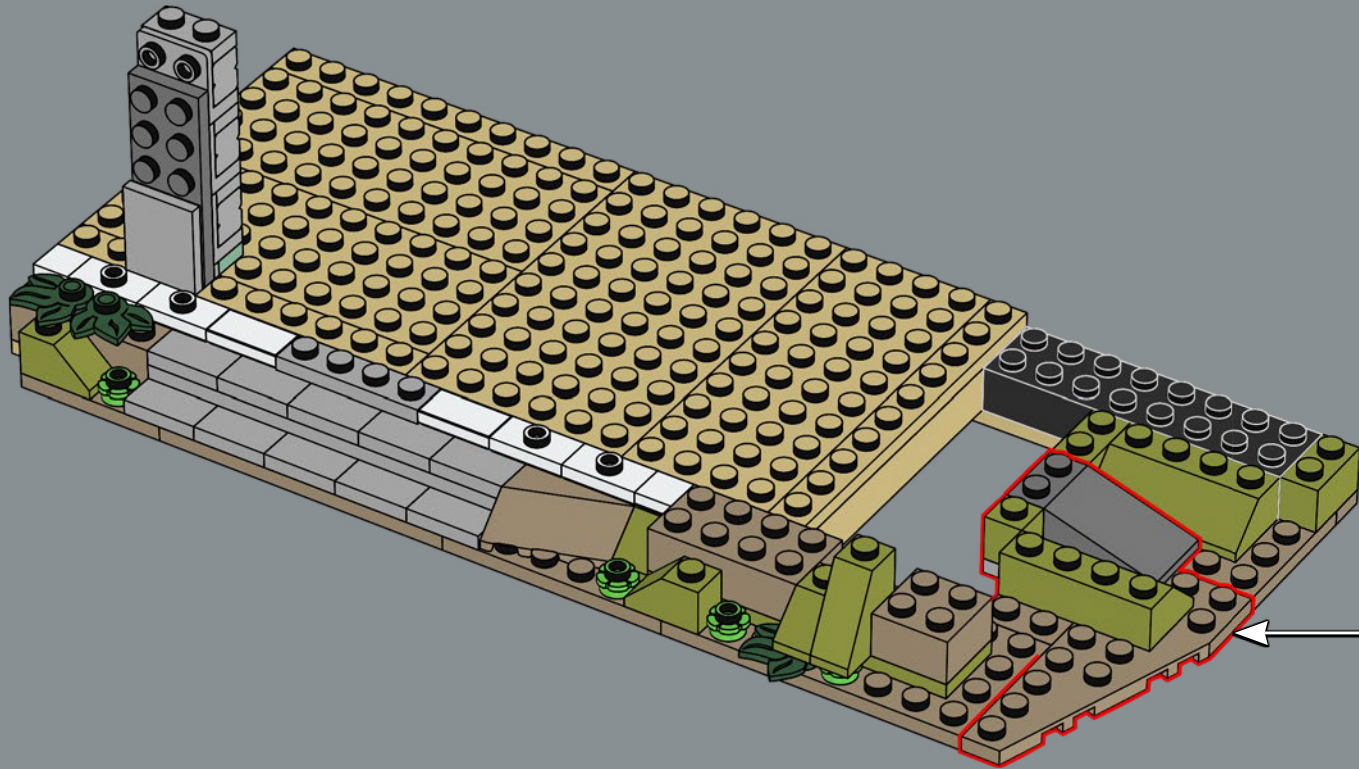
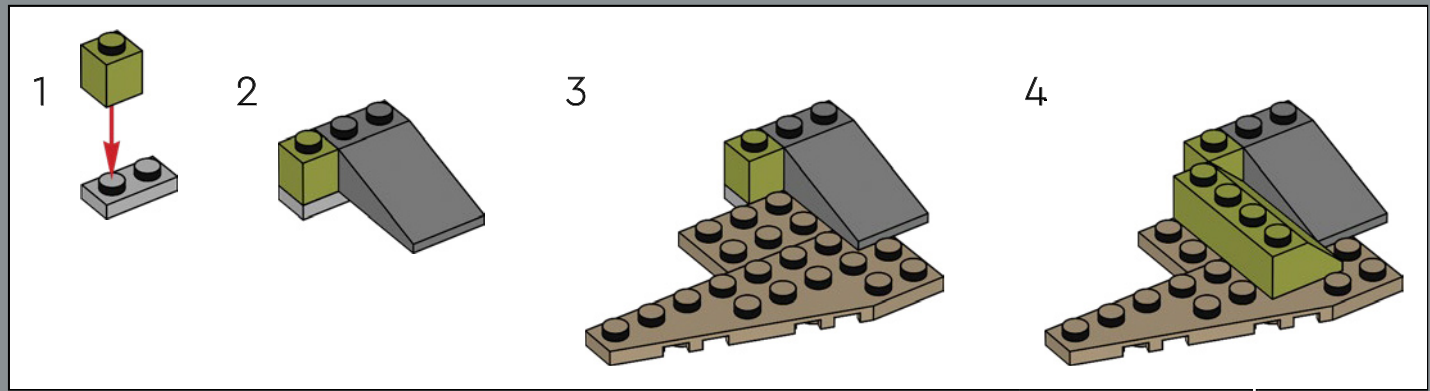

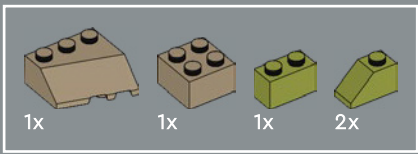

22

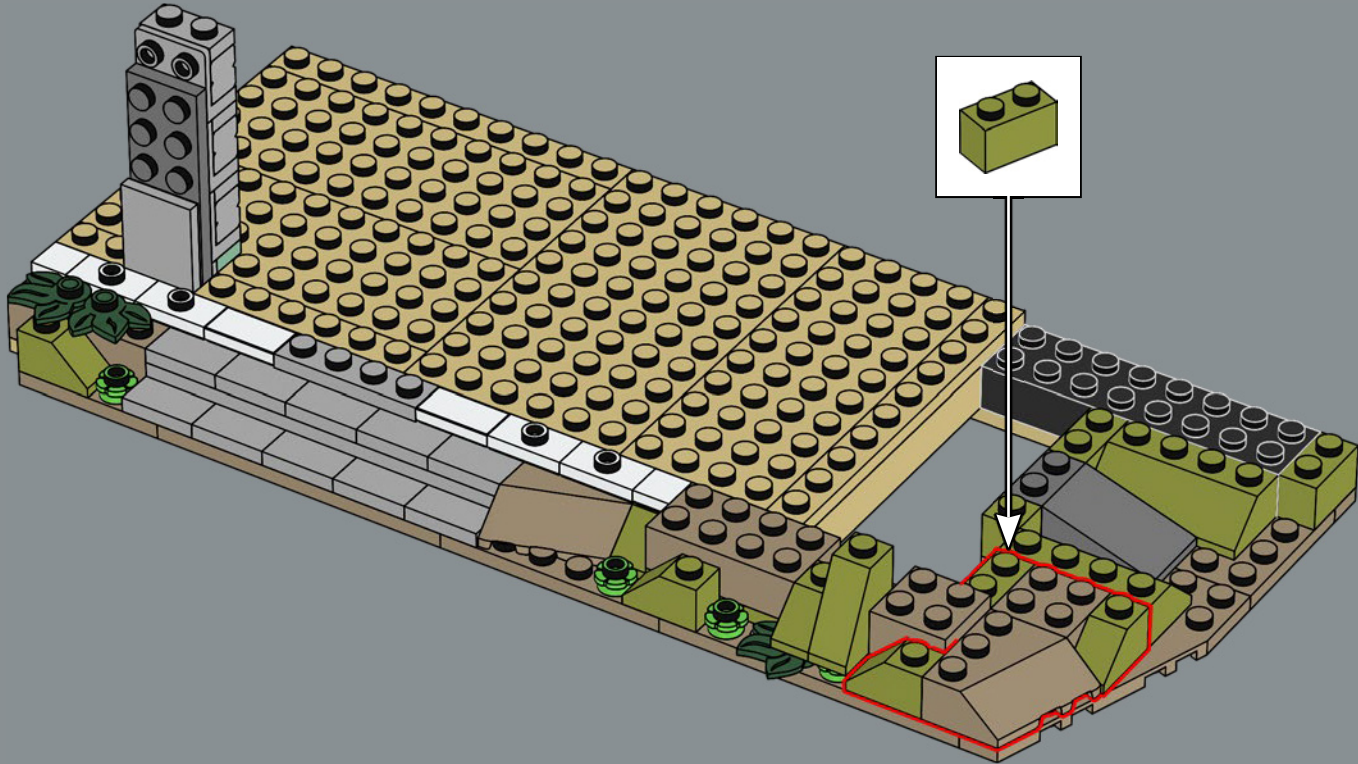

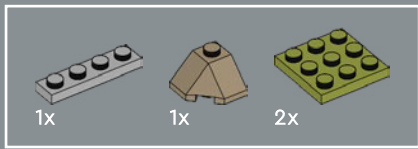

23

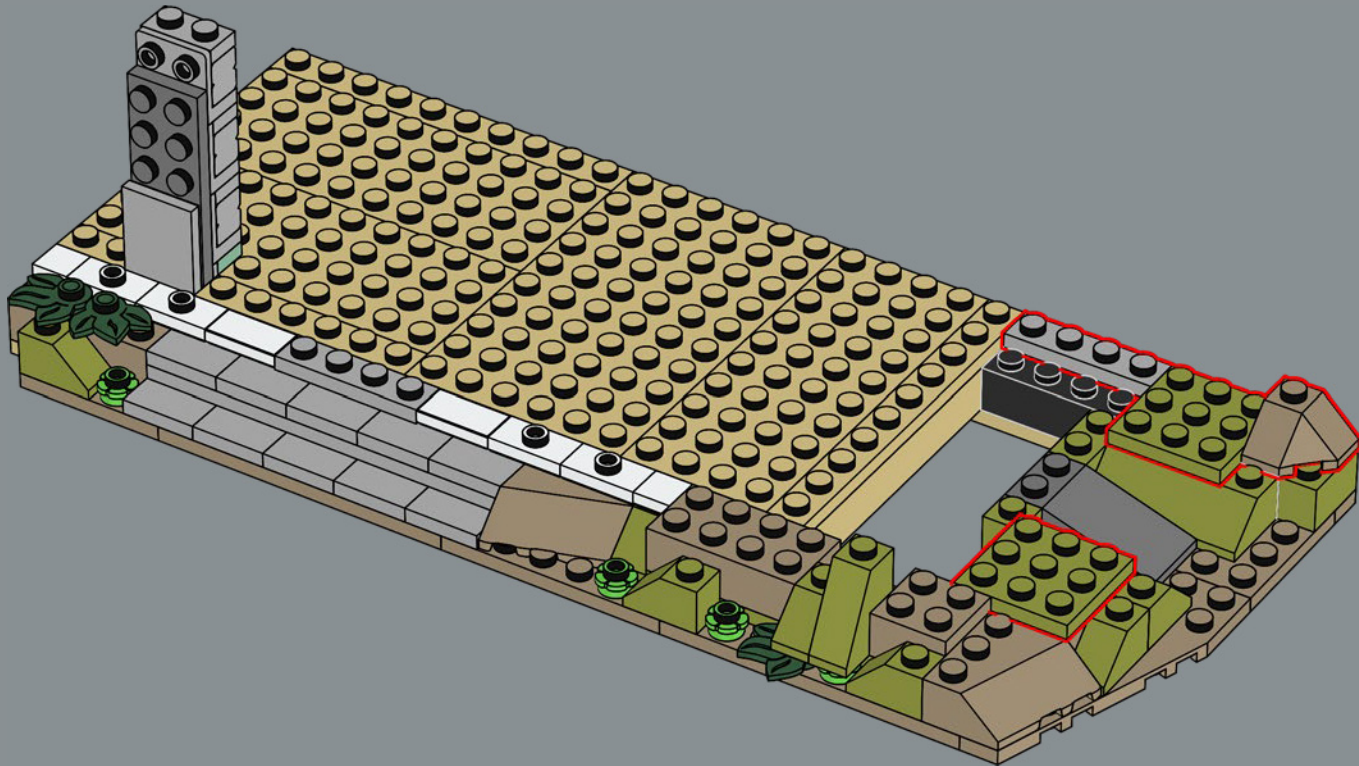

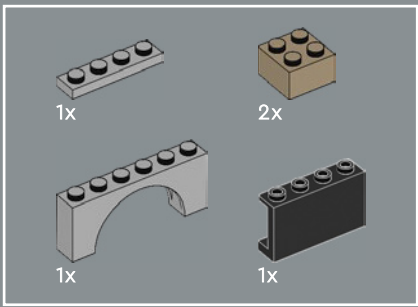

24

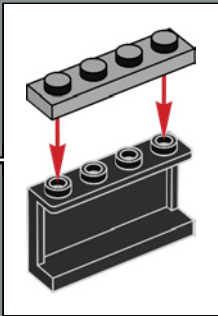
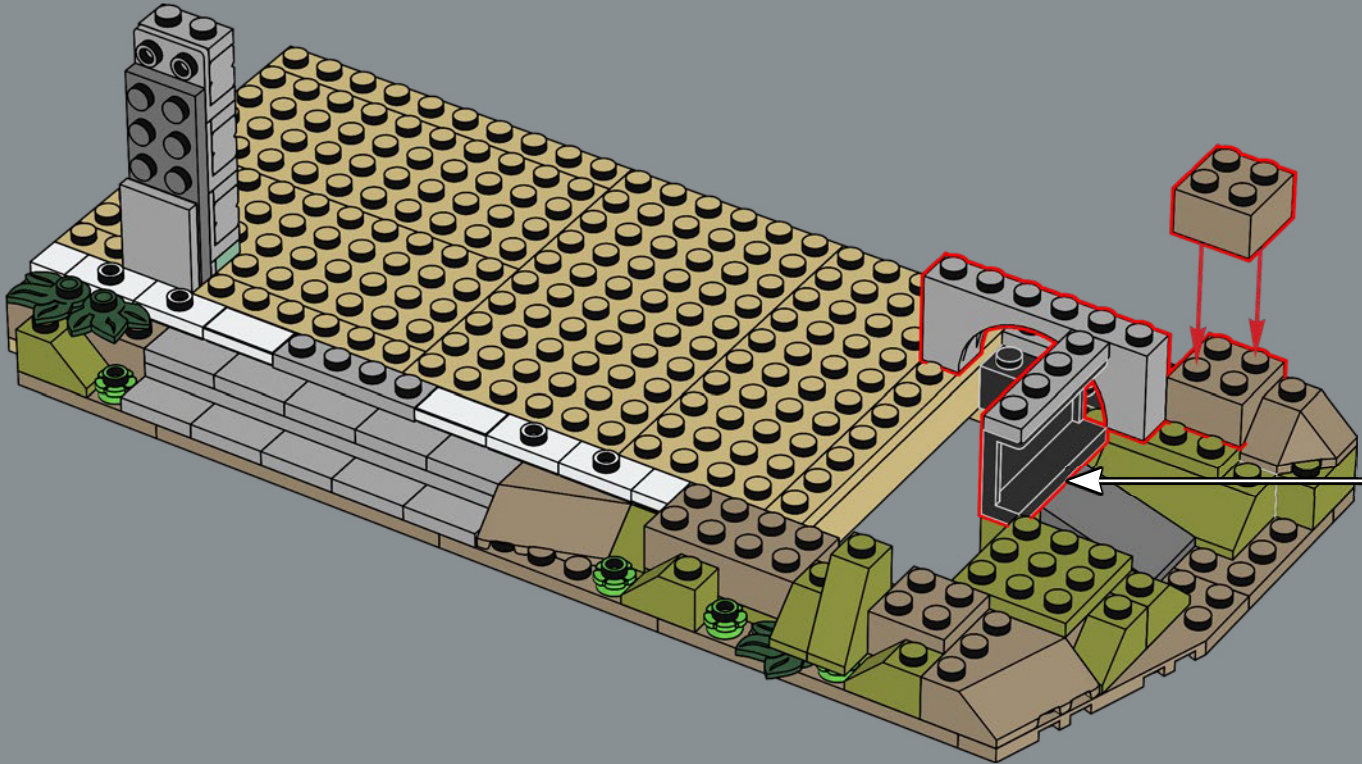

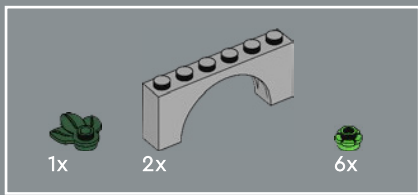

25

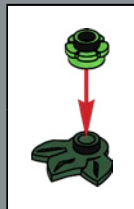
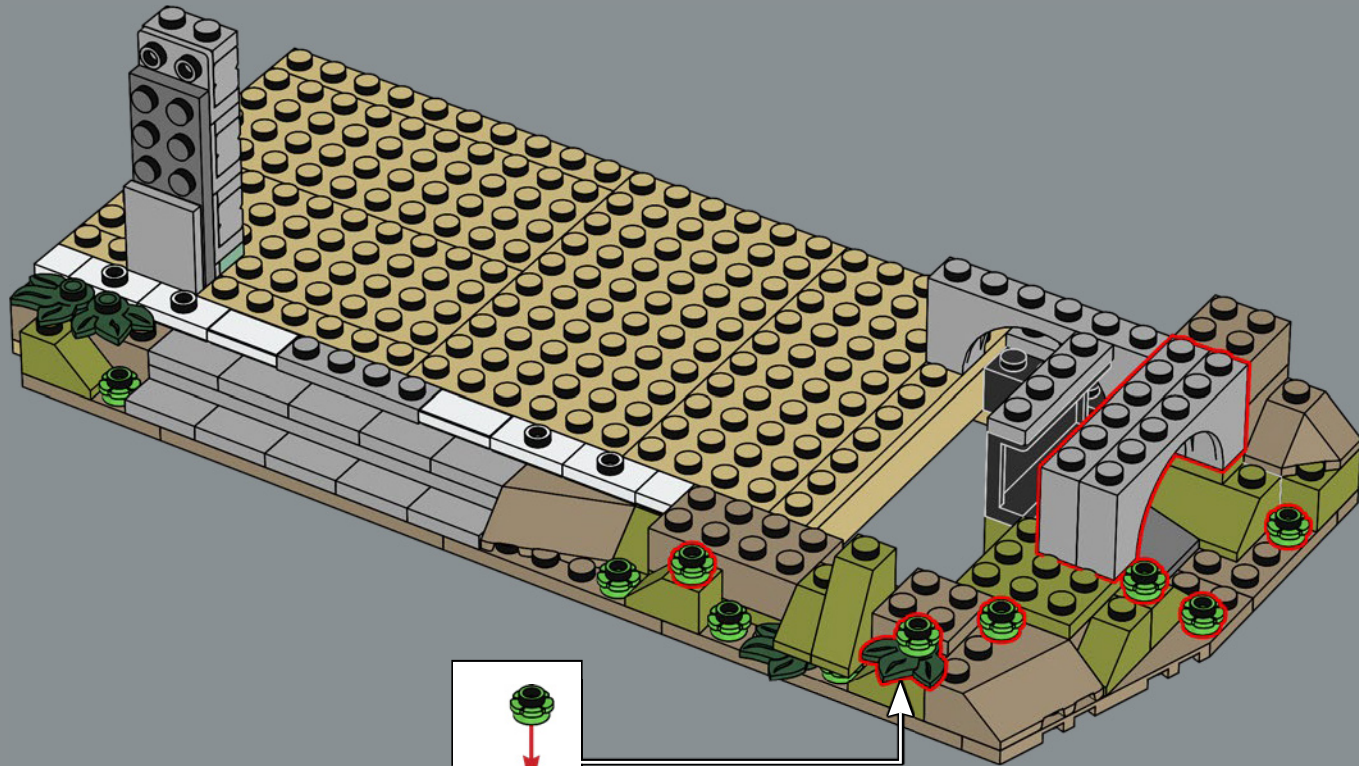

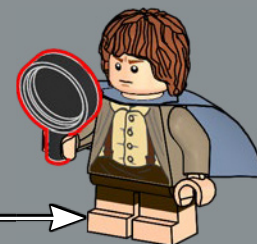
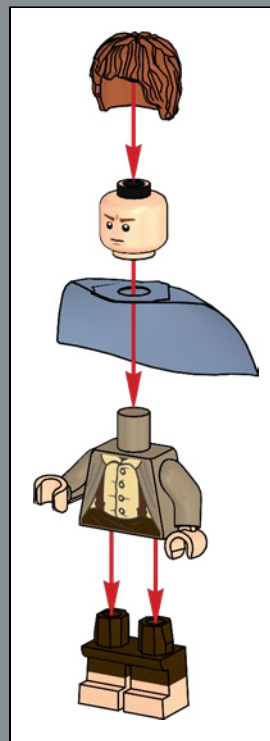
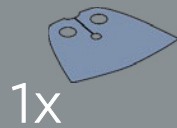
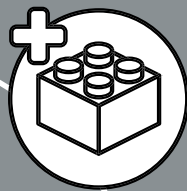

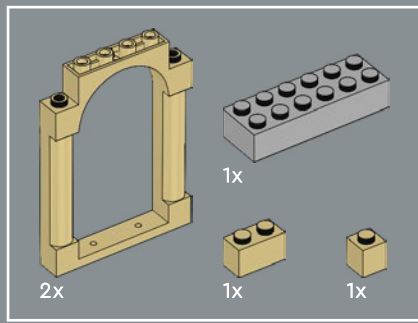

26

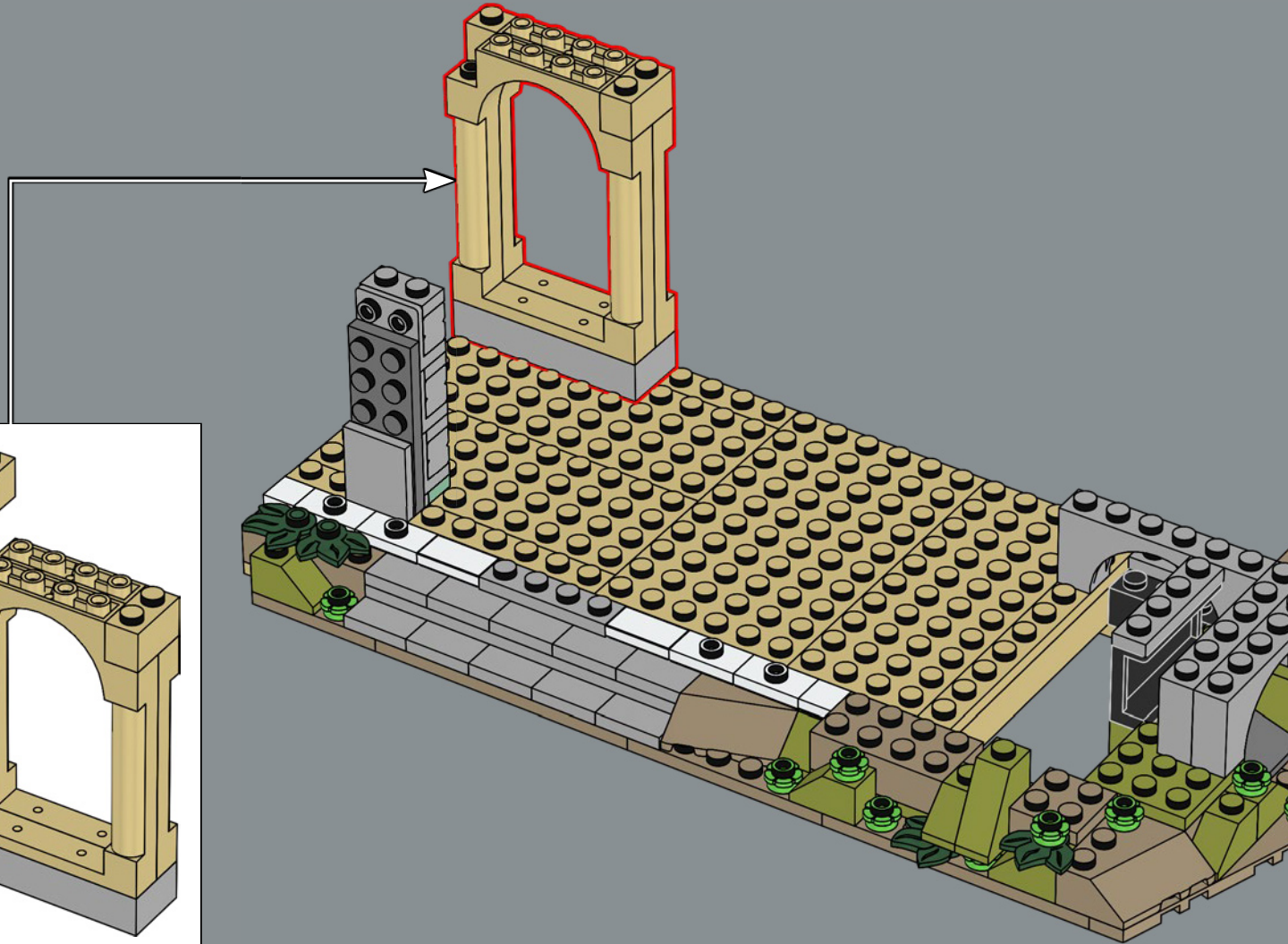
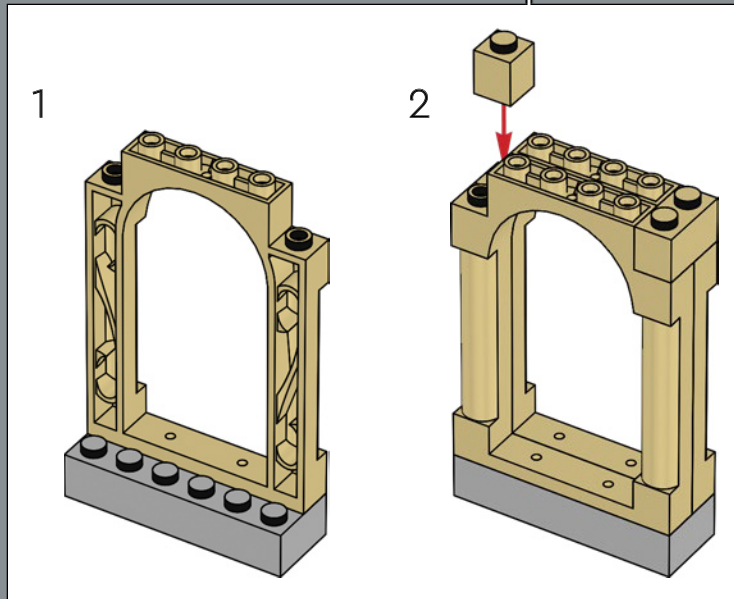

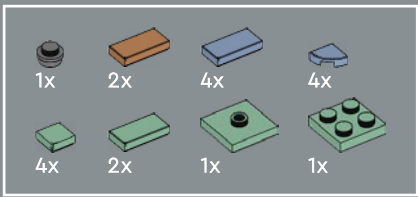

27

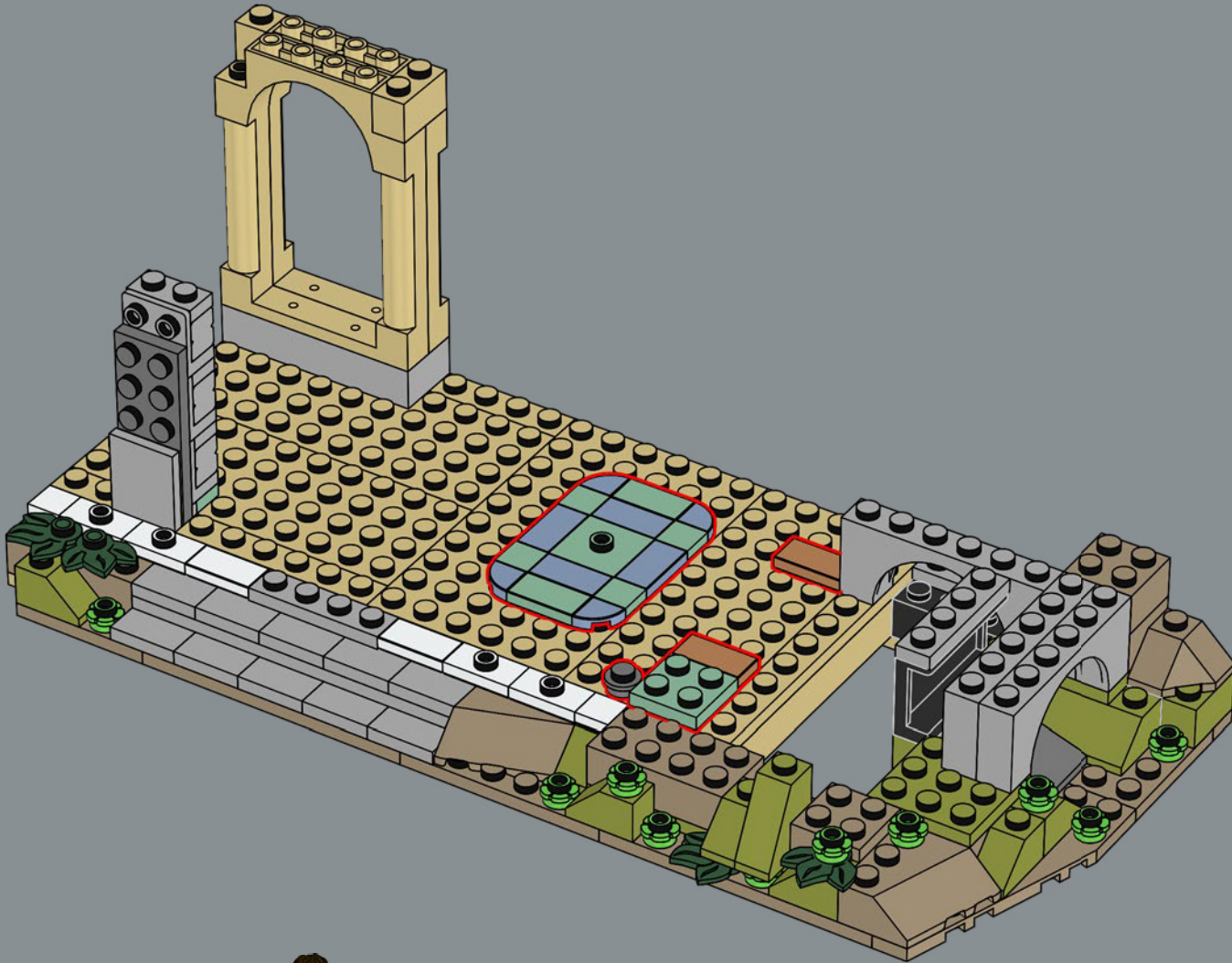

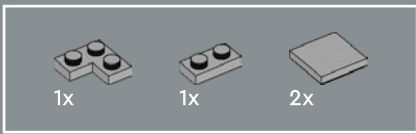

28

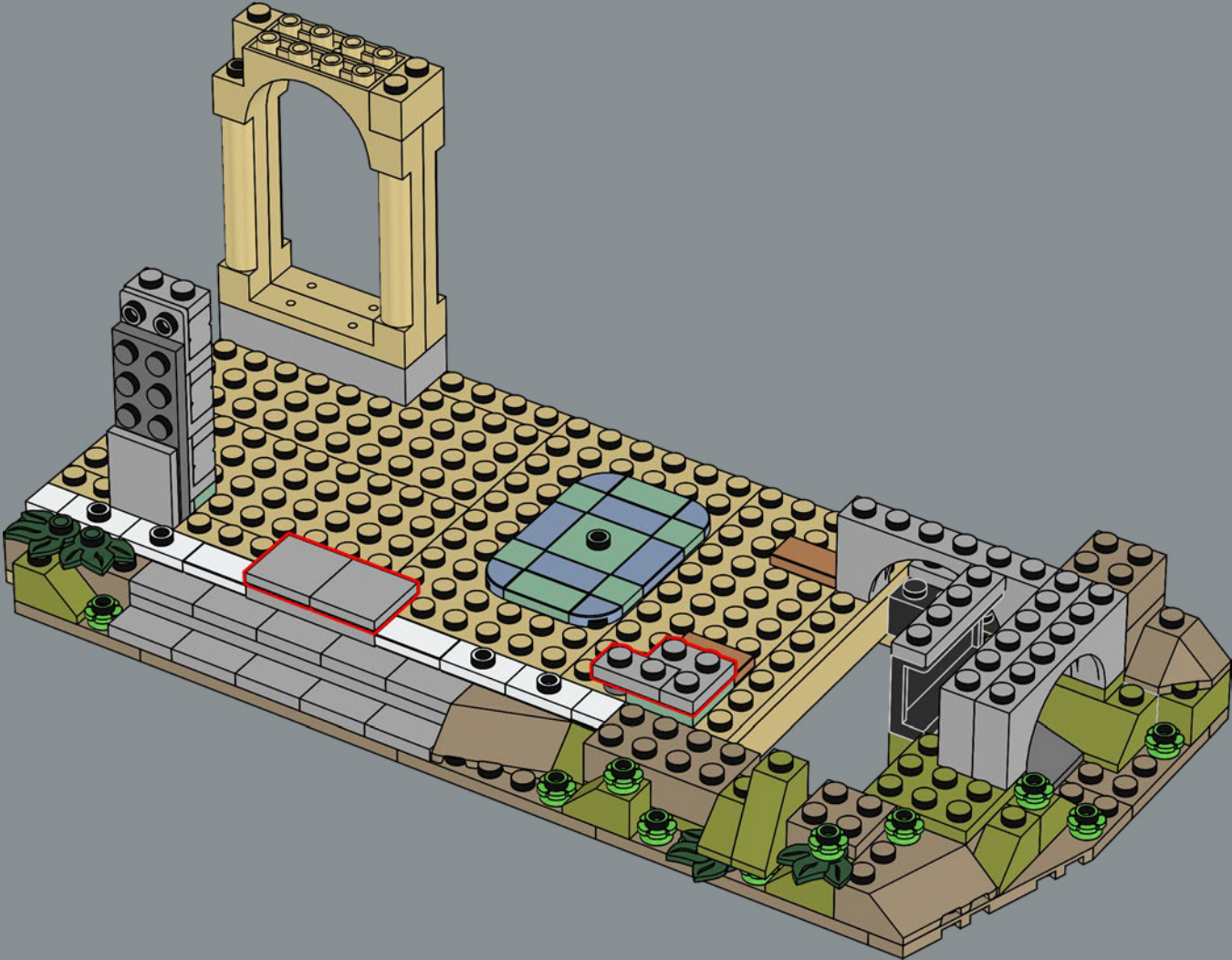



2x

29

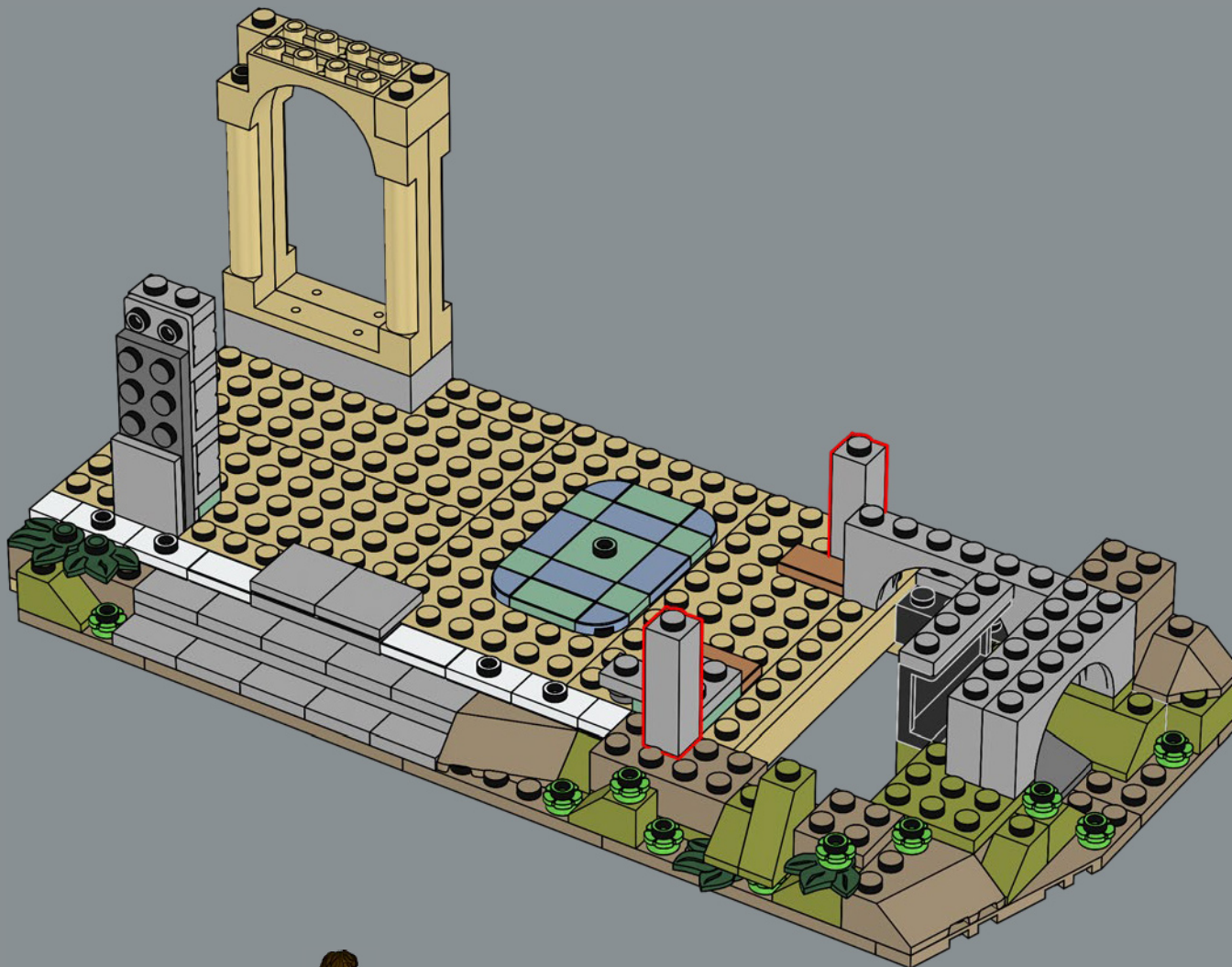



El nuevo diseño del elemento que representa un helecho se introdujo en 2023. Esta es nuestra primera oportunidad de verlo en un set (¡el modelo tiene 34!).

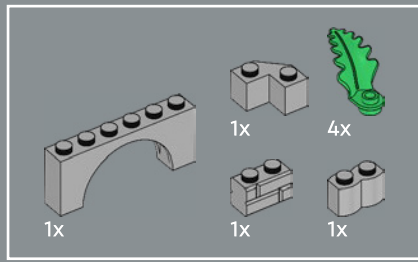

30

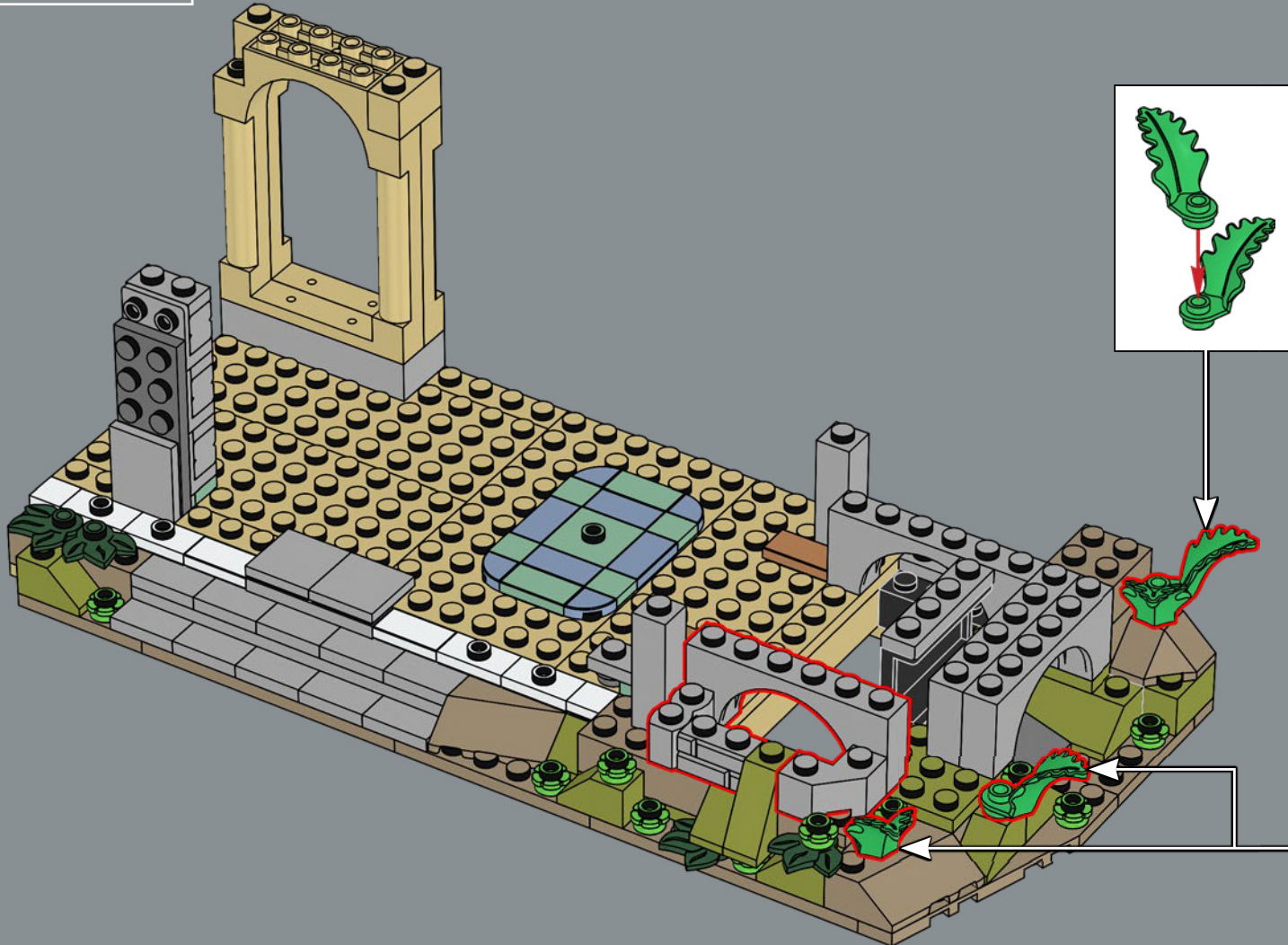

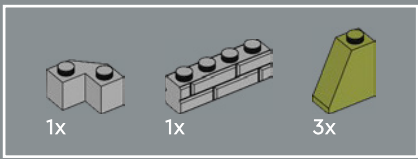

31

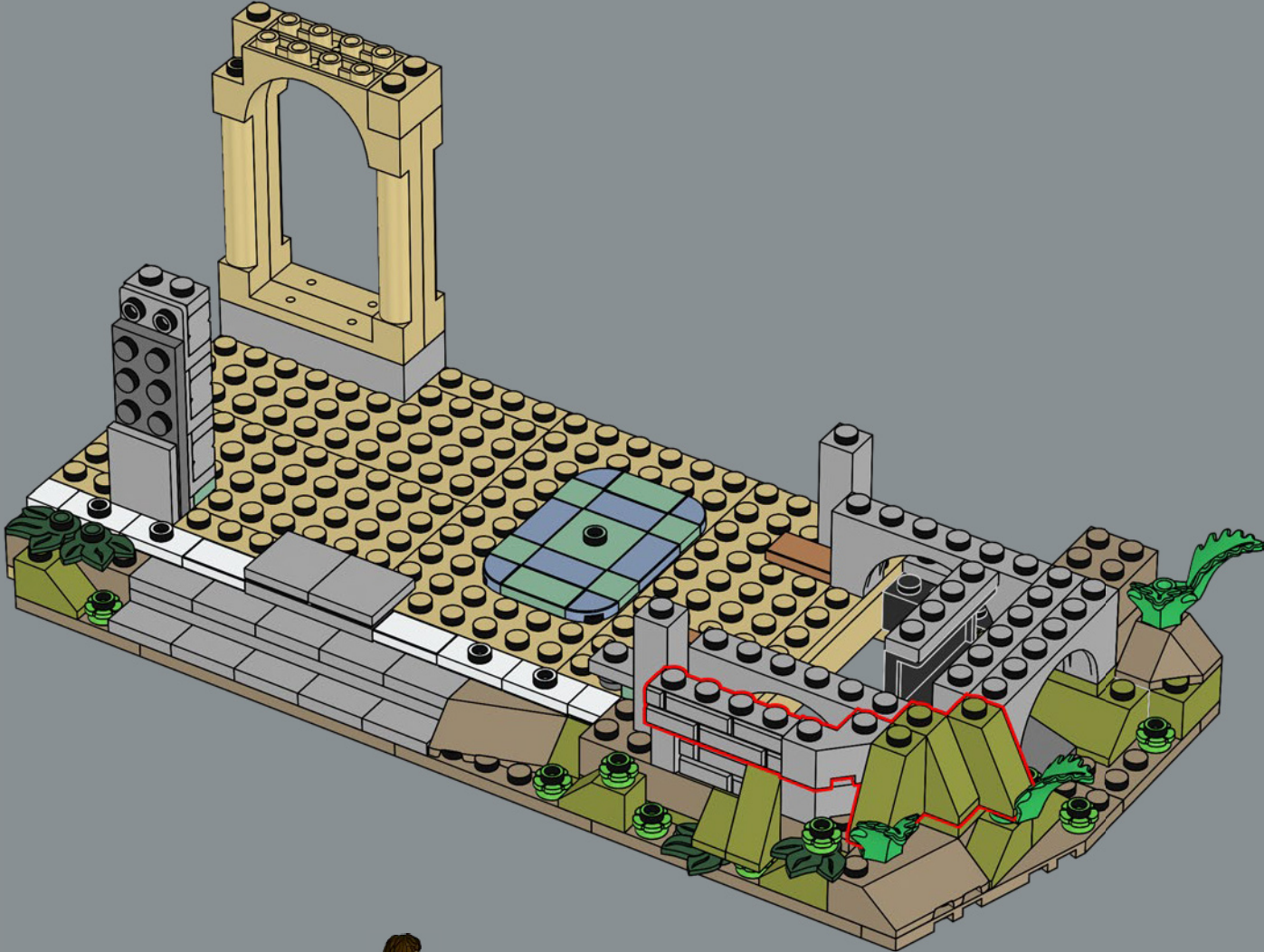

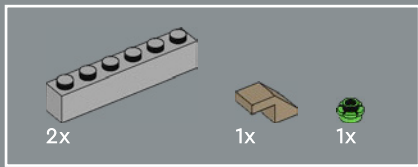

32

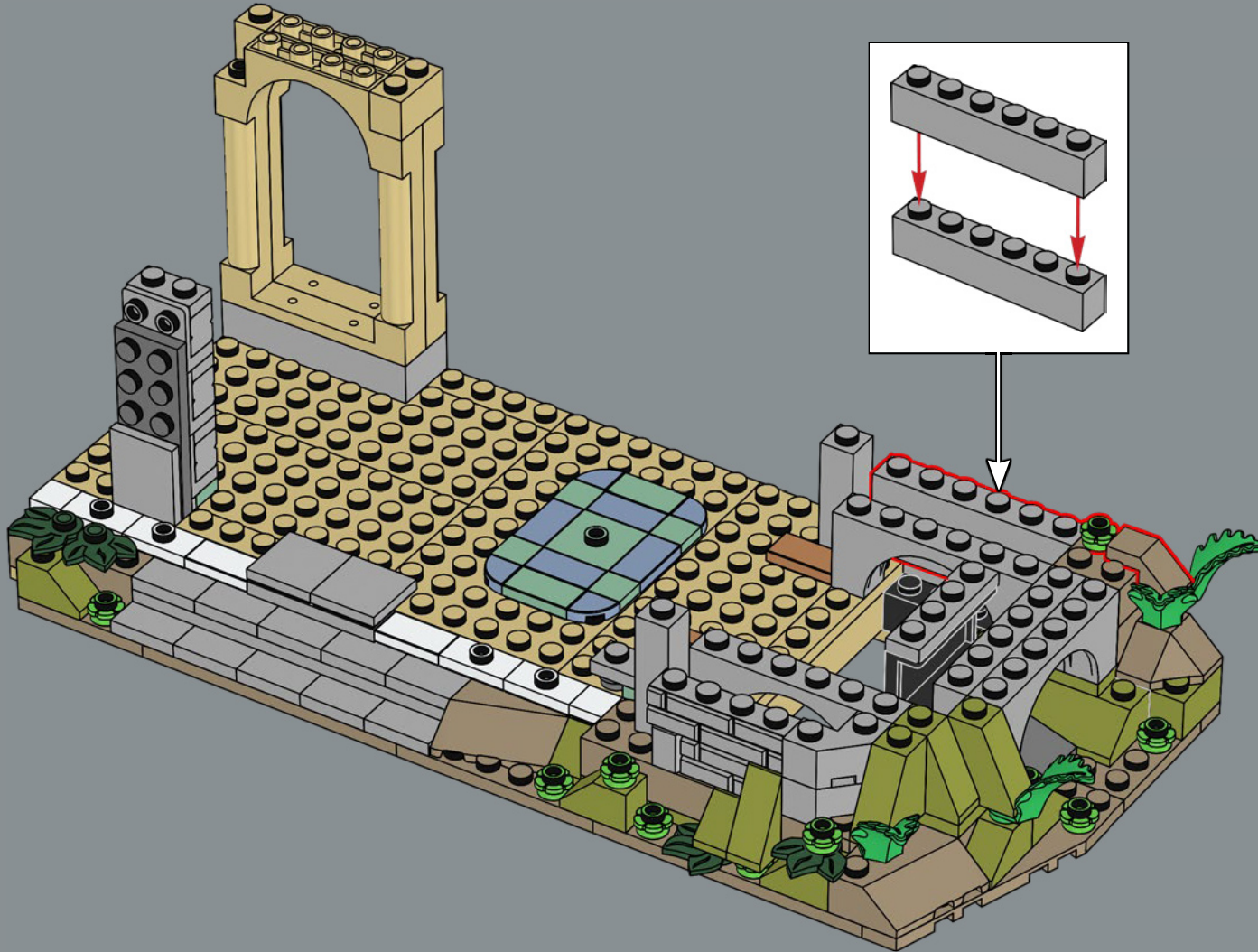

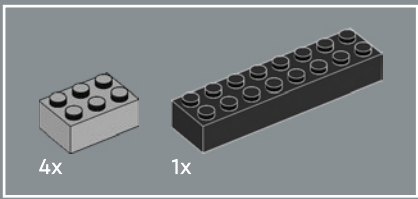

33

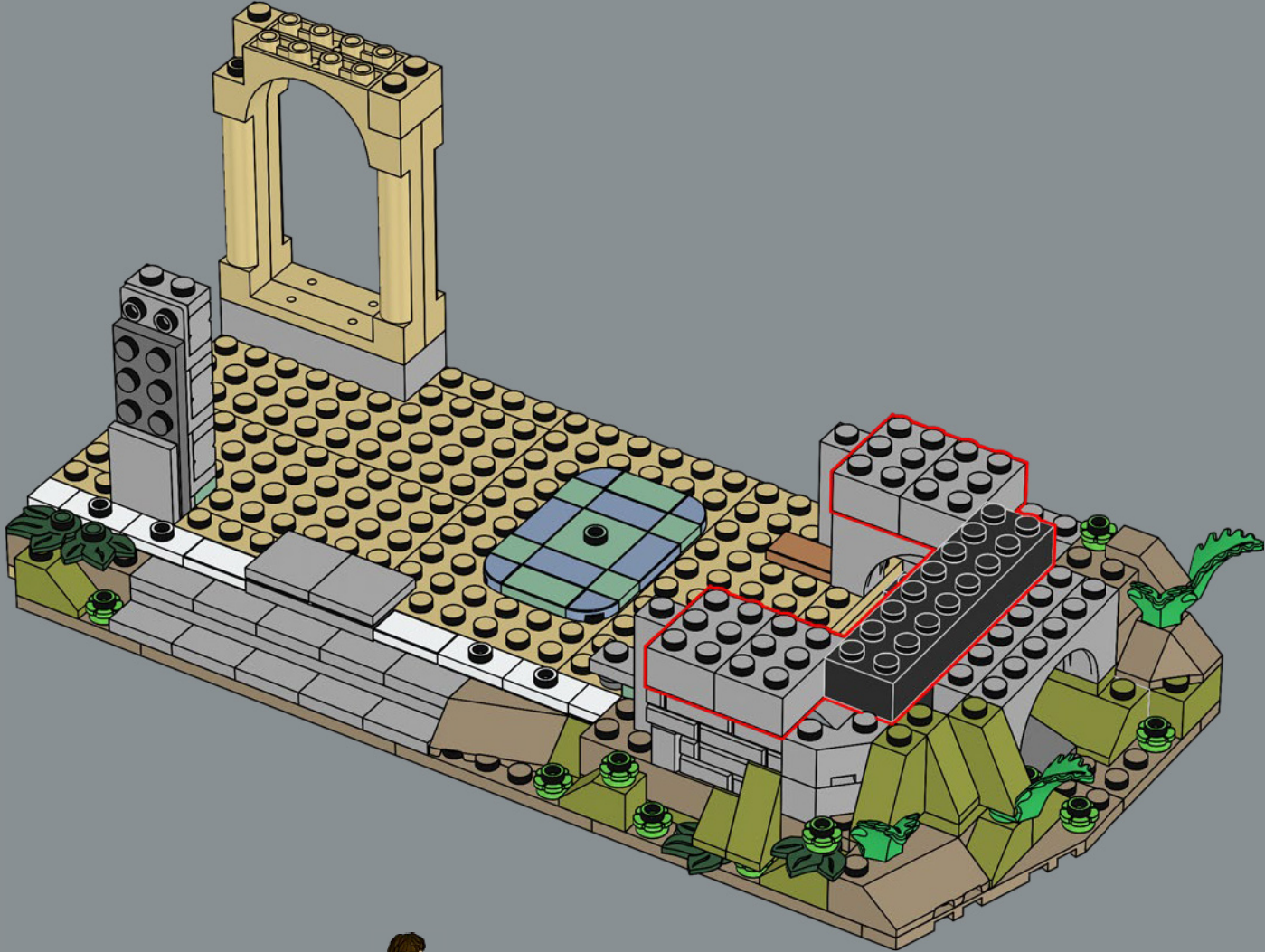

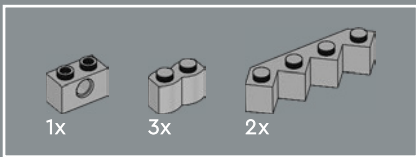

34

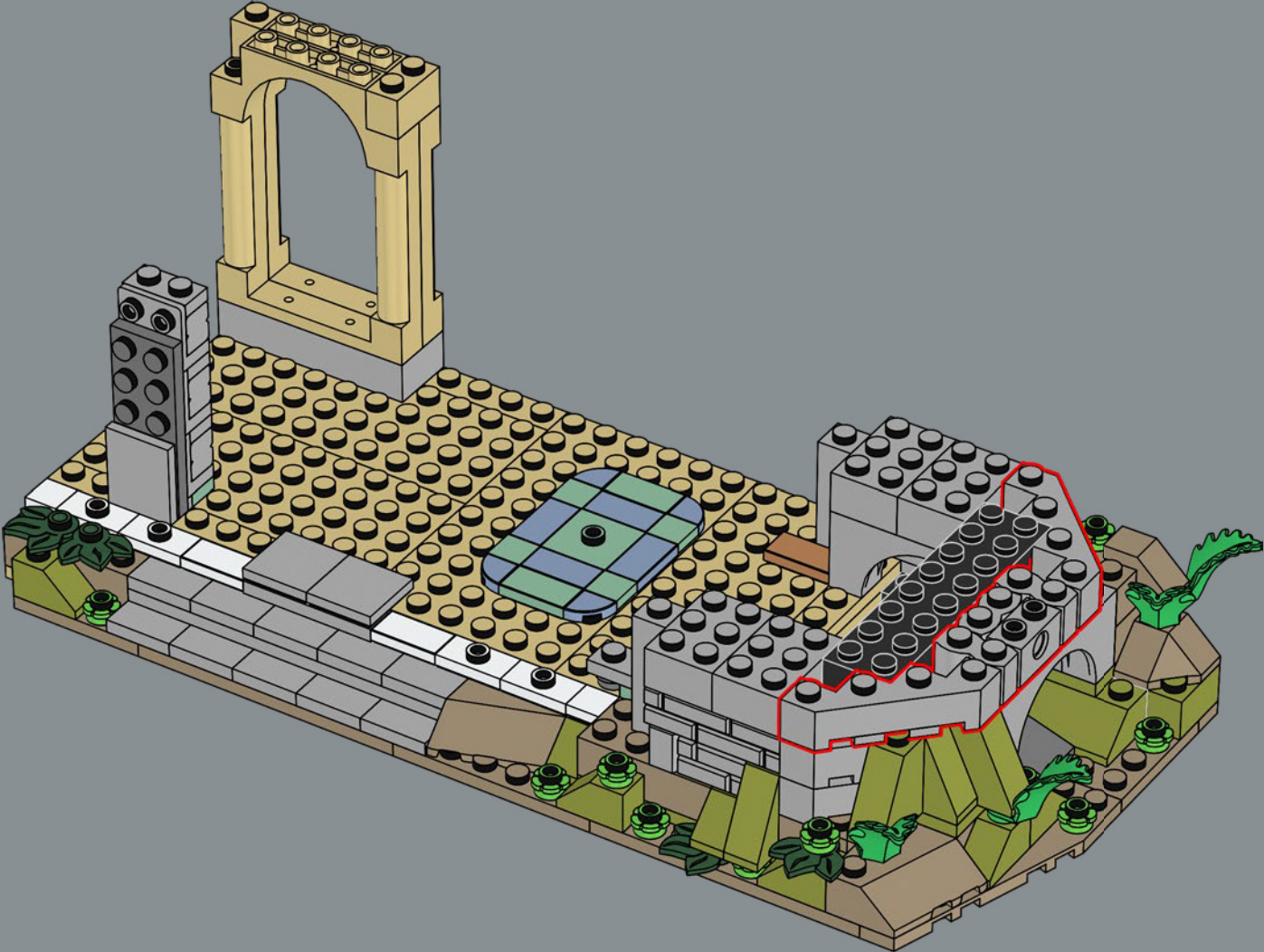

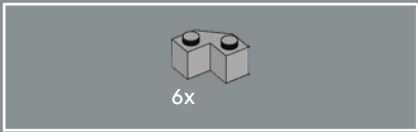

35

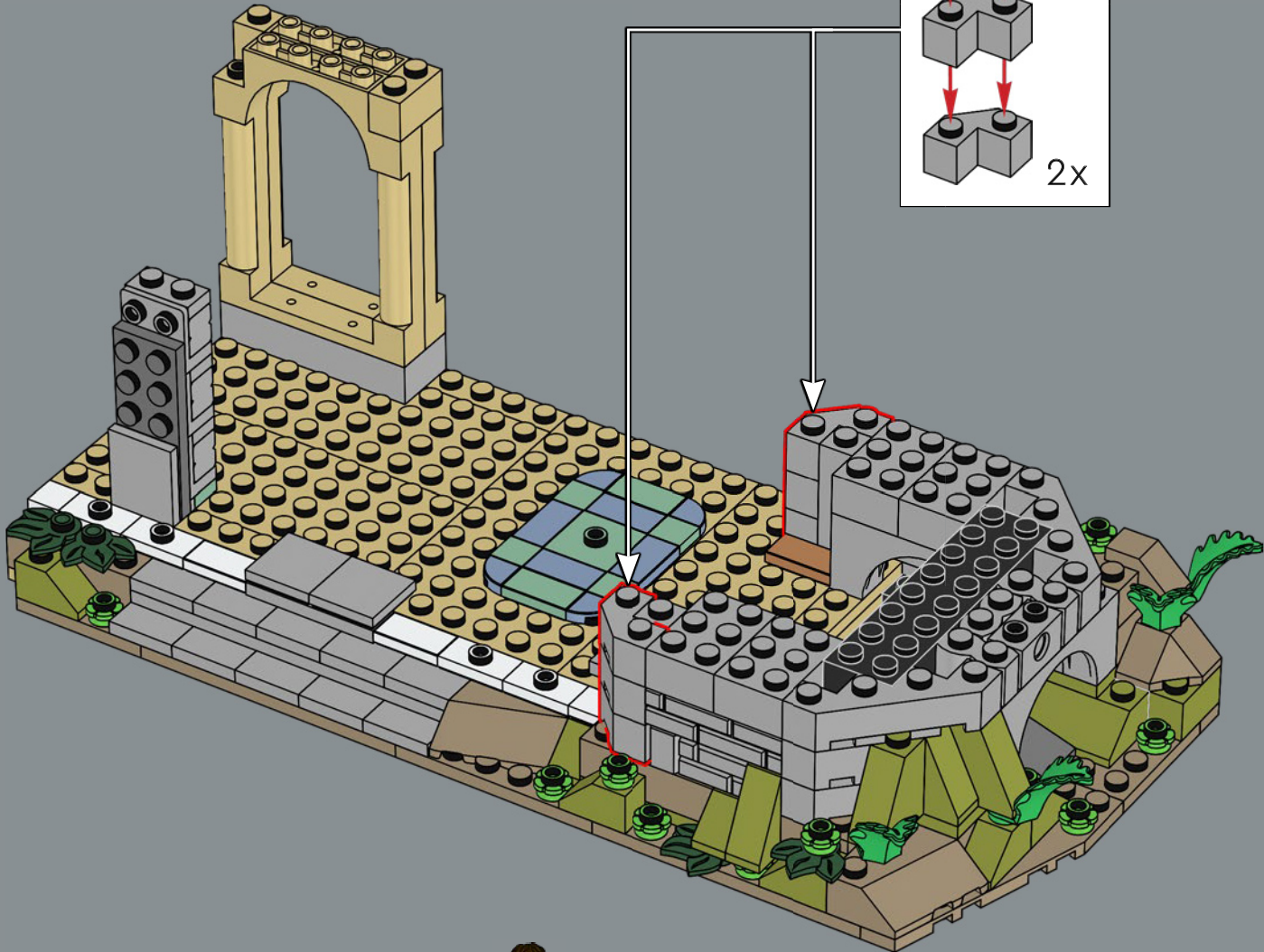
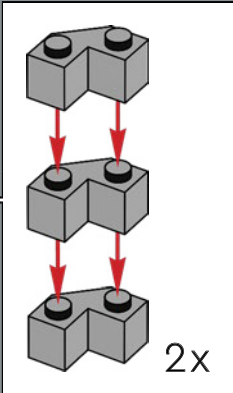

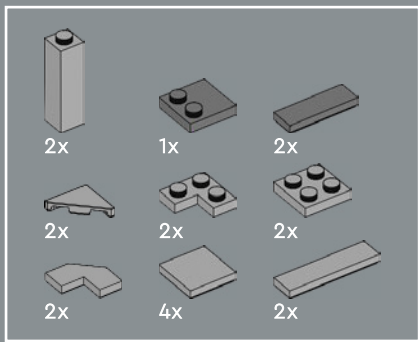

36

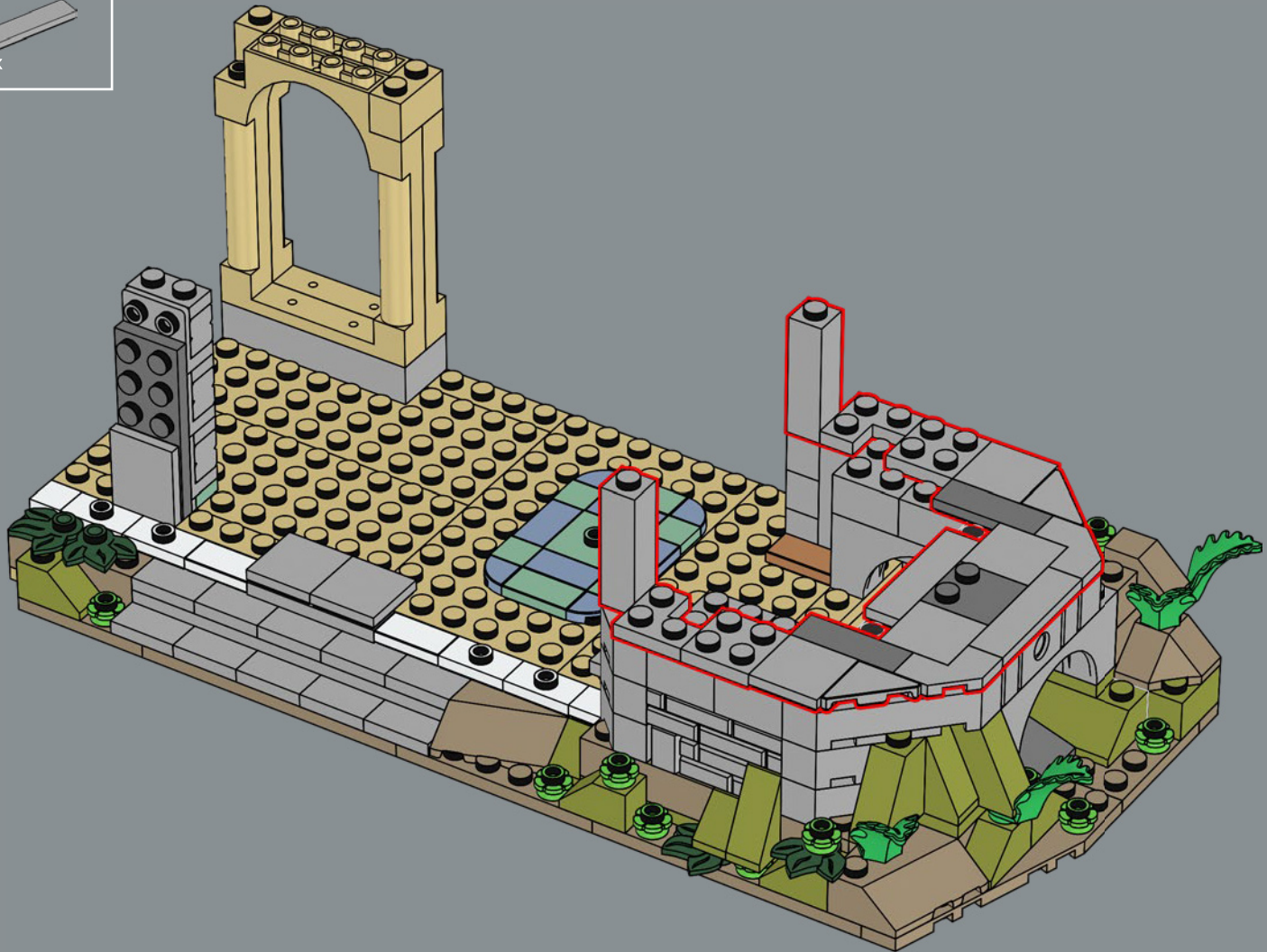

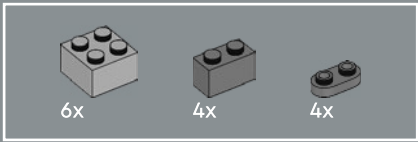

37

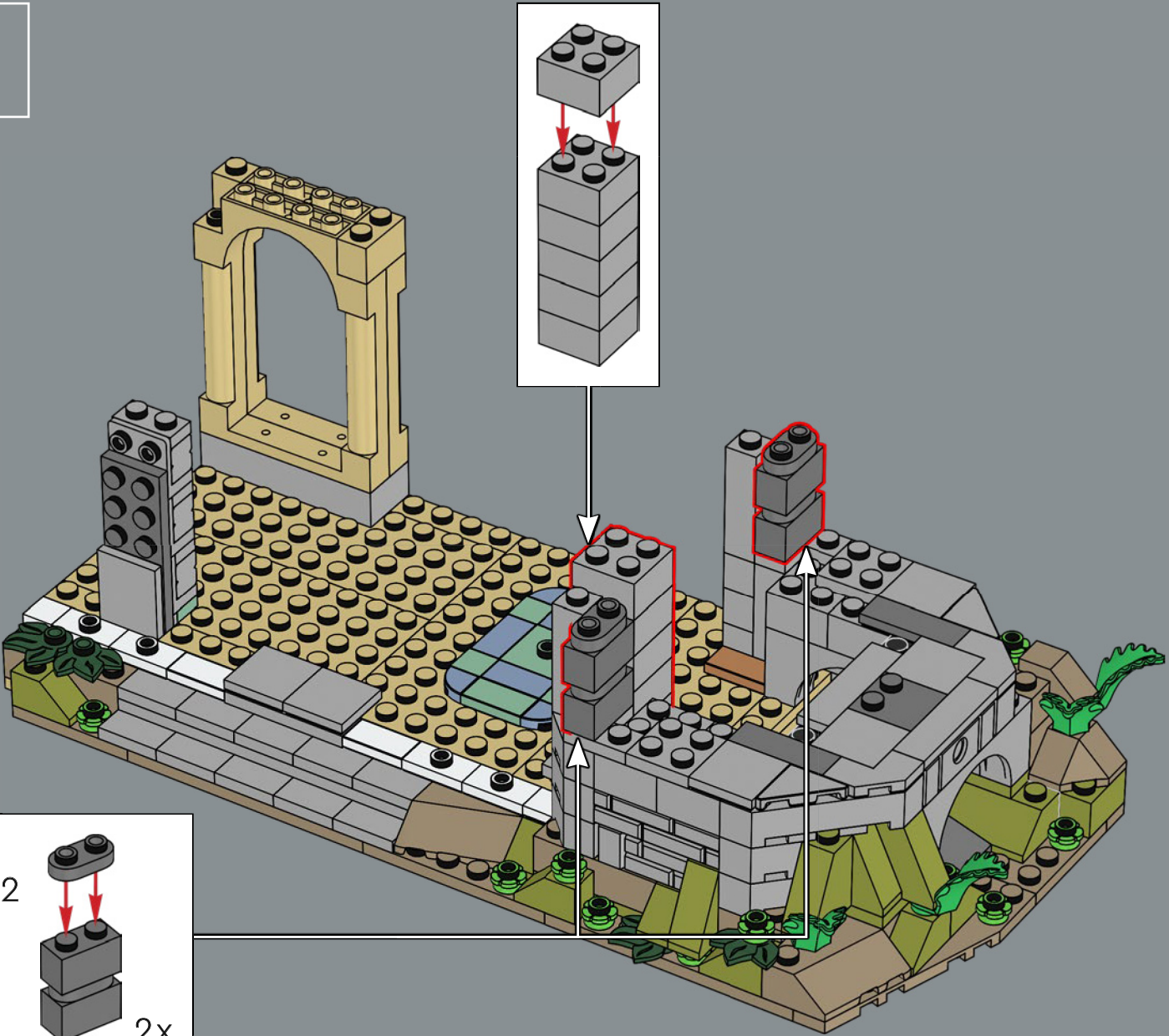

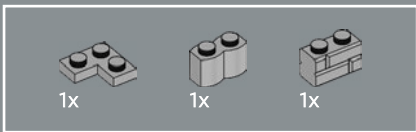

38

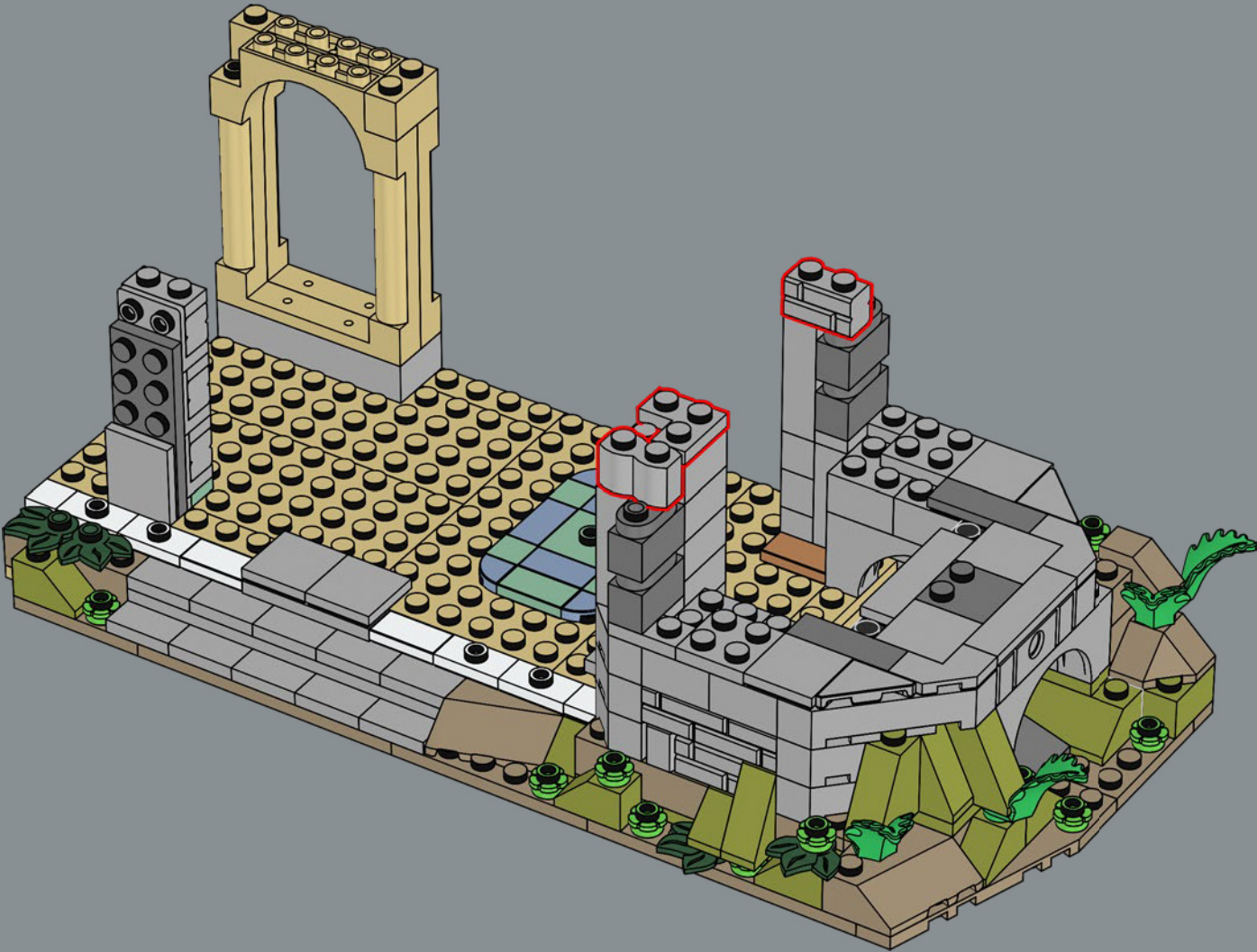



Este escondite para Samsagaz Gamyi fue de las últimas características que se incorporaron al modelo.

- 3x
- 1x
- 1x
- 3x
- 1x

39

-
-
-
-
-



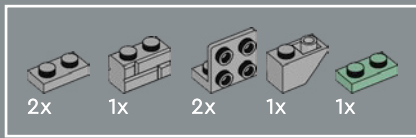

40

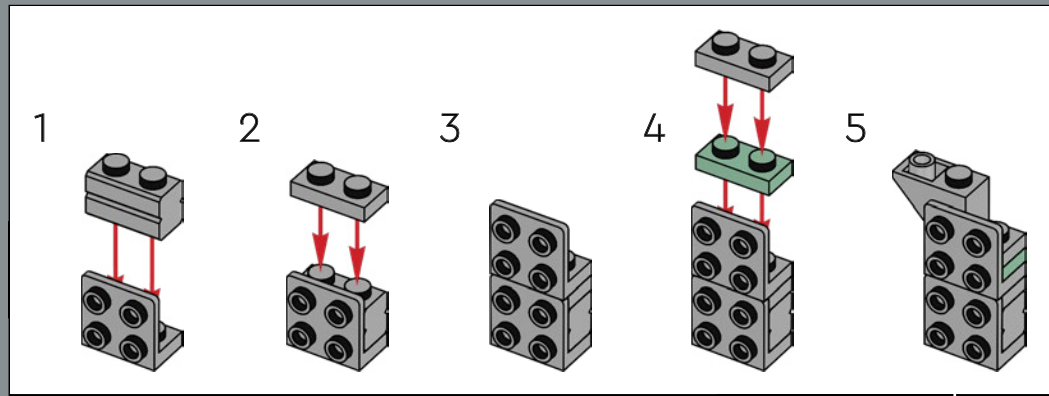
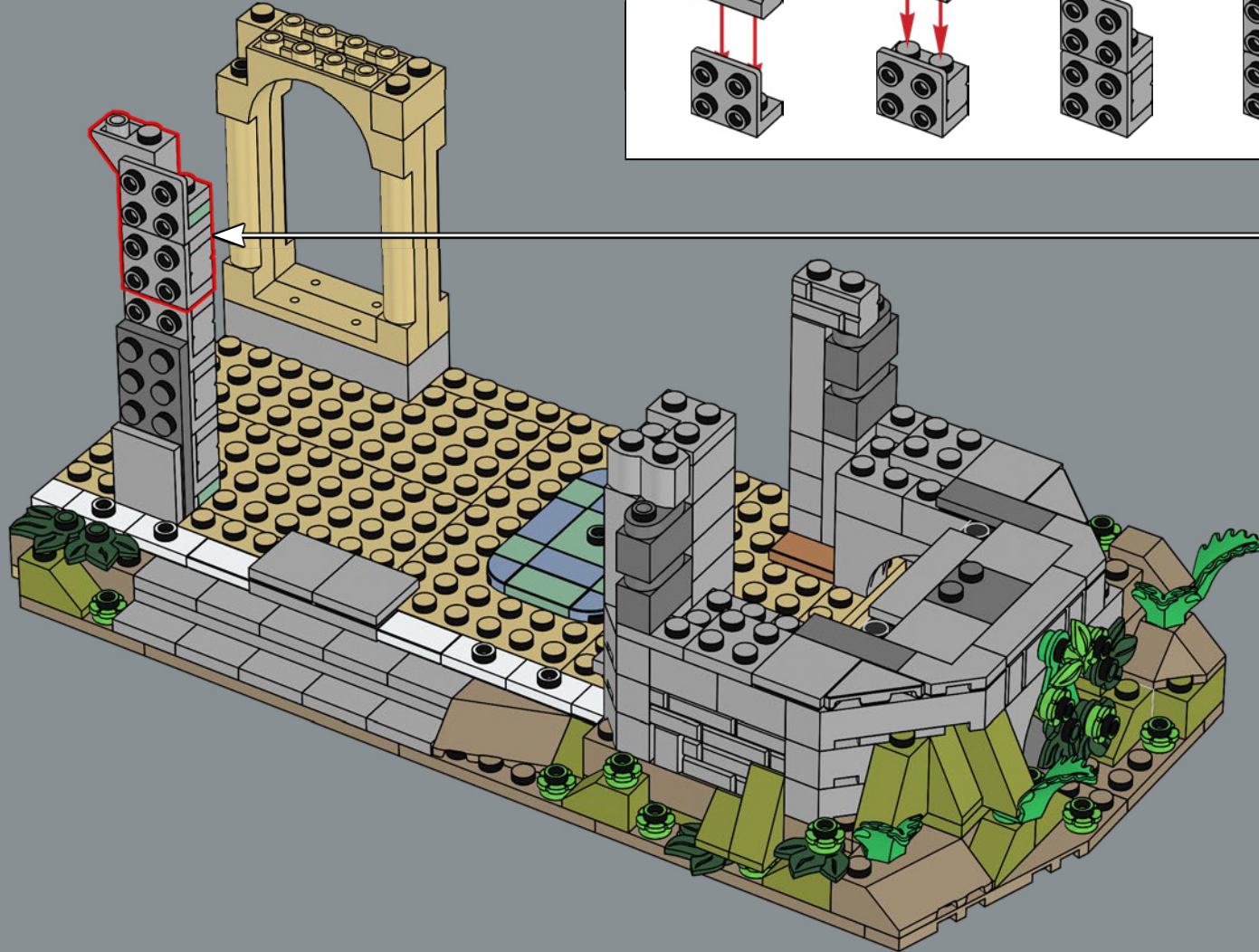

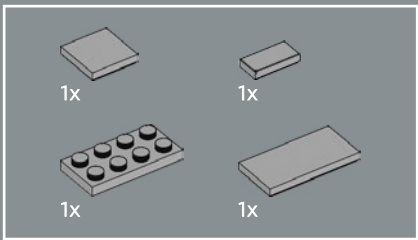

41

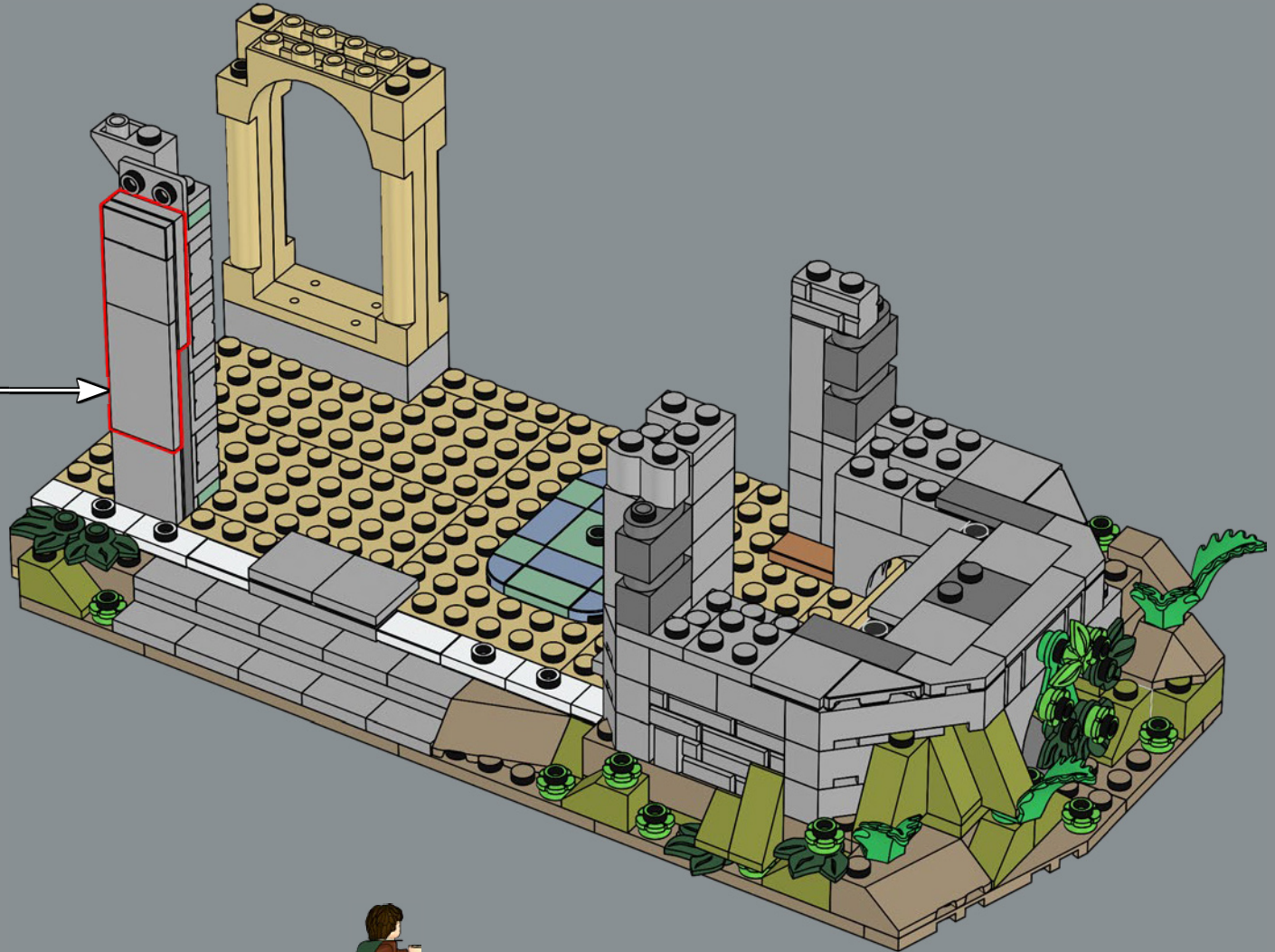
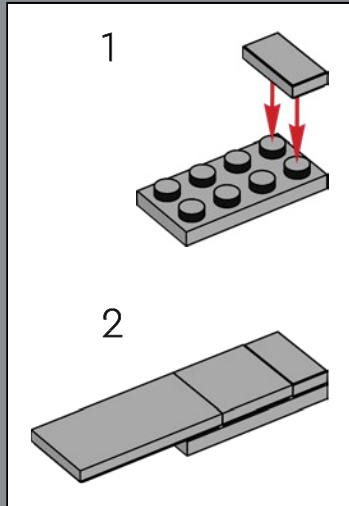

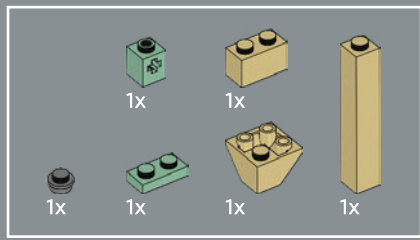

42

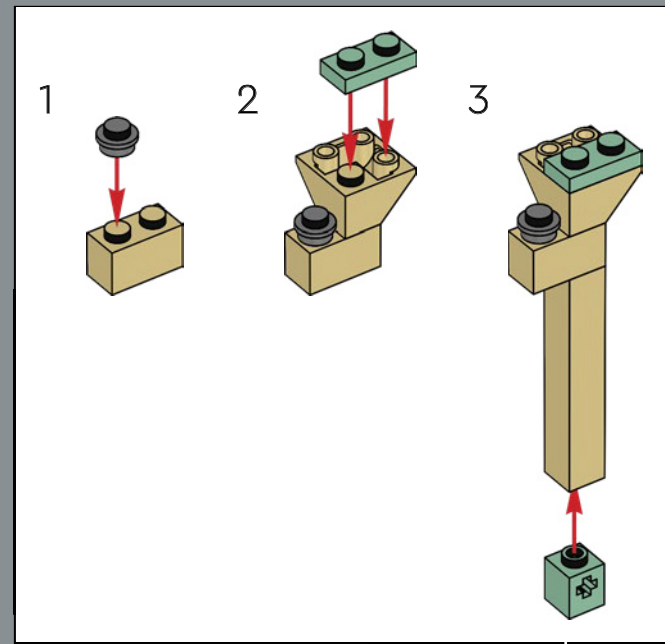
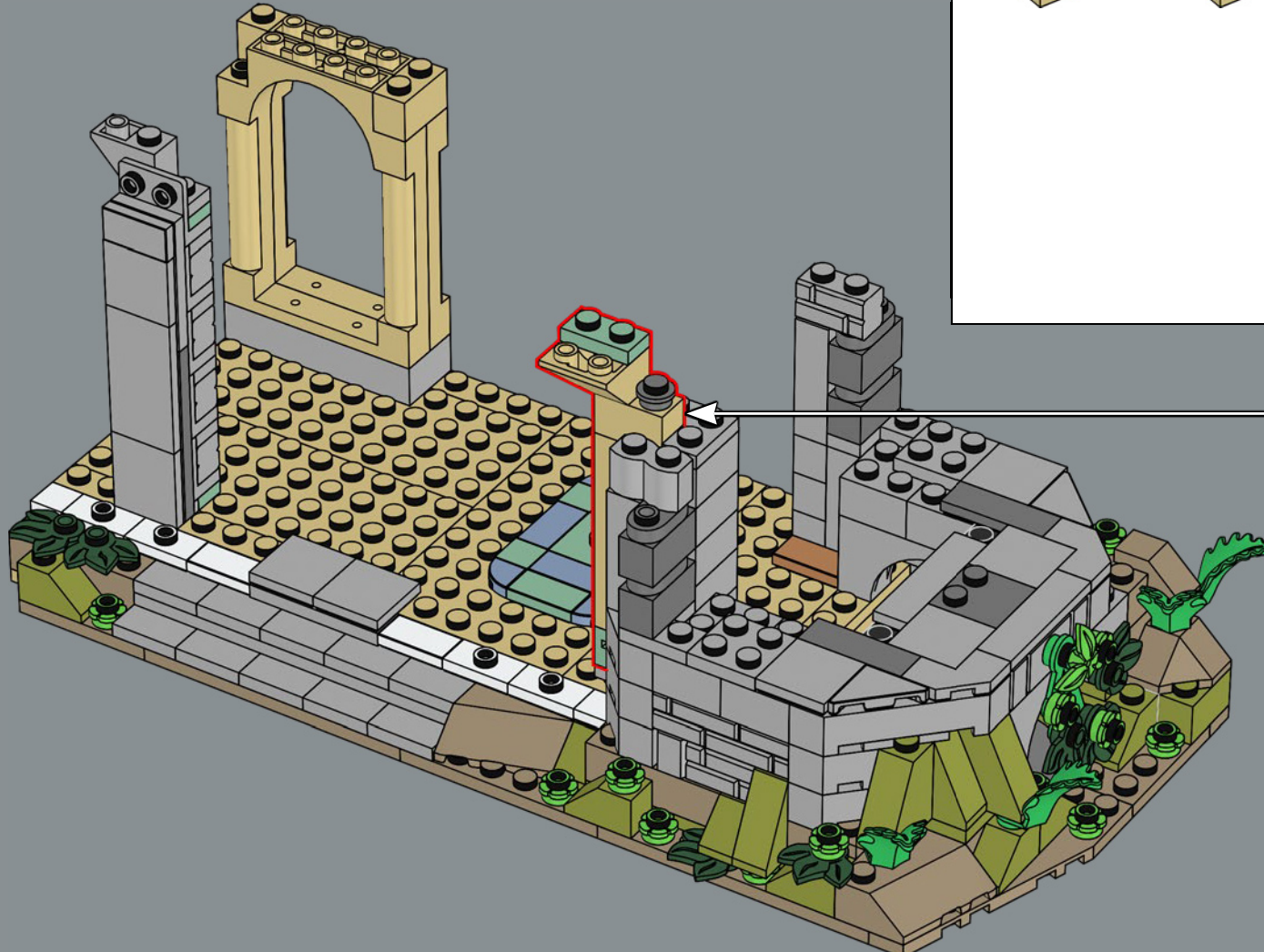

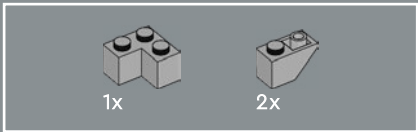

43

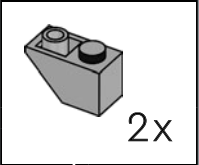

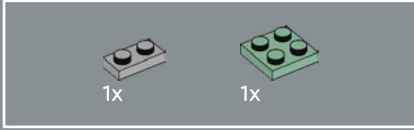
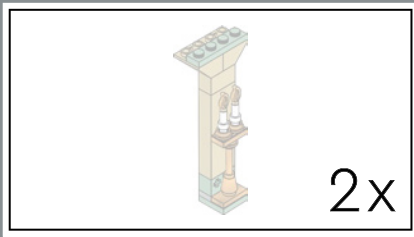

44

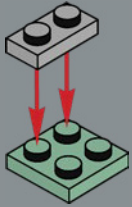

45

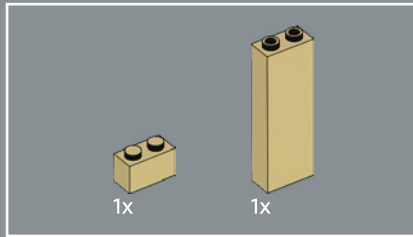
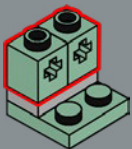

46

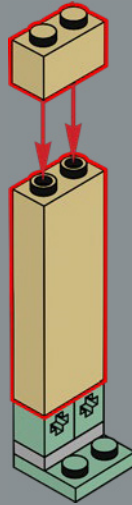

47

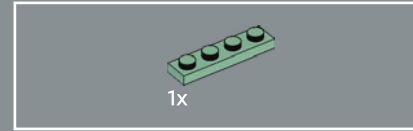
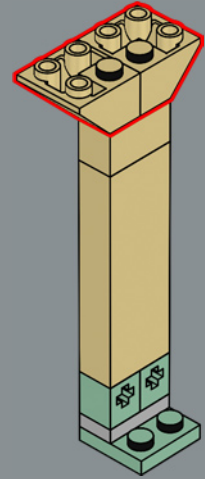

48

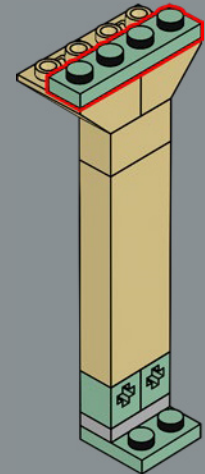

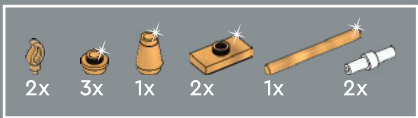

49

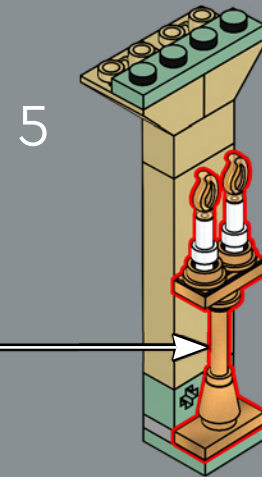
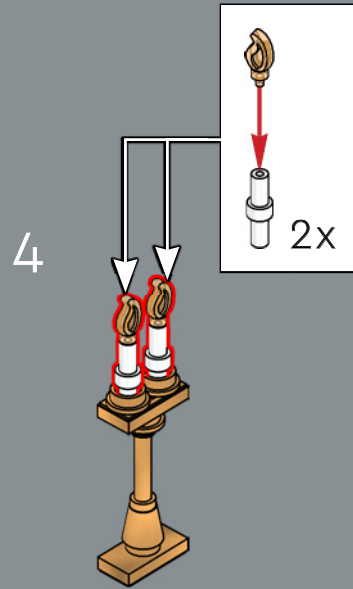
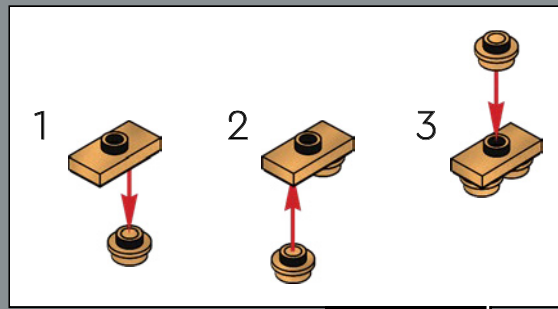
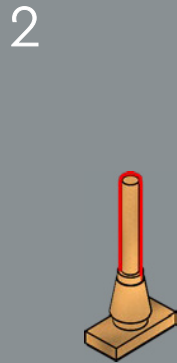
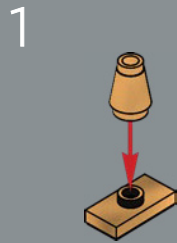

2x



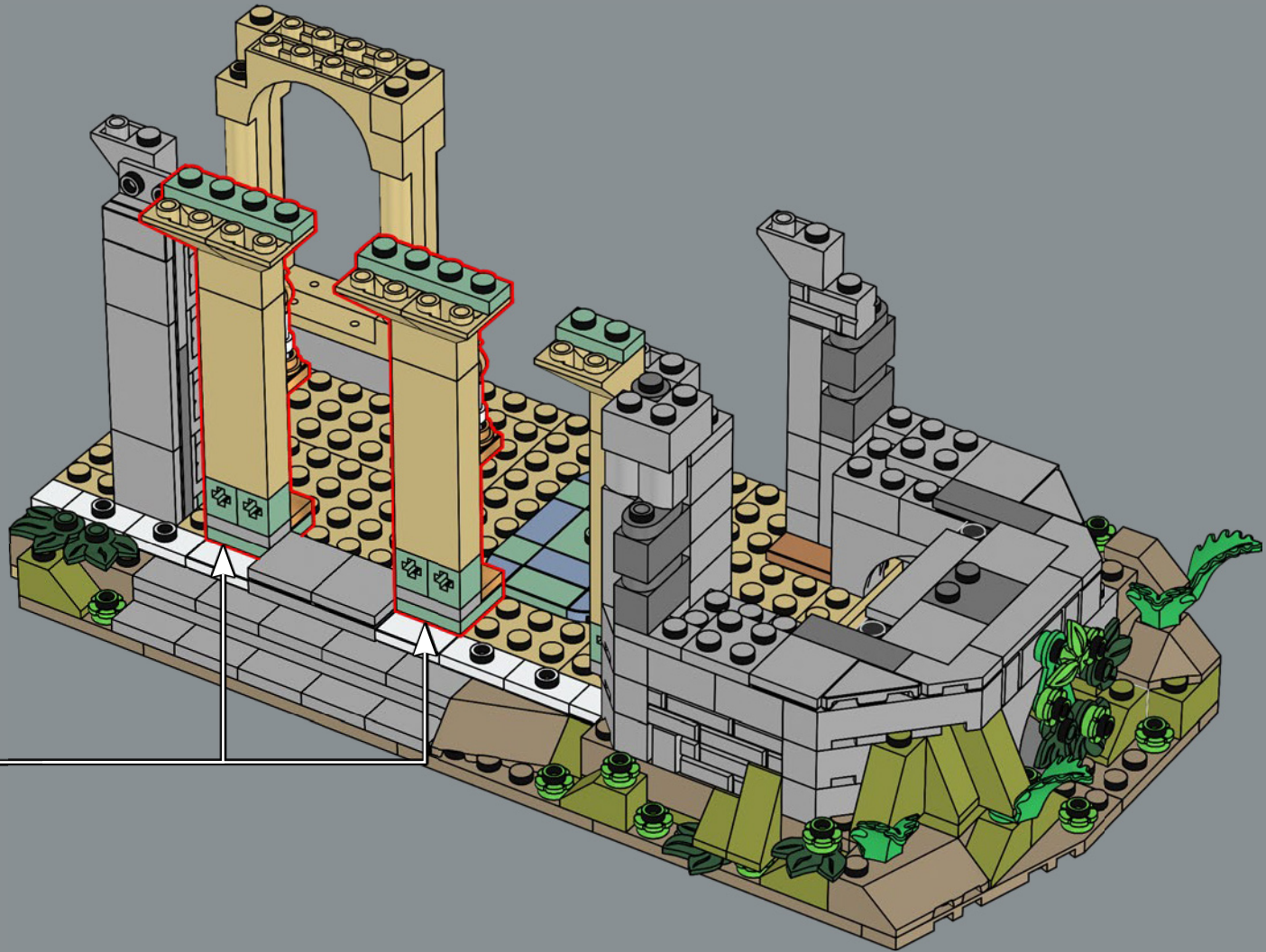

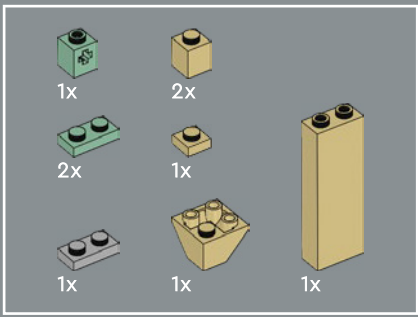

50

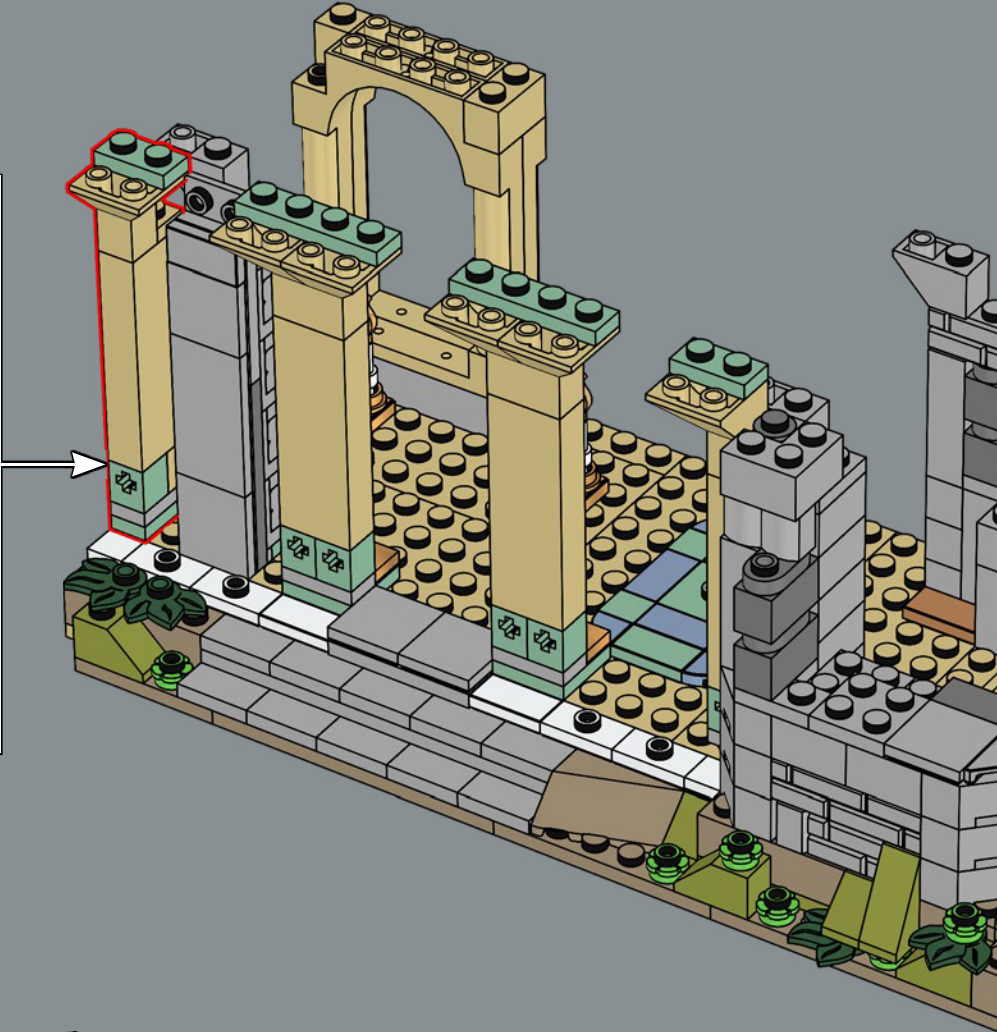
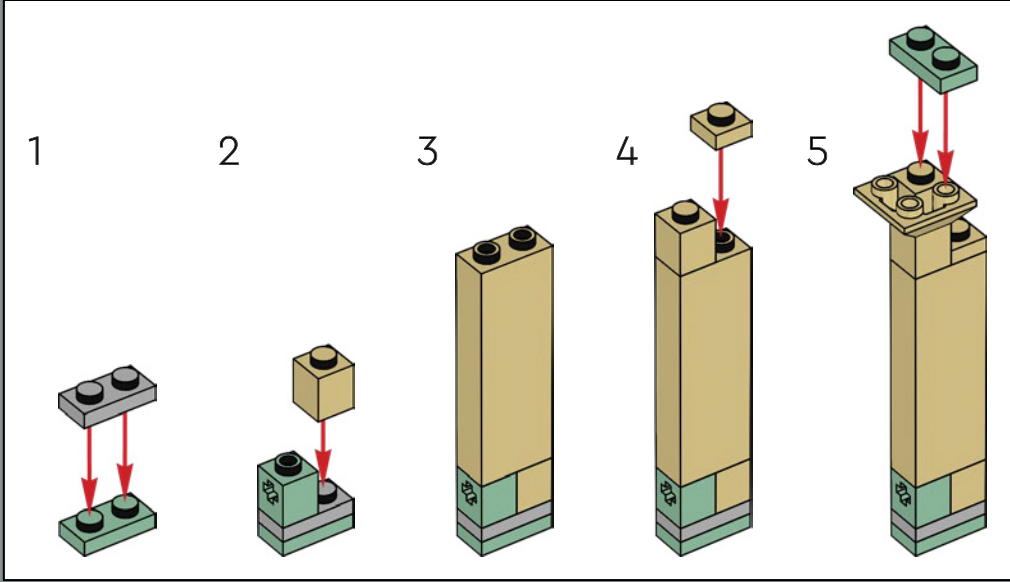

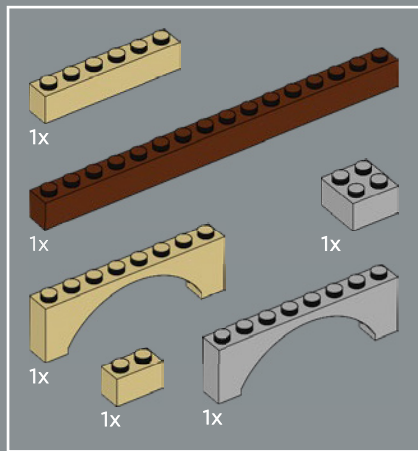

51

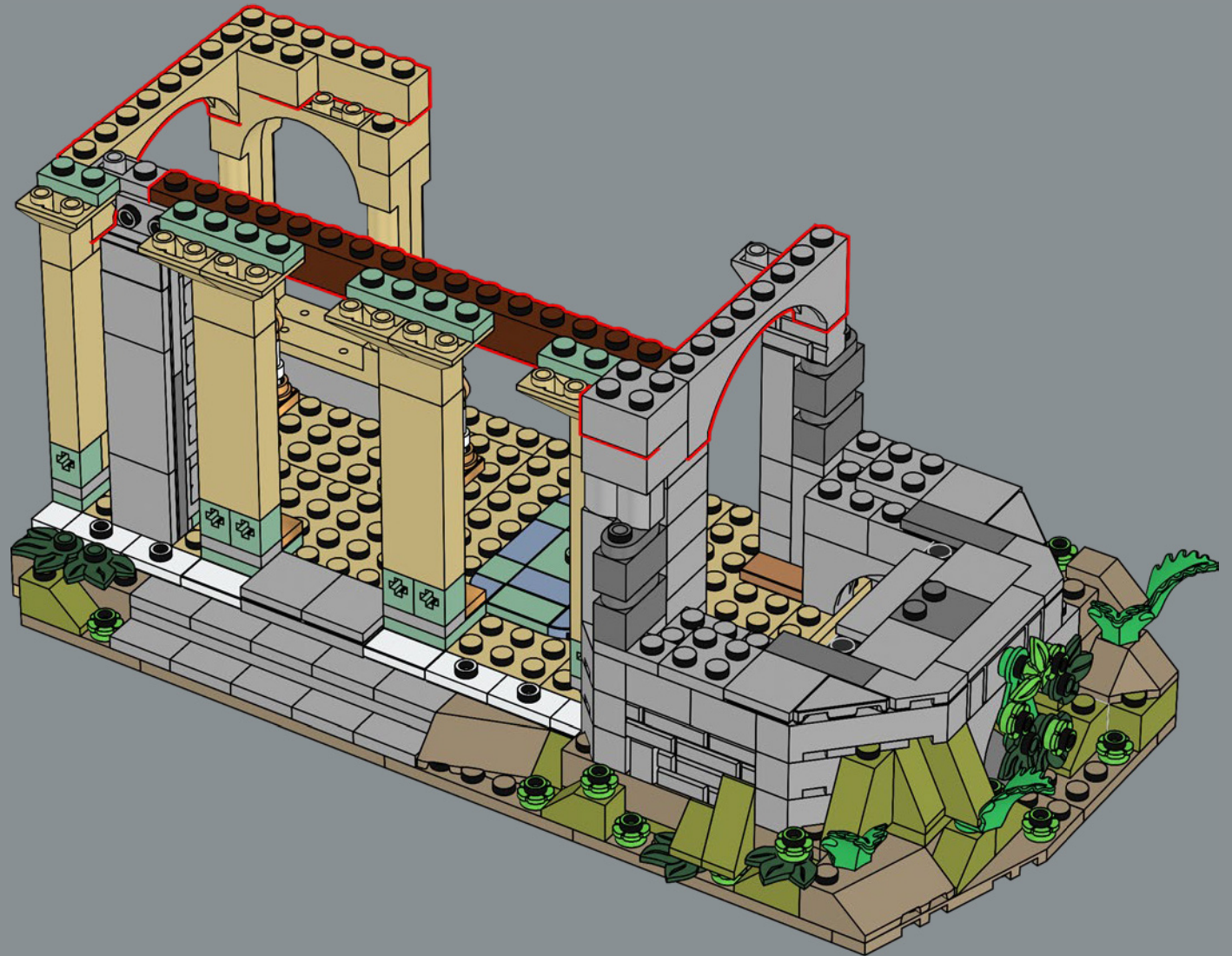

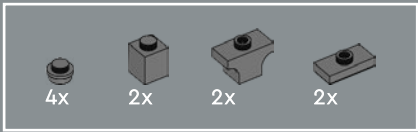

52

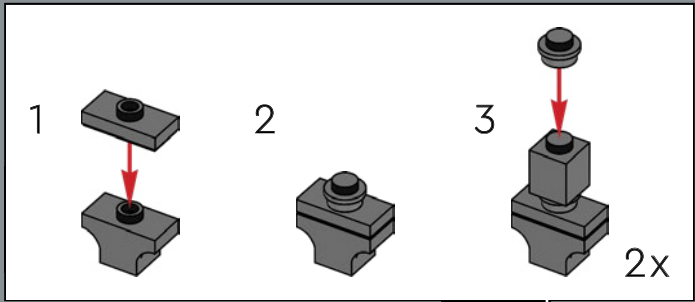
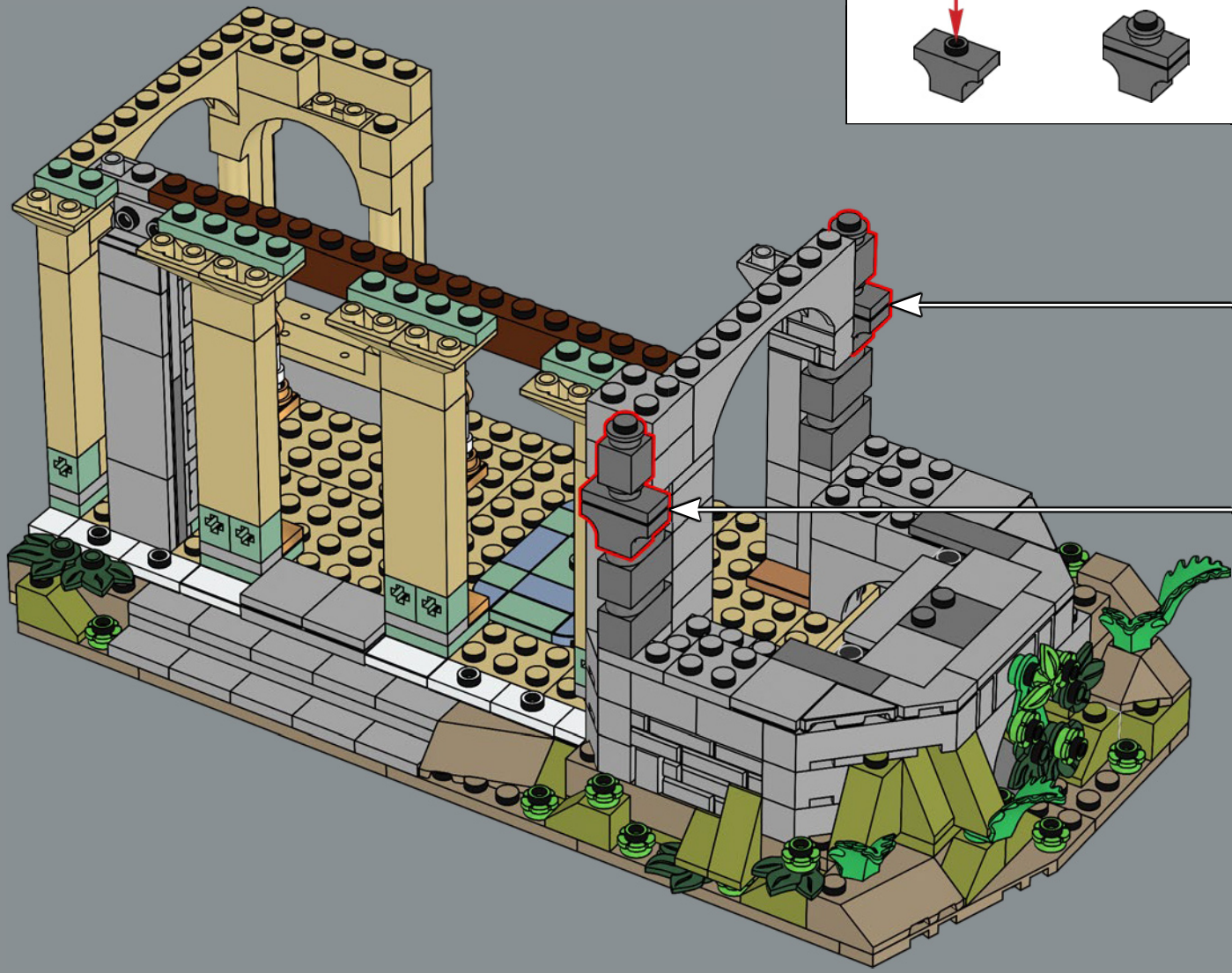

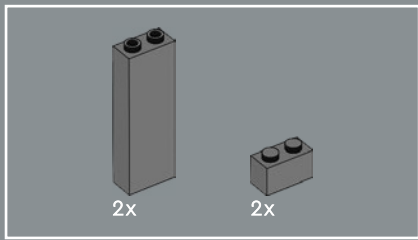

53

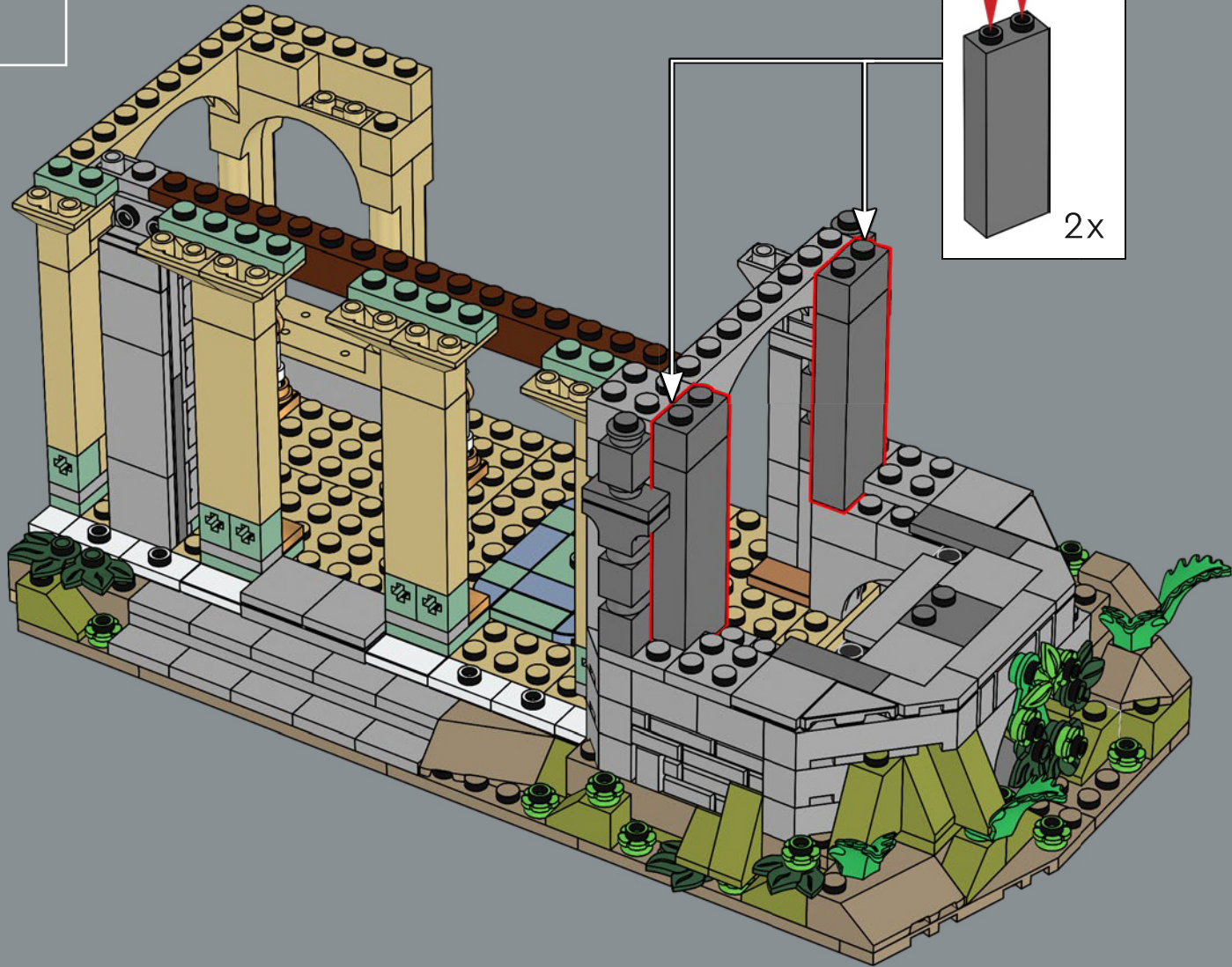



4x

54



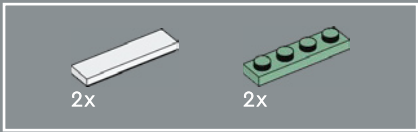

55

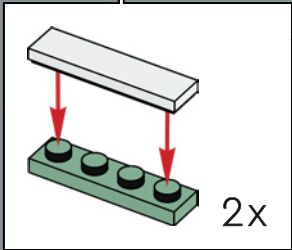
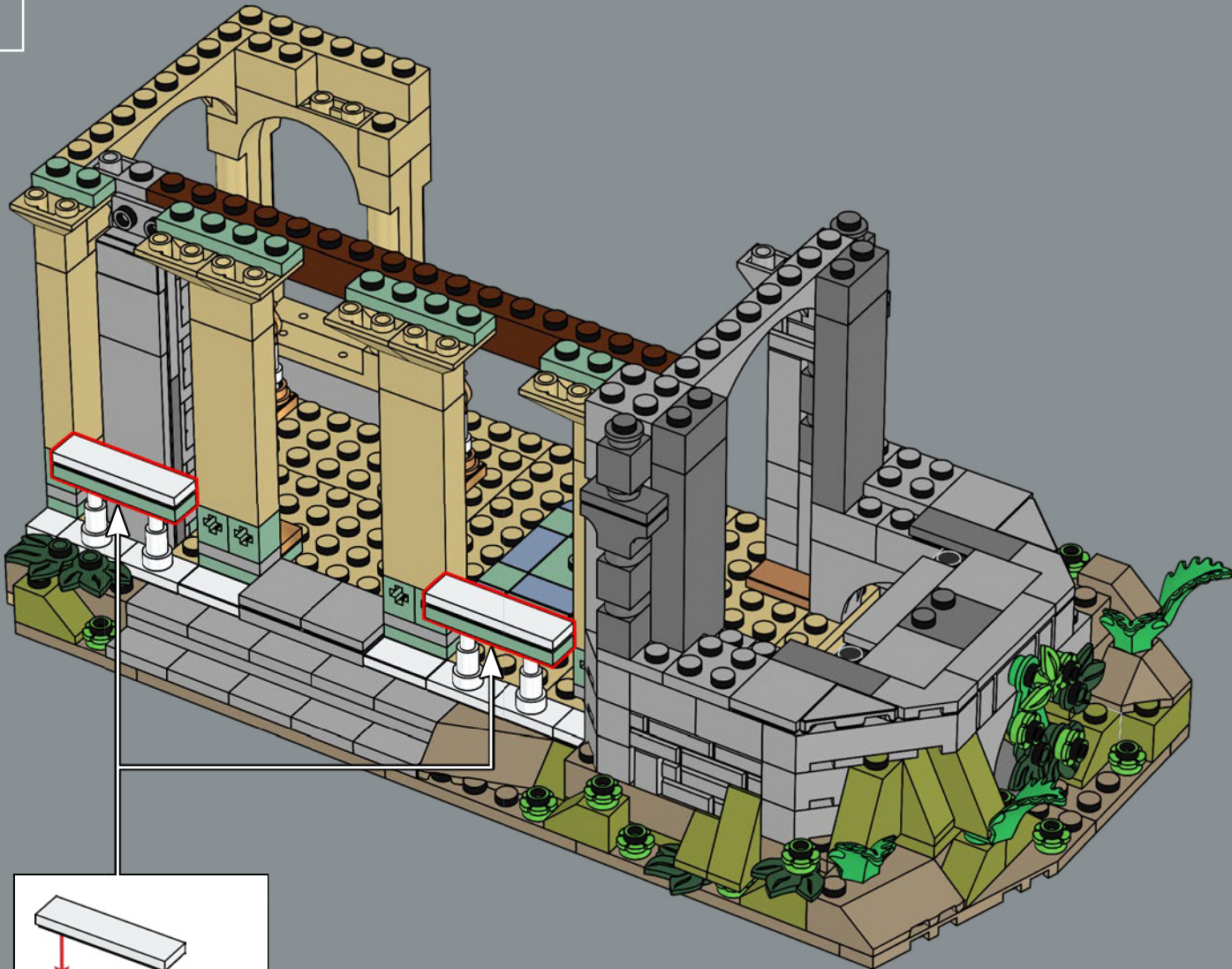

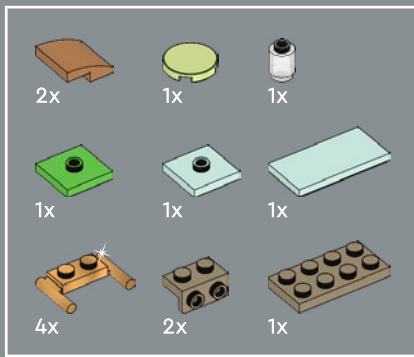

56

1



2

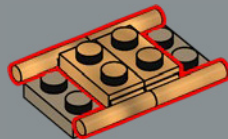

3

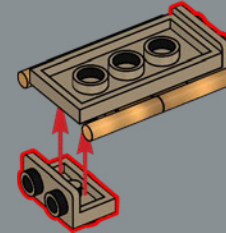

4

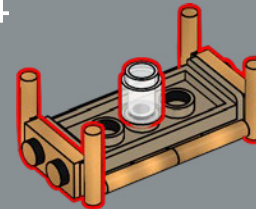

5

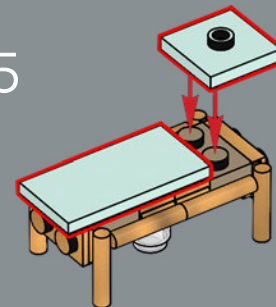

6

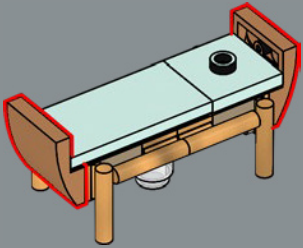

7

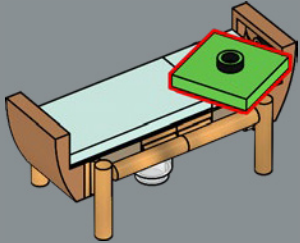

8

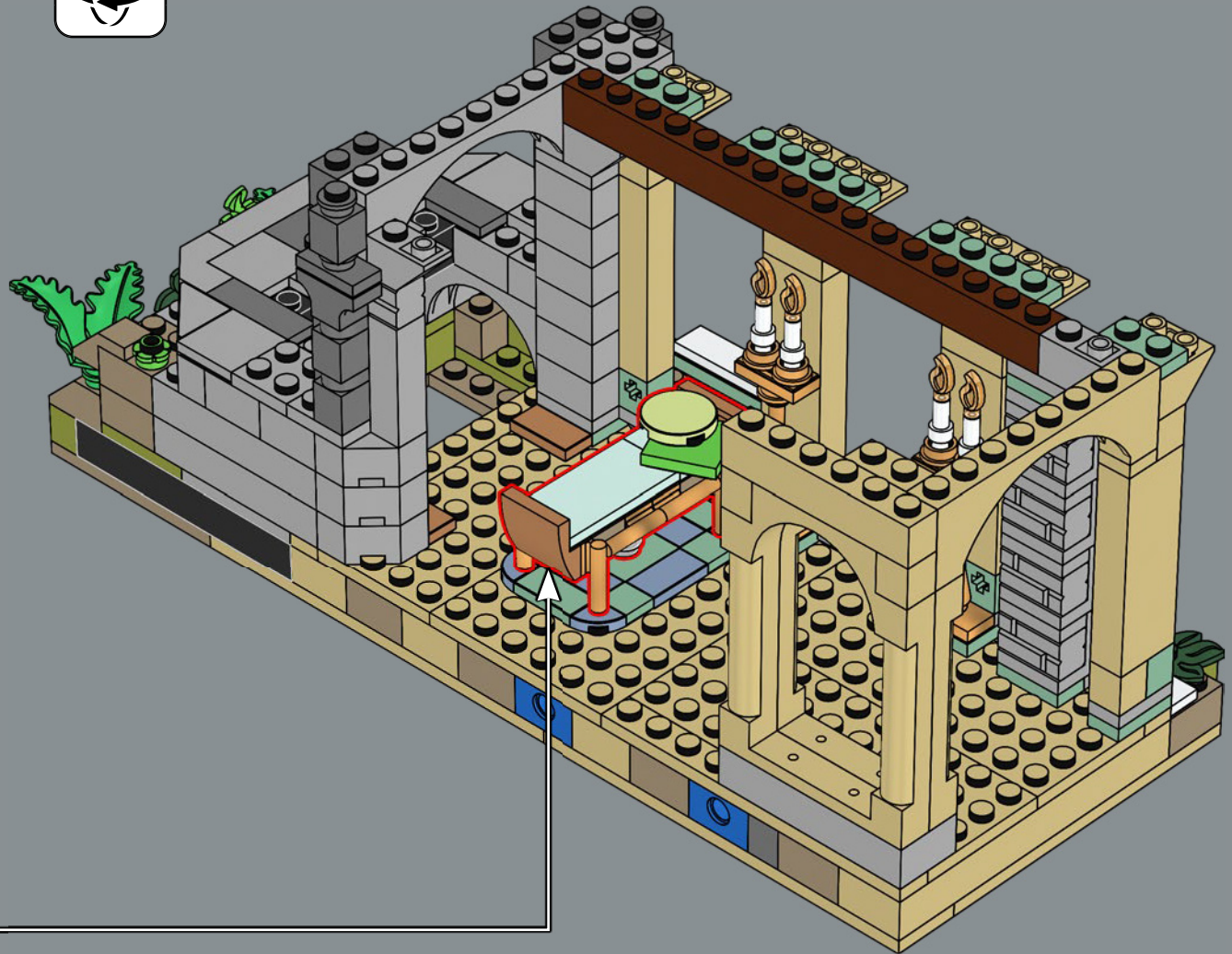
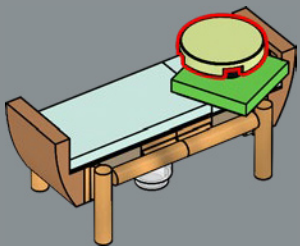

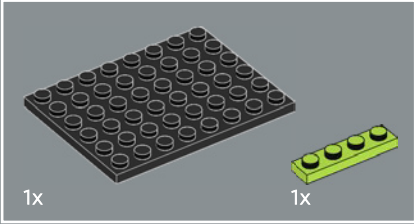
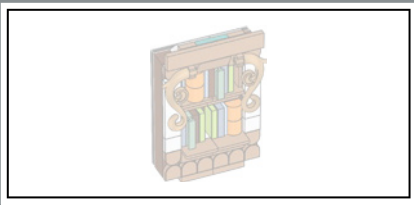

57

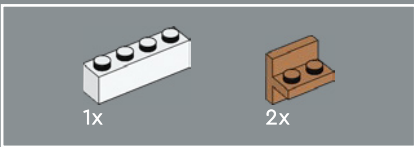
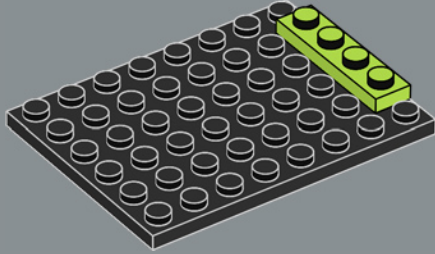

58

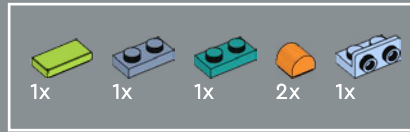
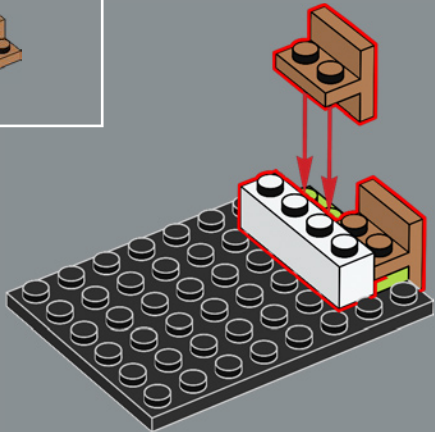

59

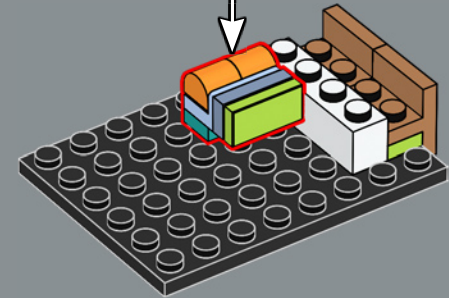
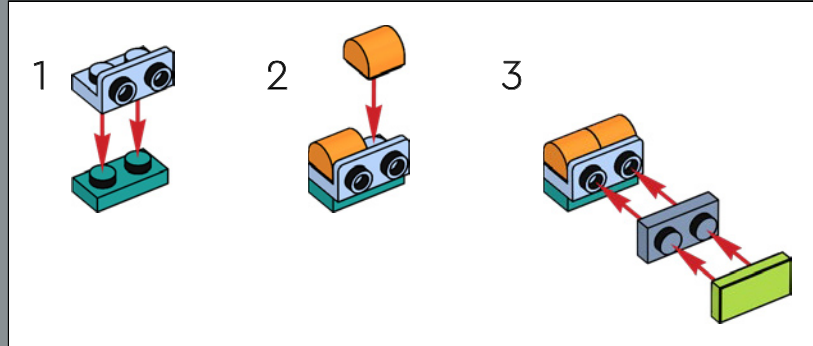

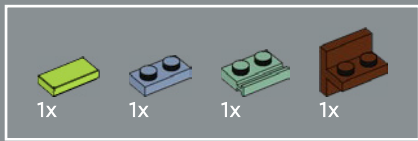

60

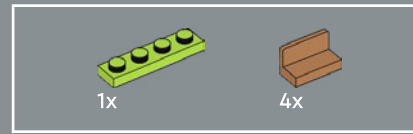
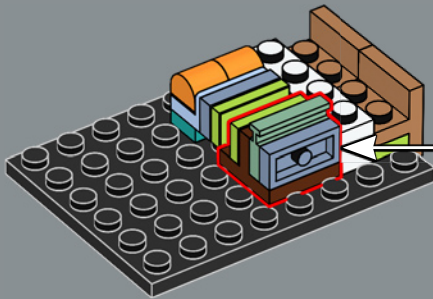
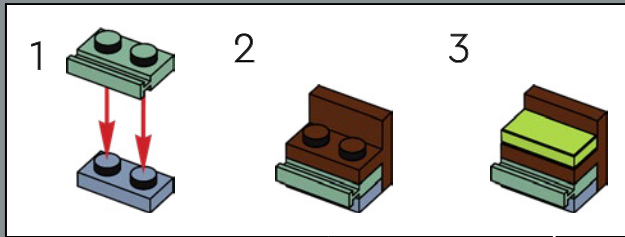

61

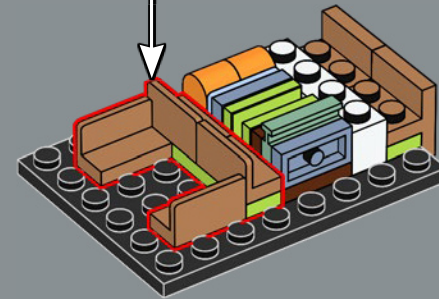
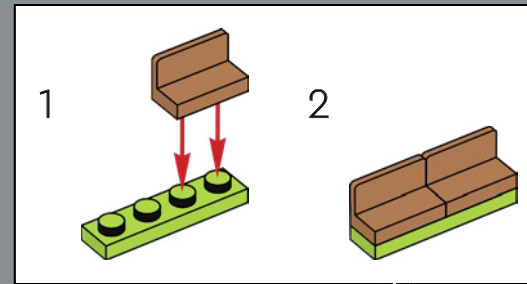

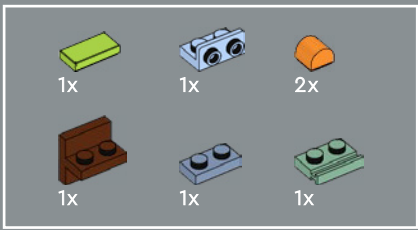

62

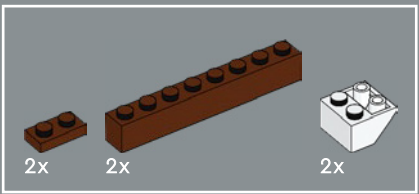
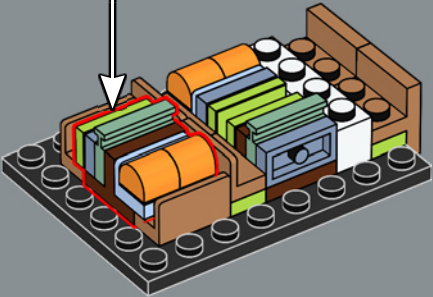
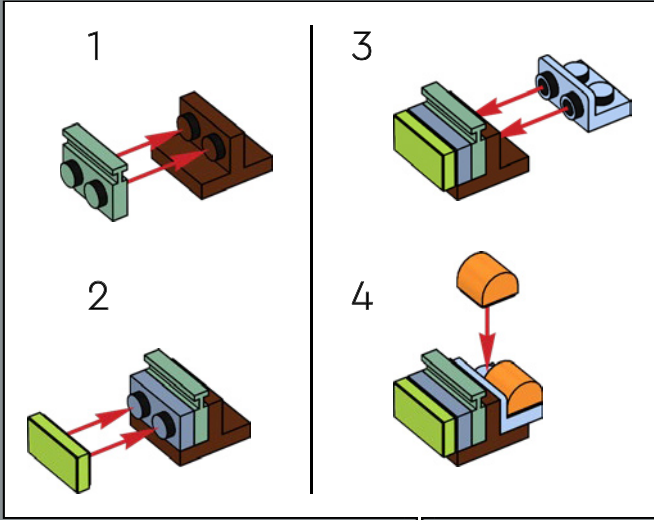

63

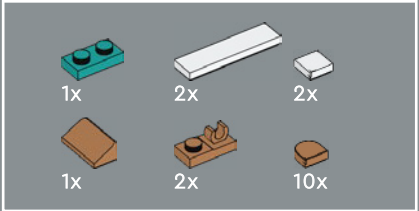
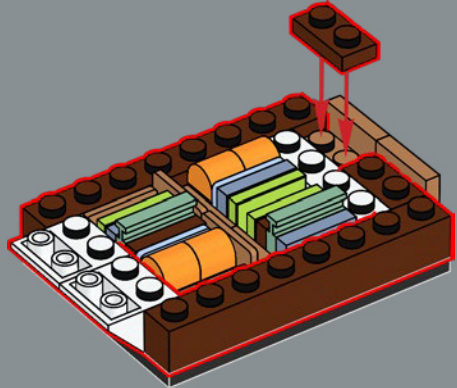

64

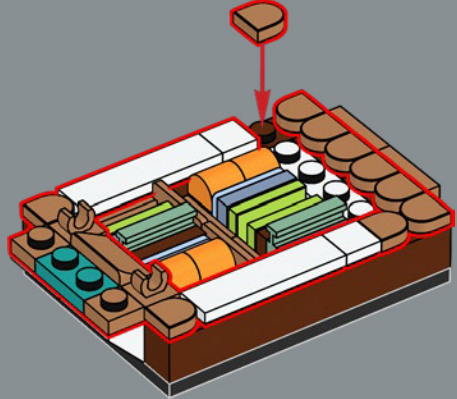

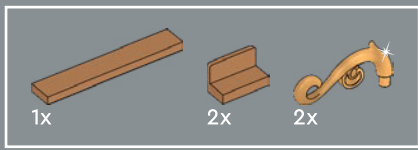

65

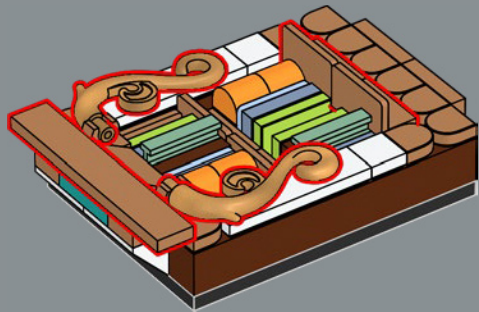

66

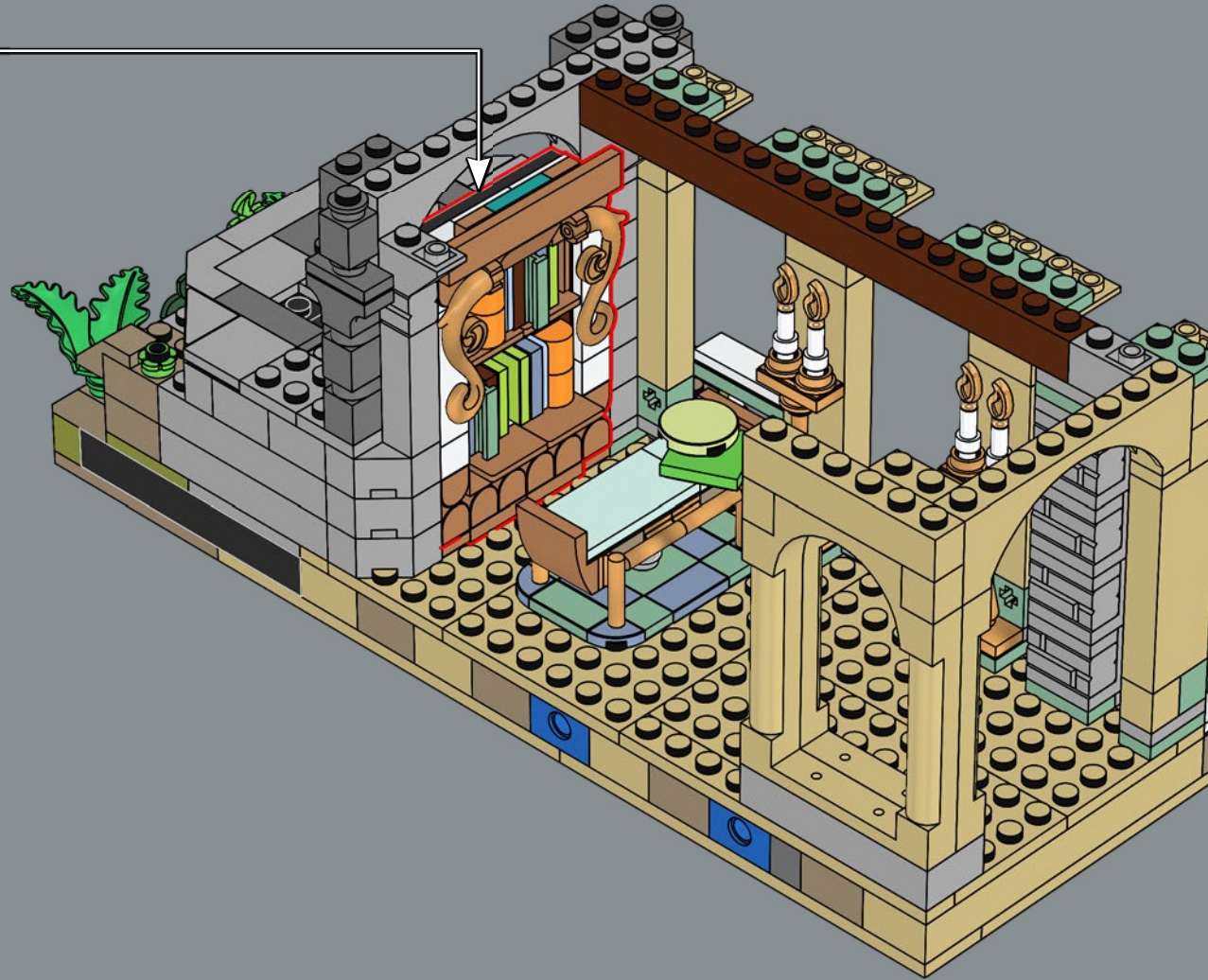

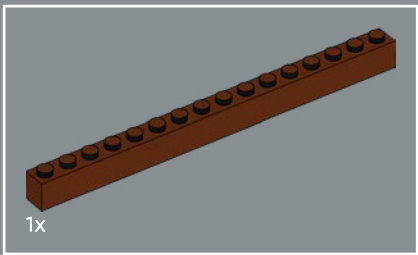

1x

67



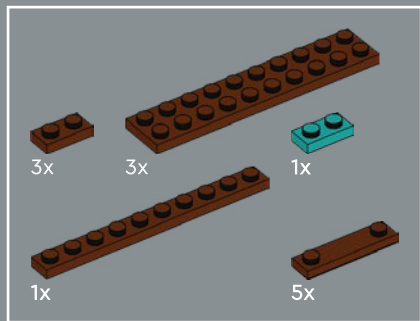

68

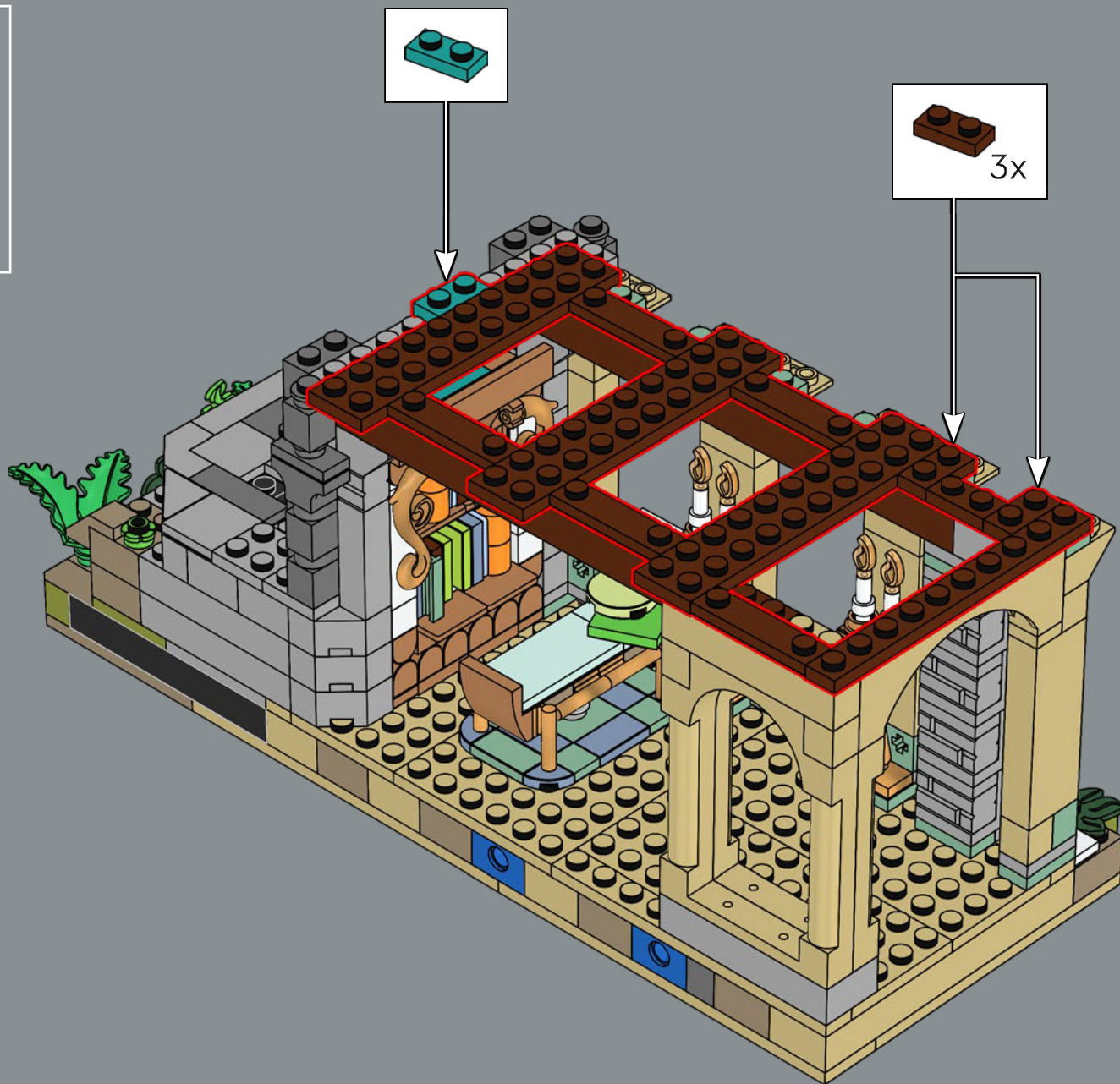

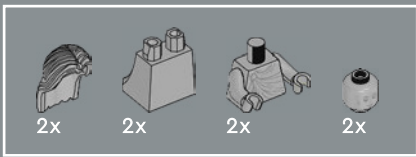

69

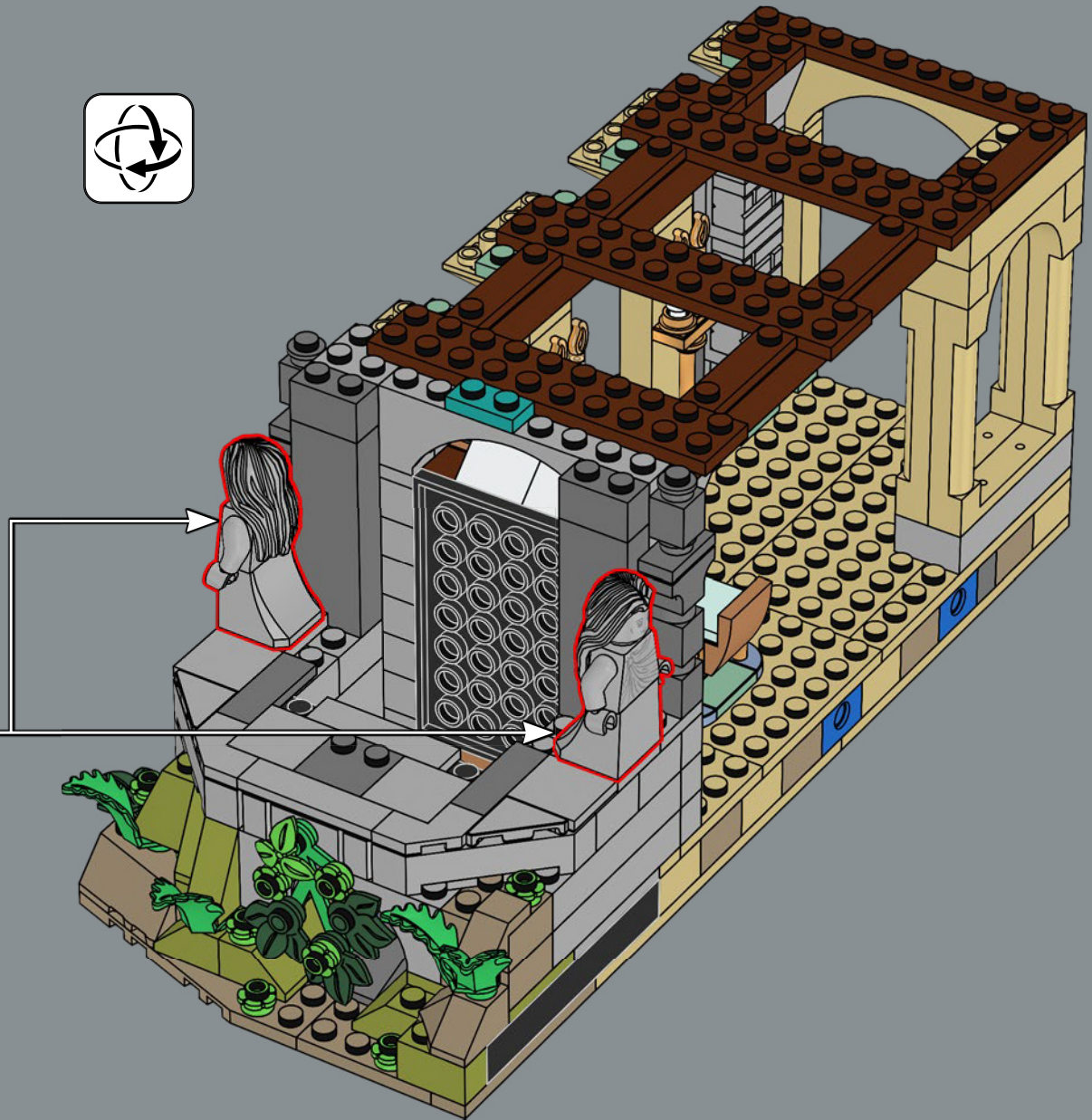
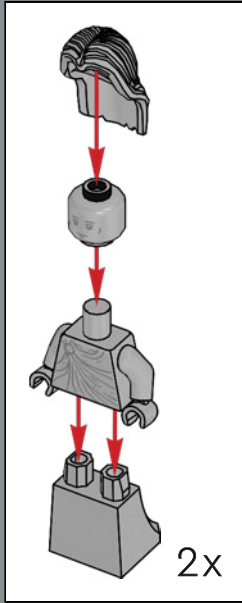

Las nuevas decoraciones para las cabezas de las estatuas tienen dos expresiones distintas: una neutra, y la otra con una mirada feroz!





70

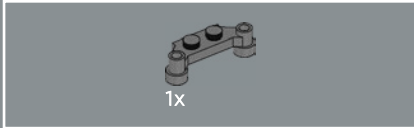
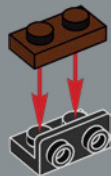

71

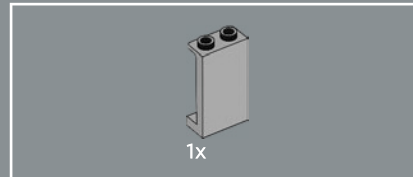
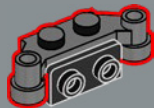

72

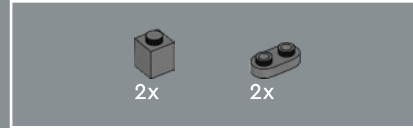
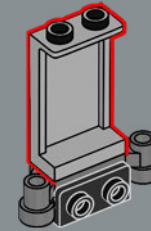

73

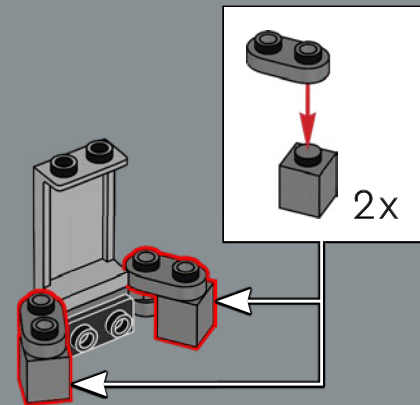



2x

74

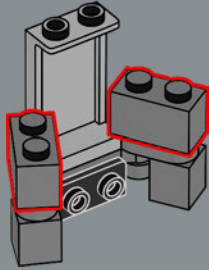

2x

75

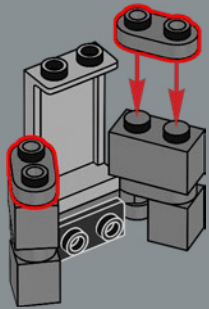

2x



2x

76

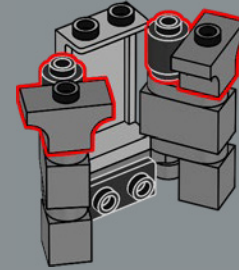

1x

77

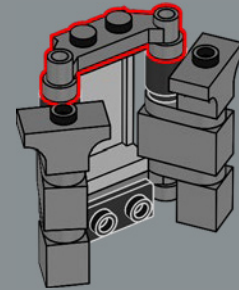

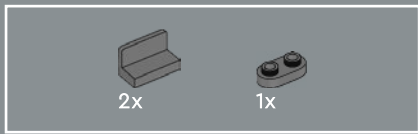

78

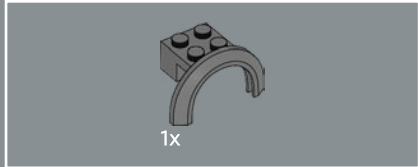
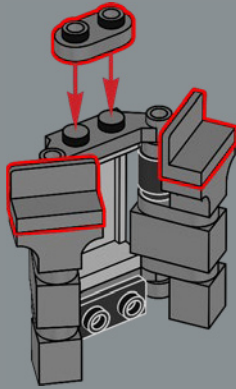

79

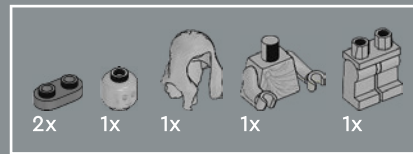
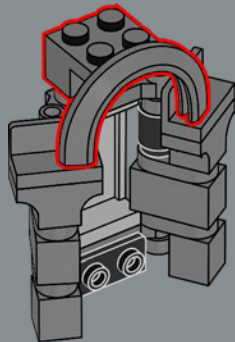

80

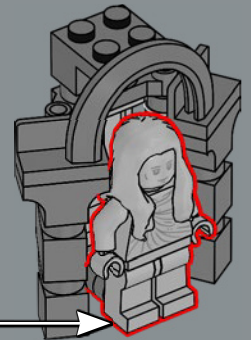
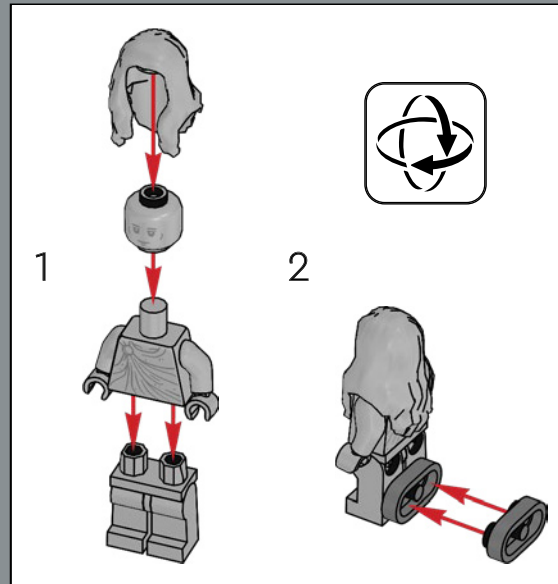



1x

81

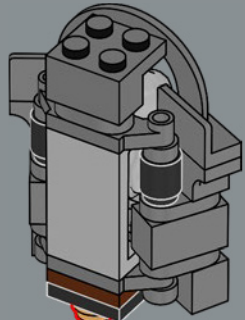

2x



82

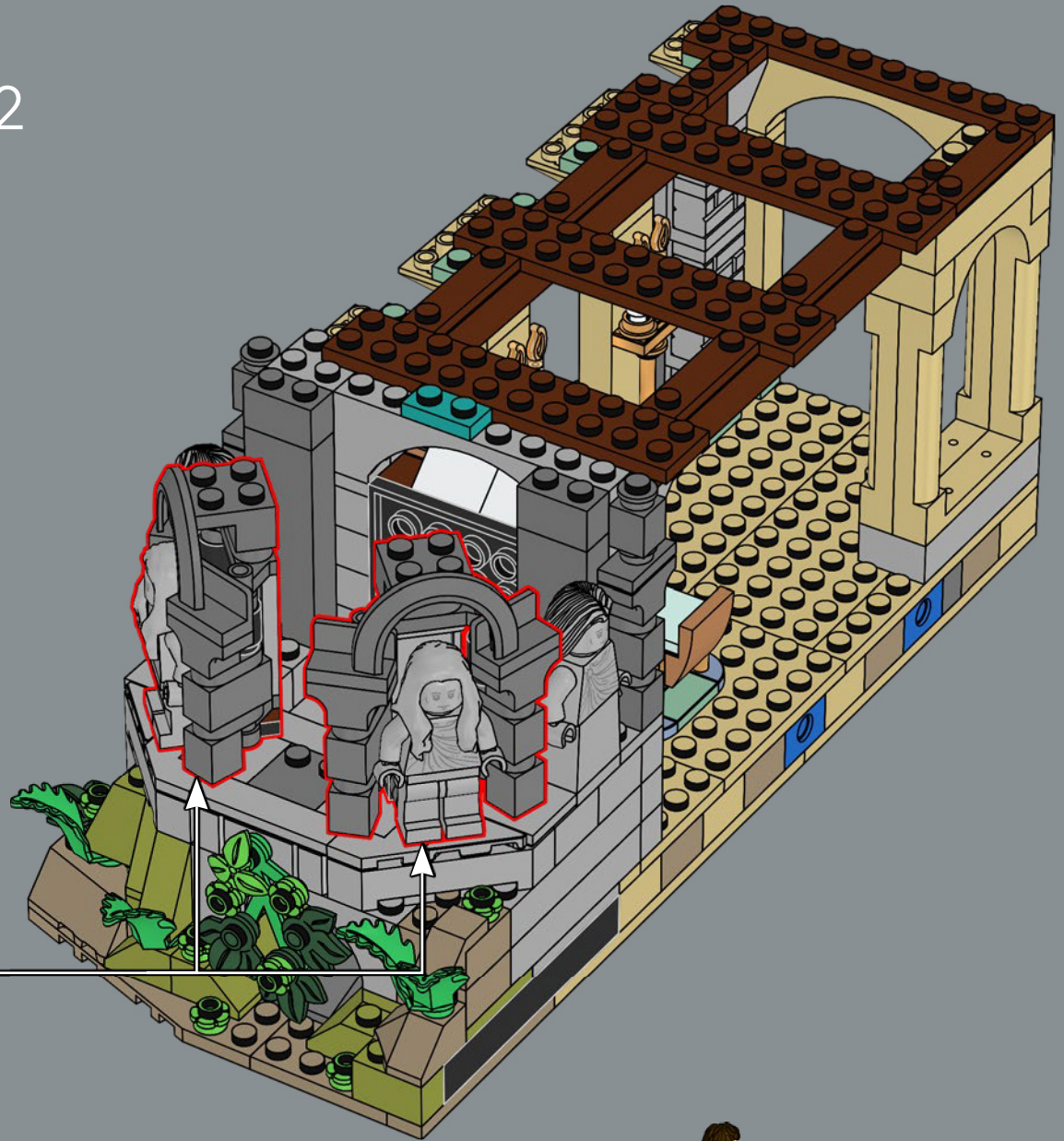

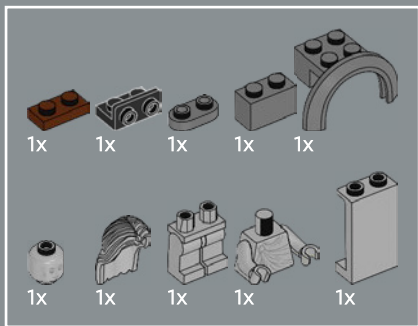

83

1

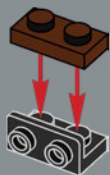

2

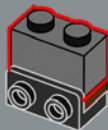

3

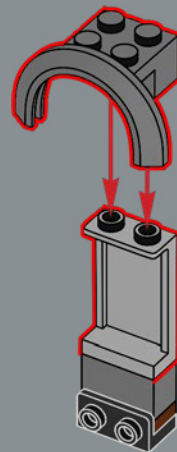

4

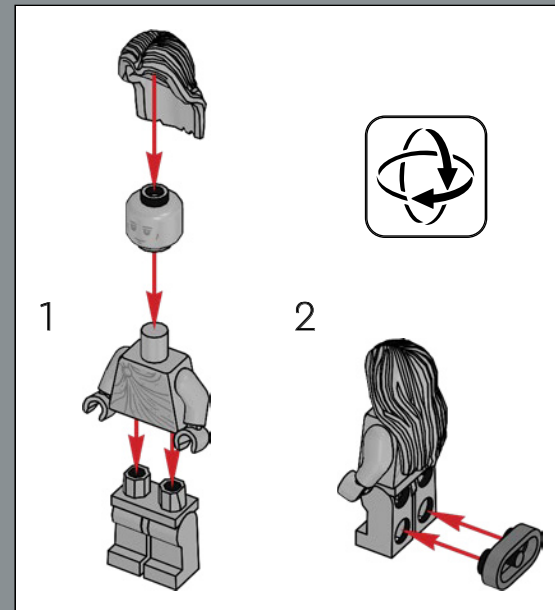

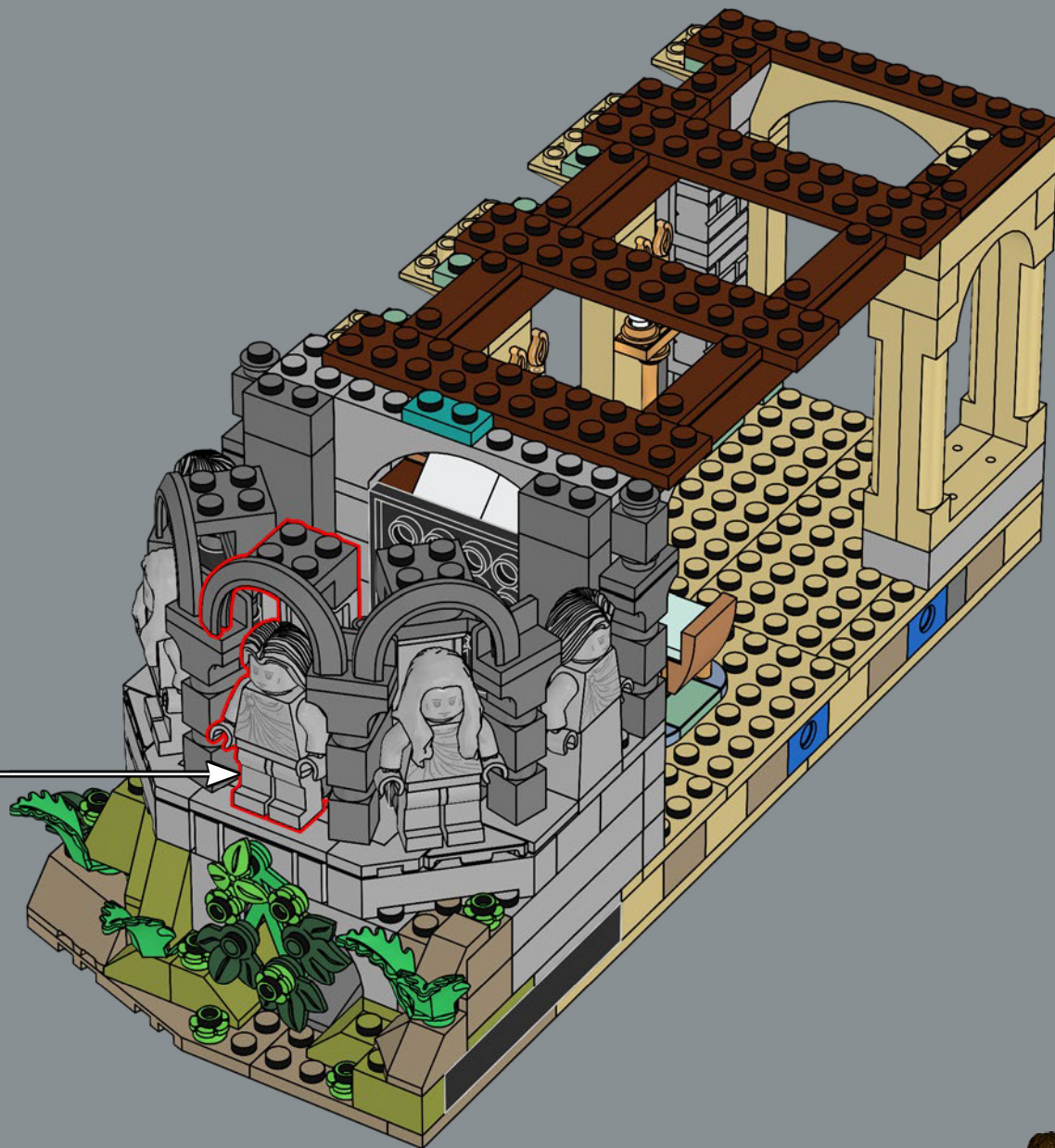

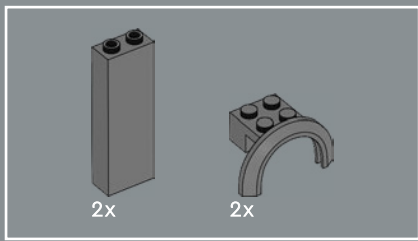

84

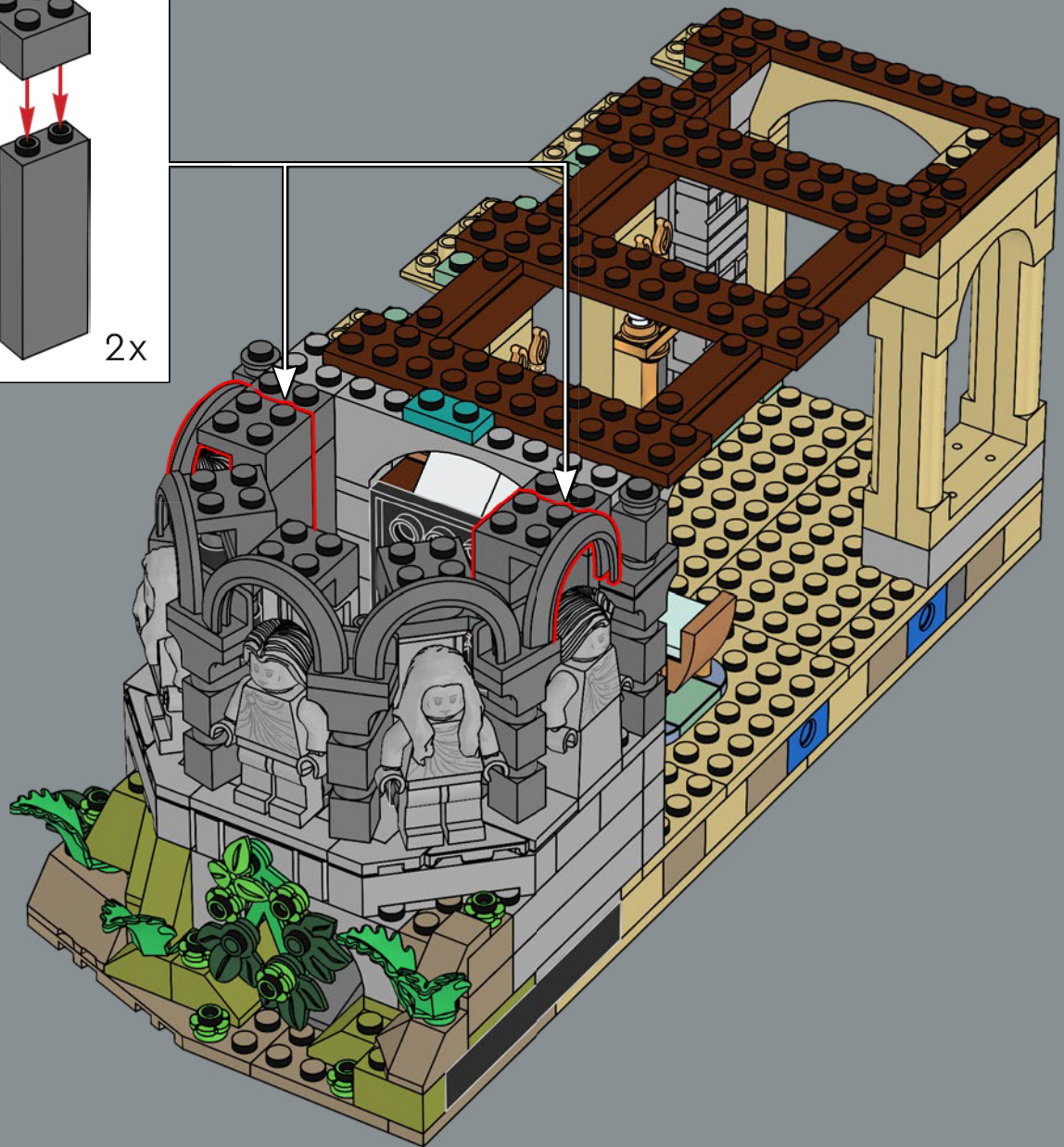
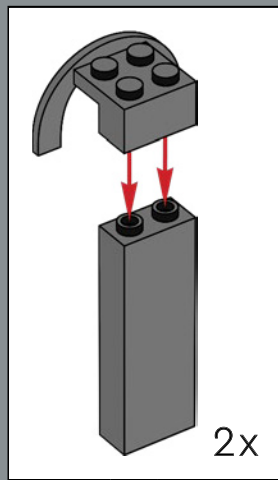

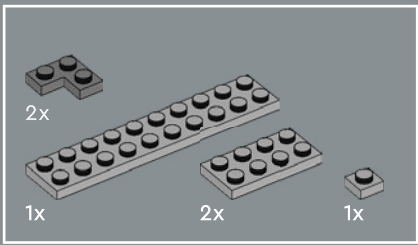

85

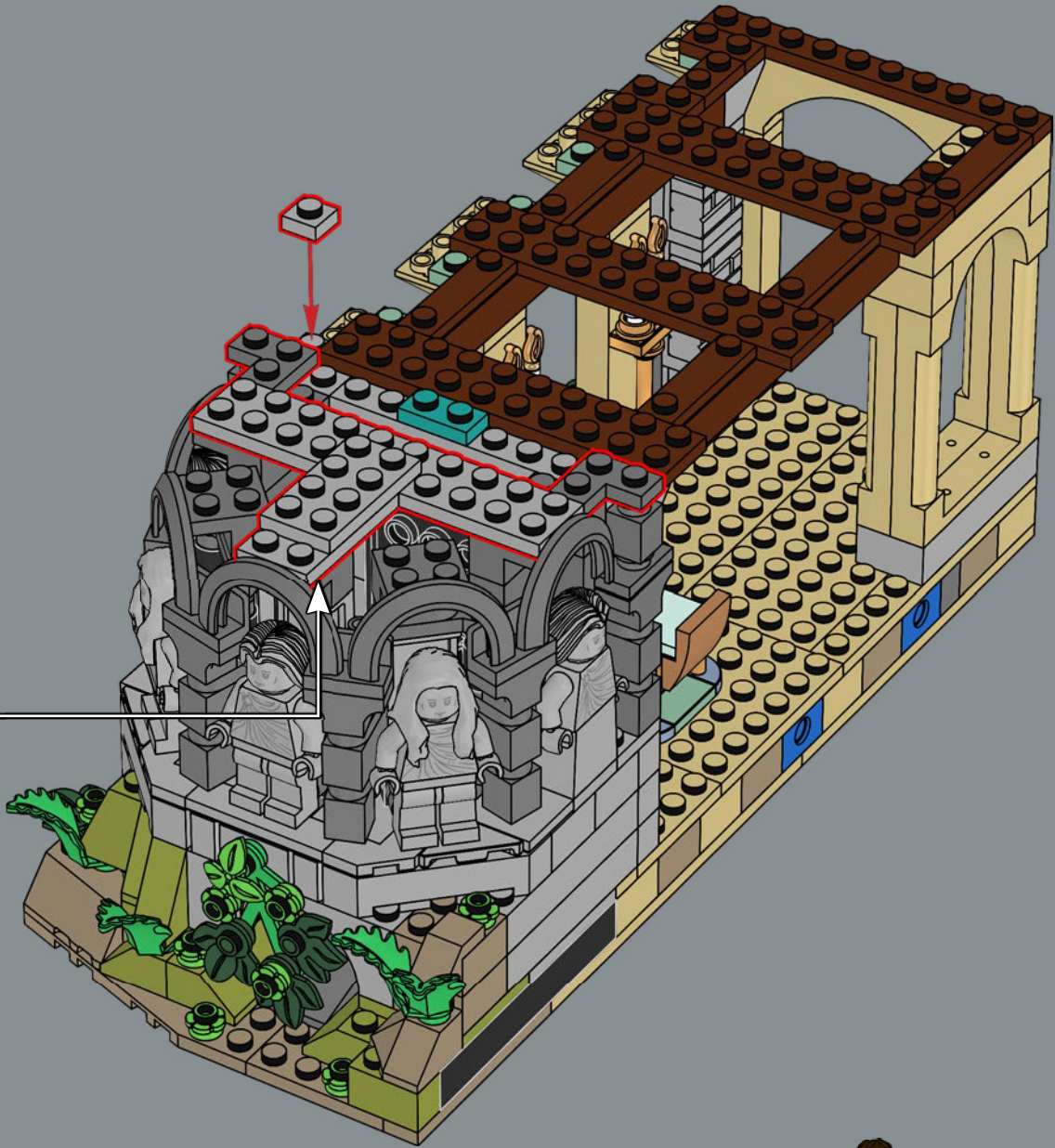
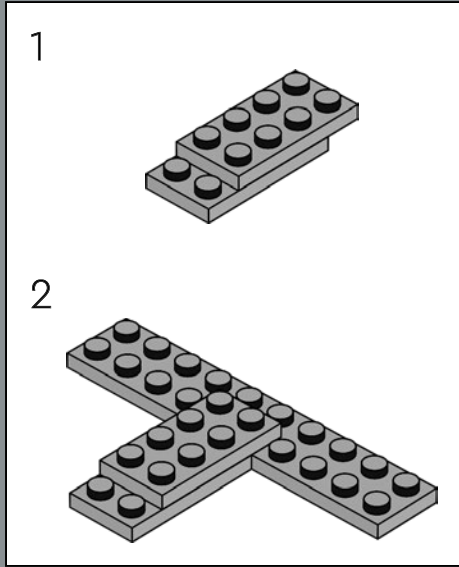

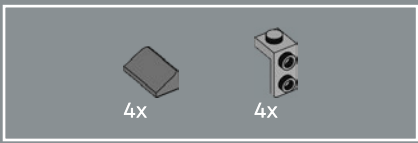

86

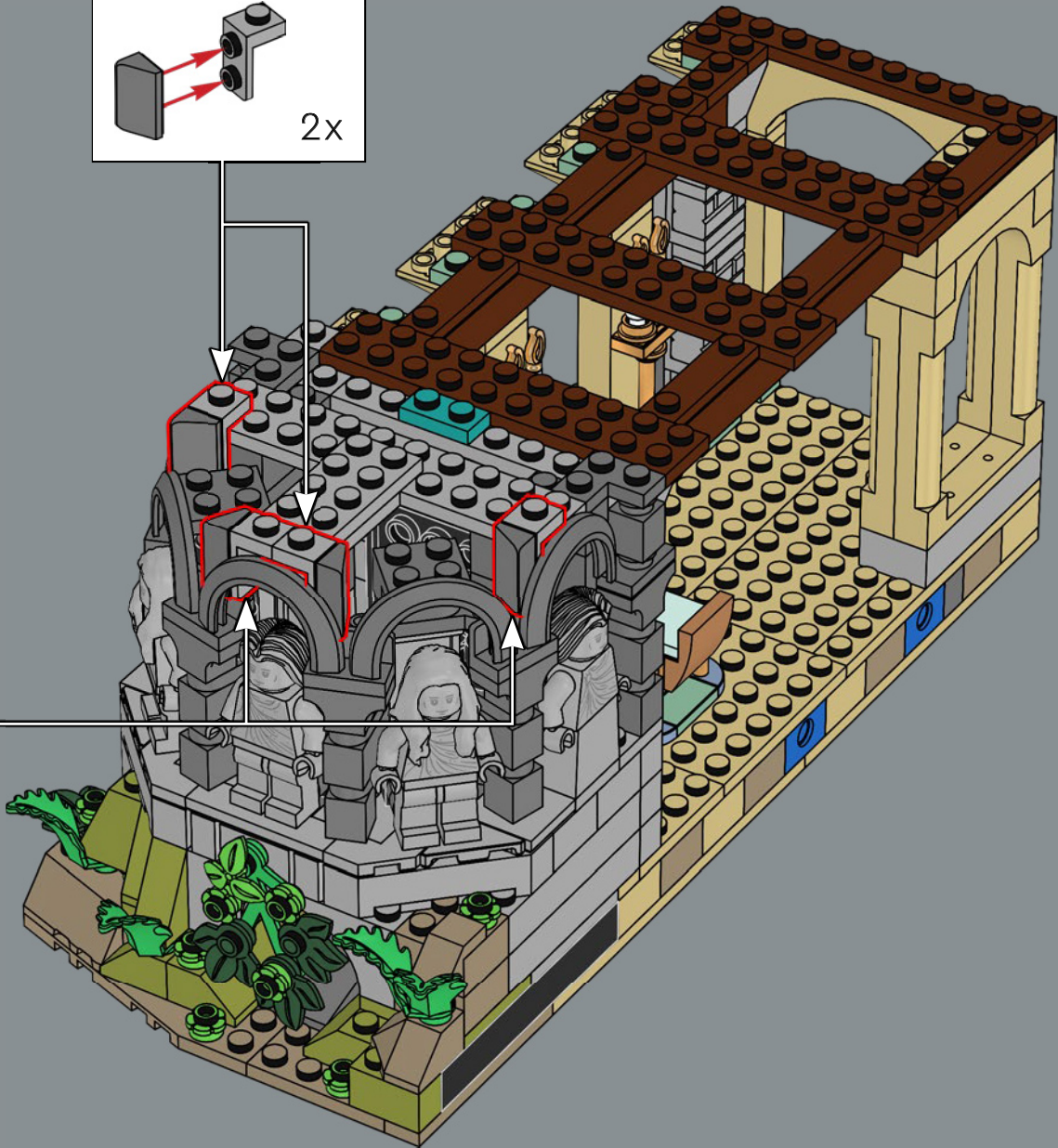
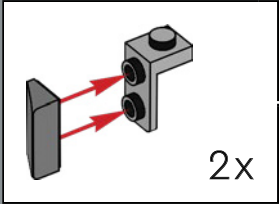
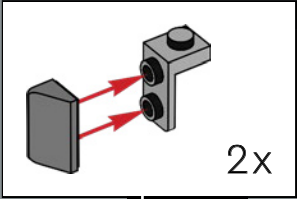

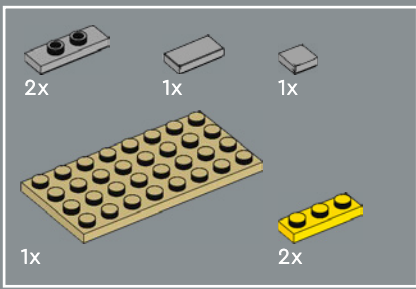

87



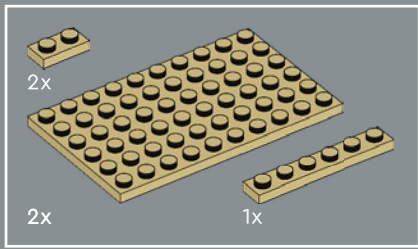

88

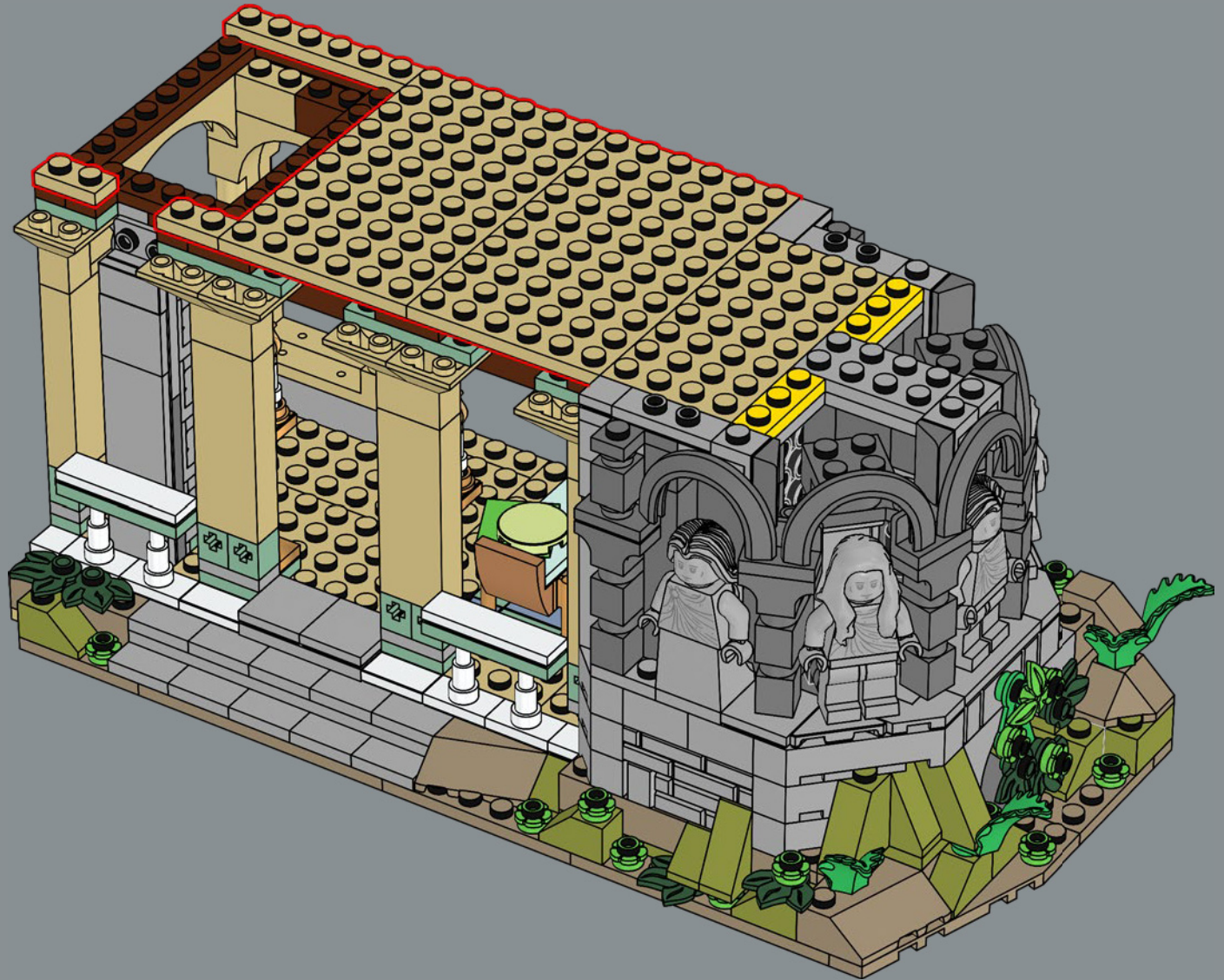

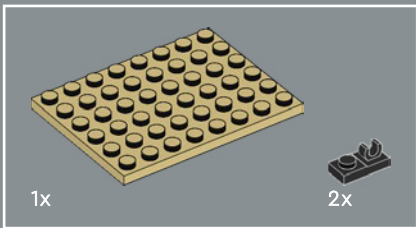
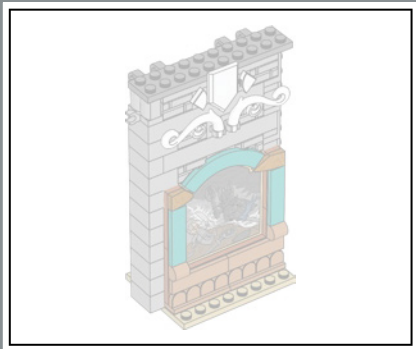

89

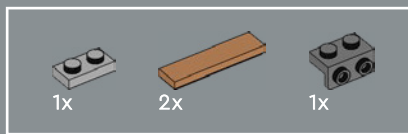
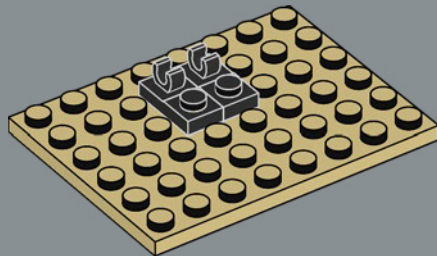

90

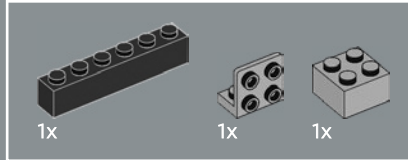
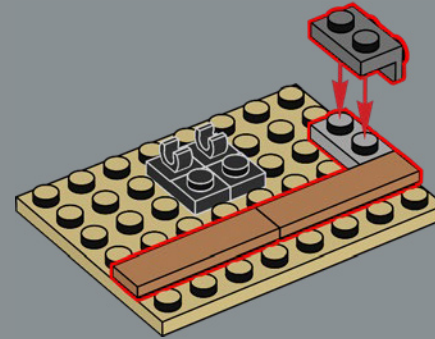

91

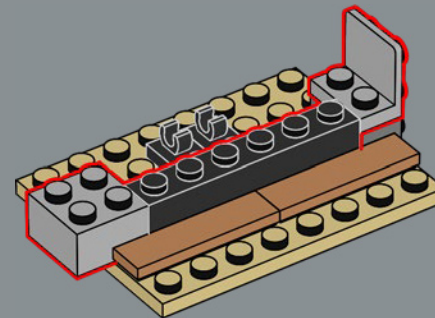

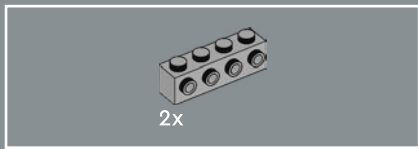

92

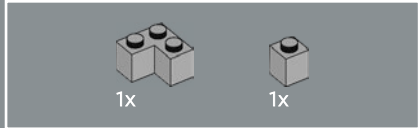
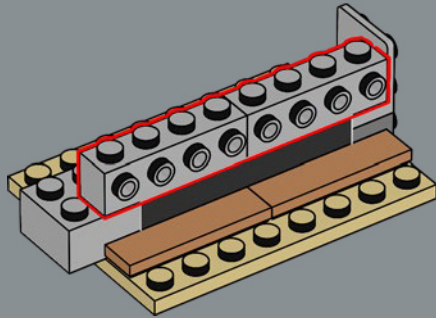

93

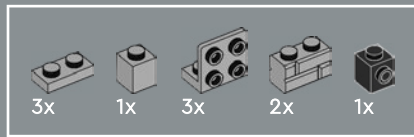
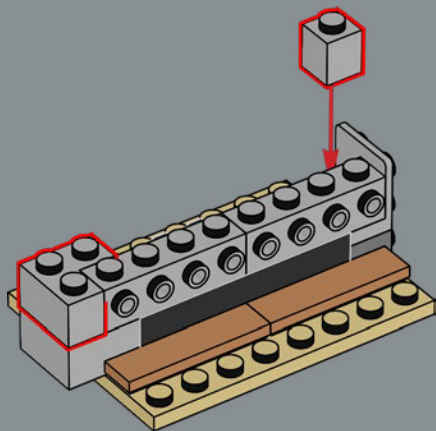

94

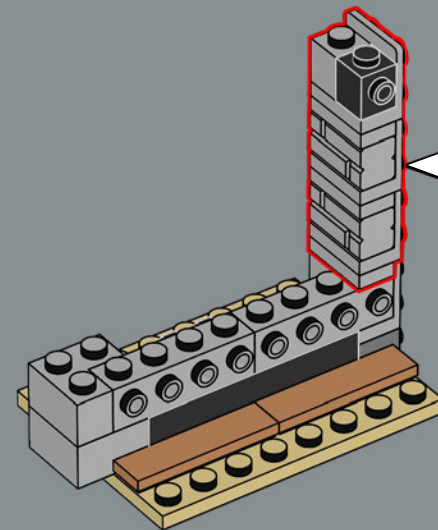
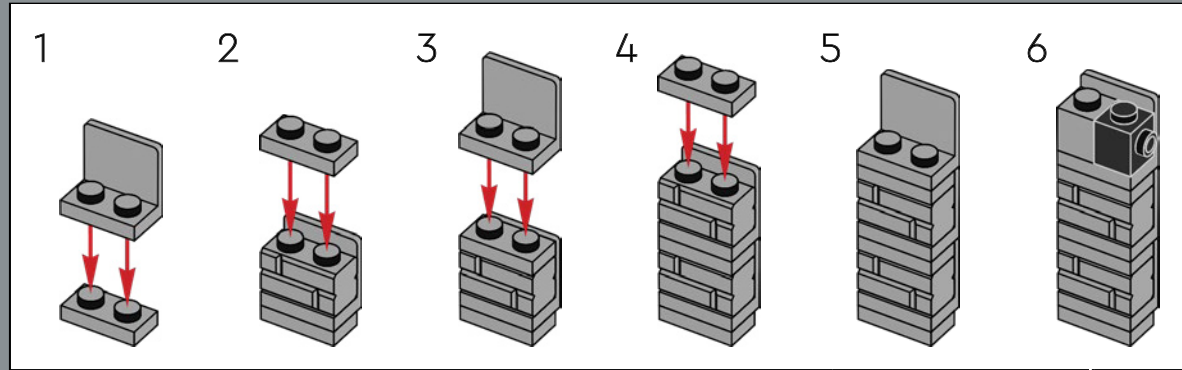

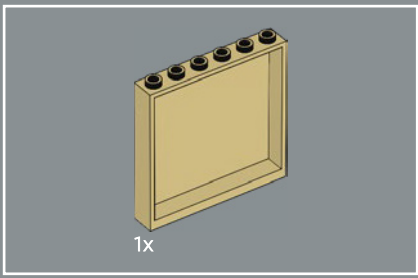

95

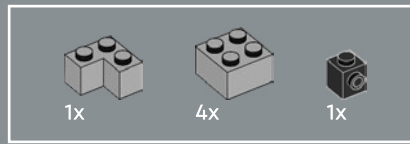
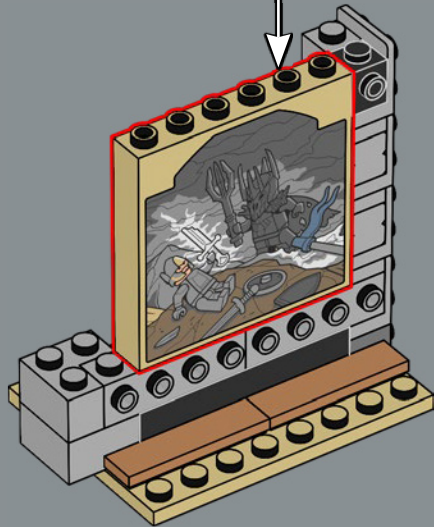
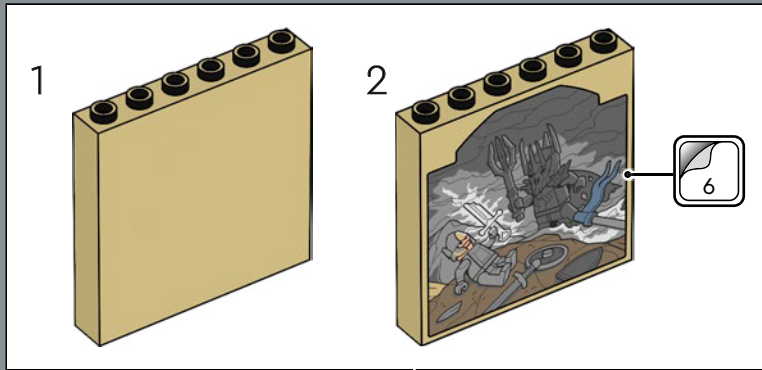

96

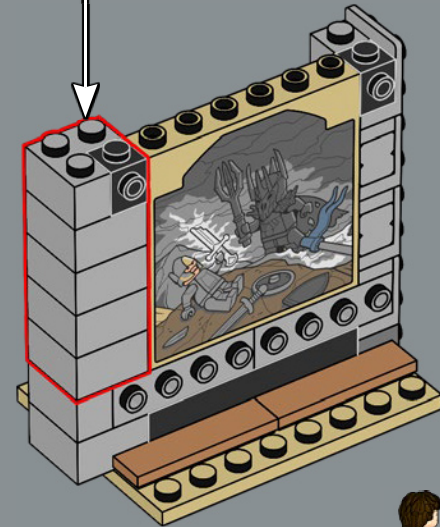
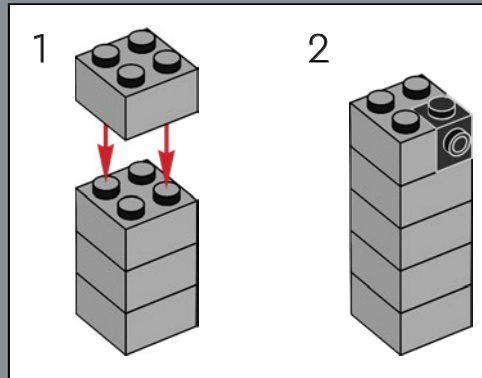

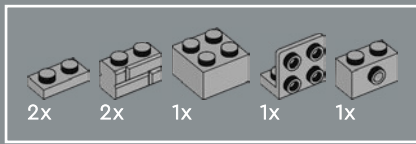

97

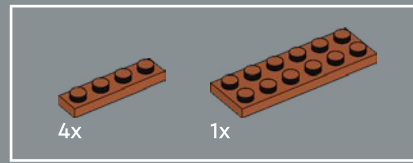
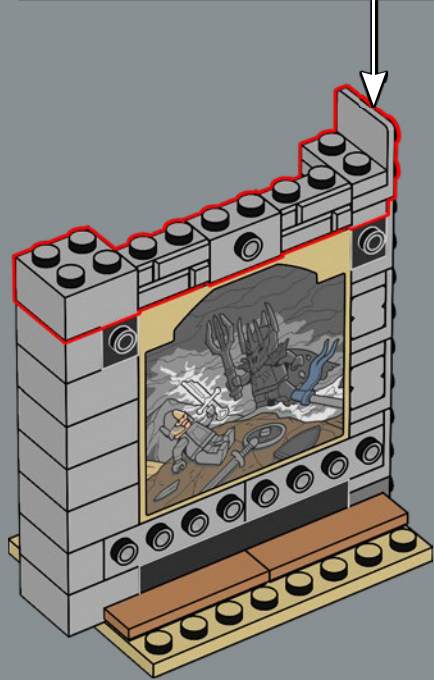
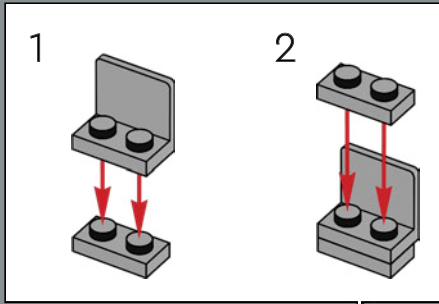

98

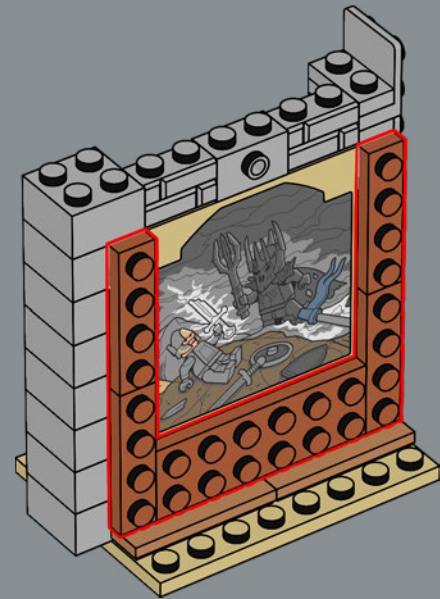

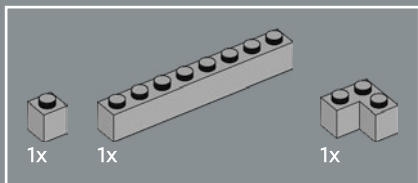

99

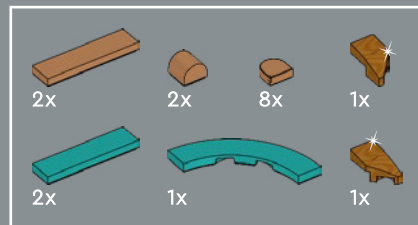
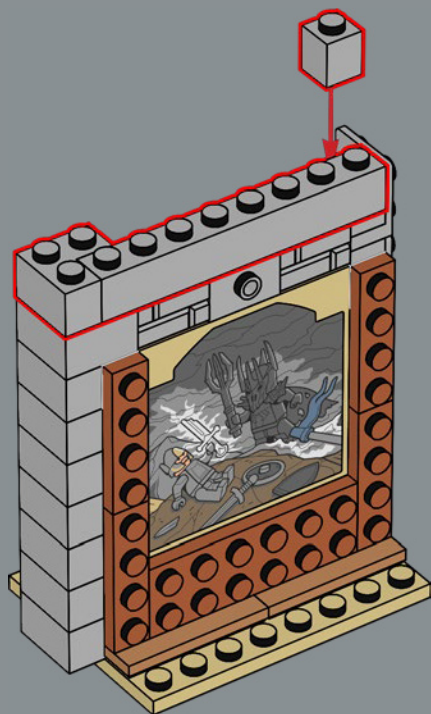

100

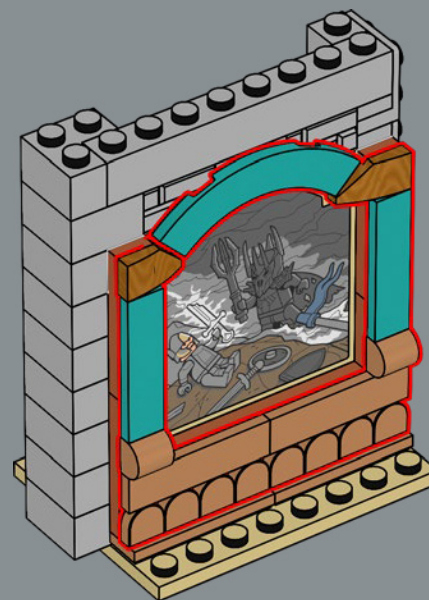

La destrucción de Sauron llevada al universo LEGO® incluye un elemento rediseñado que representa la empuñadura de Narsil y un vistoso marco azulado.



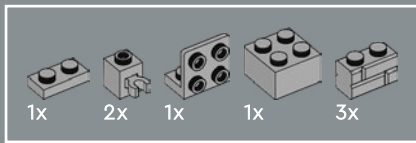

101

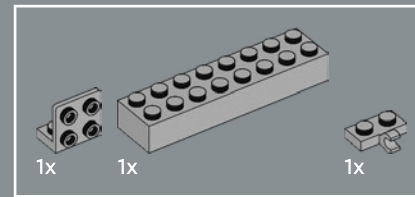
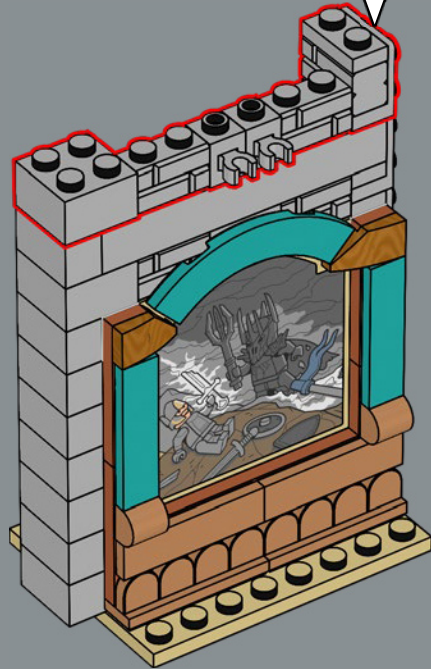
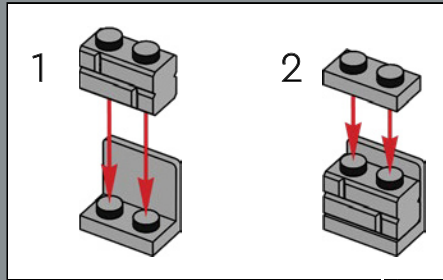

102

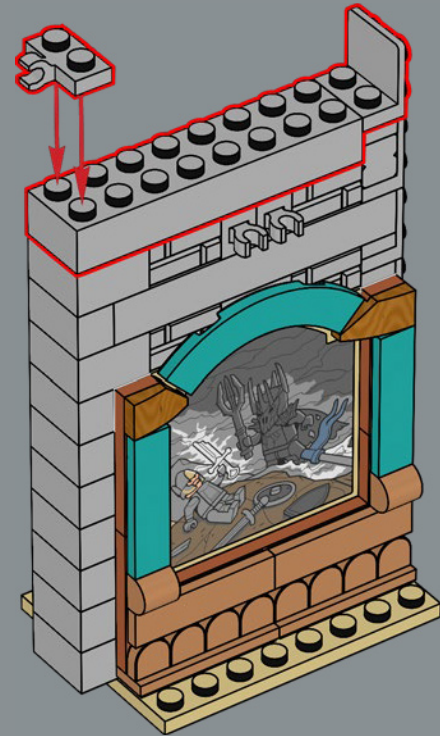

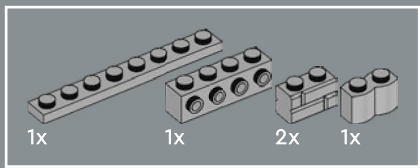

103

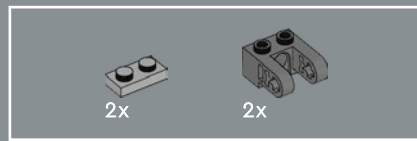
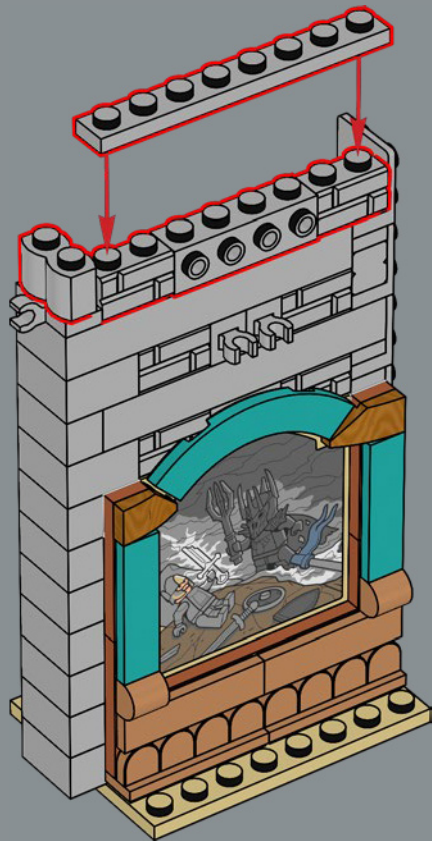

104

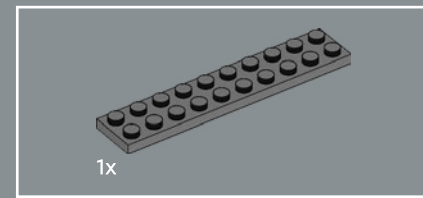
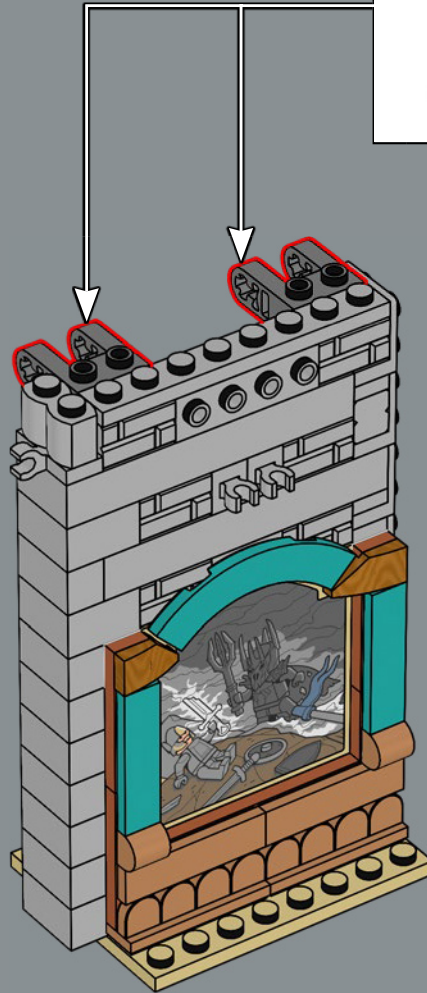
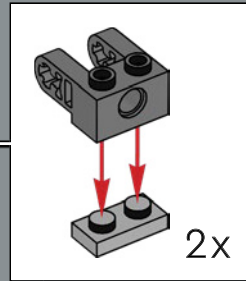

105

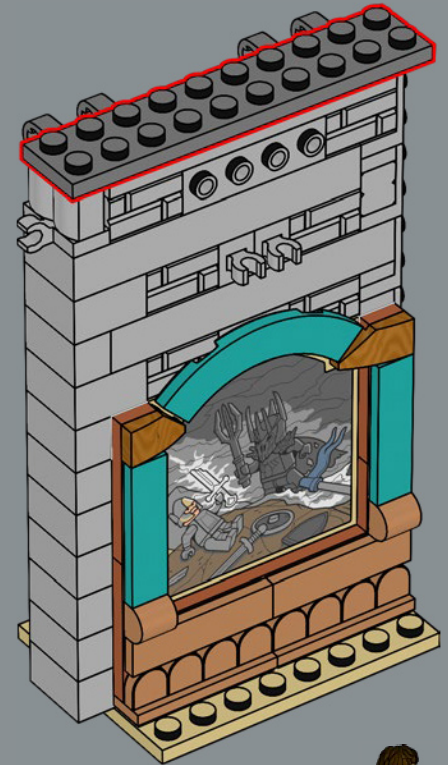



106



107

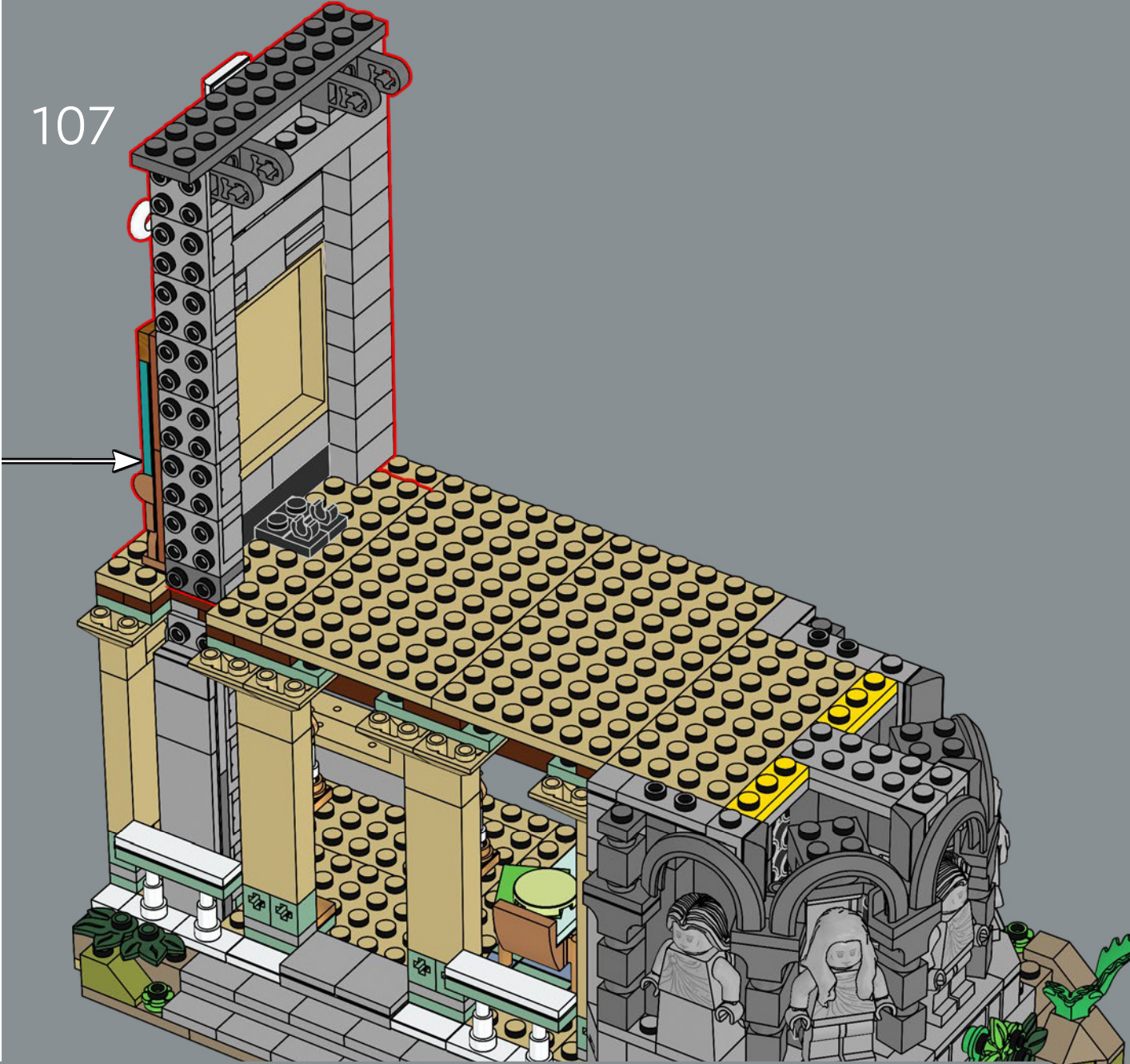

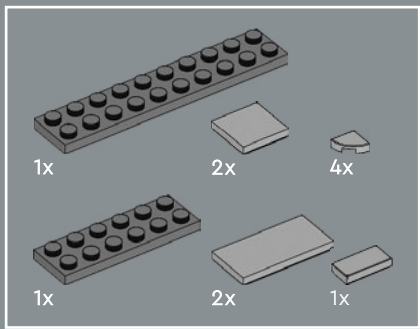

108

1

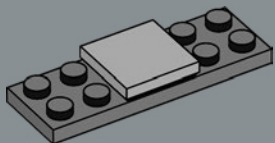

2

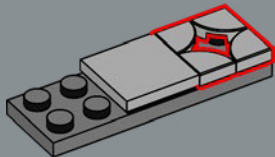

3

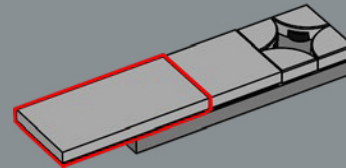

4

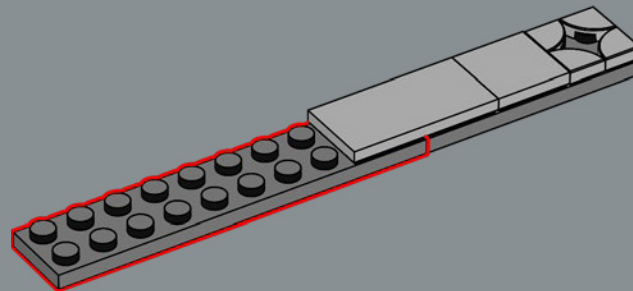

5

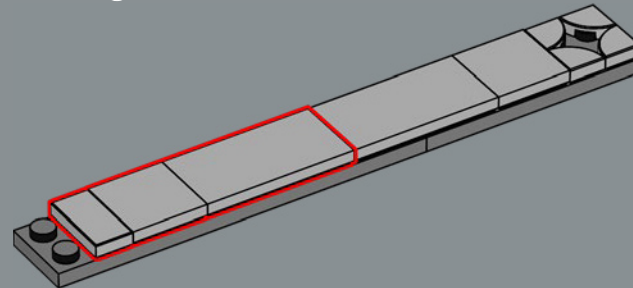

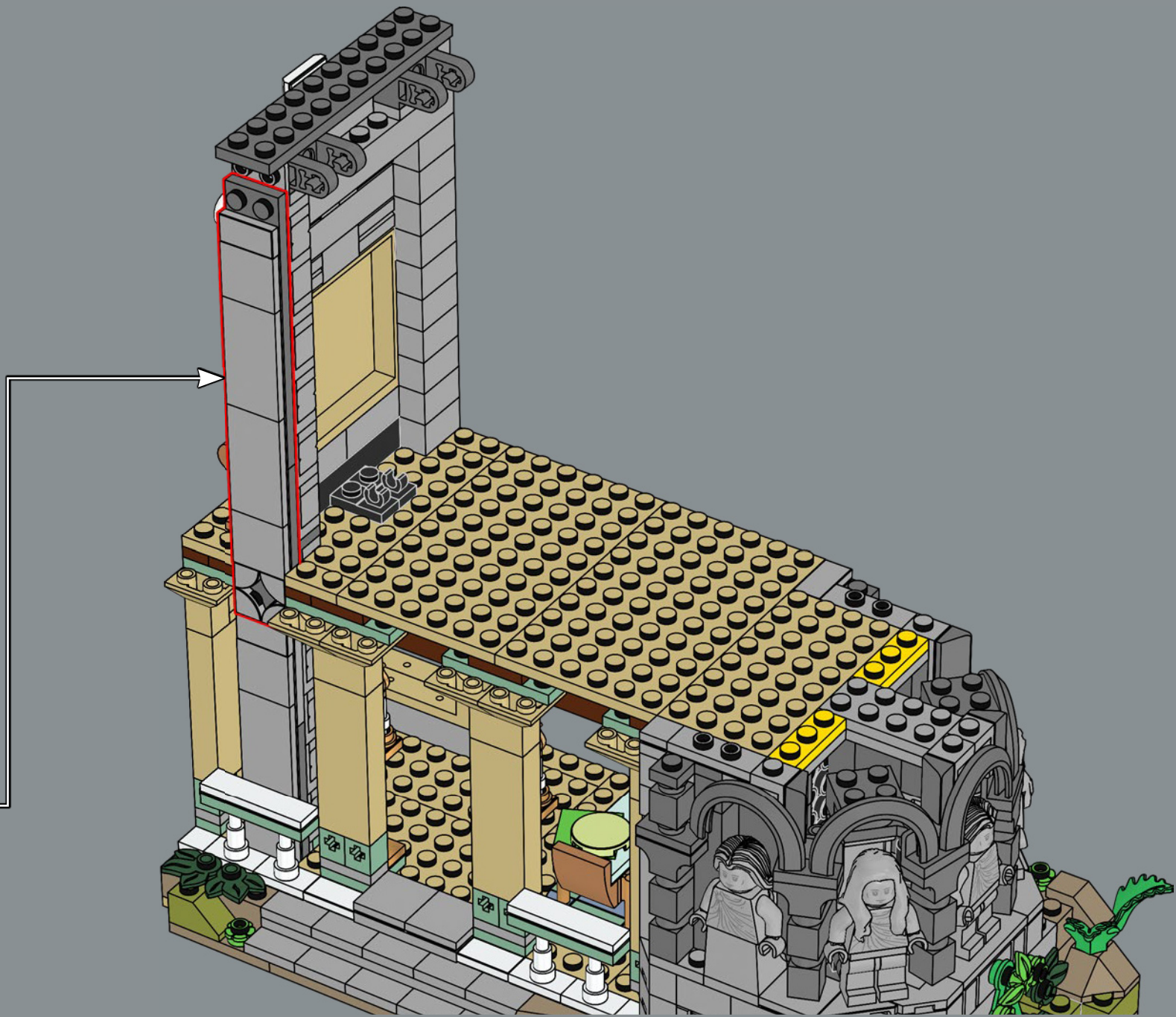

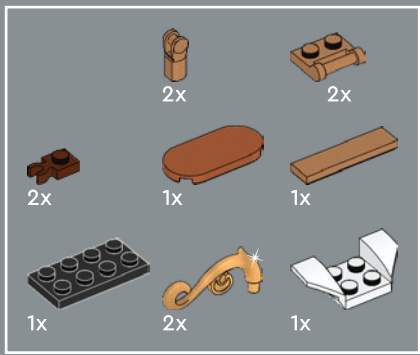

109

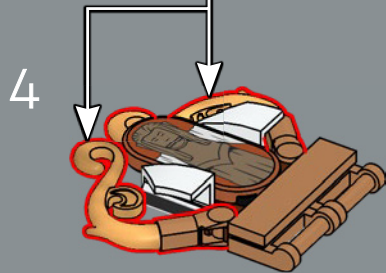
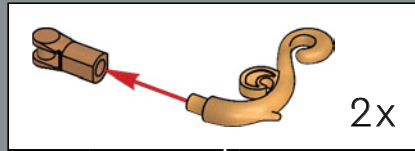
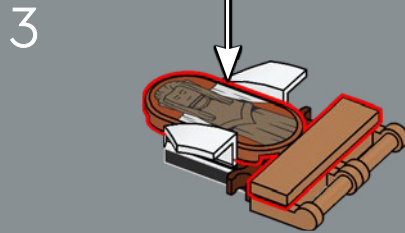
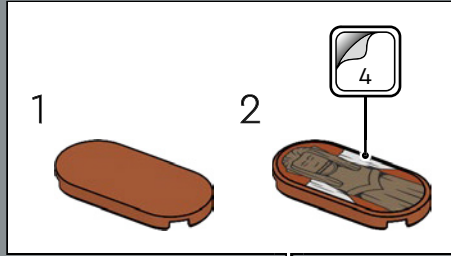
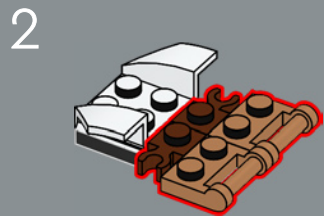
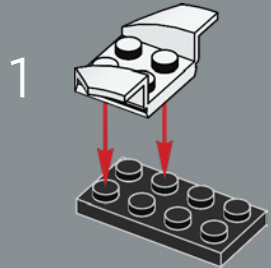

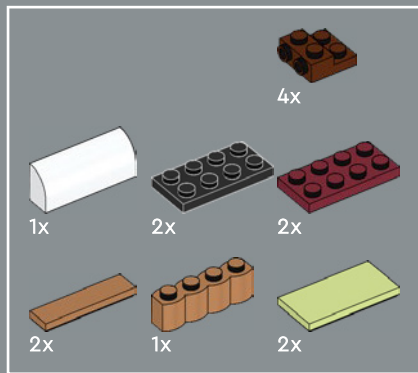

110

1

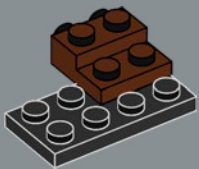

2

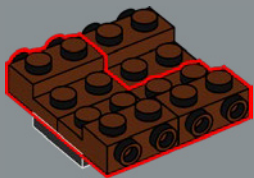

3

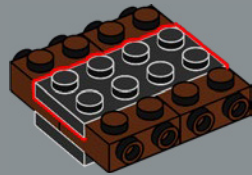

4



5



6

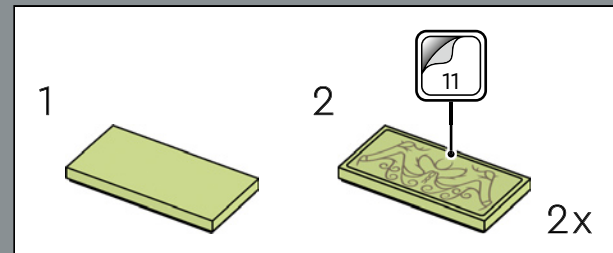
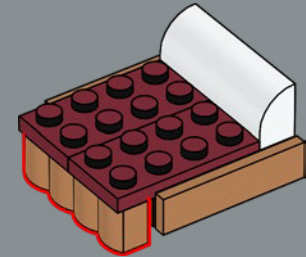

7

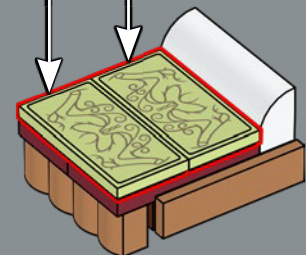

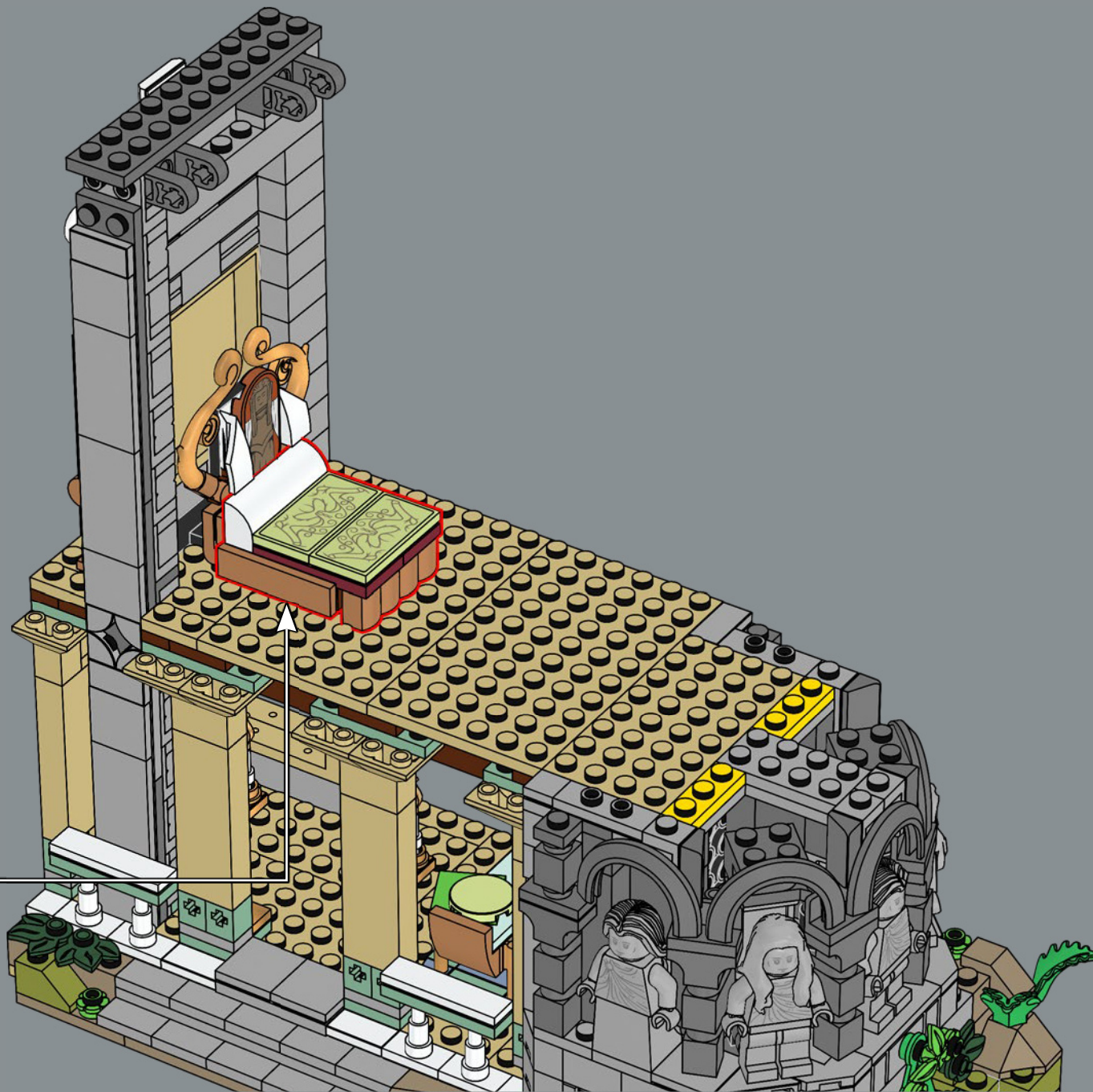



111

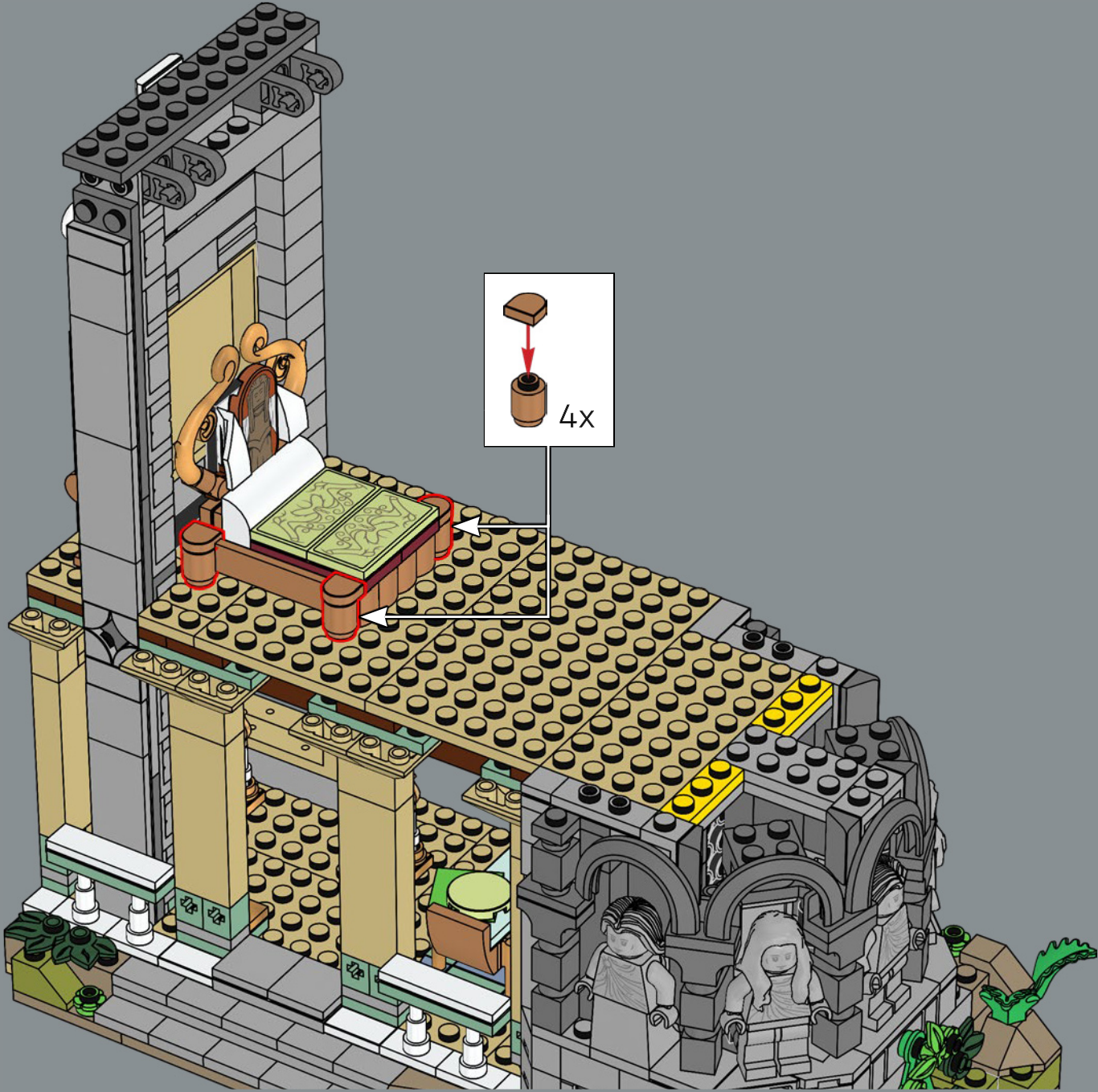

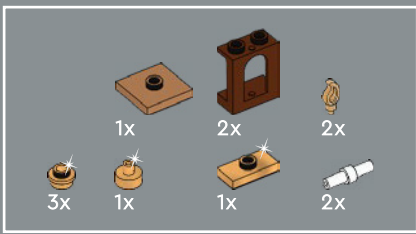

112

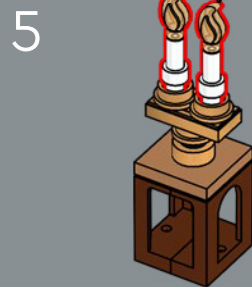
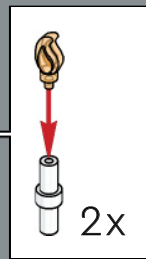
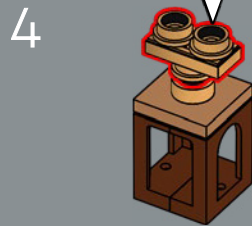
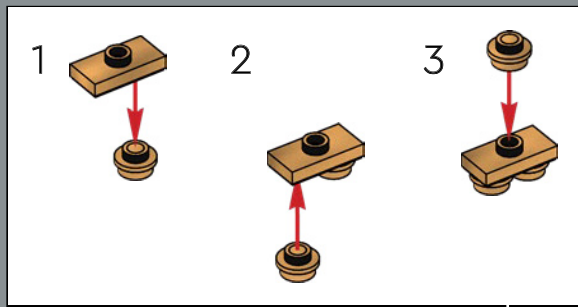
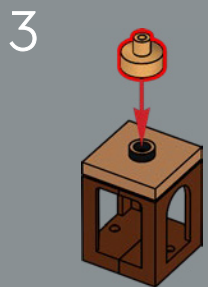
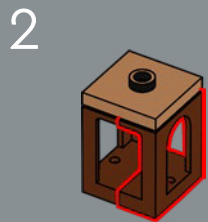
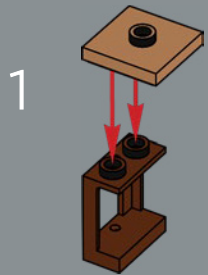

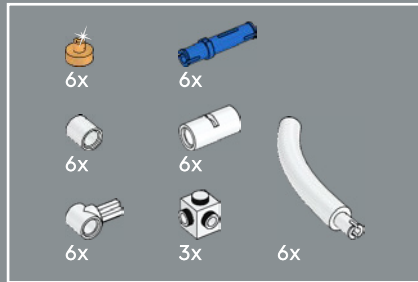
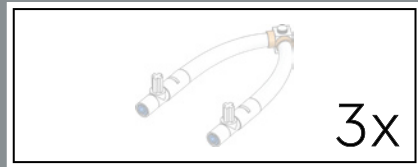

1



2



3

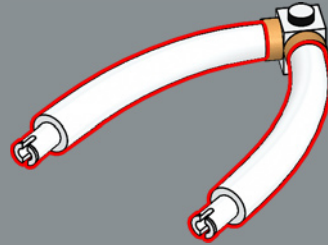

4

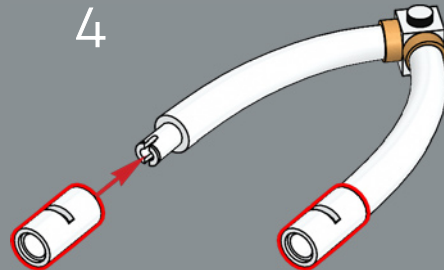

5

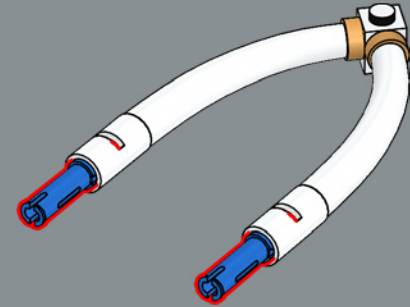

6

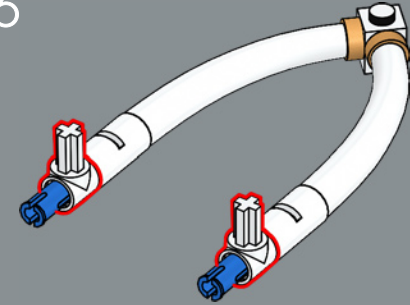

7

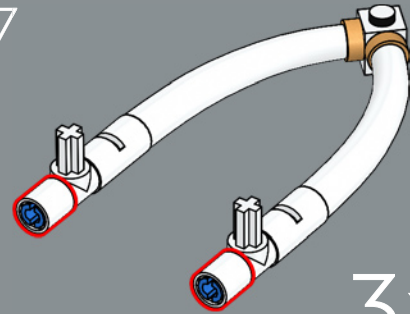

3x

113





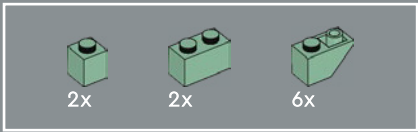

114



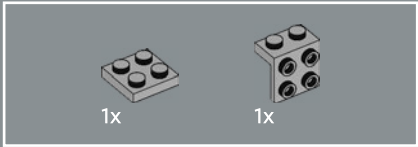
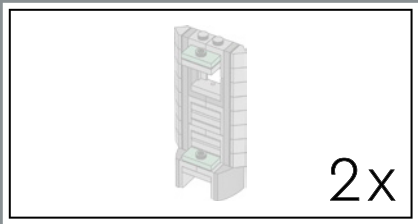

115

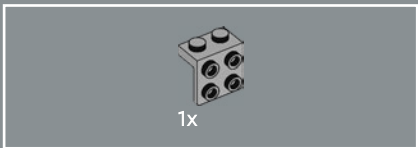
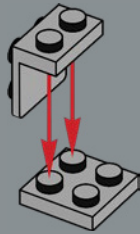

116

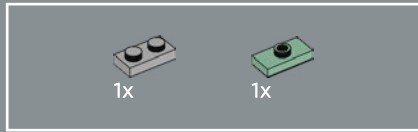
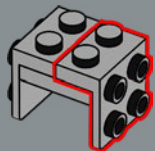

117

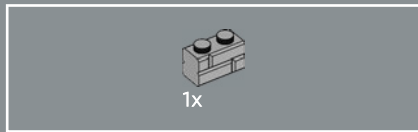
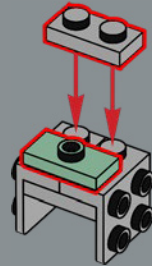

118

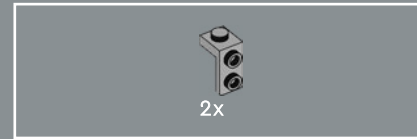
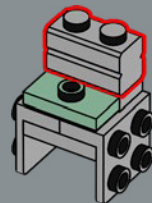

119

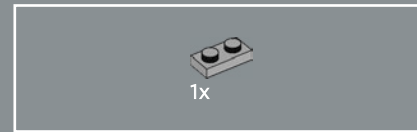
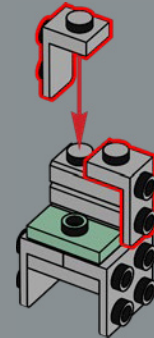

120

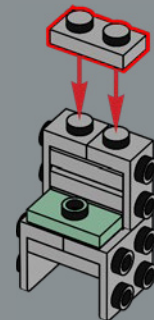

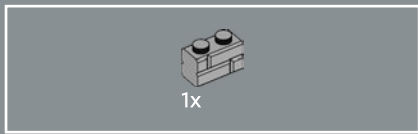

121

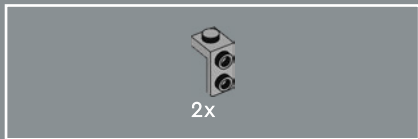
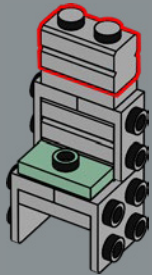

122

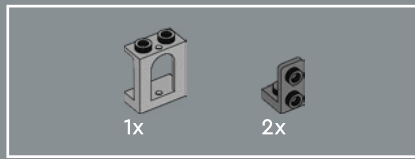
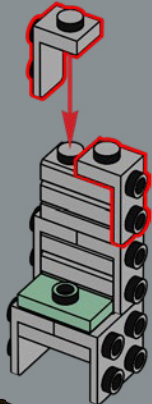

123

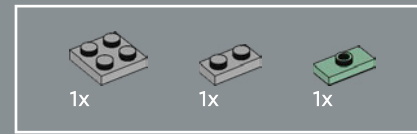
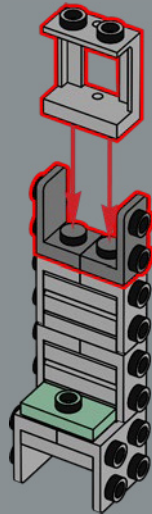

124

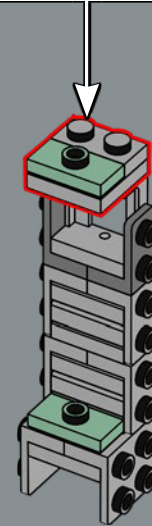
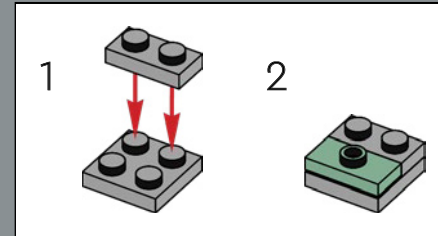



2x

125

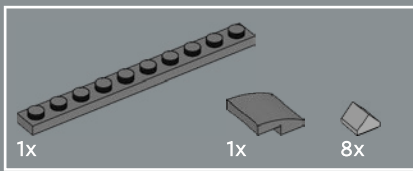
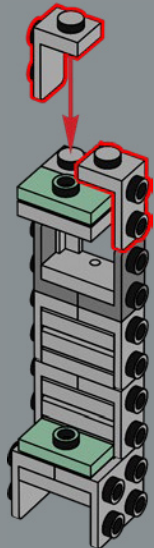

126

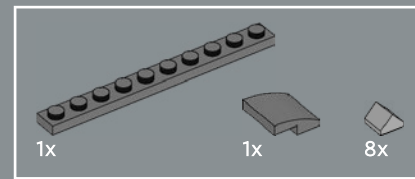
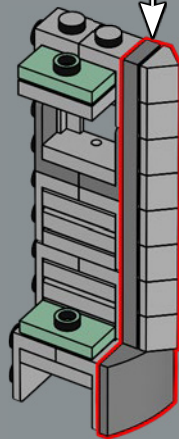
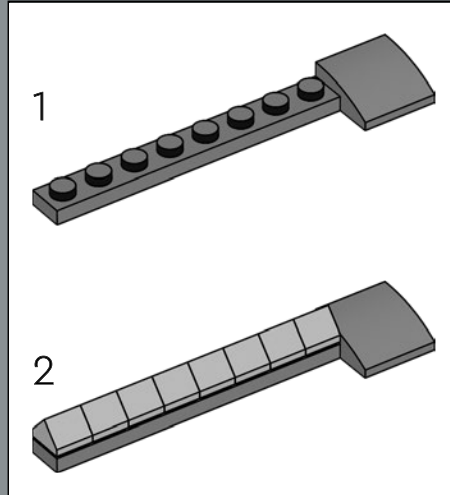

127

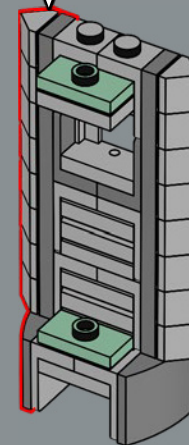
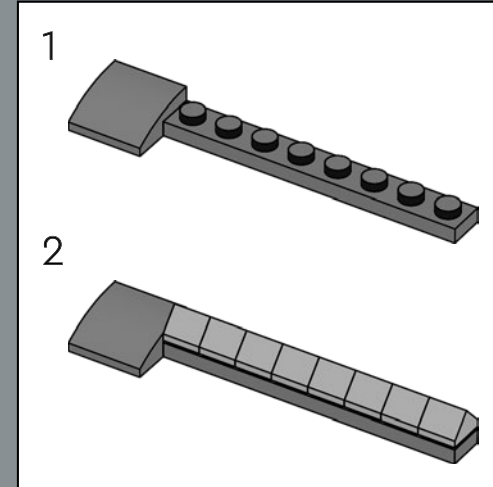

2x

128



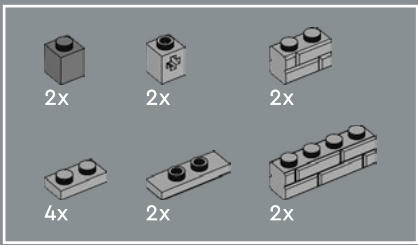

129

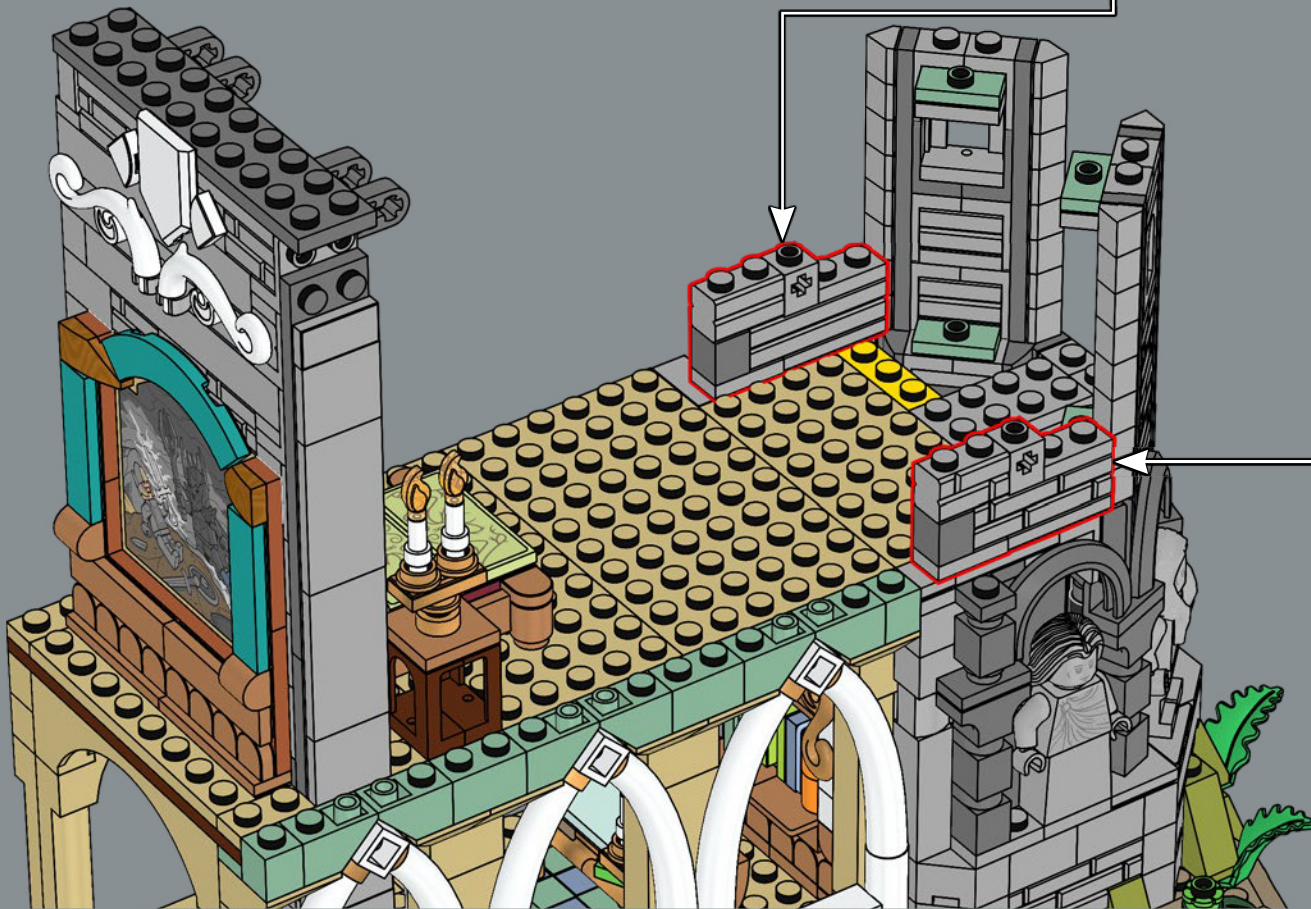
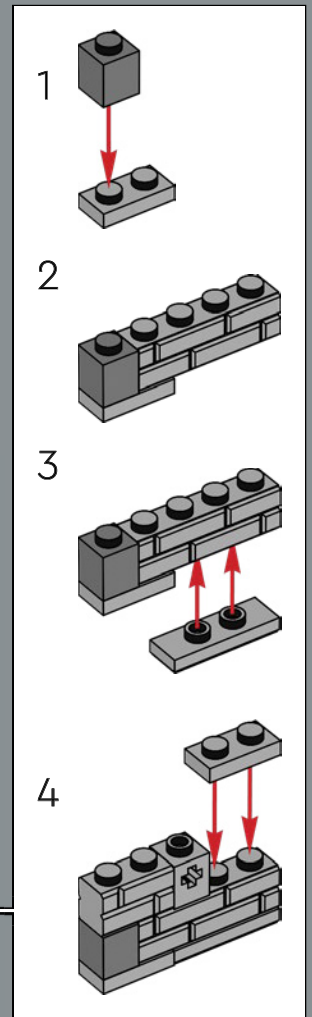
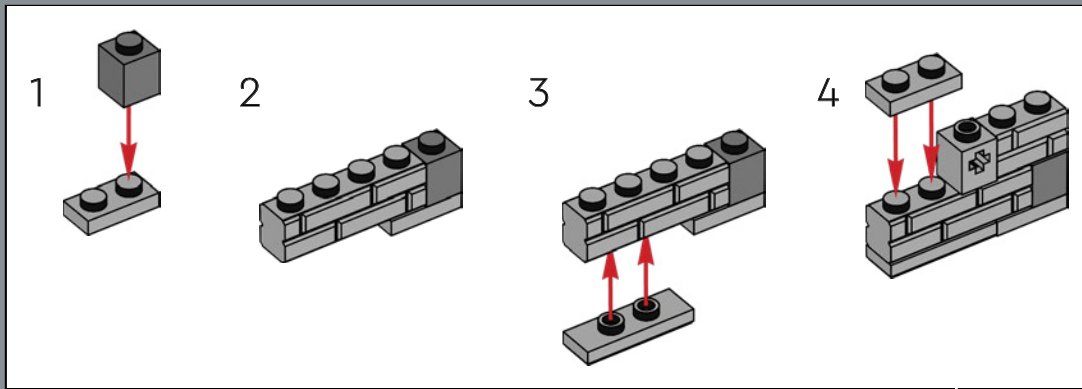

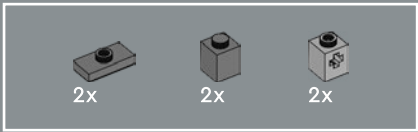

130

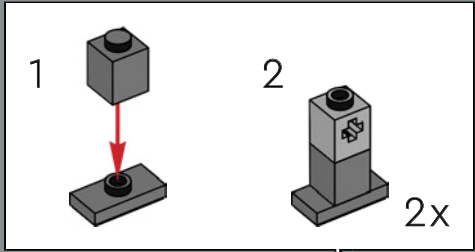

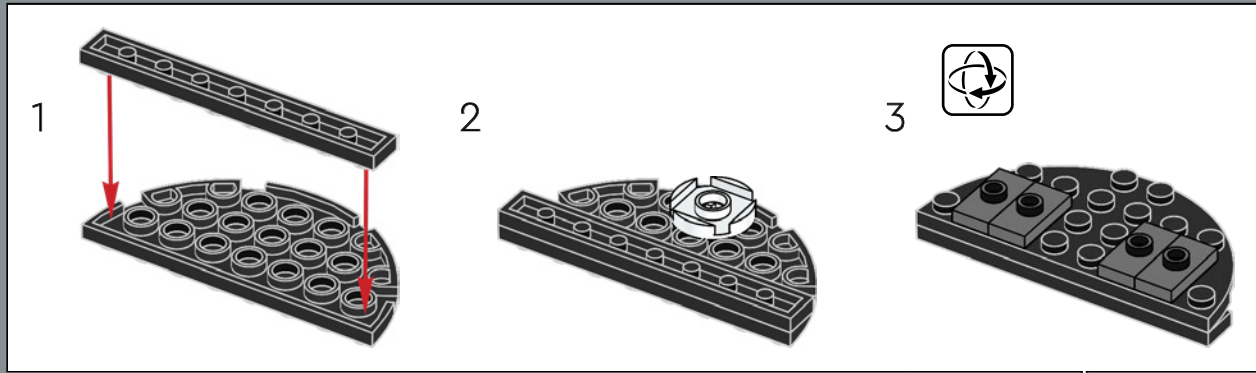
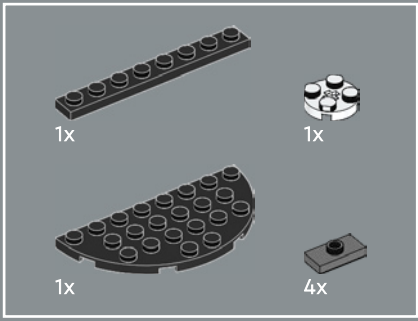

131

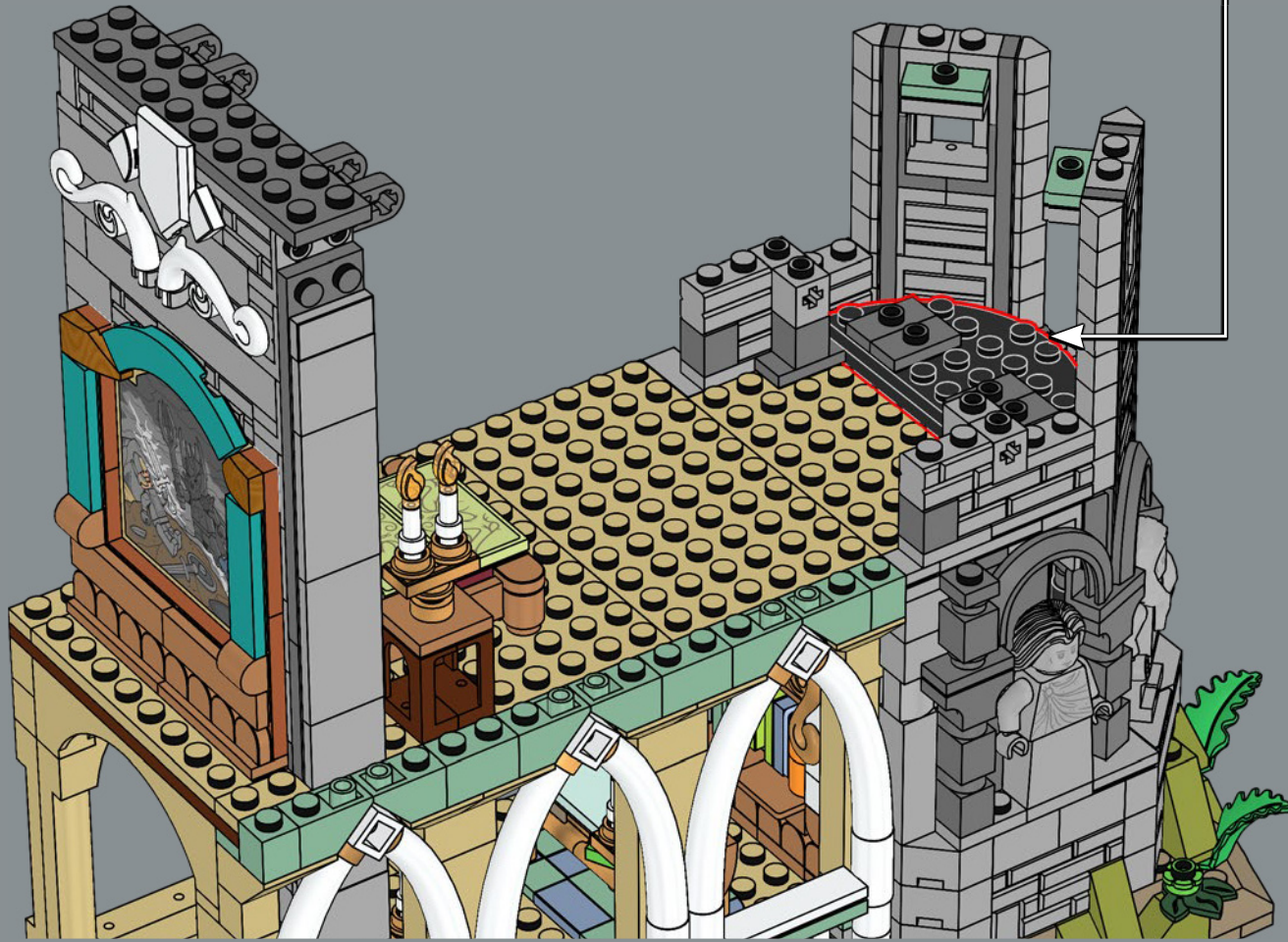

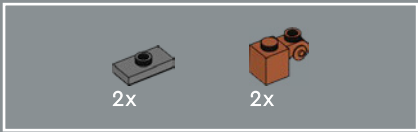

132

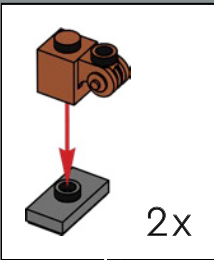

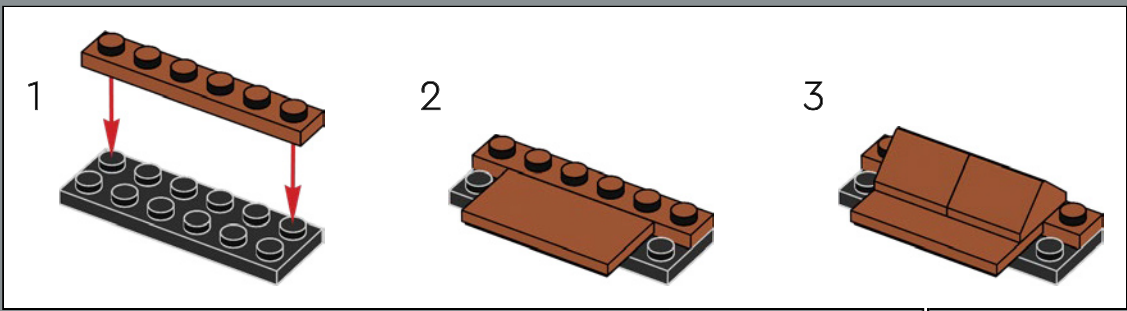
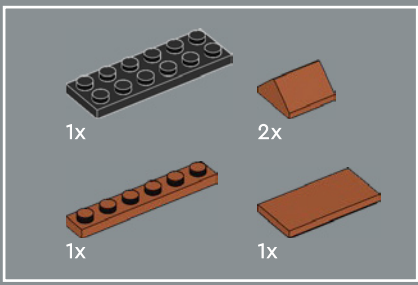

133



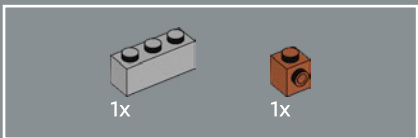

134

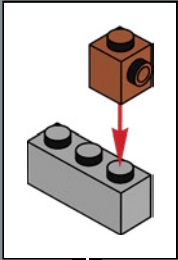



Además de ser un fantástico lugar para escribir un libro, este escritorio proporciona estabilidad estructural al techo y la torre, que se colocarán después.

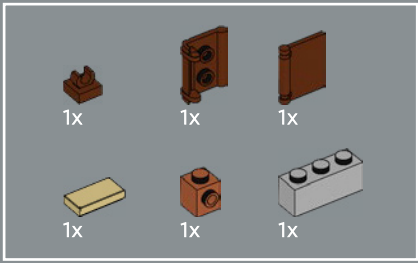

135

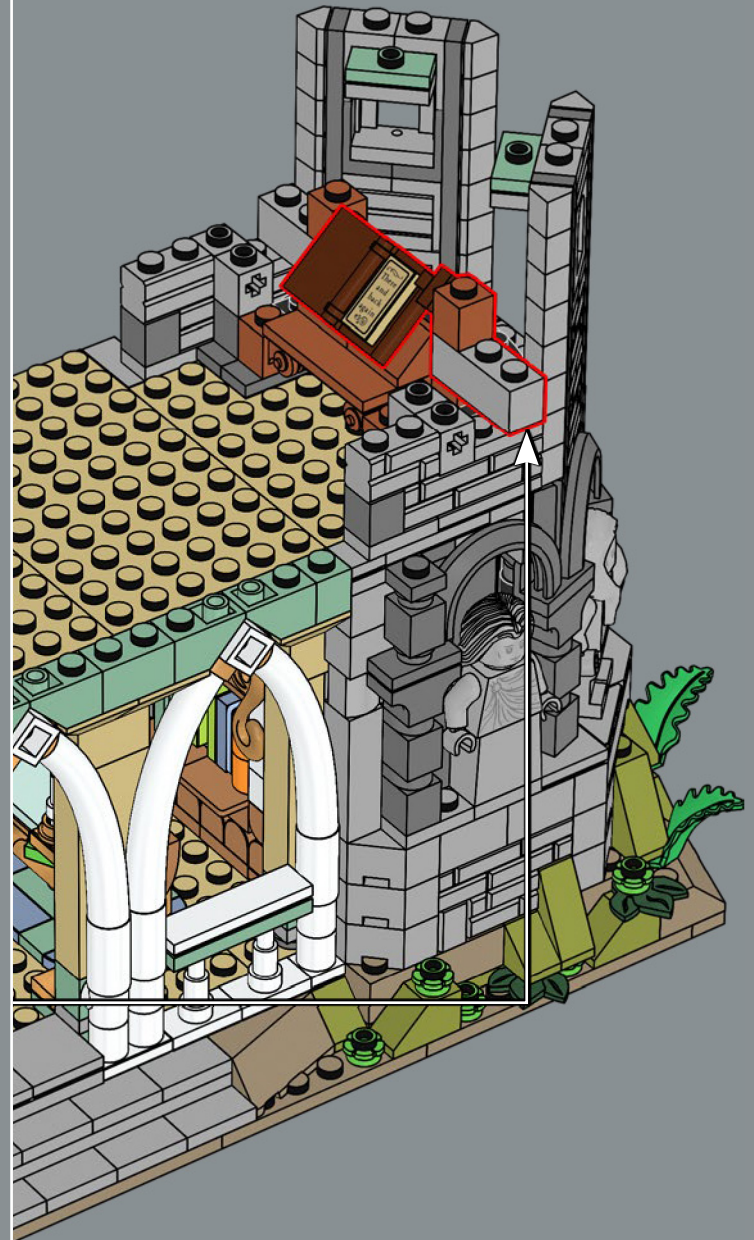
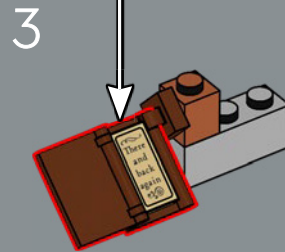
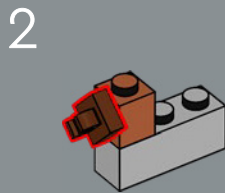
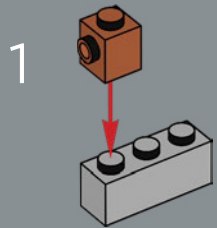
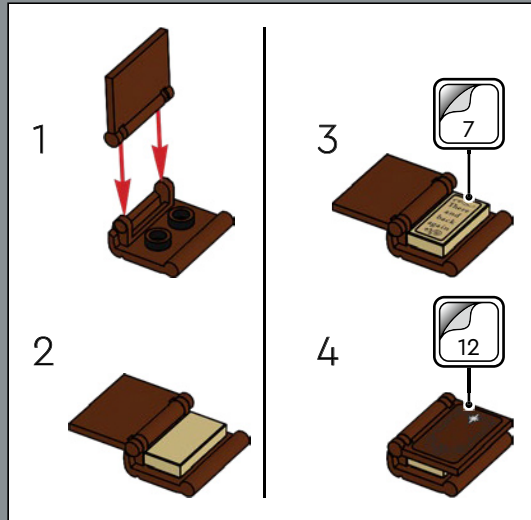

-  2x
-  1x
-  2x
-  1x
-  2x
-  2x
-  1x

136

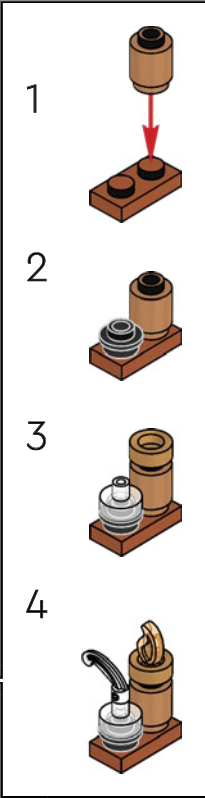
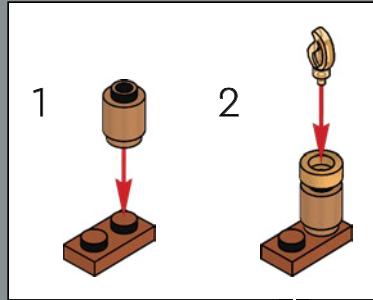

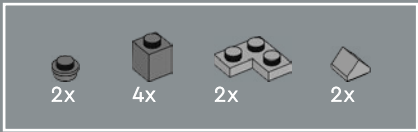

137

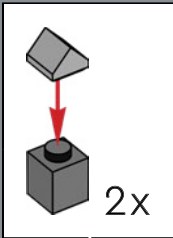



Esta es la primera vez que podemos encontrar una versión de Bilbo con más de 111 años en un set LEGO®. No dejes que vea el anillo, ¡o podría emocionarse demasiado!

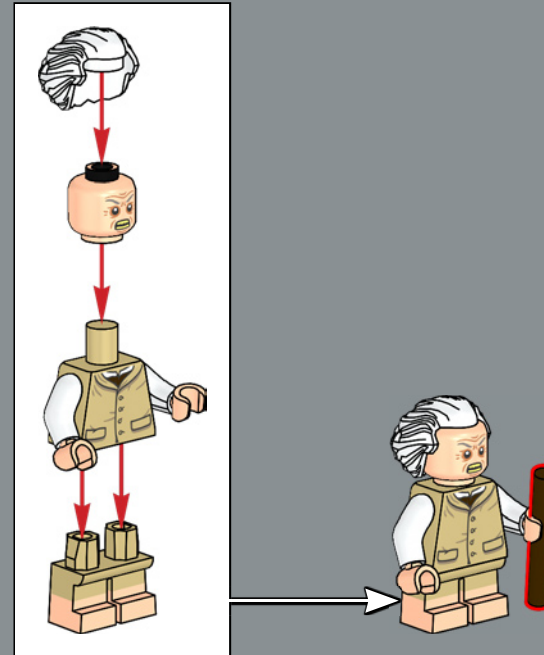

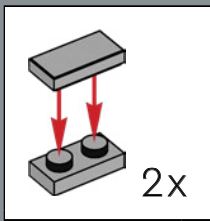
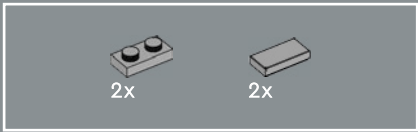

138

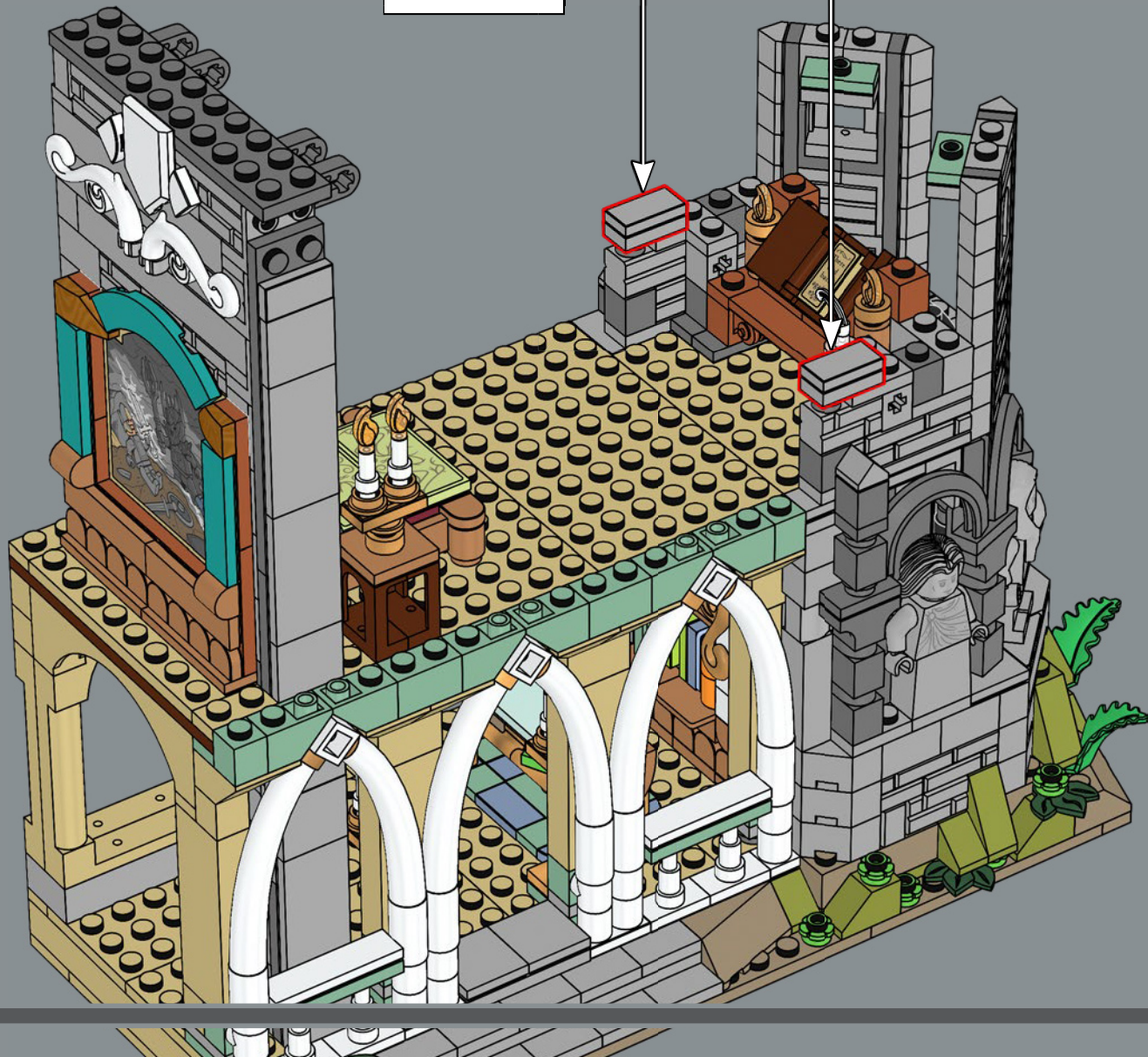

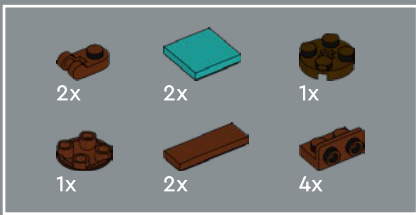

139

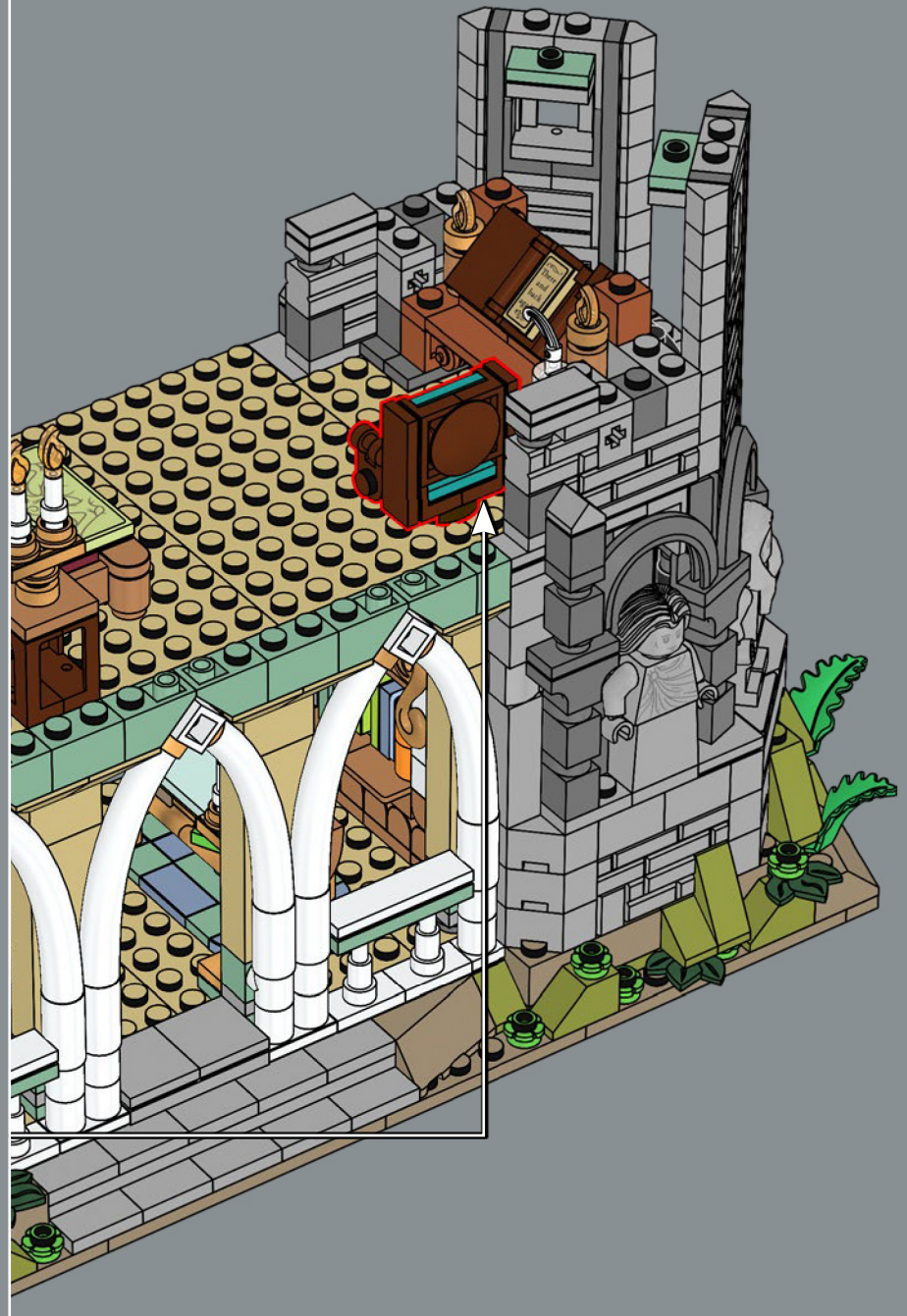
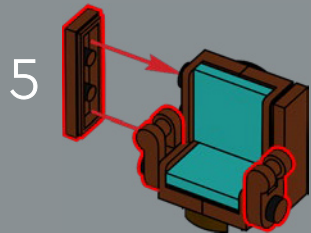
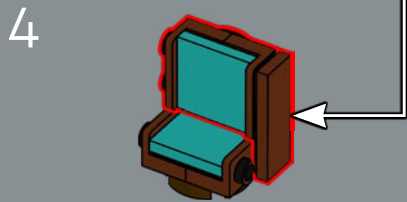
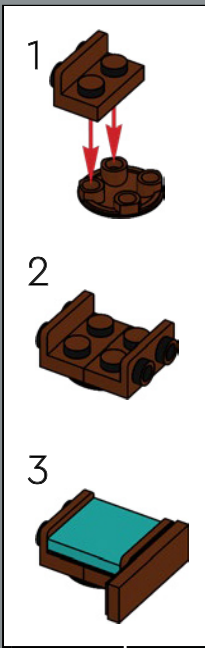
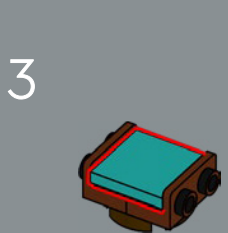
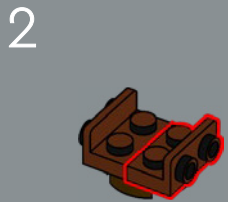
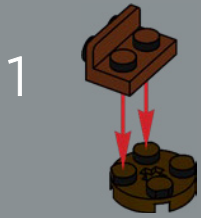

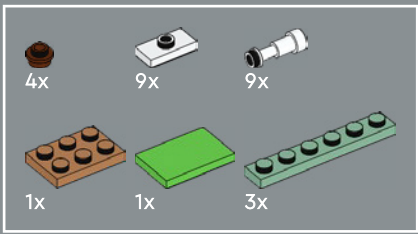

140

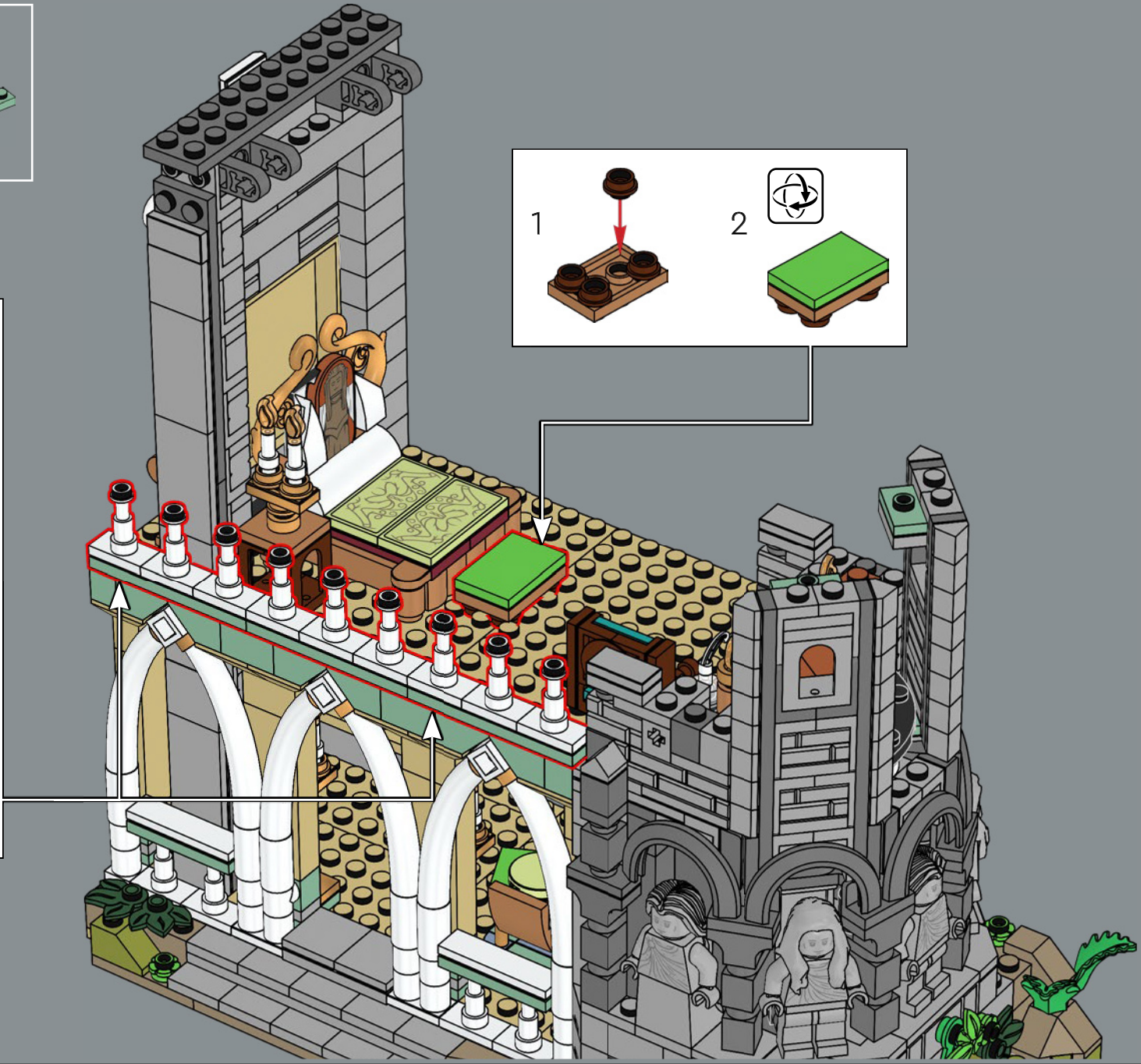
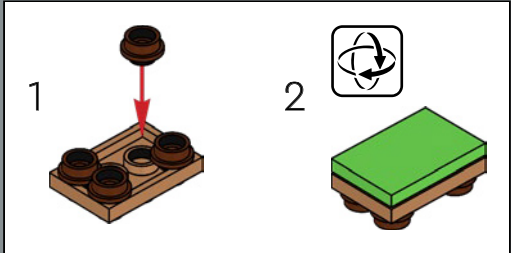
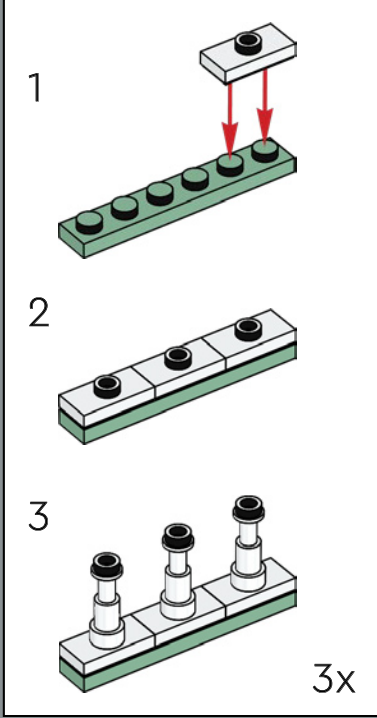

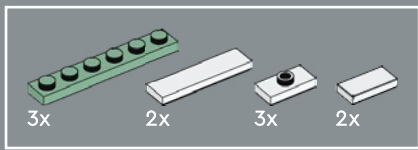

141

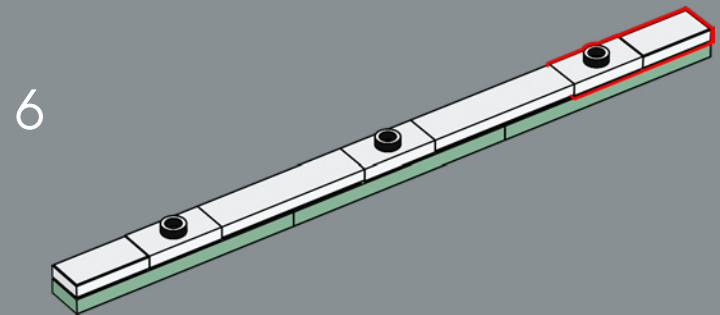
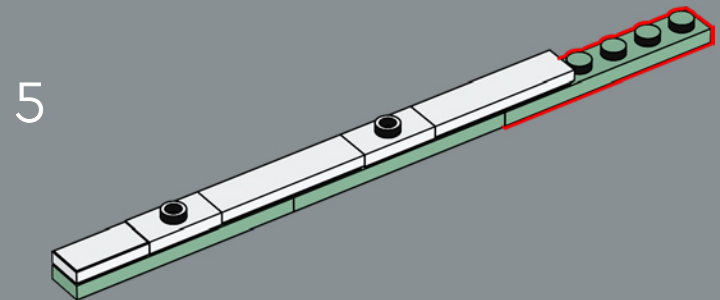
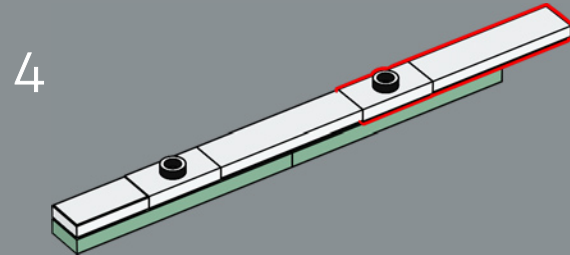
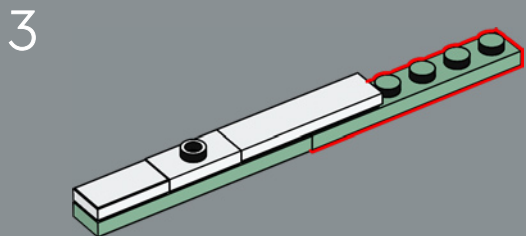
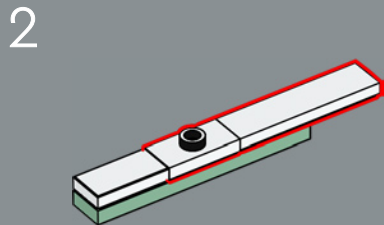
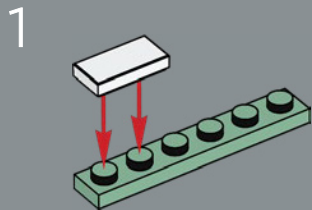



- 1x
- 2x
- 4x

142

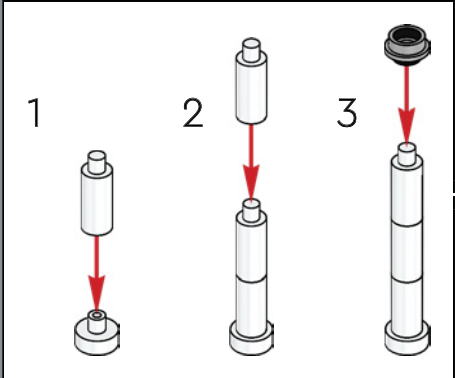

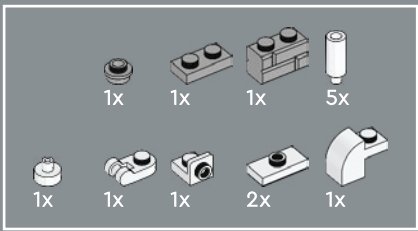

143

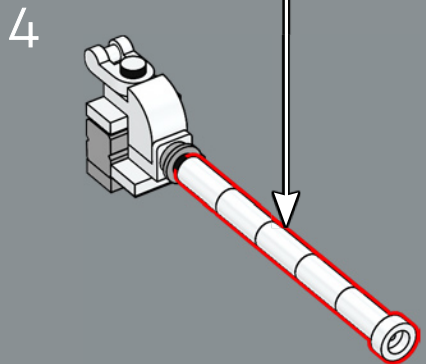
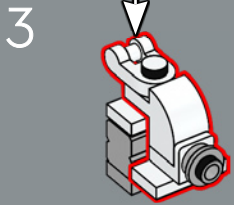
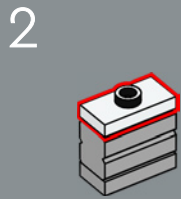
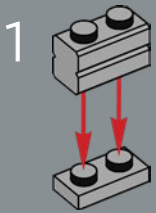
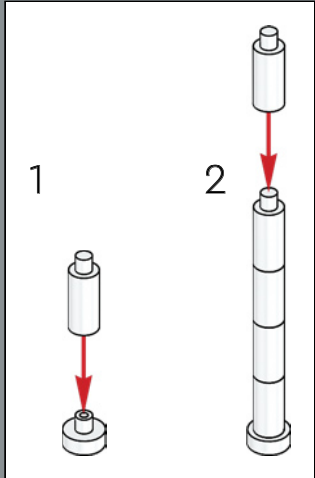
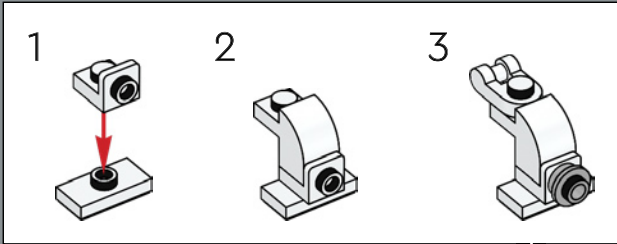

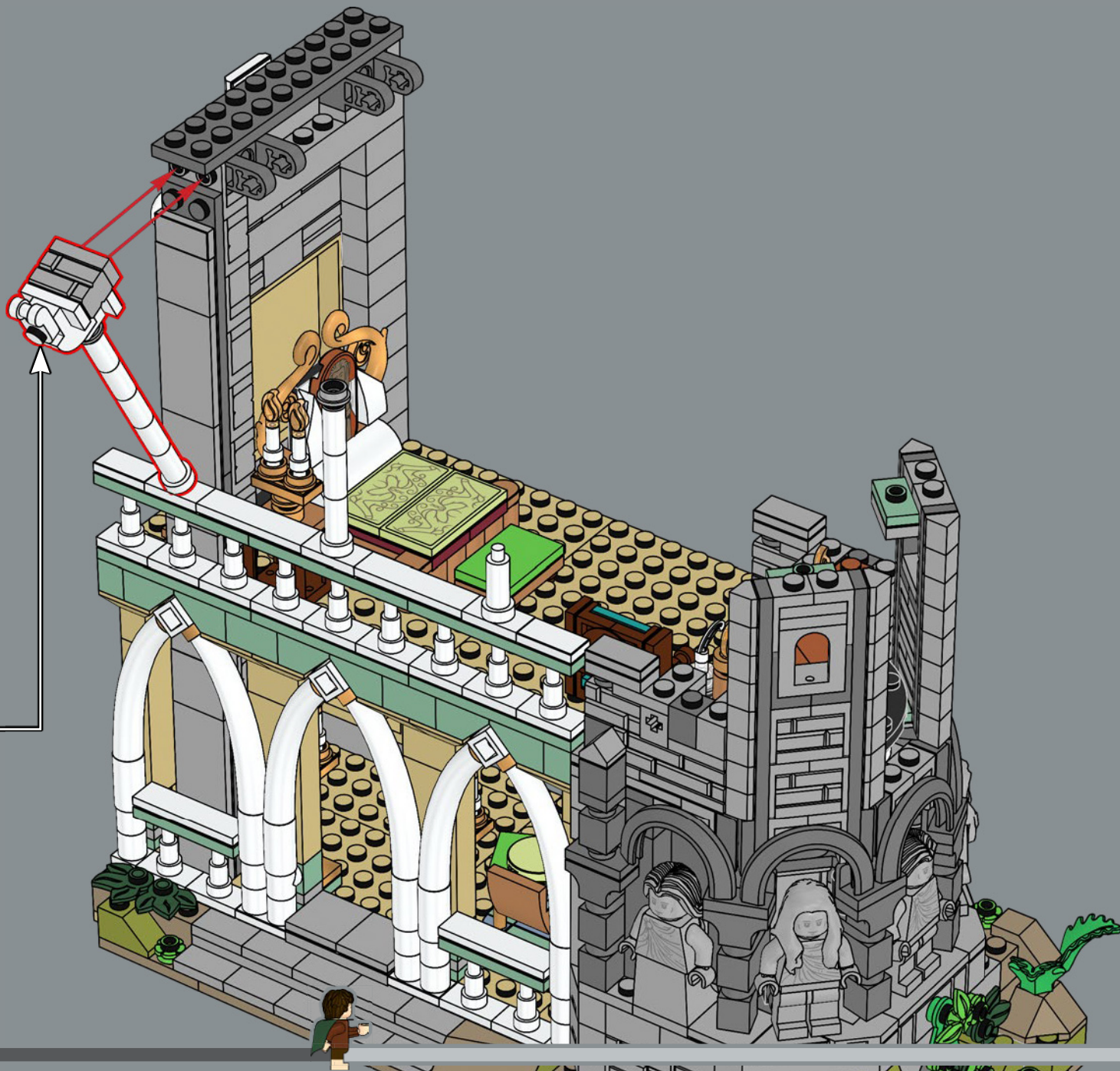

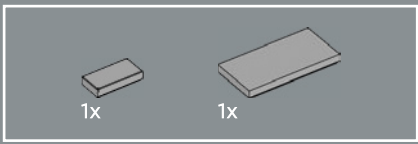

144



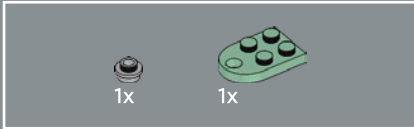
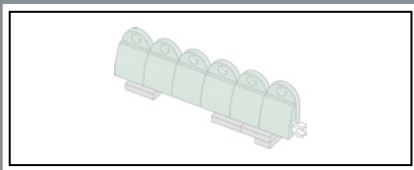

145

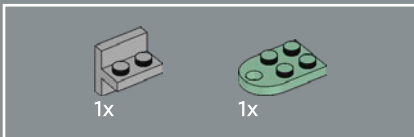
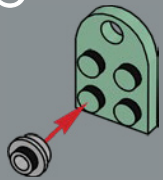

146

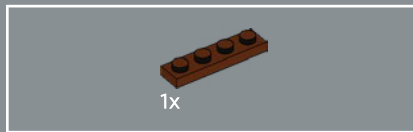
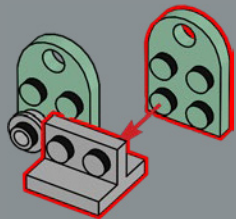

147

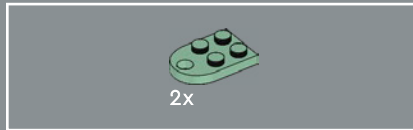
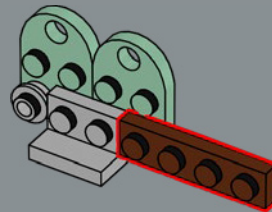

148

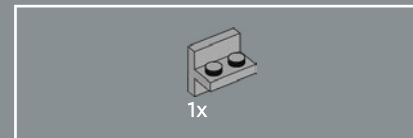
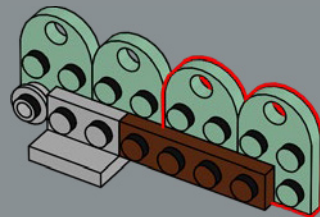

149

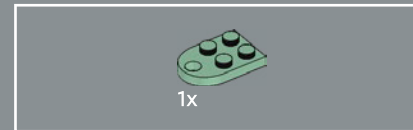
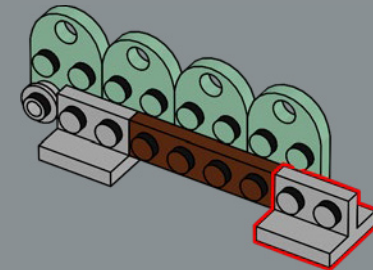

150

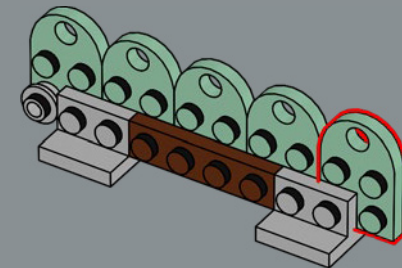

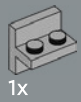

1x

151

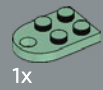
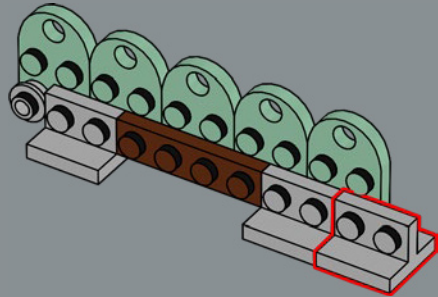

1x



1x

152

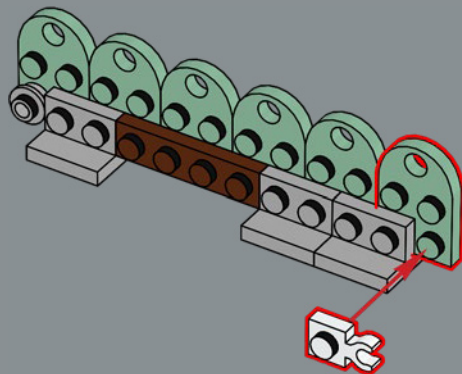

6x

153

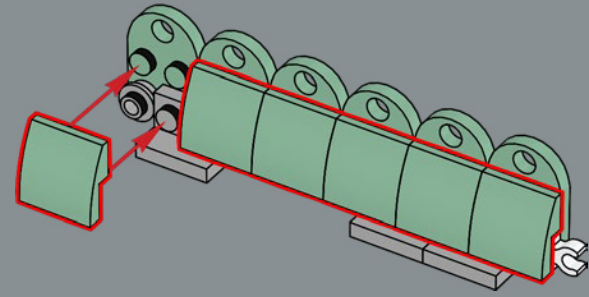

1x

154

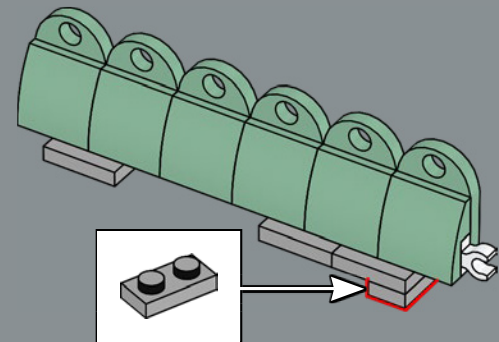

155



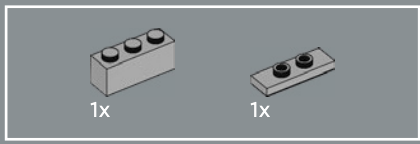

156

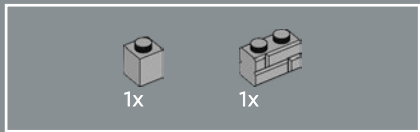
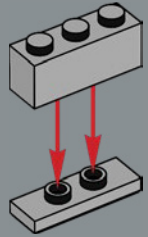

157

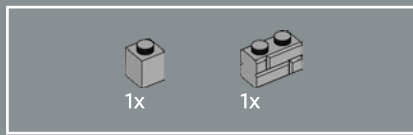
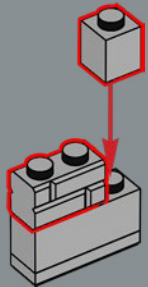

158

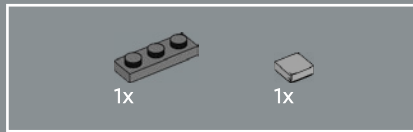
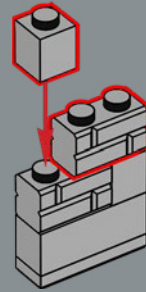

159

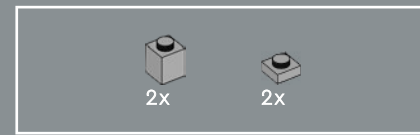
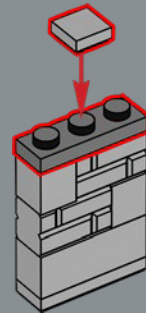

160

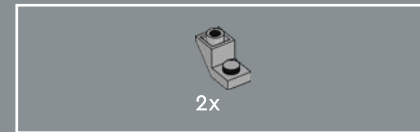
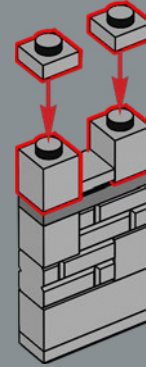

161

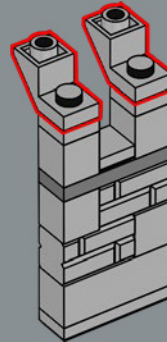

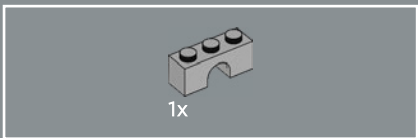

162

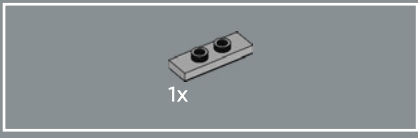
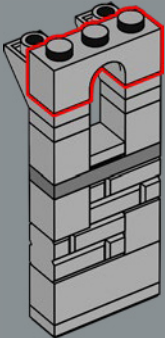

163

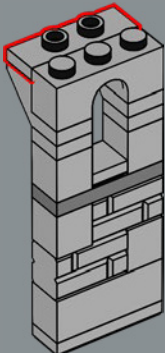

164

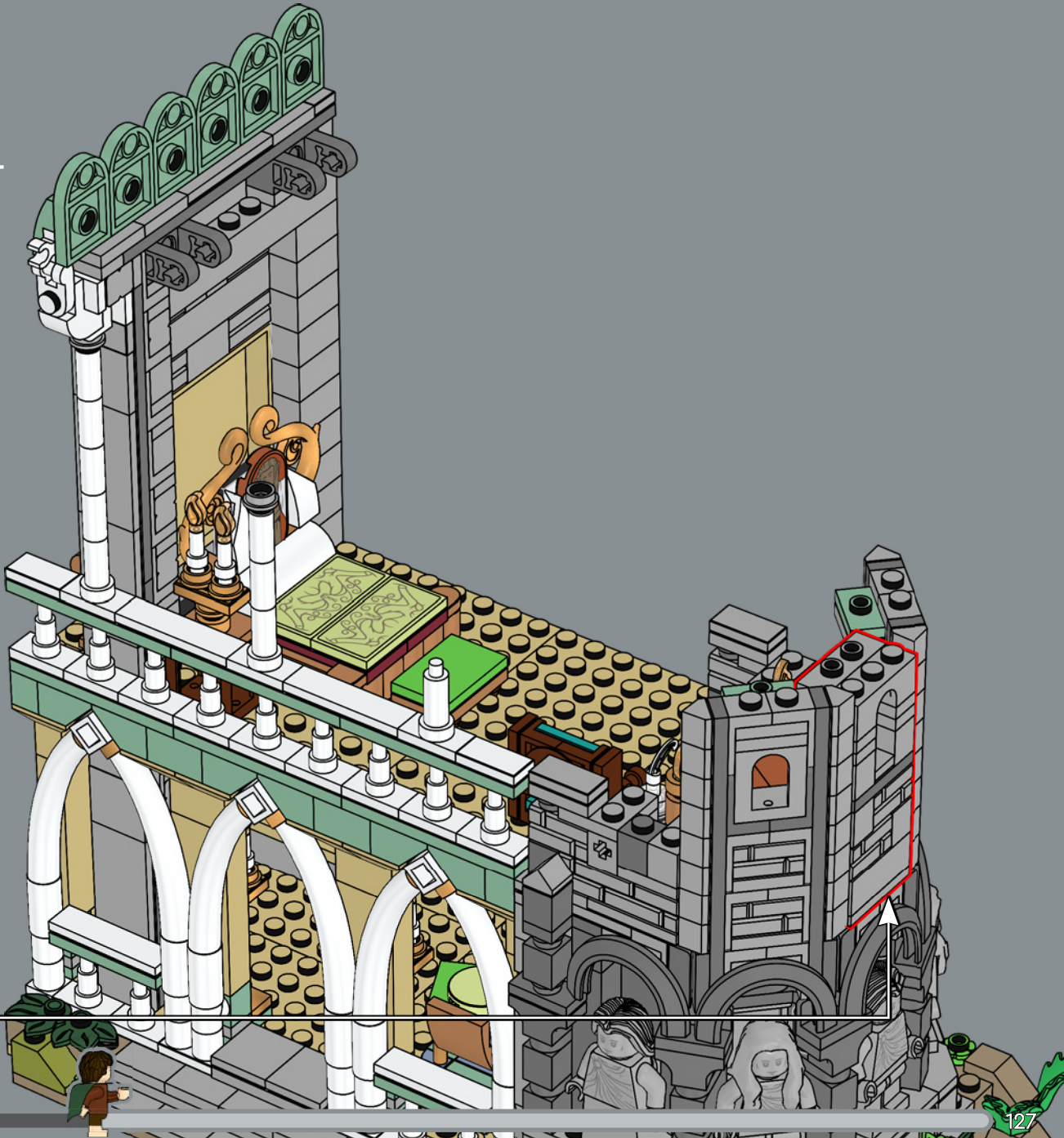

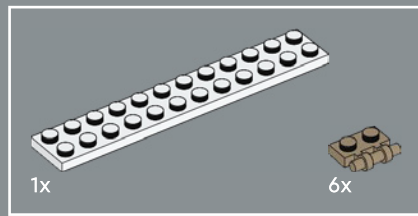

165

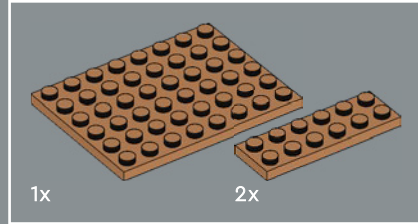
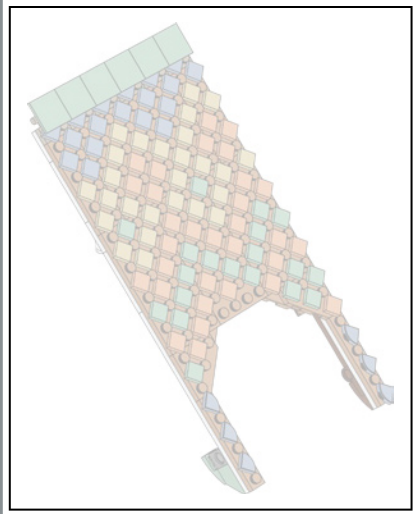
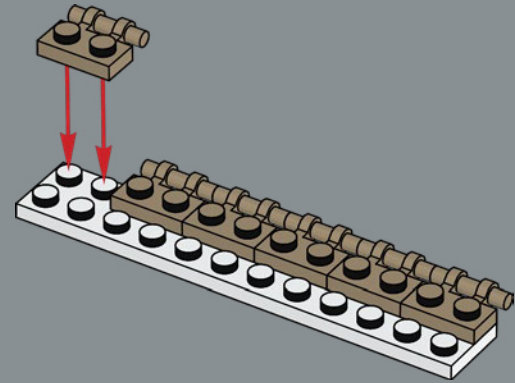

166

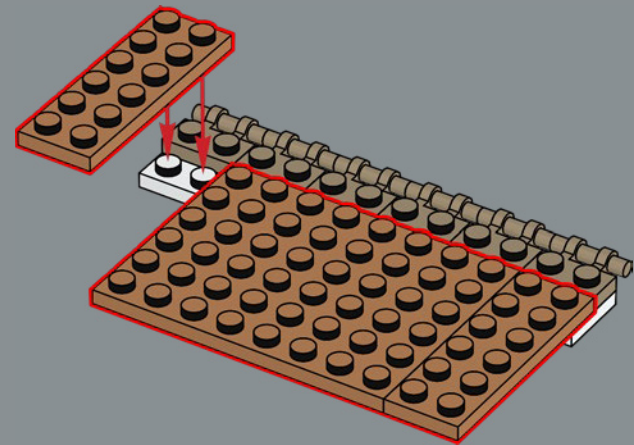

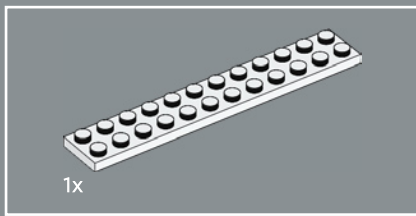

167

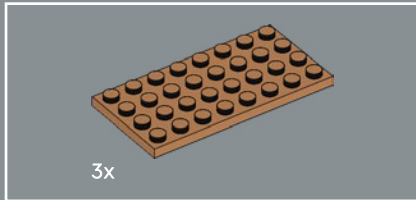
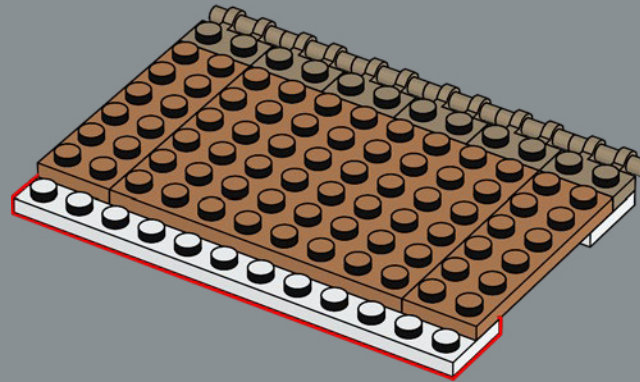

168

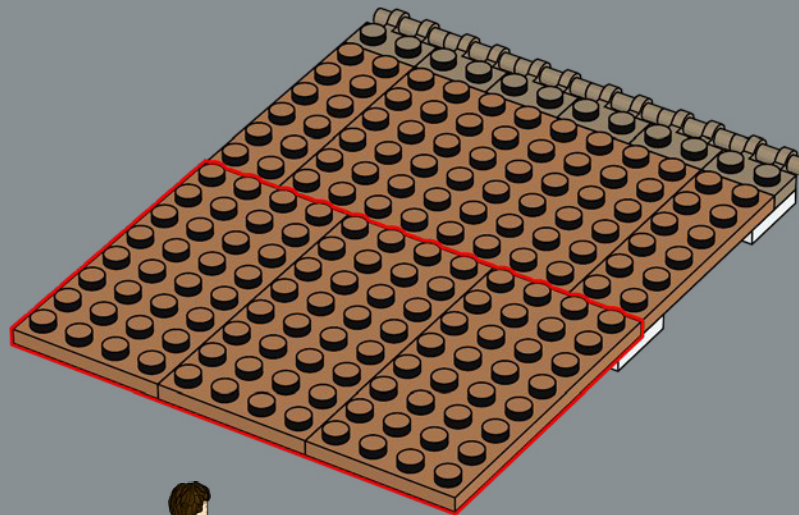

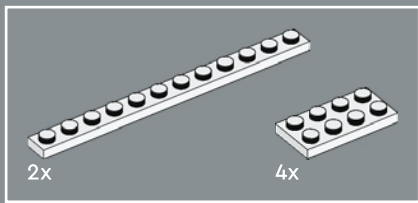

169

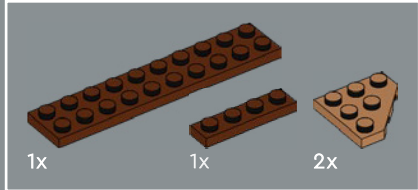
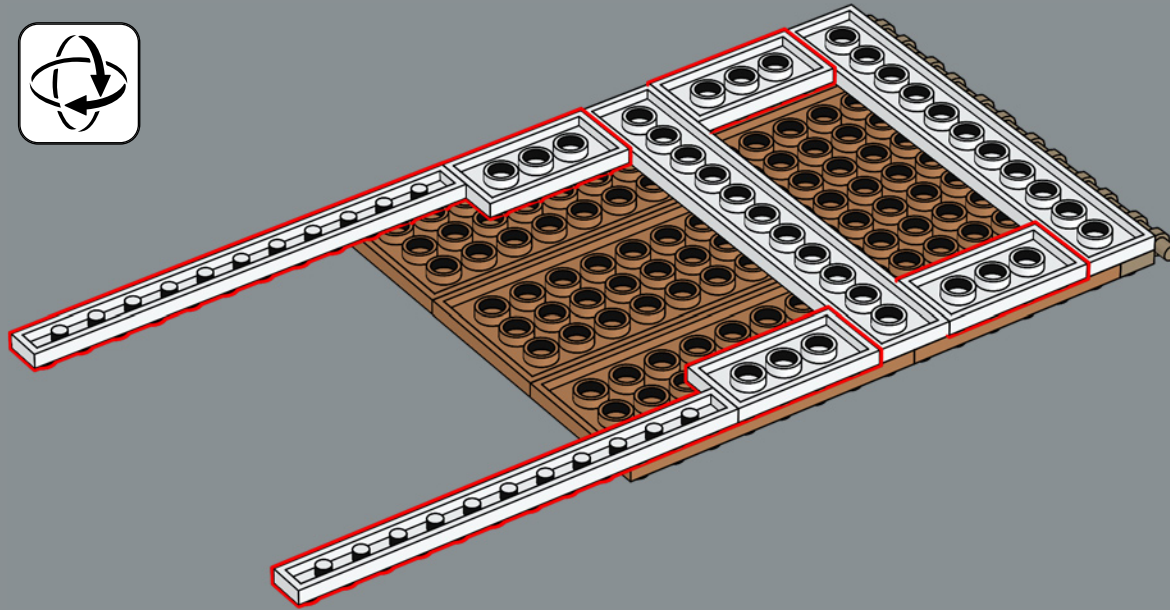

170

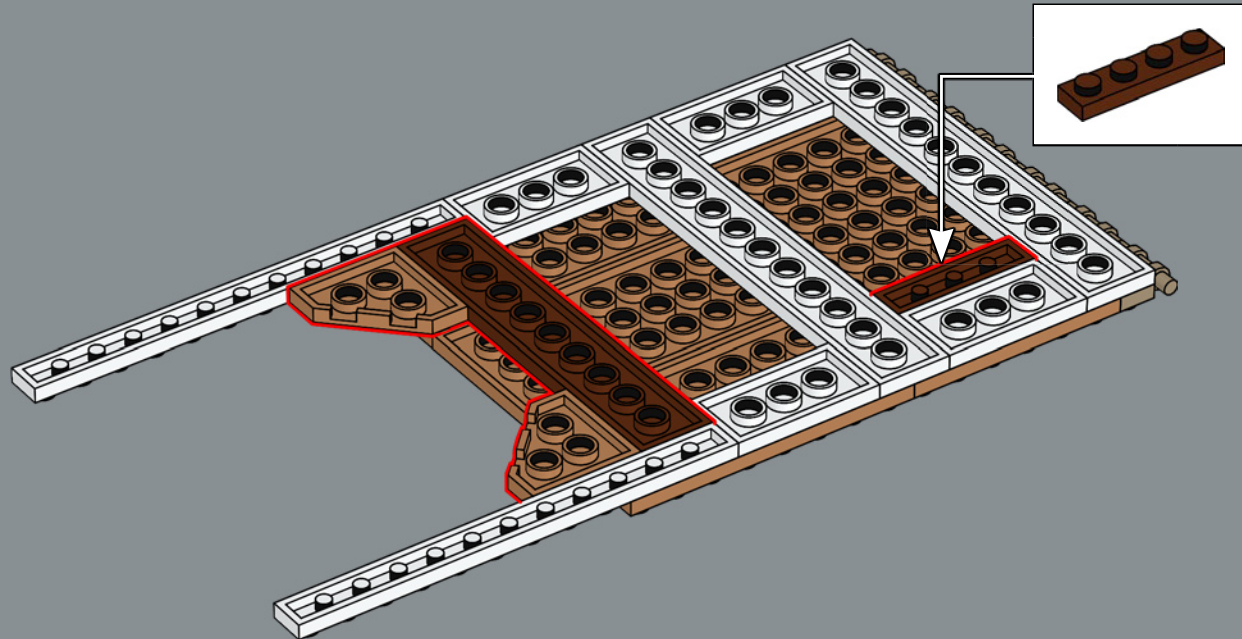

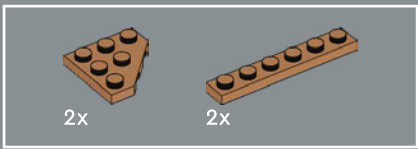

171

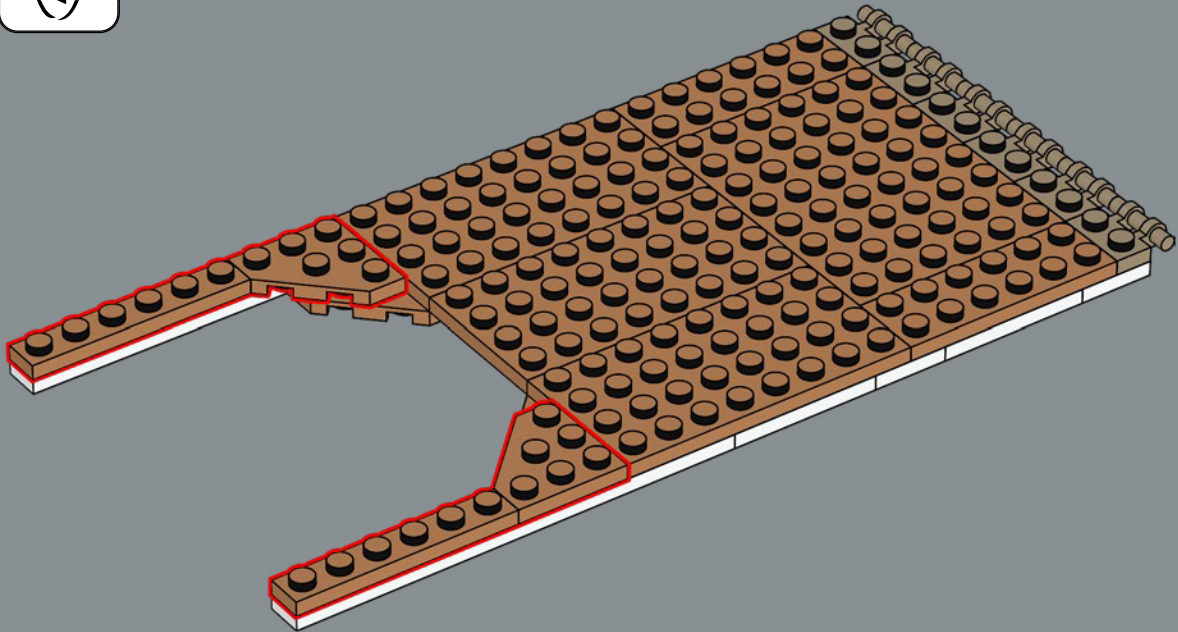



18x



172

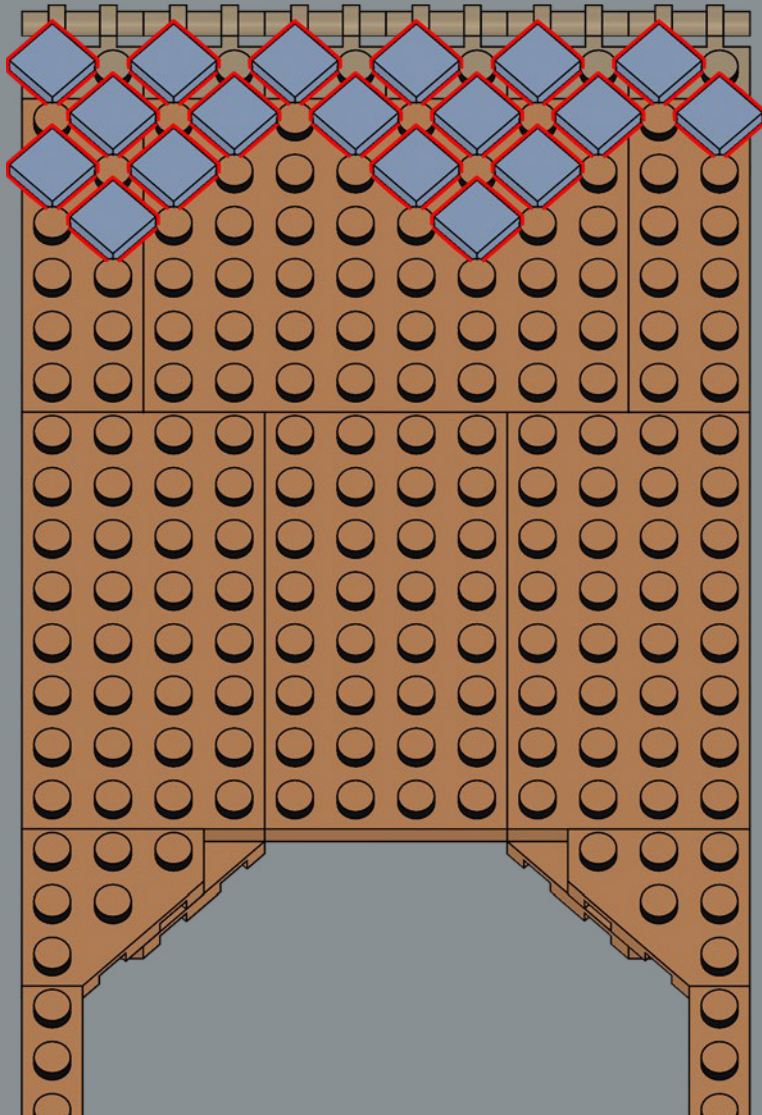

12x



8x

173

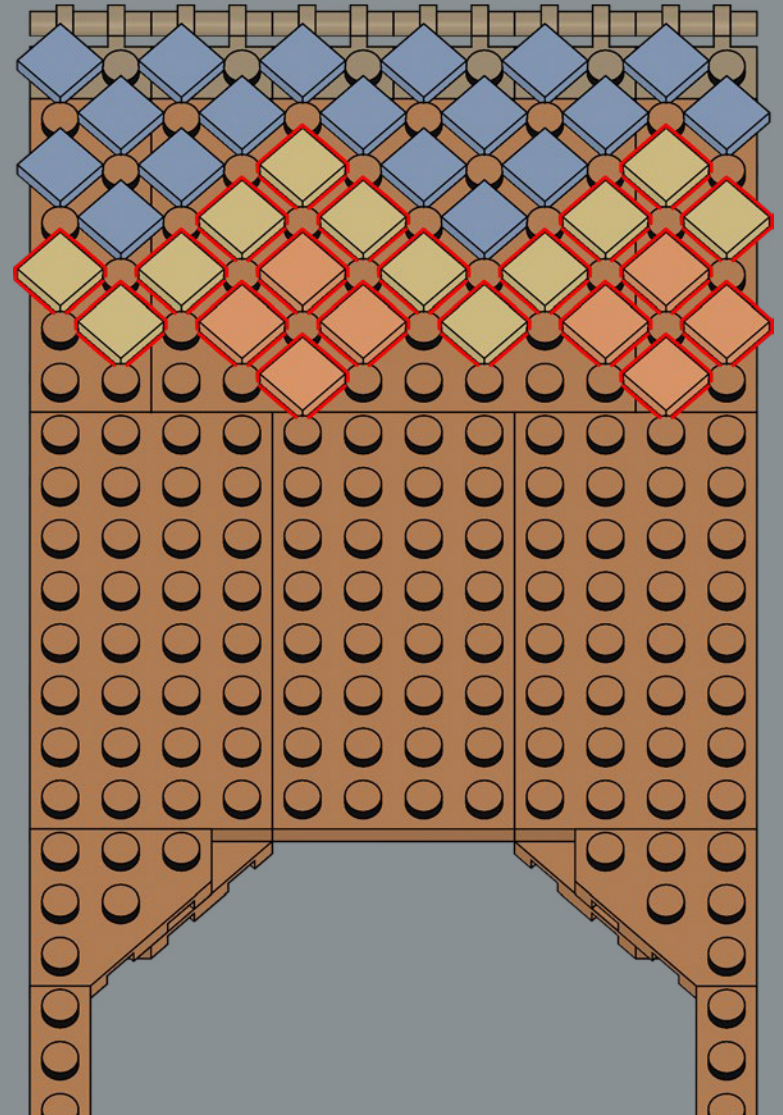

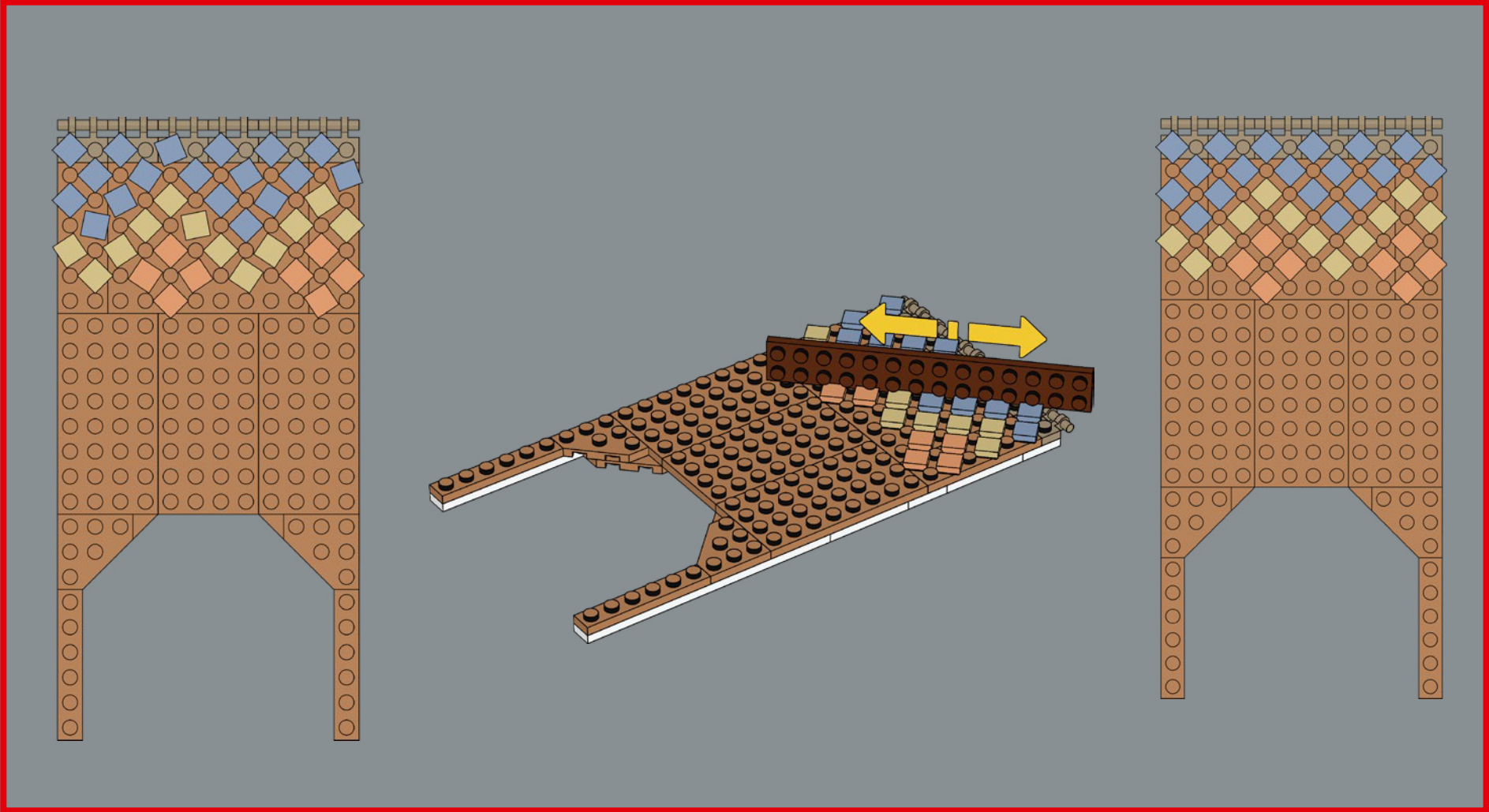



174

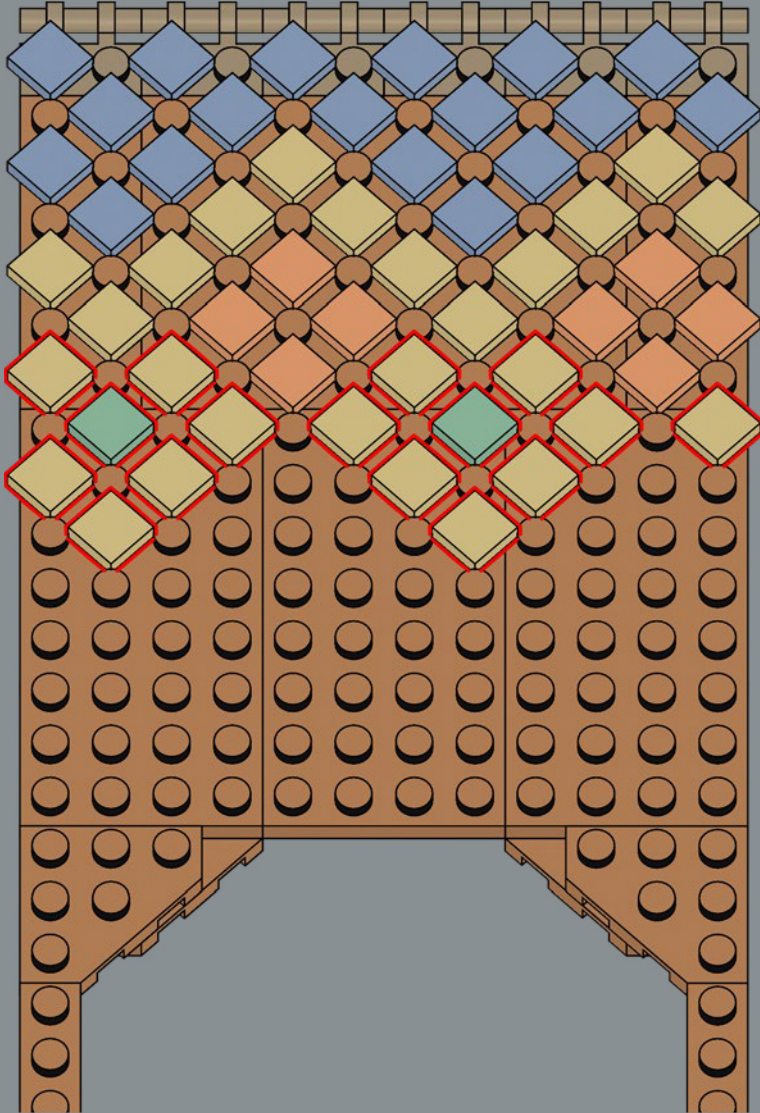

175

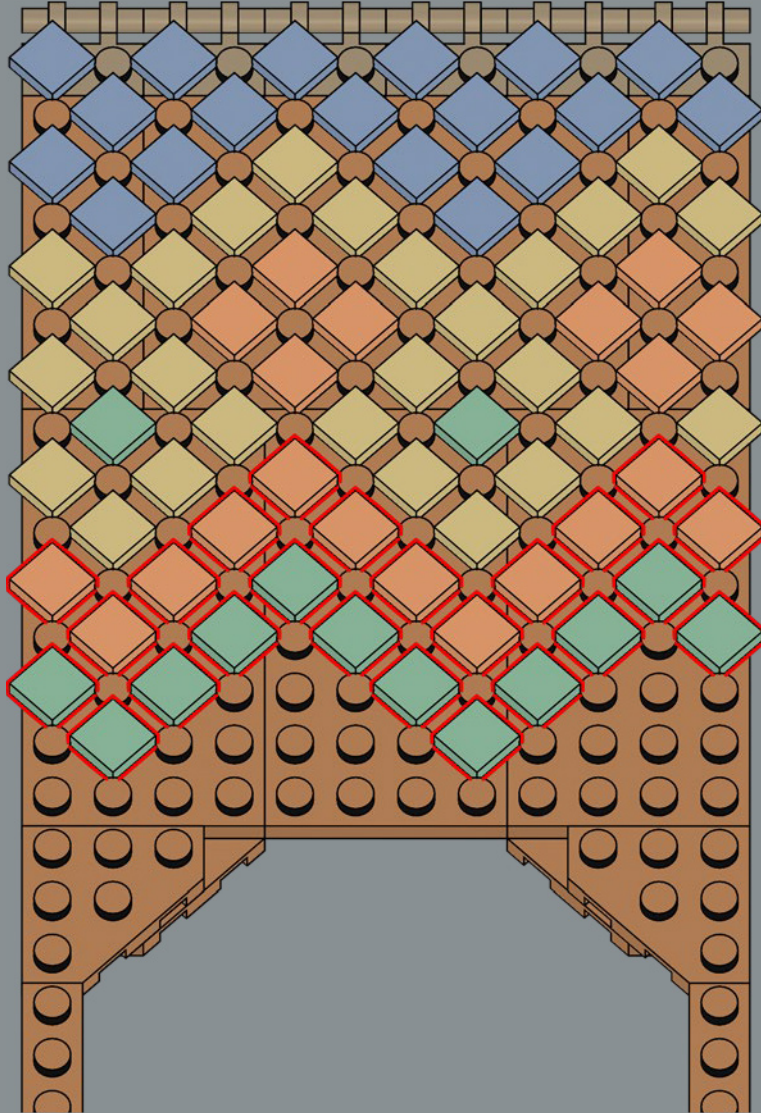



 5x	 6x	 11x
--	--	---

176

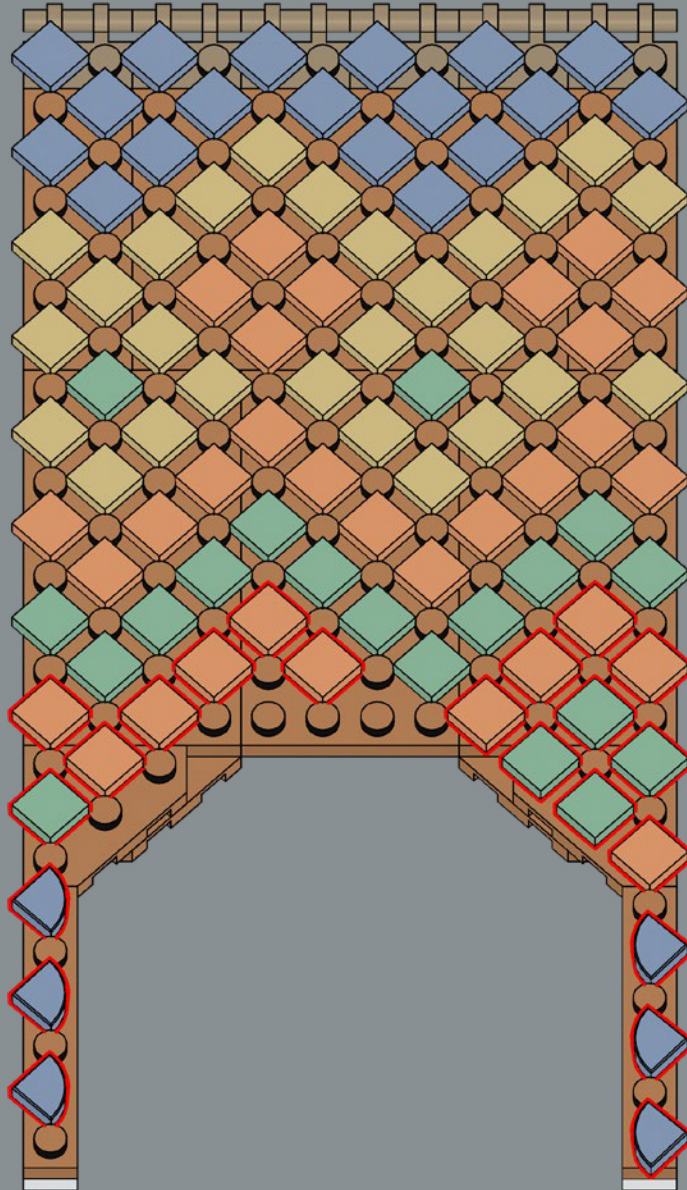

Cada una de las 94 cubiertas 1x1 del techo debe posicionarse en un ángulo de 45 grados. Pasar una placa o cubierta larga por las ranuras una vez que las piezas están colocadas en su lugar es una fantástica manera de alinearlas.



6x

177

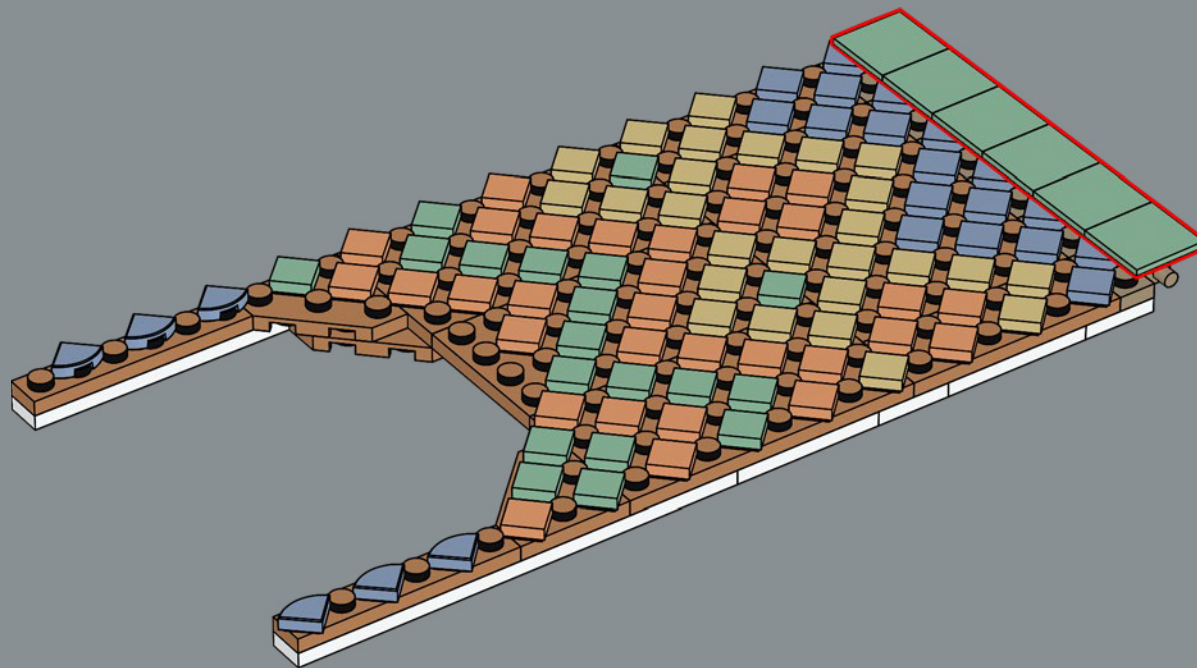

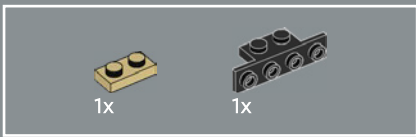

178

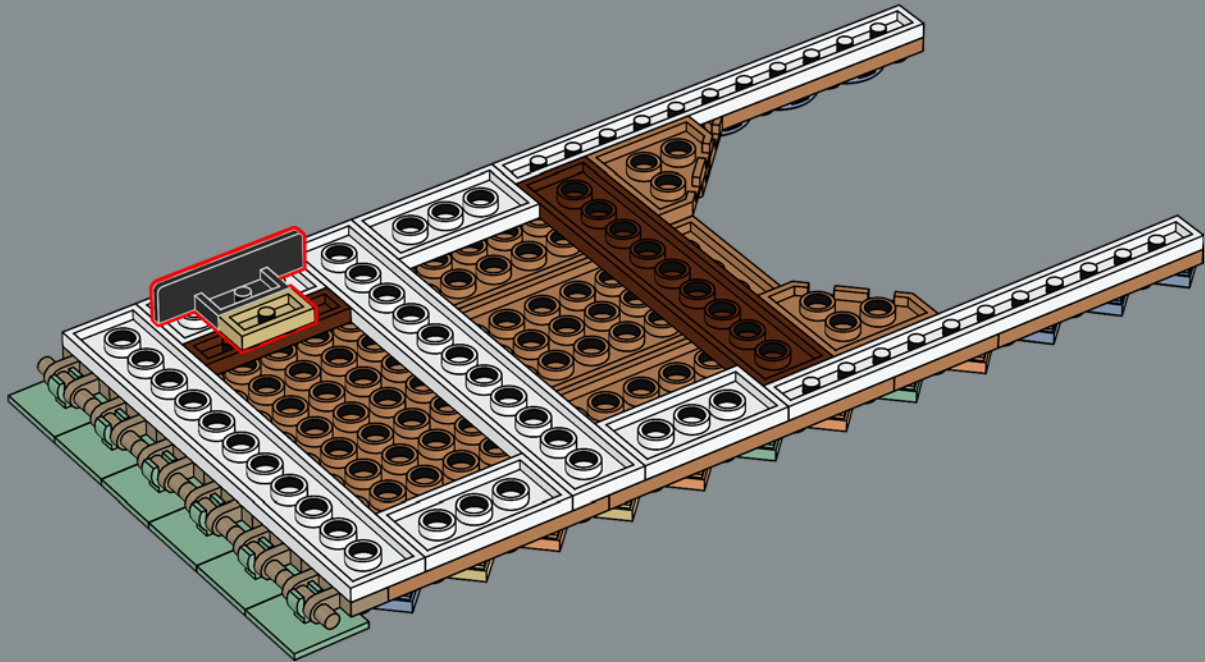



179

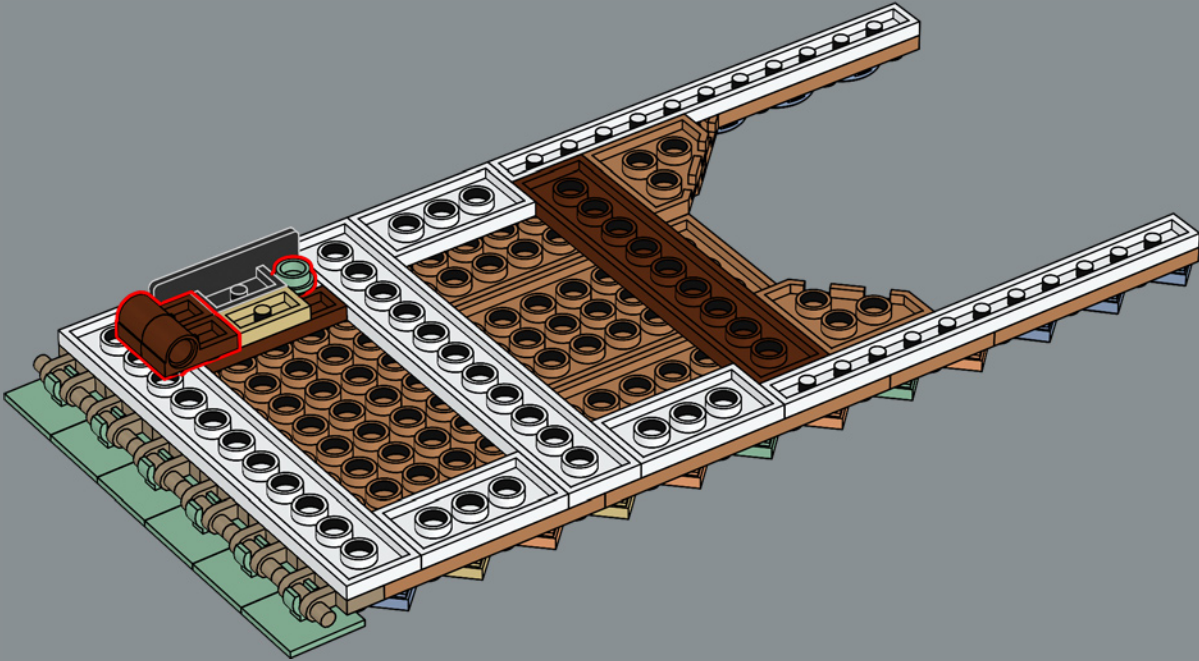

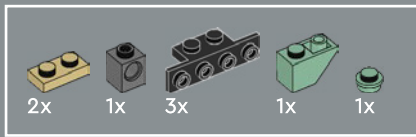

180

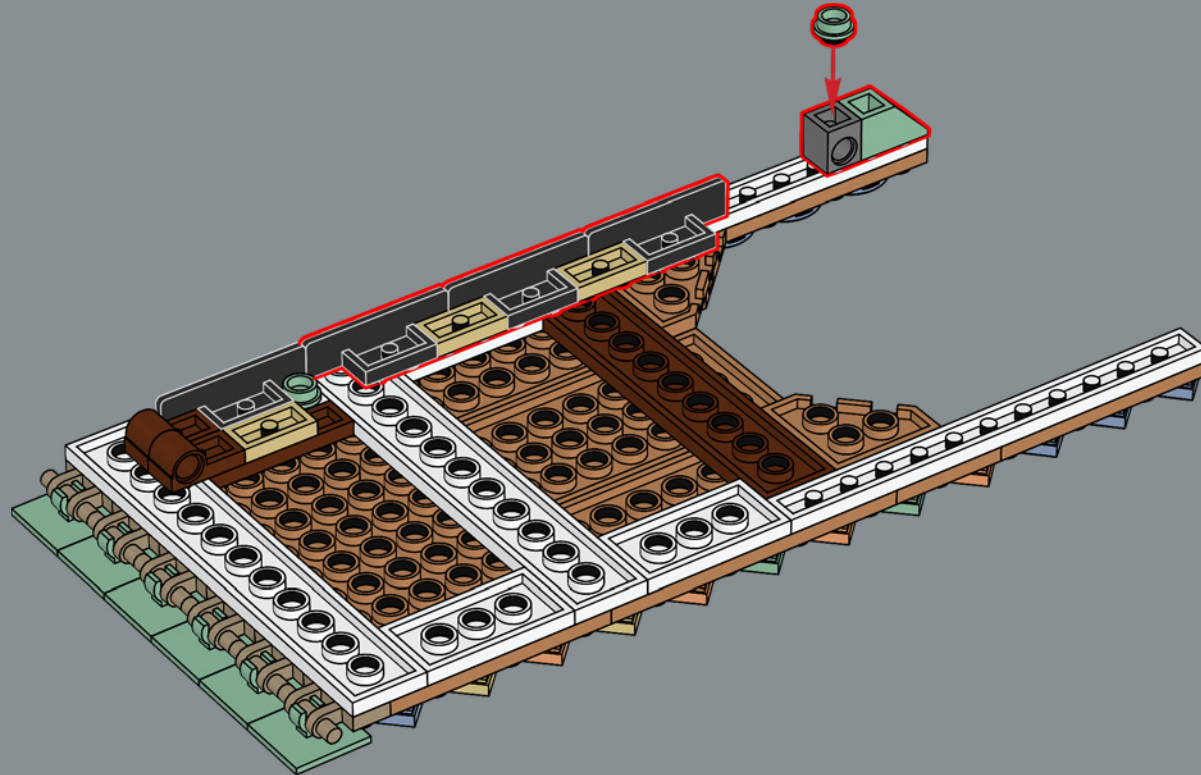

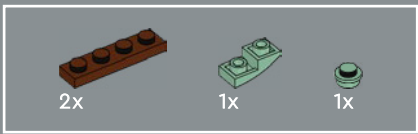

181

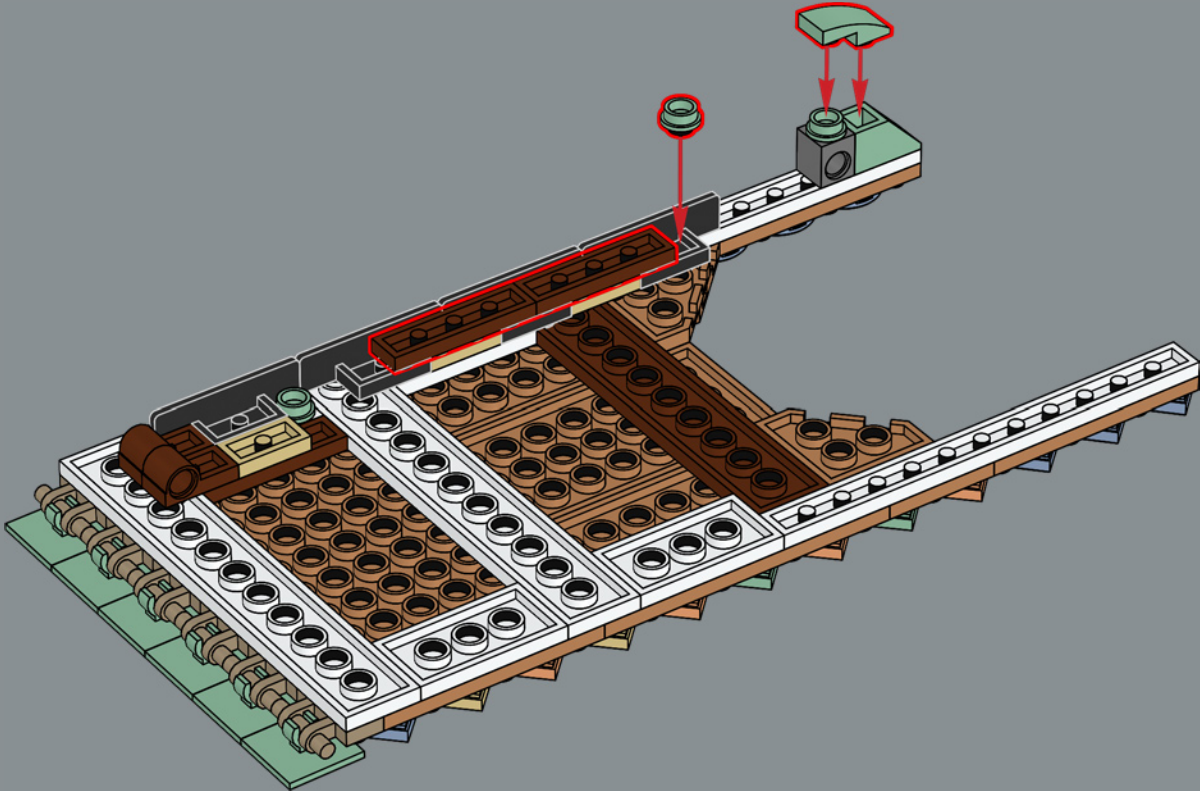

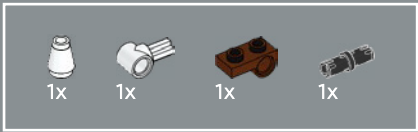

182

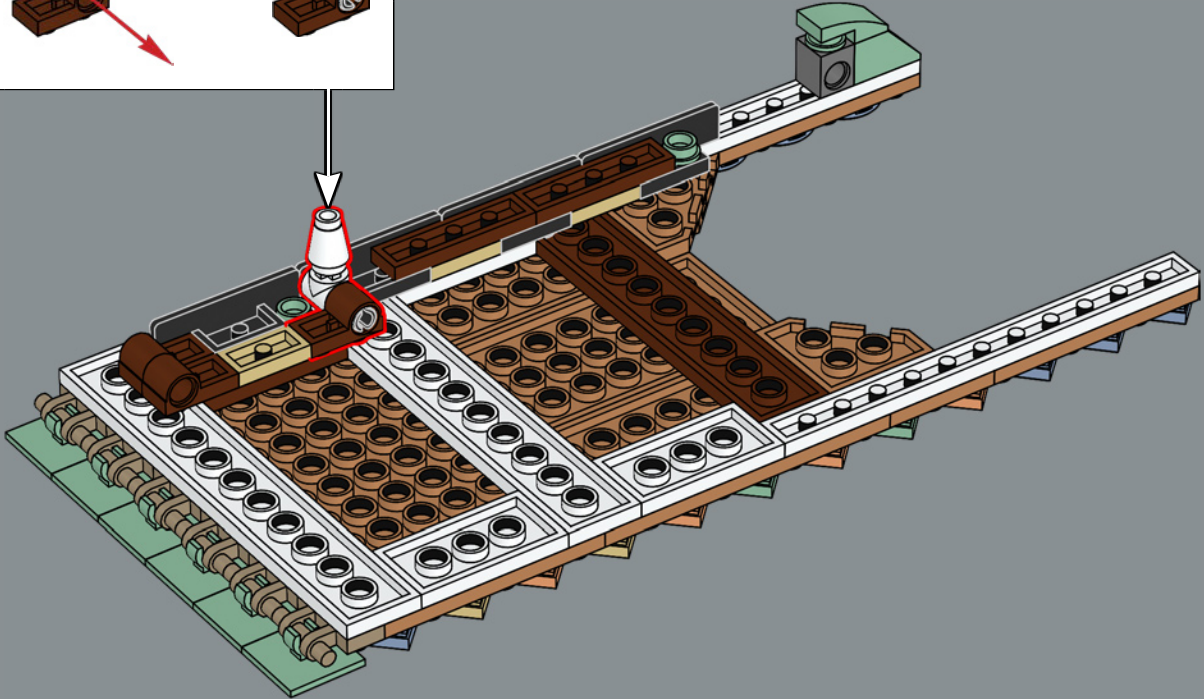
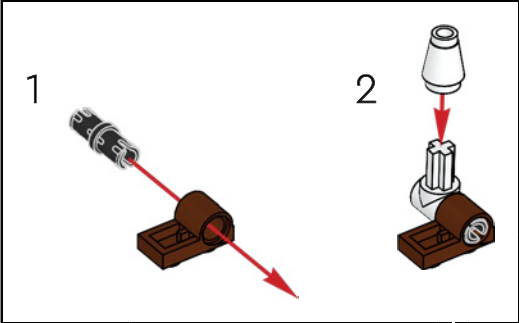

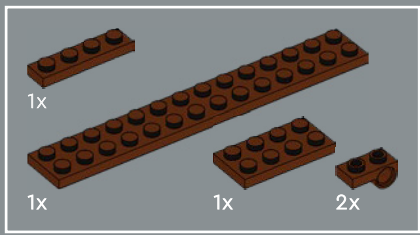

183

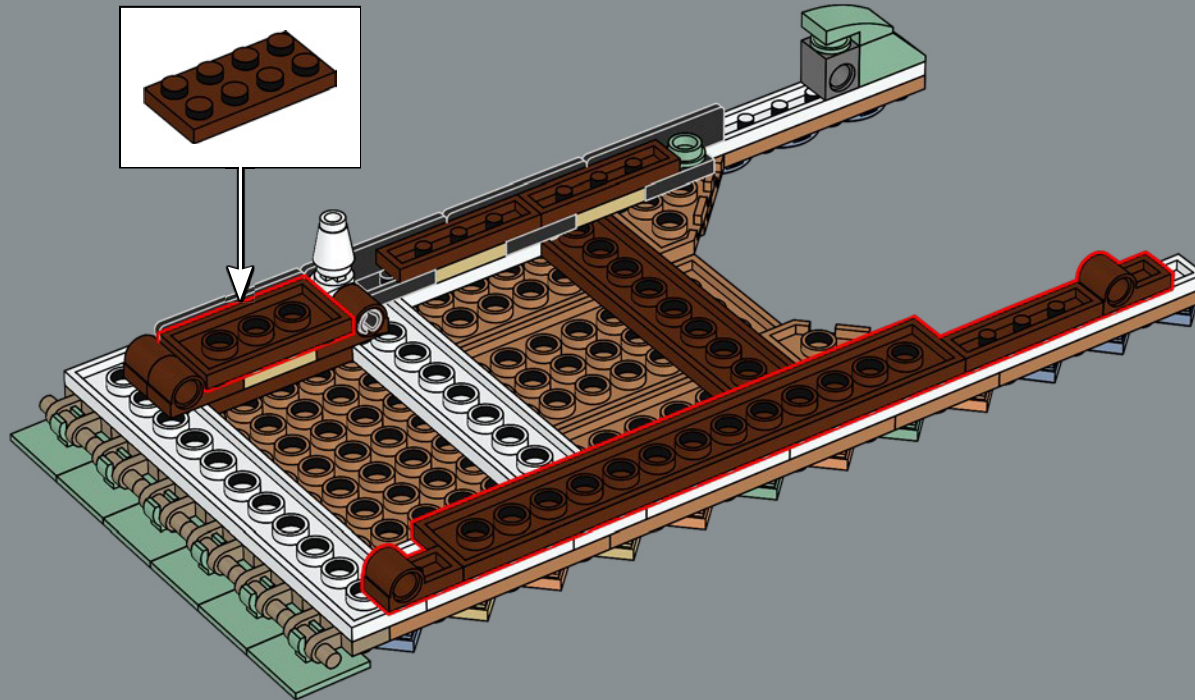

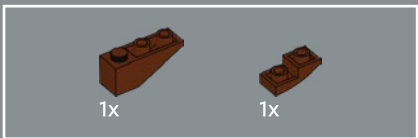

184

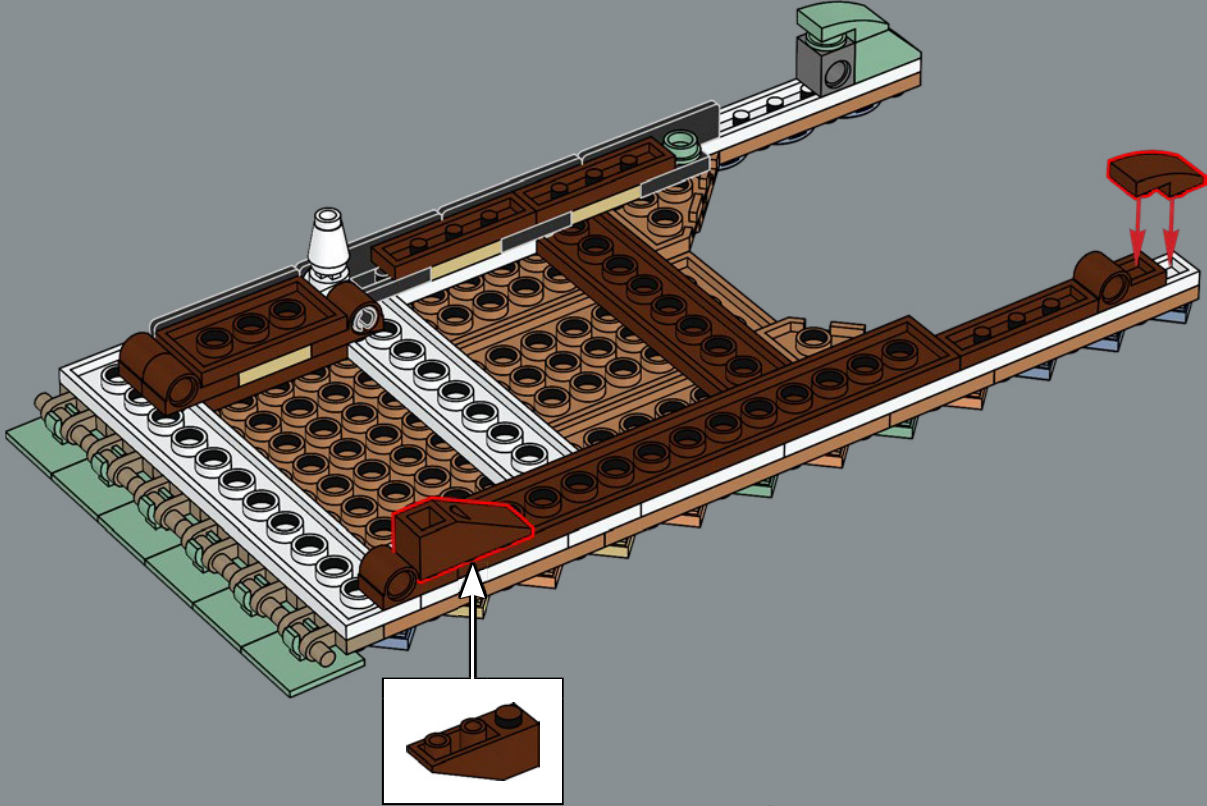

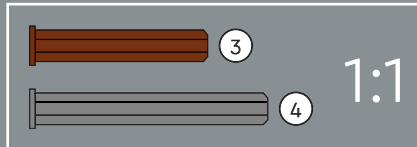
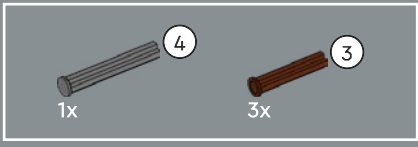

185

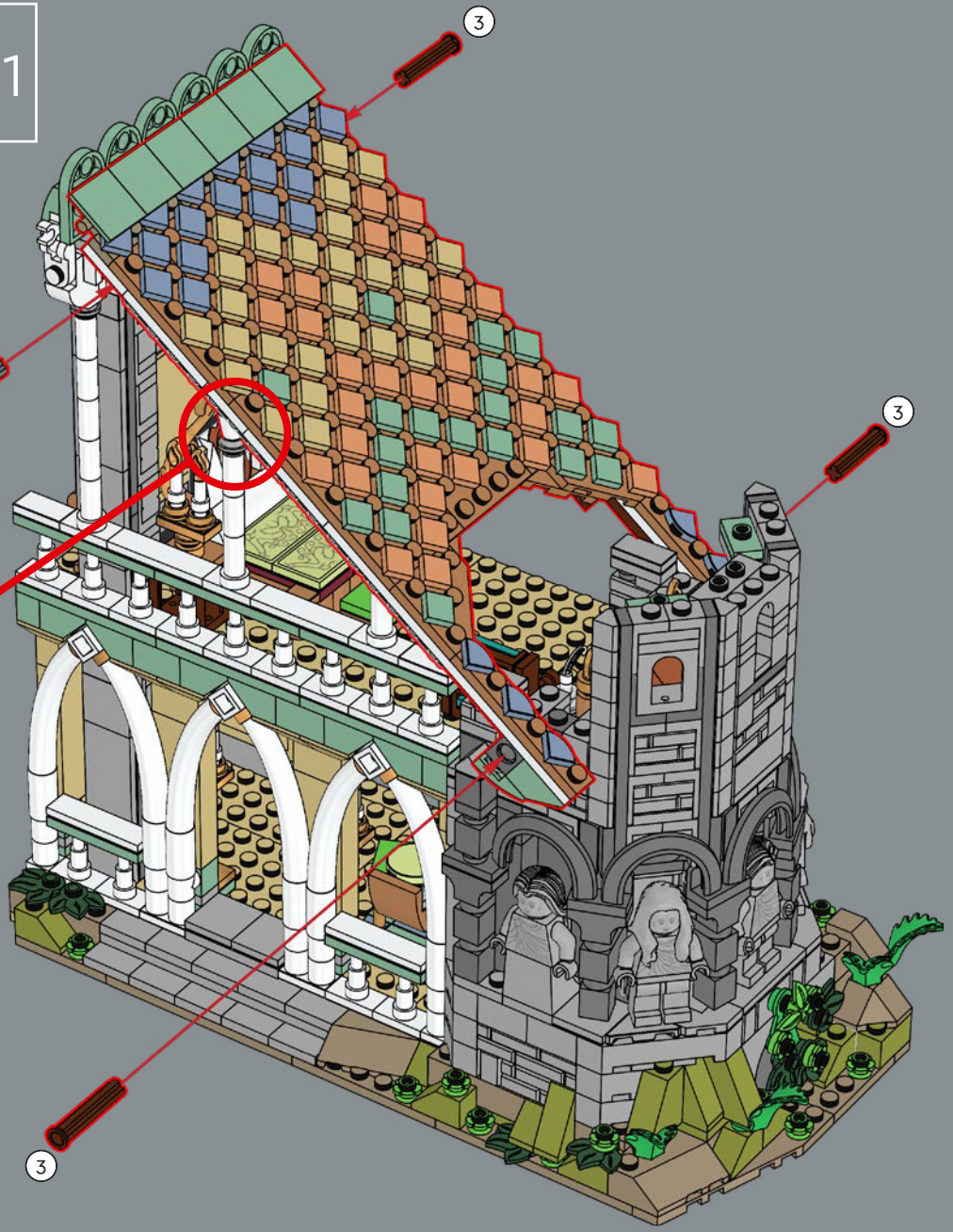
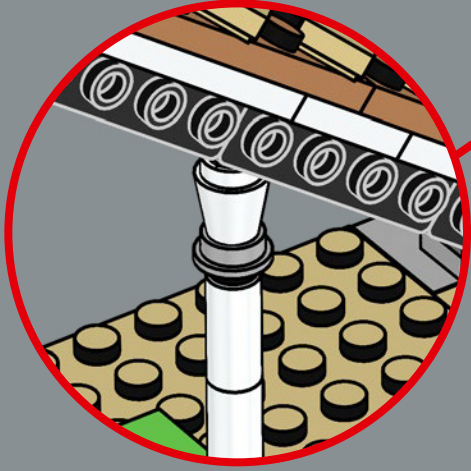
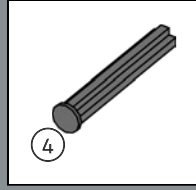

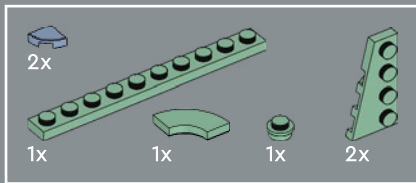

186

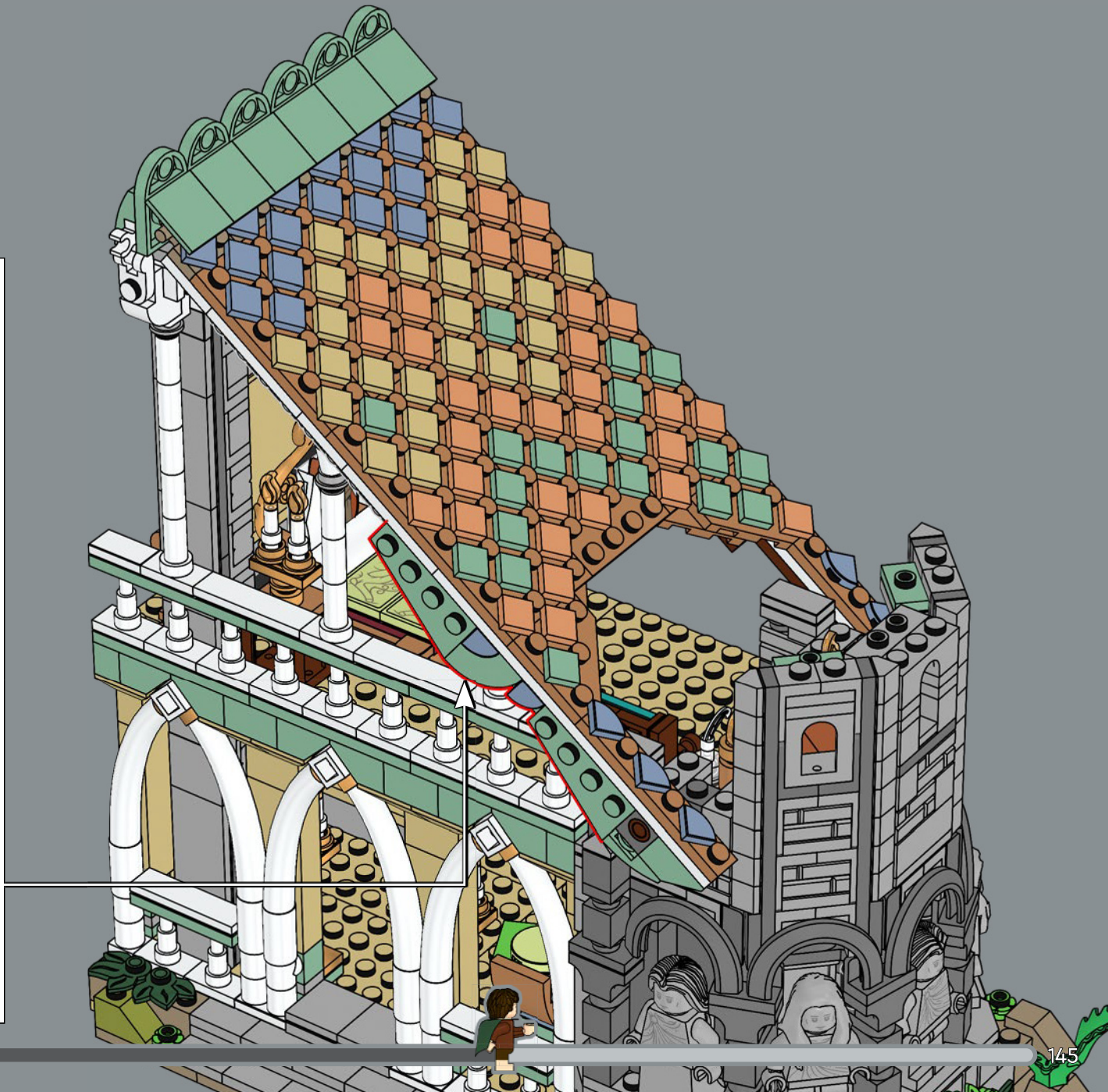
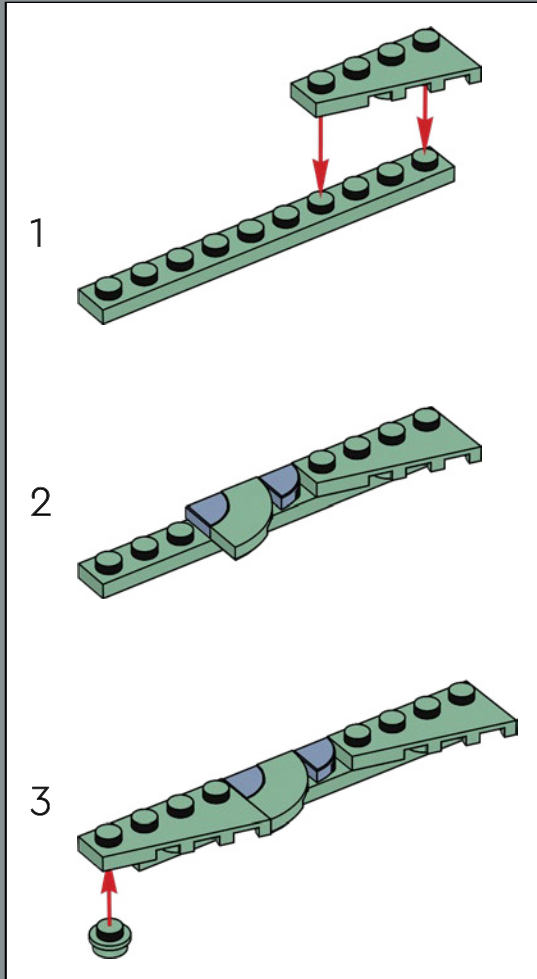

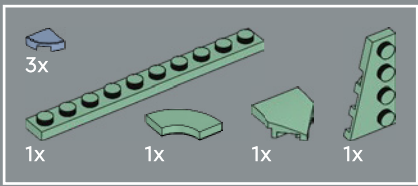

187

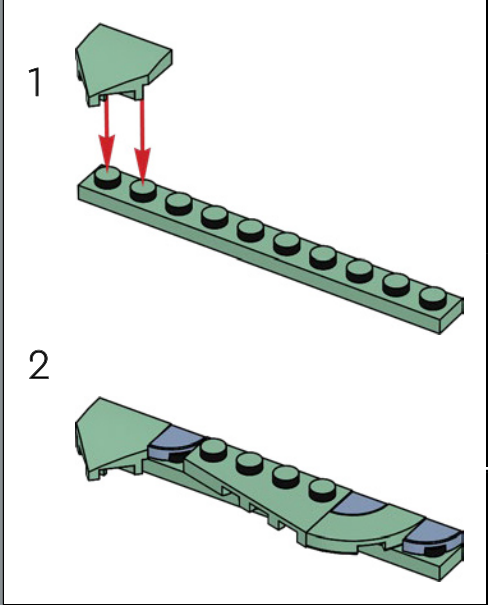

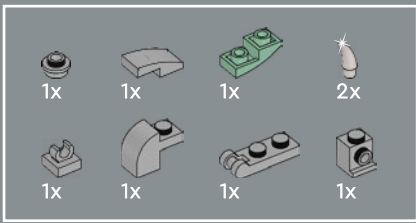

188

1

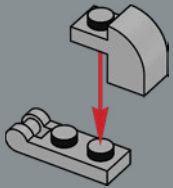

2

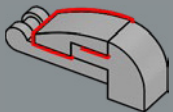

3

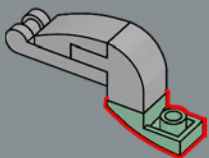

4

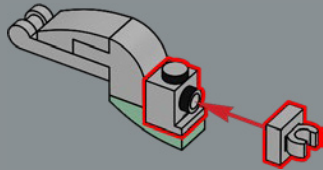

5

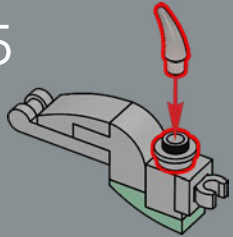

6

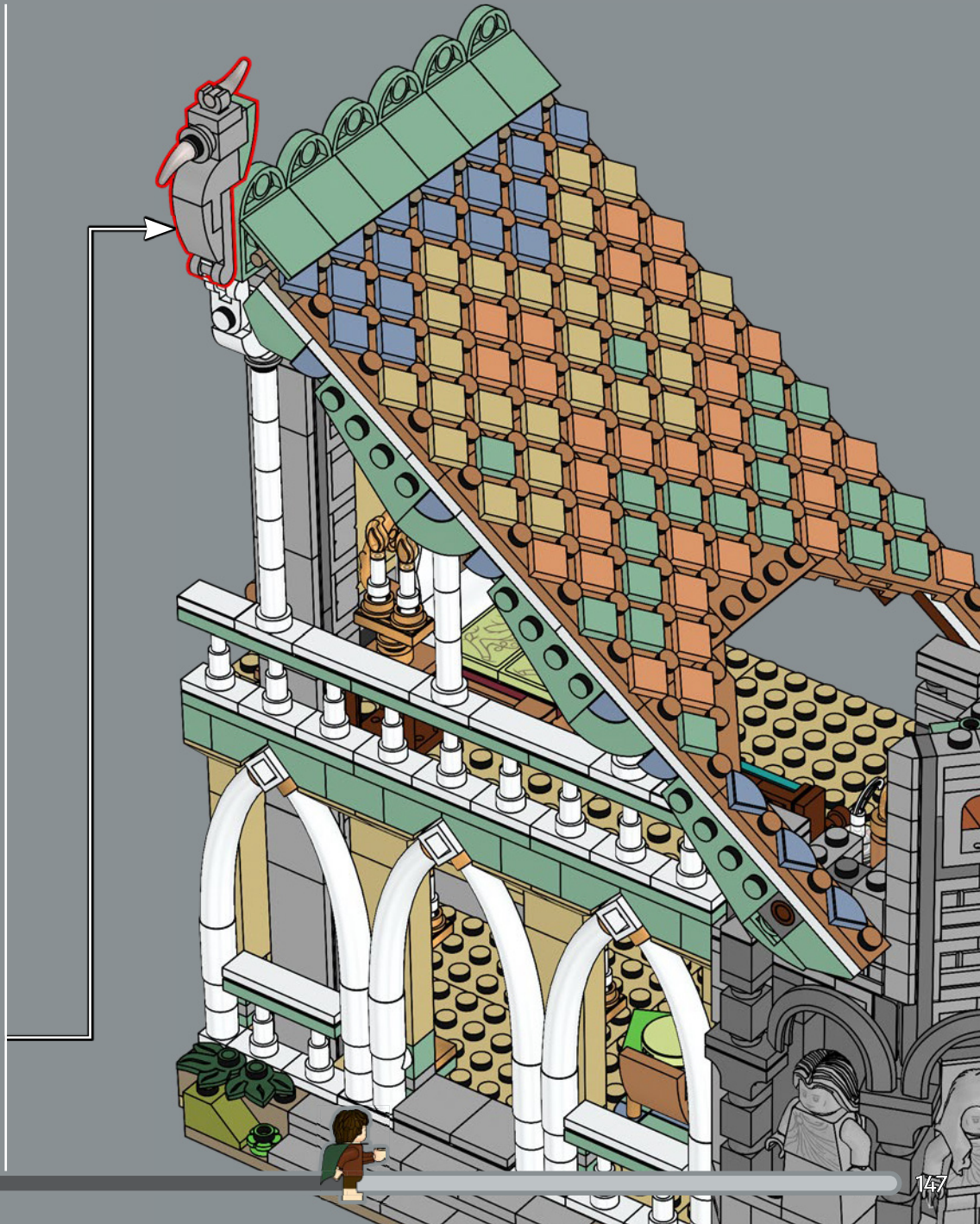
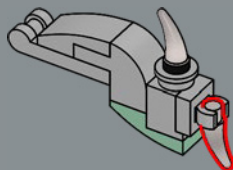

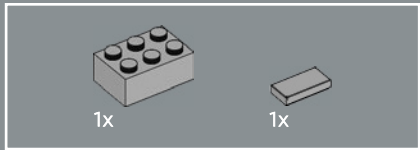

189

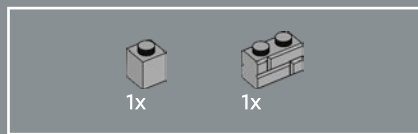
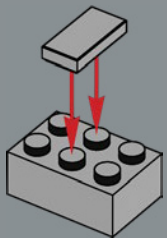

190

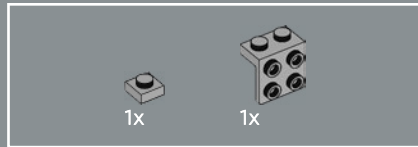
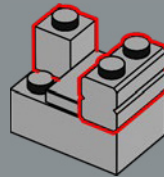

191

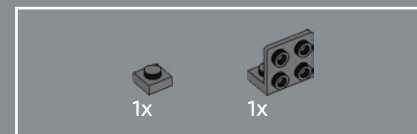
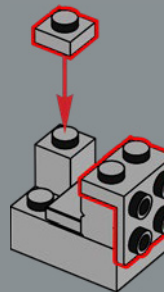

192

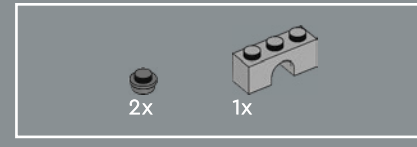
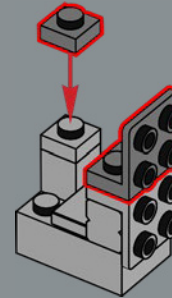

193

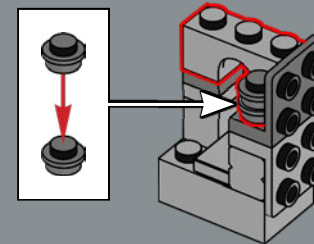

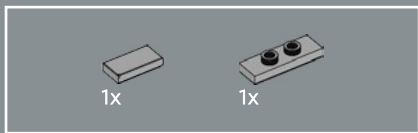

194

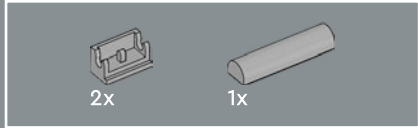
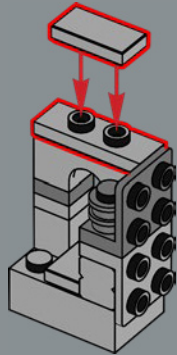

195

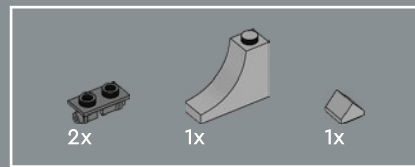
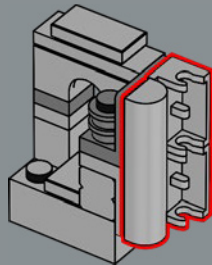

196

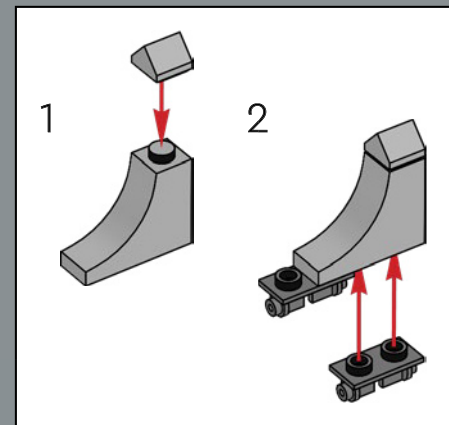
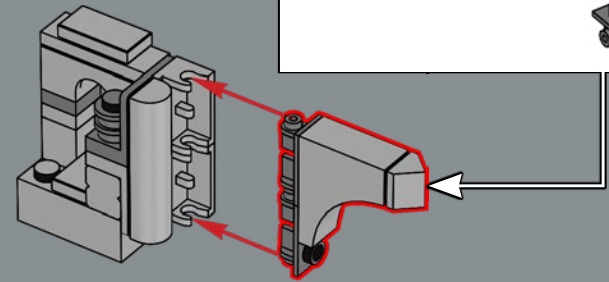

197

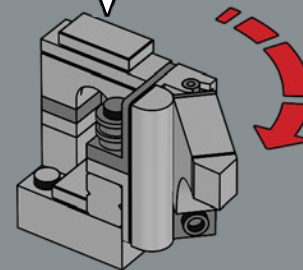

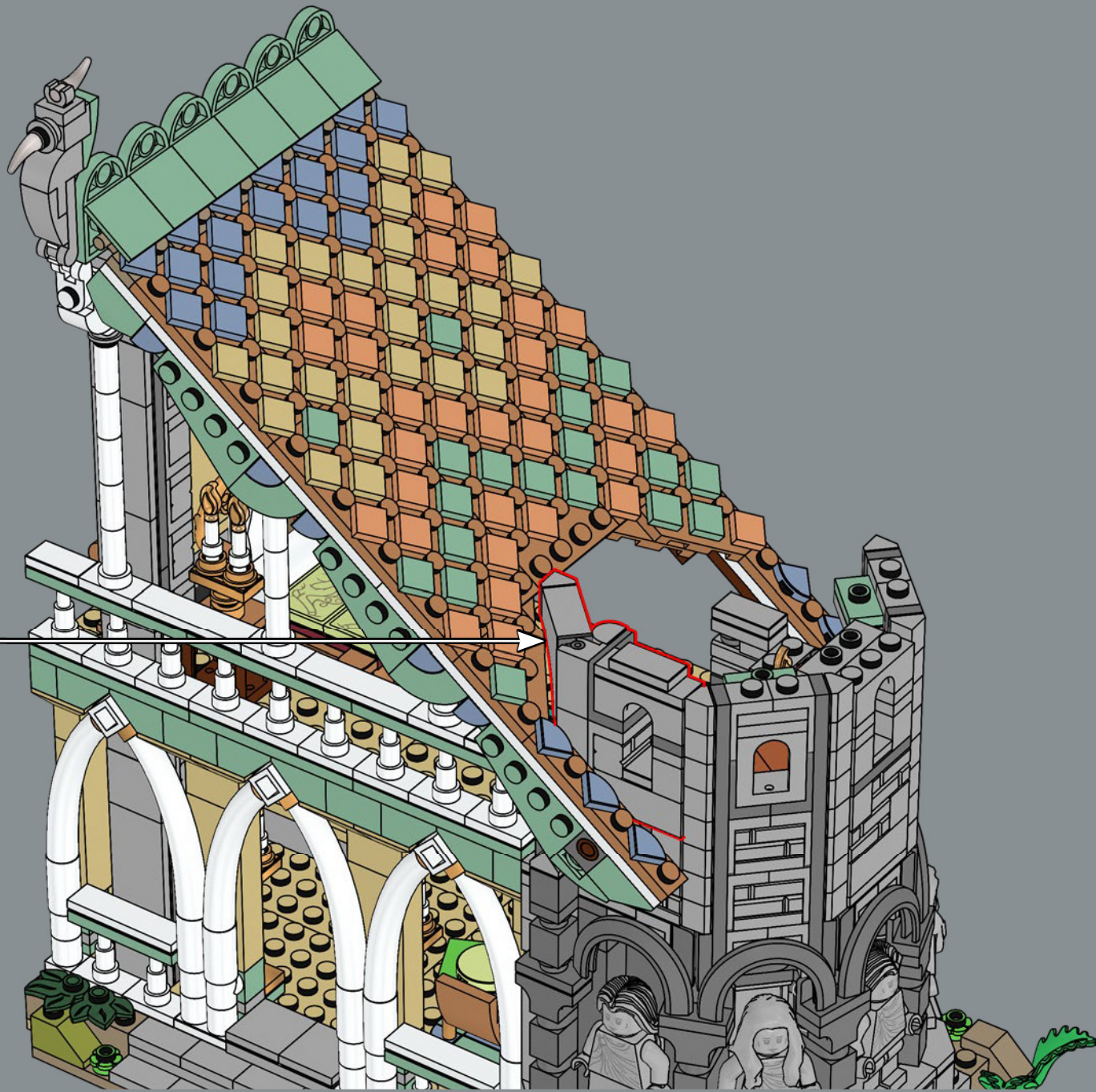

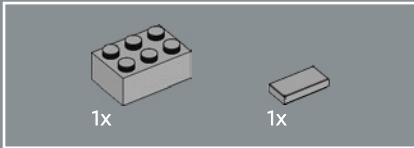
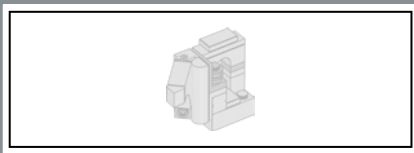

199

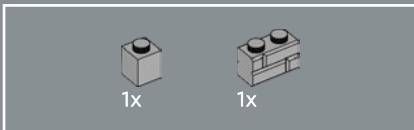
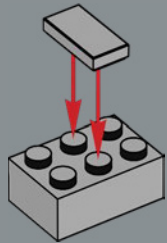

200

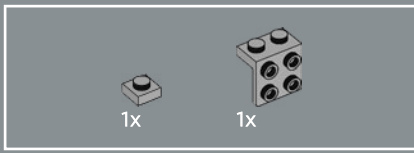
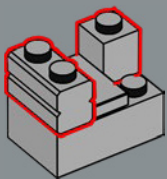

201

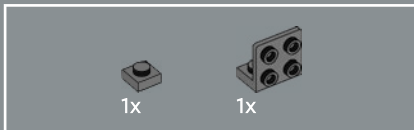
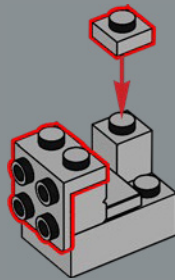

202

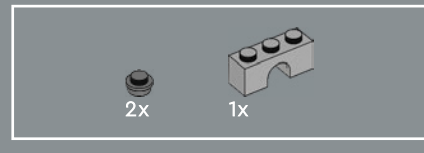
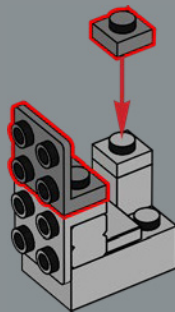

203

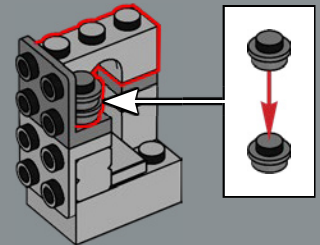

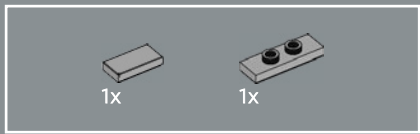

204

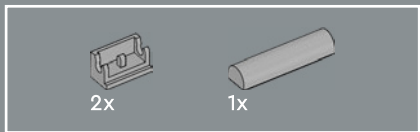
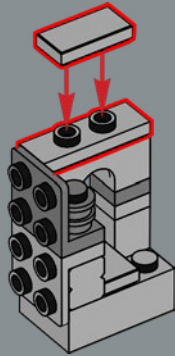

205

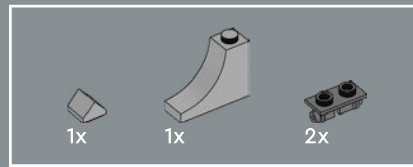
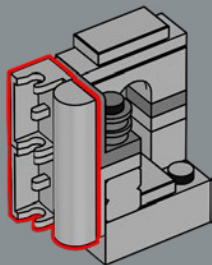

206

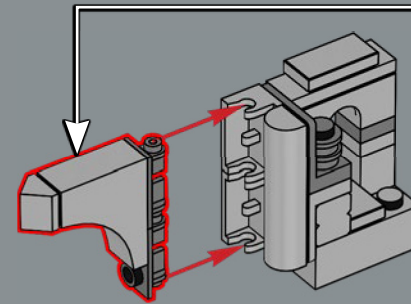
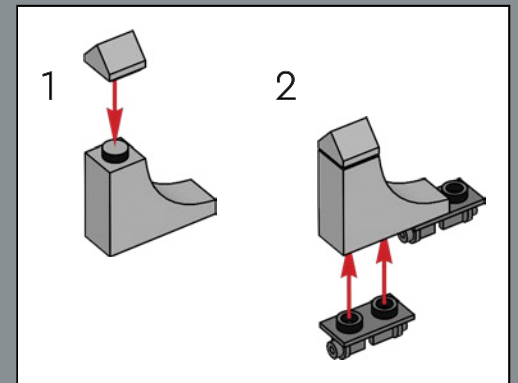

207

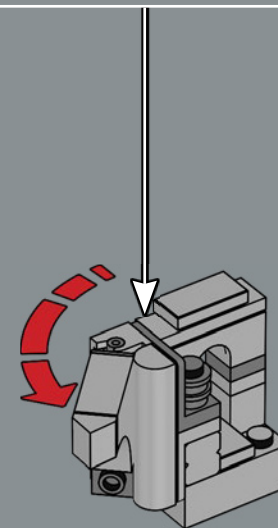

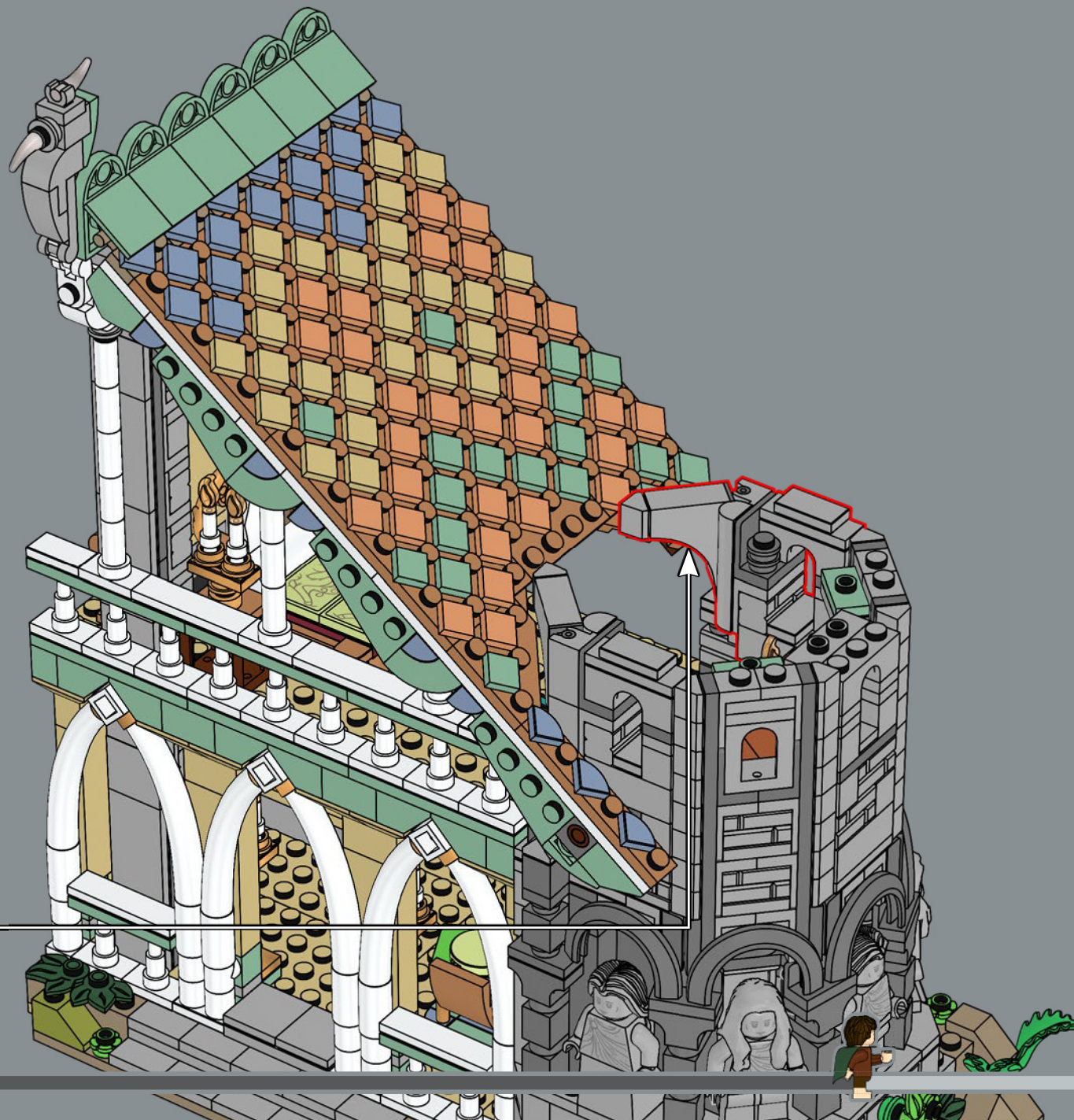

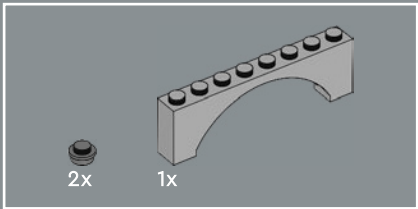

209

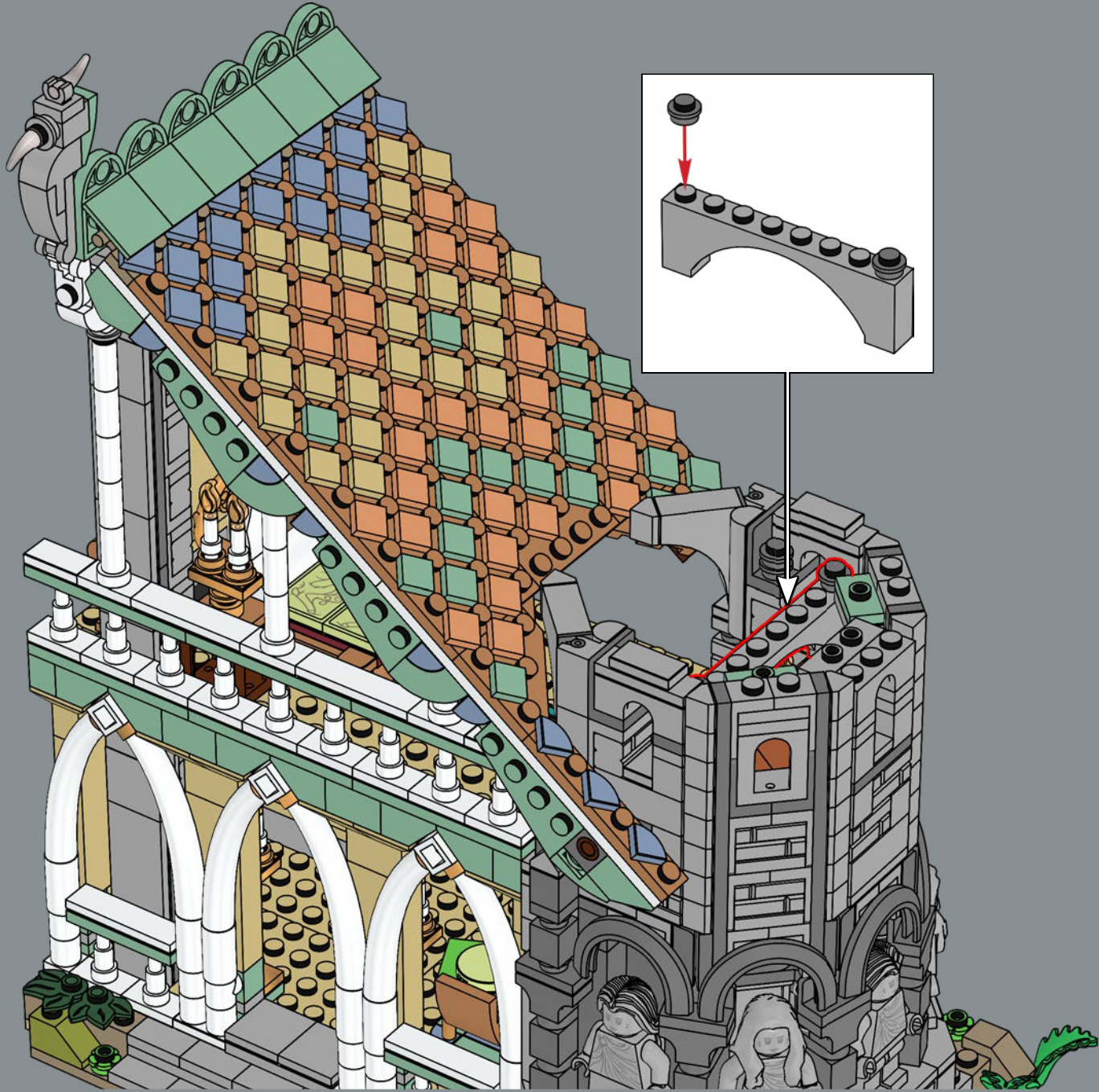

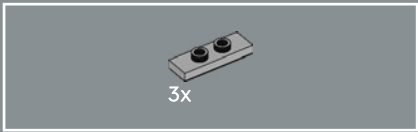

210

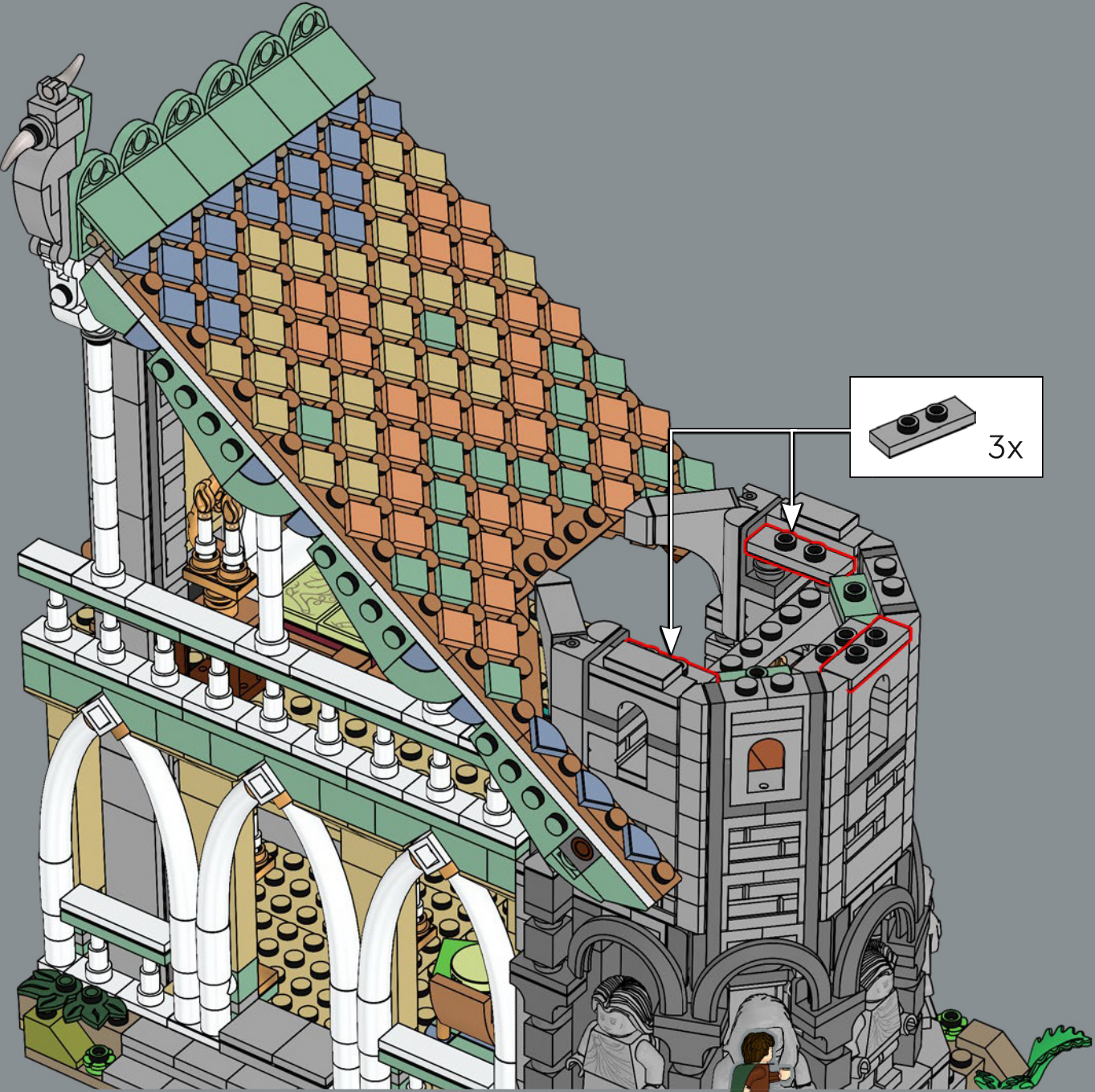



211

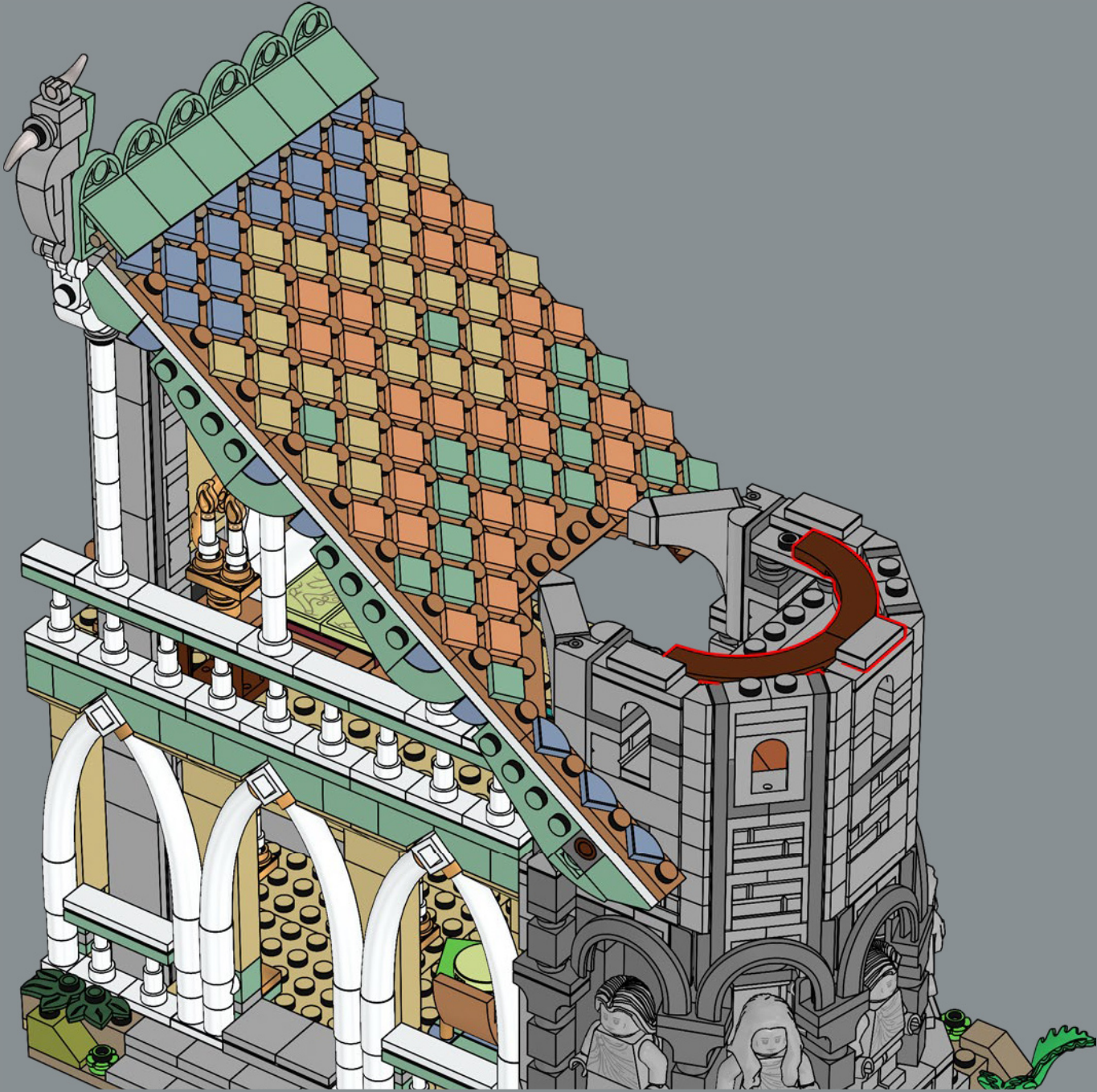

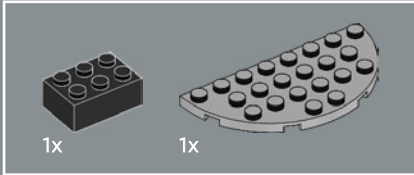
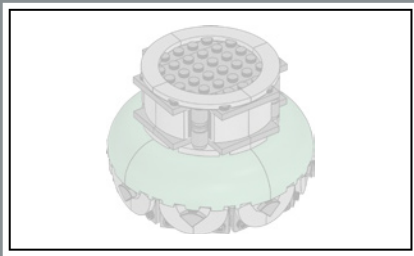

212

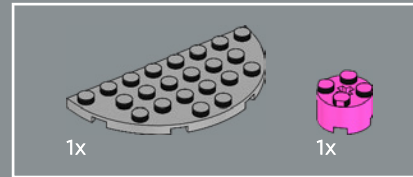
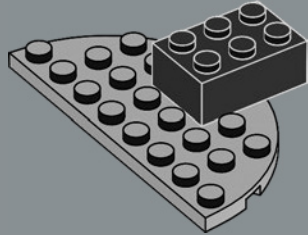

213

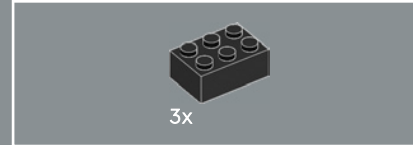
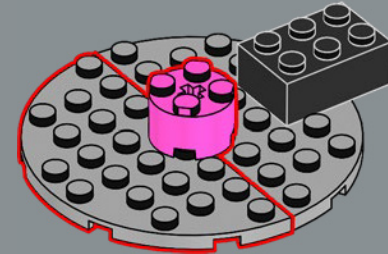

214

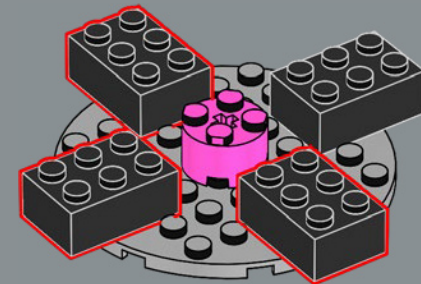

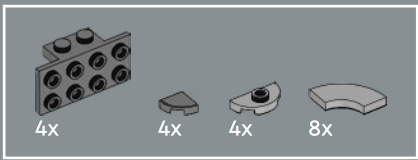

215

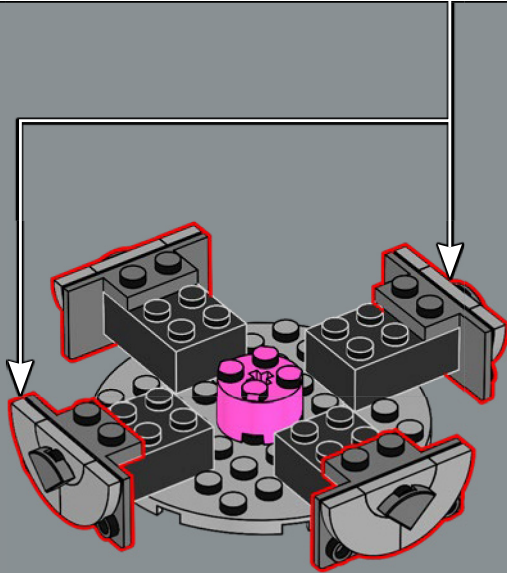
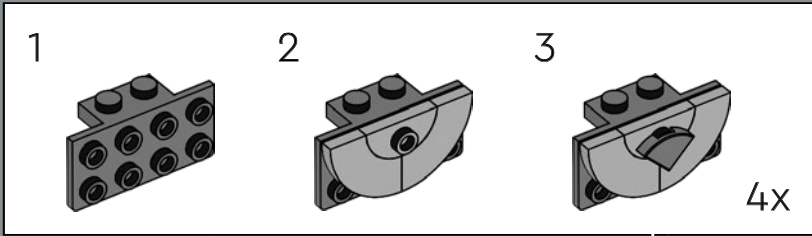

216

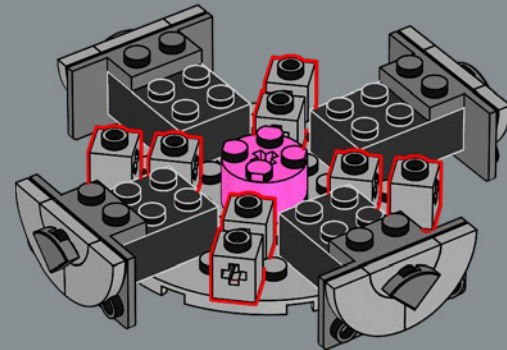

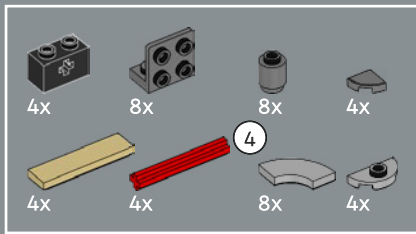

217

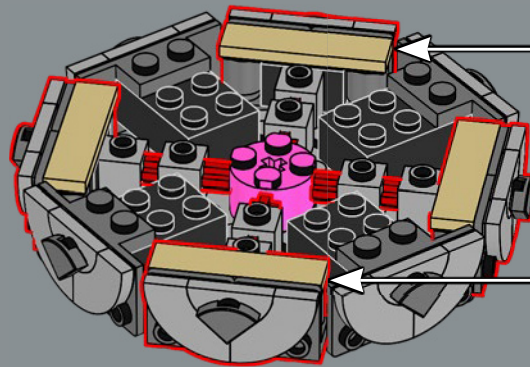
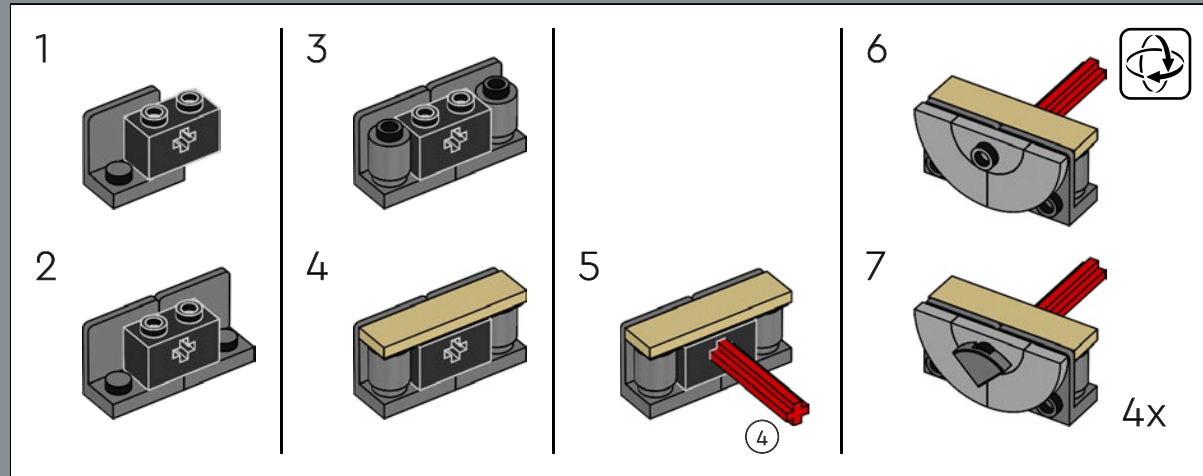

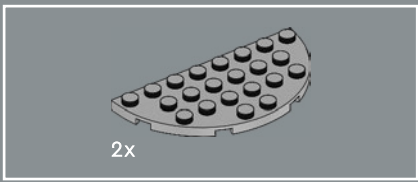

218

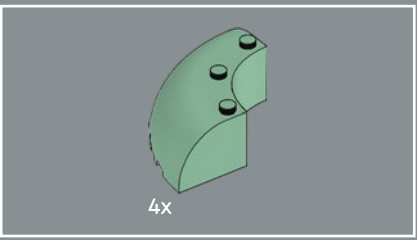
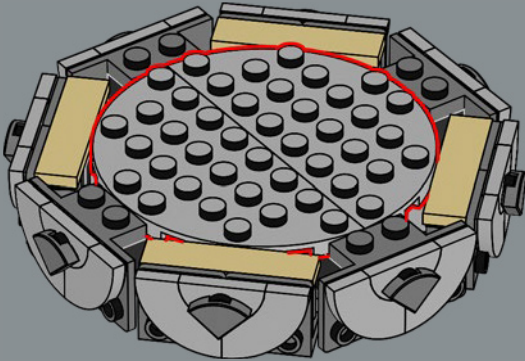

219

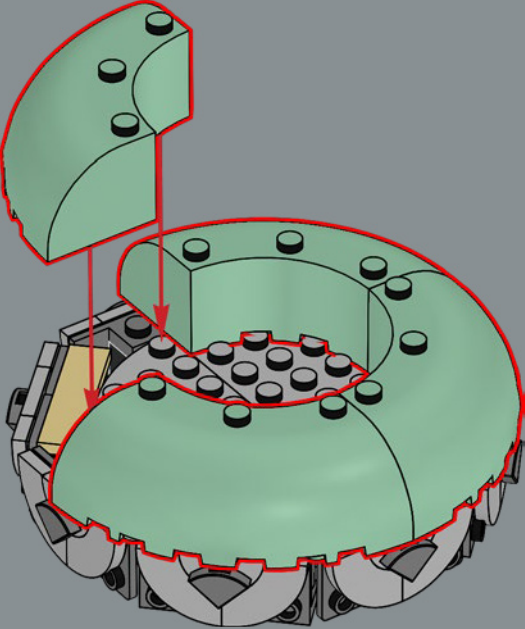

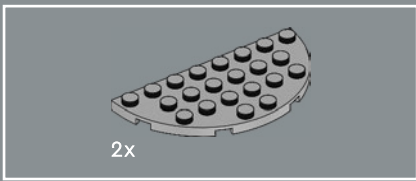

220

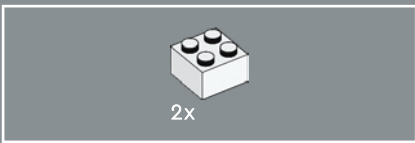
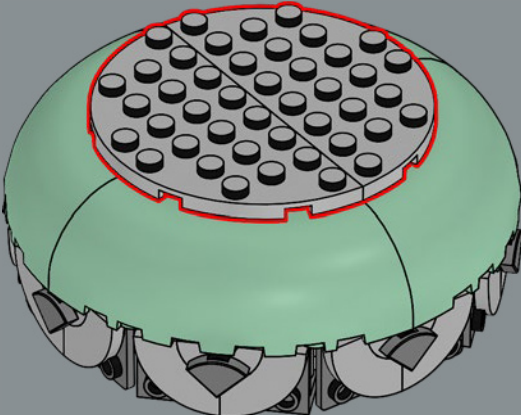

221

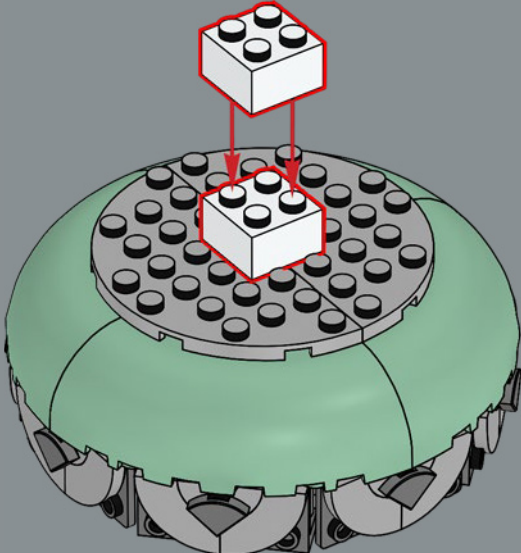

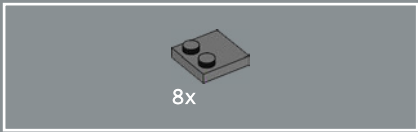

222

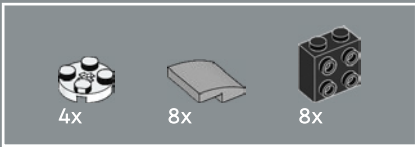
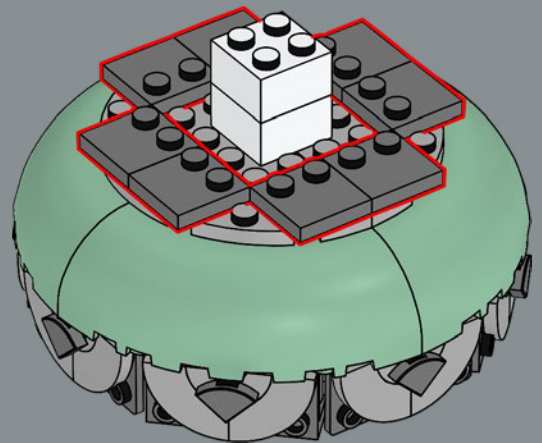

223

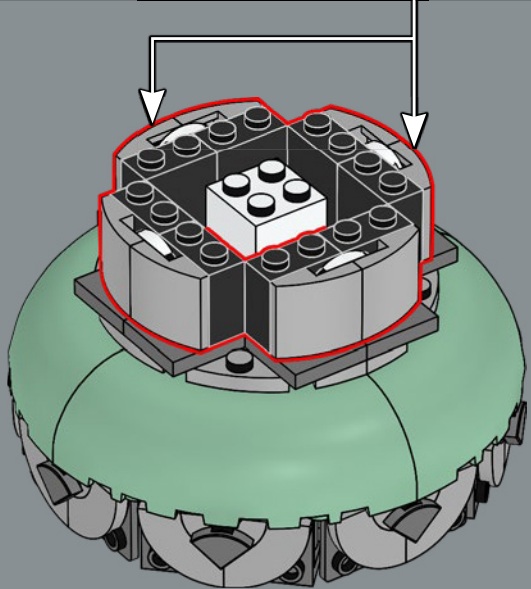
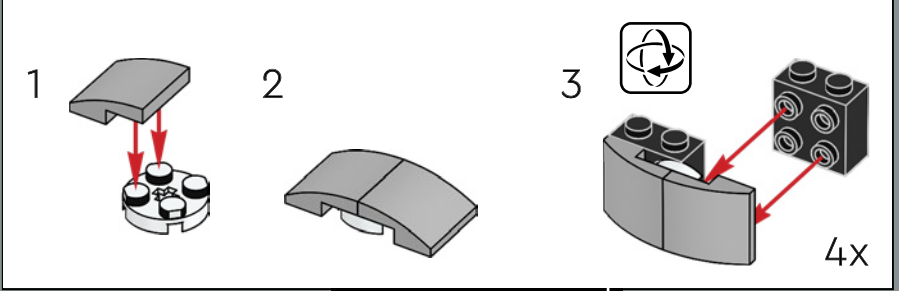

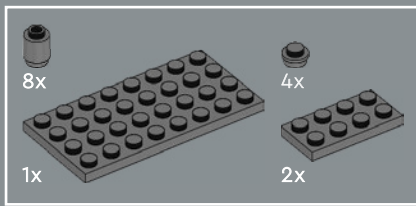

224

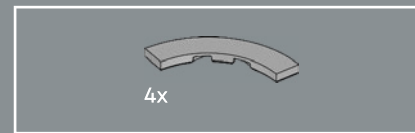
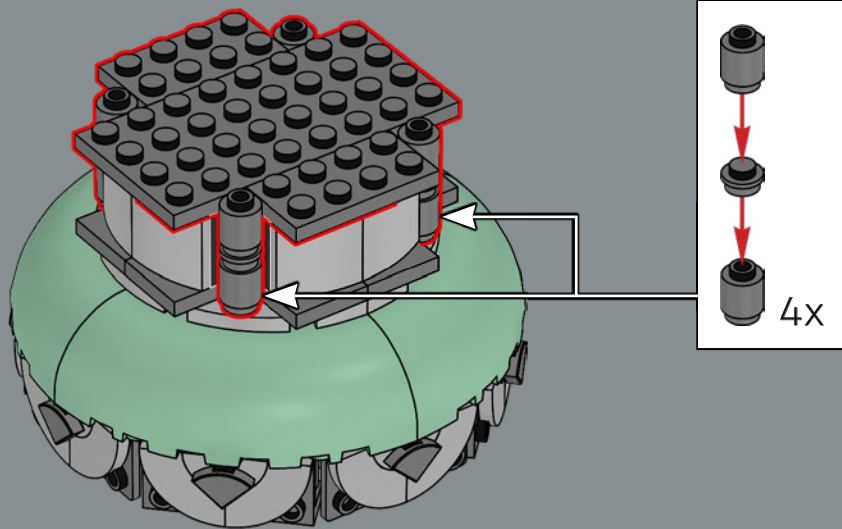

225

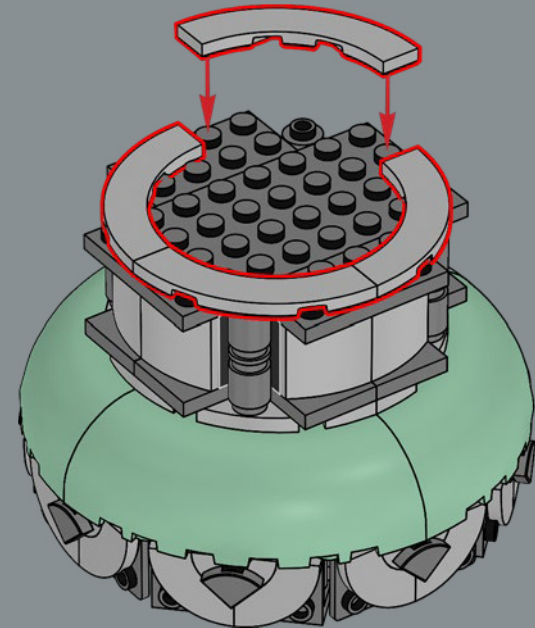



El techo de la torre está diseñado para que puedas retirarlo y observar cómo avanza Bilbo en la escritura de su libro.

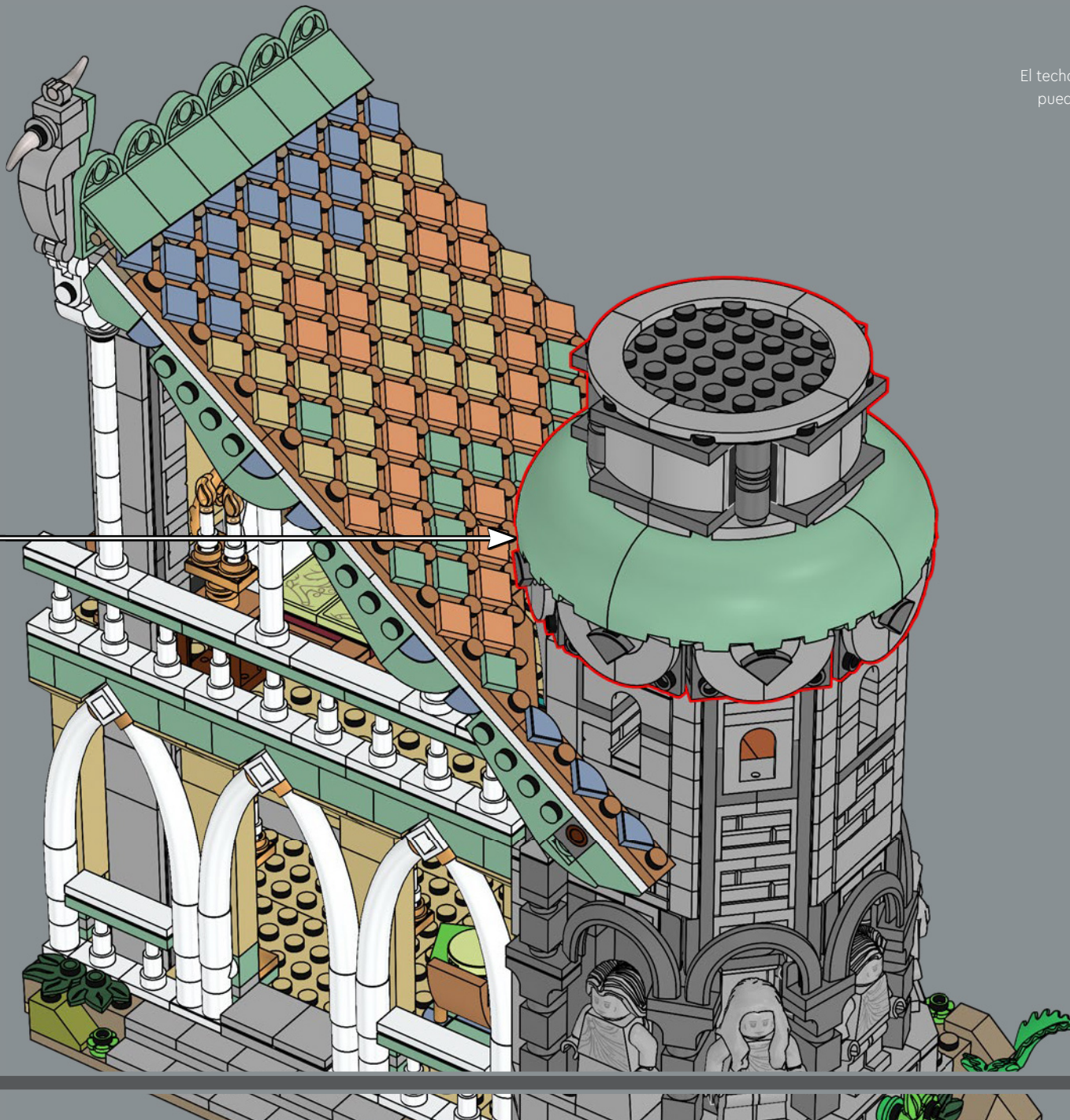



227

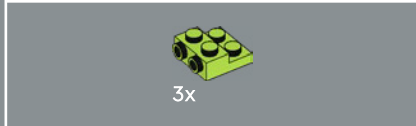
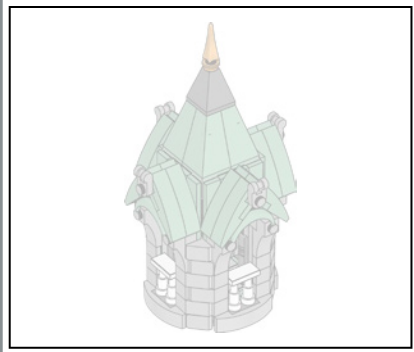
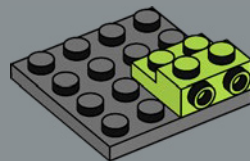

228

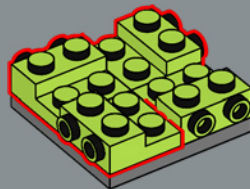

229

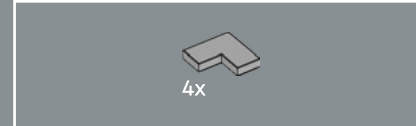
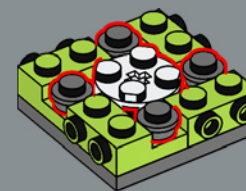

230

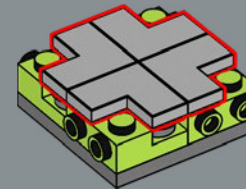



4x

231

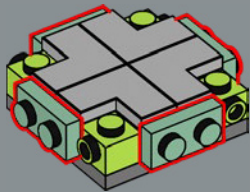

4x



8x



8x



4x

232

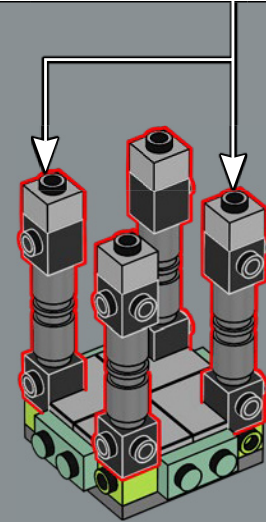
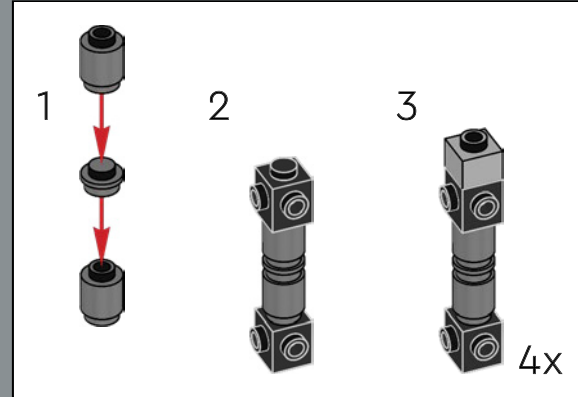

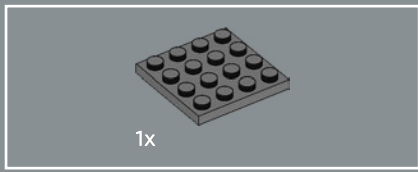

233

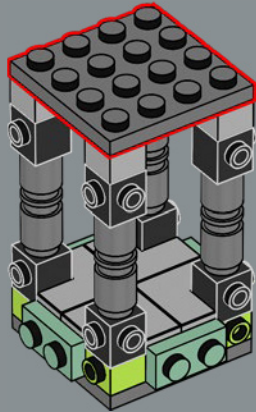

234

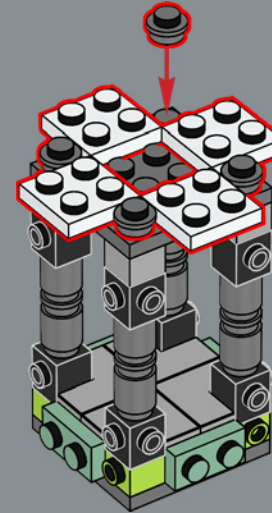

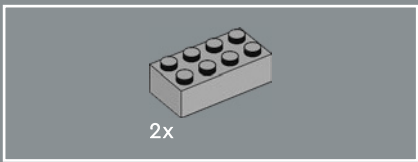

235

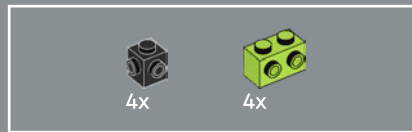
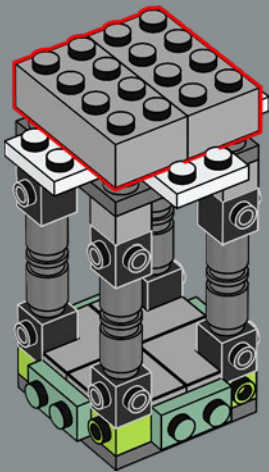

236

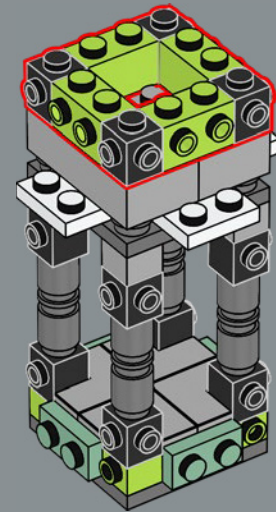

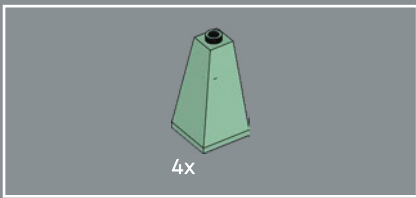

237

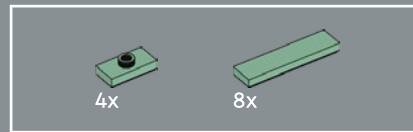
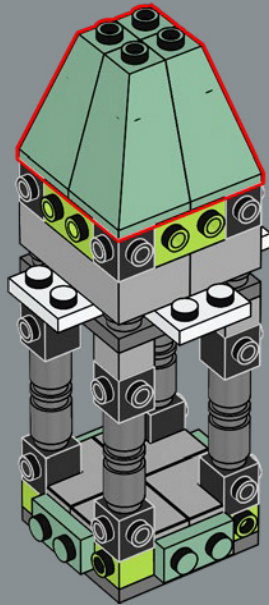

238

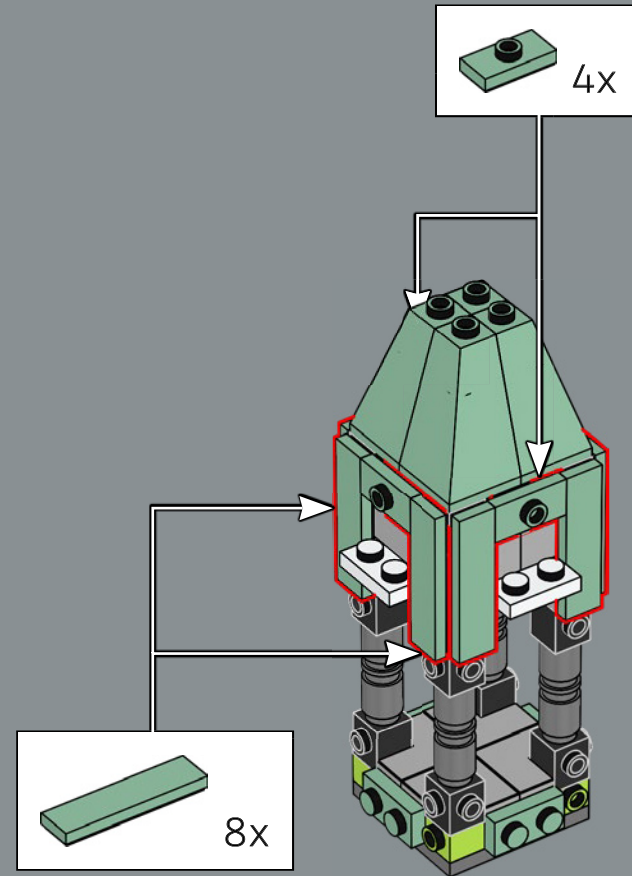

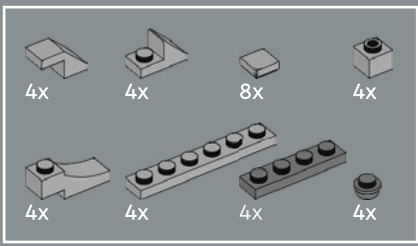

239

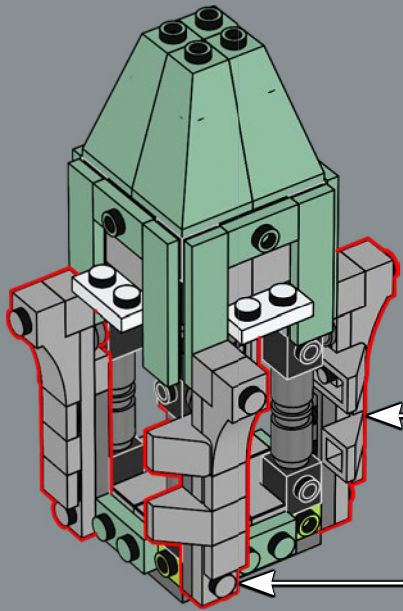
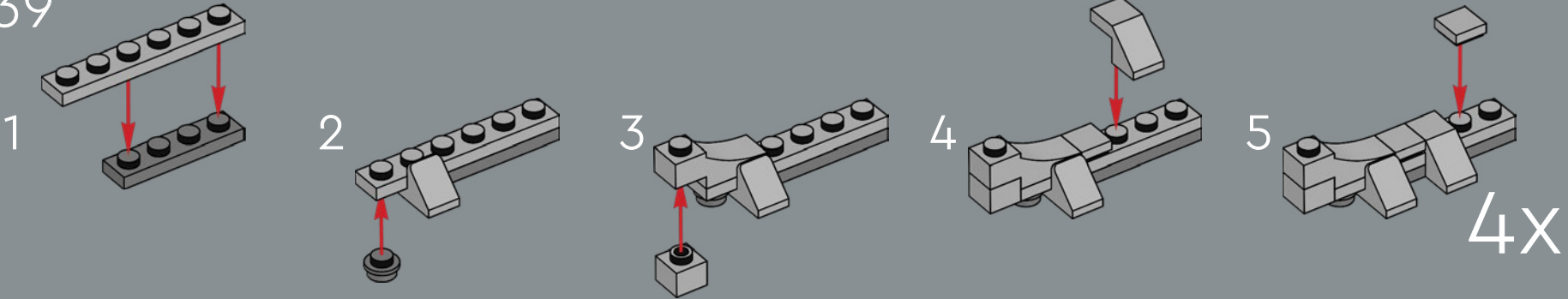

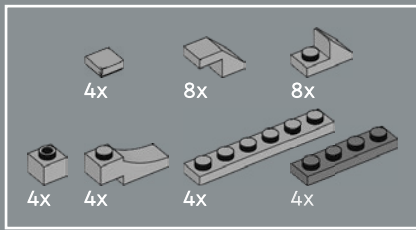

240

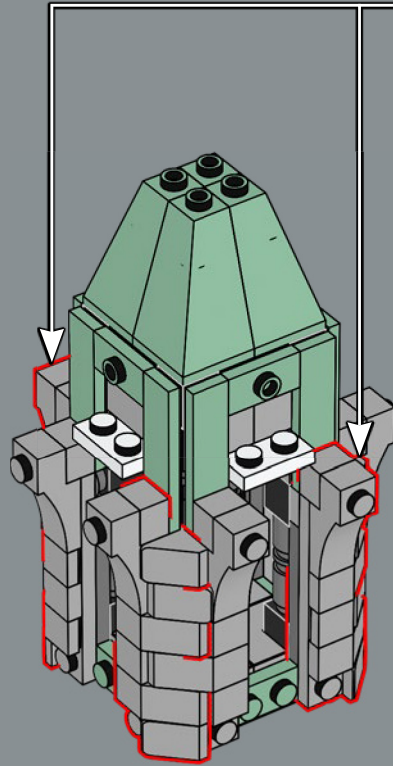
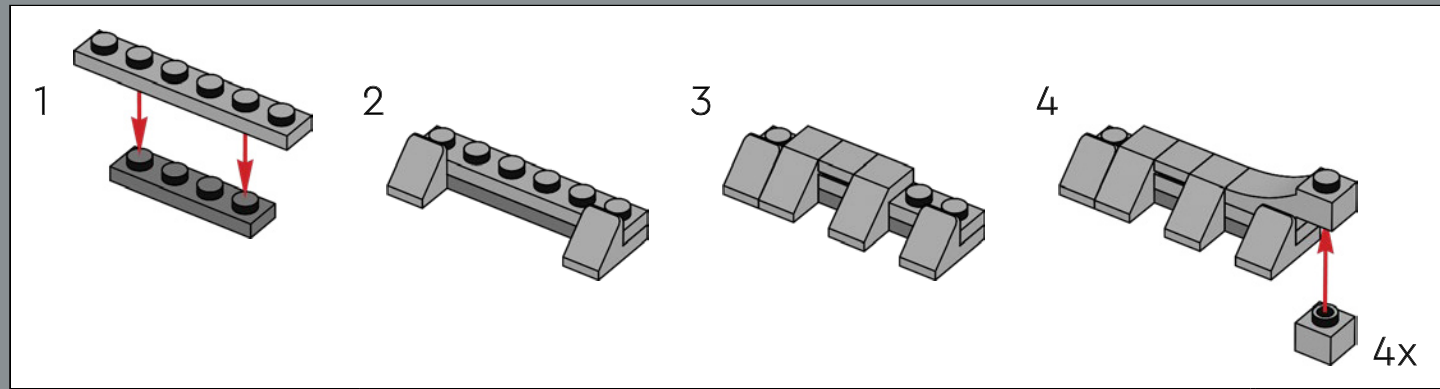



241

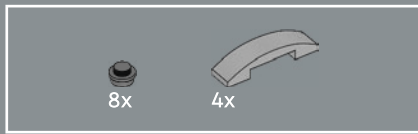
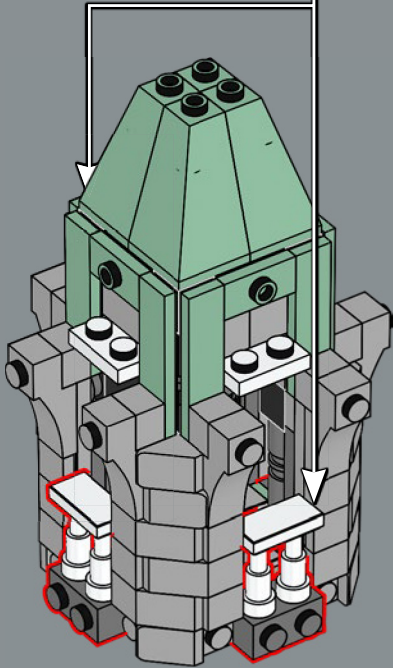
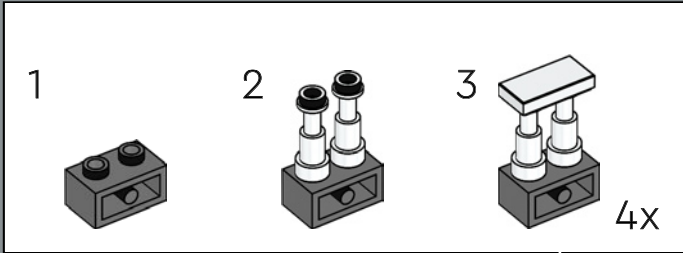

242

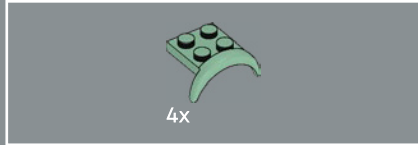
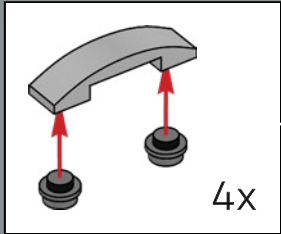

243

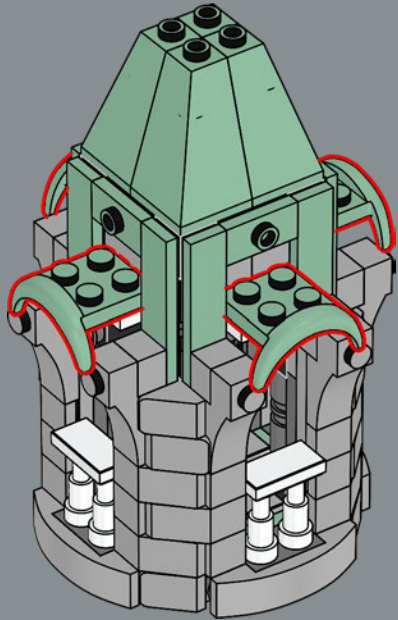
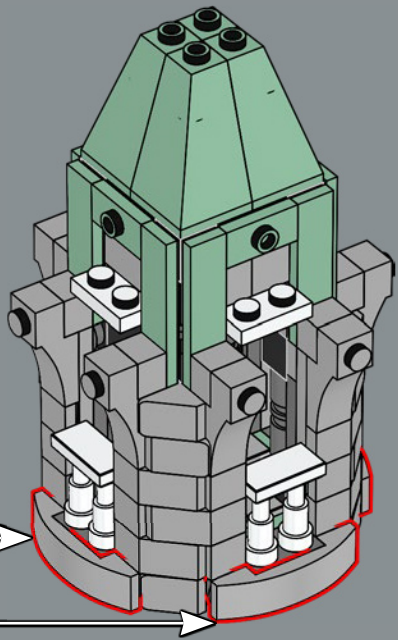

El elemento verde utilizado en la parte superior de este arco de ventana se diseñó originalmente como un arco para la rueda de un automóvil.

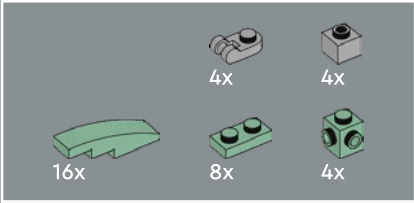

244

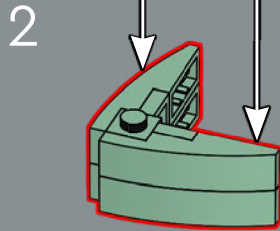
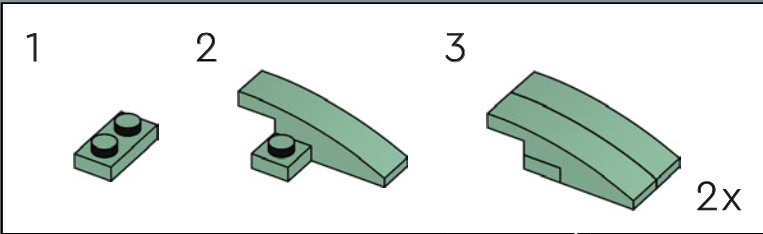
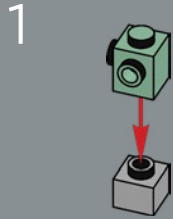

3

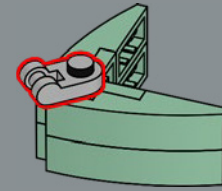

4x

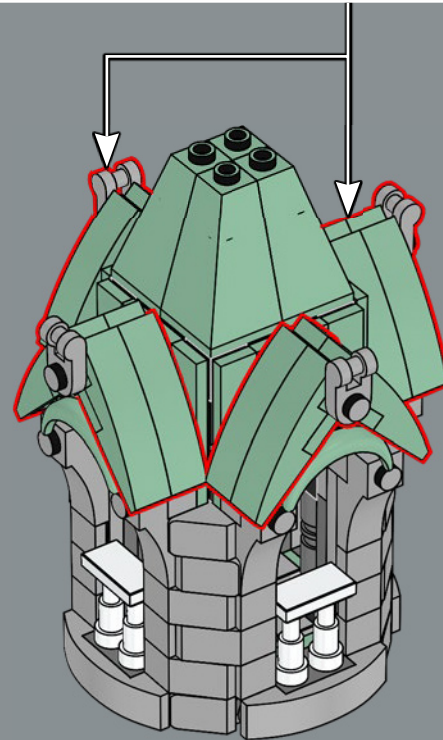



245

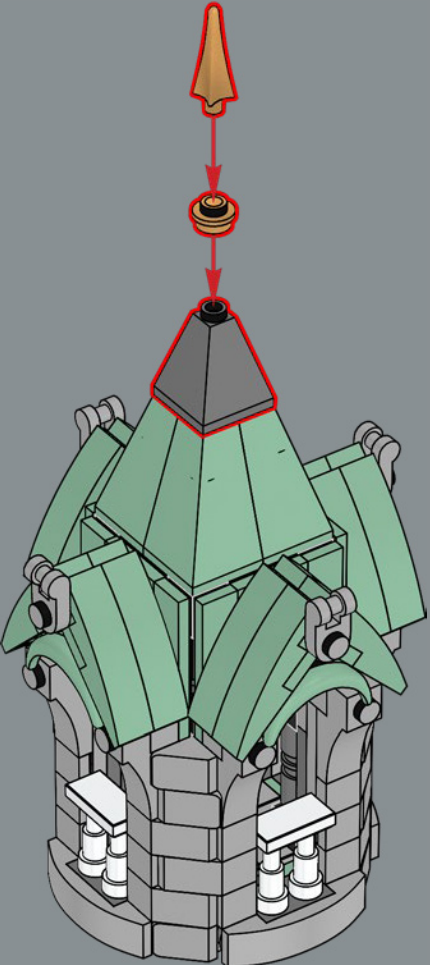

246

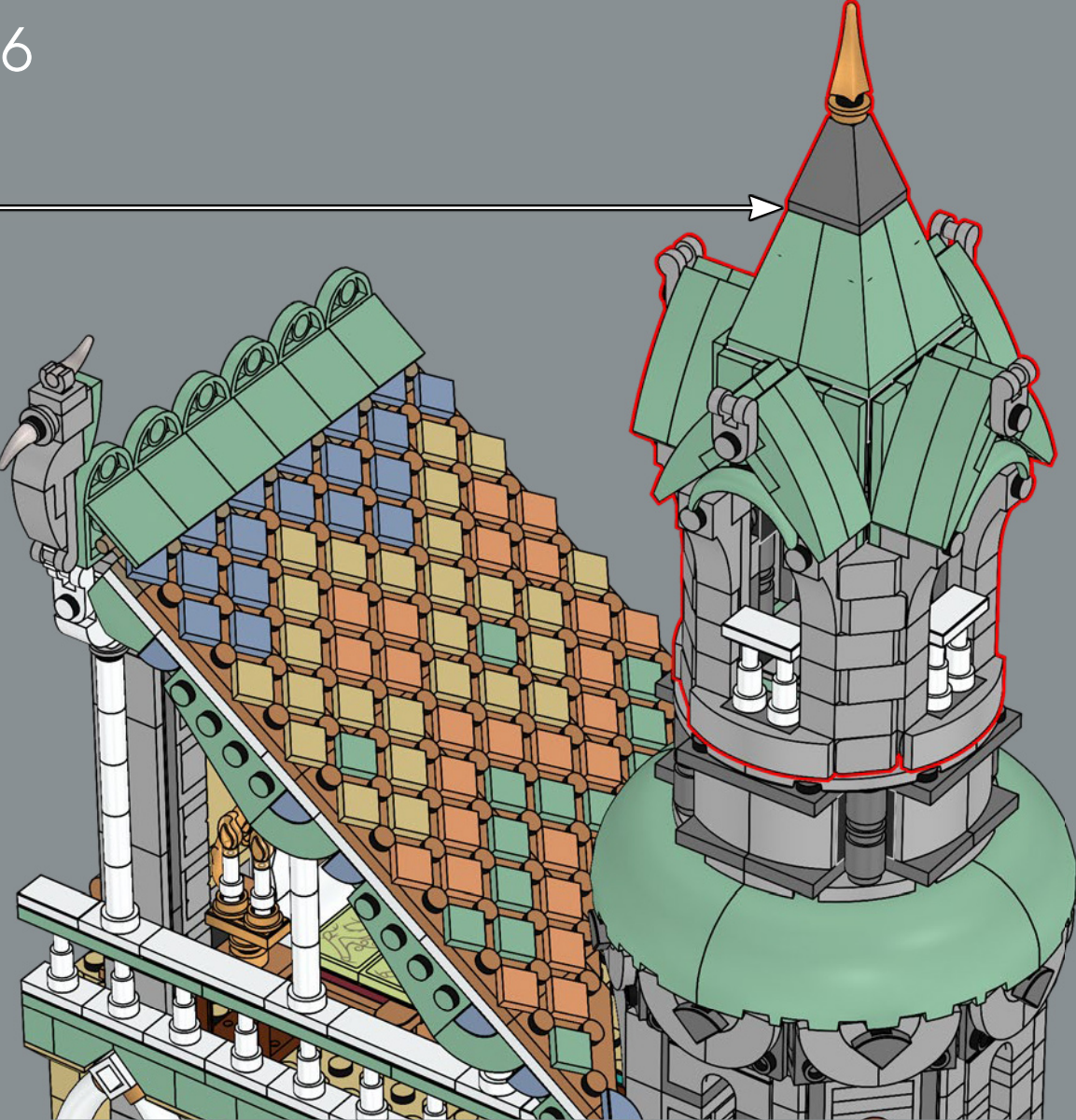

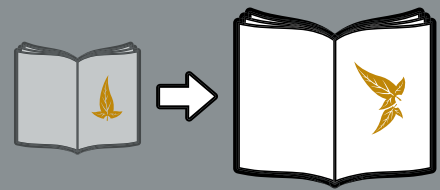

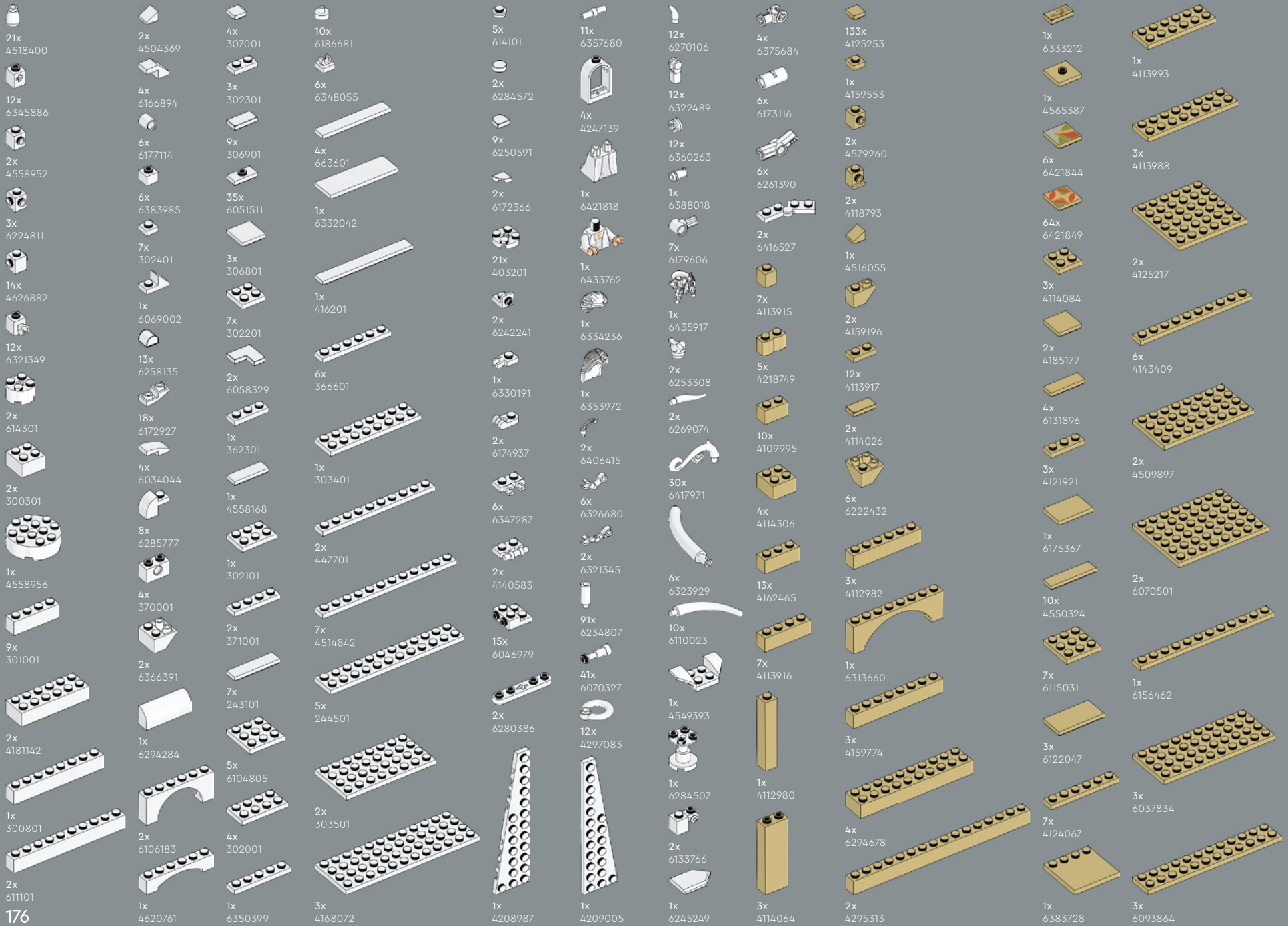

5x 4666579	1x 6310249	3x 6330584	6x 614124	1x 4529236	3x 6186675	1x 6168646	1x 452226	1x 6299492
2x 6145570	1x 6433765	130x 6419170	72x 6286830	4x 306226	1x 6335388	40x 614126	1x 4189009	1x 6321770
1x 6236914	1x 64330418	2x 6330418	1x 346024	1x 4504382	1x 6330189	1x 474026	1x 4189009	1x 6171101
1x 4512688	3x 6429962	2x 614323	5	2x 6265091	2x 6347310	2x 6195325	1x 6315887	15x 6229130
1x 4512688	7x 6421843	2x 6130008	2x 6130008	4x 6170566	1x 6338799	10x 6052126	3x 6278152	2x 6331100
4x 6273864	1x 306921	2x 370023	2x 4558954	12x 6187572	3x 6020193	1x 452826	5x 6279875	46x 6206150
3x 4624185	2x 6347308	2x 302323	2x 6228987	1x 4214559	1x 6016172	6x 452826	8x 6280097	4x 4119479
4x 6030980	1x 6187620	2x 302123	4x 407026	8x 473326	2x 6250020	6x 6116604	6x 4512363	15x 6182261
2x 4611414	1x 6001806	1x 4206482	19x 300226	20x 6275806	2x 6313191	1x 6267045	5x 6390386	1x 6235080
	1x 6066342	9x 6299413	1x 300926	5x 6138173	7x 346026	6x 6168620	2x 6227901	34x 6411022
	2x 6378120	4x 300823	1x 4181144	4x 6178922	1x 395826	2x 6280168	1x 6315573	16x 6268814
	18x 4142865	1x 300823	9x 6037390	1x 6039347	1x 6151117	1x 4558209	1x 6283610	2x 6389695
	1x 6209519	1x 300823	1x 4181144	3x 302026	1x 6115117	1x 6115117	1x 6283610	1x 6406357
	5x 243121	2x 362324	9x 6037390	1x 6039347	4x 6401209	4x 6401209	1x 4517986	5x 6395814
	5x 6129995	1x 302024	2x 611226	3x 379526	5x 6001494	1x 6133200	6x 302128	1x 6293826
		2x 300224						2x 6266964
		1x 300824						





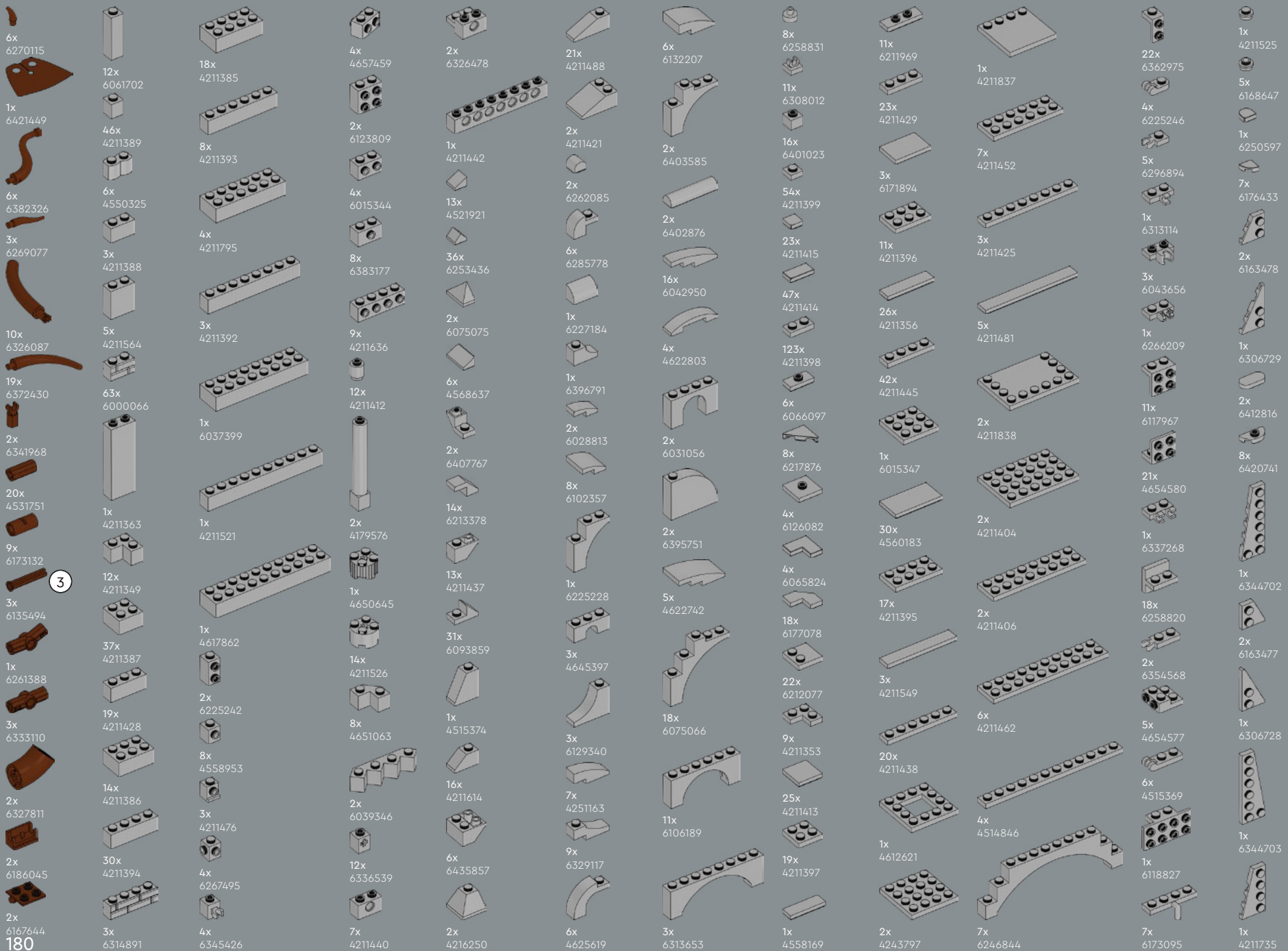

3



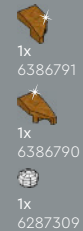
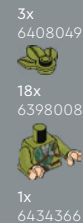
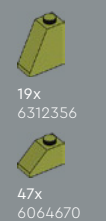
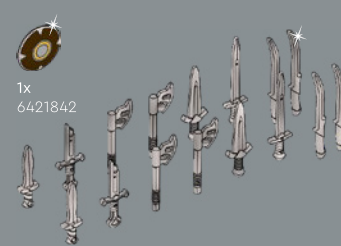
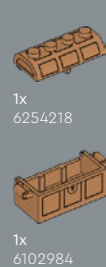
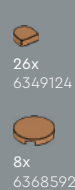
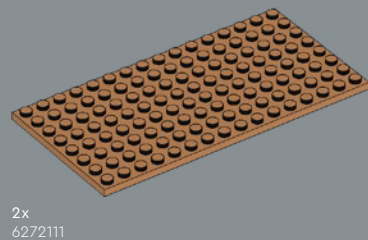
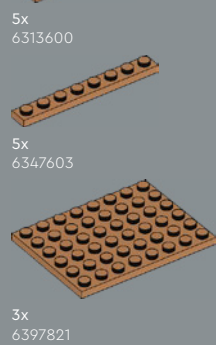
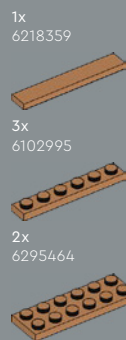

LEGO.com/service



YOU COULD WIN



YOU COULD WIN

Your feedback will help shape the future development of this product series.

Visit:

DU KÖNNTEST GEWINNEN

Dein Feedback trägt zur Weiterentwicklung dieser Produktreihe bei.

Geh auf:

VOUS POURRIEZ GAGNER

Vos commentaires nous aideront à concevoir les futurs produits de cette gamme.

Visitez :

POTRESTI VINCERE TU

La tua opinione ci aiuterà a migliorare la creazione futura di questa linea di prodotti.

Visita:

PUEDES GANAR

Tu opinión contribuirá al futuro de esta serie de productos.

Visita:

轻松获奖

您的反馈将有助于我们在今后改进本产品系列。

请访问:

LEGO.com/productfeedback

You also have the chance to win a LEGO® set.

Terms and conditions apply.*

Außerdem hast du die Chance, ein LEGO® Set zu gewinnen.

Es gelten die Teilnahmebedingungen.*

Vous pourriez également gagner un ensemble LEGO®.

Des conditions s'appliquent.*

Hai anche la possibilità di vincere un set LEGO®.

Termini e condizioni sono applicabili.*

También tienes la oportunidad de ganar un set LEGO®.

Aplican términos y condiciones.*

您还有机会赢取乐高®套装。

条款和条件适用。*

*LEGO.com/productfeedback-terms

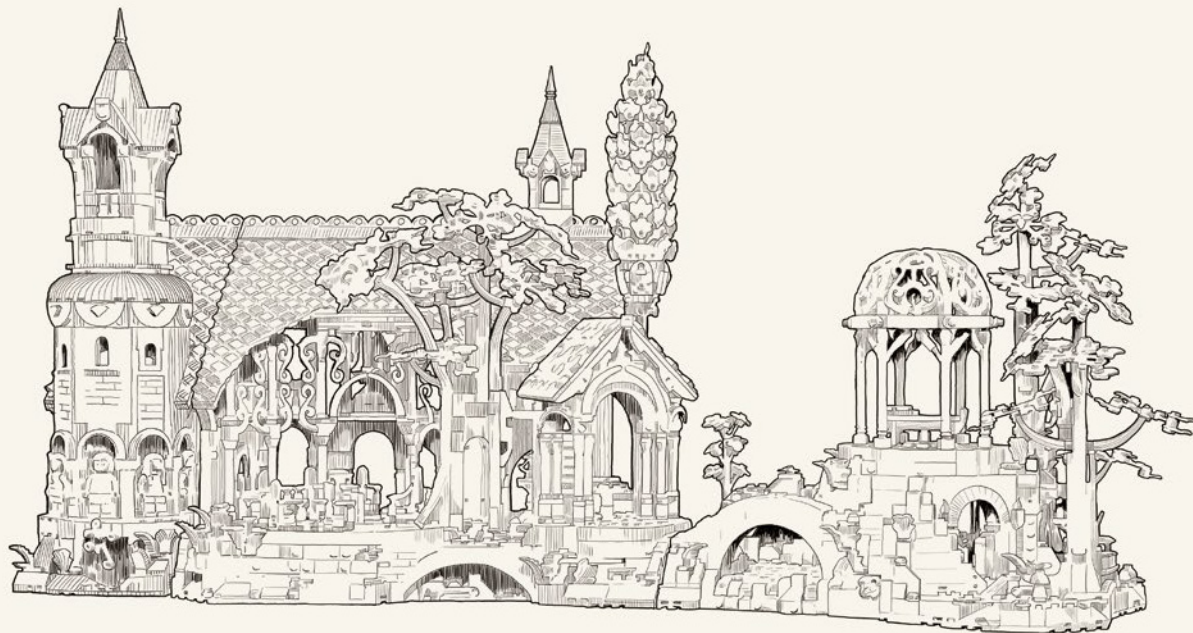

LEGO and the LEGO logo are trademarks of the LEGO Group. ©2023 The LEGO Group.

© 2023 New Line Productions, Inc. All rights reserved. The Lord of the Rings: The Fellowship of the Ring, The Lord of the Rings: The Two Towers, The Lord of the Rings: The Return of the King and the names of the characters, items, events and places therein are trademarks of The Saul Zaentz Company d/b/a Middle-earth Enterprises under license to New Line Productions, Inc. (s23)