

77

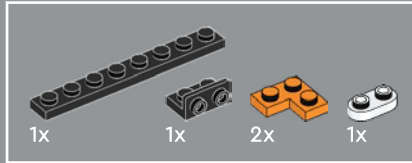

78

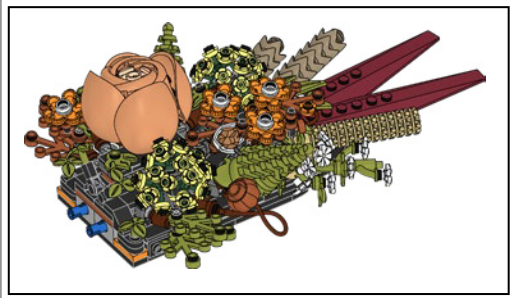

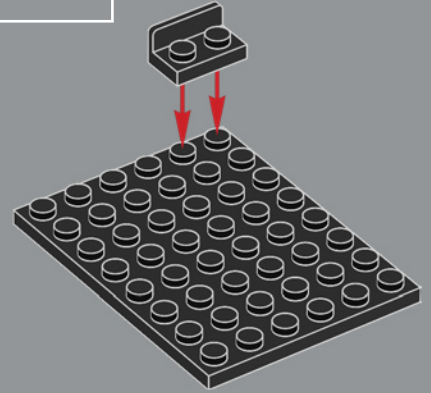
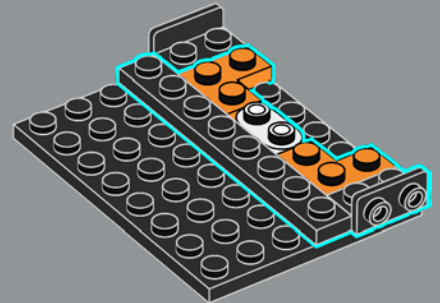
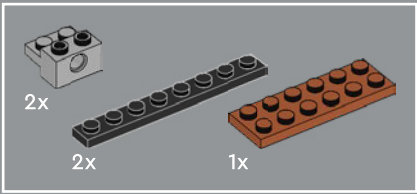

79

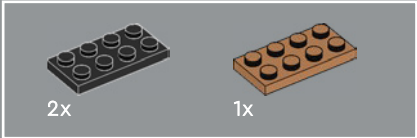
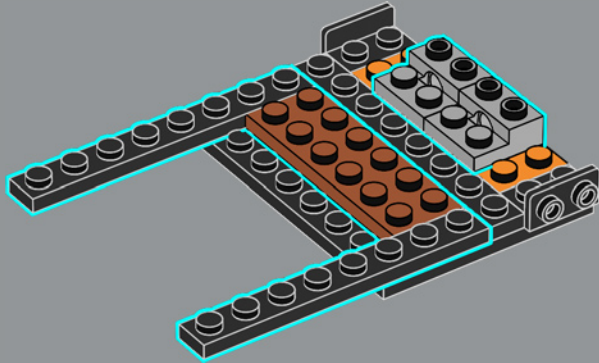

80

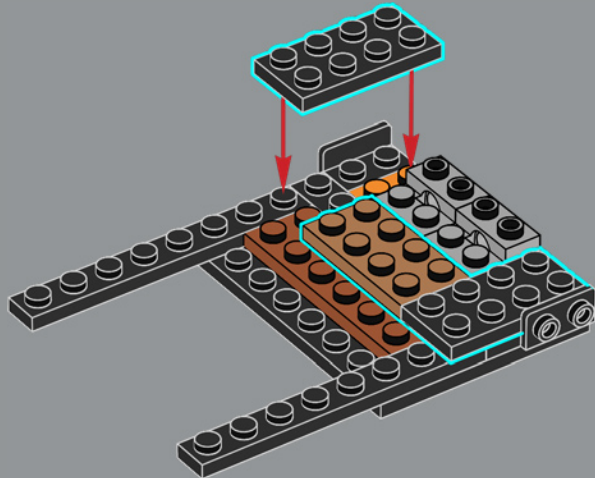

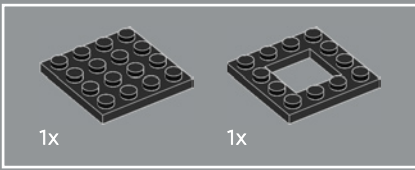

81

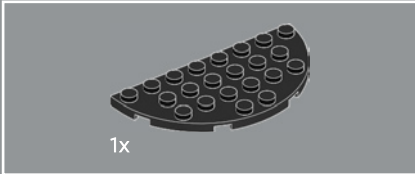
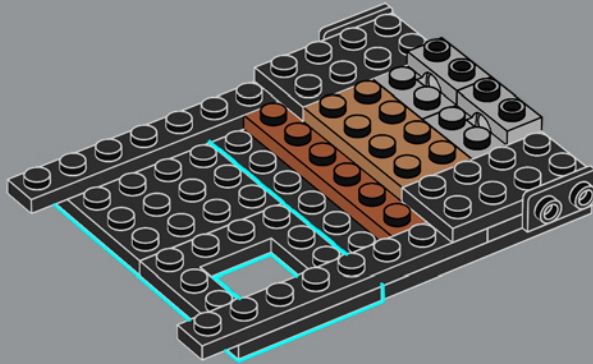

82

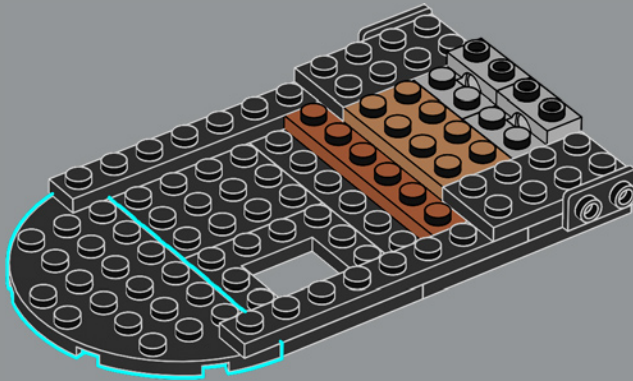

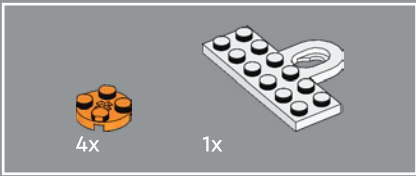

83

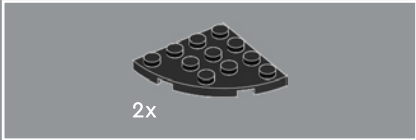
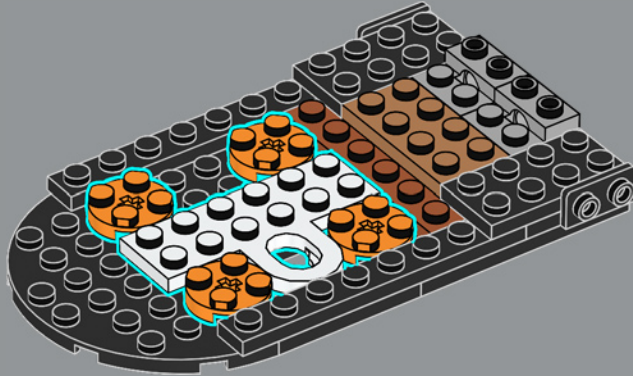

84

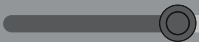
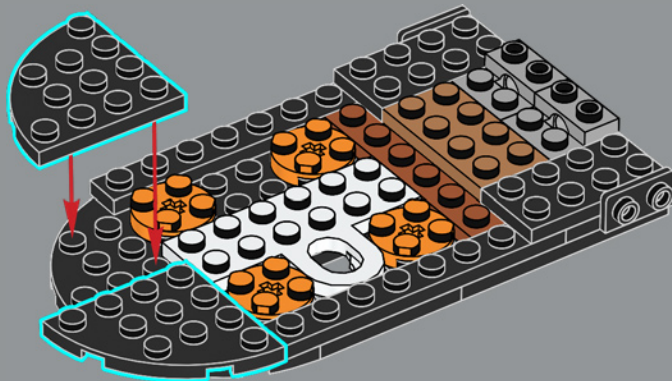

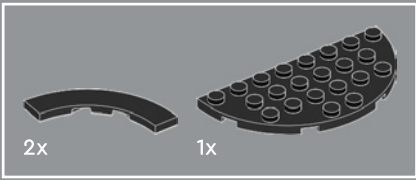

87

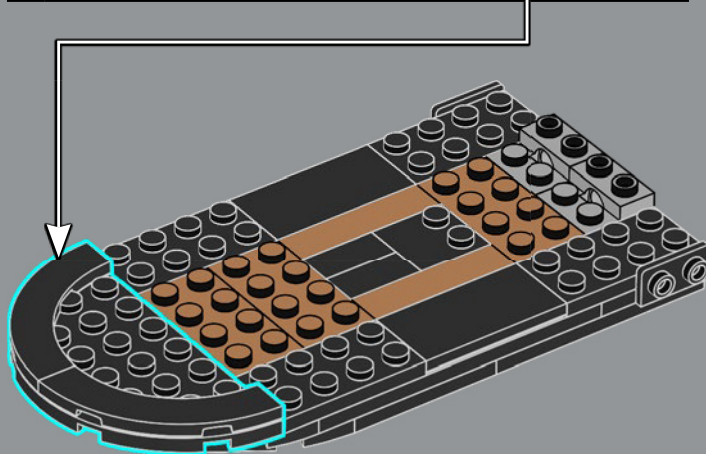
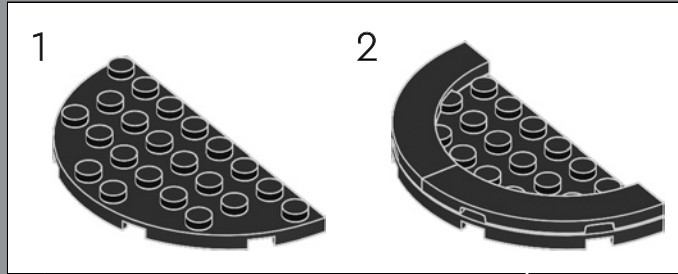

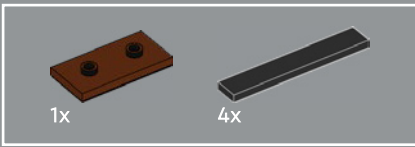

88

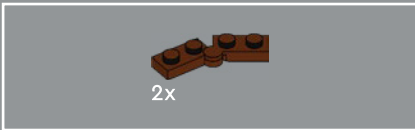
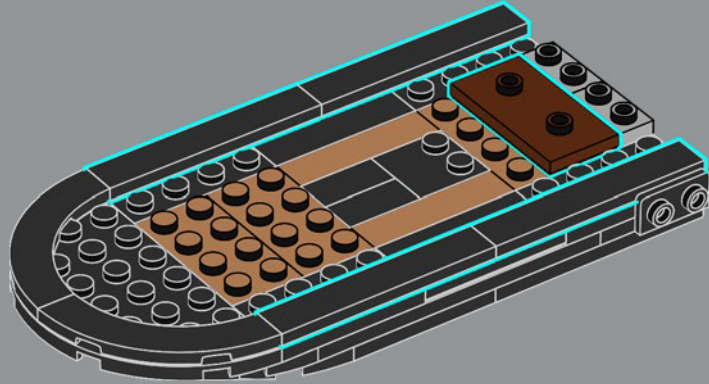

89

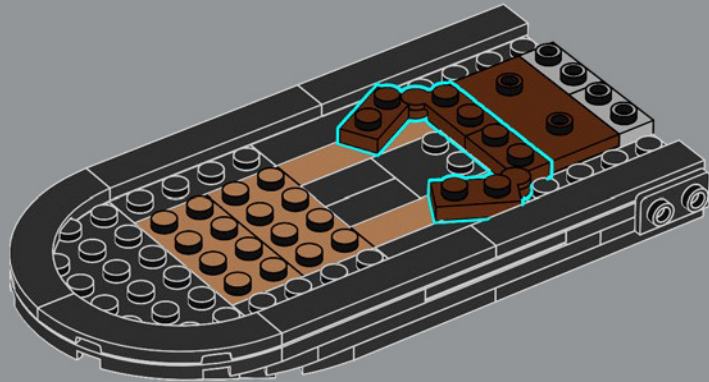

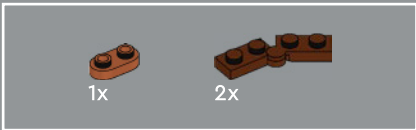

90

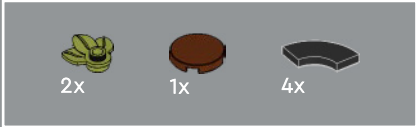
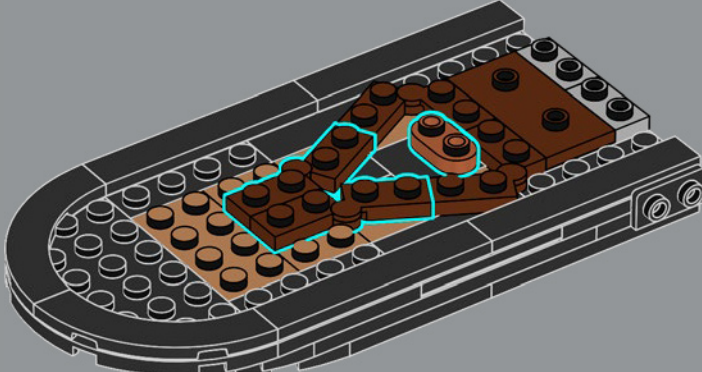

91



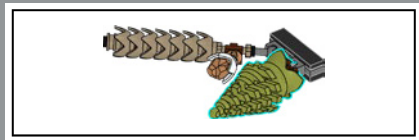

92

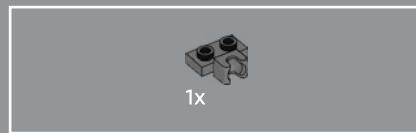
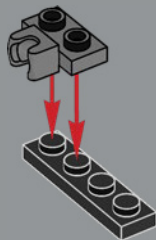

93

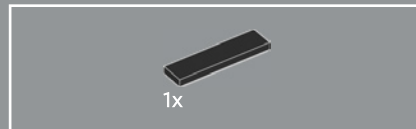
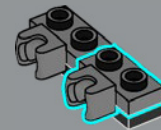

94

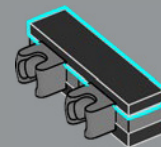



95

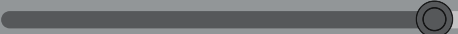
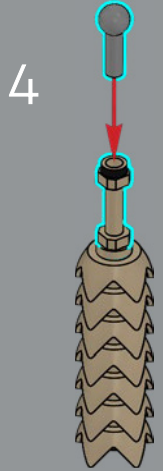
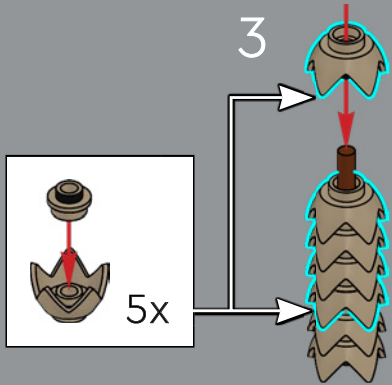
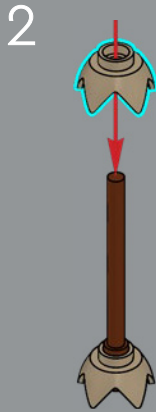
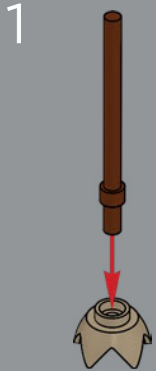



5

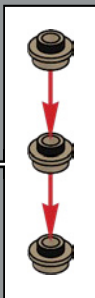

1x



1x



1x



1x

96

1



2



3

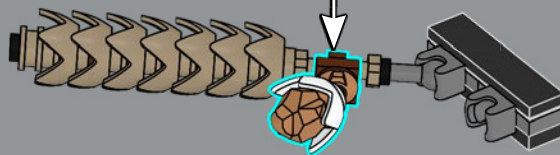

El trigo tiene coronas anidadas para replicar el aspecto corrugado de las espigas.

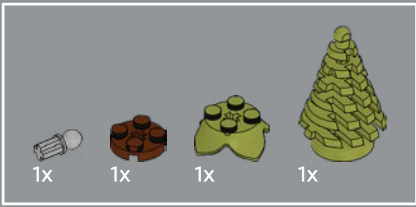

97

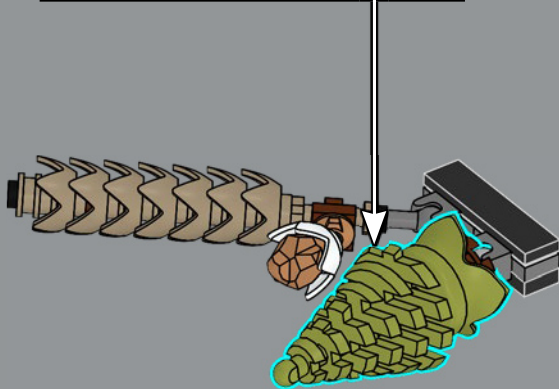
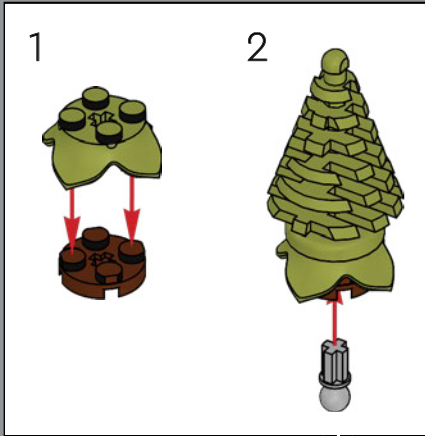

98

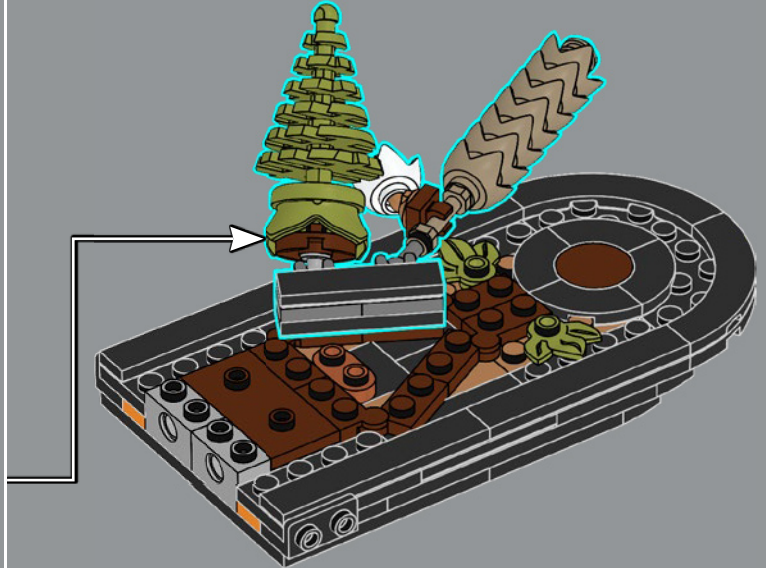

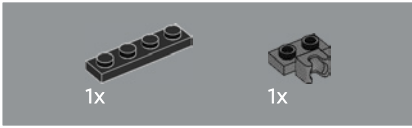
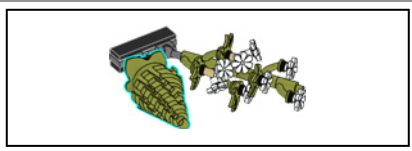

99

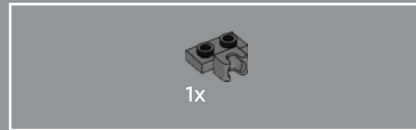
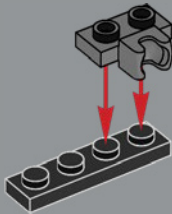

100

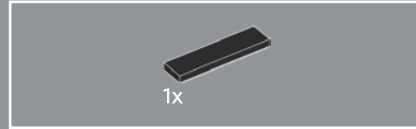
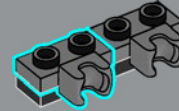

101

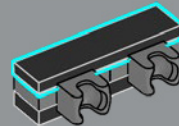

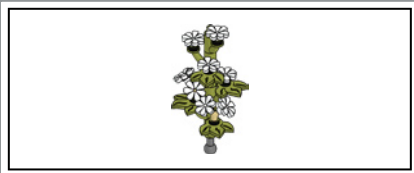

102



103

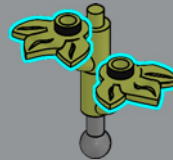

104

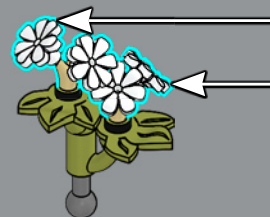
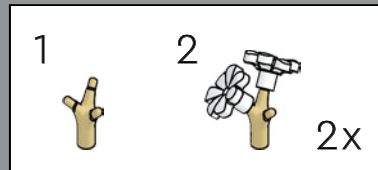

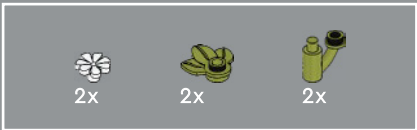

105

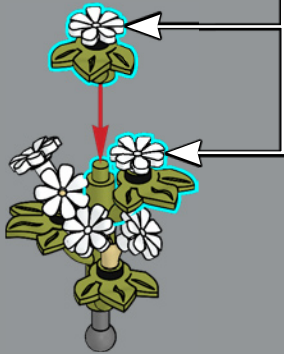
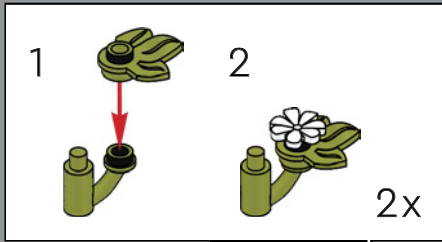

106

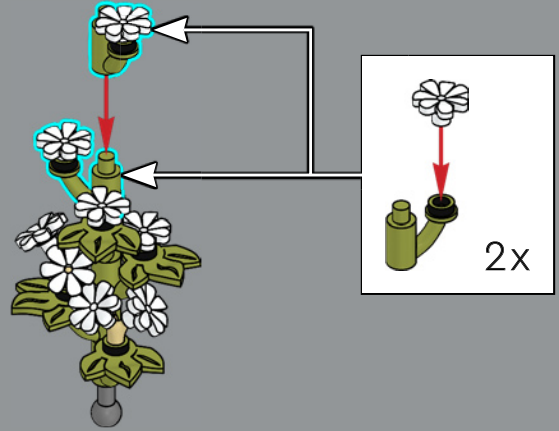

107

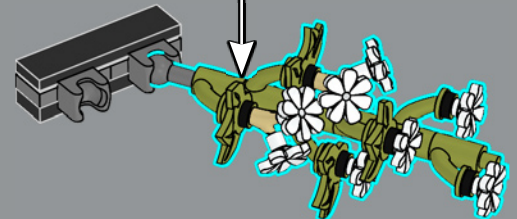

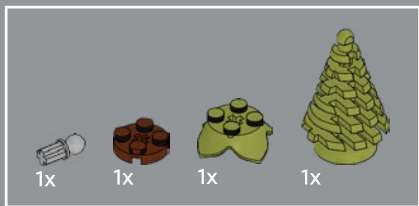

108

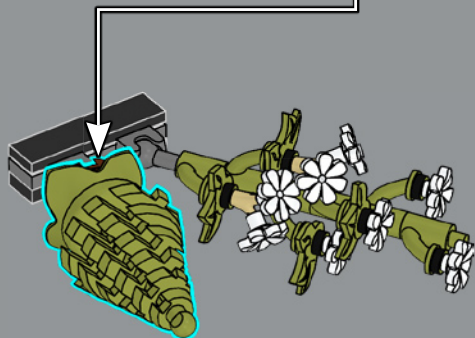
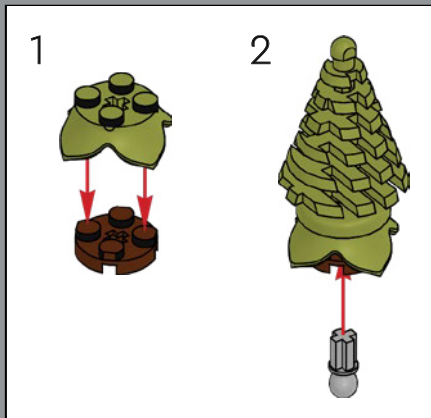

109

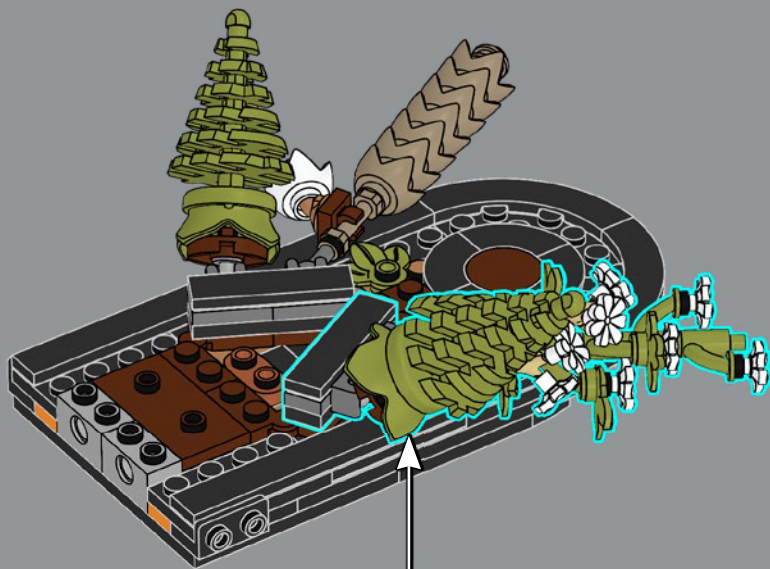

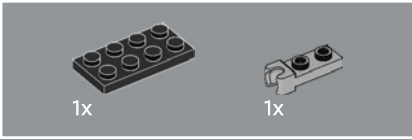
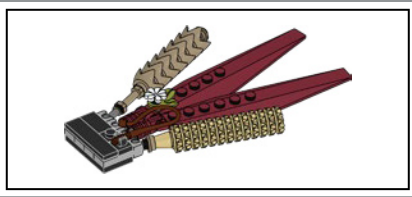

1x

1x

110

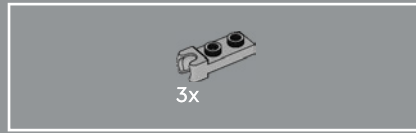

3x

111

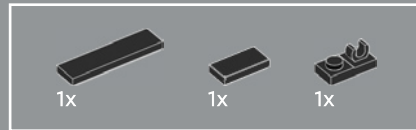
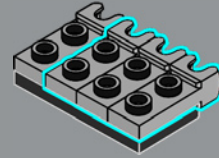

1x

1x

1x

112

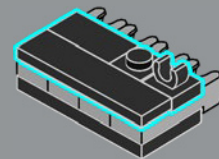

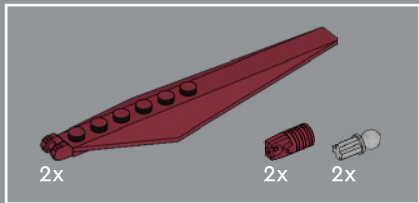

113

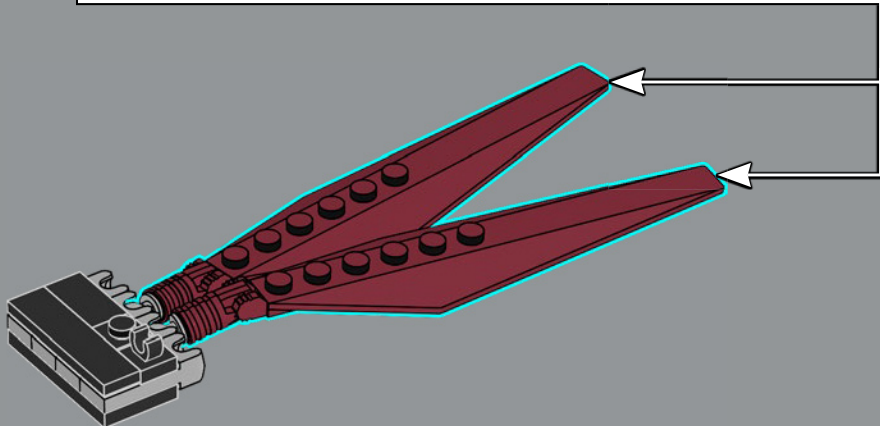
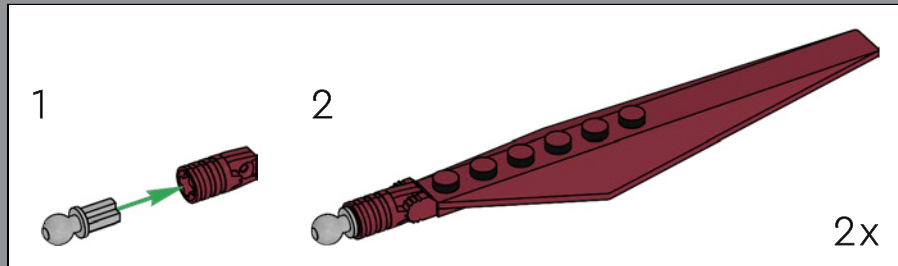

114

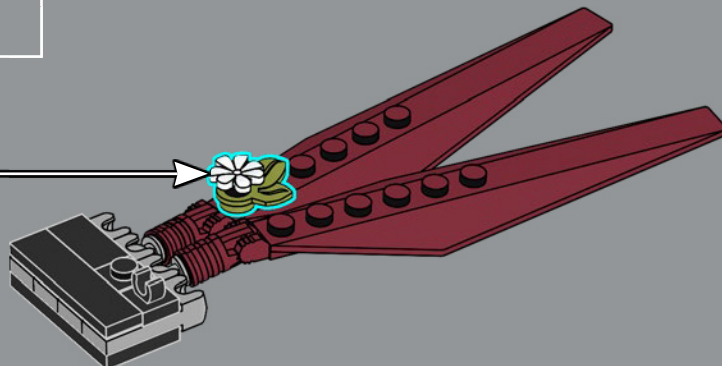
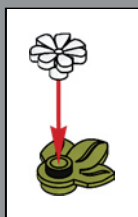



115

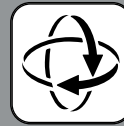
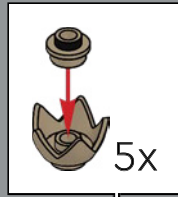
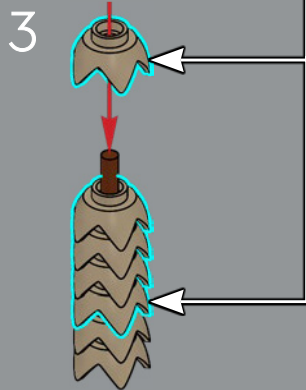
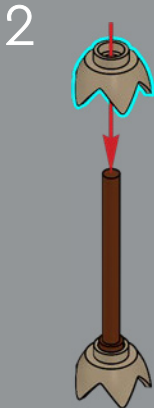
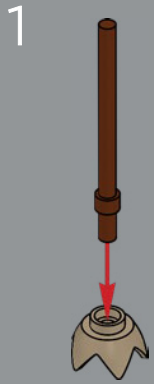

5

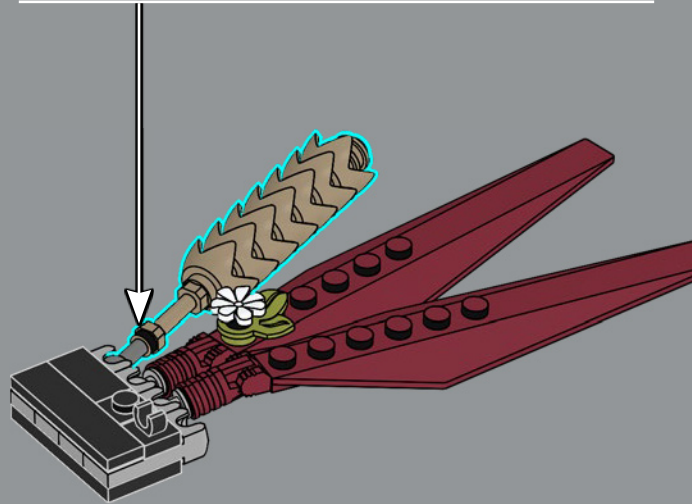

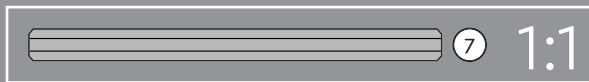
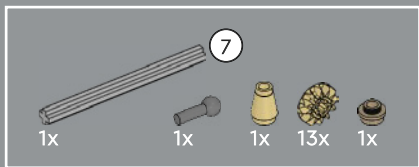

116

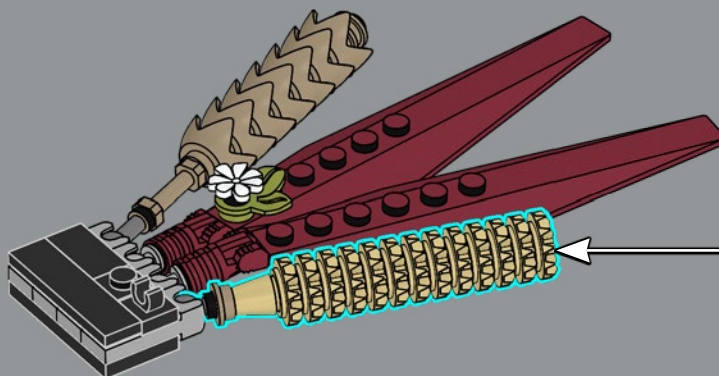
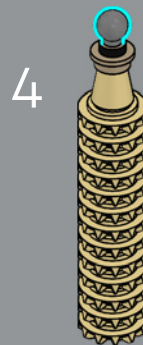
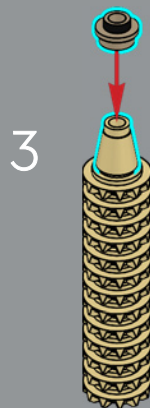
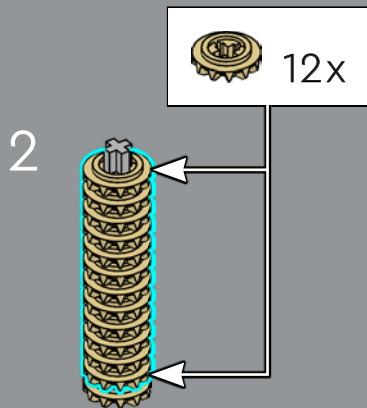



117

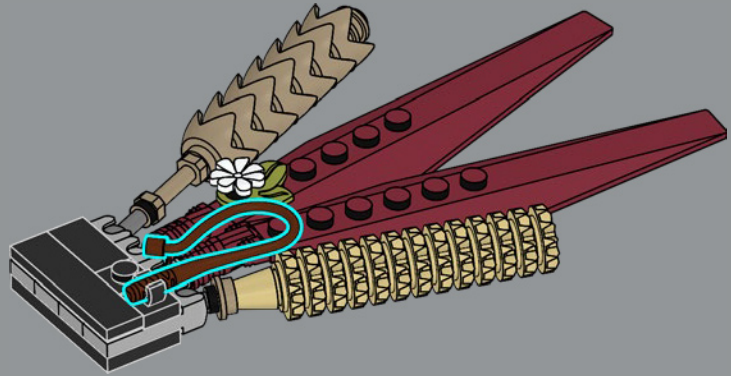

118

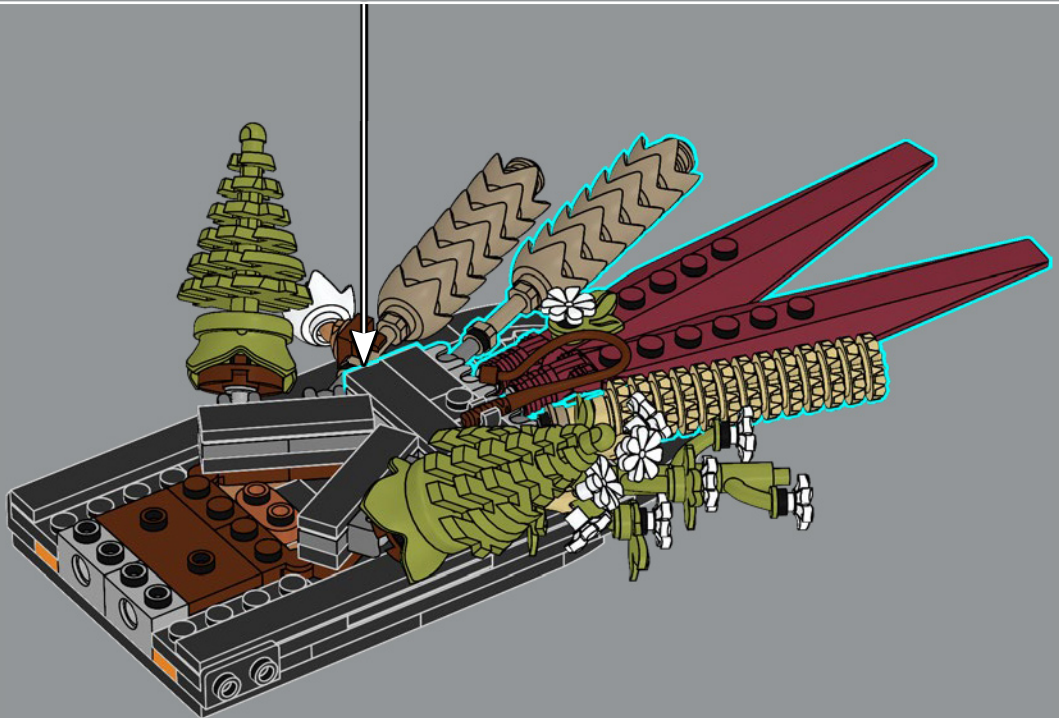

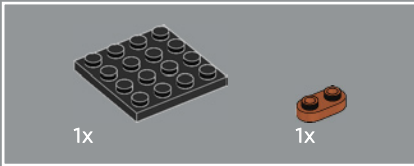
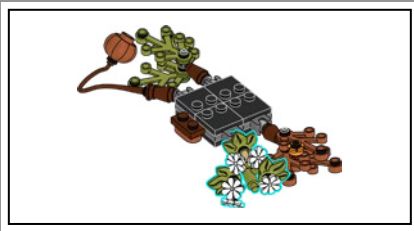

119

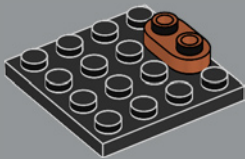

120

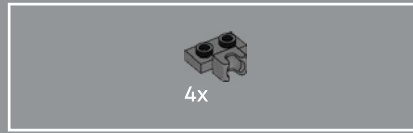
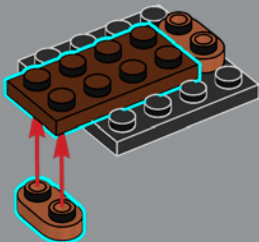

121



4x

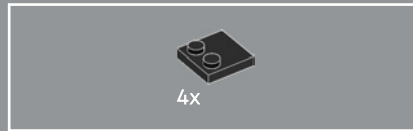
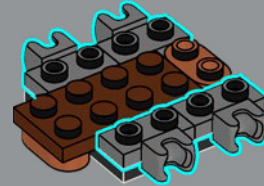

122



4x

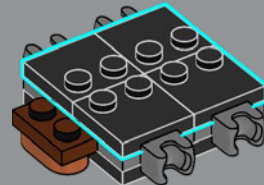

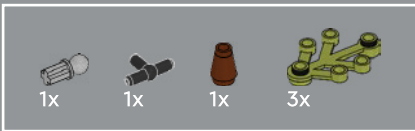

123

1

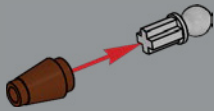

2

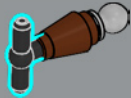

3

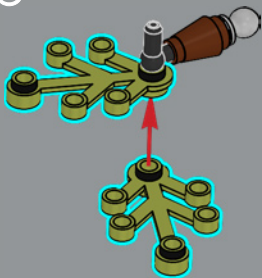

4

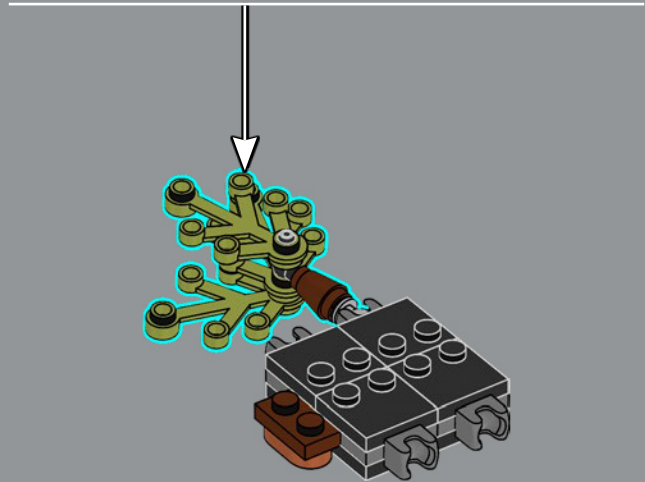
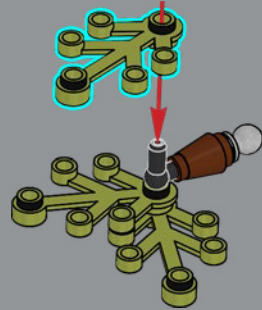

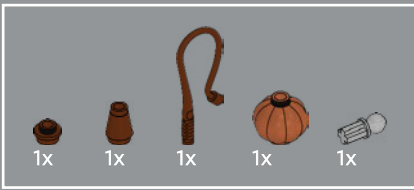

124

1

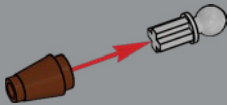

2

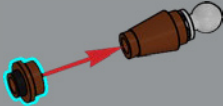

3

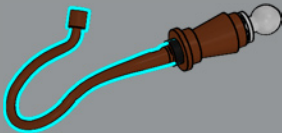

4

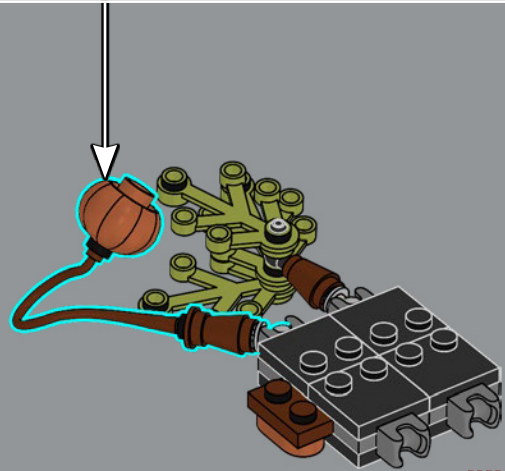
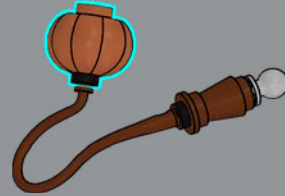

Los alquequenes, conocidos también con el peculiar nombre de *vejiga de perro*, se construyen uniendo un elemento LEGO® habitualmente utilizado para representar verduras (principalmente, calabazas) y un látigo flexible de color marrón.



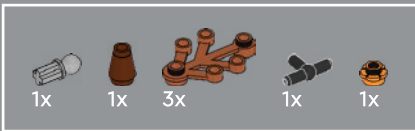

125

1

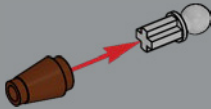

2

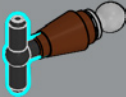

3

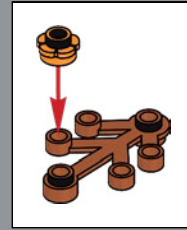
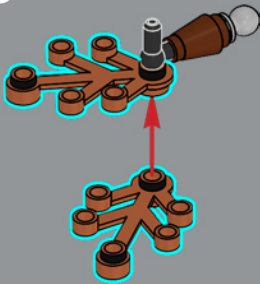

4

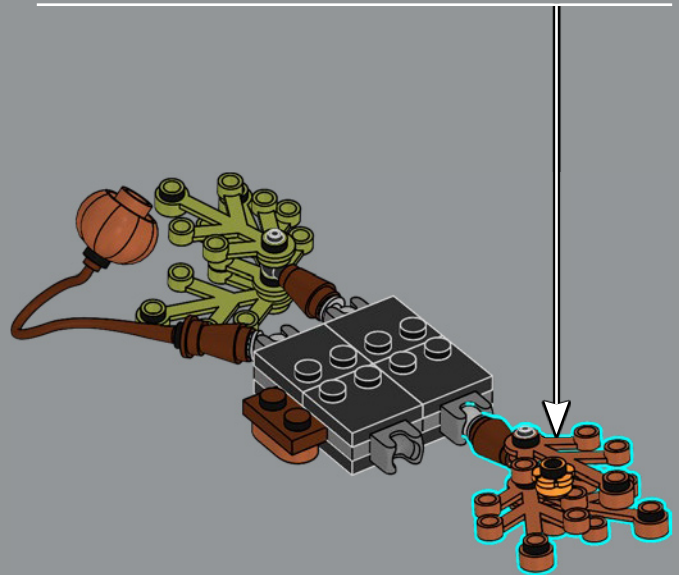
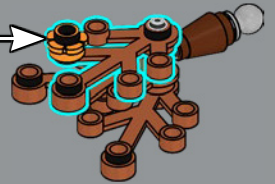

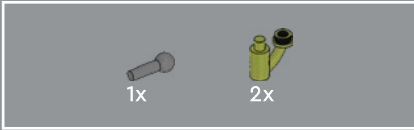
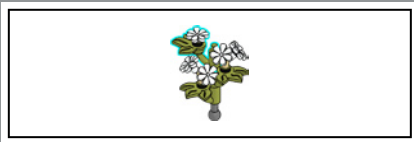

126



127

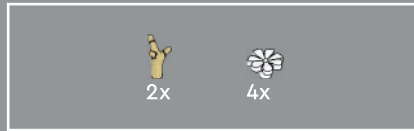
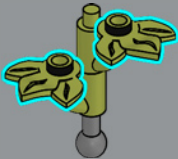

128

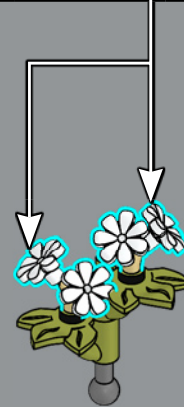
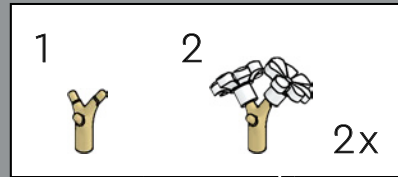

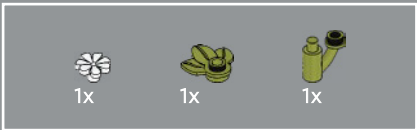

129

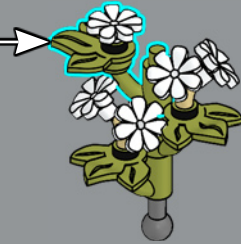
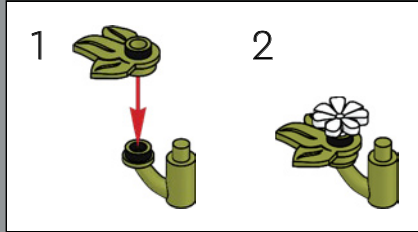

130

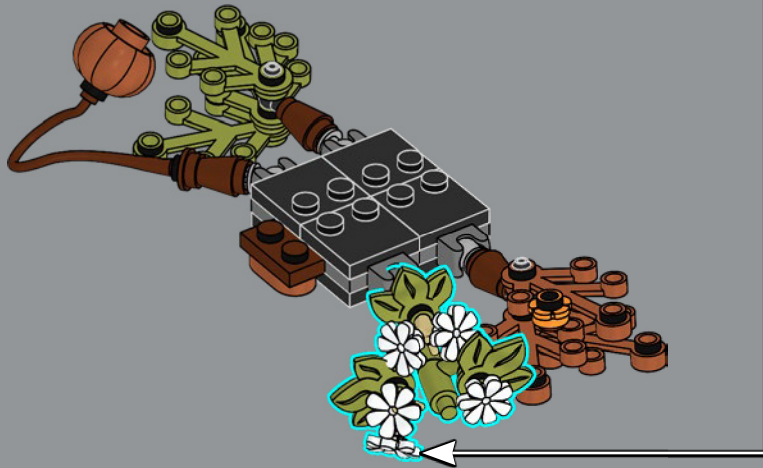

131

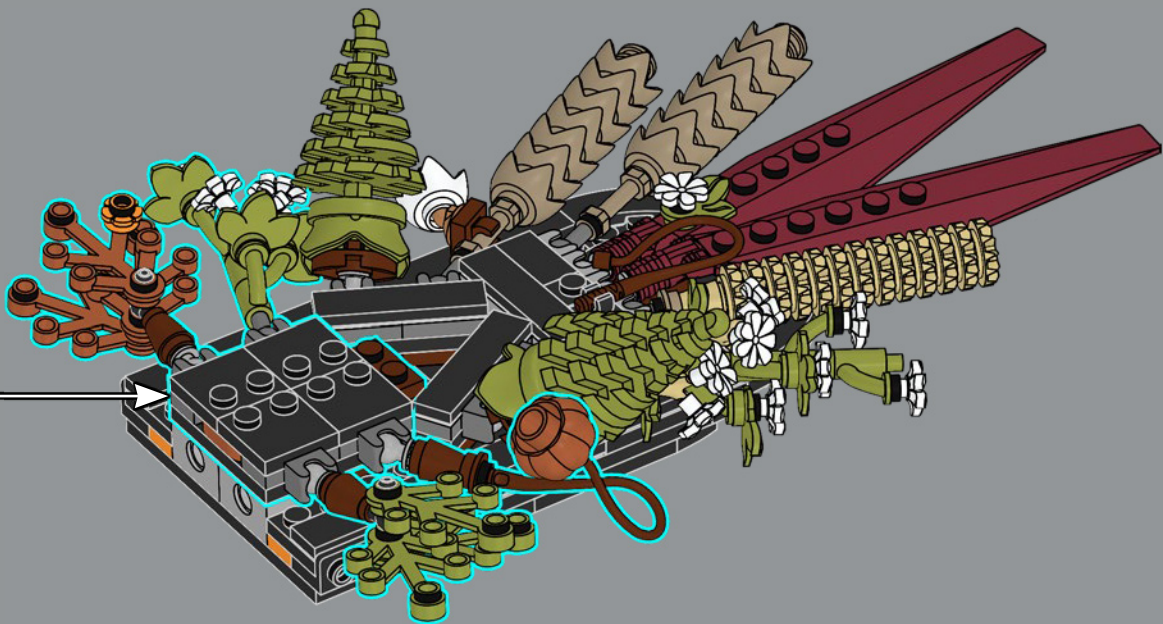

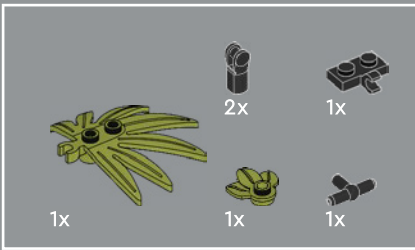

132

1

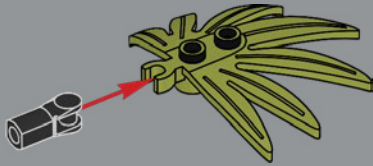

2

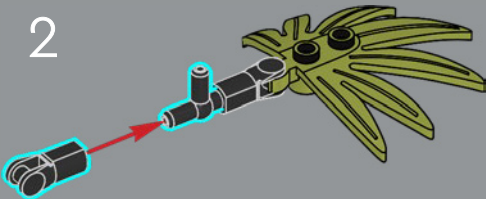

3

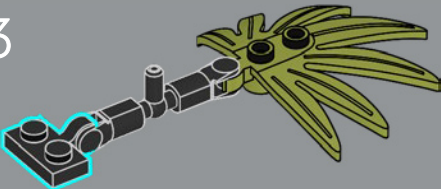

4

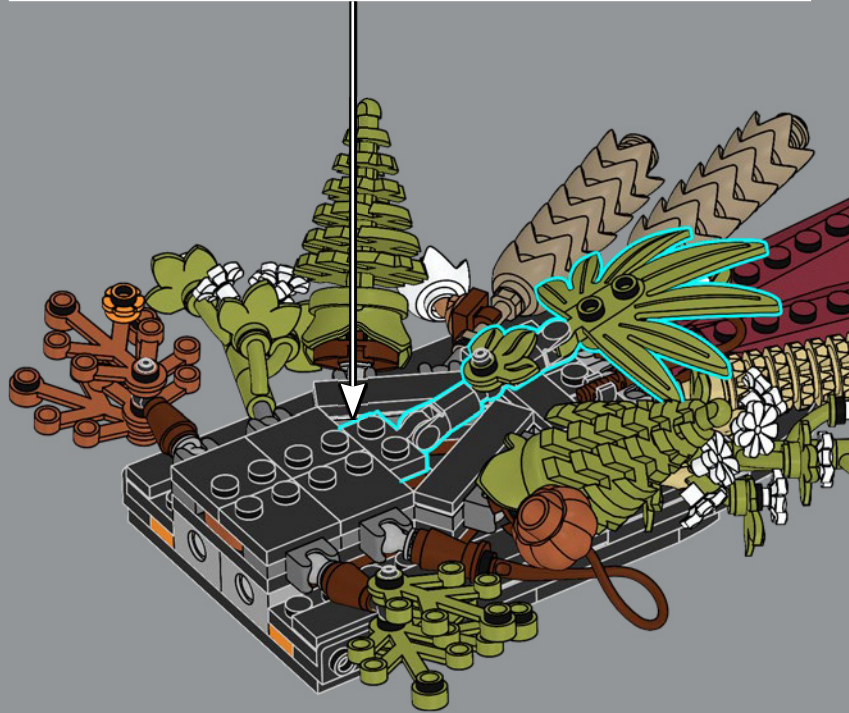
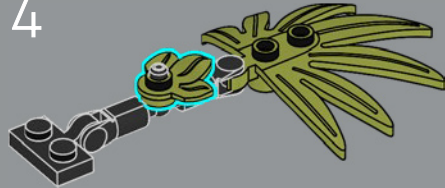

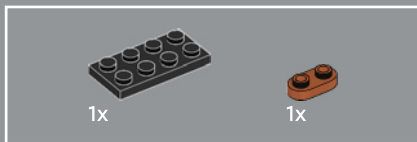
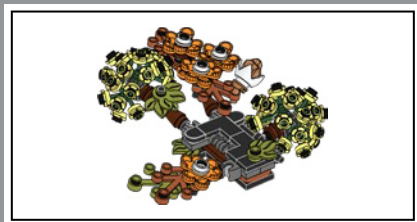

133

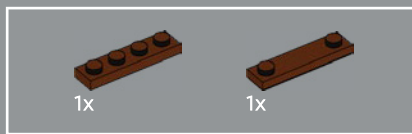
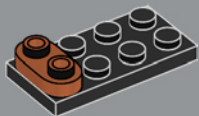

134

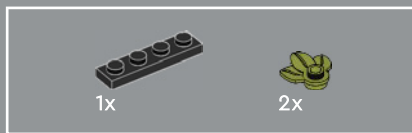
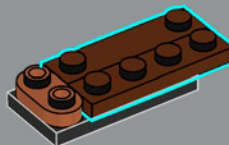

135

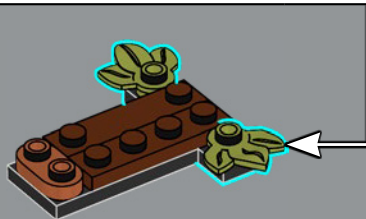
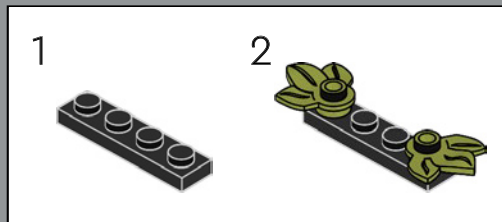

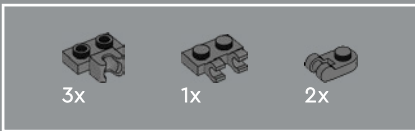

136

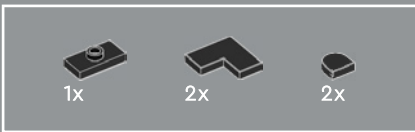
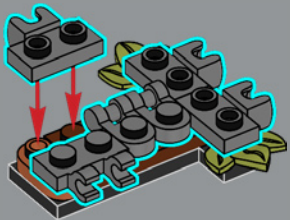

137

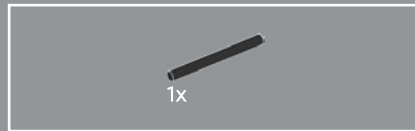
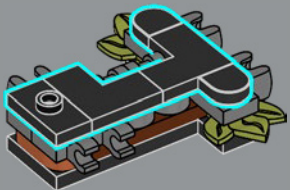

138

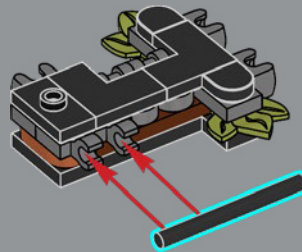

139

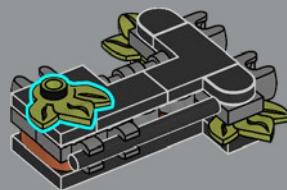

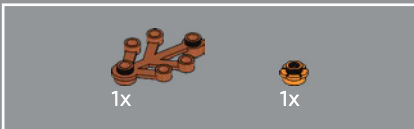
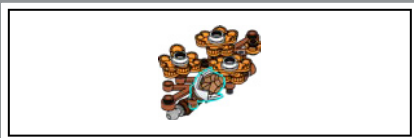

140

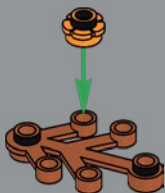

141

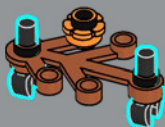

142

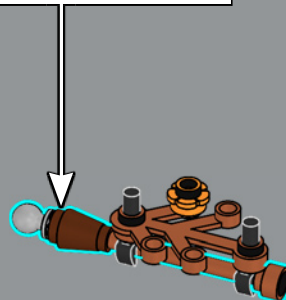
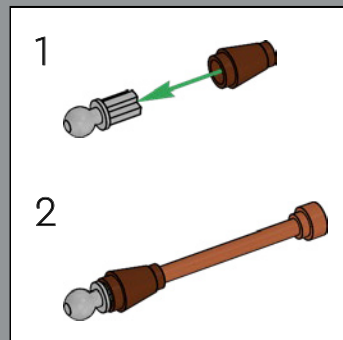

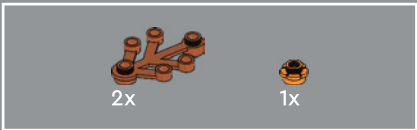

143

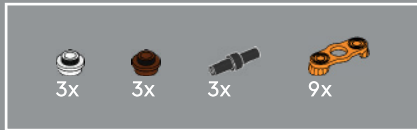
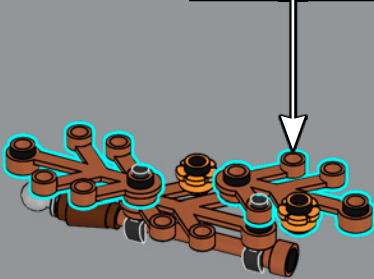
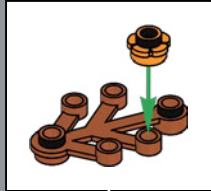

144

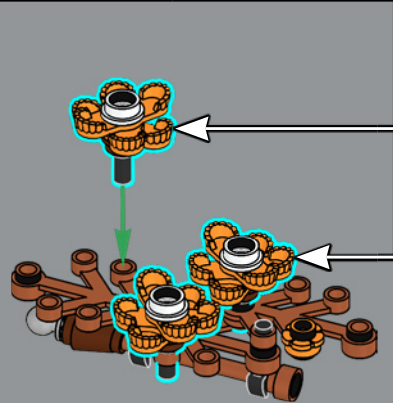
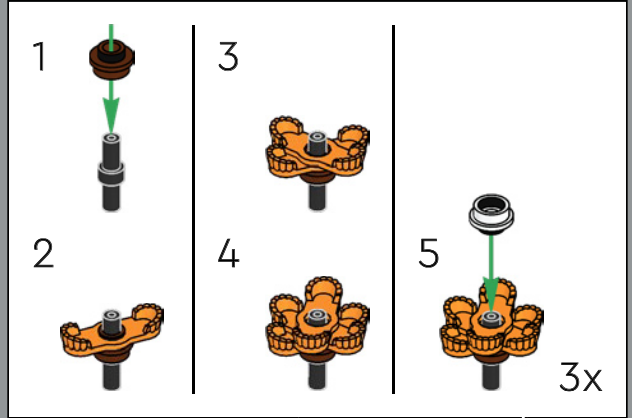



1x



1x



1x

145

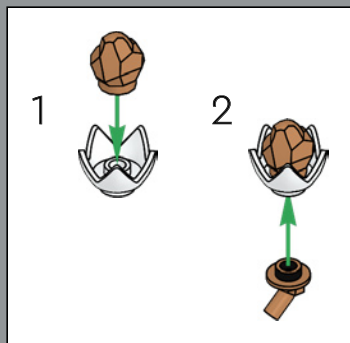

Las margaritas secas están hechas a partir de un elemento blanco que representa una corona y una inusual pieza que se usó originalmente para representar una pepita de oro.

146

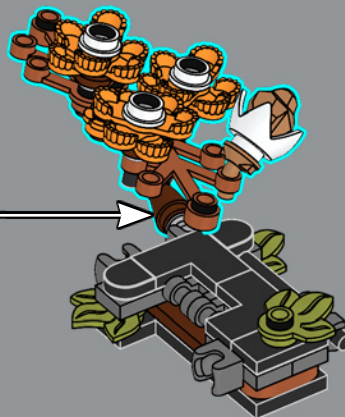

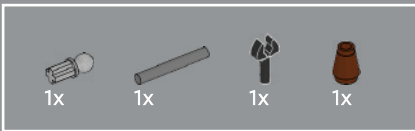

147

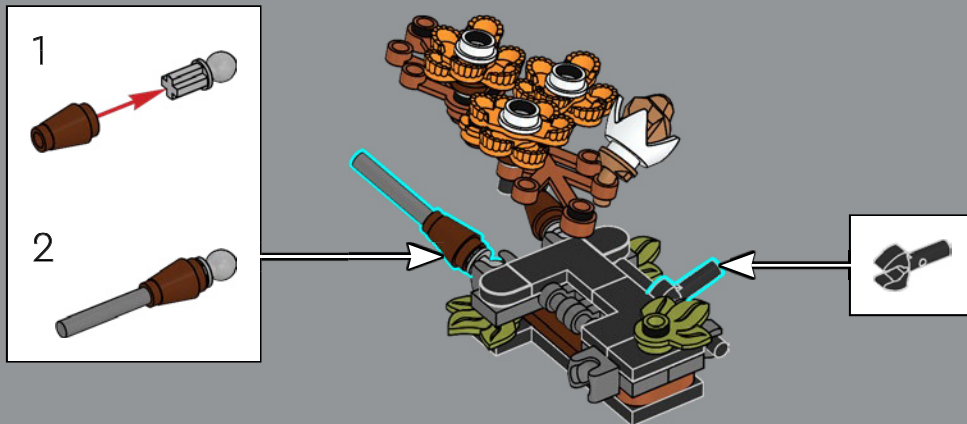



148

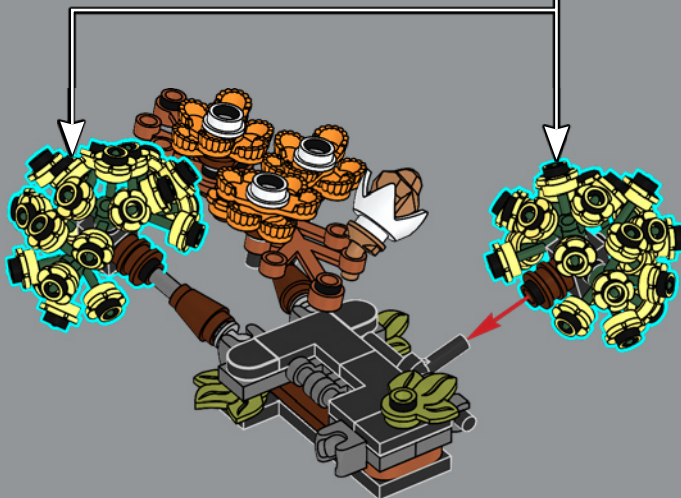
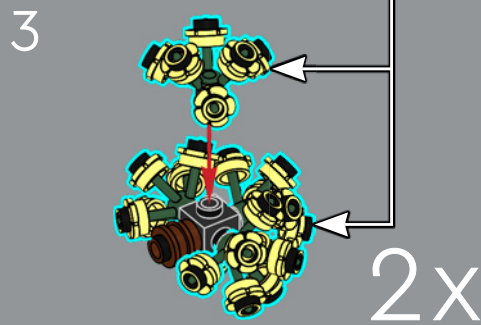
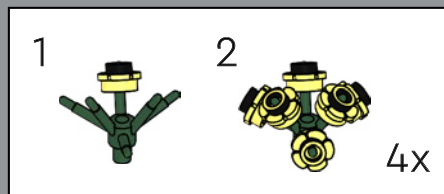
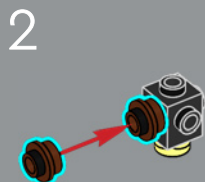
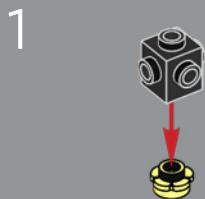



1x



2x

149

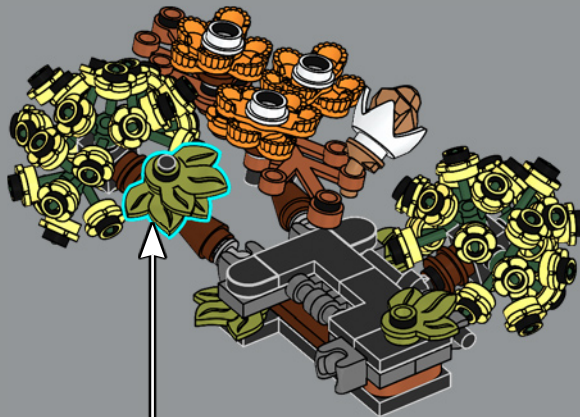

1

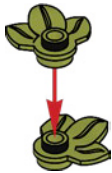

2





150

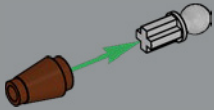

151

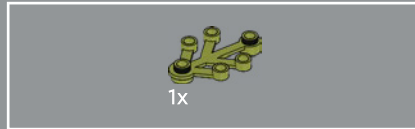
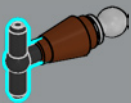

152

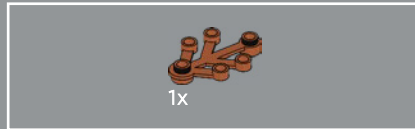
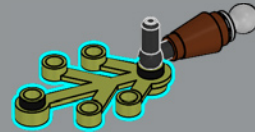

153

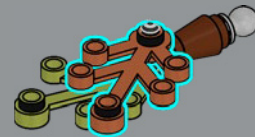

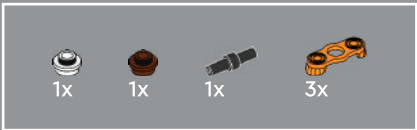

154

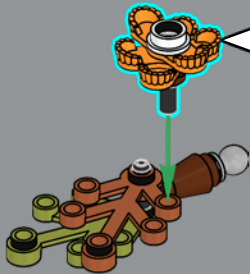
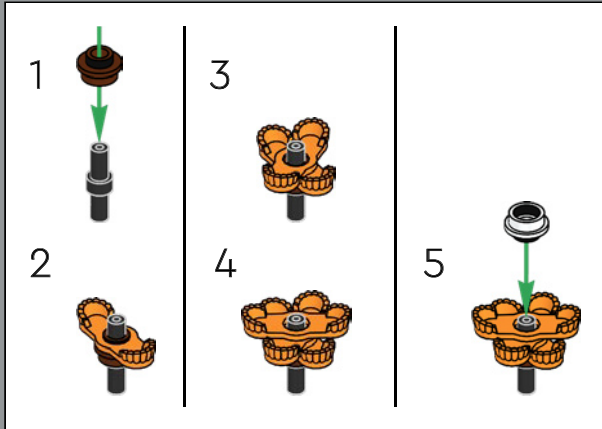

155

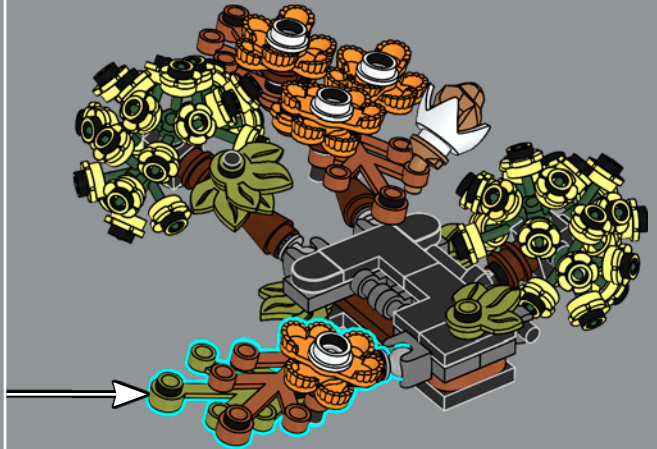

156

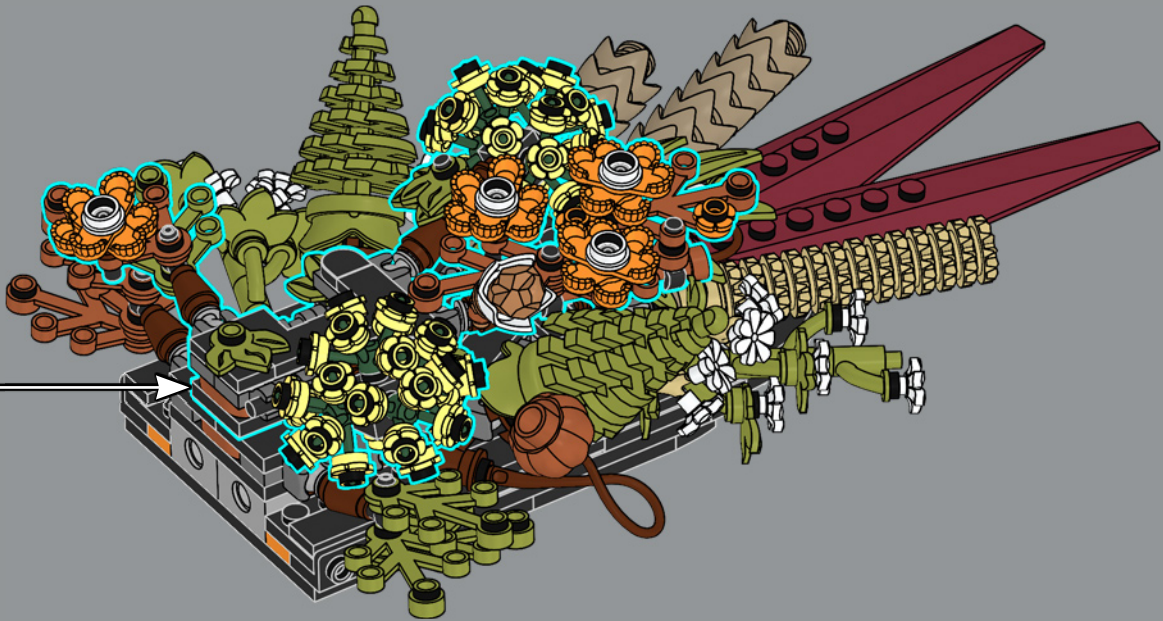

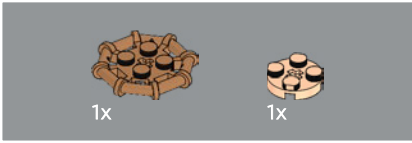
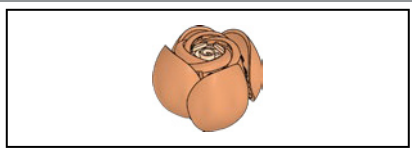

157

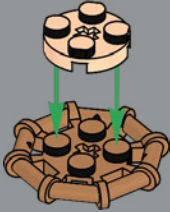

158



159

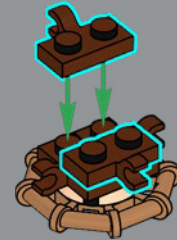

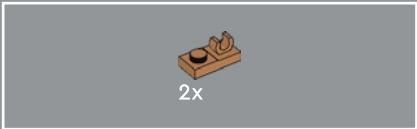

160

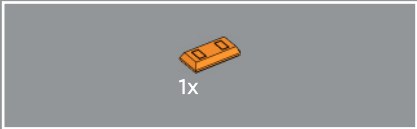
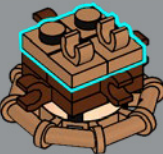

161



162

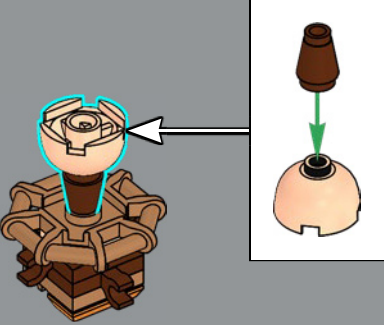

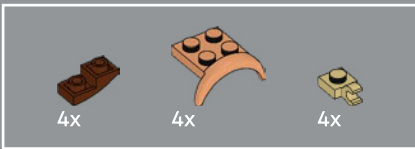

163

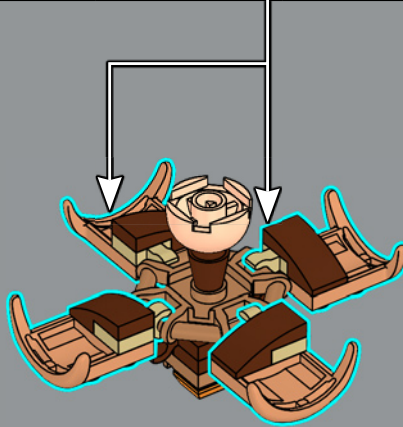
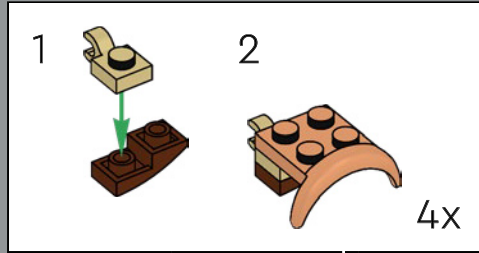

164

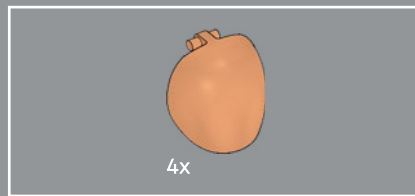
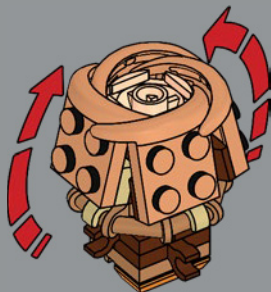

165

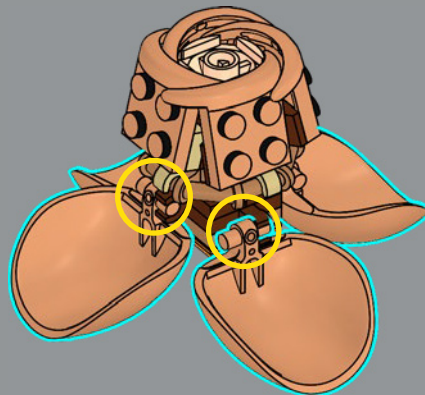

166

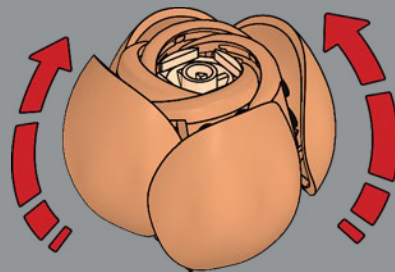



En la elaborada construcción de la rosa se utilizan nuevos guardabarros de coches como pétalos interiores y un nuevo elemento de caparazón para los pétalos exteriores.

167

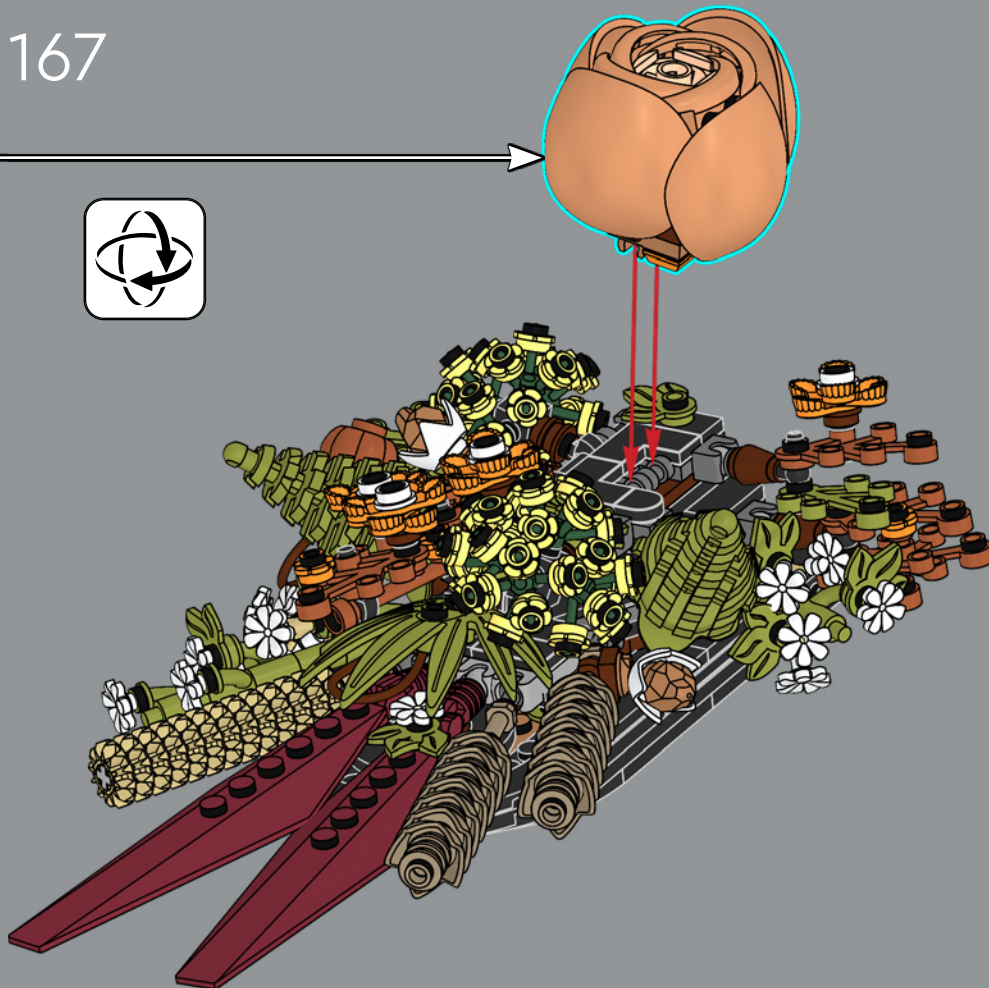



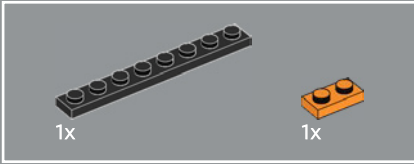

168

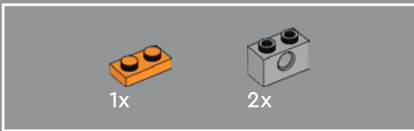
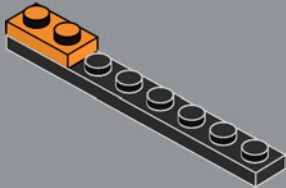

169

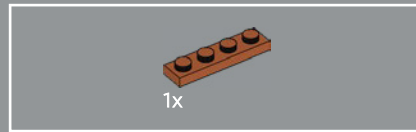
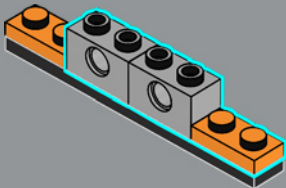

170

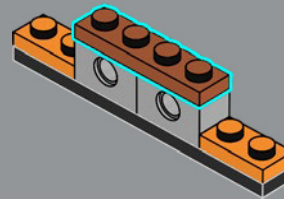

171

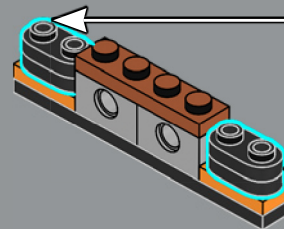
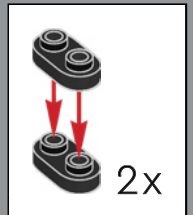

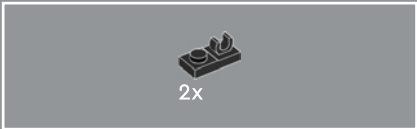

172

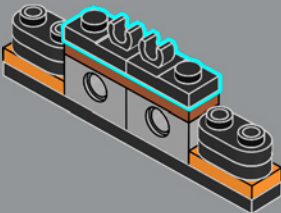

173

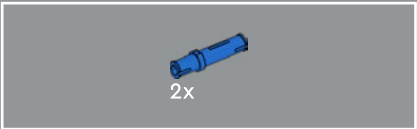
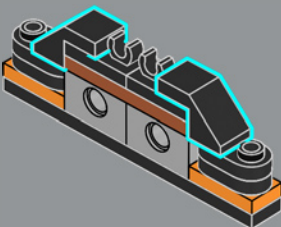

174

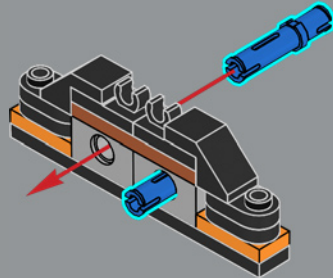



175

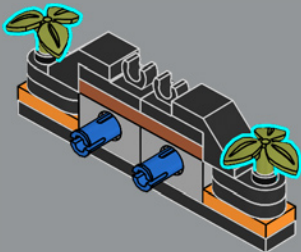

176

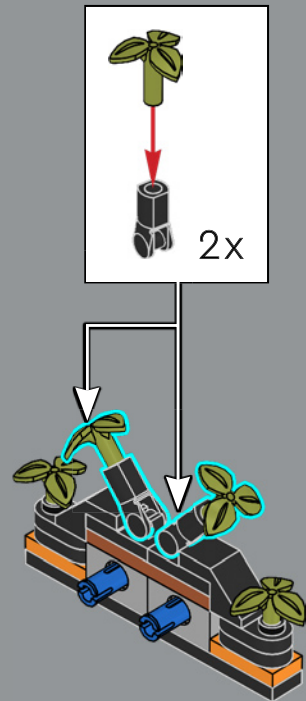

177

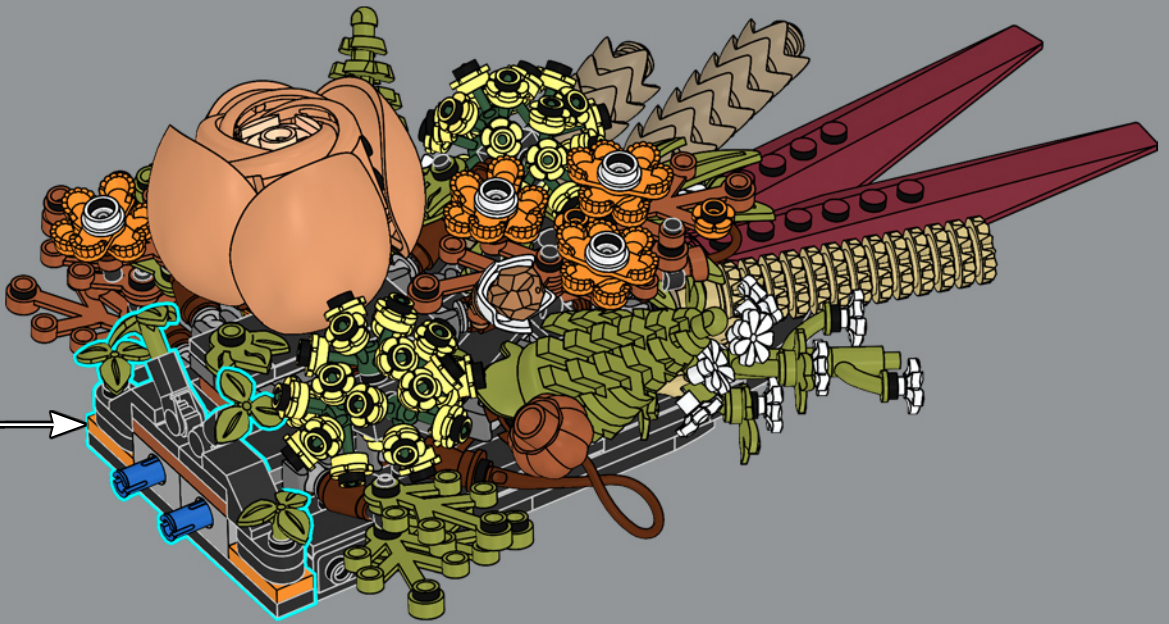



Es común que se use una delgada capa de cera para preservar las flores secas. Los elementos brillantes de este set se eligieron con el fin de replicar el aspecto encerado.

178

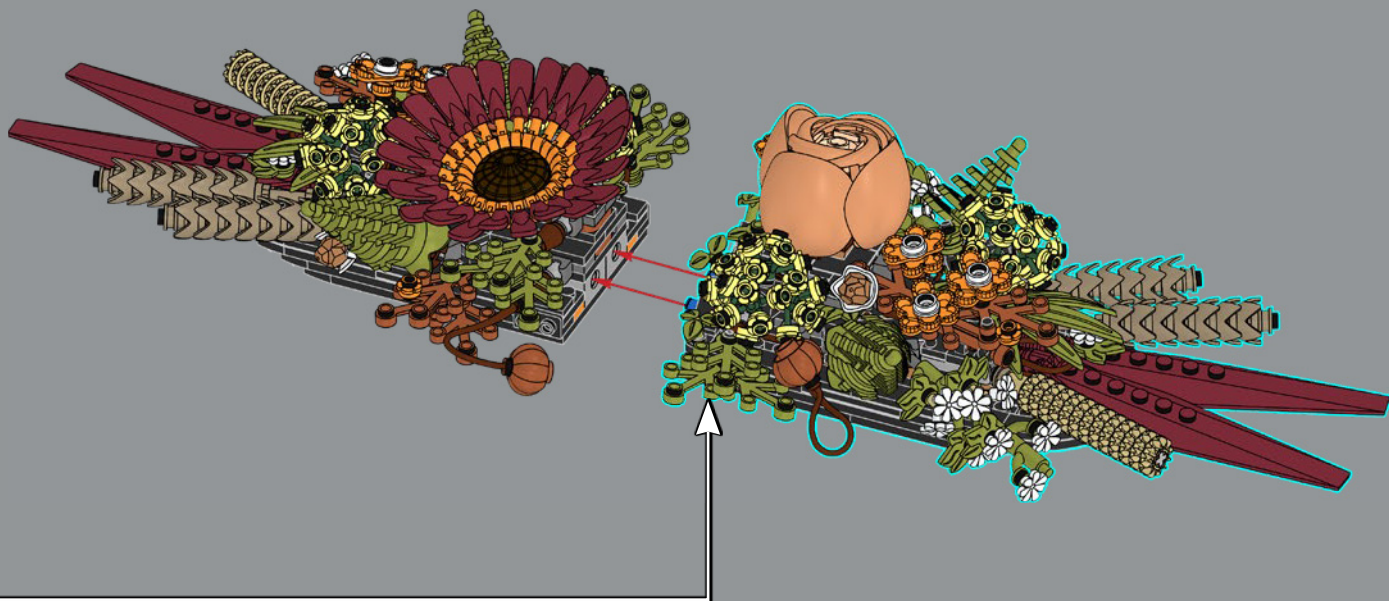

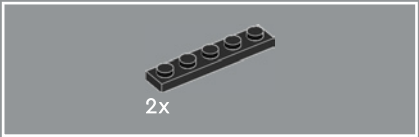

179

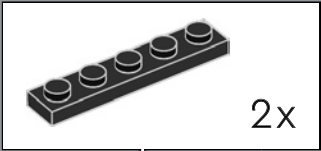

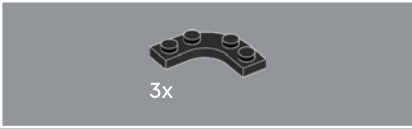
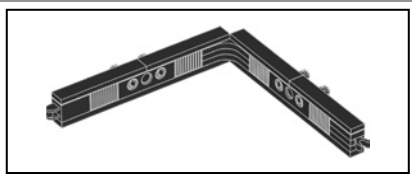

180

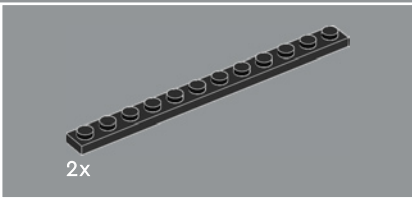
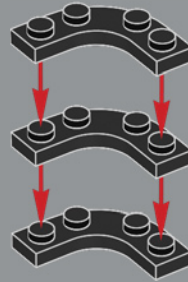

181

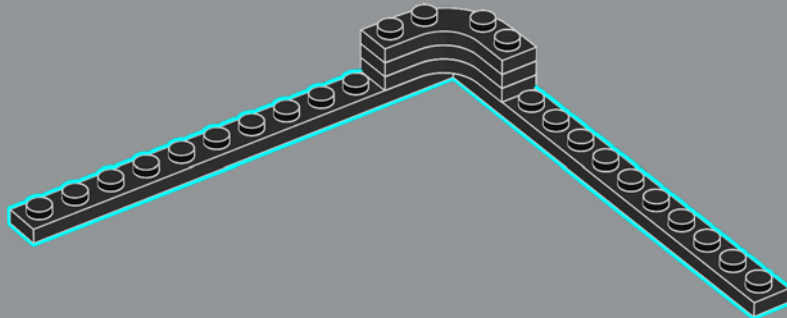

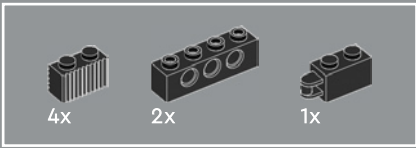

182

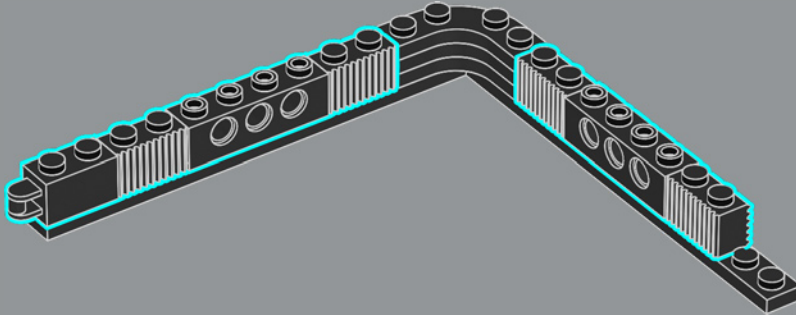

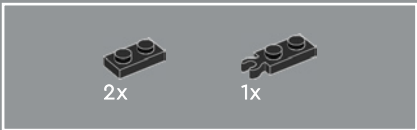

183

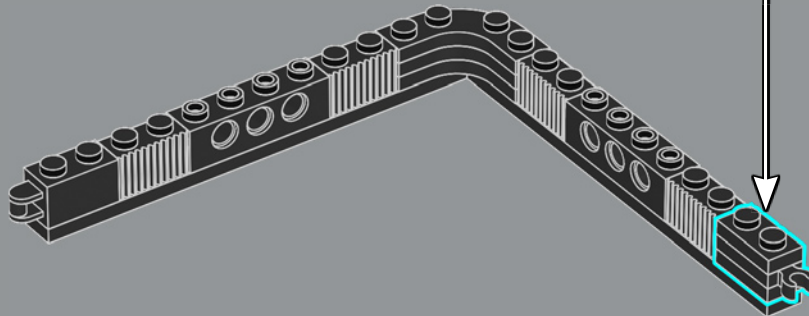
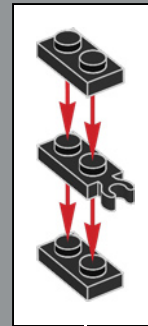

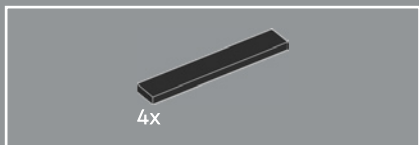

184

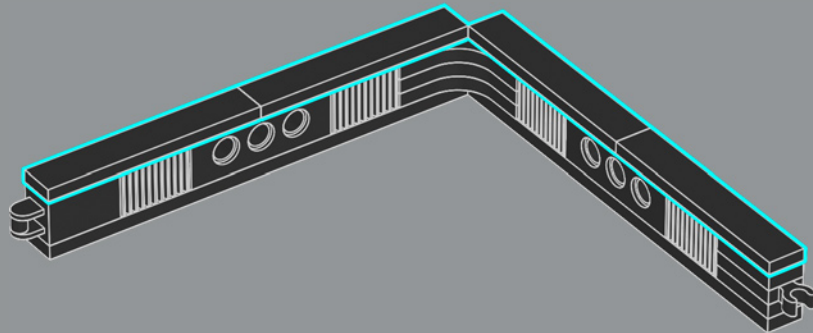

185

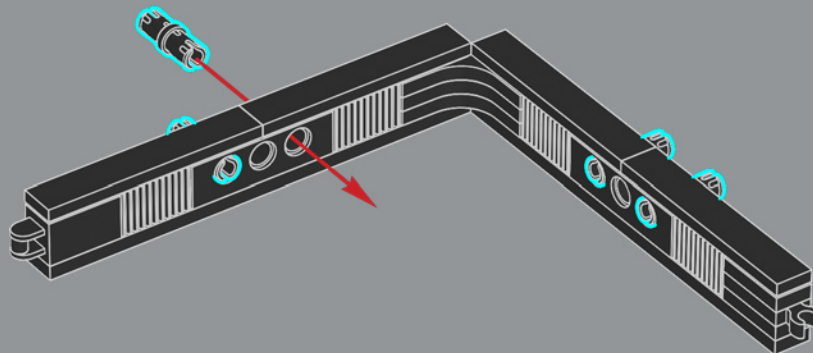

186

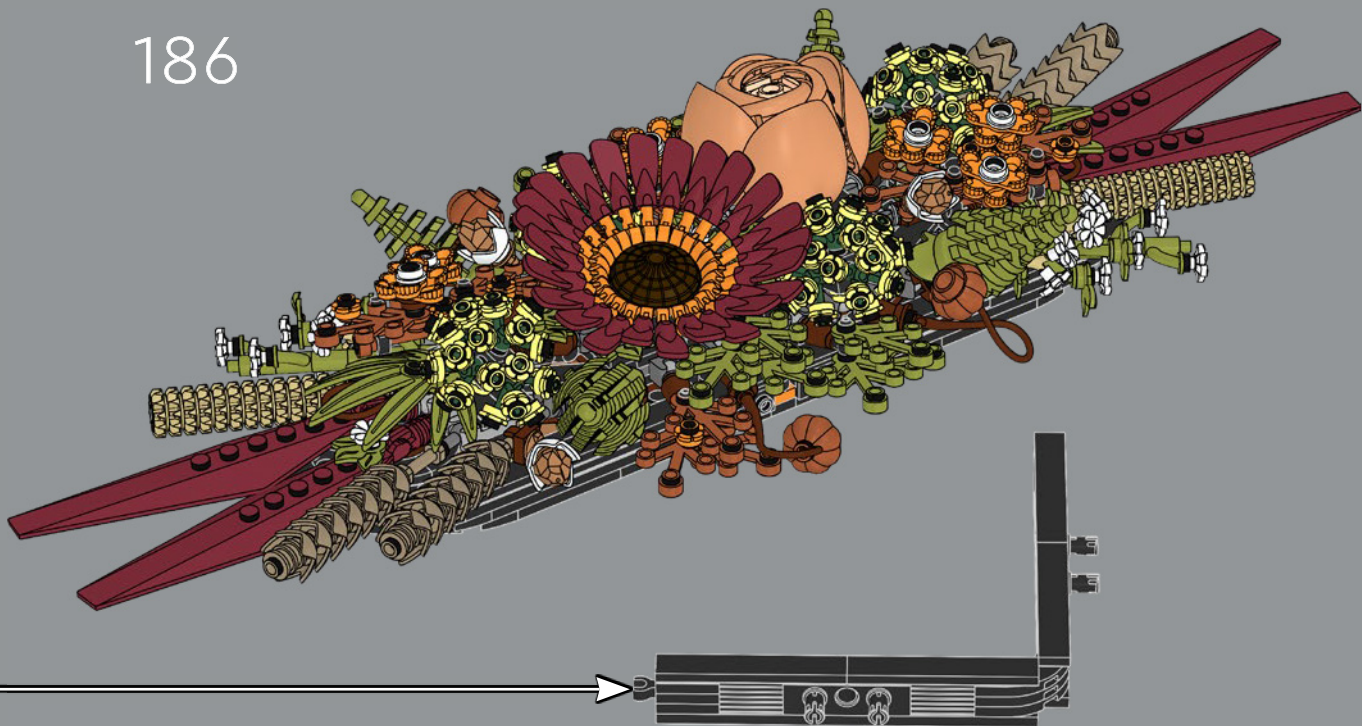

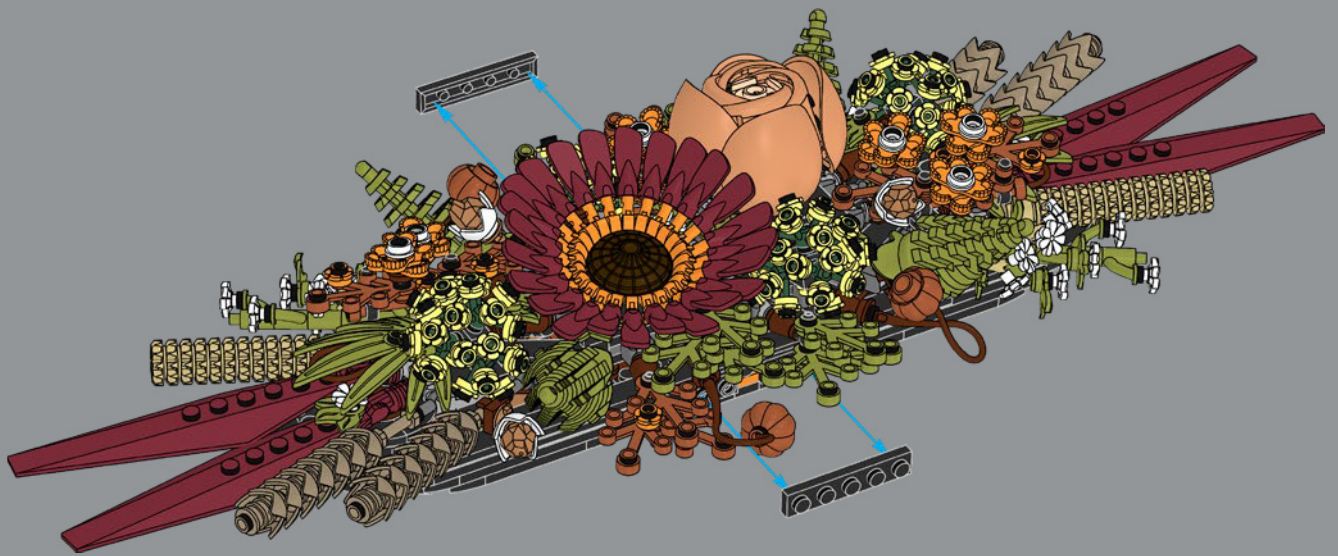

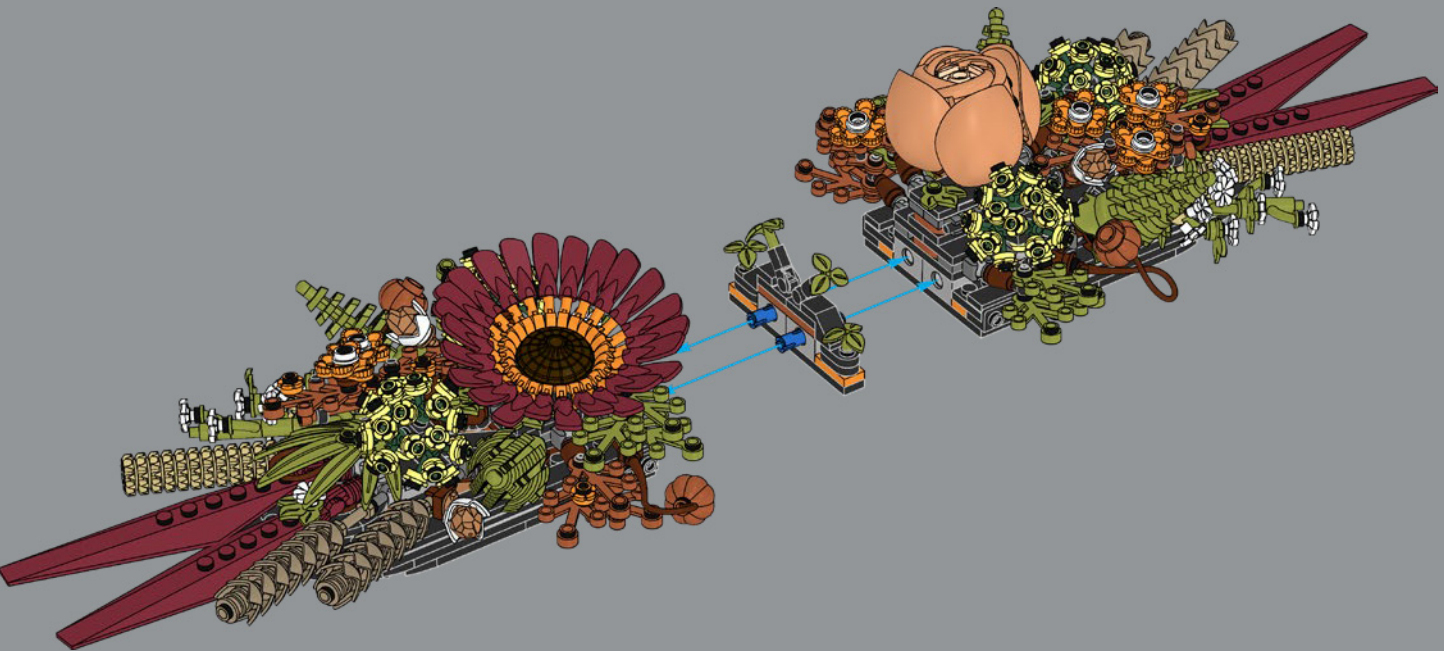

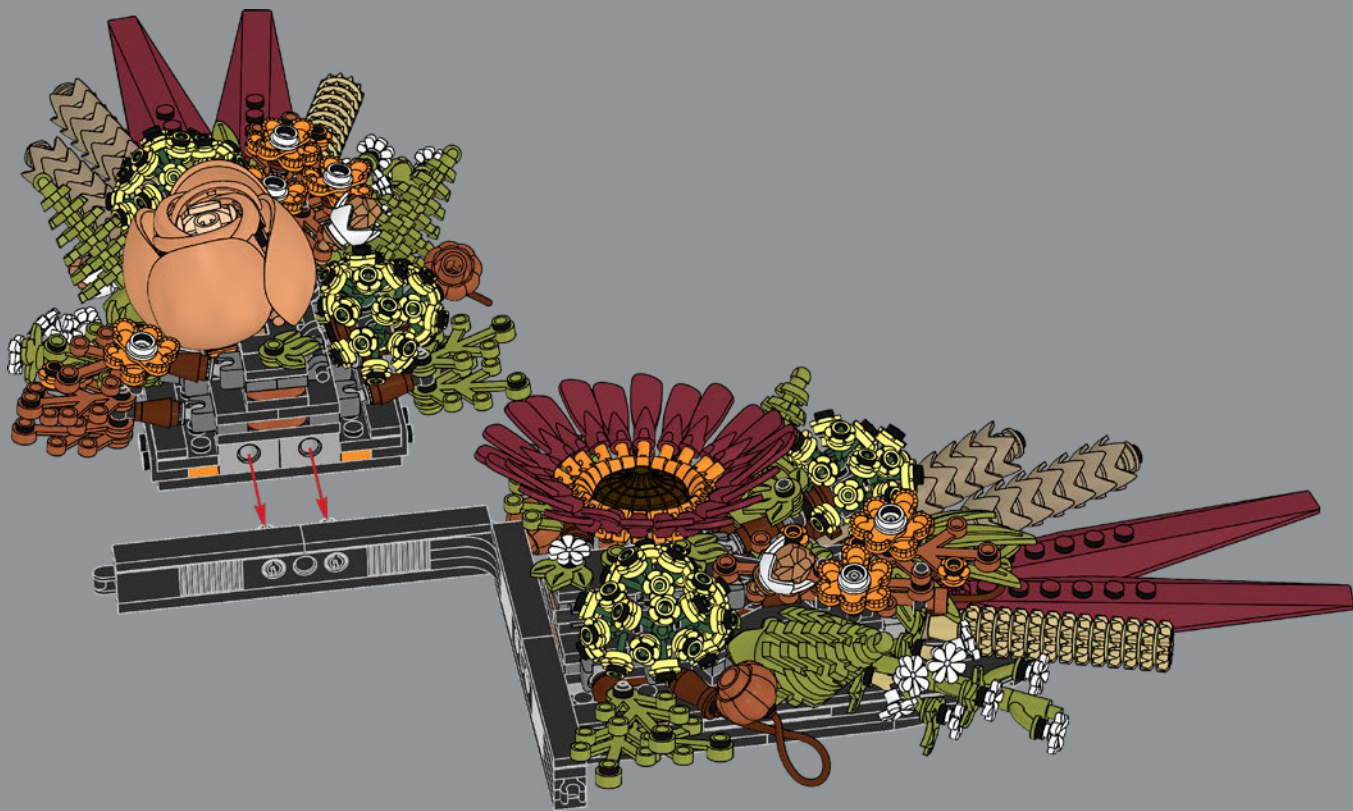



3 x 10314

