





LEGO.com/sustainable-packaging



ANDERSON WARD GRUBB

Designer du club de jazz 10312

BIENVENUE

Préparez-vous à vivre une soirée inoubliable où tous vos sens seront en éveil, avec de la musique live, des spectacles et une nourriture succulente ! Ce nouveau club tendance, qui fait la part belle à l'architecture classique et à notre musique préférée de l'âge d'or du jazz, vient compléter la série Constructions modulaires LEGO®. Qu'il s'agisse de votre premier set modulaire ou que vous ayez déjà commencé la construction de votre rue LEGO, nous vous invitons à construire à votre propre rythme.



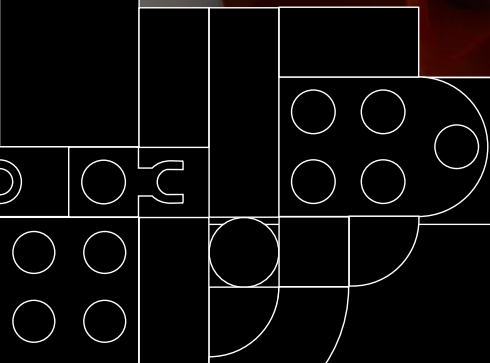

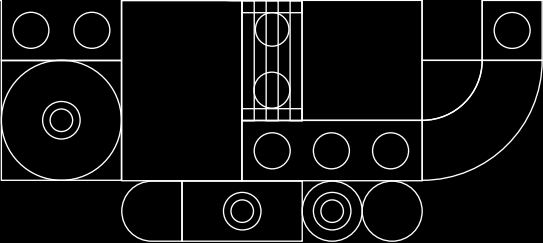

On dit que, dans le jazz, les notes qu'on ne joue pas sont aussi importantes que celles que l'on joue ! Que vous jouiez de la musique ou avec des briques LEGO®, jouez à votre façon !



LE POUVOIR DE LA MUSIQUE

La musique est une machine virtuelle à remonter le temps, qui a le potentiel de vous transporter instantanément dans des souvenirs ou des moments magiques de votre existence et de vous faire voyager là où vous rêvez d'aller. Écoutez votre album préféré sur votre platine vintage, swinguez au club de jazz LEGO® Icons et imprégnez-vous de la magie de ce lieu animé au style *mid-century*, où se rencontrent artistes, chefs cuisiniers et clients créatifs et passionnés. Assistez au concert du bureau de la gérante, cultivez les légumes utilisés en cuisine dans la serre du toit, laissez-vous envahir par le trac dans la loge, commandez quelque chose à grignoter tard dans la nuit ou mangez en terrasse lors d'une chaude soirée d'été. Pas besoin de ticket ou de réservation : votre imagination suffit pour obtenir un accès VIP.



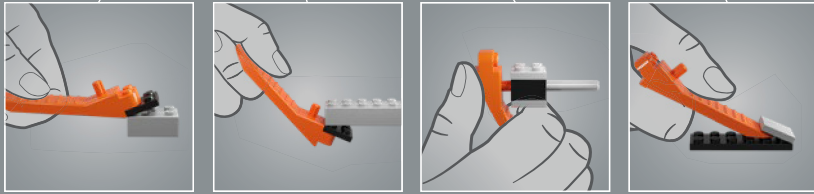
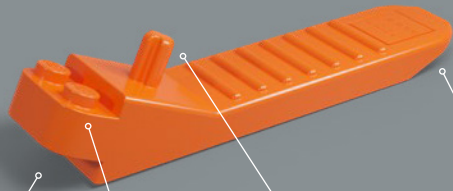
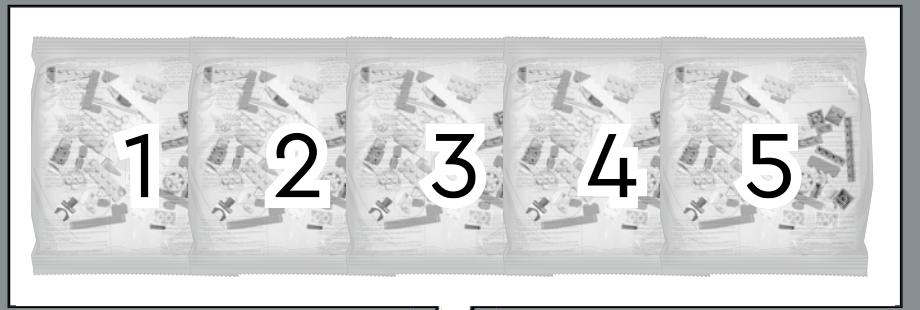

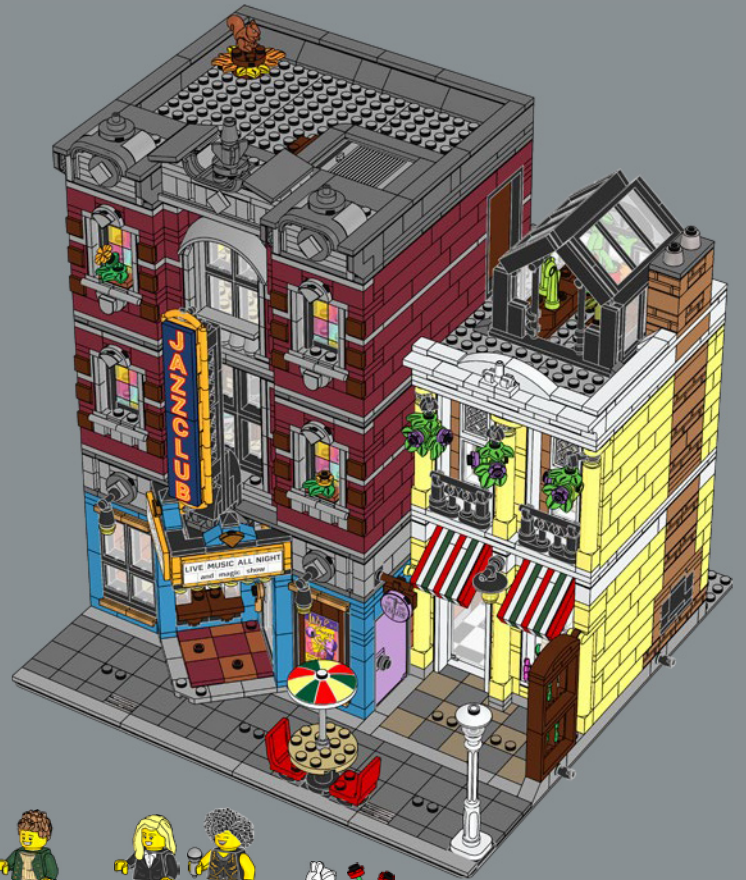
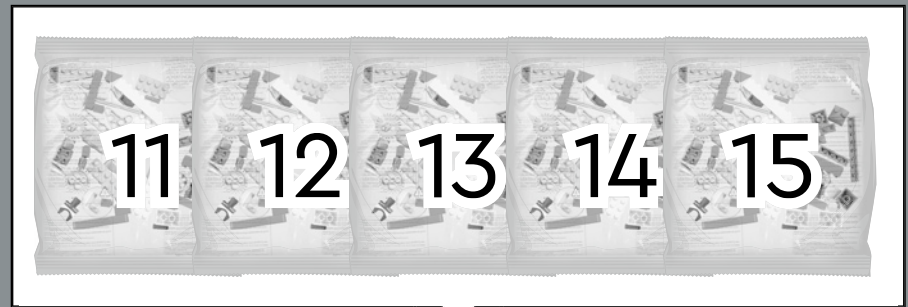
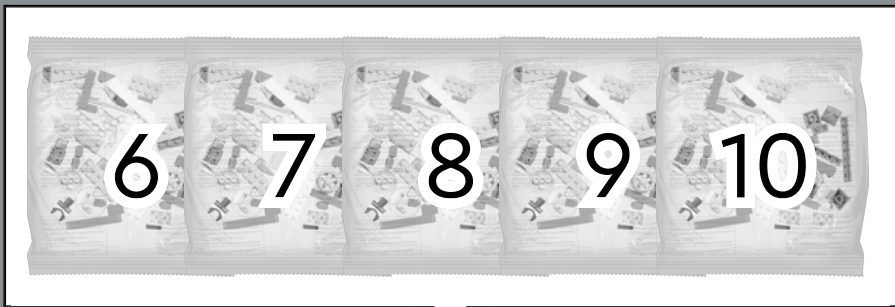

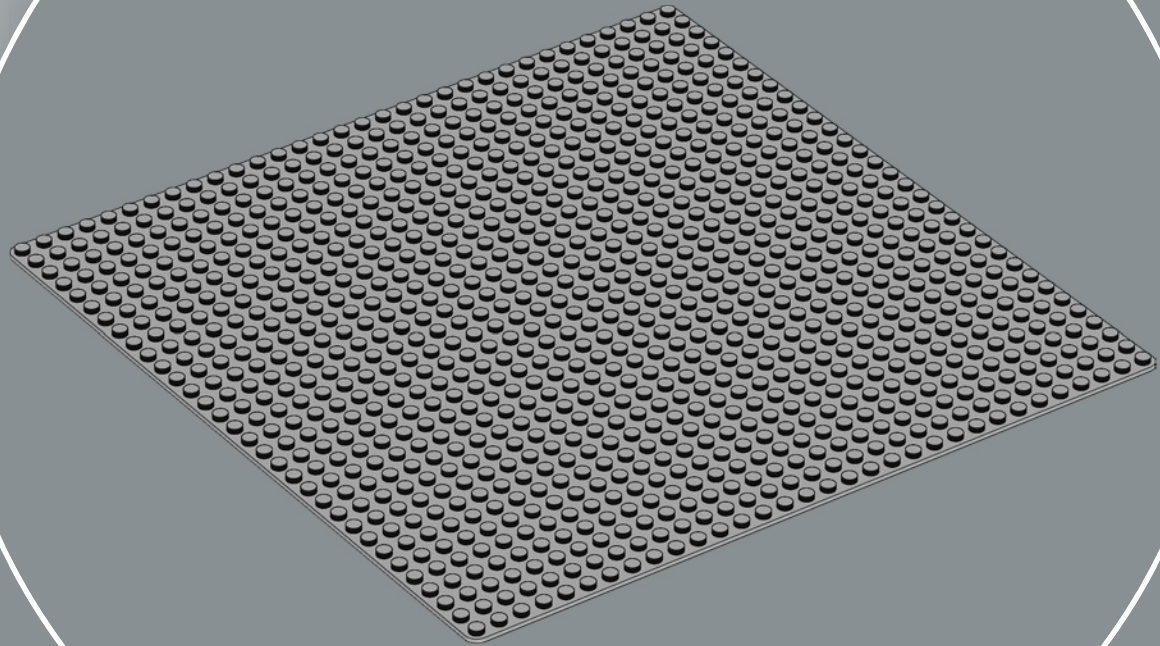
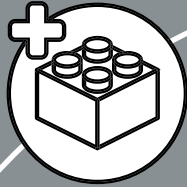

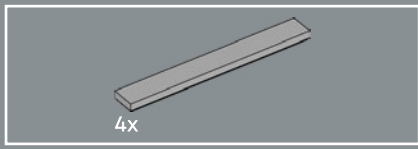

1

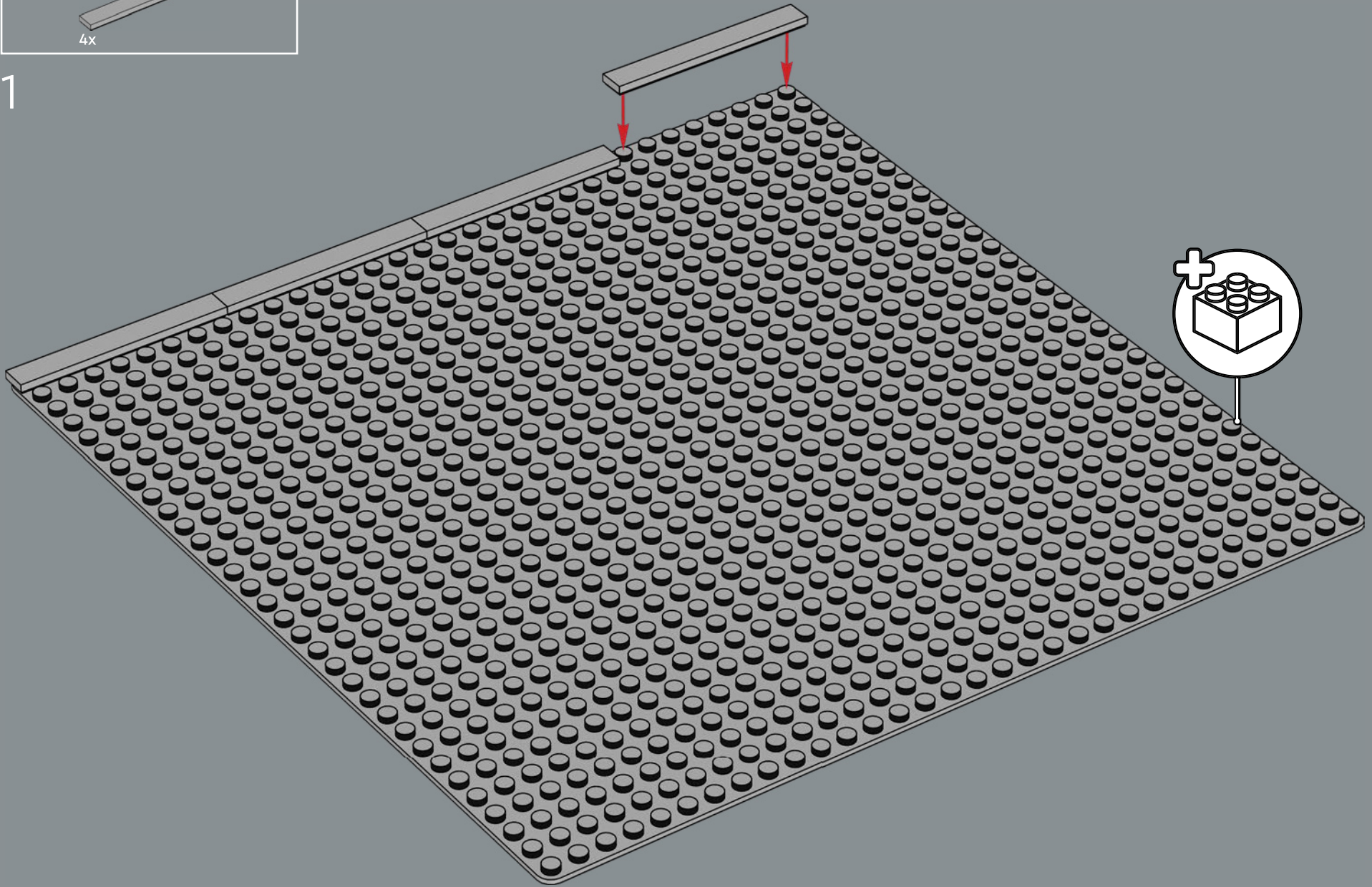

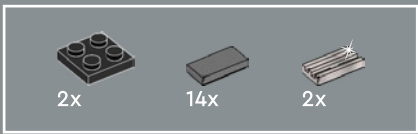

2

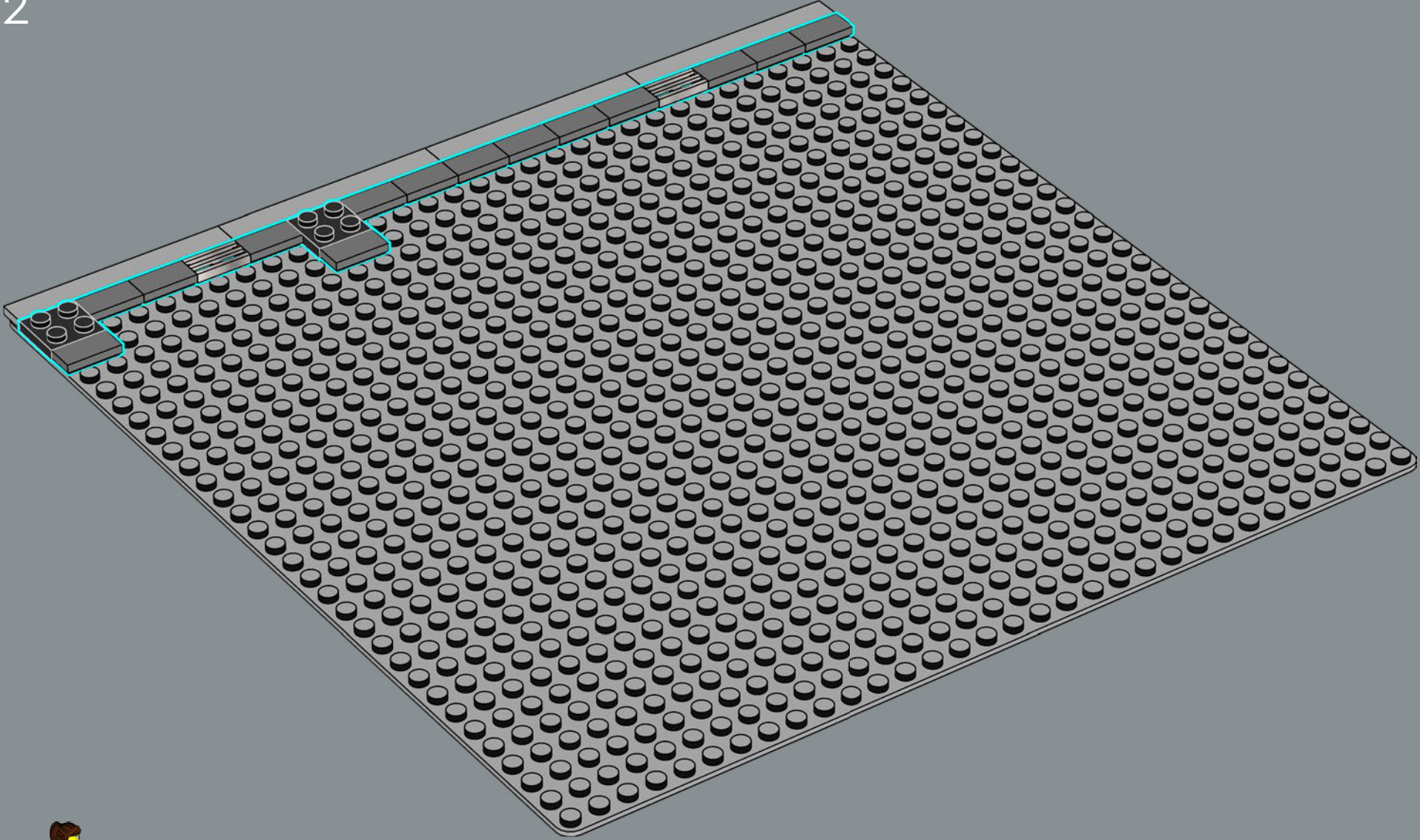

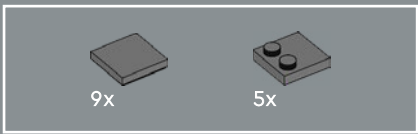

3

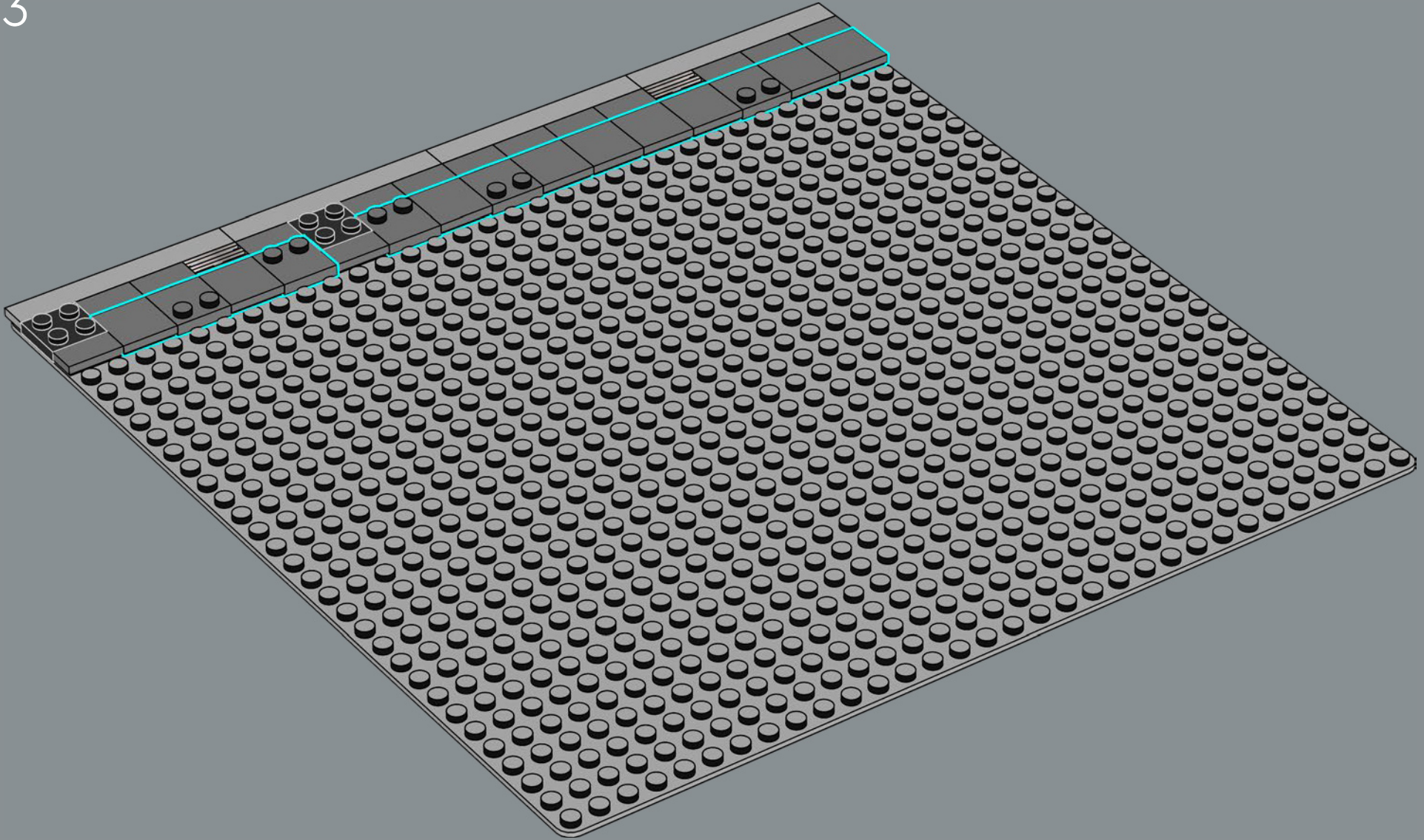

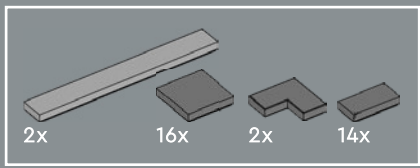

4

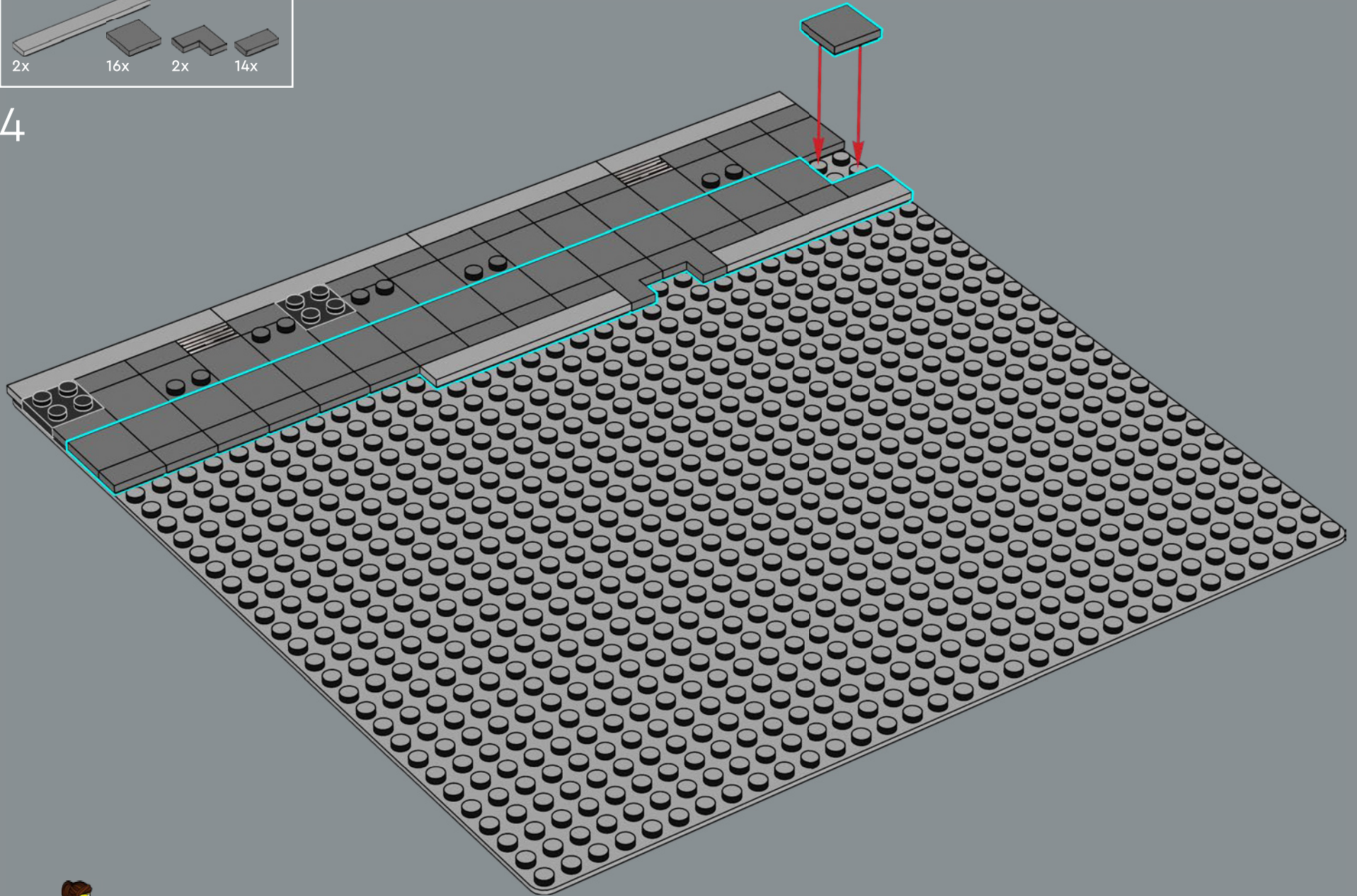

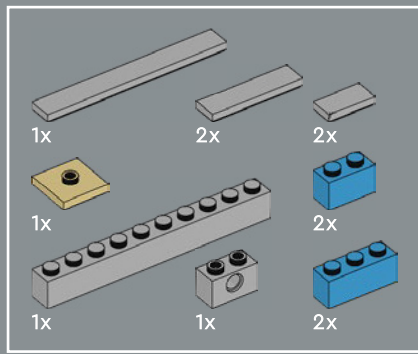

5

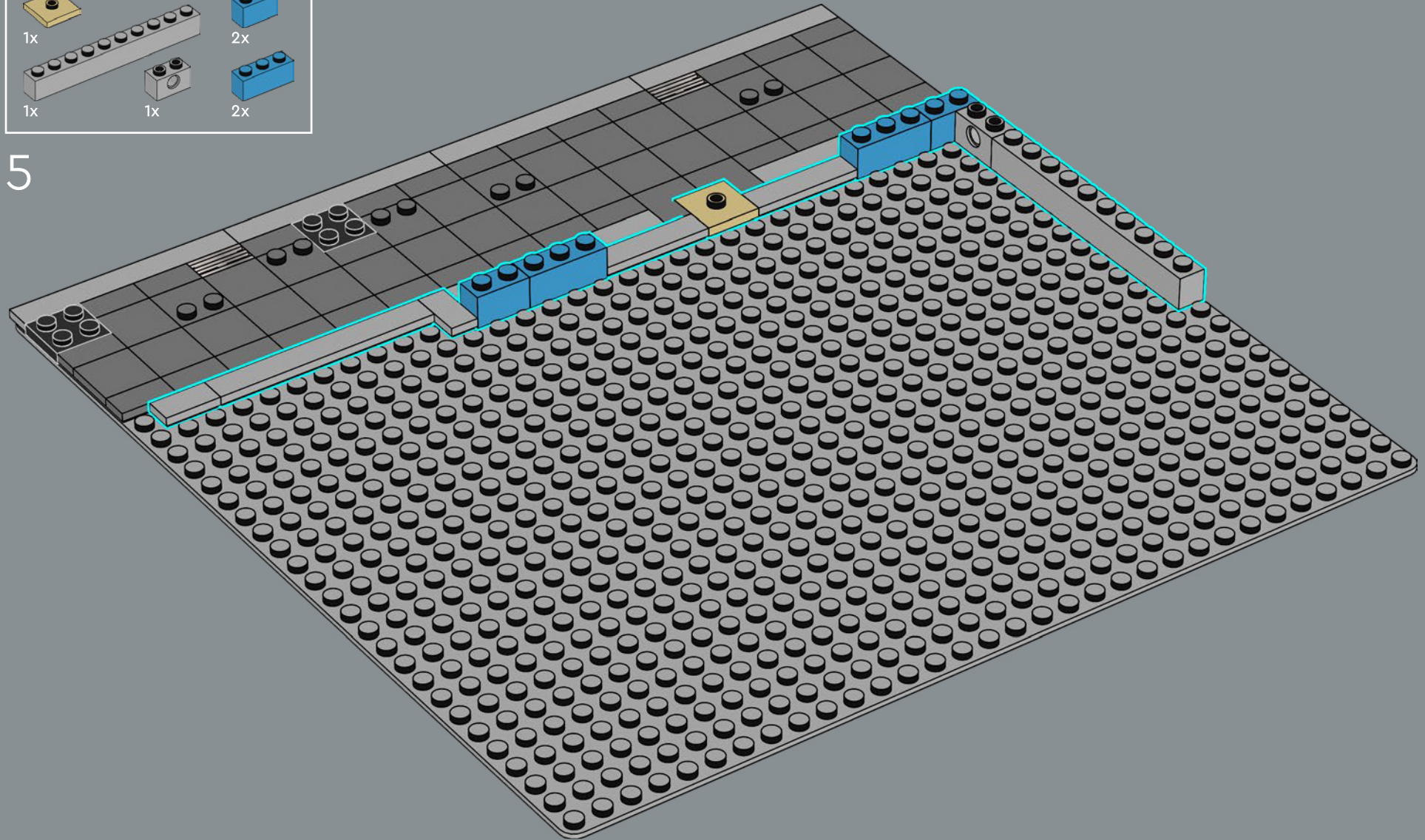

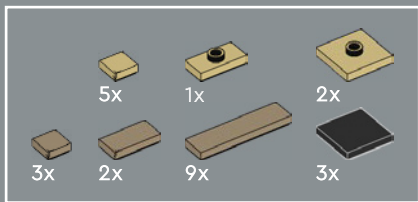

6

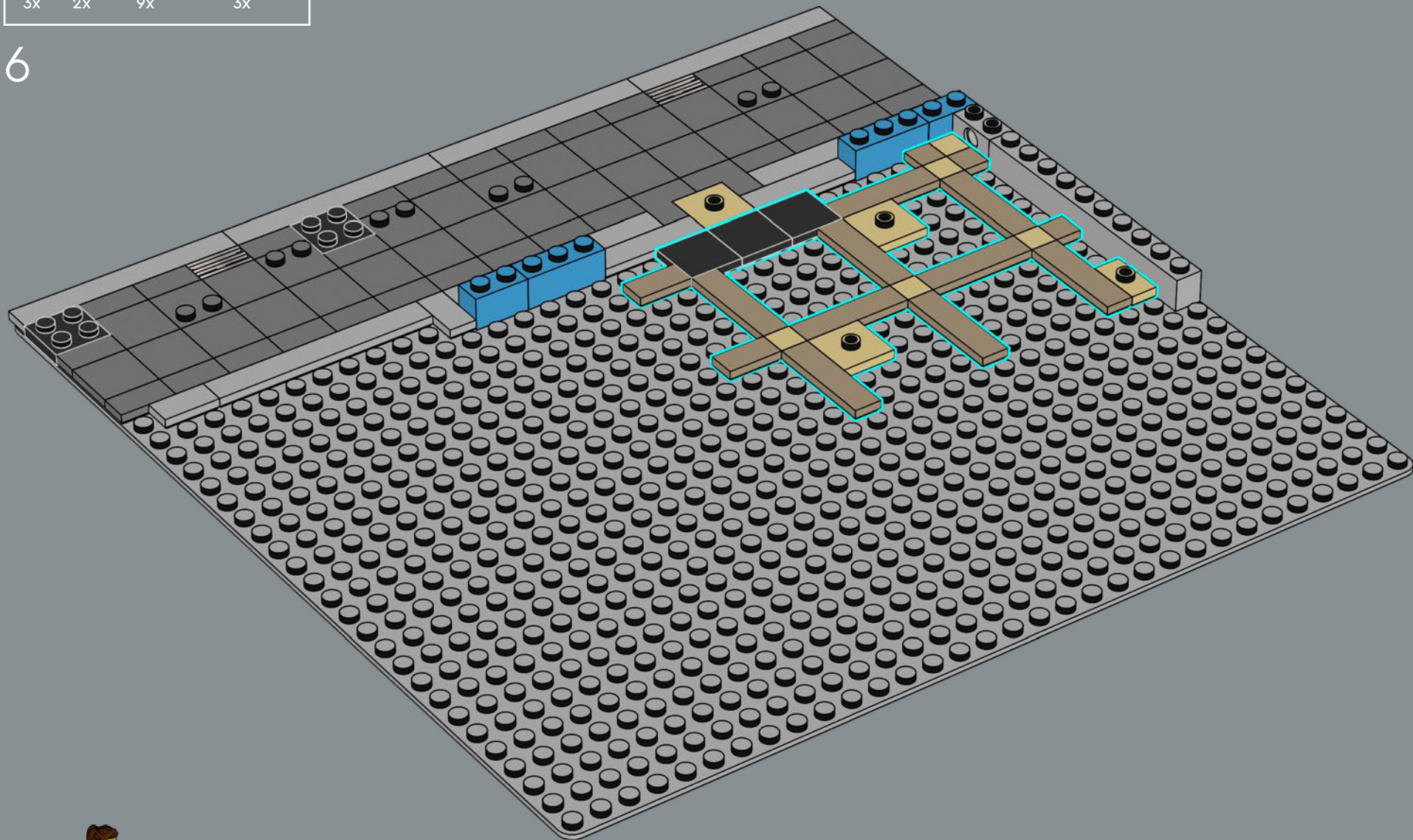

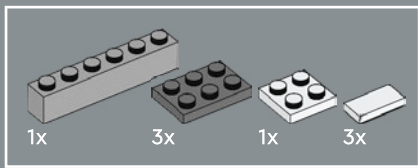

7

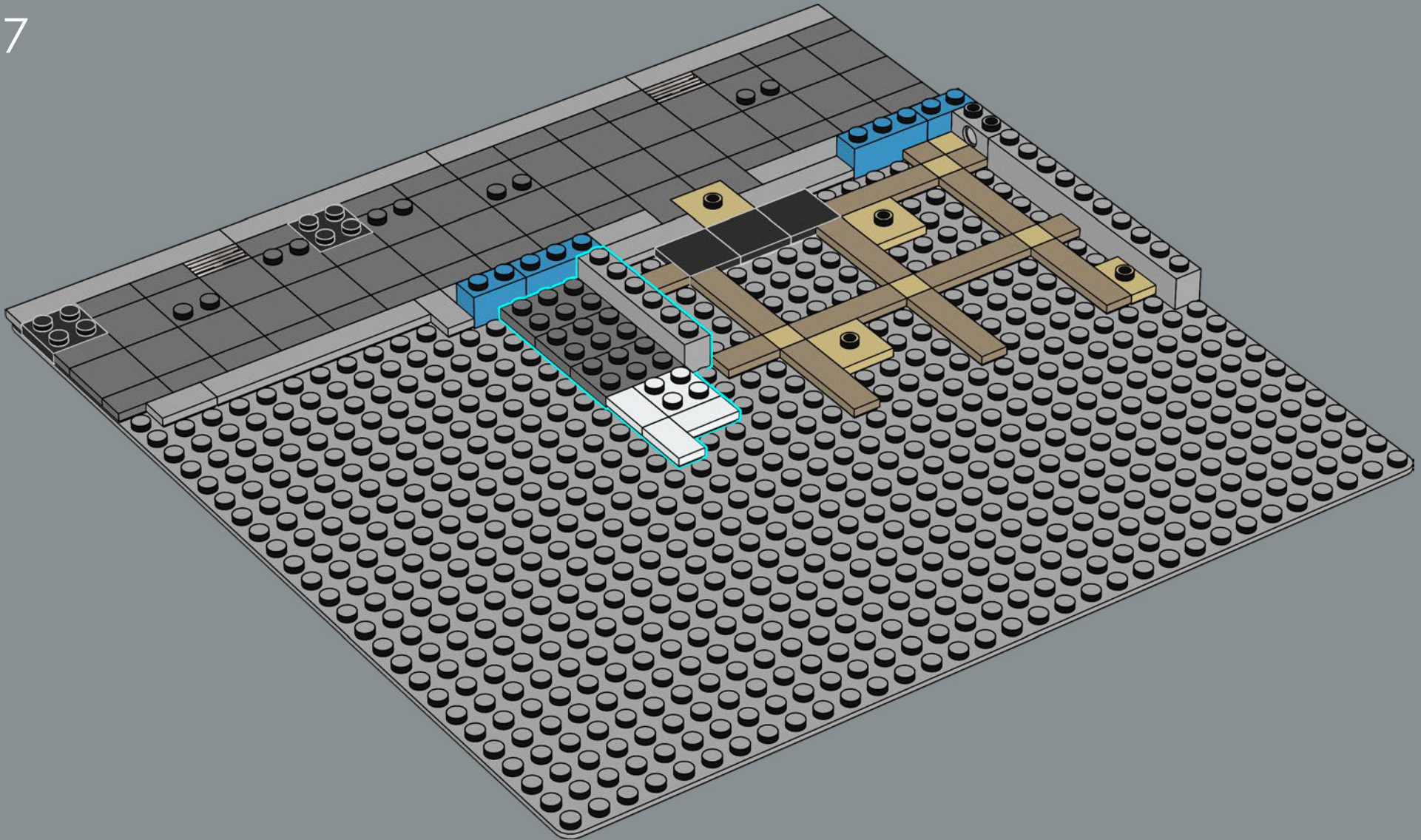

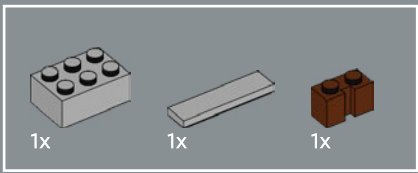

8

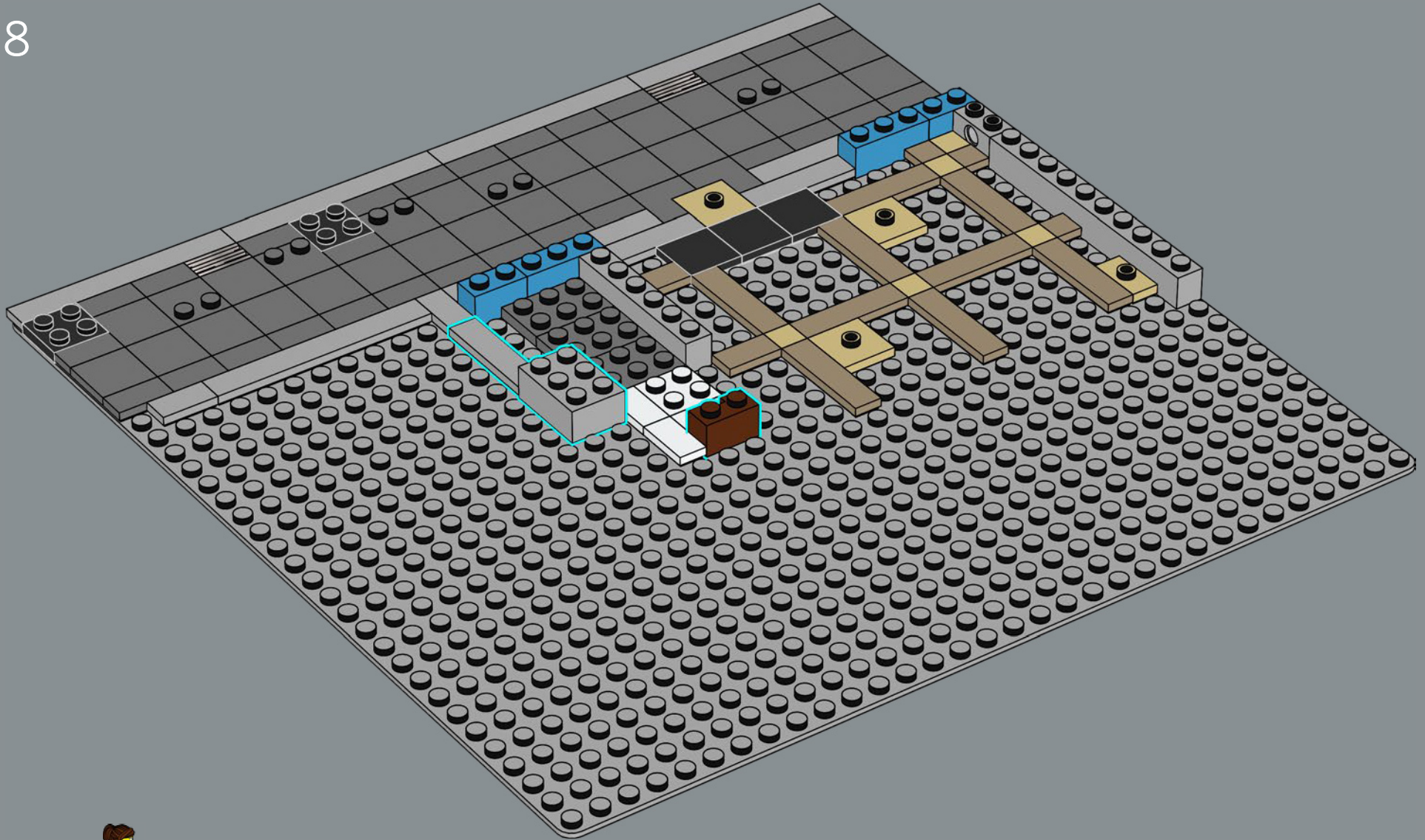

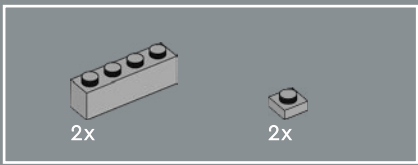

10

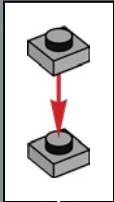

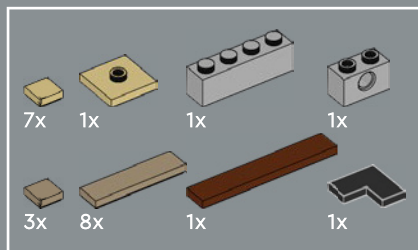

11

Le placement de ces éléments crée une ligne inclinée à 45° par rapport à la grille LEGO® globale. Le club de jazz est truffé de constructions et d'éléments orientés à 45°.

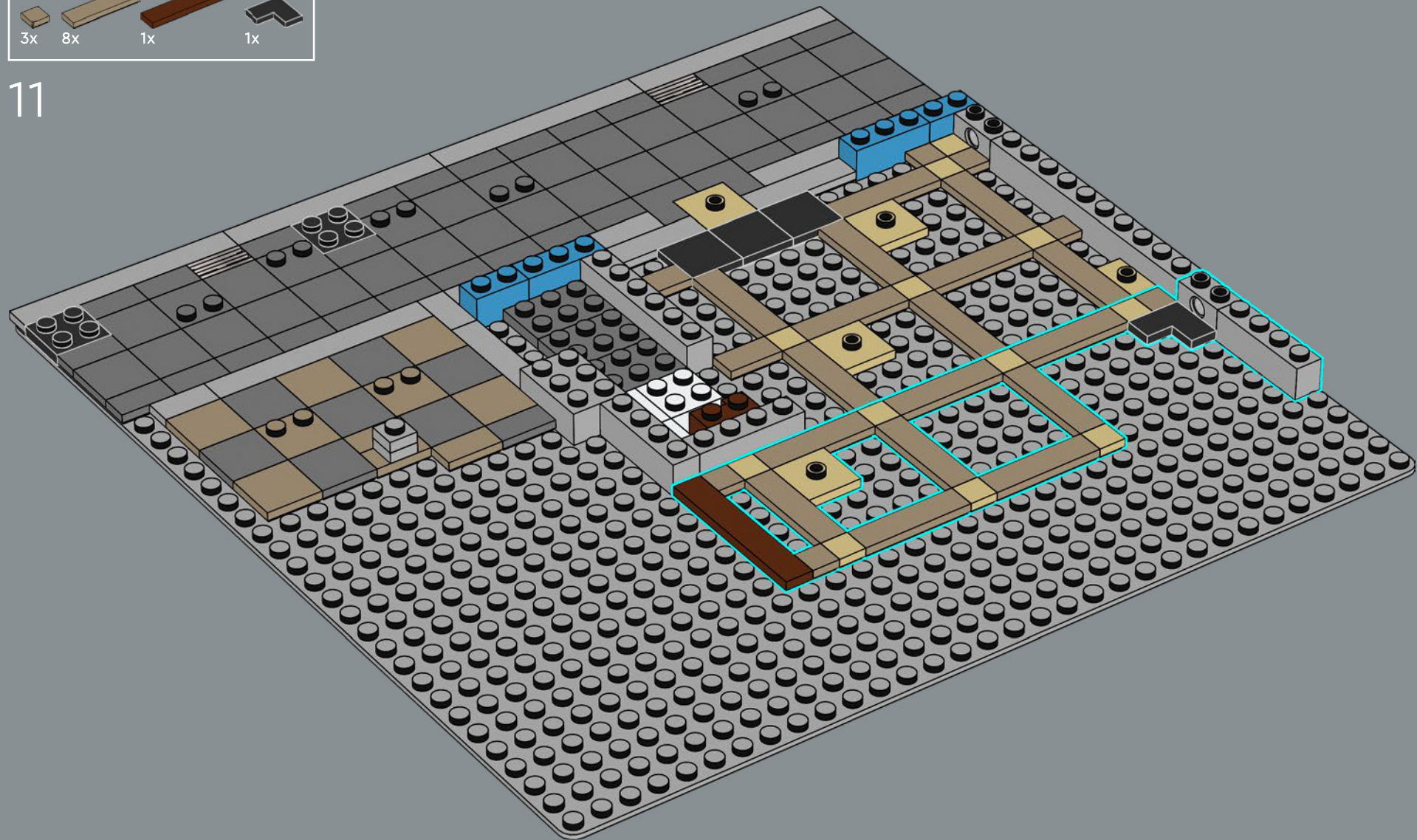

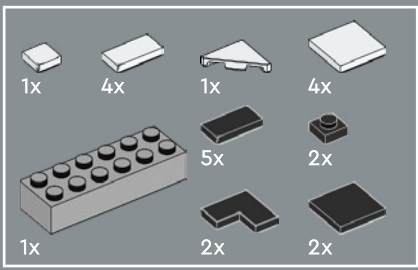

12

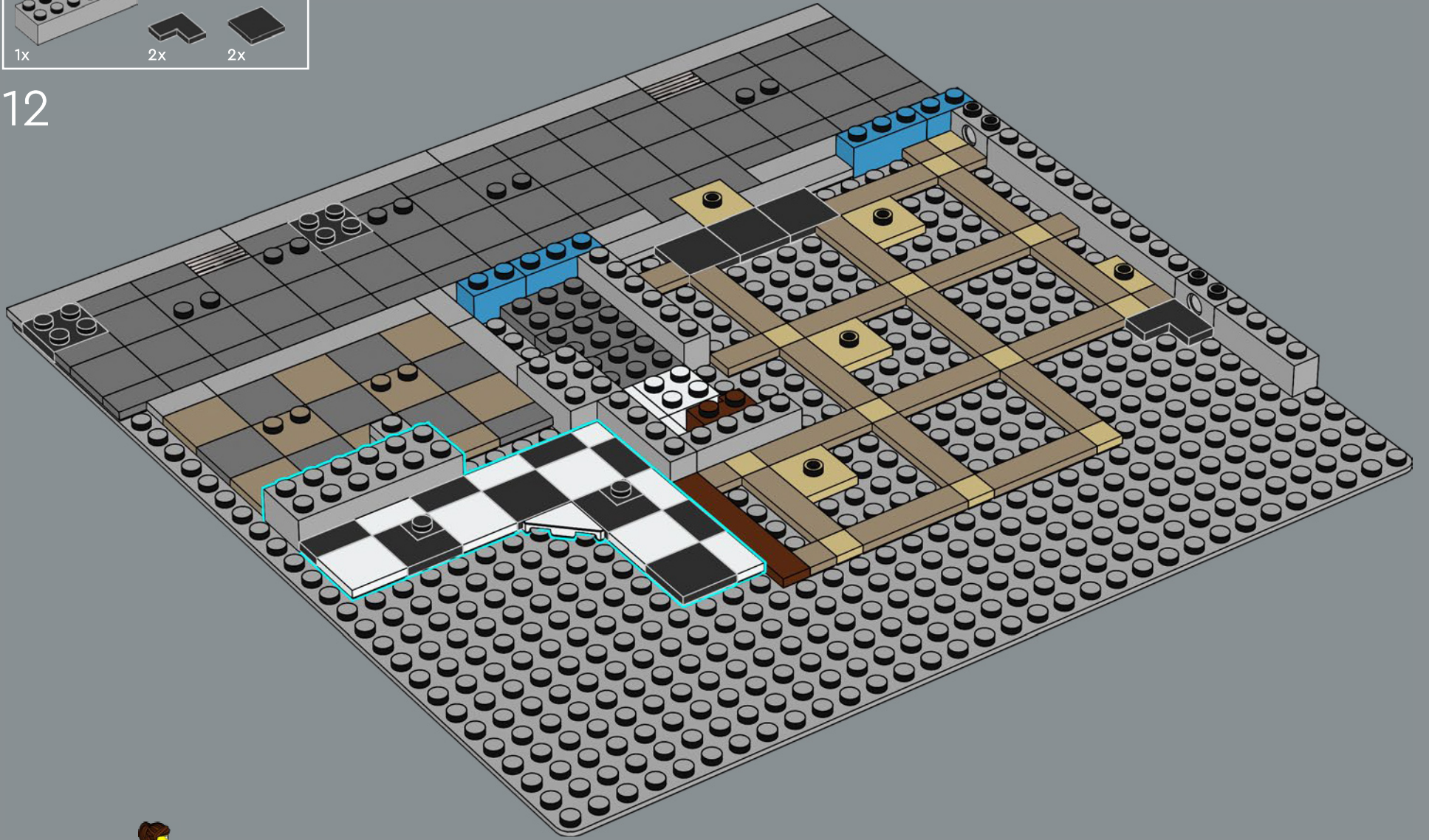

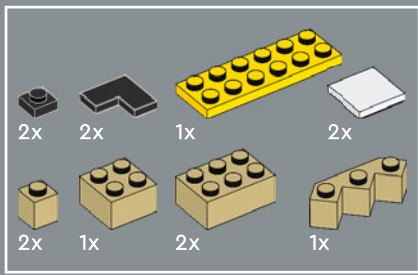

13

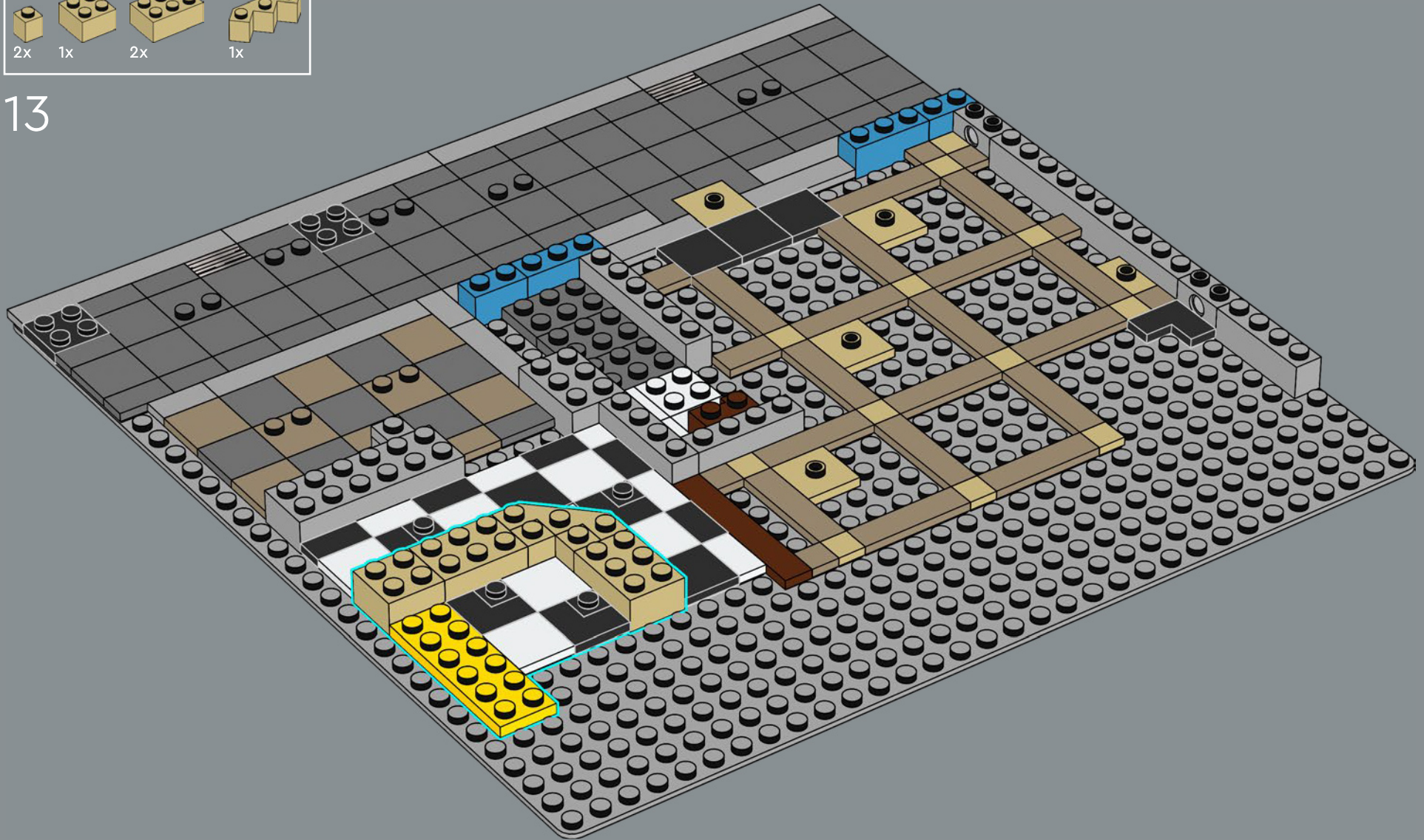

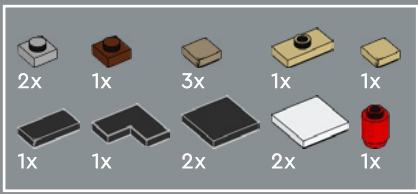

14

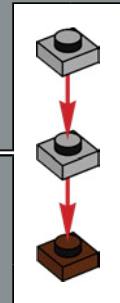
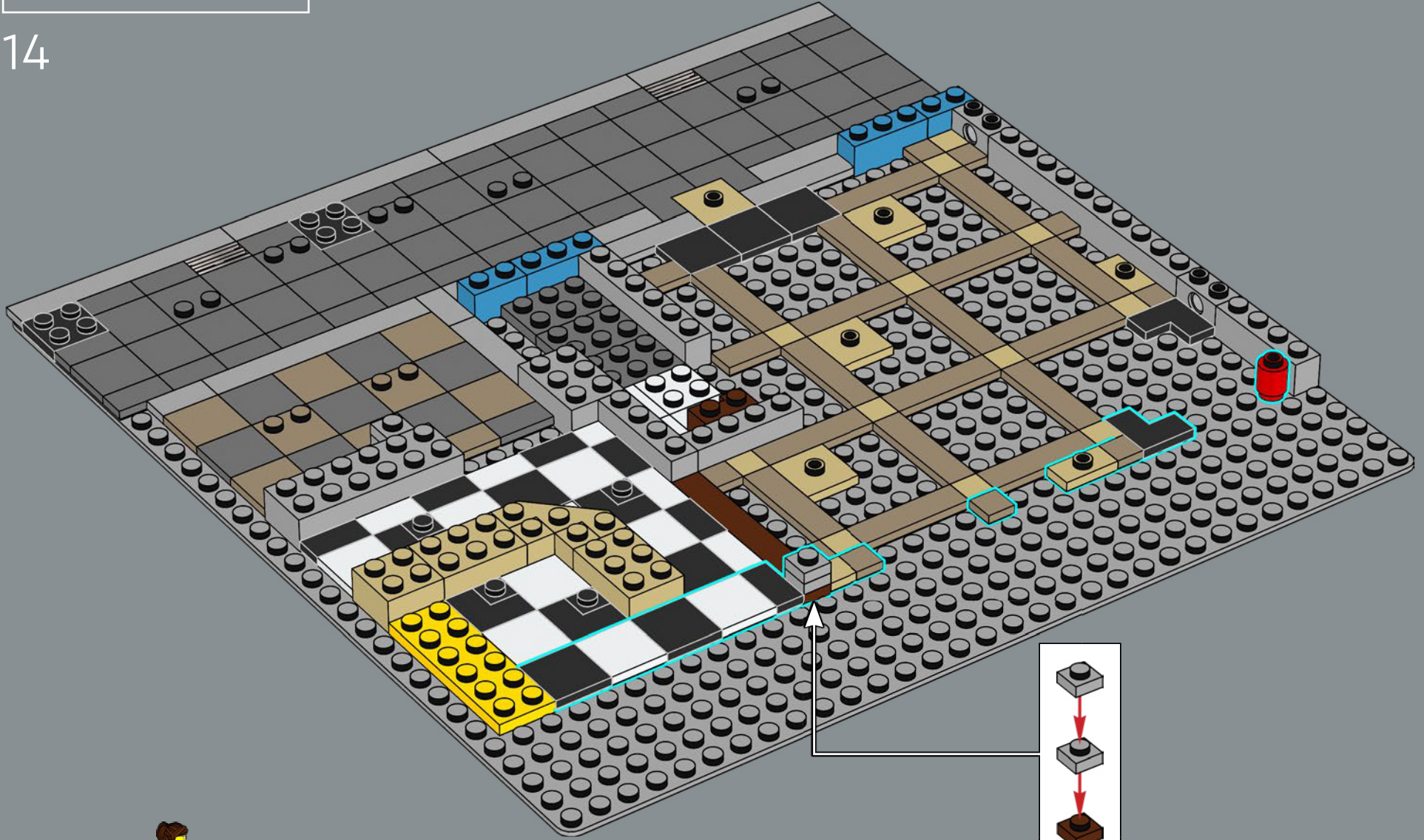

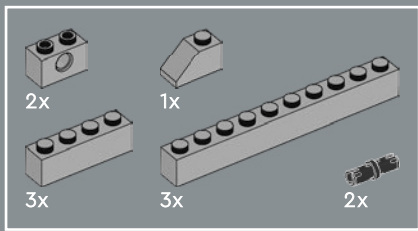

15

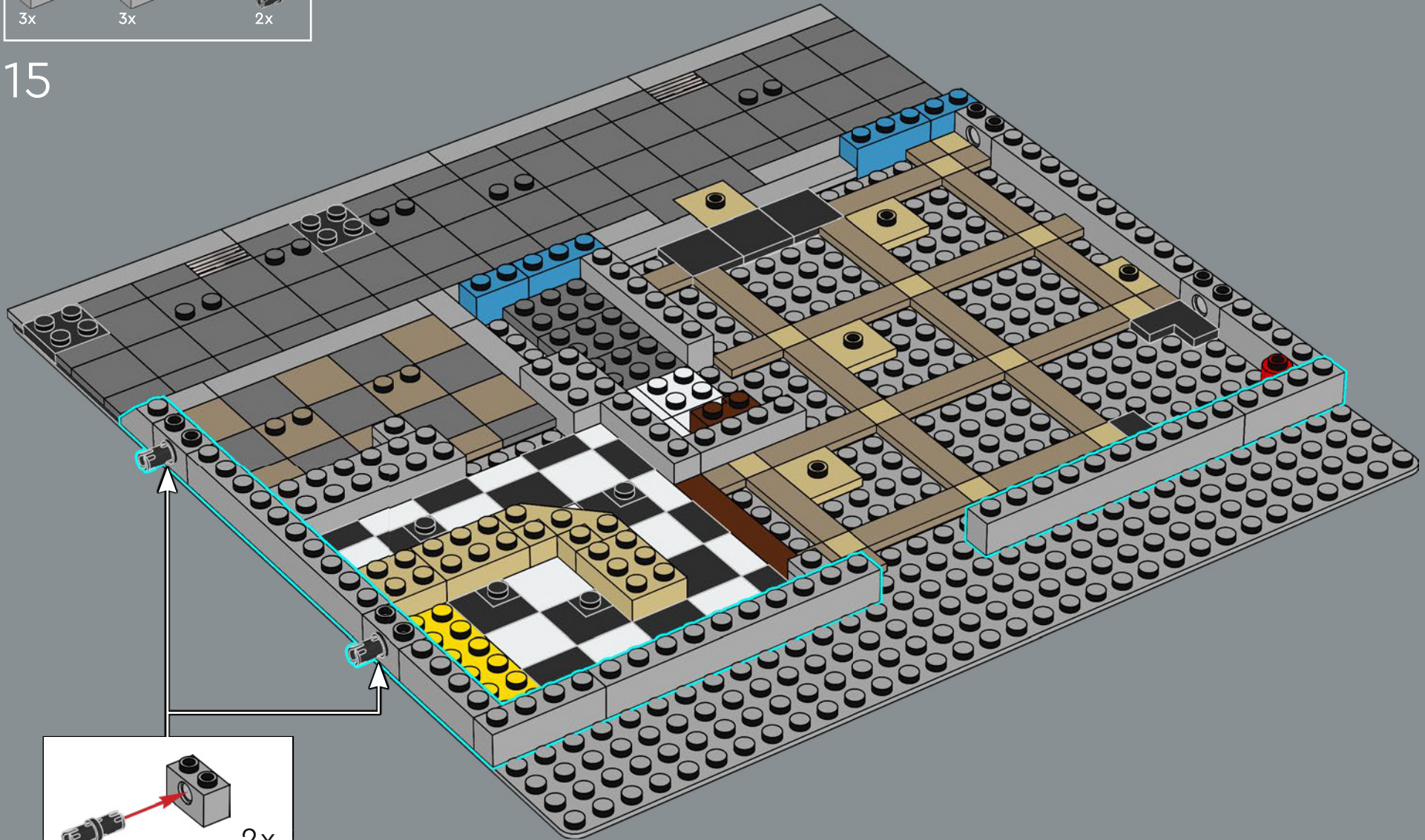

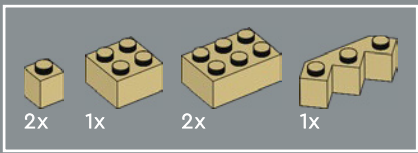

16

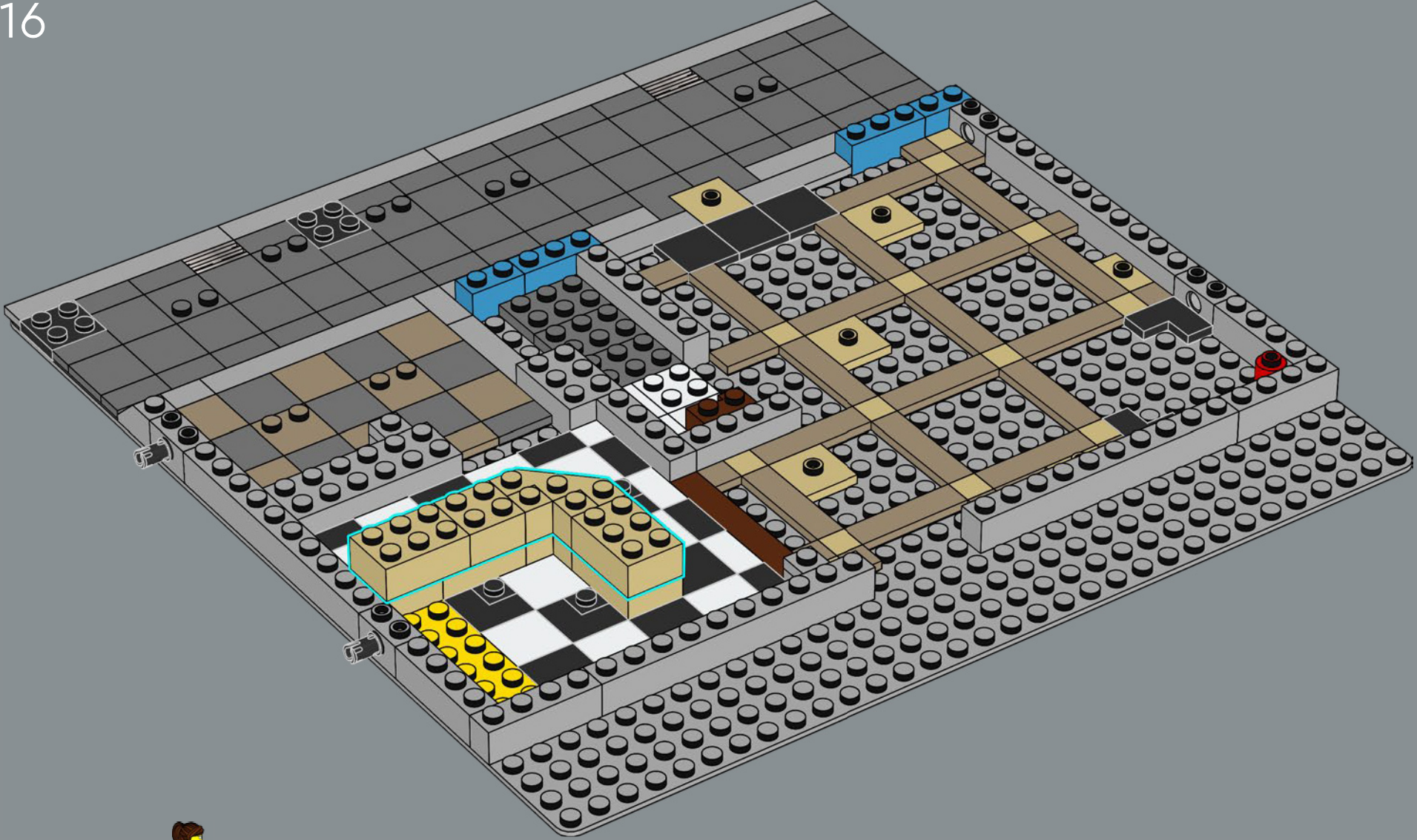



Le batteur est ravi de tester la nouvelle batterie en vente dans le magasin de musique situé dans La place de l'assemblée LEGO® 10255.

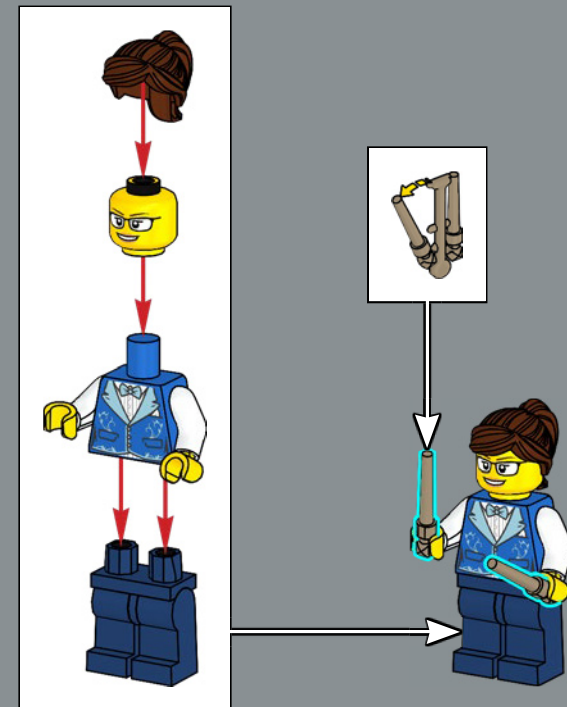

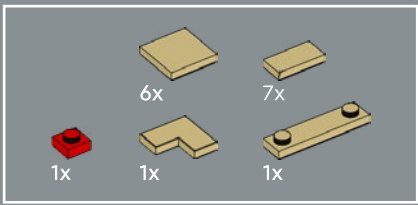

17

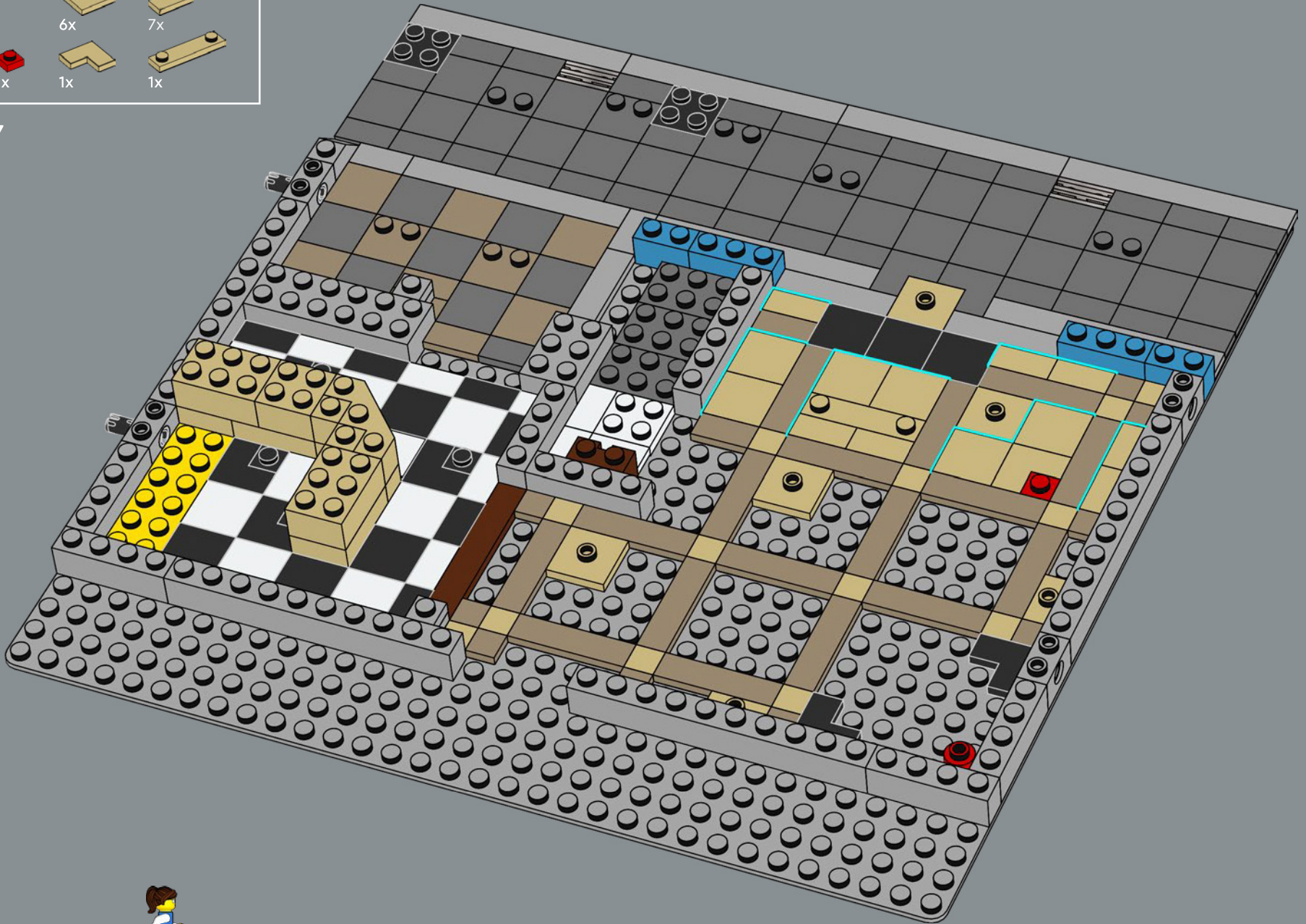

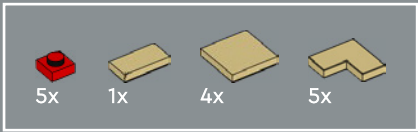

18

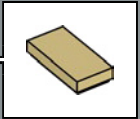
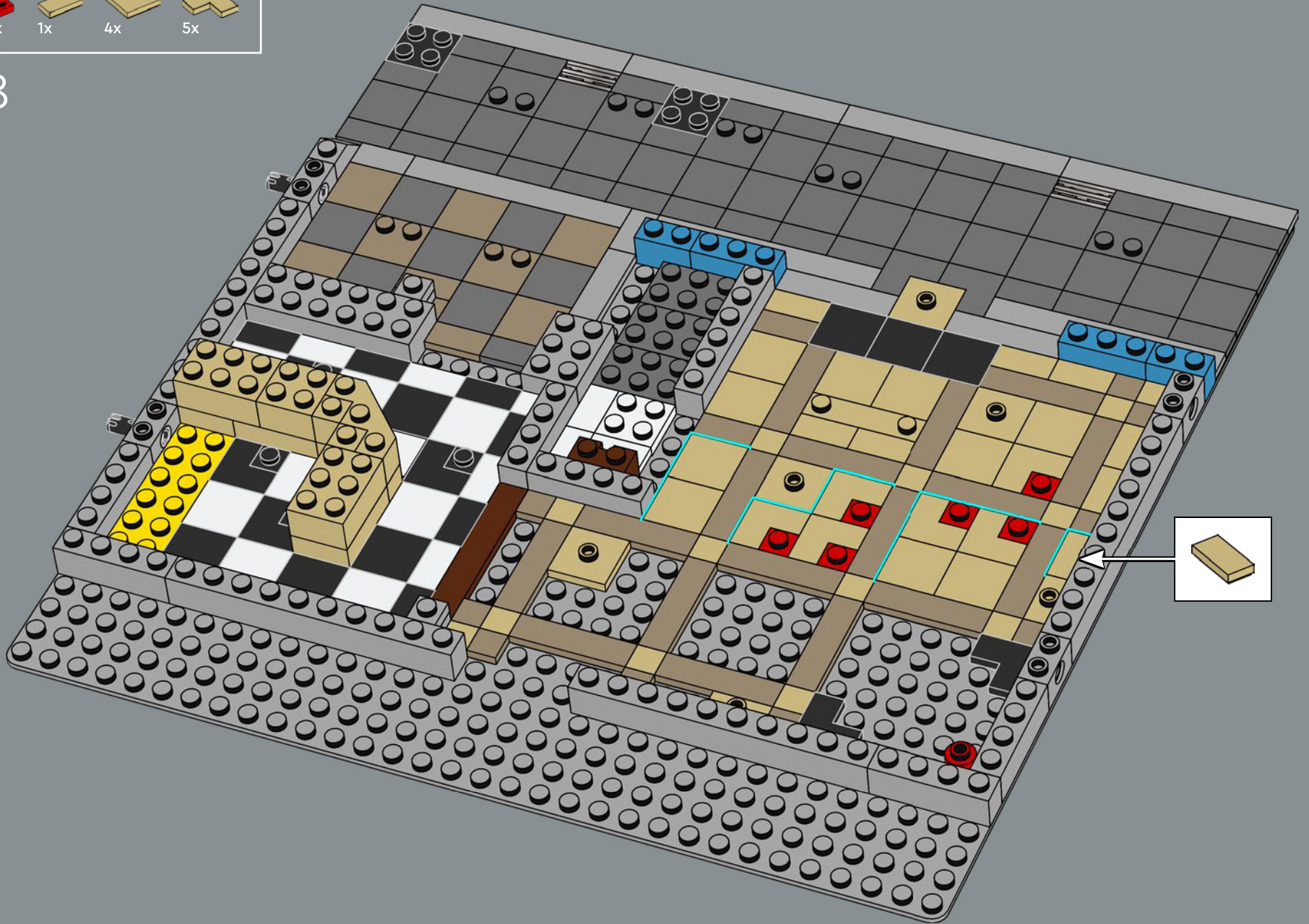

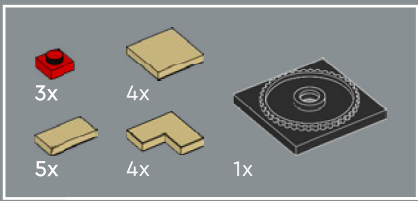

19

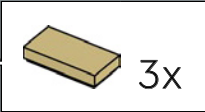
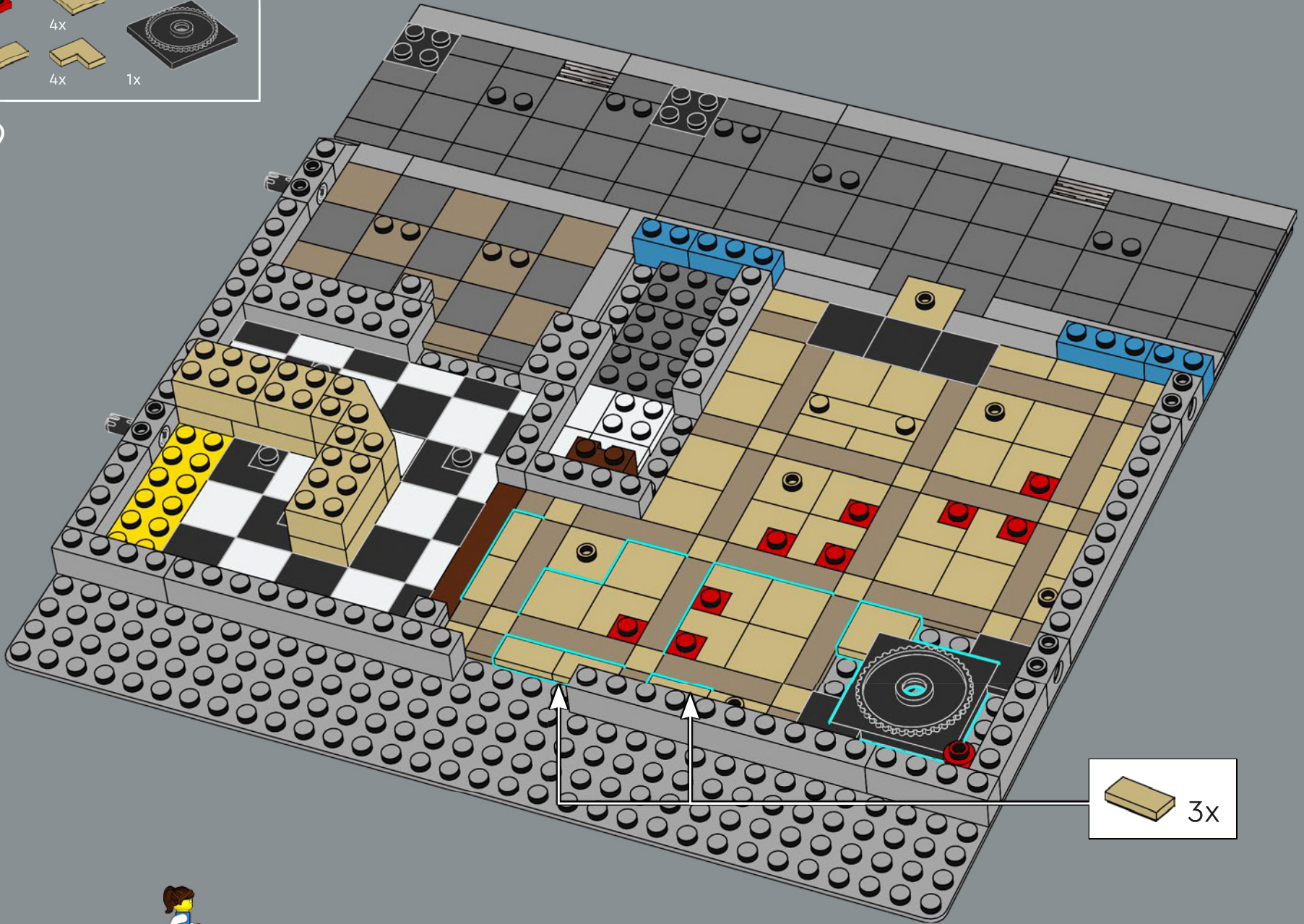

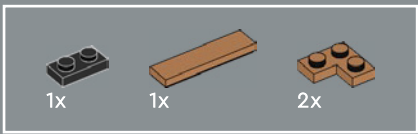

20

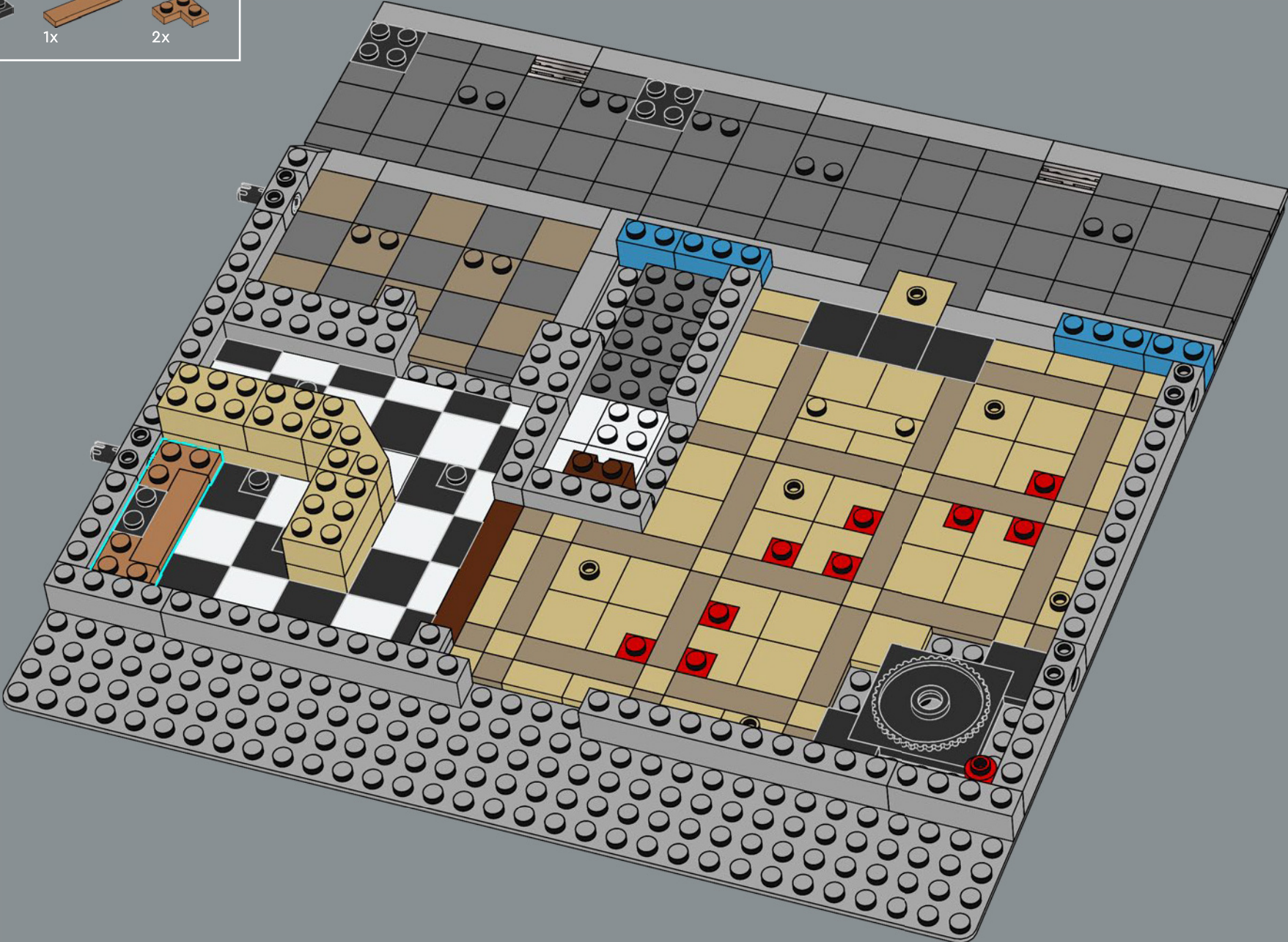

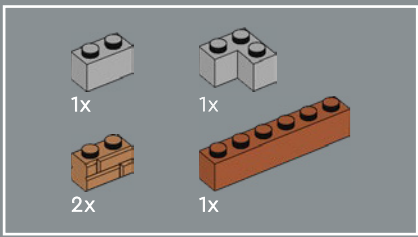

21

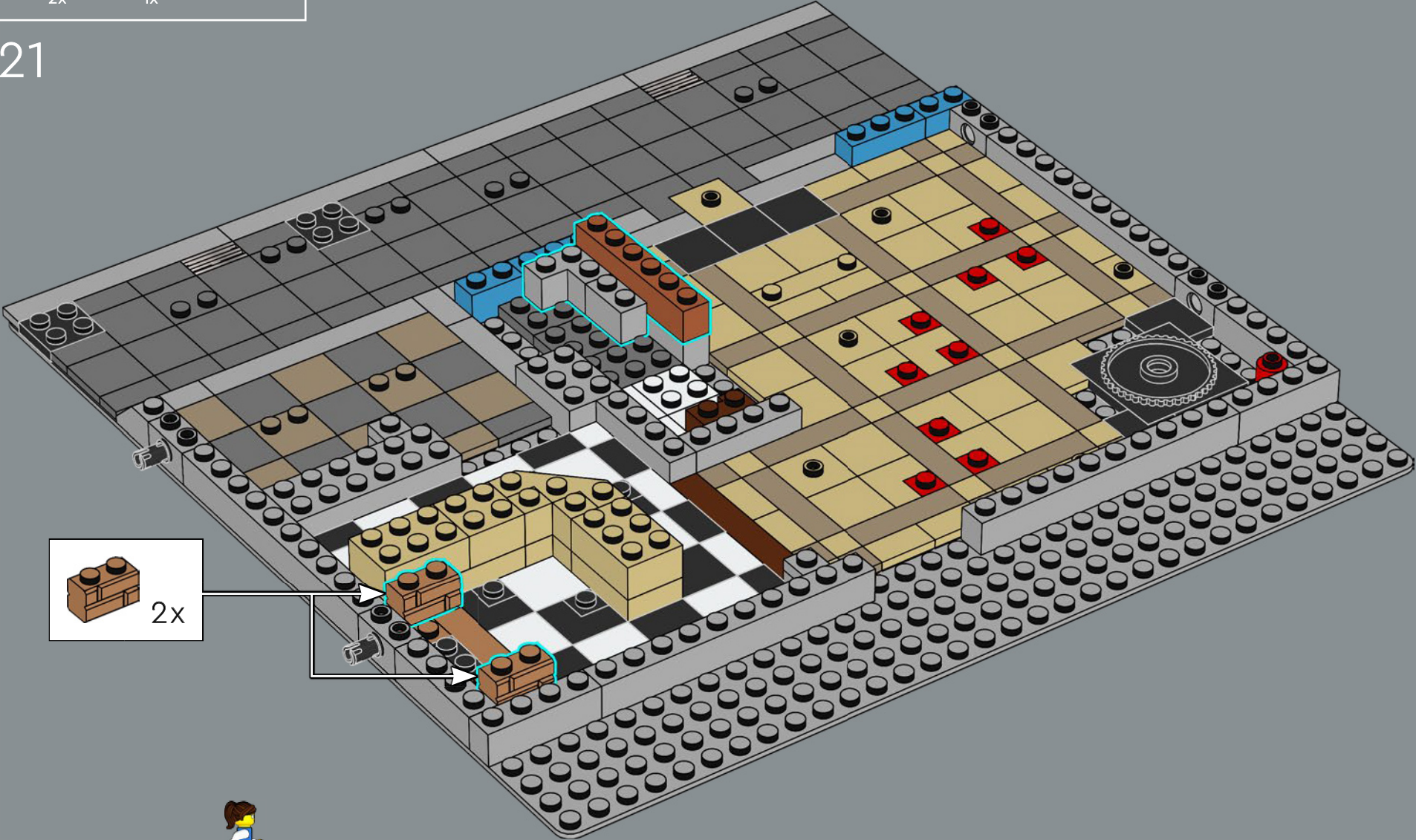

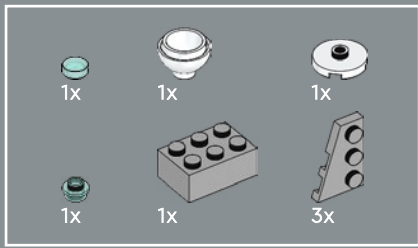

22

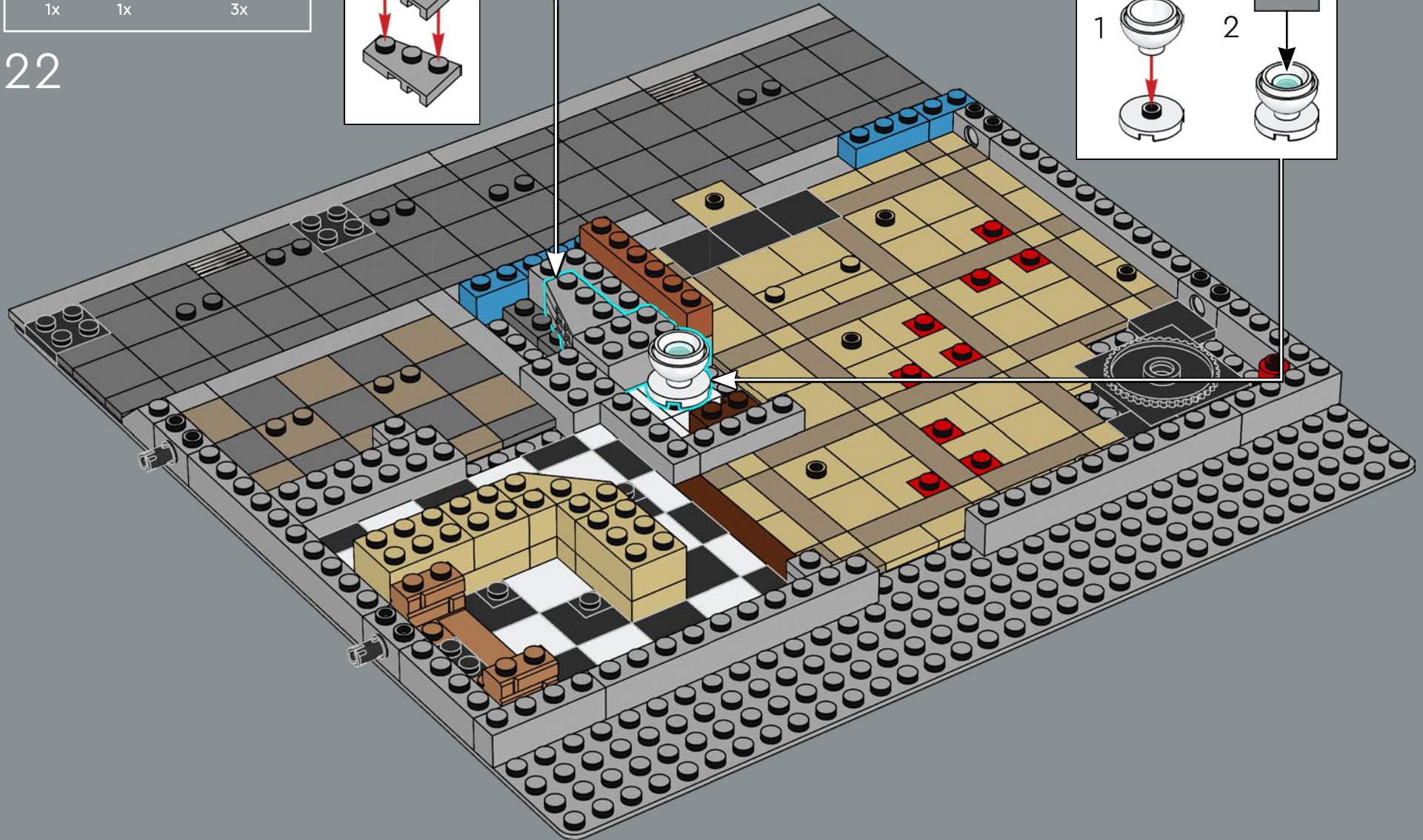
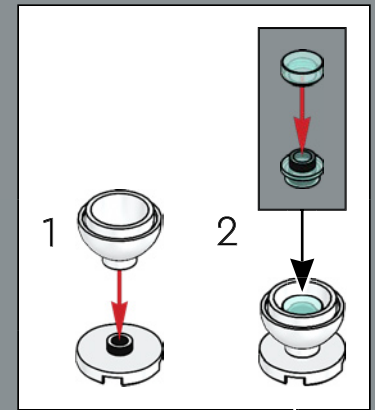
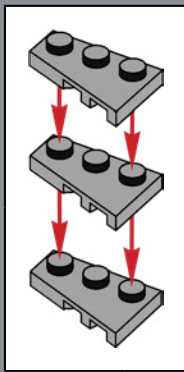

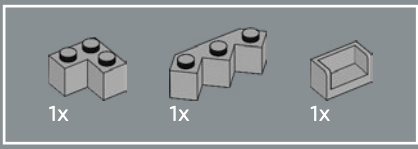

23

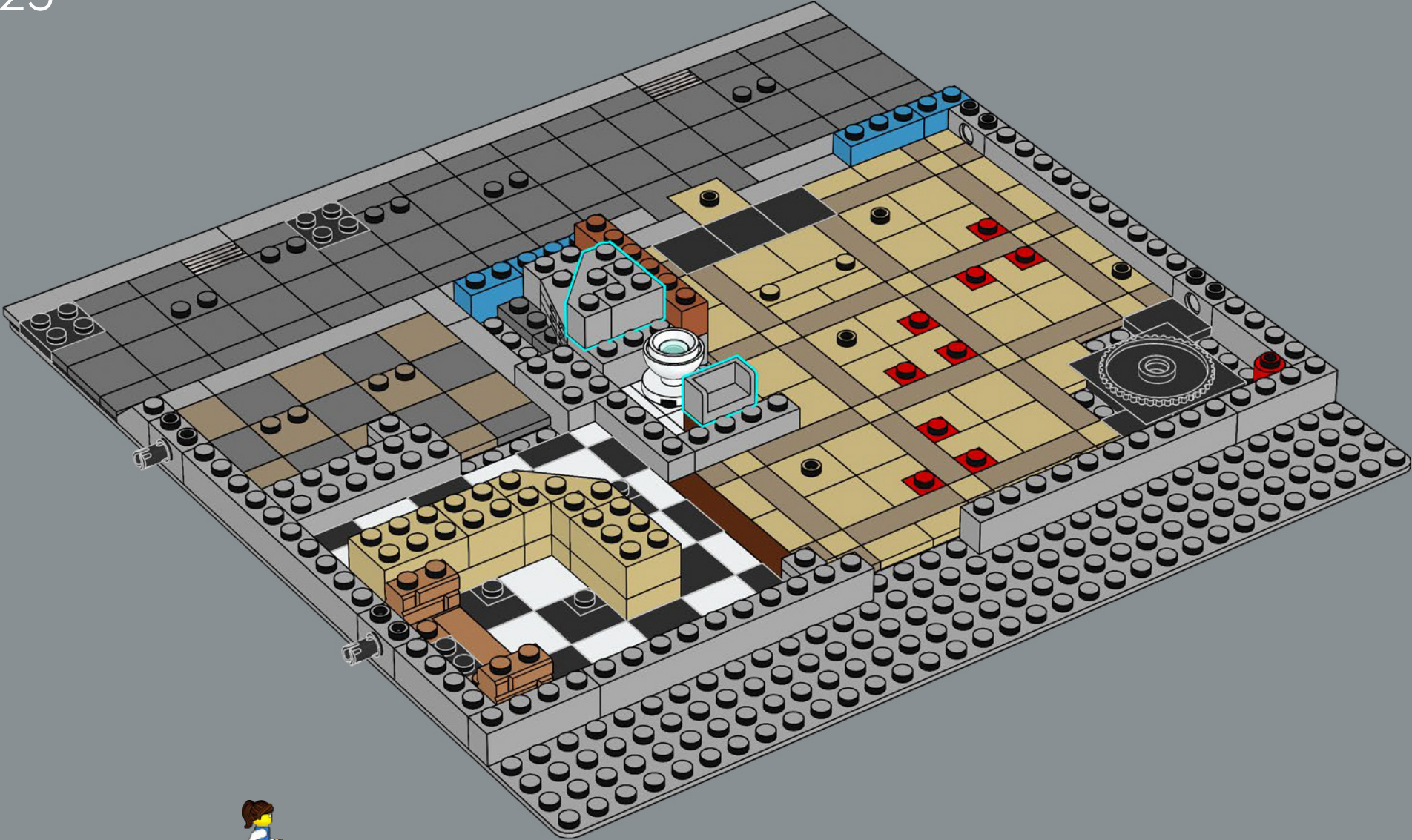

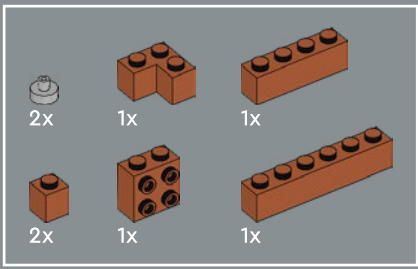

25

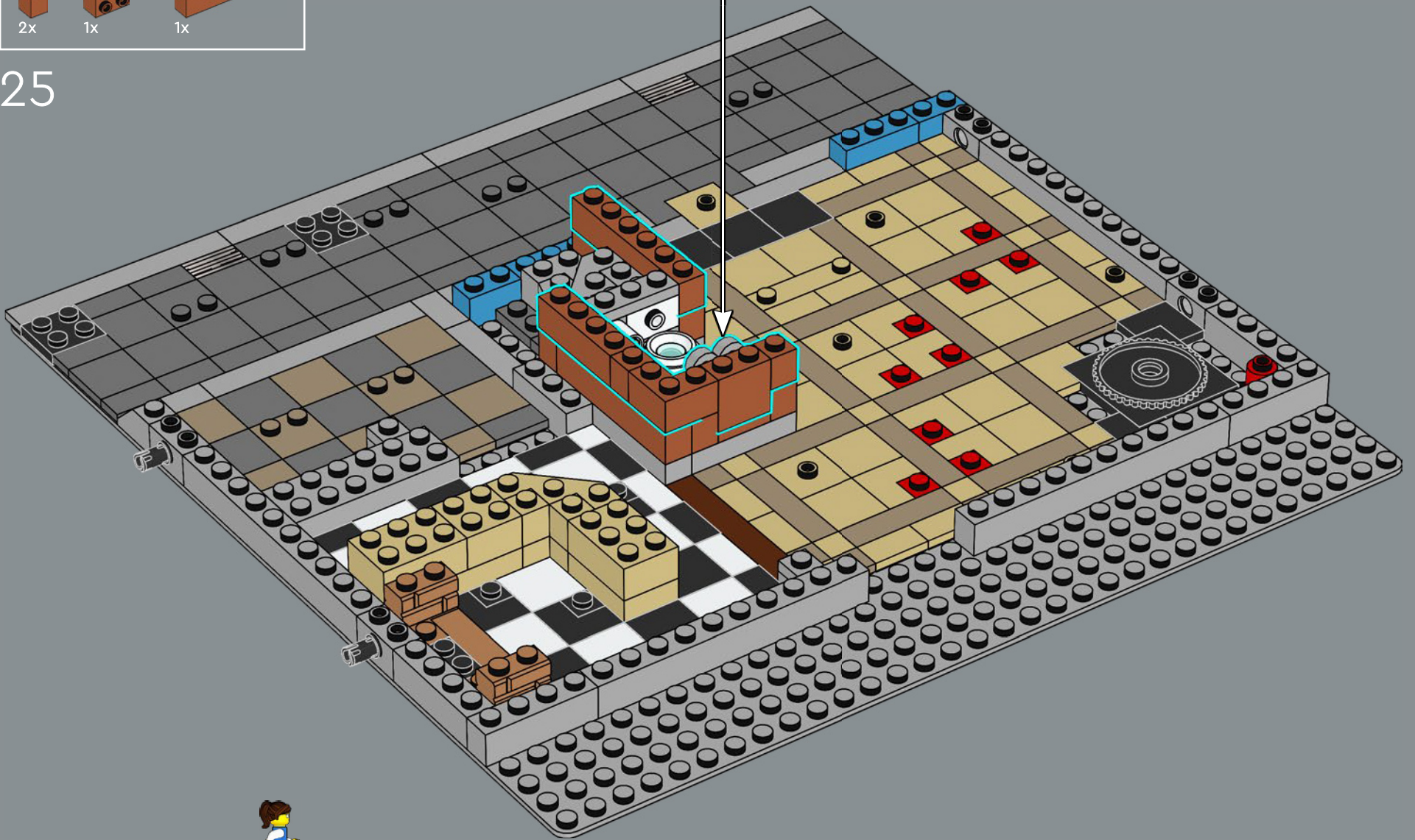
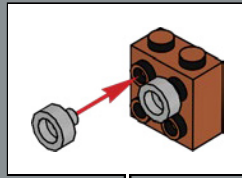

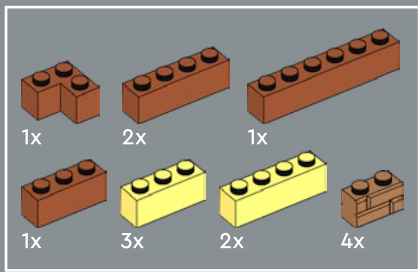

26

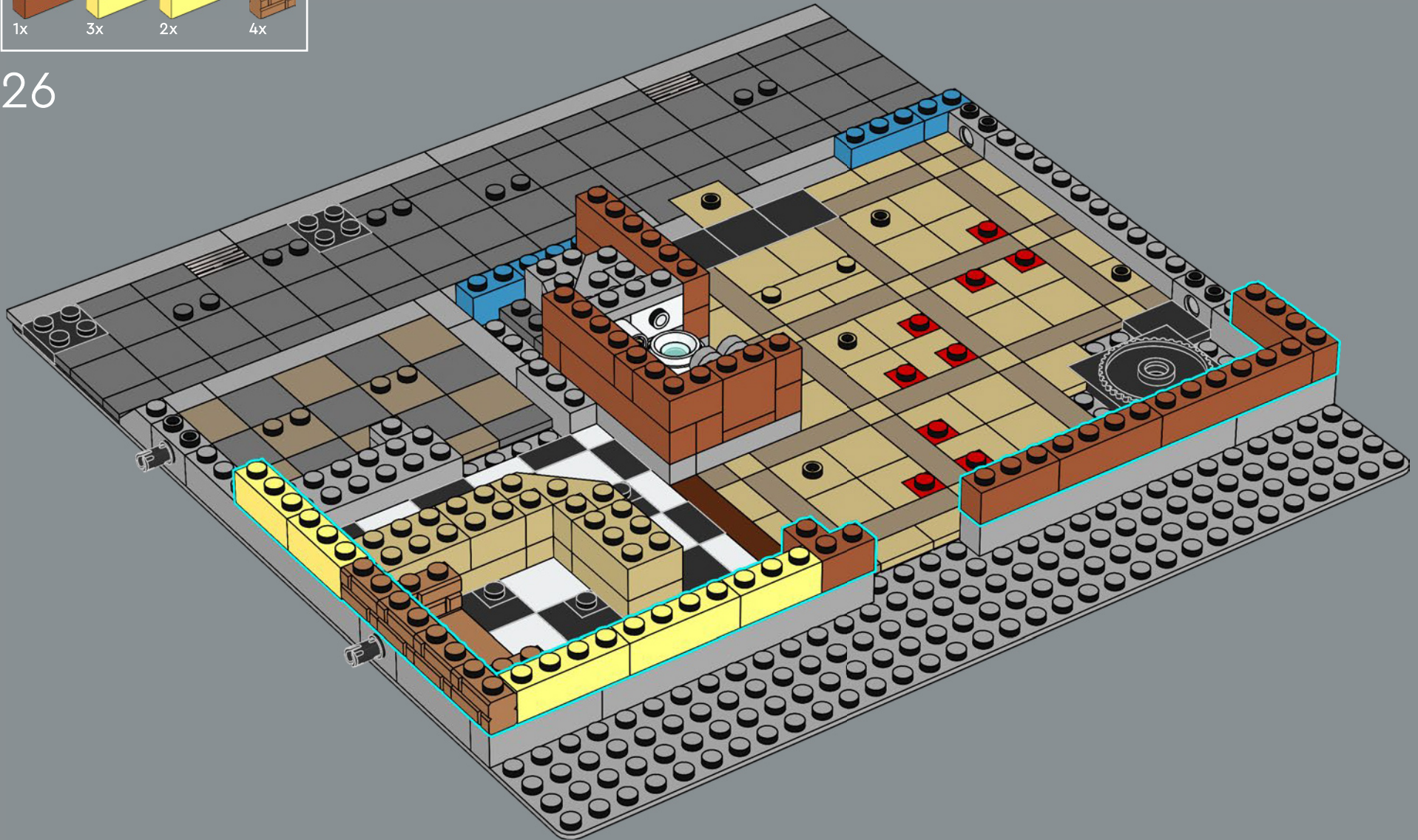

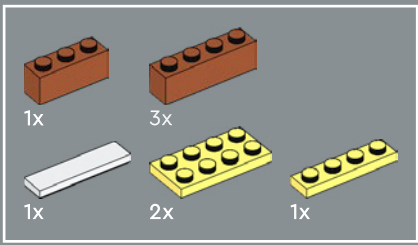

27

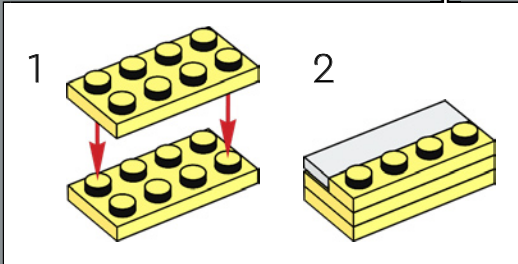
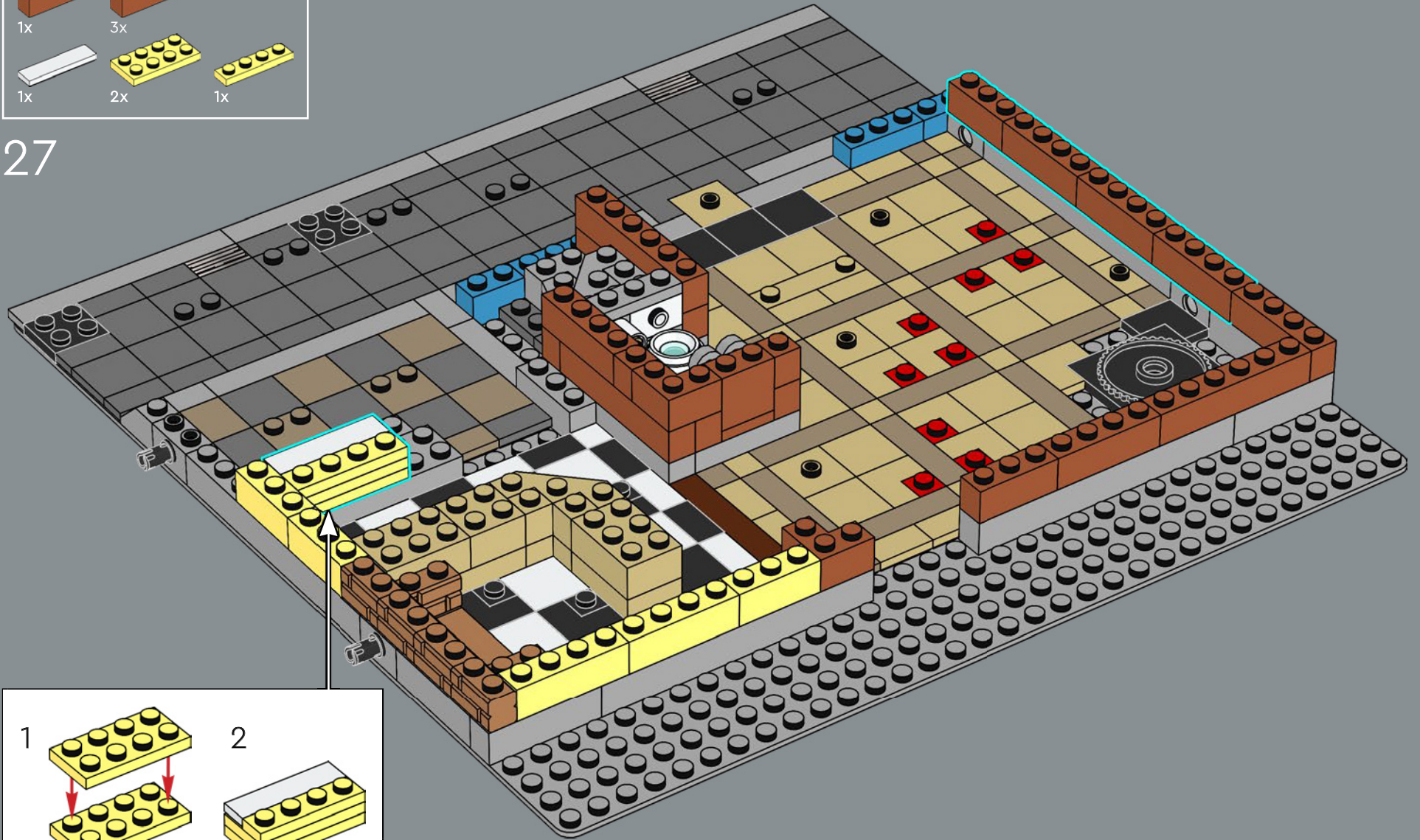

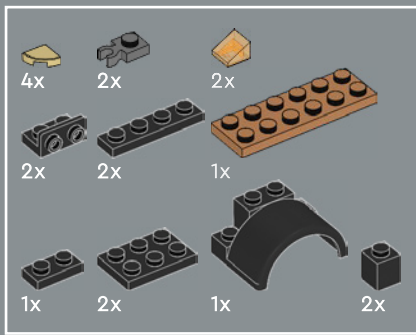

28

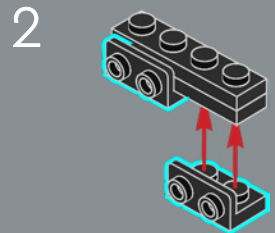
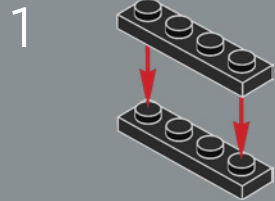

3

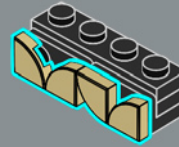

4

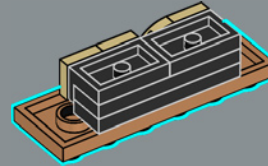

5

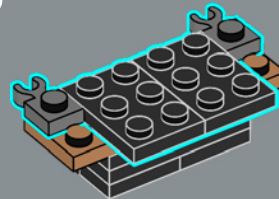

6

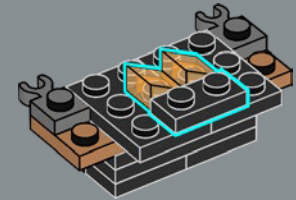

7

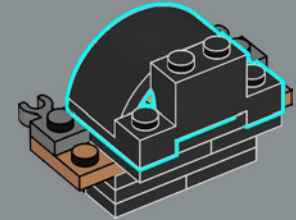

8

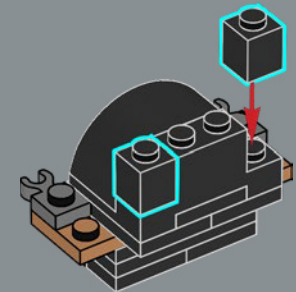

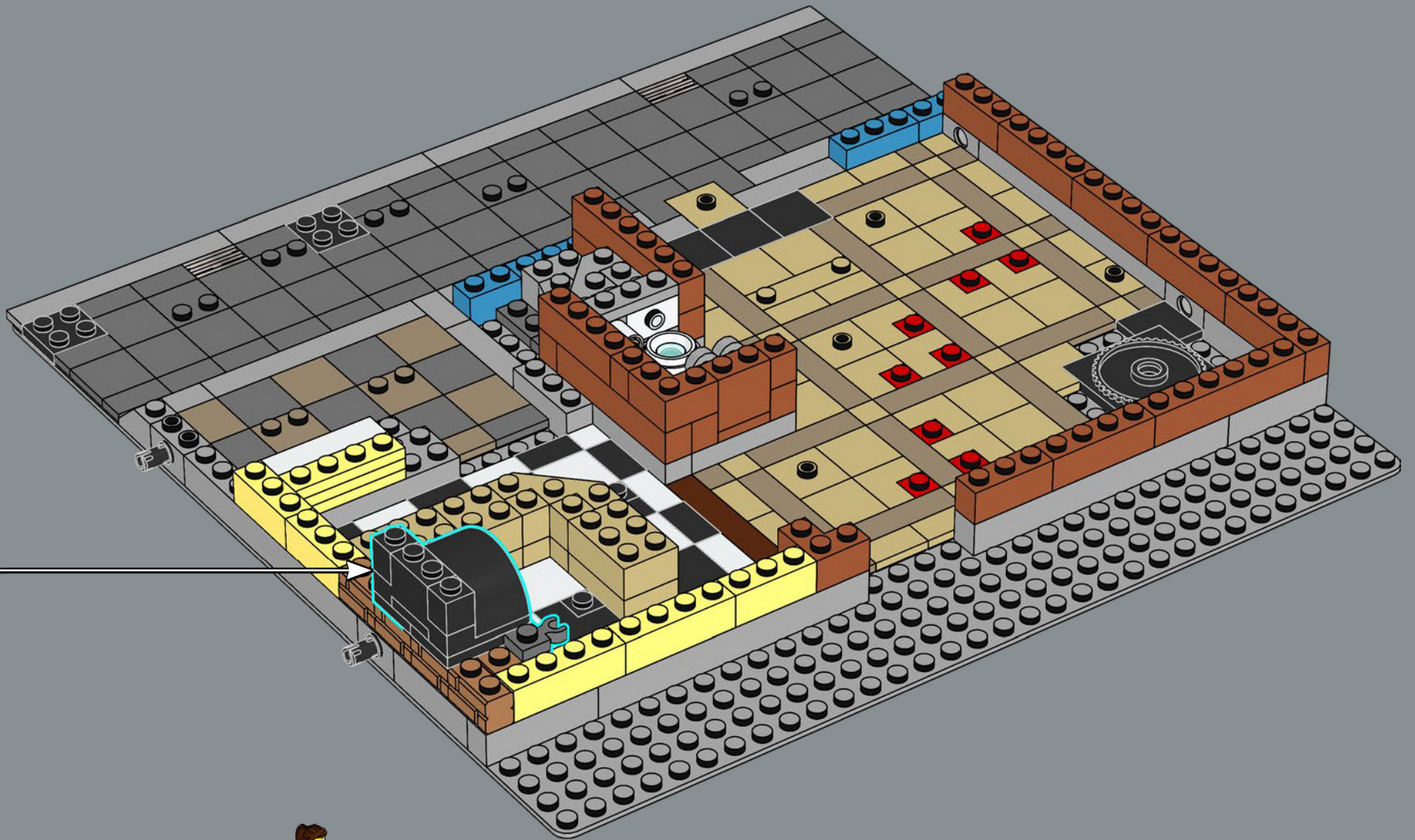

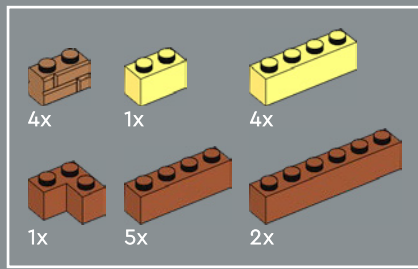

29

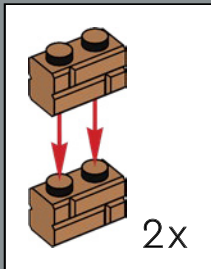
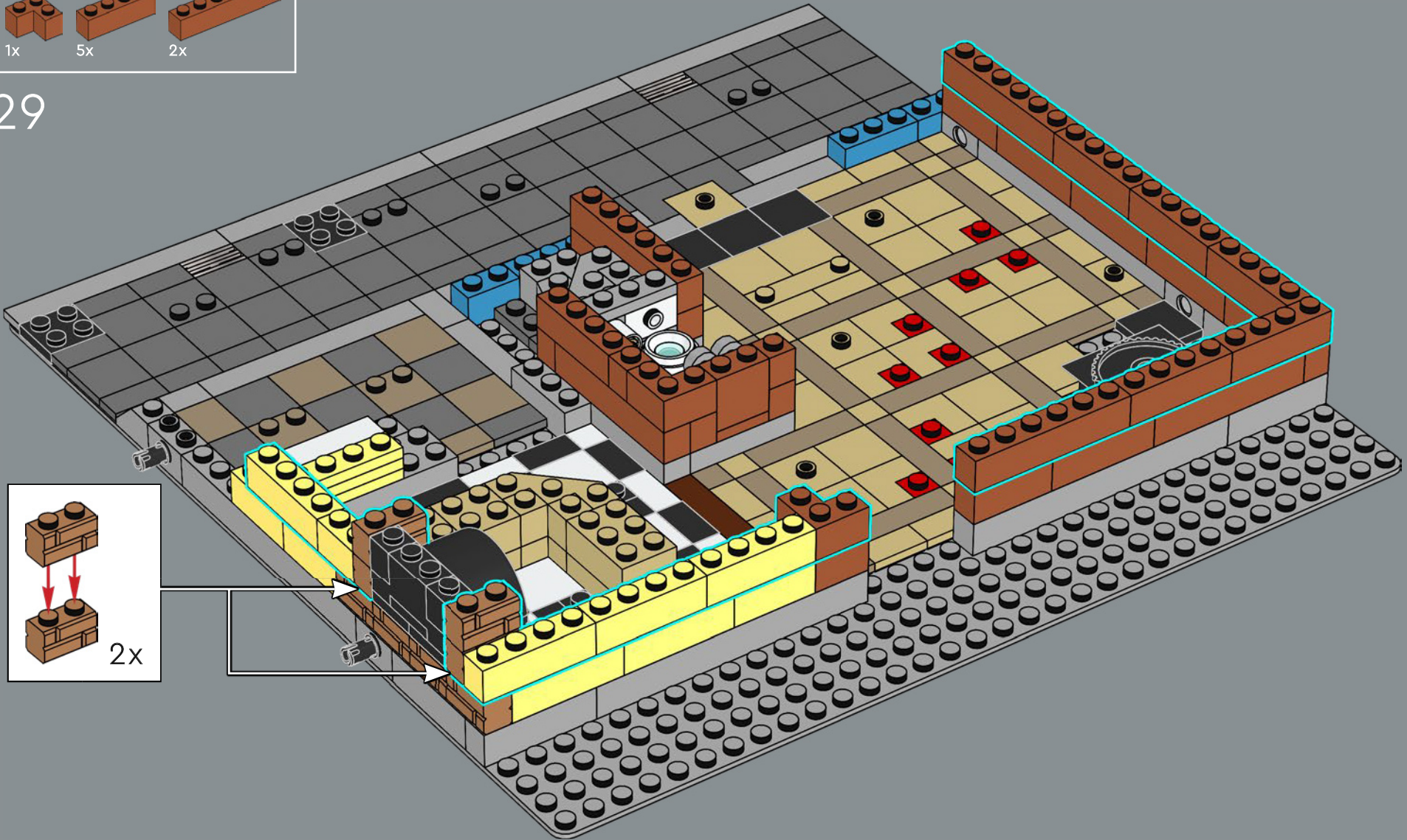

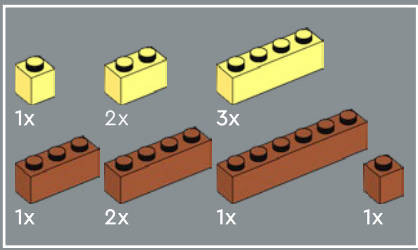

30

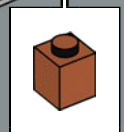
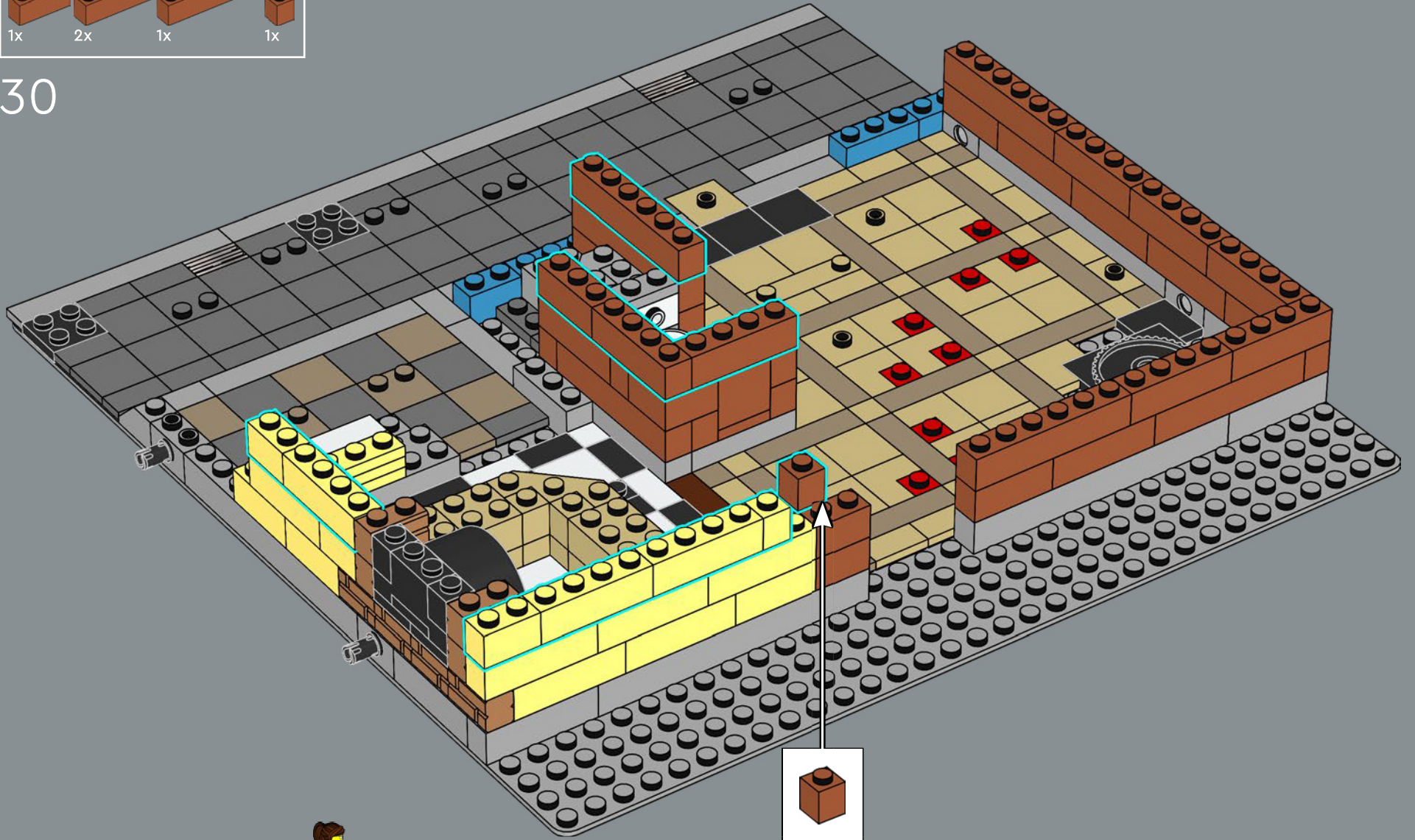

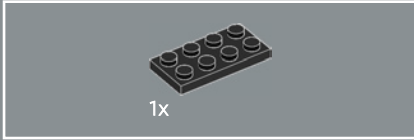
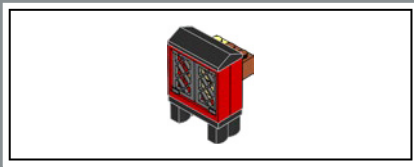

31

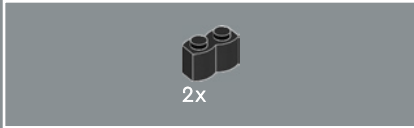
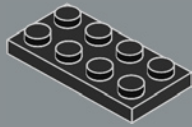

32

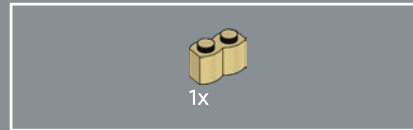
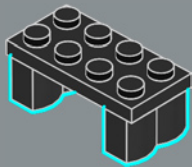

33

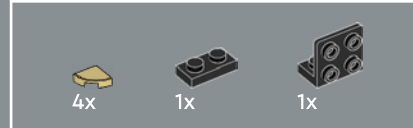
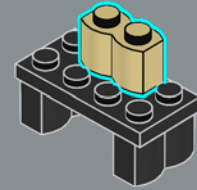

34

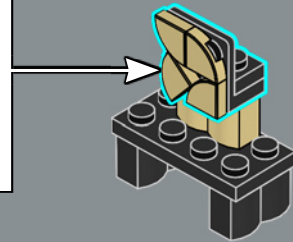
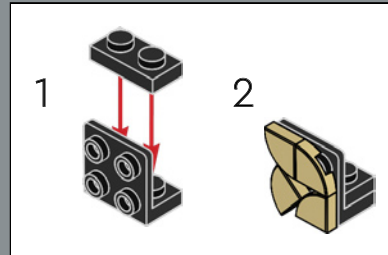

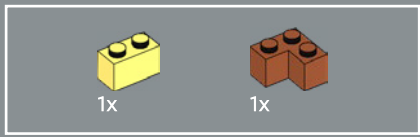

35

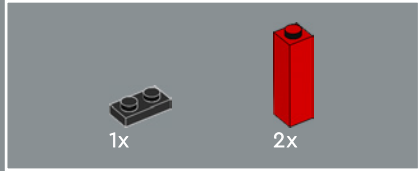
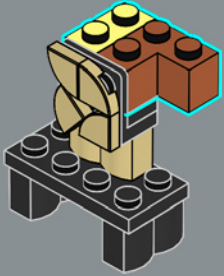

36

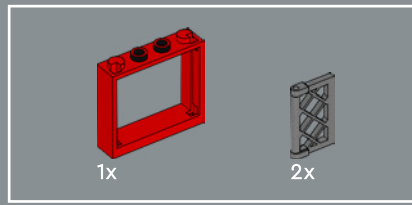
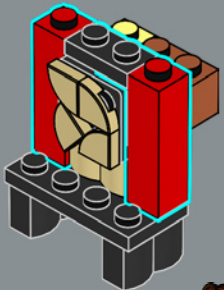

37

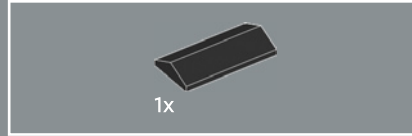
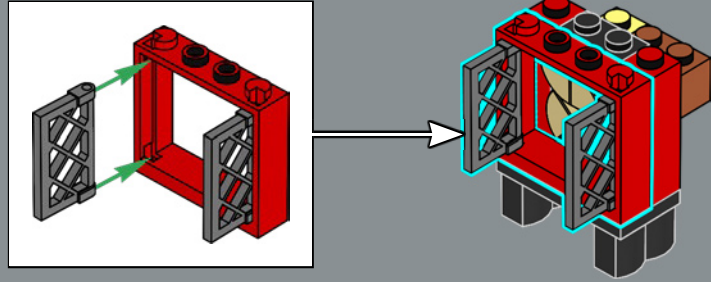

38

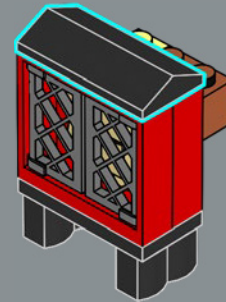



Le four à pizza au feu de bois est déjà chaud et prêt à l'emploi. Vous trouverez d'autres bûches derrière le bâtiment.

39

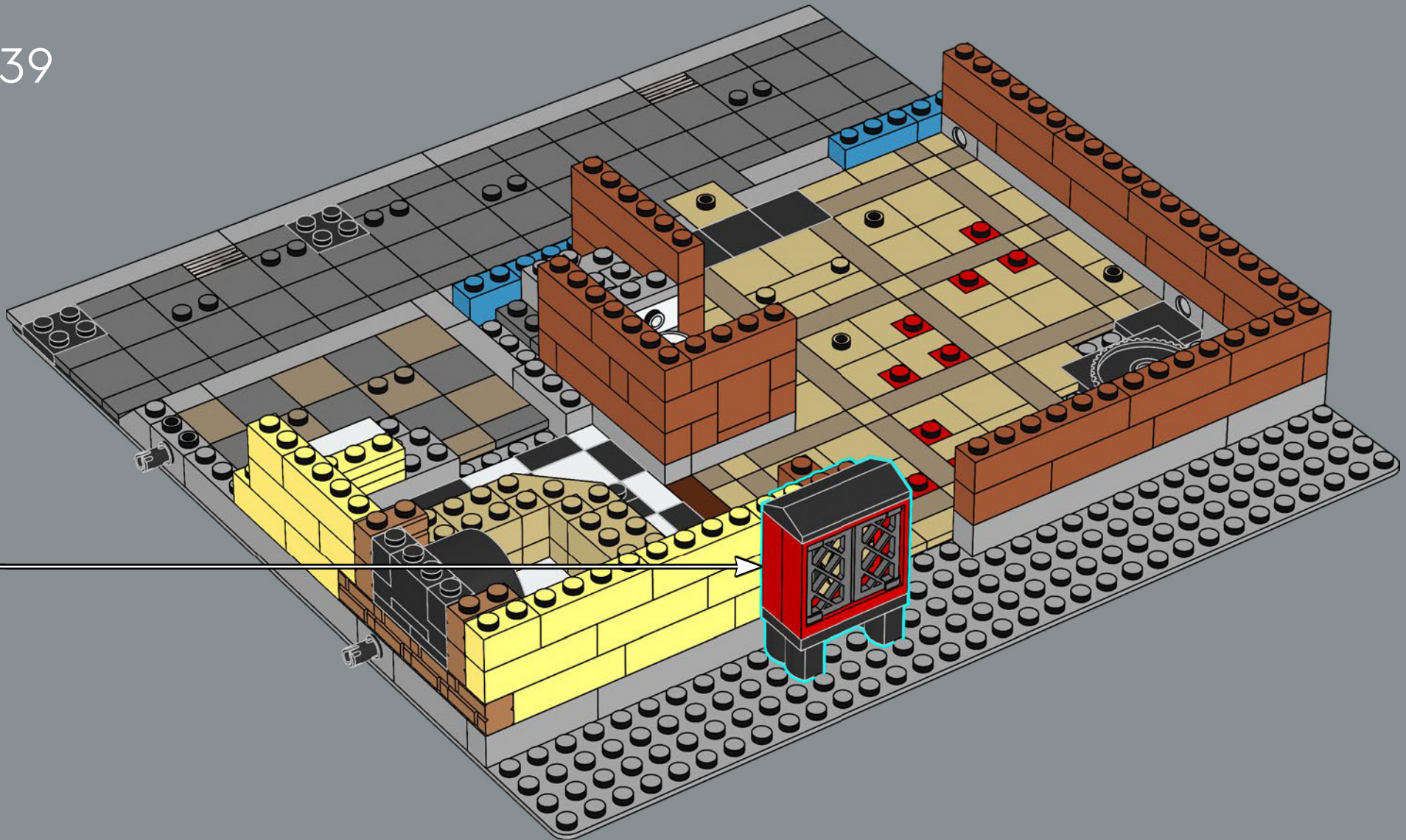

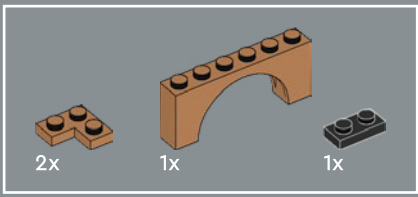

40

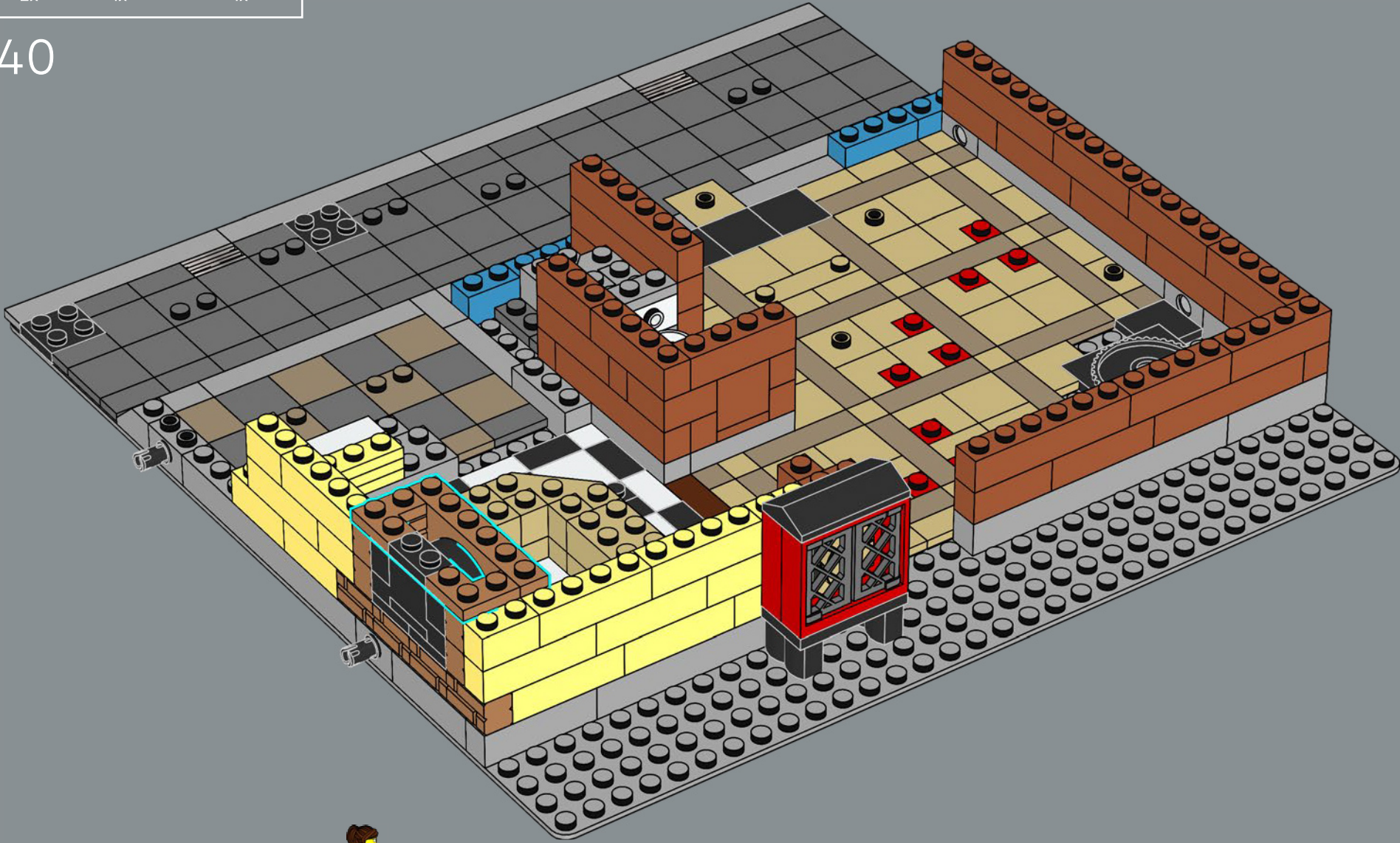

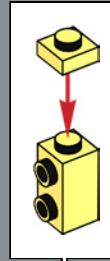
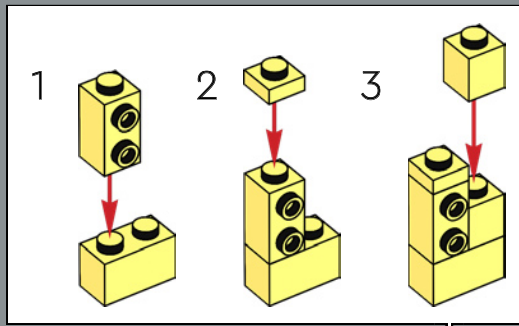
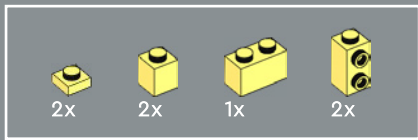

41

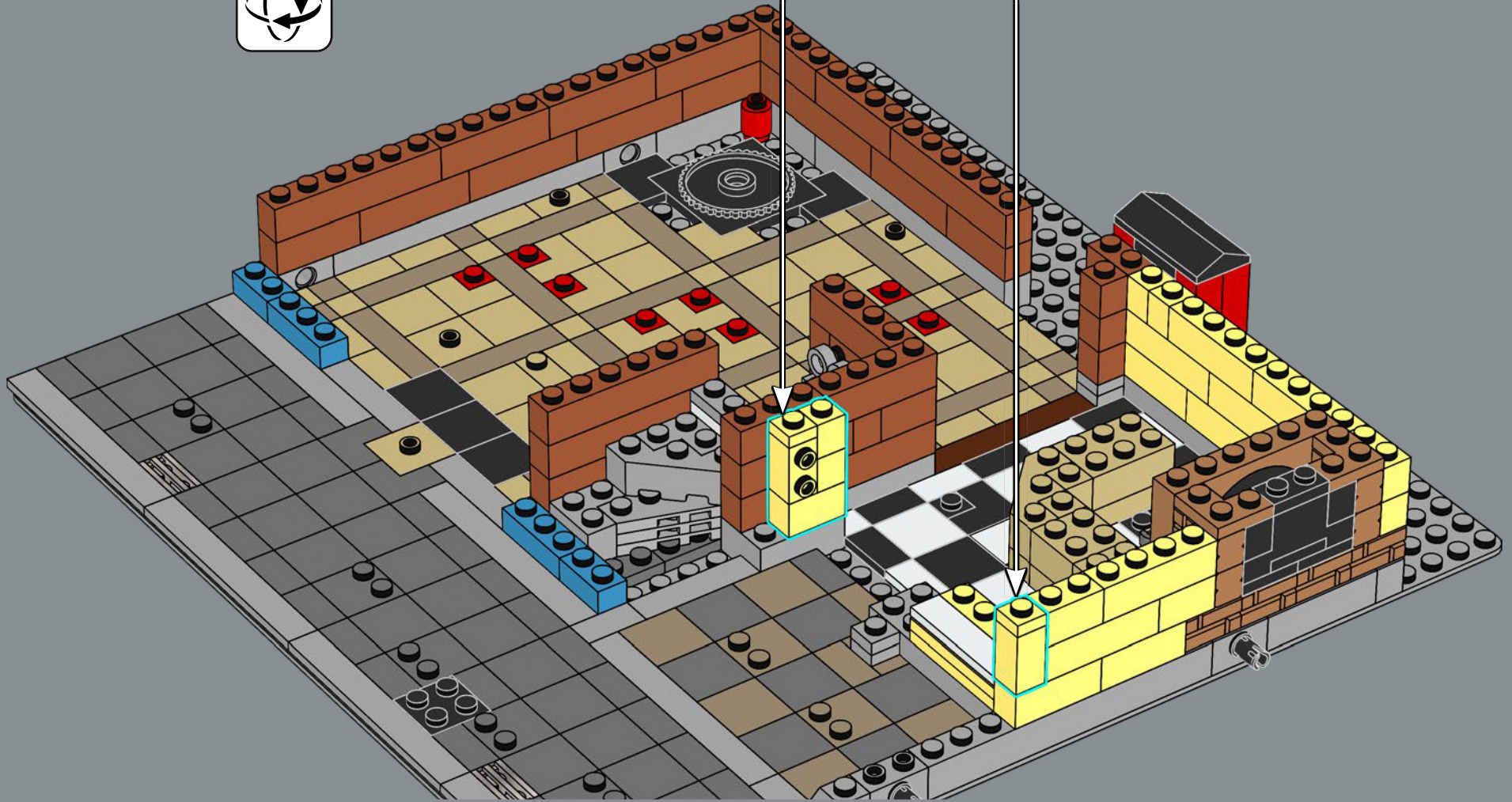

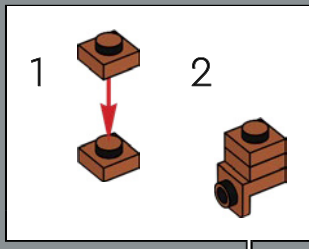
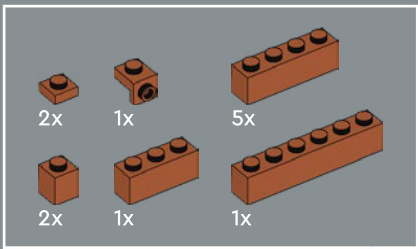

42

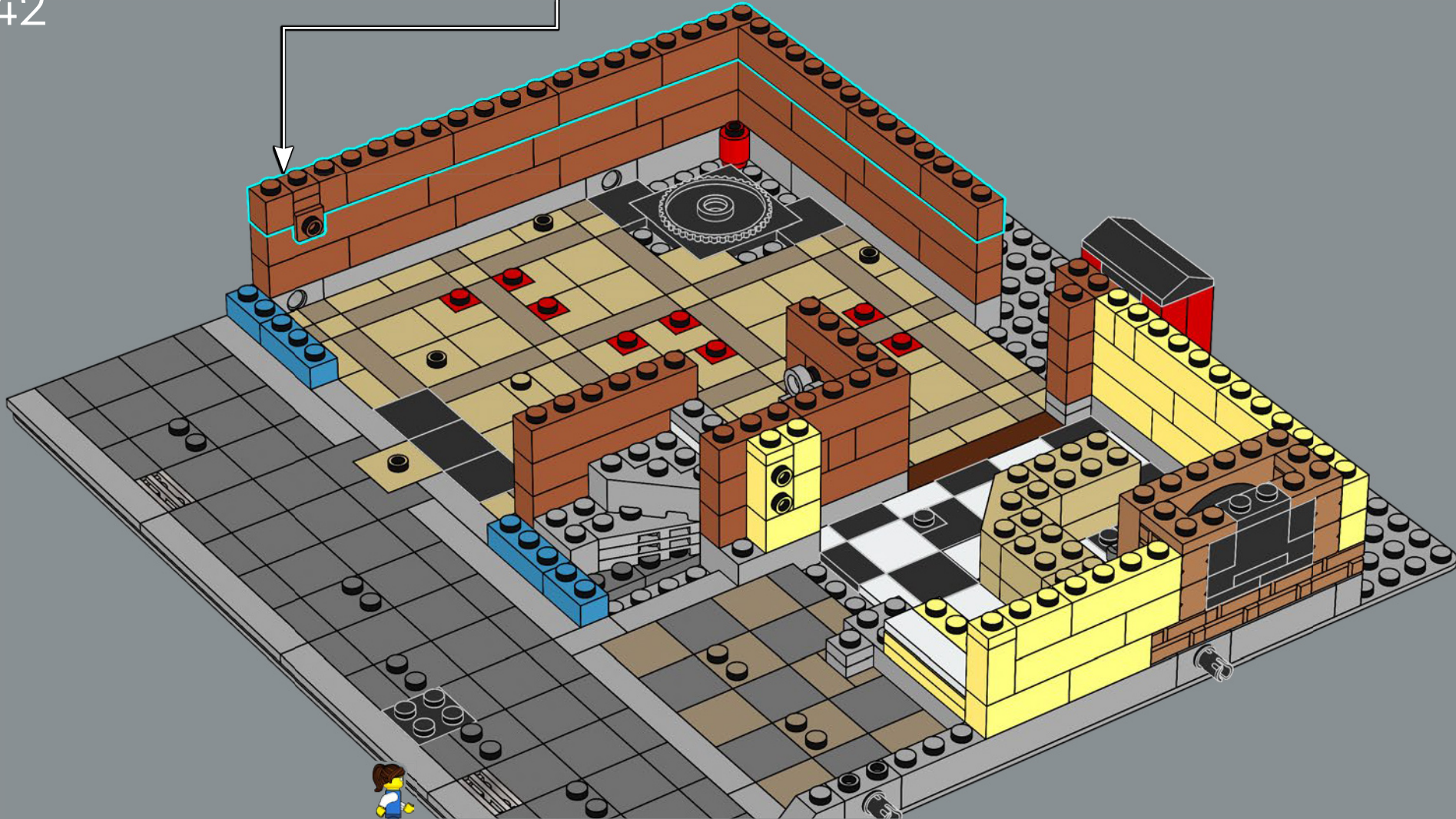

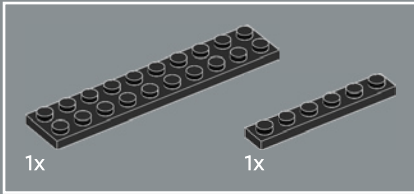
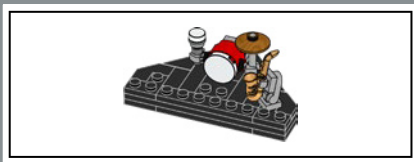

43

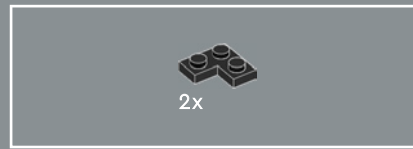
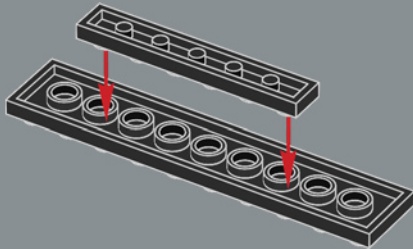

44

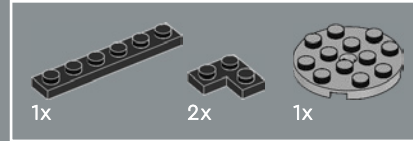
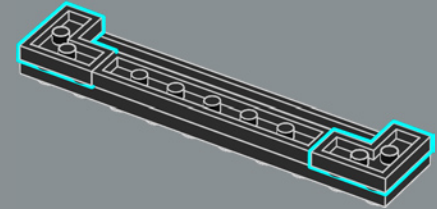

45

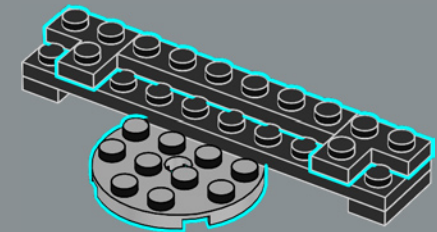

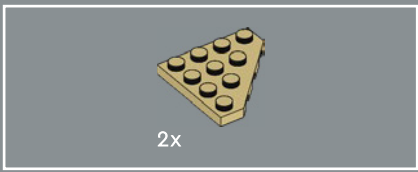

46

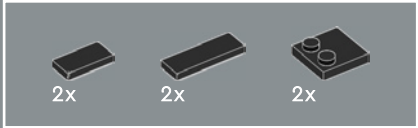
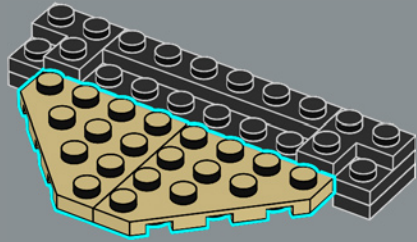

47

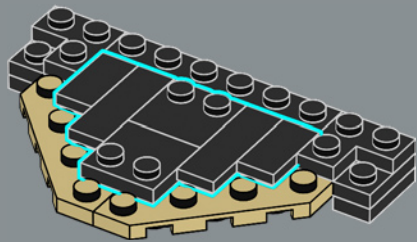

48

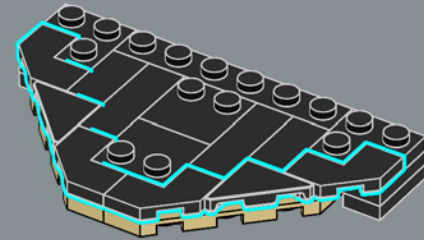

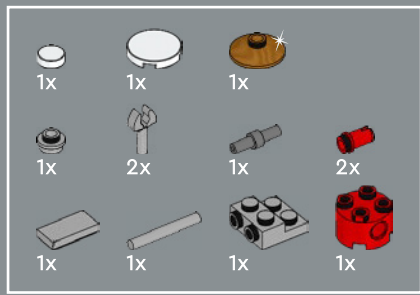

49

1

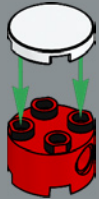

2

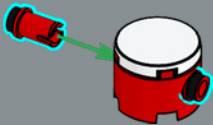

3

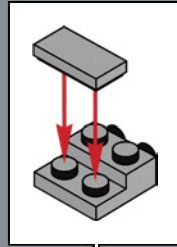

4

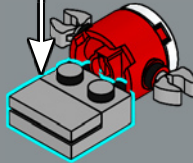

5

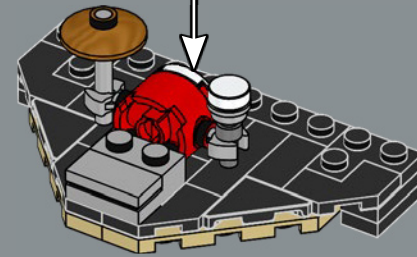
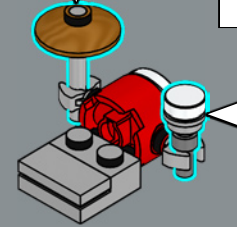
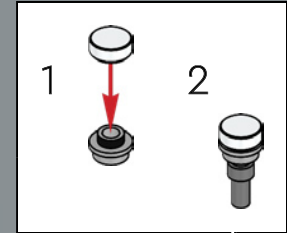
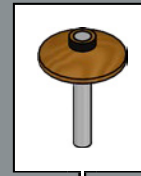



Entendez-vous le « boom-cht » de la grosse caisse et de la caisse claire, et le « tss-t-t-tss » de la cymbale ?

50

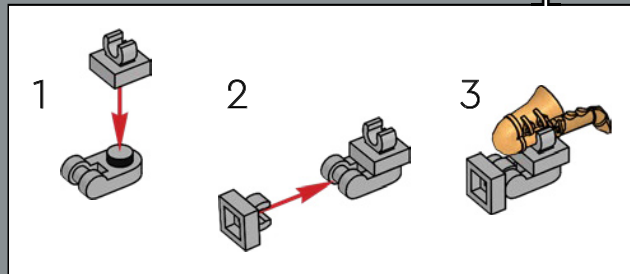
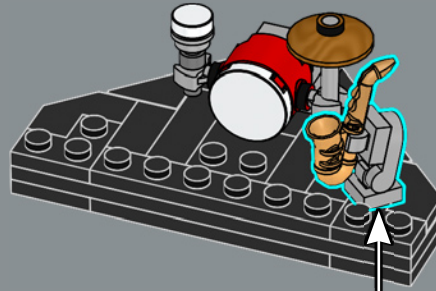

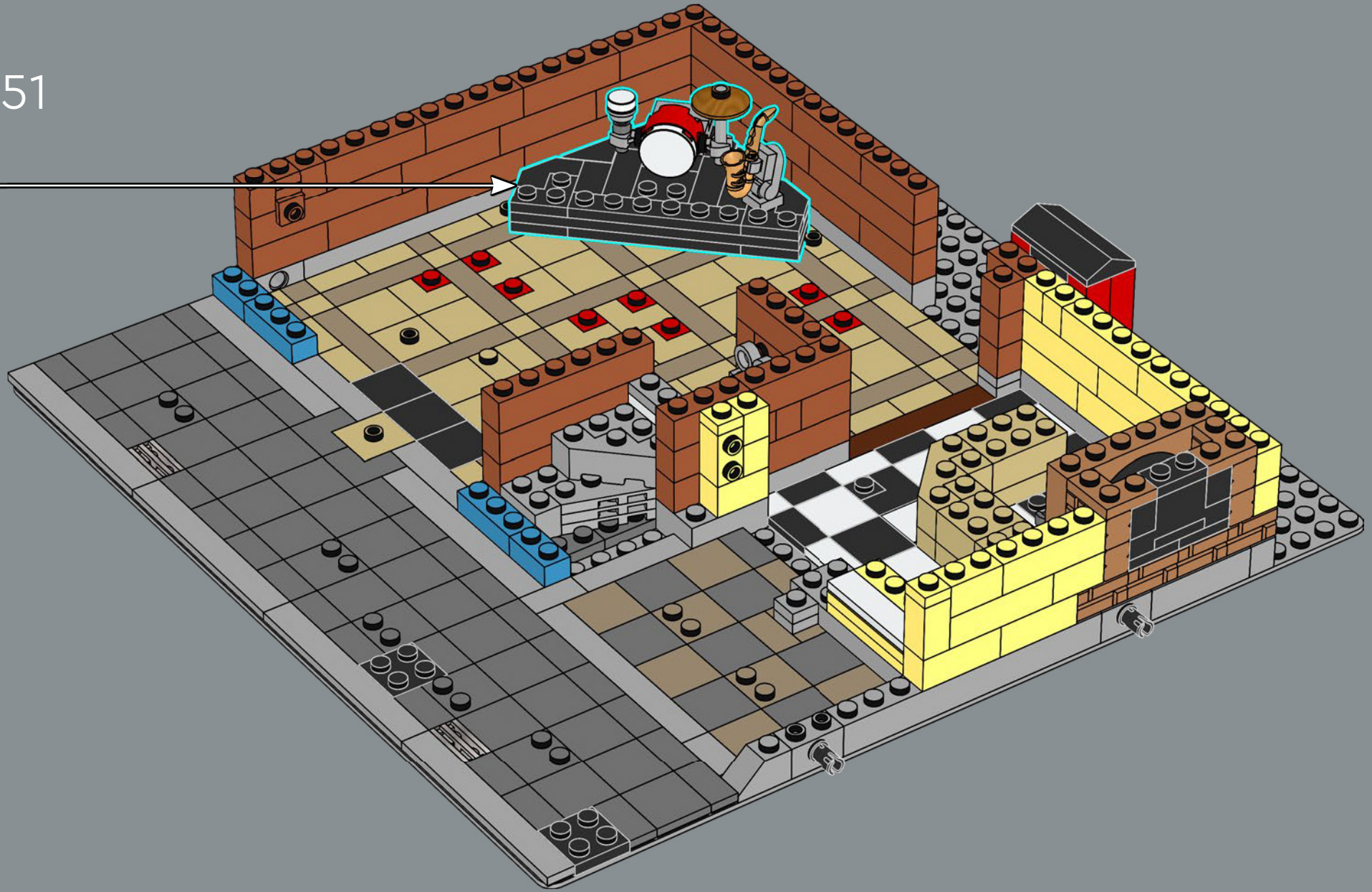



Le pizzaiolo cultive certains de ses ingrédients dans la serre sur le toit. Il achète le reste dans L'épicerie LEGO® 10185.

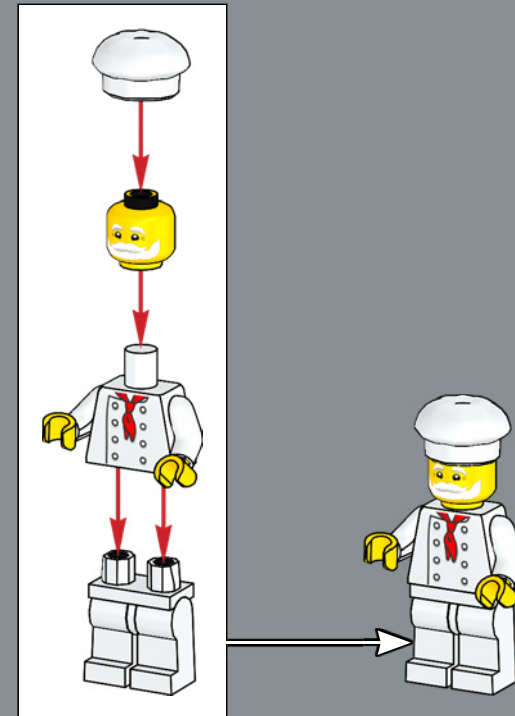

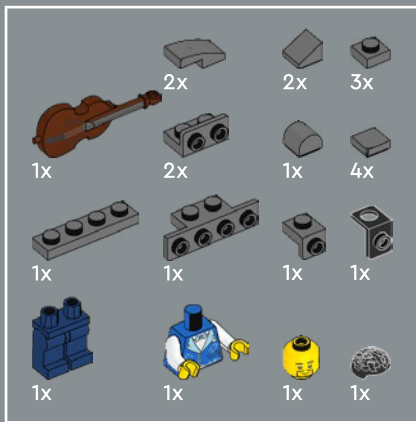

Ce soir, le bassiste joue pour la première fois au club de jazz. Il partage son temps entre la pratique de son instrument et son travail au Palace Cinema LEGO® 10232.

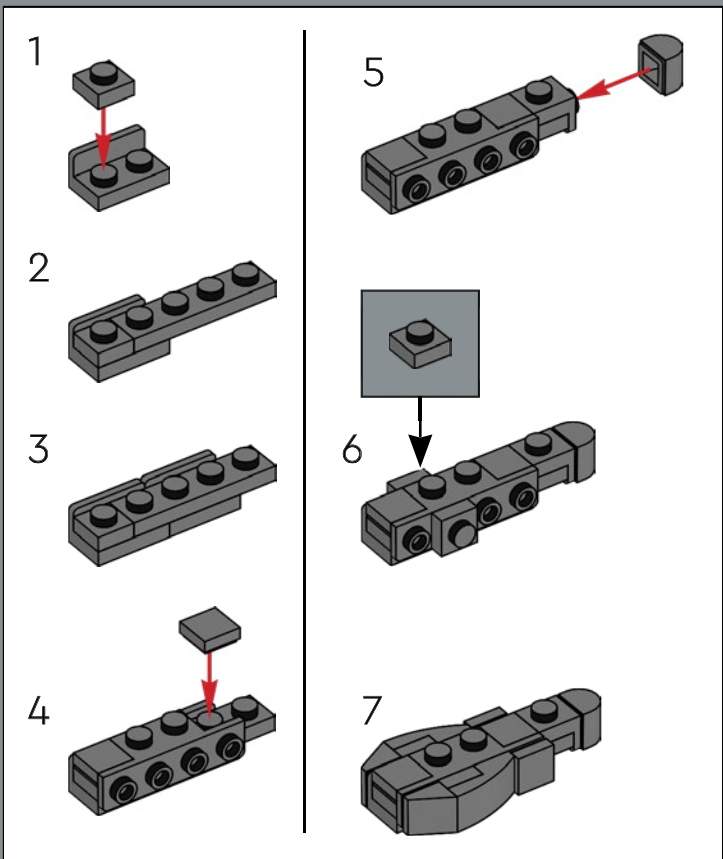

1

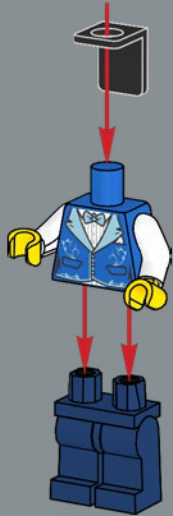

2

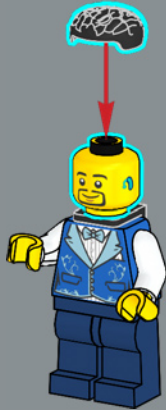

3



4





52

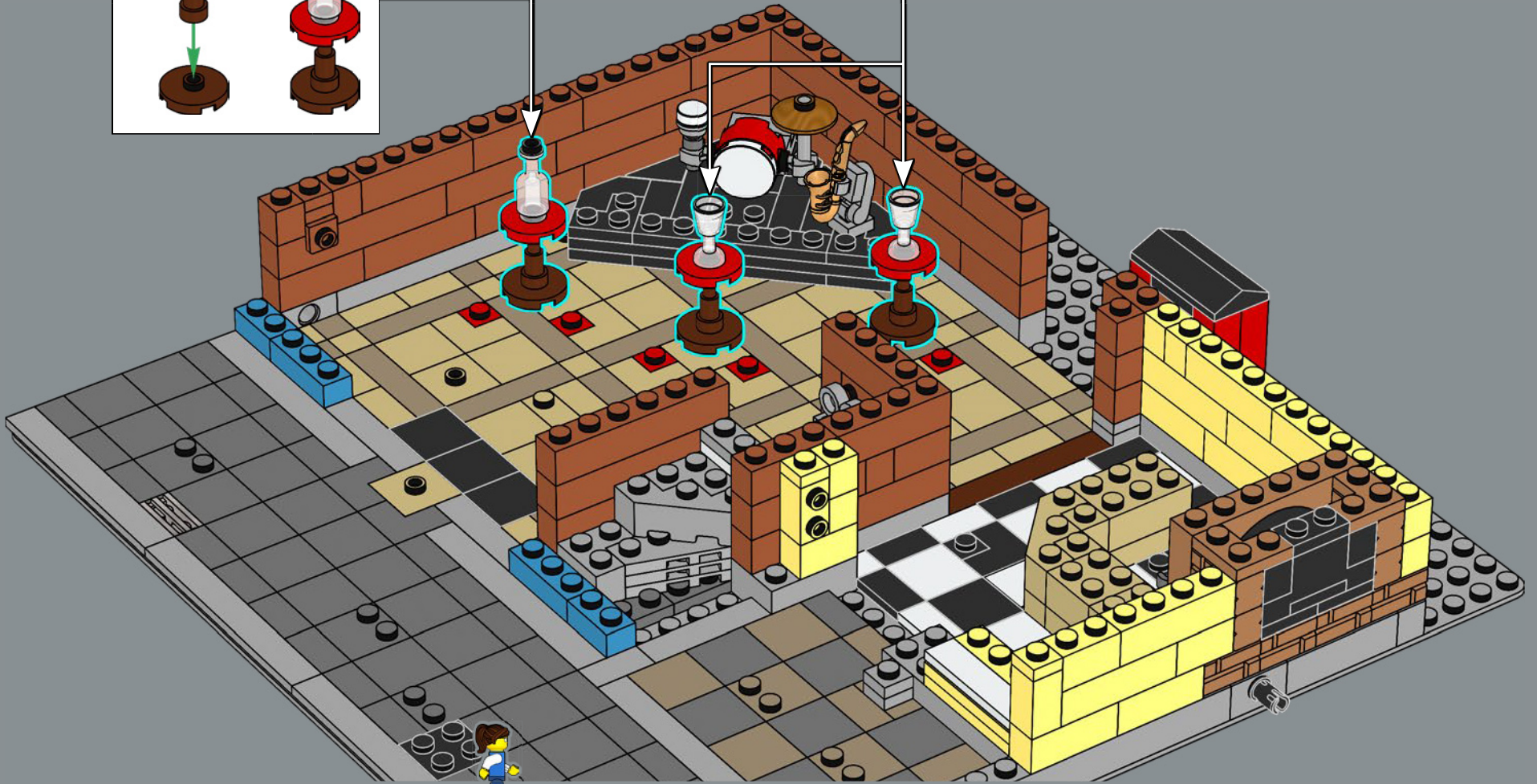
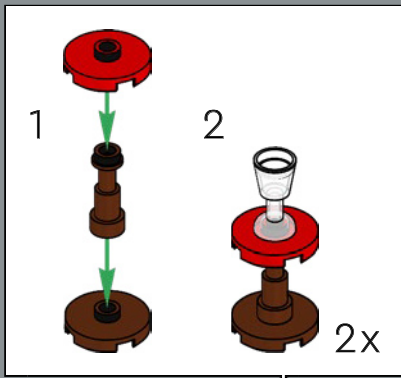
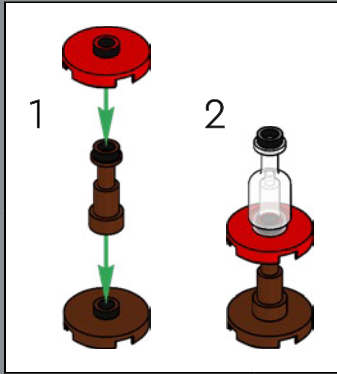



53

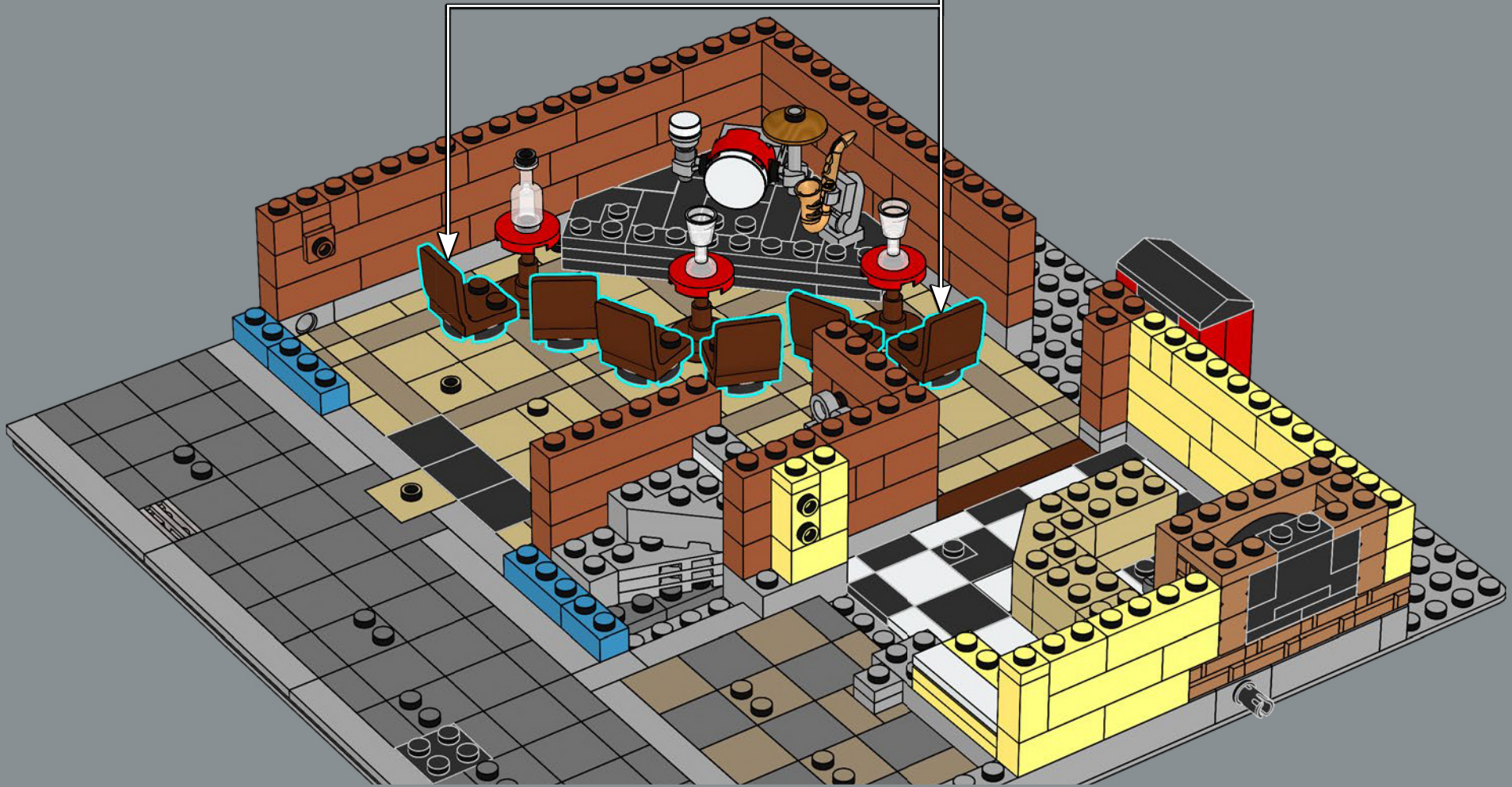
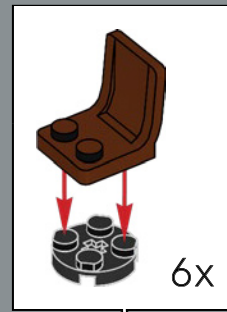

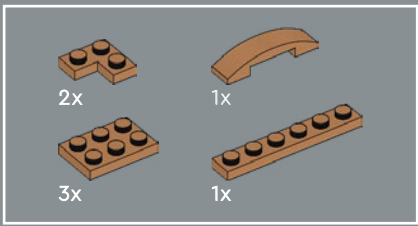

54

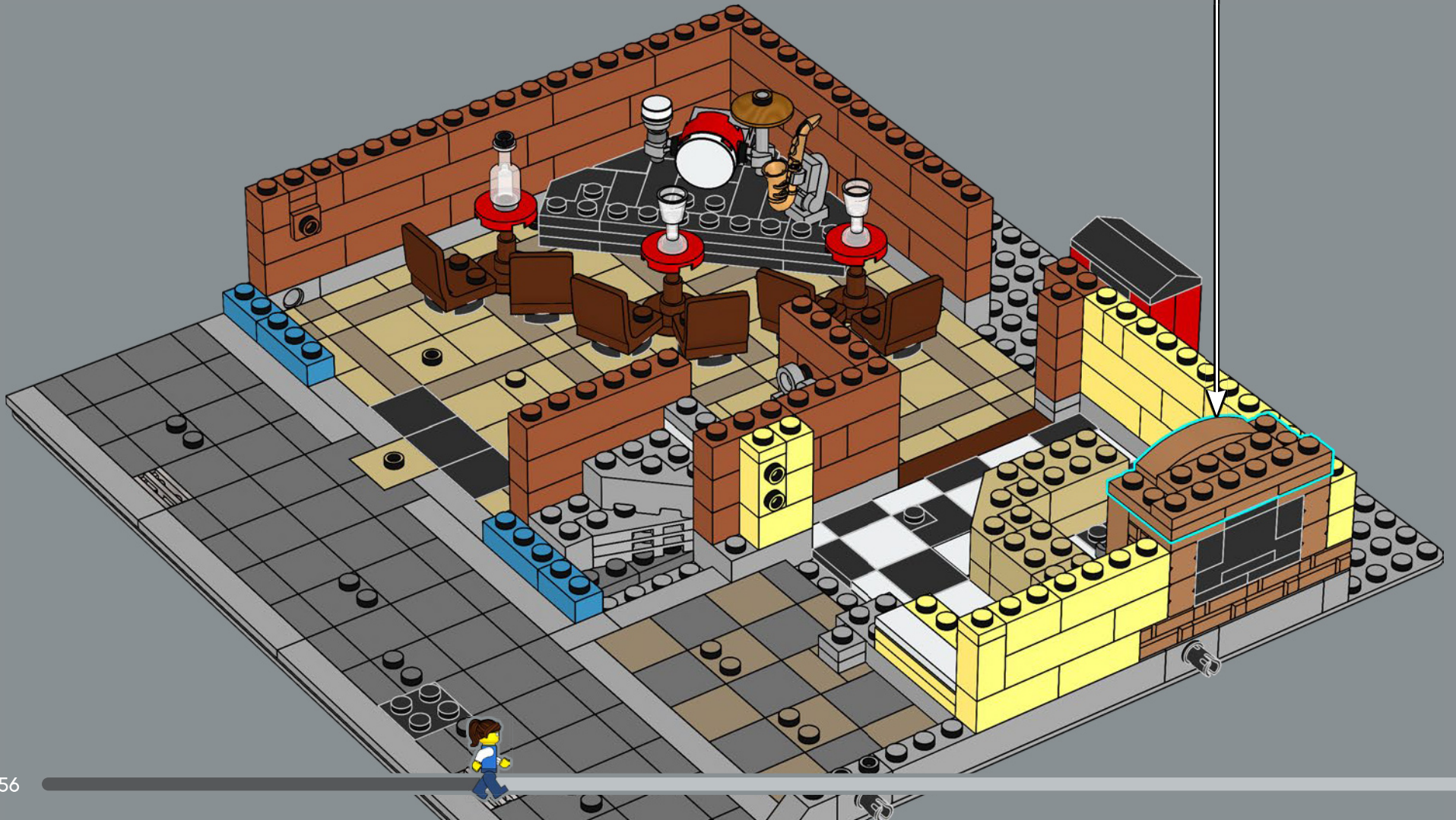
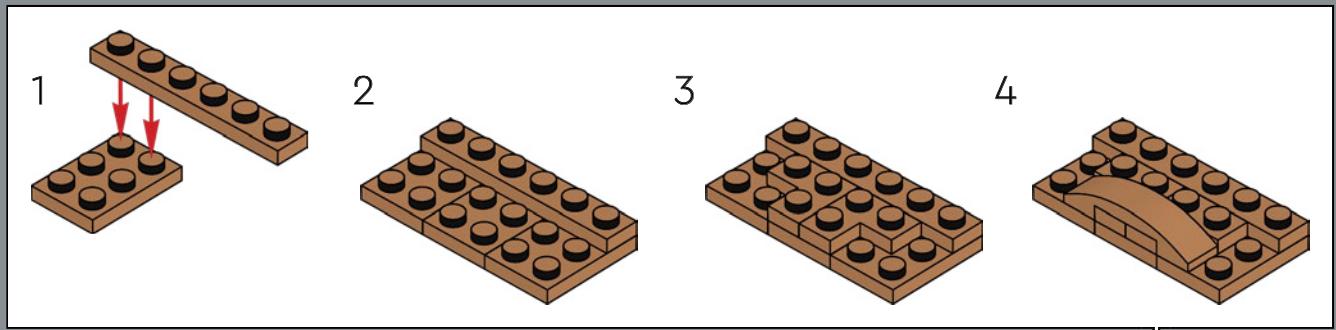

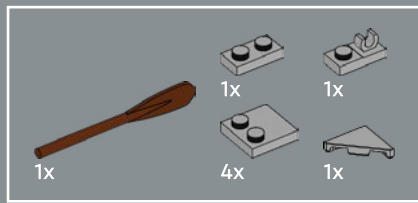

55

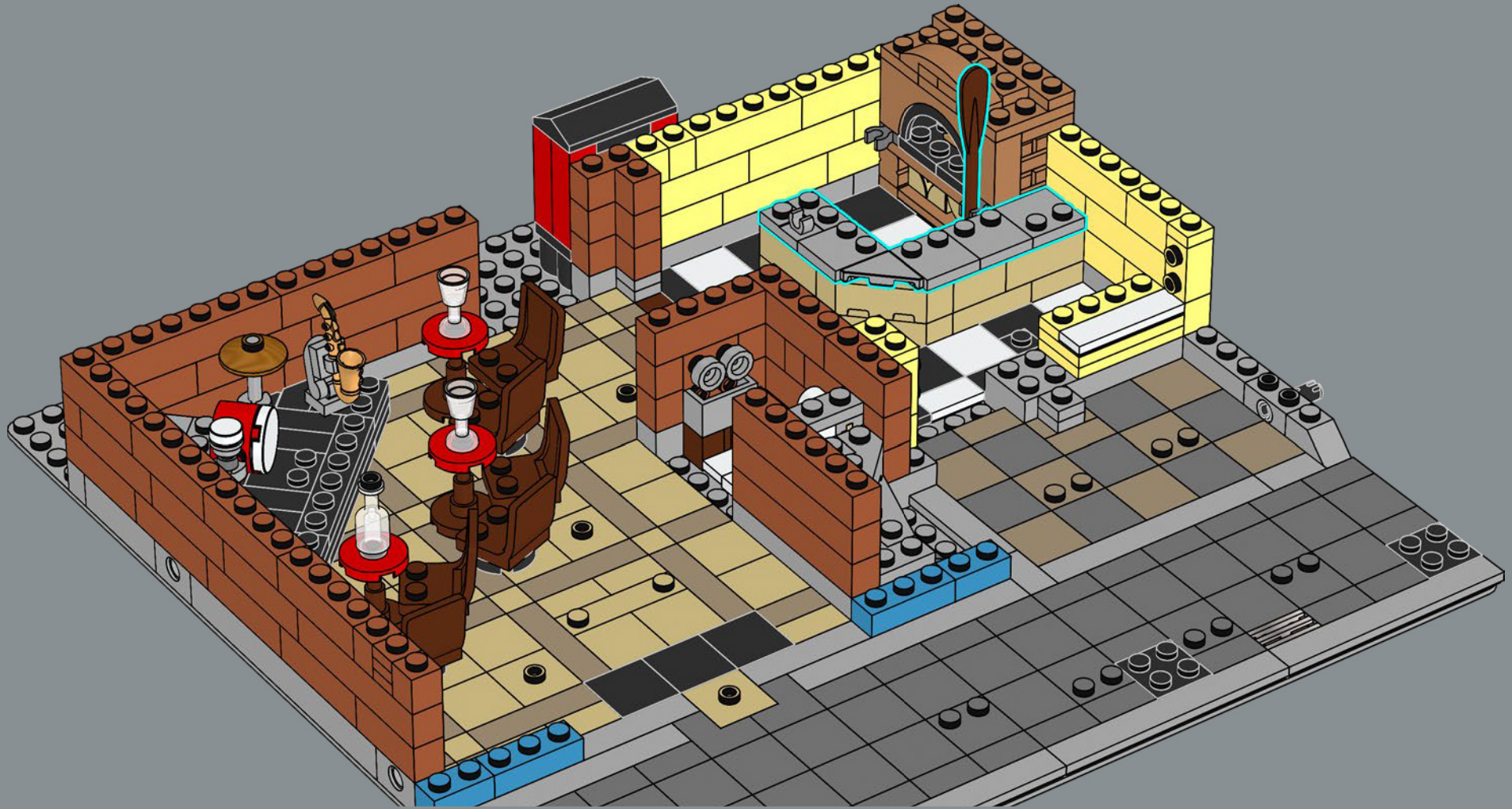

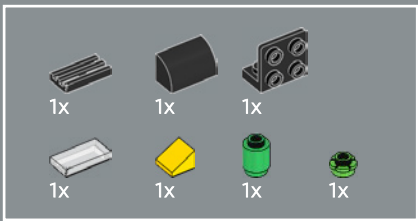

56

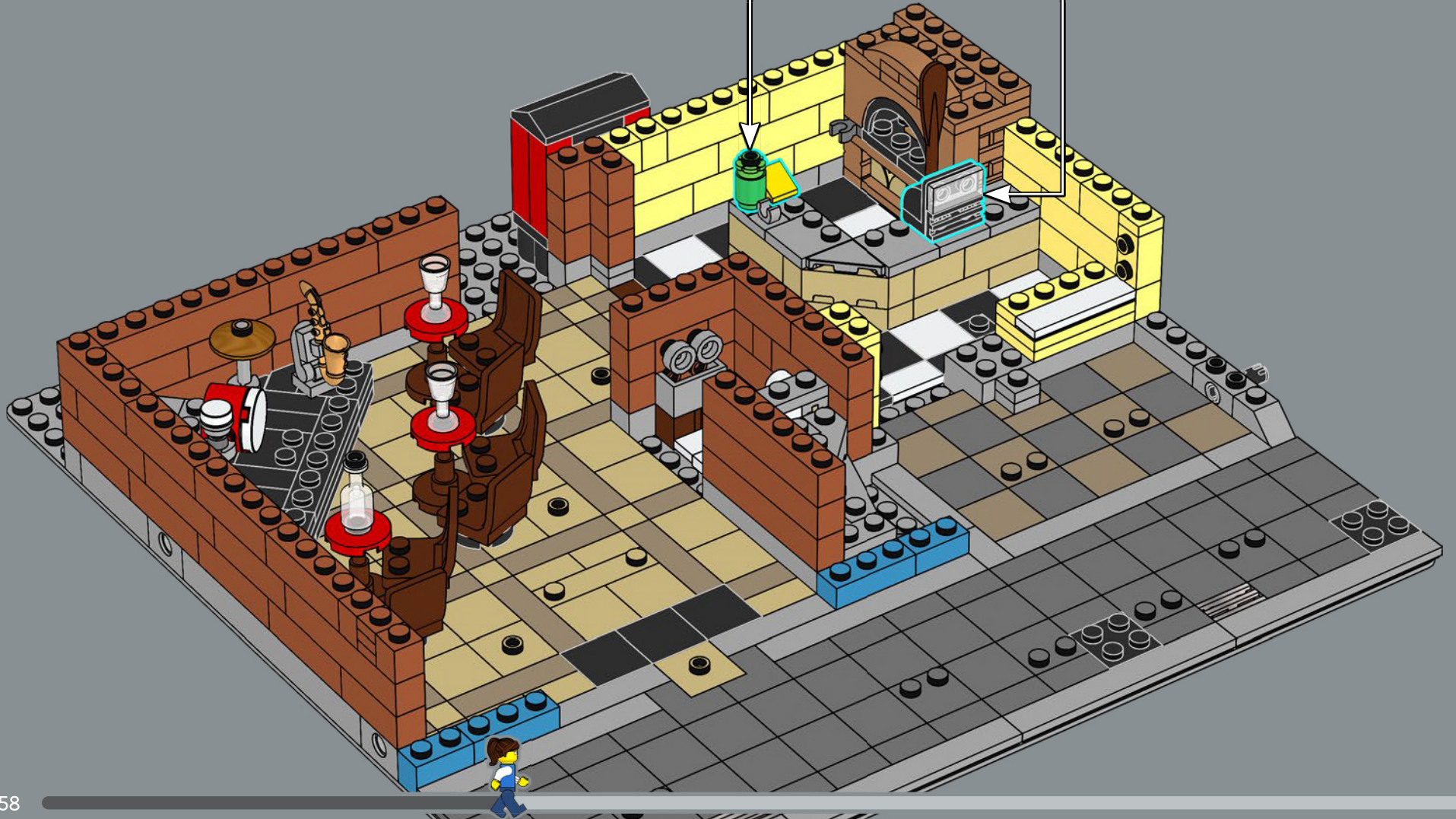
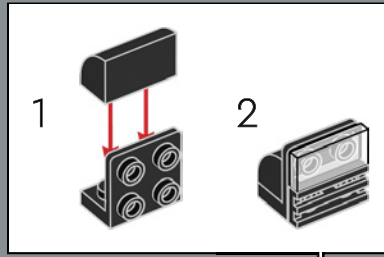
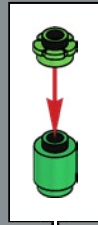

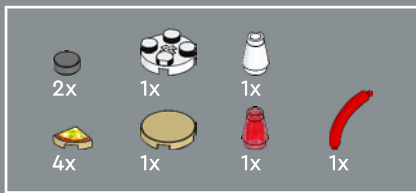

57



Une délicieuse pizza margherita arrive ! Les clients peuvent déguster la pizza en entier ou acheter une seule part.

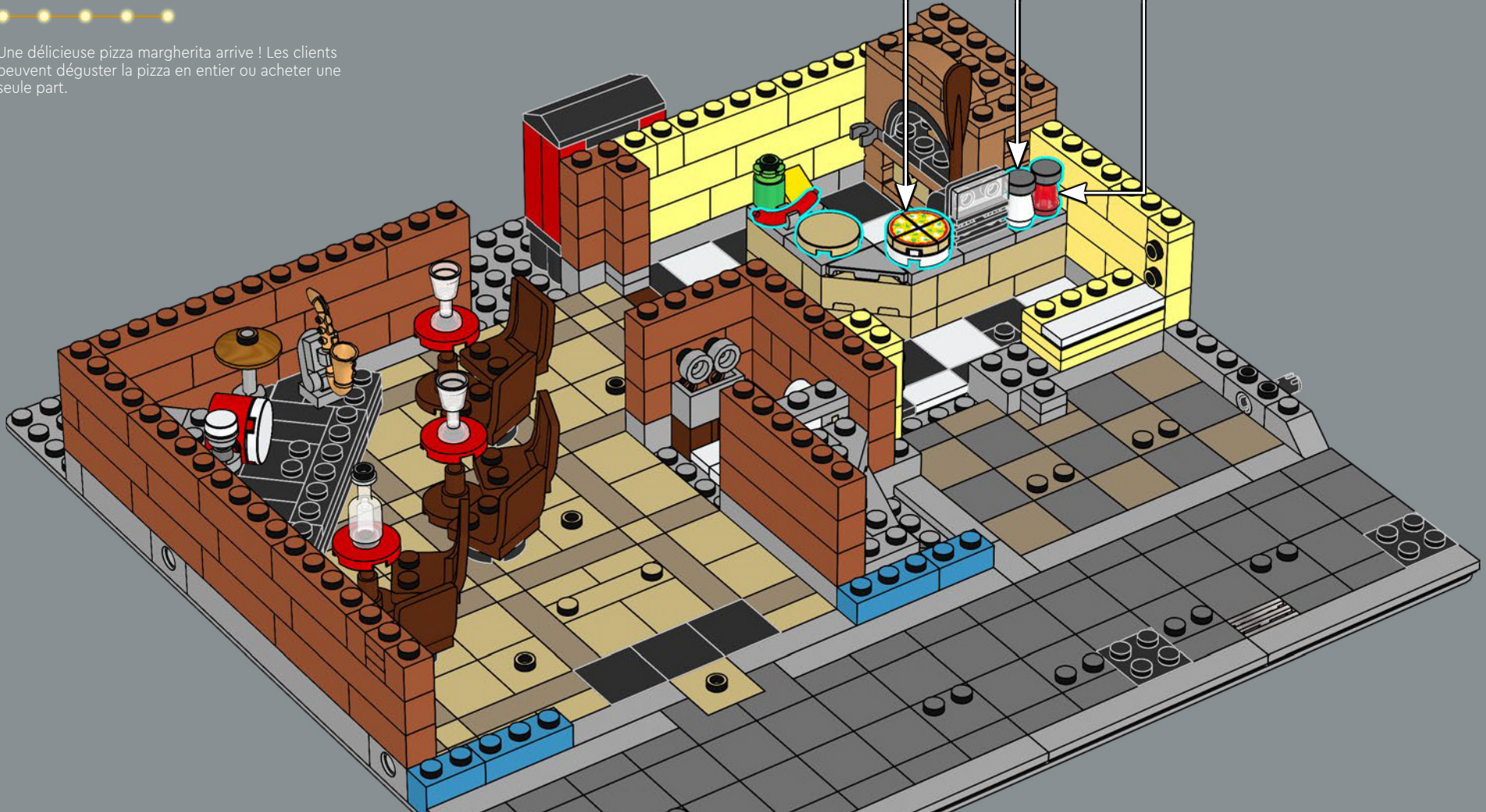

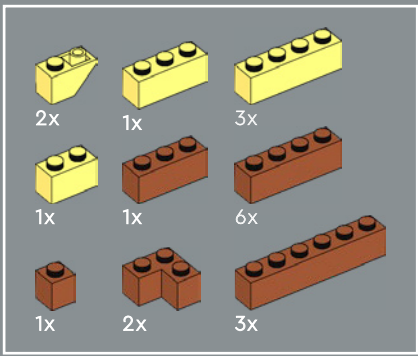

58

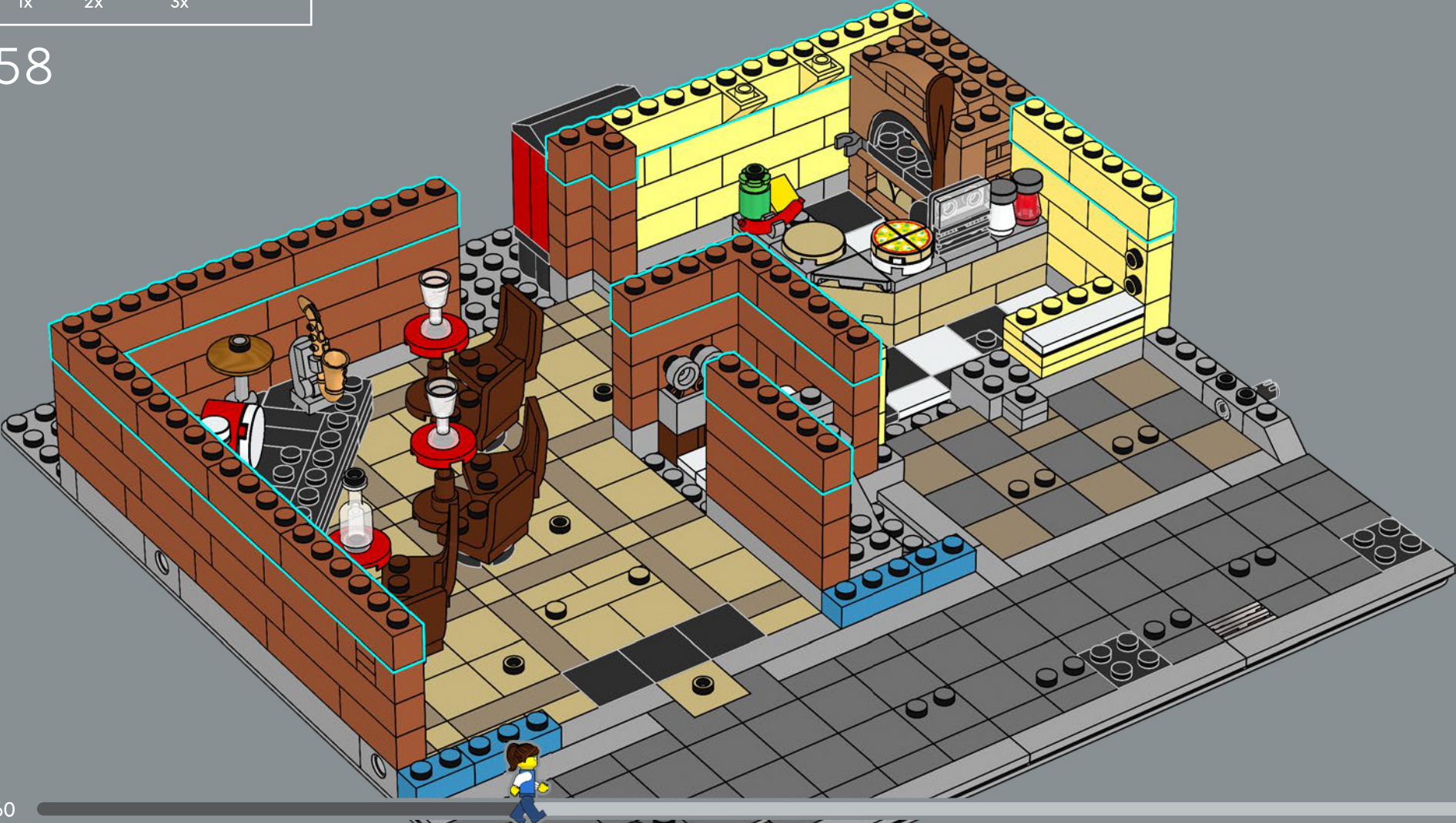

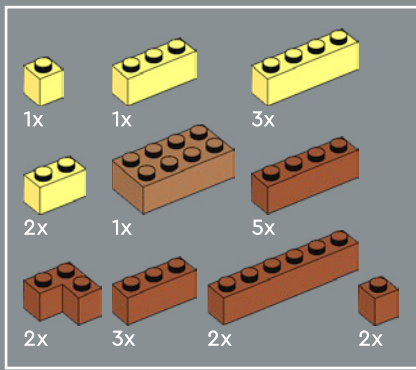

59

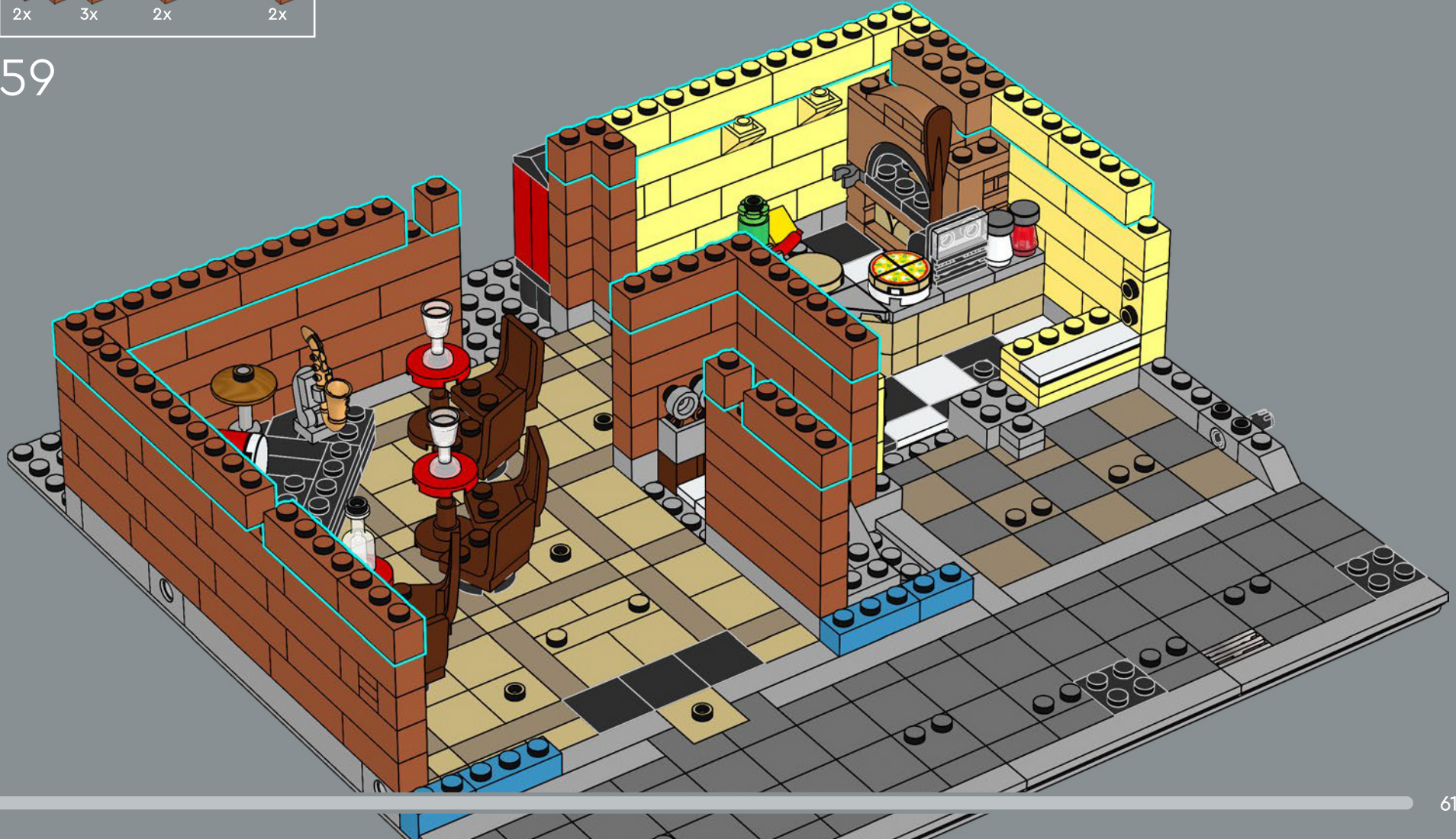

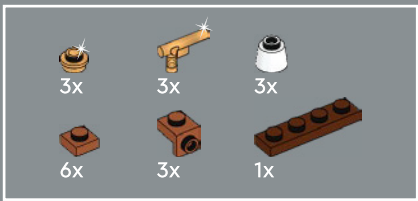

60

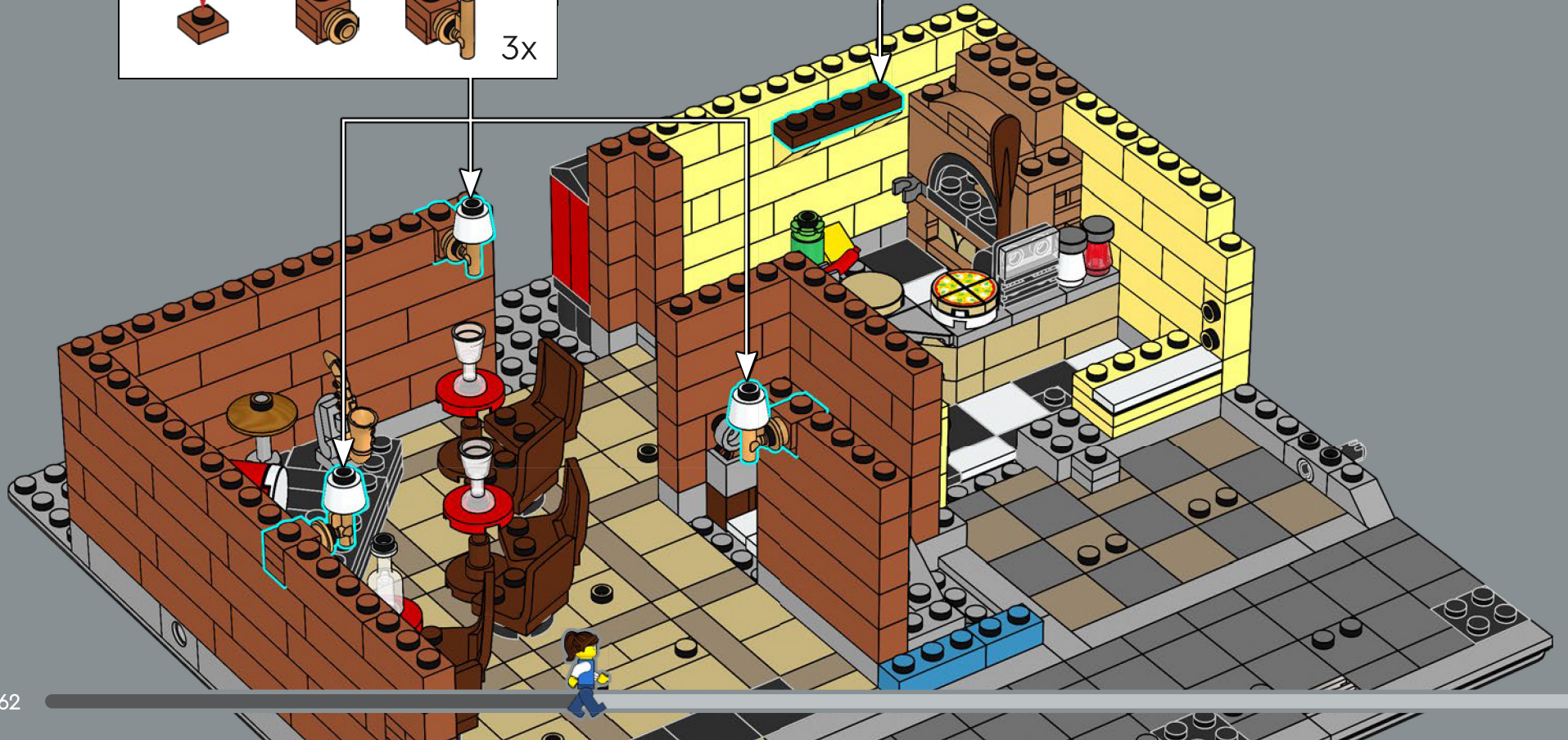
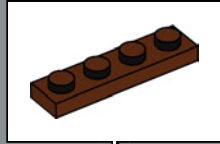
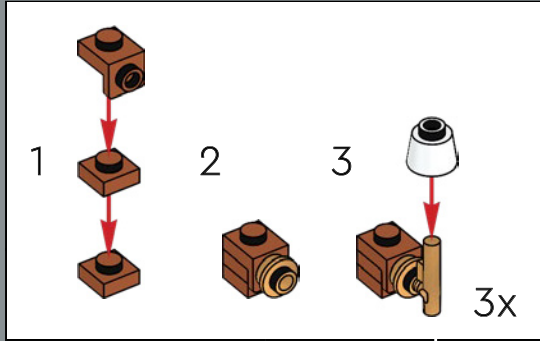

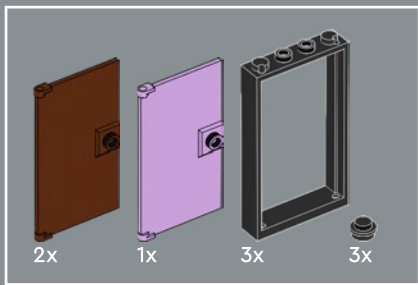

61

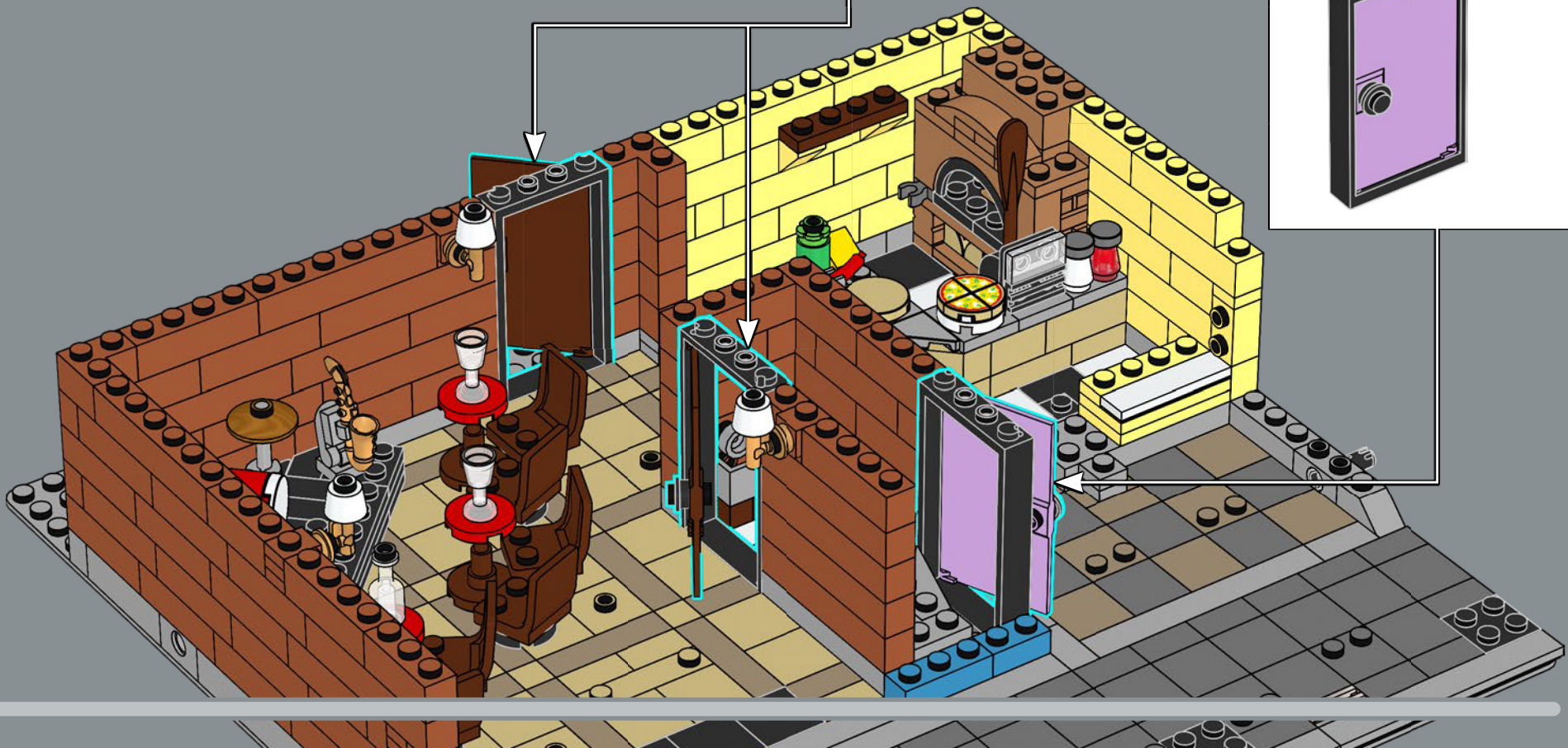
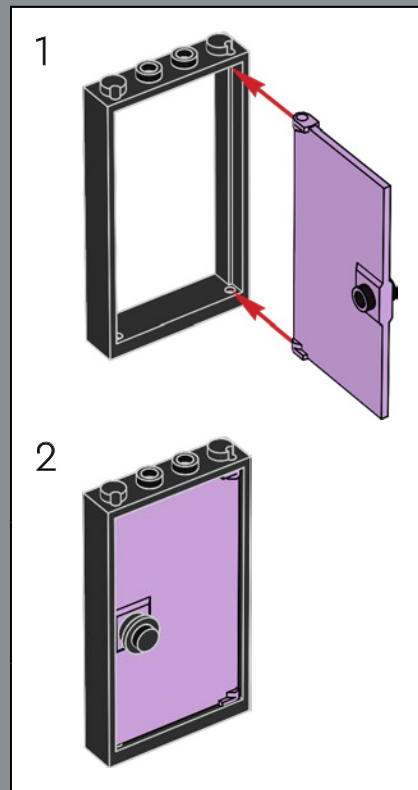
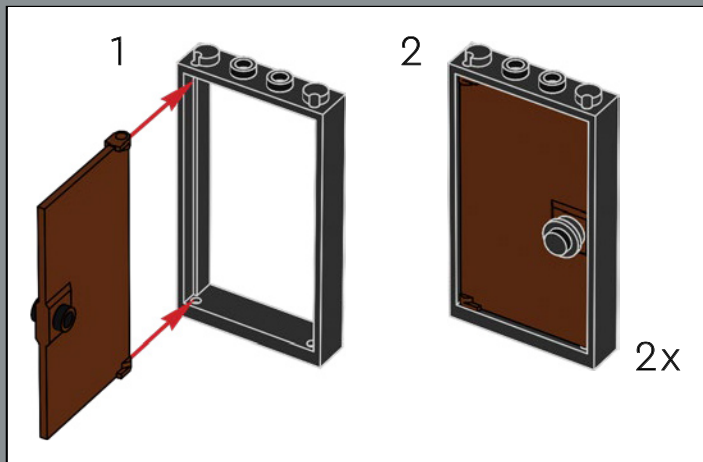

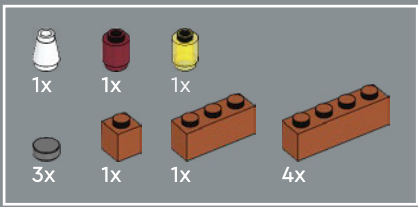

62

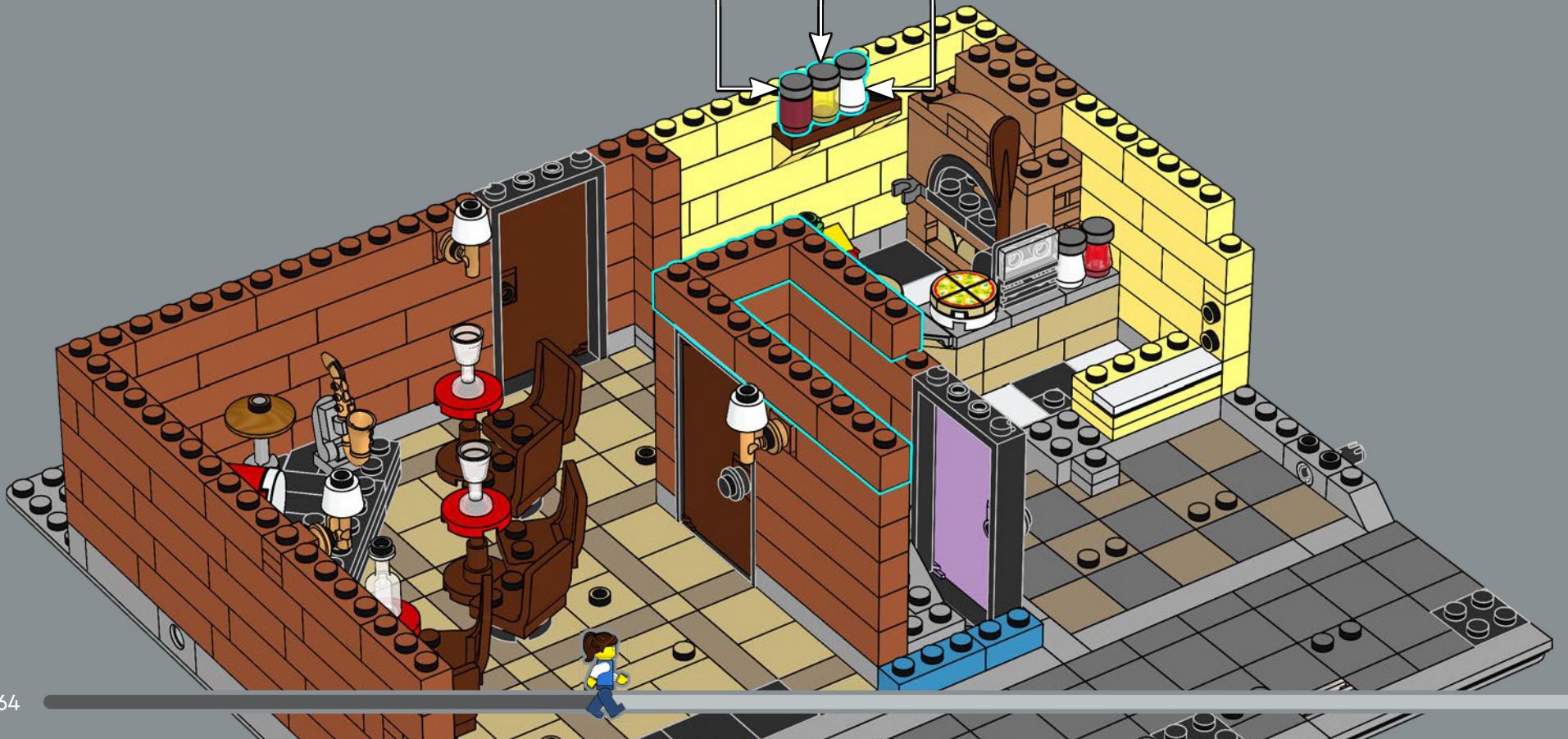
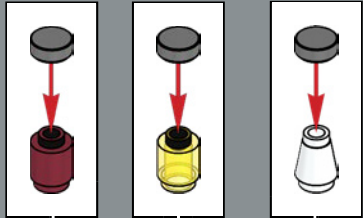

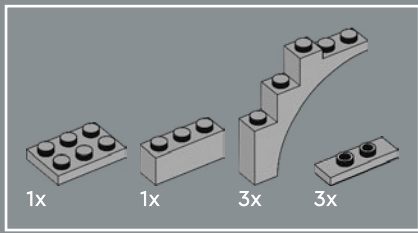

63

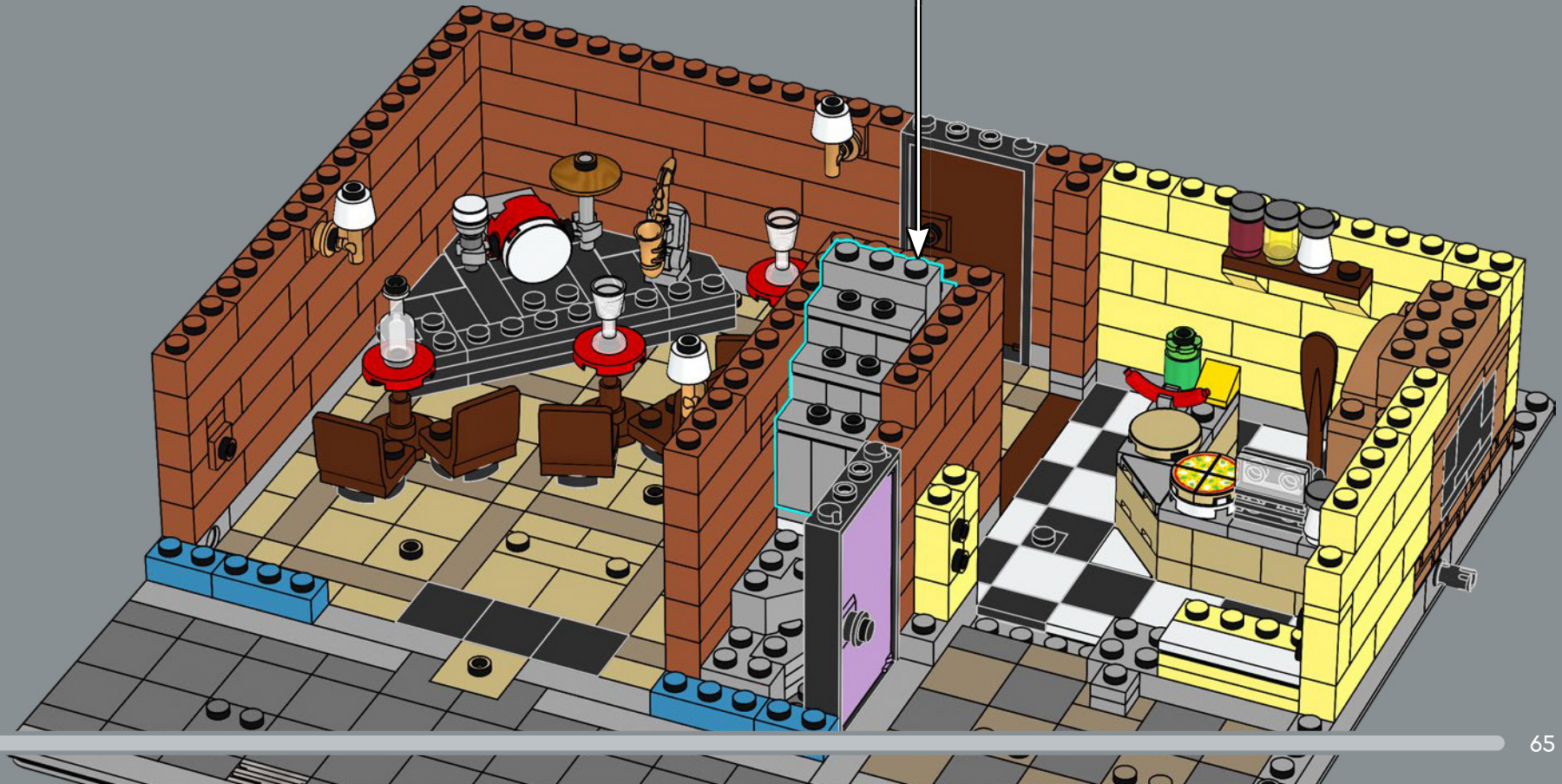
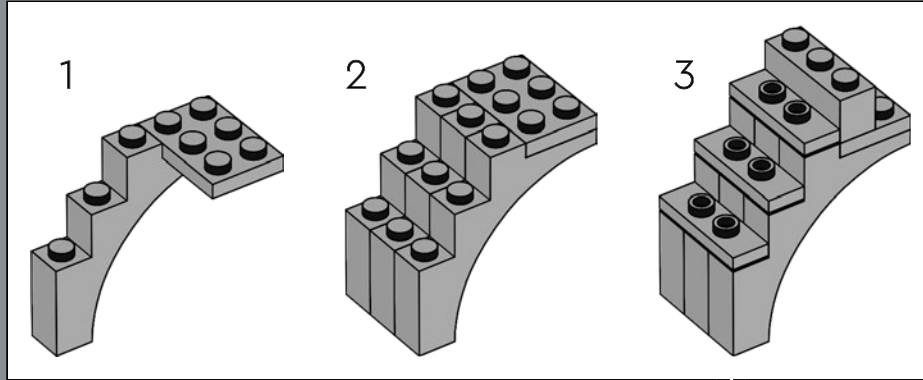

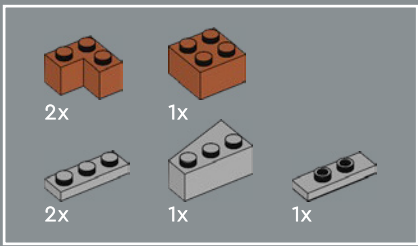

64

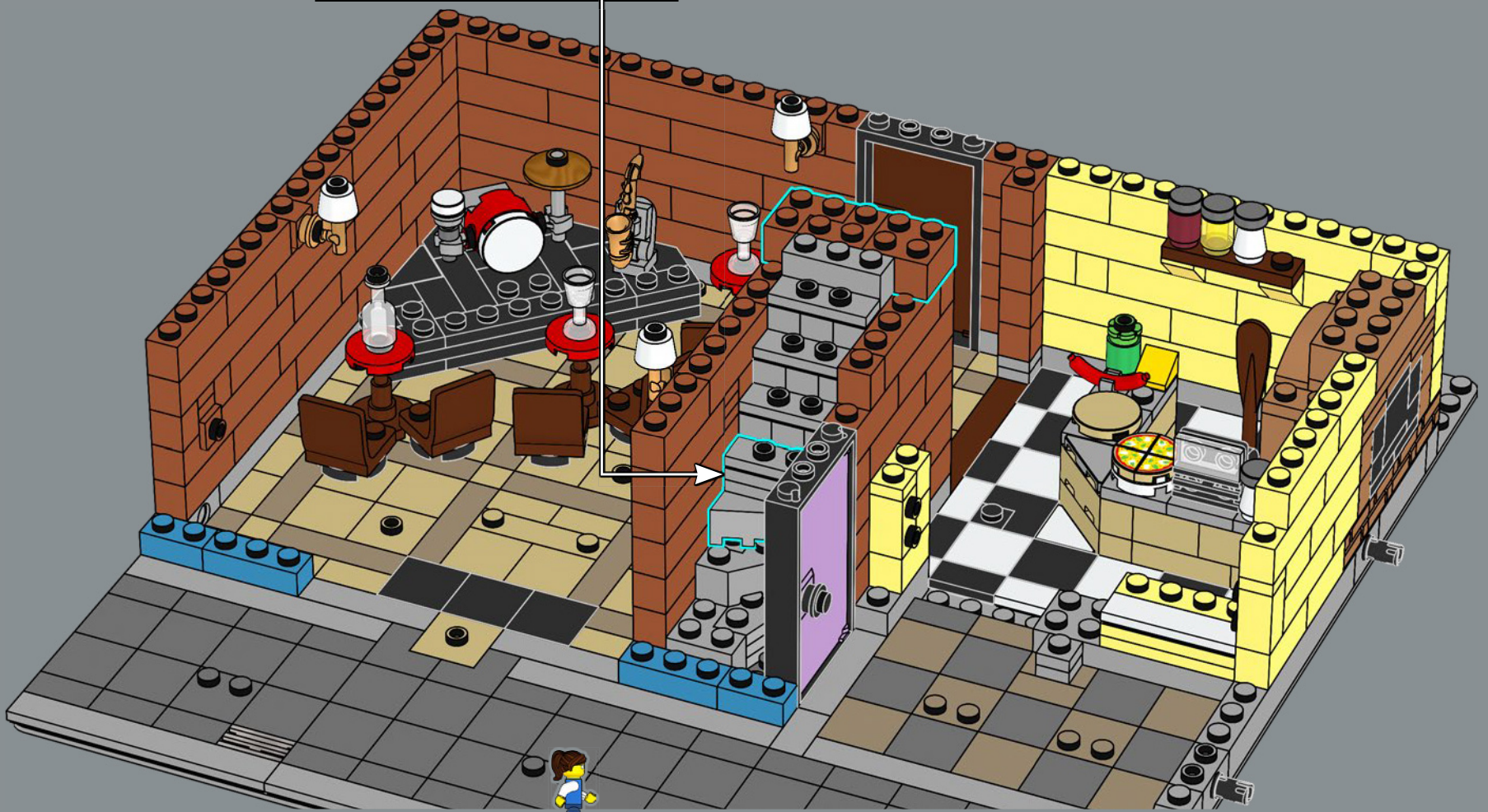
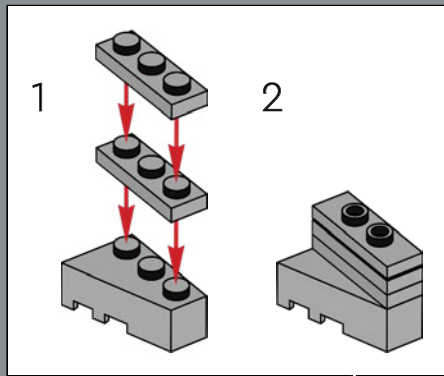

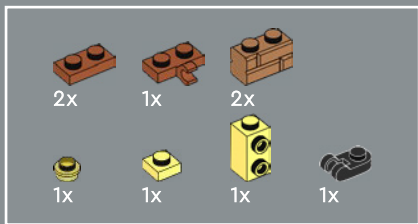

65

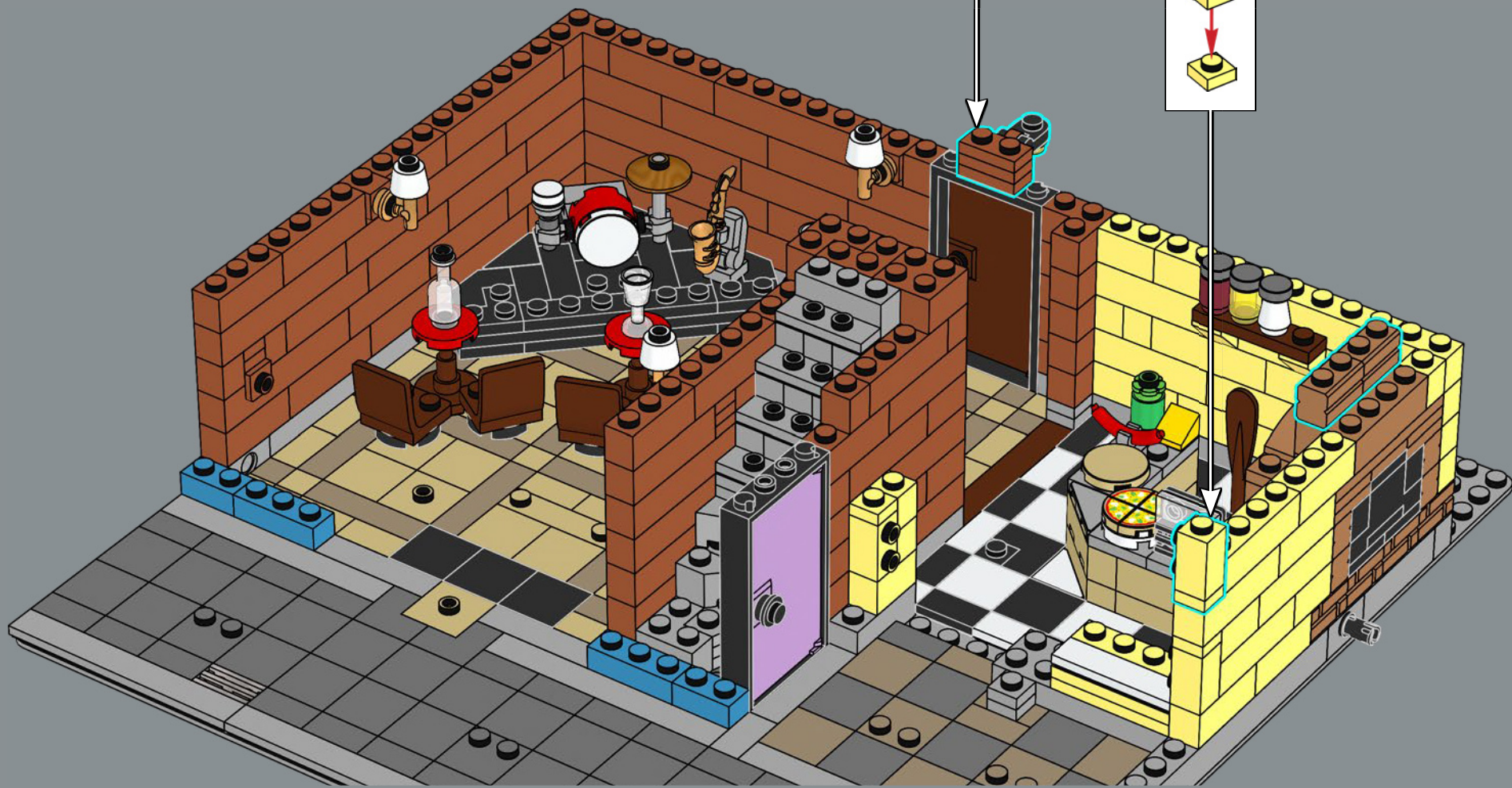
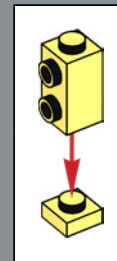
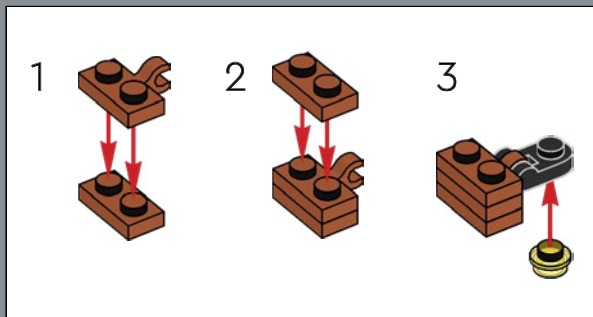

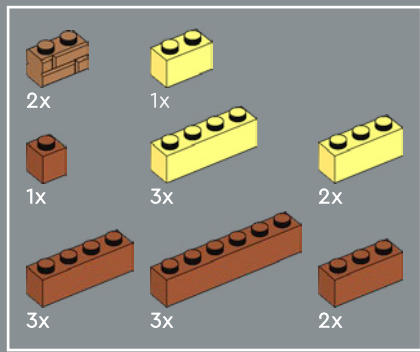

66



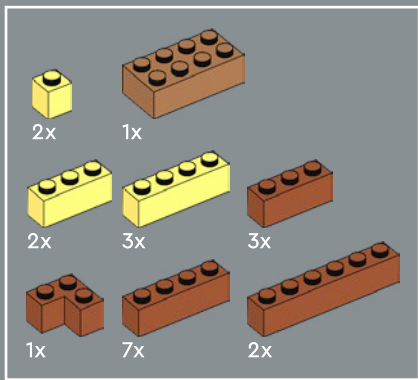

67



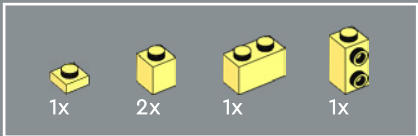

68

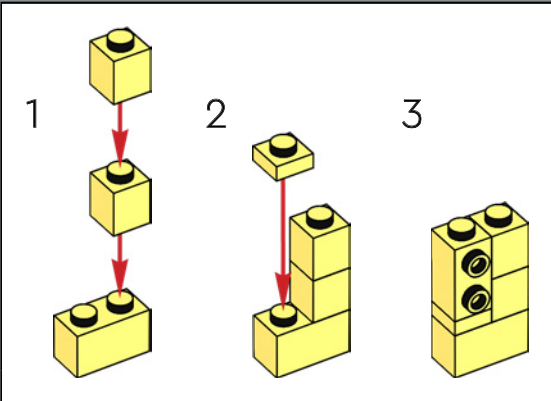

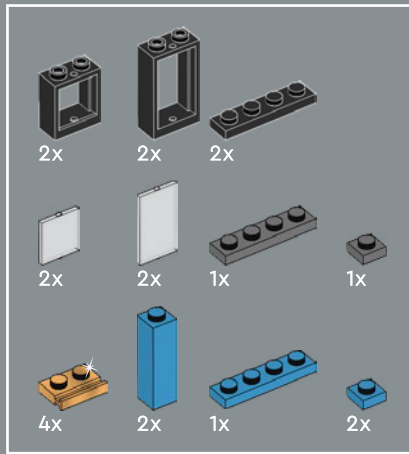
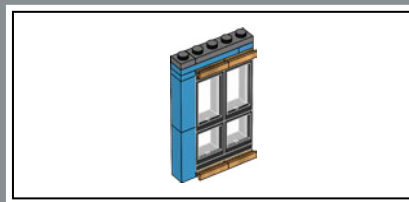

69

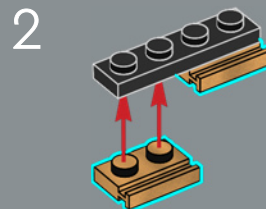
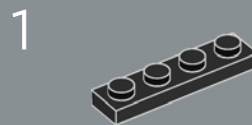

3

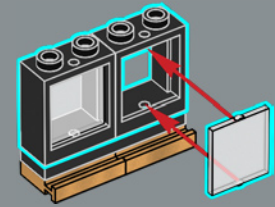

4

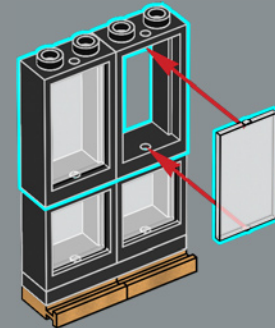

5

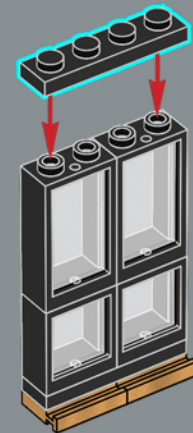

6

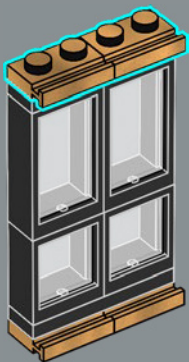

7

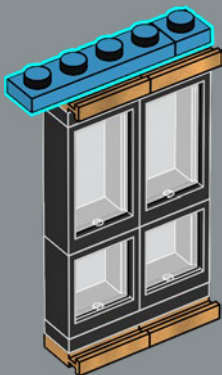

8

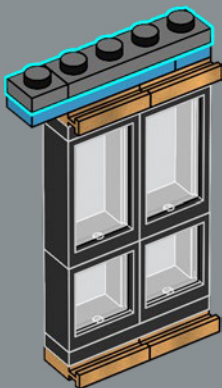

9

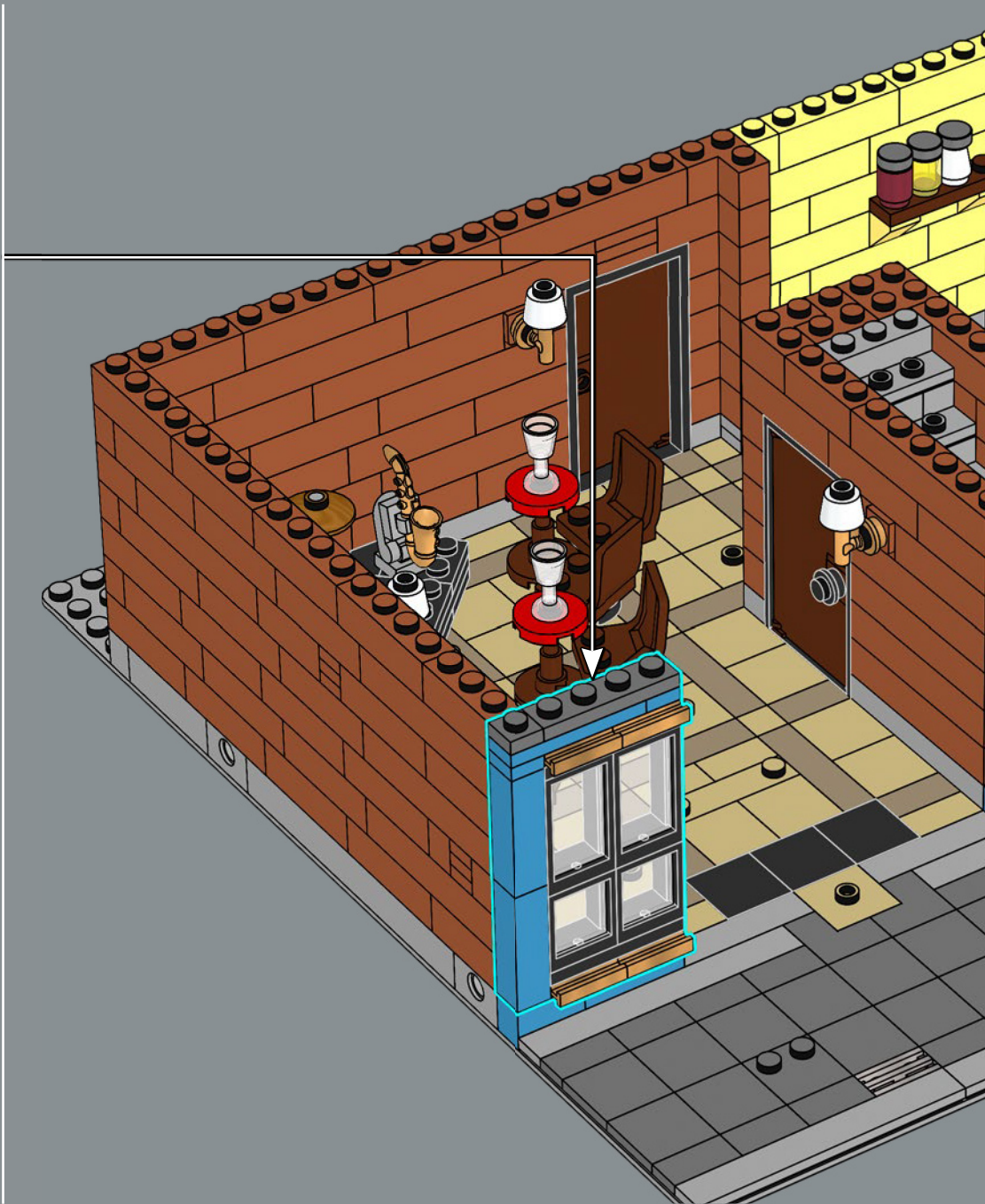
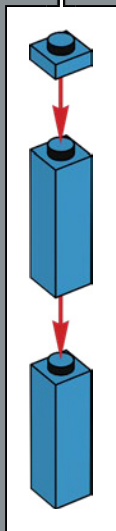
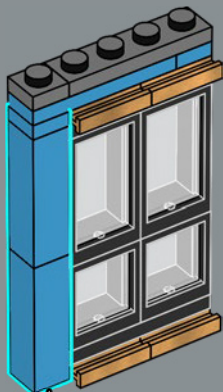

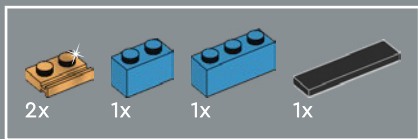

70

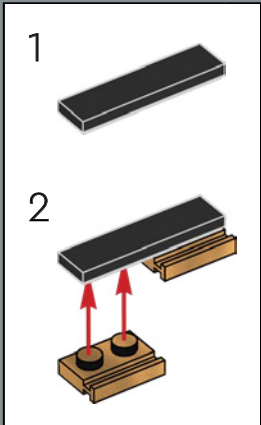
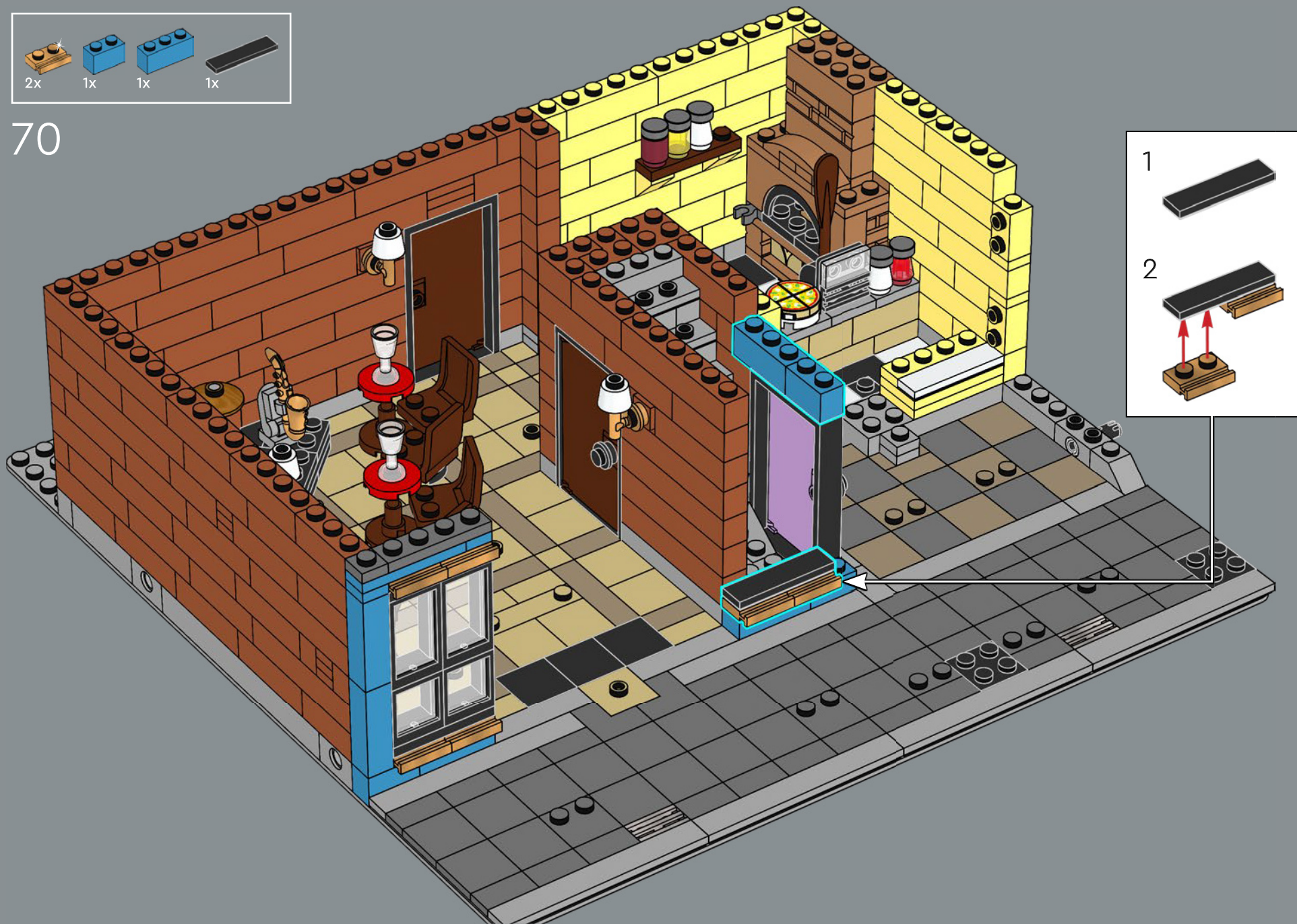

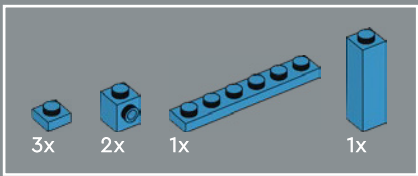

71

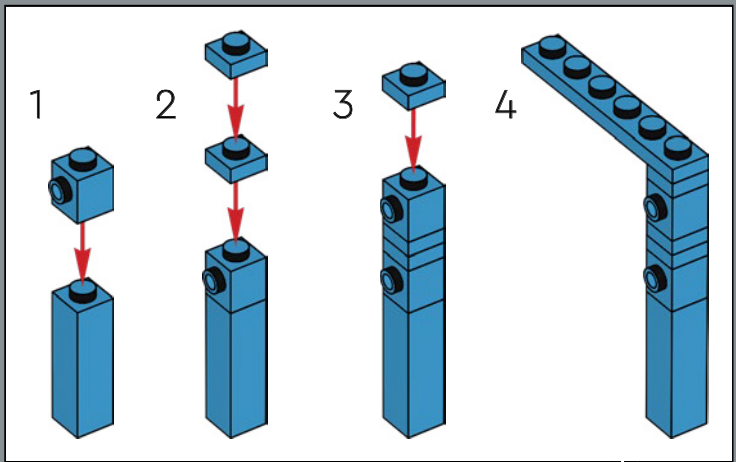

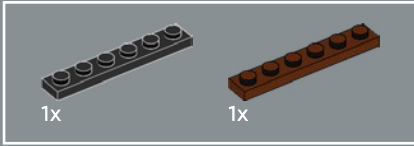

72

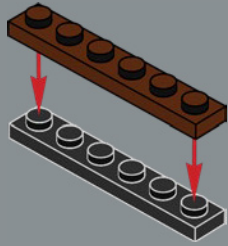

73

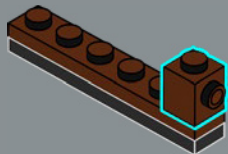

74

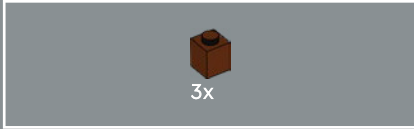

75

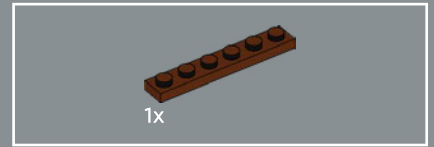

76

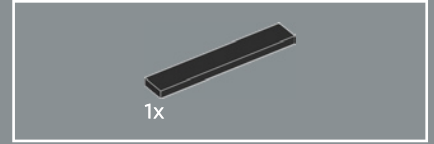

77



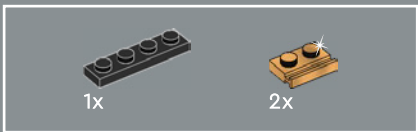

78

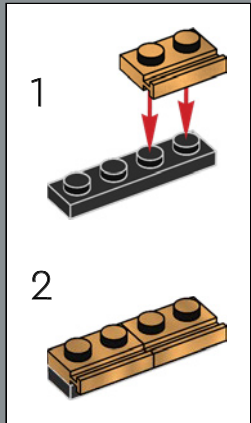

79



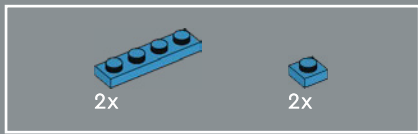

80

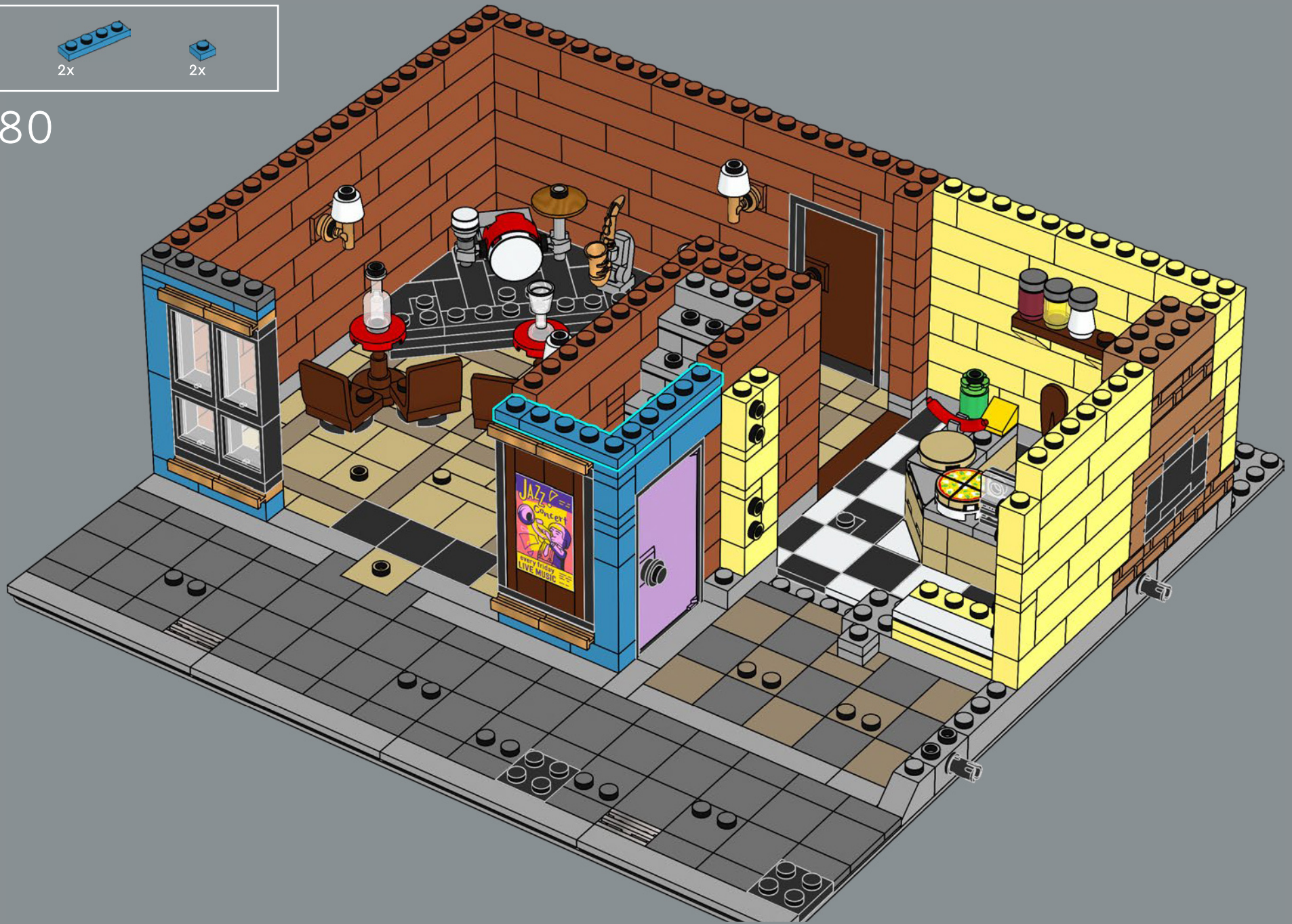

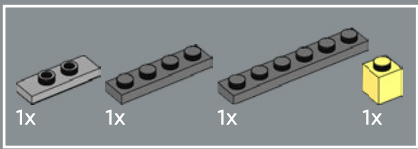

81



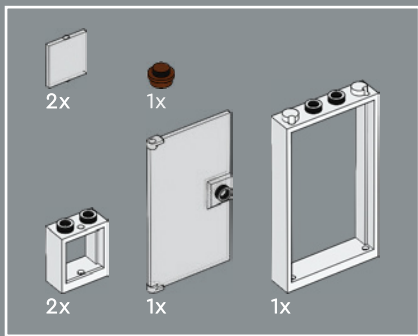

82

1

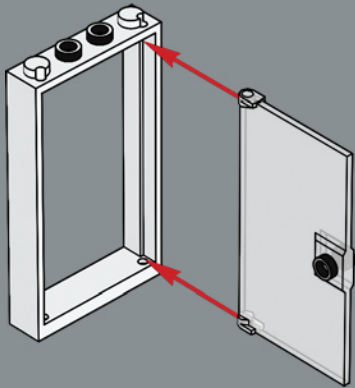

2



3

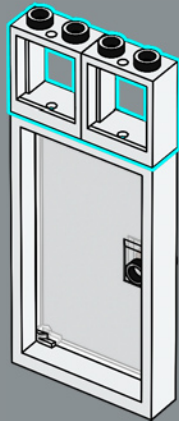

4

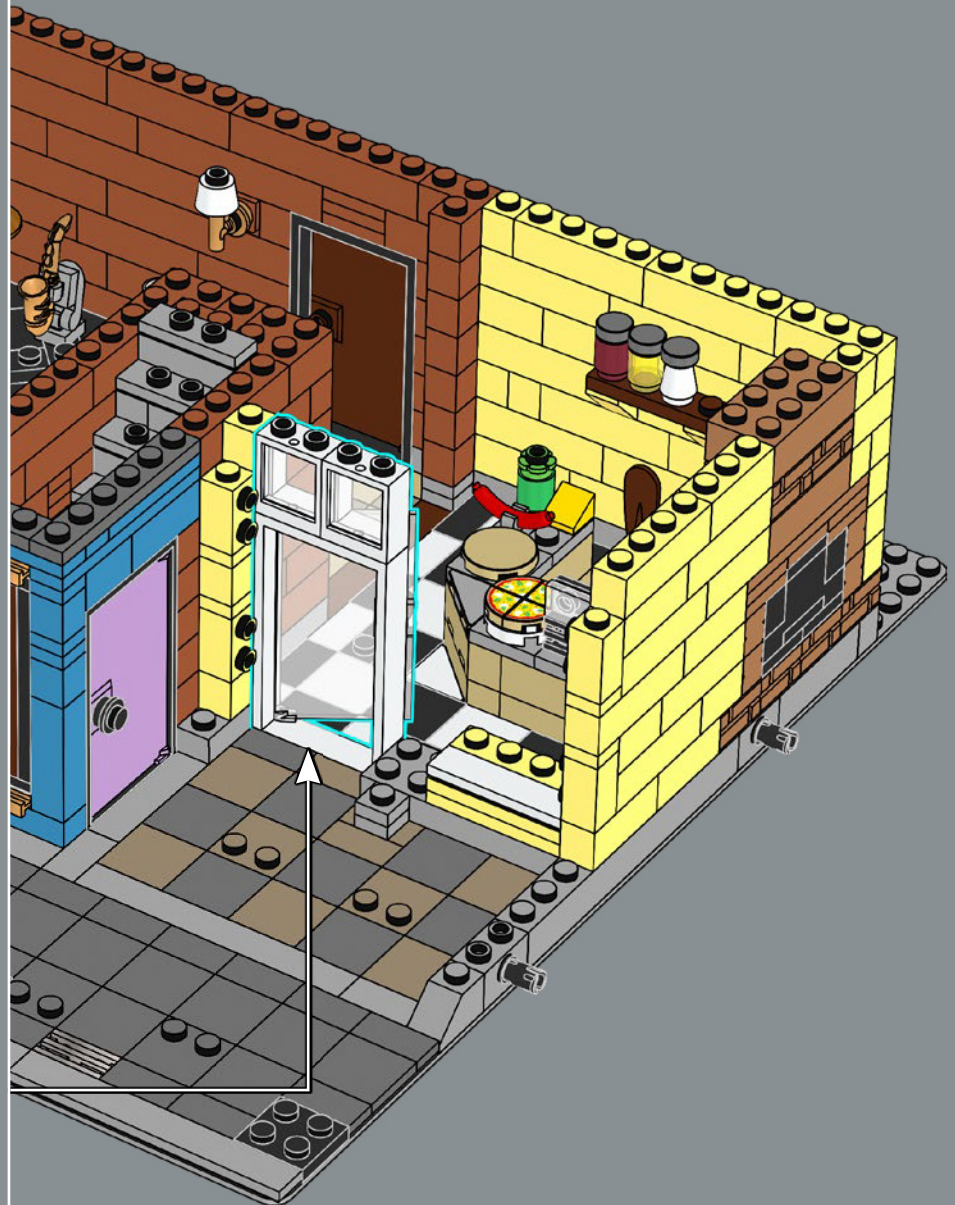
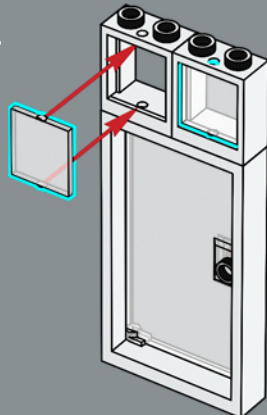

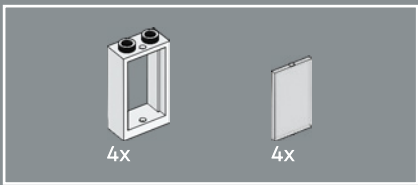

83

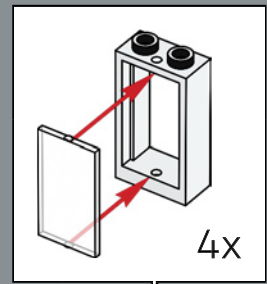

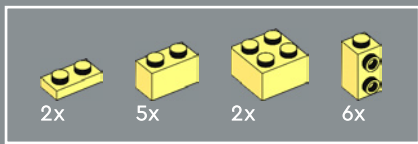

84

1

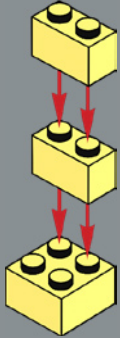

2

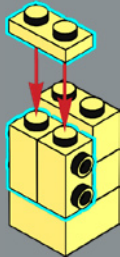

3



4

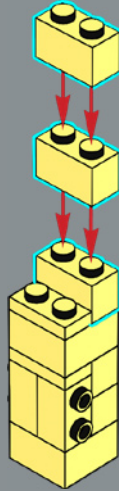

5

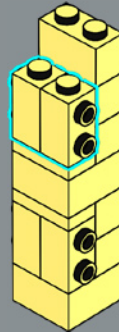

6

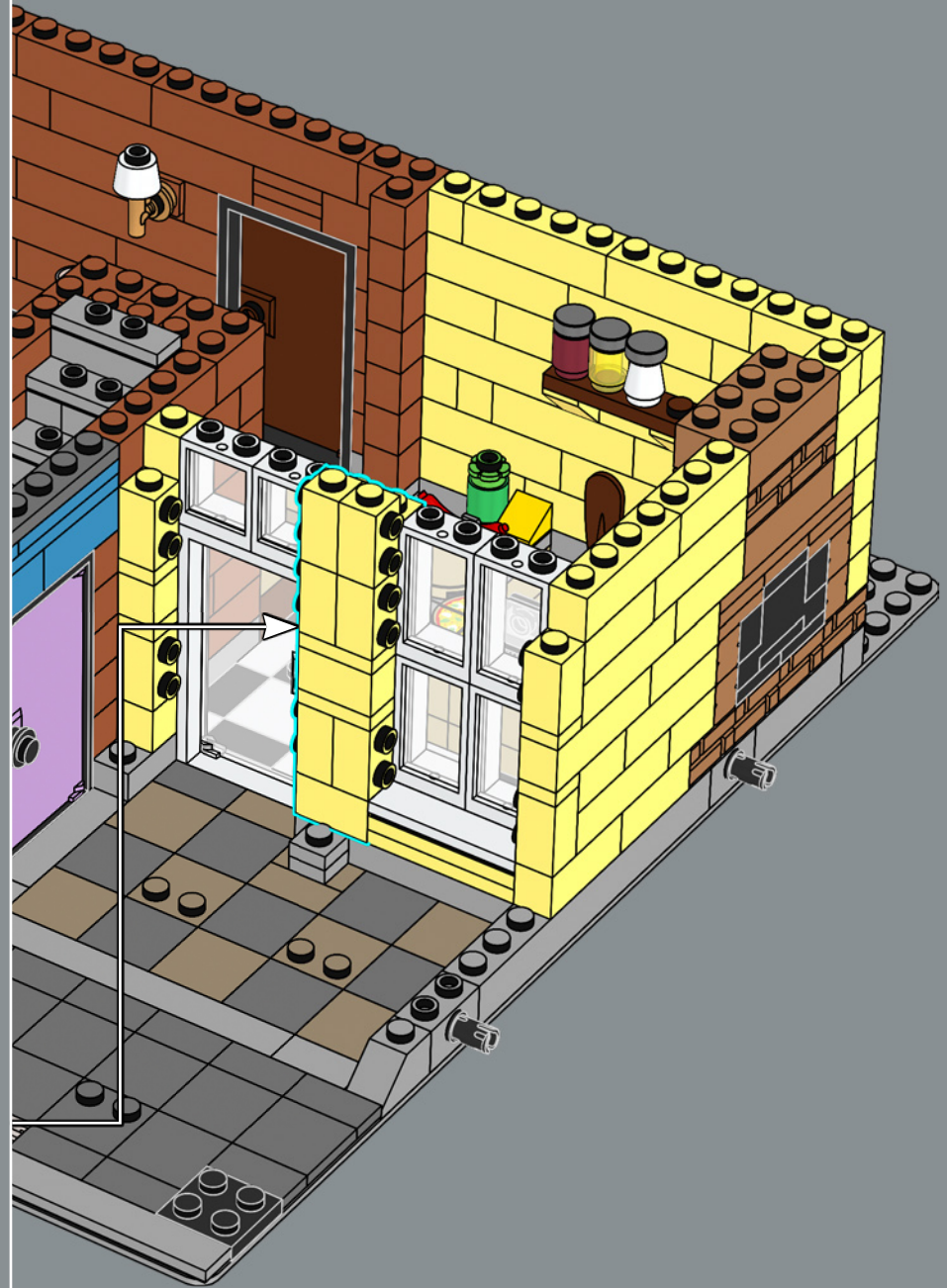
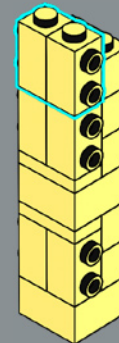



3x

85



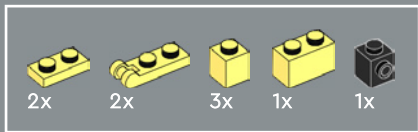

86

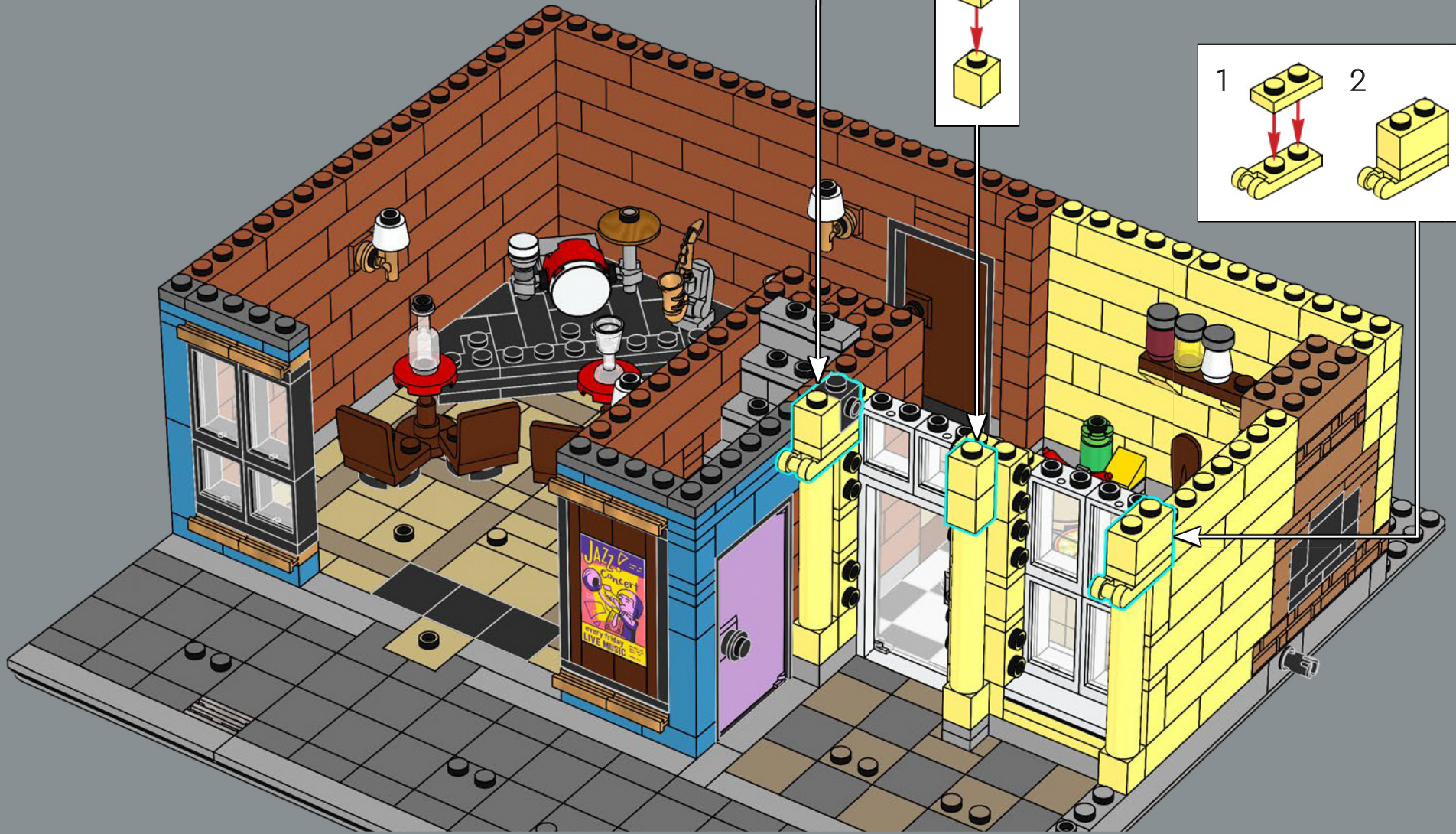
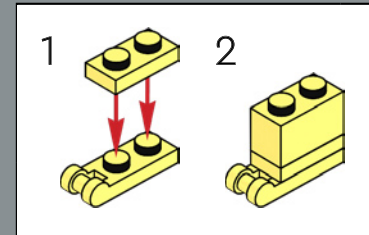
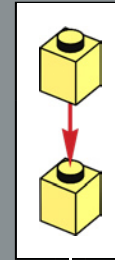
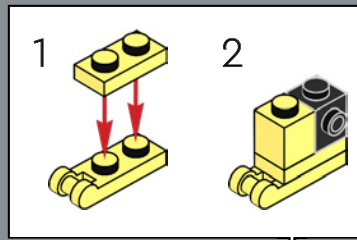



87

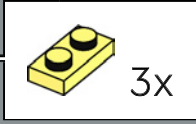
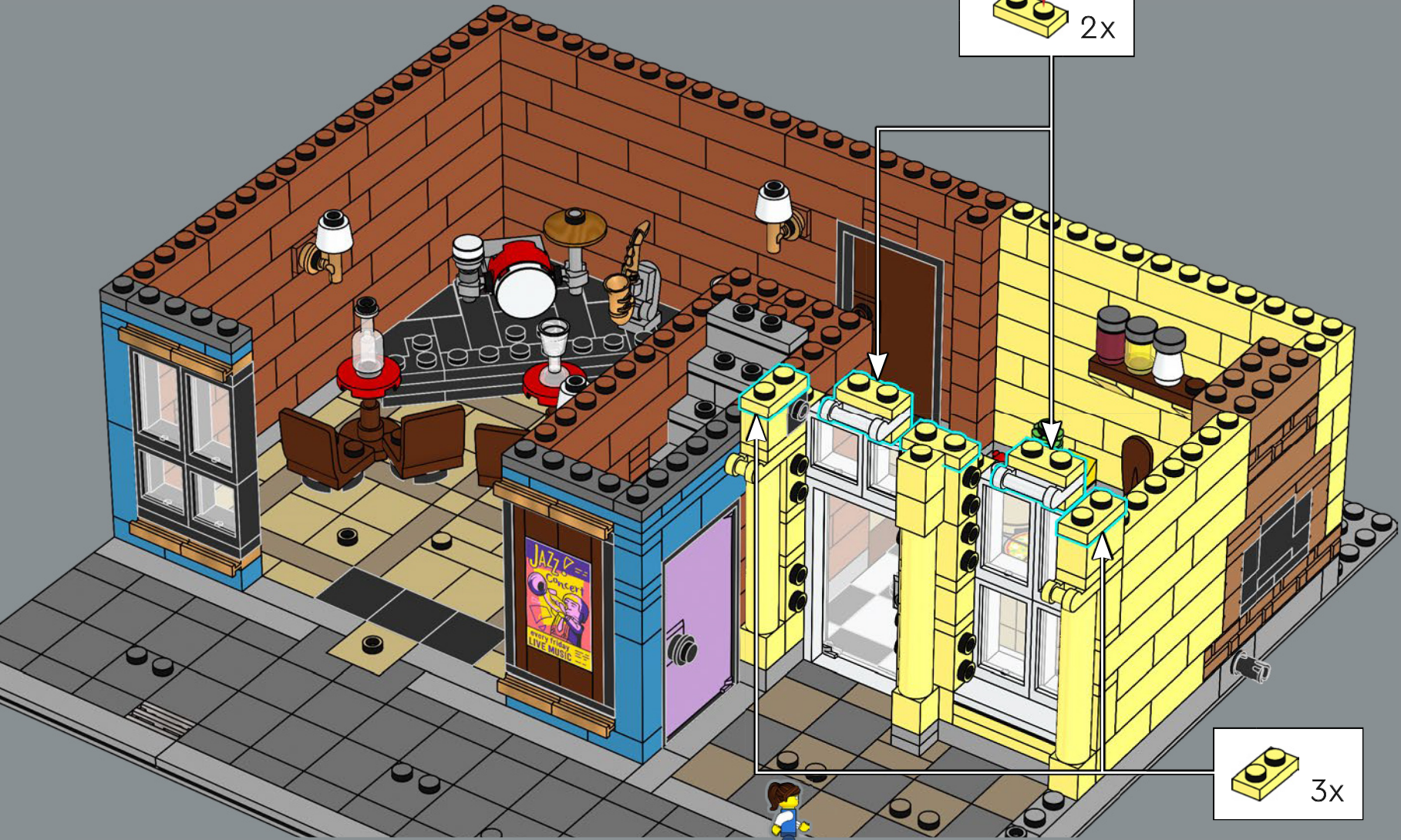
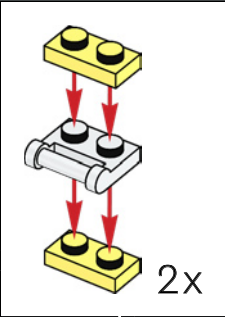

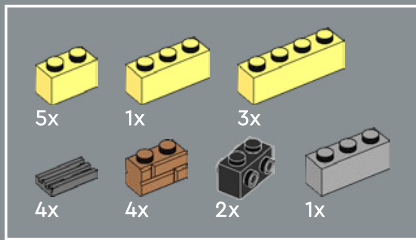

Ajoutez ces ventilateurs pour rester au frais.
Ça chauffe avec le four et la musique !

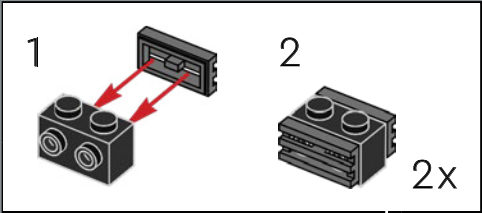

88



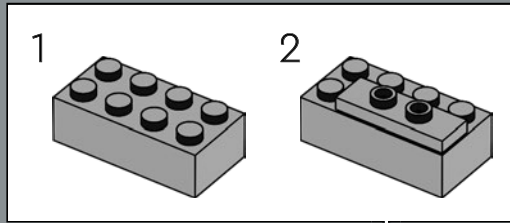
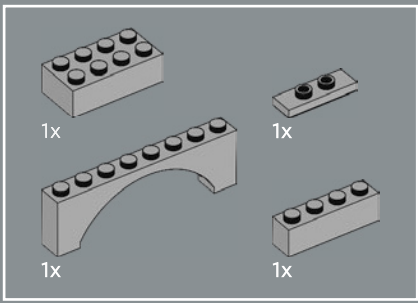

89



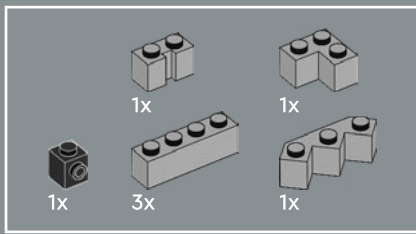

90



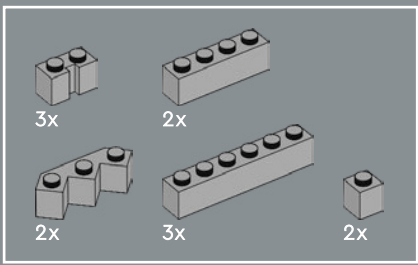

91



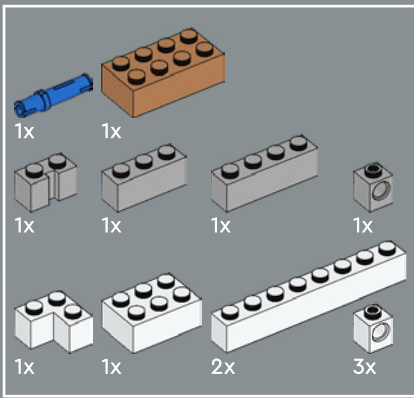

92

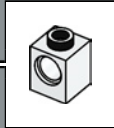
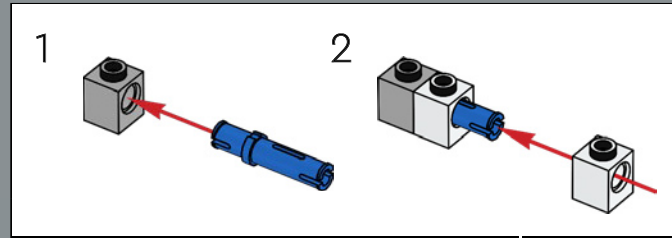

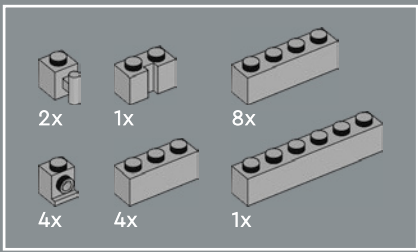

93



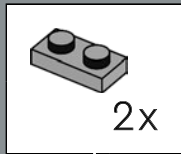
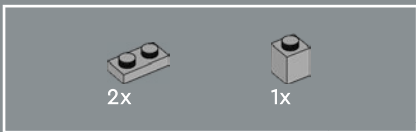

94

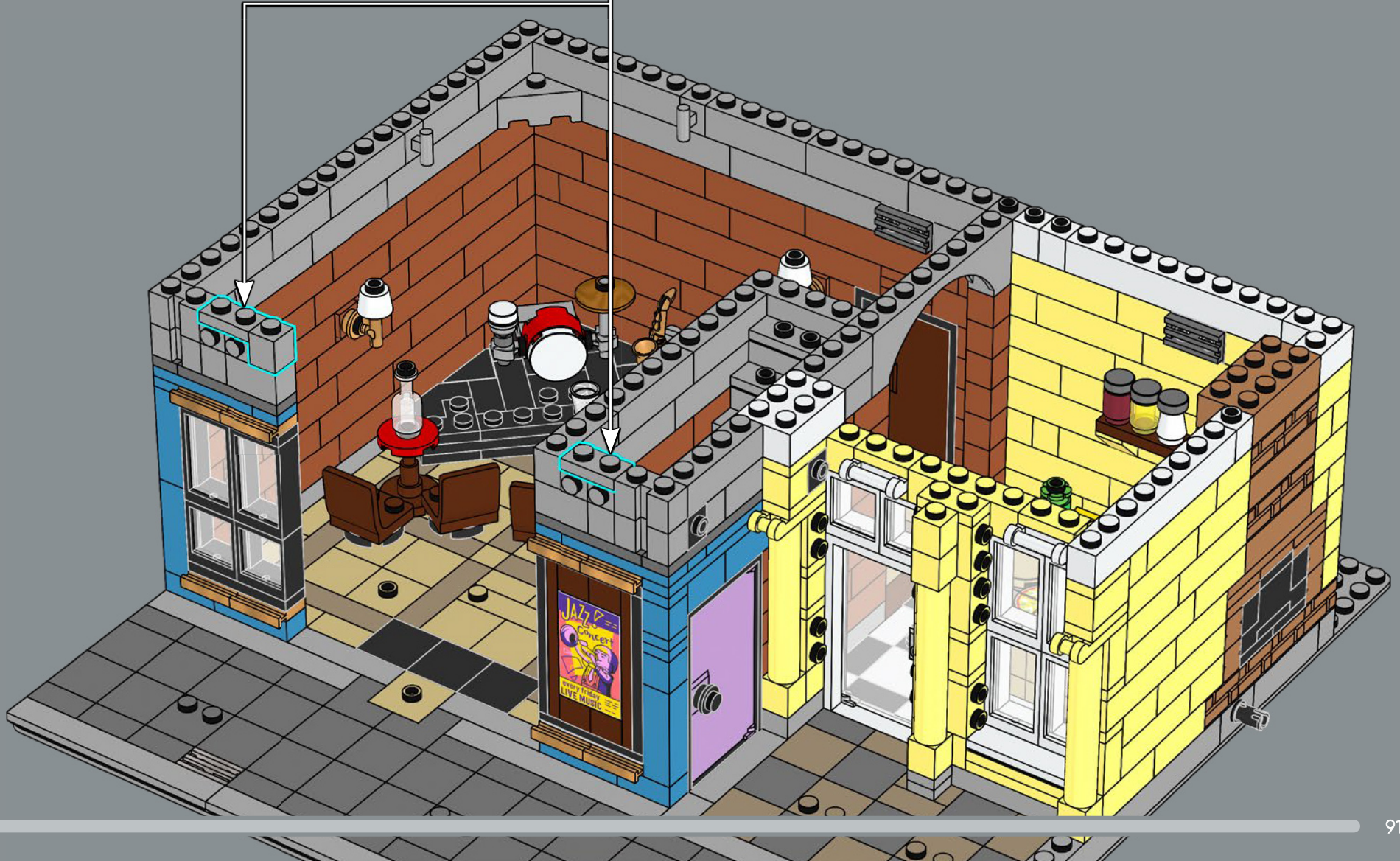

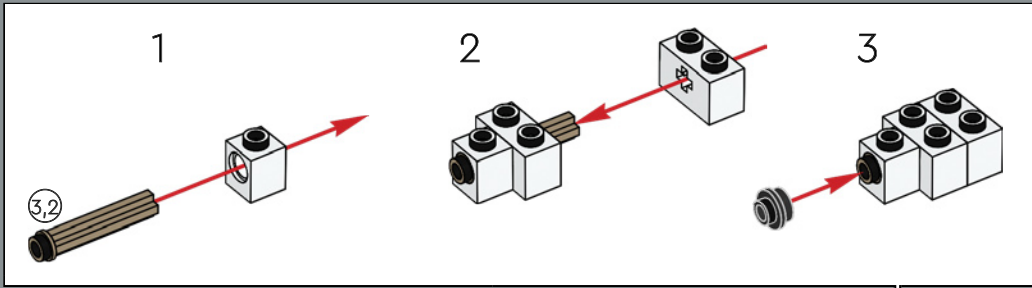
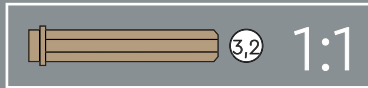
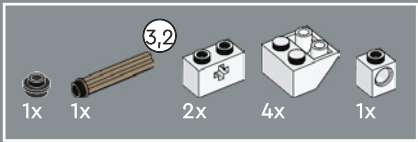

95

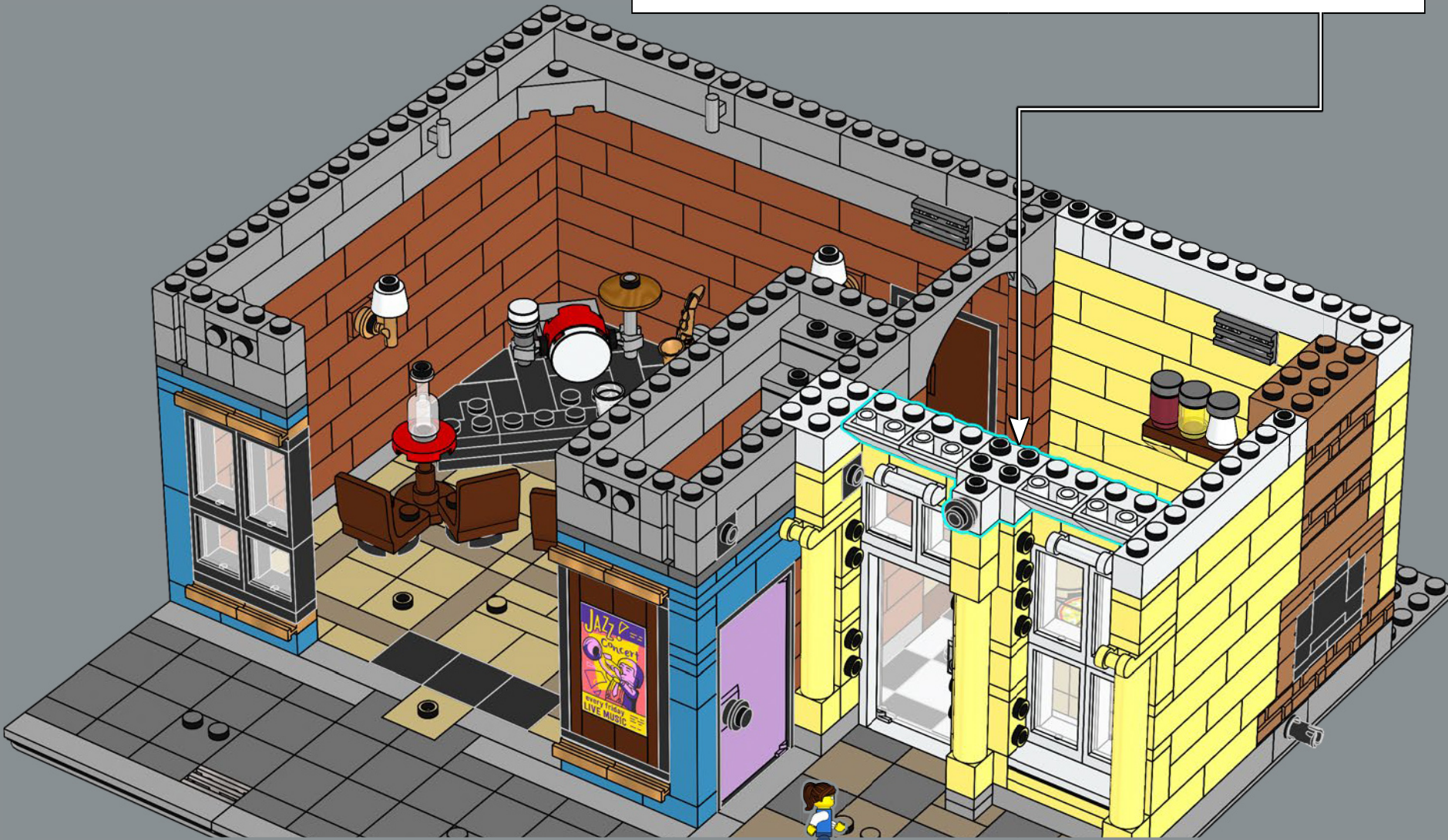

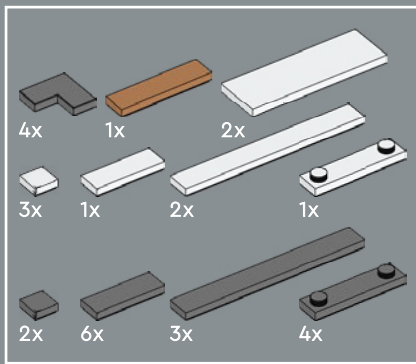

96



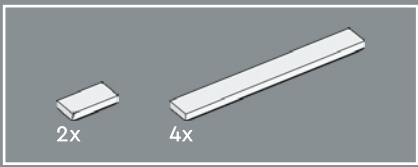

97

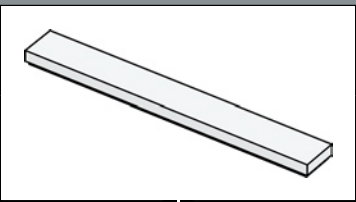



98

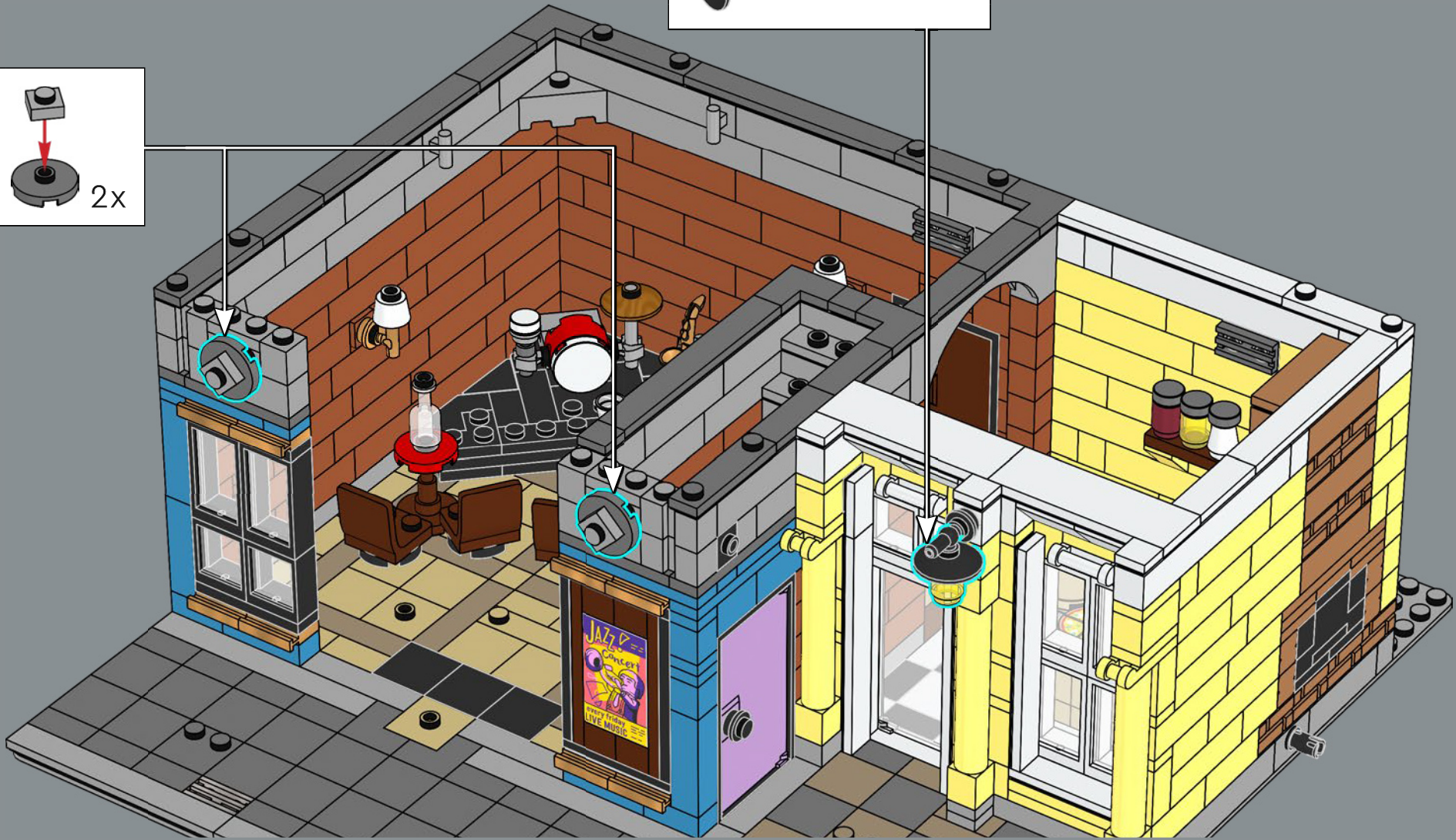
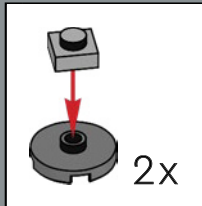
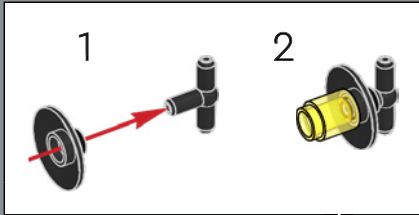

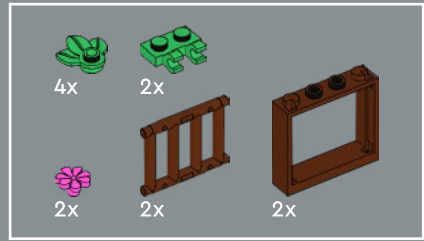

99

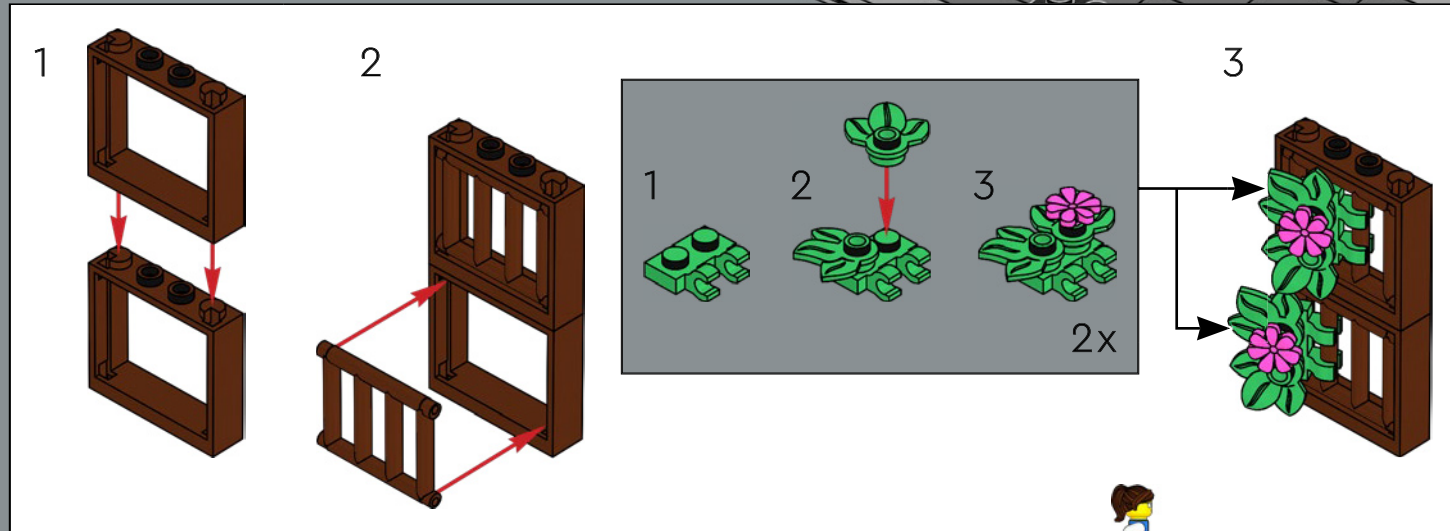



100

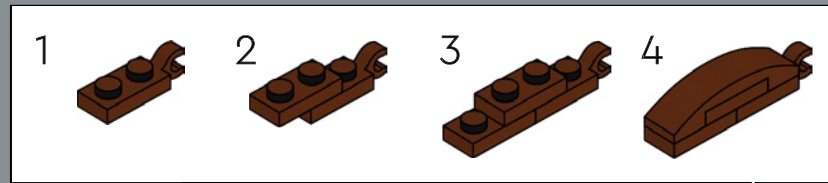

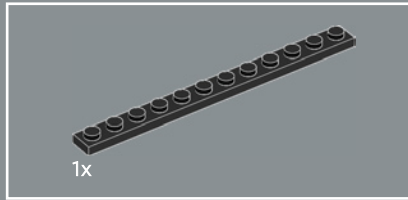

101

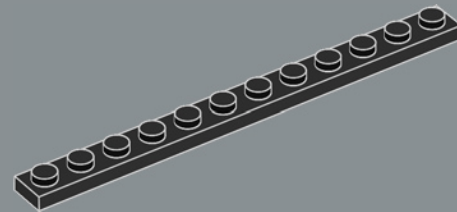

102

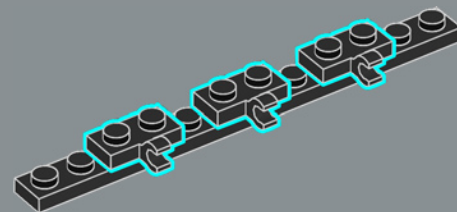

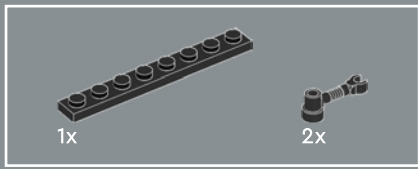

103

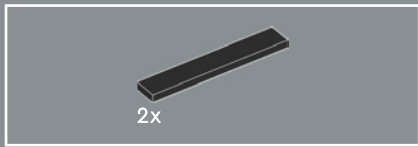
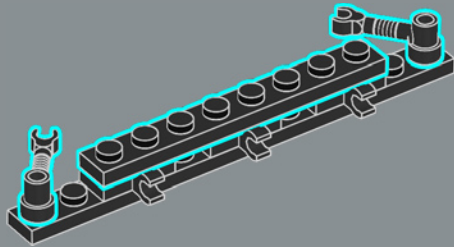

104

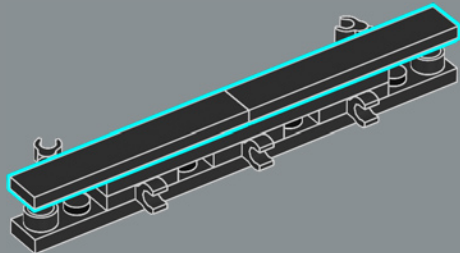

105

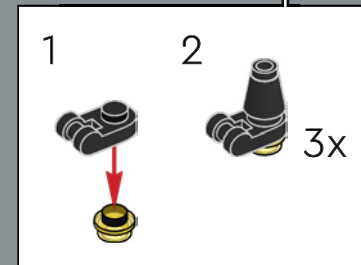
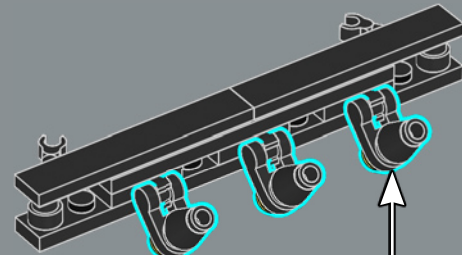

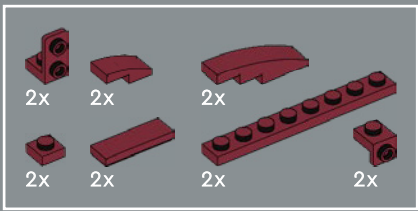

106

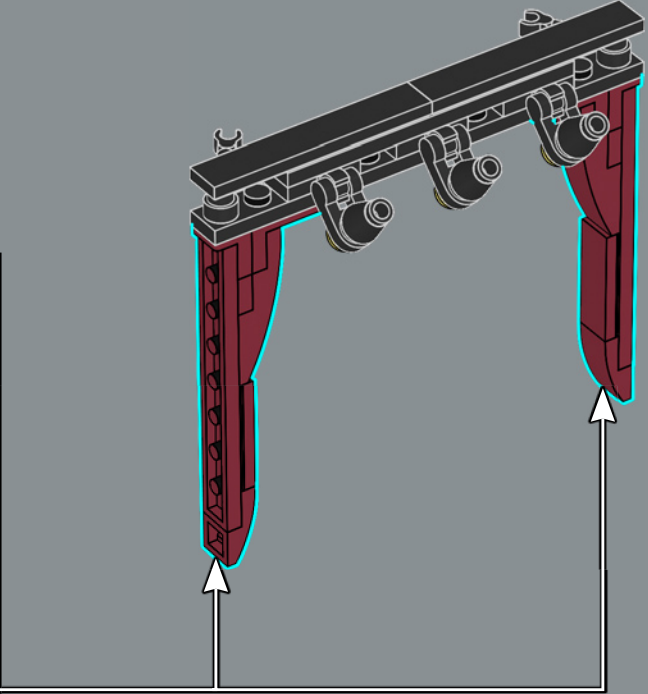
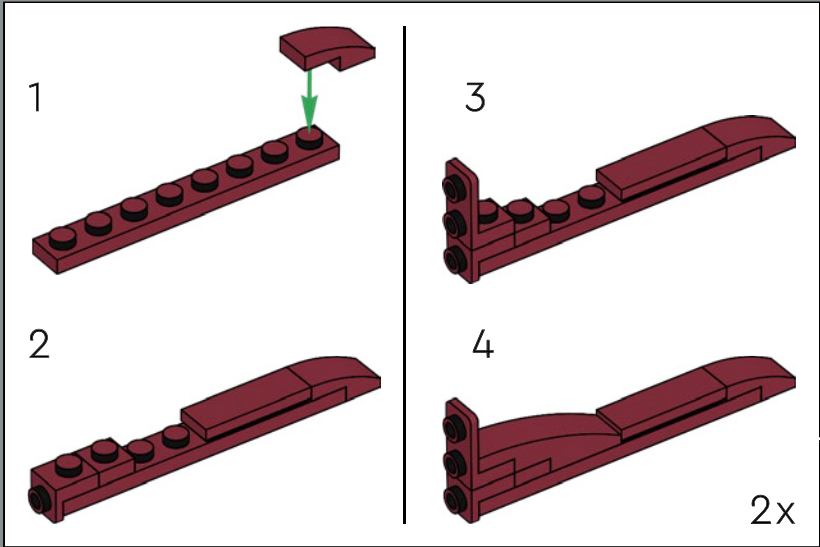



Les rideaux et l'éclairage peuvent être retirés et remplacés facilement si vous souhaitez reconfigurer la scène.

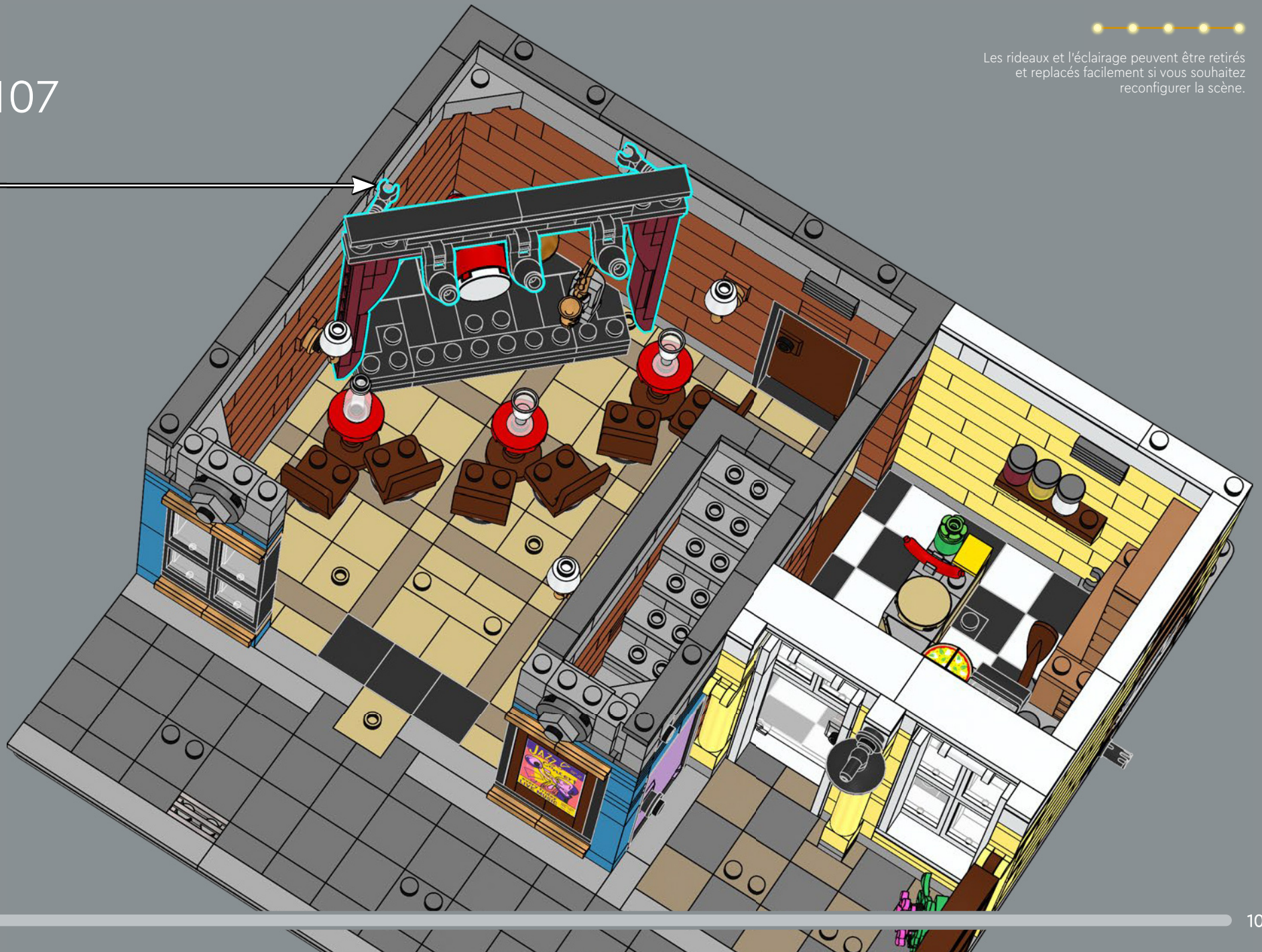

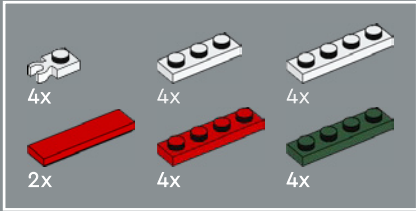

108

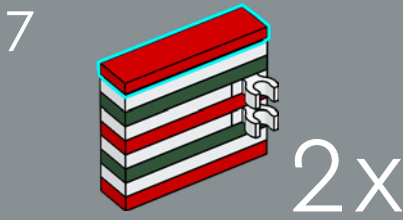
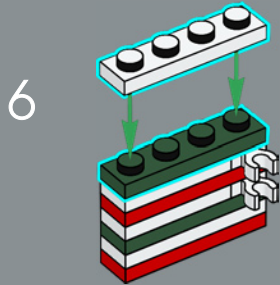
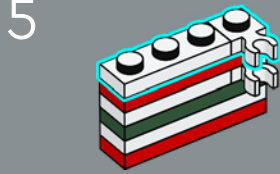
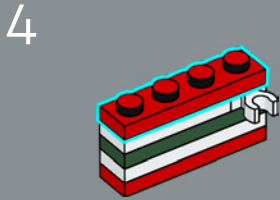
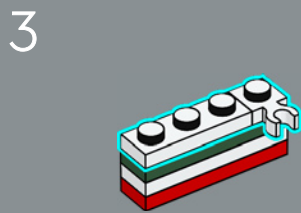
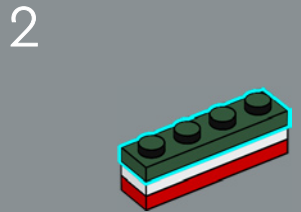
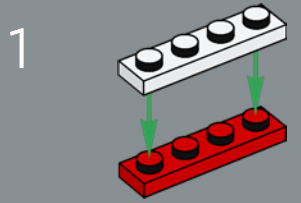



109

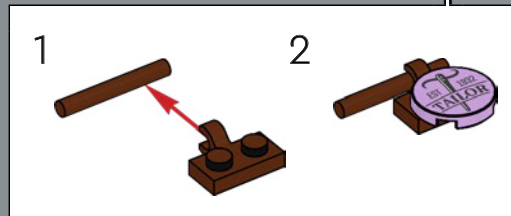
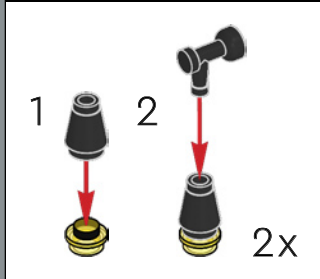

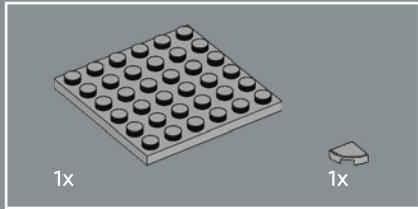
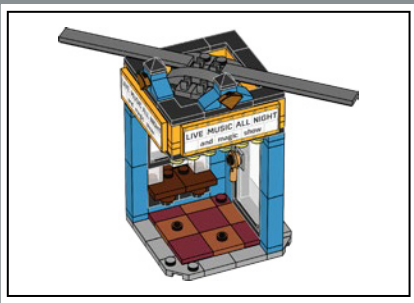

110

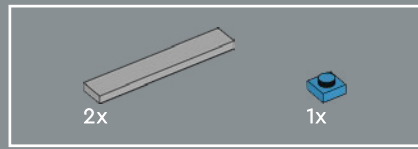
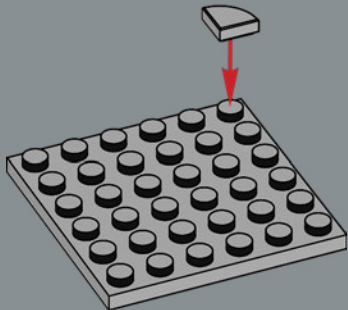

111

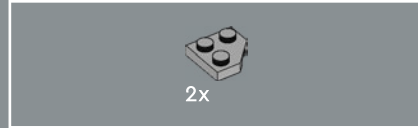
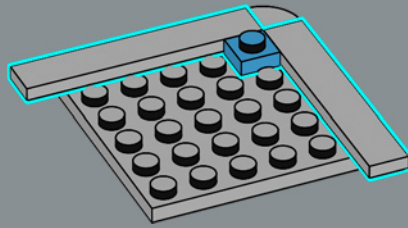

112

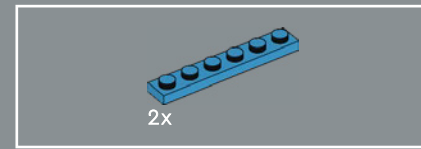
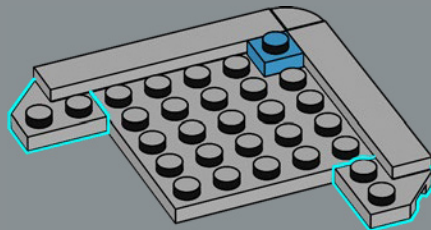

113

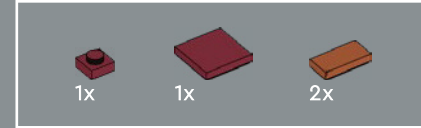
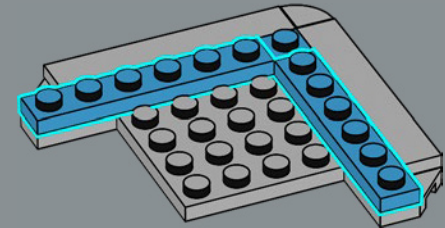

114

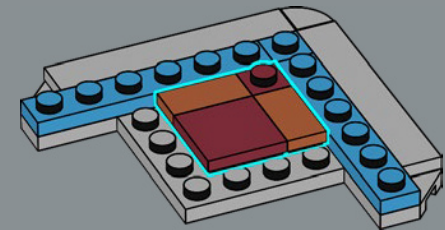

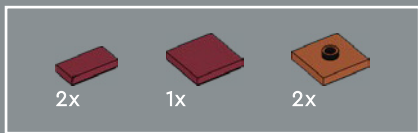

115

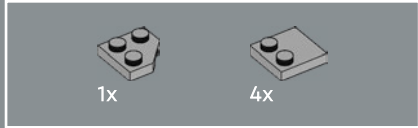
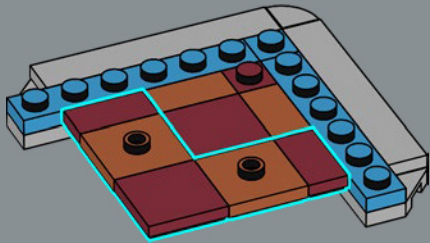

116

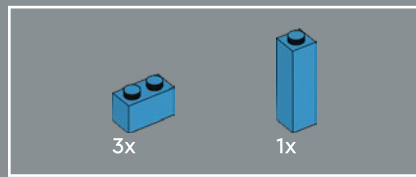
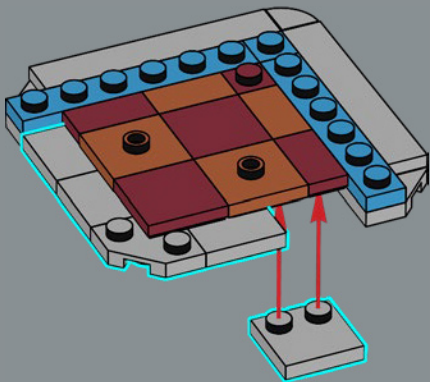

117

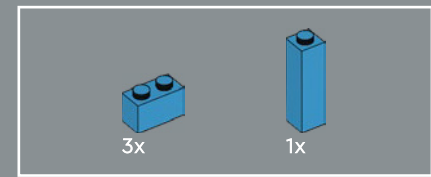
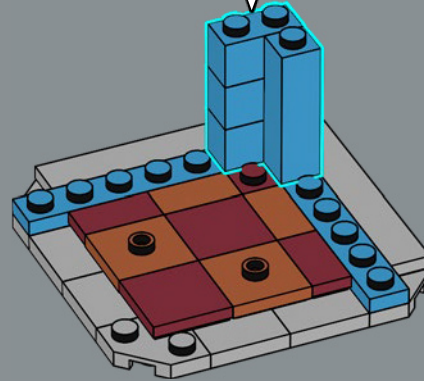
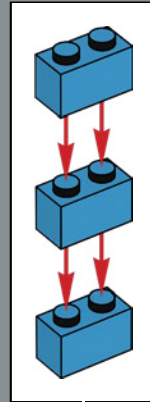

118

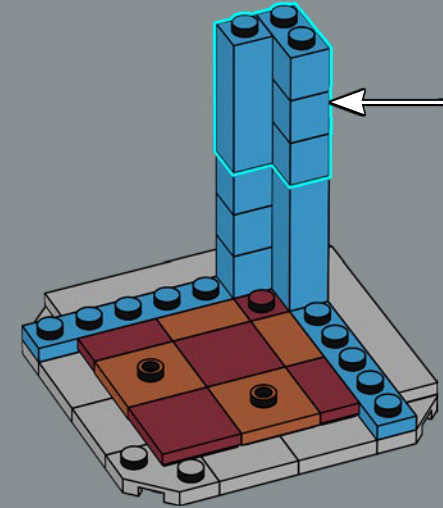
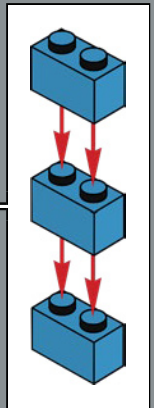

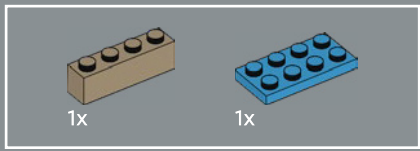

119

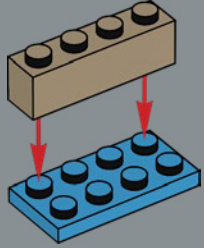

120

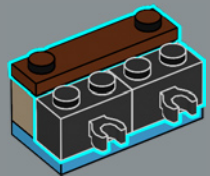

121

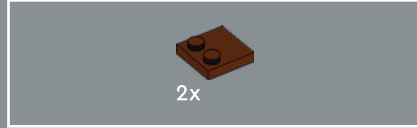
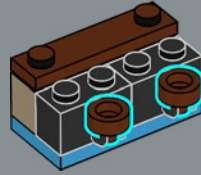

122

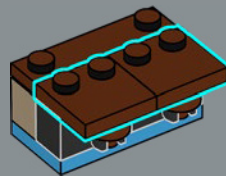

123

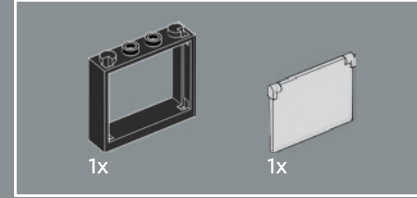
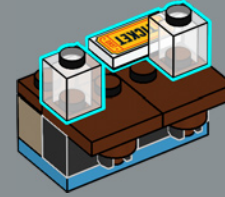

124

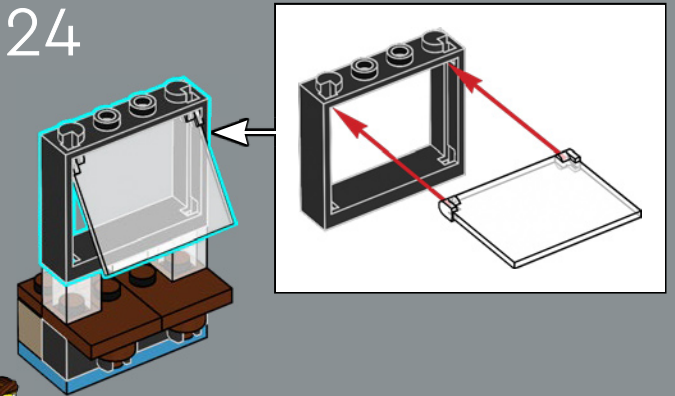

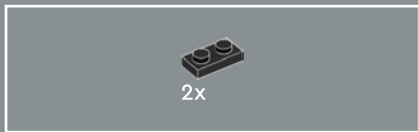

125

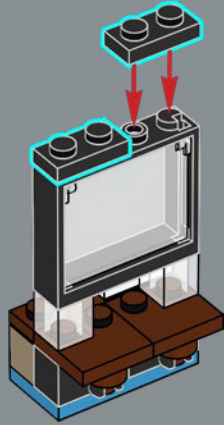

126

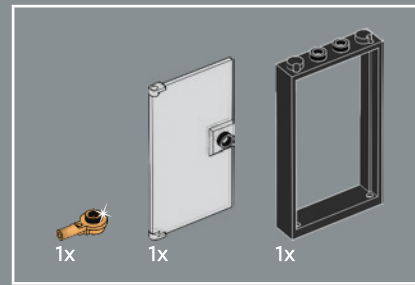
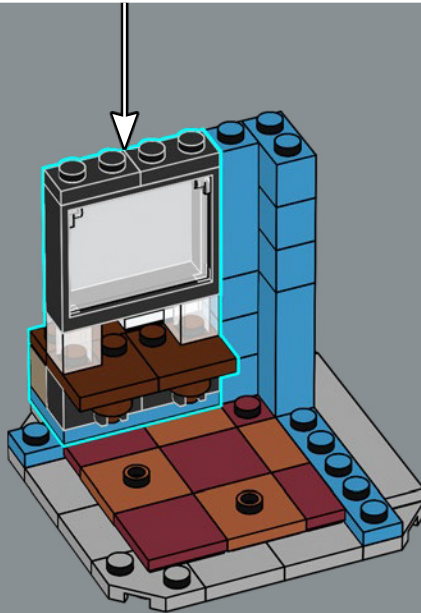

127

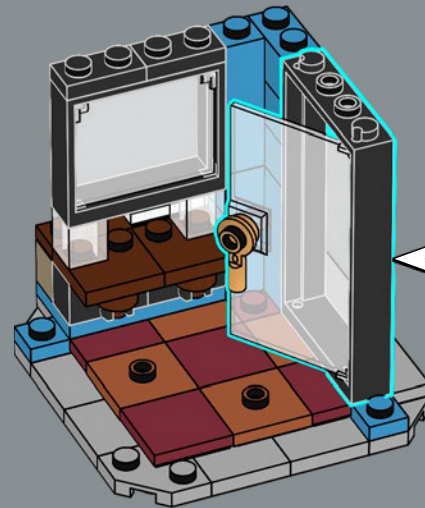
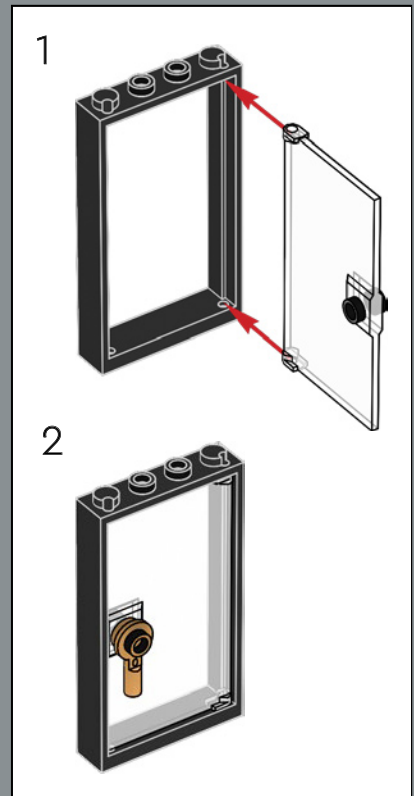



4x

128

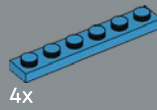
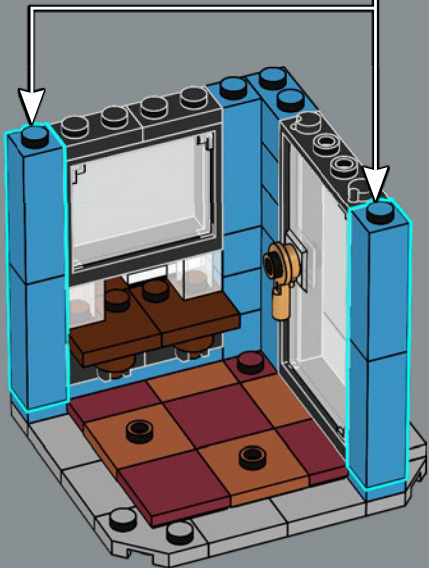
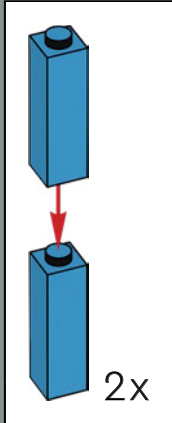

4x



2x

129

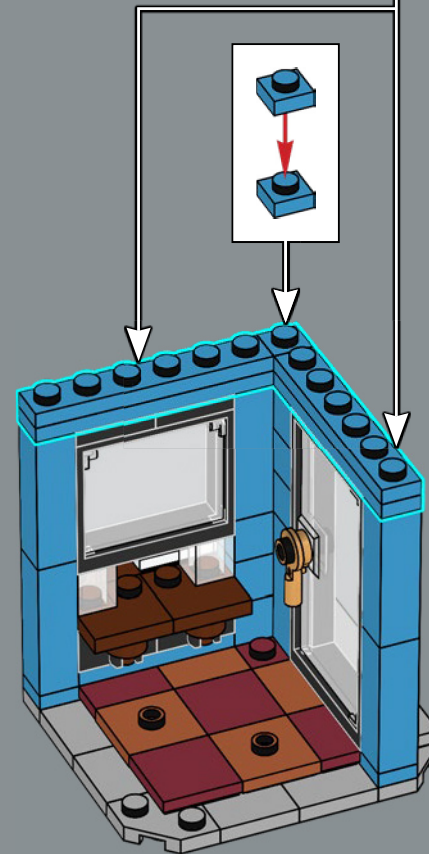
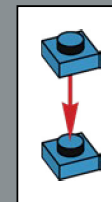
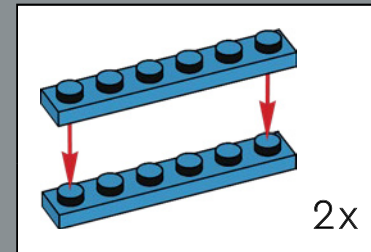

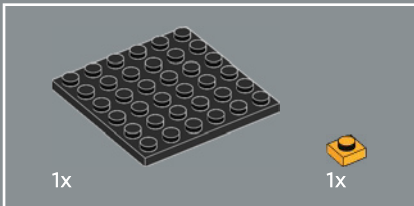

130

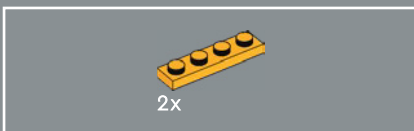
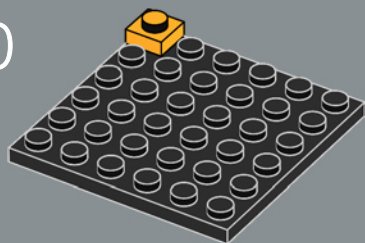

131

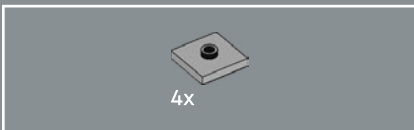
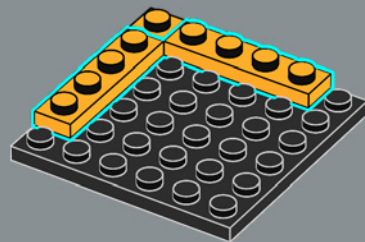

132

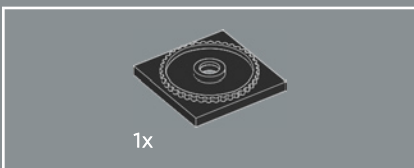
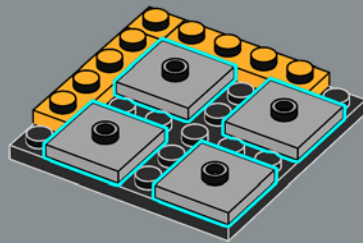

133

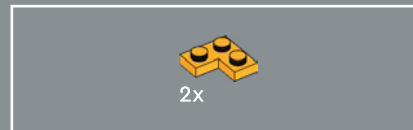
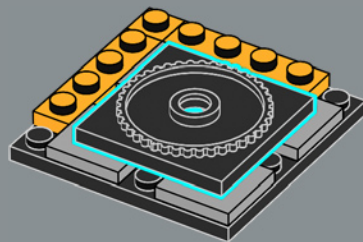

134

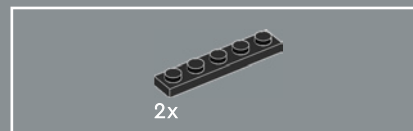
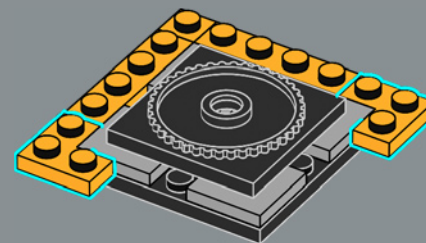

135

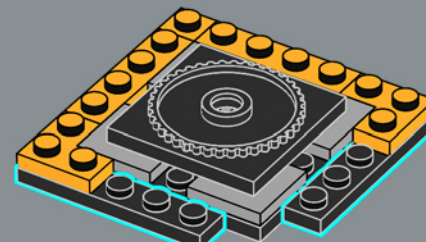

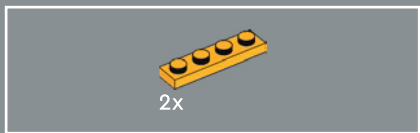

136

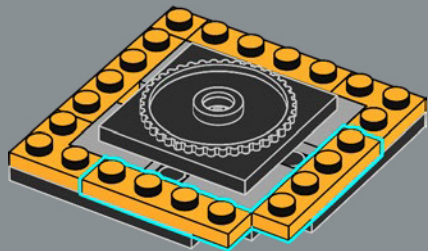

137

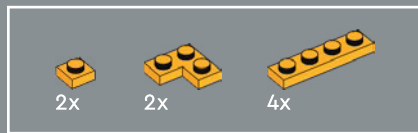
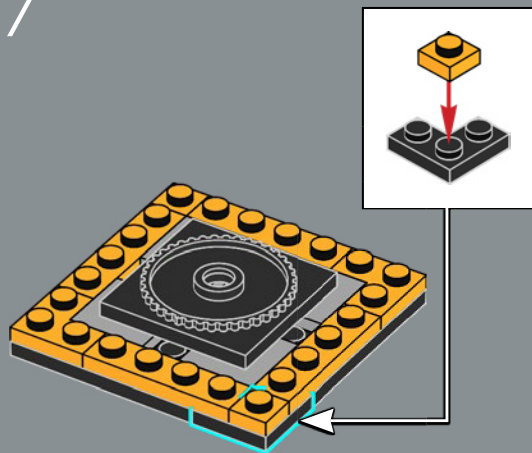

138

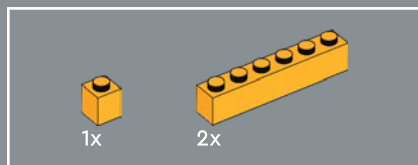
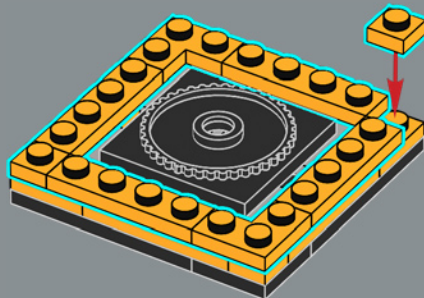

139

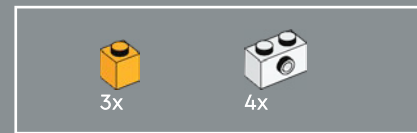
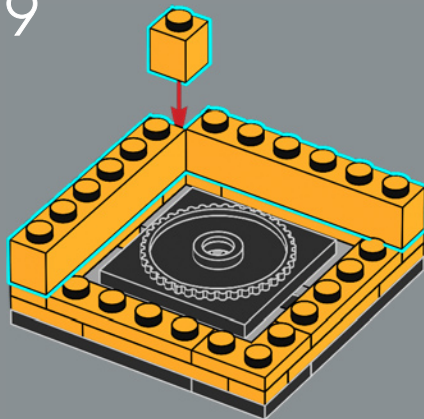

140

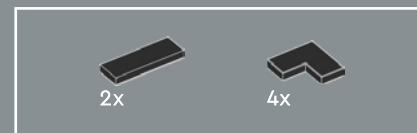
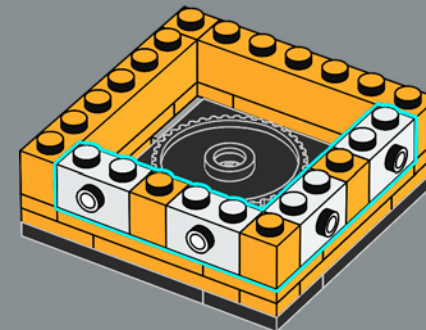

141

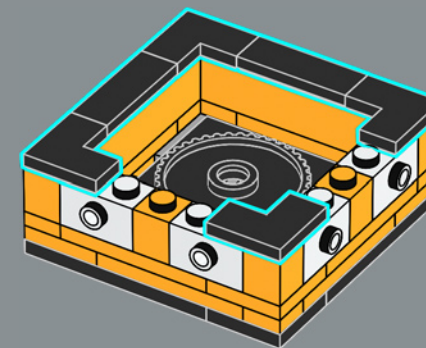



142

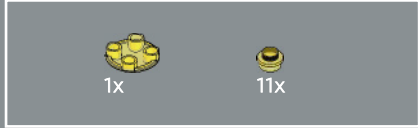
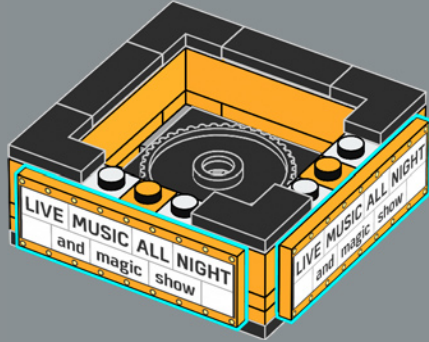

143

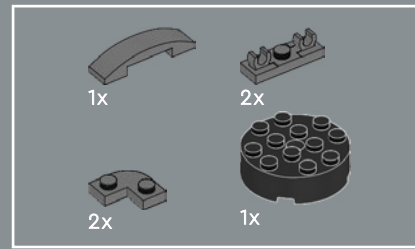
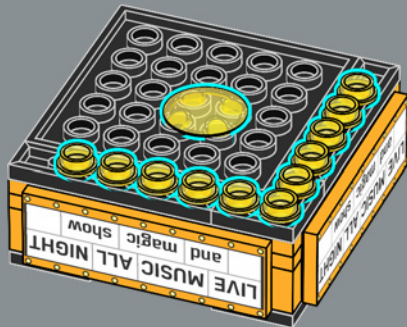

144

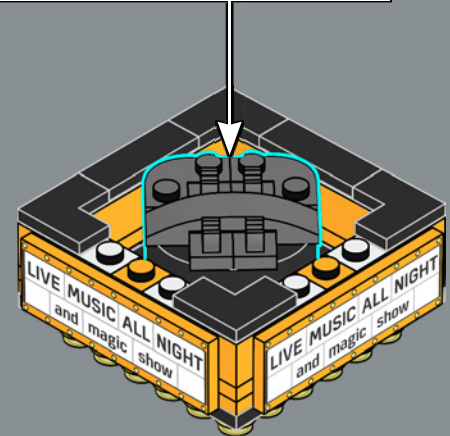
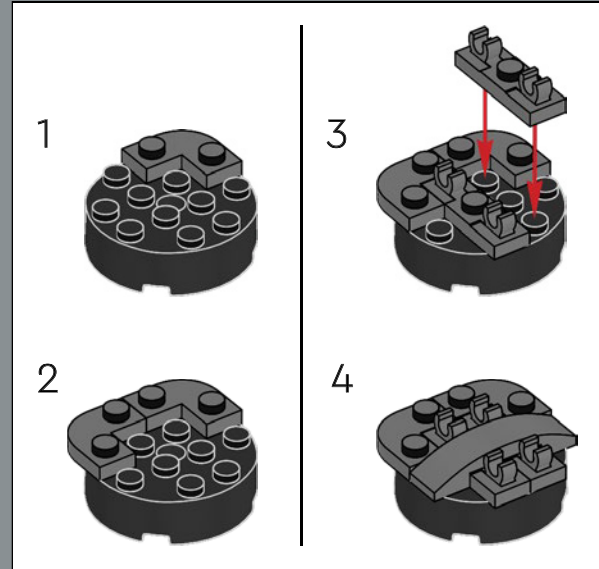



145

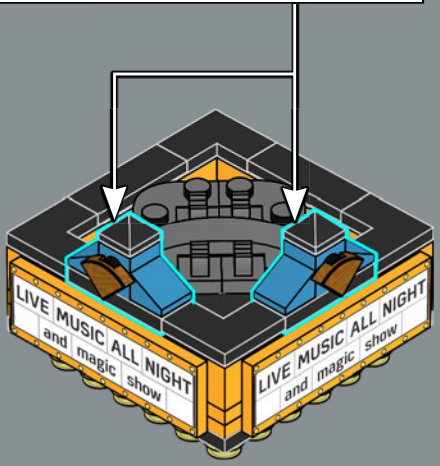

Le club de jazz apporte son soutien à la musique, mais aussi à tous les arts du spectacle. Patientez pour voir quels tours la magicienne a dans son sac.

146

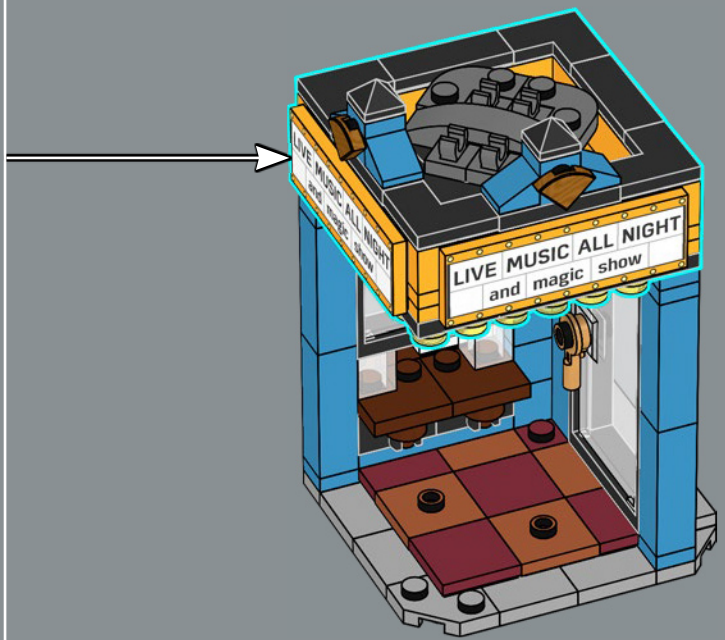

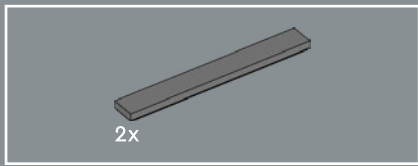

147

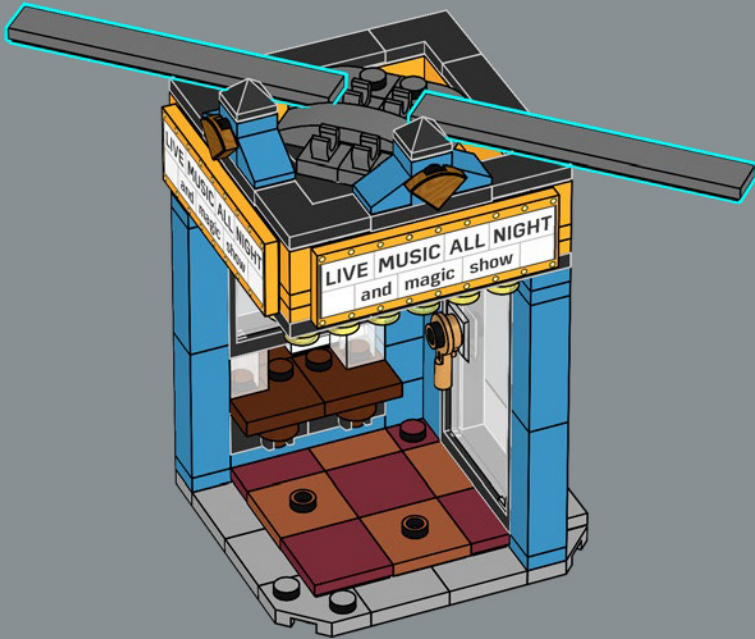

148



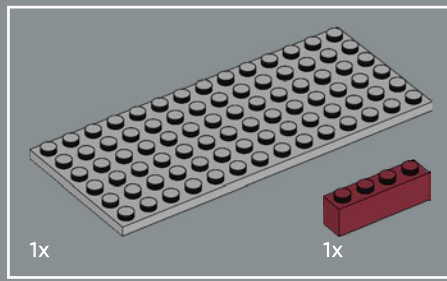

149

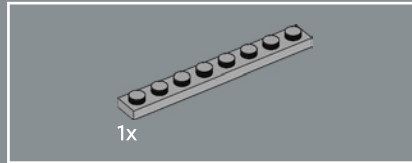
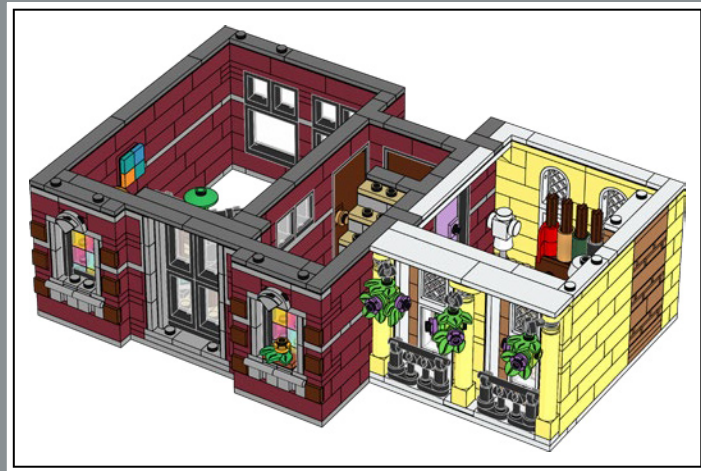
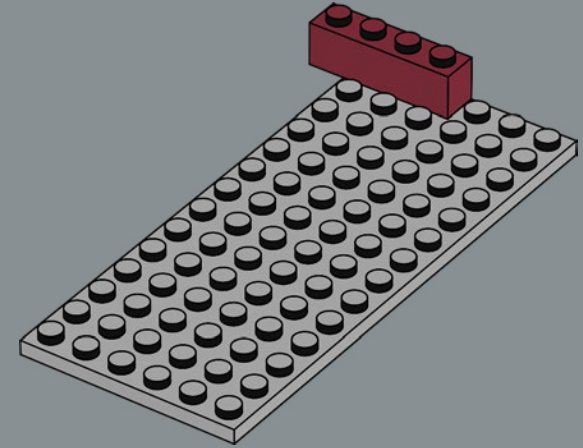

150

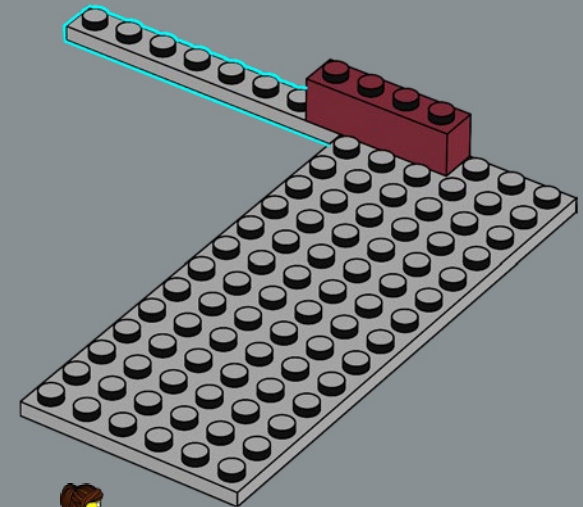

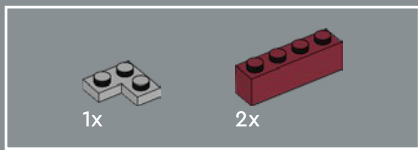

151

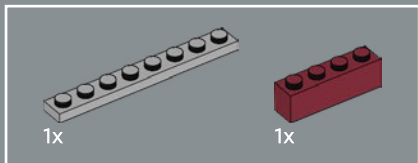
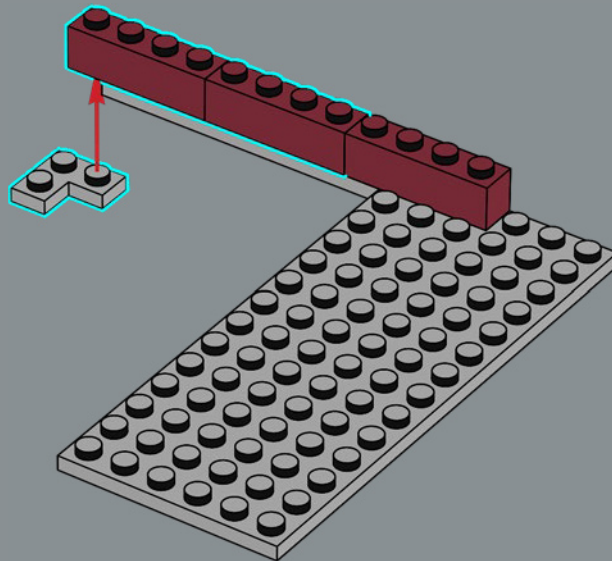

152

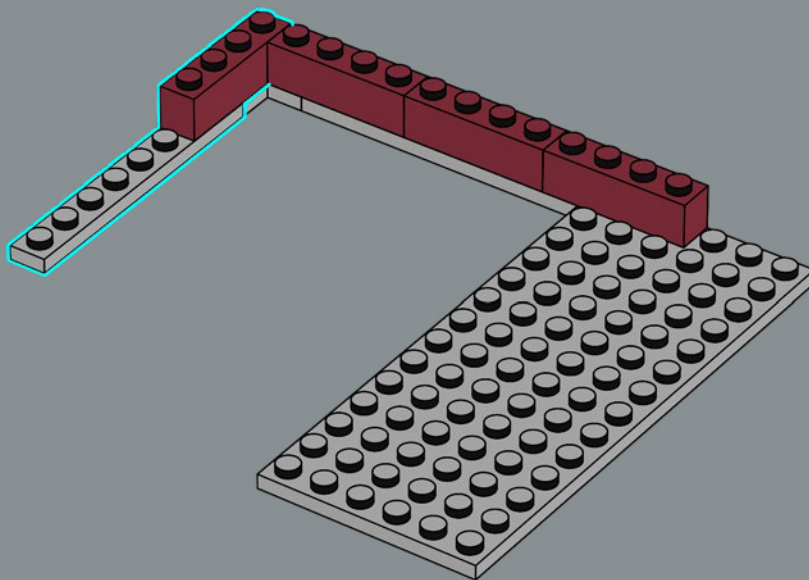

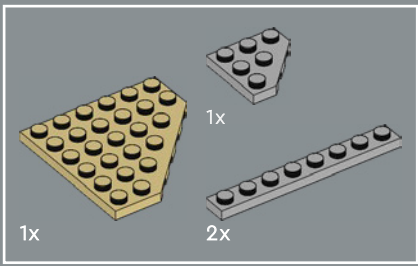

153

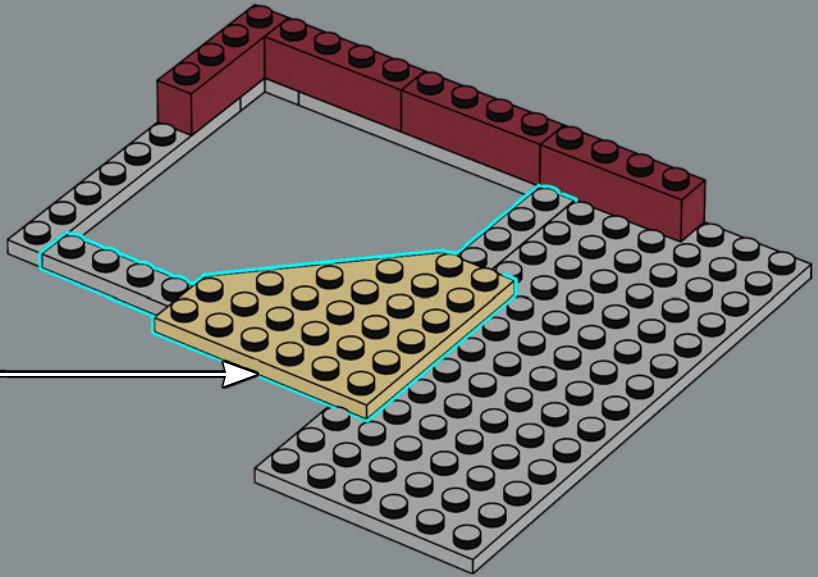
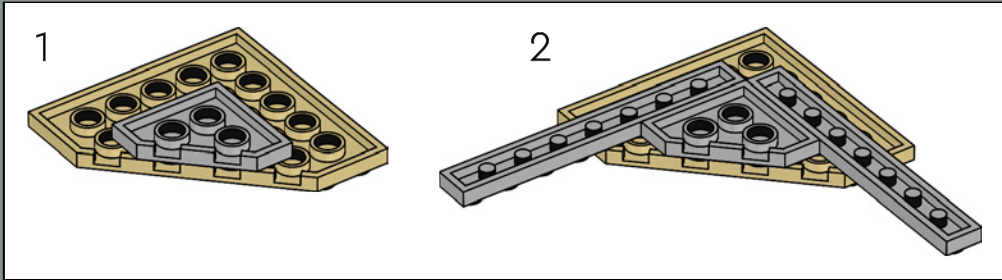

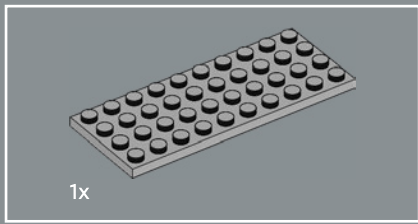

154

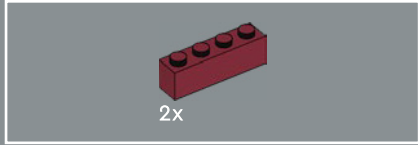
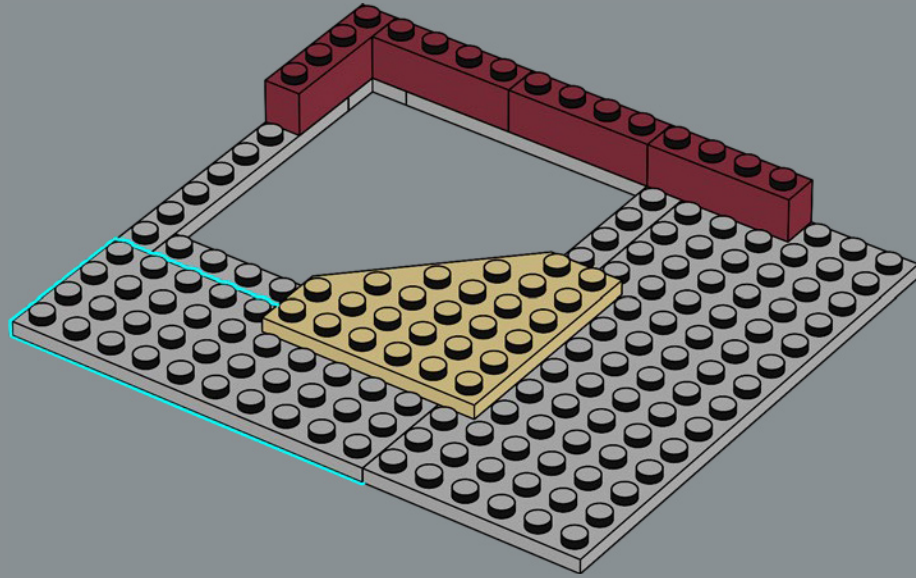

155

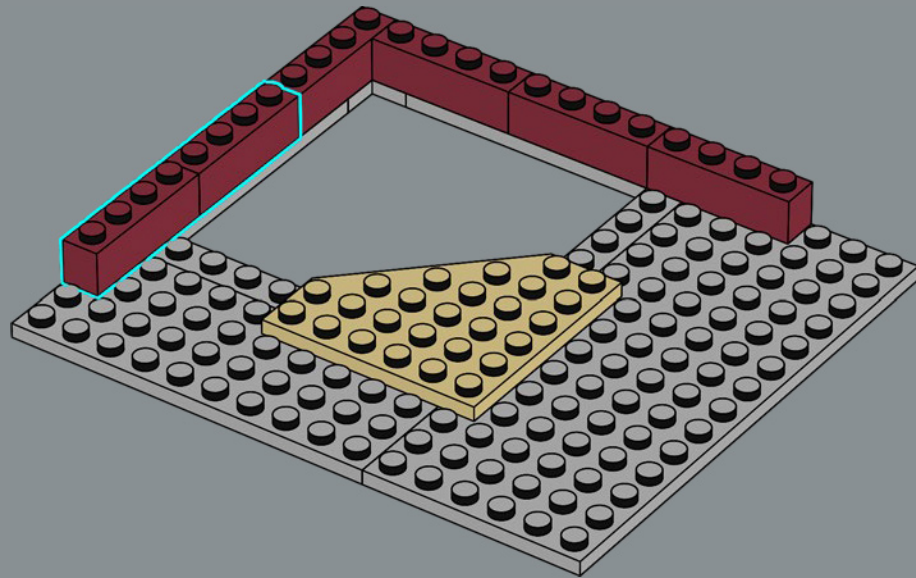

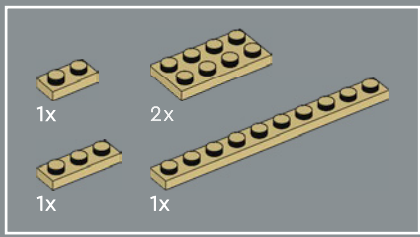

156

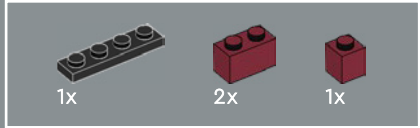
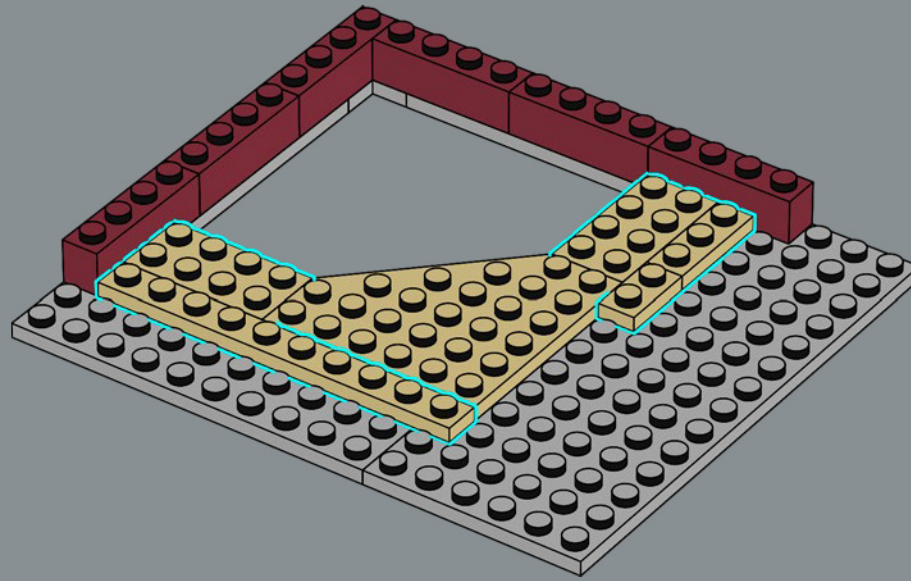

157

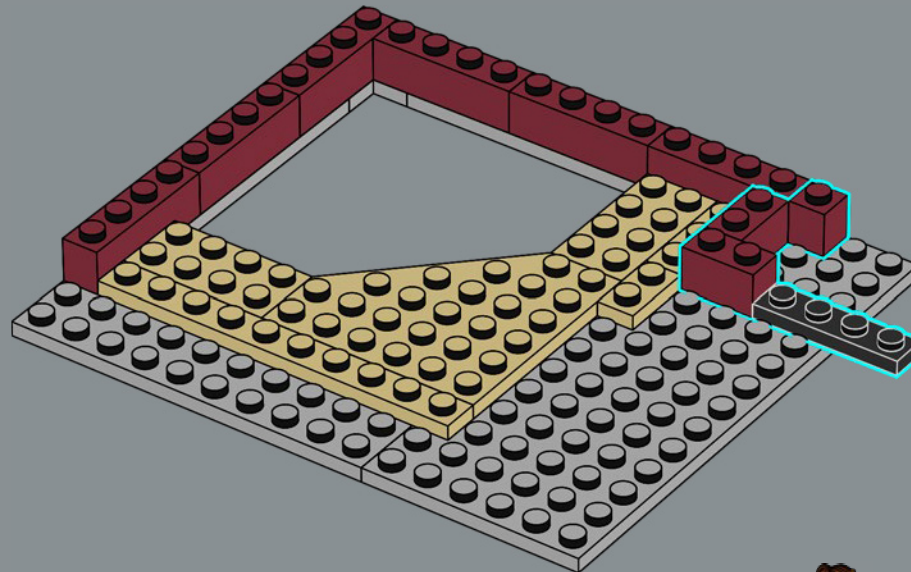

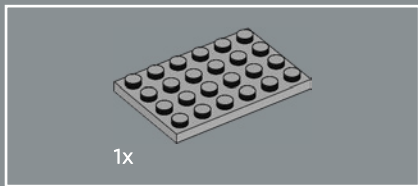

158

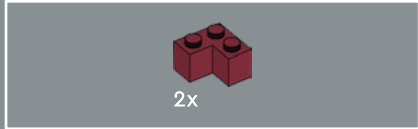
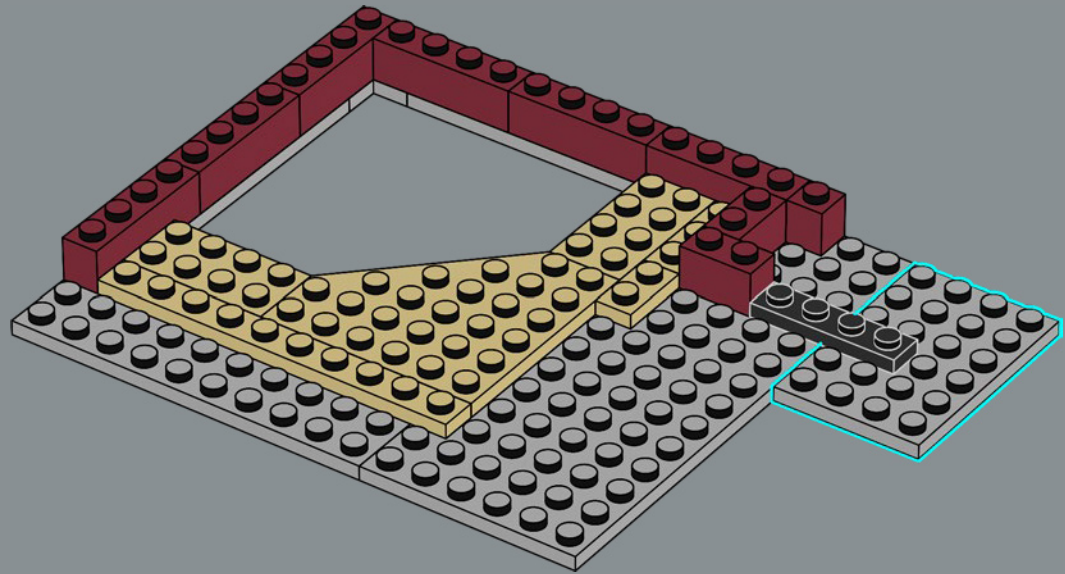

159

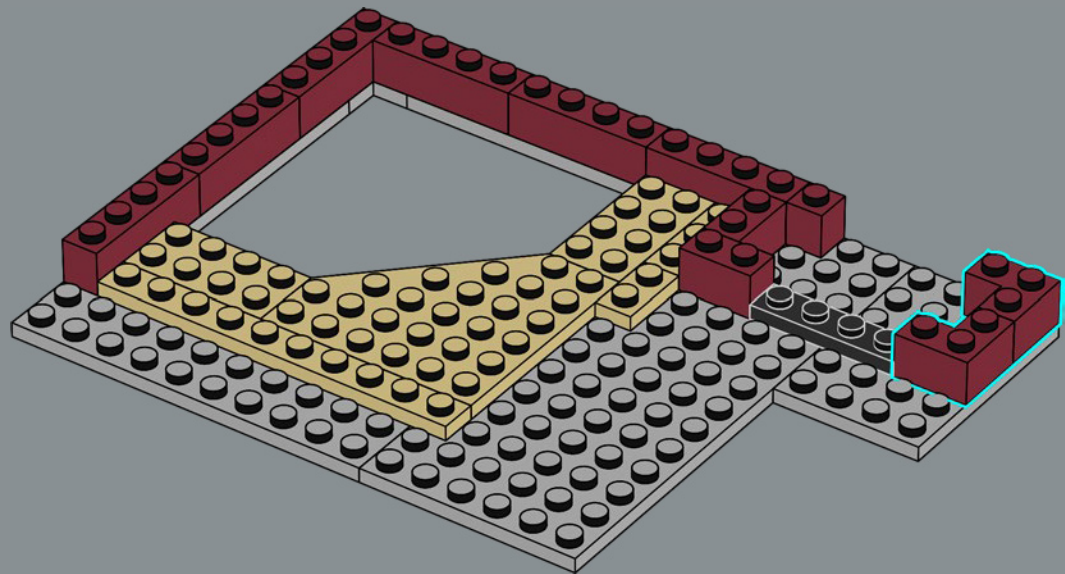

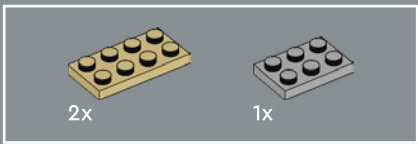

160

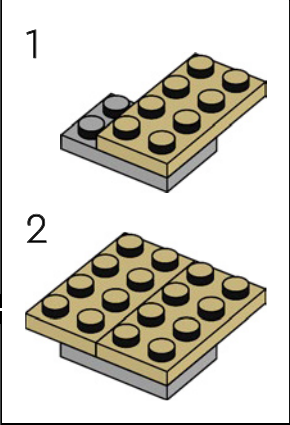
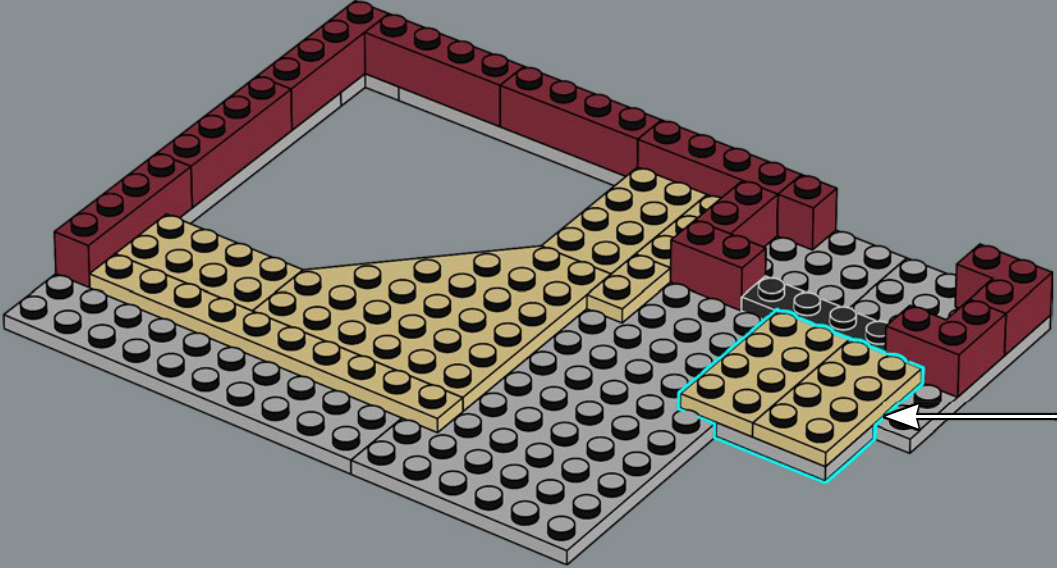

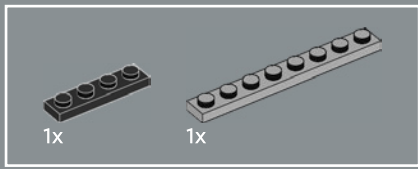

161

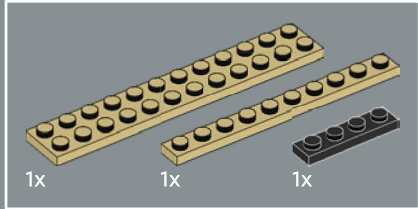
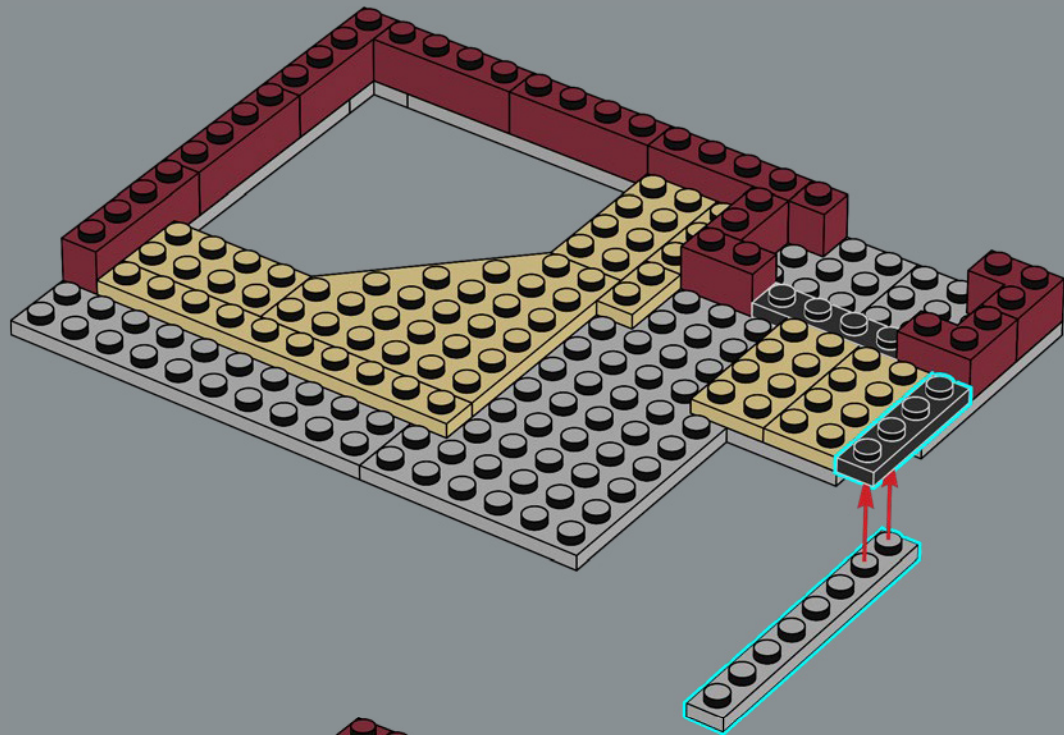

162

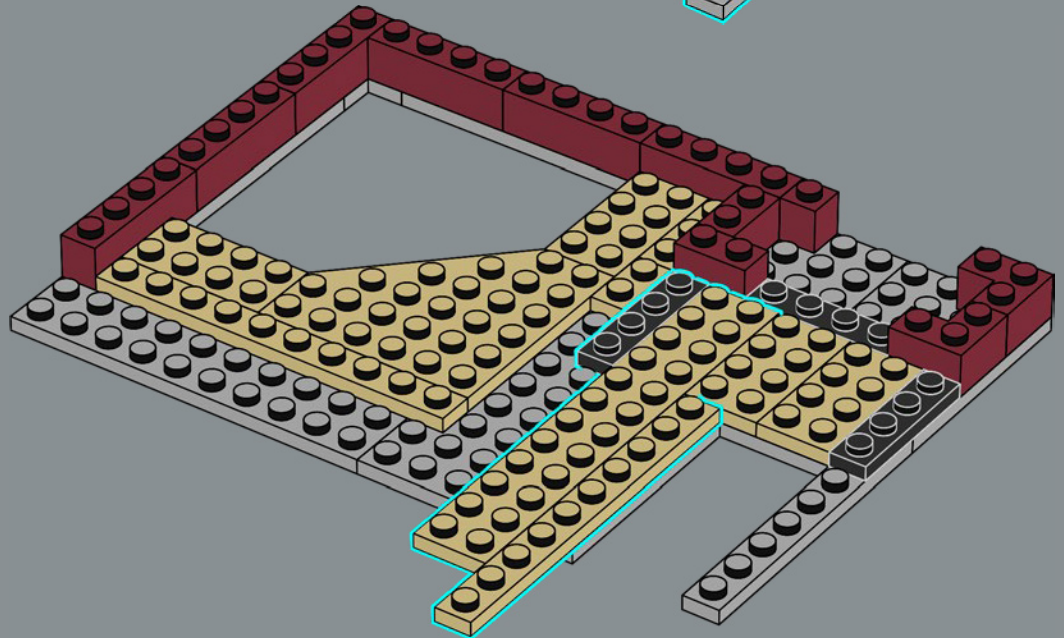

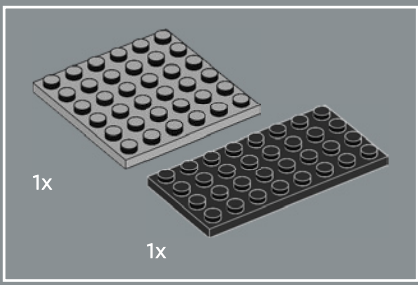

163

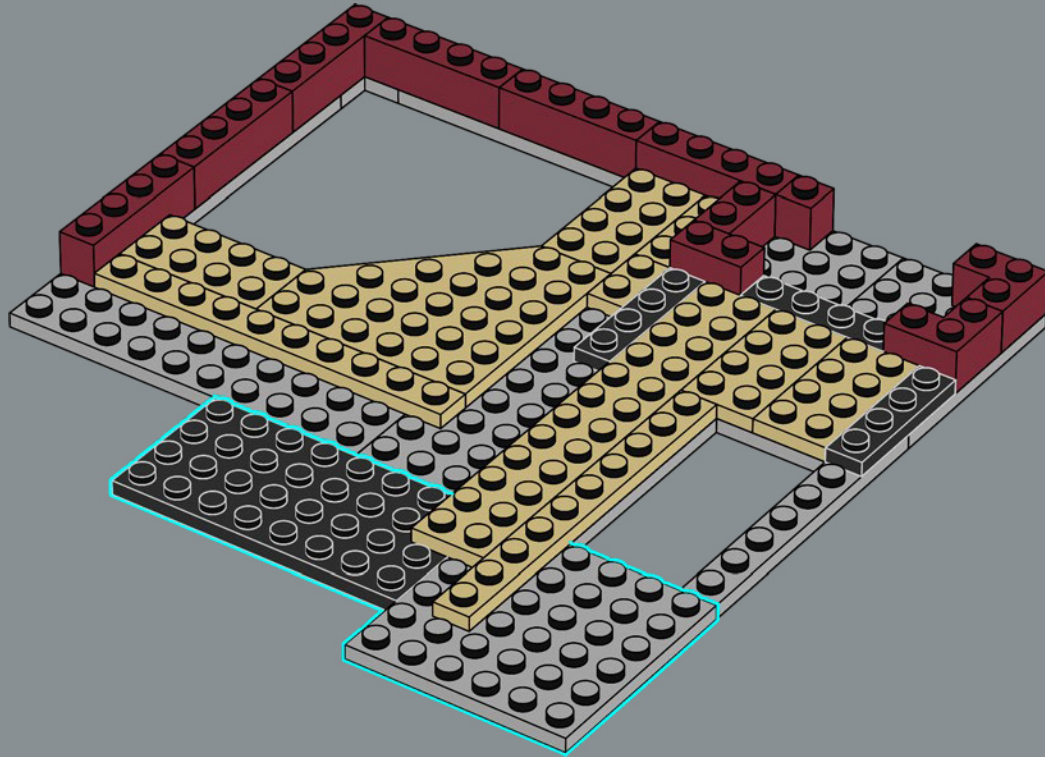

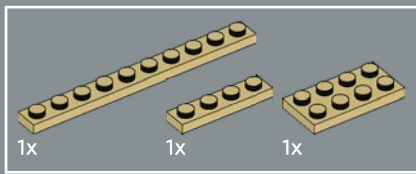

164

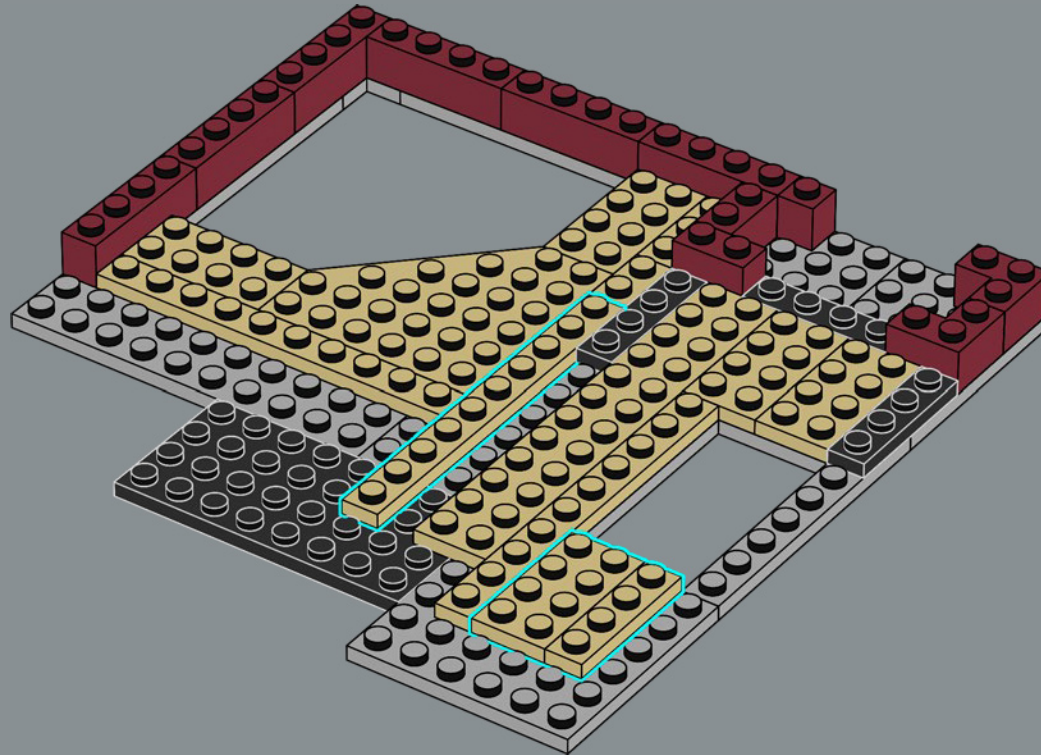

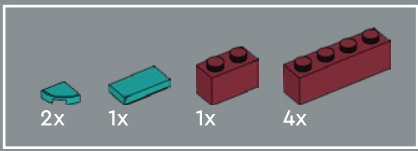

165

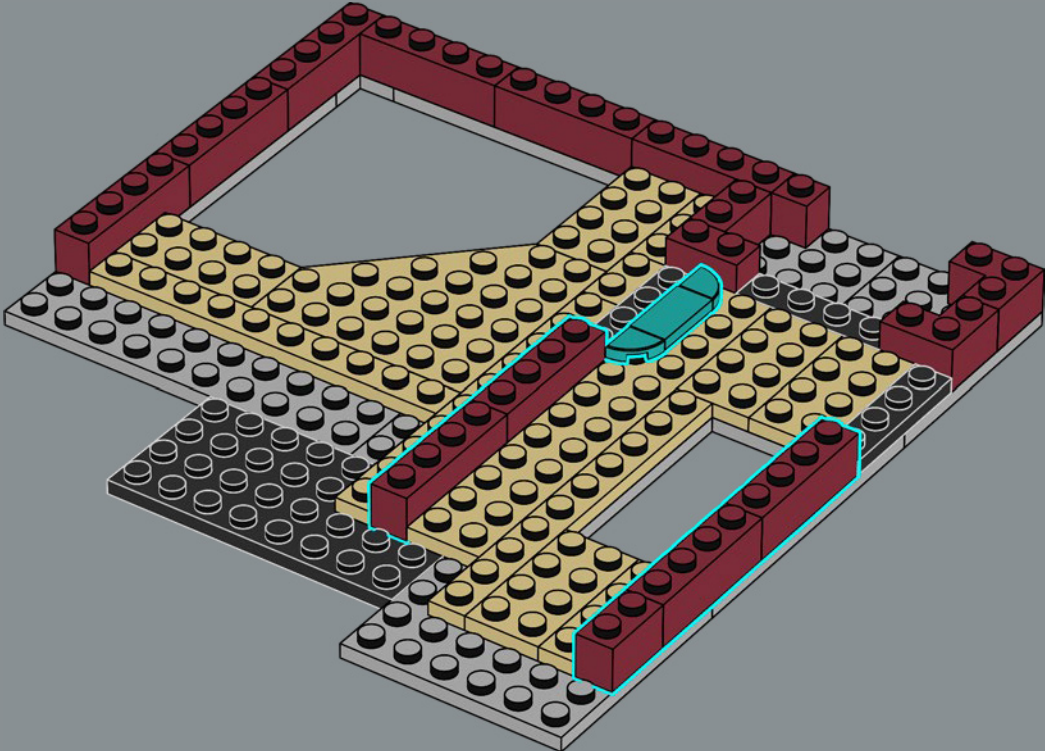

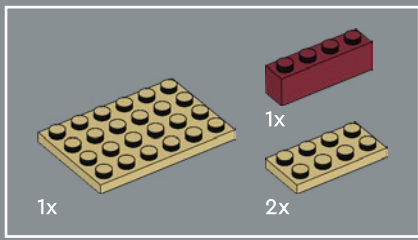

166

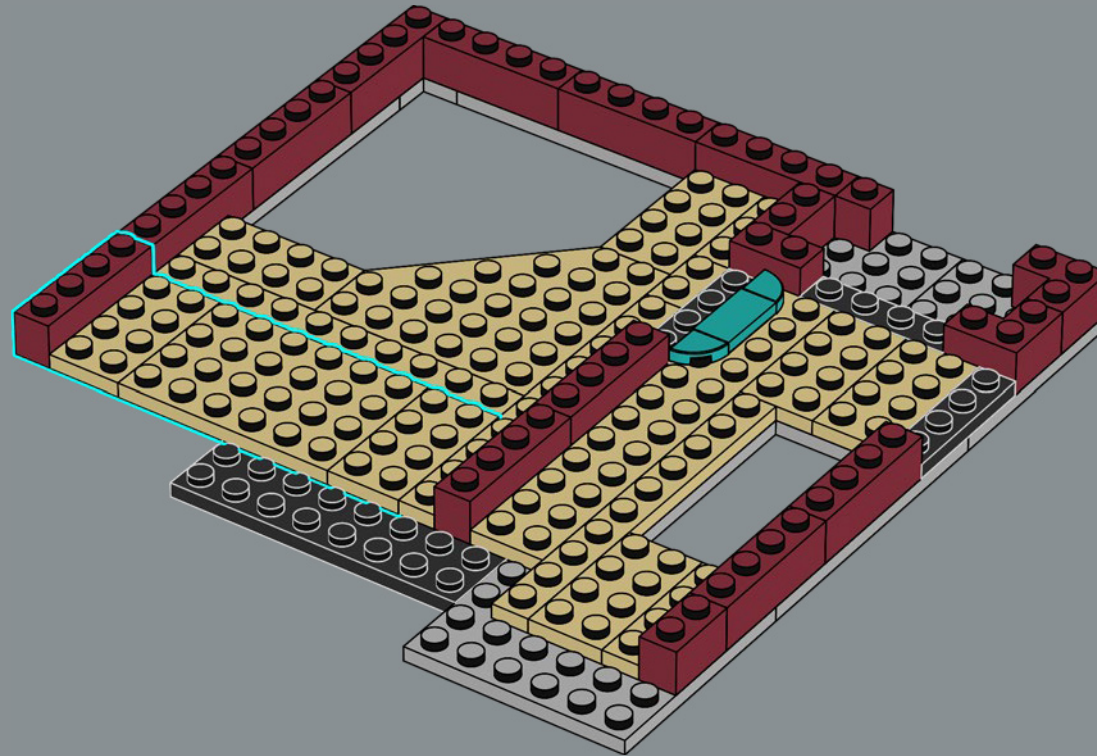

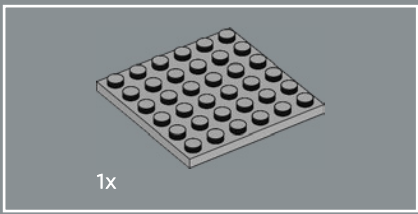

167

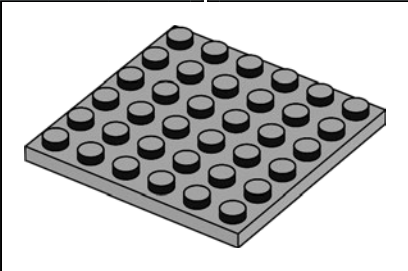
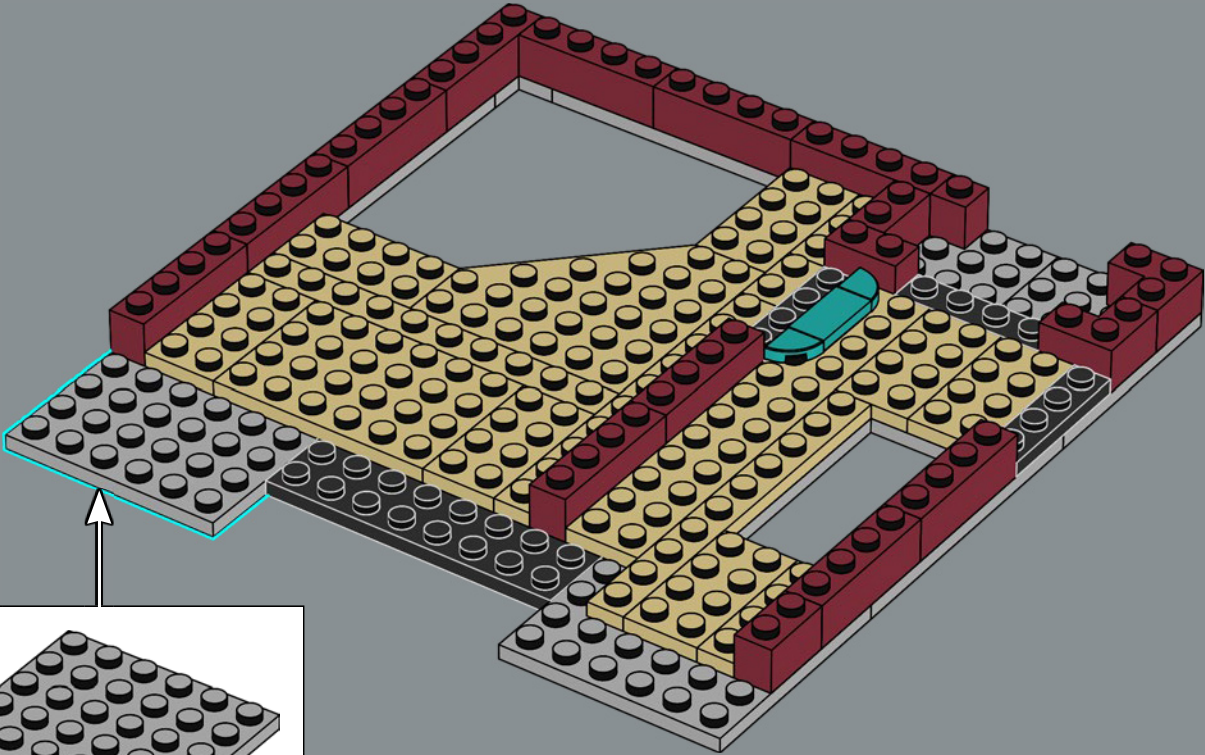

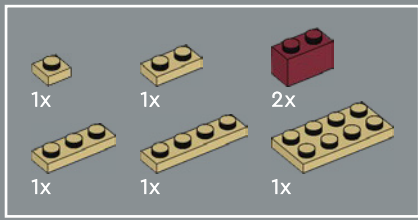

168

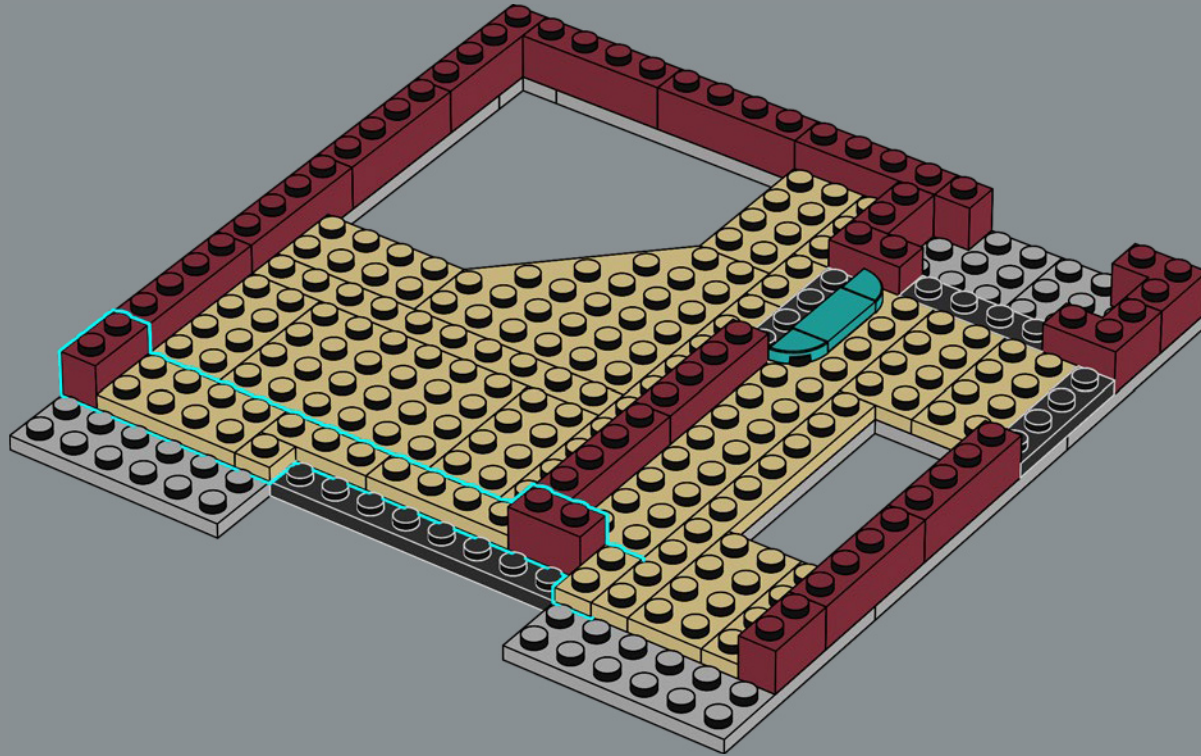

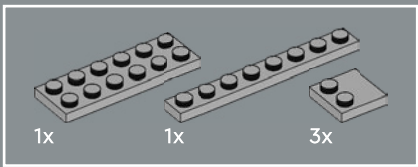

169

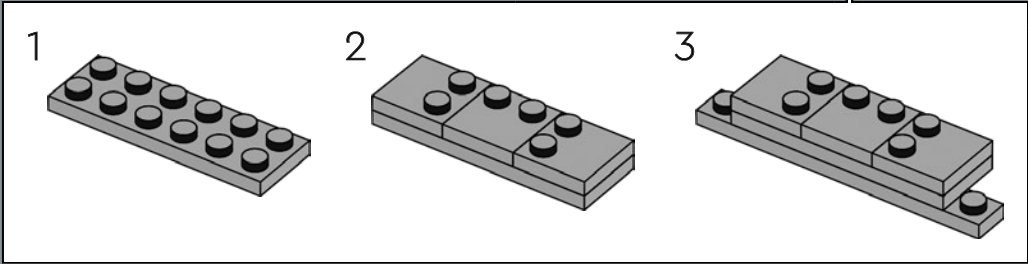
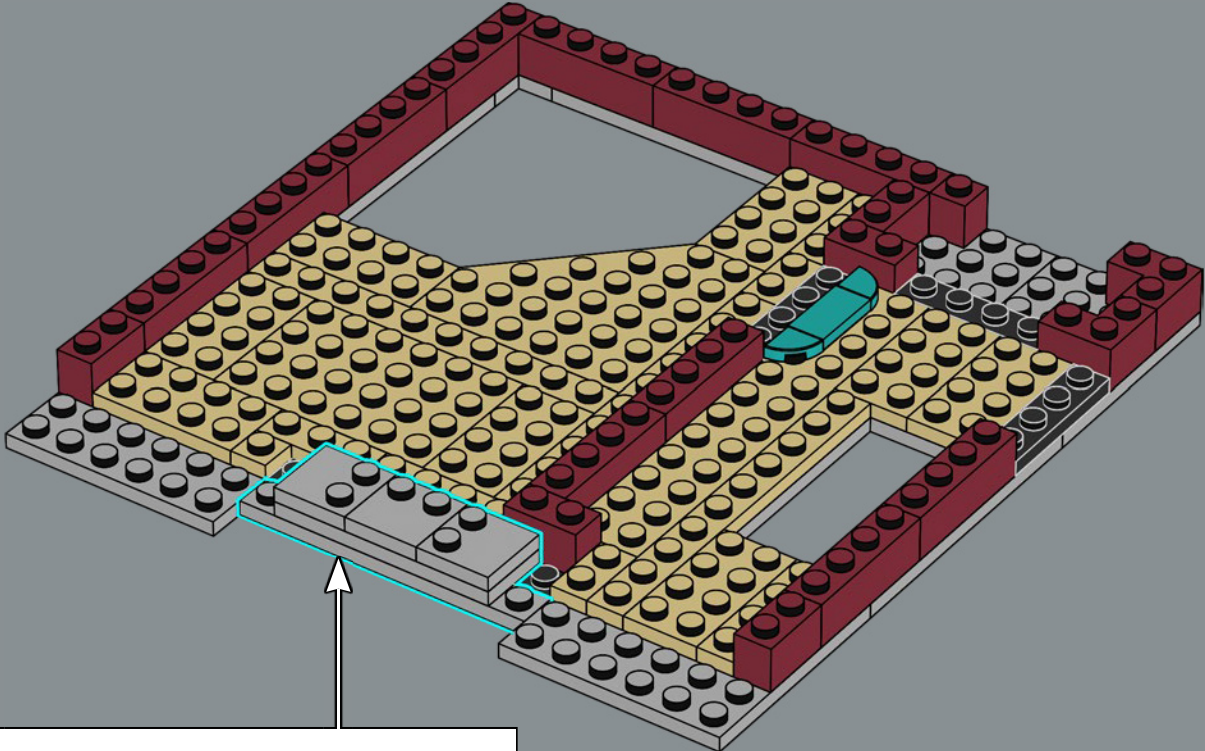

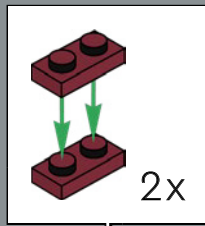
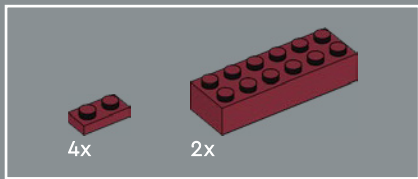

170

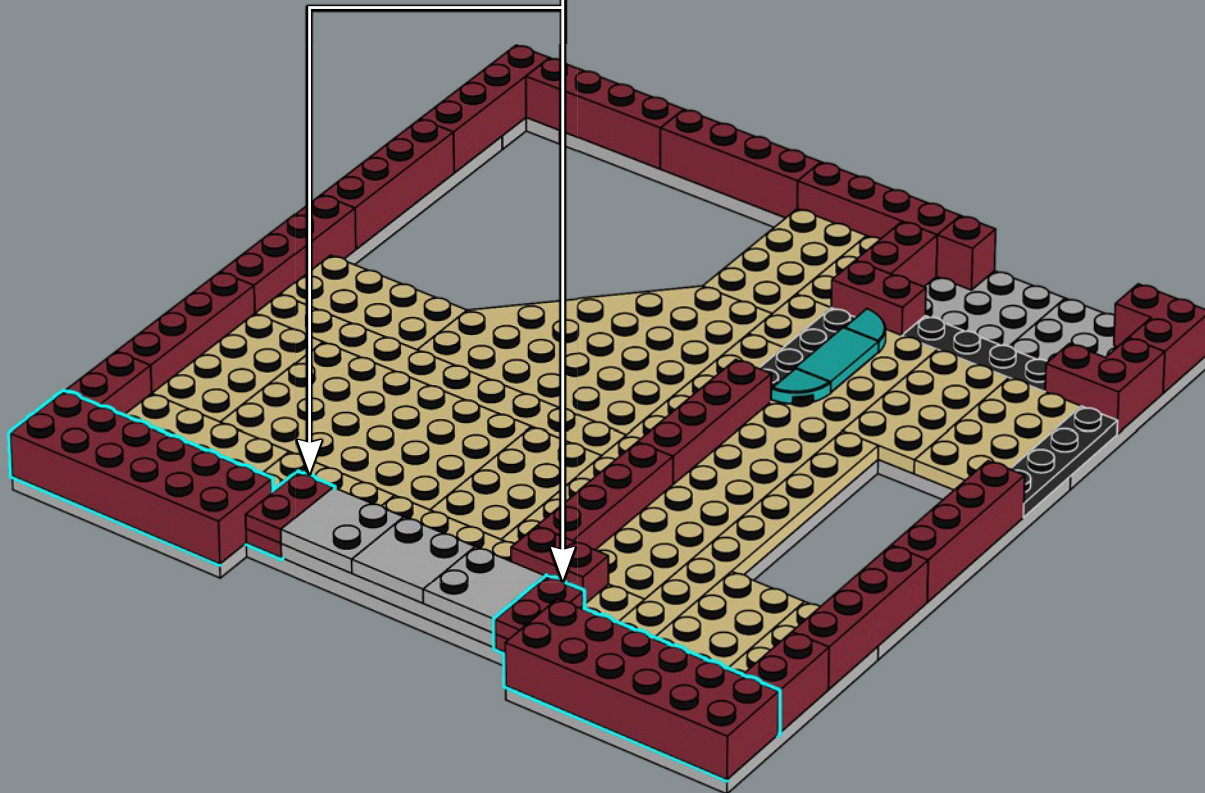



5x



4x

171

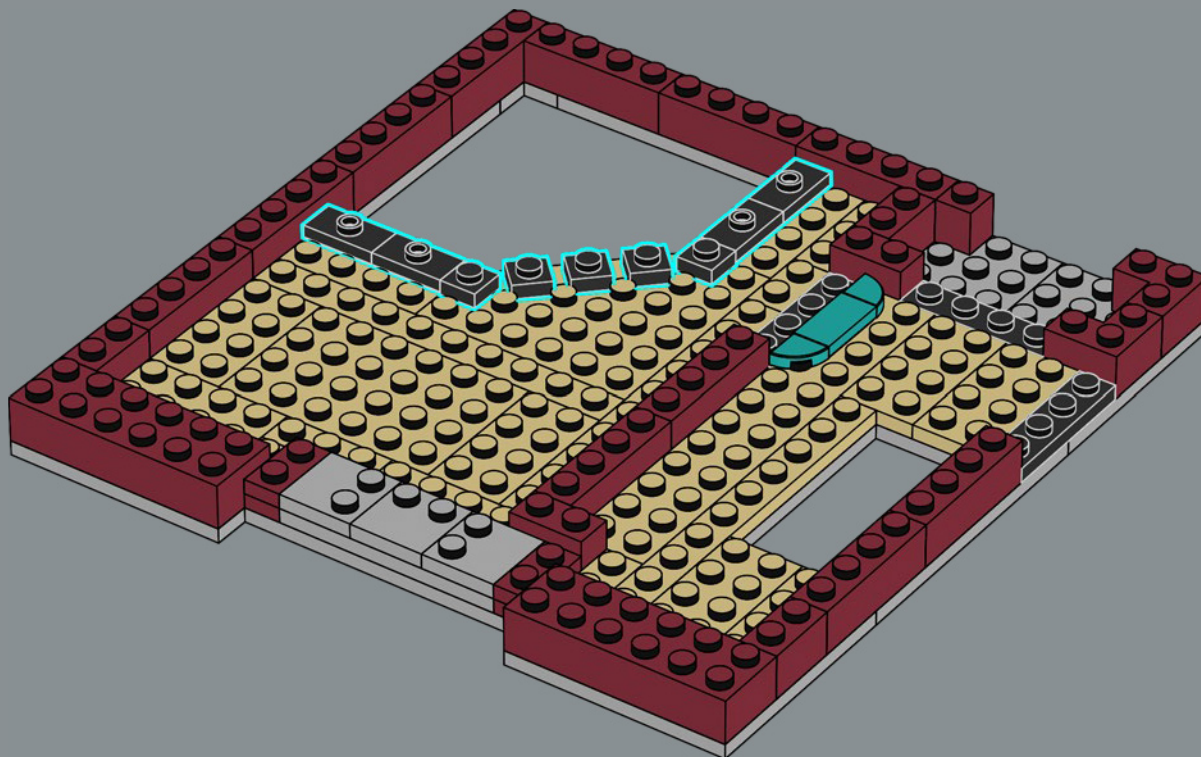

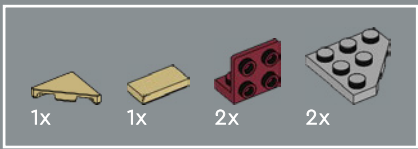

173

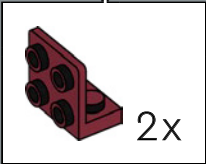
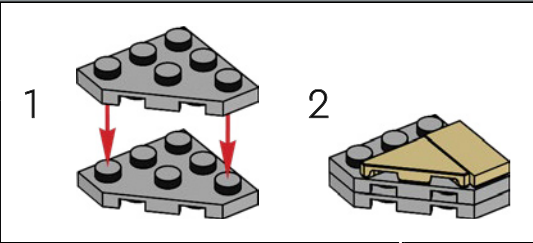
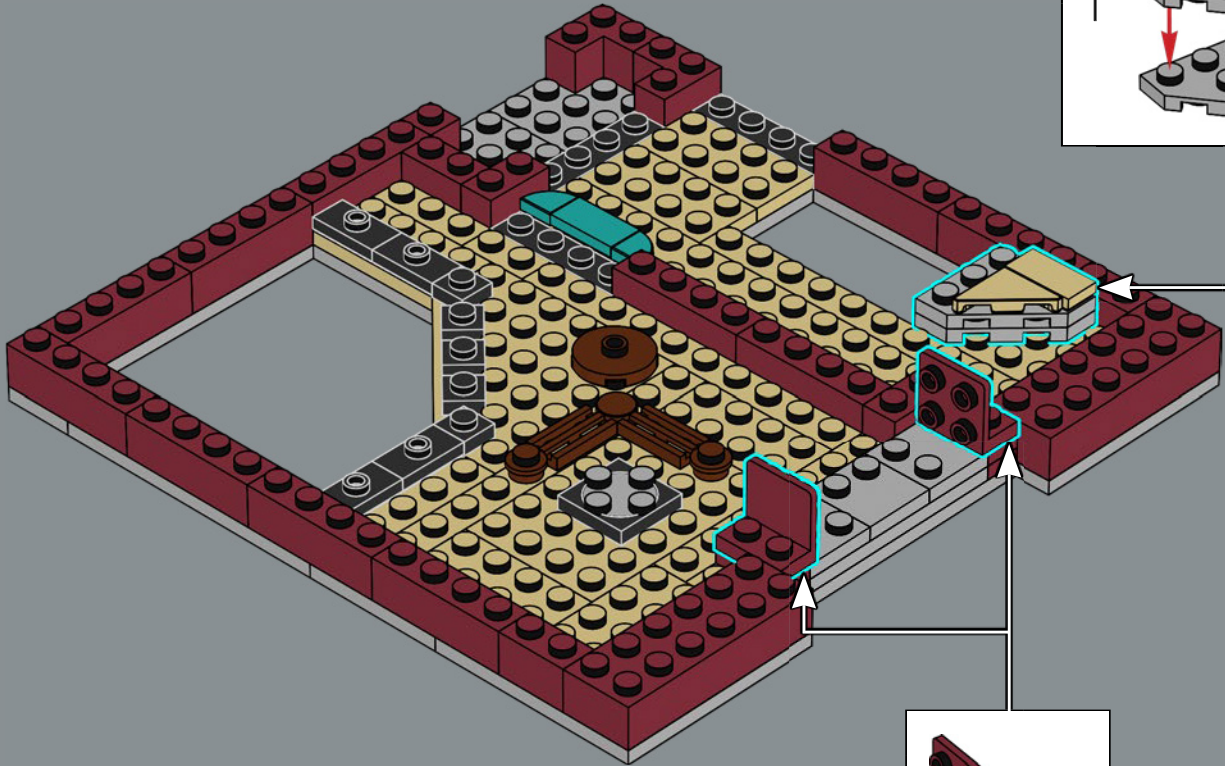

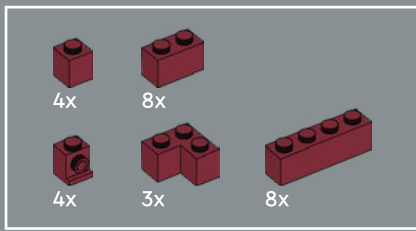

174

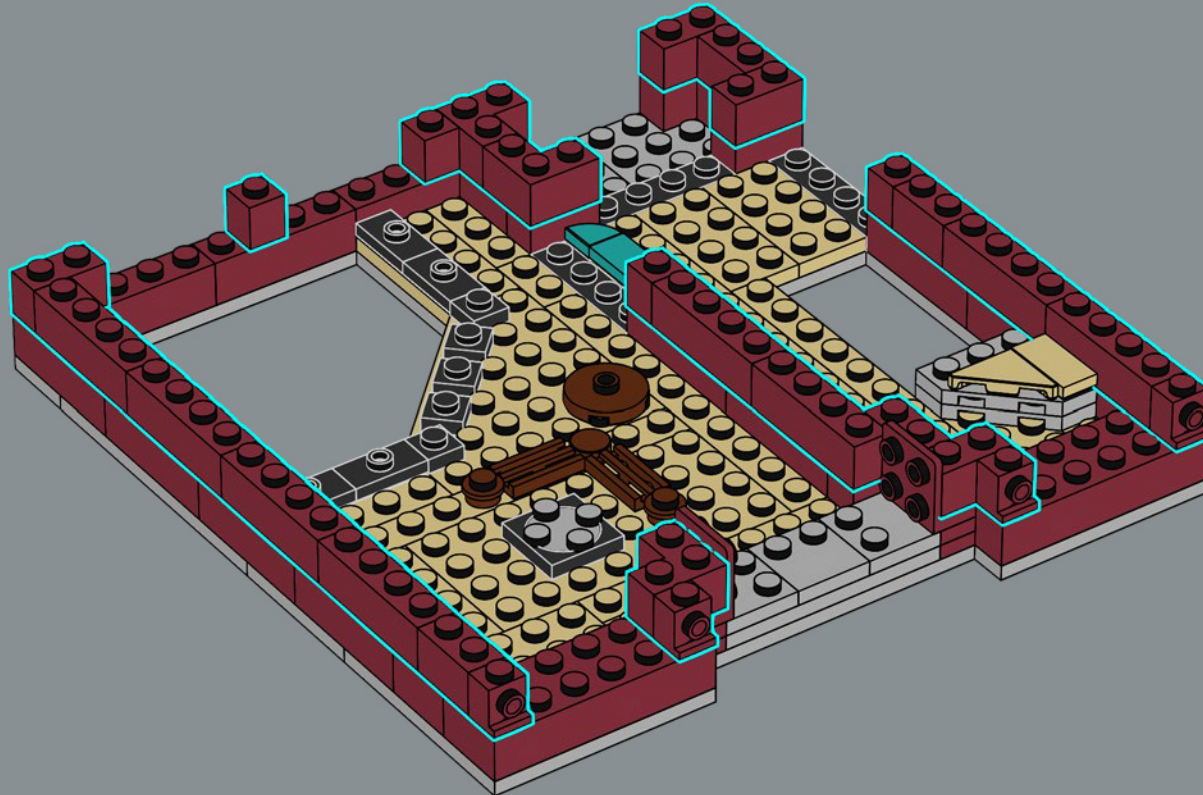

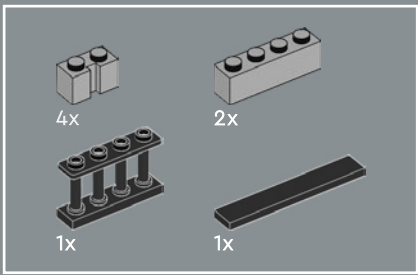

175

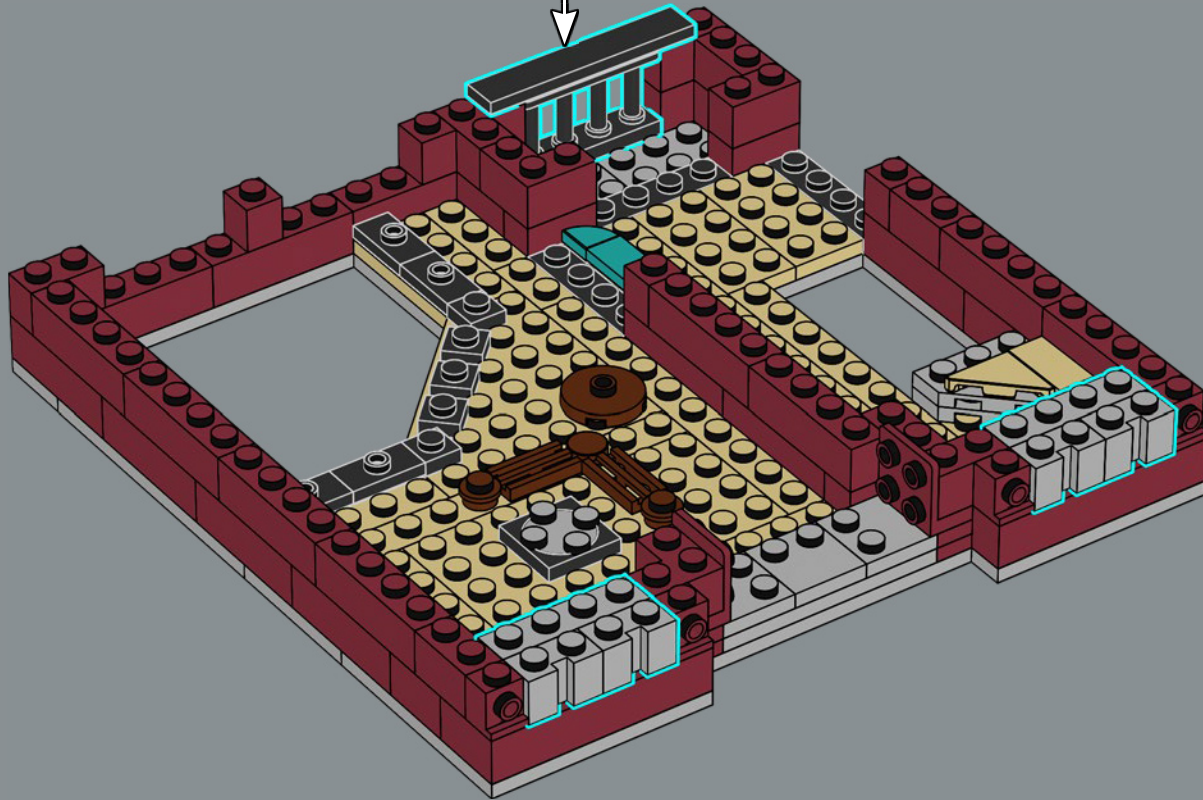
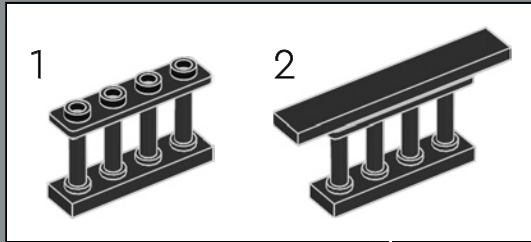

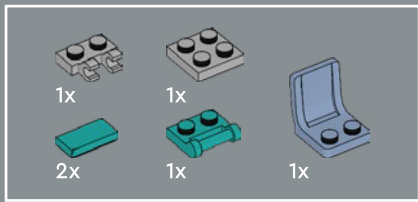

176

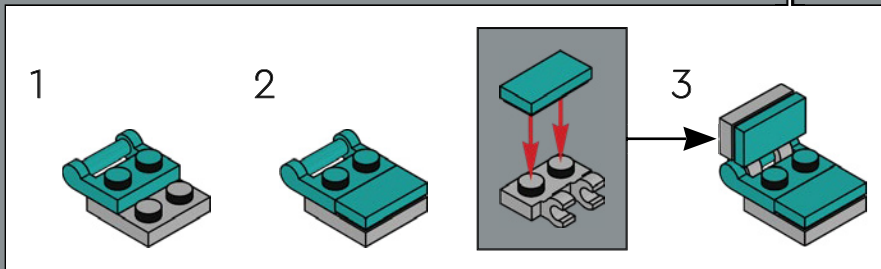
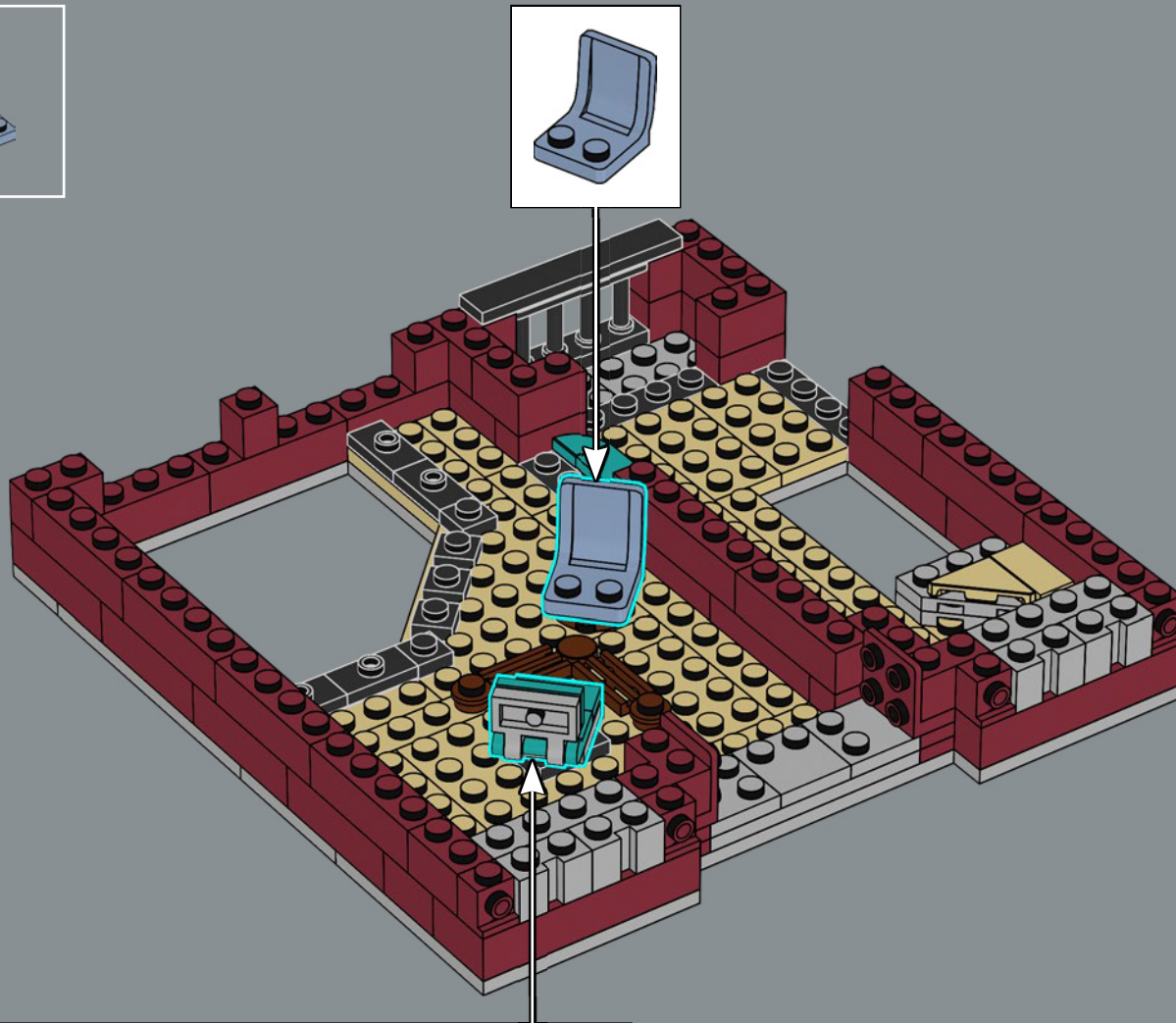



177

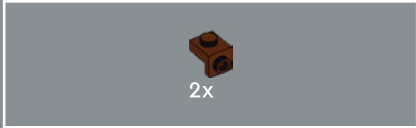
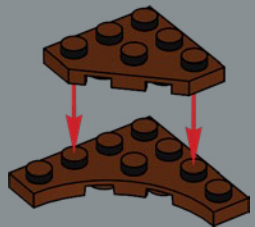

178

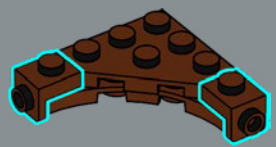

179

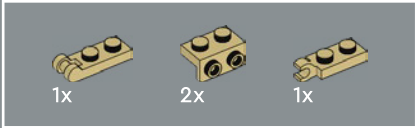
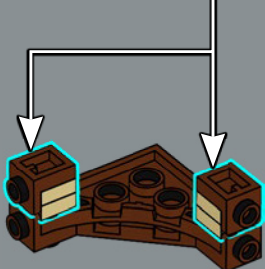
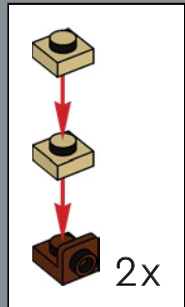

180

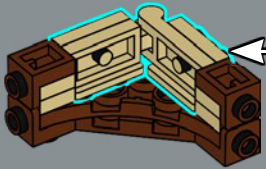
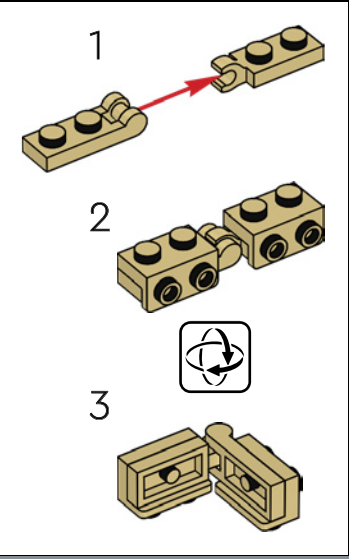

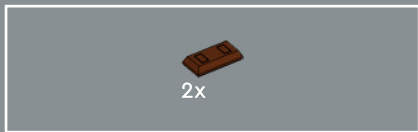

181

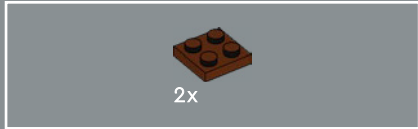
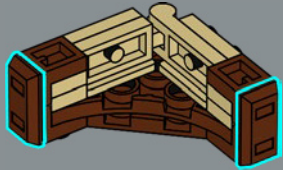

182

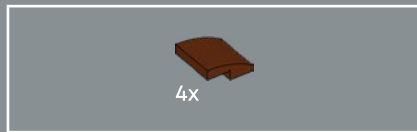
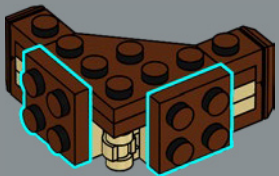

183

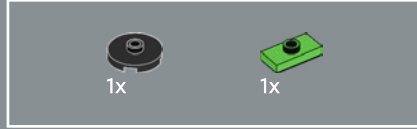
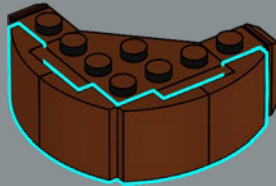

184

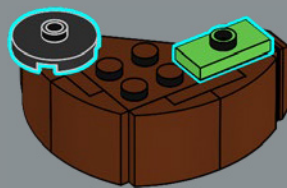

185



La propriétaire du club voulait quelque chose de spécial pour son bureau, elle a donc commandé ce bureau original orienté à 45°.

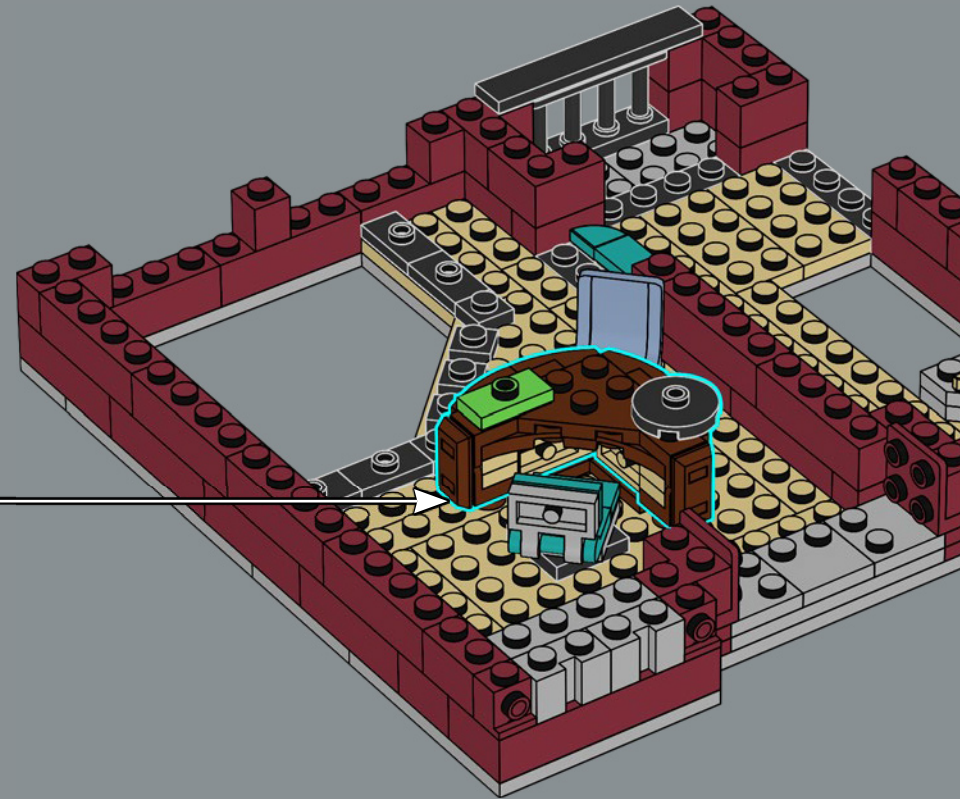

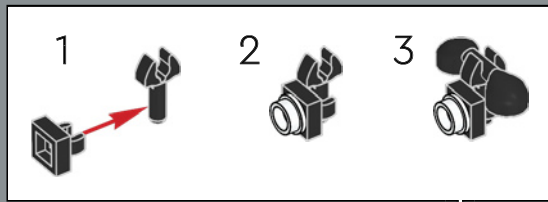

186

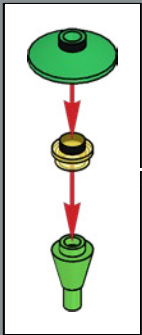
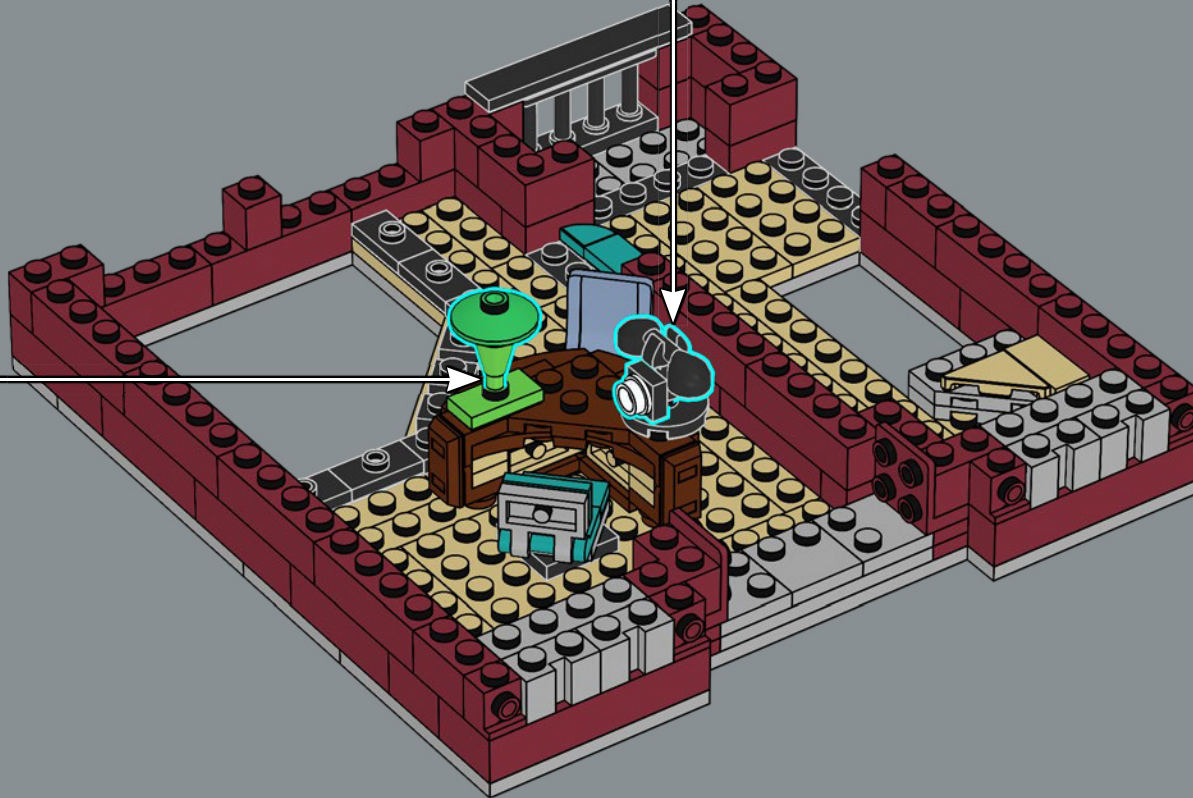



La propriétaire du club aime repérer les artistes émergents et leur donner la possibilité de briller sur scène. Elle a été l'une des premières à reconnaître le talent du saxophoniste de La place de l'assemblée LEGO® 10255.

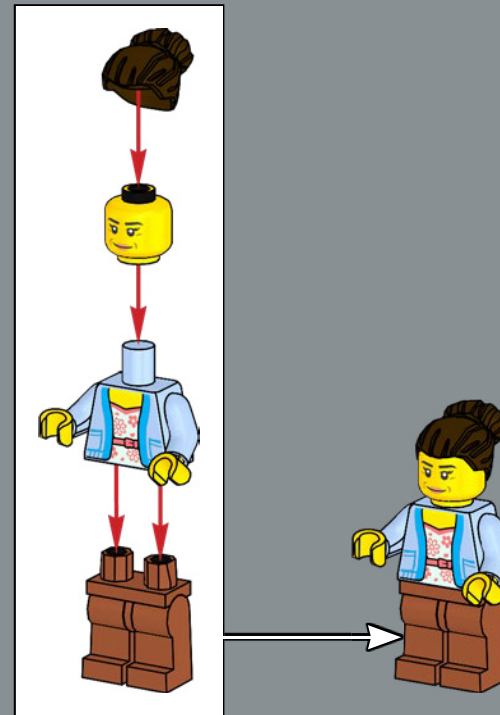



187

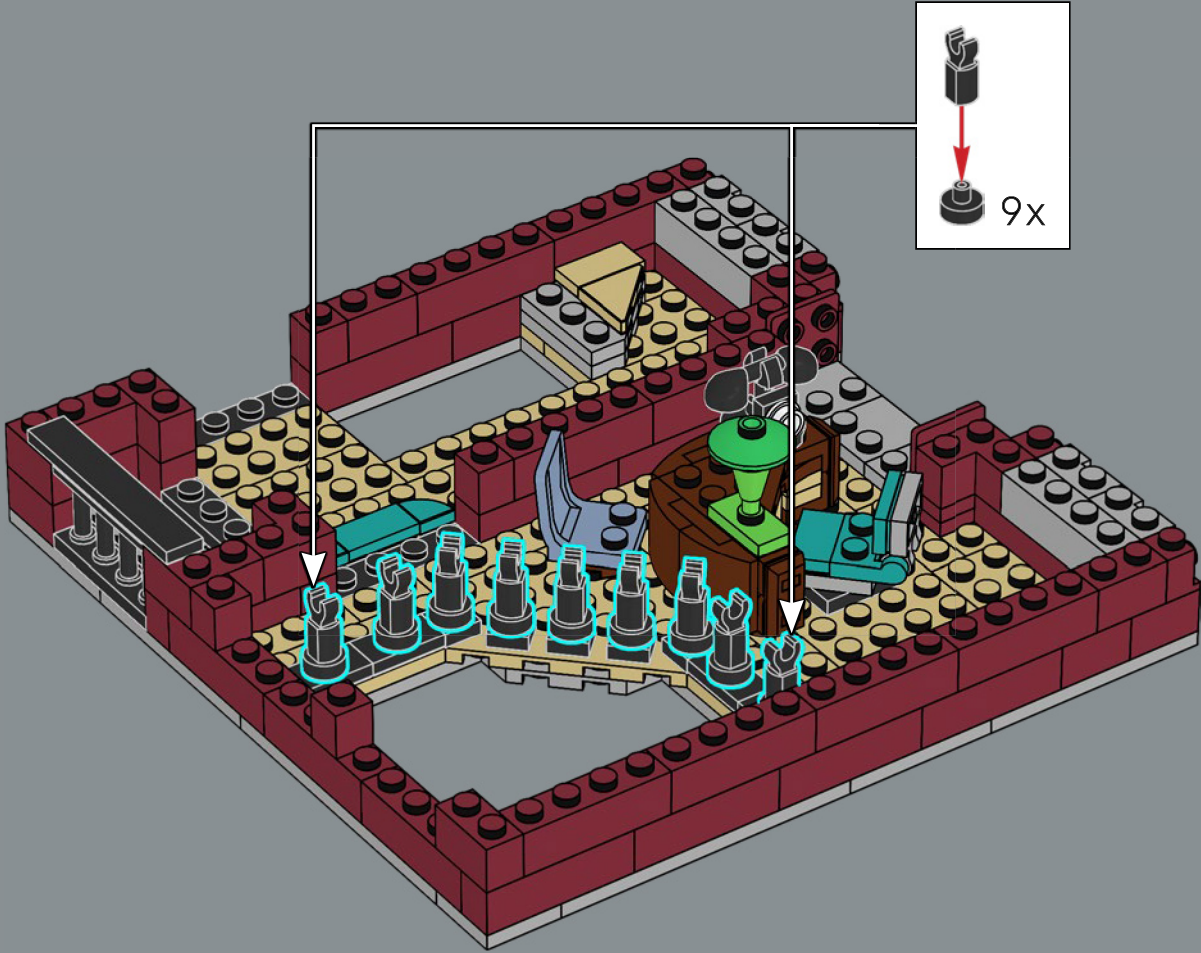



La gérante dispose de son propre balcon privé, d'où elle peut assister aux spectacles de la soirée.

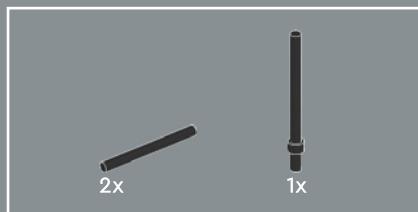

188

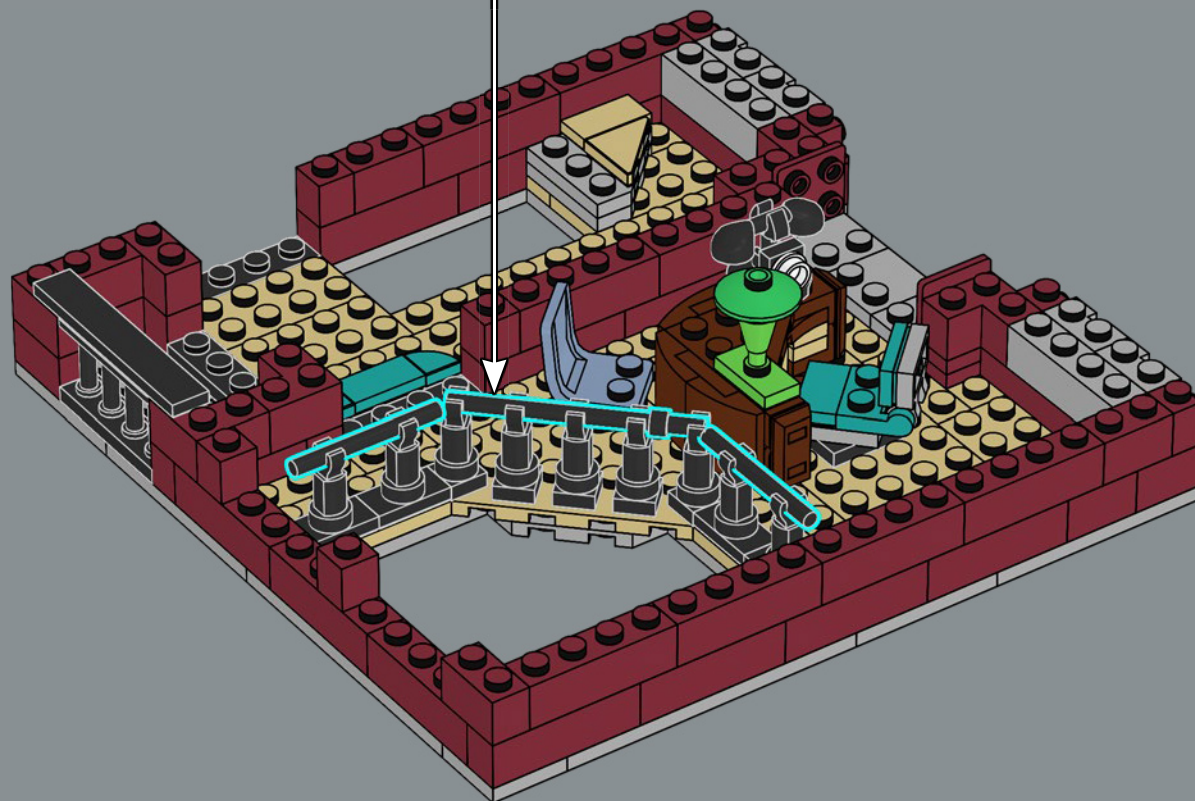

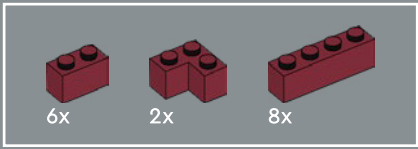

189

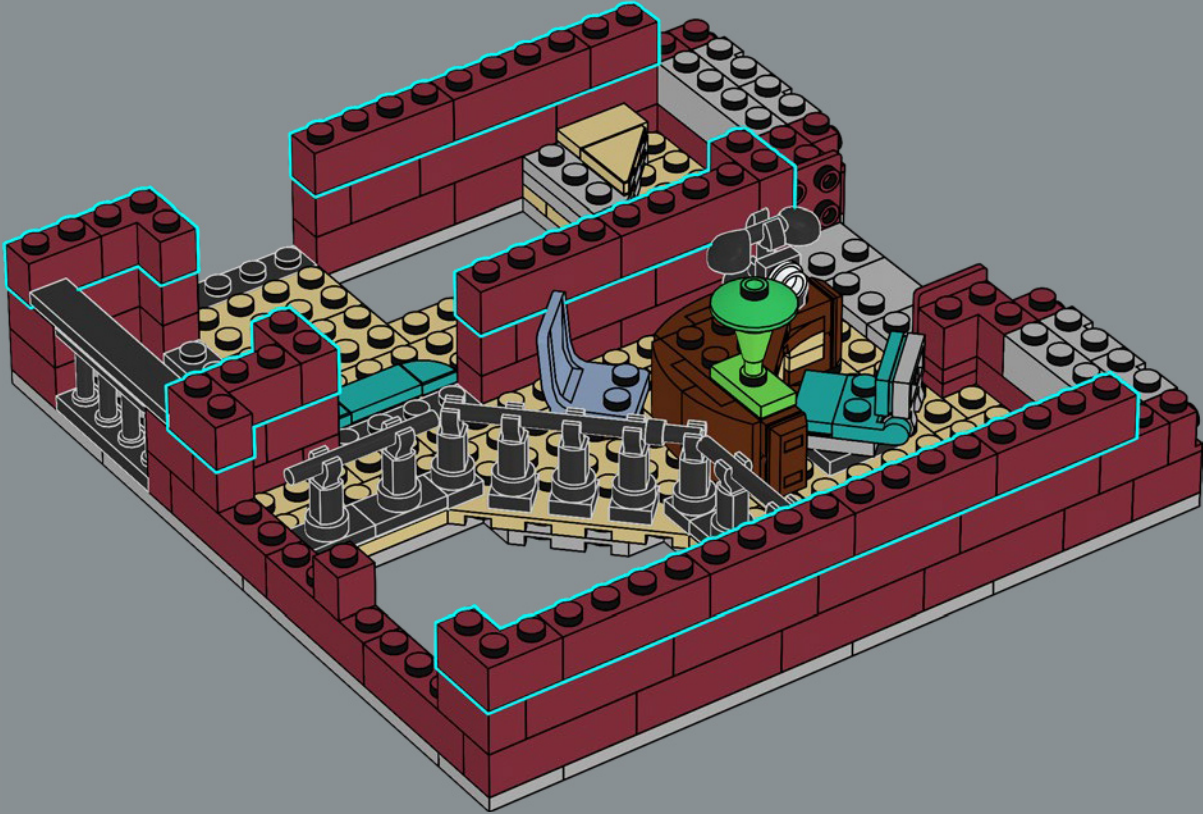

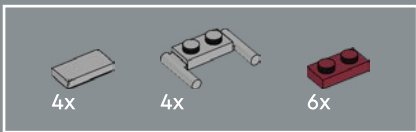

190

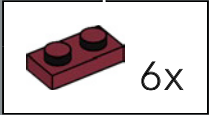
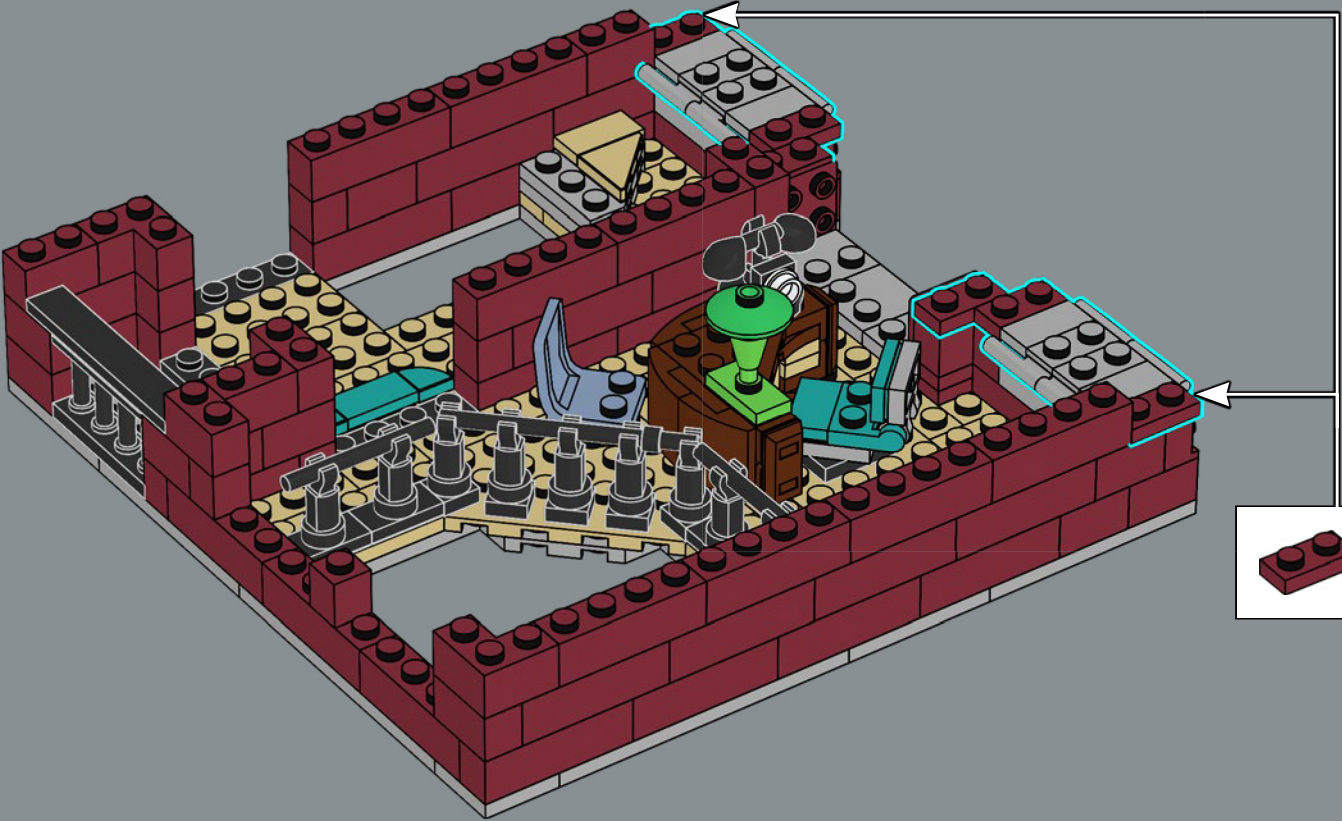

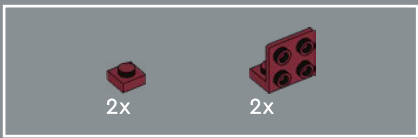

191

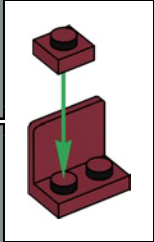
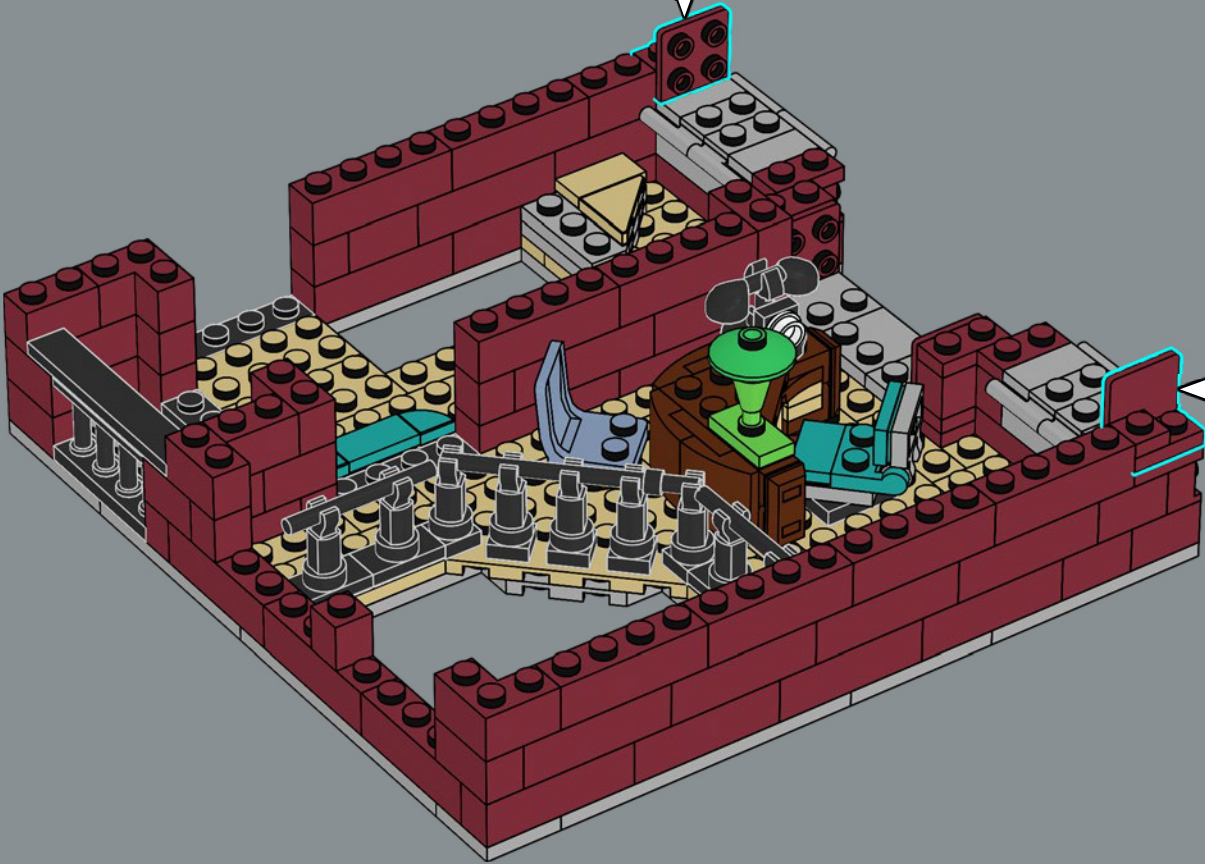
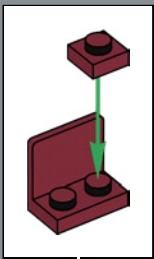



192

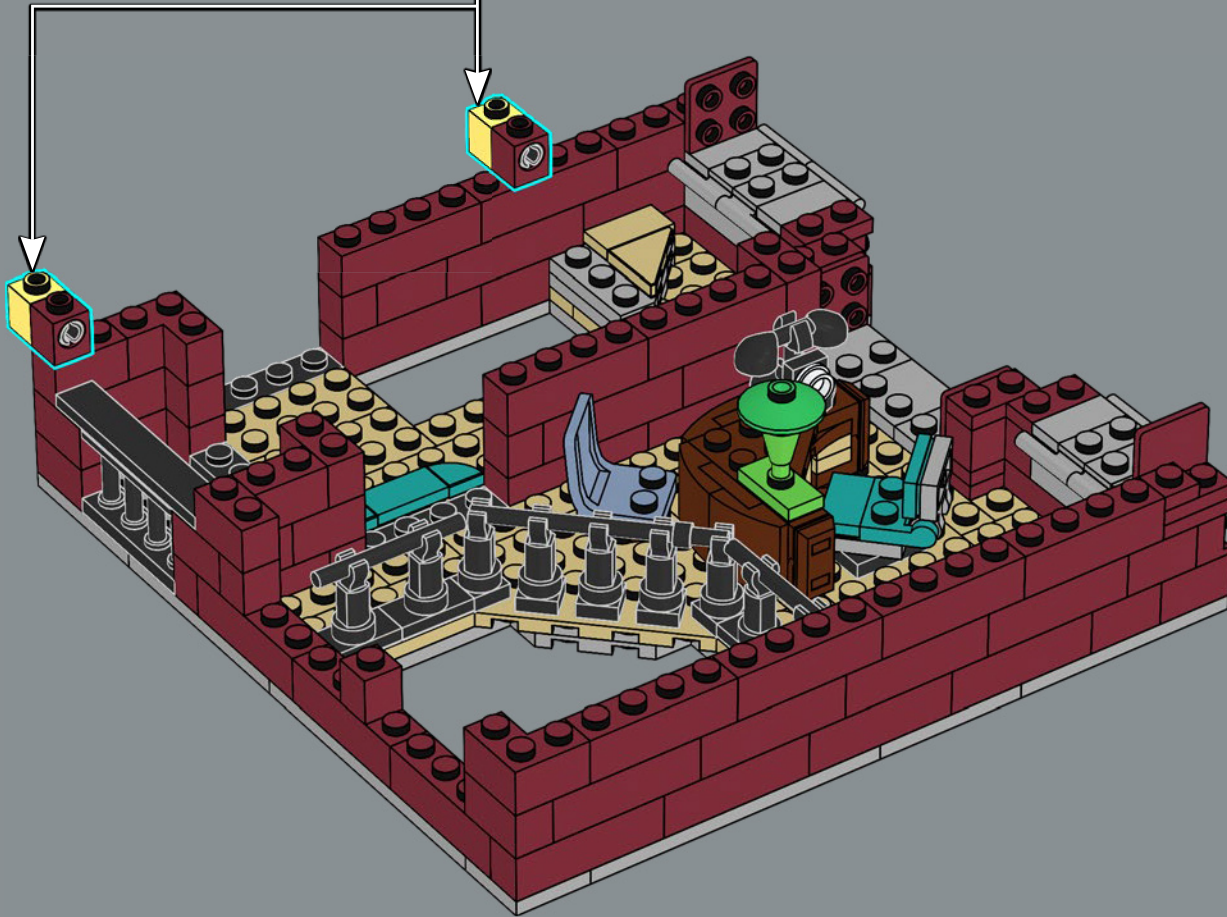
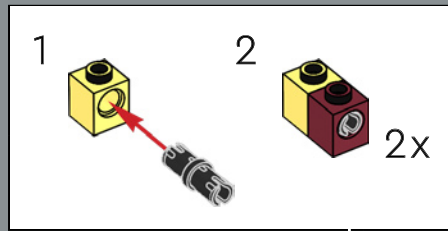

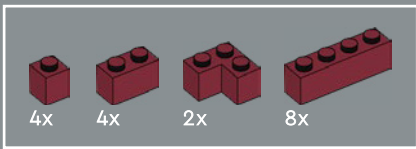

193

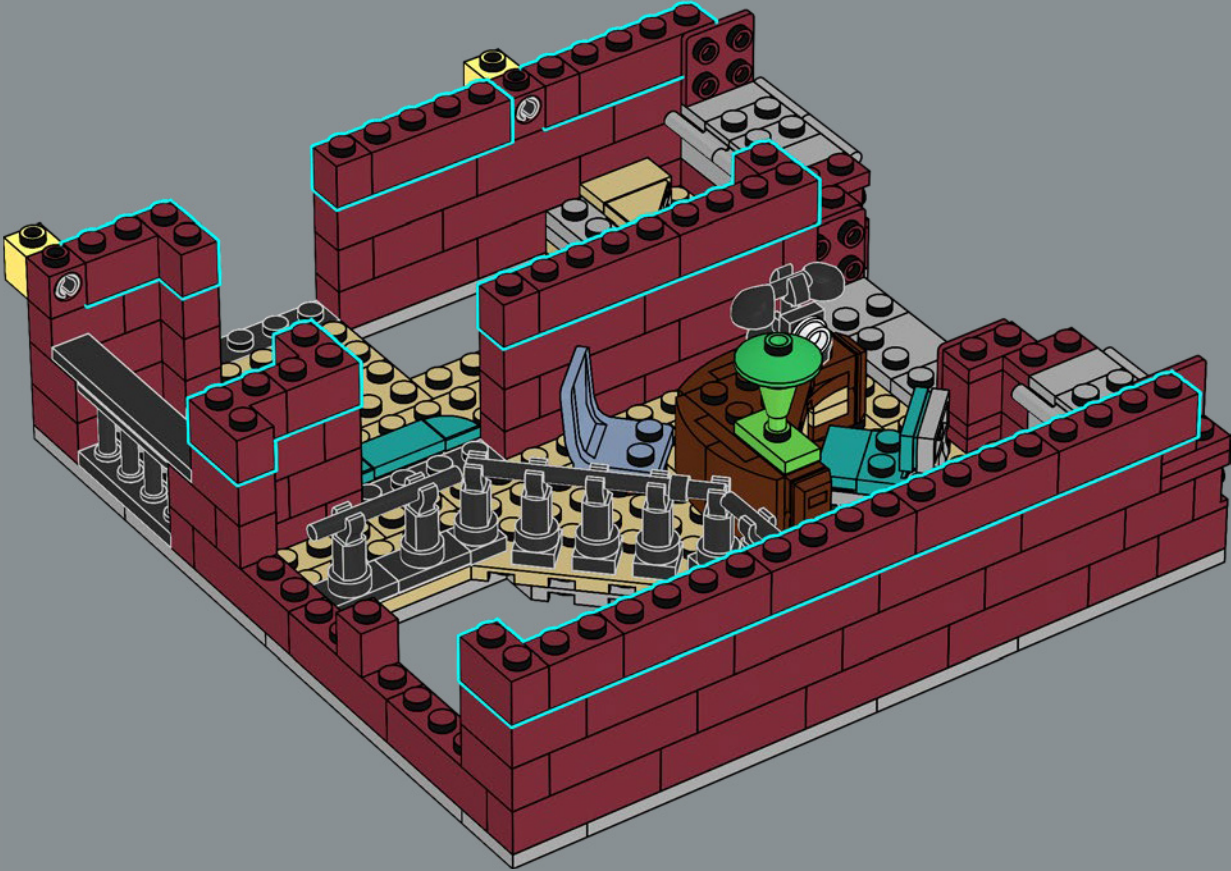

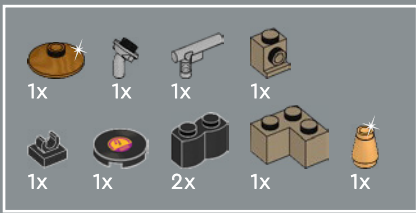

194

1

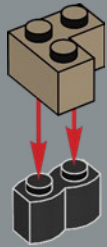

2

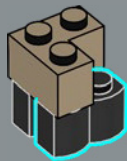

3

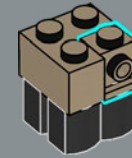

4



5

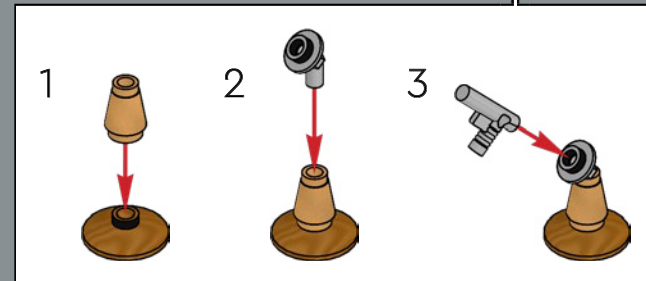



La propriétaire du club aime écouter de la musique live, mais aussi les tubes en vogue sur sa platine. En ce moment, elle aime particulièrement le nouvel album en tête du hit-parade de la star du rock du dîner au centre-ville LEGO® 10260.

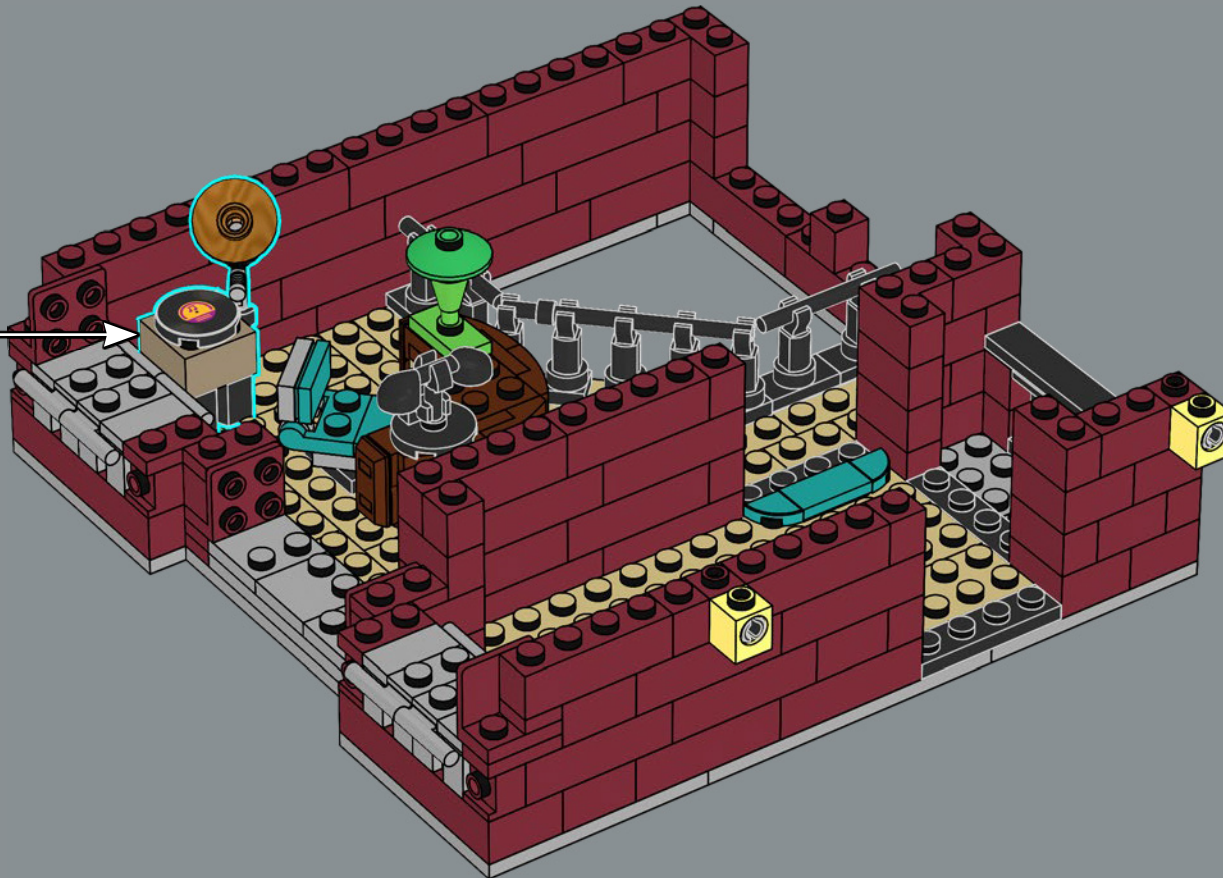

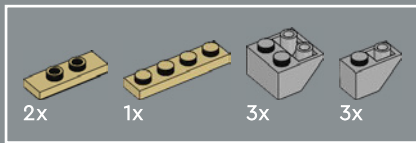

195

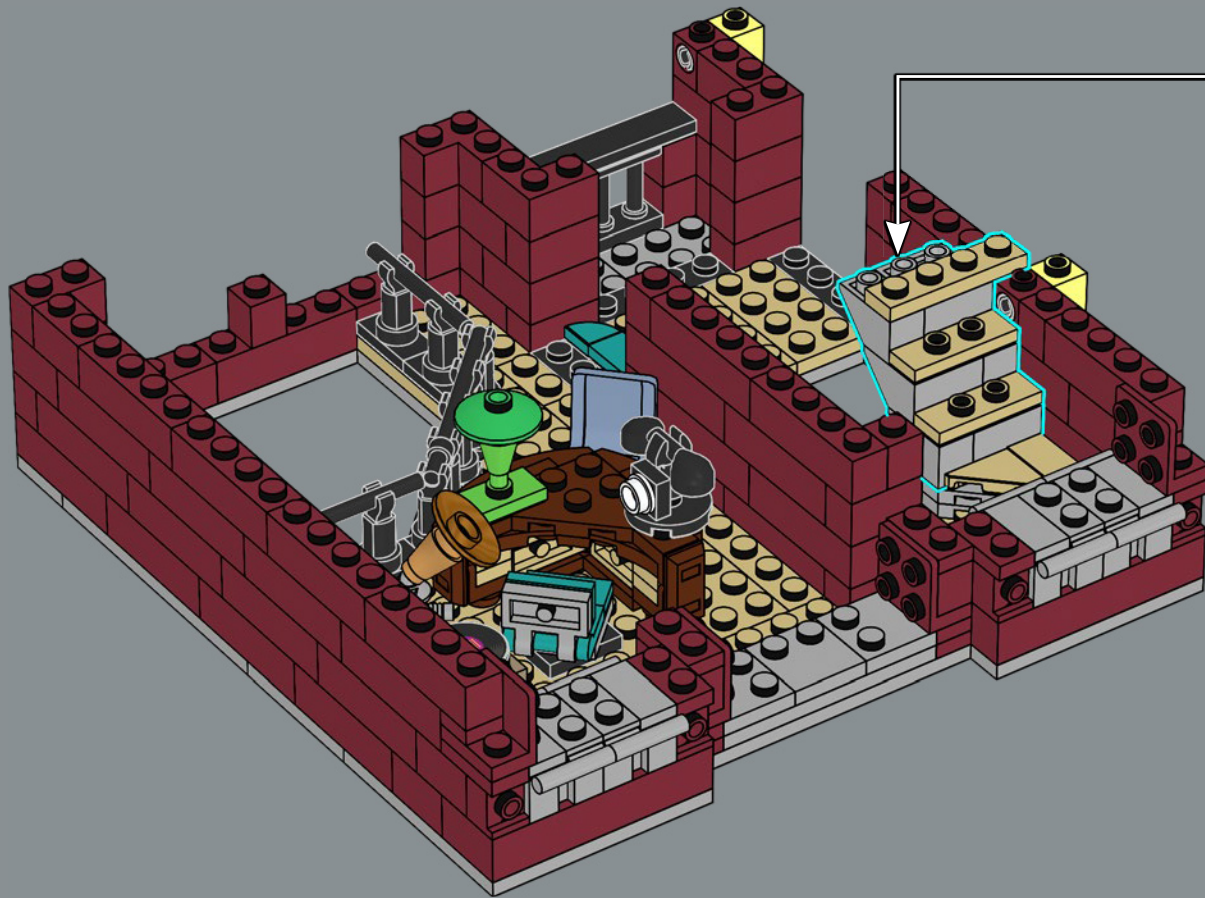
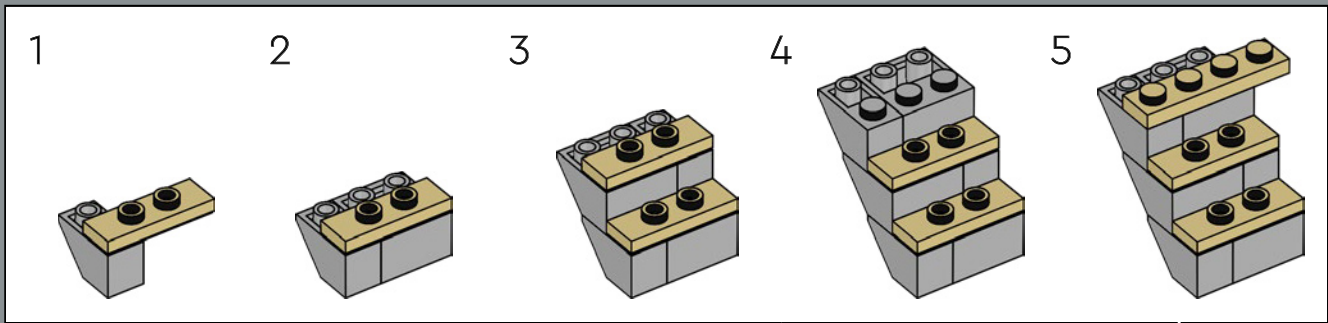



4x

196

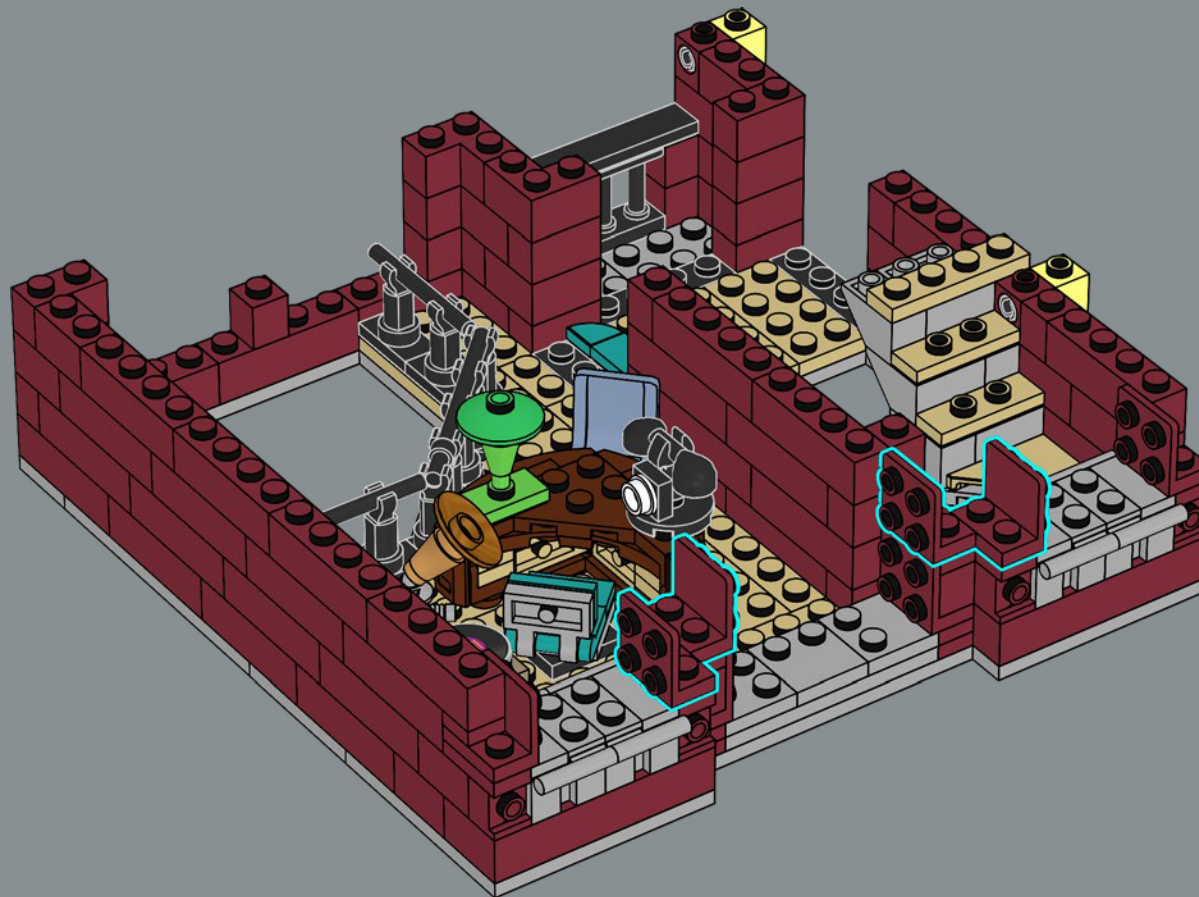

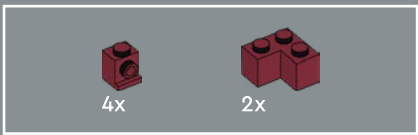

197

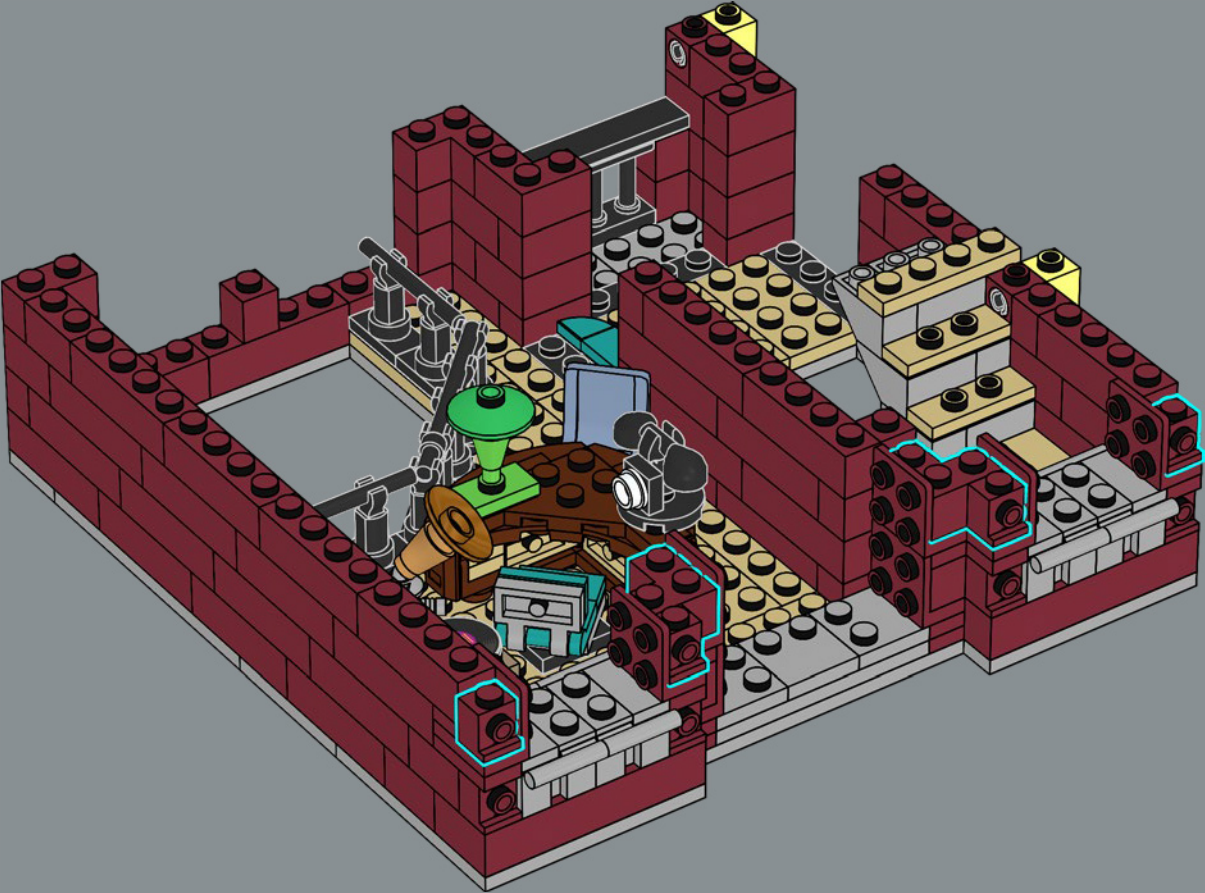



198

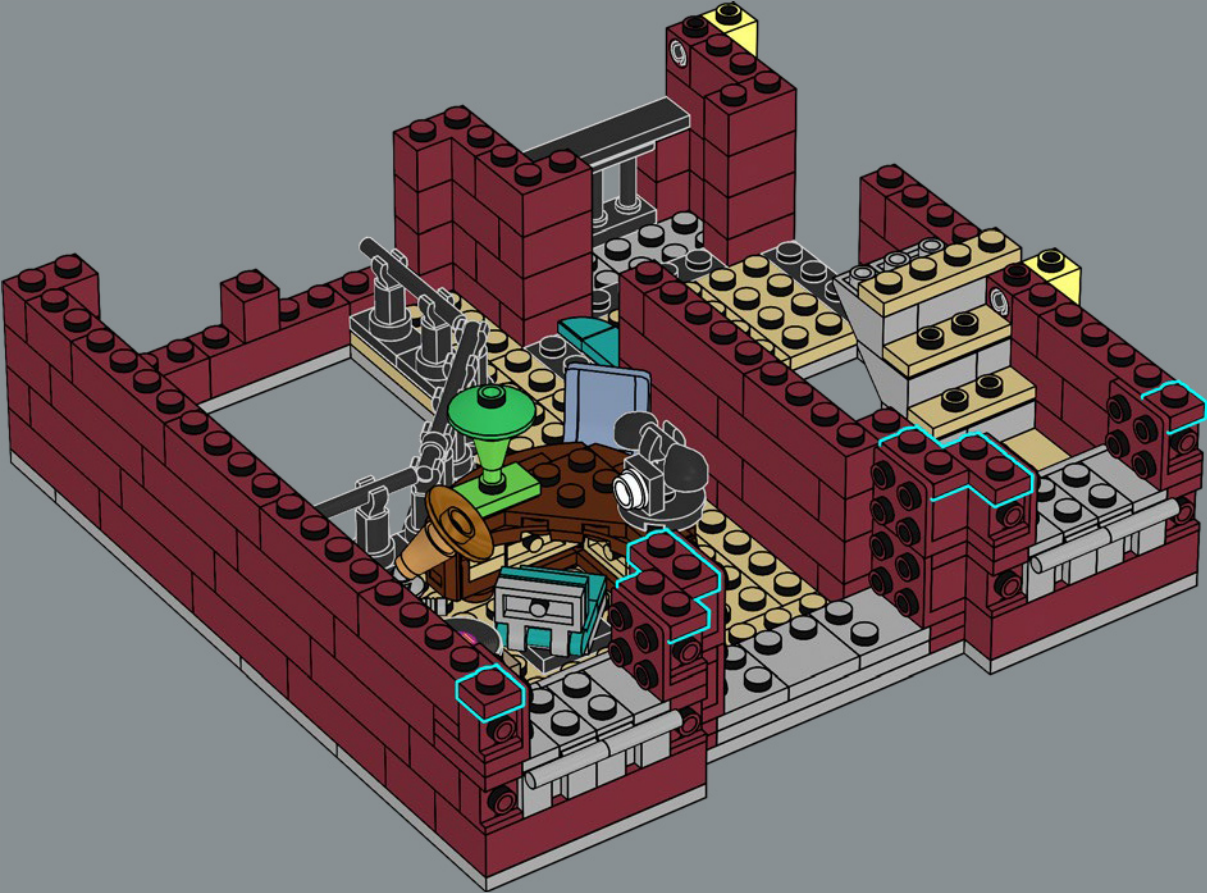

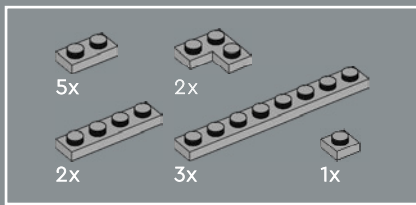

199

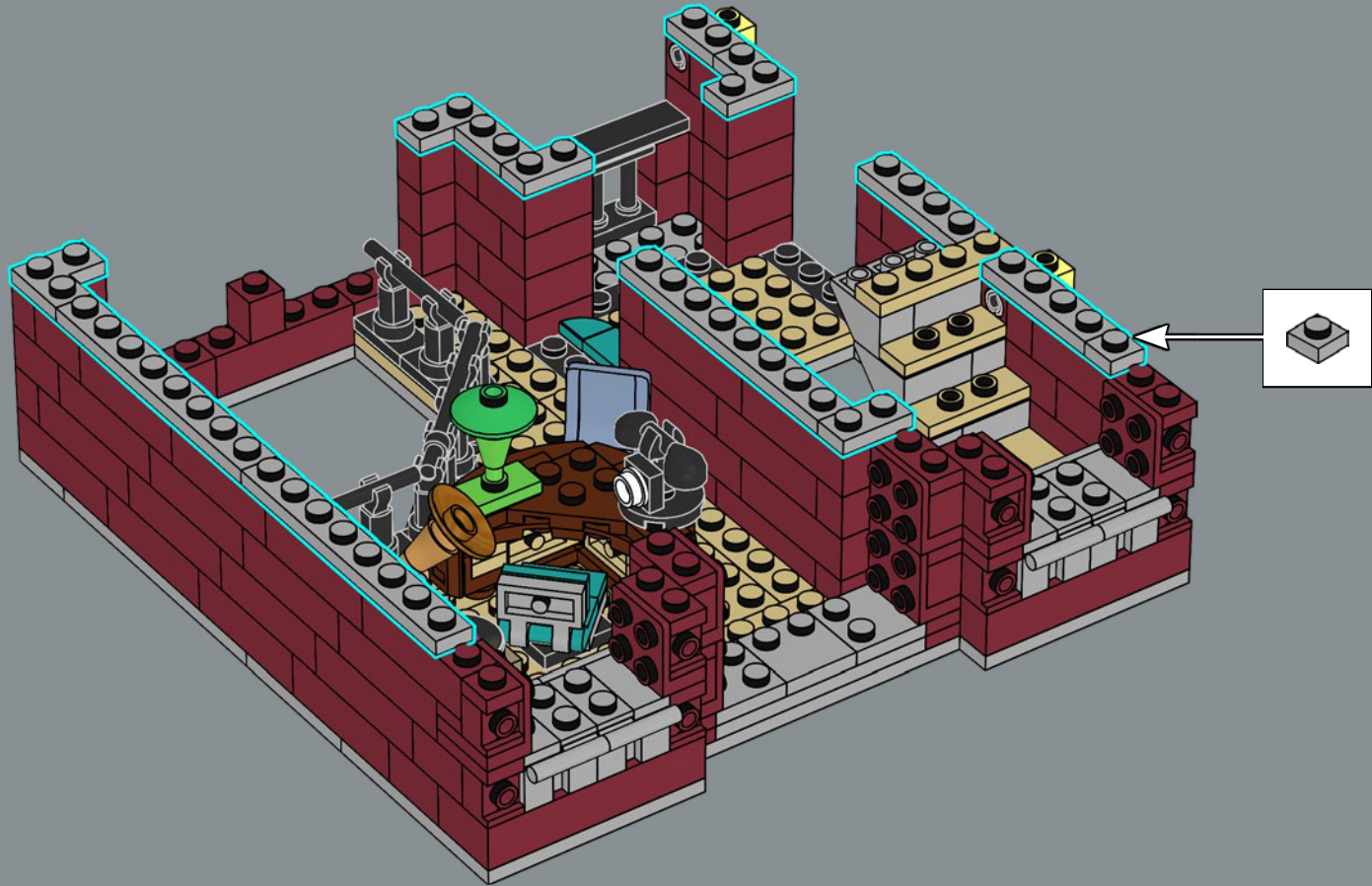



6x

200

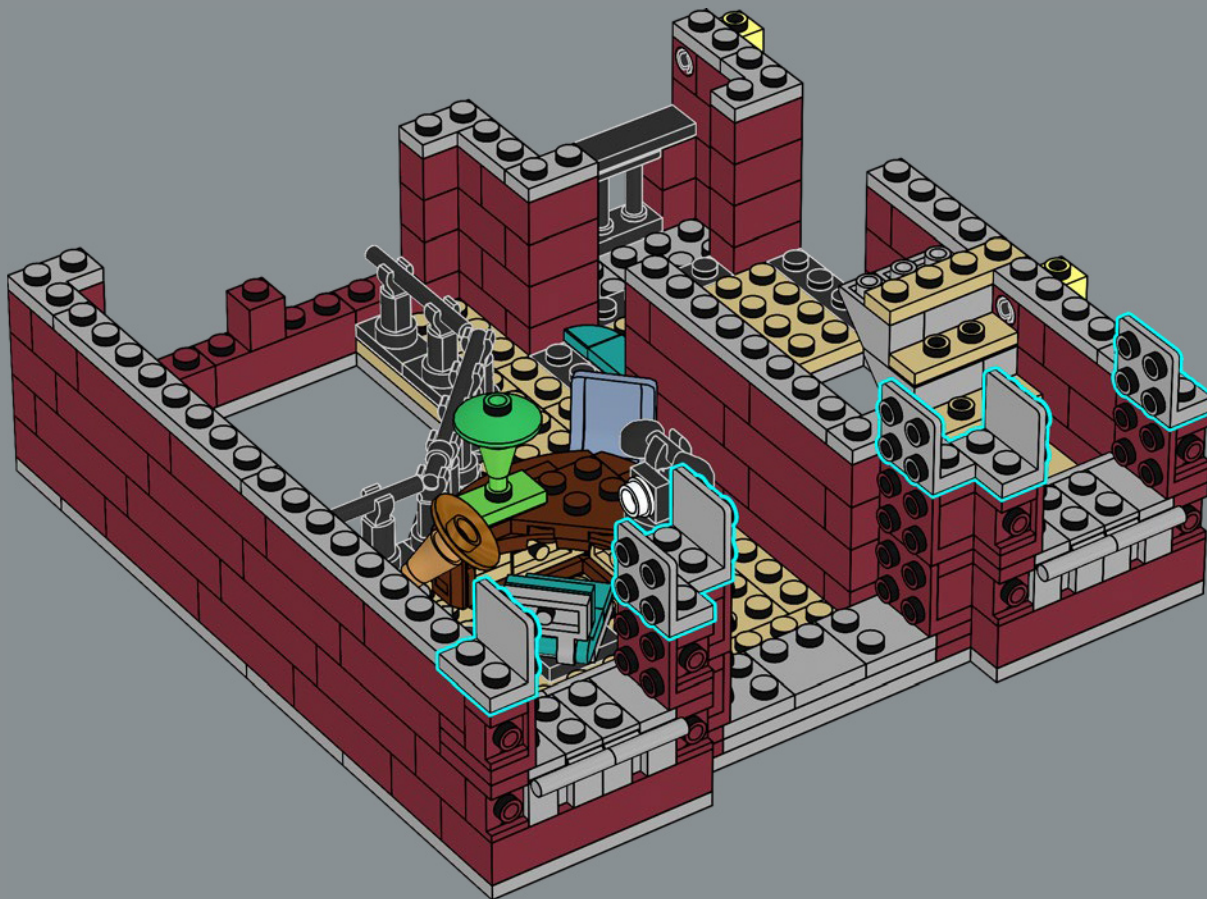

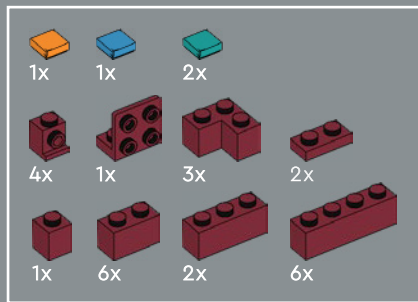

201

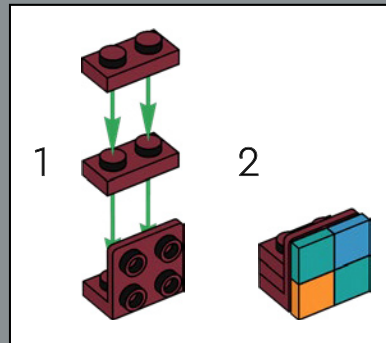

1

2

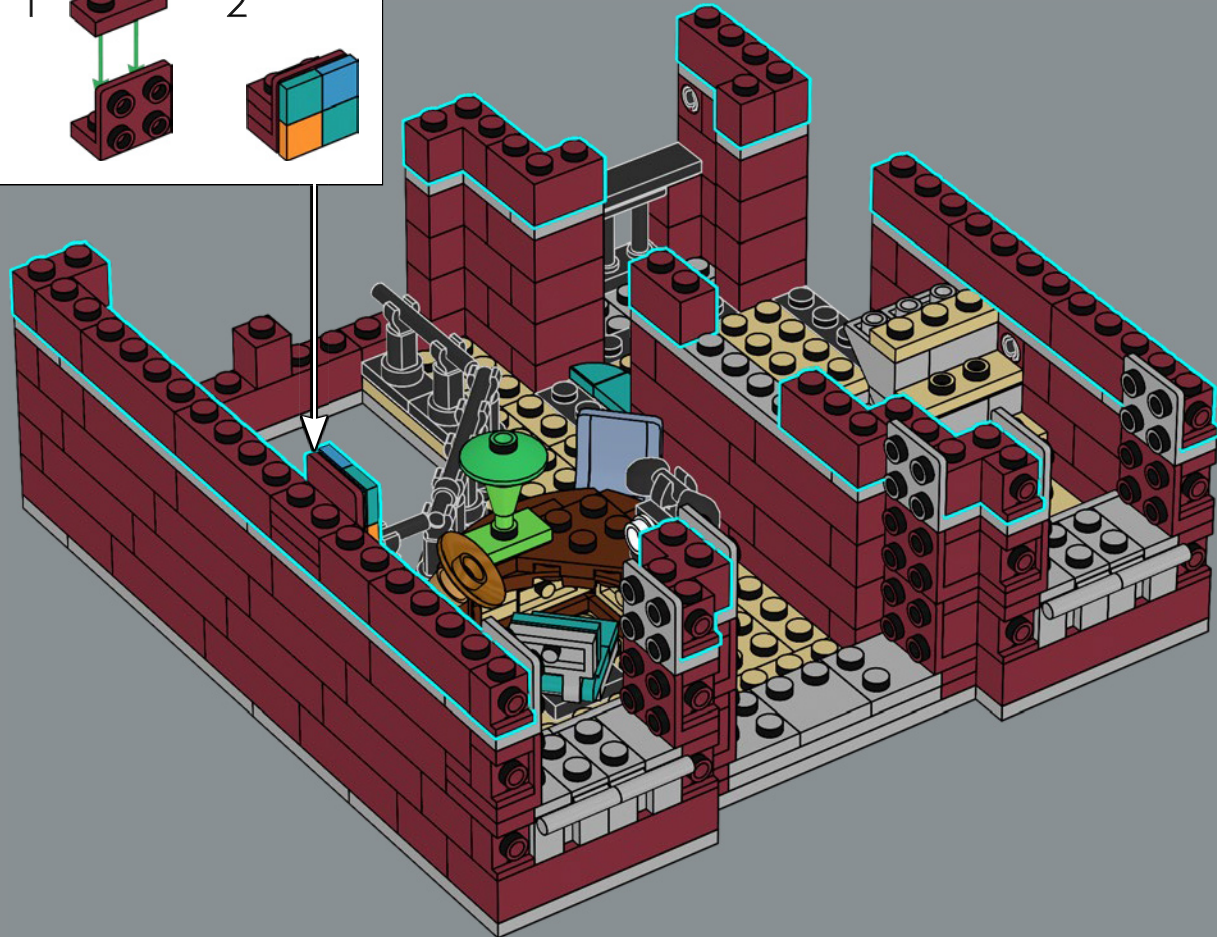

Le tableau qui se trouve dans le bureau est une œuvre de l'artiste qui habite dans le loft situé au-dessus du restaurant parisien LEGO® 10243.



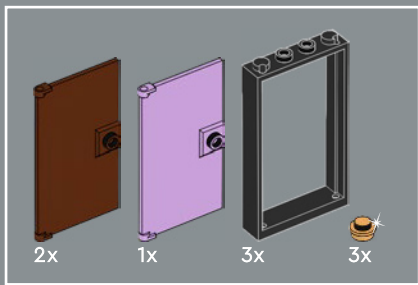

202

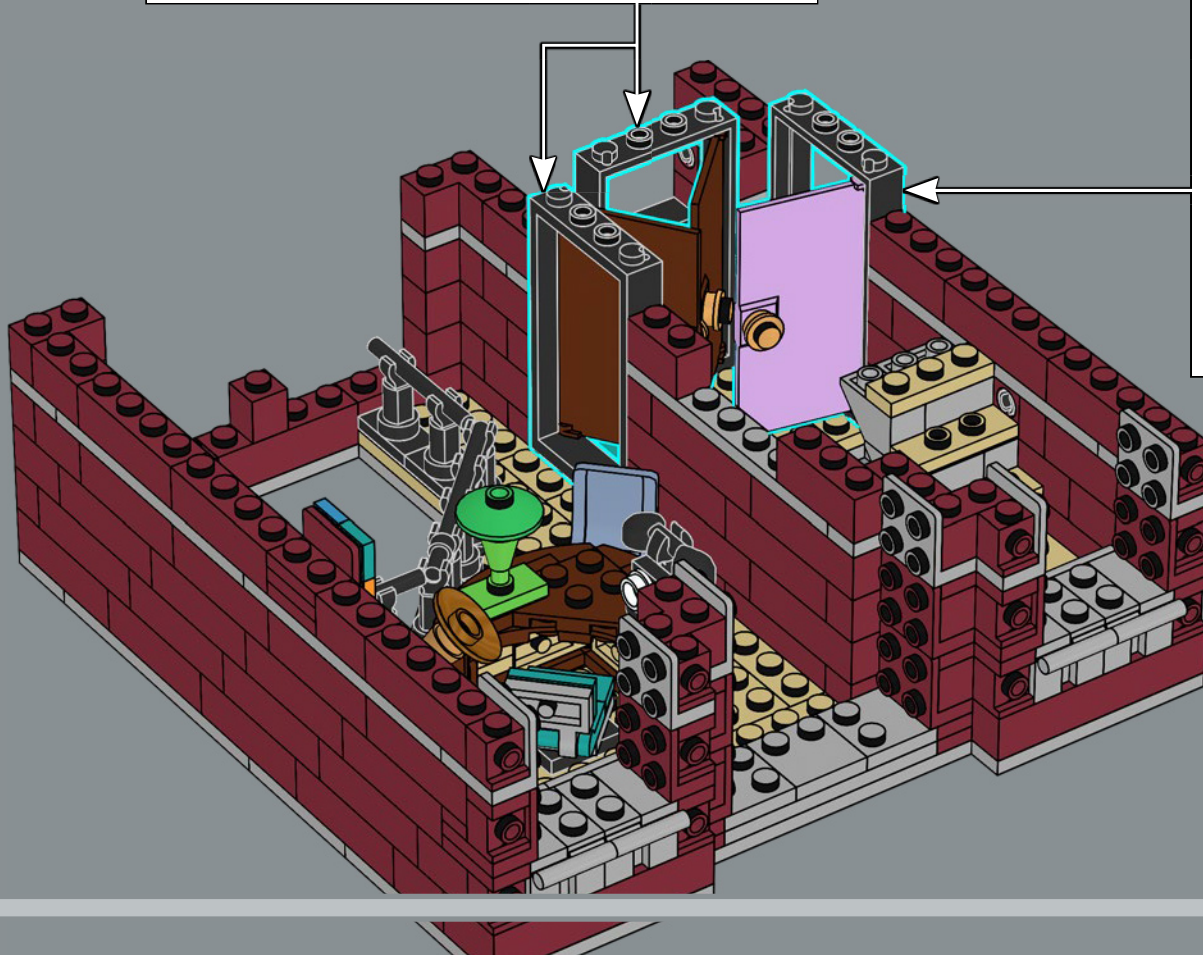
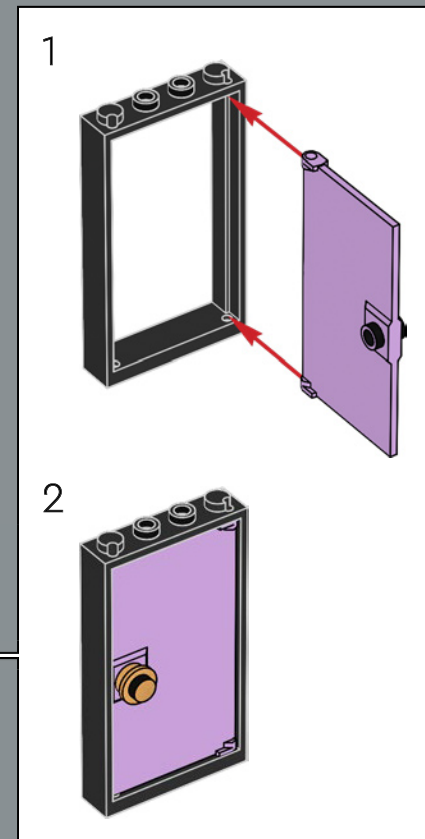
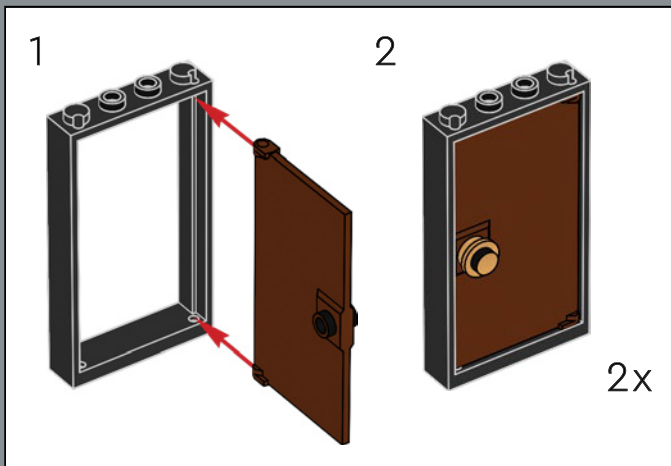

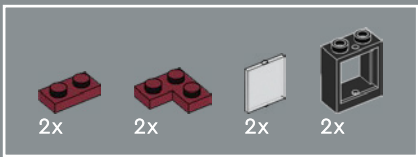

203

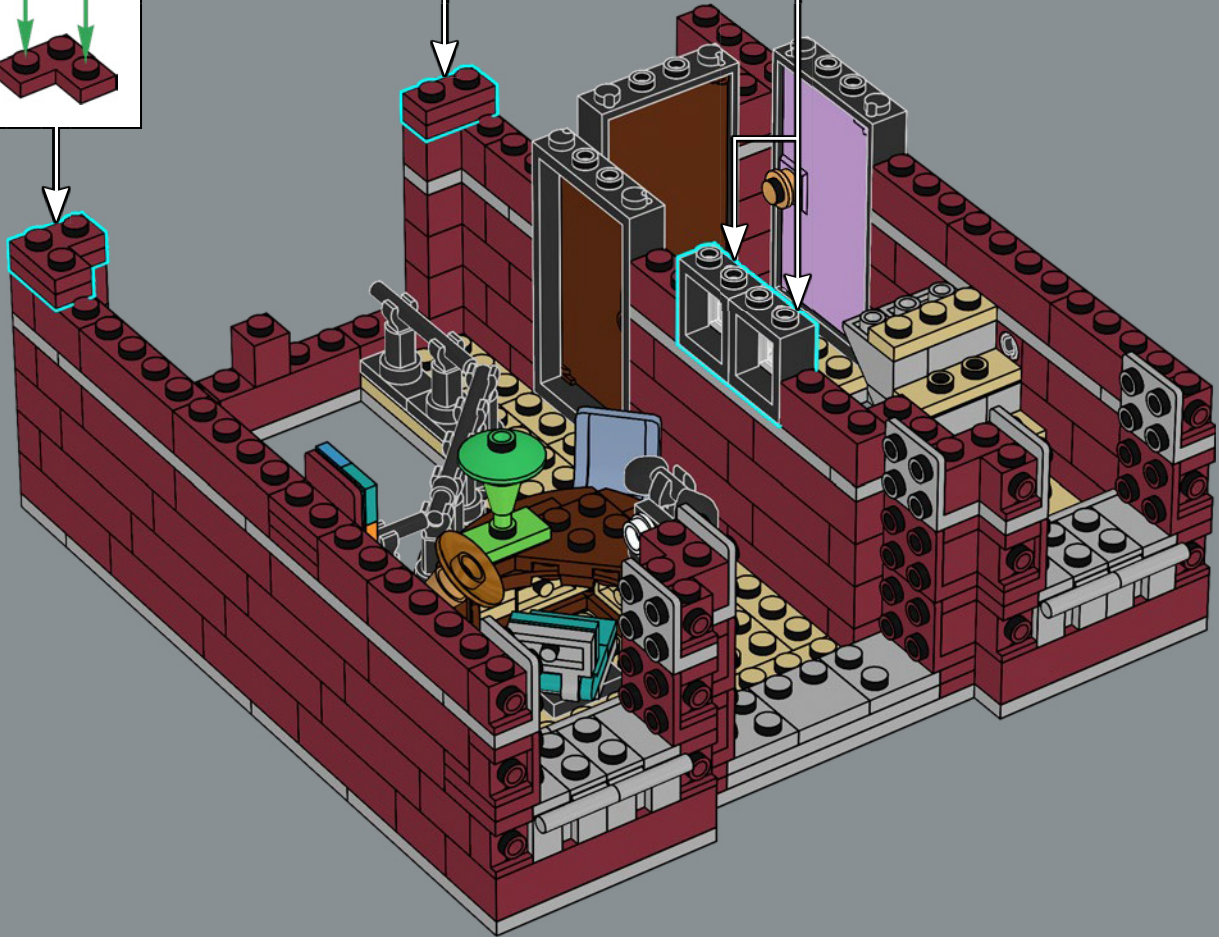
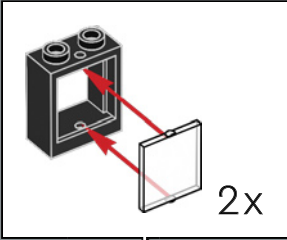
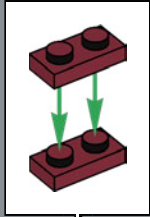
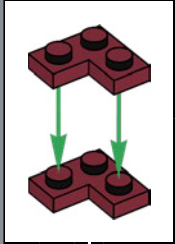

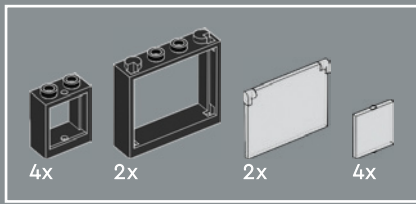

204

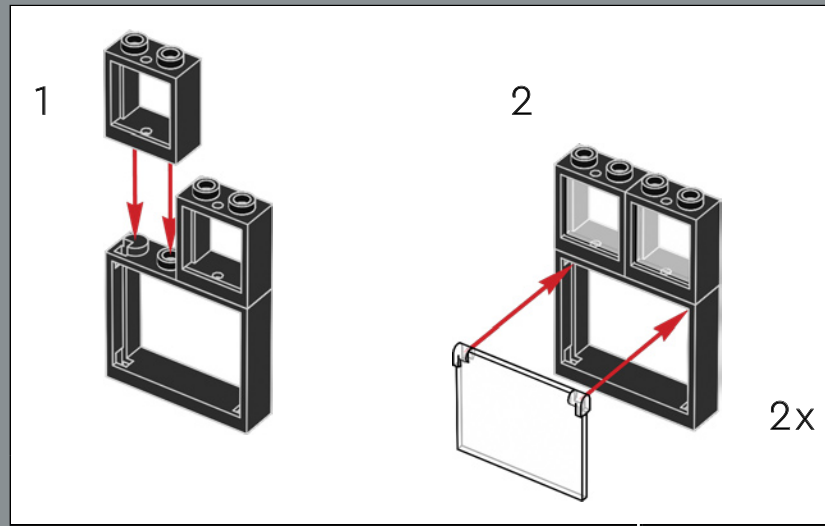



205

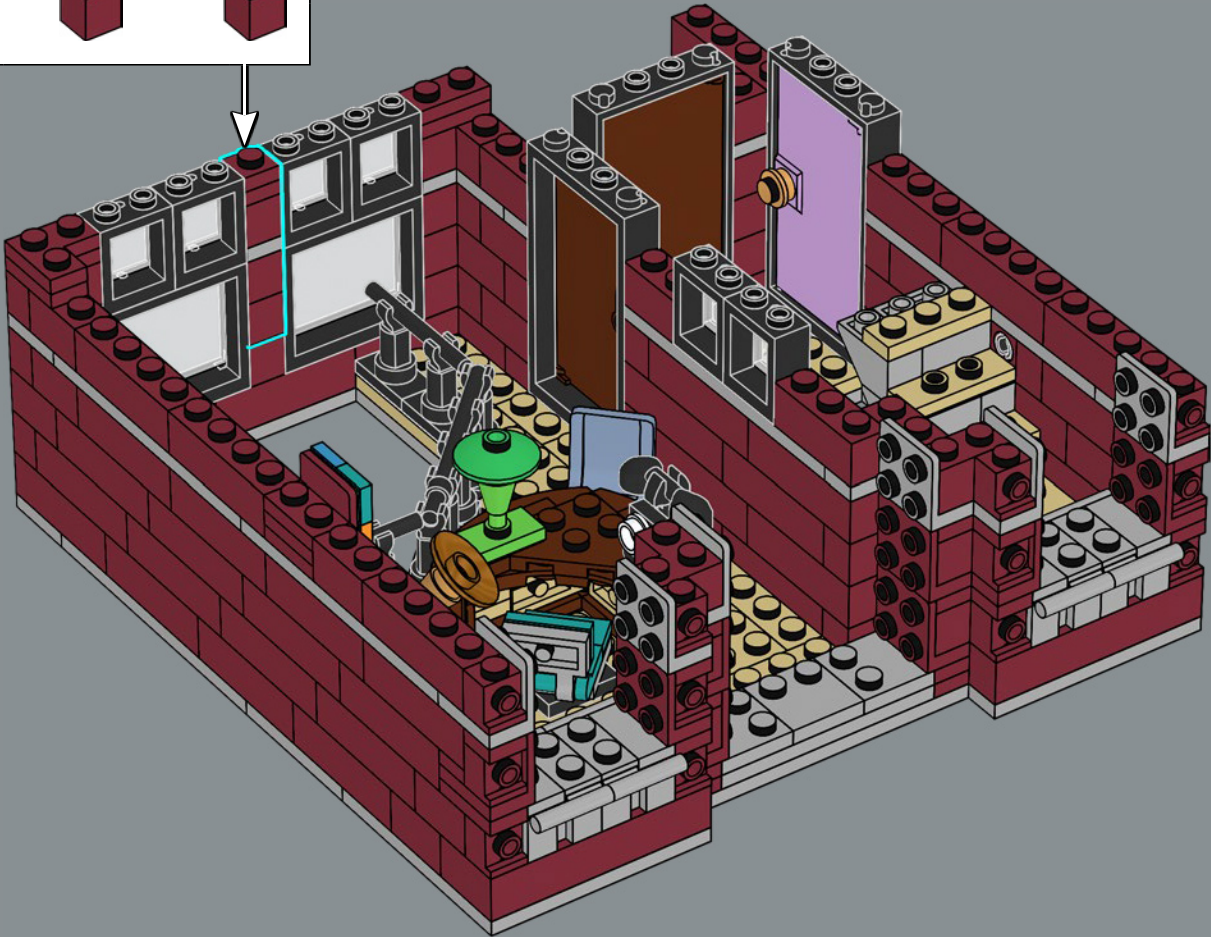
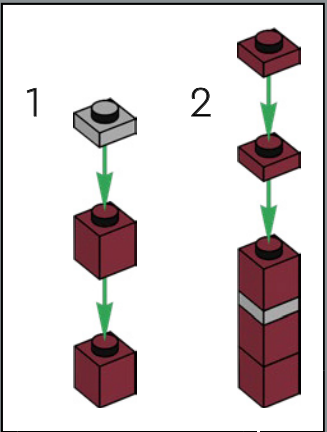

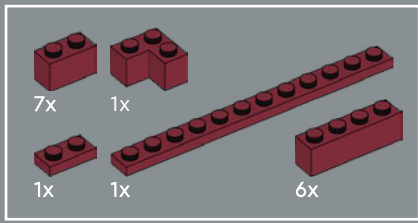

206



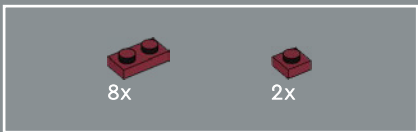

207

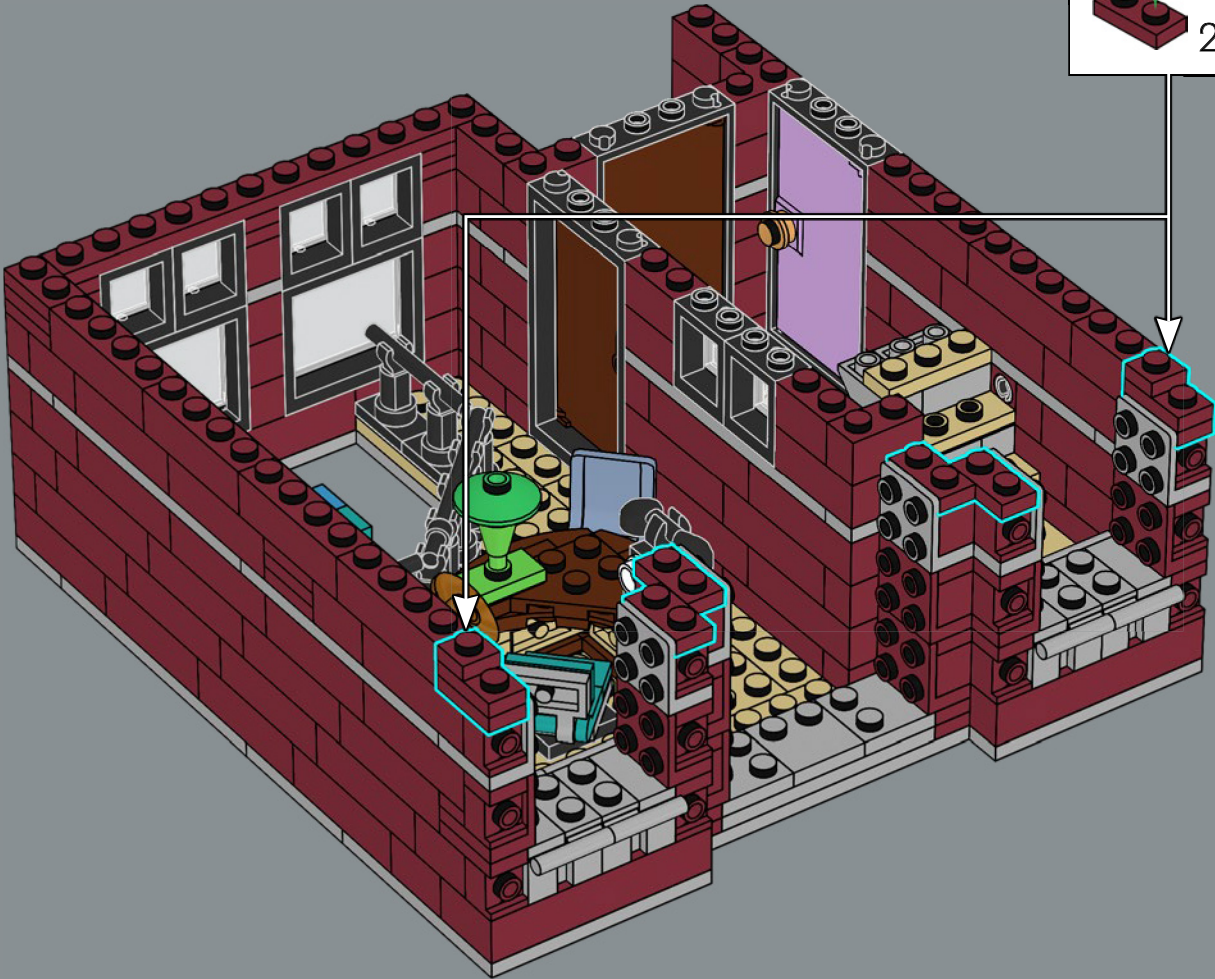
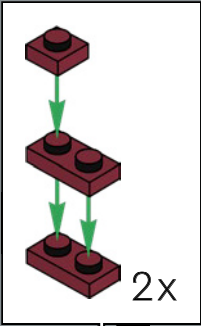

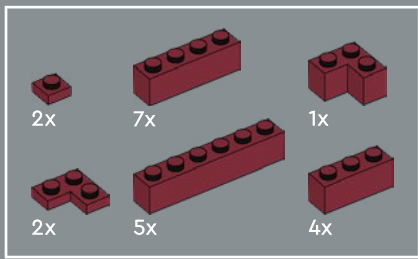

208

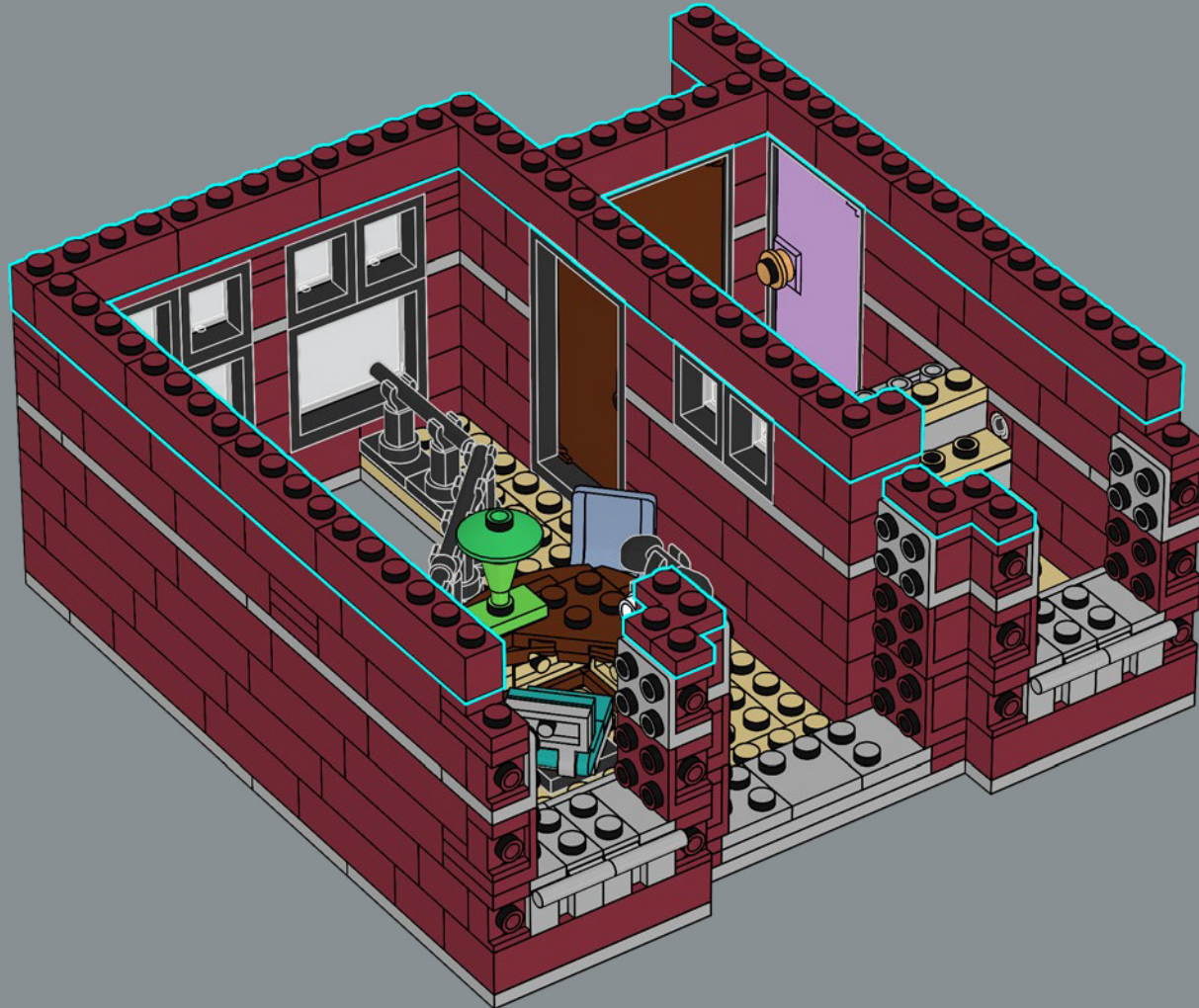



8x

209

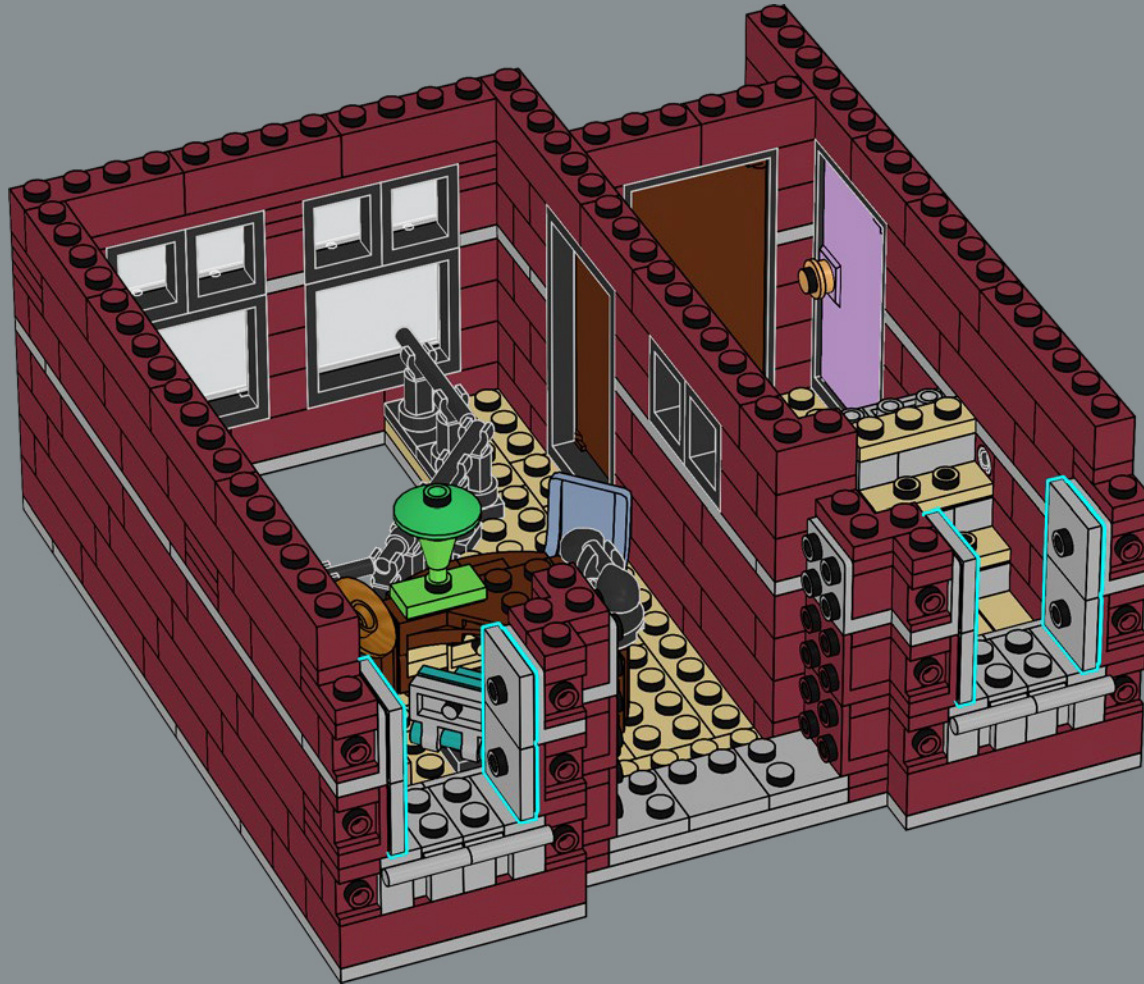

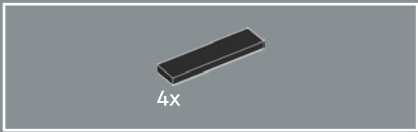

210

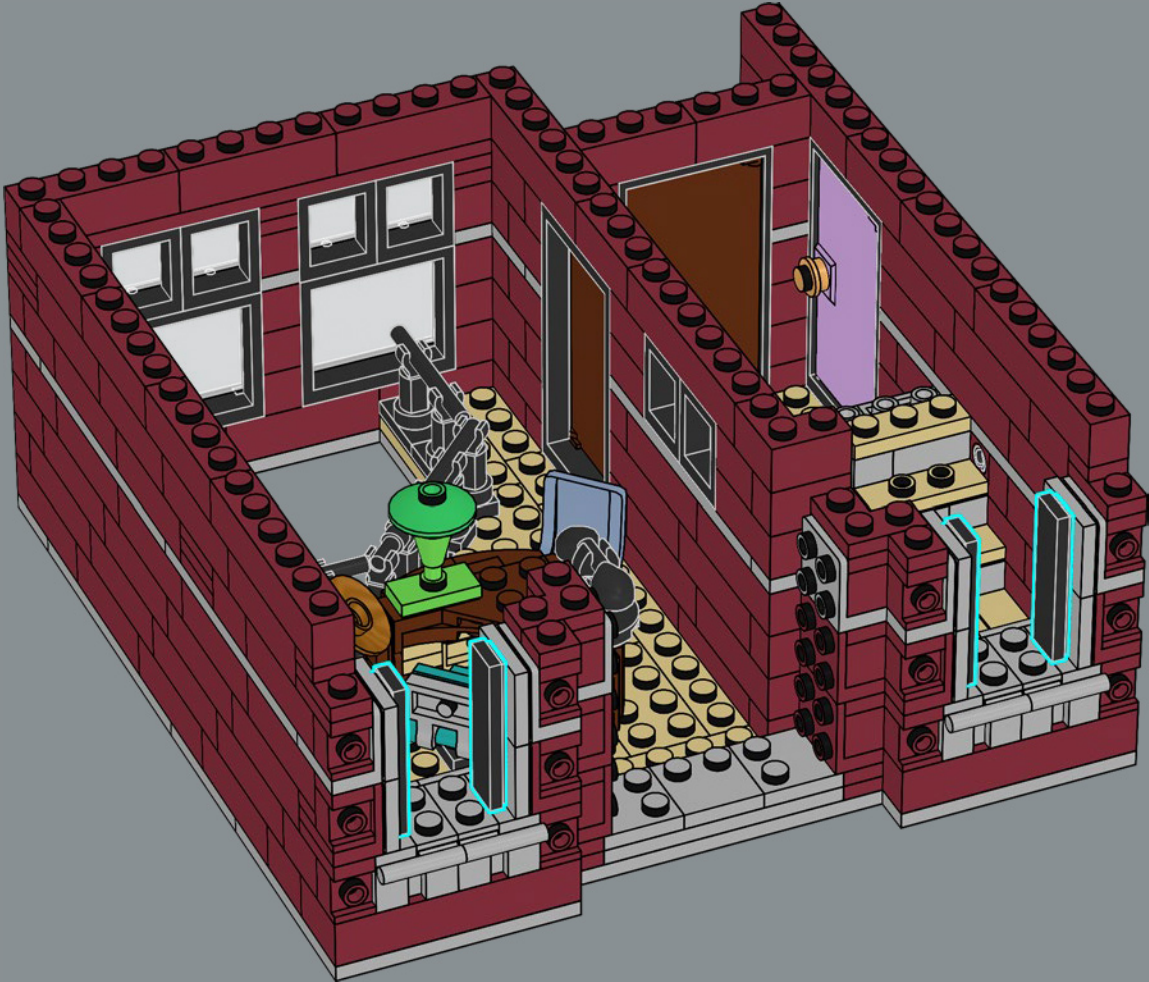

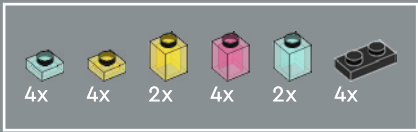

211

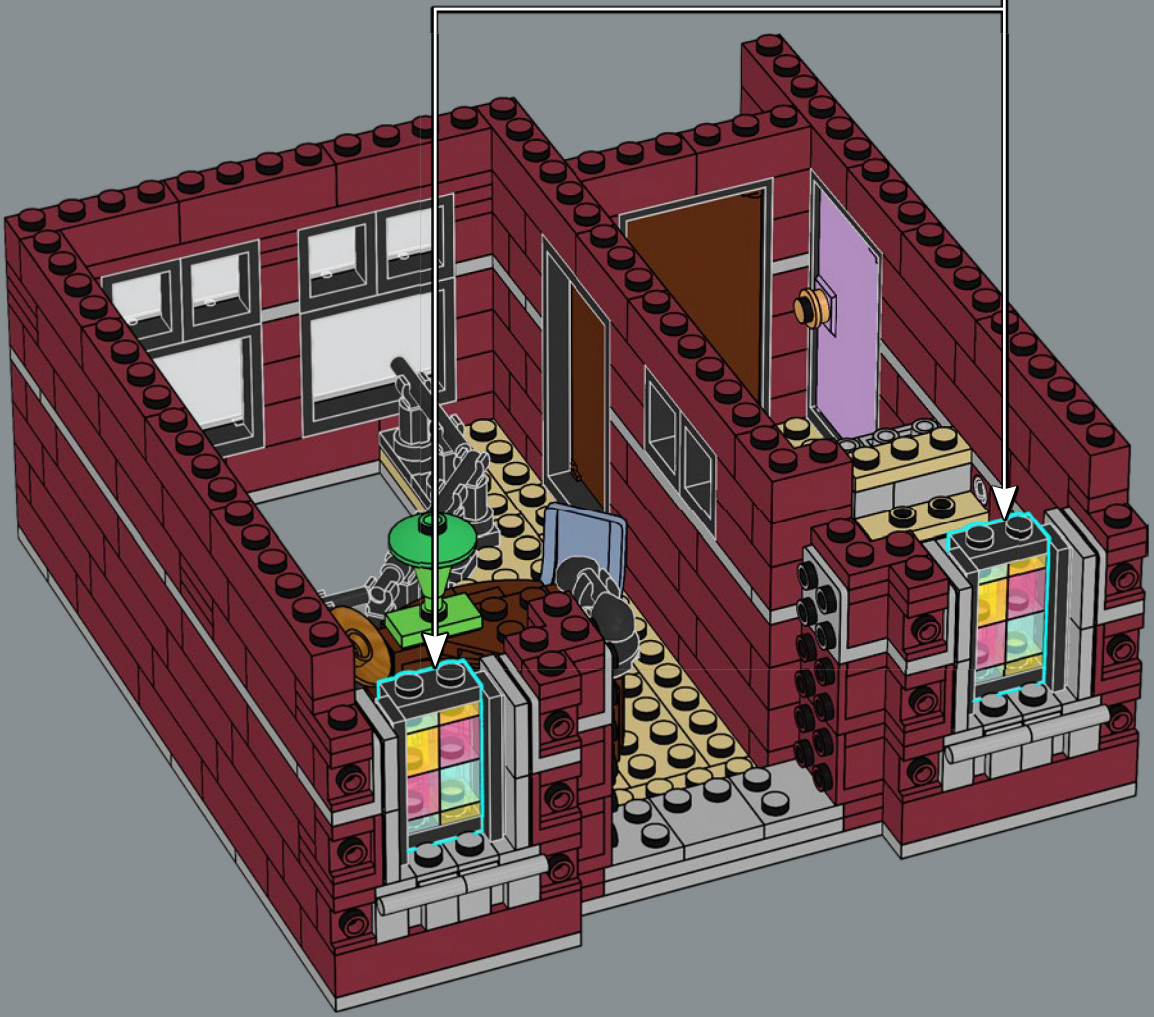
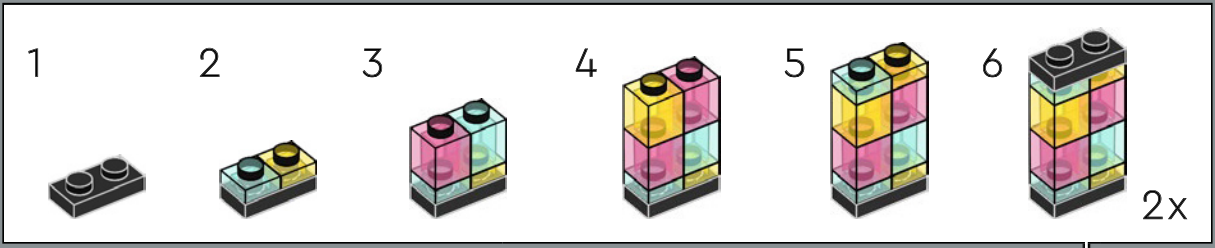

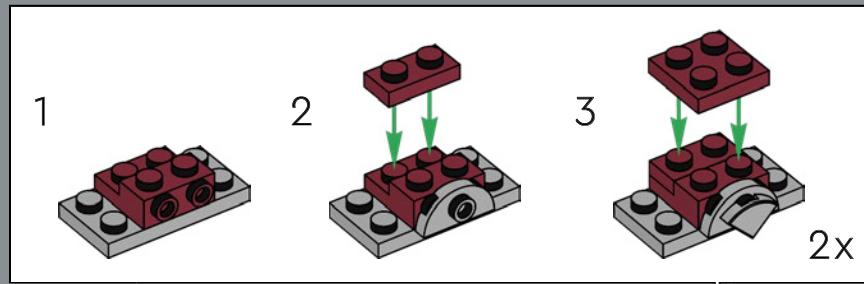
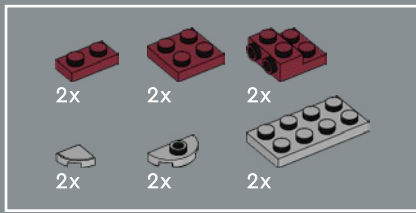

212

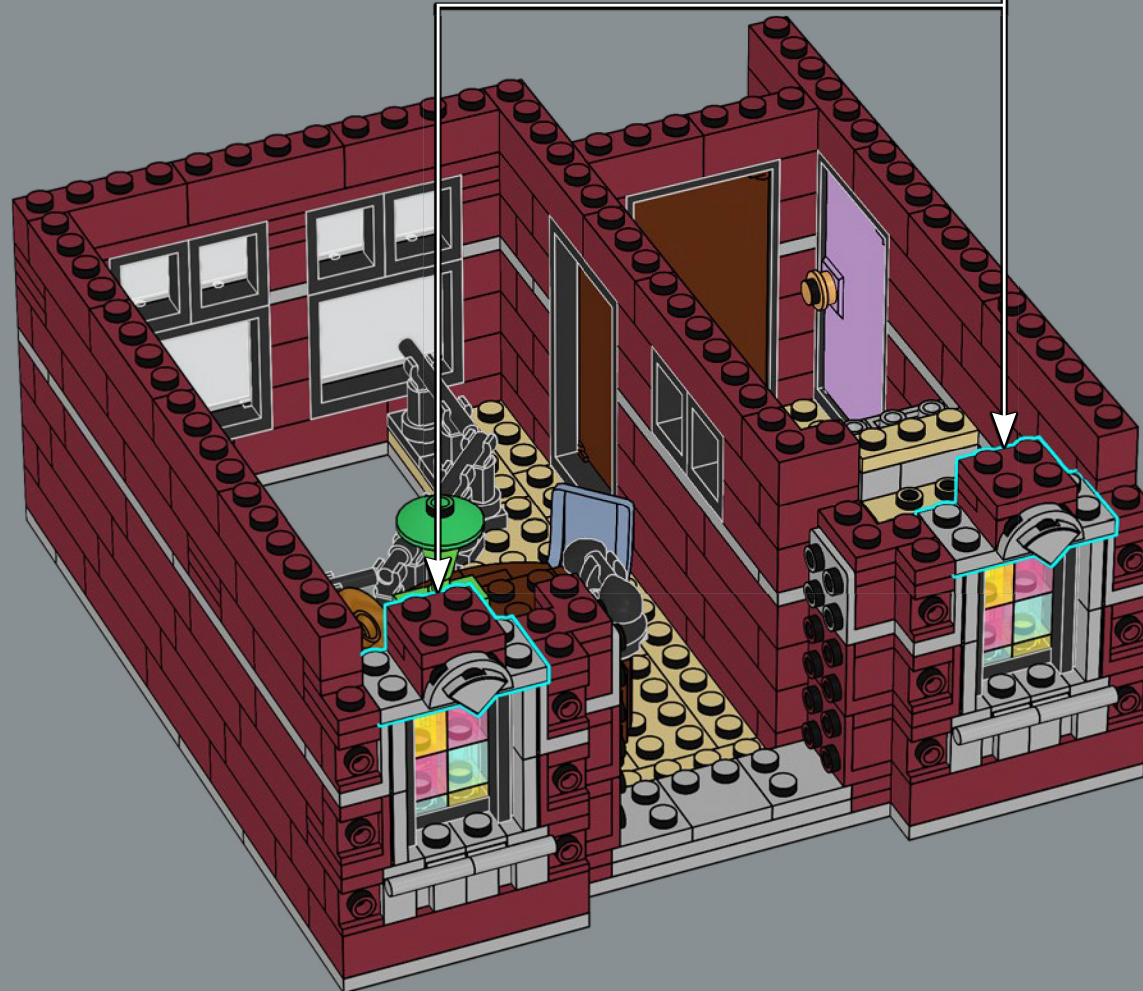

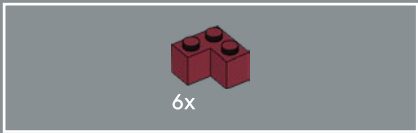

213

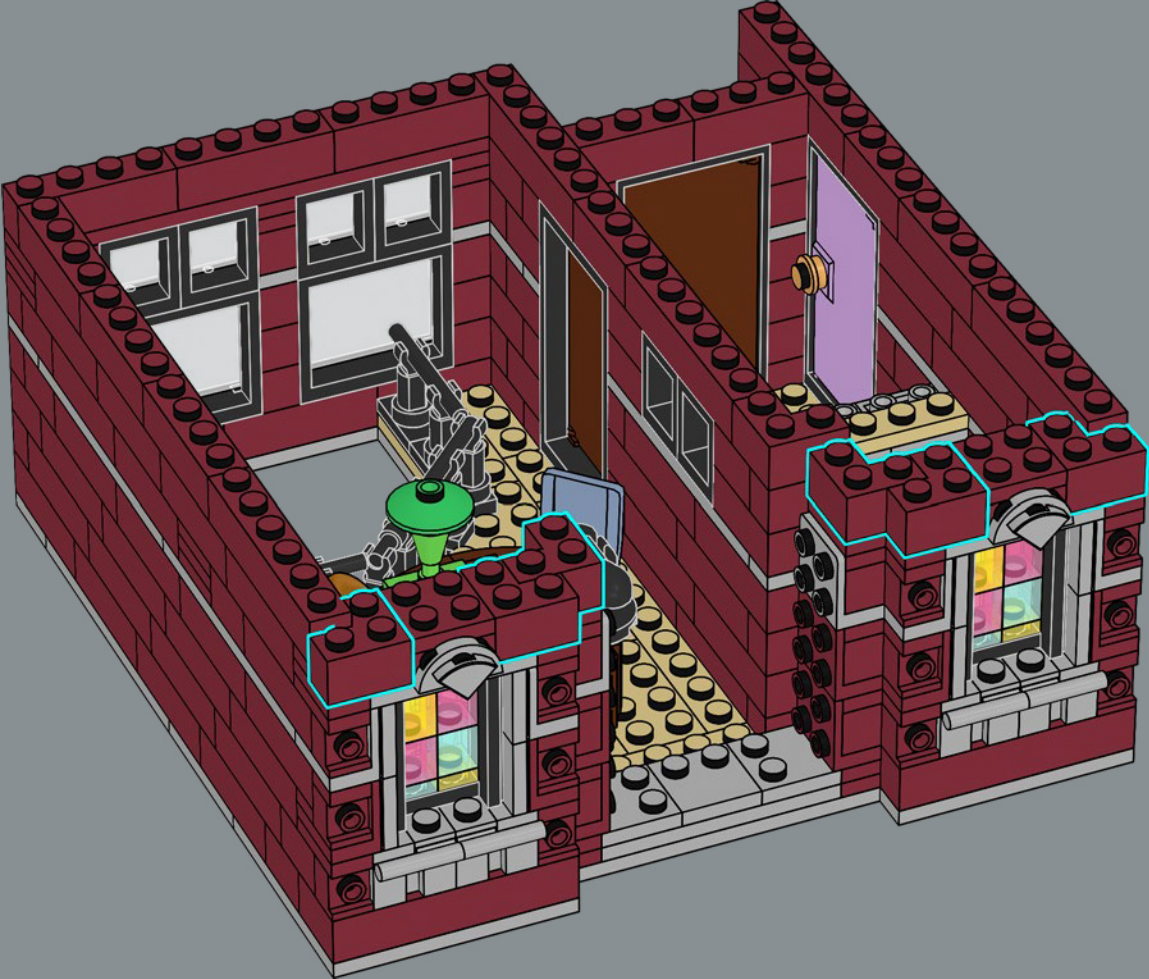

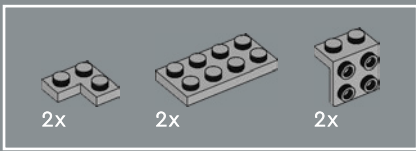

214

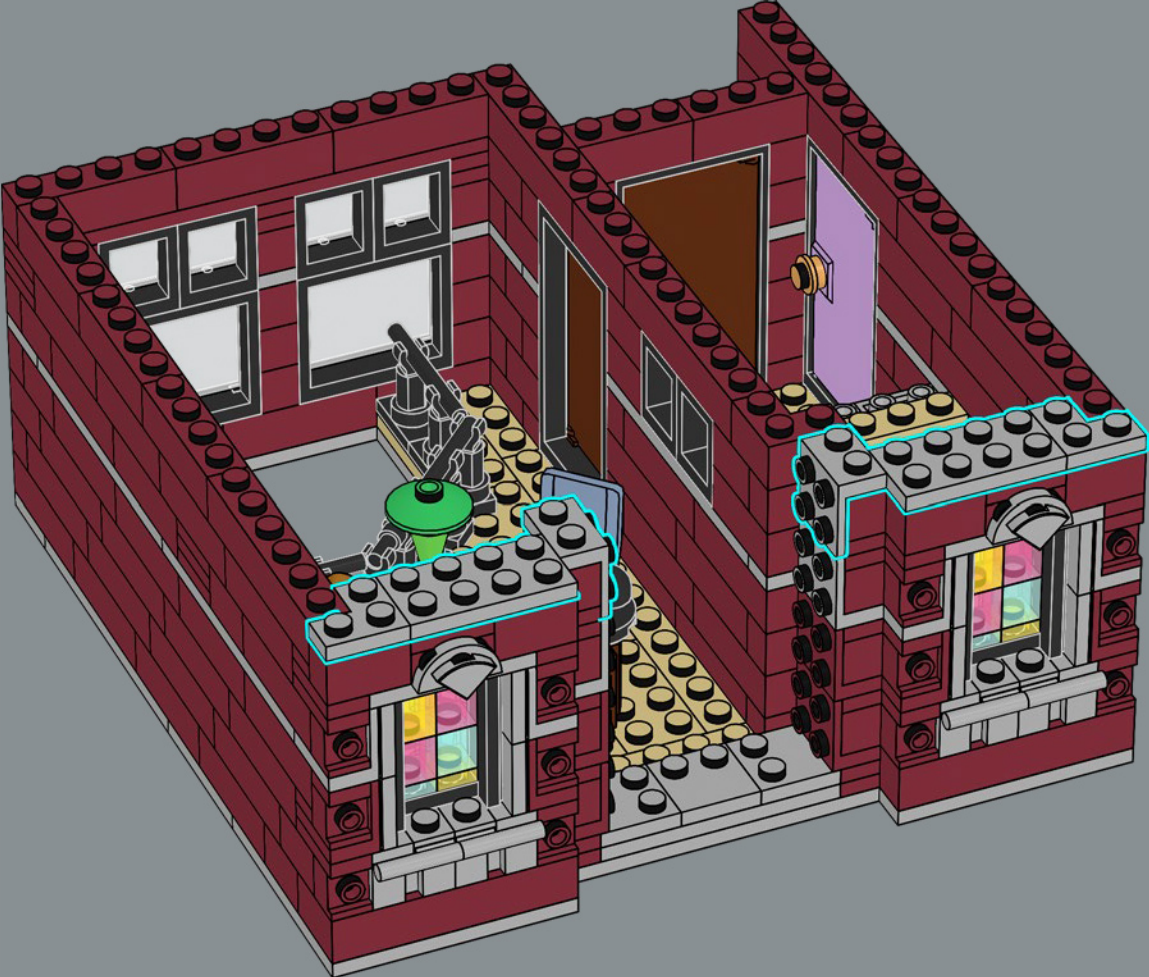

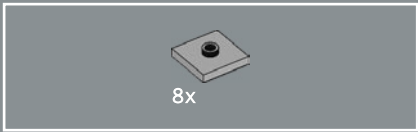

215

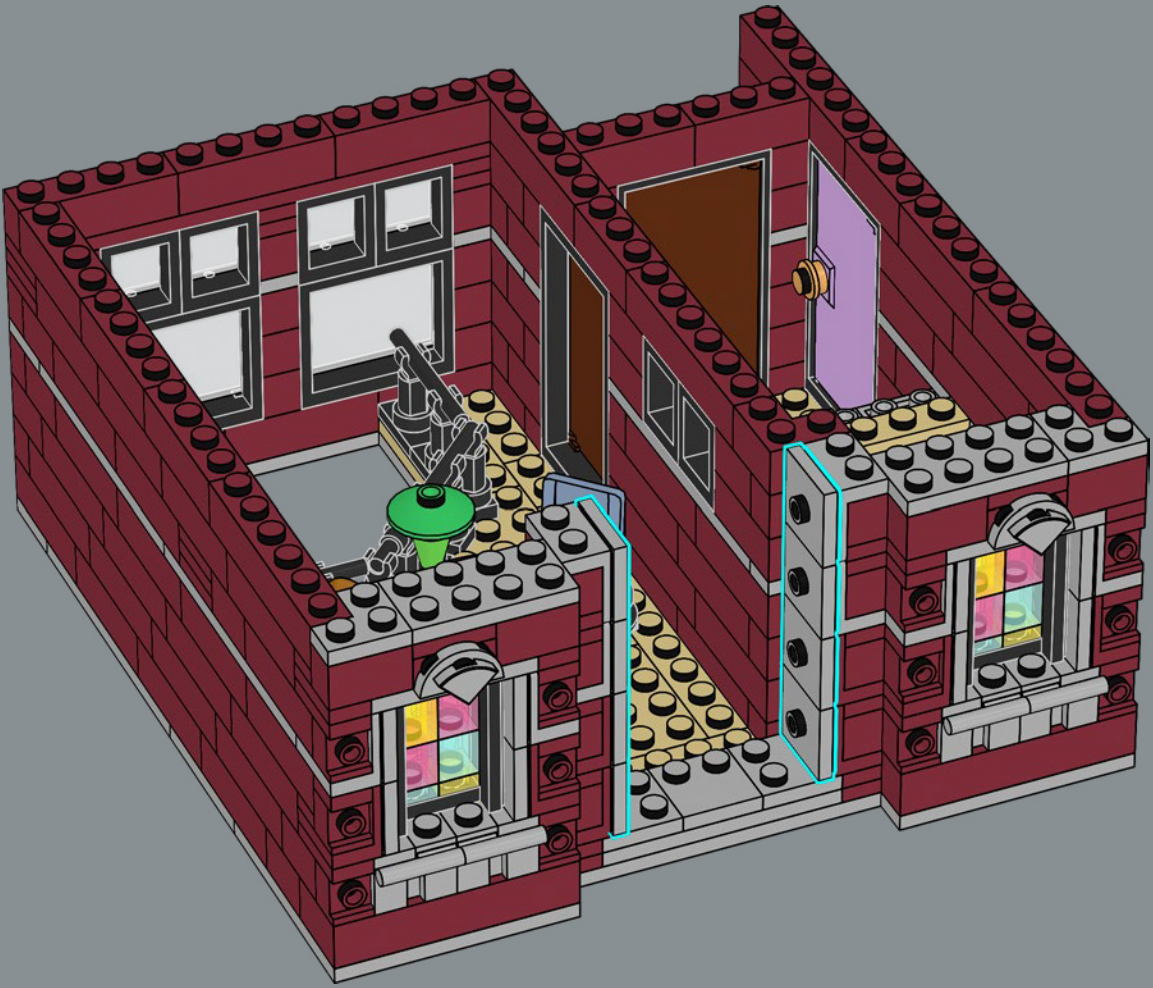

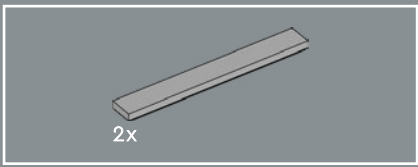

216

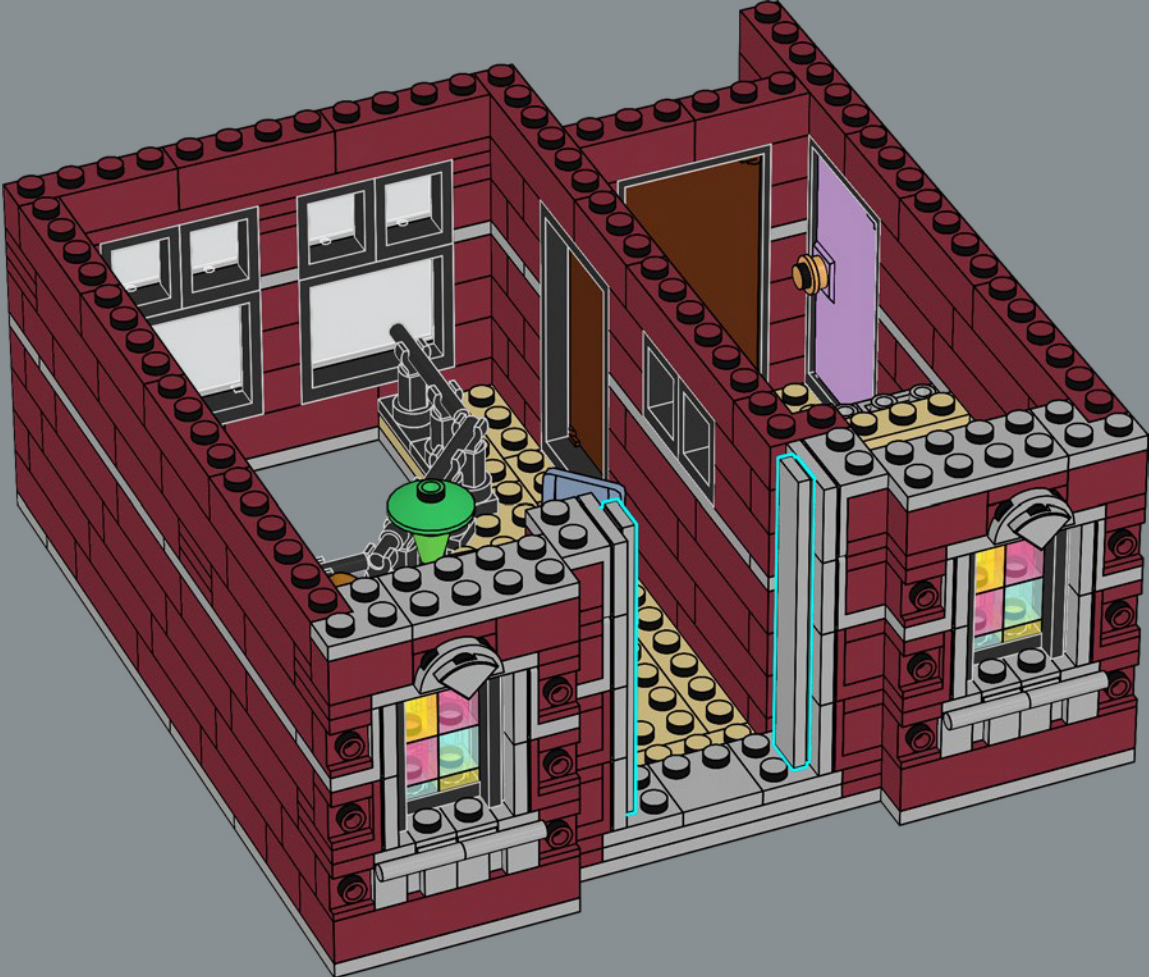

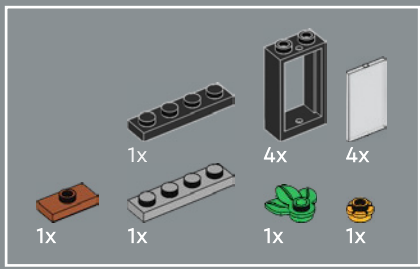

217

1

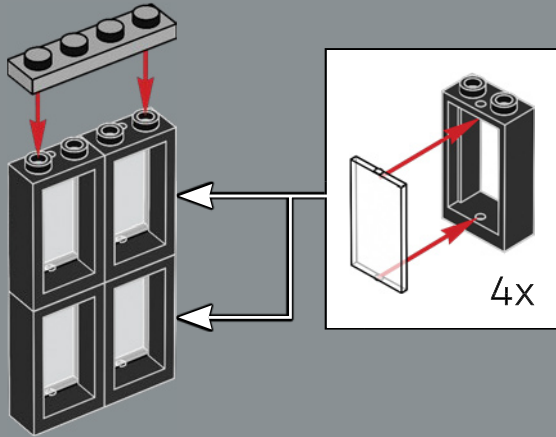

2

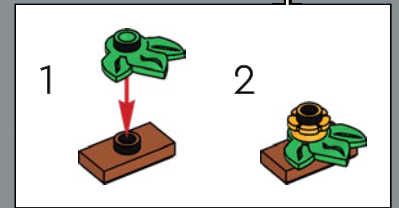
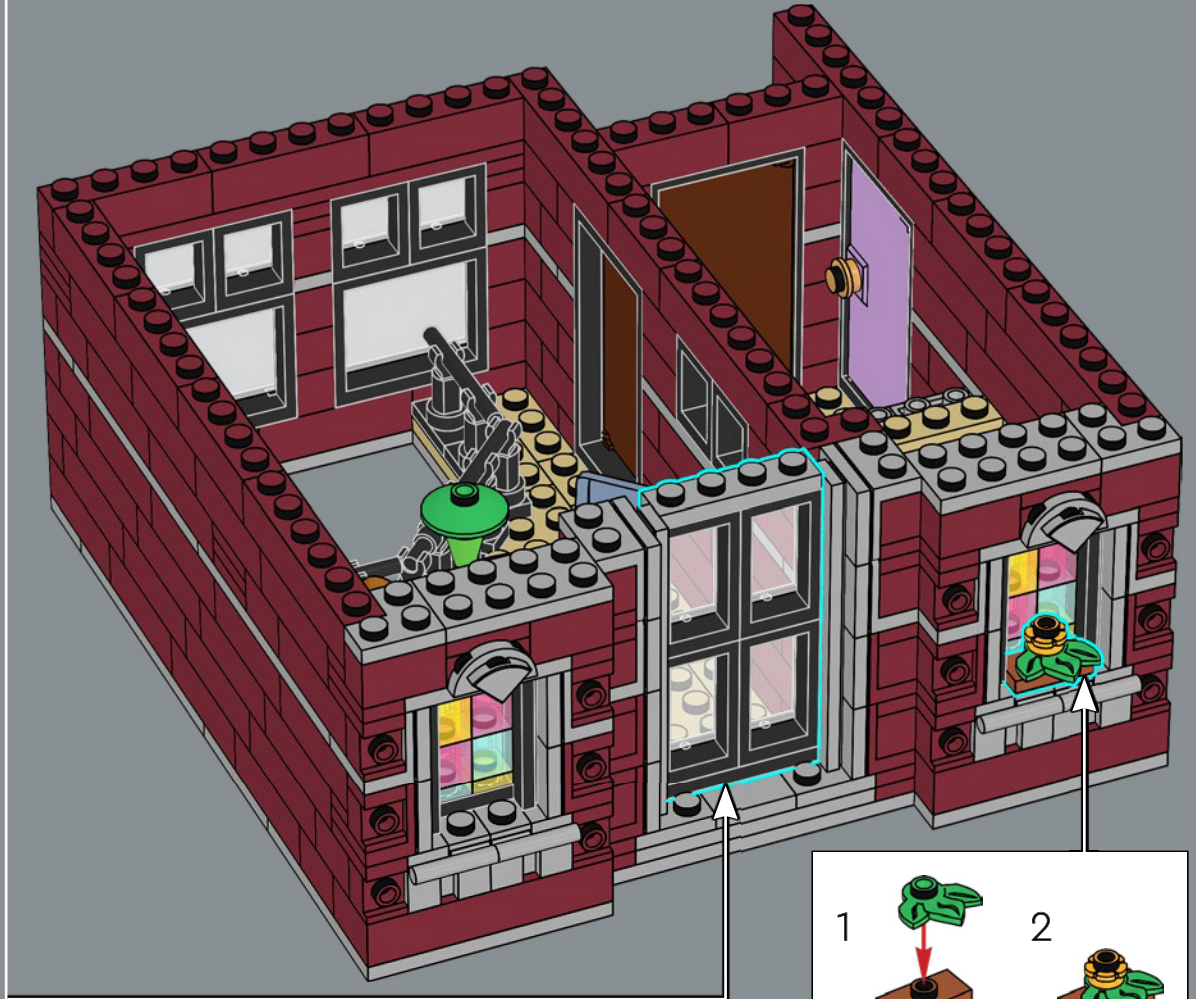
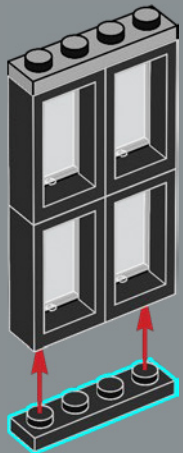

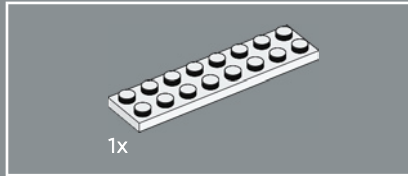
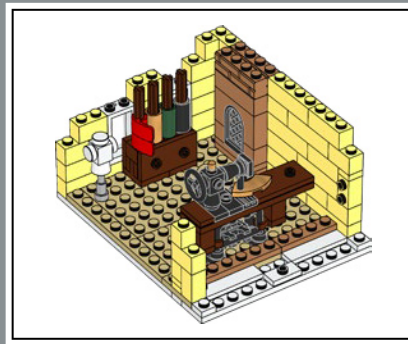

1x

218

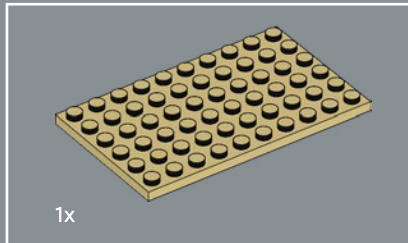
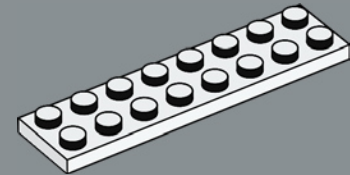

1x

219

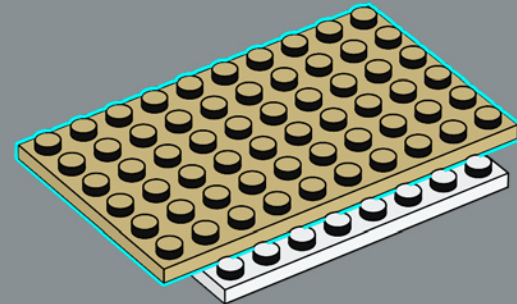

Vous avez acheté une nouvelle tenue dans Le grand magasin LEGO® 10211, mais elle ne vous convient pas ? Rendez-vous chez le couturier ; il se fera un plaisir de vous aider.

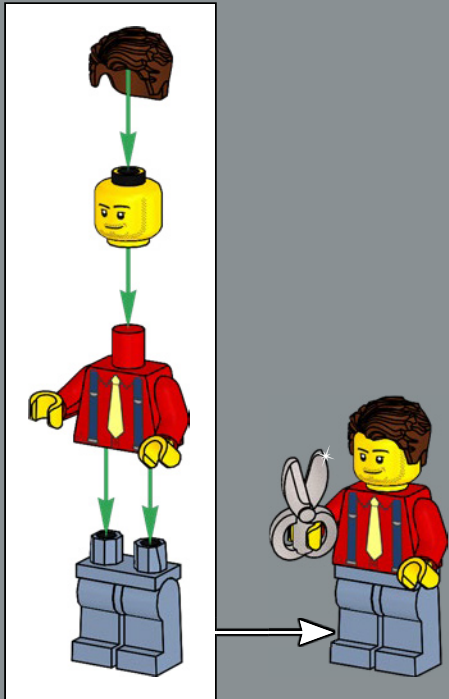

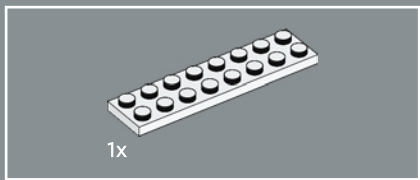

220

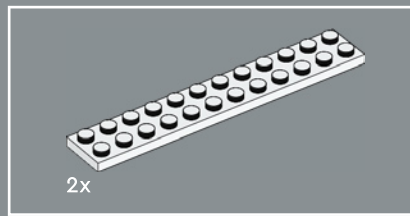
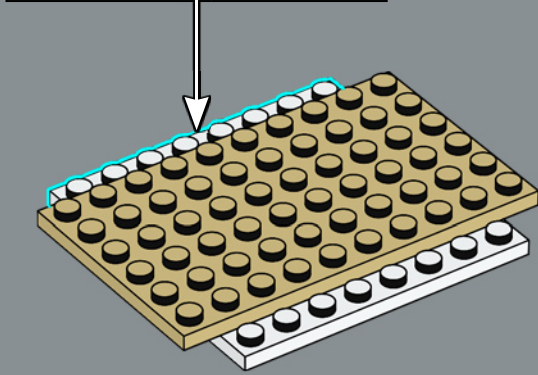
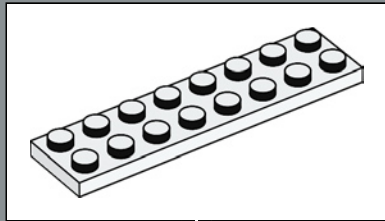

221

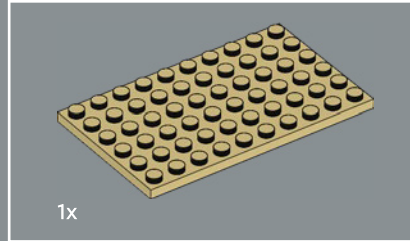
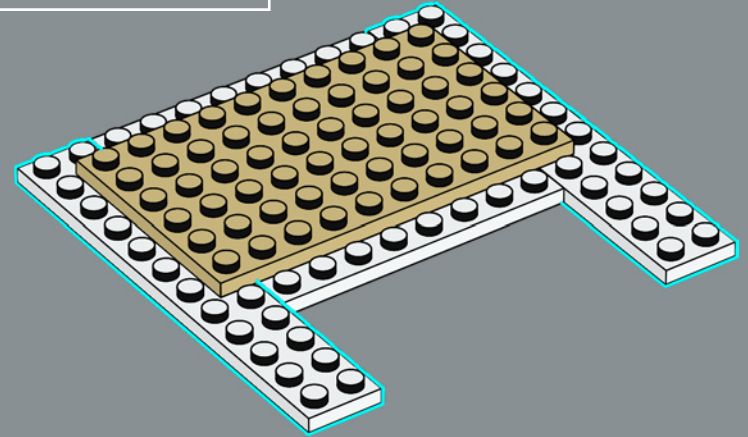

222

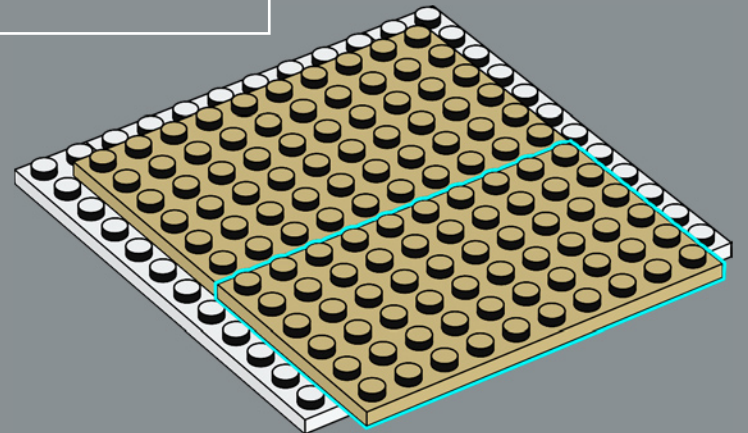

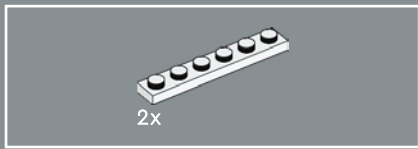

223

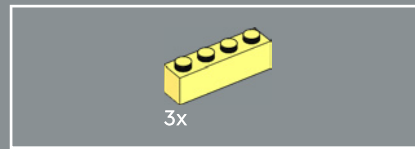
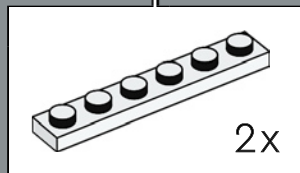
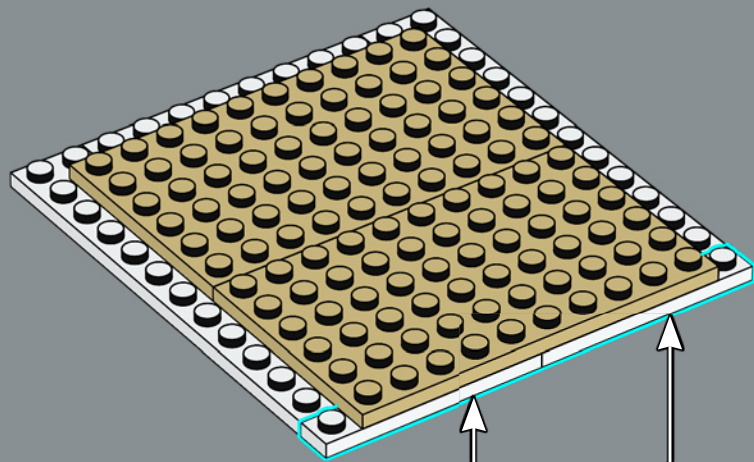

224

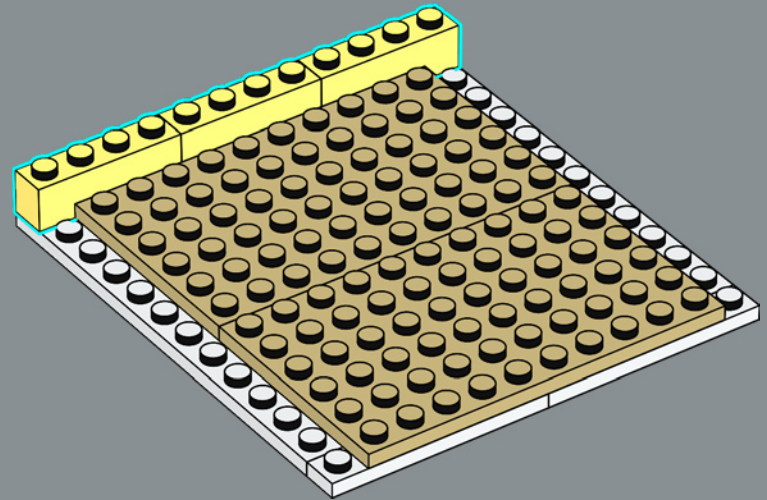

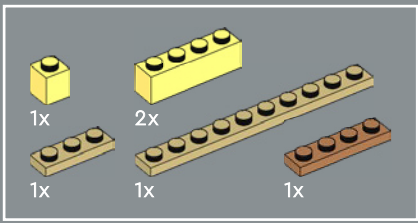

225

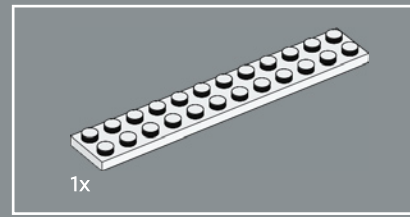
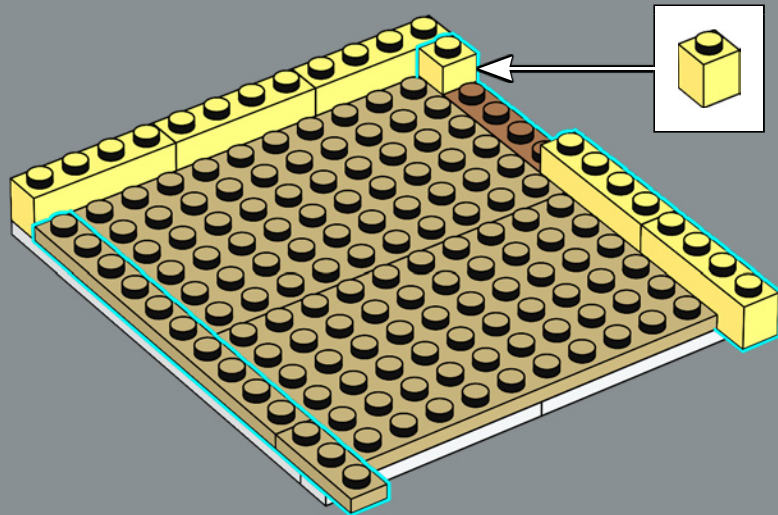

226

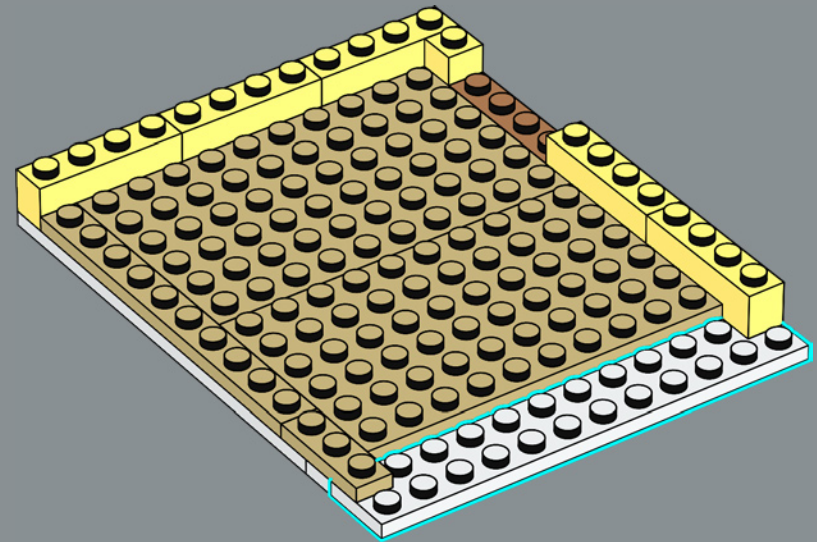

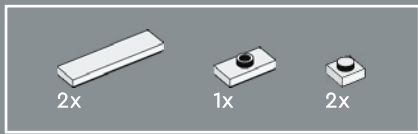

227

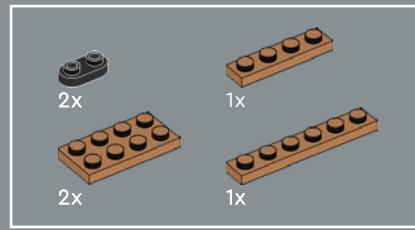
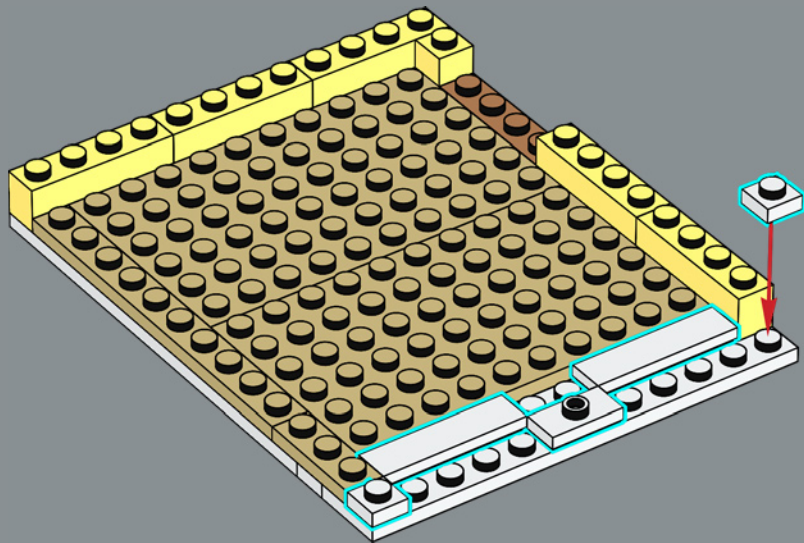

228

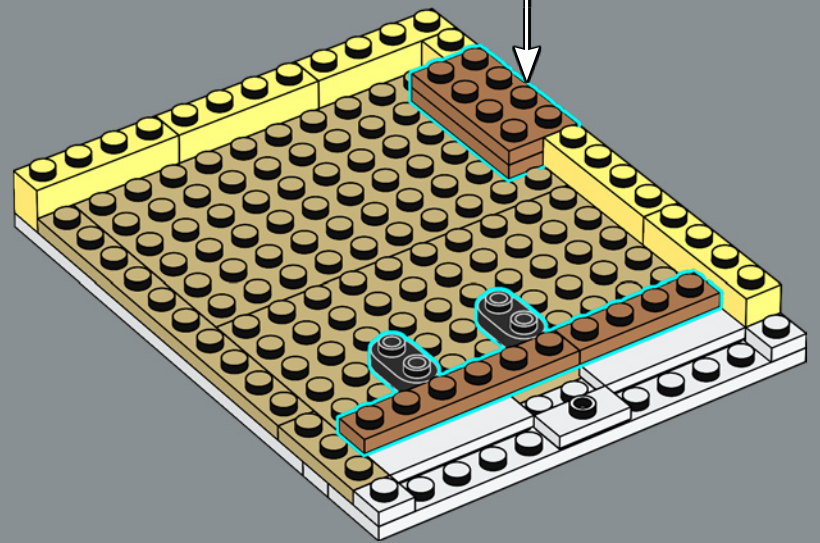
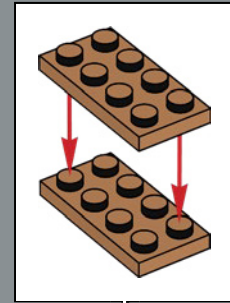

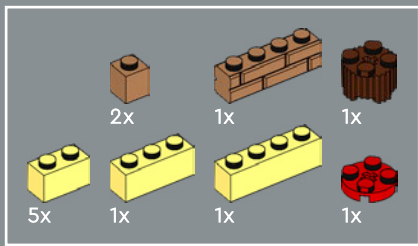

229

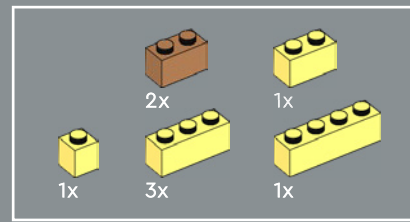
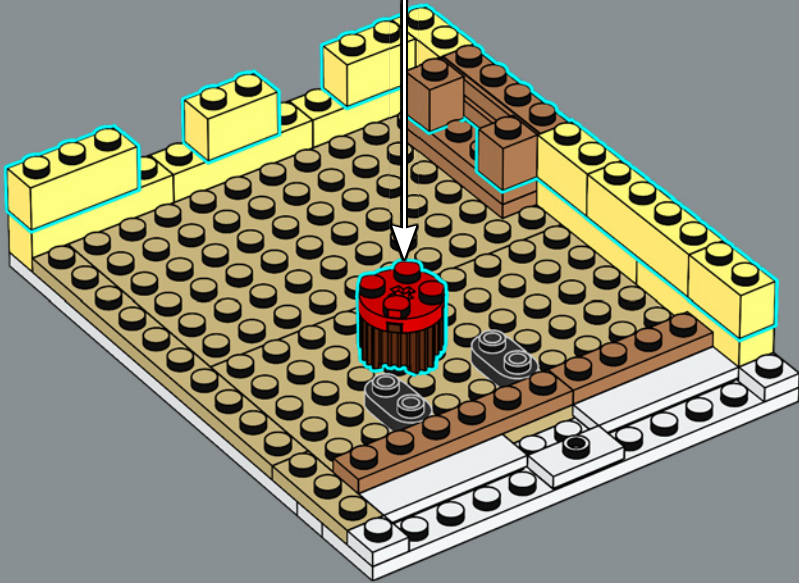
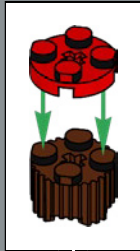

230

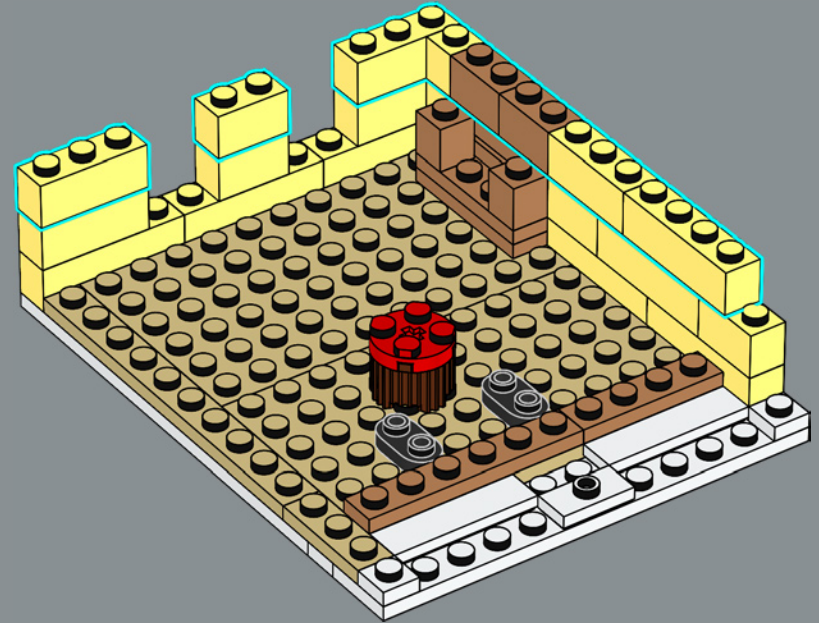



231

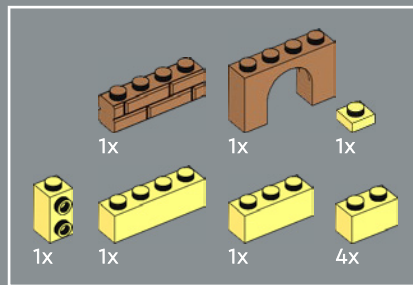
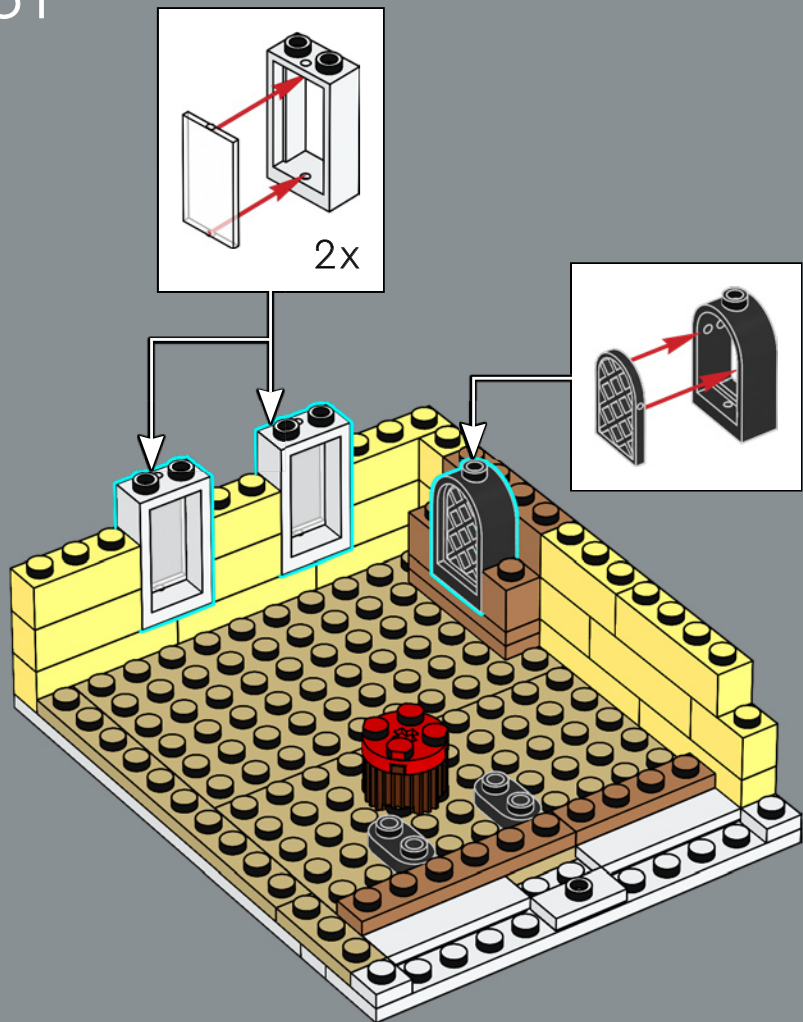

232

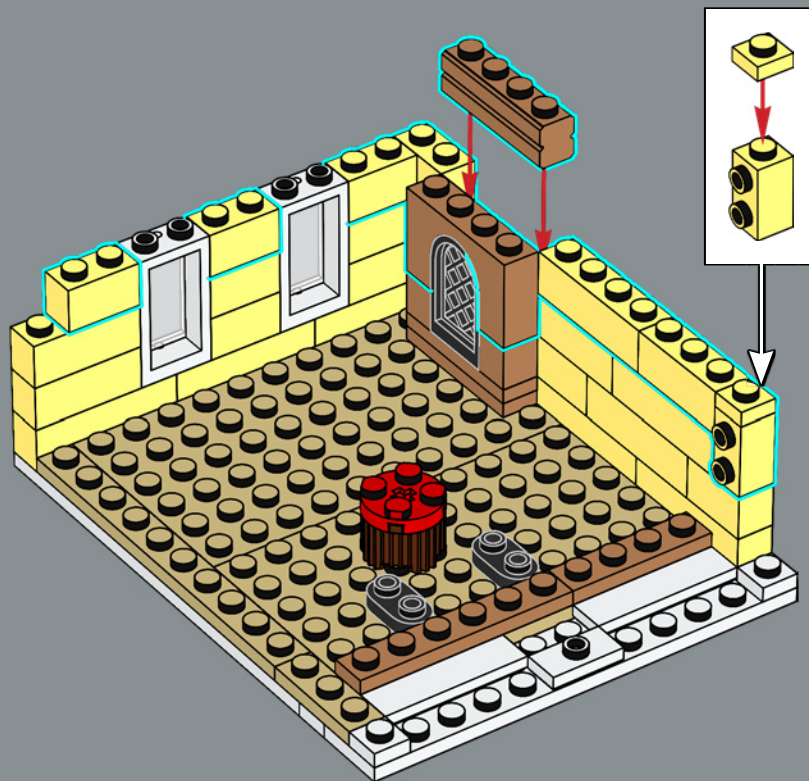

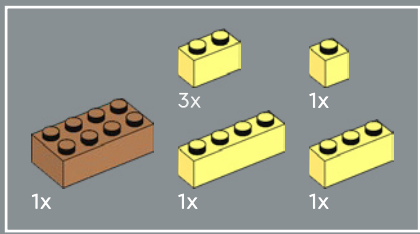

233

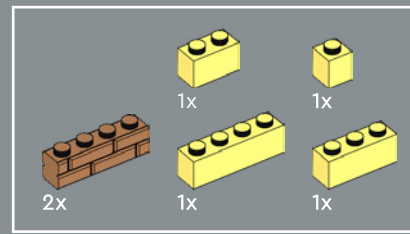
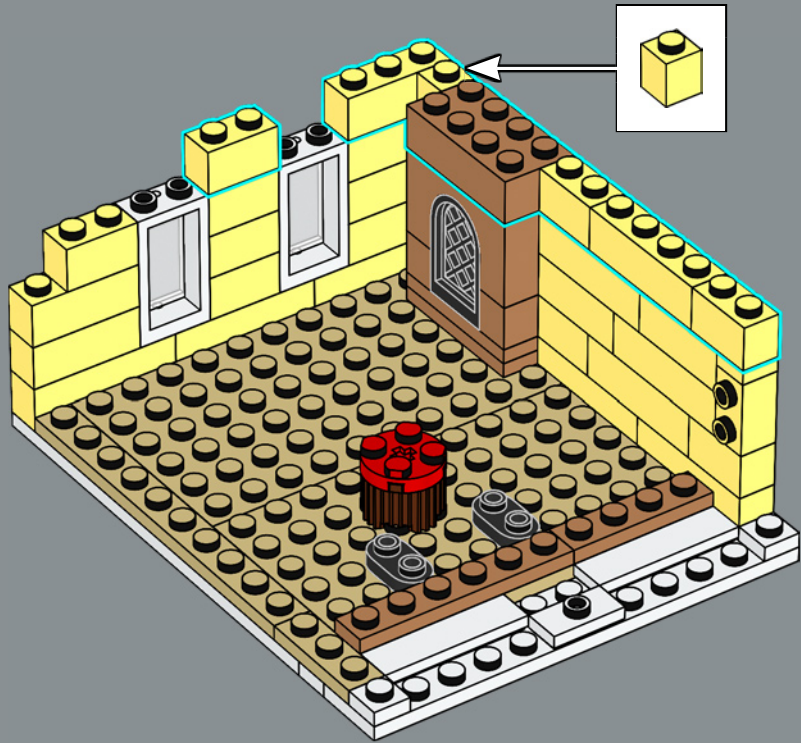

234

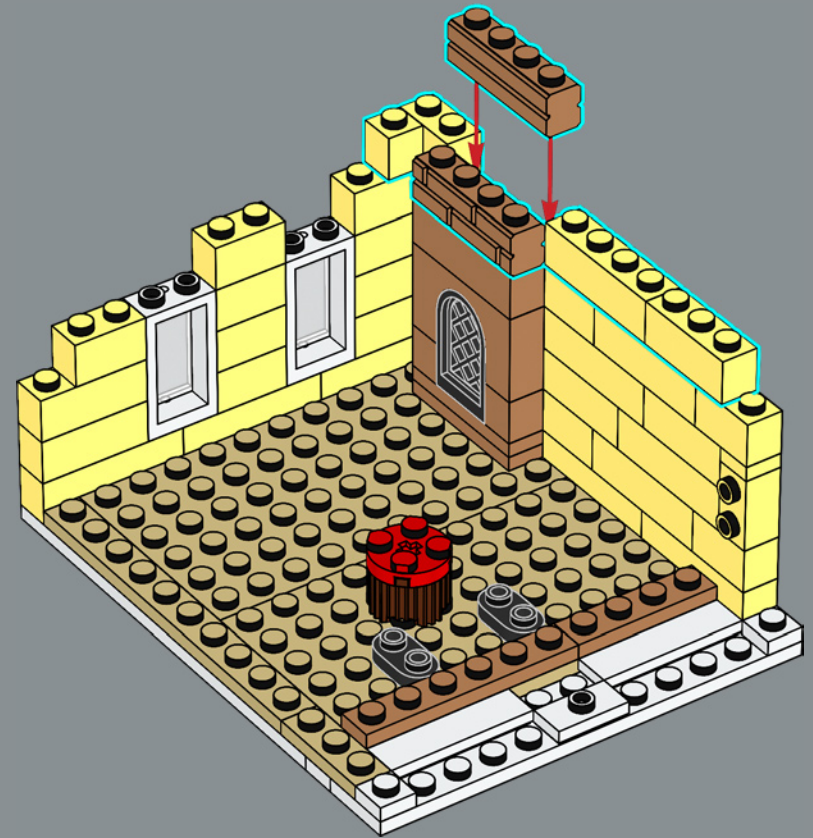

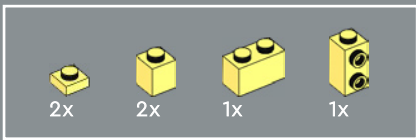

235

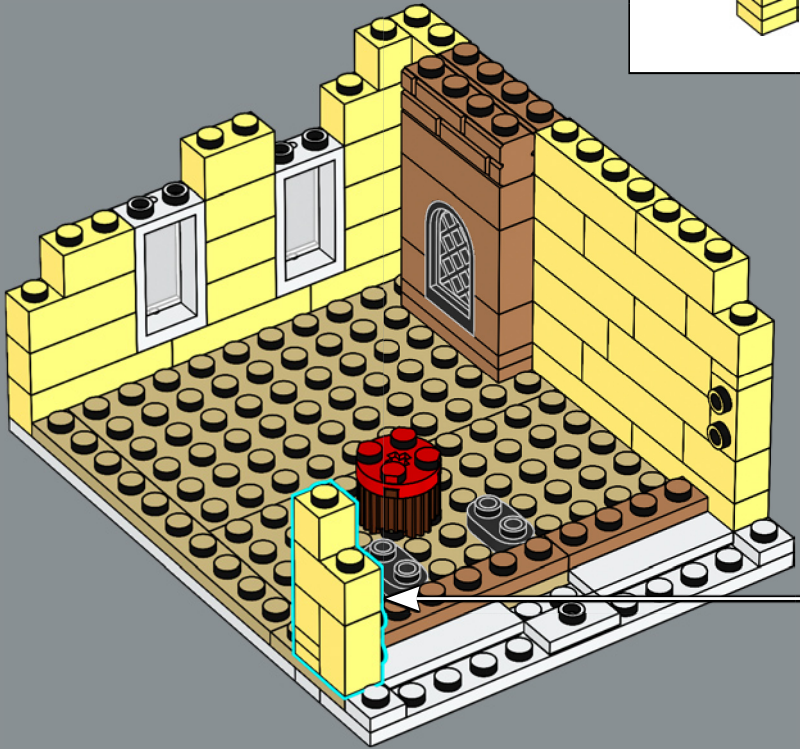
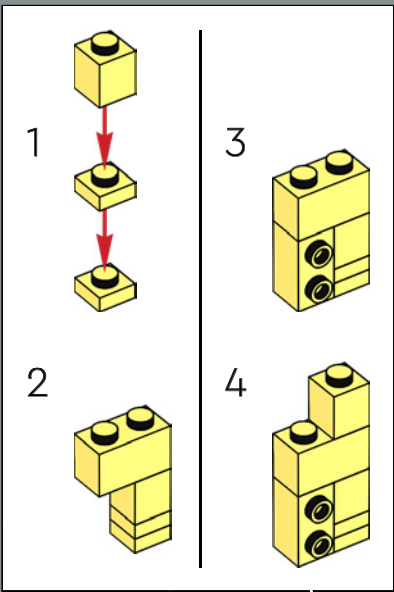

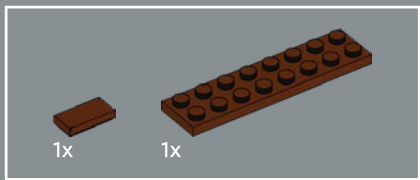

236

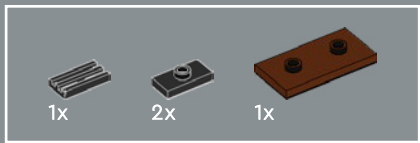
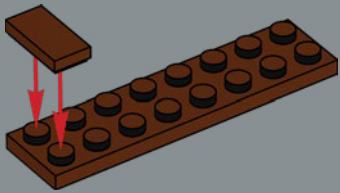

237

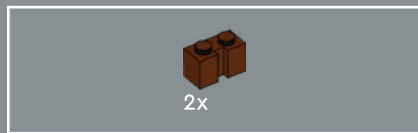
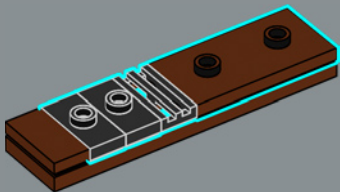

238

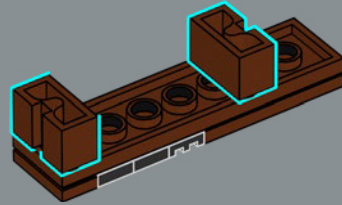

239

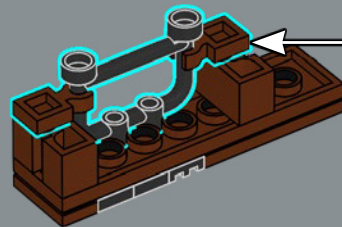
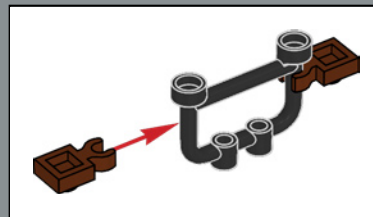

240

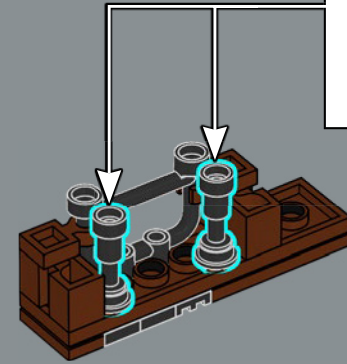
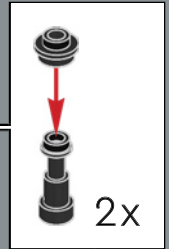

241

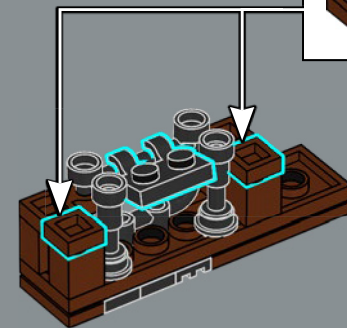

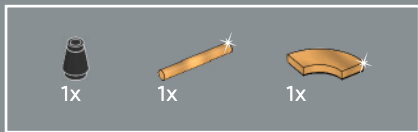

242

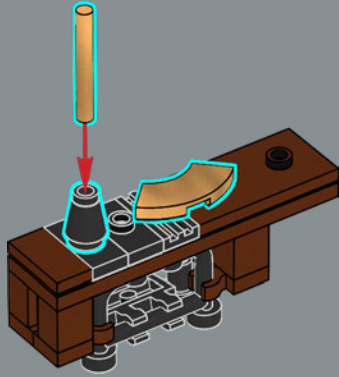

243

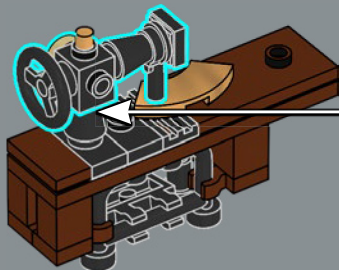
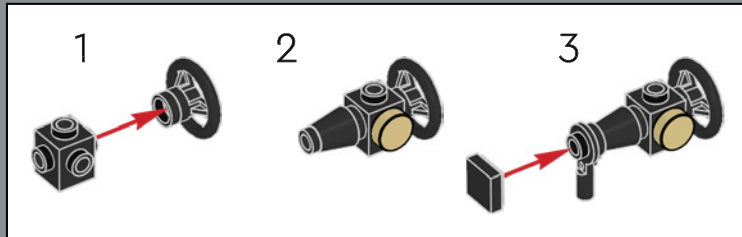

Le couturier vient de terminer la robe de la chanteuse ;
il reste du fil et du tissu dorés sur la machine à coudre !

244

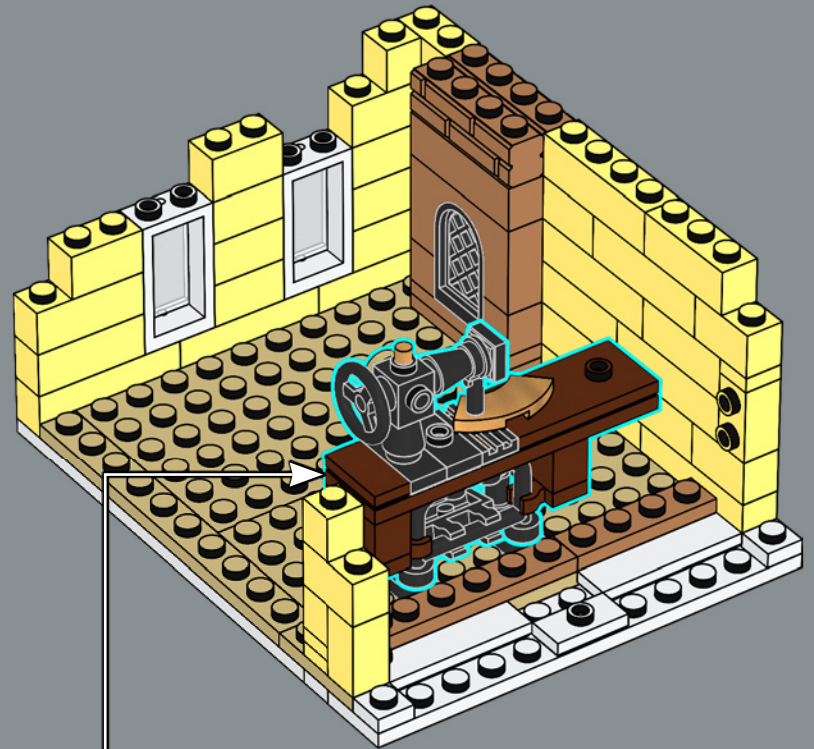

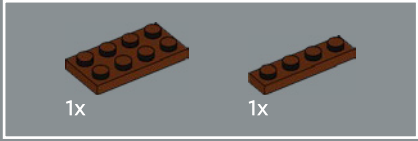

245

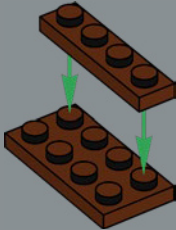

246

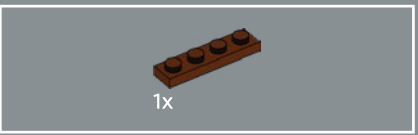
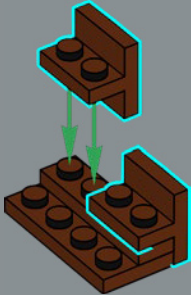

247

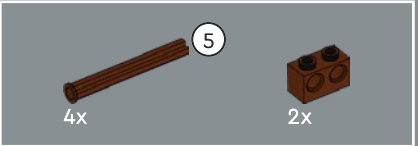
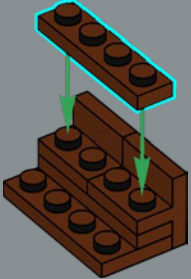

248

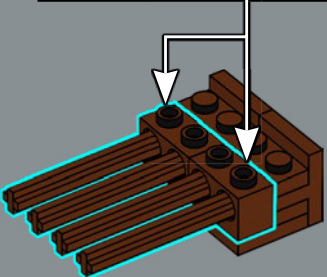
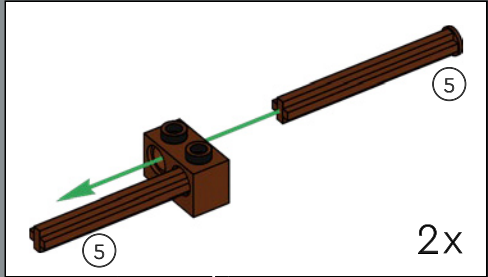

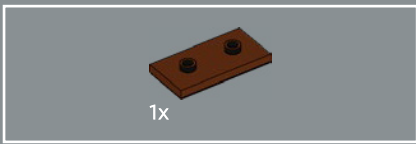

249

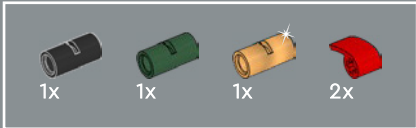
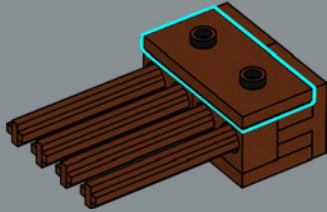

250

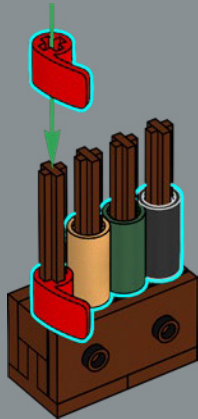

Les éléments composant le tissu rouge sont apparus pour la première fois dans des sets LEGO® Technic.

251

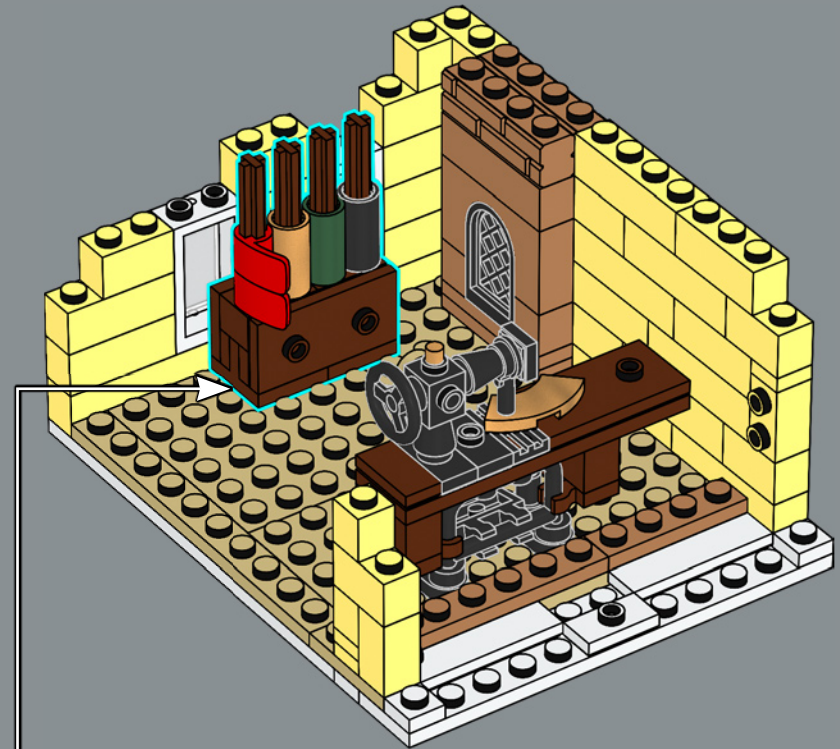

253

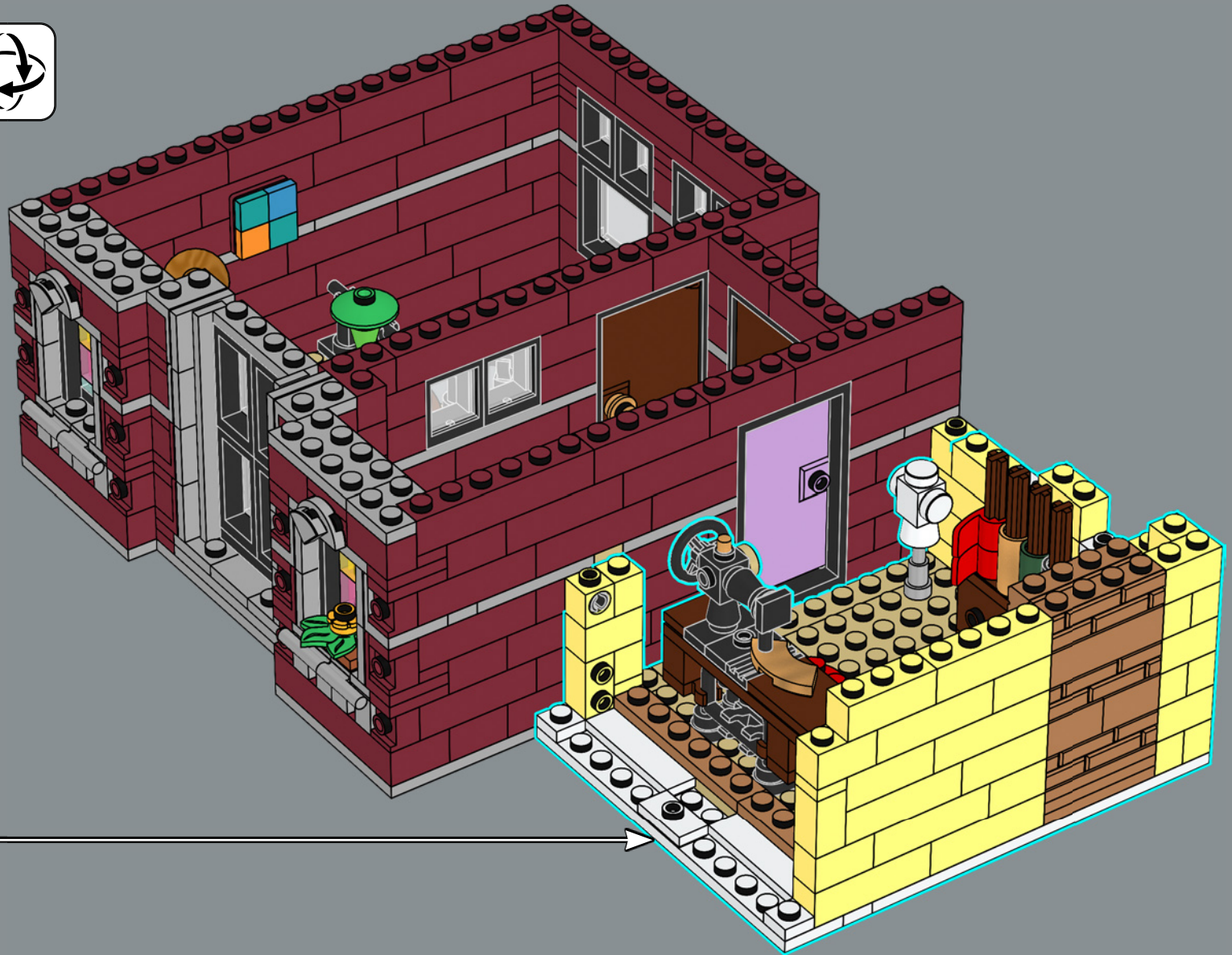

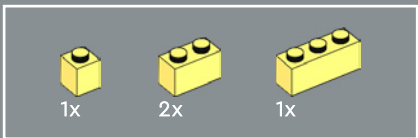

254

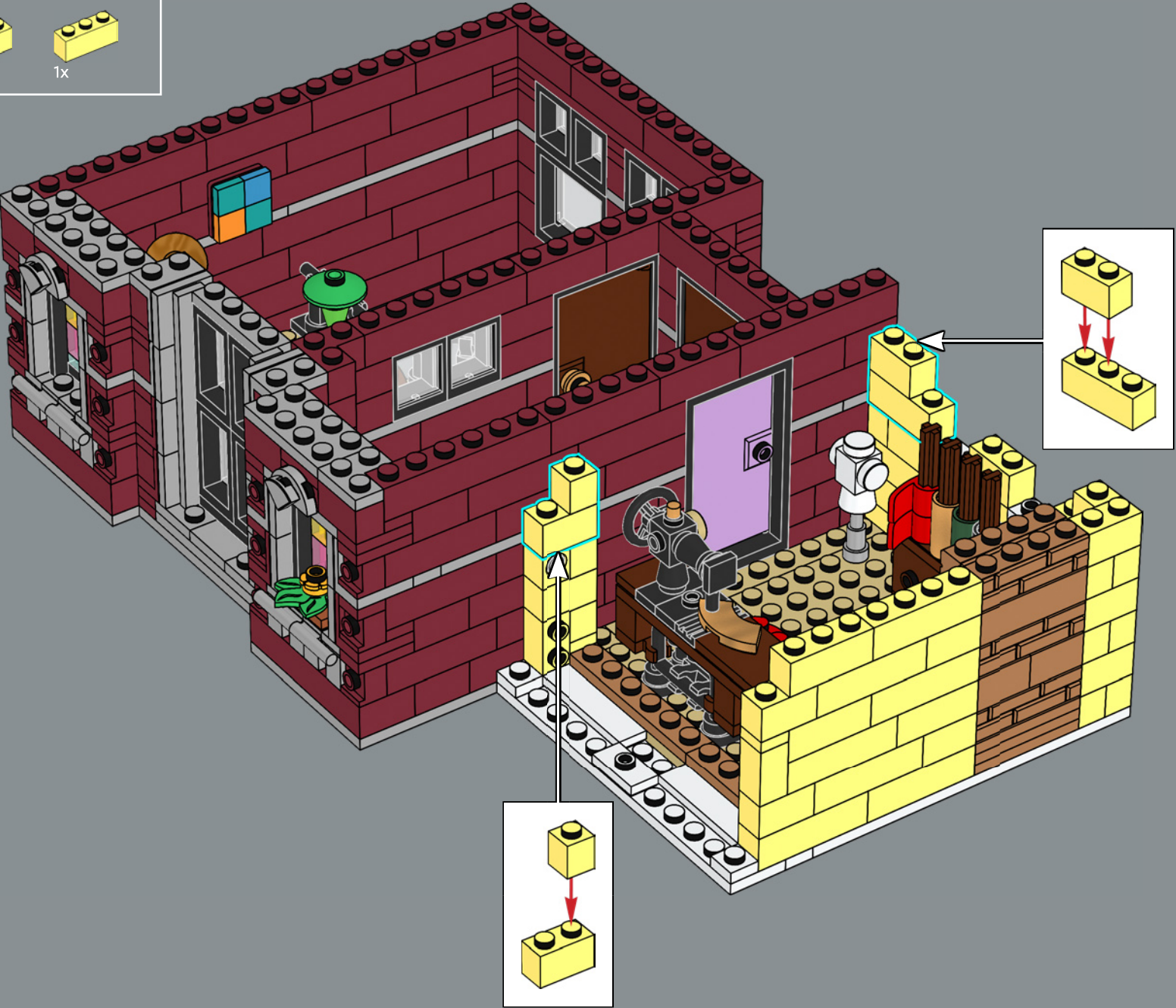

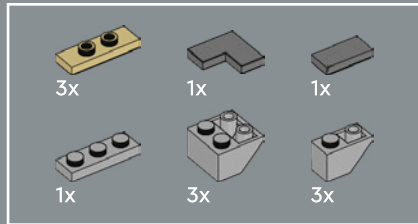

255

1

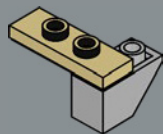

2

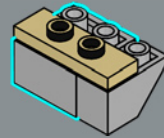

3

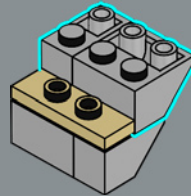

4

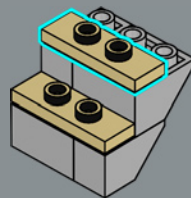

5

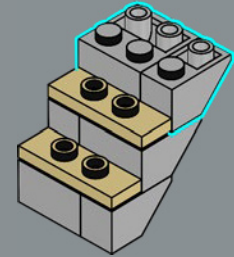

6

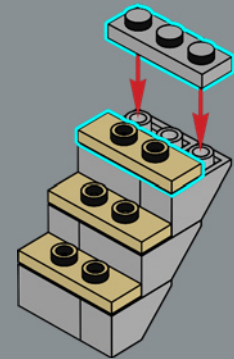

7

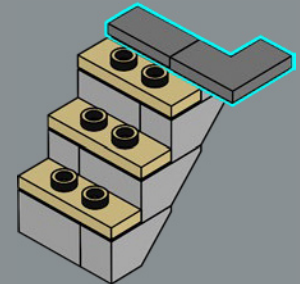

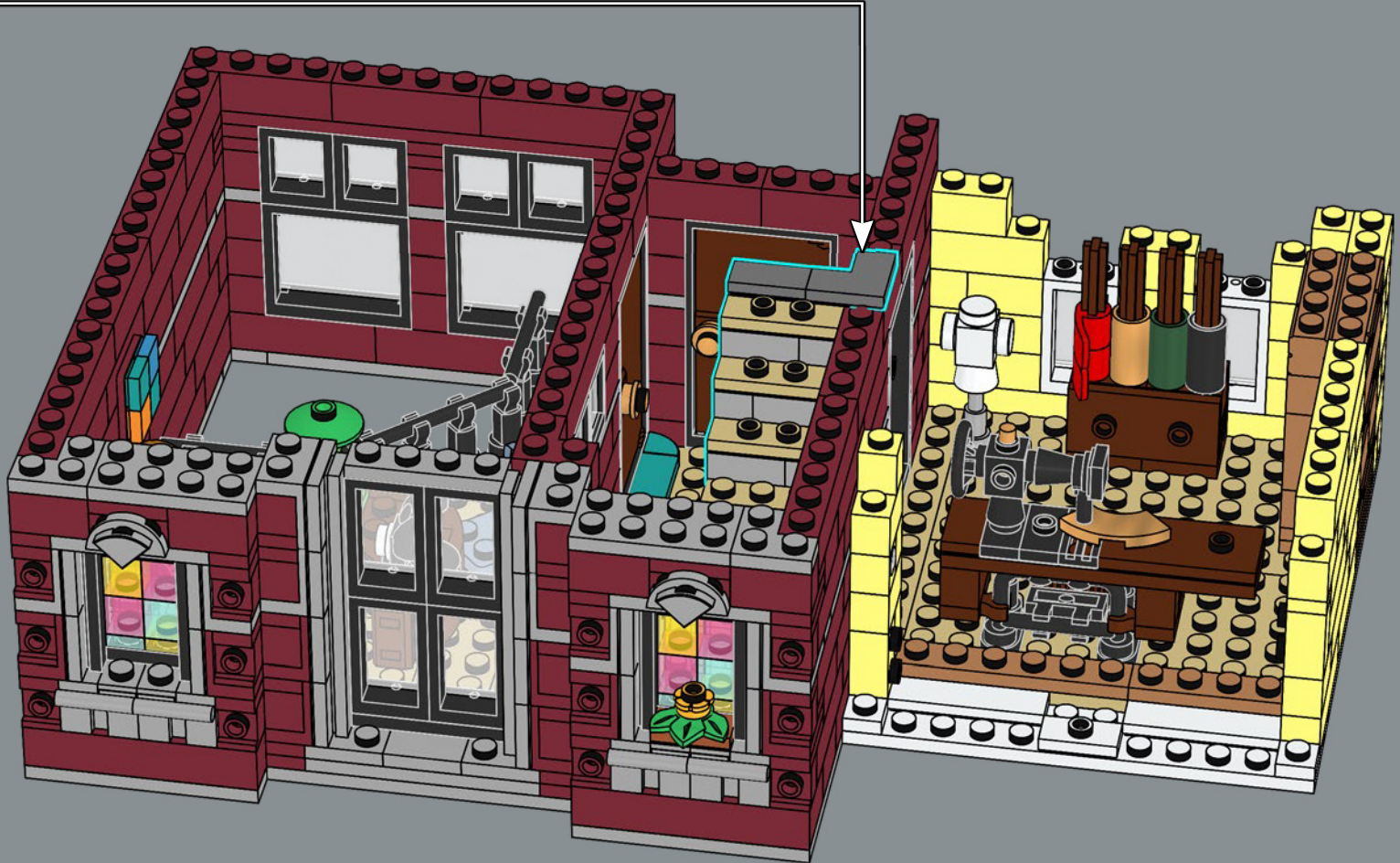



12x

256

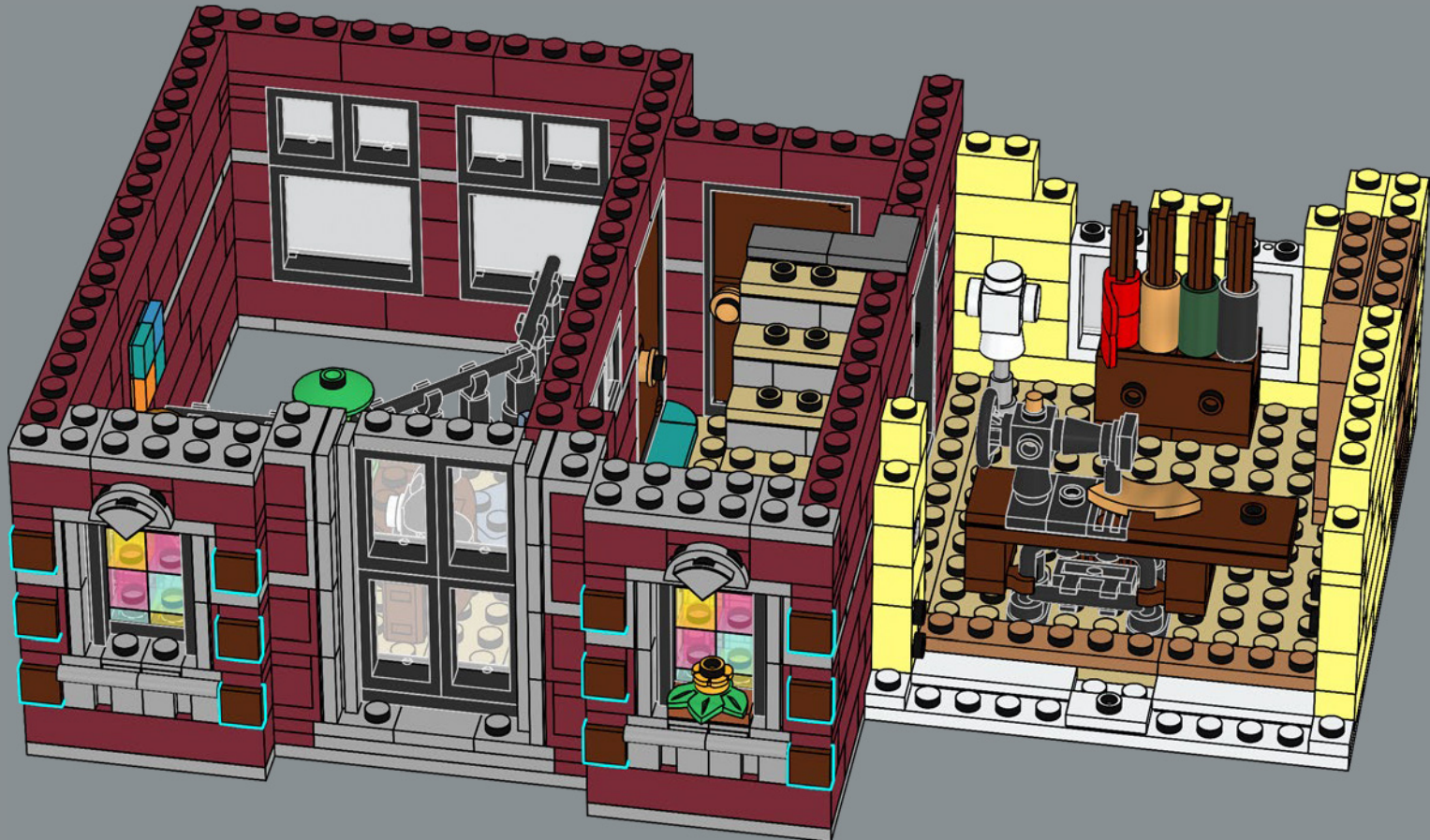

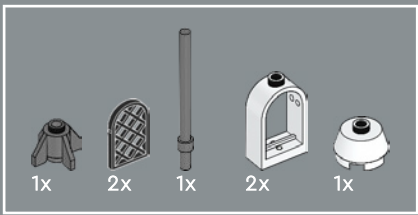

257

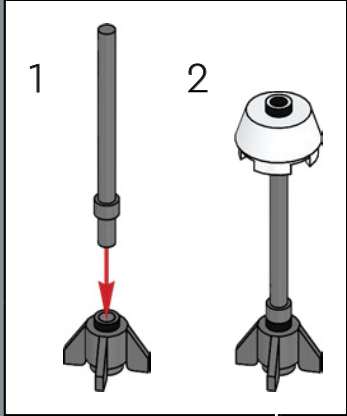
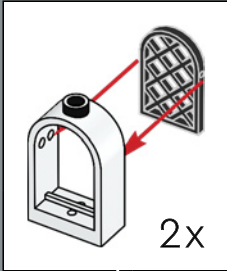
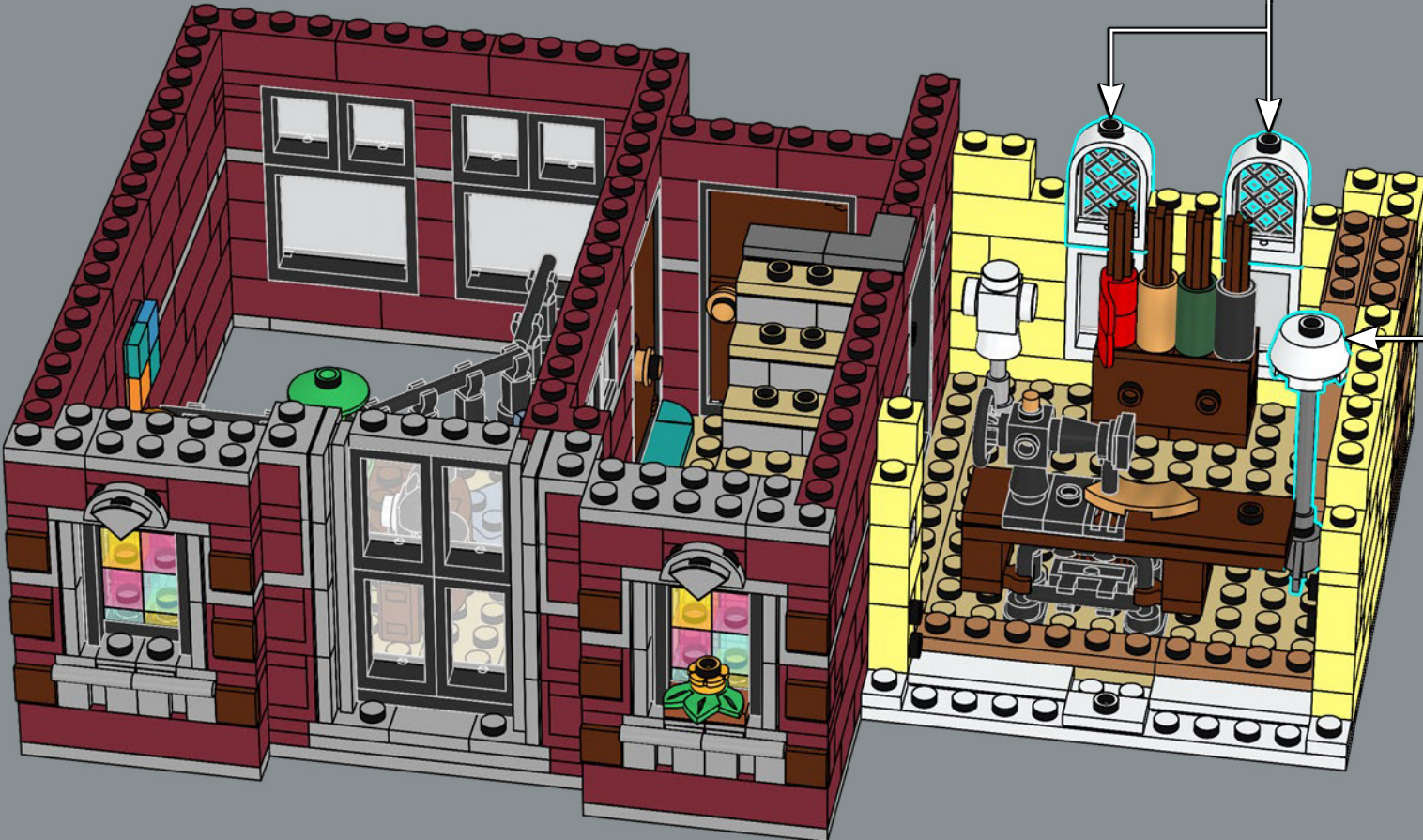

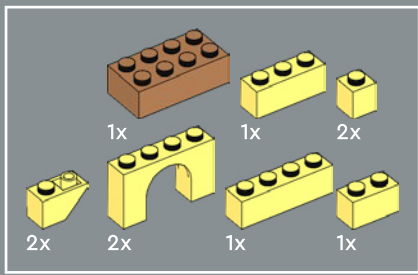

258

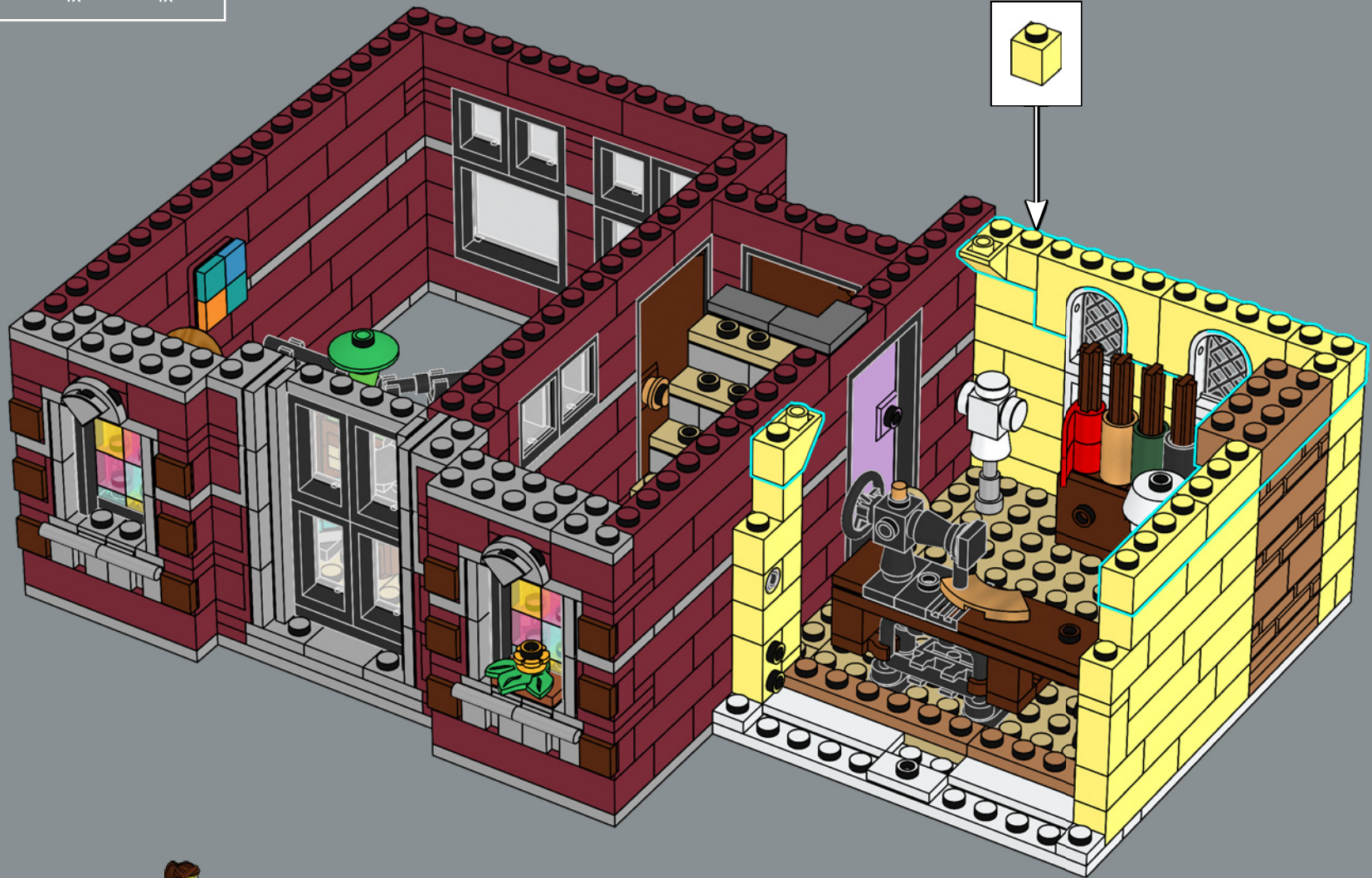



259

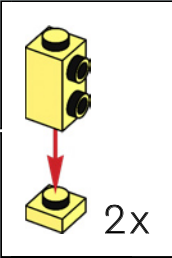
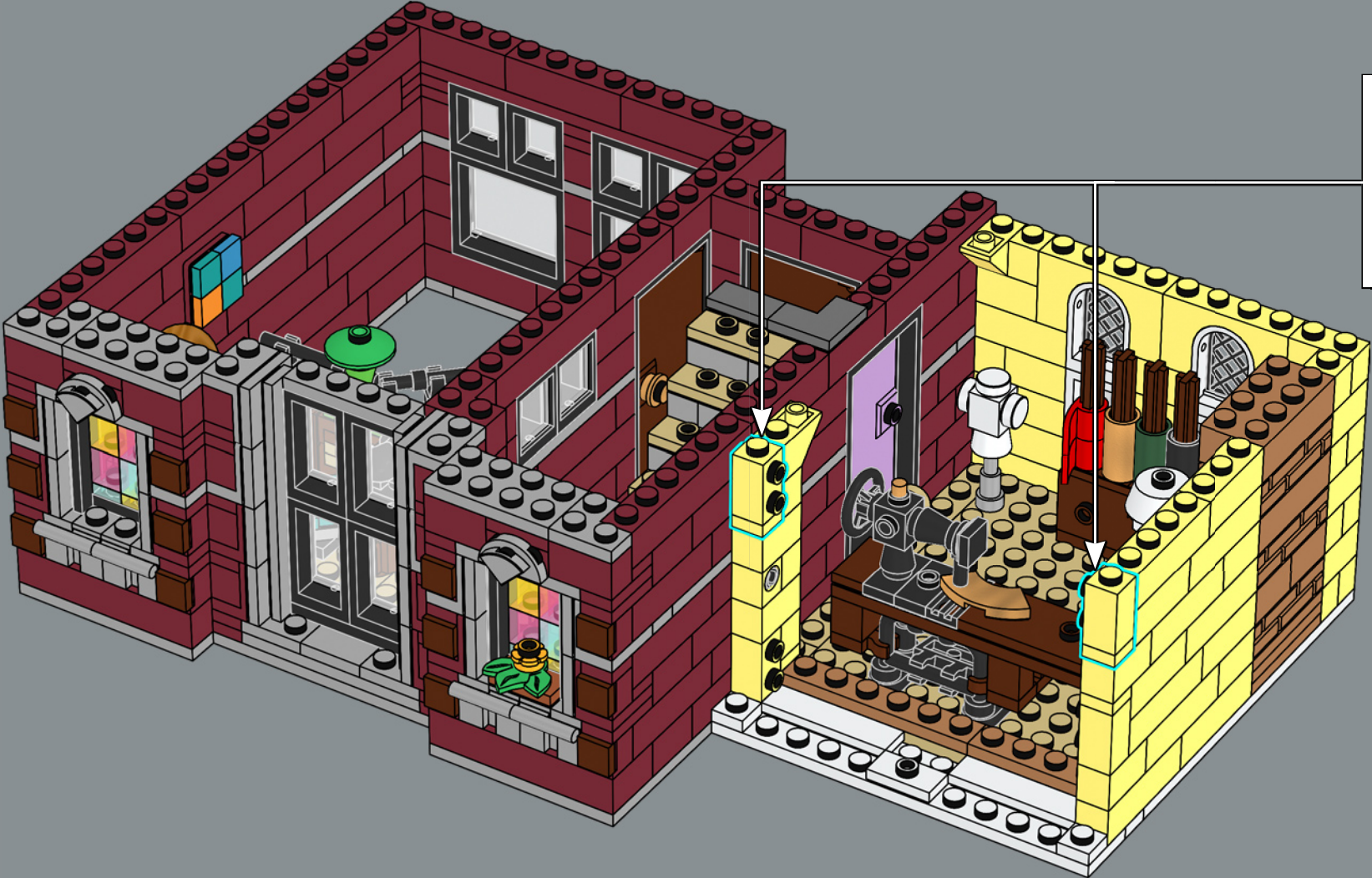

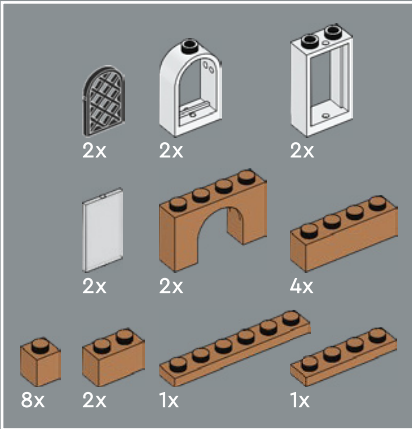
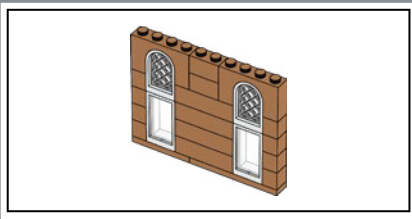

260

1

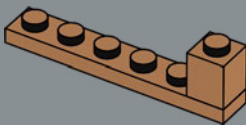

2

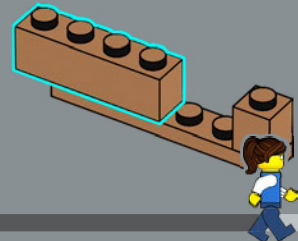

3

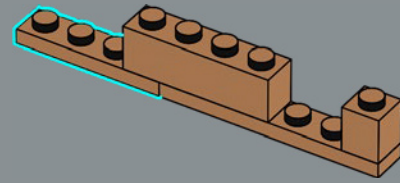

4

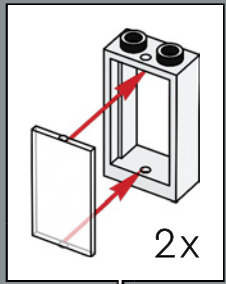
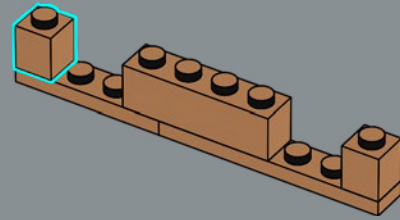

5

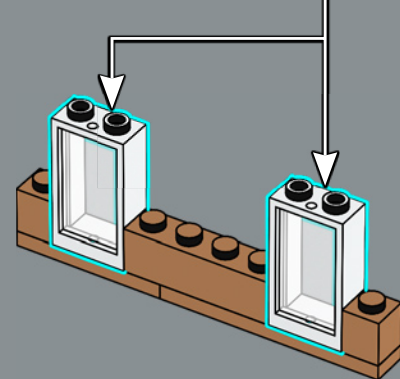

6

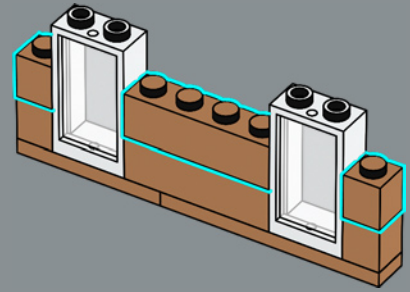

7

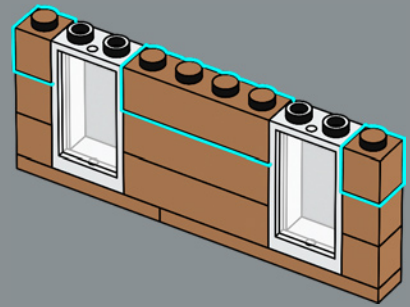

8

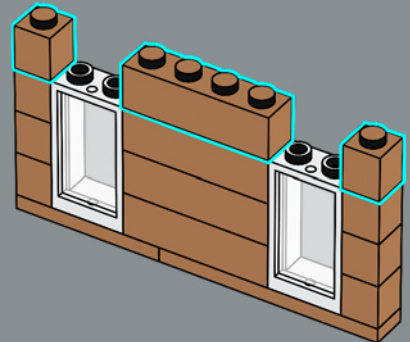

9

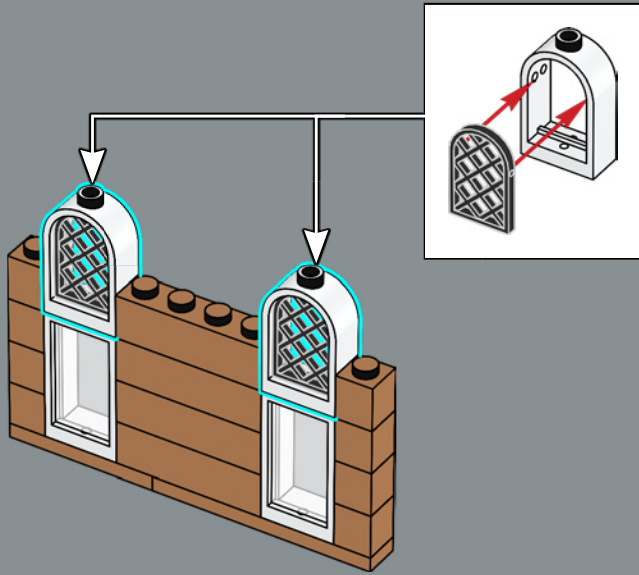

10

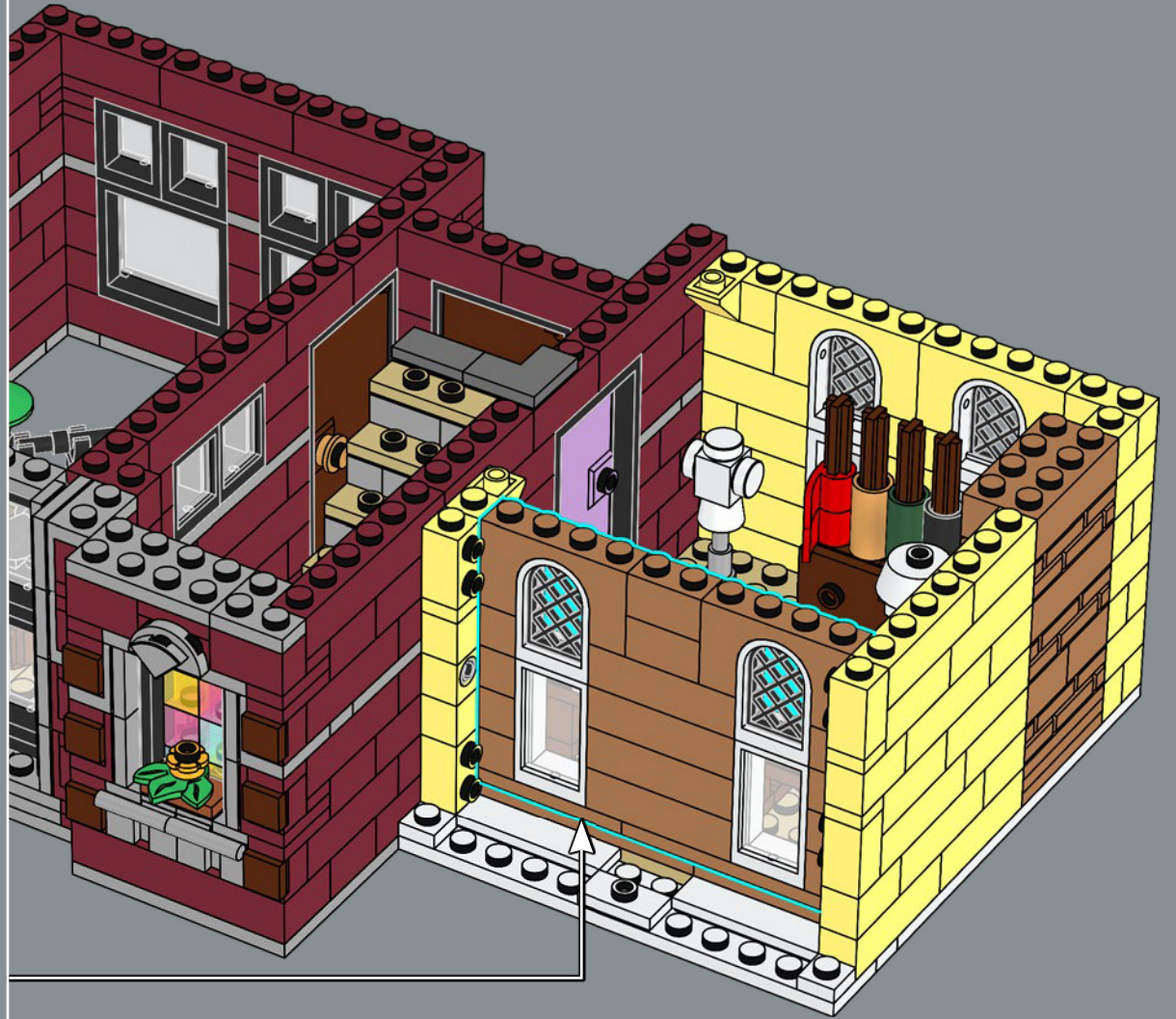
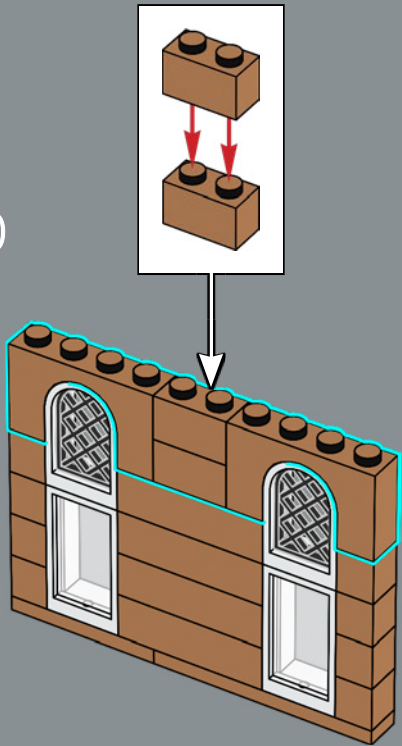

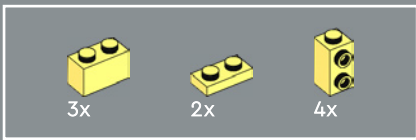

261

1

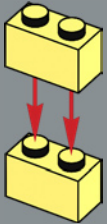

2

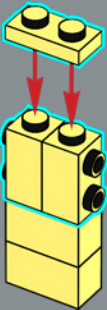

3

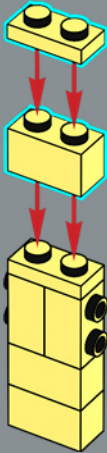

4

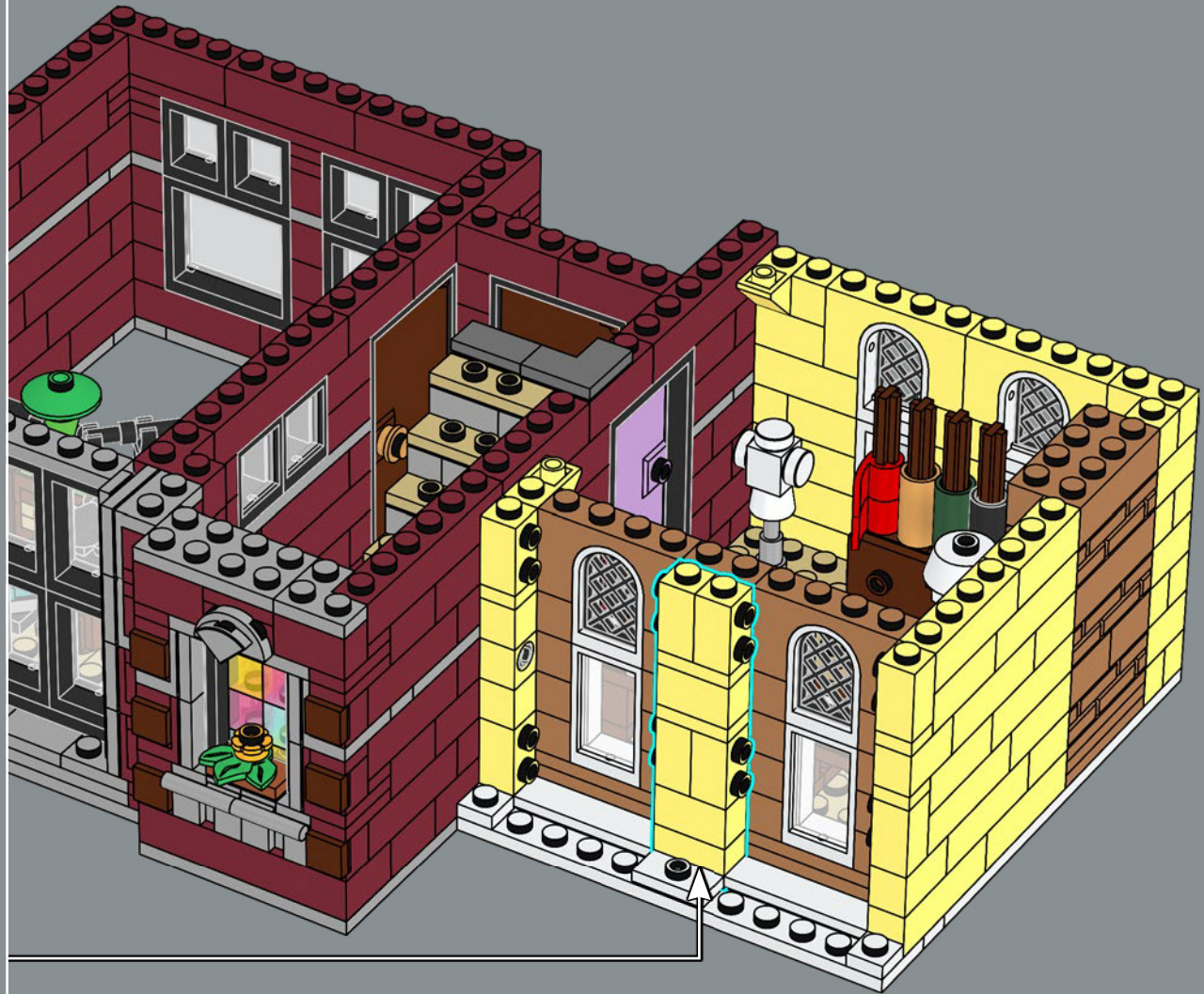
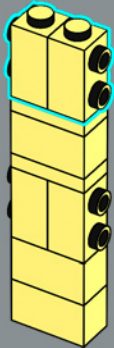

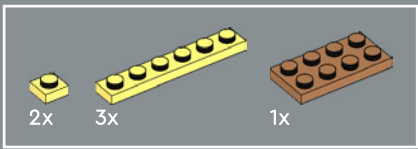

262



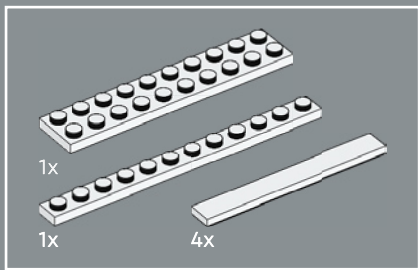

263

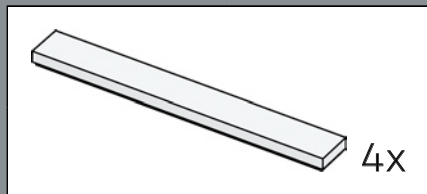

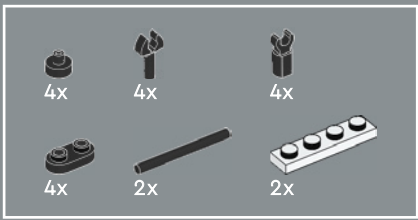

264

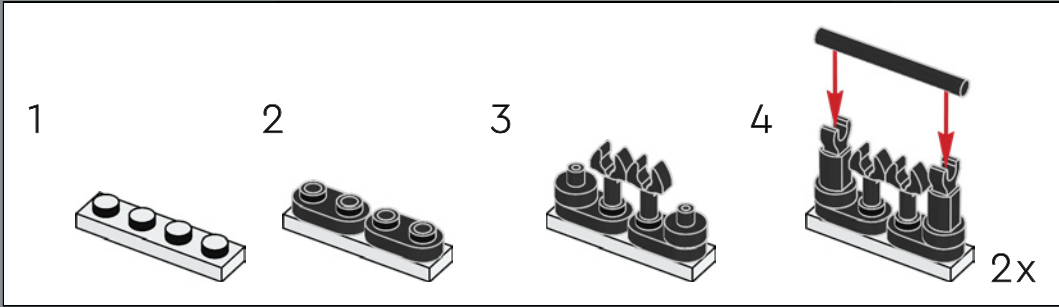

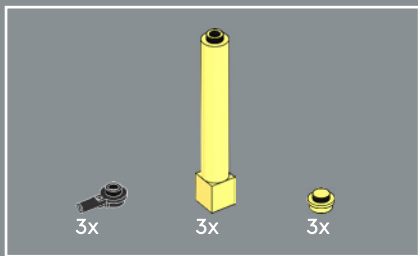

265

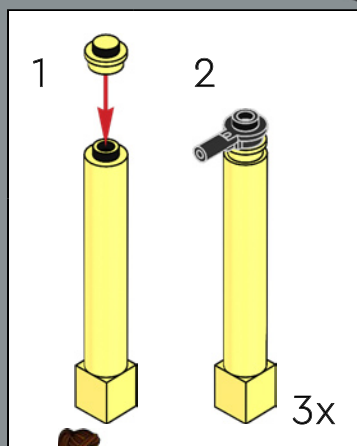
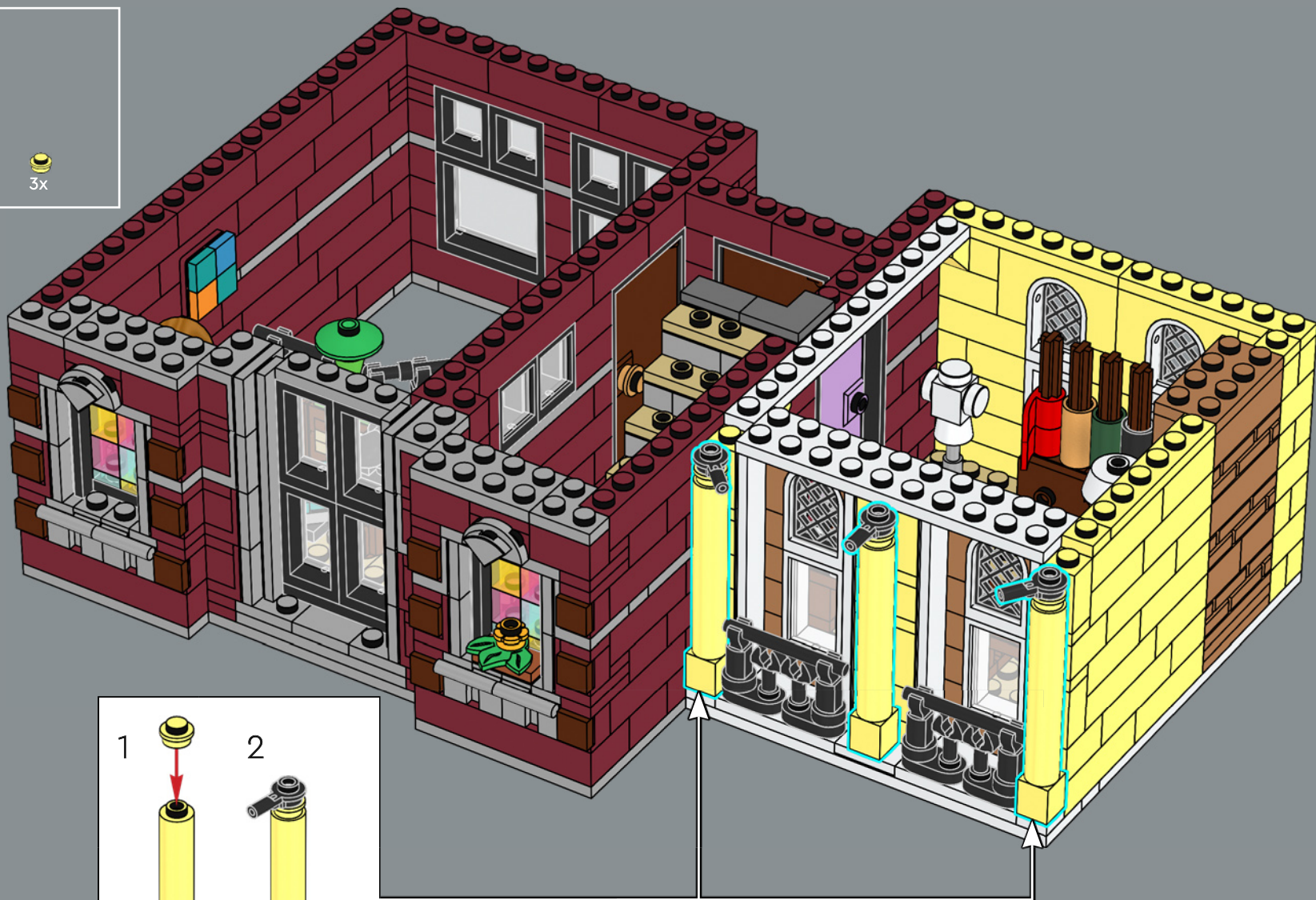



3x

266

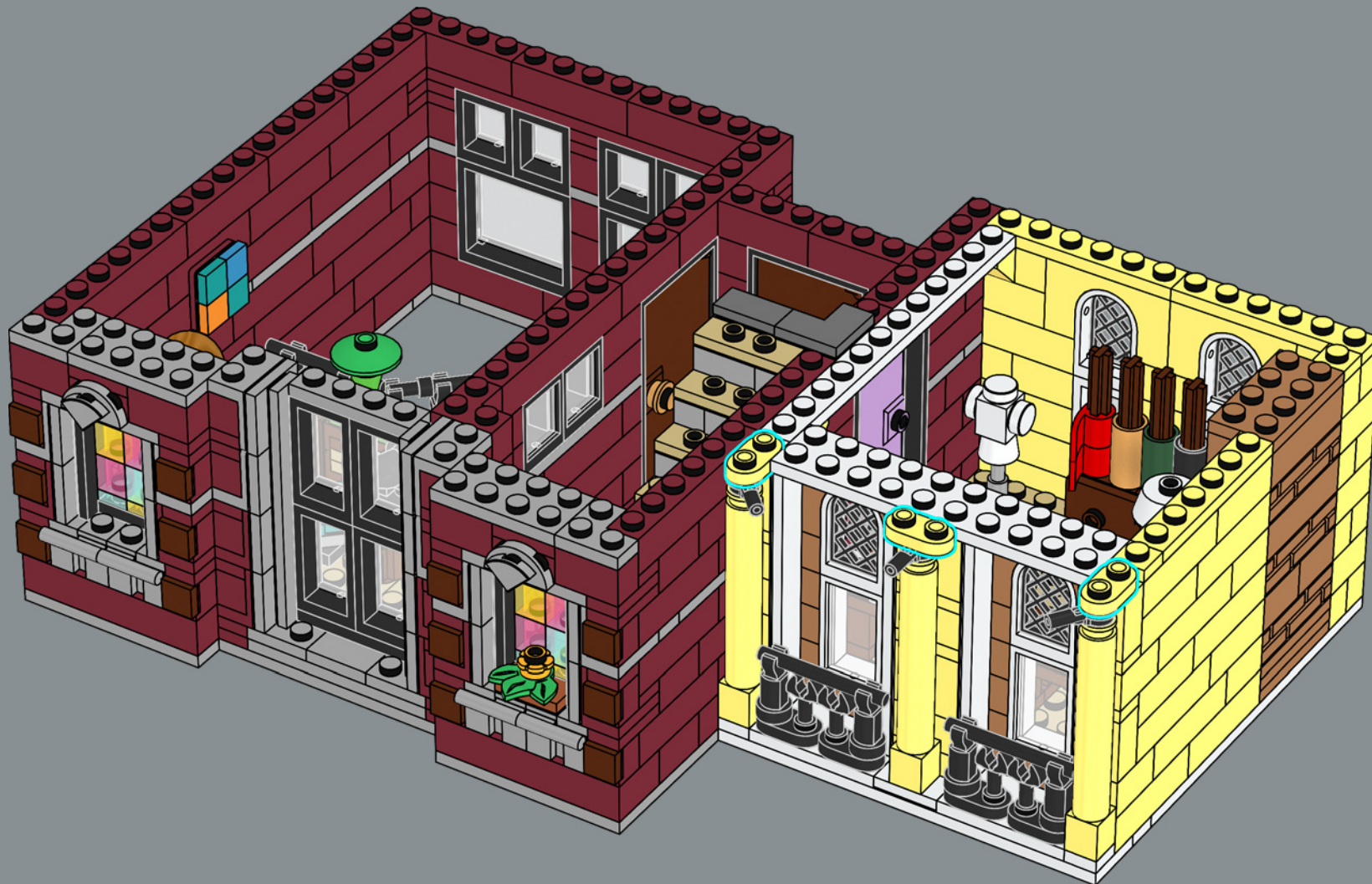

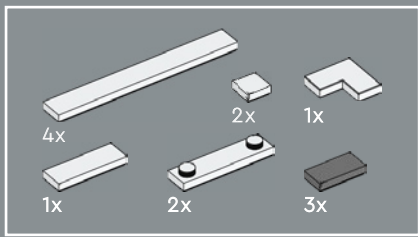

267

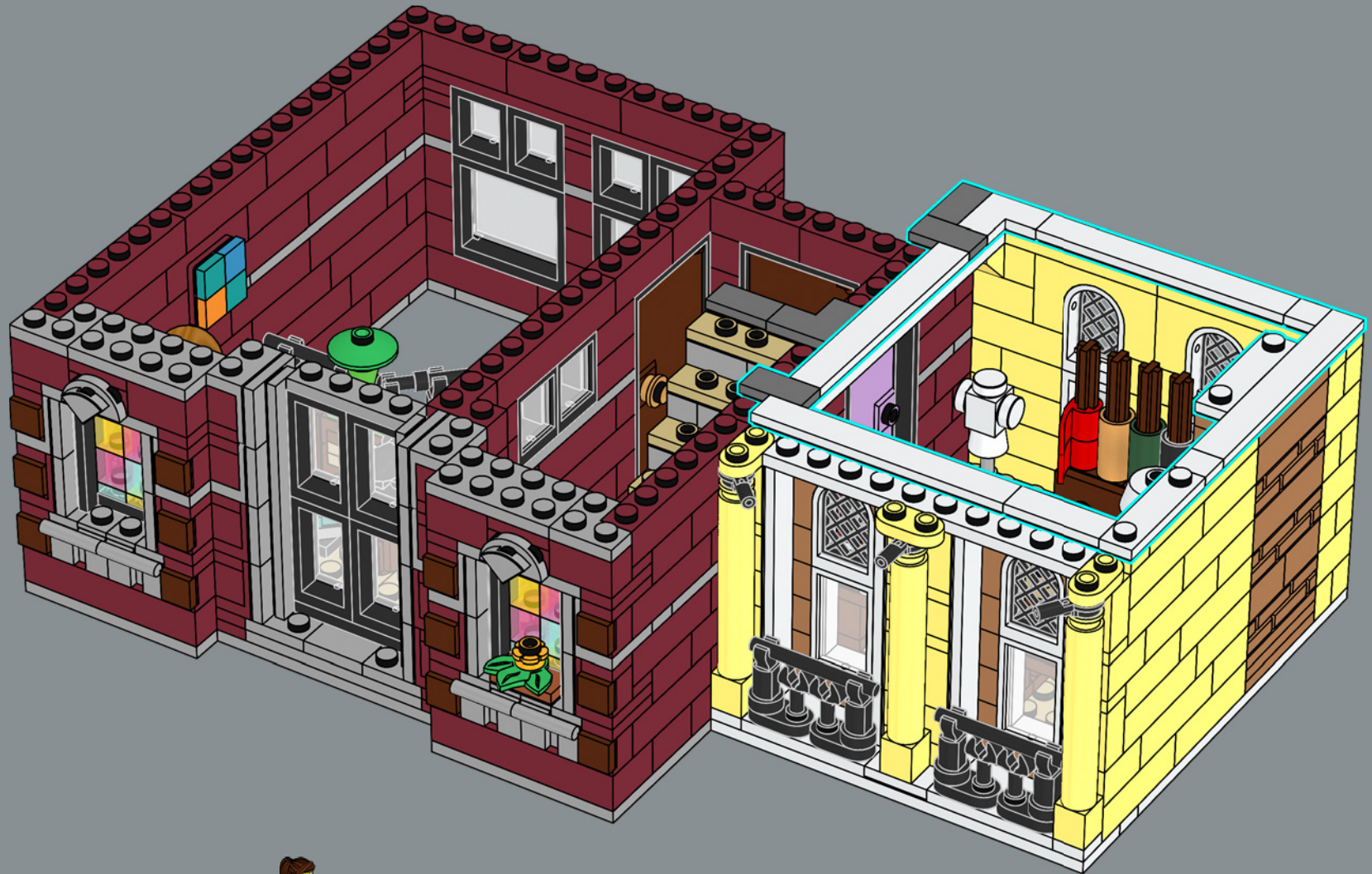

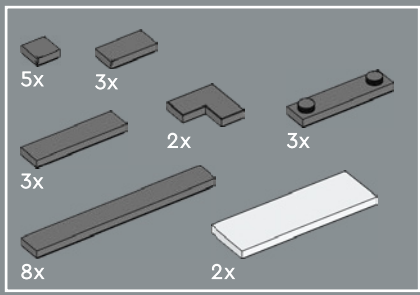

268

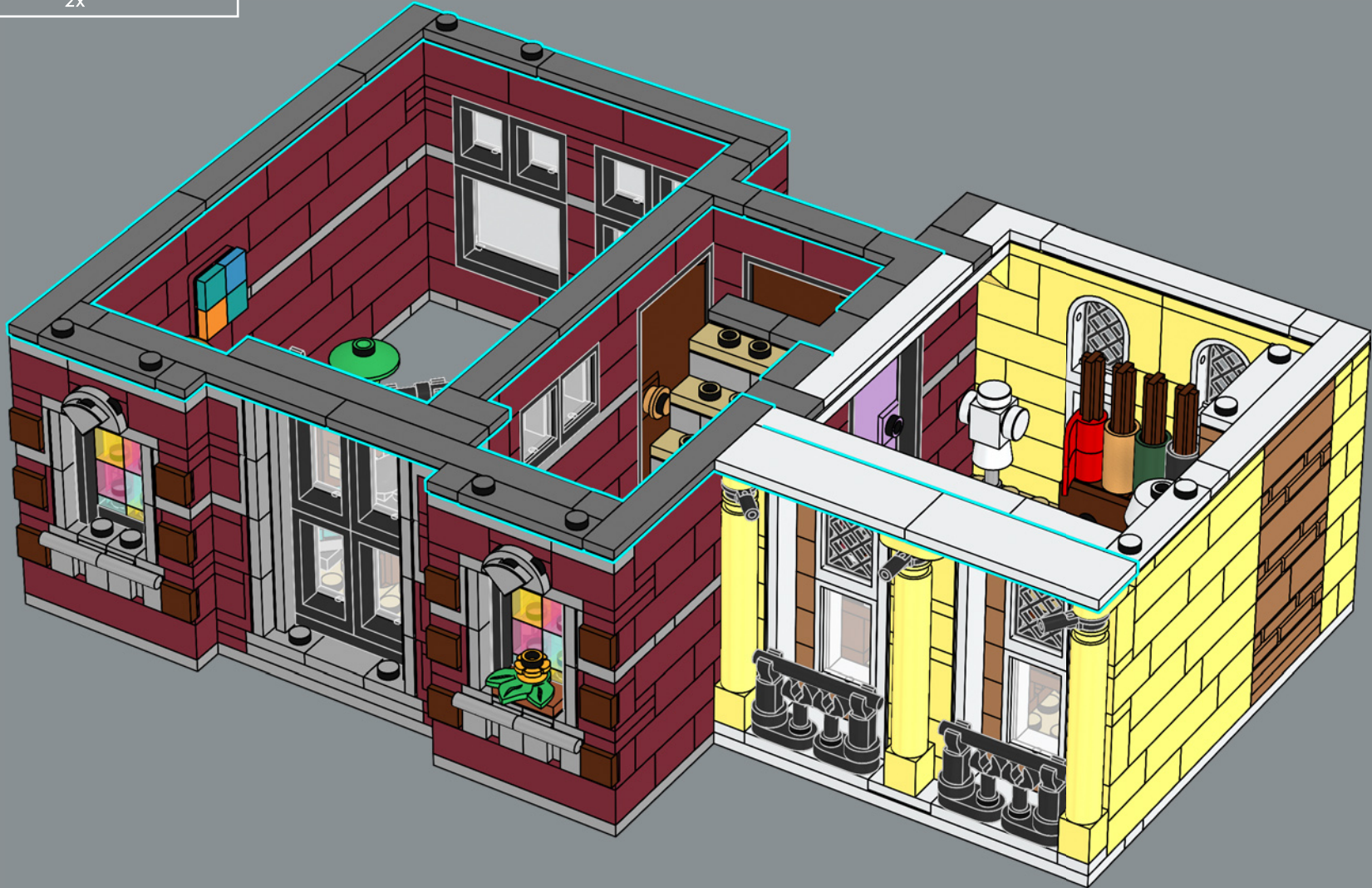



269



De la lavande suspendue, une enseigne et des portes couleur lavande... si vous avez besoin du couturier, laissez-vous guider par la lavande !

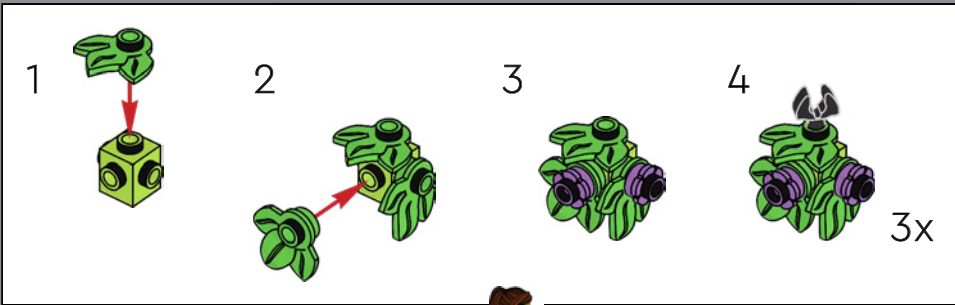

270





La chanteuse est presque prête pour le spectacle de ce soir. Elle est allée récupérer sa robe chez le couturier, a mangé un morceau à la pizzeria et a salué la gérante. Elle échauffe désormais sa voix dans sa loge.

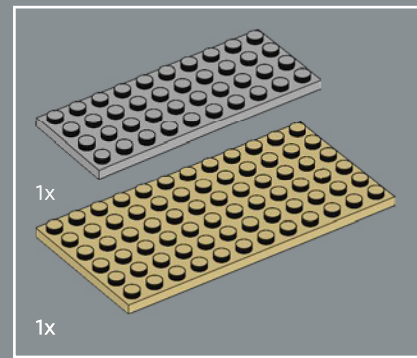
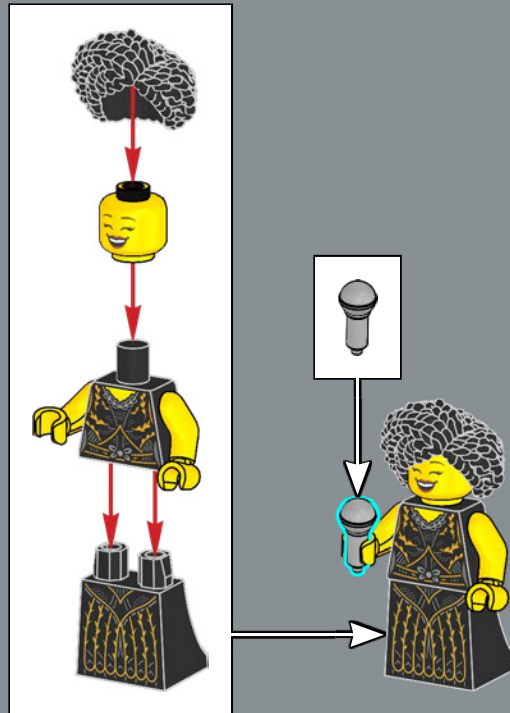
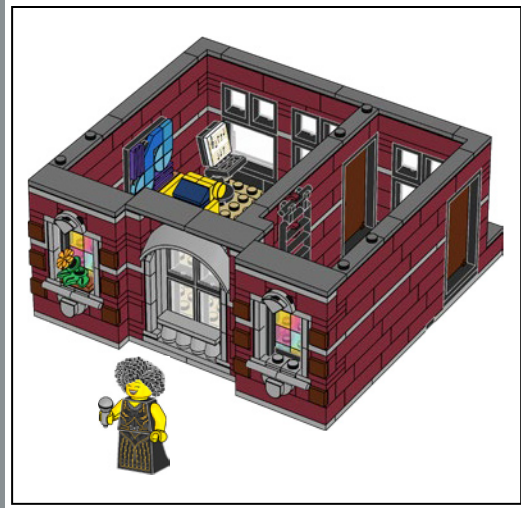

271

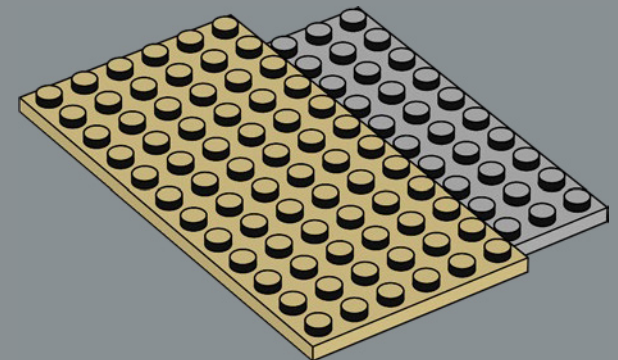

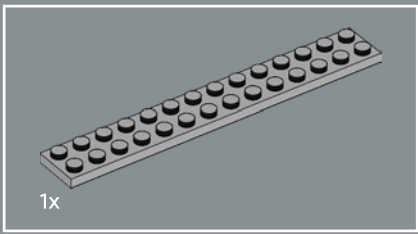

272

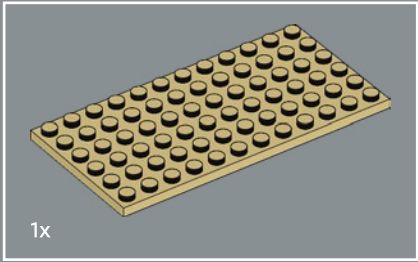
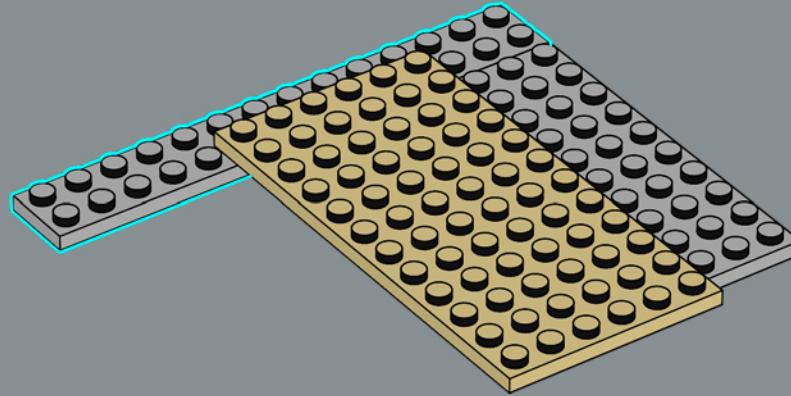

273

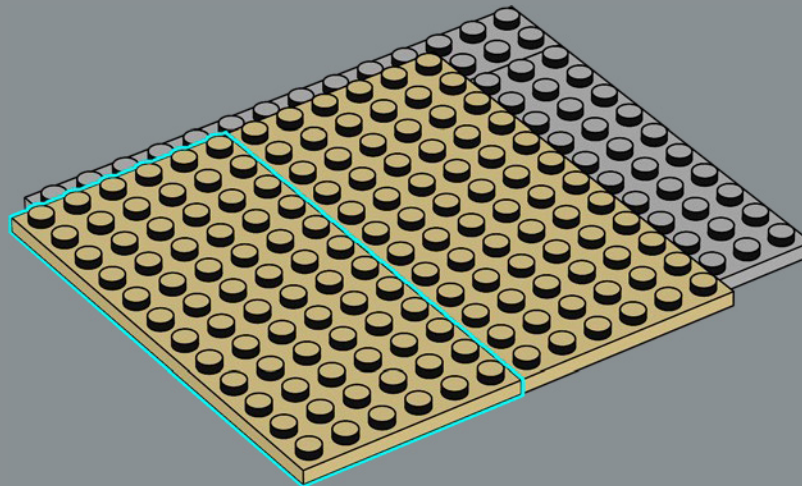

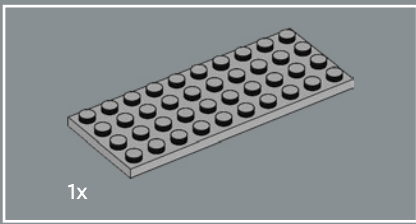

274

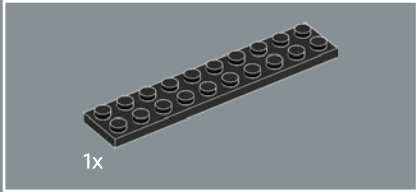
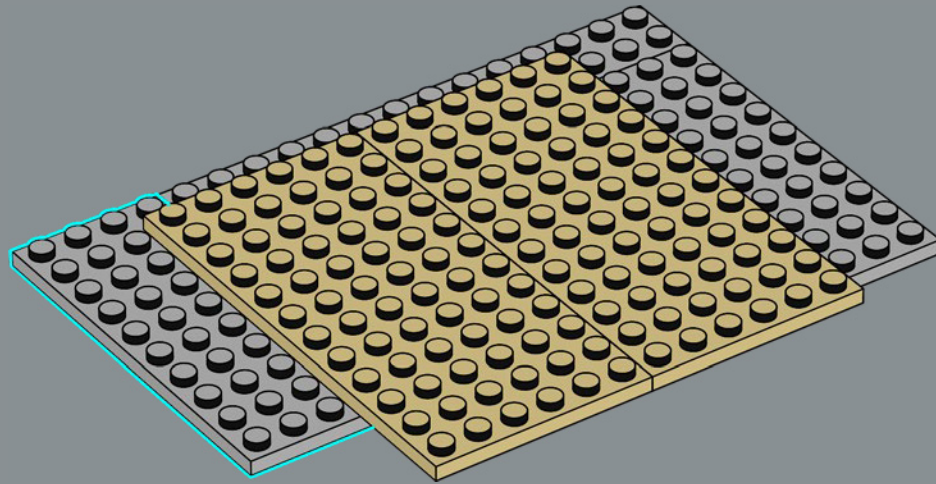

275

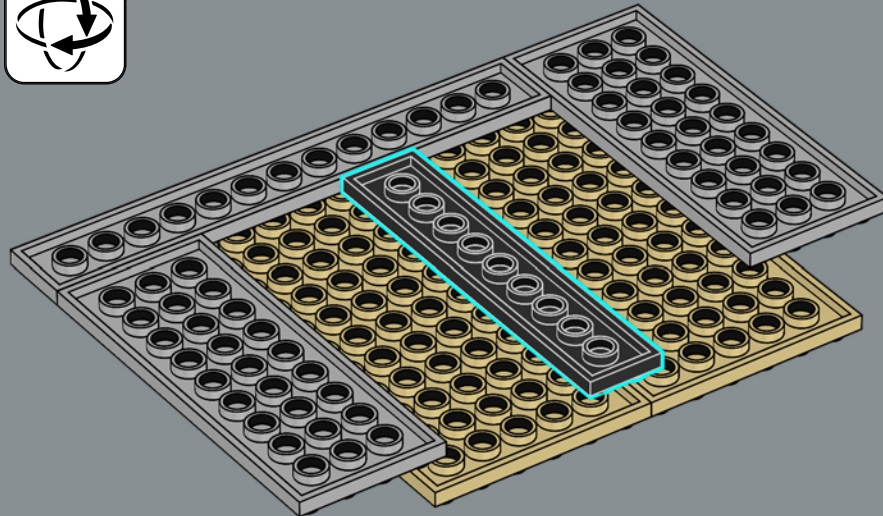

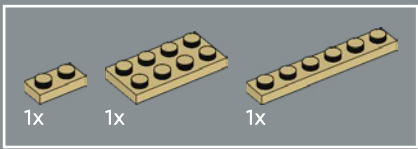

276

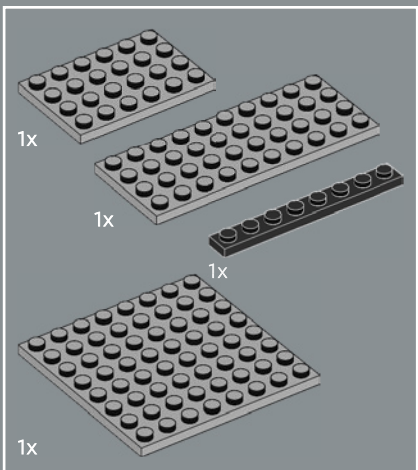
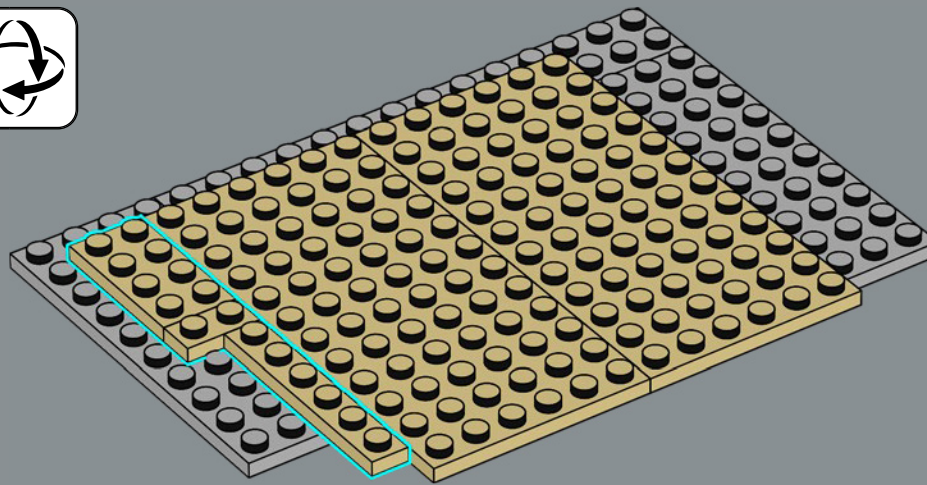

277

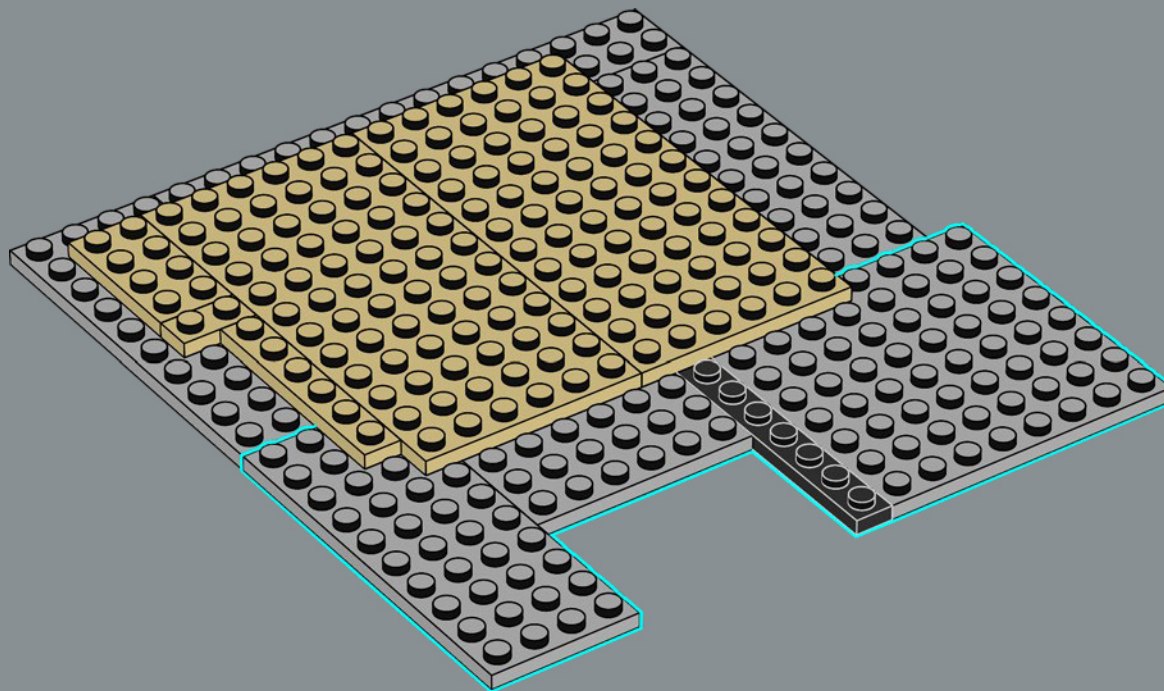

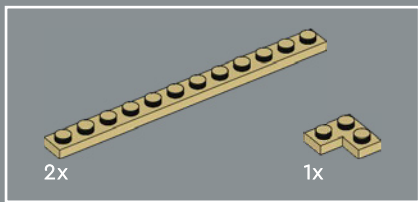

278

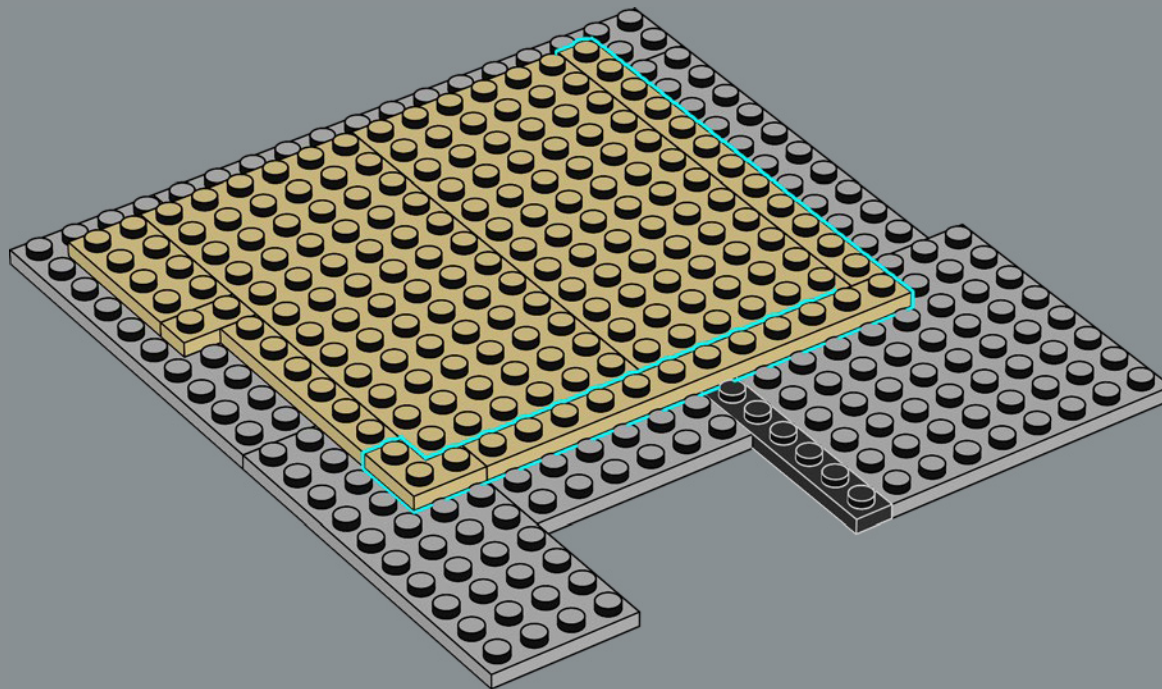

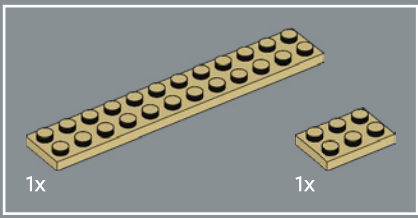

279

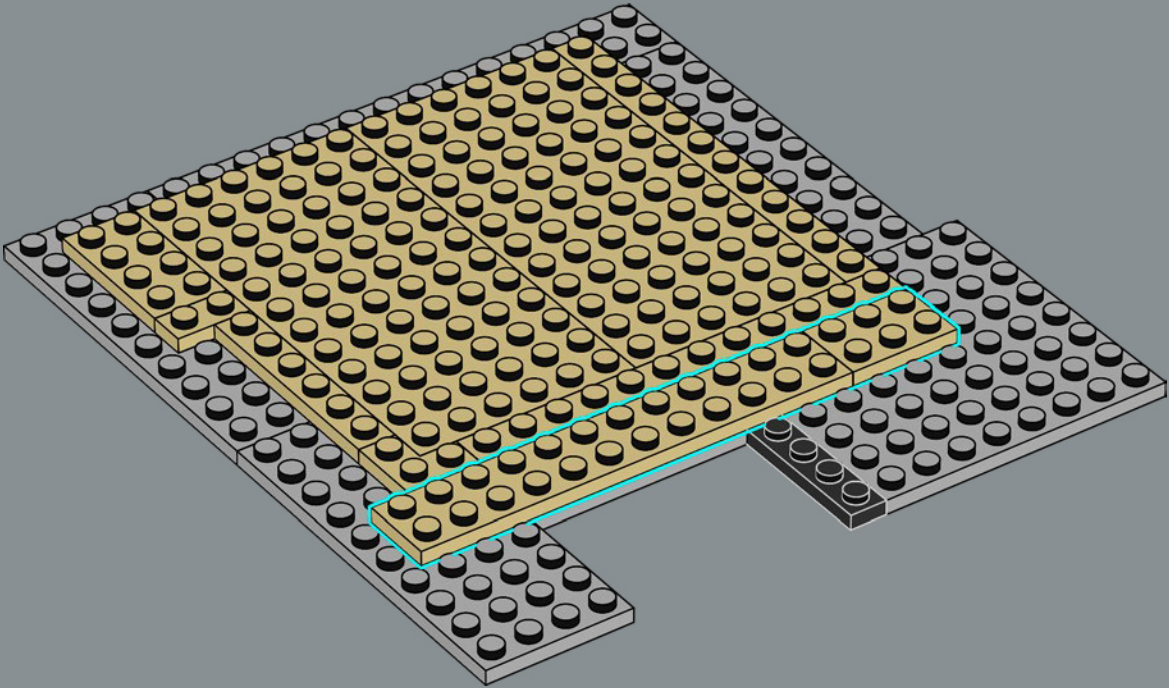

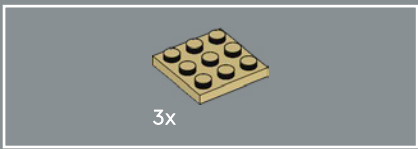

280

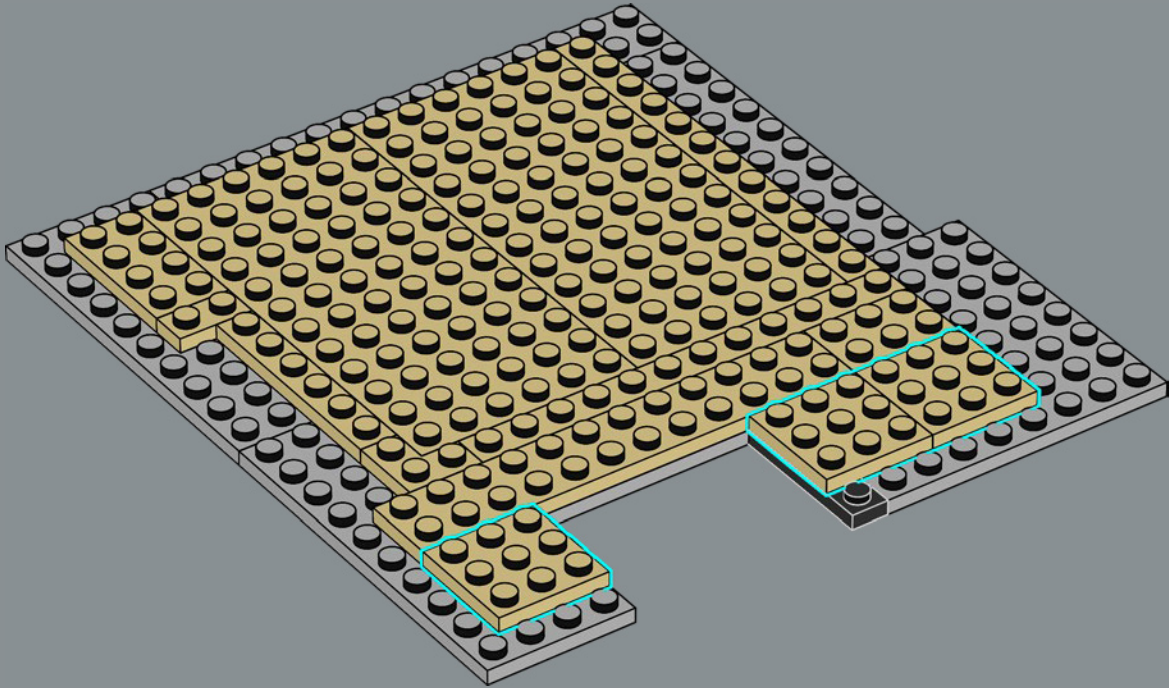

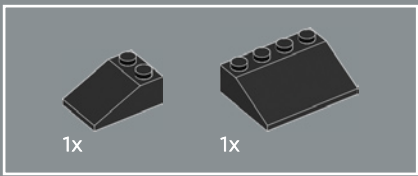

281

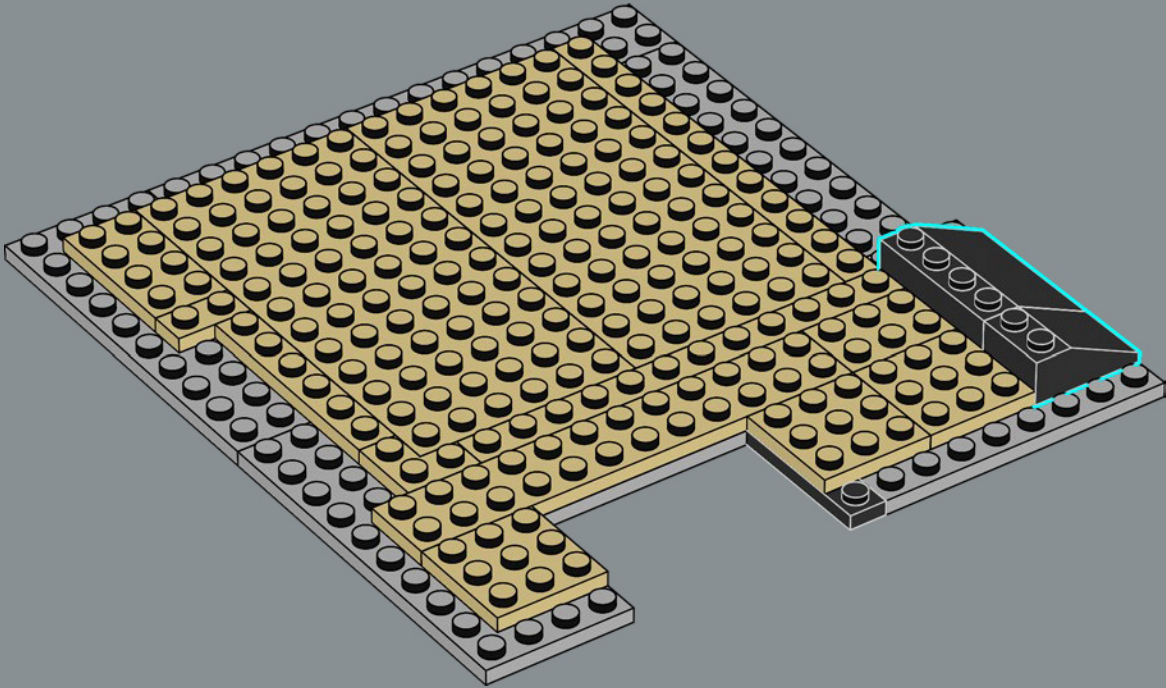

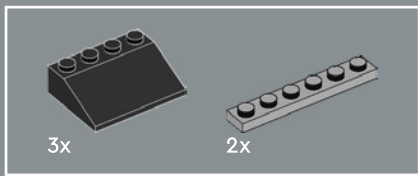

282

1

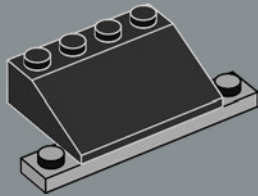

2

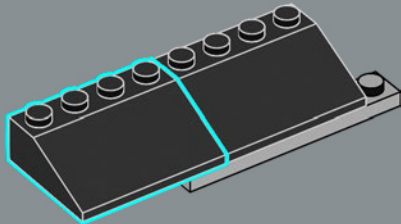

3

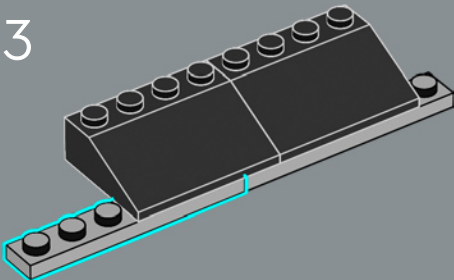

4

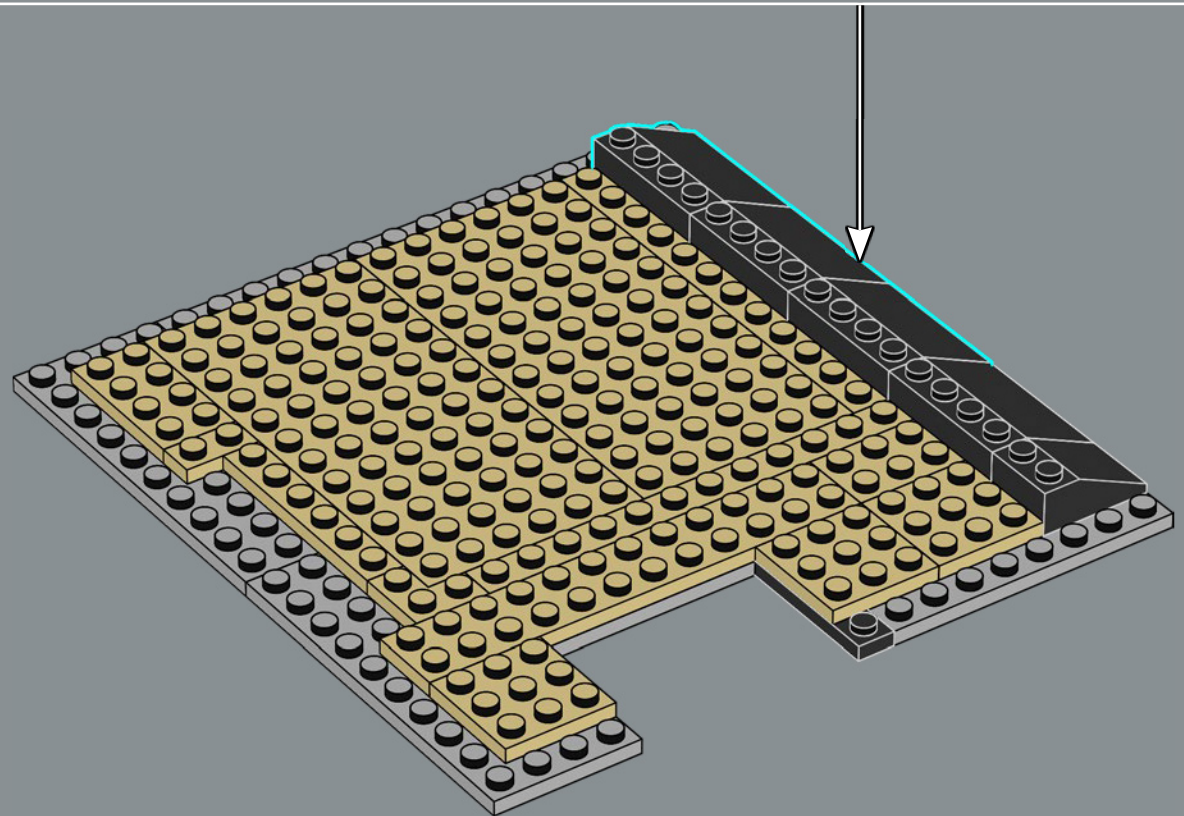
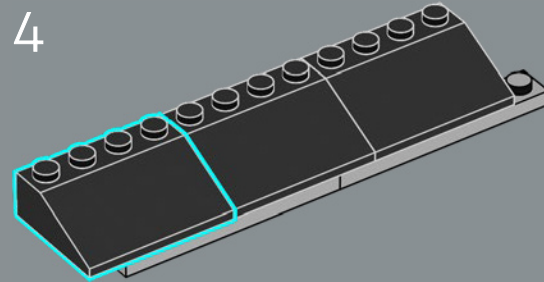

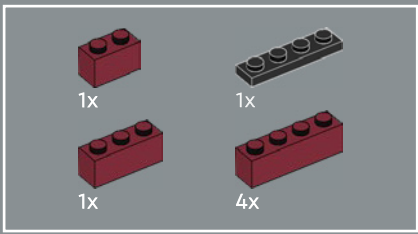

283

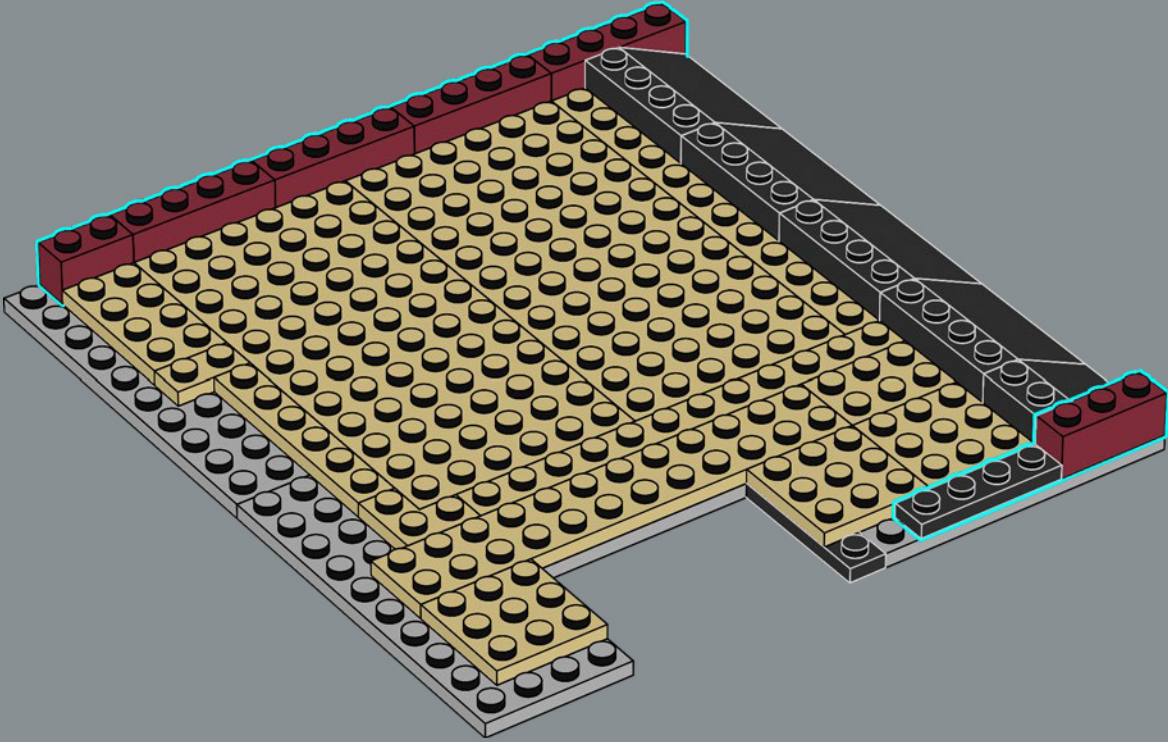

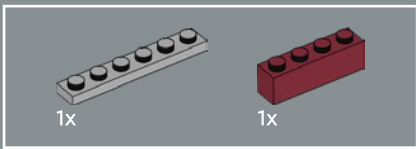

284

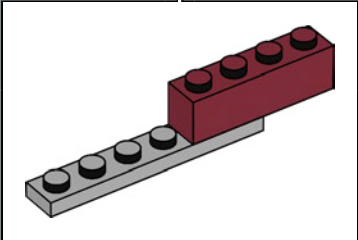
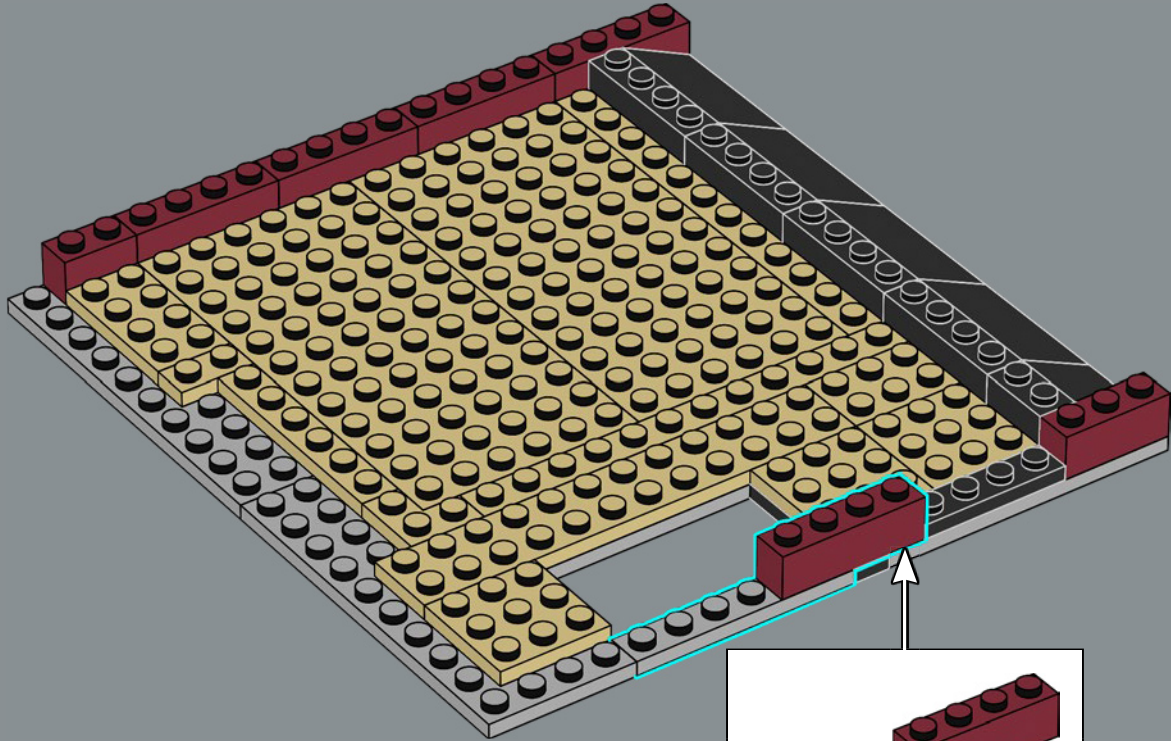

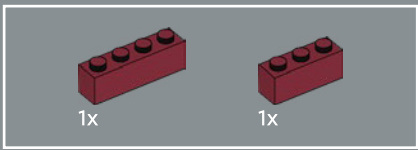

285

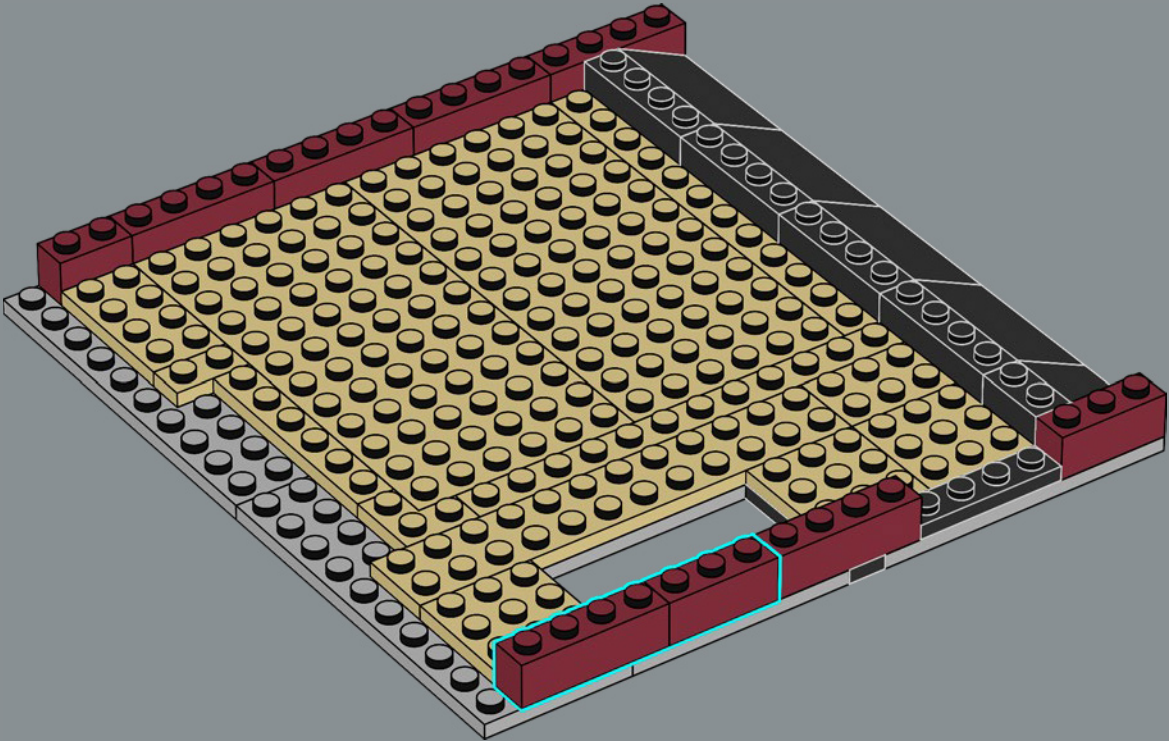

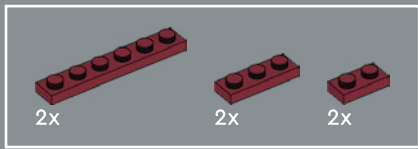

286

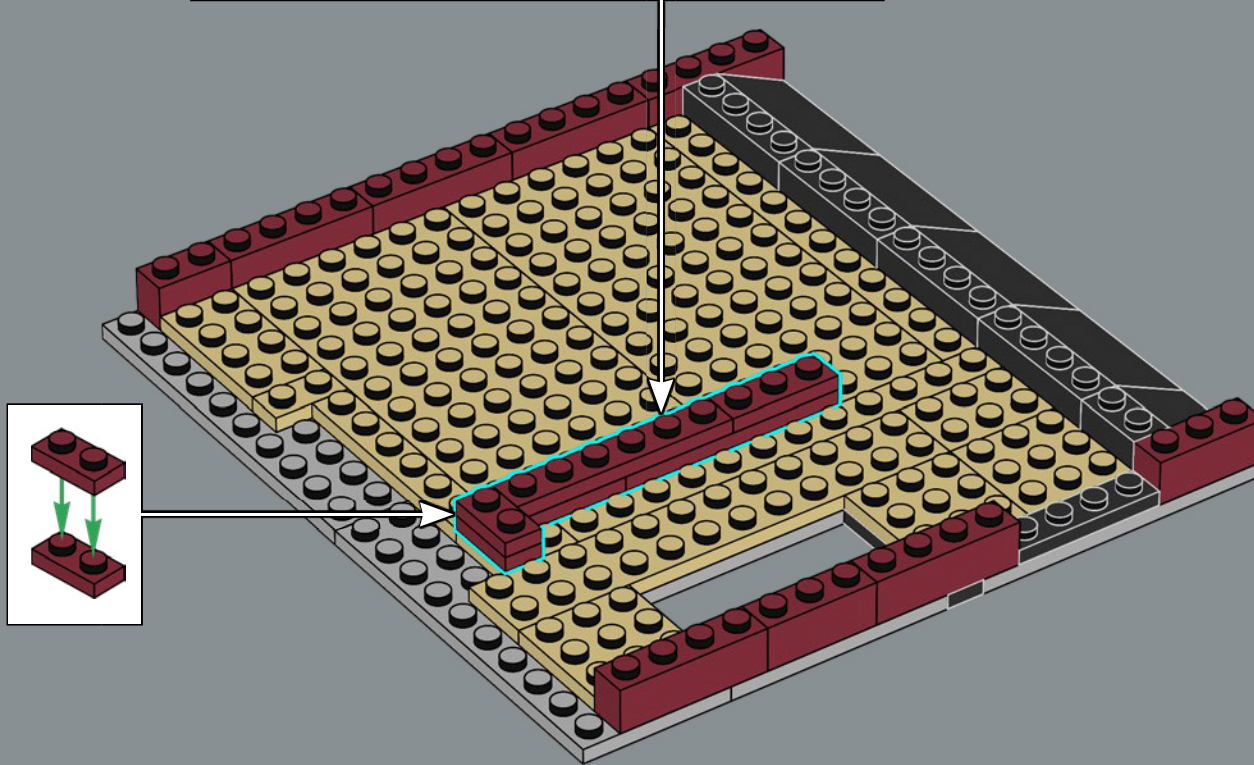
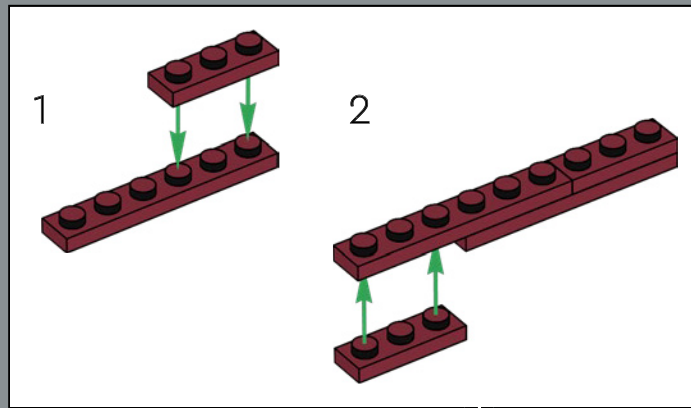

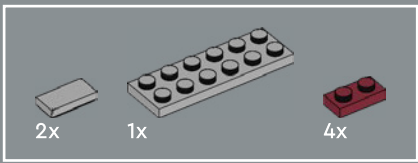

287

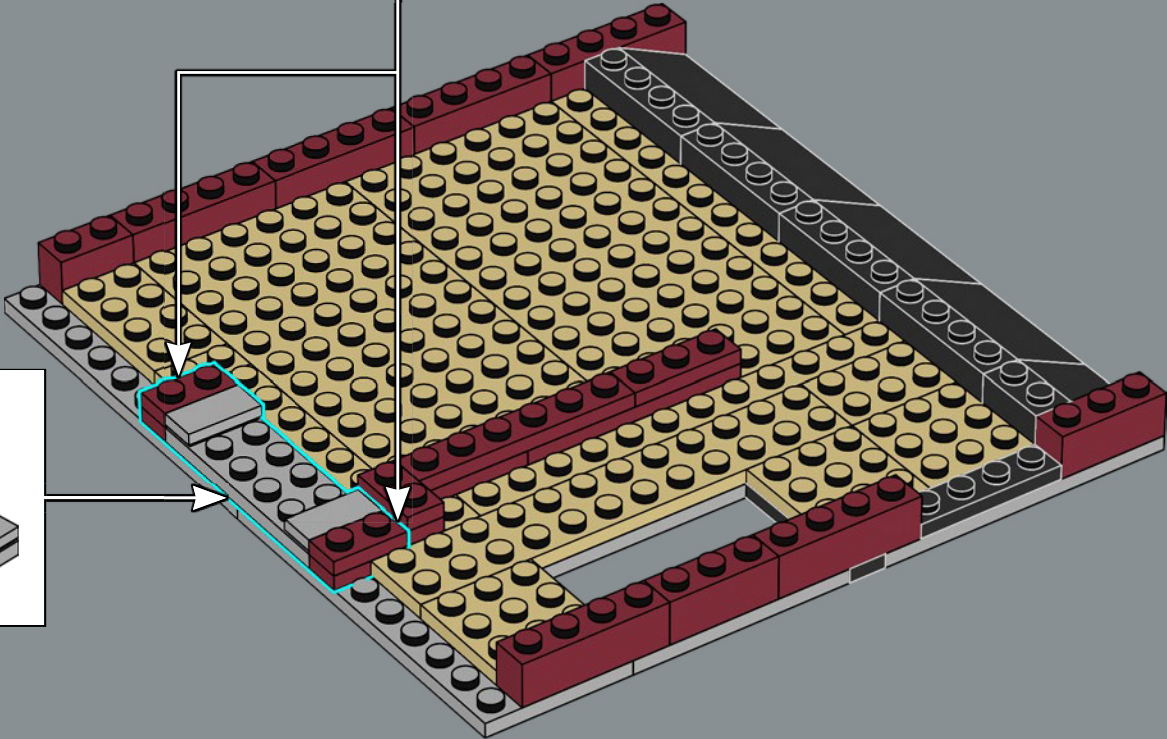
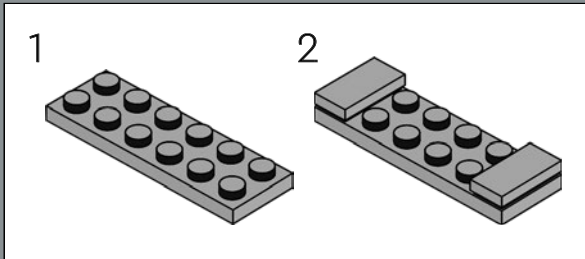
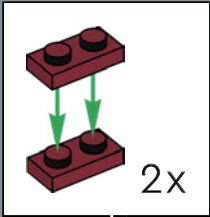

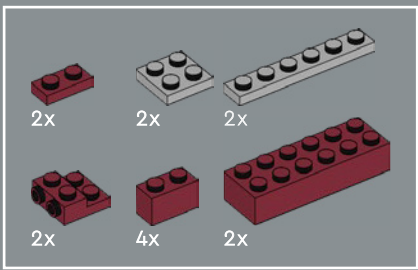

289

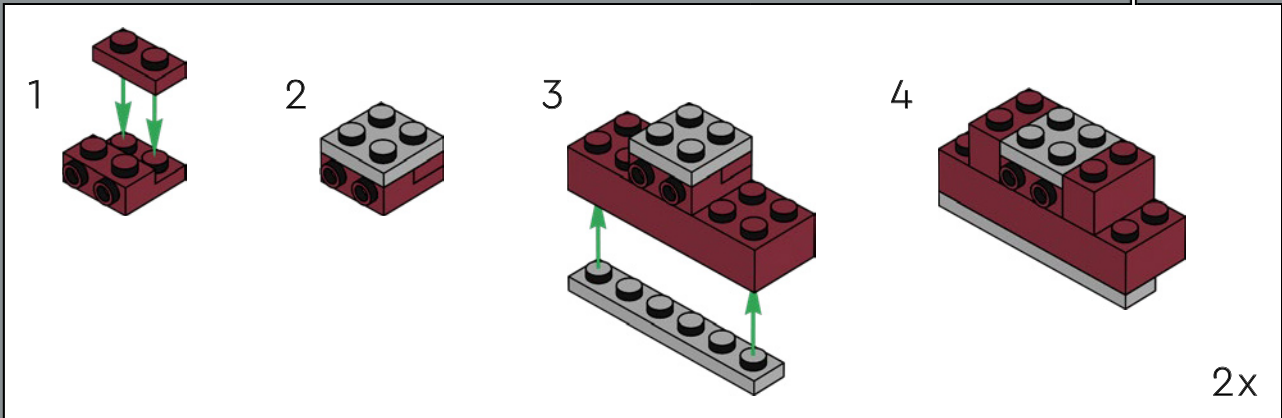
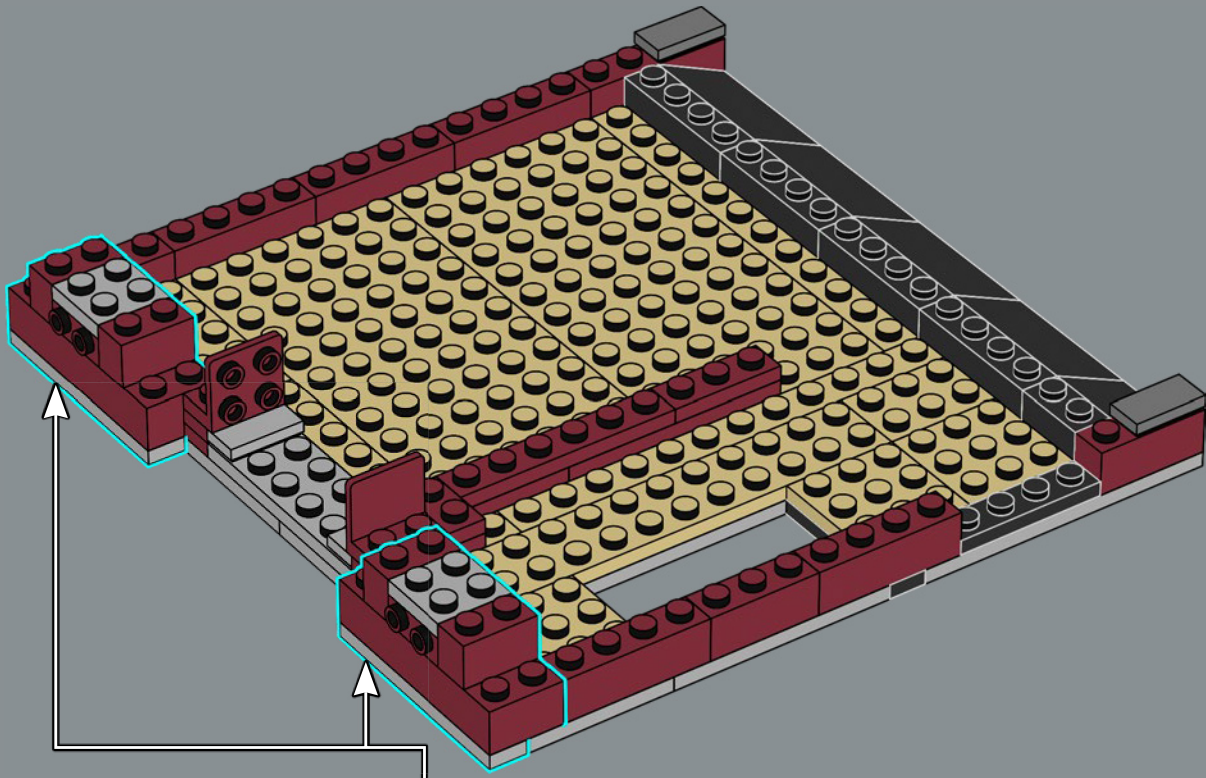

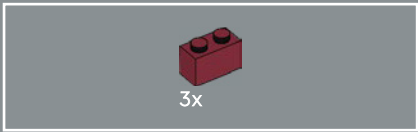

290

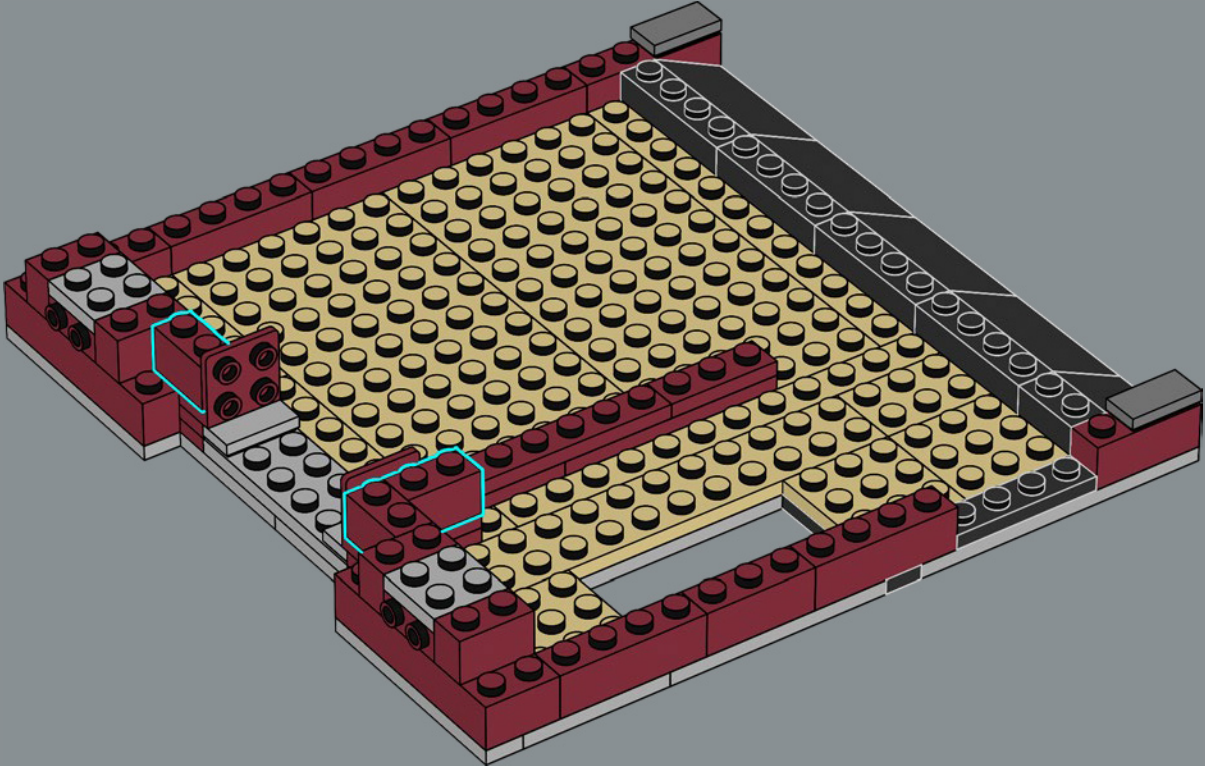

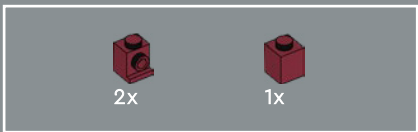

291

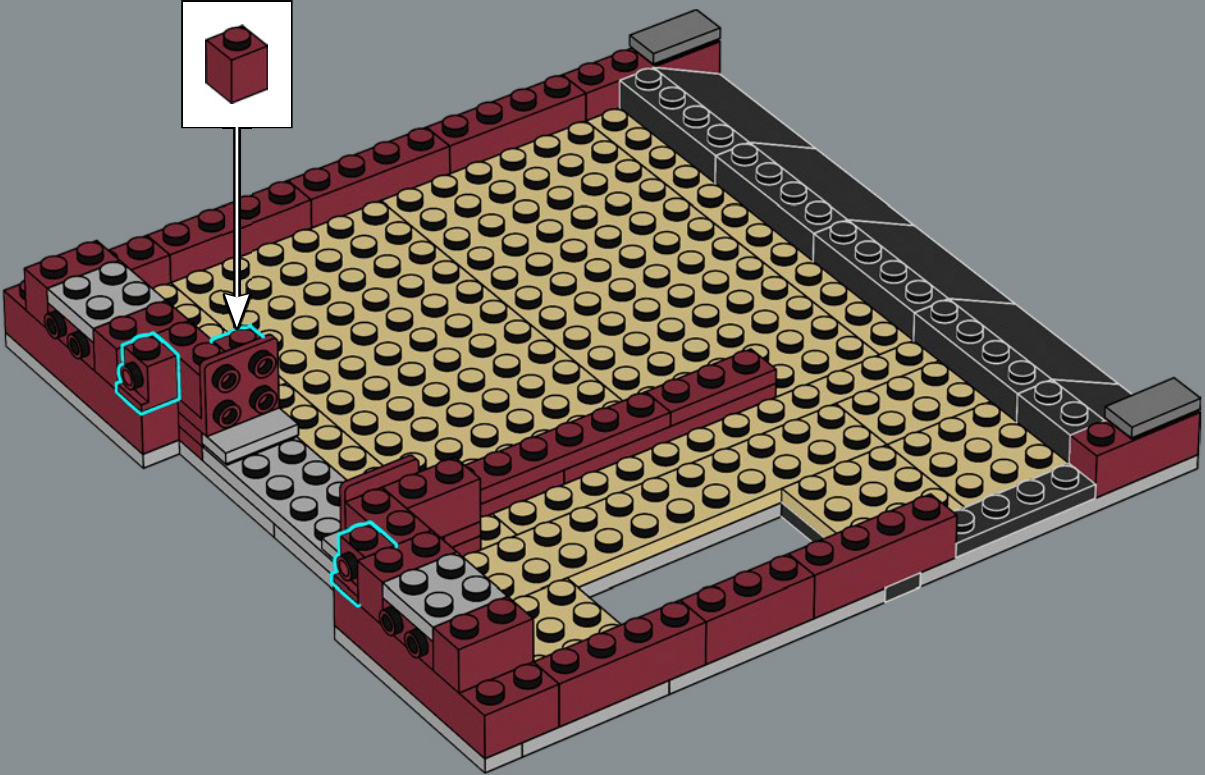



292

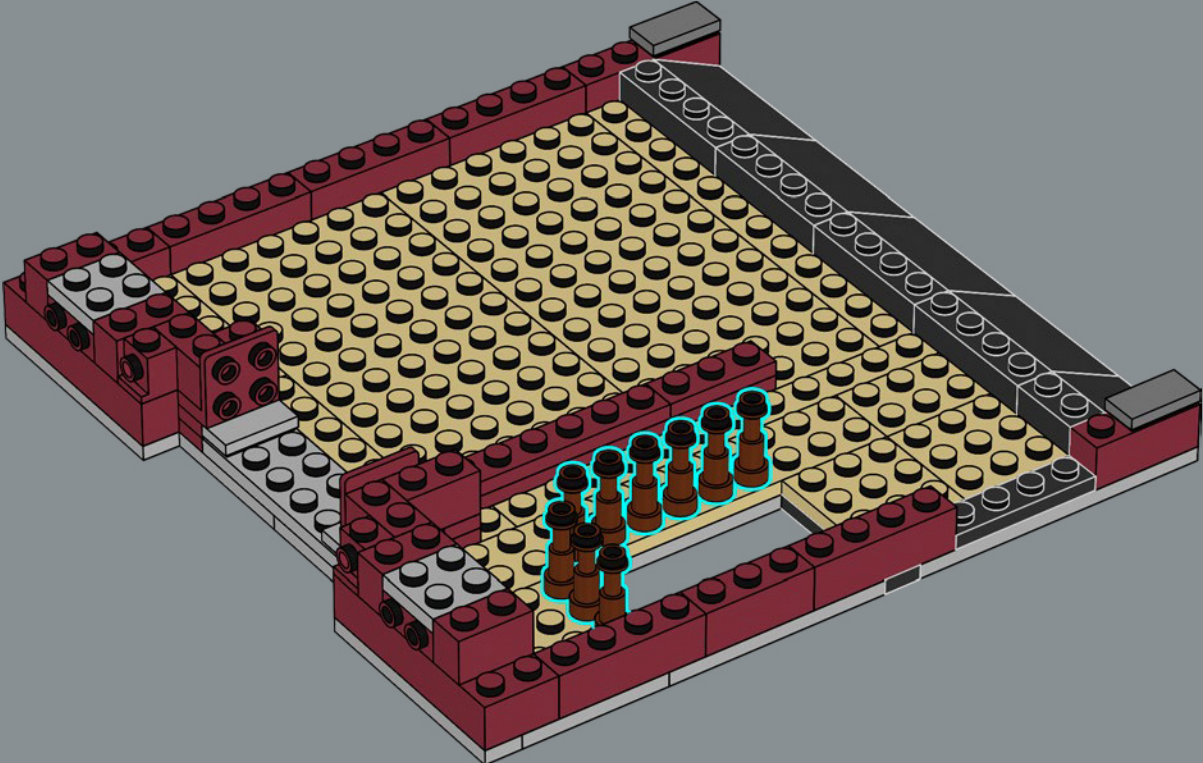



293

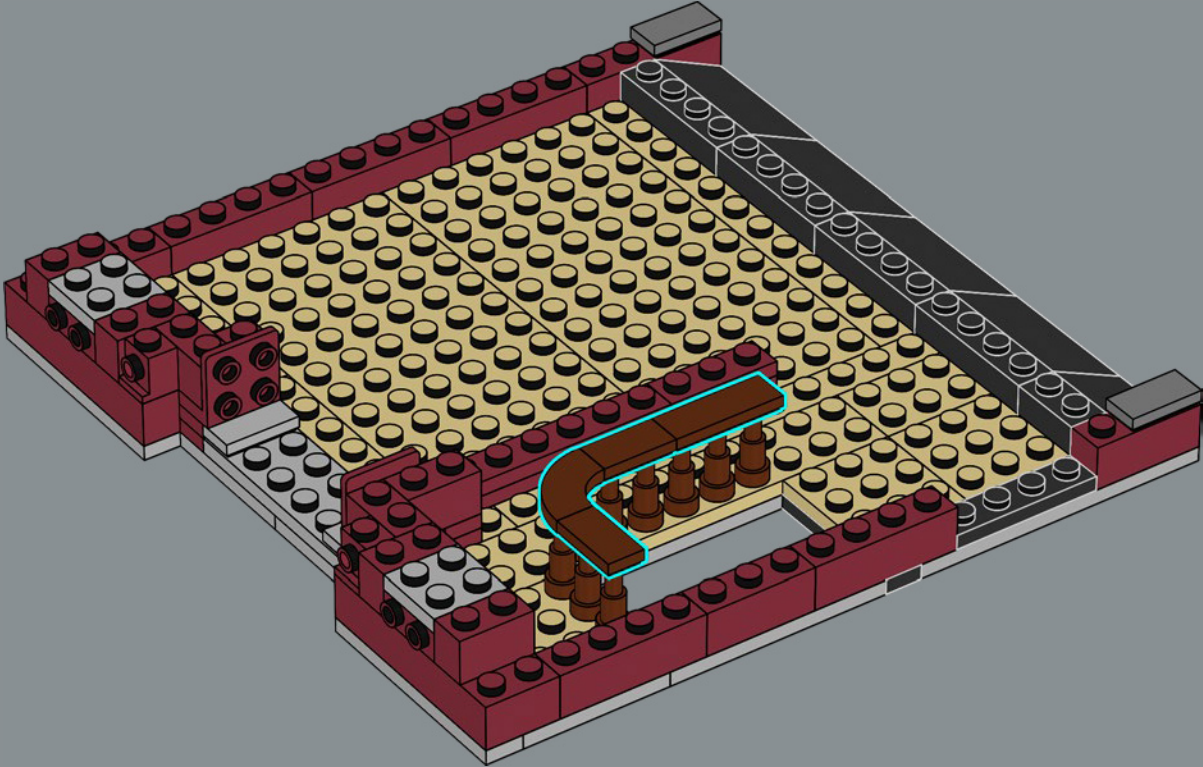

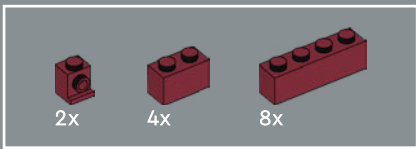

294

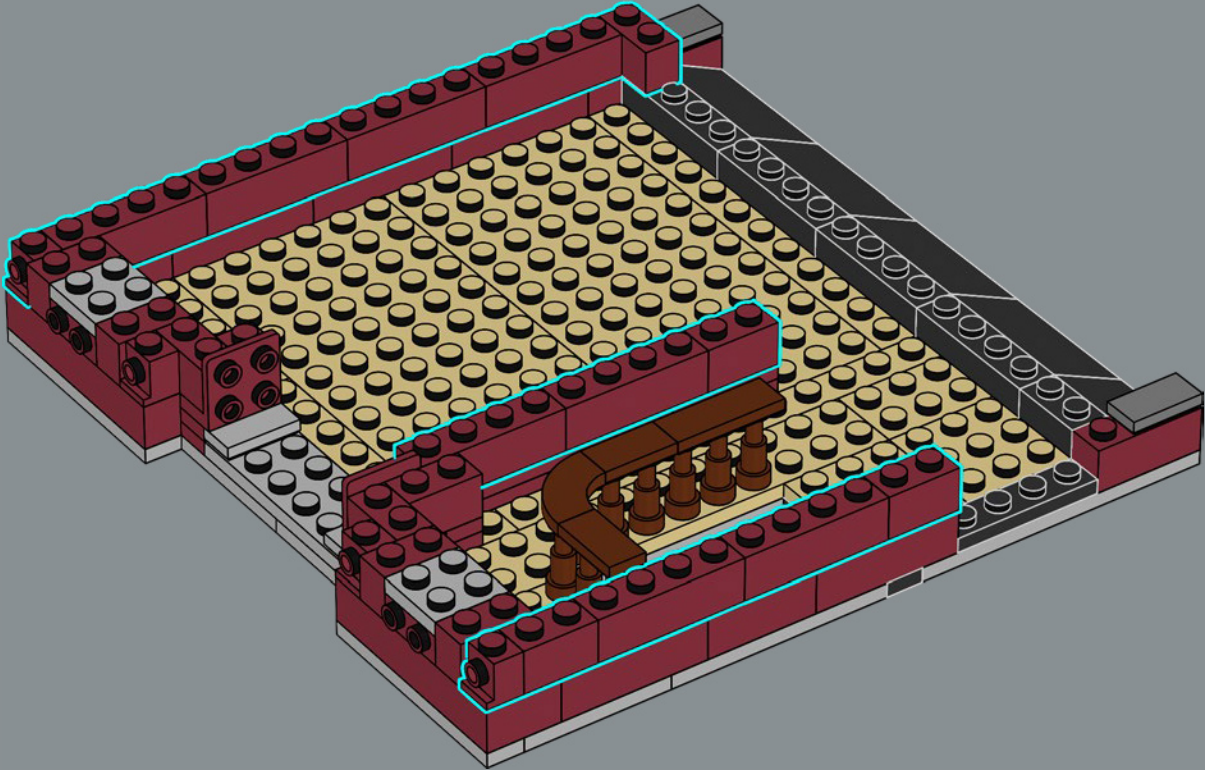

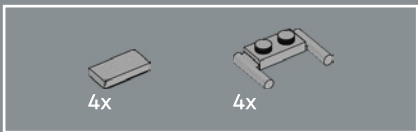

295



L'élément utilisé pour fabriquer les rebords de fenêtre (plaque 1x2 avec poignées) fait partie du système LEGO® depuis 1978 !

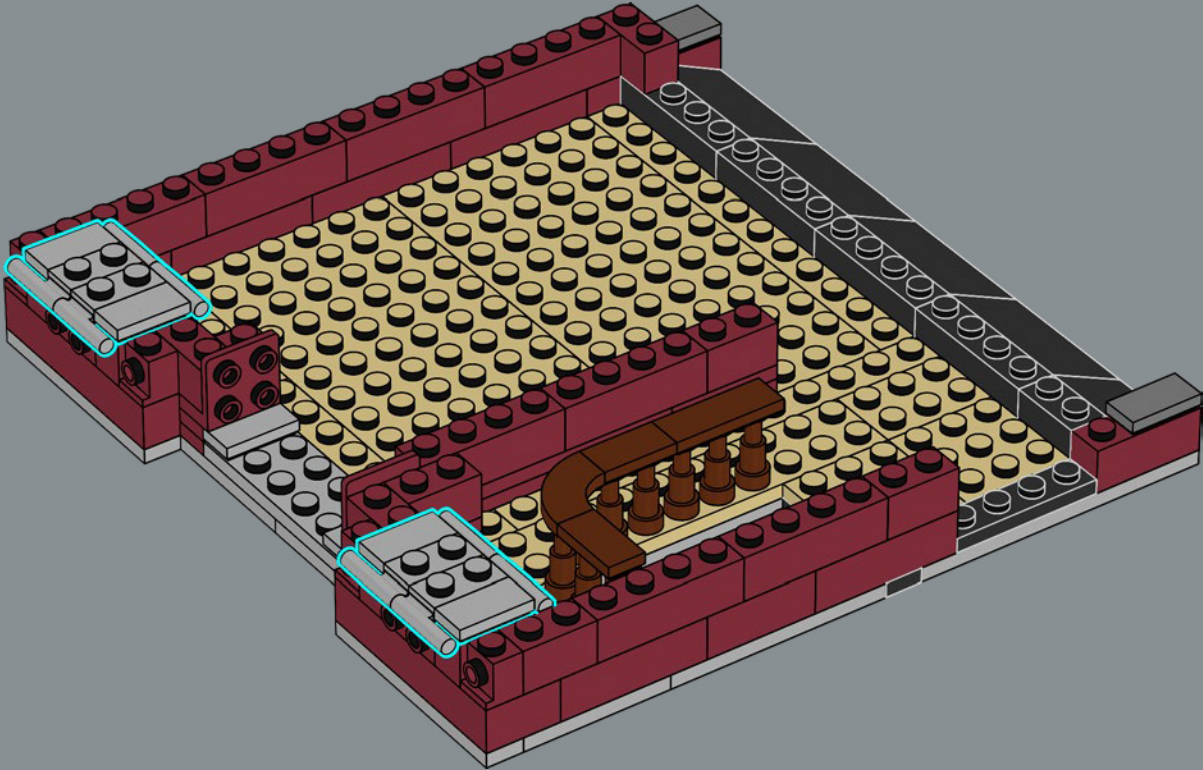

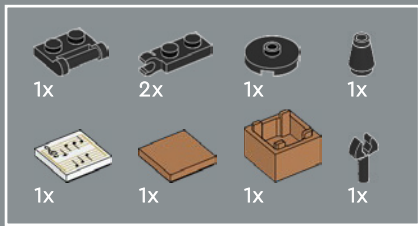

296

1



2



3

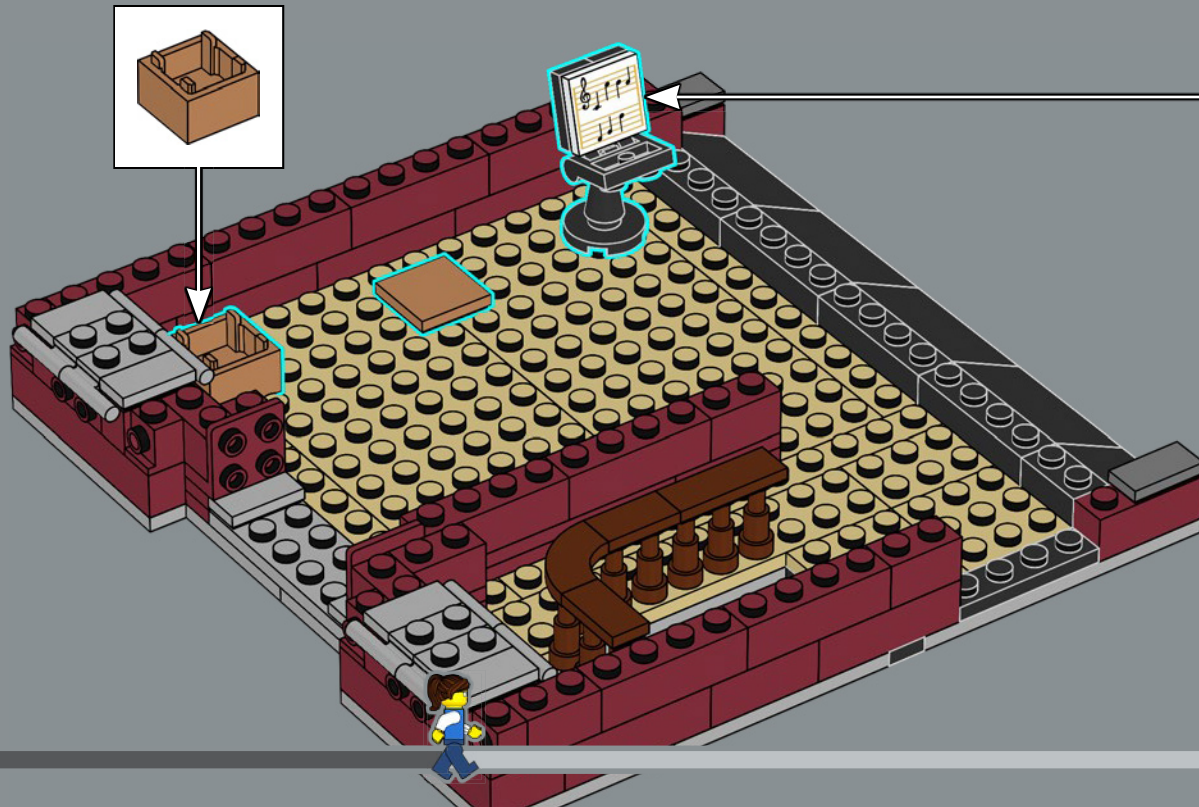
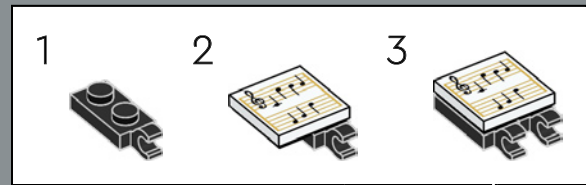

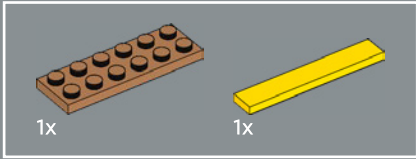

297

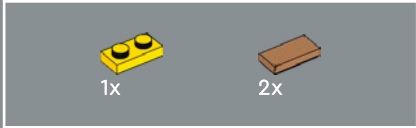
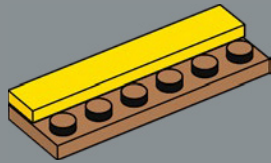

298

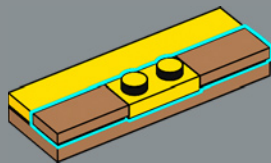

299

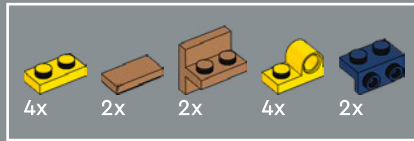
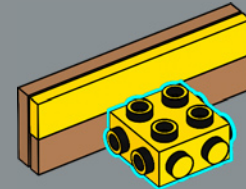

300

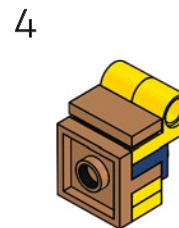
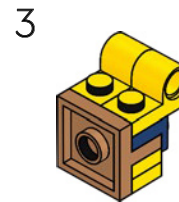
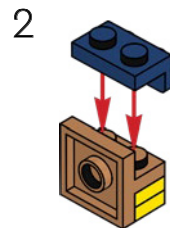
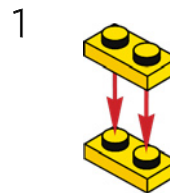

2x

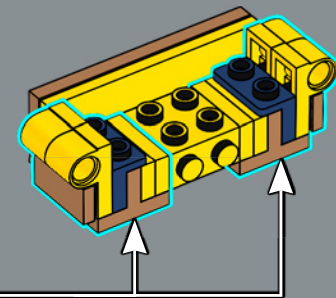

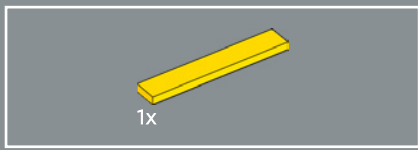

301

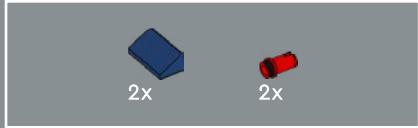
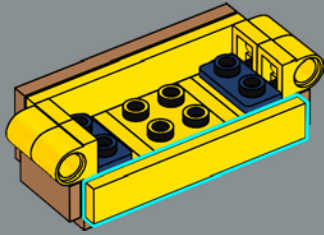

302

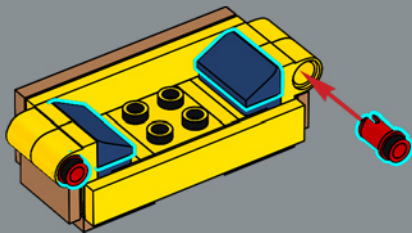

303

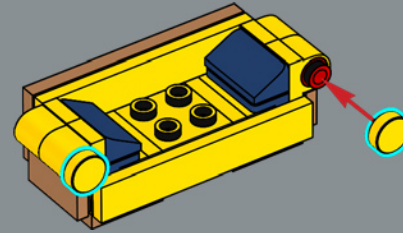

304

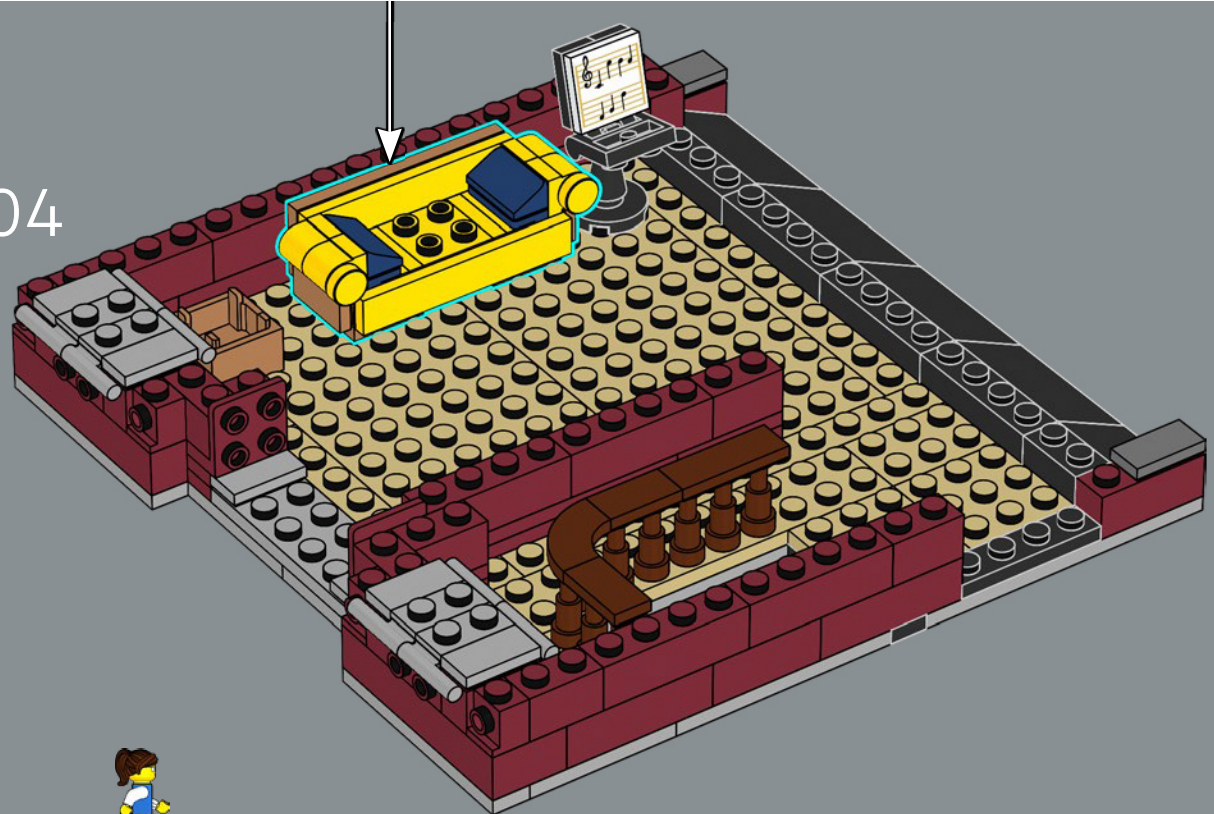



305

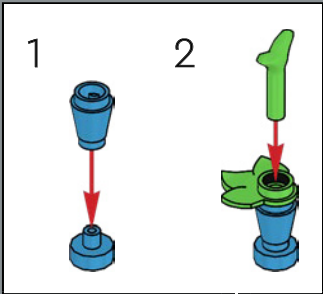

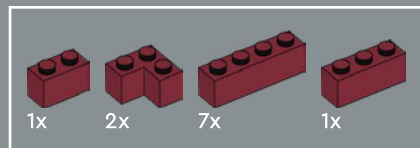

306

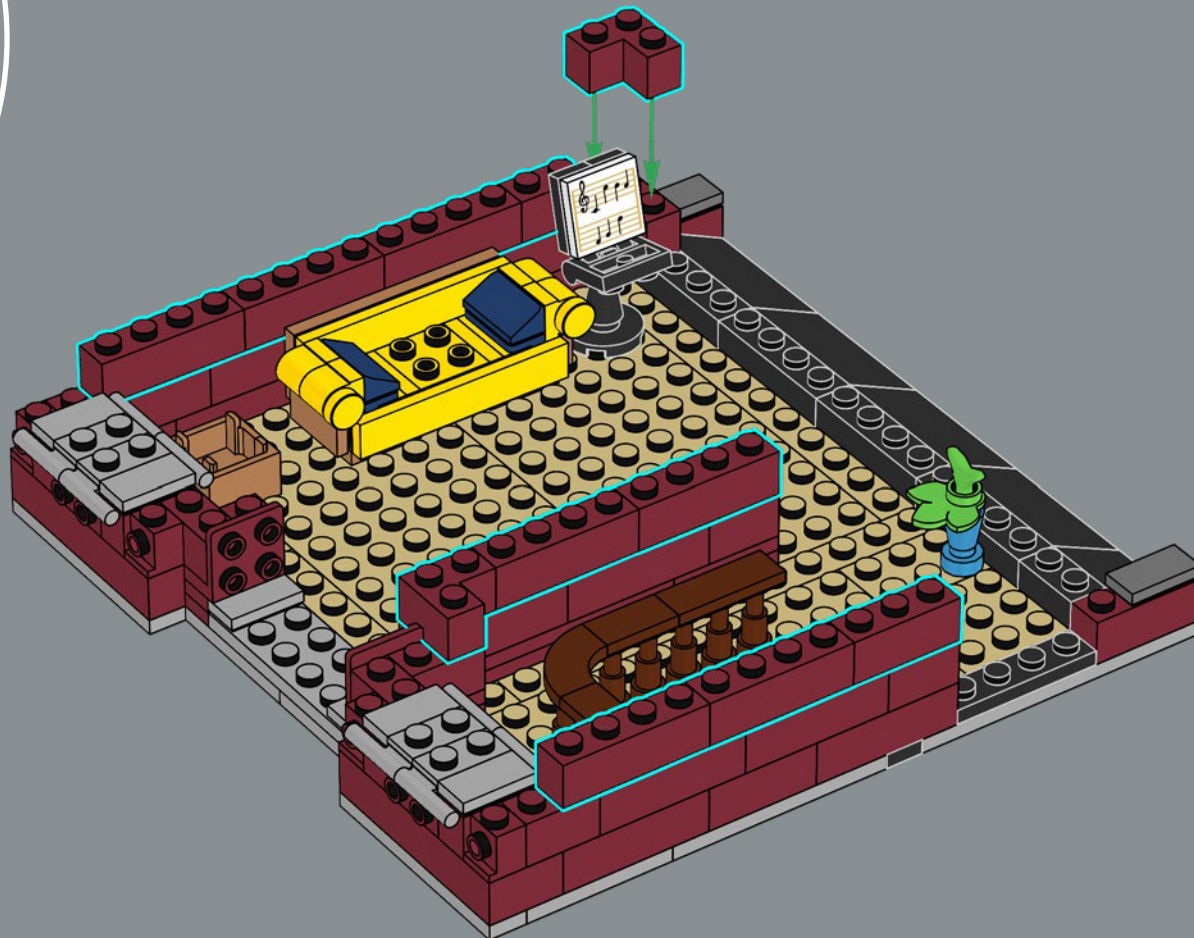

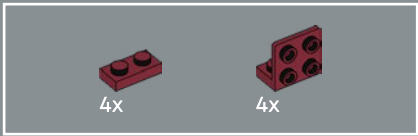

307

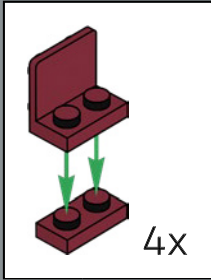

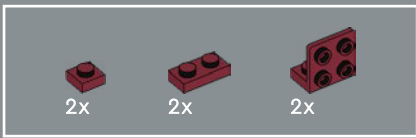

308

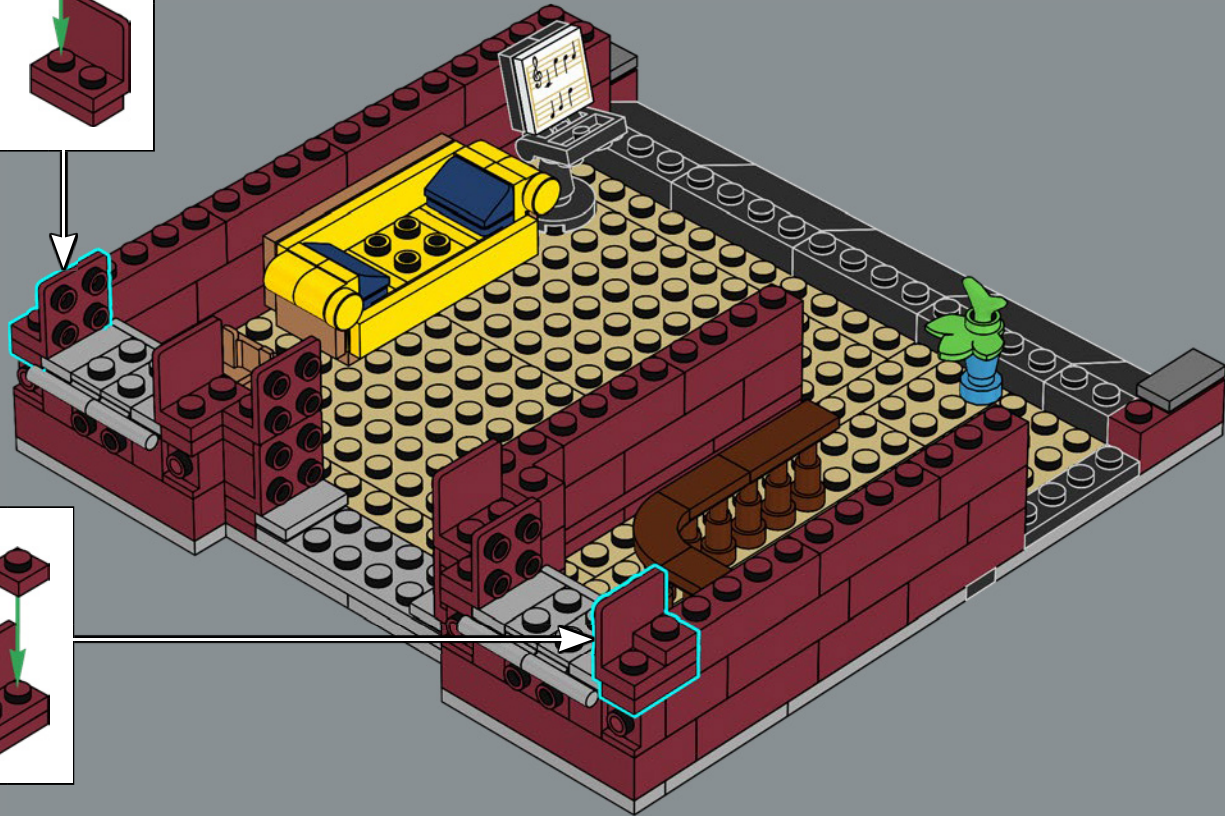
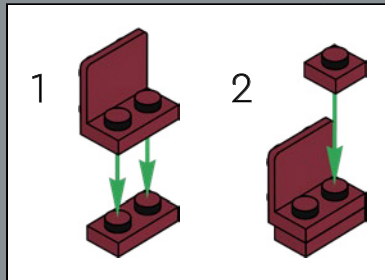
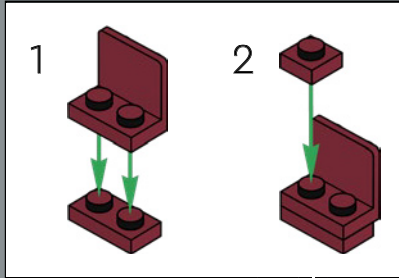

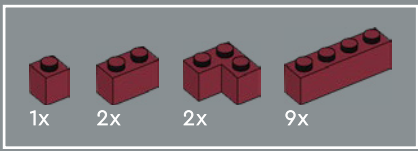

309

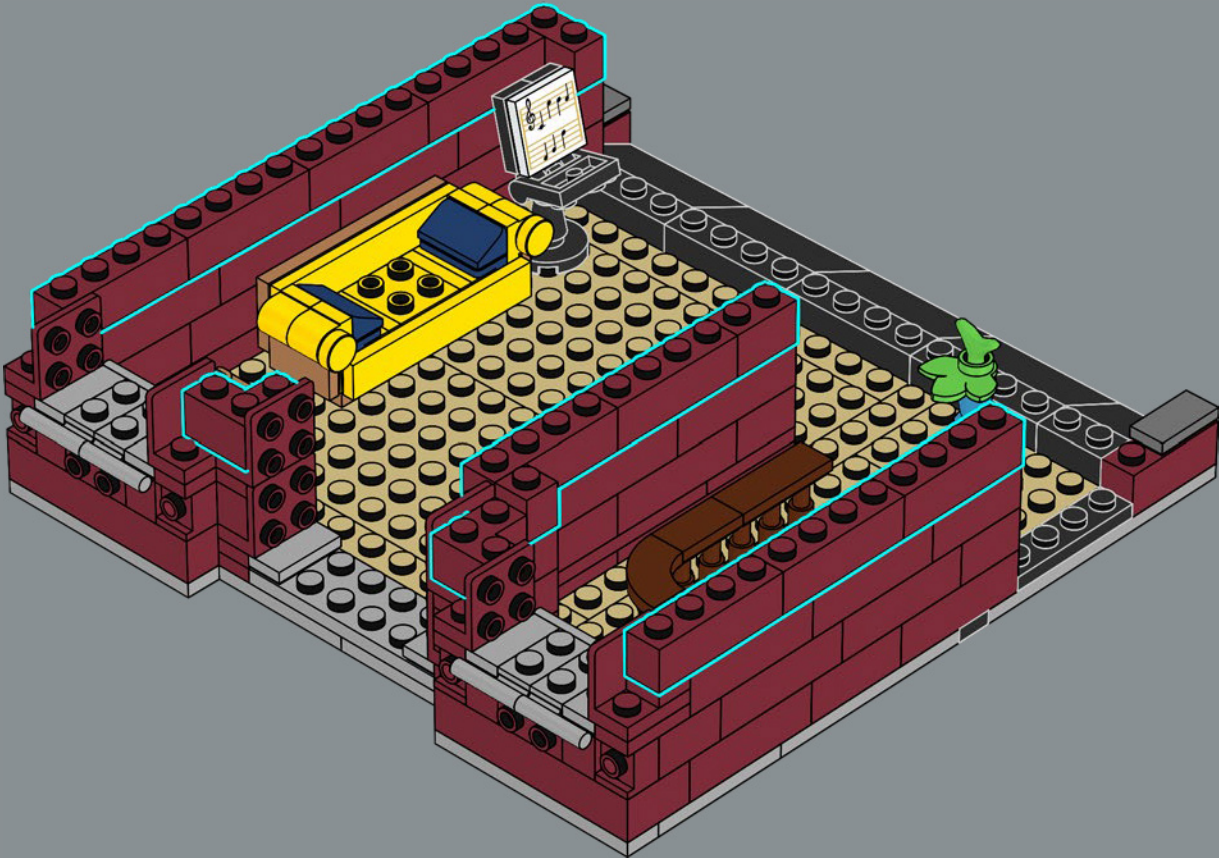



310

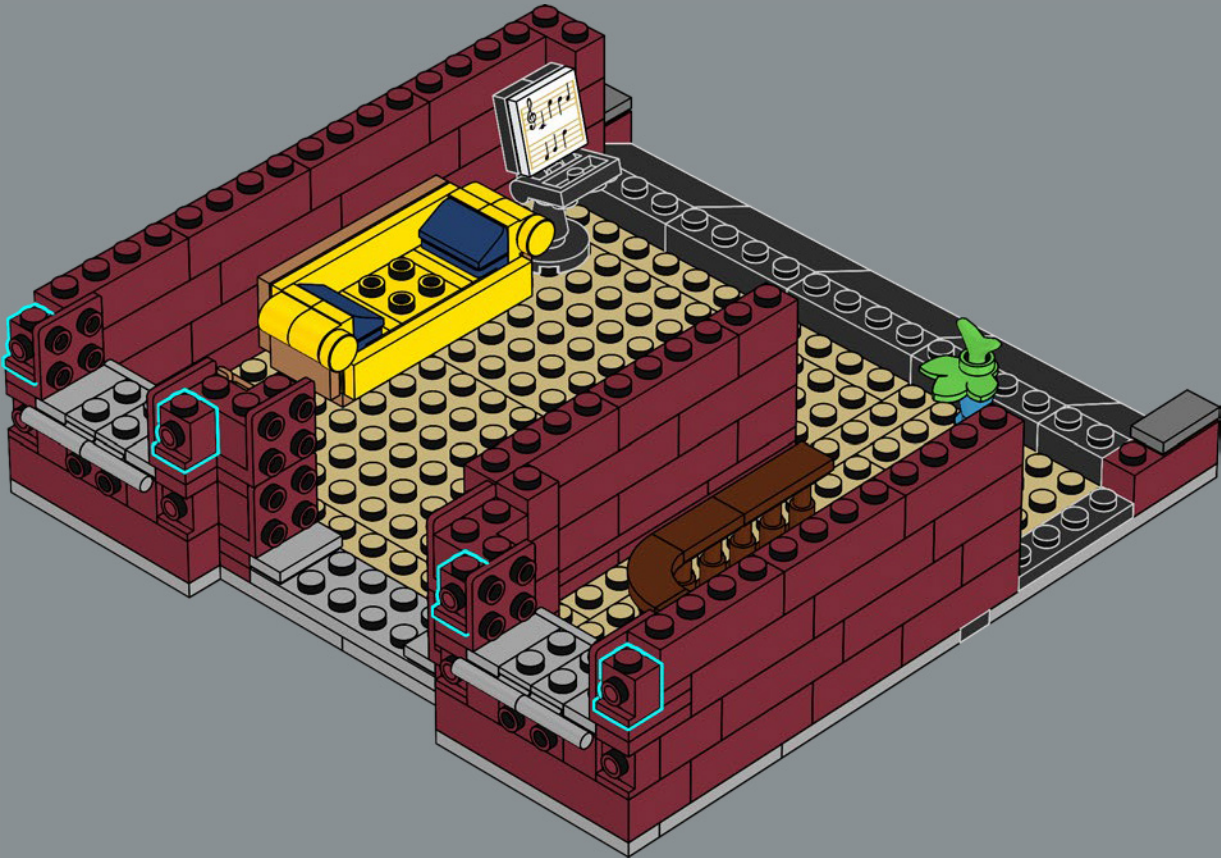



311

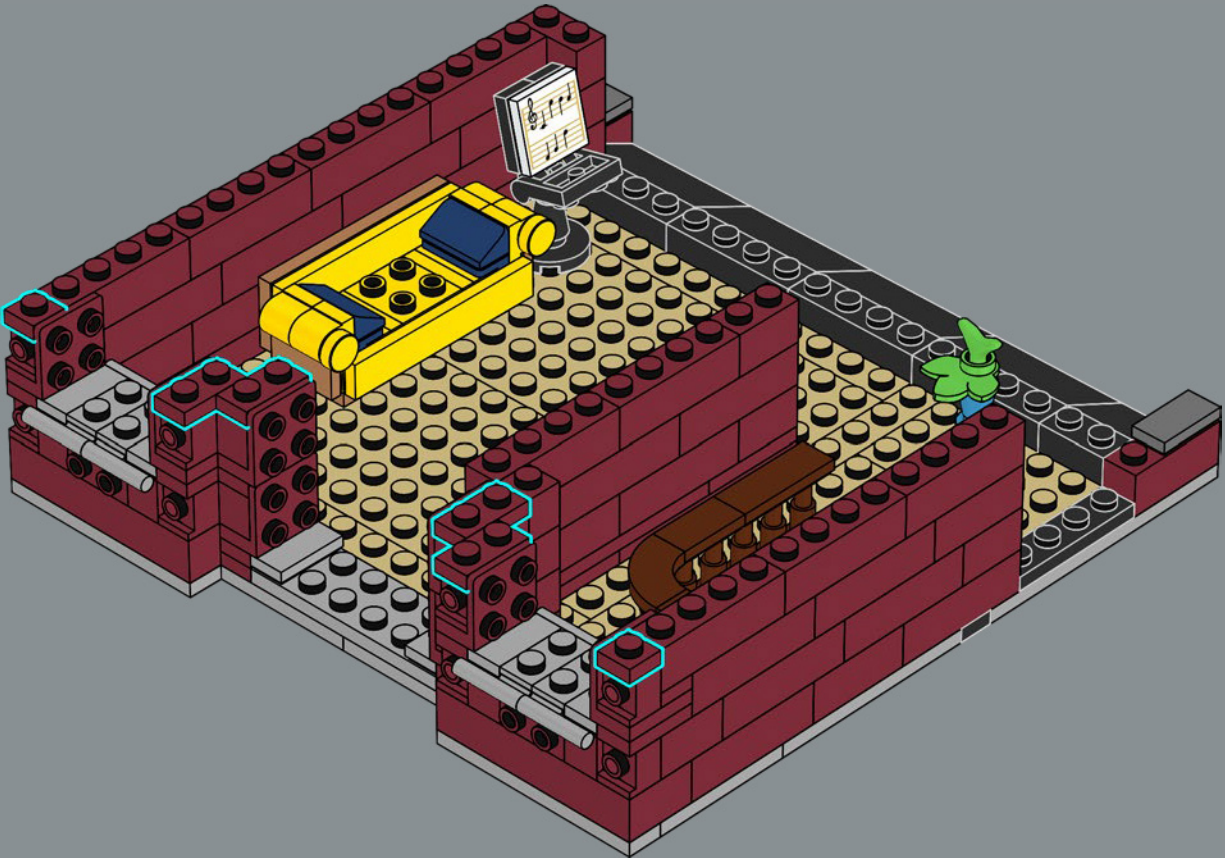

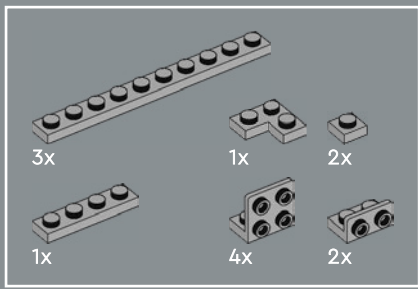

312

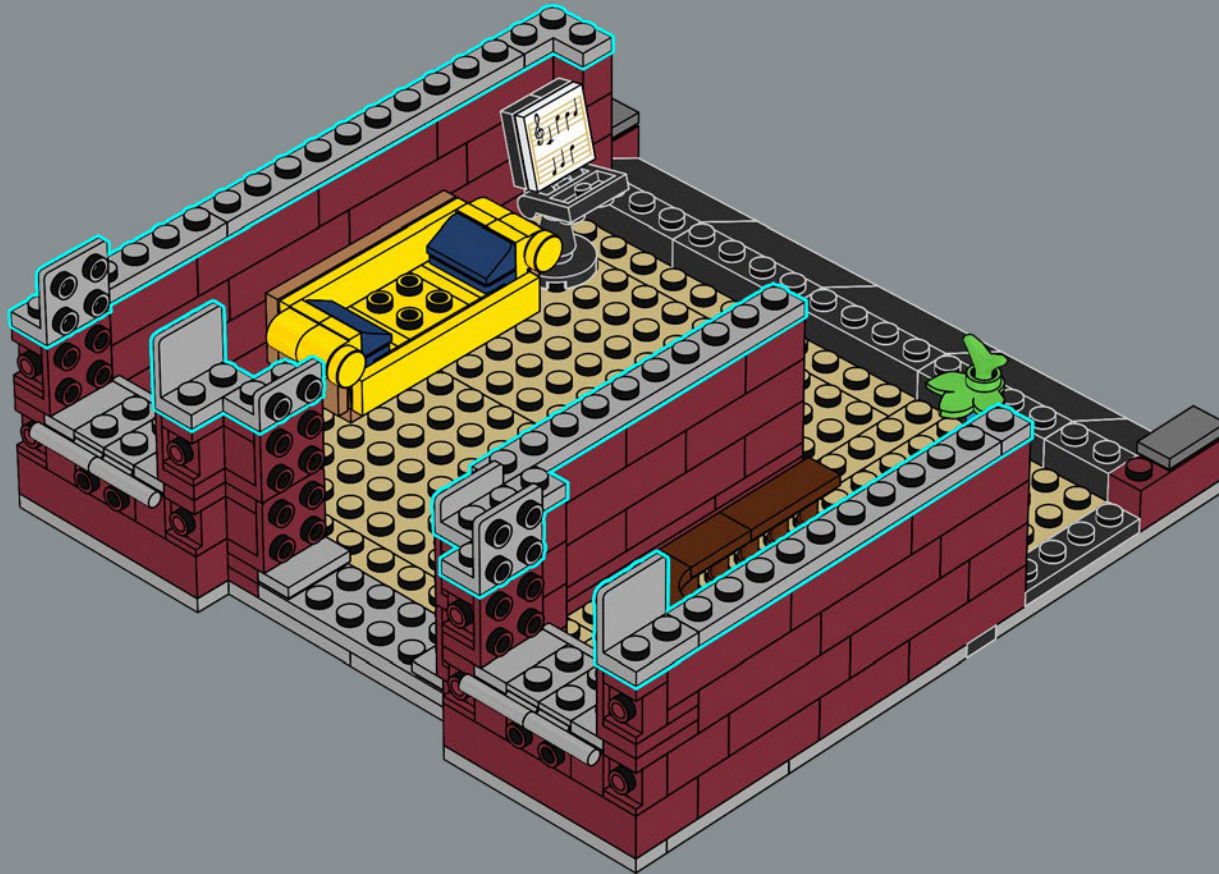

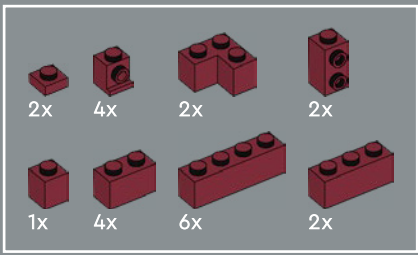

313

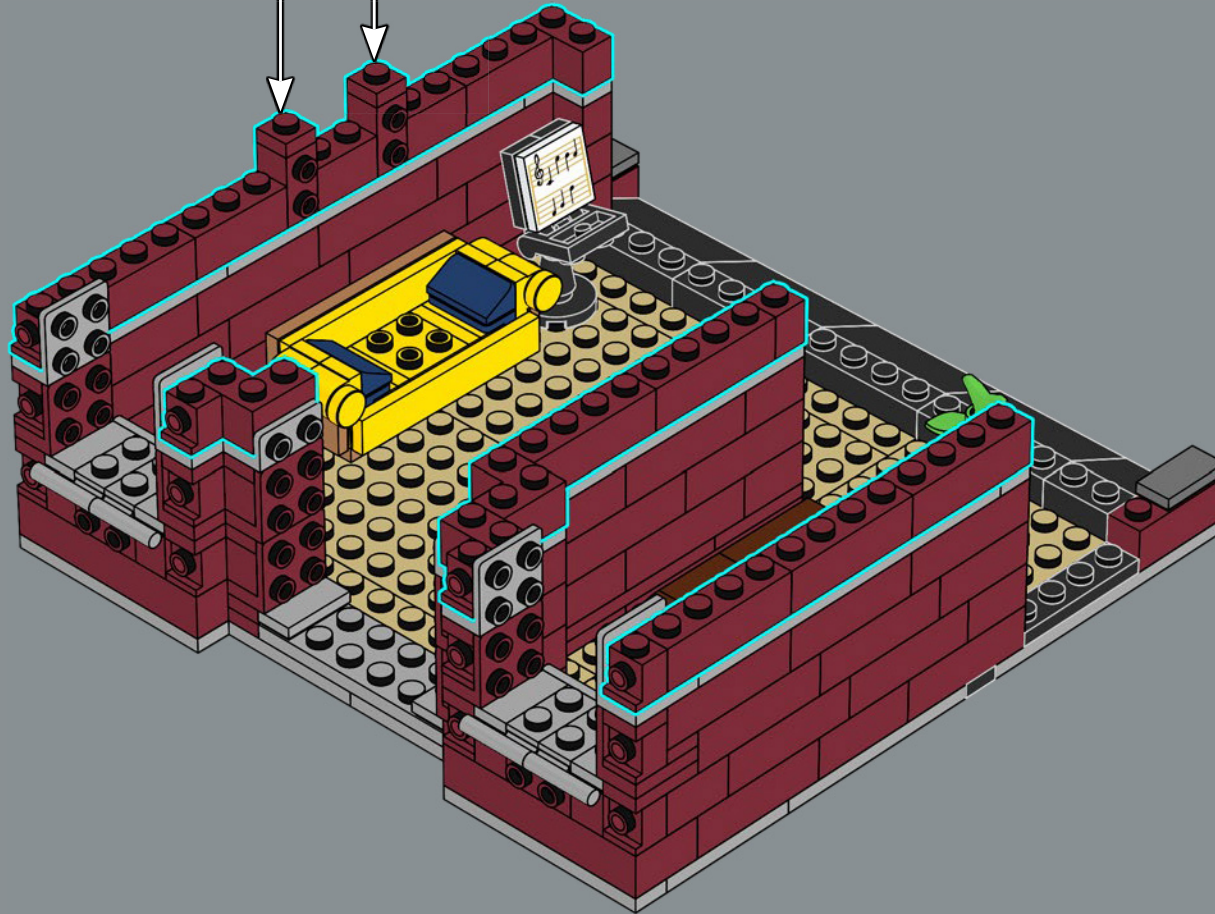
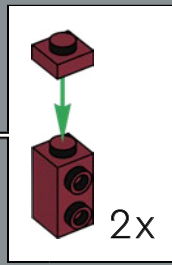

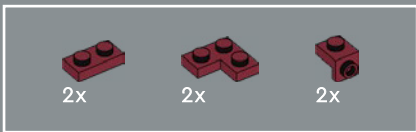

314

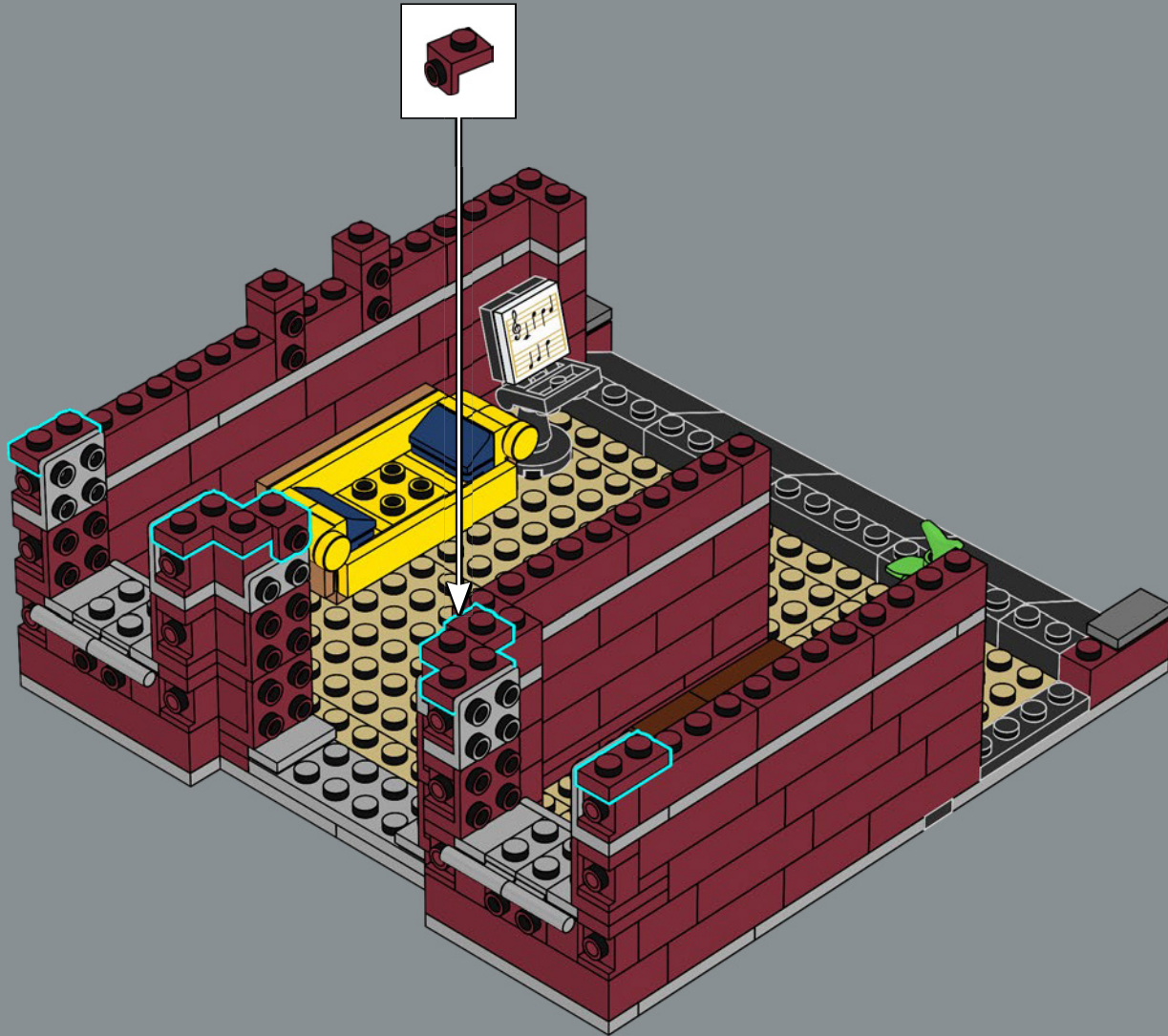

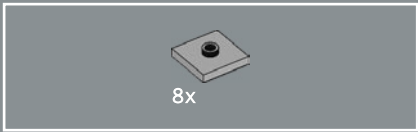

315

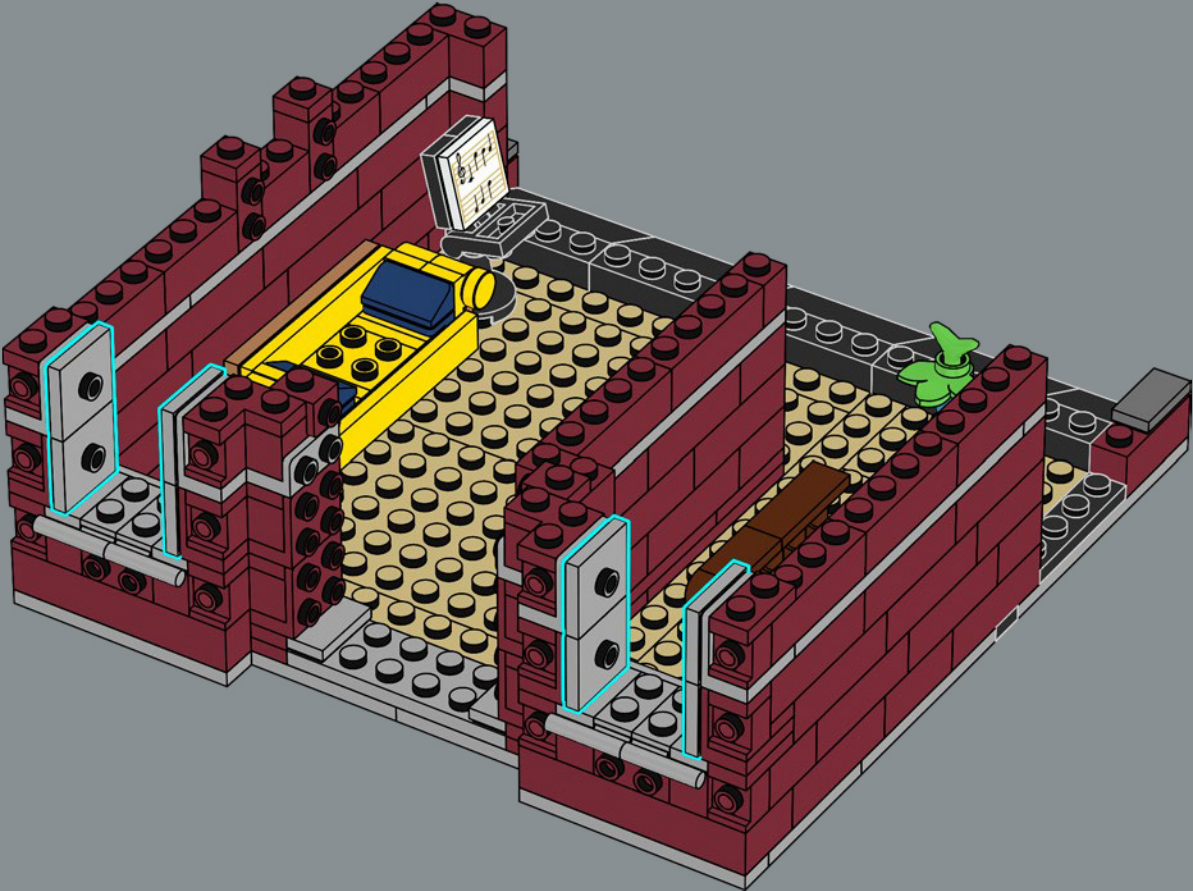

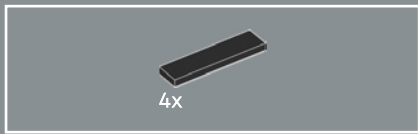



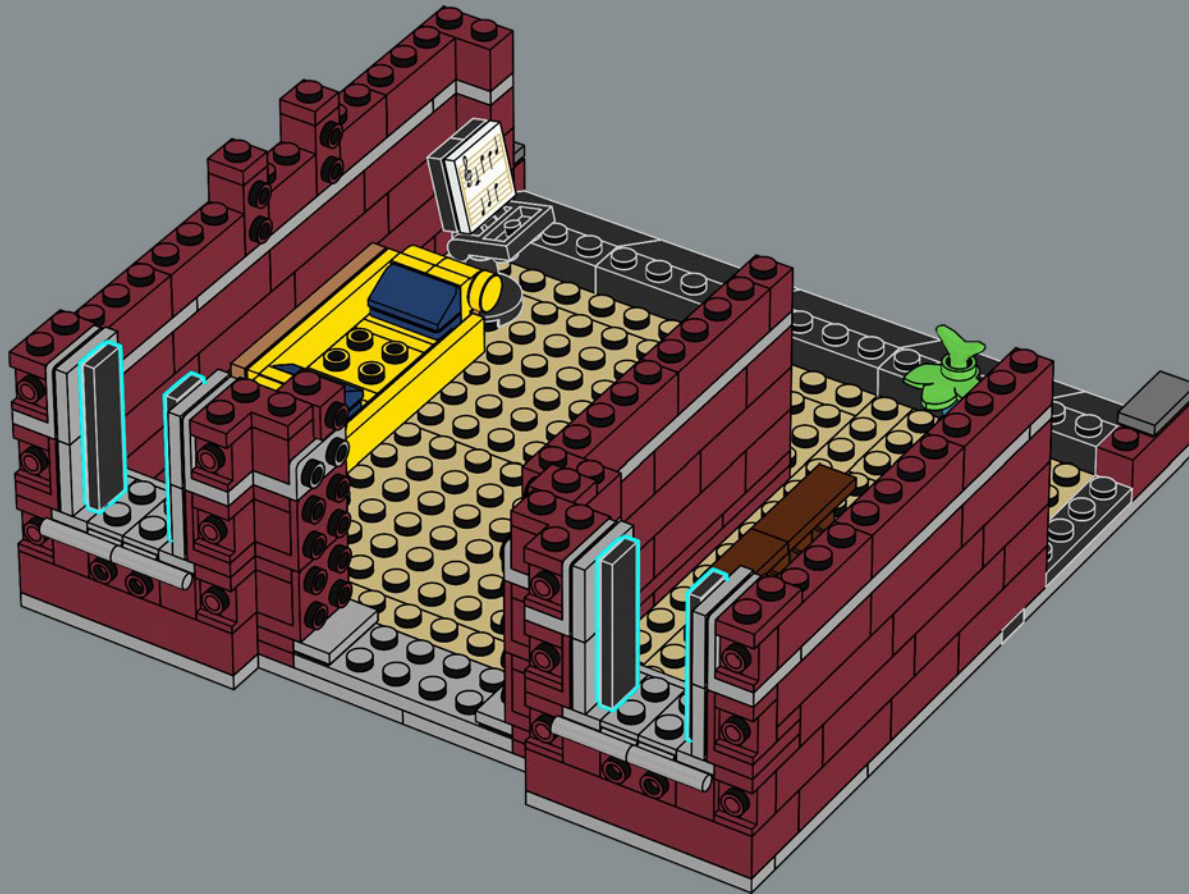



316

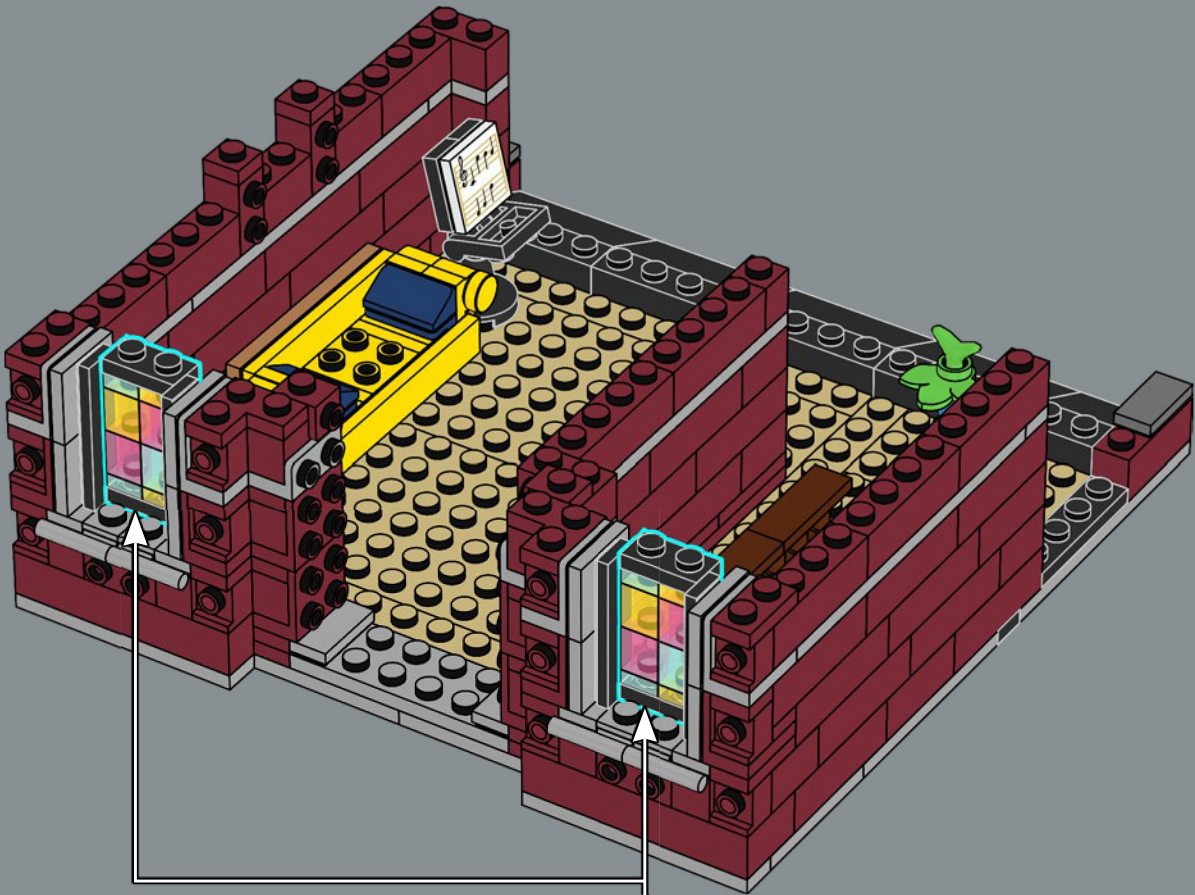

-  4x
-  4x
-  2x
-  2x
-  4x
-  4x

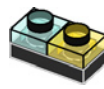
317



- 1 
- 2 
- 3 
- 4 
- 5 
- 6  2x

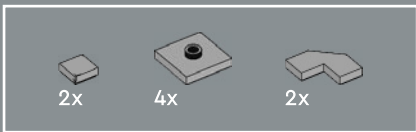

318

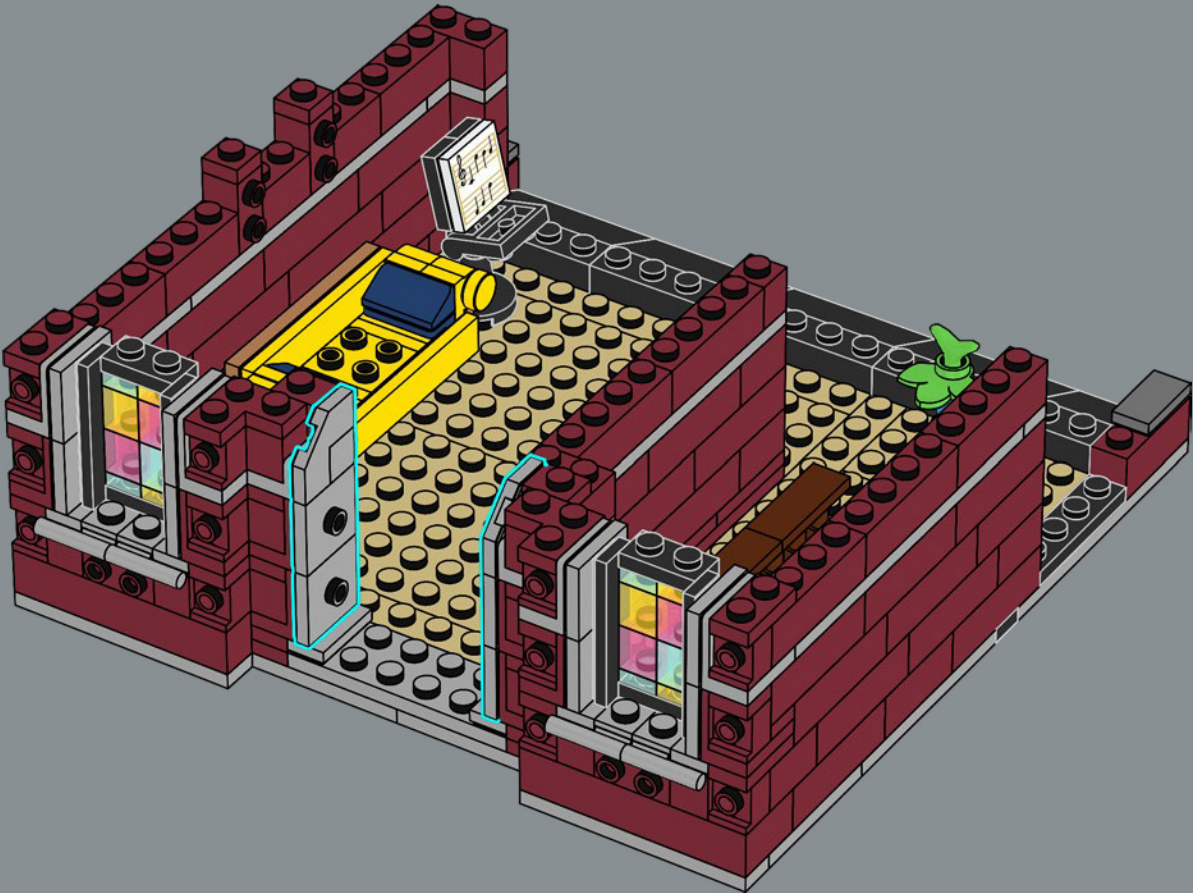

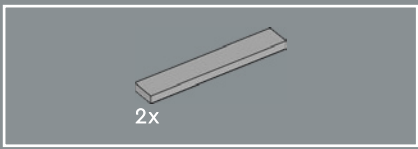

319

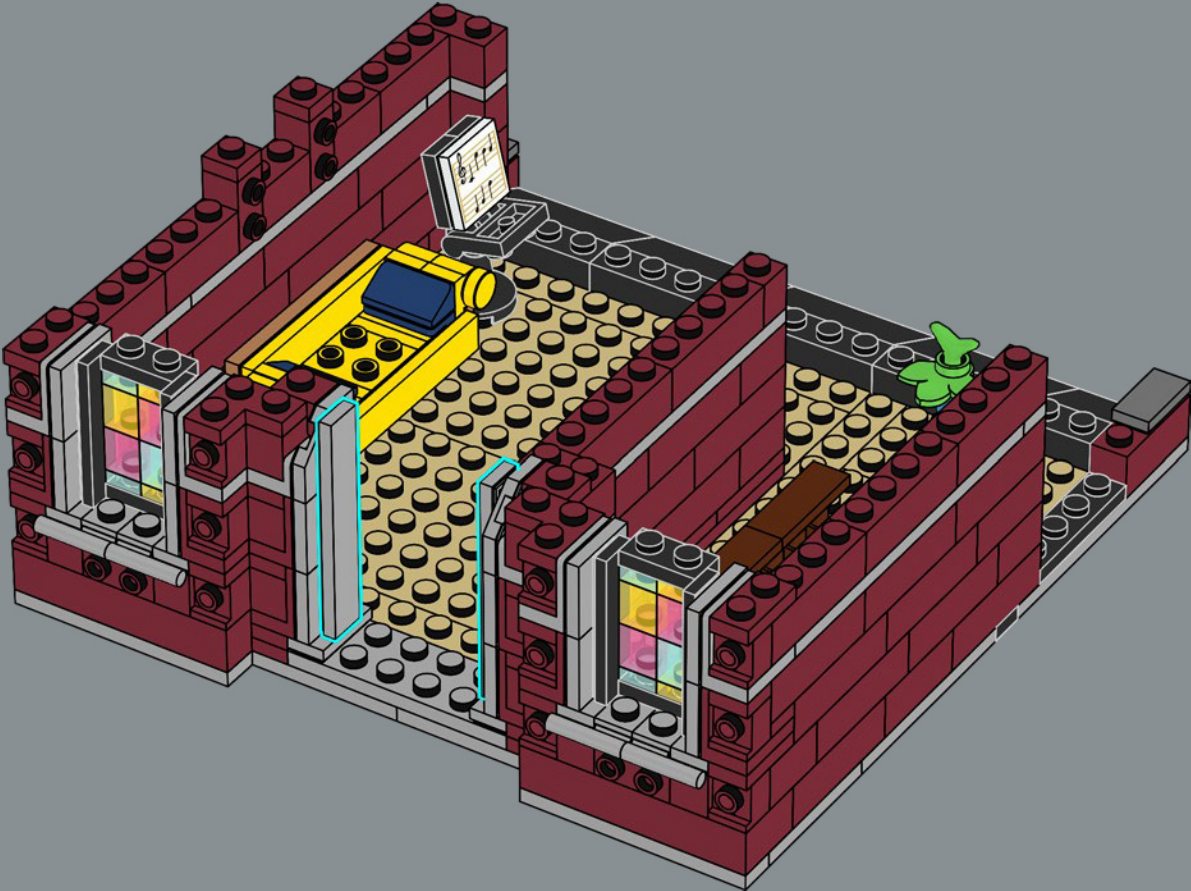

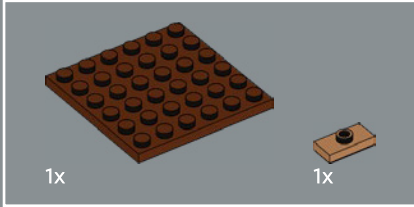
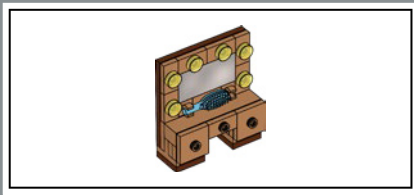

320

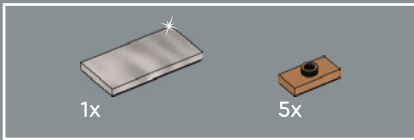
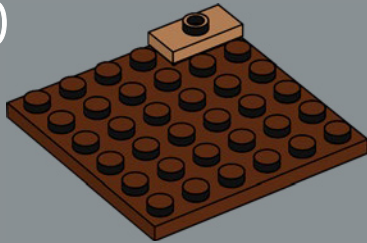

321

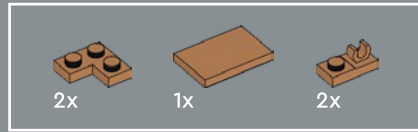
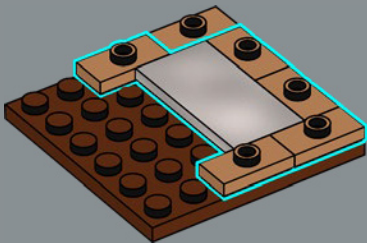

322

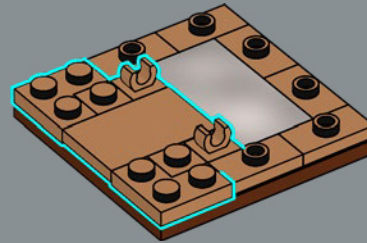

323

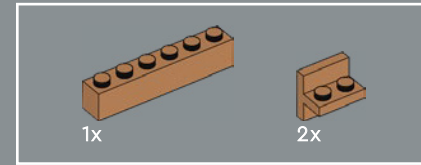
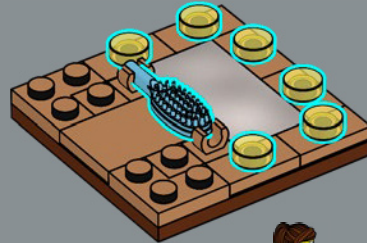

324

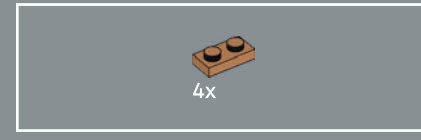
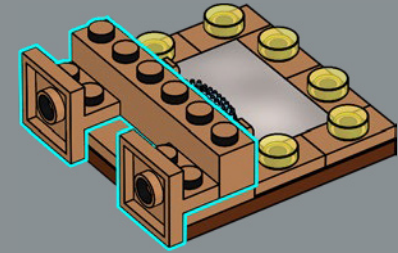

325

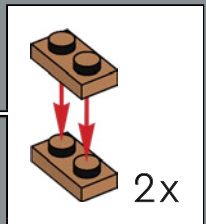
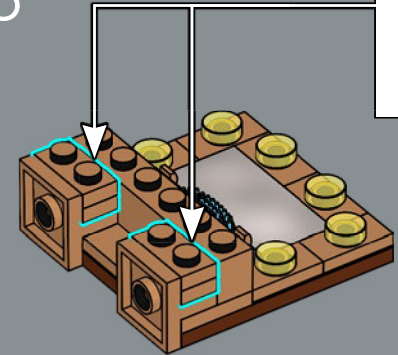



Avant de monter sur scène, prenez quelques minutes pour vous maquiller sur la coiffeuse pour briller de mille feux sous les projecteurs.

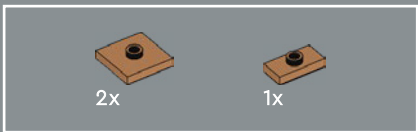

326

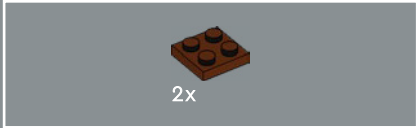
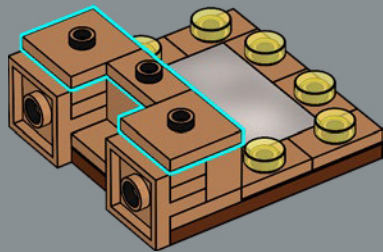

327

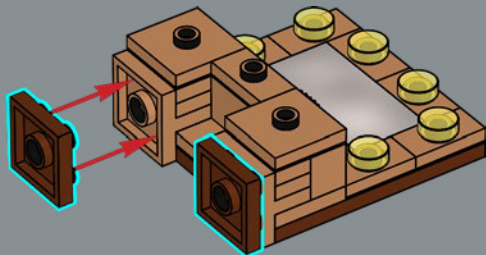

328

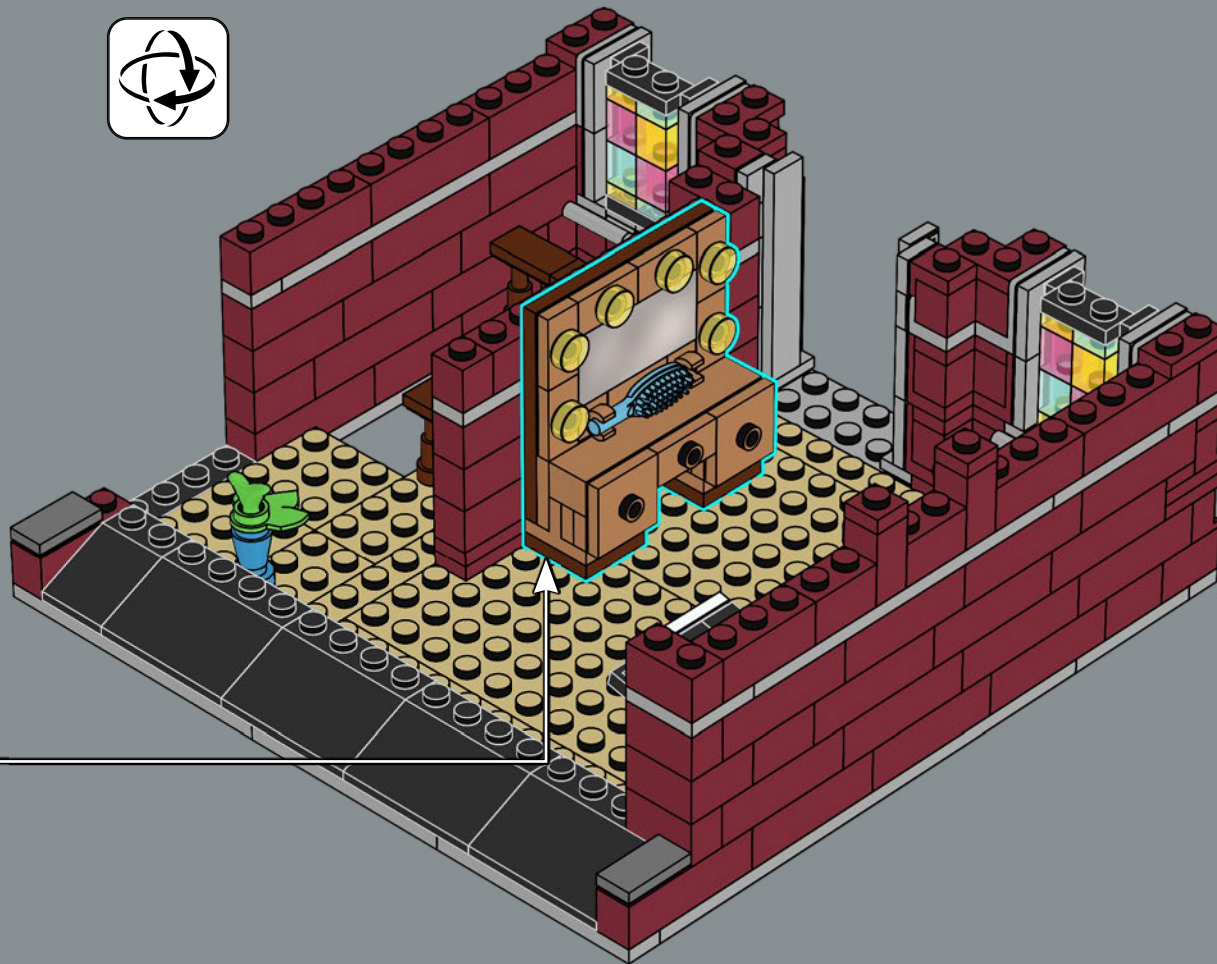

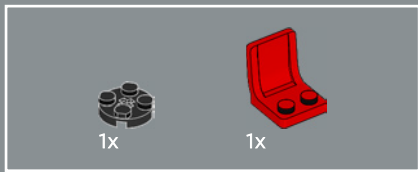

329

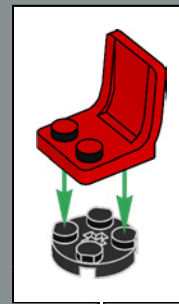

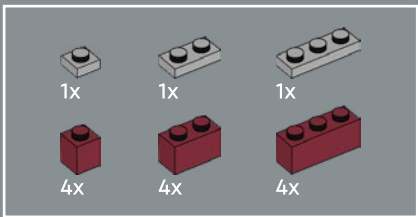

330

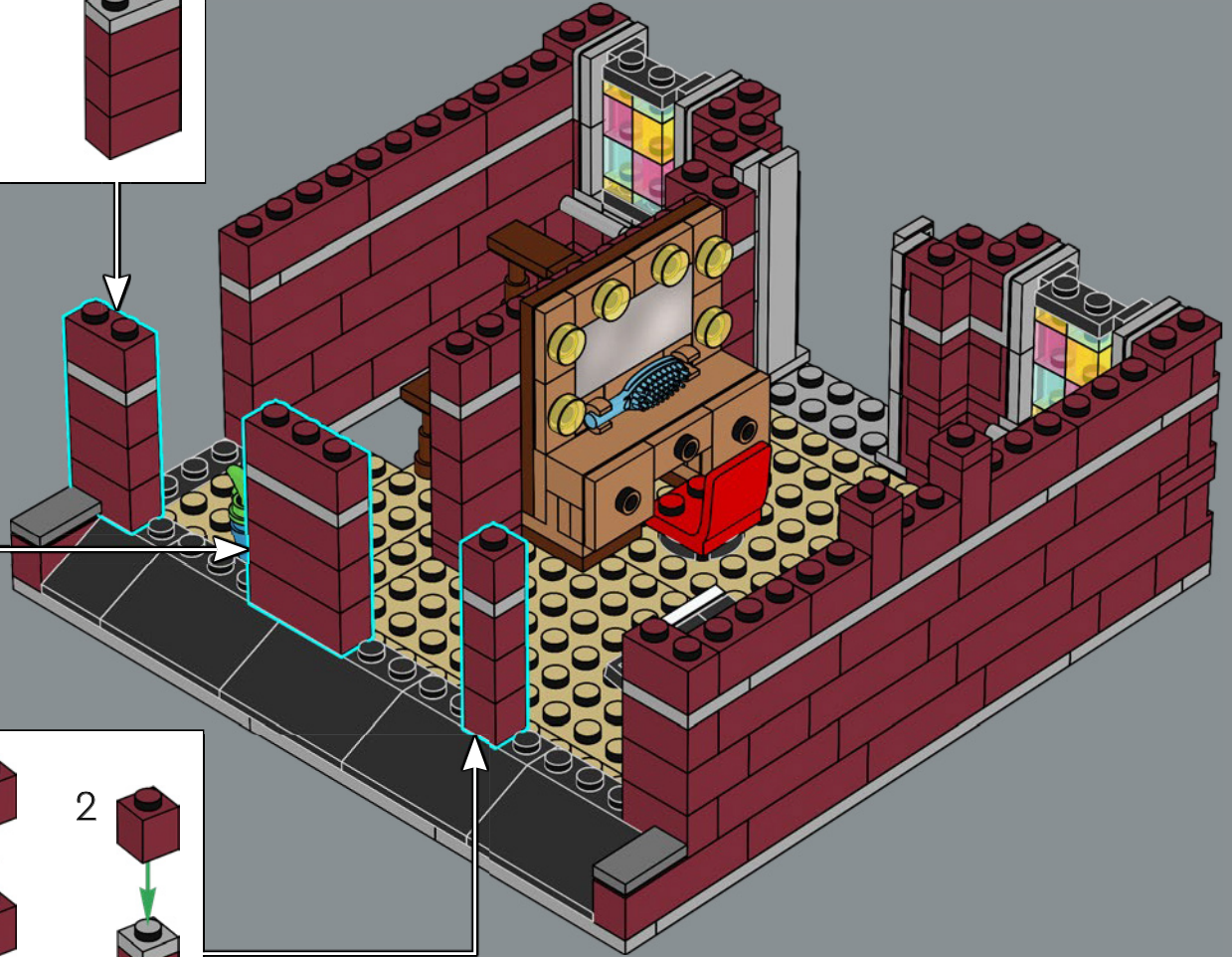
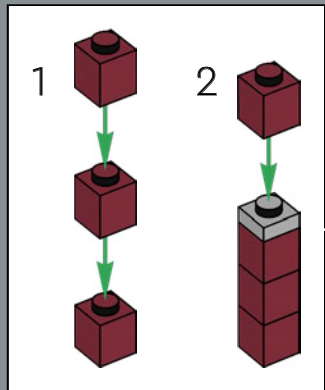
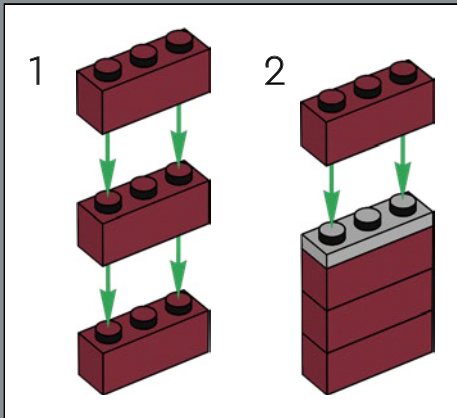
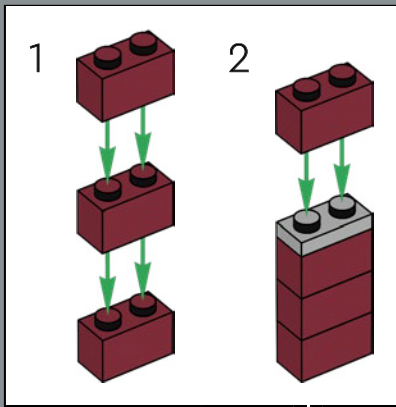

La magicienne a trouvé son fidèle acolyte, le lapin, à L'animalerie LEGO® 10218.

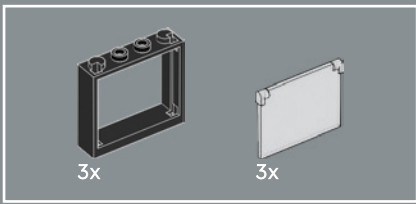

331

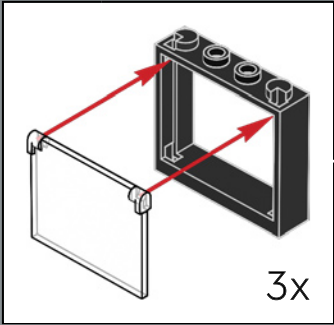
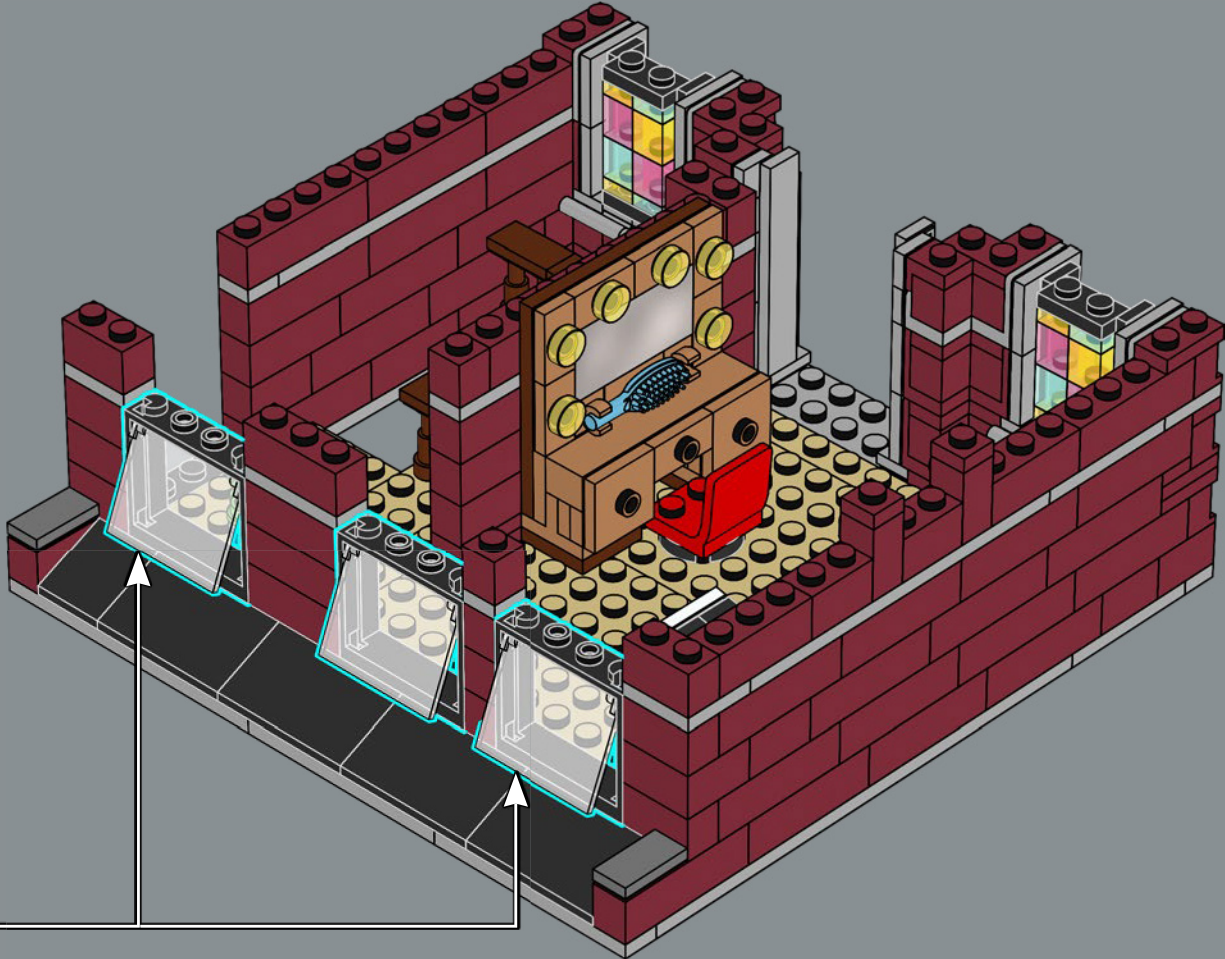

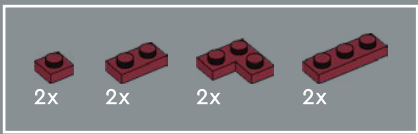

332

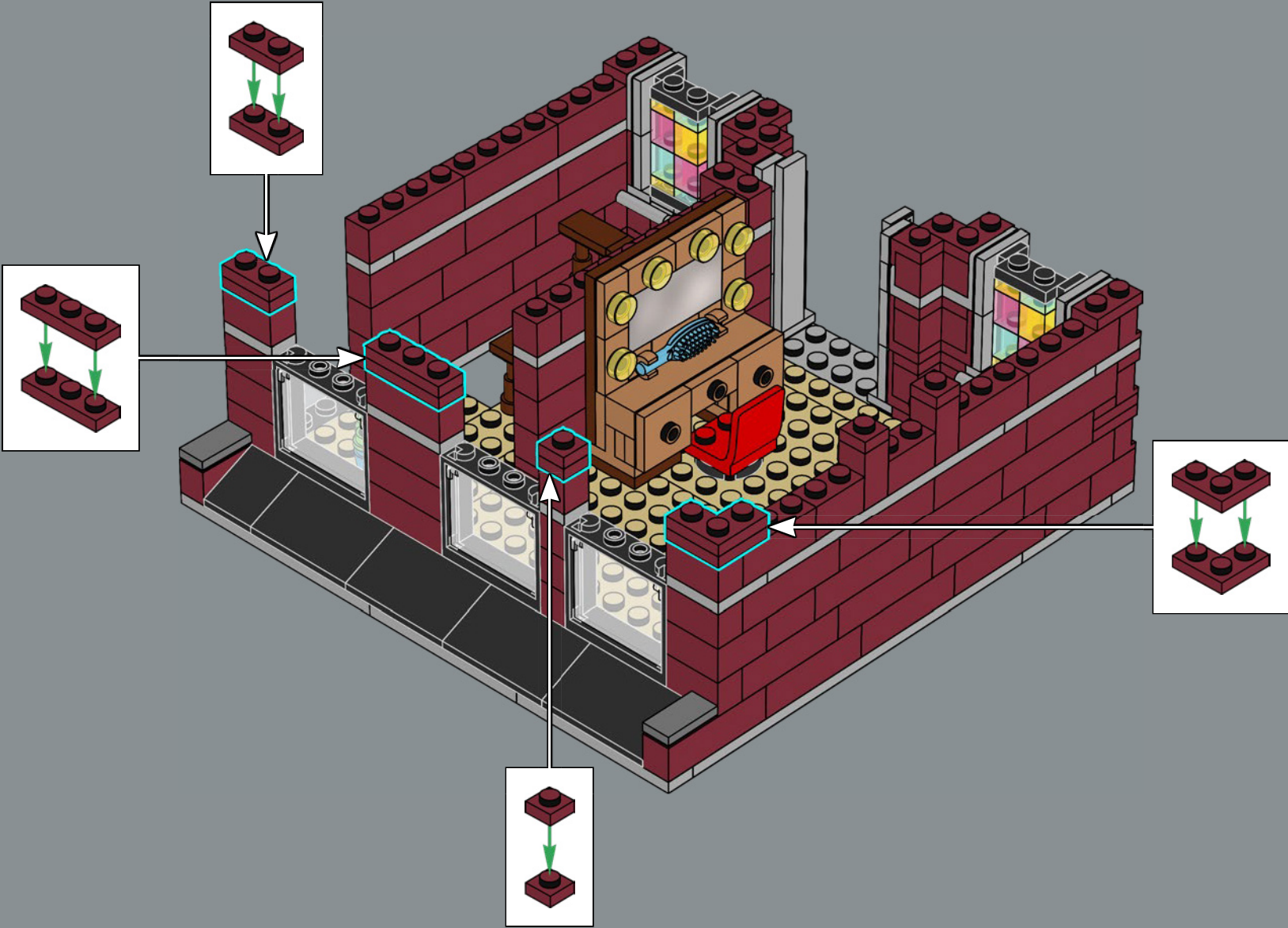

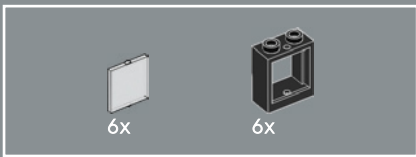

333

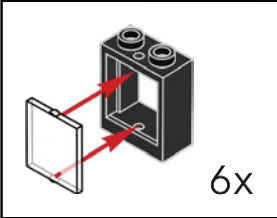

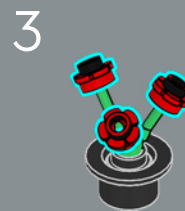
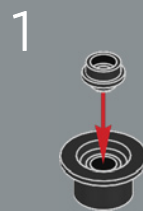
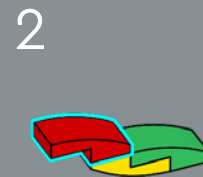
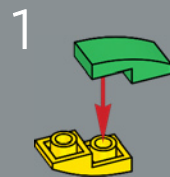
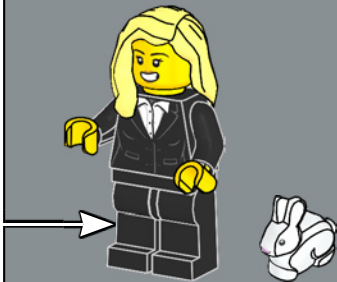
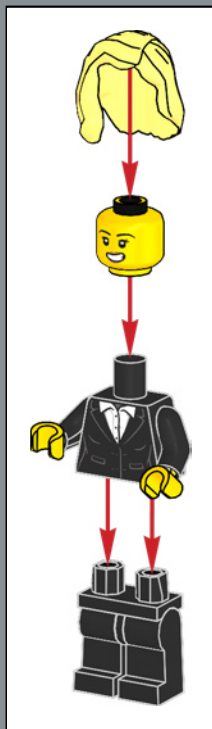

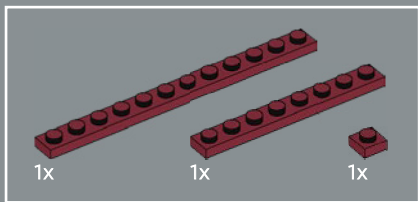

334

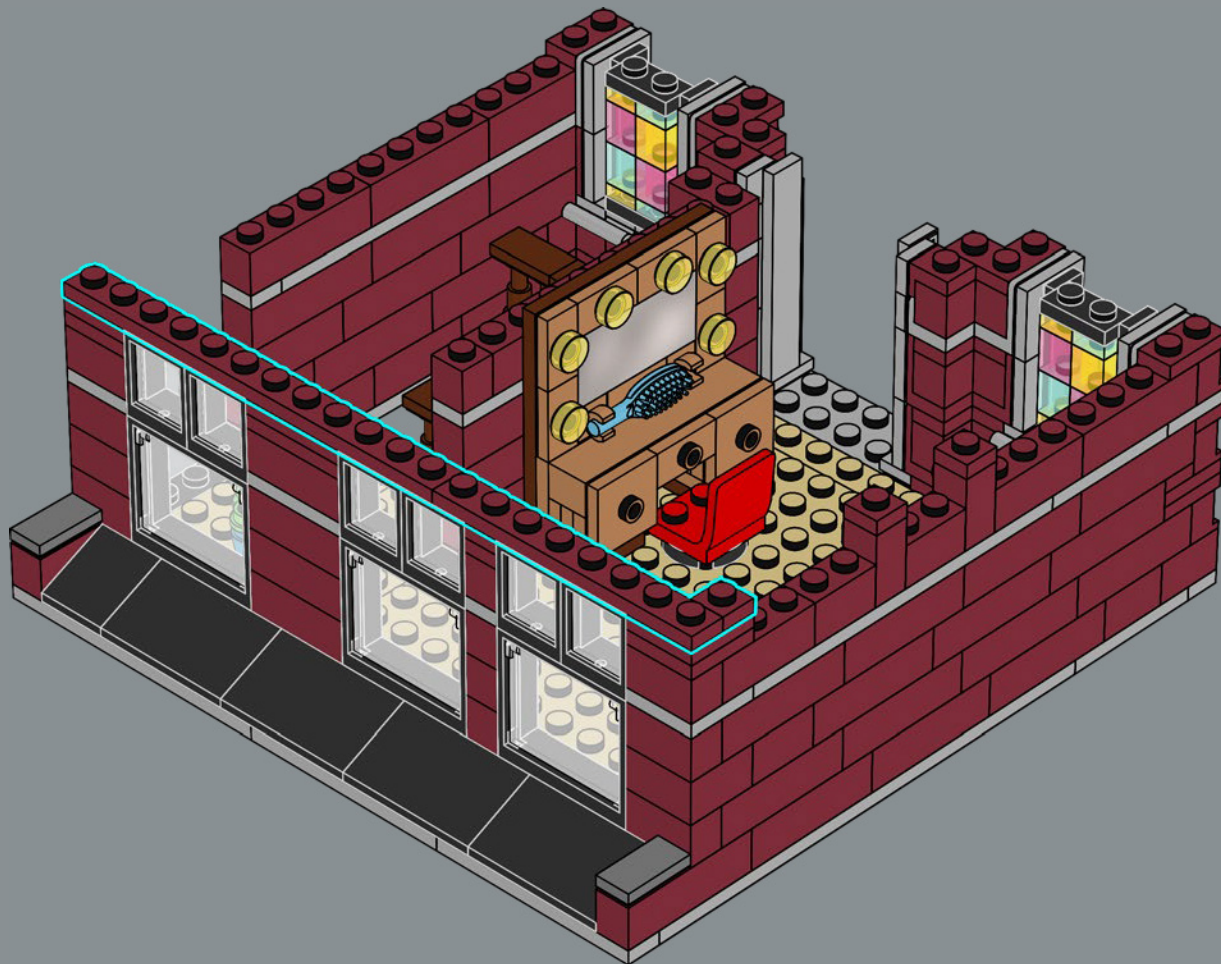

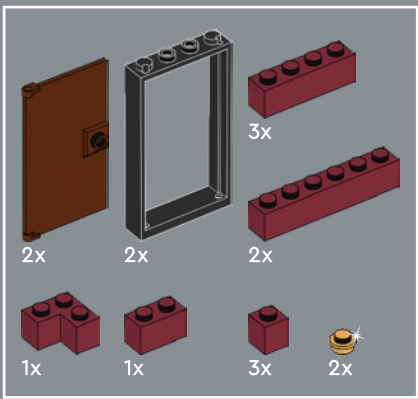

335

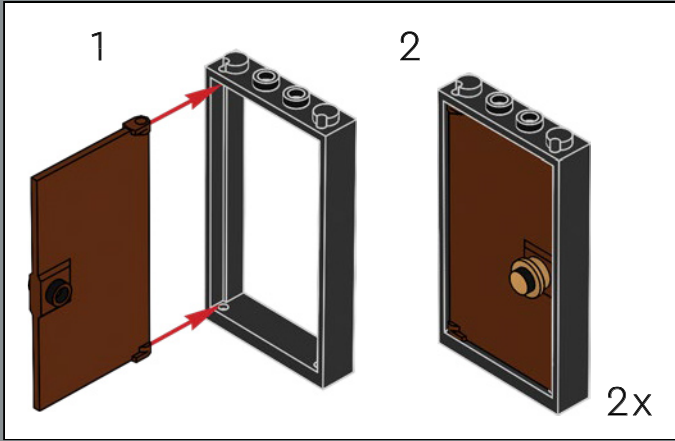

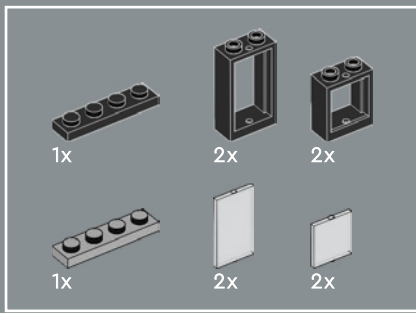

336

1

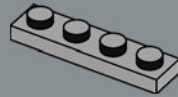

2

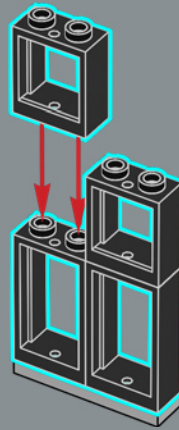

3

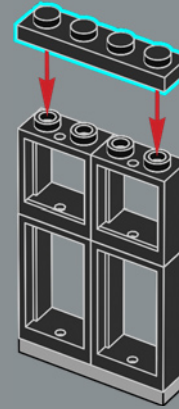

4

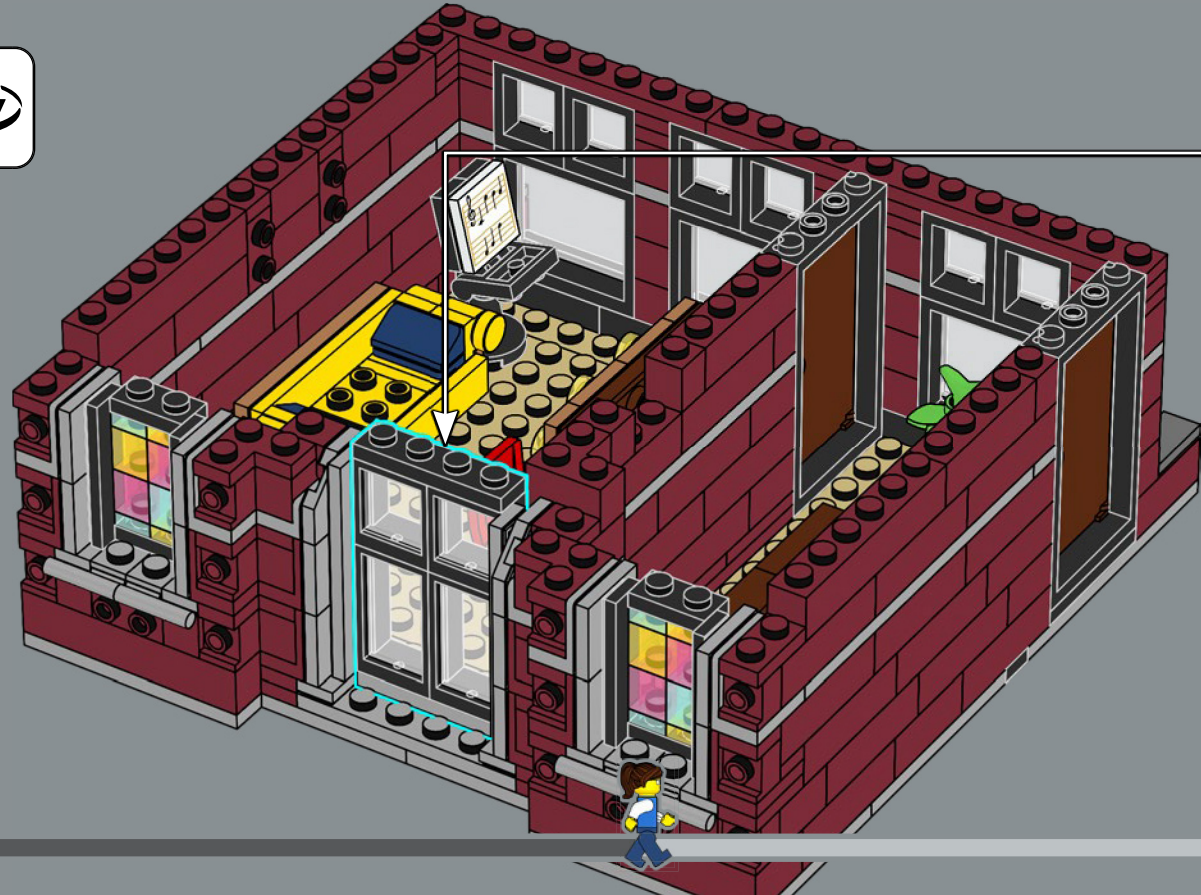
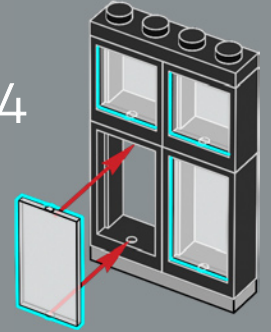

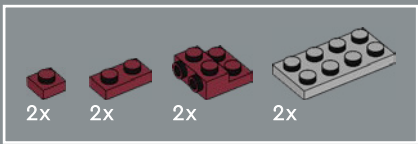

337

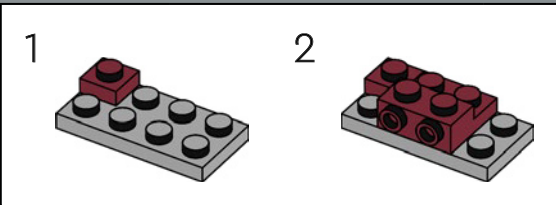
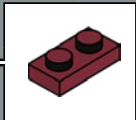
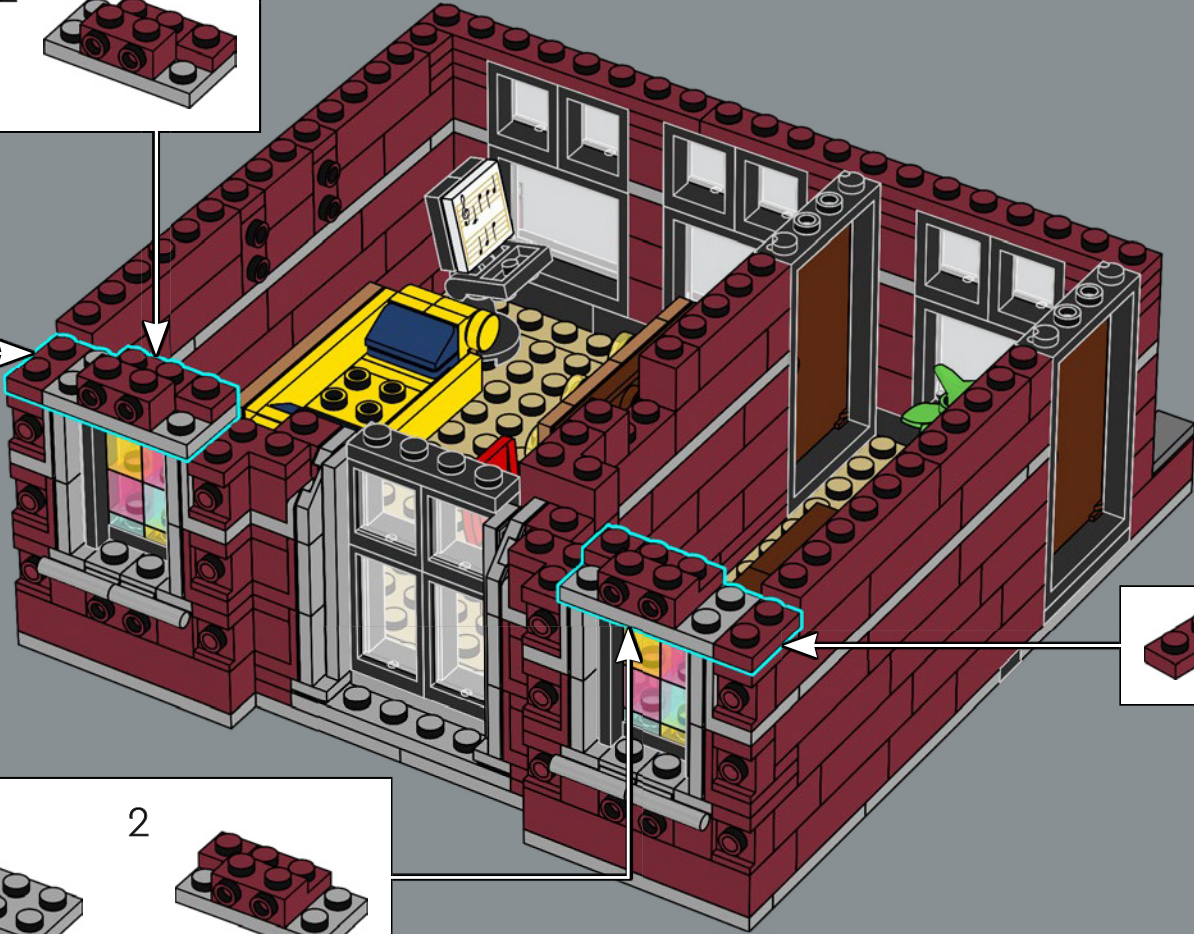
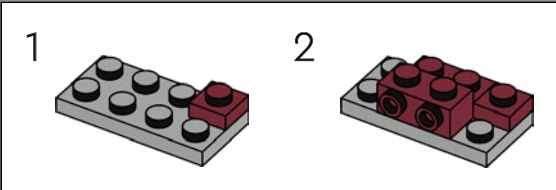

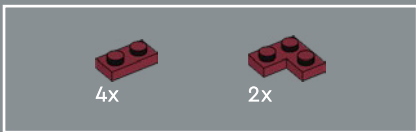

338

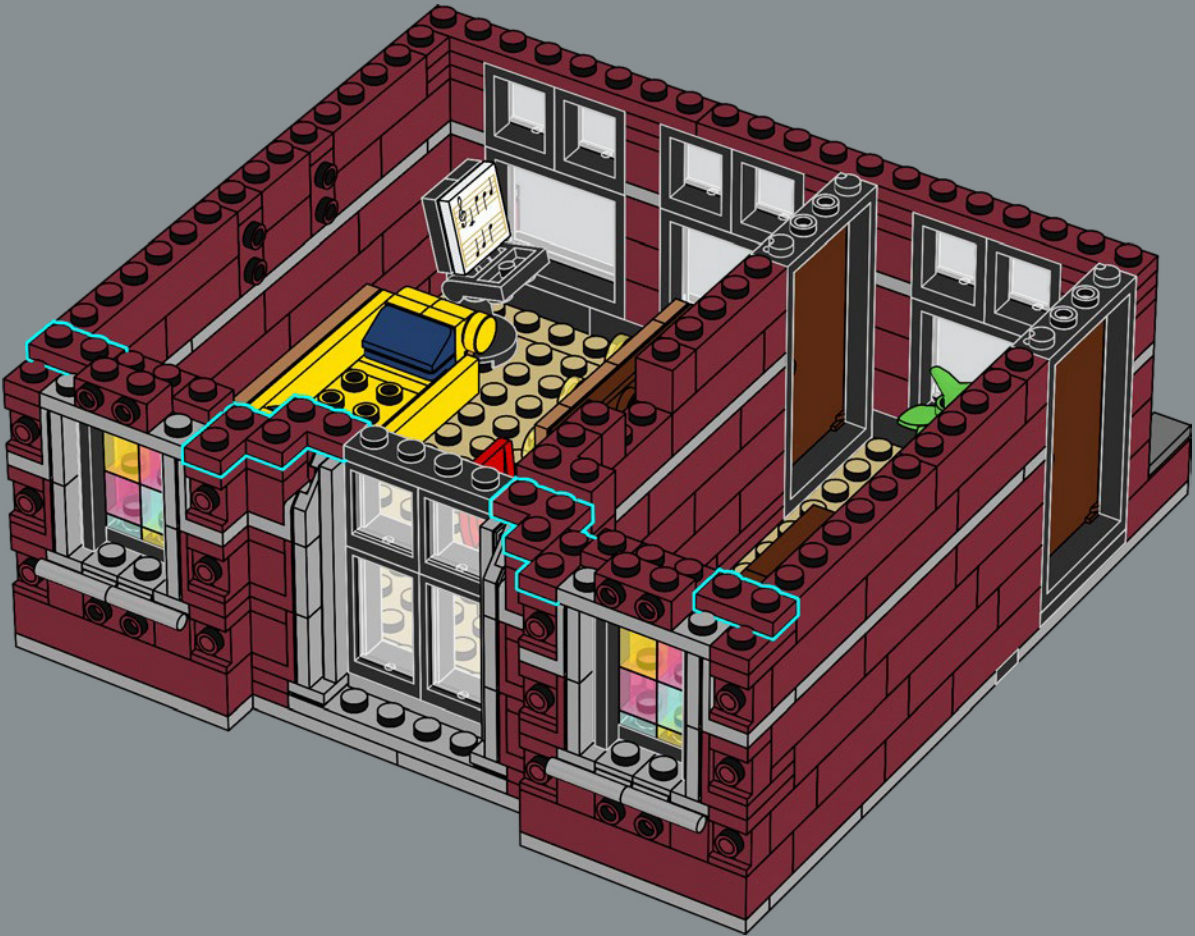

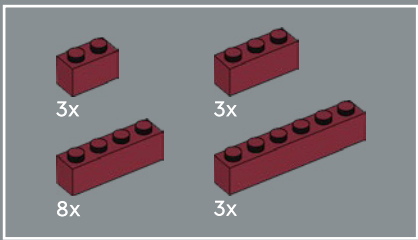

339

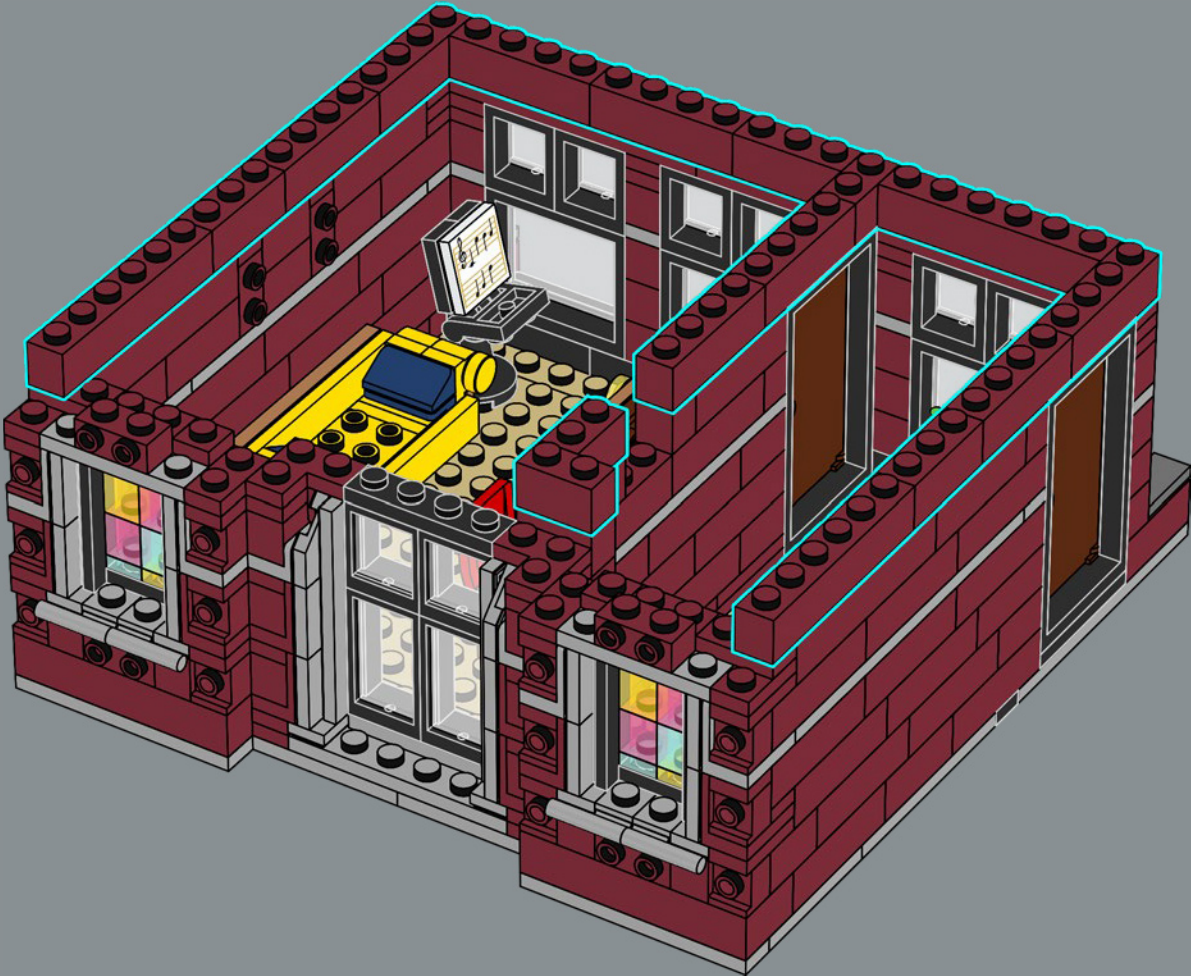

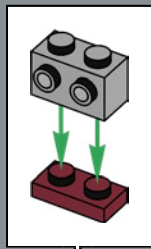
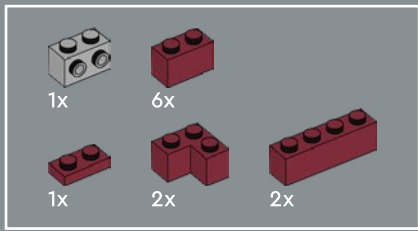

340

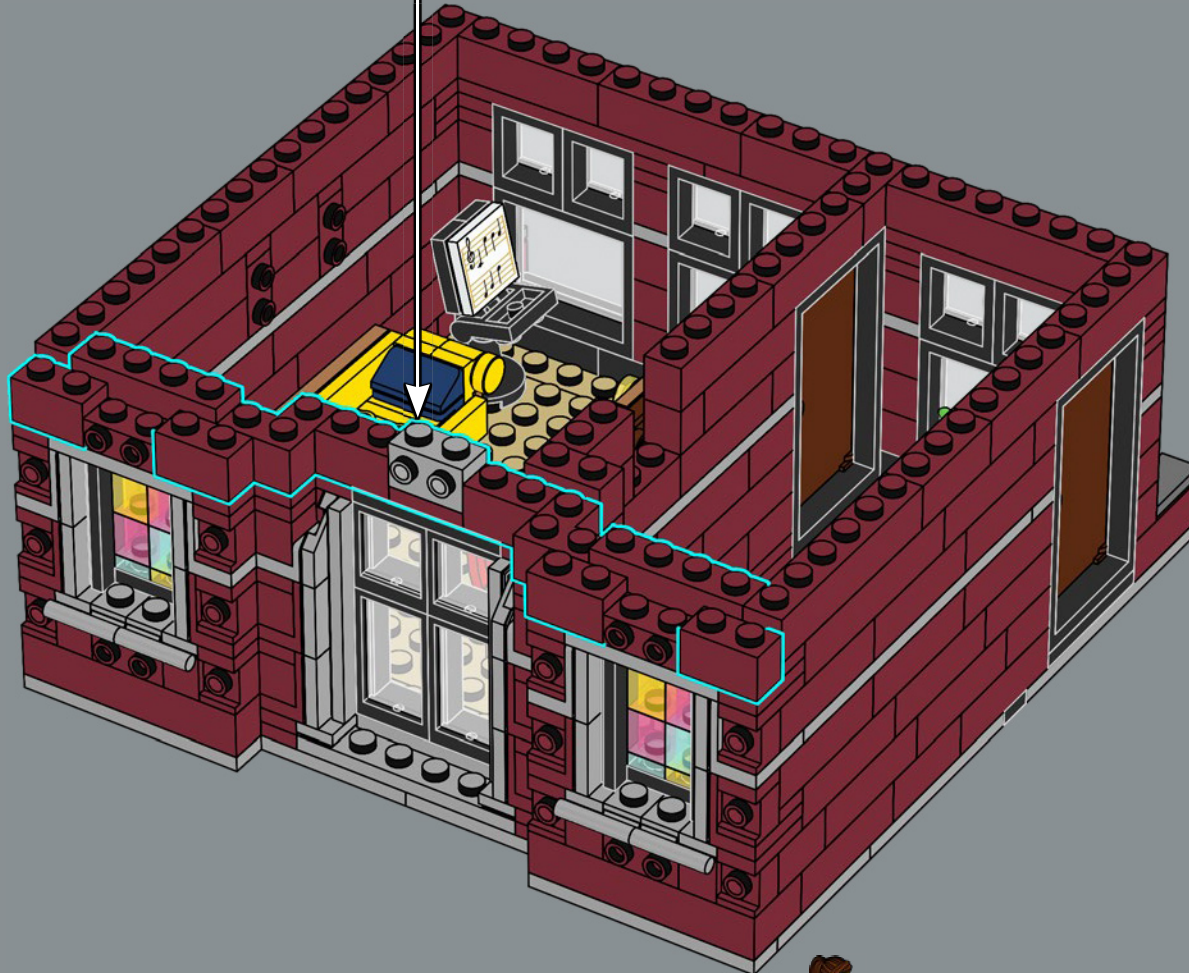

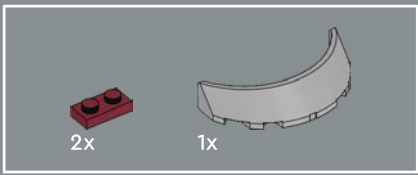

341

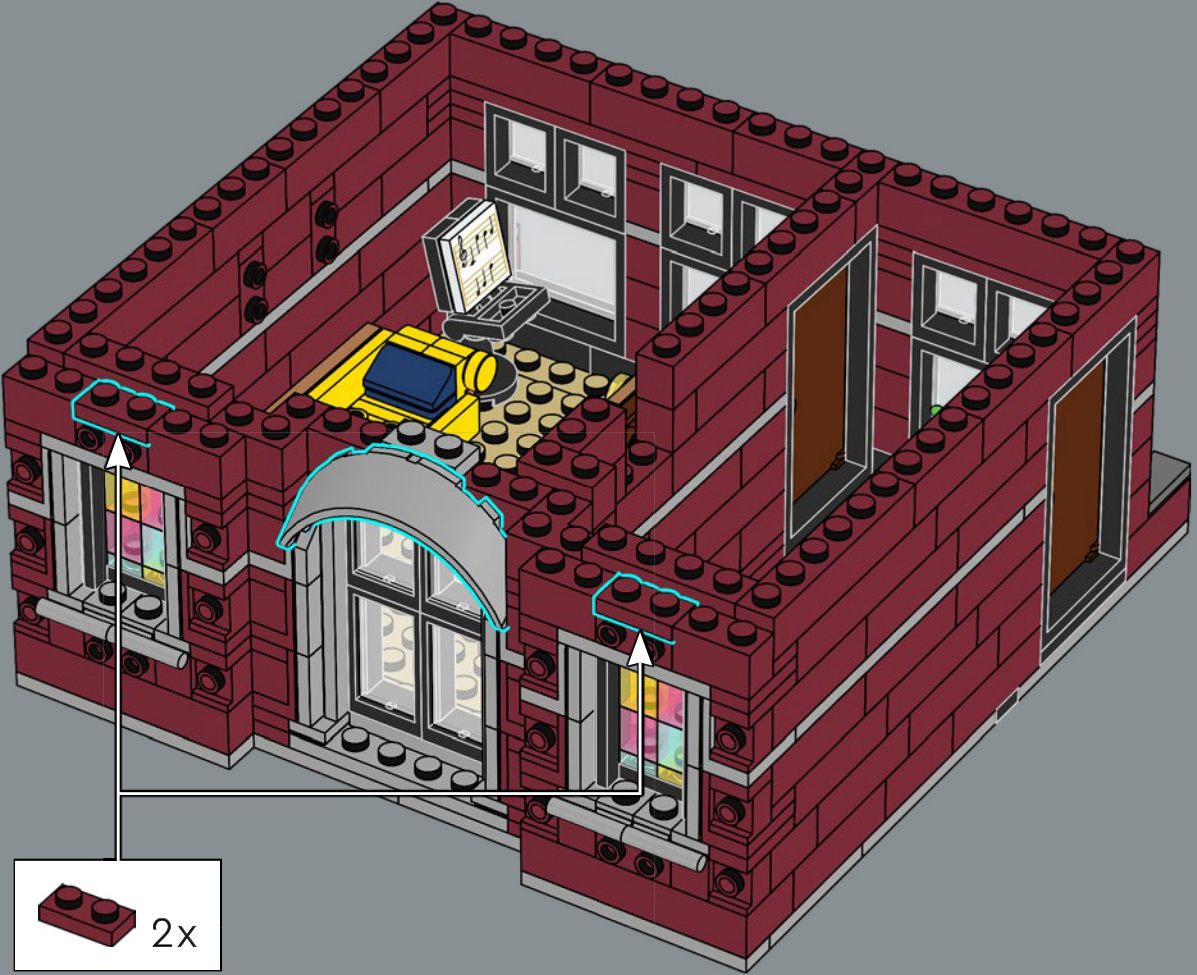

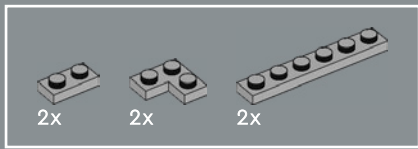

342

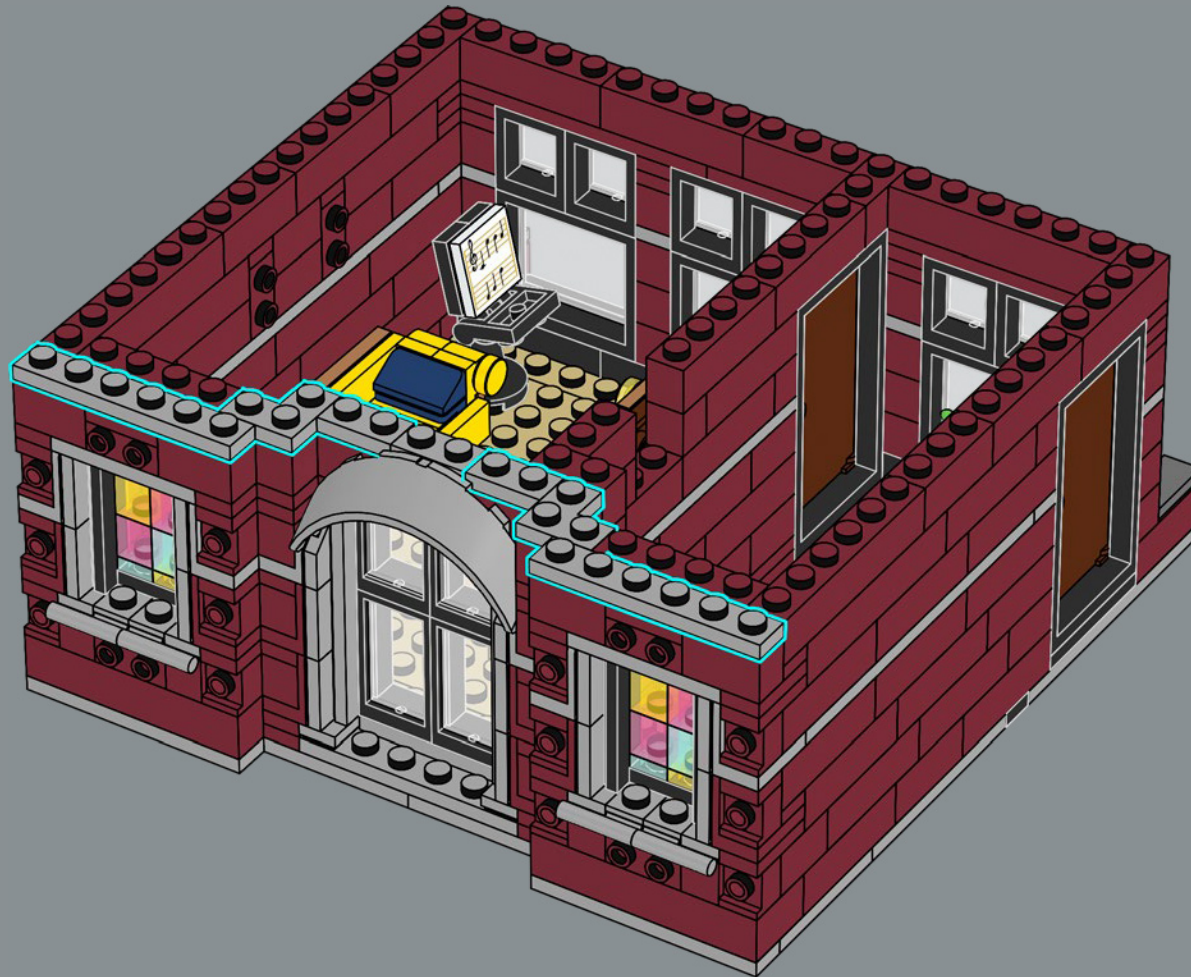

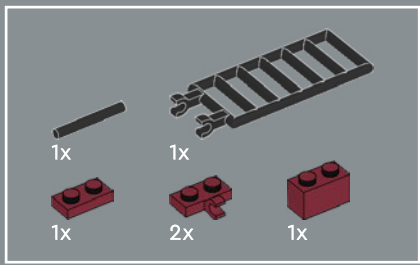

343

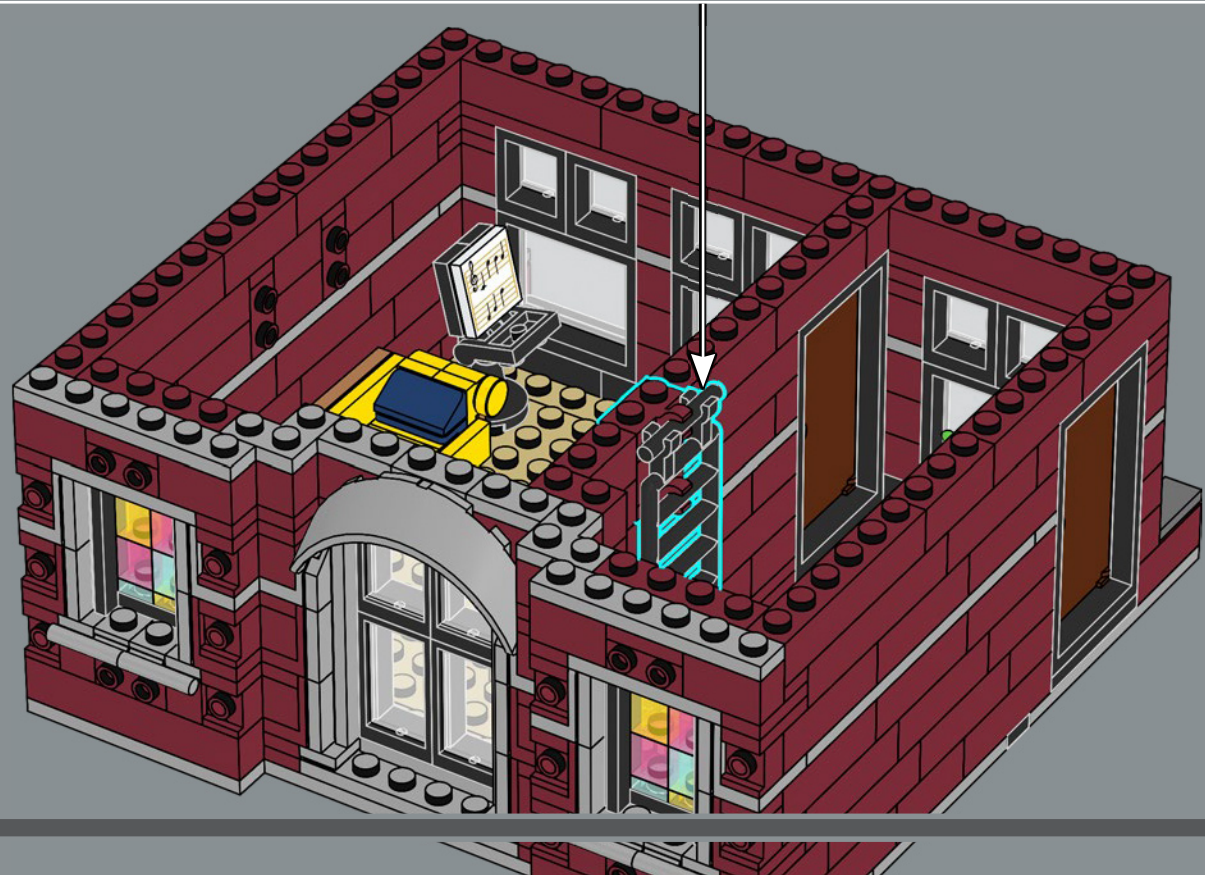
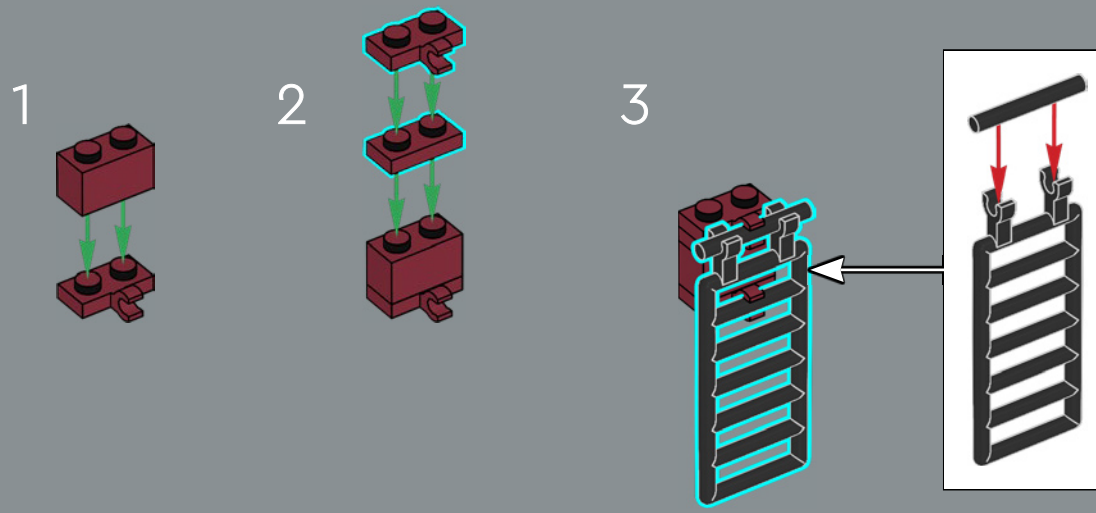

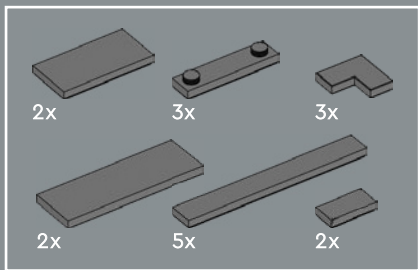

344

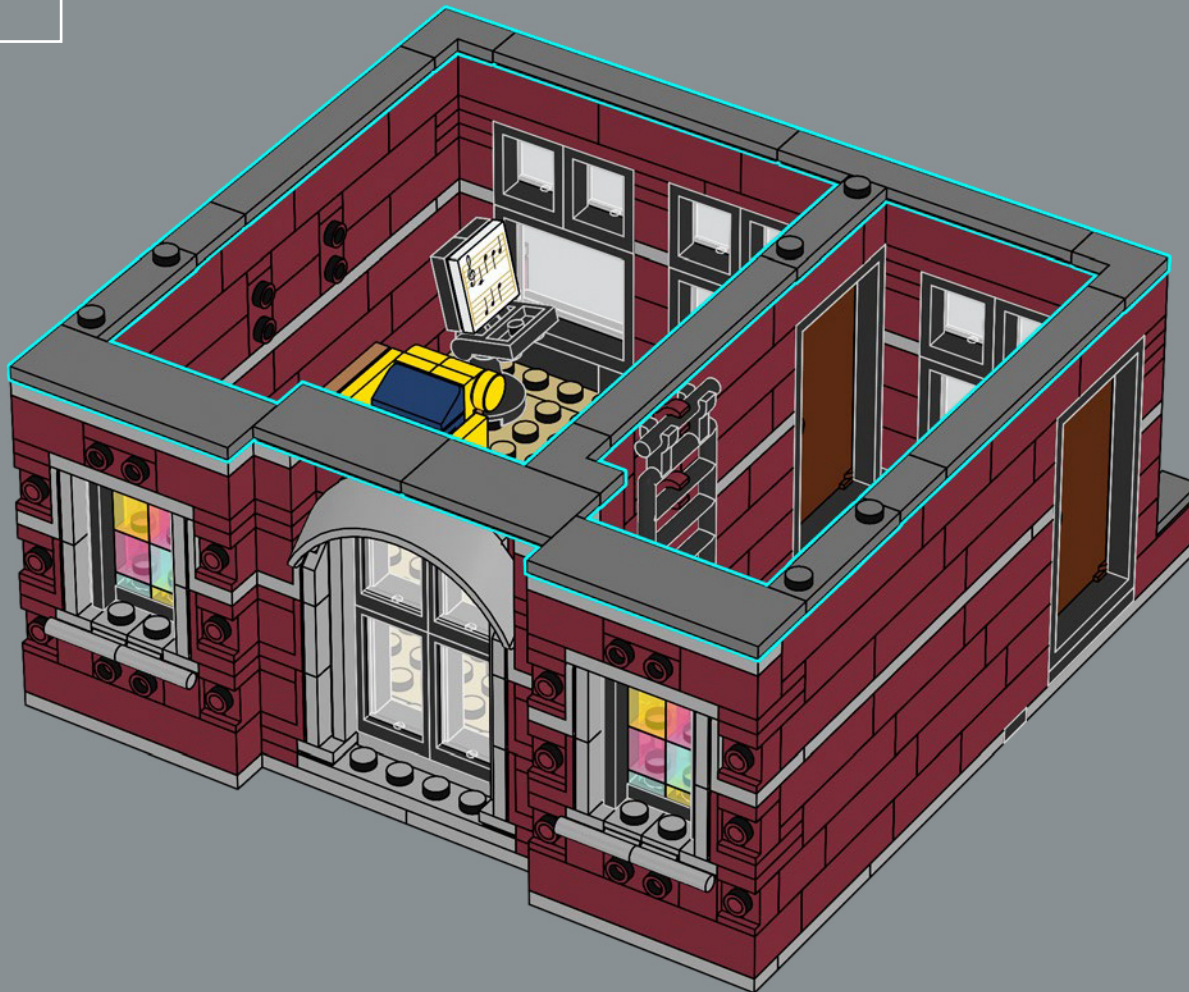

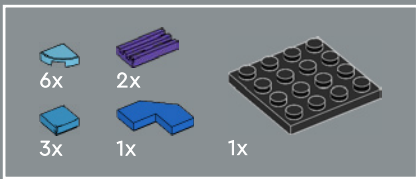

345

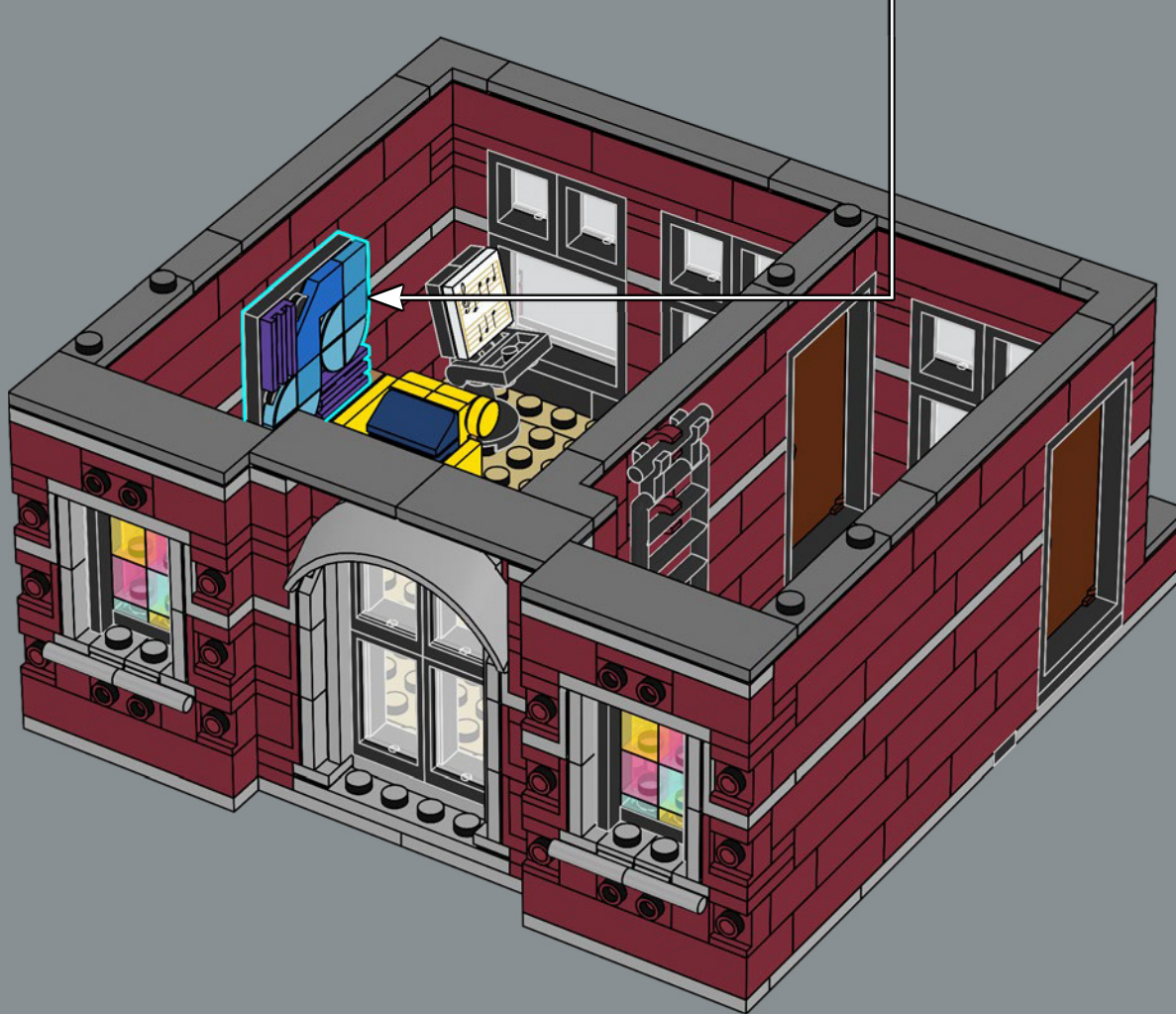
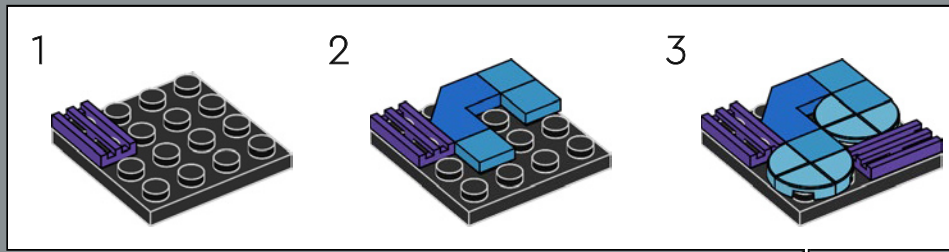

Ce tableau nommé « The Blues » a été acheté juste en bas de la rue, à la galerie d'art de L'hôtel-boutique LEGO® 10297.

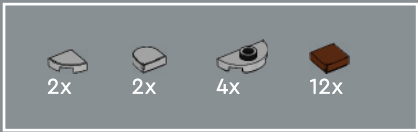

346

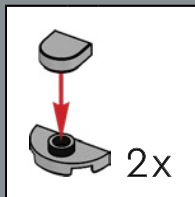
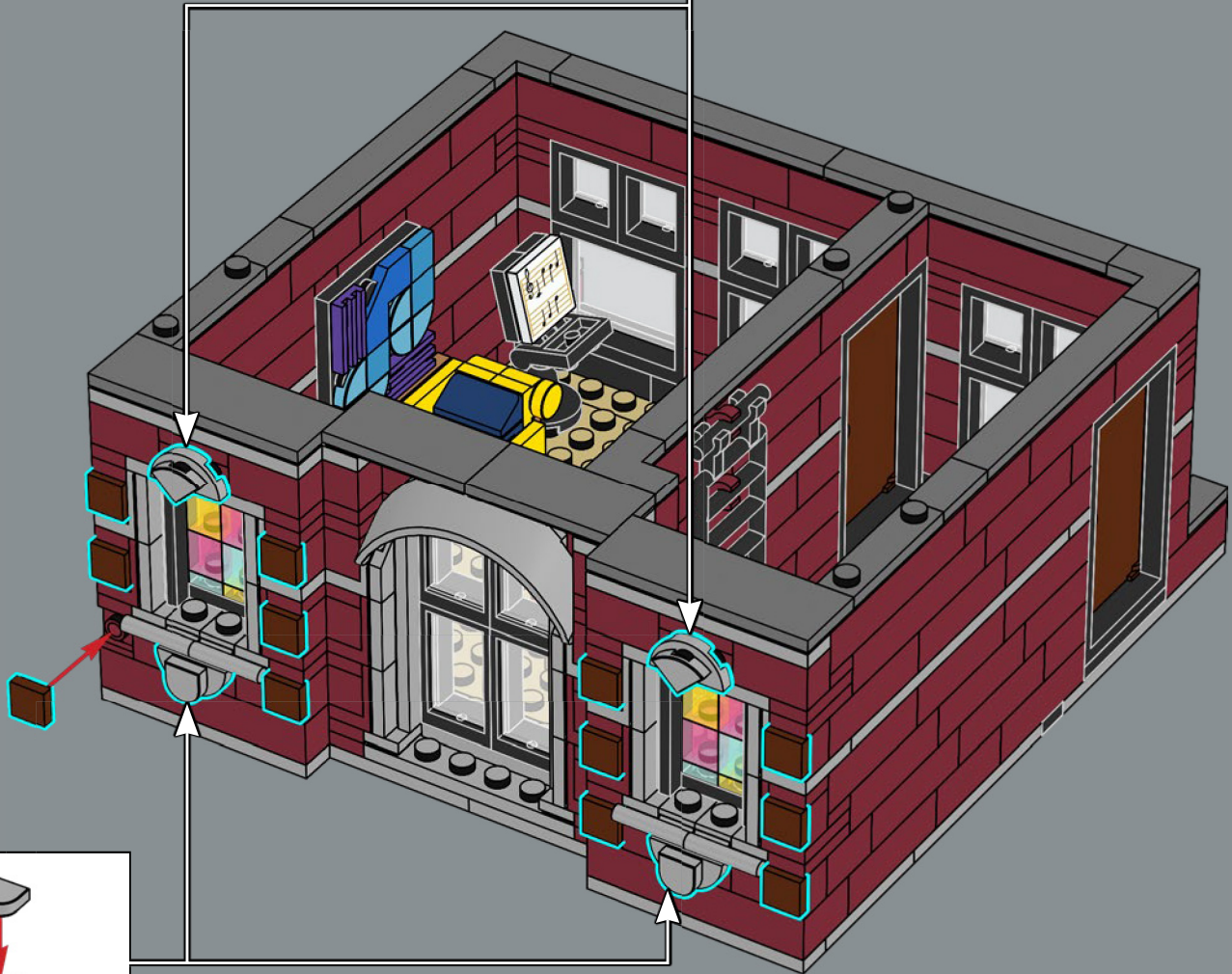
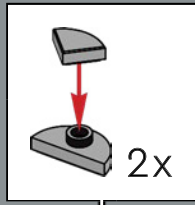

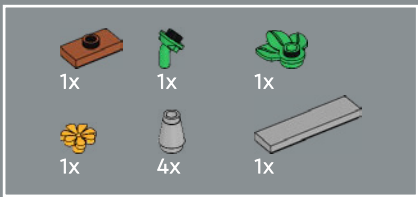

347

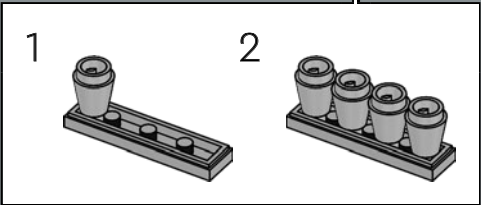
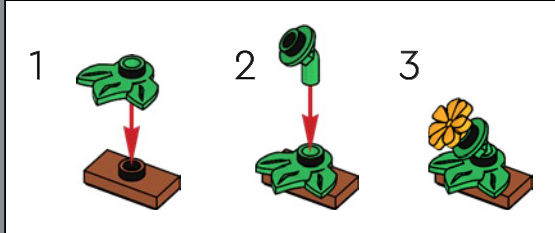
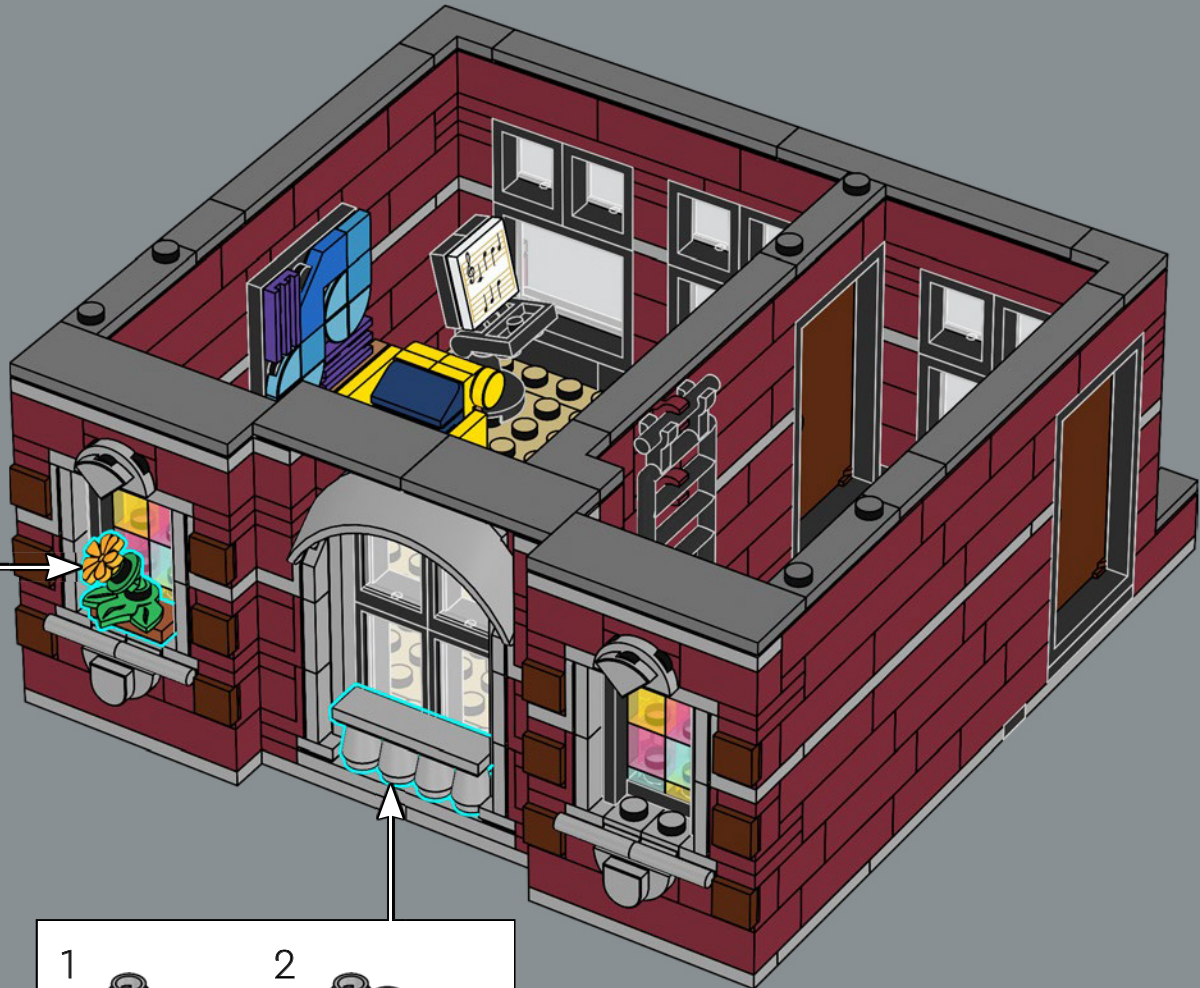

348



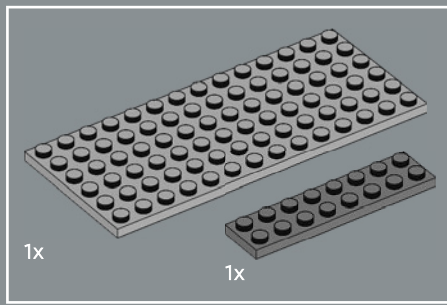

349

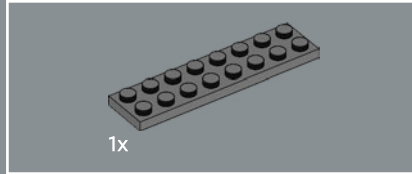
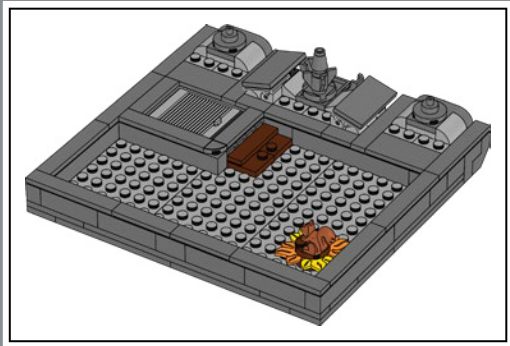
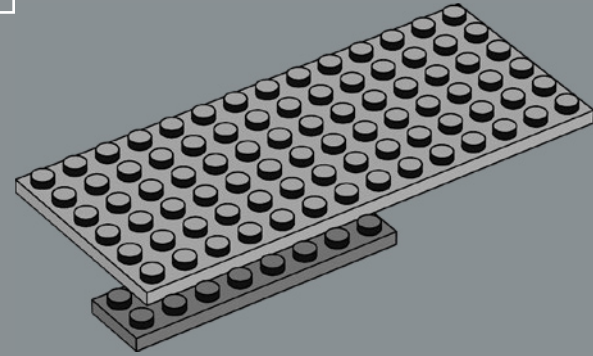

350

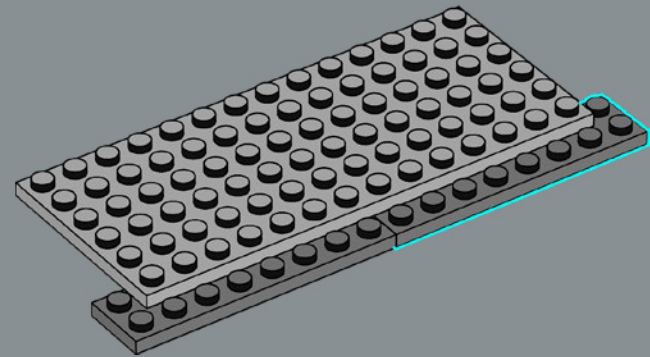

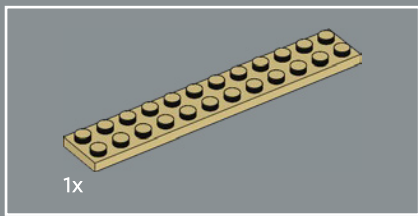

351

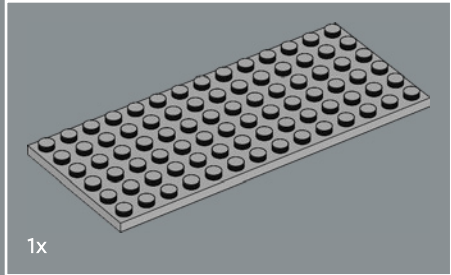
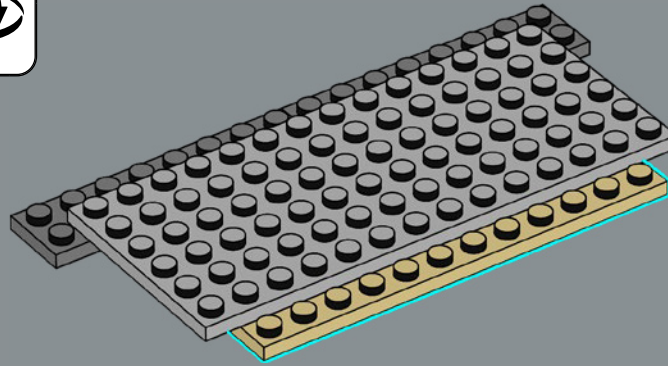

352

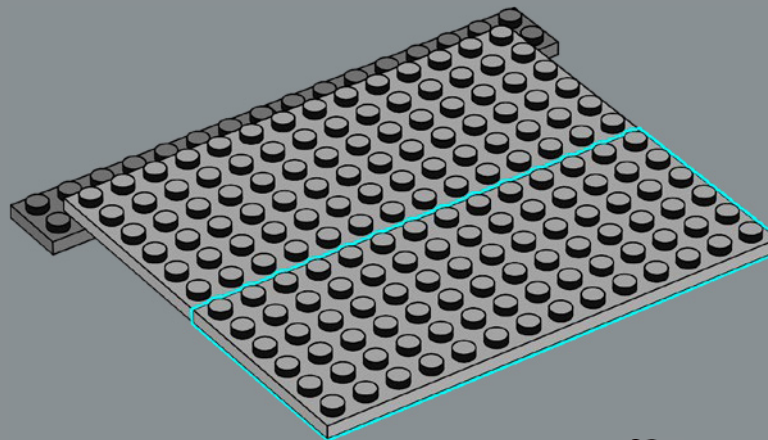

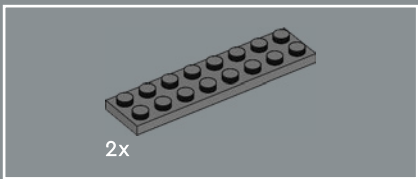

353

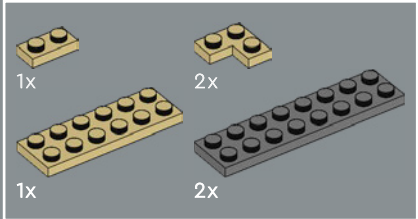
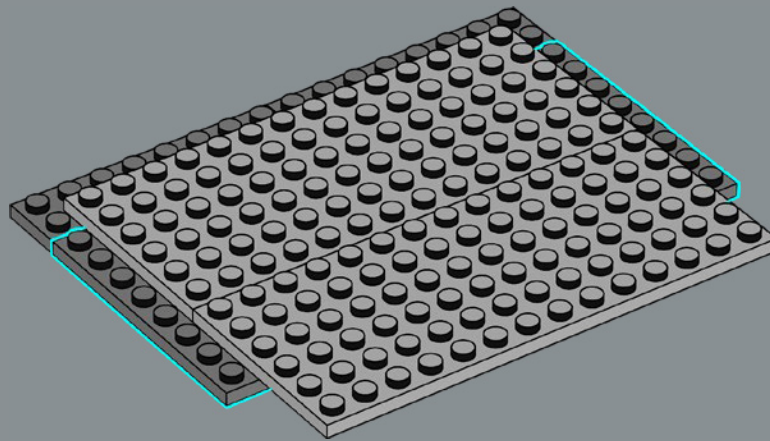

354

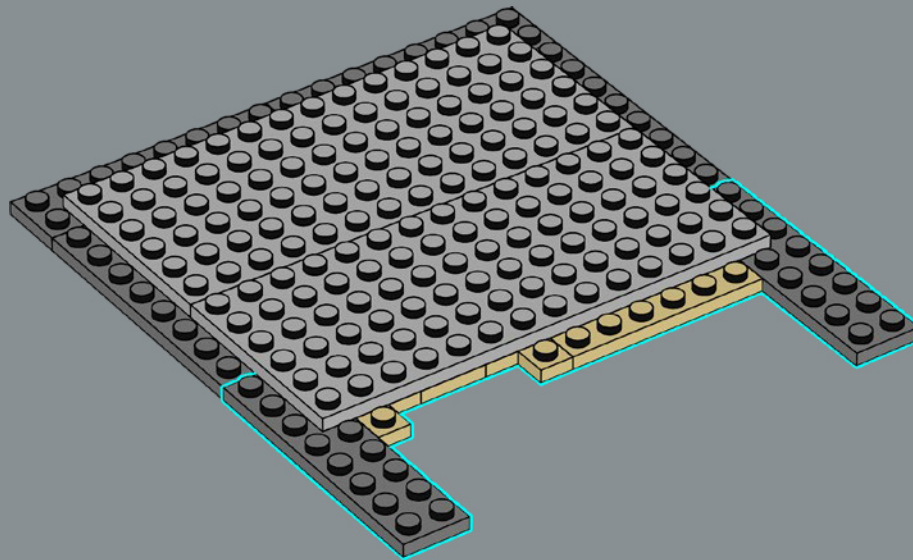

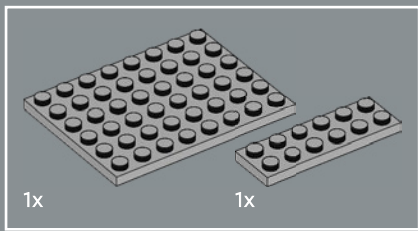

355

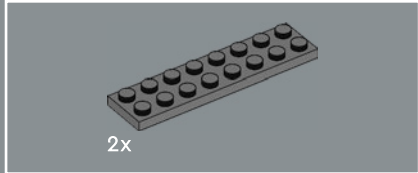
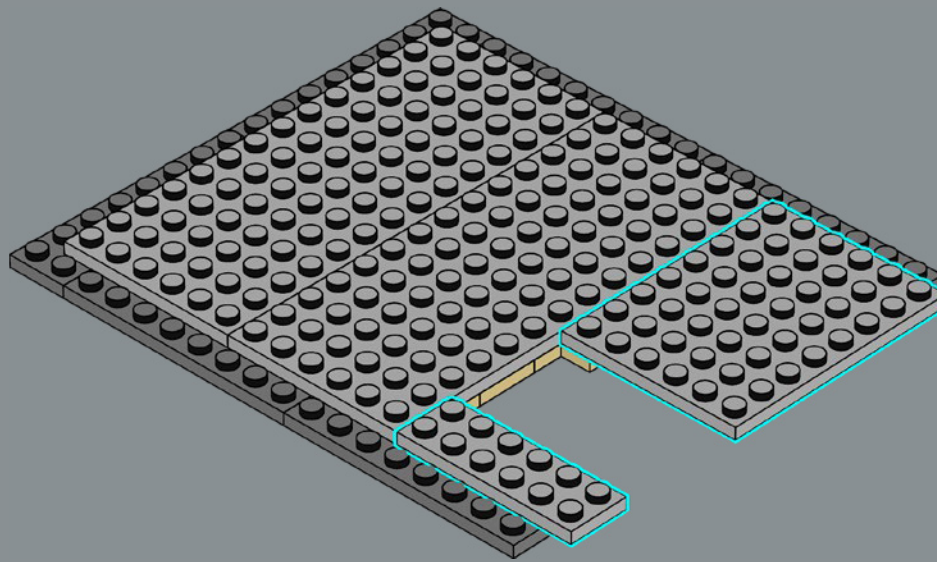

356

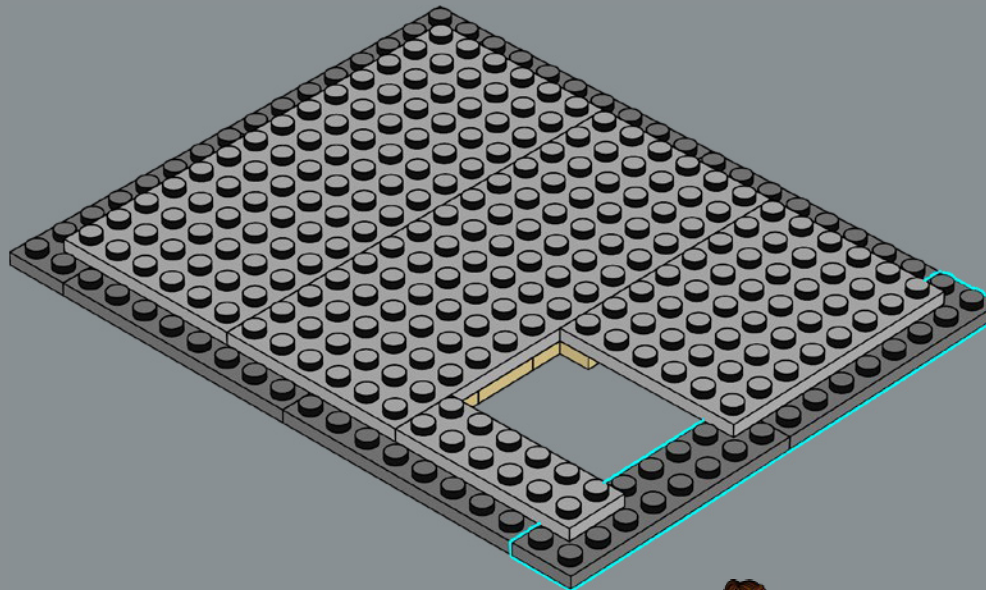

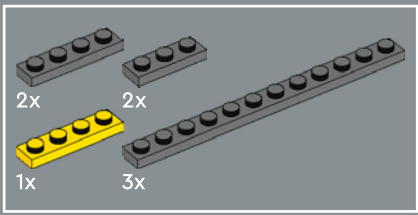

357

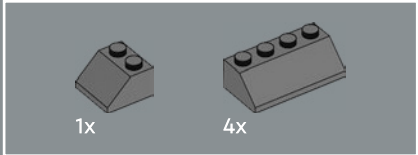
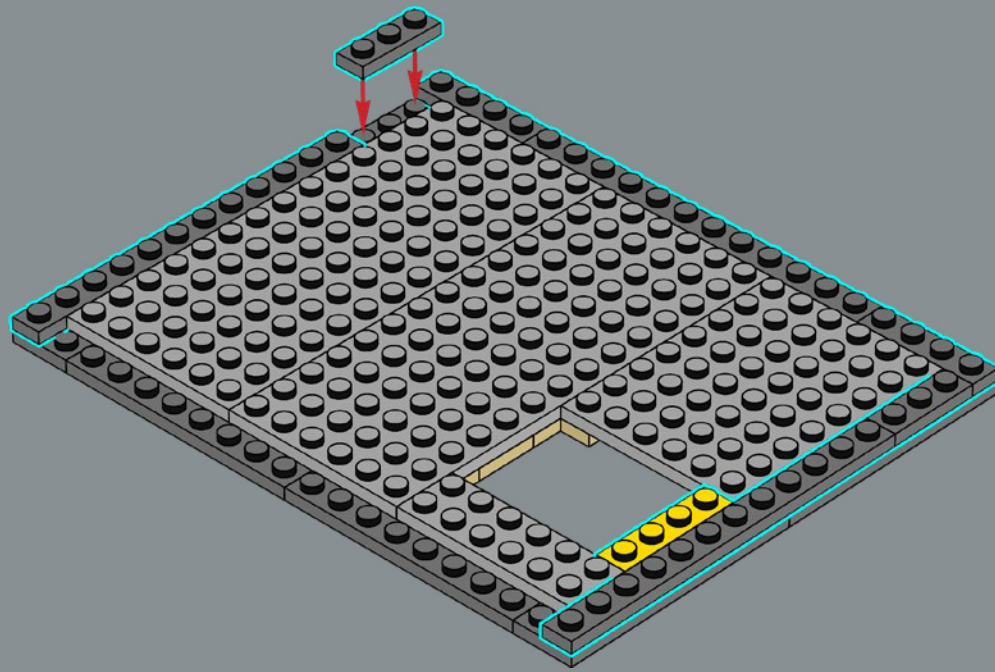

358

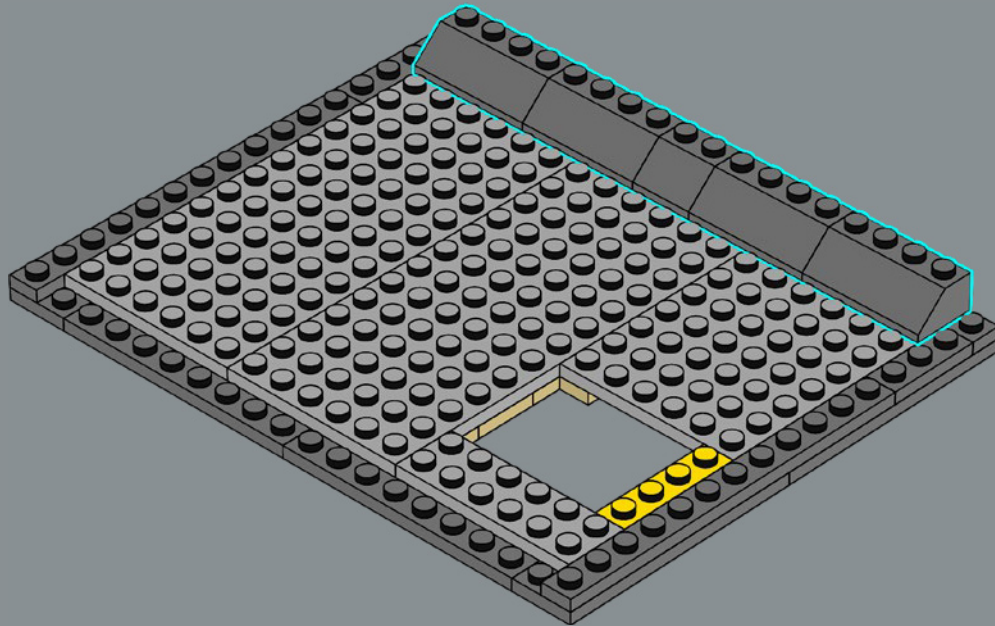

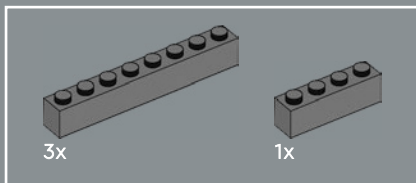

359

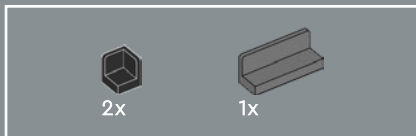
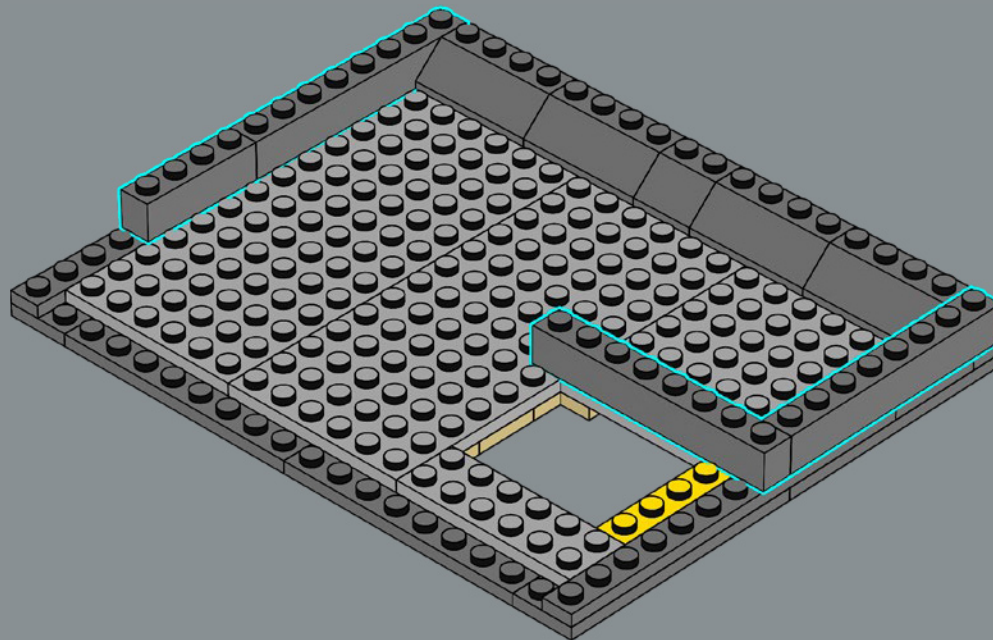

360

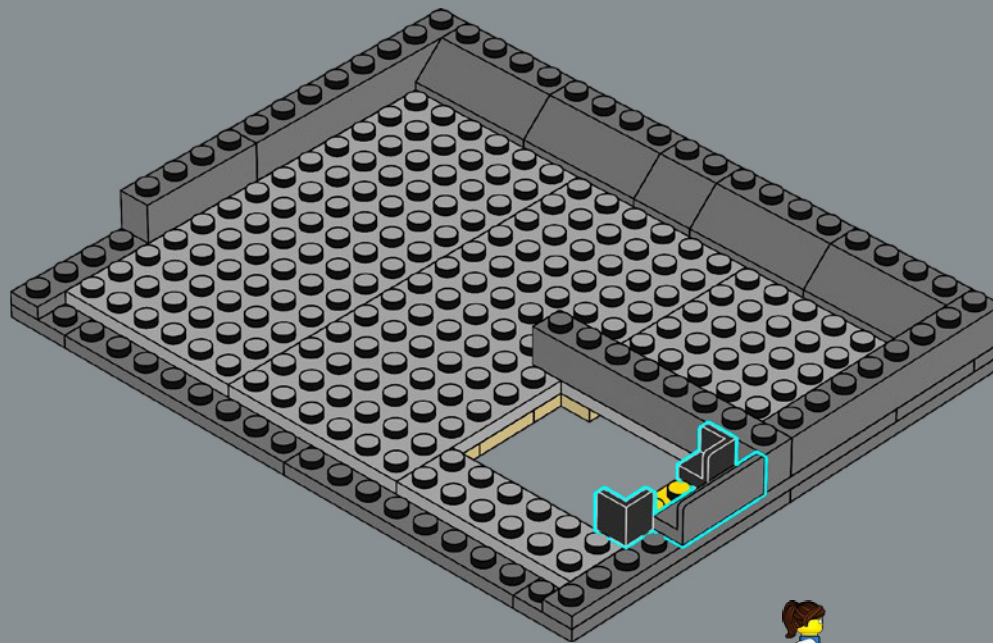

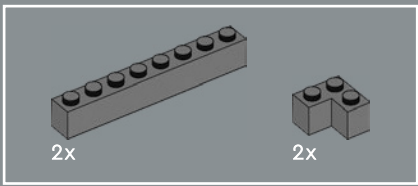

361

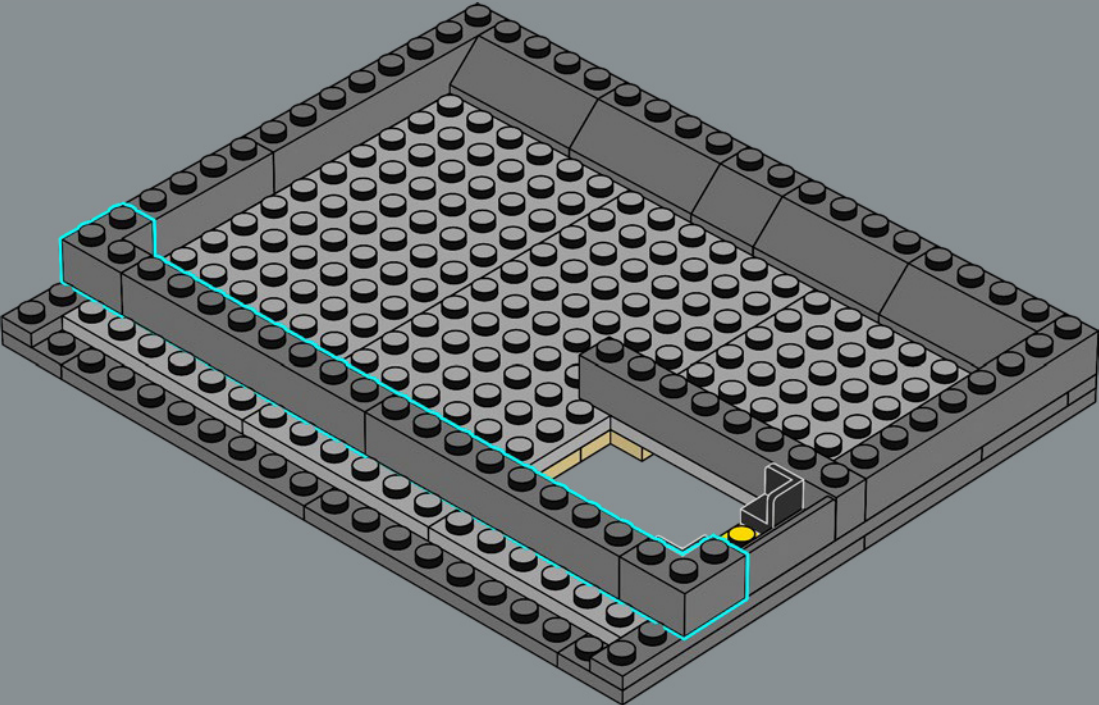

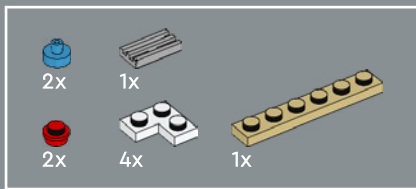

362

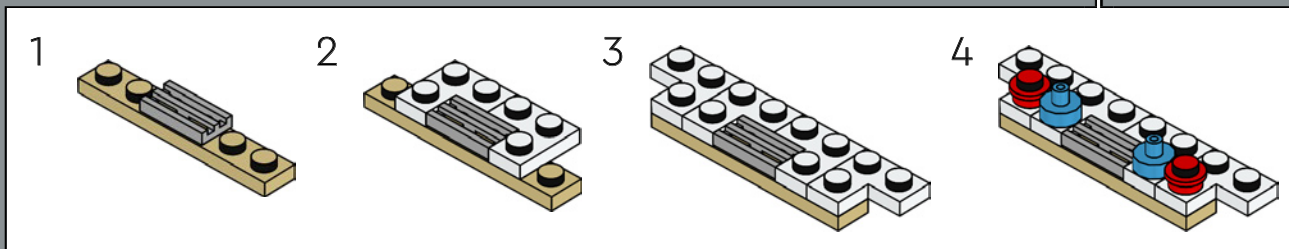
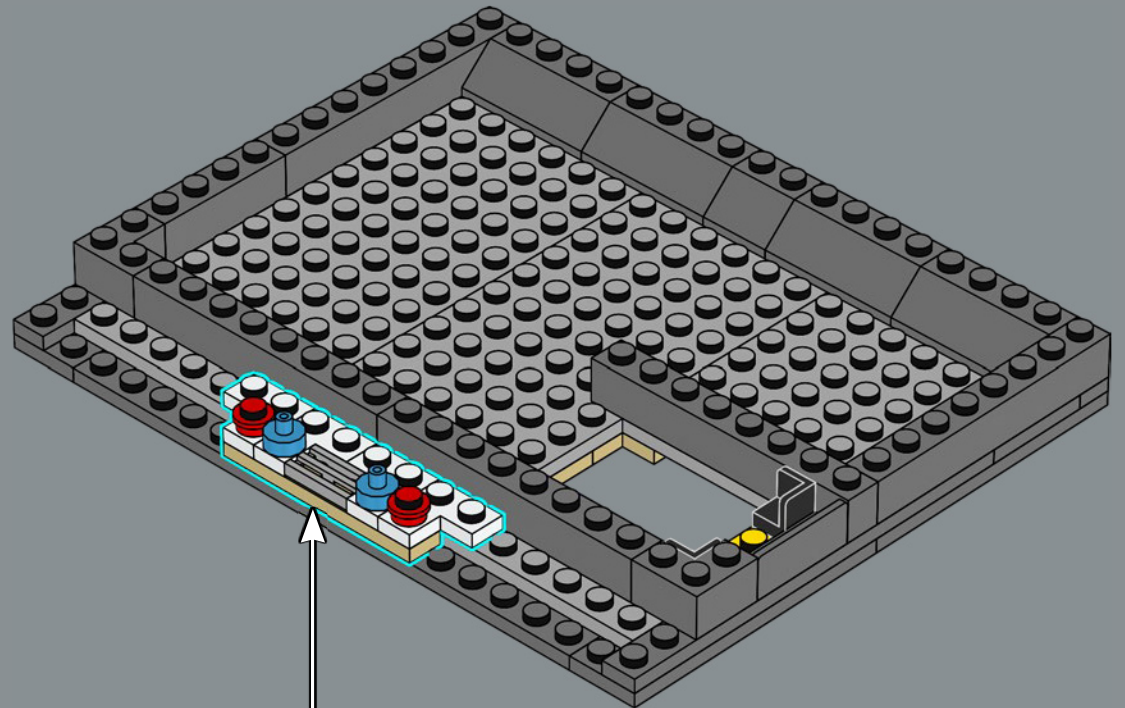

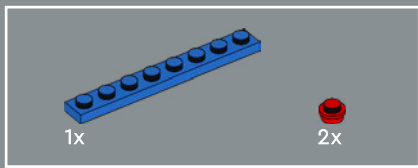

363

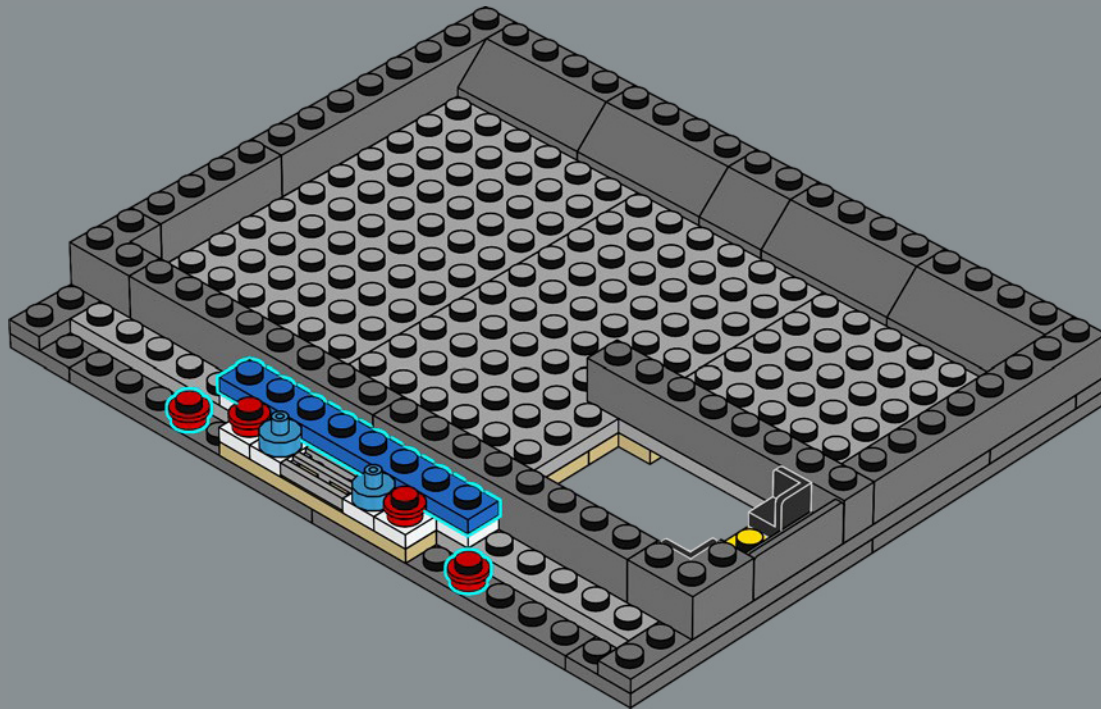

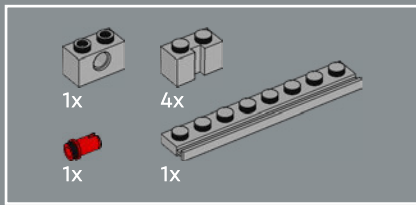

364

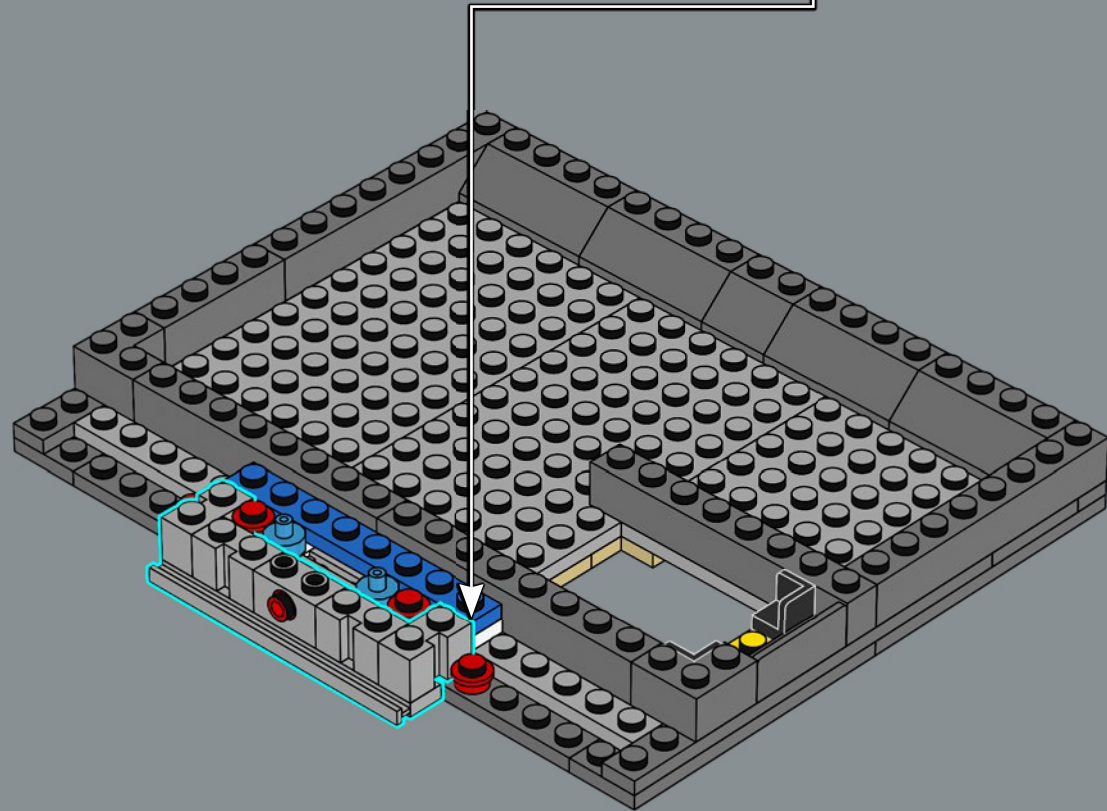
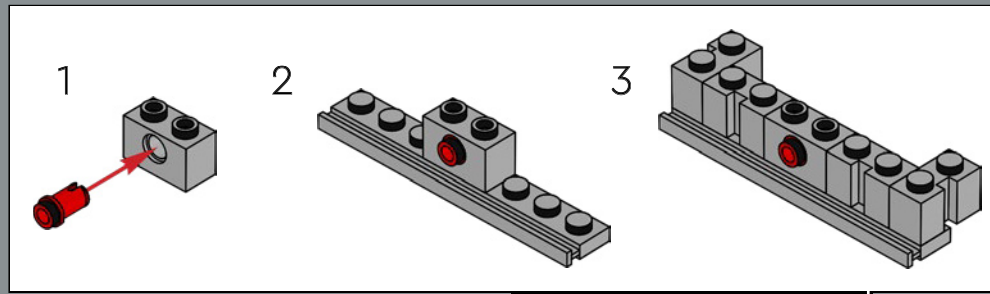

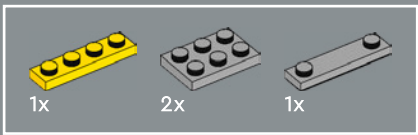

365

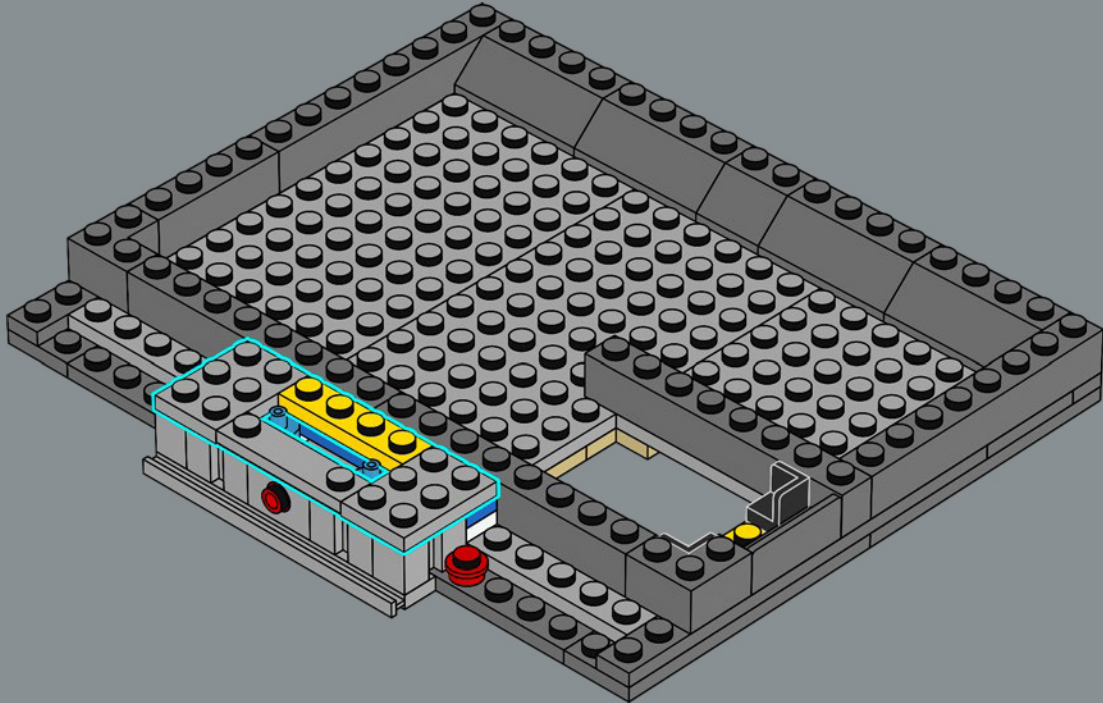

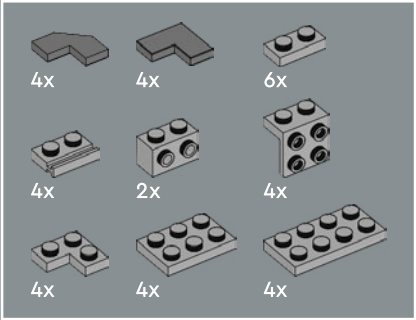
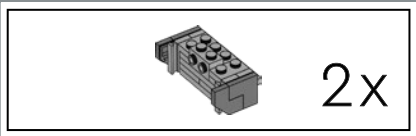

366

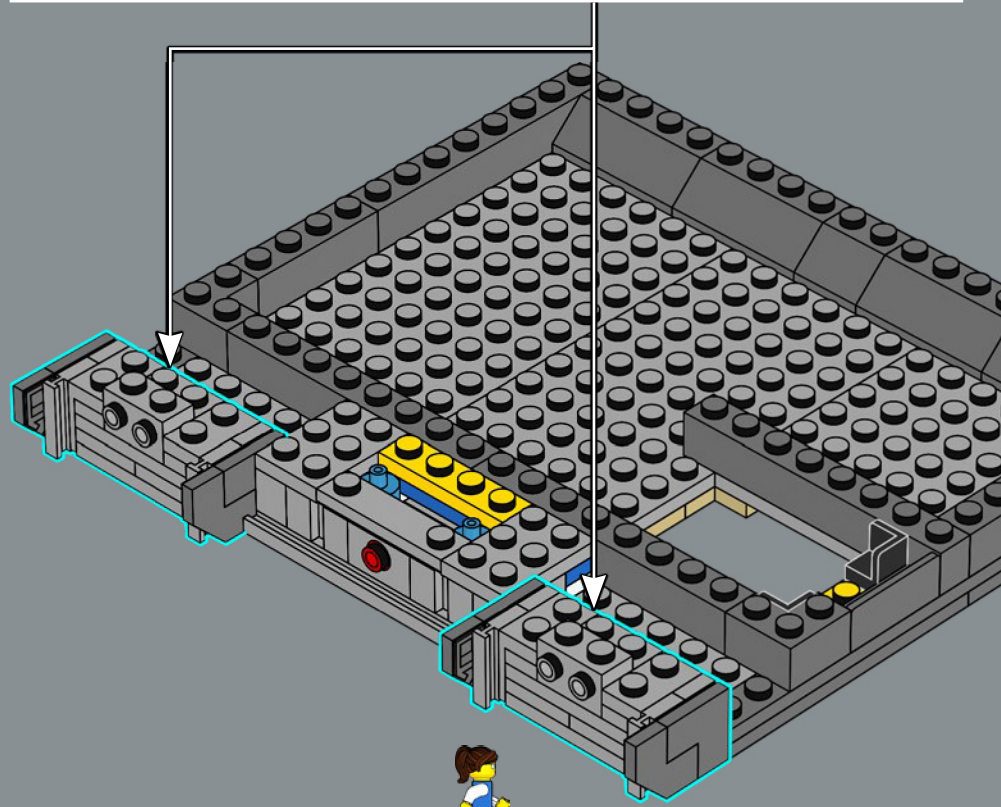
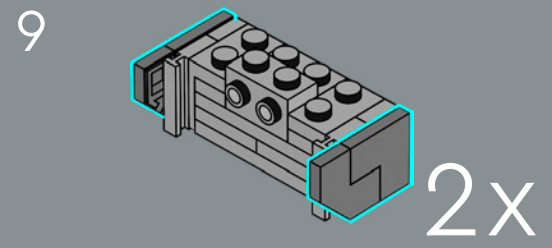
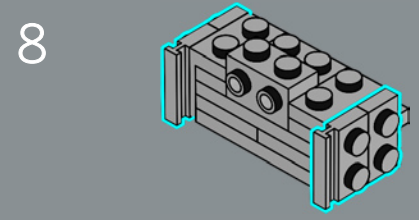
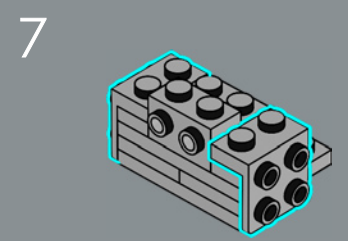
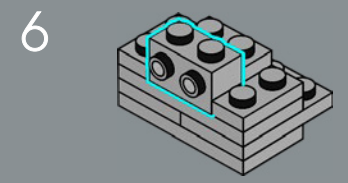
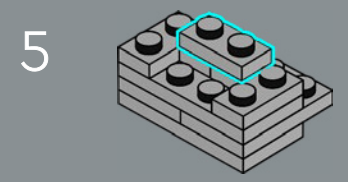
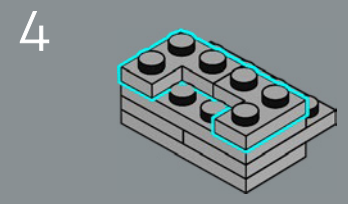
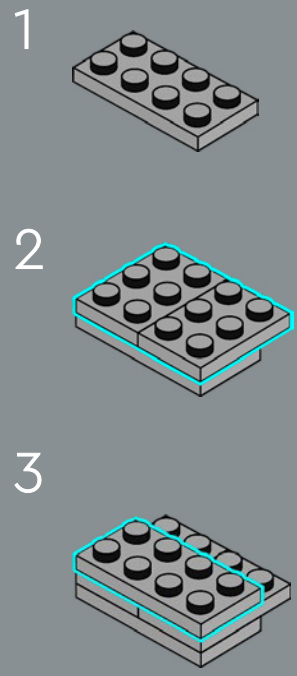

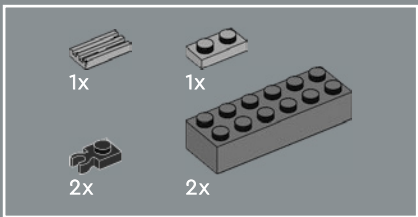

367

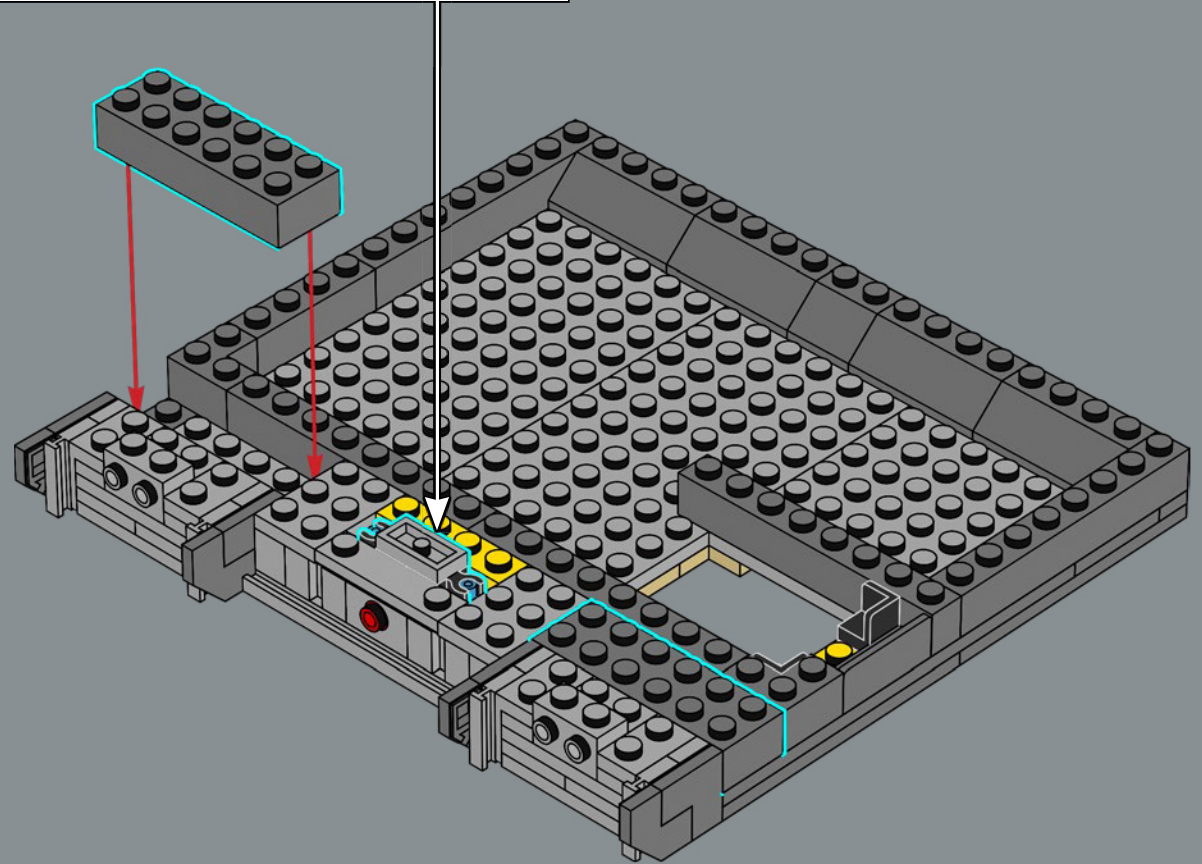
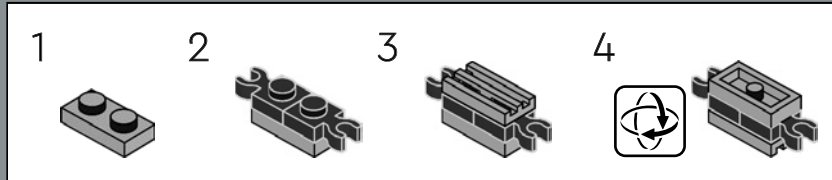

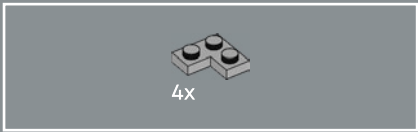

368

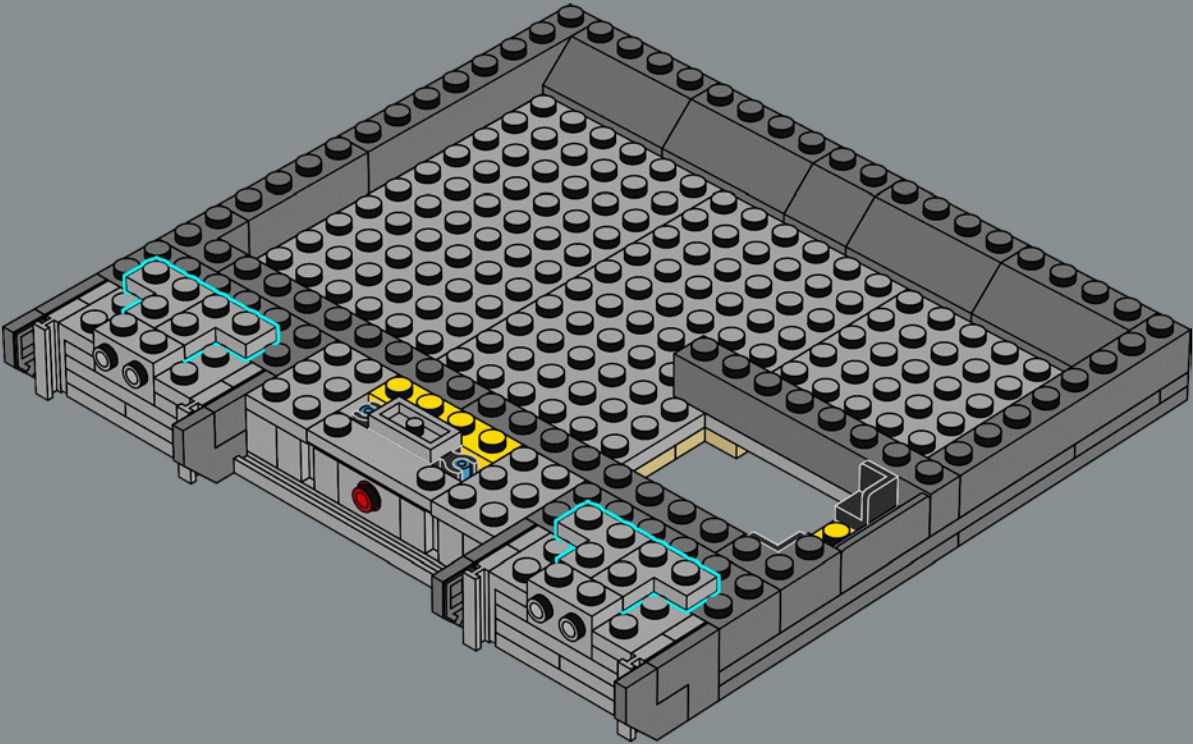

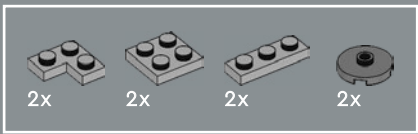

369

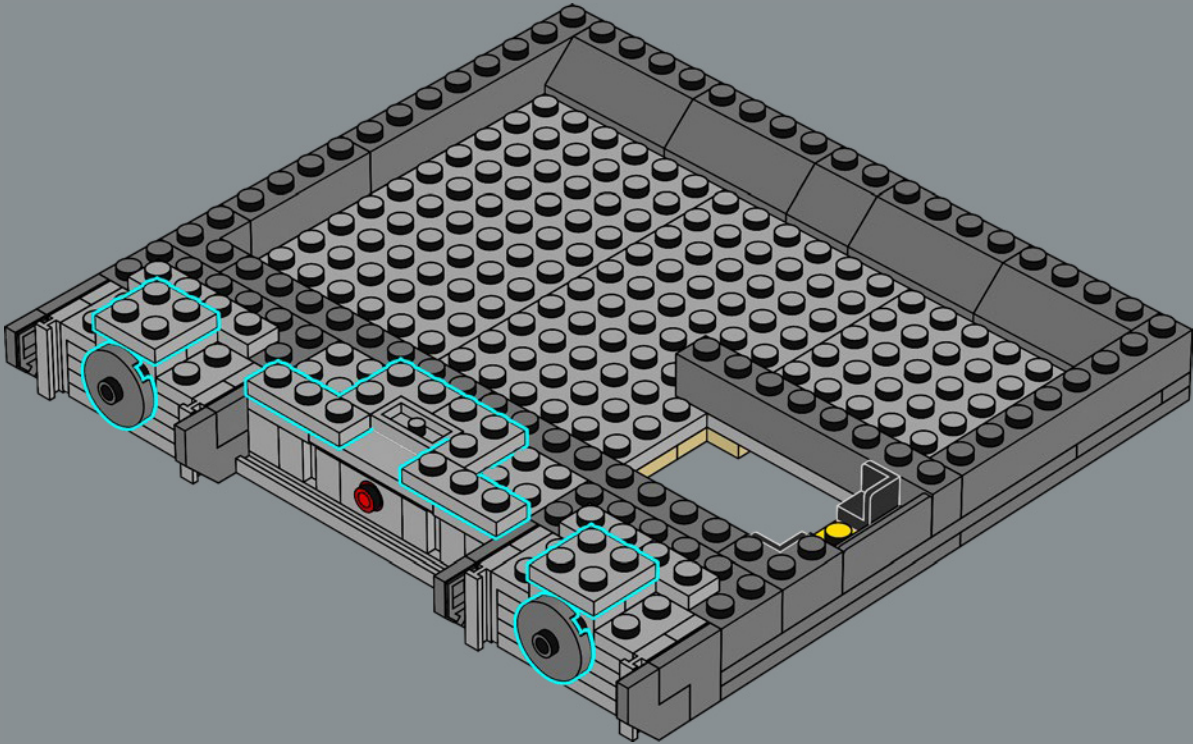



370

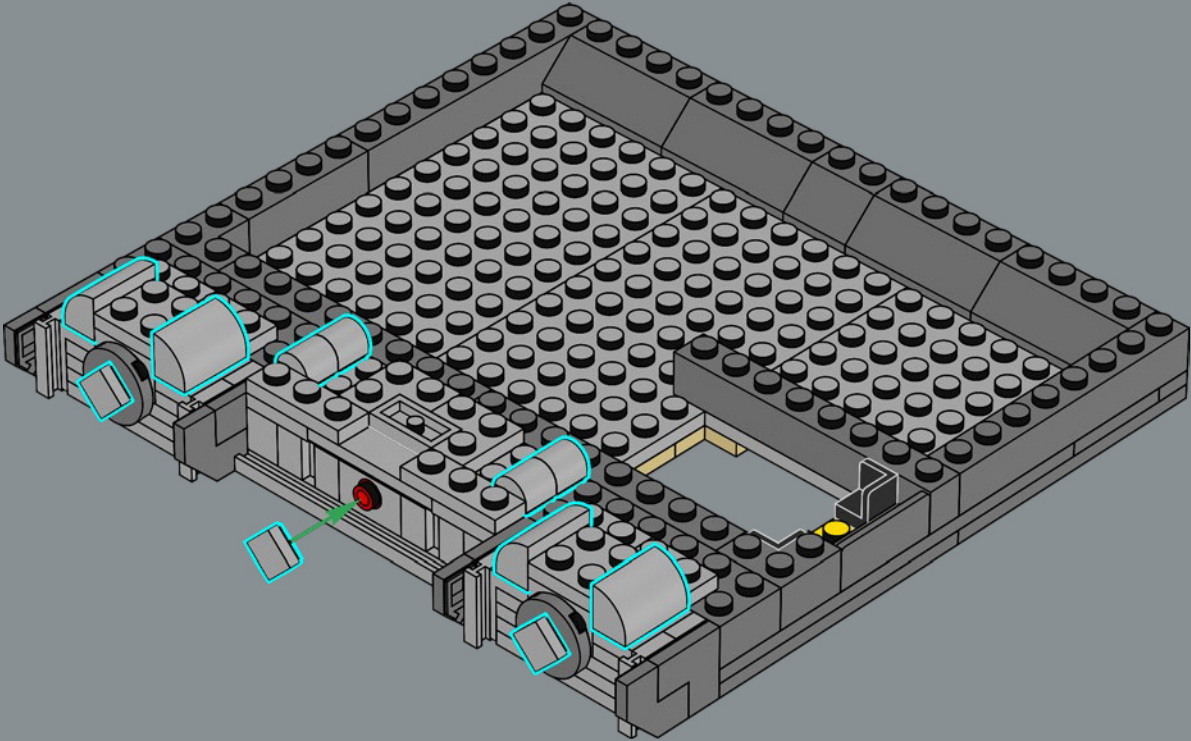

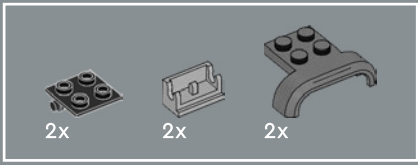

371

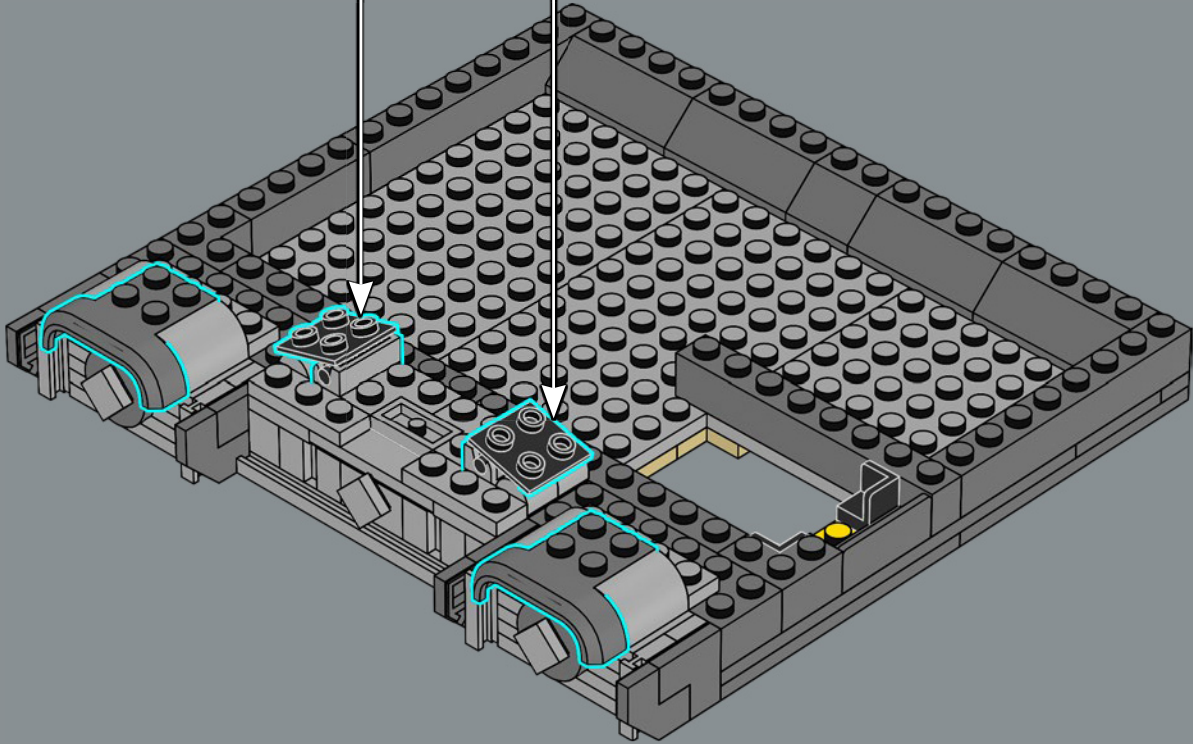
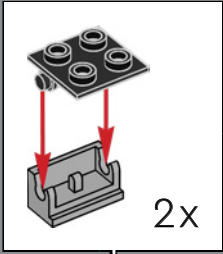

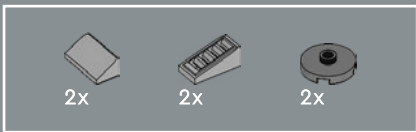

372

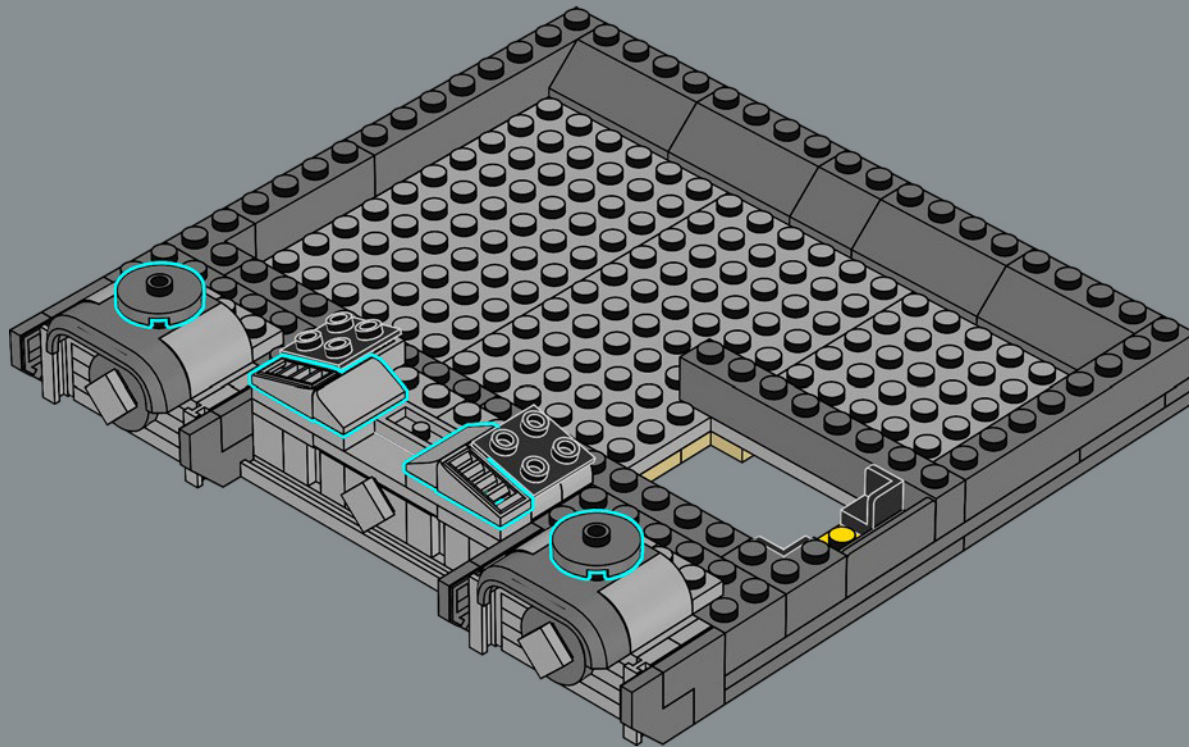

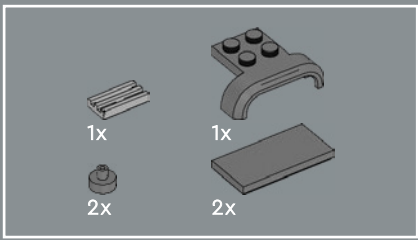

373

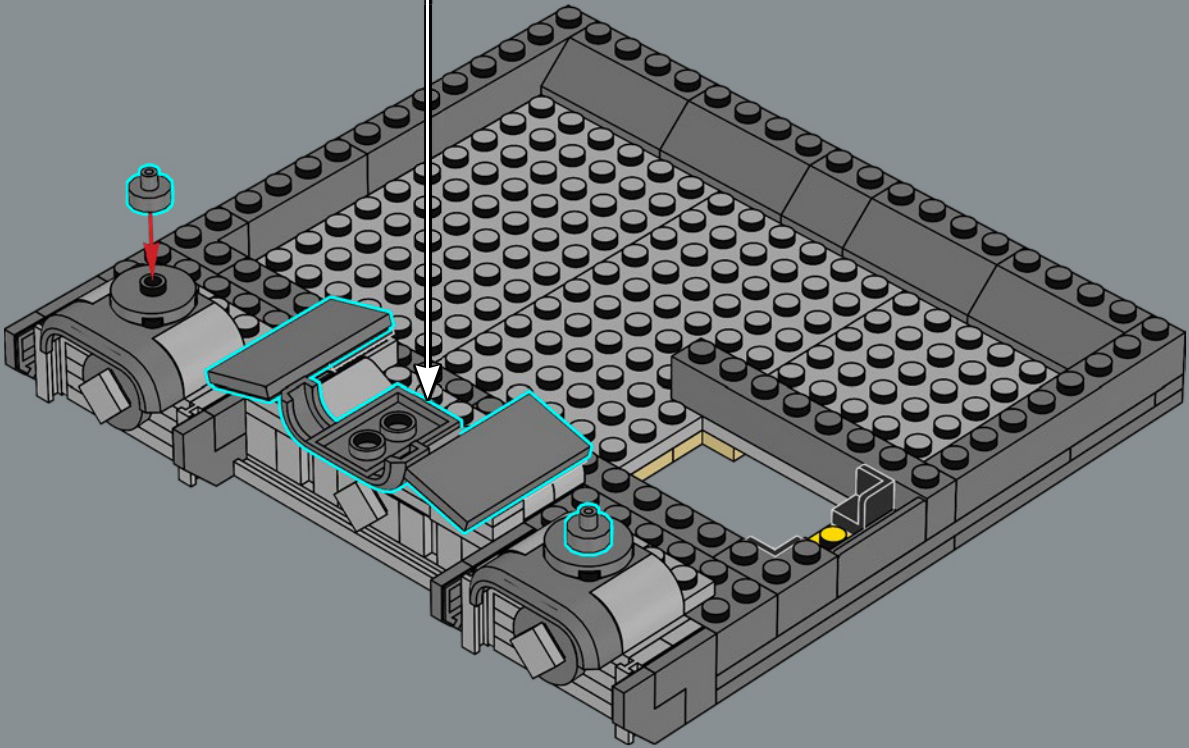
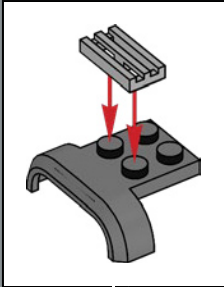



374

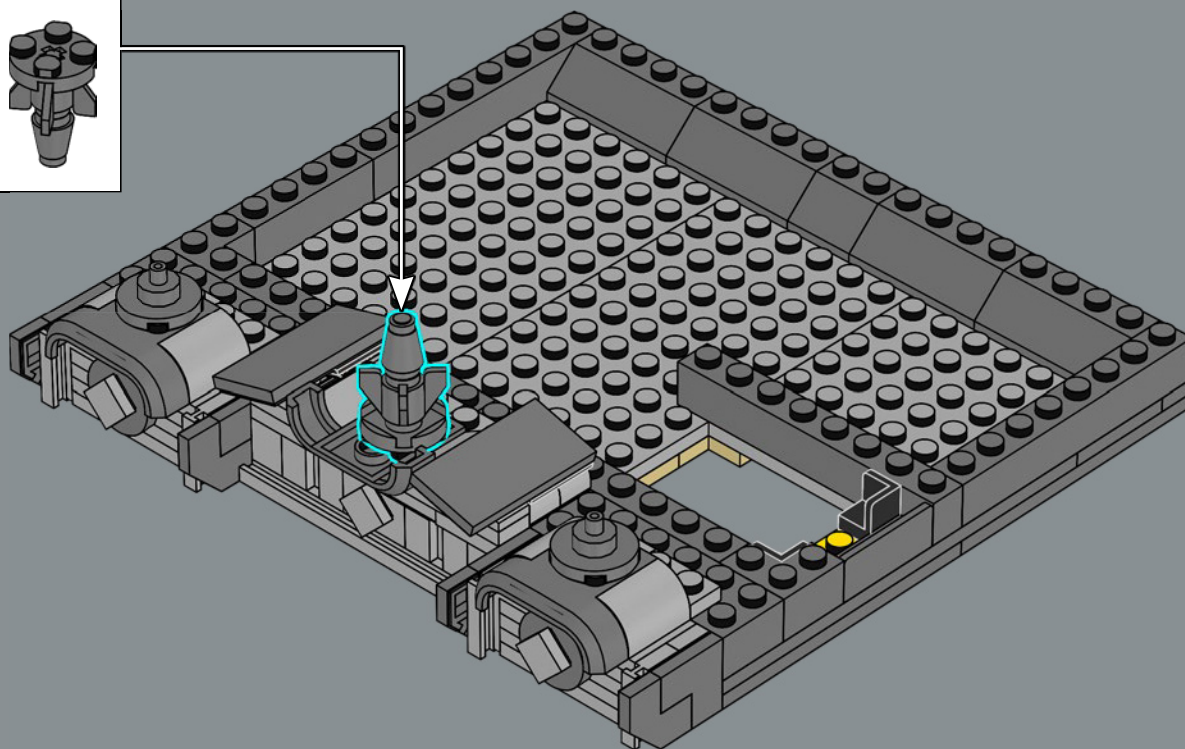
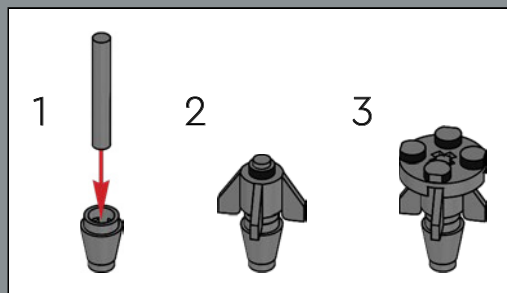

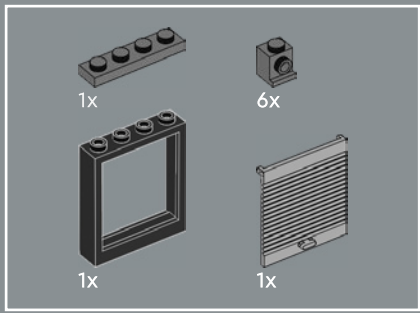

375

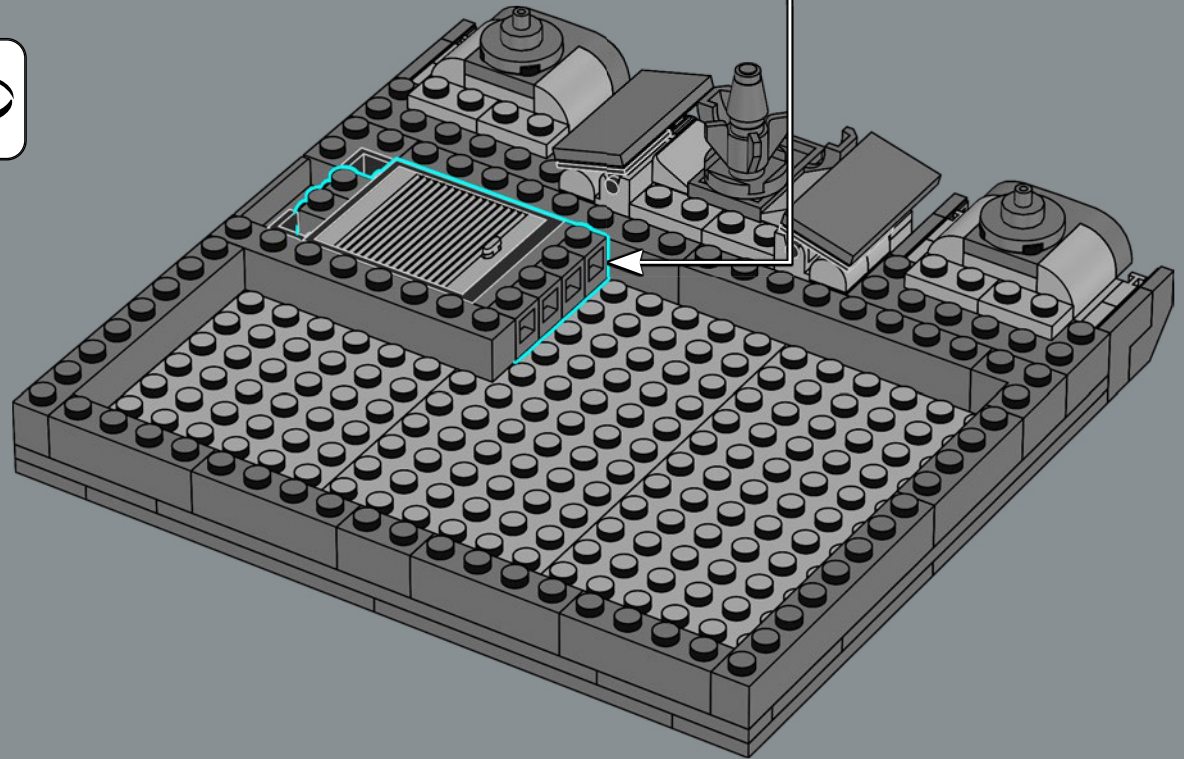
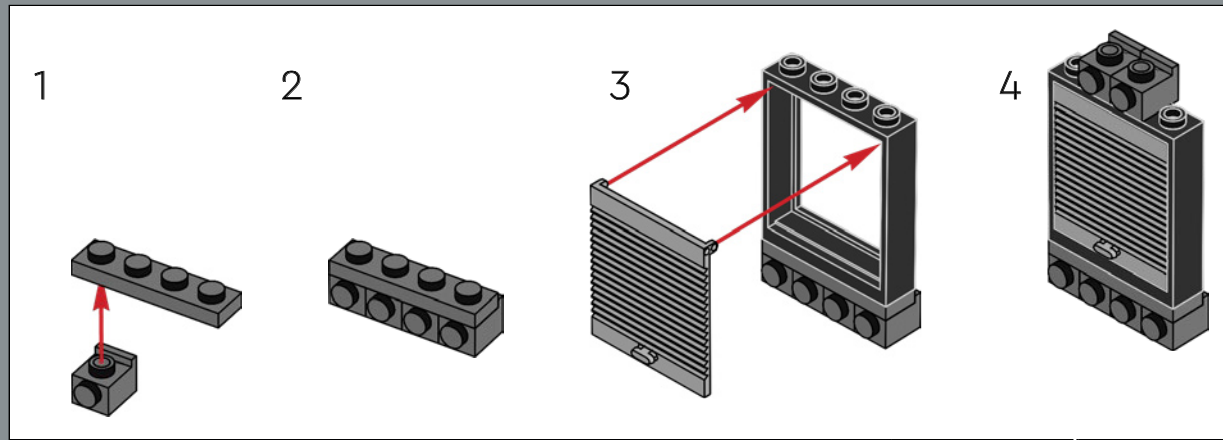

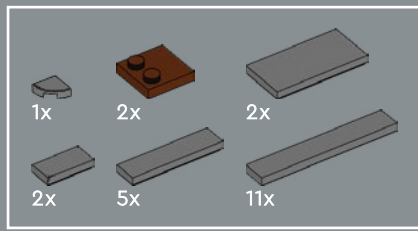

376

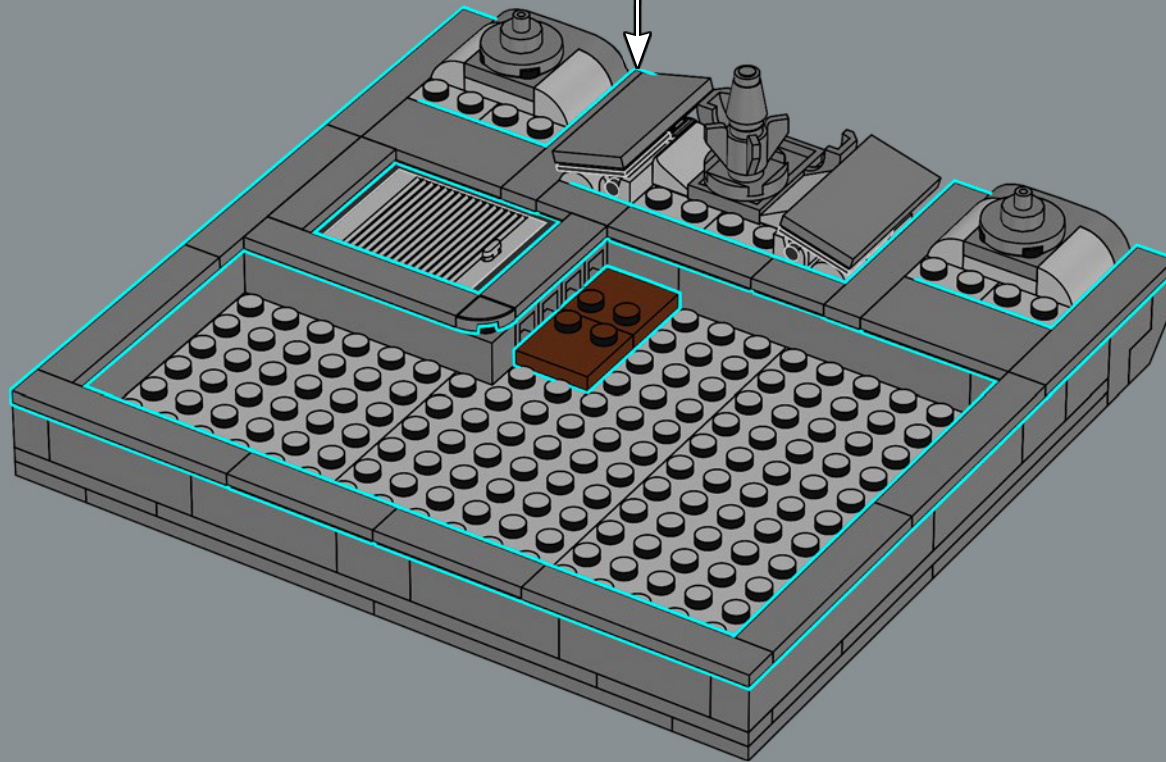
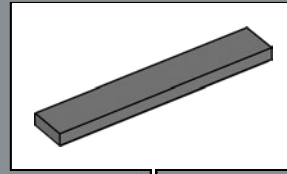

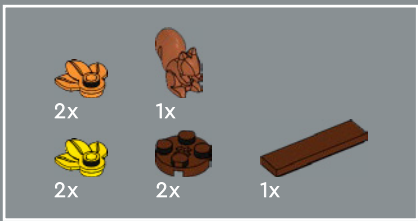

377

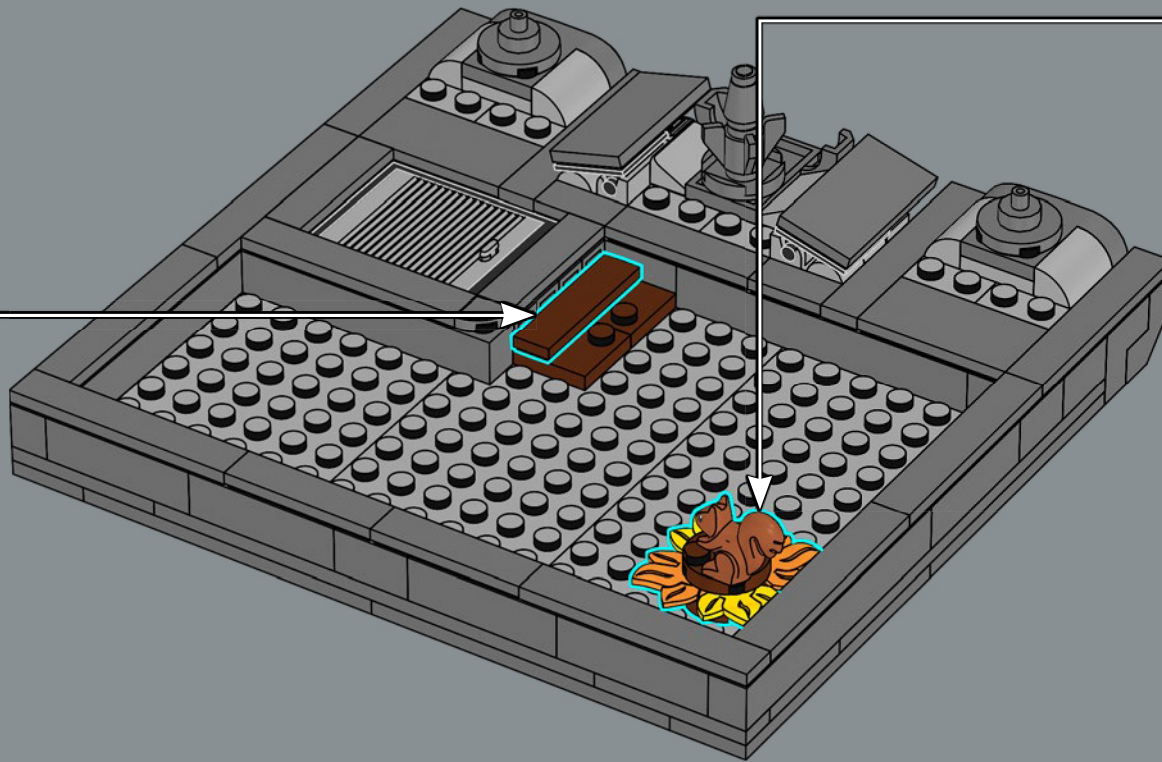
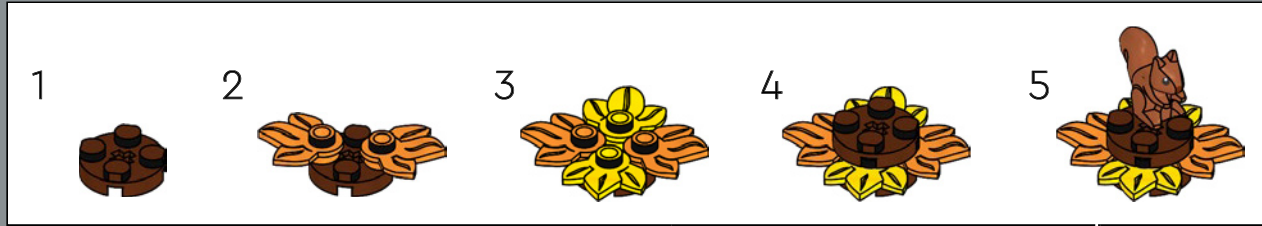



Méfiez-vous de l'écureuil espiègle ! Si vous prenez une part de pizza, celle-ci pourrait bien se volatiliser et se retrouver sur les toits !

378

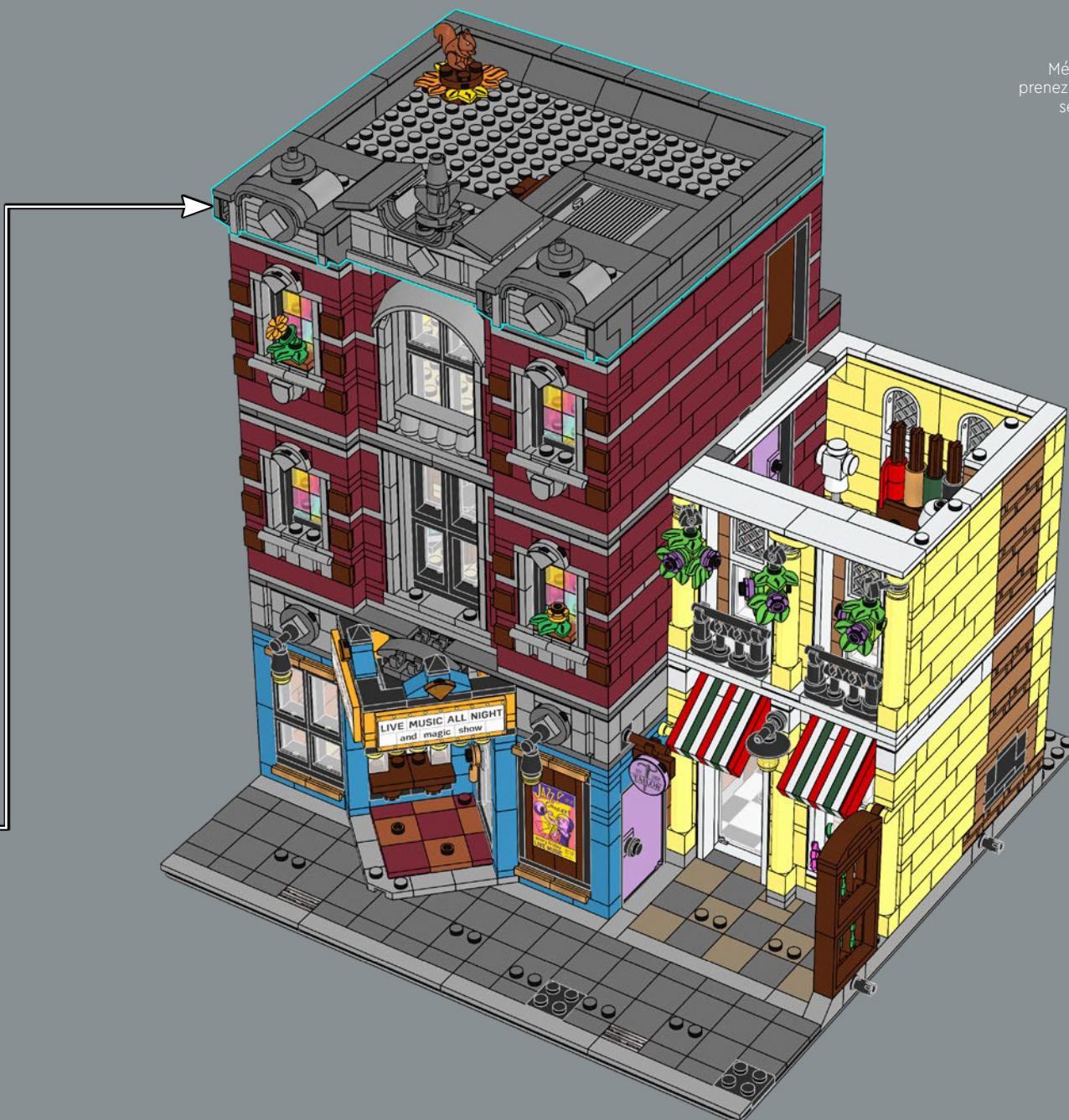

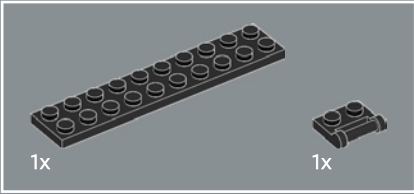

379

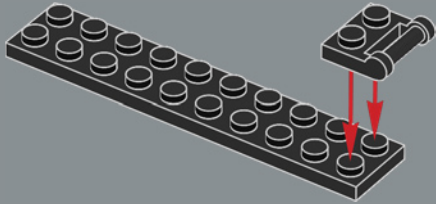

380

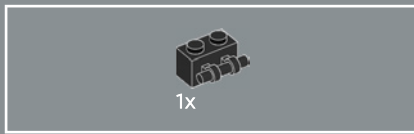
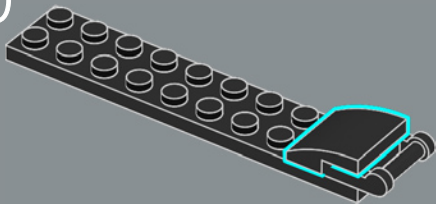

381

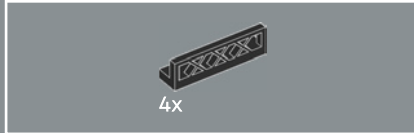
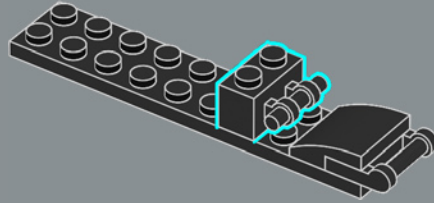

382

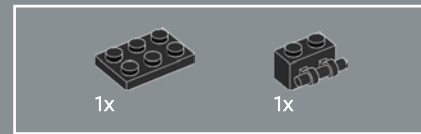
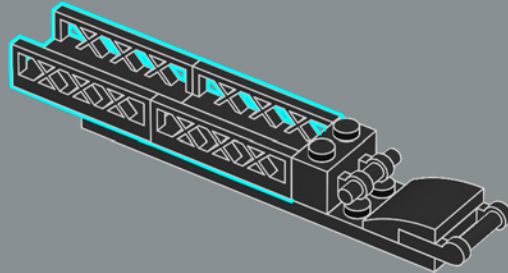

383

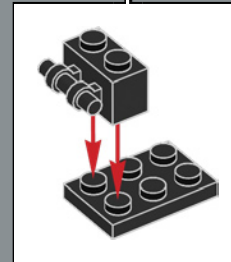
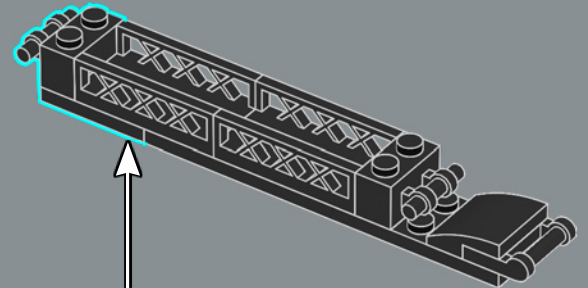

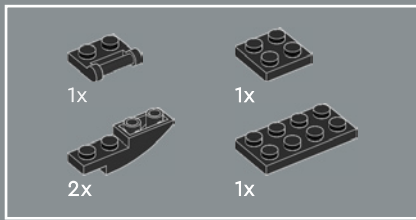

384

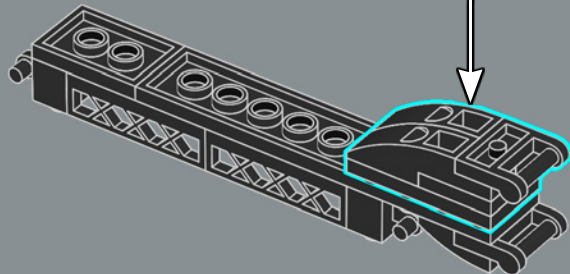
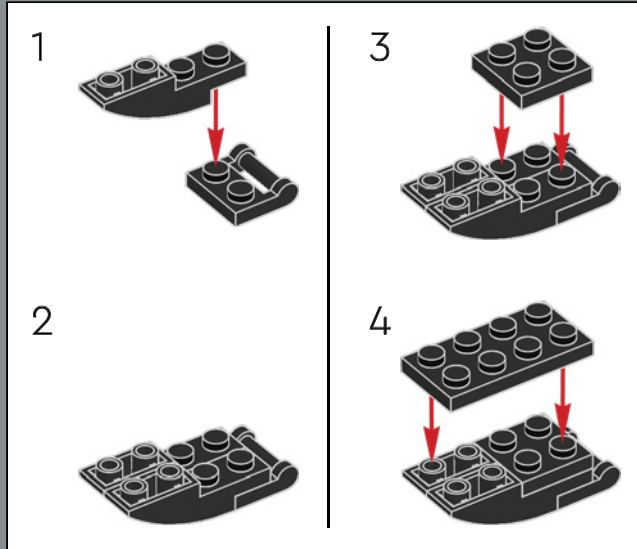

385

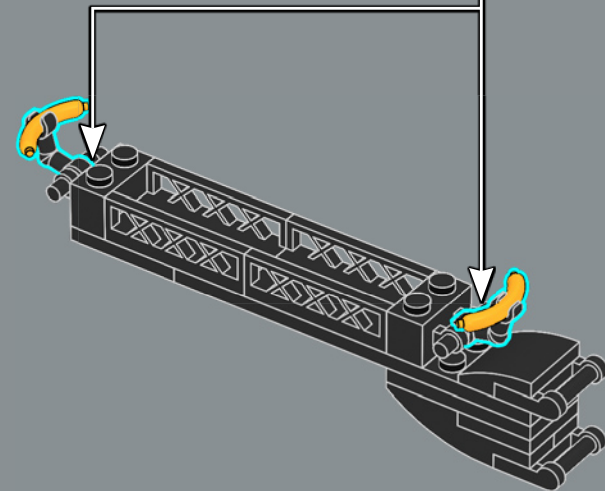
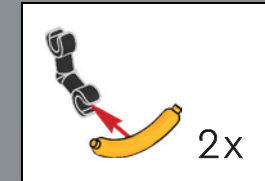

La saucisse LEGO® s'est avérée être un élément incroyablement utile. Elle existe dans 9 couleurs différentes, dans des dizaines de sets LEGO.



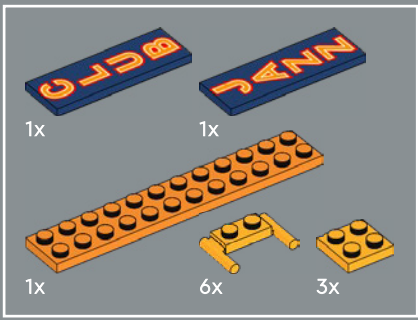

386

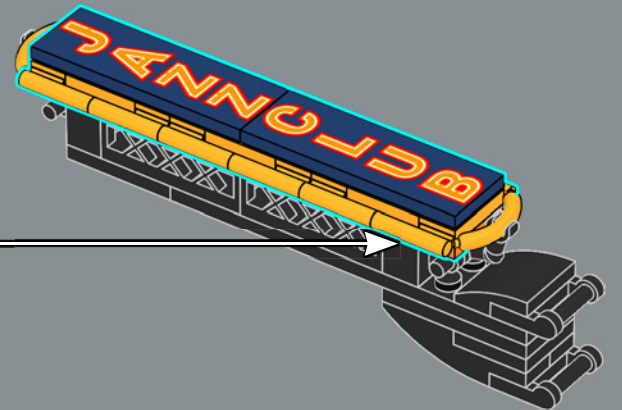
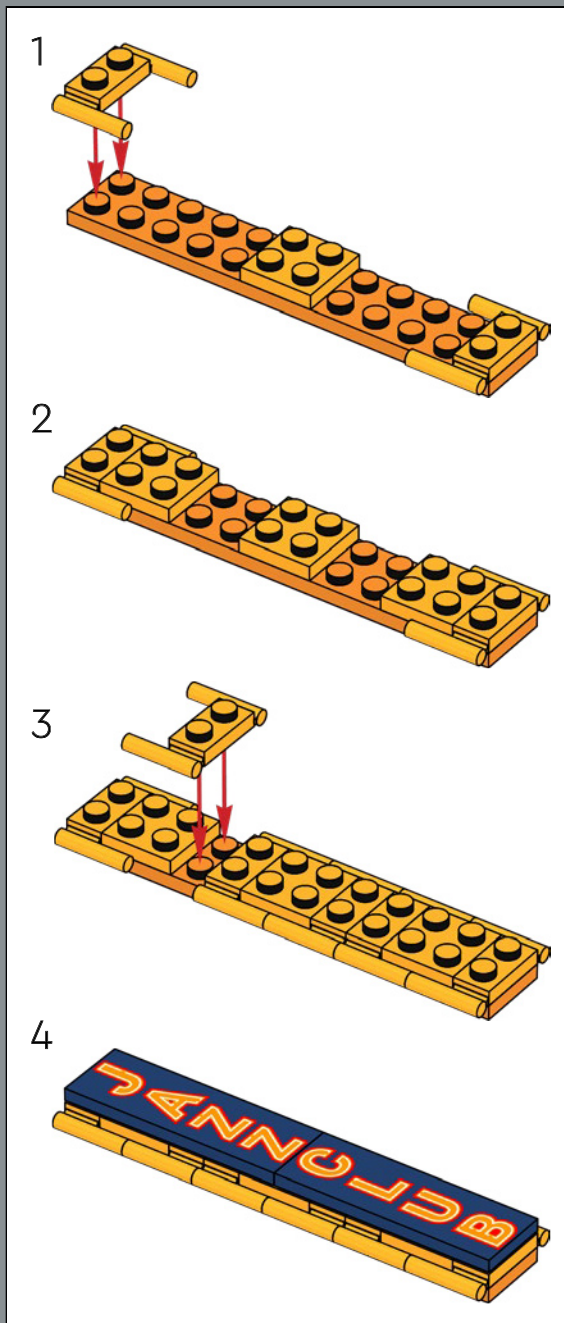



Le livreur est heureux de vous apporter une pizza, où que vous soyez en ville. Par contre, ne soyez pas surpris(e) s'il est en retard. Il adore assister aux spectacles du club de jazz, et c'est parfois difficile de le remettre au travail.

387

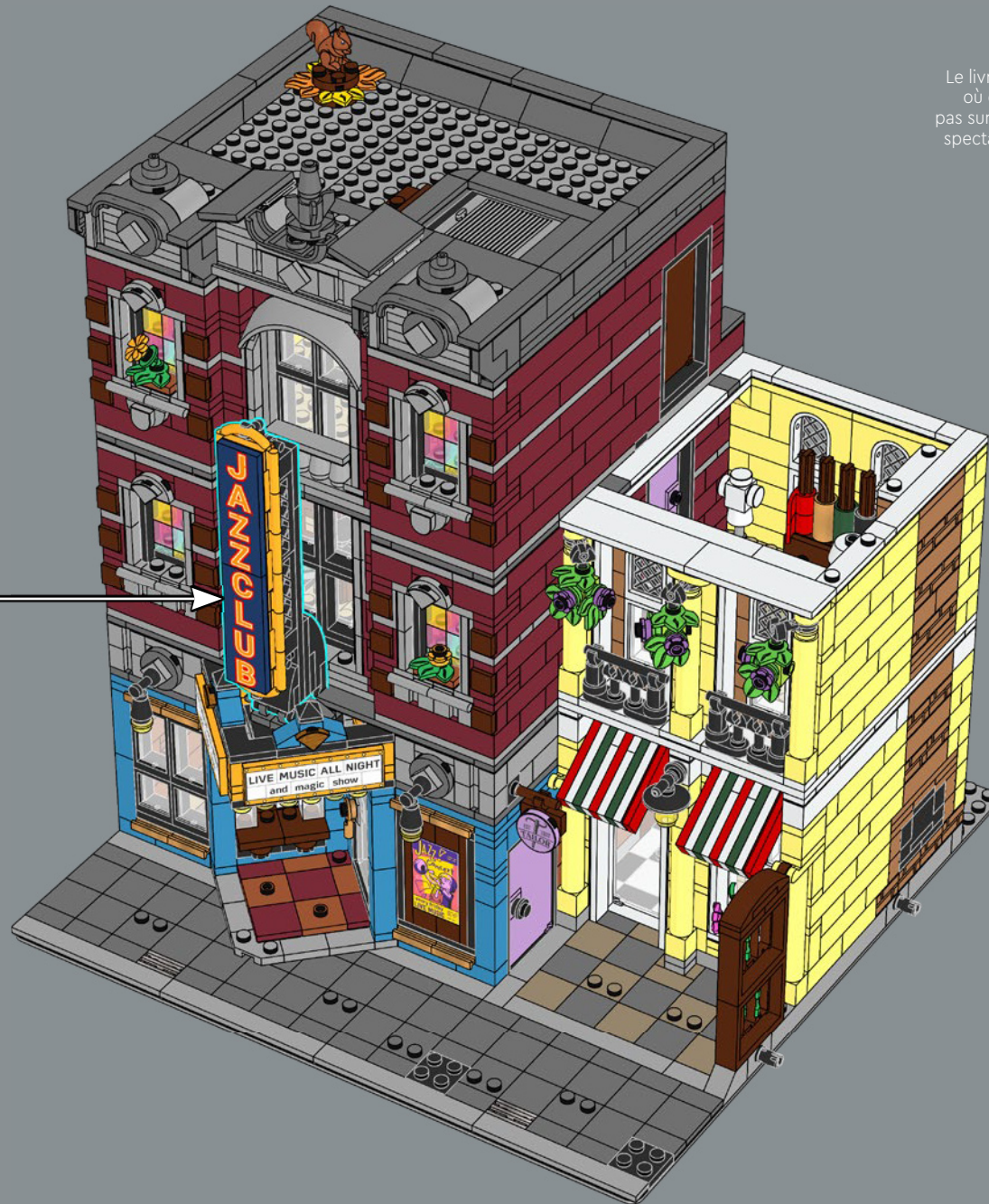

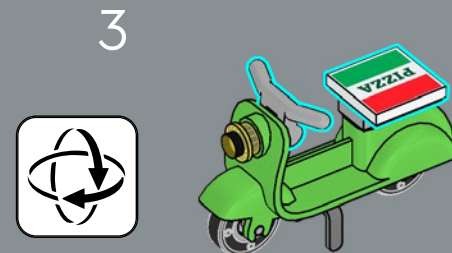
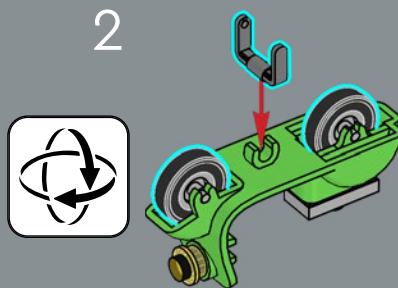
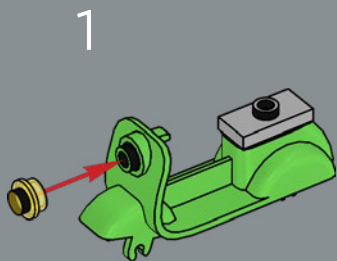
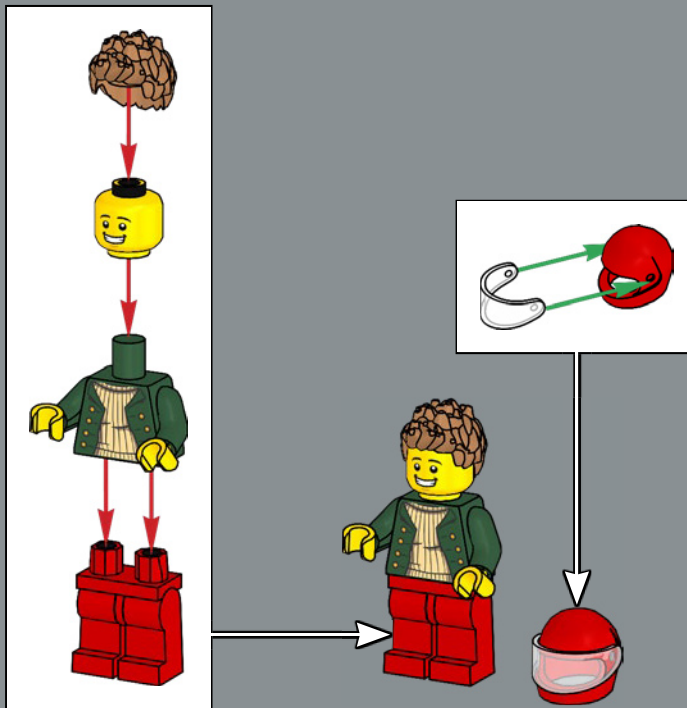

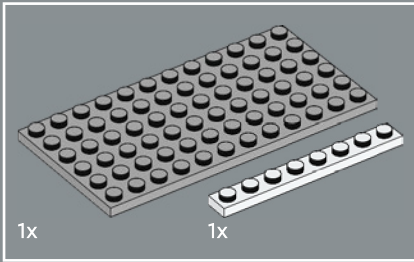
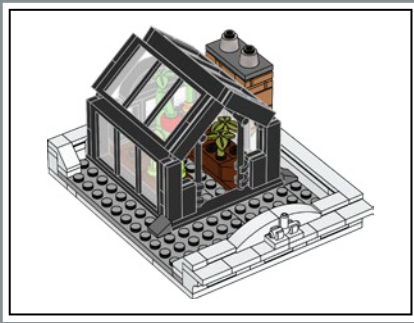

388

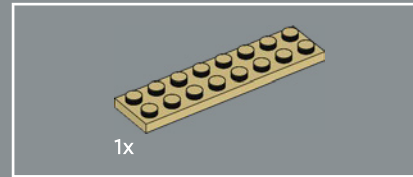
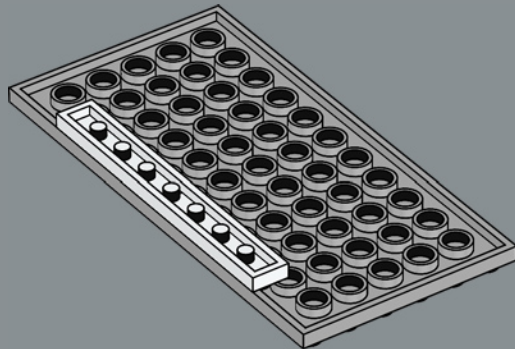

389

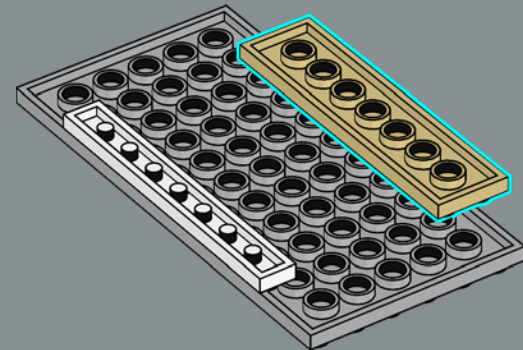

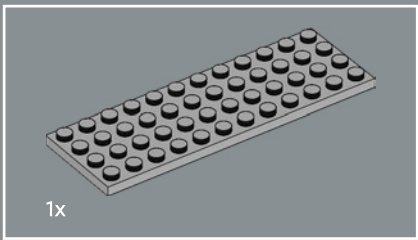

390

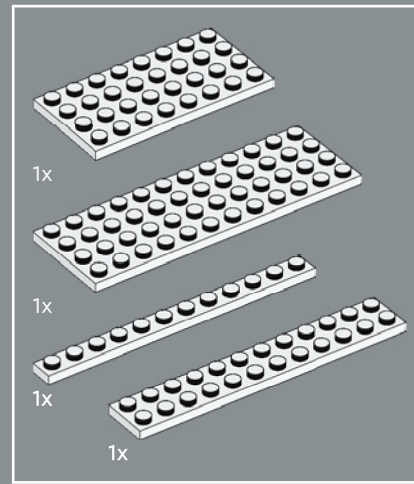
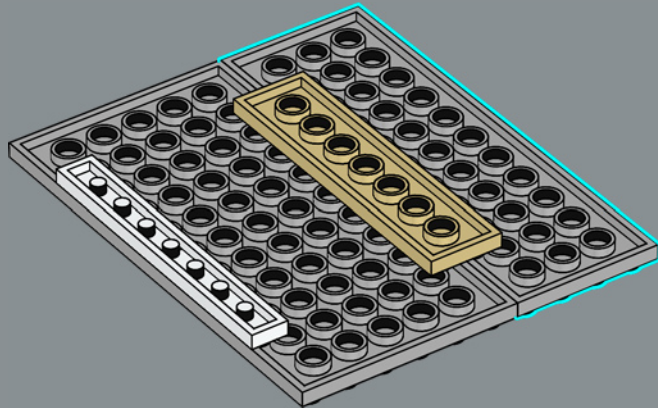

391

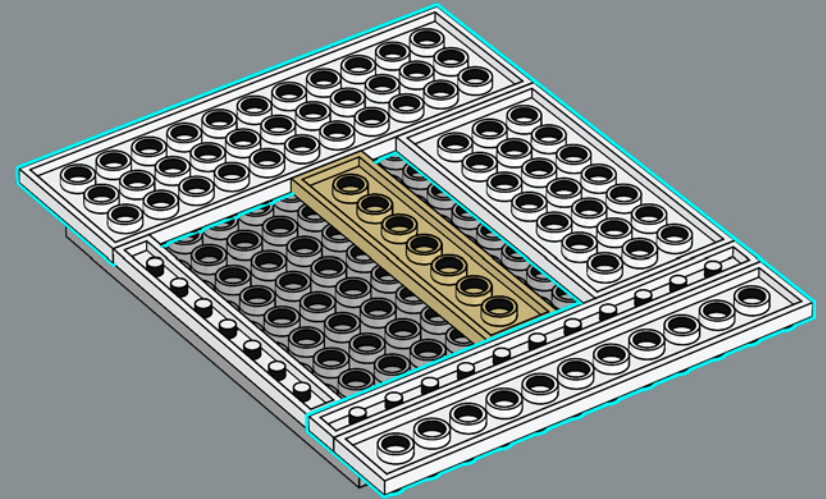

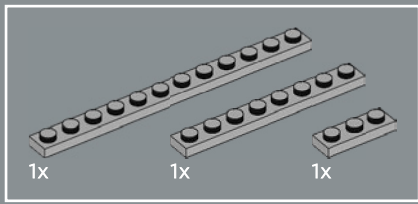

392

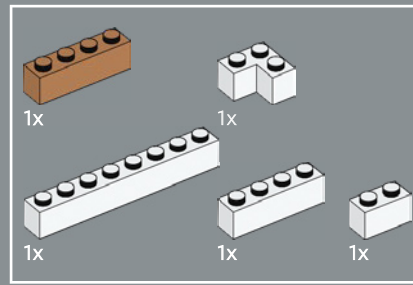
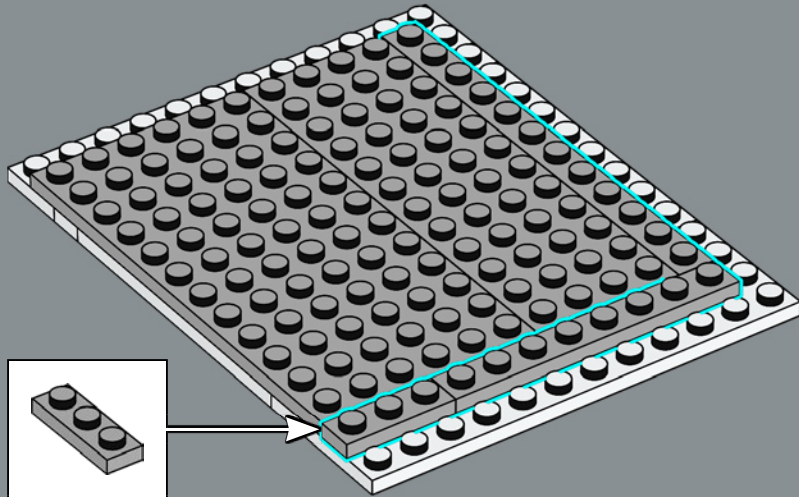

393

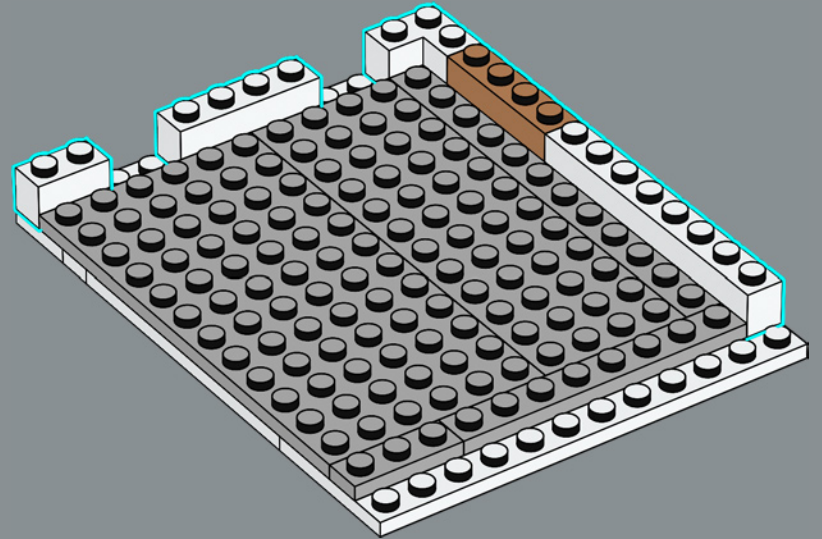



3x

394

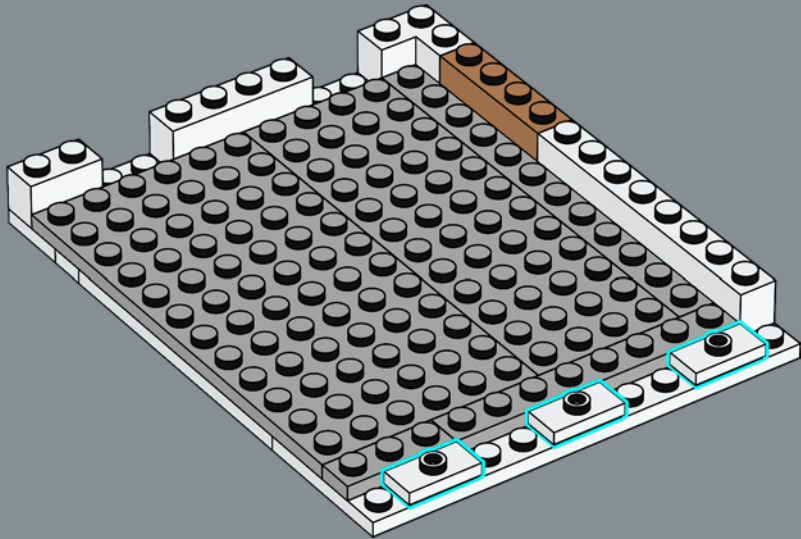

1x



1x

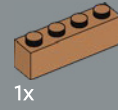

1x

395

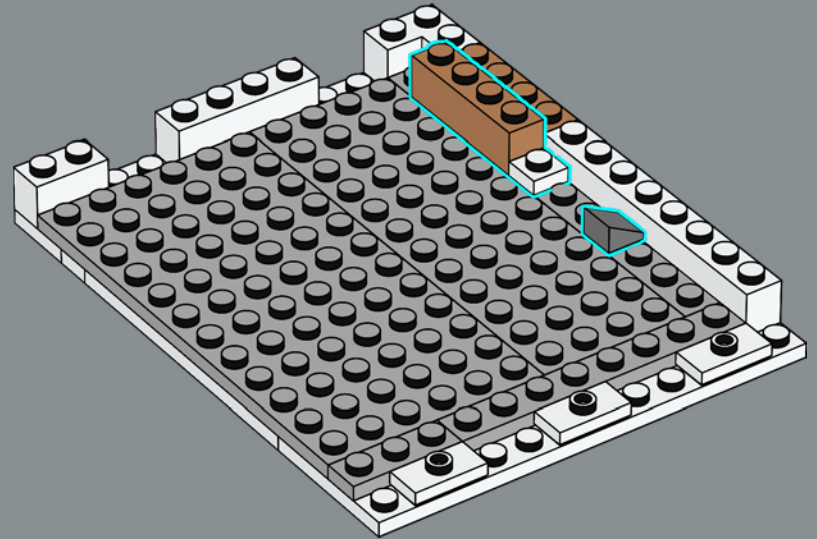

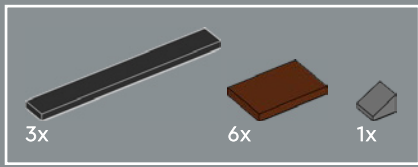

396

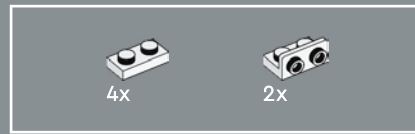
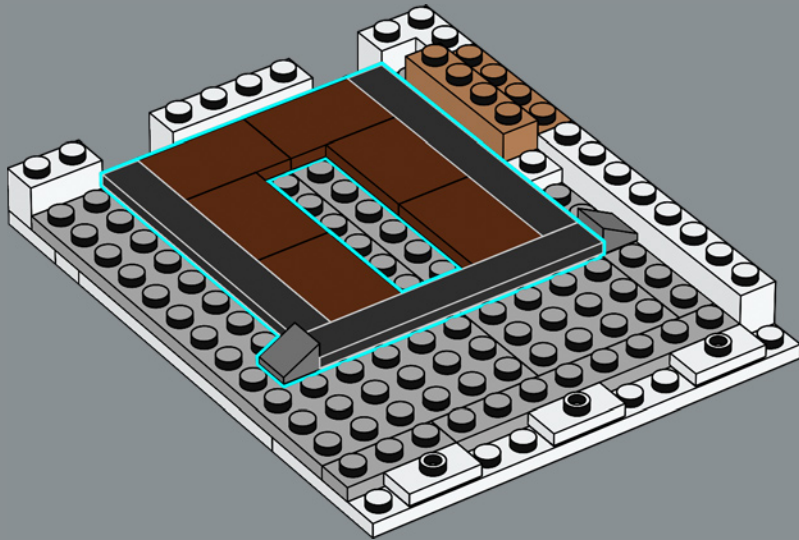

397

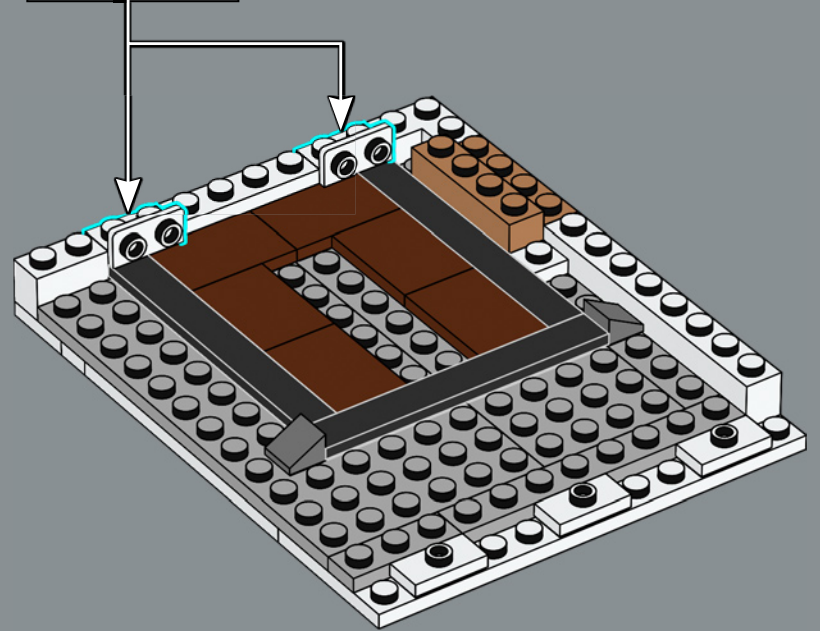
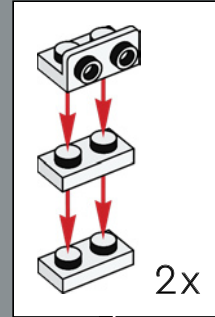

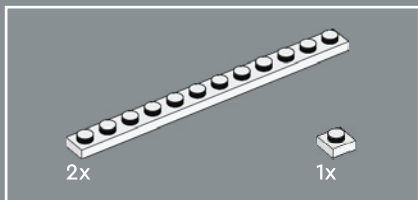

398

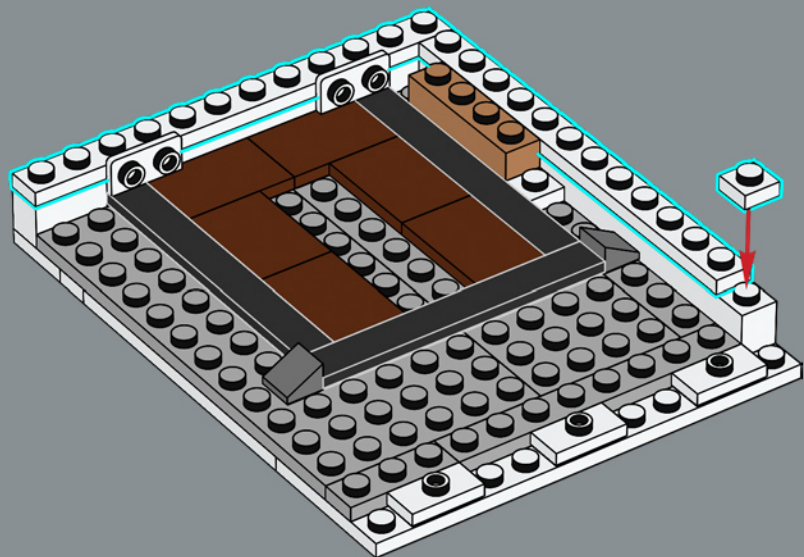

399

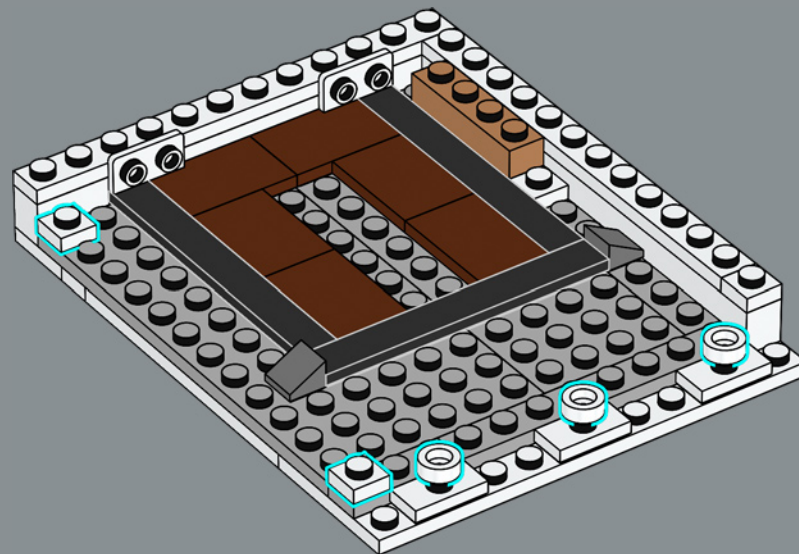



400

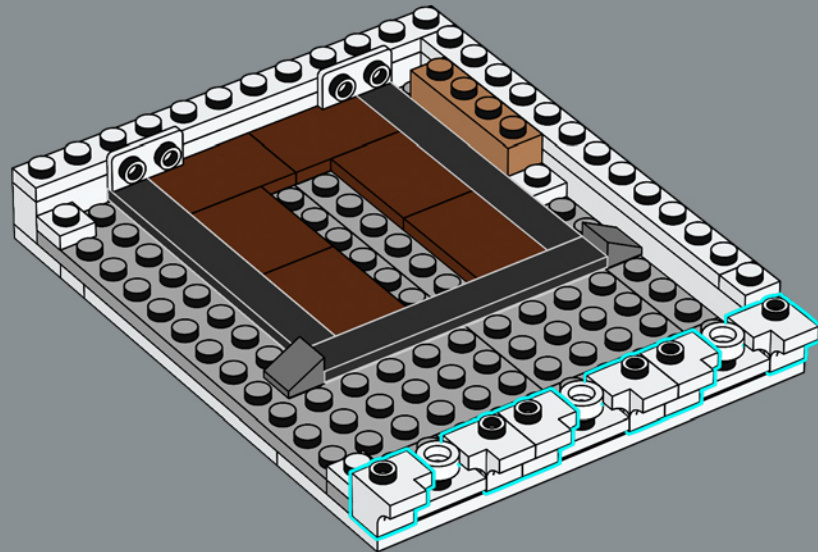

401

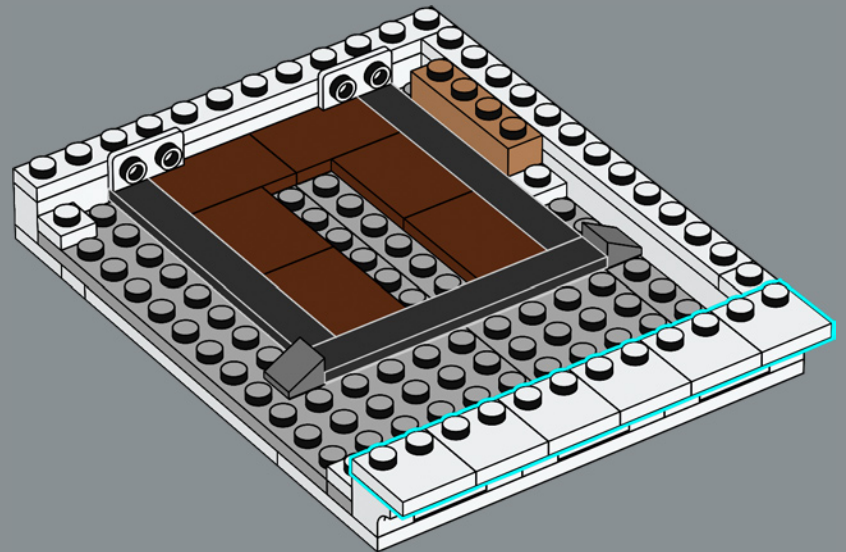

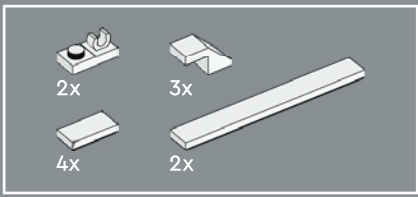

402

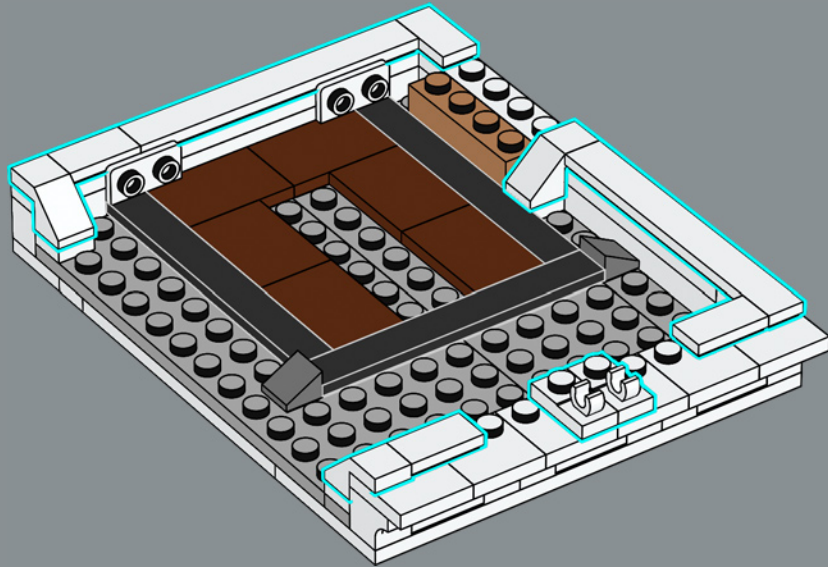

403

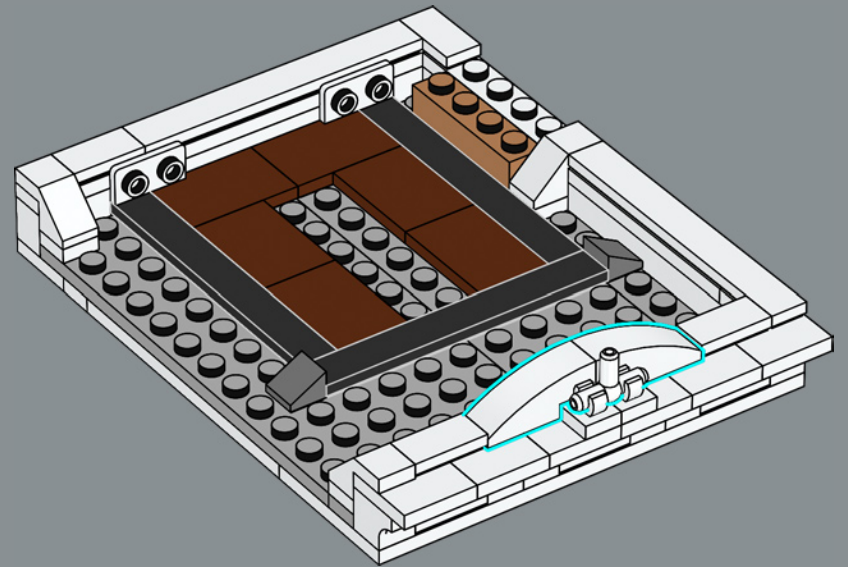

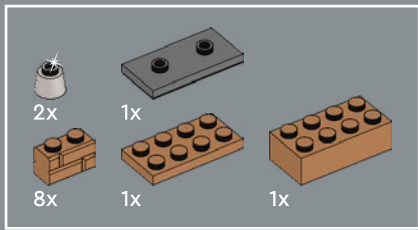

404

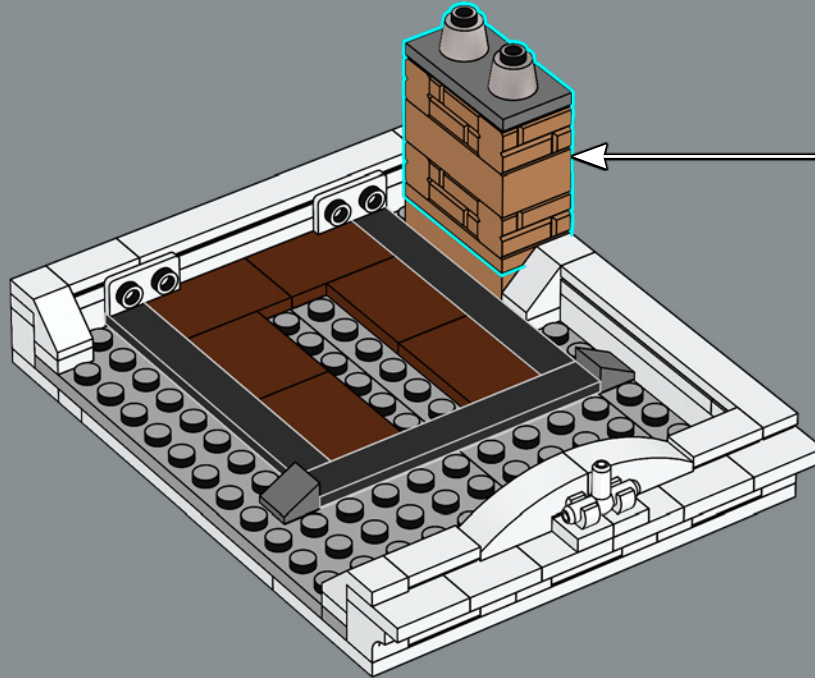
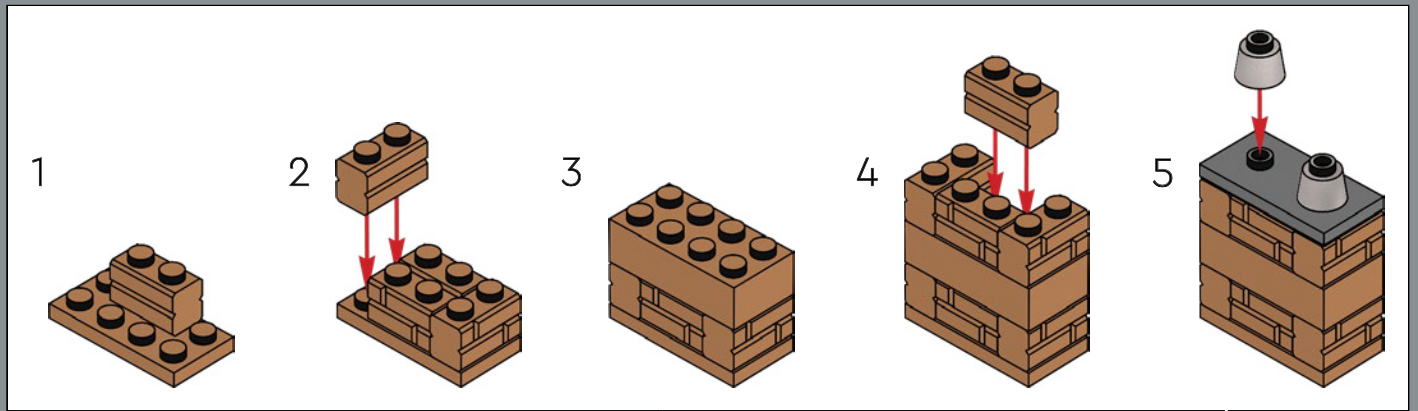

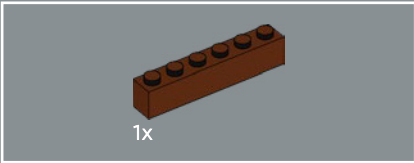

405

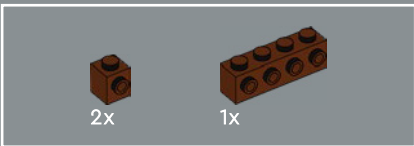
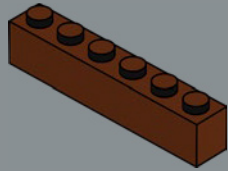

406

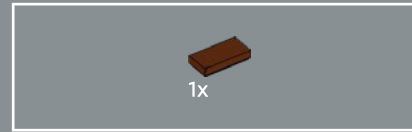
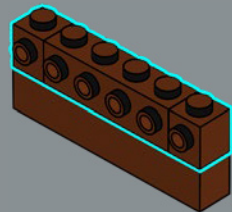

407

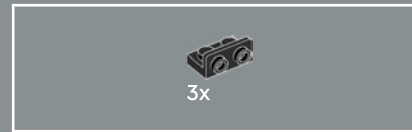
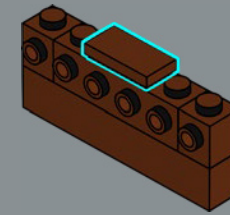

408

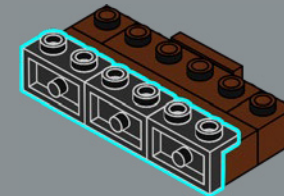

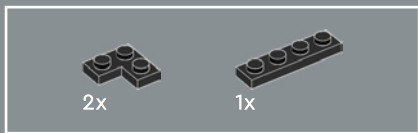

409

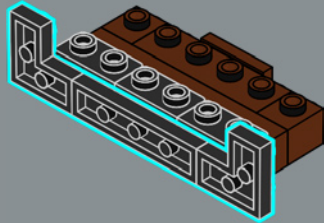

410

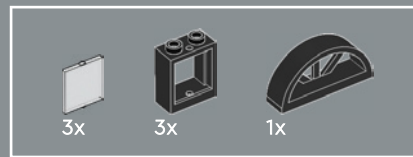
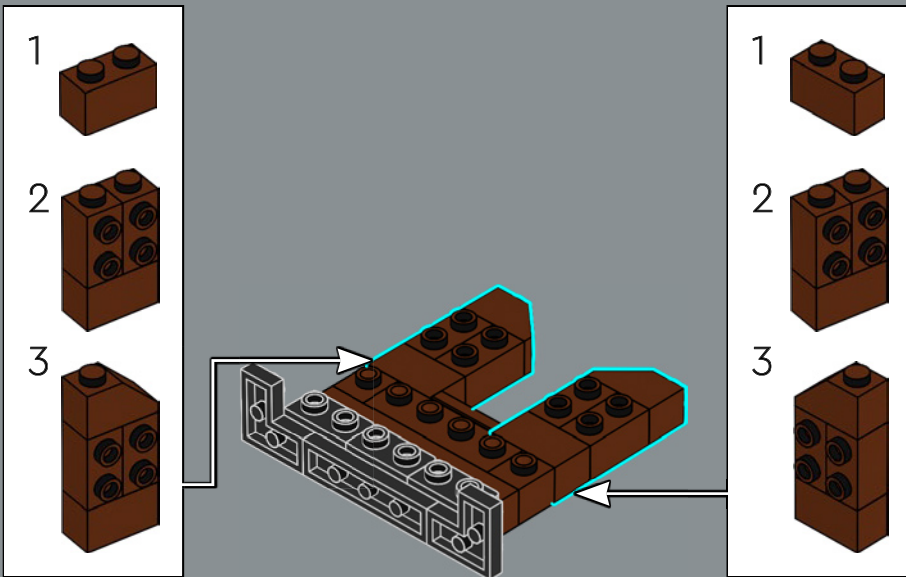

411

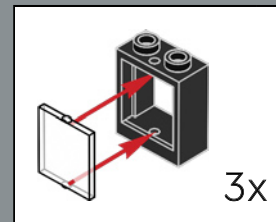
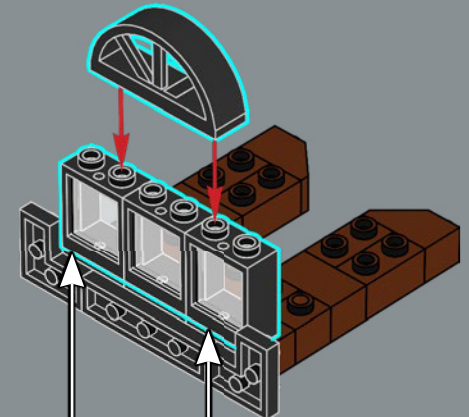

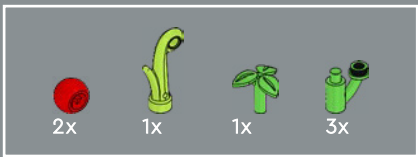

412

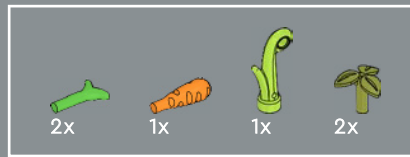
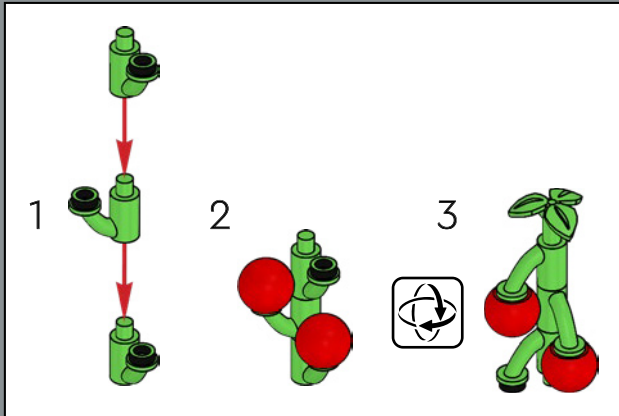

413



Le pizzaiolo cultive ses propres tomates et plein d'aromates pour ses pizzas. La carotte est toutefois réservée au lapin de la magicienne.

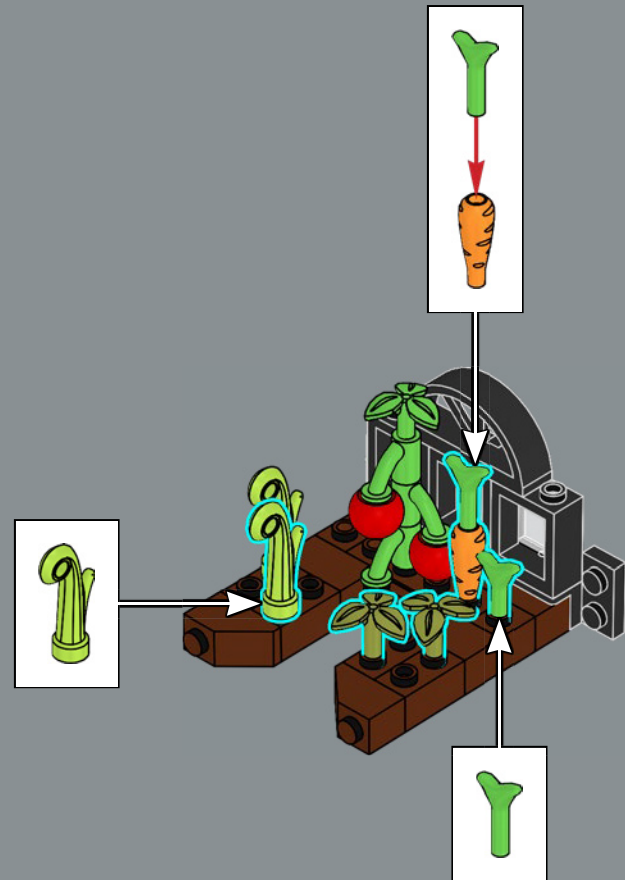

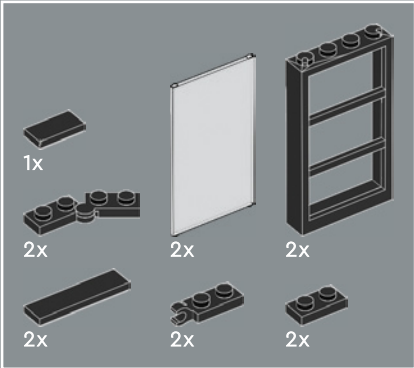

414

1



2

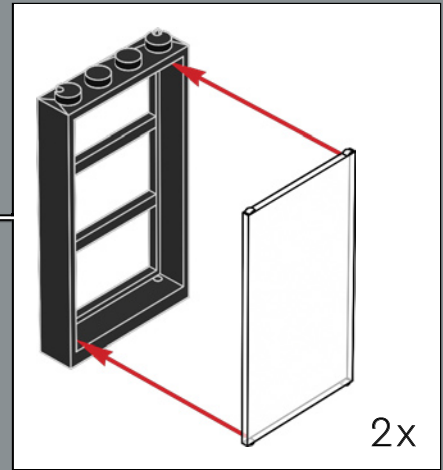
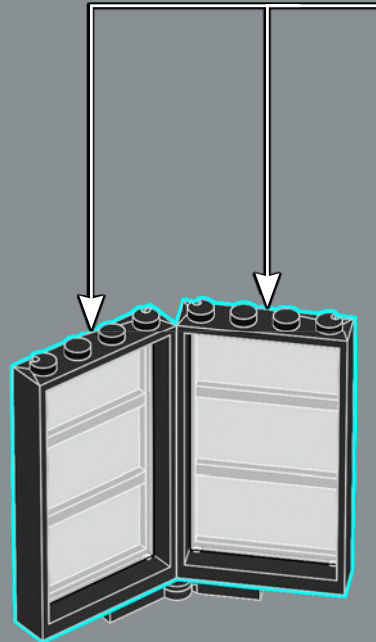

3

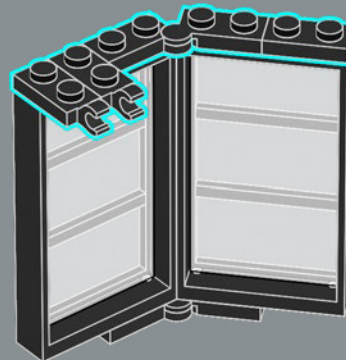

4

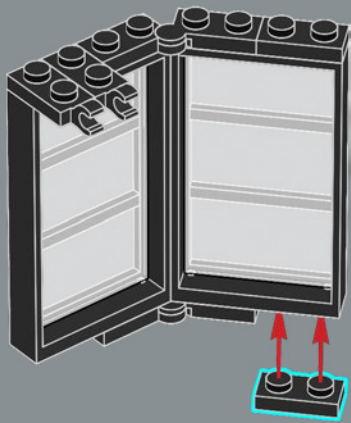

5

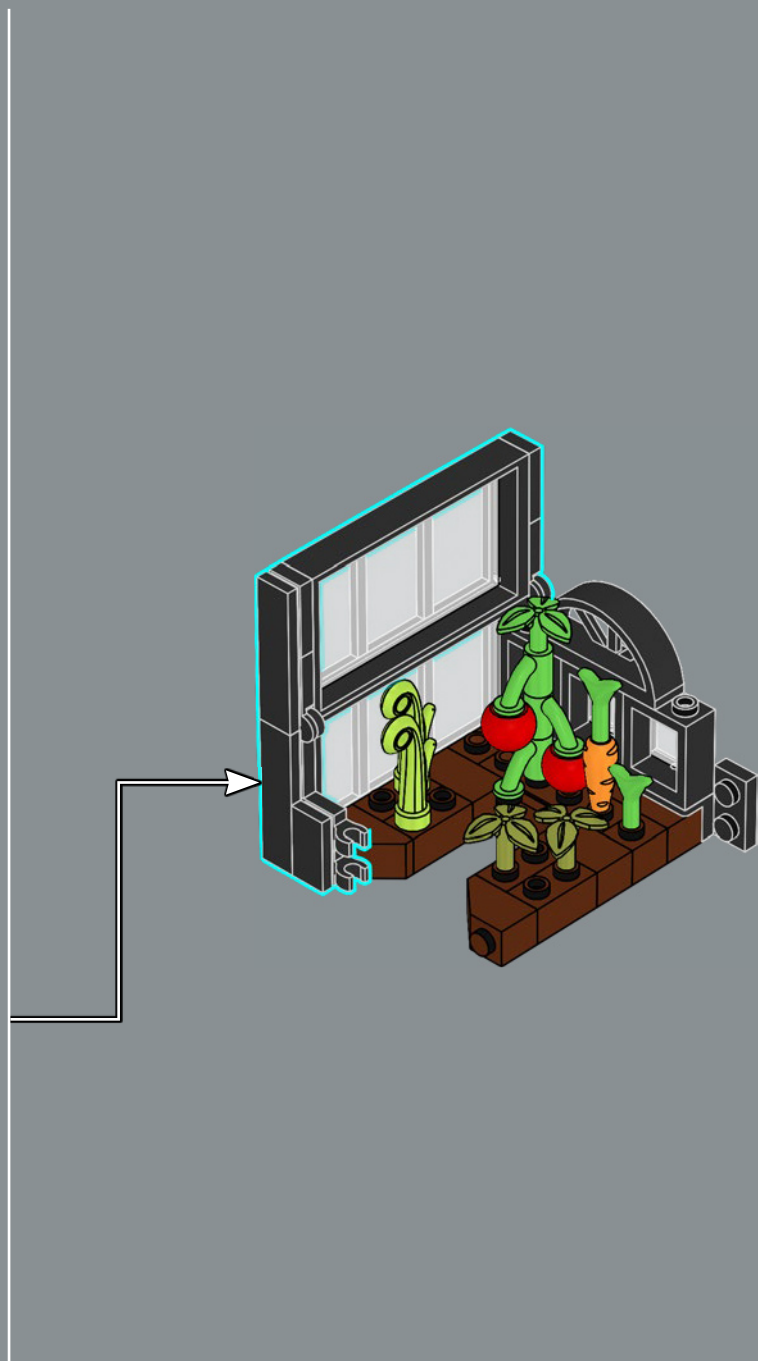
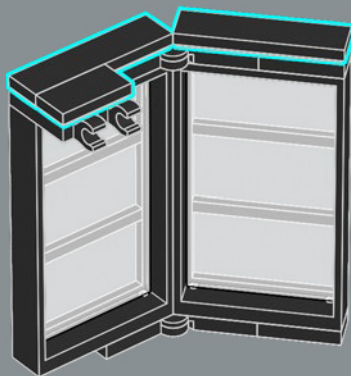

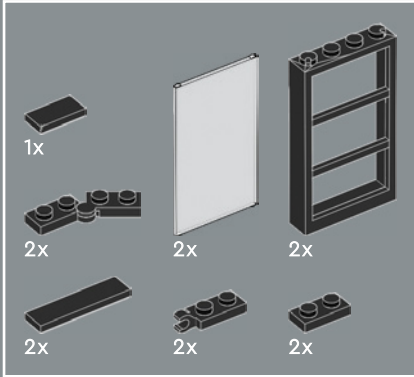
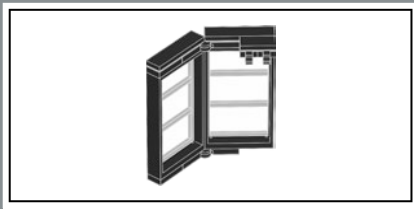

415

1

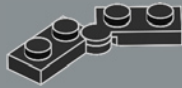

2

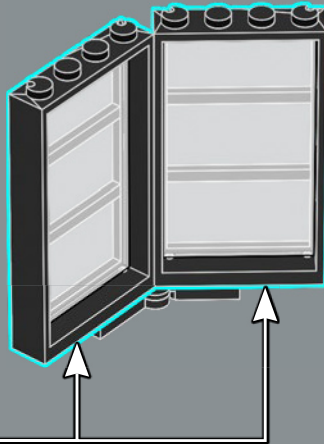
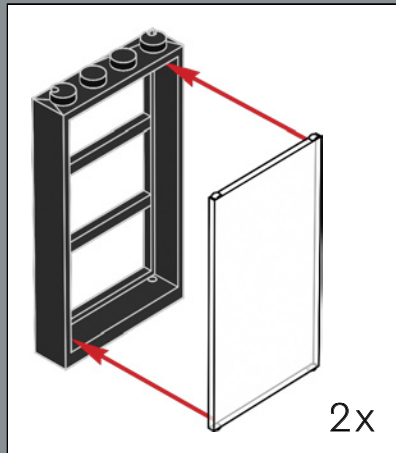

3

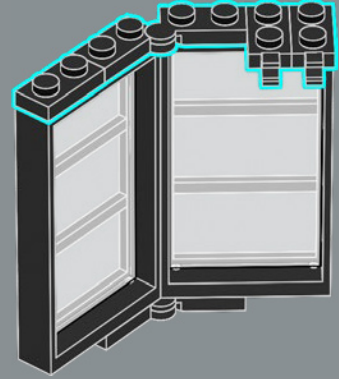

4

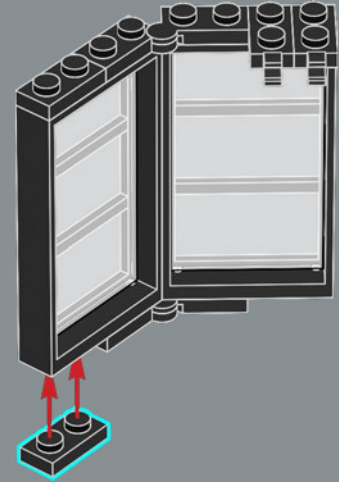

5

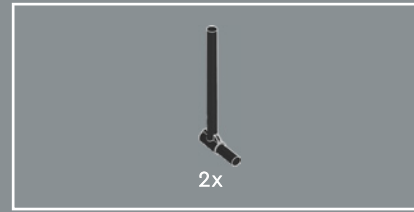
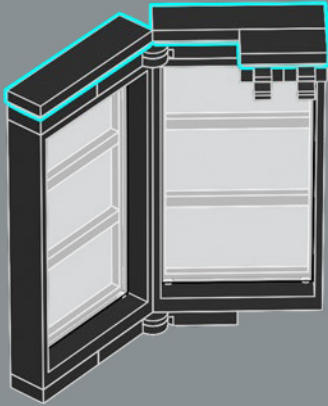

2x

416

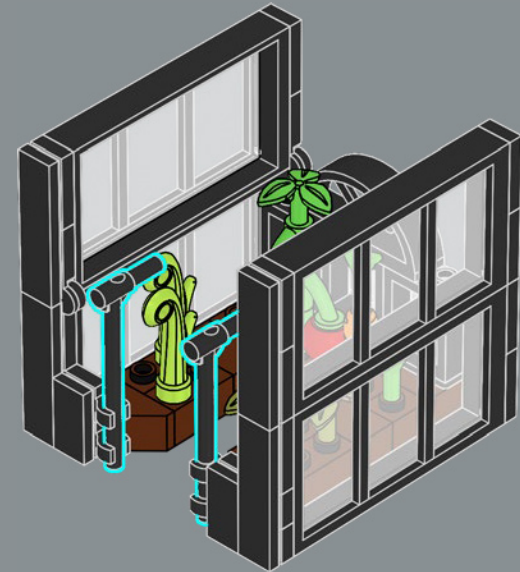
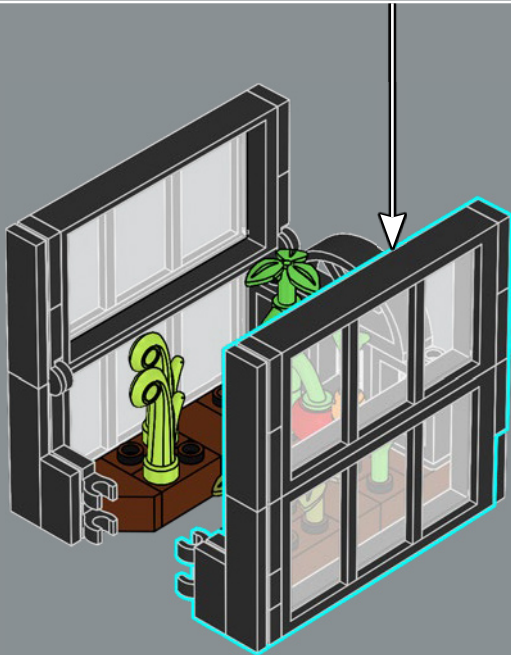

417



418



419

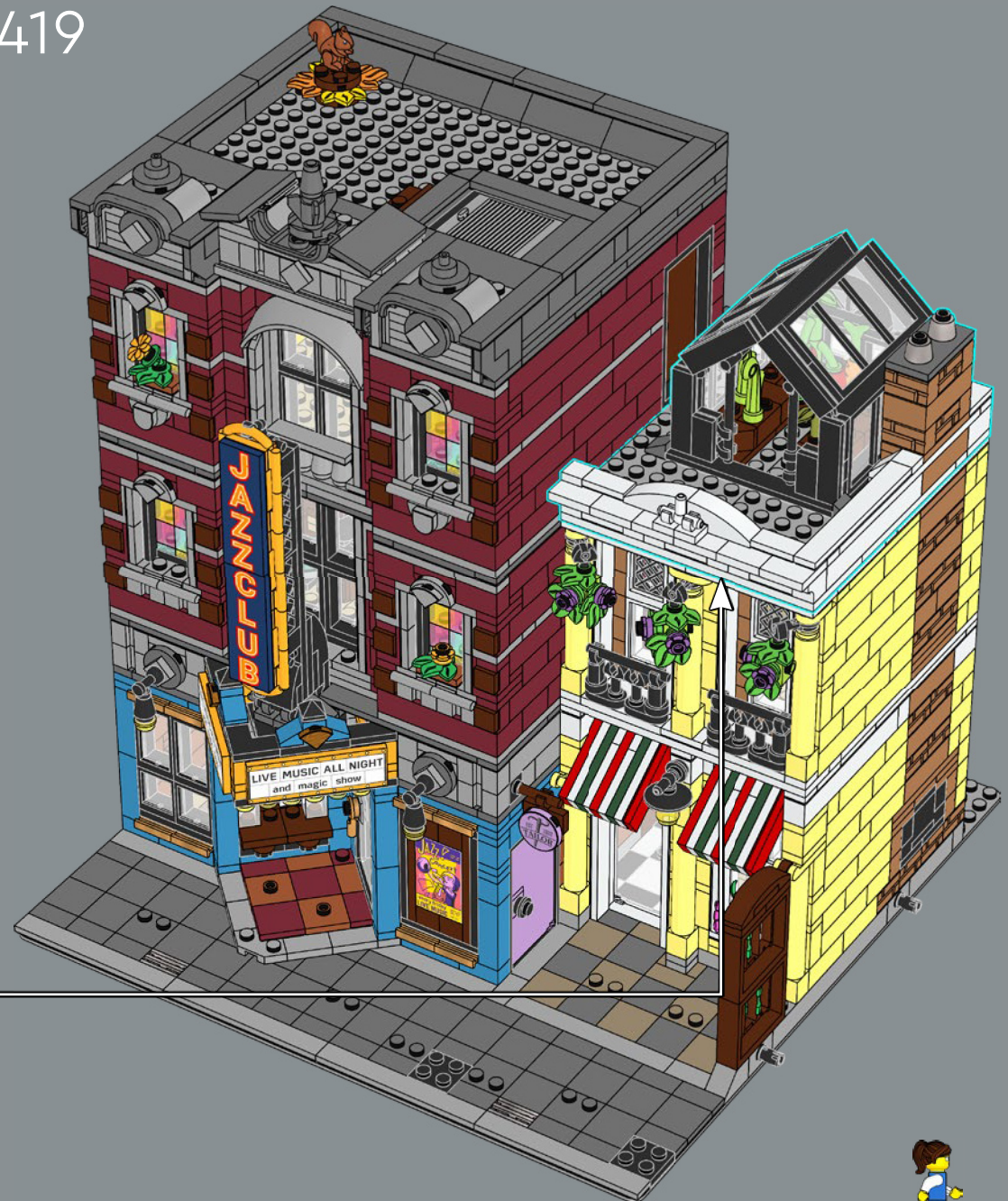



420

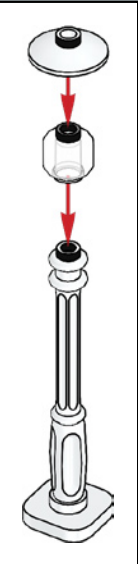
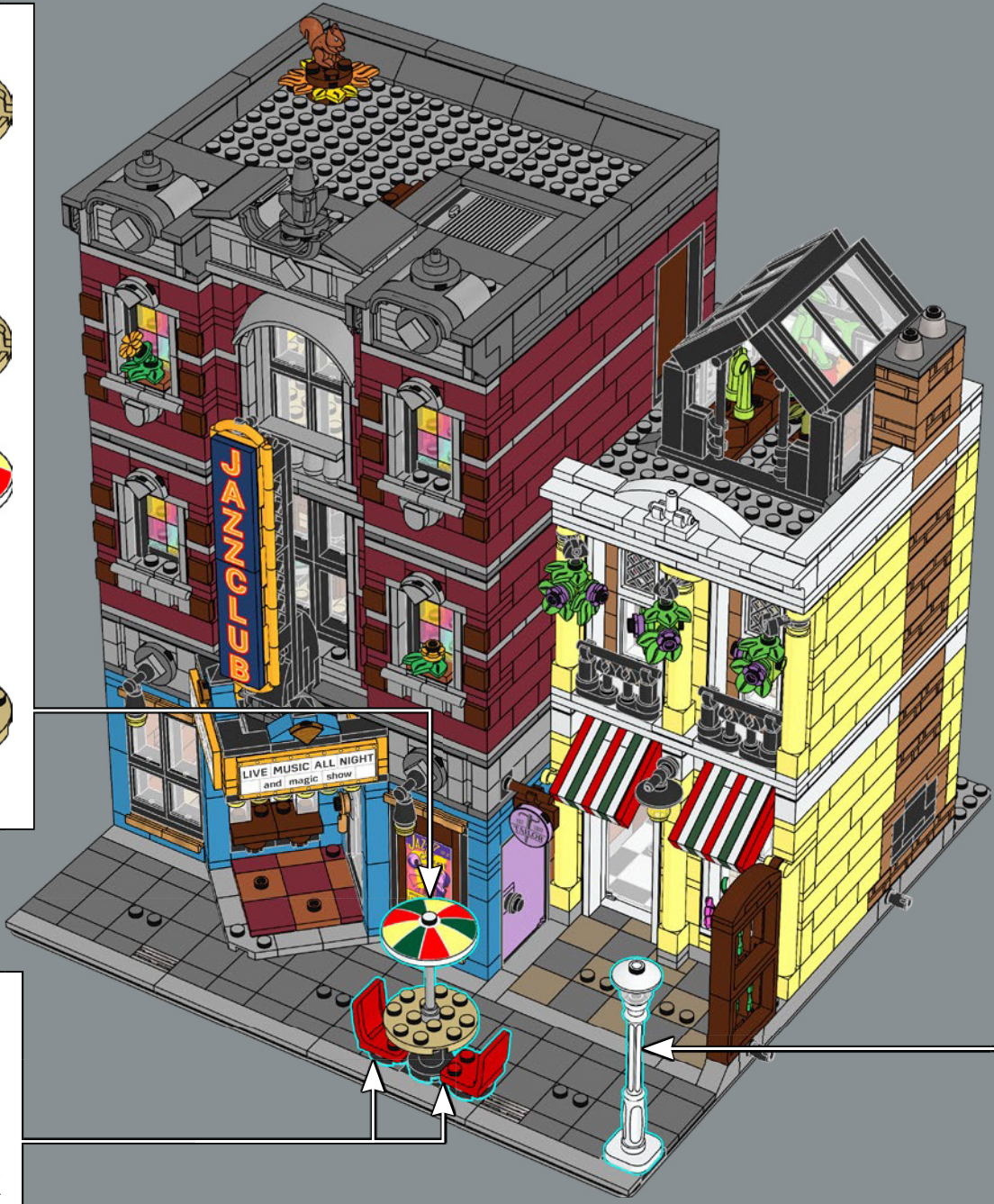
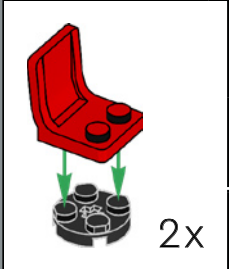
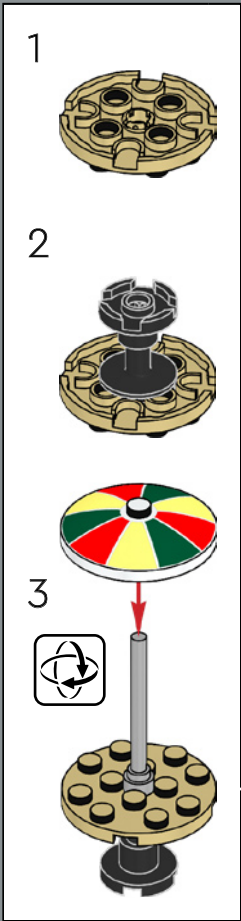



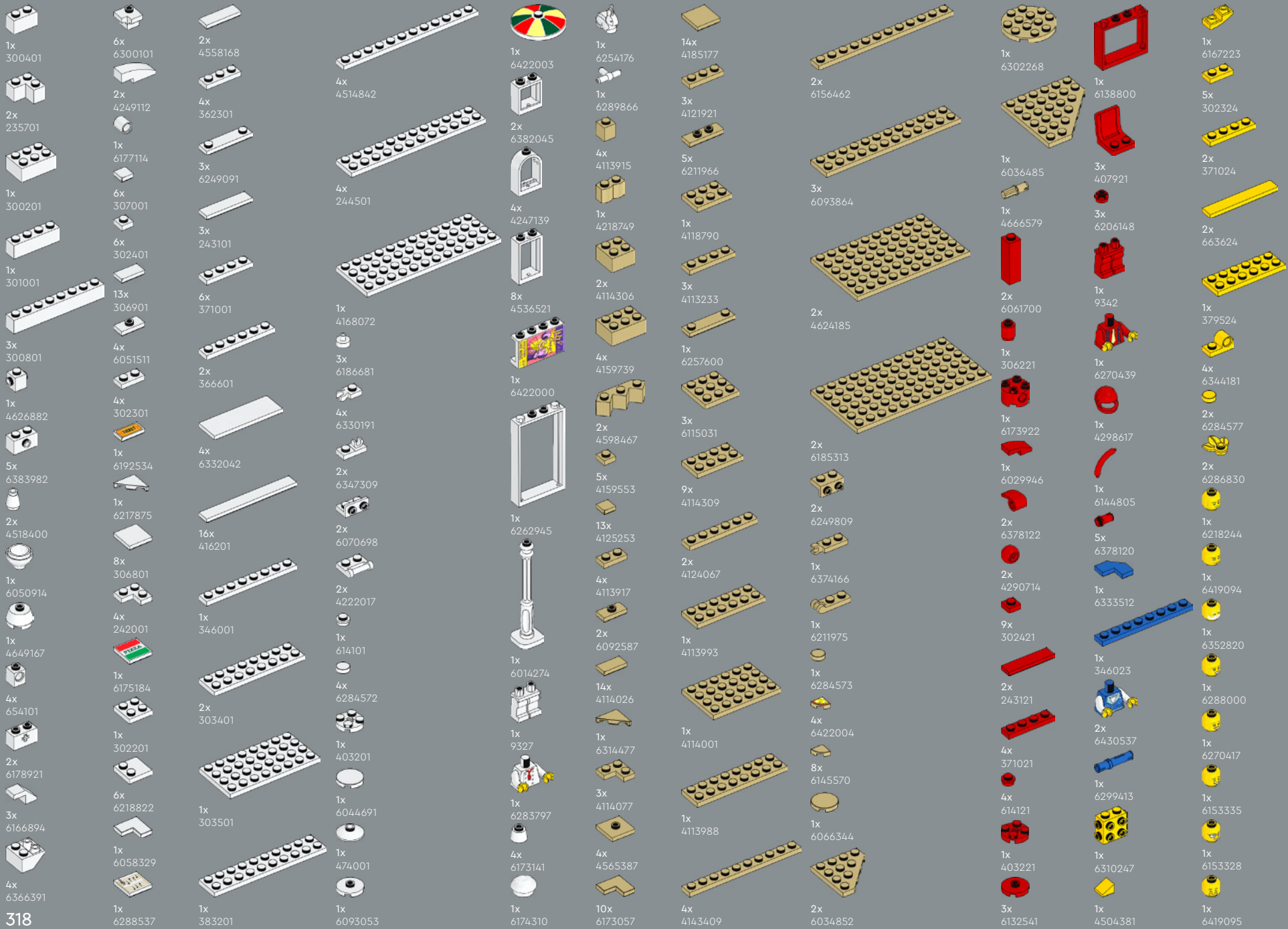

2x 300526	2x 6039869	12x 371026	1x 4514845	1x 474026	4x 6271169	1x 6431021	4x 6279875	1x 6206150
4x 4644456	9x 302426	13x 243126	13x 6186675	2x 6195325	4x 6271169	1x 6430624	1x 6173119	3x 6388070
2x 4558954	1x 307026	2x 302026	2x 6335388	2x 4106347	2x 459926	1x 6430843	2x 4141580	1x 6235080
1x 473326	2x 241226	2x 6350415	4x 6196548	5x 6173105	1x 408326	1x 6430843	2x 4124096	10x 6182261
2x 6330197	19x 302326	4x 663626	2x 6330189	1x 6408578	1x 408326	1x 6356860	1x 368026	1x 6331087
2x 4253815	10x 306926	3x 366626	4x 6157554	1x 6408578	1x 6066113	1x 6343688	4x 6416444	3x 4119479
2x 4288212	6x 6092585	1x 4243819	3x 6313116	19x 6382697	4x 4187209	1x 4105175	2x 4517986	1x 6430413
8x 4529236	2x 6214807	3x 416226	2x 6000650	8x 4536522	1x 602026	2x 6326681	1x 6104209	13x 6254484
1x 4558957	4x 6166859	3x 302226	5x 6020193	1x 6310268	1x 602026	2x 4538456	1x 306228	11x 6253417
2x 6312449	7x 242026	2x 6192346	1x 6310268	6x 4530589	6x 4530589	1x 6151289	1x 6047426	1x 6212081
1x 329826	3x 302226	2x 346026	6x 6336989	3x 4225201	1x 6170421	1x 6170808	2x 6347288	14x 6263221
1x 4529155	2x 6192346	1x 395826	4x 4225201	4x 6168646	2x 4623113	1x 6057397	1x 6229130	43x 6223040
4x 329726	7x 306826	1x 303526	3x 614126	1x 6254519	1x 6093525	1x 6396403	1x 6269971	18x 6000743
1x 6275732	10x 6133722	1x 303526	4x 6210270	1x 6337273	4x 6116604	1x 6106280	1x 6382575	1x 6361813
1x 6053077	2x 362326	3x 383226	9x 403226		1x 9339	13x 6315887	2x 6285598	8x 6186012
	4x 4558170		1x 6431014			9x 6278152	1x 6314378	
	3x 302126							

- 3x 4570877
- 2x 4614158
- 2x 6092602
- 2x 6315197
- 4x 6248949
- 1x 6313129
- 1x J5 6172566
- 1x 6384077
- 2x 6220959
- 1x 6251294
- 16x 6252258
- 21x 6254552
- 4x 6256058
- 6x 6253734
- 32
- 1x 6247362
- 1x 6168665
- 1x 6244787
- 2x 6166107
- 1x 6247369
- 1x 6337596
- 4x 6240551
- 8x 6252043
- 1x 6274739
- 1x 6306726
- 1x 6283590
- 4x 6277483
- 2x 6238674
- 8x 6252045
- 6x 6274740
- 19x 6240216
- 1x 6171728
- 1x 4267425
- 2x 6213782
- 3x 6213779
- 1x 6210775
- 2x 6240467
- 8x 6240553
- 3x 6174006
- 2x 6188696
- 1x 6306726
- 1x 4558595
- 2x 6253884
- 1x 6103249
- 1x 6240515
- 1x 6313826
- 1x 6001822
- 1x 6273590
- 9x 6055172
- 4x 4496699
- 1x 6092591
- 5x 4507045
- 2x 6396392
- 17x 6175927
- 1x 6270031
- 1x 6031821
- 2x 6216905
- 1x 6422001
- 1x 6422002
- 2x 6350417
- 2x 4162916
- 103x 6052777
- 10x 4541528
- 4x 6089268
- 2x 6311108
- 24x 4539092
- 1x 4539099
- 2x 6267414
- 2x 6173168
- 2x 6042953
- 24x 4539114
- 2x 4539090
- 61x 4539097
- 10x 4585751
- 2x 4585479
- 23x 4541376
- 70x 4539102
- 31x 4541379
- 18x 6264025
- 2x 4539105
- 4x 4539076
- 2x 4583299
- 2x 4539062
- 3x 4541507
- 2x 6253142
- 4x 6384234
- 2x 6359683
- 2x 6313126
- 17x 6335330
- 6x 6359716
- 3x 6003033
- 8x 6020073
- 2x 6422005
- 6x 6331205
- 1x 6209681
- 1x 6212994
- 2x 6430410
- 2x 6245265
- 4x 6061685
- 2x 6186542
- 4x 6073040
- 4x 6099714
- 4x 6020923
- 1x 6409778
- 1x 6349342
- 2x 4211199
- 4x 6146858
- 1x 4658005
- 24x 4211288
- 3x 4221744
- 2x 4211150
- 2x 4224243
- 4x 4211151
- 4x 4216695
- 4x 6196221
- 1x 6100769
- 6x 6311441
- 1x 6257604
- 3x 4211190
- 1x 4211194
- 2x 6307618
- 1x 4211186
- 1x 4211204
- 2x 4221590
- 1x 4211211
- 1x 4217848
- 2x 6186673
- 2x 6401027
- 2x 6238874
- 1x 6313124
- 2x 6290983
- 1x 6338135
- 3x 4216581
- 1x 6284586
- 2x 4211159
- 4x 6102360
- 1x 6342958
- 1x 6075207
- 1x 6228841
- 1x 6428805
- 1x 6267760
- 1x 6093515
- 1x 6422007
- 6x 6248918
- 2x 6271128
- 2x 4595889
- 6x 4211206
- 12x 6310449
- 4x 6159763
- 1x 4609635
- 2x 6261744
- 3x 4211242
- 2x 4211149
- 1x 4211193
- 4x 6201911
- 3x 6062574
- 3x 6103004
- 1x 6153594
- 1x 6036503
- 2x 6151461

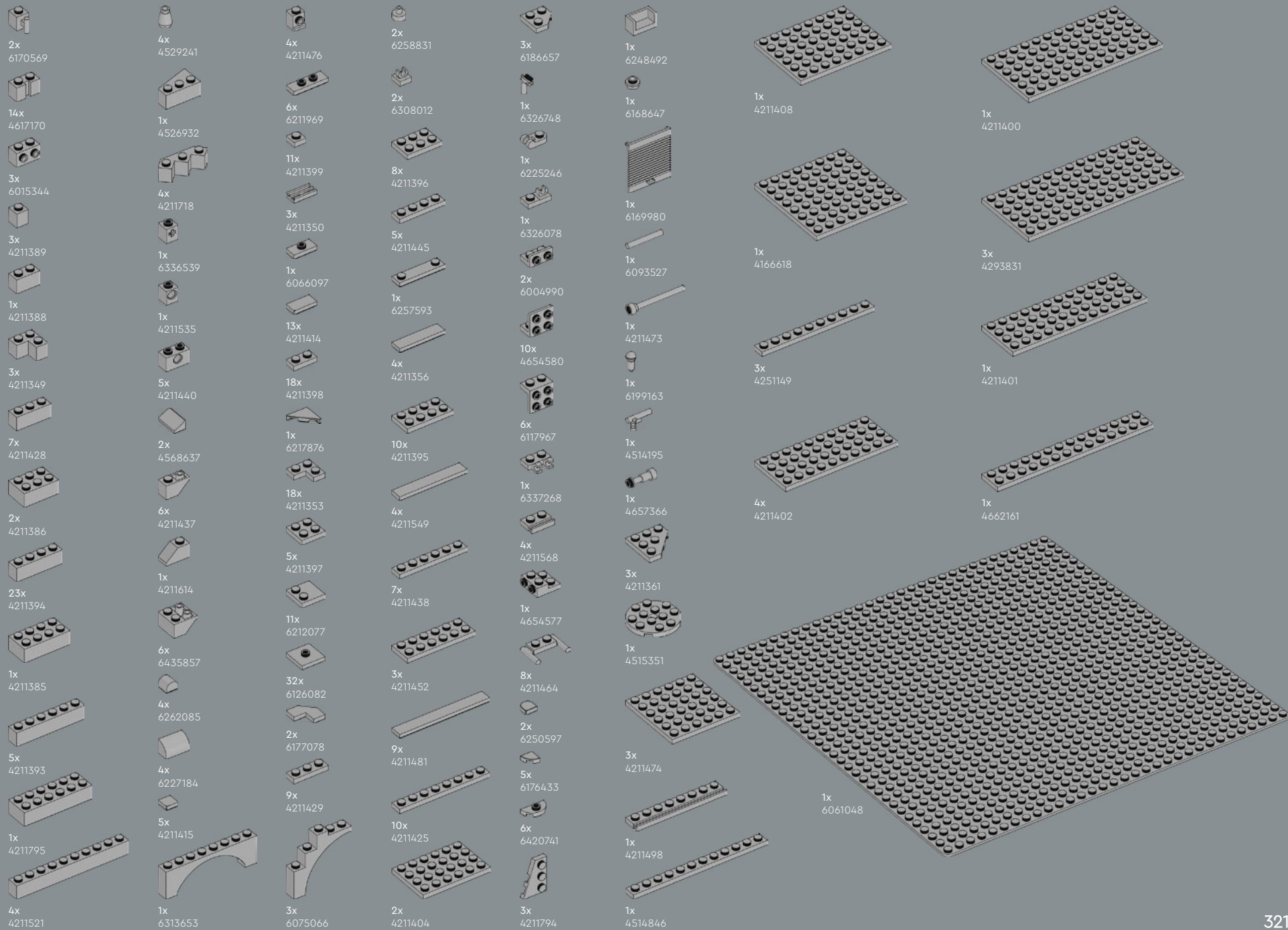

- 4x 4210719
- 11x 4210848
- 1x 4648256
- 4x 4210631
- 42x 4211052
- 16x 6247784
- 32x 4211055
- 5x 6309059
- 4x 6177079
- 6x 4568734
- 2x 4211133
- 3x 4211043
- 8x 4211053
- 6x 4211001
- 10x 6257592
- 1x 6307616
- 6x 4560184
- 1x 4211056
- 11x 4210651
- 2x 4210875
- 5x 4211099
- 2x 6321746
- 1x 6170420
- 1x 6350724
- 1x 6310596
- 1x 6245283
- 3x 6178912
- 2x 6331222
- 6x 4211044
- 1x 4529240
- 4x 4504378
- 1x 4211054
- 4x 4211127
- 1x 6333129
- 2x 6029948
- 2x 4211109
- 1x 4211103
- 2x 6271752
- 1x 6413106
- 2x 6296892
- 2x 6000606
- 18x 4211008
- 8x 4210997
- 3x 6133611
- 2x 6365692
- 1x 6271127
- 5x 6284596
- 1x 6199549
- 1x 4211042
- 6x 6115080
- 2x 6411395
- 2x 6388124
- 6x 6209684
- 1x 6149768
- 1x 6431074
- 2x 6344038
- 2x 6285465
- 6x 6150307
- 1x 6058368
- 1x 6386209
- 2x 6206151
- 21x 6022084
- 42x 6022083
- 2x 6212064
- 19x 6201646
- 35x 6036232
- 18x 6430416
- 6x 6380625
- 2x 6316263
- 4x 6070301
- 3x 6190252
- 5x 4523159
- 11x 6058014
- 13x 6201647
- 1x 6248756
- 2x 6296524
- 3x 6211356
- 2x 6296964
- 3x 6319958
- 3x 6296501
- 1x 4549990
- 2x 4655690
- 1x 4529247
- 1x 6335111
- 8x 6338242
- 3x 6190252
- 5x 4523159
- 1x 6173654
- 1x 6093529
- 1x 6038163
- 3x 6167585
- 1x 6390147
- 1x 6158322
- 10x 6057986
- 26x 4656783
- 4x 4569382
- 4x 6055309
- 6x 6223183
- 6x 6135191
- 1x 6099341
- 3x 6174192
- 1x 6273854
- 1x 6106193
- 7x 6292154
- 4x 6021997
- 4x 6218360
- 2x 6102994
- 8x 6177535
- 1x 6102990
- 3x 6334099
- 1x 6187006
- 2x 6102998
- 3x 6167700
- 4x 6093494
- 3x 6295464
- 2x 6313600
- 2x 6347304
- 4x 6313599
- 1x 6312464
- 1x 6163633
- 2x 4619636
- 2x 6317181
- 1x 6096993
- 9x 6420725
- 9x 6004943
- 3x 6154879
- 4x 6004938
- 1x 6404754
- 4x 6133838
- 4x 6151658
- 10x 6151664
- 3x 6133728
- 1x 6210675
- 7x 6151657
- 3x 6223733
- 1x 4258308
- 1x 6420734
- 2x 6092111
- 2x 6278156
- 1x 4540203
- 2x 4211469
- 2x 6251591
- 2x 6078236
- 1x 6227939



 [LEGO.com/service](https://www.LEGO.com/service)



YOU COULD WIN



YOU COULD WIN

Your feedback will help shape the future development of this product series.

Visit:

DU KÖNNTEST GEWINNEN

Dein Feedback trägt zur Weiterentwicklung dieser Produktreihe bei.

Geh auf:

VOUS POURRIEZ GAGNER

Vos commentaires nous aideront à concevoir les futurs produits de cette gamme.

Visitez :

POTRESTI VINCERE TU

La tua opinione ci aiuterà a migliorare la creazione futura di questa linea di prodotti.

Visita:

PUEDES GANAR

Tu opinión contribuirá al futuro de esta serie de productos.

Visita:

轻松获奖

您的反馈将有助于我们在今后改进本产品系列。

请访问:

LEGO.com/productfeedback

You also have the chance to win a LEGO® set.

Terms and conditions apply.*

Außerdem hast du die Chance, ein LEGO® Set zu gewinnen.

Es gelten die Teilnahmebedingungen.*

Vous pourriez également gagner un ensemble LEGO®.

Des conditions s'appliquent.*

Hai anche la possibilità di vincere un set LEGO®.

Termini e condizioni sono applicabili.*

También tienes la oportunidad de ganar un set LEGO®.

Aplican términos y condiciones.*

您还有机会赢取乐高®套装。

条款和条件适用。*

*LEGO.com/productfeedback-terms

