

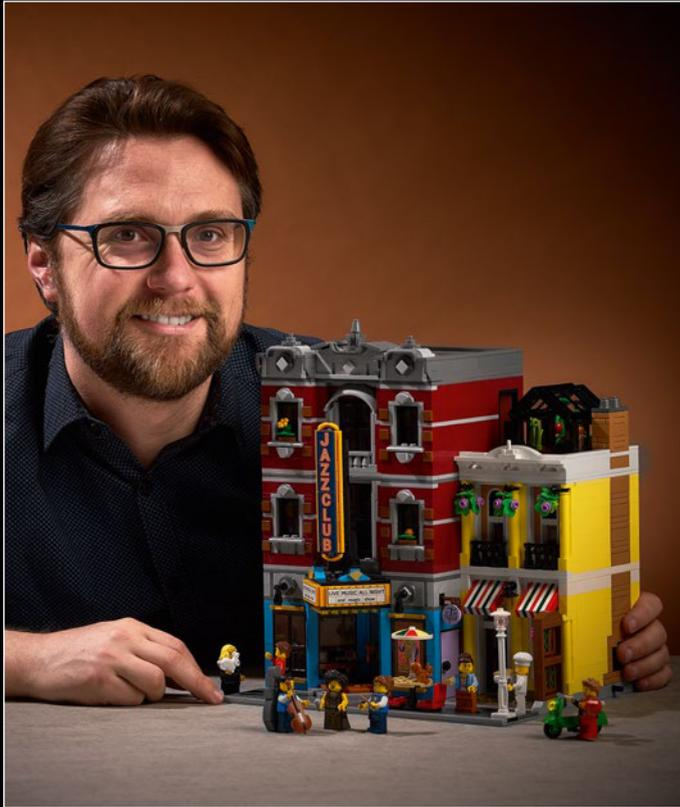



[LEGO.com/sustainable-packaging](https://LEGO.com/sustainable-packaging)



ANDERSON WARD GRUBB

*Designer des Jazz Club (10312)*

## HERZLICH WILLKOMMEN

Freu dich auf einen Abend mit Livemusik, bester Unterhaltung und köstlichem Essen! Unser jüngster Neuzugang zur LEGO® Reihe „Bauen mit Modulen“ stellt einen spektakulären Jazzclub im Stil klassischer Architektur dar. Unsere Liebe zur Musik aus dem goldenen Zeitalter des Jazz hat uns zu diesem Modell inspiriert. Ganz gleich, ob dies dein erstes Set aus dieser Reihe ist, oder du schon von Anfang an dabei bist und nach und nach deine LEGO Straße aus Modulen errichtest, du bist herzlich dazu eingeladen, mit einzustimmen und in deinem eigenen Rhythmus mitzubauen.



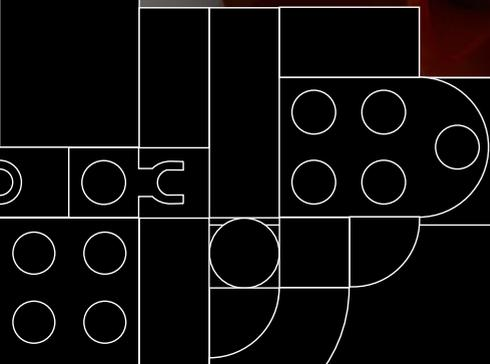

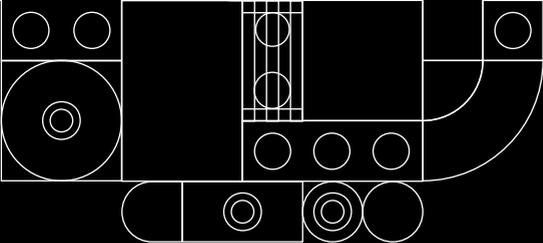

*Es heißt, dass im Jazz die nicht gespielten Noten mindestens genauso wichtig sind wie die gespielten Noten! Es ist völlig egal, ob du Musiknoten oder mit LEGO® Steinen spielst. Wichtig ist nur, dass du so spielst, wie es dir gefällt!*



## LET THE MUSIC PLAY

Musik kann als virtuelle Zeitmaschine dienen, die dir sofort magische Momente in Erinnerung ruft oder dich in deiner Fantasie an Orte reisen lässt, die du schon immer besuchen wolltest. Hör dir deine Lieblingsschallplatte auf deinem alten Plattenspieler an, begib dich in den LEGO® Icons Jazzclub und genieße die prickelnde Atmosphäre und die Magie dieses Musikschmelzriegels aus den 50er-Jahren, in dem die Gäste von ebenso kreativen wie leidenschaftlichen Musikern und Köchen verwöhnt werden. Schau dir die Show im Büro der Clubbesitzerin an. Ernte Gemüse für die Küche im Gewächshaus auf dem Dach. Spüre das Lampenfieber in der Garderobe. Bestell dir einen köstlichen Snack oder diniere an einem heißen Sommerabend im Straßencafé. Du musst dir weder ein Ticket kaufen noch einen Tisch reservieren, denn deine Fantasie verschafft dir VIP-Zugang.



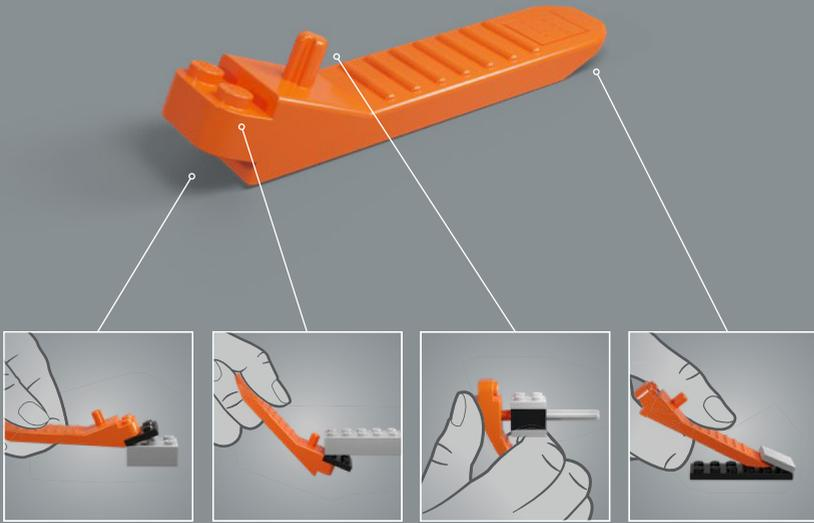
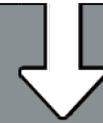
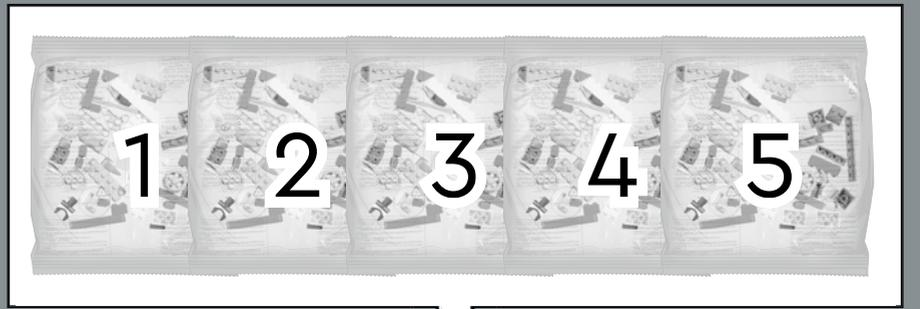

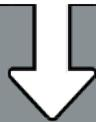
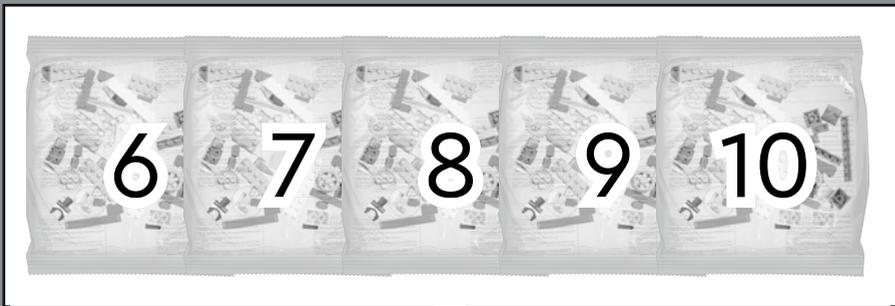

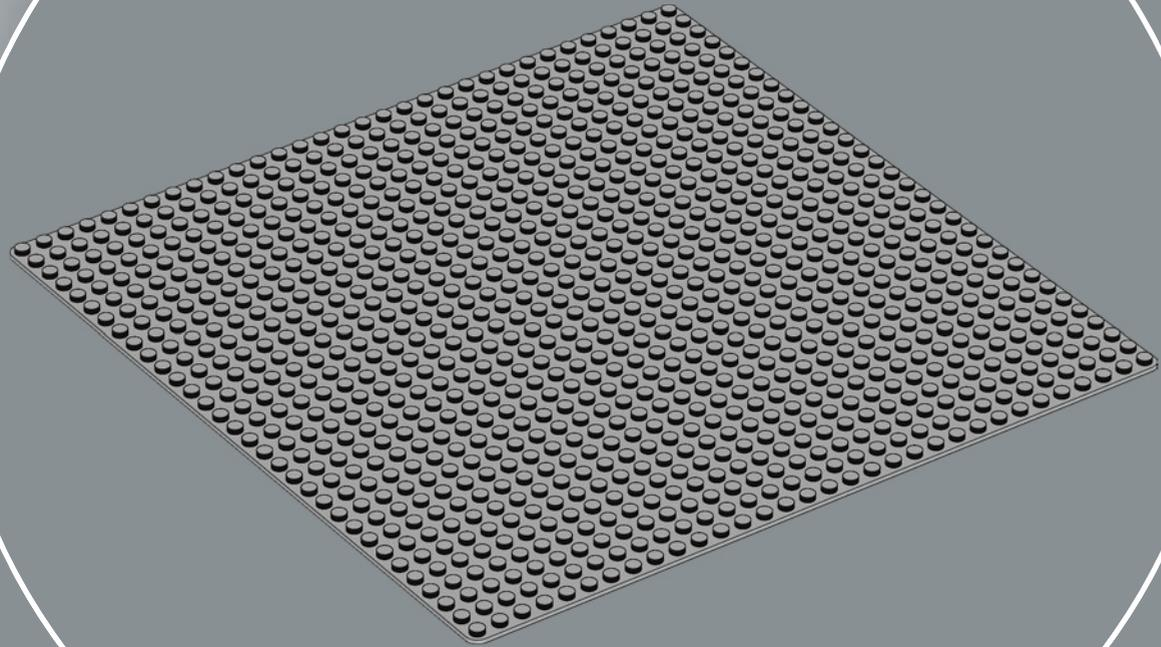
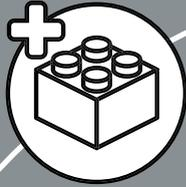



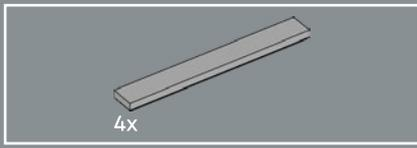

1

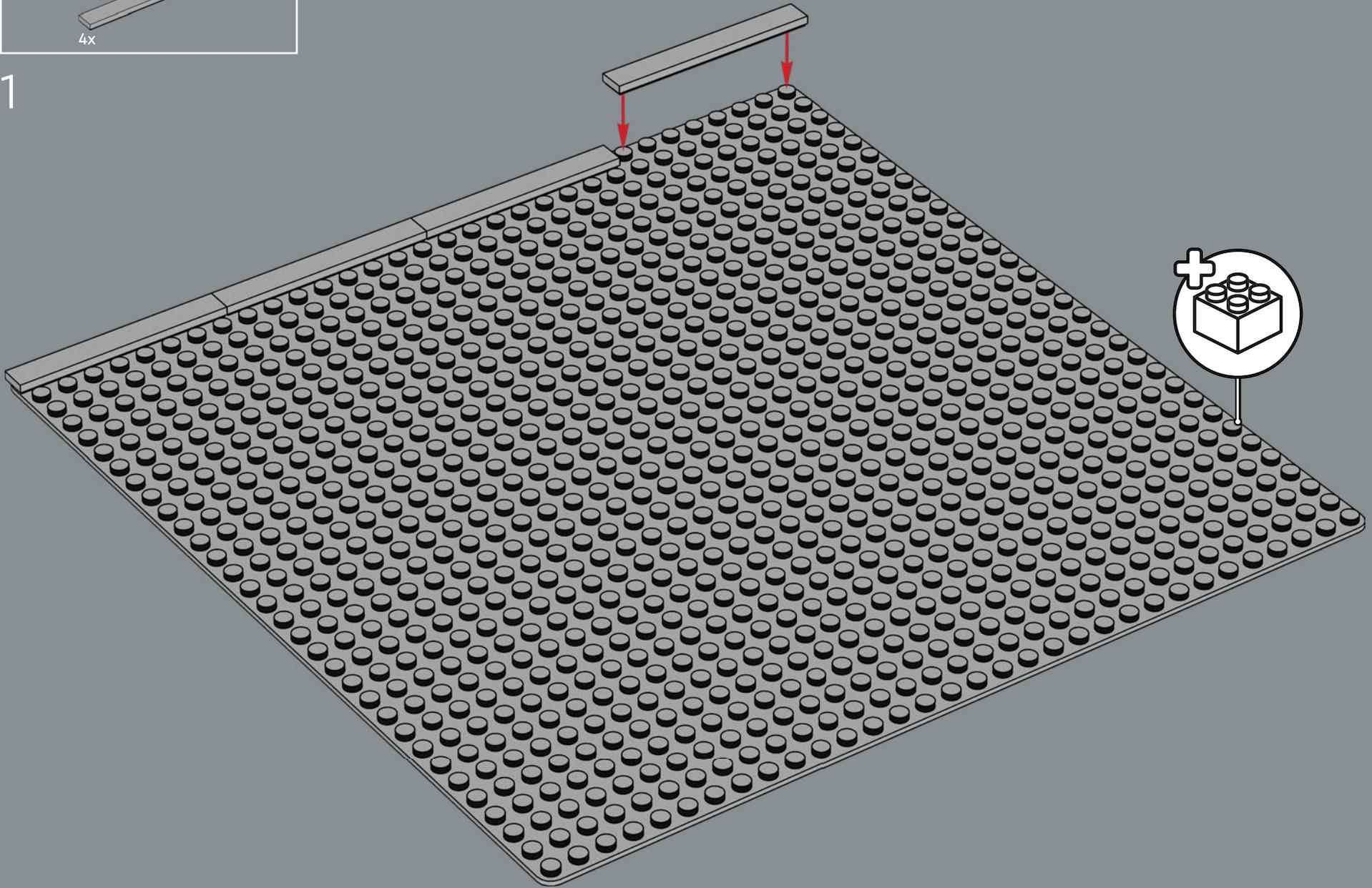

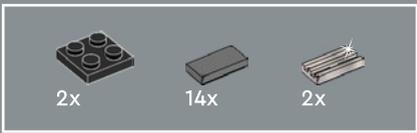

2

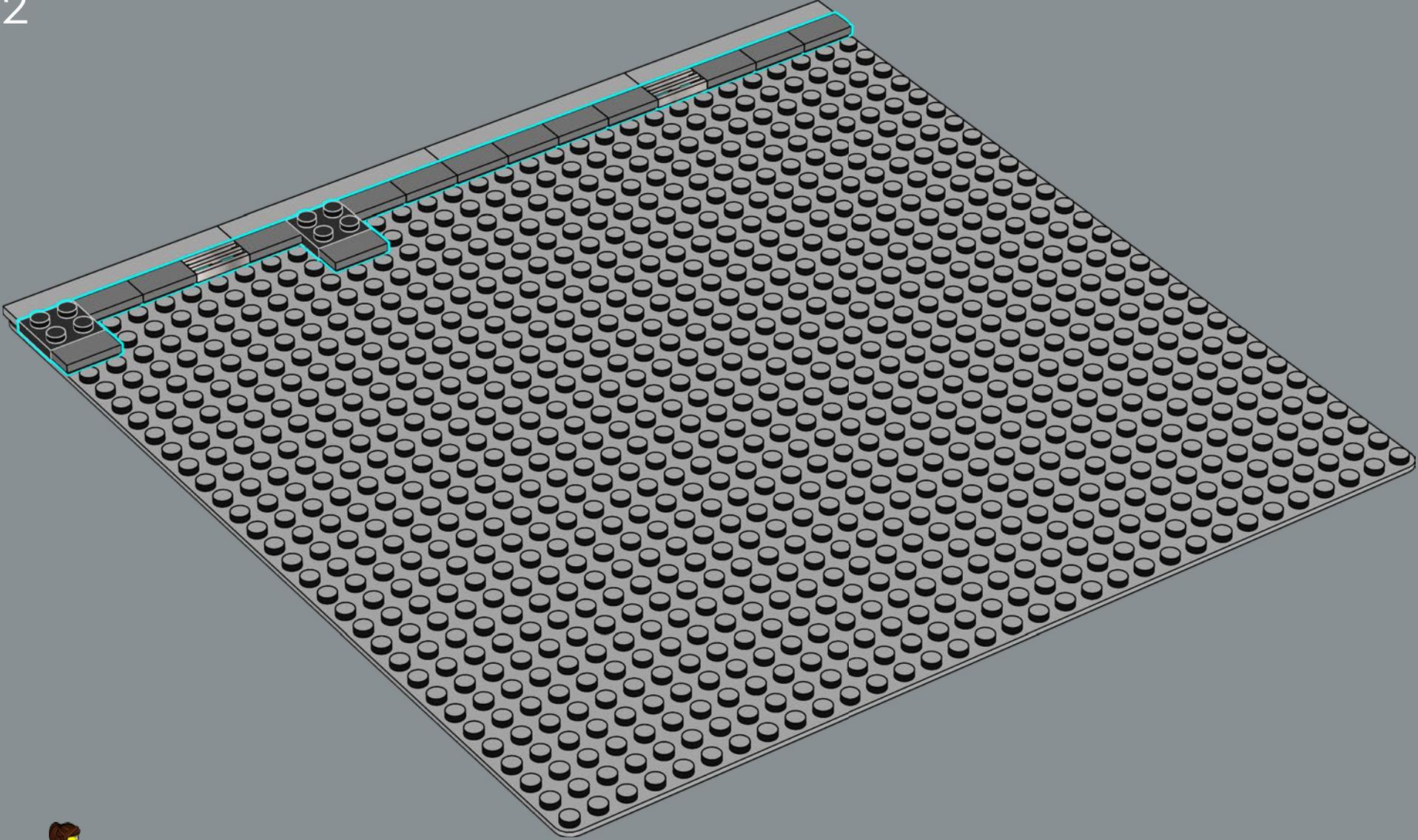

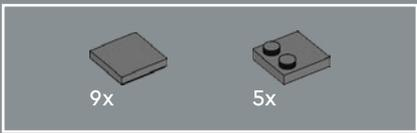

3

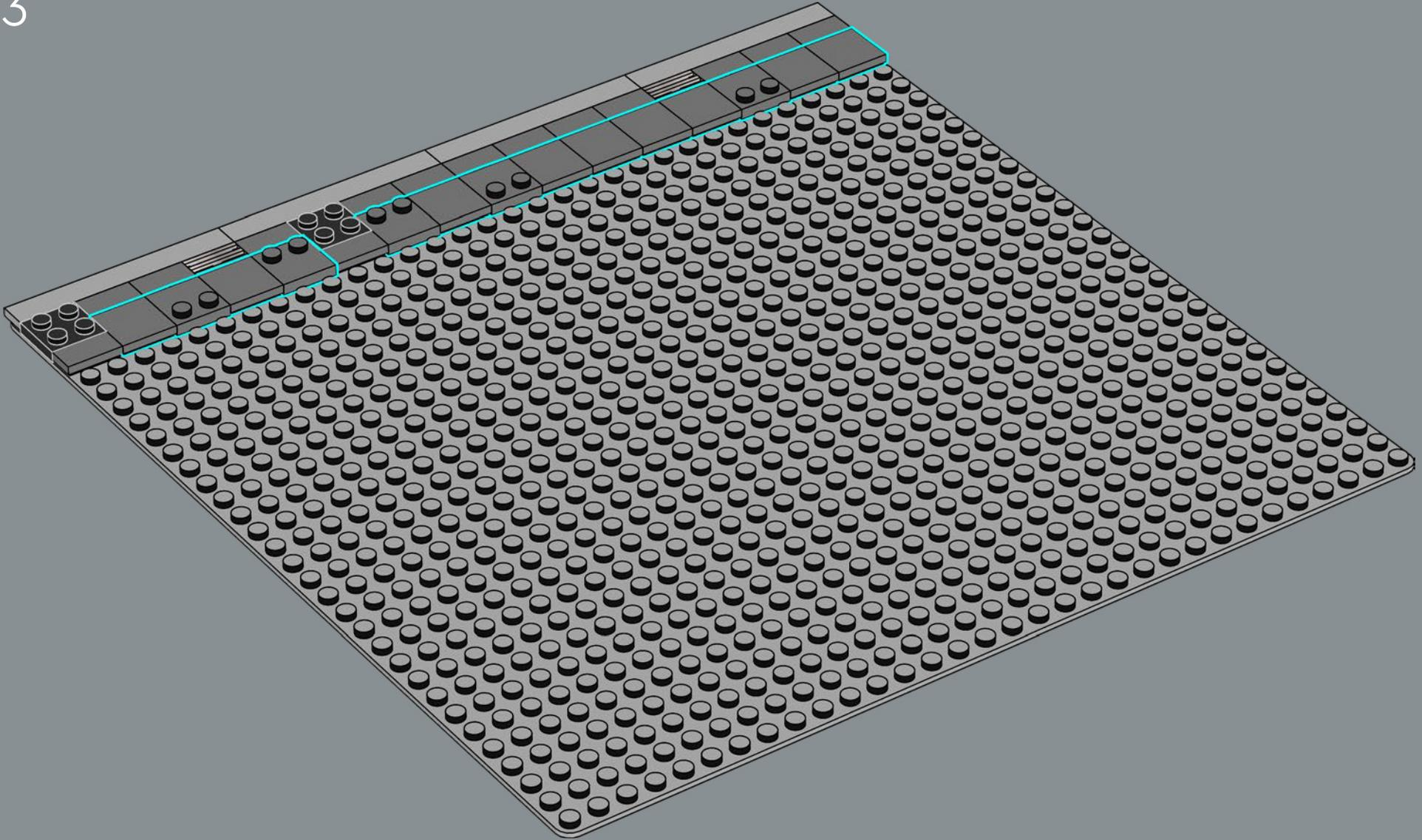

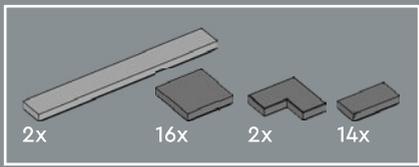

4

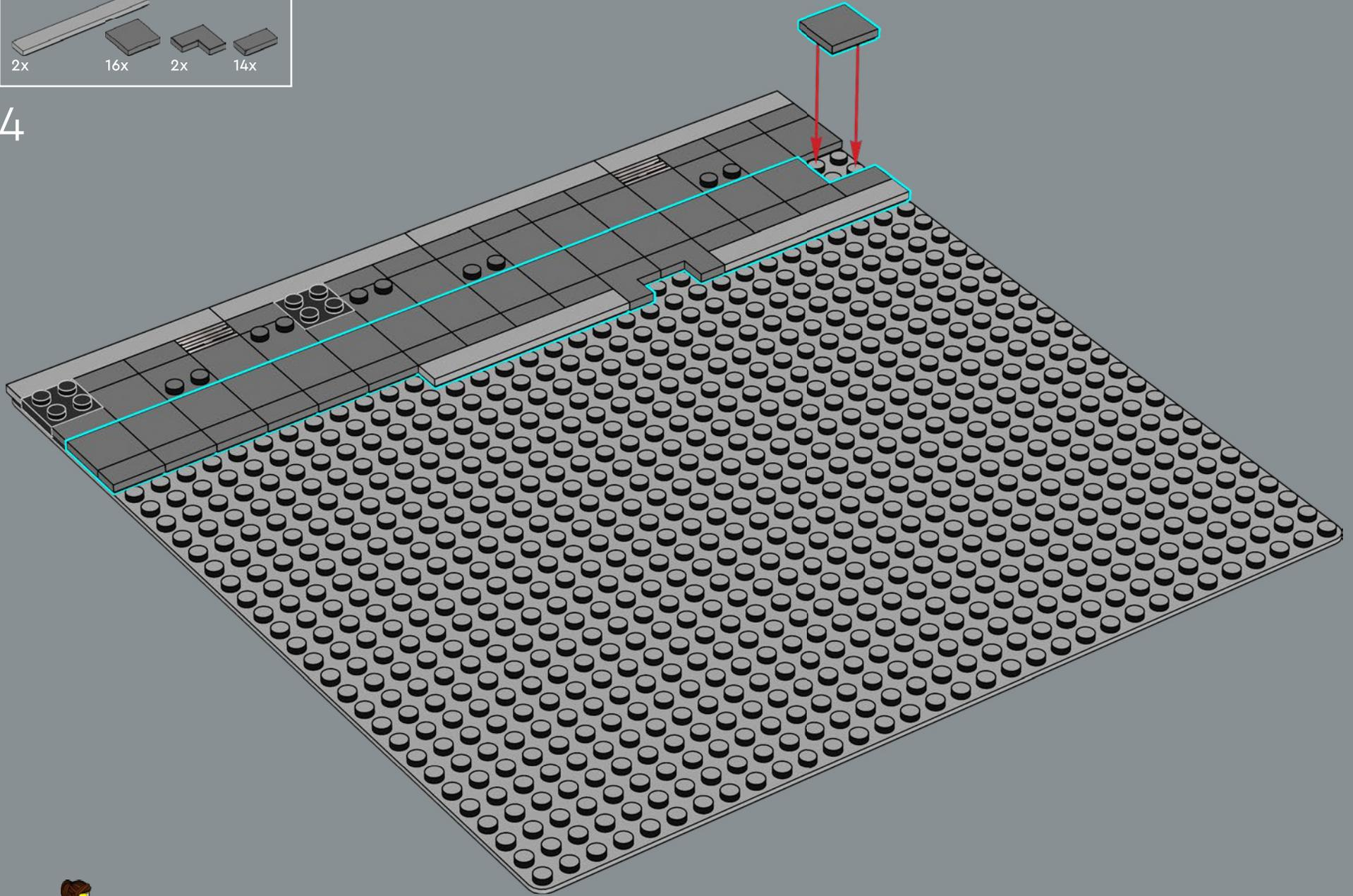

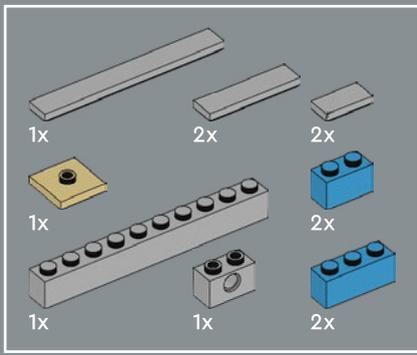

5

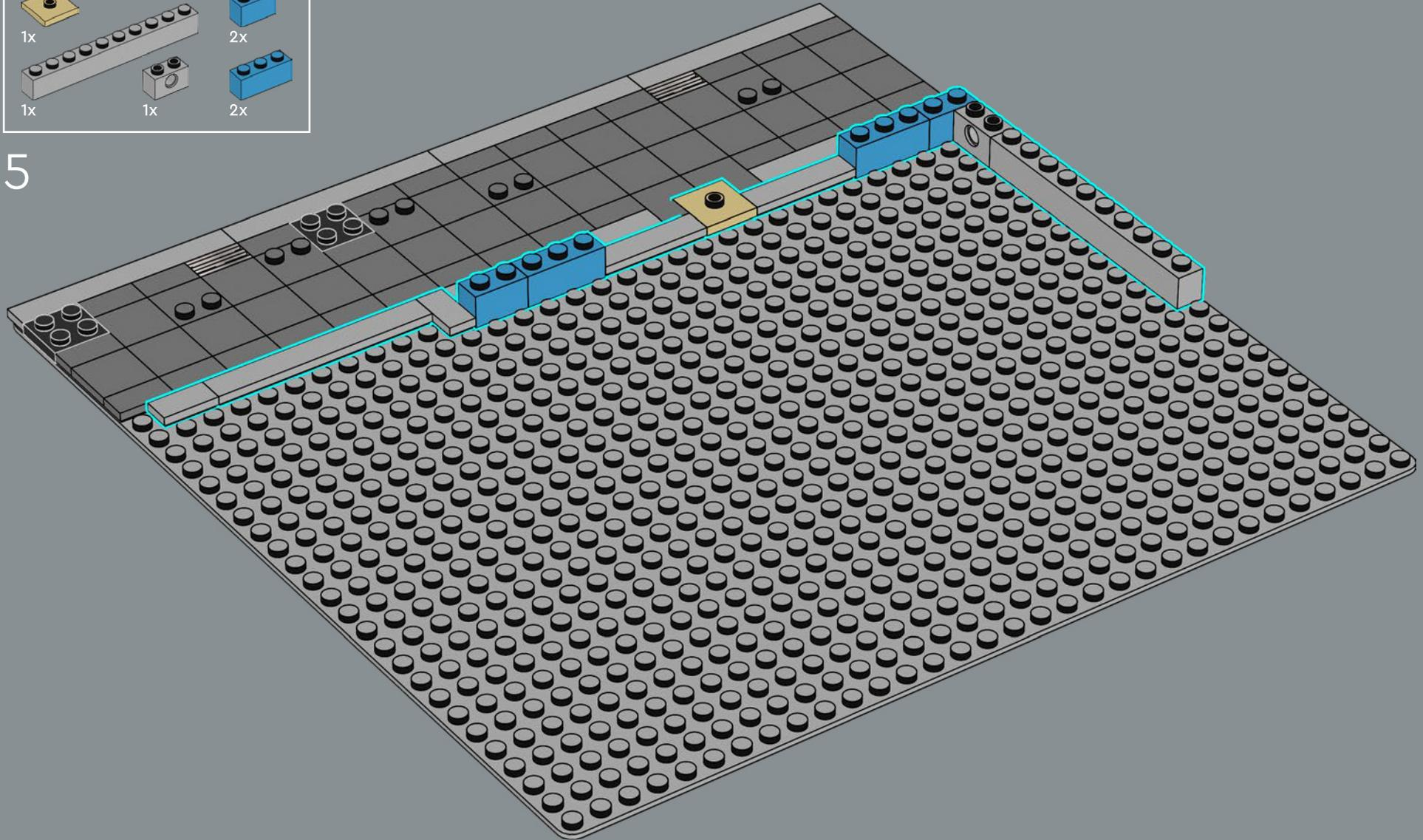

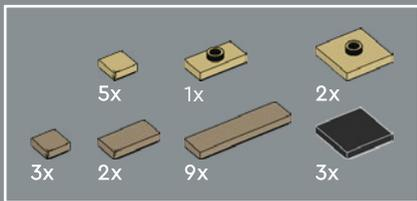

6

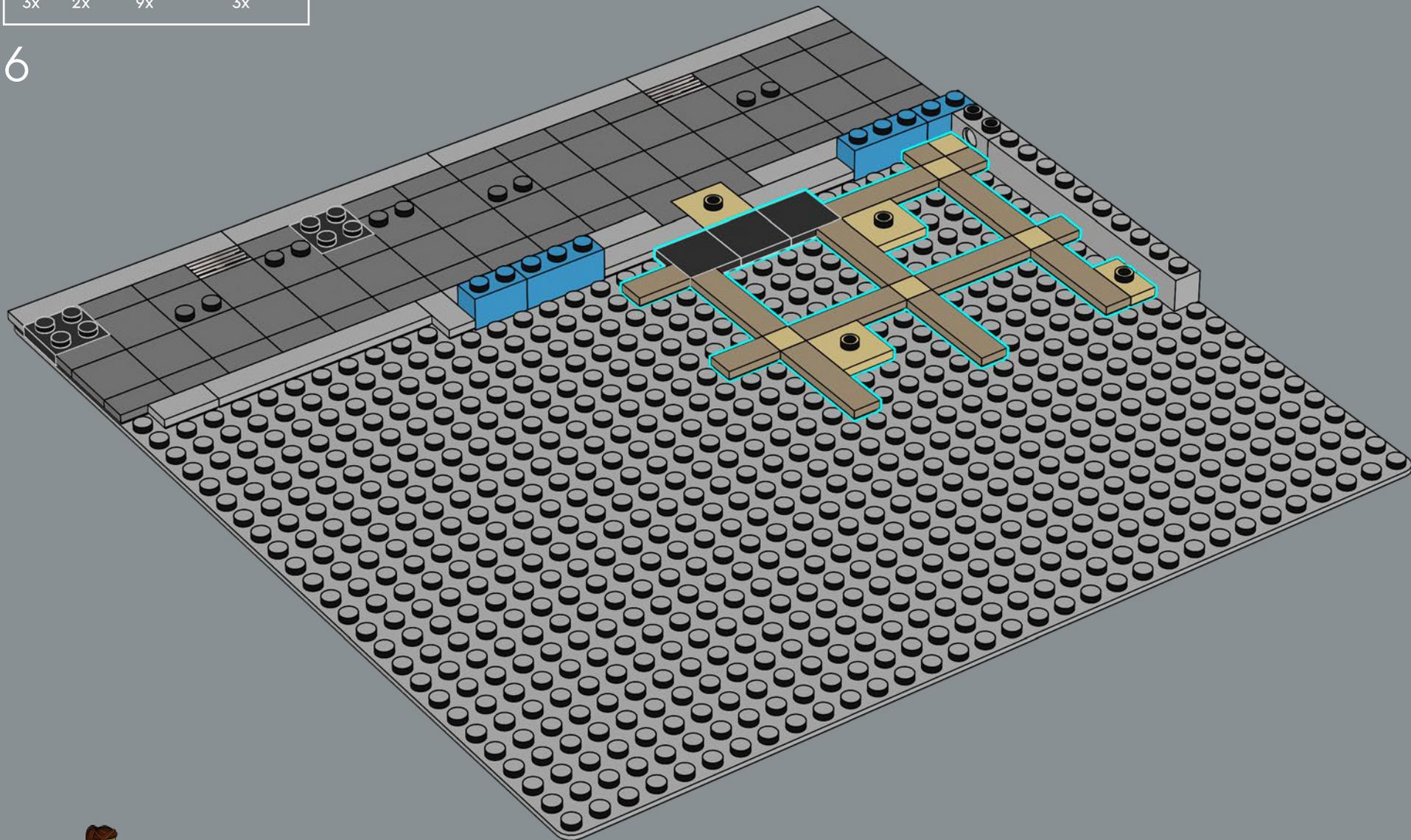

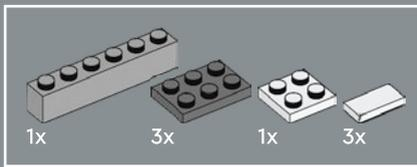

7

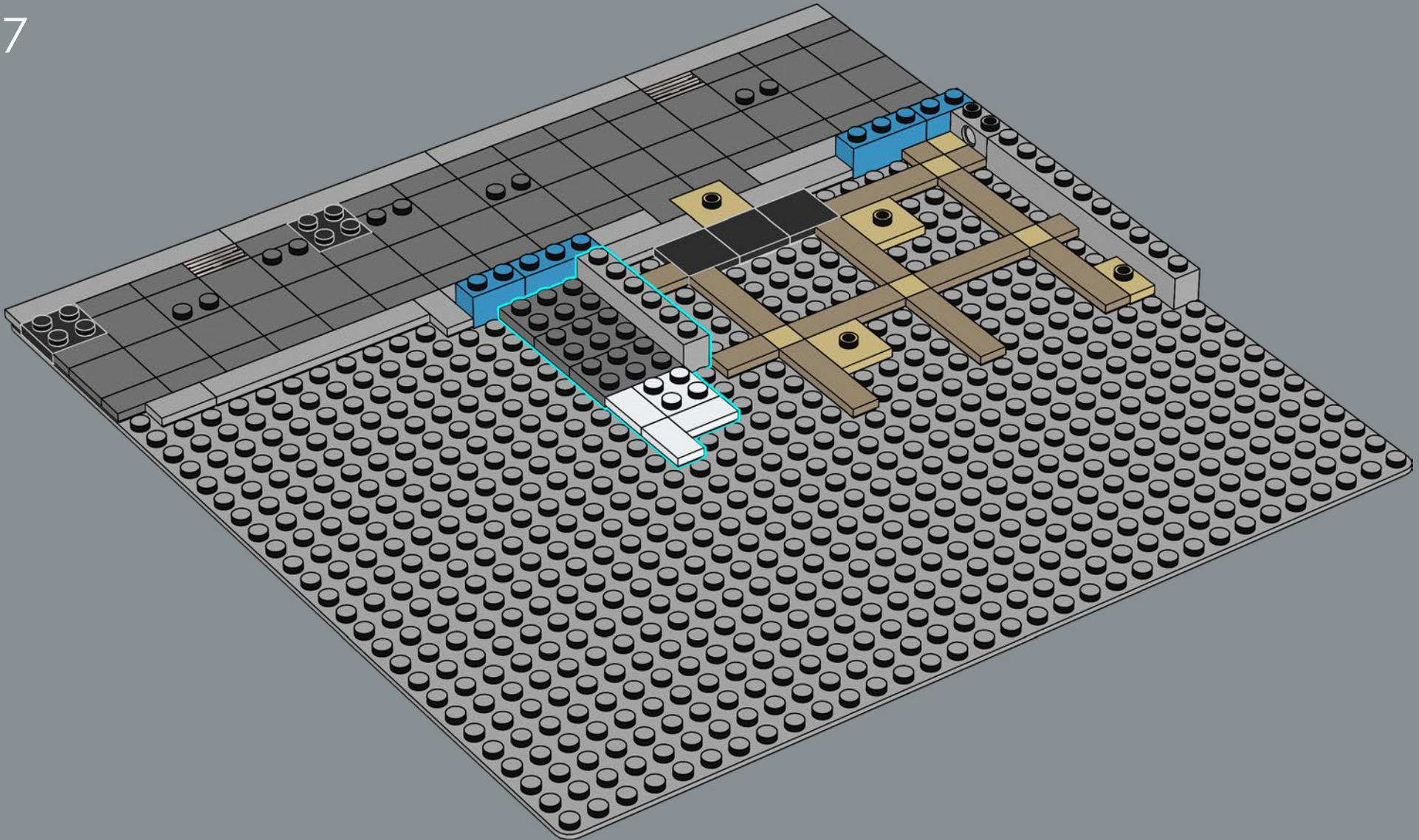

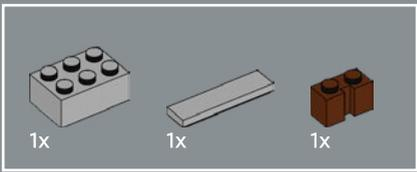

8

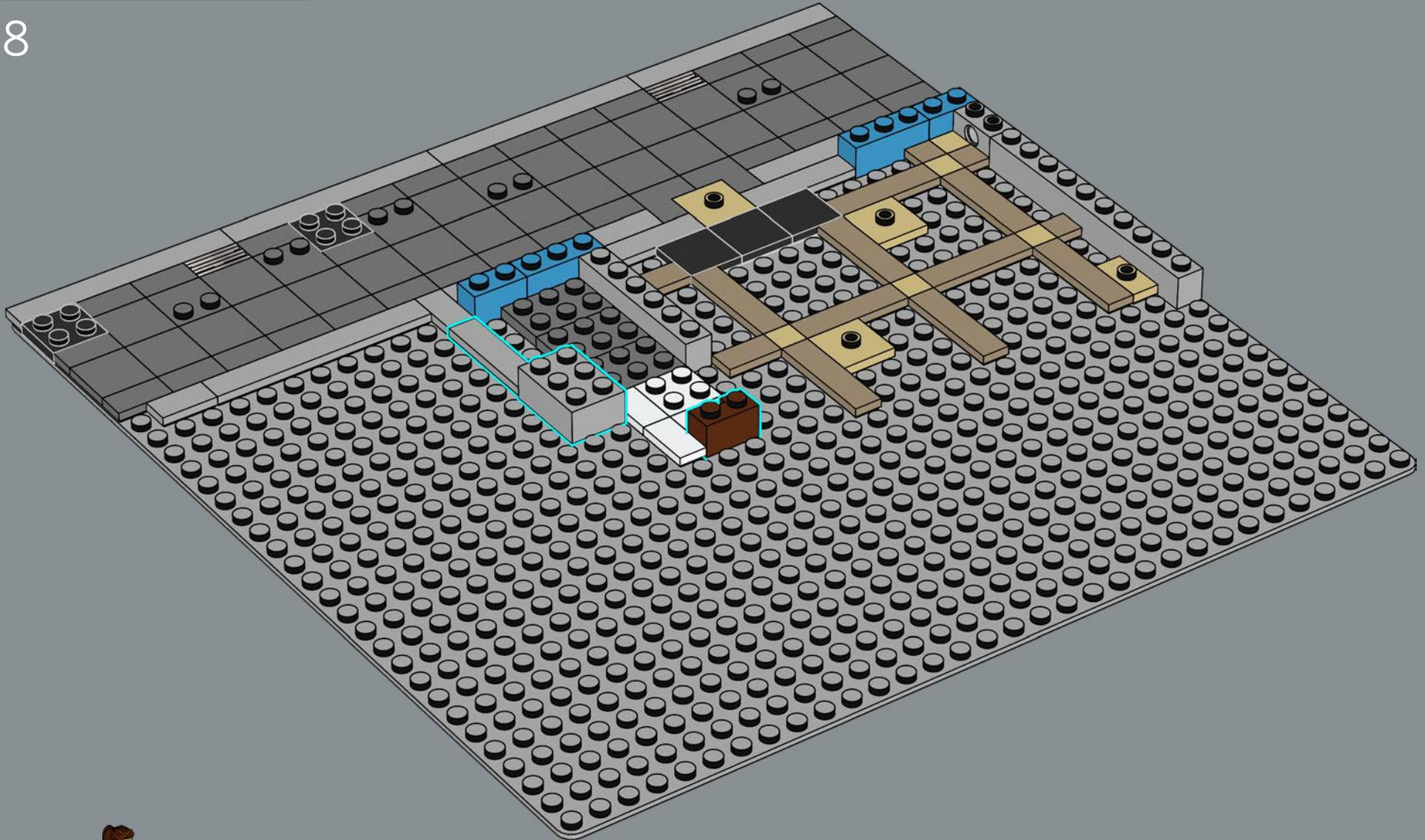





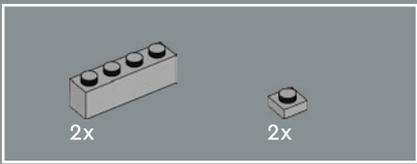

10

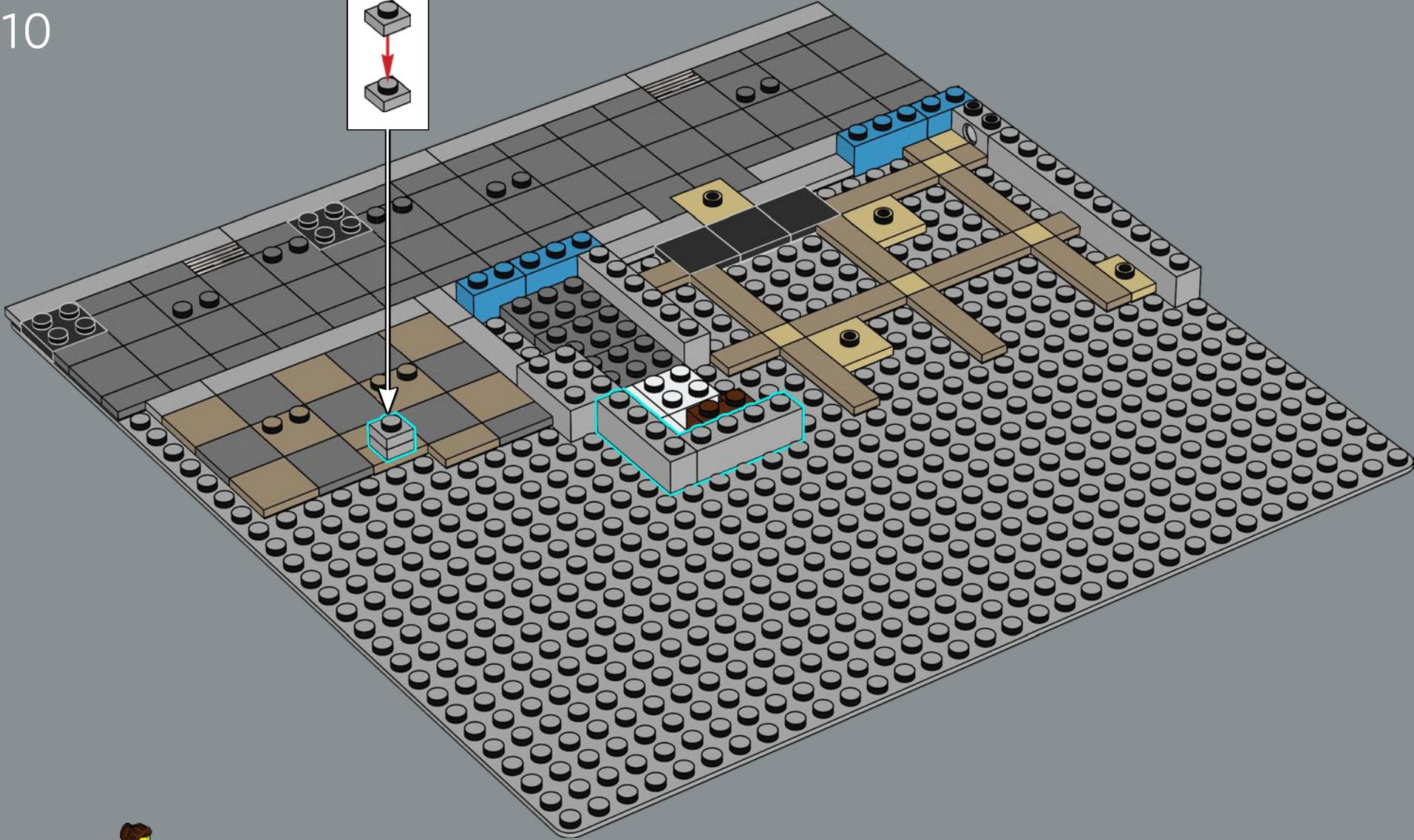
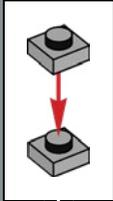

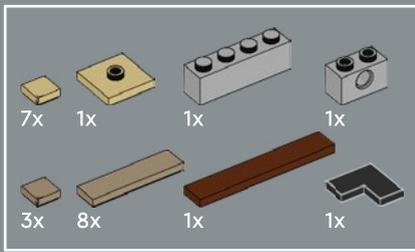

11

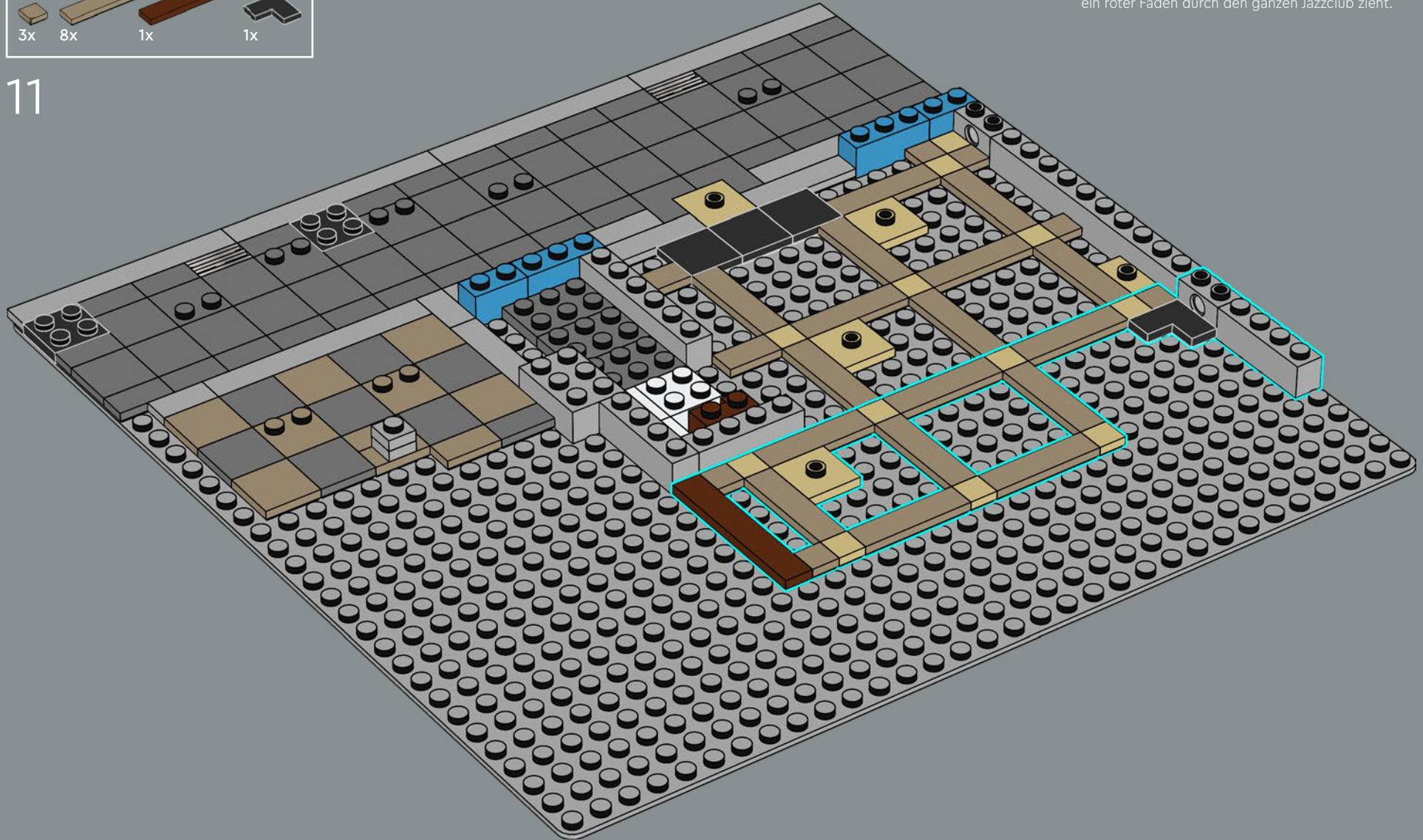

Diese Elemente werden so platziert, dass sie eine Linie bilden, die diagonal durch das quadratische LEGO® Noppenraster verläuft. Diagonal ausgerichtete Modelle und Elemente bilden ein Muster, das sich wie ein roter Faden durch den ganzen Jazzclub zieht.

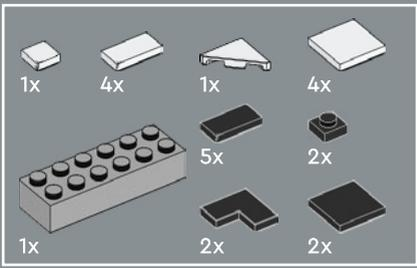

12

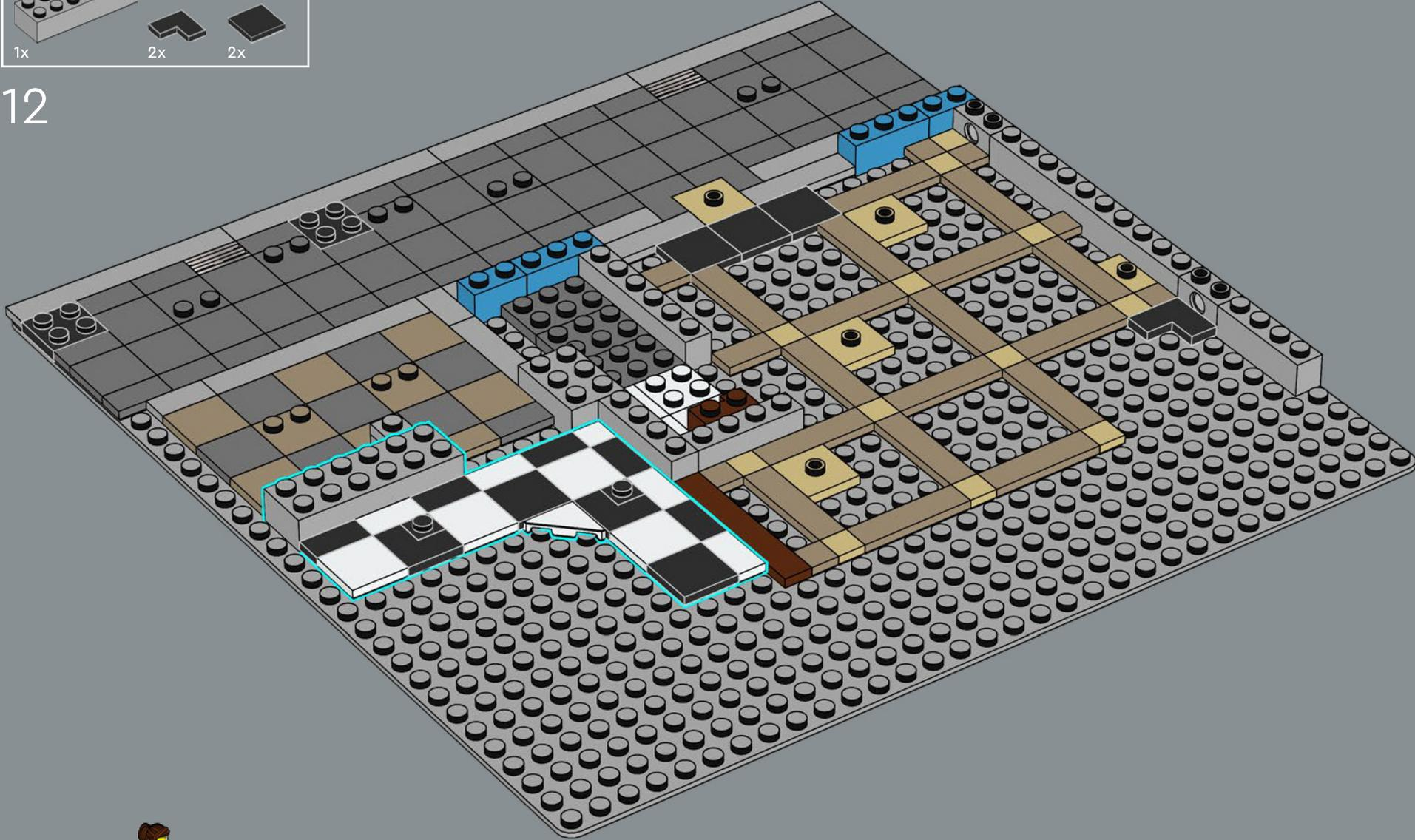

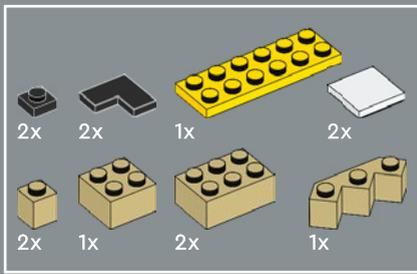

13

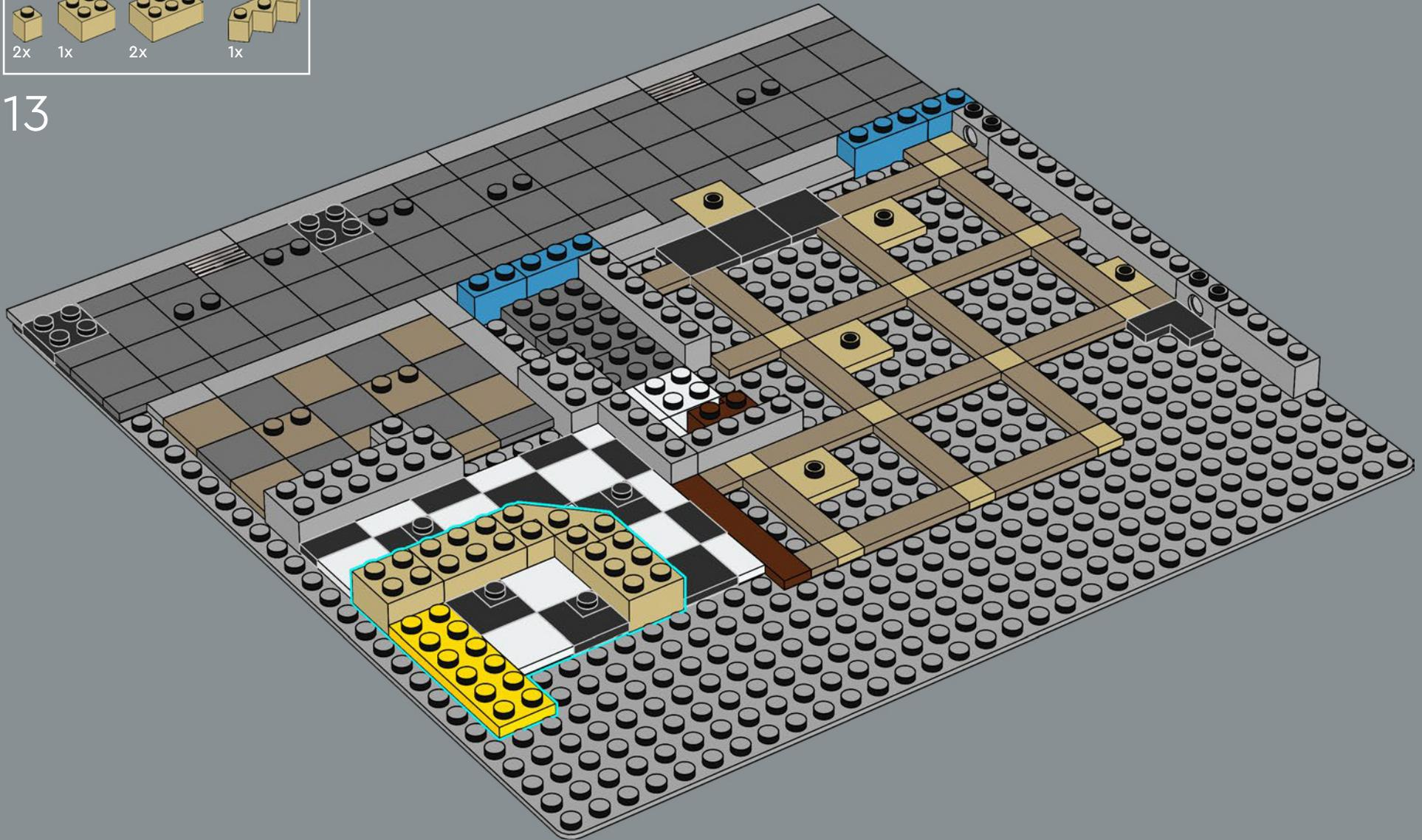

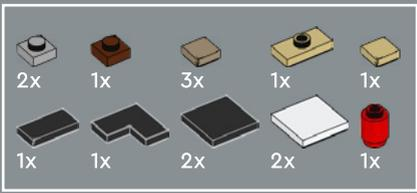

14

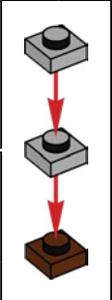
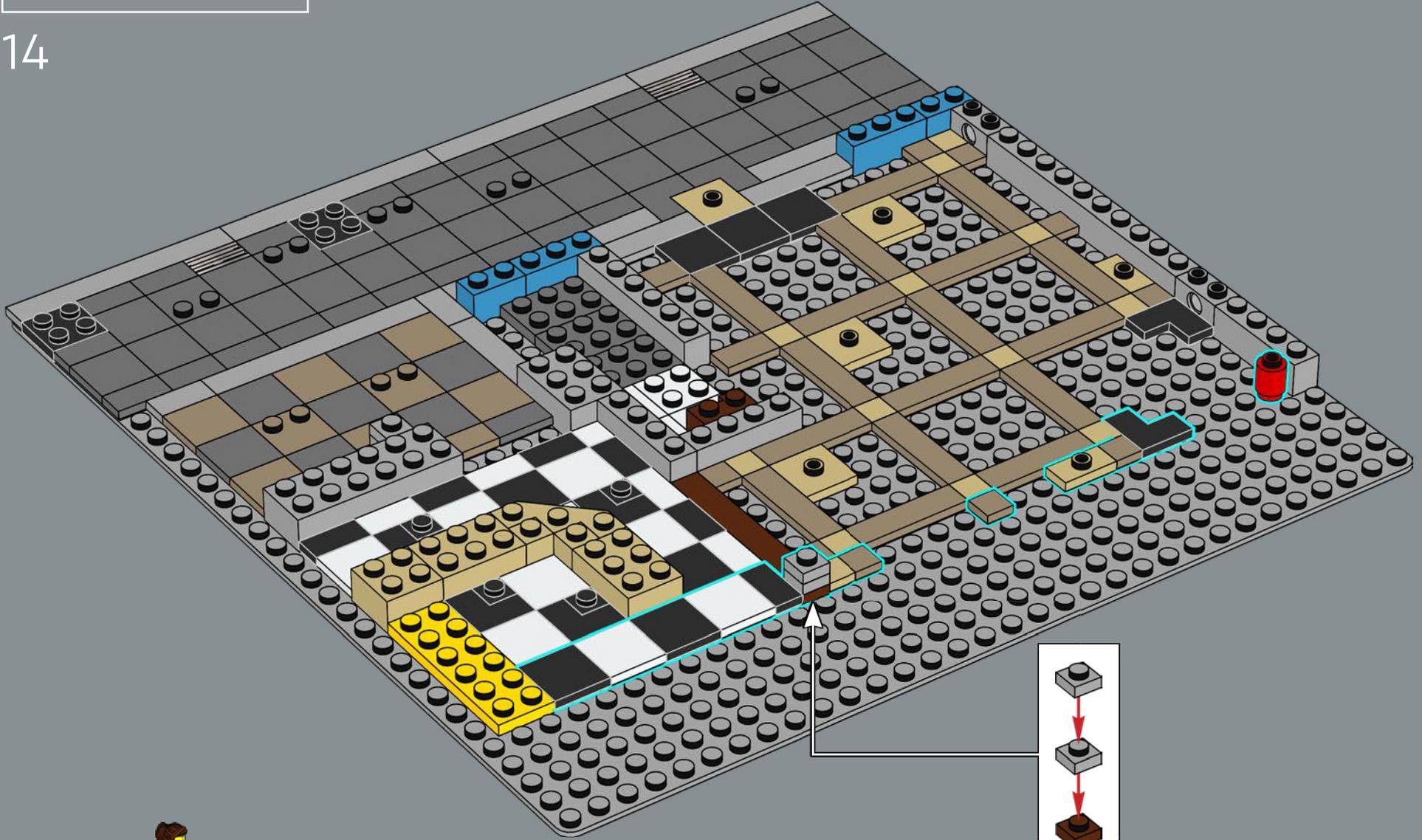

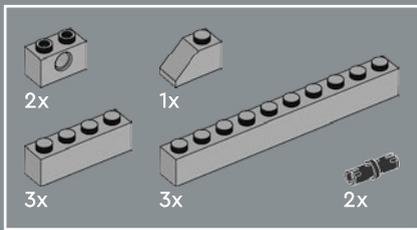

15

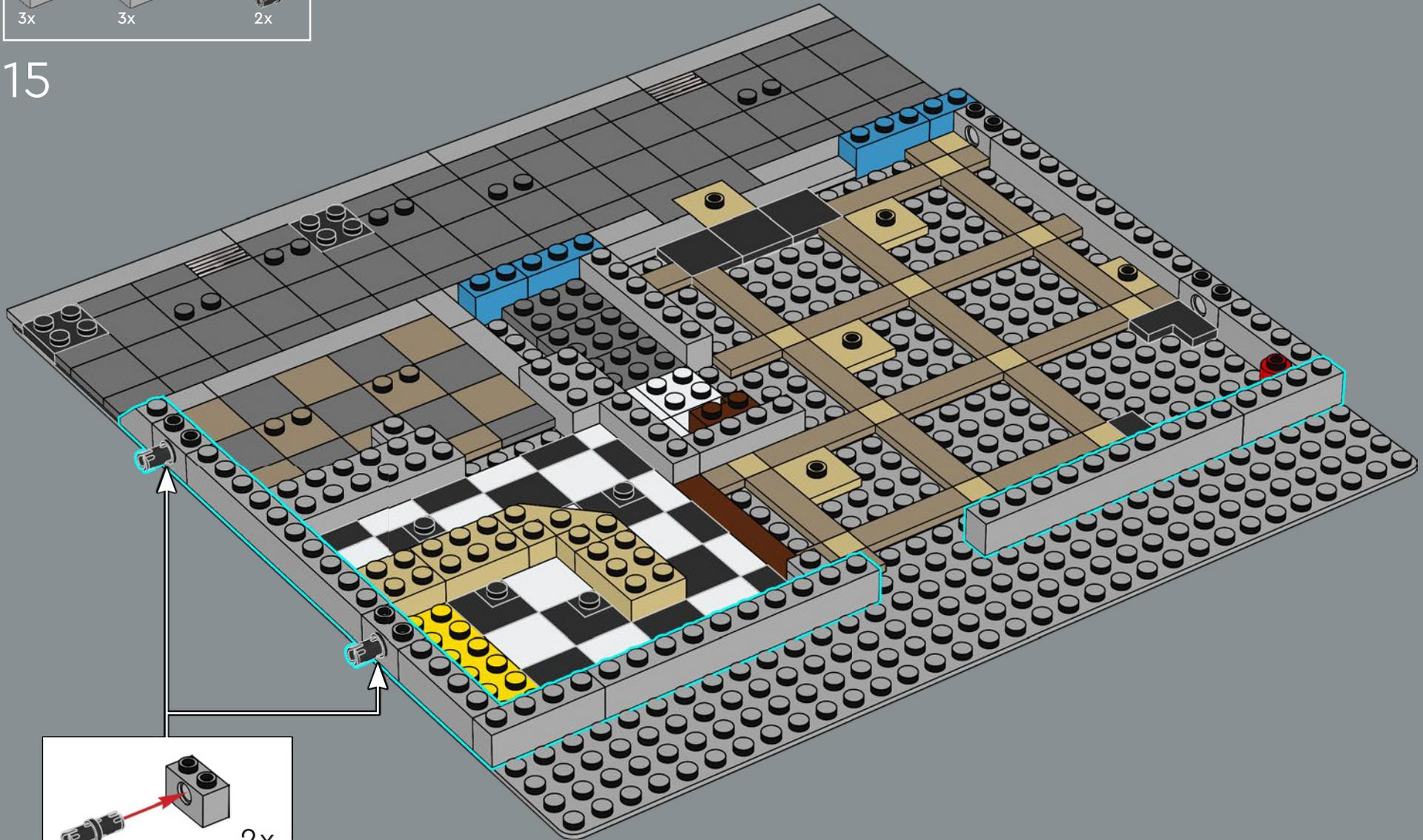

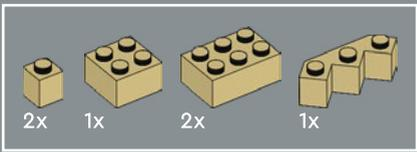

16

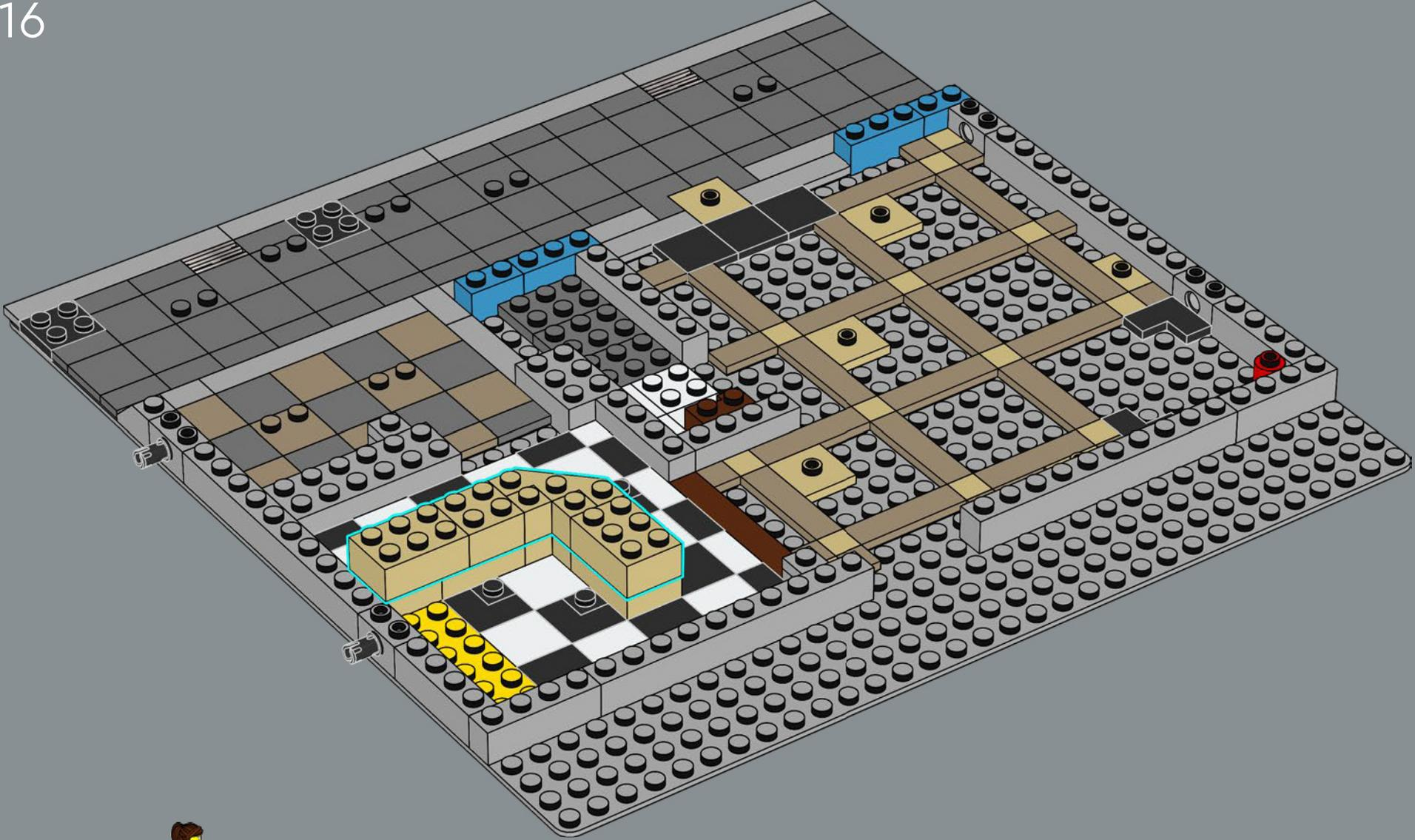





Der Schlagzeuger freut sich schon riesig darauf, im Musikladen des LEGO® Sets Stadtleben (10255) das neue Schlagzeug auszuprobieren.

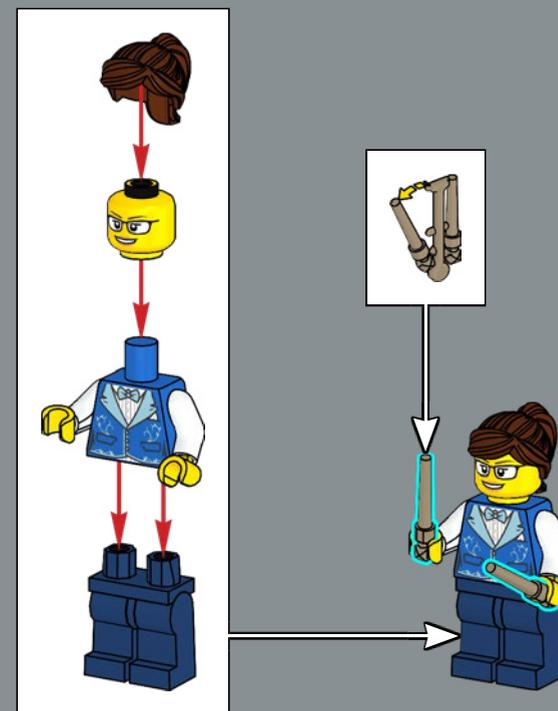



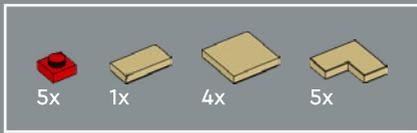

18

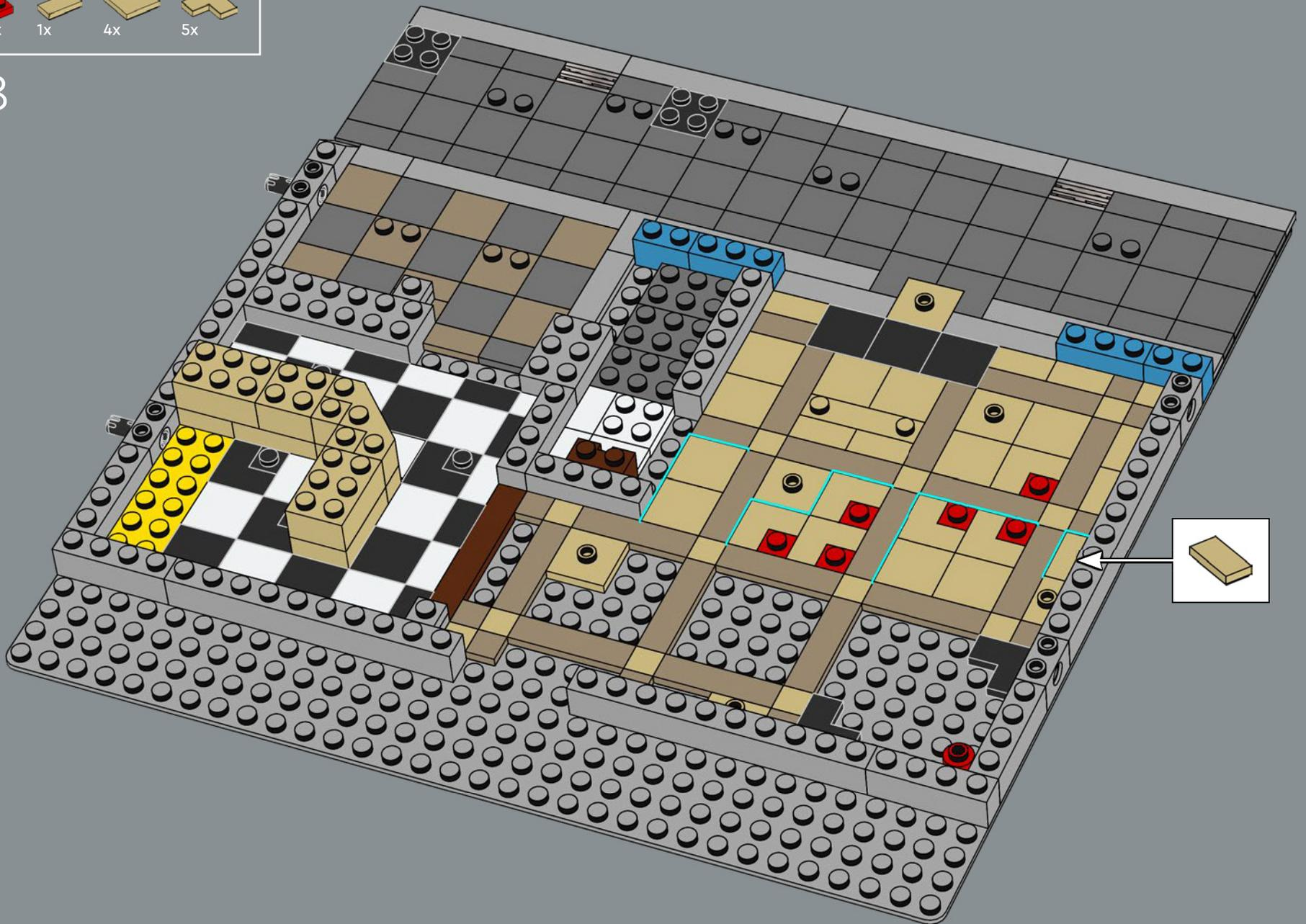

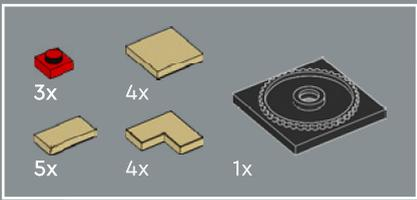

19

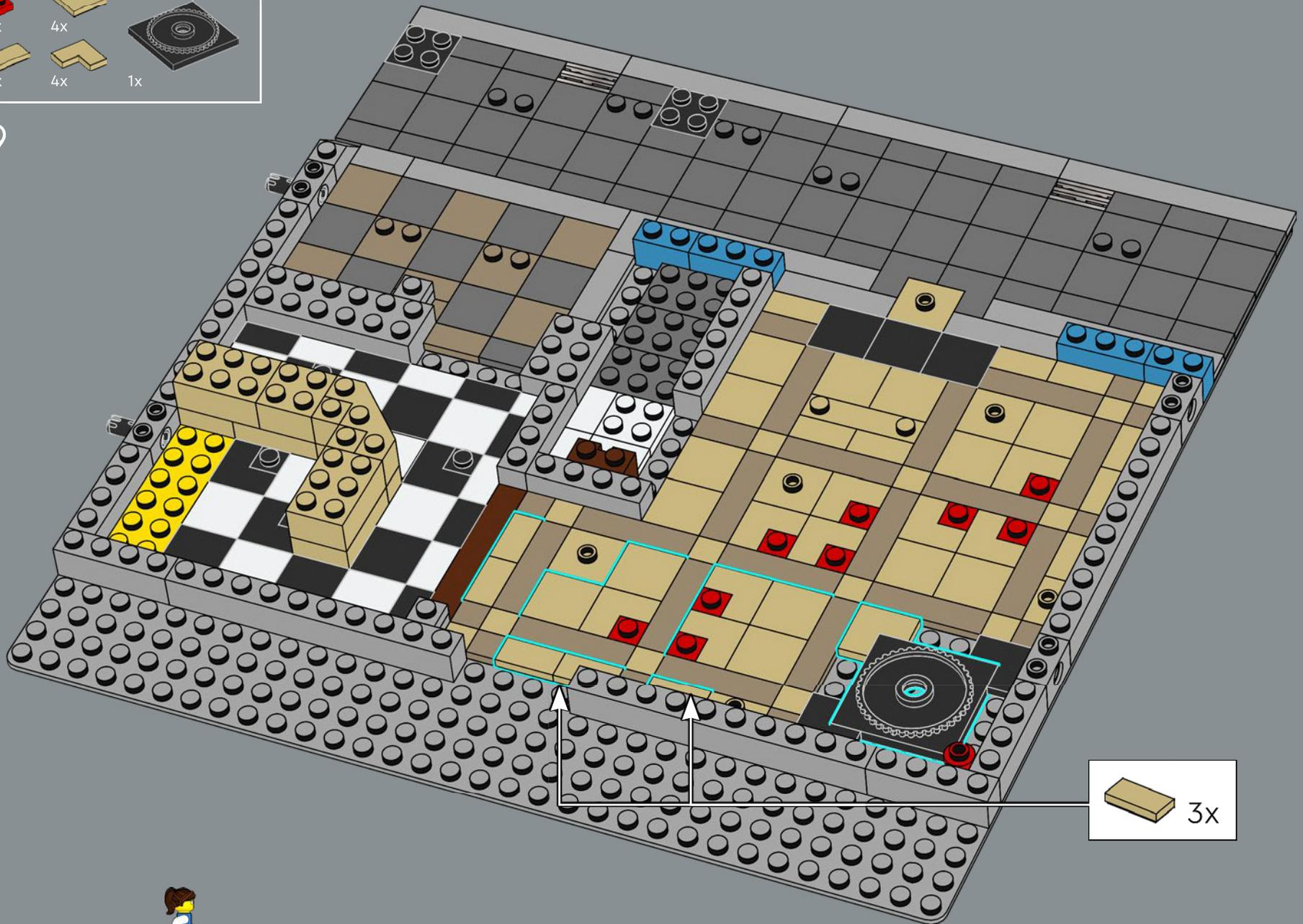

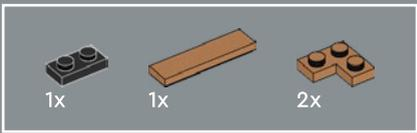

20

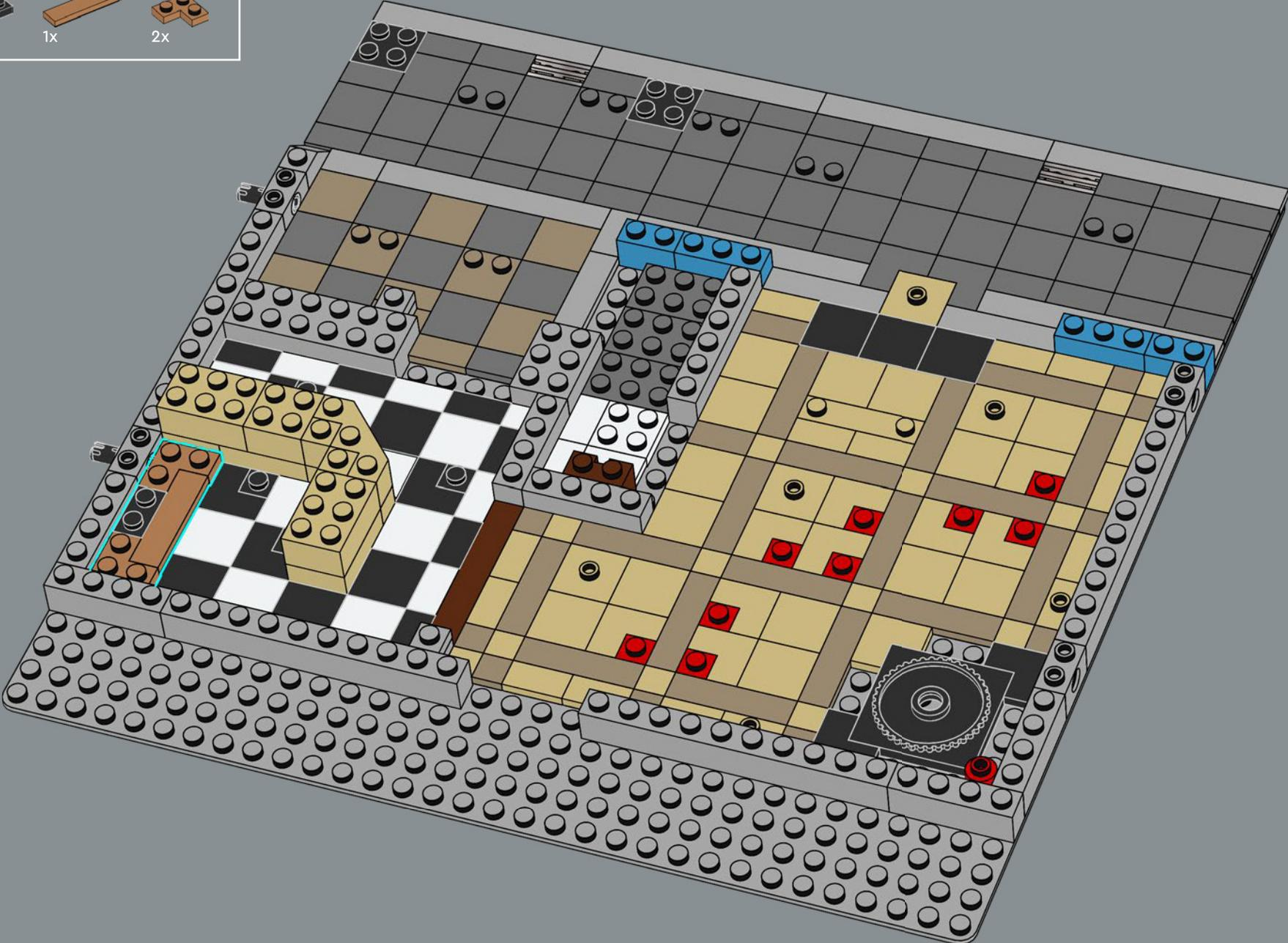

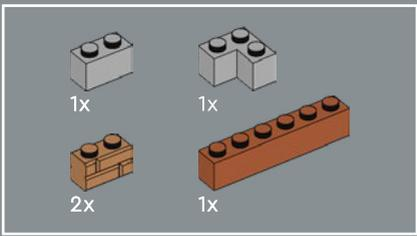

21

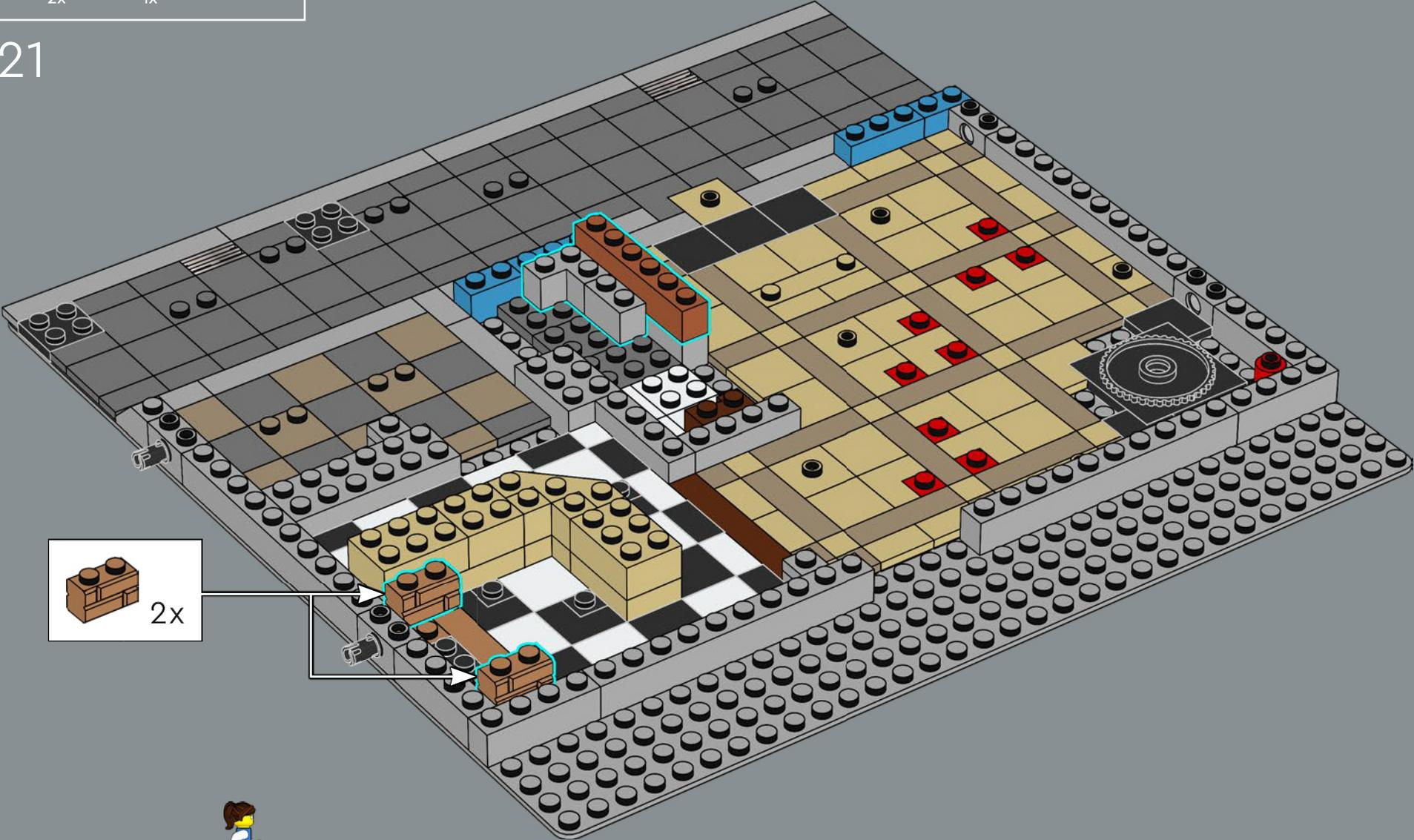



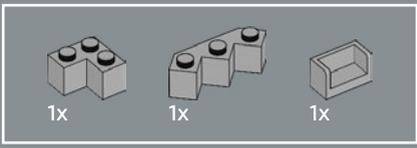

23

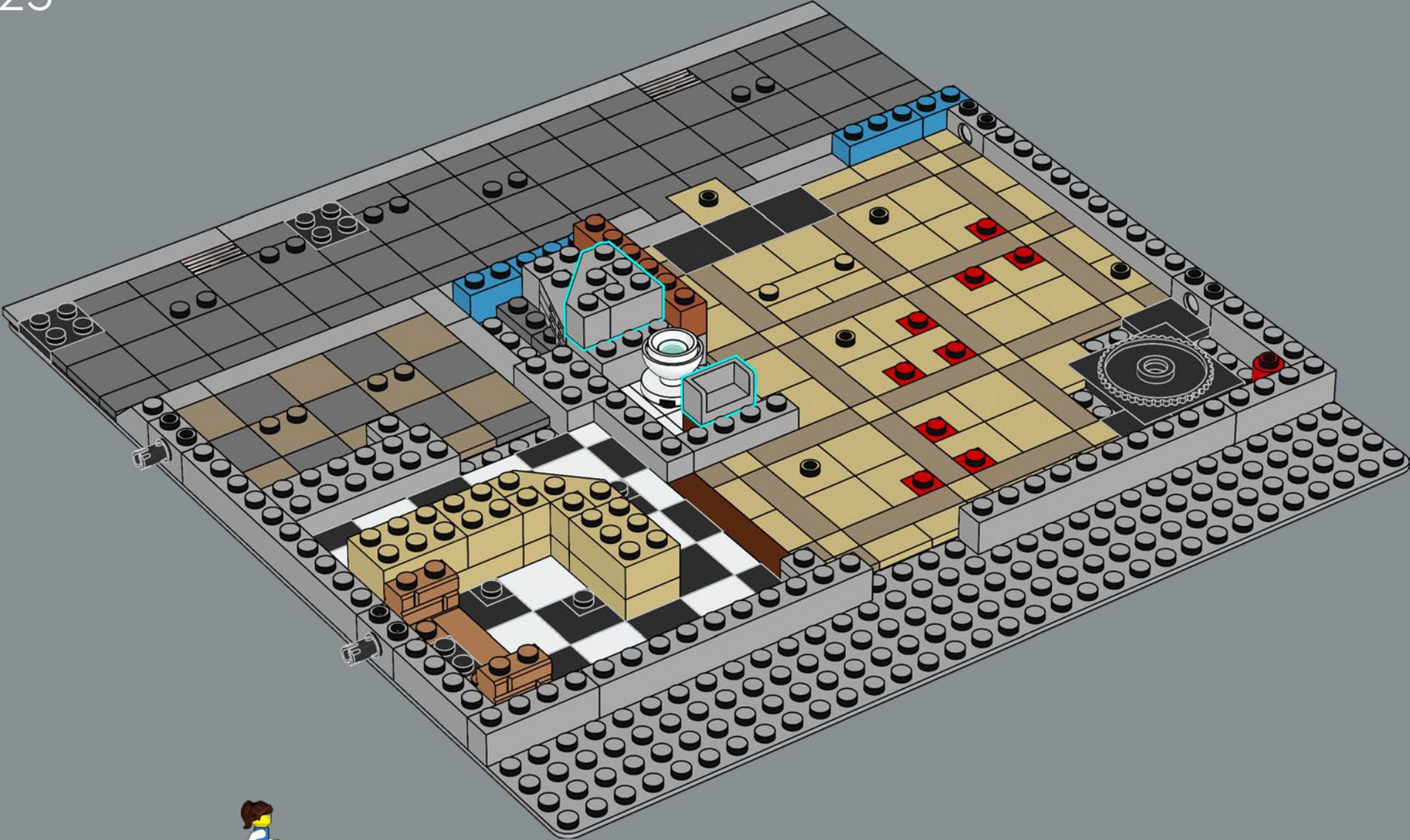





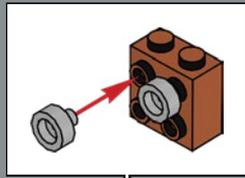
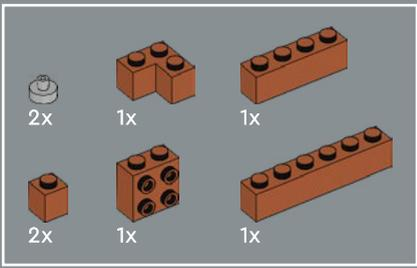

25

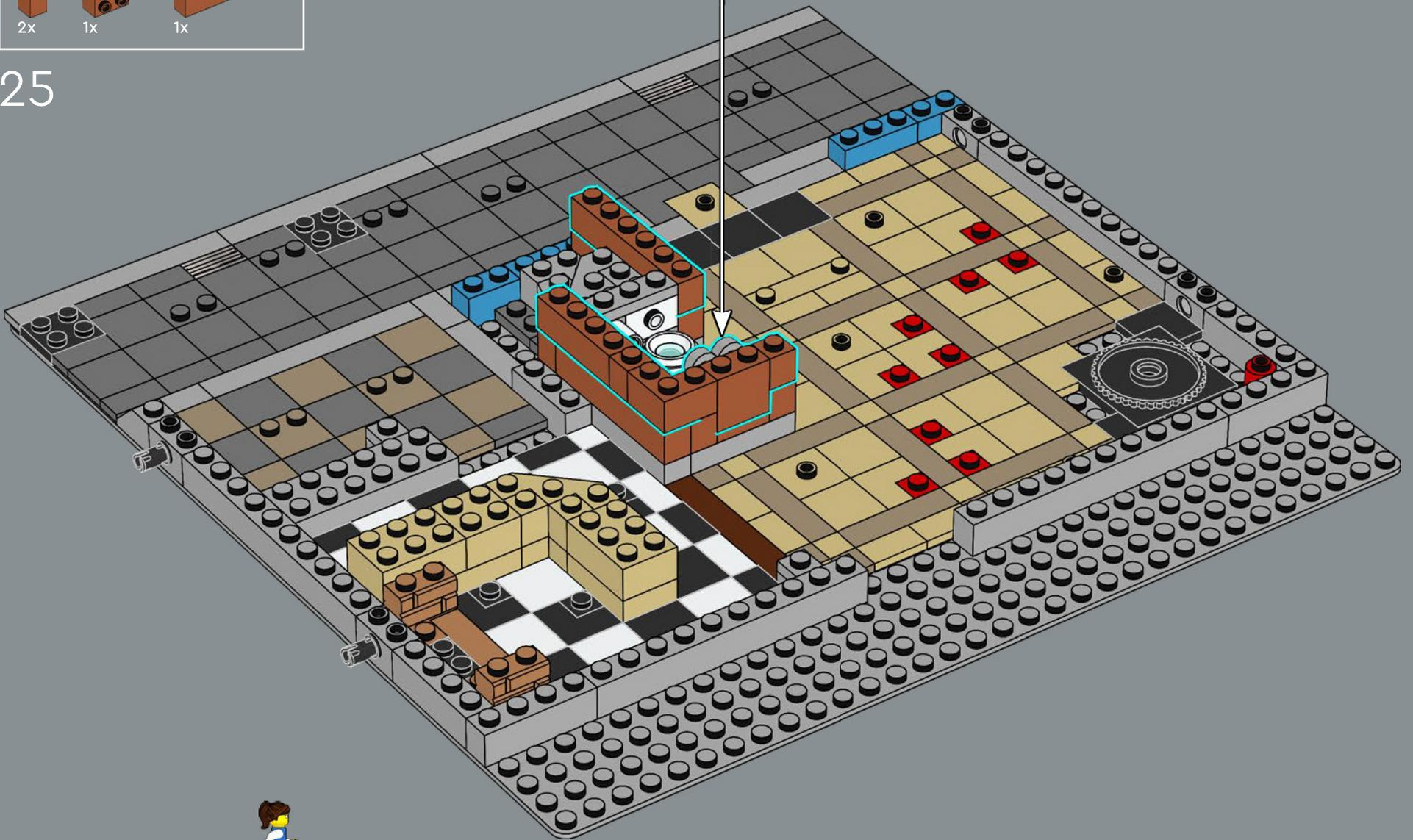

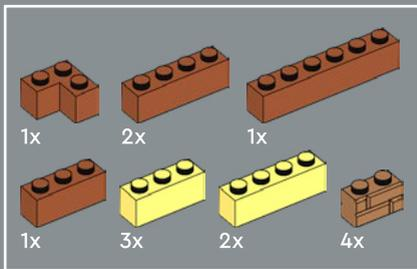

26

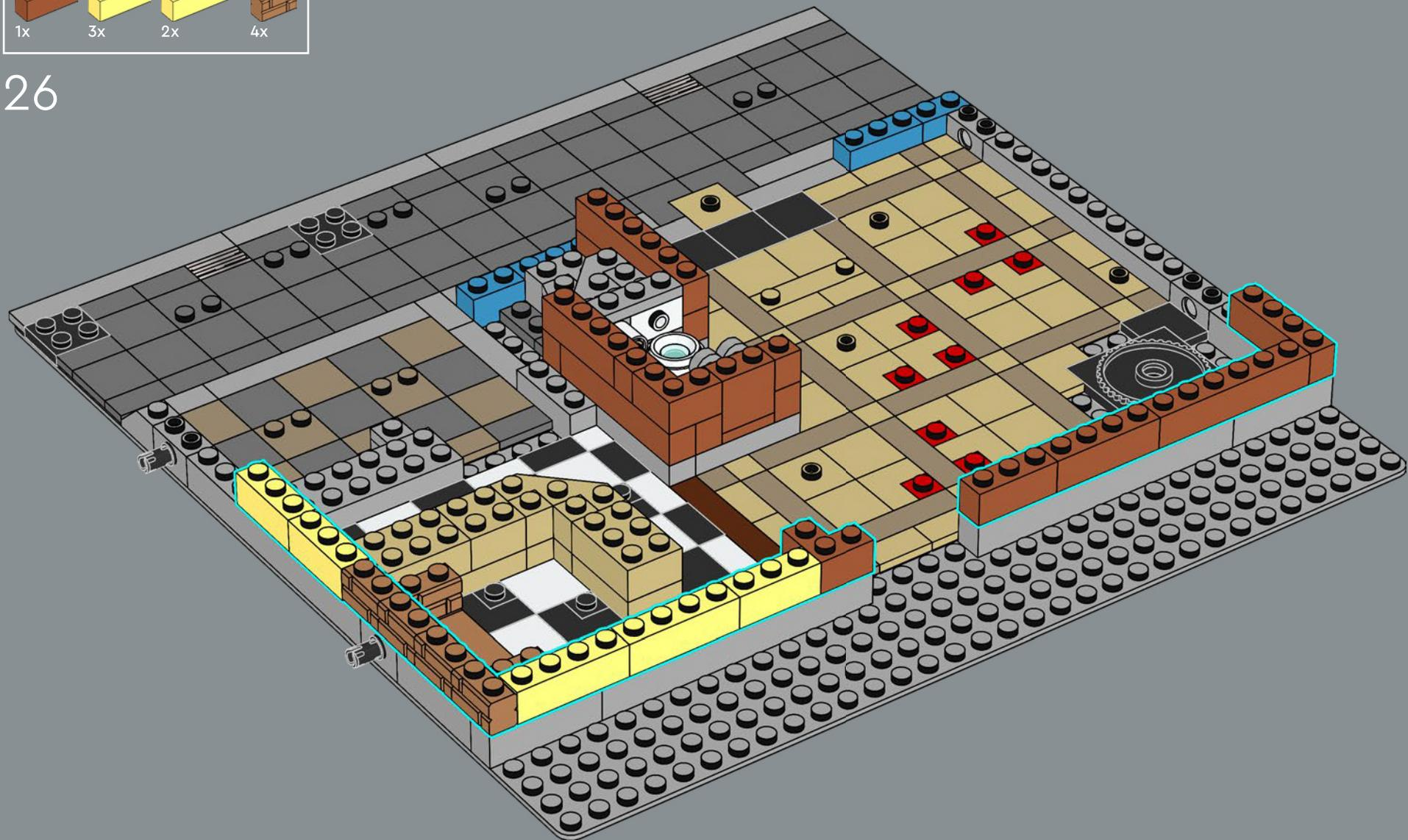

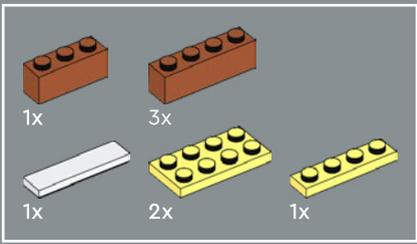

27

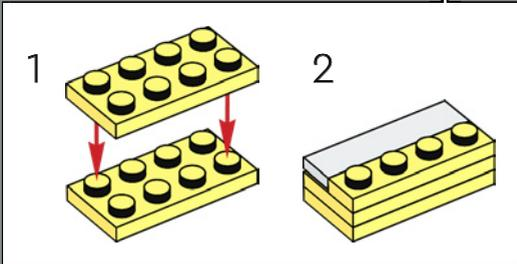
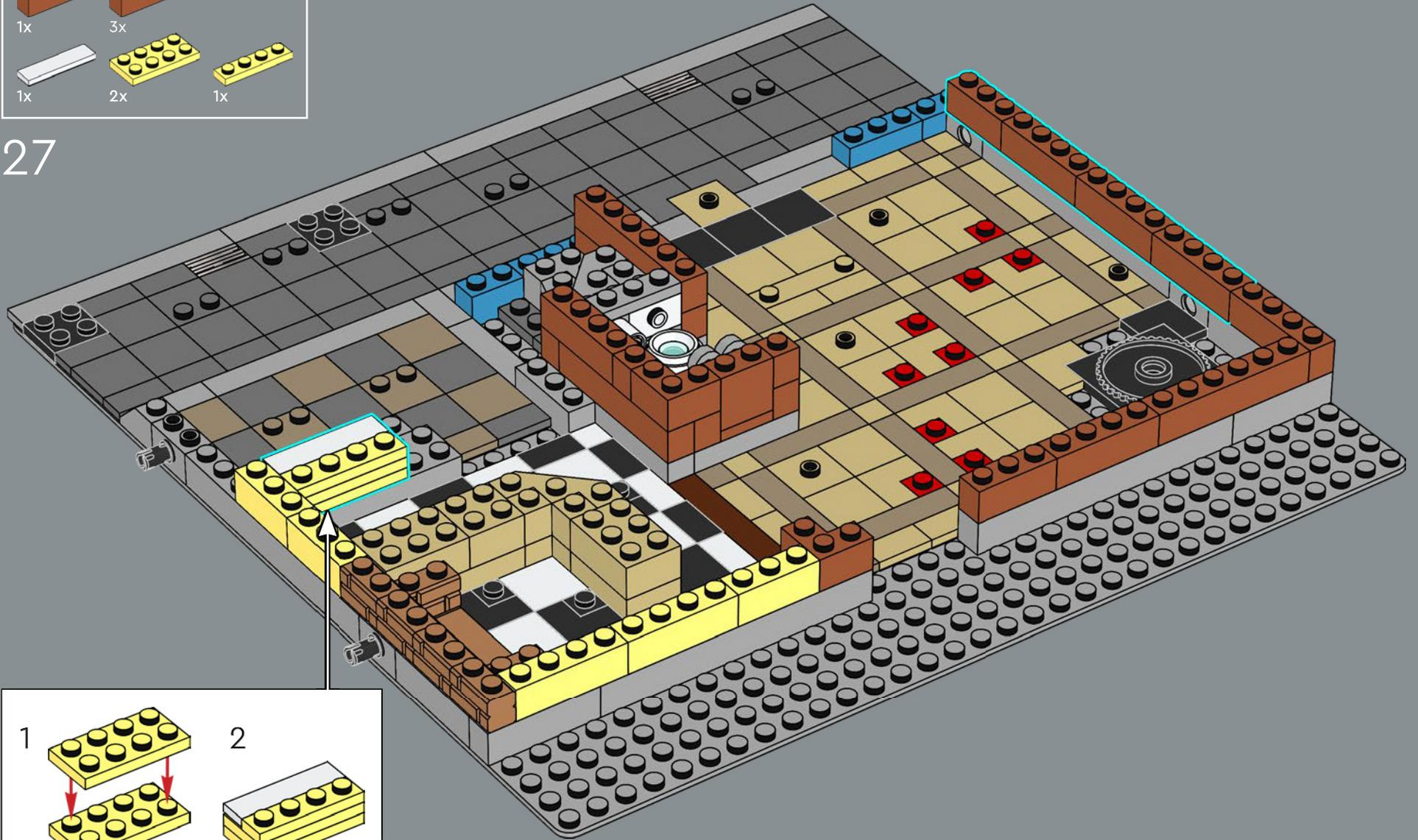

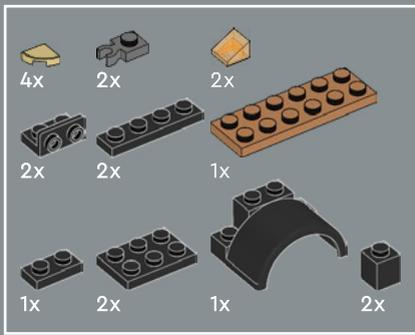

28

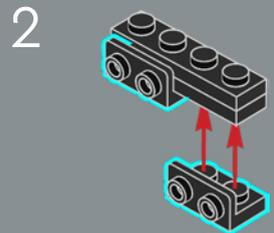
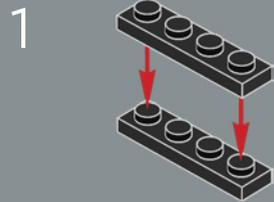

3

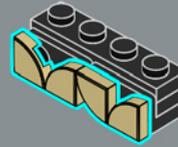

4

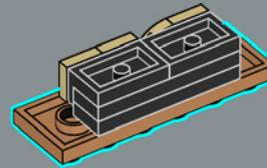

5

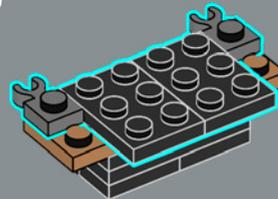

6

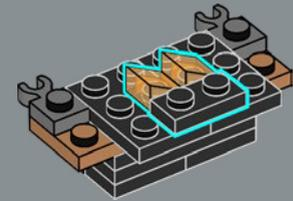

7

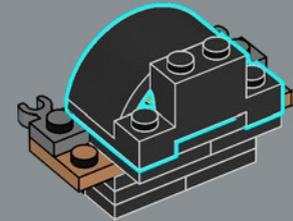

8

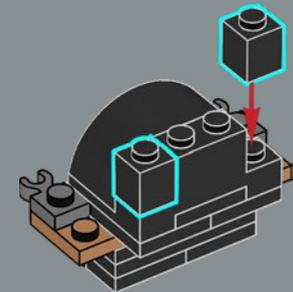

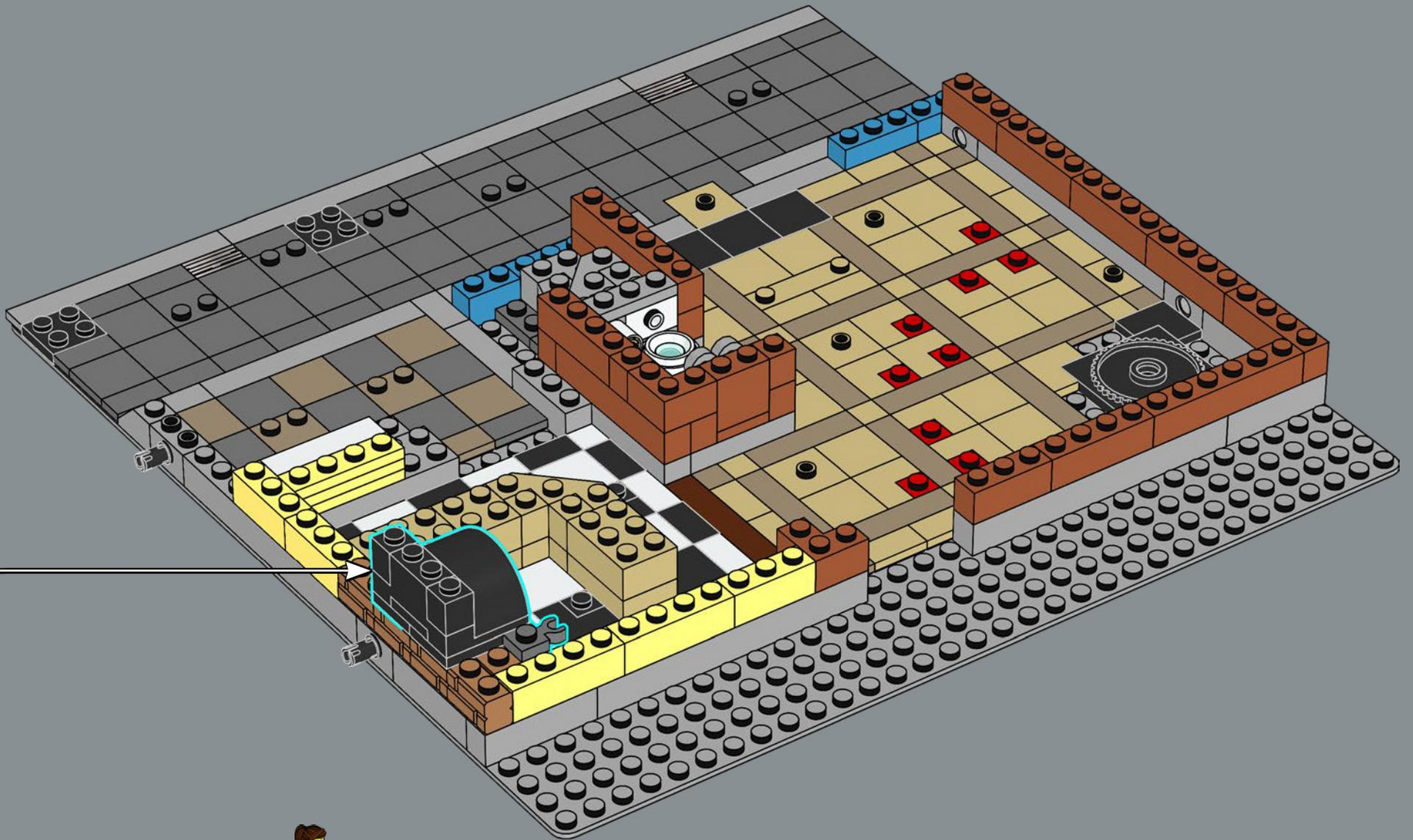

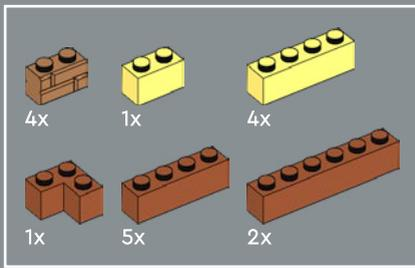

29

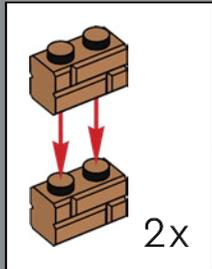
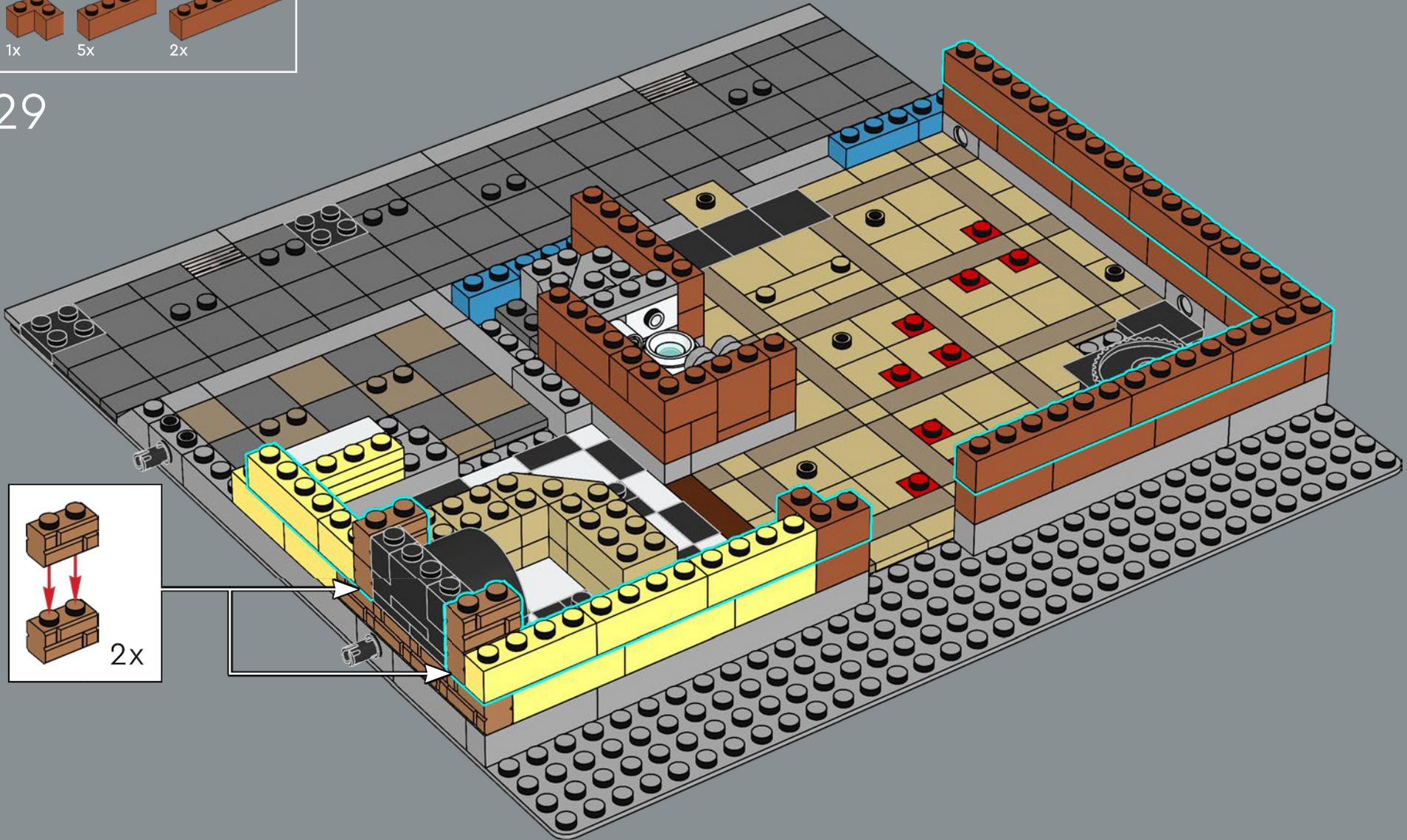

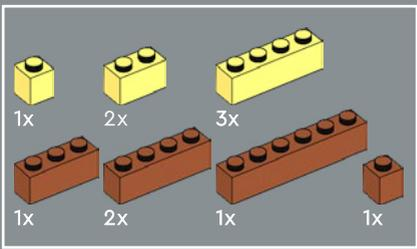

30

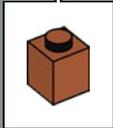
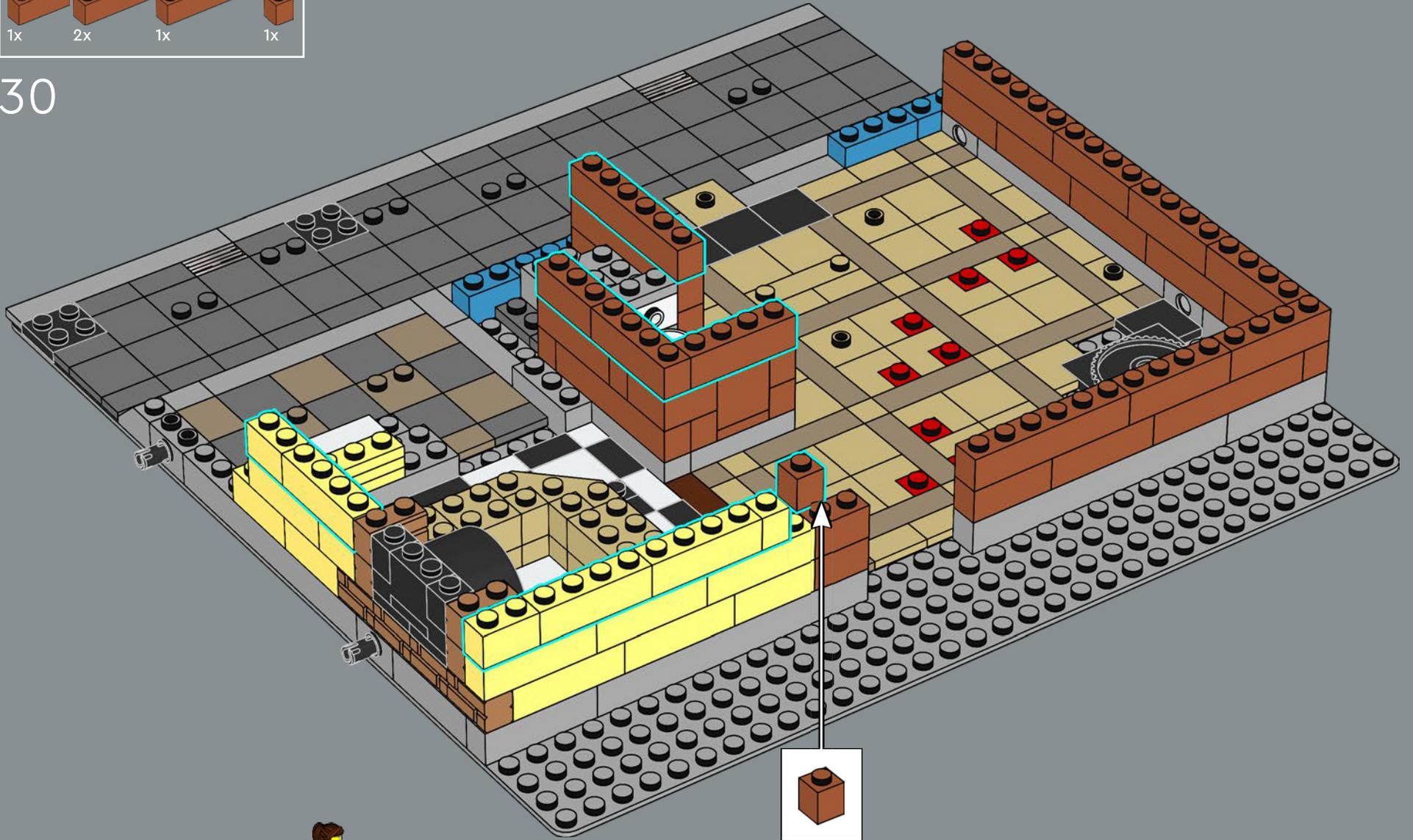



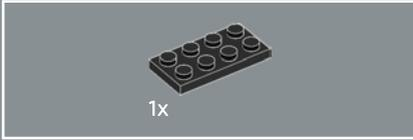
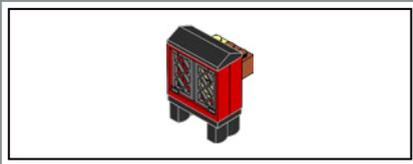

31

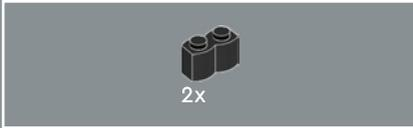
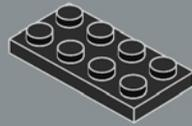

32

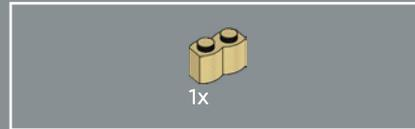
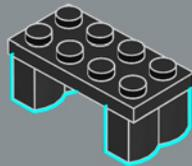

33

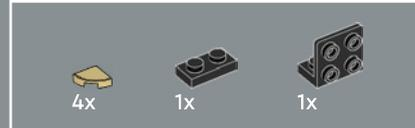
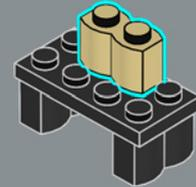

34

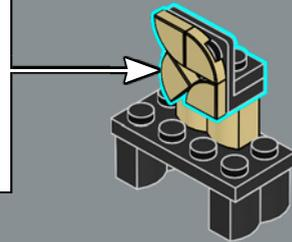
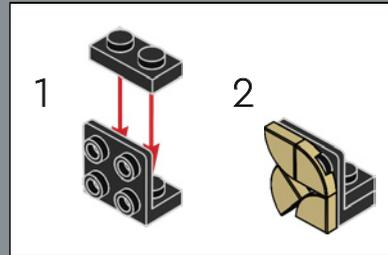

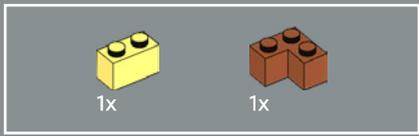

35

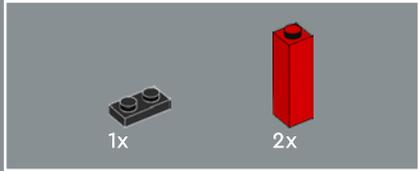
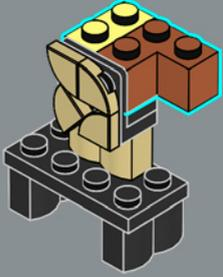

36

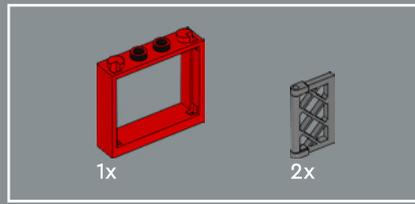
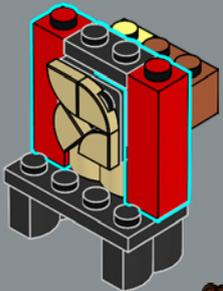

37

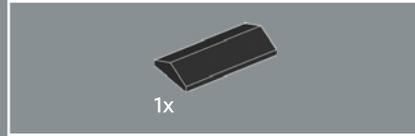
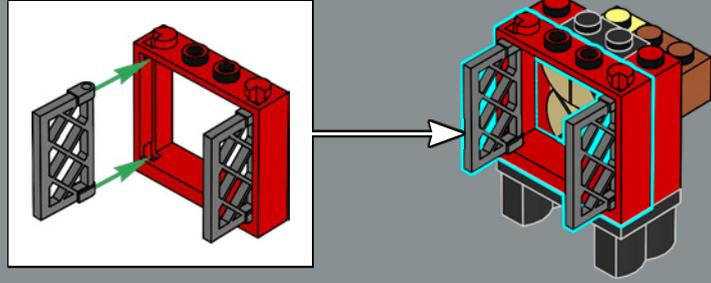

38

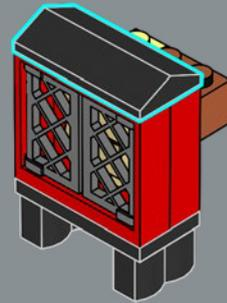



Der Holzofen für köstliche Pizzen glüht und ist einsatzbereit. Weiteres Brennholz lagert hinter dem Gebäude.

39

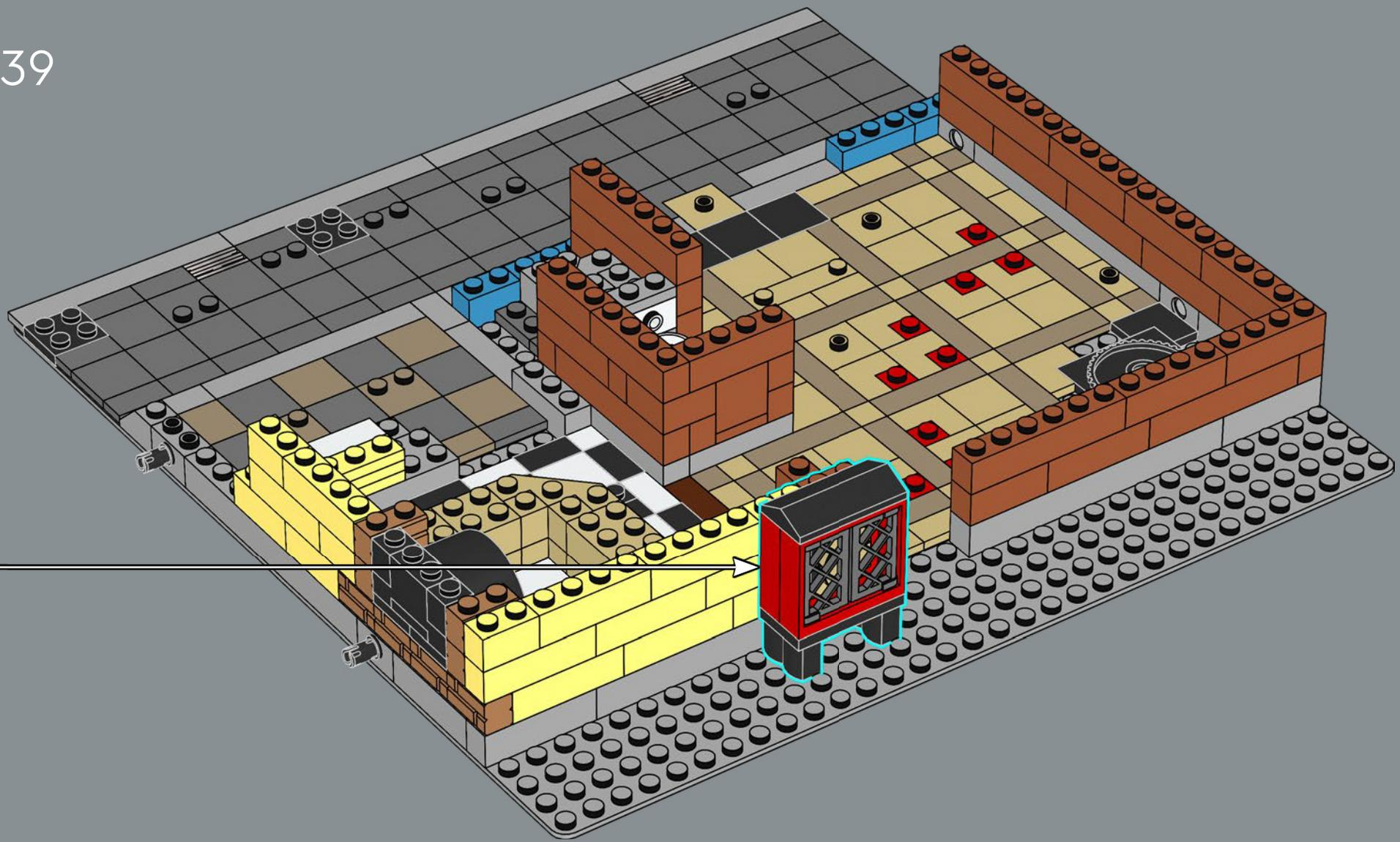

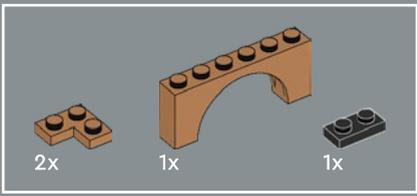

40

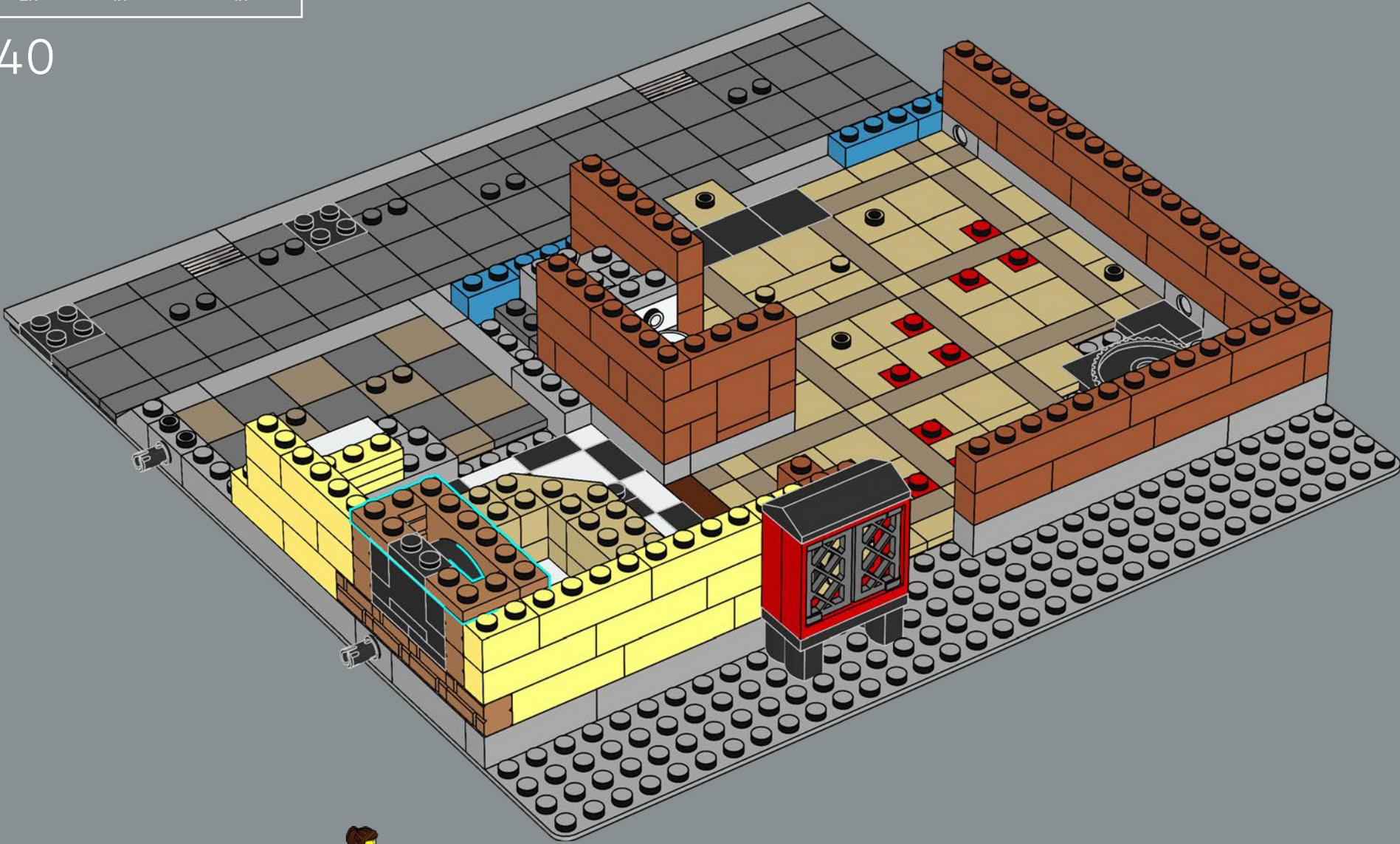

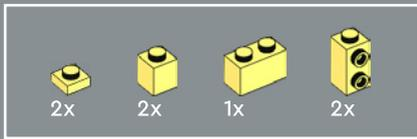

41

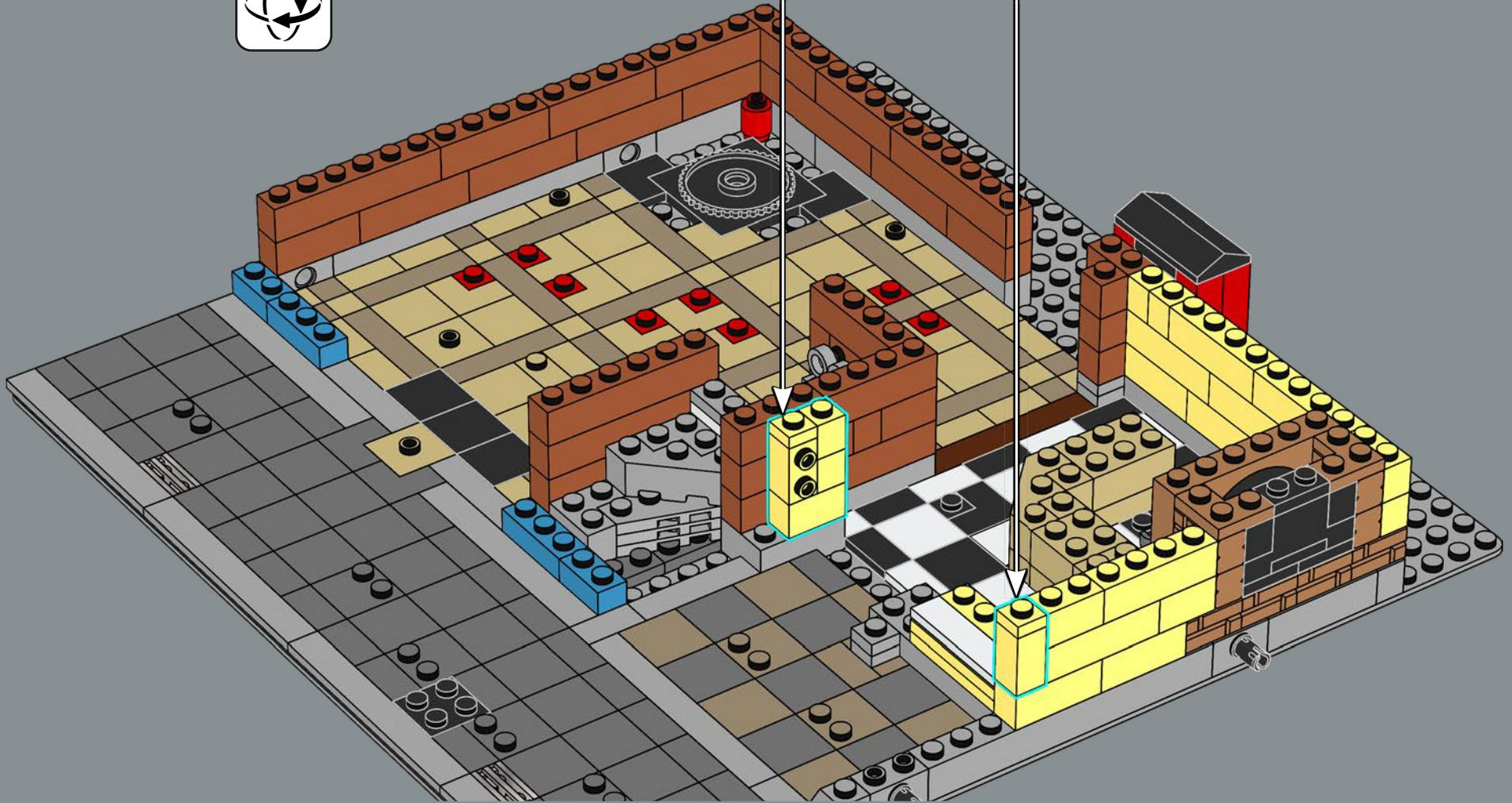
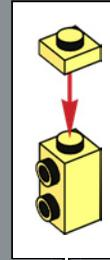
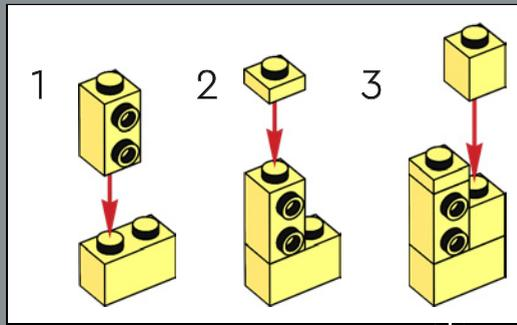

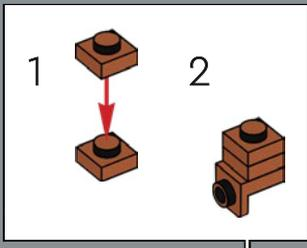
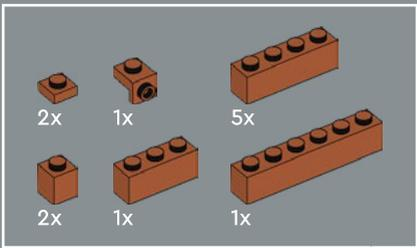

42

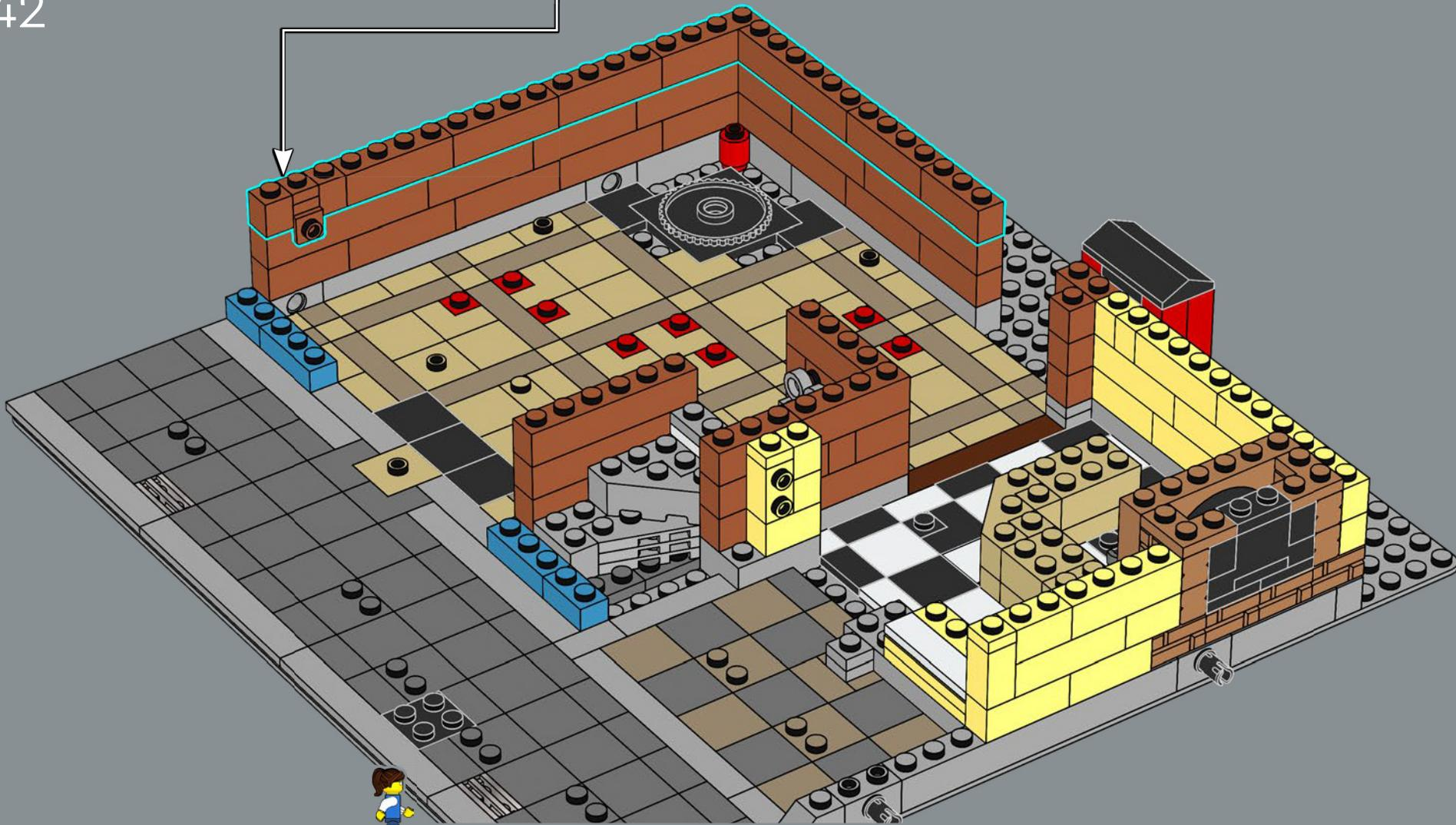

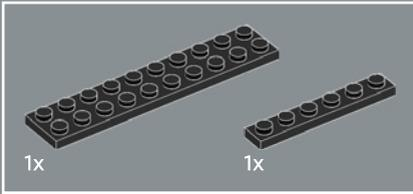
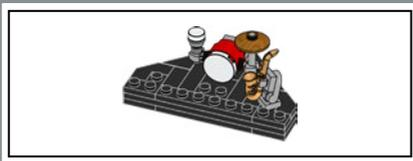

43

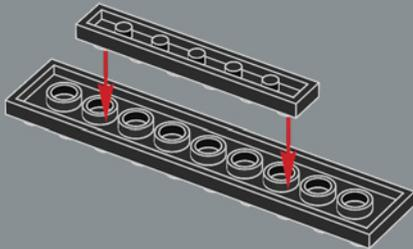

44

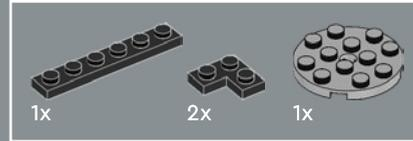
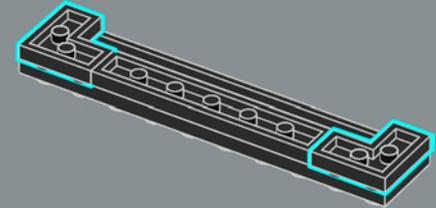

45

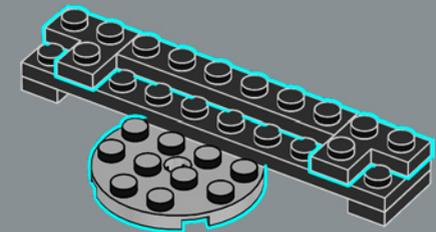
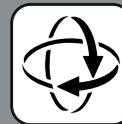

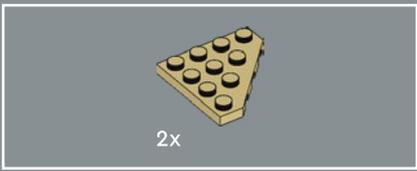

46

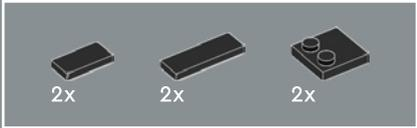
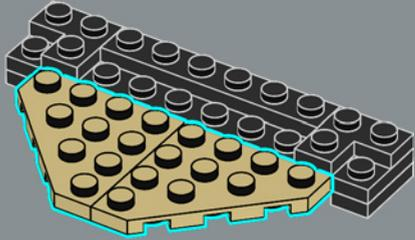

47

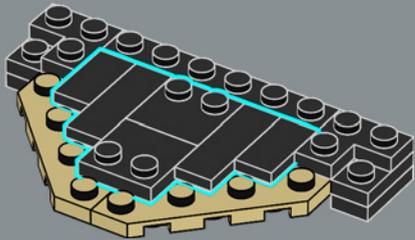

48

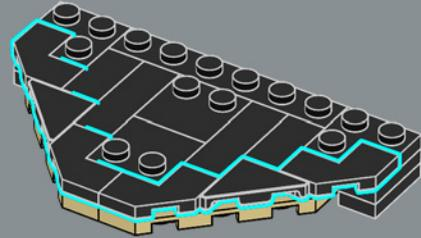



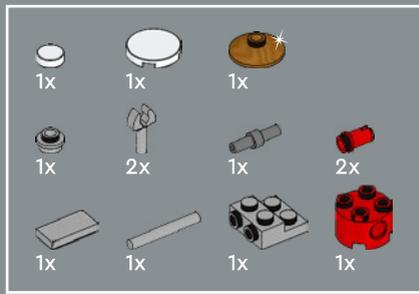

49

1

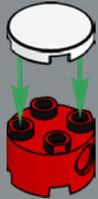

2

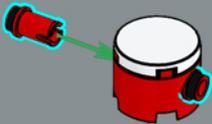

3

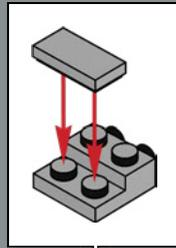

4

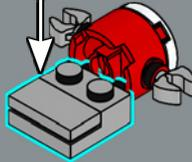

5

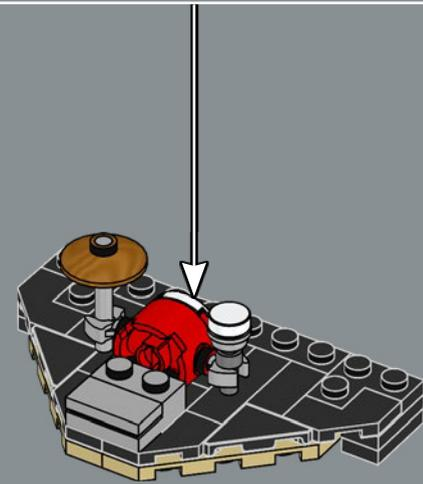
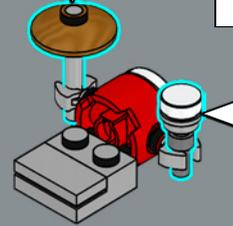
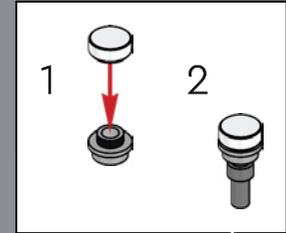
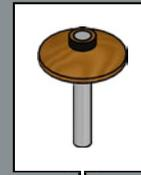



Hörst du auch das „bumm-tsch“ von Bass- und Rührtrommel und das „tss-t-t-tss“ des Beckens?

50

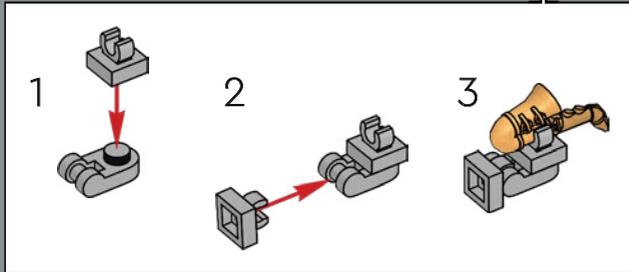
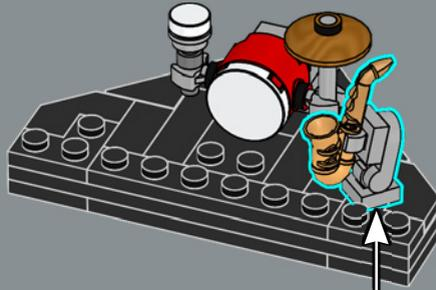

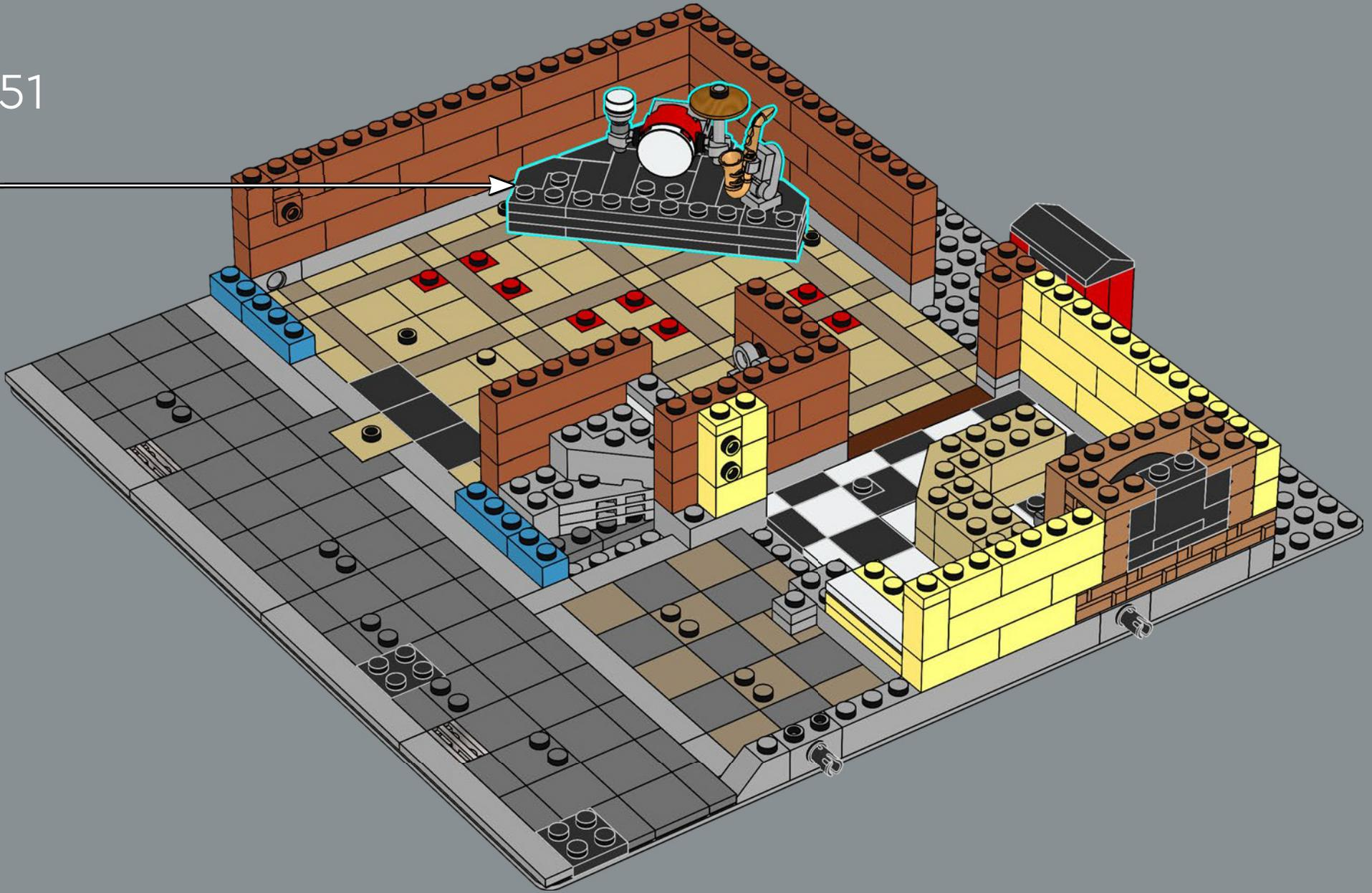



Der Pizzabäcker baut im Gewächshaus auf dem Dach einige seiner Zutaten selbst an. Weiteres Gemüse kauft er ganz frisch beim LEGO® Green Grocer (10185).

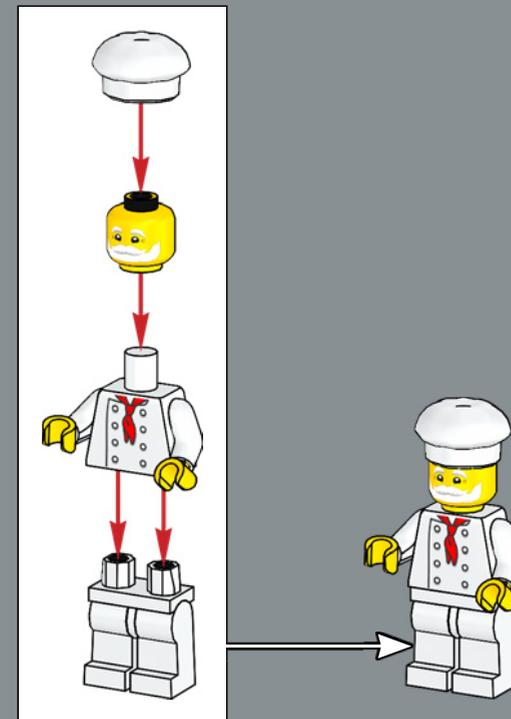





52

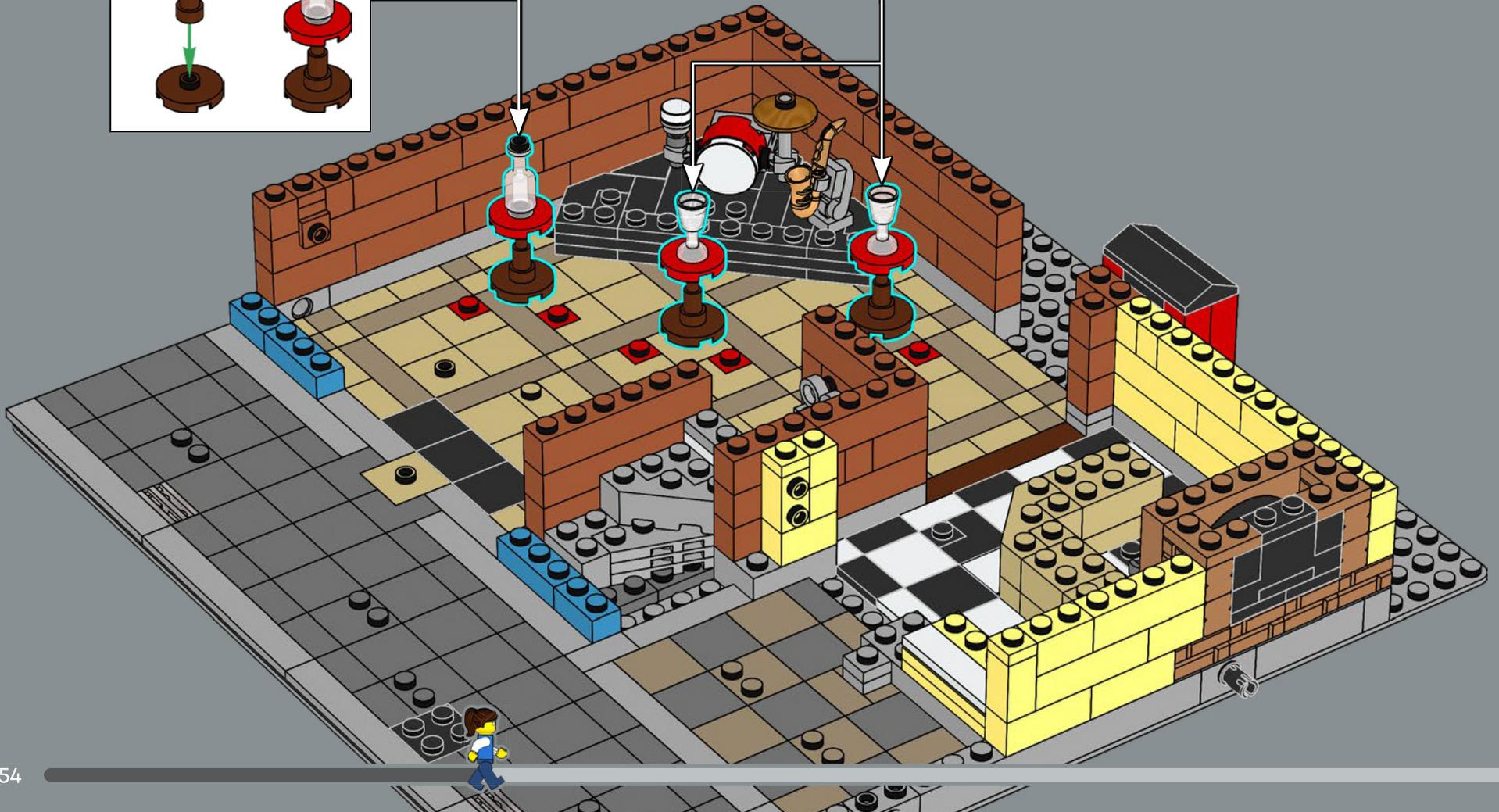
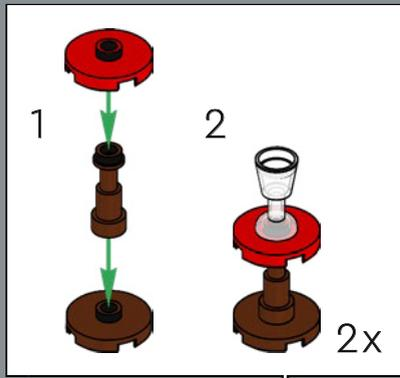
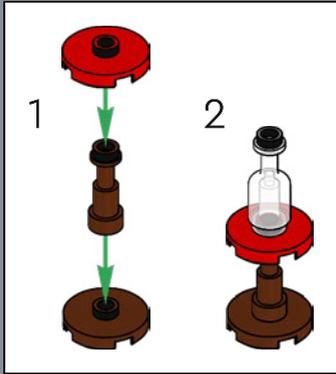

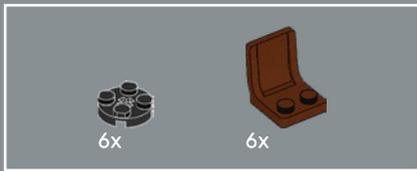

53

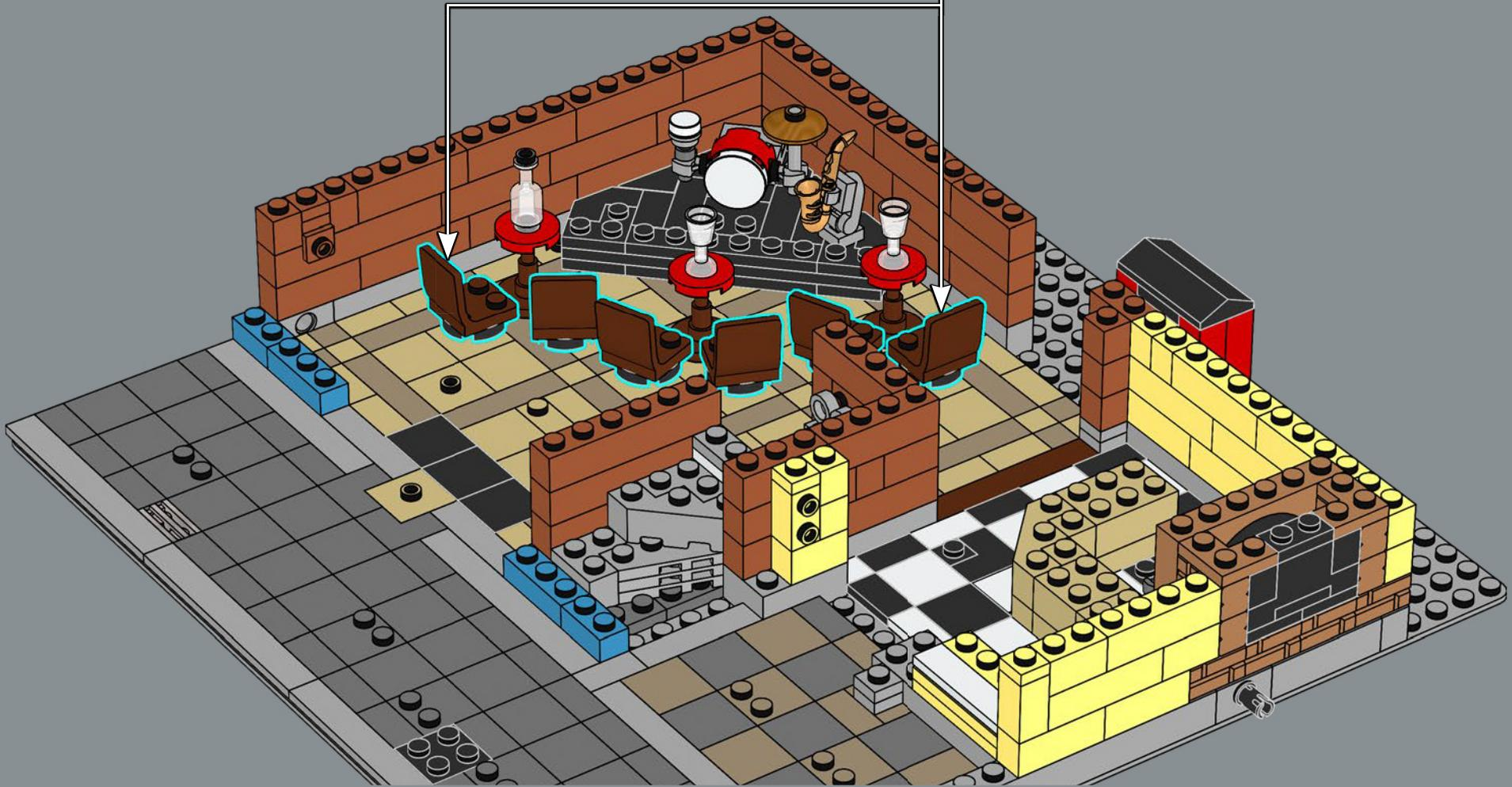
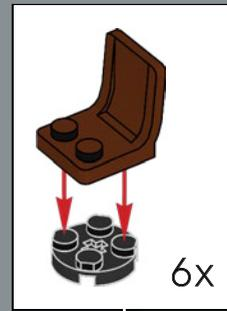

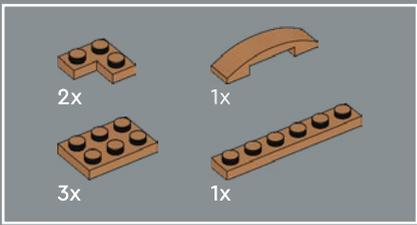

54

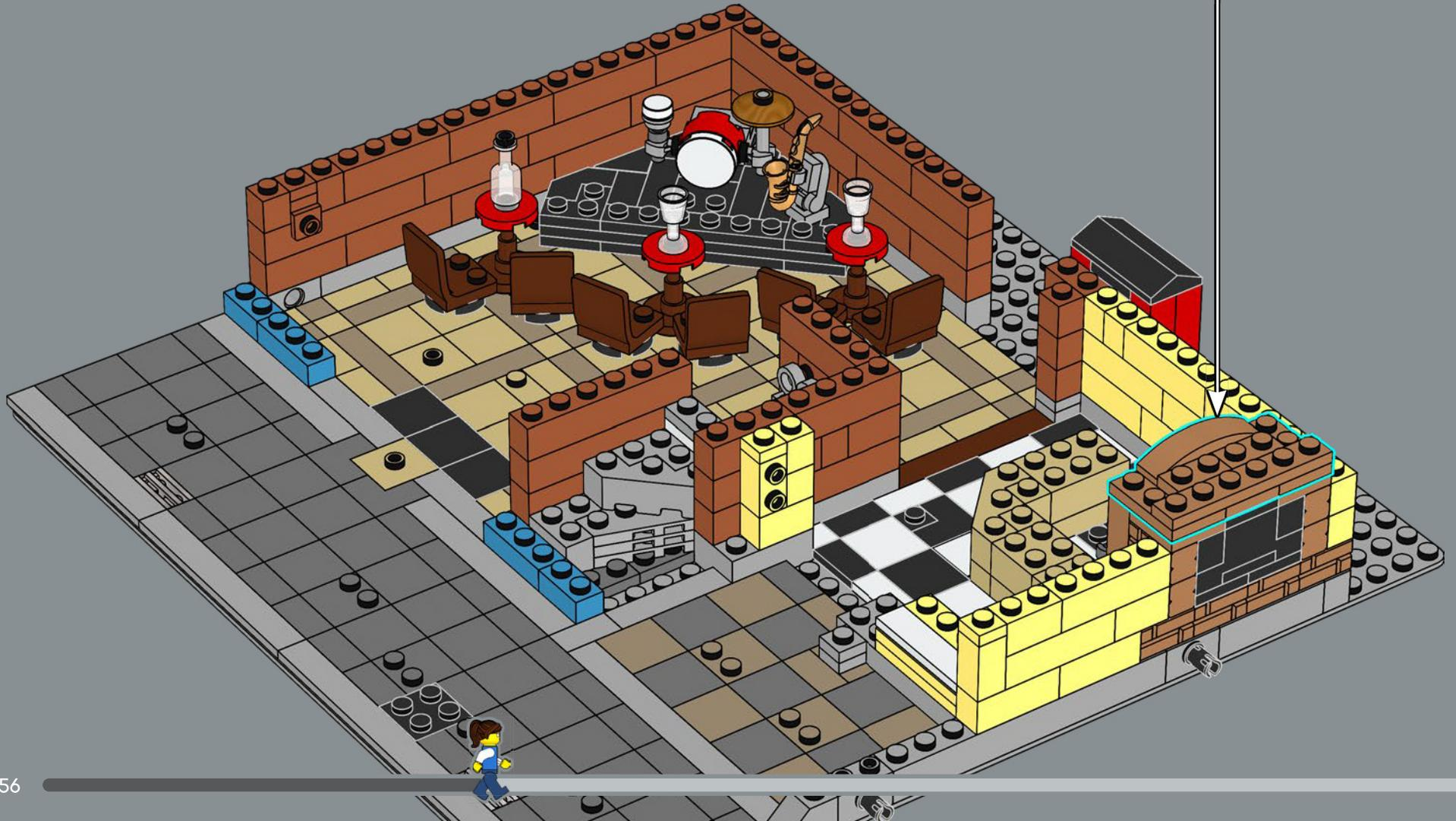
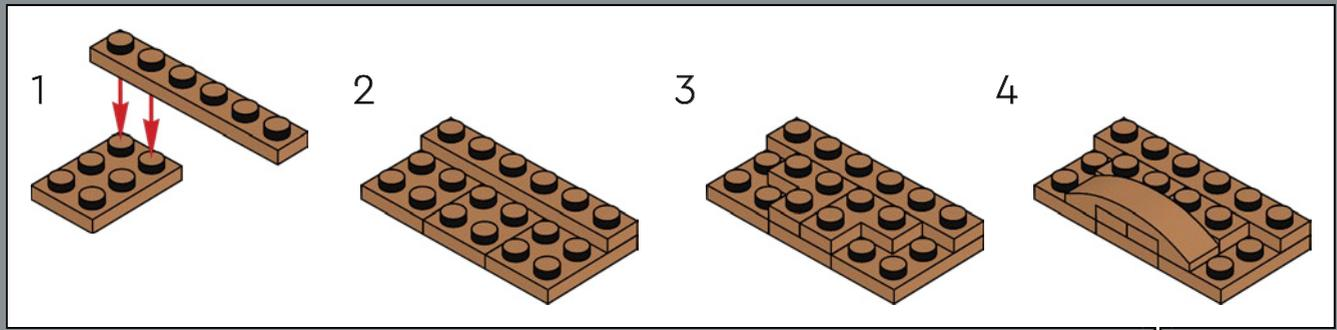



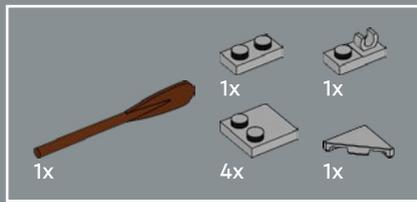

55

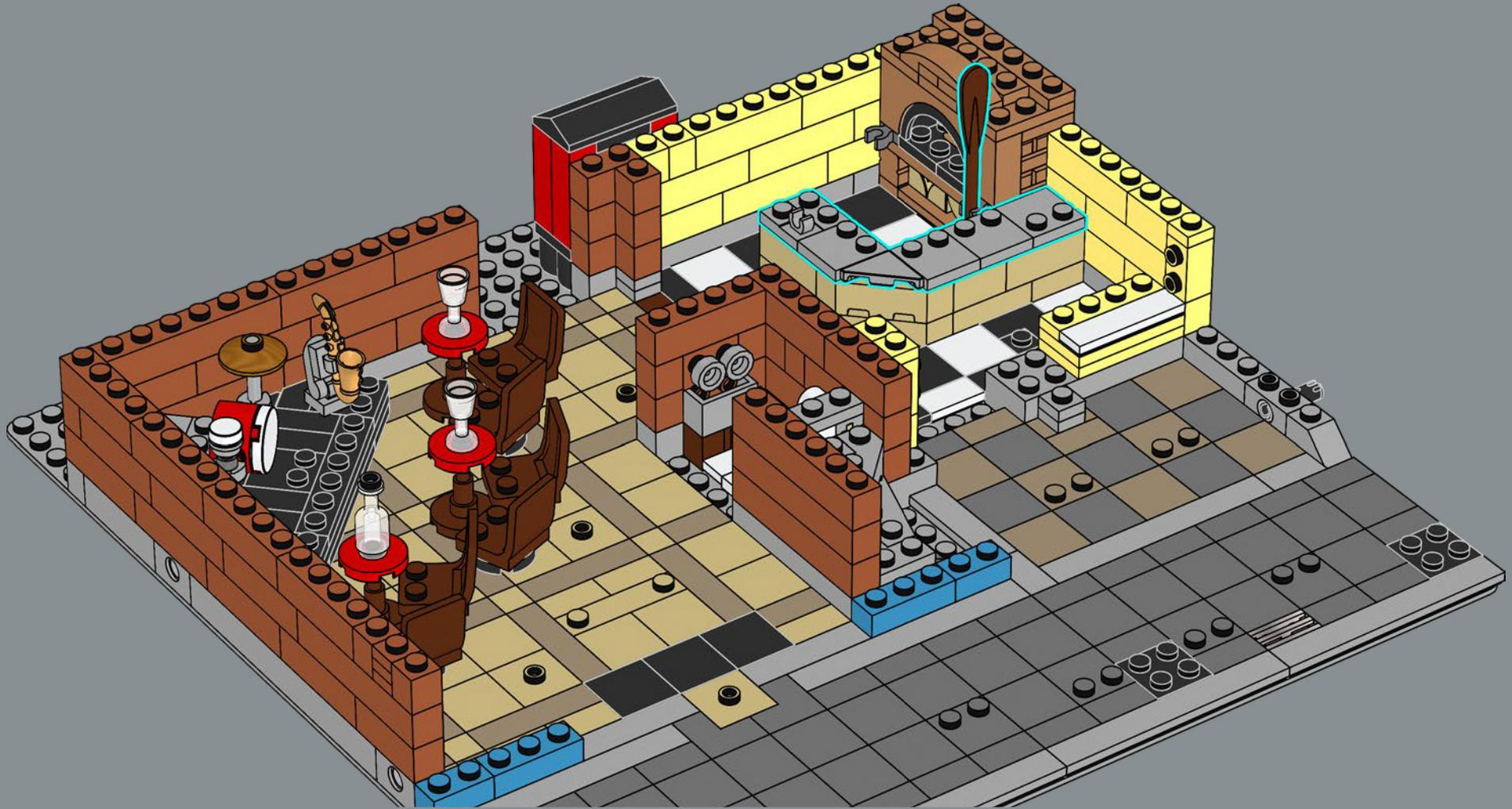

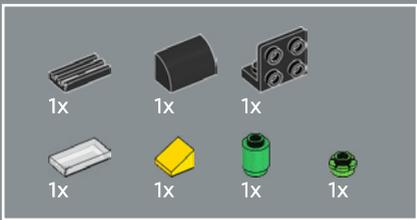

56

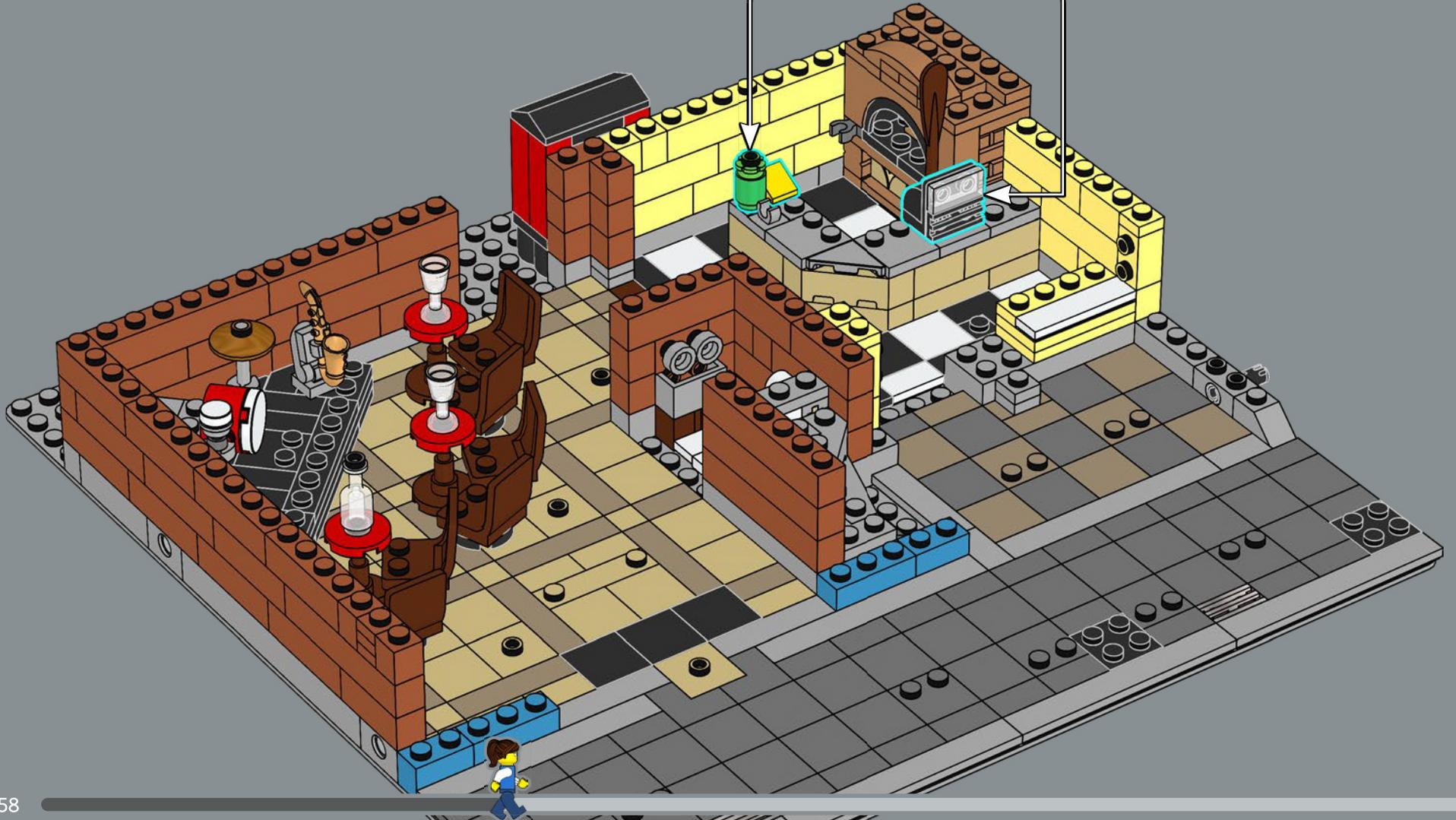
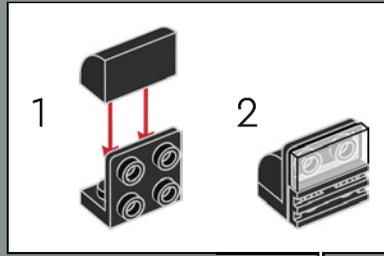
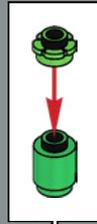

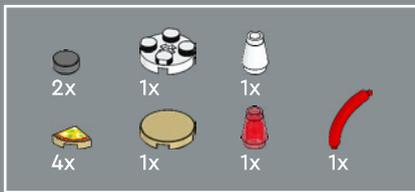

57



Hier kommt eine köstliche Pizza Margherita!  
Die Kunden können die Pizza im Ganzen oder  
einzelne Stücke davon kaufen.

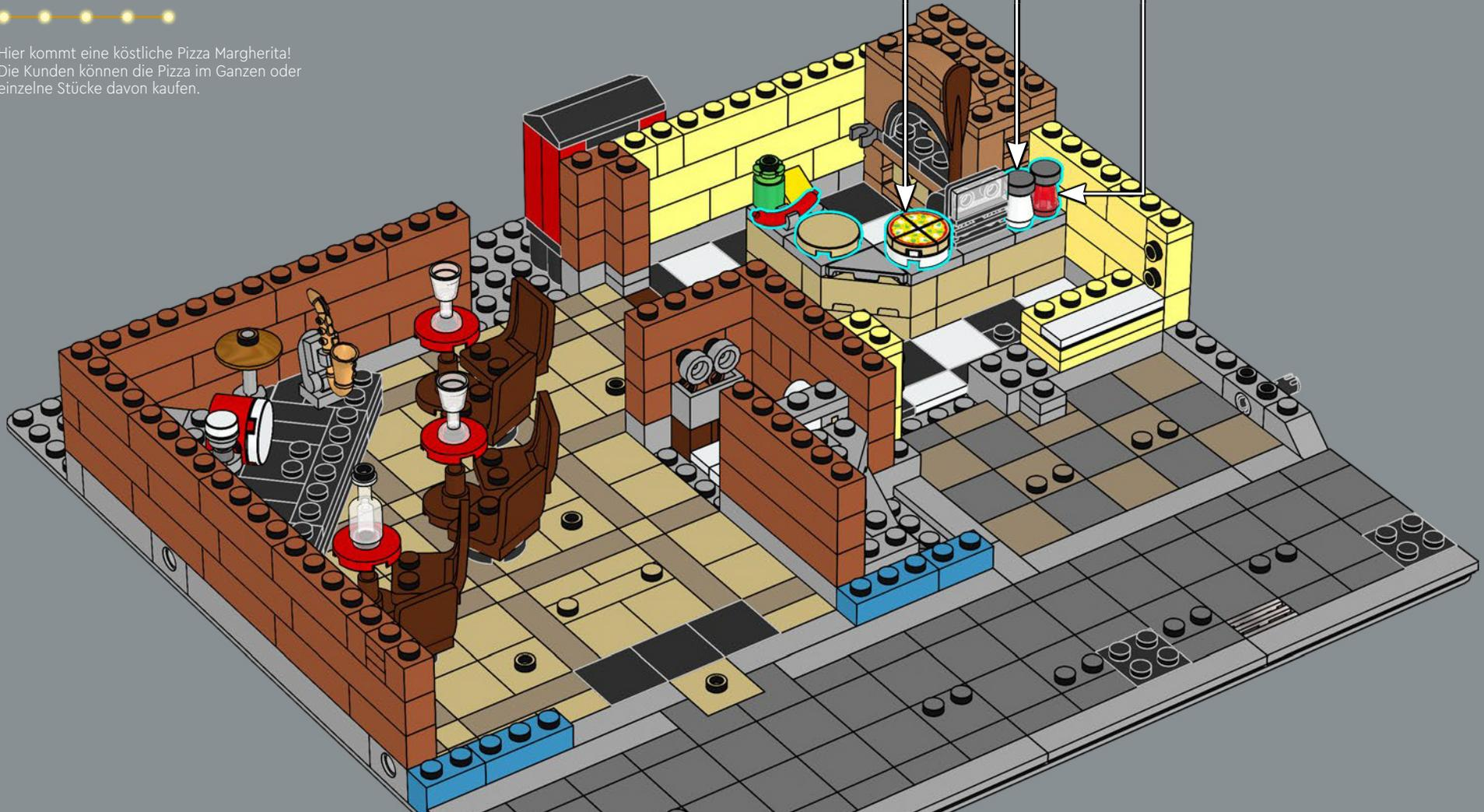

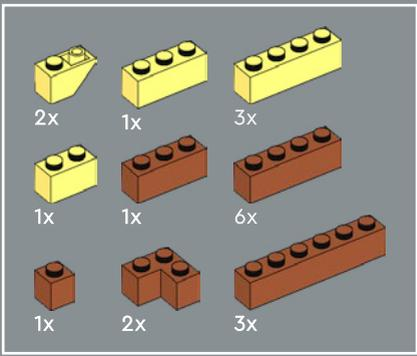

58

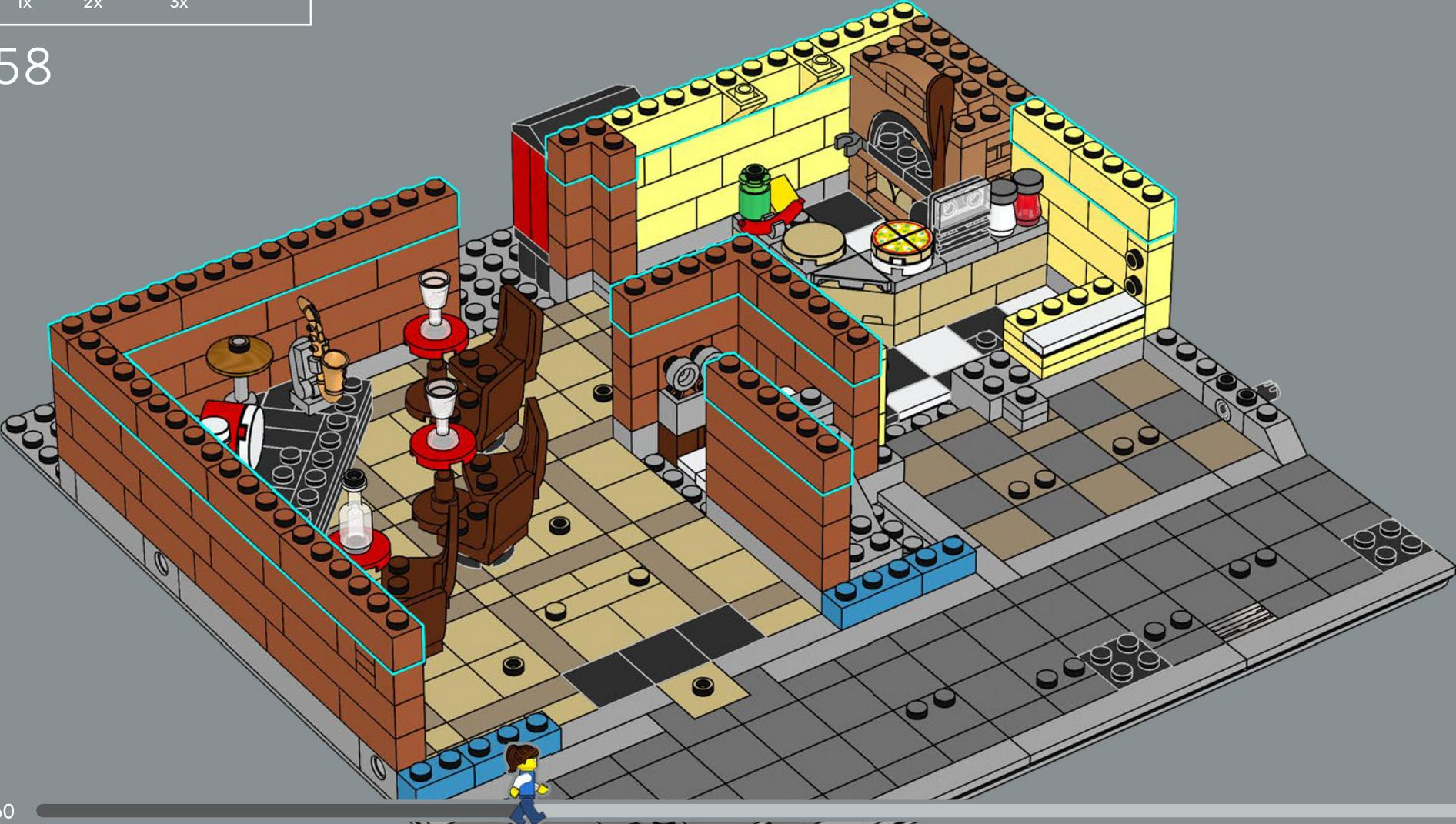

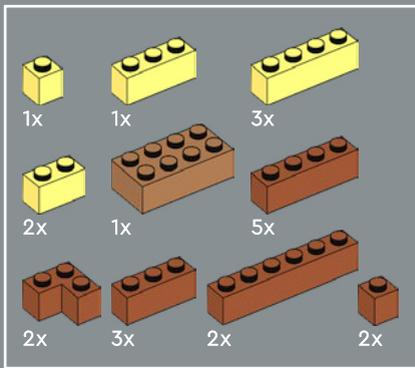

59

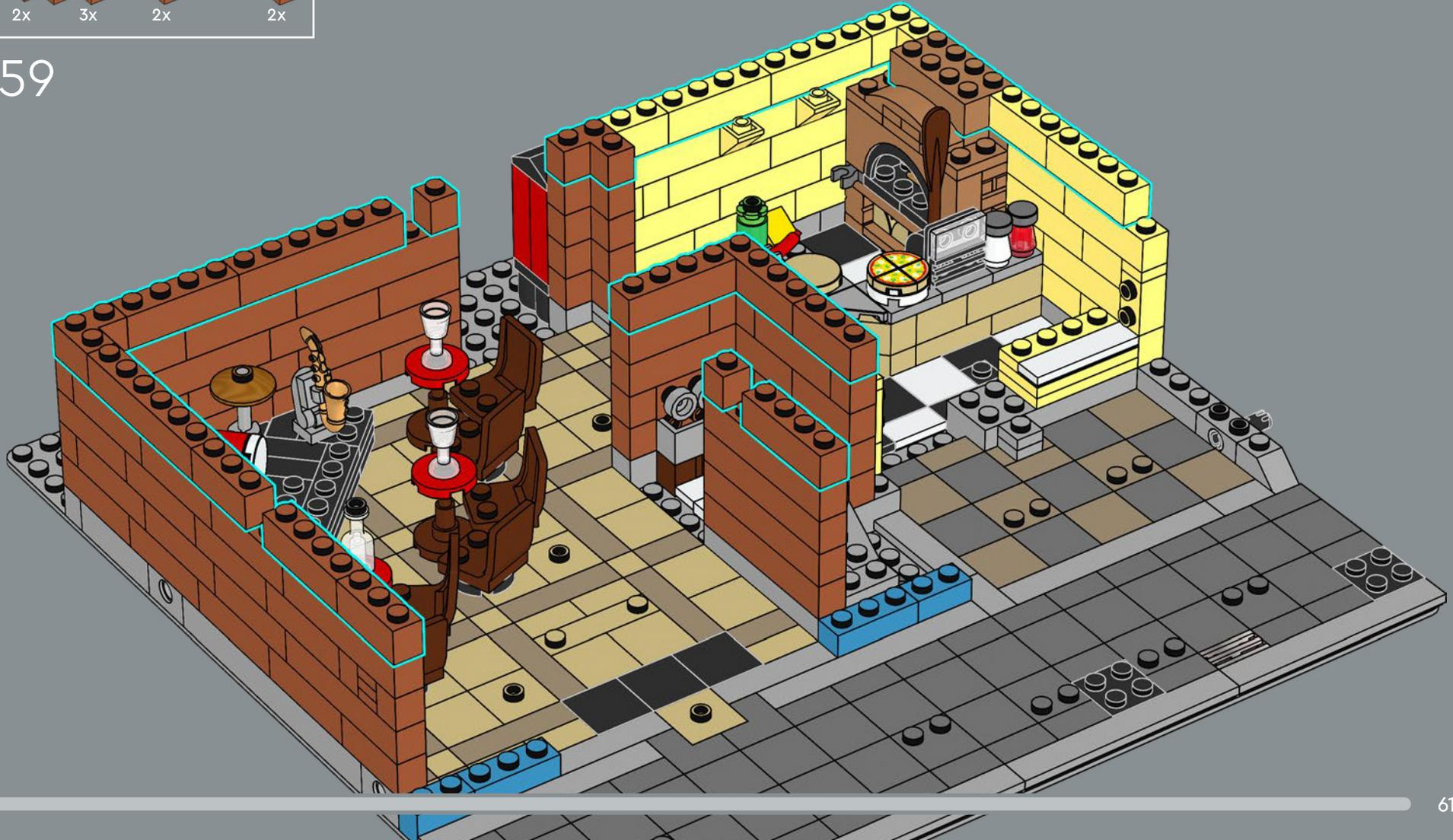

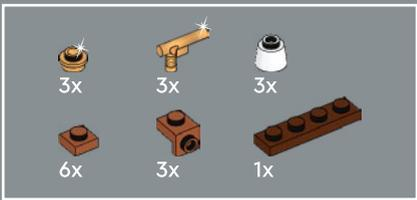

60

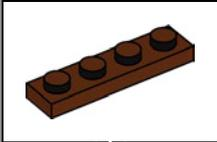
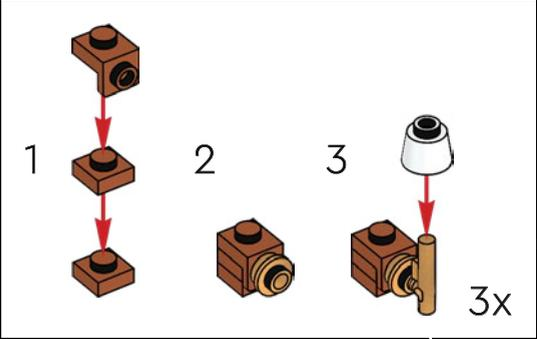

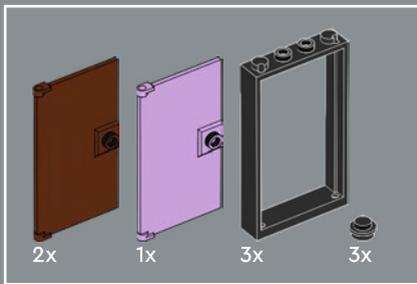

61

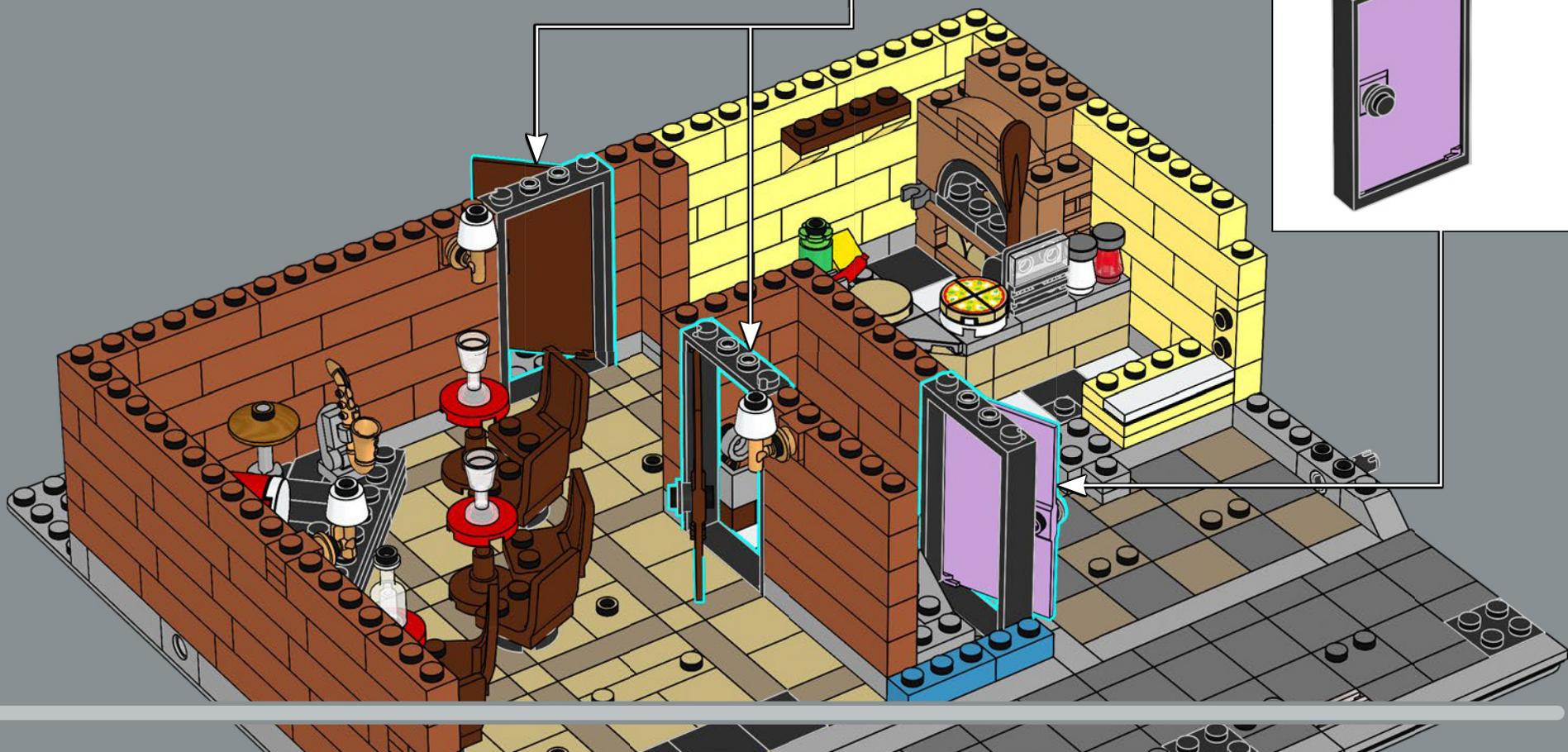
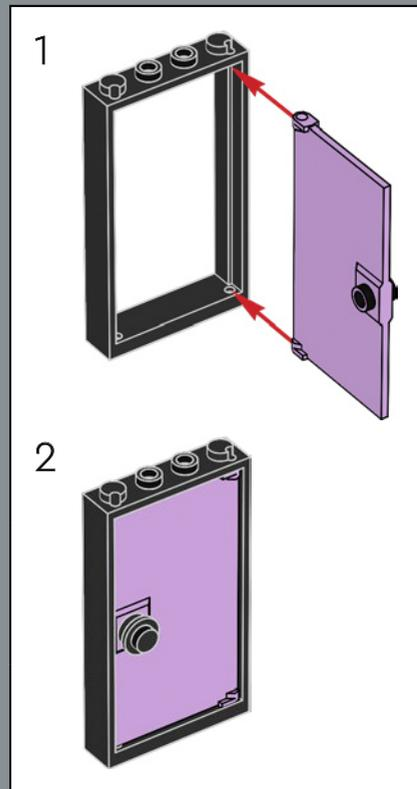
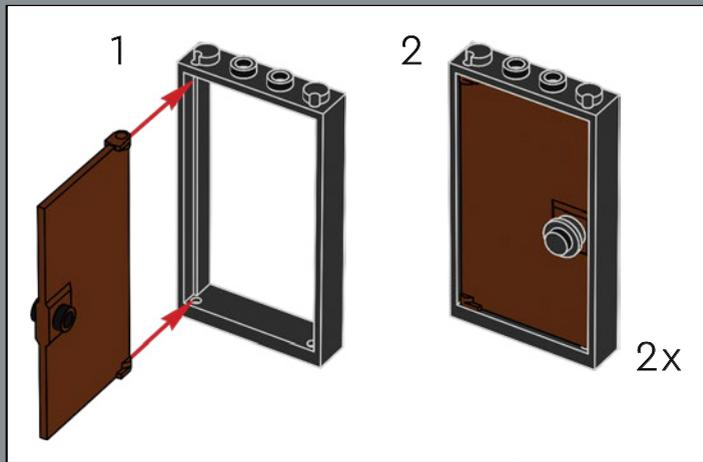

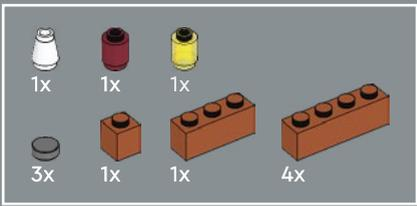

62

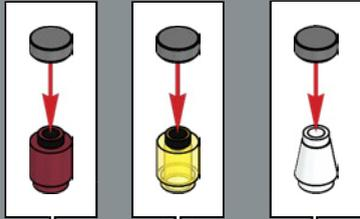



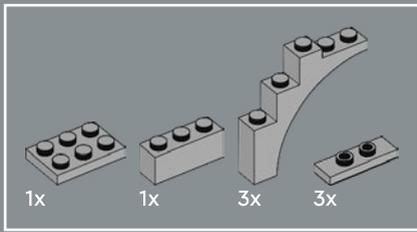

63

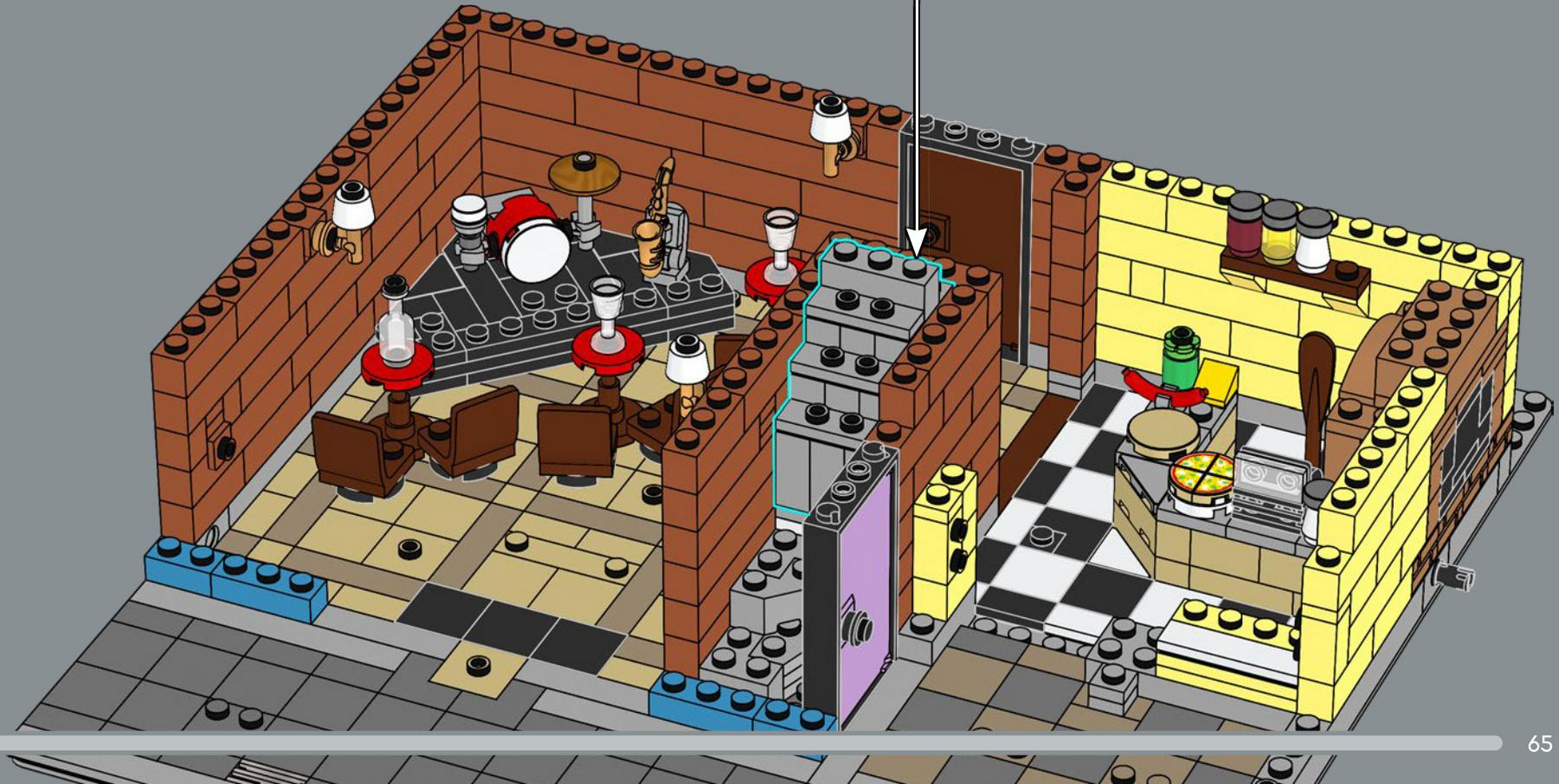
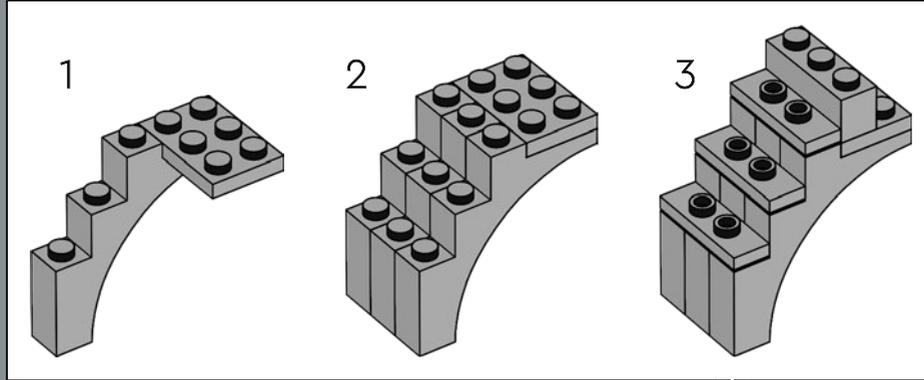

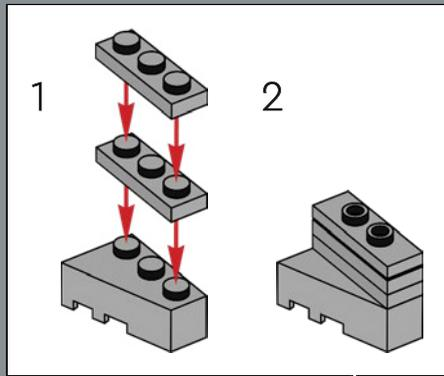
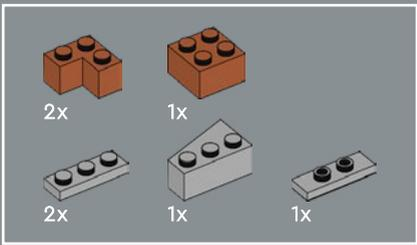

64

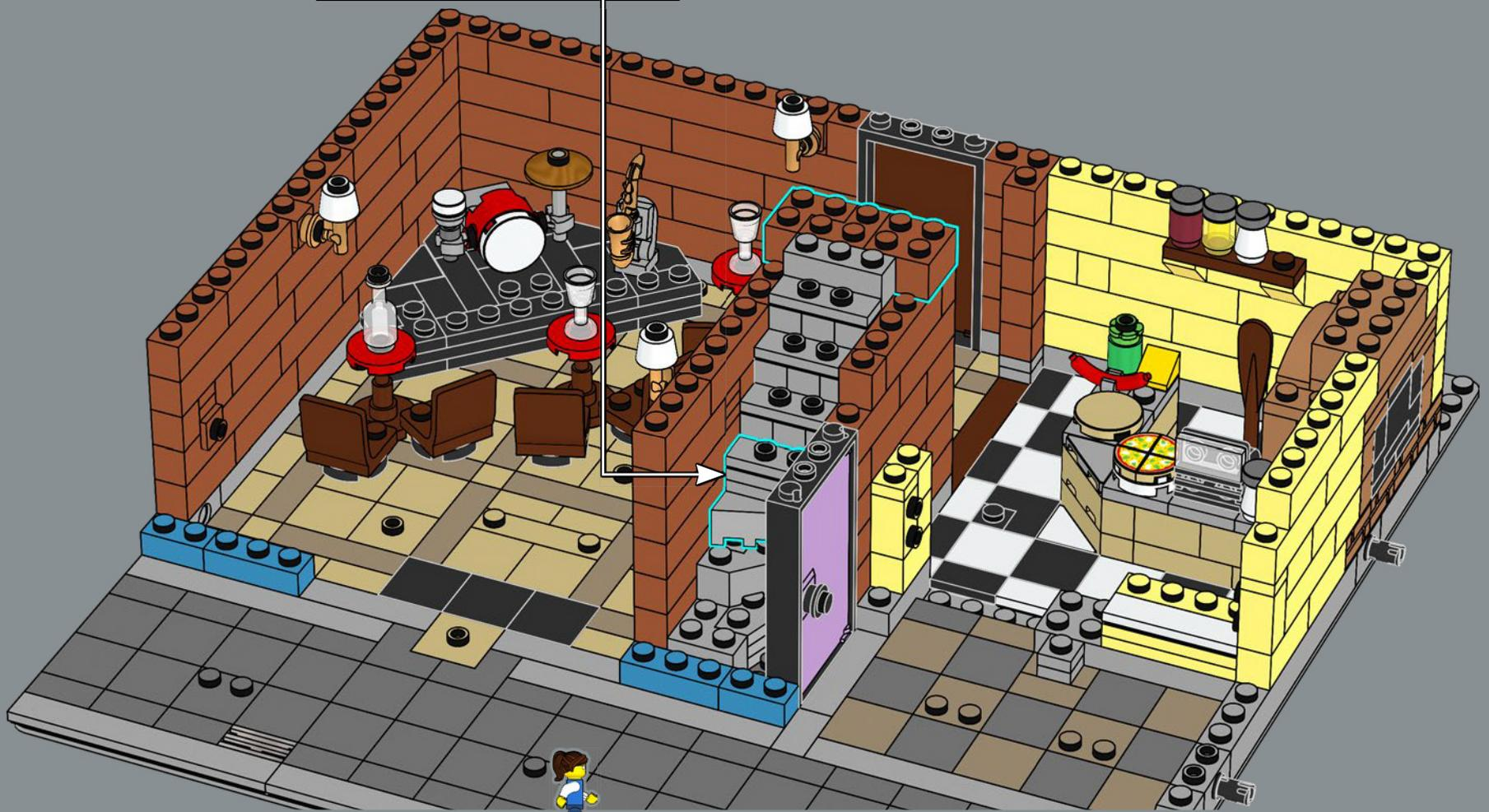

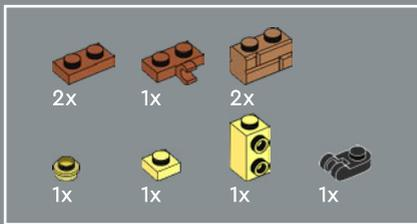

65

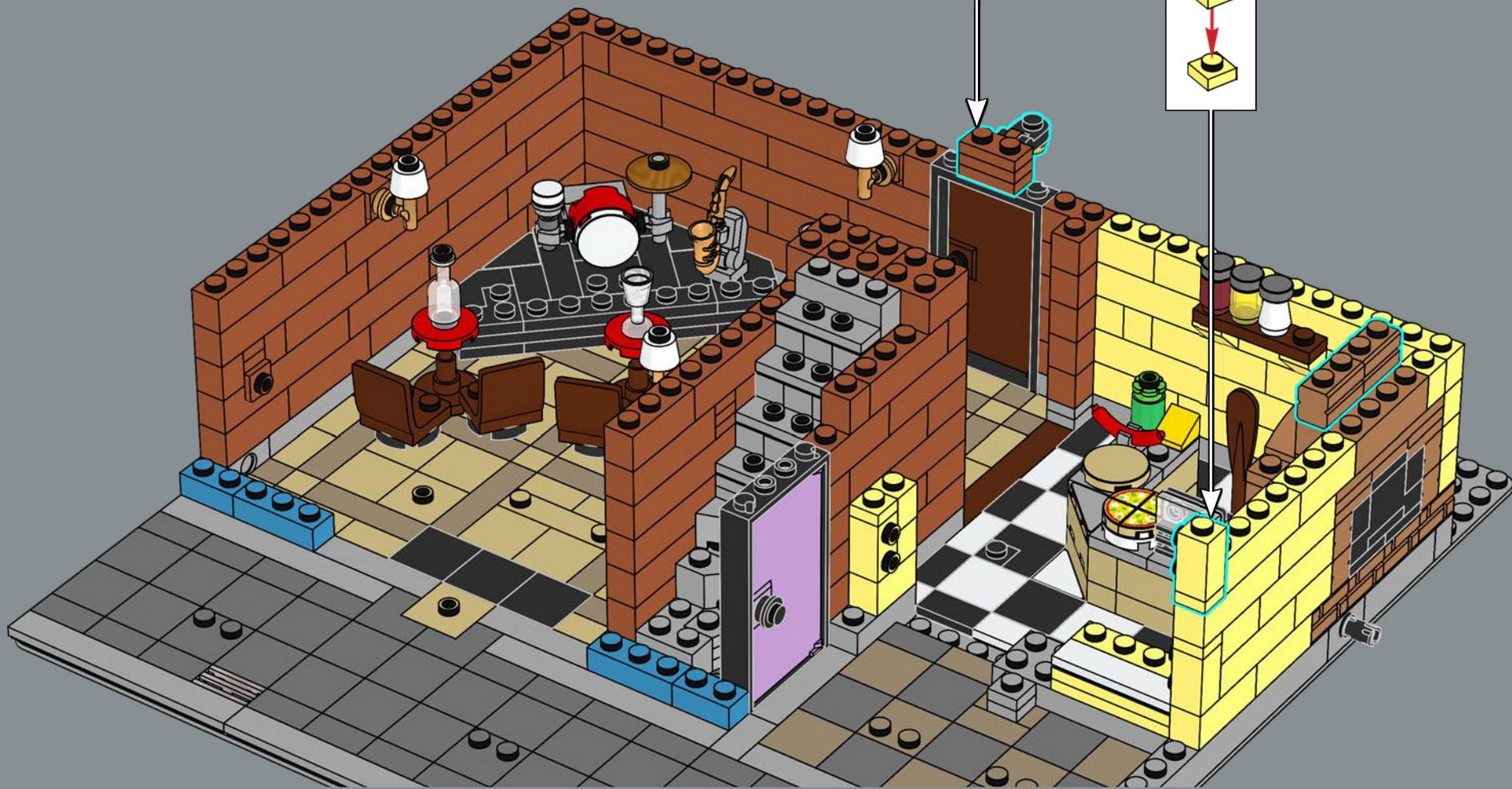
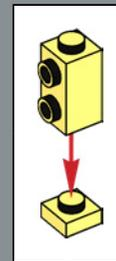
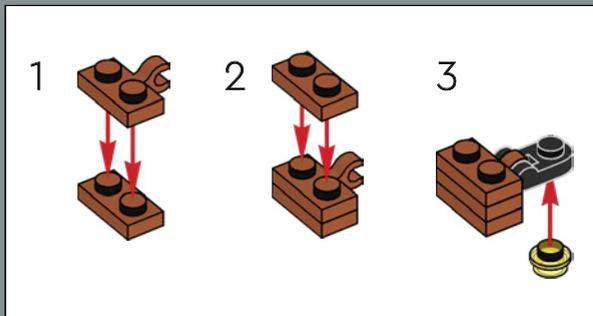

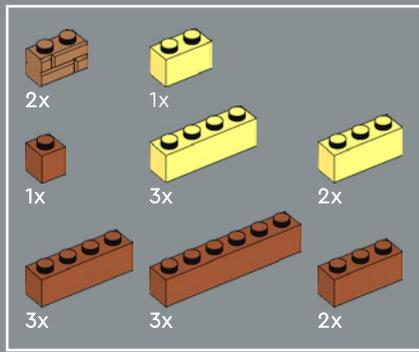

66



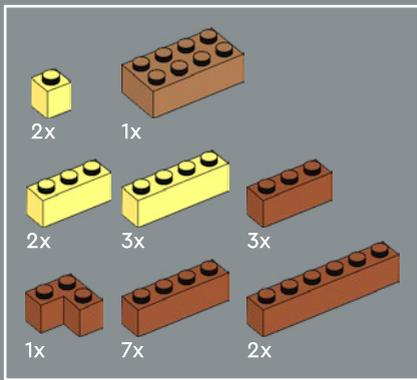

67



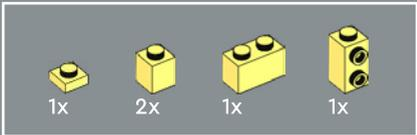

68

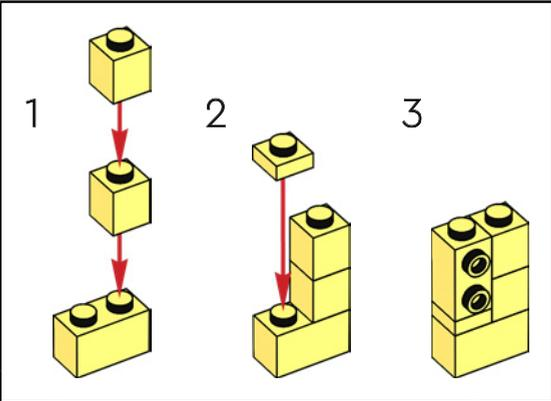



6

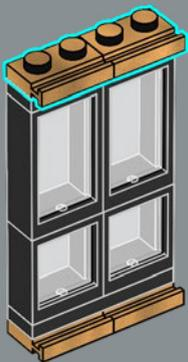

7

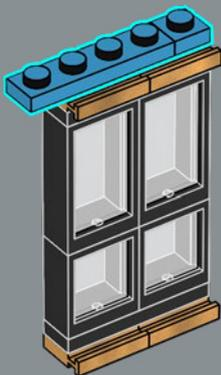

8

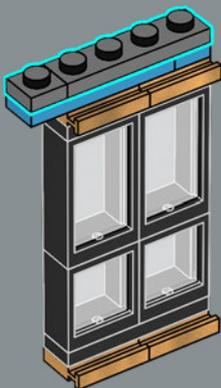

9

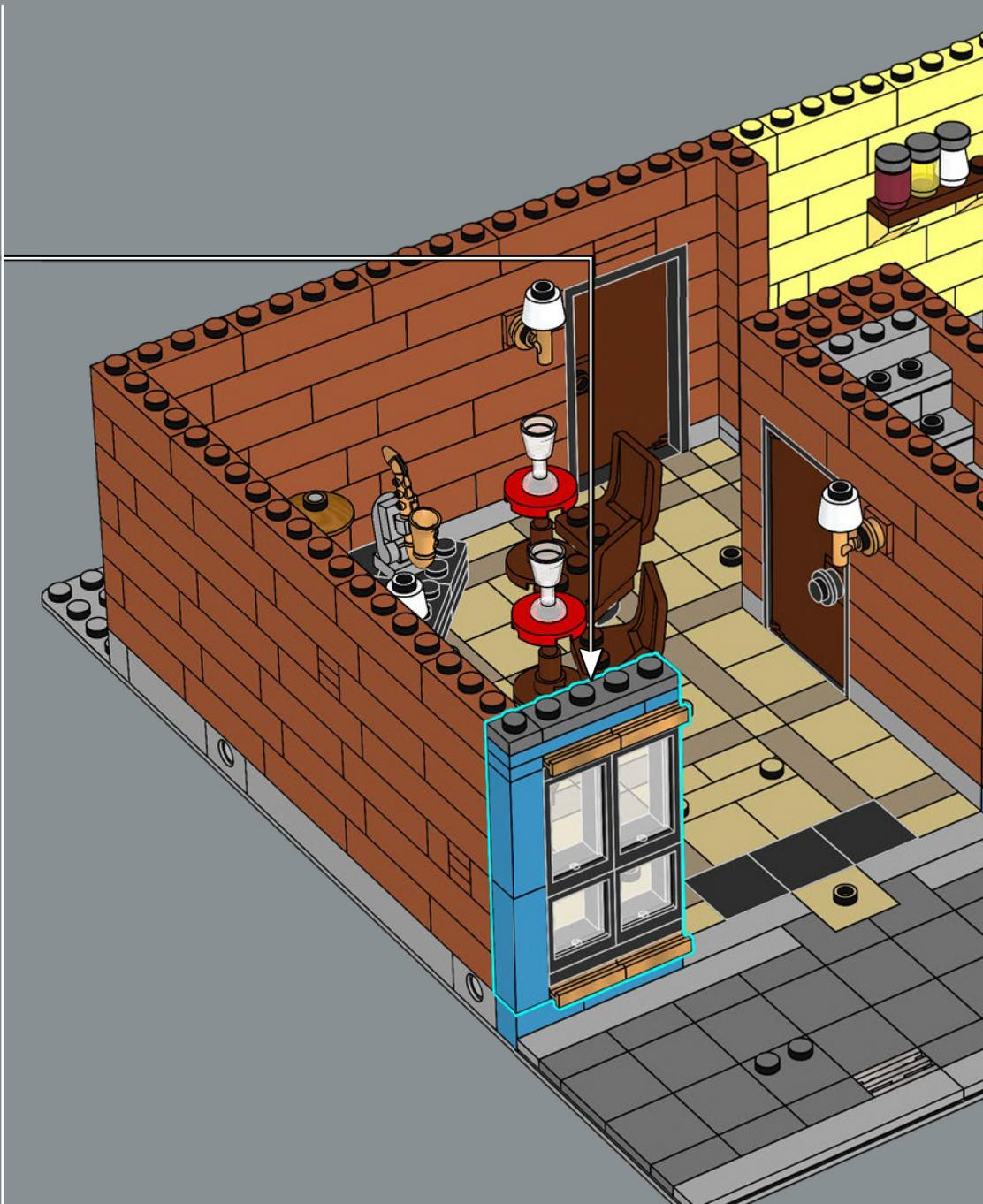
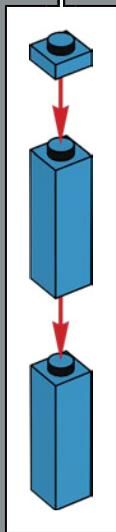
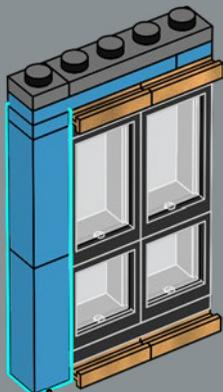



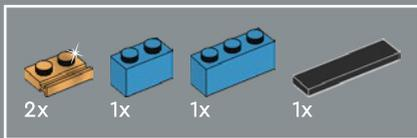

70

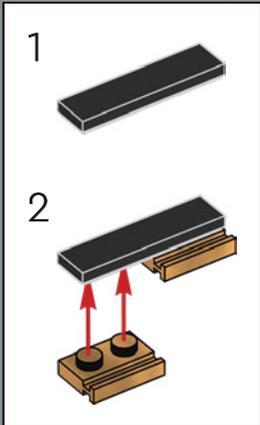

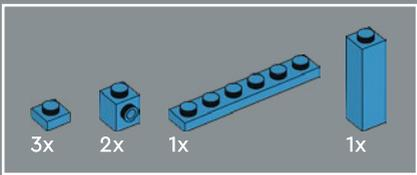

71

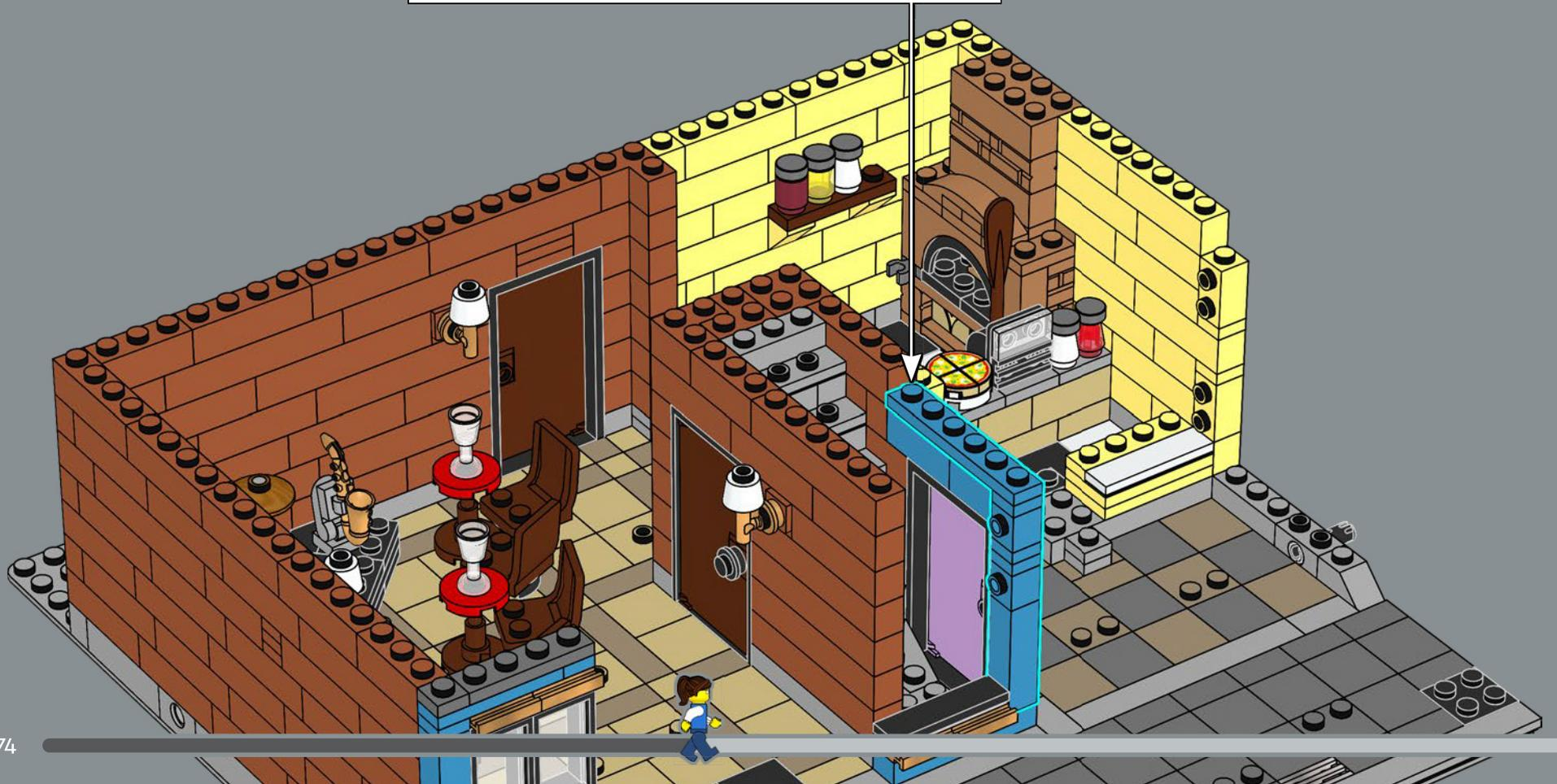
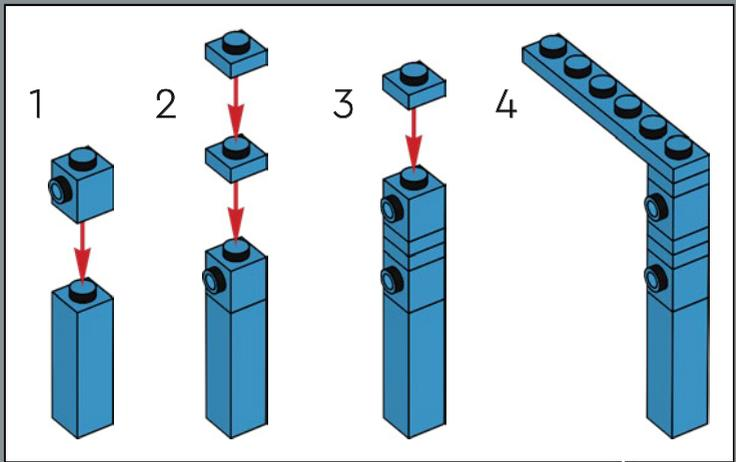

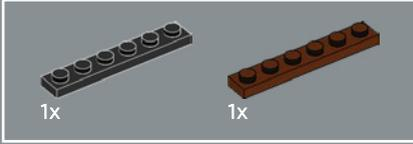

72

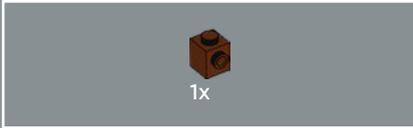
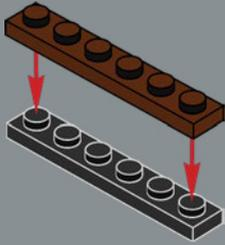

73

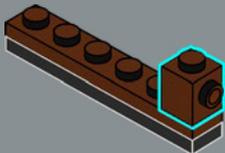

74

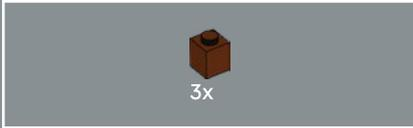

75

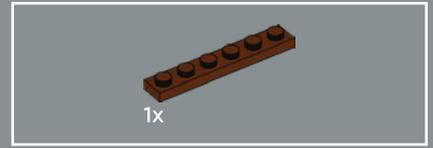

76

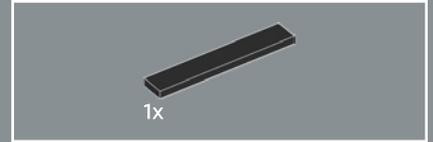

77





78

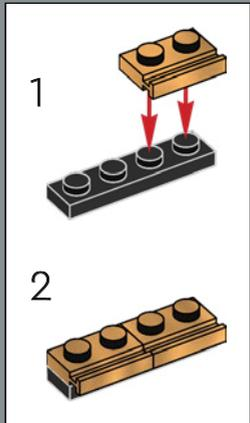

79



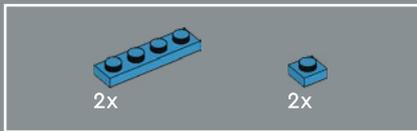

80

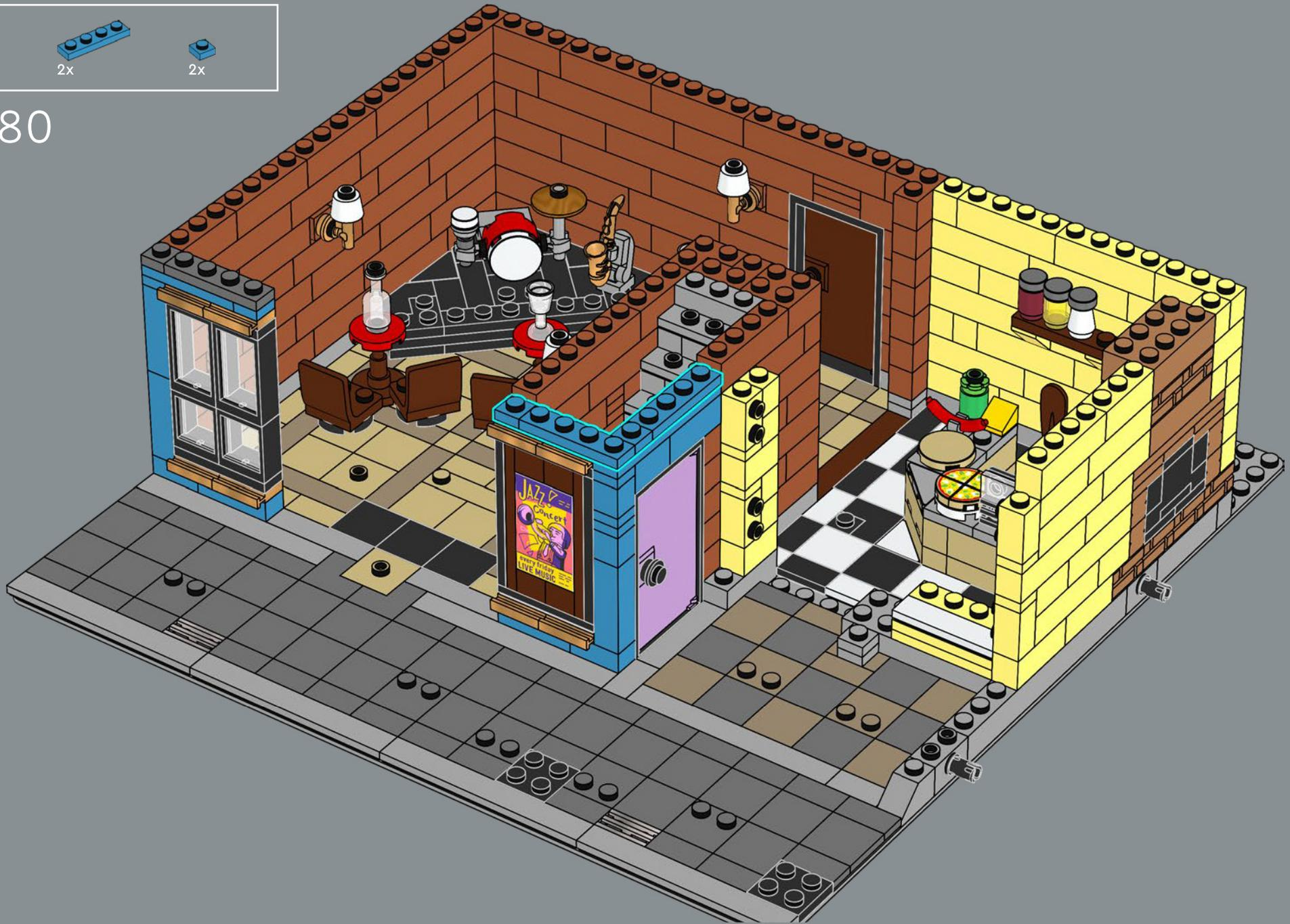

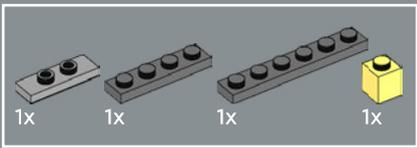

81



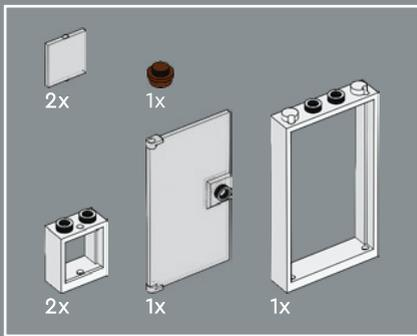

82

1

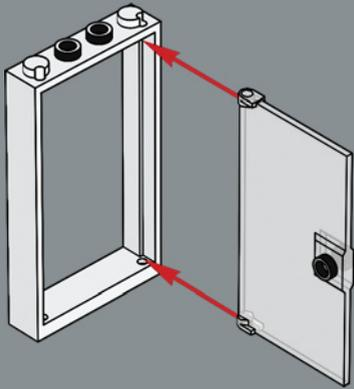

2

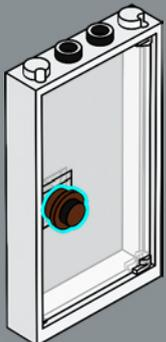

3



4

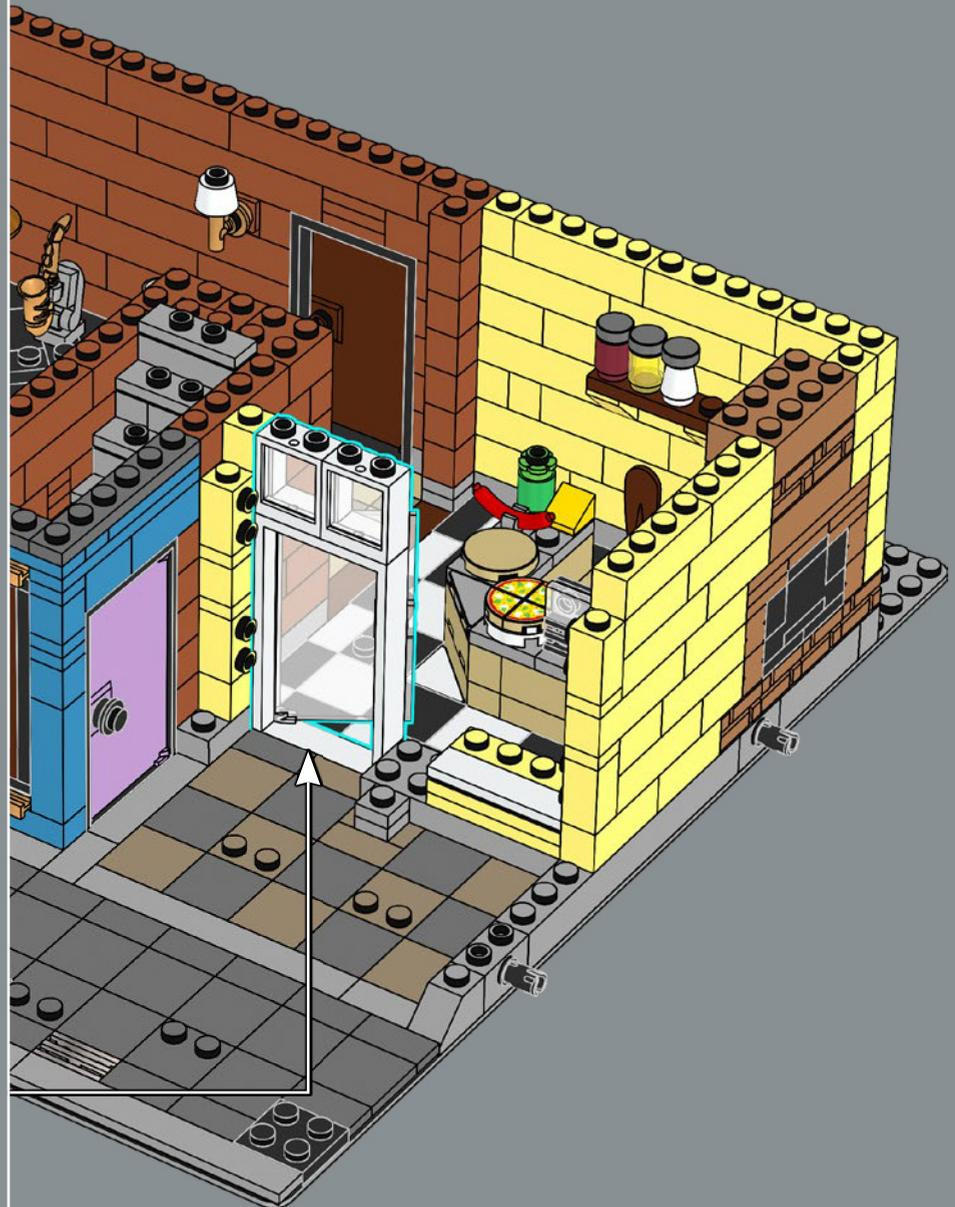
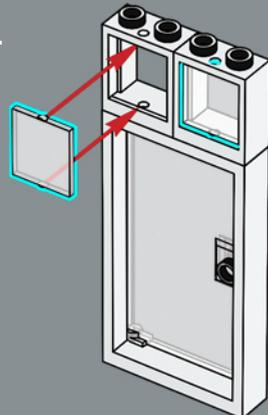

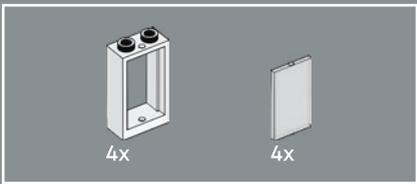

83

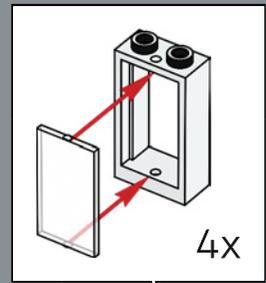



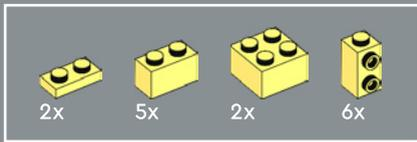

84

1

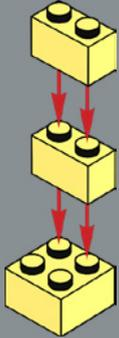

2

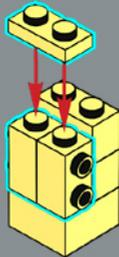

3



4

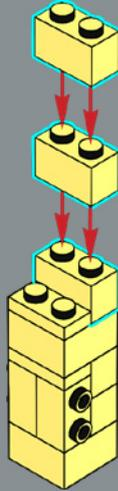

5

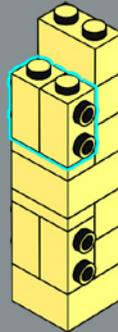

6

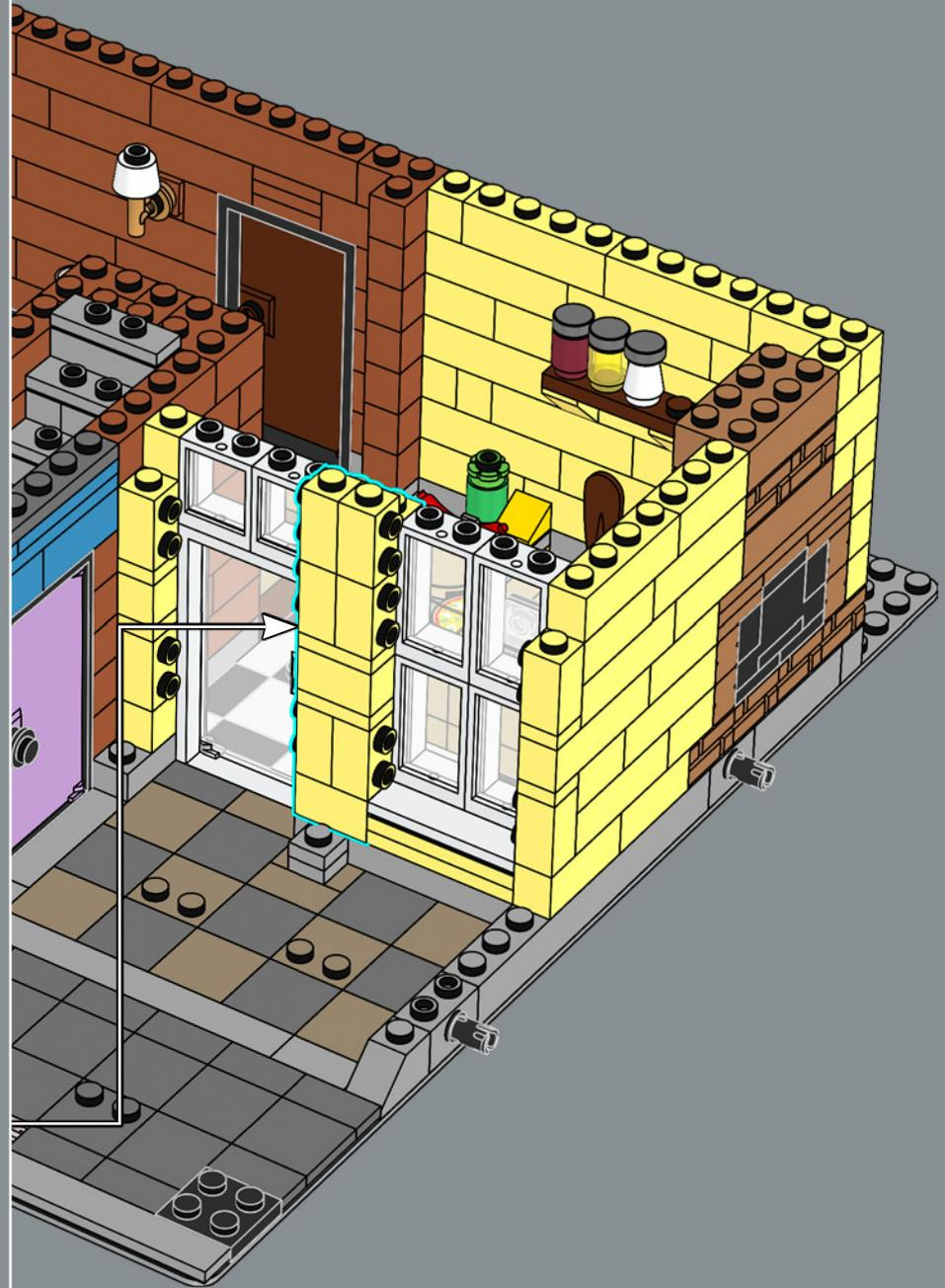
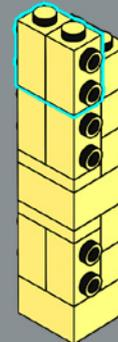



3x

85



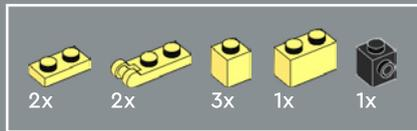

86

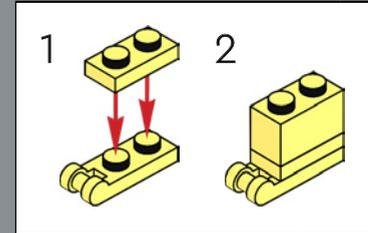
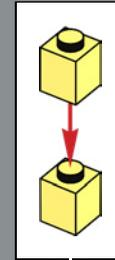
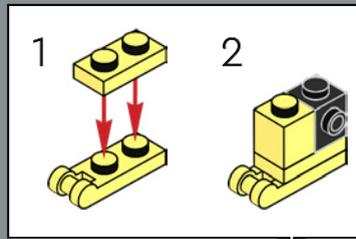



87

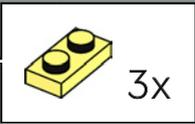
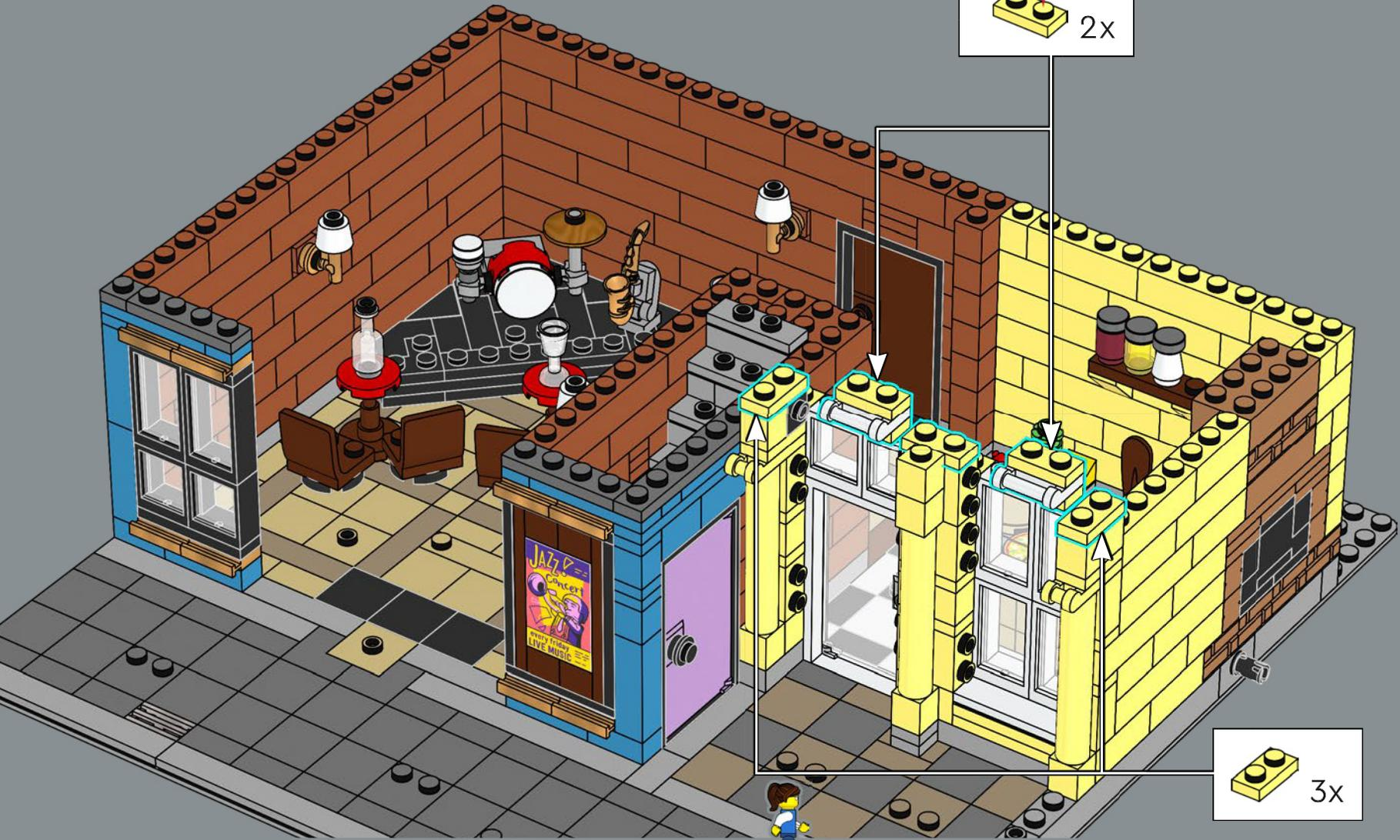
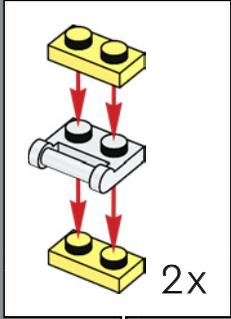

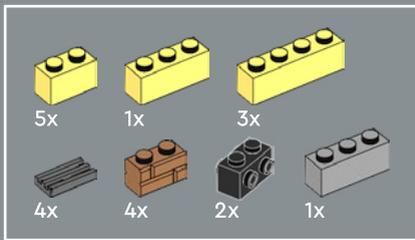

Diese Lüftungsgeräte sorgen für Abkühlung.  
Denn der Ofen und die Musik können ziemlich heiß werden.

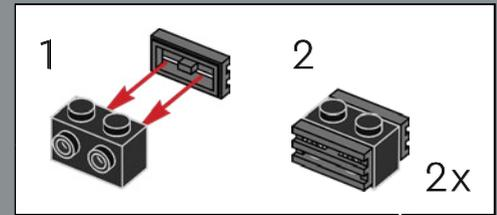

88

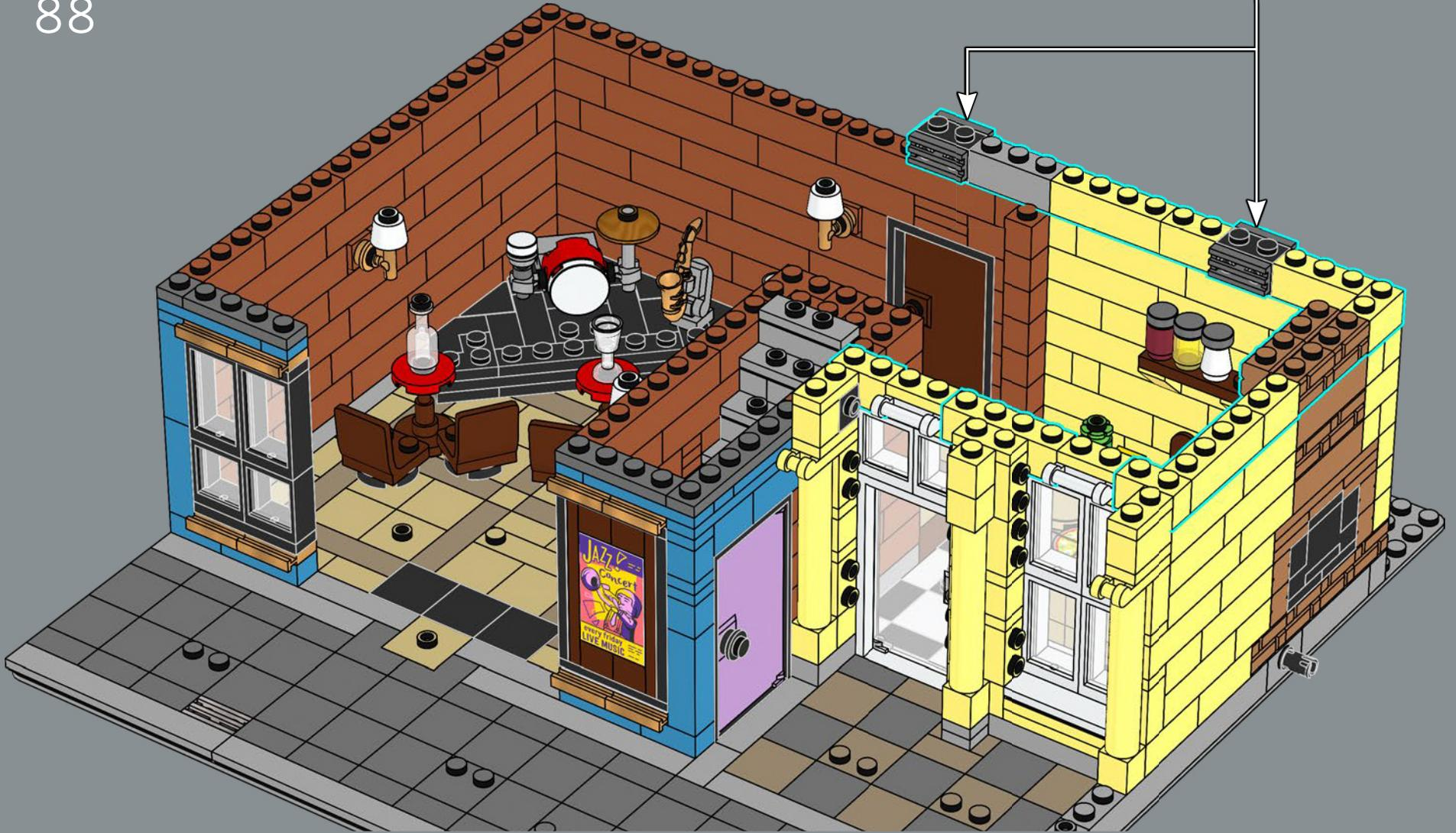

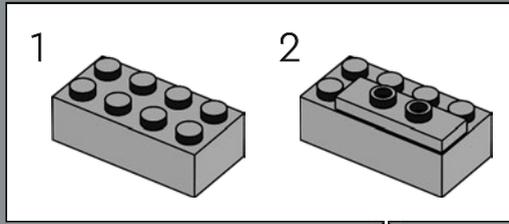
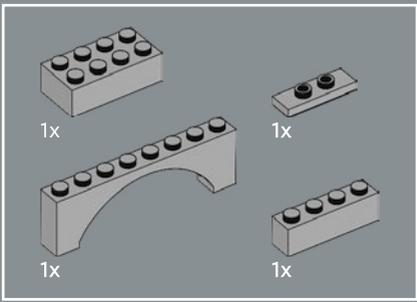

89



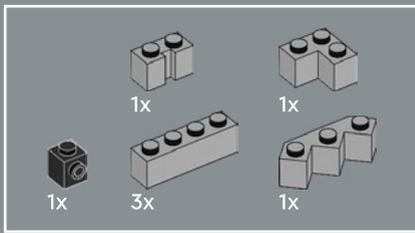

90



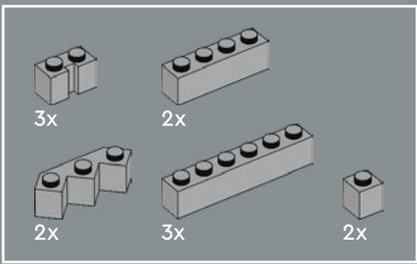

91

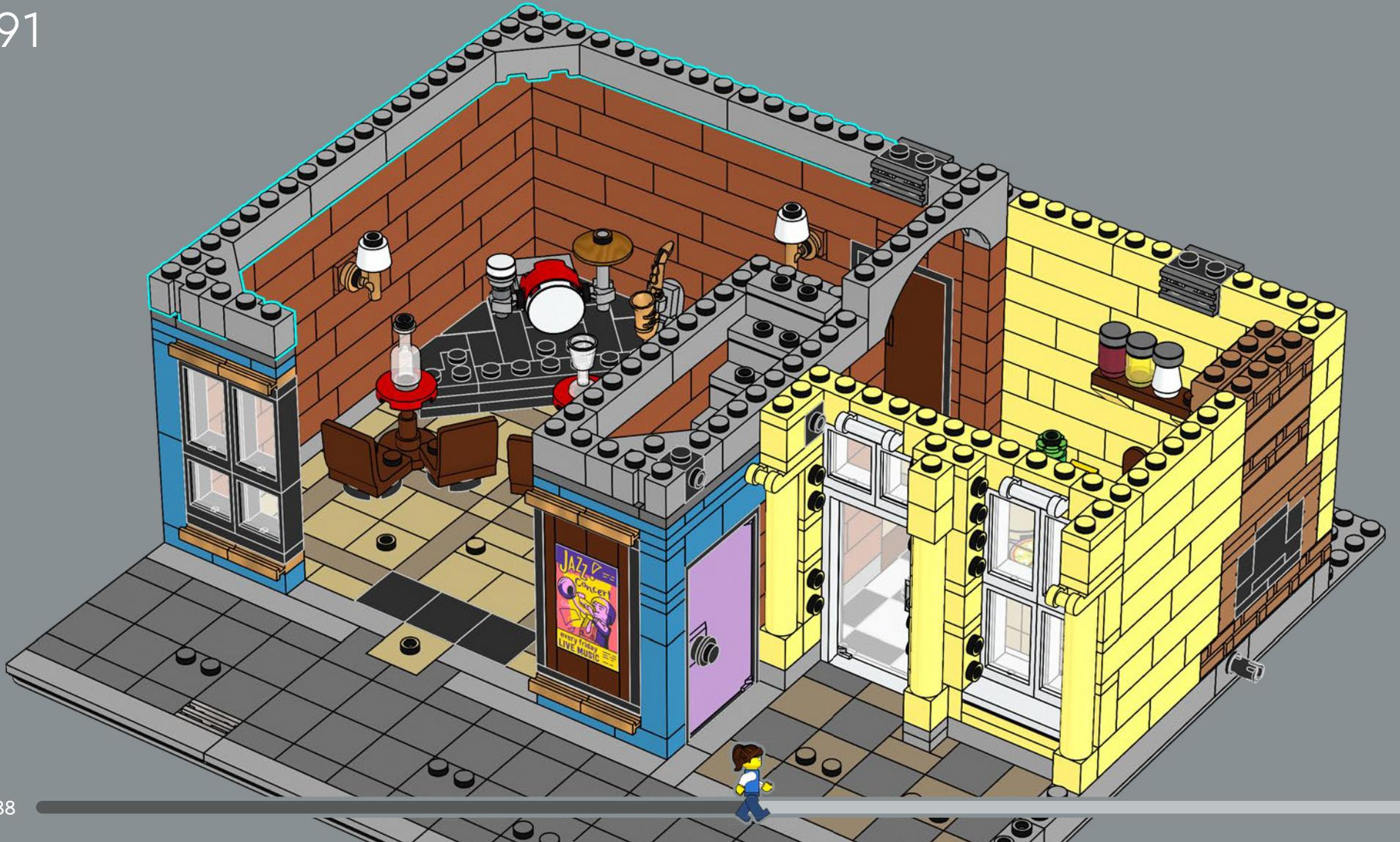



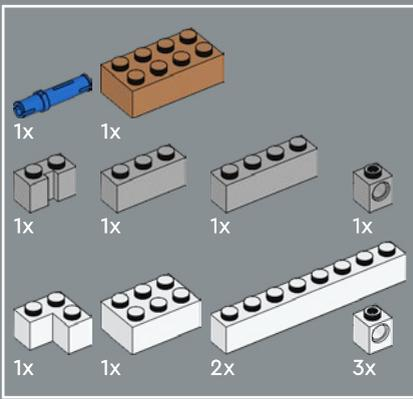

92

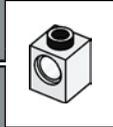
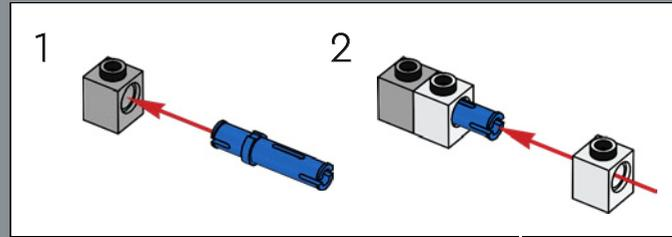

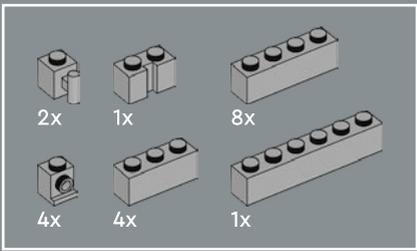

93



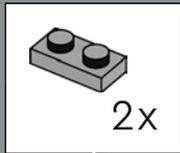

94

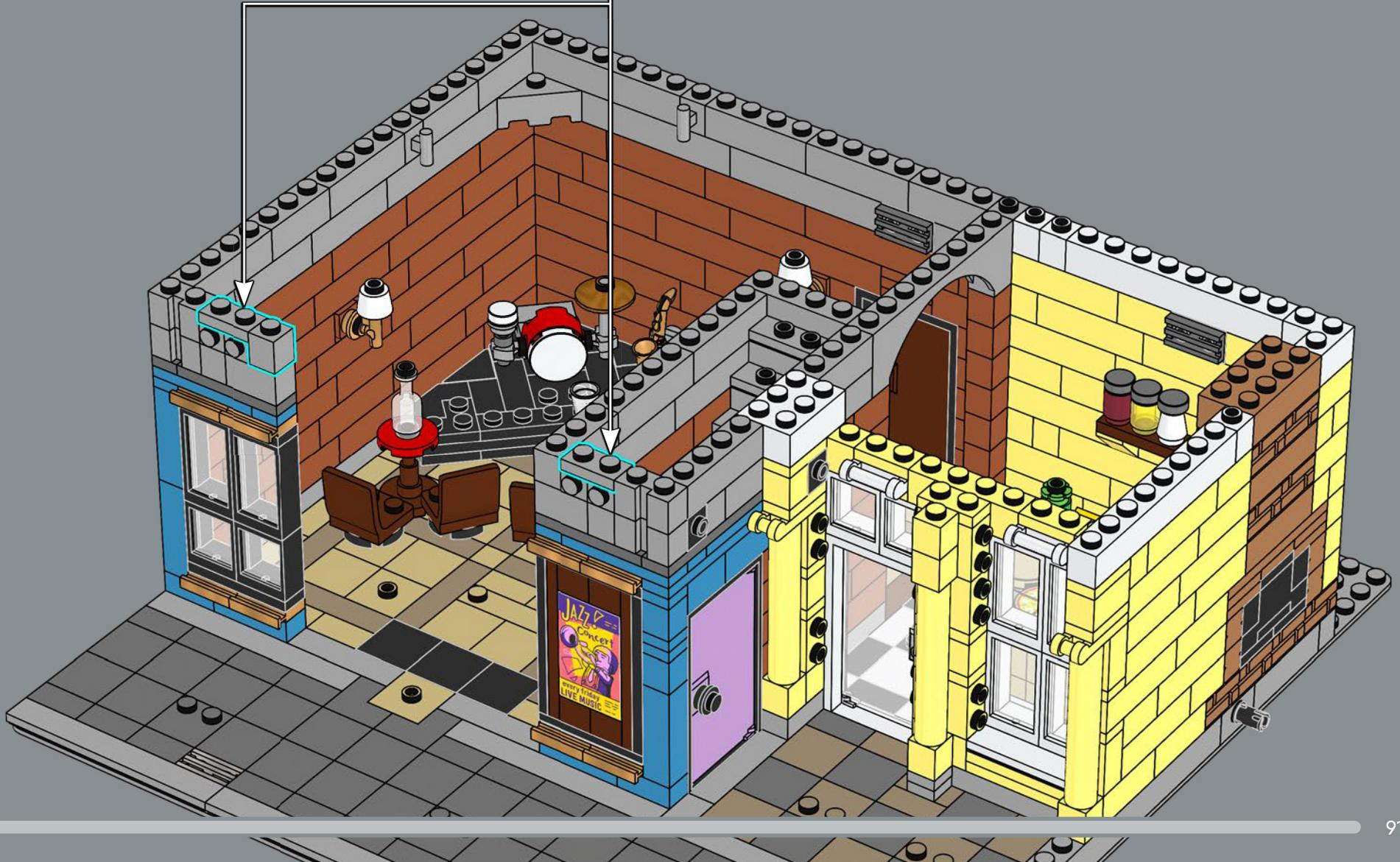

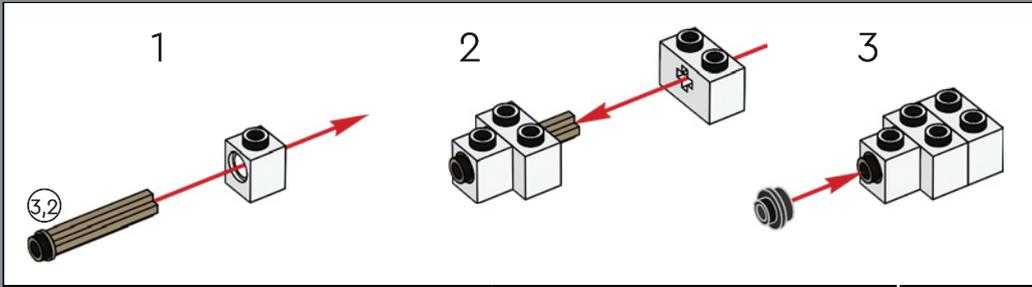
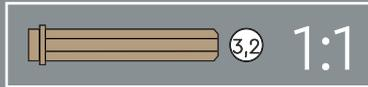
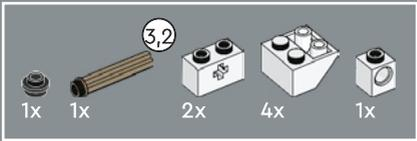

95



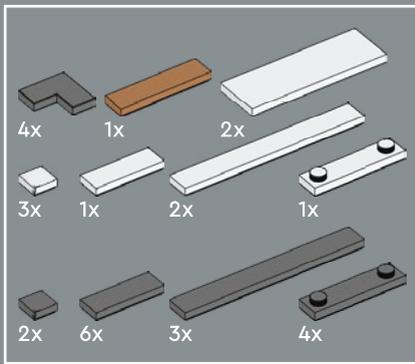

96



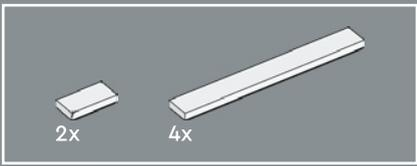

97

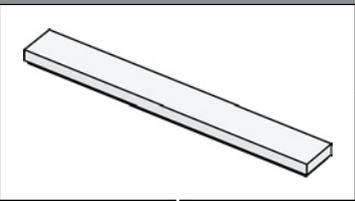



98

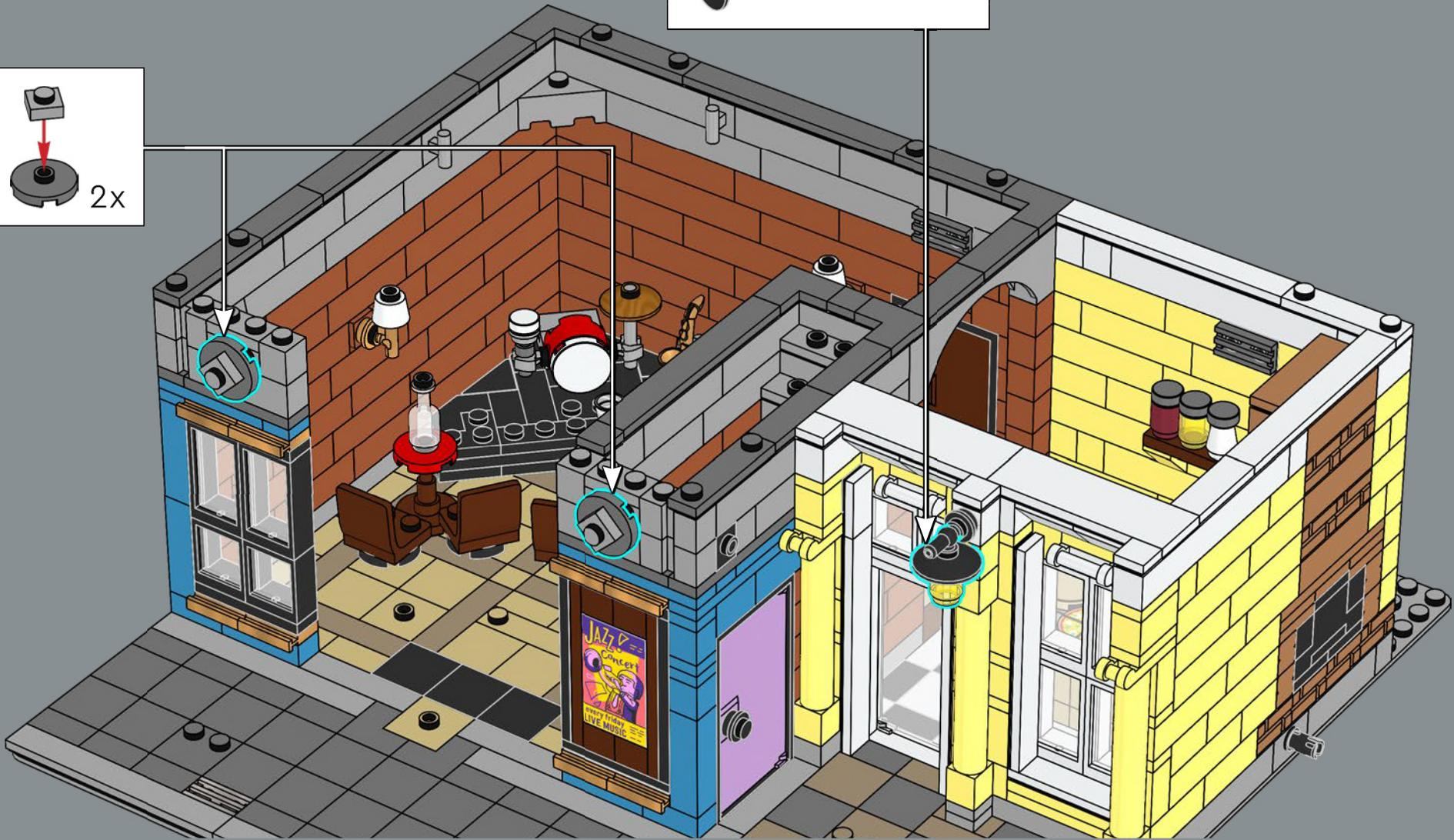
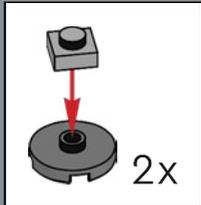
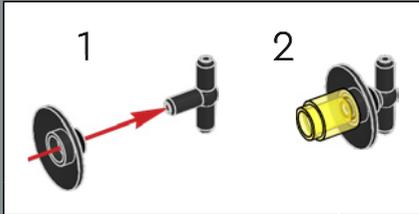

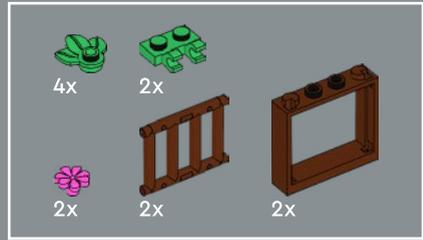

99

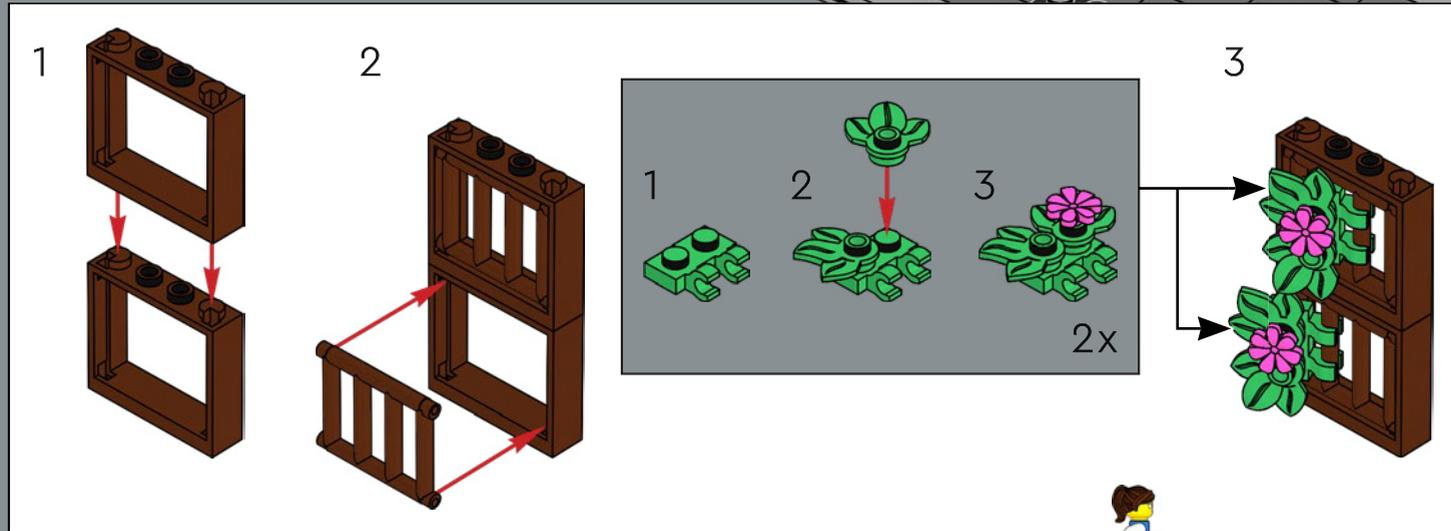





100

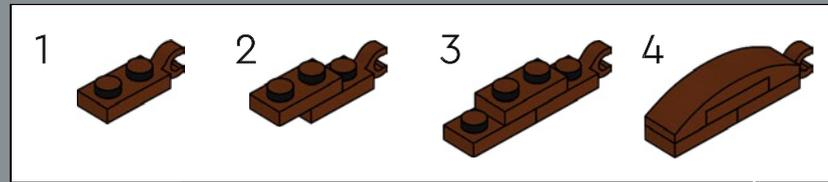

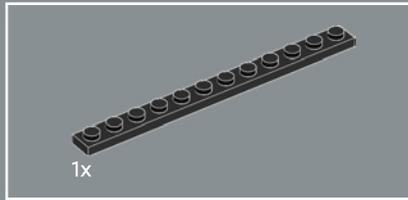

101

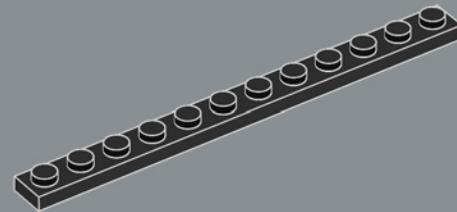

102

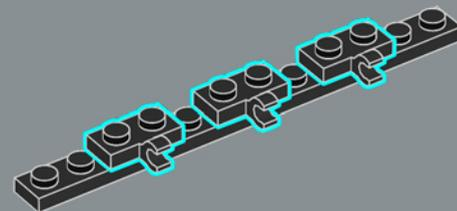

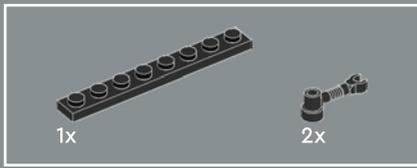

103

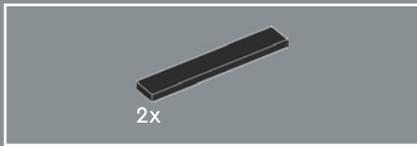
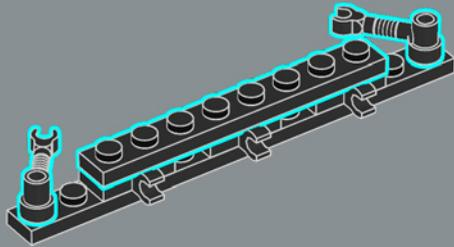

104

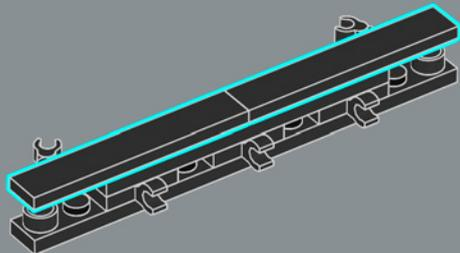

105

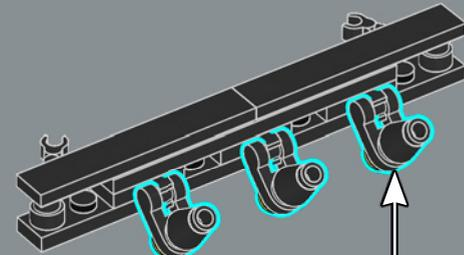

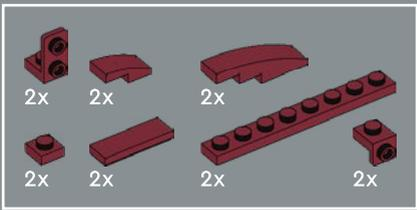

# 106

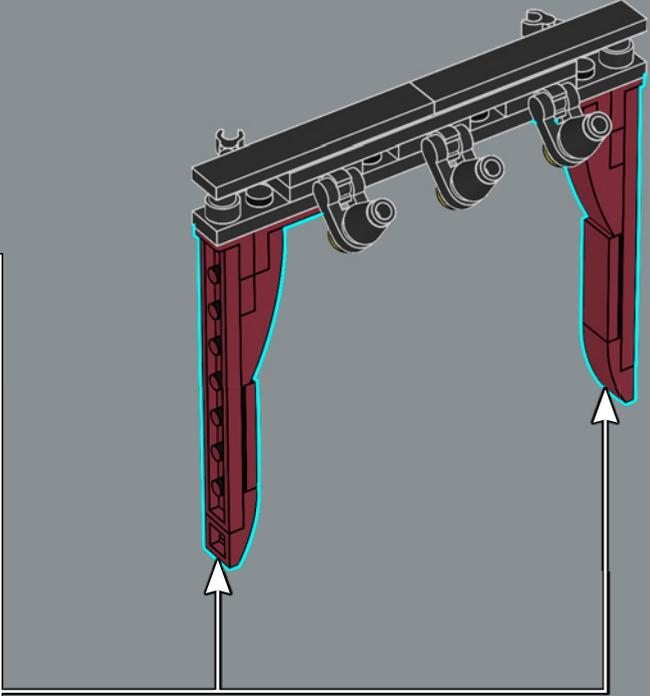
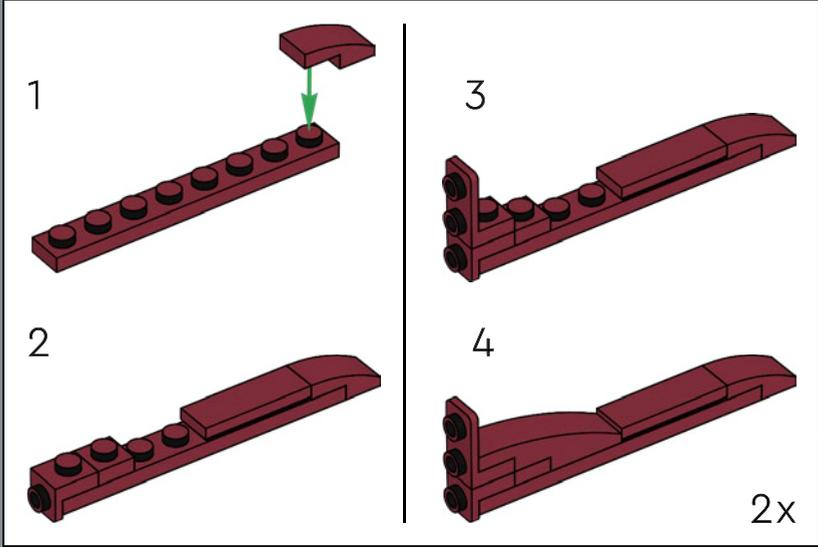

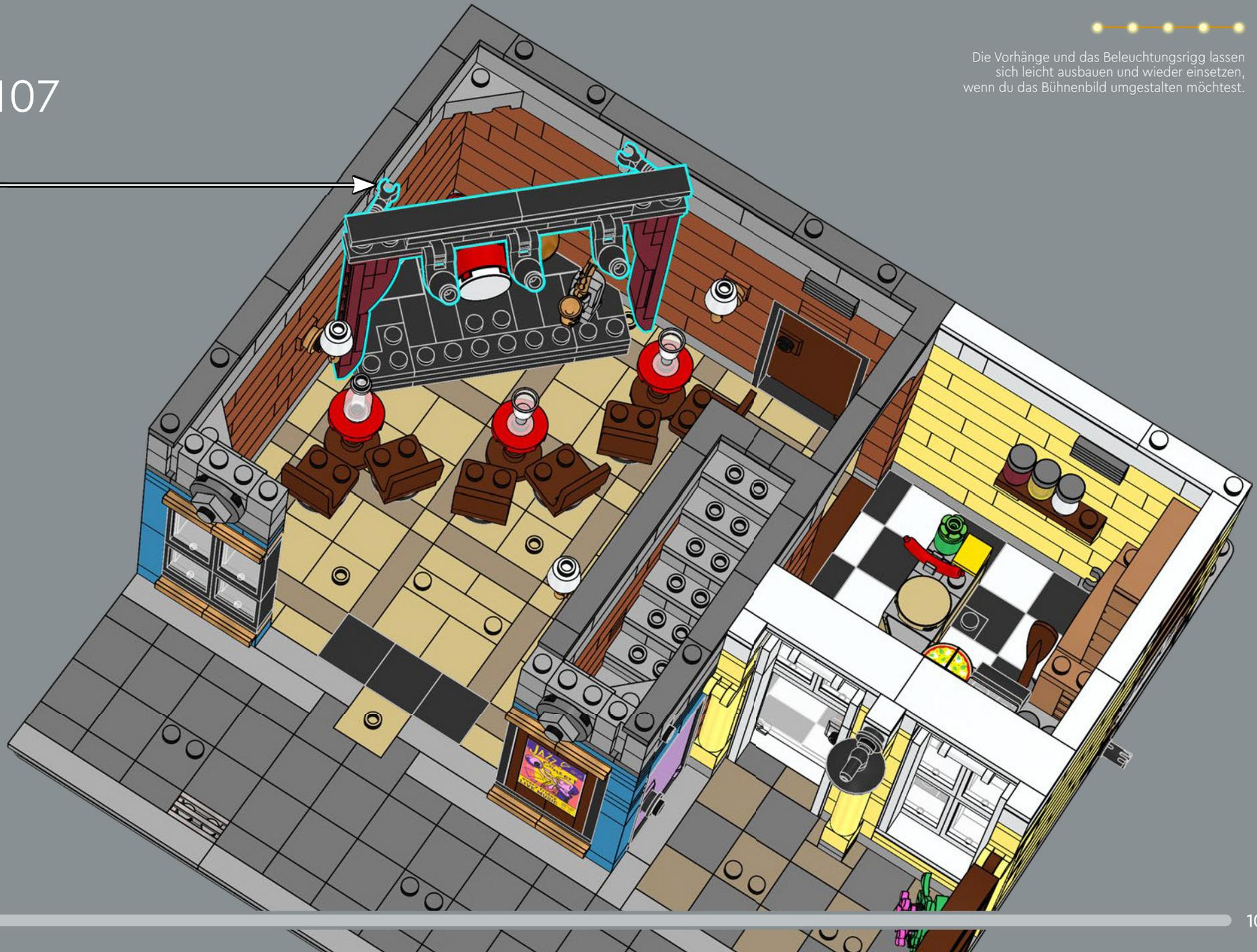

Die Vorhänge und das Beleuchtungsrigg lassen sich leicht ausbauen und wieder einsetzen, wenn du das Bühnenbild umgestalten möchtest.

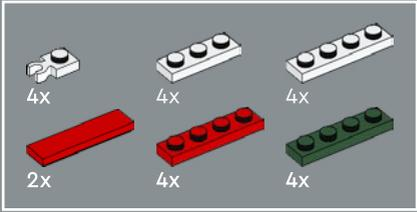

108

1

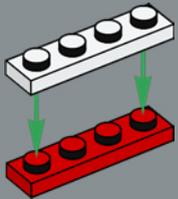

2

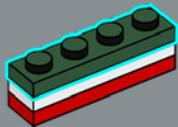

3

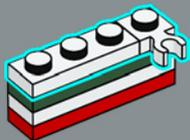

4

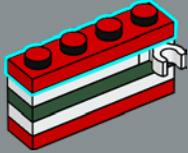

5

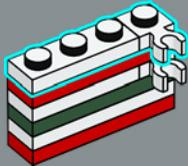

6

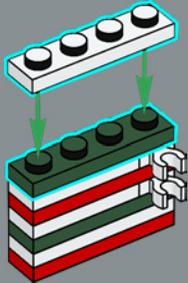

7

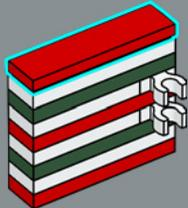

2x





109

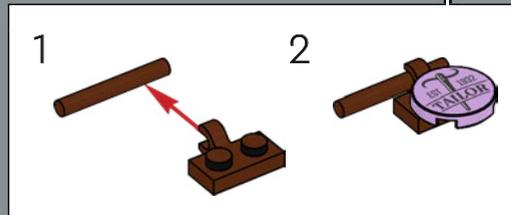
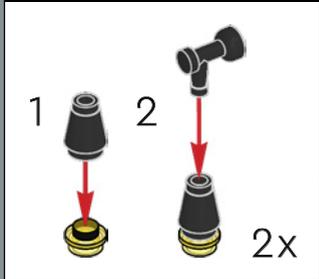

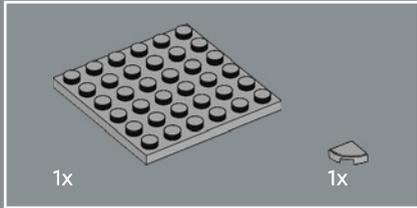
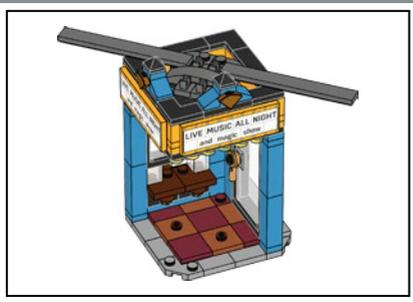

110

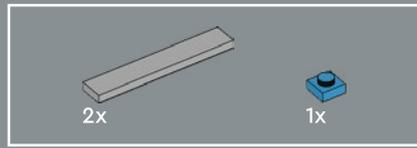
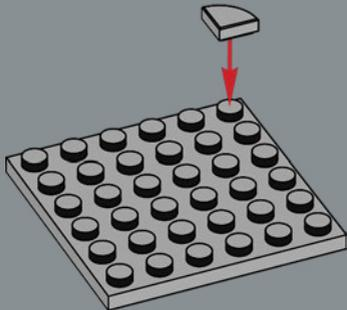

111

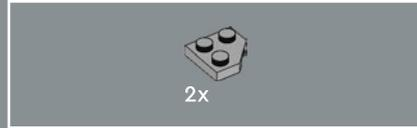
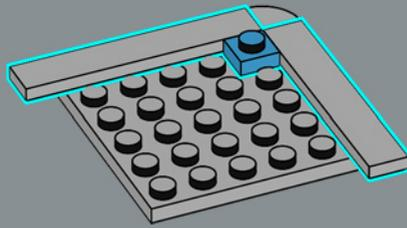

112

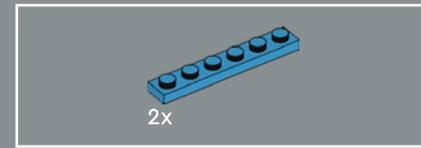
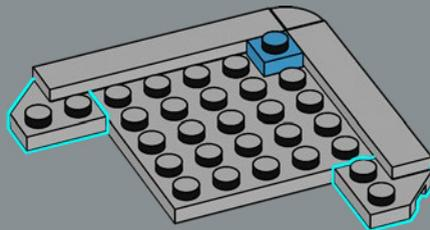

113

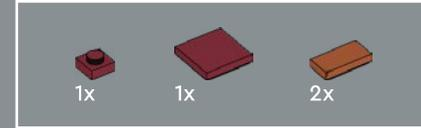
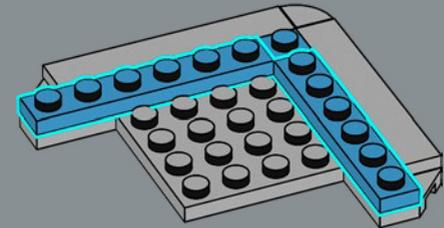

114

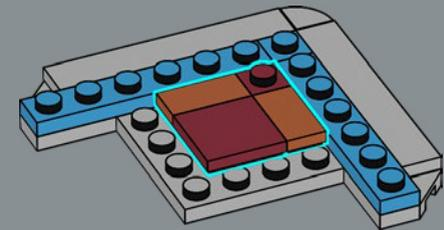



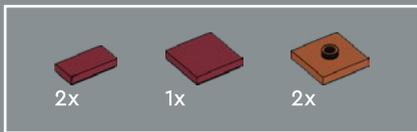

115

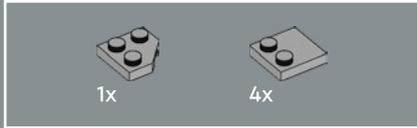
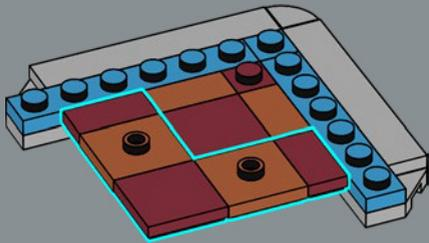

116

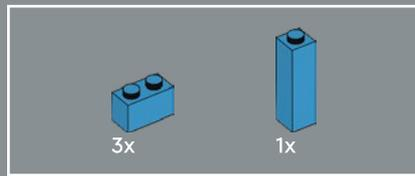
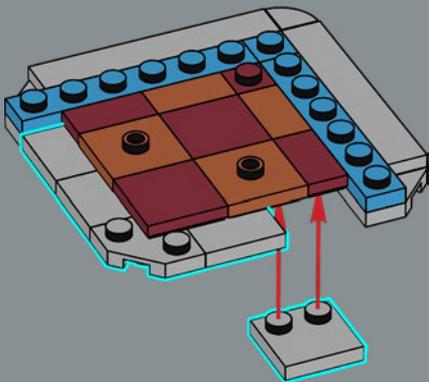

117

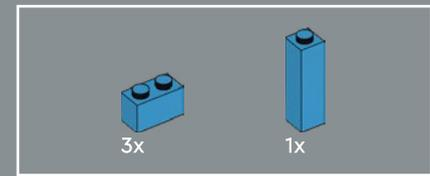
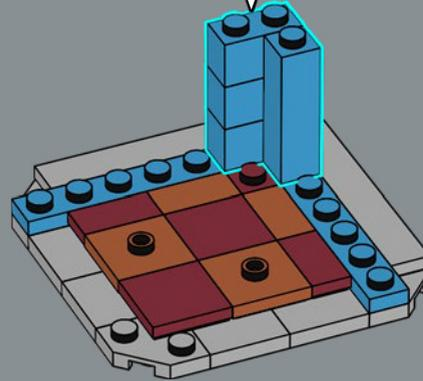
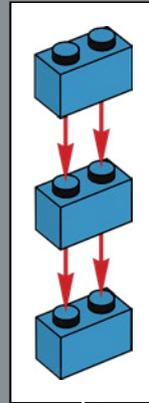

118

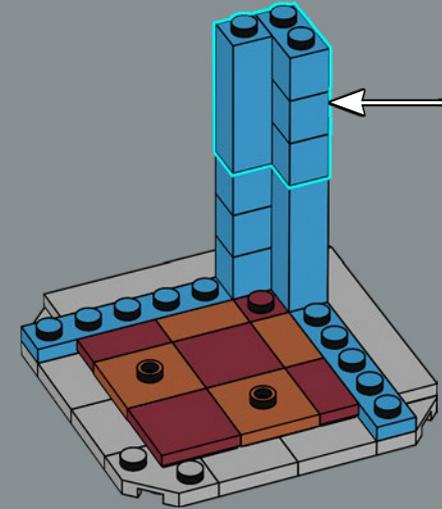
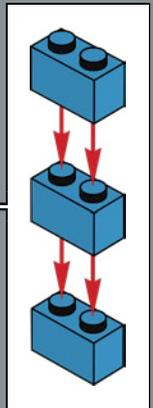

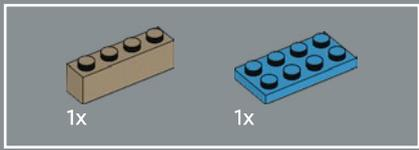

119

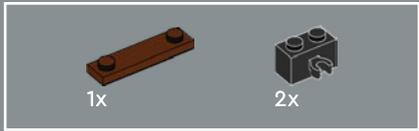
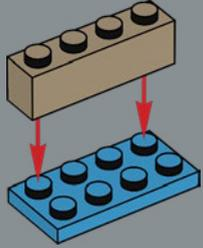

120

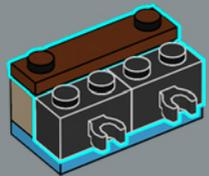

121

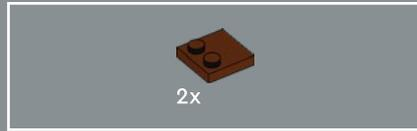
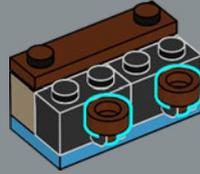

122

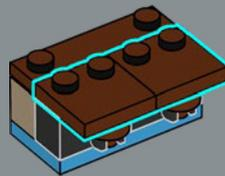

123

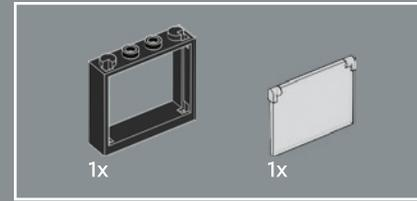

124

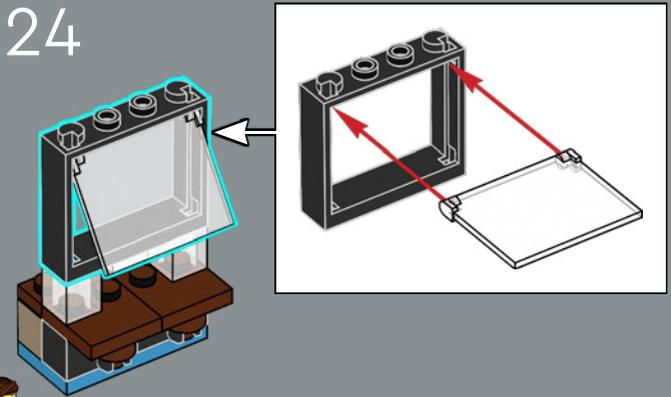



125

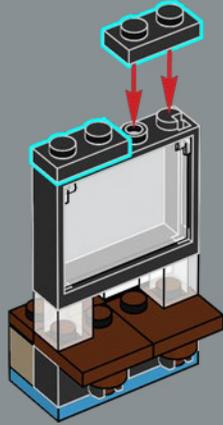

126

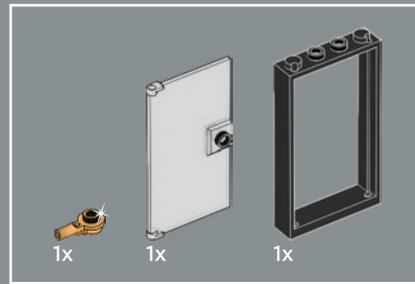
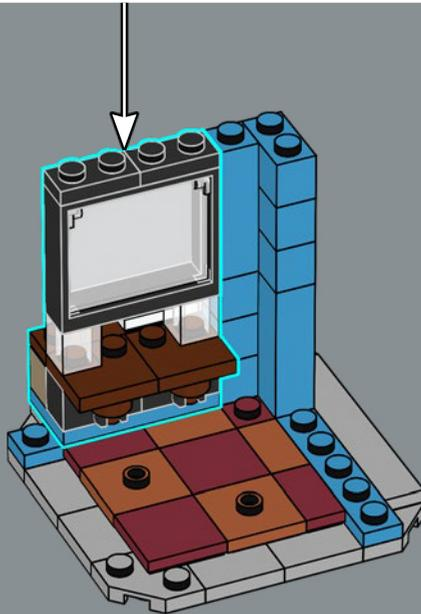

127

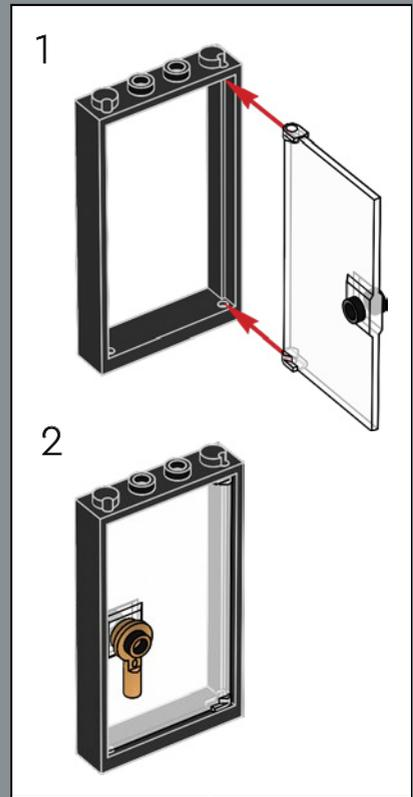
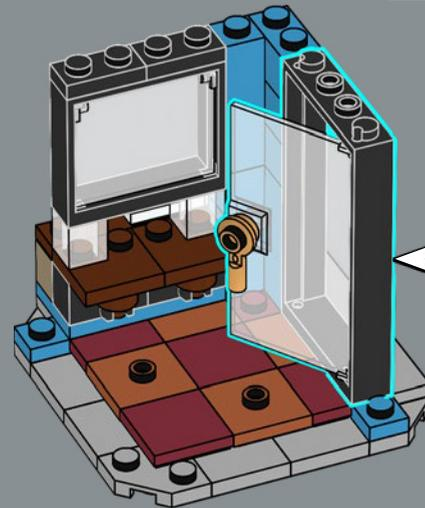

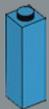

4x

128

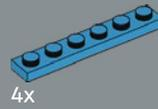
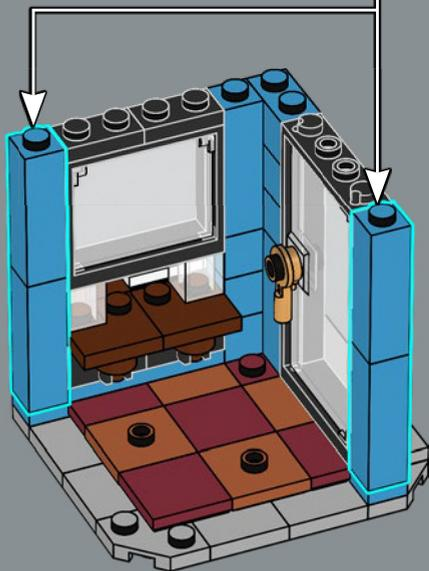
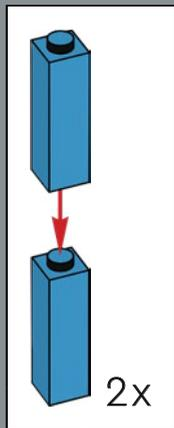

4x



2x

129

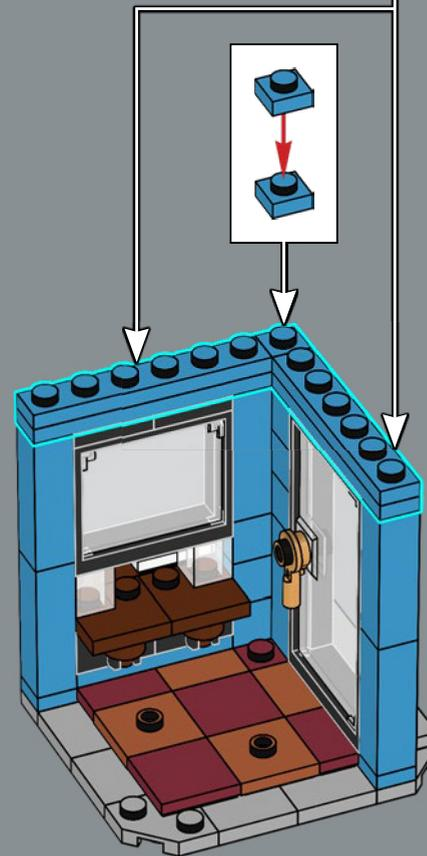
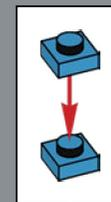
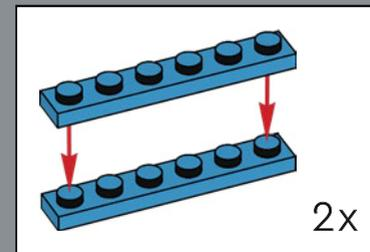

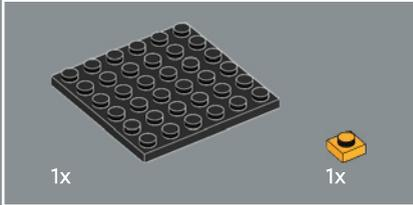
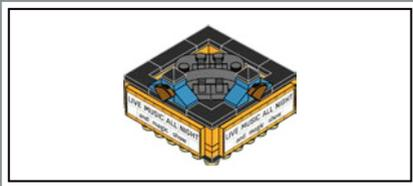

130

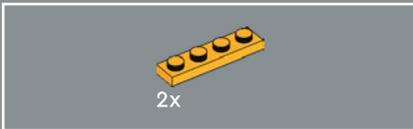
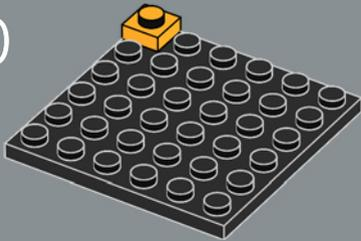

131

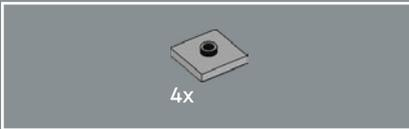
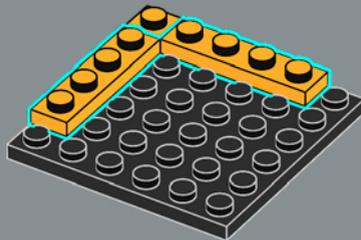

132

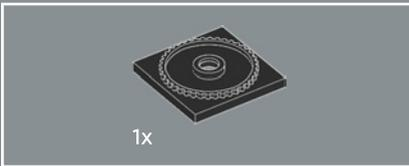
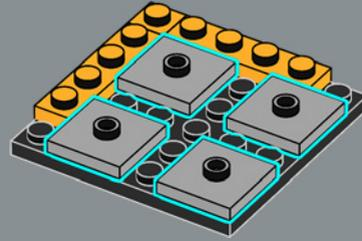

133

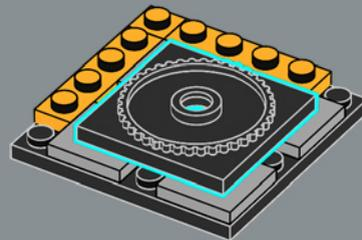

134

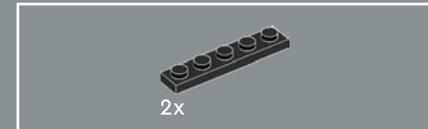
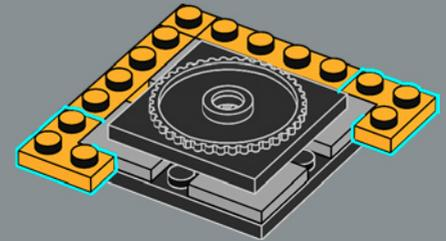

135

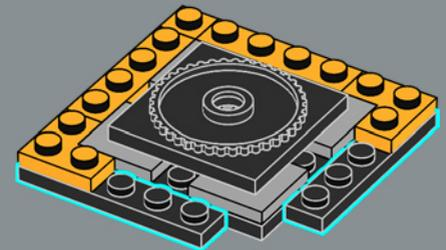

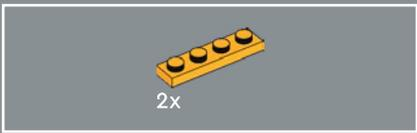

136

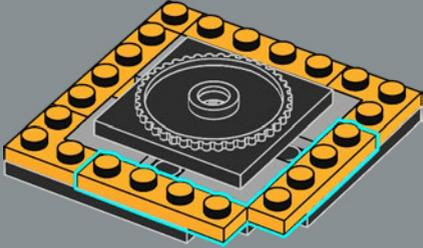

137

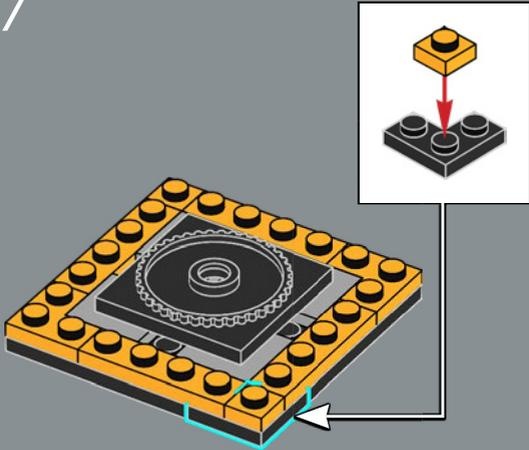

138

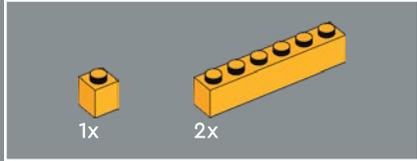
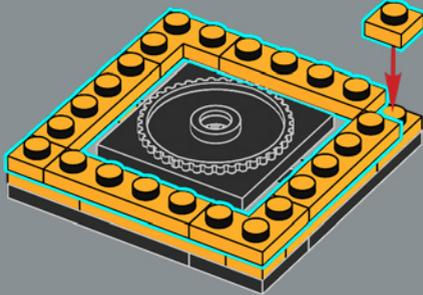

139

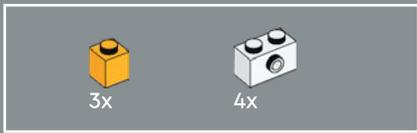
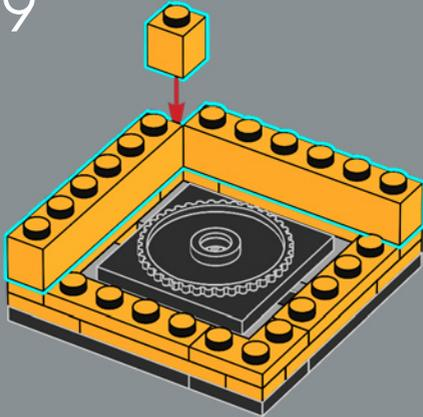

140

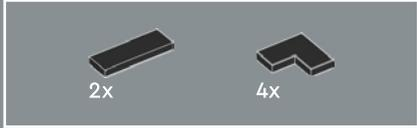
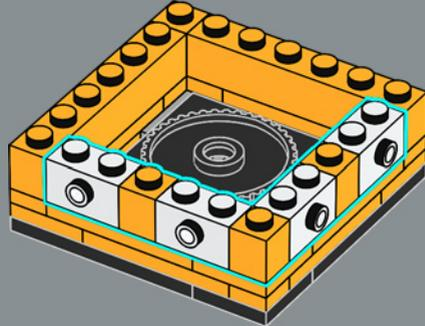

141

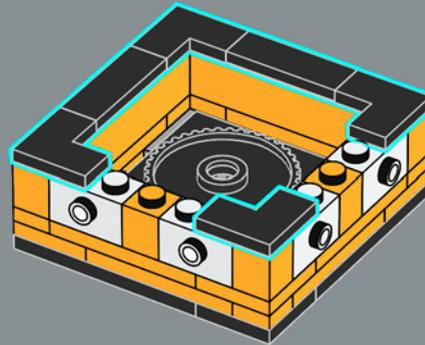



142



143

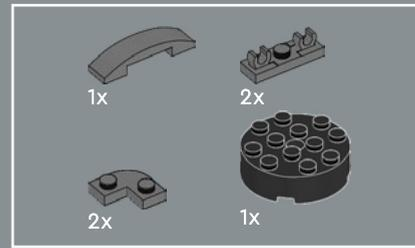
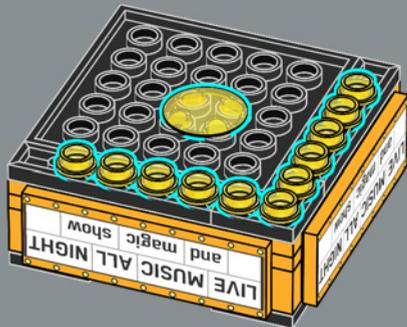

144

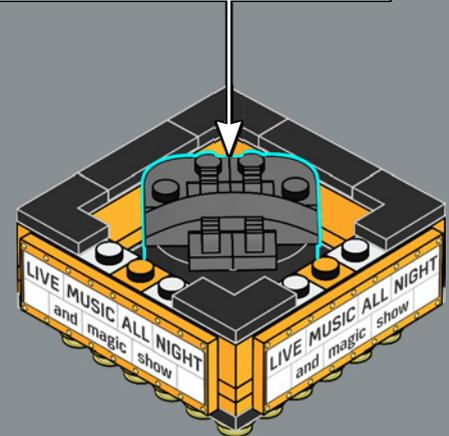
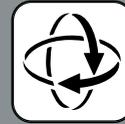
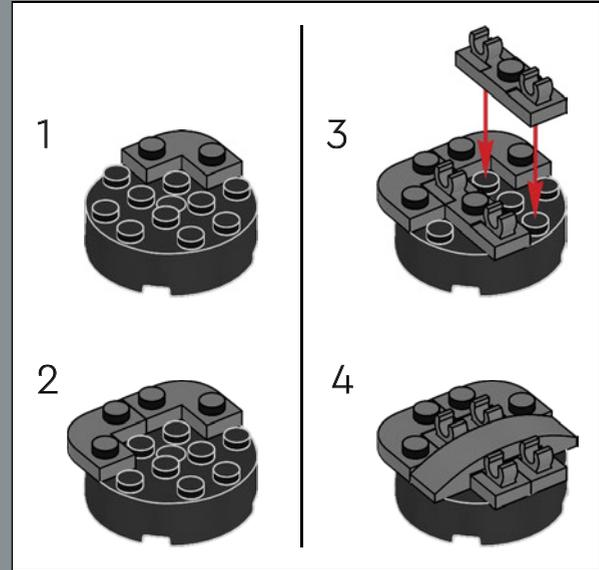



145

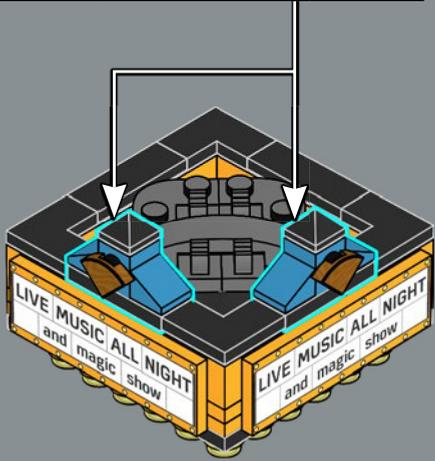
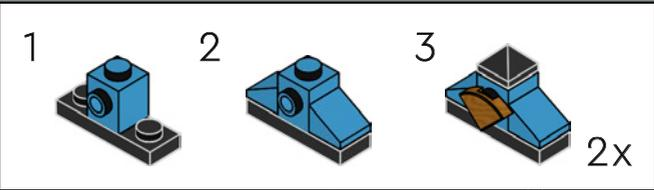

Im Jazzclub treten nicht nur Musiker auf, auch andere darstellende Künste finden hier eine Bühne. Später am Abend zeigt zum Beispiel unsere Magierin ihre neuen Tricks.

146

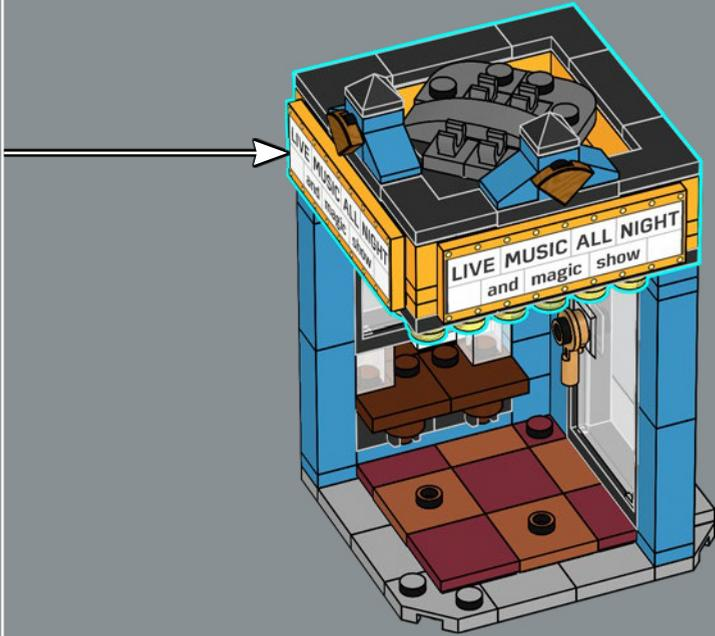



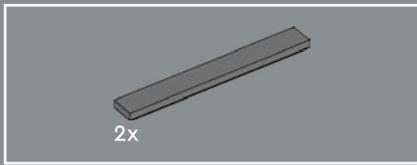

147

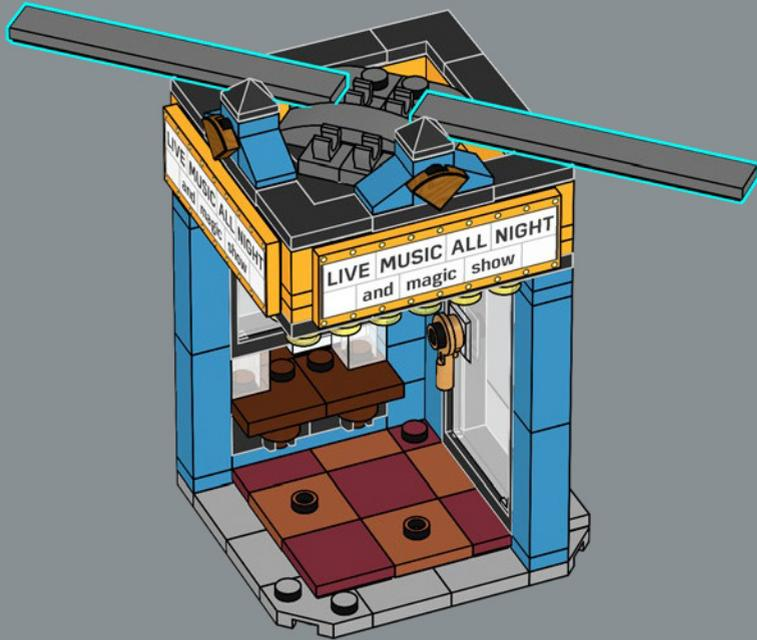

148



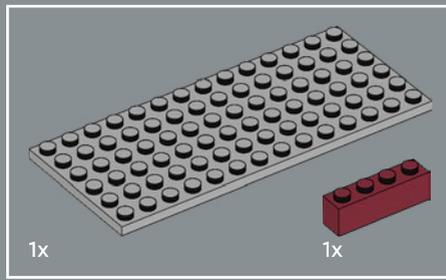

149

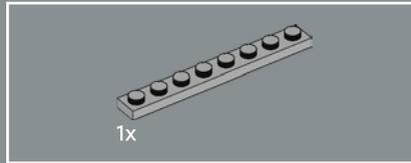
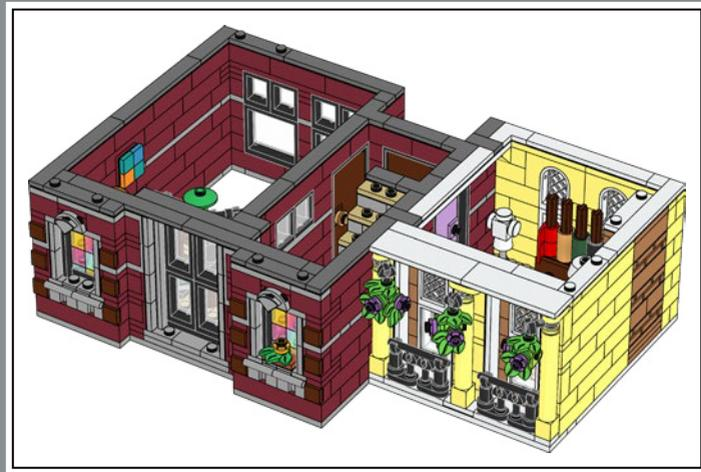
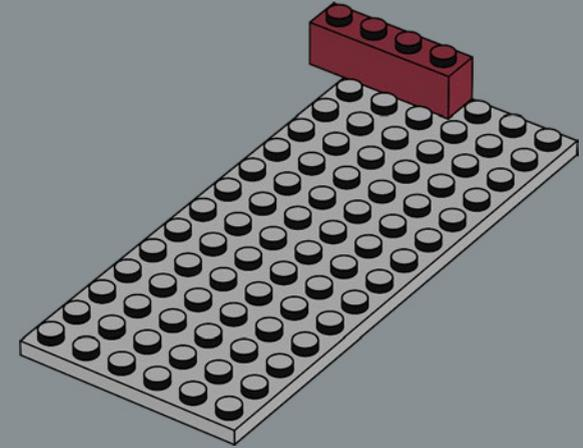

150

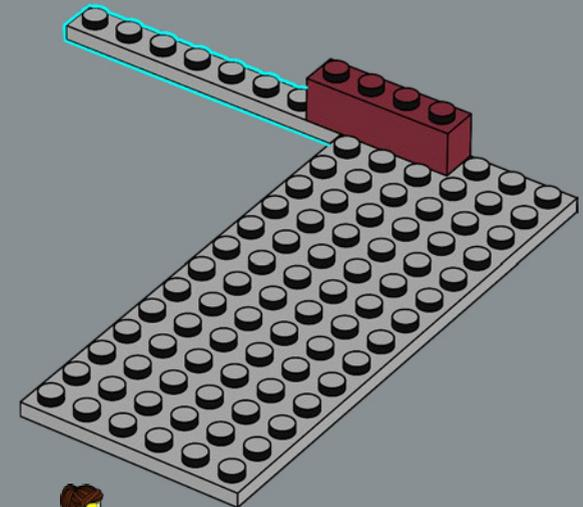

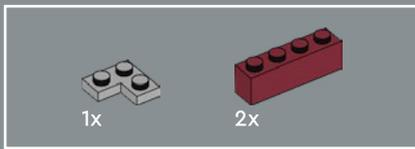

151

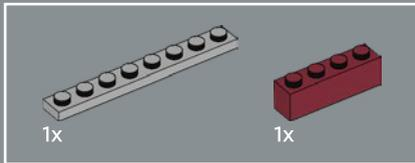
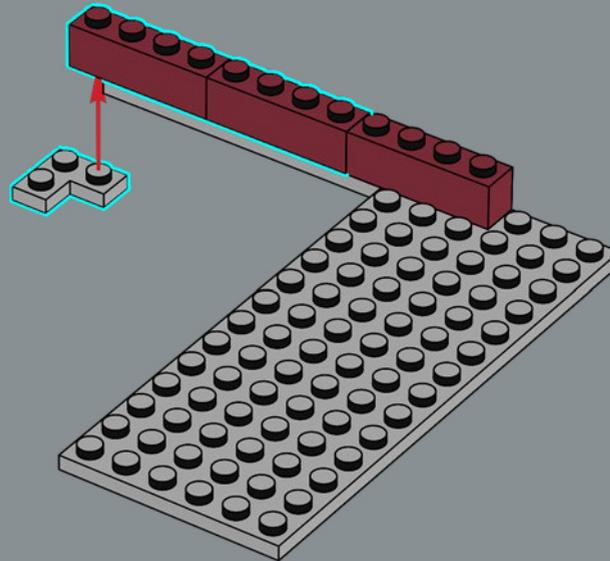

152

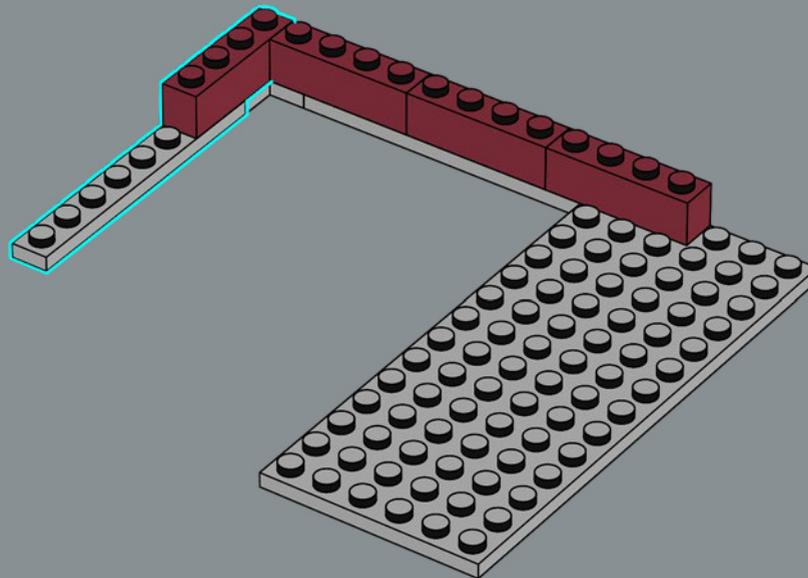

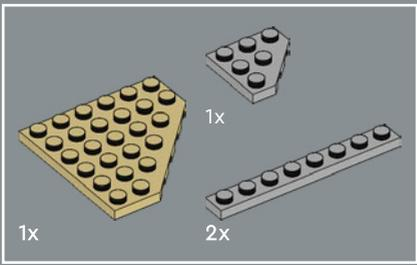

153

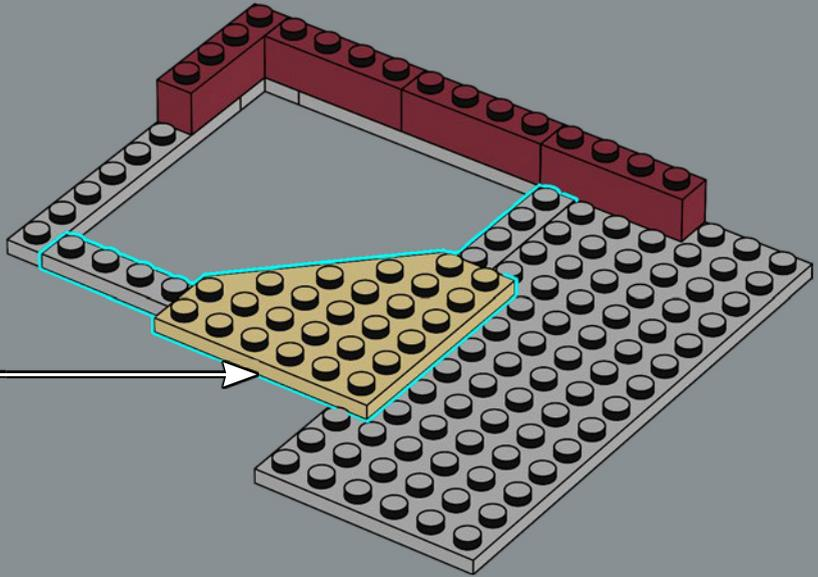
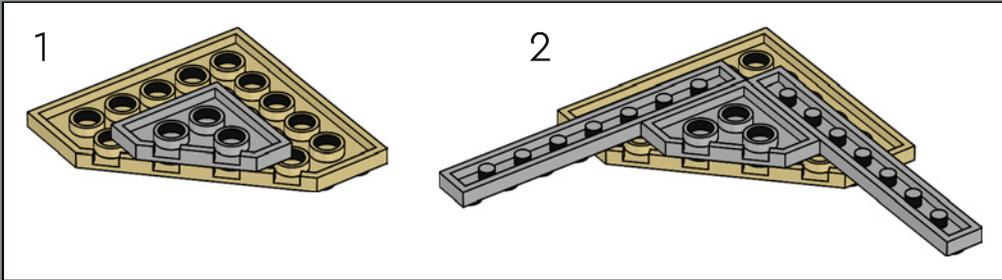

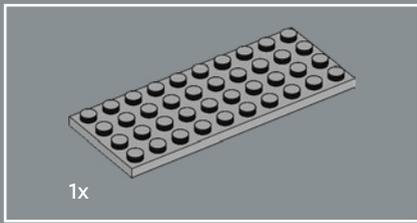

154

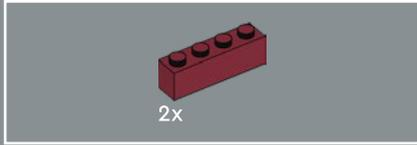
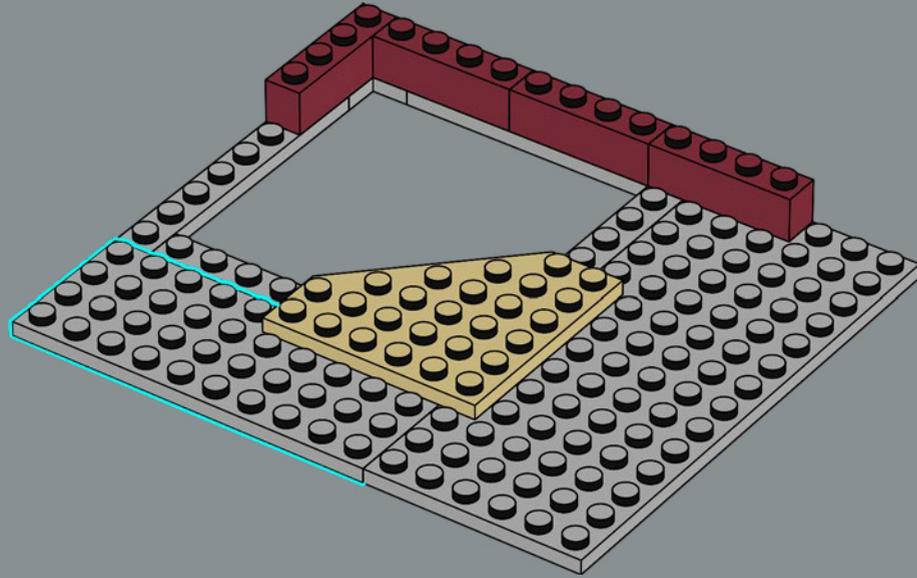

155

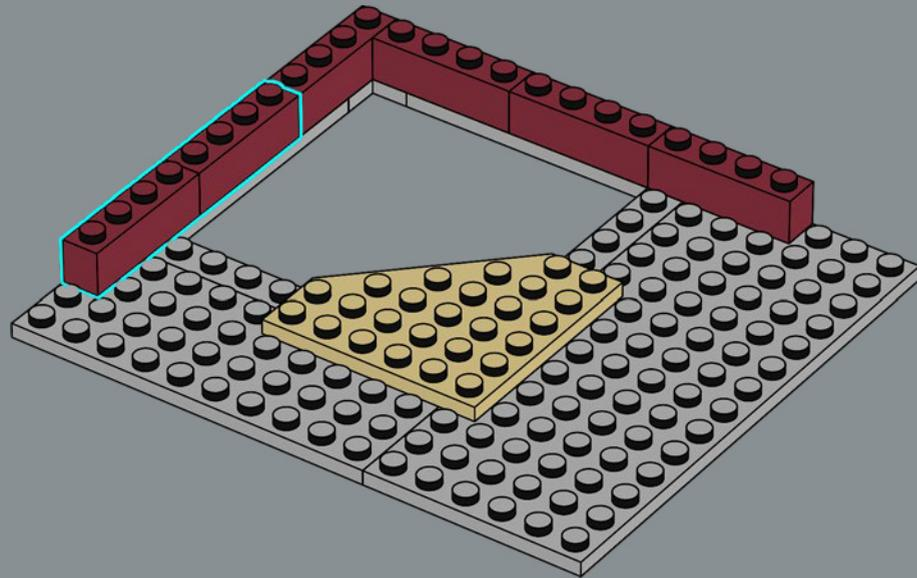

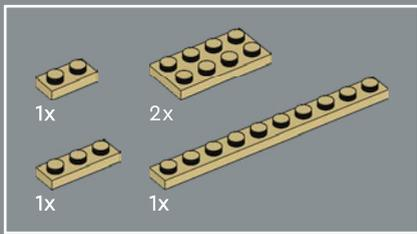

156

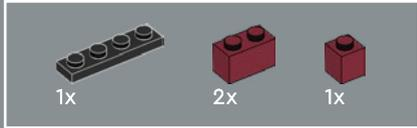
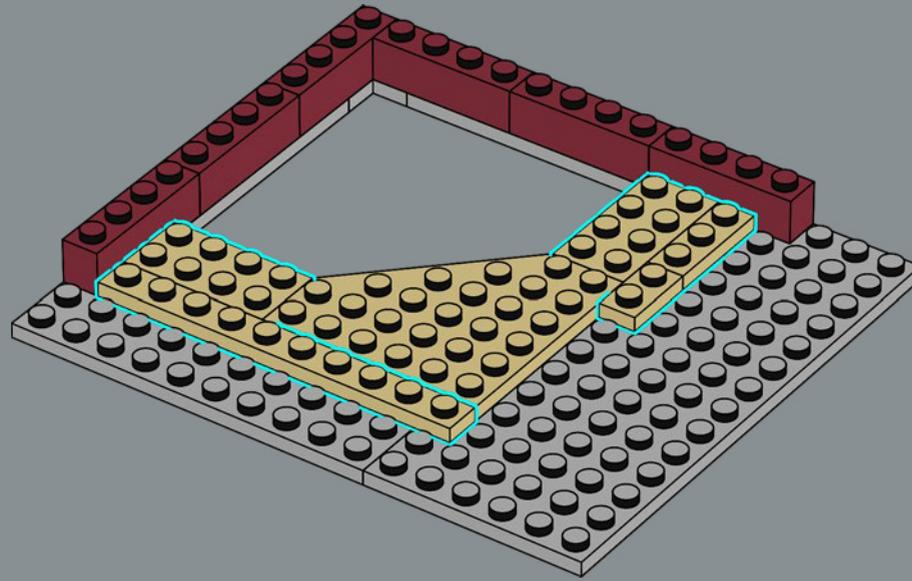

157

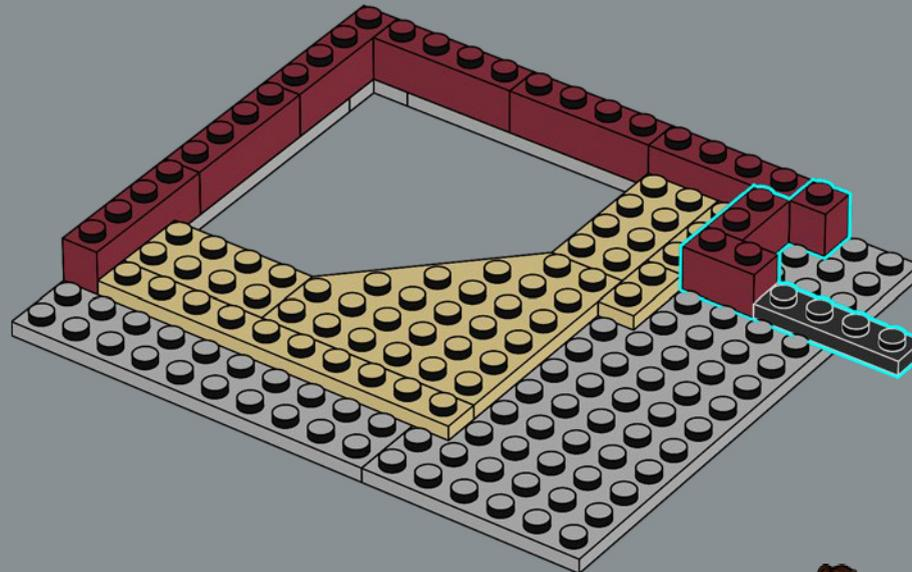

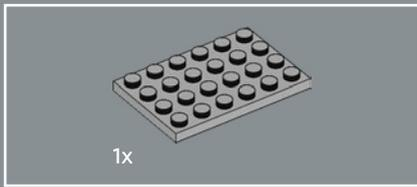

158

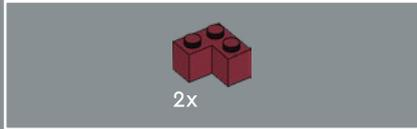
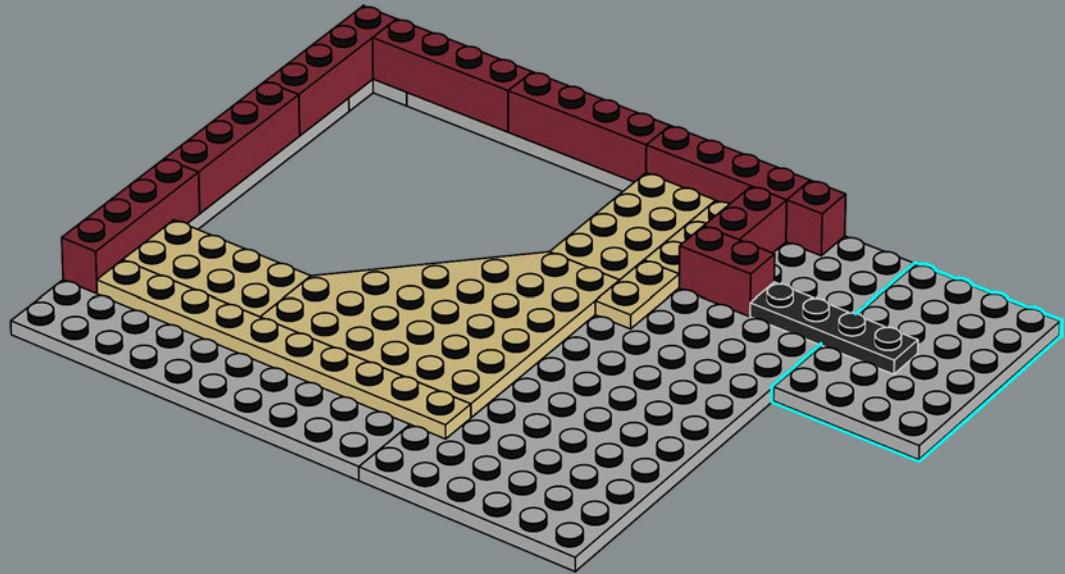

159

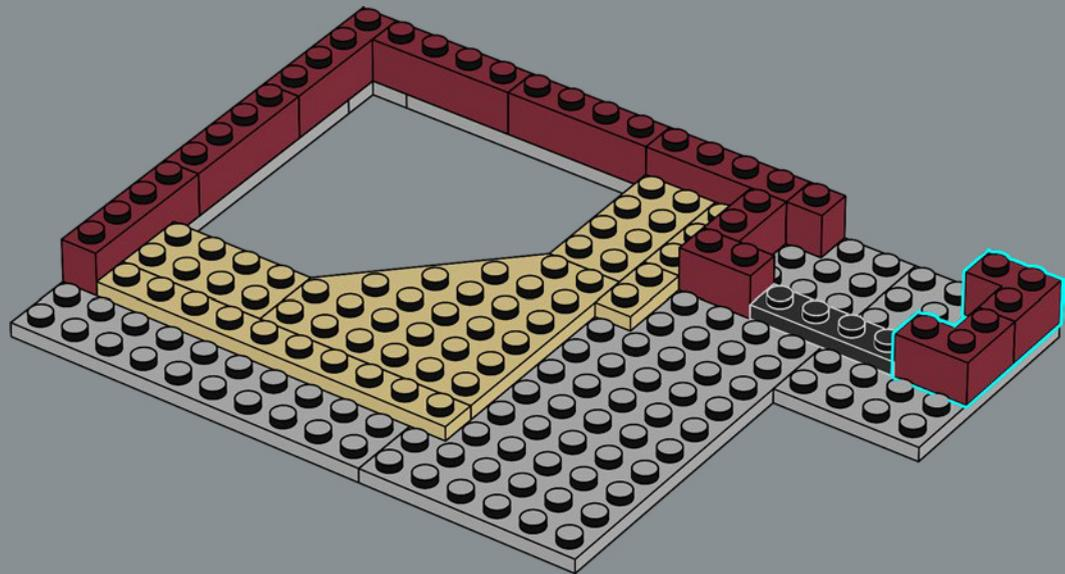

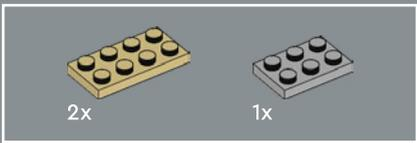

160

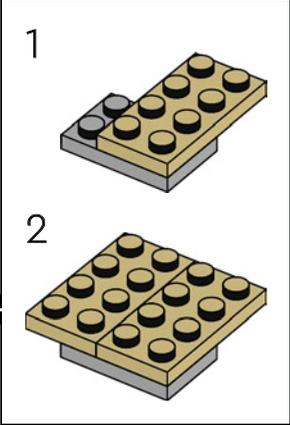
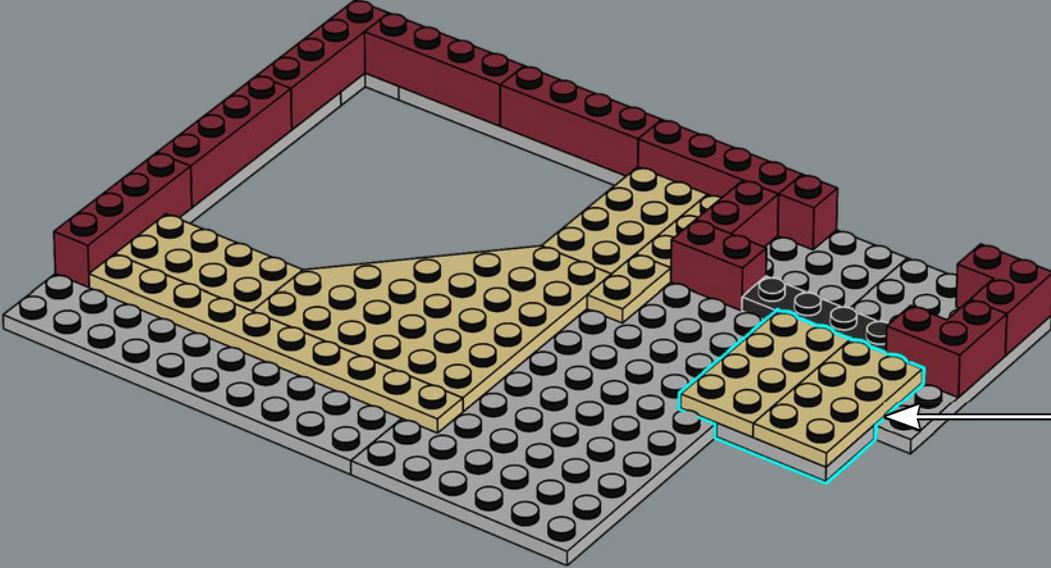



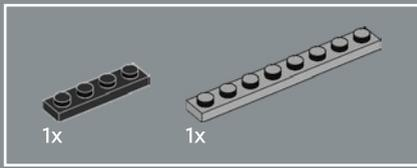

161

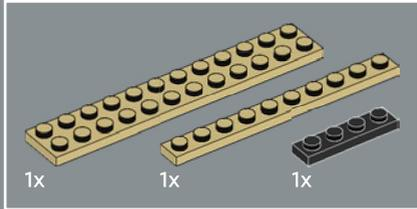
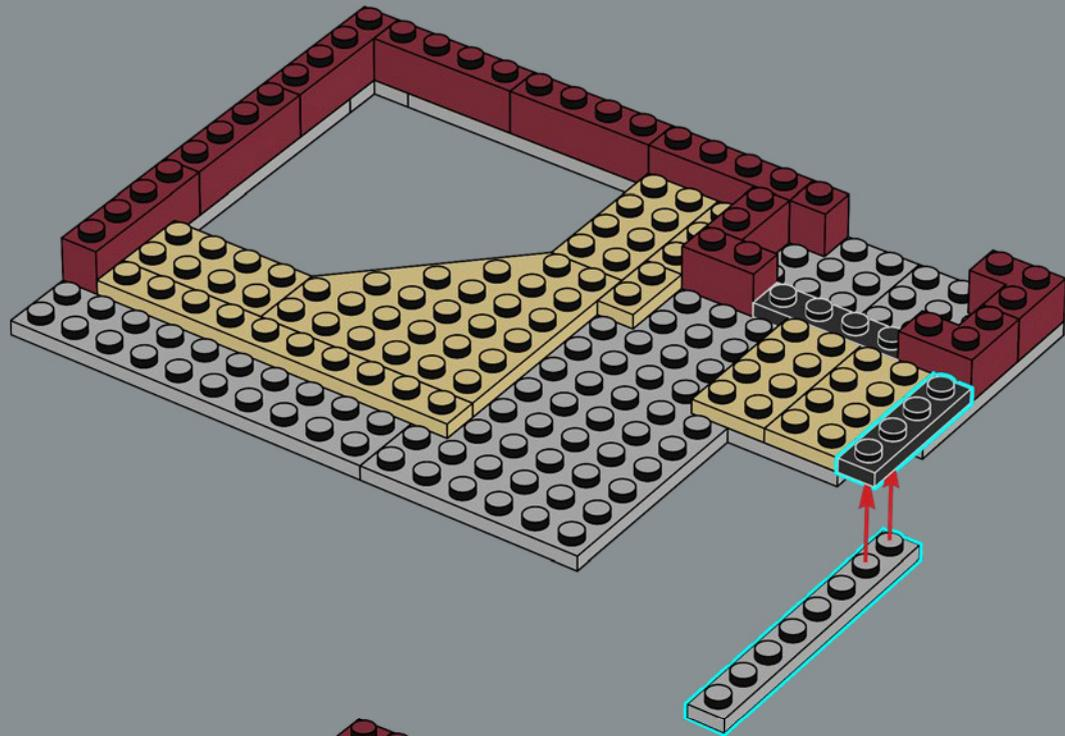

162

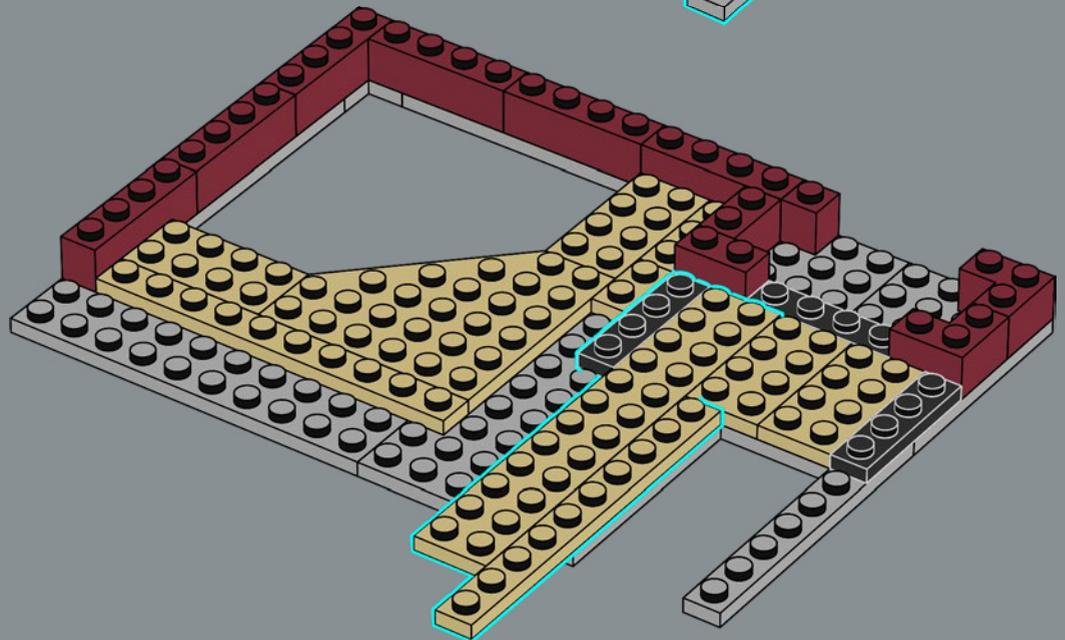

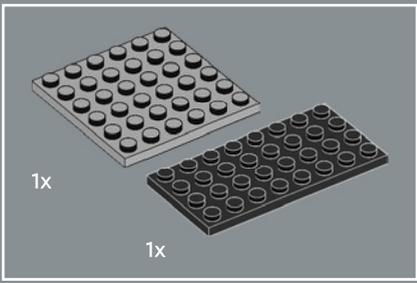

163

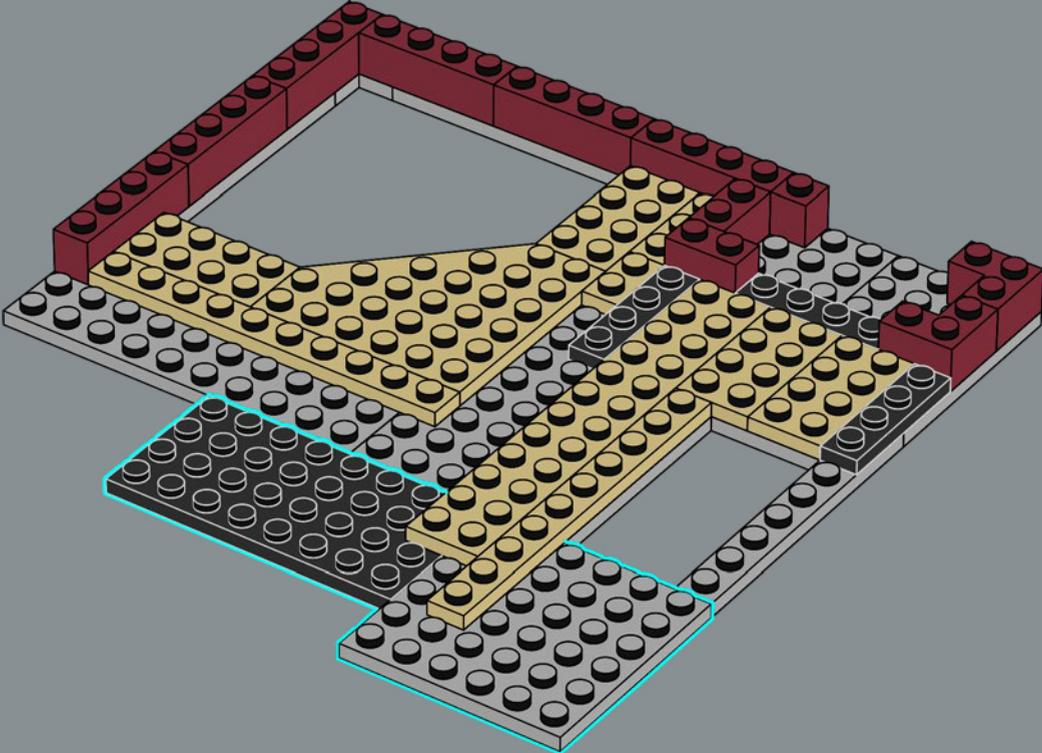

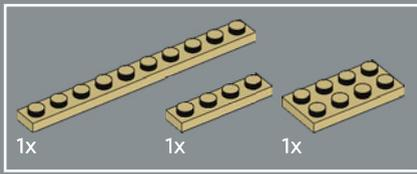

164

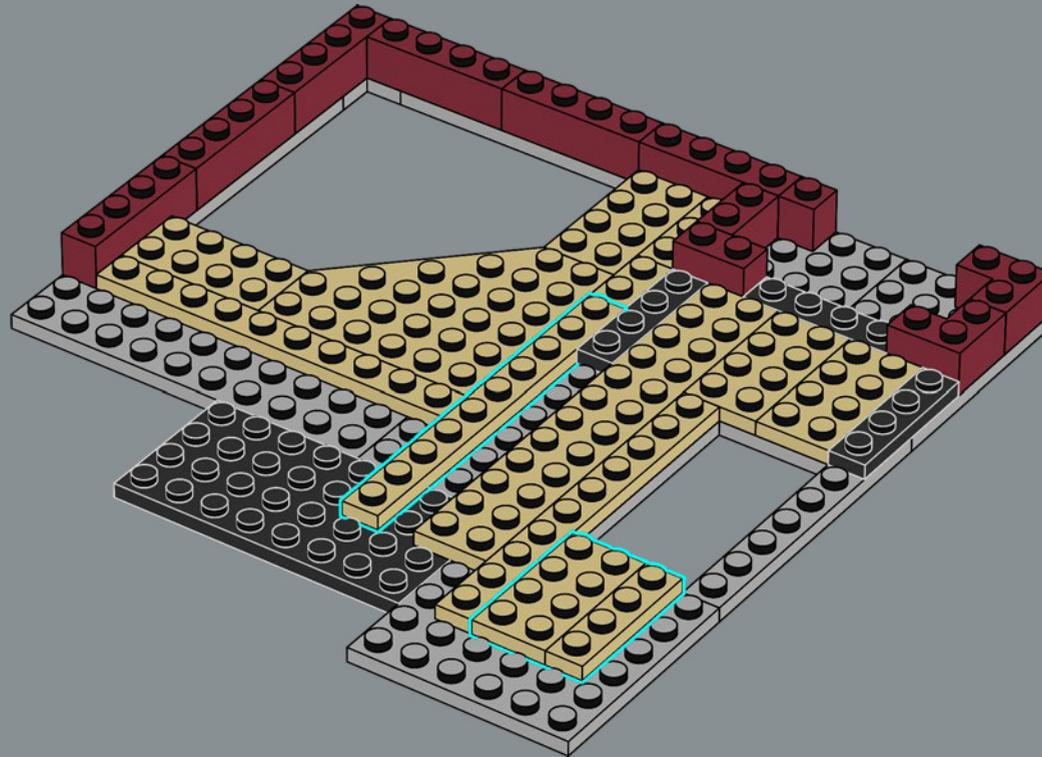

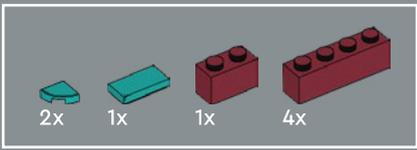

165

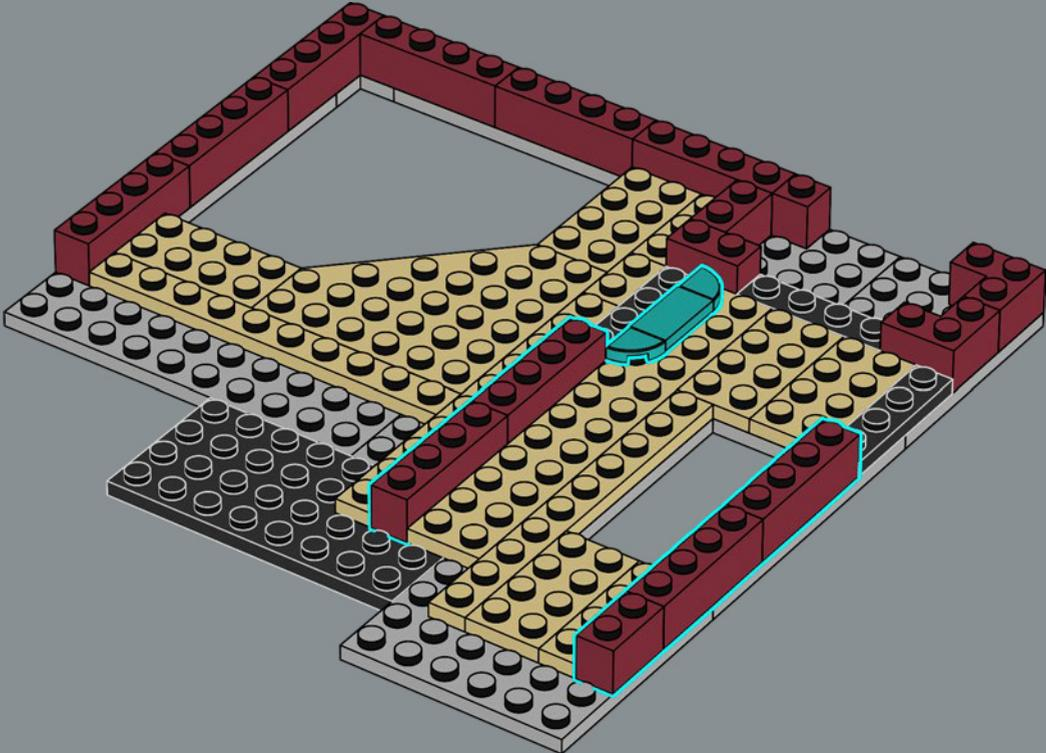

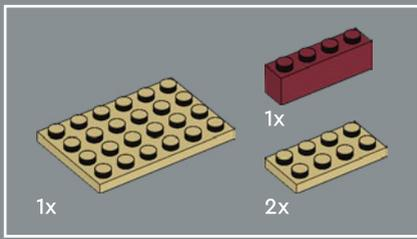

166

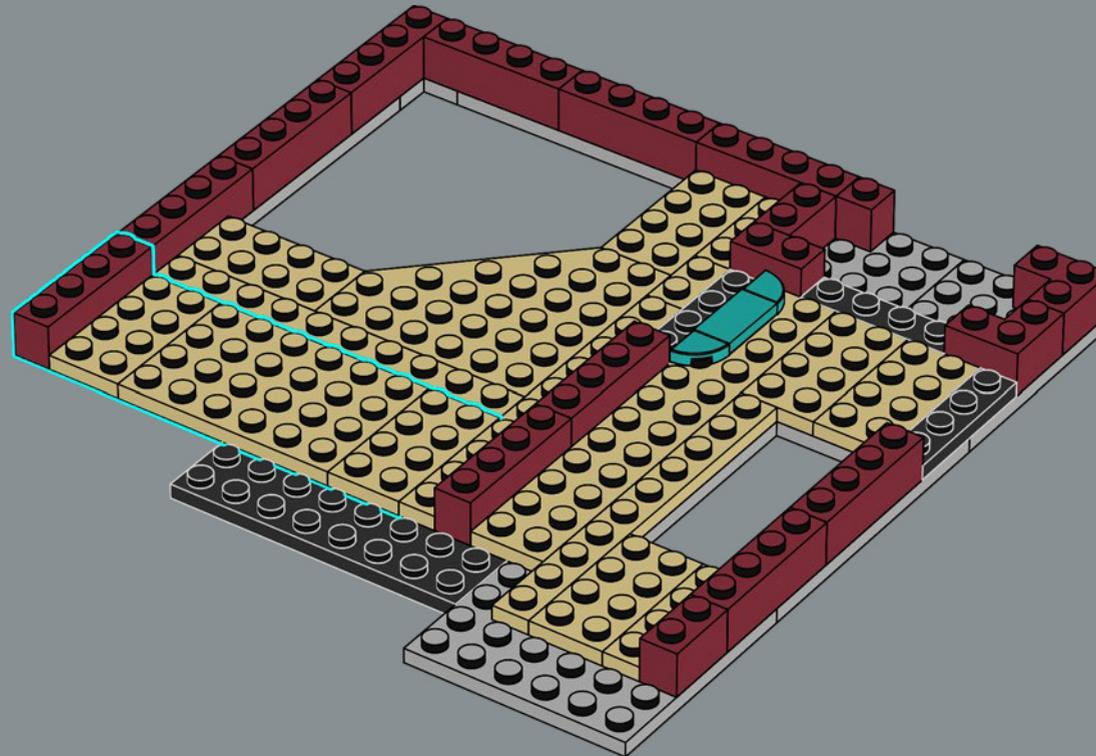

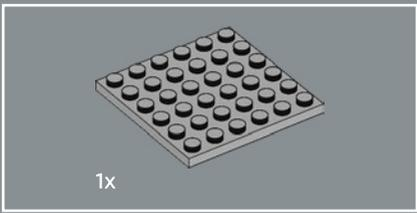

167

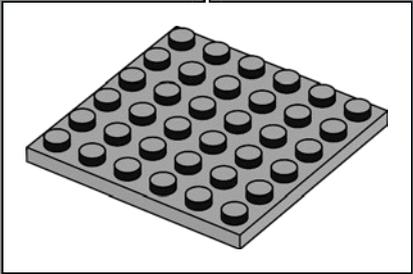
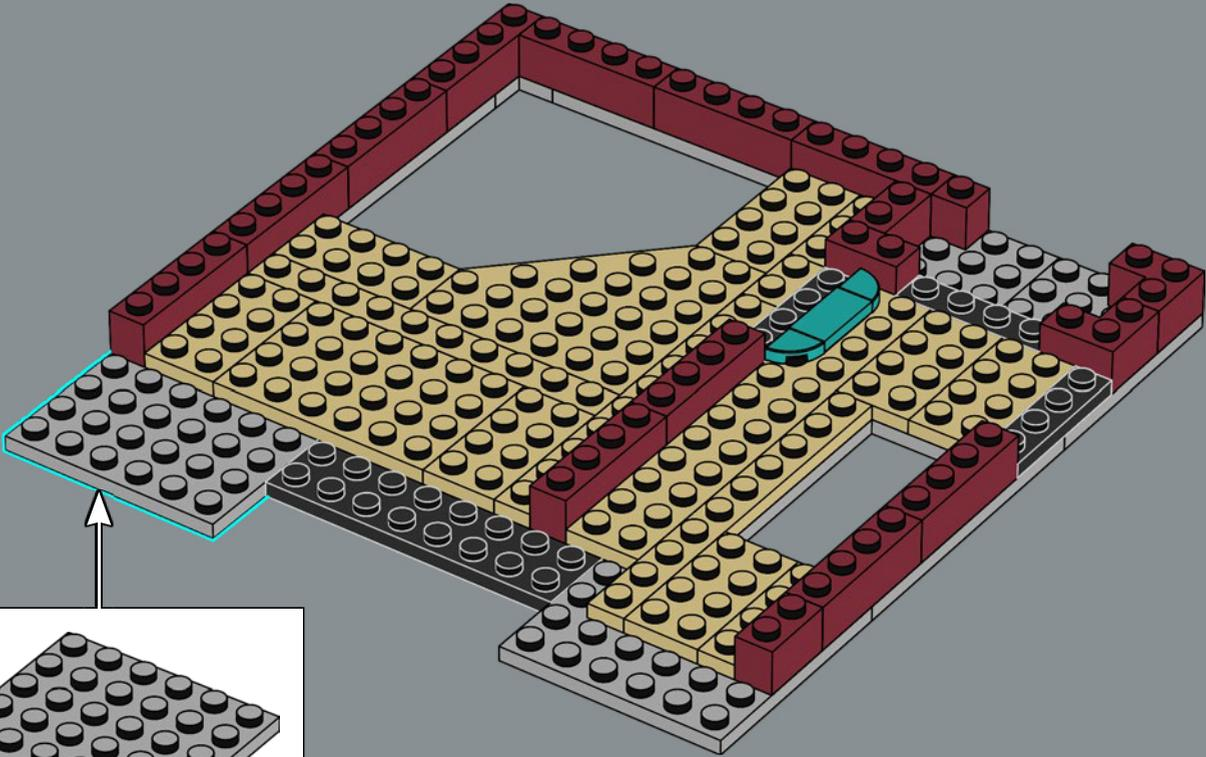

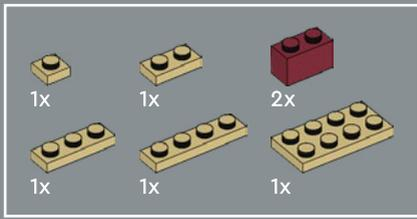

168

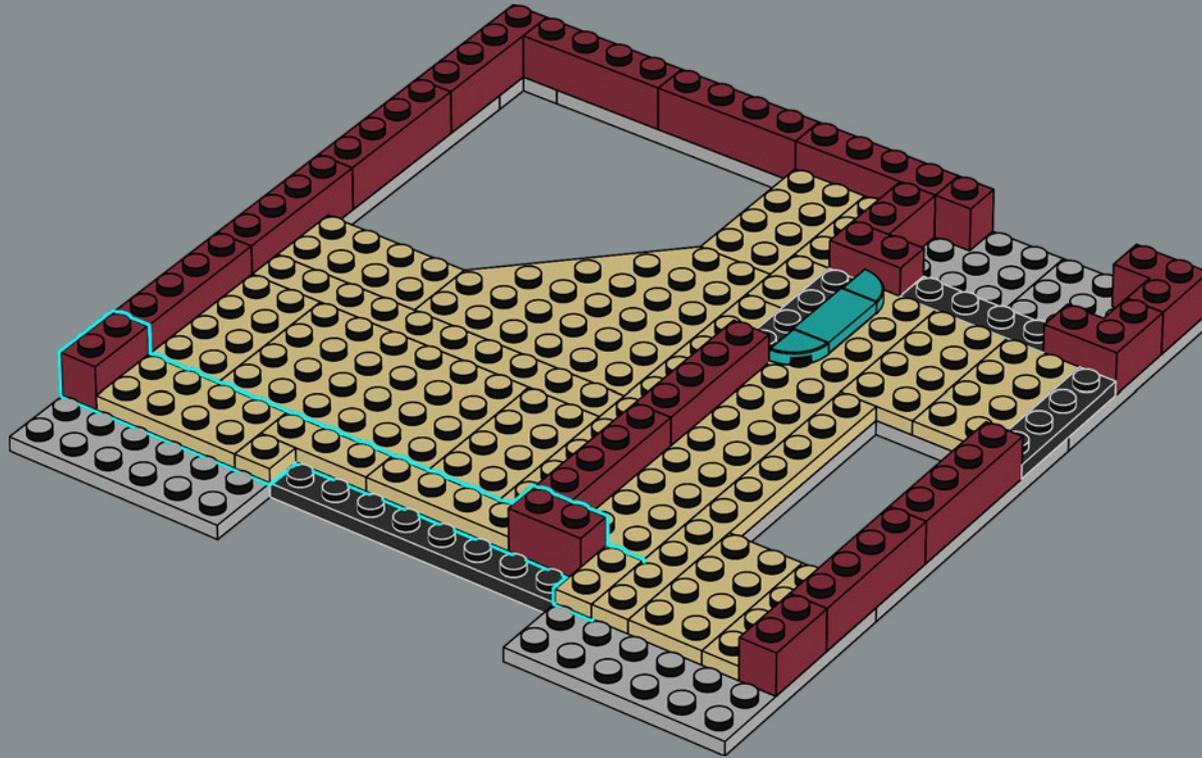

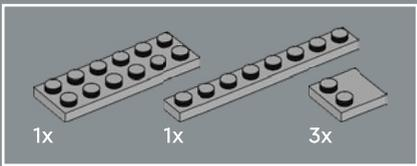

169

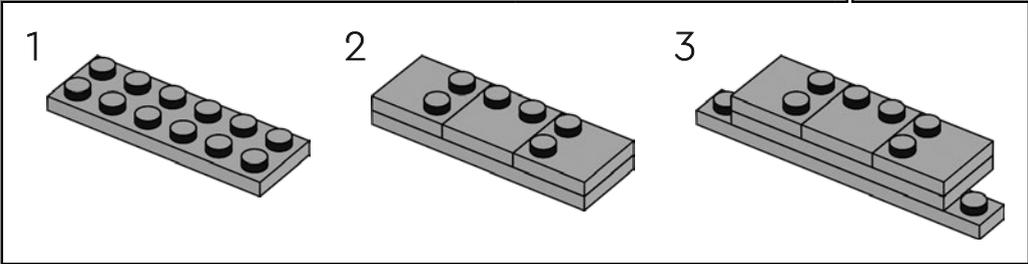
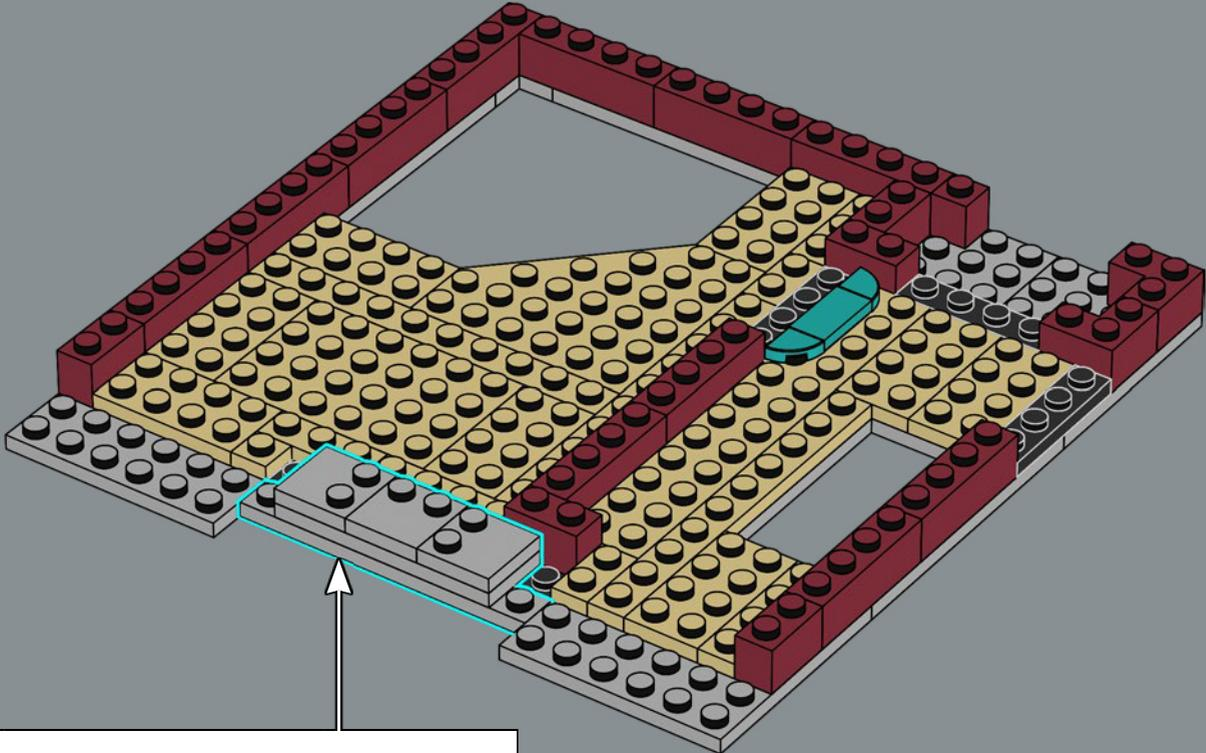



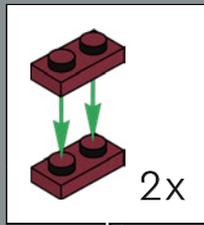
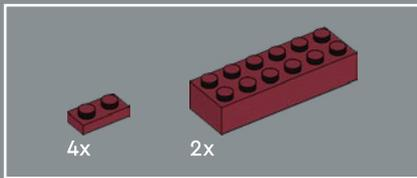

170

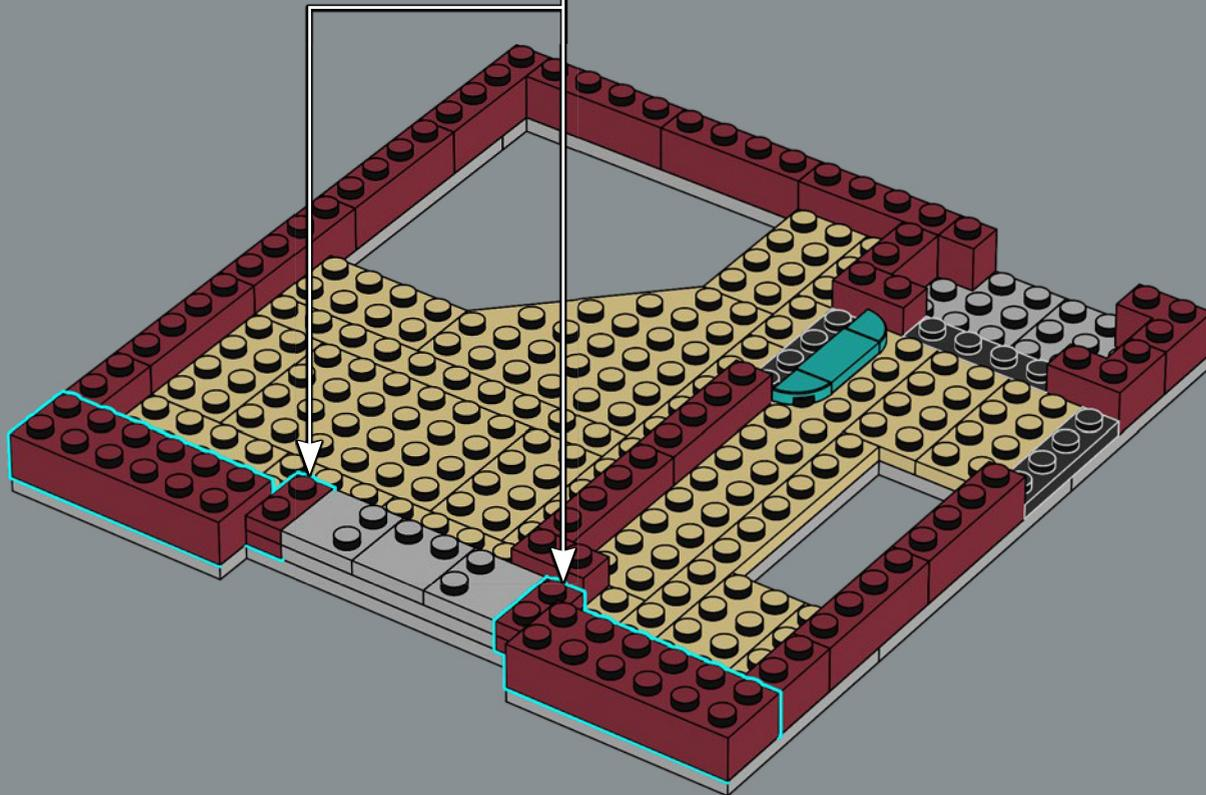

5x      4x

171

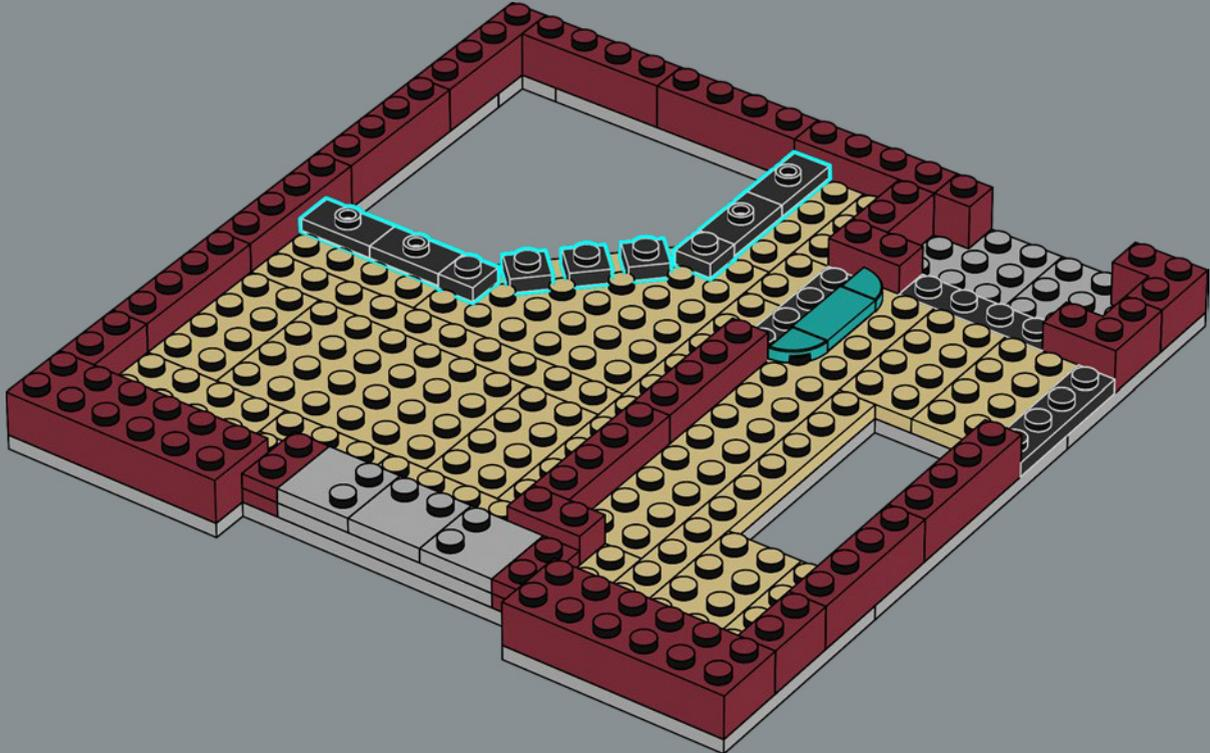



172

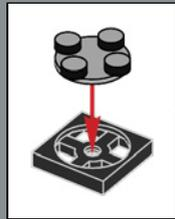
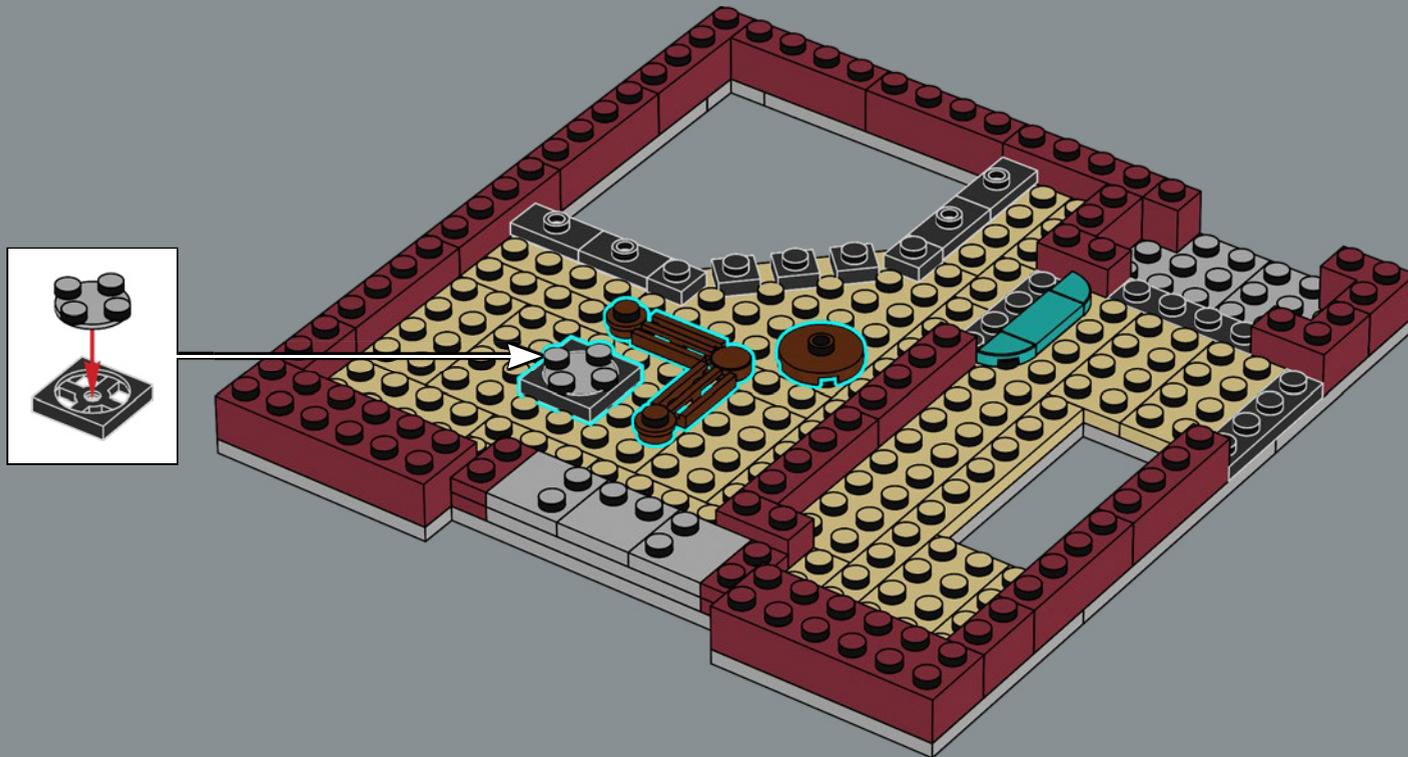

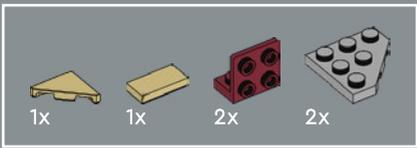

173

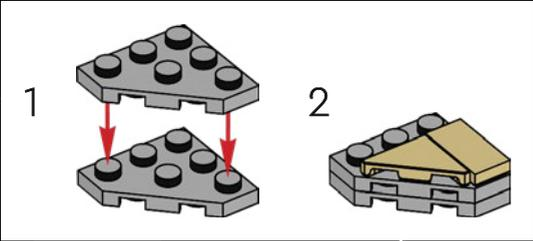

2

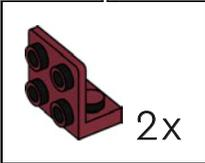
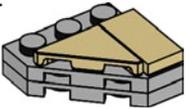



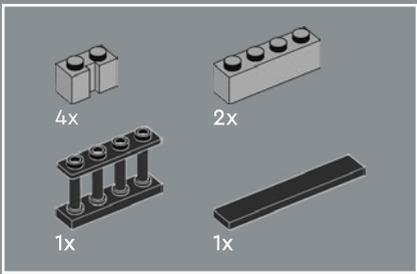

175

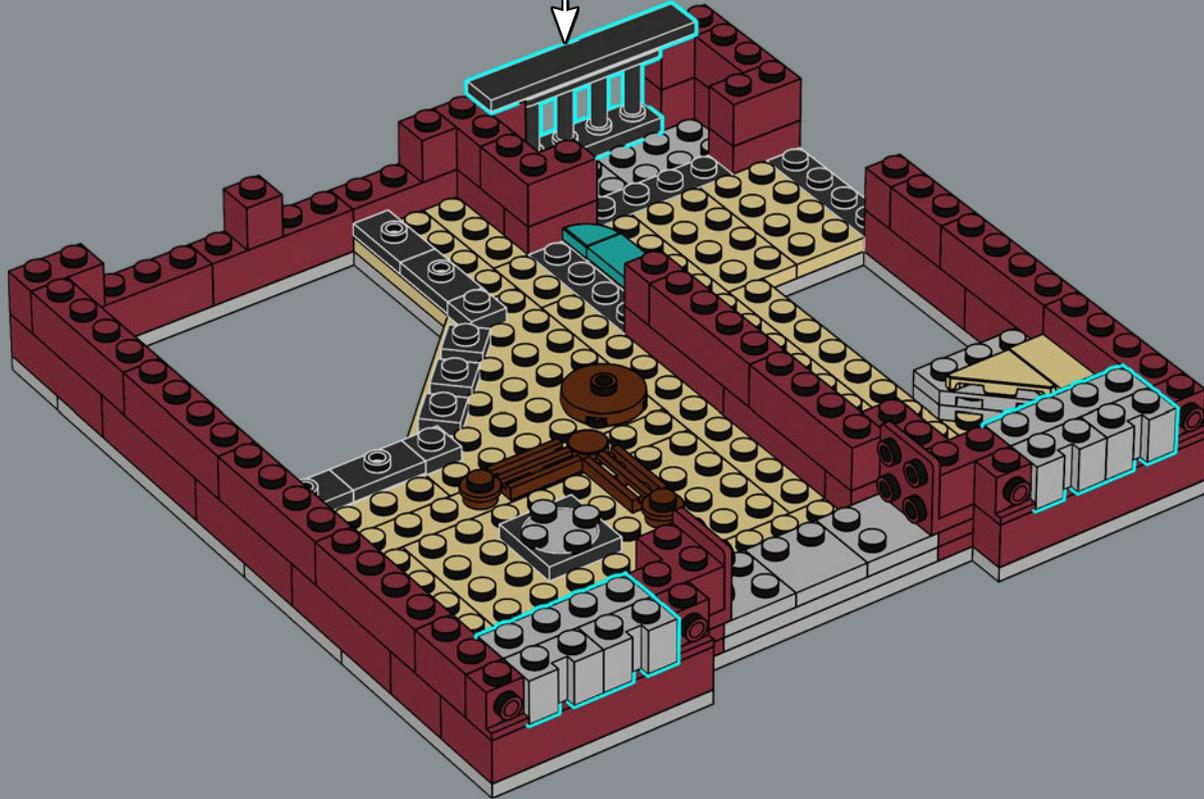
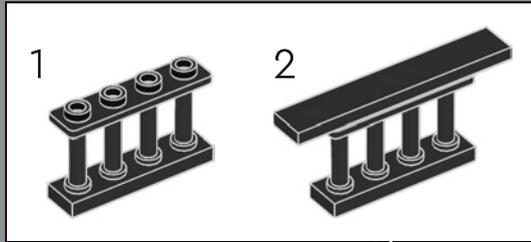

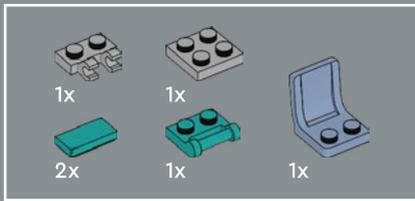

176

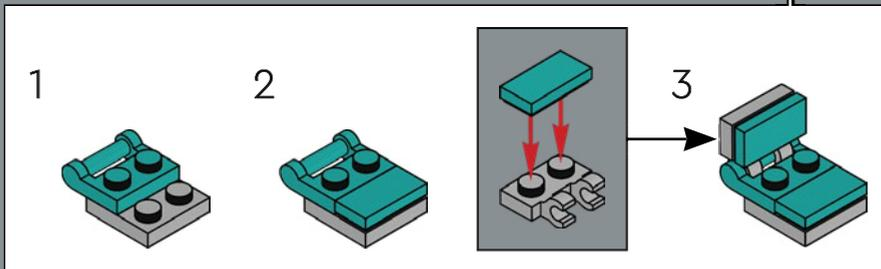
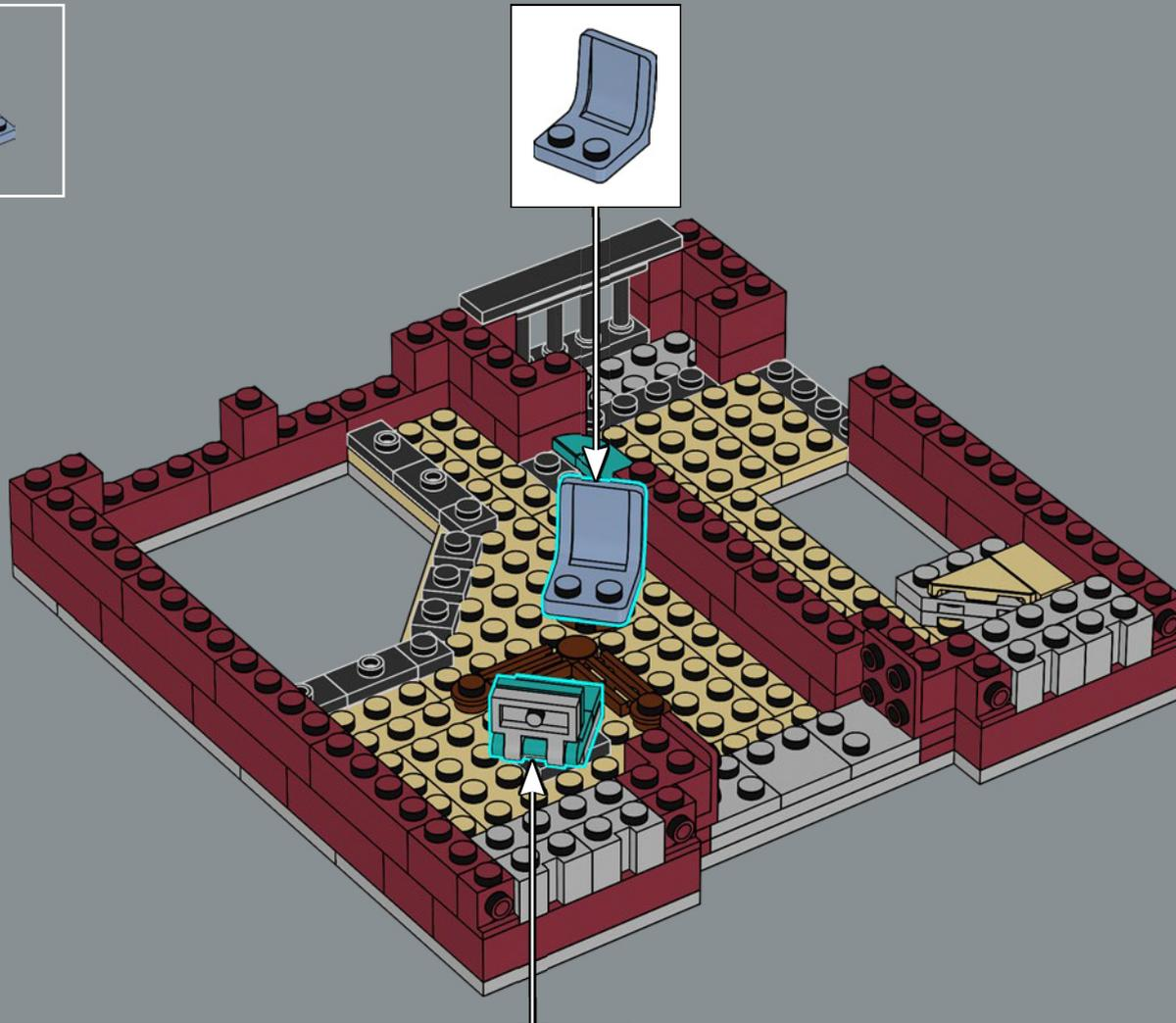



177

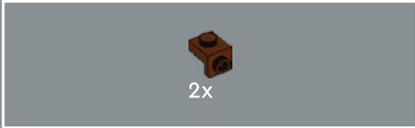
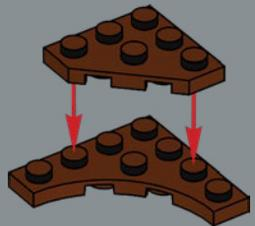

178

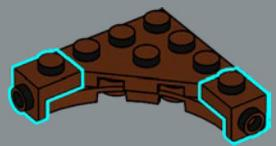

179

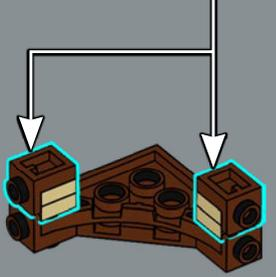
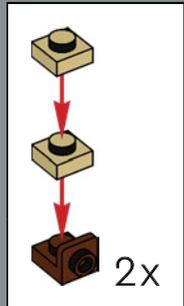

180

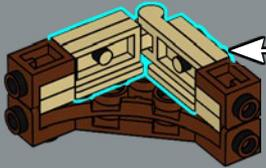
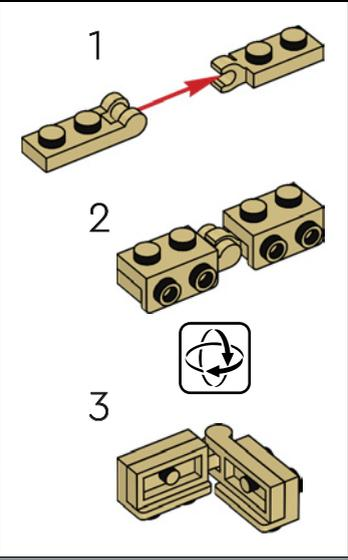





181

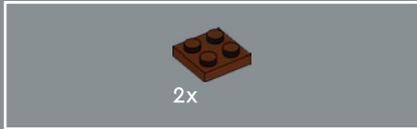

182

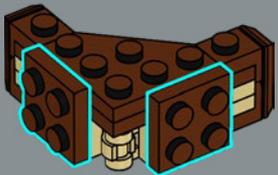

183

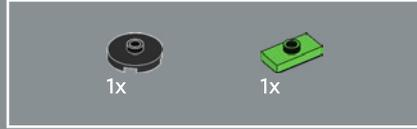
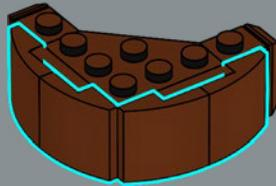

184

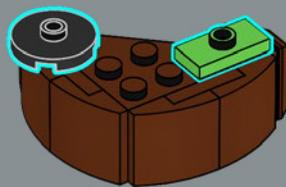

Die Clubbesitzerin wollte etwas ganz Besonderes für ihr Büro. Deshalb hat sie ihren außergewöhnlichen Schreibtisch diagonal aufgestellt.

185

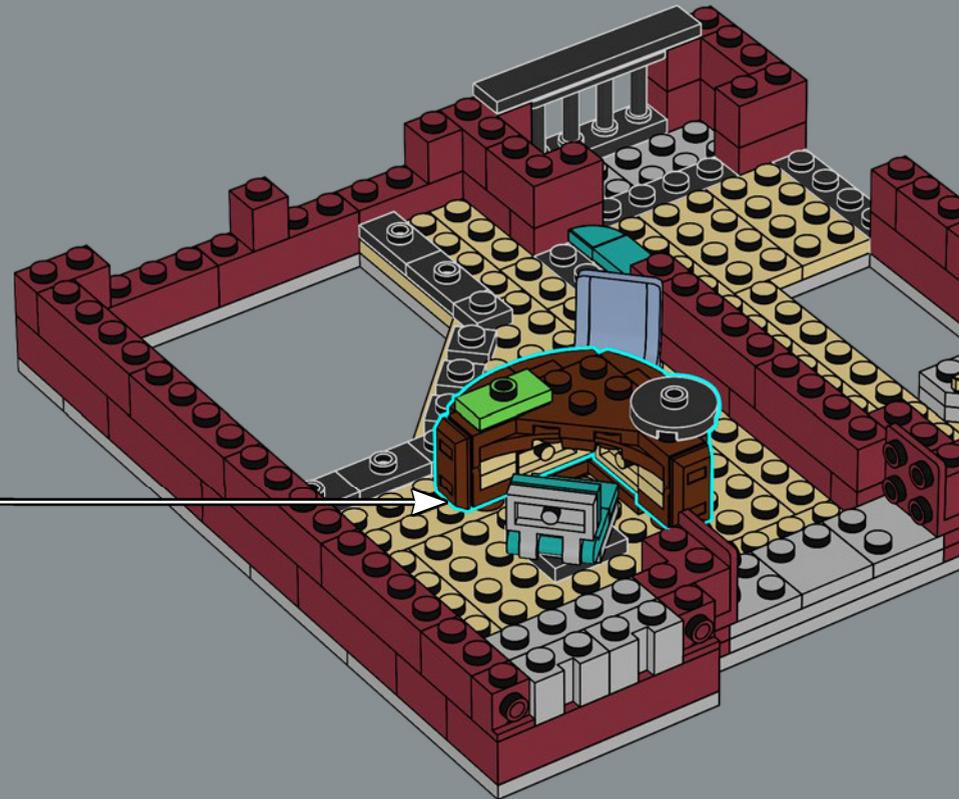



186

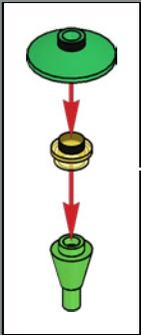
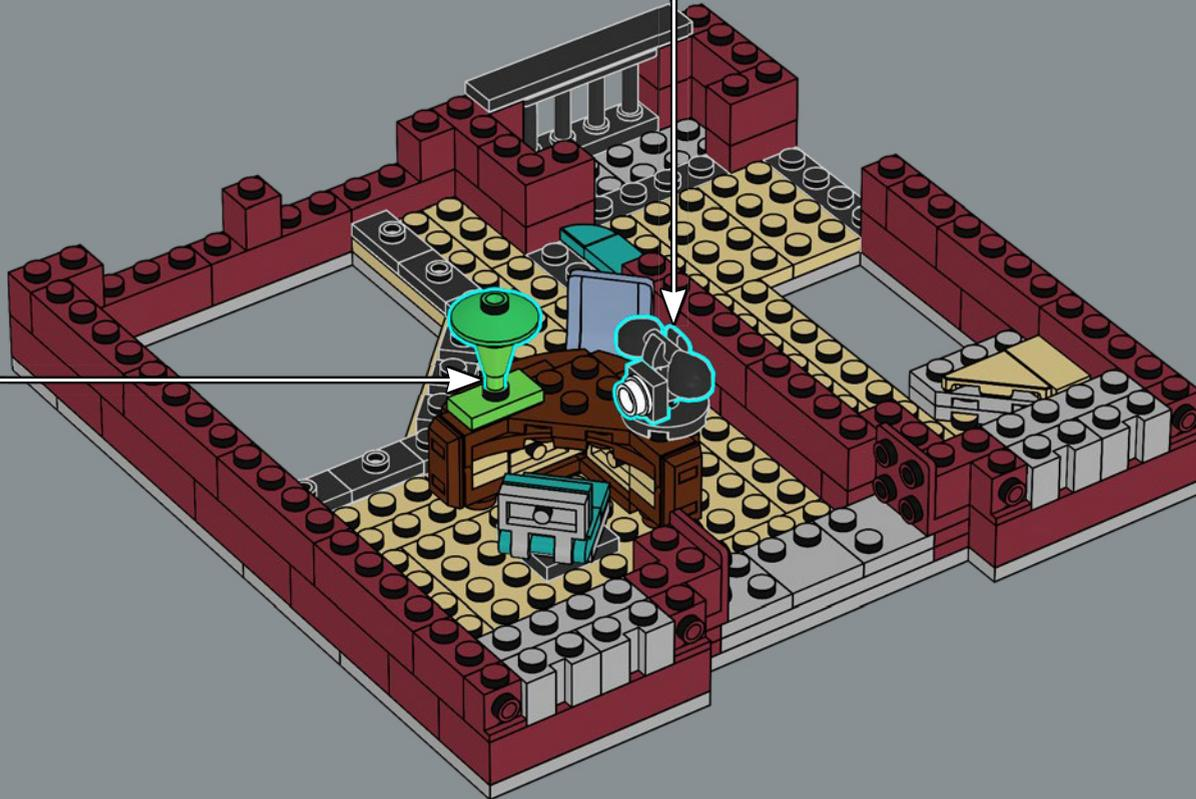



Die Clubbesitzerin liebt es, Nachwuchskünstler zu entdecken und auf der Bühne glänzen zu lassen. Als eine der Ersten hat sie das Talent des Saxofonisten aus dem LEGO® Set Stadtleben (10255) erkannt.

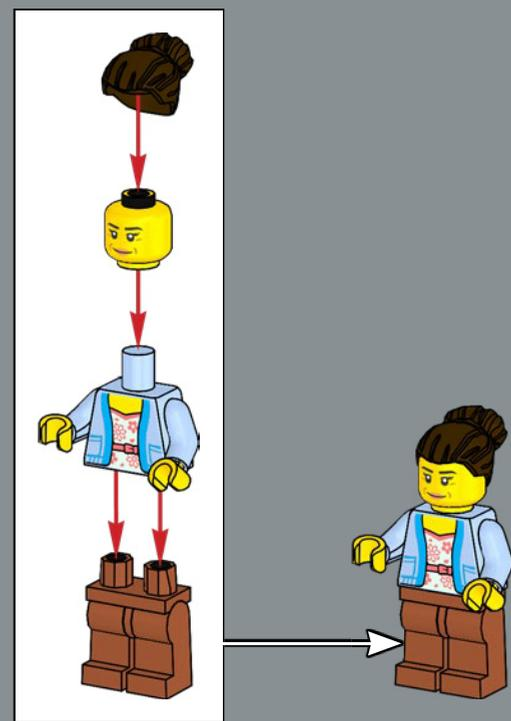



187

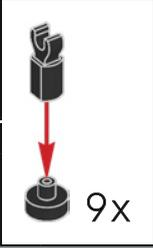
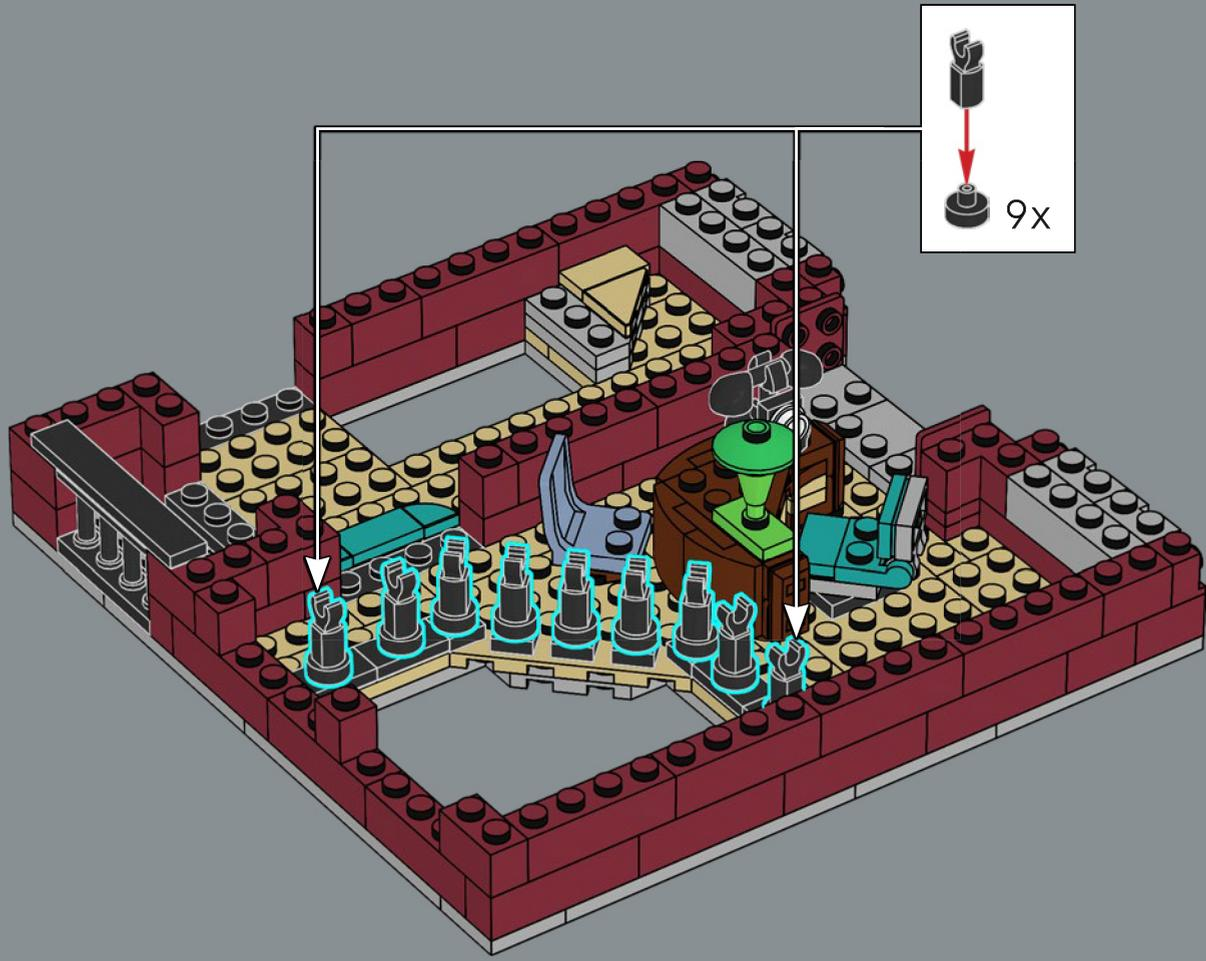



Die Geschäftsführerin hat ihren eigenen  
Privatbalkon, auf dem sie sich die abendlichen  
Darbietungen anhören kann.

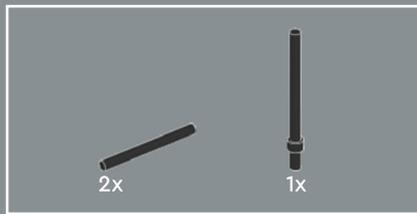

188

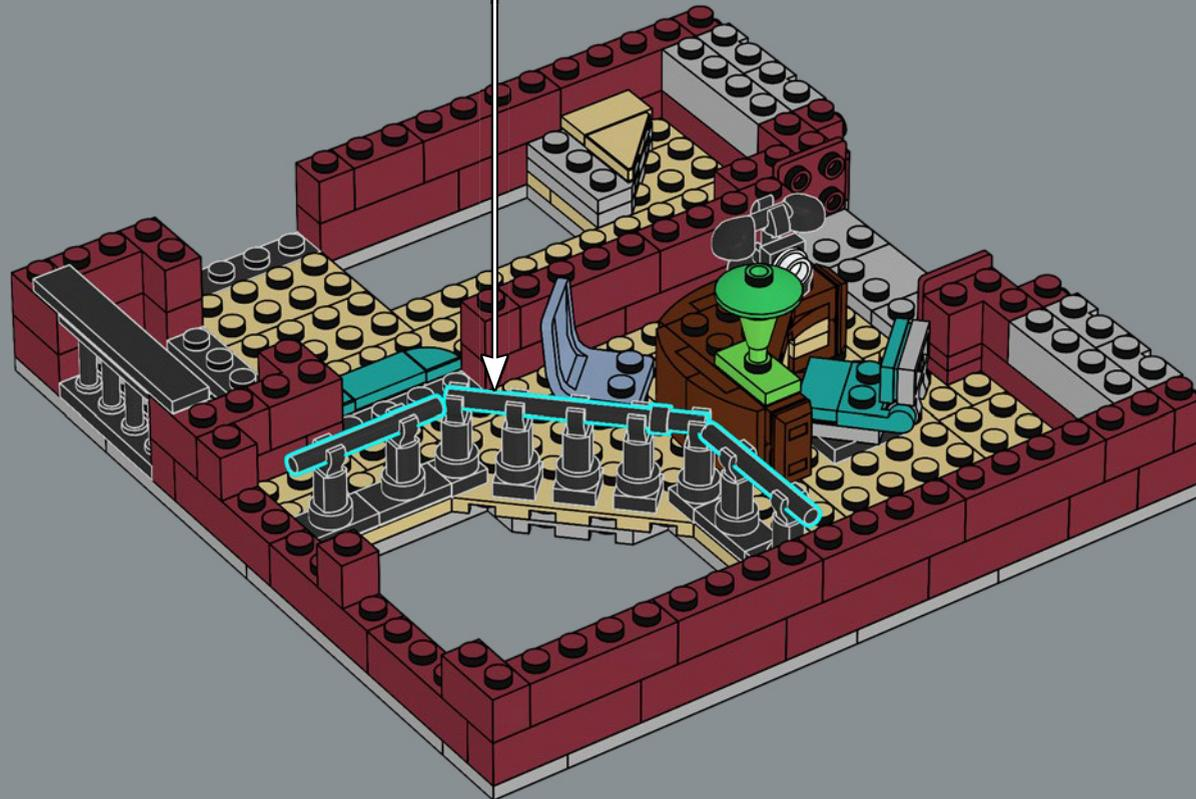

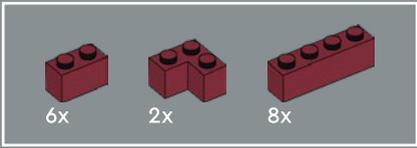

189

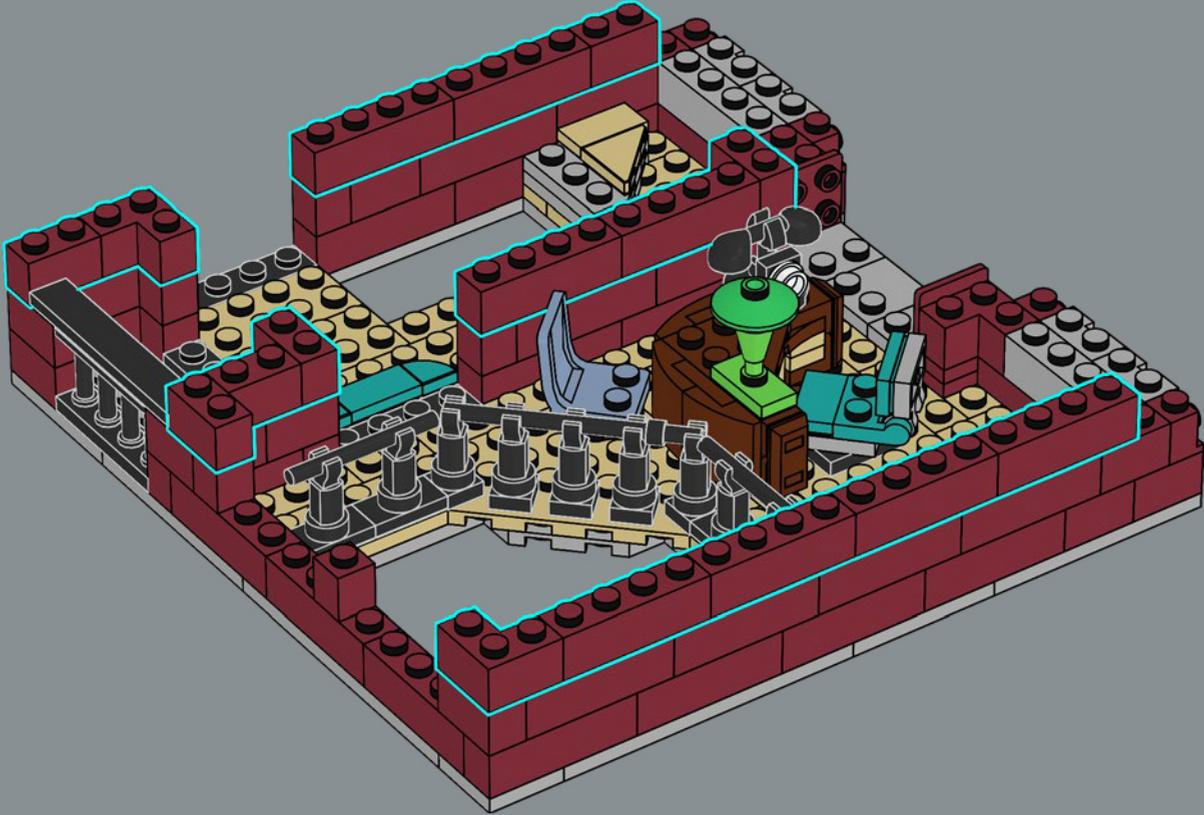

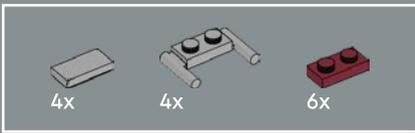

190

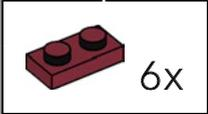



191

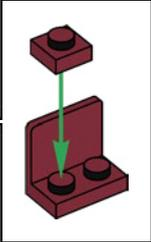
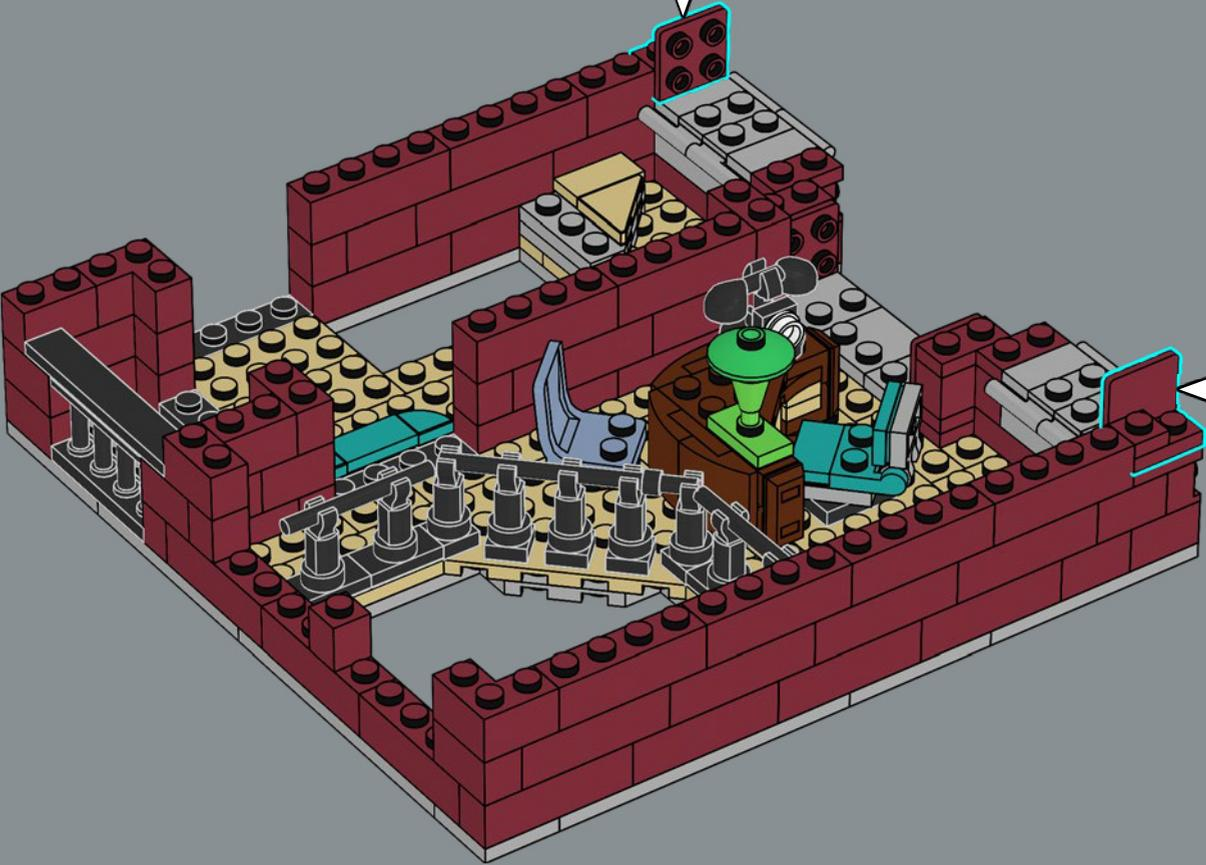
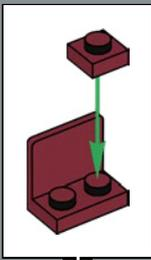





192

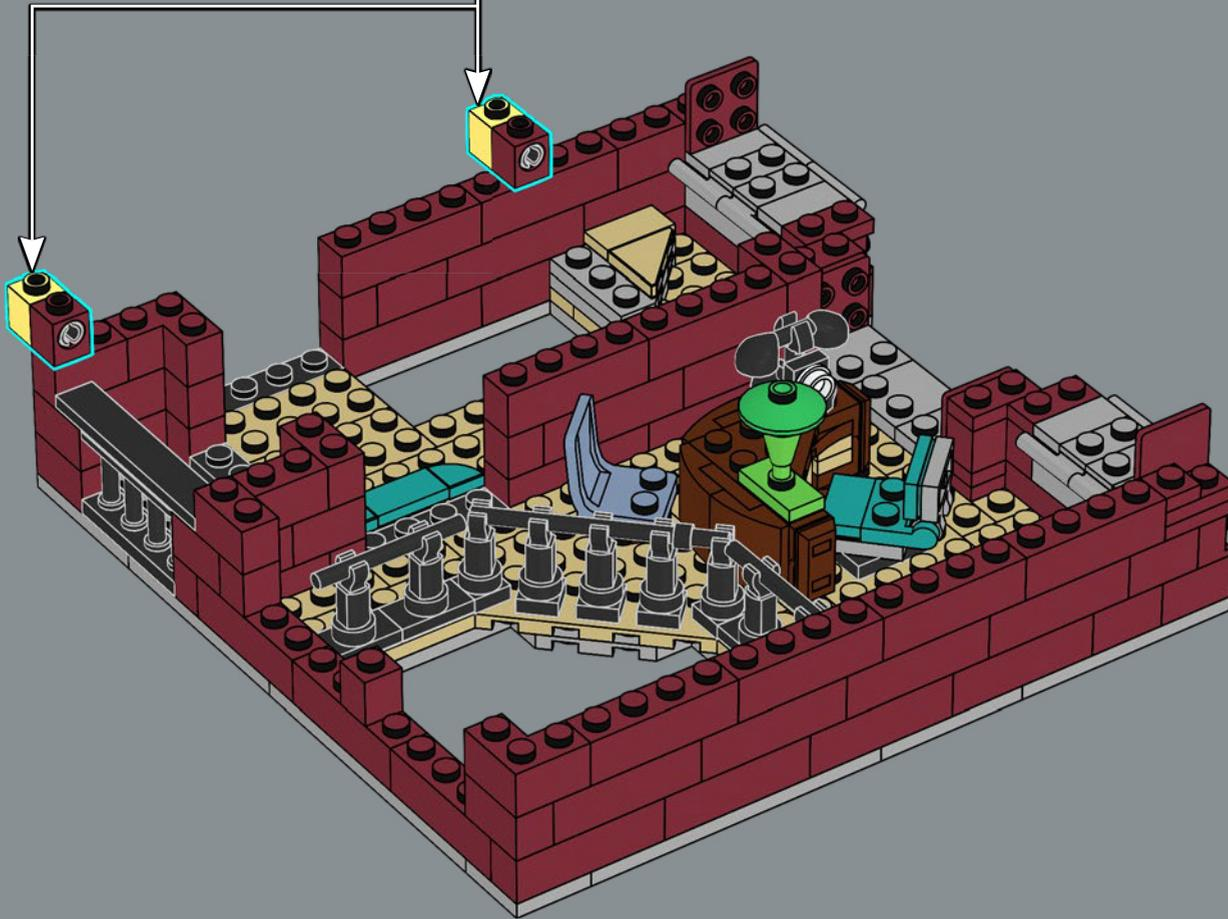
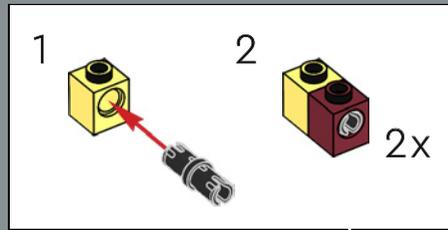

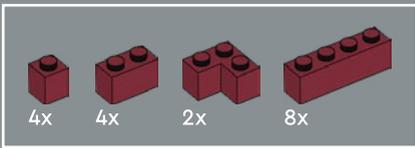

193

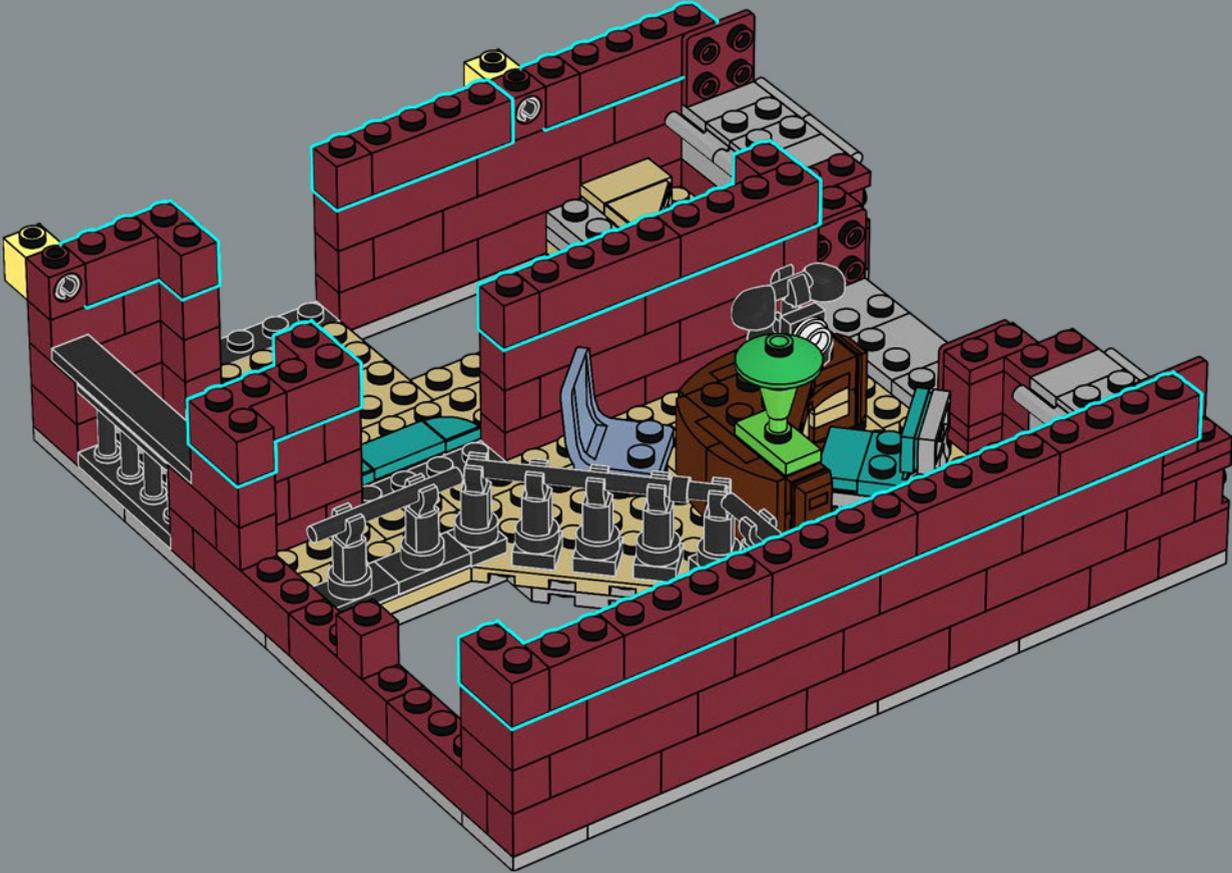

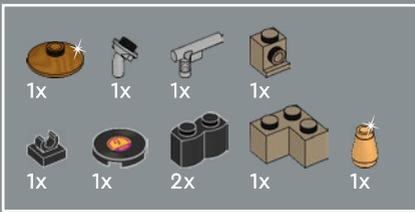

194

1

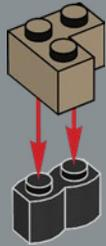

2

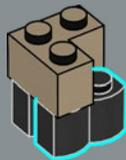

3

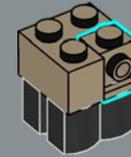

4



5

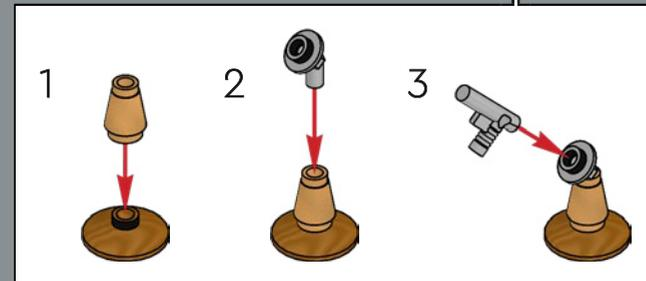



Die Clubbesitzerin liebt jedoch nicht nur Livemusik, sondern hört sich die neuesten Hits auch gern auf ihrem Plattenspieler an. Erst vor Kurzem hat sie sich das wahnsinnig erfolgreiche neue Album des Rockstars aus dem LEGO® Set Amerikanisches Diner (10260) angehört.

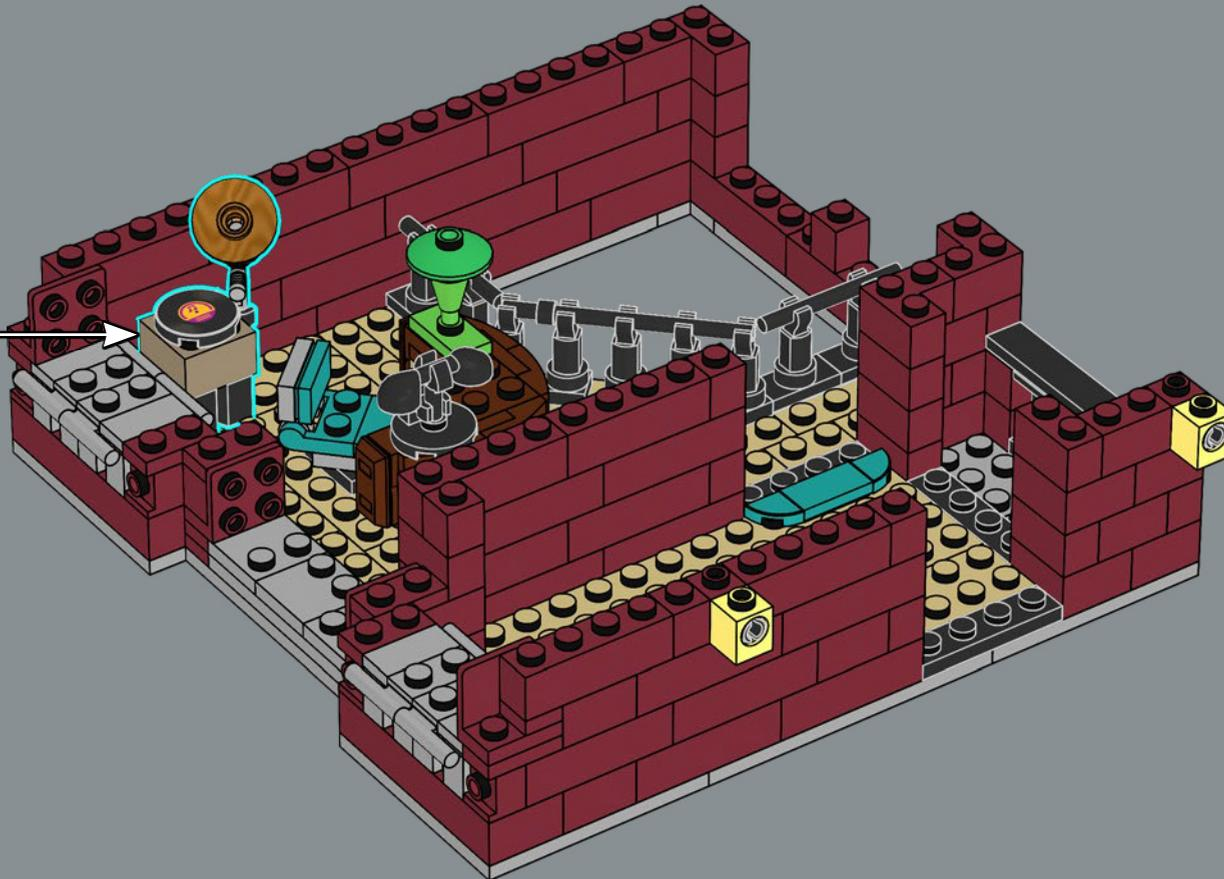

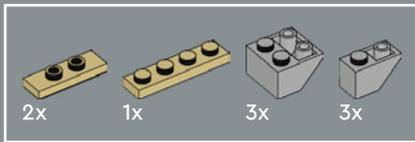

195

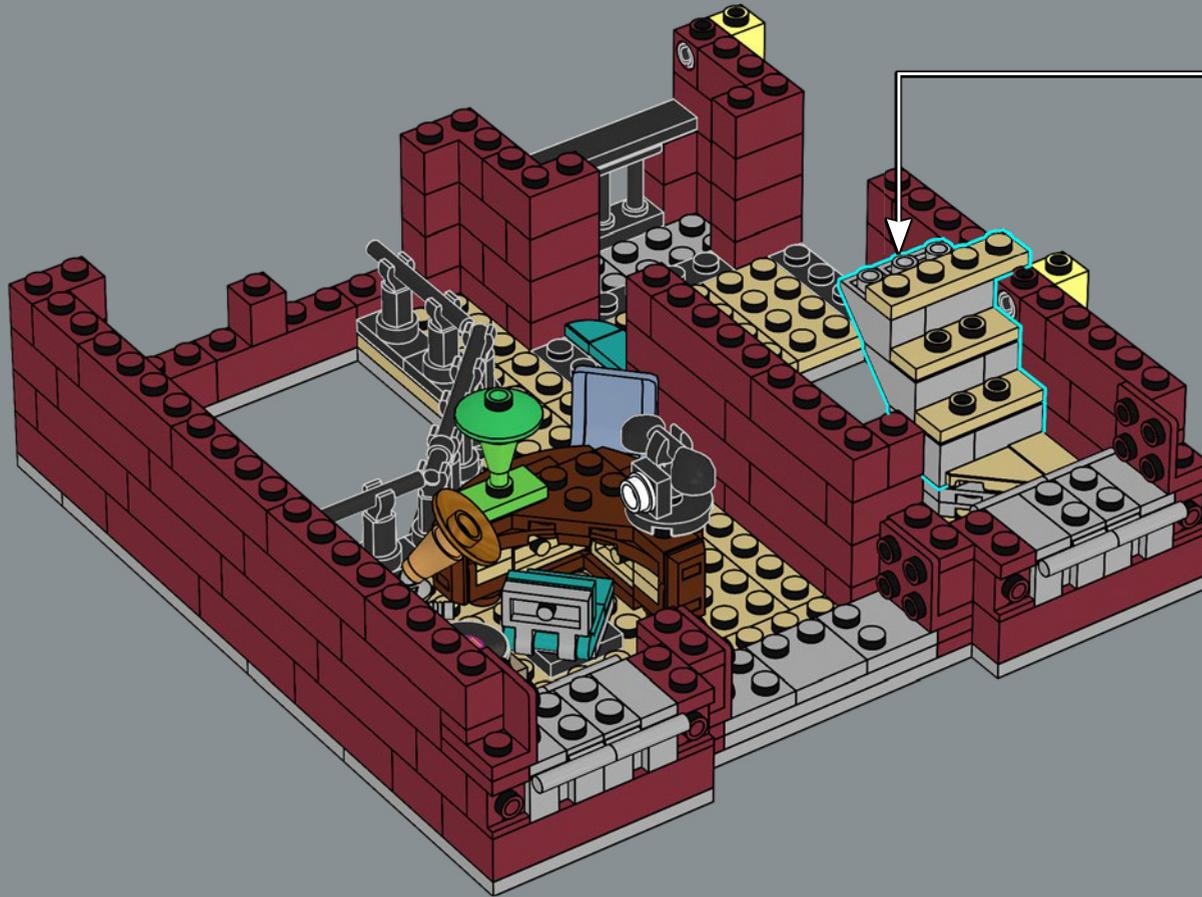
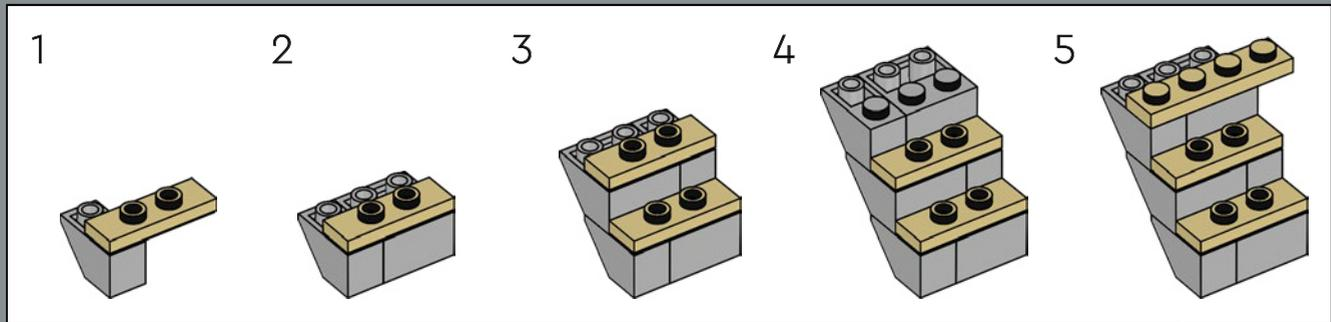



4x

196

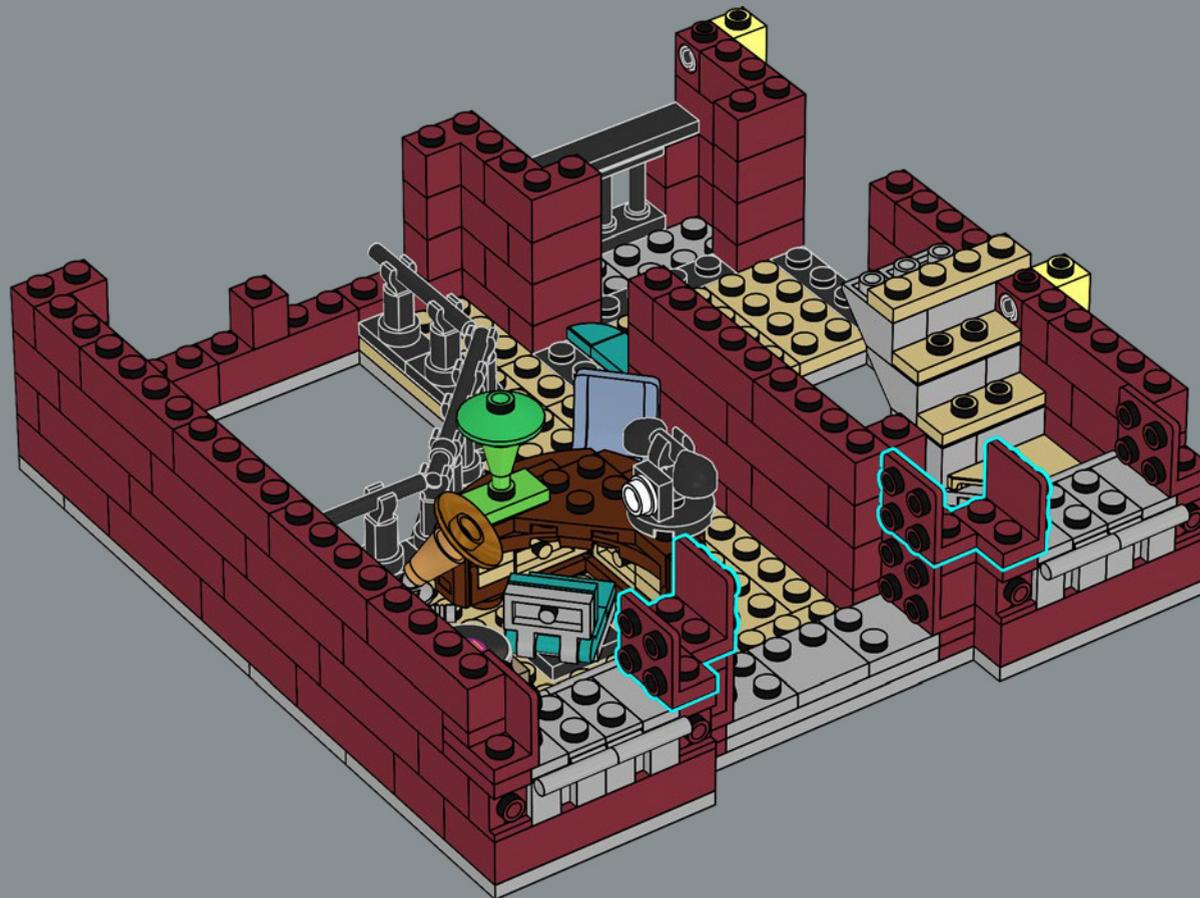



197

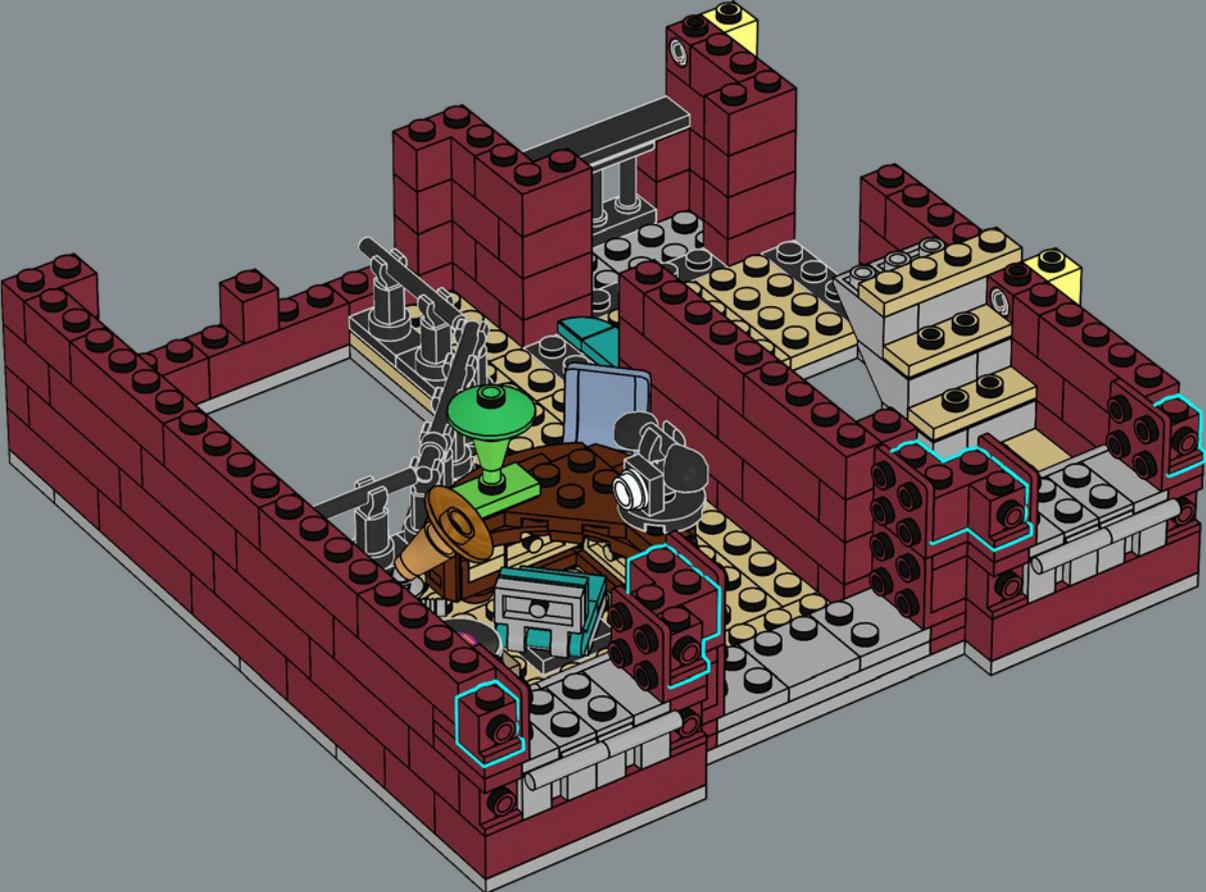



198

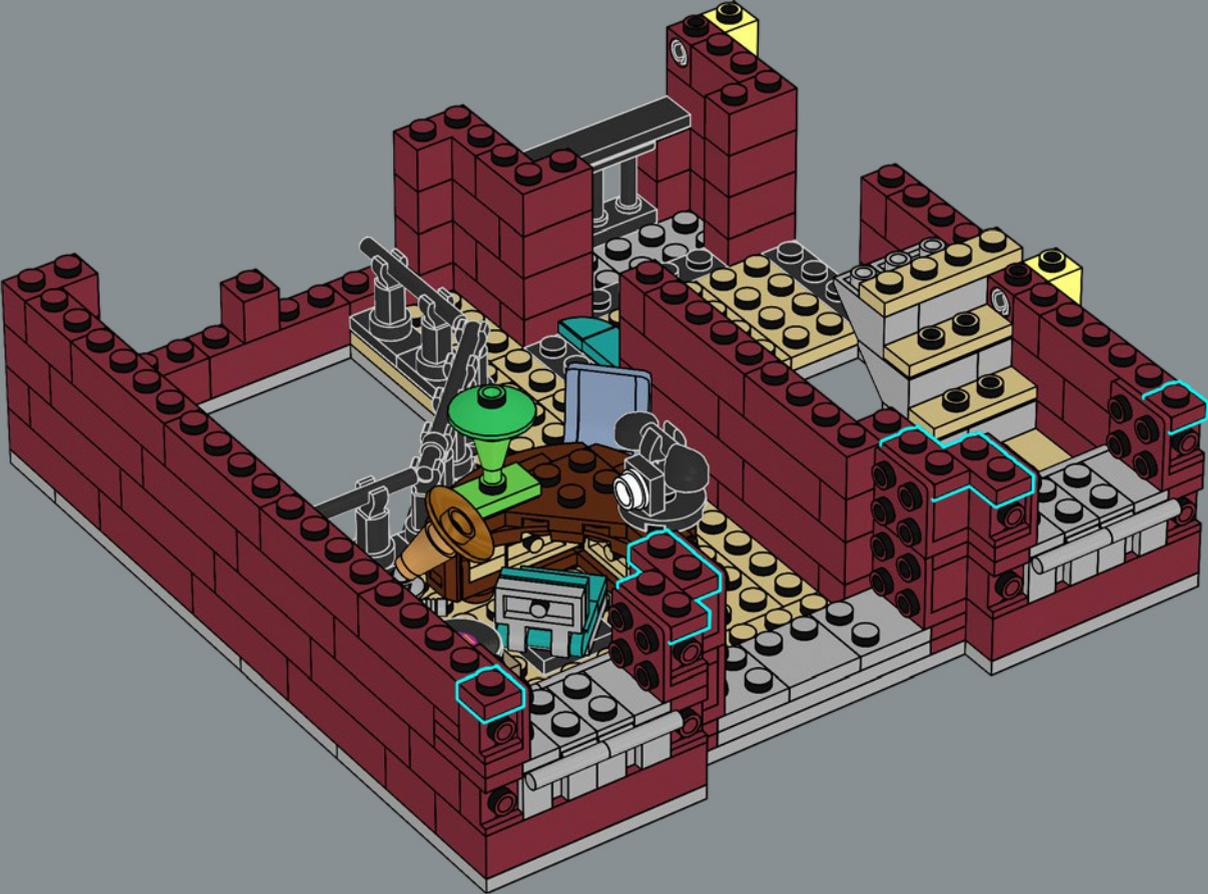



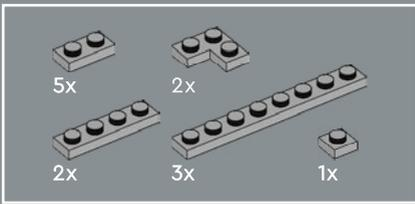

199

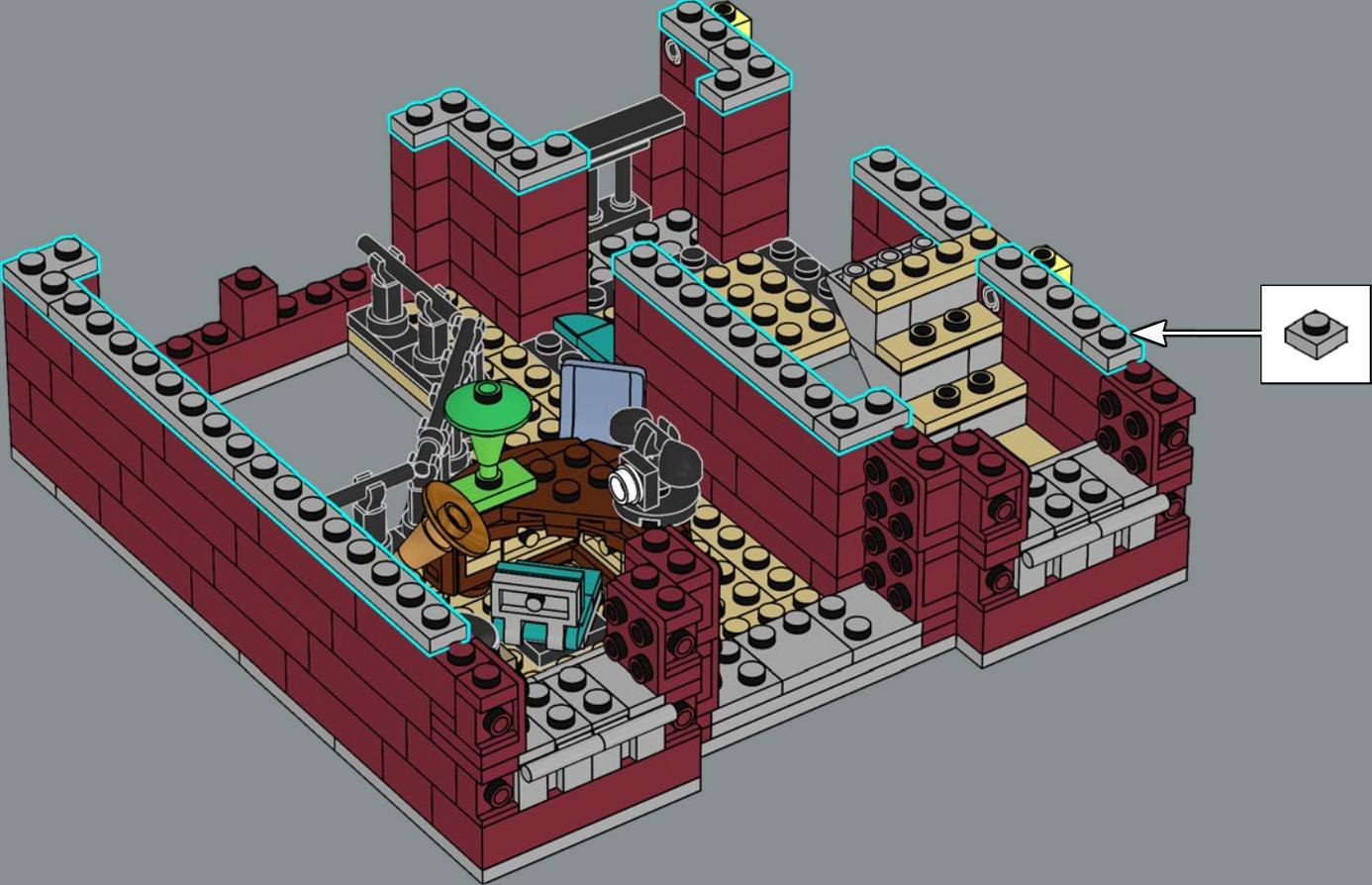



6x

200

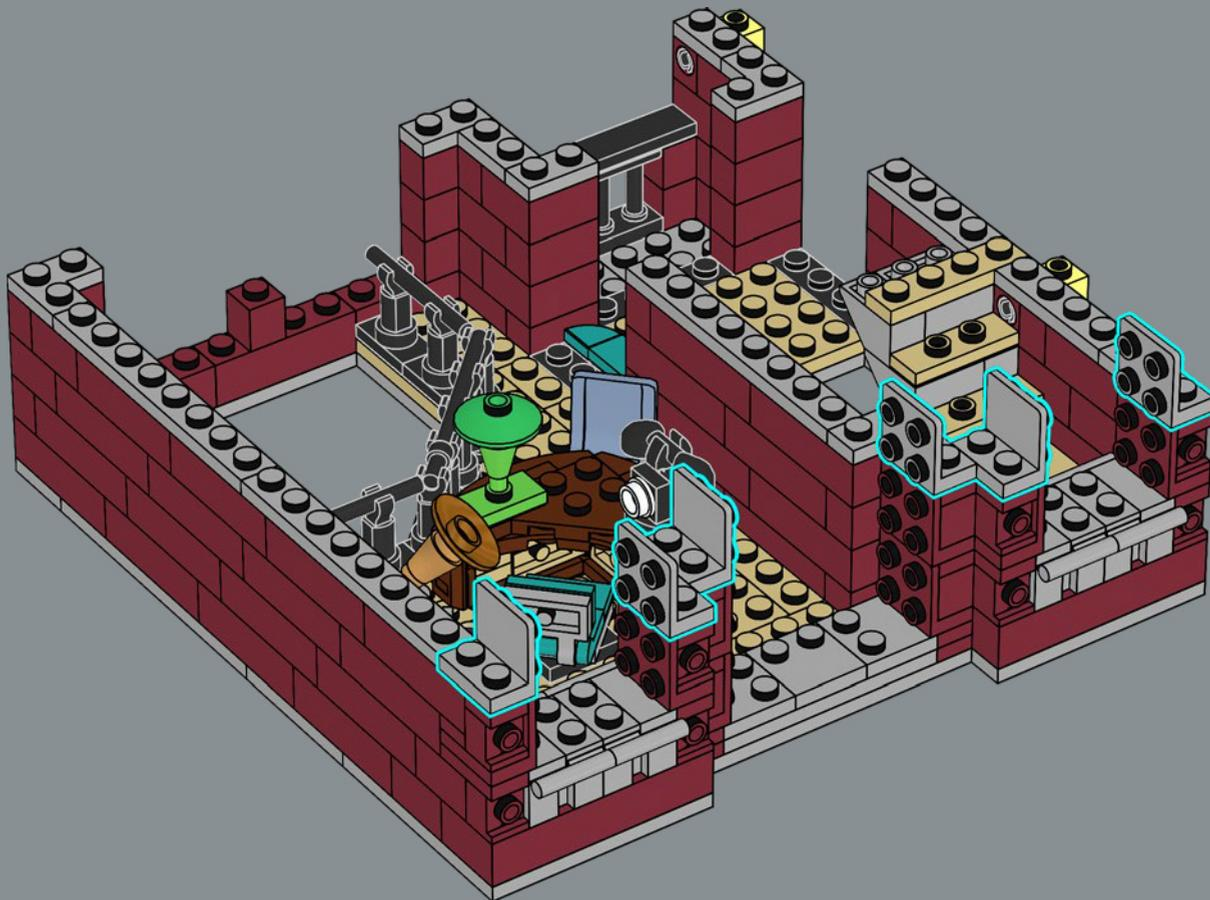



Das Wandgemälde im Büro ist ein kleines Werk des Künstlers, der im Loft über dem LEGO® Pariser Restaurant (10243) wohnt.

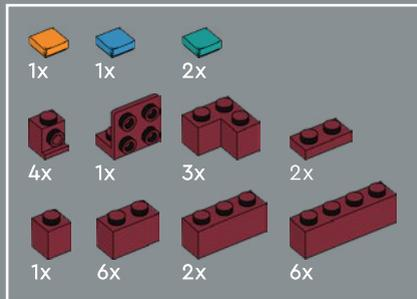

201

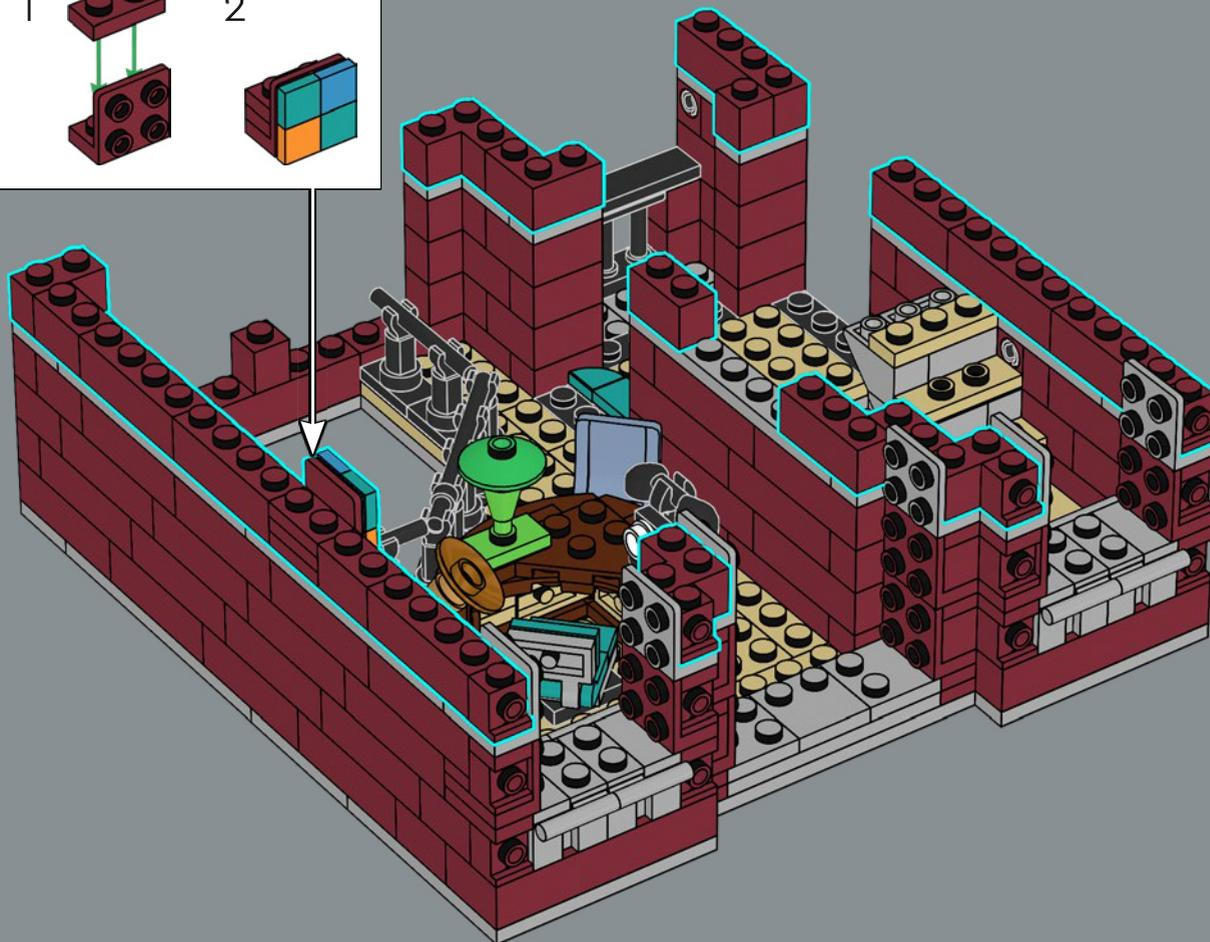
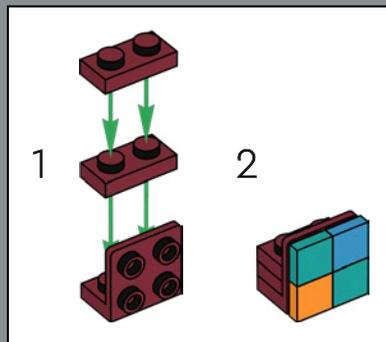



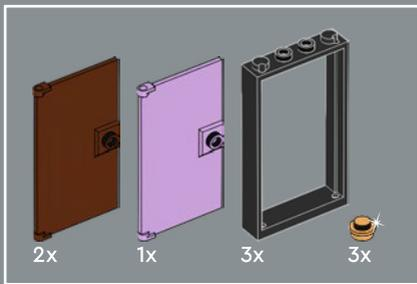

202

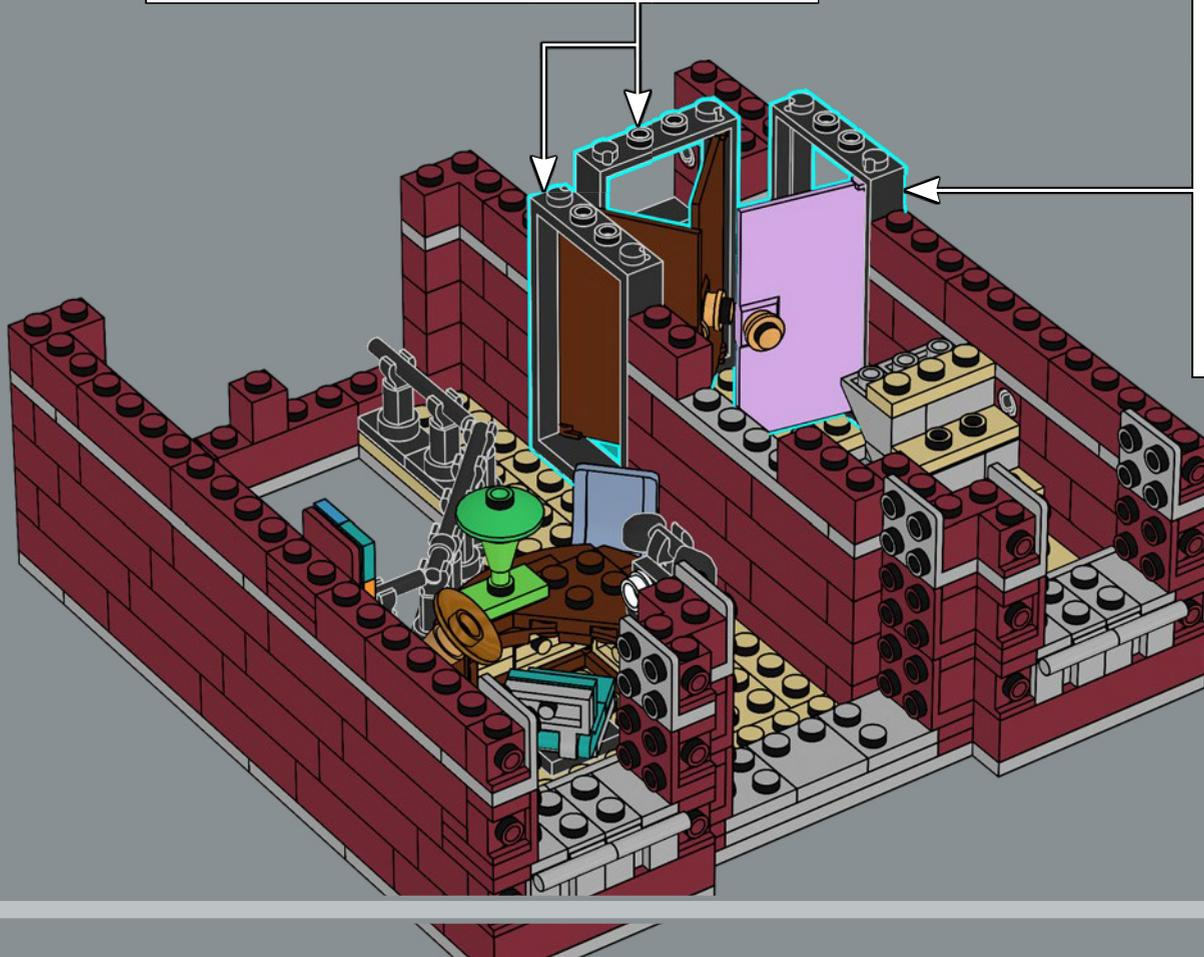
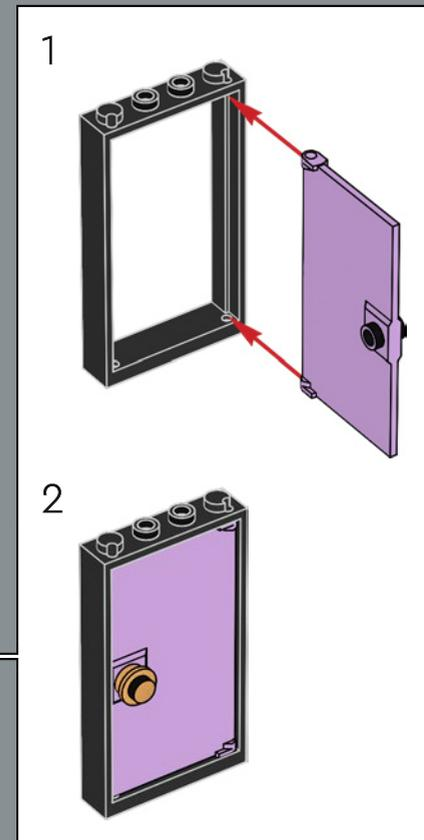
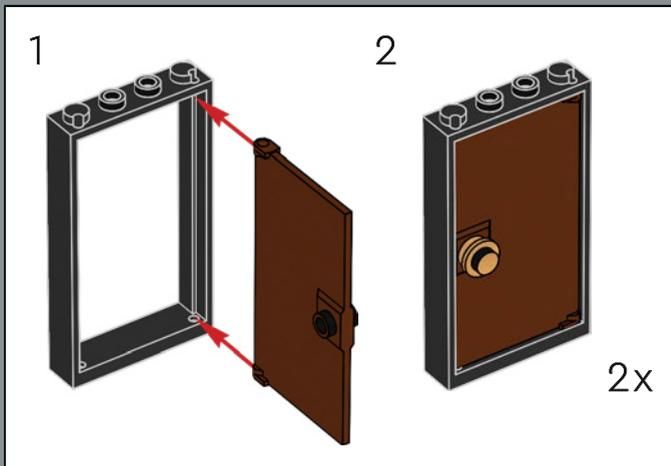

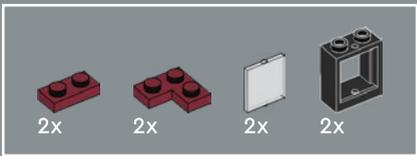

203

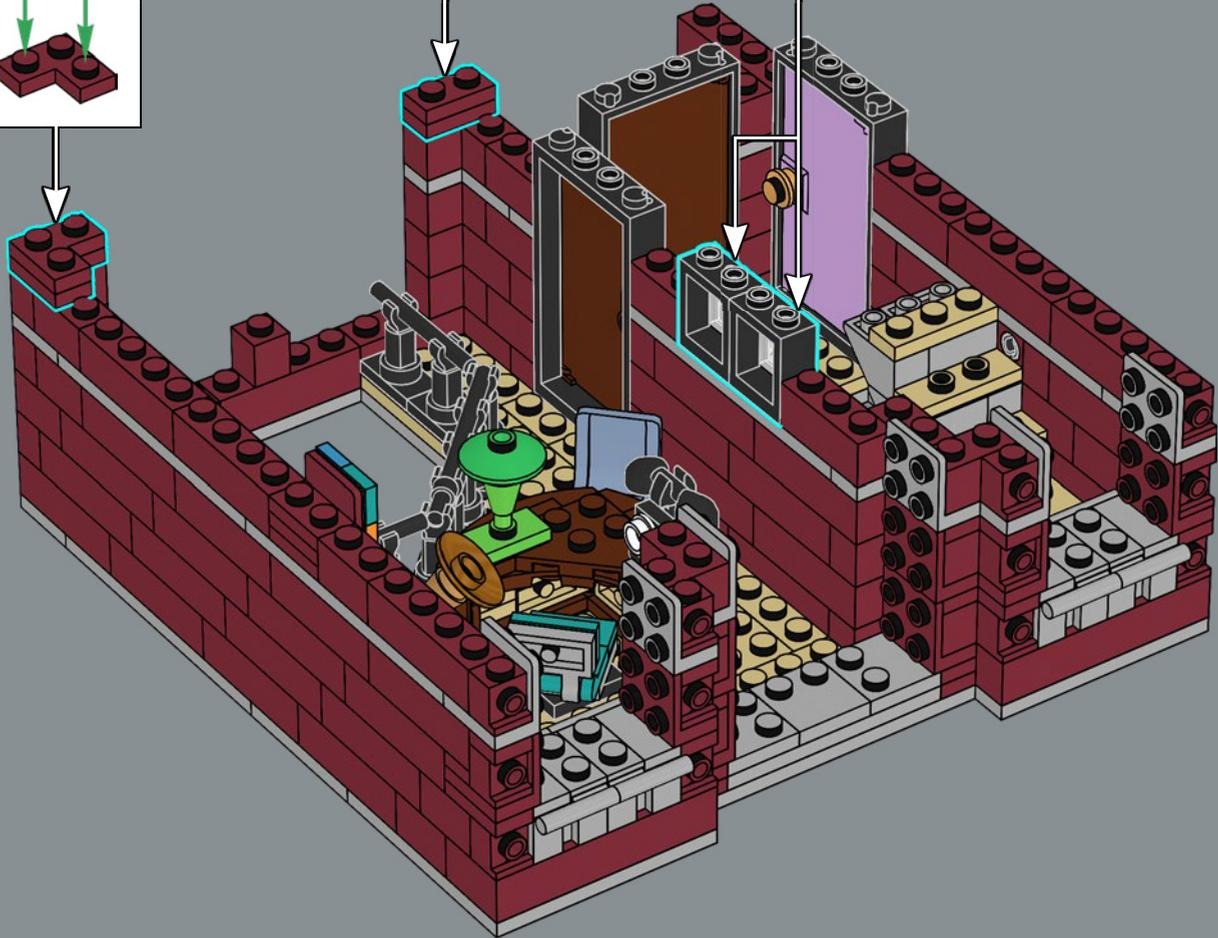
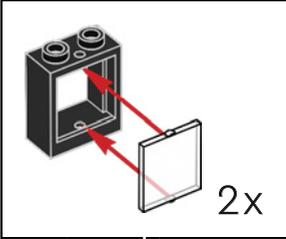
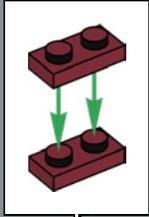
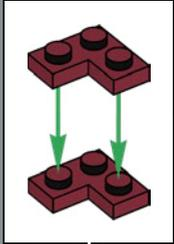

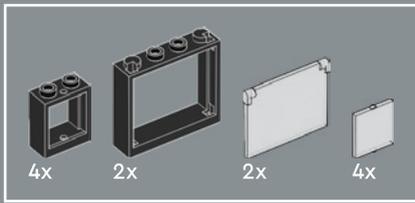

204

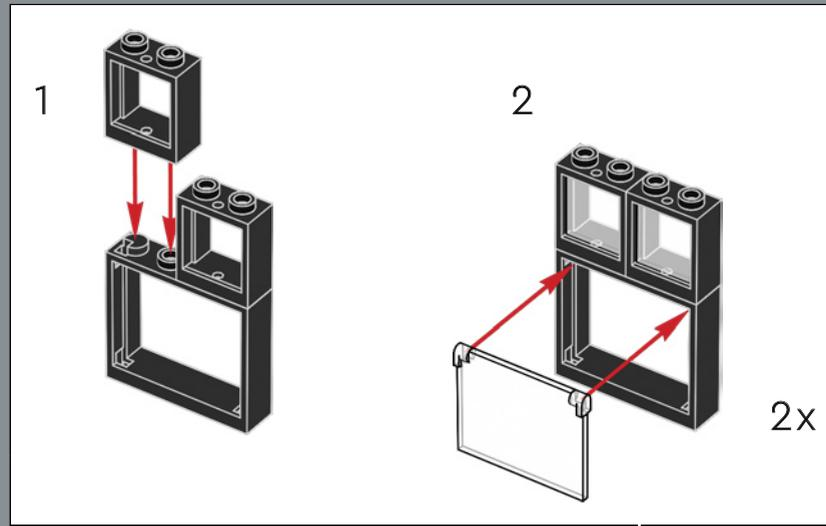



205

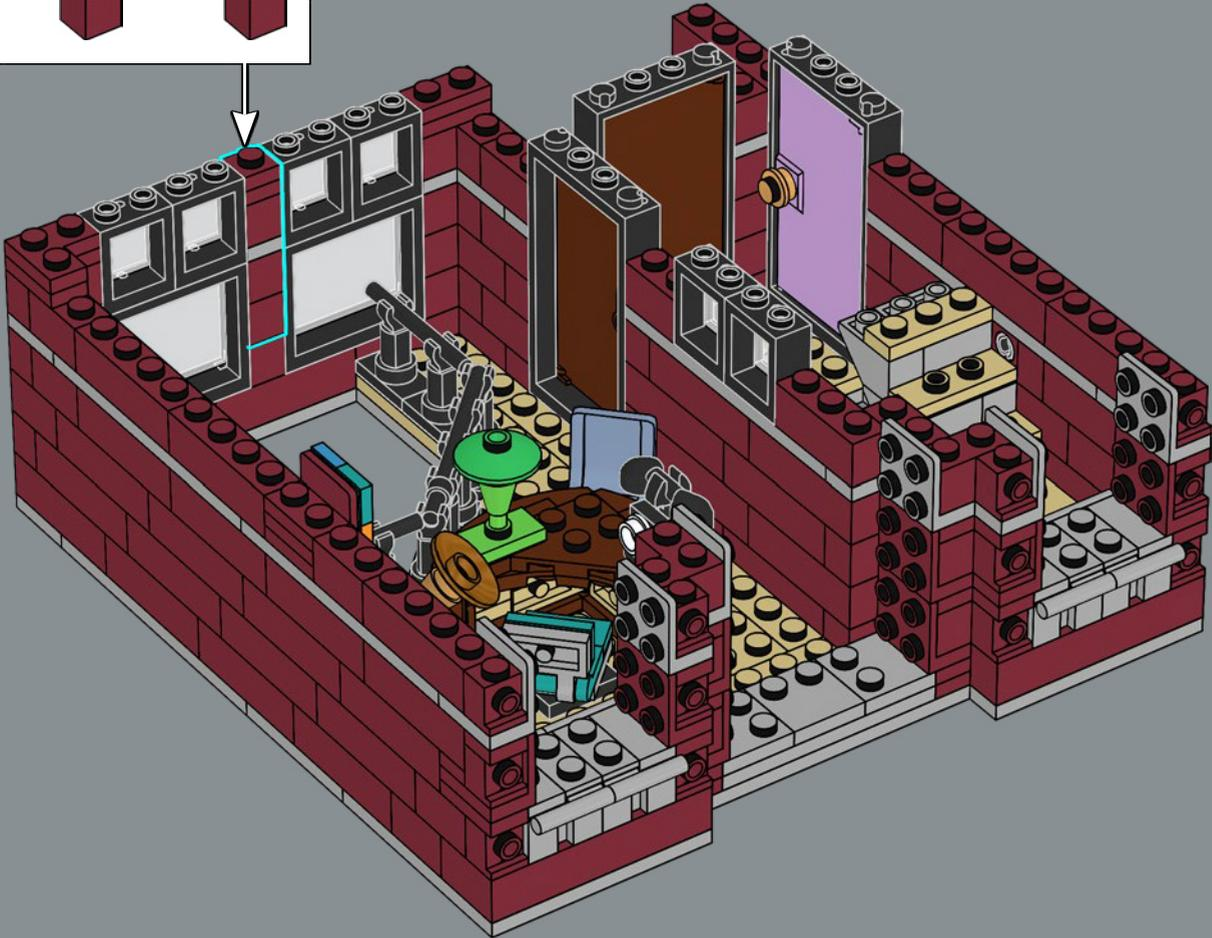
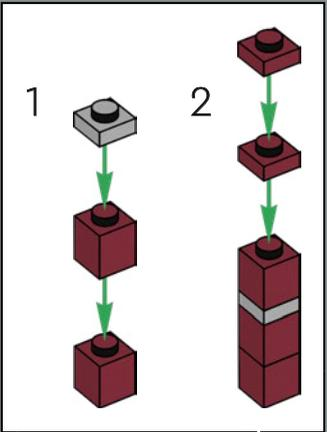



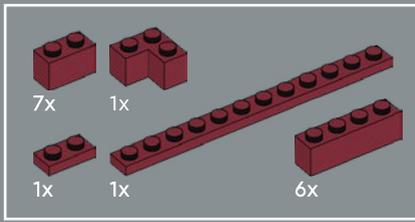

206

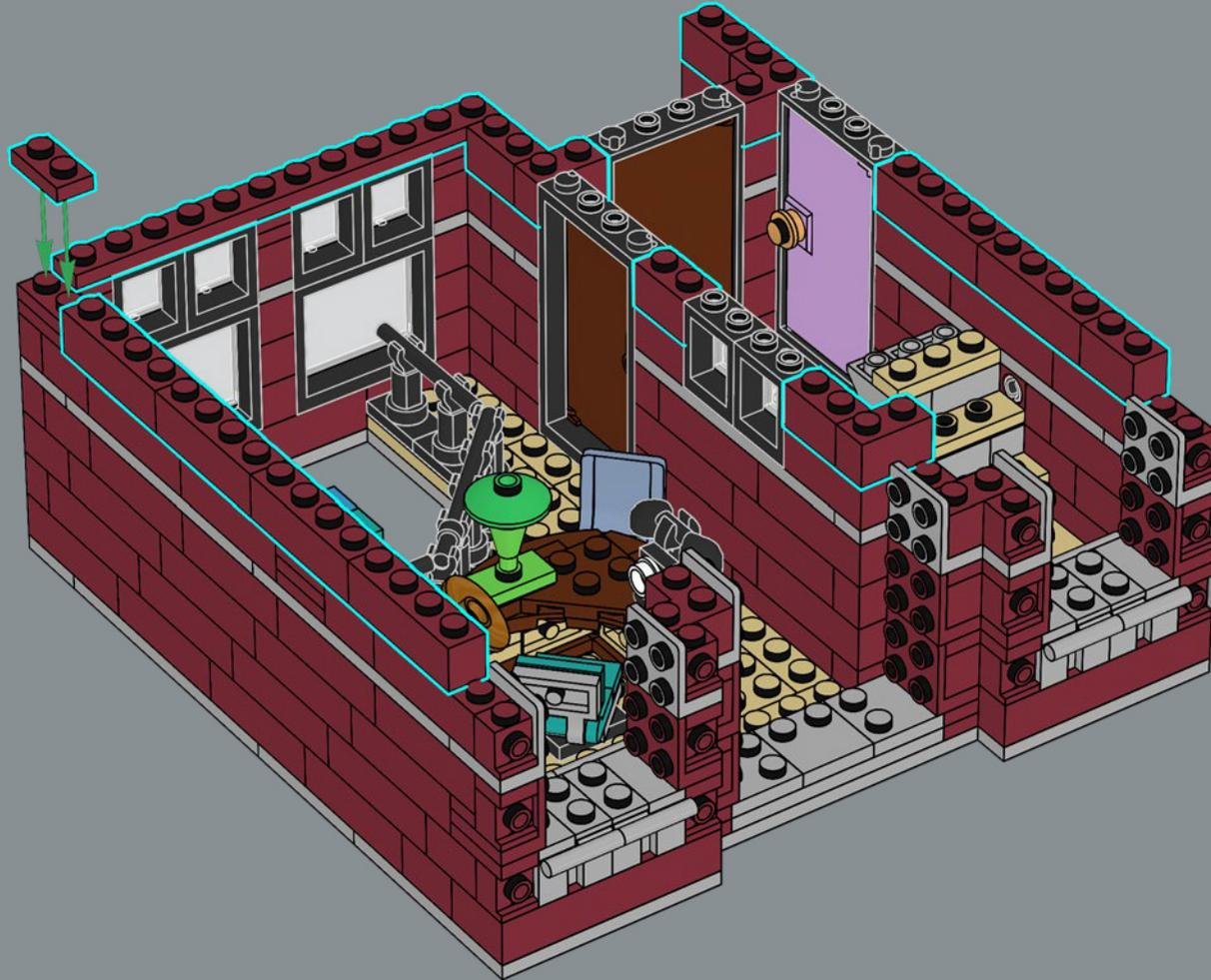



207

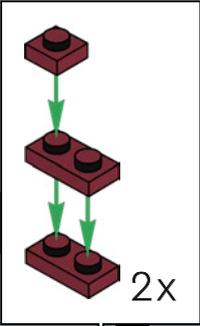

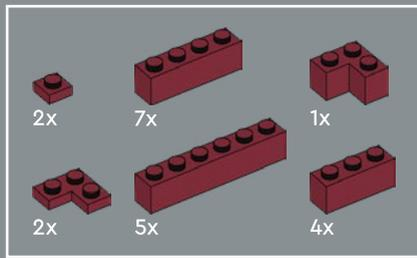

208

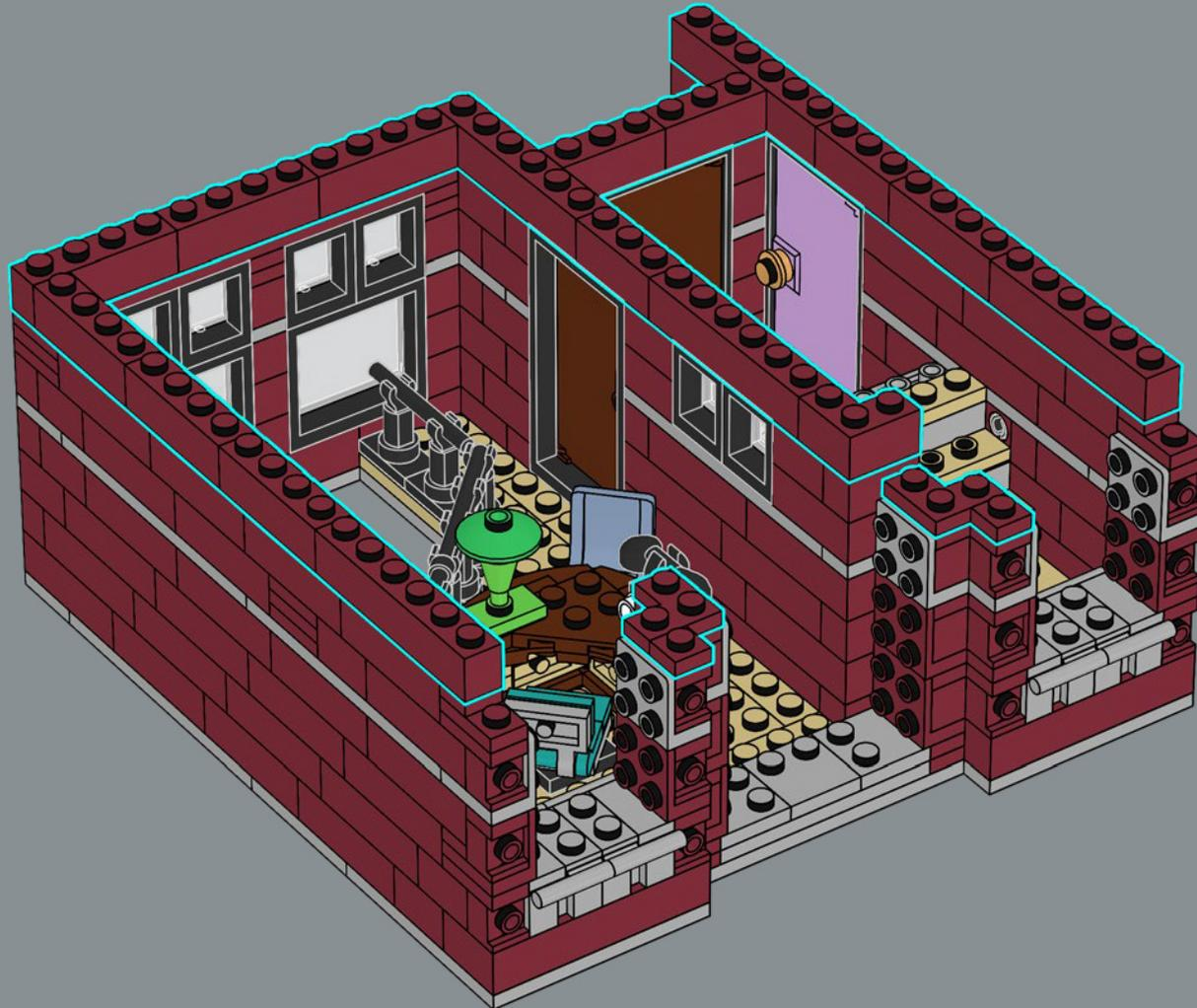



8x

209

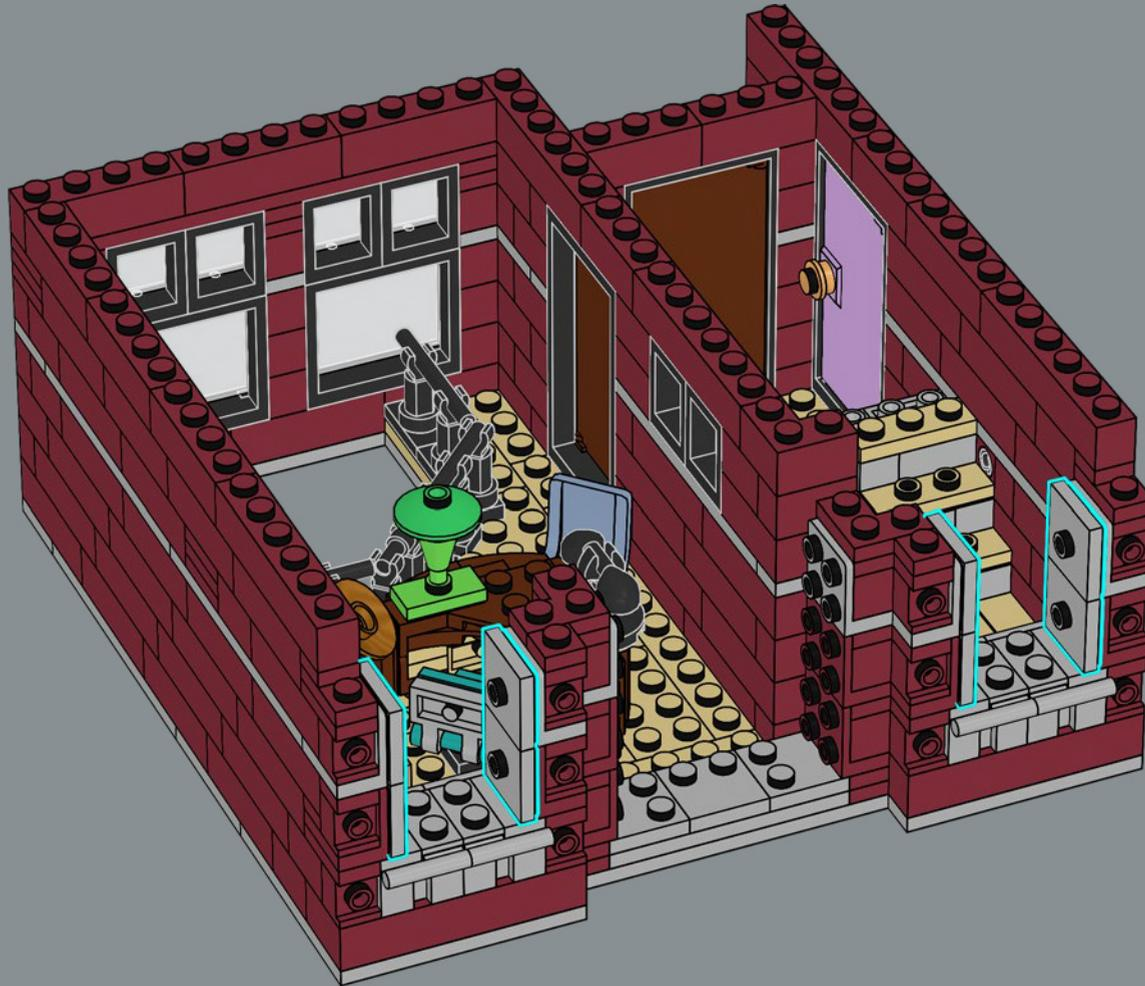

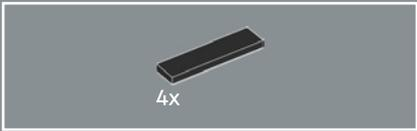

210

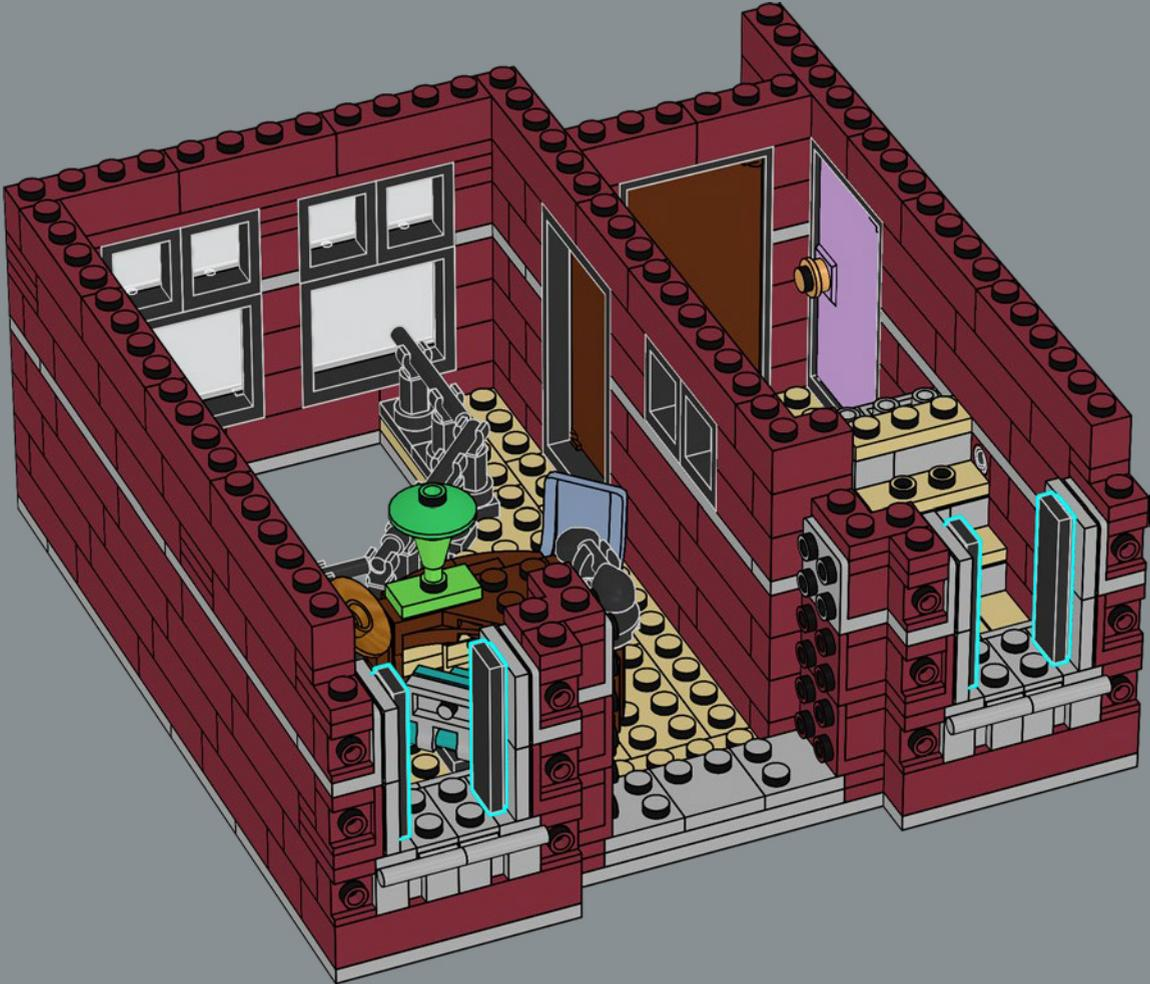

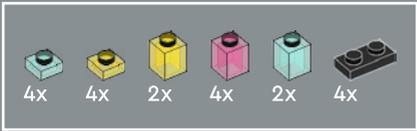

211

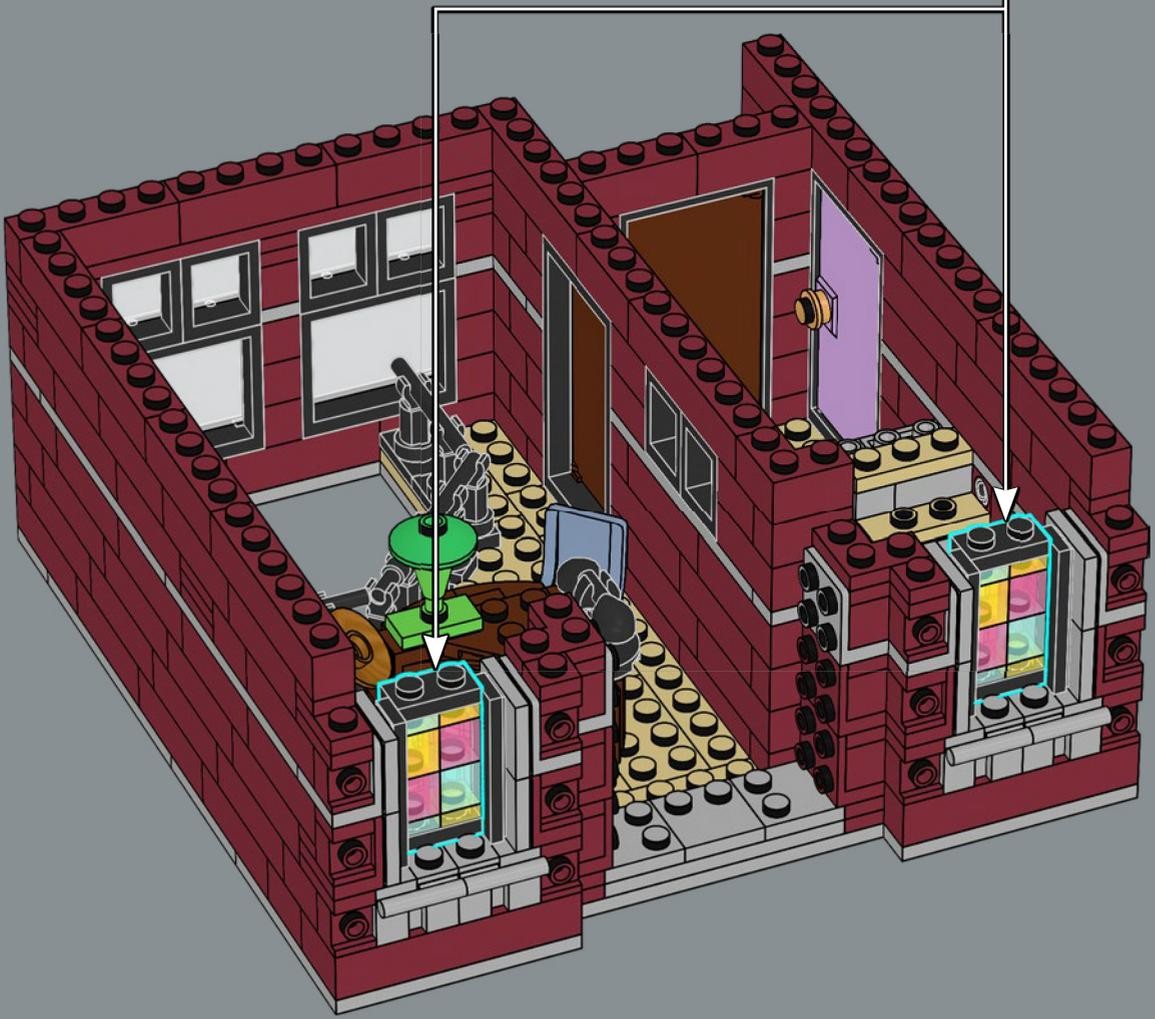
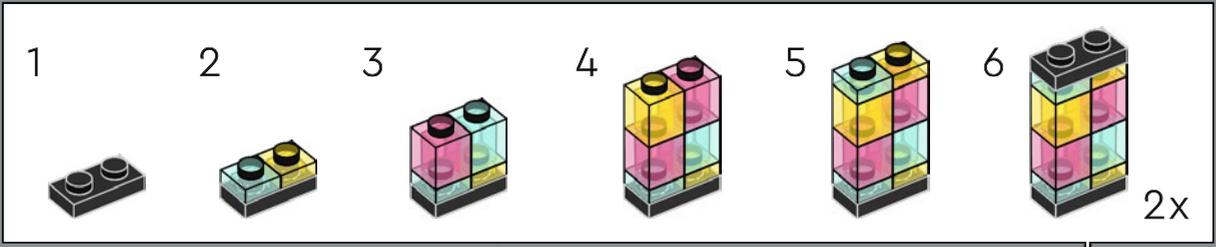

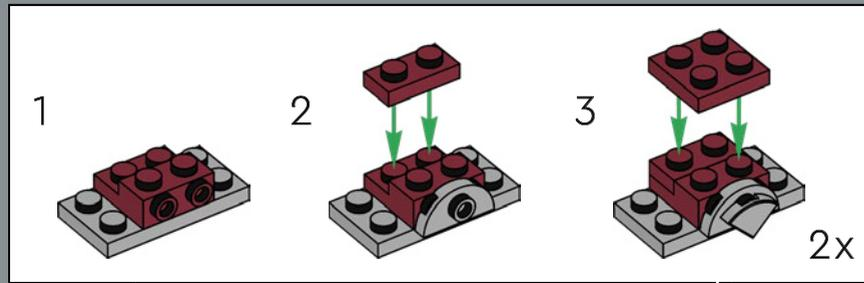
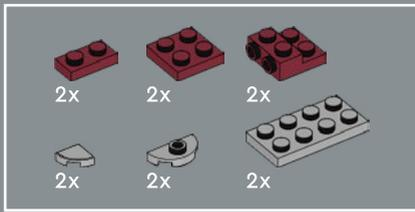

212

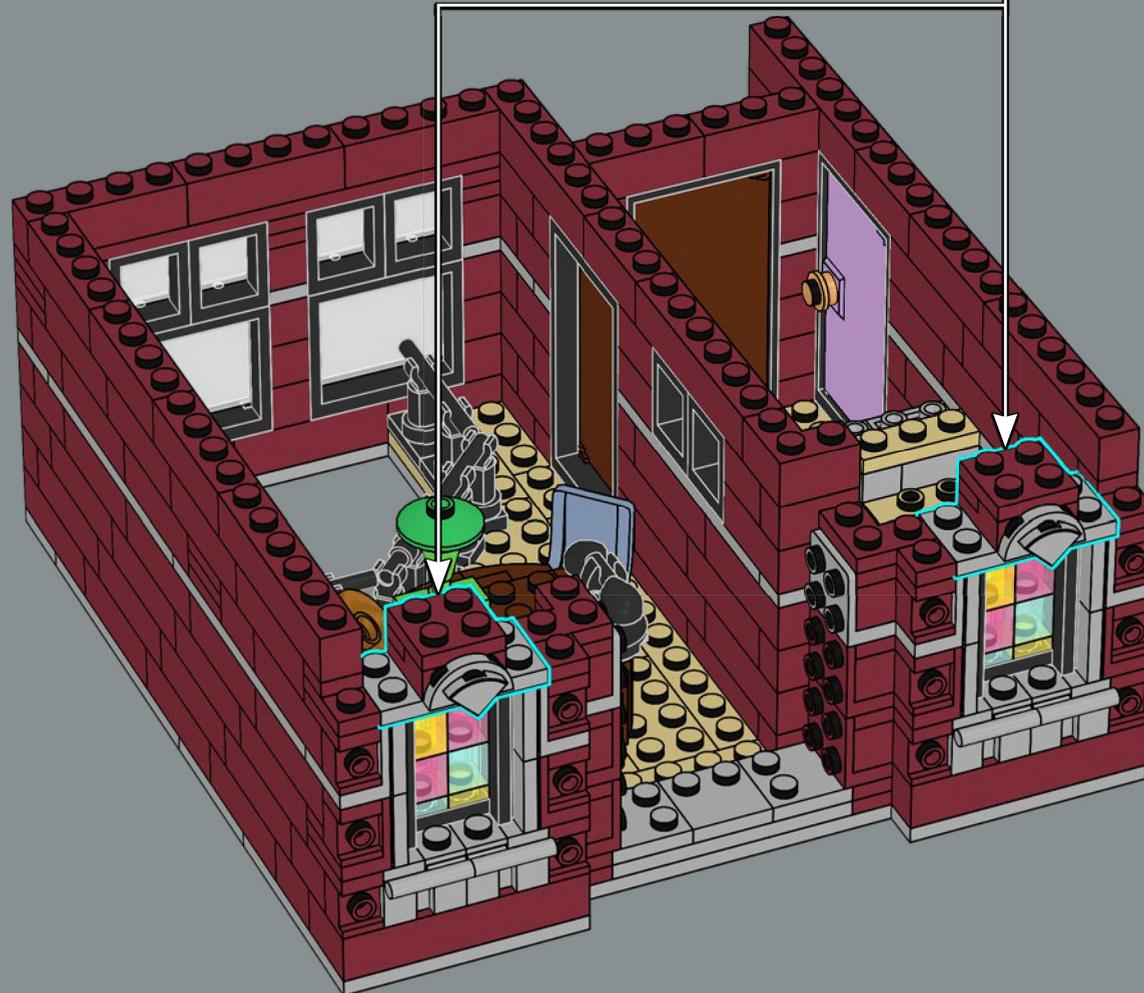

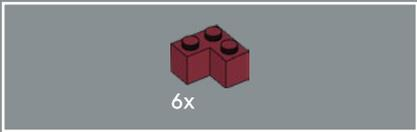

213

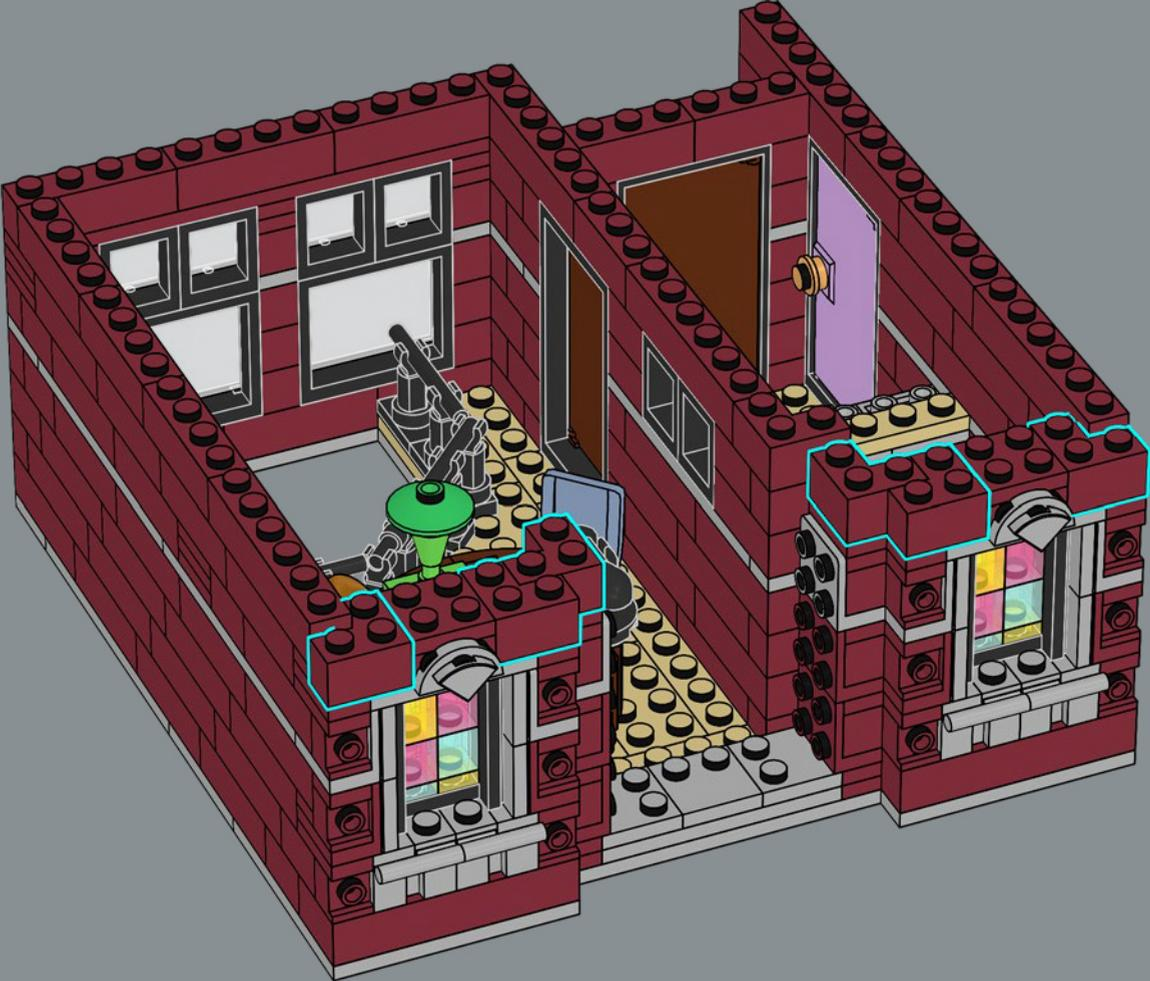



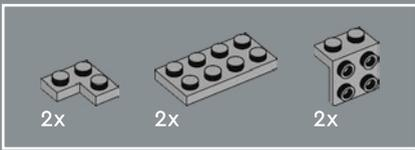

214

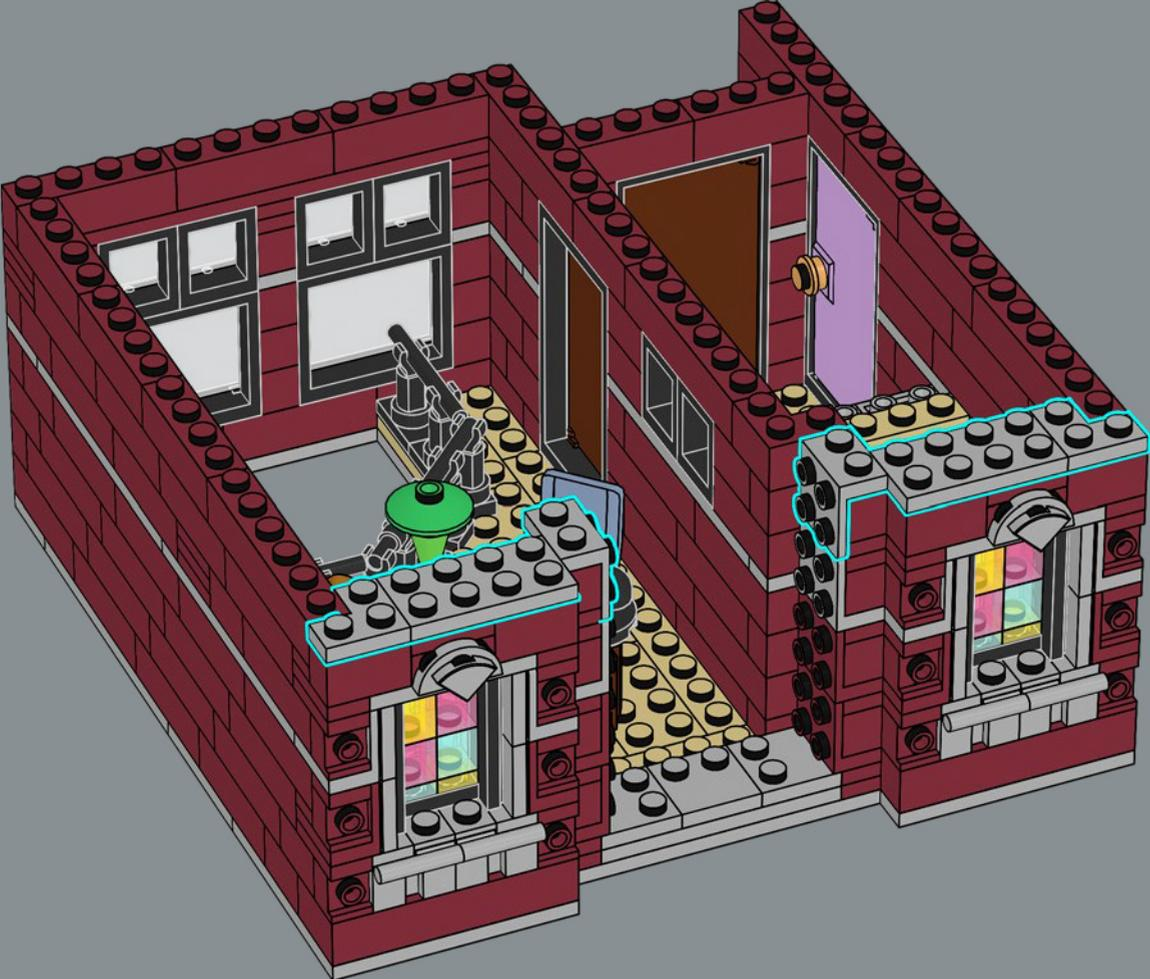



8x

215

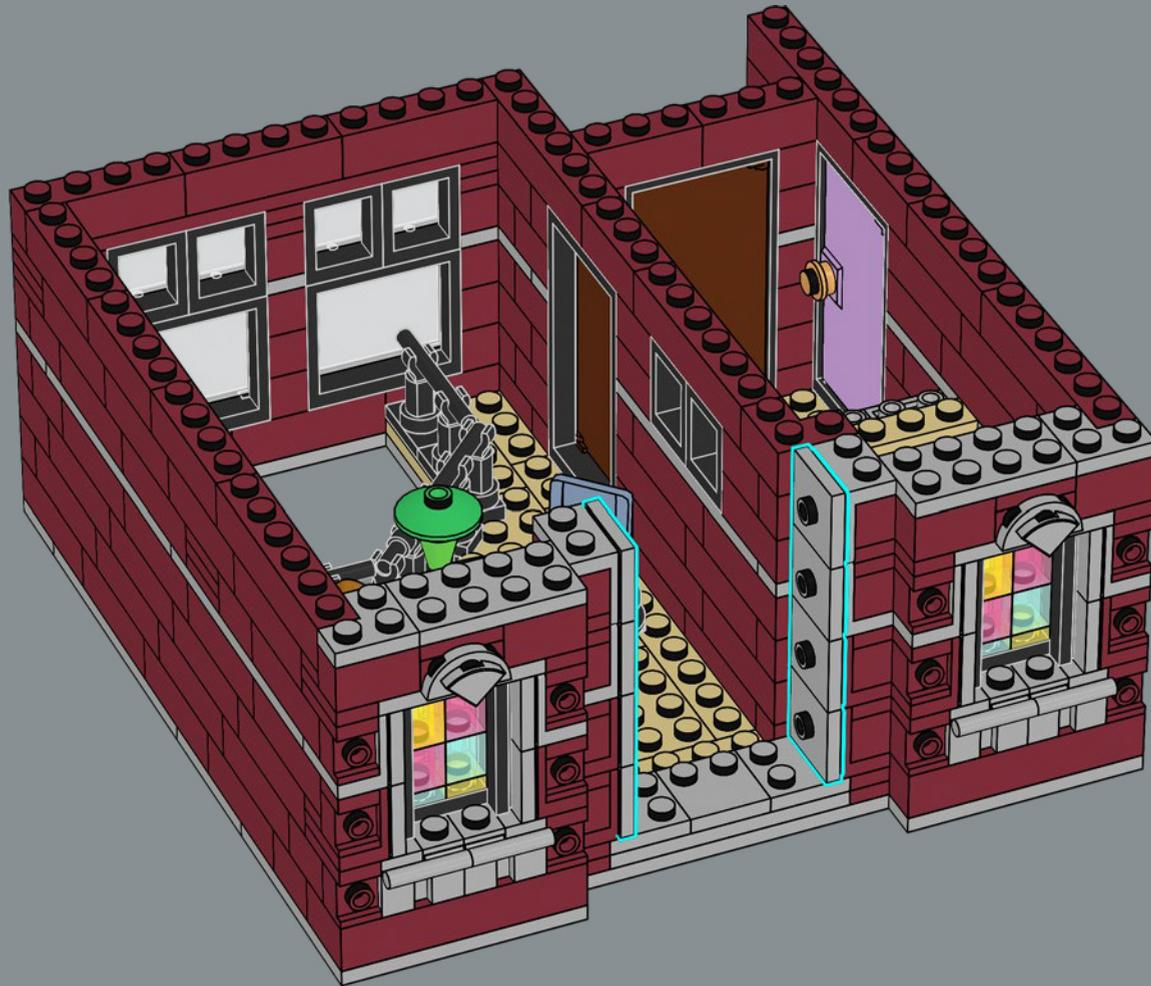

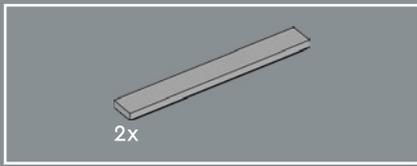

216

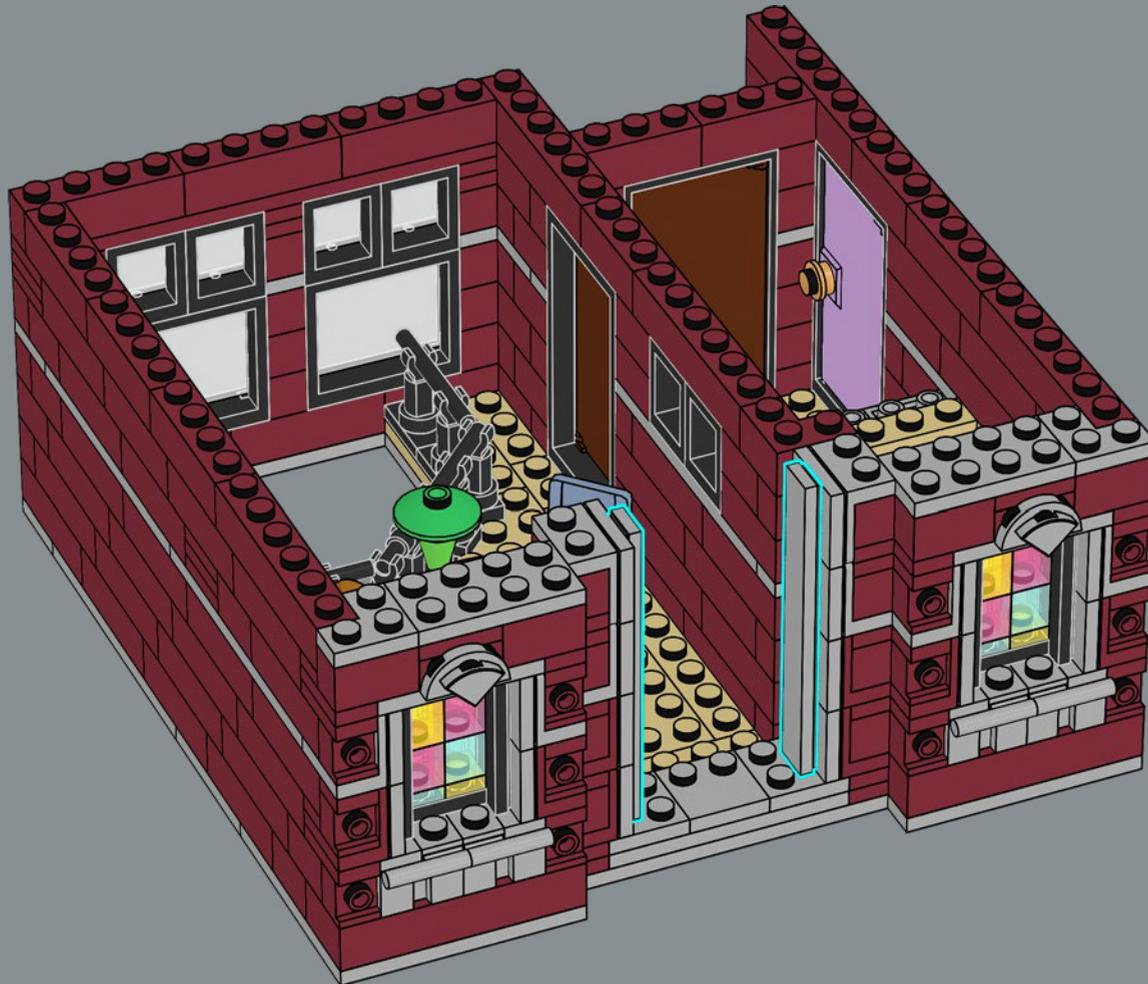

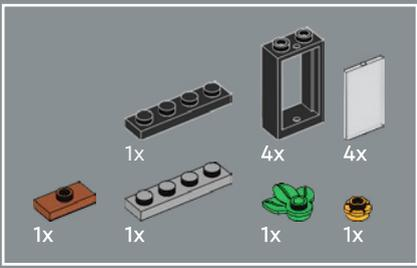

217

1

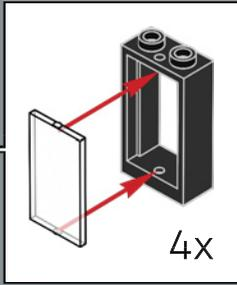
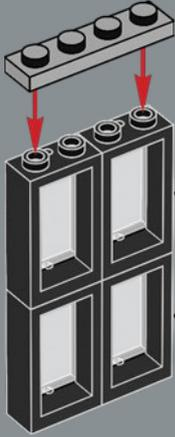

2

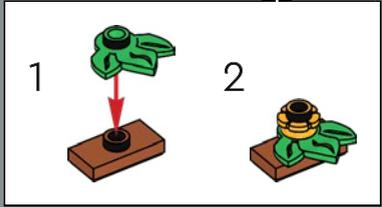
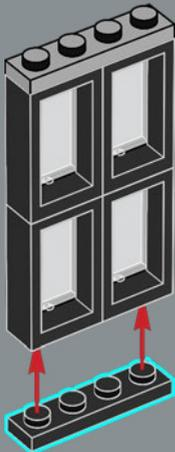

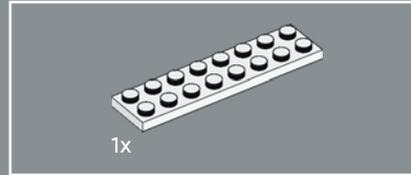
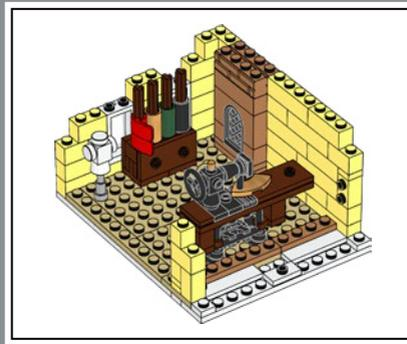
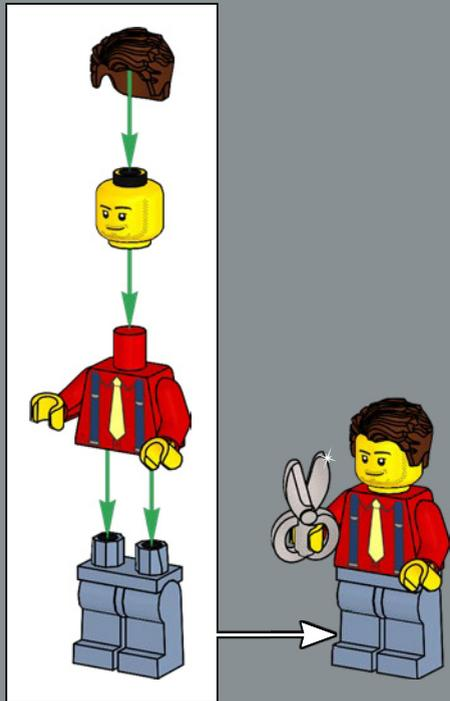

1x

218

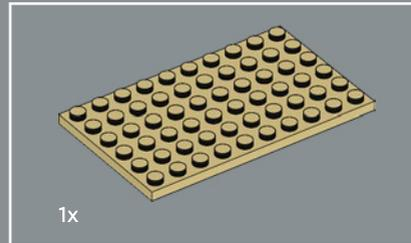

1x

219

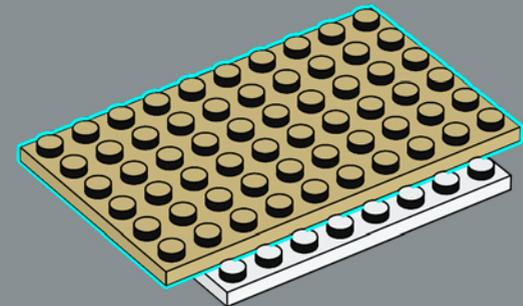

Hast du dir gerade im Großen Kaufhaus aus dem LEGO® Set 10211 ein neues Outfit gekauft, das leider nicht so gut sitzt? Dann wird dir der Schneider gern behilflich sein.

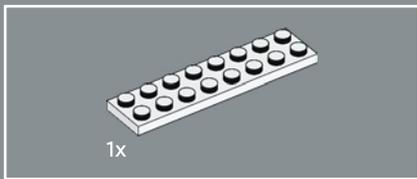

220

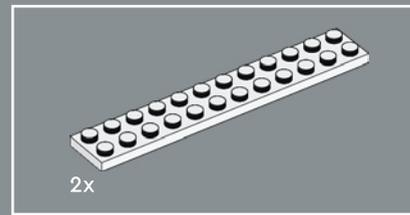
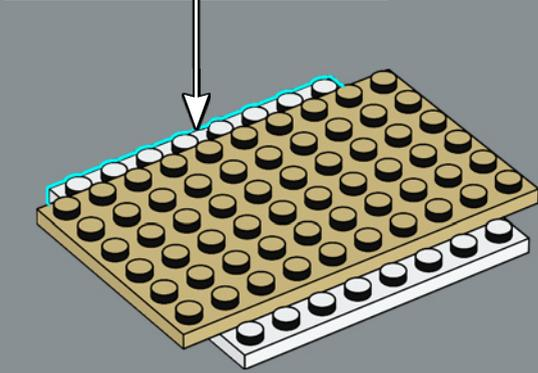
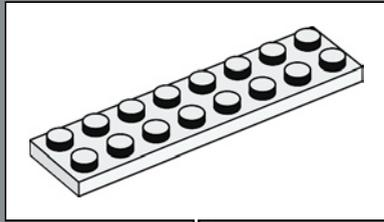

221

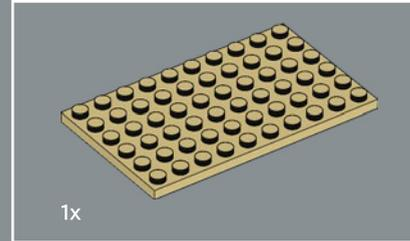
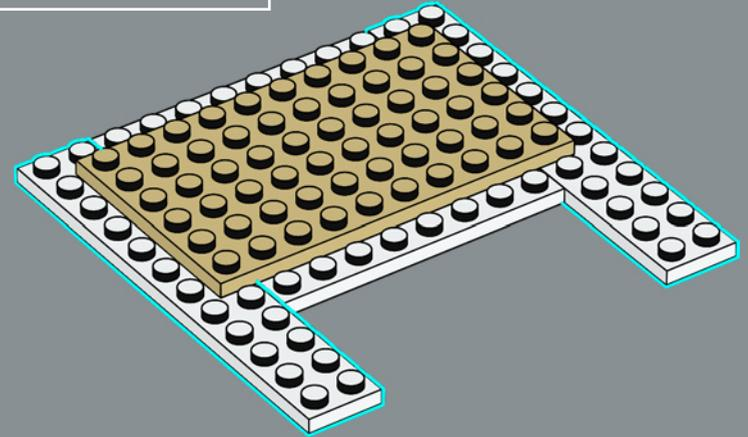

222

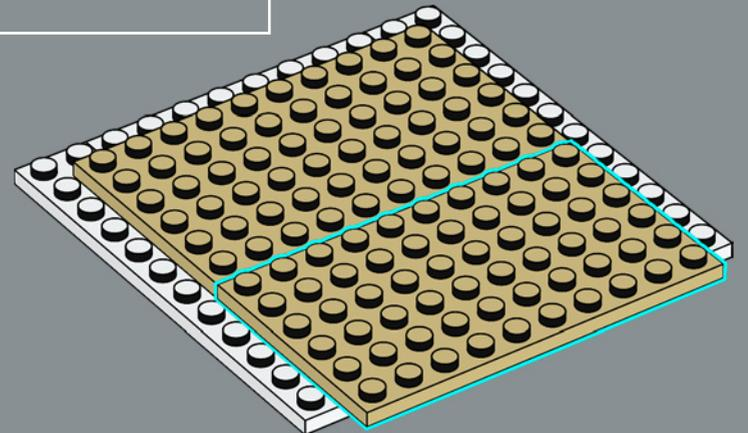

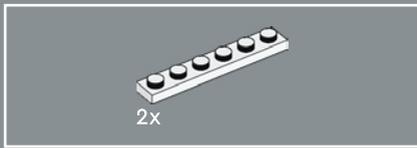

223

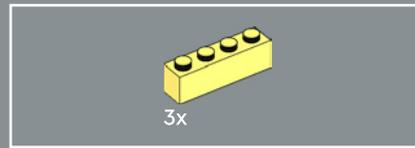
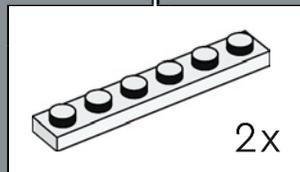
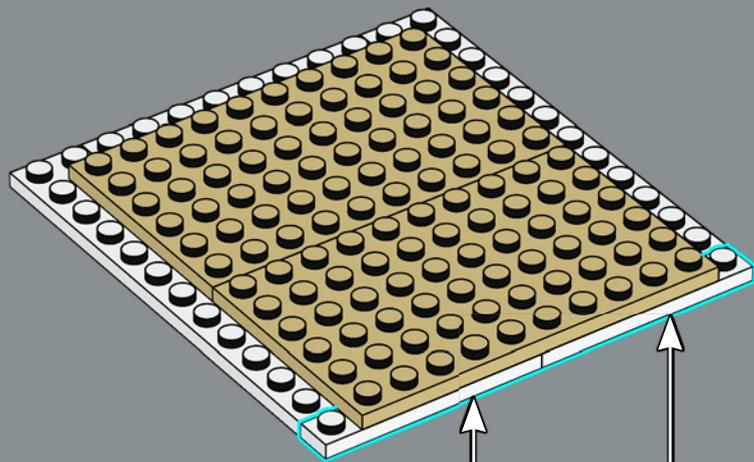

224

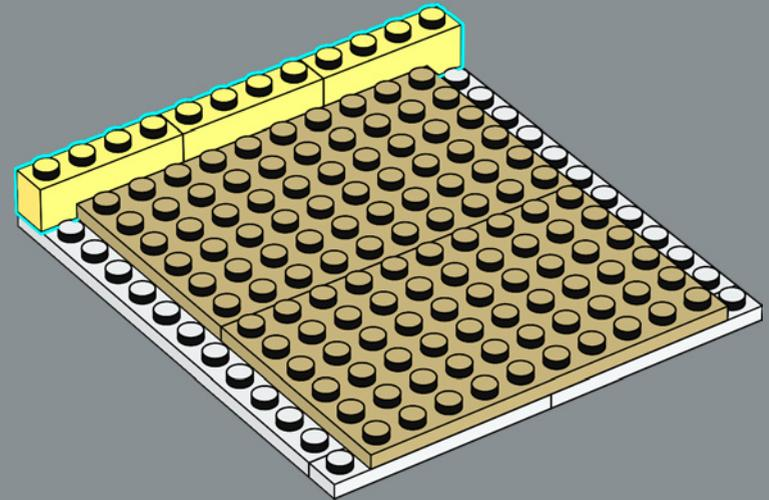

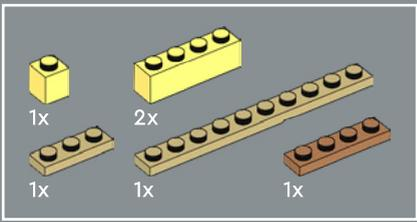

225

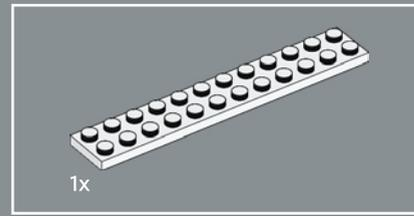
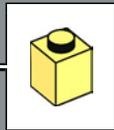
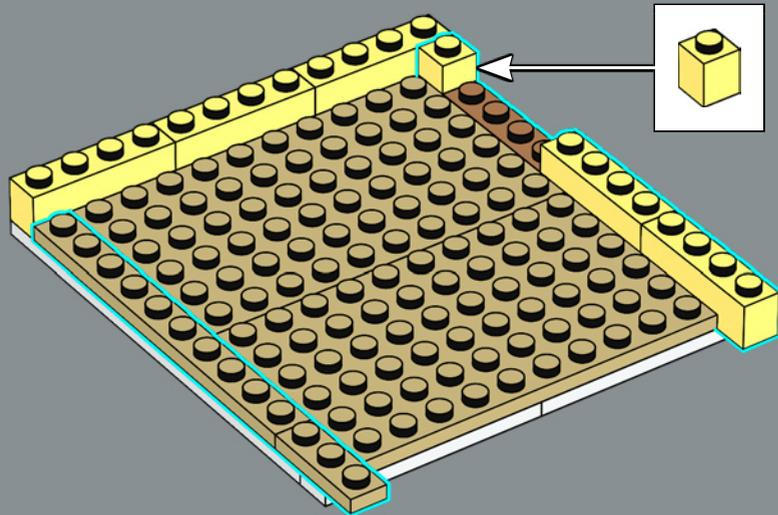

226

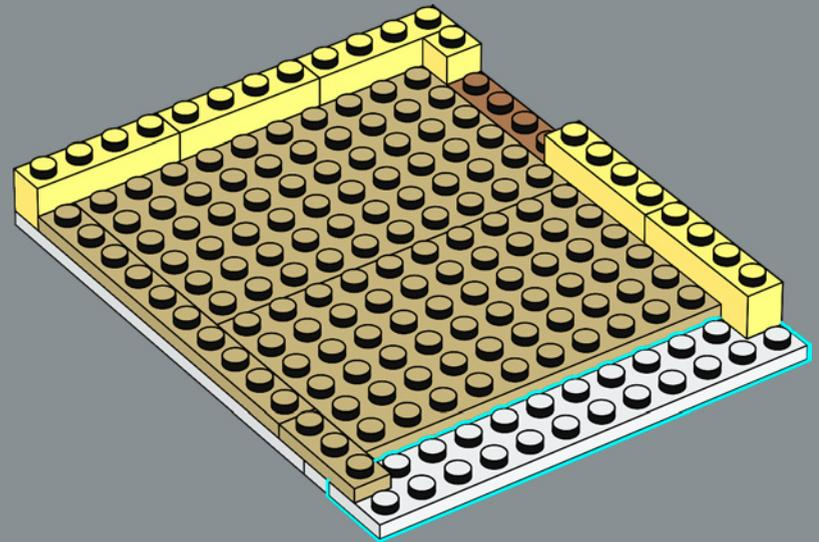



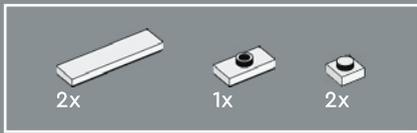

227

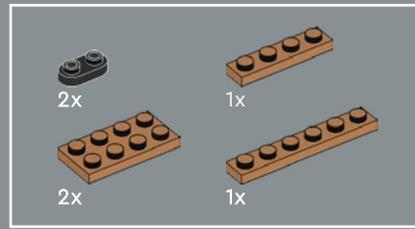
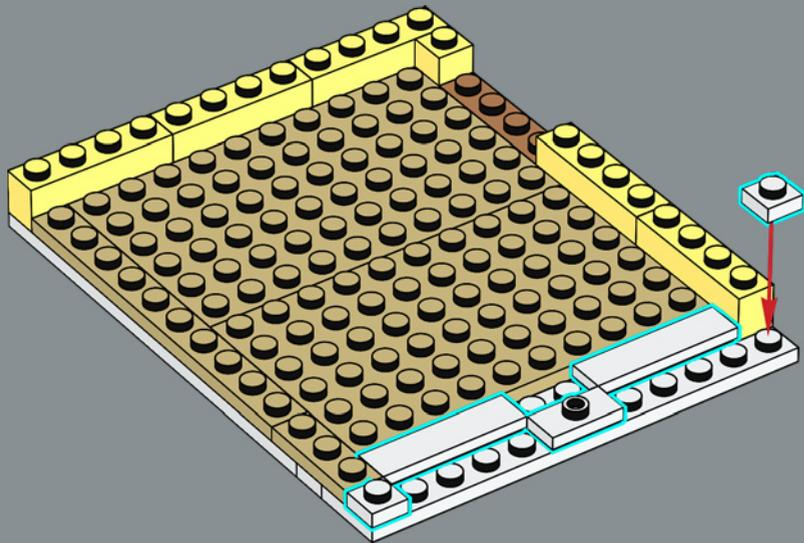

228

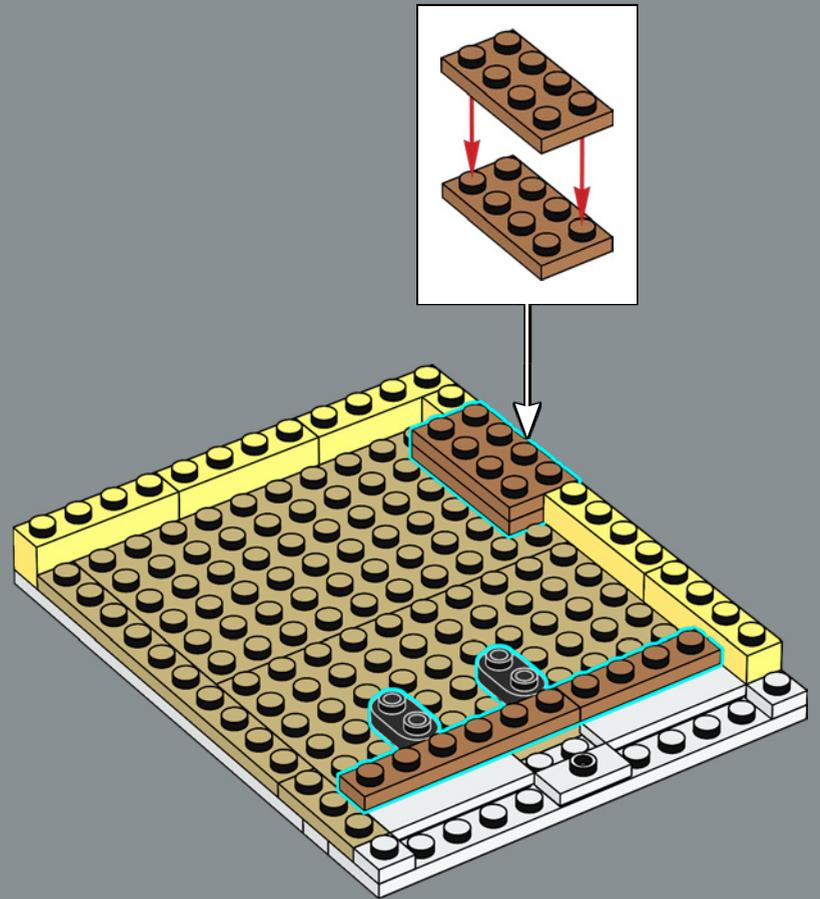

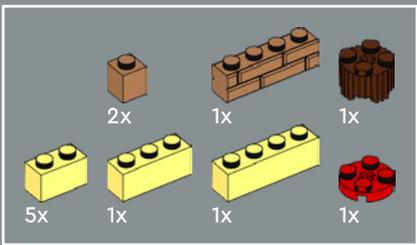

229

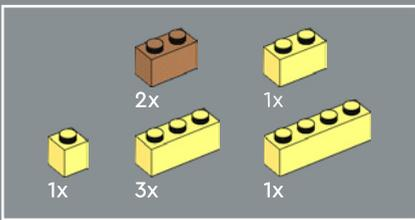
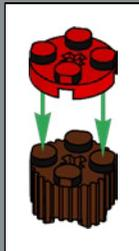

230





231

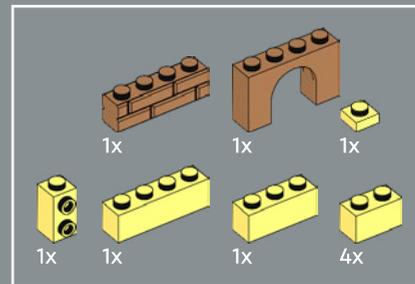
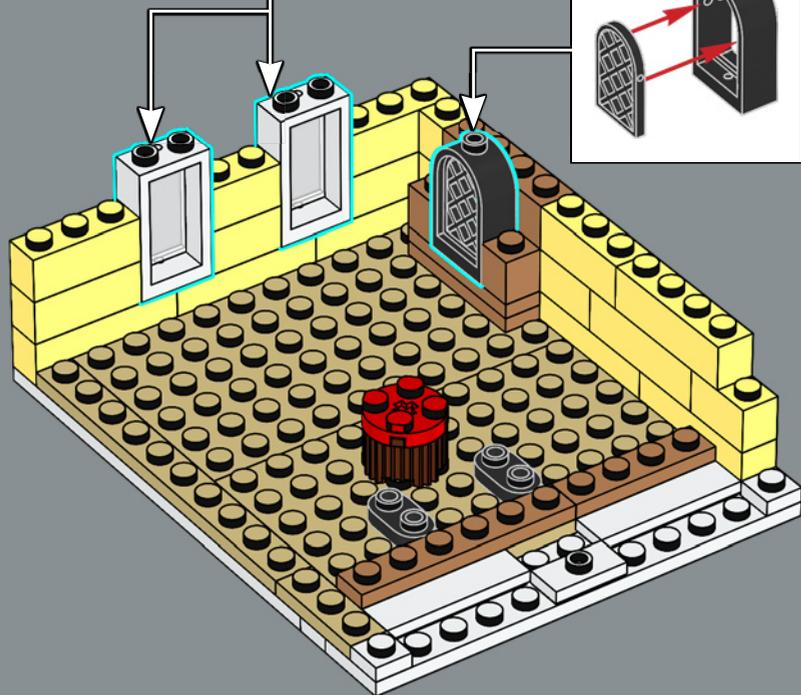
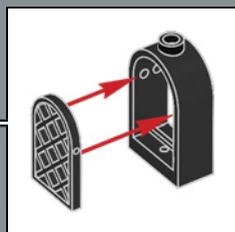
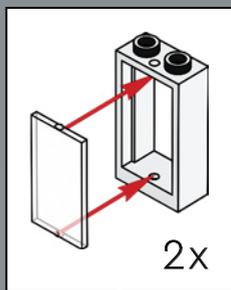

232

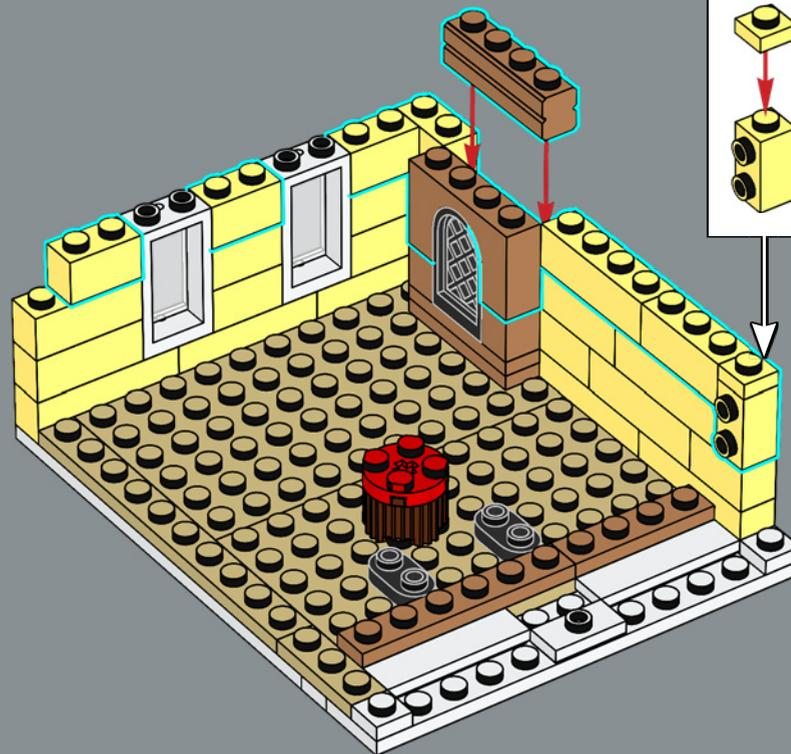
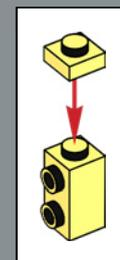

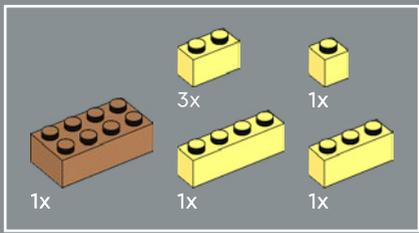

233

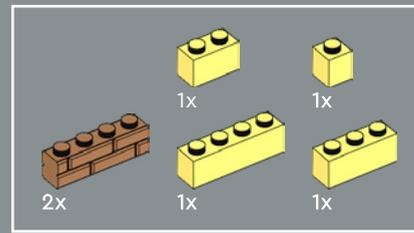
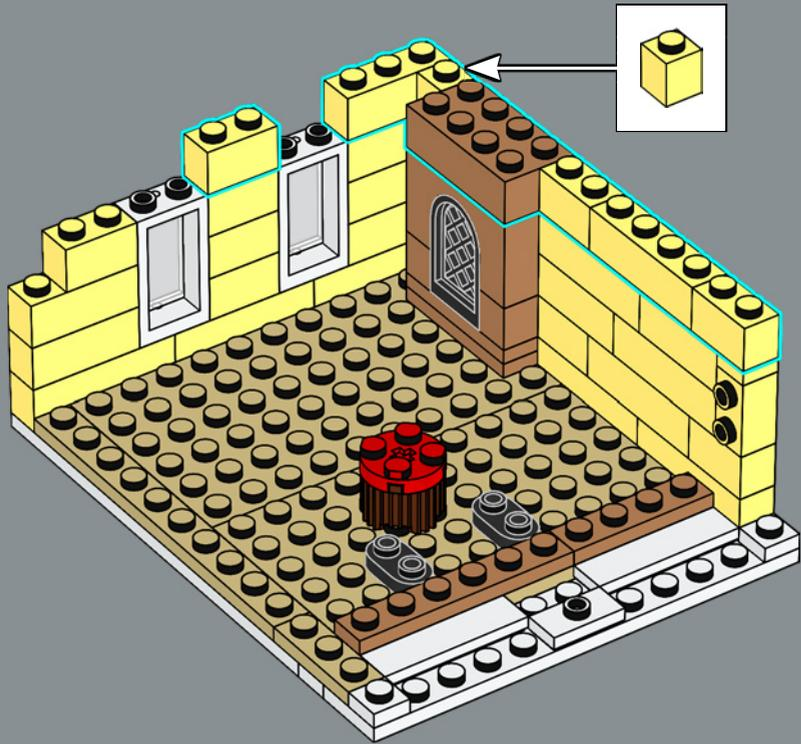

234

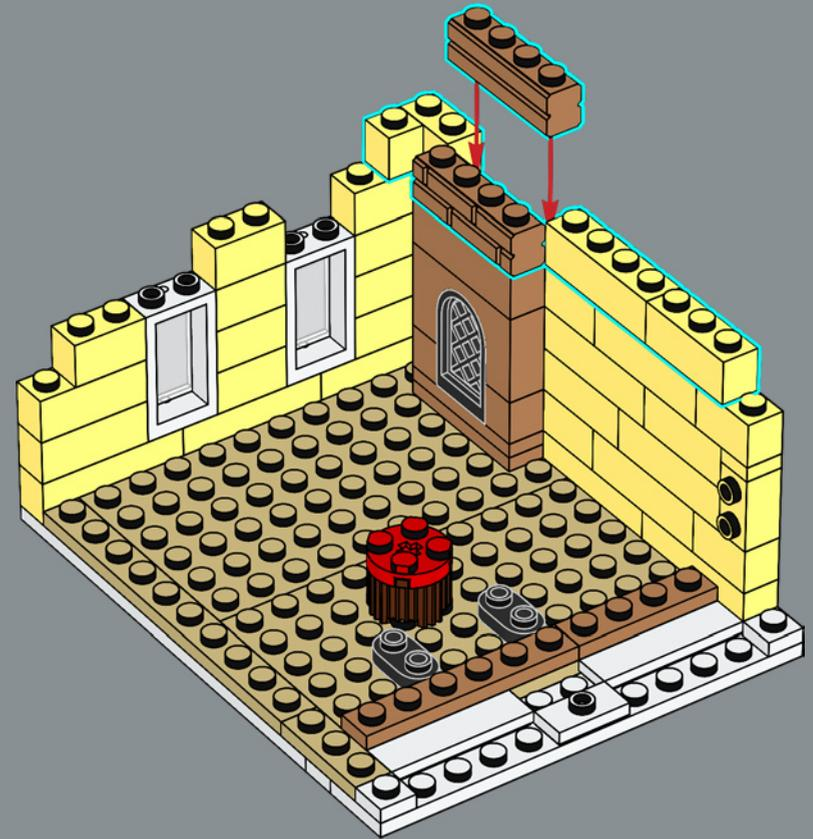

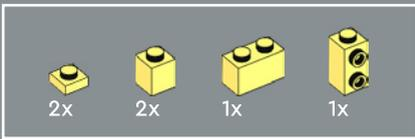

235

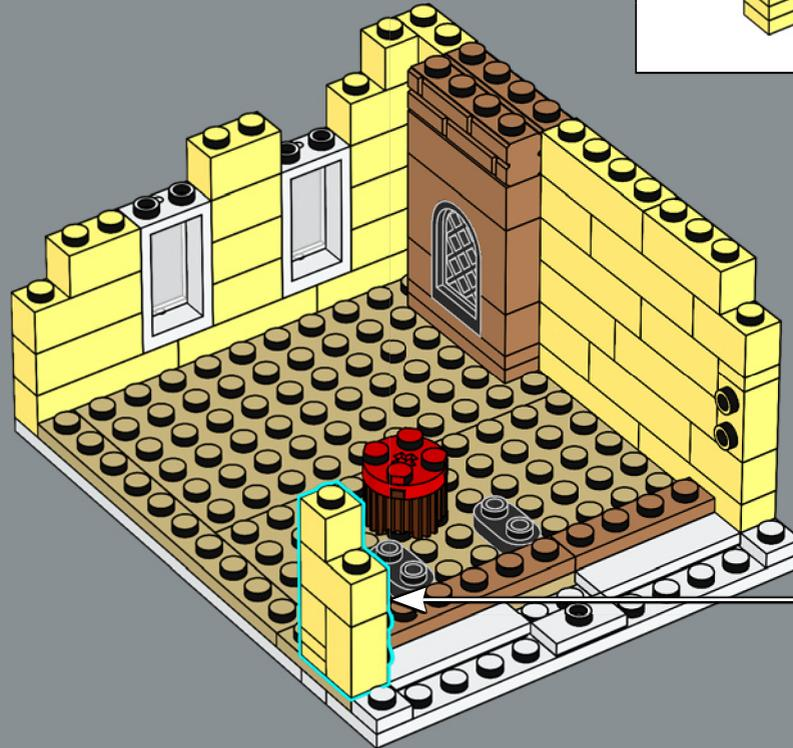
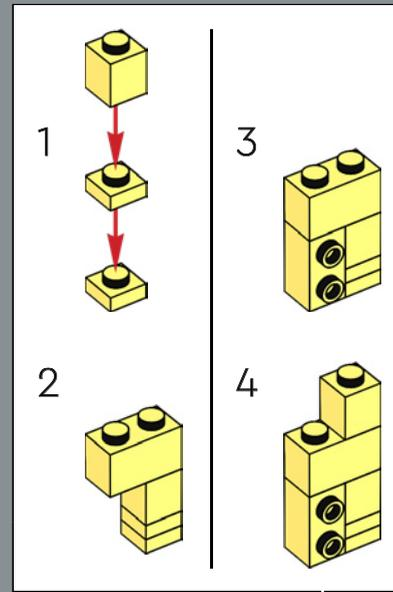

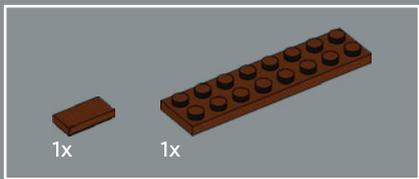

236

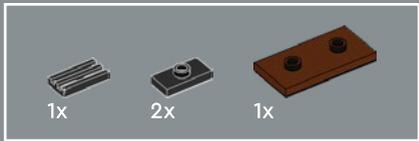
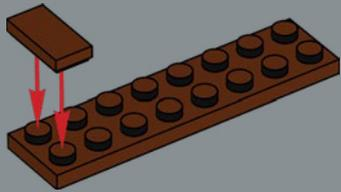

237

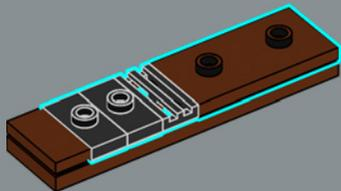

238

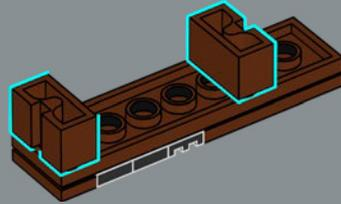

239

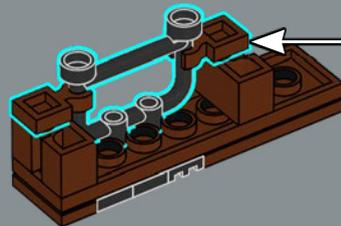
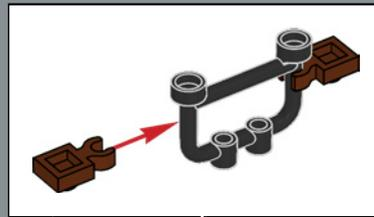

240

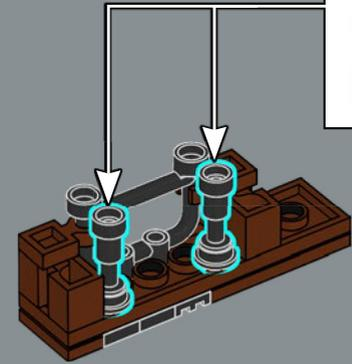
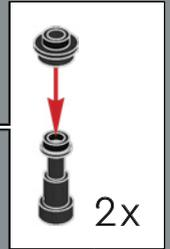

241

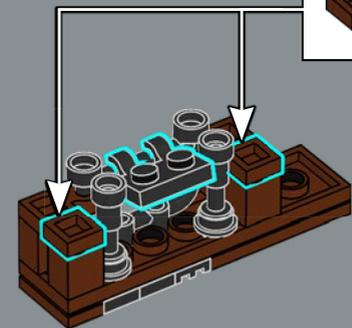



242

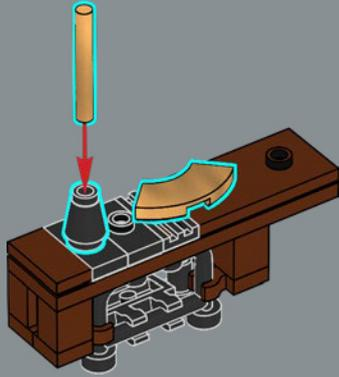

243

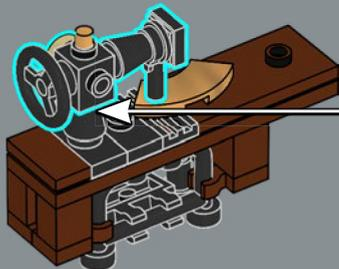
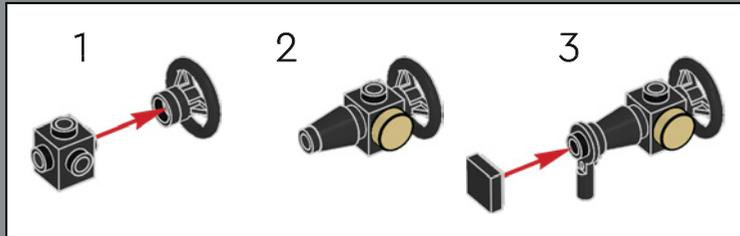

Der Schneider ist gerade mit dem Kleid der Sängerin fertig geworden. In der Nähmaschine hängen noch Goldfaden und roter Stoff.

244

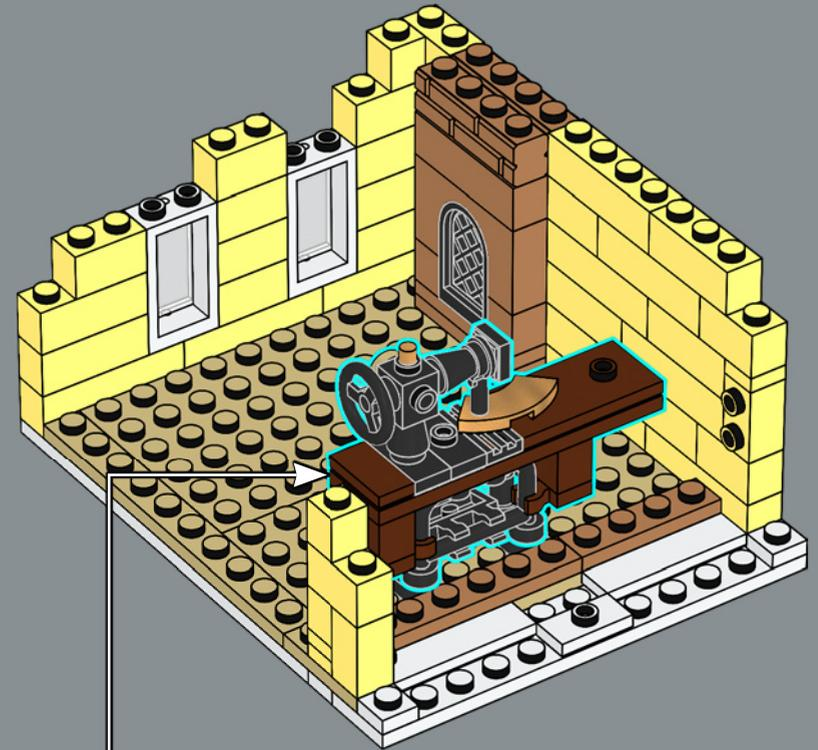

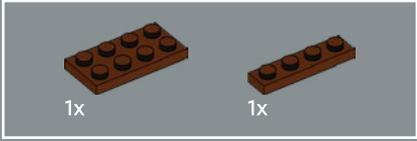
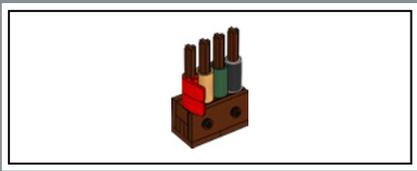

245

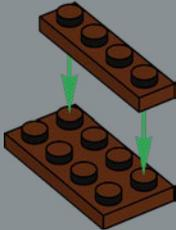

246

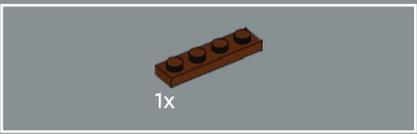
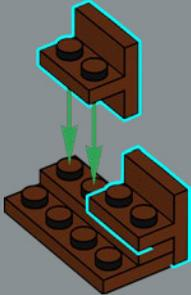

247

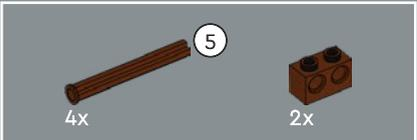
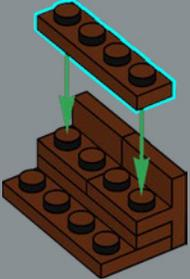

248

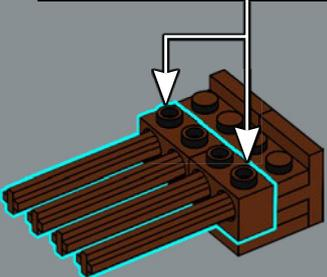
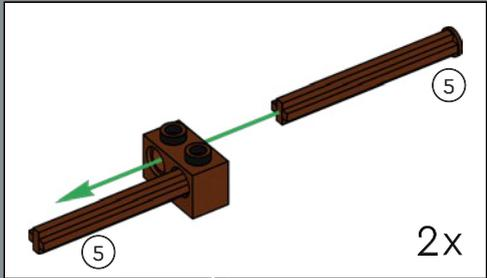



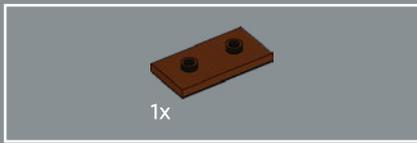

249

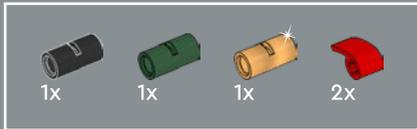
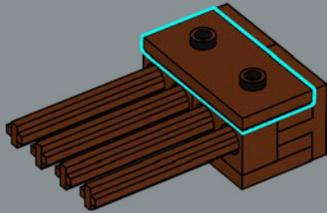

250

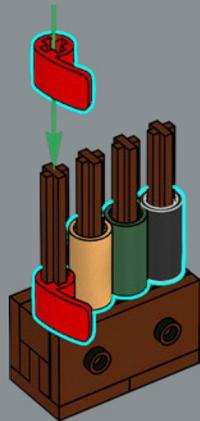

Die Elemente, die das rote Tuch darstellen, waren ursprünglich in LEGO® Technic Sets enthalten.

251

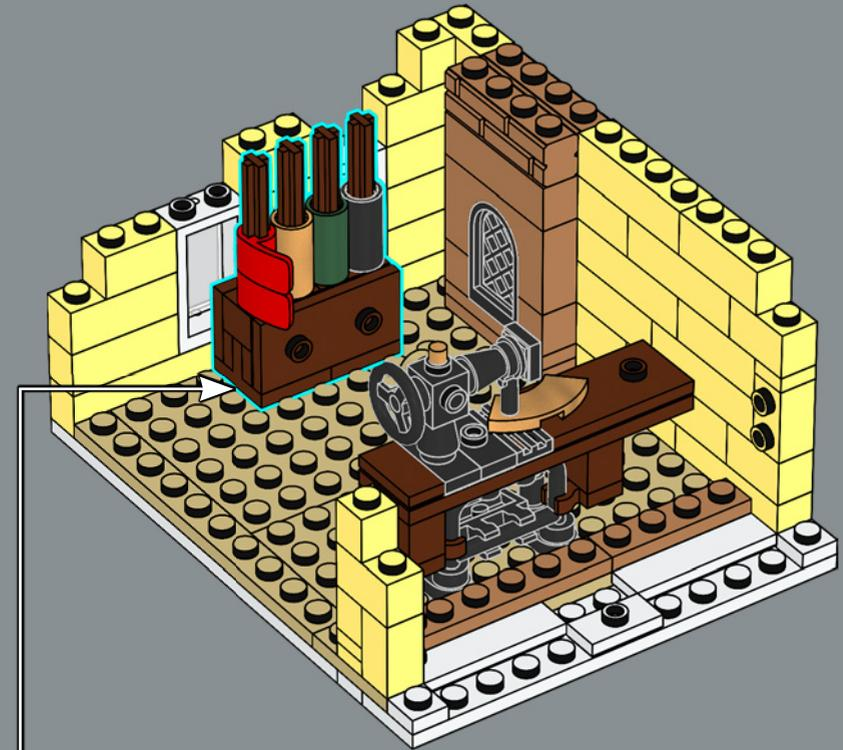

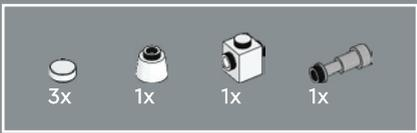

252

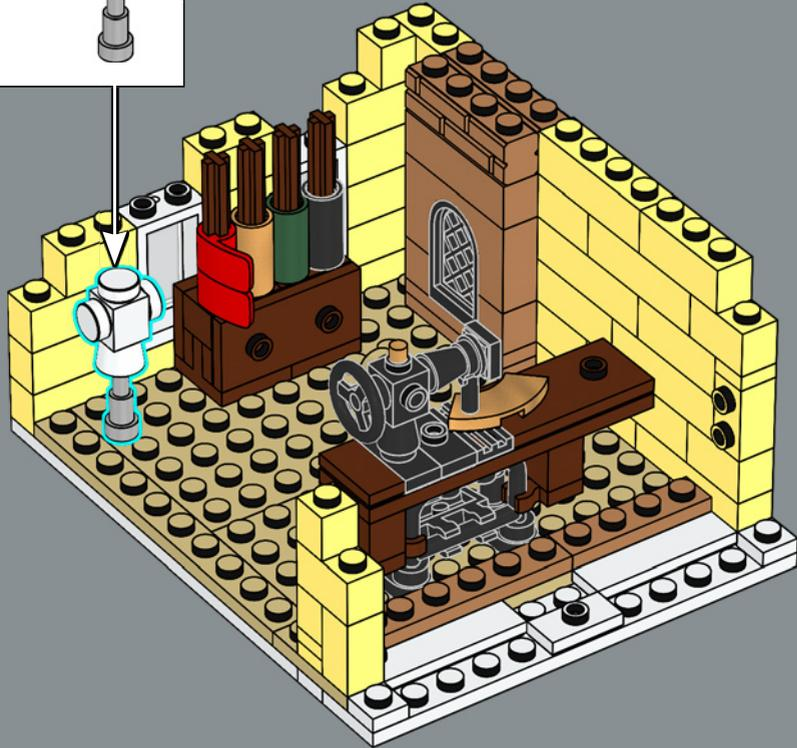
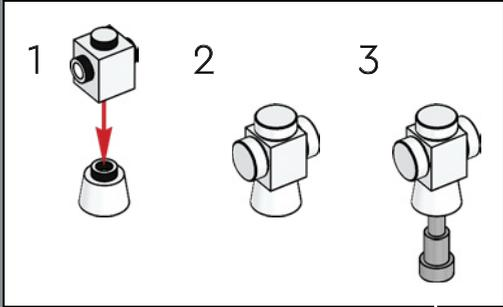

253

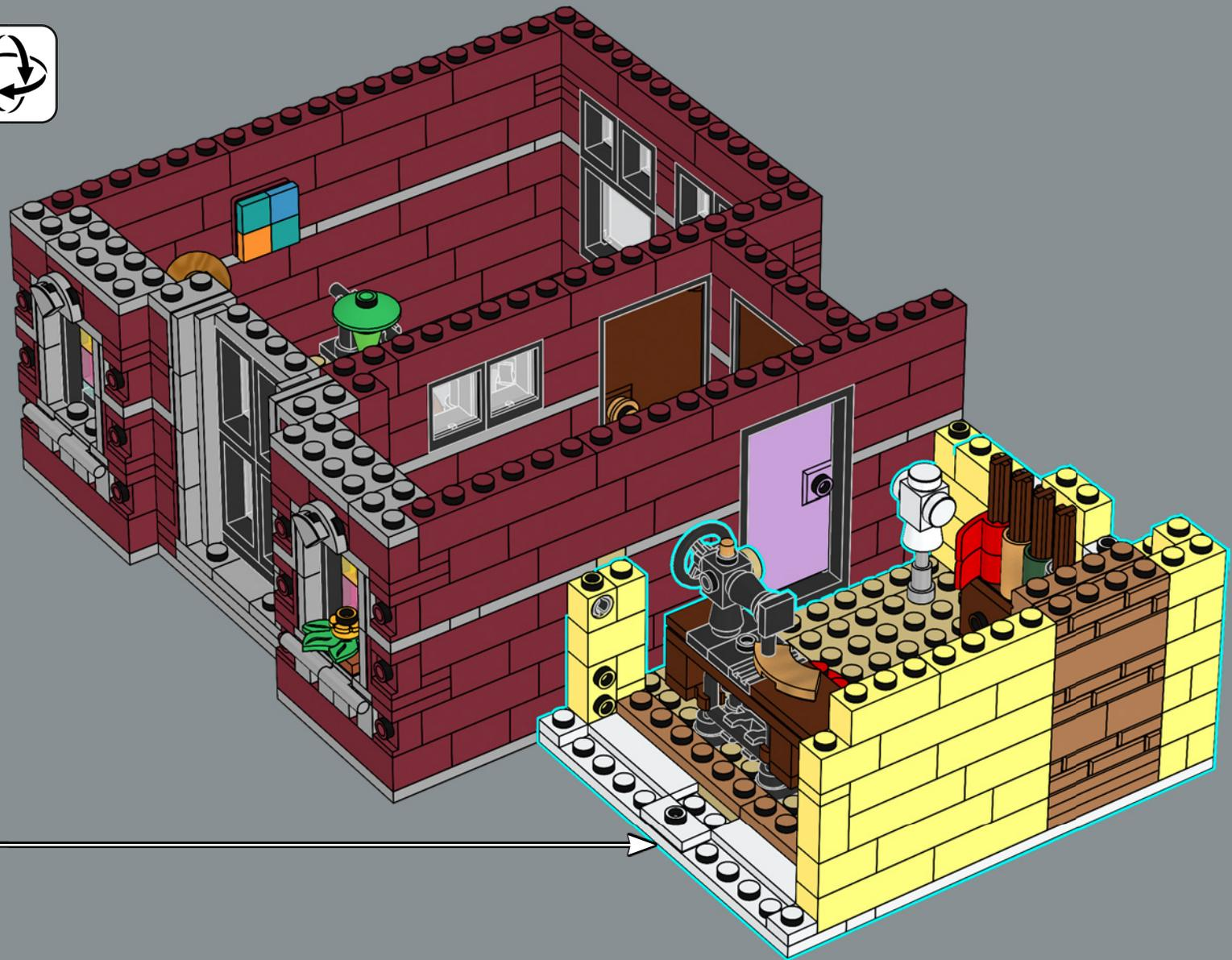

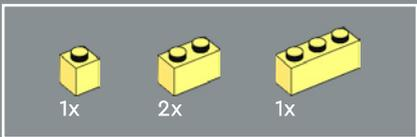

254

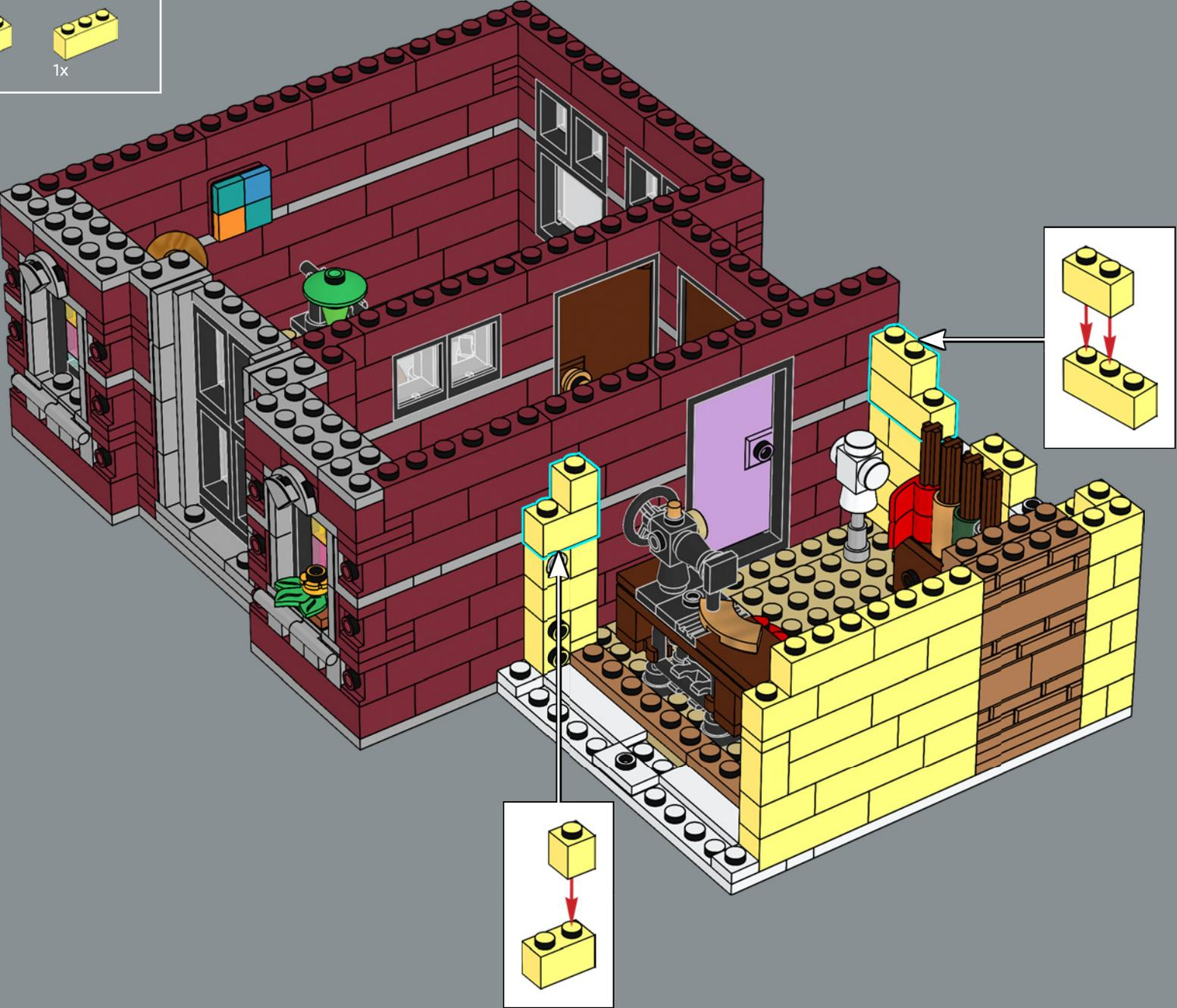

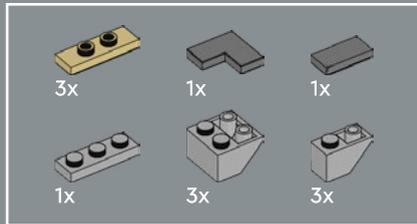

255

1

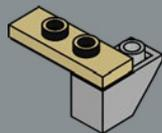

2

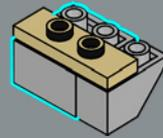

3

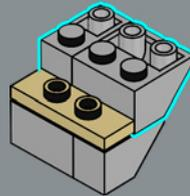

4

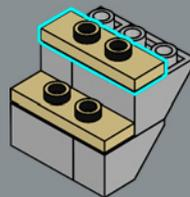

5

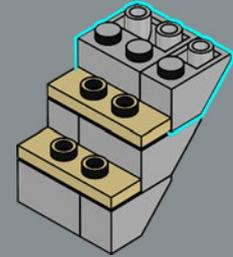

6

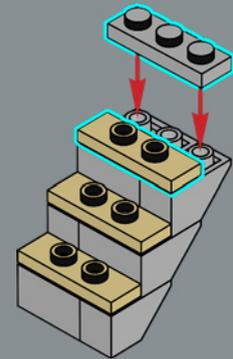

7

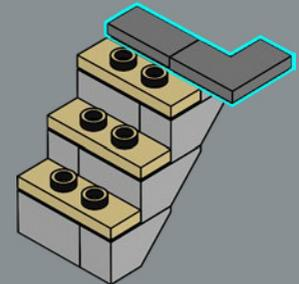





12x

256

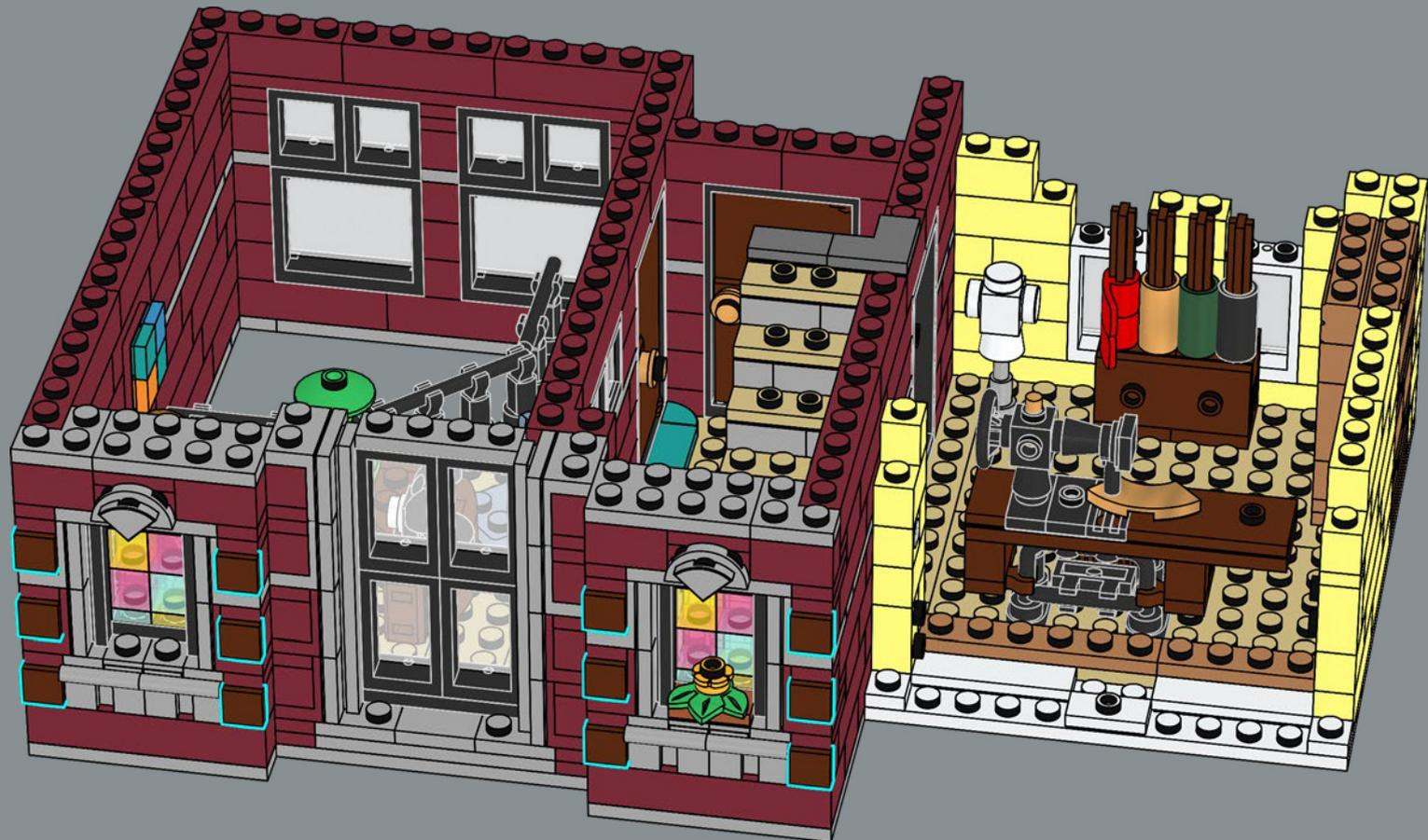

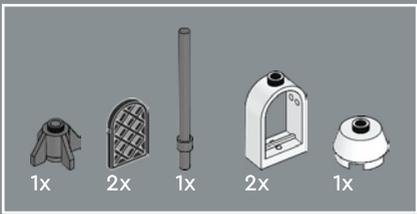

257

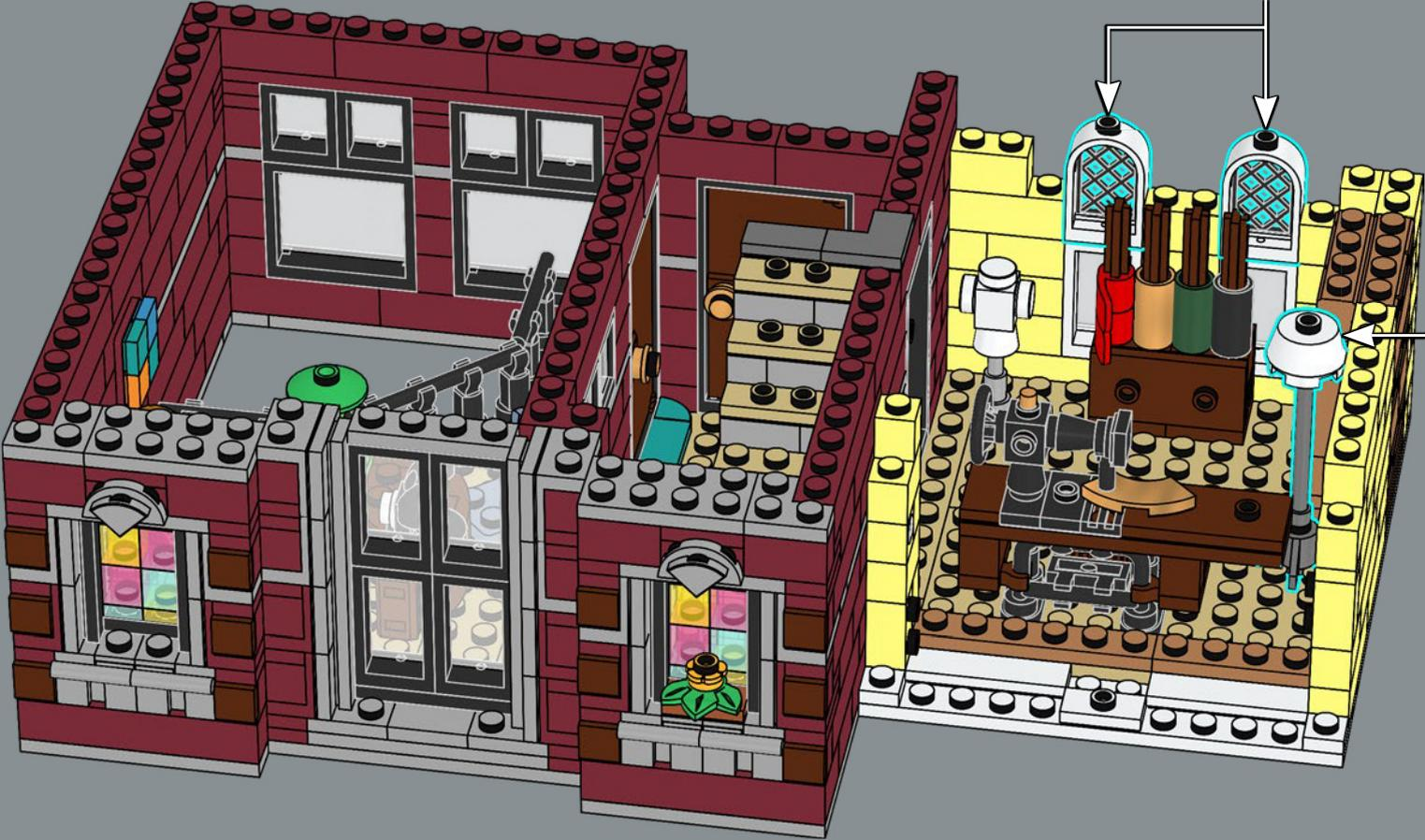
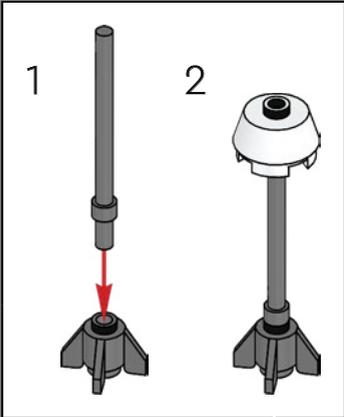
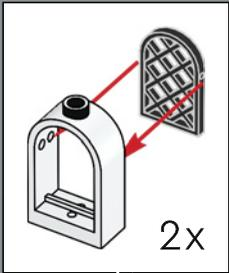



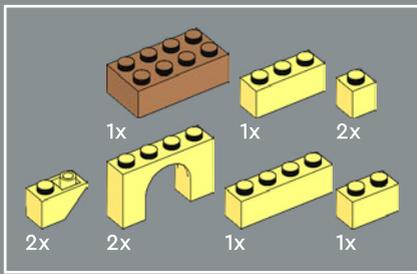

258

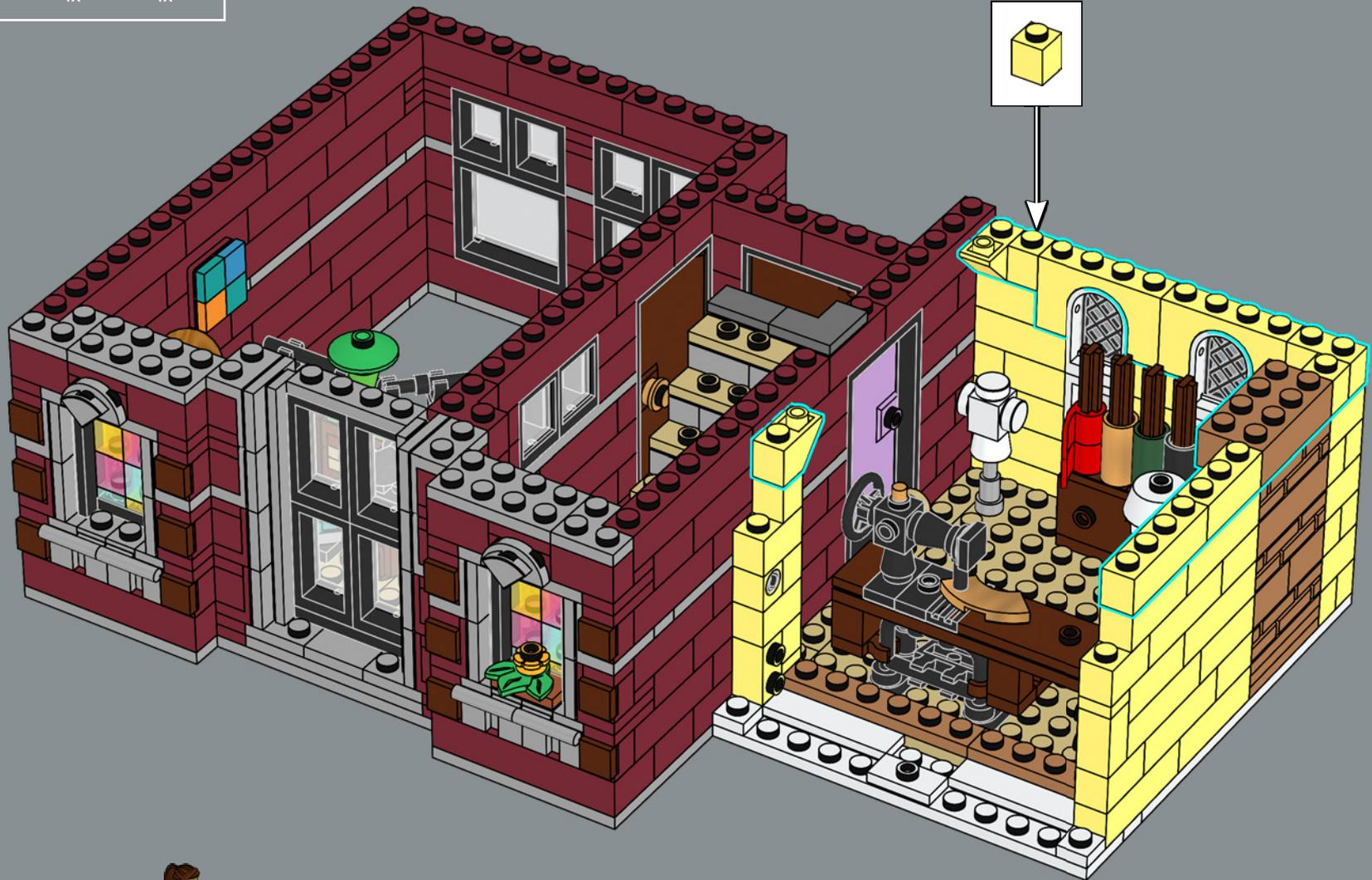

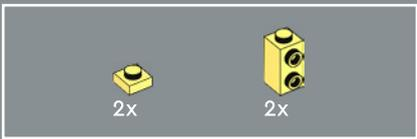

259

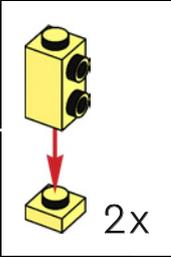
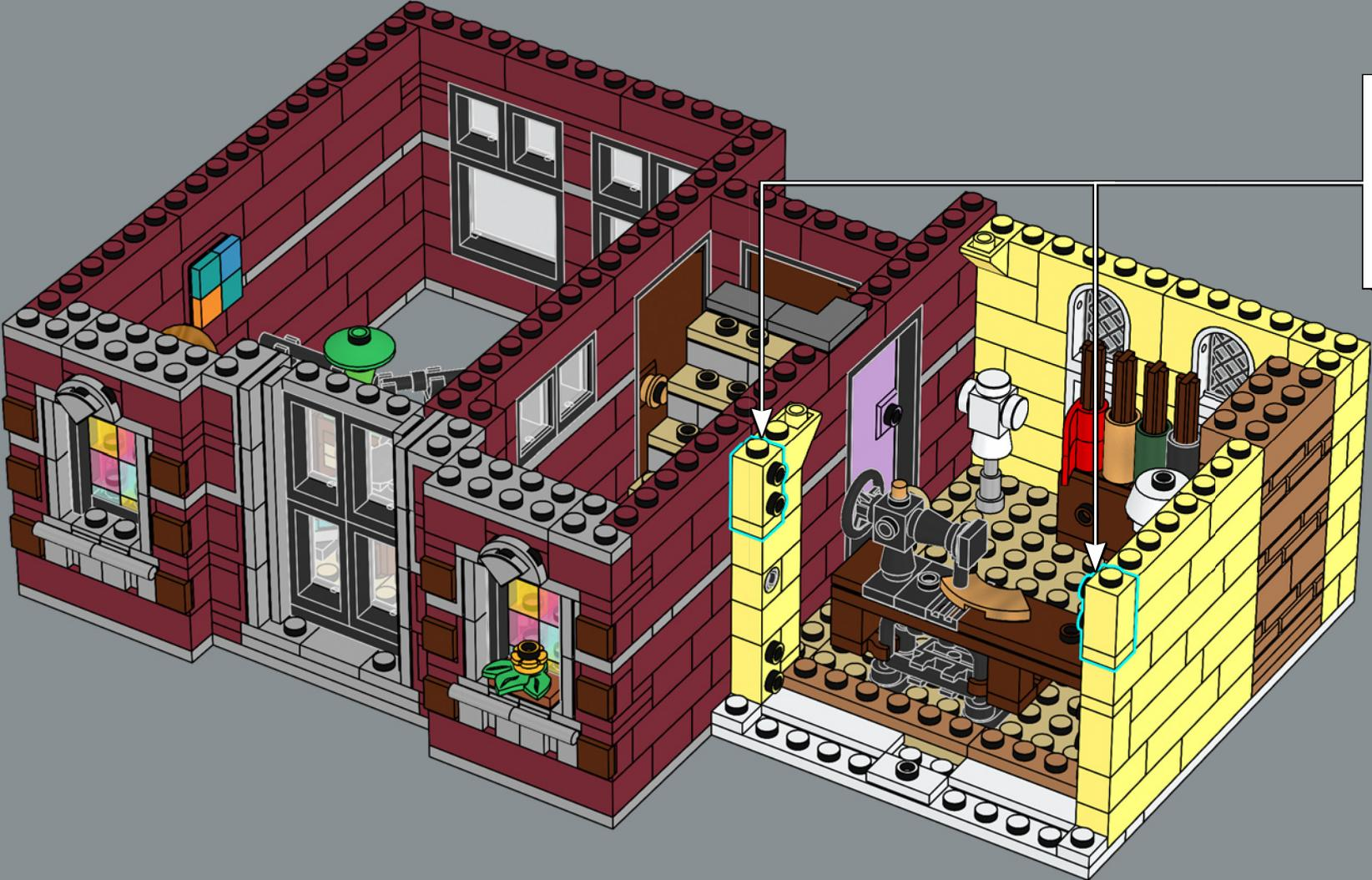

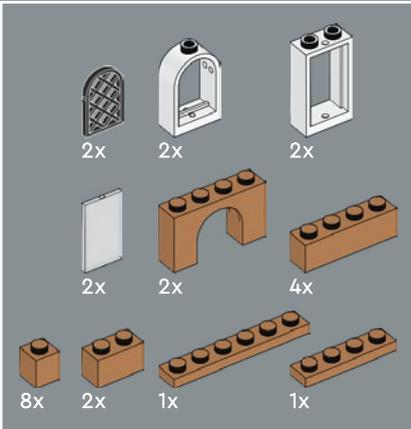
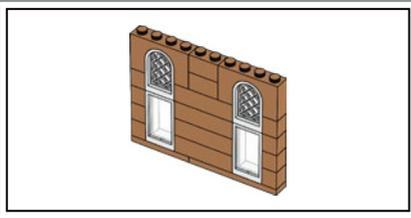

260

1

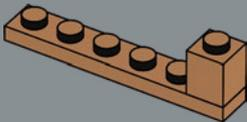

2

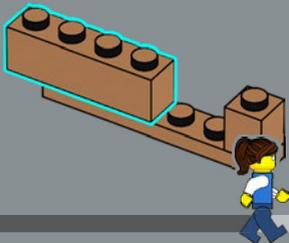

3

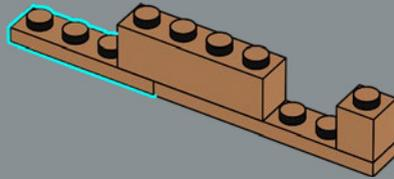

4

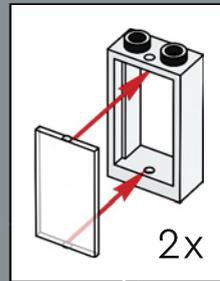
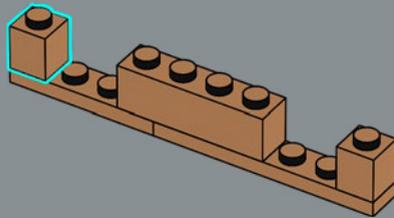

5

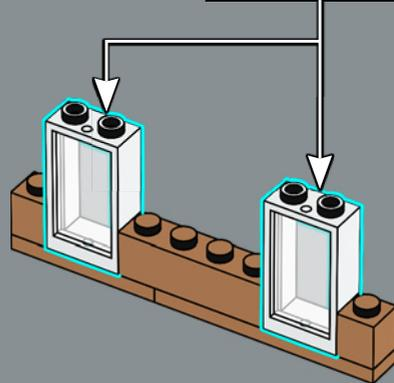

6

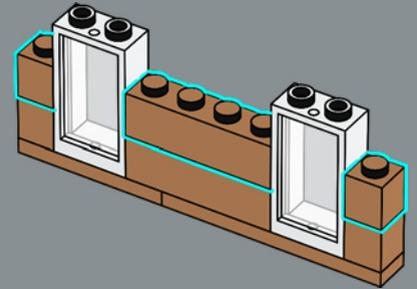

7

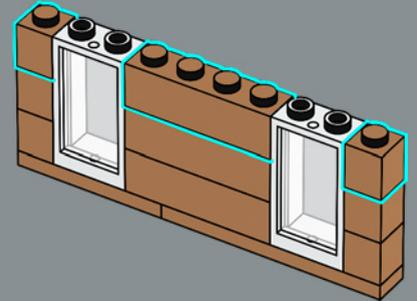

8

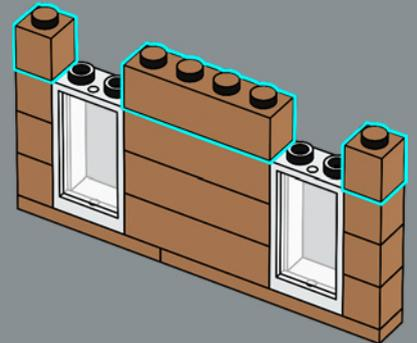

9

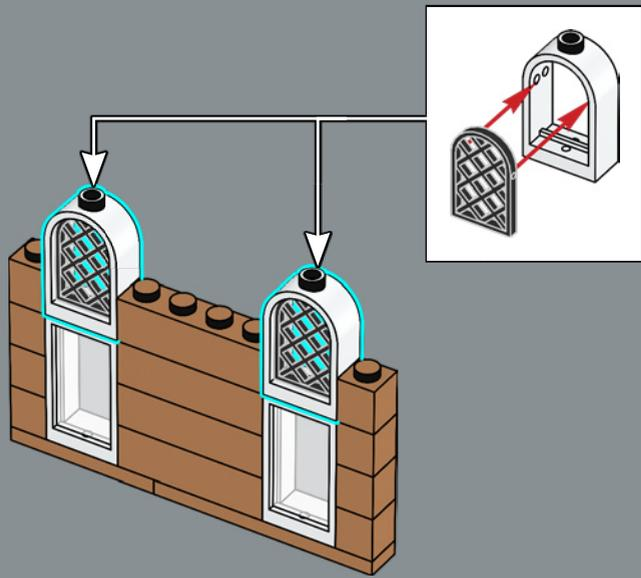

10

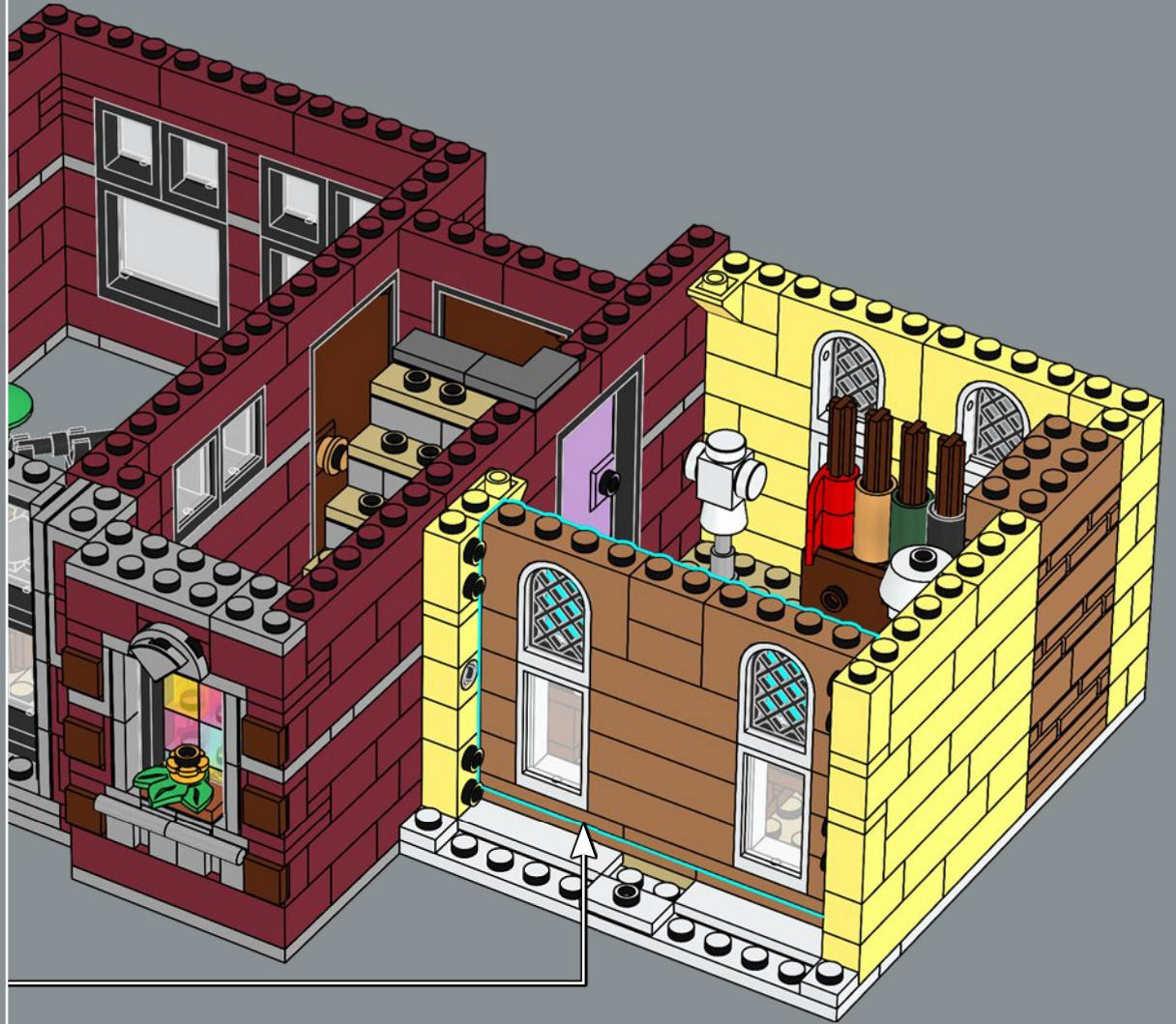
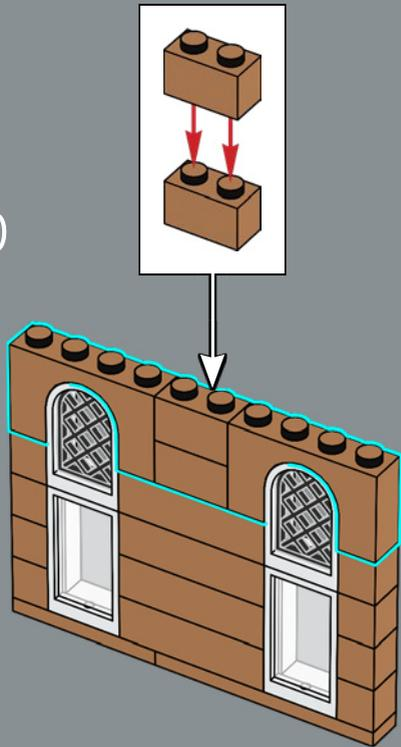



261

1

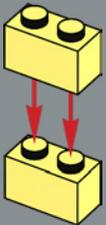

2



3

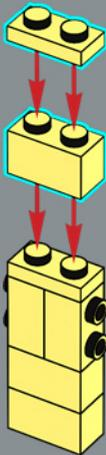

4

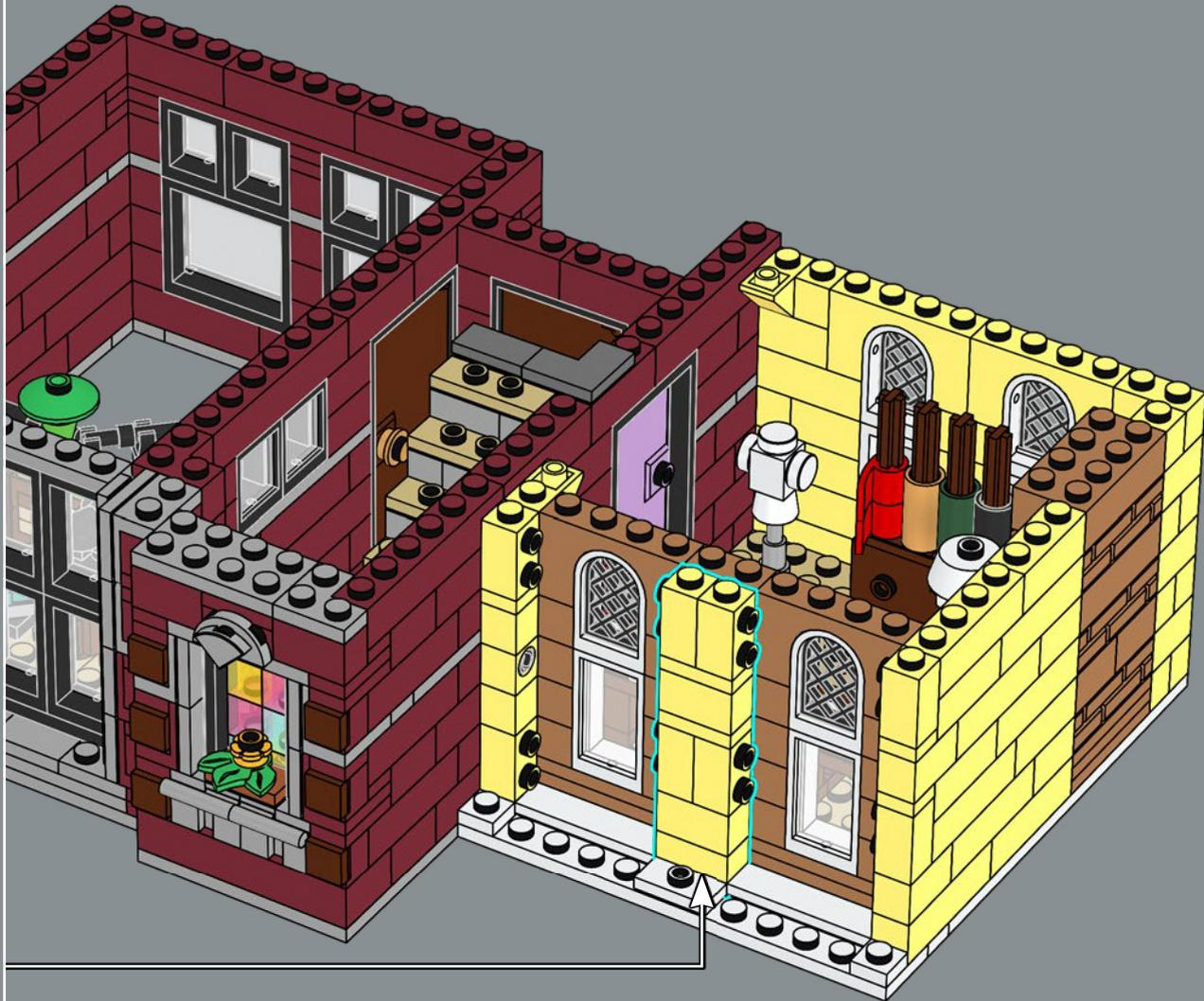
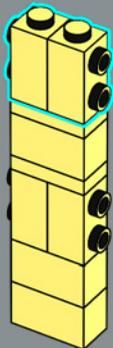

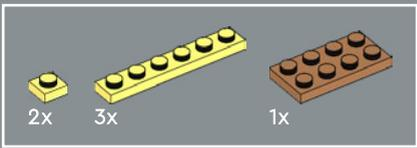

262



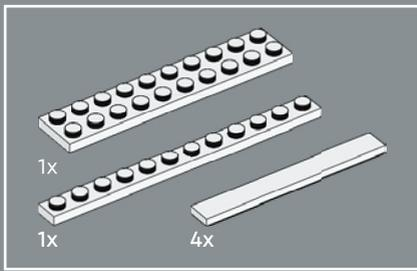

263

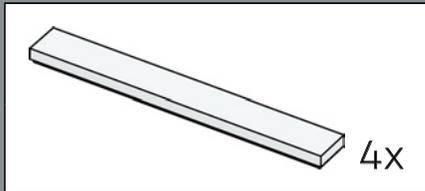

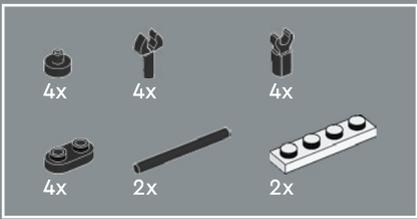

264

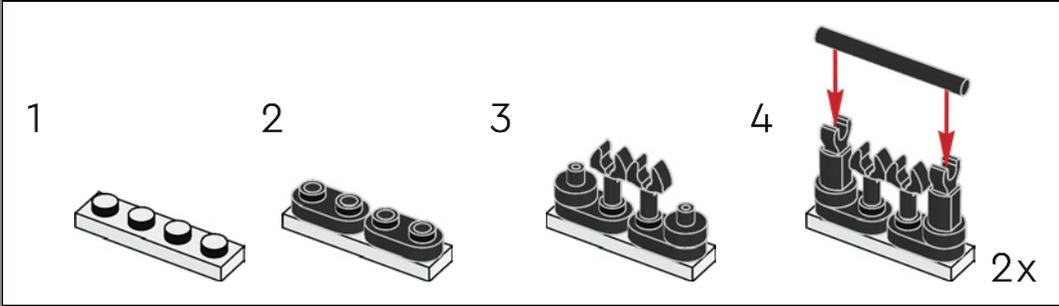



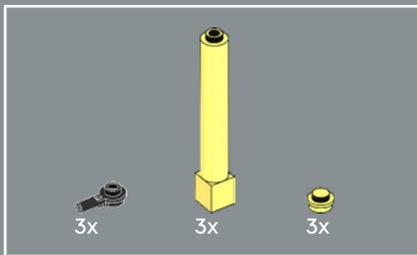

265

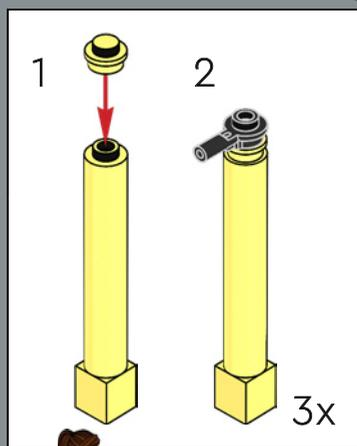
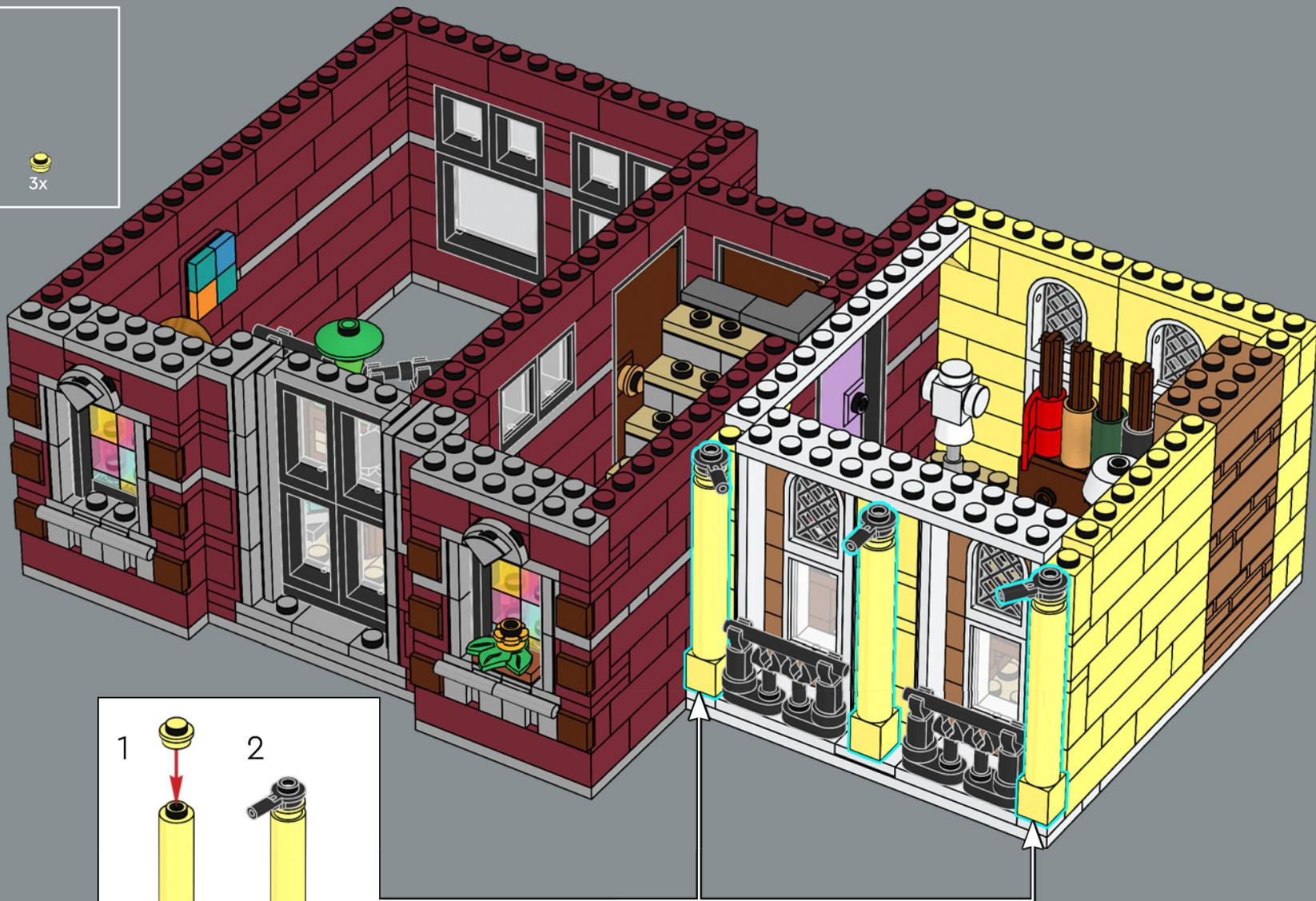



3x

266

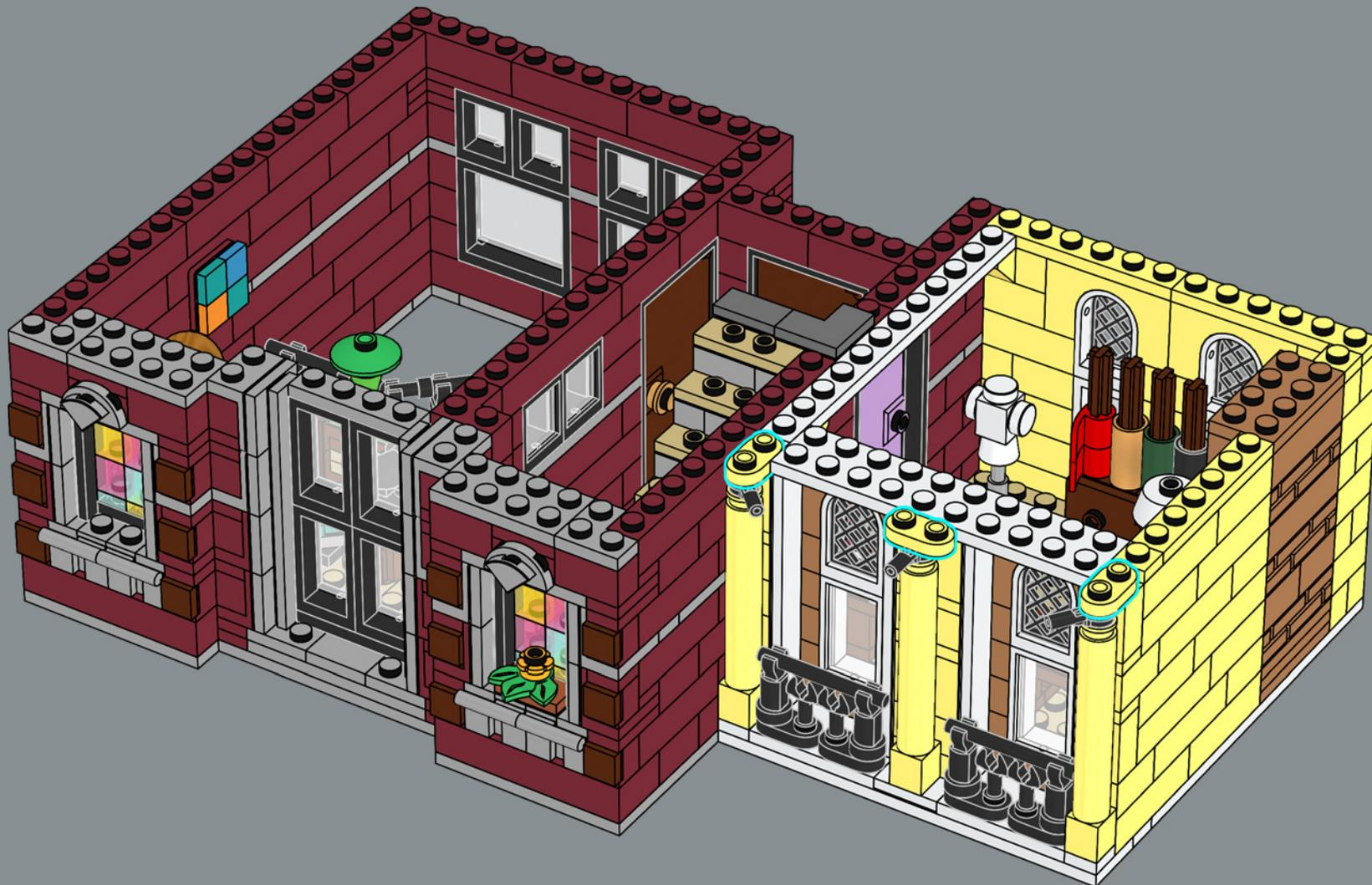

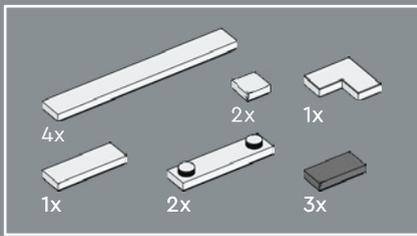

267

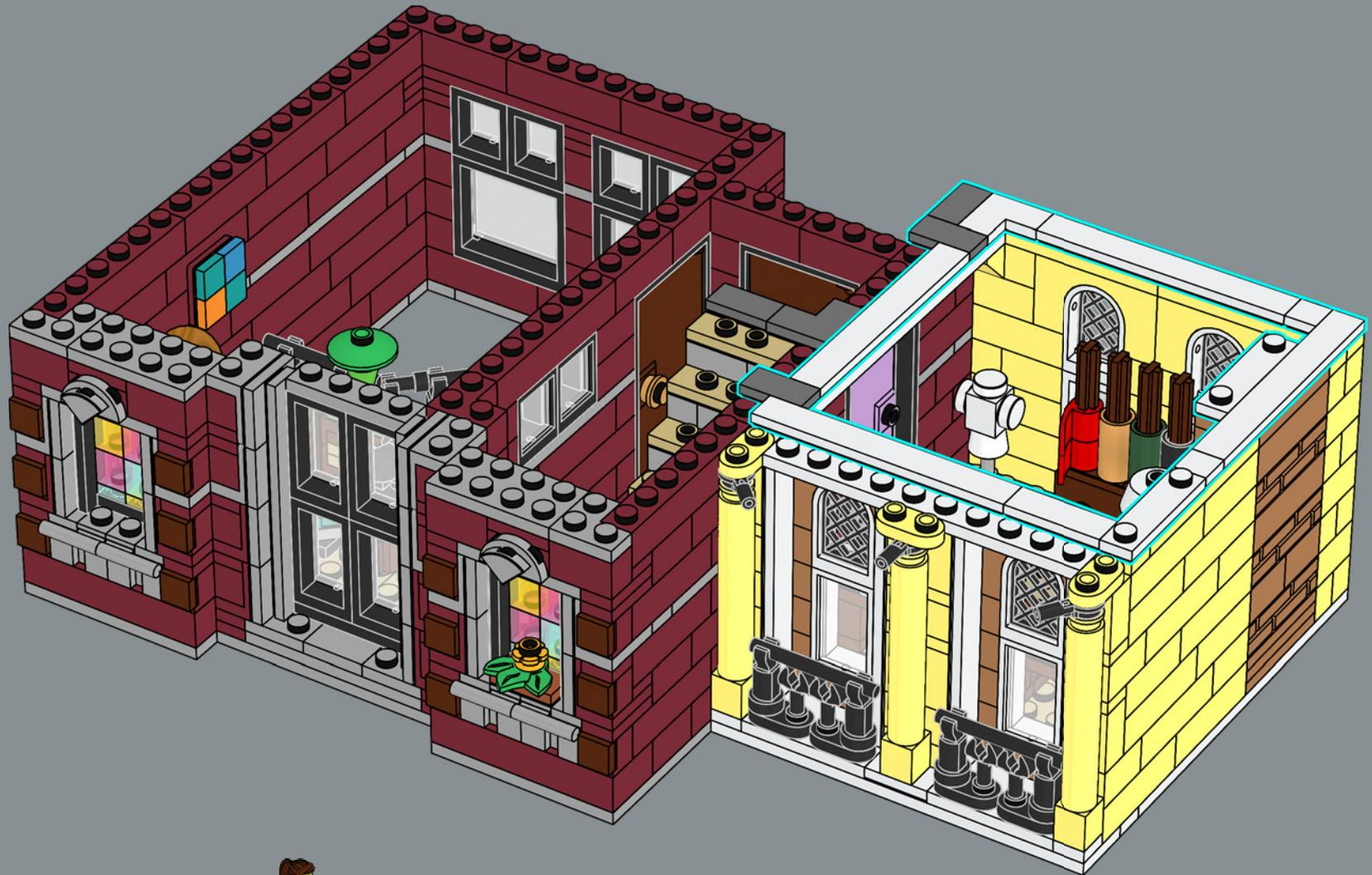

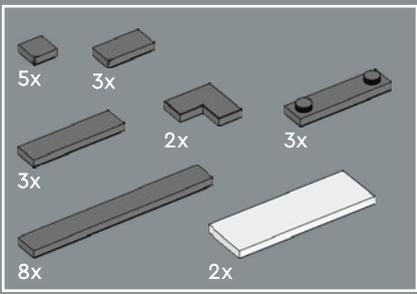

268

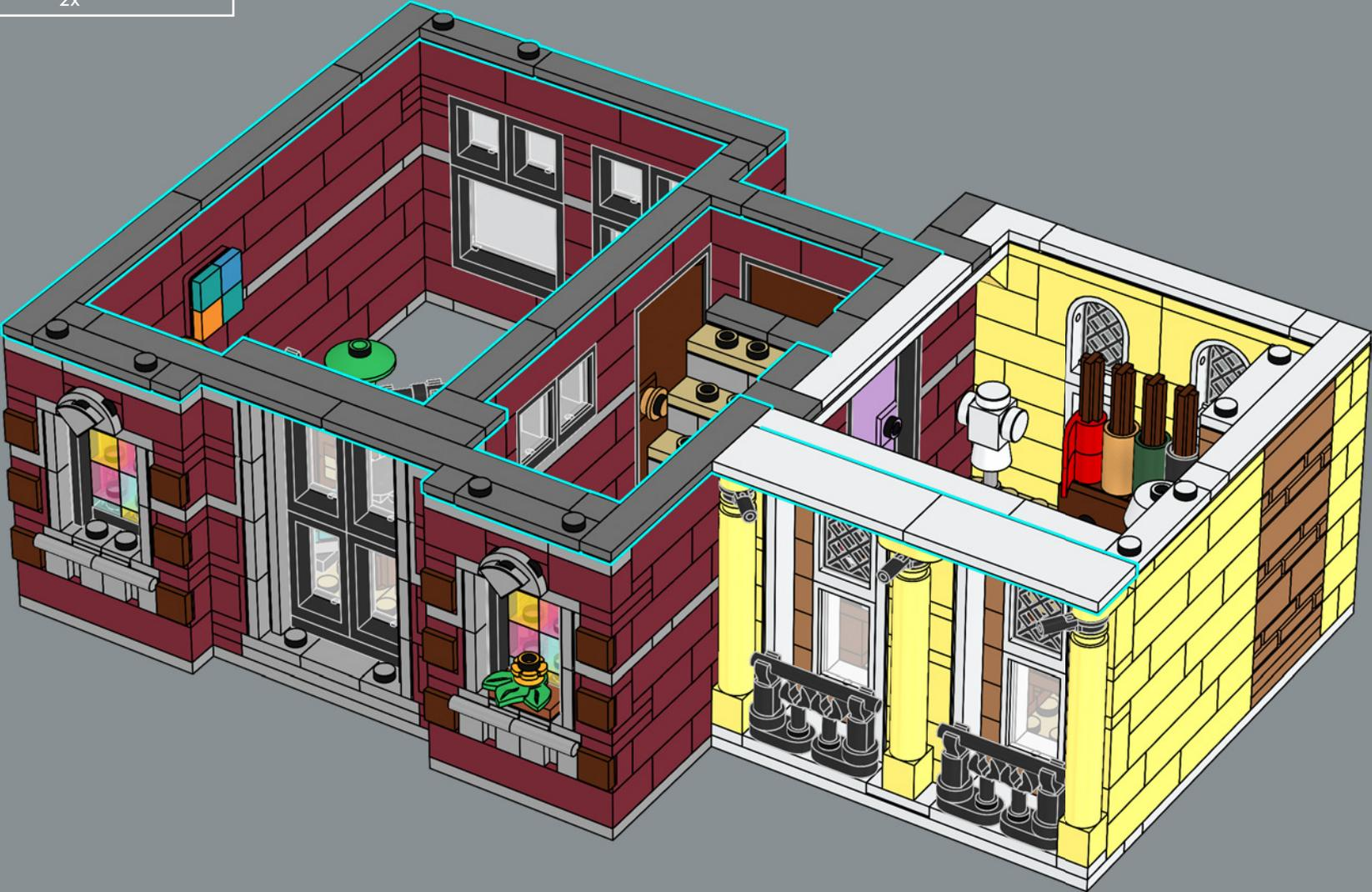



269



Lavendelfarbene Hängeblumen, ein lavendelfarbenes Schild und lavendelfarbene Türen. Wenn du zum Schneider musst, weist dir der Lavendel den Weg!

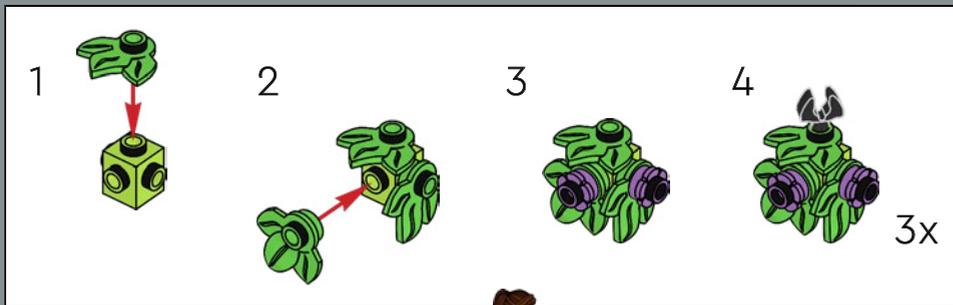

270





Die Sängerin ist schon fast für die heutige Abendshow fertig. Sie hat ihr Kleid beim Schneider abgeholt, einen Happen in der Pizzeria gegessen und noch kurz bei der Clubbesitzerin reingeschaut. Jetzt wärmt sie sich in der Garderobe auf.

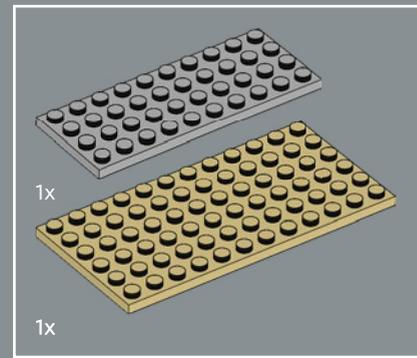

271

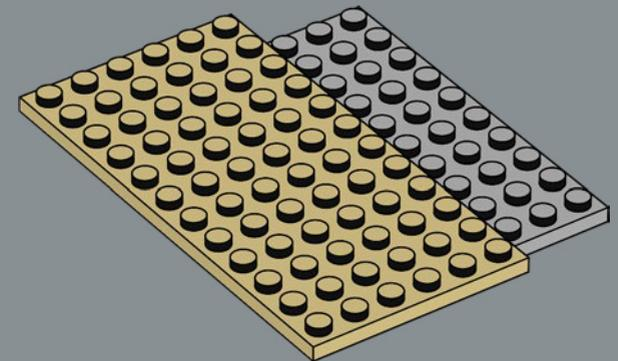
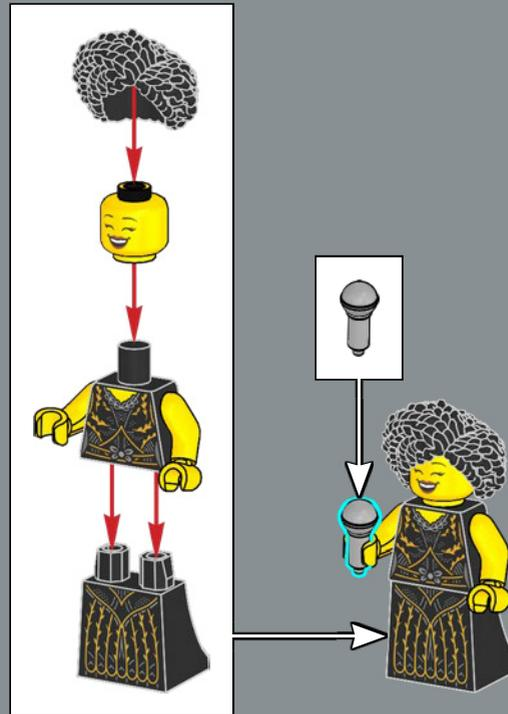
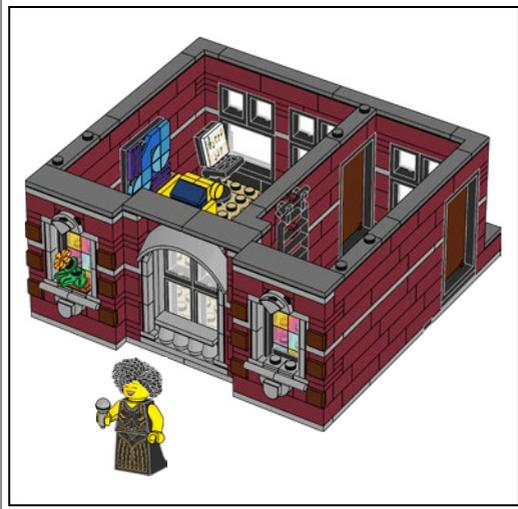

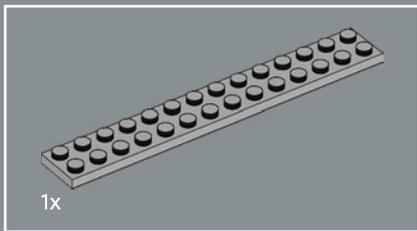

272

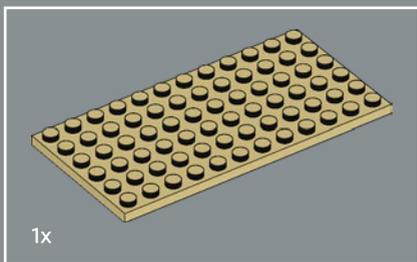
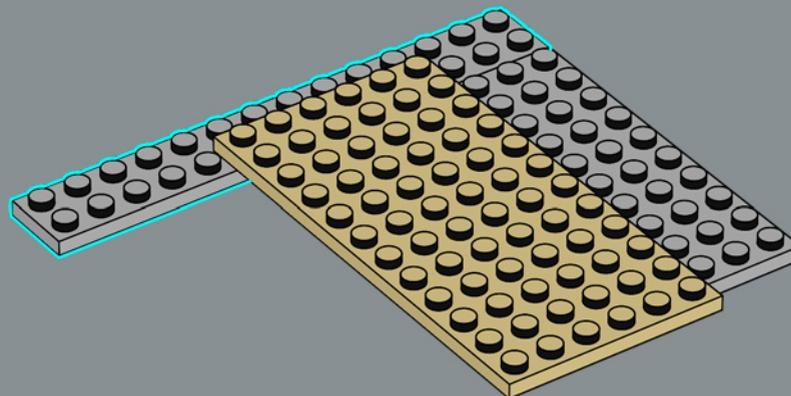

273

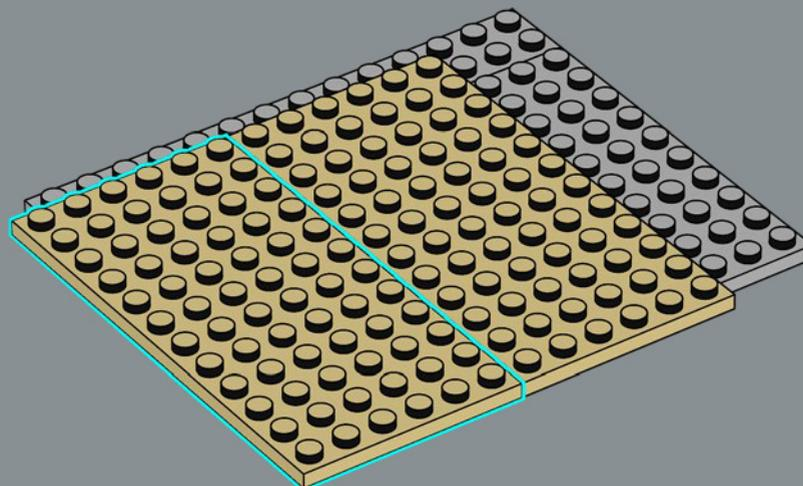



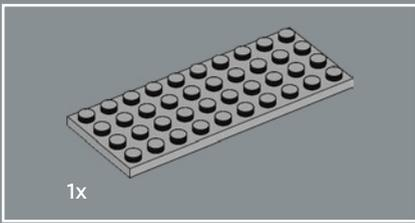

274

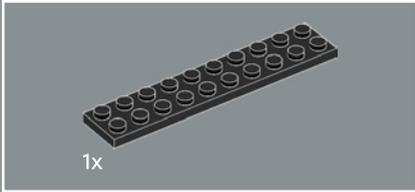
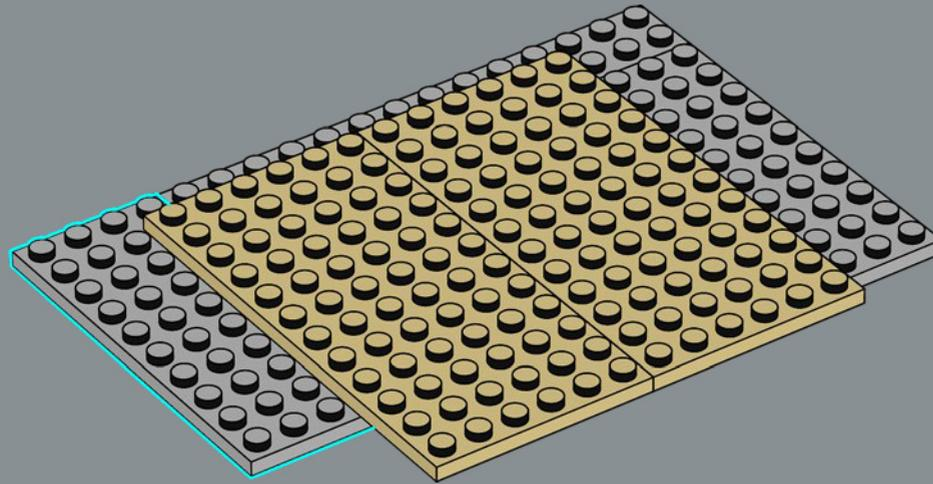

275

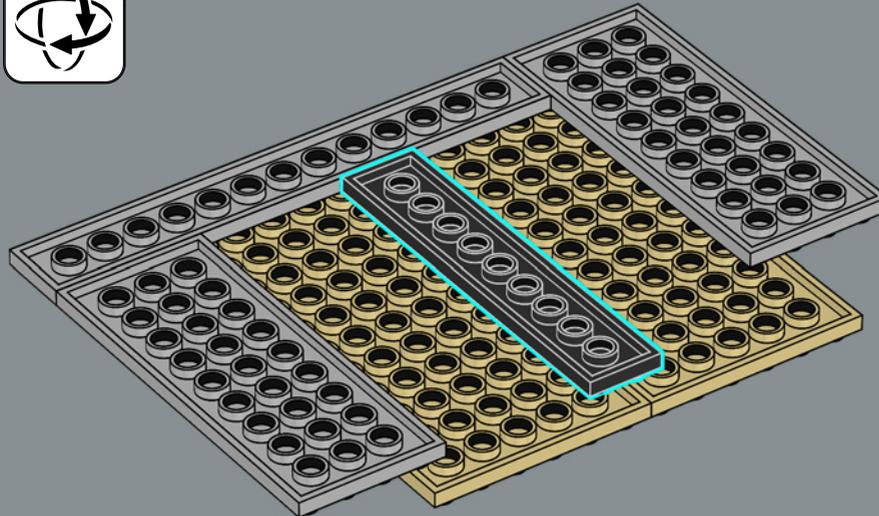

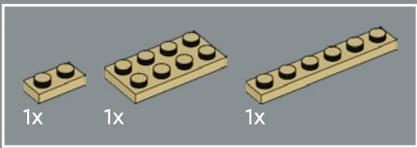

276

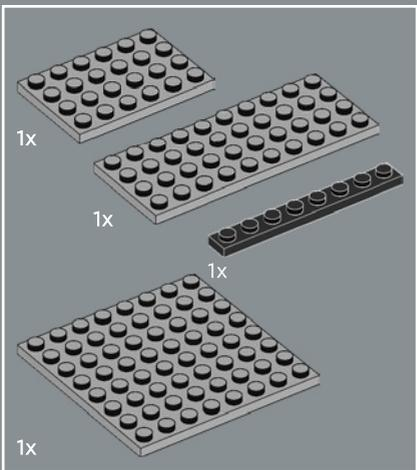
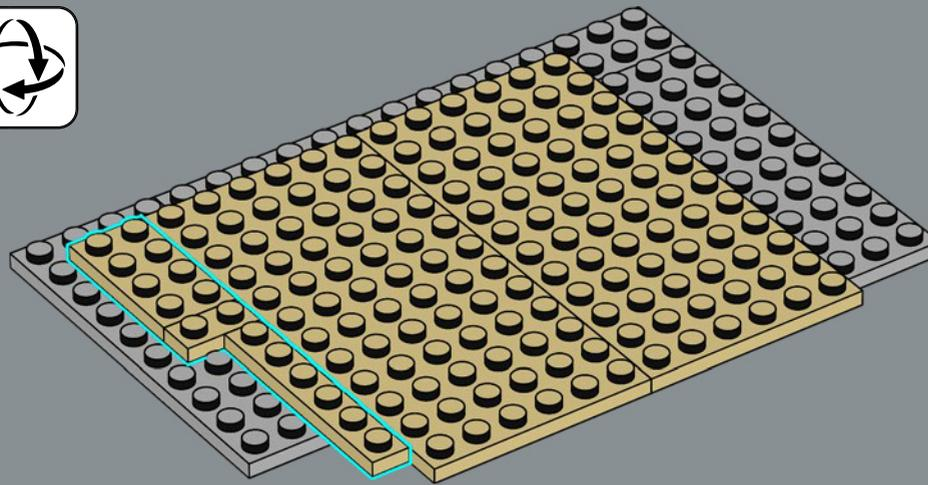

277

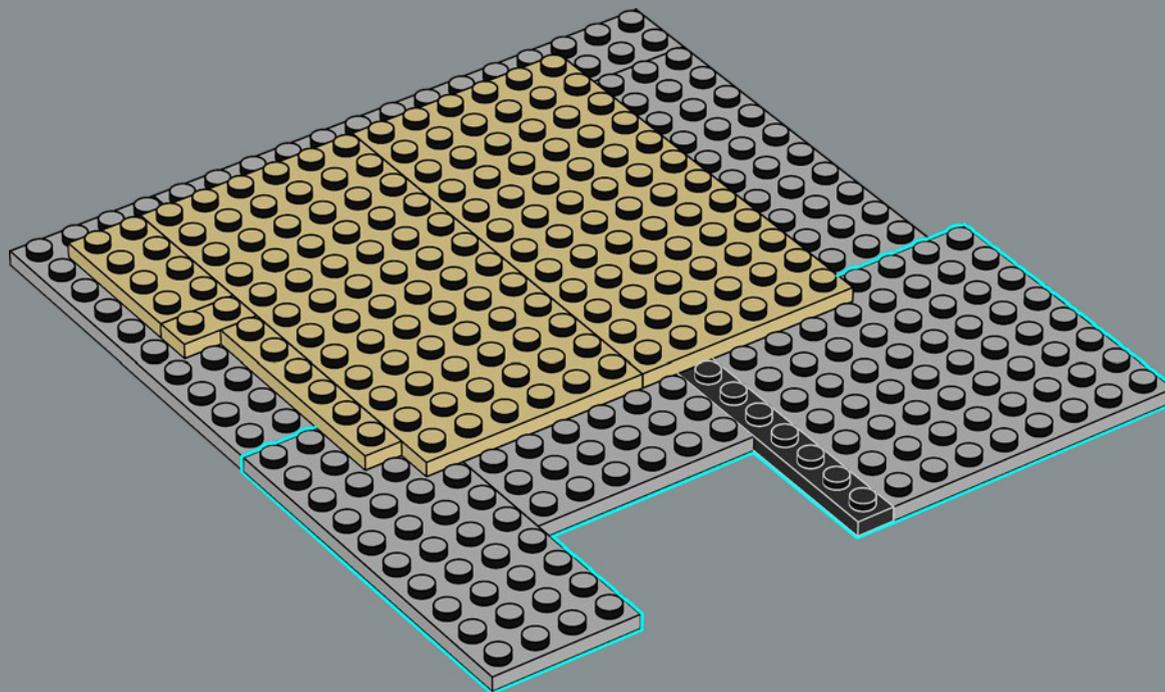

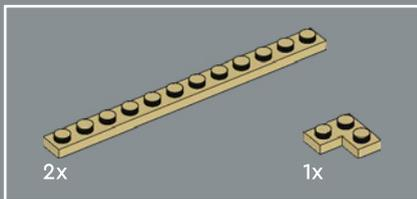

278

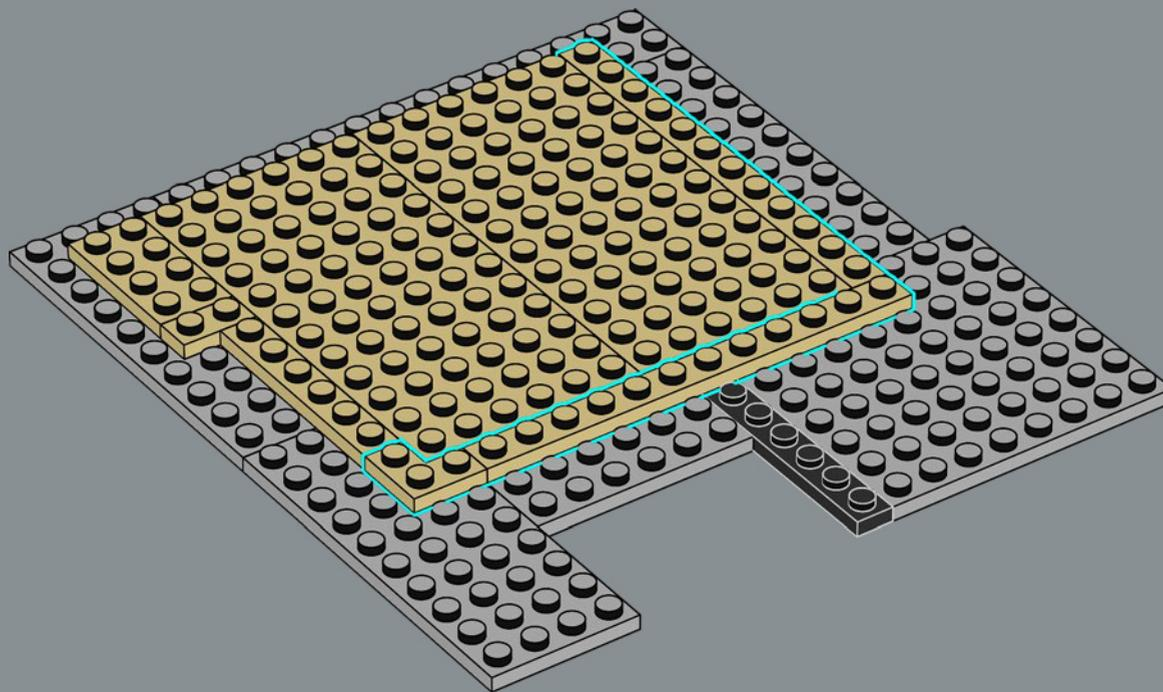

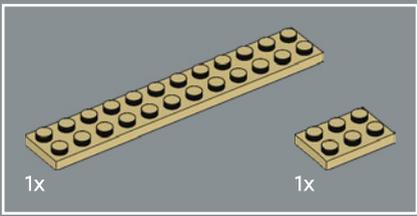

279

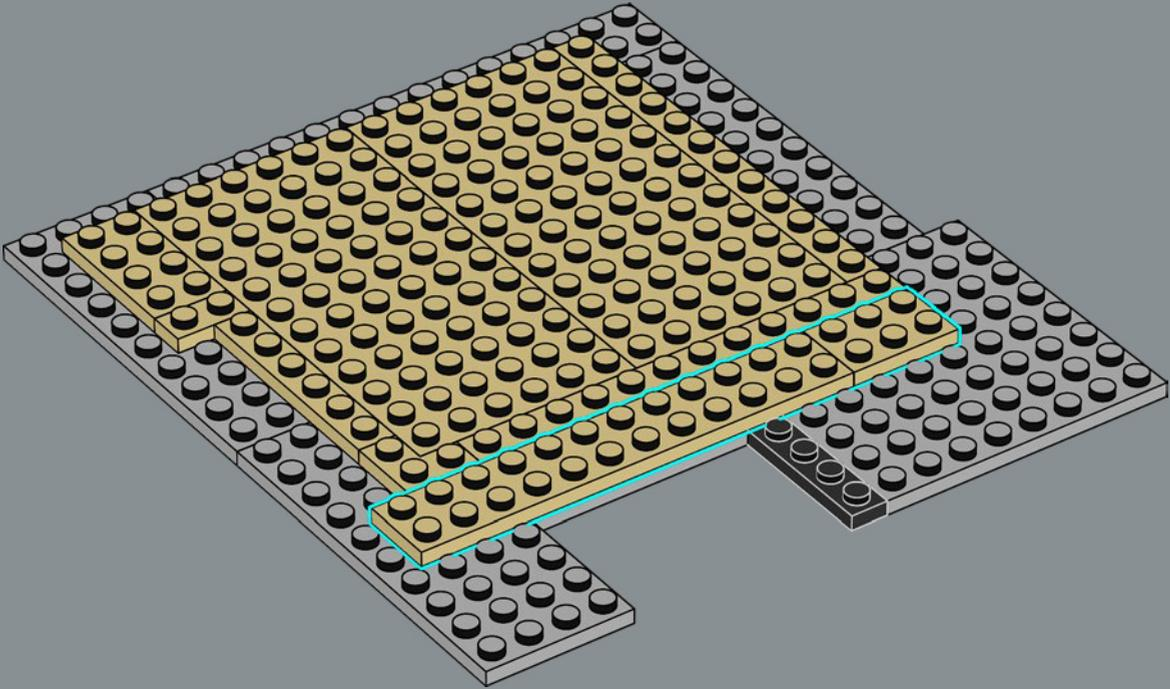

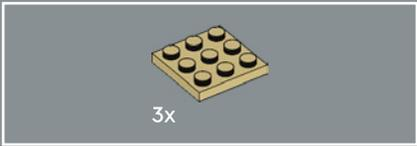

280

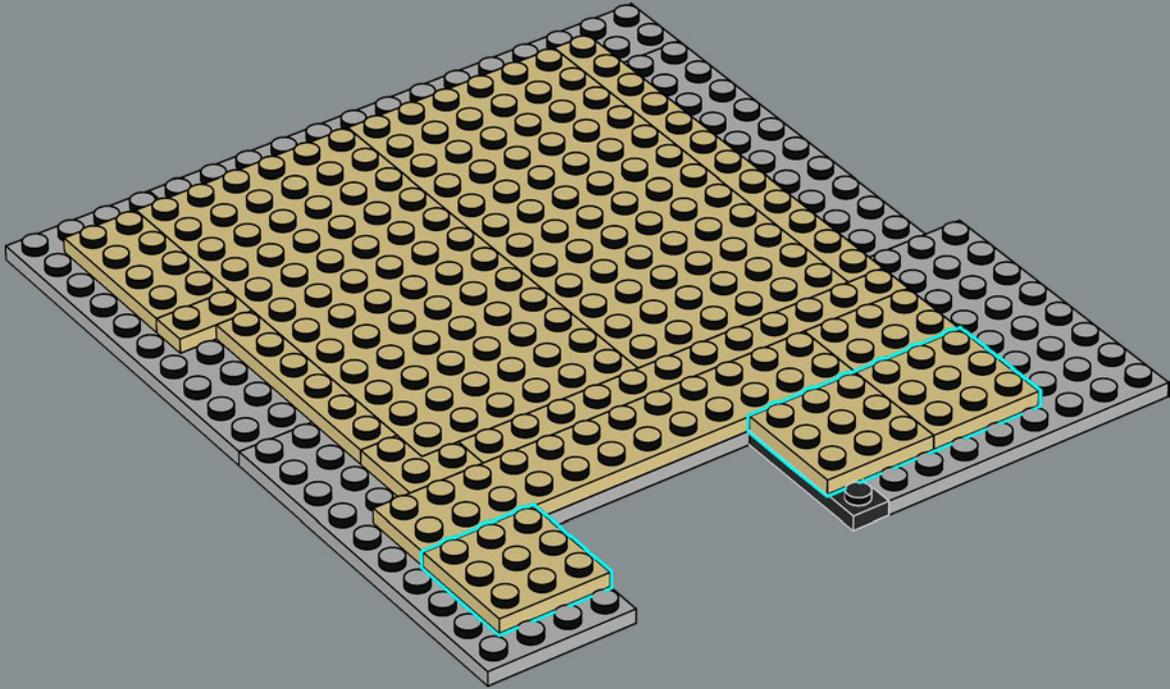

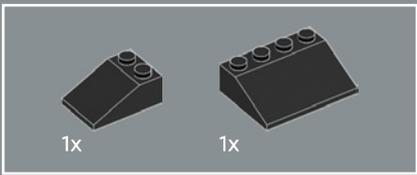

281

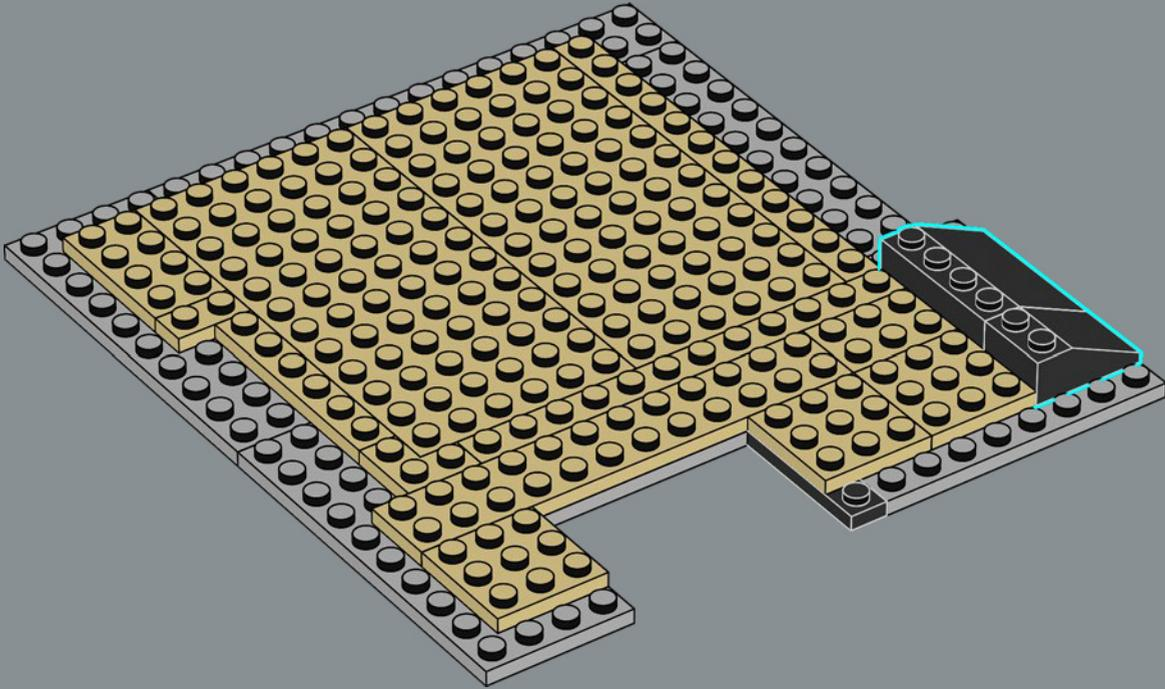

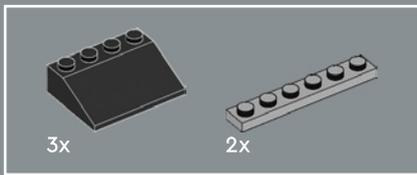

282

1

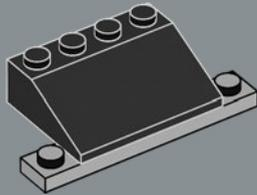

2

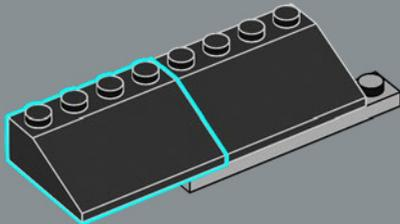

3

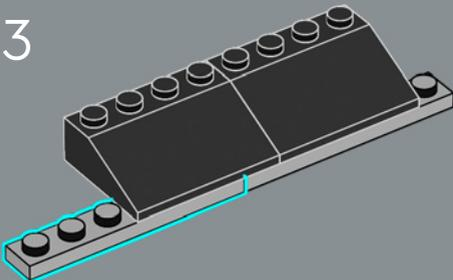

4

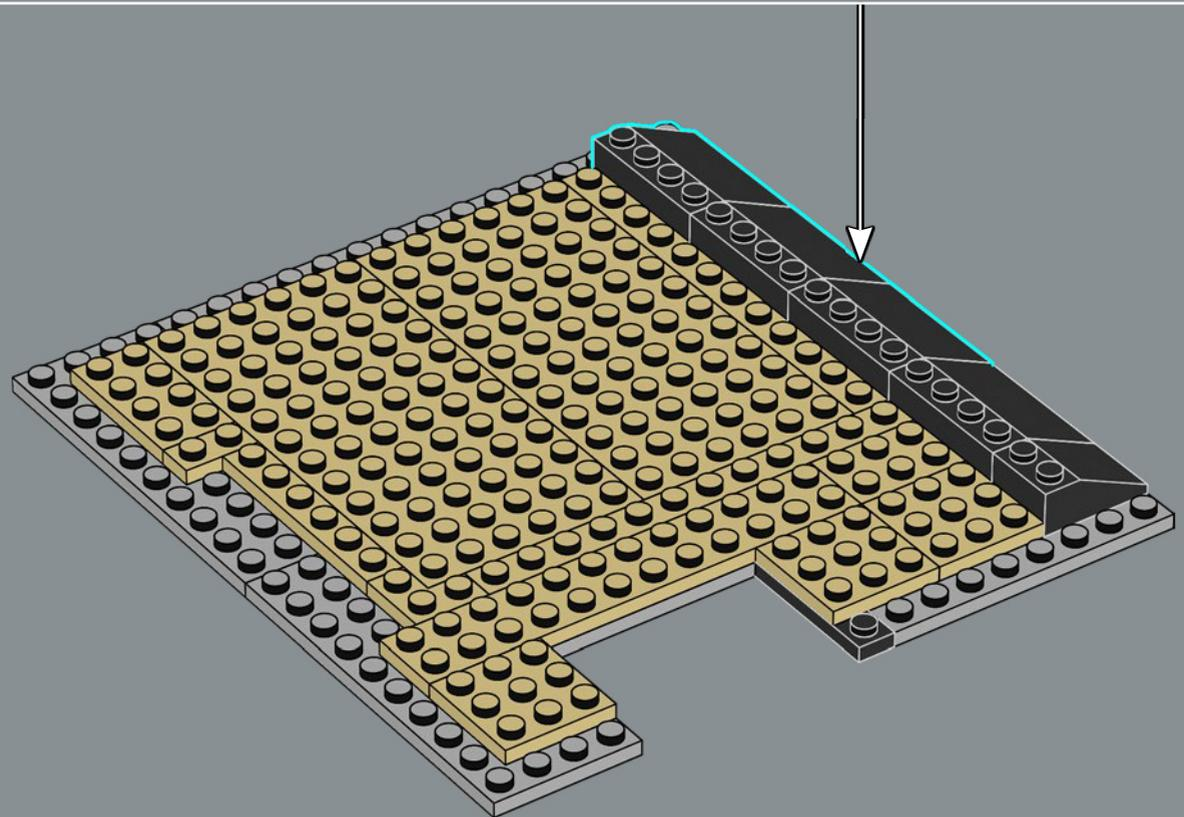
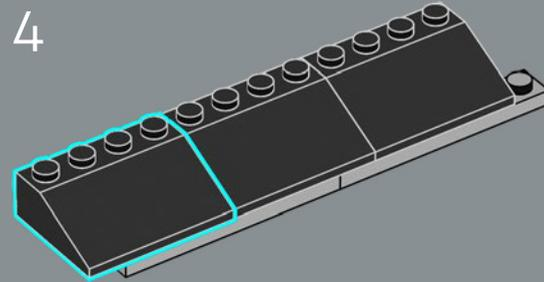

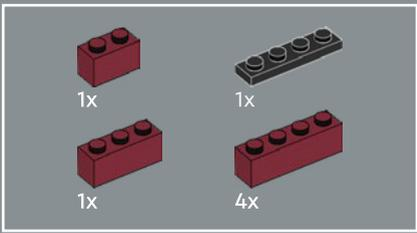

283

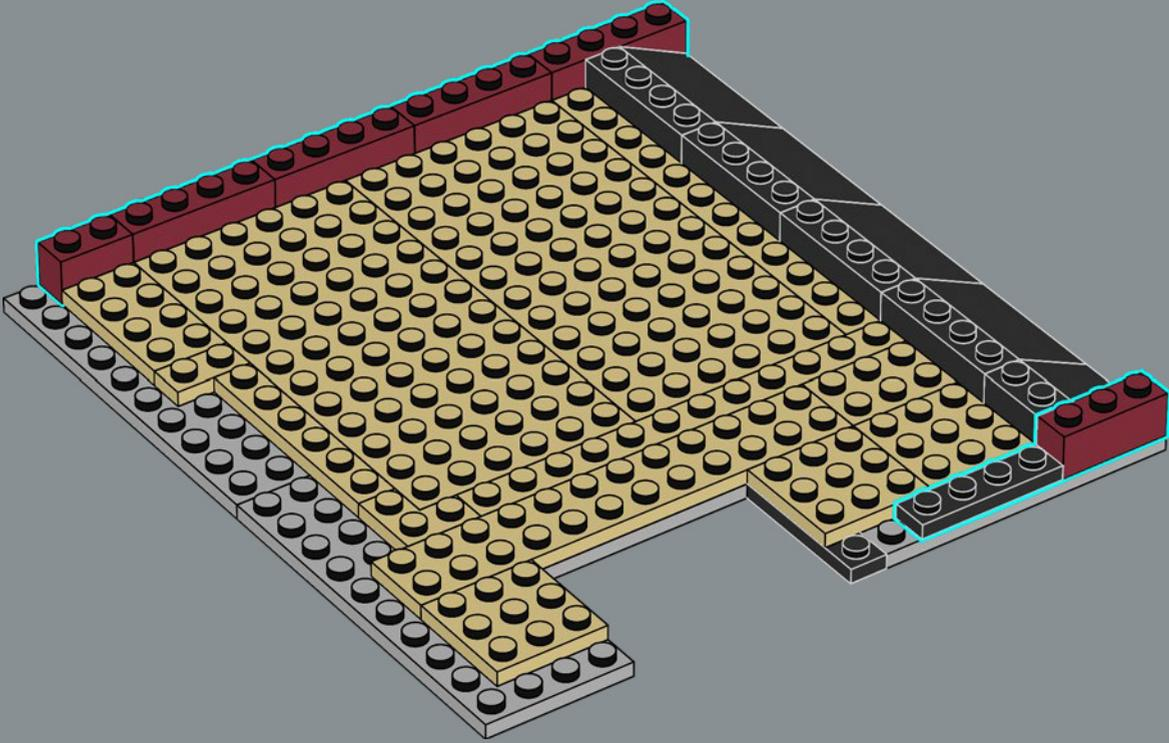



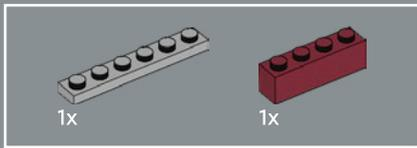

284

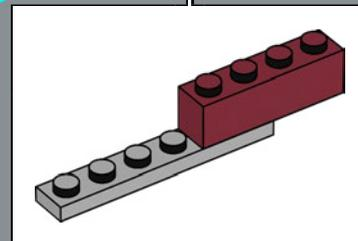
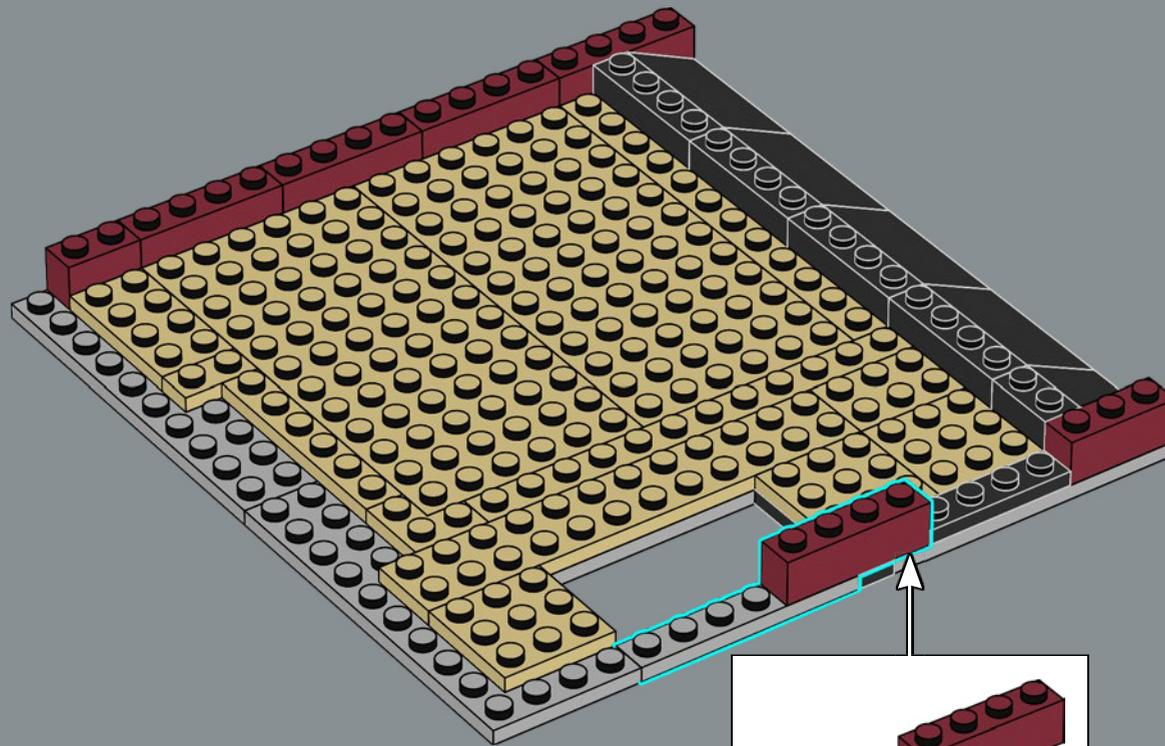

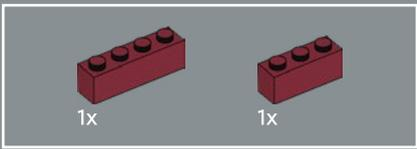

285

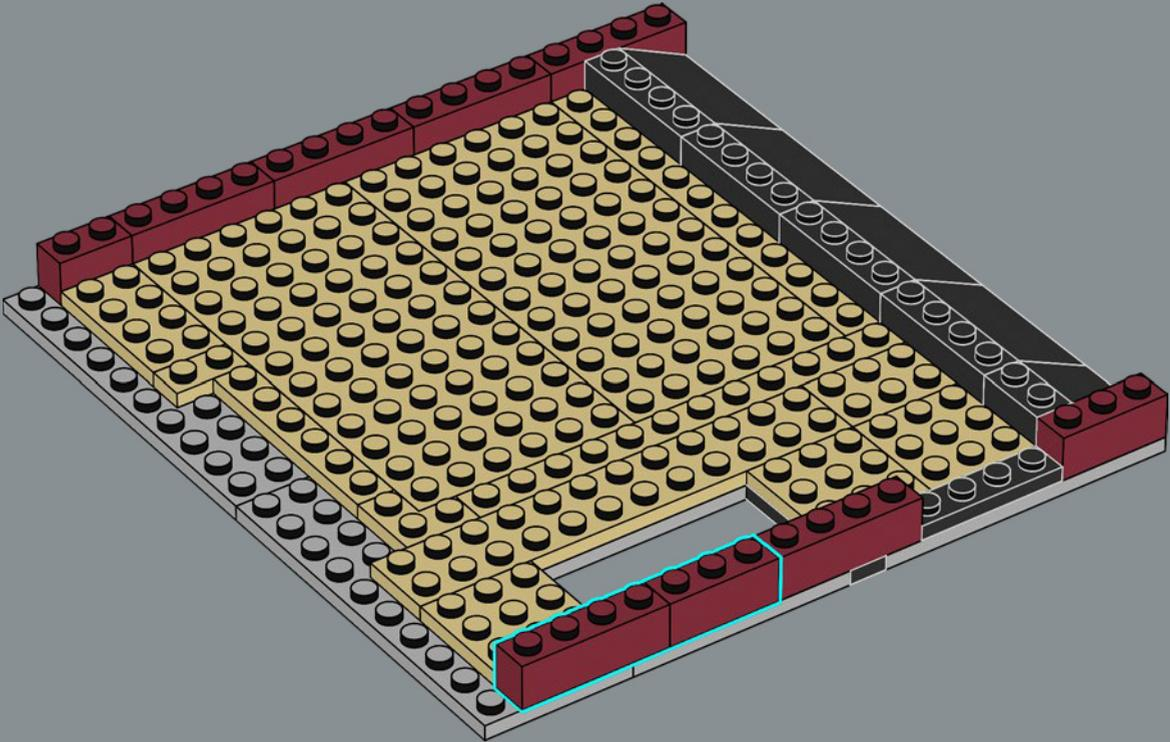

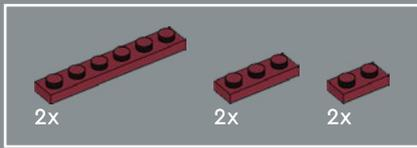

286

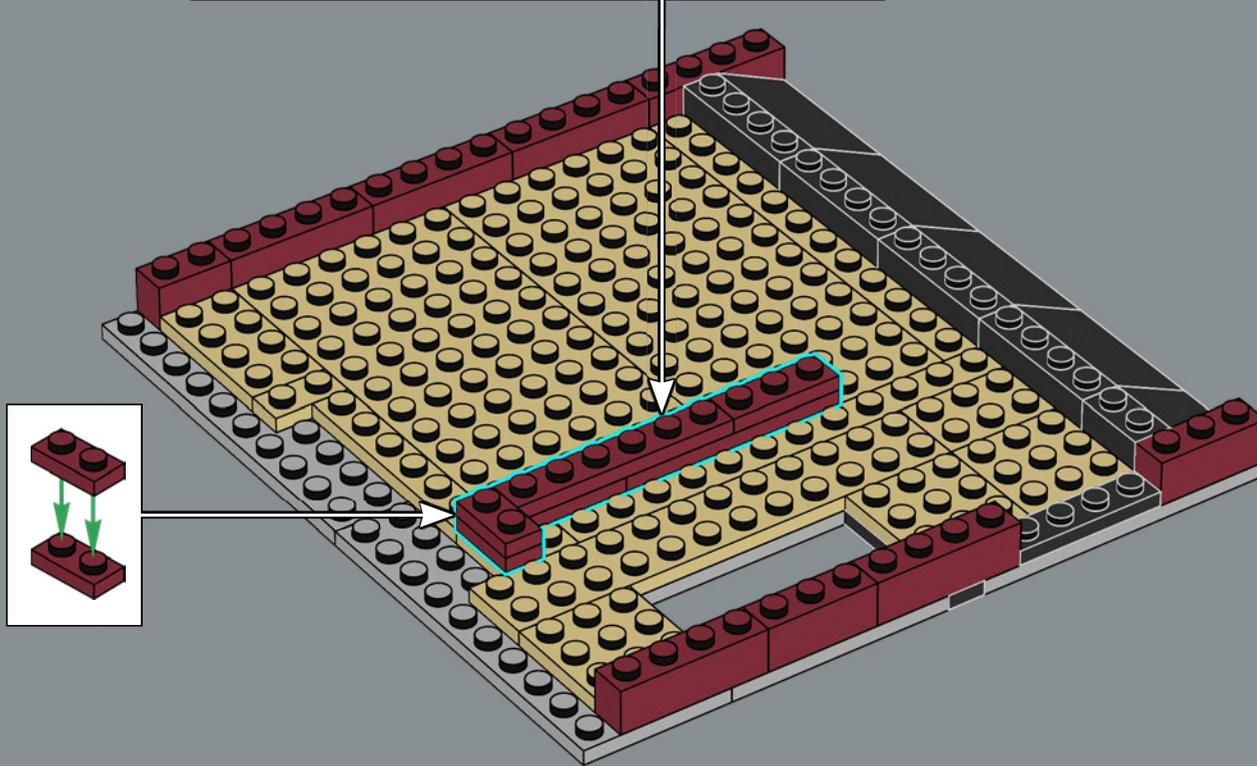
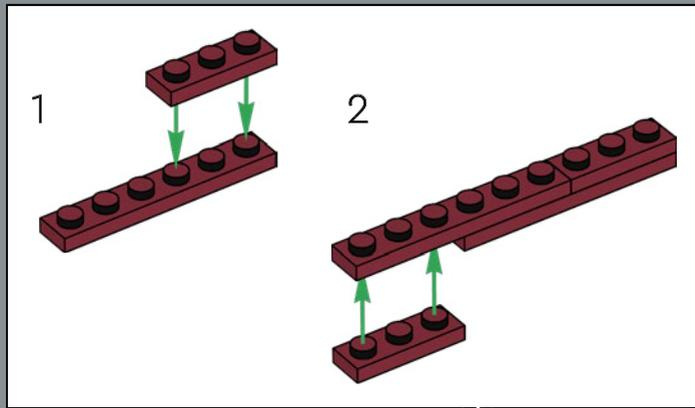



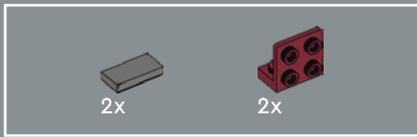

288

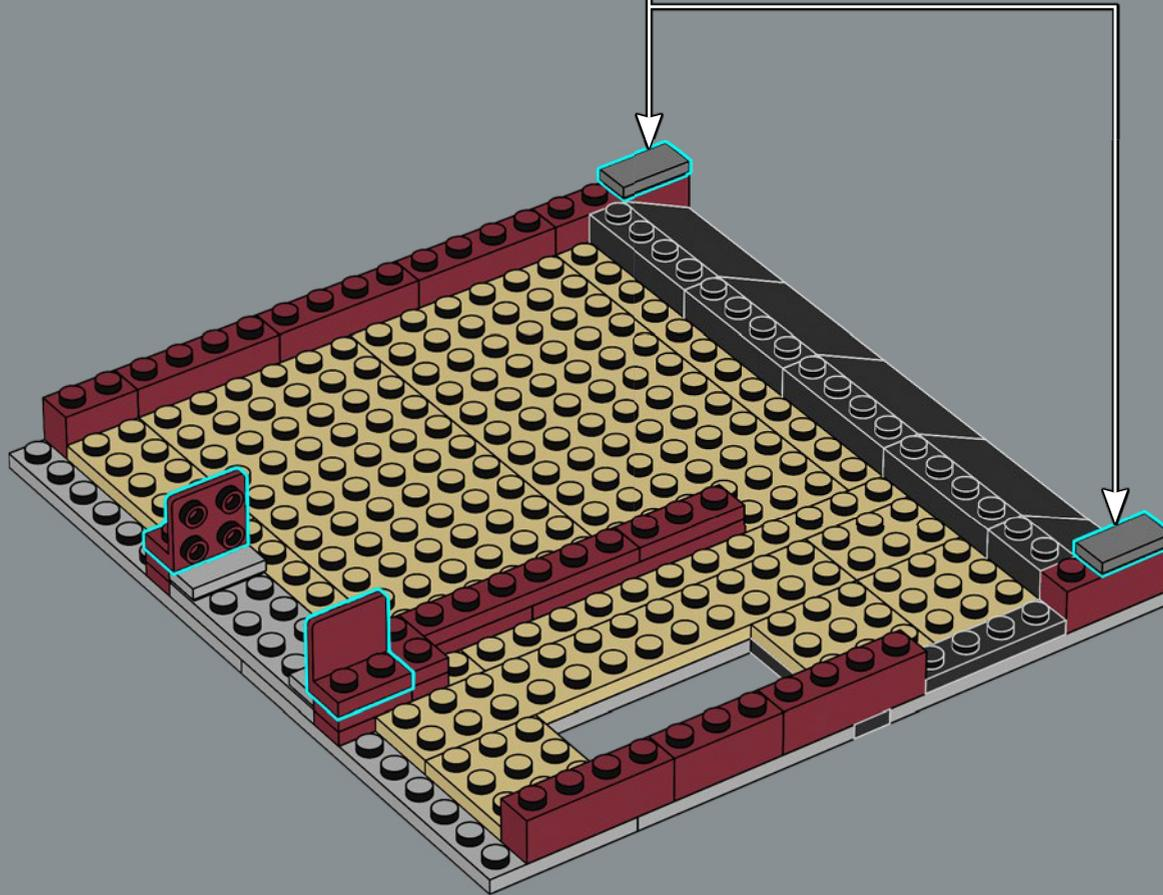
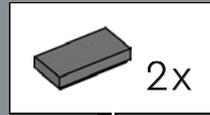

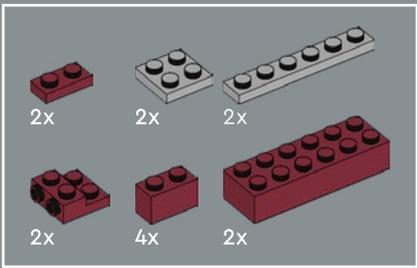

289

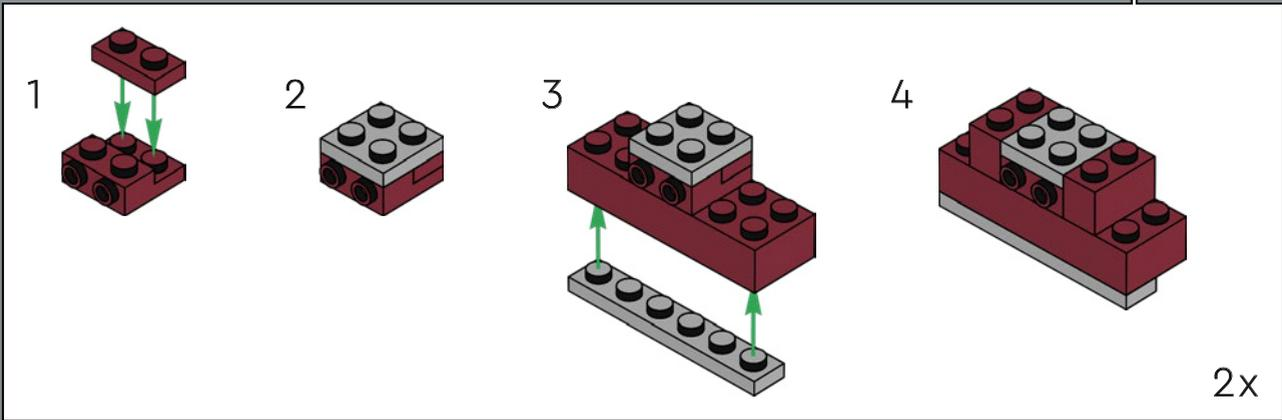
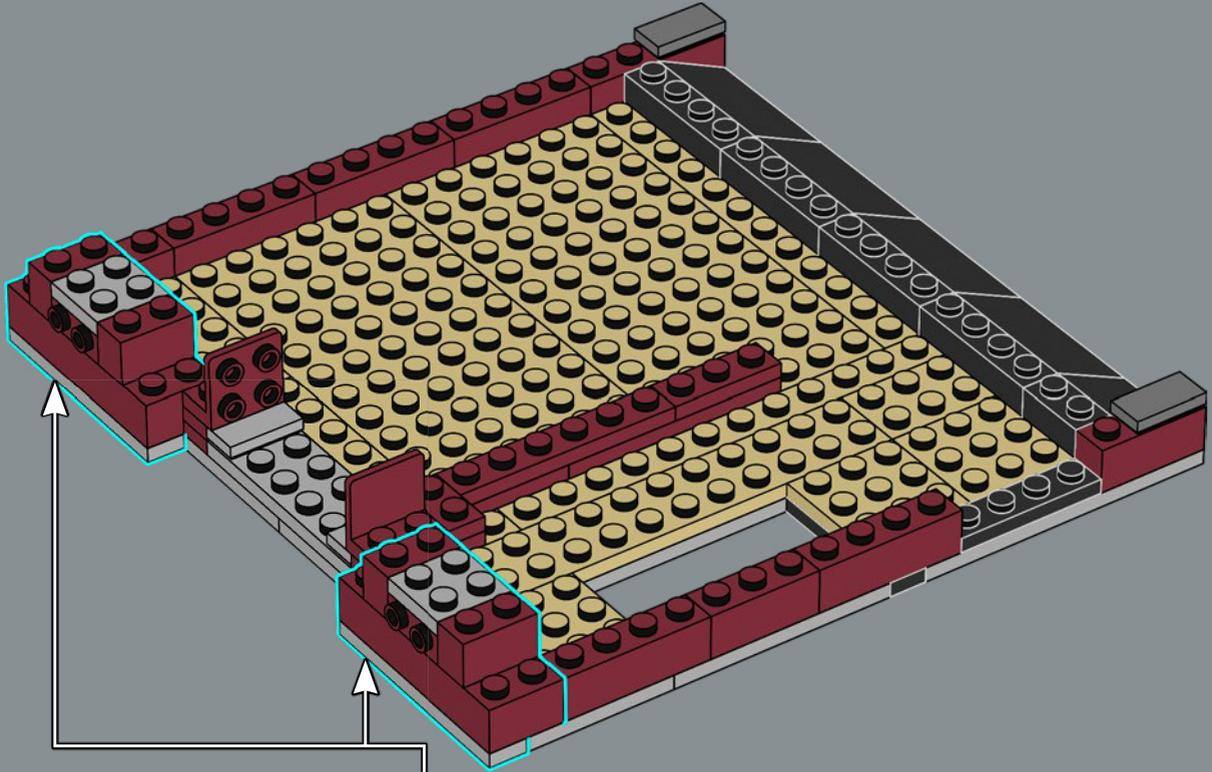

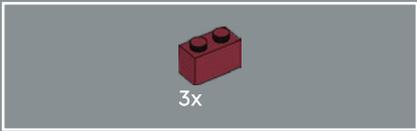

290

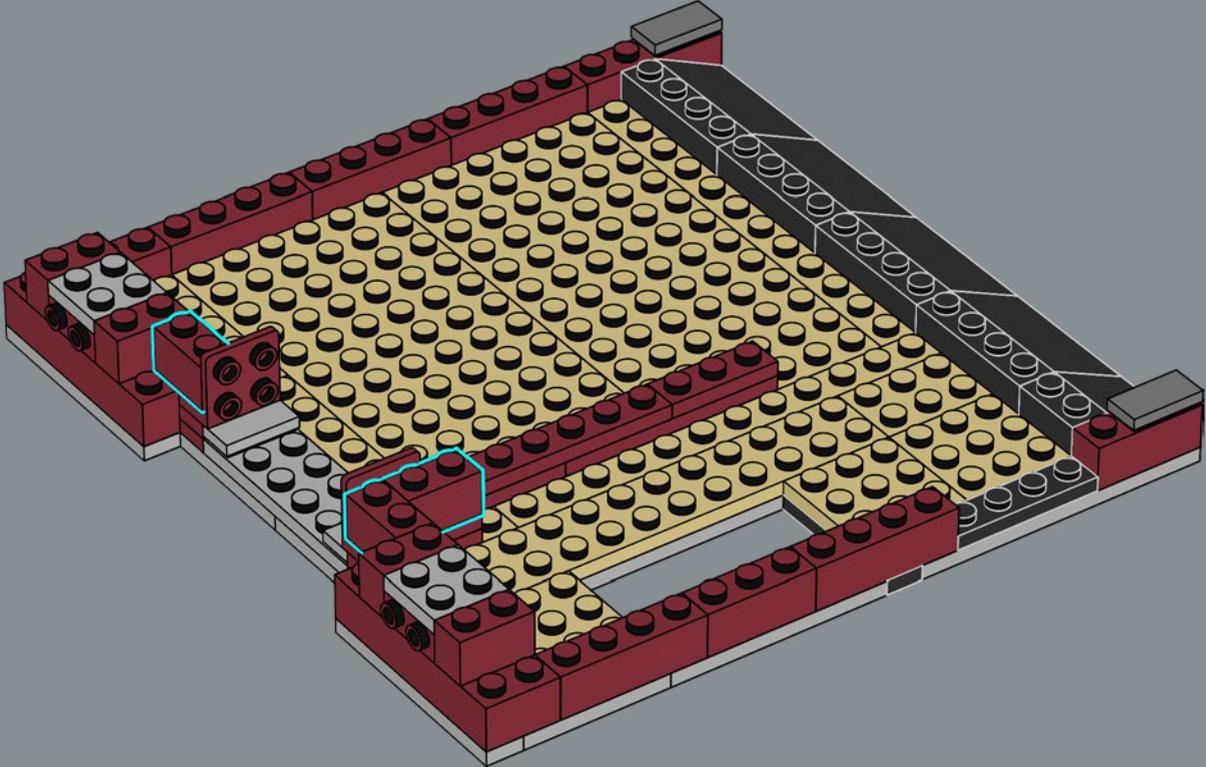

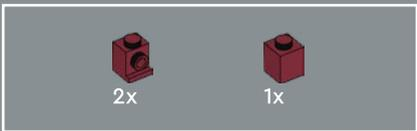

291

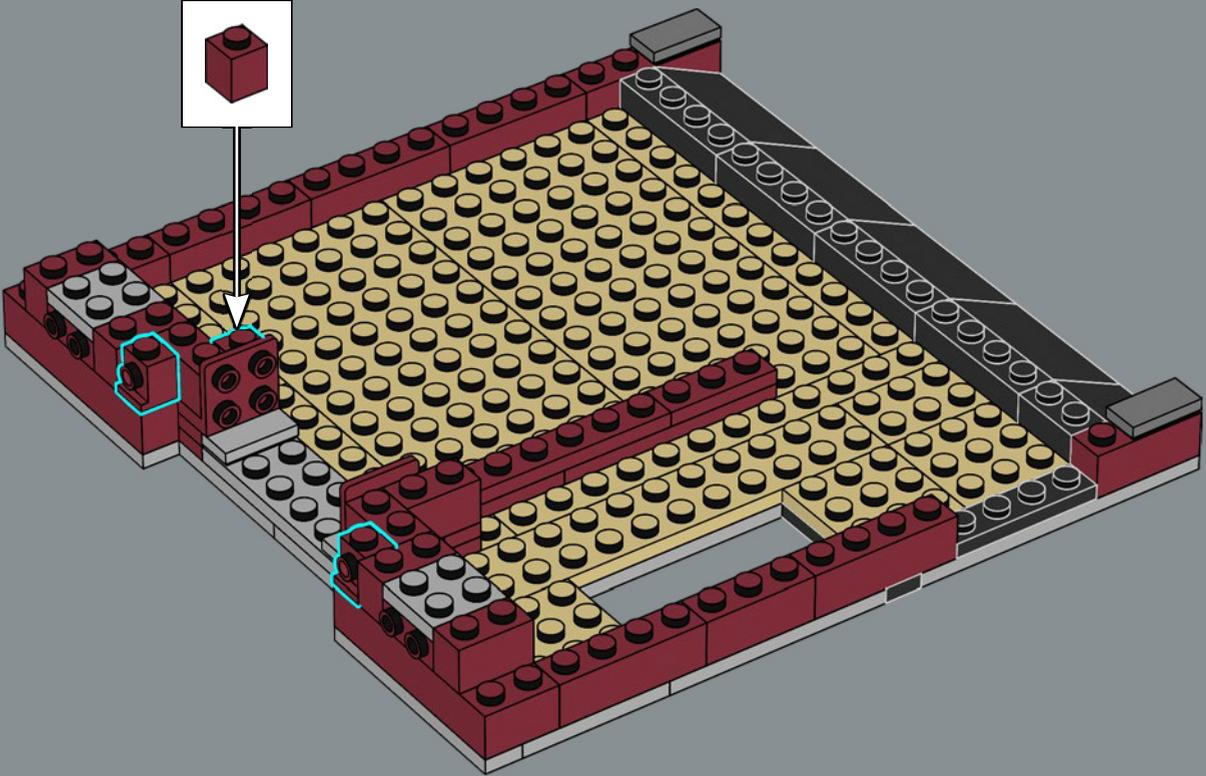





292

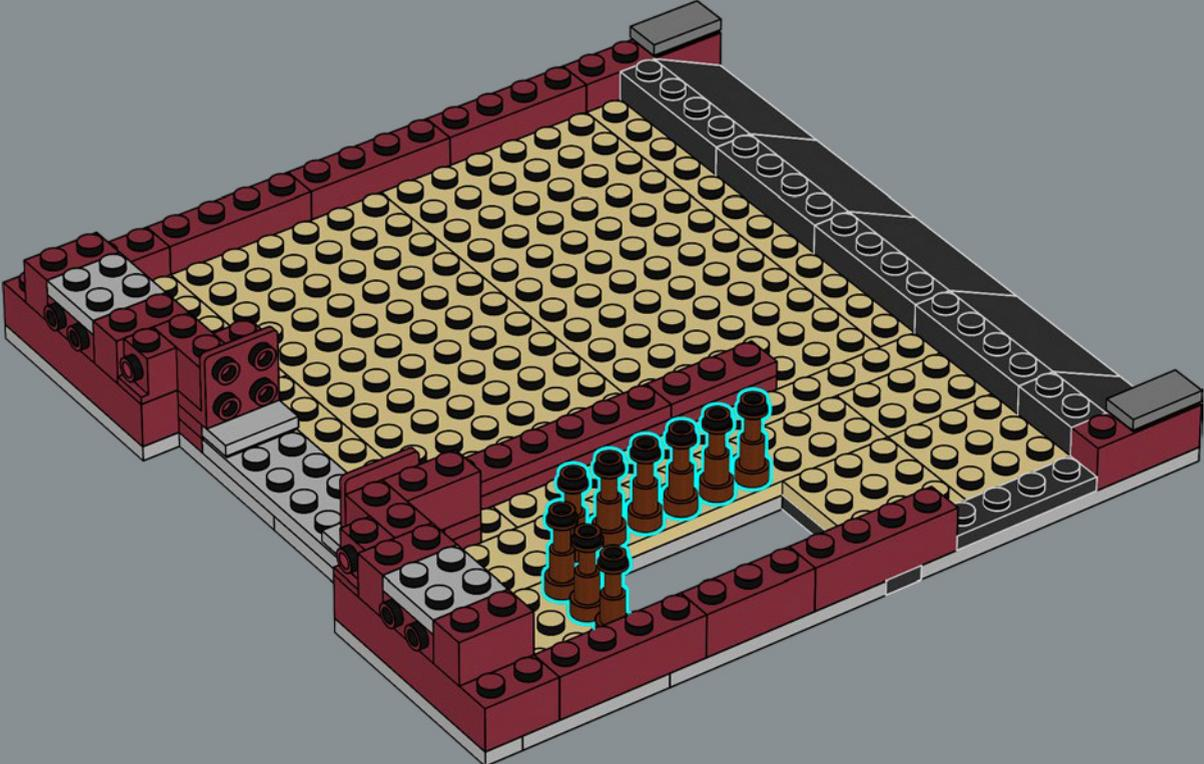

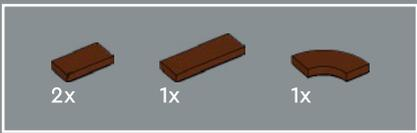

293

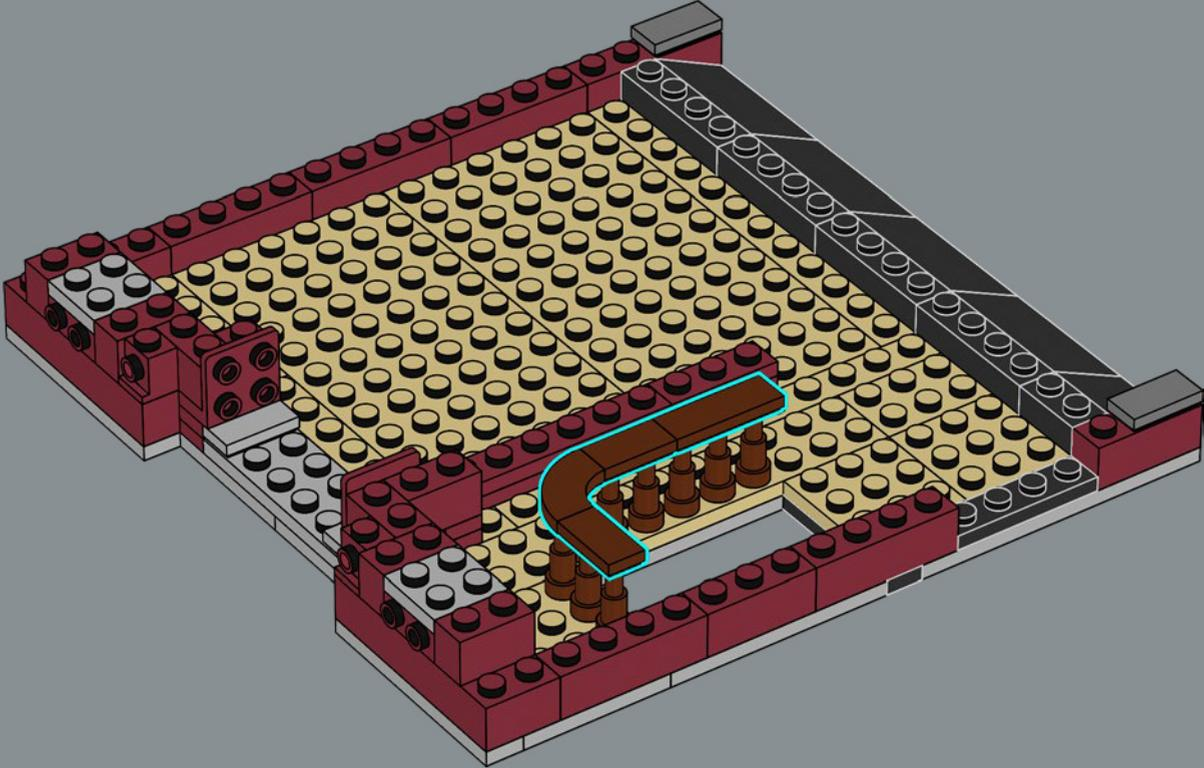

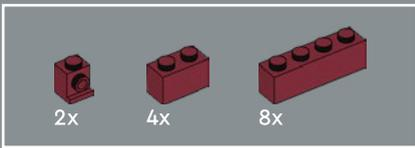

294

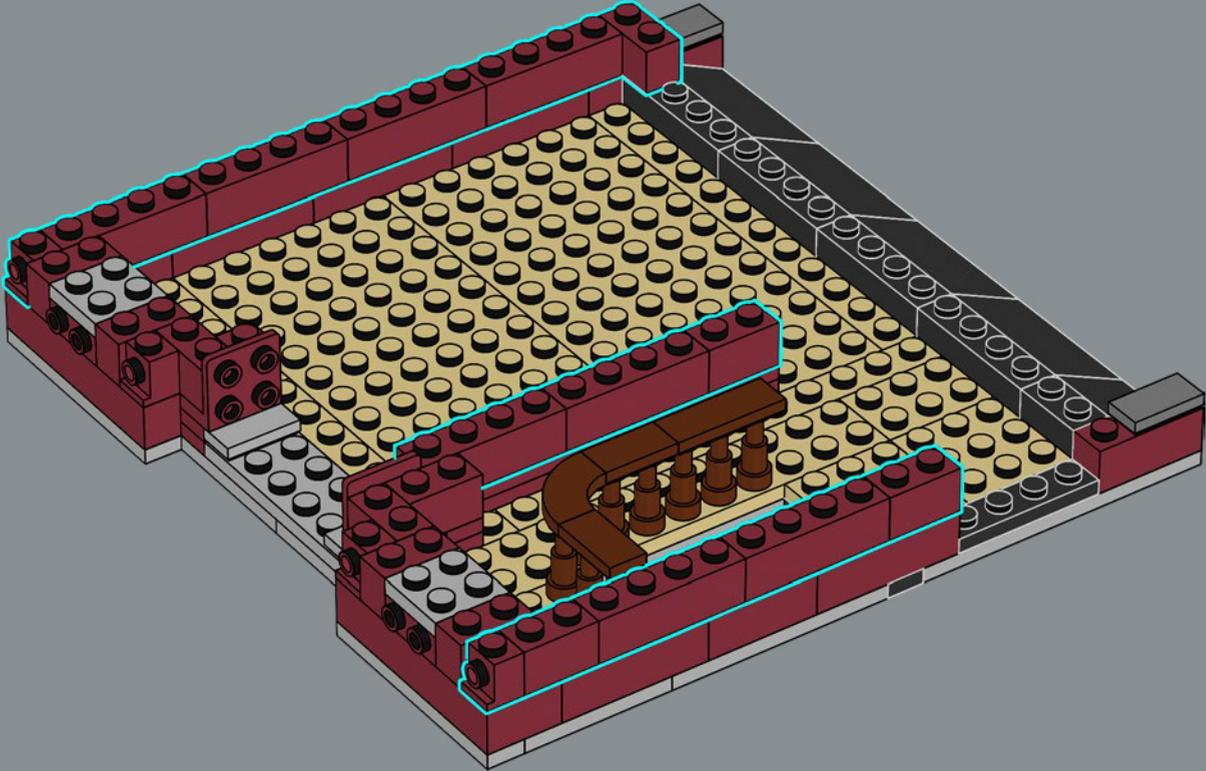

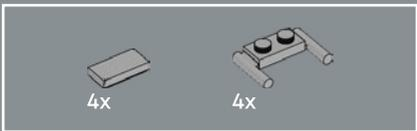

295



Das Element, das die Fenstersimse darstellt (1x2 Platte mit Griffen) wird bereits seit 1978 im LEGO® Bausystem verwendet.

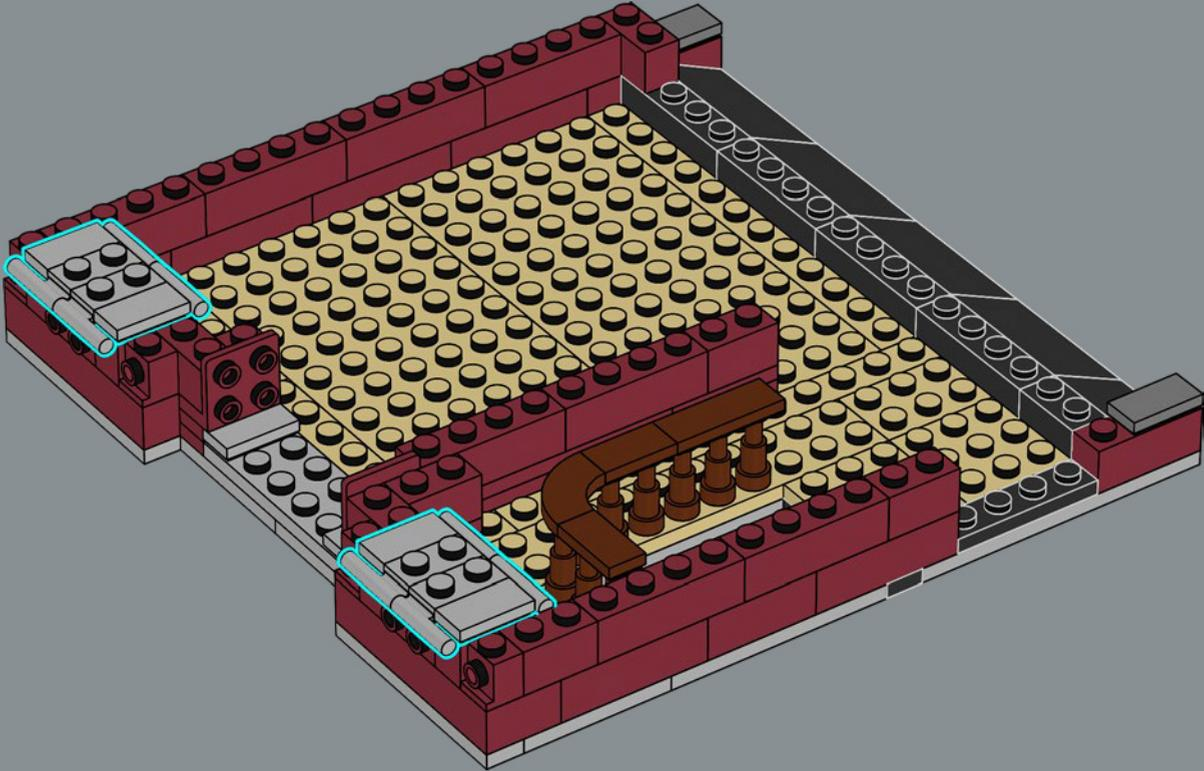



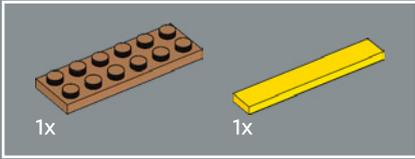

297

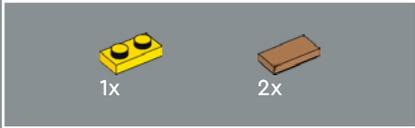
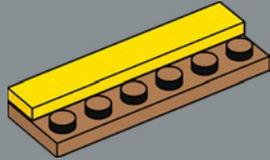

298

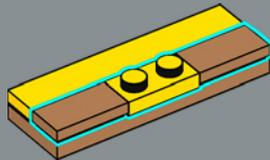

299

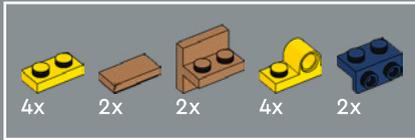
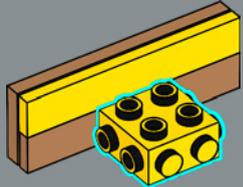

300

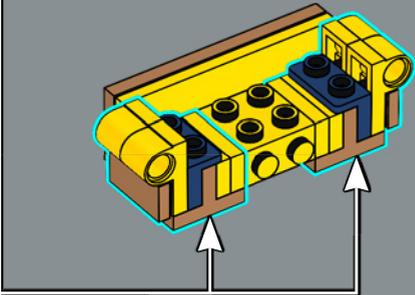
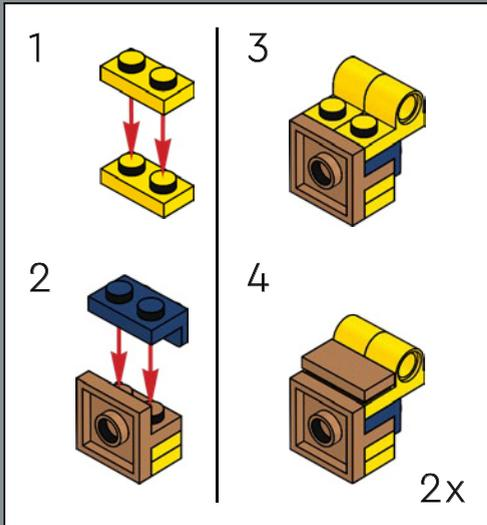

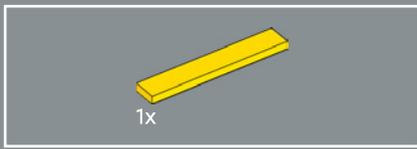

301

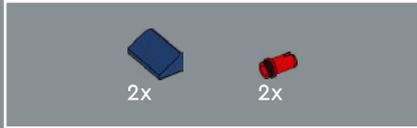
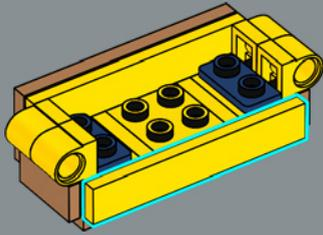

302

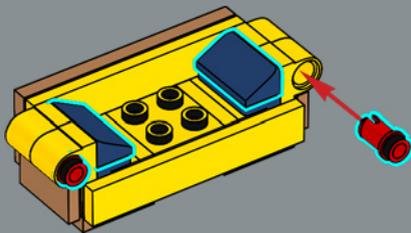

303

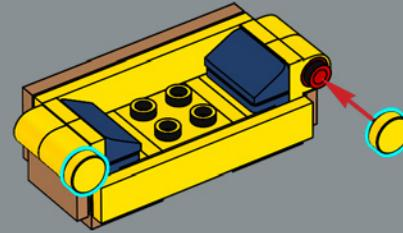

304

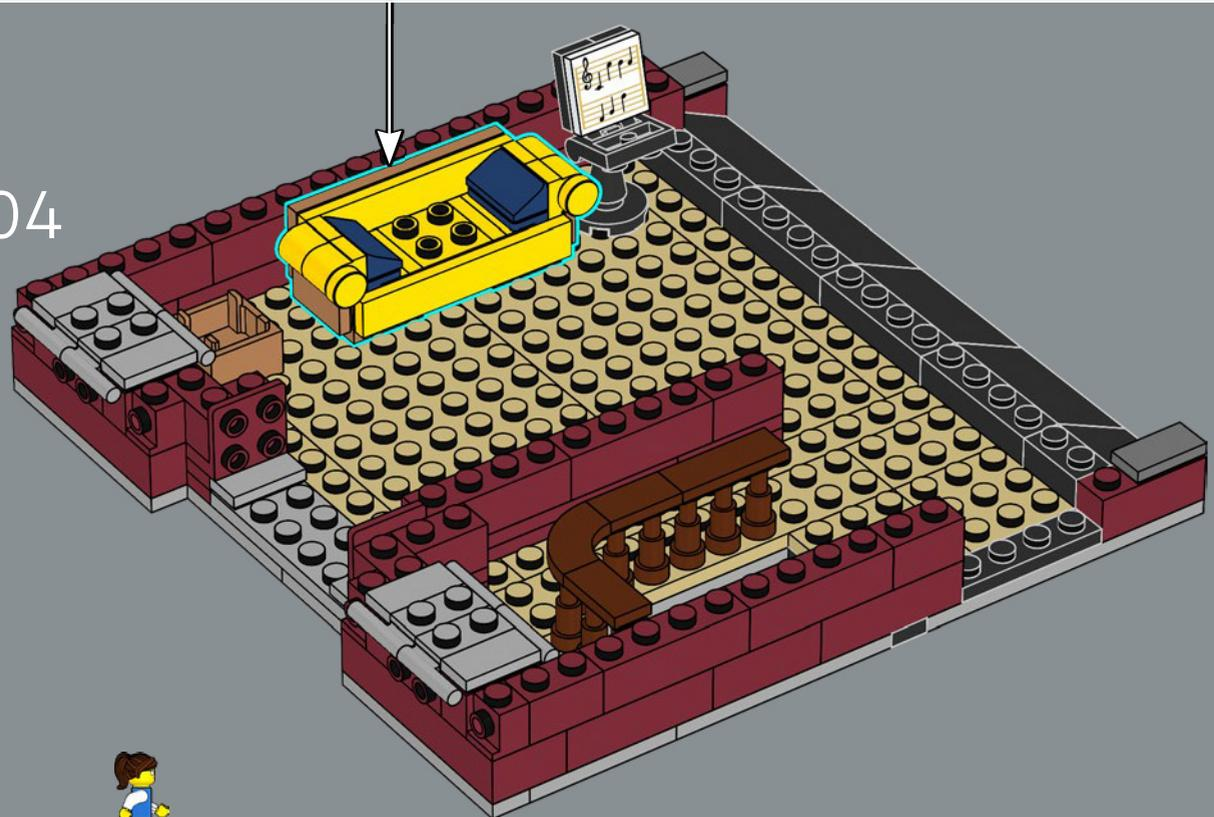



305

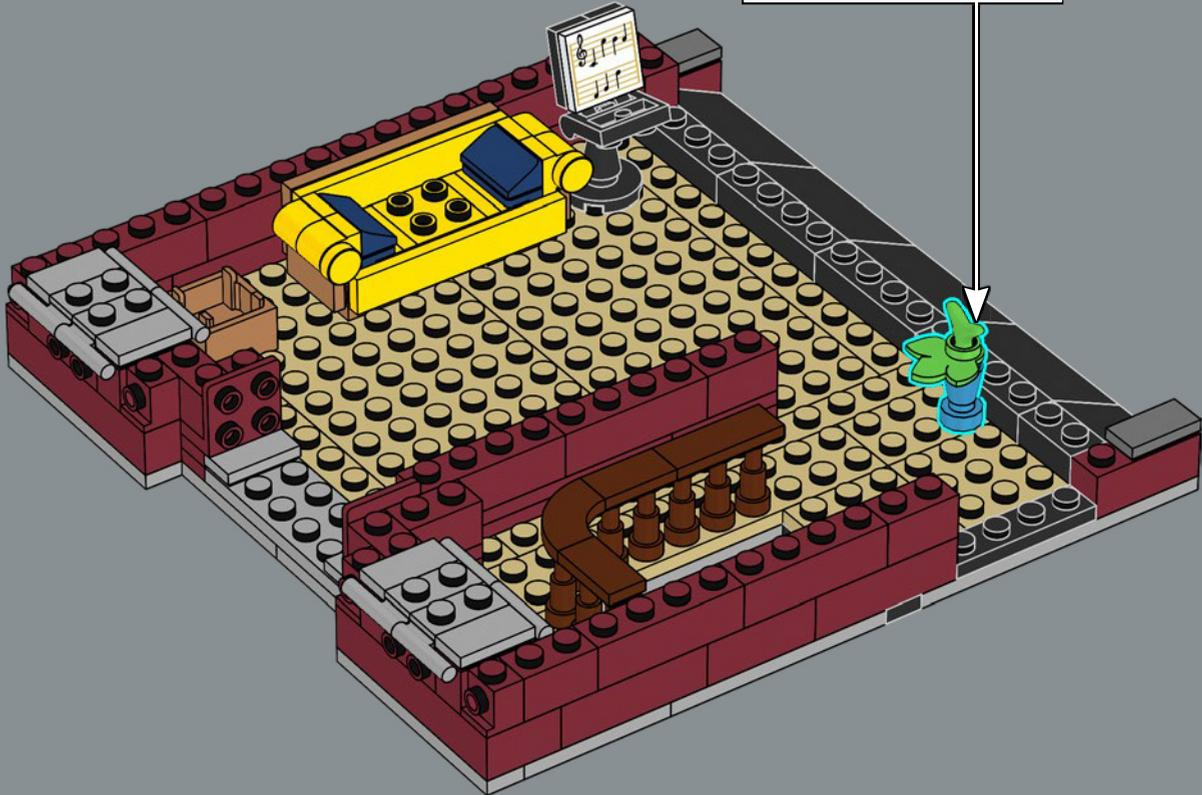
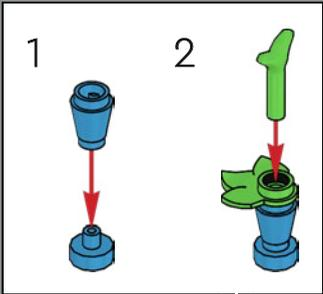





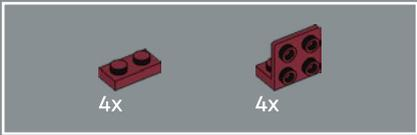

307

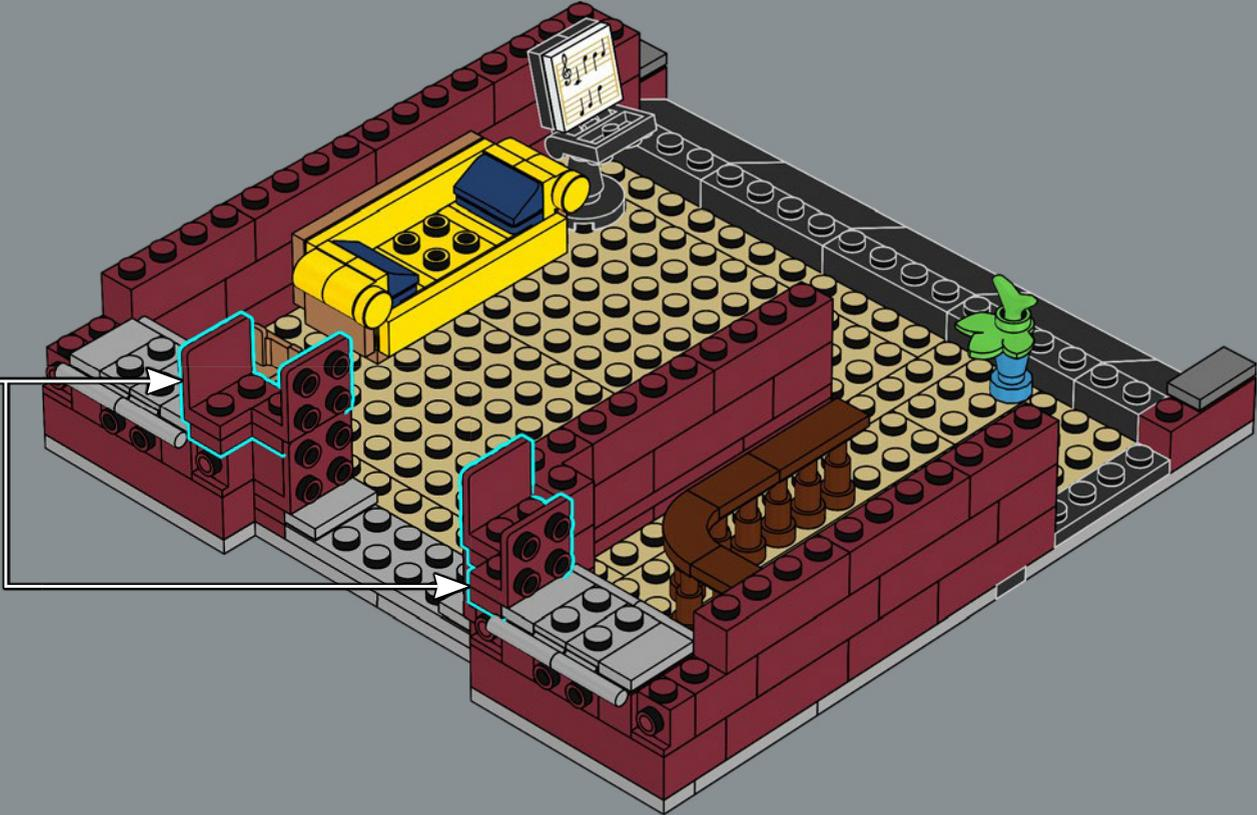
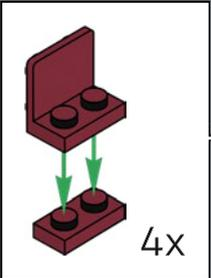



308

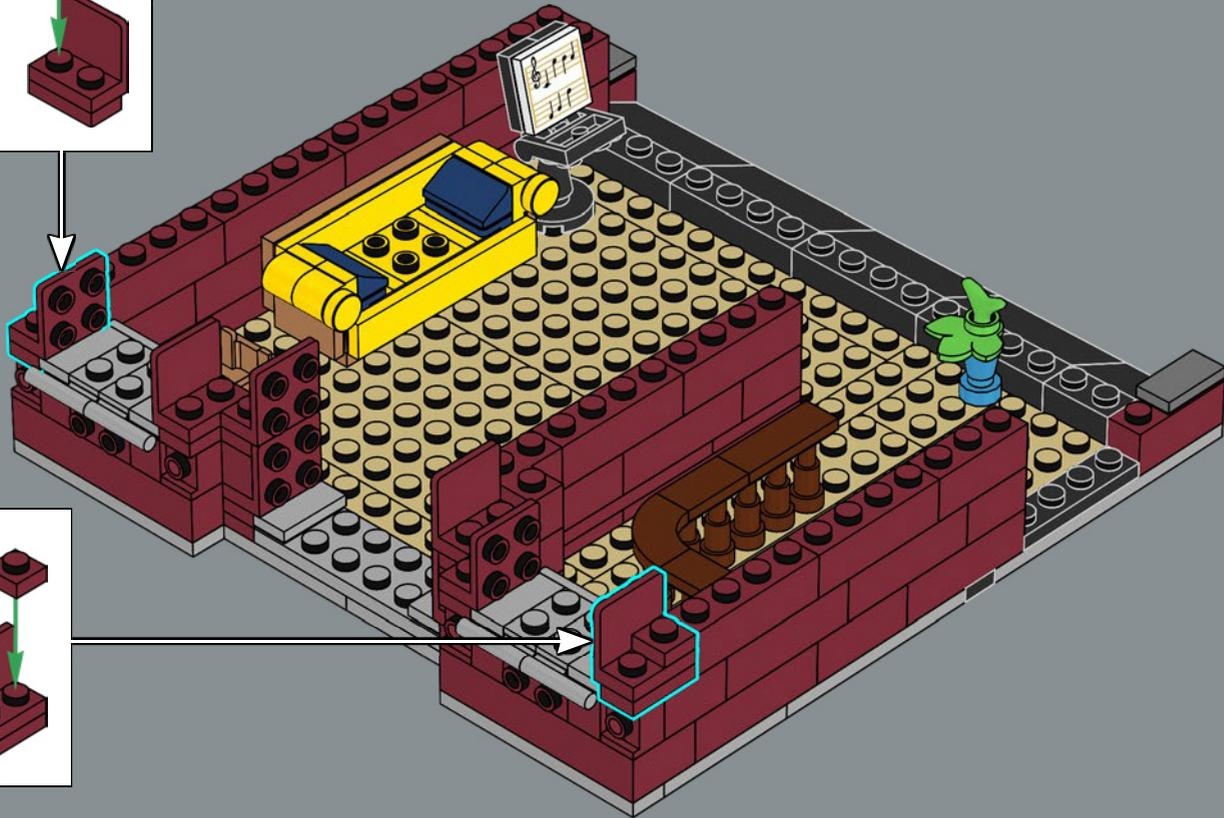
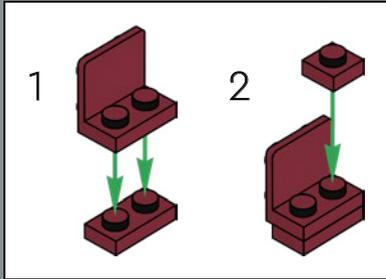
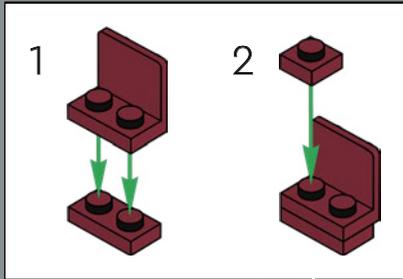

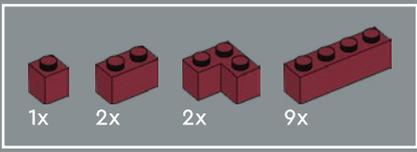

309

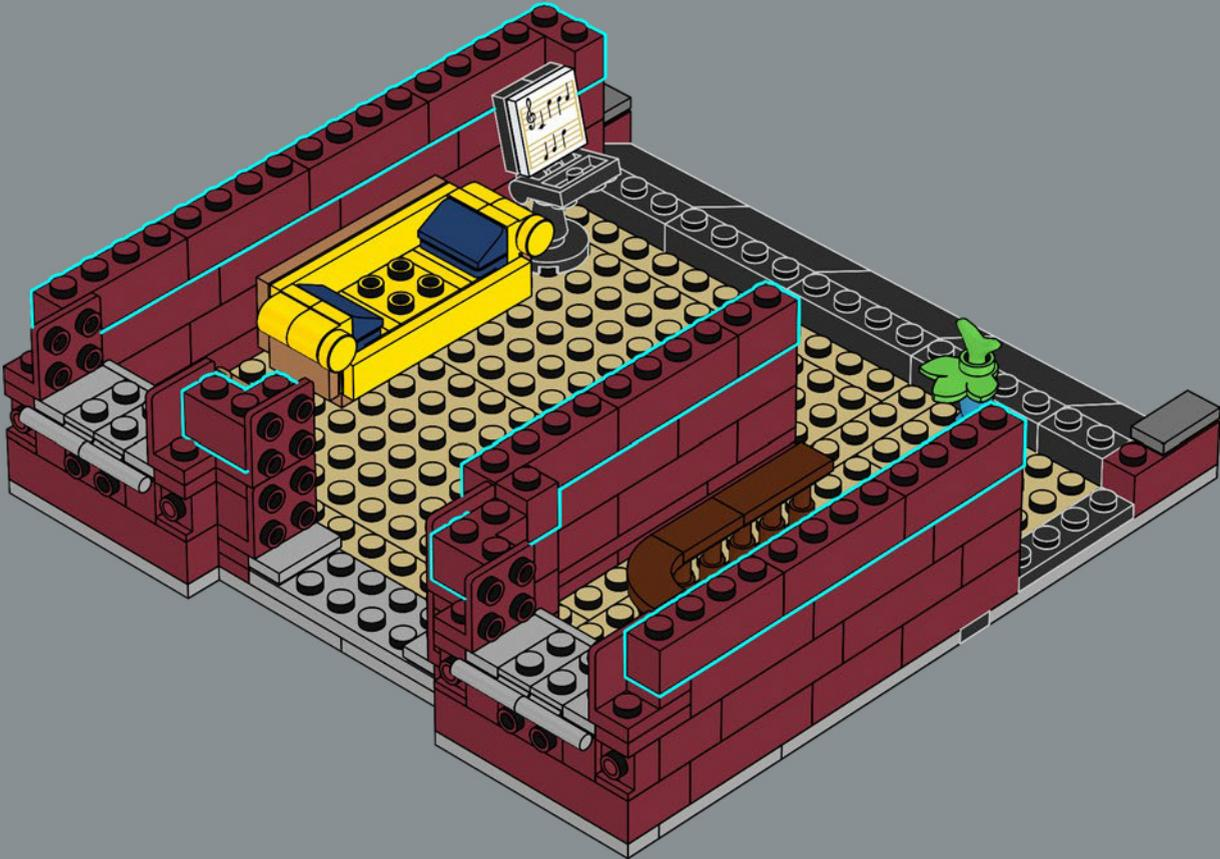



4x

310

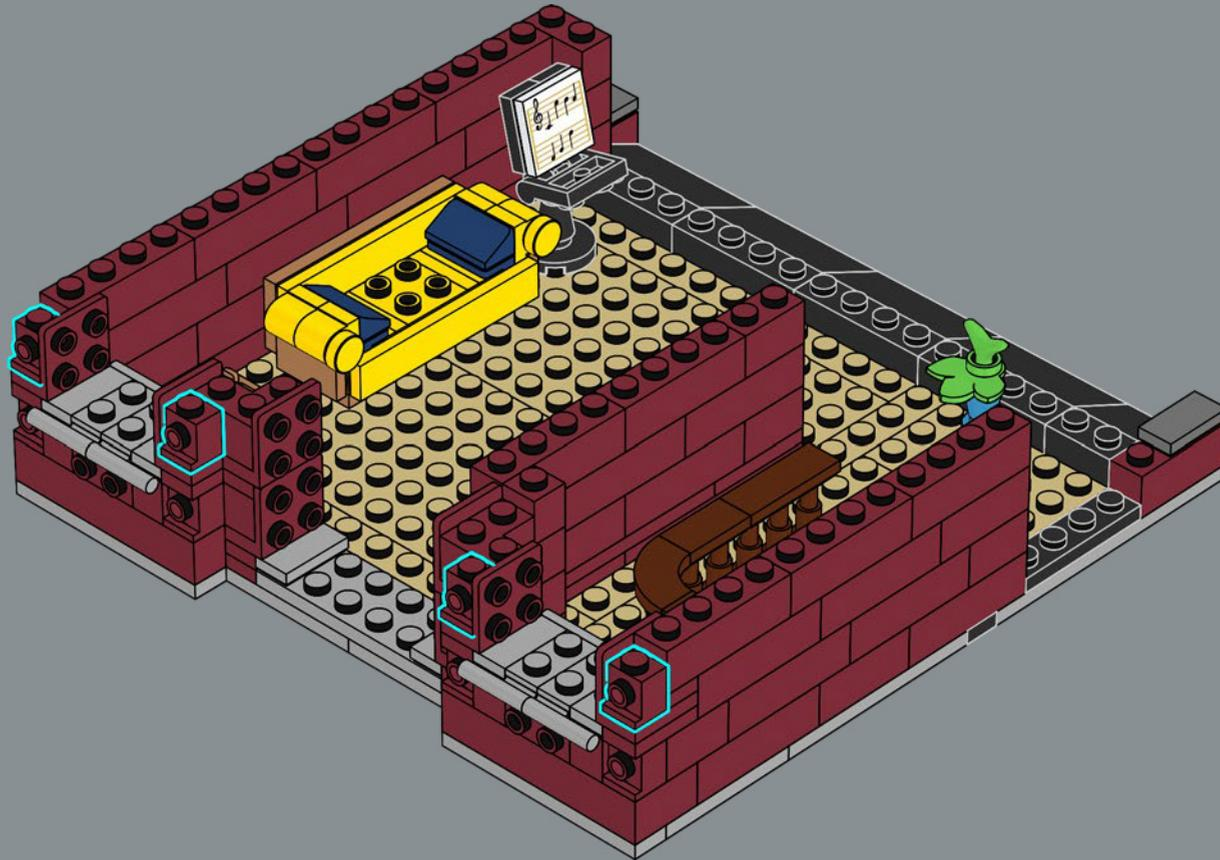



311

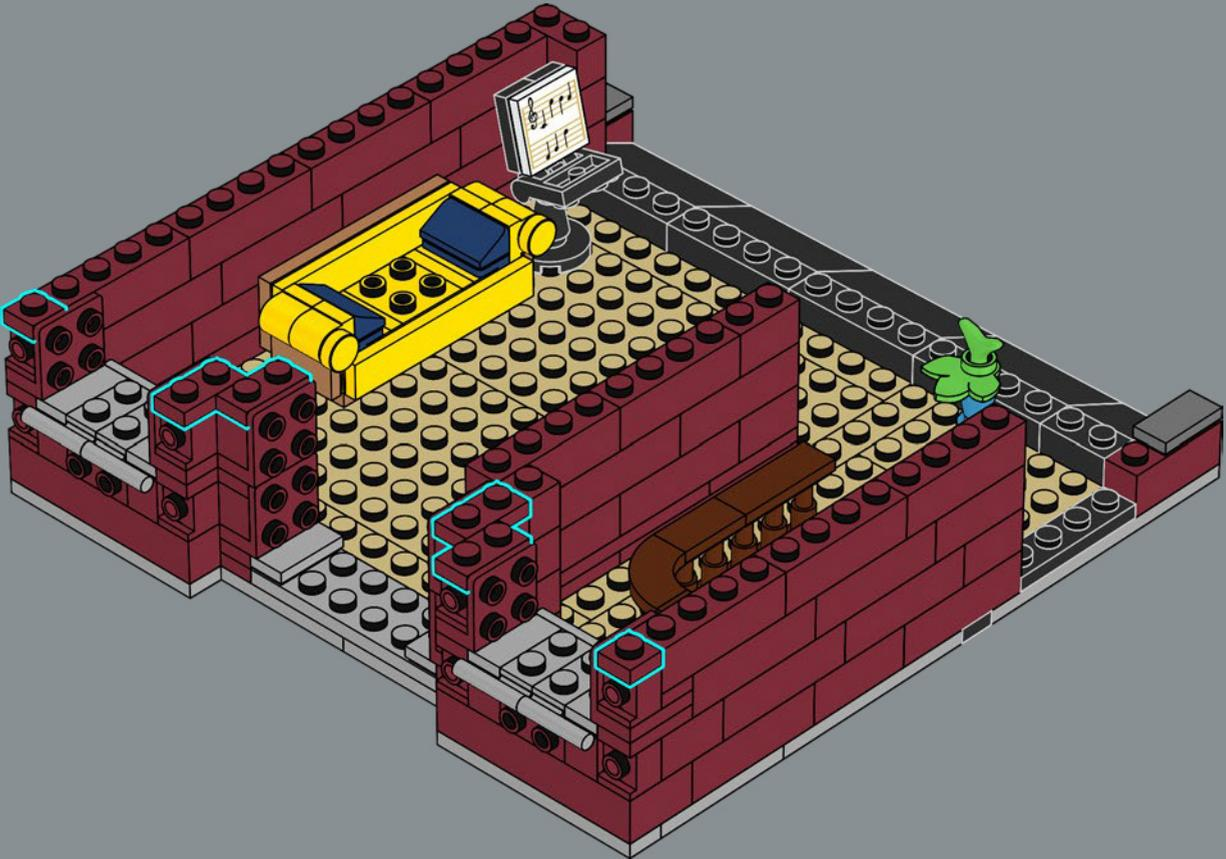



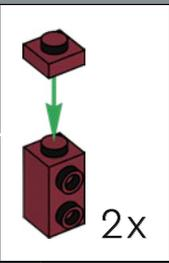
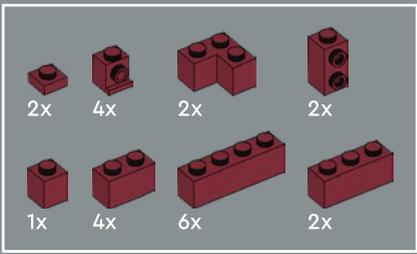

313

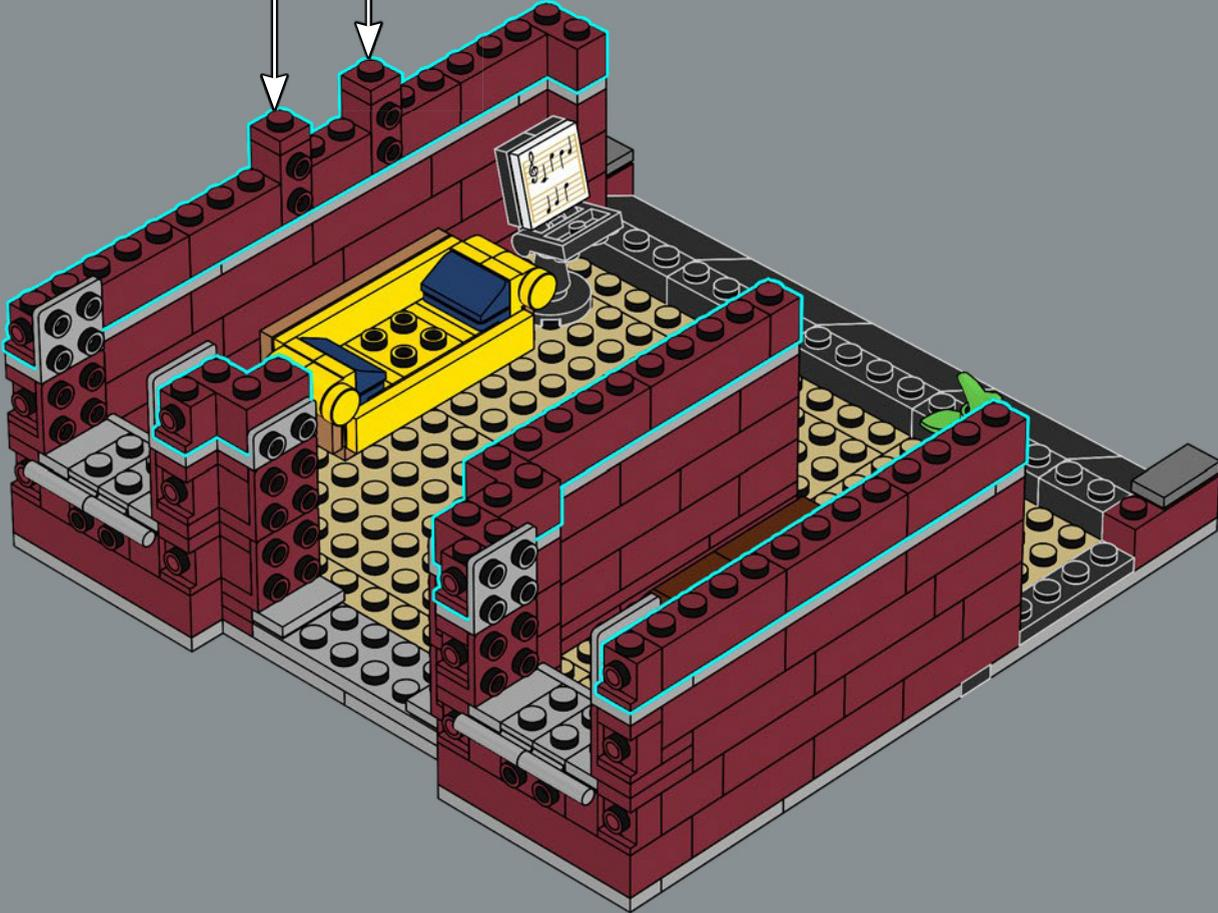



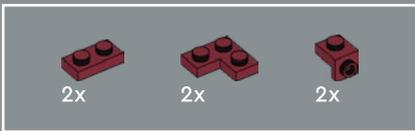

314

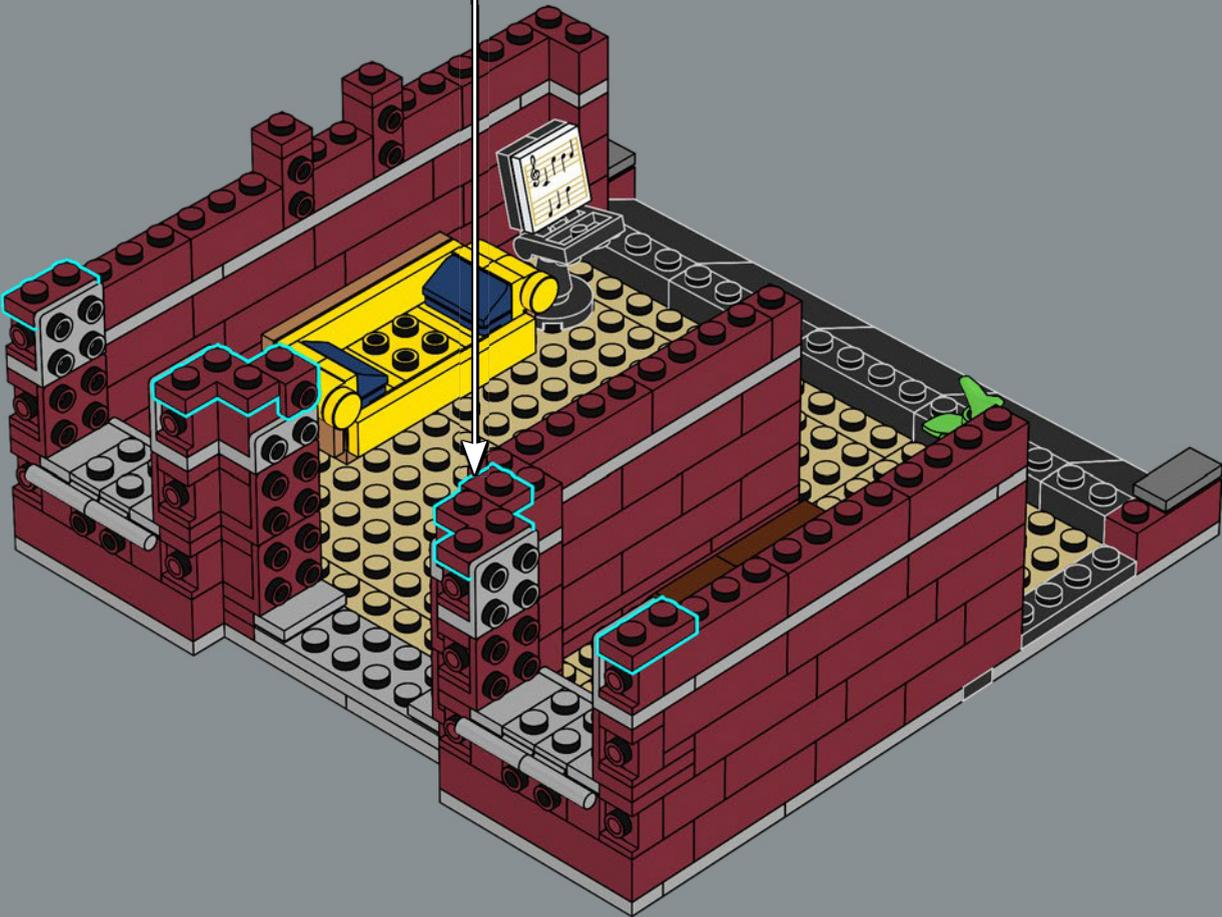

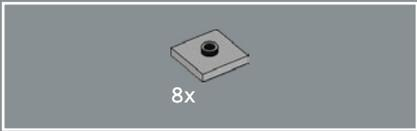

315

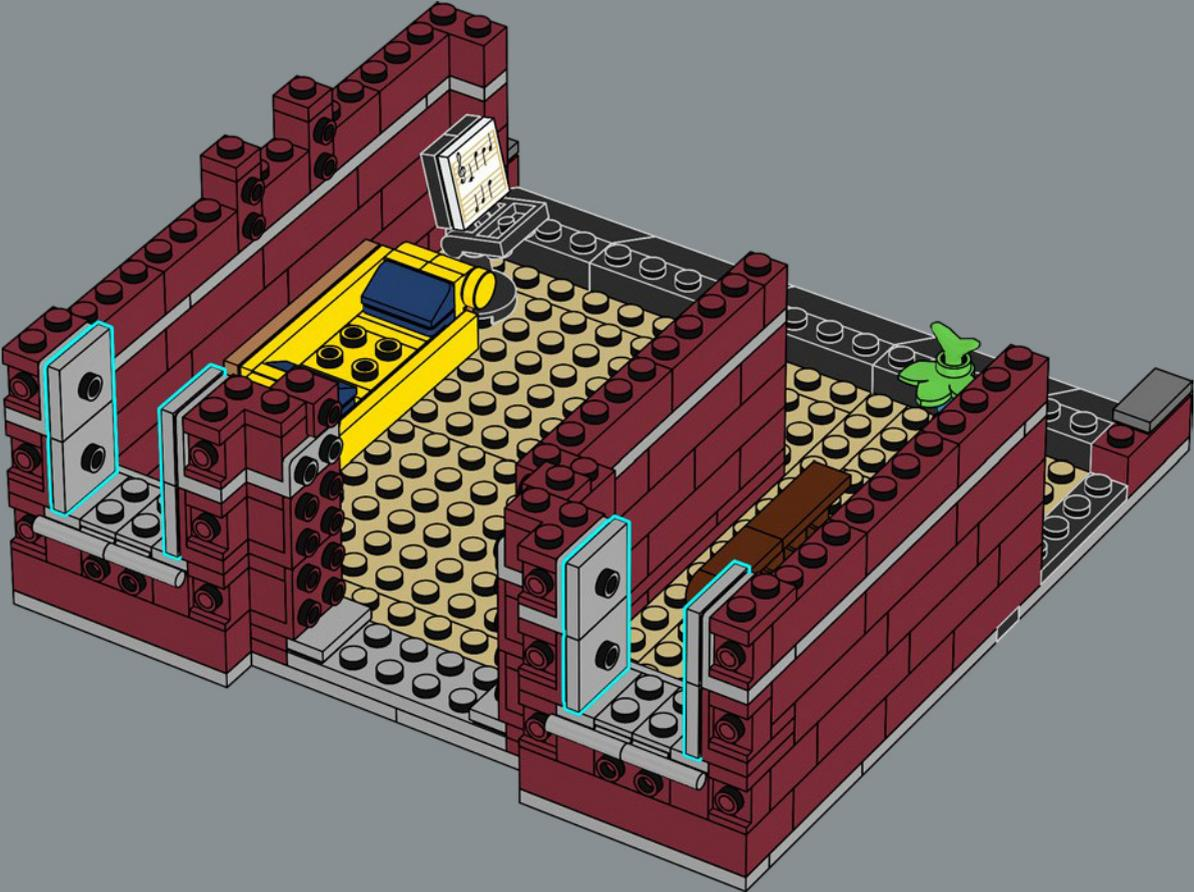

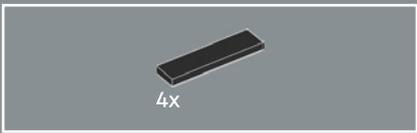

316

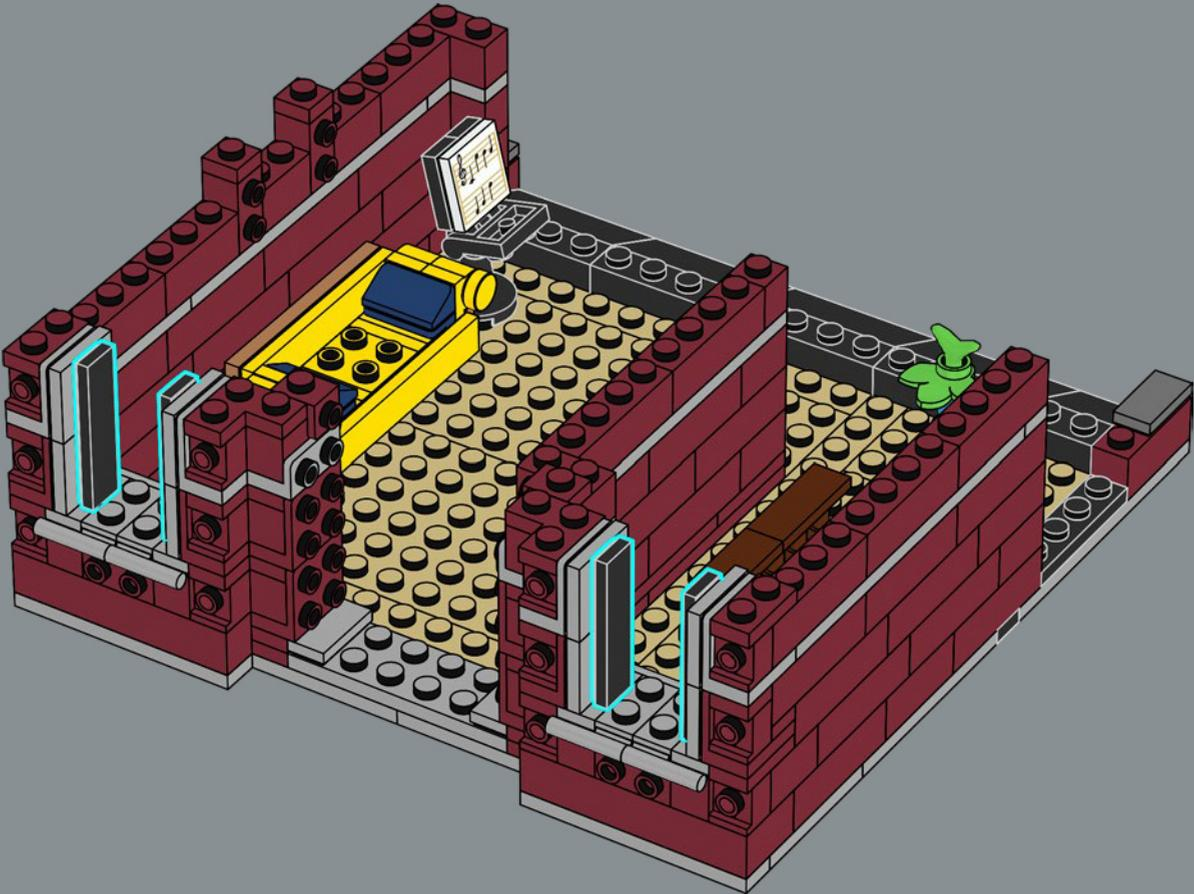



317

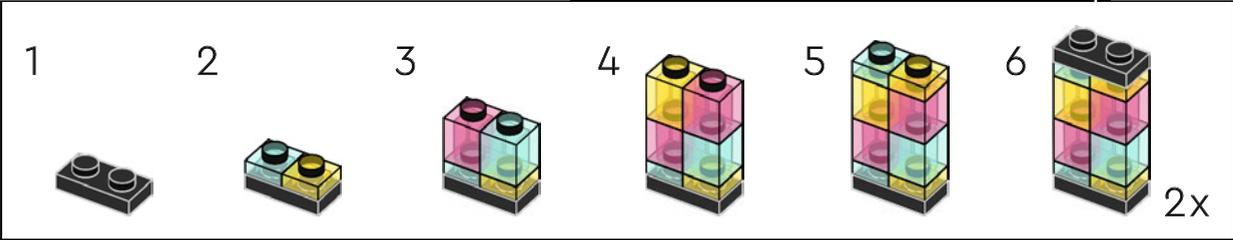
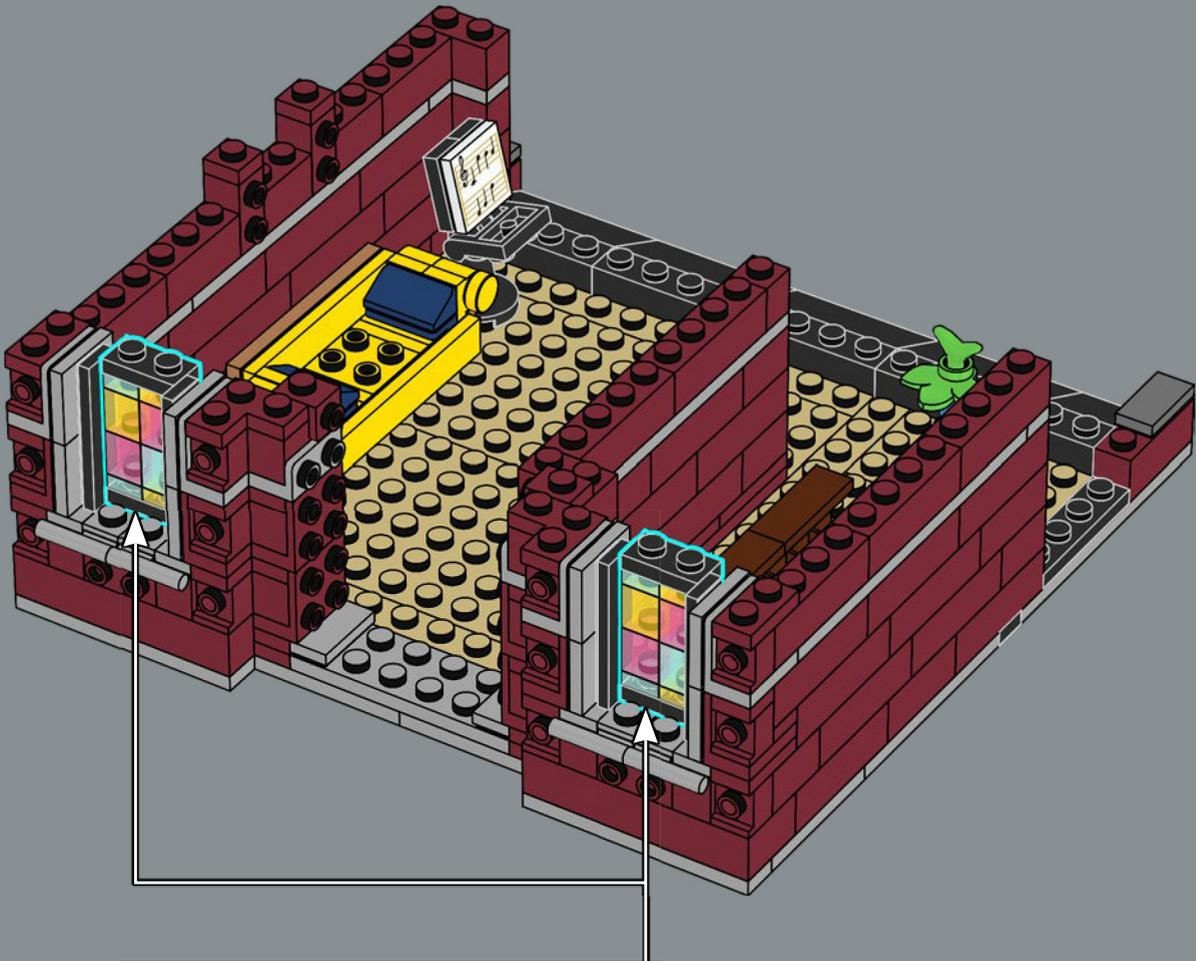

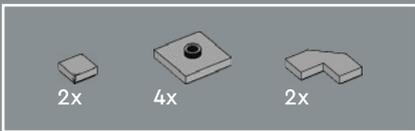

318

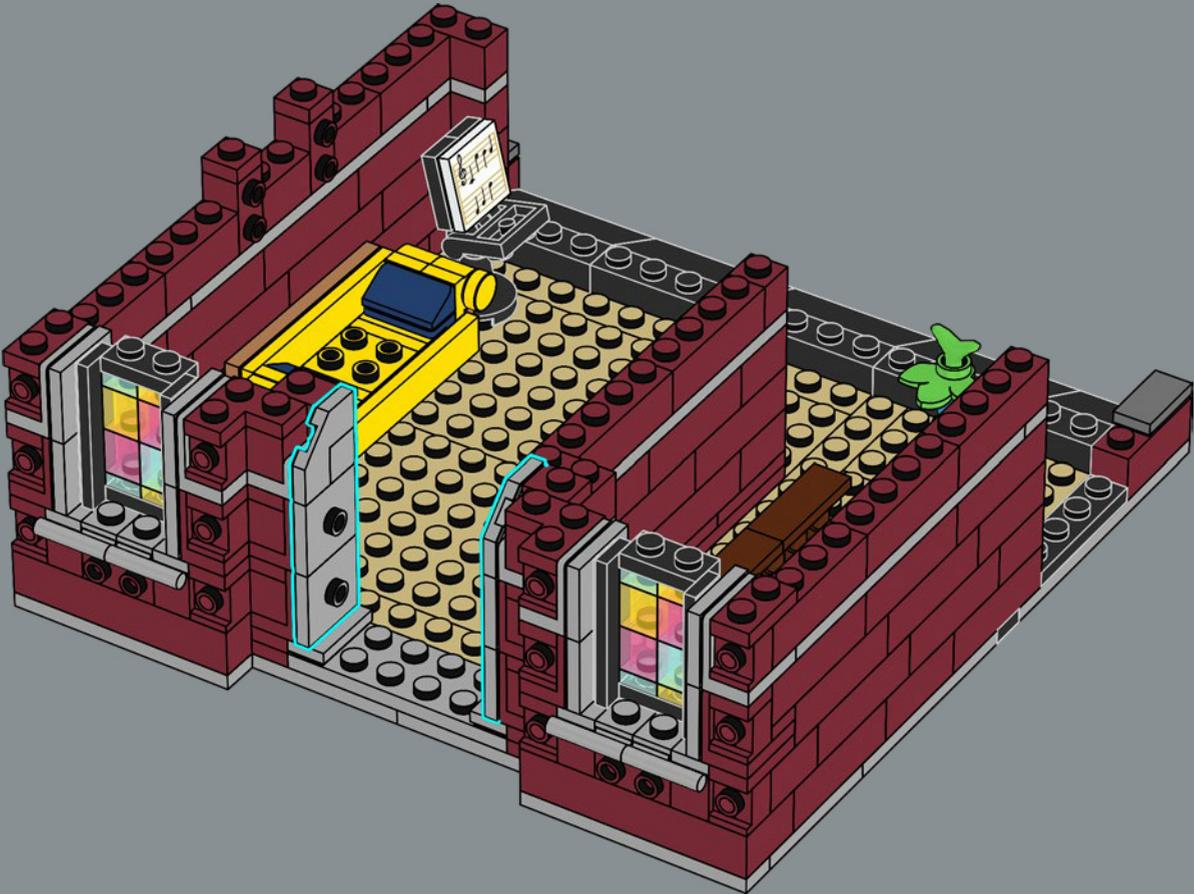

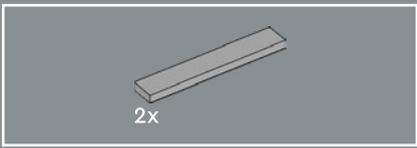

319

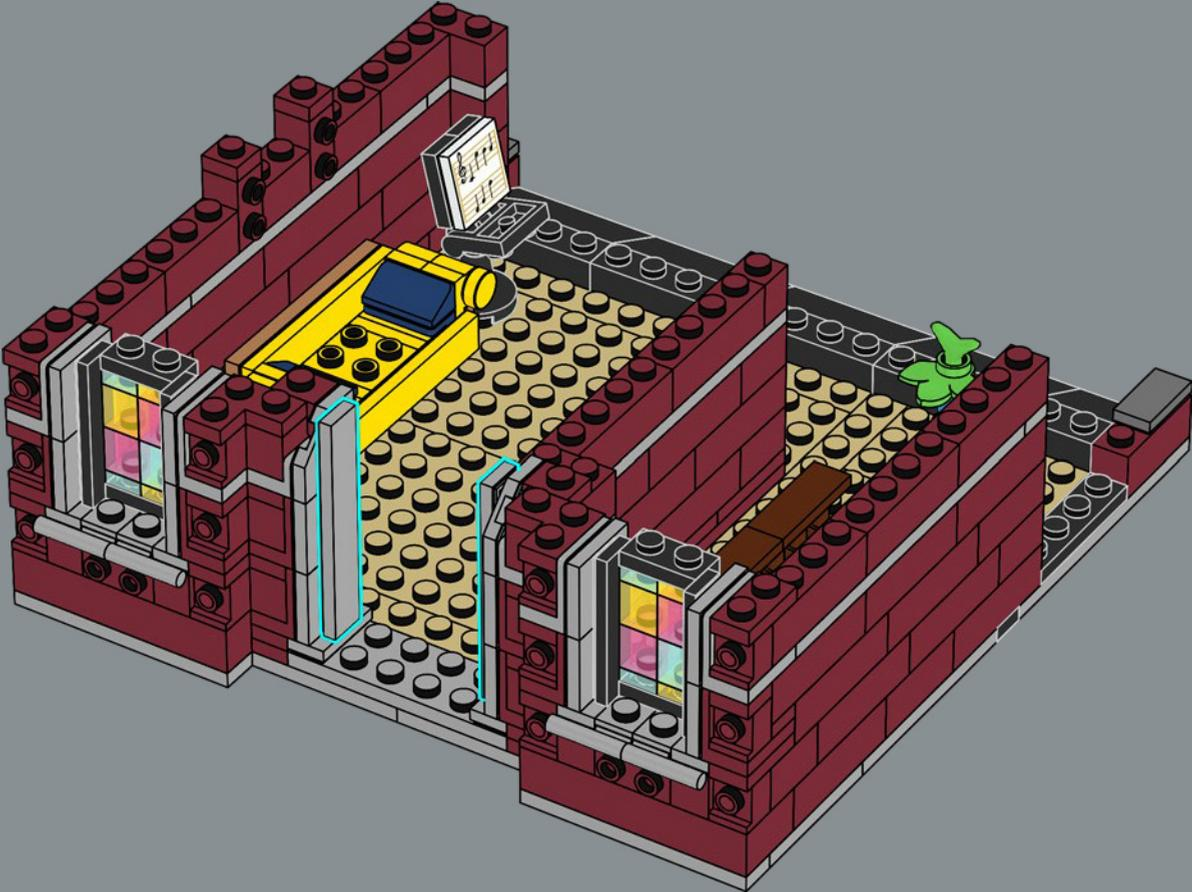

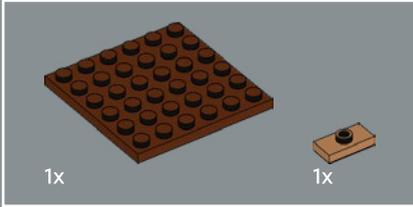
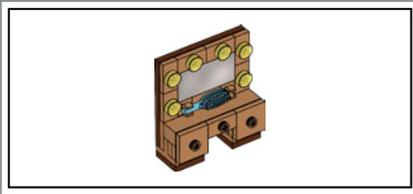

320

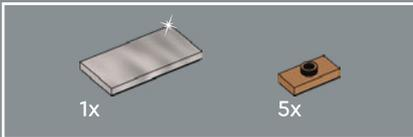
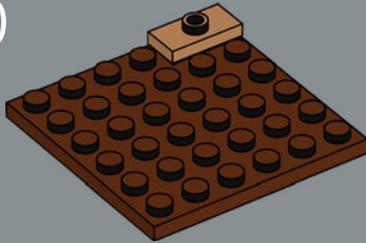

321

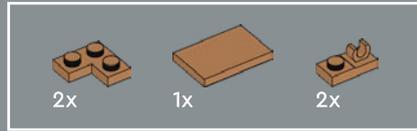
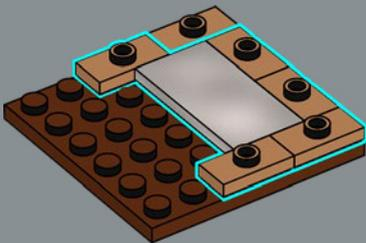

322

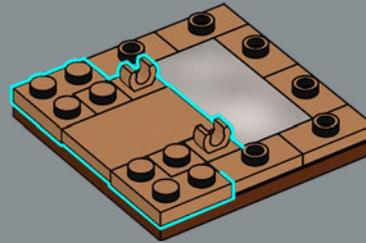

323

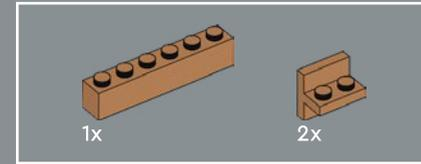

324

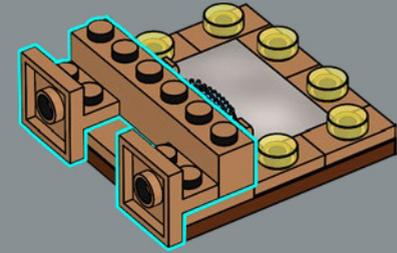

325

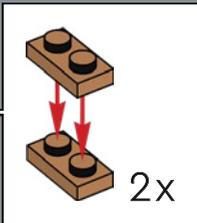
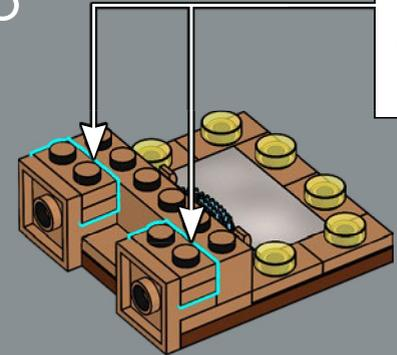

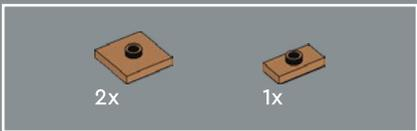

326

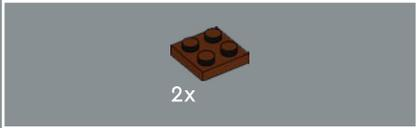
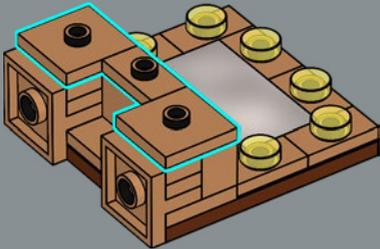

327

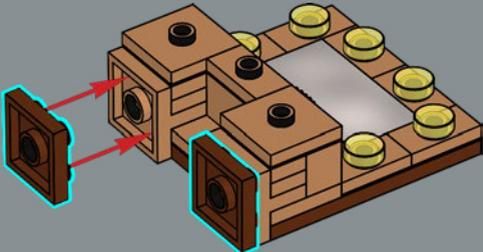

328

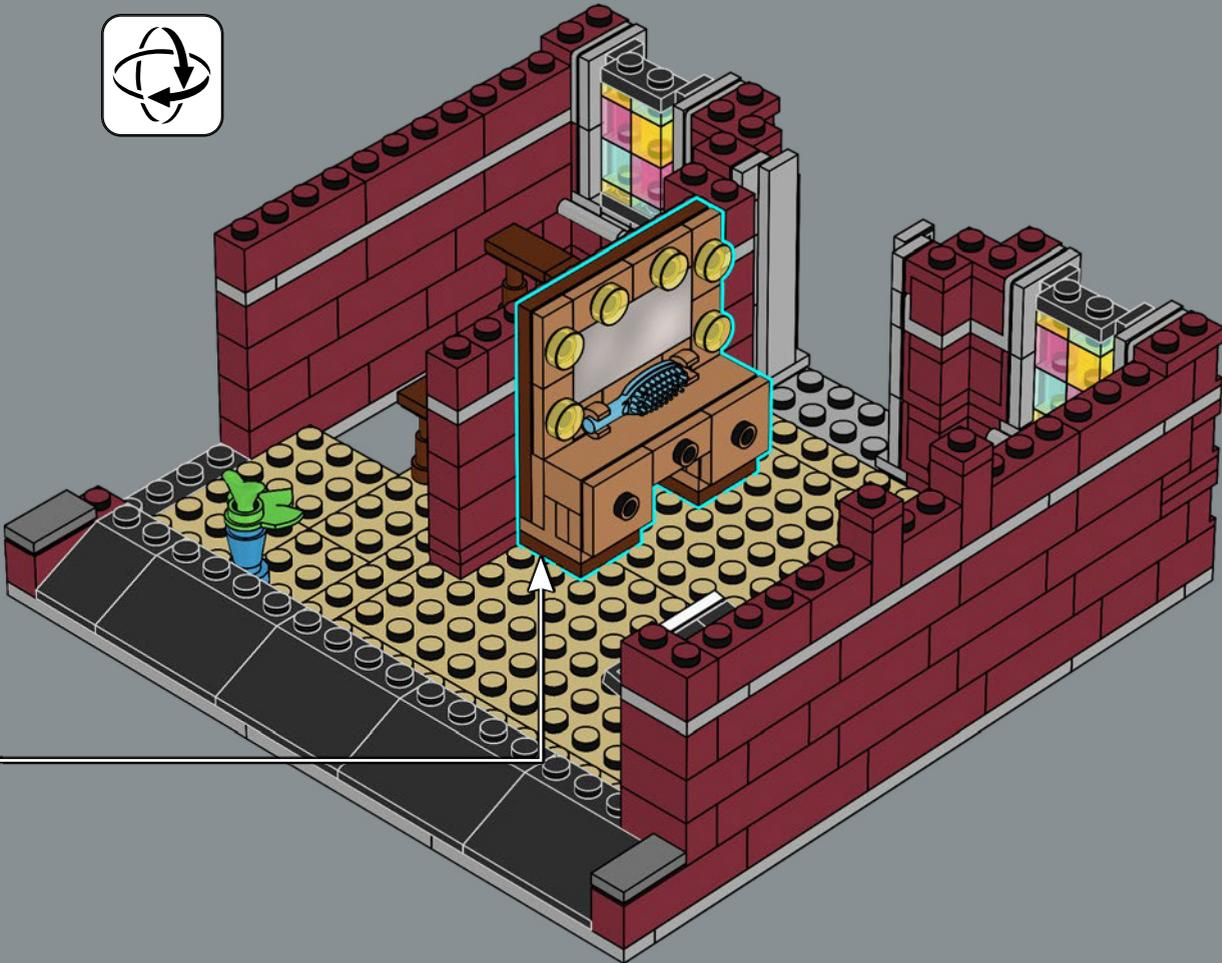

Setz dich vor deinem Auftritt noch einen Augenblick an den Schminktisch, damit du im grellen Rampenlicht umwerfend aussiehst.



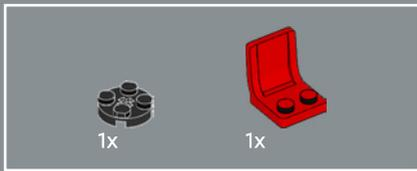

329

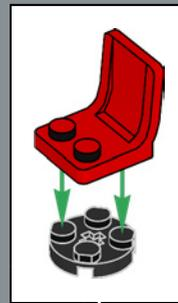

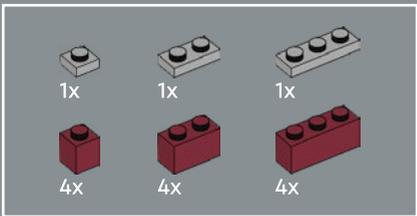

330

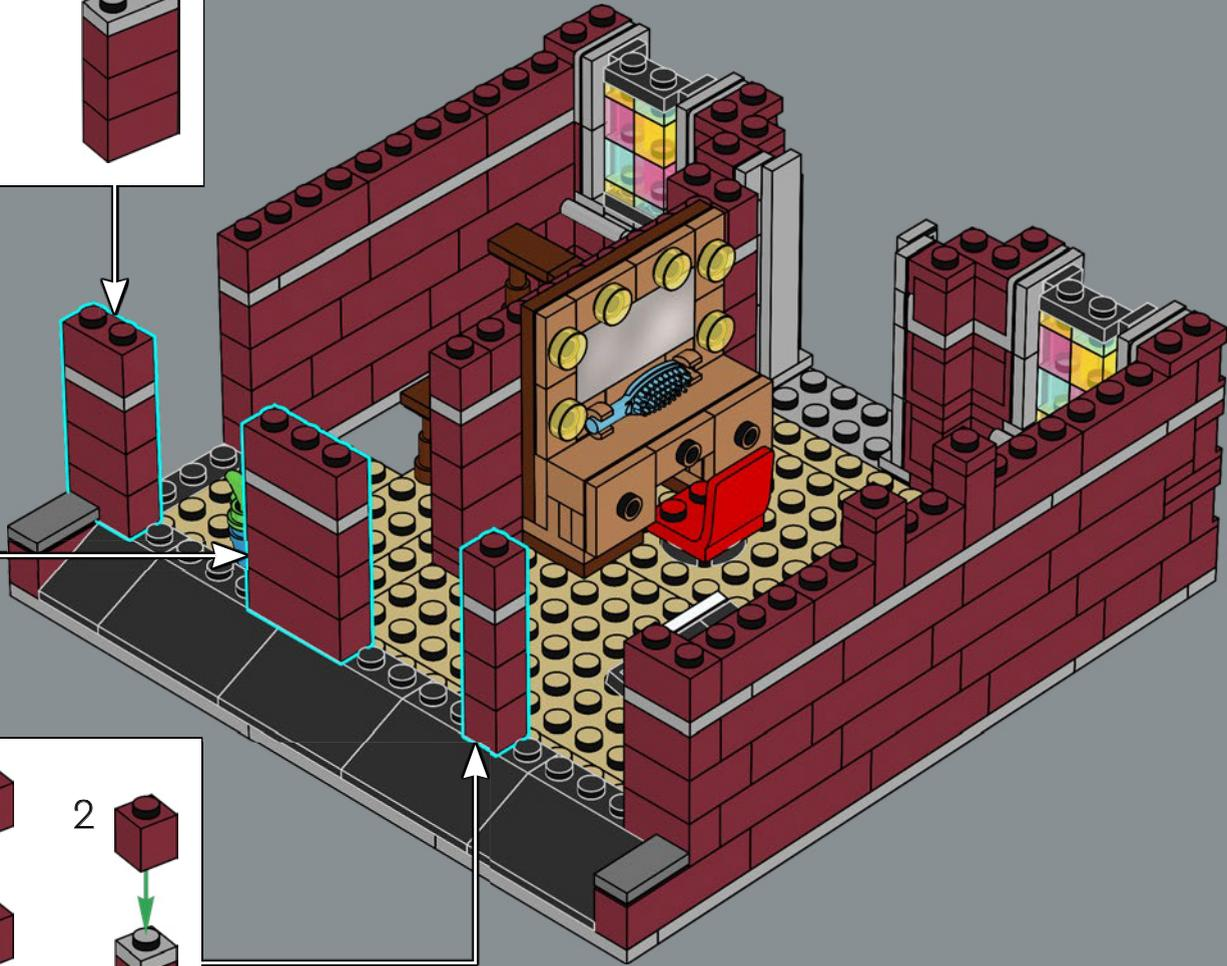
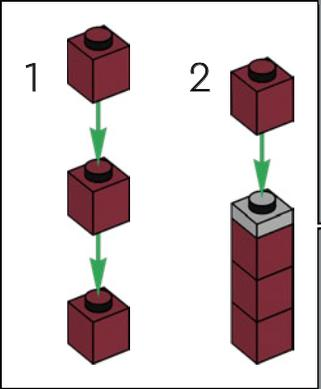
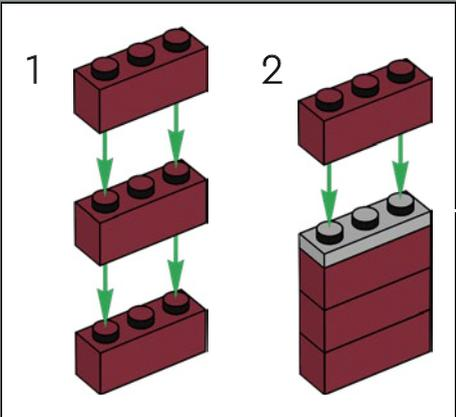
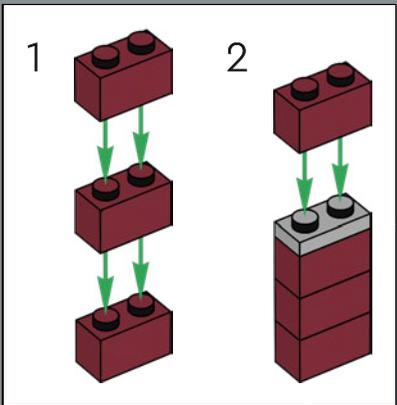

Die Magierin hat ihren treuen Assistenten, den Hasen, in der LEGO® Zoohandlung (10218) gefunden.

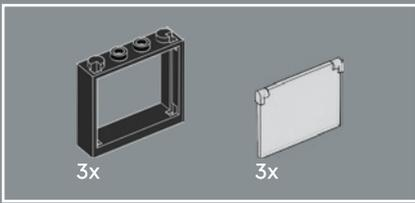

331

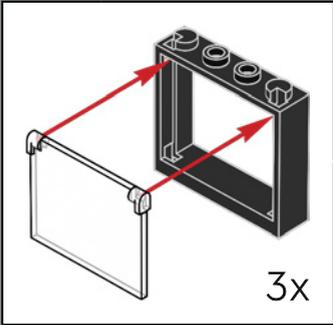
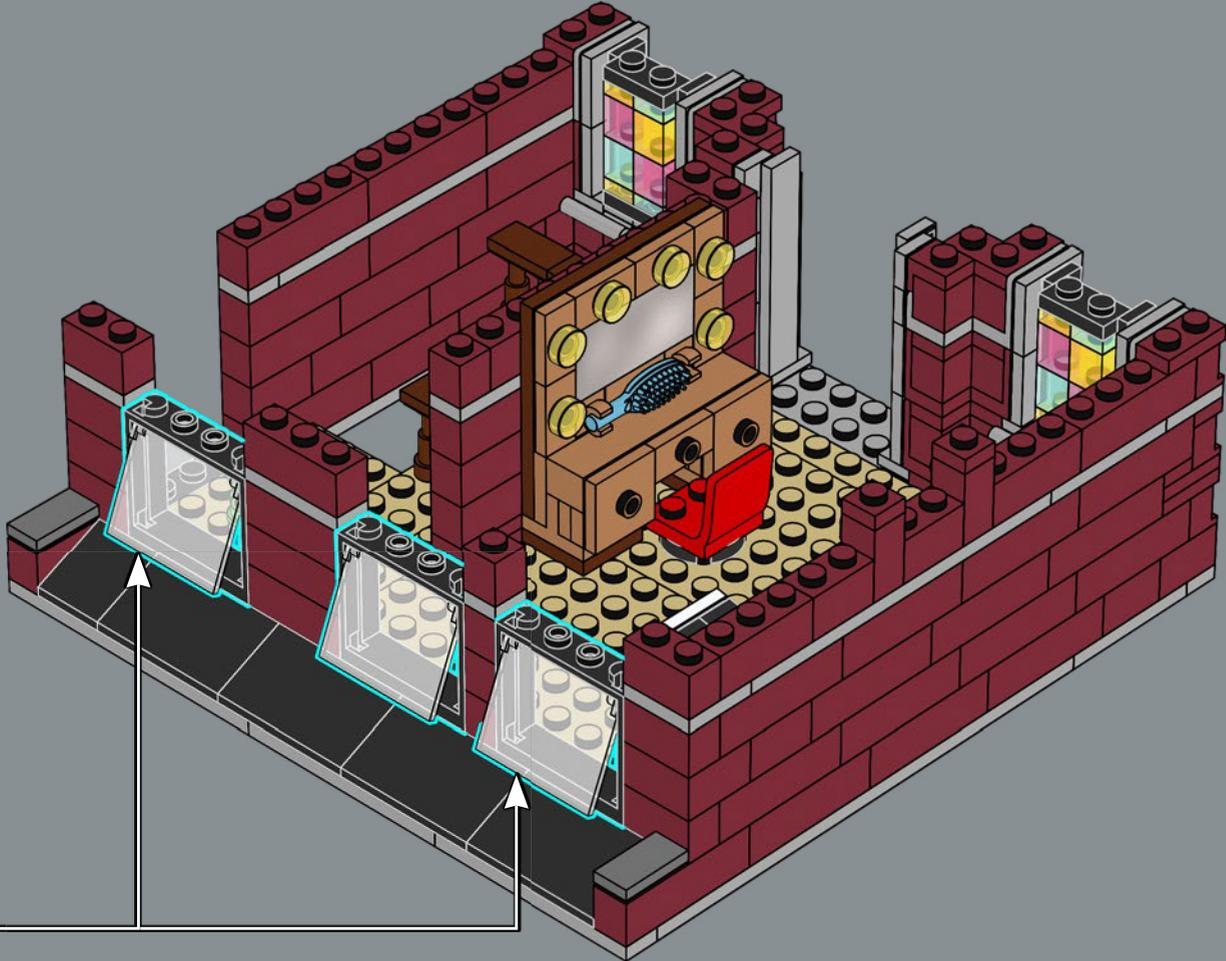

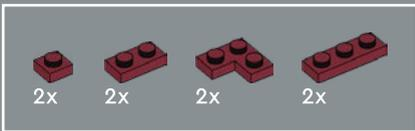

332

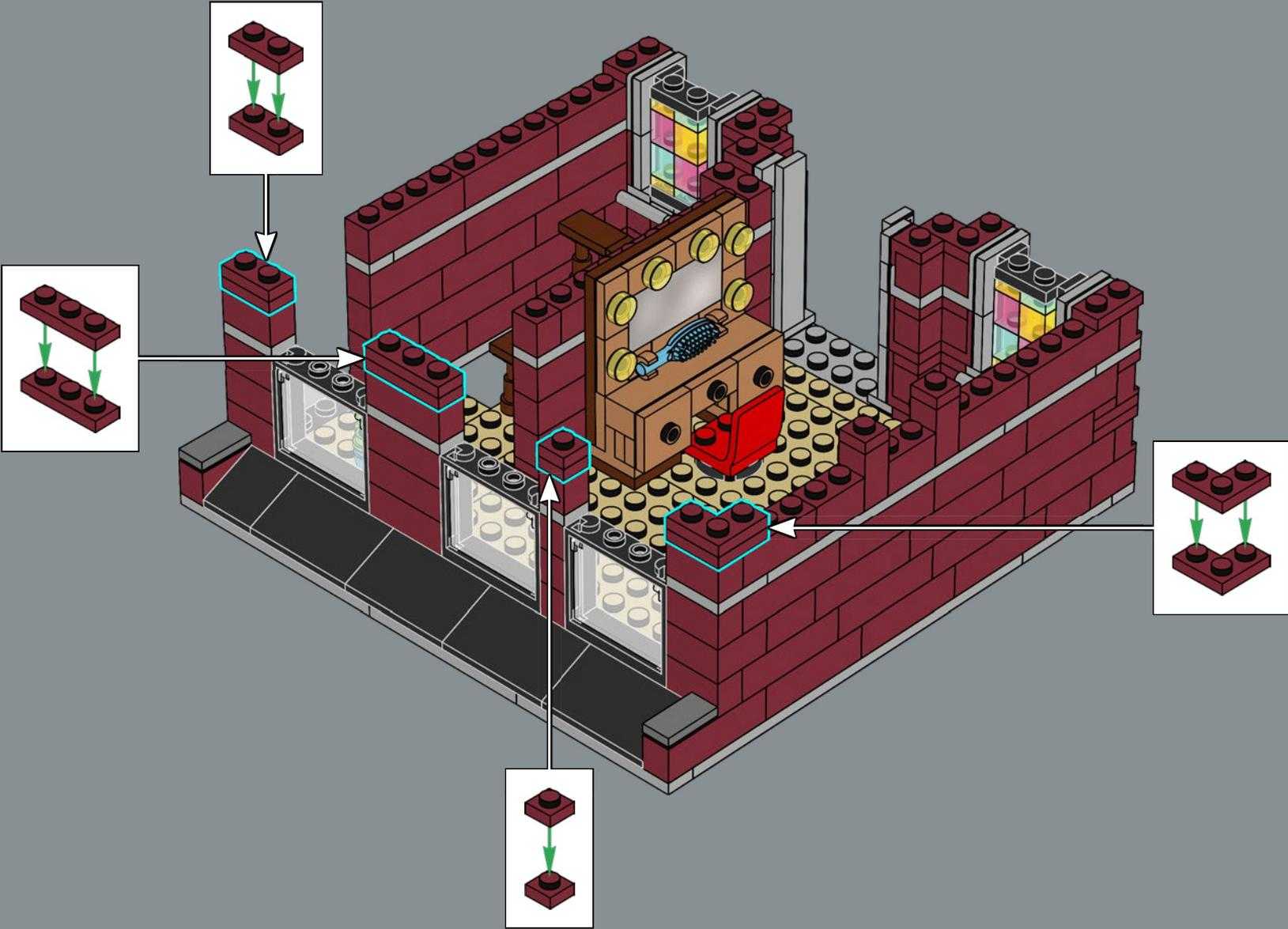

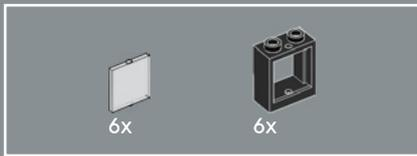

333

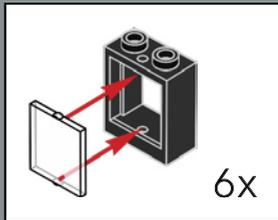
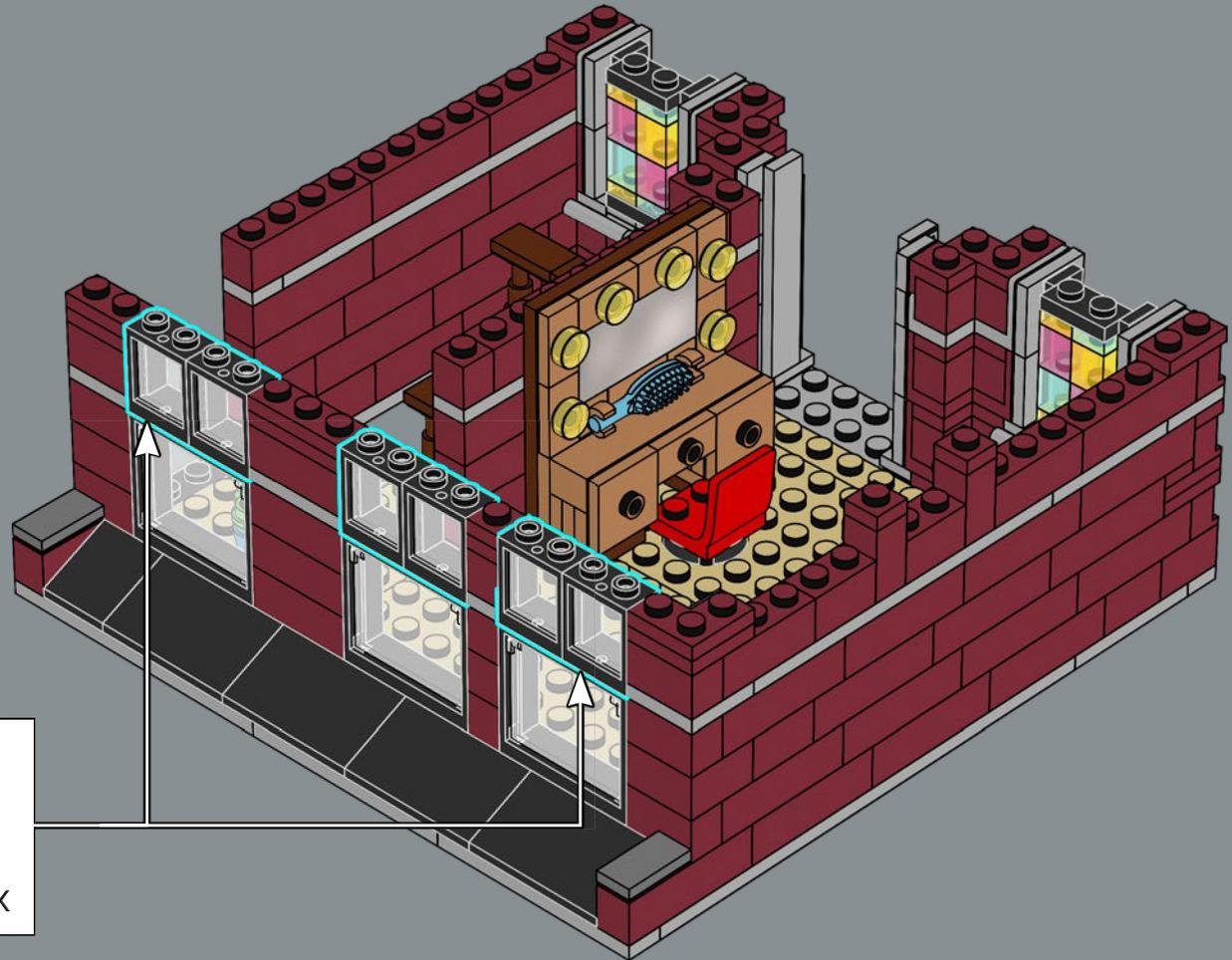

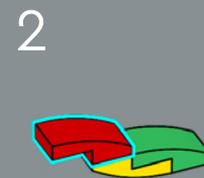
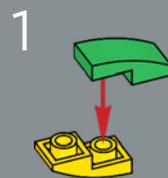
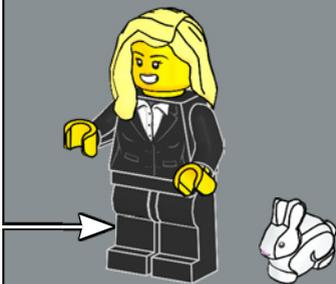
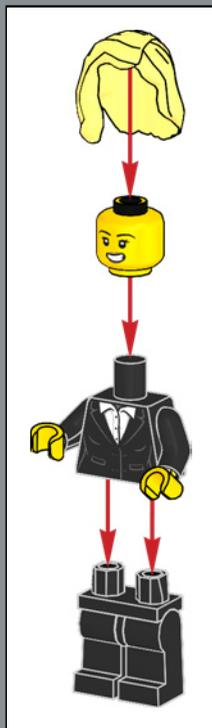

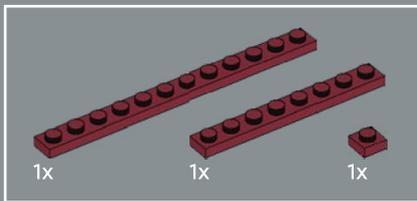

334

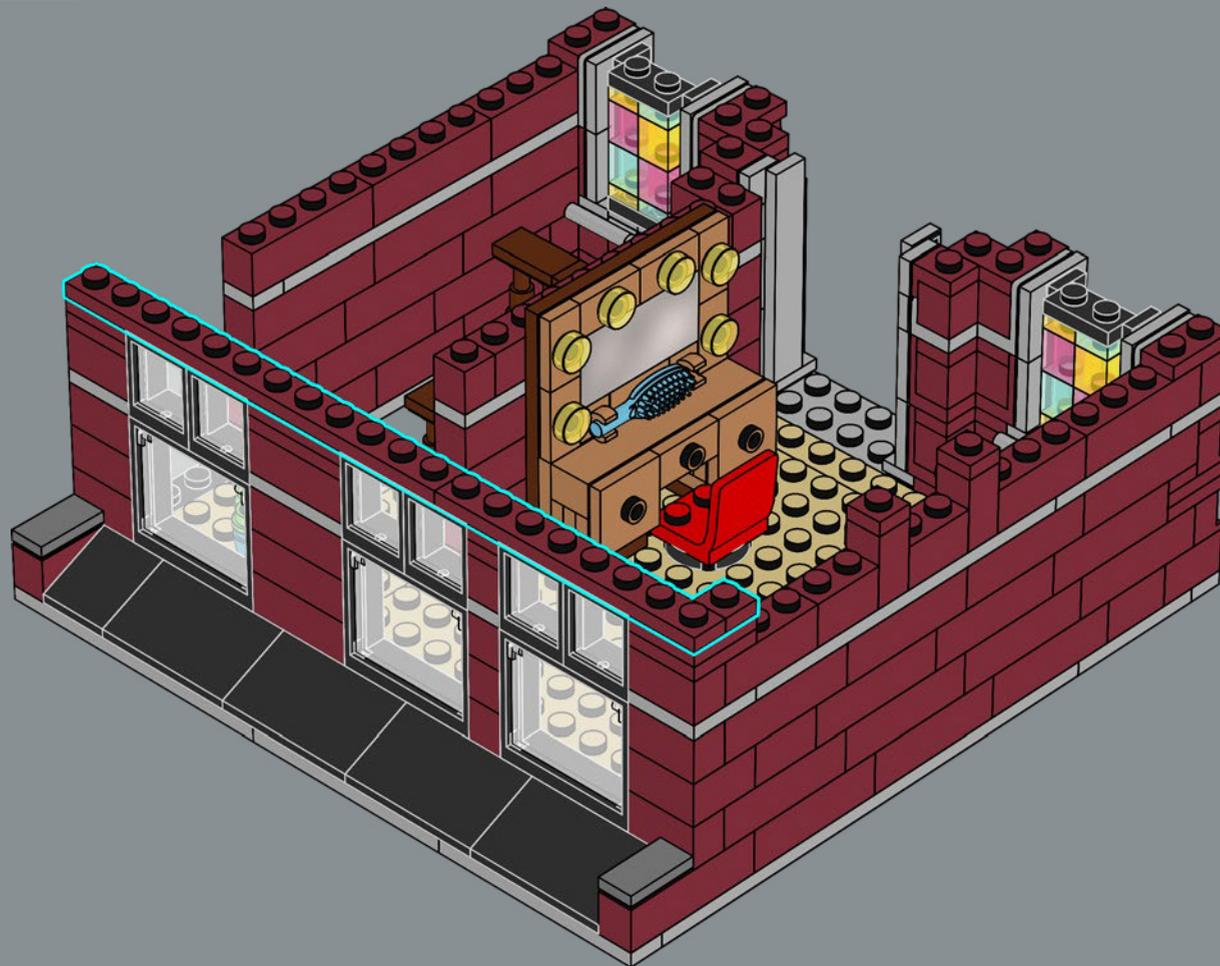

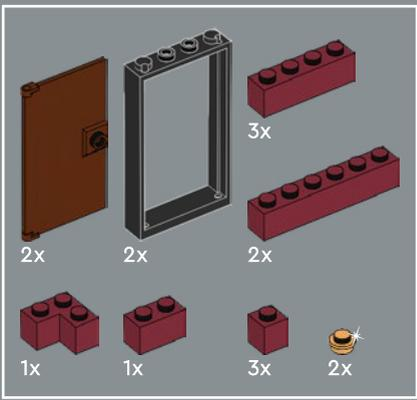

335

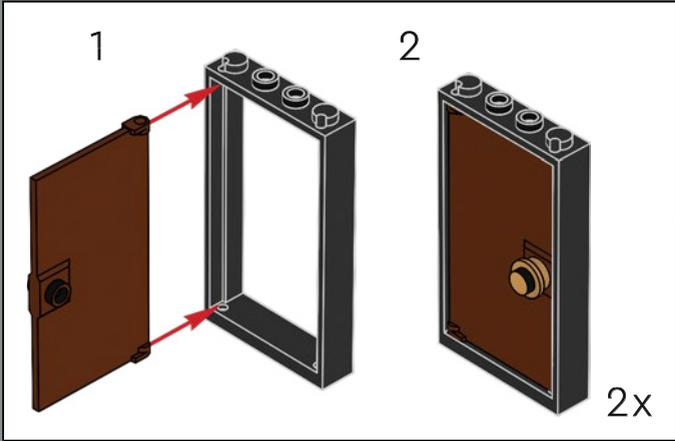



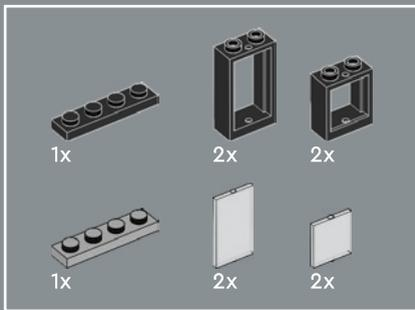

336

1

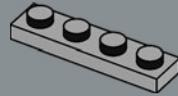

2

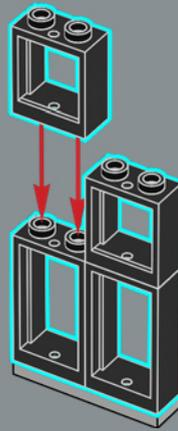

3

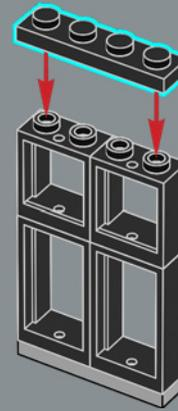

4

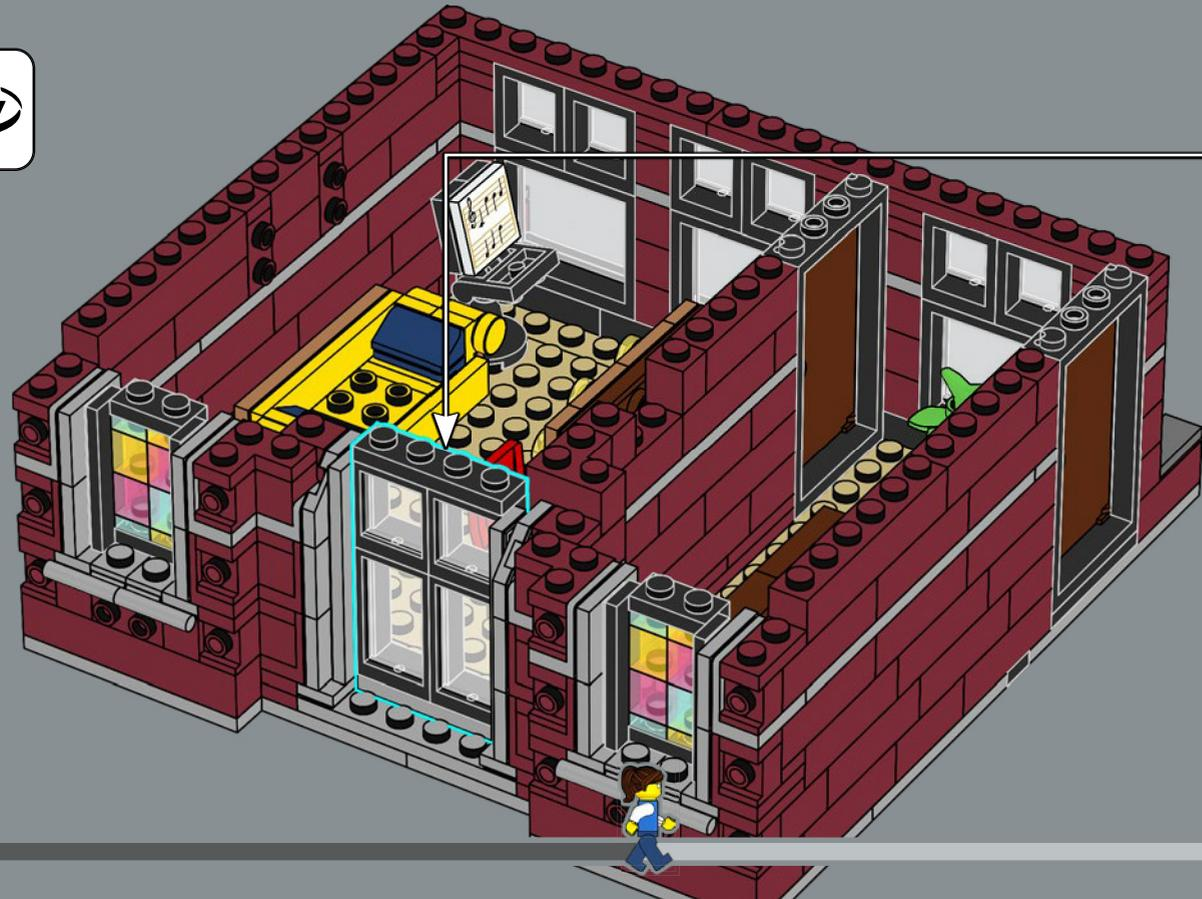
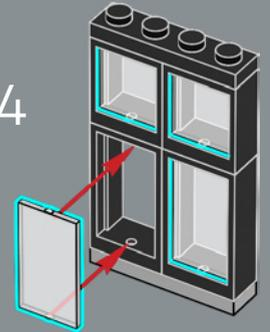

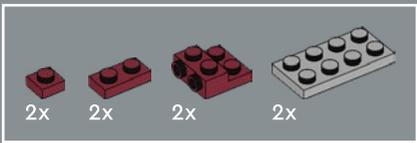

337

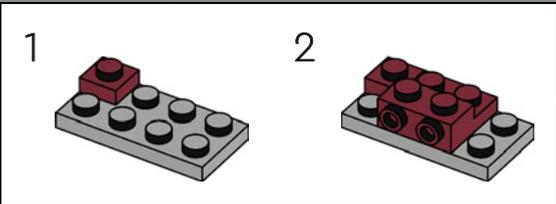
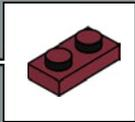
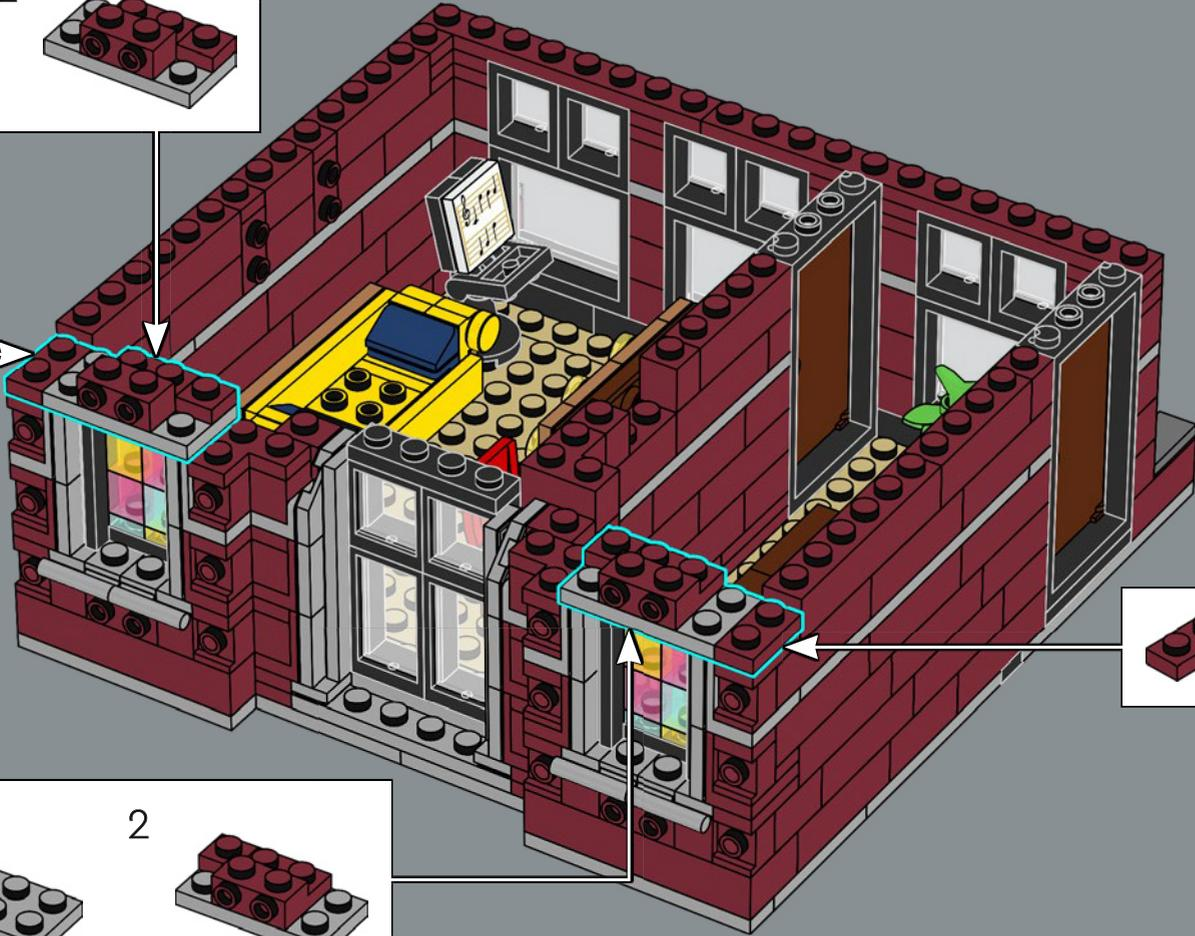
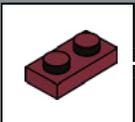
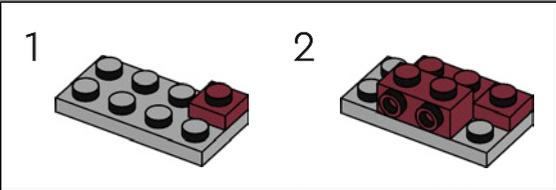



338

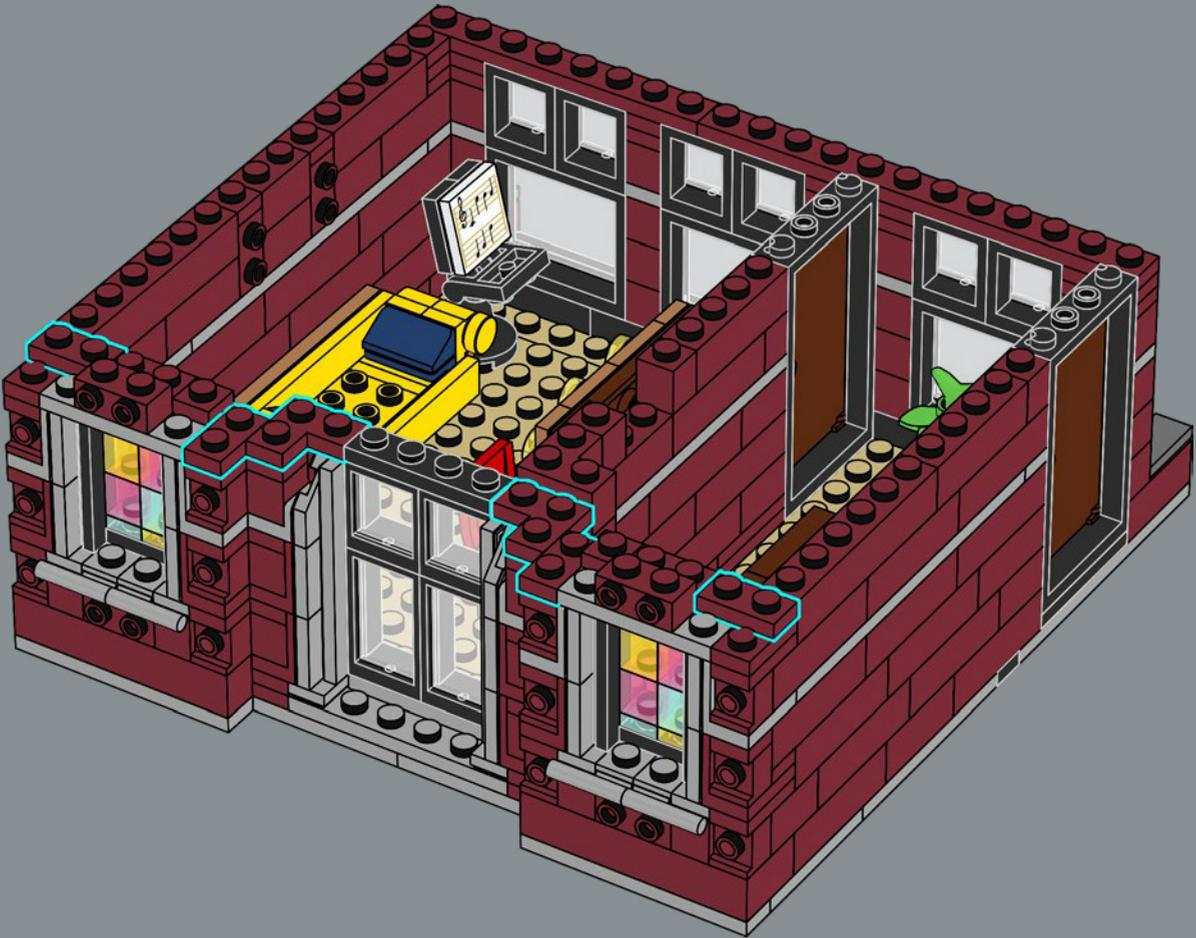

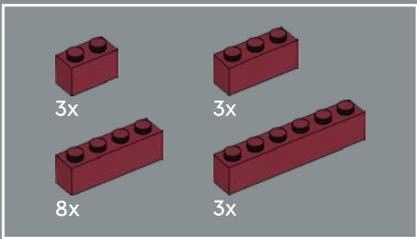

339

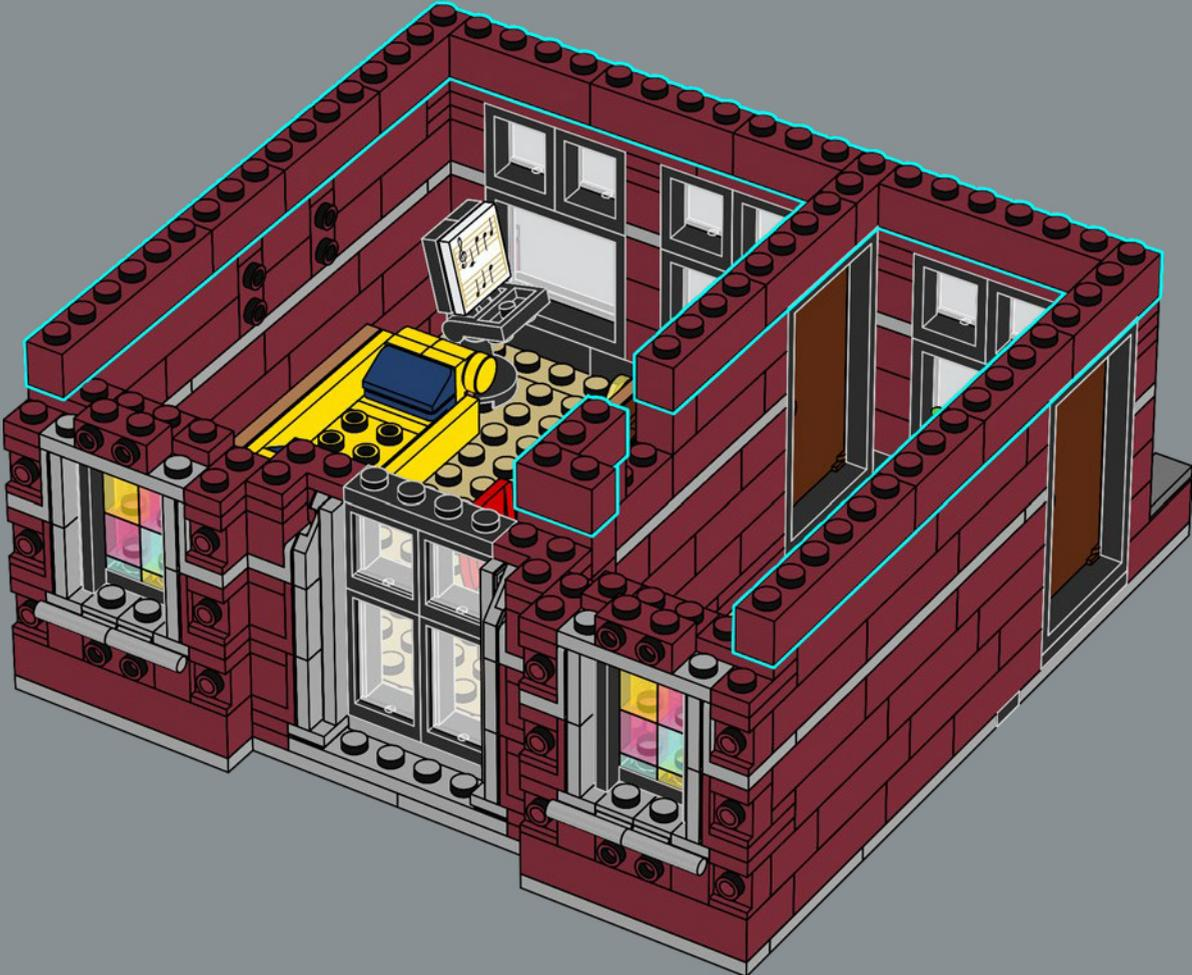

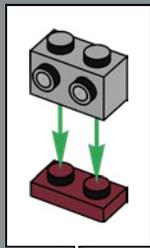
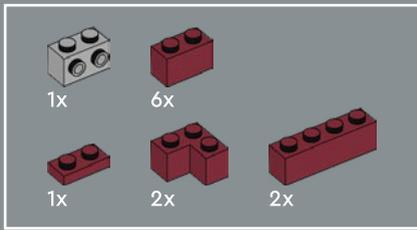

340

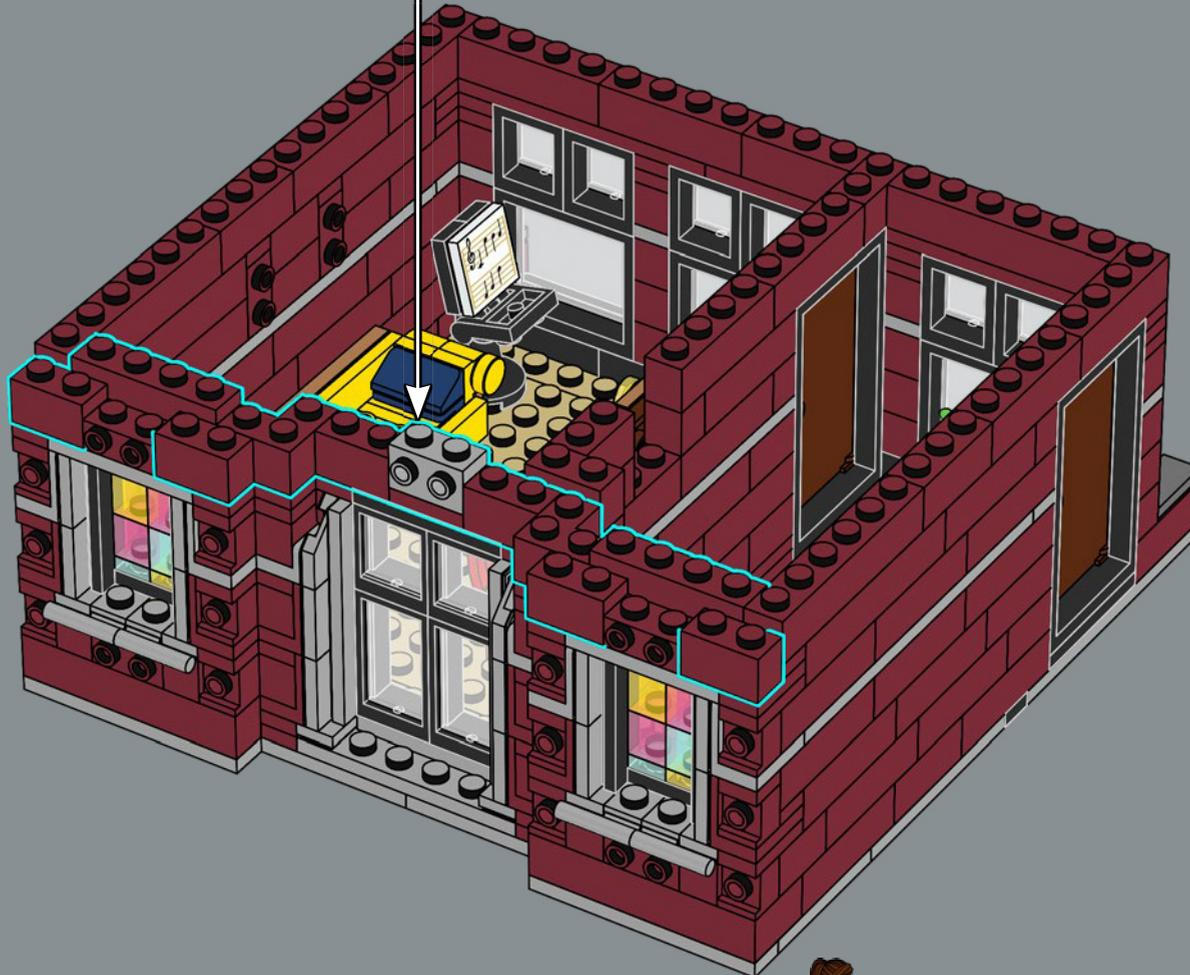

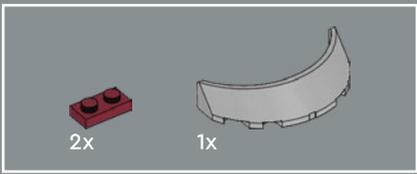

341

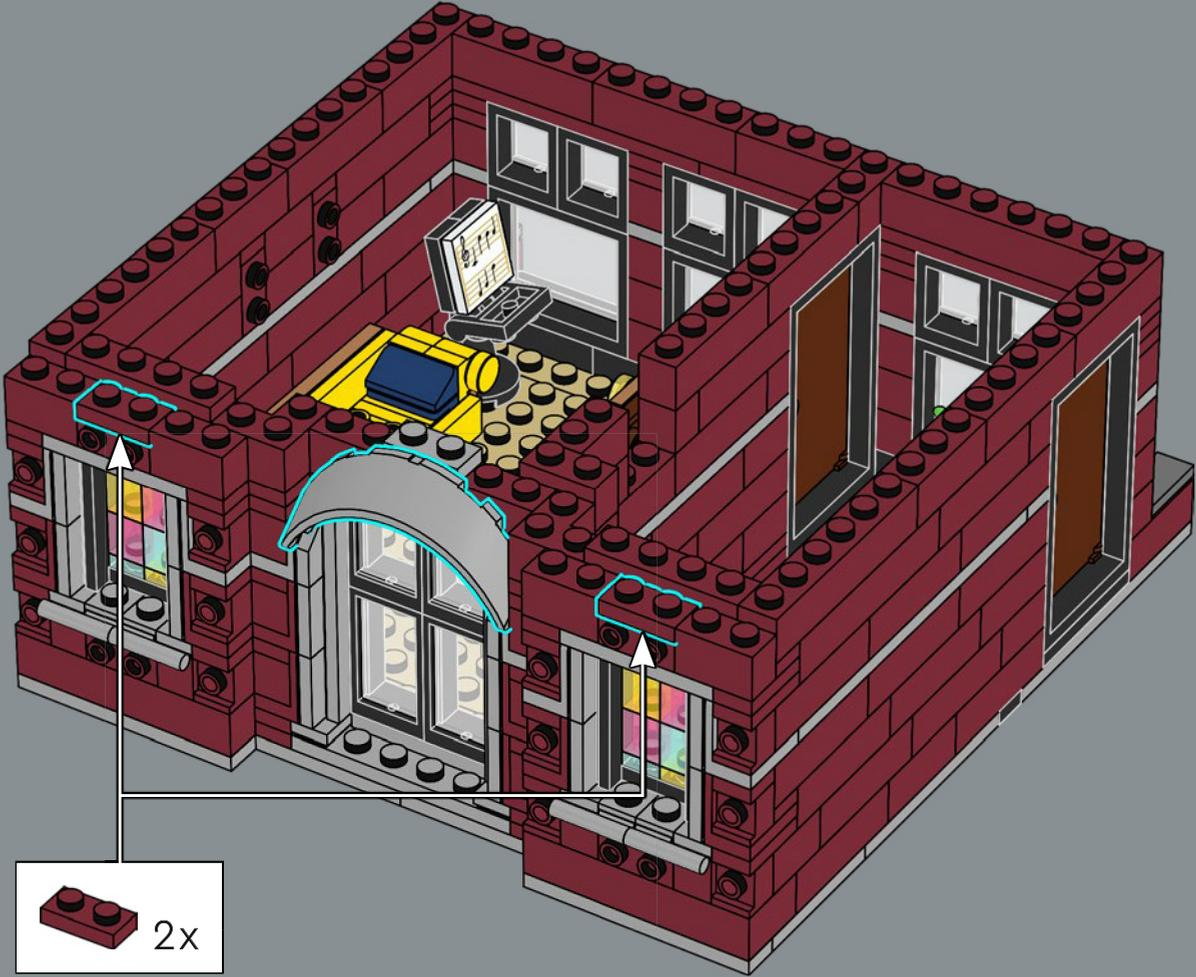

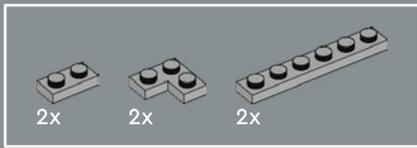

342

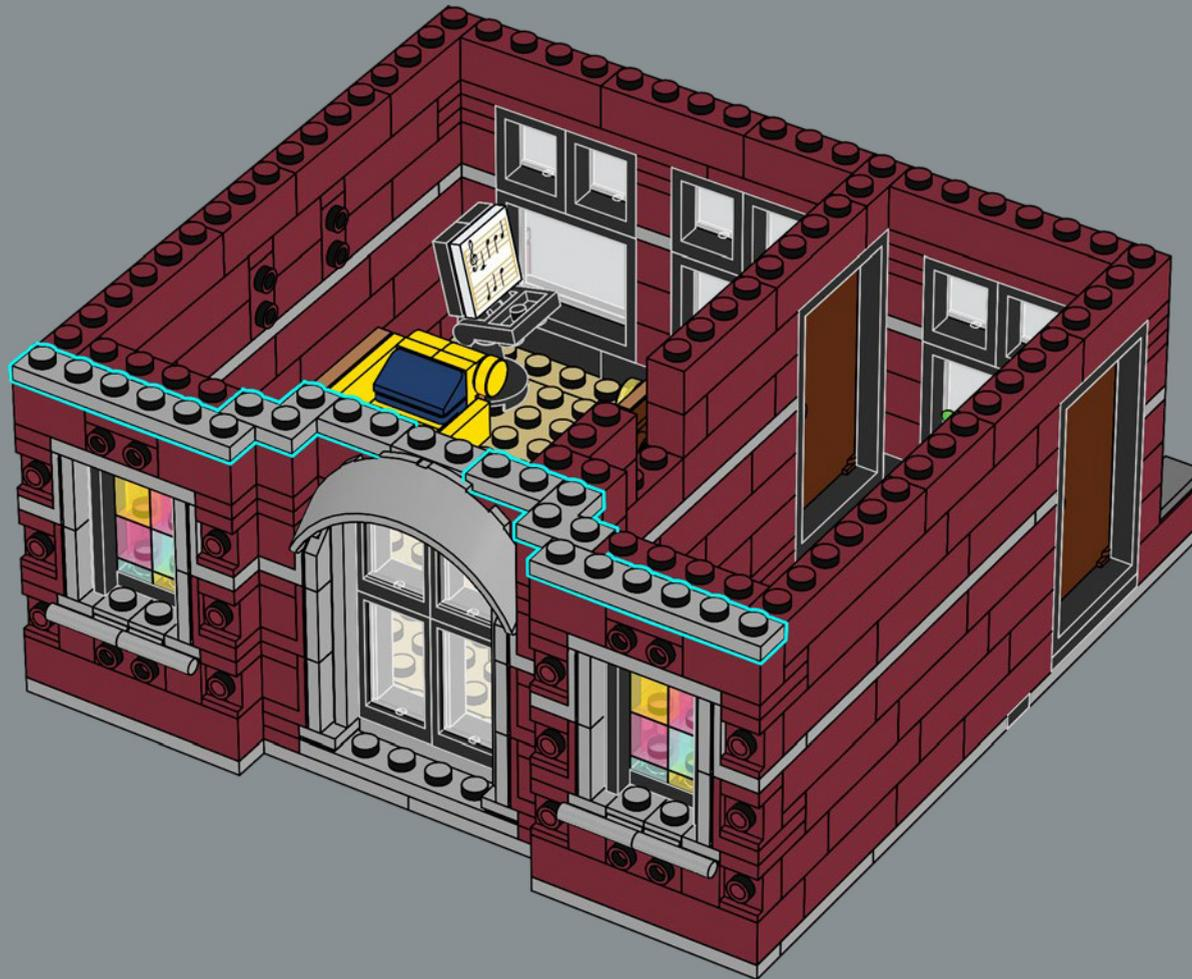

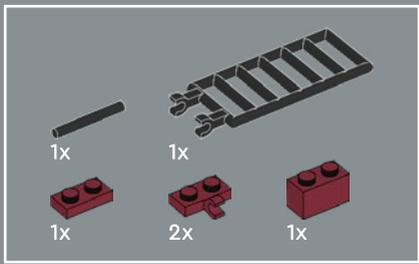

343

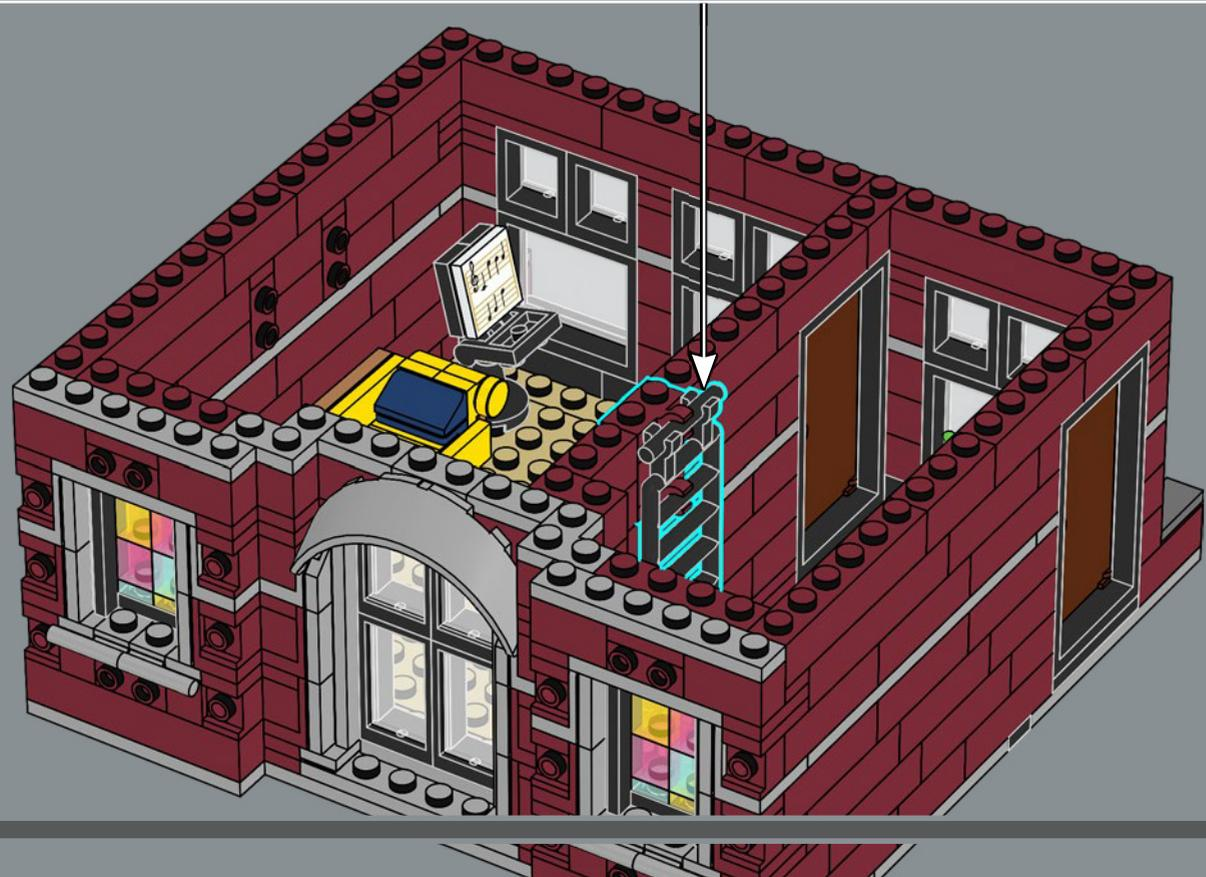
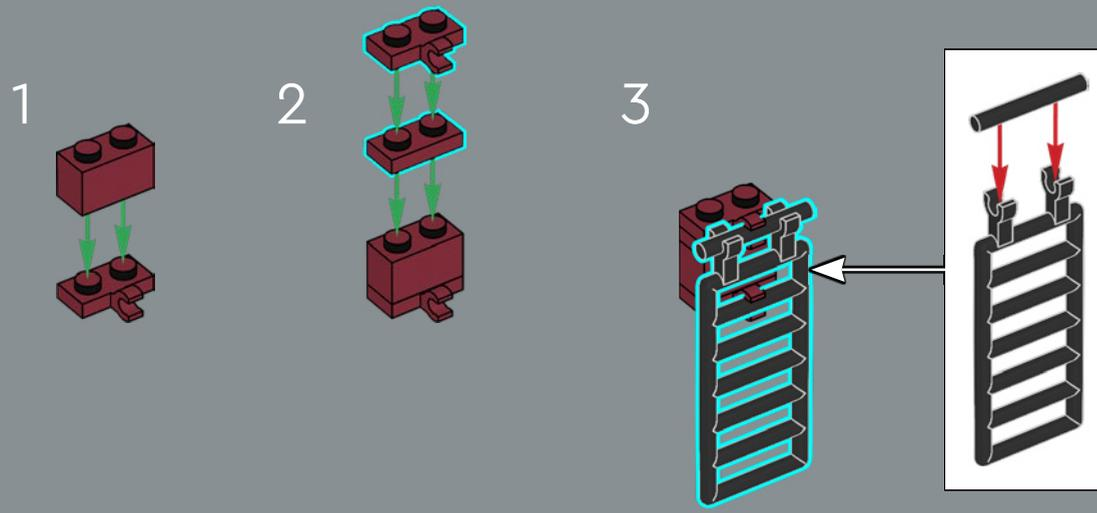



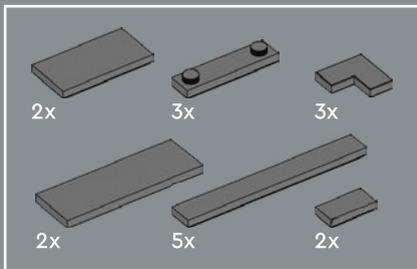

344

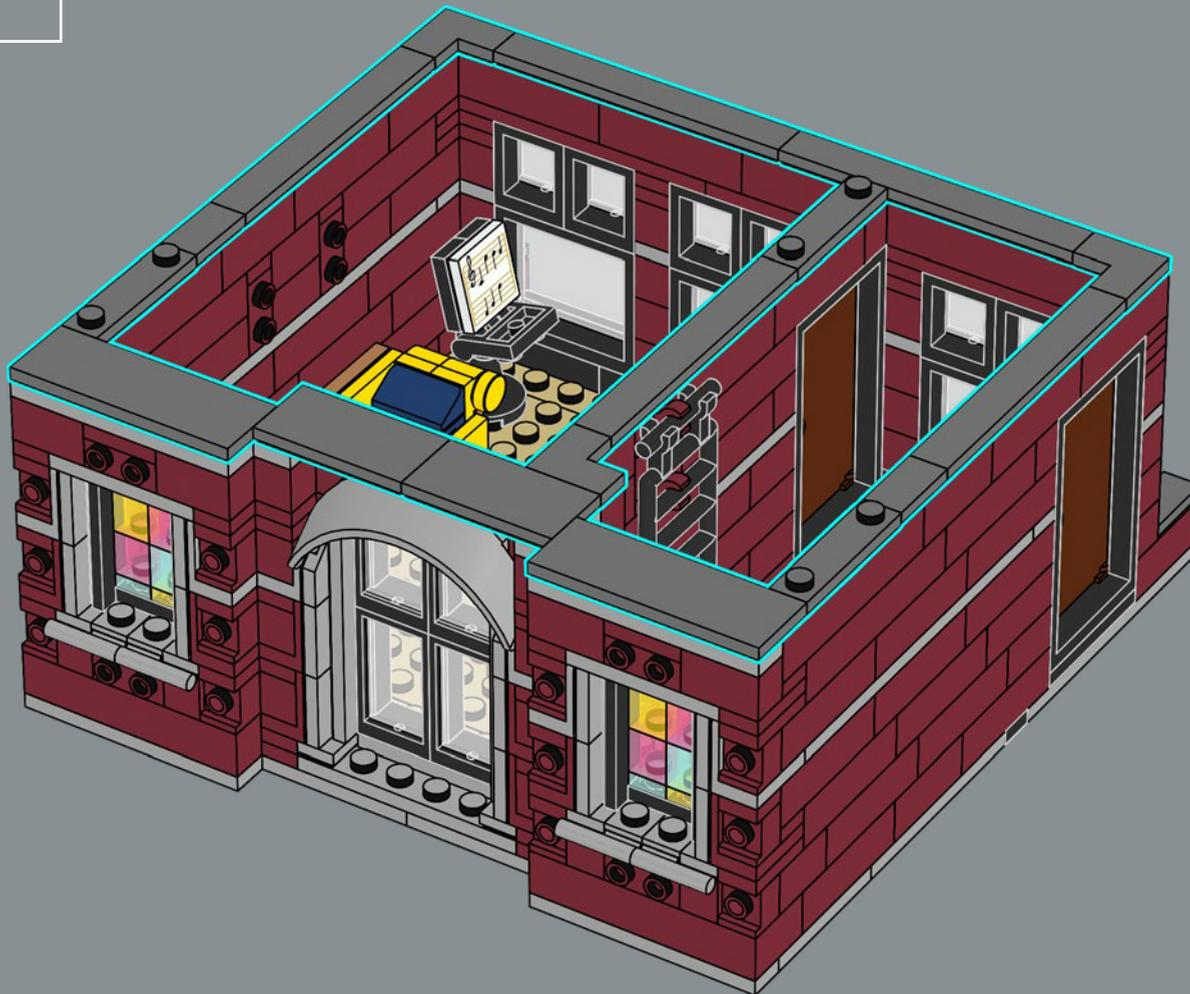

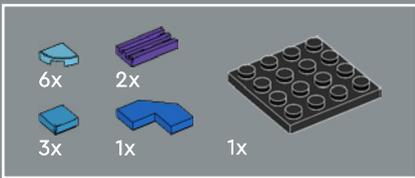

345

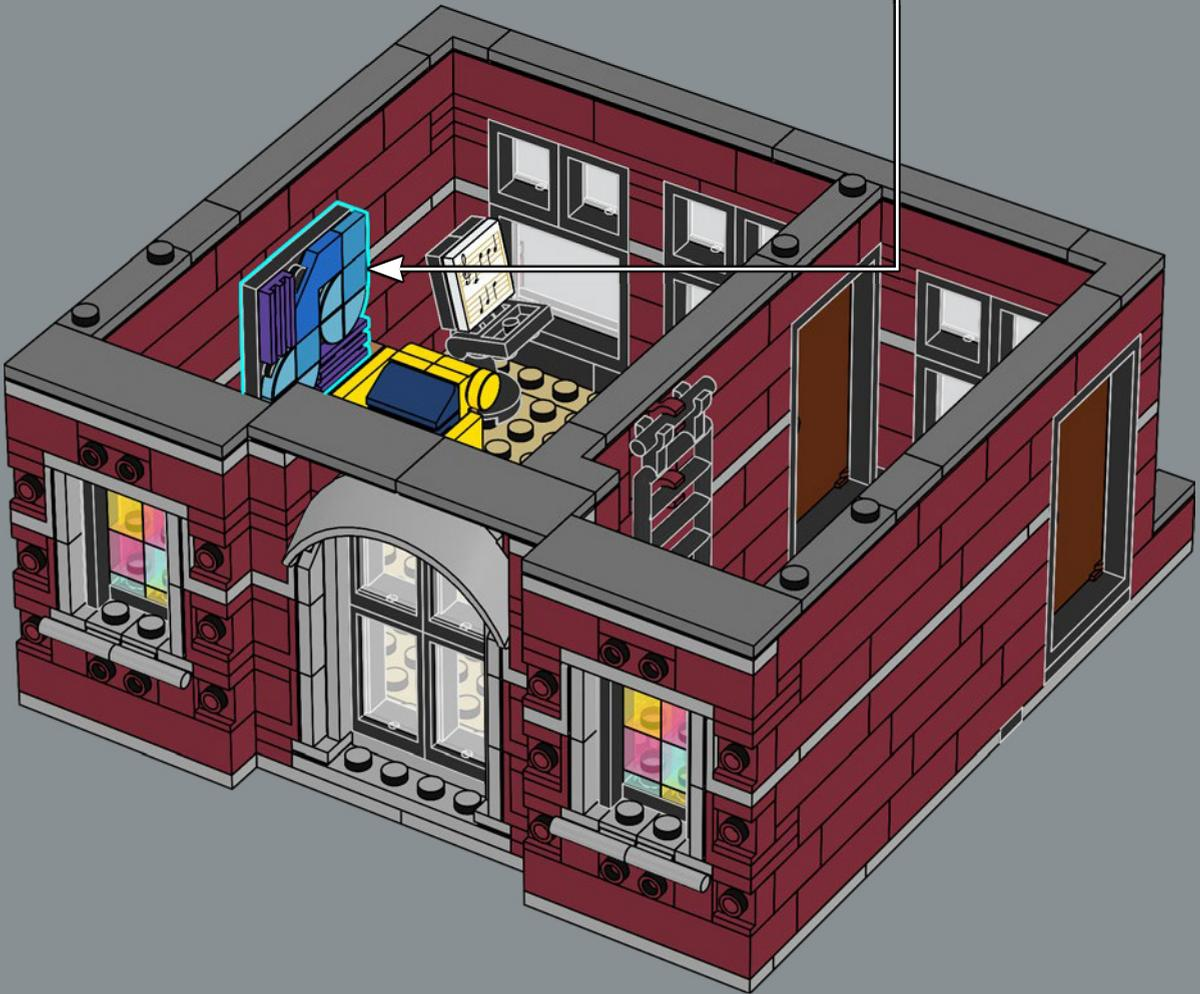
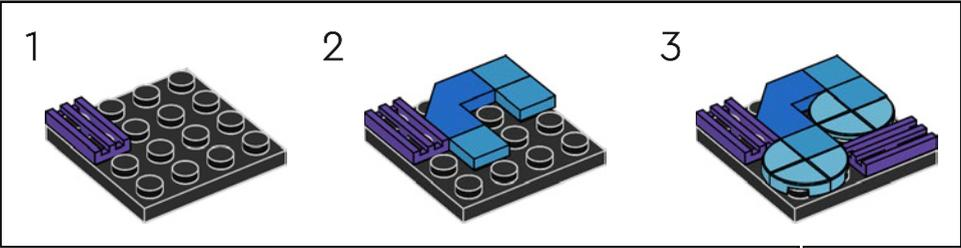

Das Gemälde „Blautöne“ stammt aus der Kunstgalerie im LEGO® Boutique-Hotel (10297) ein Stück die Straße hinunter.

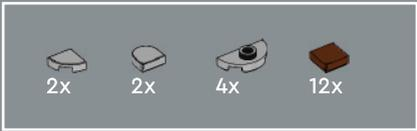

346

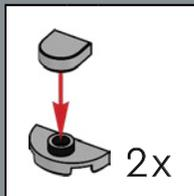
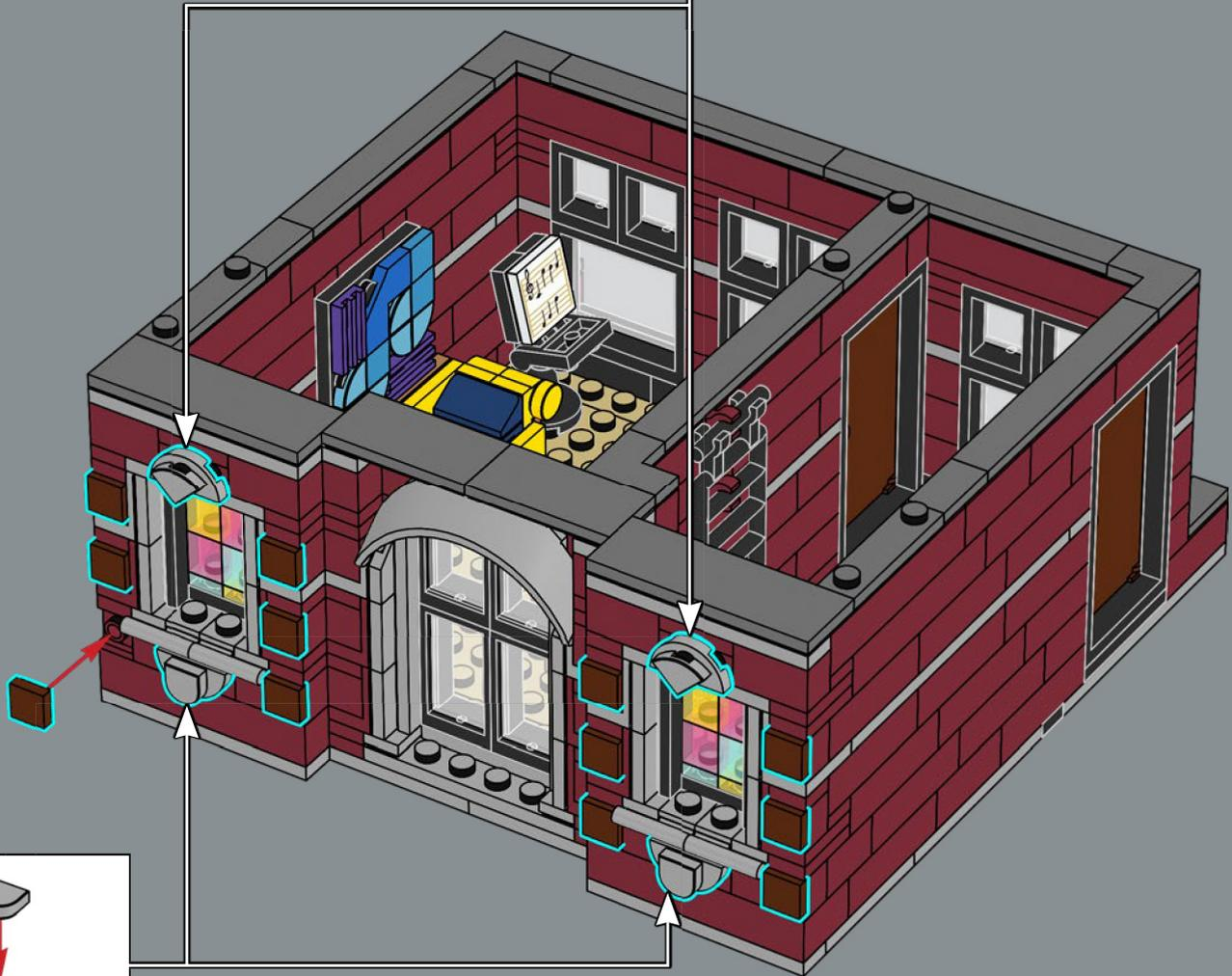
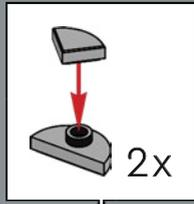

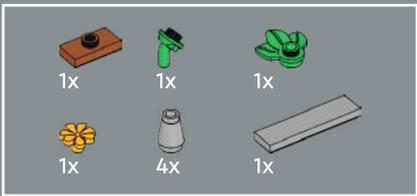

347

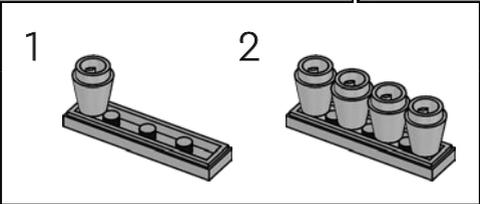
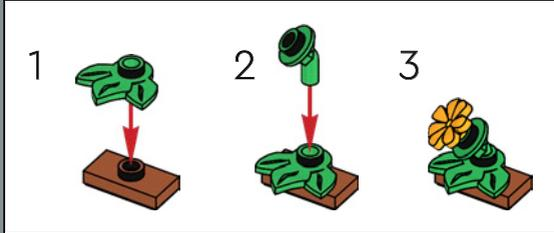
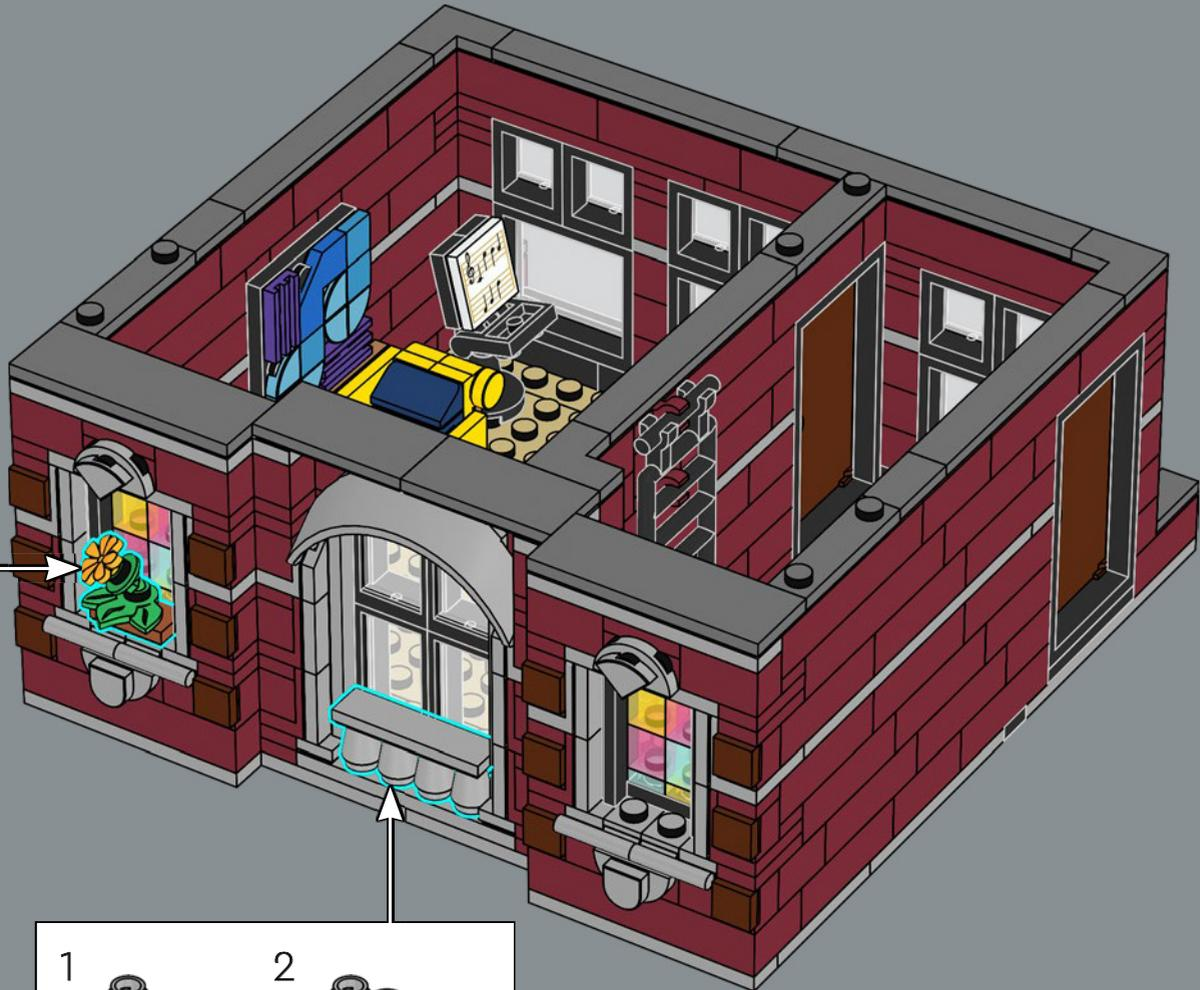

348



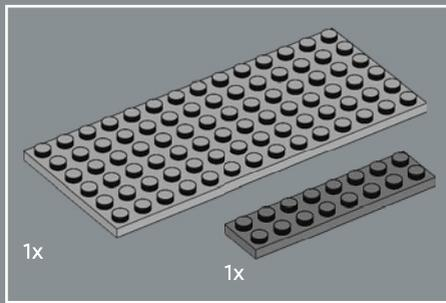

349

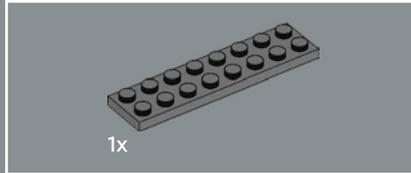
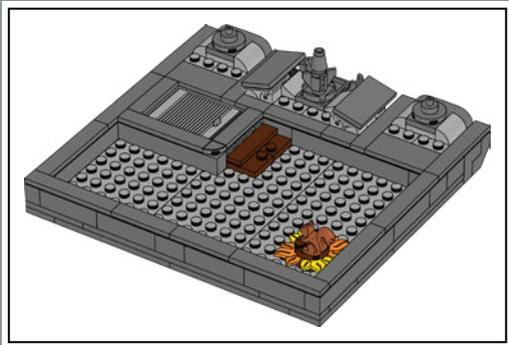
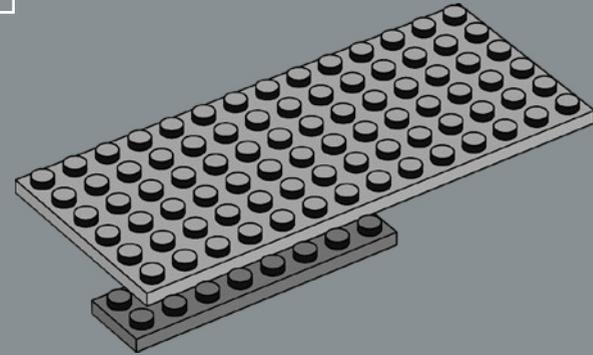

350

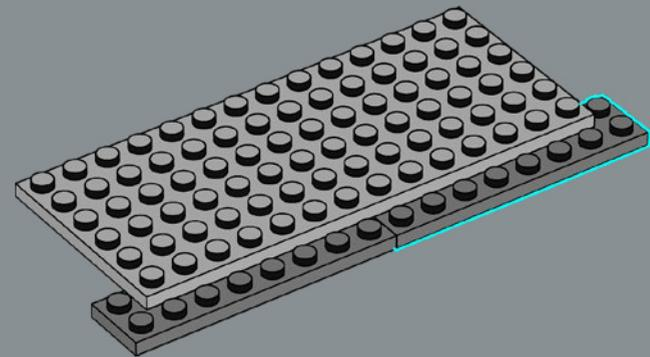

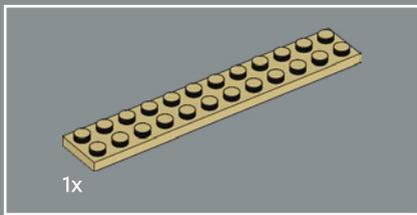

351

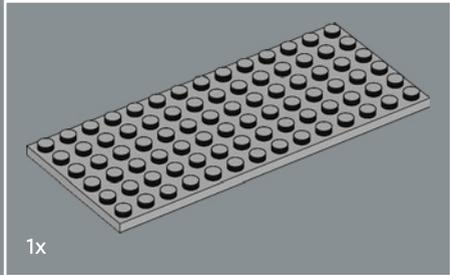
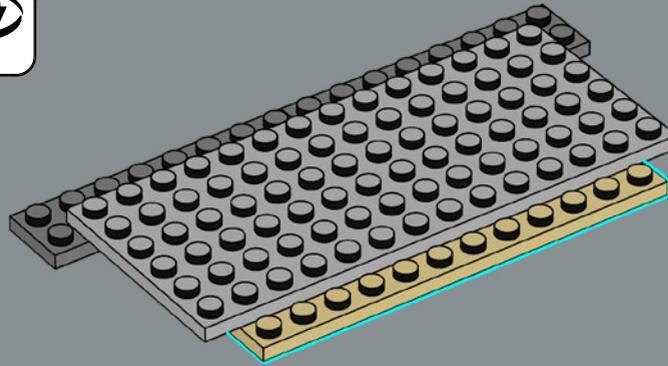

352

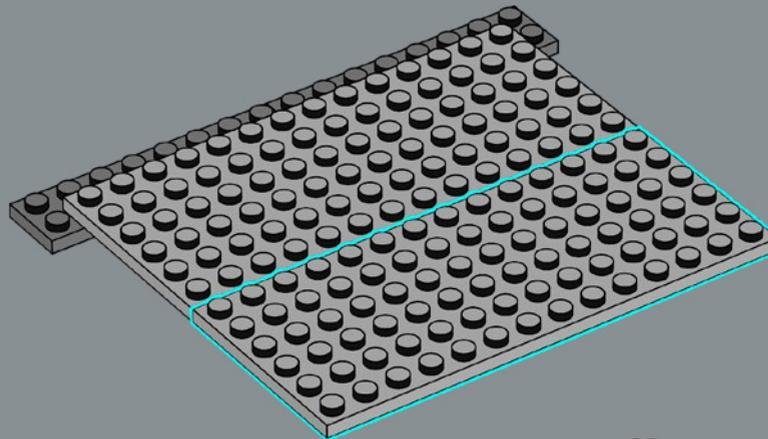

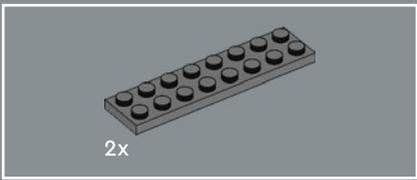

353

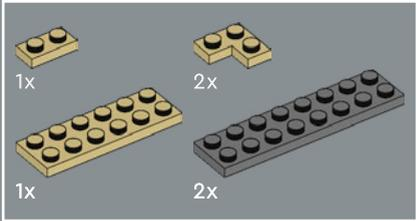
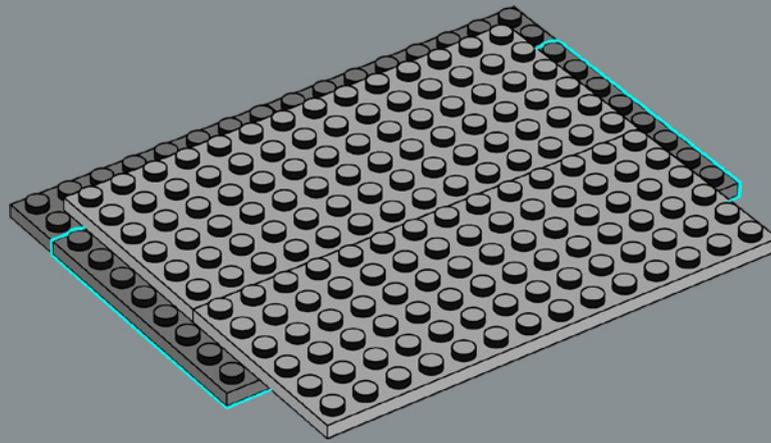

354

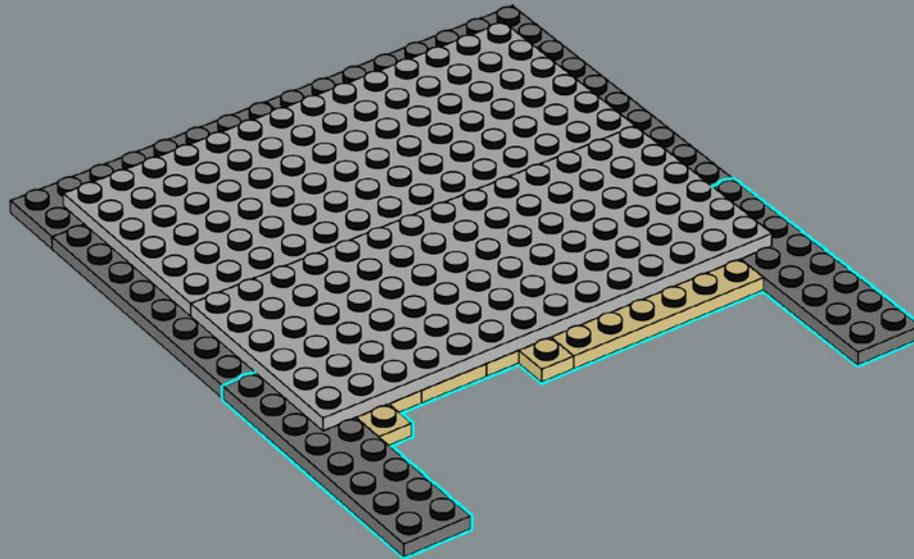



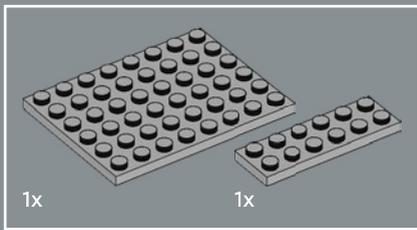

355

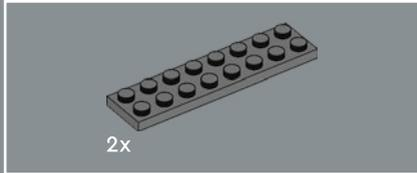
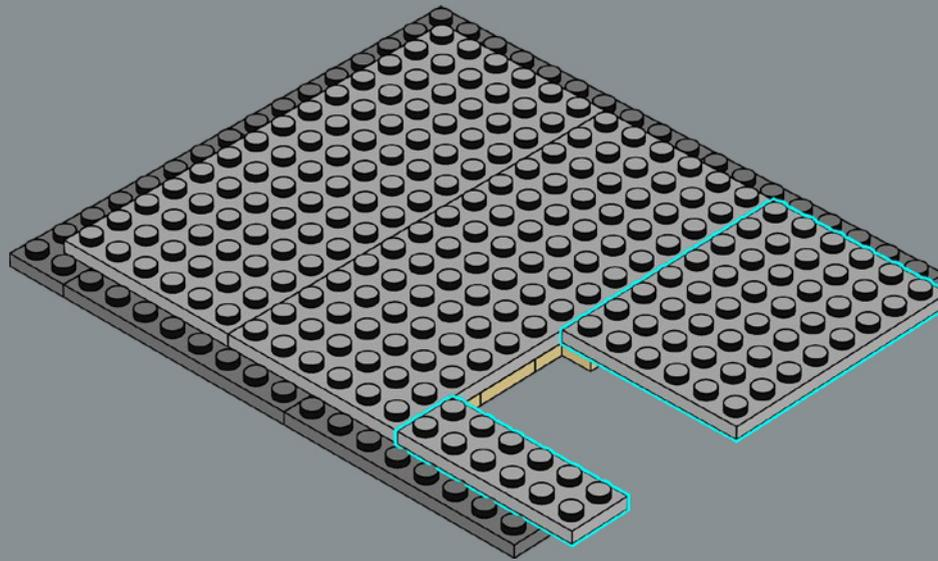

356

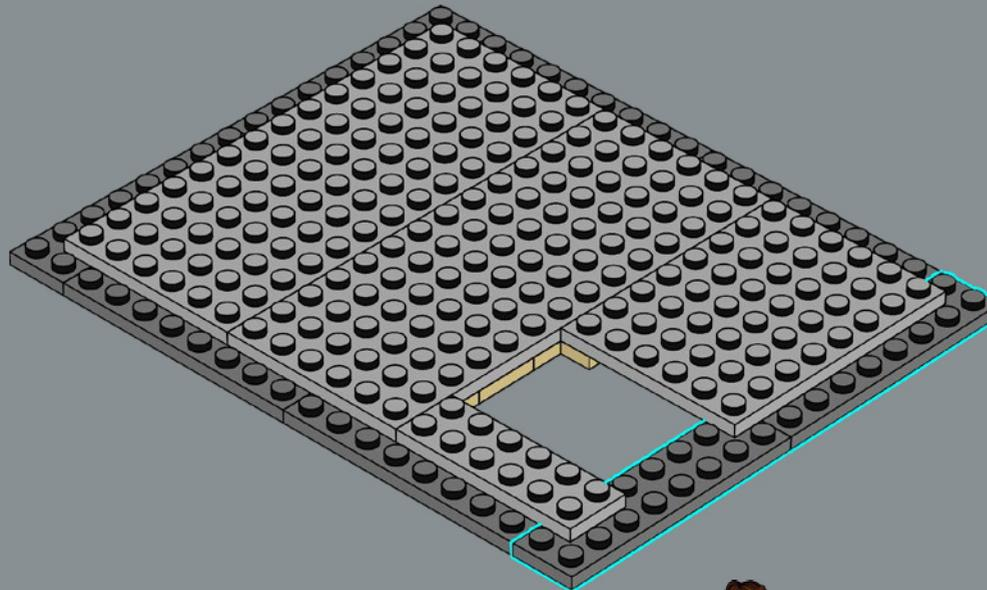

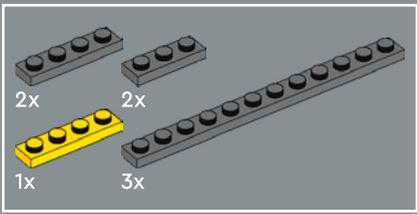

357

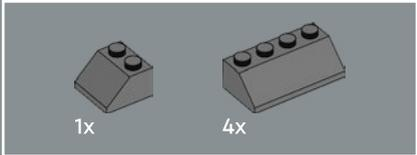
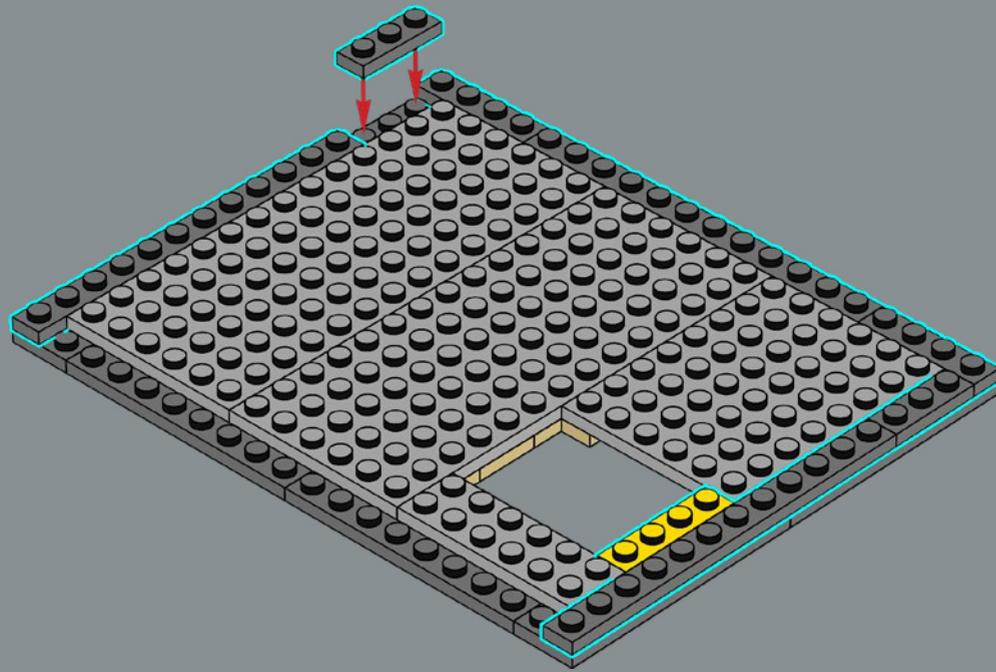

358

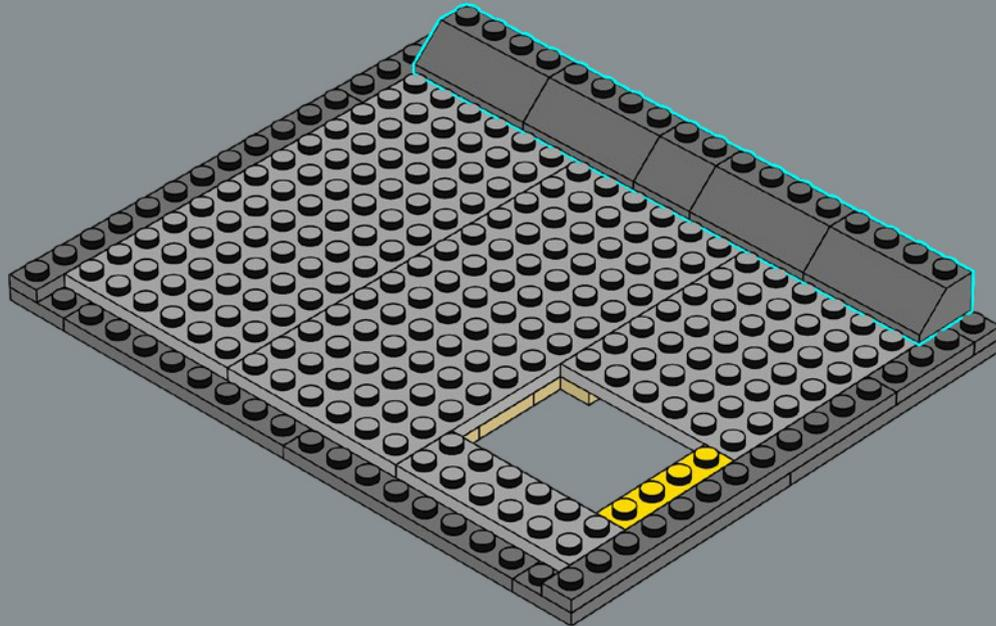

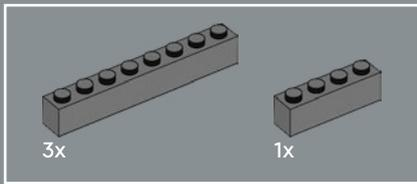

359

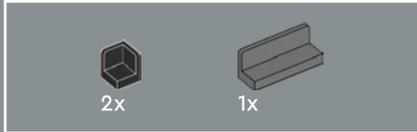
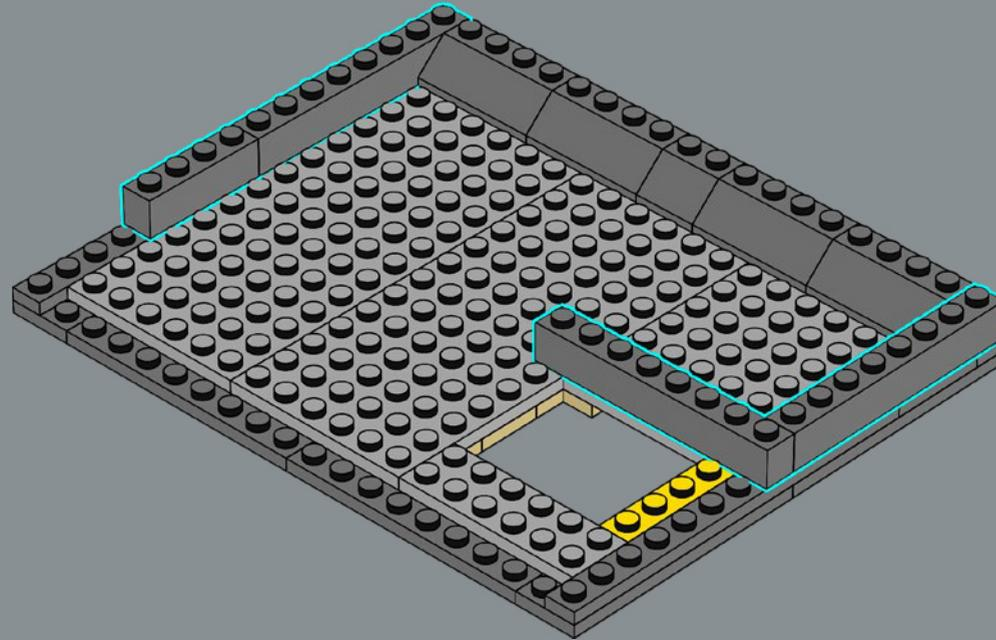

360



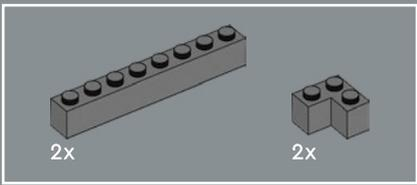

361

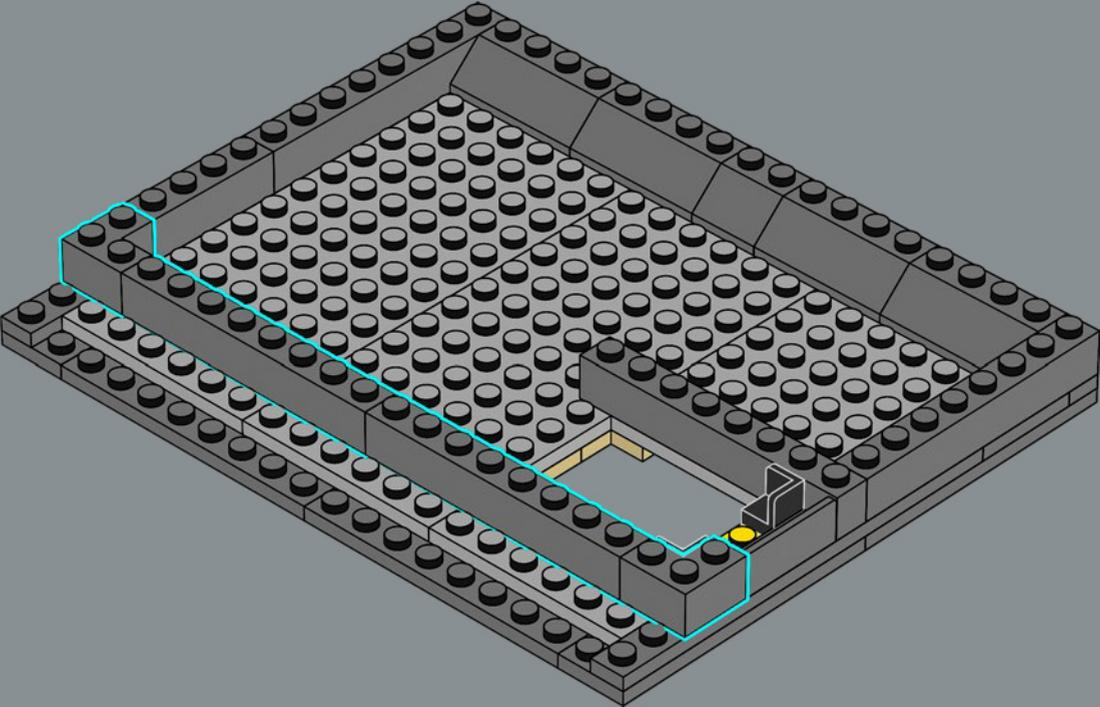

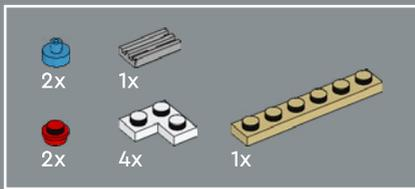

362

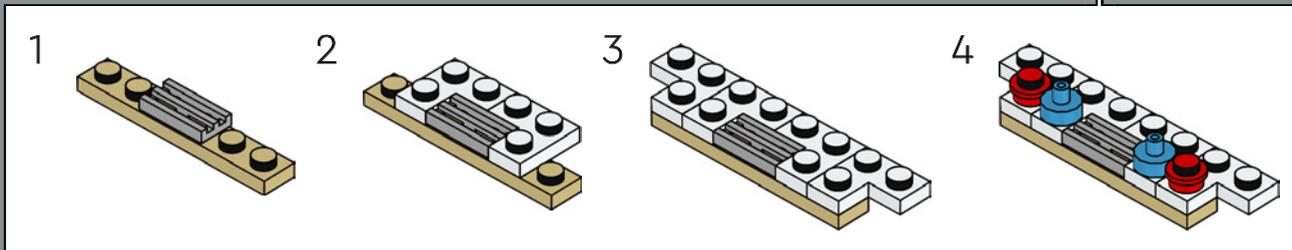
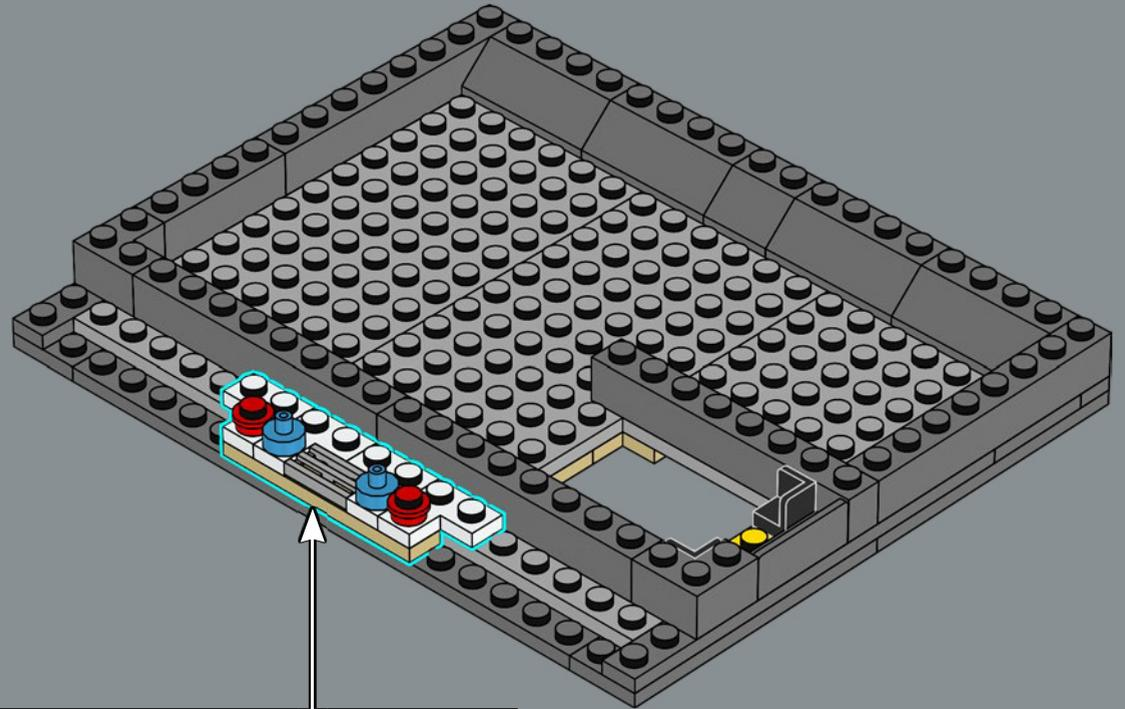

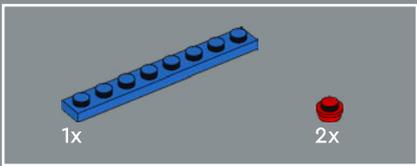

363

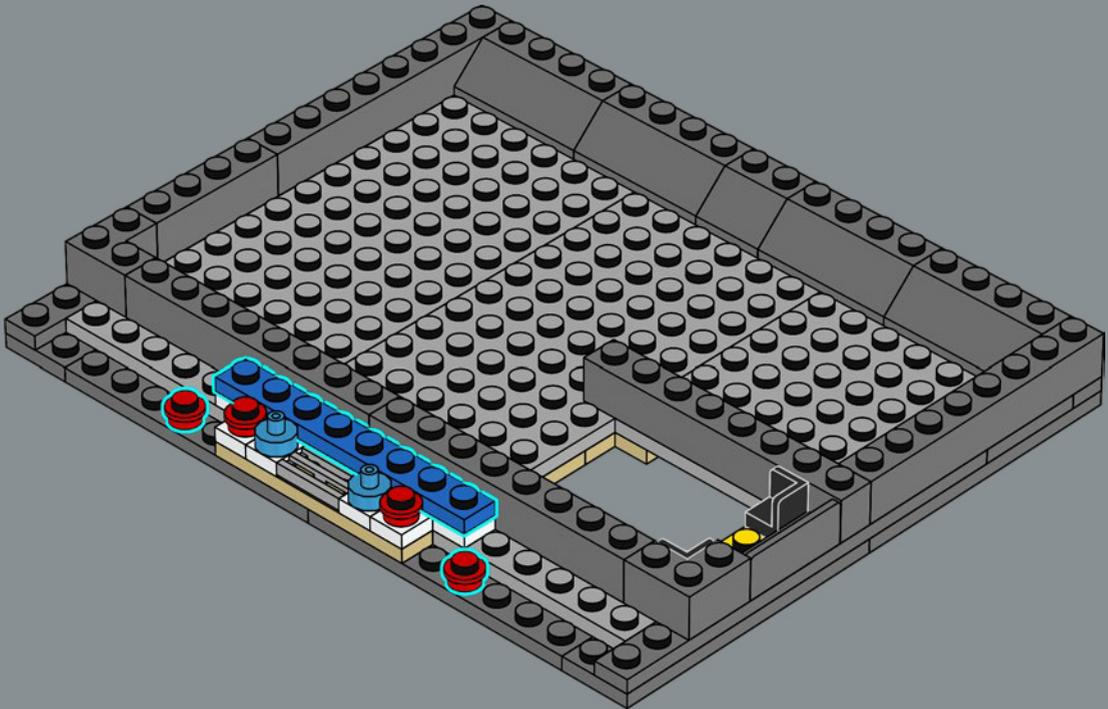

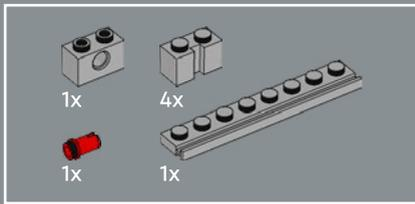

364

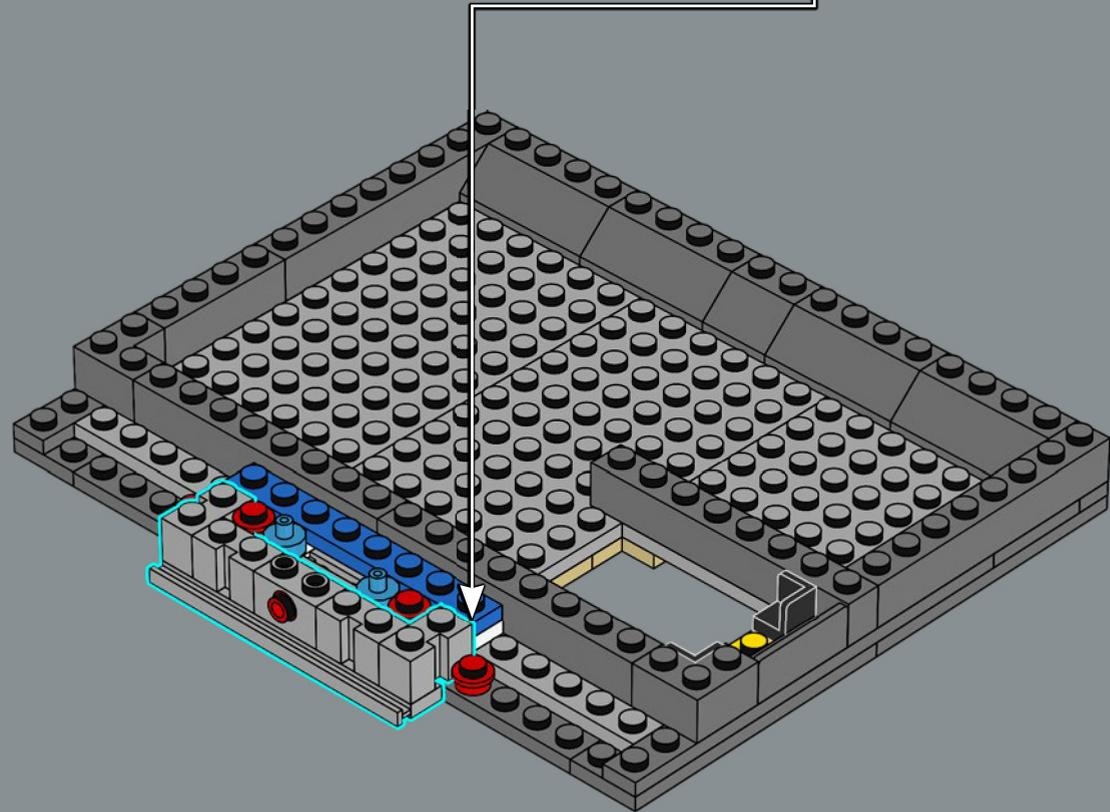
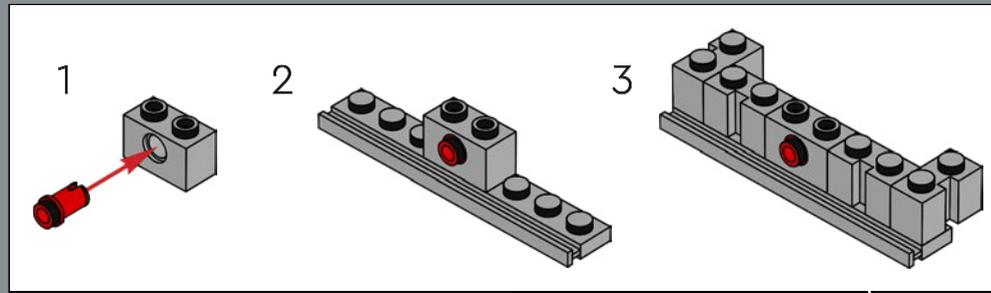

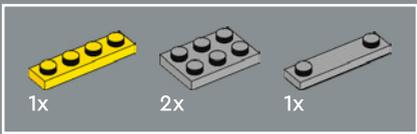

365

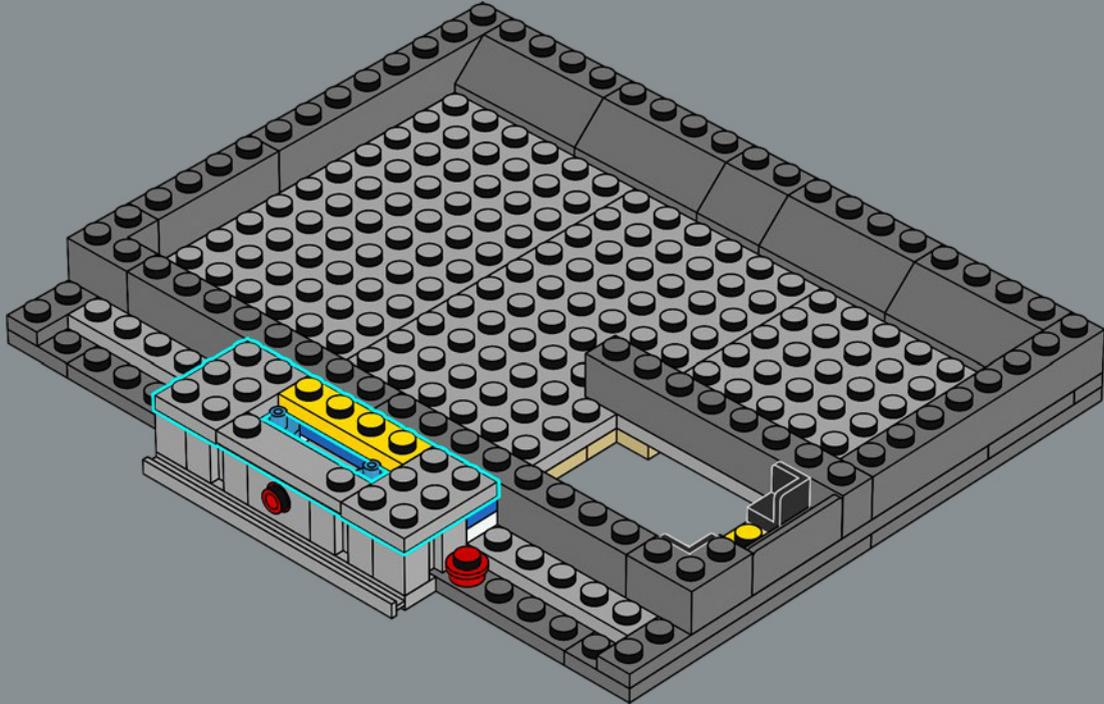



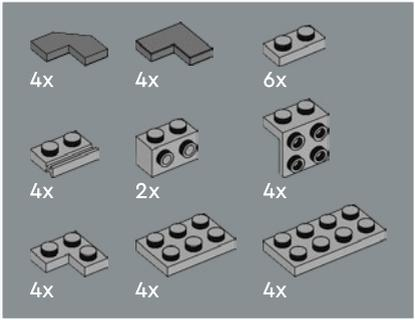
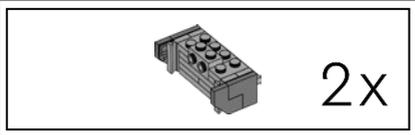

366

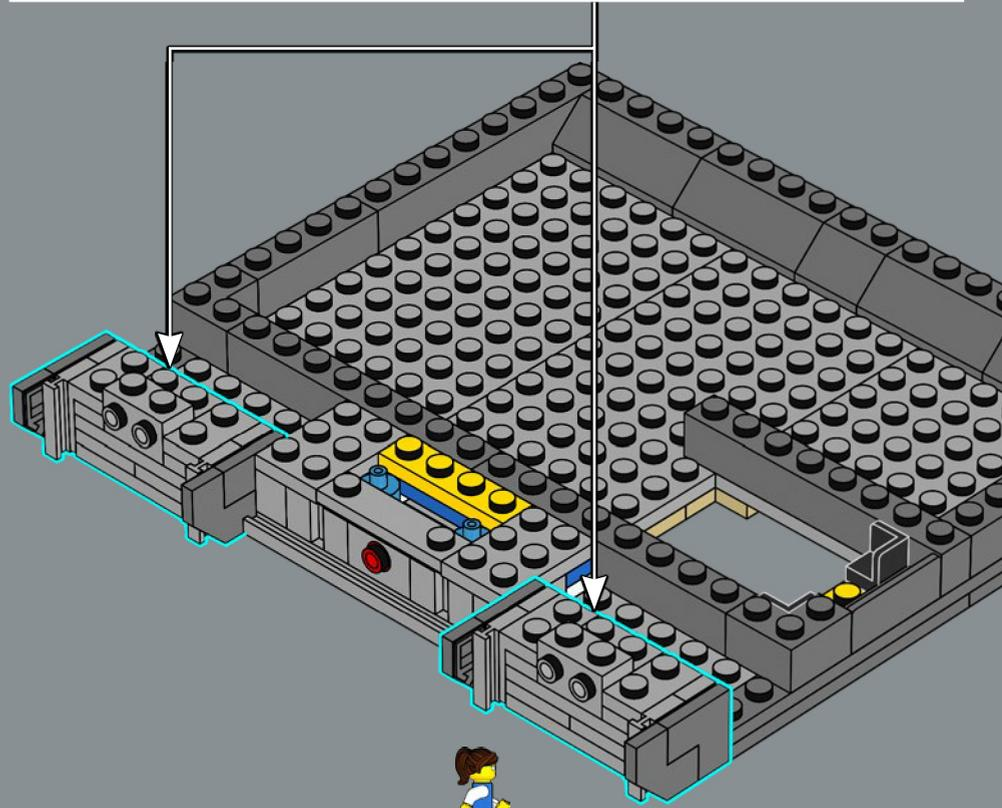
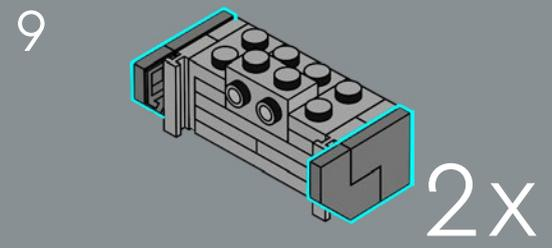
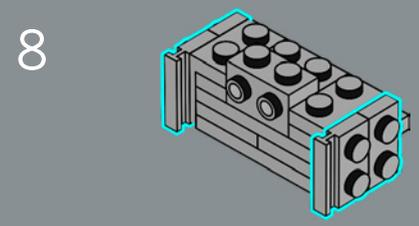
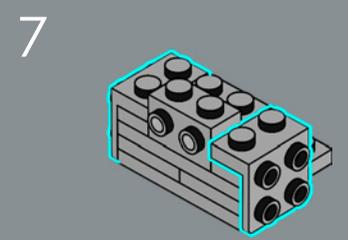
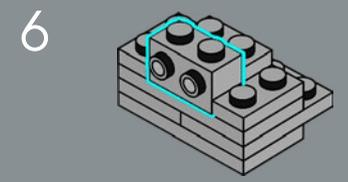
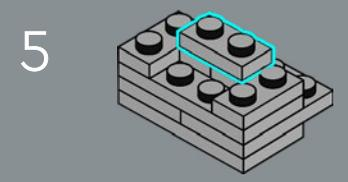
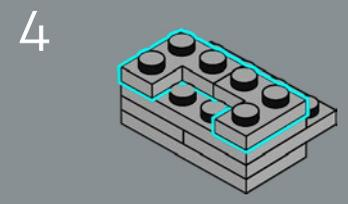
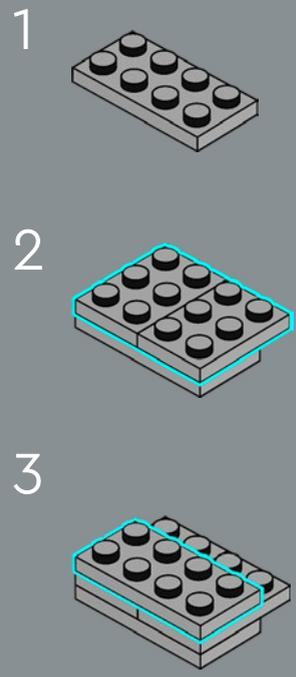

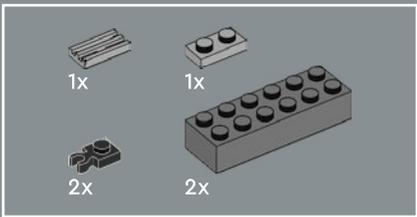

367

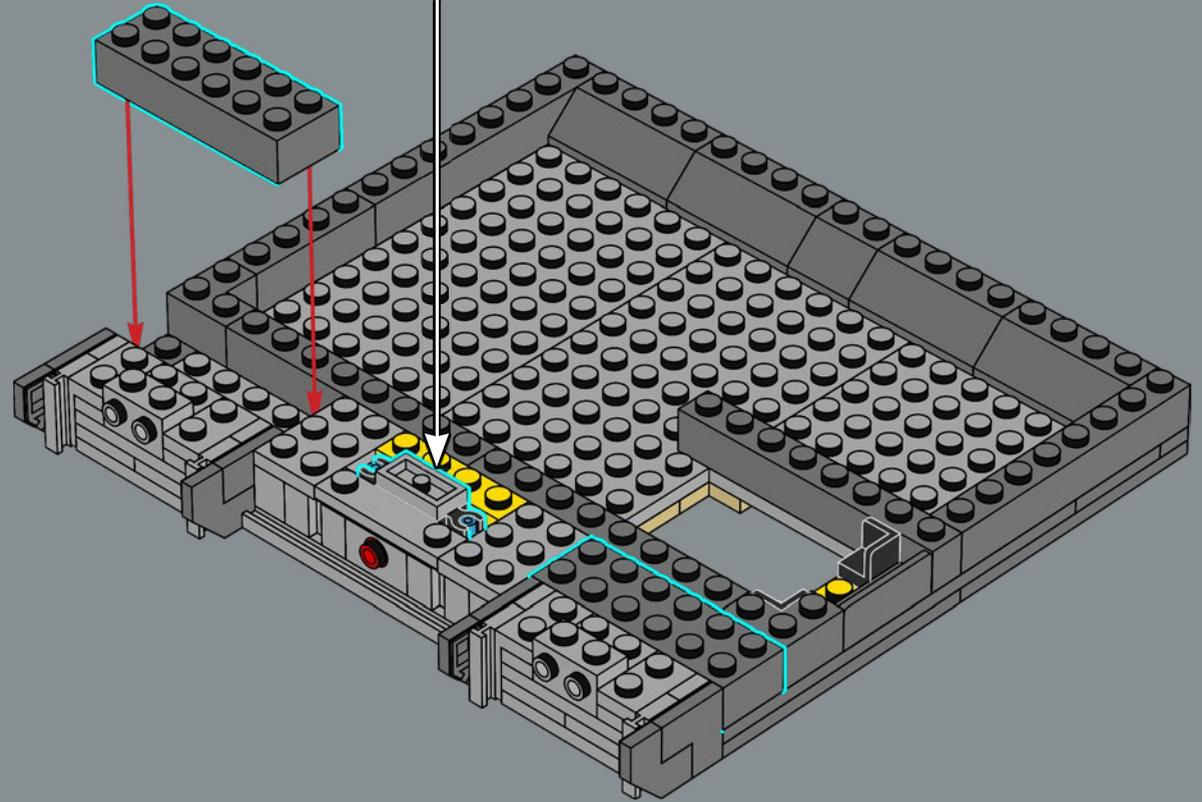
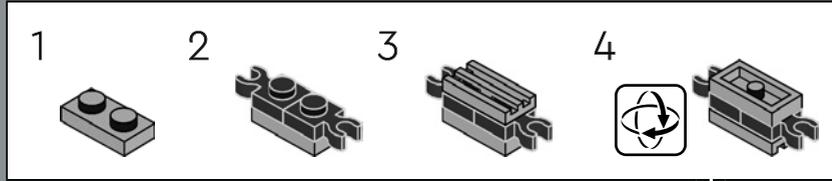

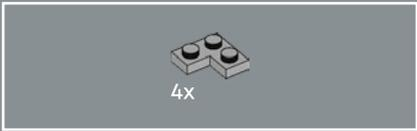

368

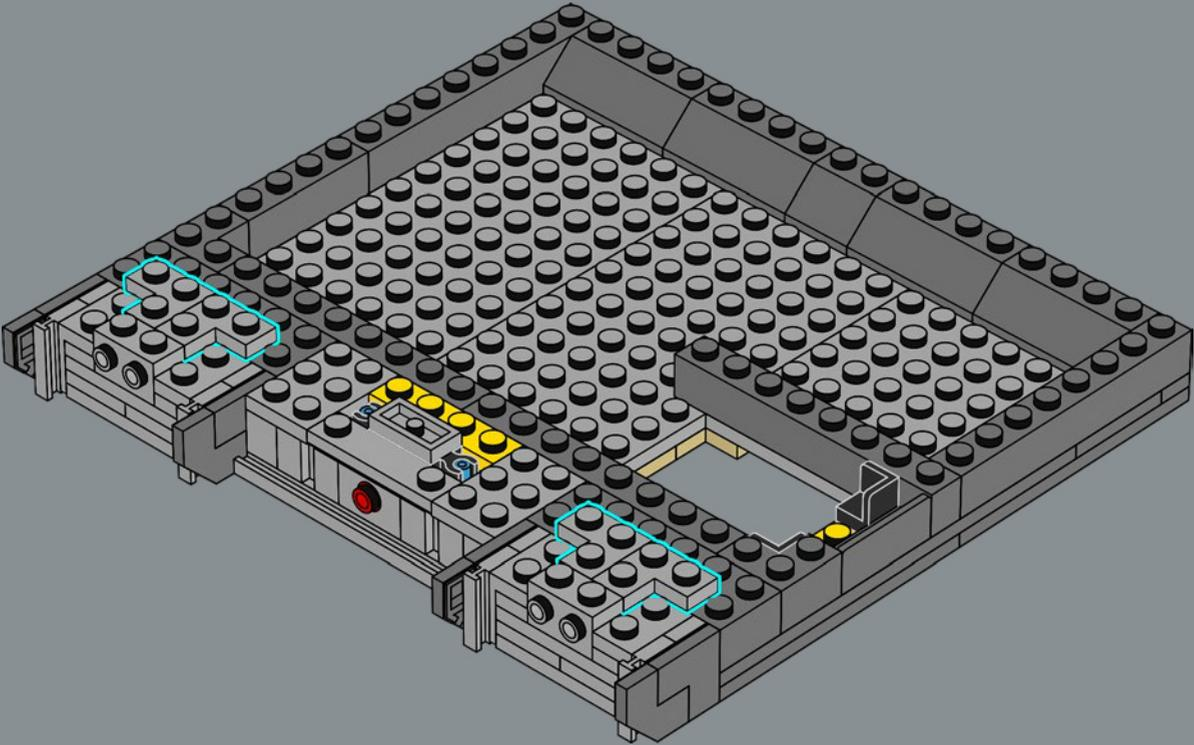

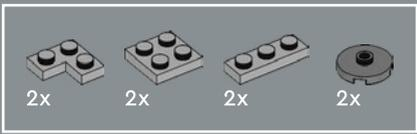

369

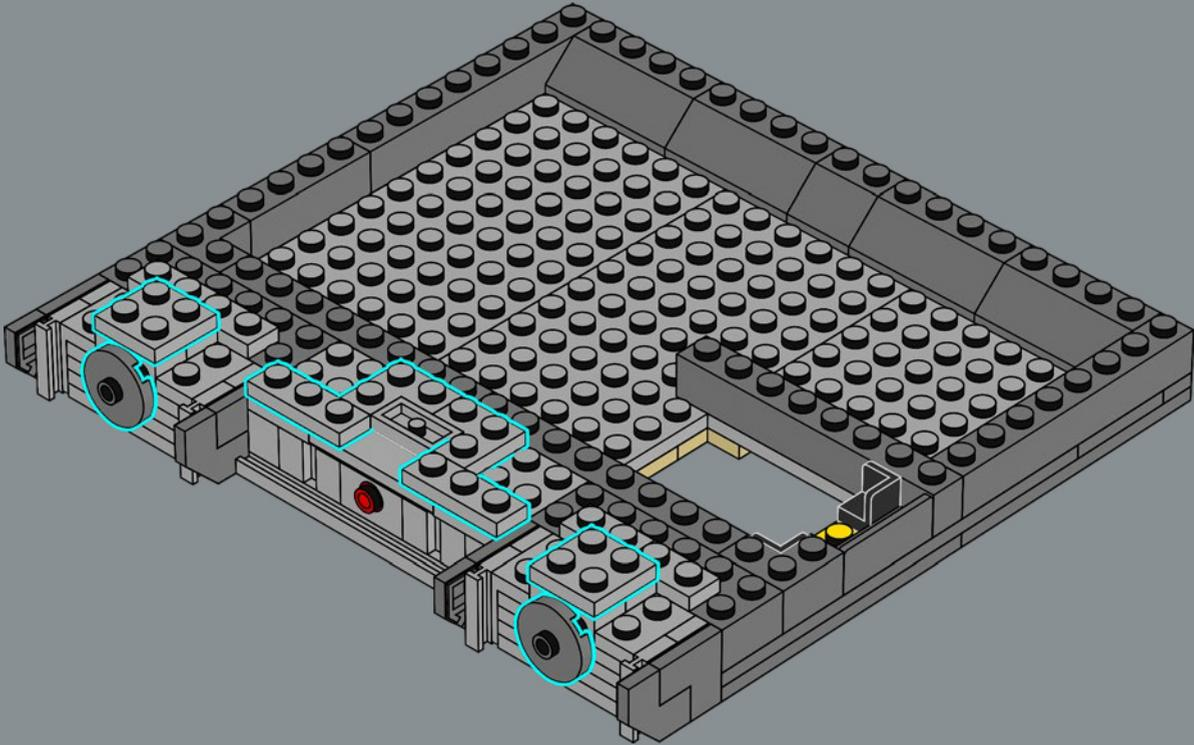



370

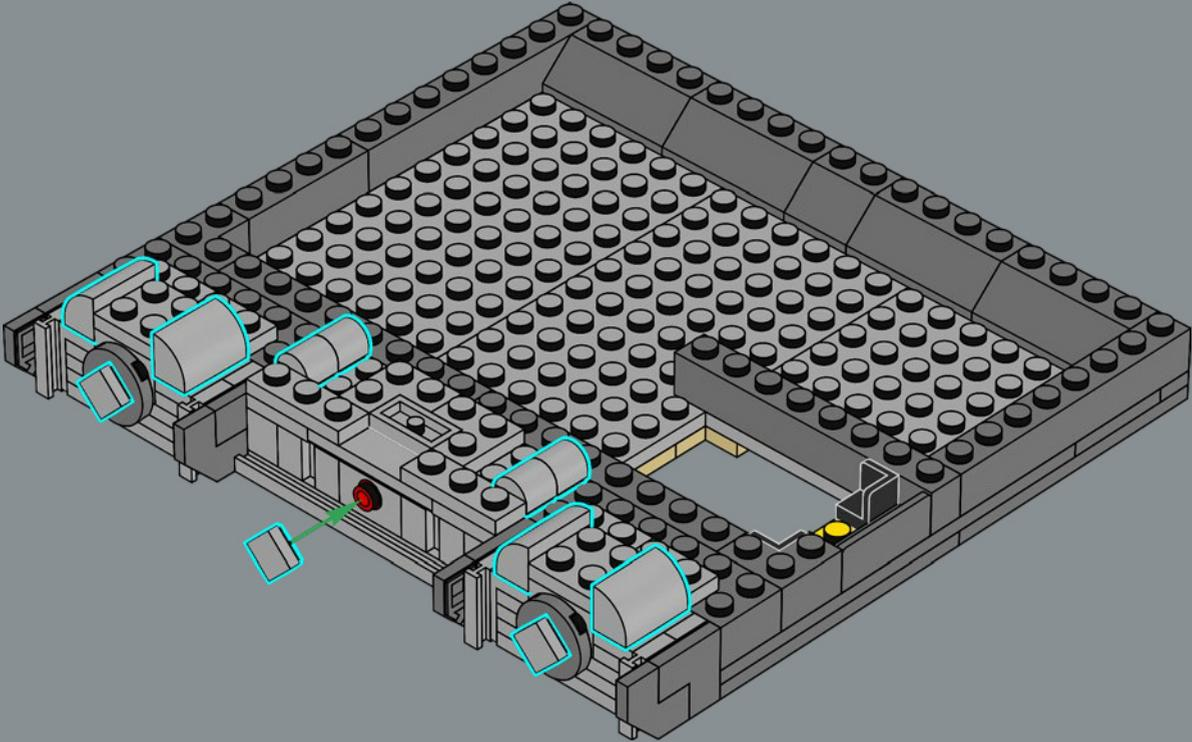

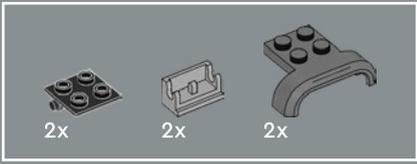

371

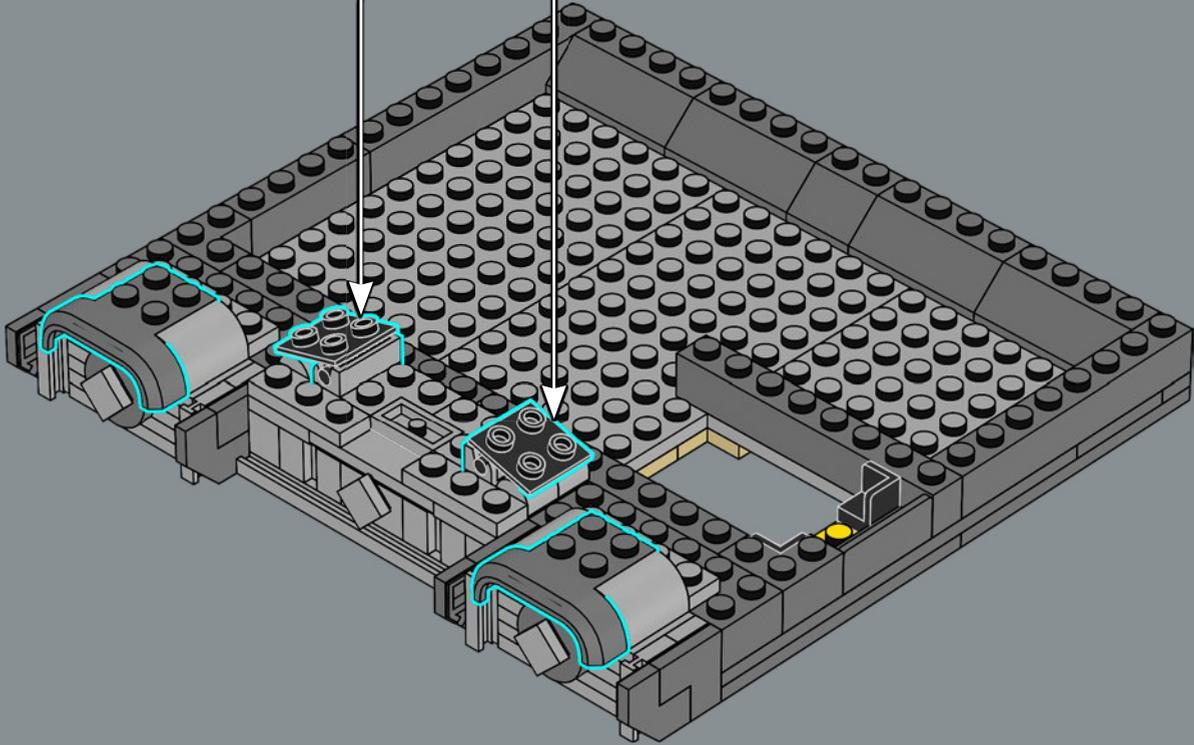
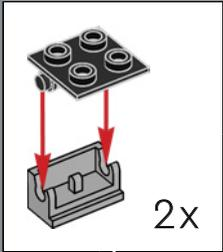



372

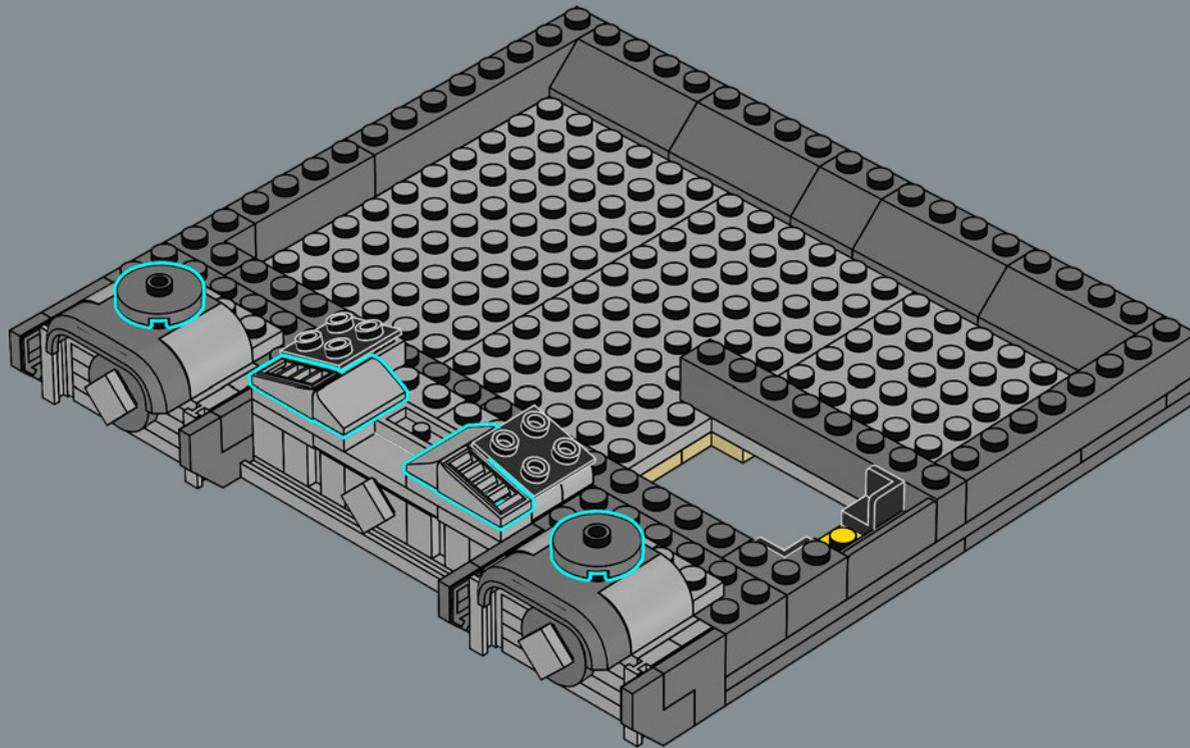

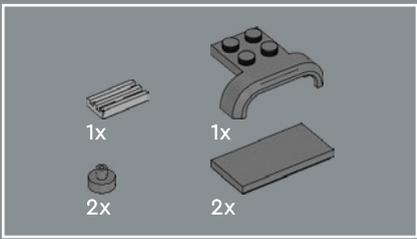

373

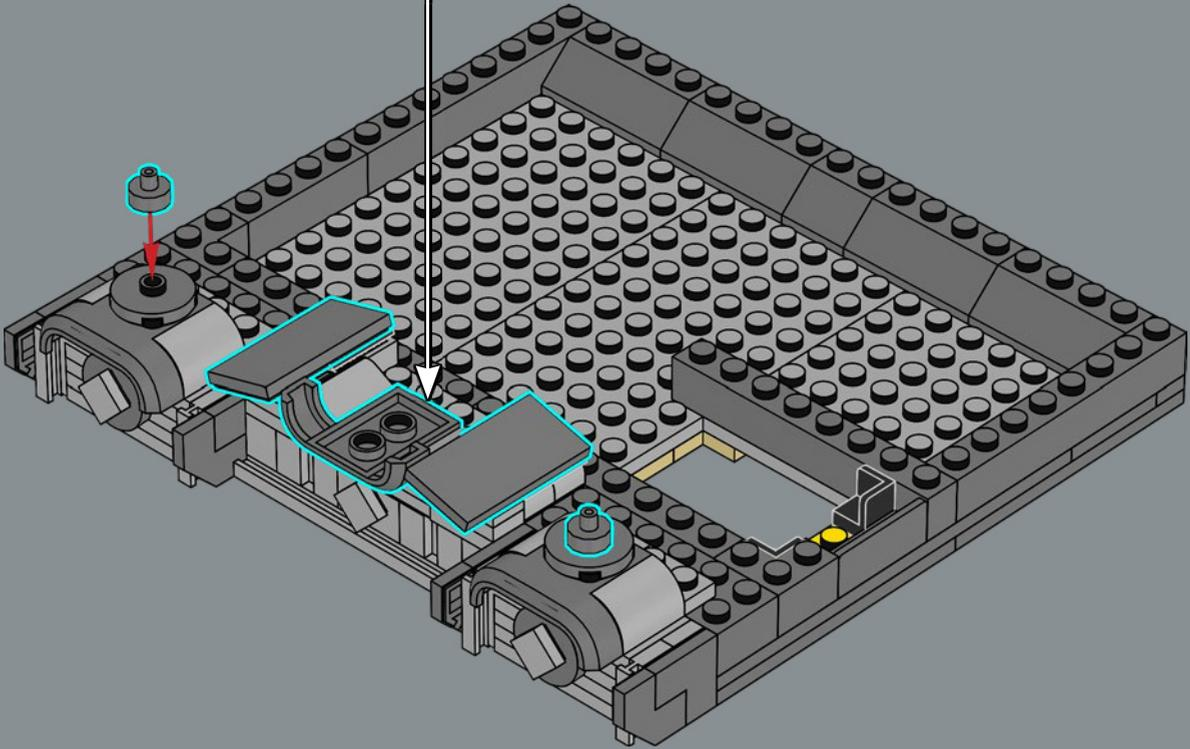
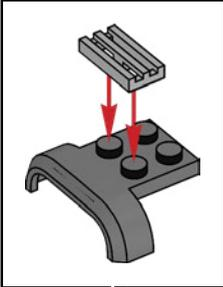





374

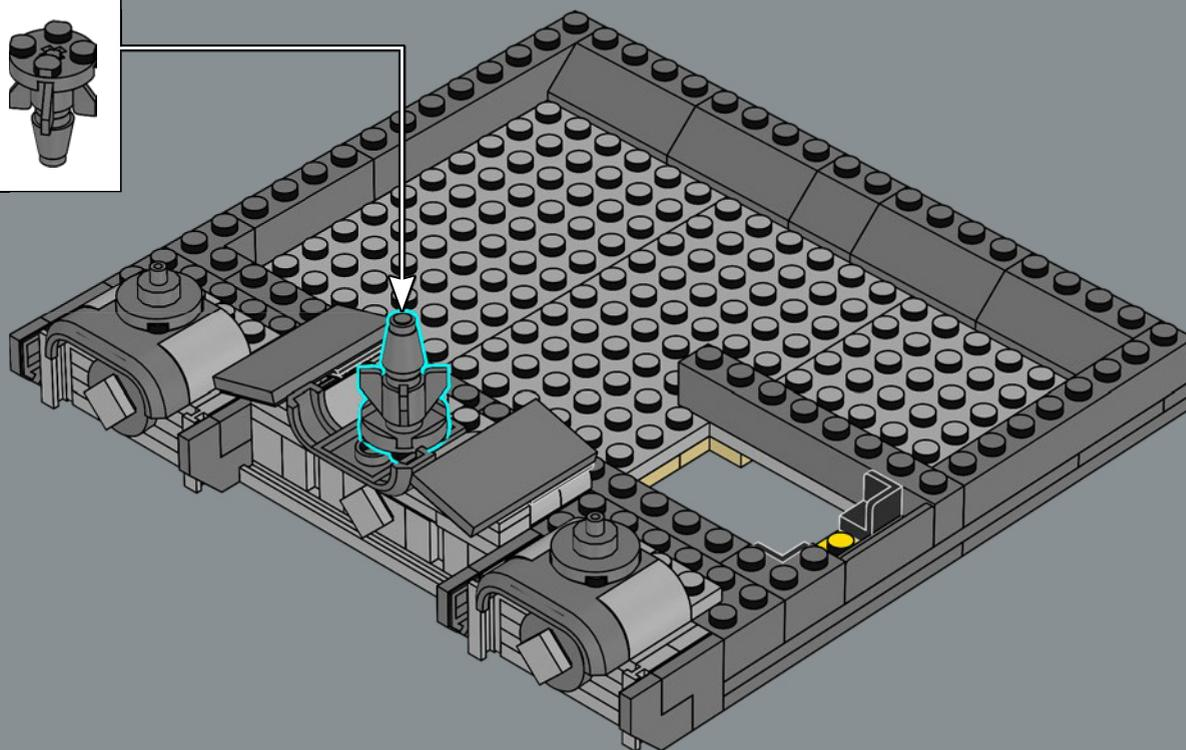
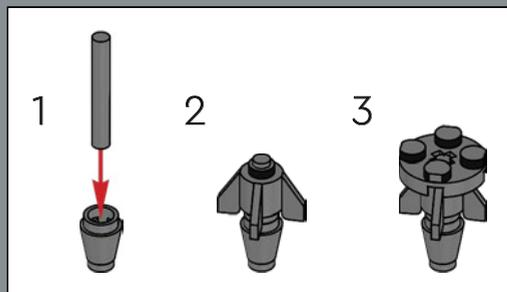

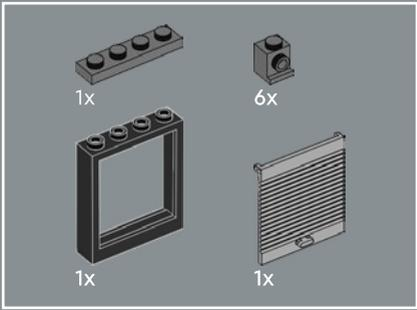

375

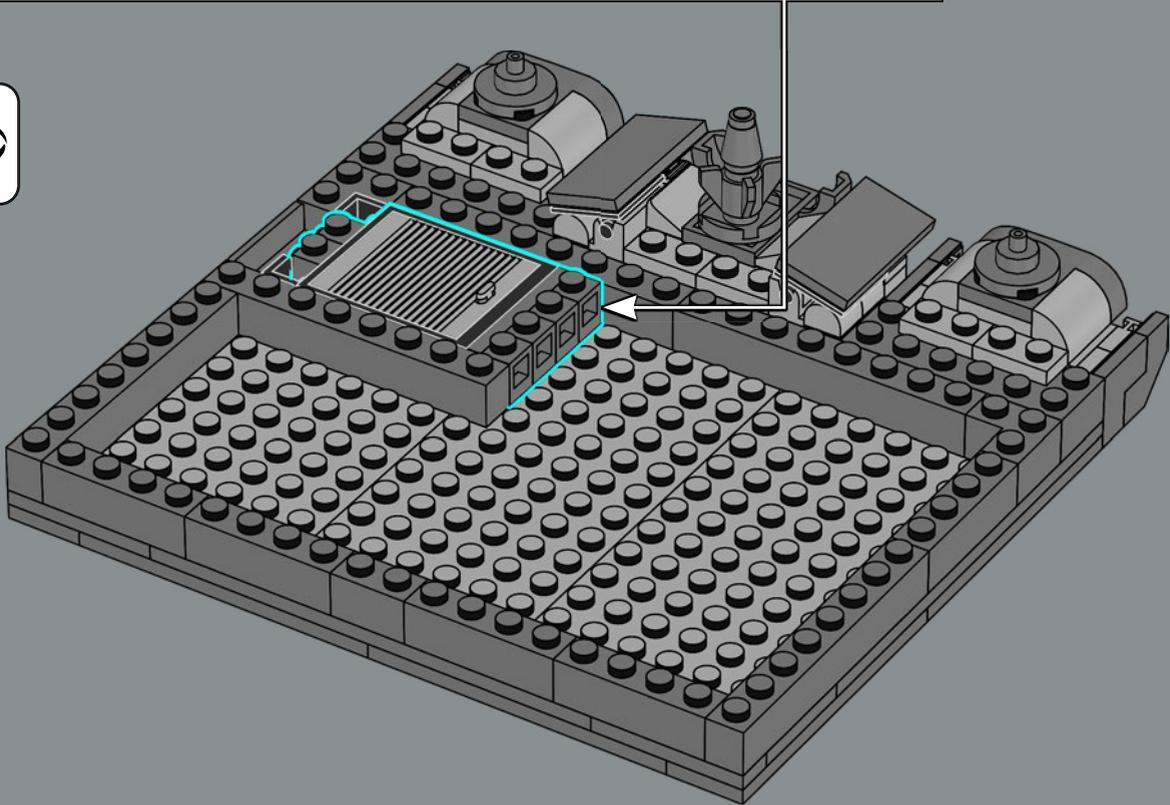
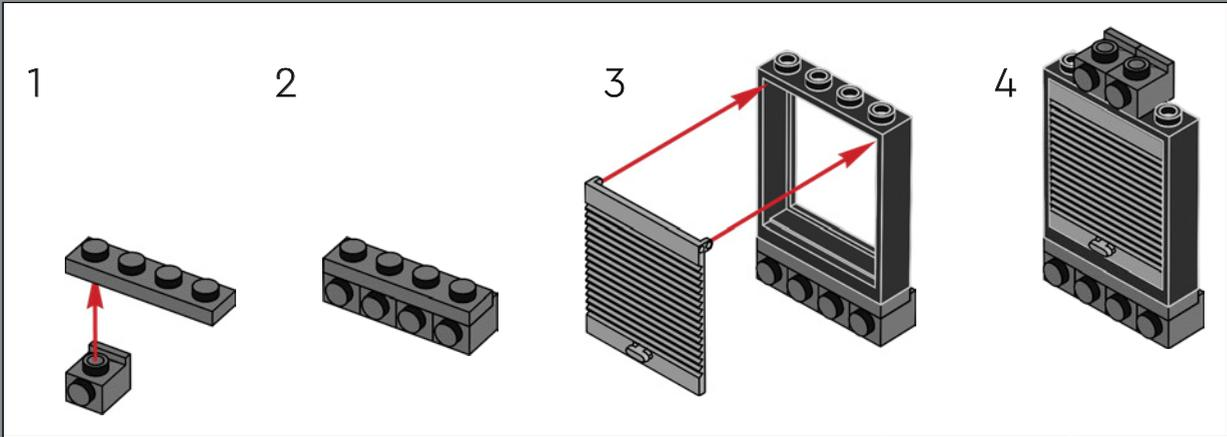

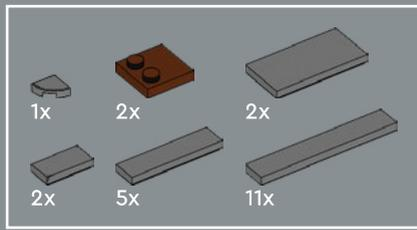

376

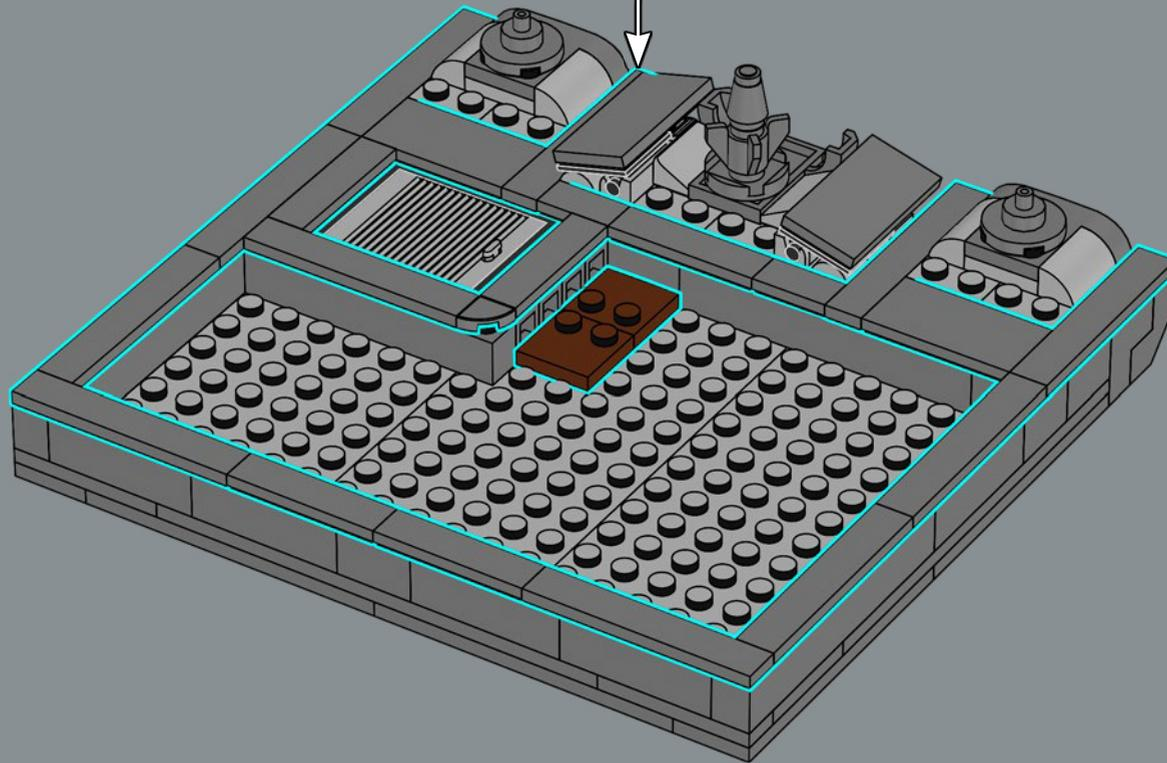
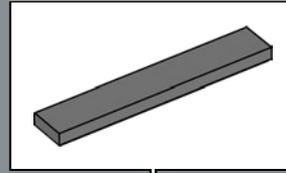

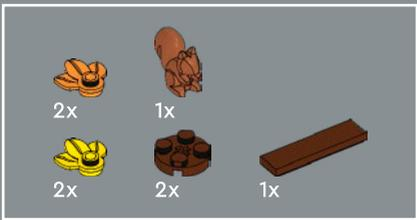

377

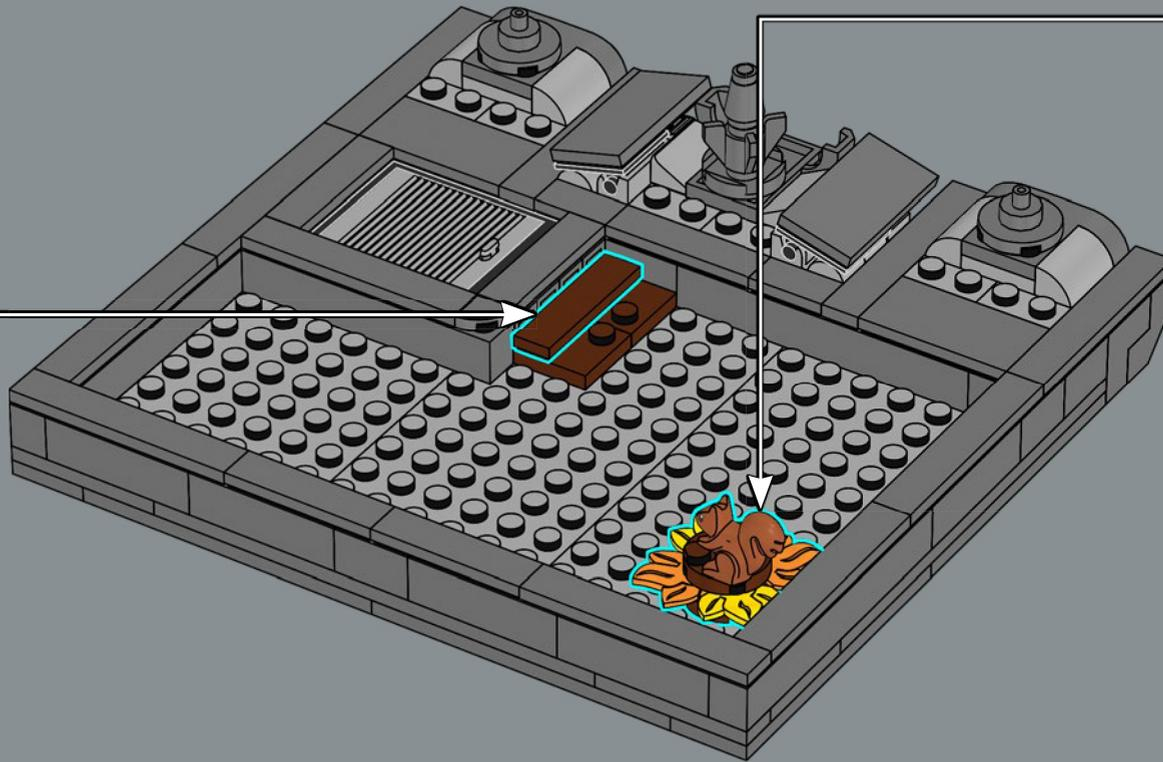
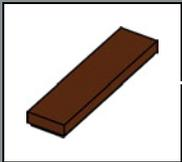
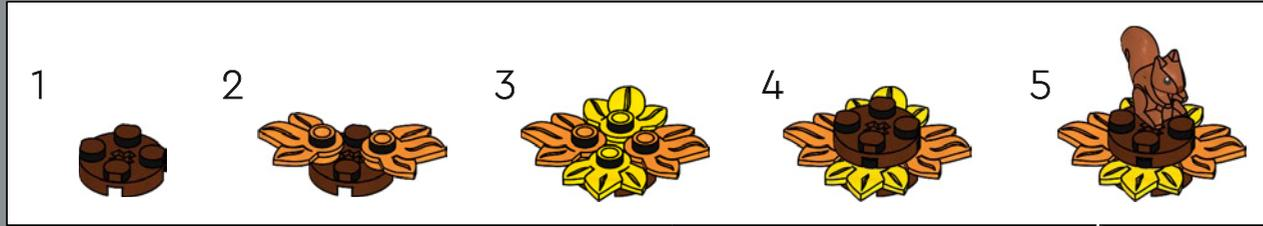



Hüte dich vor dem frechen Eichhörnchen! Wenn du dir ein Stück Pizza holst, darfst du dich nicht wundern, wenn es aus deinen Händen verschwindet und auf dem Dach landet!

378



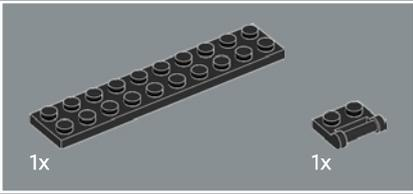

379

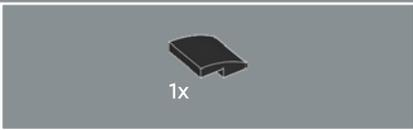
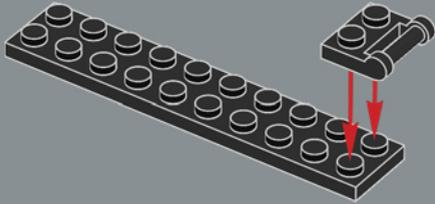

380

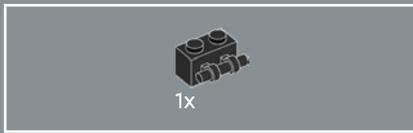
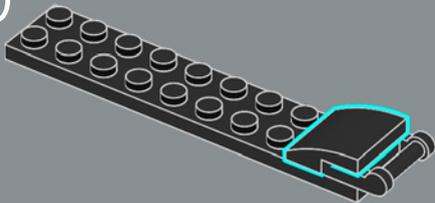

381

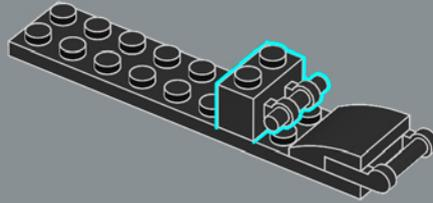

382

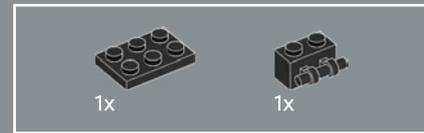
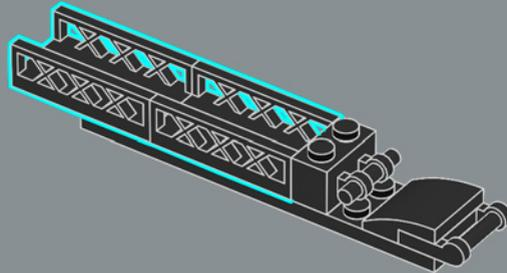

383

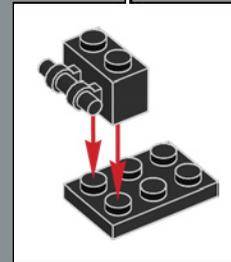
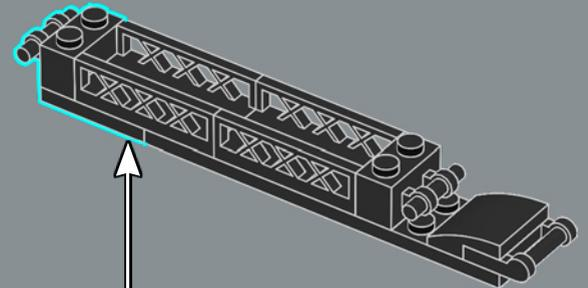

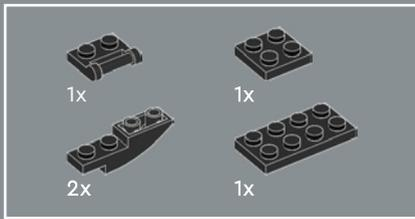

384

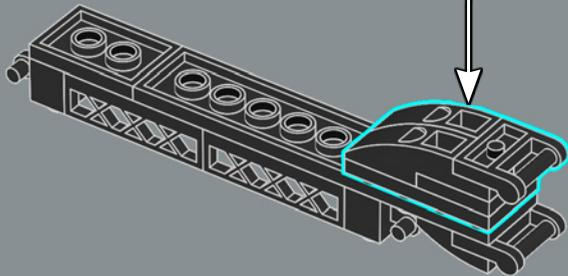
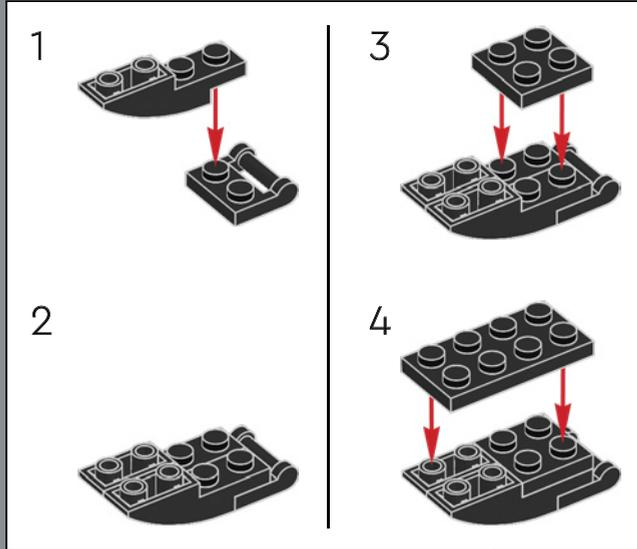

385

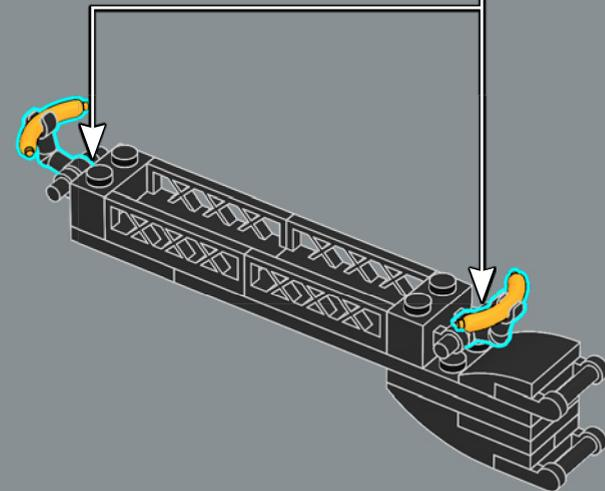
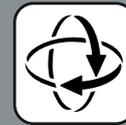
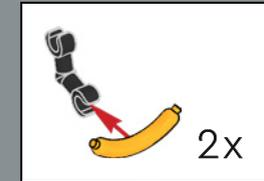

Die LEGO® Wurst hat schon häufig wertvolle Dienste geleistet. Bisher war sie bereits in 9 Farben in Dutzenden LEGO Sets enthalten.



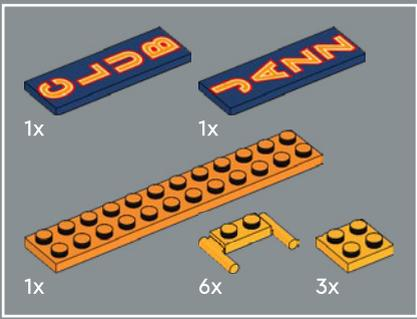

386

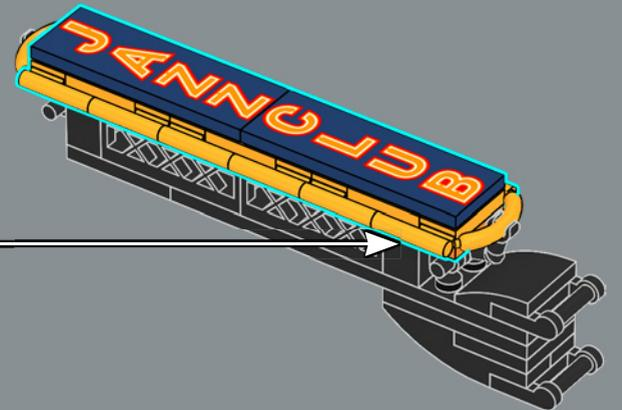
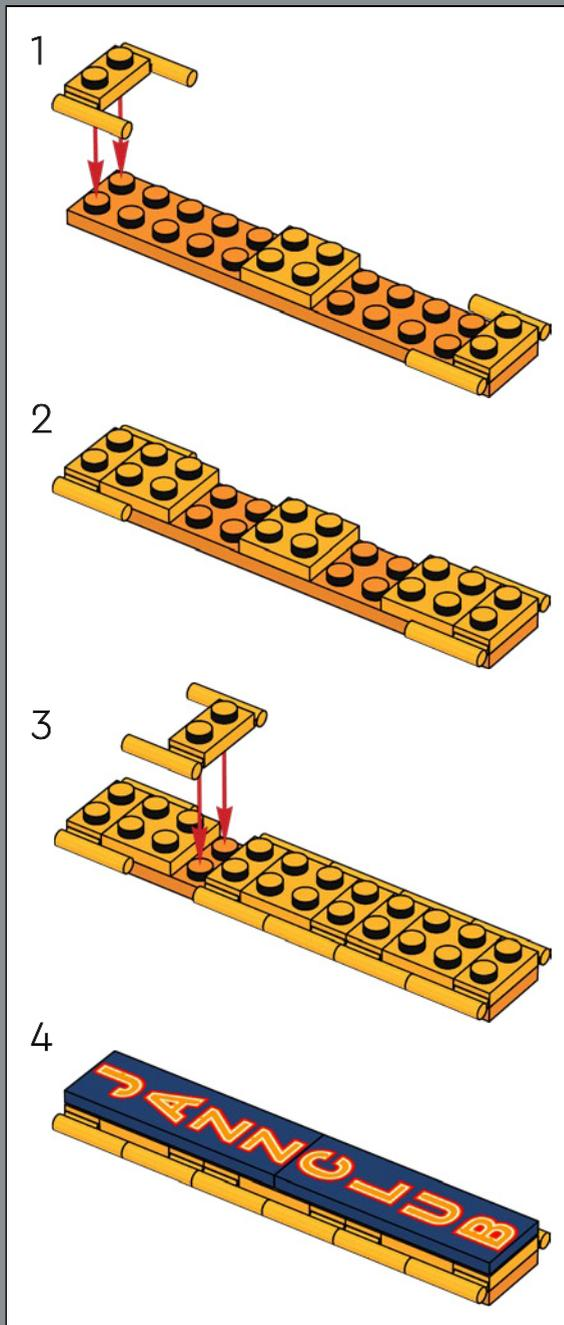



387



Der Lieferbote bringt die Pizza gern in jedes Viertel der Stadt. Wundere dich jedoch nicht, wenn er sich ein wenig verspäten sollte. Er hört sich nämlich gern die Shows im Jazzclub an. Manchmal lässt er sich dort kaum losreißen.



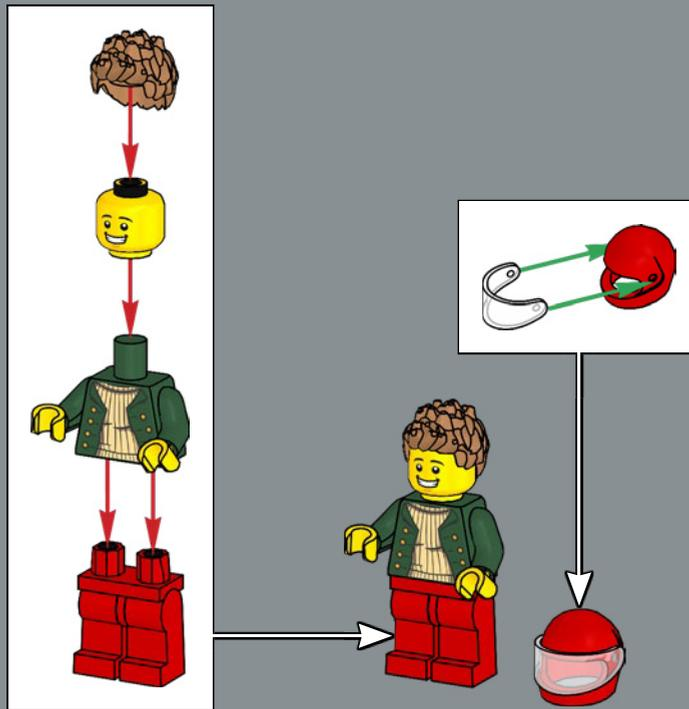

1

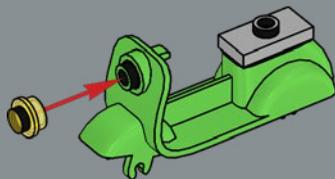

2

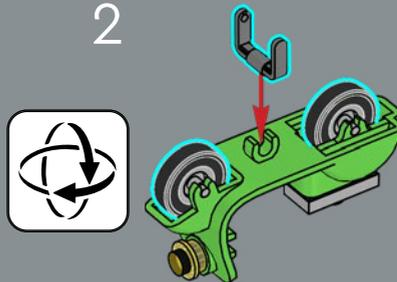

3



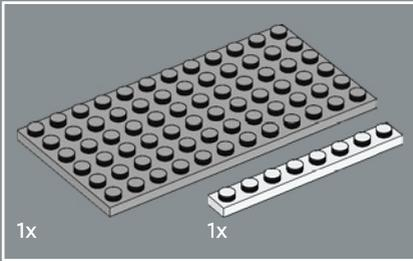
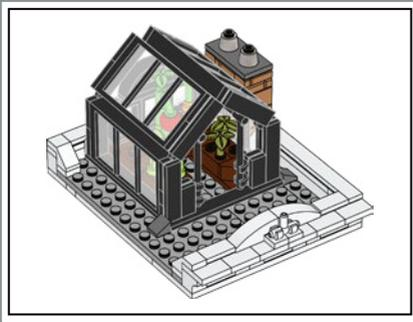

388

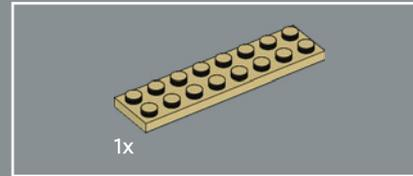
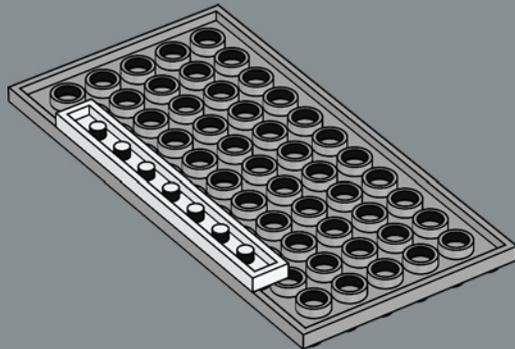

389

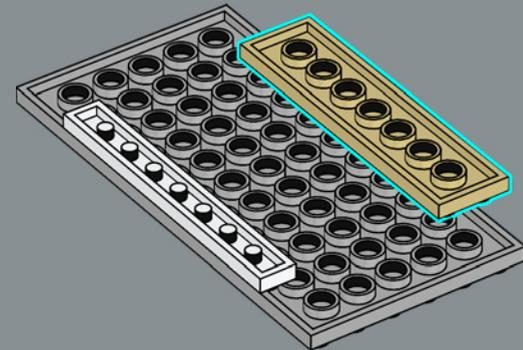

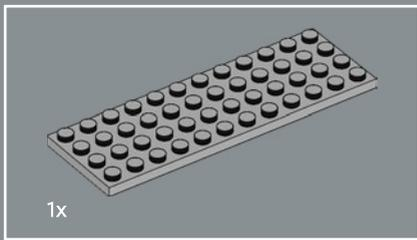

390

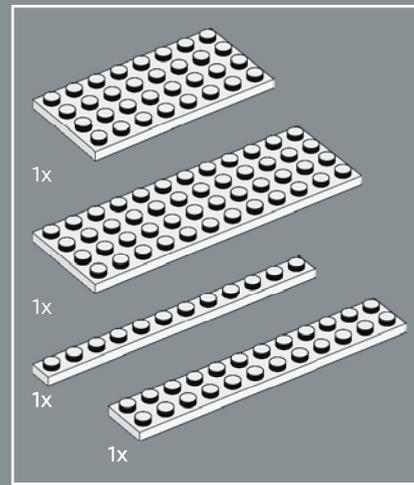
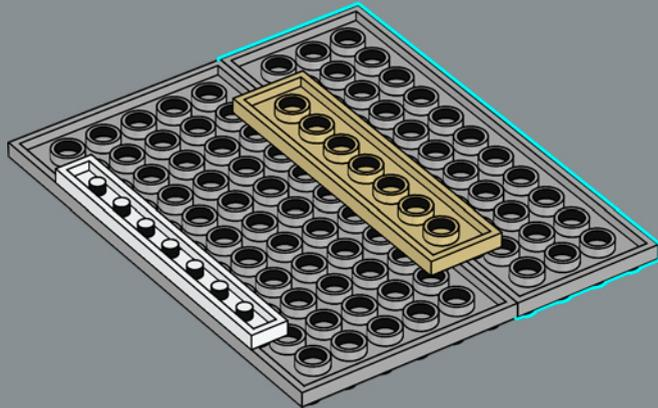

391

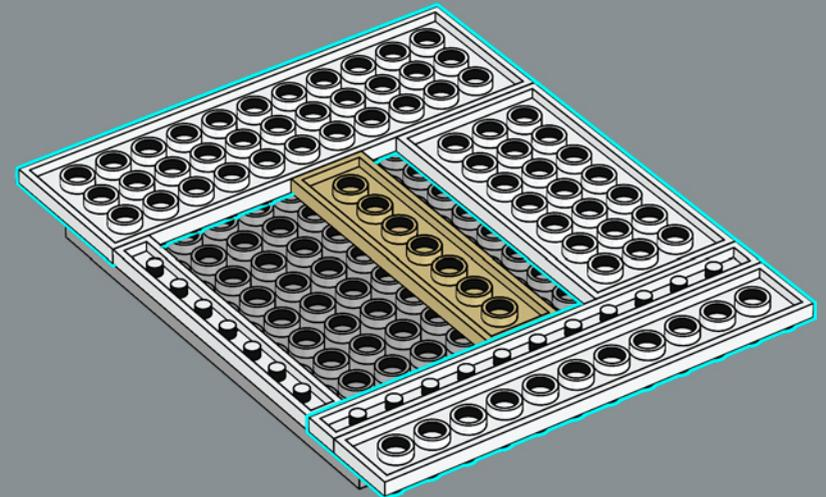

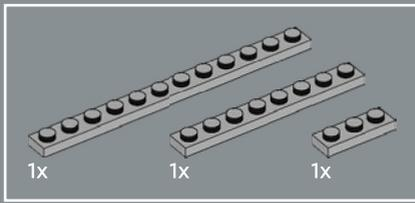

392

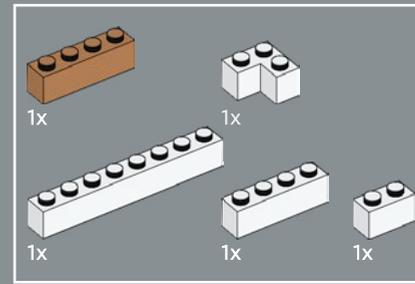
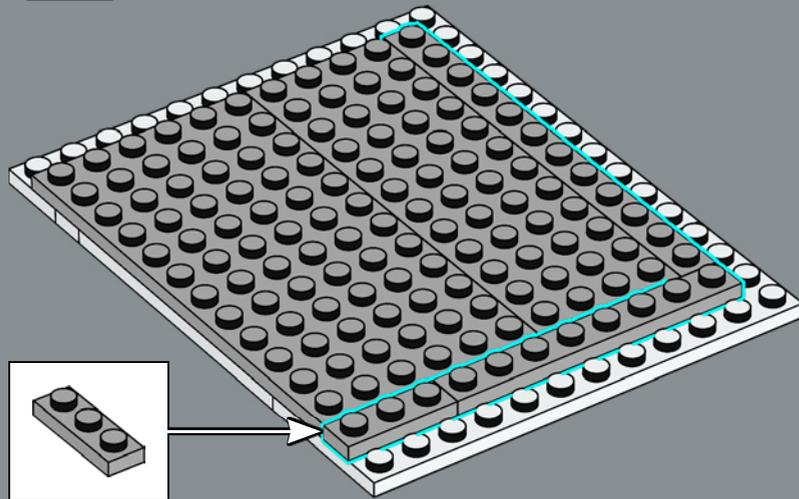

393

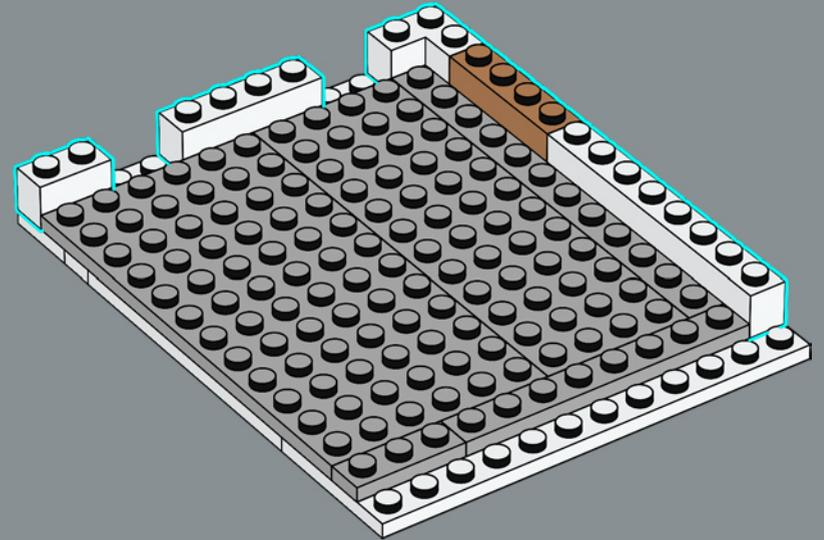



3x

394

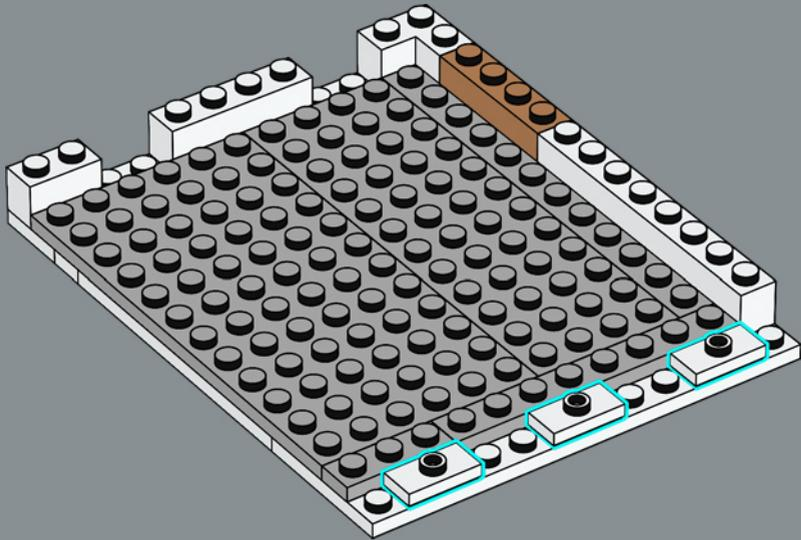

1x



1x

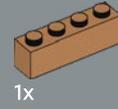

1x

395

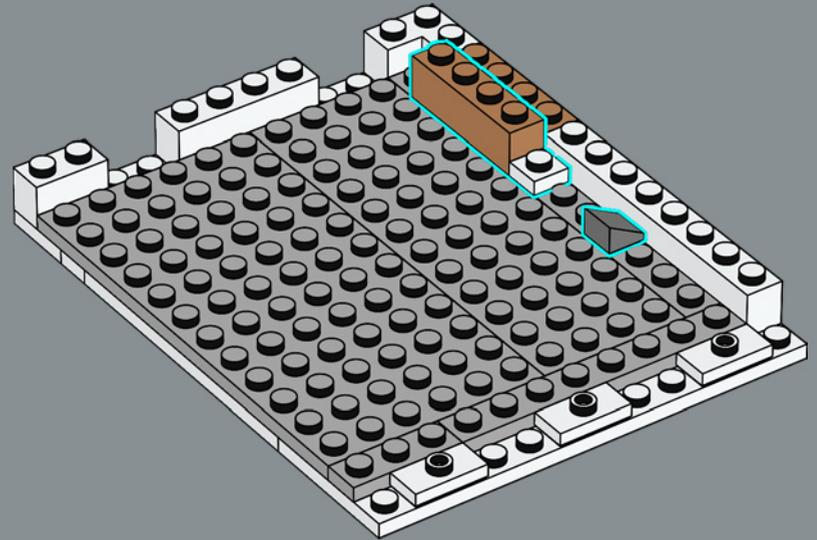

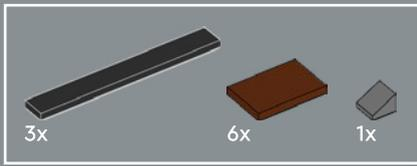

396

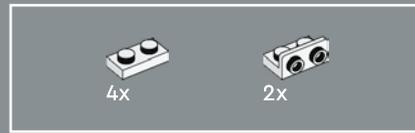
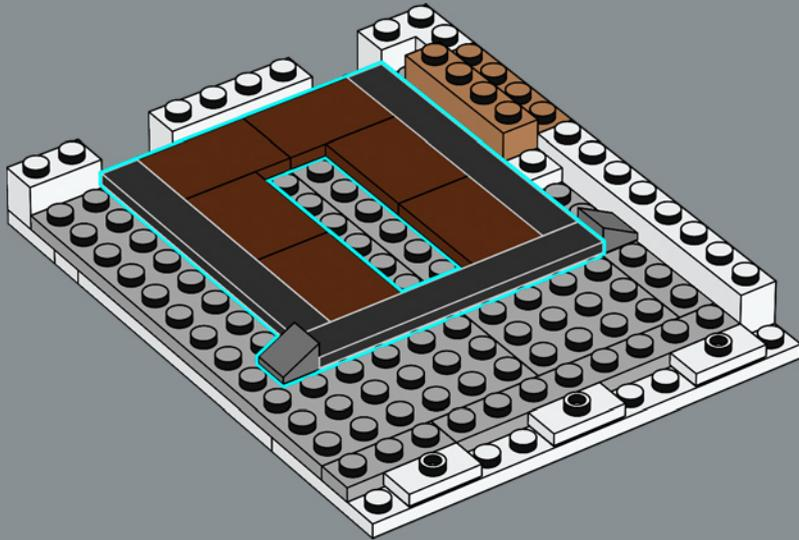

397

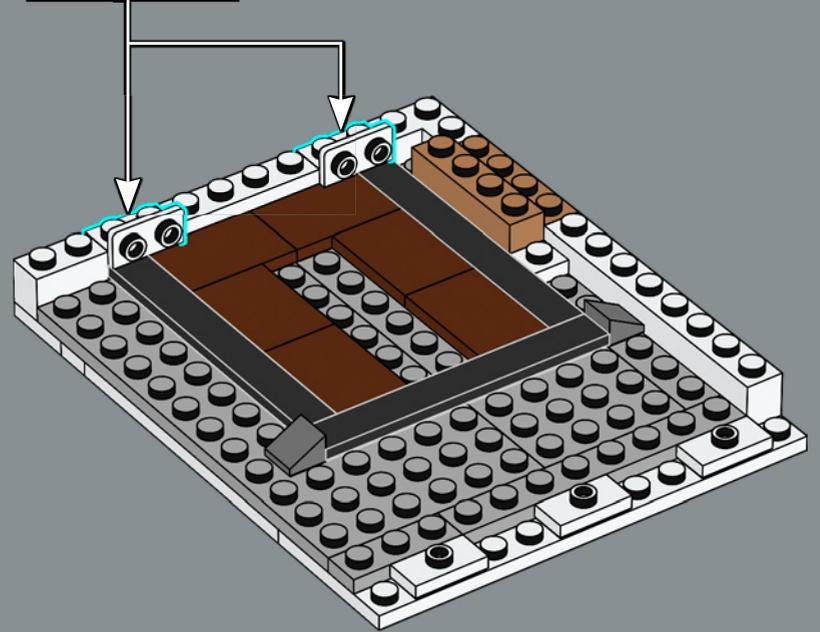
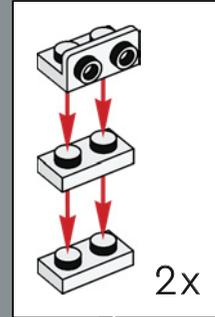

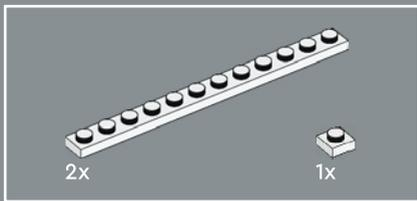

398

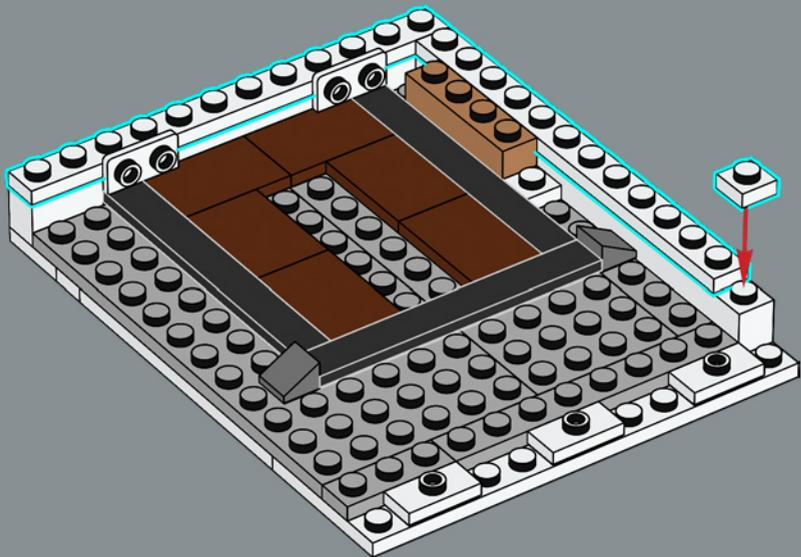

399

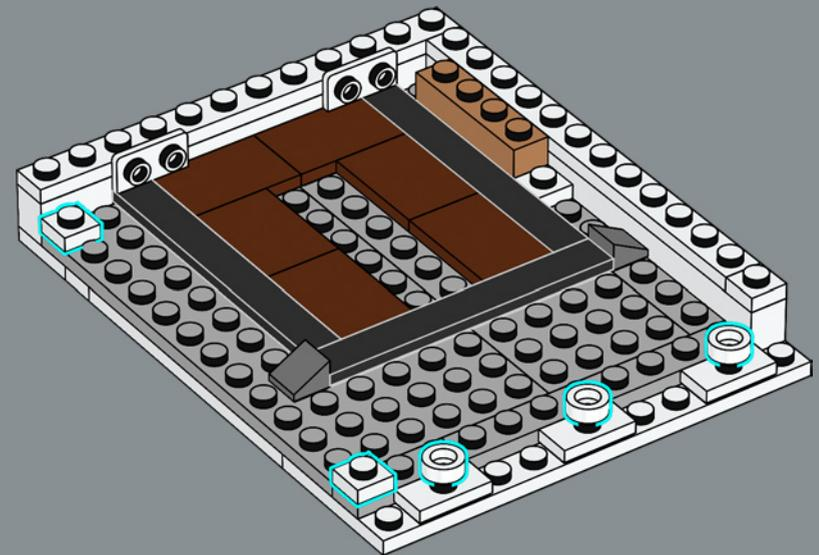





400

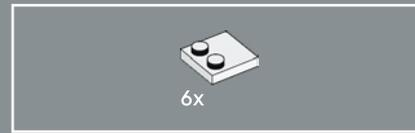
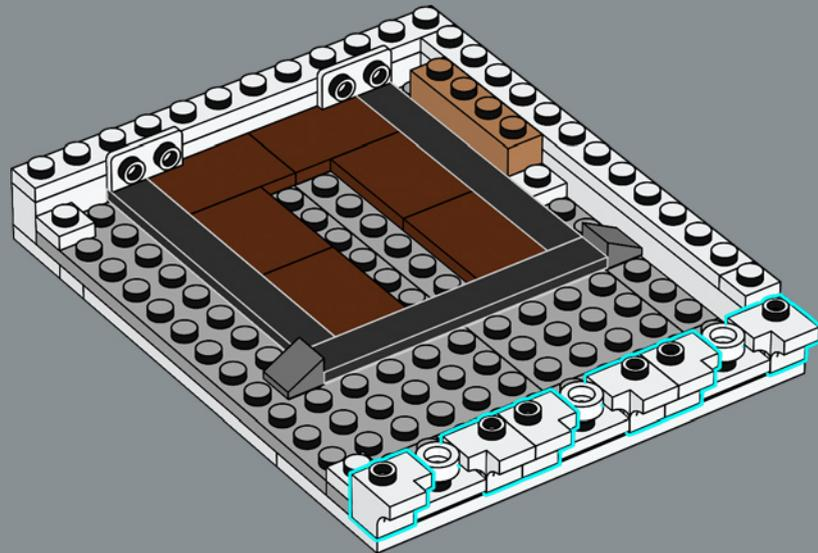

401

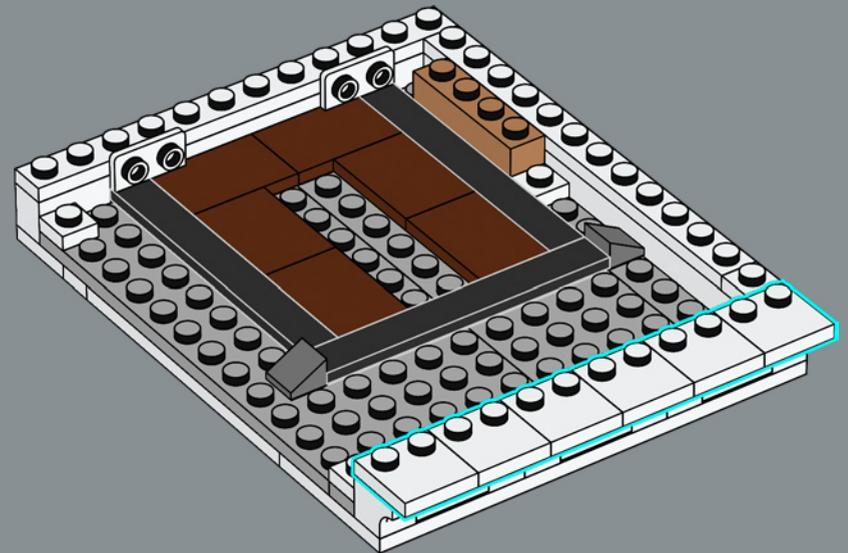

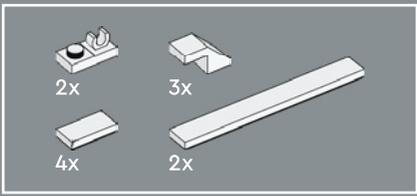

402

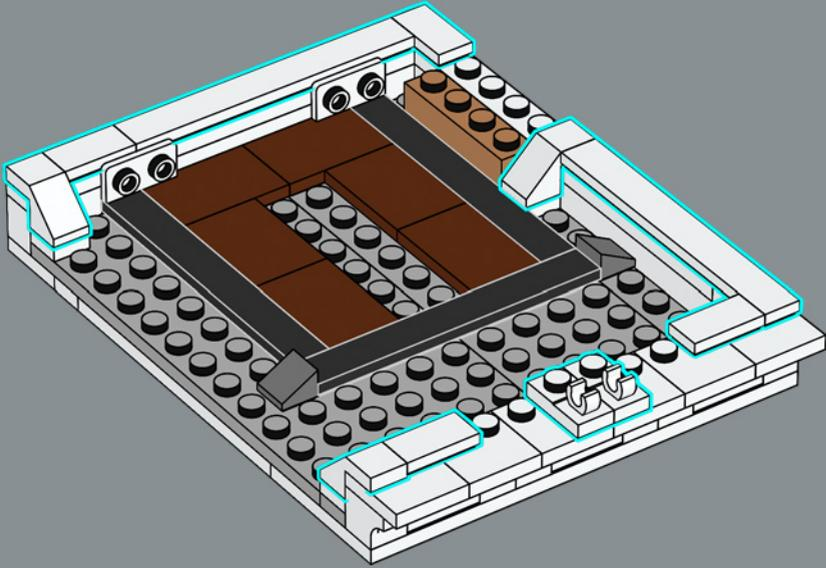

403

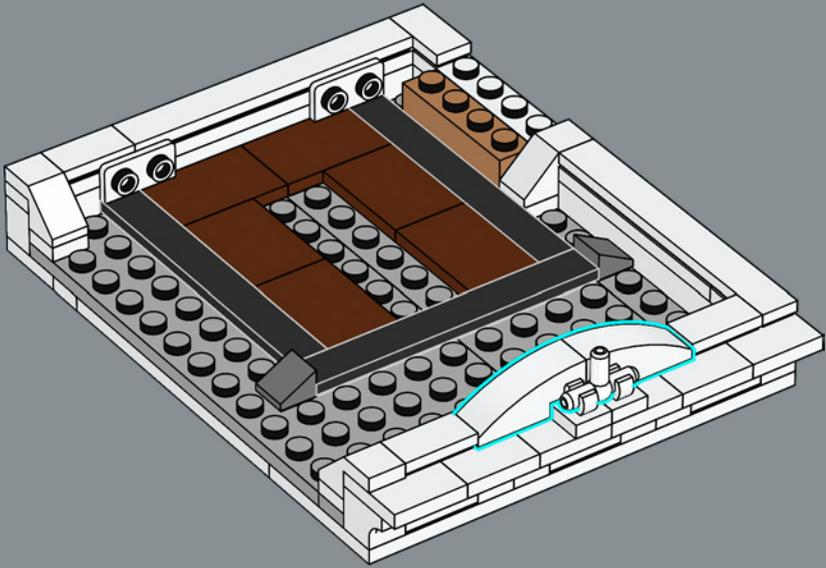

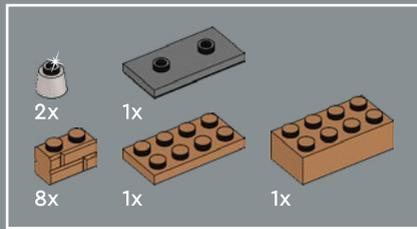

404

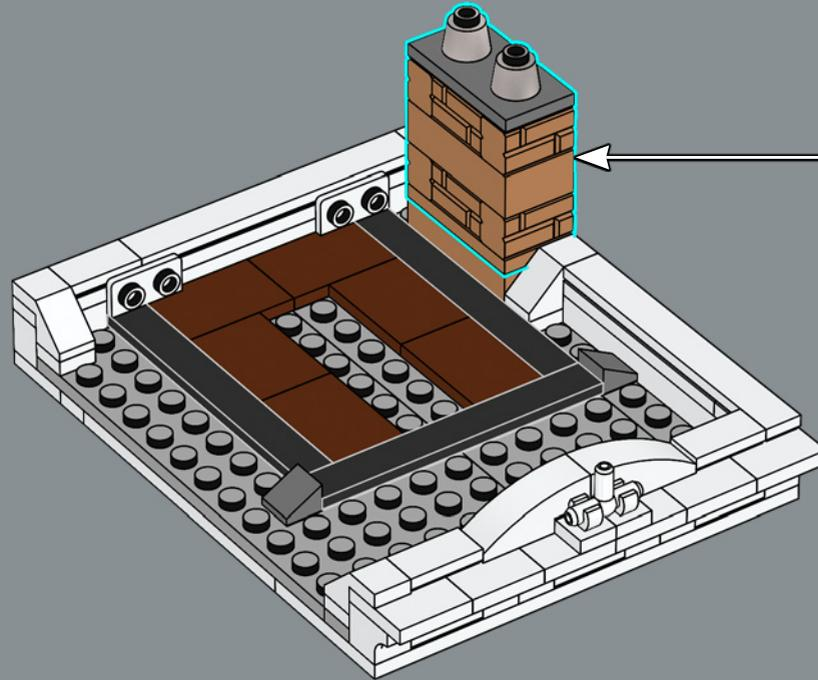
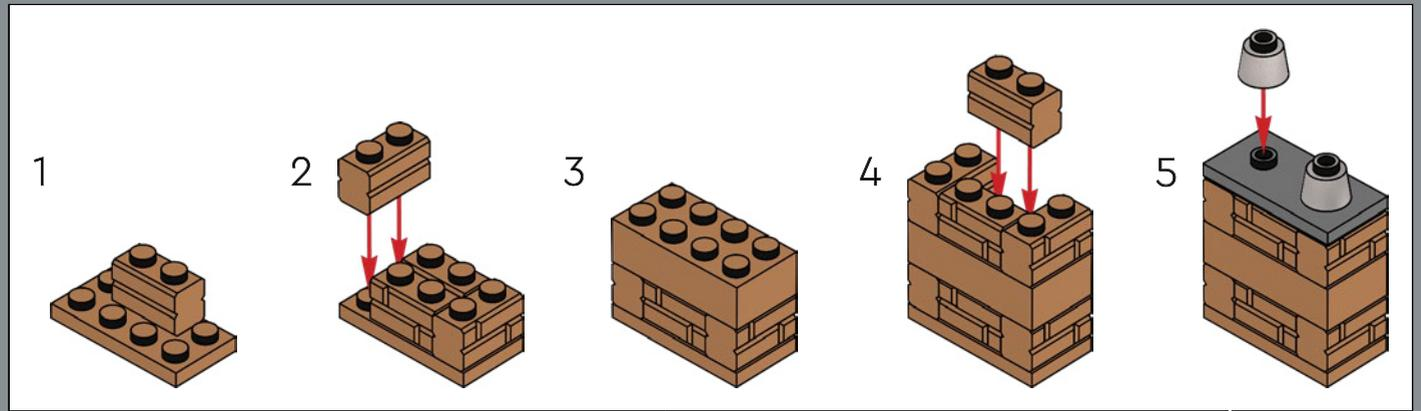

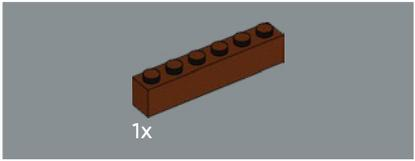

405

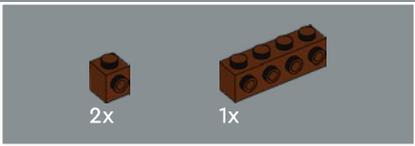
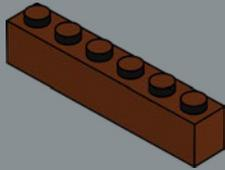

406

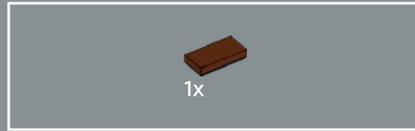
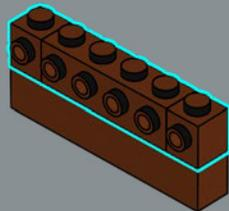

407

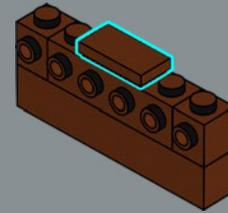

408

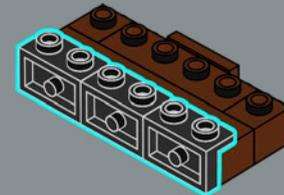
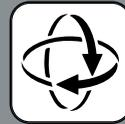

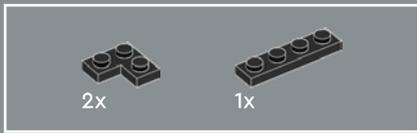

409

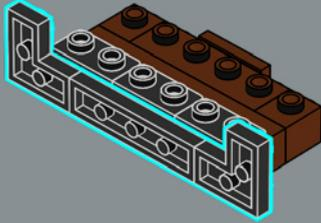

410

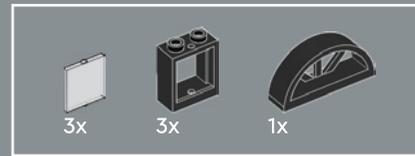
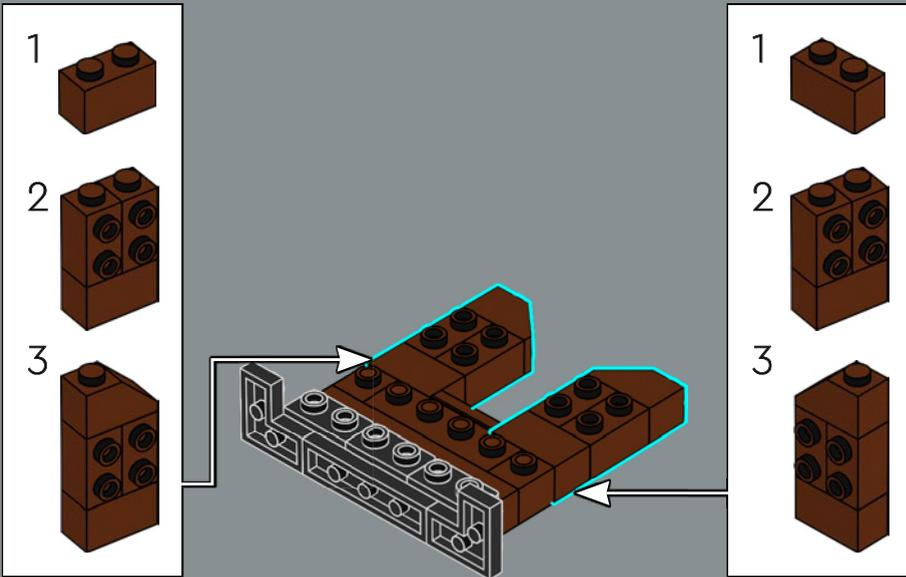

411

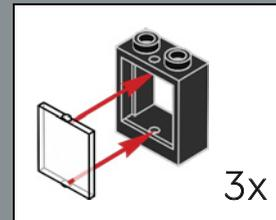
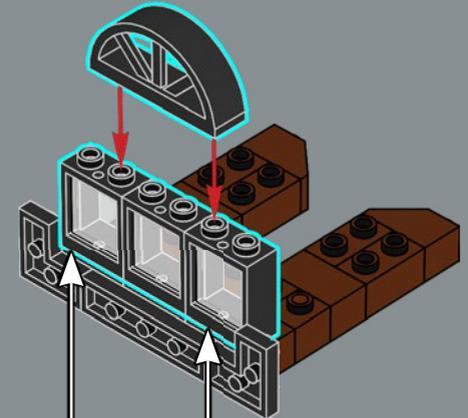



412

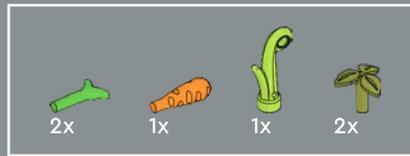
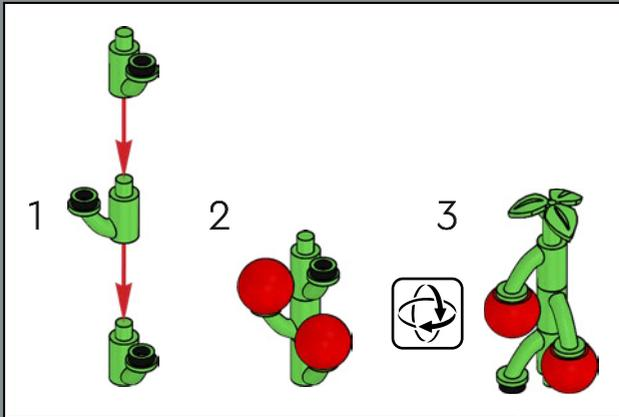

413



Der Pizzabäcker baut die Tomaten und viele Kräuter für seine Pizzen selbst an. Die Karotte ist jedoch dem Hasen der Magierin vorbehalten.

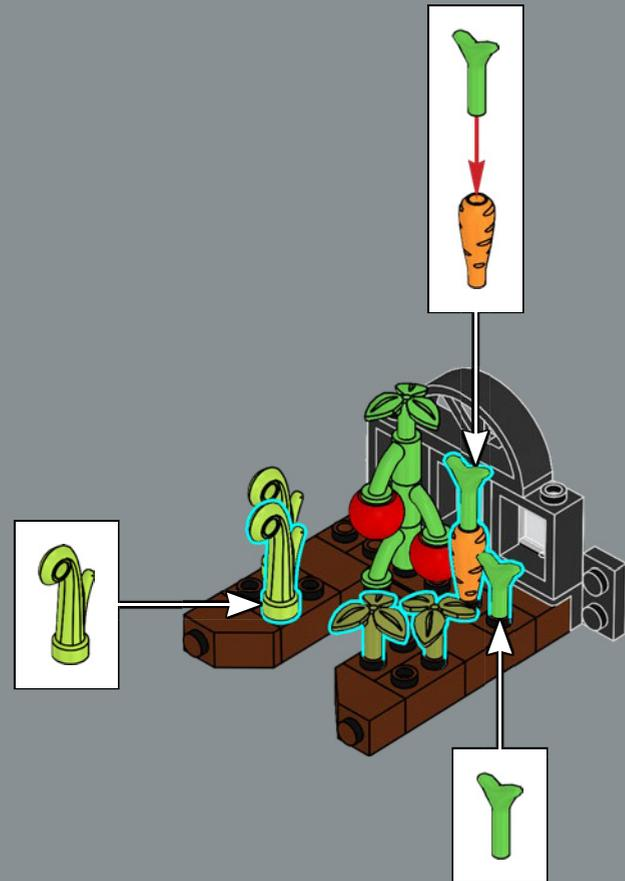

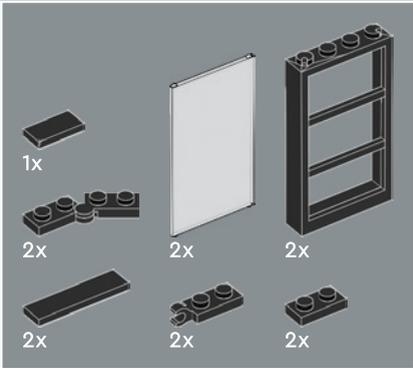

414

1



2

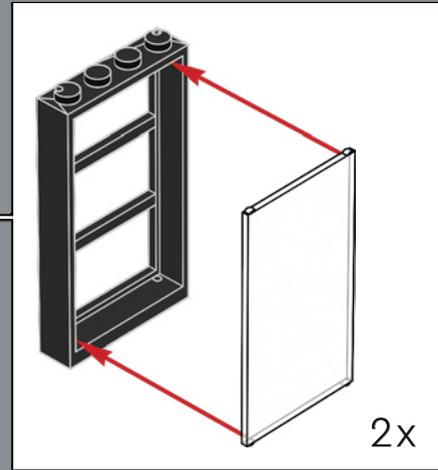
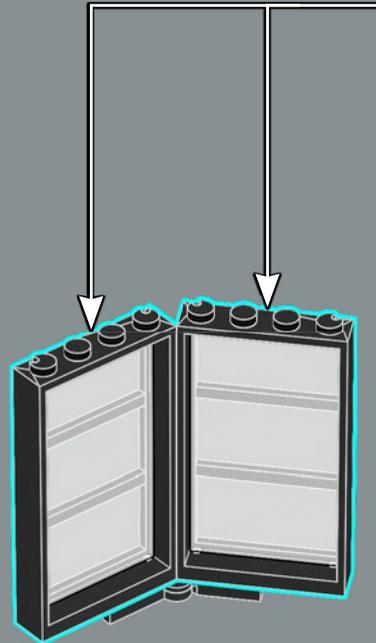

3

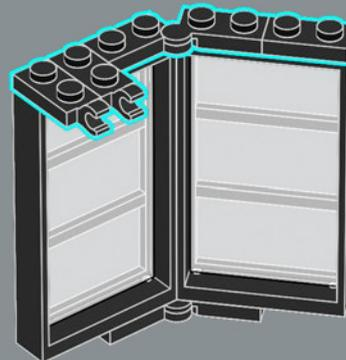

4

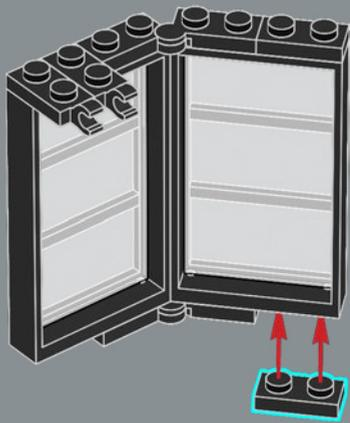

5

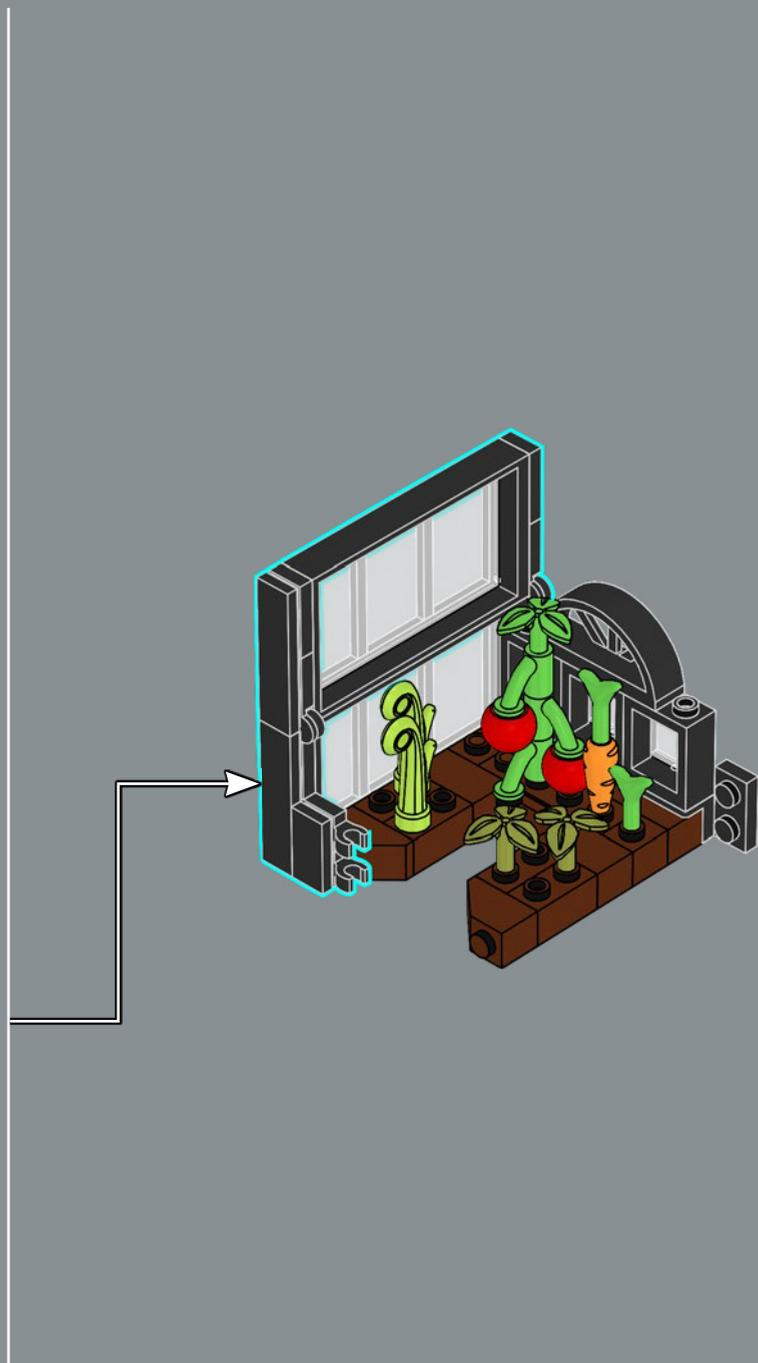
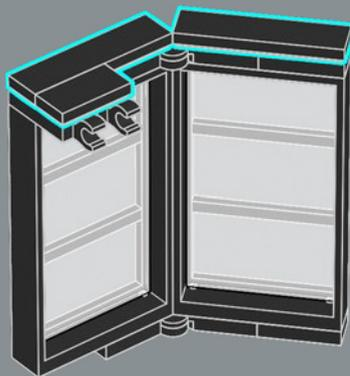



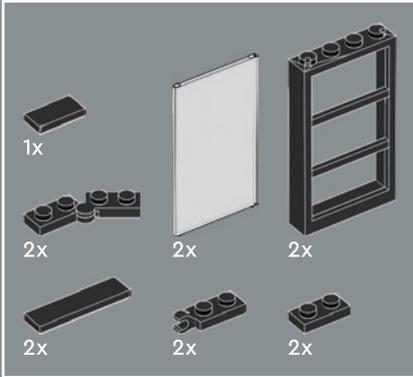
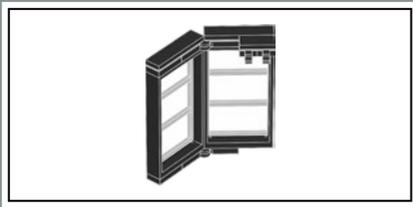

1

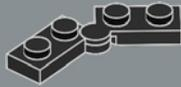

2

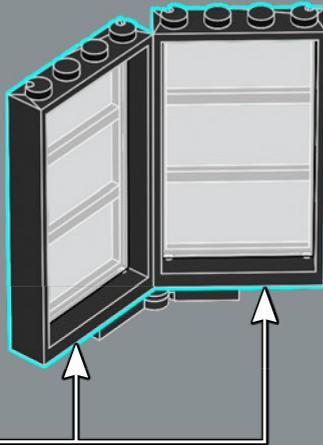

415

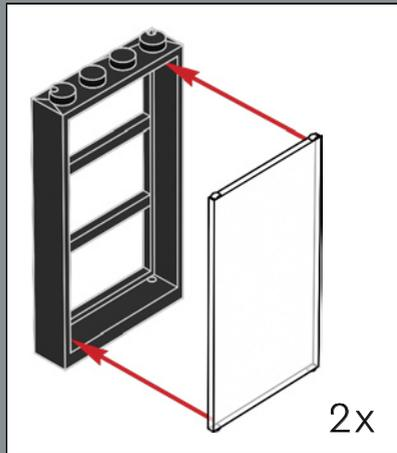

3

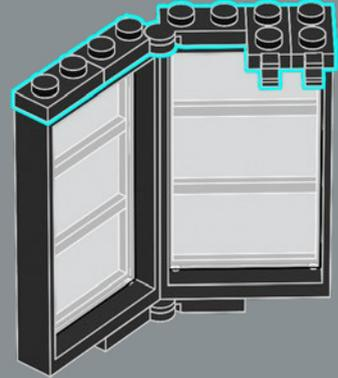

4

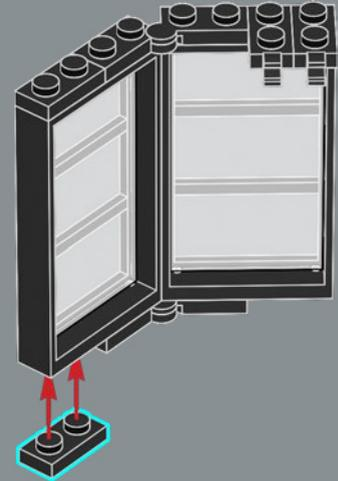

5

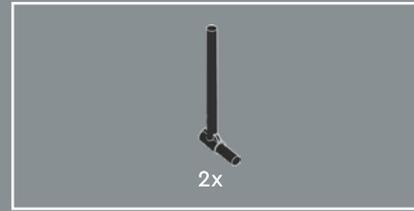
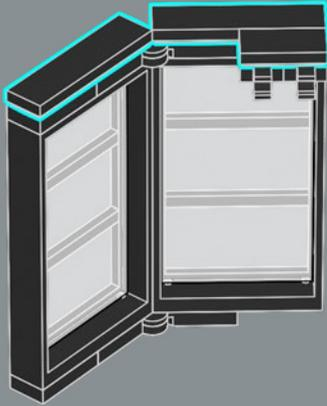

2x

416

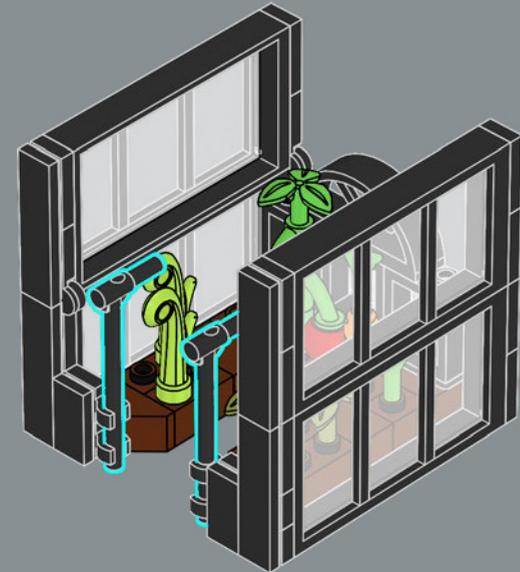
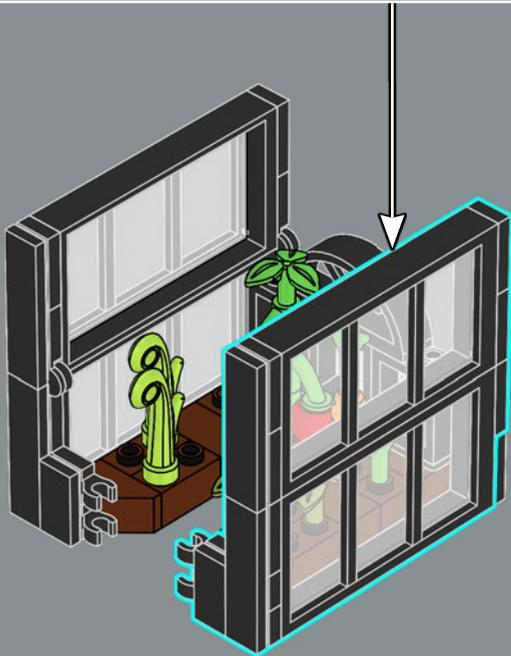

417



418



419





420

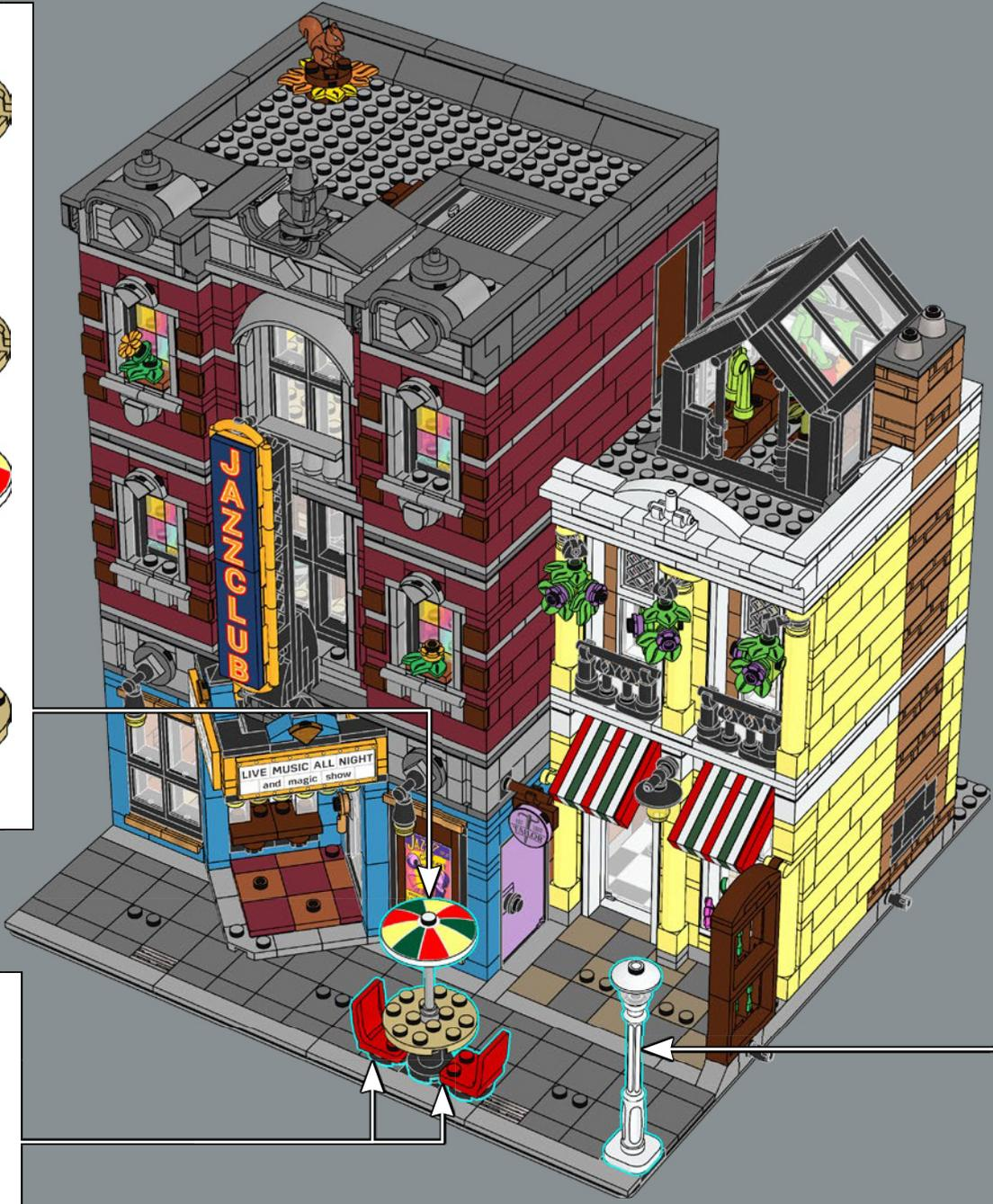
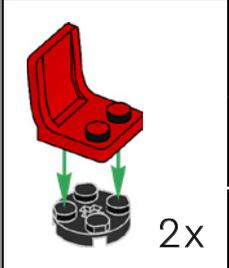
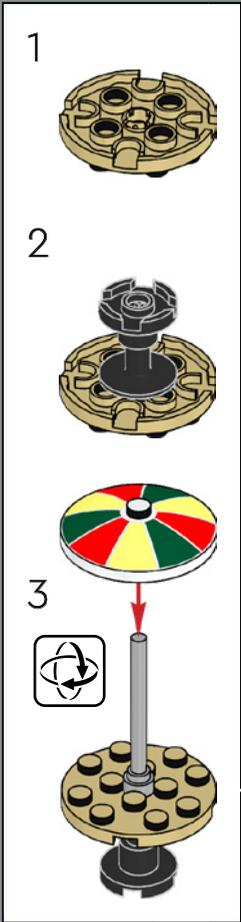



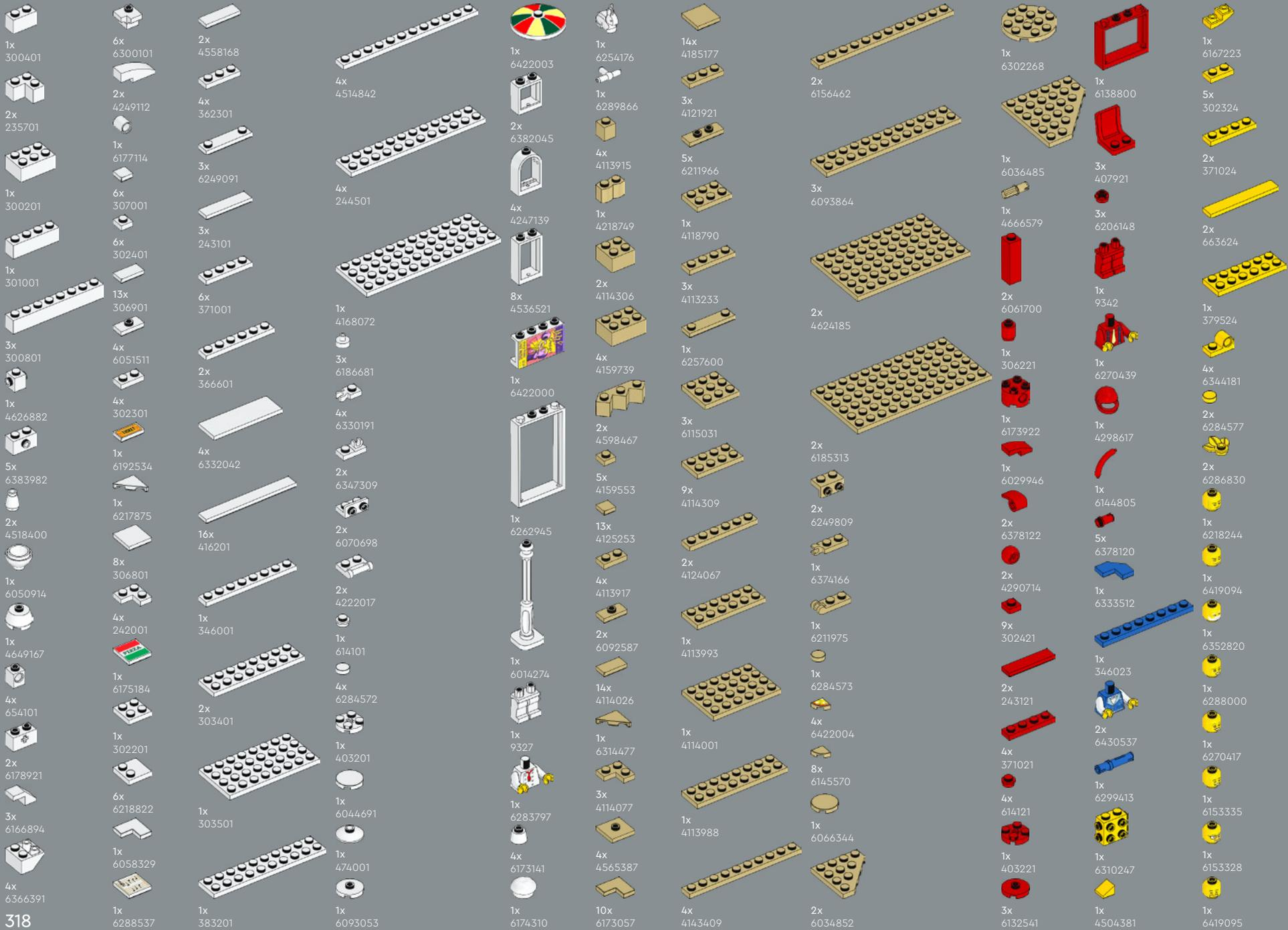

2x 300526	2x 6039869	12x 371026	1x 4514845	1x 474026	4x 6271169	1x 6431021	4x 6279875	1x 6206150
4x 4644456	9x 302426	13x 243126	13x 6186675	2x 6195325	4x 6271169	1x 6430624	1x 6173119	3x 6388070
2x 4558954	1x 307026	2x 302026	2x 6335388	2x 4106347	2x 459926	1x 6430843	2x 414580	1x 6235080
1x 473326	2x 241226	2x 6350415	4x 6196548	5x 6173105	1x 408326	1x 6430843	2x 4124096	10x 6182261
2x 6330197	19x 302326	4x 663626	2x 6330189	1x 6408578	1x 408326	1x 6356860	1x 368026	1x 6331087
2x 4253815	10x 306926	3x 366626	4x 6157554	1x 6408578	1x 6066113	1x 6343688	4x 6416444	3x 4119479
2x 4288212	6x 6092585	1x 4243819	3x 6313116	19x 6382697	4x 4187209	1x 4105175	2x 4517986	1x 6430413
8x 4529236	2x 6214807	3x 416226	2x 6000650	8x 4536522	1x 602026	2x 6326681	1x 6104209	13x 6254484
1x 4558957	4x 6166859	3x 416226	5x 6020193	1x 6310268	1x 602026	2x 4538456	1x 306228	11x 6253417
2x 6312449	7x 242026	2x 346026	1x 6310268	6x 4530589	6x 4530589	1x 6151289	1x 6047426	1x 6212081
1x 329826	3x 302226	2x 346026	6x 6336989	3x 4225201	1x 6170421	1x 6170808	2x 6347288	14x 6263221
1x 4529155	2x 6192346	1x 395826	4x 4225201	4x 6168646	2x 4623113	1x 6057397	1x 6229130	43x 6223040
4x 329726	7x 306826	1x 303526	3x 614126	1x 6254519	1x 6093525	1x 6396403	1x 6269971	18x 6000743
1x 6275732	10x 6133722	1x 303526	4x 6210270	1x 6337273	4x 6116604	1x 6106280	1x 6382575	1x 6361813
1x 6053077	2x 362326	3x 383226	9x 403226		1x 9339	13x 6315887	2x 6285598	8x 6186012
	4x 4558170		1x 6431014			9x 6278152	1x 6314378	
	1x 302126							

- 3x 4570877
- 2x 4614158
- 2x 6092602
- 2x 6315197
- 4x 6248949
- 1x 6313129
- 1x J5 6172566
- 1x 6384077
- 2x 6220959
- 1x 6251294
- 16x 6252258
- 21x 6254552
- 4x 6256058
- 6x 6253734
- 32
- 1x 6247362
- 1x 6168665
- 1x 6244787
- 2x 6166107
- 1x 6247369
- 1x 6337596
- 4x 6240551
- 8x 6252043
- 1x 6274739
- 1x 6306726
- 1x 6283590
- 4x 6277483
- 2x 6238674
- 8x 6252045
- 6x 6274740
- 19x 6240216
- 1x 6171728
- 1x 4267425
- 2x 6213782
- 3x 6213779
- 1x 6210775
- 2x 6240467
- 8x 6240553
- 3x 6174006
- 2x 6188696
- 1x 6306726
- 1x 4558595
- 2x 6253884
- 1x 6103249
- 1x 6240515
- 1x 6313826
- 1x 6001822
- 1x 6273590
- 9x 6055172
- 4x 4496699
- 1x 6092591
- 5x 4507045
- 2x 6396392
- 17x 6175927
- 1x 6270031
- 1x 6031821
- 2x 6216905
- 1x 6422001
- 1x 6422002
- 2x 6350417
- 2x 4162916
- 103x 6052777
- 10x 4541528
- 4x 6089268
- 2x 6311108
- 24x 4539092
- 1x 4539099
- 2x 6267414
- 2x 6173168
- 2x 6042953
- 24x 4539114
- 2x 4539090
- 61x 4539097
- 10x 4585751
- 2x 4585479
- 23x 4541376
- 70x 4539102
- 31x 4541379
- 18x 6264025
- 2x 4539105
- 4x 4539076
- 2x 4583299
- 2x 4539062
- 3x 4541507
- 2x 6253142
- 4x 6384234
- 2x 6359683
- 2x 6313126
- 17x 6335330
- 6x 6359716
- 3x 6003033
- 8x 6020073
- 2x 6422005
- 6x 6331205
- 1x 6209681
- 1x 6212994
- 2x 6430410
- 2x 6245265
- 4x 6061685
- 2x 6186542
- 4x 6073040
- 4x 6099714
- 4x 6020923
- 1x 6409778
- 1x 6349342
- 2x 4211199
- 4x 6146858
- 1x 4658005
- 24x 4211288
- 3x 4221744
- 2x 4211150
- 2x 4224243
- 4x 4211151
- 4x 4216695
- 4x 6196221
- 1x 6100769
- 6x 6311441
- 1x 6257604
- 3x 4211190
- 1x 4211194
- 2x 6307618
- 1x 4211186
- 1x 4211204
- 2x 4221590
- 1x 4211211
- 1x 4217848
- 2x 6186673
- 2x 6401027
- 2x 6238874
- 1x 6313124
- 2x 6290983
- 1x 6338135
- 3x 4216581
- 1x 6284586
- 2x 4211159
- 4x 6102360
- 1x 6342958
- 1x 6075207
- 1x 6228841
- 1x 6428805
- 1x 6267760
- 1x 6093515
- 1x 6422007
- 6x 6248918
- 2x 6271128
- 2x 4595889
- 6x 4211206
- 12x 6310449
- 4x 6159763
- 1x 4609635
- 2x 6261744
- 3x 4211242
- 2x 4211149
- 1x 4211193
- 4x 6201911
- 3x 6062574
- 3x 6103004
- 1x 6153594
- 1x 6036503
- 2x 6151461



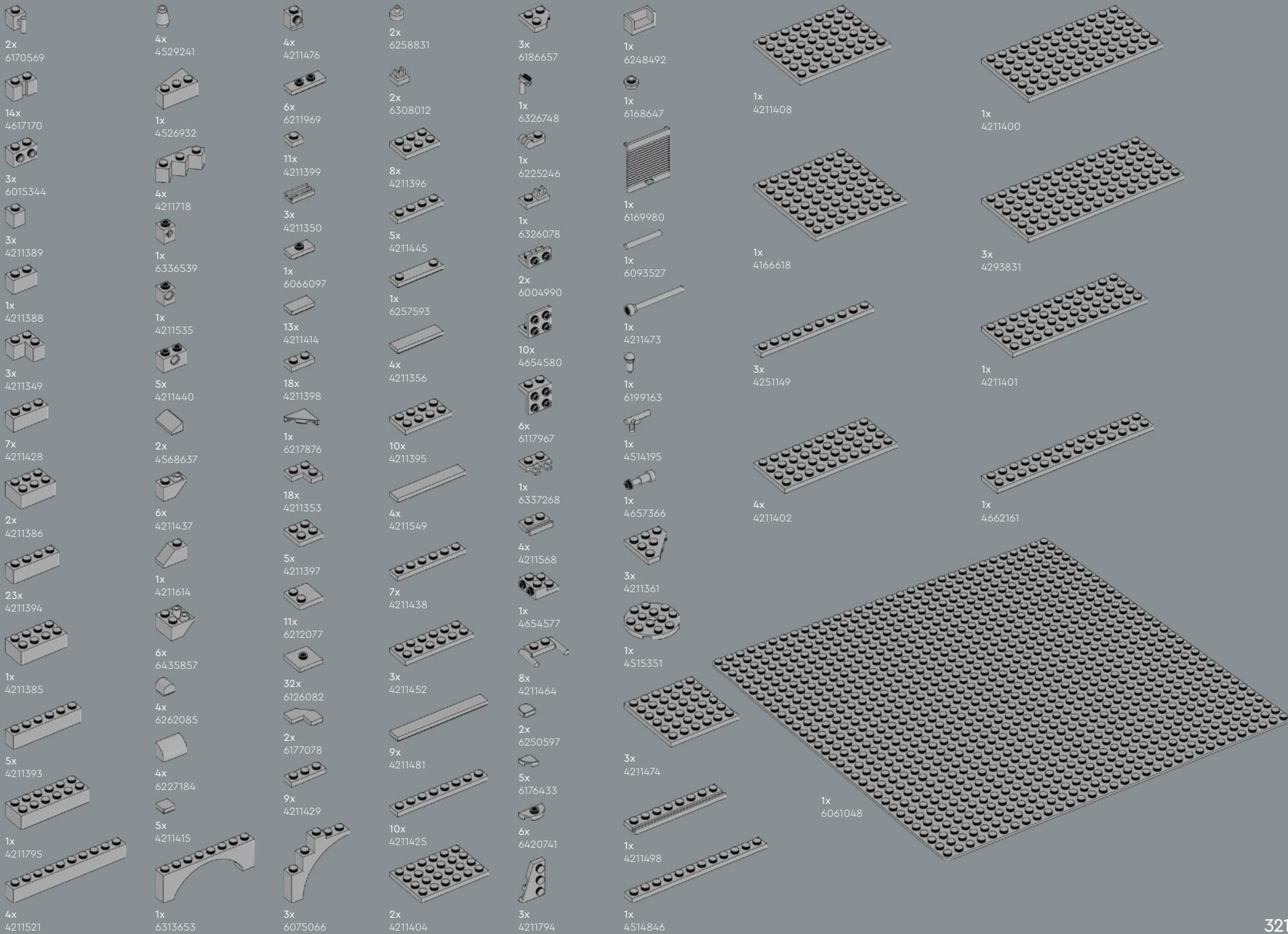





# YOU COULD WIN



## YOU COULD WIN

Your feedback will help shape the future development of this product series.

Visit:

## DU KÖNNTEST GEWINNEN

Dein Feedback trägt zur Weiterentwicklung dieser Produktreihe bei.

Geh auf:

## VOUS POURRIEZ GAGNER

Vos commentaires nous aideront à concevoir les futurs produits de cette gamme.

Visitez :

## POTRESTI VINCERE TU

La tua opinione ci aiuterà a migliorare la creazione futura di questa linea di prodotti.

Visita:

## PUEDES GANAR

Tu opinión contribuirá al futuro de esta serie de productos.

Visita:

## 轻松获奖

您的反馈将有助于我们在今后改进本产品系列。

请访问:

---

**[LEGO.com/productfeedback](https://LEGO.com/productfeedback)**

---

You also have the chance to win a LEGO® set.

Terms and conditions apply.\*

Außerdem hast du die Chance, ein LEGO® Set zu gewinnen.

Es gelten die Teilnahmebedingungen.\*

Vous pourriez également gagner un ensemble LEGO®.

Des conditions s'appliquent.\*

Hai anche la possibilità di vincere un set LEGO®.

Termini e condizioni sono applicabili.\*

También tienes la oportunidad de ganar un set LEGO®.

Aplican términos y condiciones.\*

您还有机会赢取乐高®套装。

条款和条件适用。\*

\*[LEGO.com/productfeedback-terms](https://LEGO.com/productfeedback-terms)

