

La tour Eiffel

Livret 1

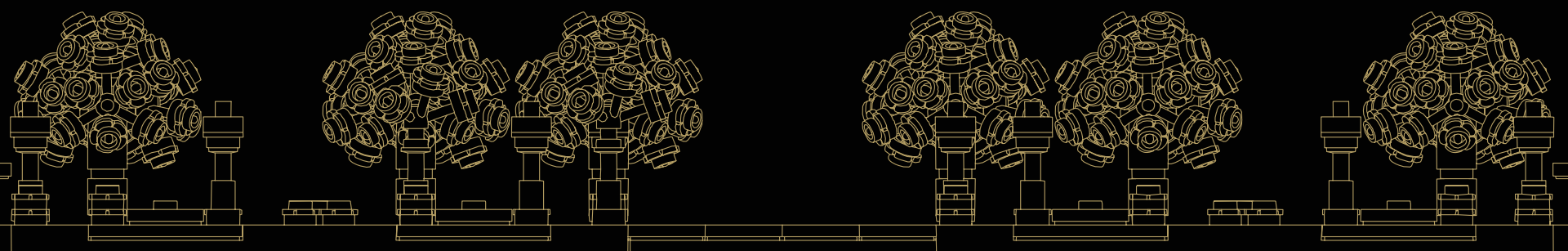



We're transitioning from single-use plastic to paper-based packaging. As we progress, you may find a mix of paper and plastic in our boxes.

Wir stellen von Einwegkunststoff-Verpackungen auf Verpackungen auf Papierbasis um. Möglicherweise findest du in der Übergangszeit sowohl Papier als auch Kunststoff in unseren Boxen.

Nous passons progressivement des emballages en plastique à usage unique aux emballages à base de papier. Au cours de cette transition, il est possible que vous trouviez à la fois du papier et du plastique dans nos boîtes.

Stiamo passando dalla plastica monouso agli imballaggi basati su carta. In questo periodo, potrete trovare un mix di carta e di plastica nelle nostre confezioni.

Estamos cambiando las bolsas de plástico desechables por bolsas con base de papel. Conforme avanzamos en este propósito, puede que encuentres una mezcla de papel y de plástico en nuestras cajas.

Estamos a fazer a transição do uso de plástico descartável nas embalagens por embalagens à base de papel. À medida que progredimos nesta transição poderá encontrar um misto de papel e plástico nas nossas caixas

Átállunk az egyszer használatos műanyagról a papír alapú csomagolásra. Az átállás folyamatos, ezért előfordulhat, hogy papír és műanyag zacskót egyaránt találás a dobozainkban.

Mēs pārejam no vienreizlietojamās plastmasas uz iepakojumu, kurā izmantots papīrs. Pārejas procesa laikā kārbās var būt gan papīra, gan plastmasas daļas.

Facem tranziția de la ambalajele de unică folosință din material plastic la ambalaje pe bază de hârtie. Pe măsură ce avansăm, s-ar putea să găsești un amestec de hârtie și material plastic în cutiile noastre.

我们正在从一次性塑料包装向纸质包装过渡。在此过程中，你可能会发现我们同时采用纸质包装和塑料包装！

La tour Eiffel

La tour Eiffel est l'impressionnante structure en treillis métallique située sur le Champ de Mars à Paris. Elle doit son nom à l'ingénieur Gustave Eiffel, dont l'entreprise a conçu et construit la tour pour en faire l'entrée spectaculaire de l'Exposition universelle de 1889. Cette structure de 324 m de haut est l'un des monuments les plus célèbres au monde, et c'est aussi le symbole de la ville de Paris et de la France.



L'idée originale

Lorsque la France décide d'organiser une Exposition universelle pour marquer le centenaire de la Révolution française, un concours officiel est lancé pour trouver la pièce maîtresse parfaite pour cet événement. Parmi les 107 projets présentés, la commission choisit la vision de Gustave Eiffel de la tour de fer de 300 m de haut.

Deux ingénieurs de l'entreprise Eiffel, Maurice Koechlin et Émile Nouguier, ont l'idée d'un grand pylône formé de quatre poutres en treillis écartées à la base et se rejoignant au sommet. Stephen Sauvestre, l'architecte de l'entreprise, propose d'habiller les pieds de socles en maçonnerie et de relier les quatre montants et le premier étage par des arcs décoratifs.

Pour Gustave Eiffel, la structure doit symboliser « l'art de l'ingénieur moderne mais aussi le siècle de l'Industrie et de la Science dans lequel nous vivons ».

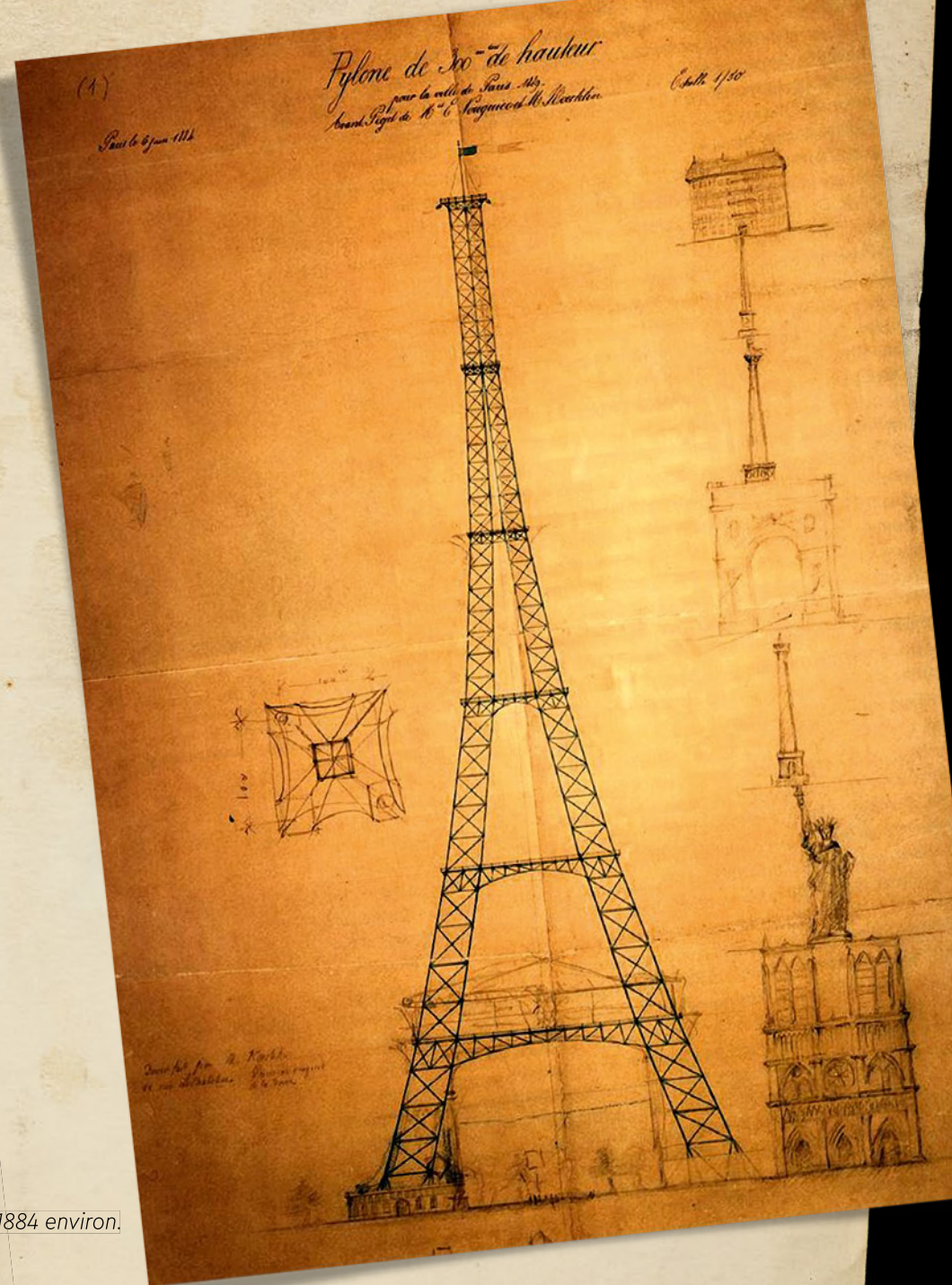

Une esquisse préliminaire de la tour datant de 1884 environ.

Gustave Eiffel

(1832 – 1923)

Né le 15 décembre 1832 à Dijon, Gustave Eiffel est un ingénieur et un constructeur exceptionnellement doué. Diplômé de l'École Centrale des Arts et Manufactures en 1855, il fonde sa propre entreprise de construction en 1864.

Il se fait un nom en créant de nombreuses structures métalliques variées, comme des ponts ferroviaires, des viaducs ou encore l'ossature de la Statue de la Liberté. Son entreprise et lui sont célèbres pour leur ingéniosité et leur inventivité, dont la culmination est la construction de la tour Eiffel.

**« Je devrais être jaloux de la tour.
Elle est plus célèbre que moi. »**

GUSTAVE EIFFEL



En construction

La société de Gustave Eiffel produit plus de 5 000 croquis afin de préparer le montage des 18 038 pièces individuelles permettant de former la tour. Les travaux de fondation démarrent en janvier 1887 et le montage de la tour commence le 1er juillet de la même année.

Tous les éléments sont préparés dans l'usine d'Eiffel située à Levallois-Perret dans la banlieue de Paris. La tour est montée à l'aide de grues à vapeur fixées sur celle-ci durant la construction.

Deux ans, deux mois et cinq jours plus tard, la structure est achevée et, en mars 1889, Eiffel emmène un groupe de membres du gouvernement, accompagnés de journalistes, au sommet de la plus haute structure du monde. Les ascenseurs ne fonctionnant pas encore, l'ascension à pied dure plus d'une heure. En arrivant, Eiffel déploie un grand drapeau tricolore, au son de 25 coups de fusil.

Le petit appartement que Gustave Eiffel a construit au sommet de la tour pour recevoir des invités est désormais ouvert au public. Il recèle des décorations d'époque et des représentations en cire réalistes d'Eiffel et de quelques invités de marque.

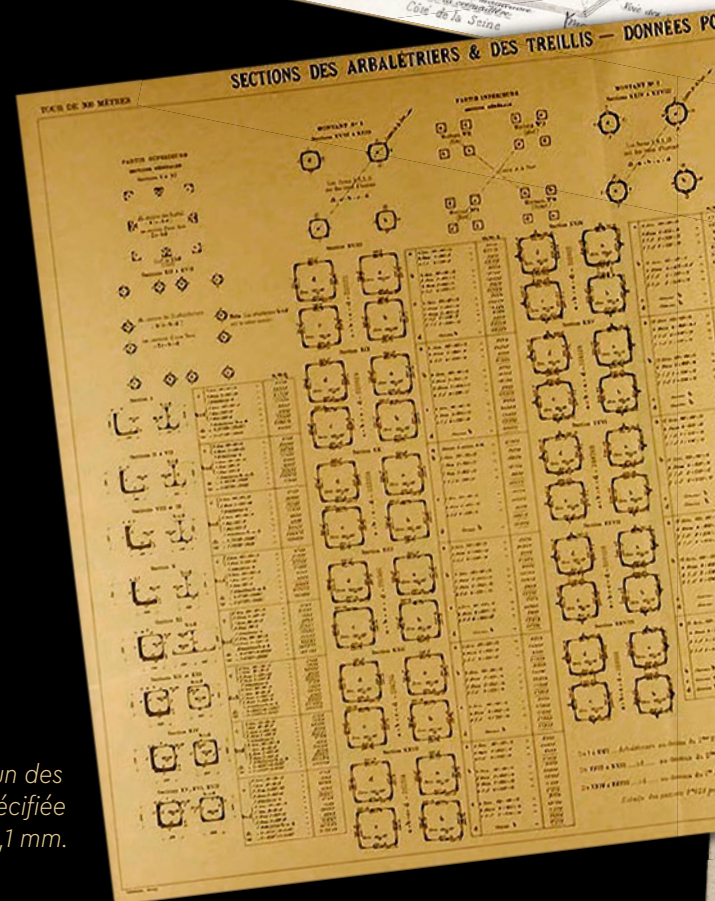
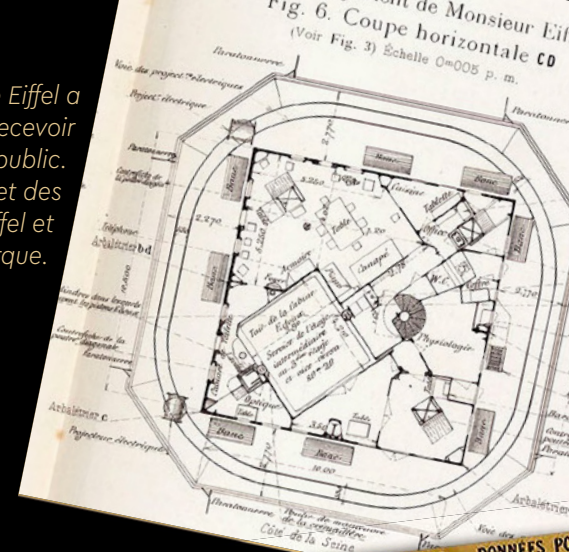

La position de chacun des 2 500 000 trous de rivet est spécifiée avec une précision de 0,1 mm.

Tel

Essai

Transmission

Loi de la corde

Changement de direction

Calcul de l'effort

Abattement b d

Remarque: on suppose que les poutres sont rigides

Calcul de la déformation



7 décembre 1887



20 mars 1888



15 mai 1888

LE CALCUL DE L'OSSATURE

DE XXXI

GRANDS DE L'ÉLEVATION

États 1903, p. 10

TABLIÉAU DES PILES

Éléments	Volume	Poids
1	10000	100000
2	20000	200000
3	30000	300000
4	40000	400000
5	50000	500000
6	60000	600000
7	70000	700000
8	80000	800000
9	90000	900000
10	100000	1000000
11	110000	1100000
12	120000	1200000
13	130000	1300000
14	140000	1400000
15	150000	1500000
16	160000	1600000
17	170000	1700000
18	180000	1800000
19	190000	1900000
20	200000	2000000
21	210000	2100000
22	220000	2200000
23	230000	2300000
24	240000	2400000
25	250000	2500000
26	260000	2600000
27	270000	2700000
28	280000	2800000
29	290000	2900000
30	300000	3000000
31	310000	3100000
32	320000	3200000
33	330000	3300000
34	340000	3400000
35	350000	3500000
36	360000	3600000
37	370000	3700000
38	380000	3800000
39	390000	3900000
40	400000	4000000
41	410000	4100000
42	420000	4200000
43	430000	4300000
44	440000	4400000
45	450000	4500000
46	460000	4600000
47	470000	4700000
48	480000	4800000
49	490000	4900000
50	500000	5000000
51	510000	5100000
52	520000	5200000
53	530000	5300000
54	540000	5400000
55	550000	5500000
56	560000	5600000
57	570000	5700000
58	580000	5800000
59	590000	5900000
60	600000	6000000
61	610000	6100000
62	620000	6200000
63	630000	6300000
64	640000	6400000
65	650000	6500000
66	660000	6600000
67	670000	6700000
68	680000	6800000
69	690000	6900000
70	700000	7000000
71	710000	7100000
72	720000	7200000
73	730000	7300000
74	740000	7400000
75	750000	7500000
76	760000	7600000
77	770000	7700000
78	780000	7800000
79	790000	7900000
80	800000	8000000
81	810000	8100000
82	820000	8200000
83	830000	8300000
84	840000	8400000
85	850000	8500000
86	860000	8600000
87	870000	8700000
88	880000	8800000
89	890000	8900000
90	900000	9000000
91	910000	9100000
92	920000	9200000
93	930000	9300000
94	940000	9400000
95	950000	9500000
96	960000	9600000
97	970000	9700000
98	980000	9800000
99	990000	9900000
100	1000000	10000000

TABLIÉAU DES SECTIONNES

Section	Volume	Poids
1	10000	100000
2	20000	200000
3	30000	300000
4	40000	400000
5	50000	500000
6	60000	600000
7	70000	700000
8	80000	800000
9	90000	900000
10	100000	1000000
11	110000	1100000
12	120000	1200000
13	130000	1300000
14	140000	1400000
15	150000	1500000
16	160000	1600000
17	170000	1700000
18	180000	1800000
19	190000	1900000
20	200000	2000000
21	210000	2100000
22	220000	2200000
23	230000	2300000
24	240000	2400000
25	250000	2500000
26	260000	2600000
27	270000	2700000
28	280000	2800000
29	290000	2900000
30	300000	3000000
31	310000	3100000
32	320000	3200000
33	330000	3300000
34	340000	3400000
35	350000	3500000
36	360000	3600000
37	370000	3700000
38	380000	3800000
39	390000	3900000
40	400000	4000000
41	410000	4100000
42	420000	4200000
43	430000	4300000
44	440000	4400000
45	450000	4500000
46	460000	4600000
47	470000	4700000
48	480000	4800000
49	490000	4900000
50	500000	5000000
51	510000	5100000
52	520000	5200000
53	530000	5300000
54	540000	5400000
55	550000	5500000
56	560000	5600000
57	570000	5700000
58	580000	5800000
59	590000	5900000
60	600000	6000000
61	610000	6100000
62	620000	6200000
63	630000	6300000
64	640000	6400000
65	650000	6500000
66	660000	6600000
67	670000	6700000
68	680000	6800000
69	690000	6900000
70	700000	7000000
71	710000	7100000
72	720000	7200000
73	730000	7300000
74	740000	7400000
75	750000	7500000
76	760000	7600000
77	770000	7700000
78	780000	7800000
79	790000	7900000
80	800000	8000000
81	810000	8100000
82	820000	8200000
83	830000	8300000
84	840000	8400000
85	850000	8500000
86	860000	8600000
87	870000	8700000
88	880000	8800000
89	890000	8900000
90	900000	9000000
91	910000	9100000
92	920000	9200000
93	930000	9300000
94	940000	9400000
95	950000	9500000
96	960000	9600000
97	970000	9700000
98	980000	9800000
99	990000	9900000
100	1000000	10000000

Nota: Les comparaisons ont été faites sur la base des données de la 1^{re} partie.

Les unités de mesure sont en mètres et en tonnes.



21 août 1888



26 décembre 1888



15 mars 1889

15 mai 1888

La tour : l'entrée de l'Exposition universelle.

Exposition universelle 1889

L'Exposition universelle de 1889 compte plus de 61 000 exposants individuels, dont 25 000 étrangers, et aborde les thèmes de la science, la technologie, l'ingénierie industrielle et les beaux-arts. L'Exposition occupe deux grands sites de la ville et reçoit 32 millions de visiteurs pendant 6 mois. La tour Eiffel remporte un succès immédiat auprès du public et de longues files d'attente se forment pour effectuer l'ascension. Les billets coûtent 2 francs pour le premier étage, 3 pour le deuxième et 5 pour le sommet, avec un billet à moitié prix le dimanche. À la fin de l'Exposition, en octobre 1889, la tour aura accueilli, à elle seule, près de deux millions de visiteurs.

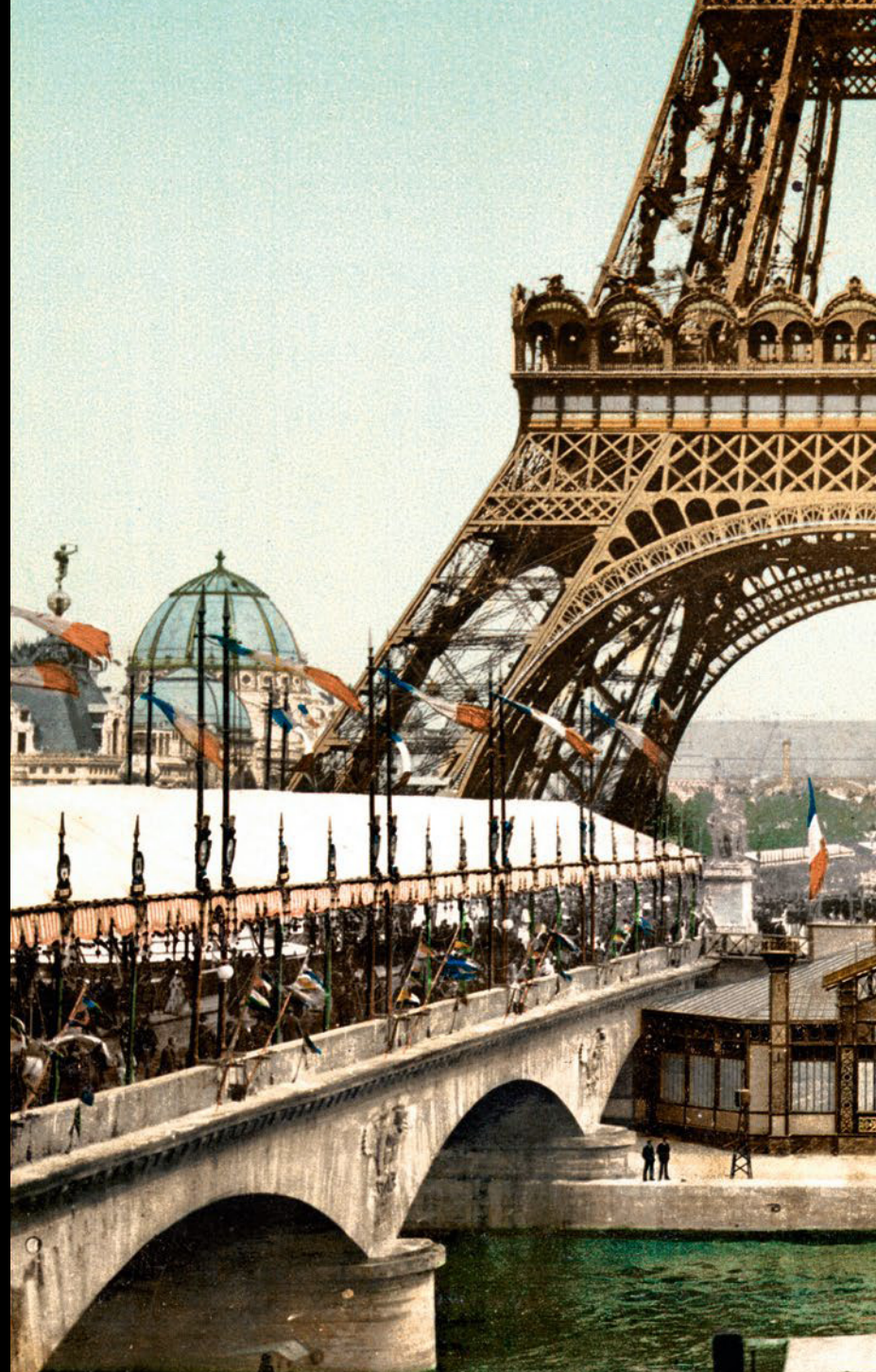



La plus haute structure du monde

Les constructeurs, les architectes et les ingénieurs n'ont eu de cesse de chercher à atteindre les étoiles en créant des structures vertigineuses. Au fur et à mesure de l'amélioration des outils et technologies, les efforts en ce sens se sont également accélérés. La tour Eiffel a été la première structure au monde à dépasser à la fois la barre des 200 mètres et des 300 mètres de hauteur et est devenue la plus haute structure artificielle à son achèvement en 1889. Elle le demeurera jusqu'en 1930, date de l'inauguration du Chrysler Building de 319 m de haut à New York, aux États-Unis.

Jusqu'à nos jours

Selon le permis accordé à Eiffel, la tour doit être détruite au bout de 20 ans. Pour y remédier, il a l'ingénieuse idée de lui attribuer une vocation scientifique et de montrer son intérêt pour les communications. Un laboratoire de météorologie et une petite soufflerie sont installés, et plus de 5 000 tests scientifiques sont effectués au fil des ans. Avec l'avènement de la télégraphie sans fil, le sommet de la tour se transforme en accueillant de multiples antennes. Elle culmine à 324 mètres suite à la pose à son sommet d'une antenne de télévision.

Aujourd'hui, la Tour Eiffel accueille plus de visiteurs que tout autre monument payant au monde, soit environ sept millions de personnes par an. Environ 500 employés assurent son fonctionnement quotidien, permettant à des foules enthousiastes d'admirer des vues panoramiques sur la ville.





« Parce que nous sommes des ingénieurs,
croit-on donc que la beauté ne nous
préoccupe pas dans nos constructions et
qu'en même temps que nous faisons solide
et durable, nous ne nous efforçons pas de
faire élégant ? »

GUSTAVE EIFFEL



« J'ai eu la chance d'aller deux fois au sommet de la tour Eiffel quand j'étais enfant. »

ROK ZGALIN KOBE

Les mots de l'équipe de design

Rok Zgalin Kobe, designer senior LEGO®, fait partie de l'équipe qui a donné vie à cette version LEGO de l'emblématique tour Eiffel.

« Mon objectif était de créer un superbe modèle LEGO, fidèle à la tour originale. J'ai essayé de recréer au mieux les principes structurels de la tour avec le système LEGO. Par exemple, les fermes porteuses du modèle sont placées comme sur l'original. Et tout comme sur la structure d'origine, l'étape critique de la construction LEGO est de relier les pieds au premier étage.

Le plus grand défi pour les sets de cette taille est de faire en sorte qu'ils soient stables et constructibles, mais aussi de créer des instructions de montage LEGO logiques. Ainsi, il faut s'assurer que le manuel peut être suivi sans générer d'erreurs, tout en veillant à ce que la construction soit suffisamment complexe pour être intéressante.

Je me sens vraiment honoré d'avoir participé à la création de la version LEGO de l'une des structures les plus célèbres de toute l'histoire de l'humanité. J'avais déjà créé des versions petit format de la tour, mais ce modèle LEGO, qui est le plus haut jamais créé, est totalement différent ! »



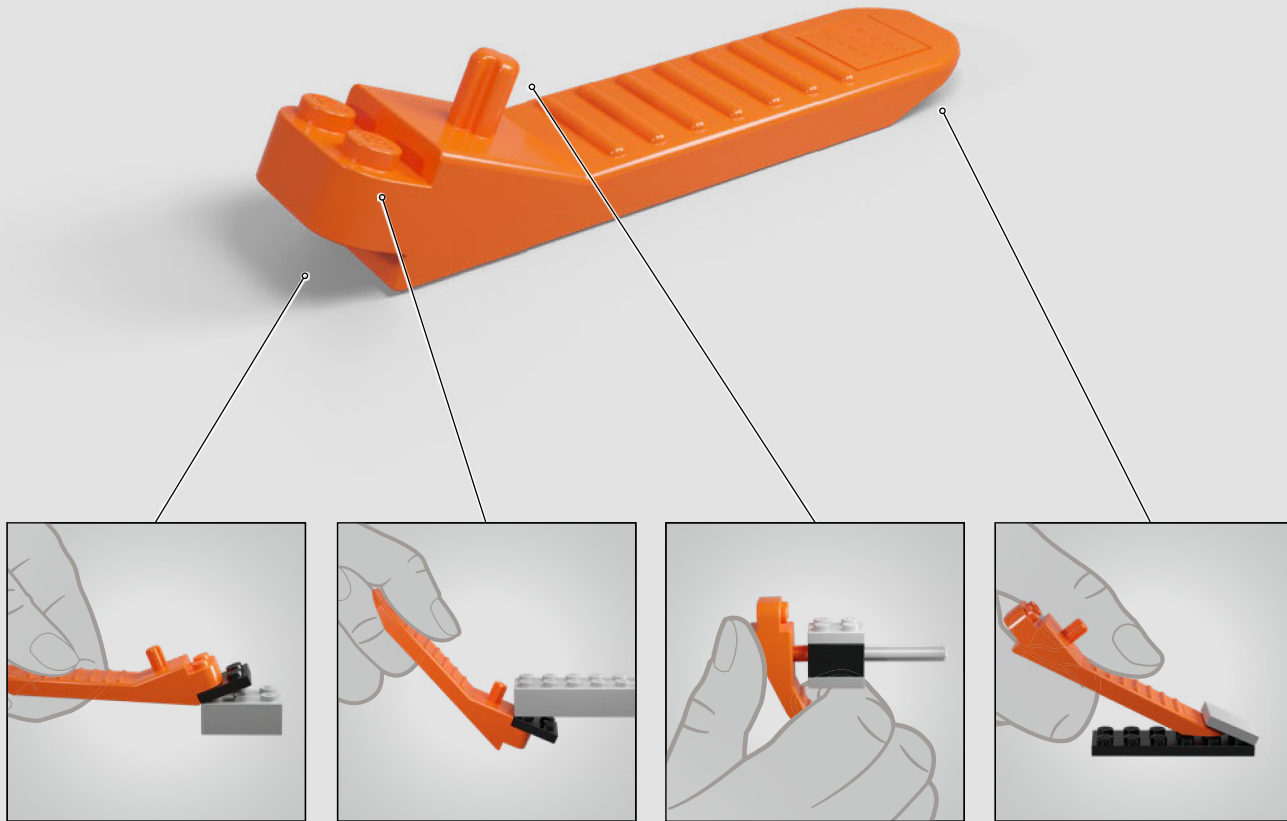



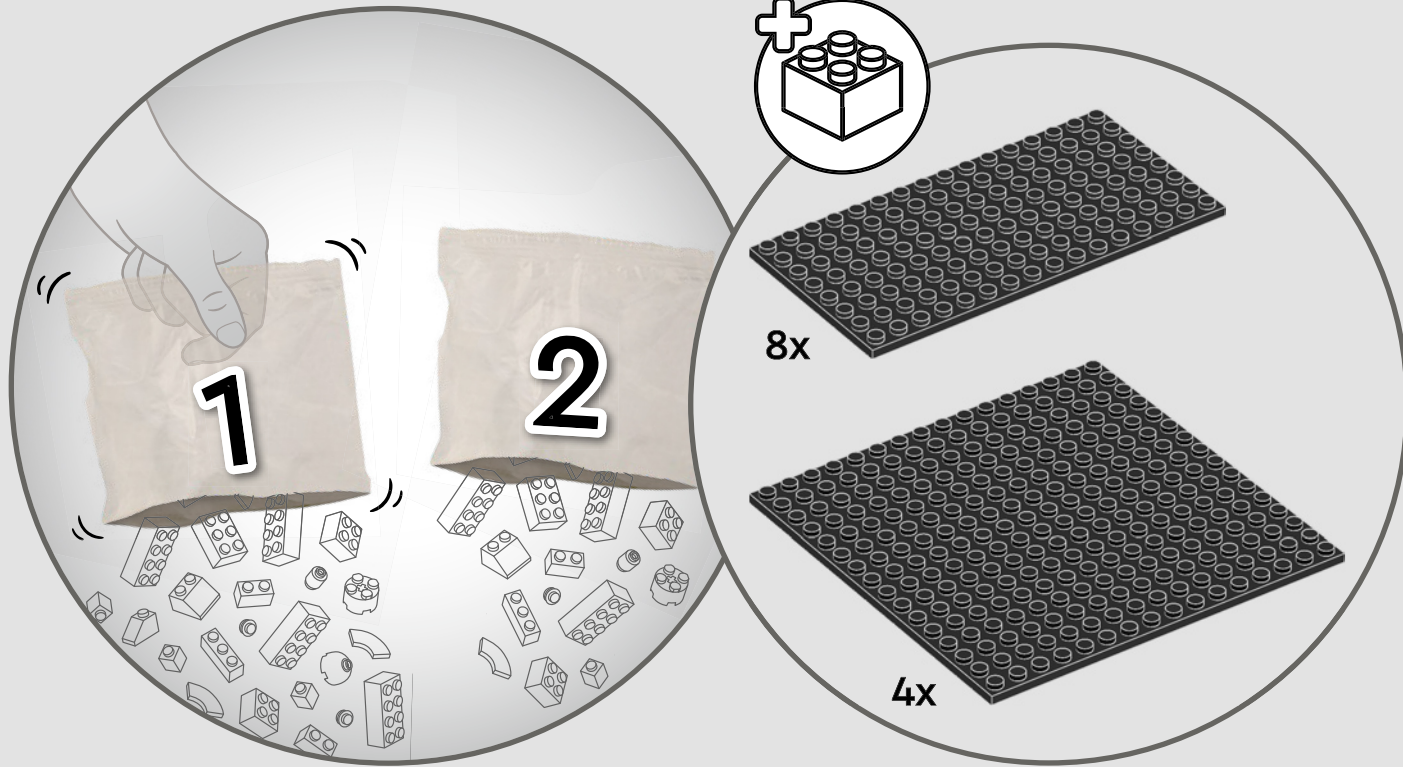



La construction de la tour Eiffel a coûté près de 8 millions de francs-or, soit 1,02 million de livres sterling.

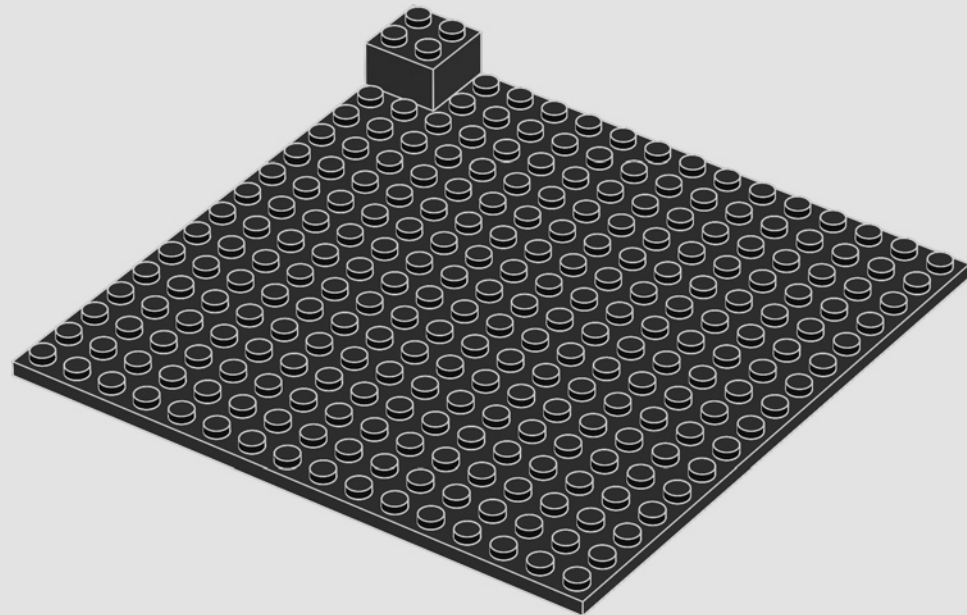
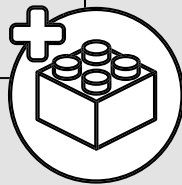
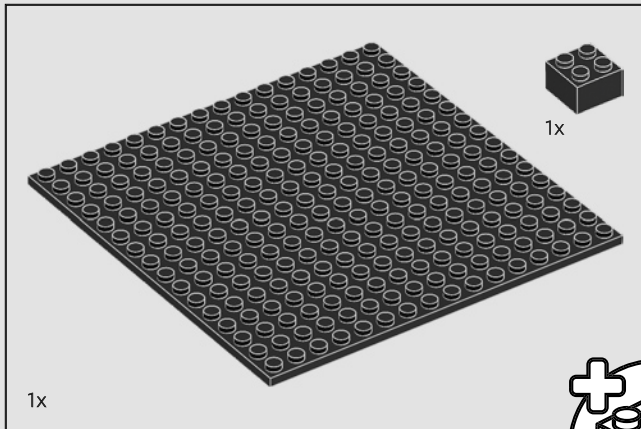
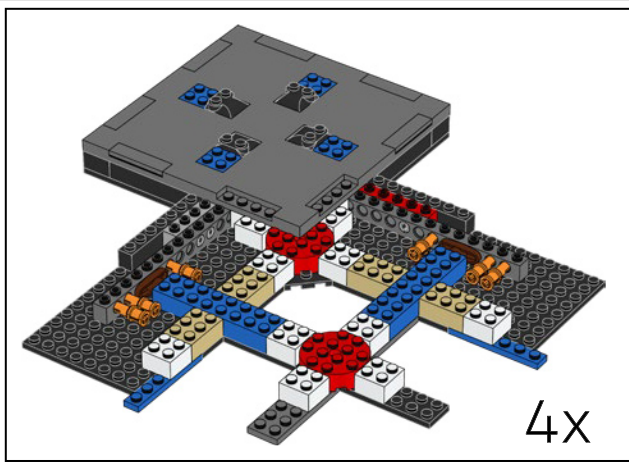

1

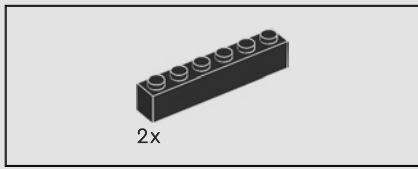

2

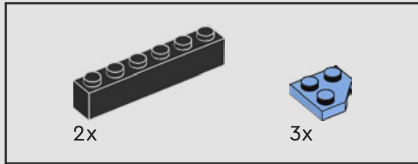
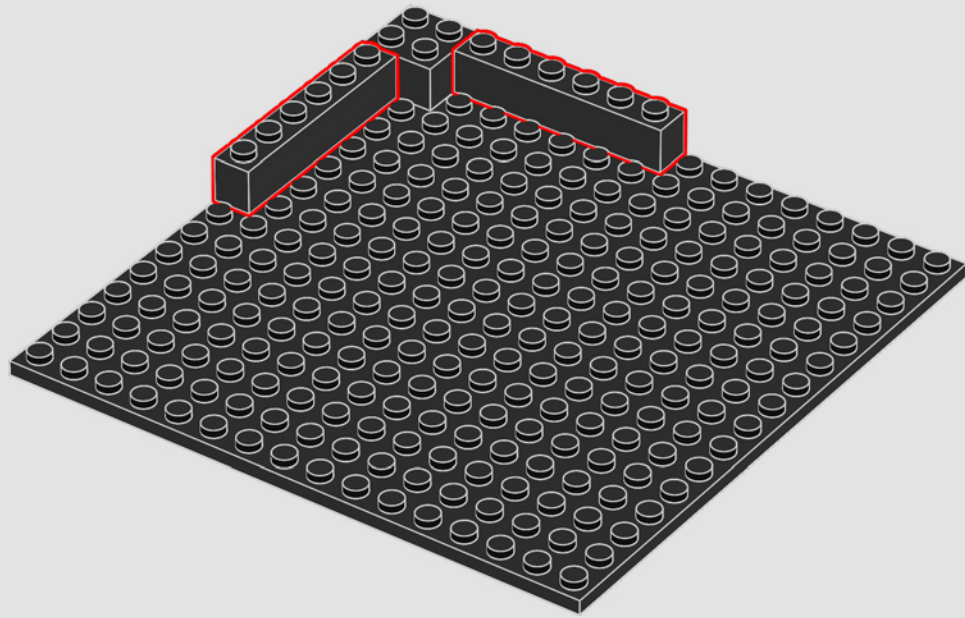

3

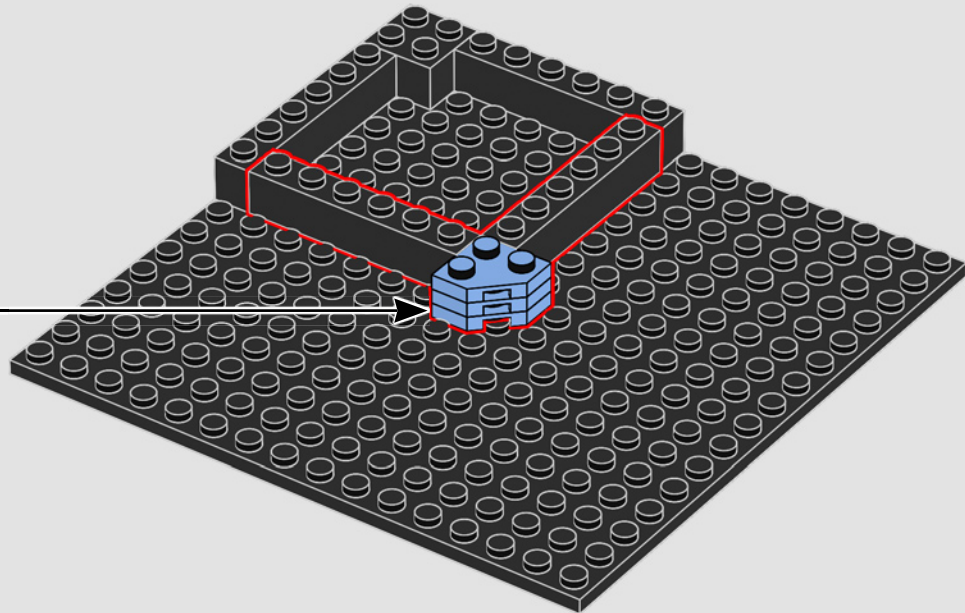
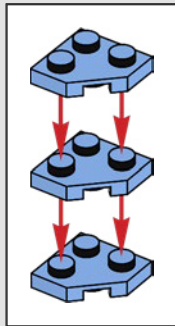

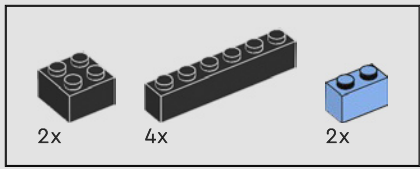

4

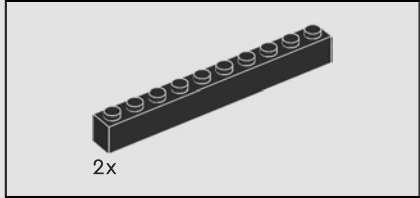
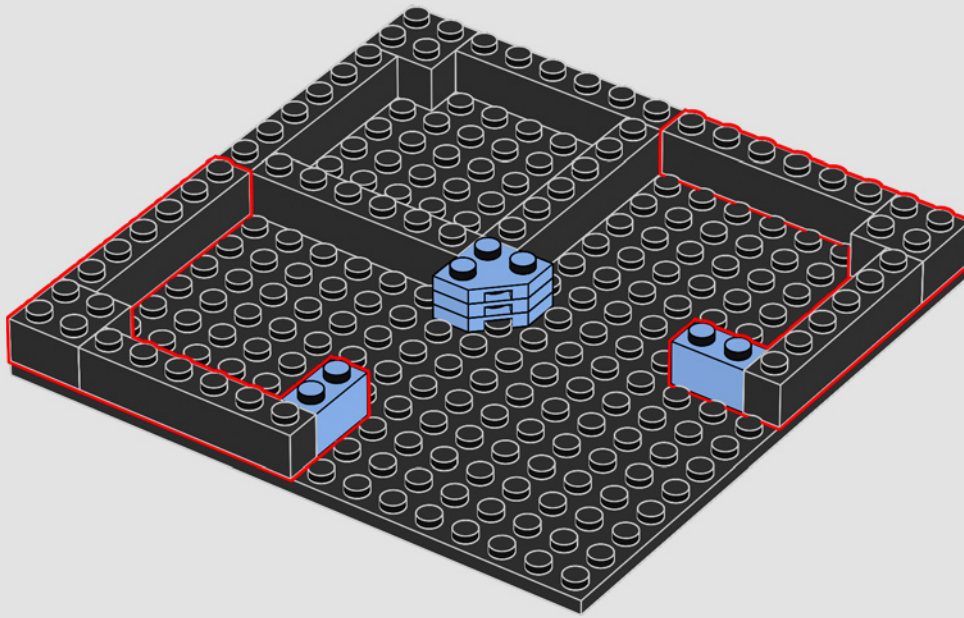

5

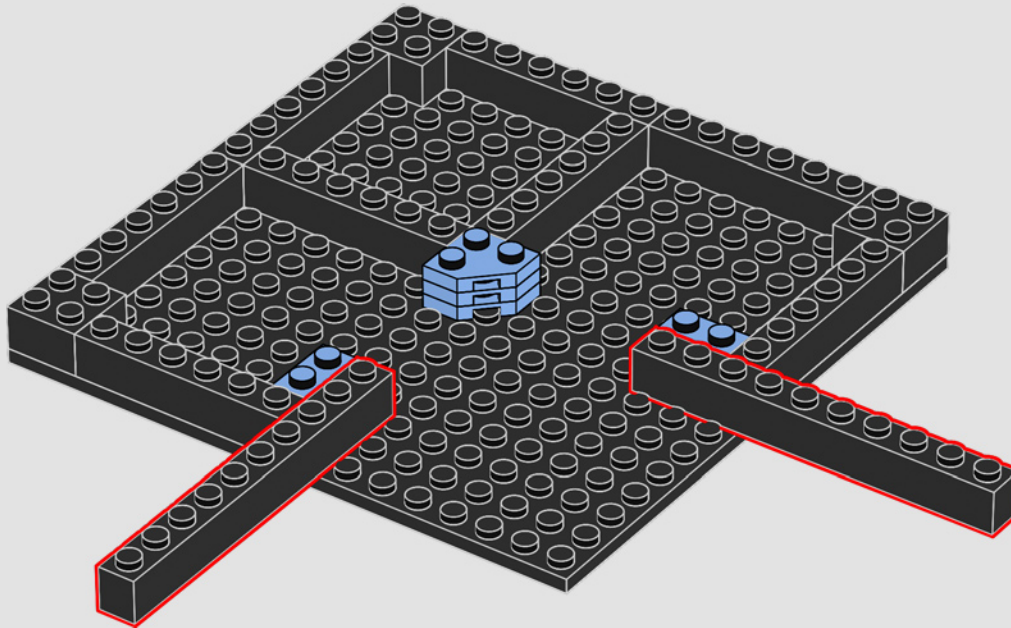

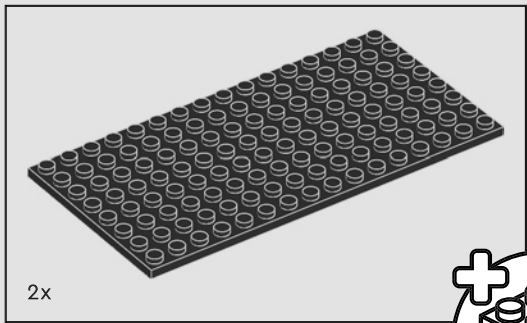

2x

6

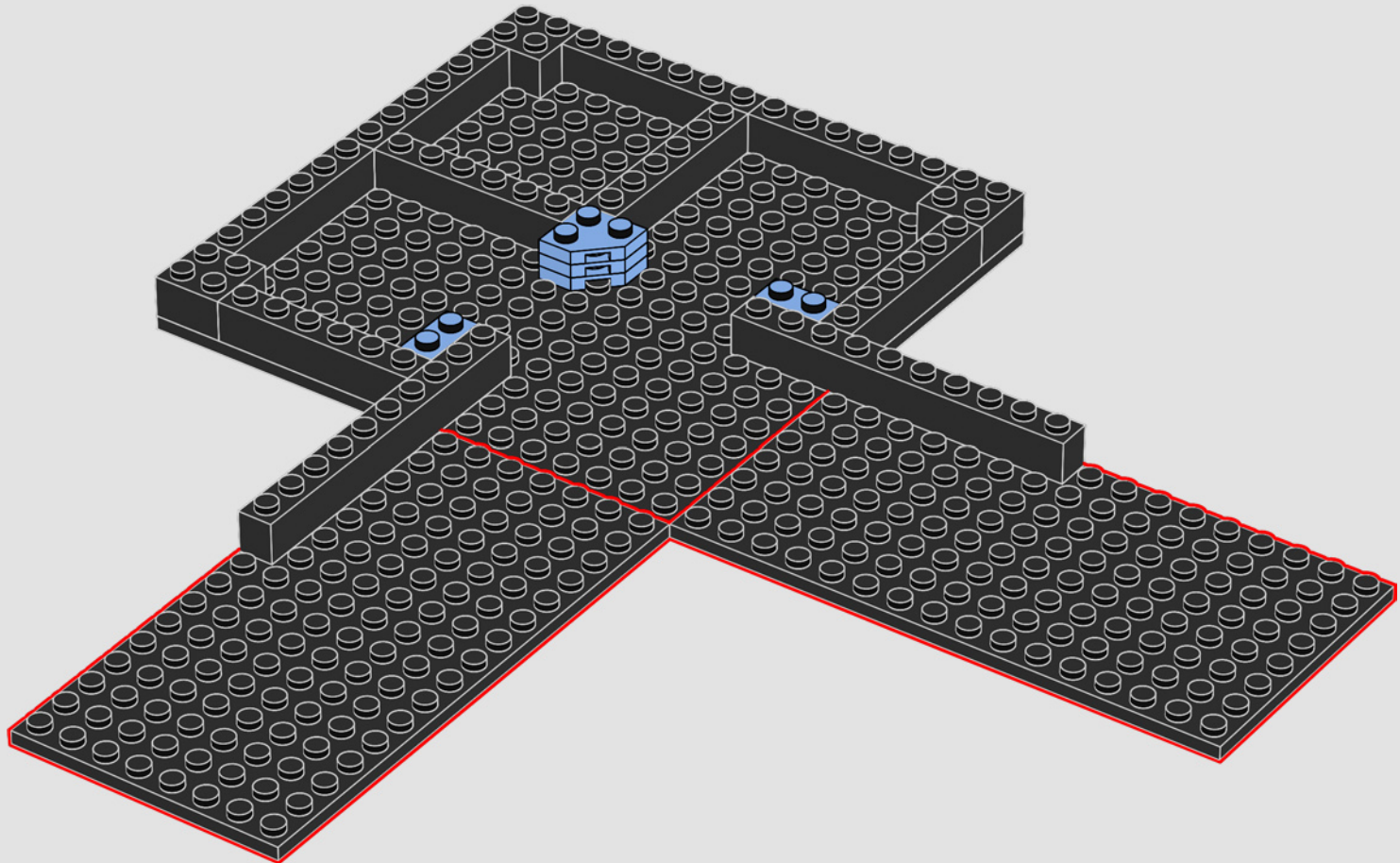
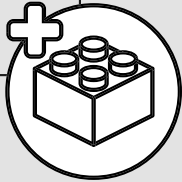

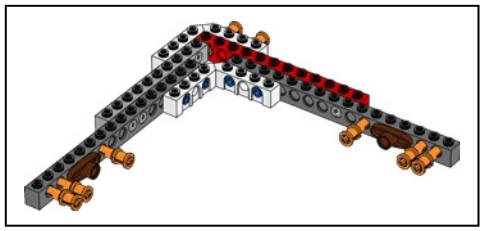

1

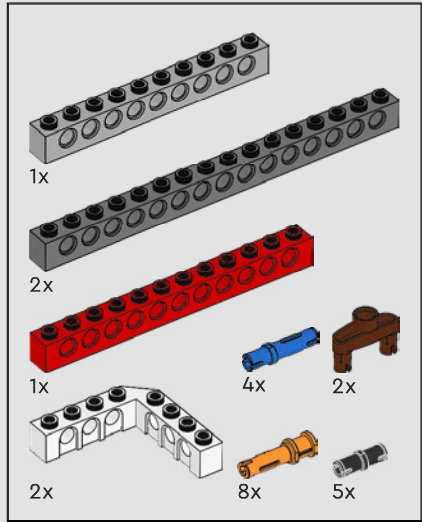
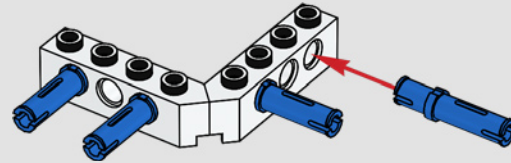

7

2

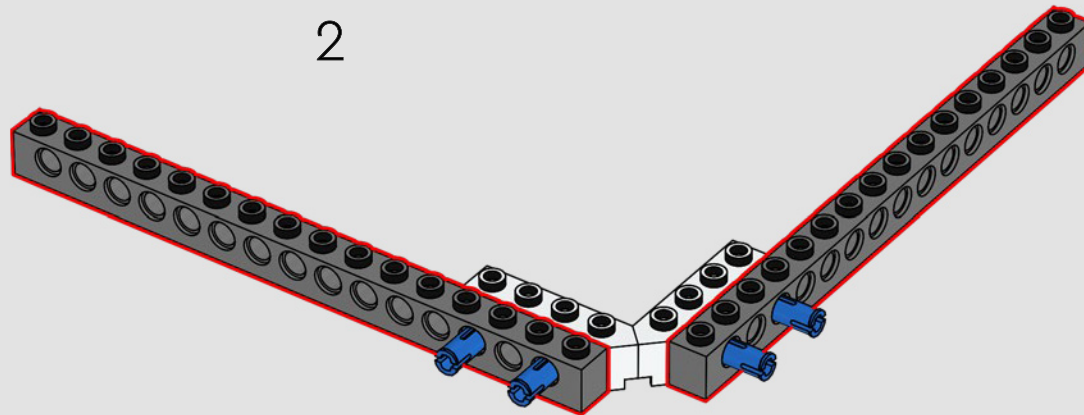

3

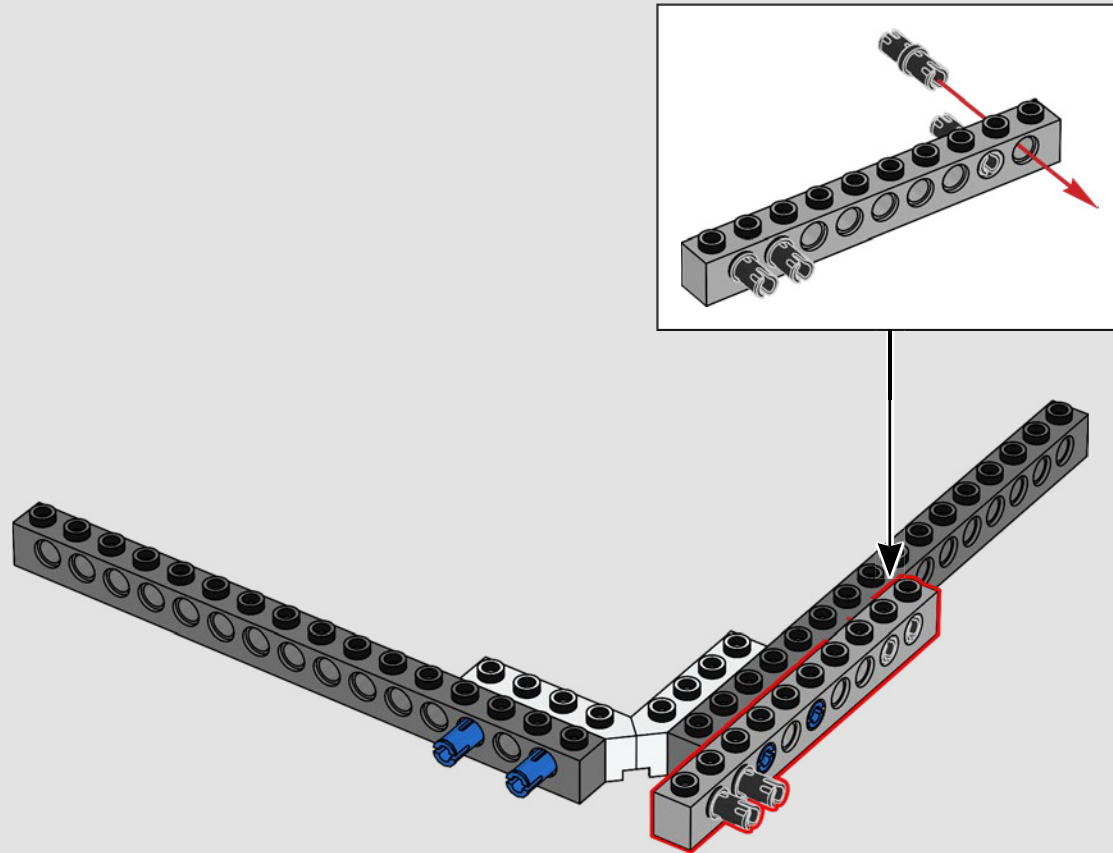

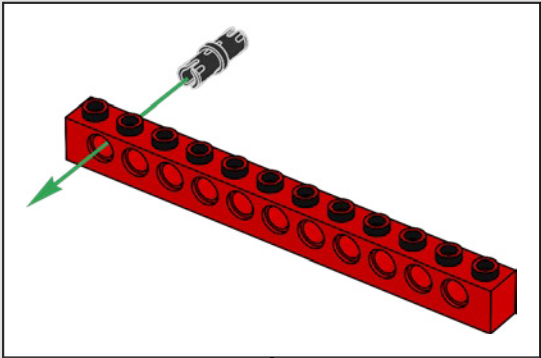

4

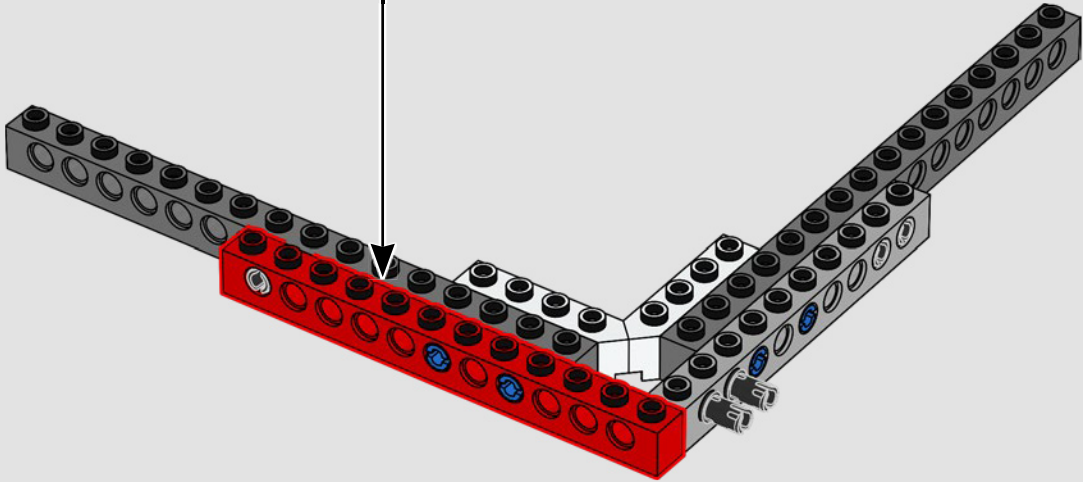

5

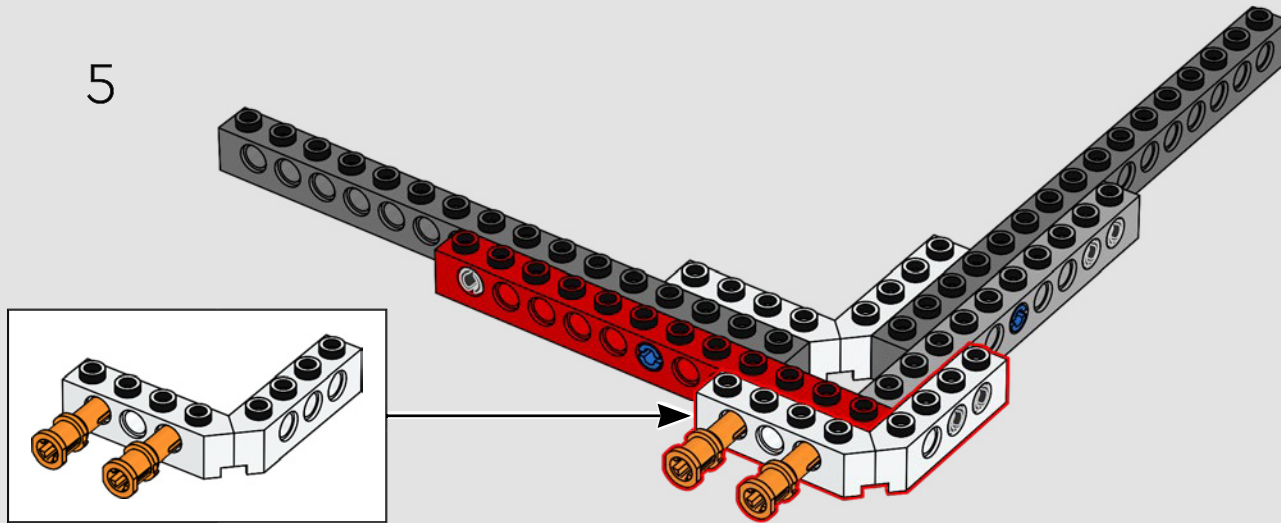

6

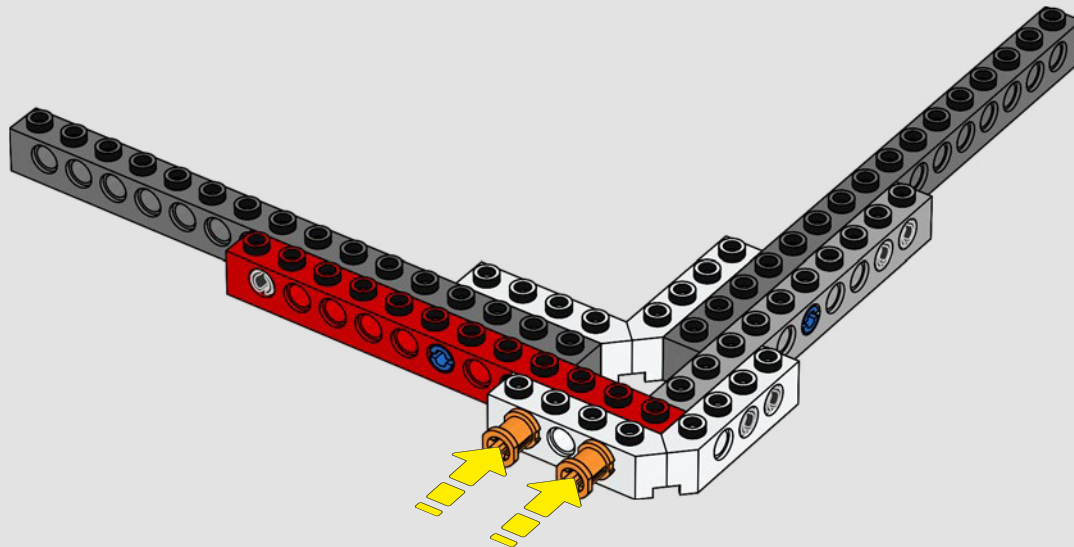



7

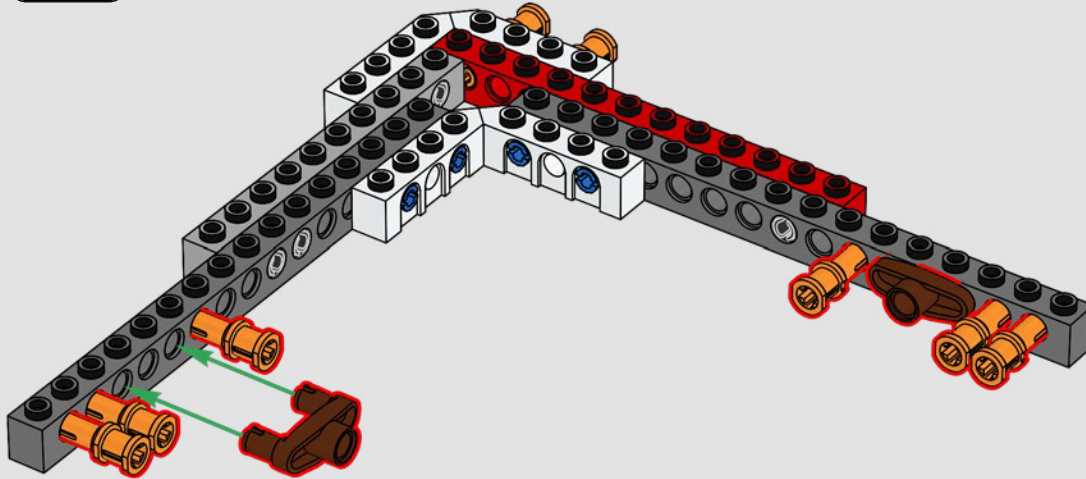

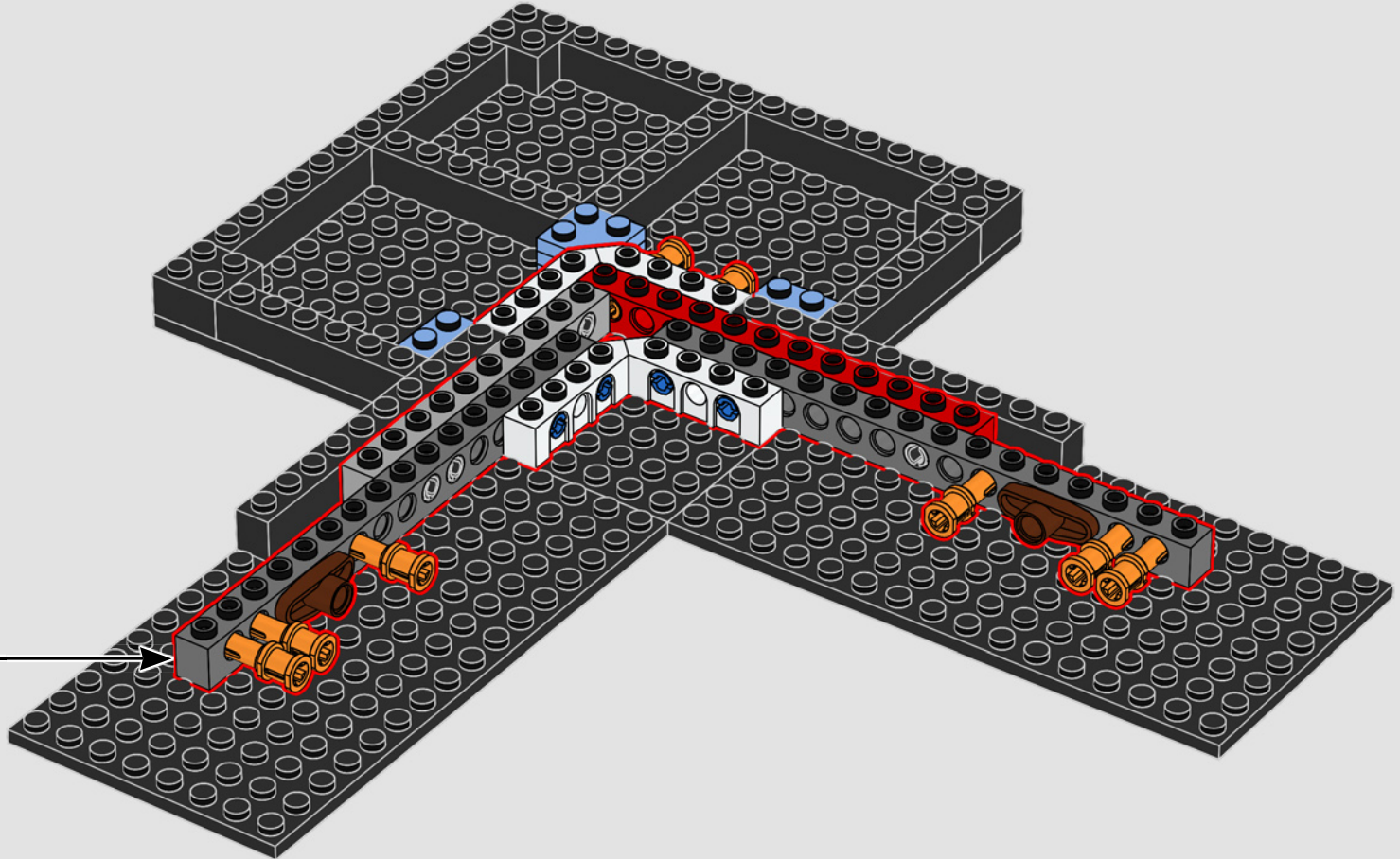



2x

8

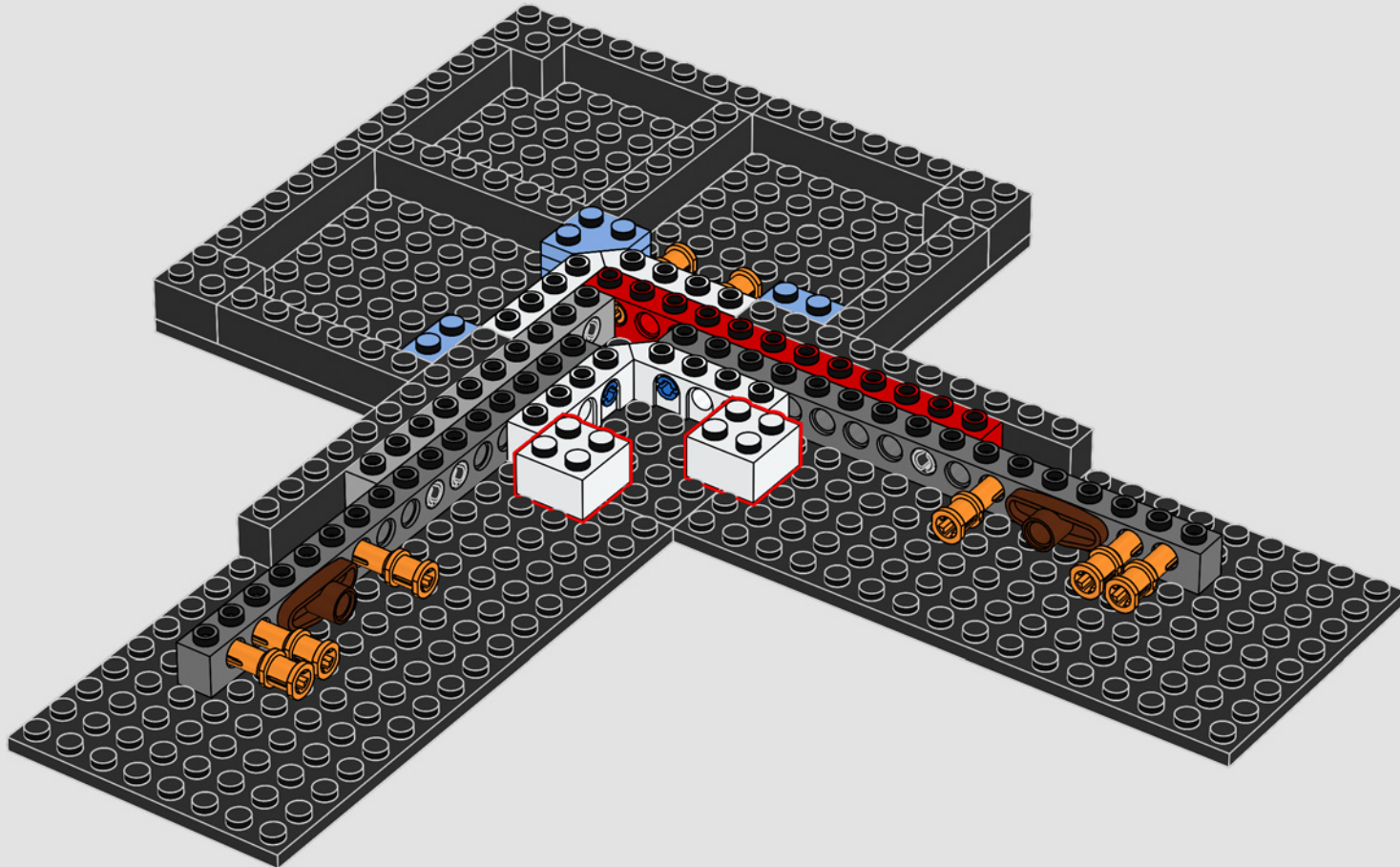

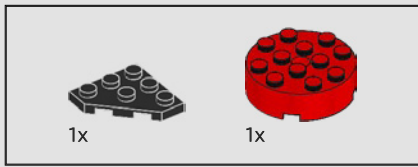

9

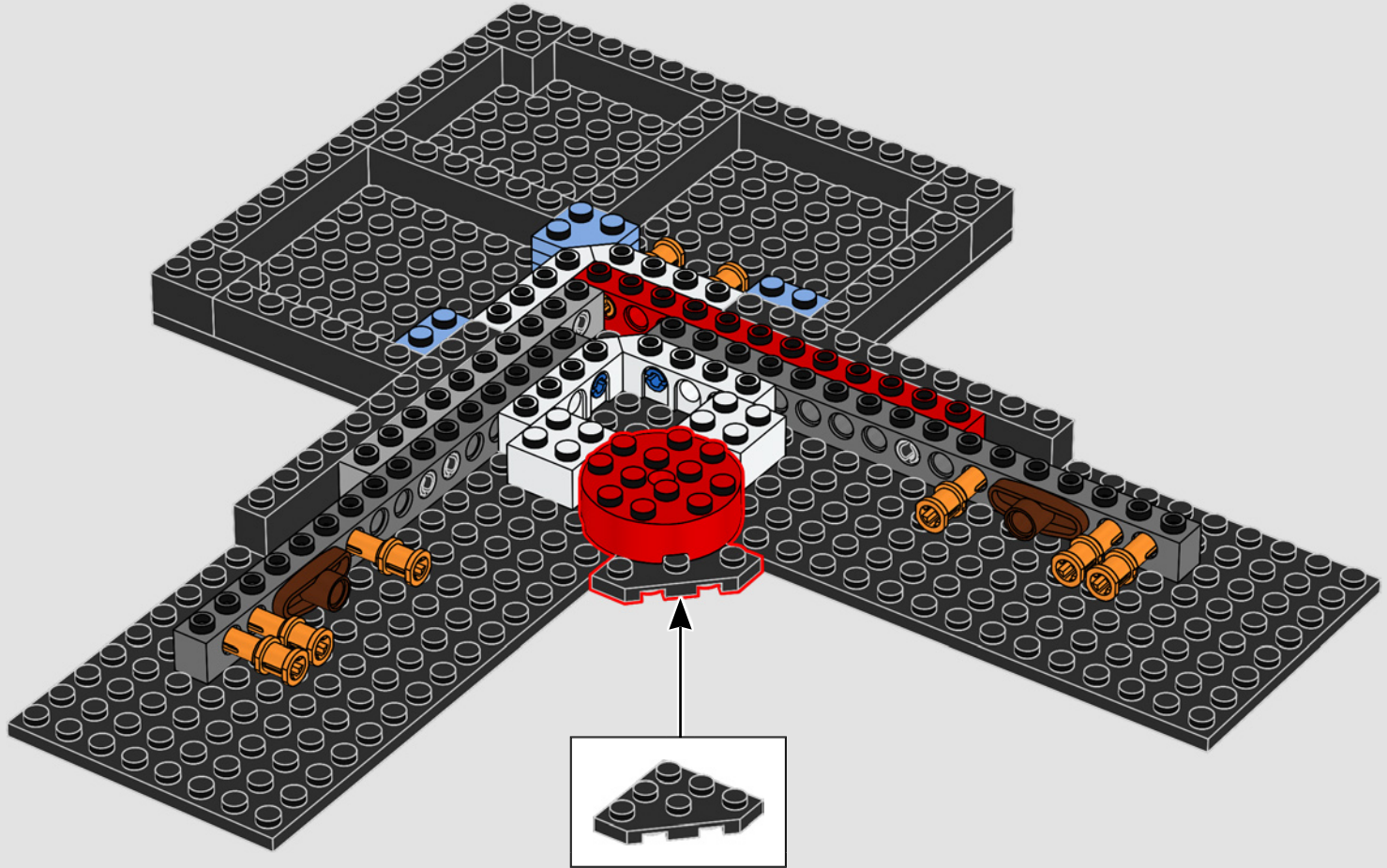

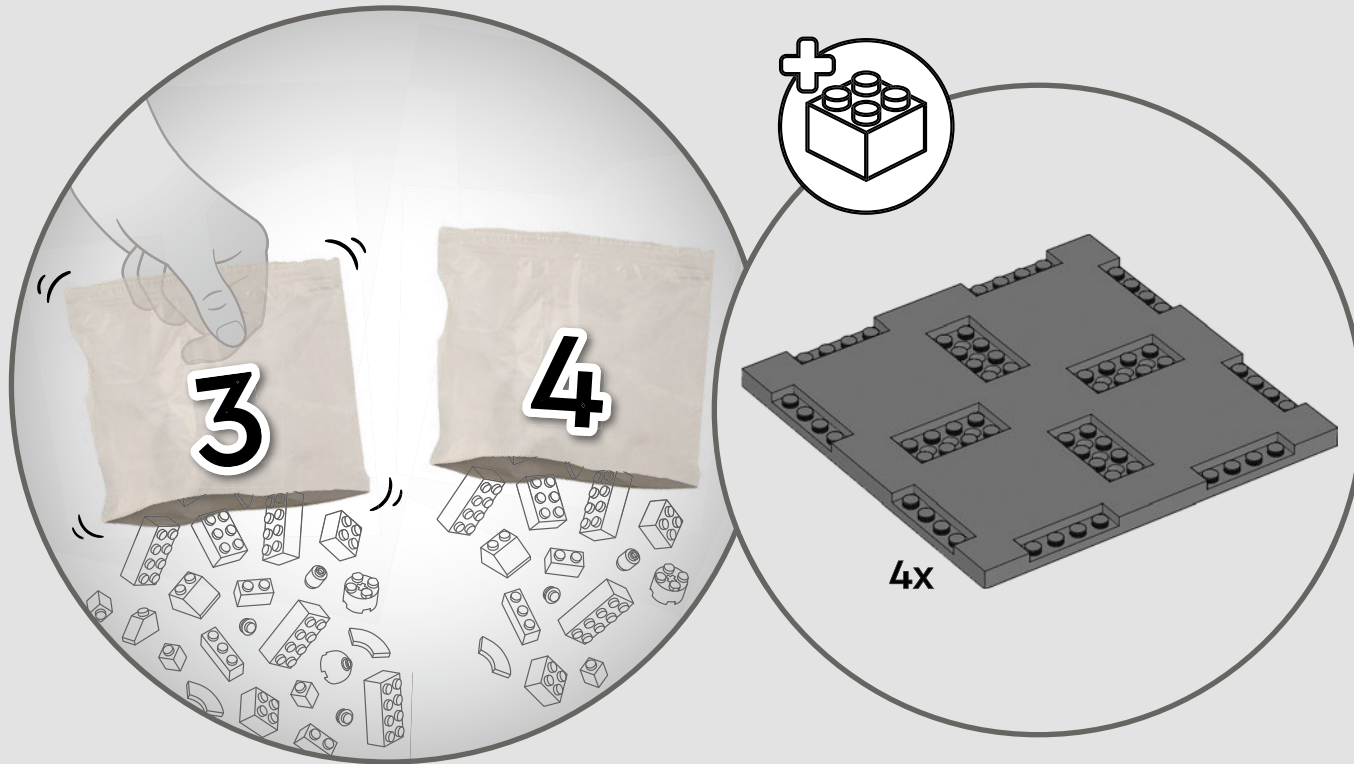

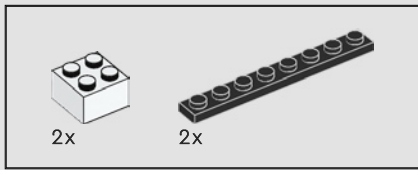

10

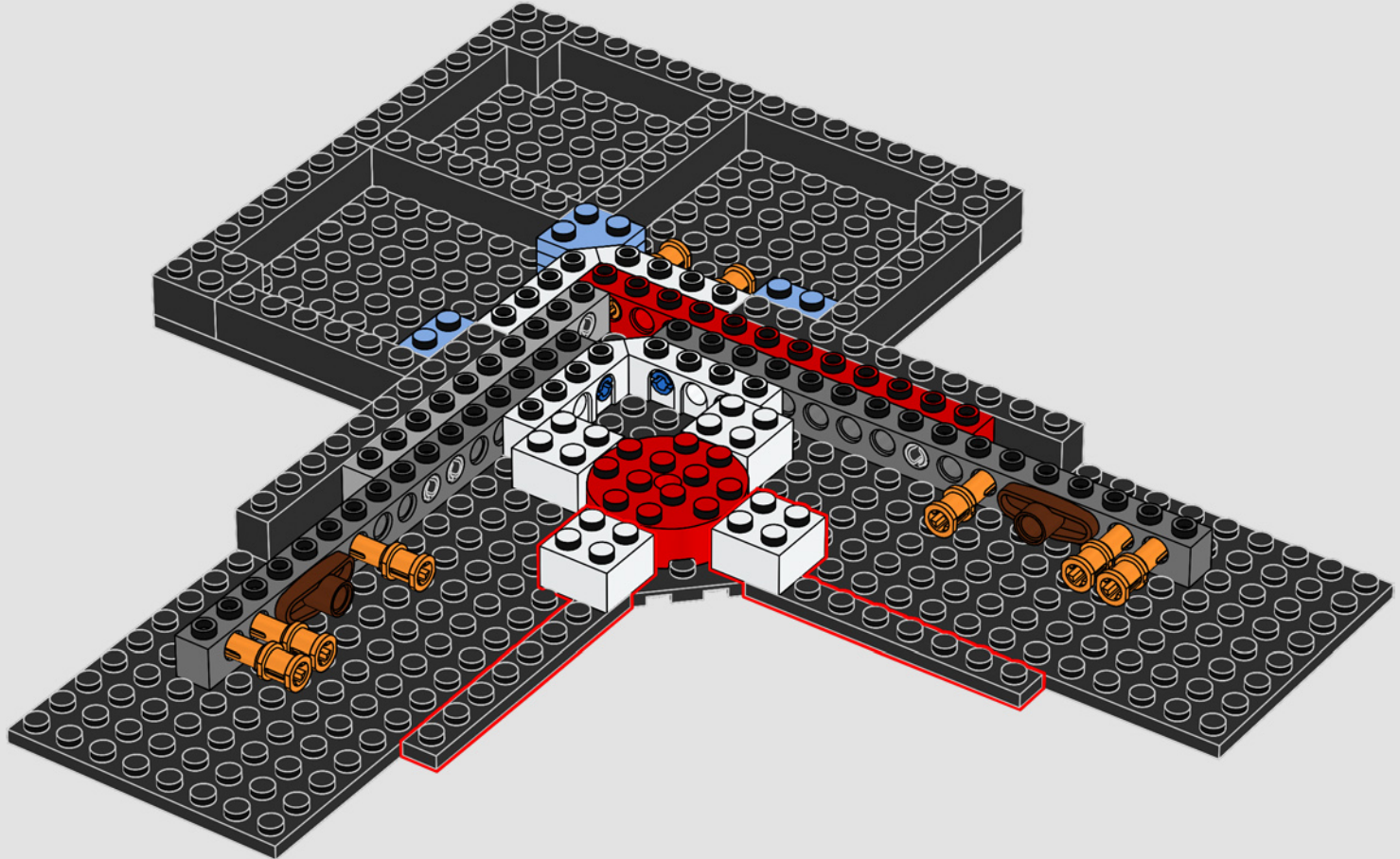

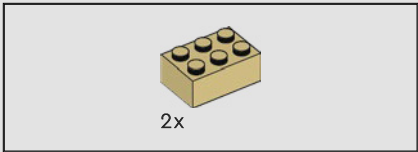

11

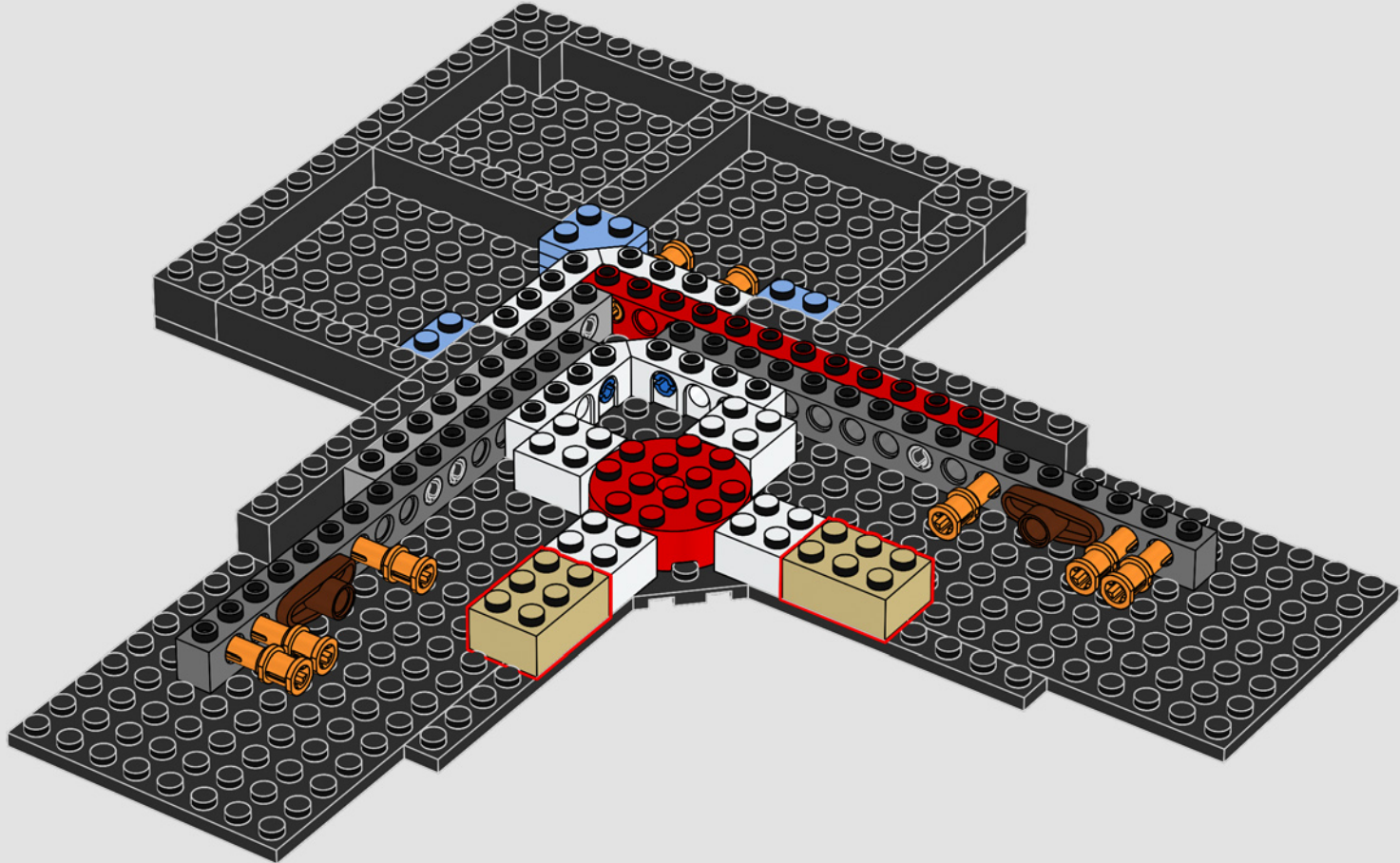

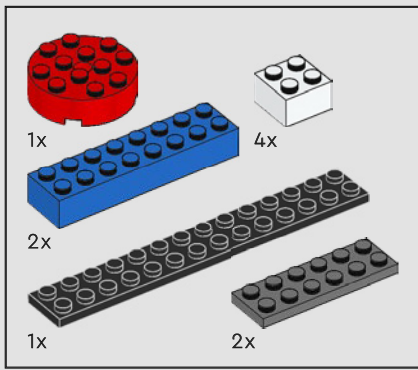

12

1

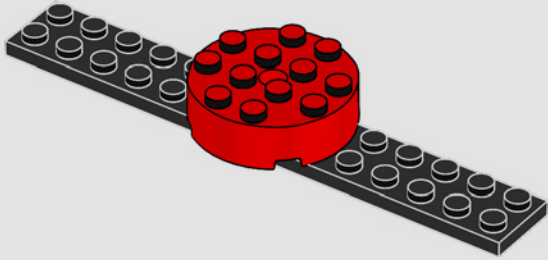

2

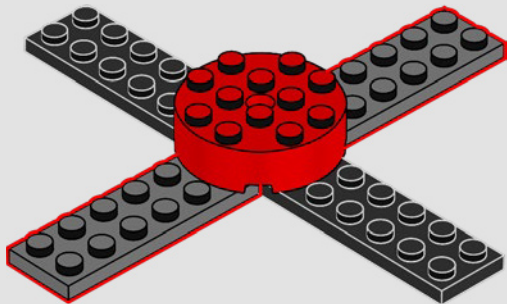

3

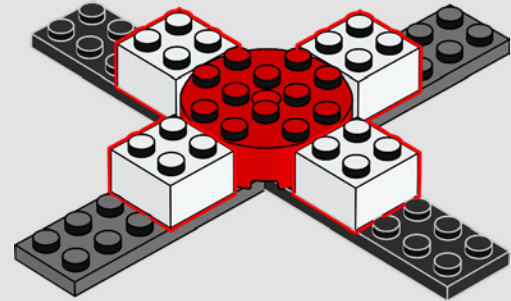

4

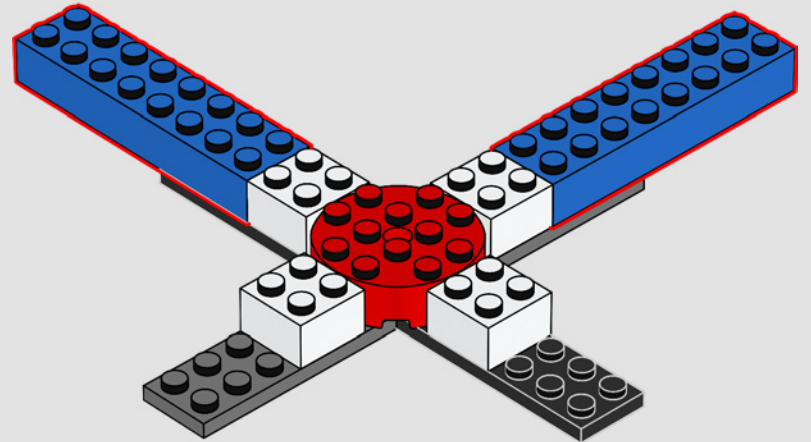

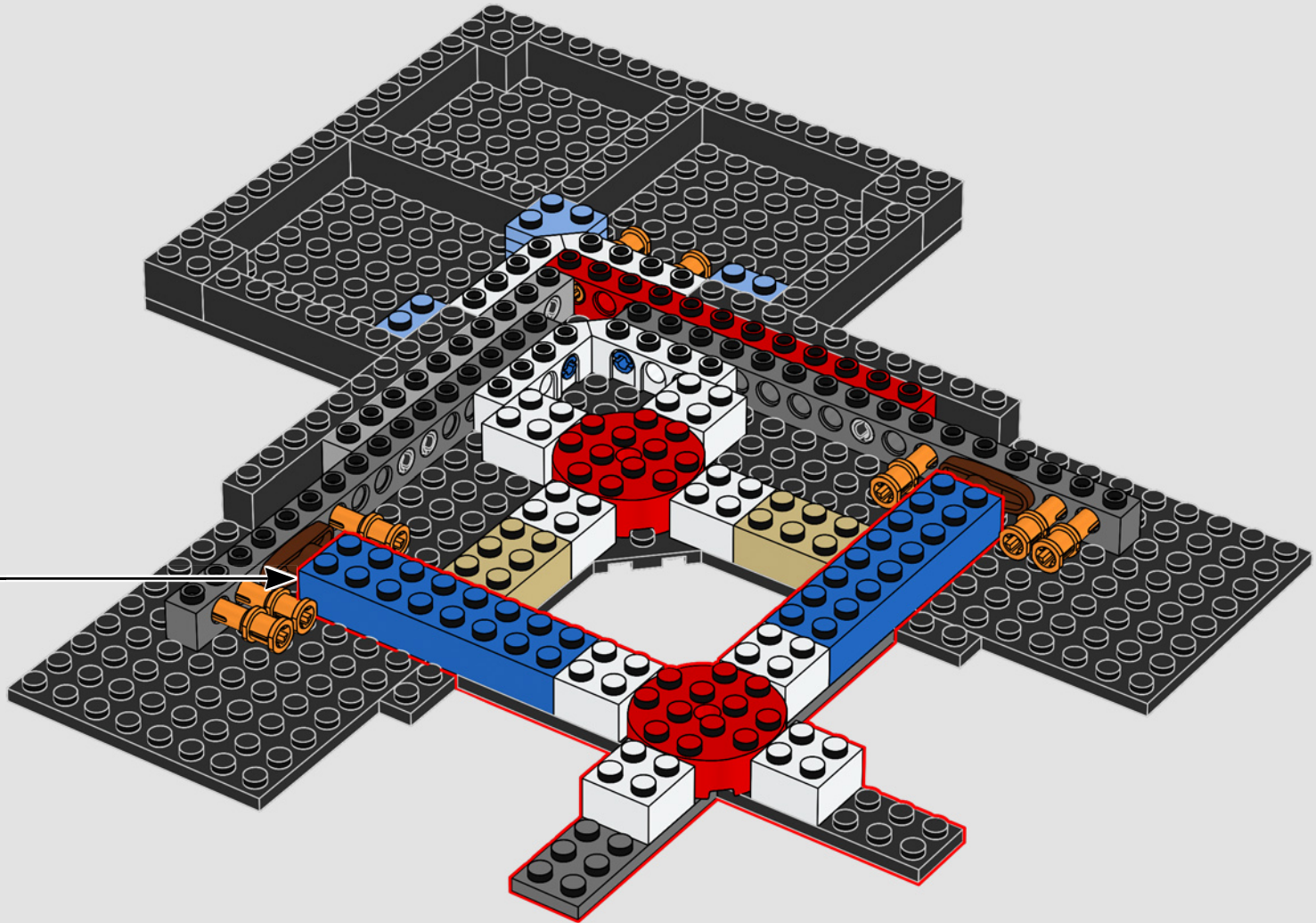

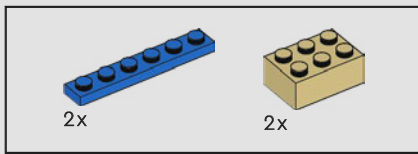

13

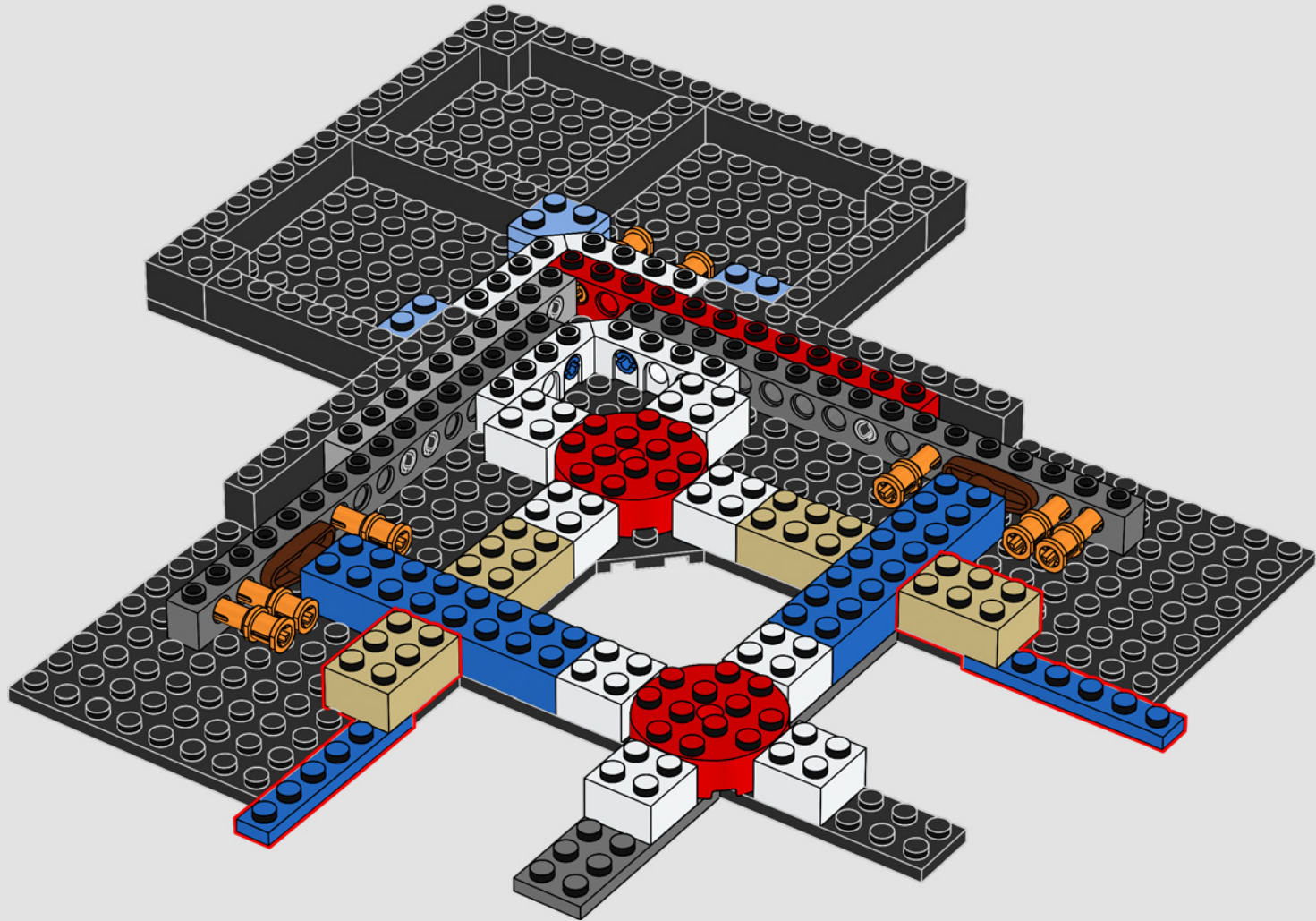

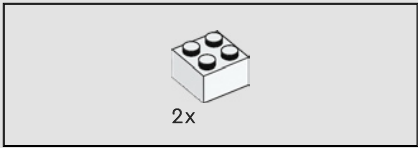

14

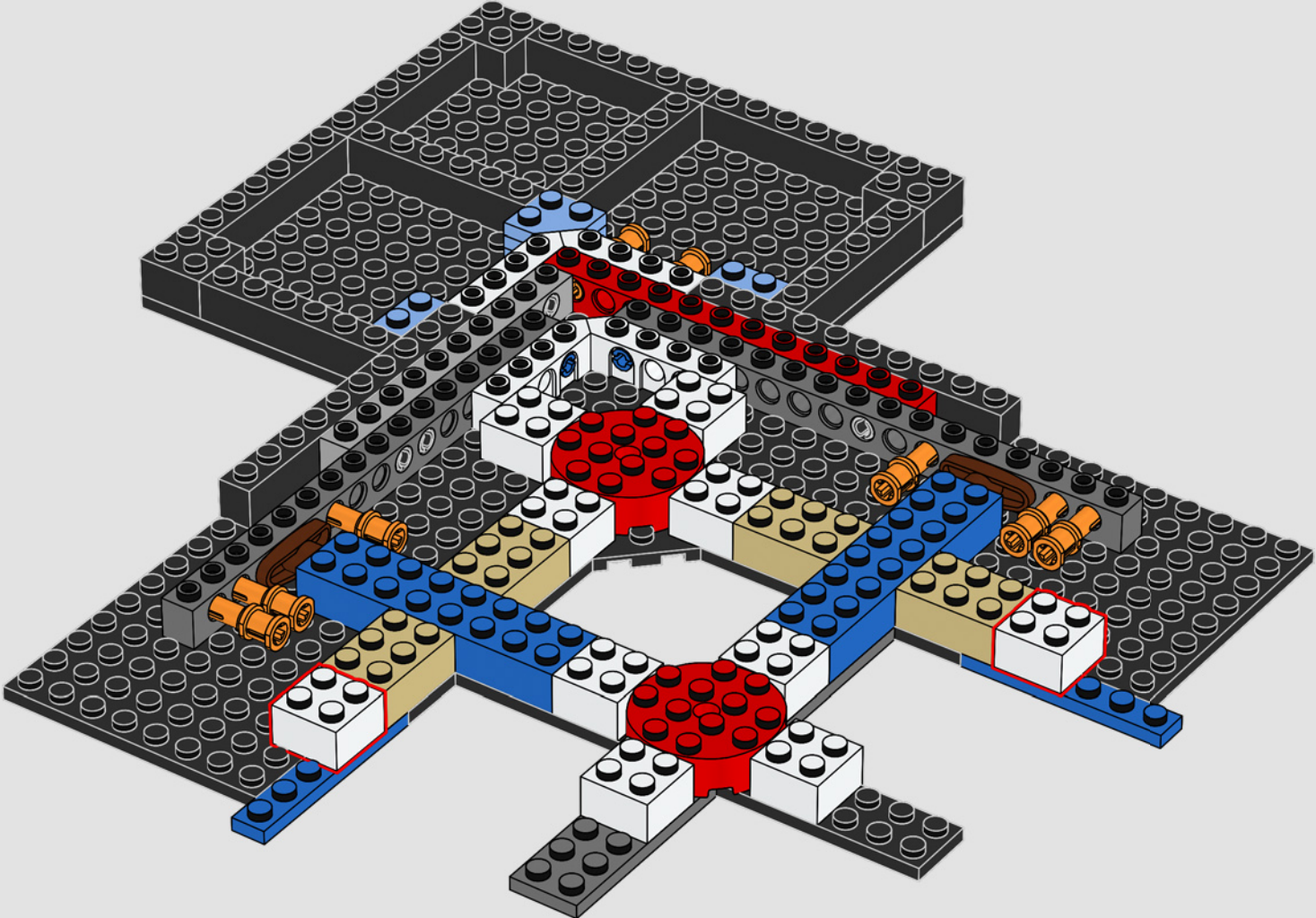

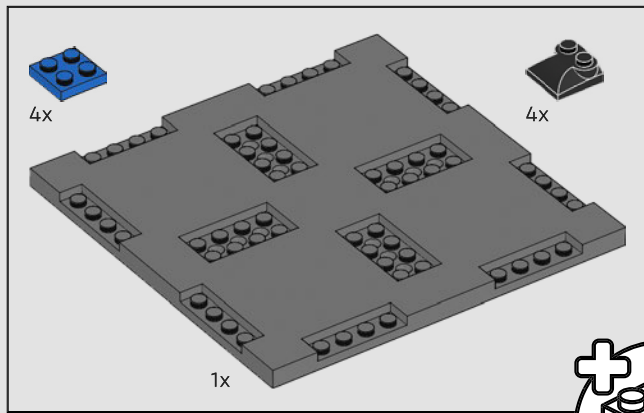

15

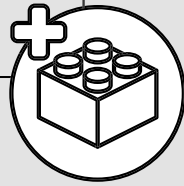

1

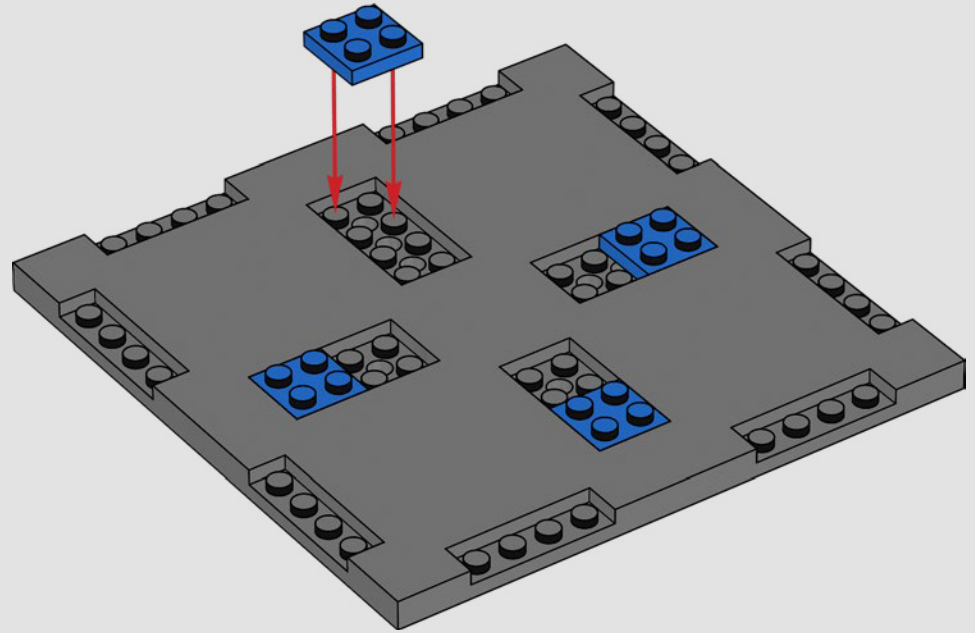

2

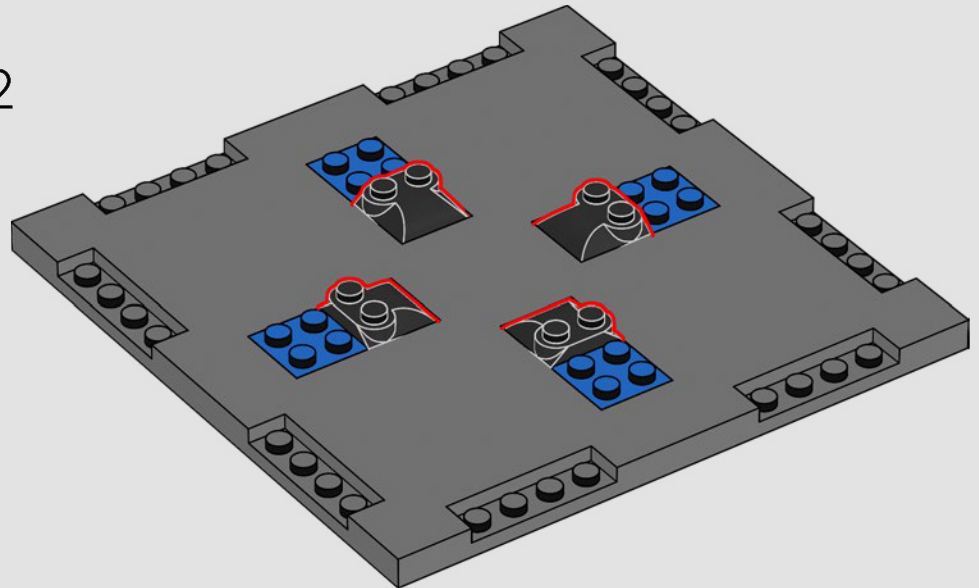

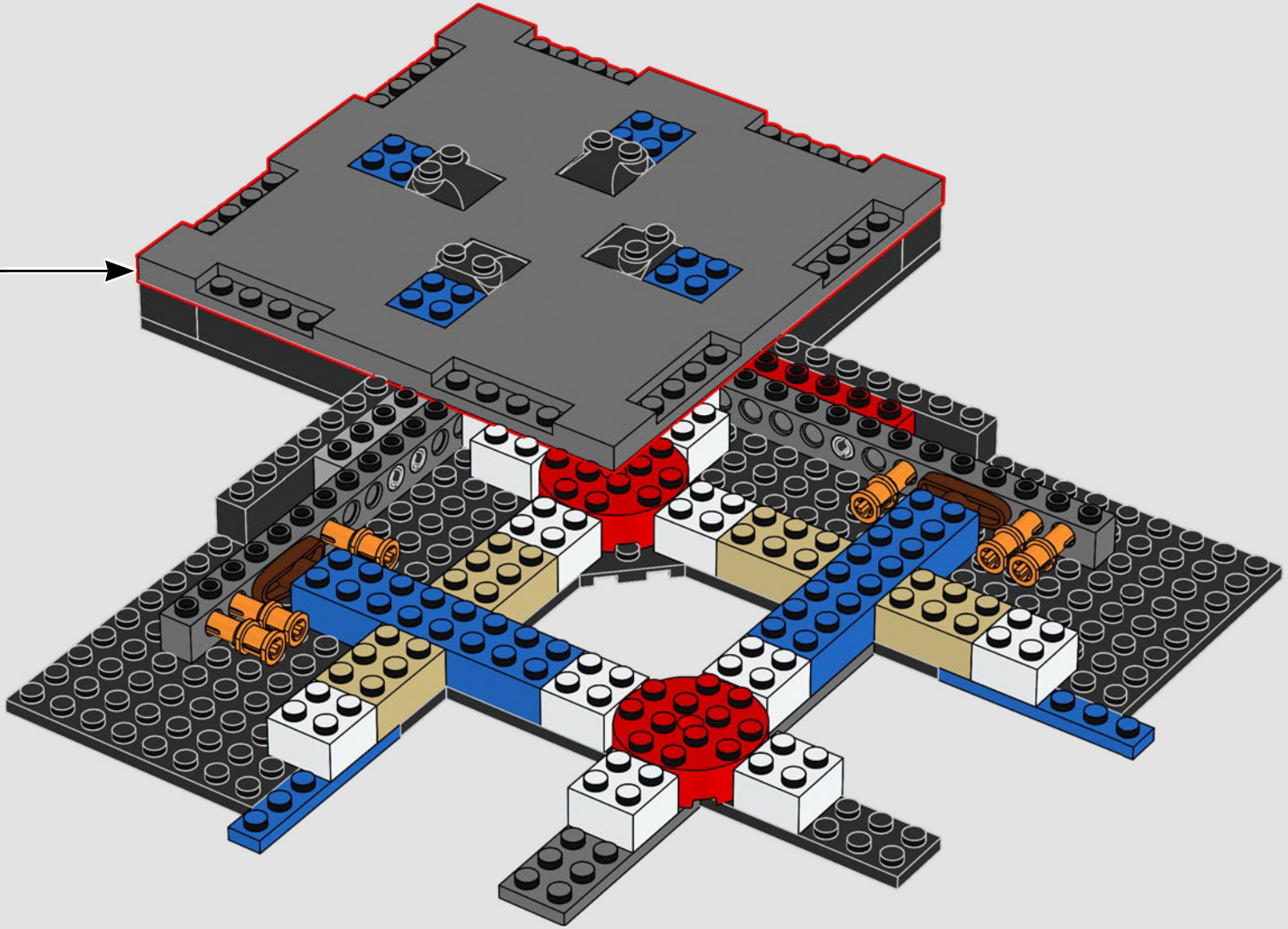

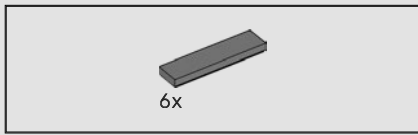

16

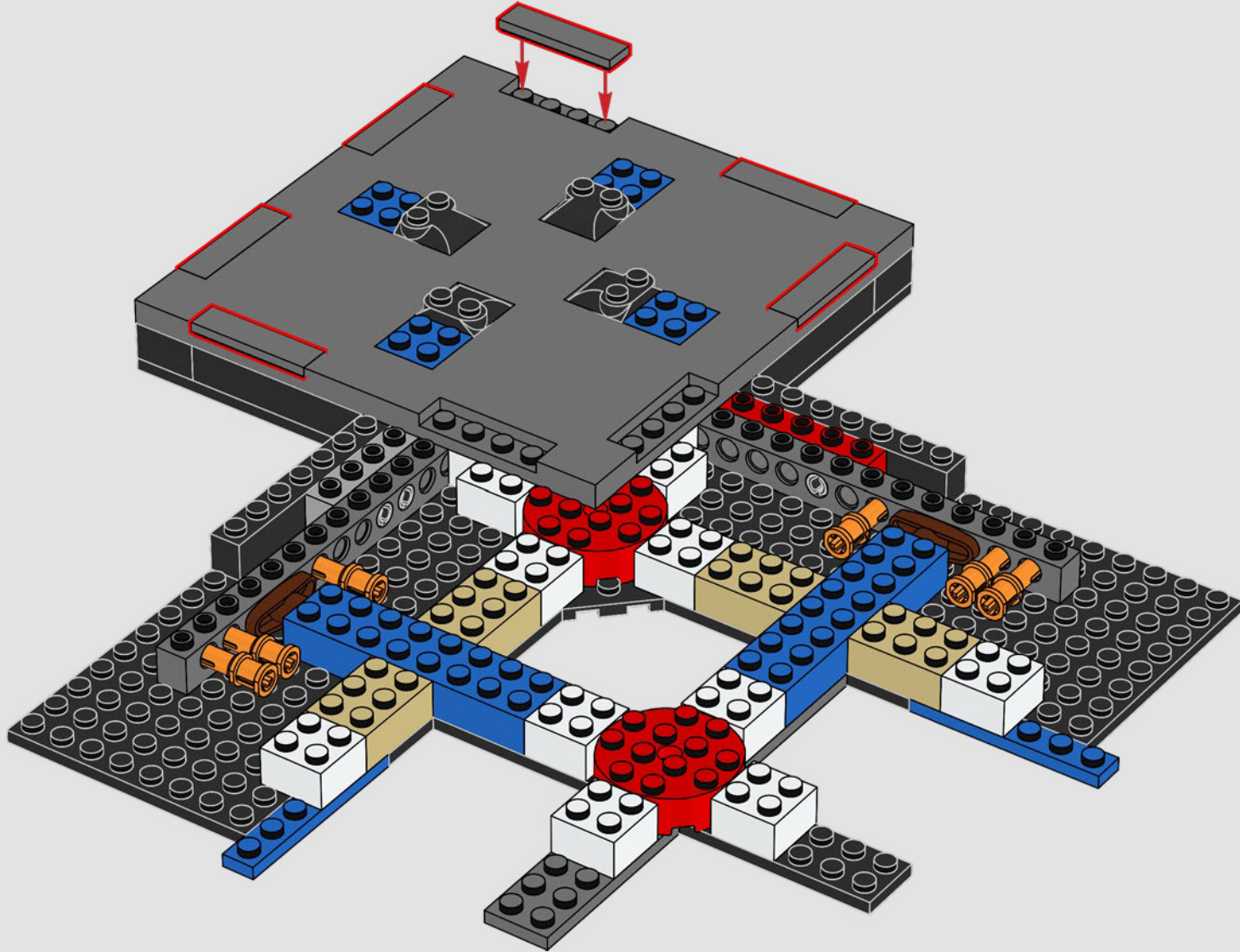

4x

17

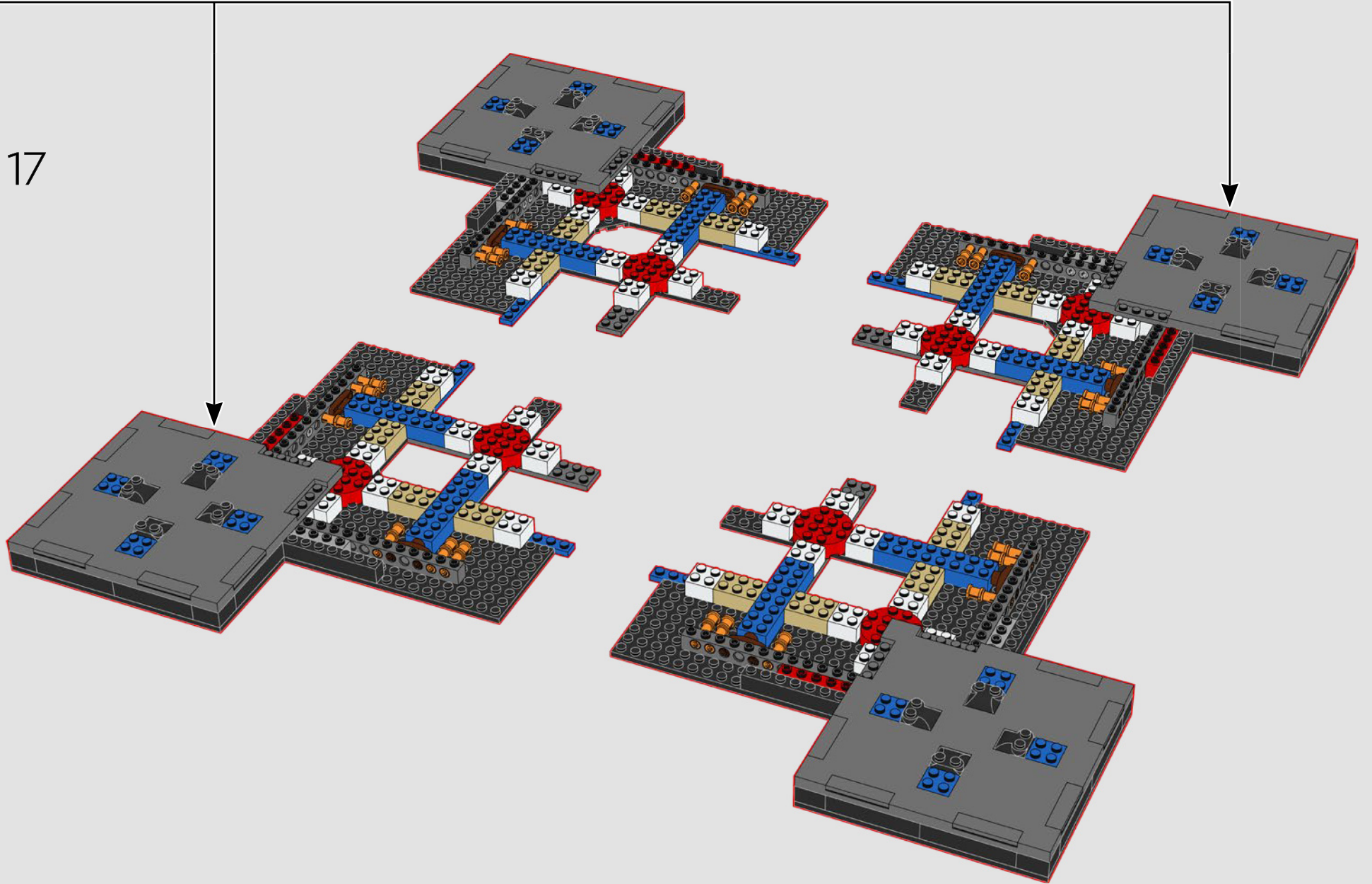



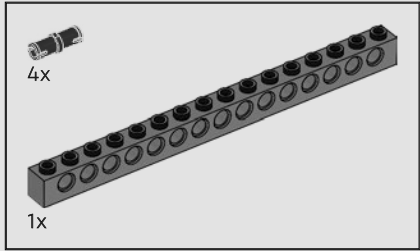
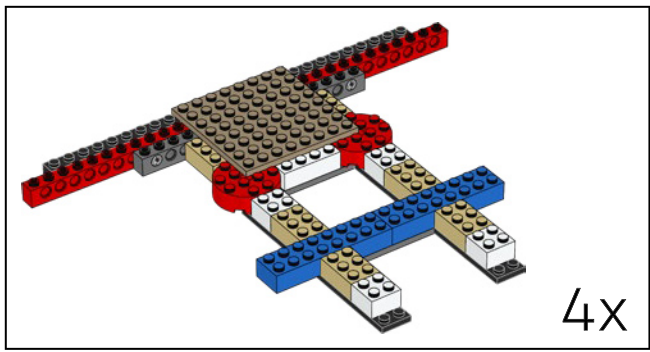

18

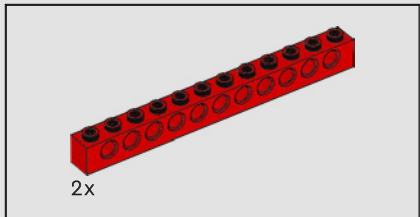
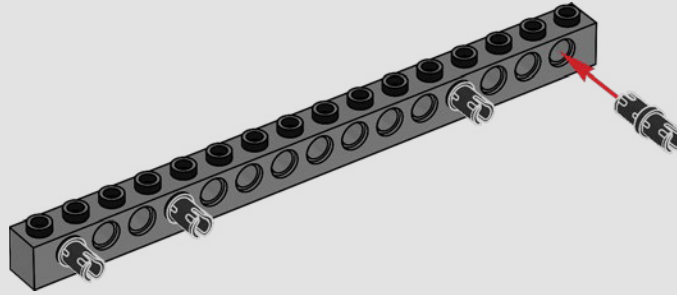

19

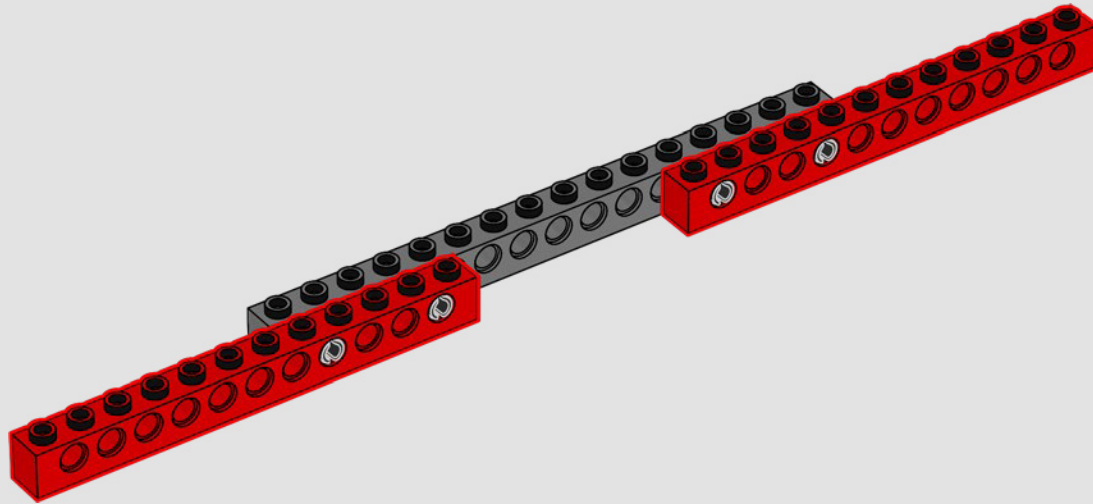

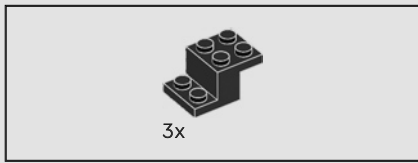

20

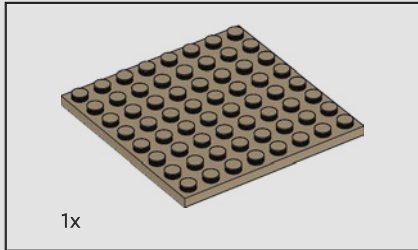
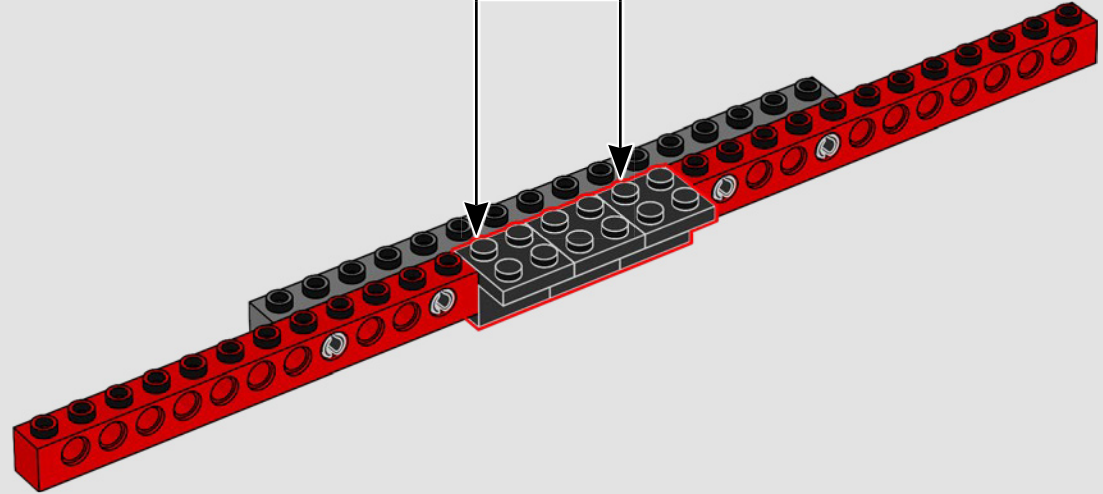
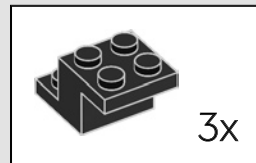

21

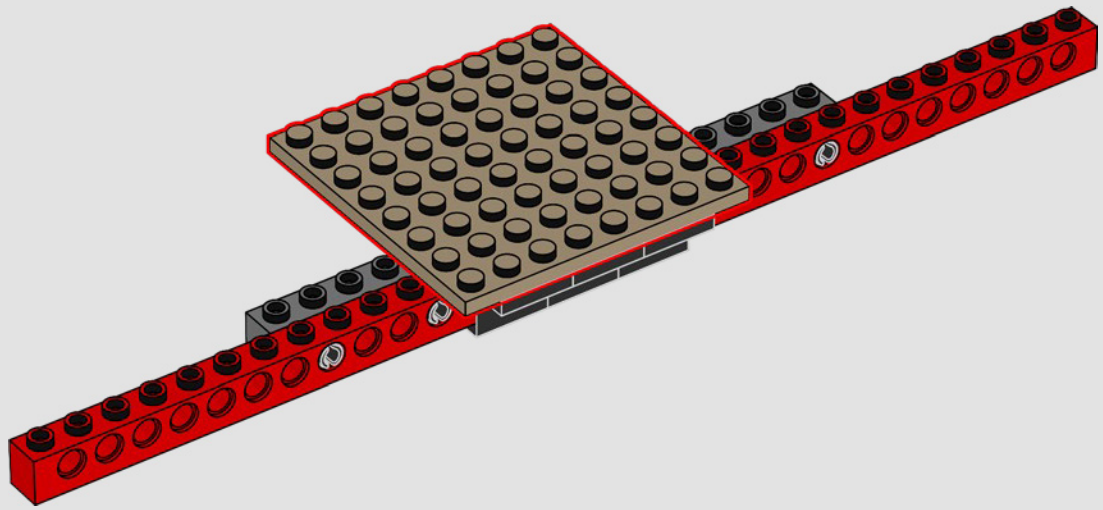



22

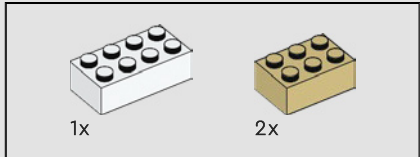
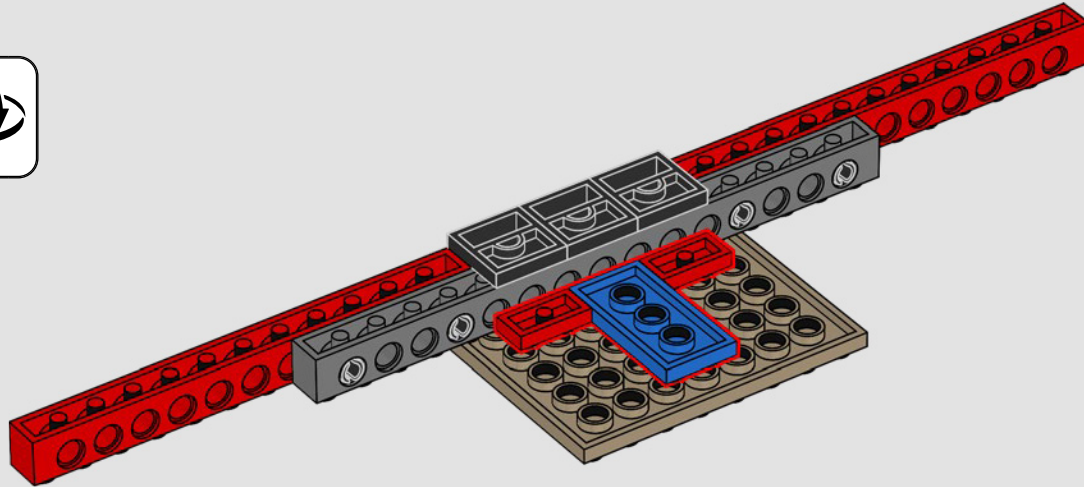

23

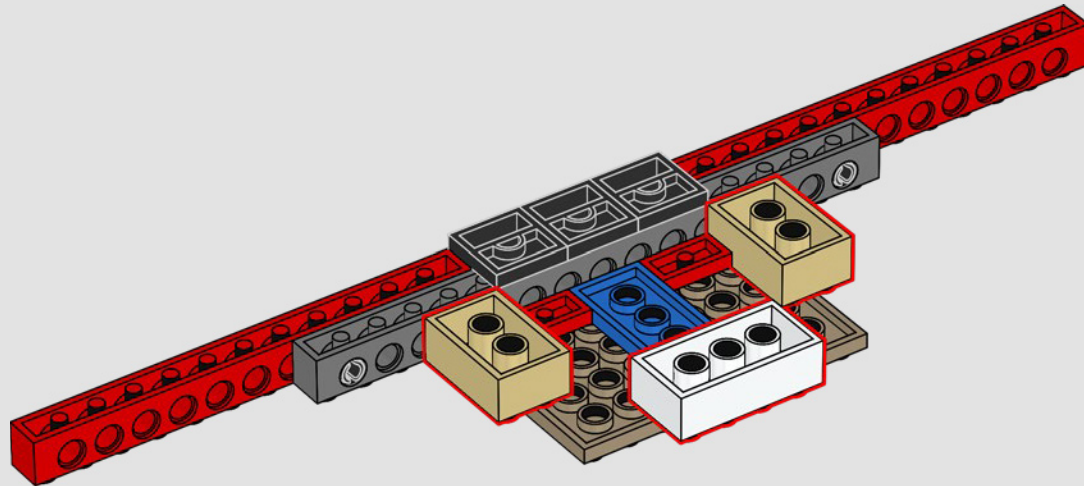



24

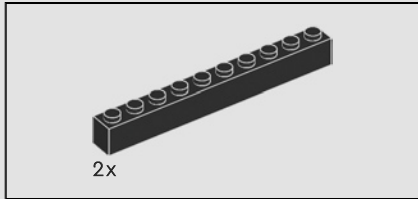
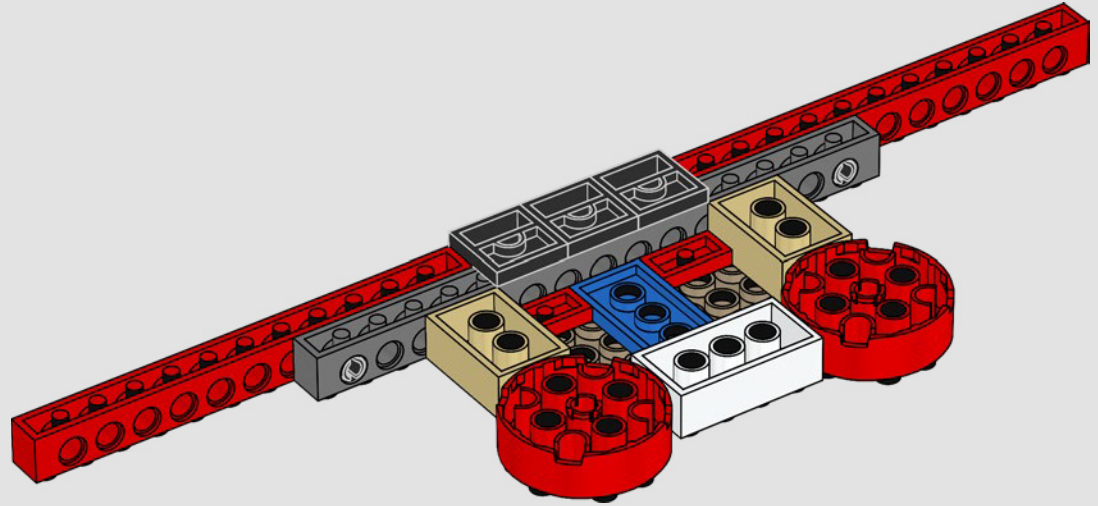

25

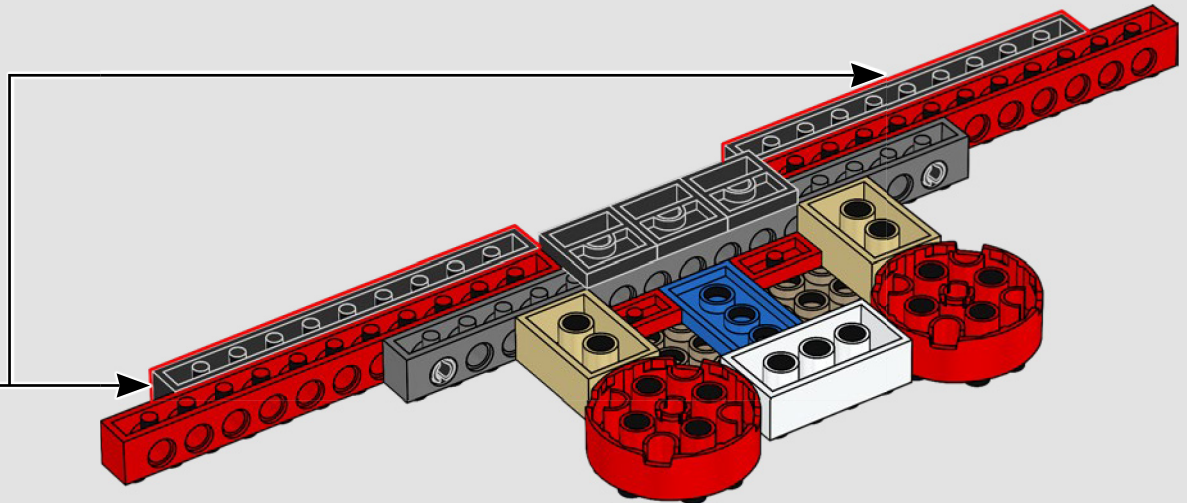
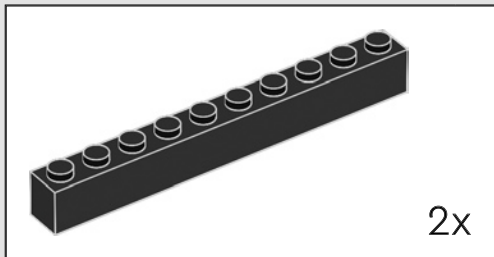

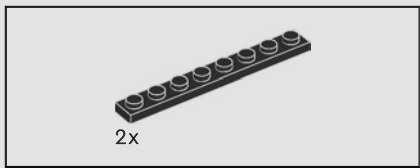

26

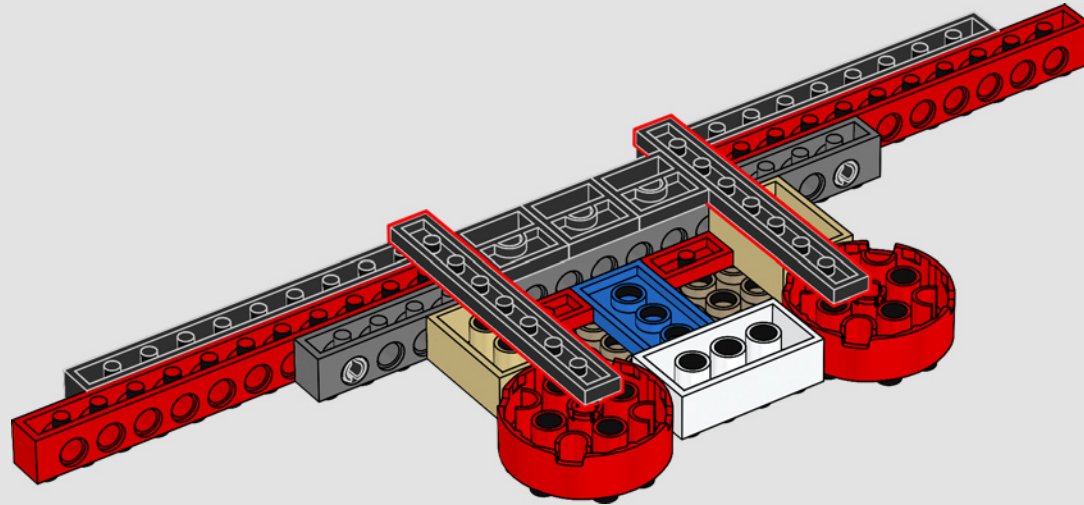

27

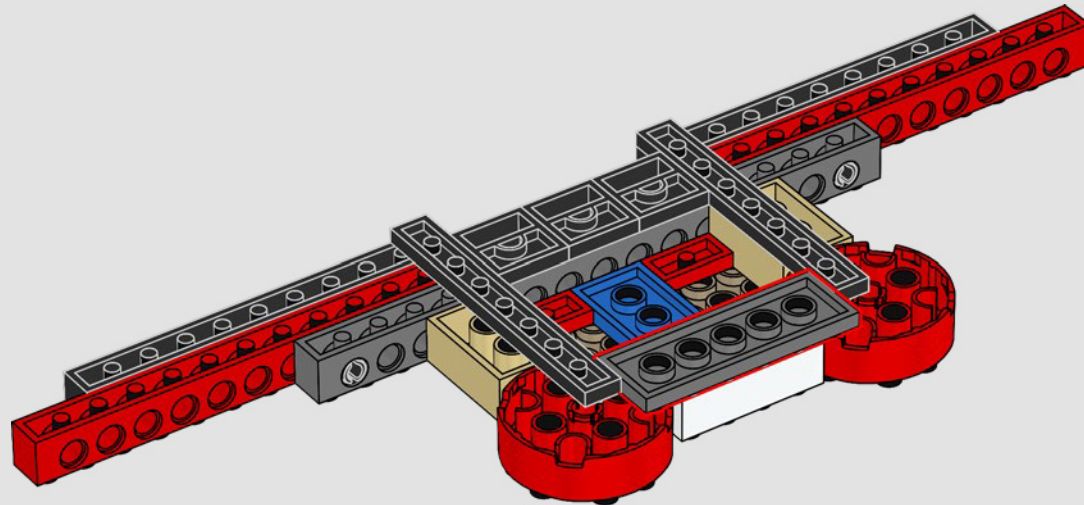

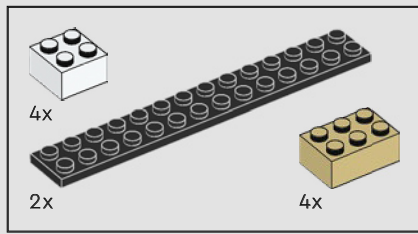

28

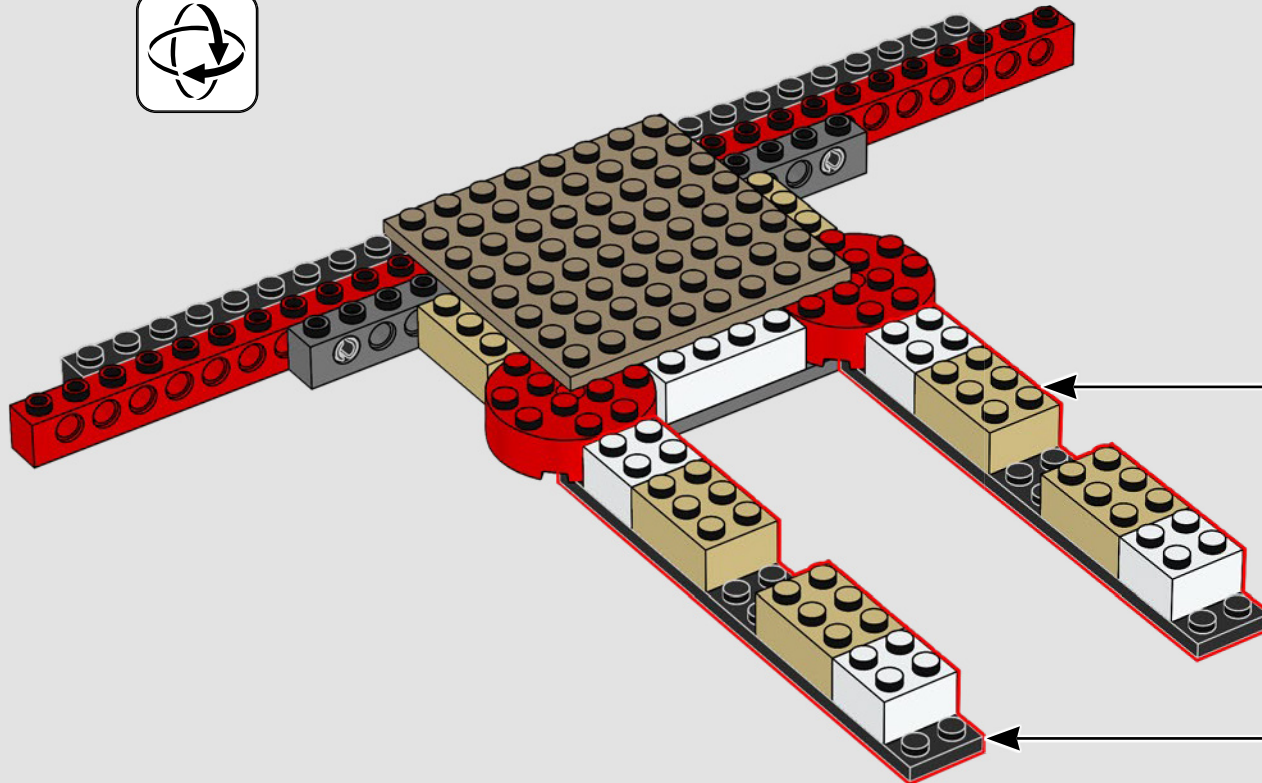
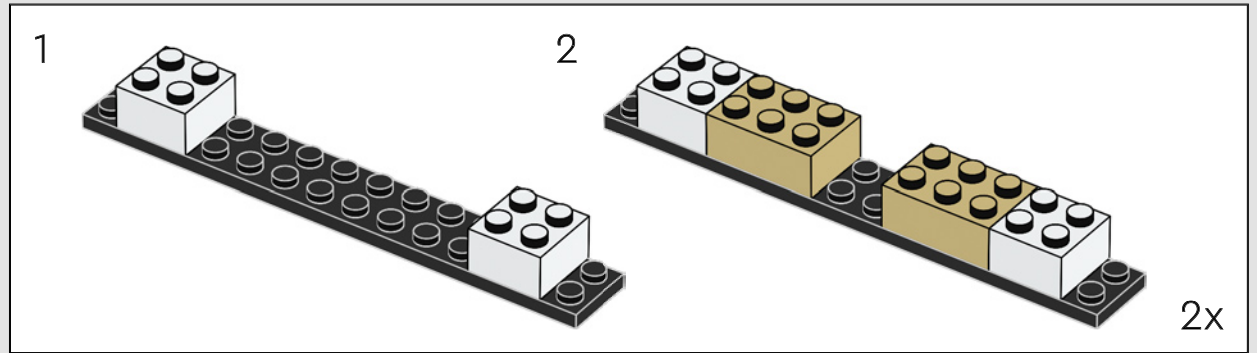

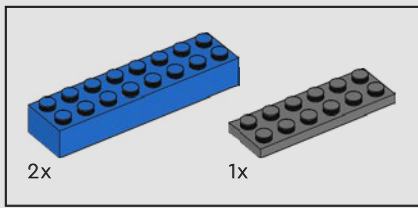

29

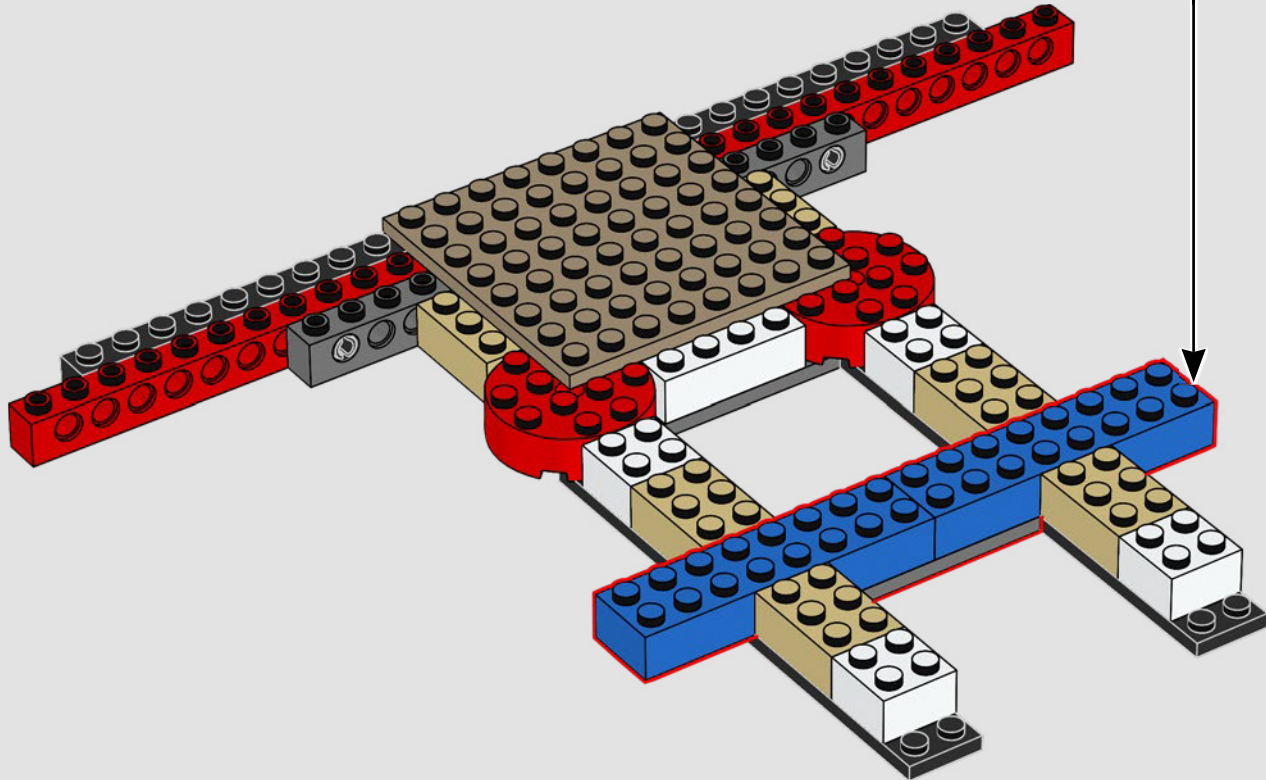
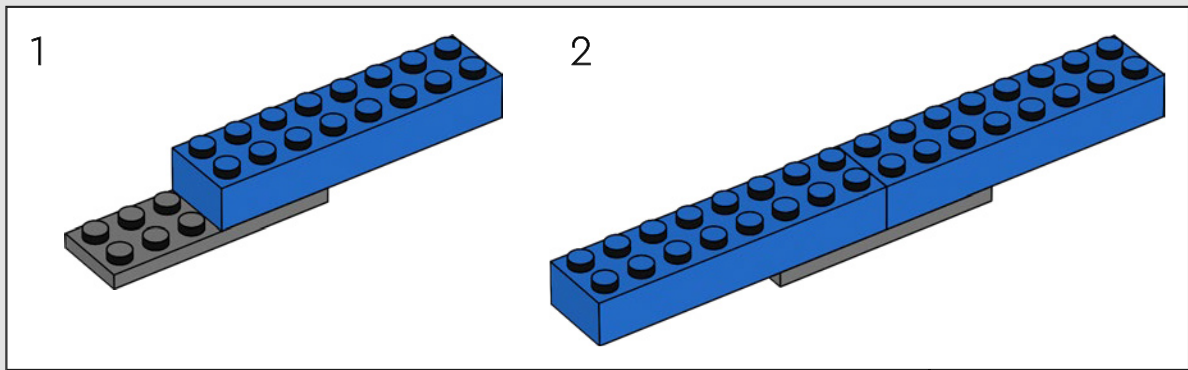

4x

30

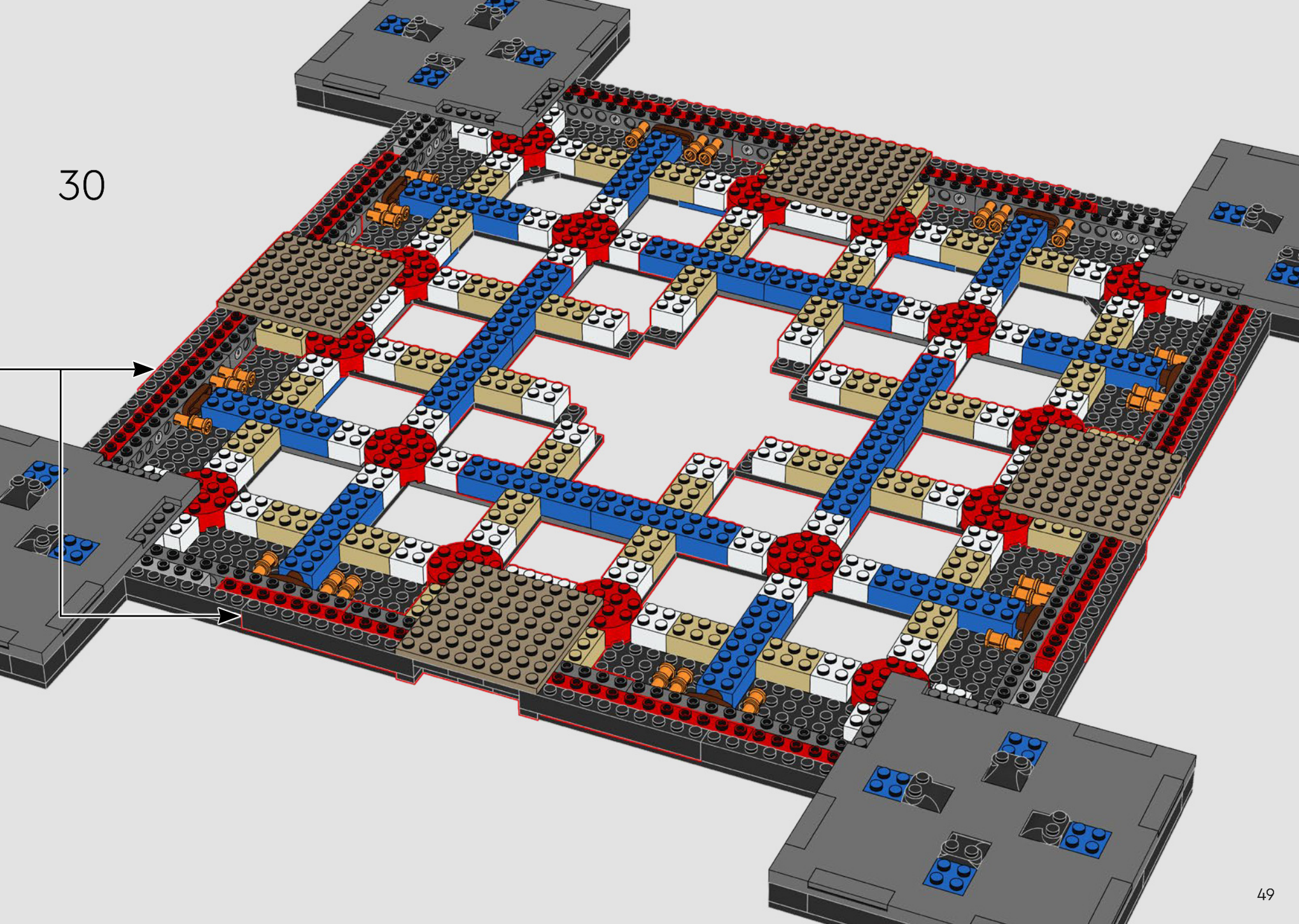

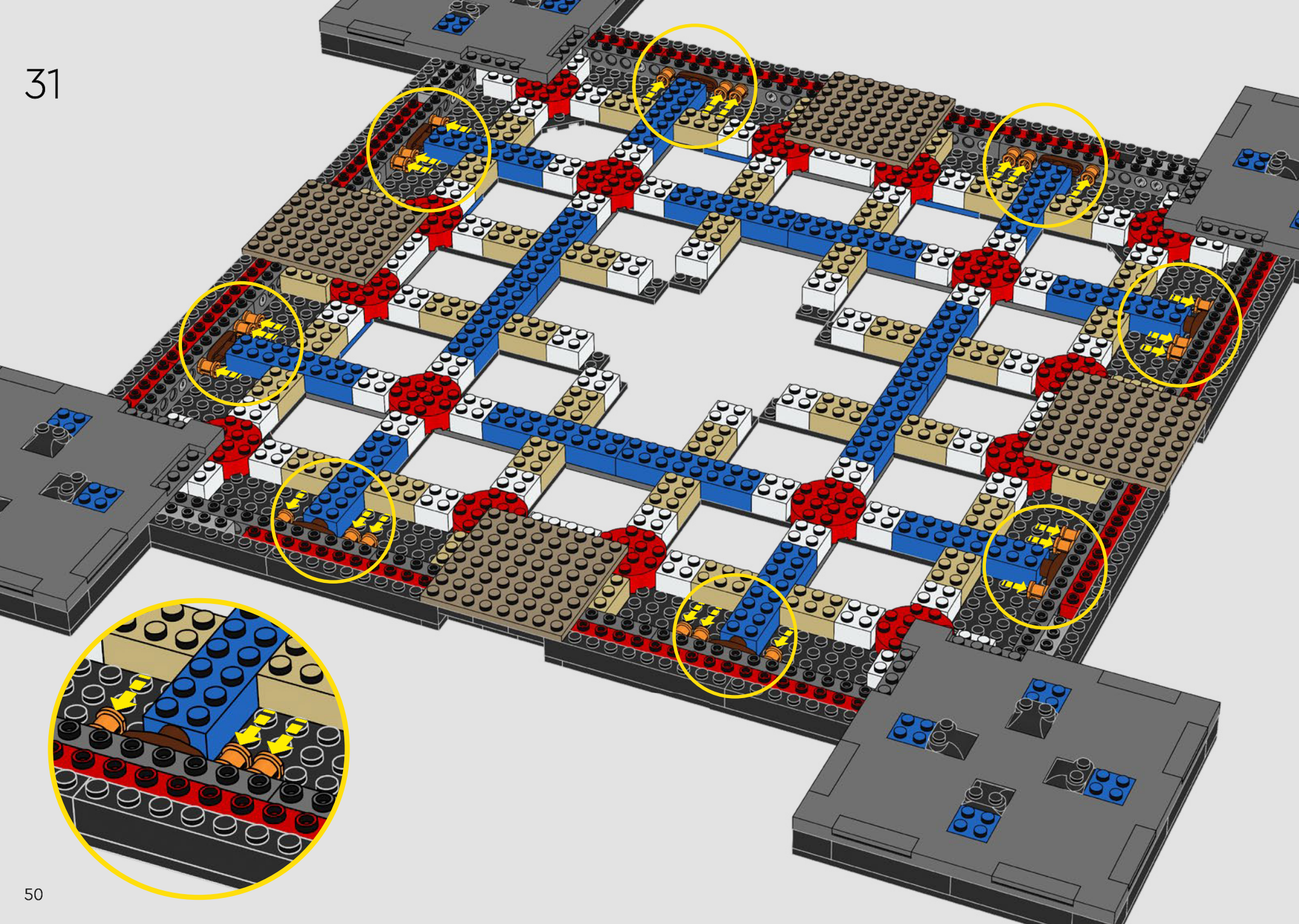

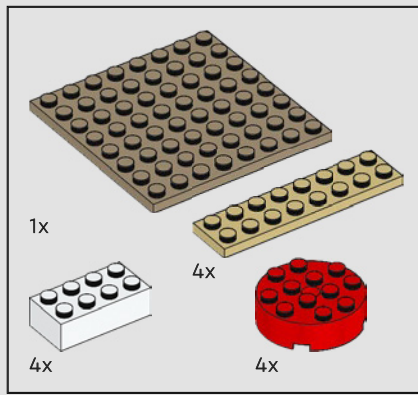

32

1

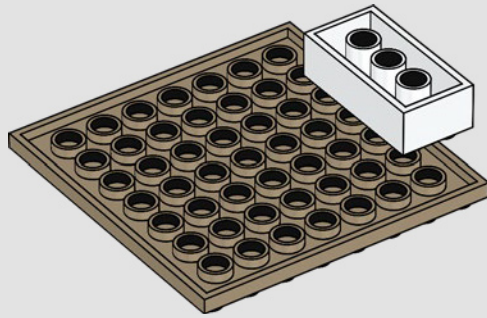

2

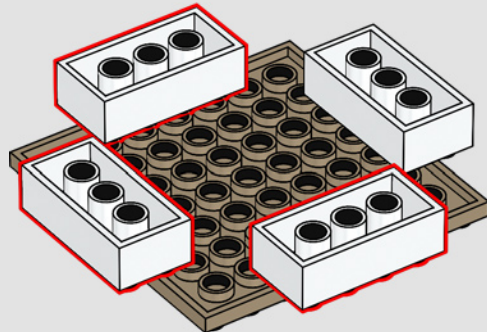

3

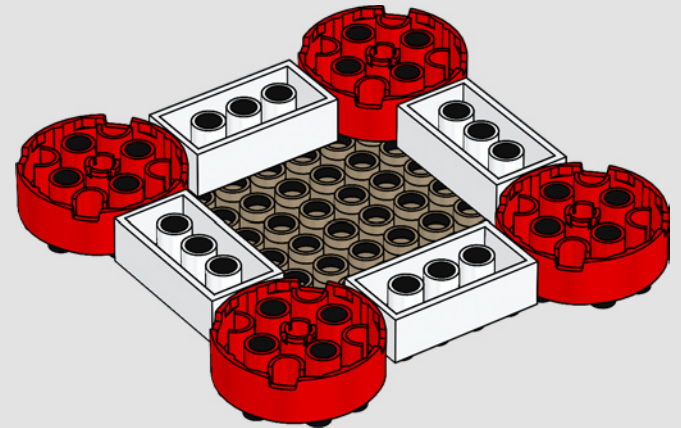

4

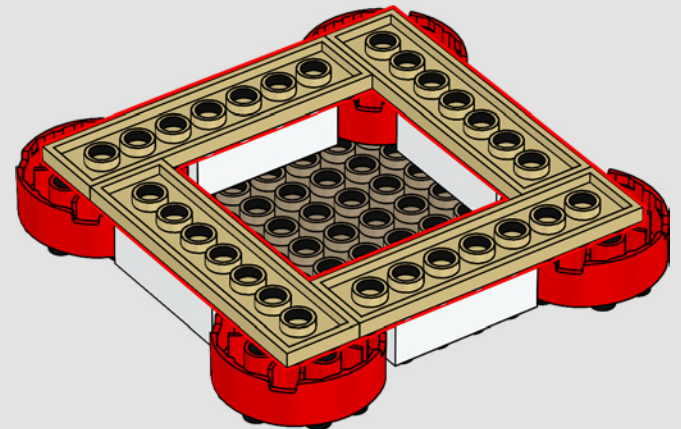

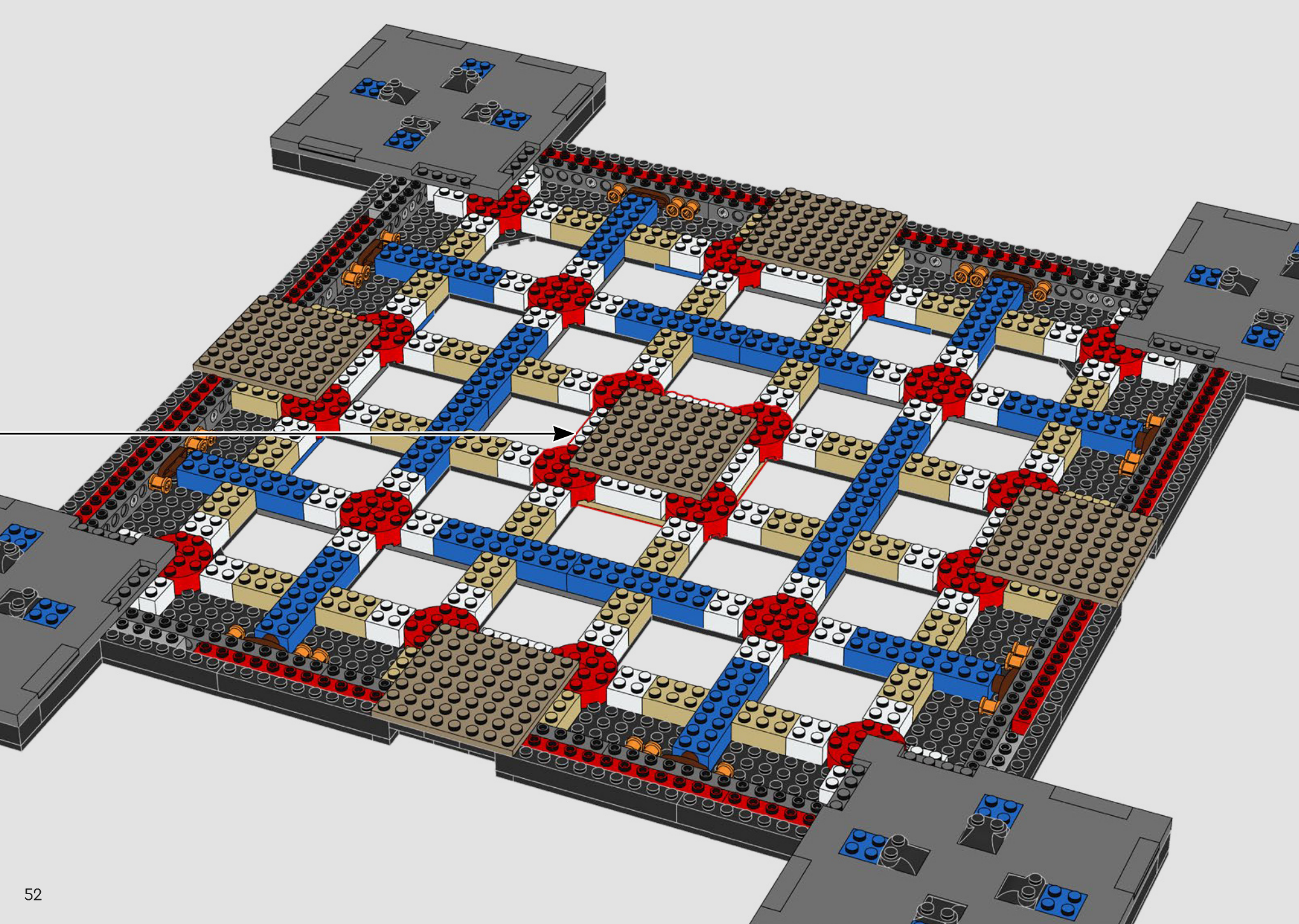

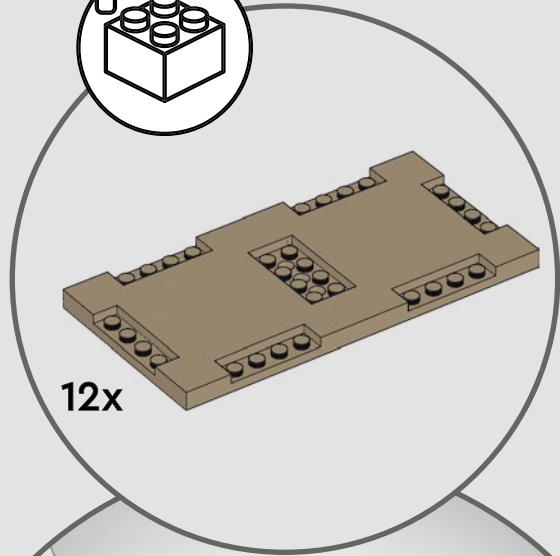
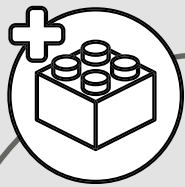

12x

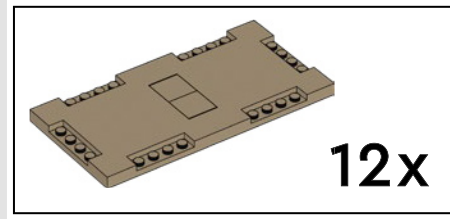

12x

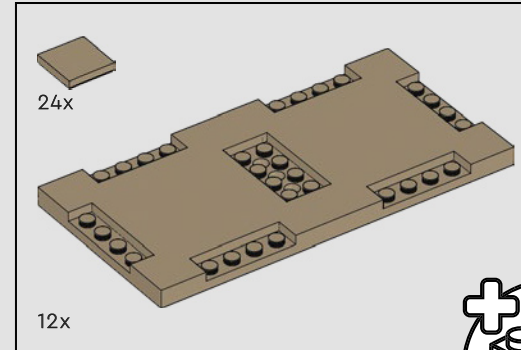

24x

12x

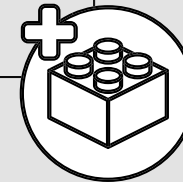

33

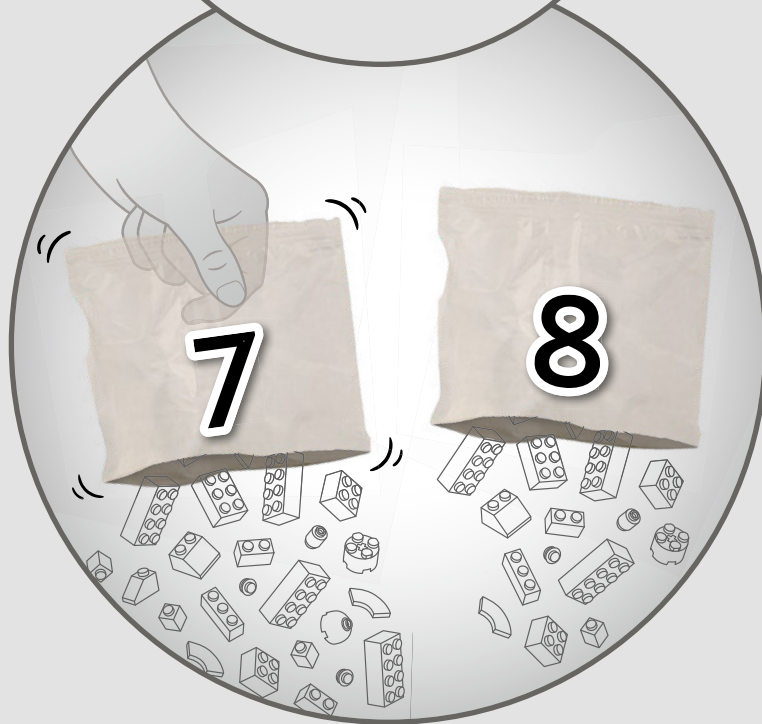

7

8

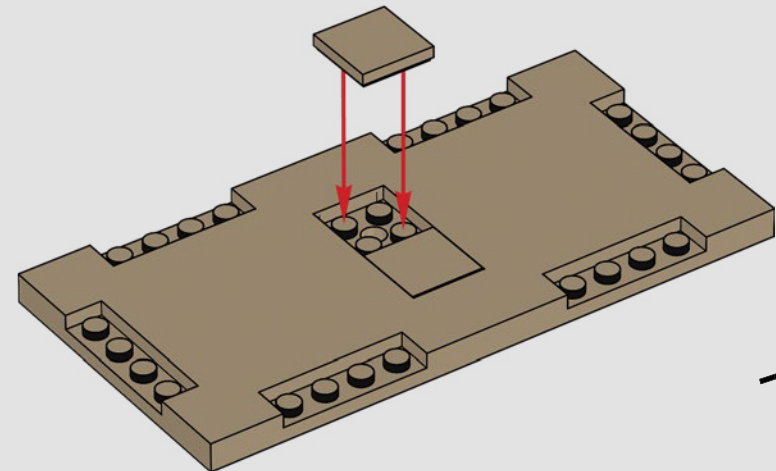

12x

34

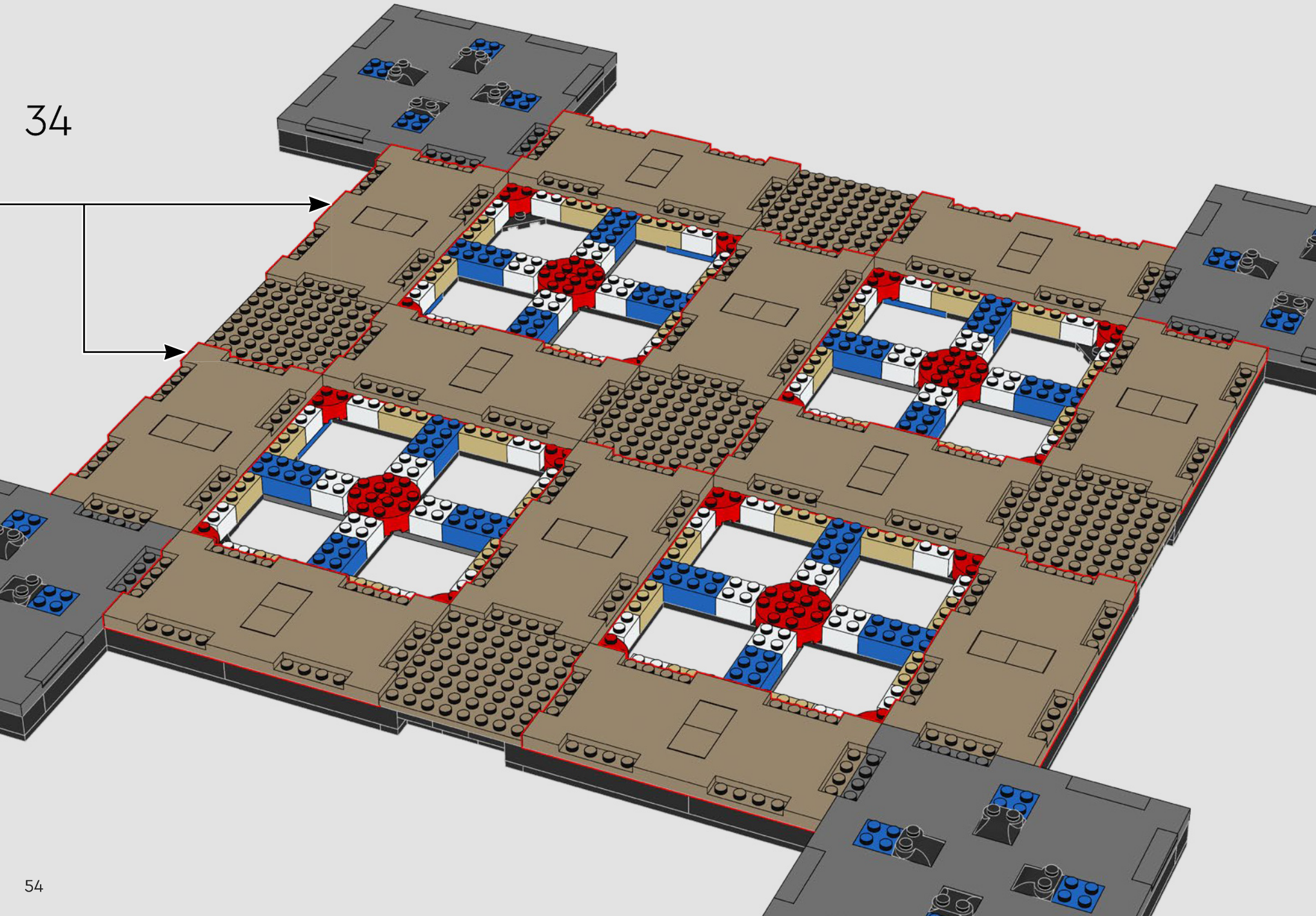

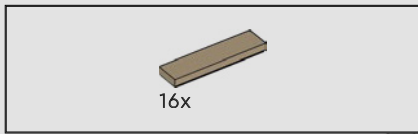

35

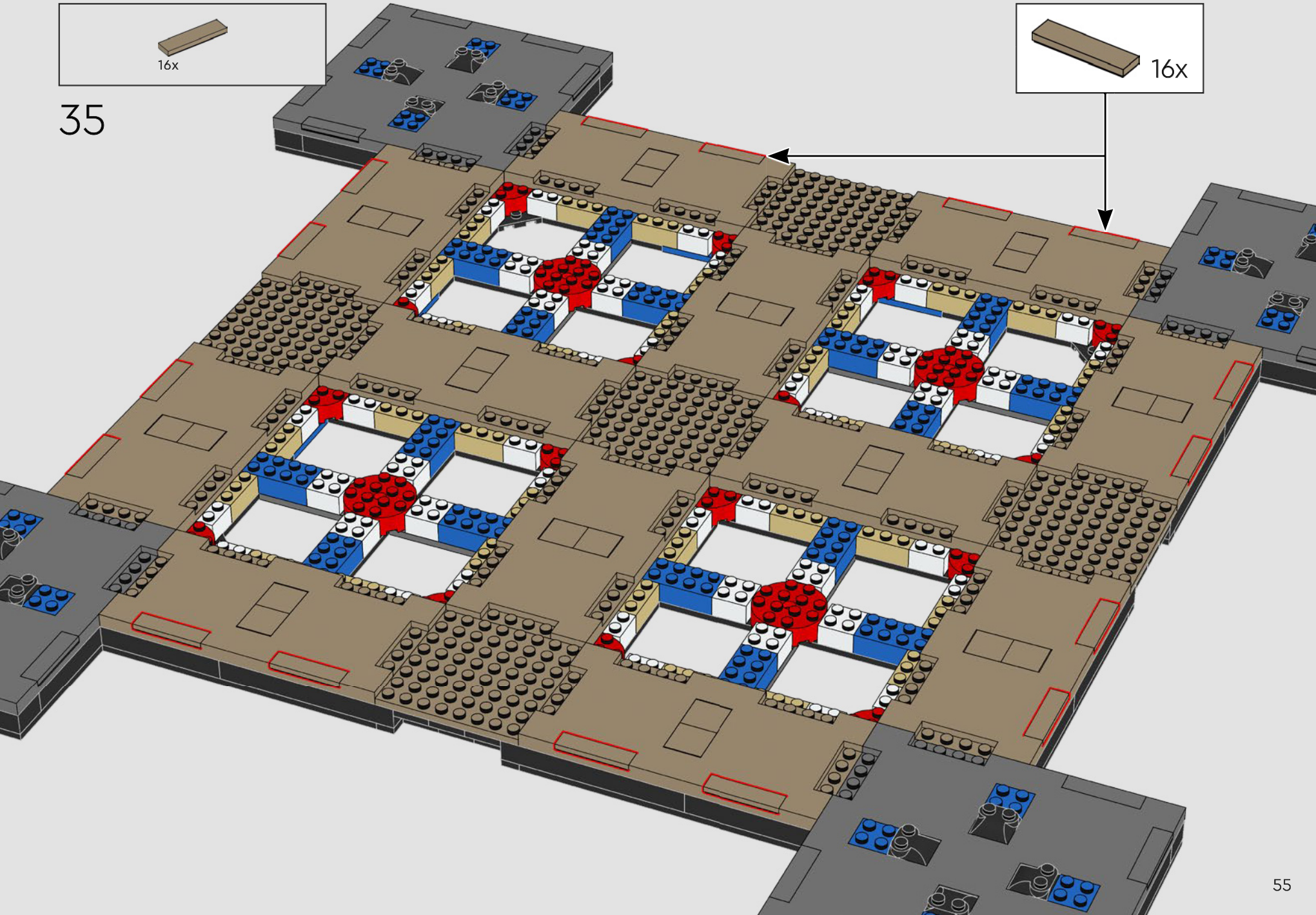
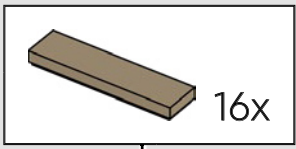

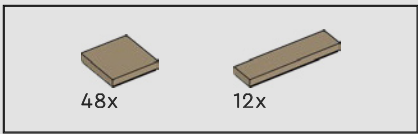

36

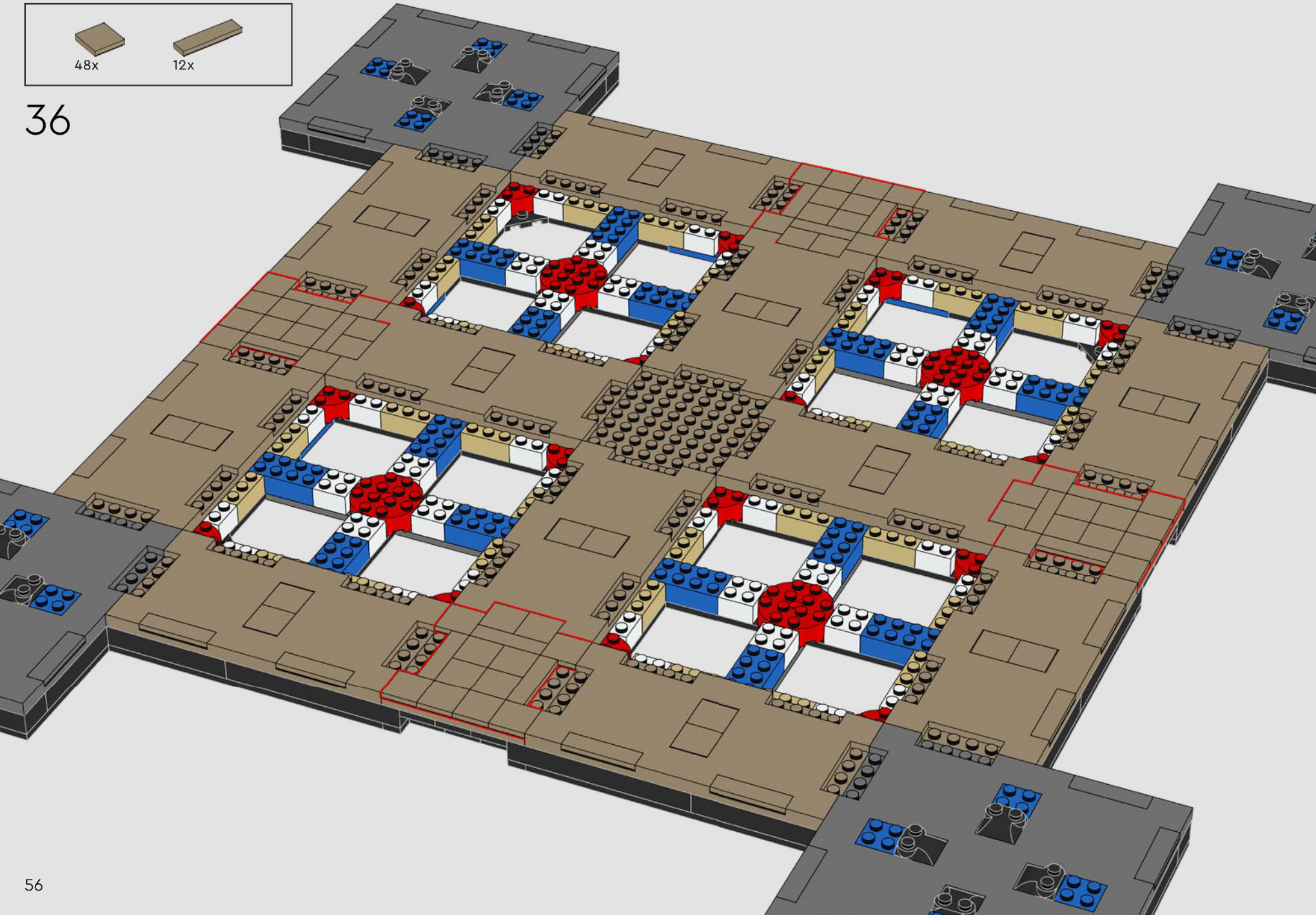

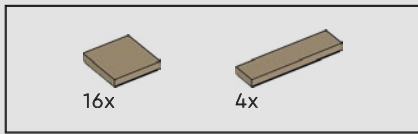

37

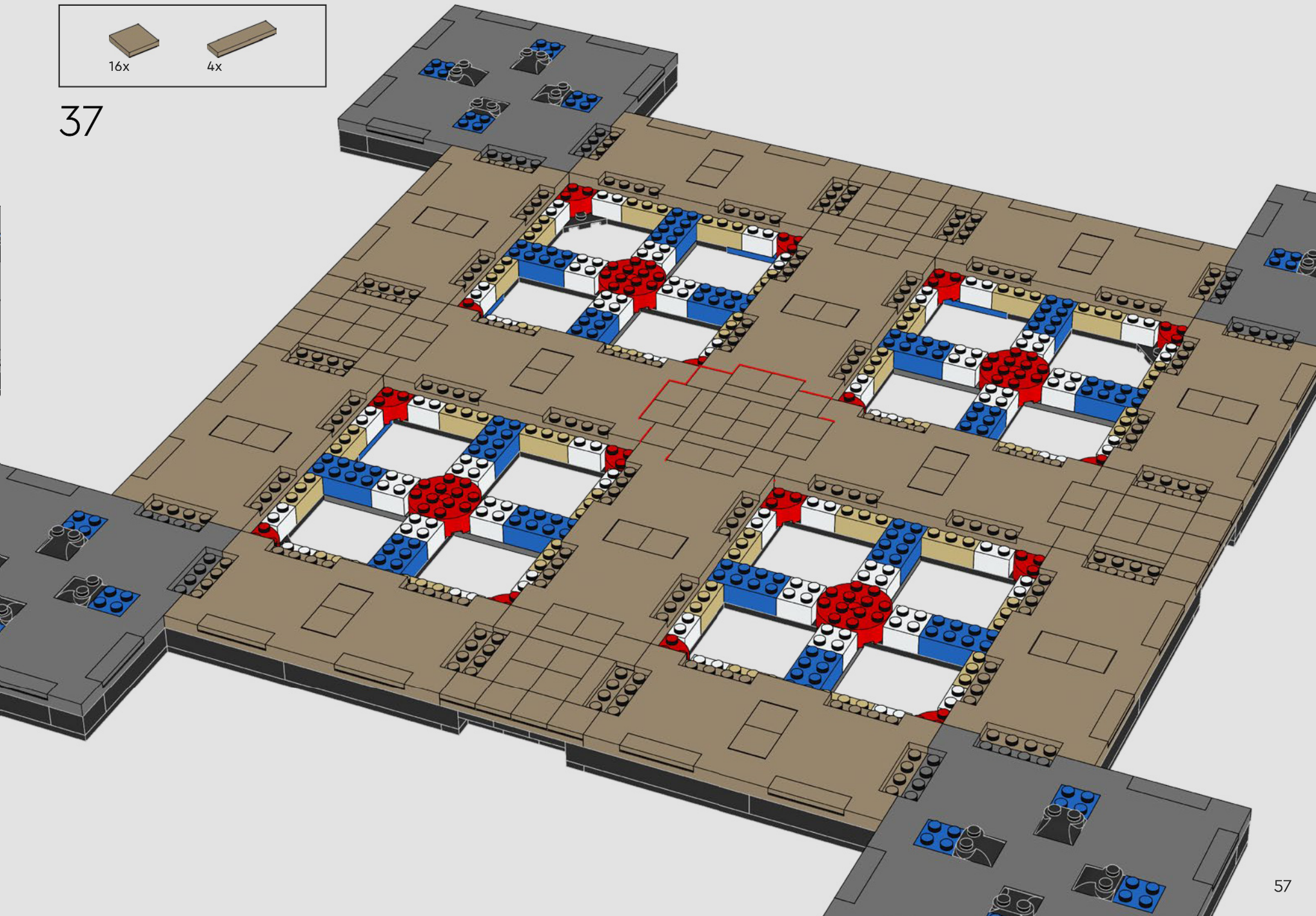

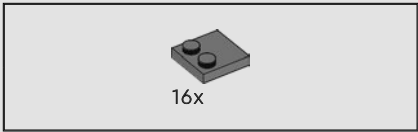

38

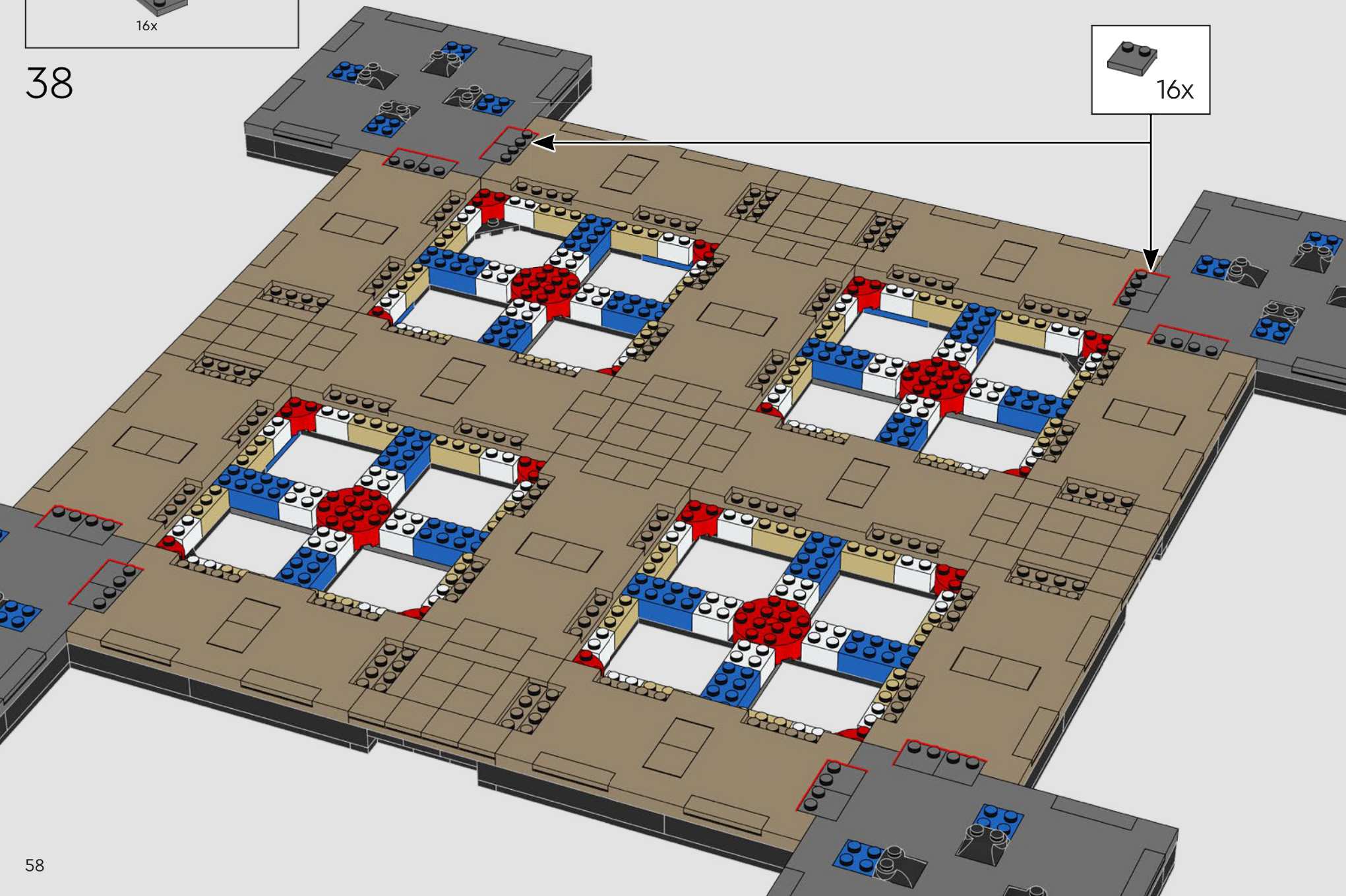
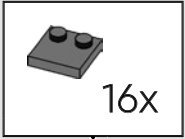

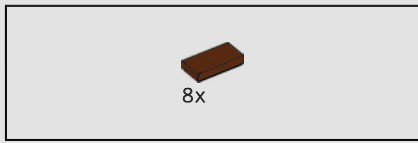

39

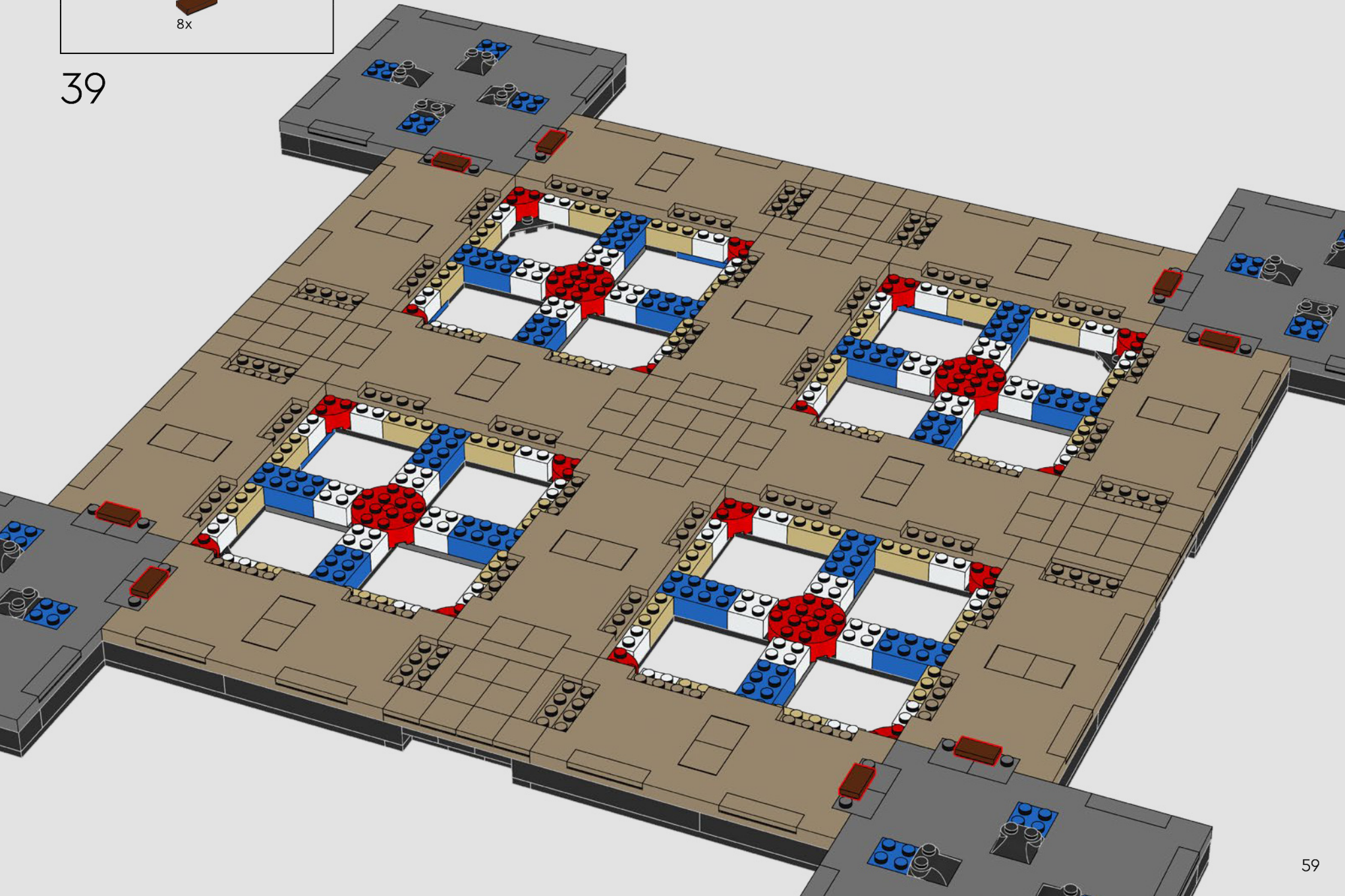

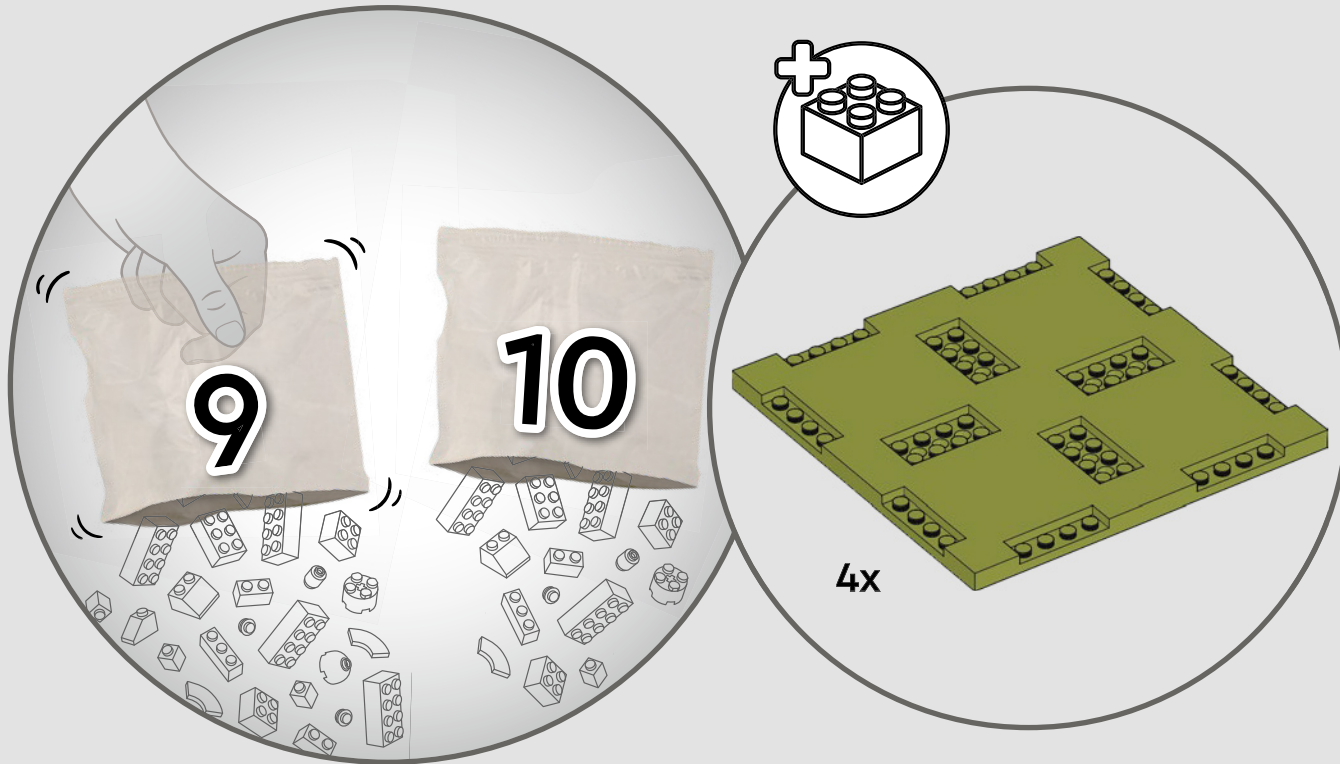

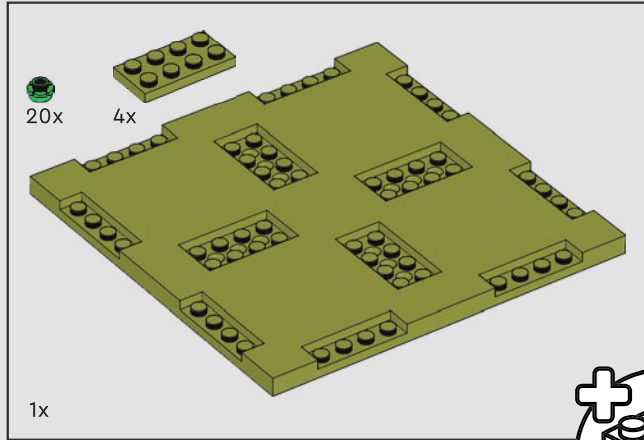
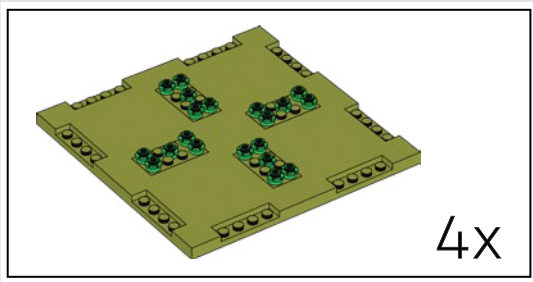

40

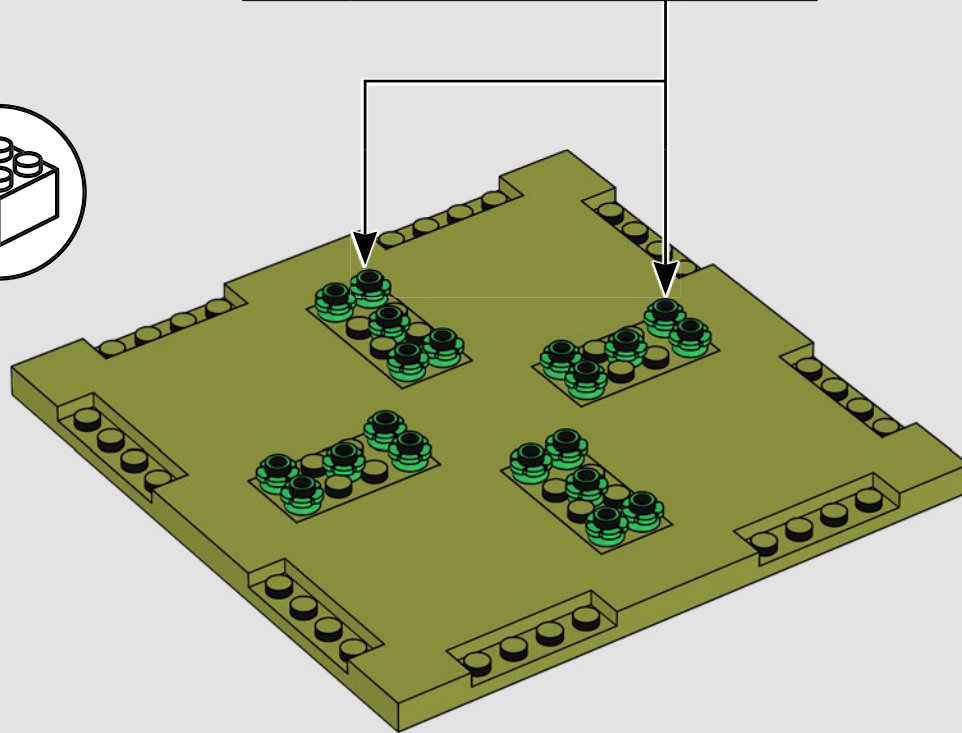
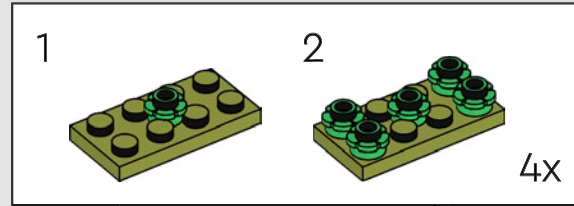
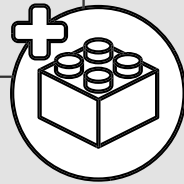

41

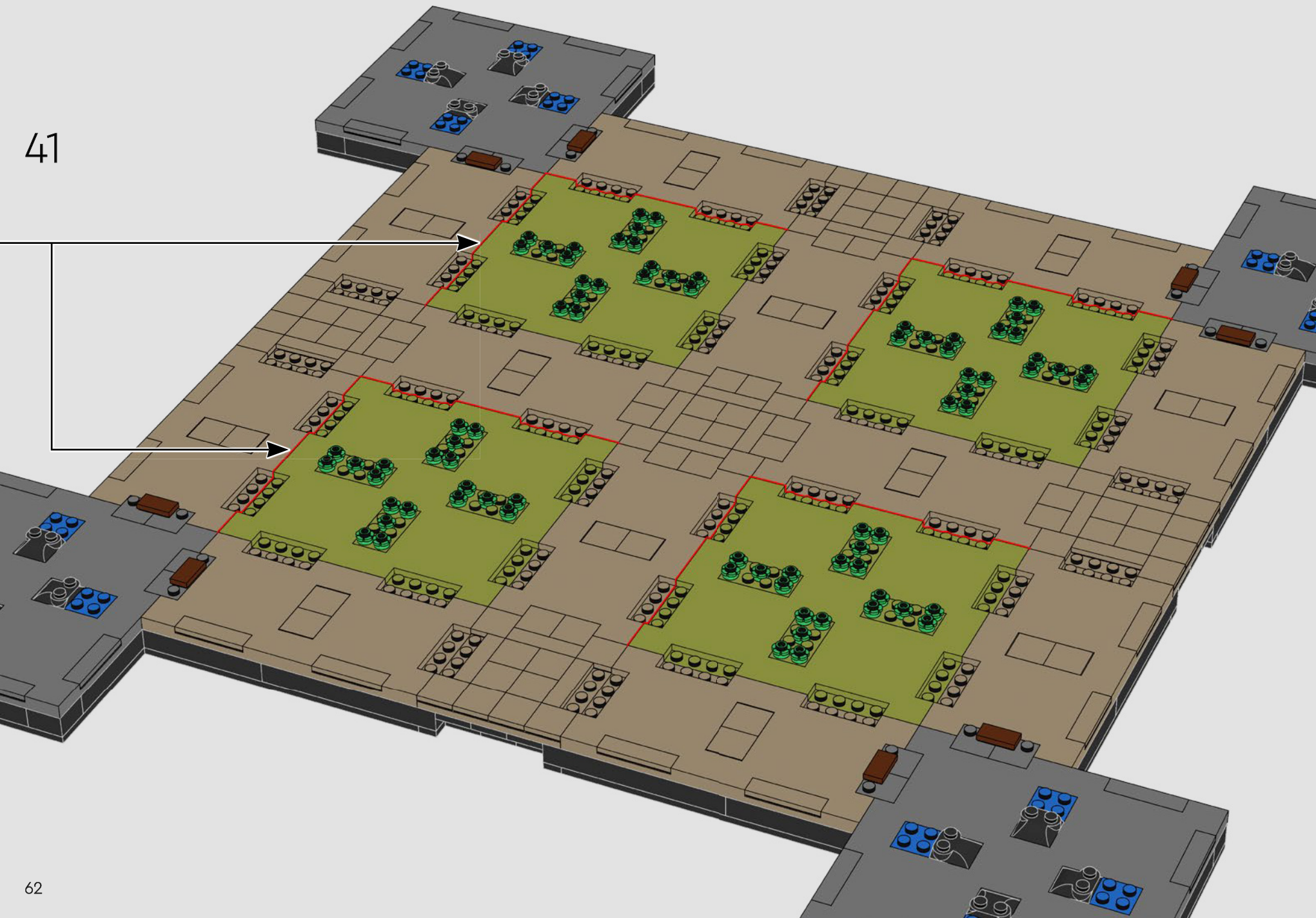

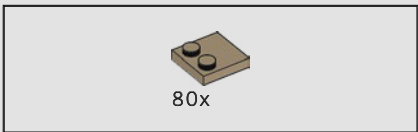

42





40x

43

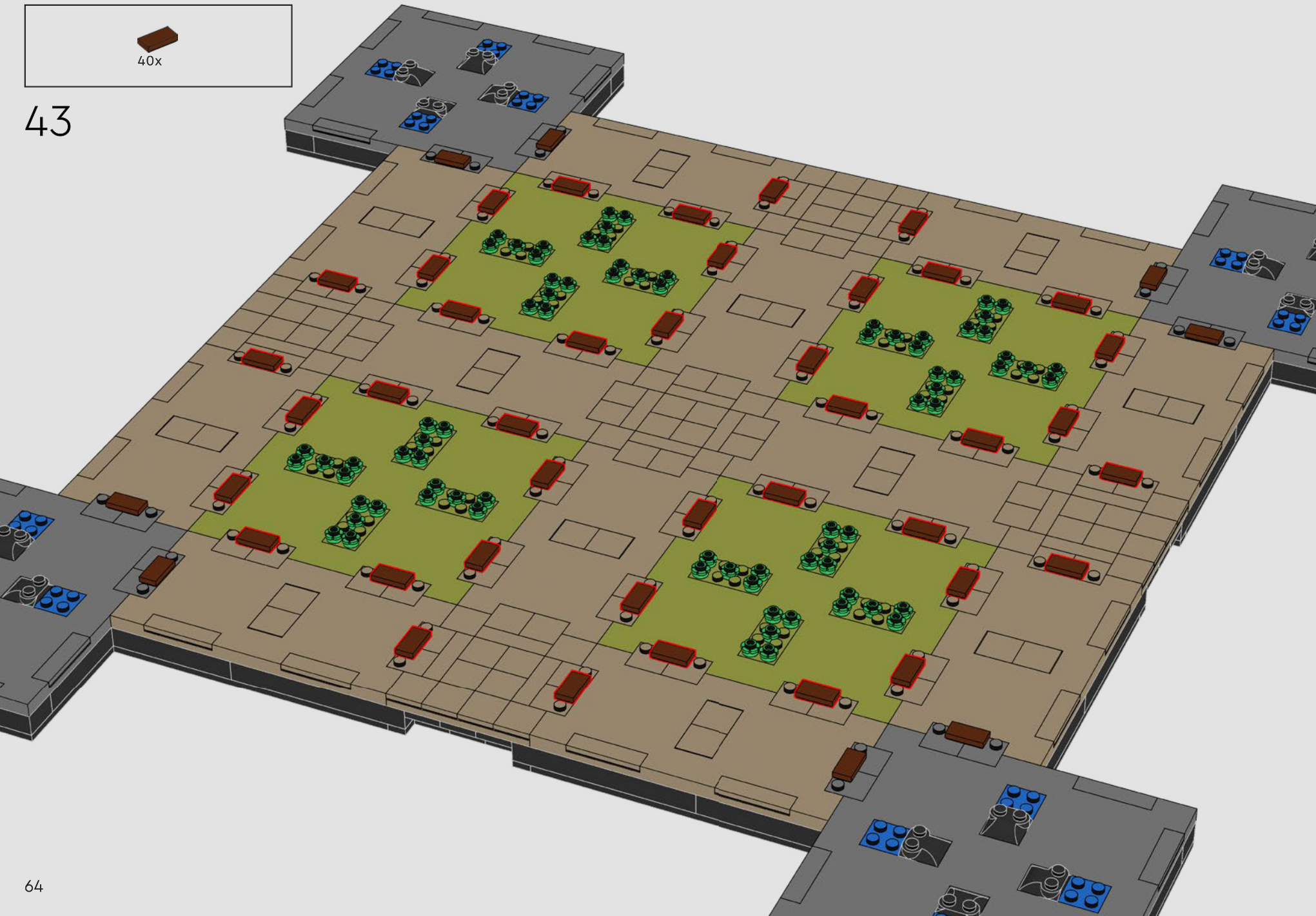

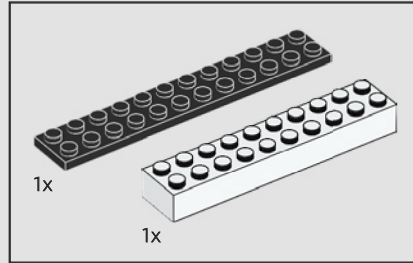
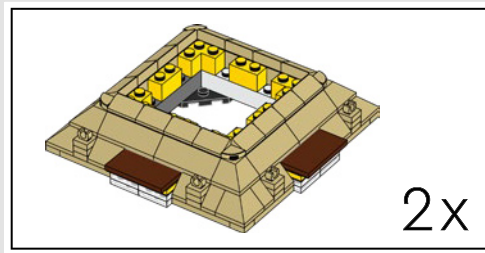

44

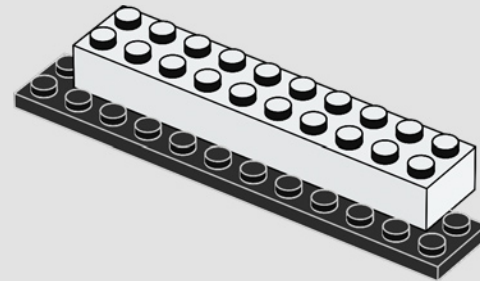

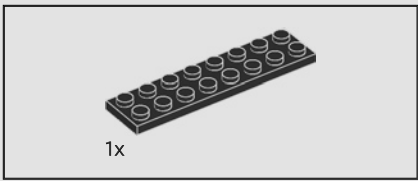

45

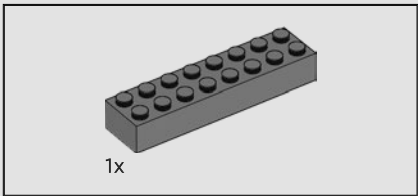
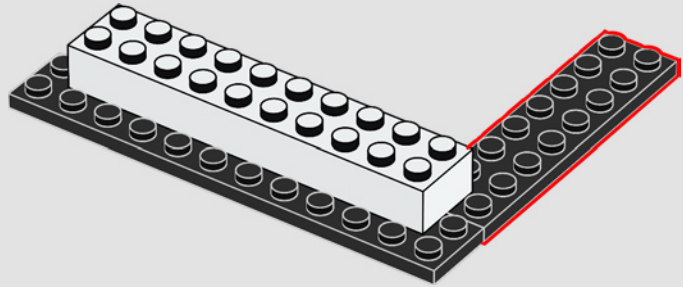

46

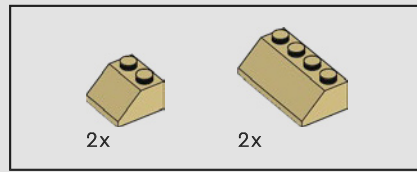
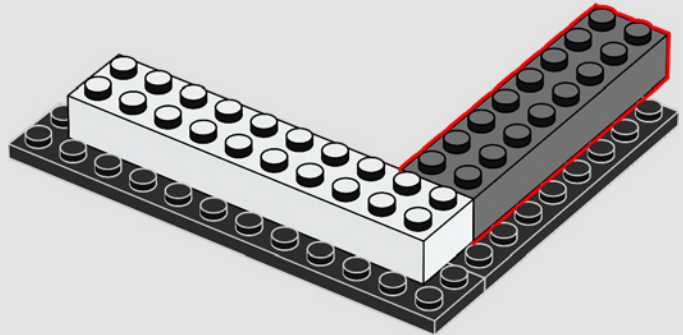

47

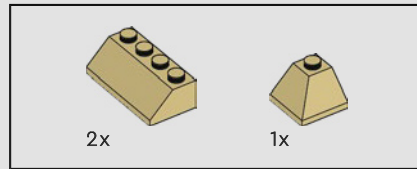
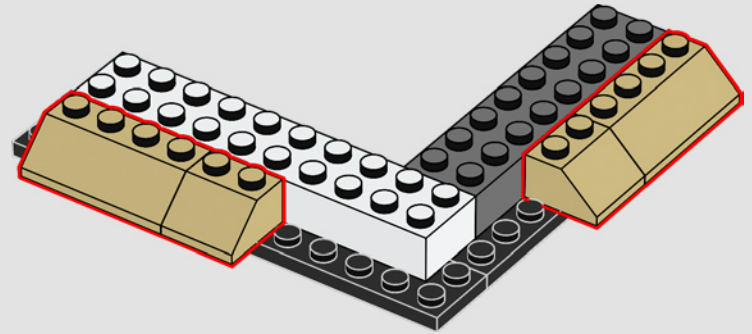

48

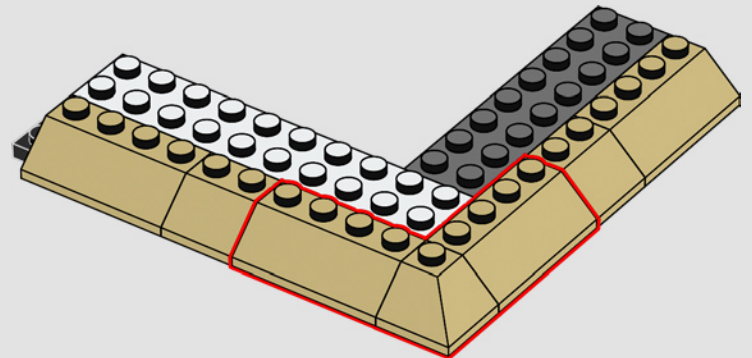

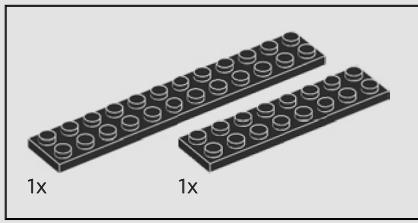

49

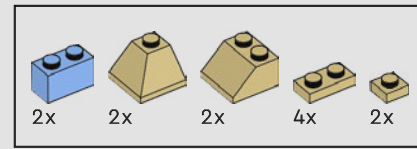
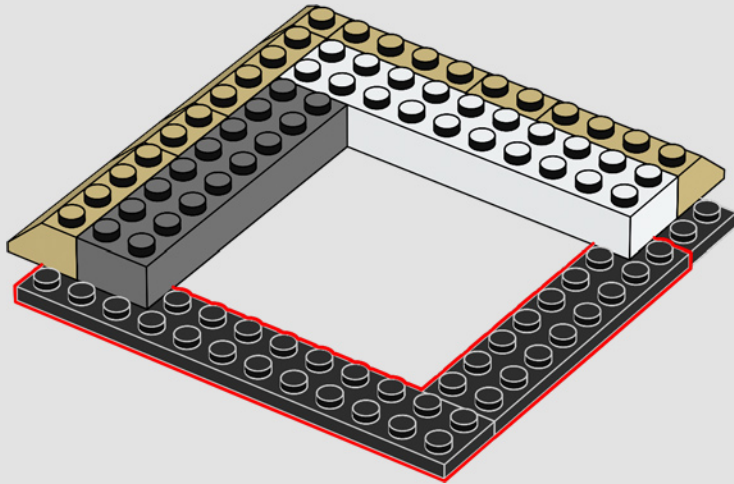

50

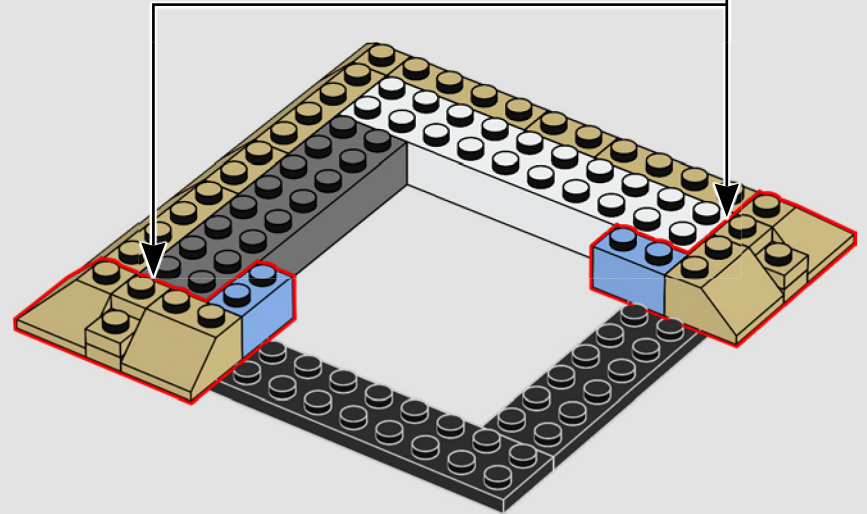
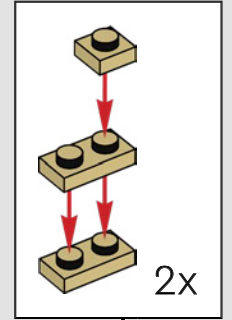

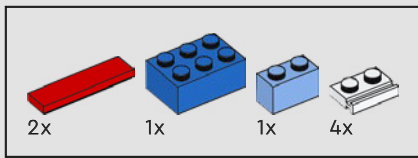

51

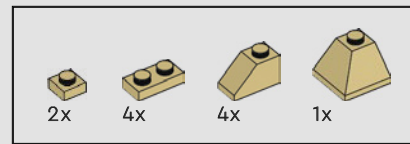
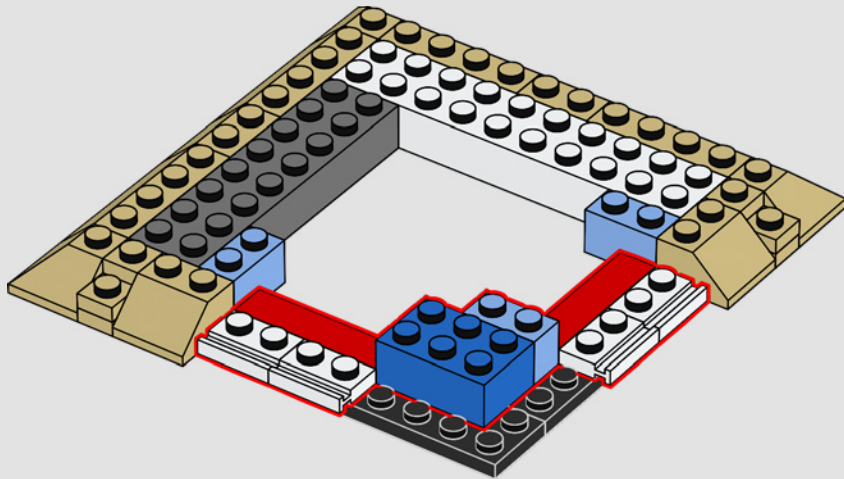

52

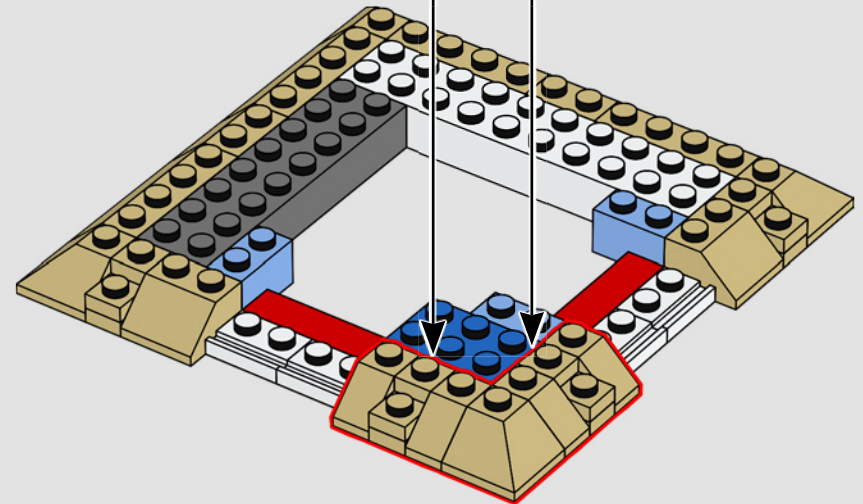
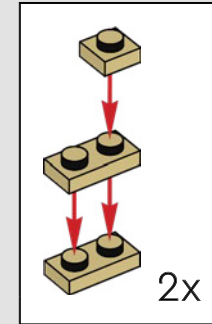

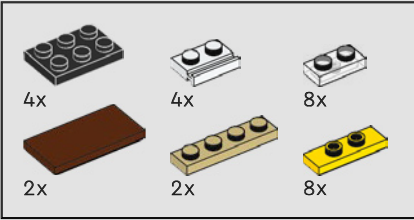
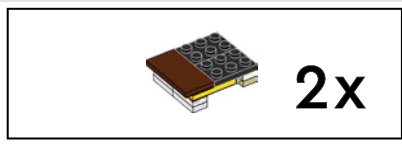

53

1

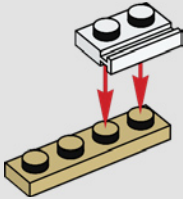

2

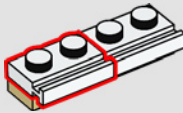

3

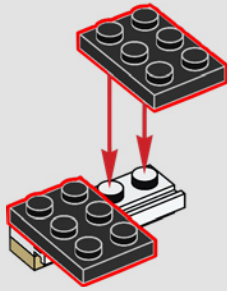

4

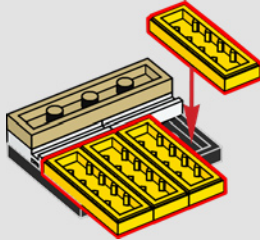

5

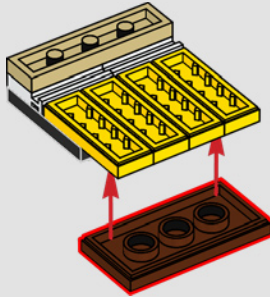

6

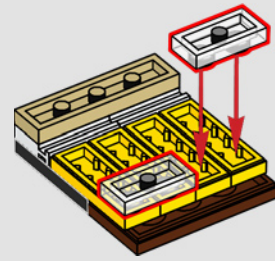

7

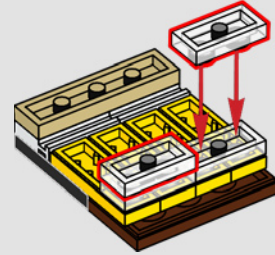

2x

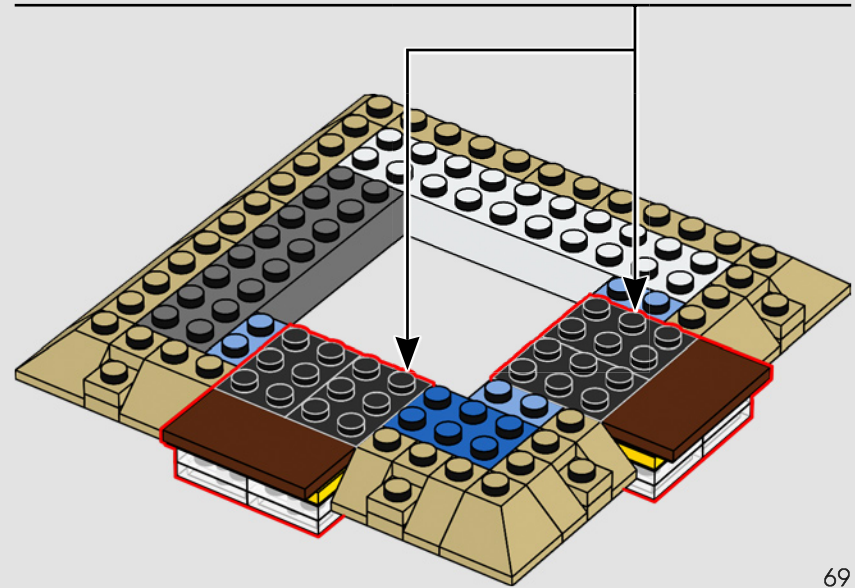



54

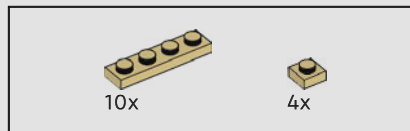
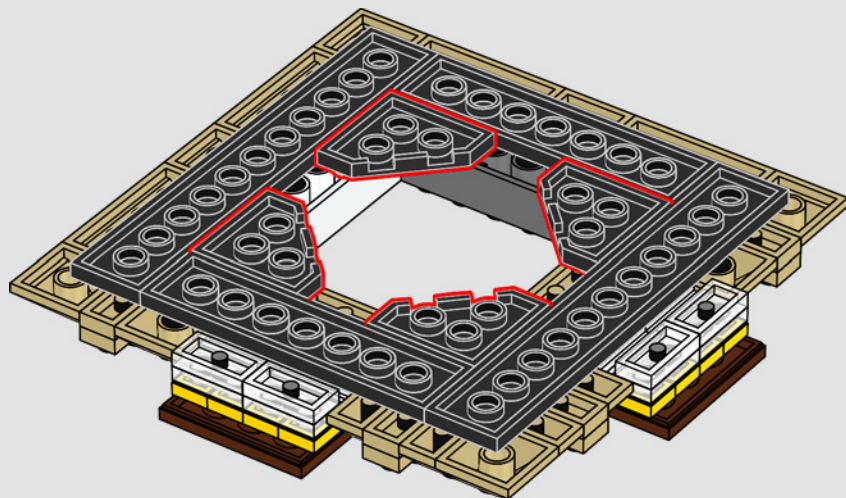

55

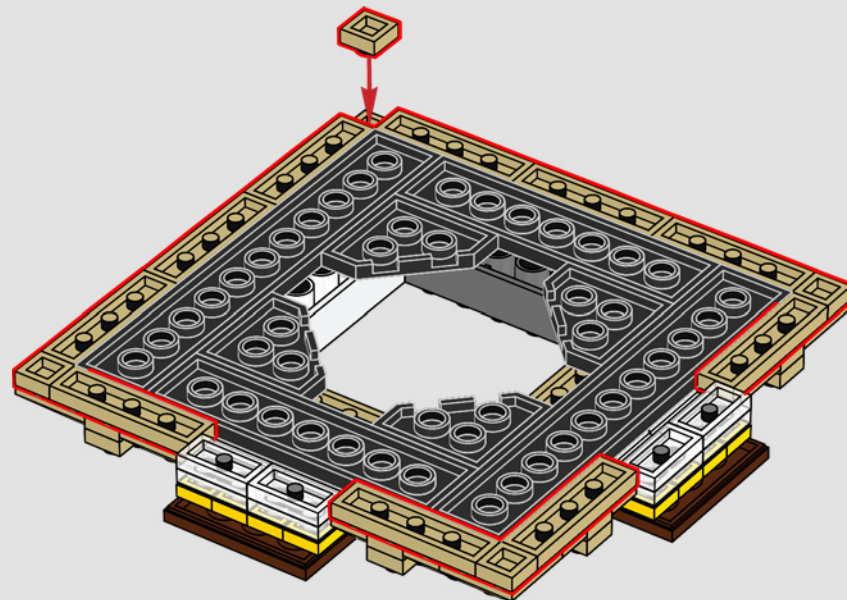

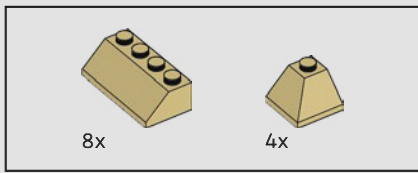

56

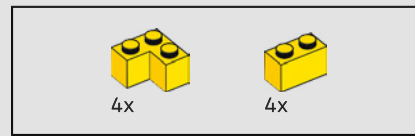
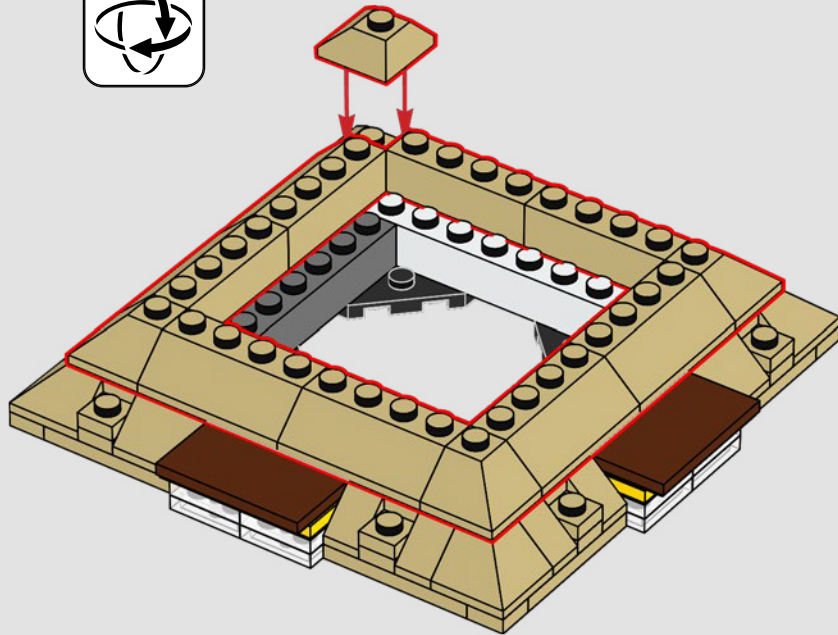

57

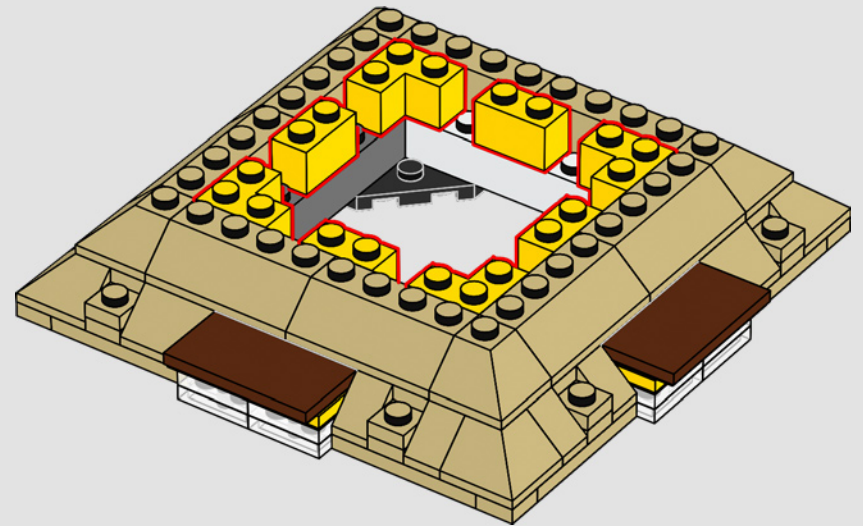



16x

58

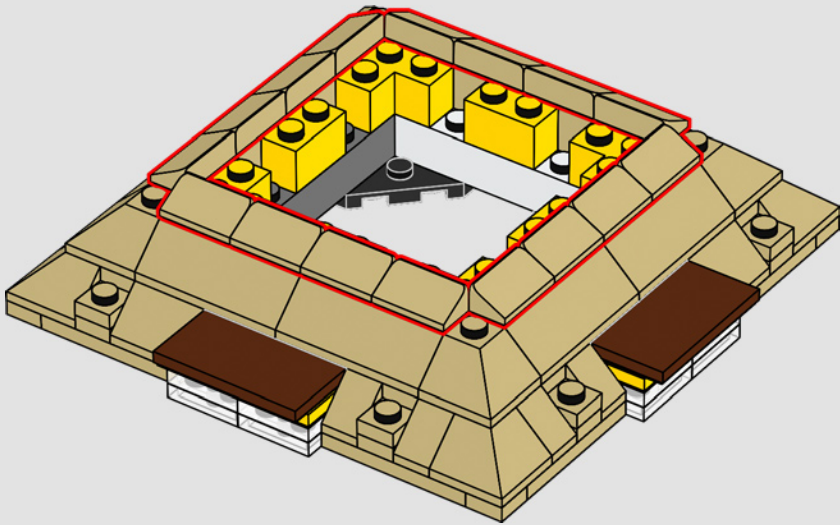

4x



4x

59

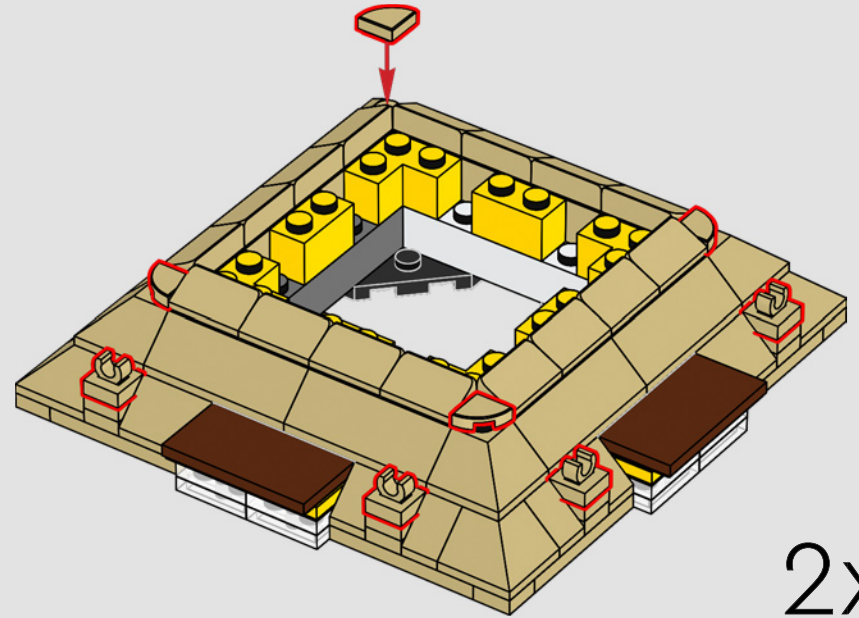

2x

60

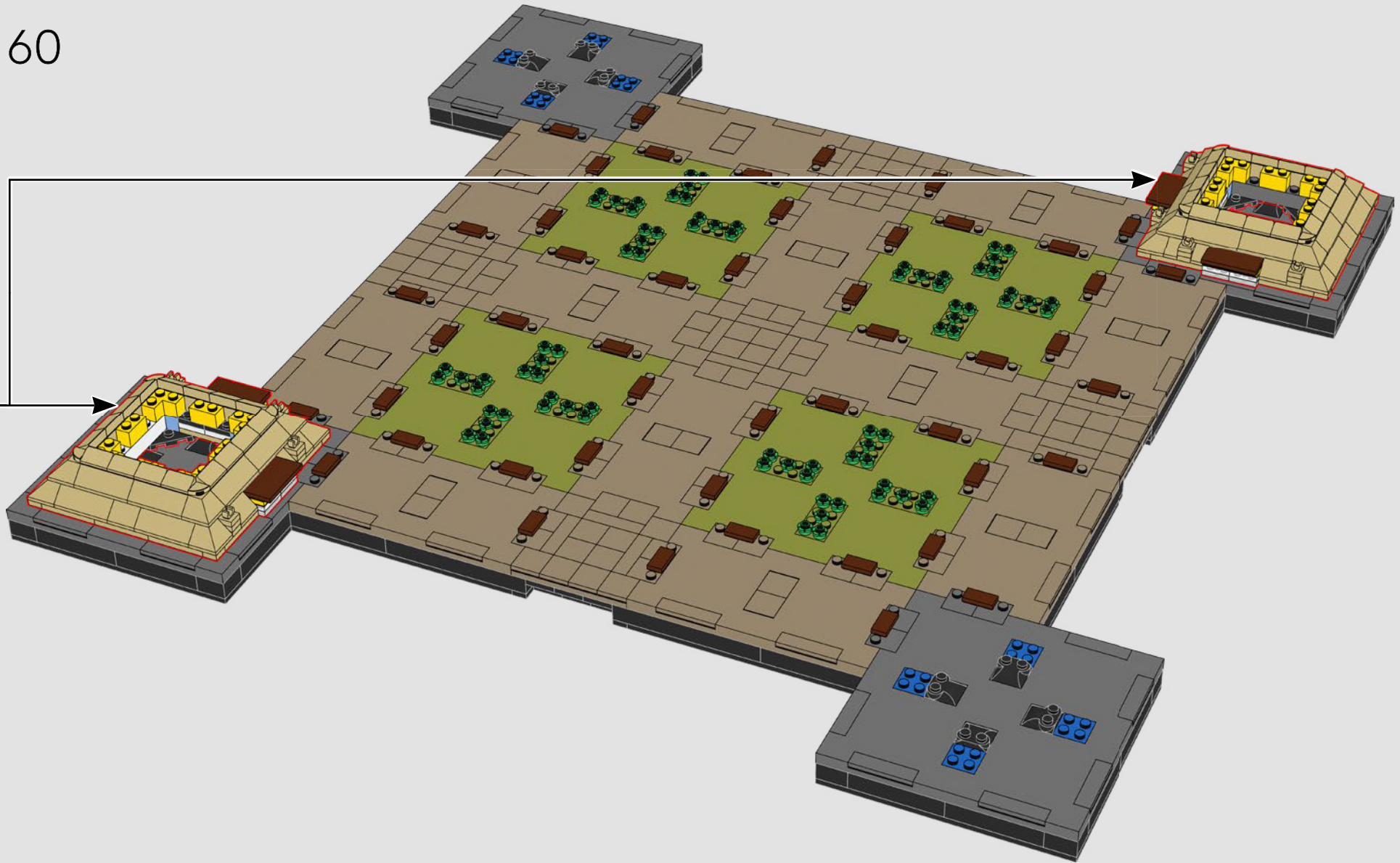

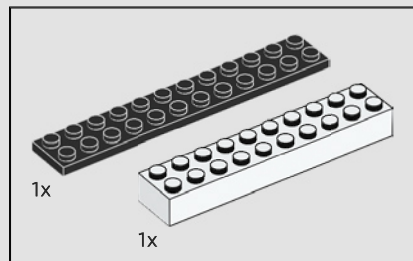
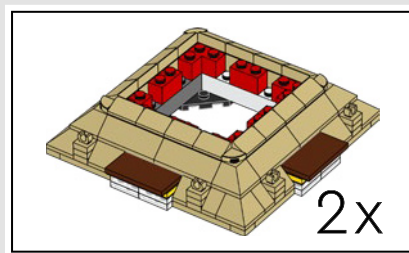

61

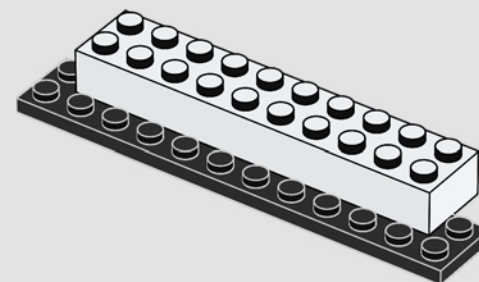

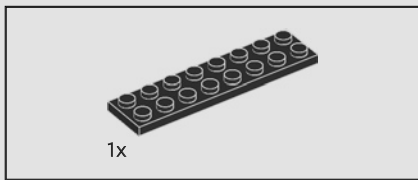

62

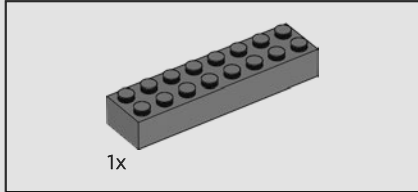
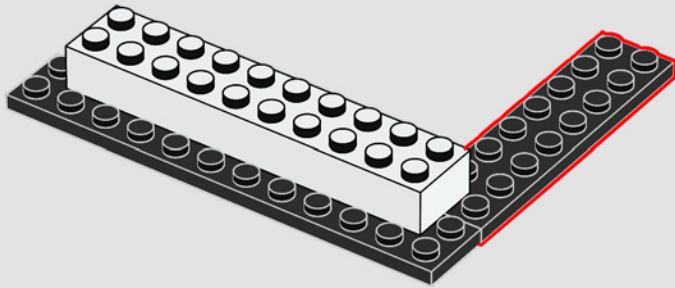

63

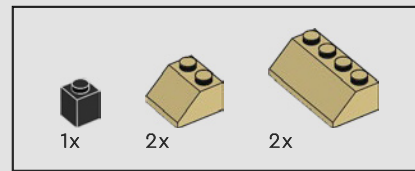
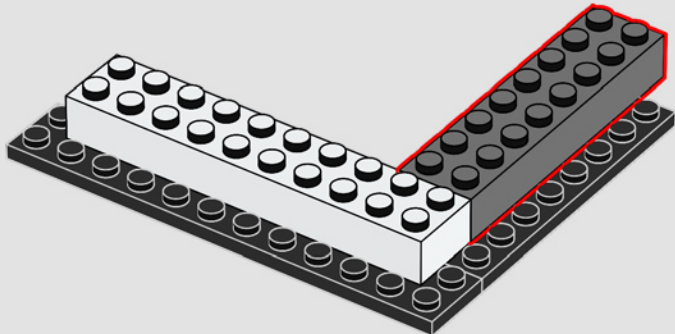

64

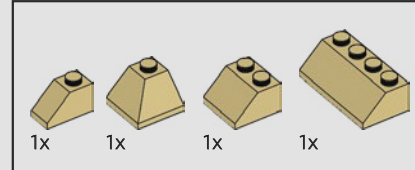
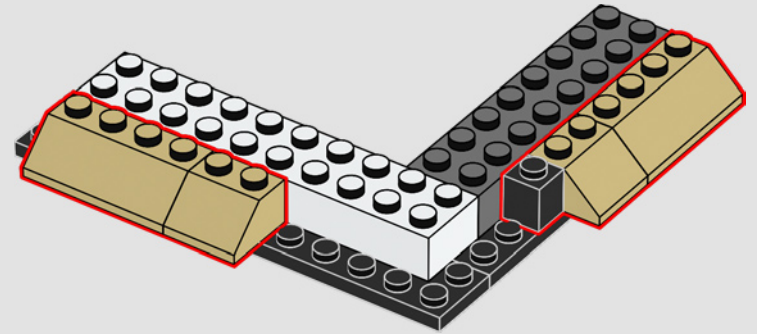

65

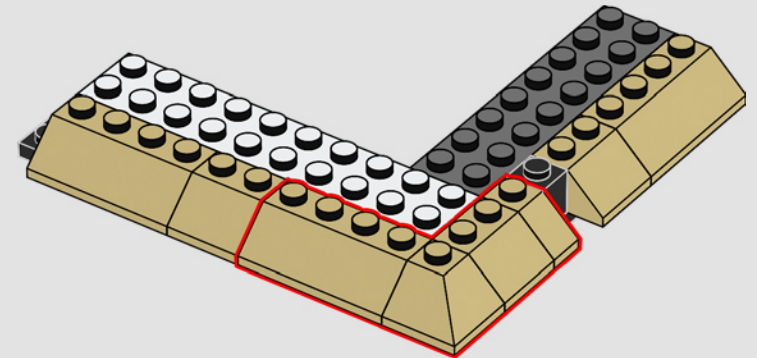

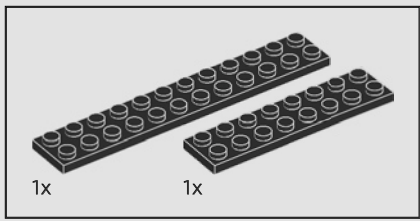

66

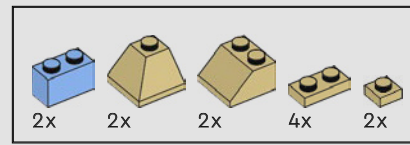
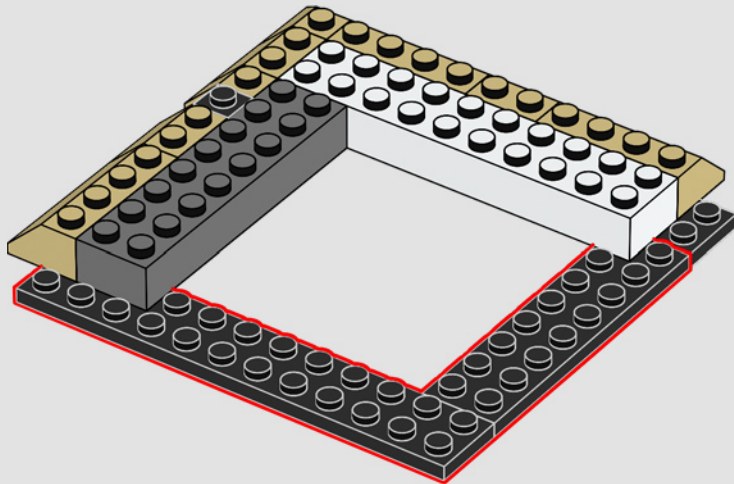

67

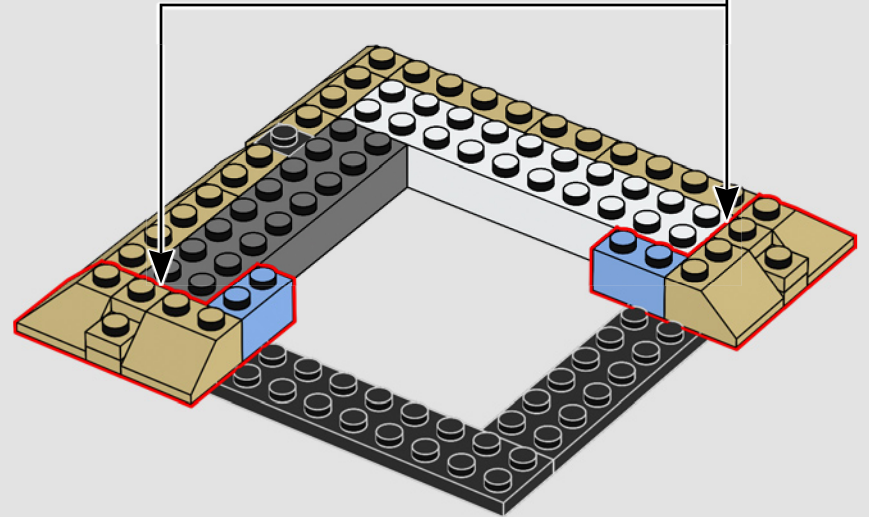
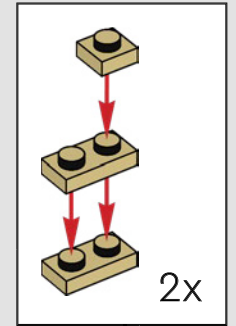

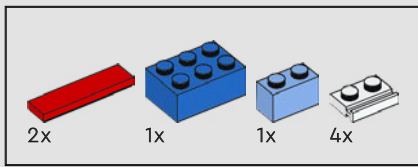

68

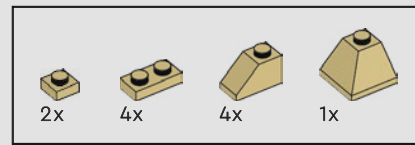
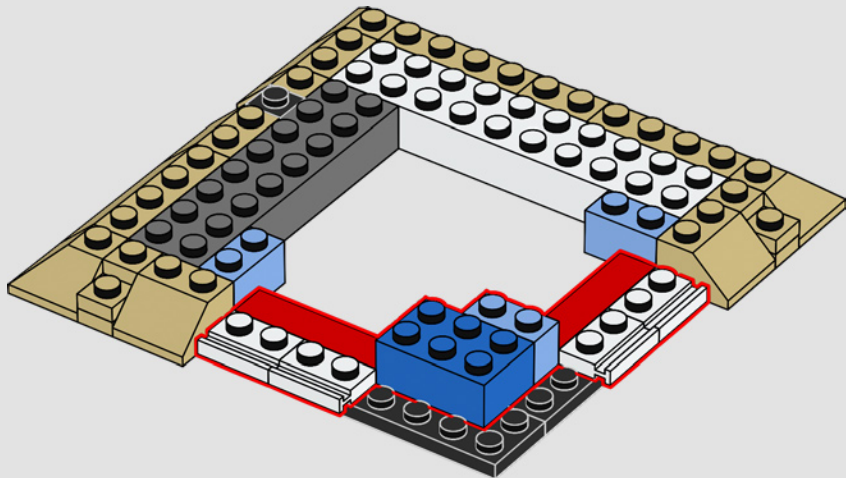

69

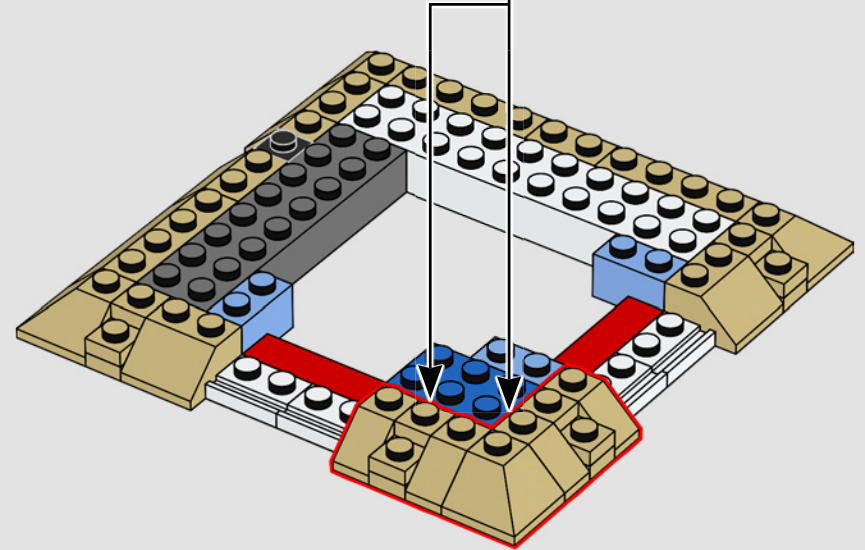
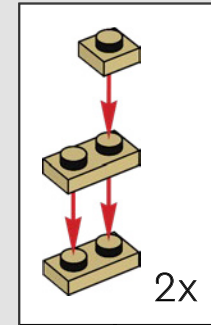

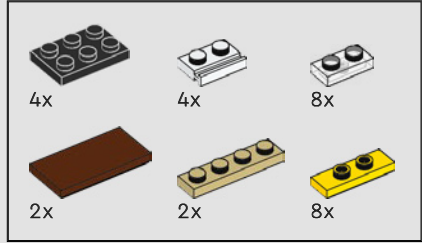

70

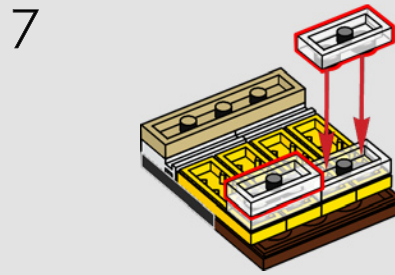
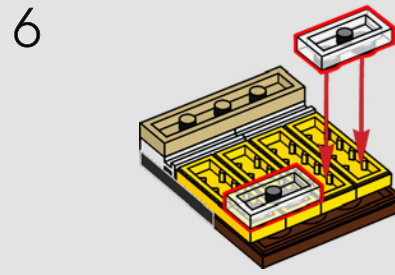
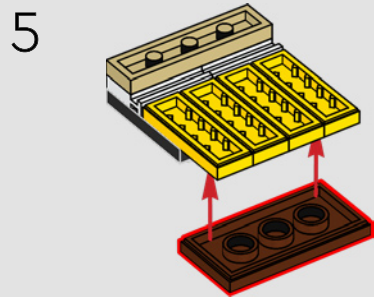
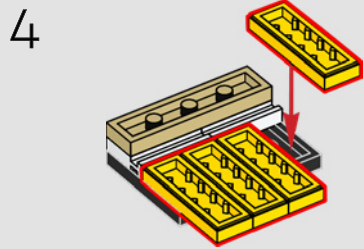
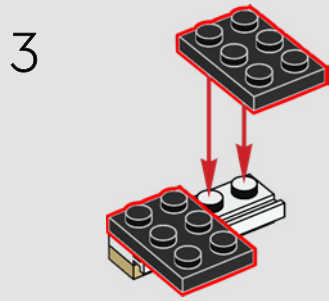
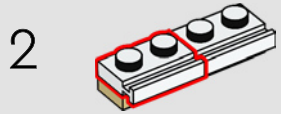
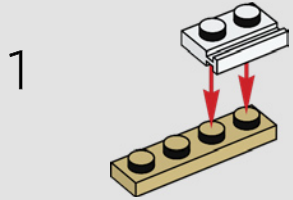

2x

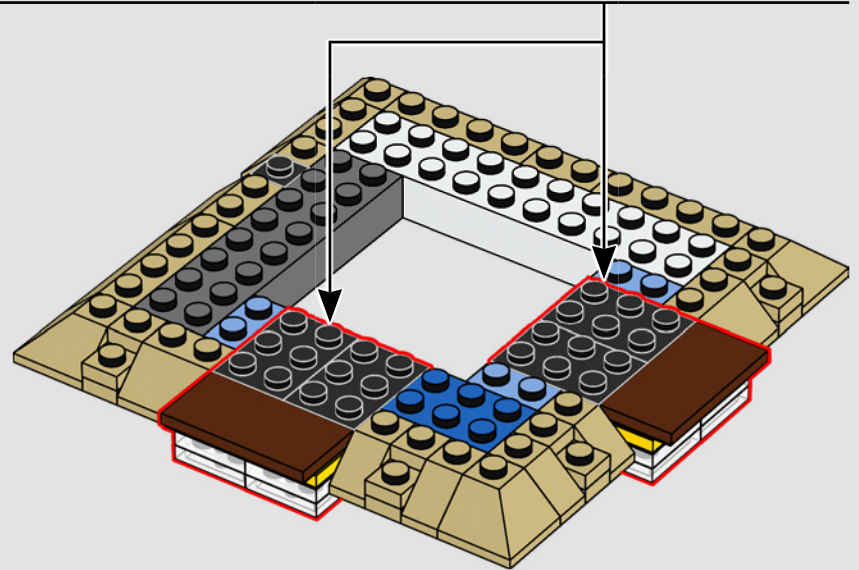

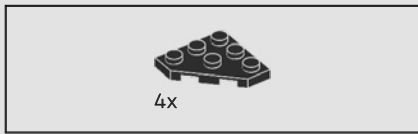

71

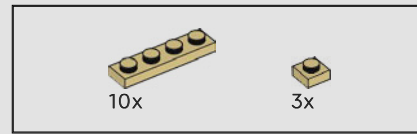
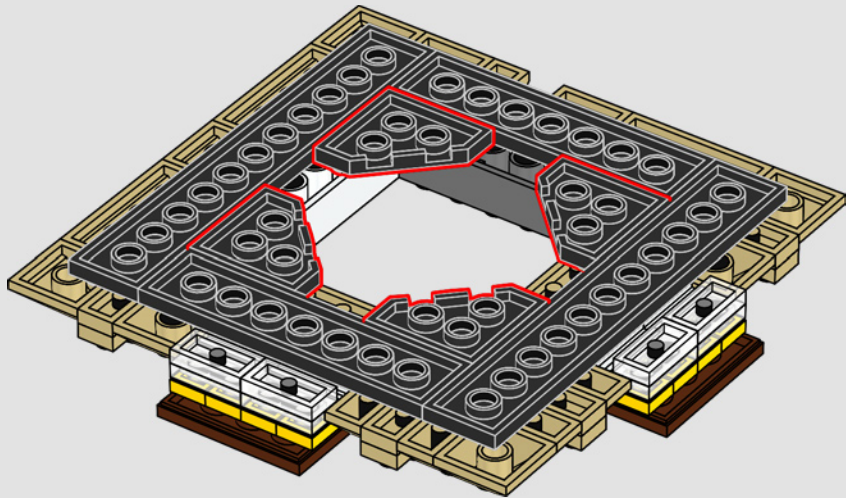

72

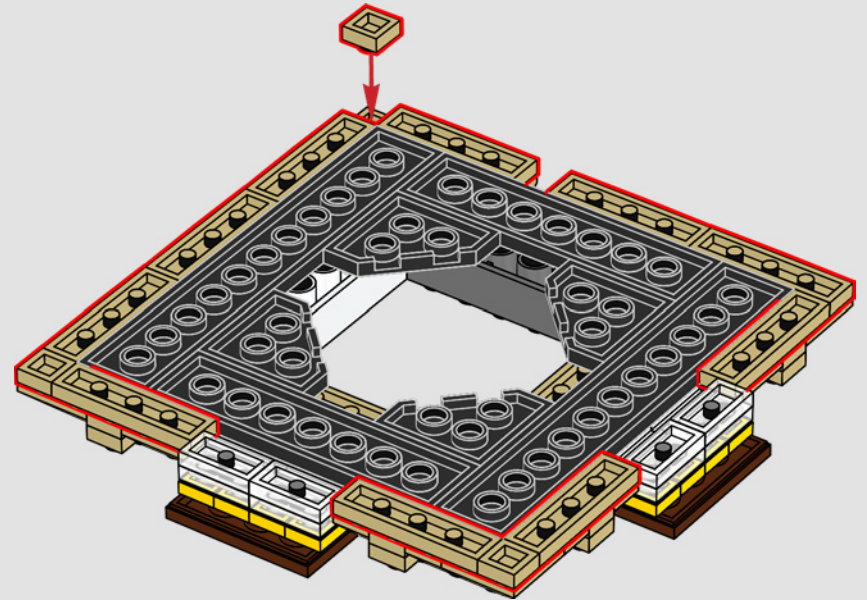

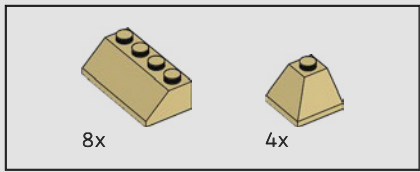

73

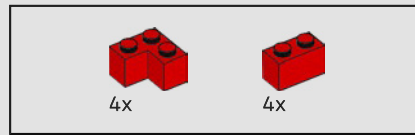
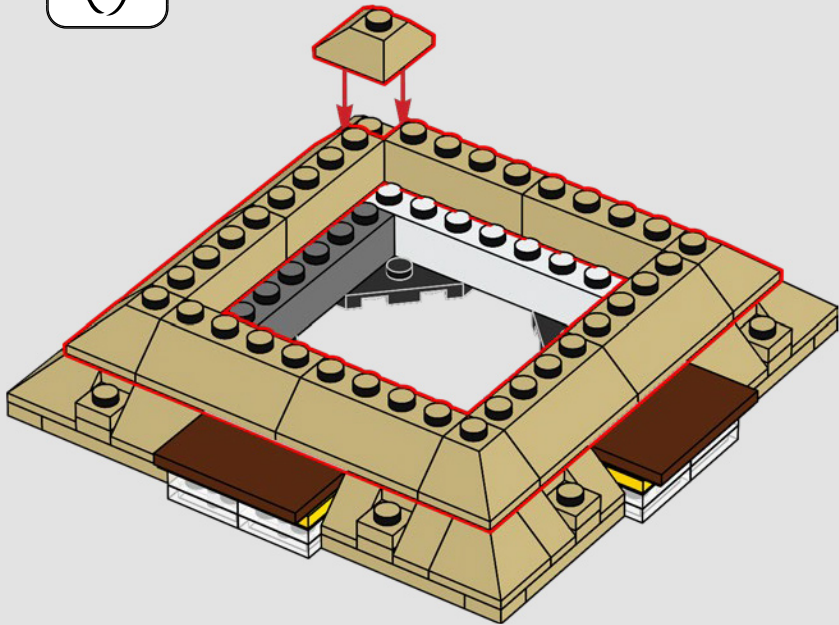

74

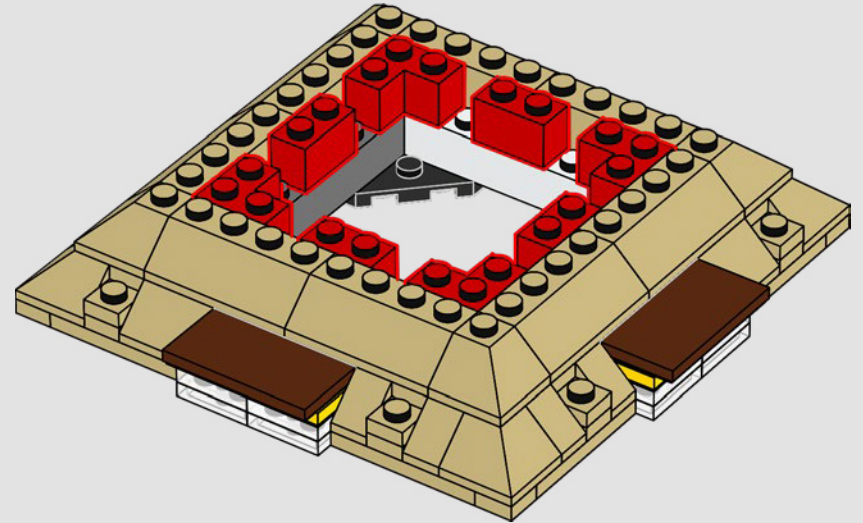

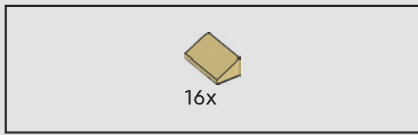

75

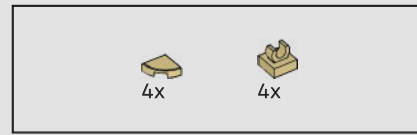
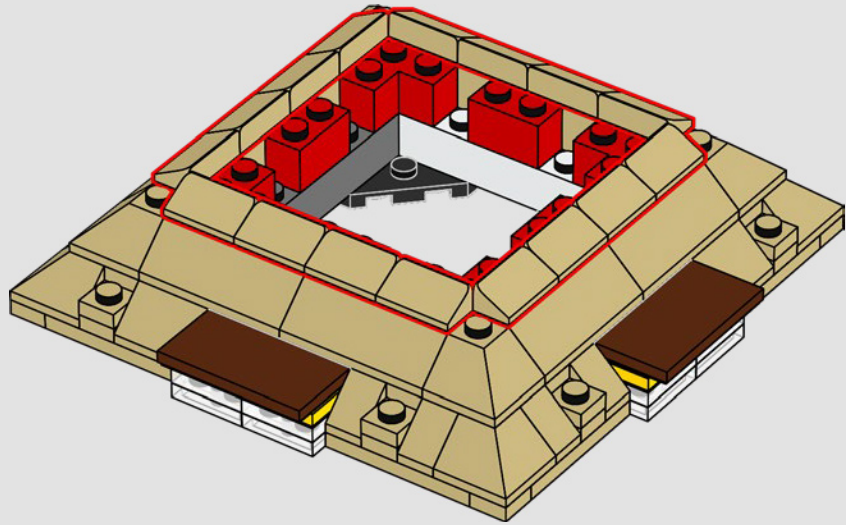

76

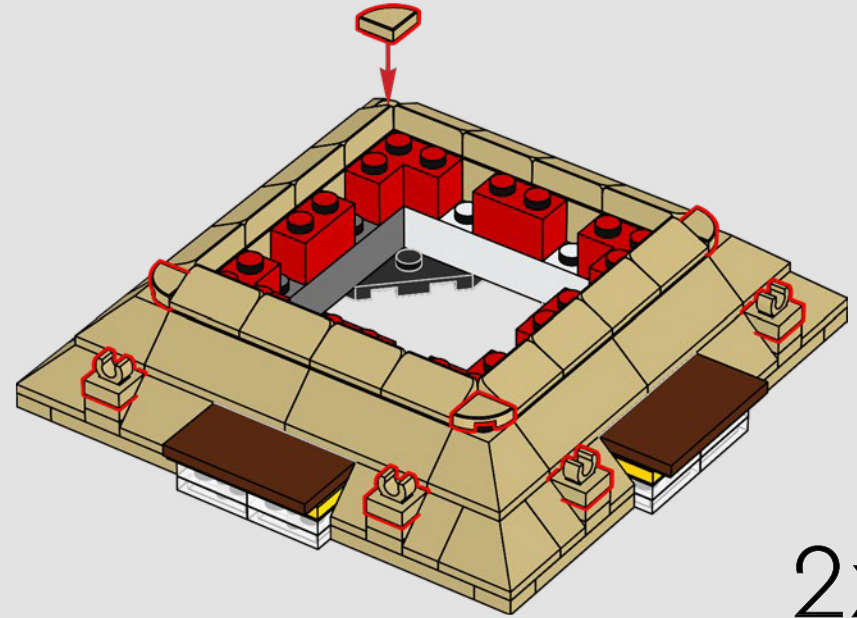

2x

77

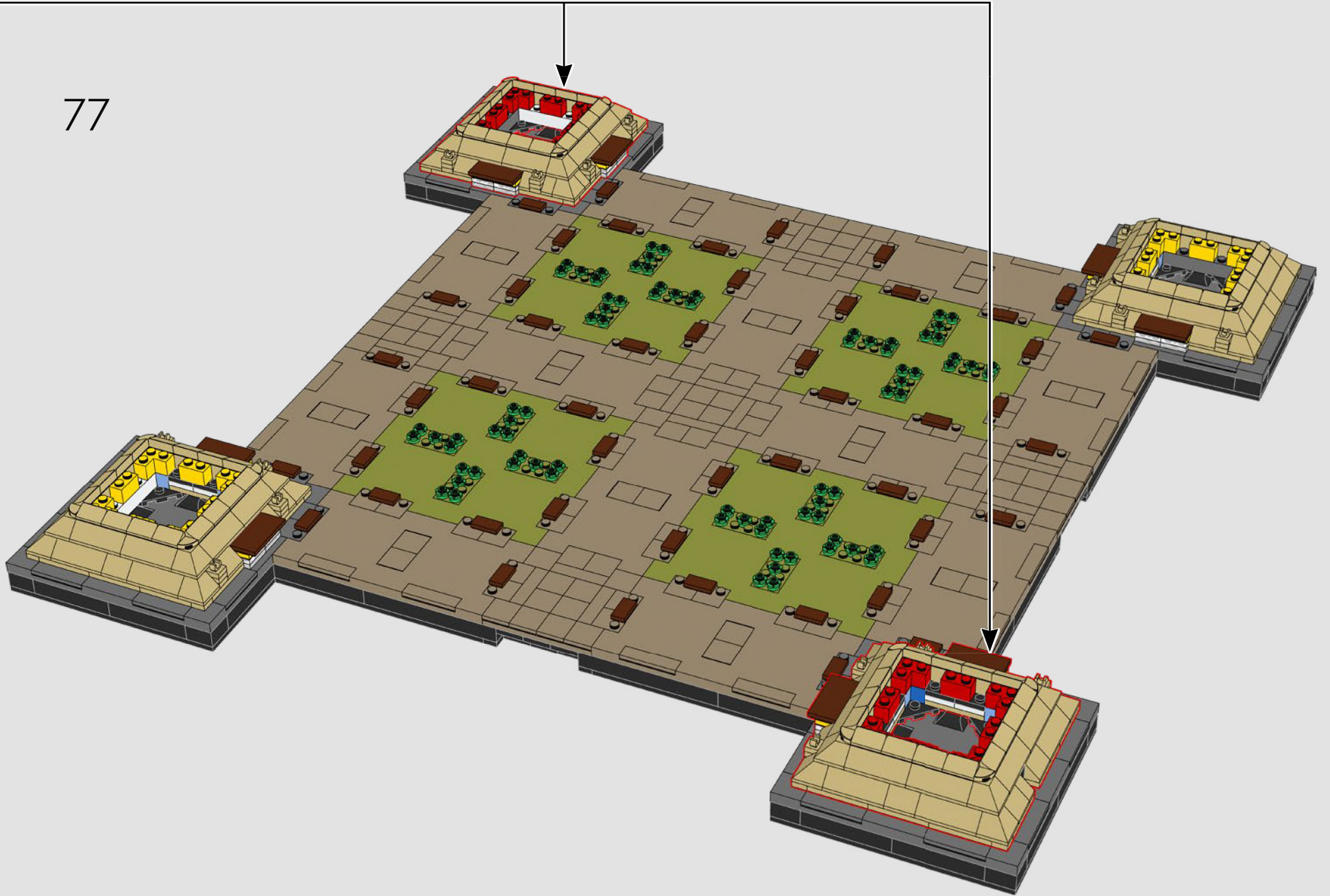



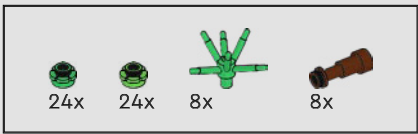

78

1

2

3

4

8x

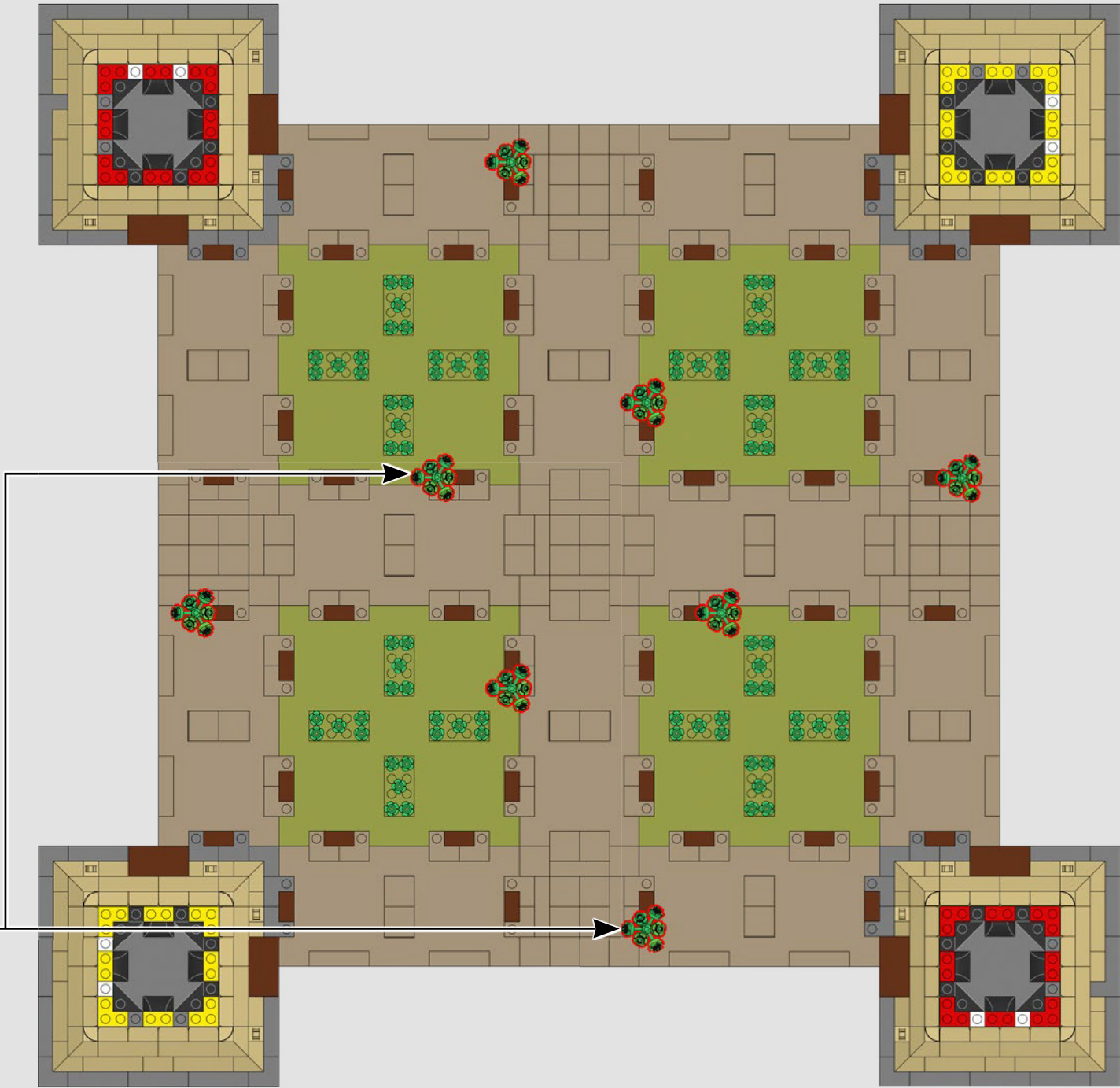

64x

79

1 

2 

 32x

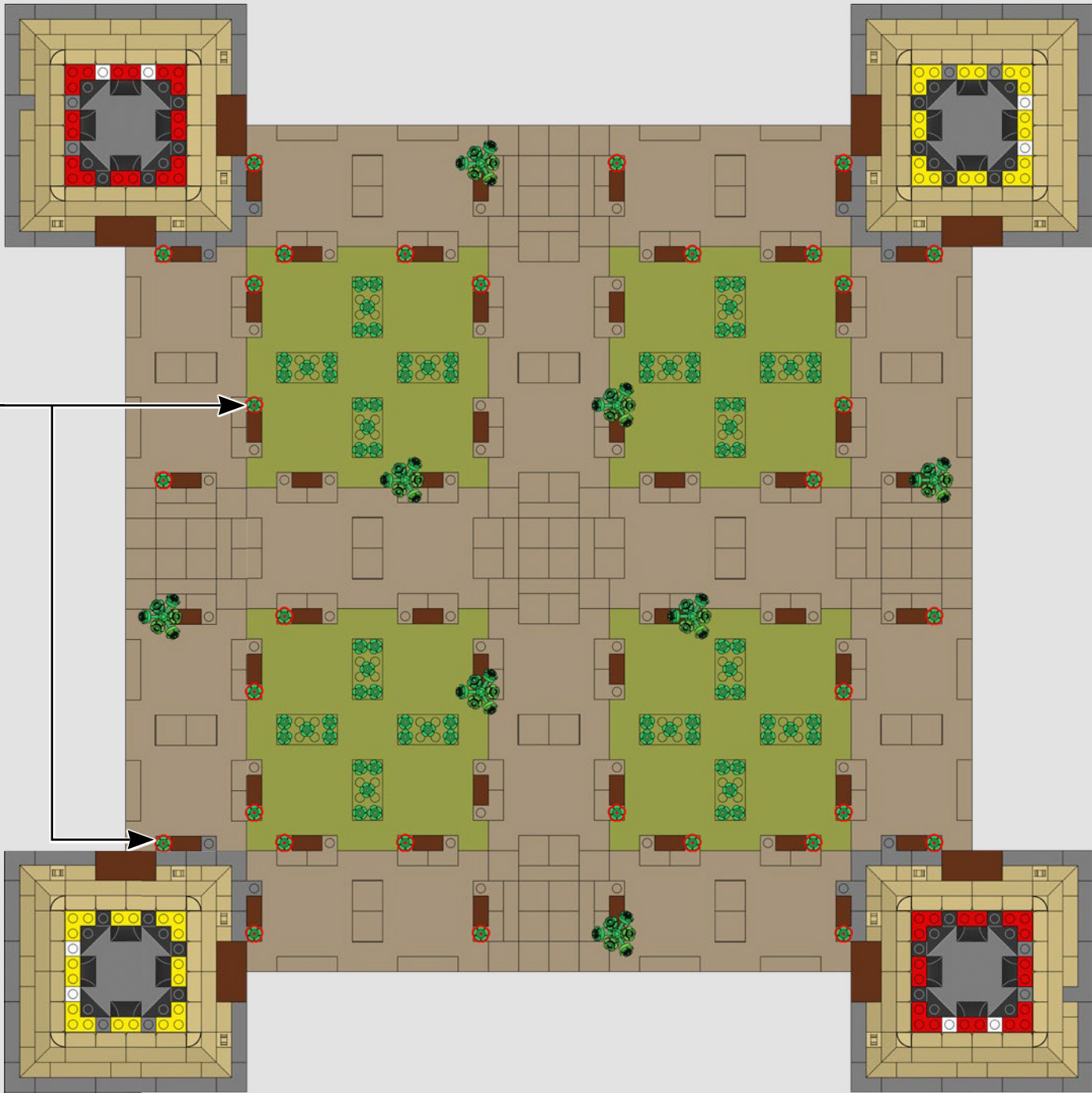



80

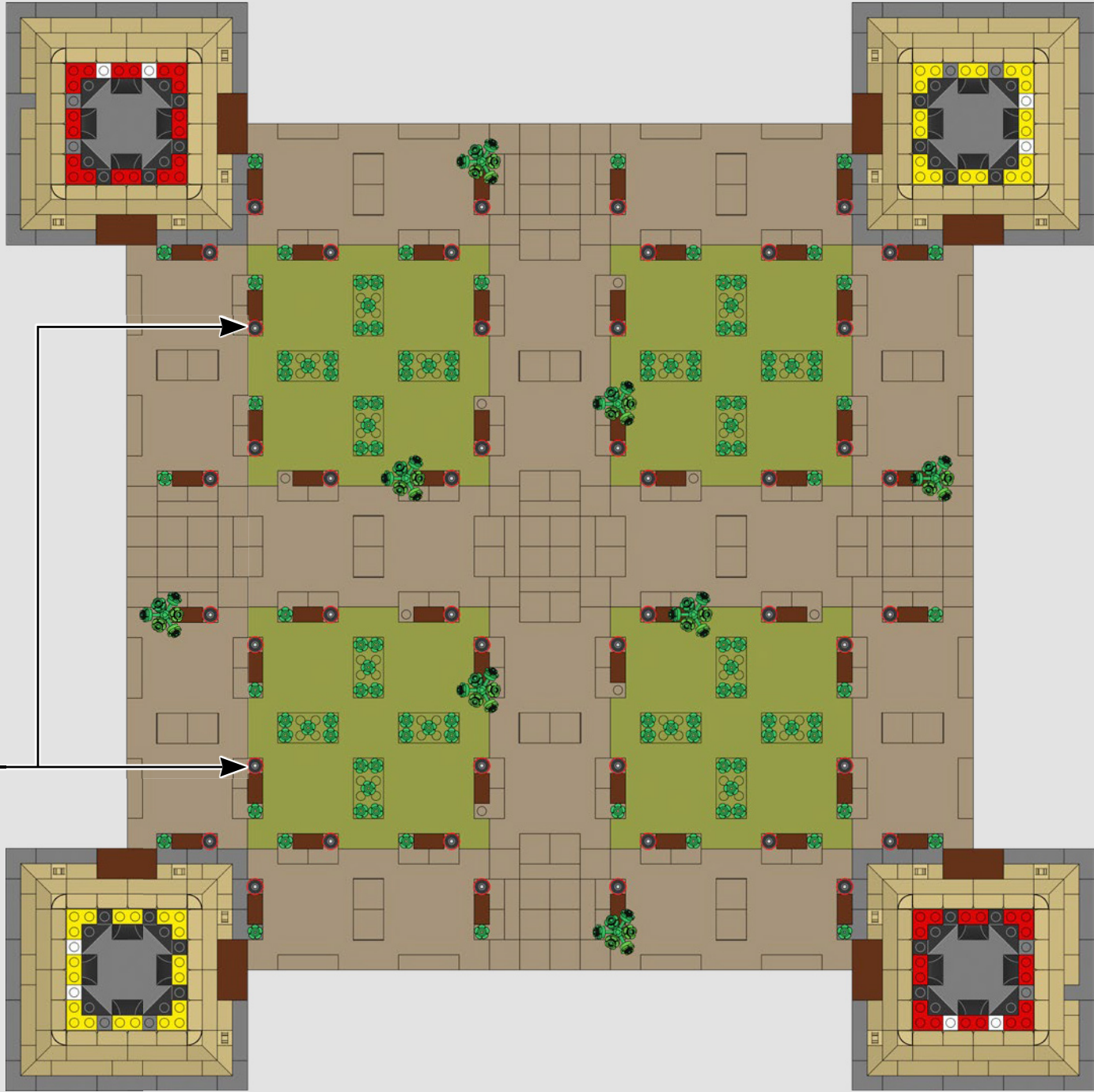
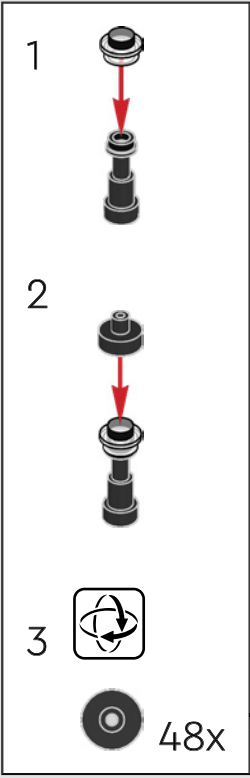



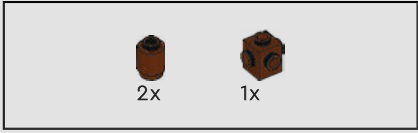
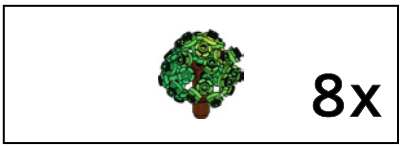

81

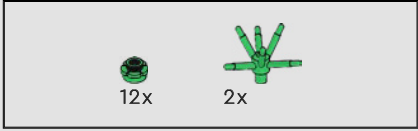

82

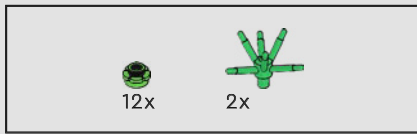
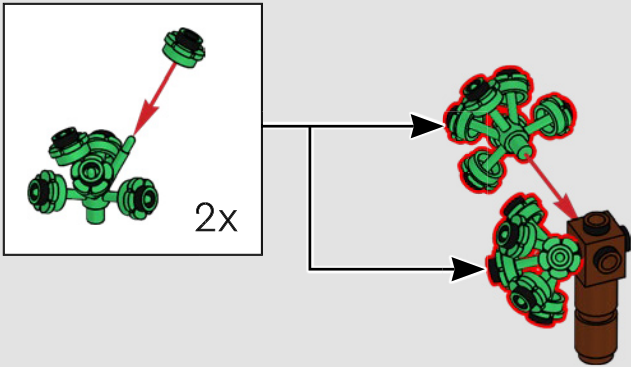

83

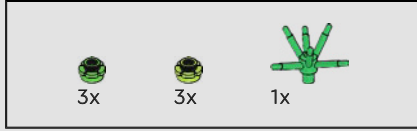
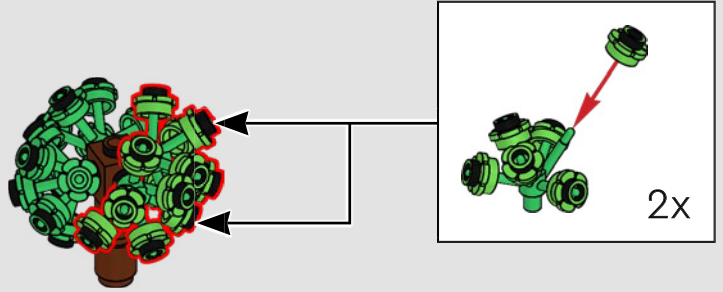

84

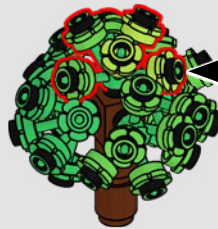
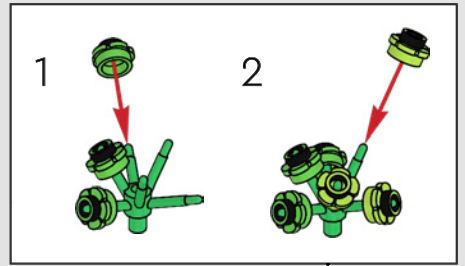

85

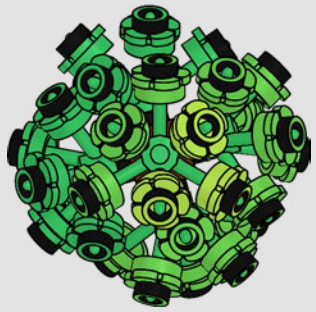

8x

86

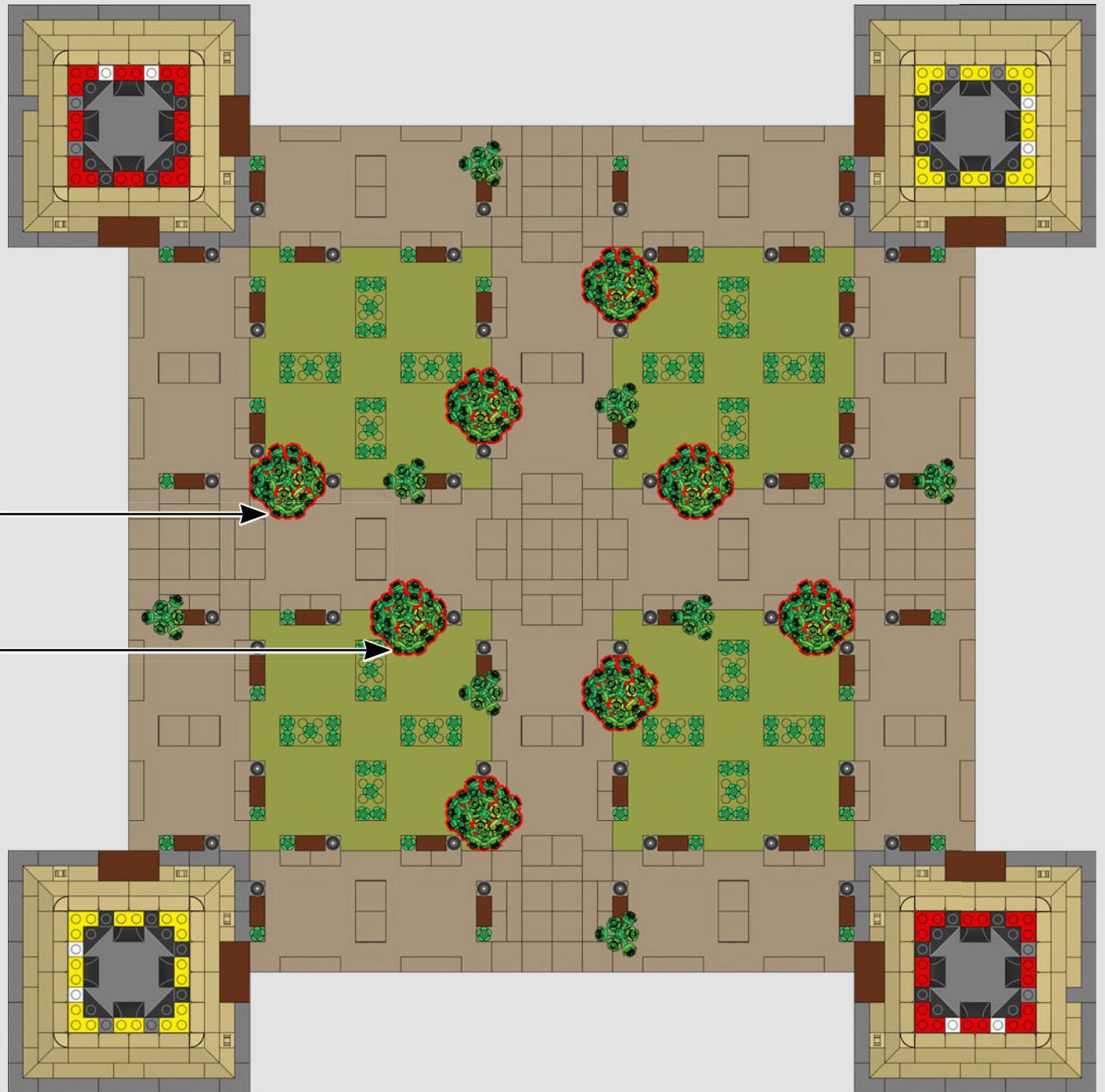



La base du modèle LEGO® fait allusion à l'époque de l'inauguration de la tour au XIX^e siècle. Elle présente des sentiers ouverts et paysagers, emplis de verdure, ainsi que des lampadaires et des bancs typiquement parisiens.

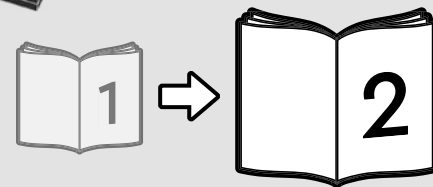



FEEDBACK AND WIN



FEEDBACK AND WIN

Your feedback will help shape the future development of this product series.

Please visit:

FEEDBACK UND GEWINNEN

Dein Feedback trägt zur Weiterentwicklung dieser Produktreihe bei.

Geh auf:

COMMENTEZ ET GAGNEZ

Vos commentaires nous aideront à concevoir les futurs produits de cette gamme.

Rendez-vous sur :

COMENTA Y GANA

Tu opinión nos ayudará a dar forma al desarrollo de esta serie de productos en el futuro.

Visita:

反馈有奖

您的反馈将有助于我们在今后改进本系列产品。

请访问：

[LEGO.com/productfeedback](https://www.lego.com/productfeedback)

By completing, you will automatically enter a drawing to win a LEGO® set.

Terms & Conditions apply.

Durch Ausfüllen nimmst du automatisch an der Verlosung eines LEGO® Preises teil.

Es gelten die Teilnahmebedingungen.

En envoyant vos commentaires, vous serez automatiquement inscrit(e) à un tirage au sort qui vous permettra de remporter un prix LEGO®.

Offre soumise à conditions.

Al contestar, participarás automáticamente en el sorteo y podrás ganar un set LEGO®.

Sujeto a Términos y Condiciones.

完成我们的反馈调查，即可自动进入抽奖环节，赢取乐高®套装。

适用《条款和条件》。

