



Booklet available in English on  
Heft in deutscher Sprache erhältlich auf  
Livret disponible en français sur  
Libretto disponibile in italiano su  
Folleto disponible en español en  
如需中文版手册, 请访问

# A long, long time ago

*Once there was a big castle.  
With valiant knights, horses,  
kings, queens and tournaments.  
And lots of adventures every day.*

So started the LEGO® product catalogue description of the now iconic 375 Castle set when

it launched in 1978. Often referred to today as the “Yellow” or “Original Castle”, it was the beginning of a much-loved medieval adventure that would continue uninterrupted all the way to 1999. As part of

the LEGO 90th anniversary celebrations, we’ve chosen to pay homage to this popular theme with a new Lion Knights’ Castle inspired by the classic 6080 King’s Castle set from 1984.

1978



## 375 Castle

The original castle that started it all! The striking yellow walls of this castle were hinged to create multiple configurations and access the interior for easy play. While the yellow walls were quickly phased out for a more realistic grey, the hinged wall design is still seen in LEGO castles today. Some of the oddities in this model are the brick-built horses and the classic space helmet with a new visor used as a helmet for the knights.

1984



6080 King's Castle

1986



6074 Black Falcon's Fortress

1987



6066 Camouflaged Outpost

The original secret hideout of the forestmen! An ancient oak tree nestles its roots around a giant boulder, but there is more here than meets the eye! A secret rotating rock door gives access to the forestmen's cave and a hinged back opens to reveal the play space inside. This set included a total of 6 different forestmen, including their enigmatic leader.

1992



6086 Black Knight's Castle

The pinnacle of a classic castle! This impressive fortress is built on a raised baseplate, giving space for a dungeon below the courtyard. The castle continued the tradition of a working drawbridge and portcullis, while also including a secret back gate for quick escapes or midnight adventures. The Black Knight's Castle was home to 4 armoured knights on horseback, 6 soldiers, a wolfpack bandit and even a ghost!

1992



6038  
Wolfpack Renegades

1997



6097  
Night Lord's  
Castle

2000



6091  
King Leo's  
Castle

2004



8781  
Castle of Morcia

2009



10193 Medieval Market Village

Medieval Market Village is one of the few sets to show us life beyond the castle walls. It features two beautifully detailed half-timber village buildings, a waterwheel to power the forge hammer, soldiers, stables, a horse-drawn cart and even a pair of cows!

2016



70317  
The Fortrex

## A New Castle Classic

It's always a challenge to reinvent a much-revered LEGO® theme, but our new Lion Knights' Castle blends more complex LEGO building with the spirit of original sets such as 6080 King's Castle to create a model packed with fun features and functions.

We started by placing the main tower on top of a large LEGO rock formation, so the model appears taller. This also made it possible to include hidden rooms and dark dungeons underneath the castle itself. The walls are movable, and the model can be separated to give better access to the castle, revealing the many trap doors, secret passages and hidden hideouts.

2022



This new version of a classic castle takes advantage of modern building techniques and includes plenty of features that pay homage to the original Castle sets of old.

90 years  
of play



LEGO YELLOW CASTLE, 1978

To celebrate 90 years of LEGO play in 2022, we asked fans to vote for the classic LEGO themes they most wanted to see revived with a special anniversary set. Tens of thousands of fans took part in the poll and Classic Castle was one of the clear winners!

## From the Design Team

As the original Castle had always been a favourite theme for them as kids, LEGO® Designers, Mike Psiaki and Milan Madge had always dreamed of working together on a large LEGO castle set. Mike describes how the model evolves:

*This model came from a vote held as part of the celebrations for LEGO's 90th birthday in 2022. We set out to try and merge as many of the popular earlier Castle sets into a new ultimate castle model. We went through many rounds of exploration of the castle's overall shape and size. We started building small sections of walls, half-timber gates, and drawbridges; playing around with different functions and aesthetics to try to figure out what would work well. Early on, Milan discovered a type of drawbridge that used a counterweight at the back of the bridge instead of traditional chains connected to the bridge's front. We knew immediately that we wanted to fit it somewhere in the castle, but it wasn't until quite late in the development that it became the main gate.*

LEGO Graphic Designer Ashwin Visser then played a central role in many of those small but important touches that make the set feel complete. This included reworking the graphic design of the Lion Knights, creating new flags and shields for the castle walls and battlements, and introducing the caparison element (the horse clothing) in both blue and red for the two horses. The finishing touch was the completely new cape and shield for the Lady of the Castle.

1984



2022



### Spot the difference

*It was decided the classic LEGO Lion Knights needed a little design update to match the newer editions of the Black Falcon Knights who appeared in the Medieval Blacksmith 21325 set. Designing the new Lion Knight shield logo was especially challenging, attempting to recreate such an iconic logo that fans know and love into something new but still recognisable.*

**Ashwin Visser, LEGO Graphic Designer**



Left to right  
Michael Psiaki, LEGO® Design Master  
Milan Madge, LEGO® Designer  
Ashwin Visser, LEGO® Graphic Designer

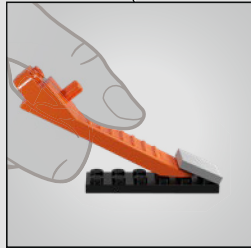
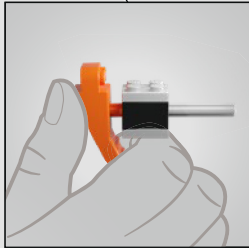
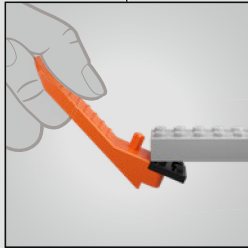
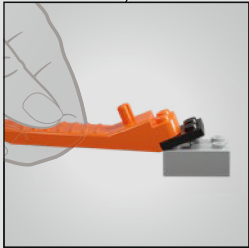
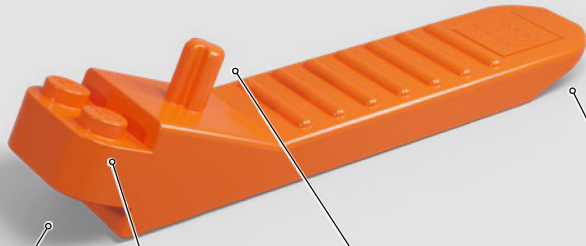



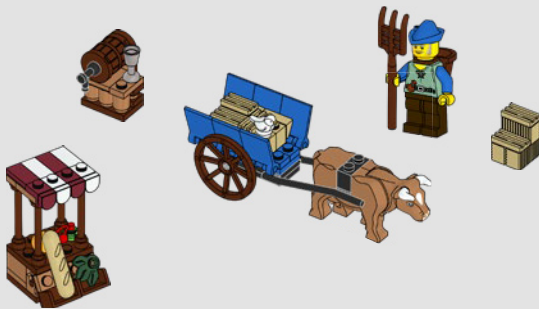
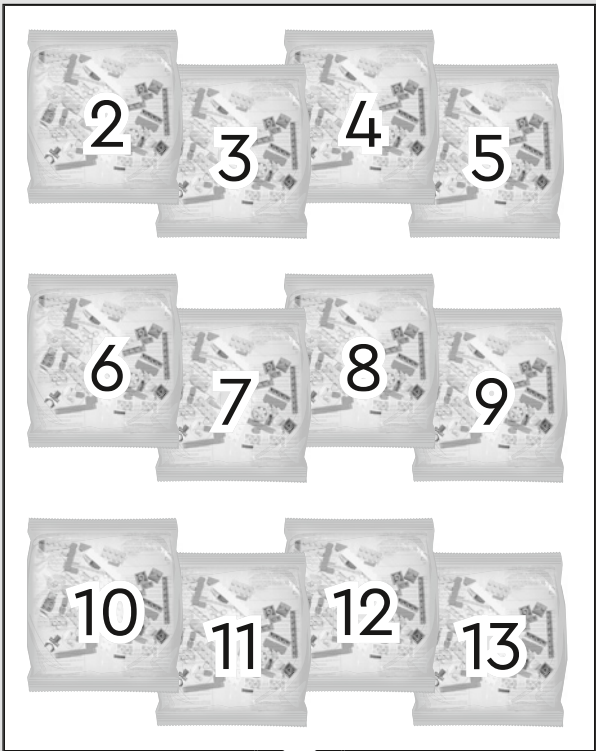

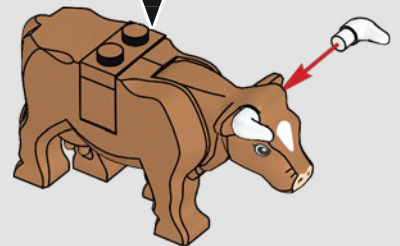
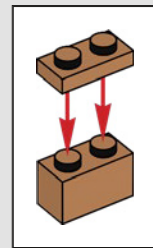
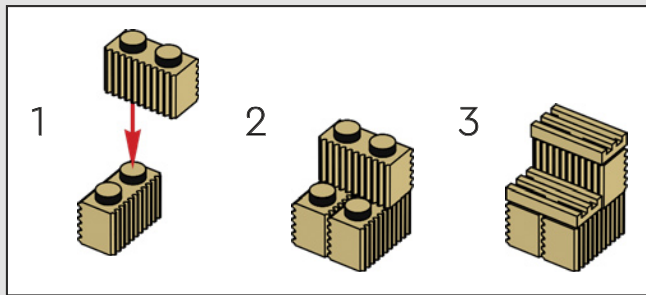
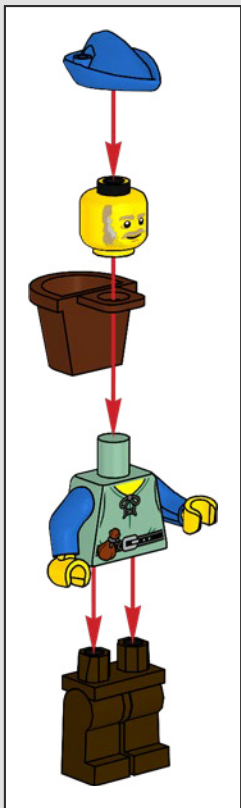

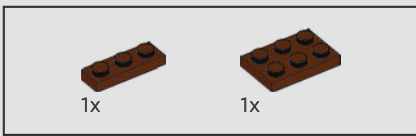

1

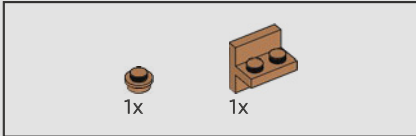
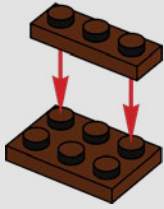

2

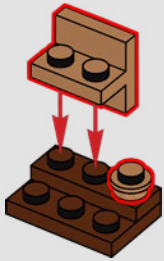

3

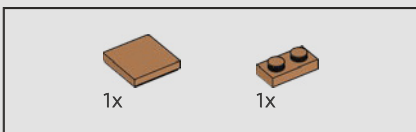
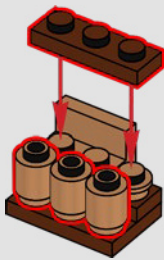

4

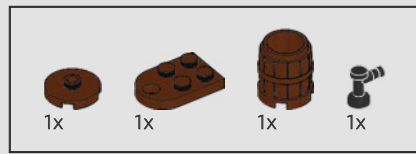
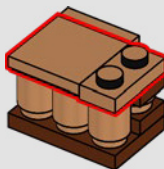

5

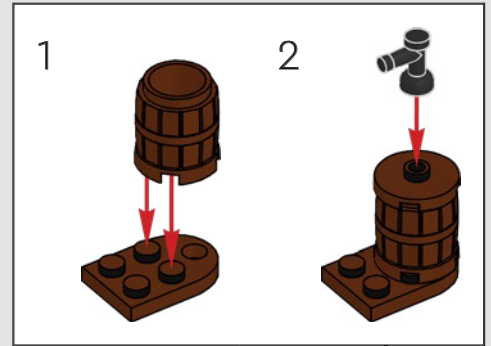

6



*Yon firkin contains a drink so potent  
it could turn a beard white!*

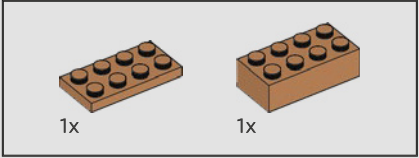
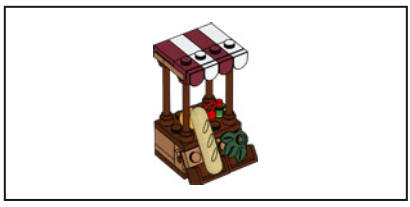

1

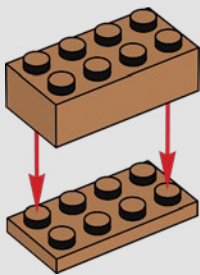

2

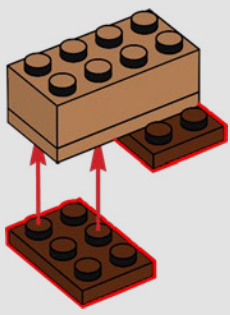

3

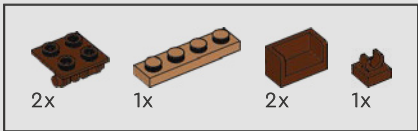
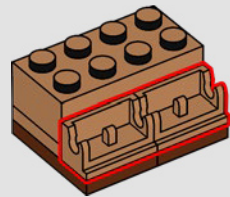

4

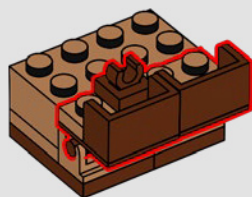
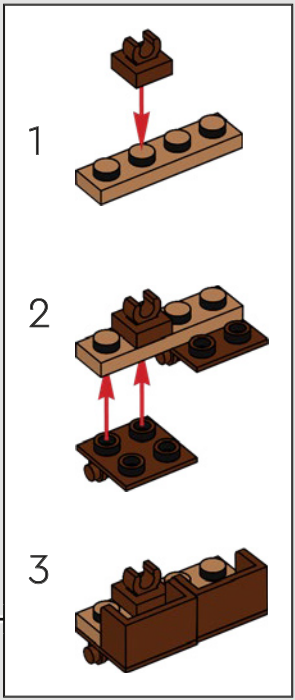

5

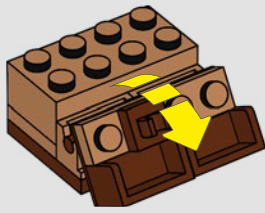

6

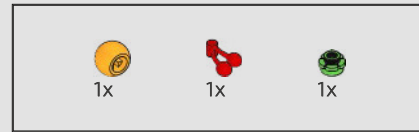
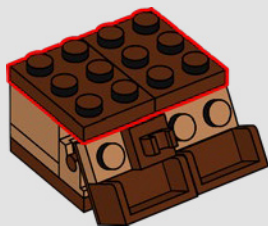

7



8

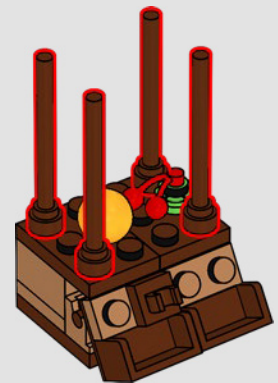

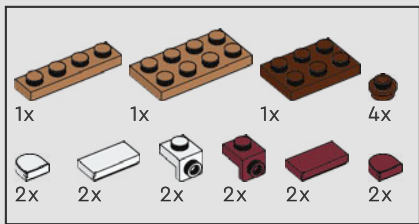

9

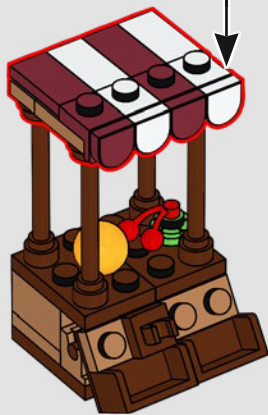
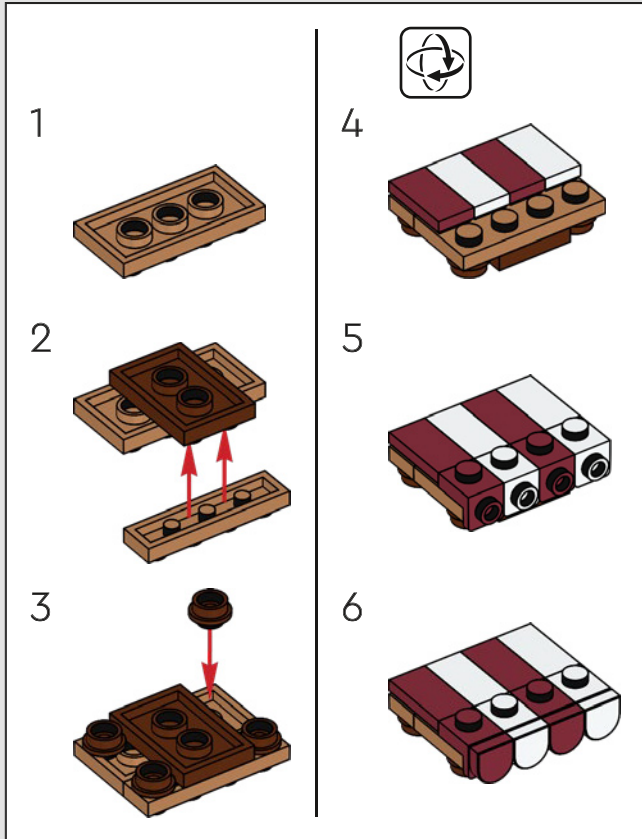

10

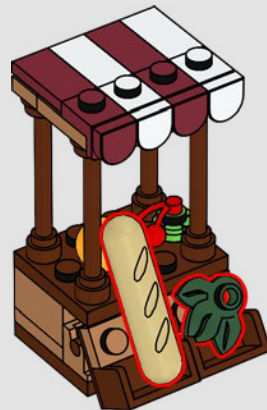

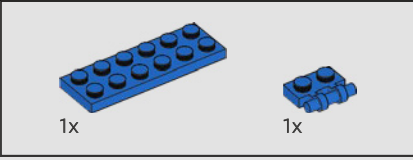
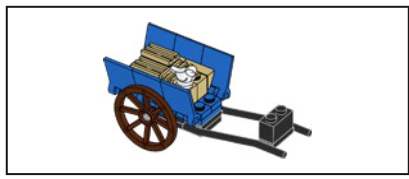

1

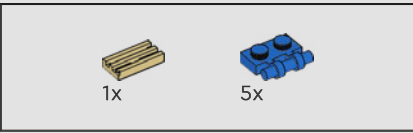
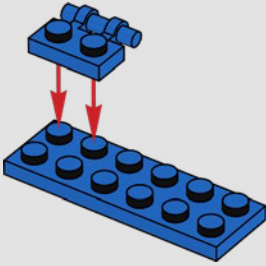

2

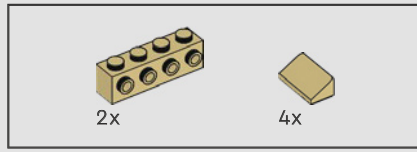
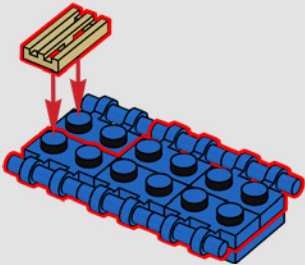

3

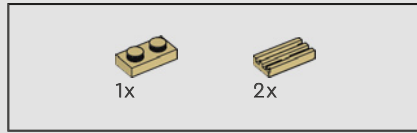
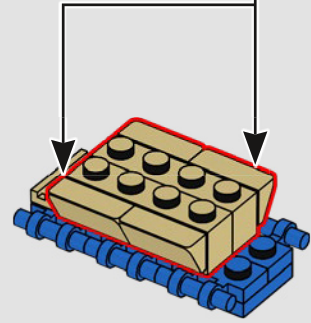
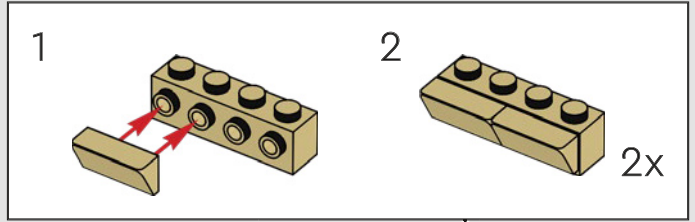

4

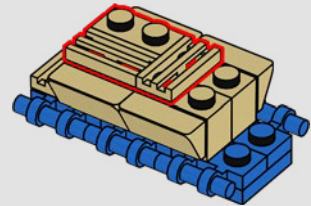

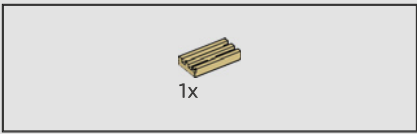

5

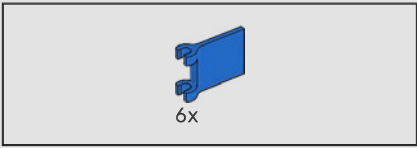
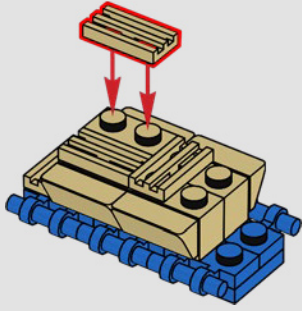

6

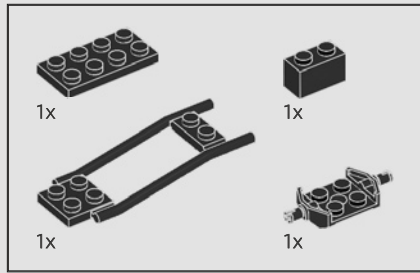
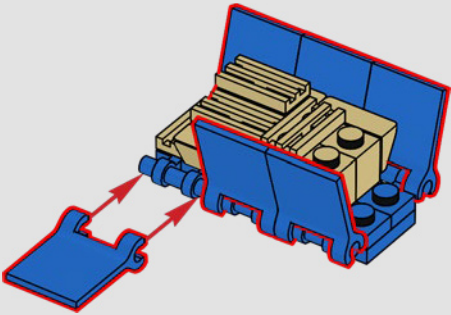

7

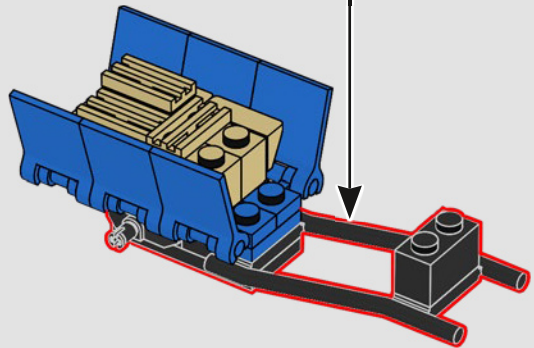
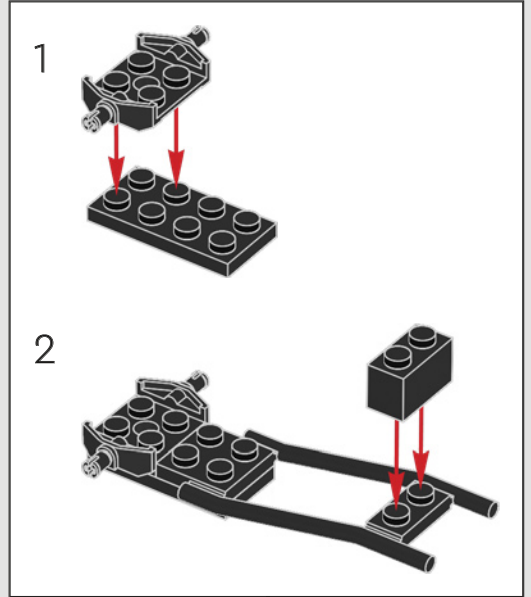





*Yon cart is drawn by oxen? An oddity as this reminds one of Cousin Willa's windship.*

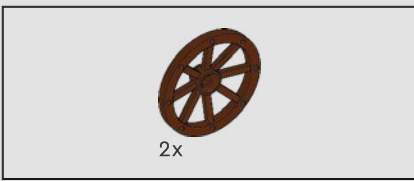

8

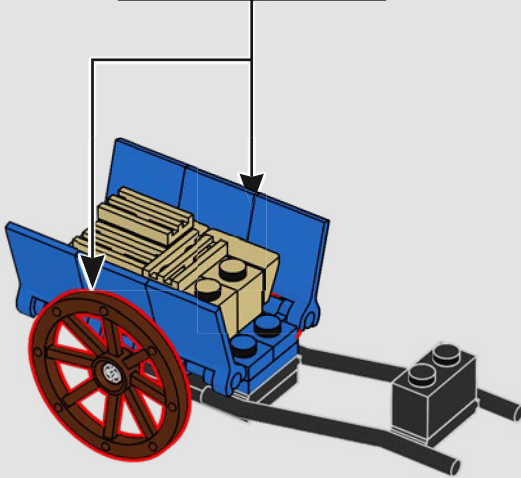
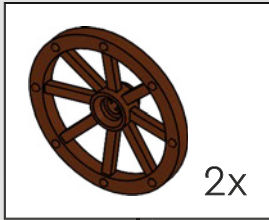

9

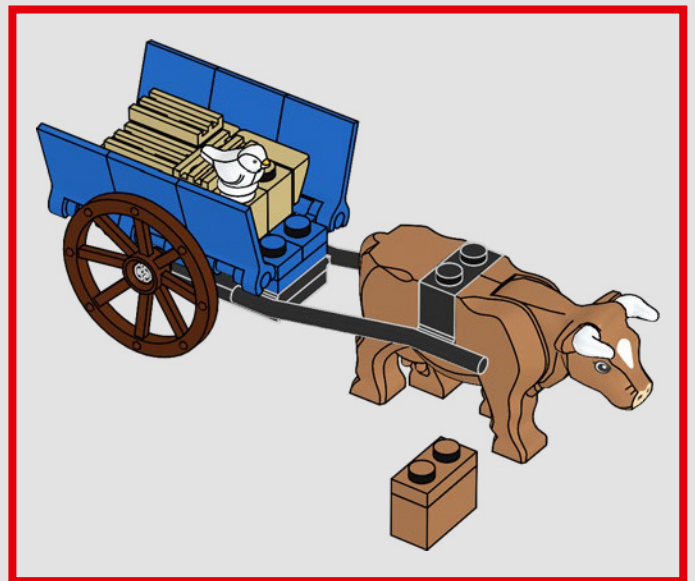
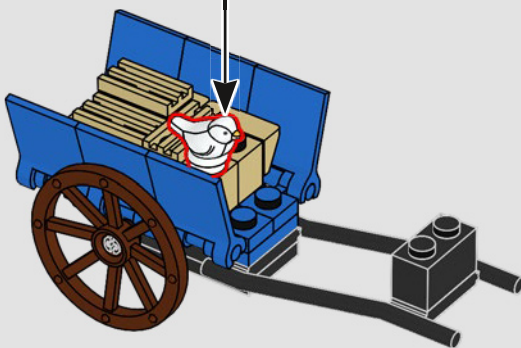

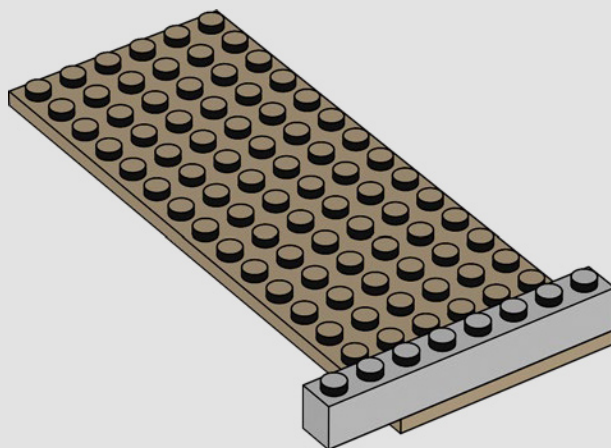
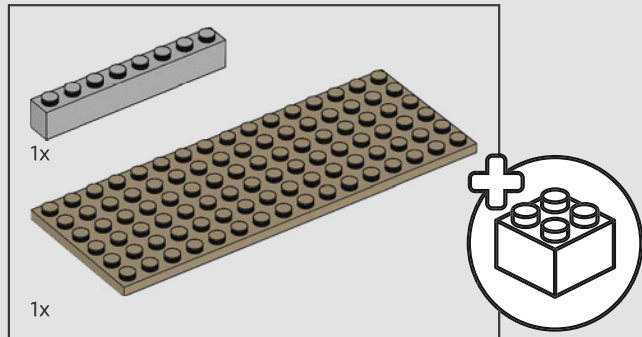
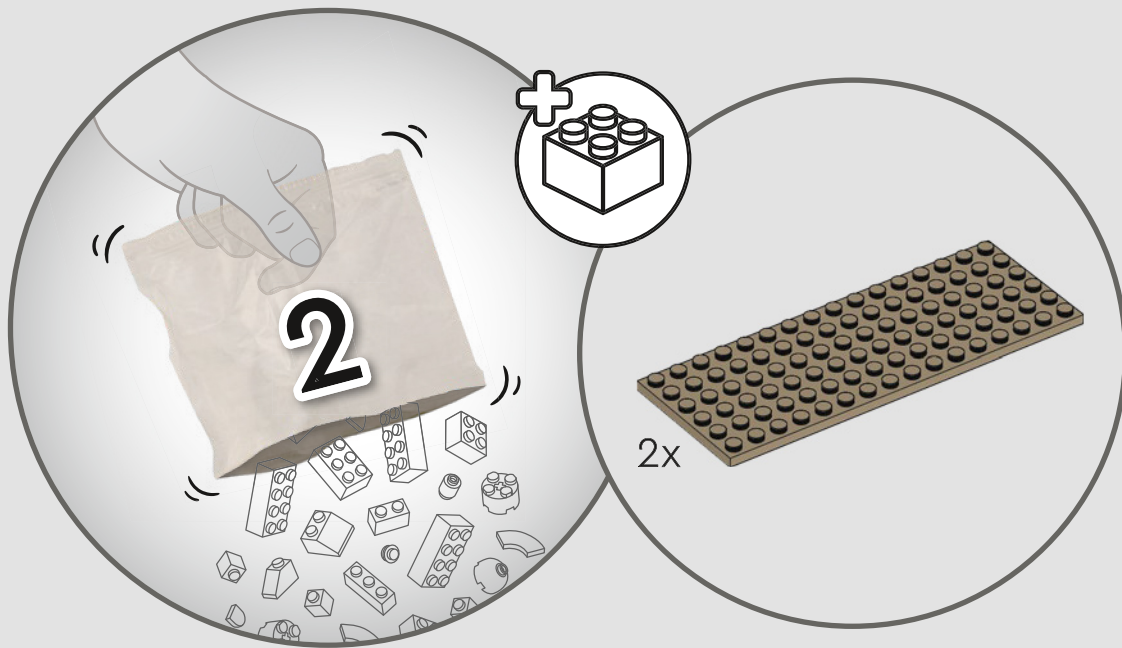

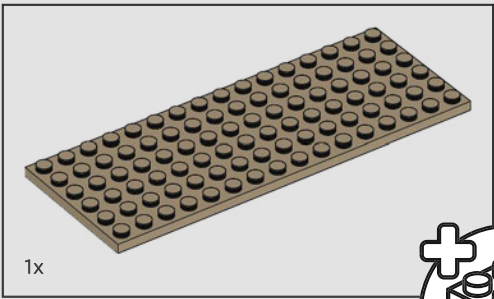

1x

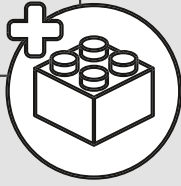

2

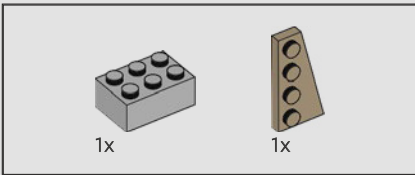
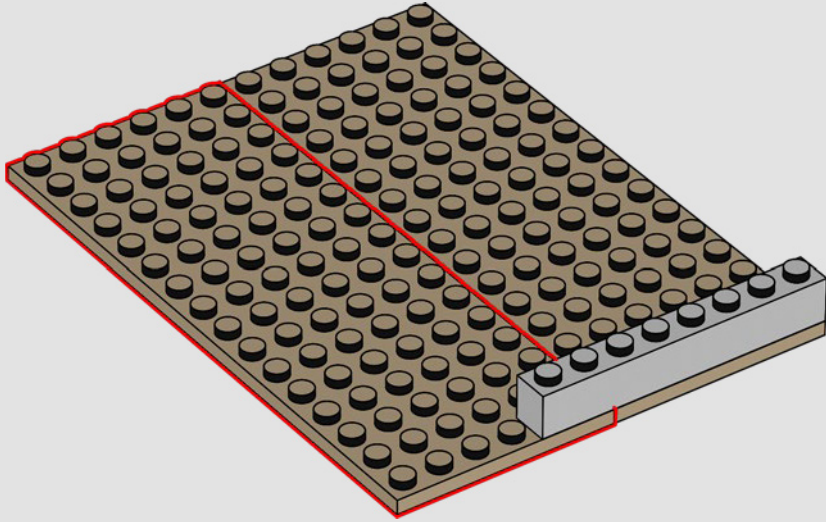

1x

1x

3

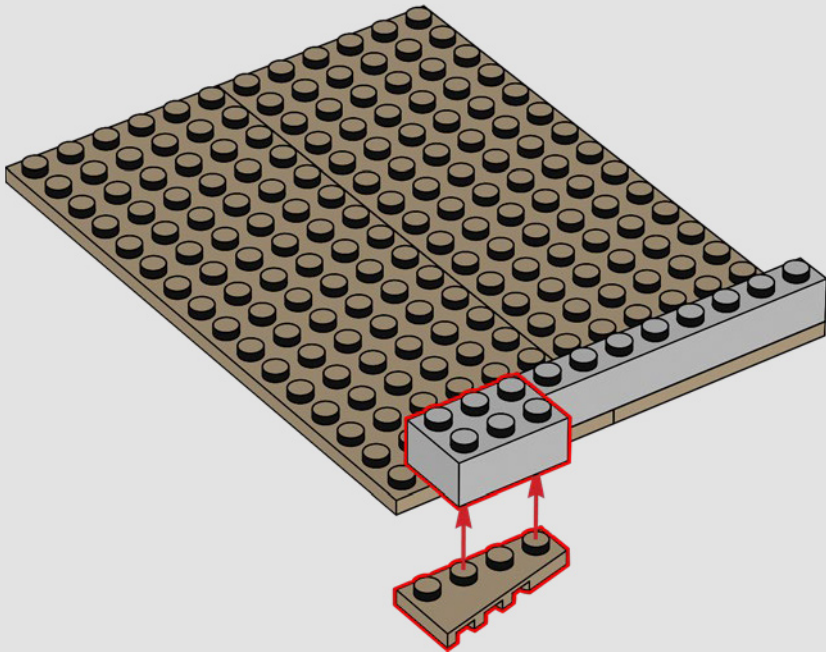

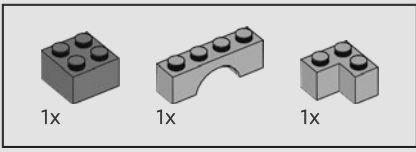

4

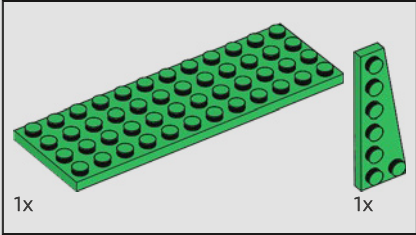
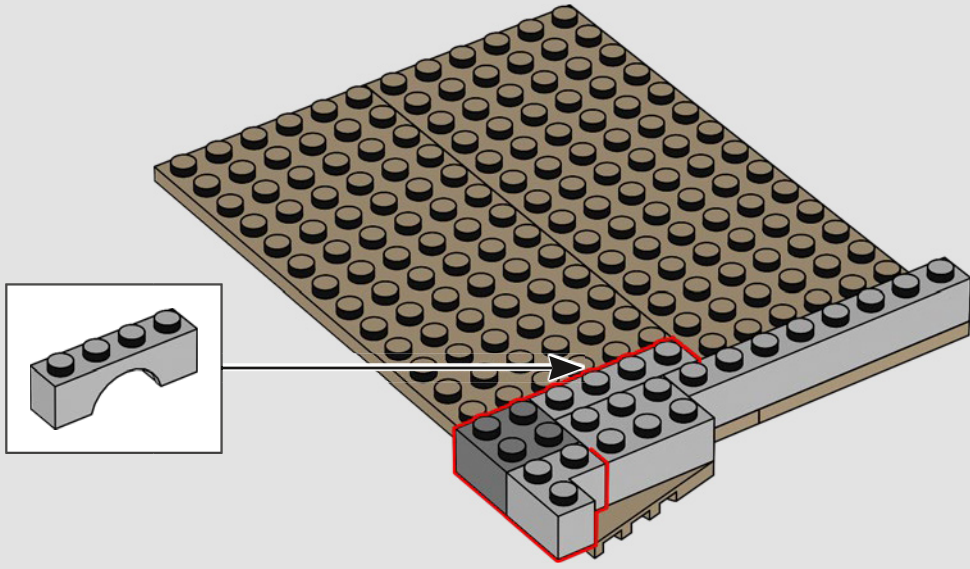

5

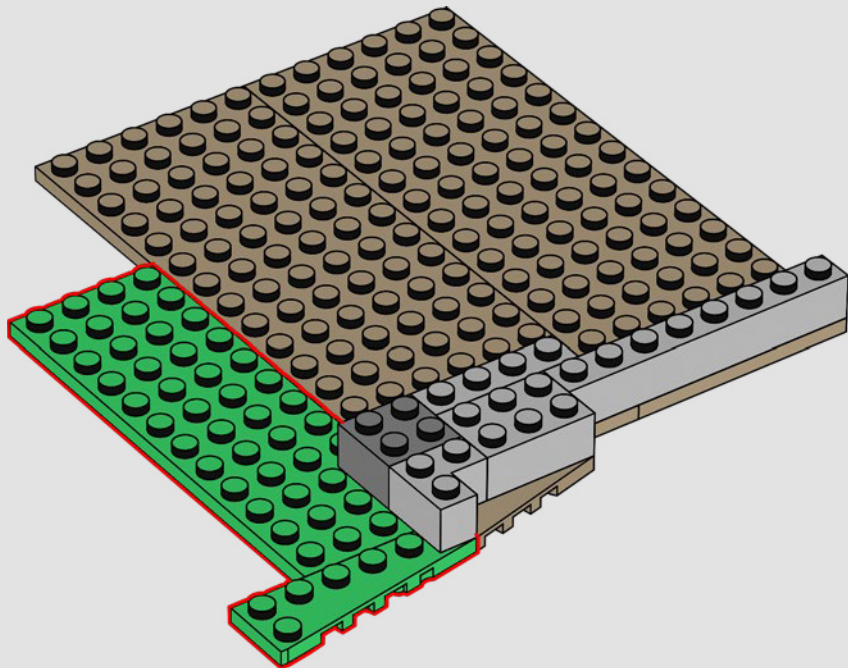

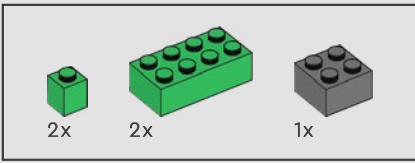

6

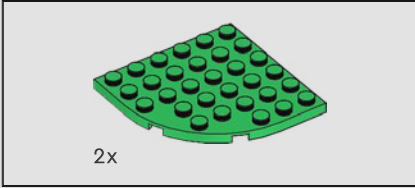
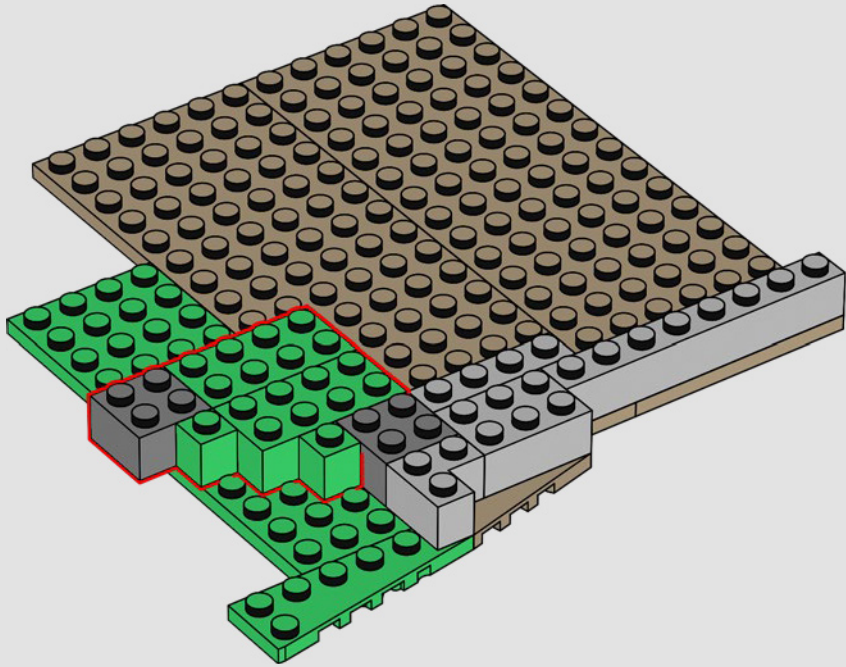

7

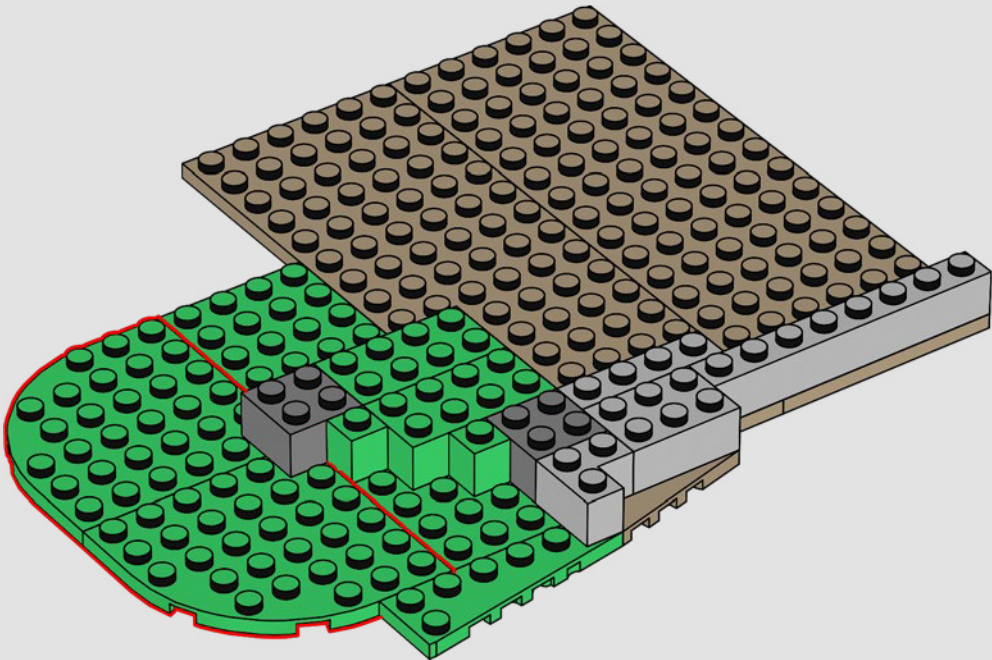

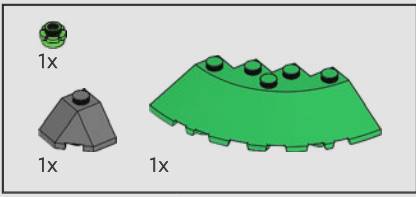

8

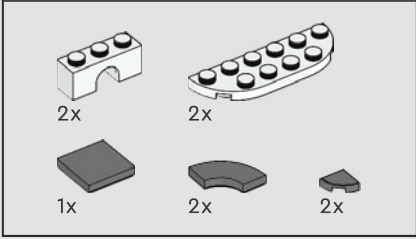
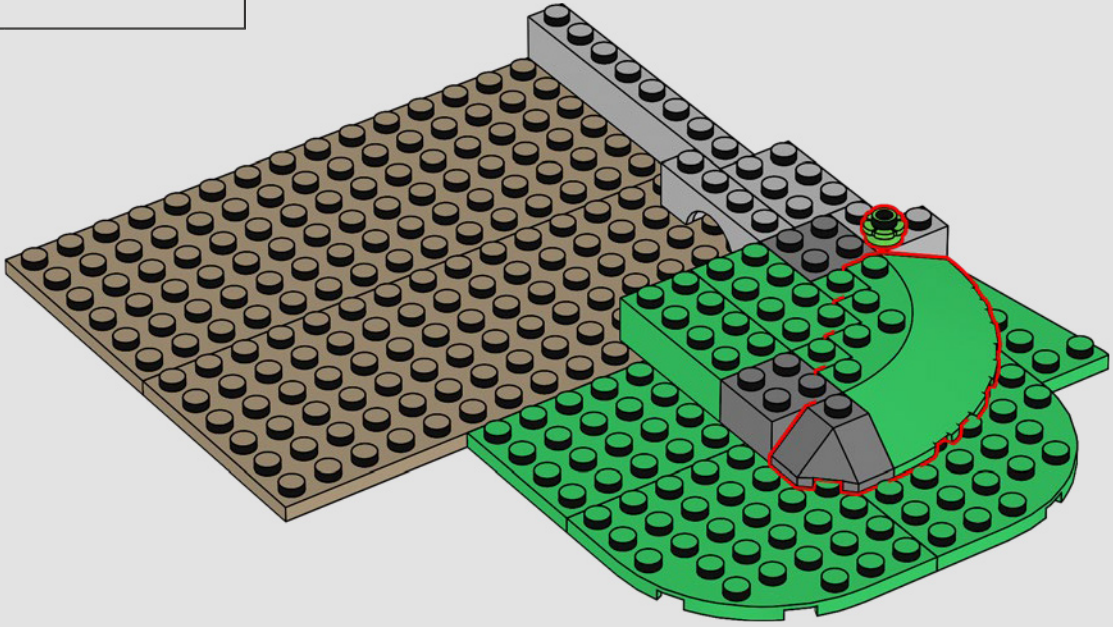

9

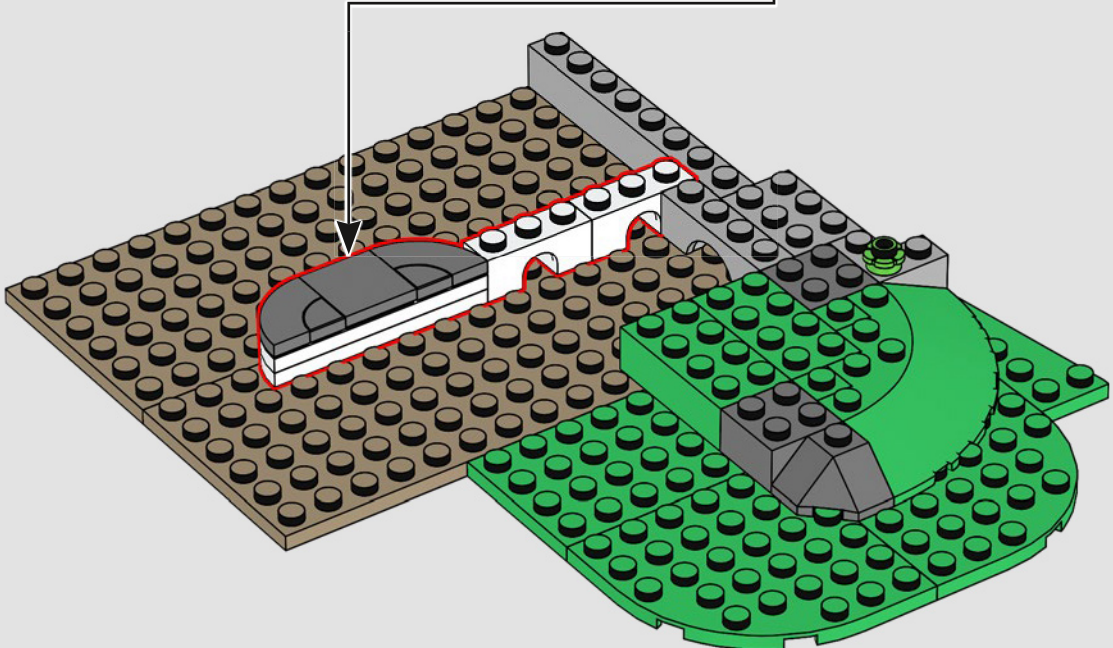
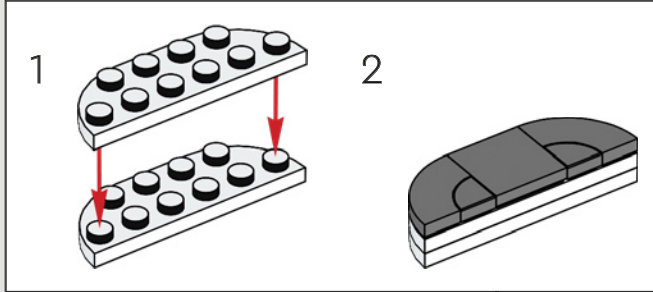



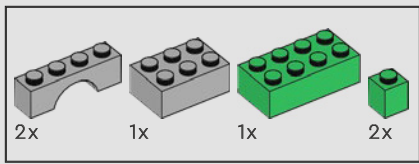

11

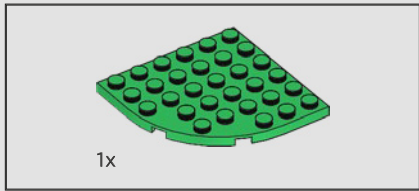
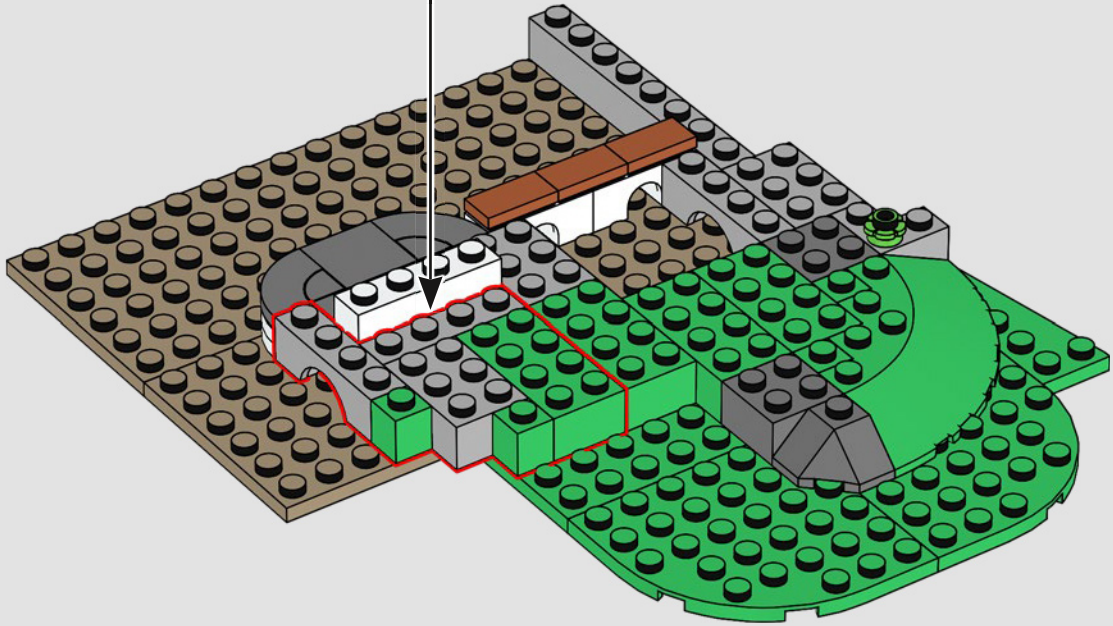
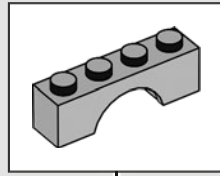

12

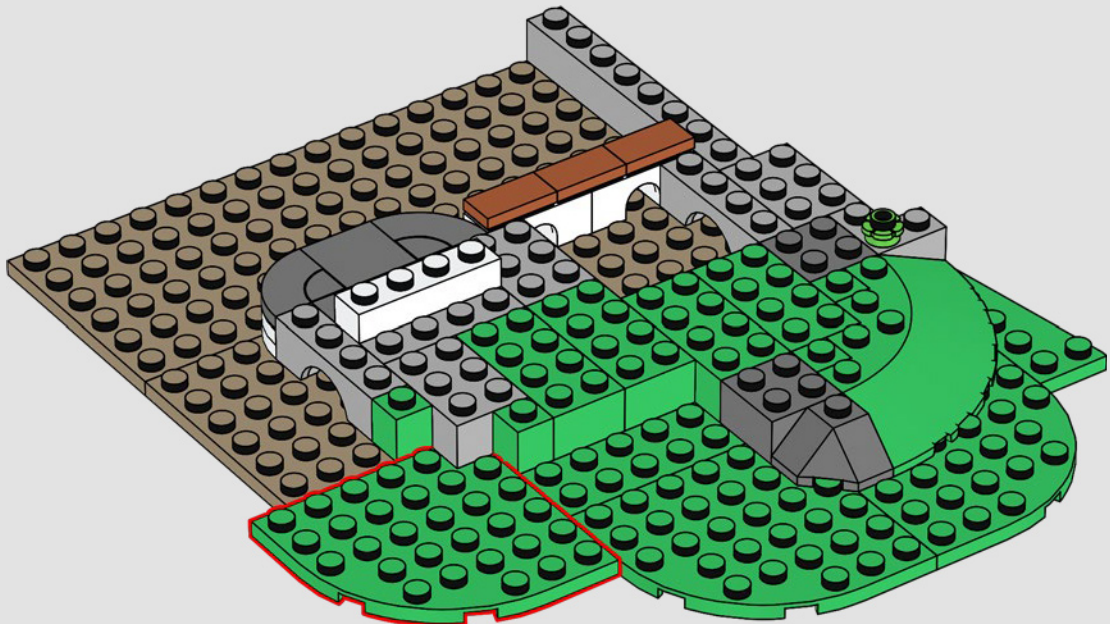



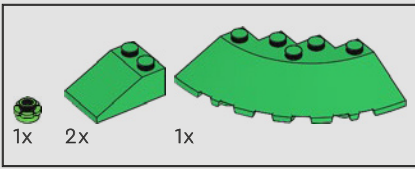

13

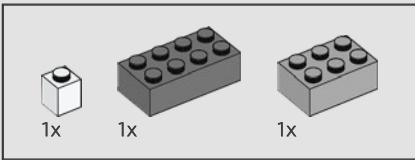
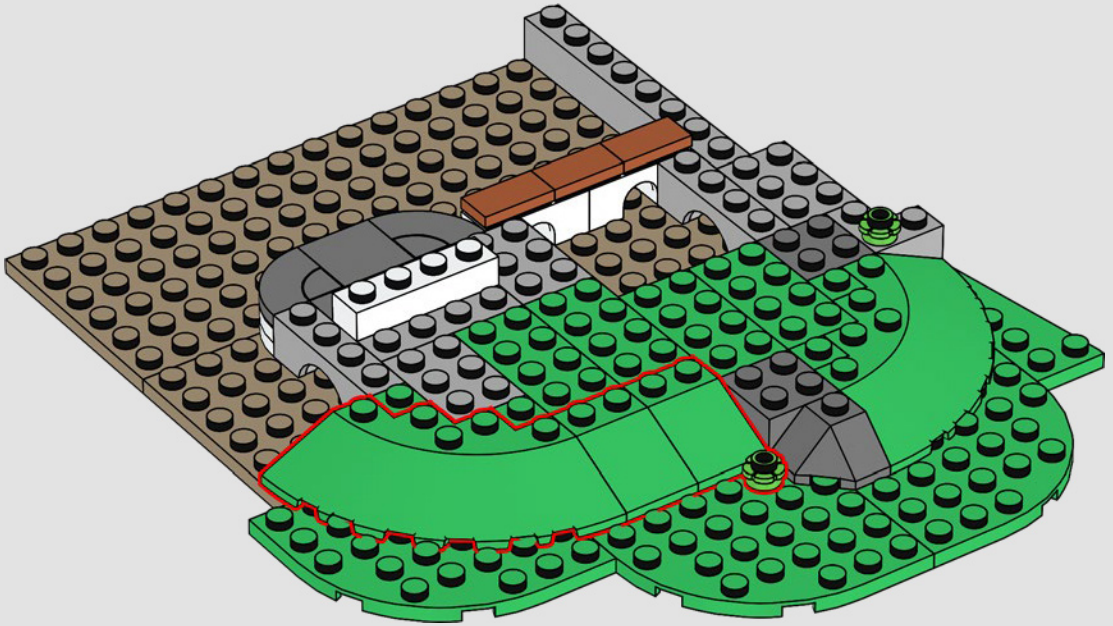

14

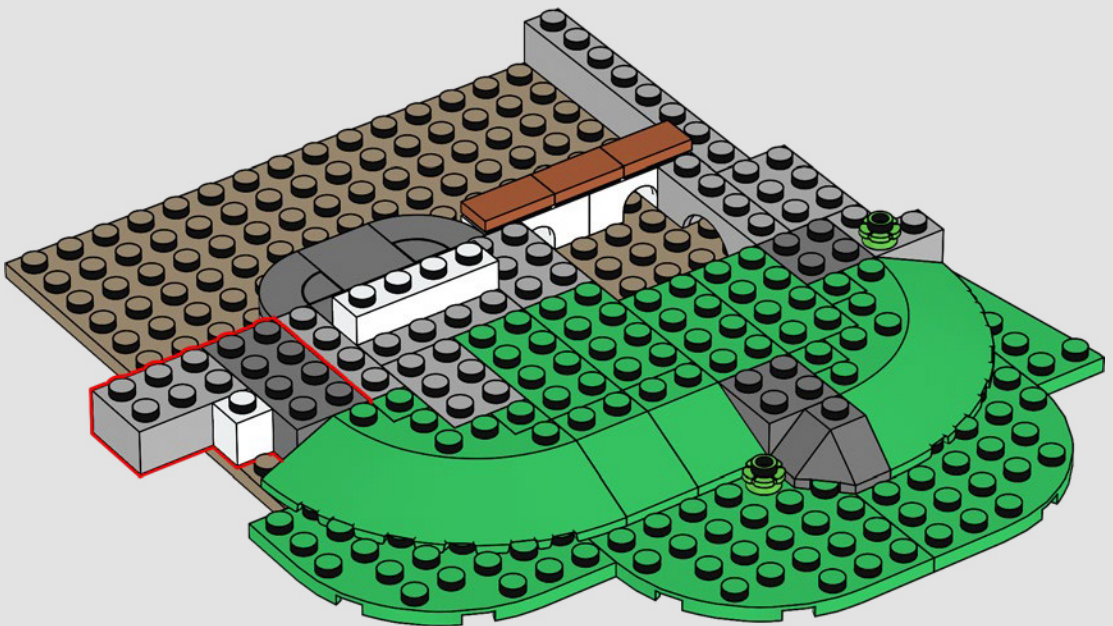

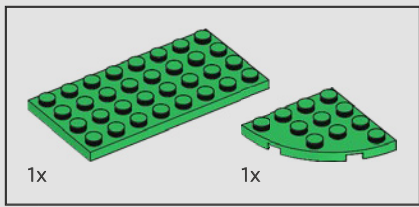

15

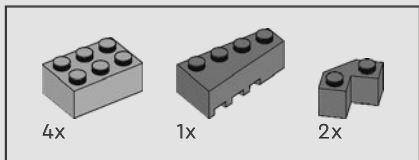
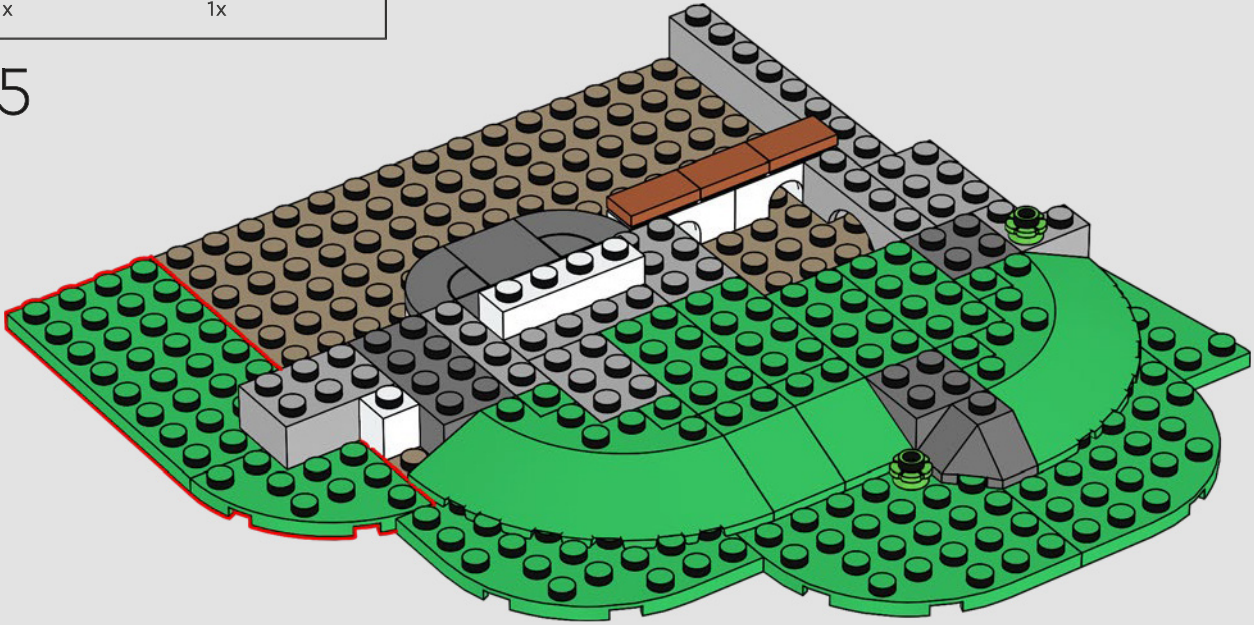

16

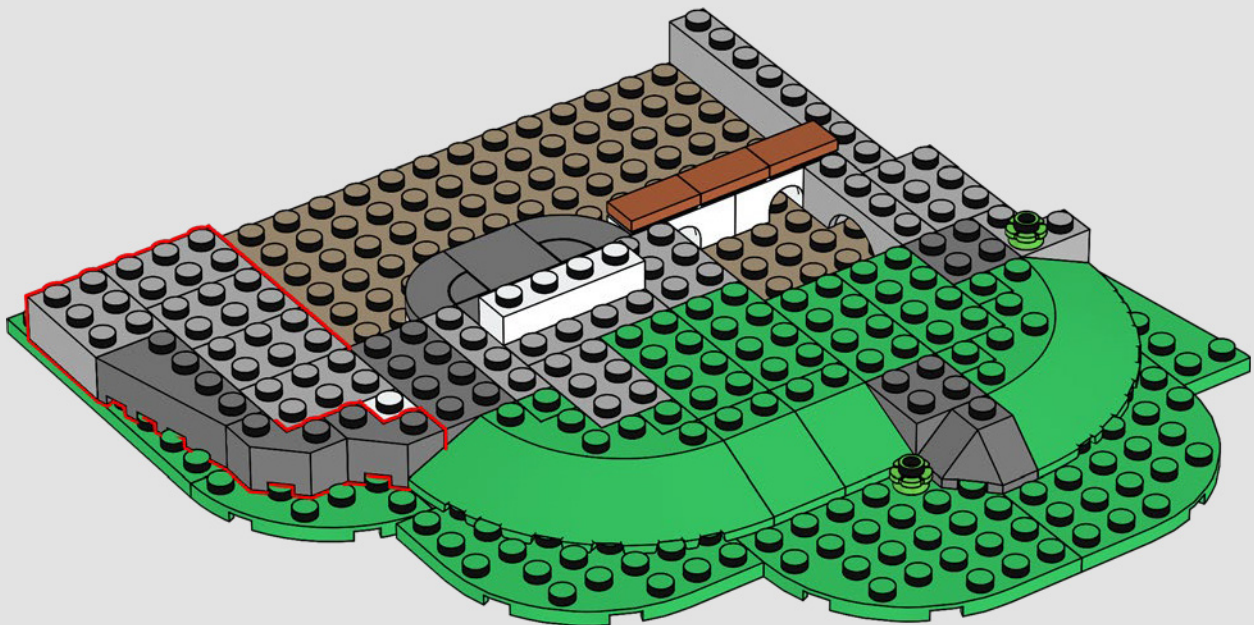

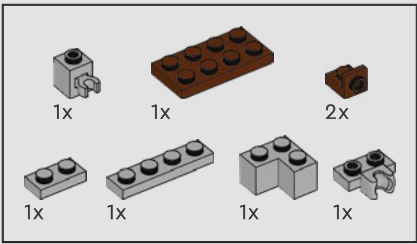

17

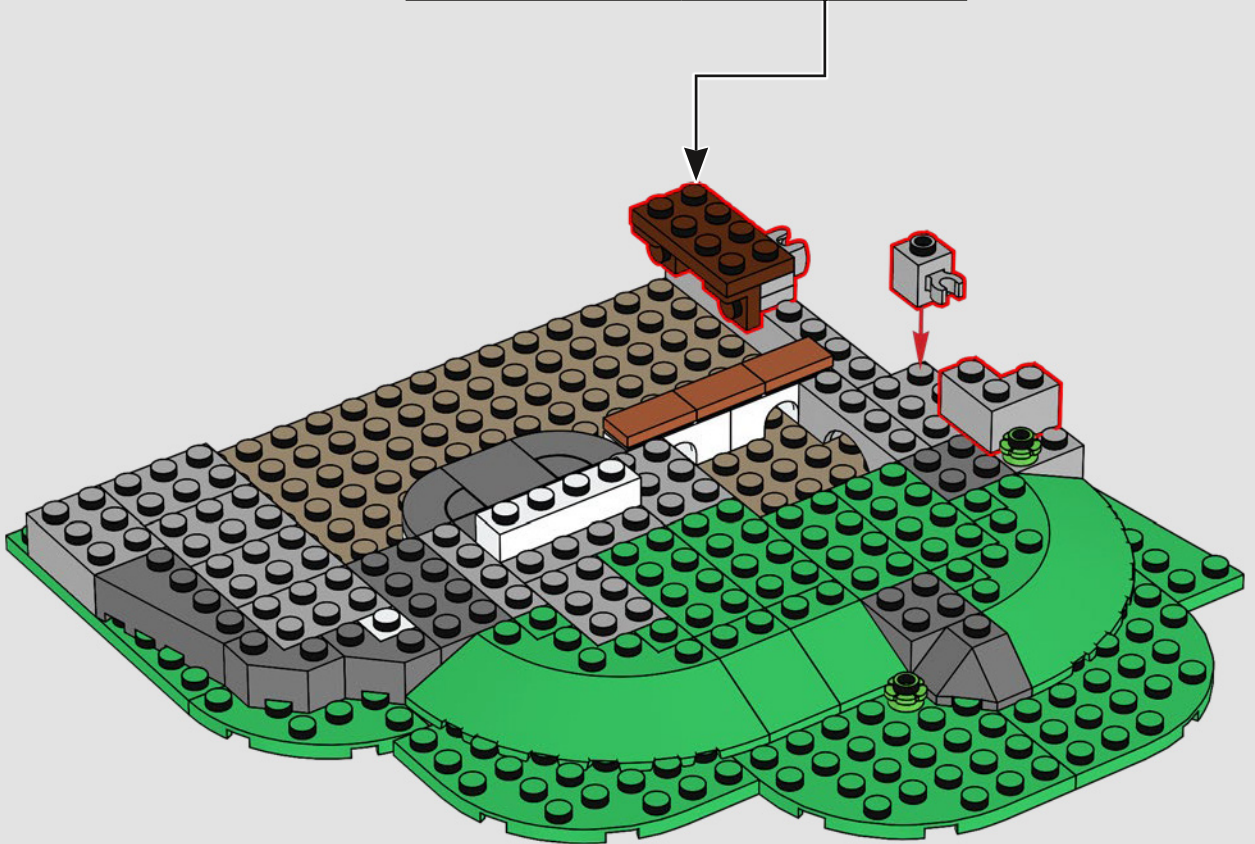
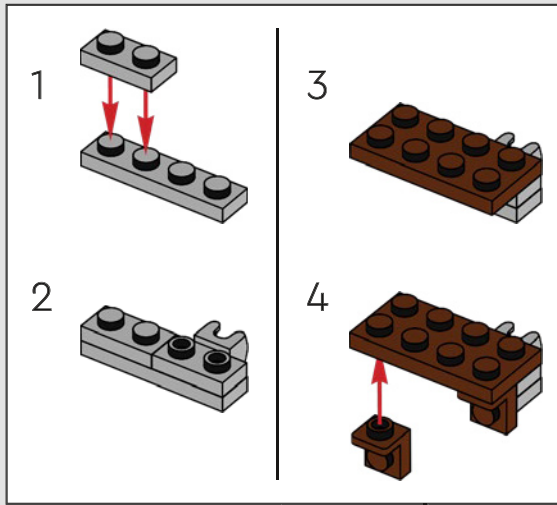

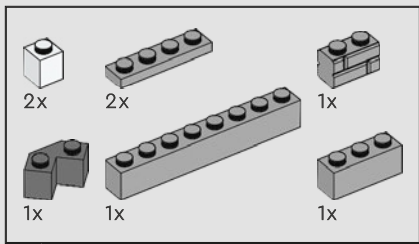

18

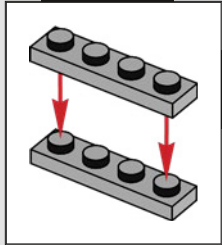
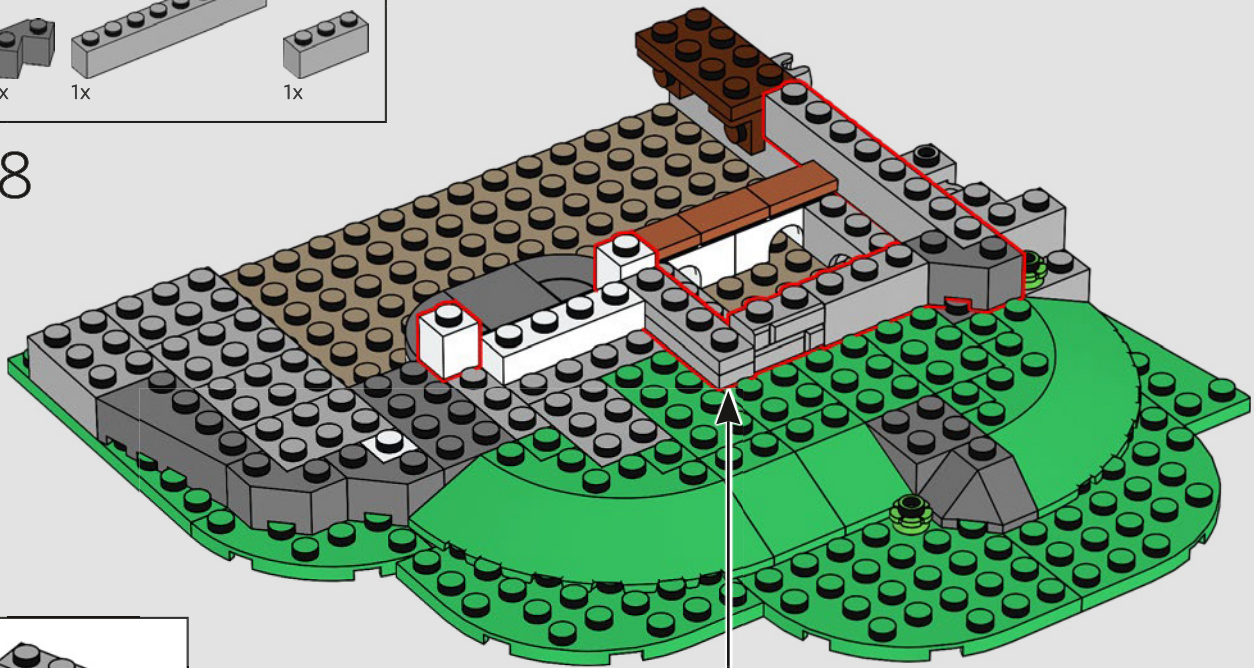

19

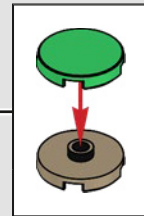
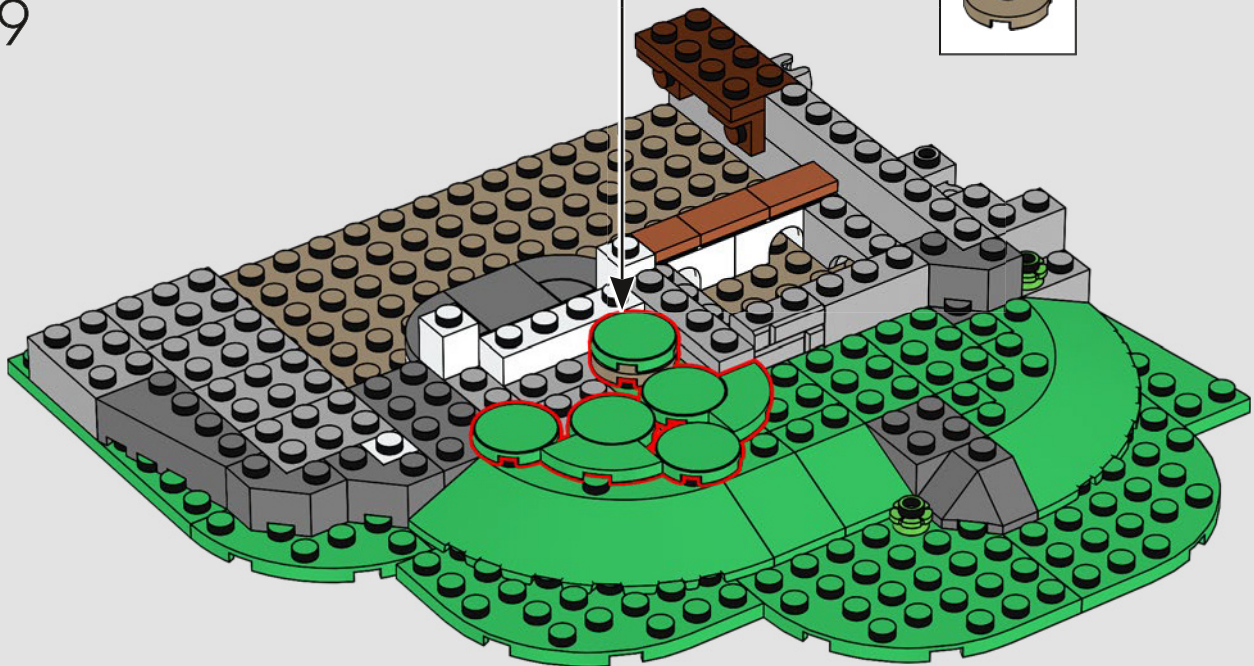

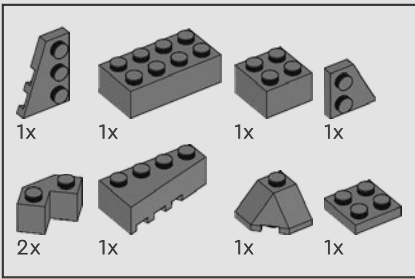

20

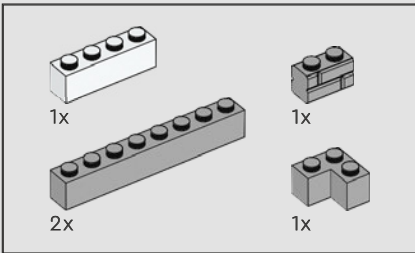
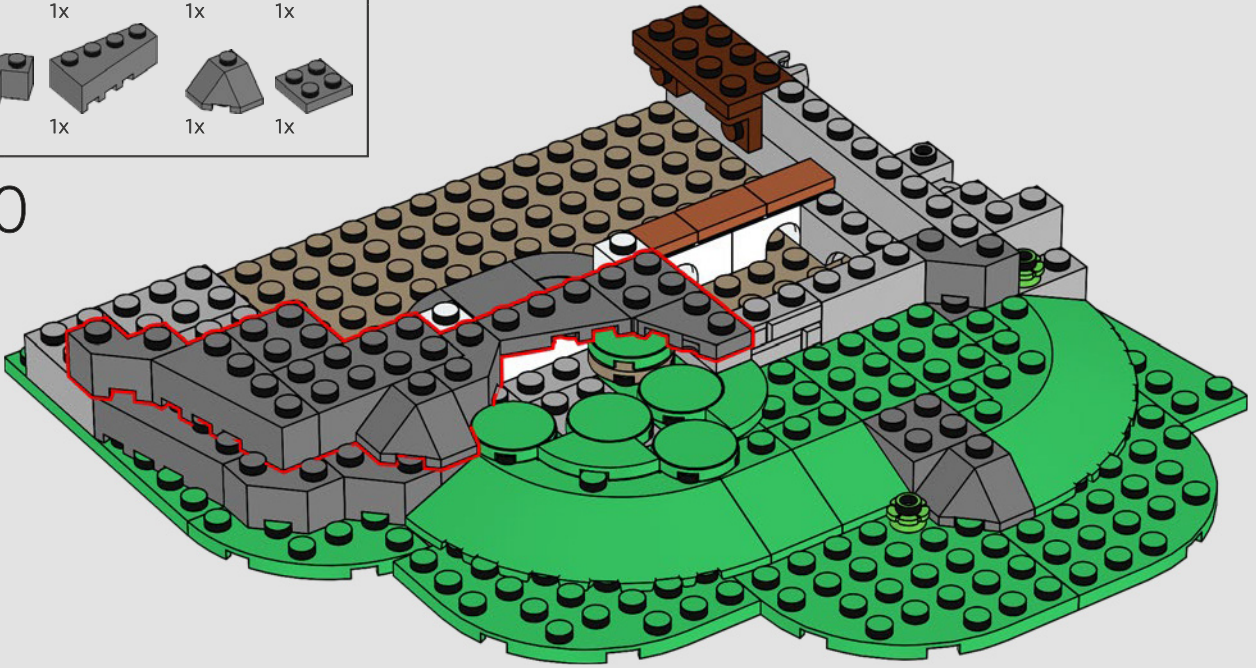

21

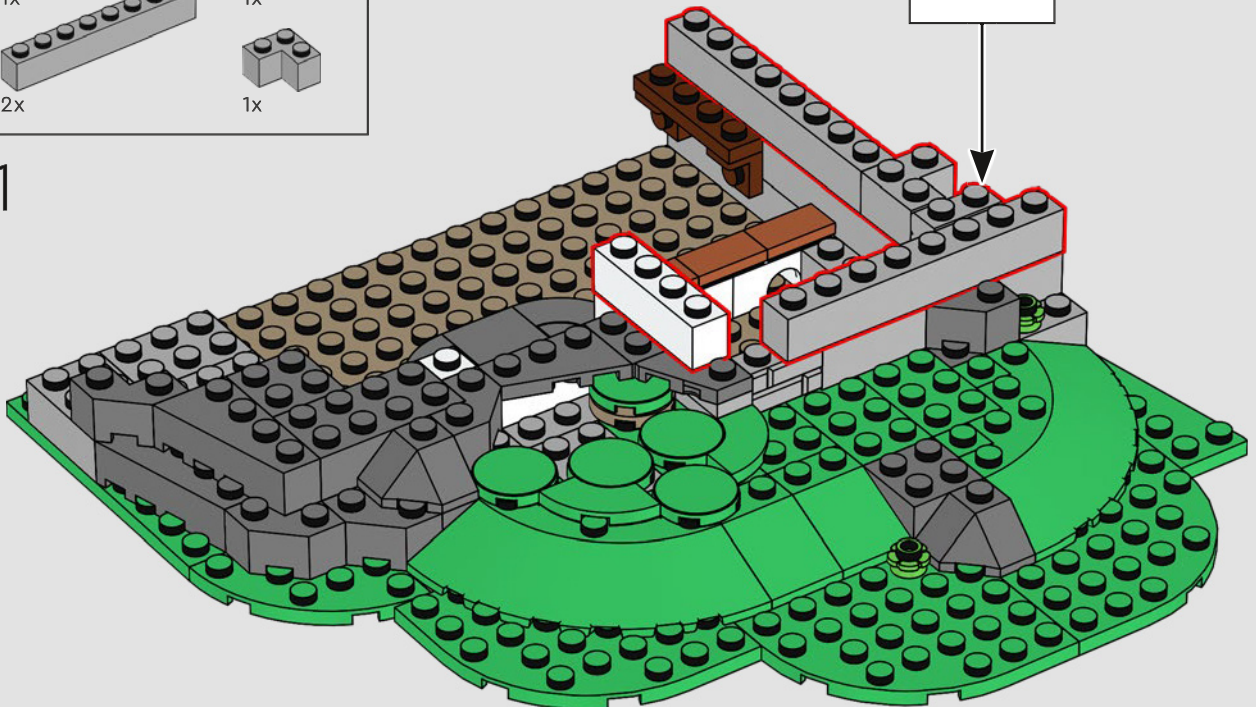
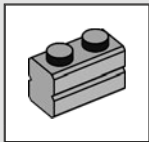

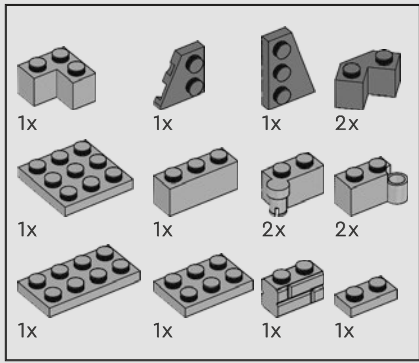

22

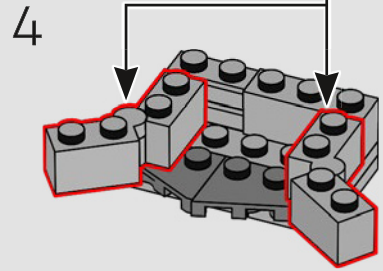
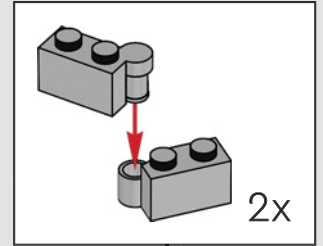
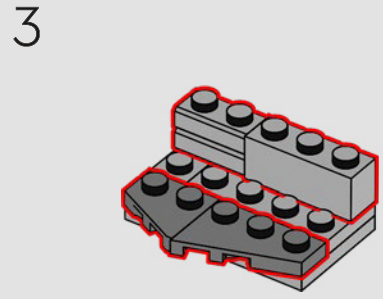
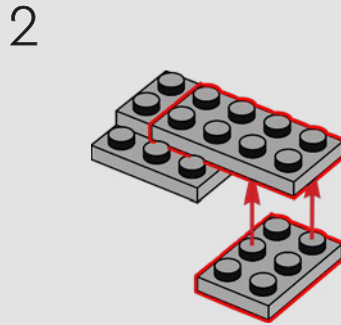
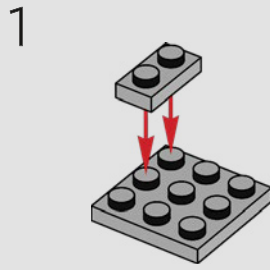

*How can these walls fit together?  
There's a magic at work here never  
seen before!*

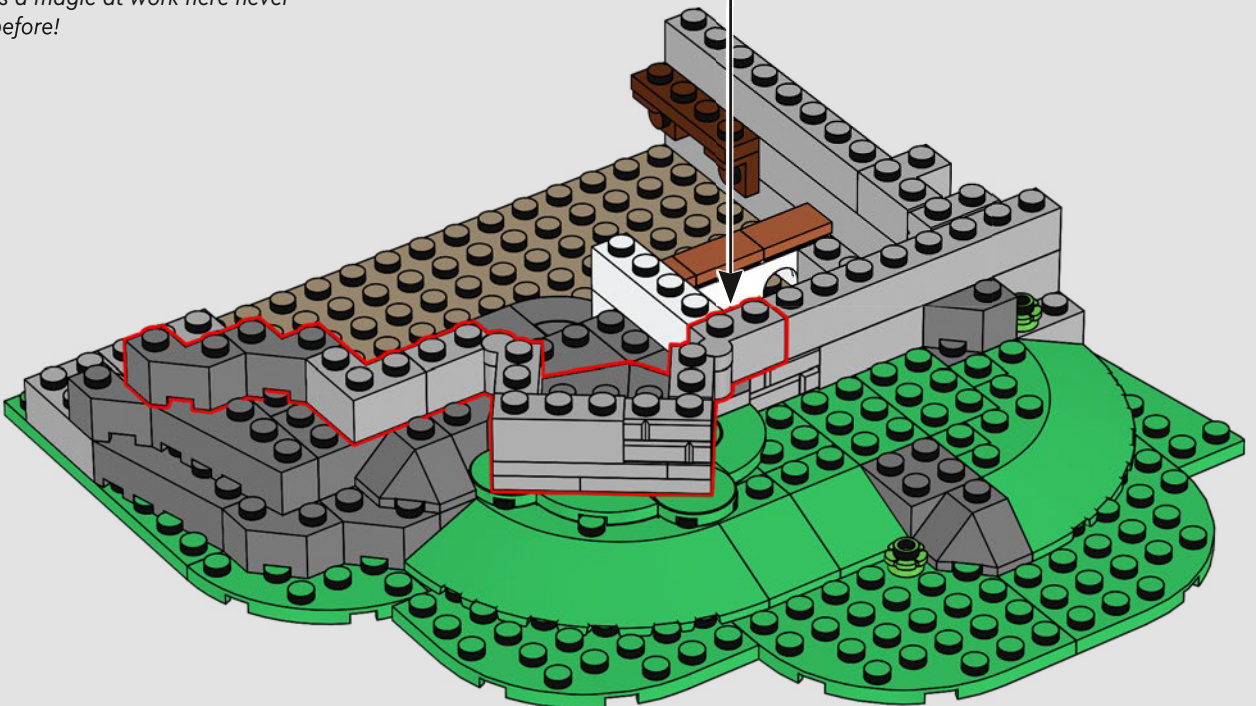

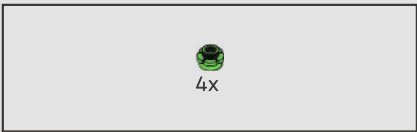

23

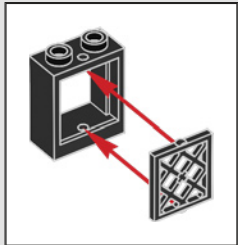
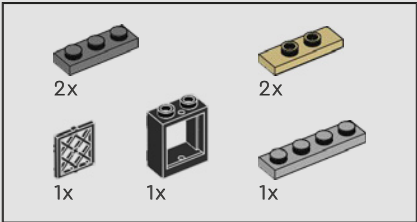
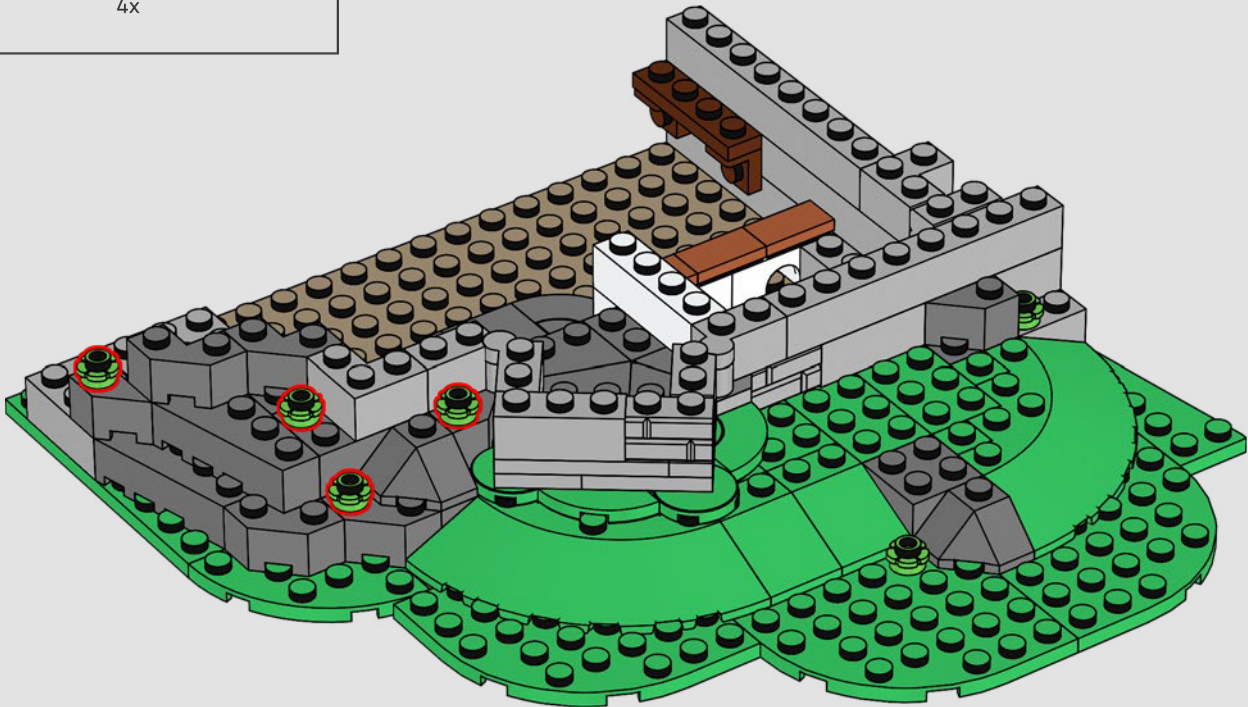

24

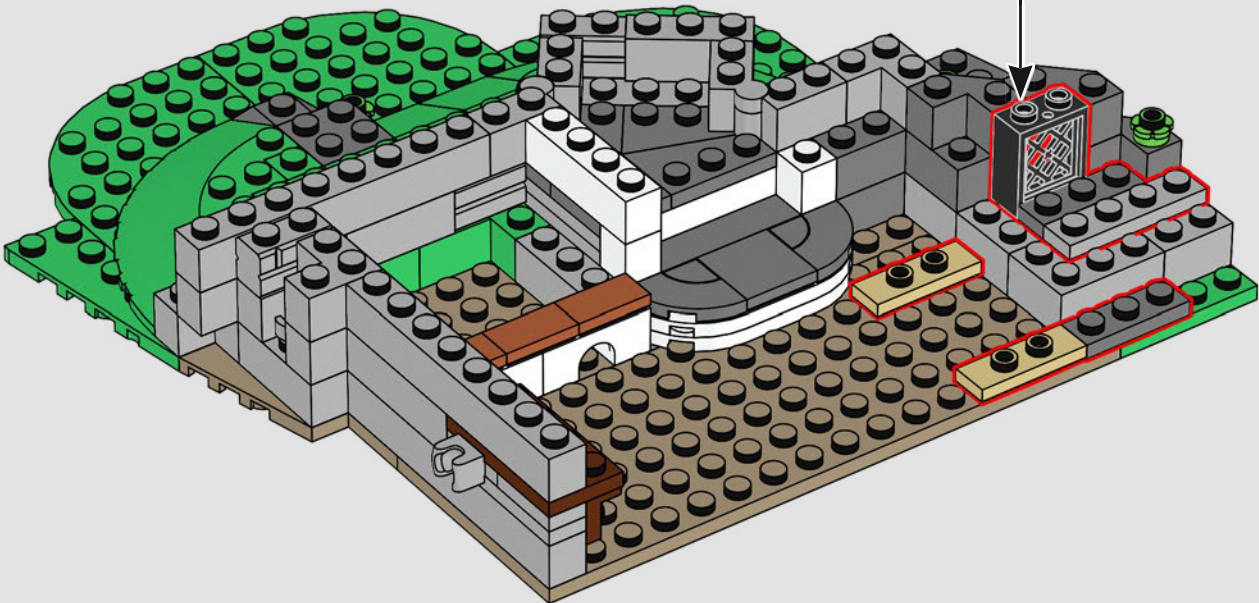



Looks like someone sat on a 1x1 brick!  
Or have they stretched a plate?

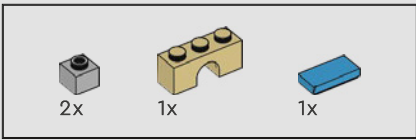

25

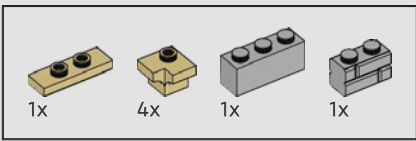
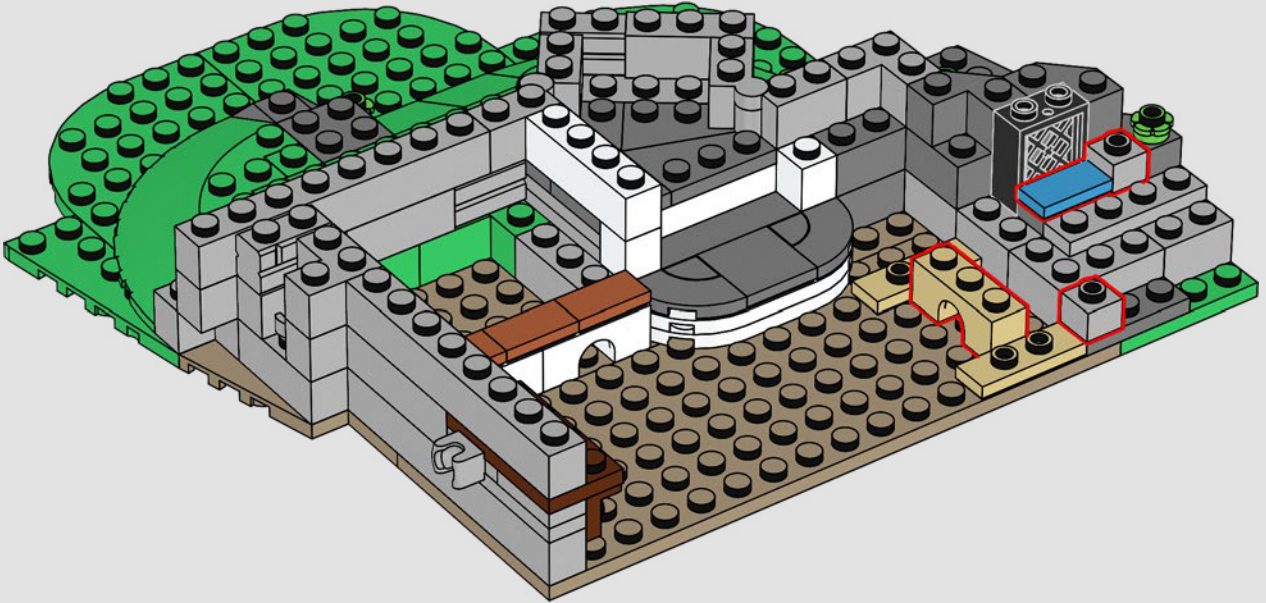

26

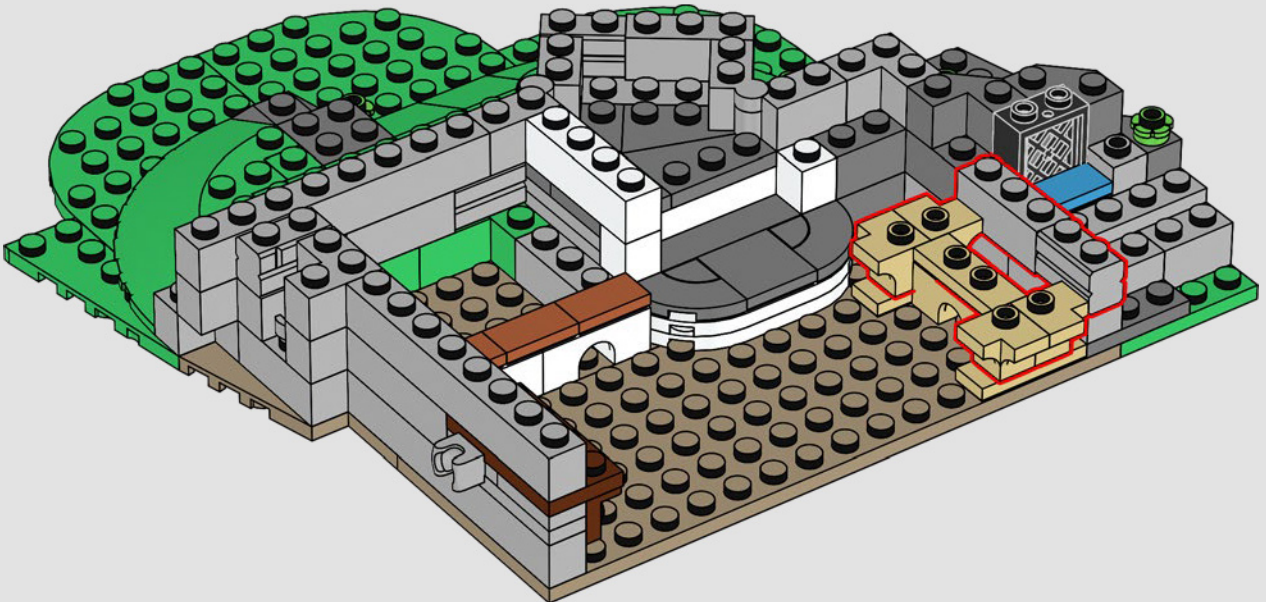



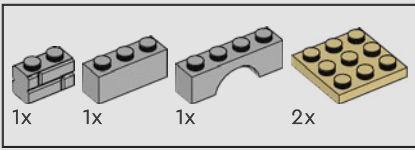

27

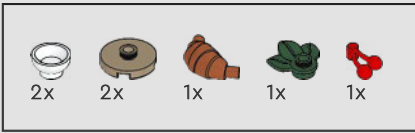
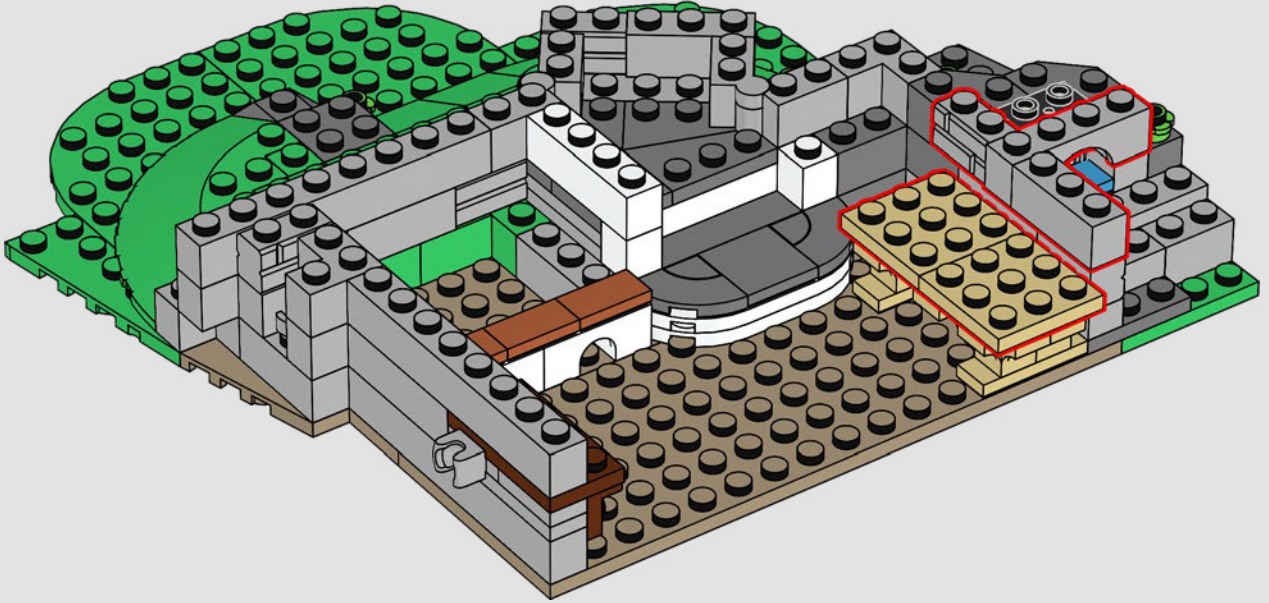

28

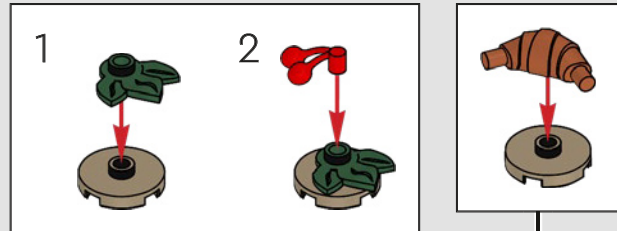

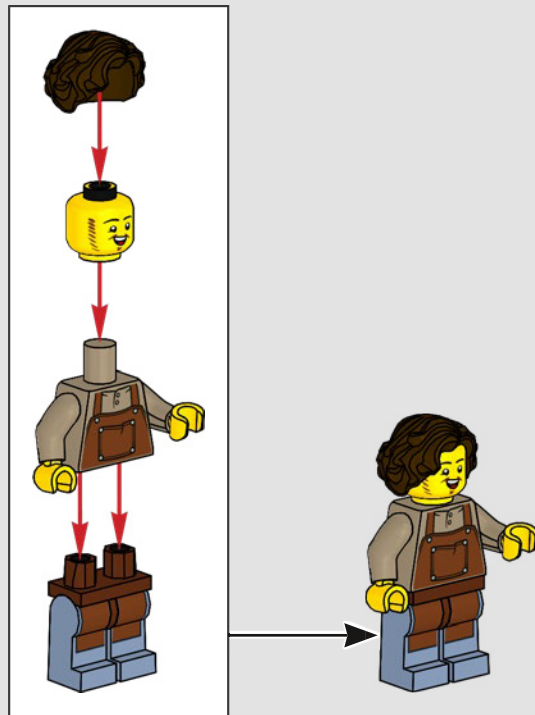



What doth such oddly placed candle  
illuminate?

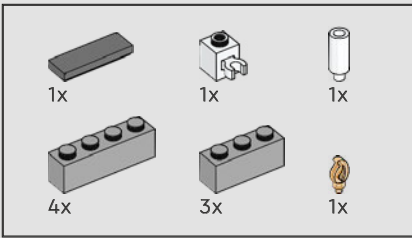

29

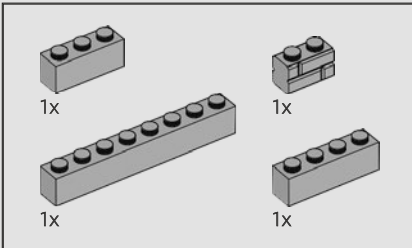
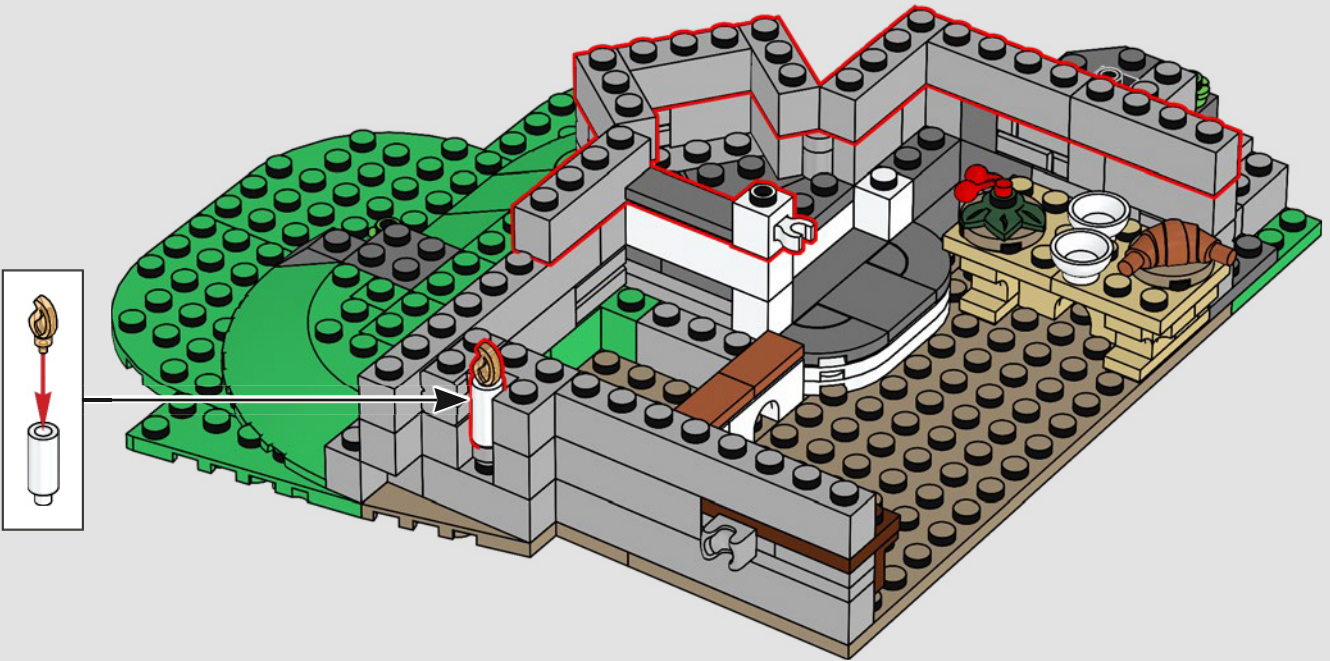

30

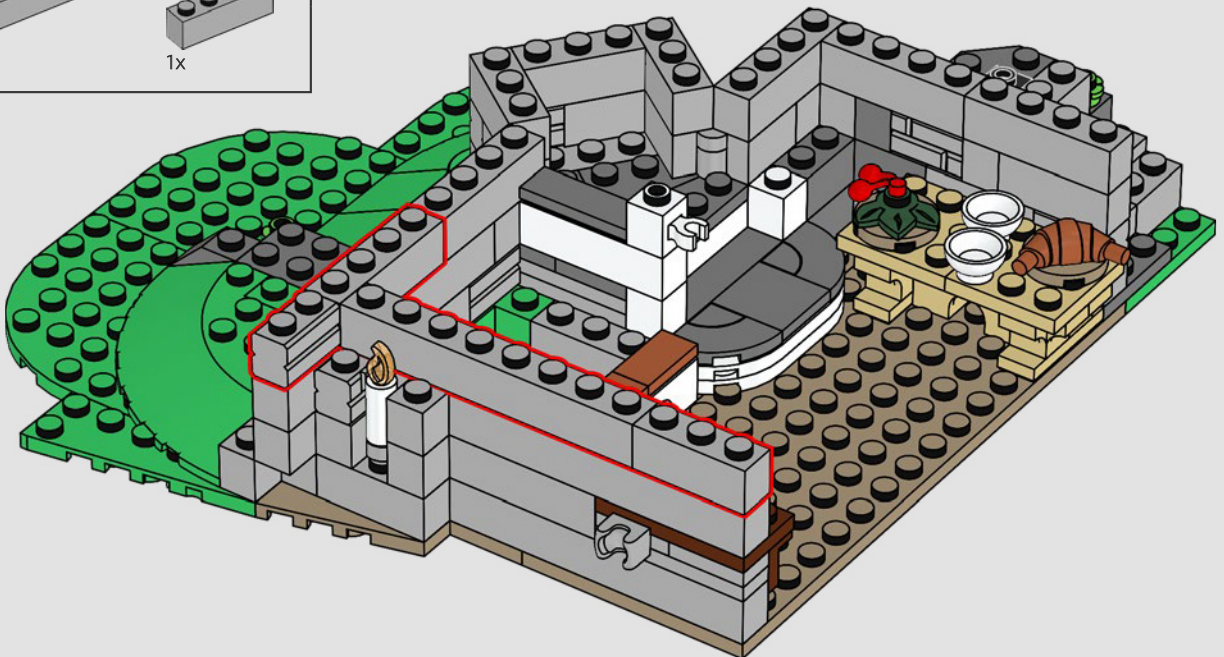

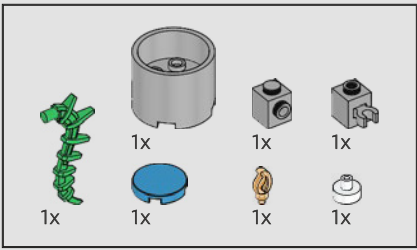

31

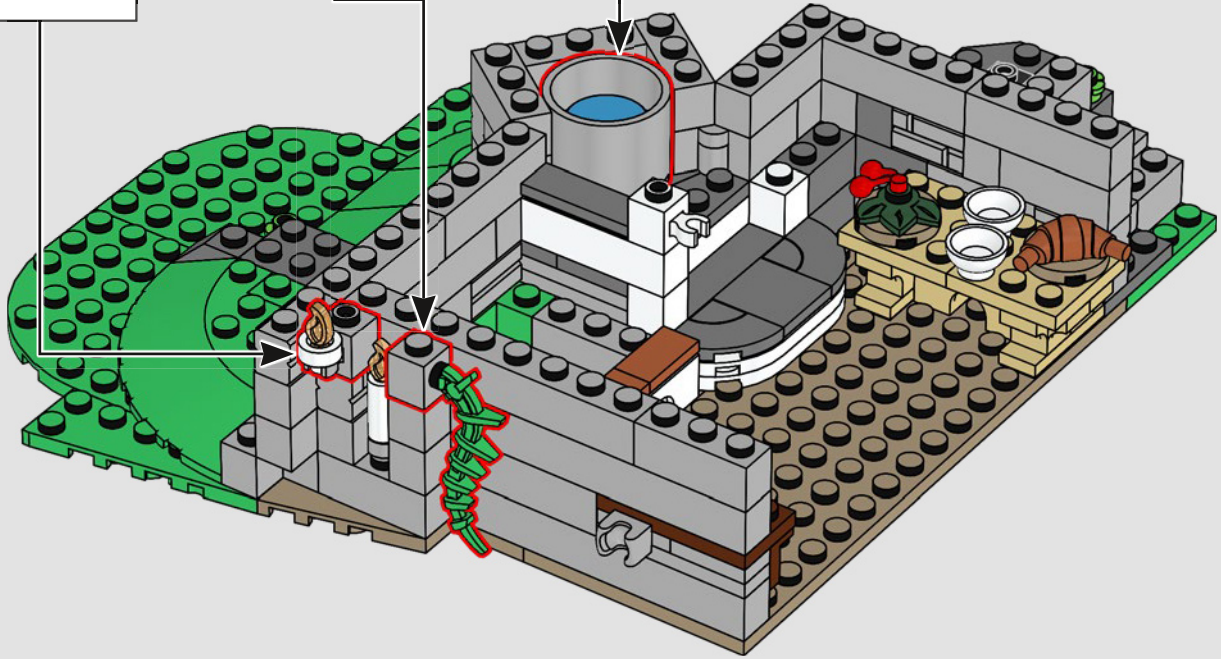
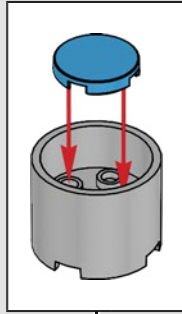
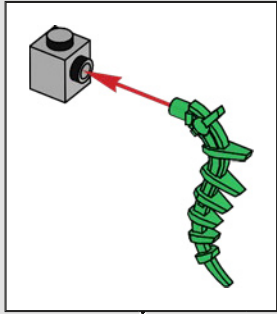
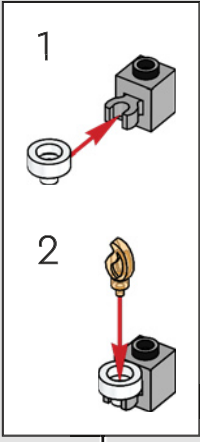

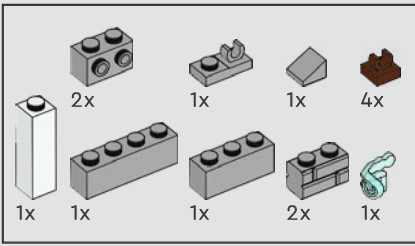

32

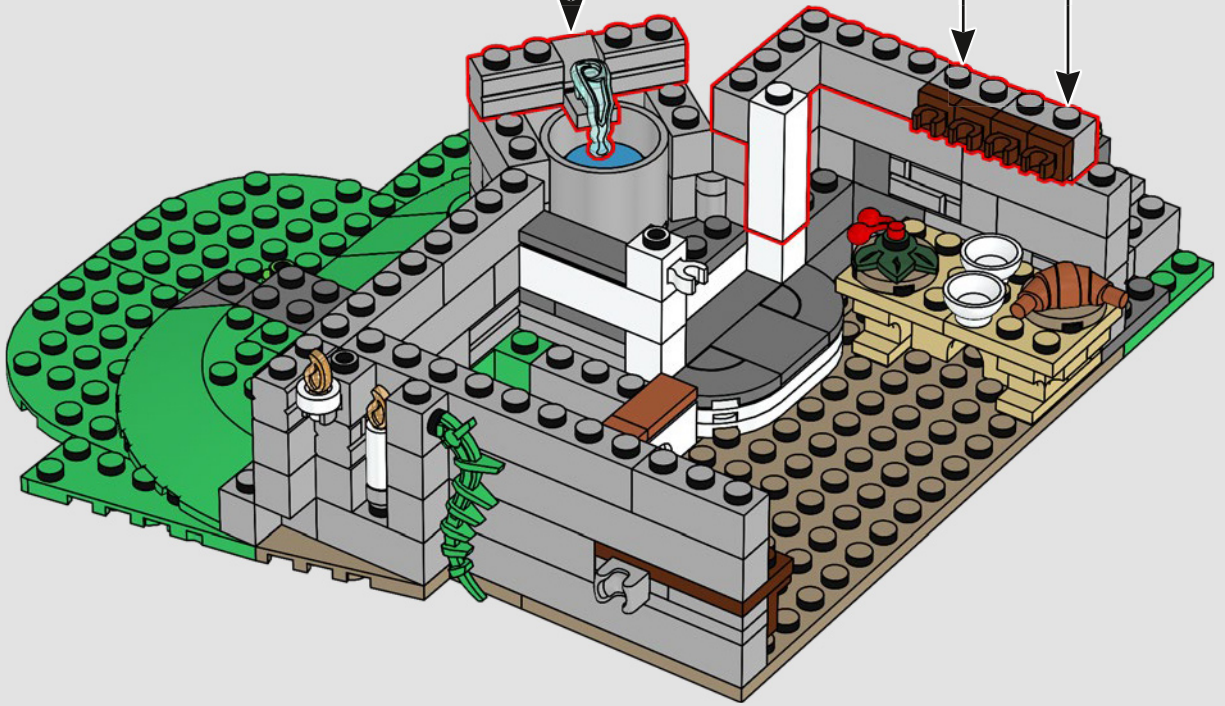
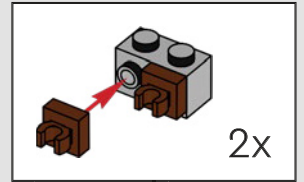
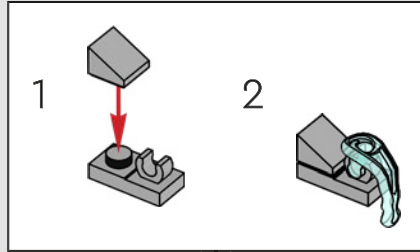

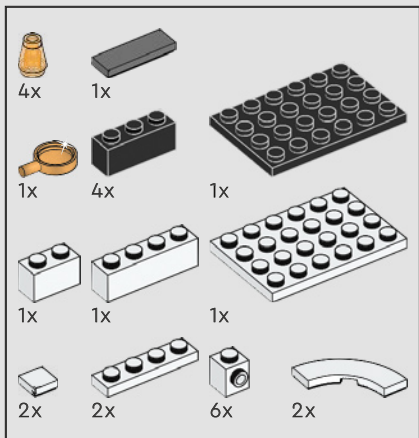

33

1

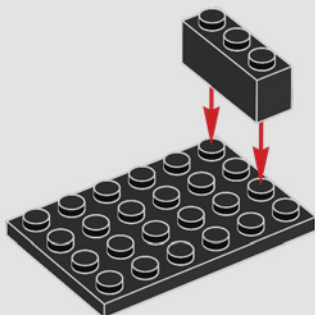

2

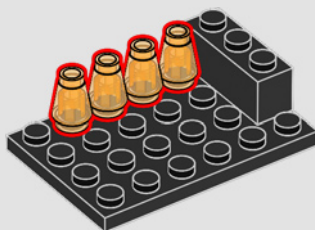

3

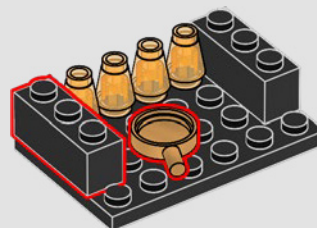

4

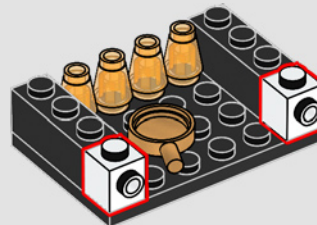

5

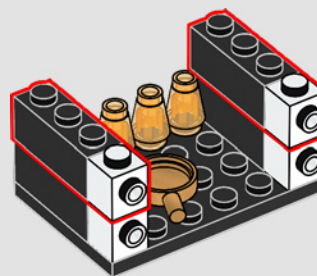

6

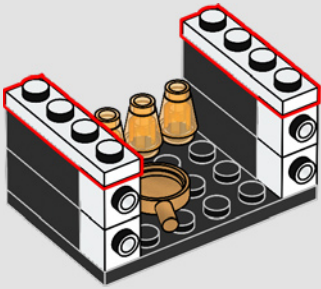

8

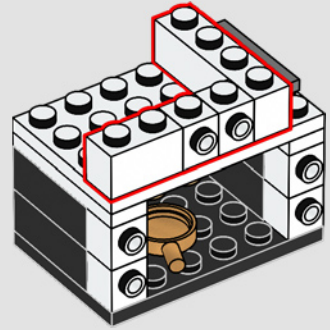

7

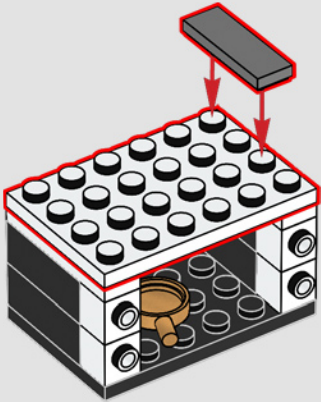

9

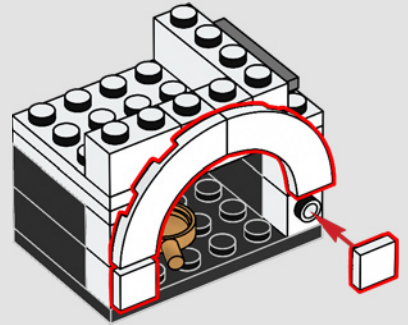

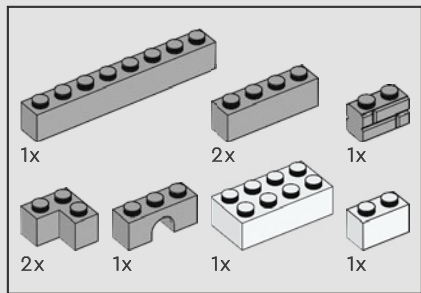

34

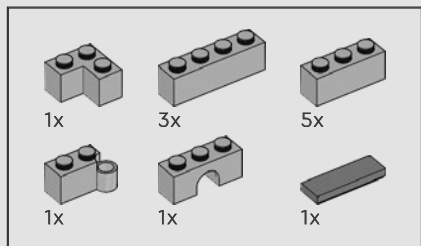
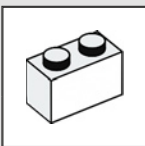
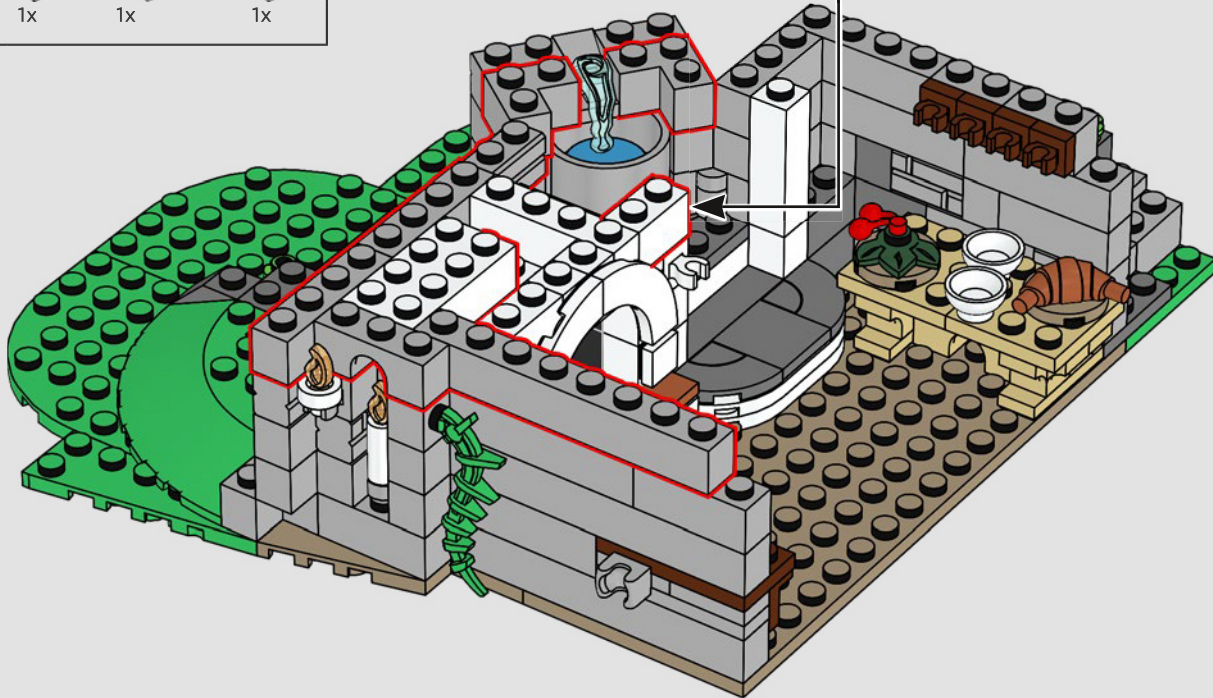

35

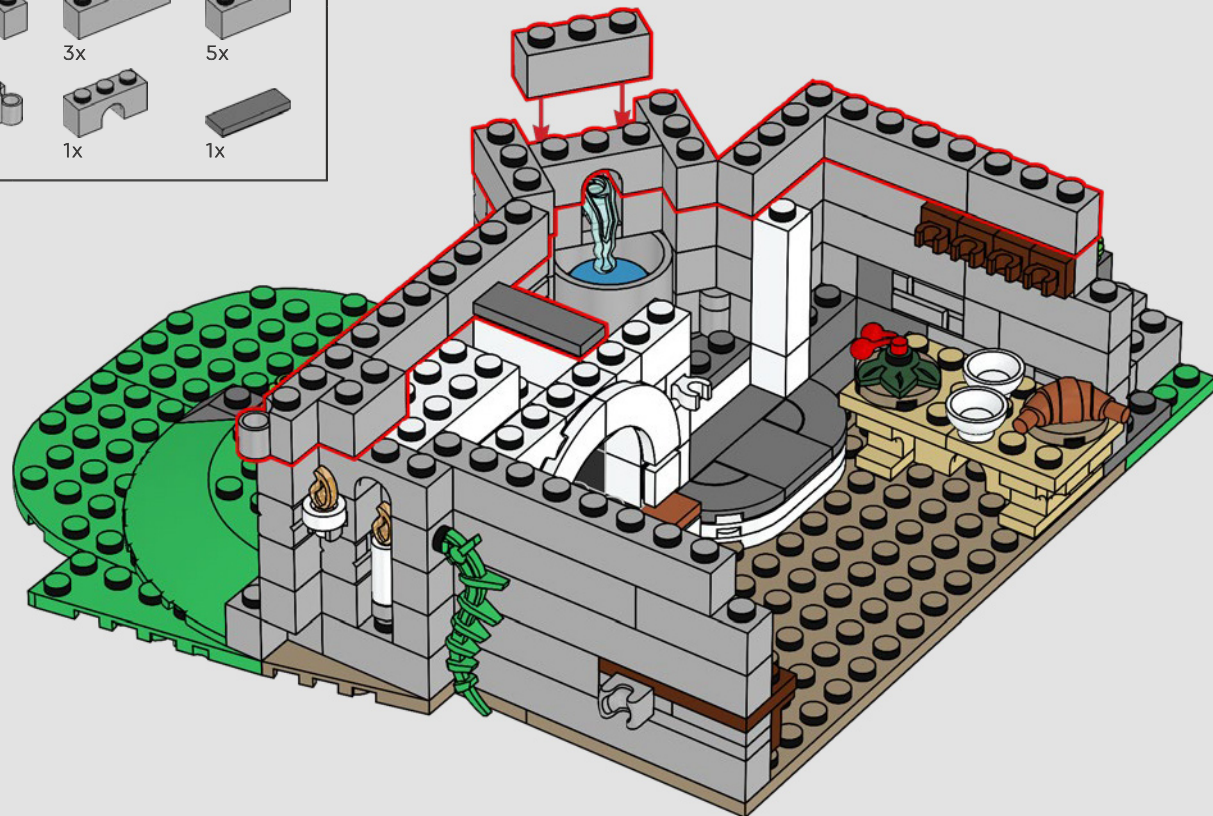



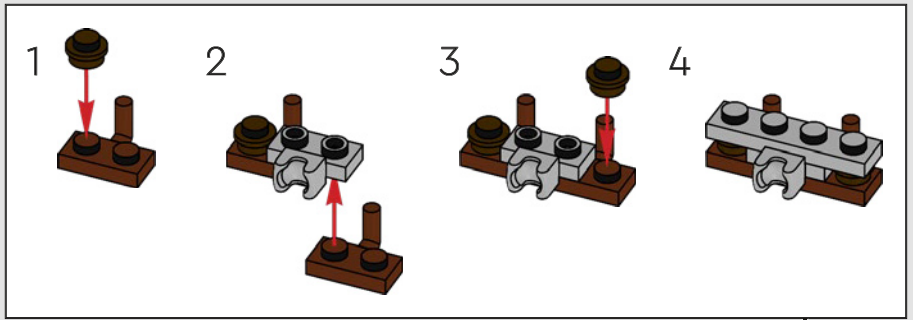
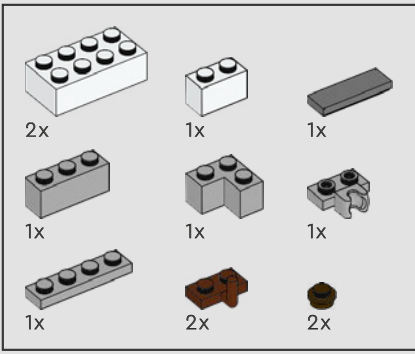

36

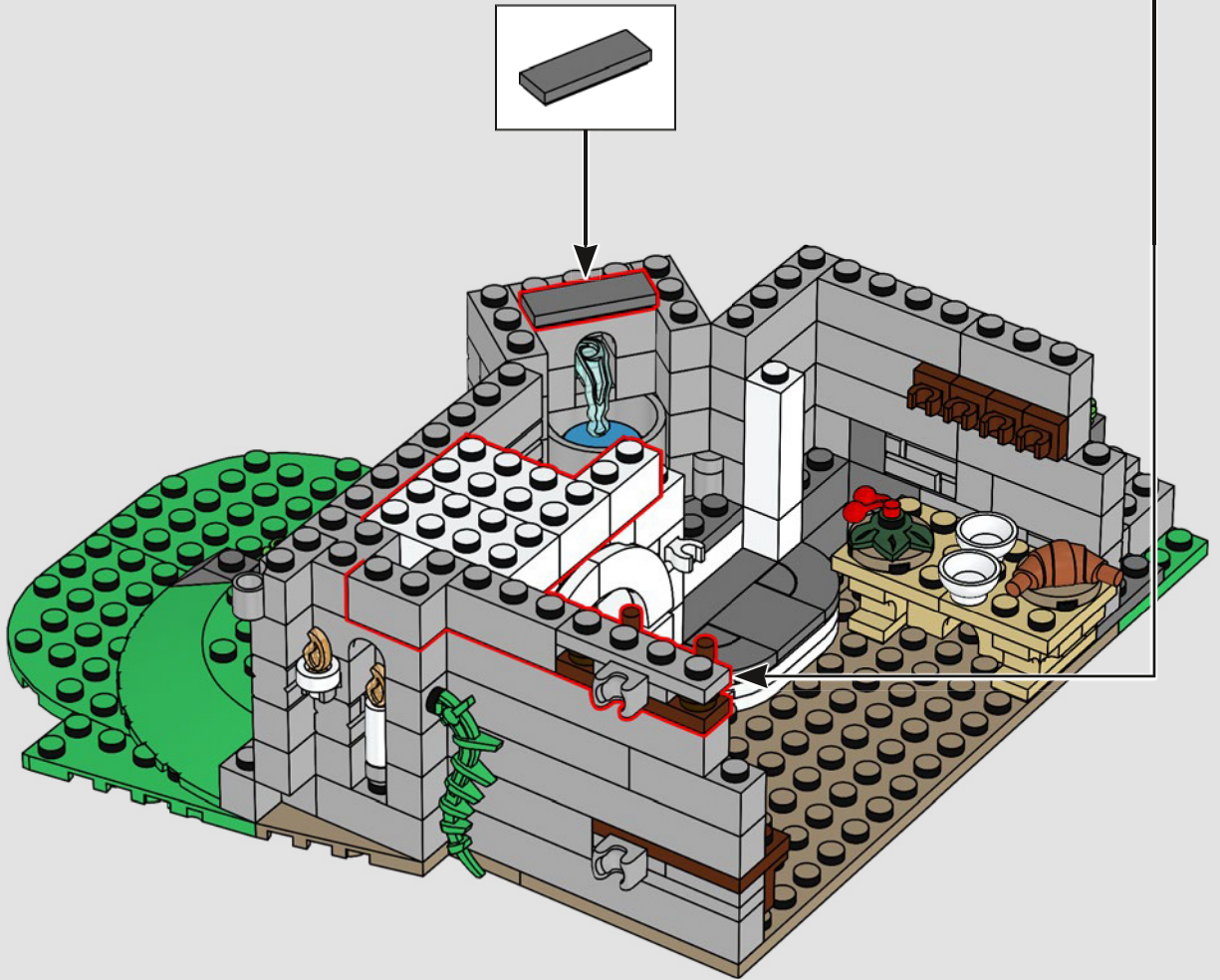

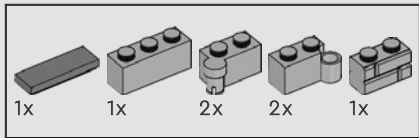

37

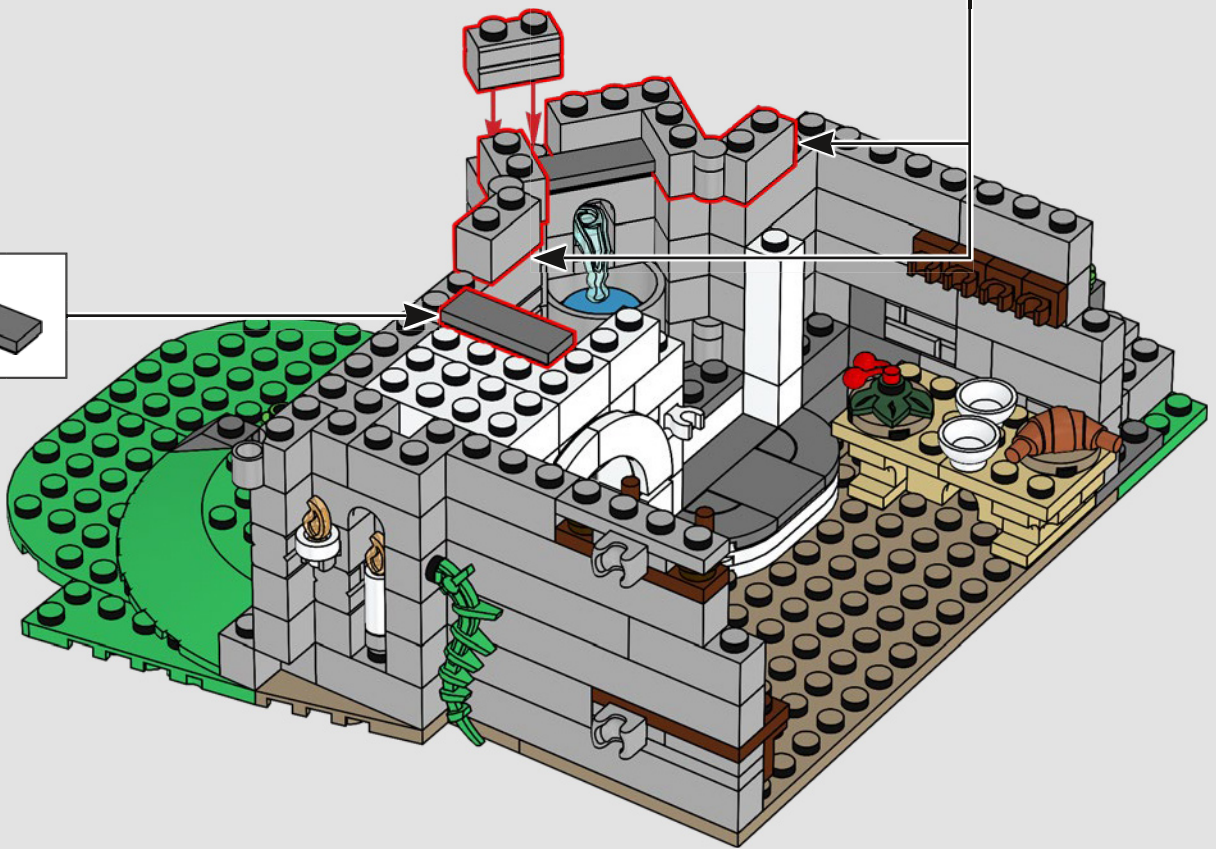
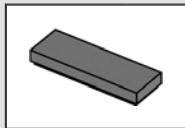
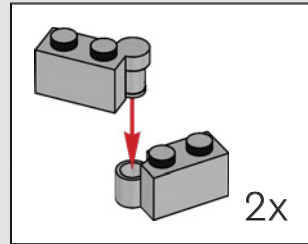

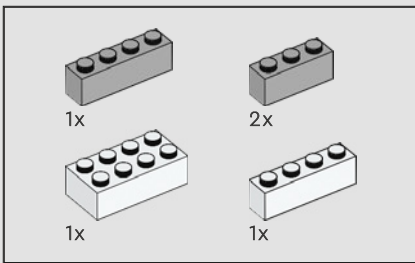

38

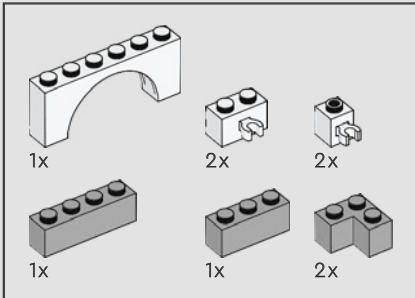
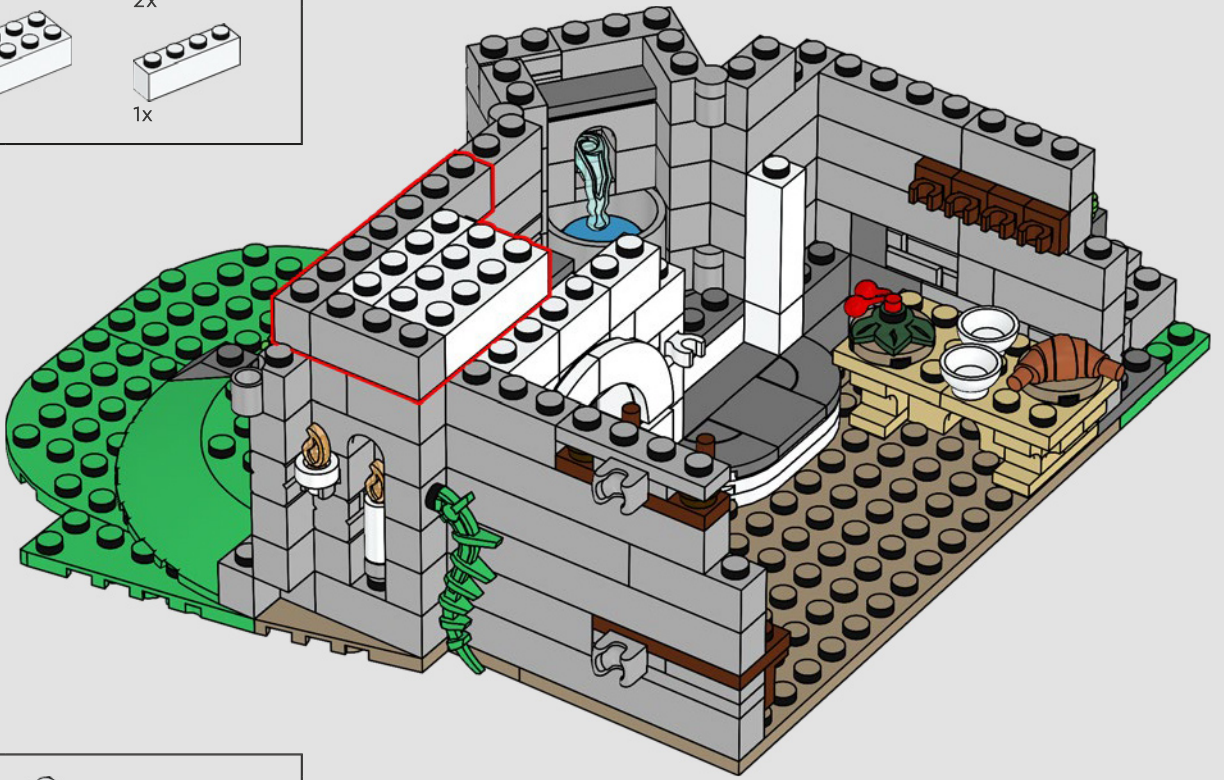

39

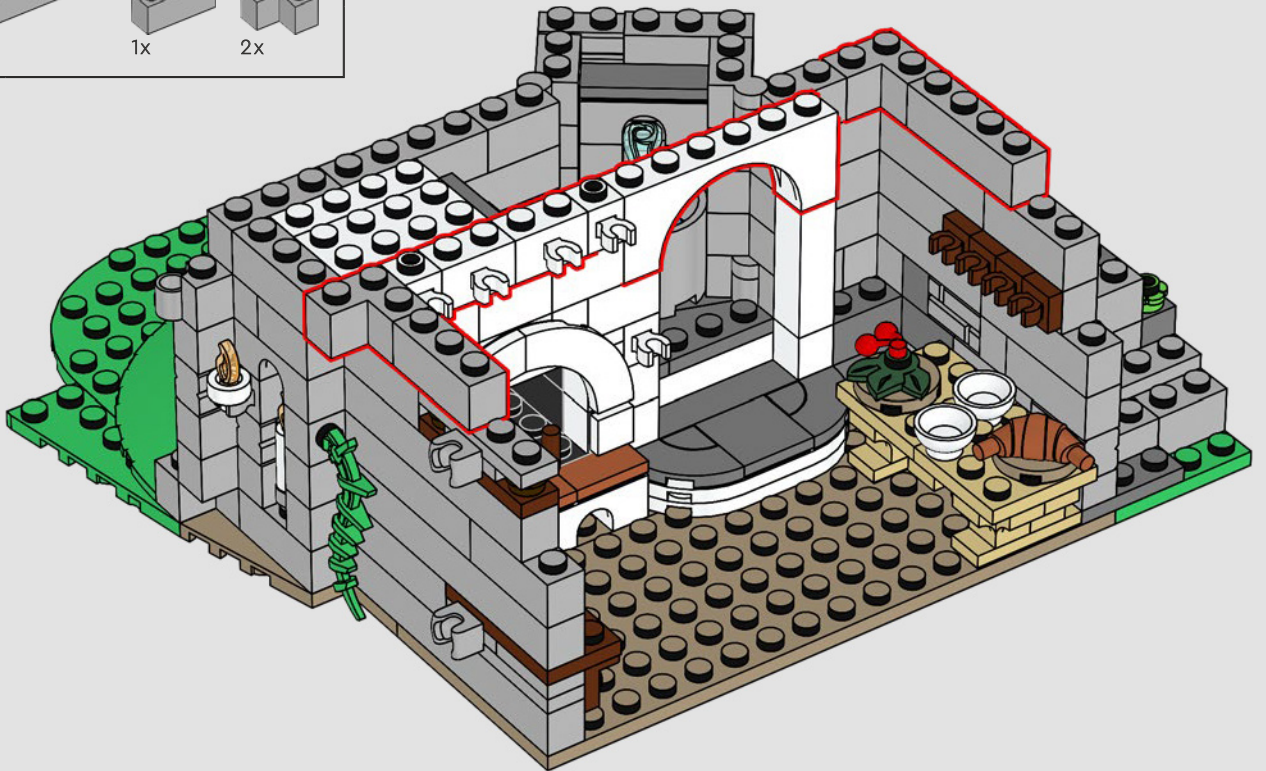



40

1

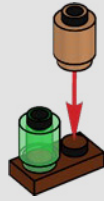

2

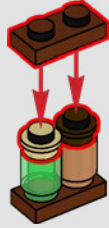

3



4



5



6

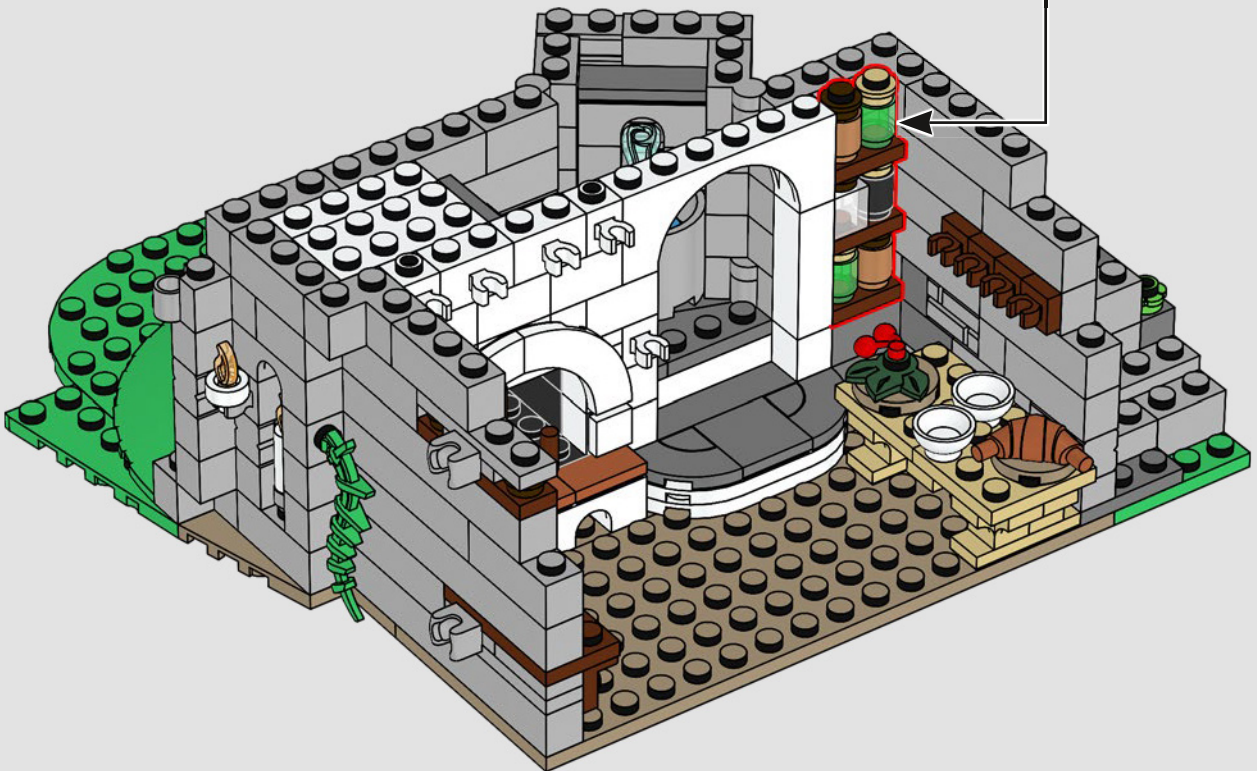



*Are those turnips, or carrots? If only they didn't share such a similar colour.*

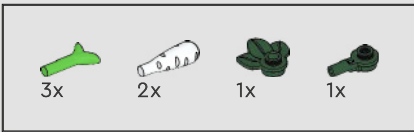

41

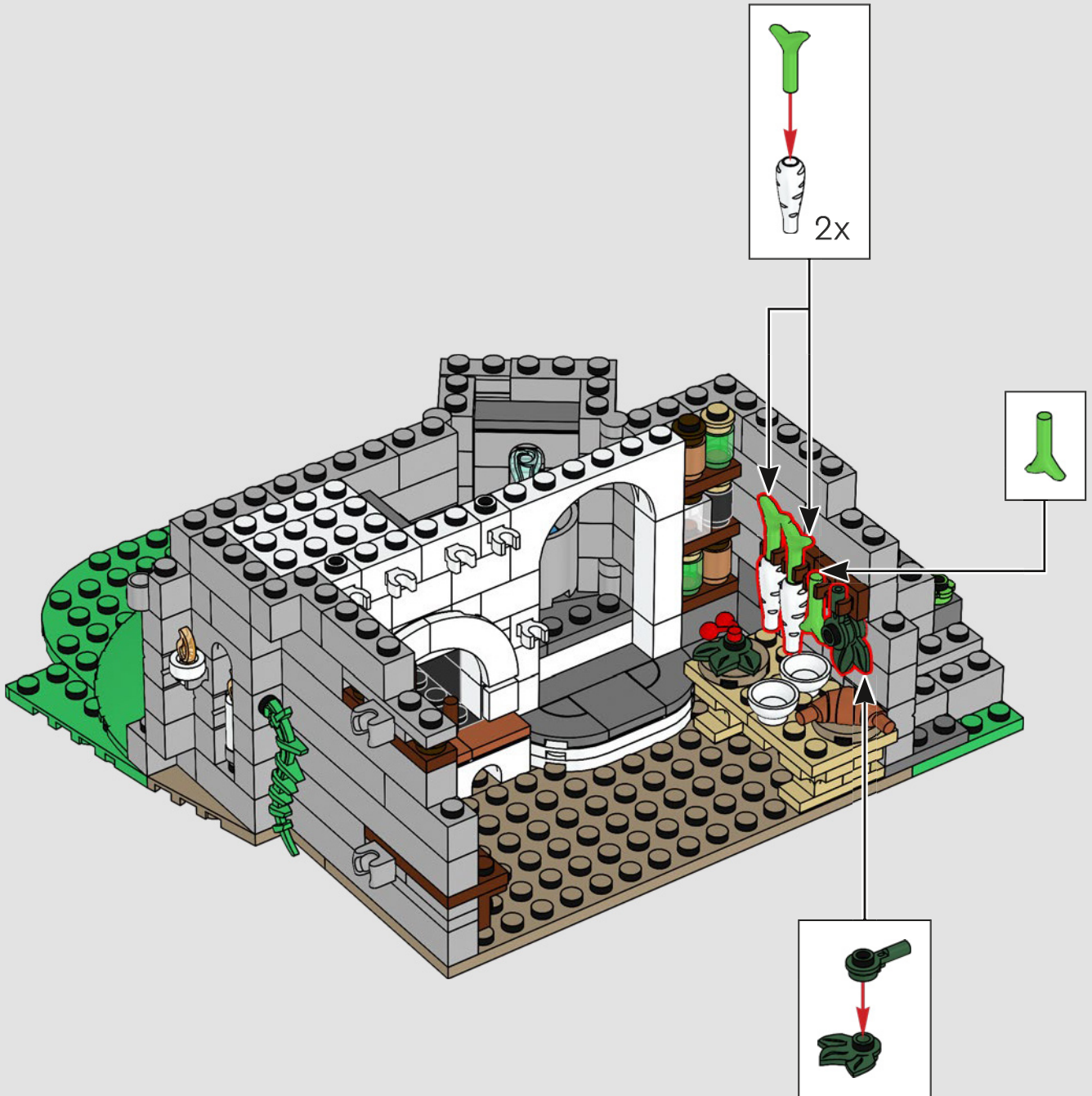

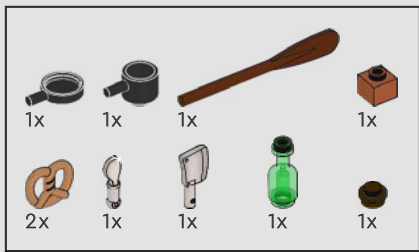

42

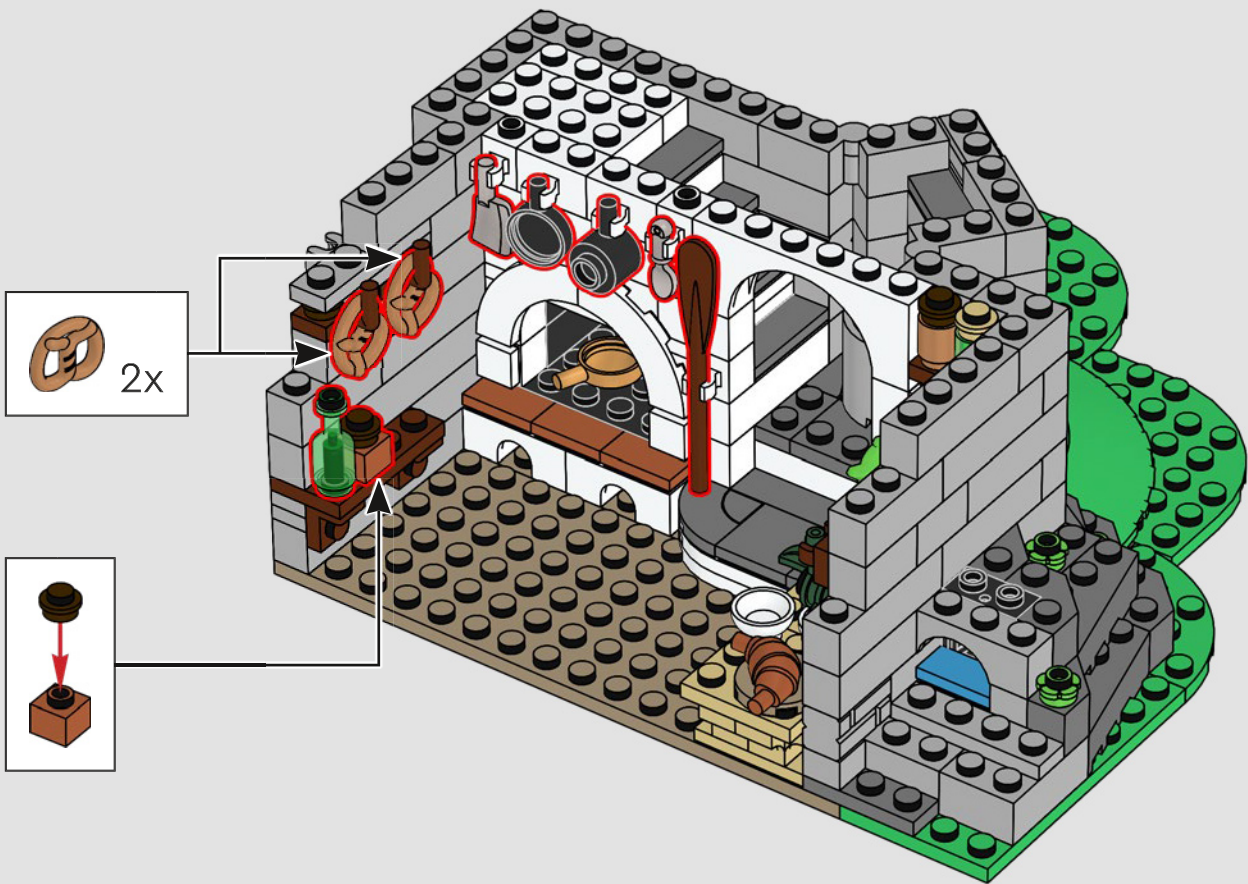

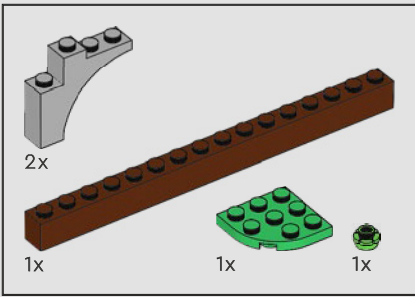

43

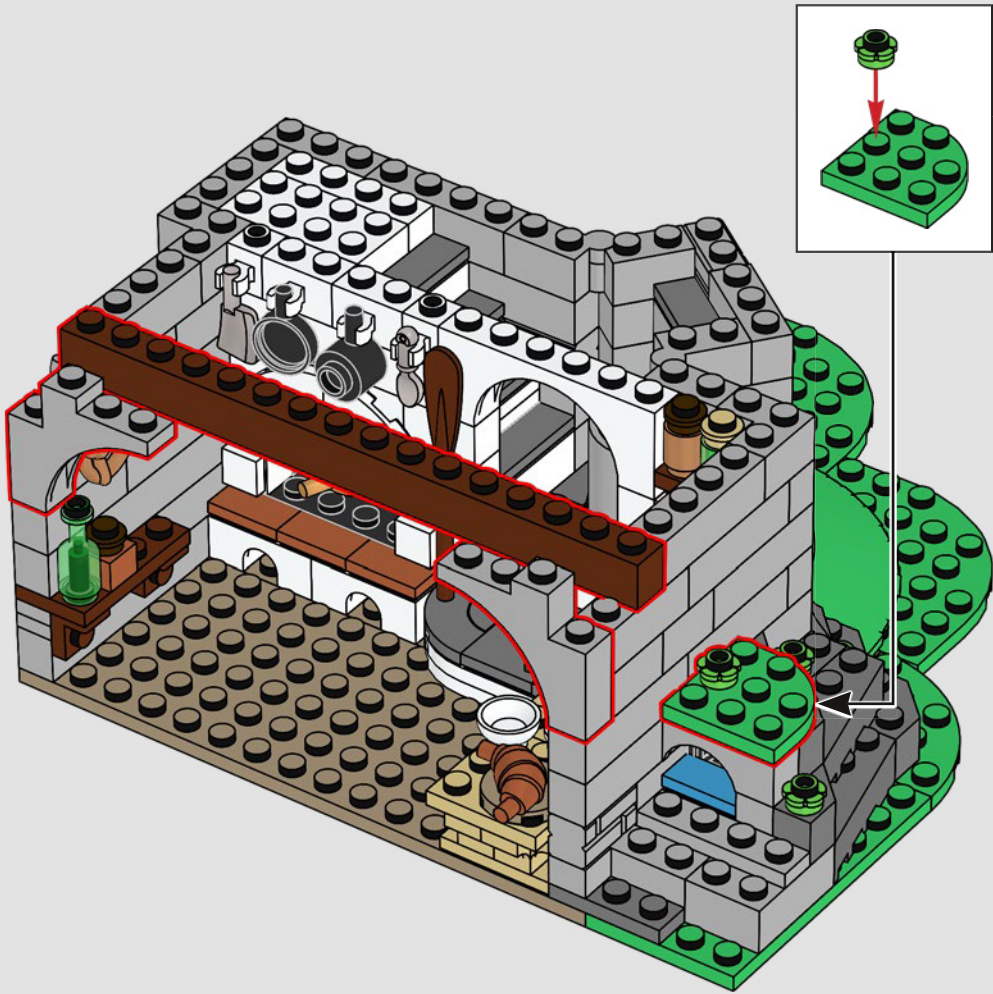

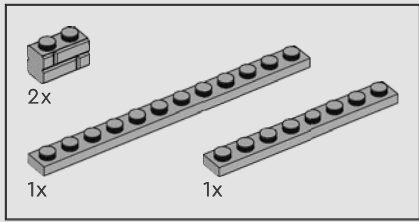

44

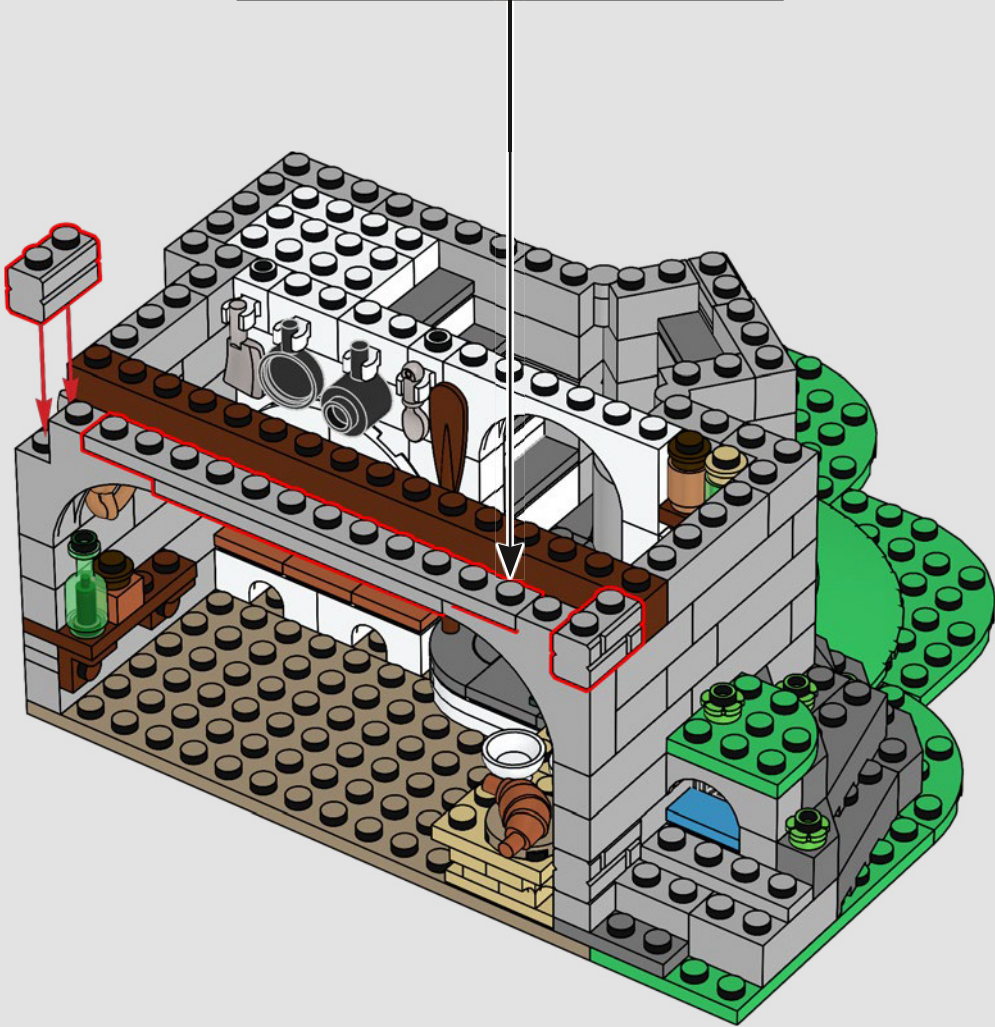
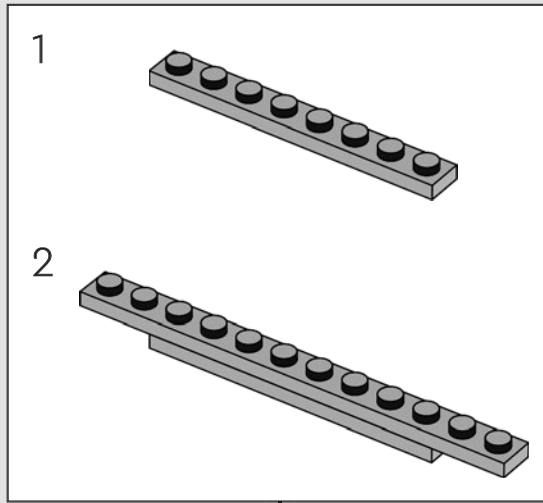



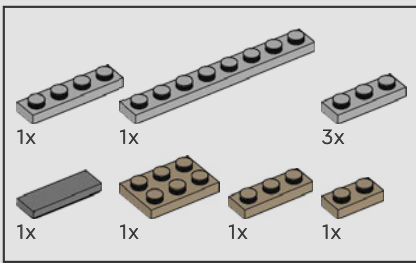

45

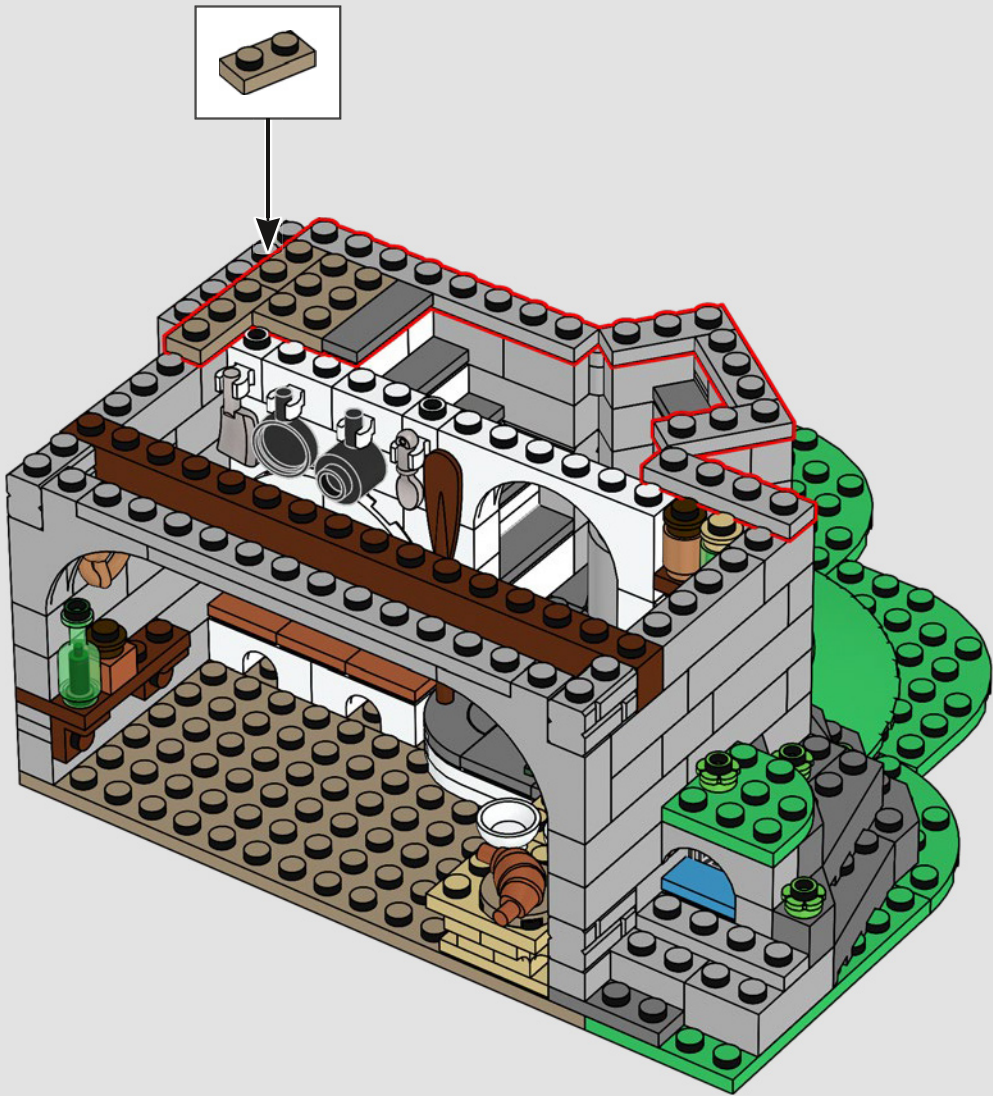

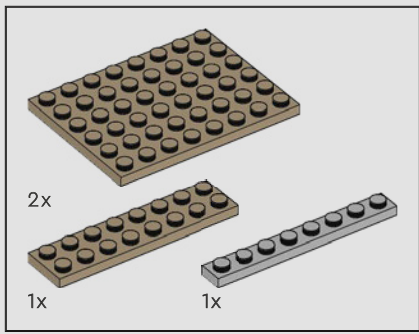

46

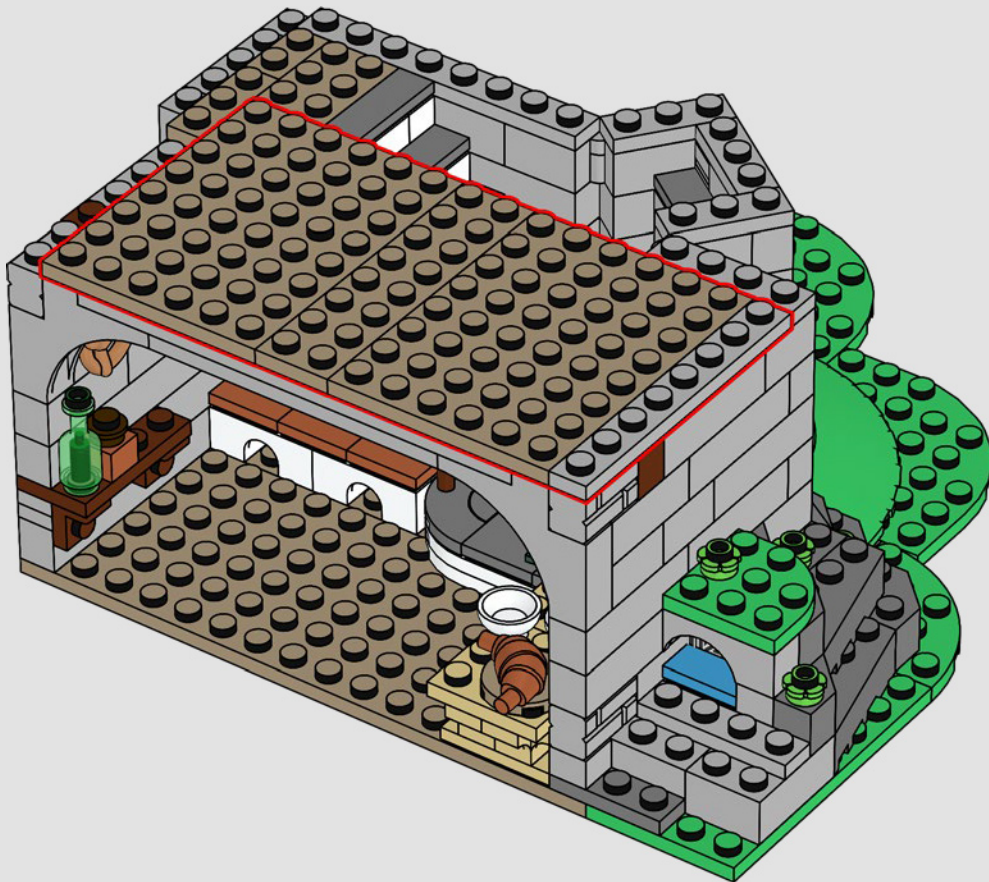

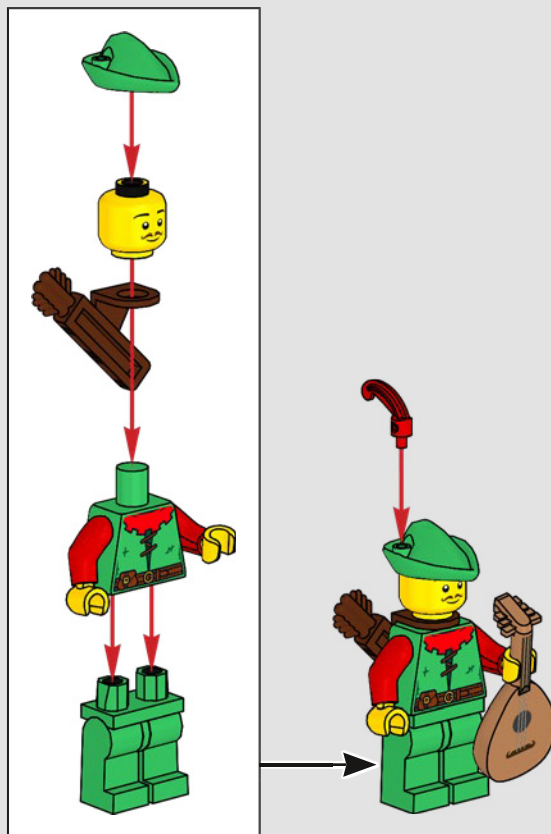

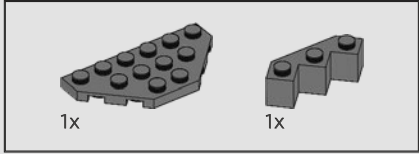
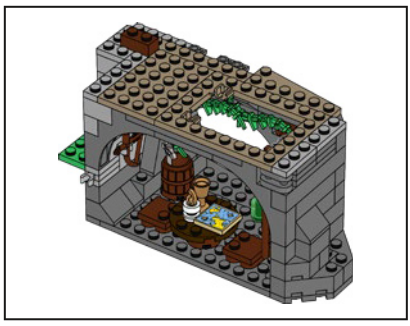

47

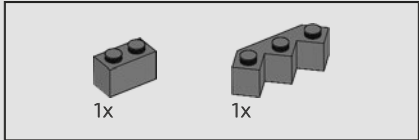
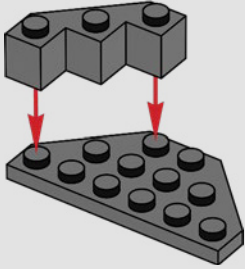

48

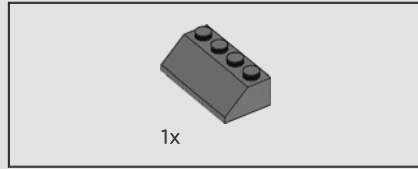
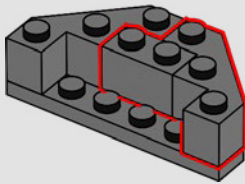

49

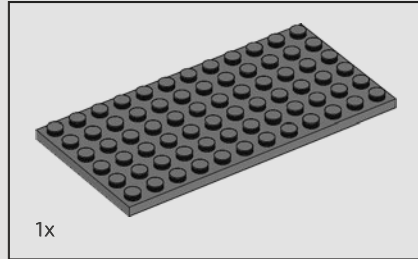
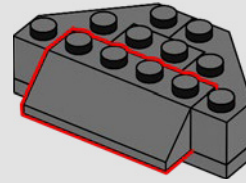

50

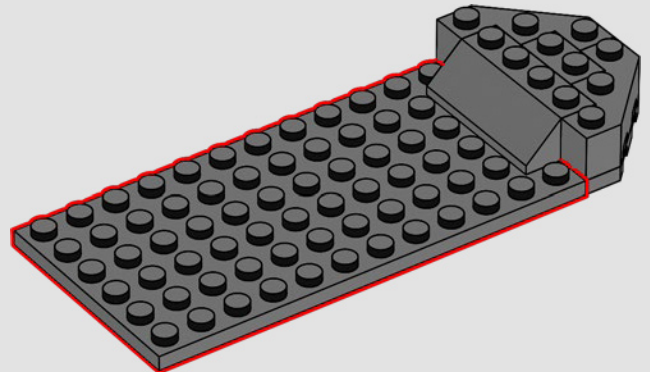

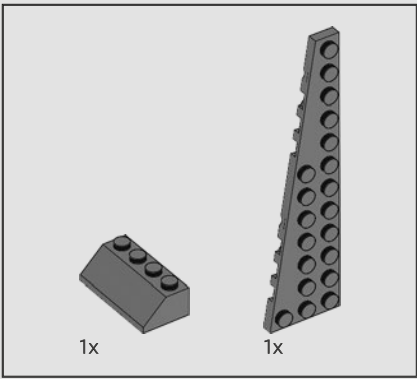

51

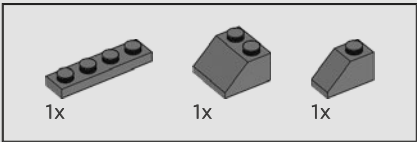
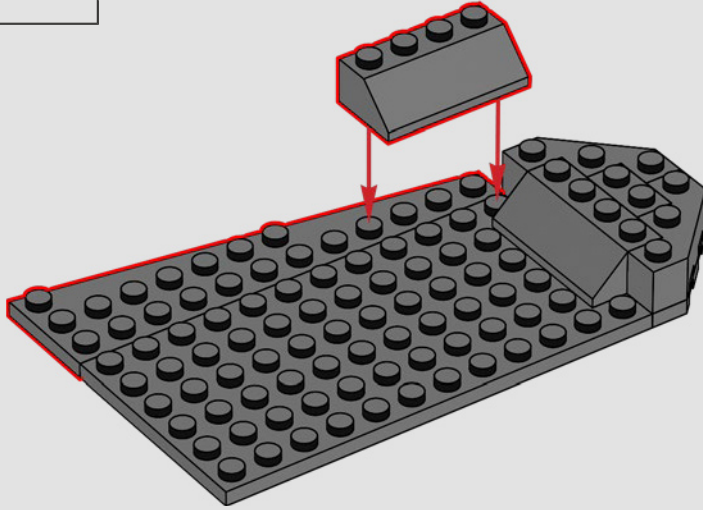

52

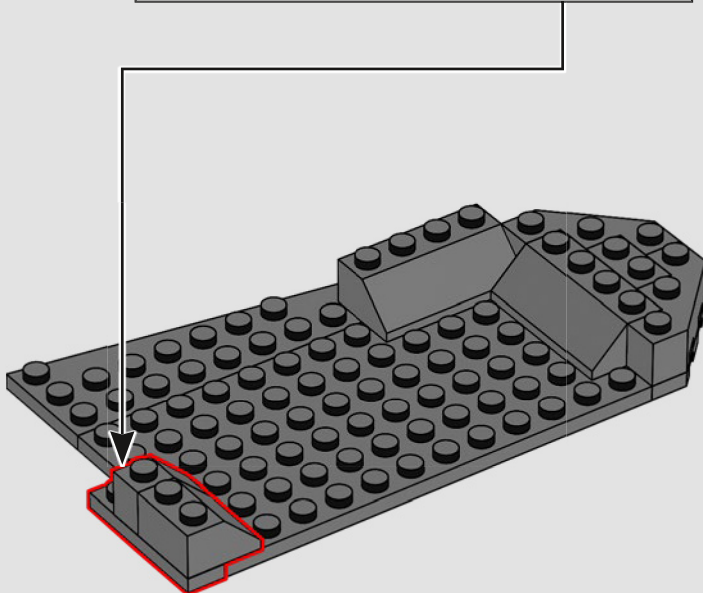
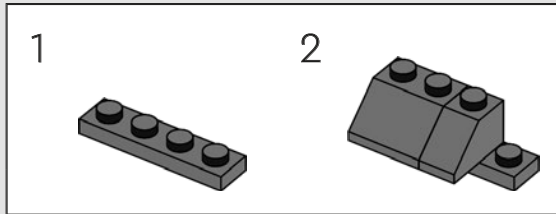

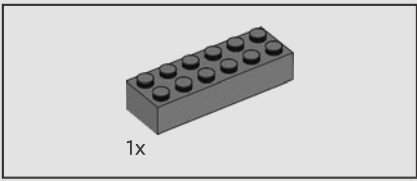

53

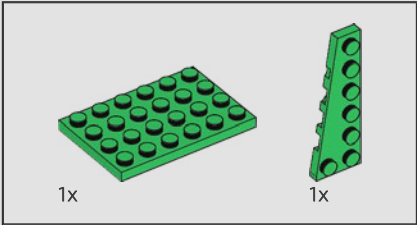
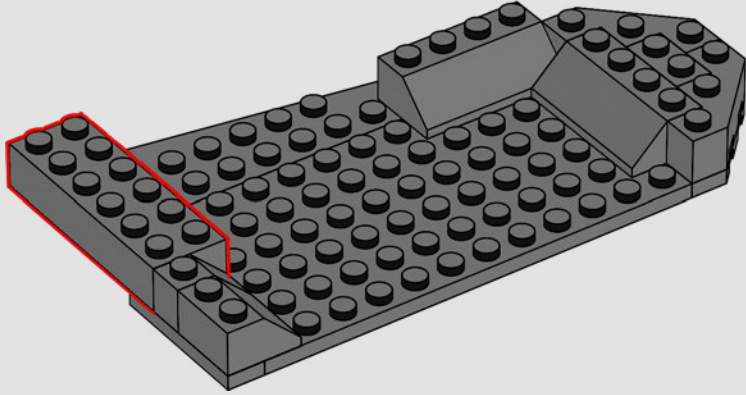

54

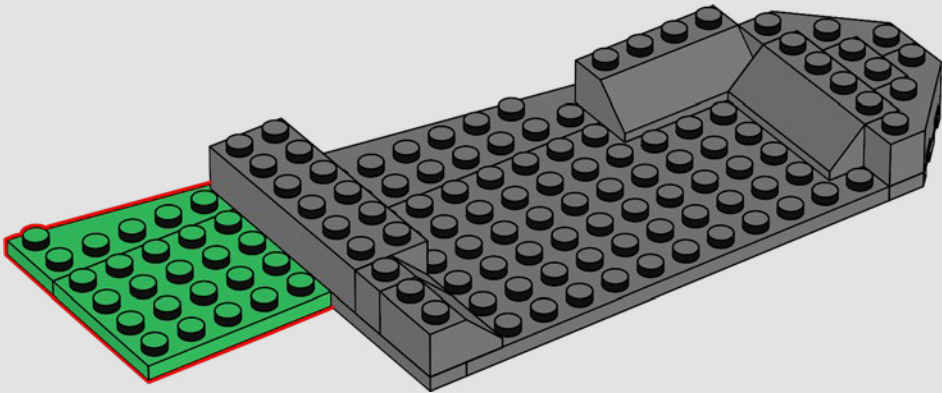

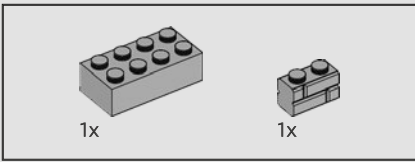

55

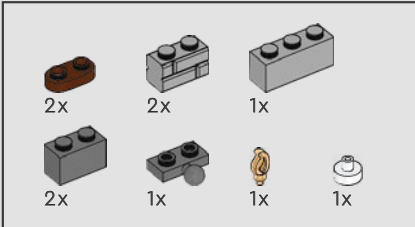
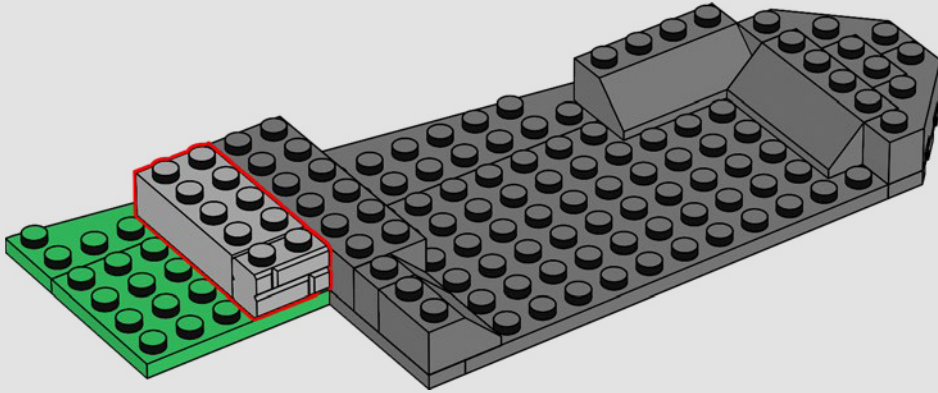

56

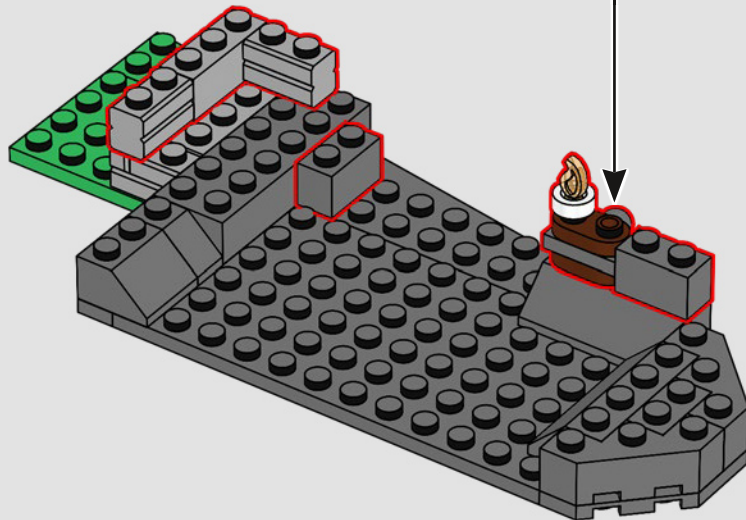
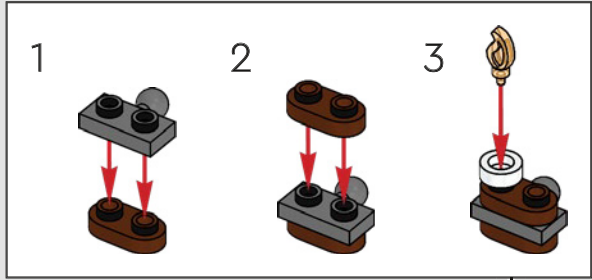

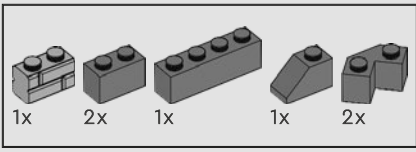

57

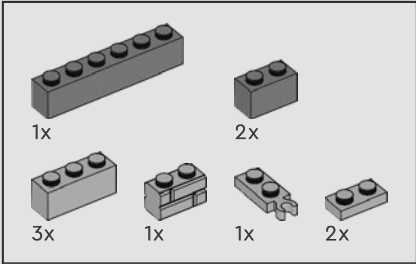
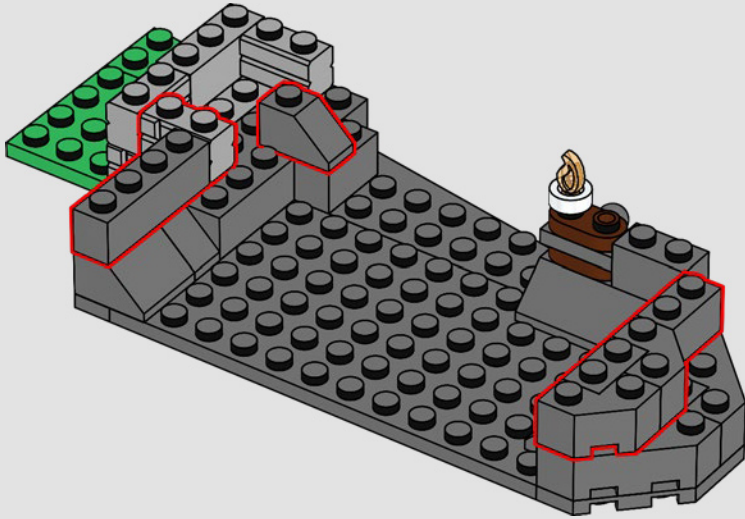

58

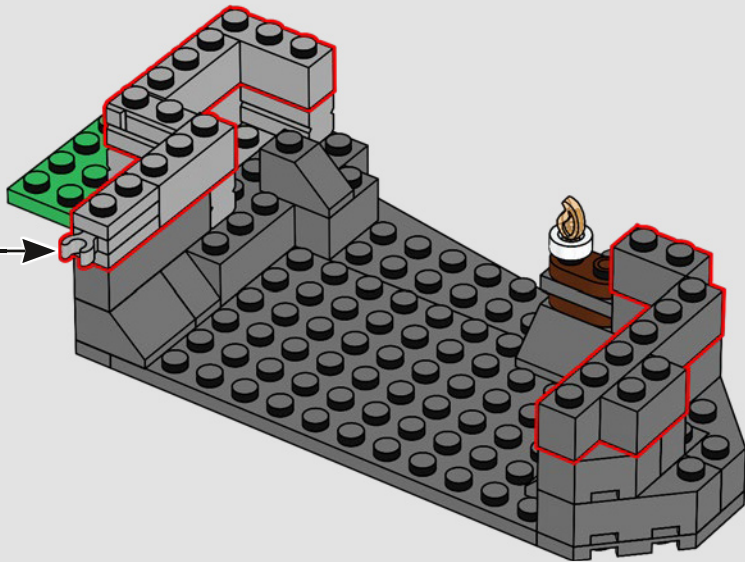
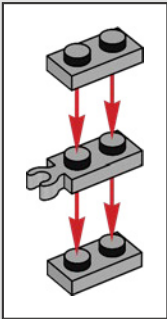



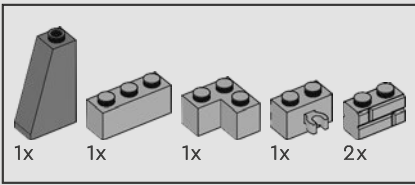

59

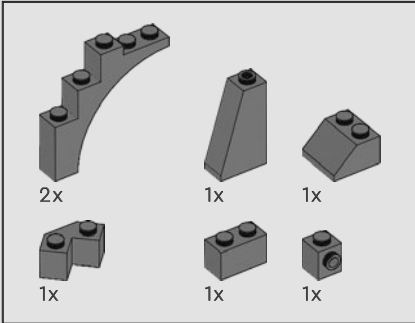
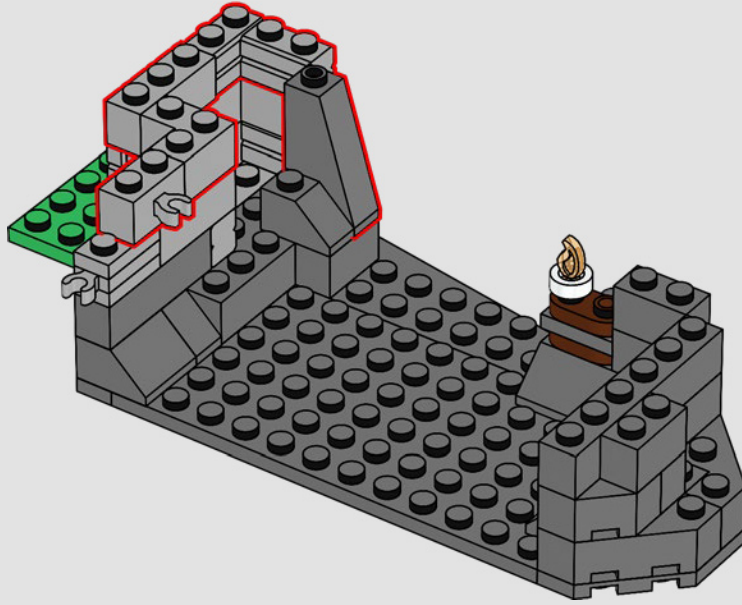

60

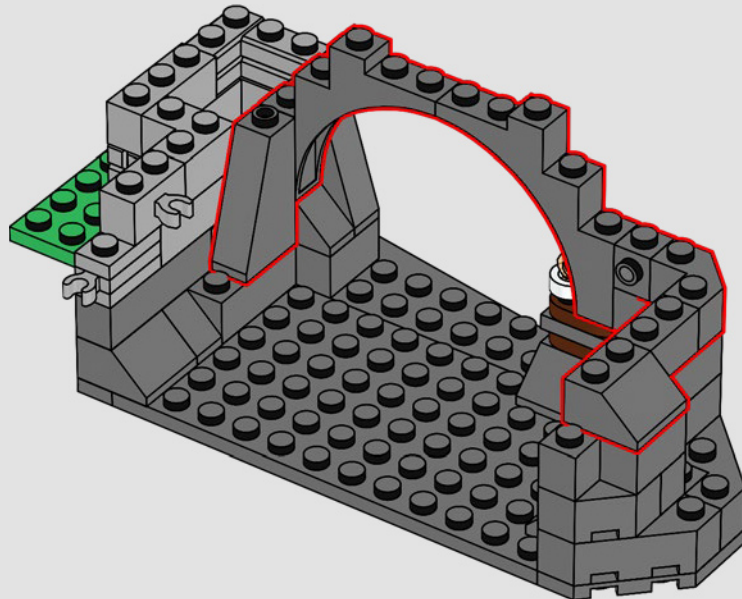

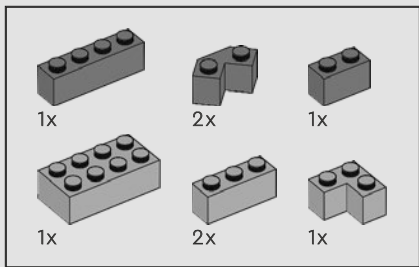

61

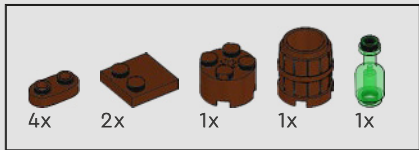
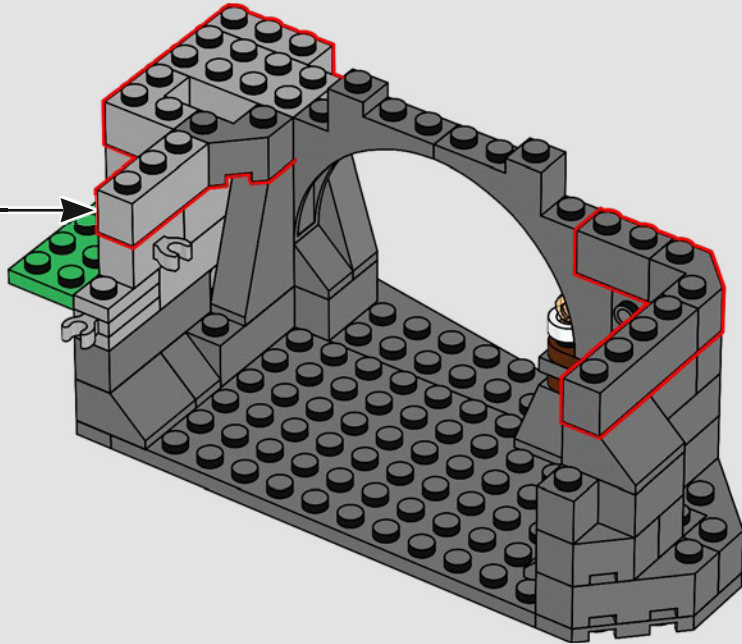
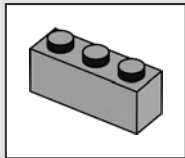

62

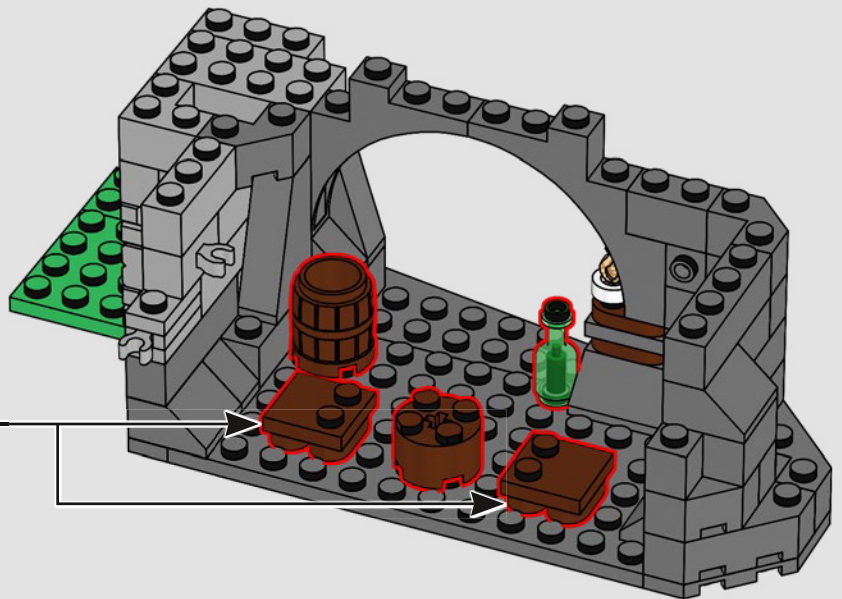
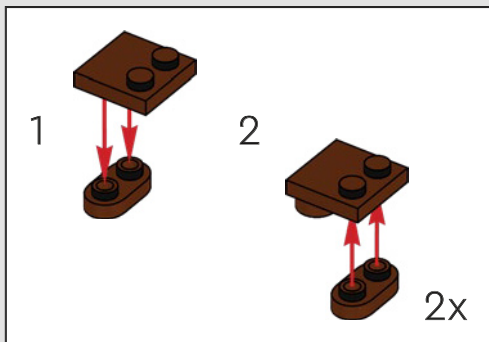



A bowman could really get some good practice with this target.

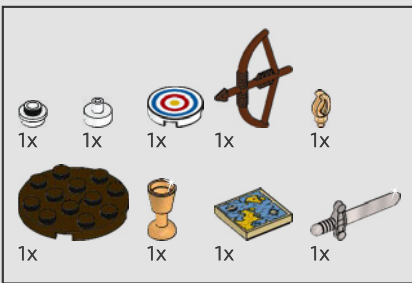

63

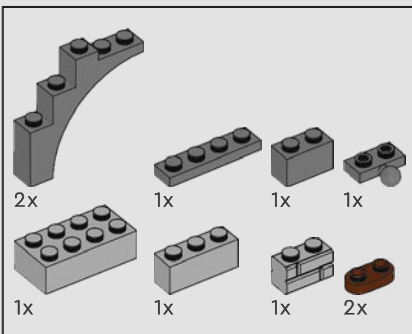
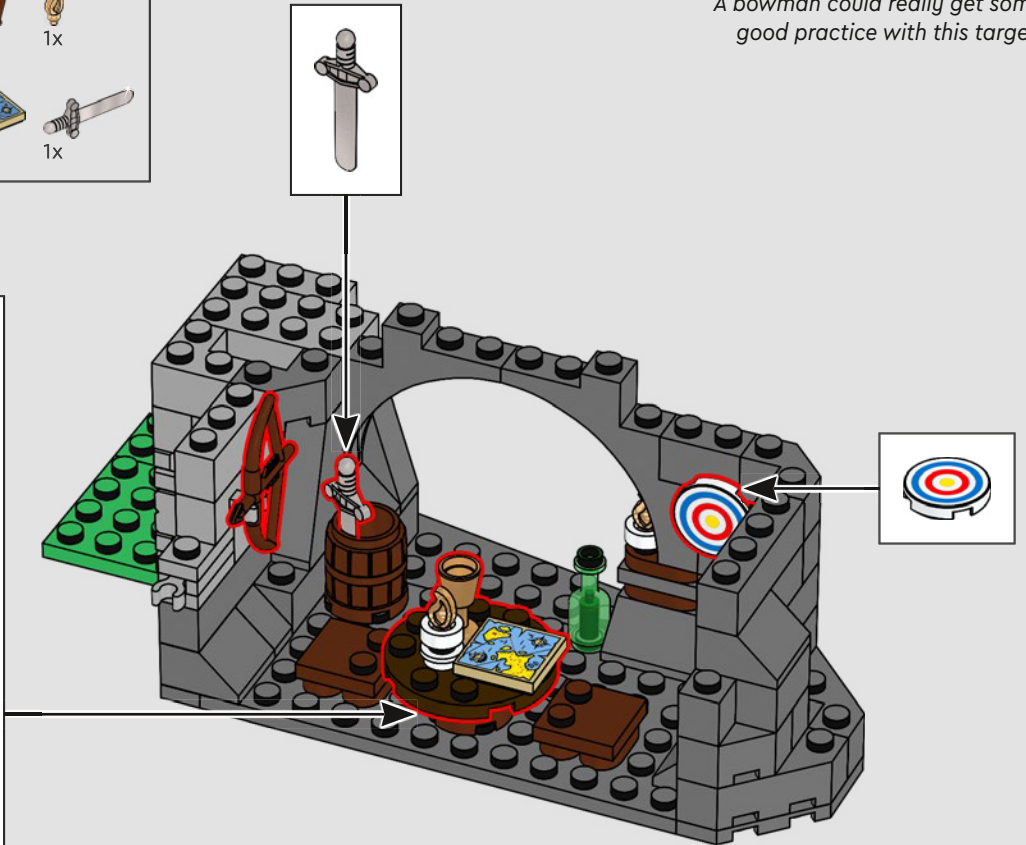
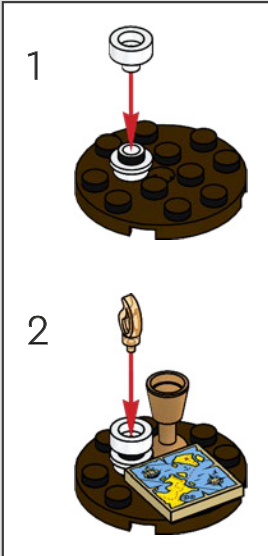

64

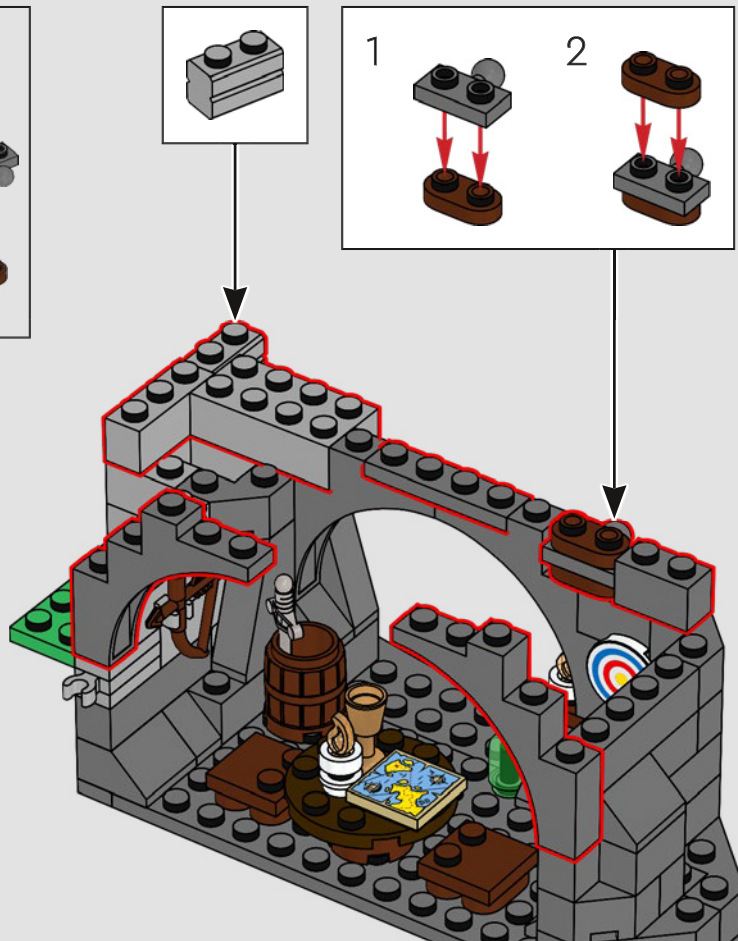
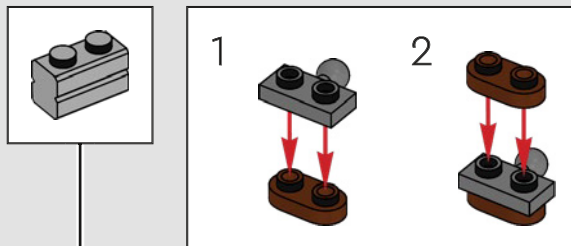

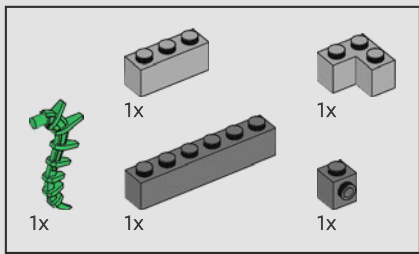

65

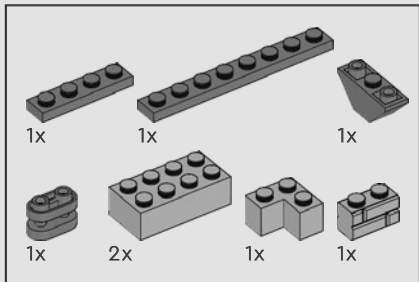
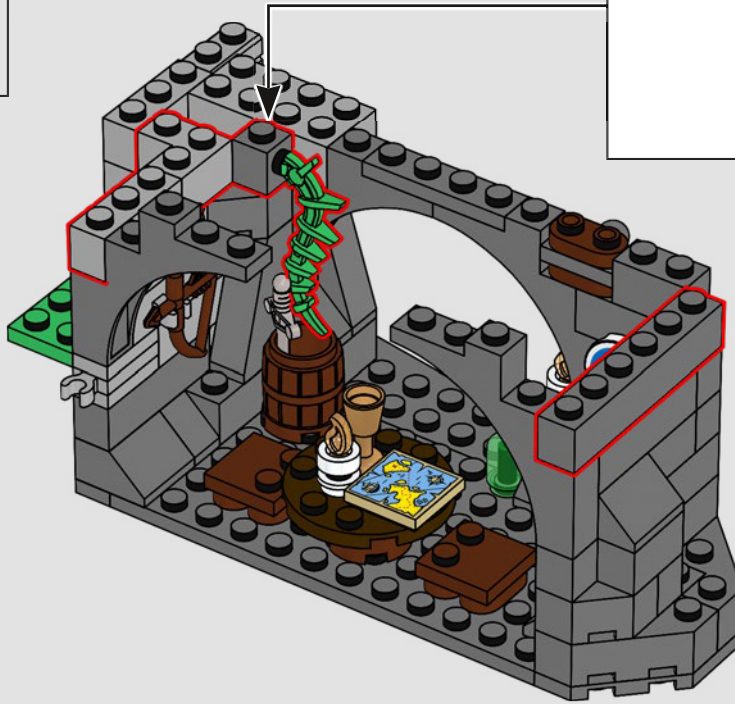
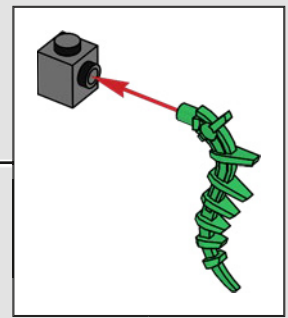

66

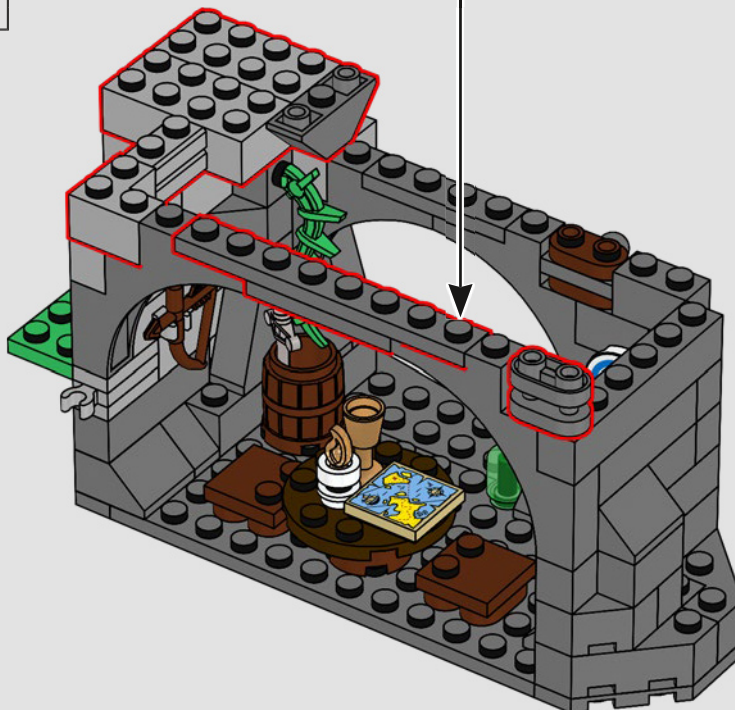
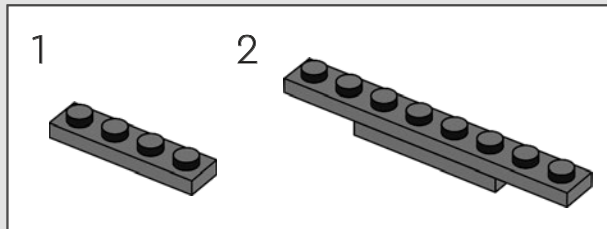

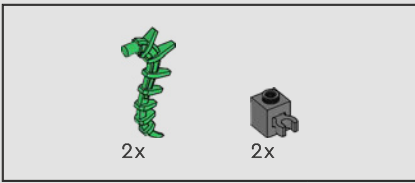

67

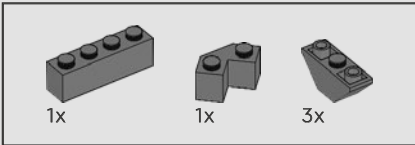
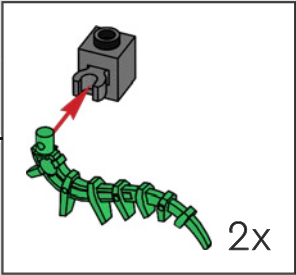
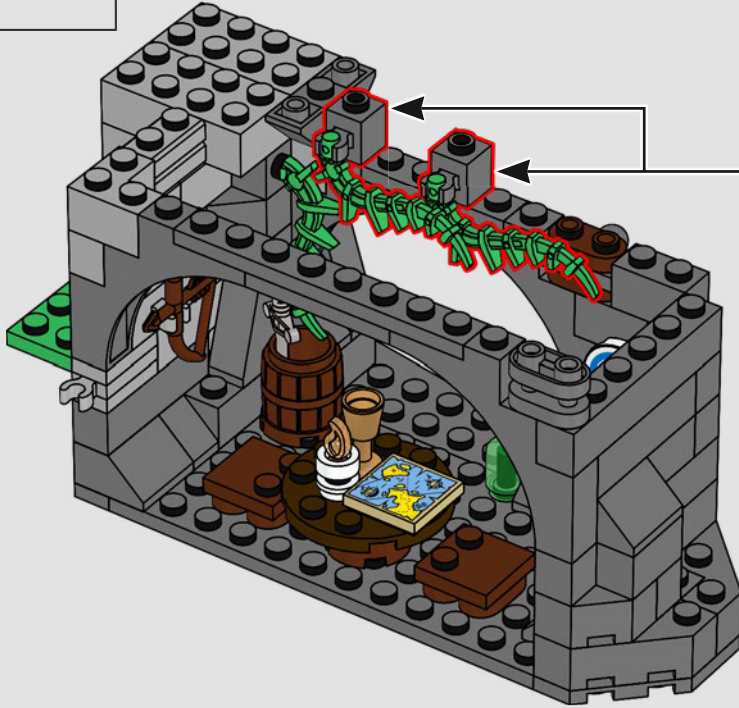

68

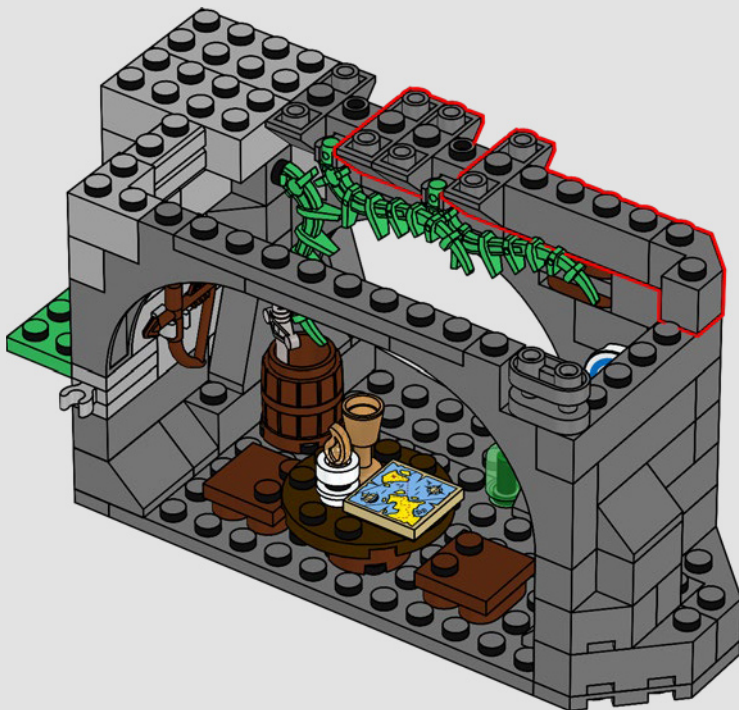

*Such a peculiar map. What could all this blue represent? Surely no sea is so large...*

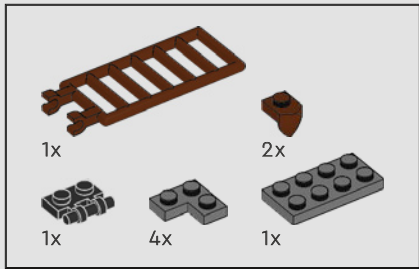

69

1

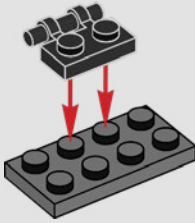

2

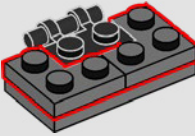

3

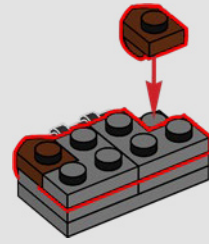

4

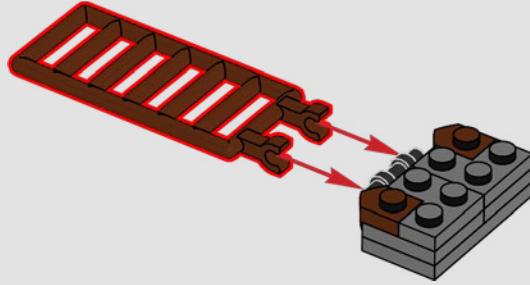

5

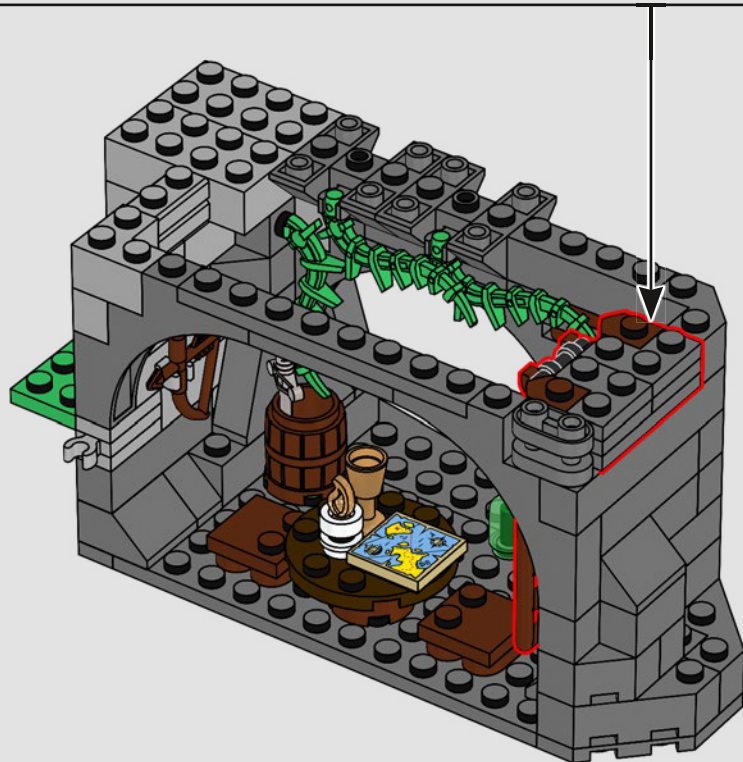
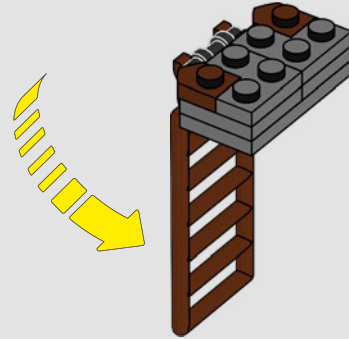

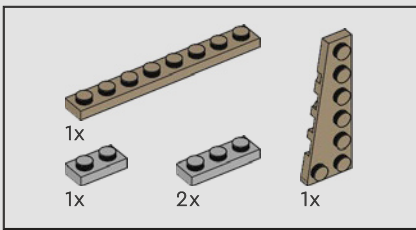

70

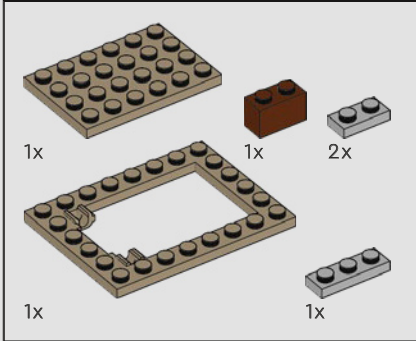
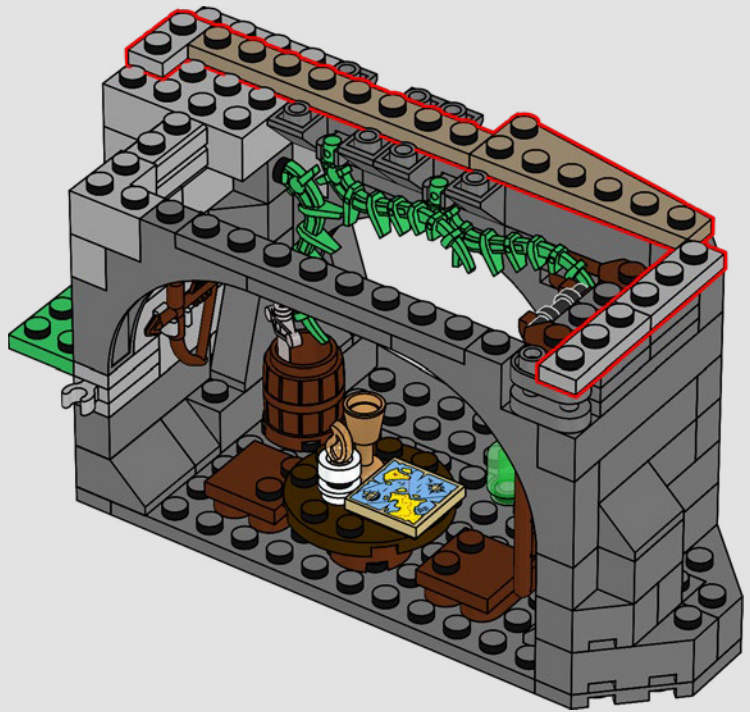

71

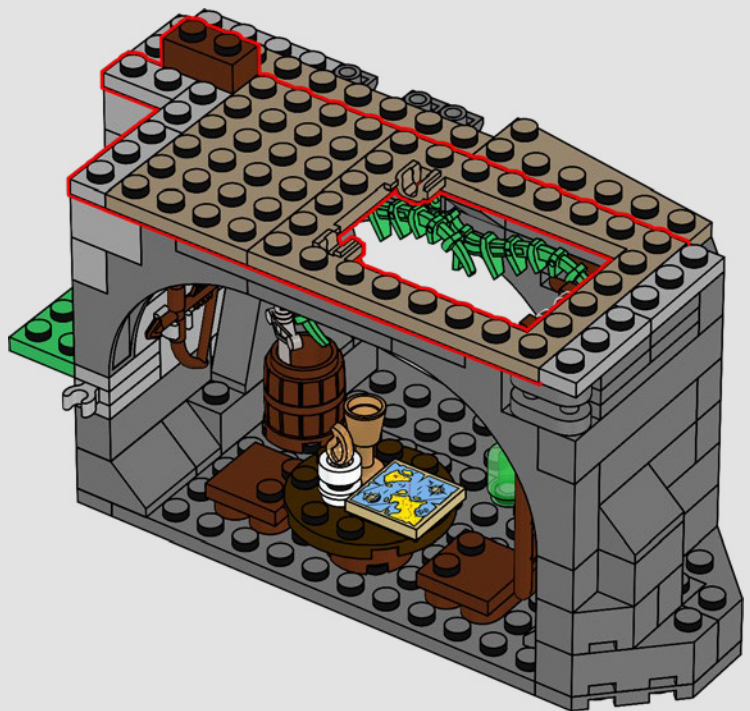

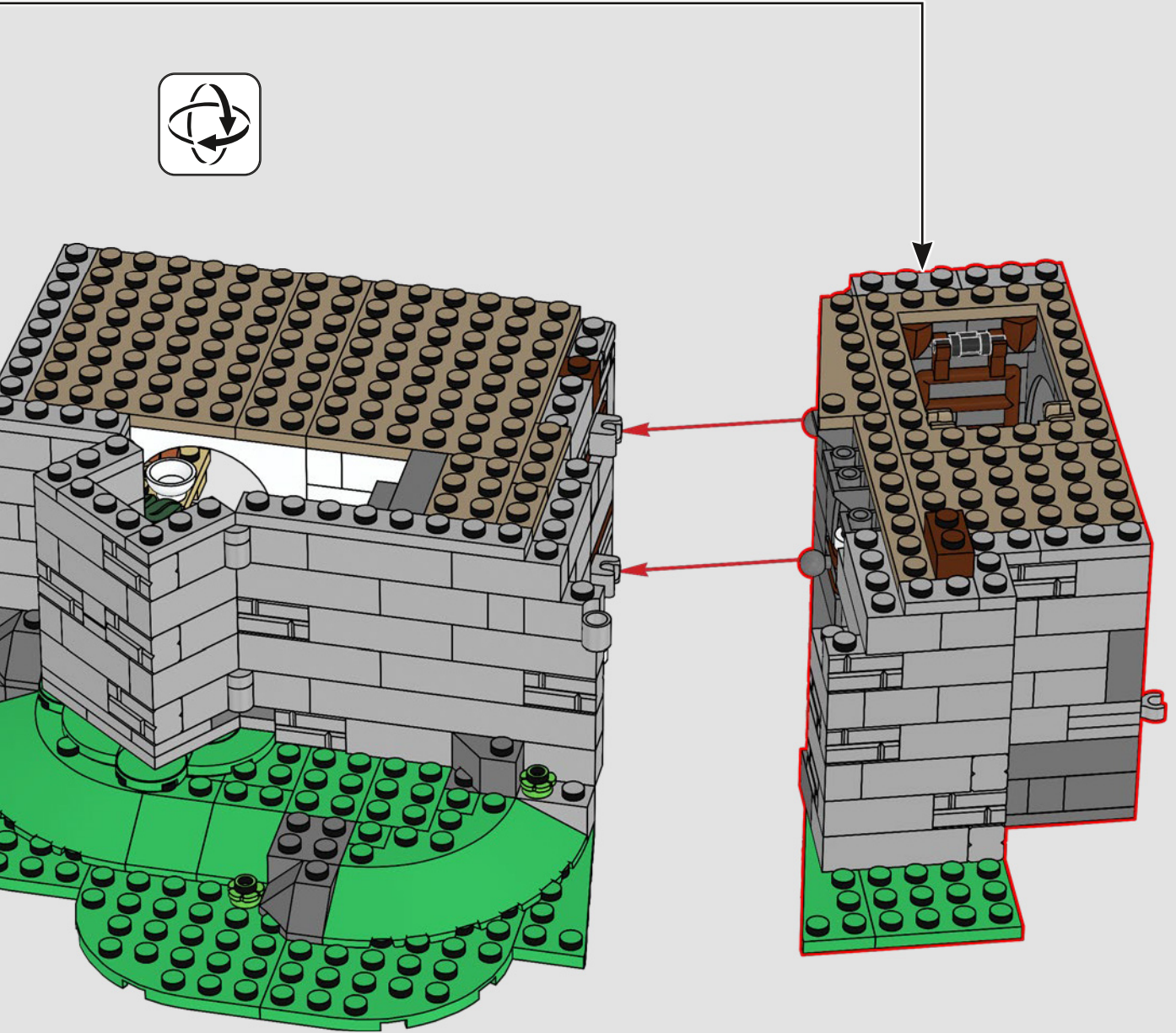



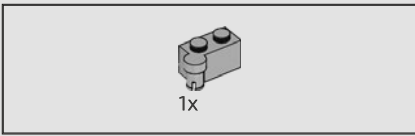

73

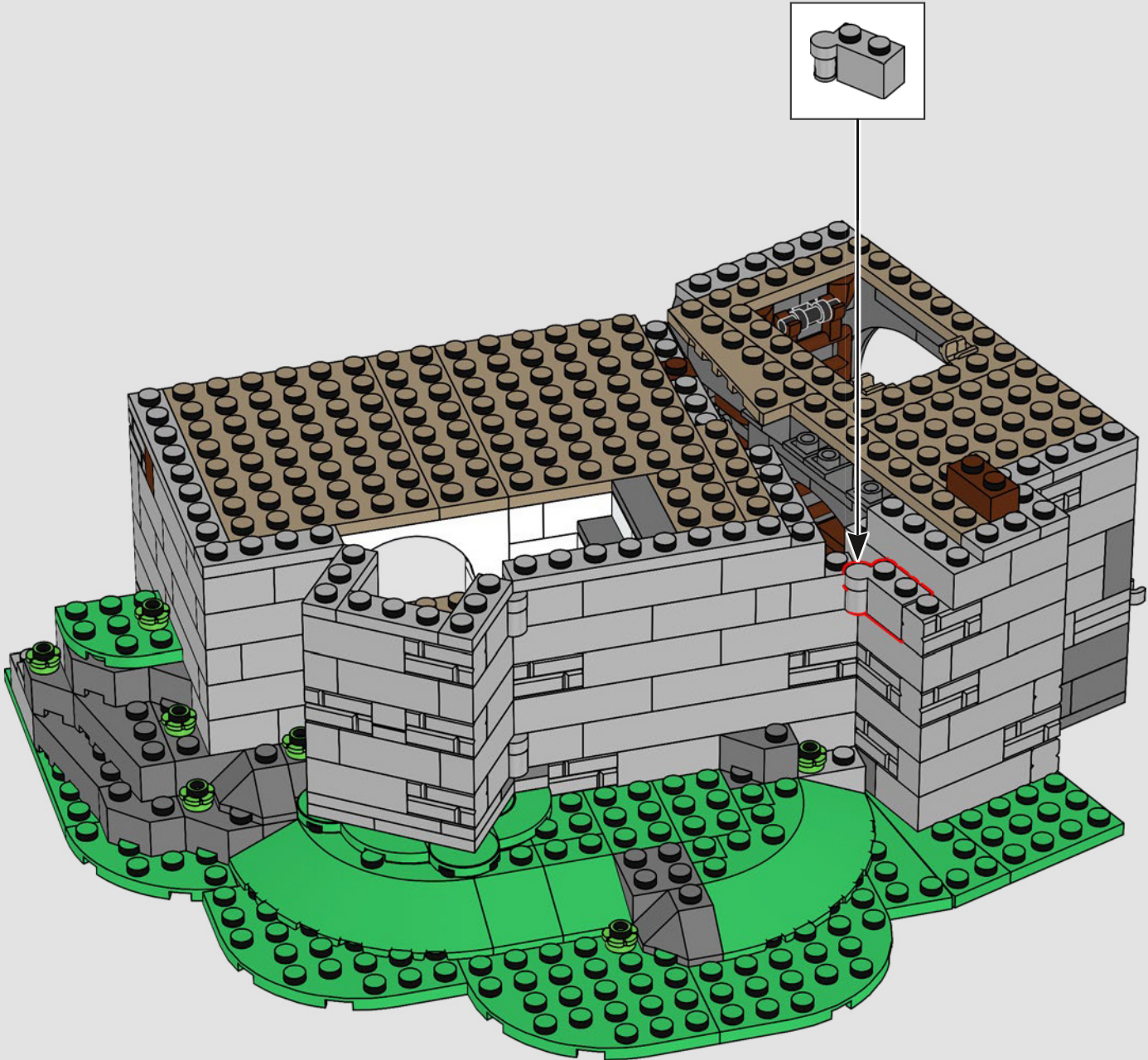

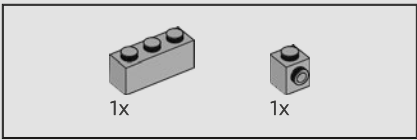

74

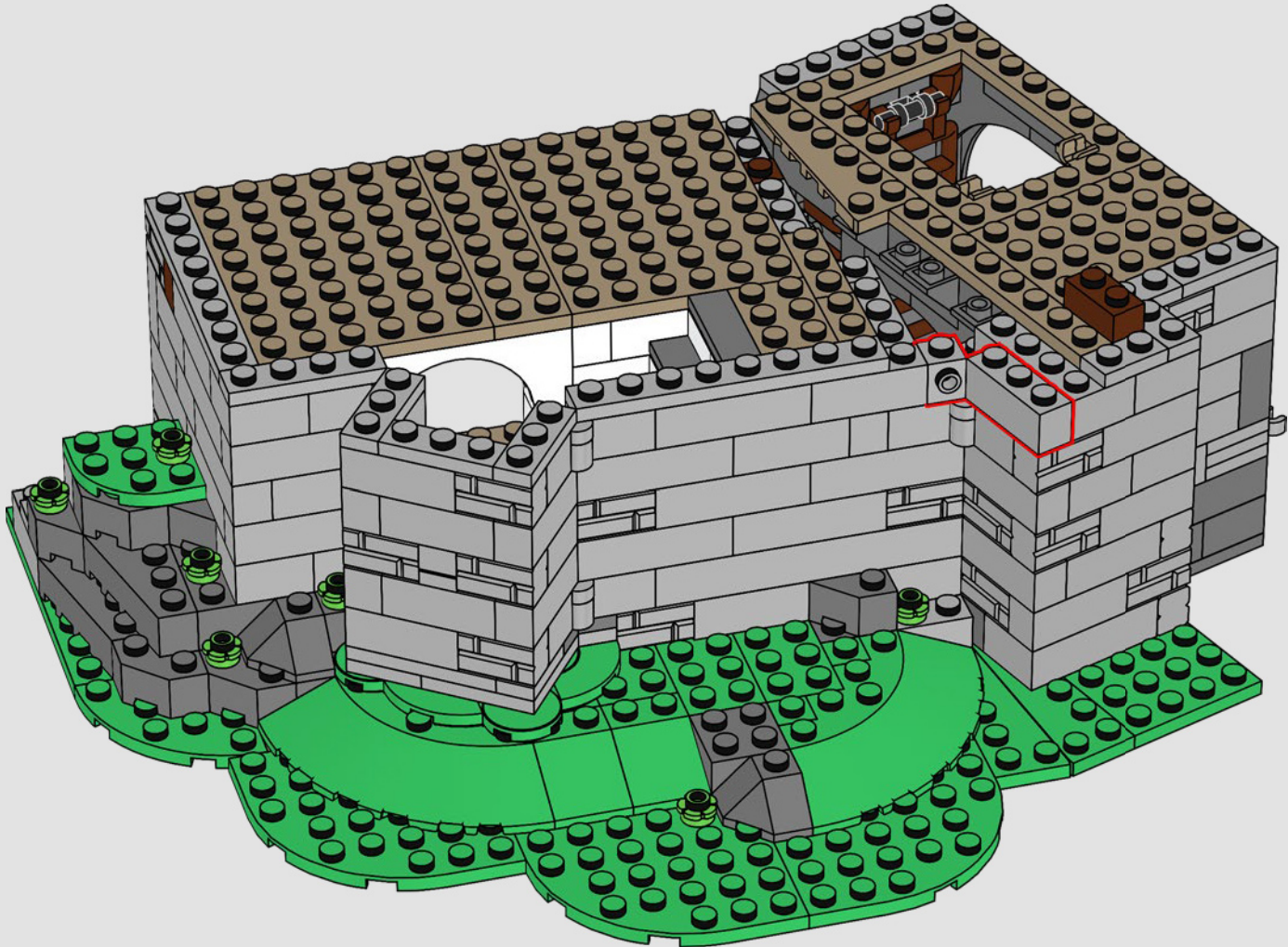

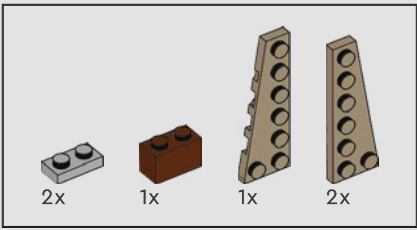

75

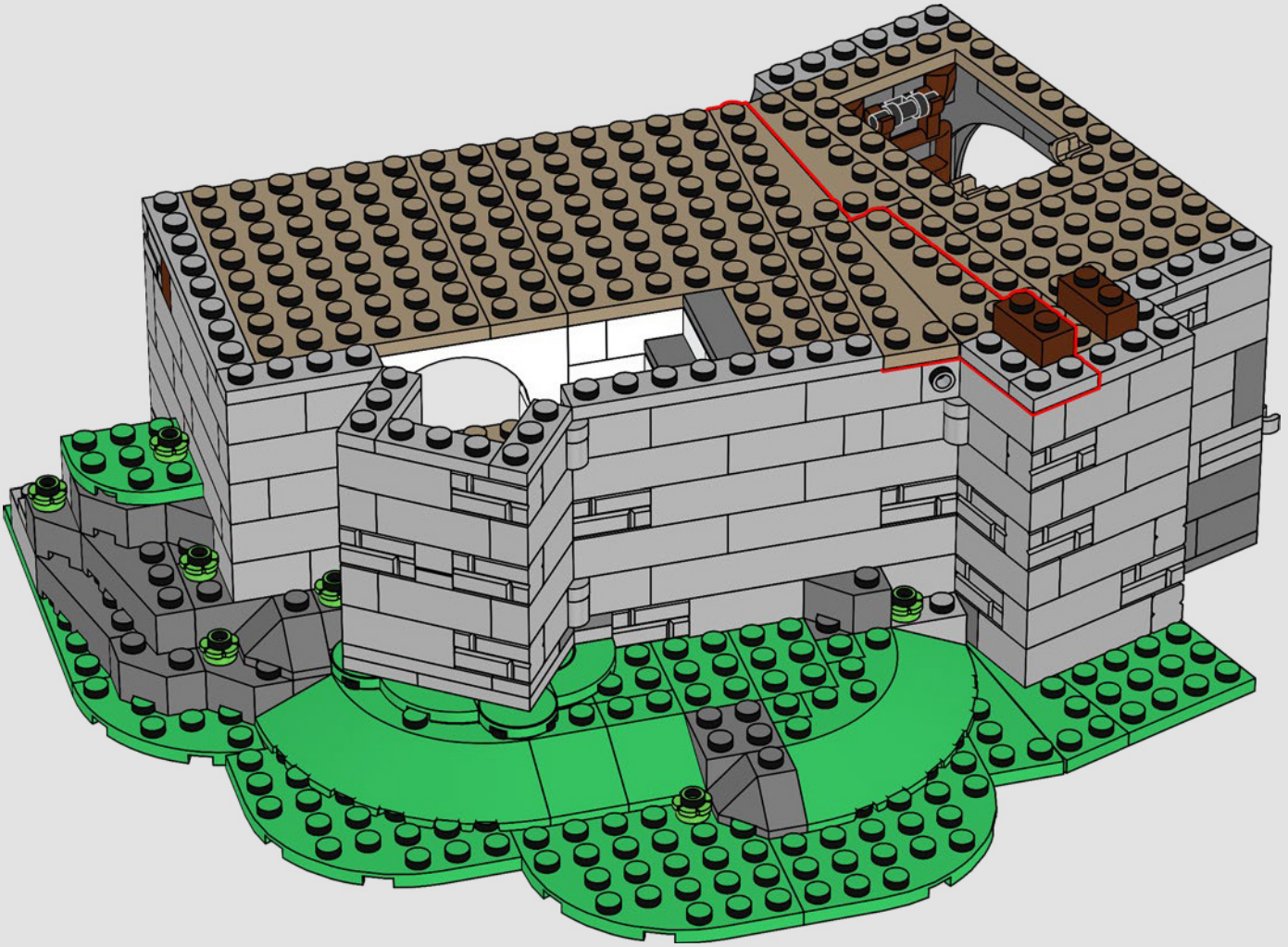

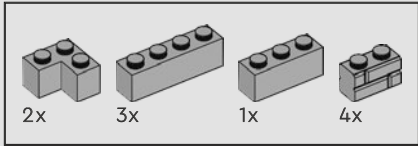

76

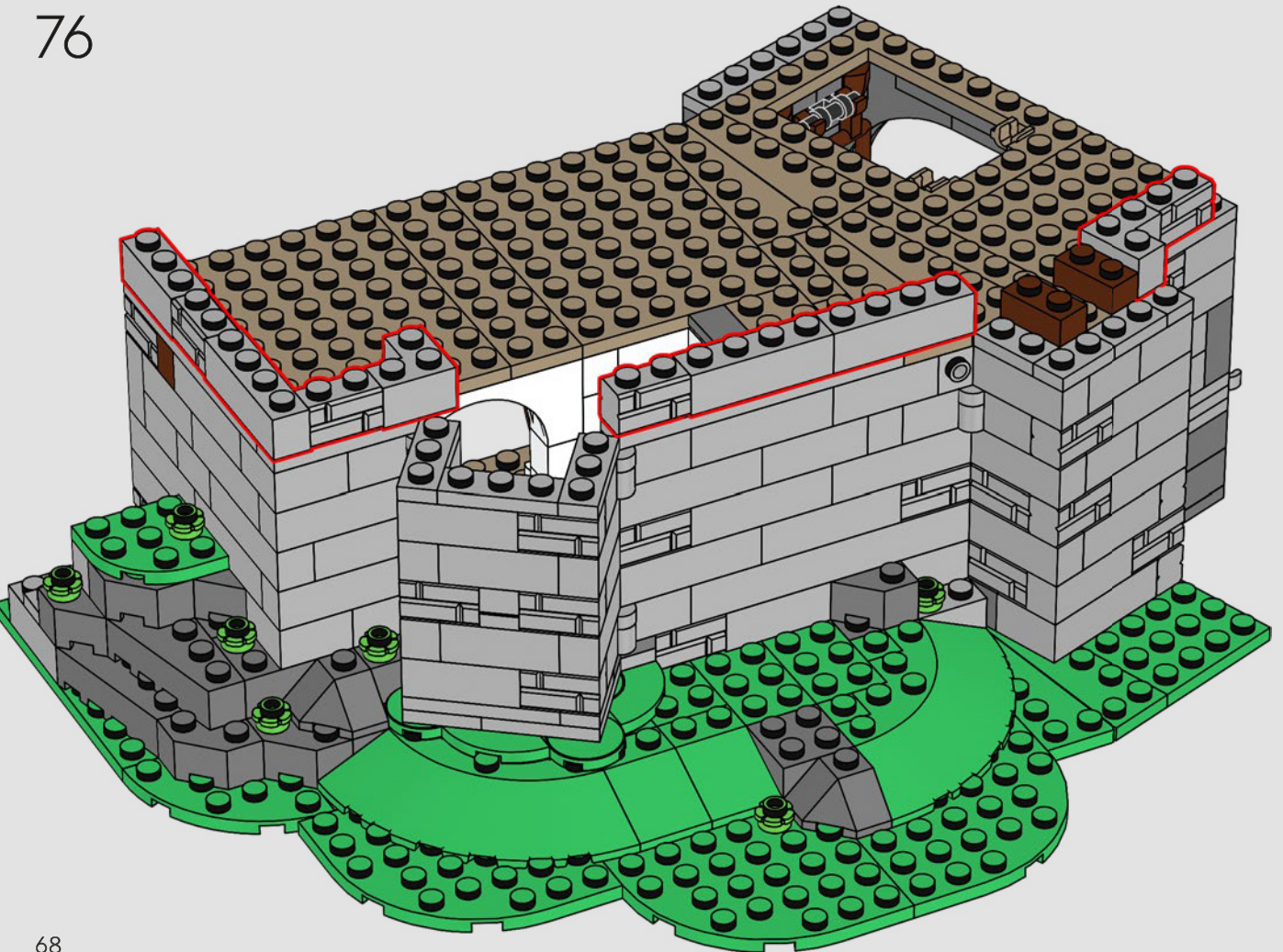

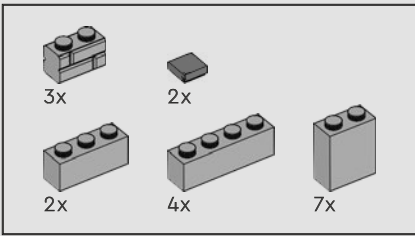

77

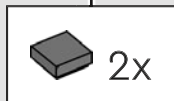
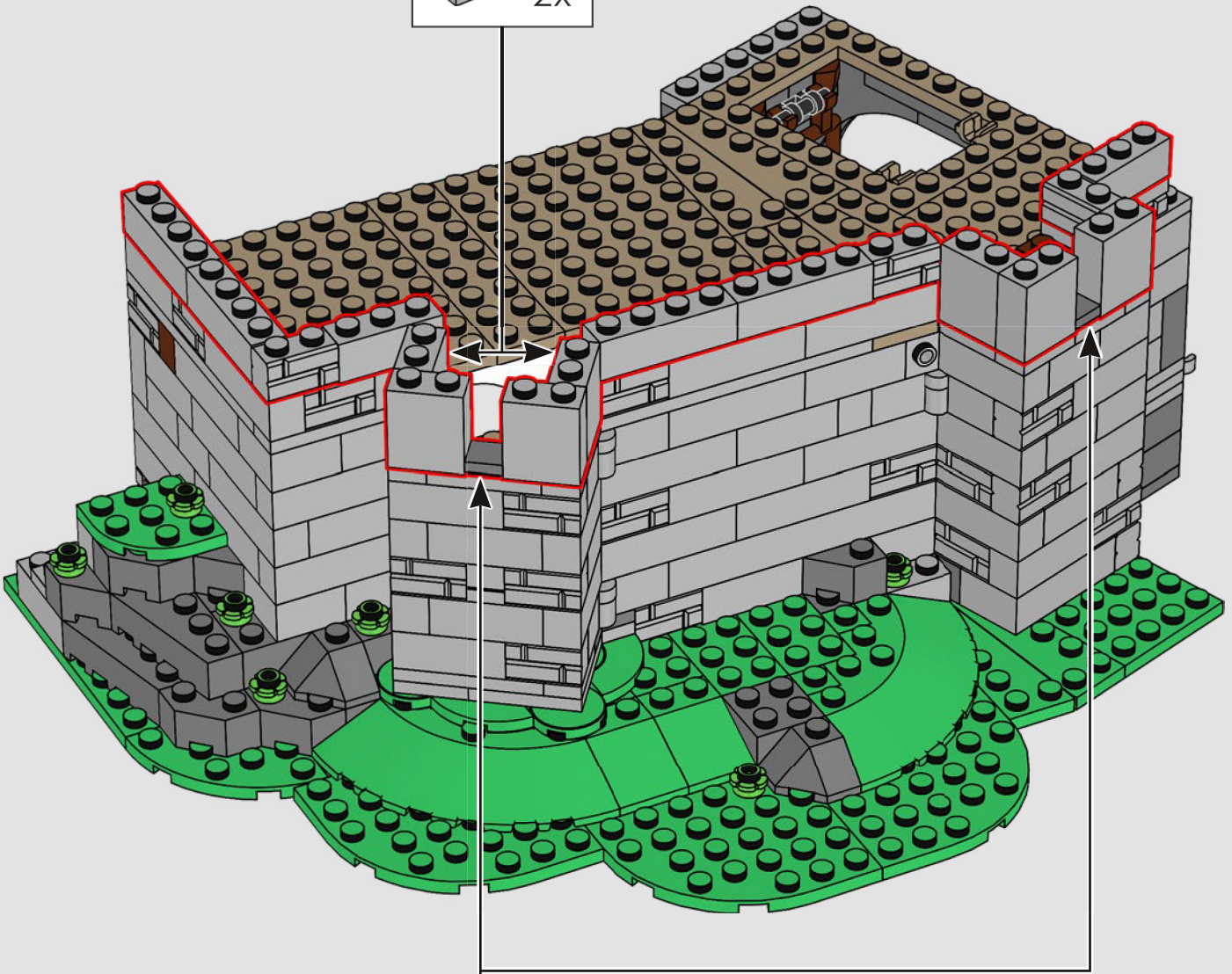
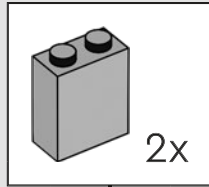

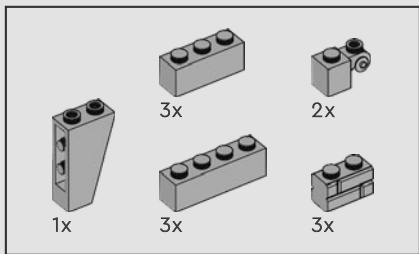

78

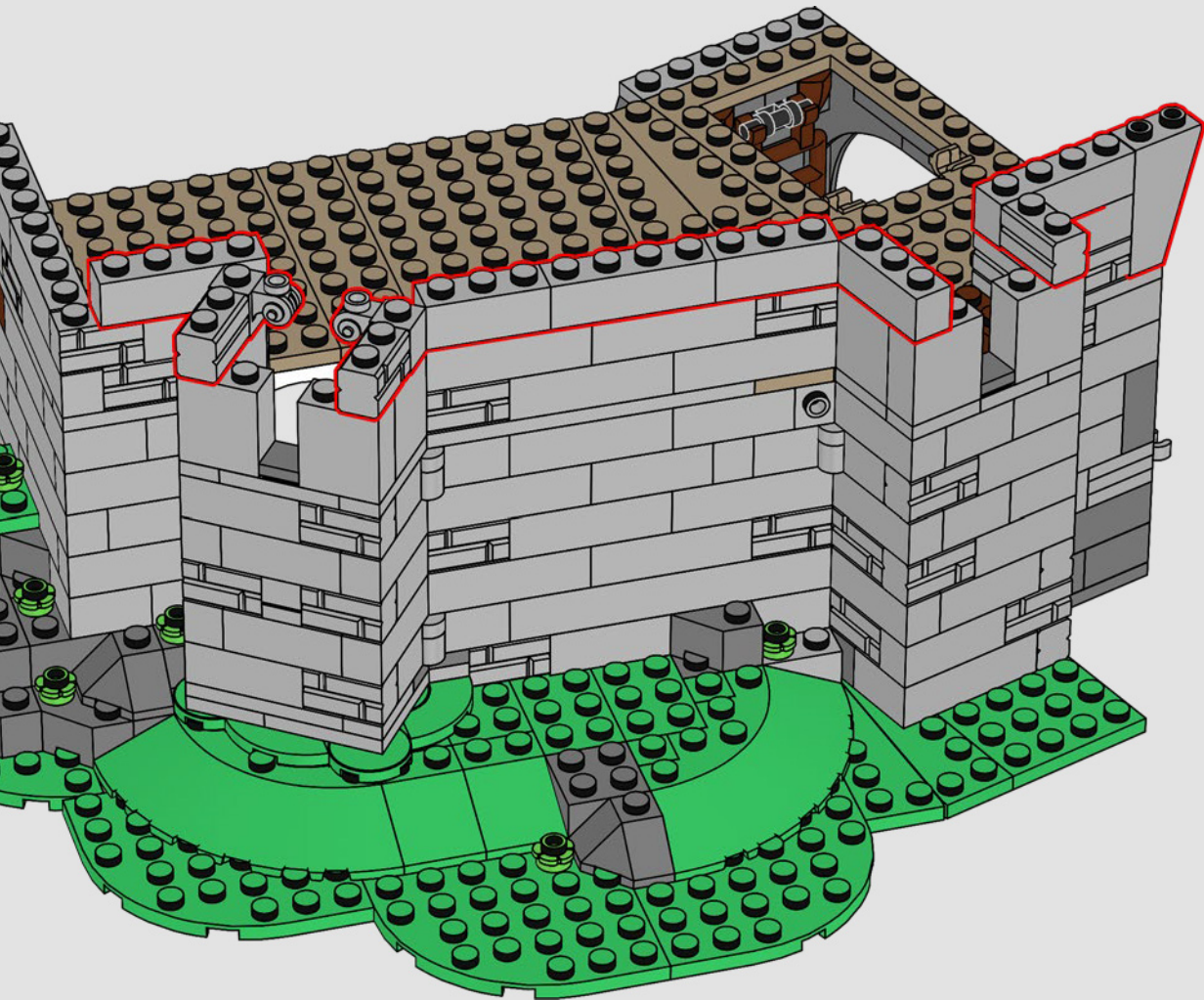

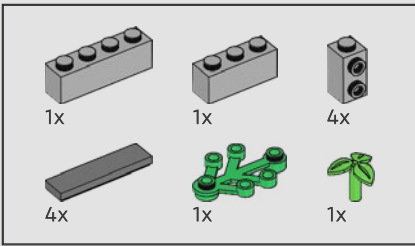

79

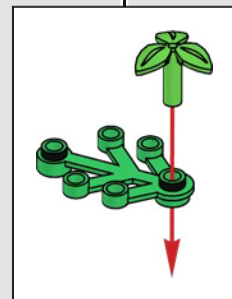
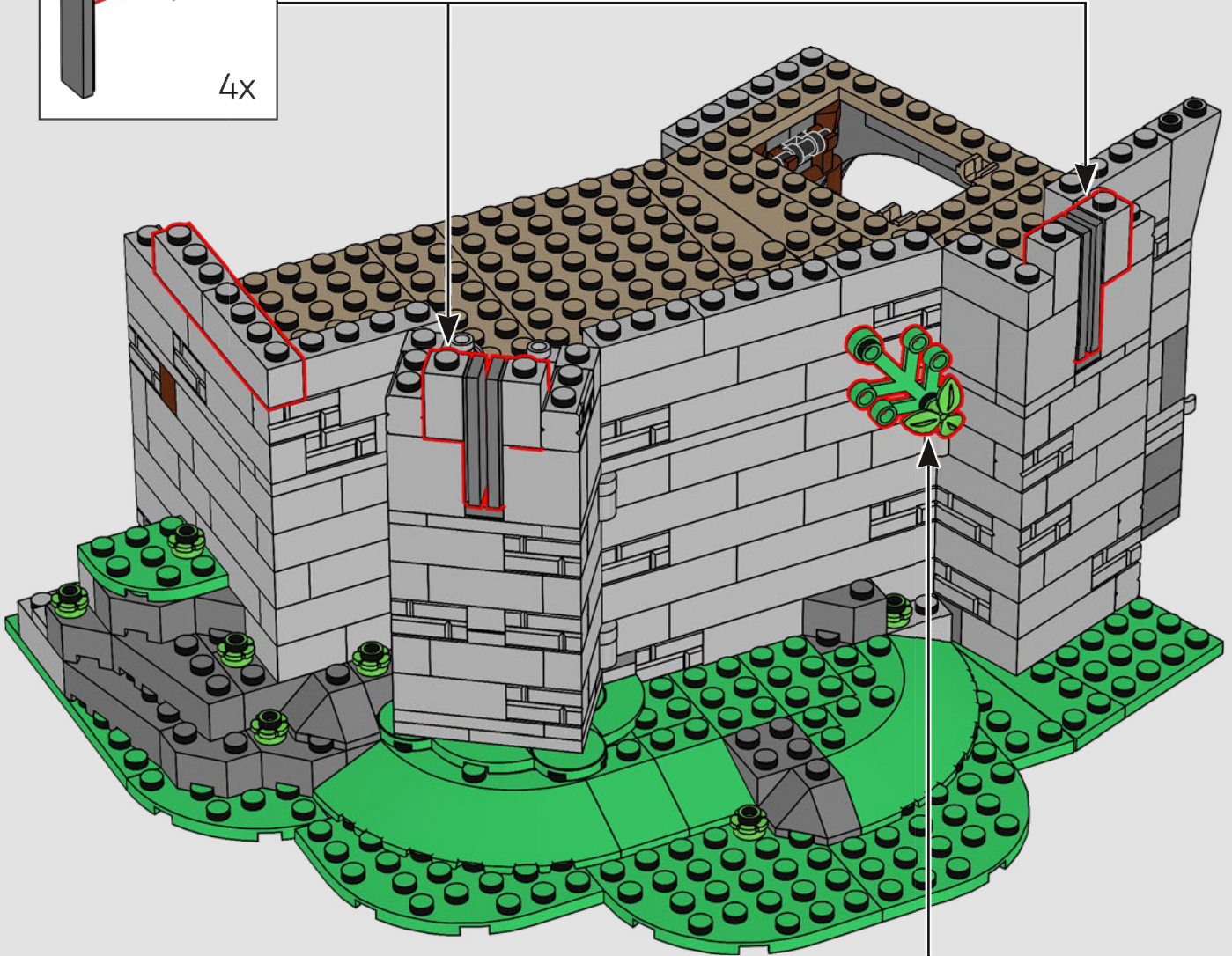
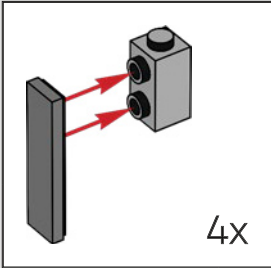

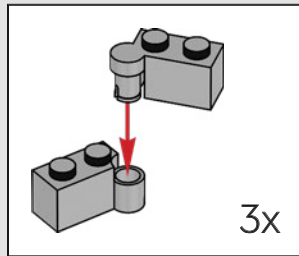
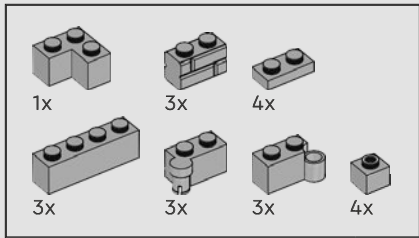

80

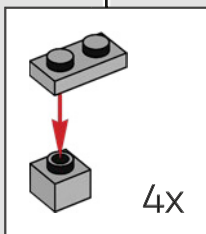



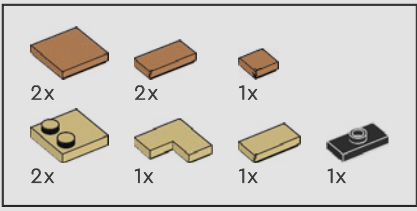

81



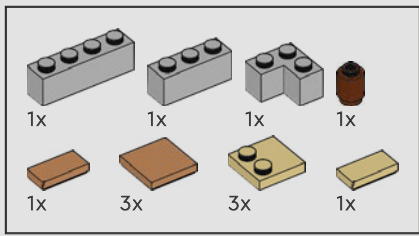

82

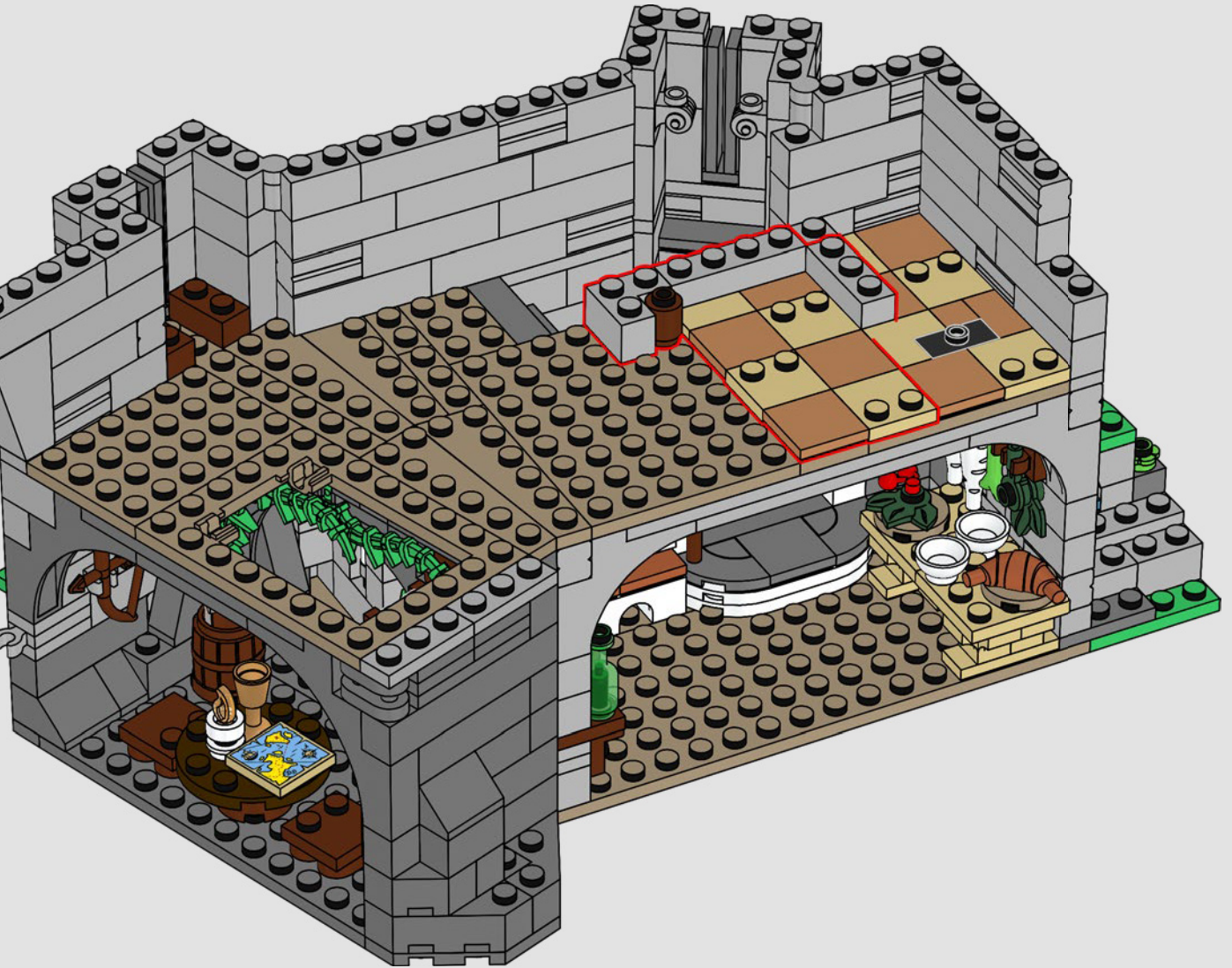

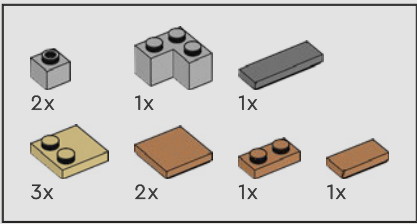

83





Why ever is this entrance being covered?  
Is yon chamber down below meant to be  
hidden from her Ladyship?

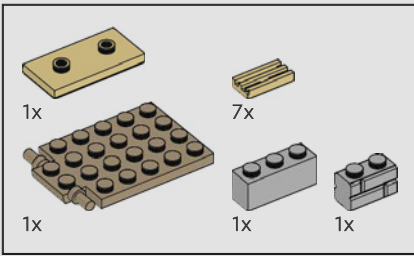

84

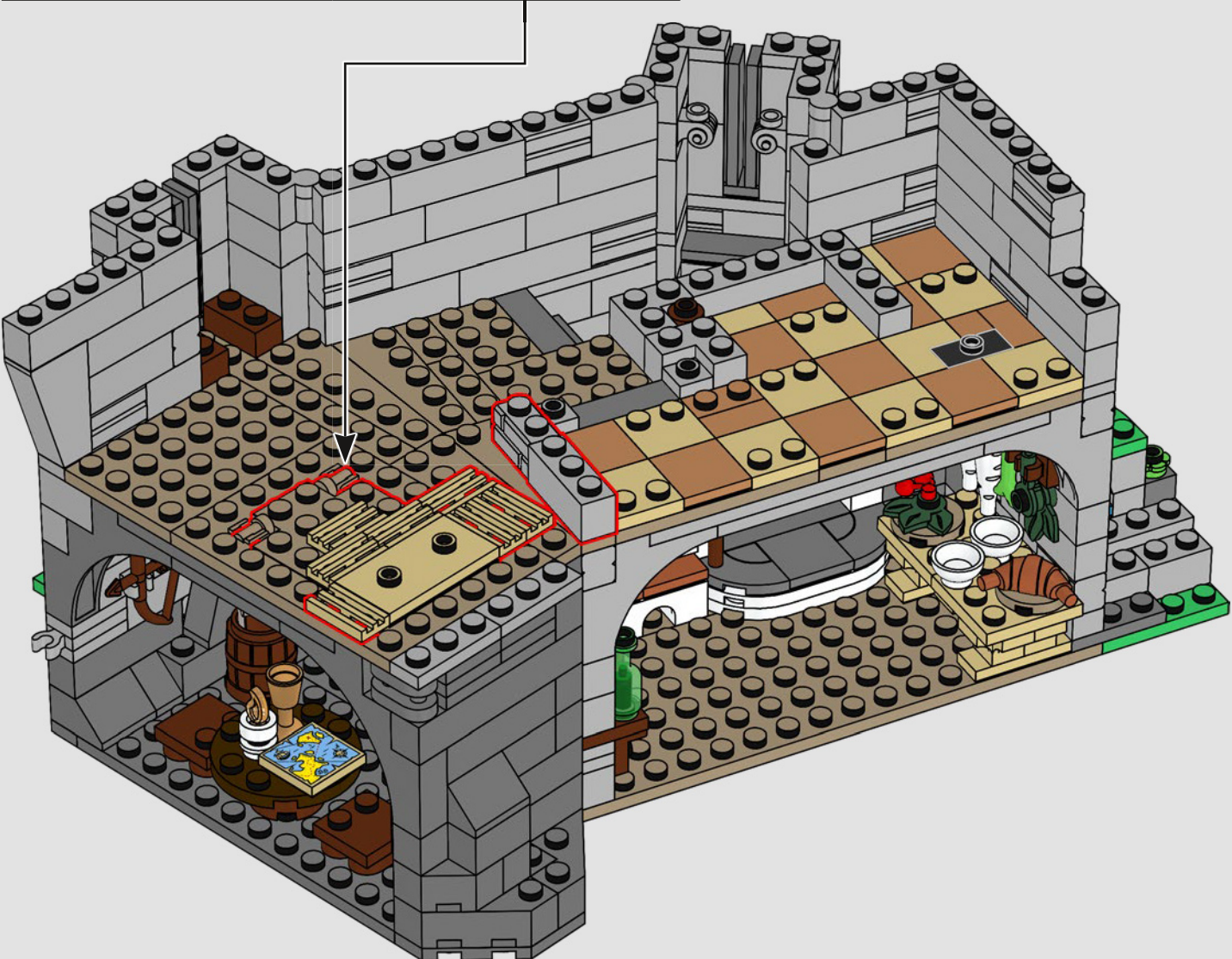
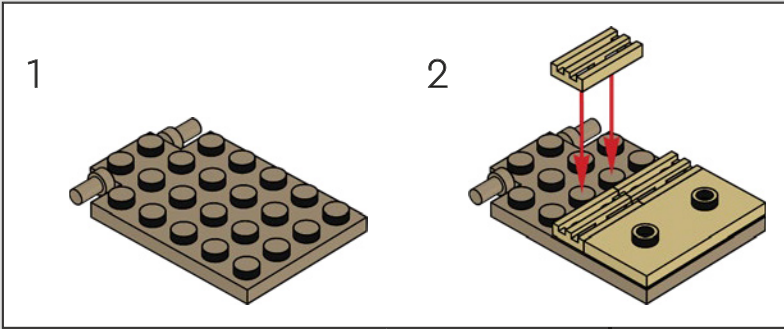

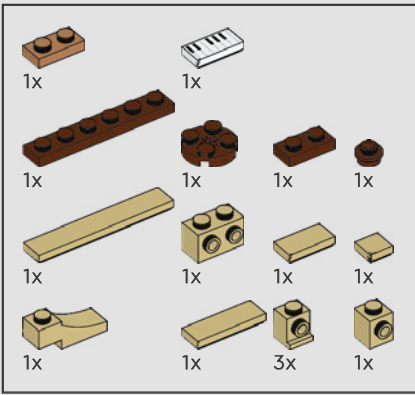

85

1

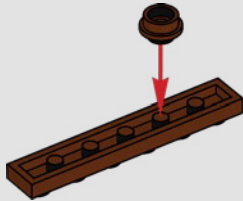

2

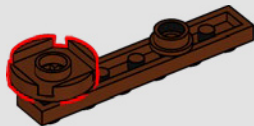

3

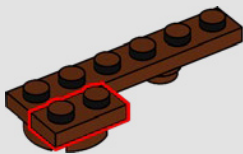

4

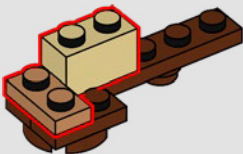

5

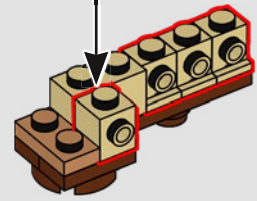
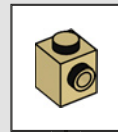

6

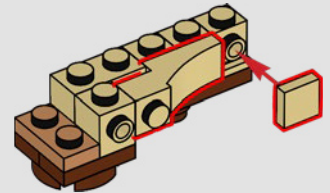

7

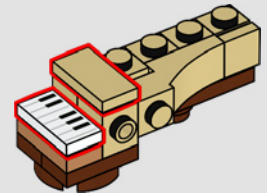

8

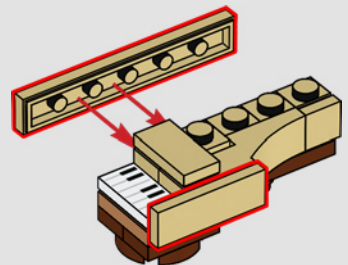



*Hark, are those the melodious sounds of a harpsichord? What a modern musical marvel!*

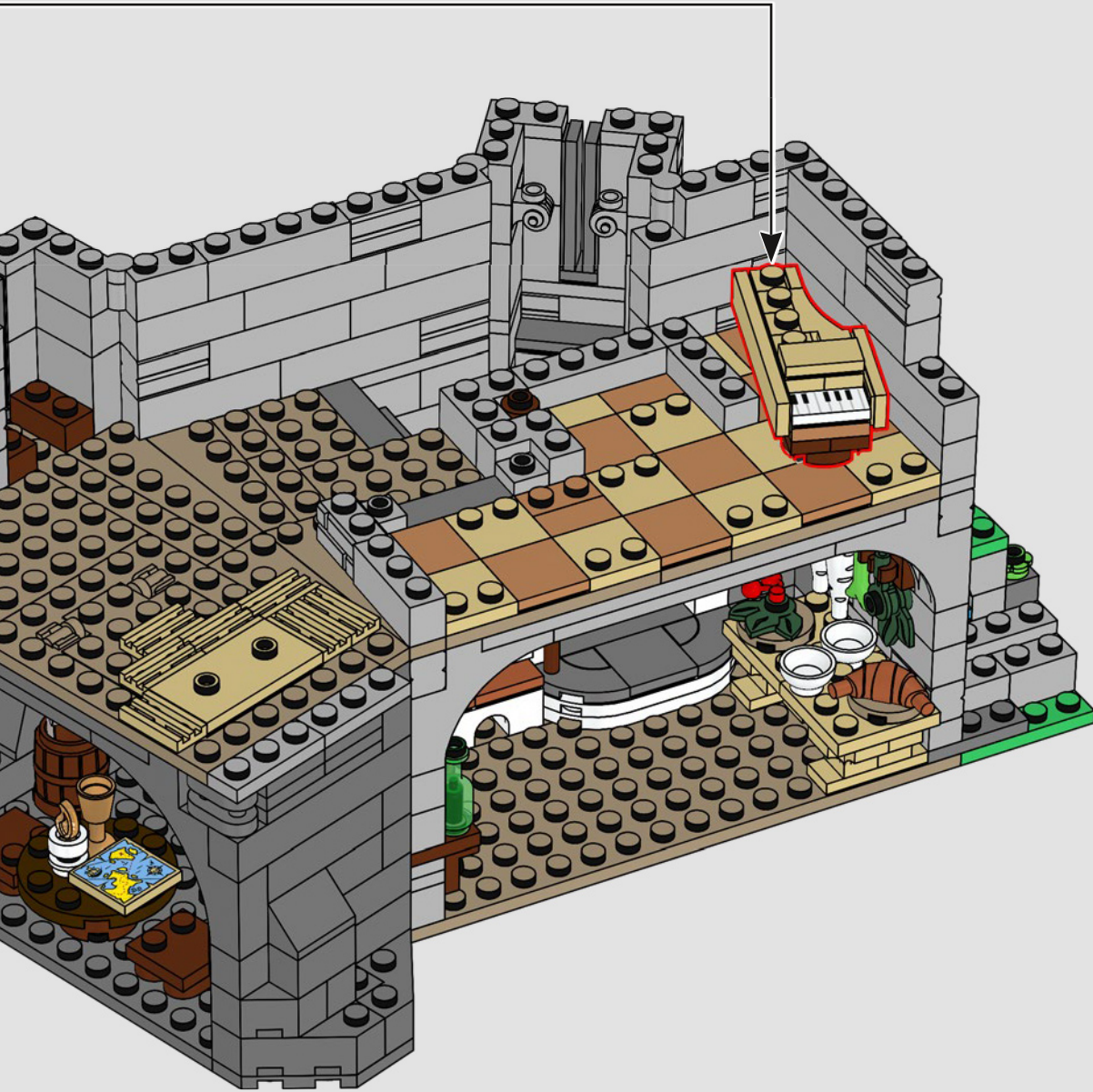

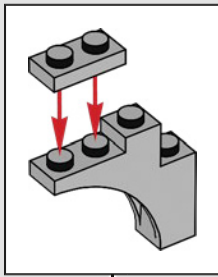
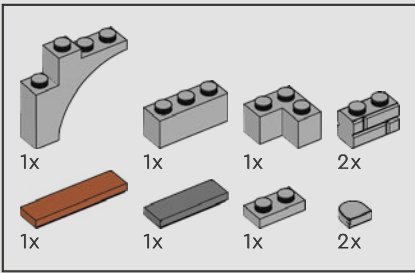

86

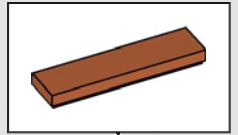
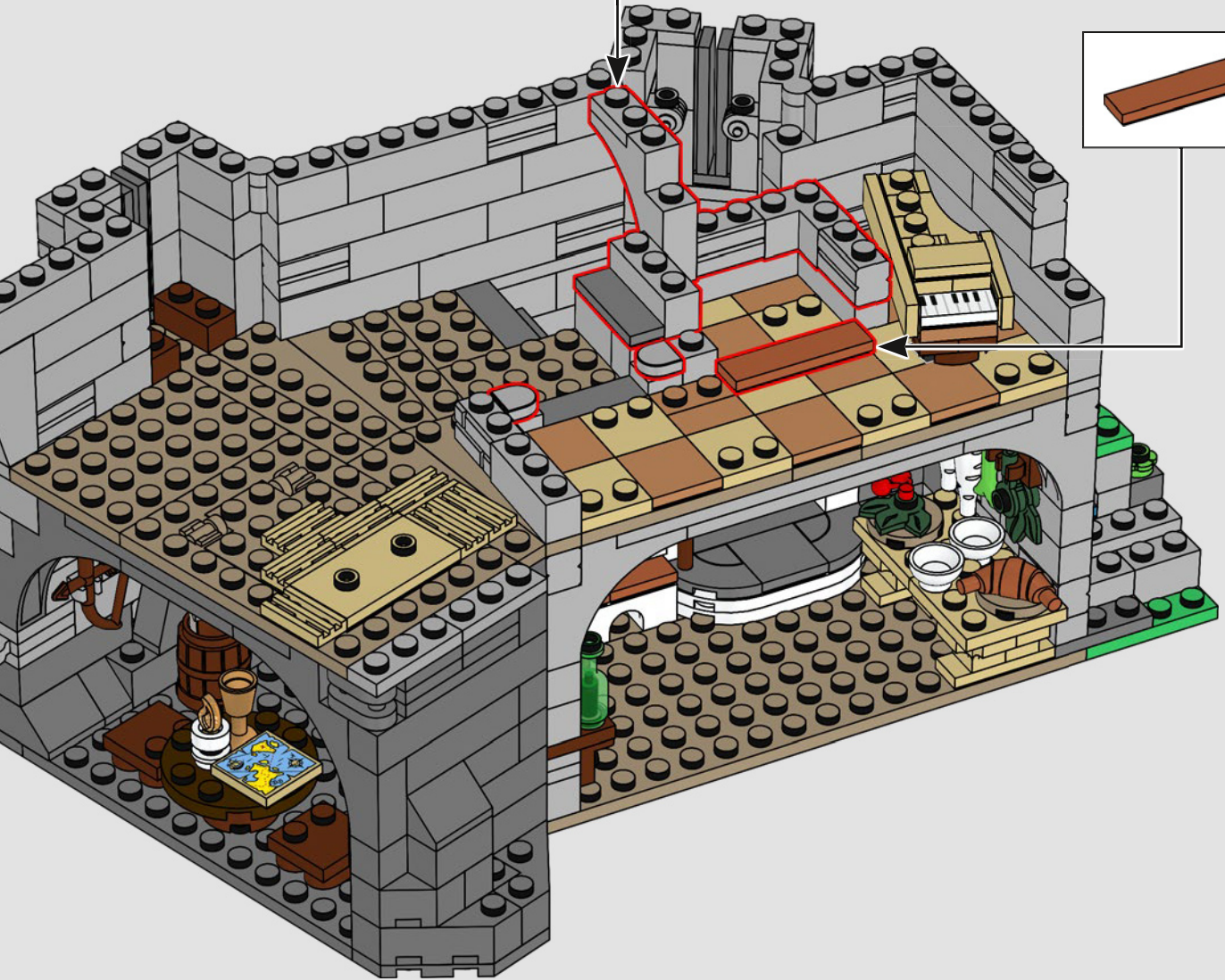

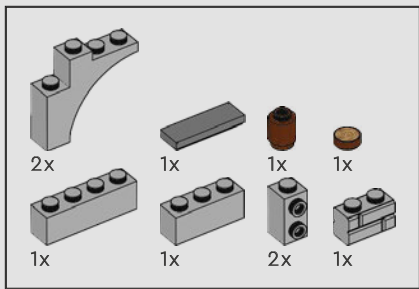

87

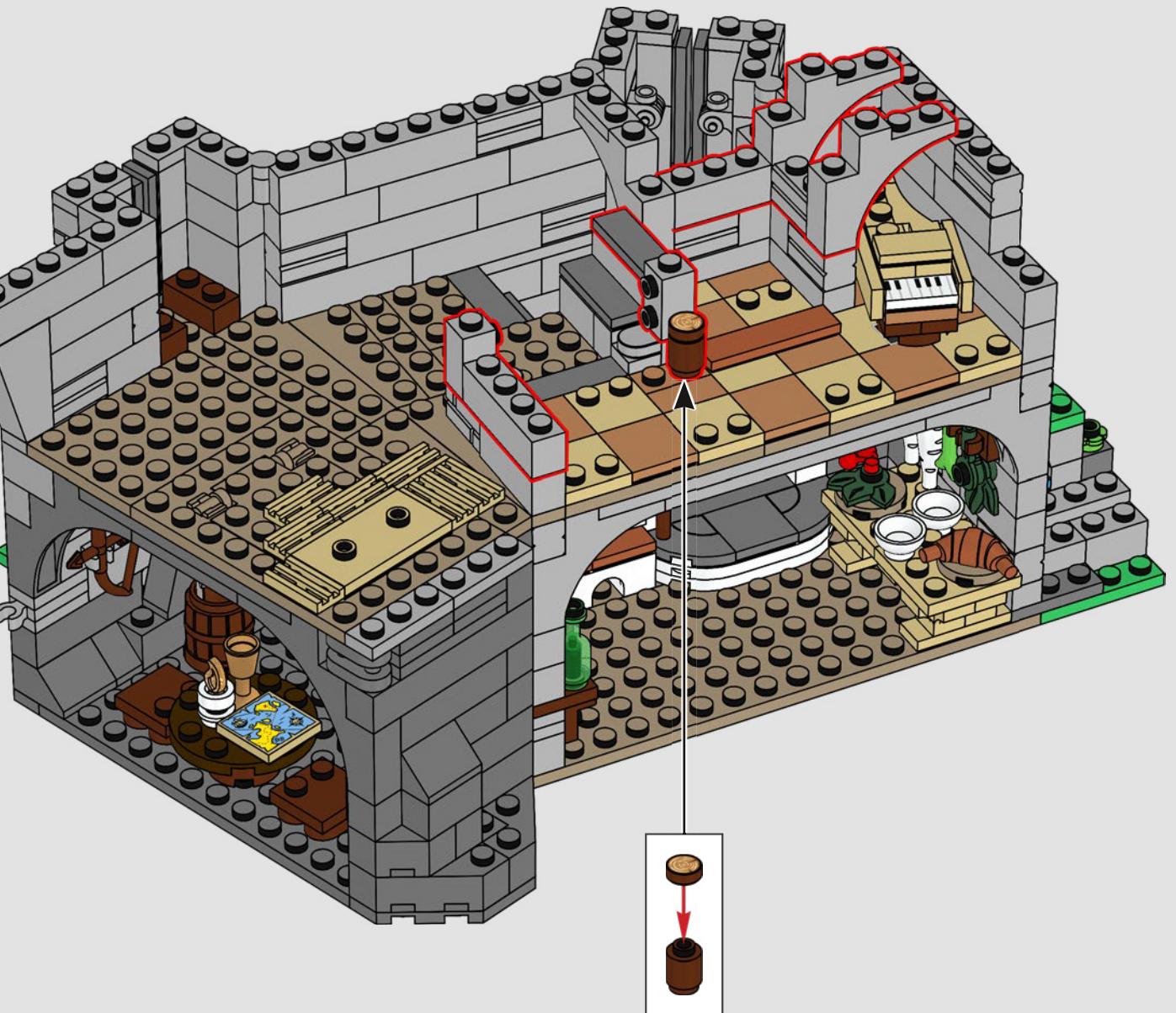



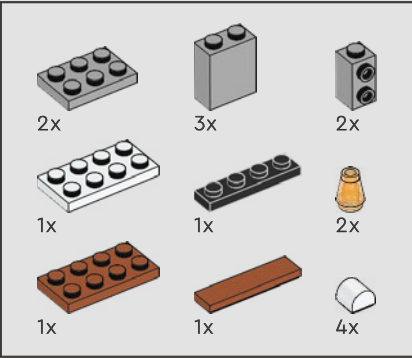
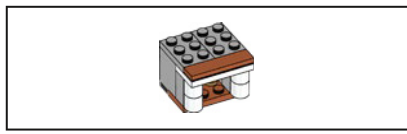

88

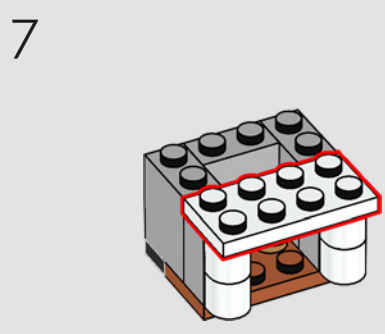
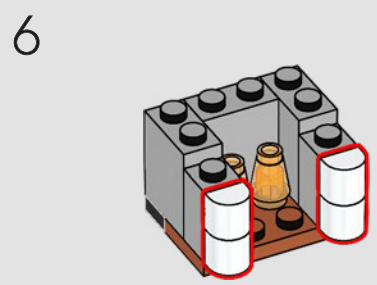
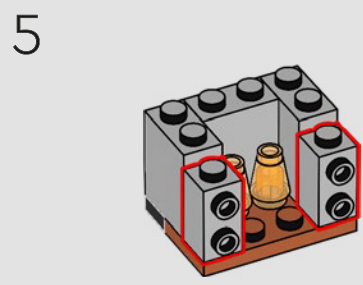
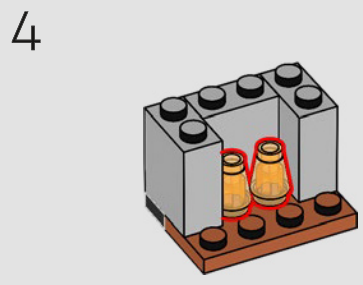
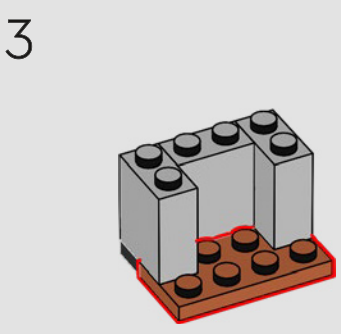
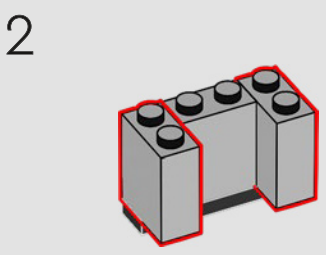
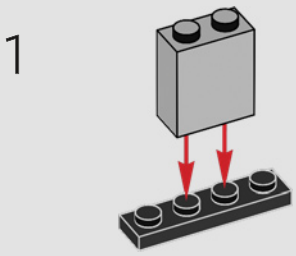

8

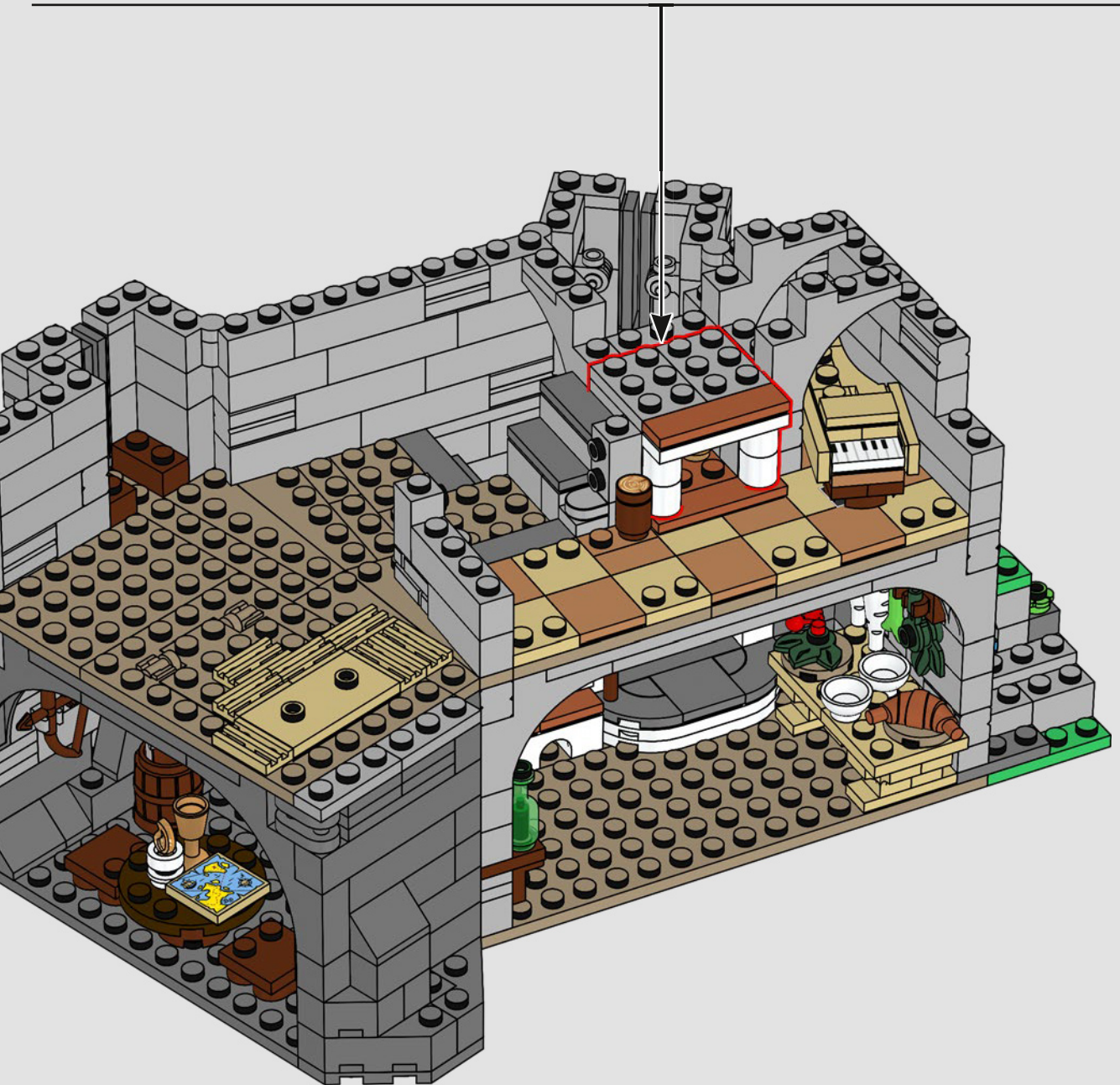
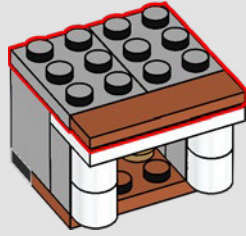

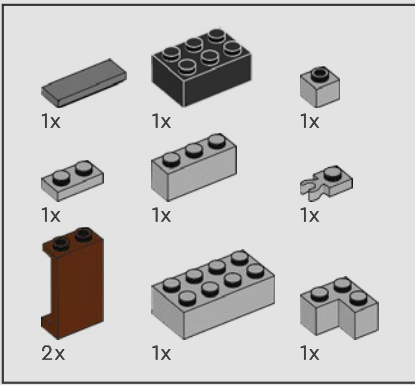

89

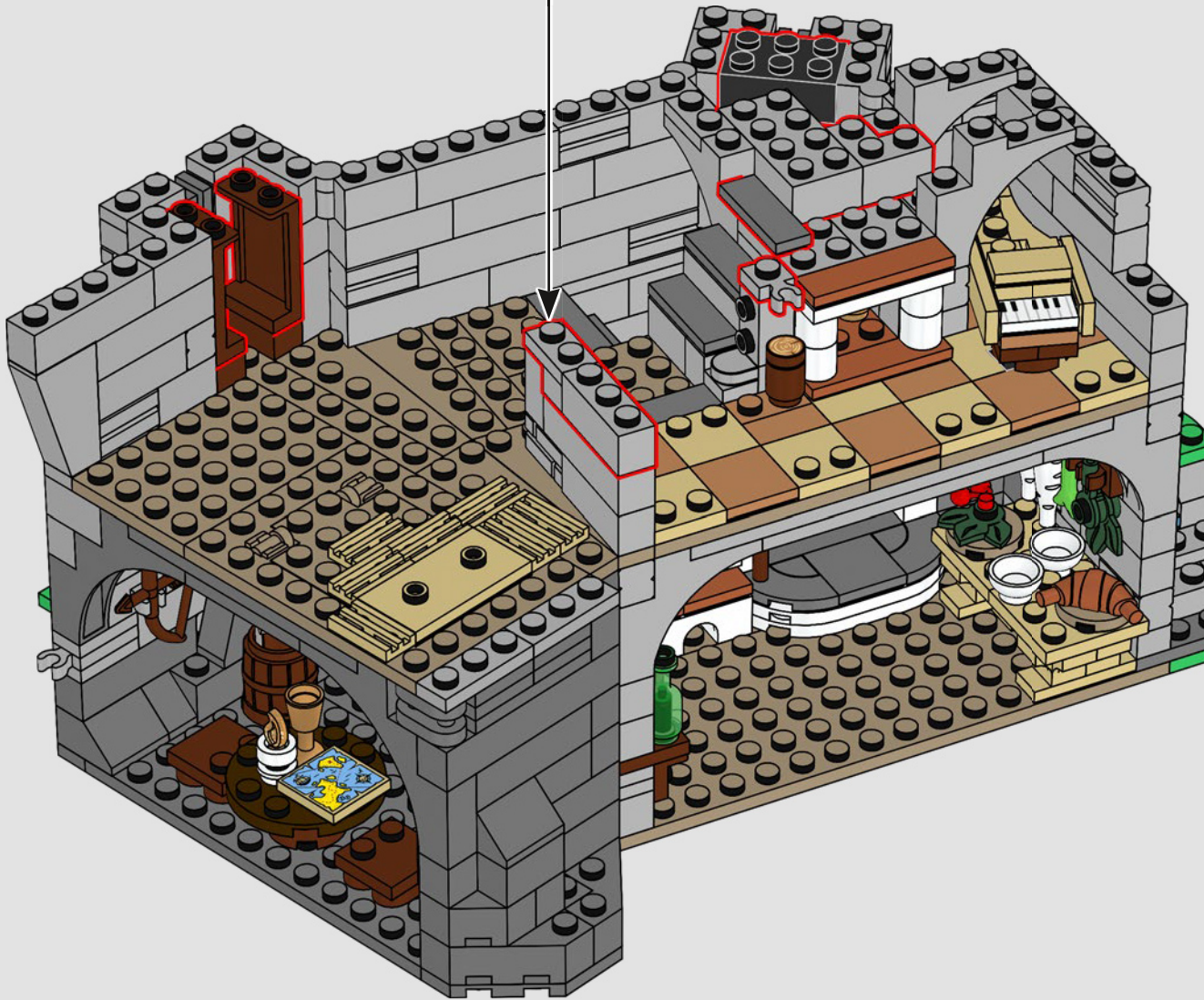
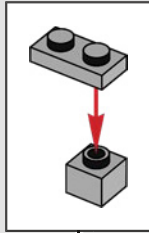

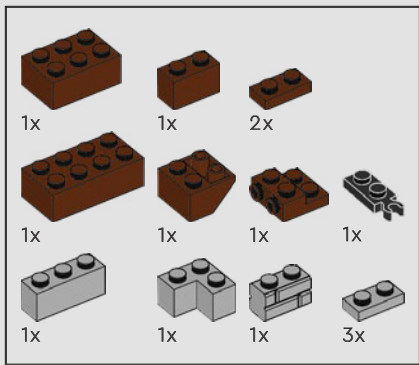

90

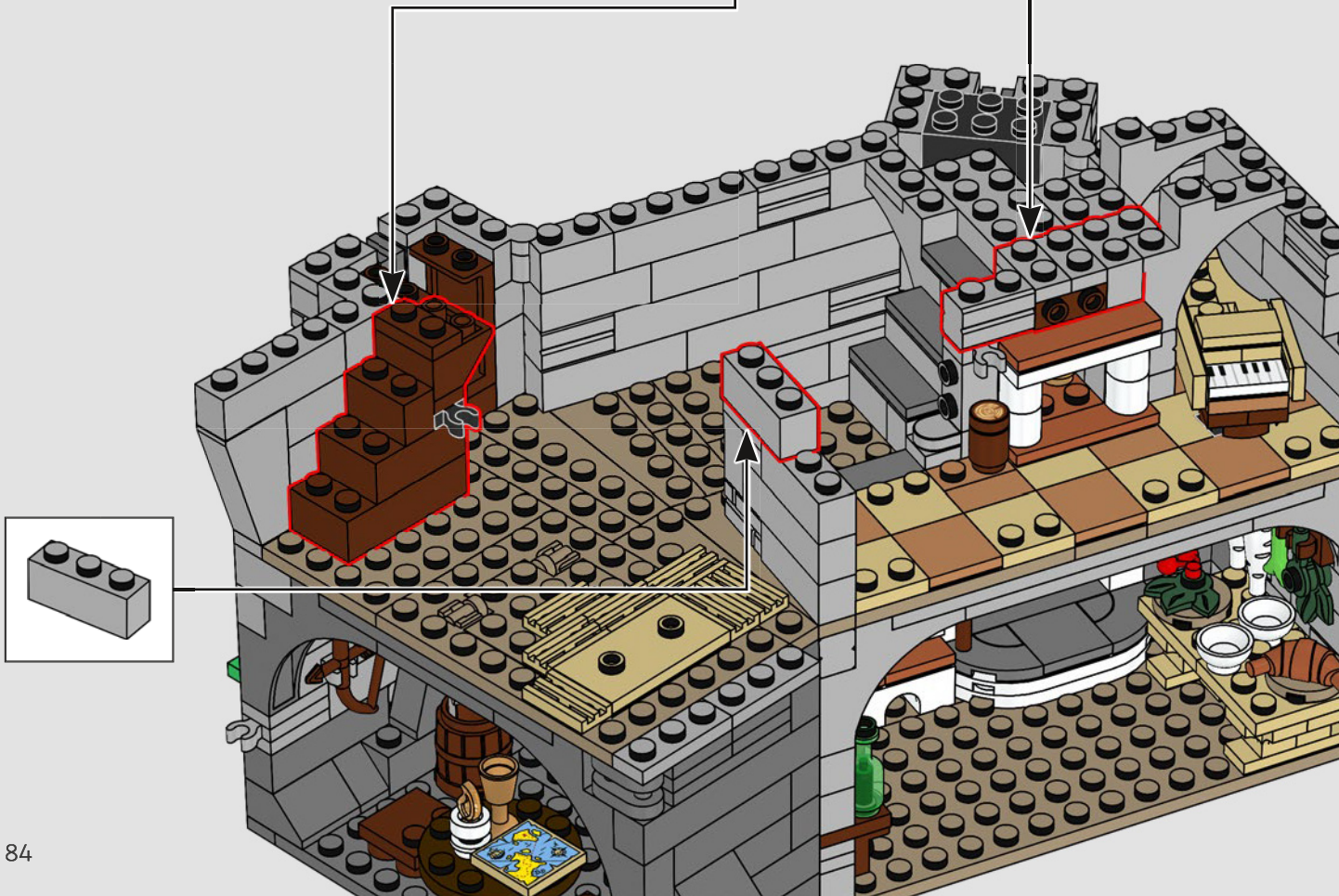
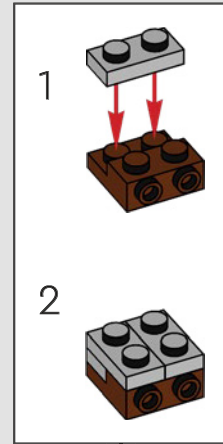
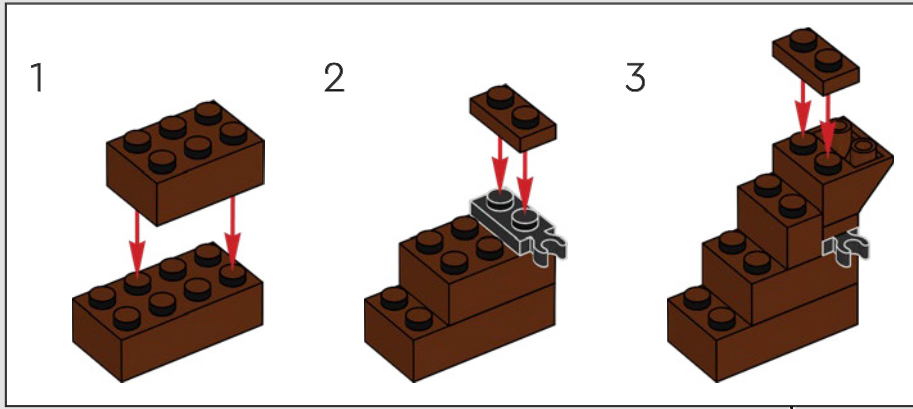

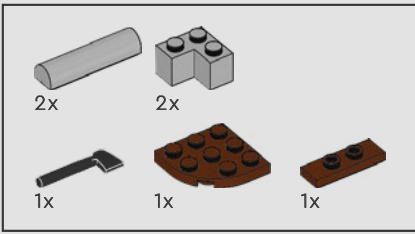

91

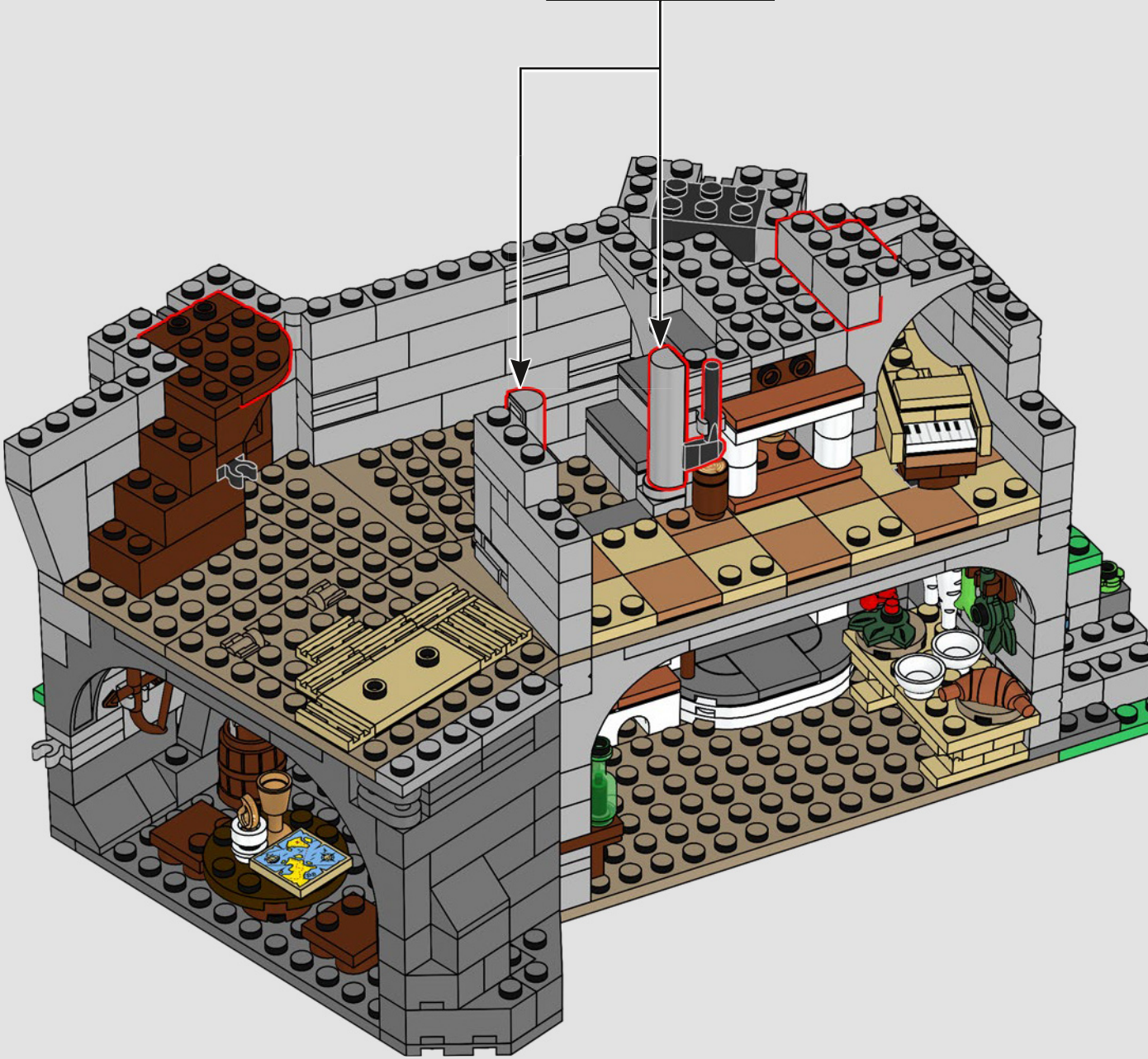
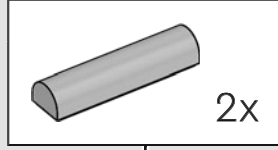

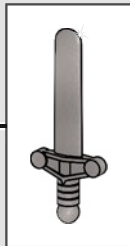
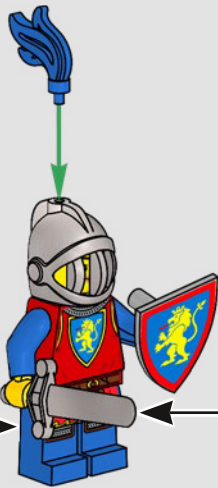
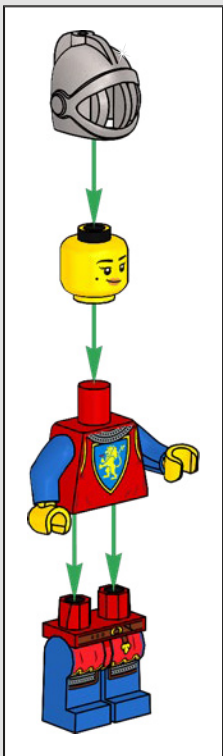

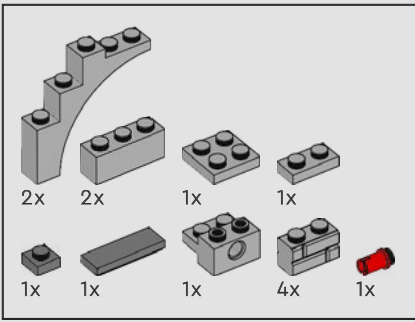

92

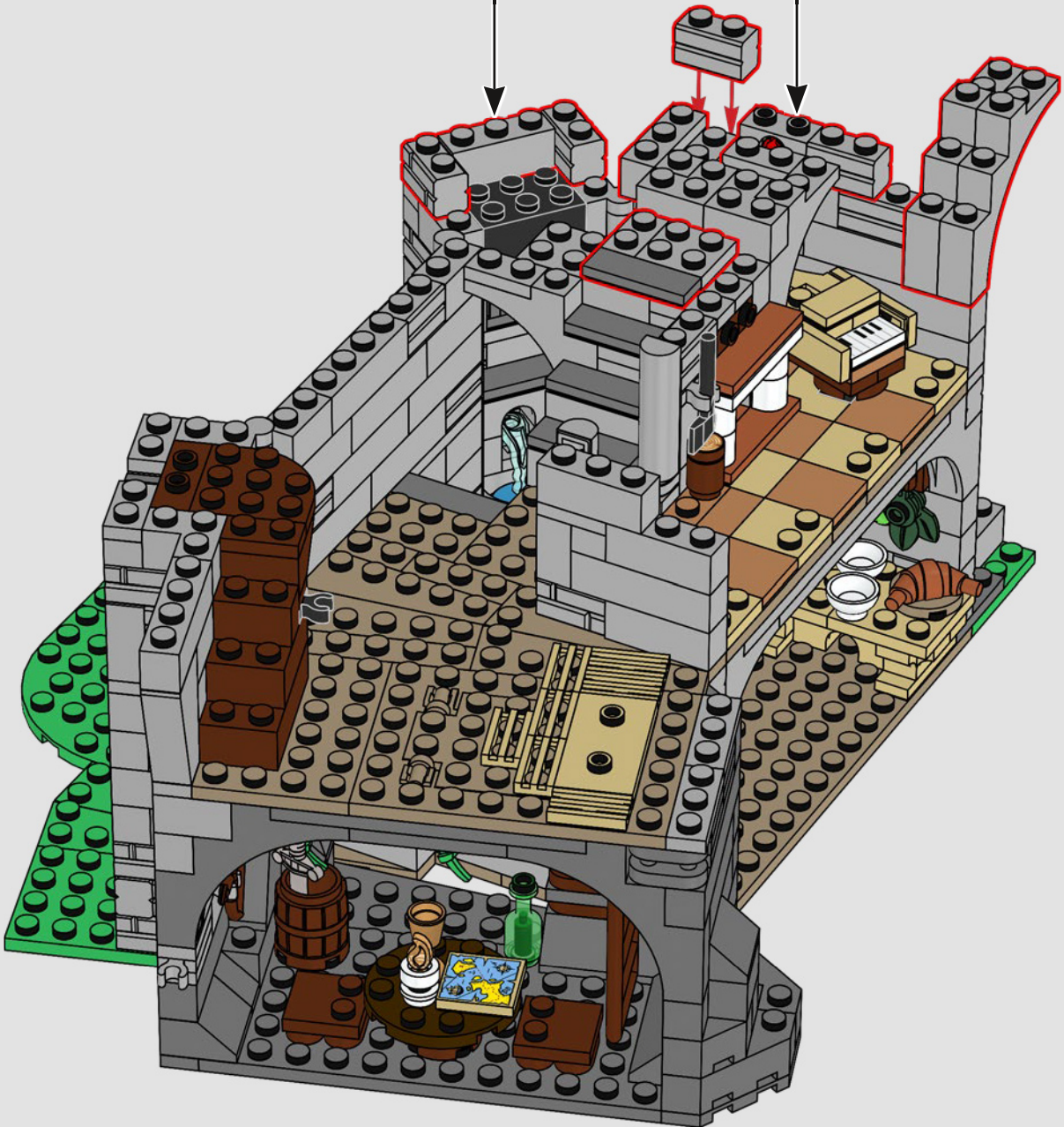
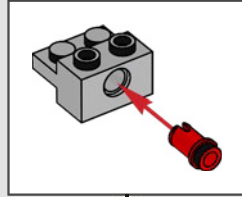
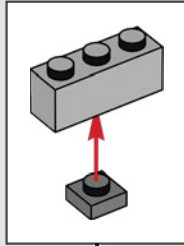

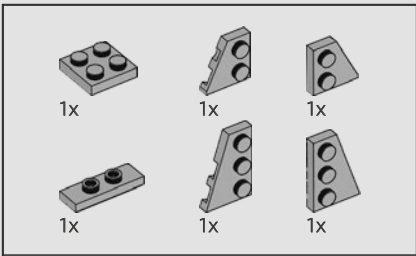

93

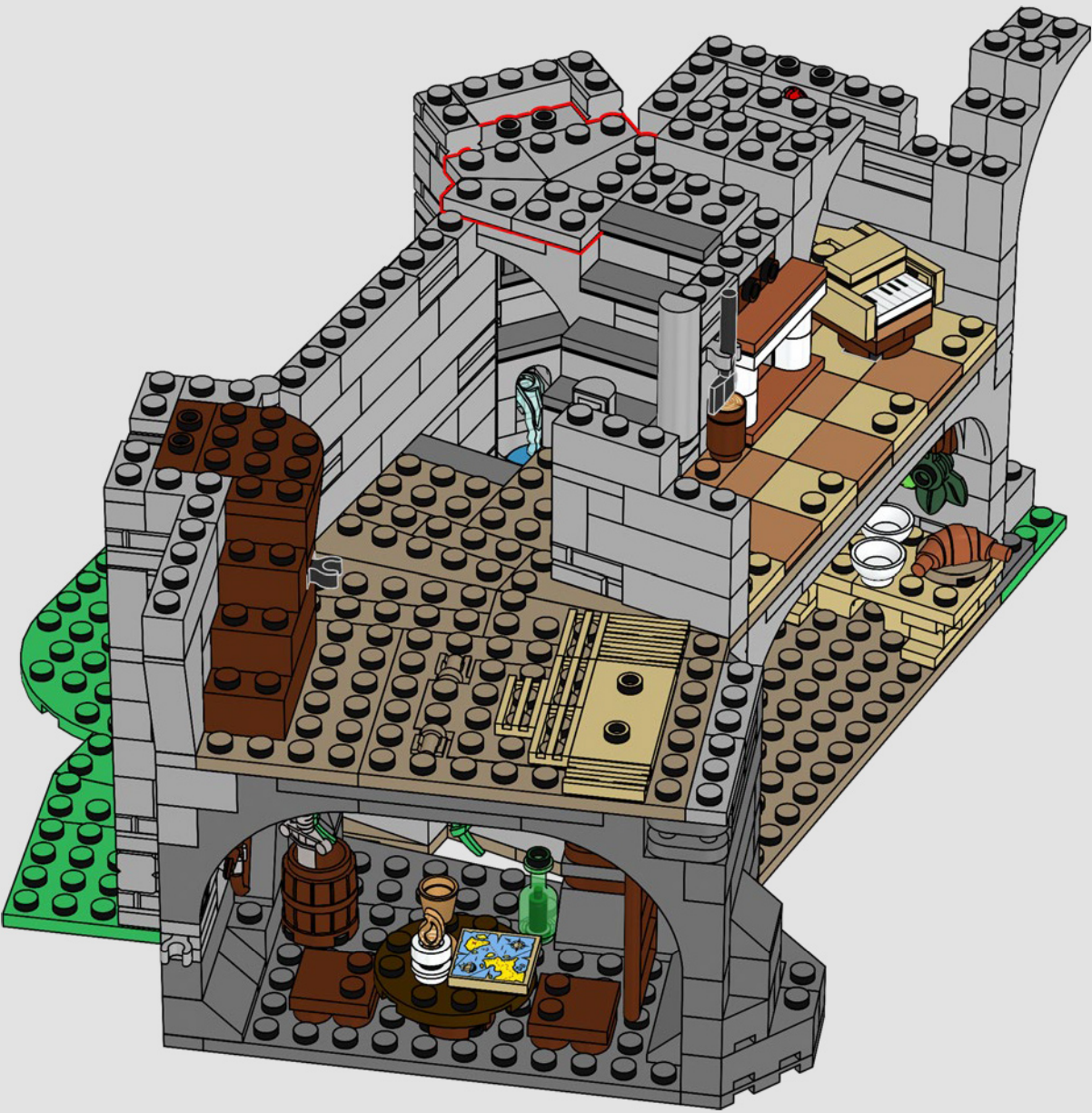



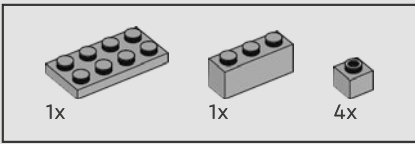

94

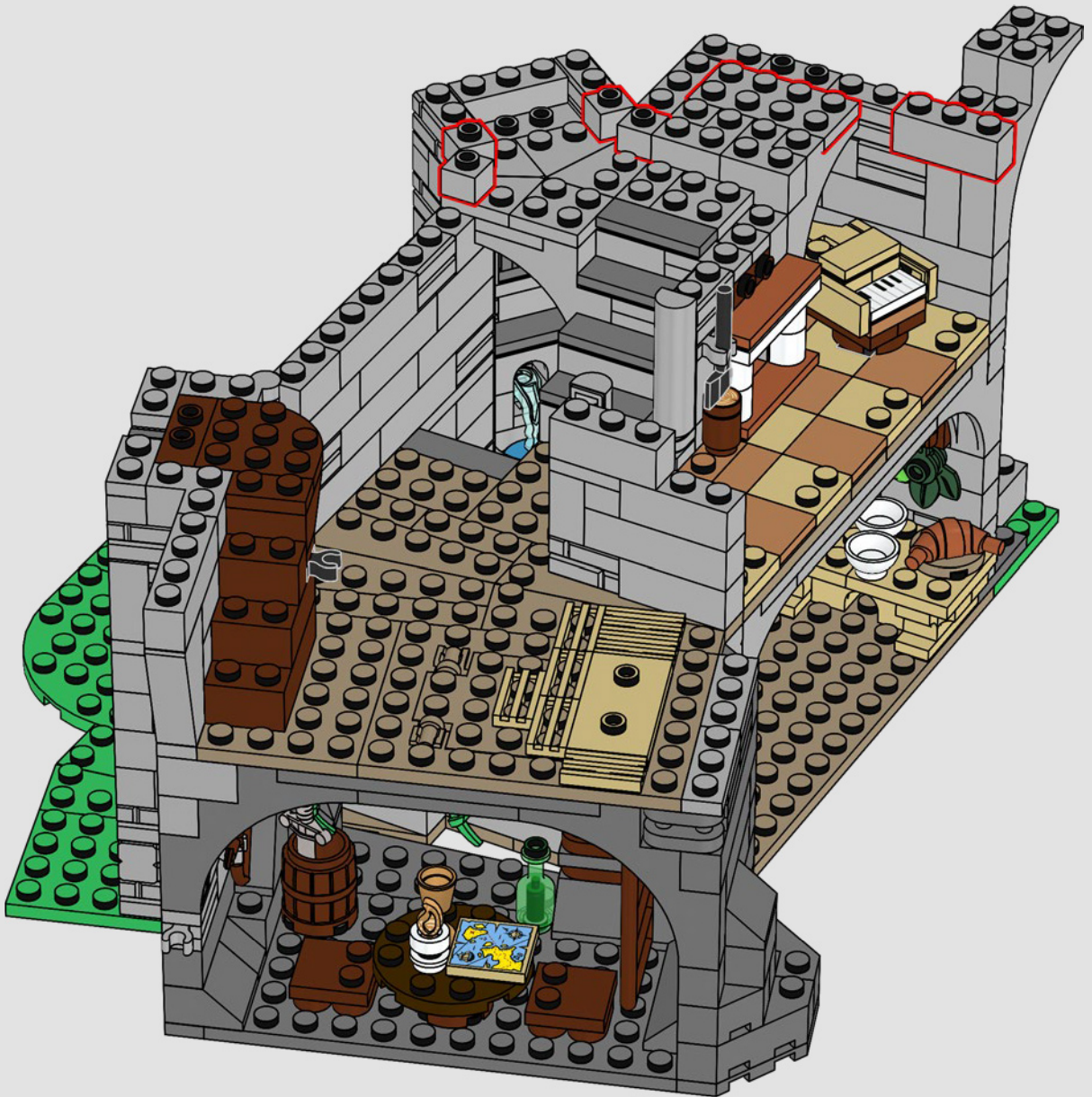

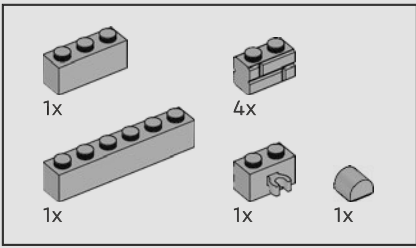

95

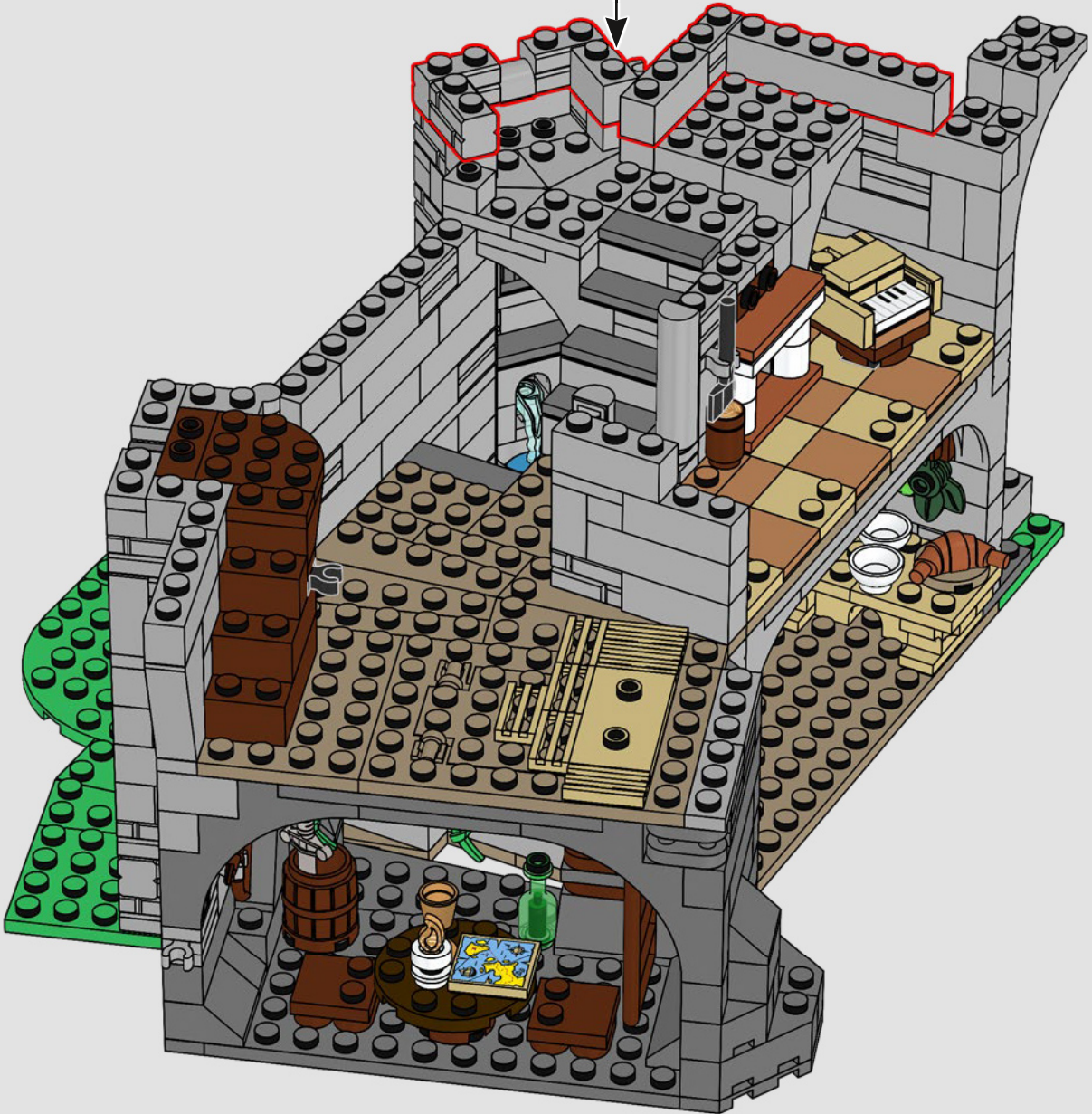
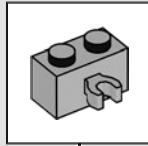

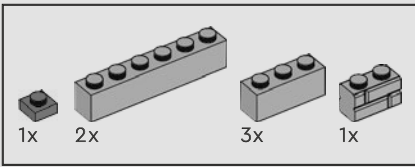

96

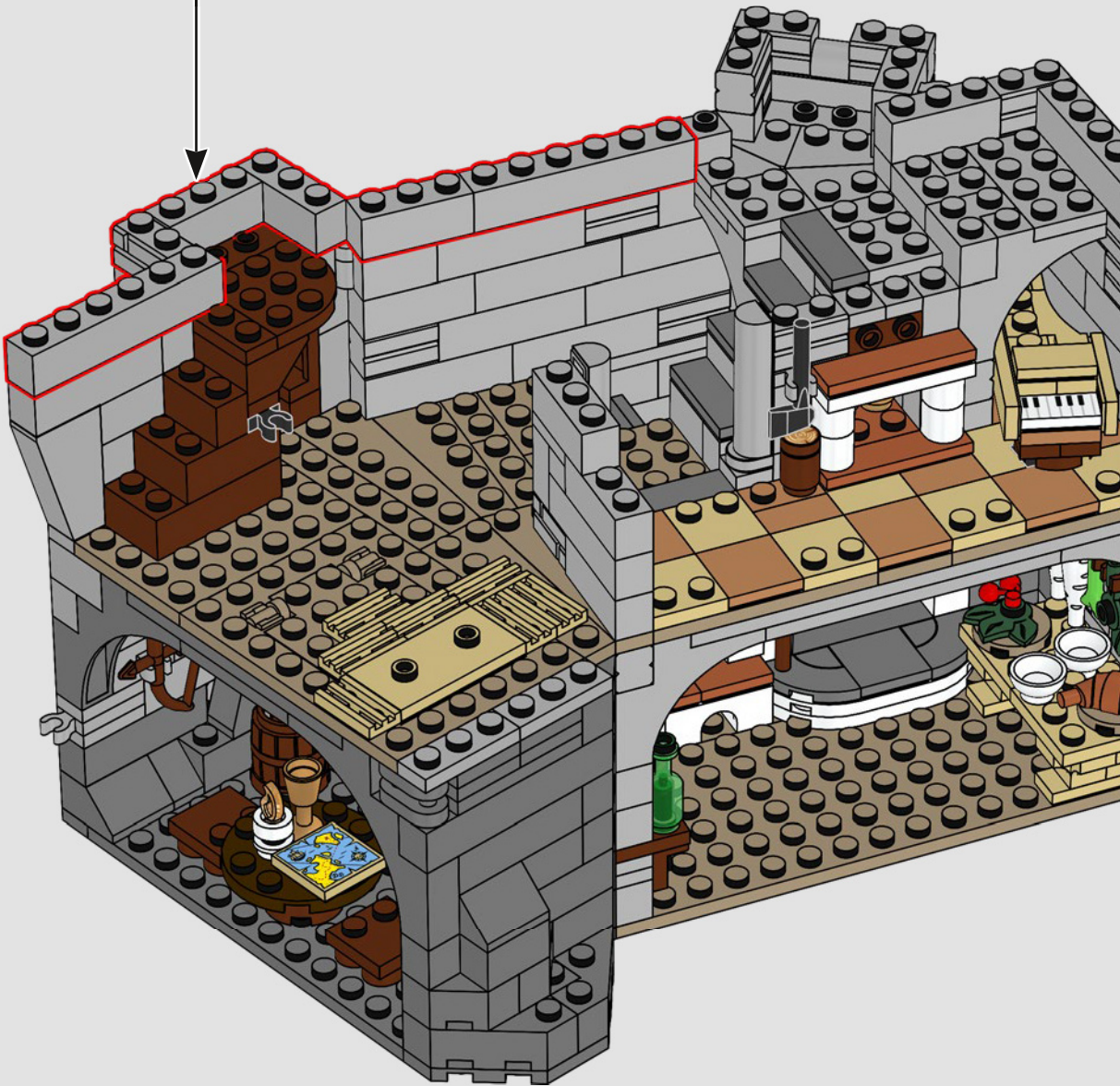
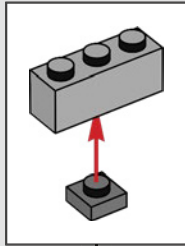

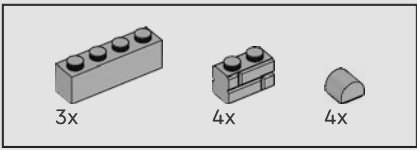

97

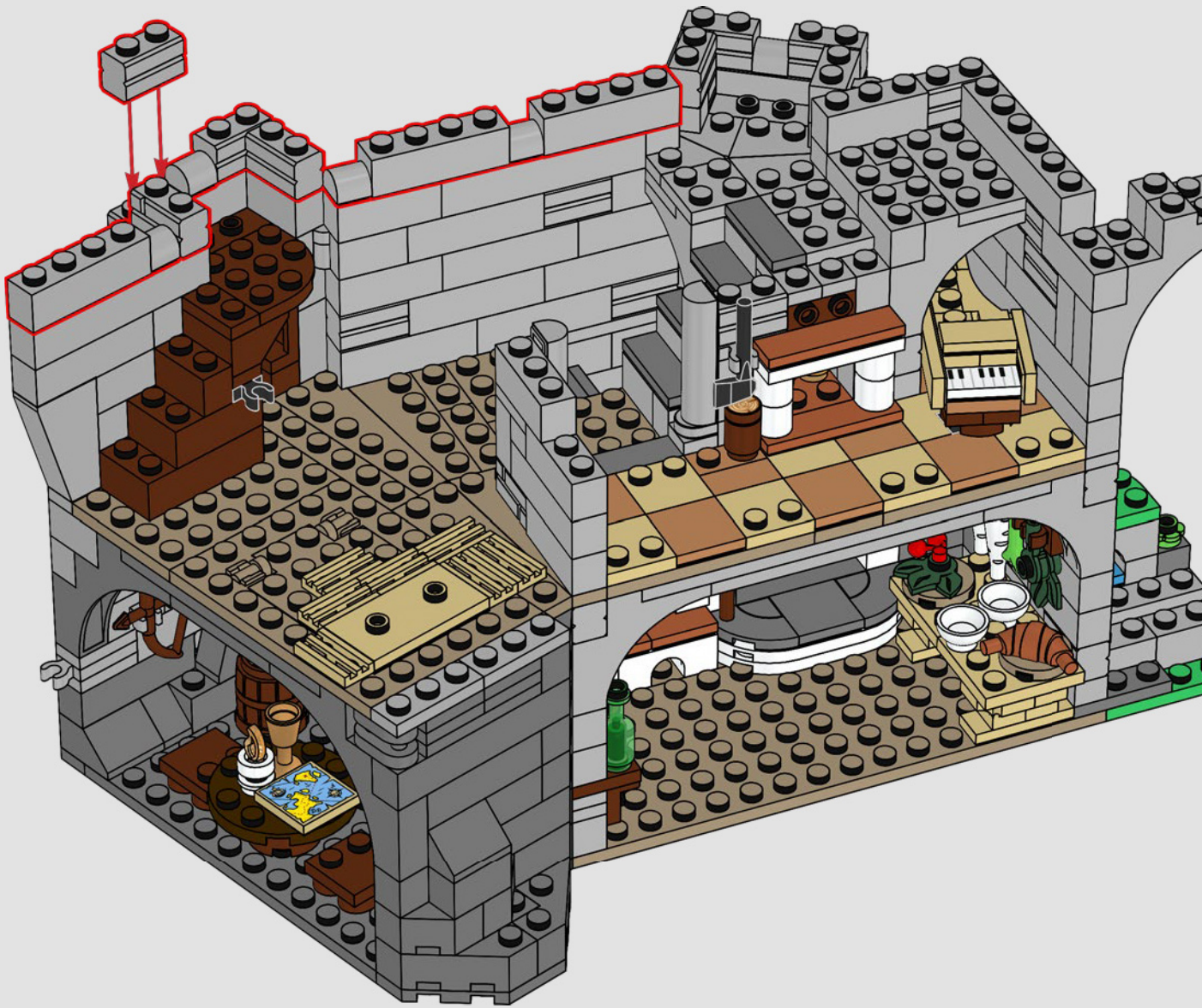



'Tis a majestic crenelation atop yon curtain wall!

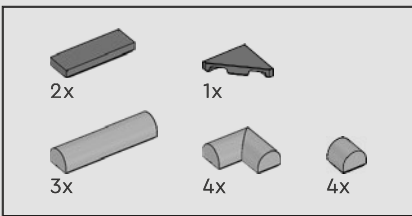

98



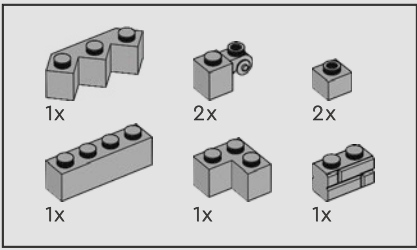

99

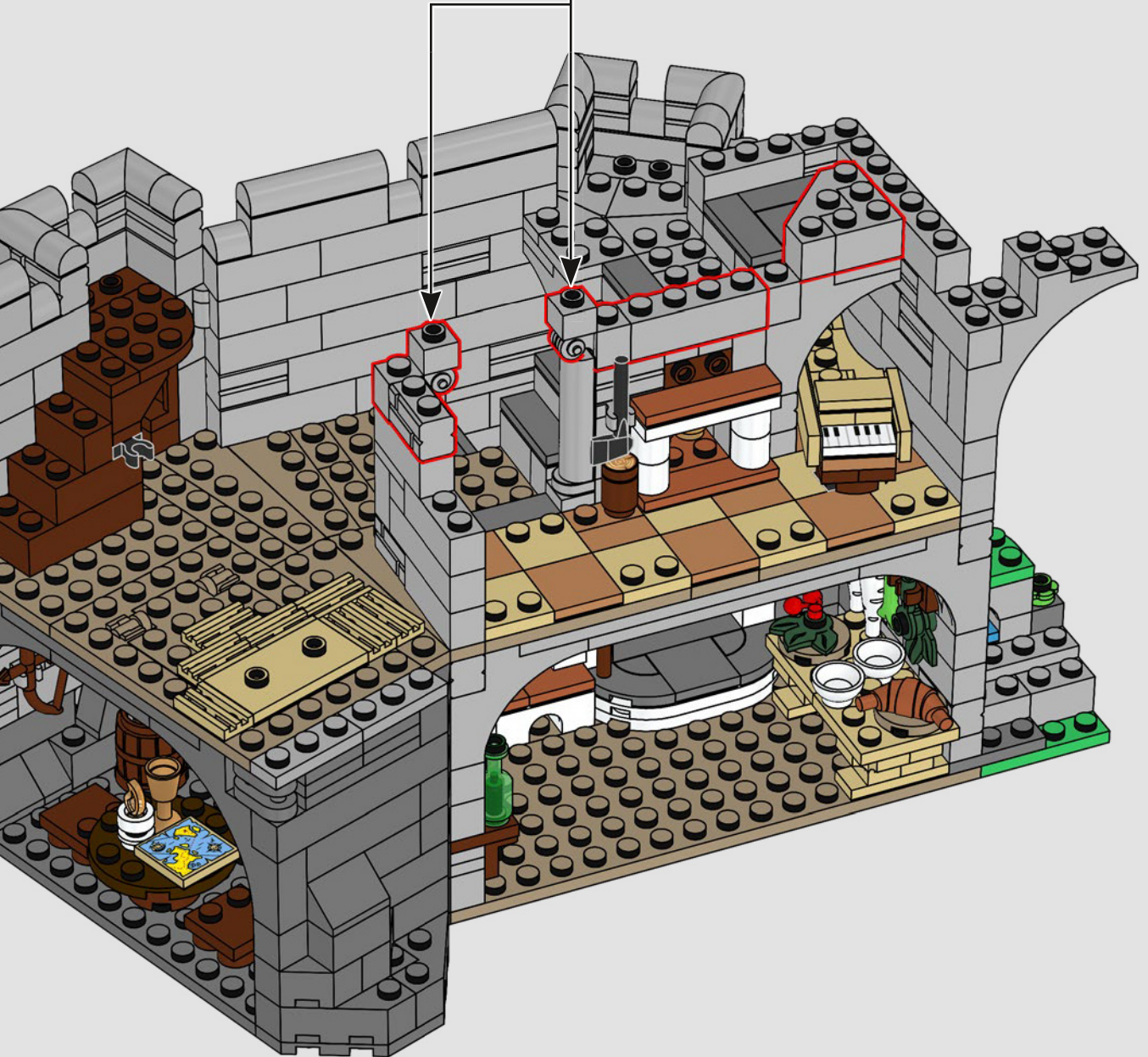
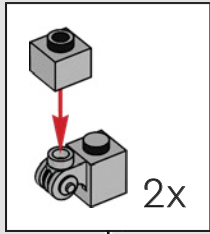



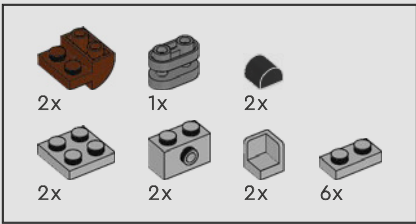

101

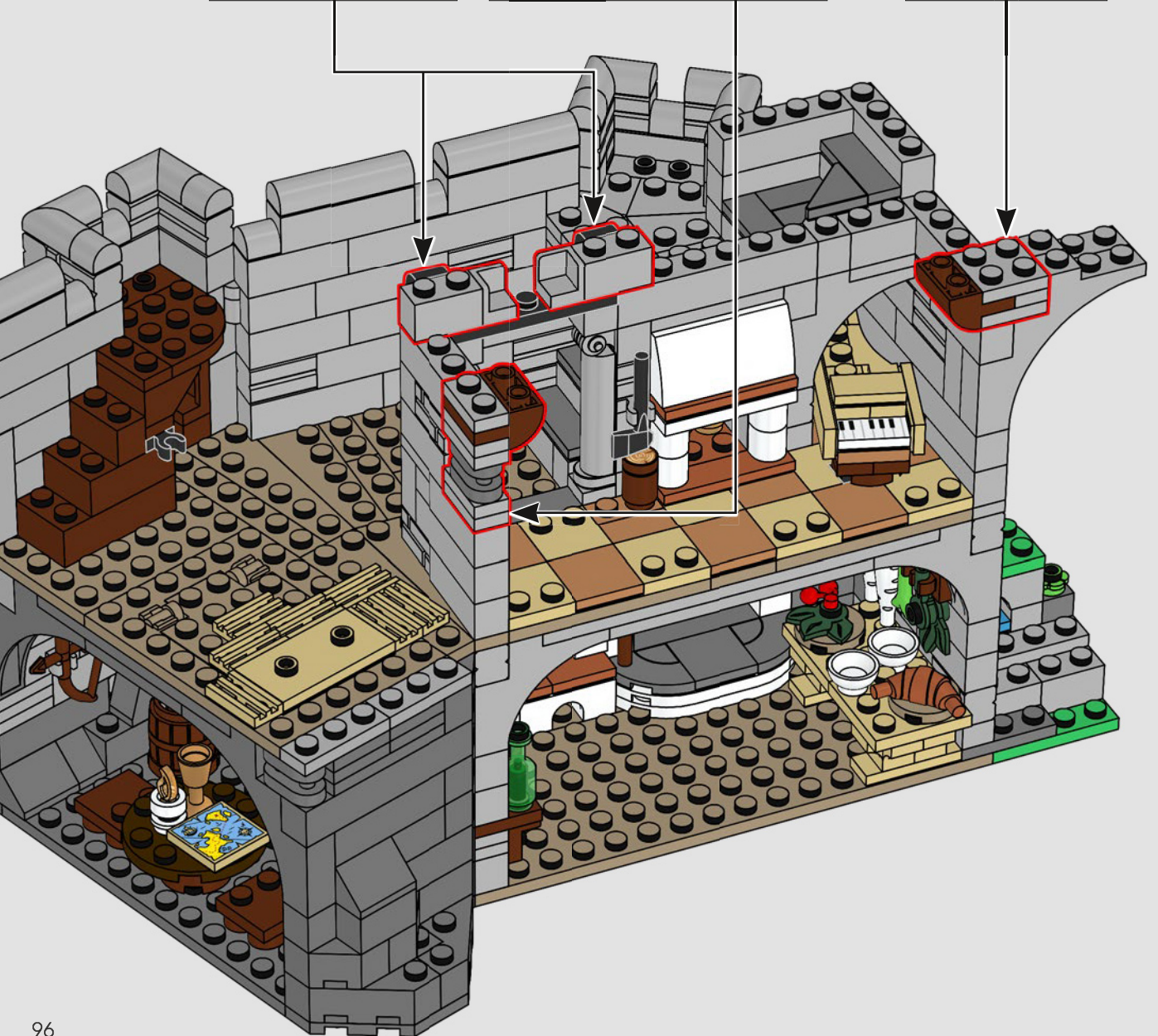
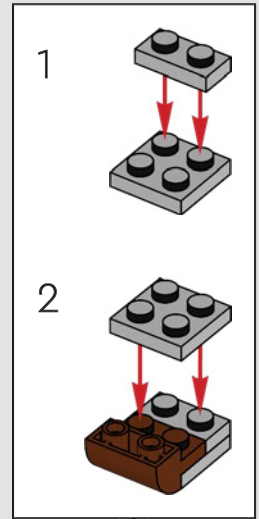
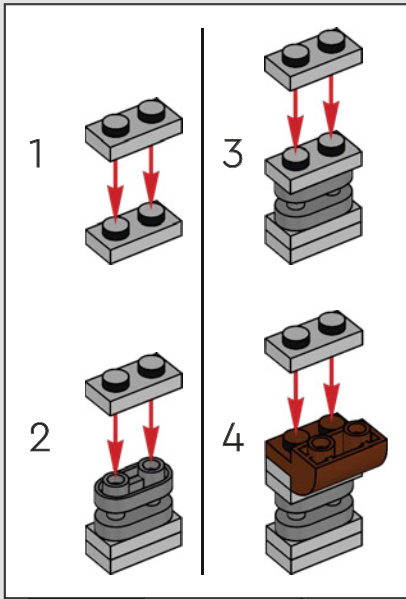
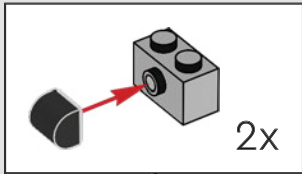



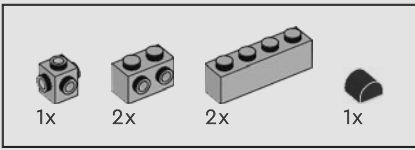

102

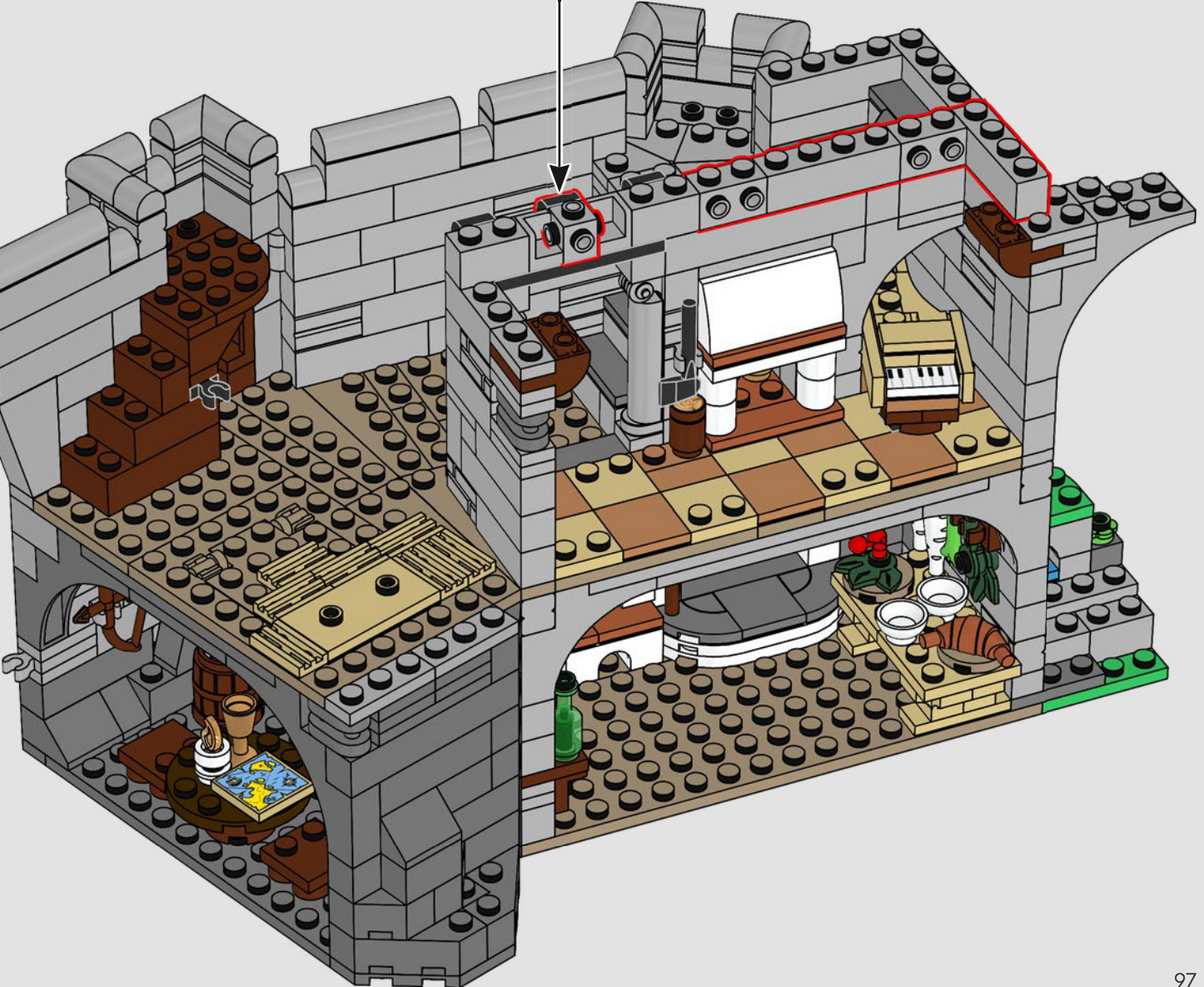
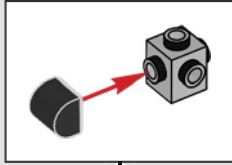

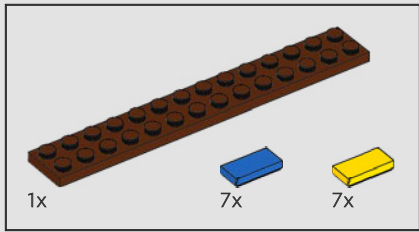

103

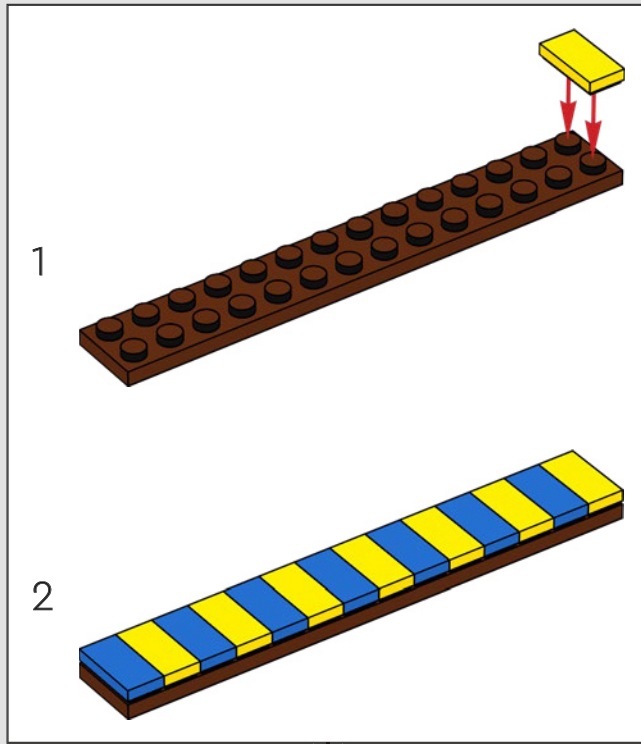

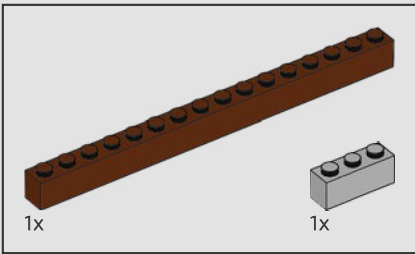

104



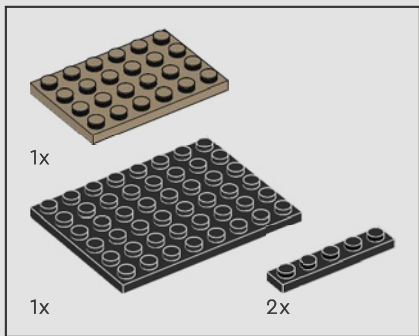

105

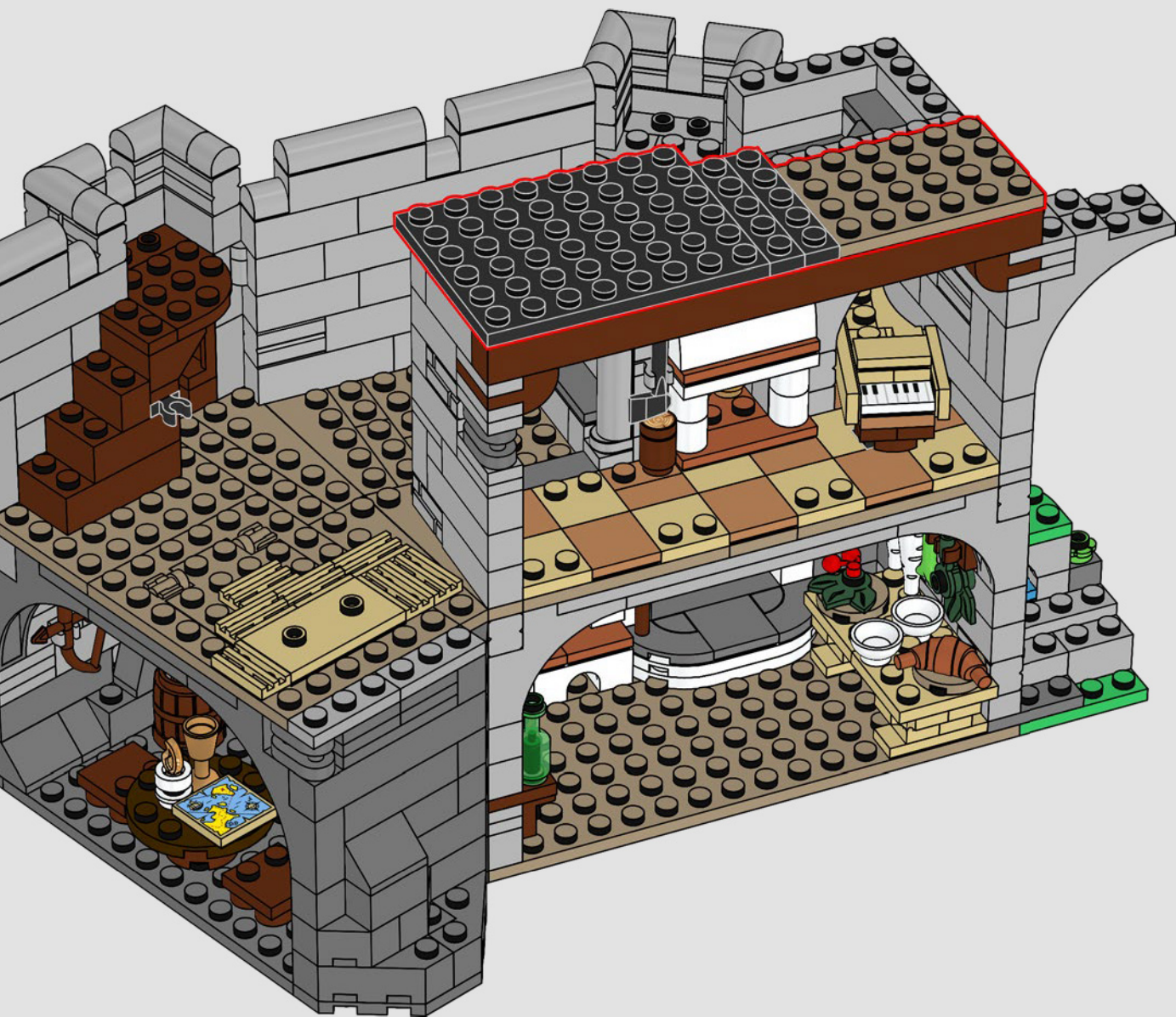

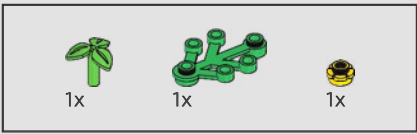

106

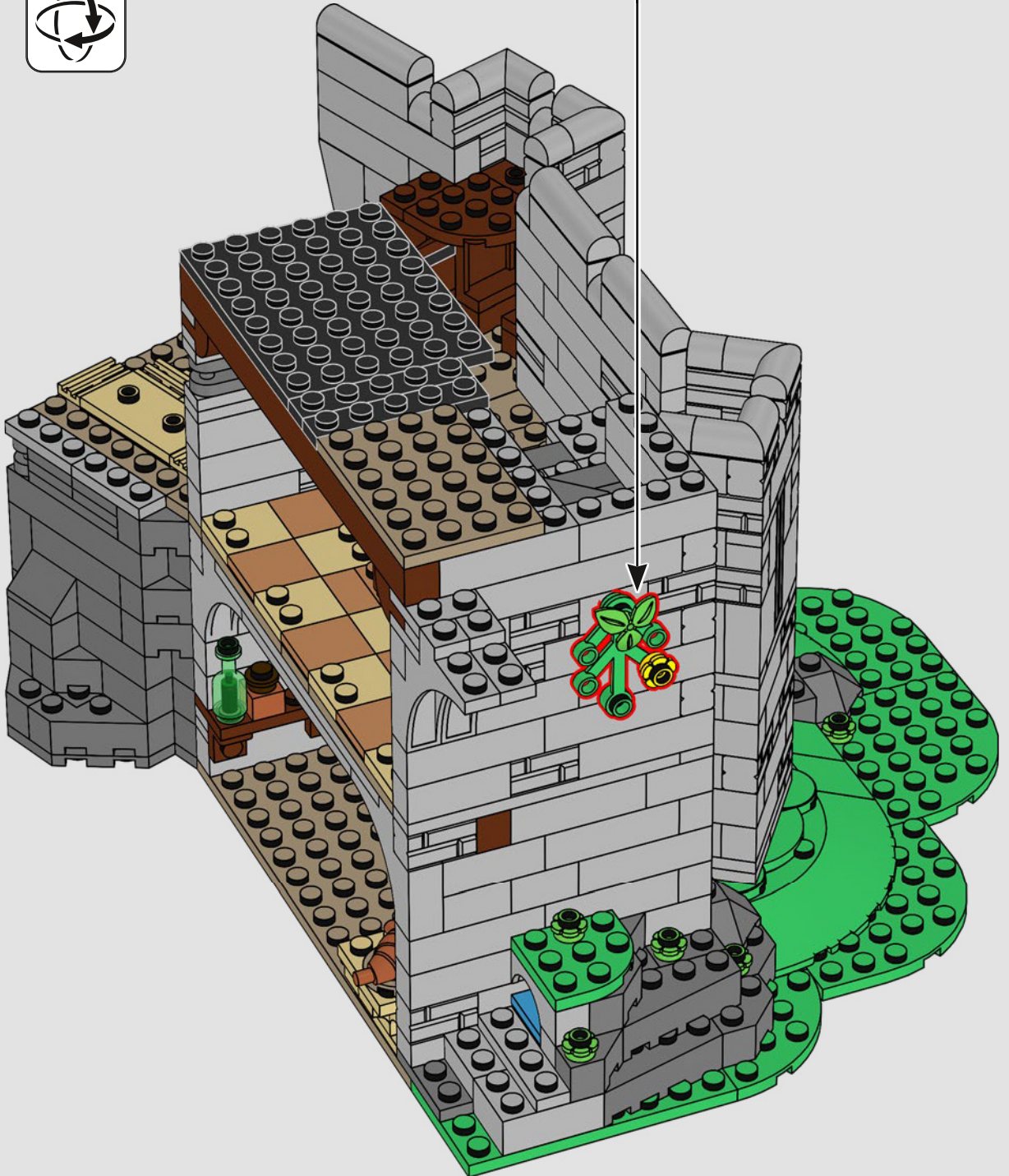
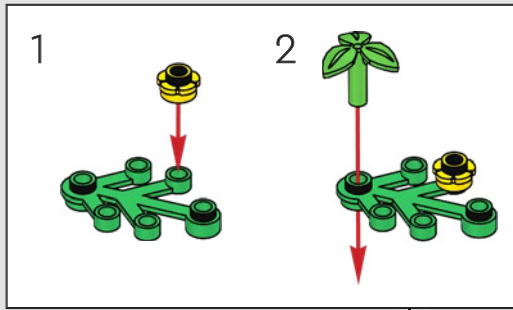

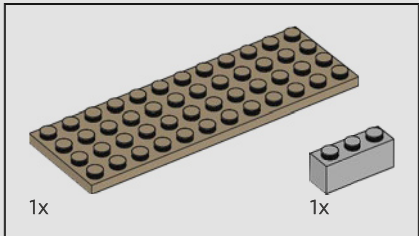
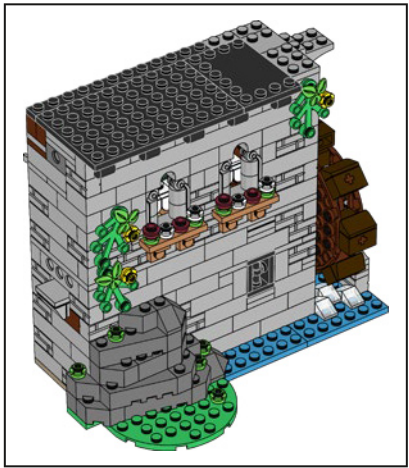

107

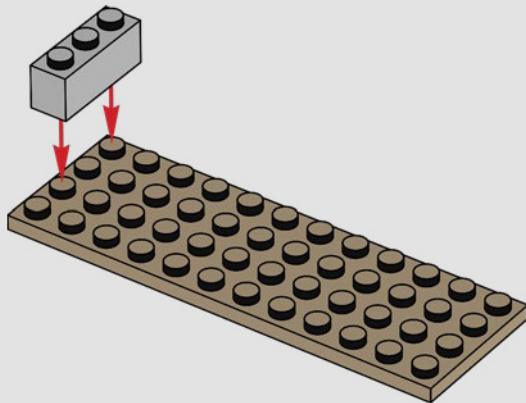

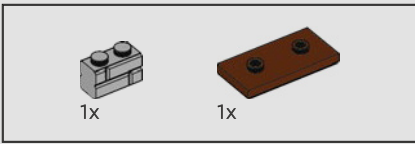

108

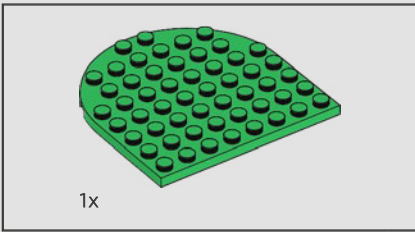
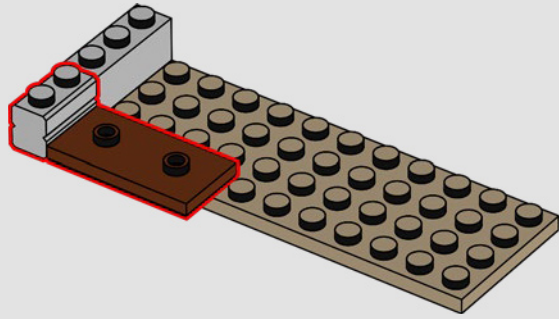

109

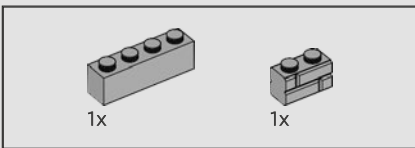
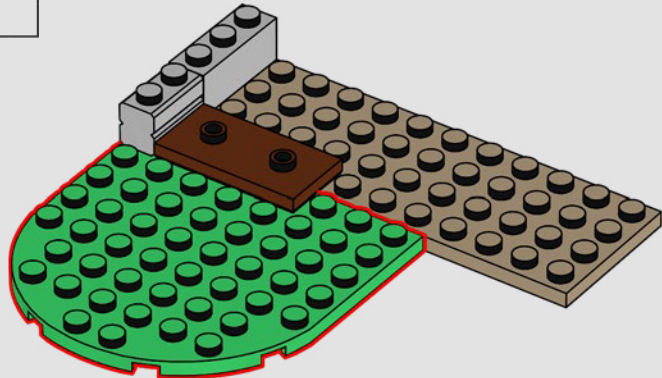

110

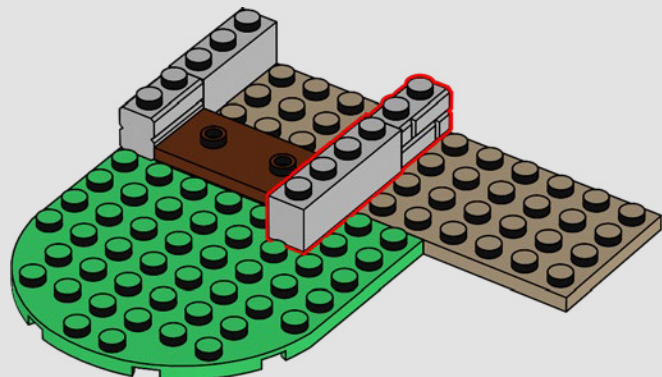

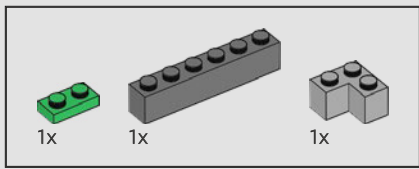

111

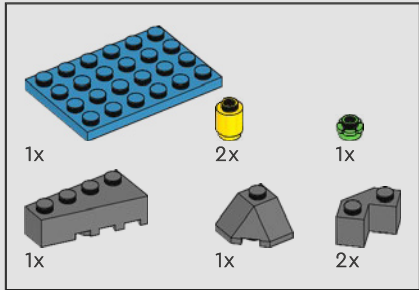
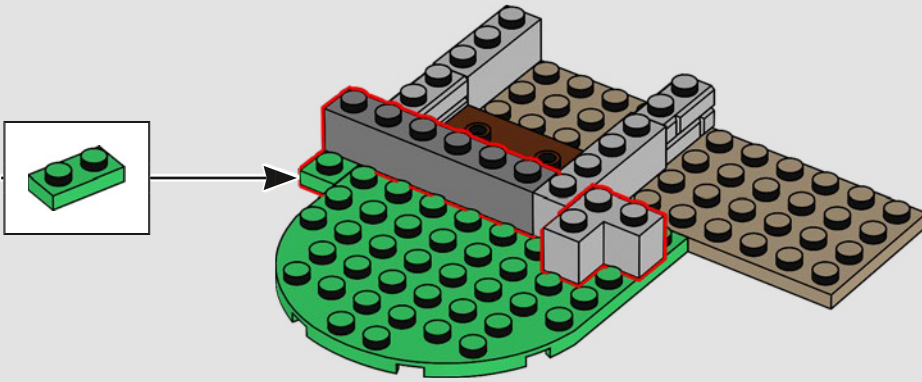

112

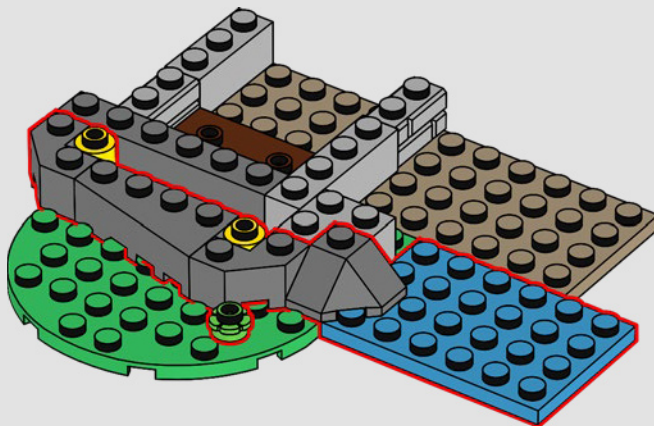



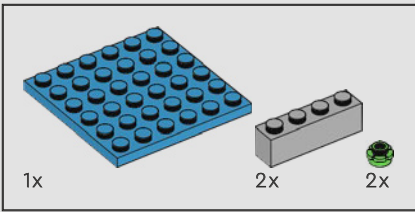

113

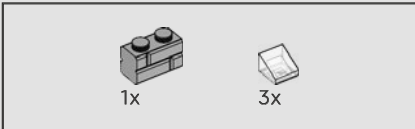
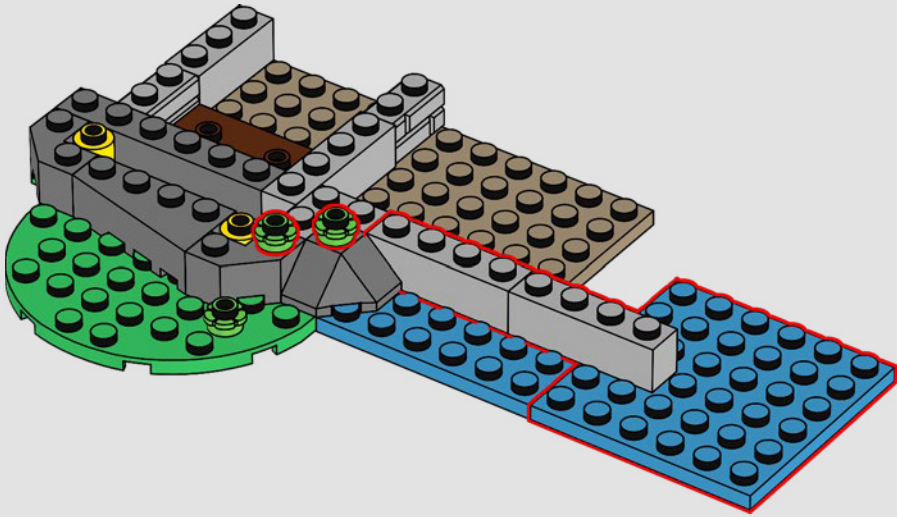

114

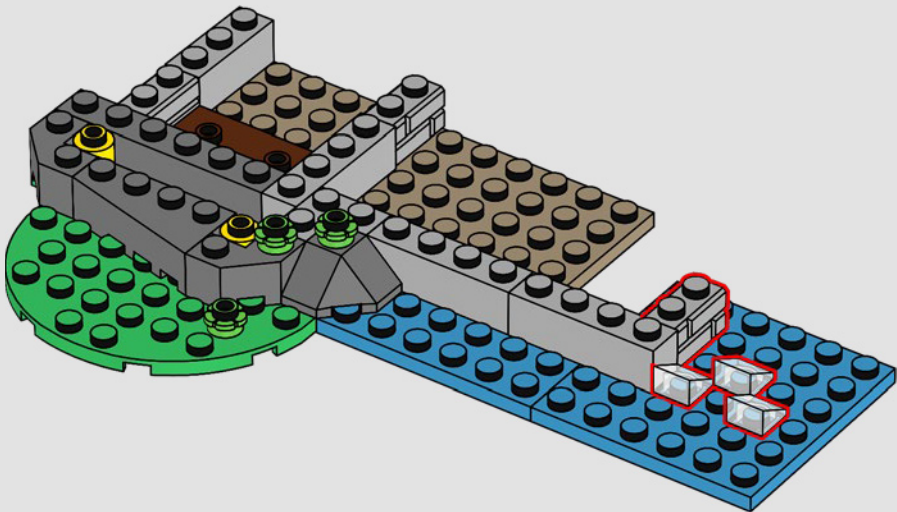

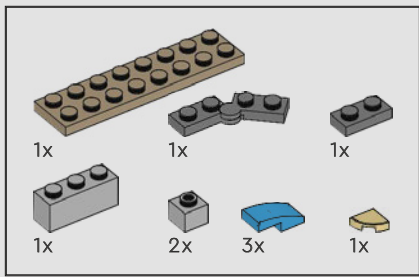

115

1

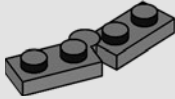

2

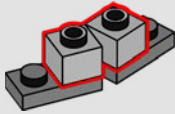

3

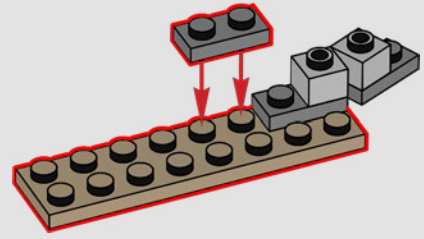

4

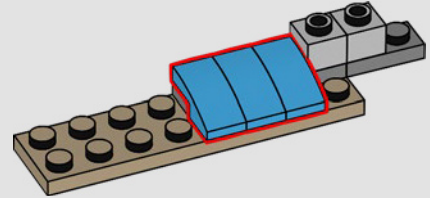

5

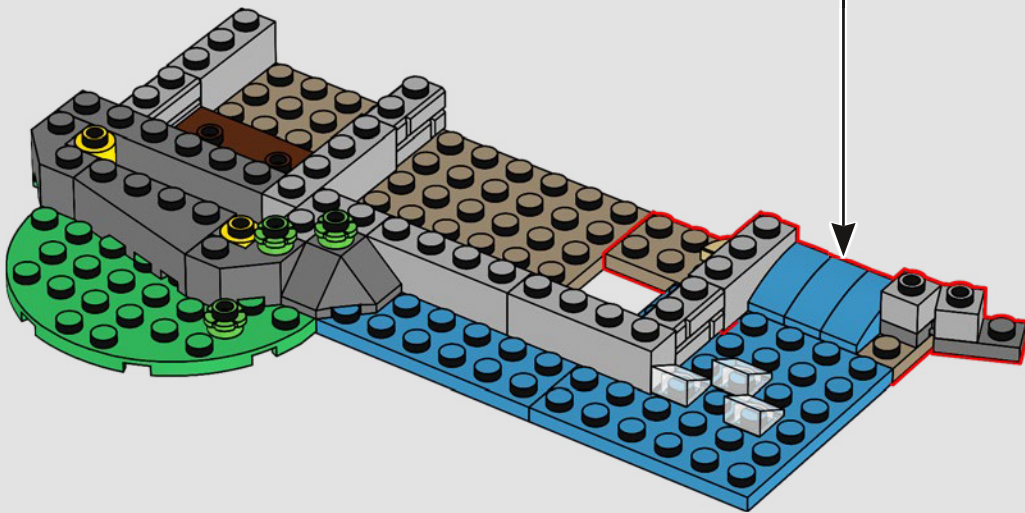
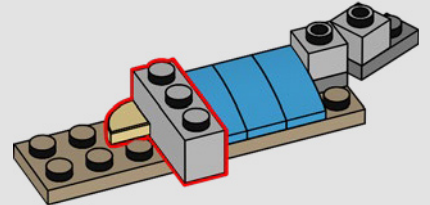

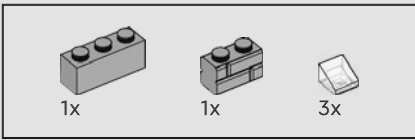

116

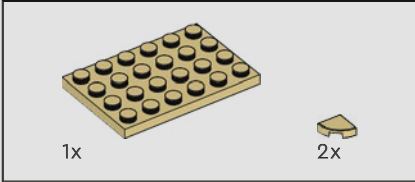
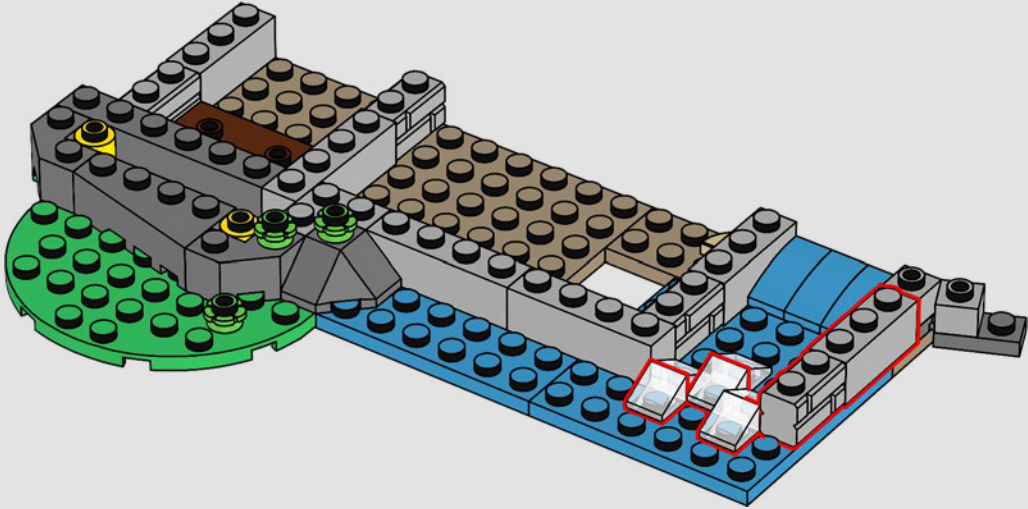

117

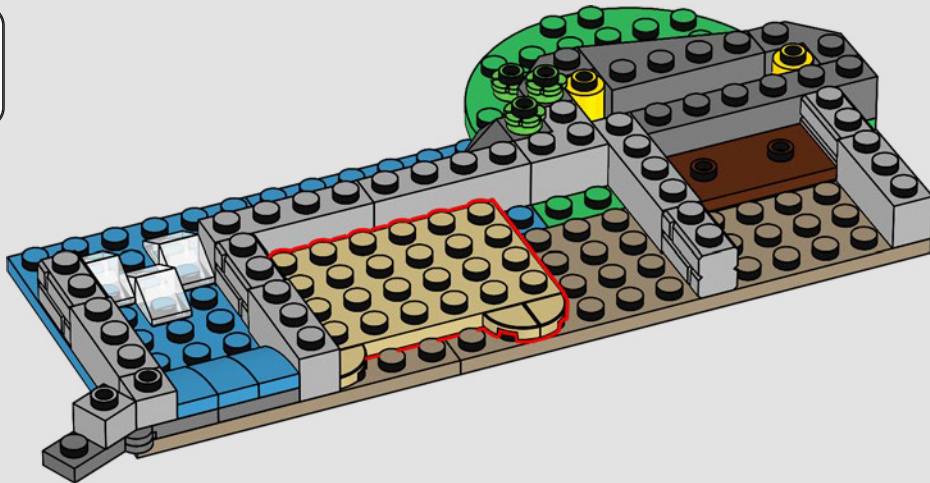



*This looks a fine spot to place a millstone of some kind, it could even be powered by yon stream...*

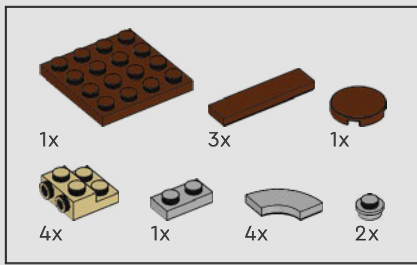

118

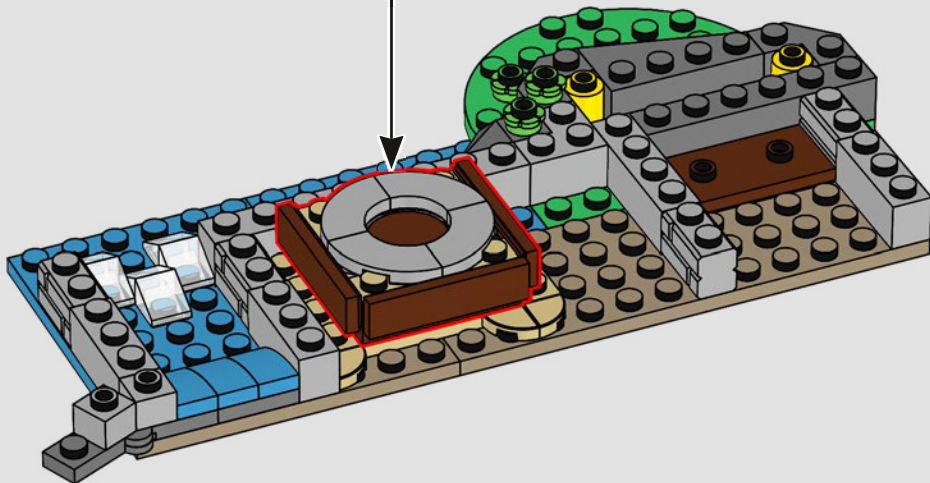
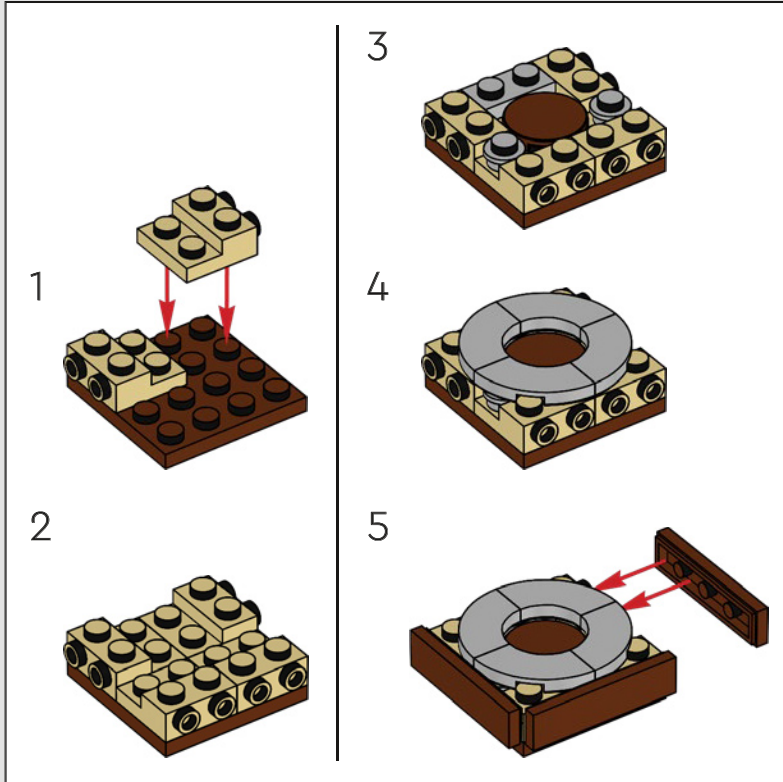

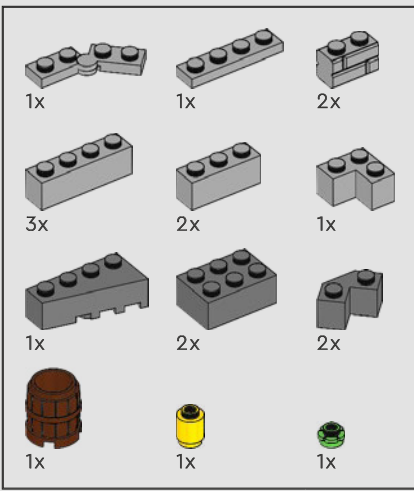

119

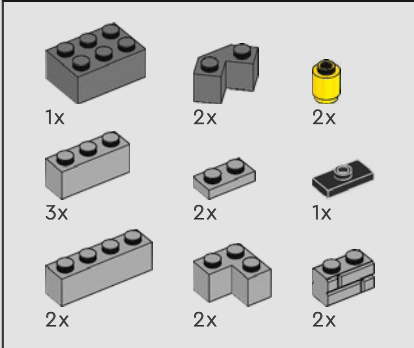
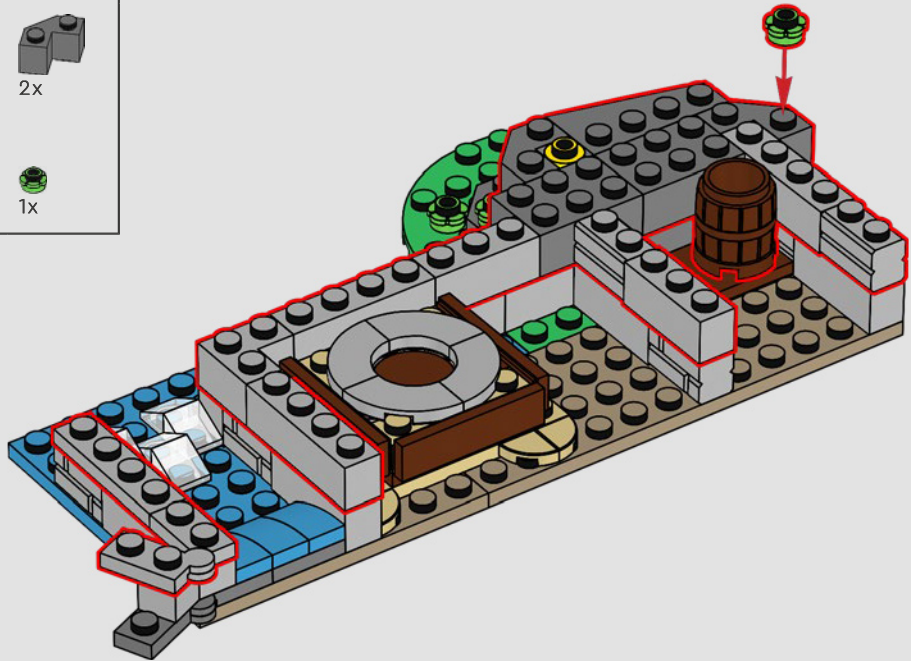

120

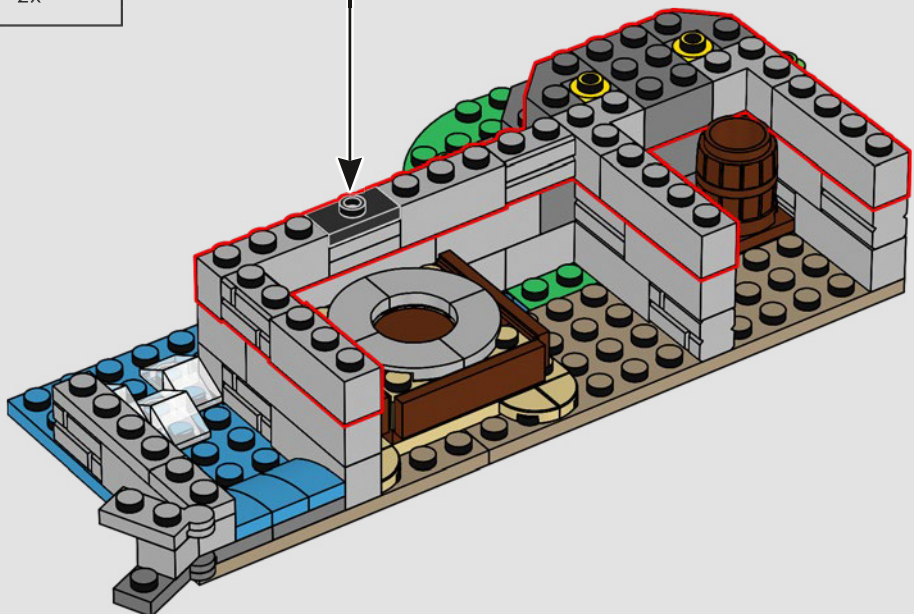
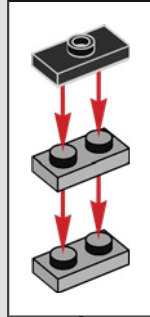

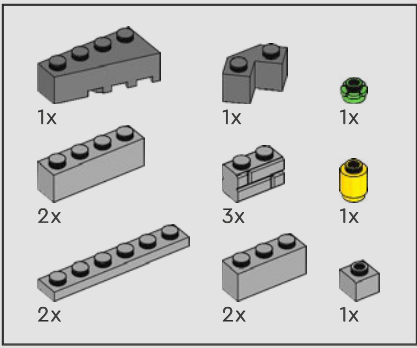

121

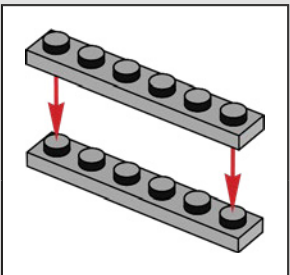
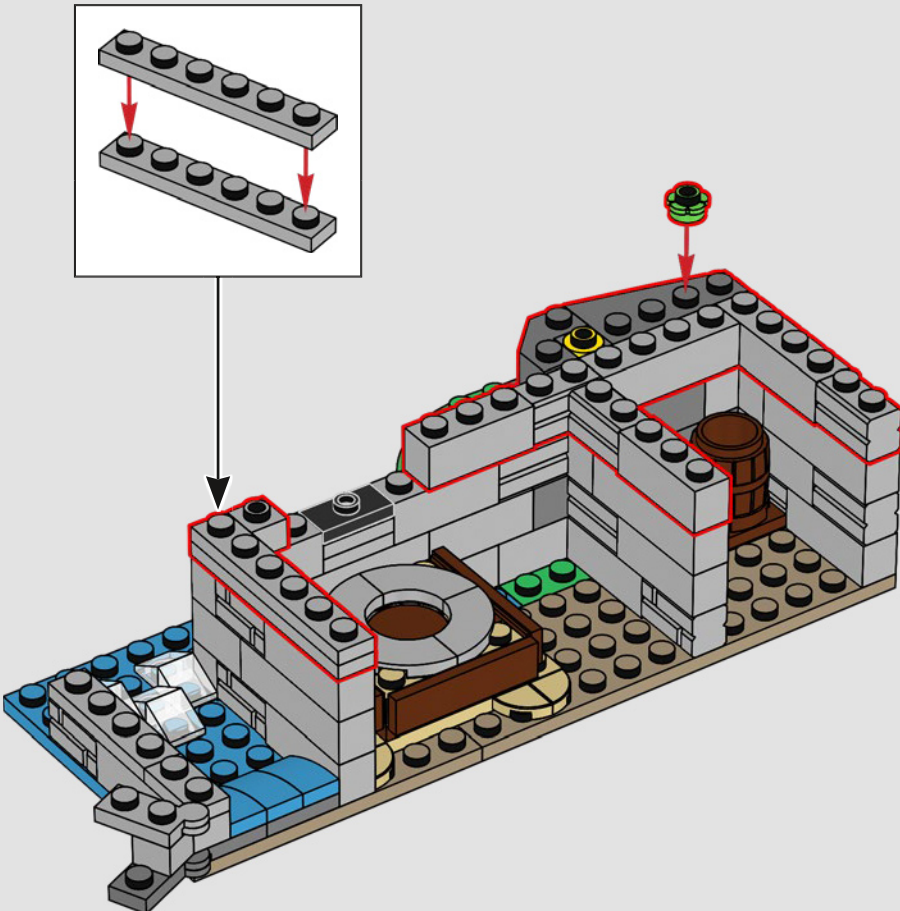

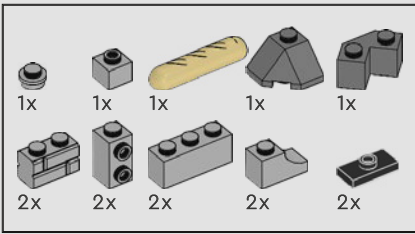

122

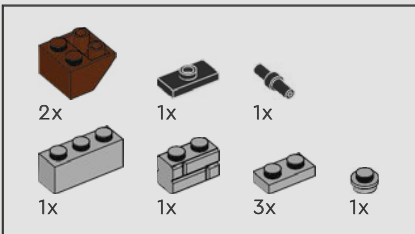
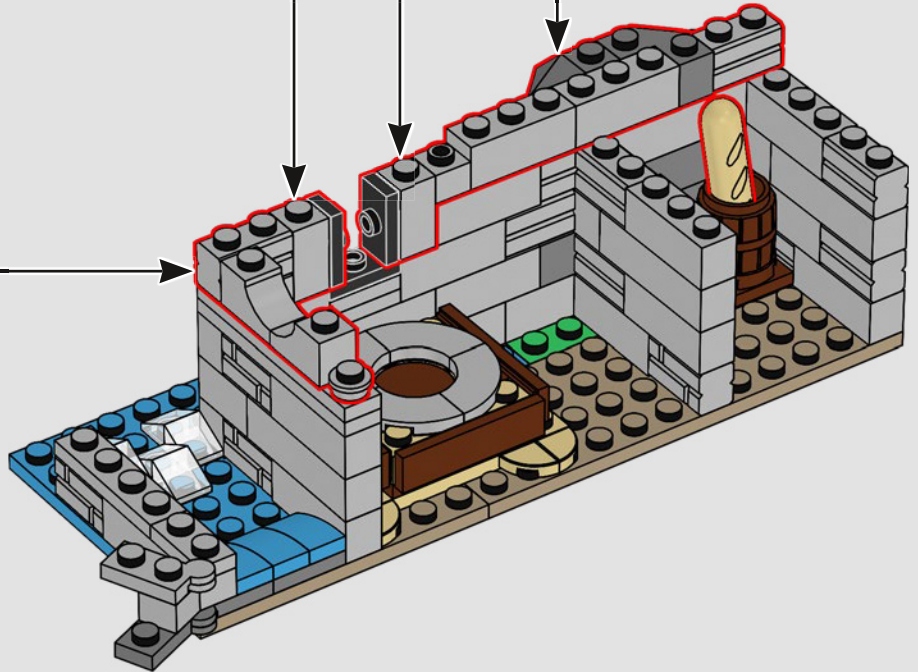
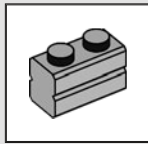
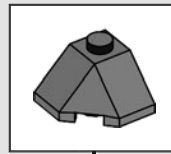
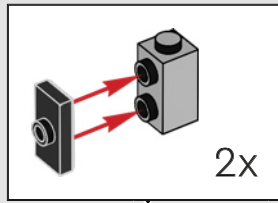

123

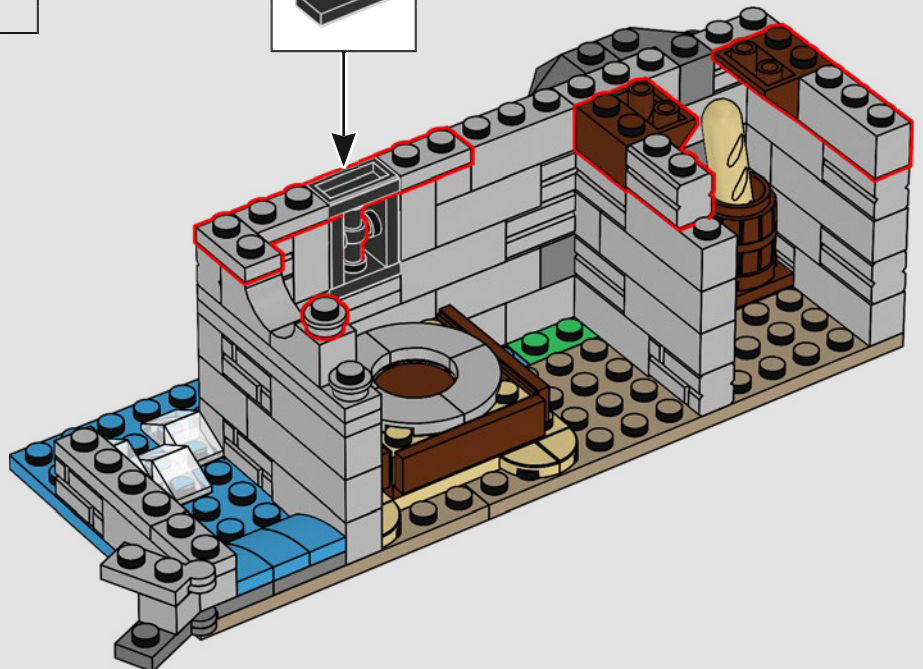
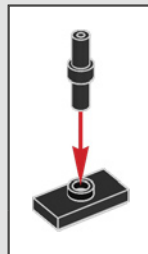

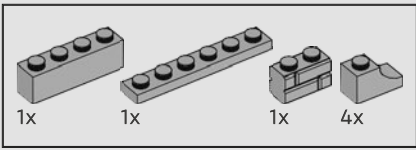

124

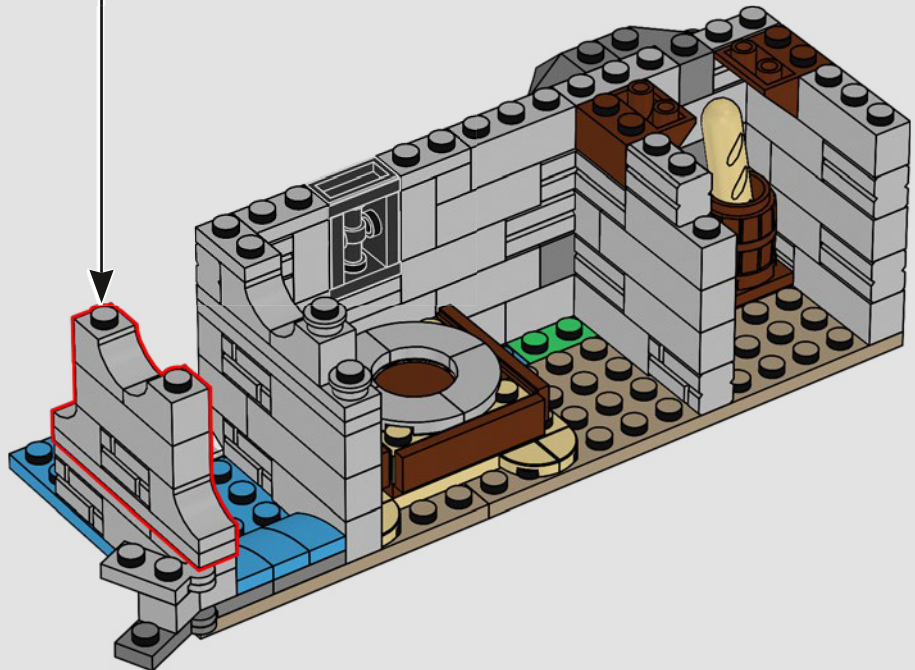
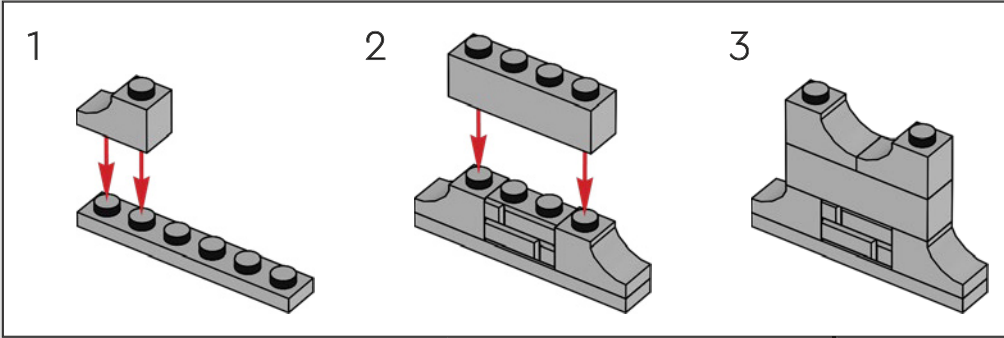



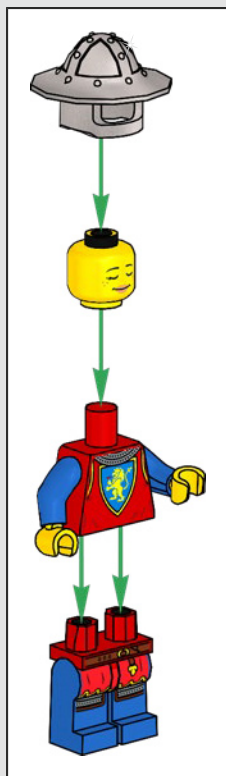

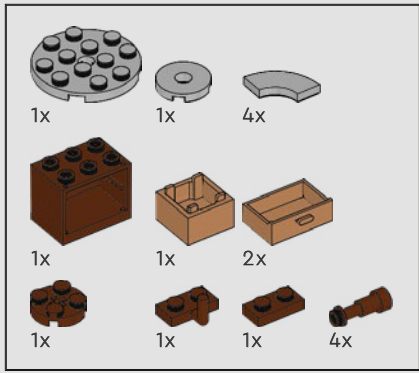

125

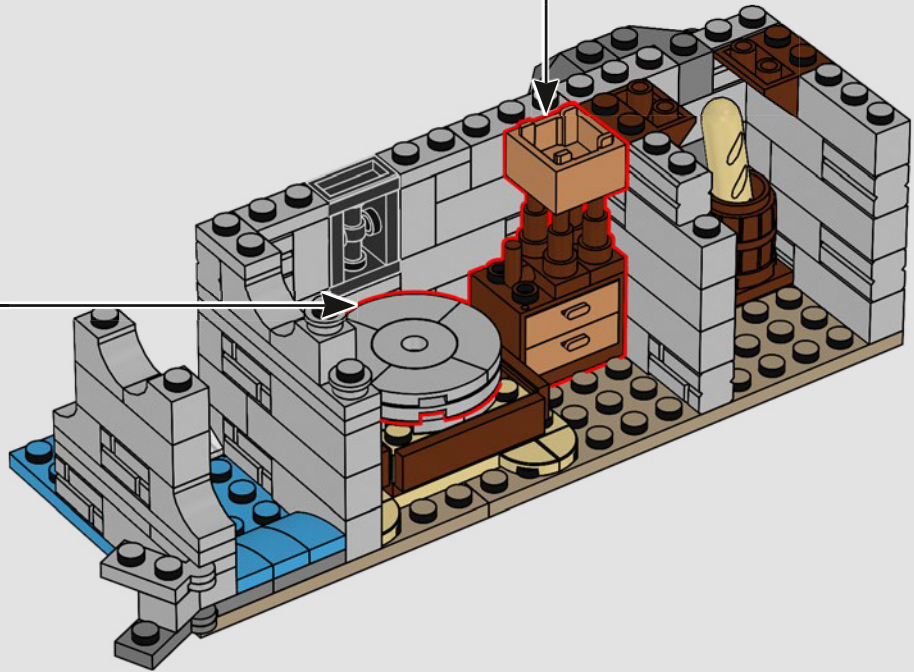
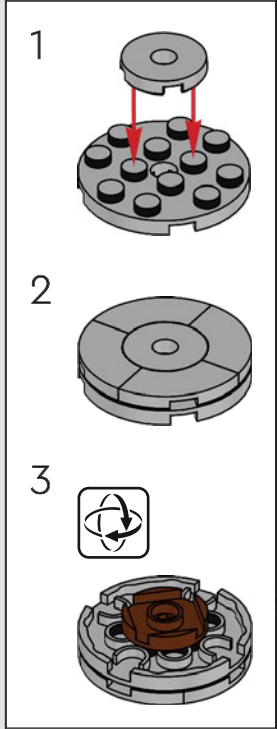
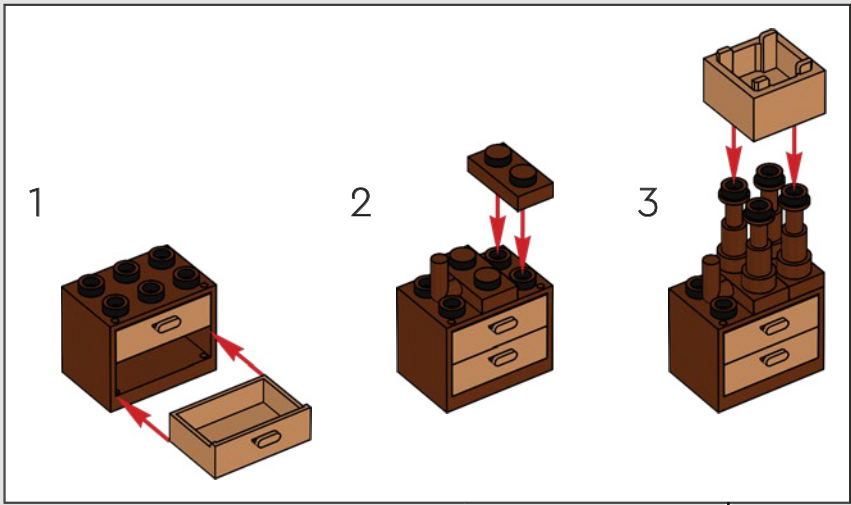

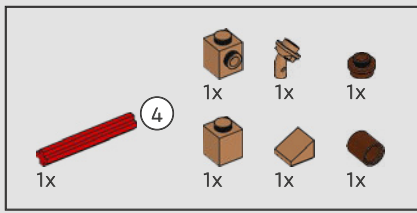

126

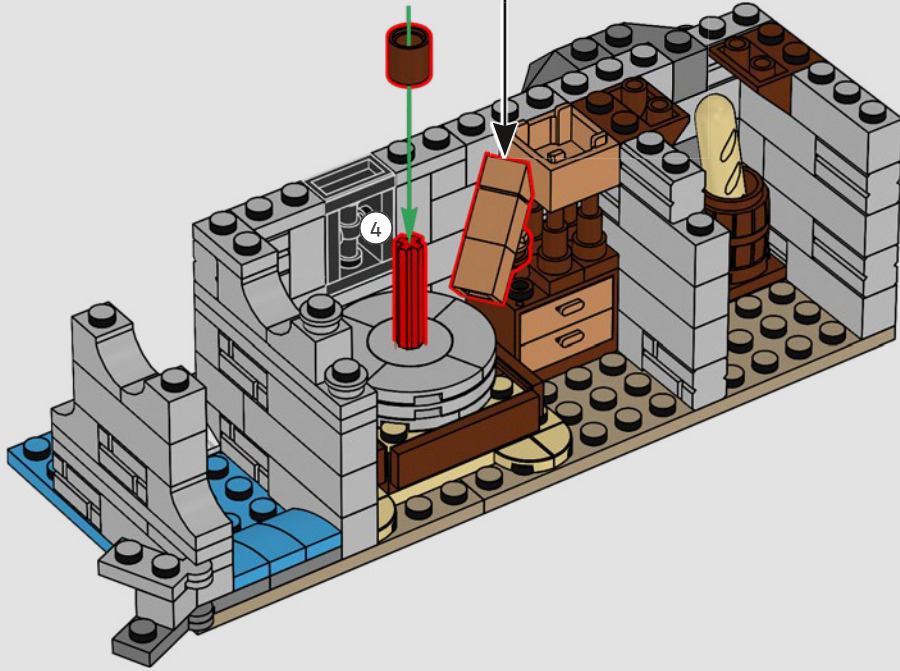
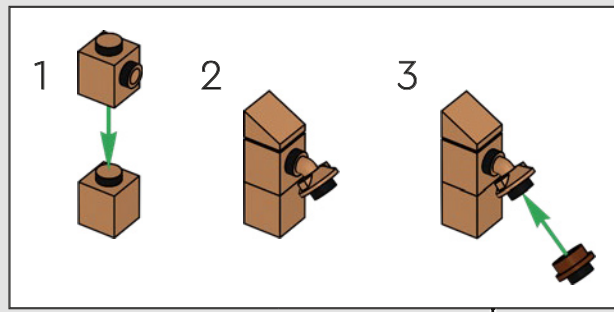

127

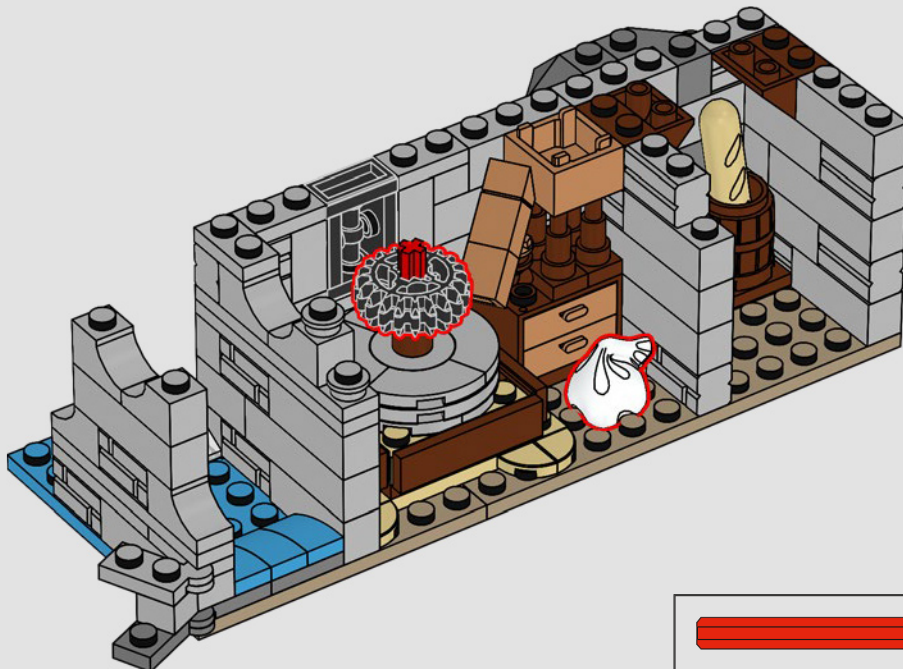

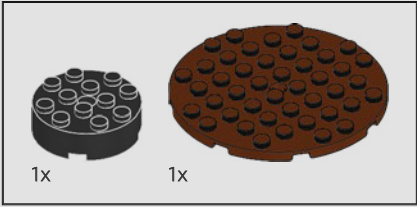
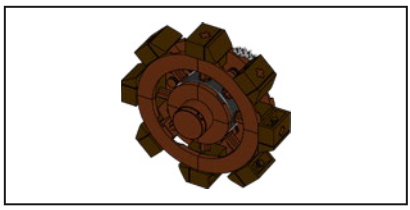

128

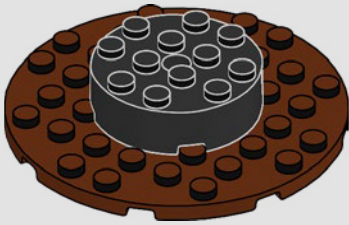

129

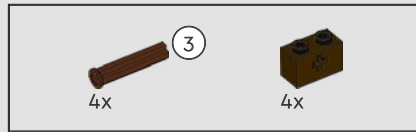
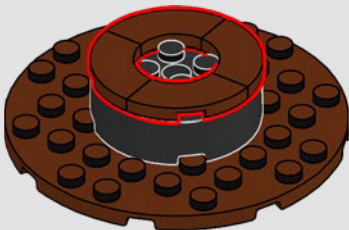

130

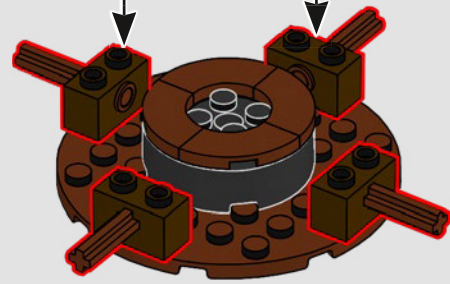
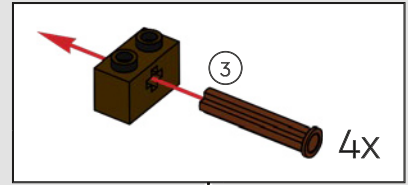

131

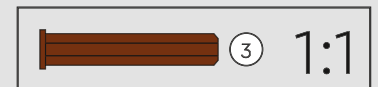
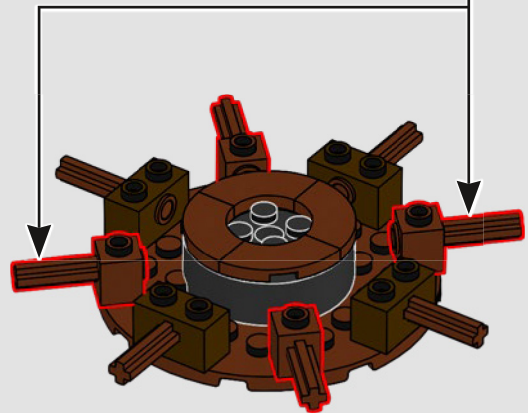
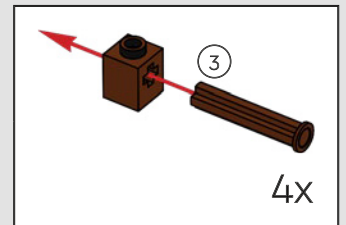

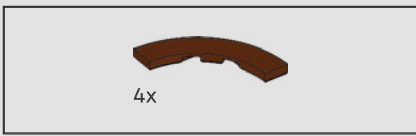

132

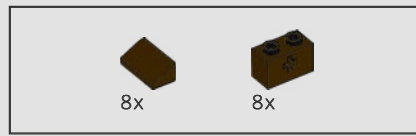
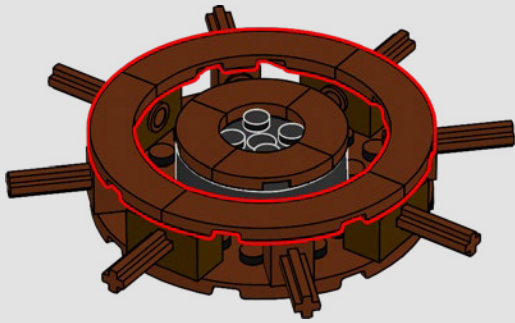

134

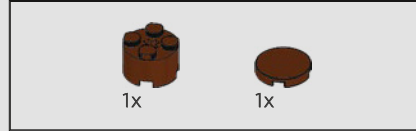
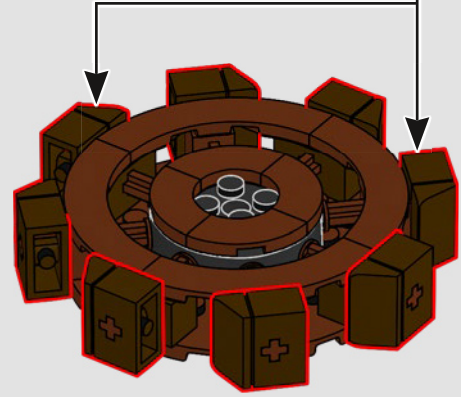
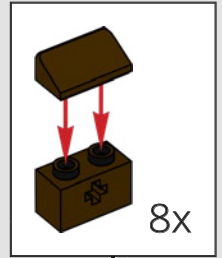

135

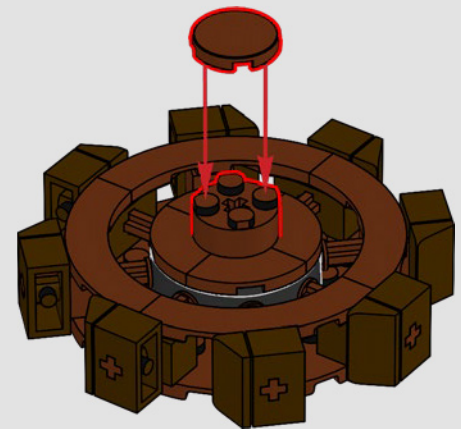

133

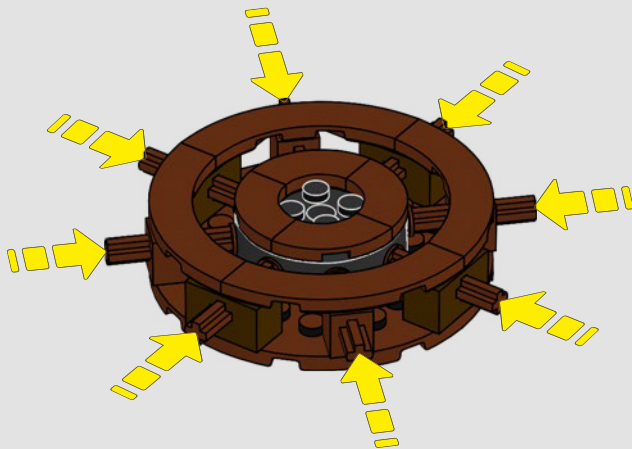

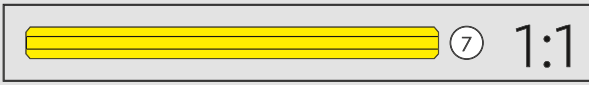
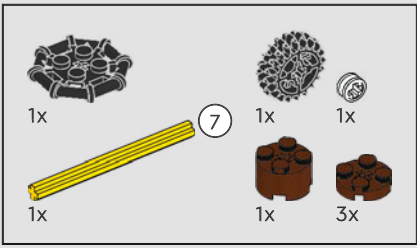

136

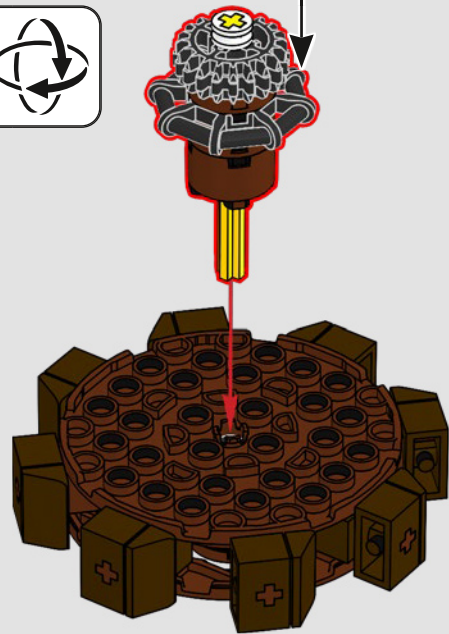
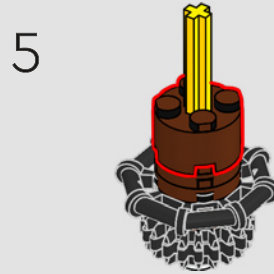
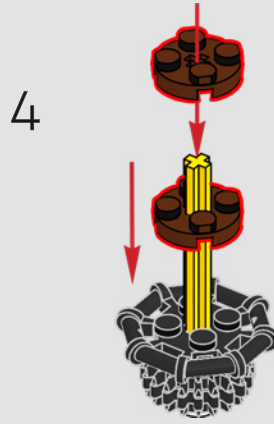
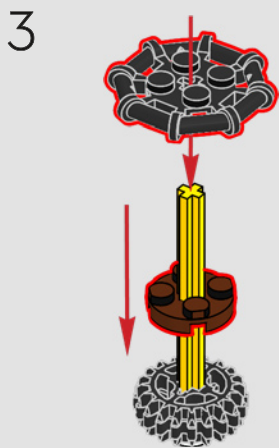
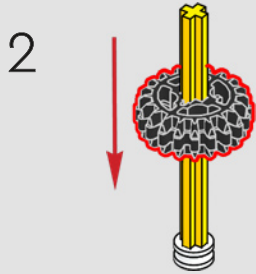
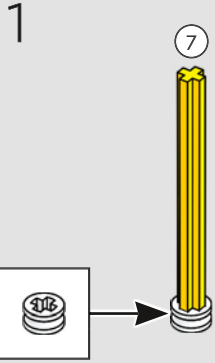



*The power of this waterwheel is immense!  
It will be perfect to turn the millstone!*

137

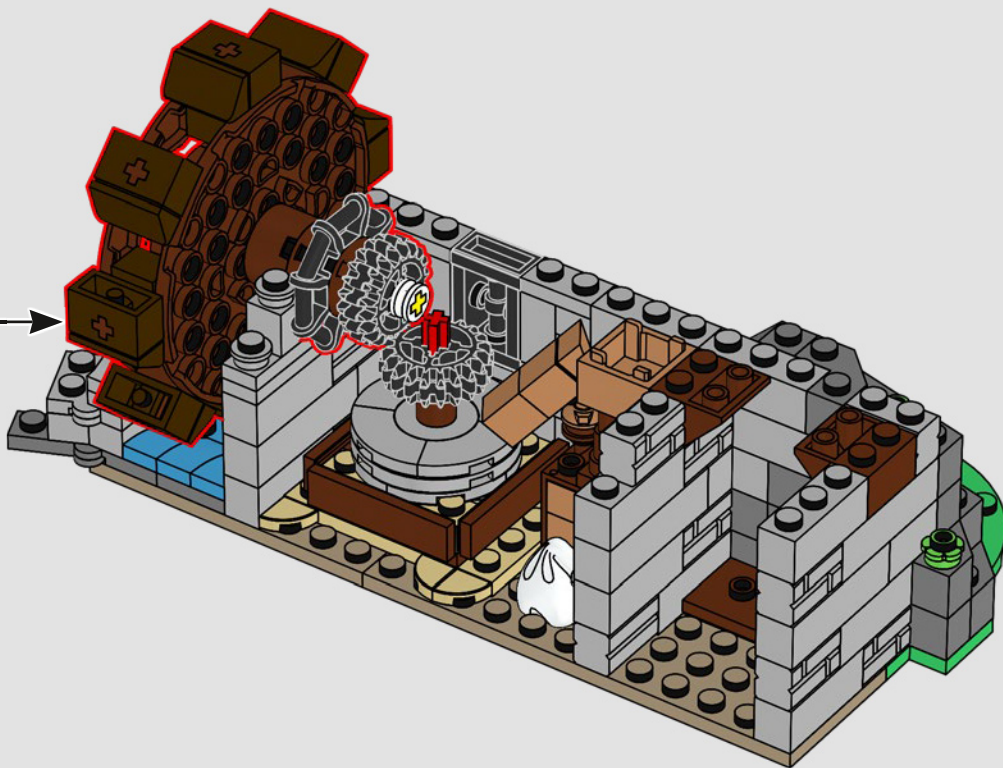

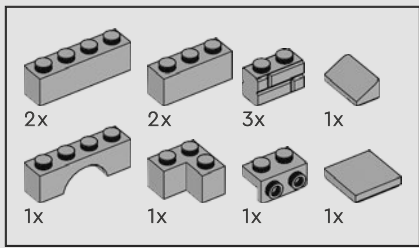

138

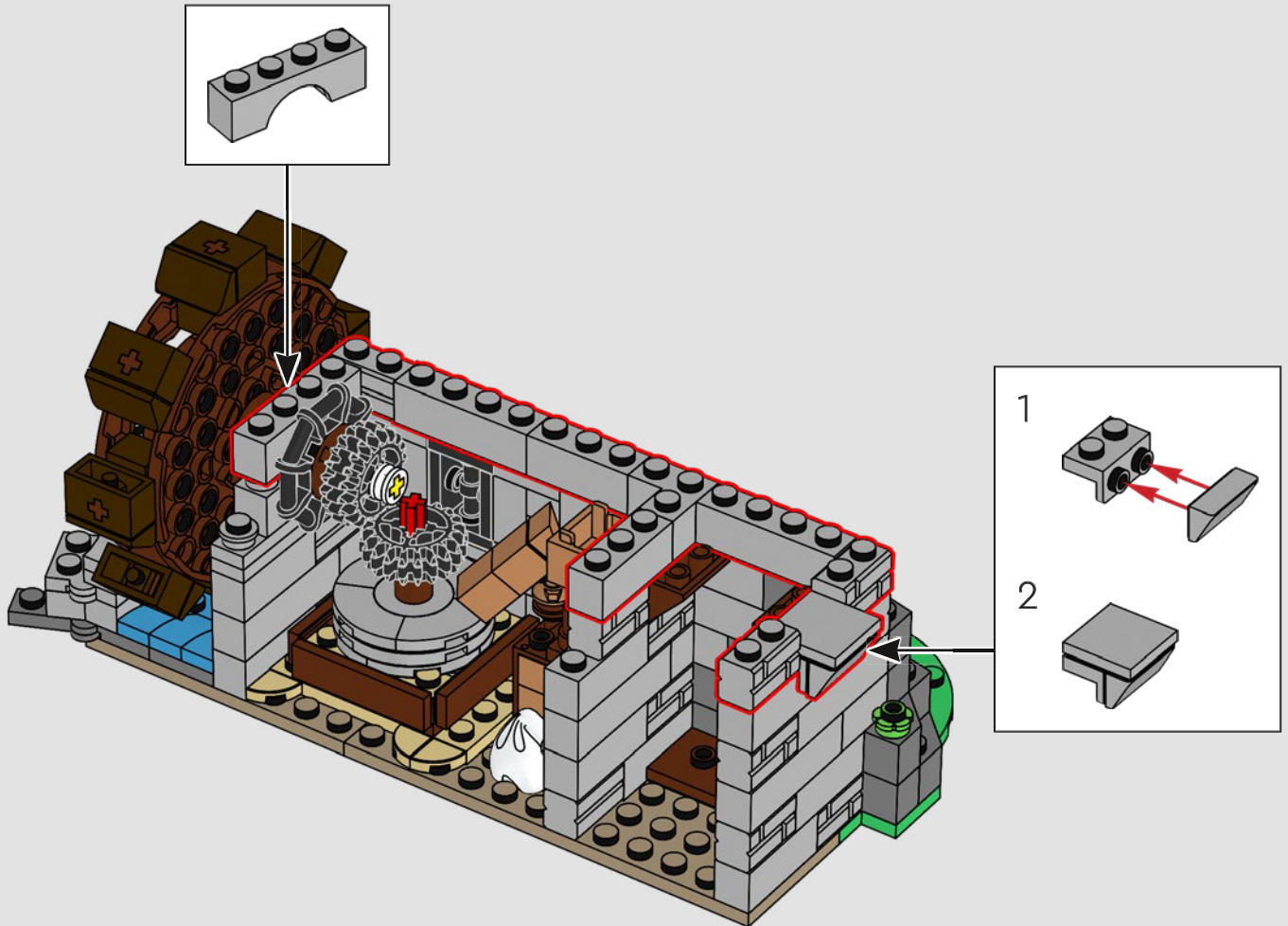





A bird's nest!

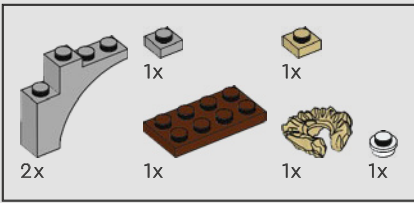

139

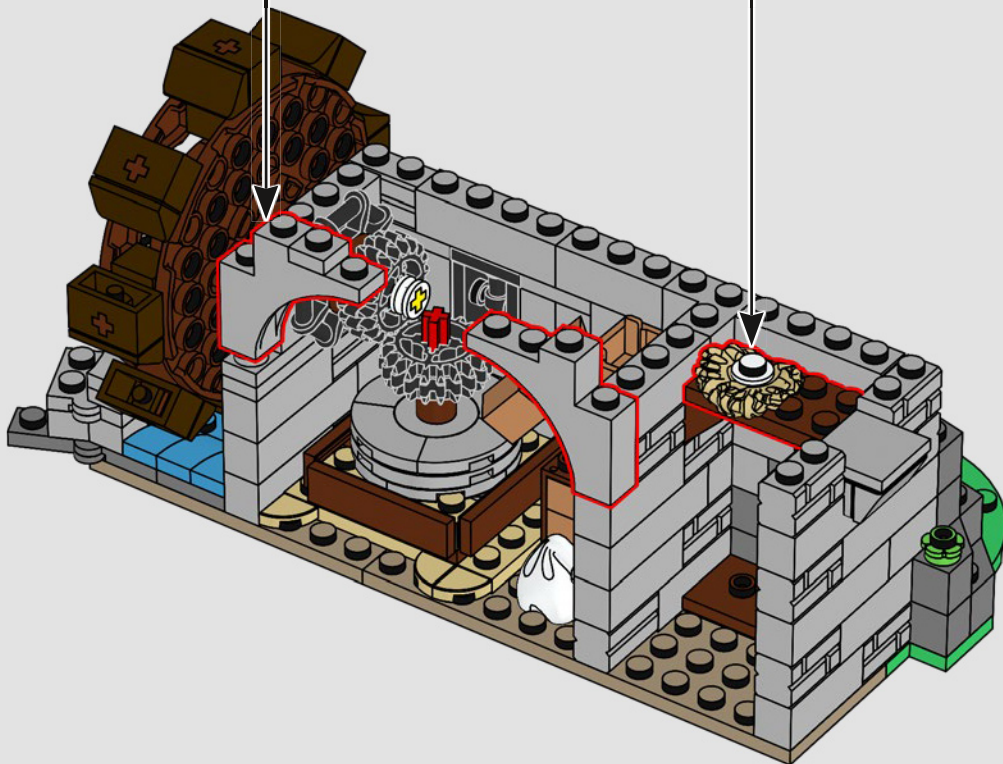
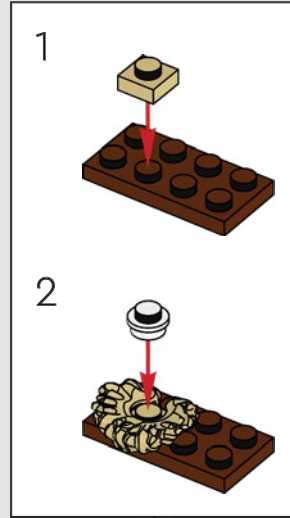
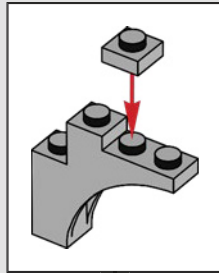

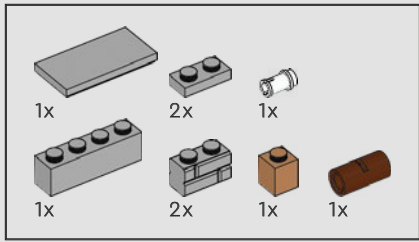

140

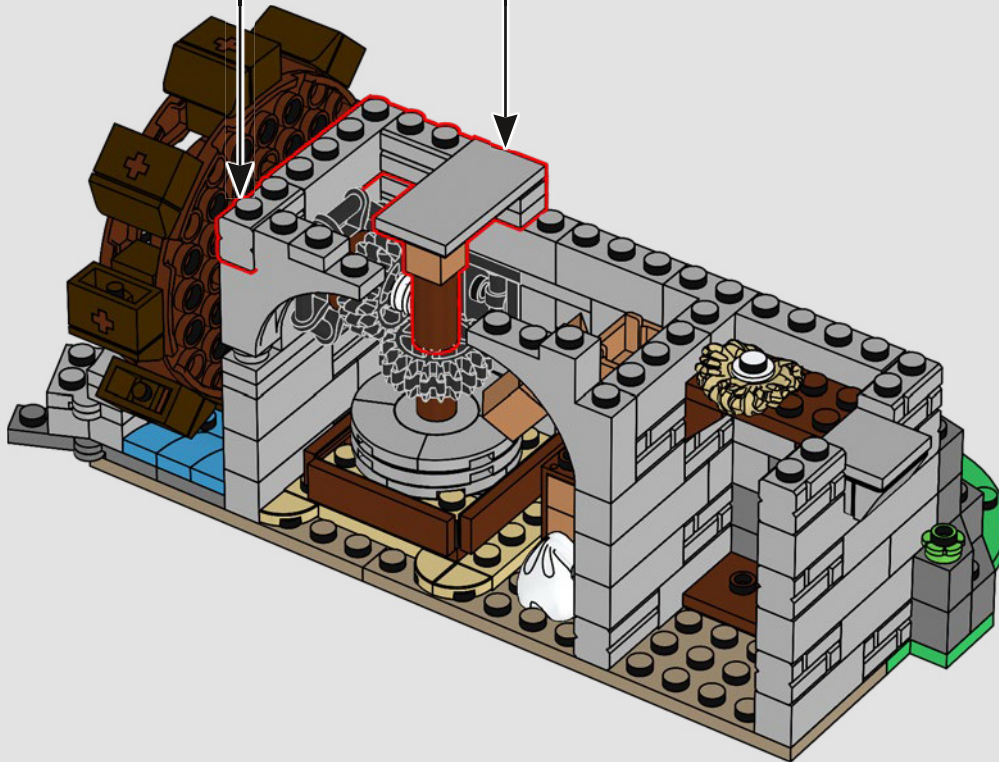
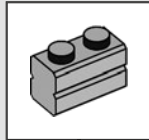
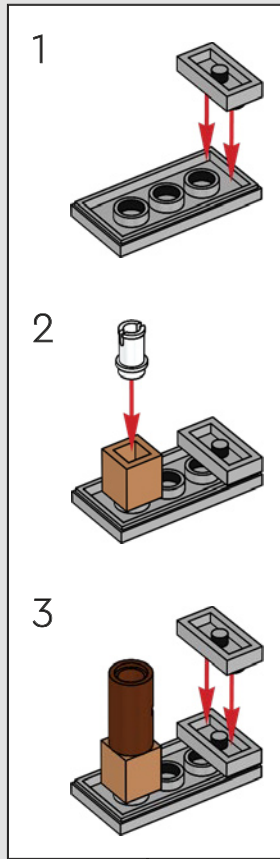

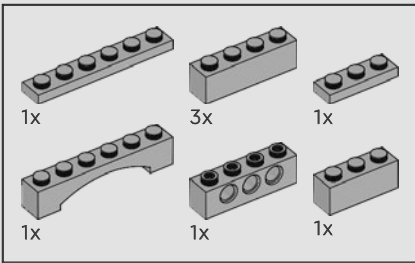

141

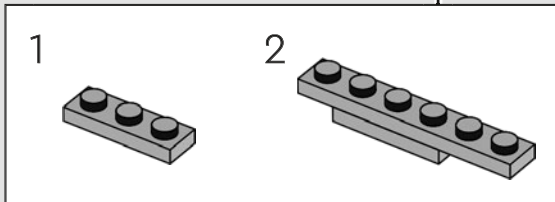
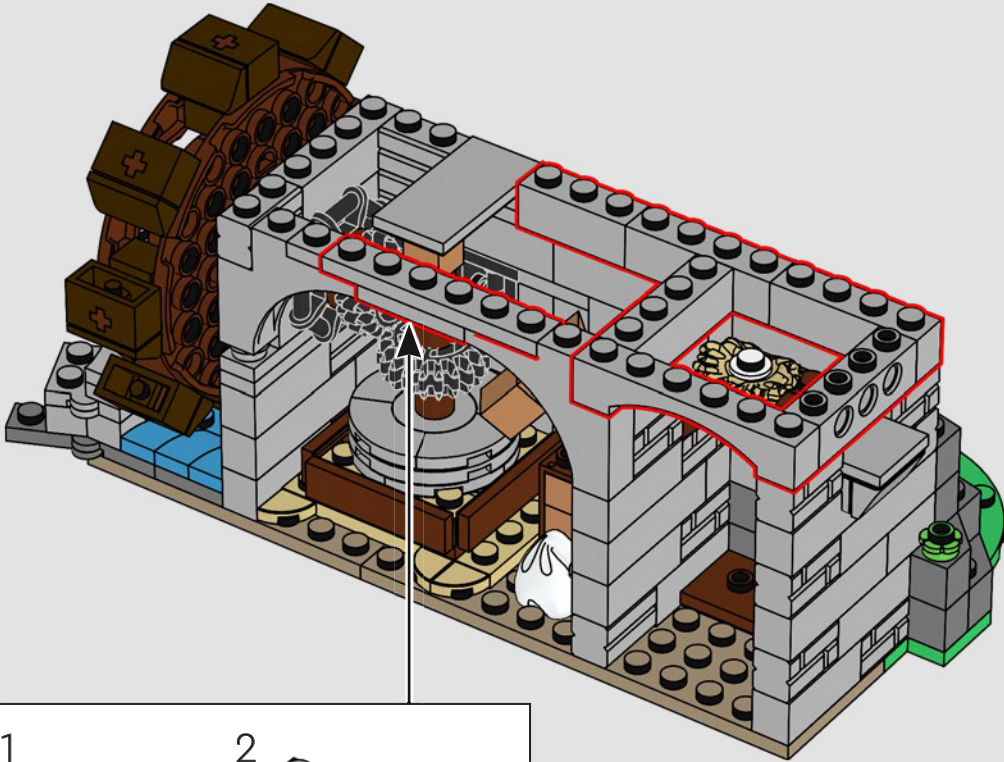

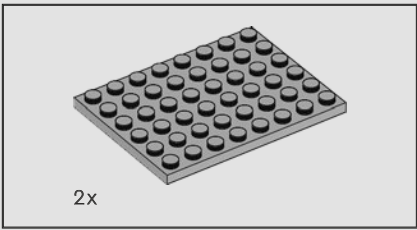

142

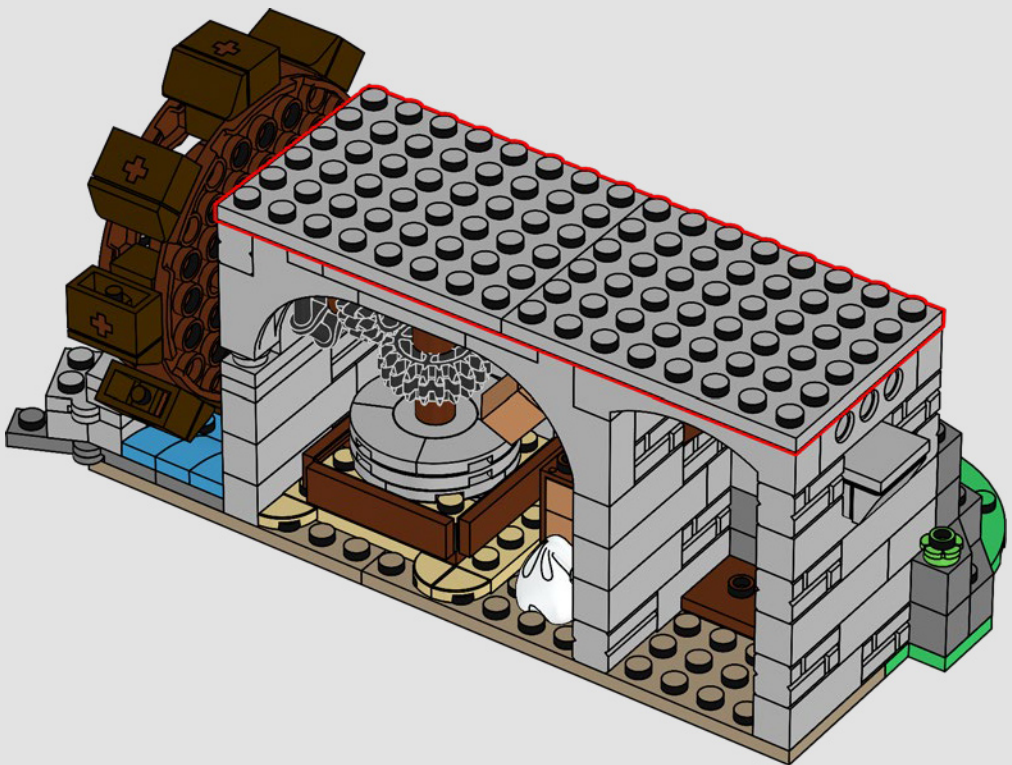

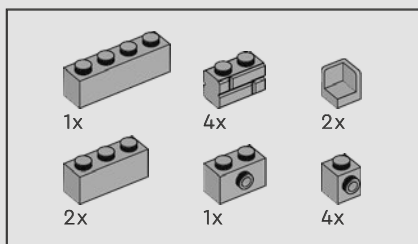

143

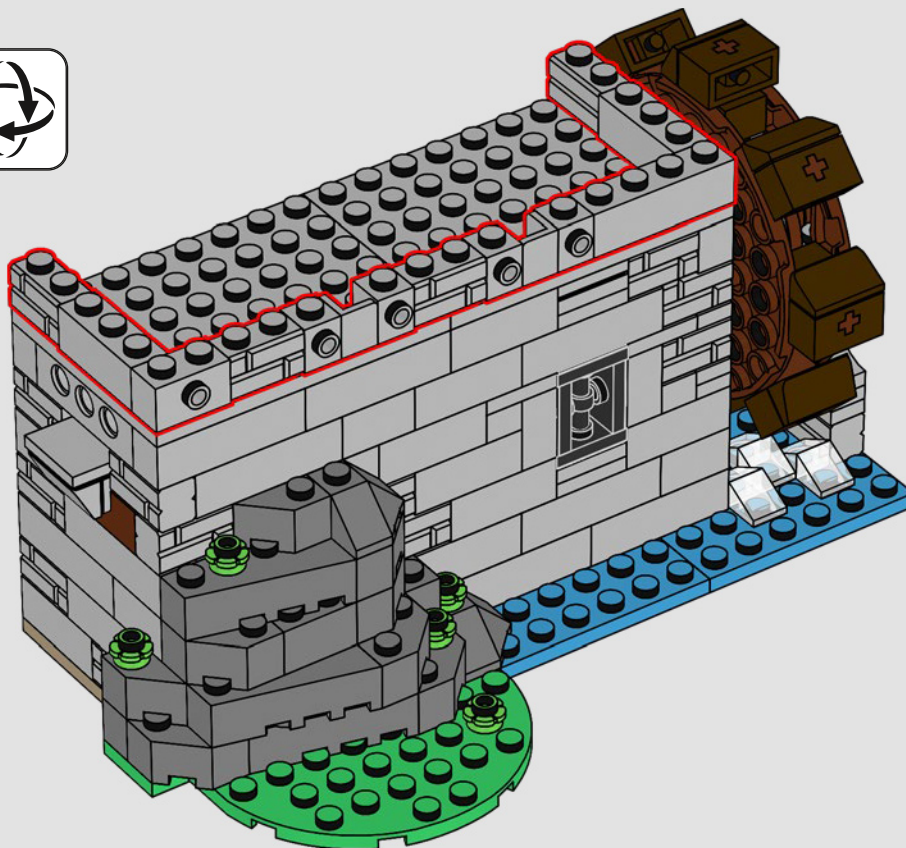

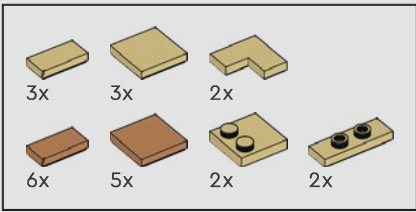

144

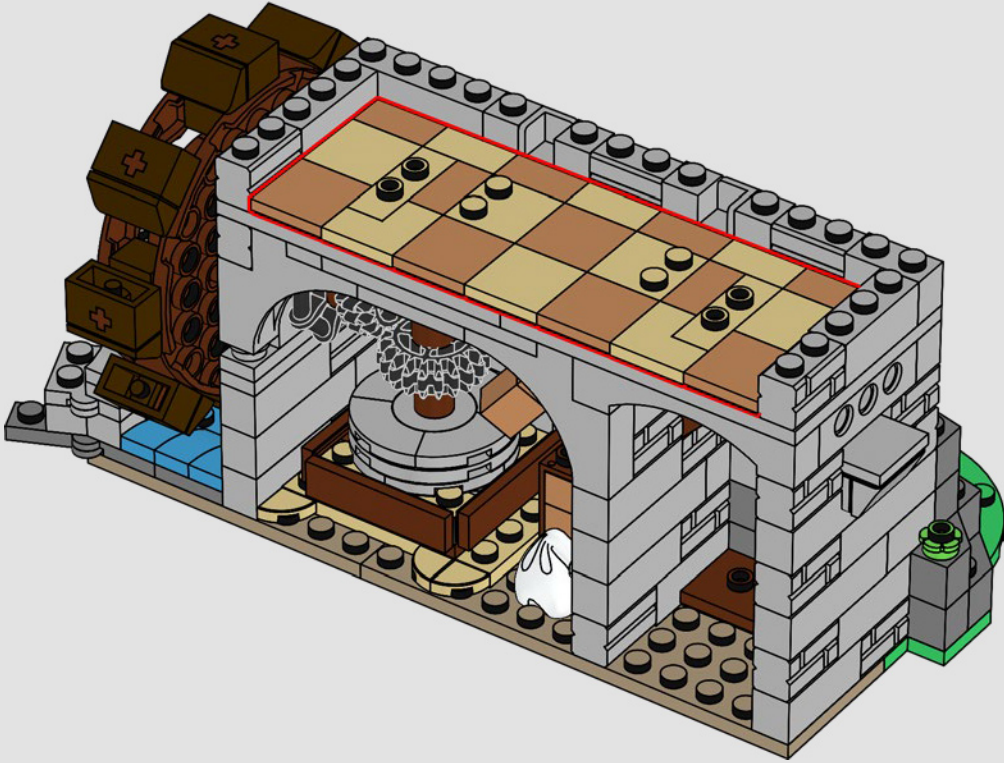

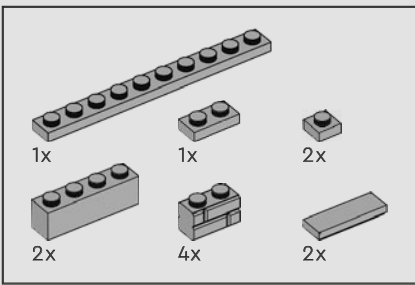

145

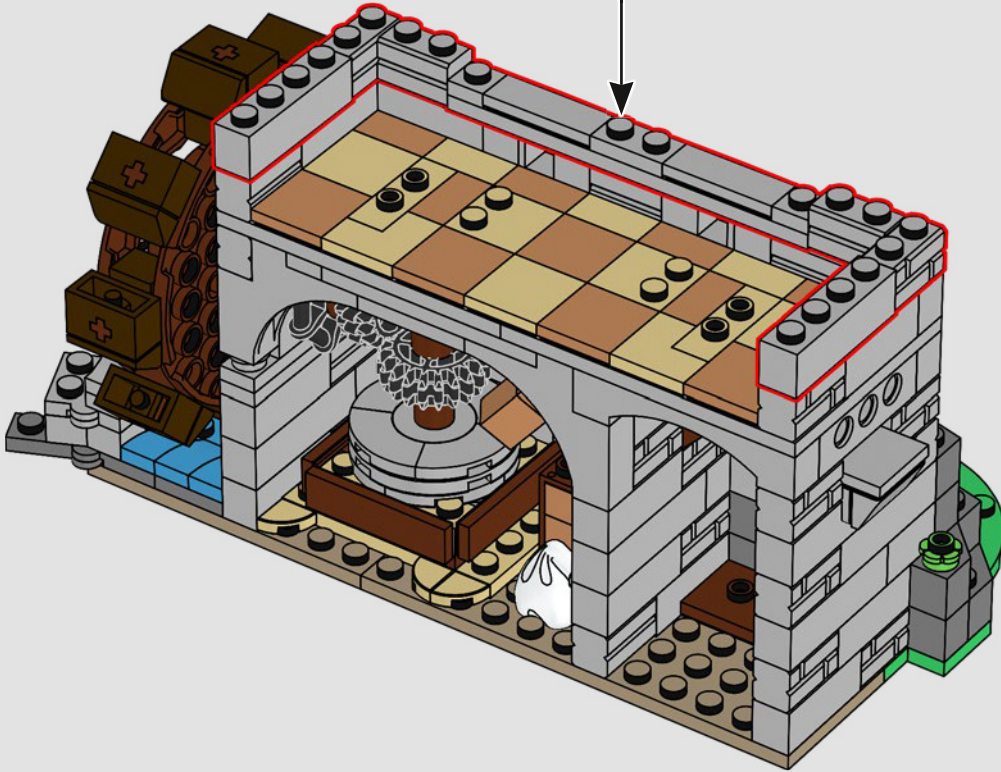
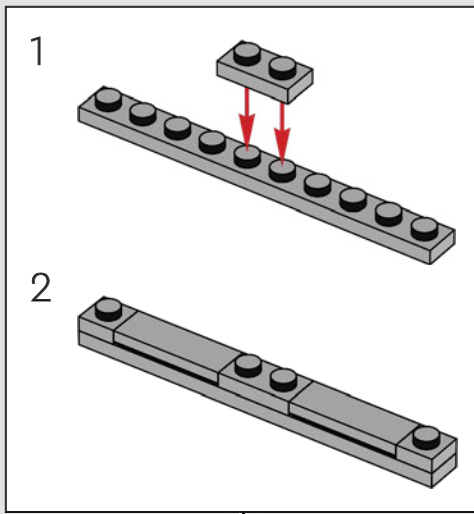

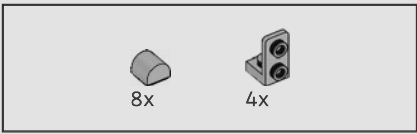

146

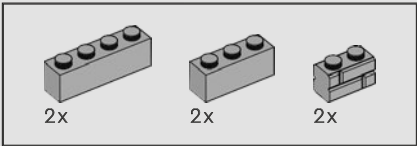
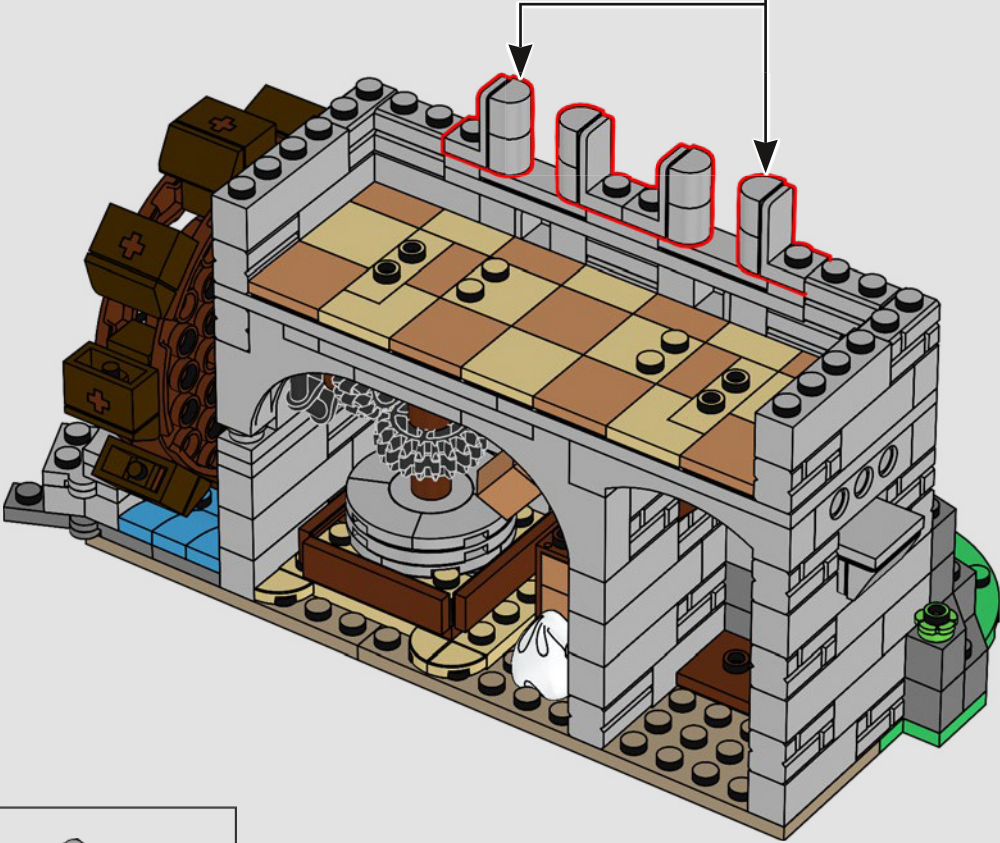
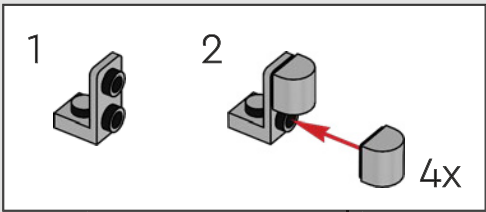

147

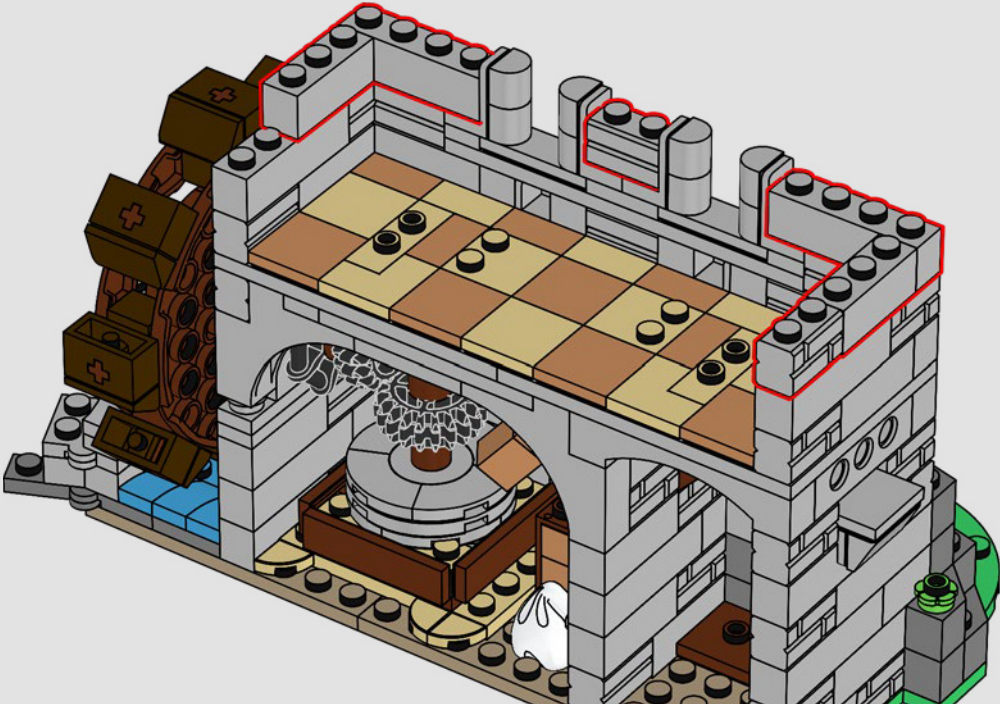



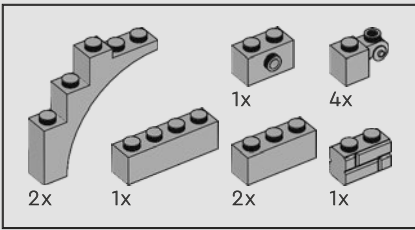

148

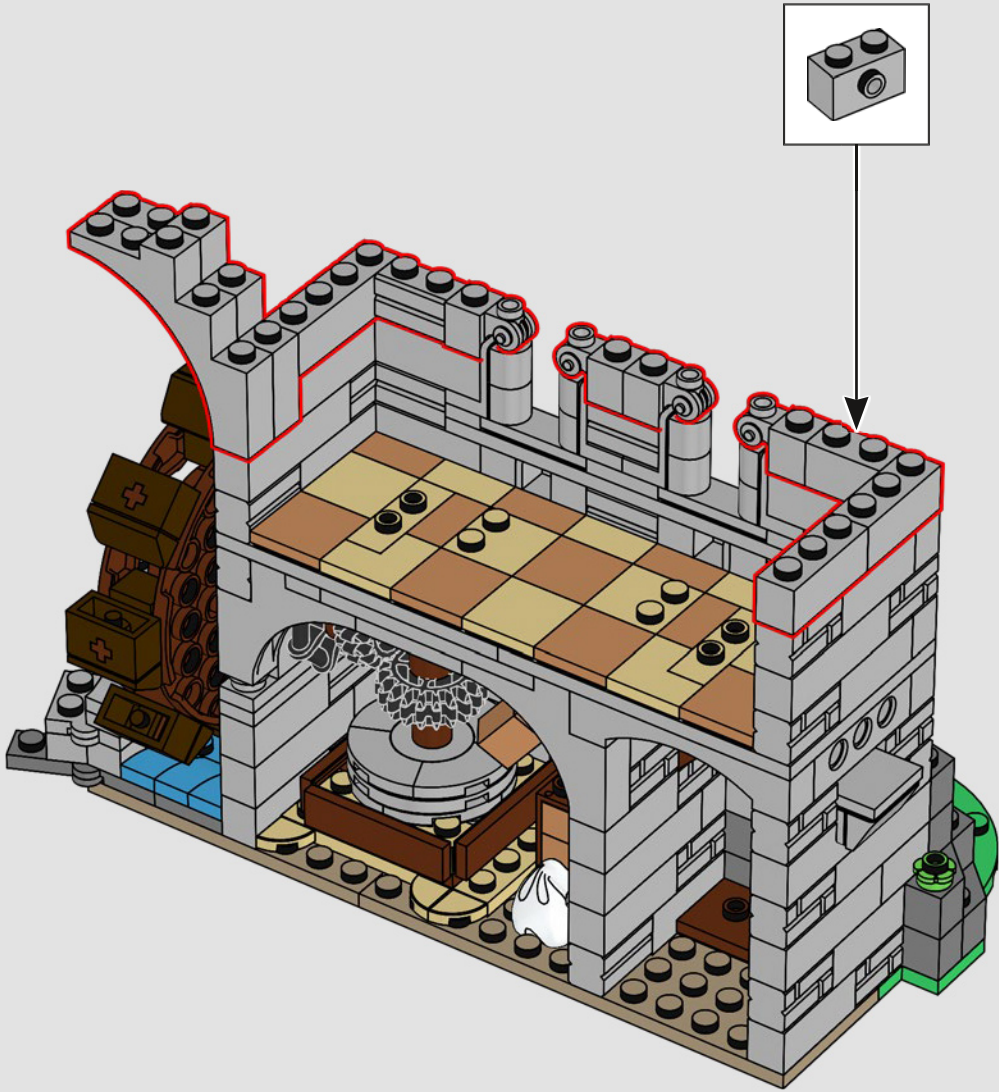

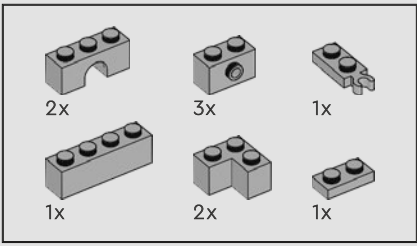

149

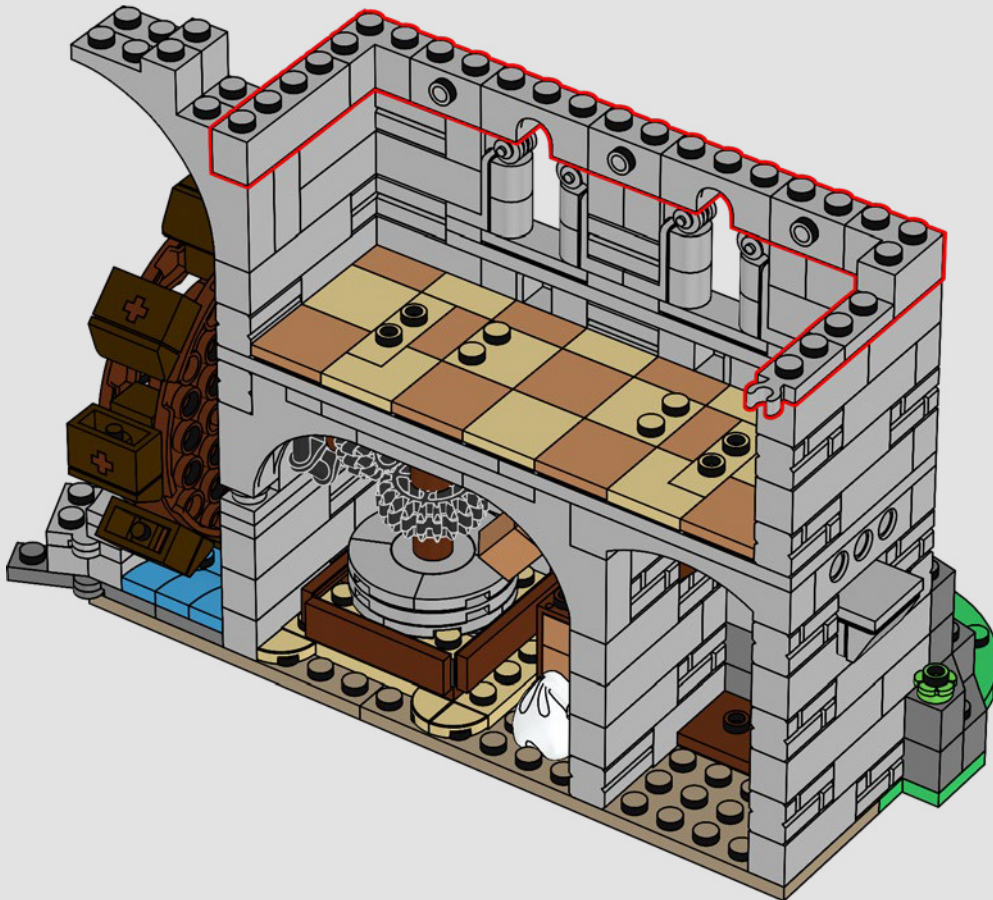

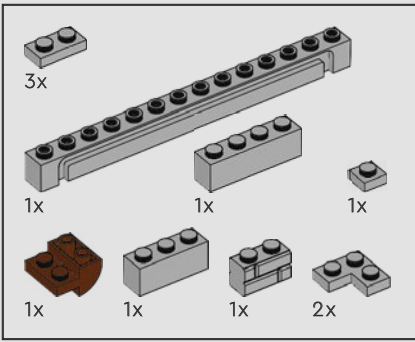

150

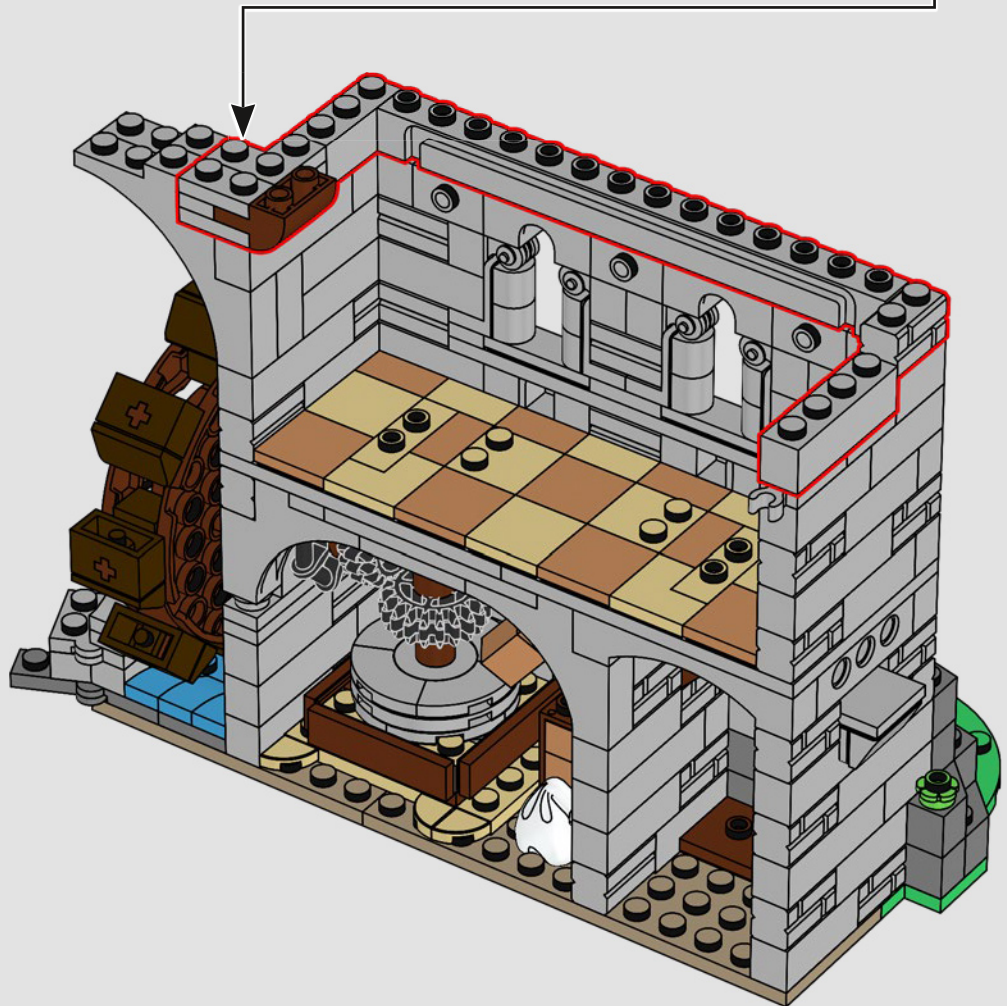
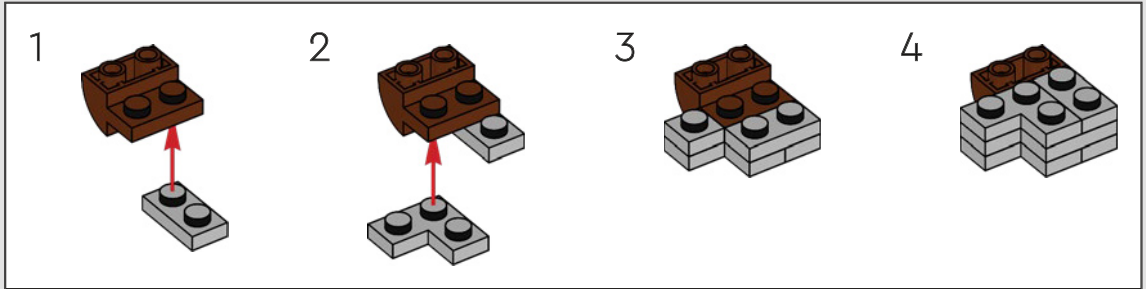

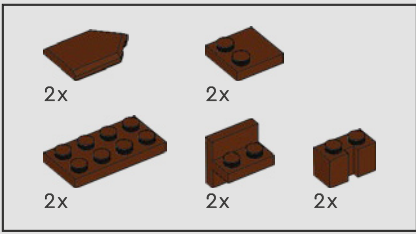

151

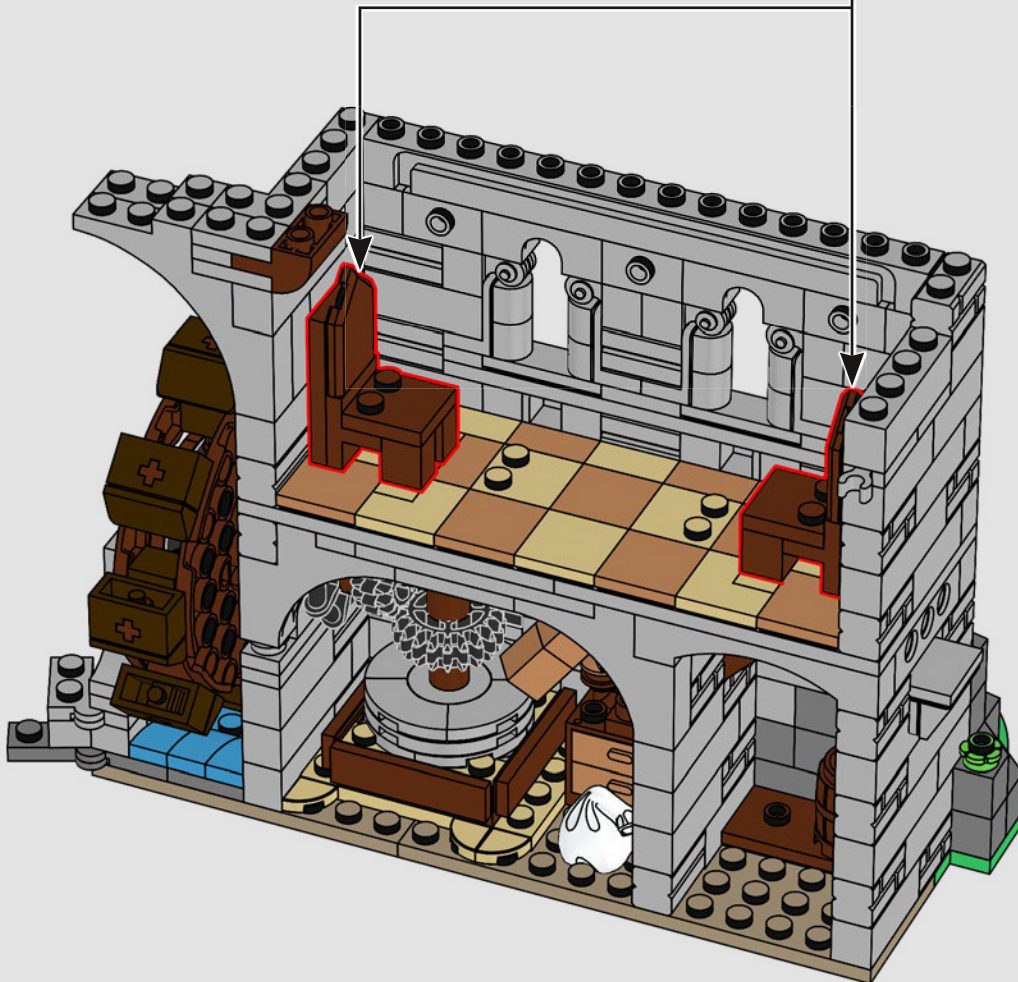
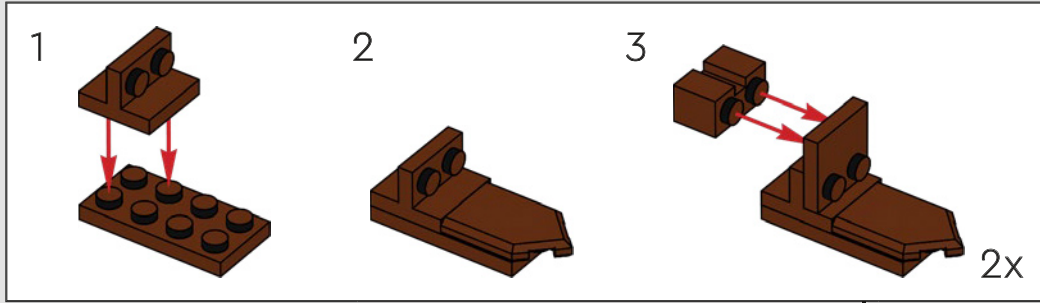

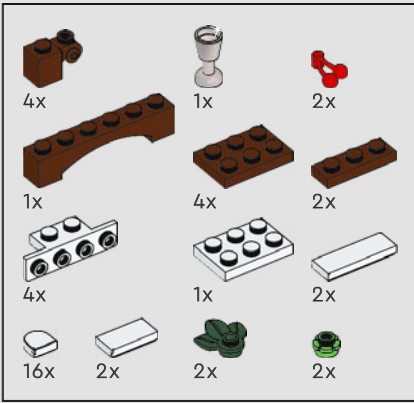
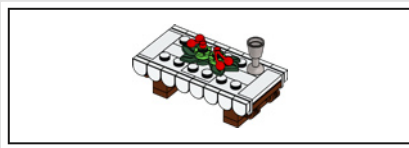

152

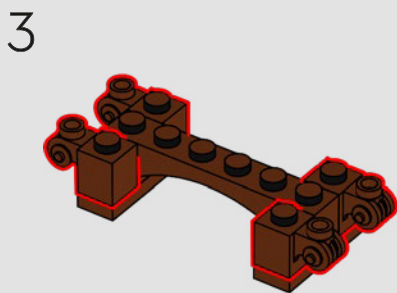
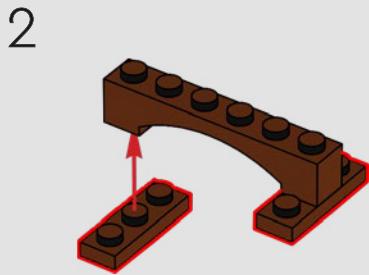
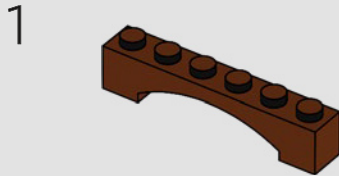

The board is set, but where is the feast?

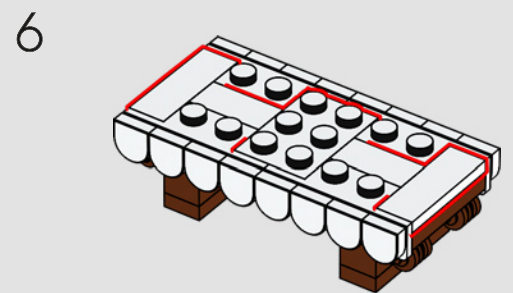
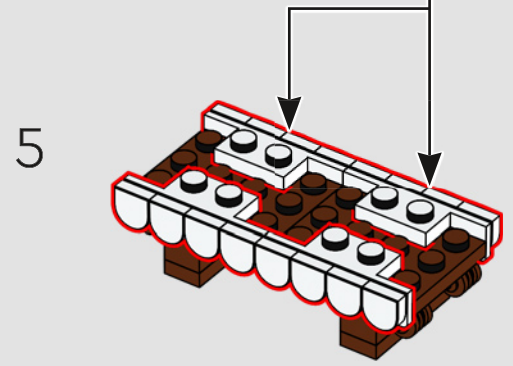
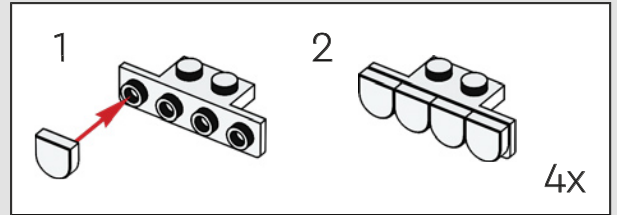
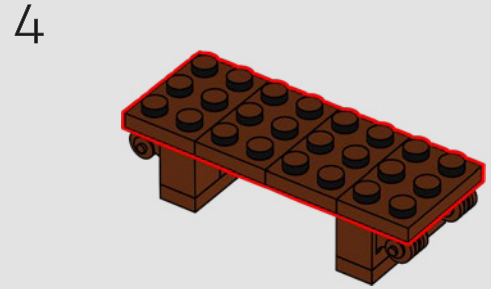

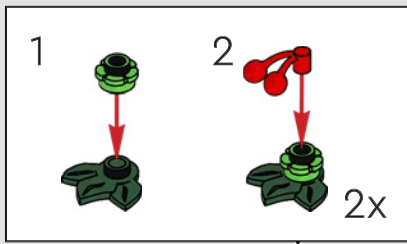

7

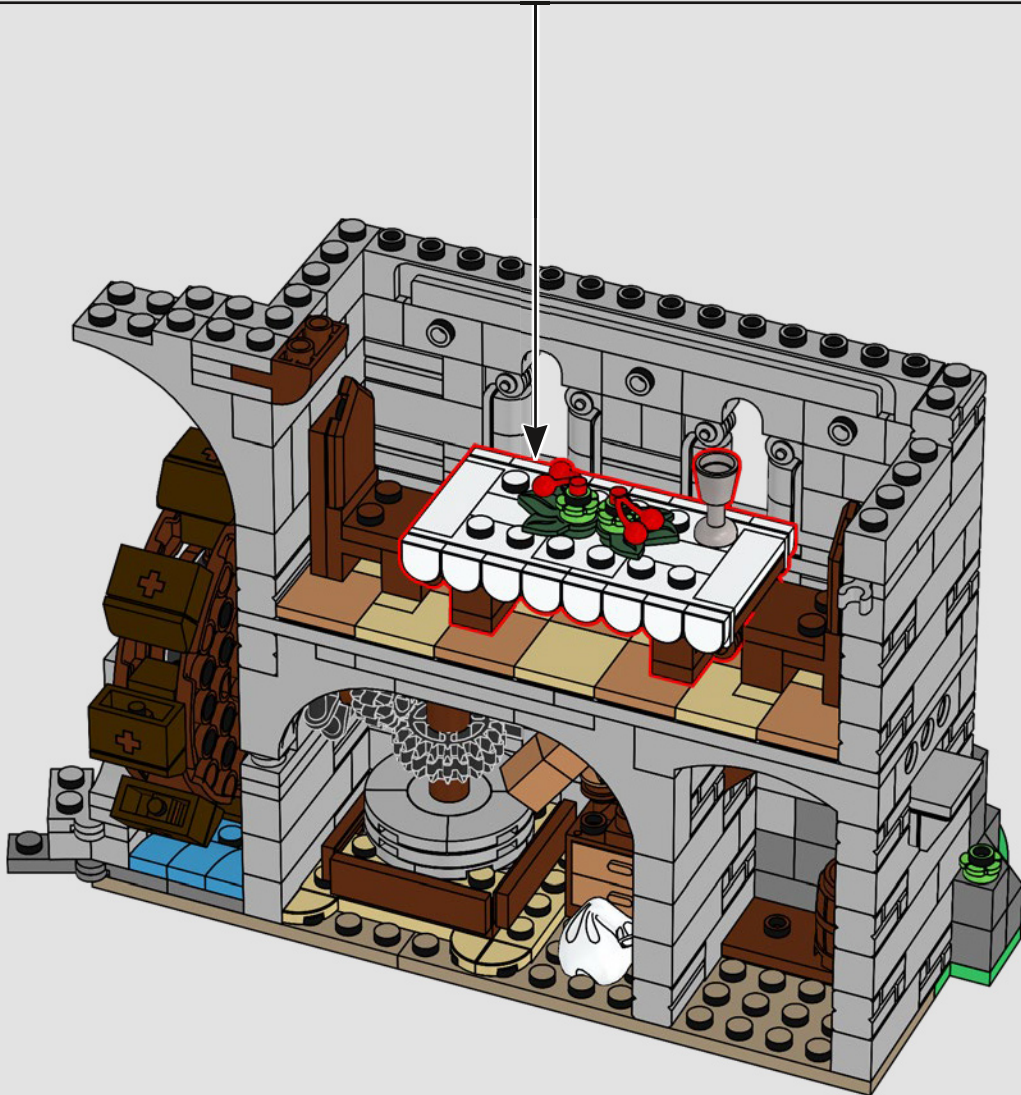
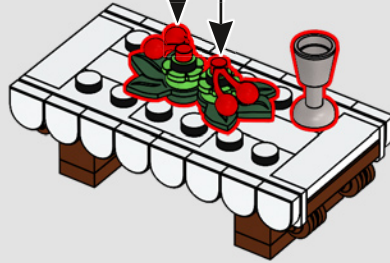



What a lovely shade of pink. Yon heraldry from days of yore reminds of a simpler time...

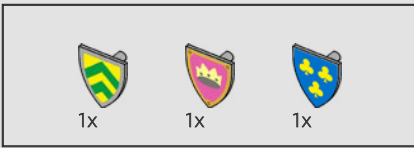

153



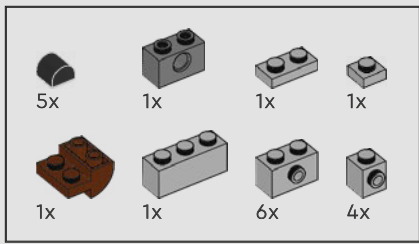

154

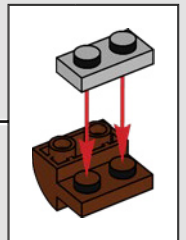
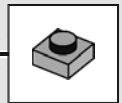
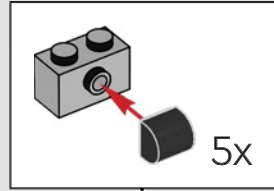
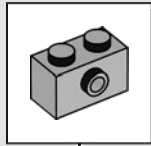
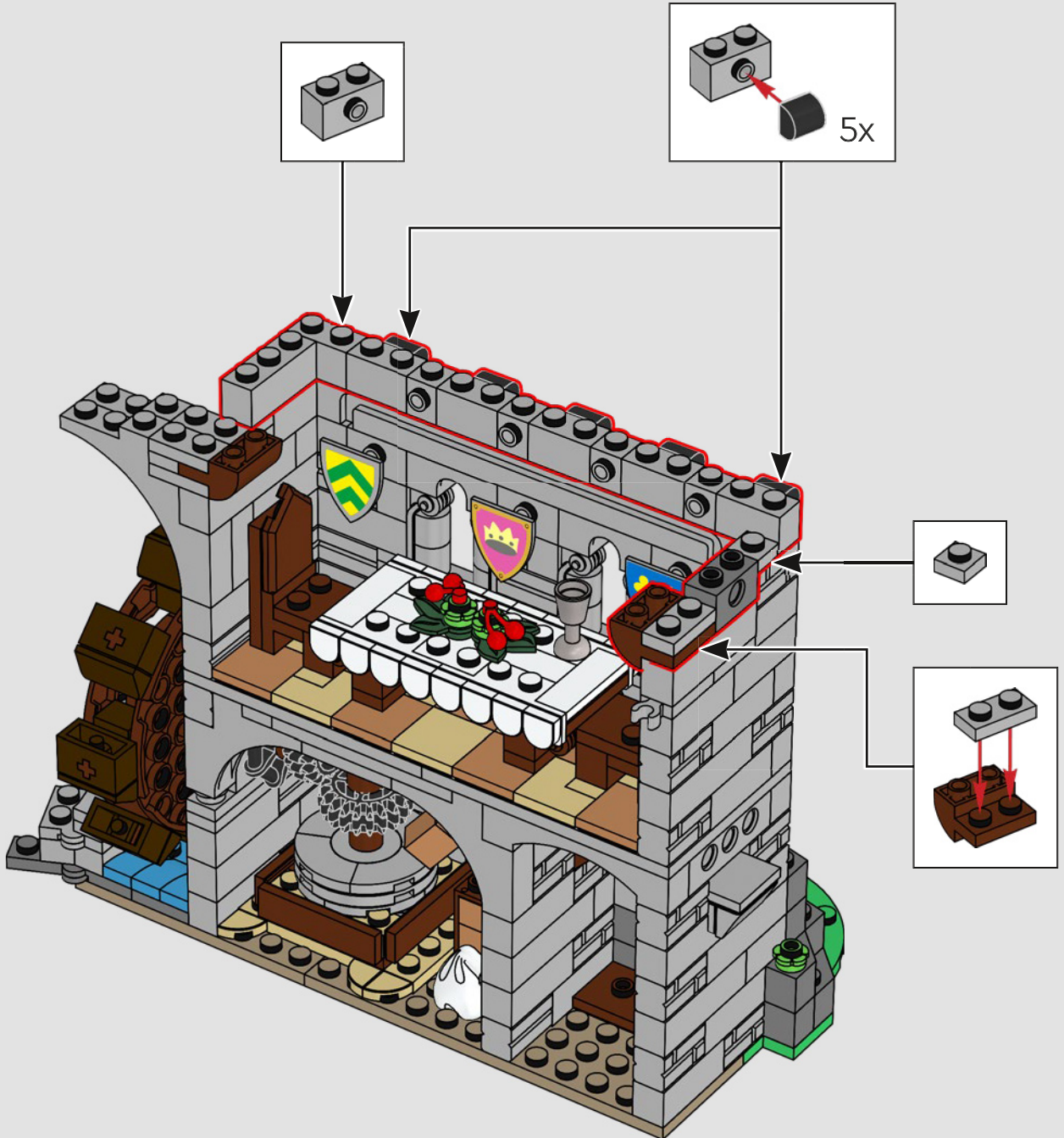



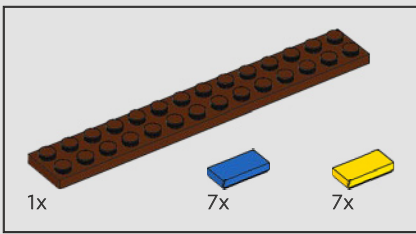

155

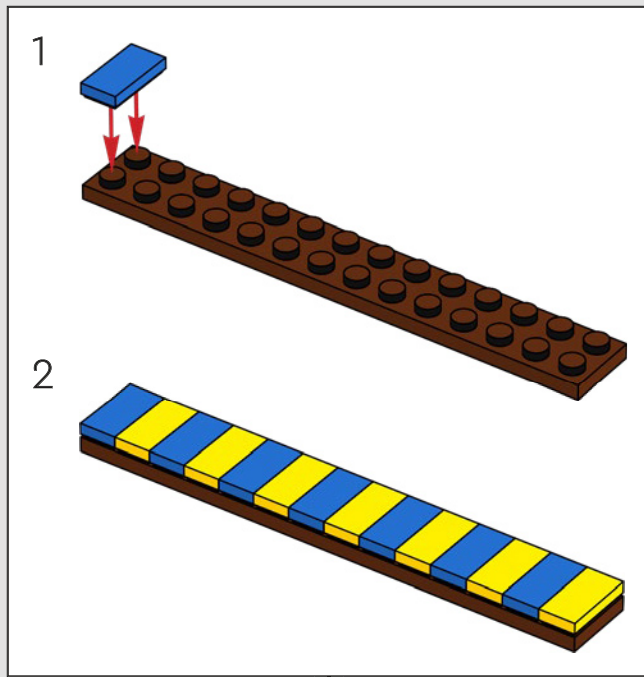

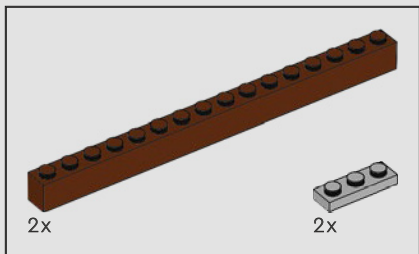

156

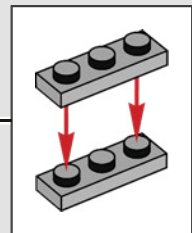

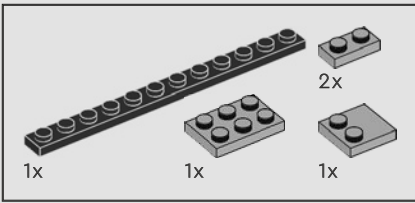

157

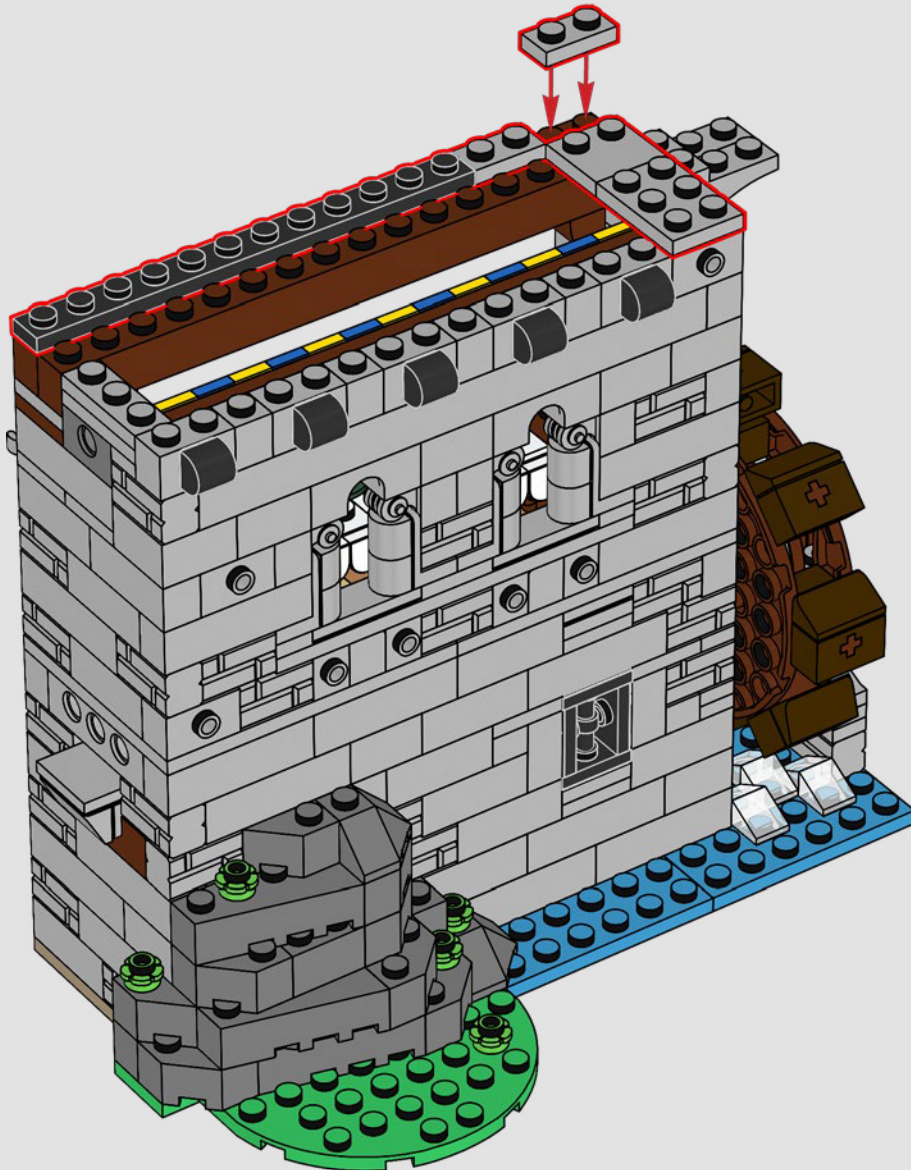

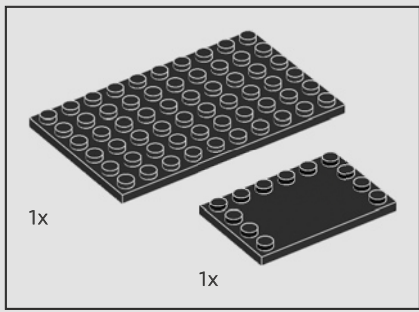

158

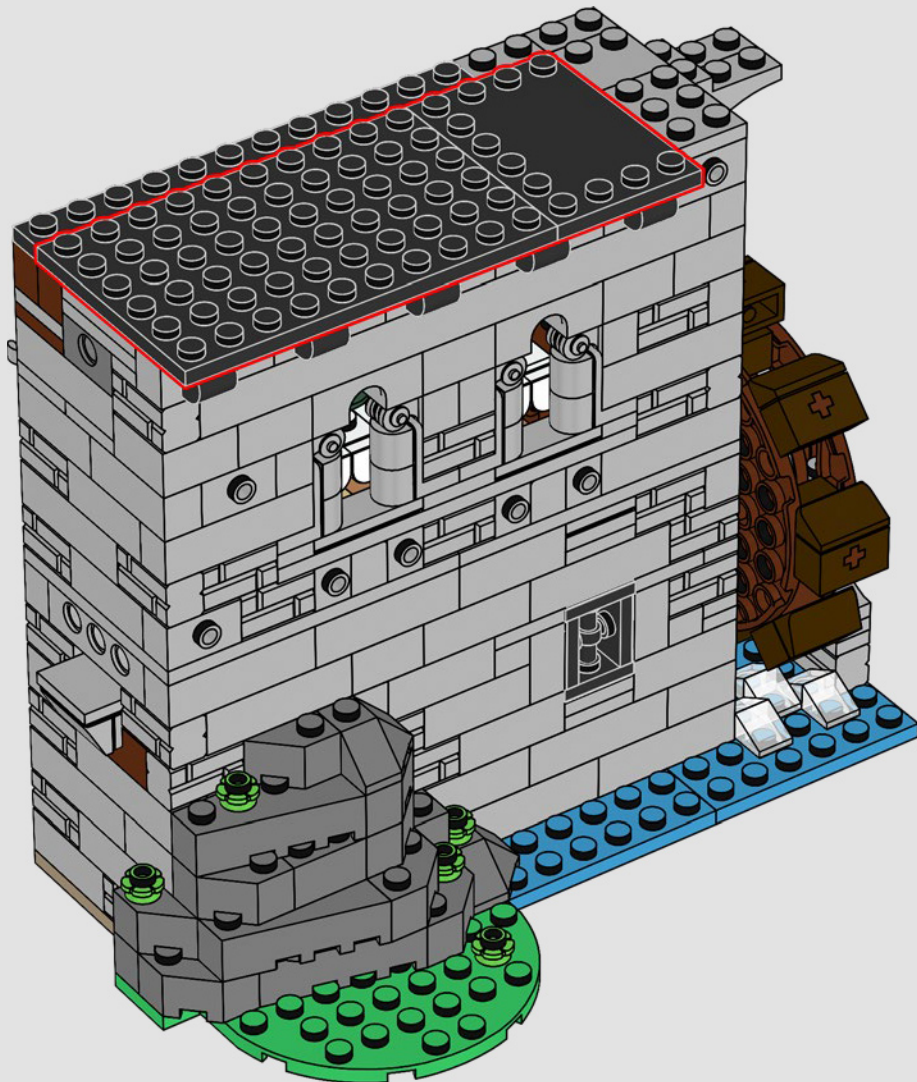



159

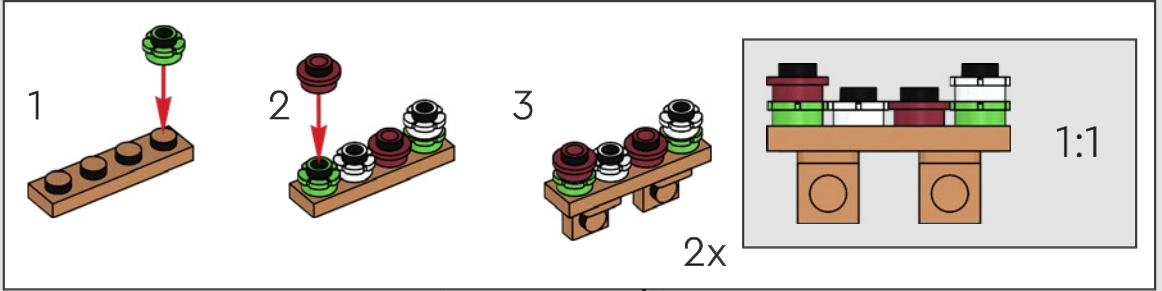

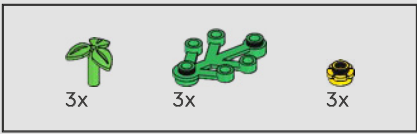

160

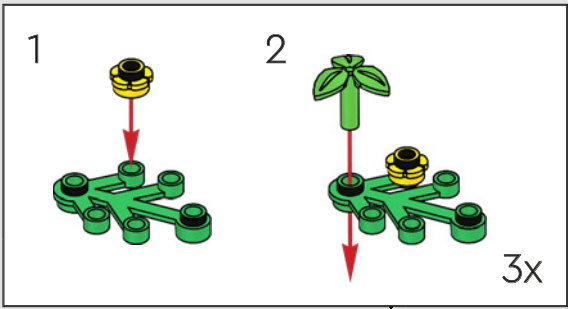

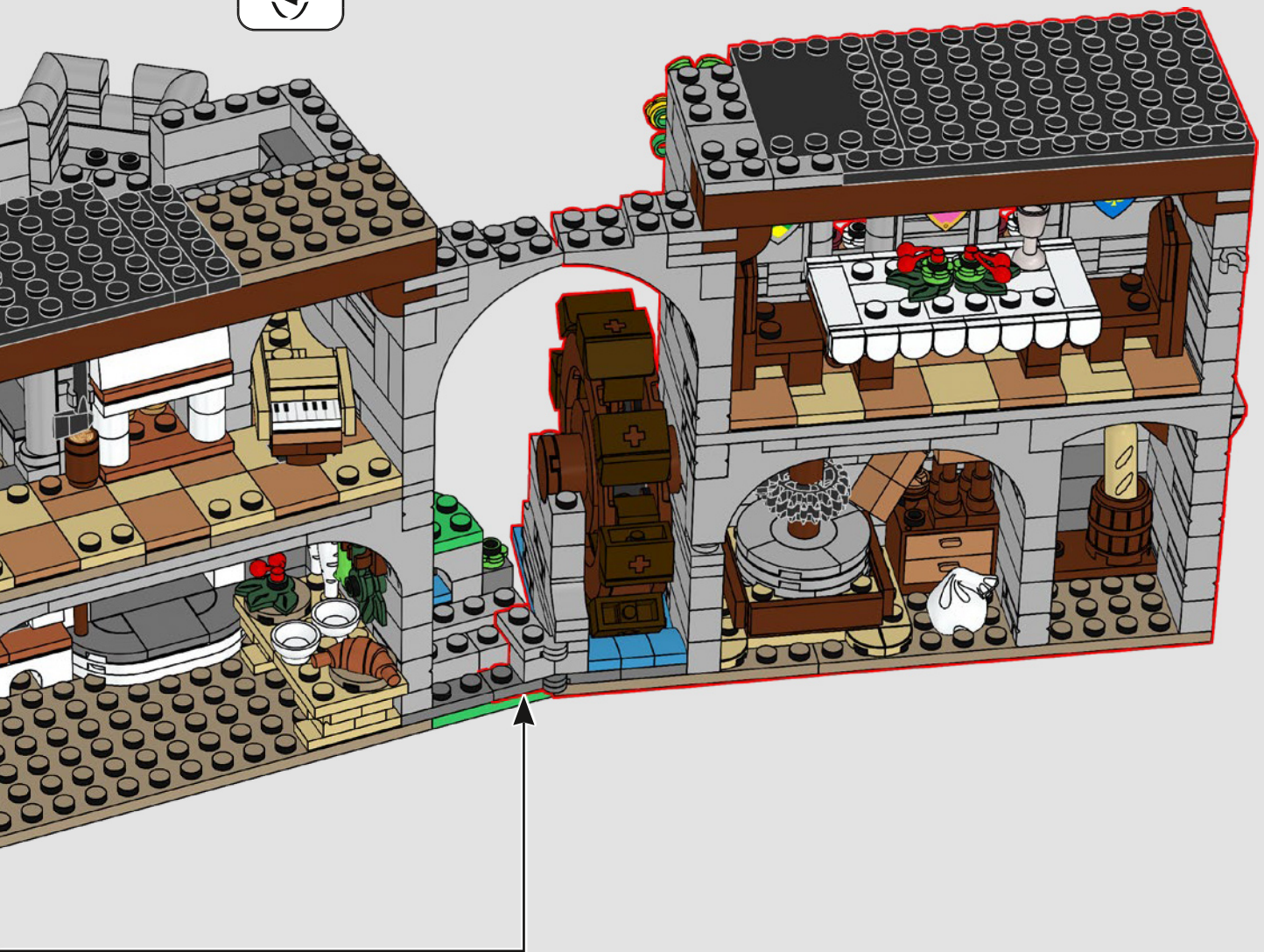

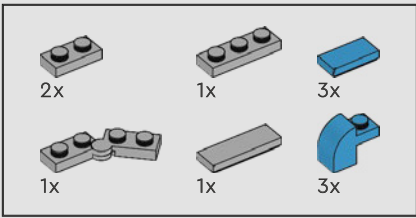

162

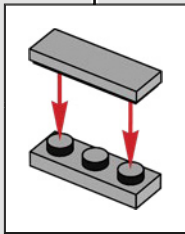
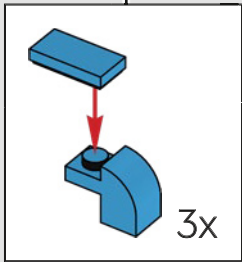
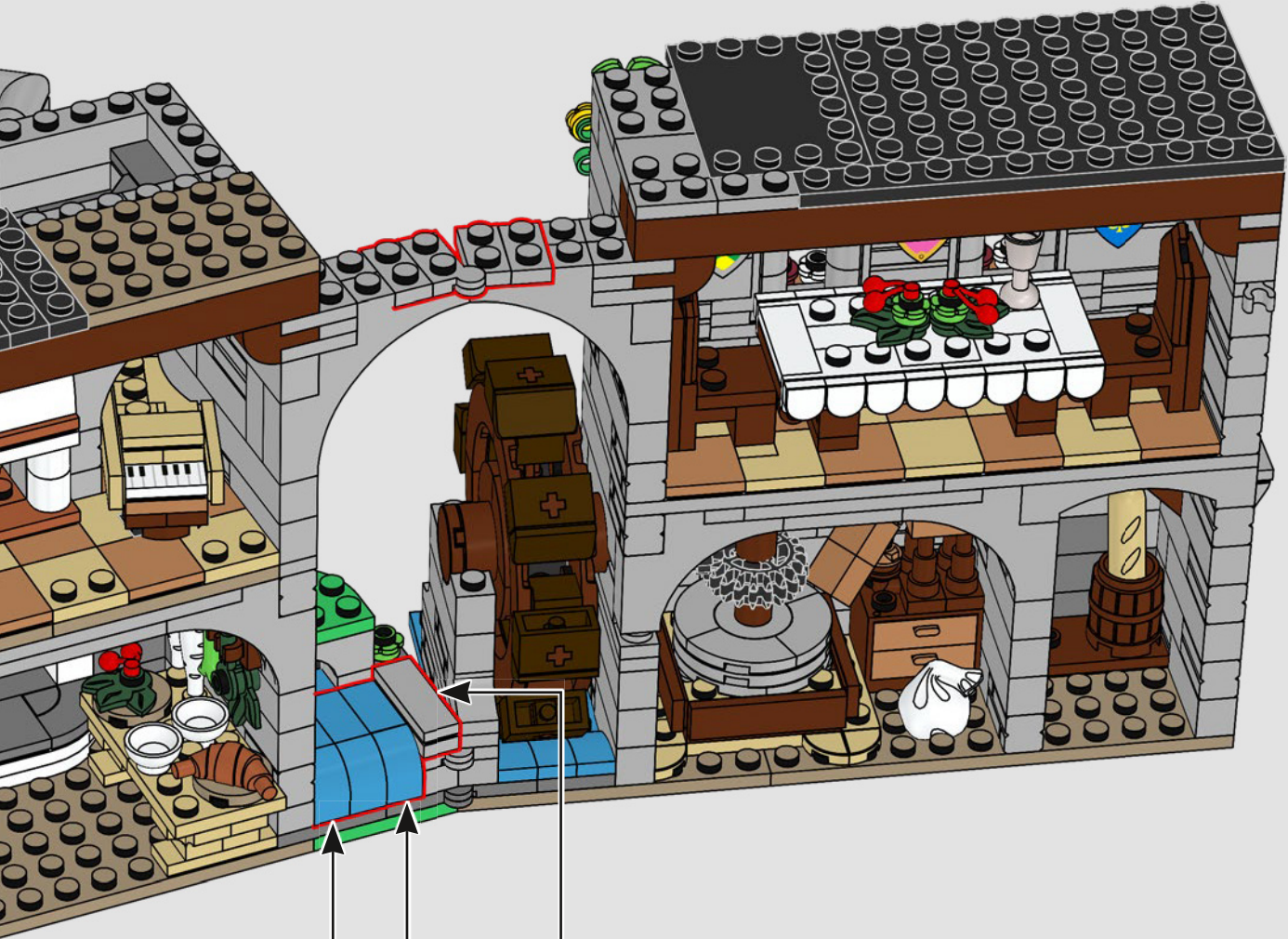



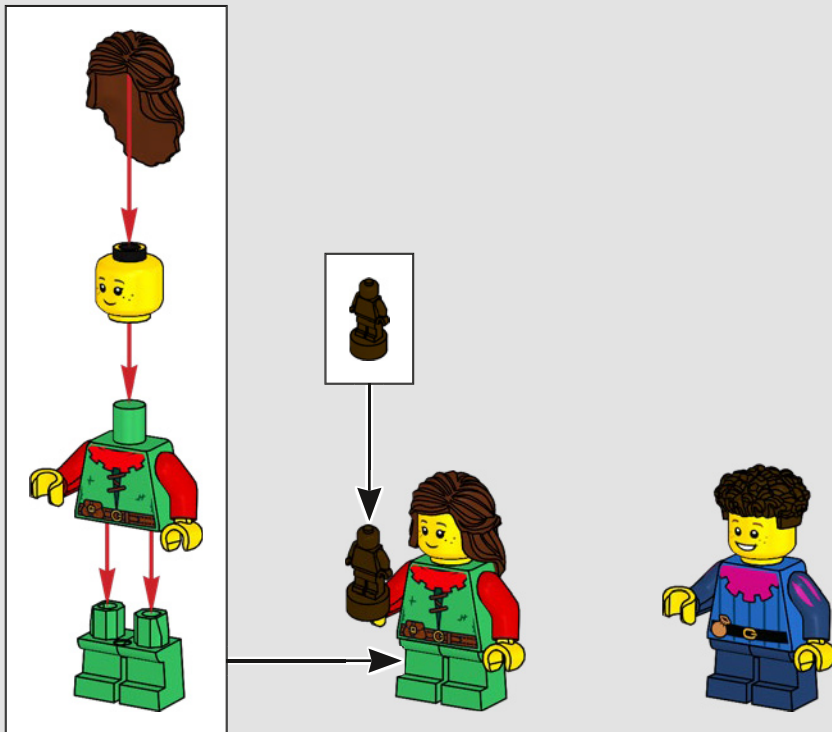

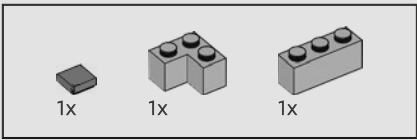

163

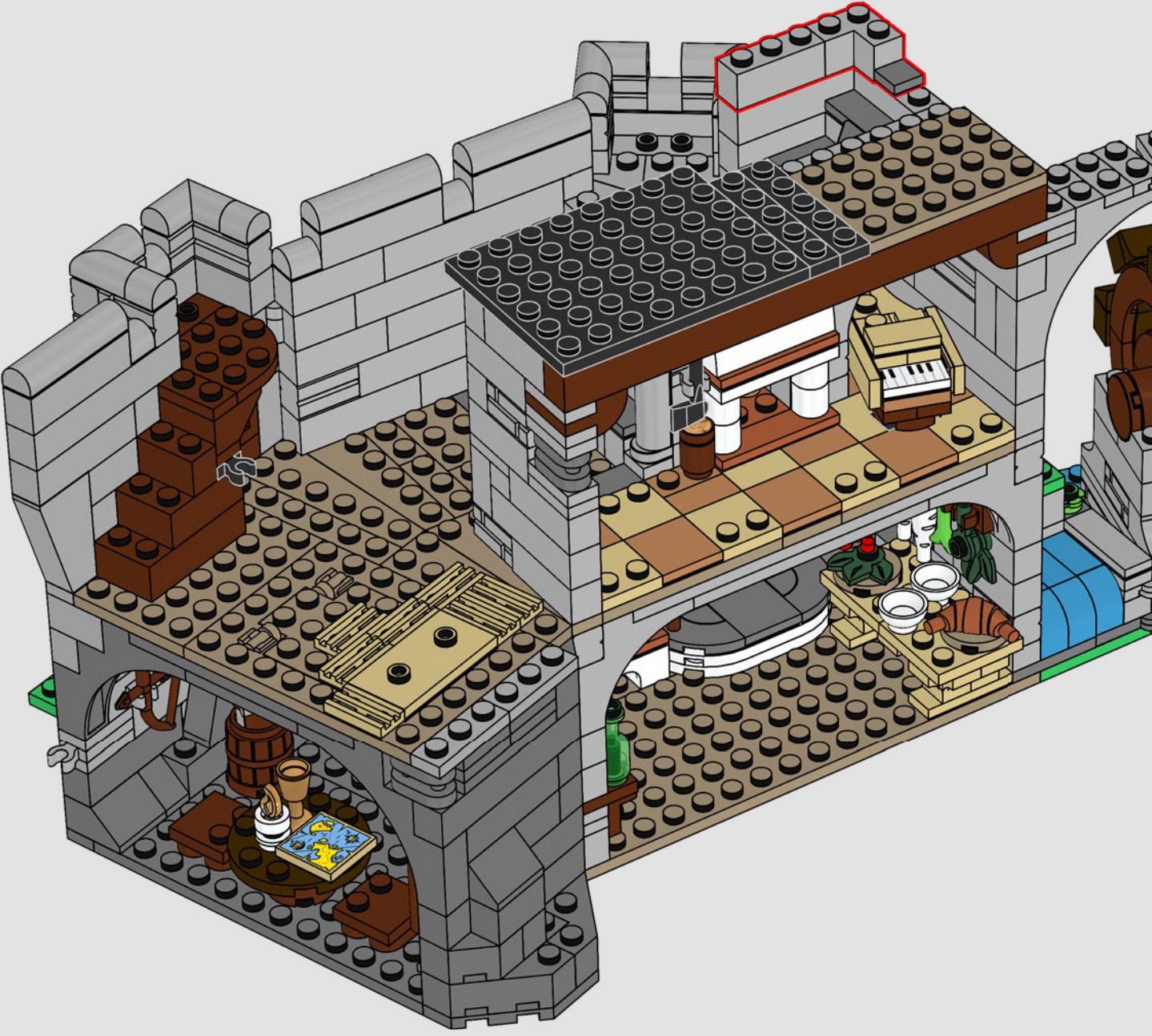

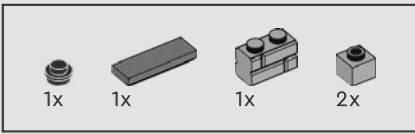

164

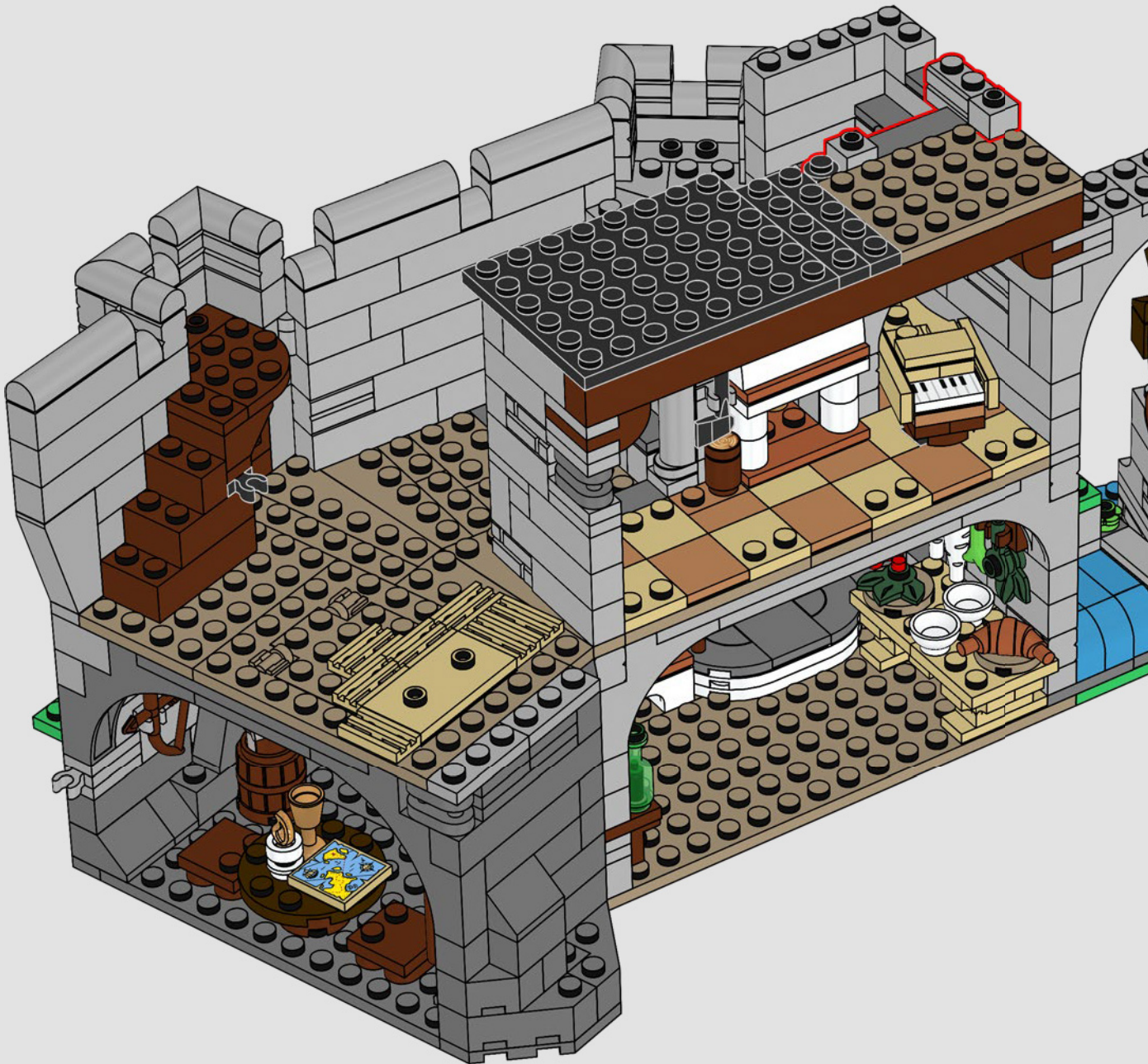

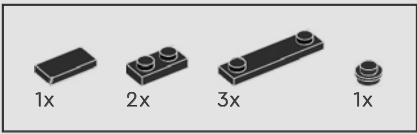

165



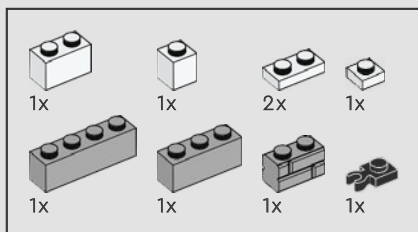

166

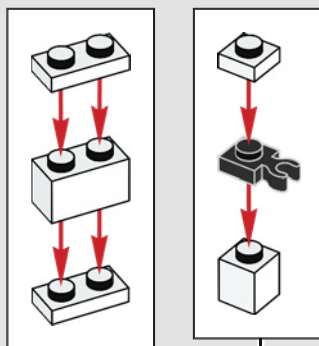

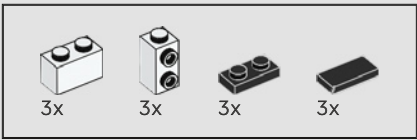

167

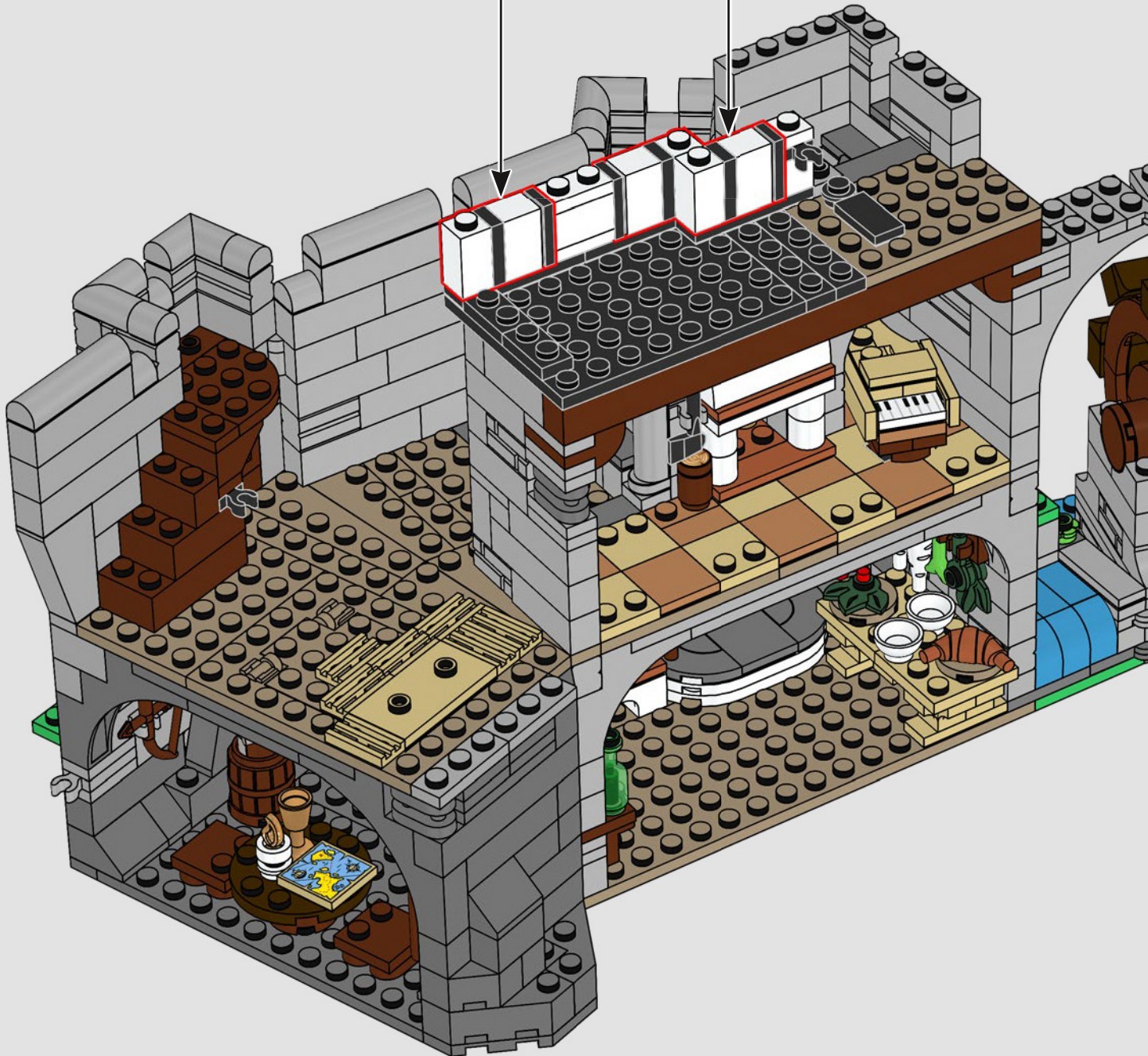
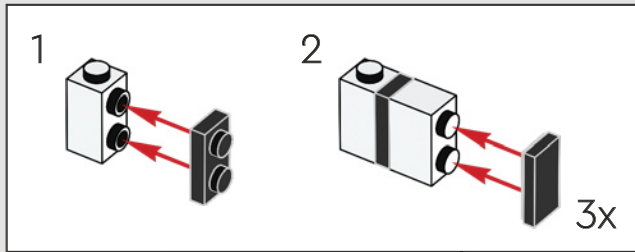

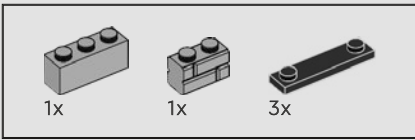

168

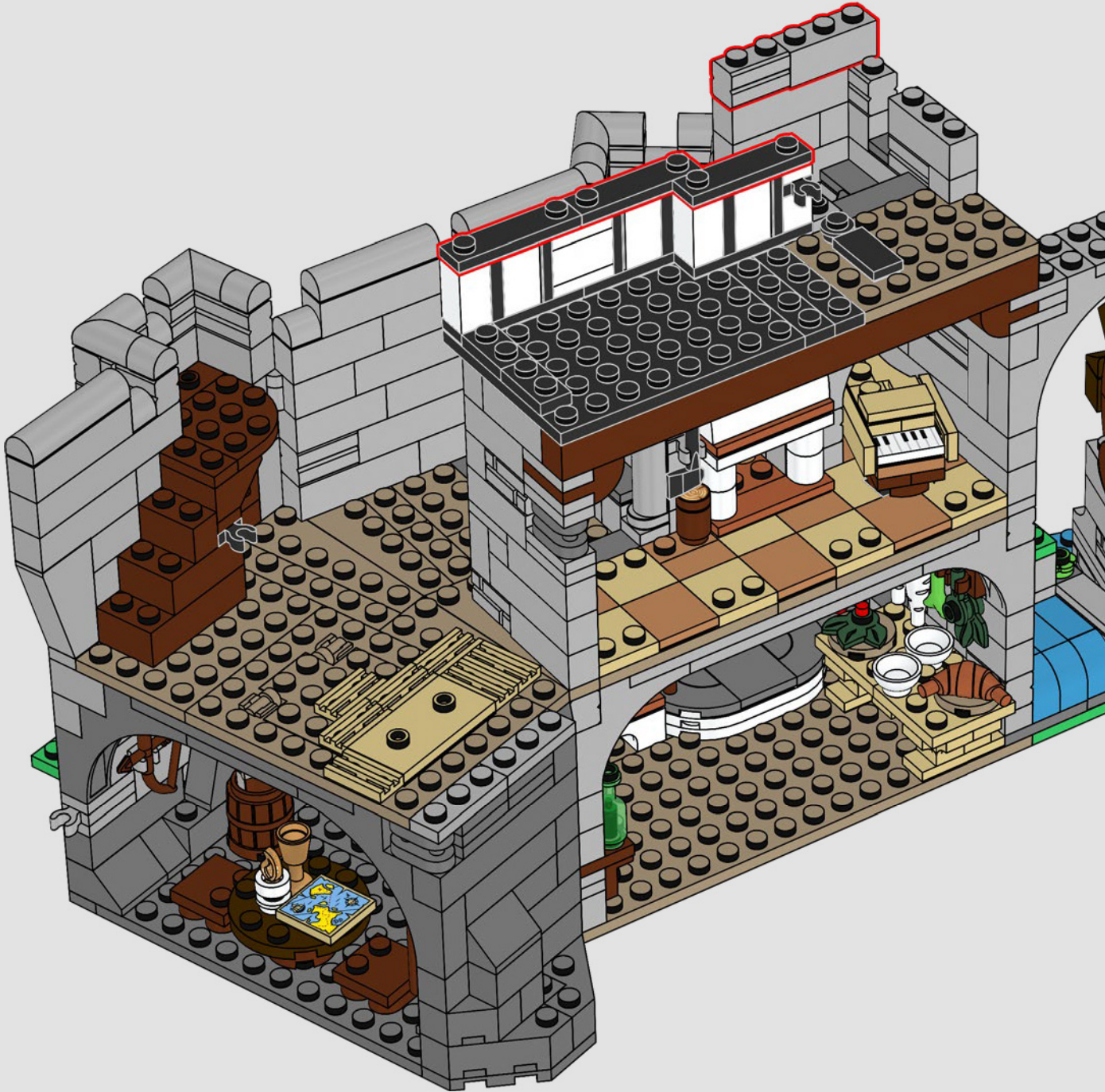

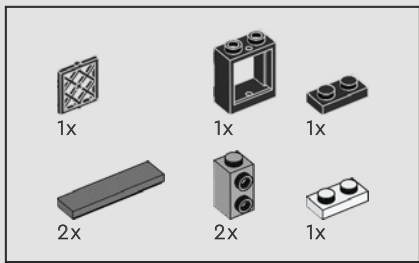

169

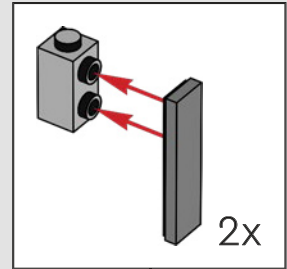
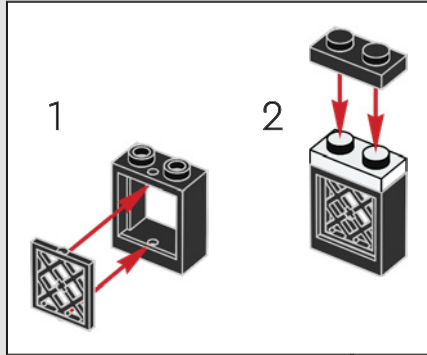



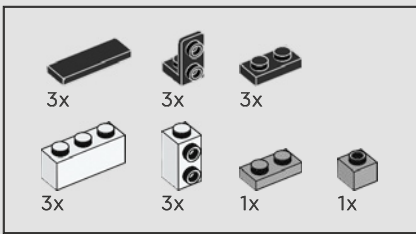

170

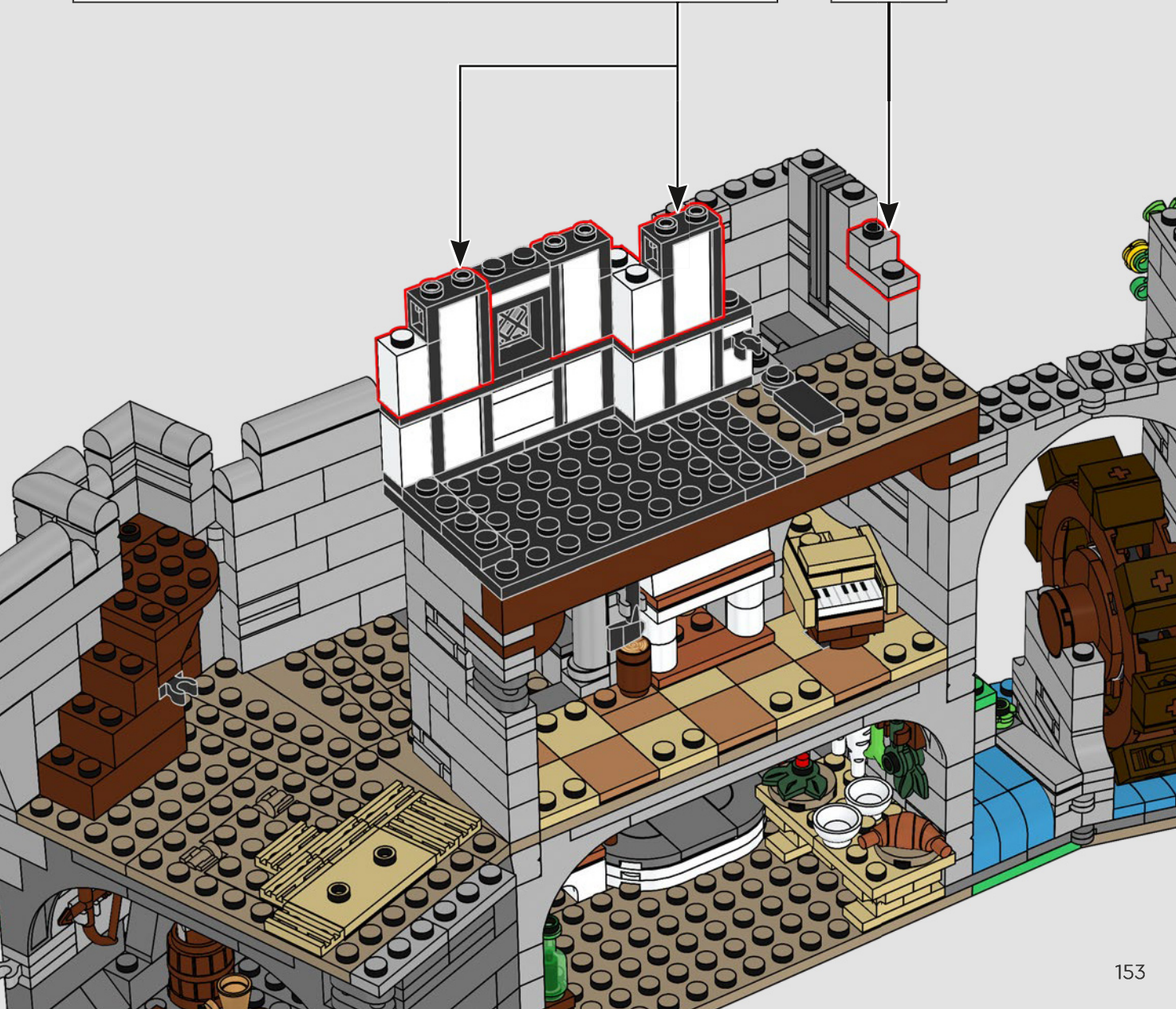
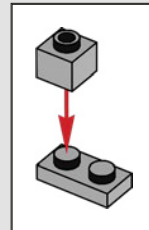
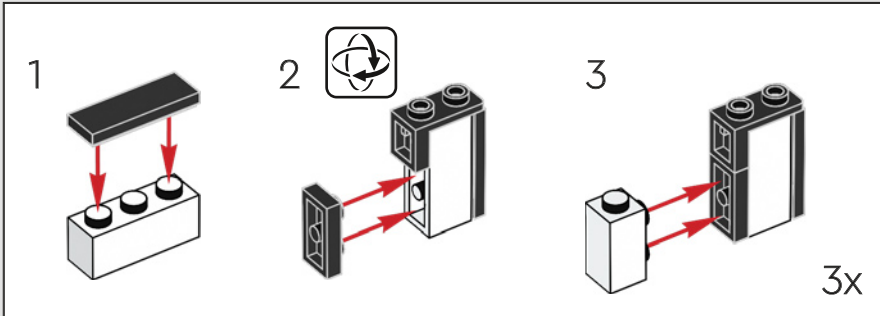

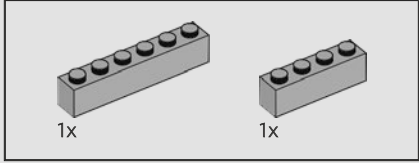
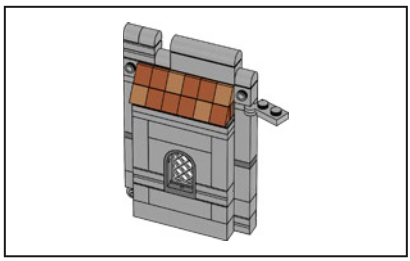

171

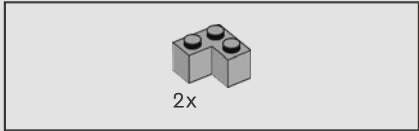
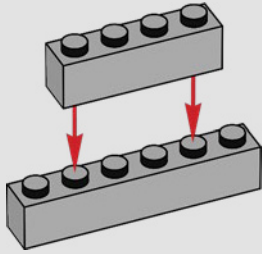

172

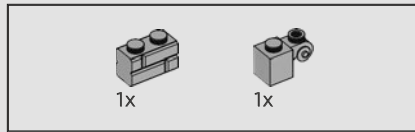
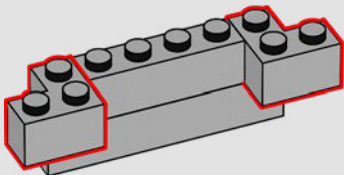

173

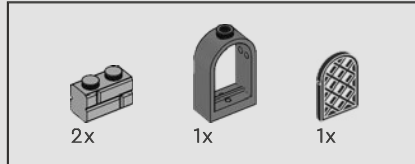
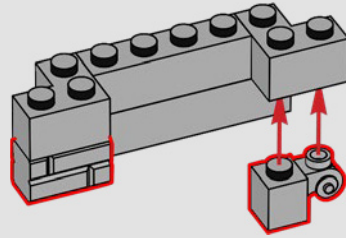

174

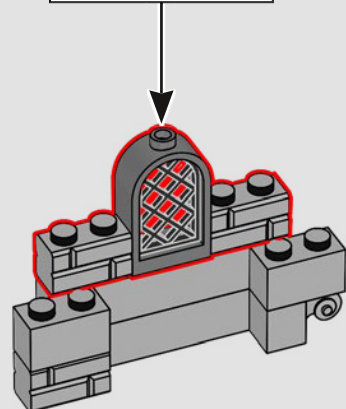
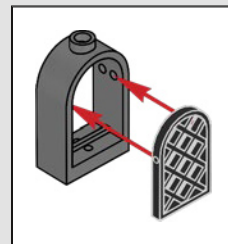

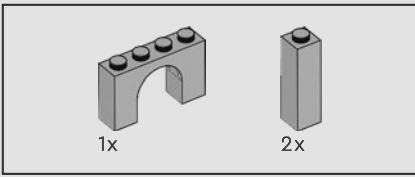

175

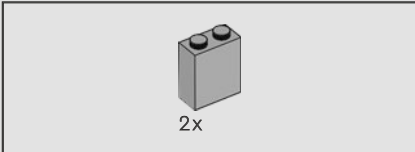
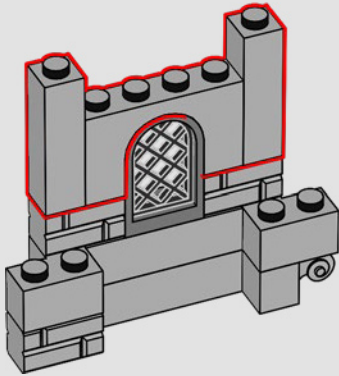

176

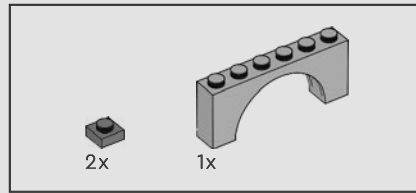
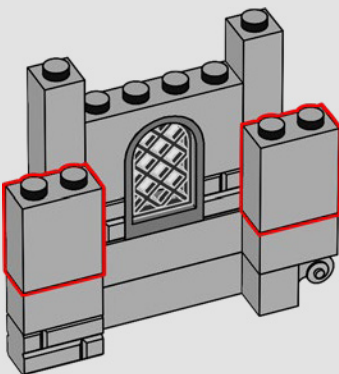

177

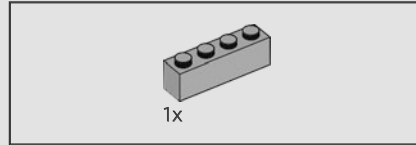
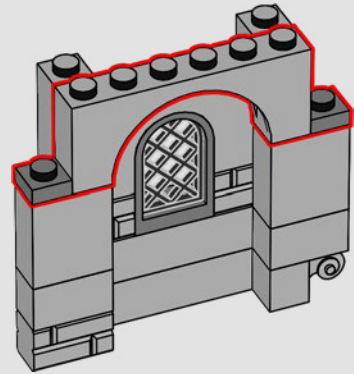

178

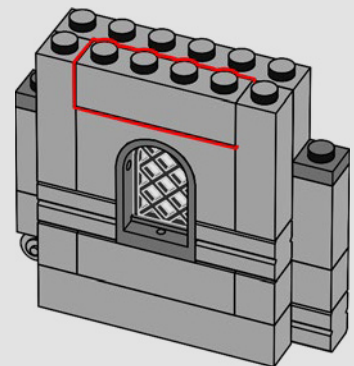

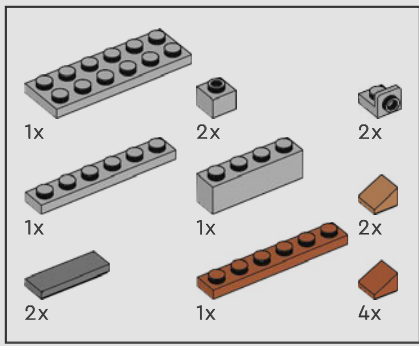

179

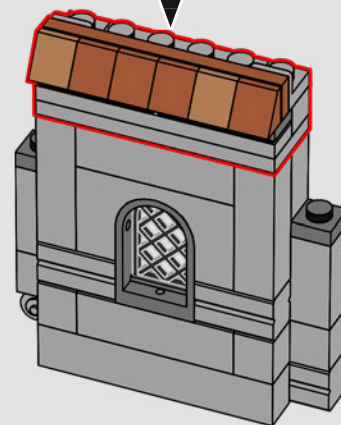
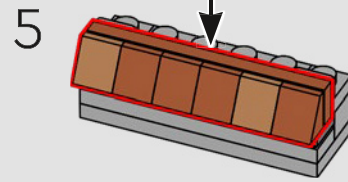
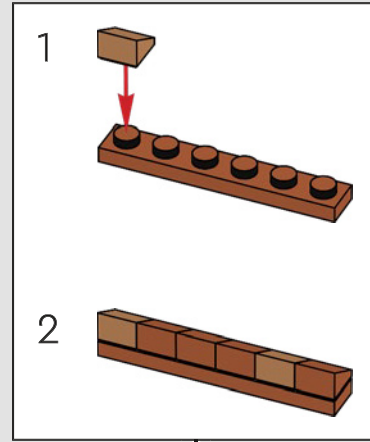
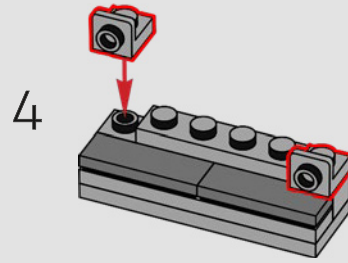
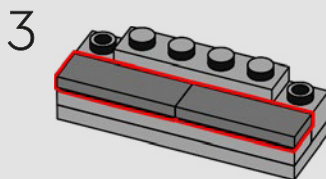
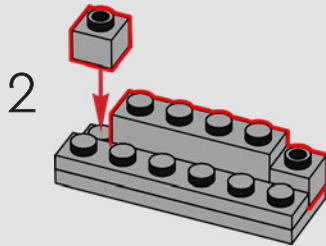
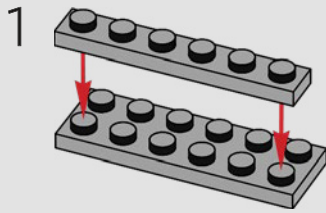

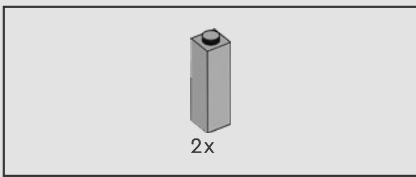

180

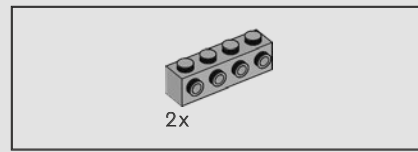
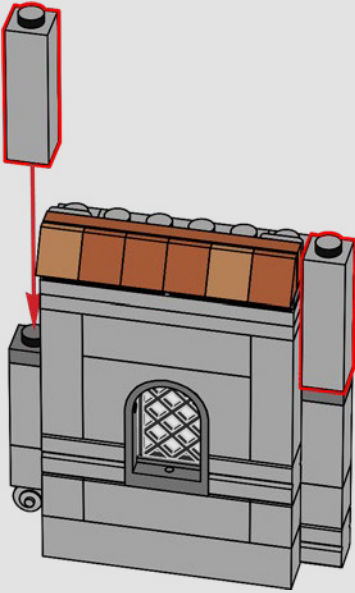

182

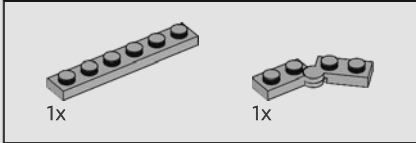
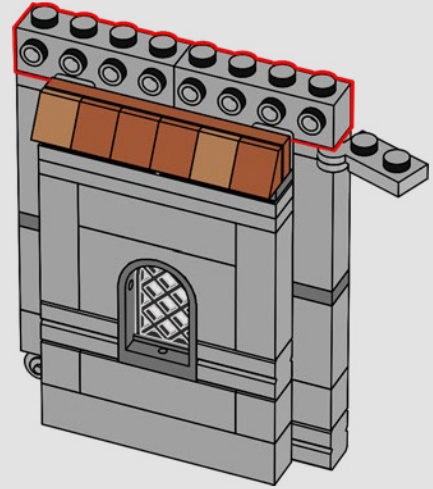

181

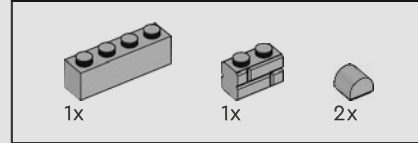
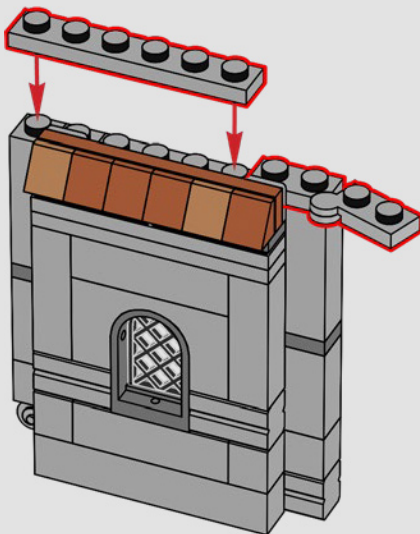

183

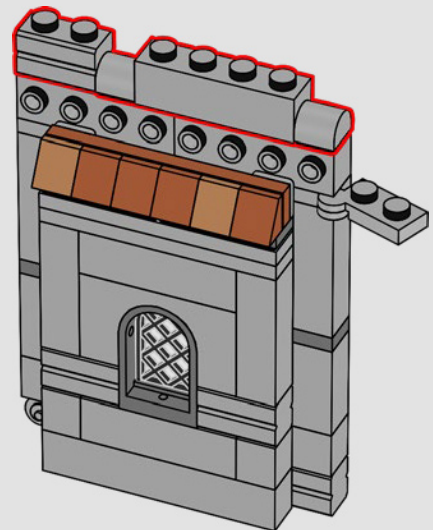

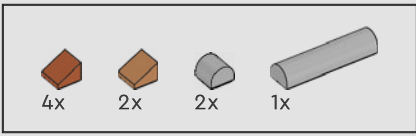

184

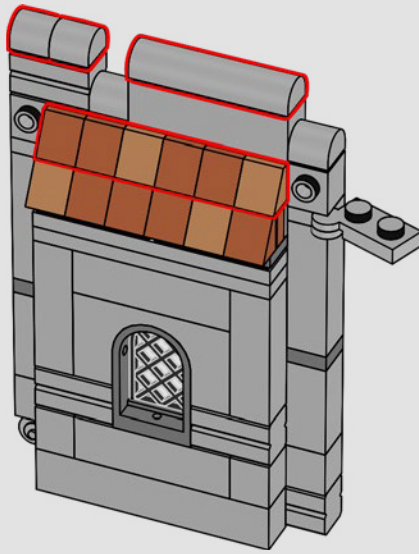

185





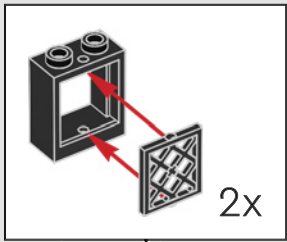

6

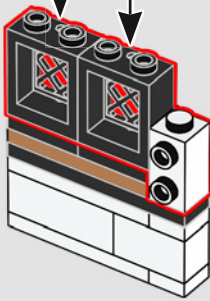

7

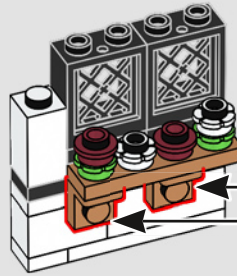



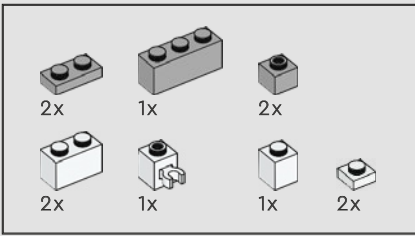

187

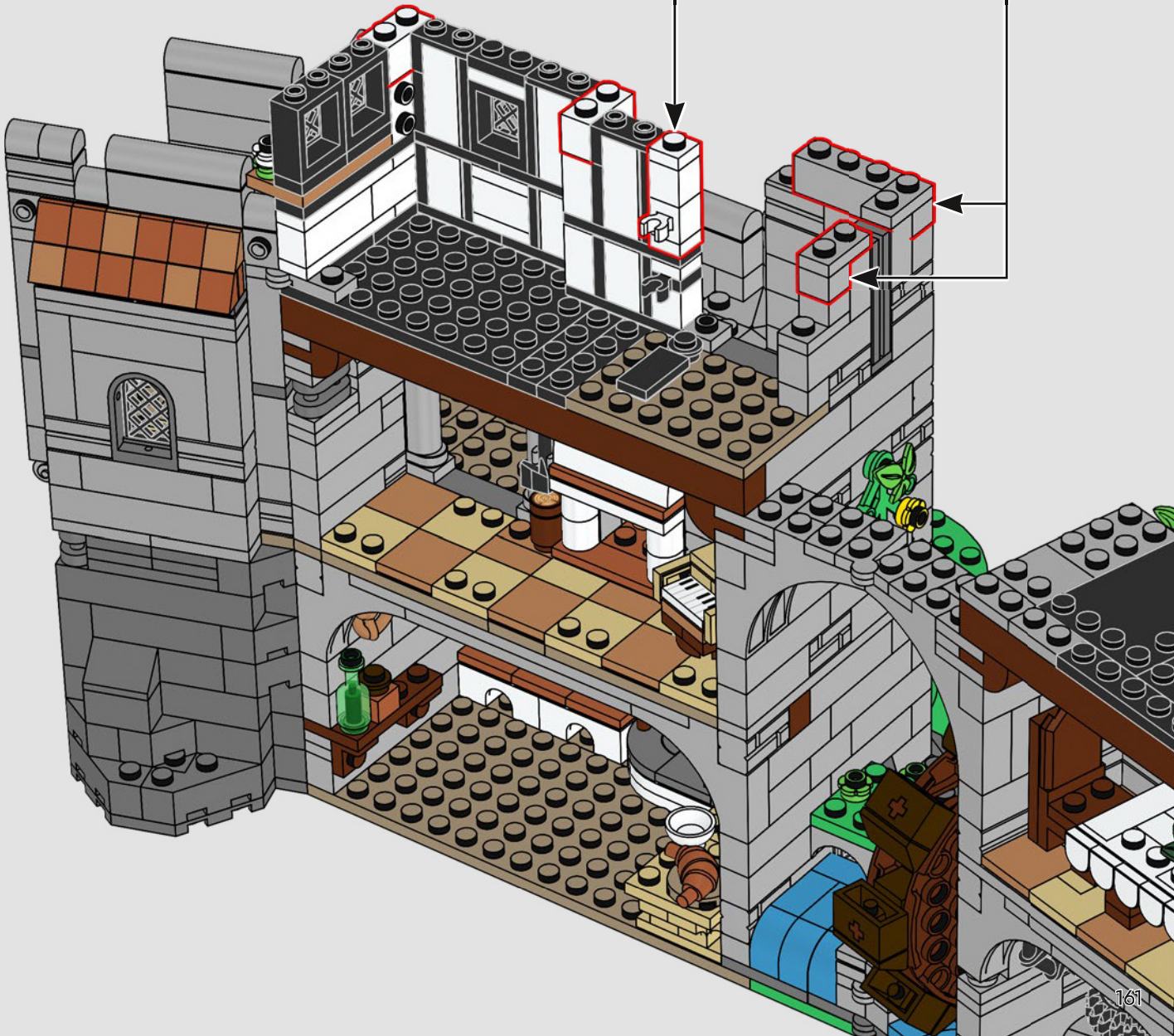
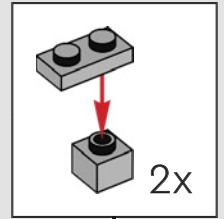
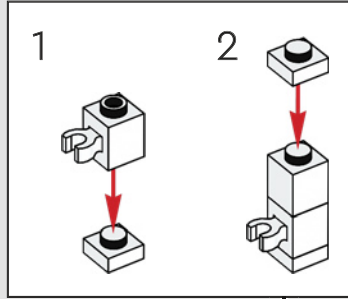

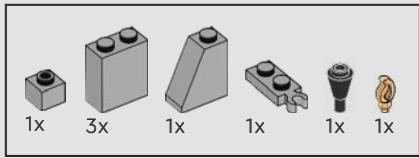

188

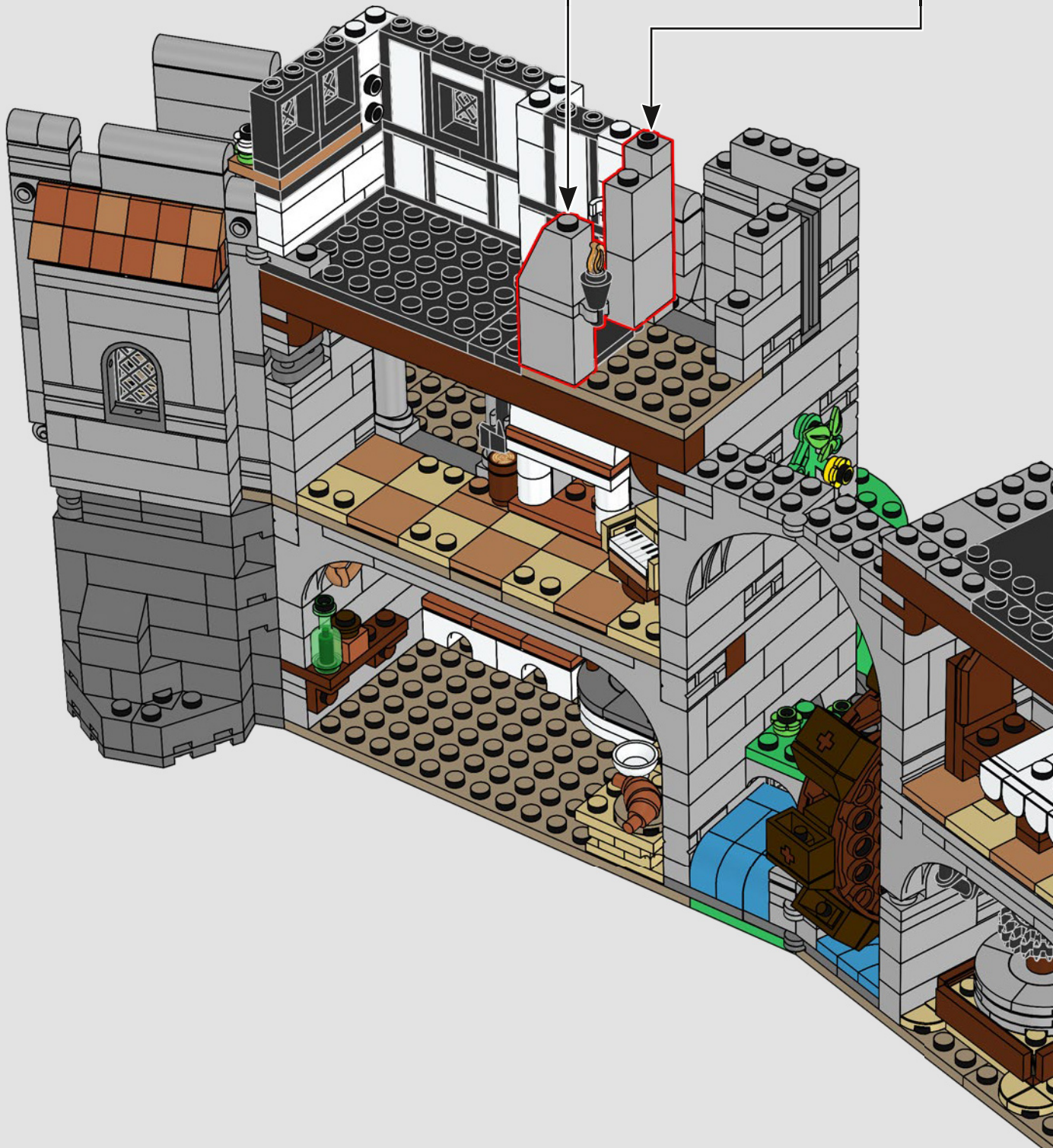
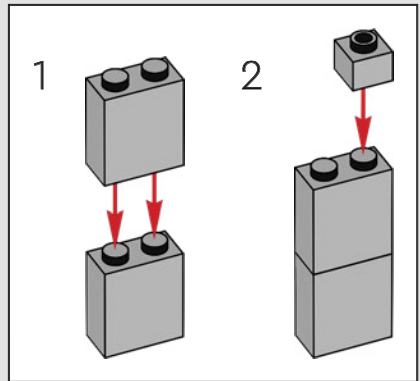
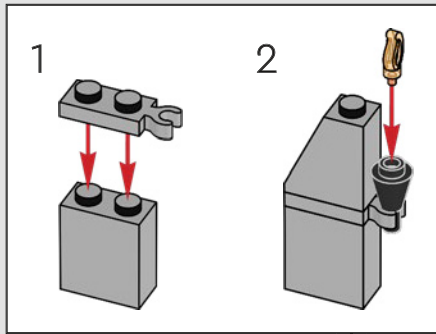

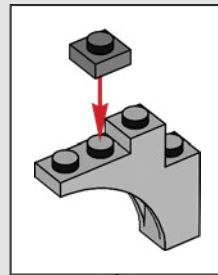
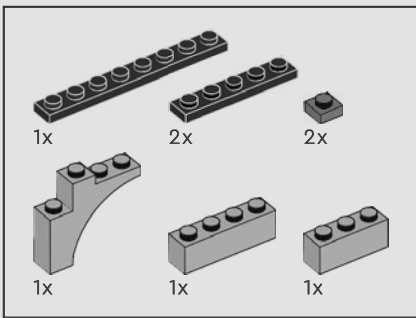

189

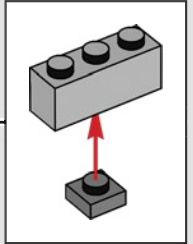
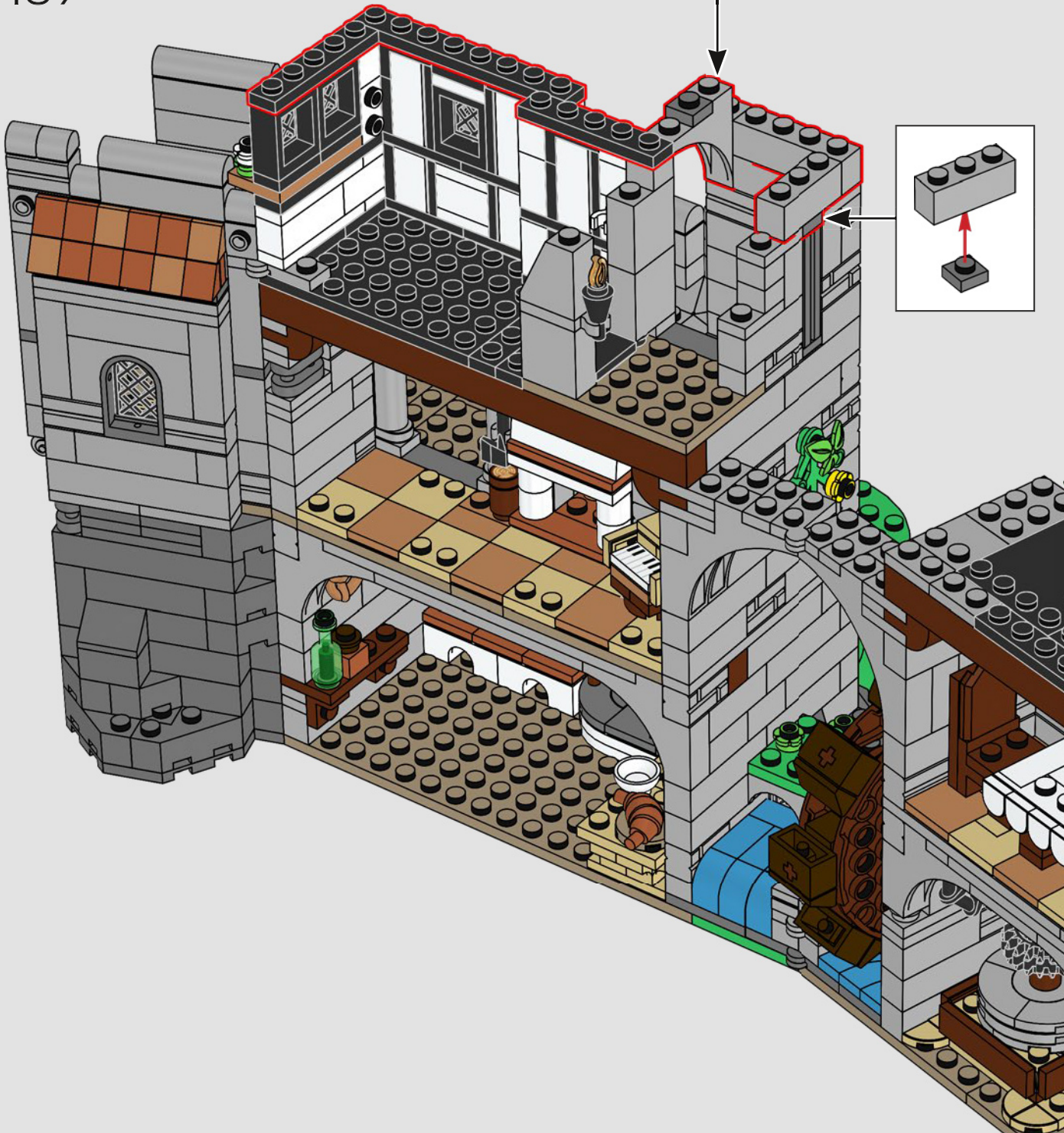

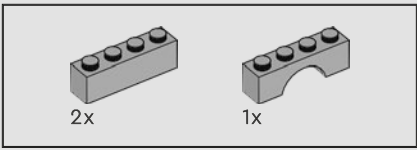

190

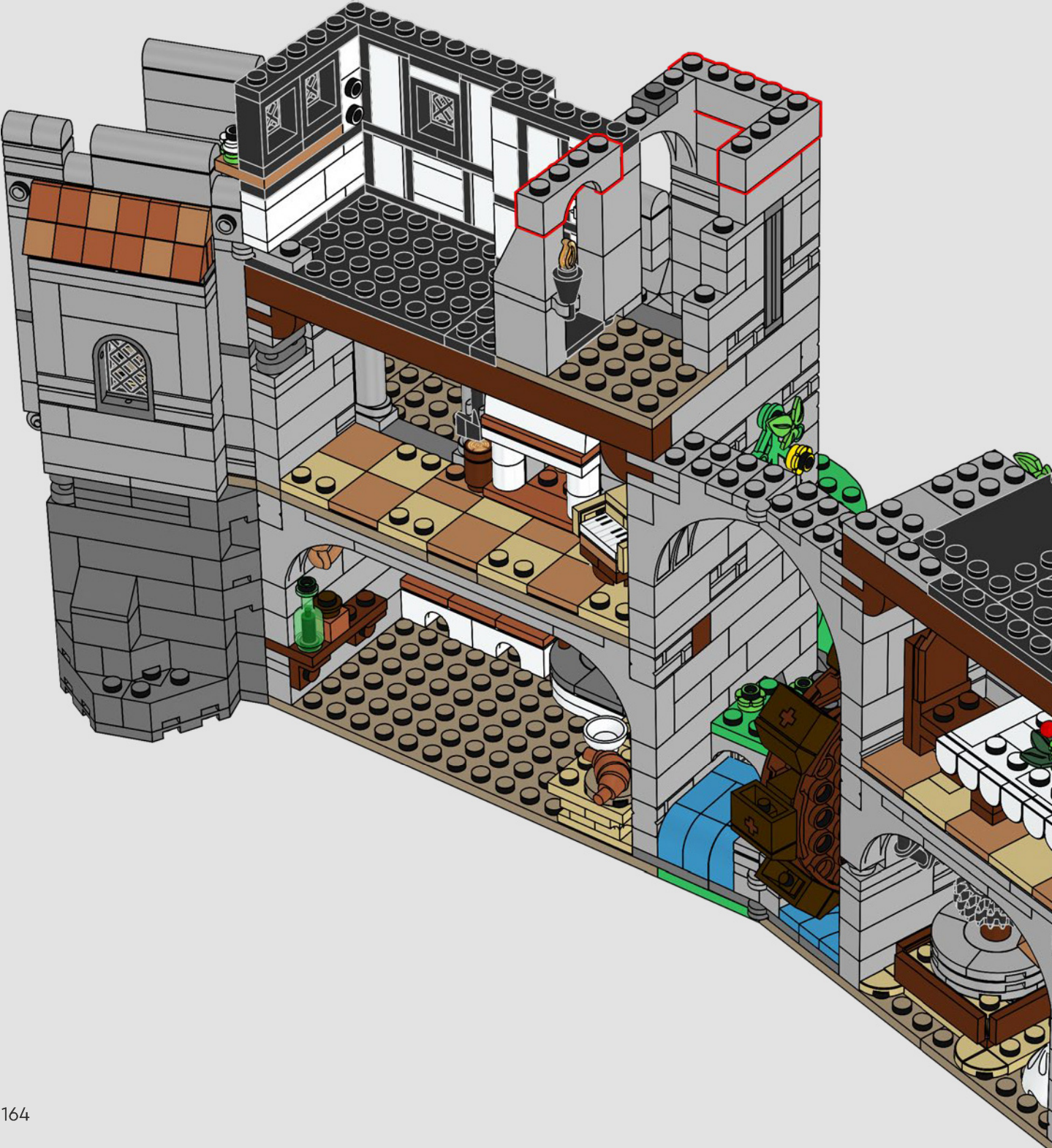



What a beautiful curio! Doth remind  
of a castle from generations ago...



191

1

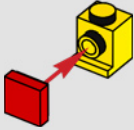

2

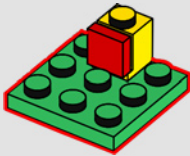

3

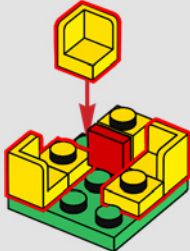

4

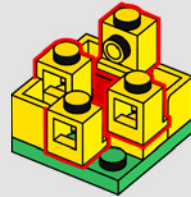

5

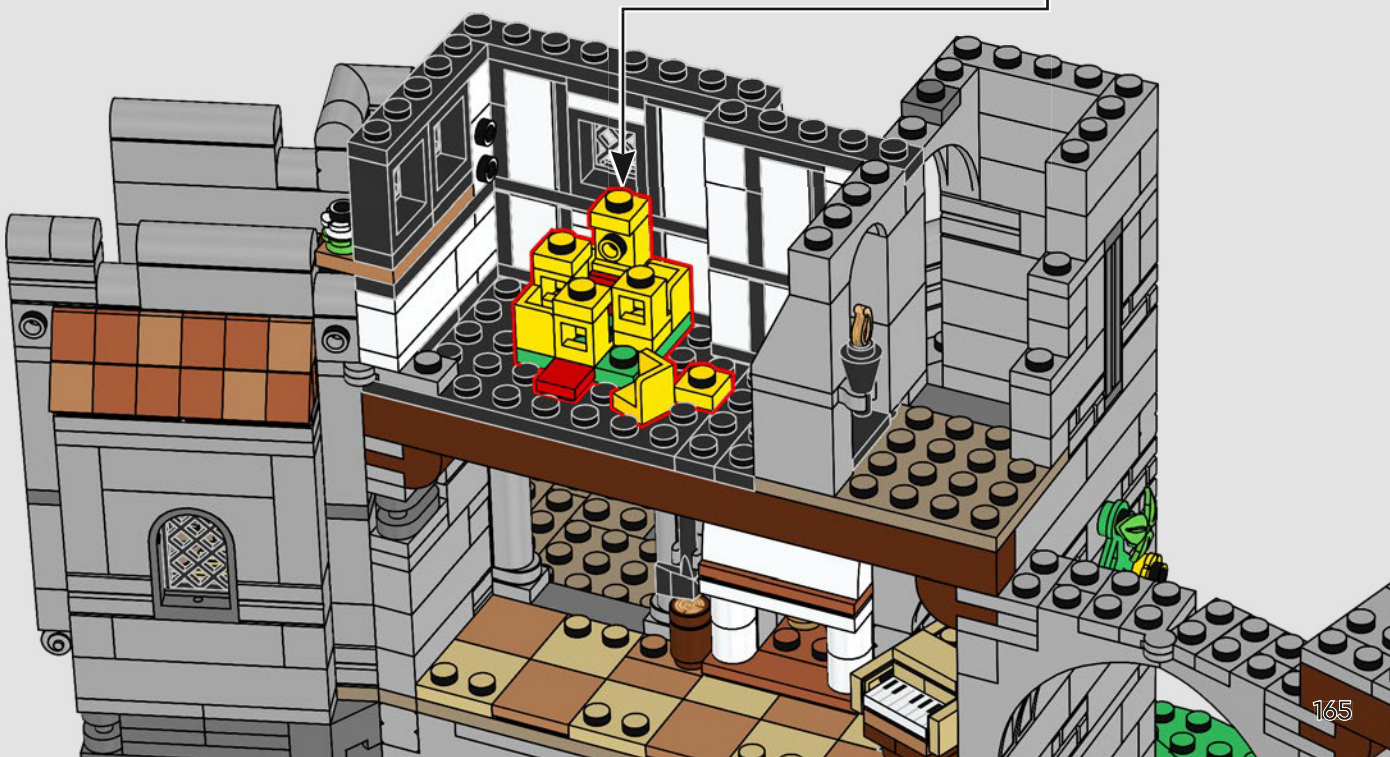
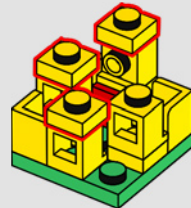

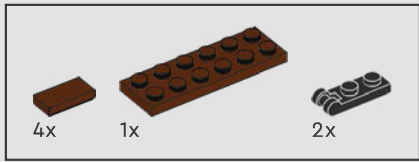

192

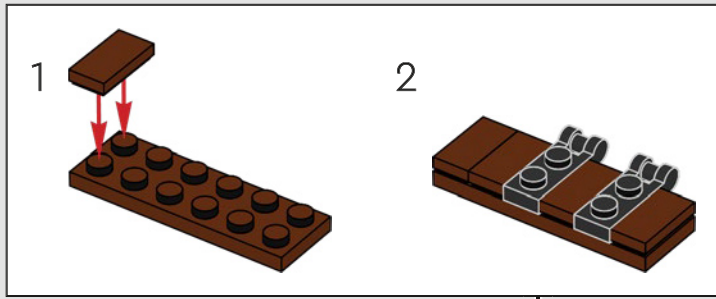

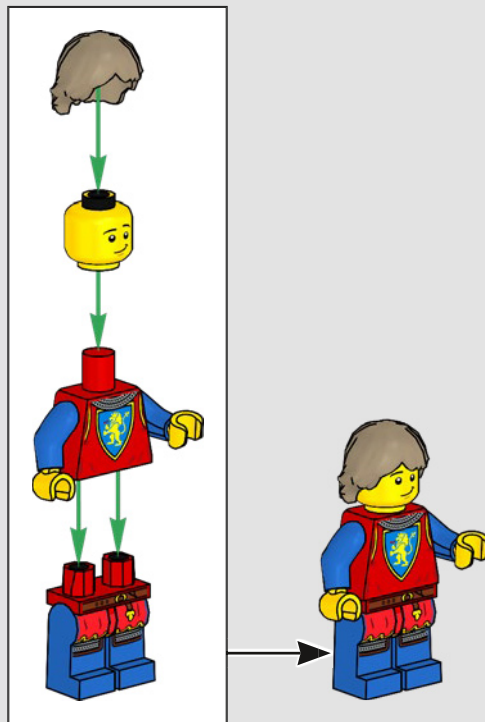

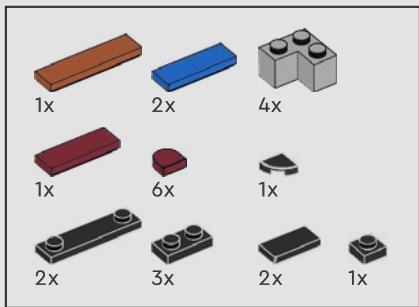

193

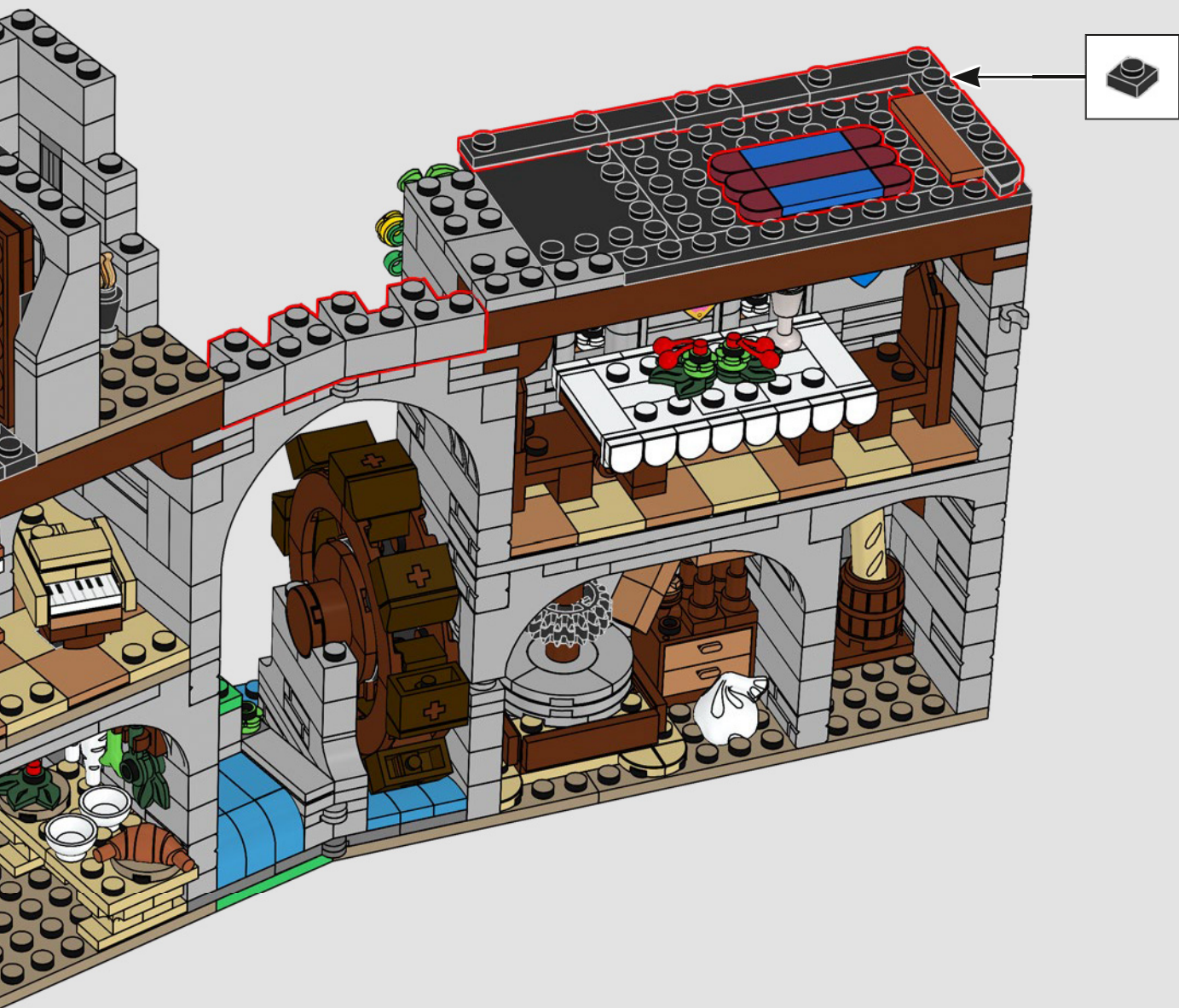



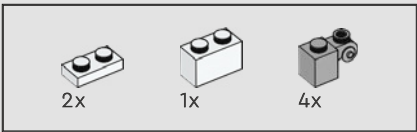

194

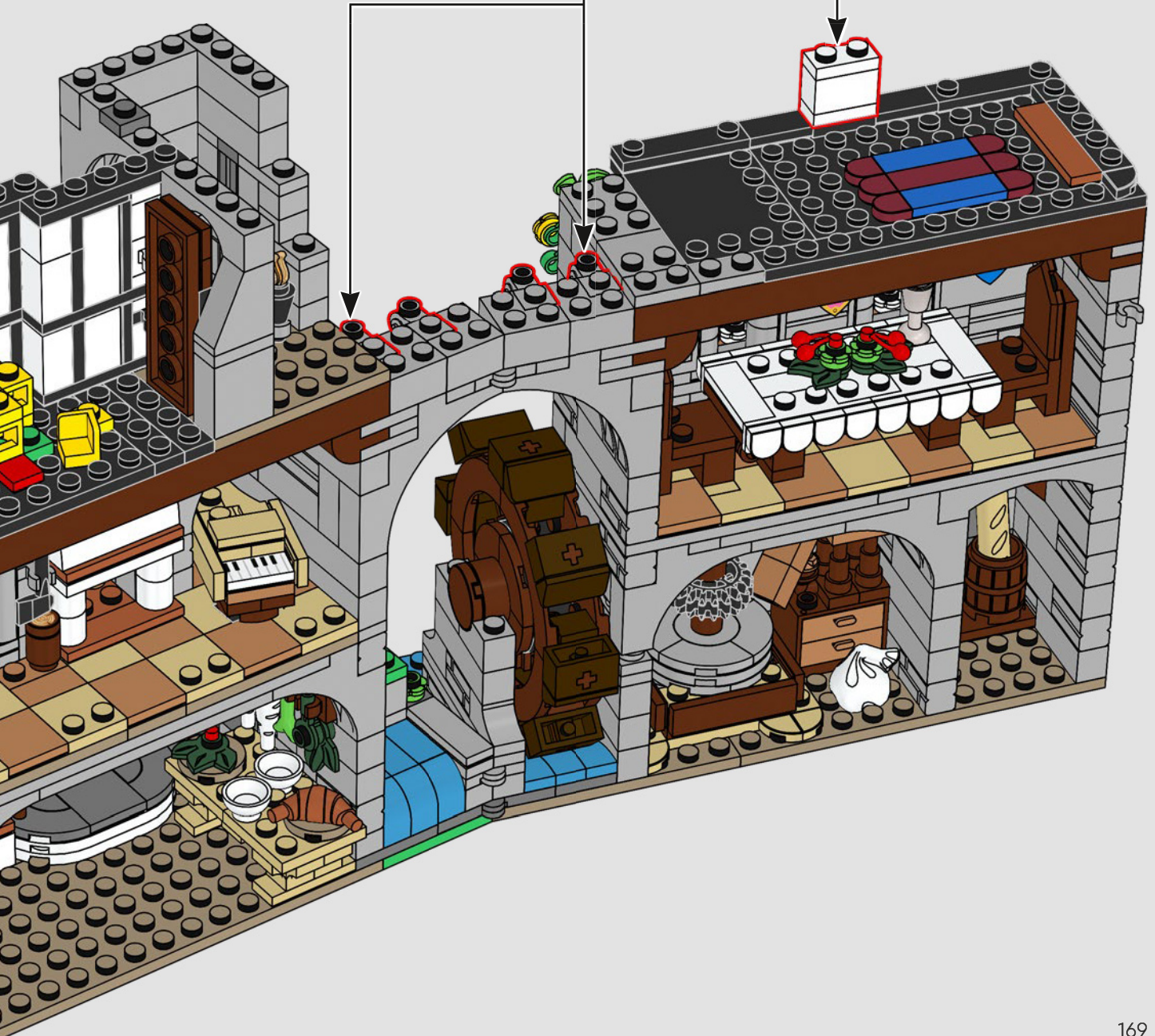
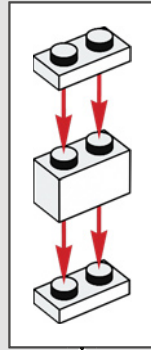
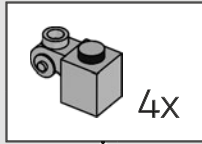

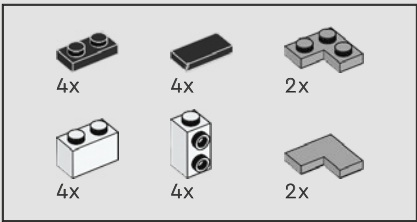

195

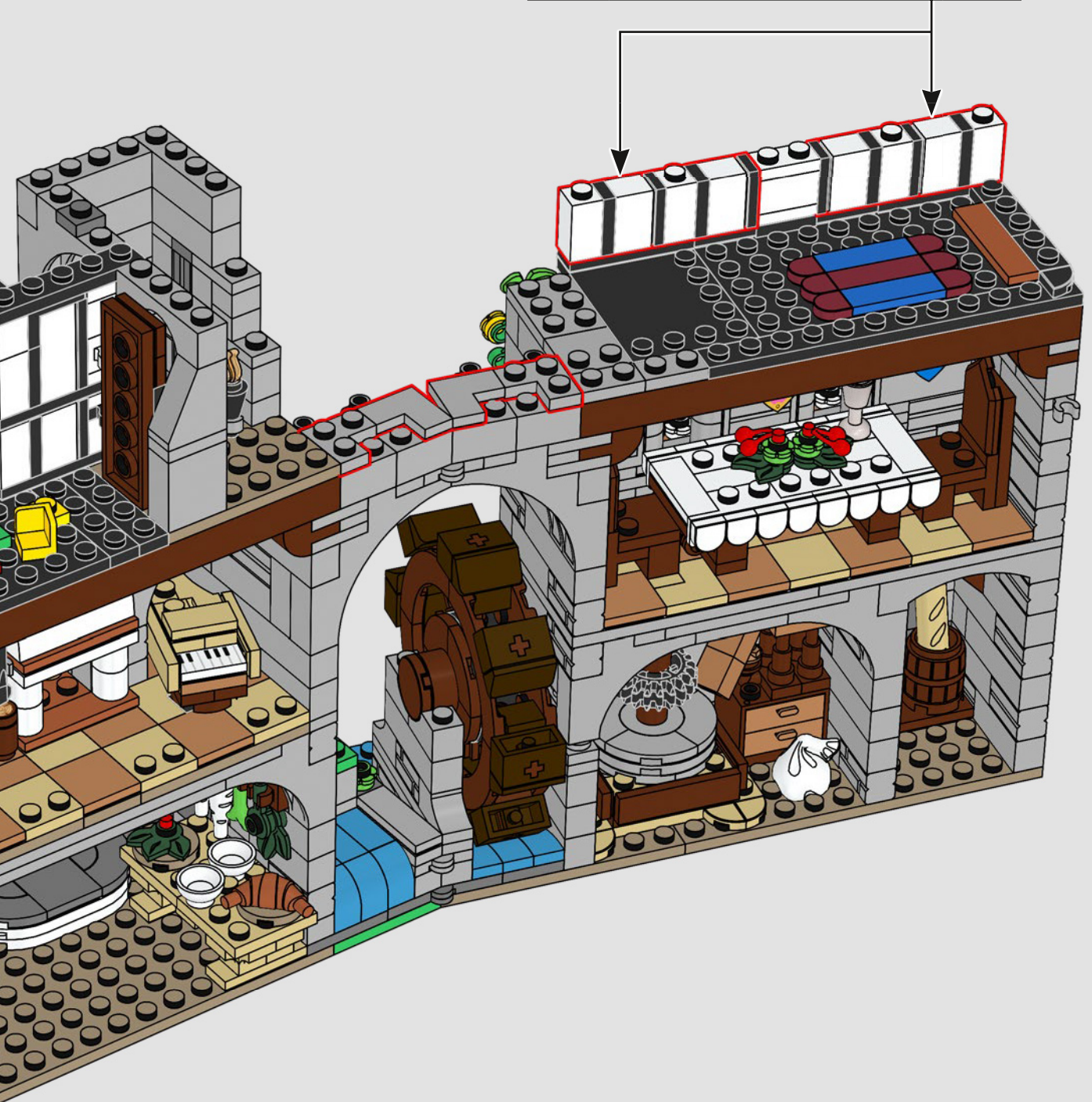
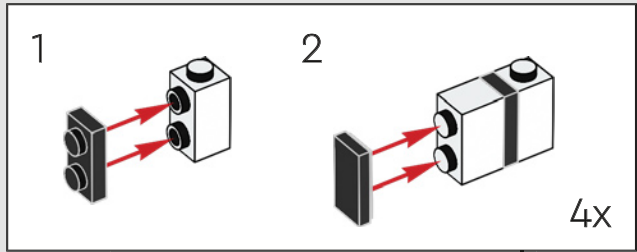

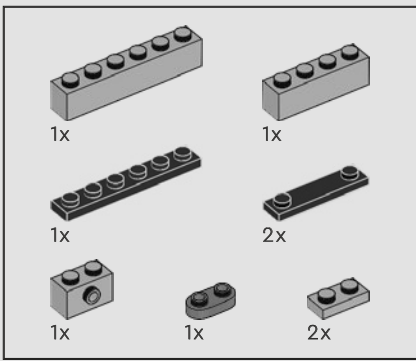

196

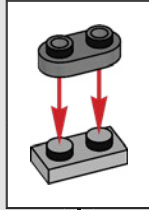



197

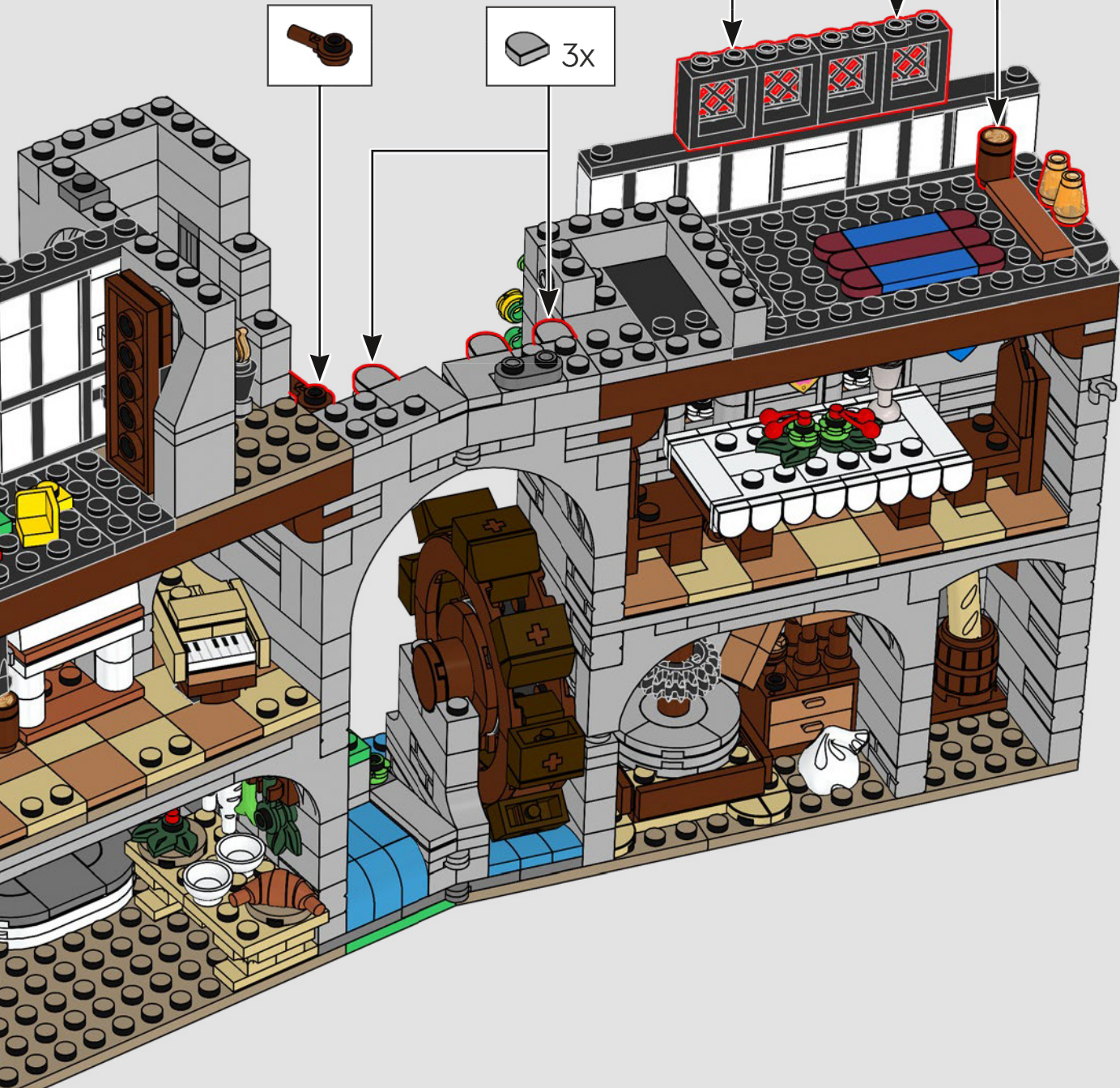
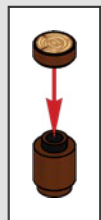
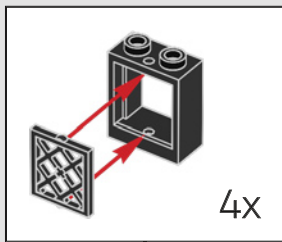

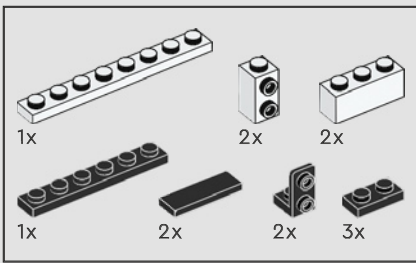

198

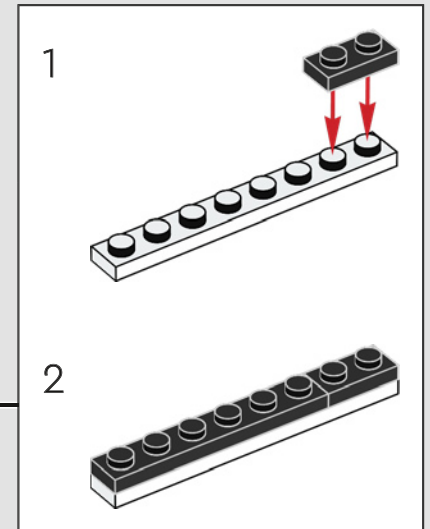
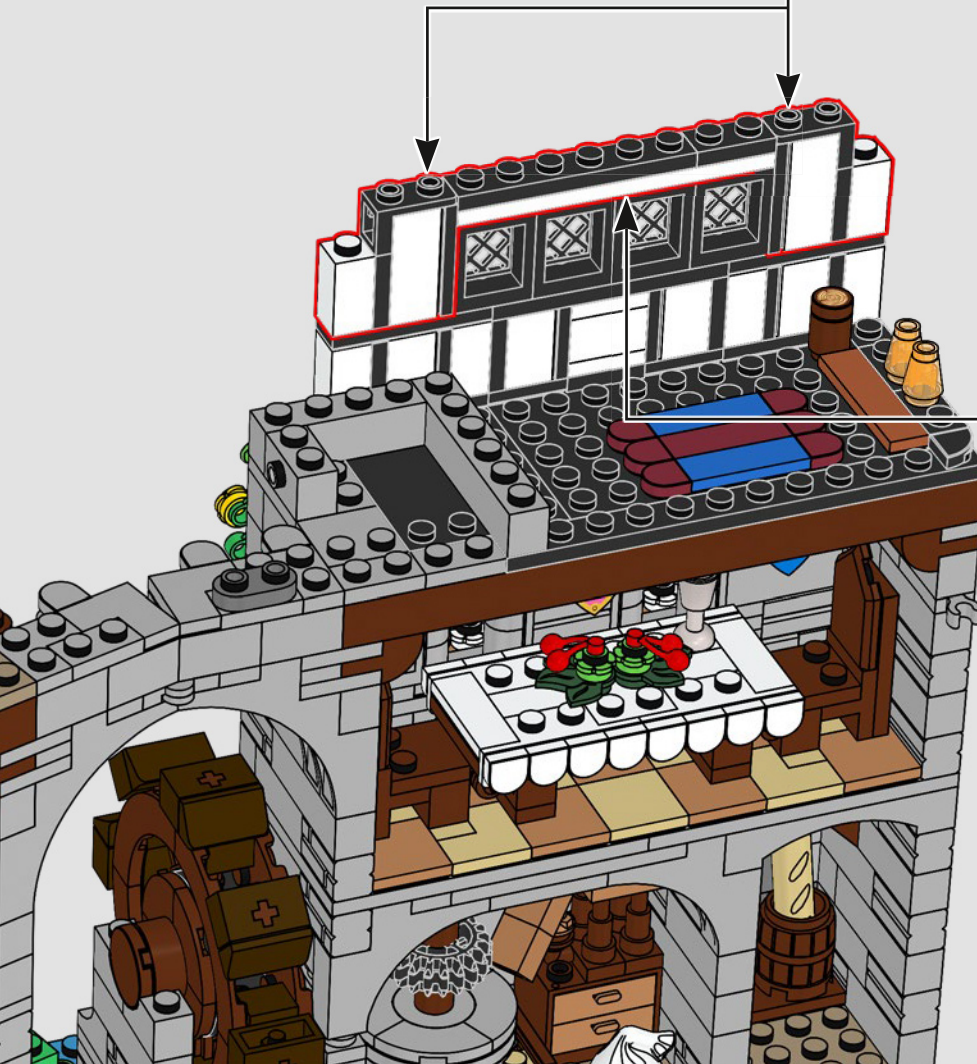
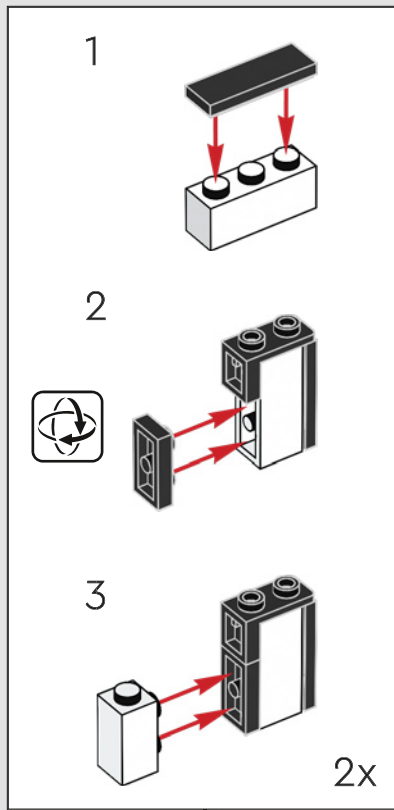

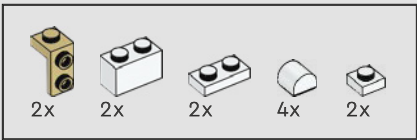

199

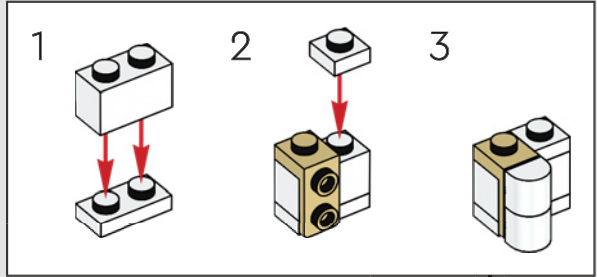
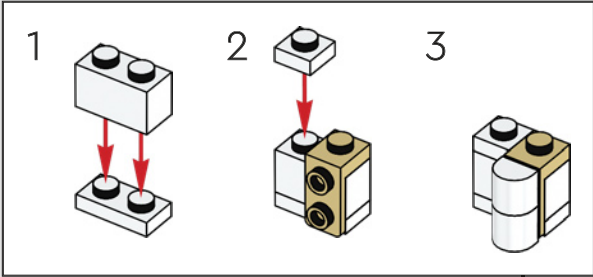

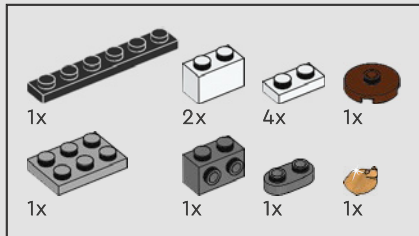

200

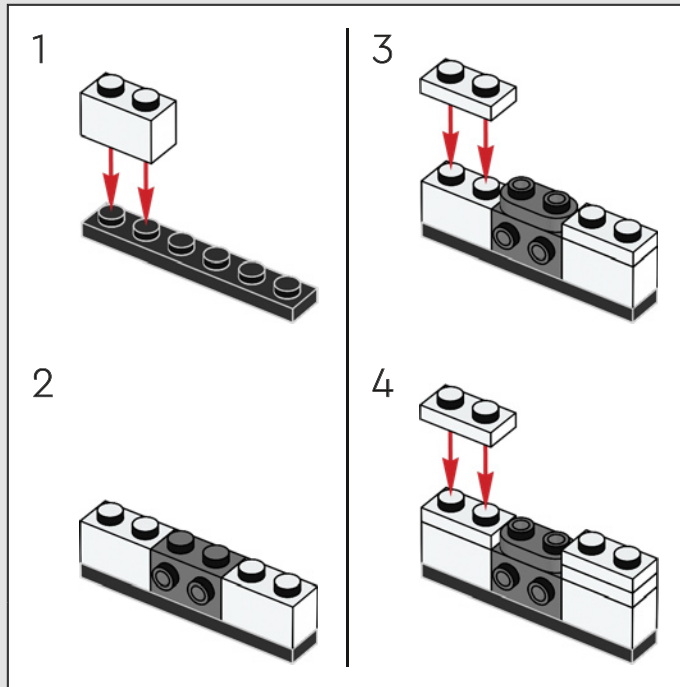
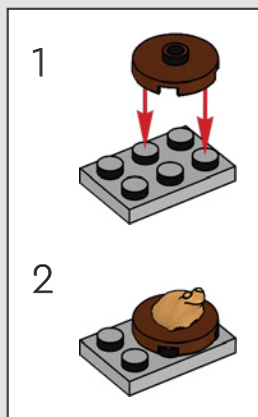

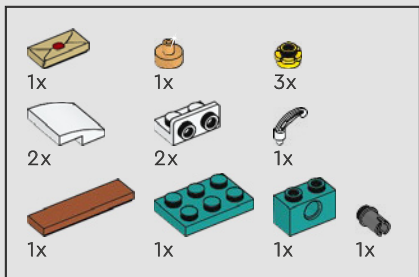

201



What's this odd letter here on the table, and with Lord Basil's seal on it!!

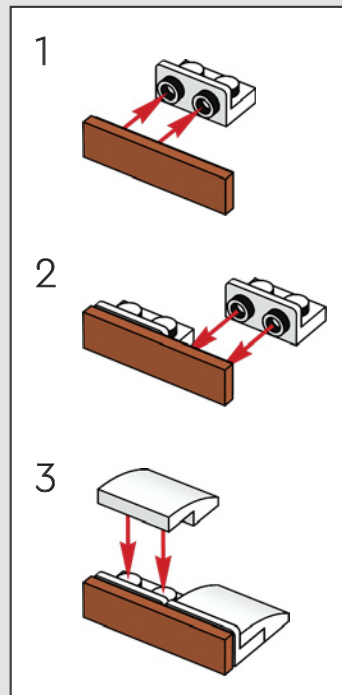
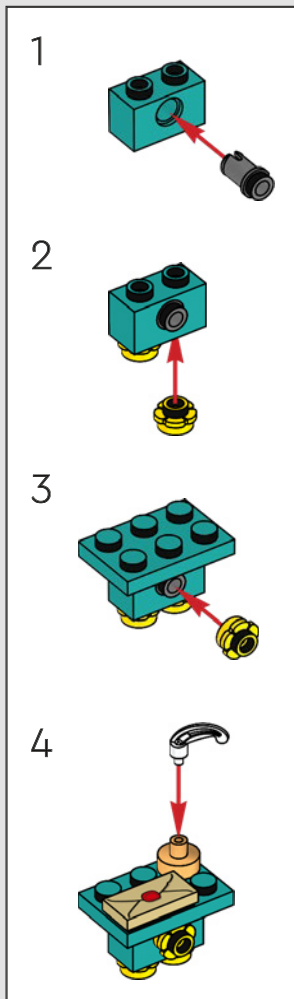



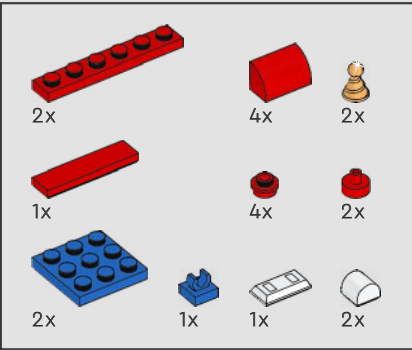
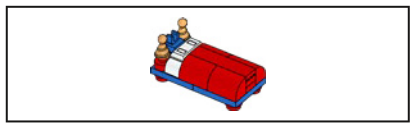

202

1

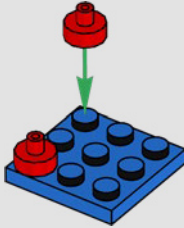

2

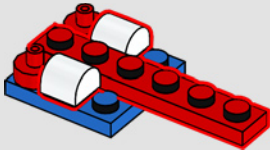

3

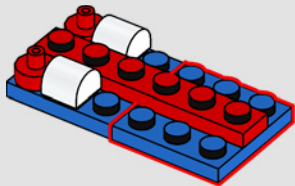

4

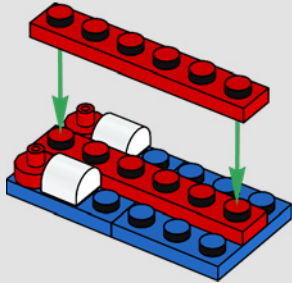

5

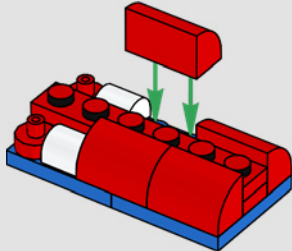

6

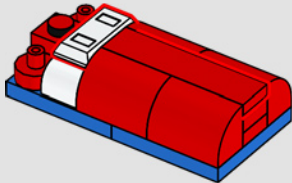

7

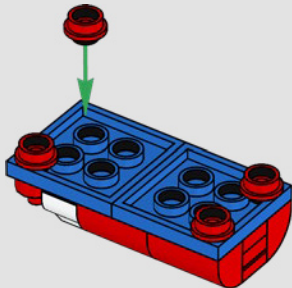

8

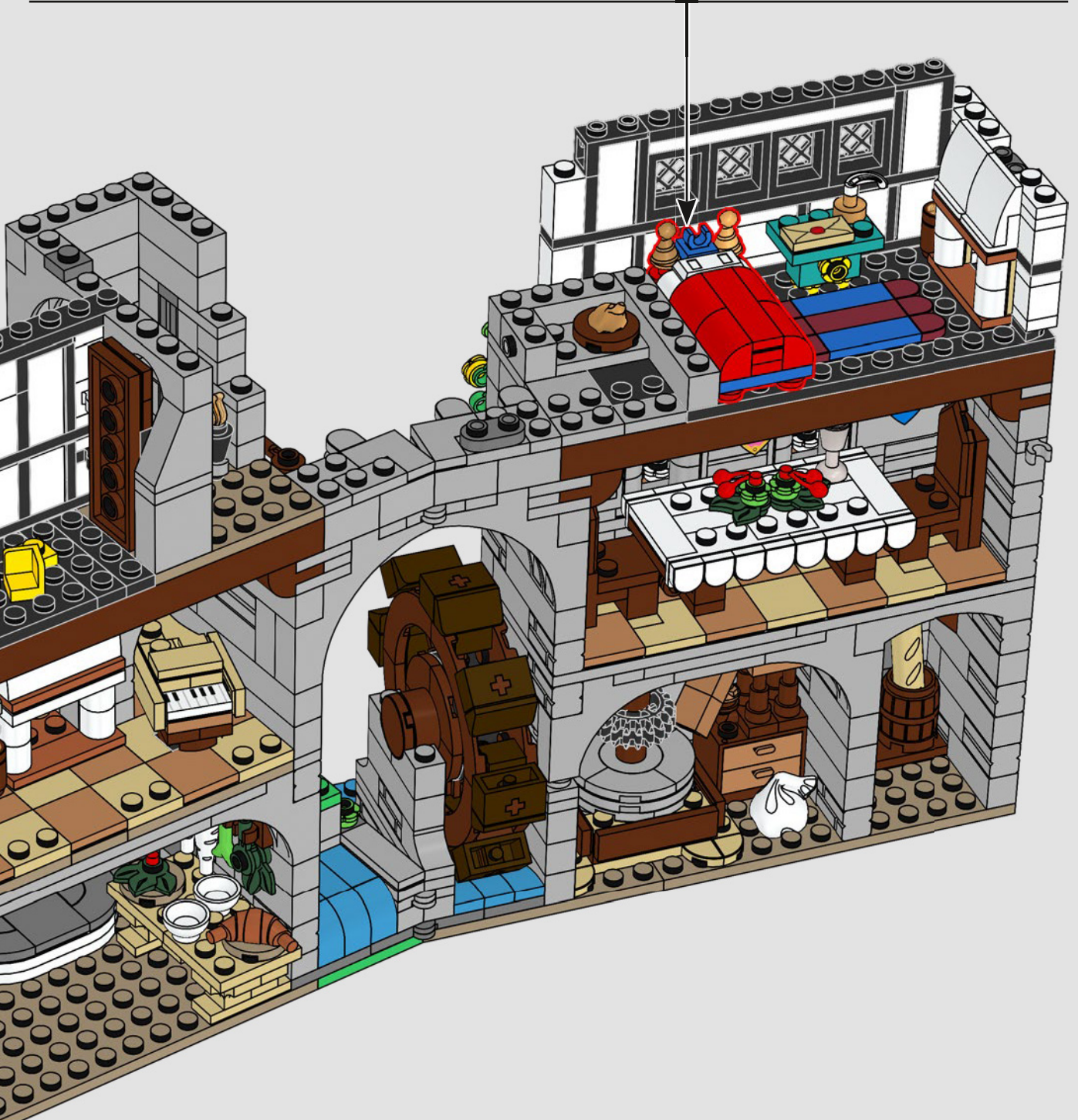
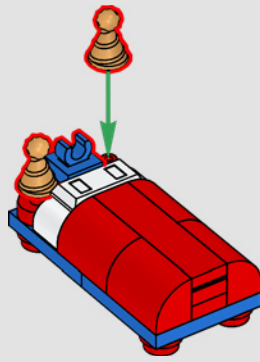

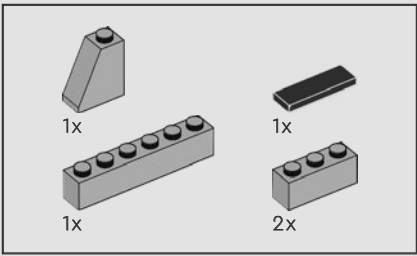

203

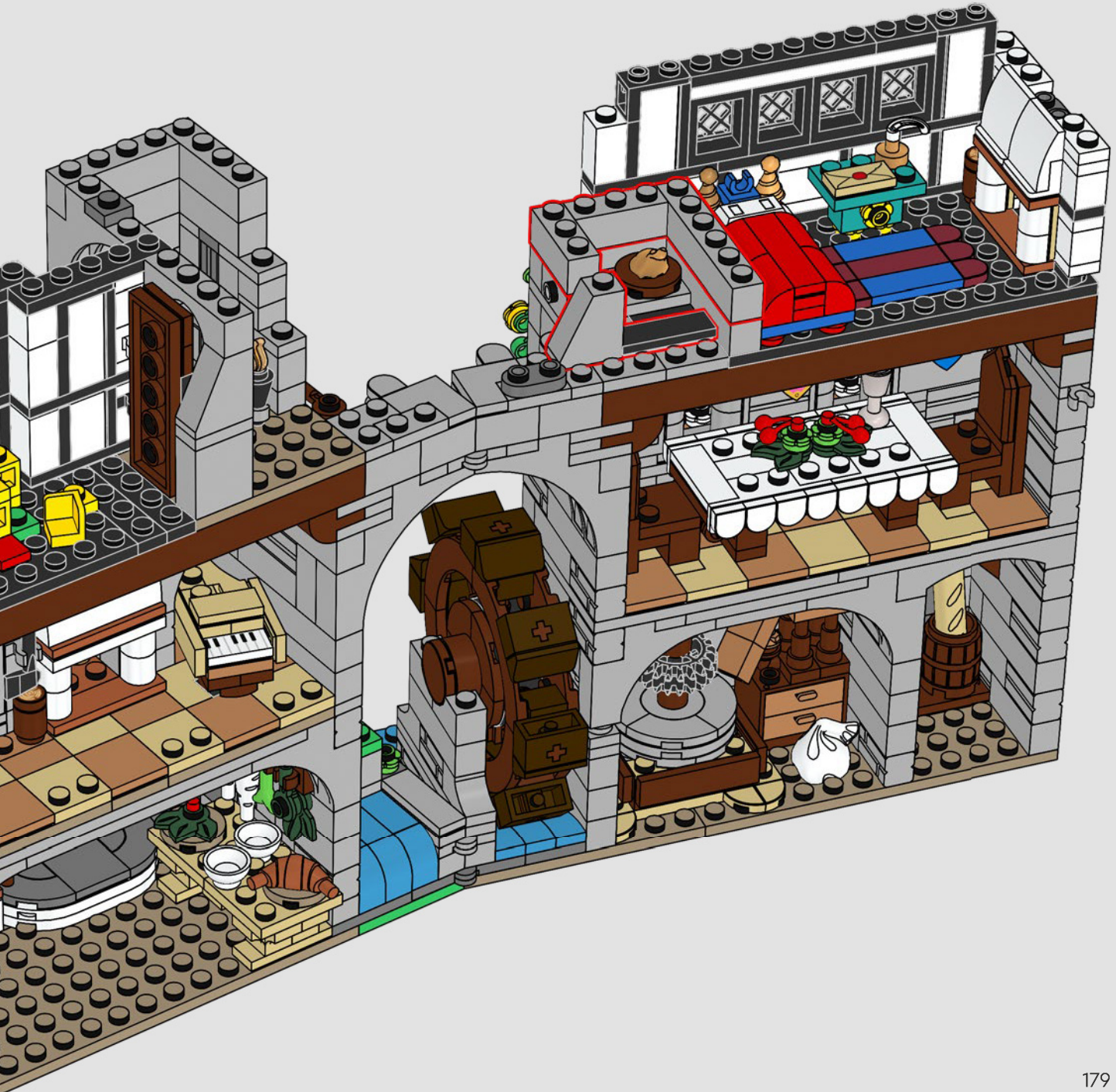

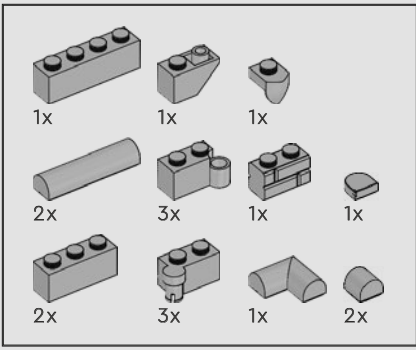

204

1

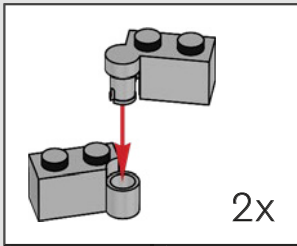
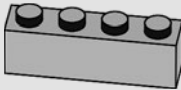

2

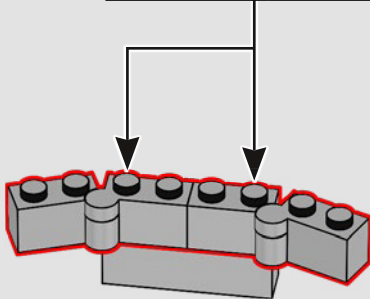

3

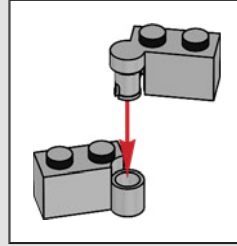
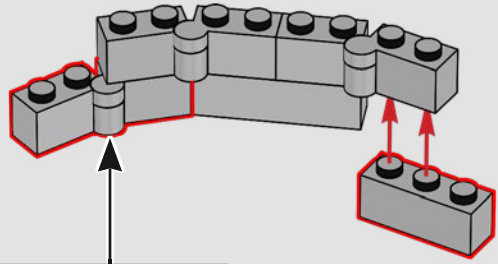

4

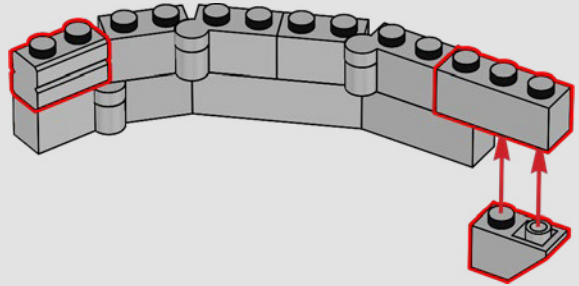

5

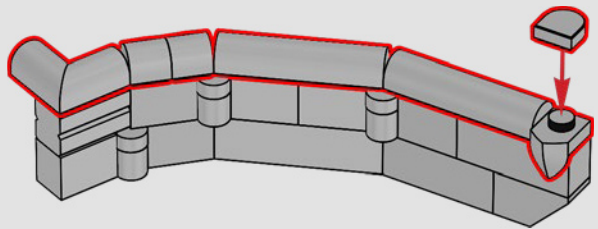





*There's a magic in this wall! Some extra study will be required to get to the bottom of this mystery.*

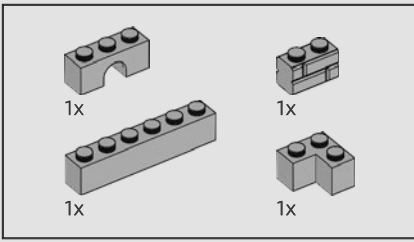

205

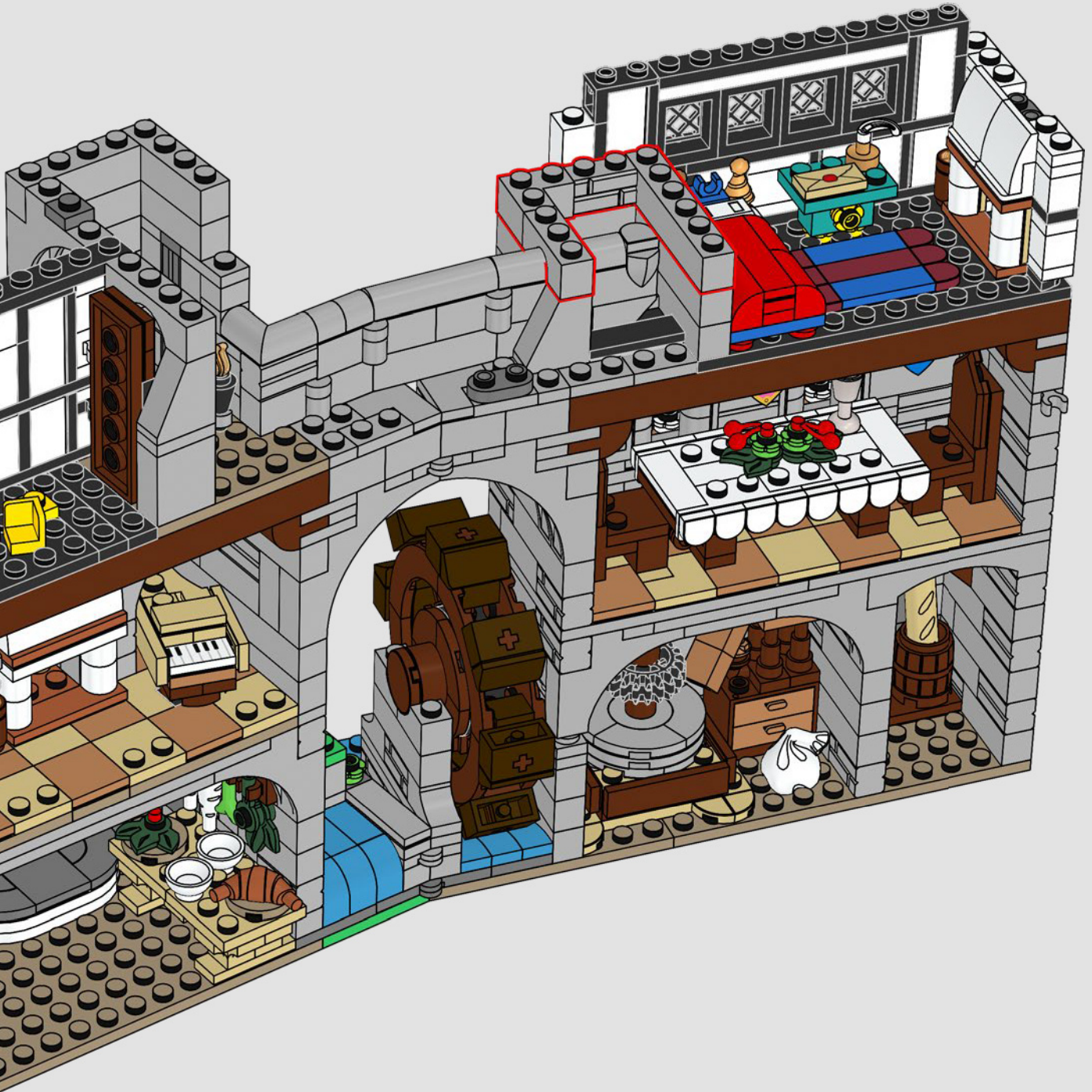

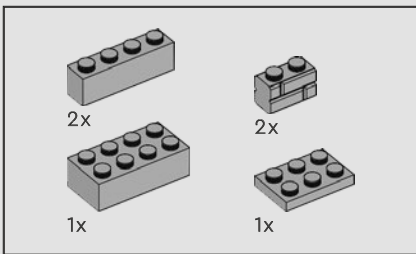

206

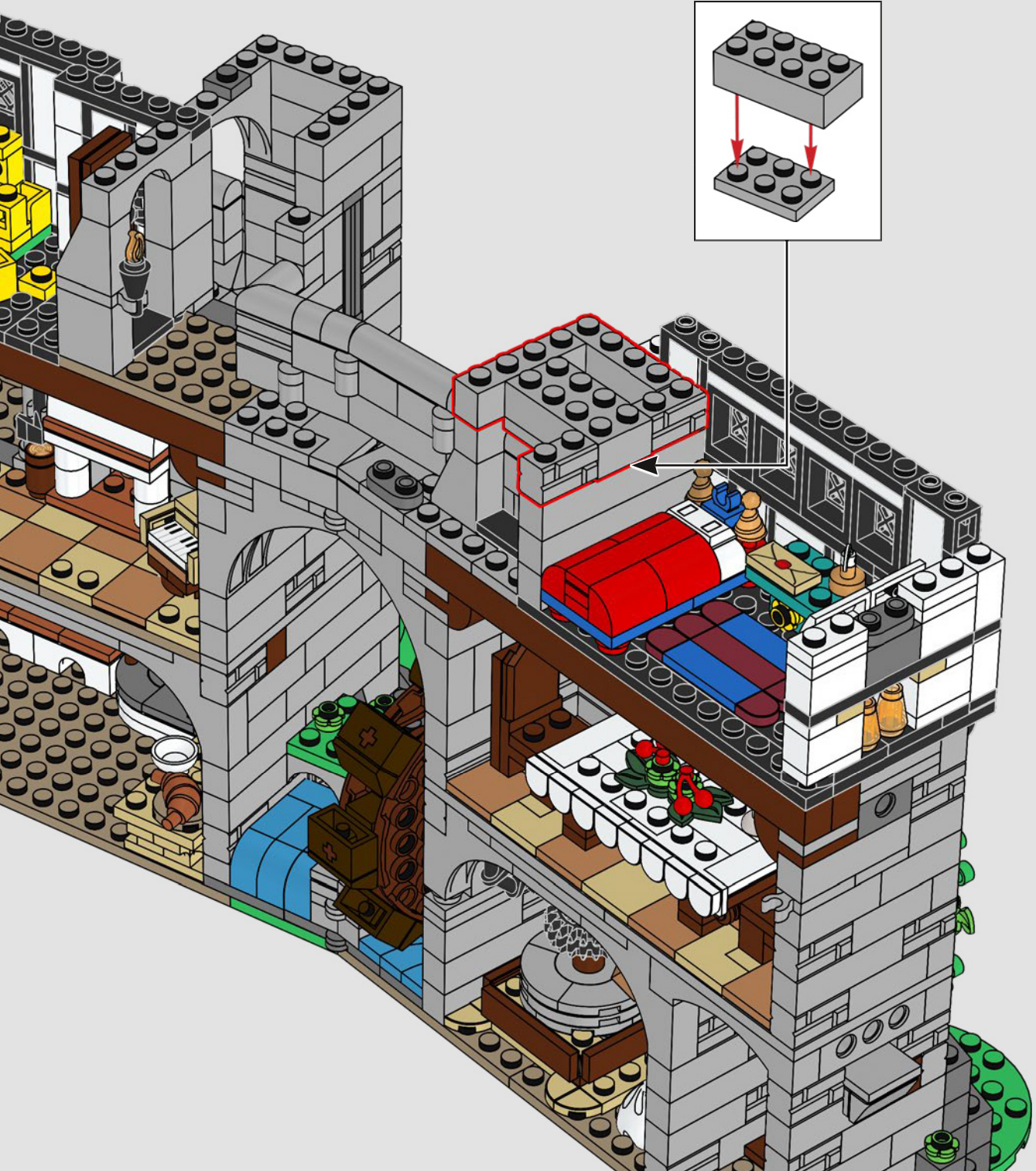

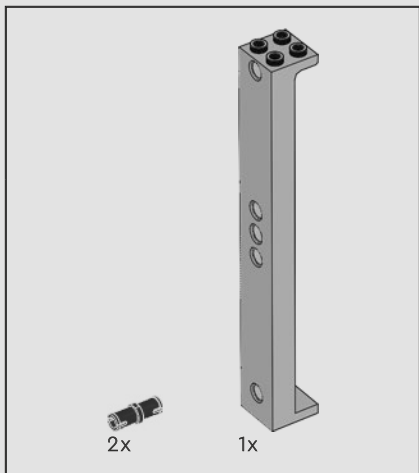

207

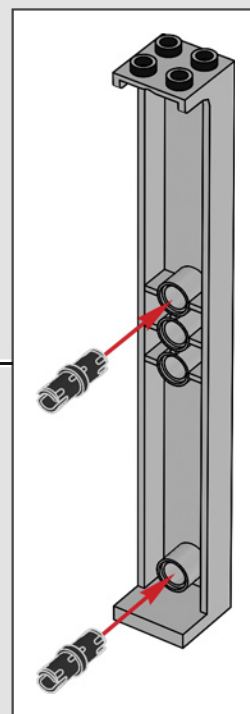
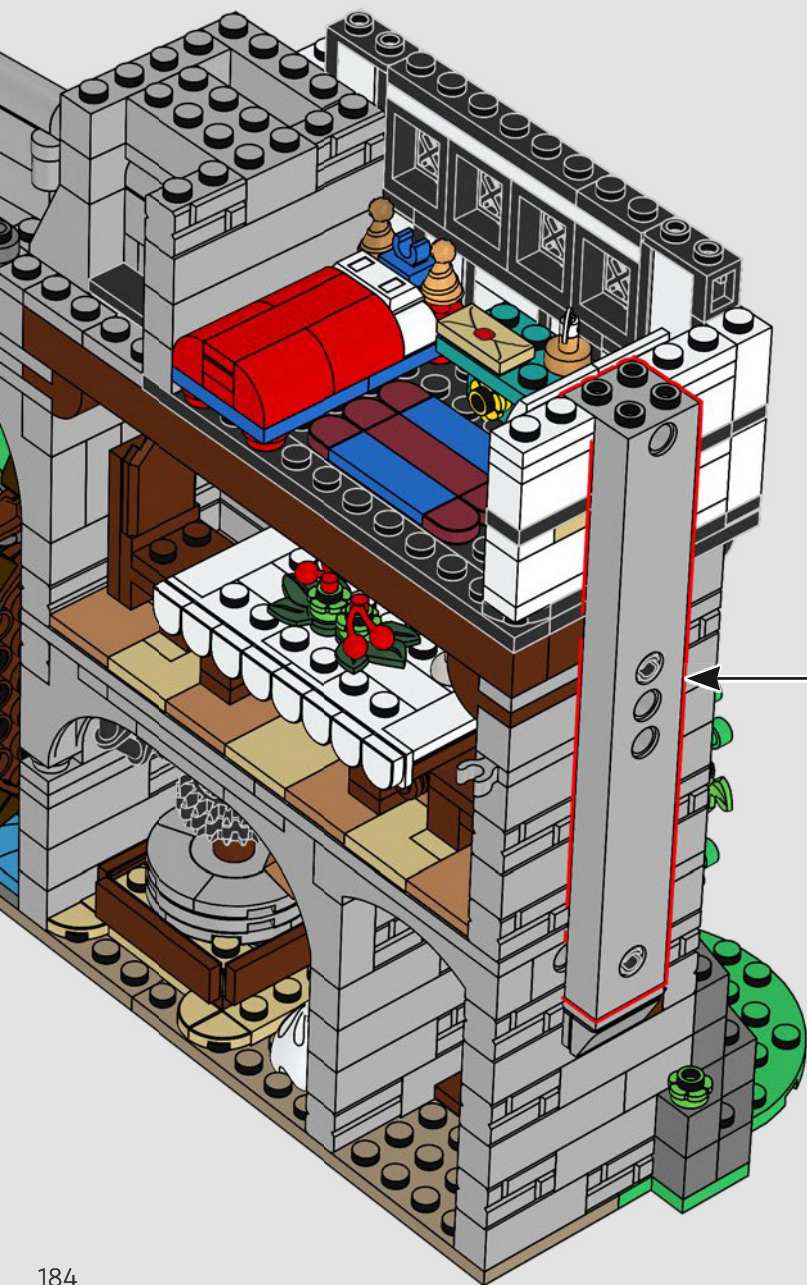



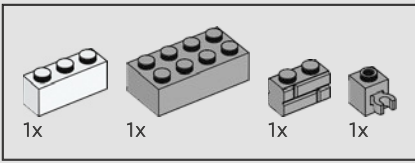

208



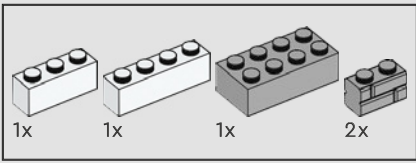

209



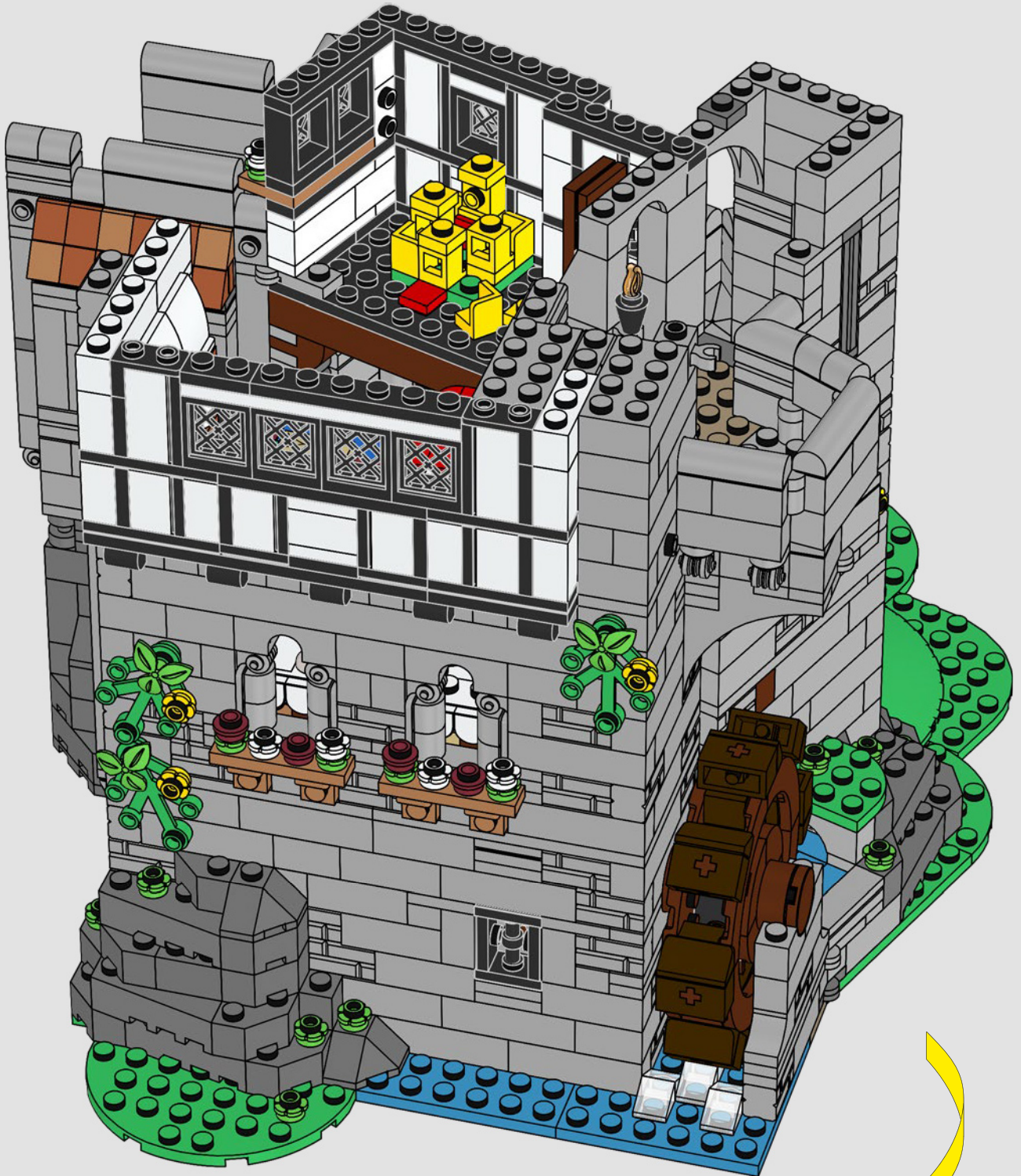

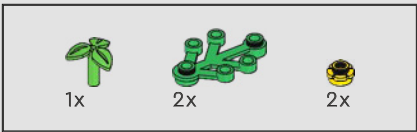

211

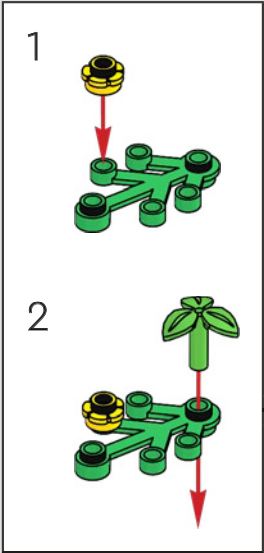
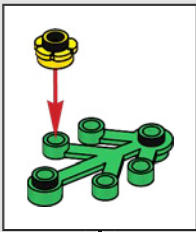



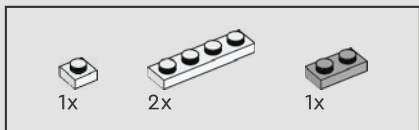

214

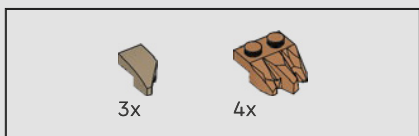
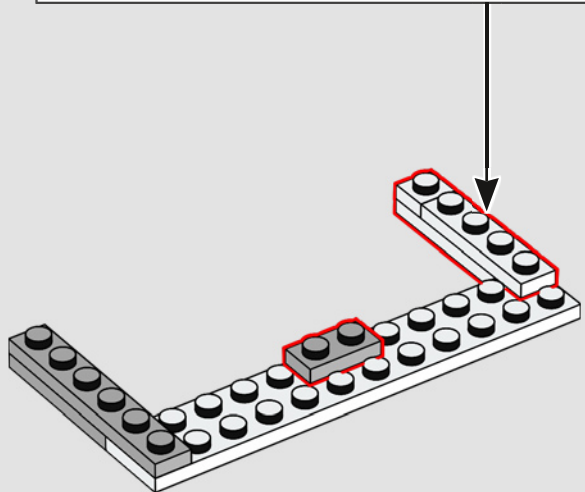
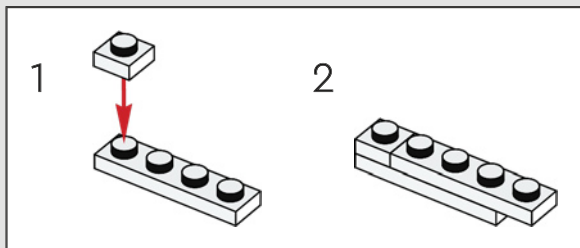

215

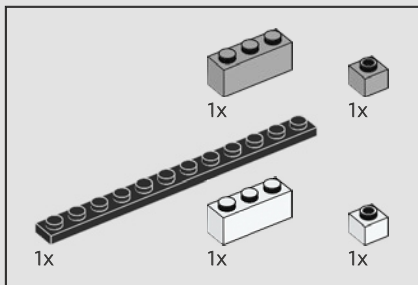
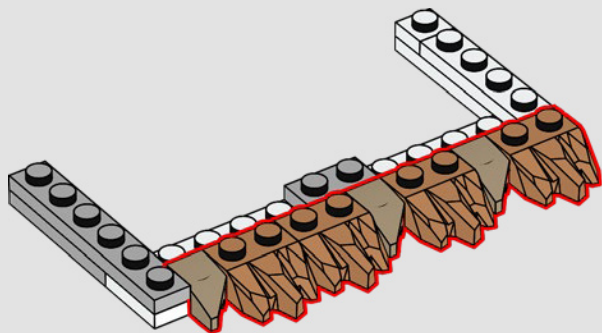

216

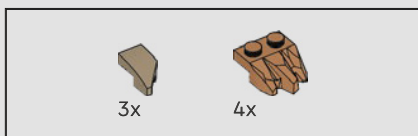
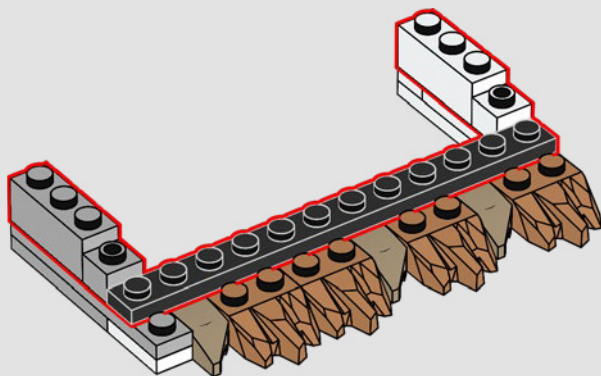

217

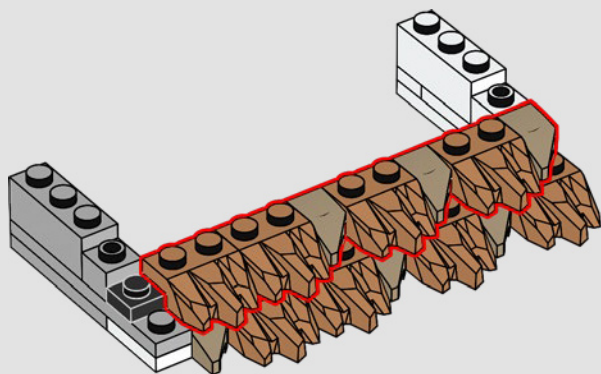

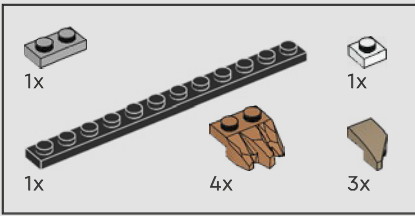

218

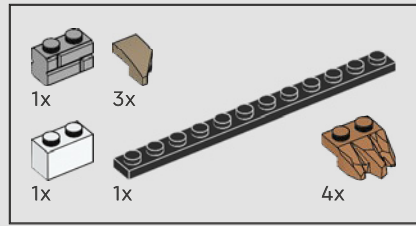
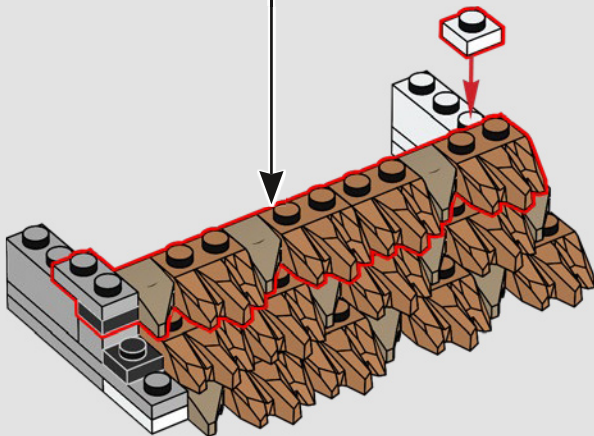
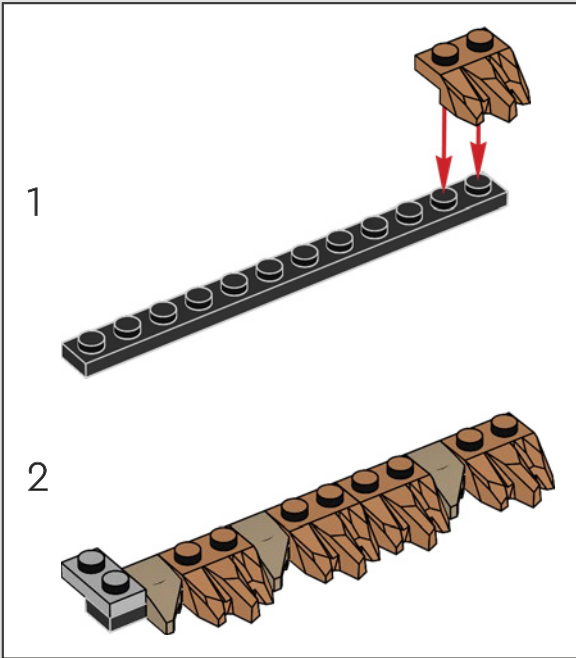

219

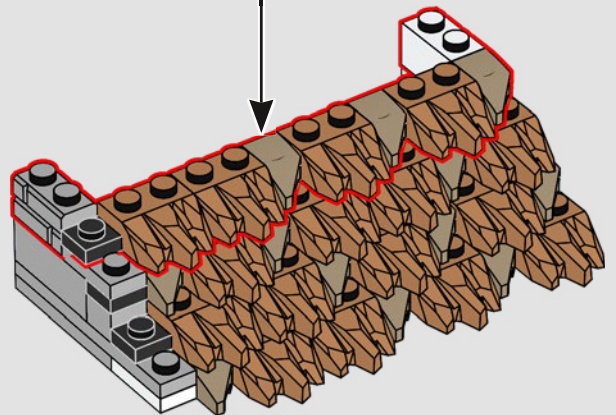
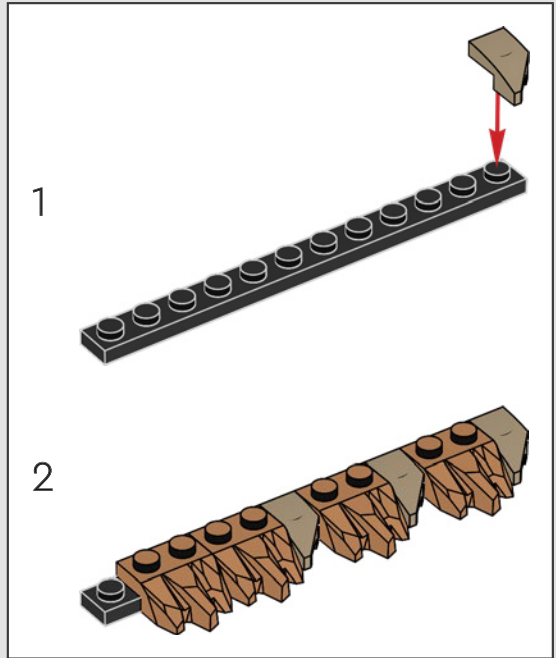

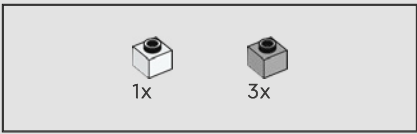

220

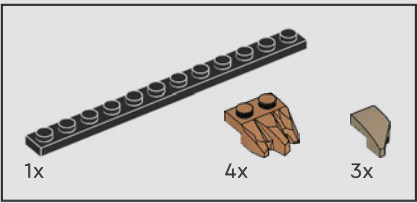
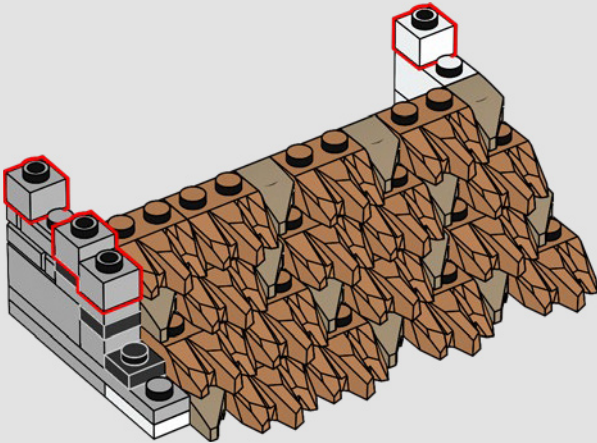

221

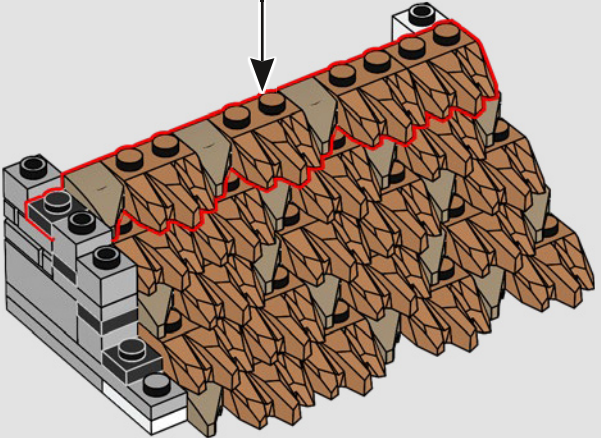
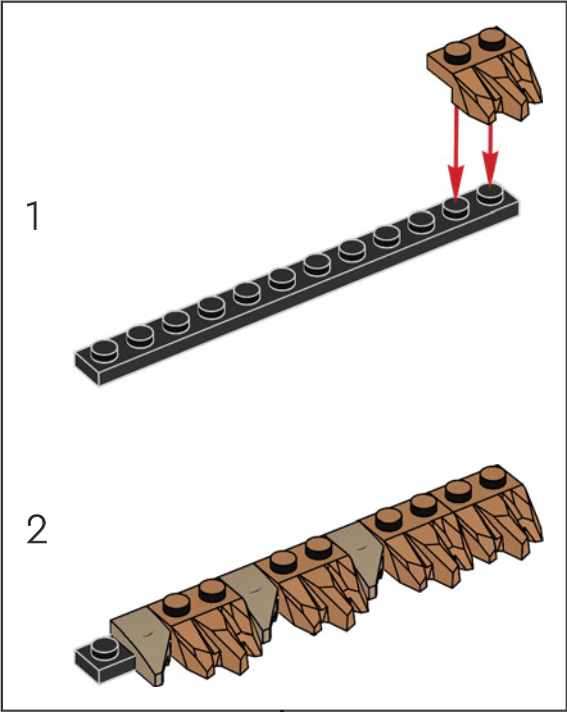



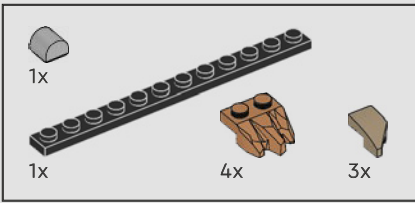

222

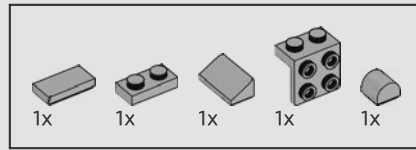
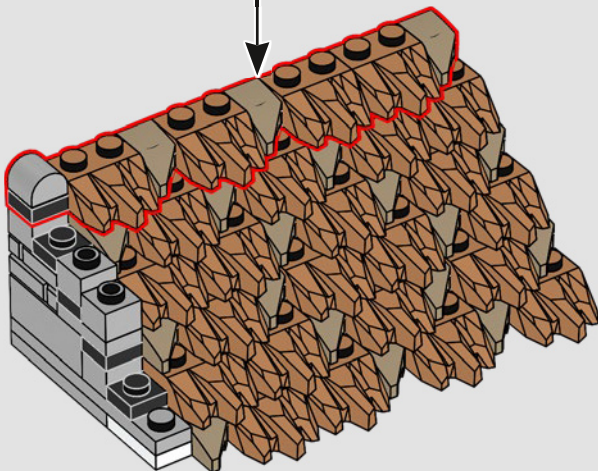
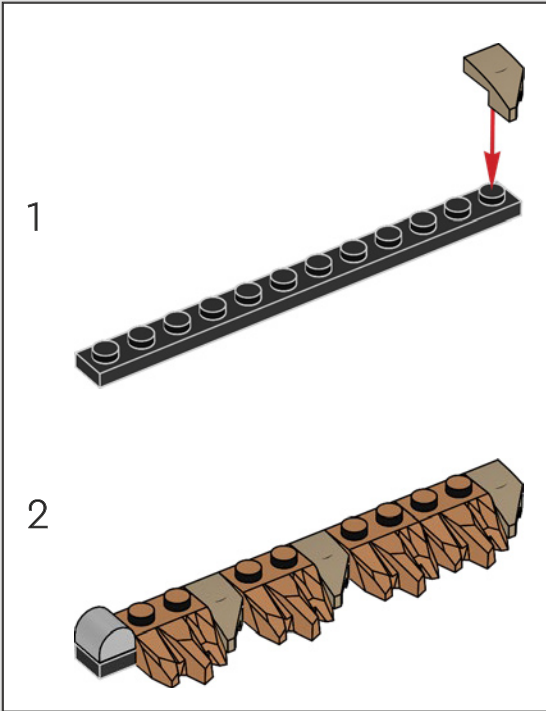

223

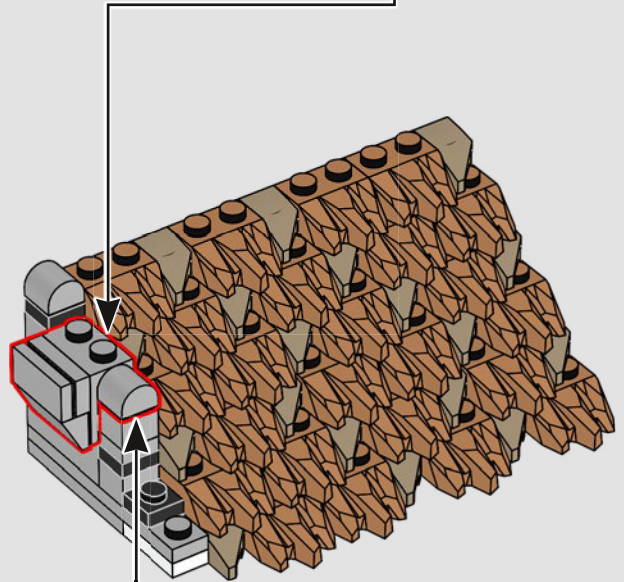
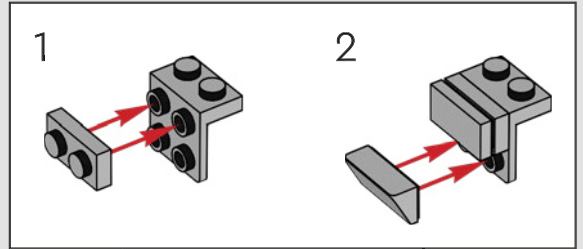



*This roof should keep the chambers warm and dry. What an ingenious material this straw!*

224



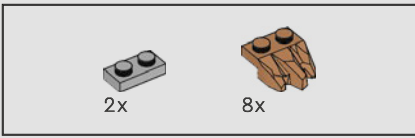

225

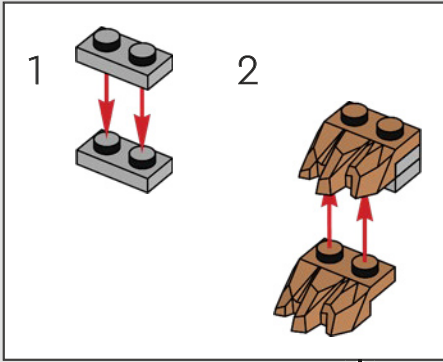

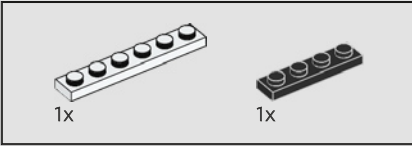
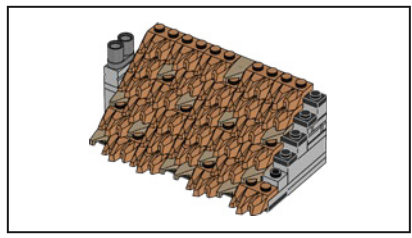

226

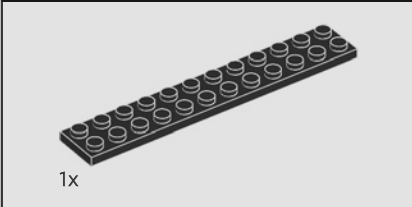
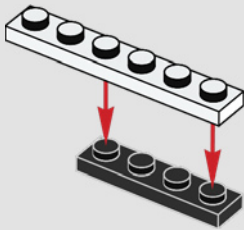

227

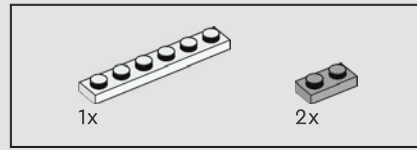
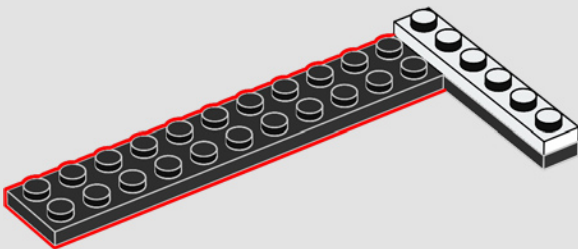

228

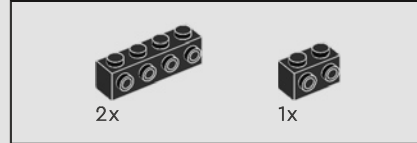
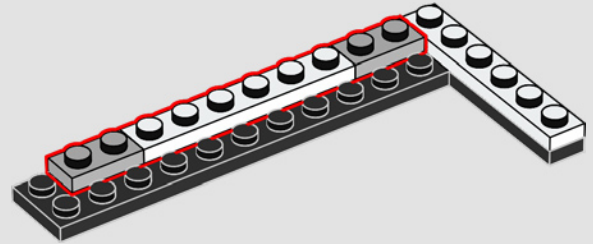

229

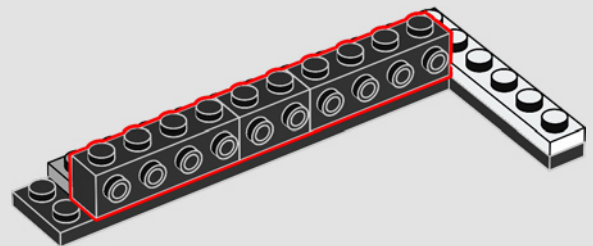

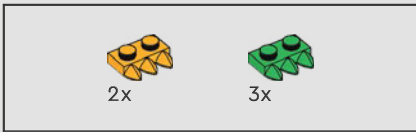

230

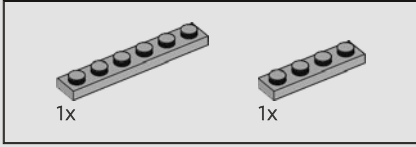
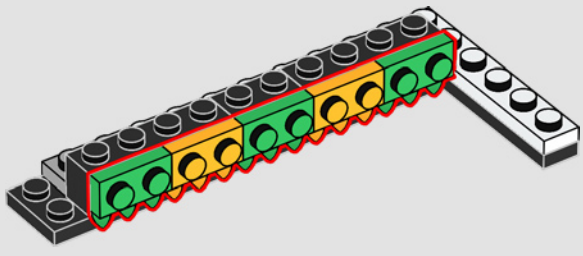

231

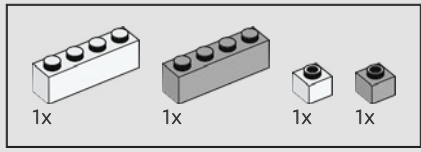
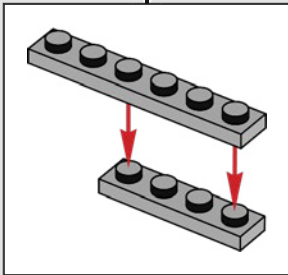
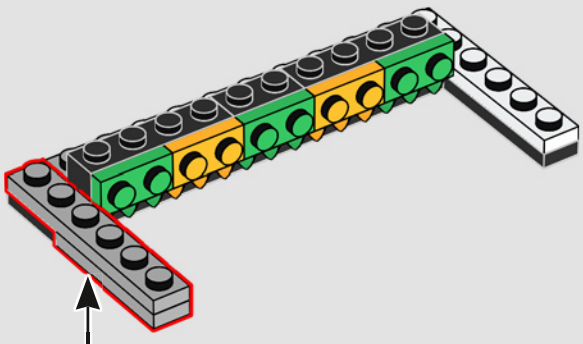

232

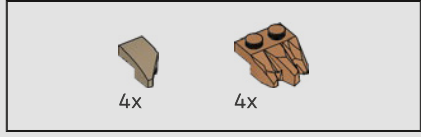
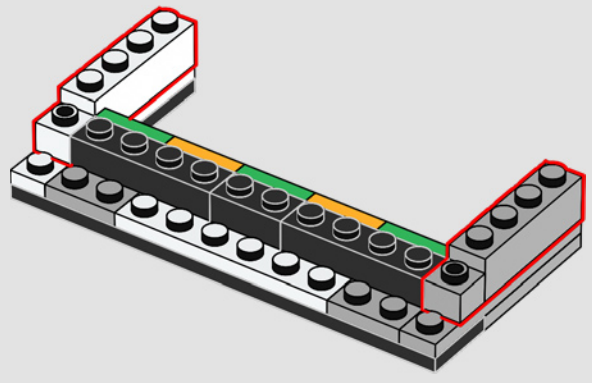

233

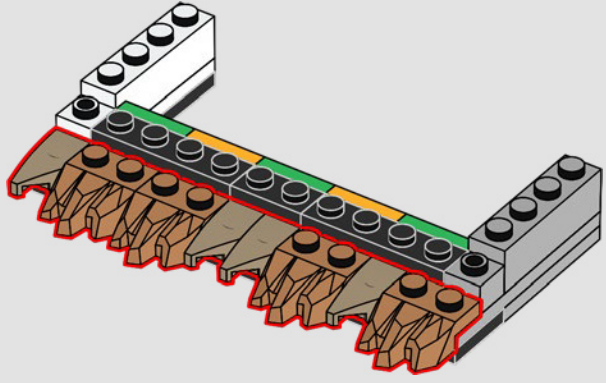

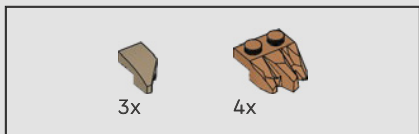

234

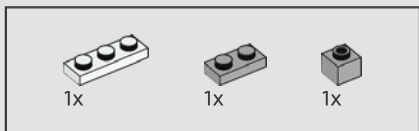
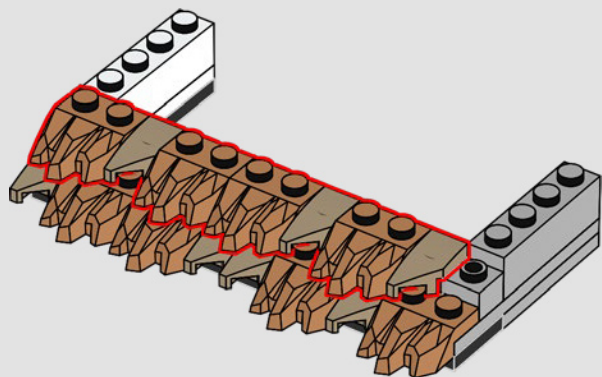

235

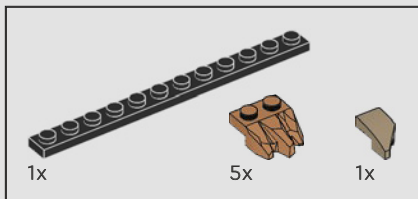
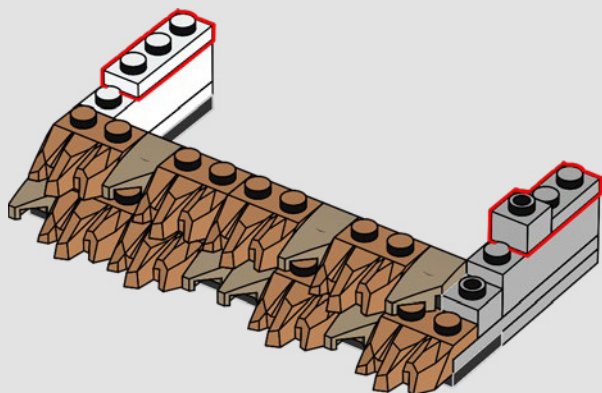

236

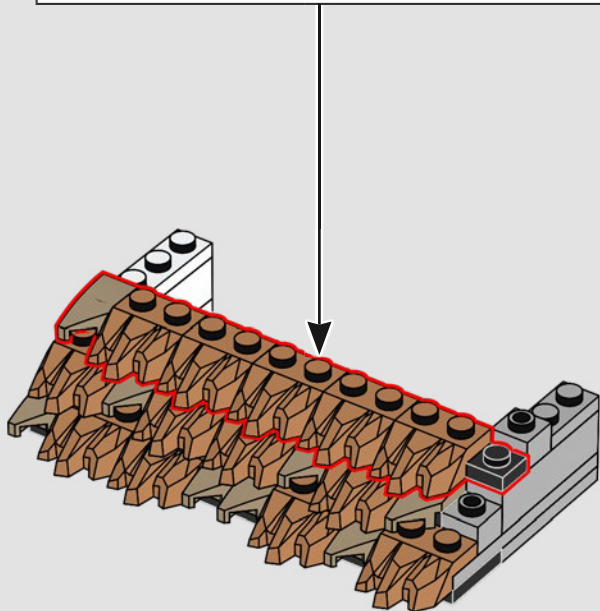
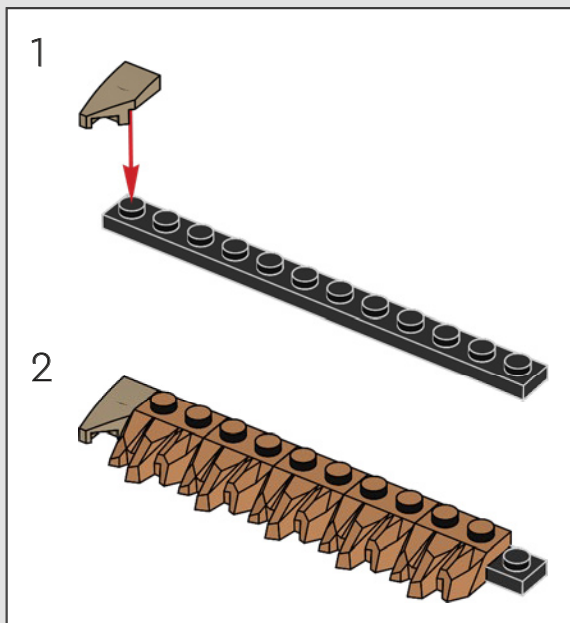

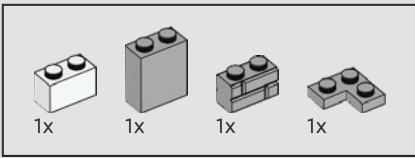

237

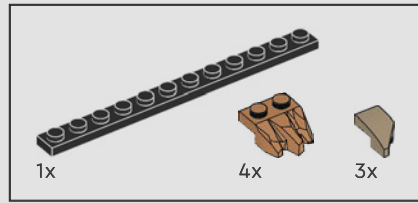
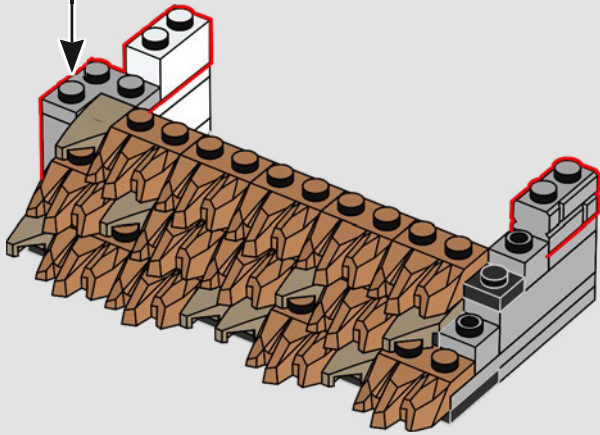
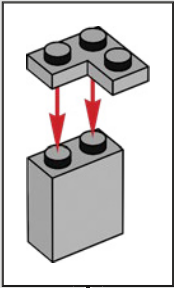

238

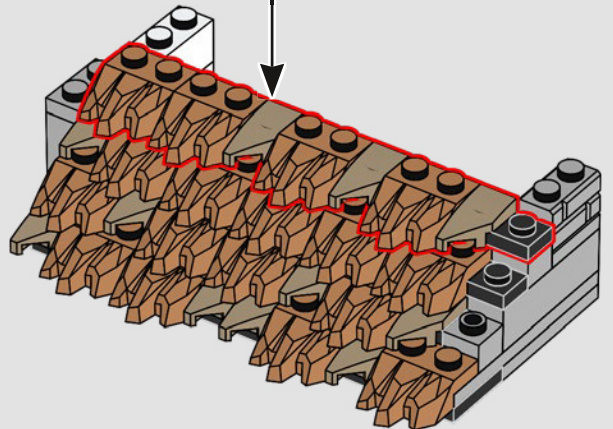
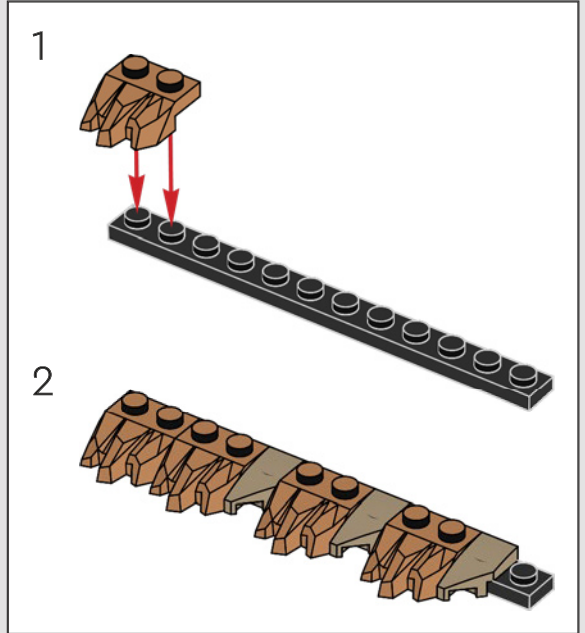

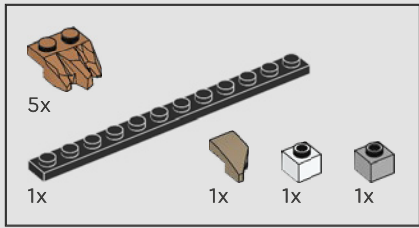

239

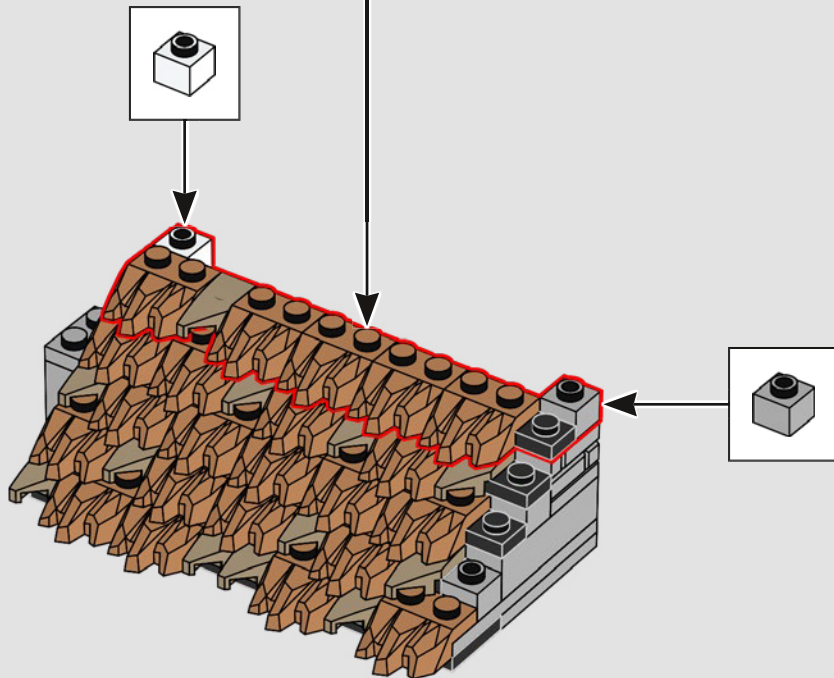
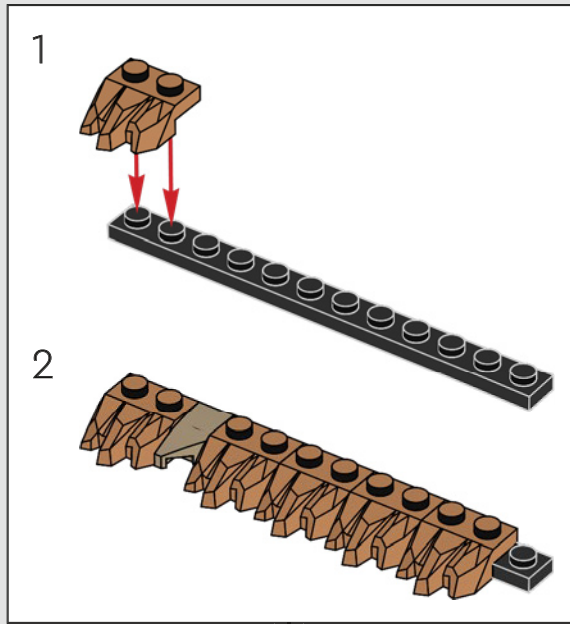



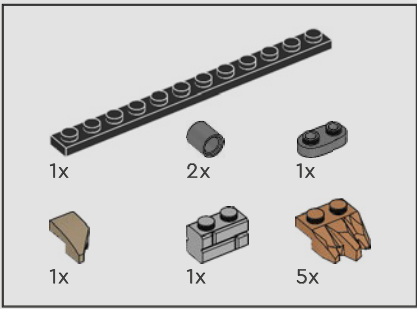

240

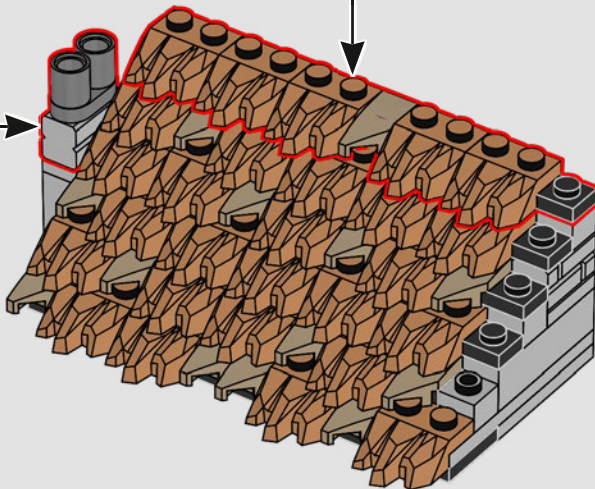
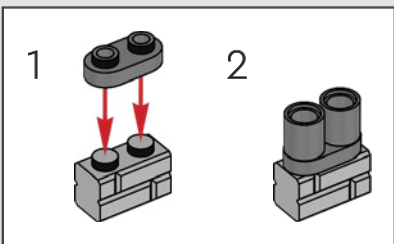
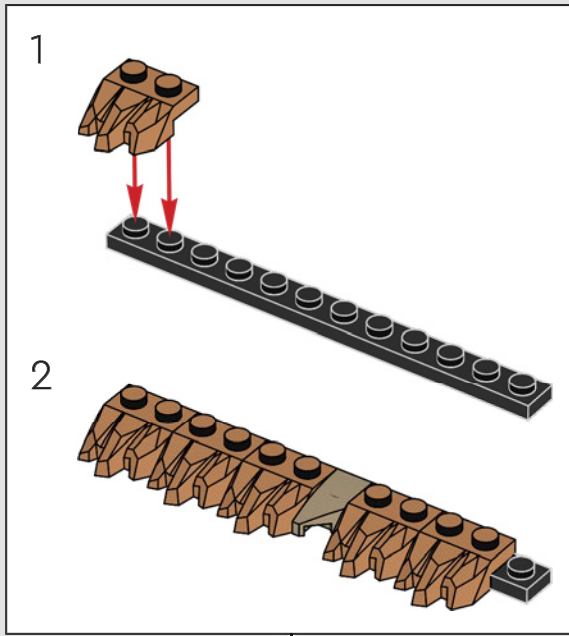

241

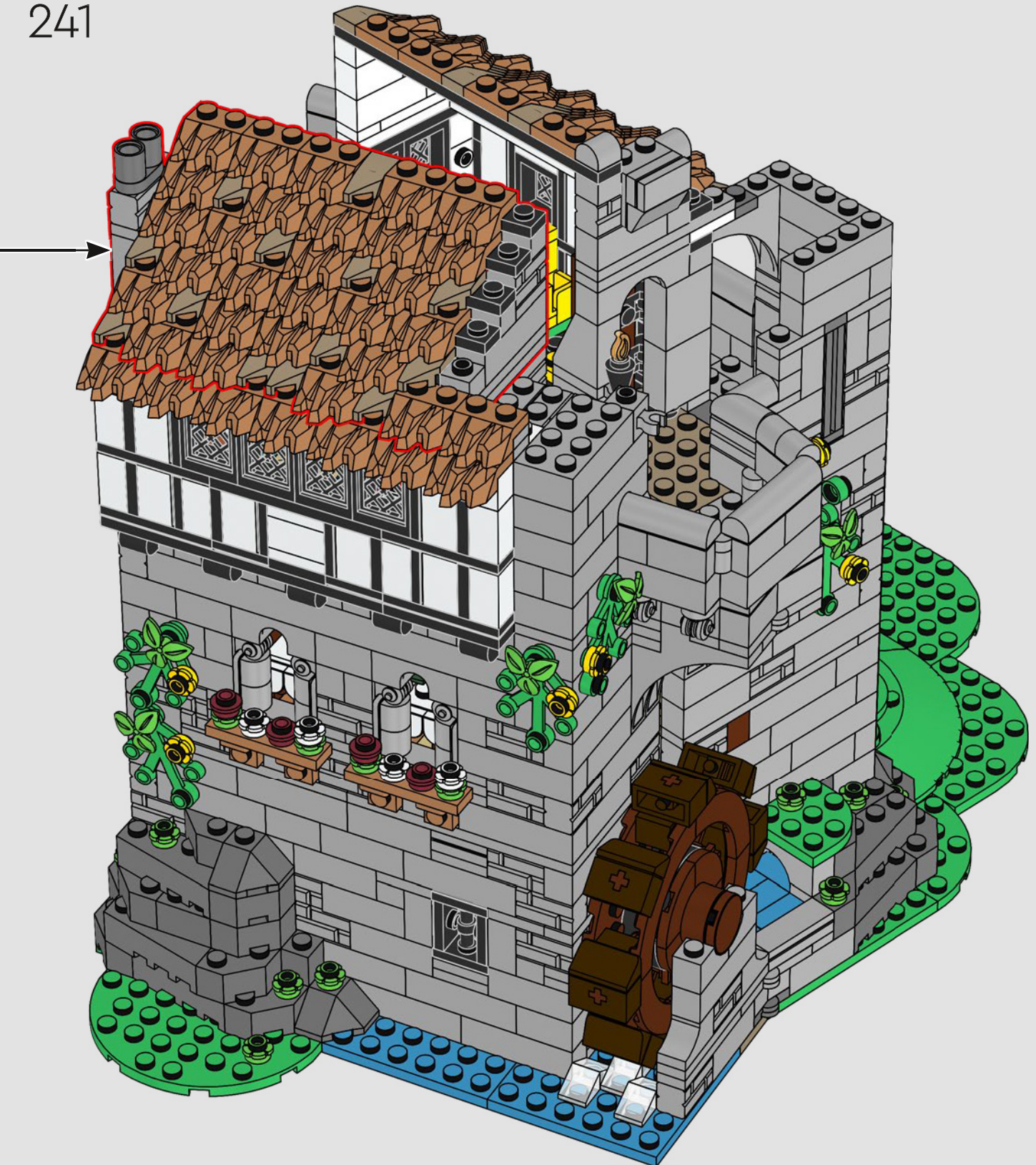

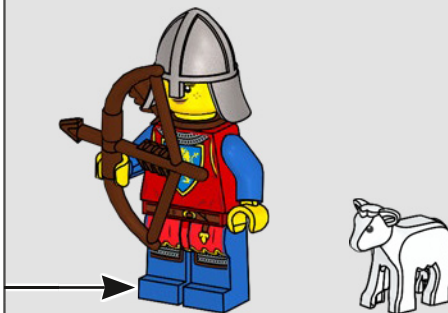
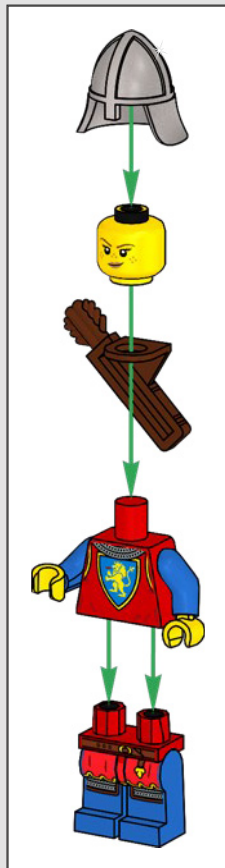

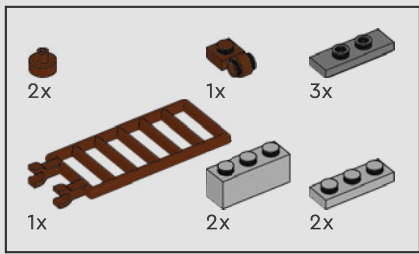

242

1

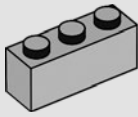

2

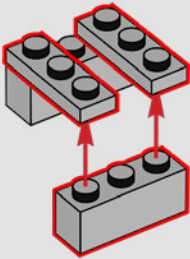

3

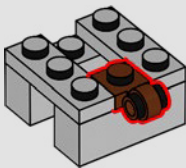

4

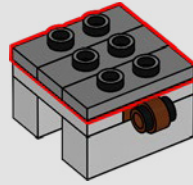

5

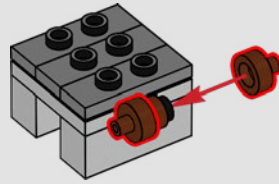

6

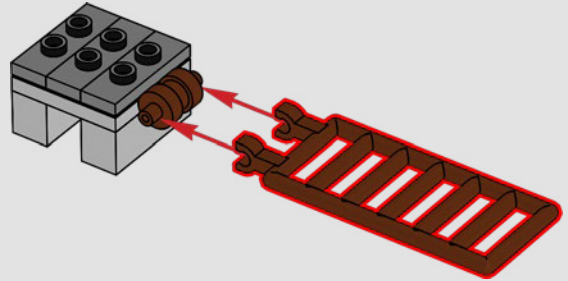

7

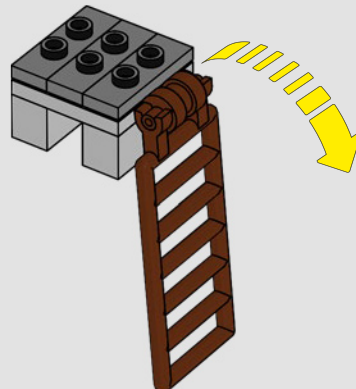



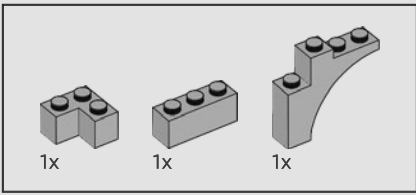

243



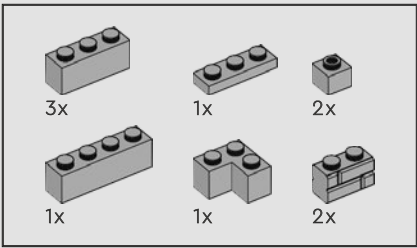

244

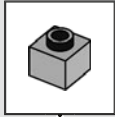
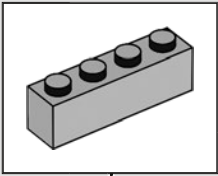

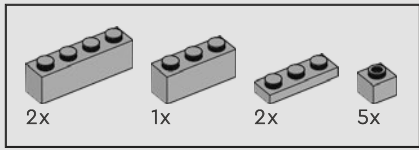

245





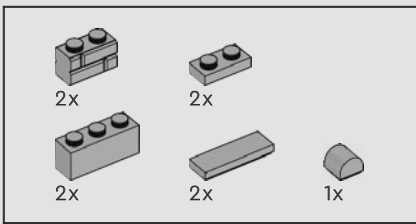

246

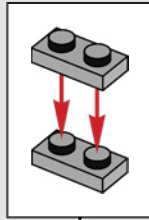

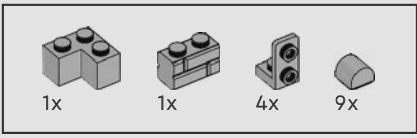

247

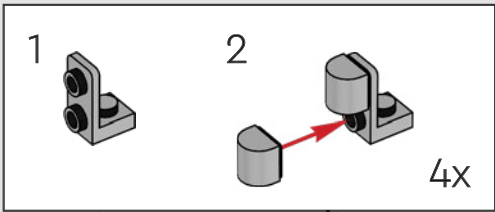

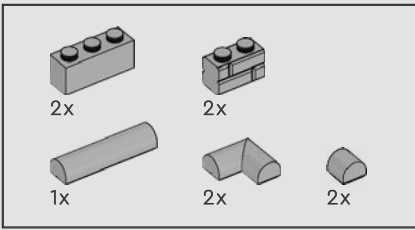

248



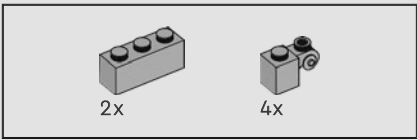

249



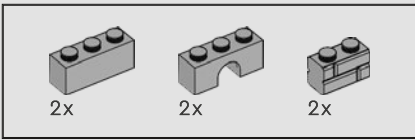

250



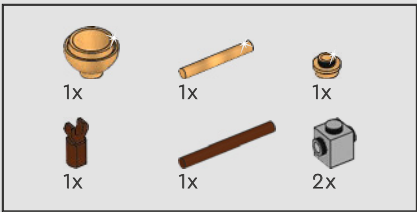

*This bell will do well to warn the townsfolk if the wolfpack marauders should one day return...*

251

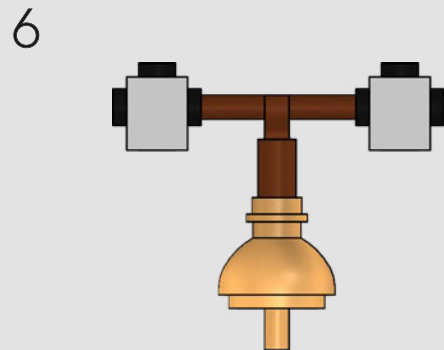
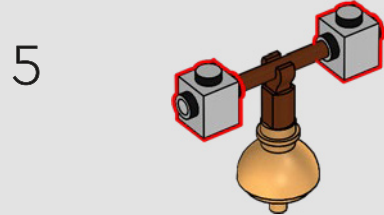
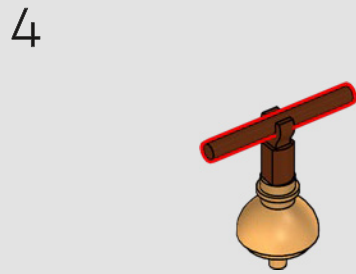
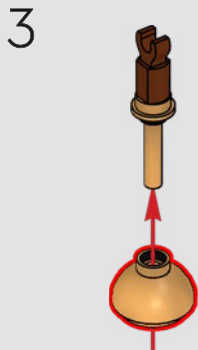
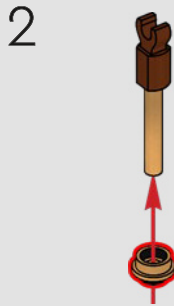
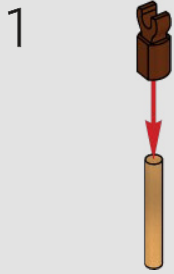



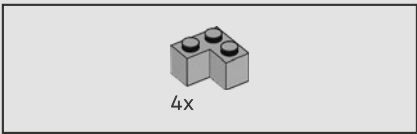

252







2x



4x

253



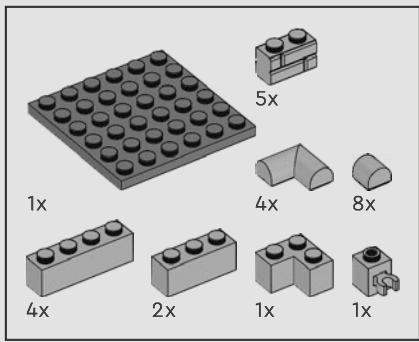

254

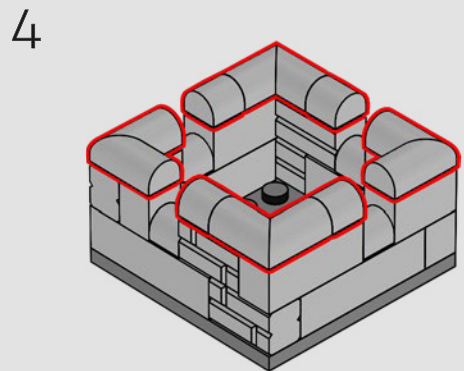
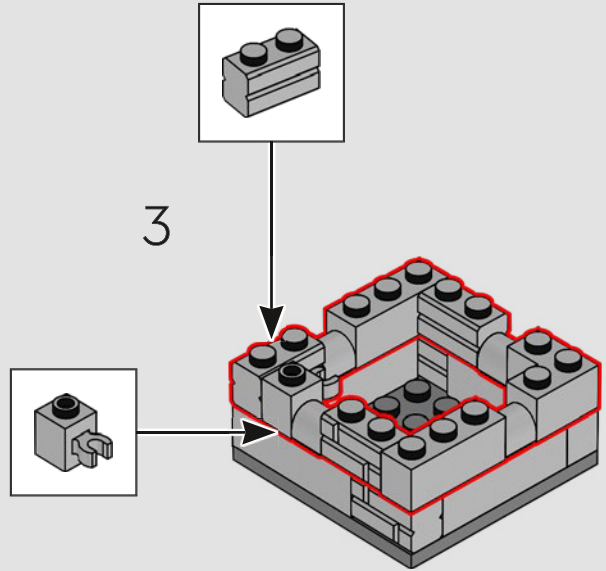
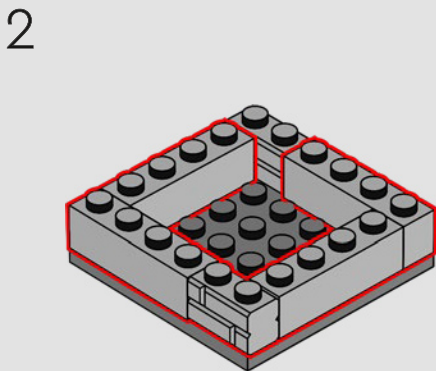
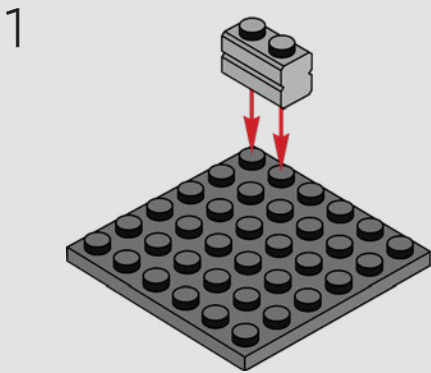



12x

255

12x



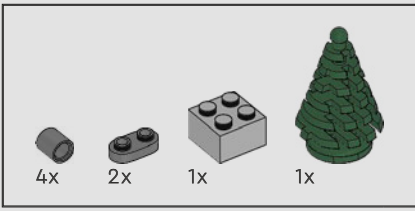

256

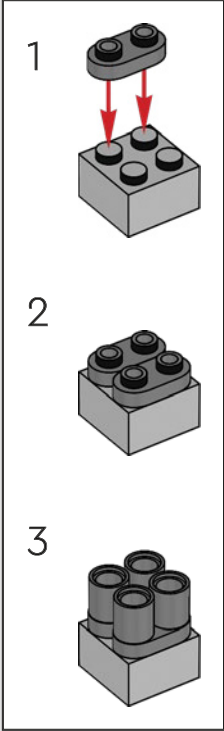

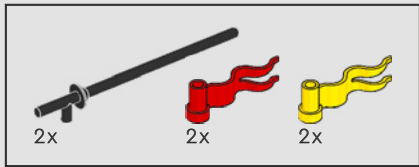

257

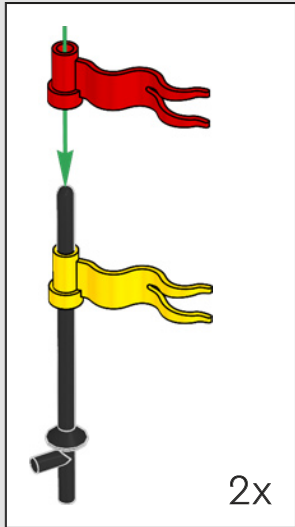

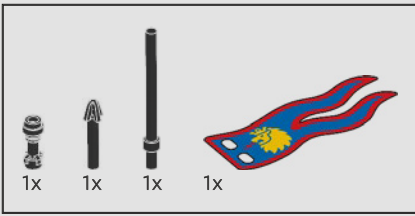

258

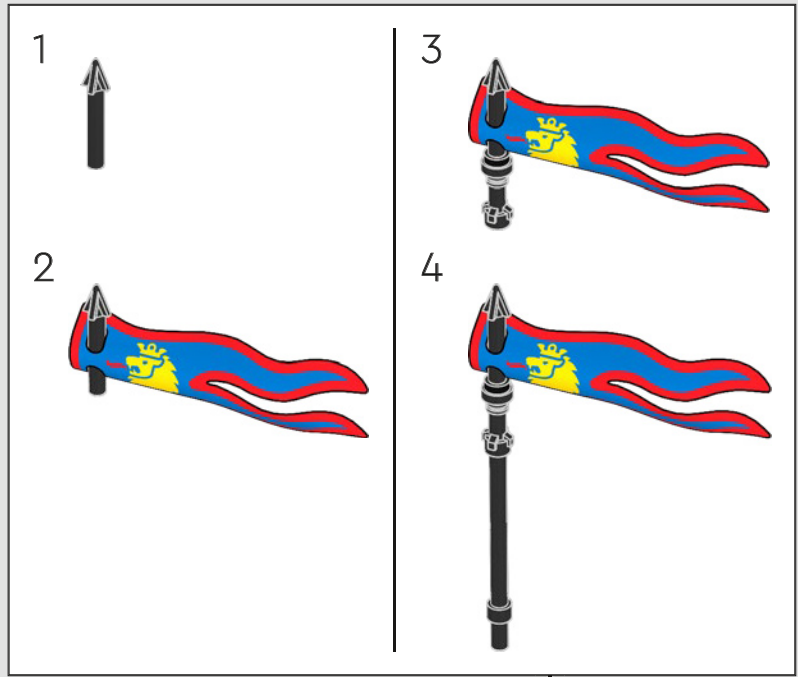



*These dark pines are refreshing.  
They've never been such a dark  
shade of green before...*

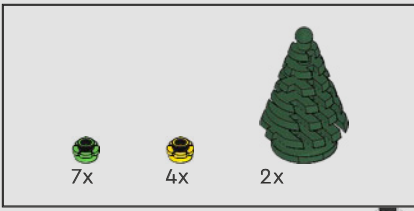

259

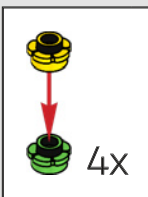



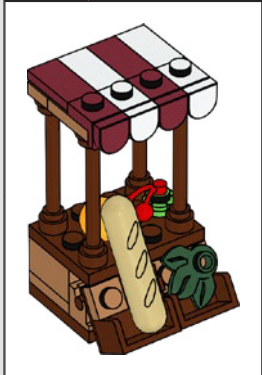

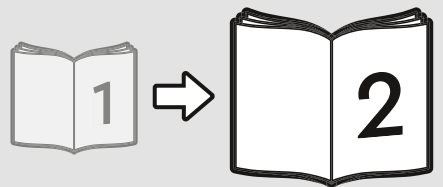



# FEEDBACK AND WIN

## FEEDBACK AND WIN

Your feedback will help shape the future development of this product series.

Please visit:

## FEEDBACK UND GEWINNEN

Dein Feedback trägt zur Weiterentwicklung dieser Produktreihe bei.

Geh auf:

## COMMENTEZ ET GAGNEZ

Vos commentaires nous aideront à concevoir les futurs produits de cette gamme.

Rendez-vous sur :

## COMENTA Y GANA

Tu opinión nos ayudará a dar forma al desarrollo de esta serie de productos en el futuro.

Visita:

## 反馈有奖

您的反馈将有助于我们在今后改进本系列产品。

请访问：

[LEGO.com/productfeedback](https://www.lego.com/productfeedback)

By completing, you will automatically enter a drawing to win a LEGO® set.

Terms & Conditions apply.

Durch Ausfüllen nimmst du automatisch an der Verlosung eines LEGO® Preises teil.

Es gelten die Teilnahmebedingungen.

En envoyant vos commentaires, vous serez automatiquement inscrit(e) à un tirage au sort qui vous permettra de remporter un prix LEGO®.

Offre soumise à conditions.

Al contestar, participarás automáticamente en el sorteo y podrás ganar un set LEGO®.

Sujeto a Términos y Condiciones.

完成我们的反馈调查，即可自动进入抽奖环节，赢取乐高®套装。

适用《条款和条件》。

