

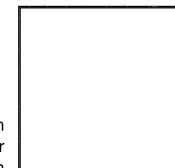

Real Madrid Santiago Bernabéu Stadium

Book 1 | Livre 1 | Libro 1

Booklet available in English on
Livret disponible en français sur
Folleto disponible en español en



HALA MADRID!

Named by FIFA as the 'Most Successful and Best Football Club of the 20th Century' and passionately supported by 600 million fans globally, Real Madrid Club de Fútbol is one of the most famous names in world soccer. Founded in 1902 and located in the heart of the Spanish capital, Real Madrid continues to be owned and run by its 90,000 Socios (members).

The club's 81,044-capacity Santiago Bernabéu Stadium has provided the backdrop to many of the Los Blancos' (The Whites) legendary victories, as well as countless other UEFA and FIFA finals. With the club celebrating its 120th anniversary, what better time to present the LEGO® version of this iconic soccer temple. Enjoy.

¡HALA MADRID!

Désigné par la FIFA comme le « meilleur club de football du 20^e siècle » et appuyé par 600 millions de partisans passionnés à travers le monde, le Real Madrid Club de Fútbol est célèbre dans le monde entier. Fondé en 1902 et résidant au cœur de la capitale espagnole, le Real Madrid est toujours détenu et géré par ses 90 000 socios (membres).

Capable d'accueillir 81 044 spectateurs, le stade Santiago Bernabéu a été le théâtre de nombreuses victoires légendaires de *Los Blancos* (« les blancs »), ainsi que d'innombrables autres finales de l'UEFA et de la FIFA. Le 120^e anniversaire du club est le moment tout désigné pour présenter la version LEGO de ce temple emblématique du monde du soccer. Profitez-en !

¡HALA MADRID!

Nombrado por la FIFA como "el mejor y más exitoso club de fútbol del siglo XX" y apoyado con pasión por 600 millones de seguidores por todo el orbe, el Real Madrid Club de Fútbol es uno de los nombres más notorios de la escena futbolística mundial. Fundado en 1902 y con sede en el corazón de la capital española, el Real Madrid sigue estando bajo la propiedad y administración de sus más de 90.000 socios.

El Estadio Santiago Bernabéu, hogar del club con capacidad para 81.044 asistentes, ha sido el escenario de muchas de las legendarias victorias de los blancos, así como de incontables finales de la UEFA y la FIFA. Ahora que el club está por celebrar su 120 aniversario, no podría haber un mejor momento para presentar la versión LEGO de este emblemático templo del fútbol. Esperamos que lo disfrutes.





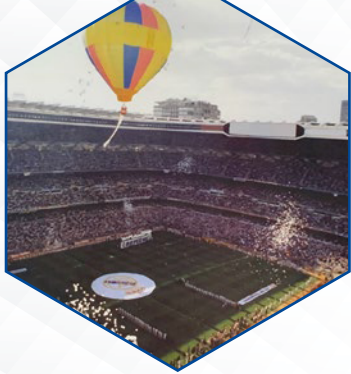

ii Ma
i A
para
La
BANC

Building a Legend

When Santiago Bernabéu was elected Club President in 1943, he dreamed of building a state-of-the-art stadium with a capacity for 100,000 fans. Critics called his project both overly ambitious and “pharaonic,” but Bernabéu persevered, and after three years of construction, the New Chamartín Stadium was inaugurated in December

of 1947. It was one of the most modern grounds in the world and would go on to bear witness to some of the most brilliant episodes in the history of Real Madrid. In 1955 the club decided to mark the vision of Santiago Bernabéu by renaming the stadium in his honor.

La création d’une légende

Lorsque Santiago Bernabéu est élu président du club en 1943, il rêve de construire un stade ultramoderne pouvant accueillir 100 000 partisans. Ses détracteurs reprochent à son projet d’être trop ambitieux et « pharaonique ». Néanmoins, Bernabéu ne se laisse pas abattre. En décembre 1947, après trois ans de construction, le nouveau stade Chamartín est inauguré.

C’était l’un des terrains les plus modernes du monde, et il allait être le théâtre de certains des chapitres les plus brillants de l’histoire du Real Madrid. En 1955, le club décide de célébrer la vision de Santiago Bernabéu en rebaptisant le stade en son honneur.

La construcción de una leyenda

Cuando se eligió a Santiago Bernabéu como presidente del club en 1943, su sueño era construir un estadio de vanguardia con capacidad para 100.000 fanáticos. Los críticos calificaron su proyecto como “demasiado ambicioso” e incluso “faraónico”, pero Bernabéu perseveró y, luego de tres años de construcción, el Nuevo Estadio de Chamartín se inauguraba en

diciembre de 1947. Se trataba de uno de los campos de juego más modernos del mundo, que llegaría dar fe de algunos de los episodios más brillantes de la historia del Real Madrid. En 1955, el club decidió celebrar la visión de Santiago Bernabéu rebautizando el estadio en su honor.



Brochures delivered to members and board of directors

Brochures remises aux membres et au conseil d’administration

Folletos distribuidos entre los miembros y los integrantes de la junta directiva





“ Madrid,
Madrid,
Madrid.
HALA MADRID!
And nothing more,
And nothing more,
HALA MADRID!

Chant sung by Real Madrid fans

« Madrid,
Madrid,
Madrid.
¡HALA MADRID!
Et rien de plus,
Et rien de plus,
¡HALA MADRID! »

*Chant entonné par les partisans
du Real Madrid*

“ Madrid,
Madrid,
Madrid.
¡HALA MADRID!
Y nada más,
y nada más,
¡HALA MADRID!

*Himno entonado por los fanáticos
del Real Madrid*

A history of success

Une longue série de succès

Una historia de éxito



The club's name is changed to Real Madrid after King Alfonso XIII grants the Real (Royal) title to the club.

Le club est rebaptisé « Real Madrid » après que le roi Alfonso XIII ait adjoint le titre *Real* (« royal ») au club.

El club cambia su nombre a Real Madrid después de que el rey Alfonso XIII le otorgara el título de Real.

1902

The Madrid Football Club is founded on March 6, 1902. They play on land next to the city's old bullring and use the local tavern as changing rooms.

Le club de football de Madrid est fondé le 6 mars 1902. Les joueurs jouent sur un terrain situé à côté des anciennes arènes de la ville et utilisent la taverne locale comme vestiaire.

El Madrid Football Club se fundó el 6 de marzo de 1902. Celebraba sus partidos en los terrenos aledaños a la antigua plaza de toros de la ciudad y sus jugadores usaban una taberna cercana como vestidor.

1920



In 1924, the Club built the Old Chamartín, a historic sports ground with a capacity for 15,000 spectators.

En 1924, le club entreprend la construction du vieux stade Chamartín, une enceinte sportive historique pouvant accueillir 15 000 spectateurs.

En 1924, el club construyó el Viejo Chamartín, un histórico campo deportivo con capacidad para 15.000 espectadores.

1924



Model of the New Chamartín stadium project.

Maquette du projet du nouveau stade Chamartín.

Modelo del proyecto del estadio Nuevo Chamartín.

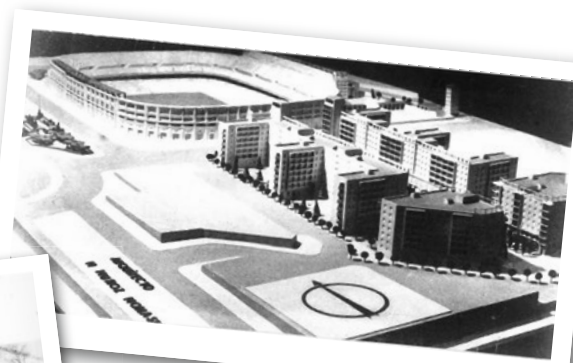

The official name was 'Campo del Real Madrid Fútbol Club' but the fans called it 'Chamartín'.

Son nom officiel est « Campo del Real Madrid Fútbol Club », mais les partisans le surnomment « Chamartín ».

Su nombre oficial era Campo del Real Madrid Fútbol Club, pero sus seguidores lo llamaron Chamartín.

1932

Real Madrid wins its first national league title after the professional sports league La Liga was founded in 1929.

Le Real Madrid remporte son premier titre de champion national après la création de la ligue sportive professionnelle La Liga en 1929.

El Real Madrid gana su primer título de liga nacional después de la fundación de la liga profesional La Liga, que tuvo lugar en 1929.

1939

The 25,000-capacity Old Chamartín stadium reopens after refurbishment.

Le vieux stade Chamartín, d'une capacité de 25 000 spectateurs, rouvre ses portes après avoir été rénové.

Después de su remodelación, el estadio Viejo Chamartín reabre sus puertas con capacidad para 25.000 asistentes.

Santiago Bernabéu initiating the construction of the new Chamartín Stadium.

Santiago Bernabéu iniciando la construcción del estadio Nuevo Chamartín.

Santiago Bernabéu lance la construction du nouveau stade Chamartín.



Sabino Barinaga scored the first goal in this stadium in its inauguration match against Os Belenenses.

Sabino Barinaga marque le premier but dans l'histoire du stade lors du match d'inauguration contre le Belenenses.

Sabino Barinaga marcó el primer tanto en este estadio en su partido inaugural frente al Os Belenenses.

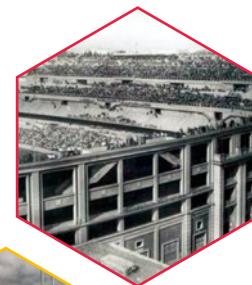

The New Chamartín stadium is inaugurated with a 3-1 victory over Os Belenenses from Portugal.

Le nouveau stade Chamartín est inauguré par une victoire 3-1 contre le Belenenses du Portugal.

El estadio Nuevo Chamartín se inaugura con una victoria de 3-1 sobre el Os Belenenses de Portugal.

Construction starts on the second phase of the stadium's expansion to increase the capacity to 125,000 spectators.

La deuxième partie des travaux d'agrandissement du stade, visant à porter sa capacité à 125 000 spectateurs, est amorcée.

Comienza la construcción de la segunda etapa de la ampliación del estadio para aumentar su capacidad a 125.000 butacas.



1943

Ex-player Santiago Bernabéu is elected Club President.

L'ancien joueur Santiago Bernabéu est élu président du club.

Se elige al exjugador Santiago Bernabéu como presidente del club.

1947

1952

1955

Club members unanimously decide to change the name of the stadium to Estadio Santiago Bernabéu.

Les membres du club décident à l'unanimité de renommer le stade Estadio Santiago Bernabéu.

Los miembros del club deciden por unanimidad cambiar el nombre del estadio a Estadio Santiago Bernabéu.

Perfect view of New Chamartín stadium on a match day.

Vista perfecta del estadio Nuevo Chamartín en un día de partido.

Vue parfaite sur le nouveau stade Chamartín un jour de match.





Real Madrid wins the European Cup in their own stadium after a 2-0 victory over Fiorentina.

Le Real Madrid remporte la Coupe d'Europe dans son propre stade après une victoire de 2-0 contre la Fiorentina.

El Real Madrid gana la Copa de Europa en su propio estadio después de derrotar al Fiorentina por 2-0.



1957

New lighting ensures the Bernabéu becomes the best illuminated stadium in Europe.

Grâce à un nouvel éclairage, le Bernabéu devient le stade le mieux éclairé d'Europe.

Con la nueva iluminación, el Bernabéu se convertía en el estadio mejor iluminado de Europa.

1957



1960

Real Madrid wins 5-1 over the Argentinian Club Peñarol in the final of the Intercontinental Cup.

Le Real Madrid gagne 5-1 face au club argentin Peñarol en finale de la Coupe intercontinentale.

El Real Madrid vence 5-1 al club argentino Peñarol en la final de la Copa Intercontinental.

1969

Inauguration of exterior lighting outside the stadium.

Inauguration de l'éclairage extérieur du stade.

Inauguración de la iluminación exterior alrededor del estadio.



1972

The 25th anniversary of the stadium is celebrated with the installation of an electric scoreboard, the first one at a Spanish club.

Le 25^e anniversaire du stade est célébré par l'installation d'un tableau d'affichage électrique, le premier d'un club espagnol.

El 25 aniversario del estadio se celebra con la instalación de un marcador eléctrico, el primero adquirido por un club español.

Real Madrid President Luis de Carlos and FIFA president Joao Havelange looking at the refurbishment model.

Le président du Real Madrid, Luis de Carlos, et le président de la FIFA, João Havelange, examinant le modèle de rénovation.



1980

The refurbishment of the stadium starts in preparation for the 1982 World Cup. A metal canopy covers 75% of the stands while capacity is reduced to 98,776 spectators.

Les travaux de rénovation du stade commencent en vue de la Coupe du monde de 1982. Un toit en métal est installé pour couvrir 75 % des tribunes, et la capacité est réduite à 98 776 spectateurs.

Comienza la remodelación del estadio en preparación para la Copa Mundial de 1982. Se instala un toldo metálico que cubre el 75 % de las localidades a la vez que el aforo se reduce a 98.776 asistentes.



Bernabéu hosts the final of the World Cup between Germany and Italy, where the Italians are crowned champions after winning 3-1 in a thrilling match.

Bernabéu accueille la finale de la Coupe du monde entre l'Allemagne et l'Italie, où les Italiens sont couronnés champions après avoir remporté la victoire 3-1.

El Bernabéu alberga el partido final de la Copa Mundial entre Alemania e Italia, en el que los italianos se coronan campeones después de ganar 3-1 en un estremecedor encuentro.

1982

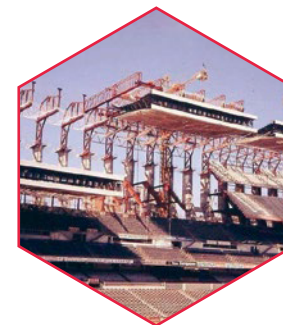



Real Madrid celebrates the stadium's 50th anniversary by winning the domestic league title.

Le Real Madrid célèbre le 50^e anniversaire du stade en remportant le championnat national.

El Real Madrid celebra el 50 aniversario del estadio ganando el título de liga del país.



A new mixed surface is installed, blending natural grass with 17 million synthetic fibers.

Une nouvelle surface mixte, mêlant du gazon naturel à 17 millions de fibres synthétiques, est installée.

Se instala una nueva superficie híbrida, que combina césped natural con 17 millones de fibras sintéticas.

1992

Renovation work begins to modernize the stadium. The canopy from 1982 is raised into the air while 20,000 new seats are added.

Les travaux de rénovation pour moderniser le stade sont amorcés. Le toit de 1982 est relevé et 20 000 nouveaux sièges sont ajoutés.

Comienzan los trabajos de renovación para modernizar el estadio. Se aumenta la altura del toldo instalado en 1982 a la vez que se incorporan 20.000 butacas nuevas.

1997



2002

1996-97 national league title celebration at Estadio Santiago Bernabéu.

Célébration du titre de champion national 1996-1997 au stade Santiago Bernabéu.

Celebración del título de liga nacional de 1996-97 en el Estadio Santiago Bernabéu.

“A setting full of emotions that will define Real Madrid’s future, the greatest stadium in the world.”

Florentino Pérez, Club President

«Un cadre plein d’émotions qui définira l’avenir du Real Madrid; le plus grand stade du monde.»

Florentino Pérez, président du club

“Un escenario lleno de emociones que definirá el futuro del Real Madrid, el estadio más grandioso del mundo”.

Florentino Pérez, presidente del club



UEFA awards the Santiago Bernabéu Elite Stadium status, the highest category possible and a requirement to continue hosting major finals.

L’UEFA décerne au Santiago Bernabéu le statut de stade Élite, la plus haute des distinctions et une condition pour qu’un stade continue à accueillir les grandes finales.

La UEFA otorga al Santiago Bernabéu la categoría de Estadio de Élite, el mayor rango posible y un requisito indispensable para seguir albergando finales de gran relevancia.

The stadium hosts the Champions League Final between Inter Milan and Bayern Munich, with the Italians enjoying a 2-0 victory.

Le stade accueille la finale de la Ligue des champions entre l’Inter Milan et le Bayern Munich. Les Italiens l’emportent 2-0.

El estadio alberga el partido final de la Liga de Campeones entre el Inter de Milán y el Bayern de Múnich, que culmina con una victoria 2-0 para los italianos.

2007



2010

2018

History was made when the Copa Libertadores final was staged outside of the American continent for the first time. River Plate beat Boca Juniors 3-1 to ensure victory.

Une nouvelle page de l’histoire est écrite lorsque la finale de la Copa Libertadores est tenue en dehors du continent américain pour la première fois. River Plate remporte la victoire 3-1 contre Boca Juniors.

En un hecho histórico, la final de la Copa Libertadores se celebra por primera vez fuera del continente americano. El River Plate se consagró campeón tras vencer por 3-1 al Boca Juniors.

2020

Work begins to completely revamp the Bernabéu. Plans include raising the stadium’s height by 32 ft. (10 meters) and adding a retractable roof.

Les travaux de rénovation complète du Bernabéu sont lancés. Les plans prévoient entre autres l’augmentation de la hauteur du stade de 10 m et l’ajout d’un toit rétractable.

Comienzan los trabajos para reformar por completo el Bernabéu. Los planes incluyen aumentar la altura del estadio en 10 m e incorporar un techo retráctil.



From the design team

One of the most exciting aspects of this model was exploring the history of the Estadio Santiago Bernabéu. The stadium is full of invisible artifacts of past eras. When you're building the first tier of seating, you're traveling back in time to the stadium in the 1940s. The gallery is an echo of the 1950s and the roof is an artifact of the 1980s and

the World Cup hosted here. Buried throughout the building are the memories of fans, the excitement and tears experienced at matches on this ground for 75 years.

Milan Madge, LEGO® Designer.

Un mot de l'équipe de conception

L'un des aspects les plus passionnants de ce modèle a été d'explorer l'histoire de l'Estadio Santiago Bernabéu. Le stade regorge d'artefacts invisibles des époques passées. Lorsque vous construisez le premier niveau de sièges, vous remontez le temps jusqu'au stade des années 1940. La tribune est un écho des années 1950 et

le toit est un artefact des années 1980 et de la Coupe du monde de football organisée ici. Enfouis dans le bâtiment sont les souvenirs des partisans, l'exaltation ressentie et les larmes versées lors des matchs ayant eu lieu sur ce terrain depuis 75 ans.

Milan Madge, concepteur LEGO®.

Impresiones del equipo de diseño

Uno de los aspectos más emocionantes de este modelo fue explorar la historia del Estadio Santiago Bernabéu. El estadio está repleto de detalles imperceptibles que datan de eras pasadas. Construir el primer nivel de gradas representa un viaje atrás en el tiempo, al estadio de la década de 1940. La galería es un eco de los años 50 y el techo data de los 80 y de la Copa

Mundial que aquí se celebró. Por todo el lugar se encuentran enterrados los recuerdos de los fanáticos, la emoción y el llanto a los que han dado lugar los encuentros disputados en esta cancha a lo largo de 75 años.

Milan Madge, diseñador de LEGO®



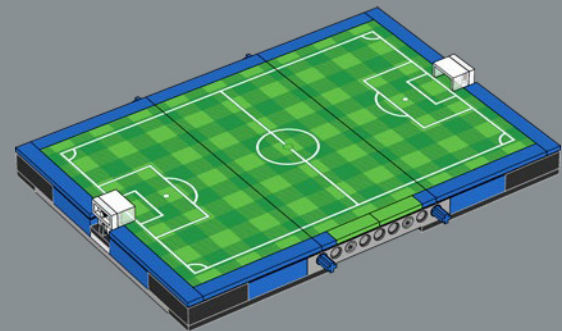
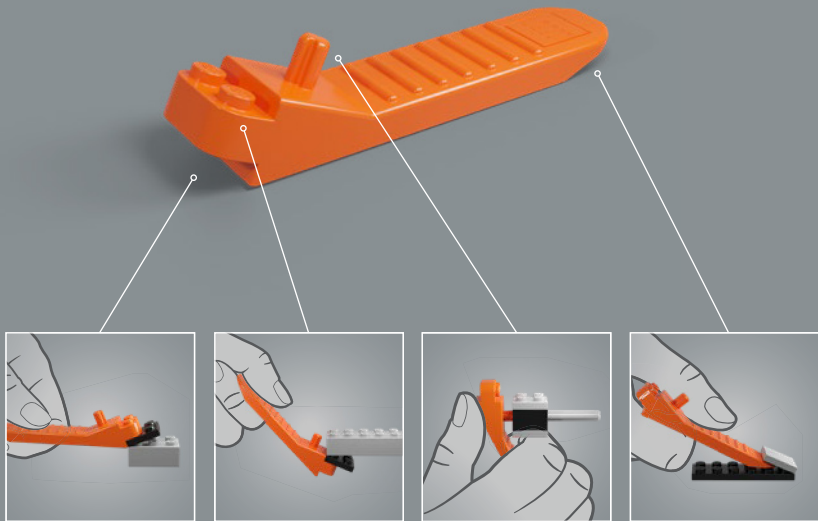

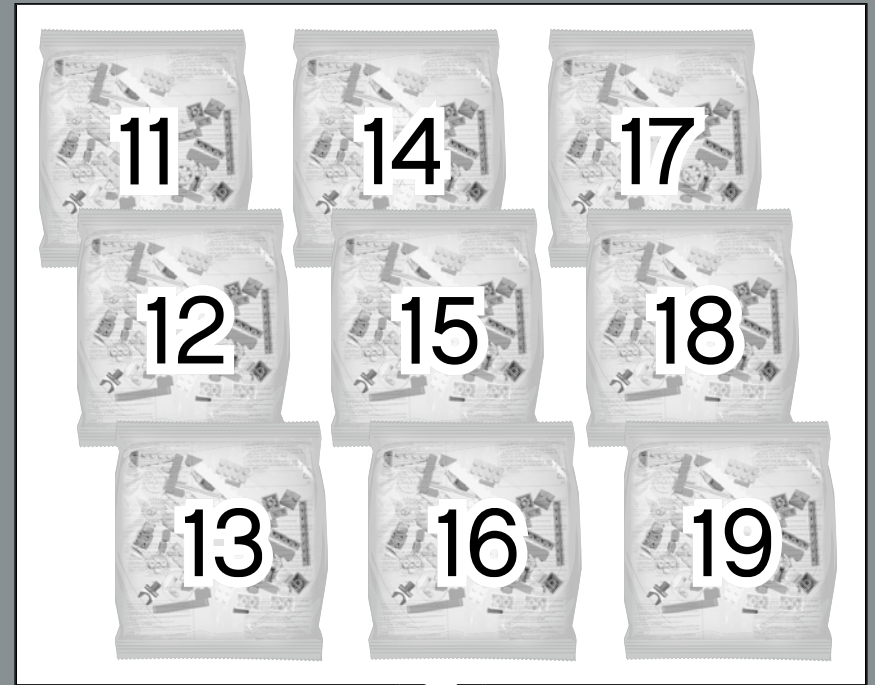
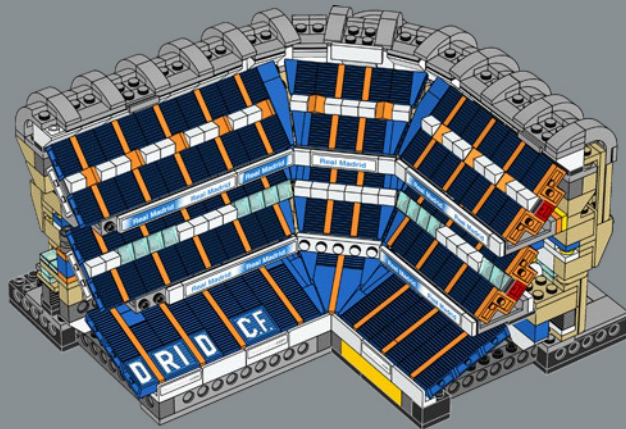
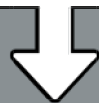
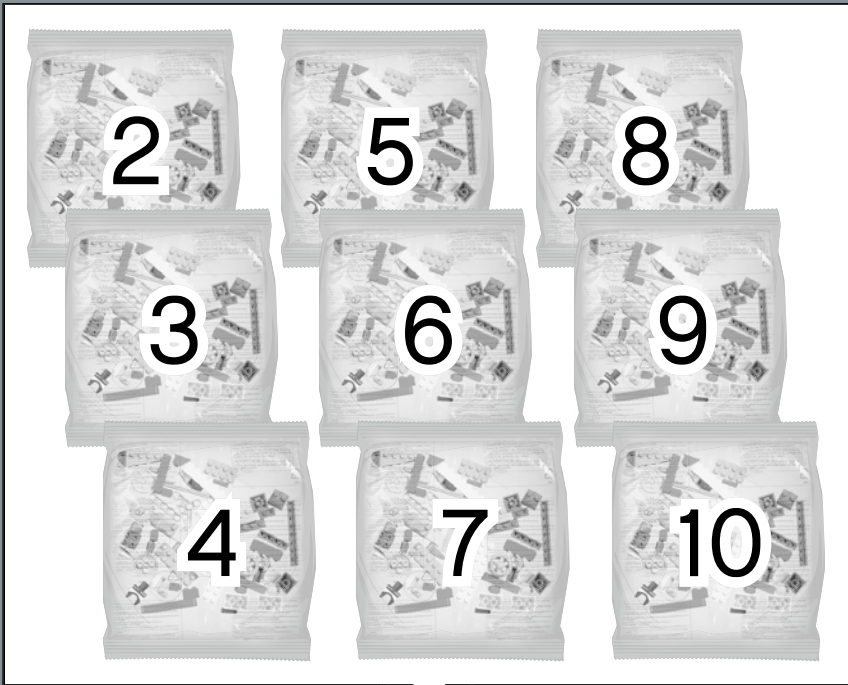

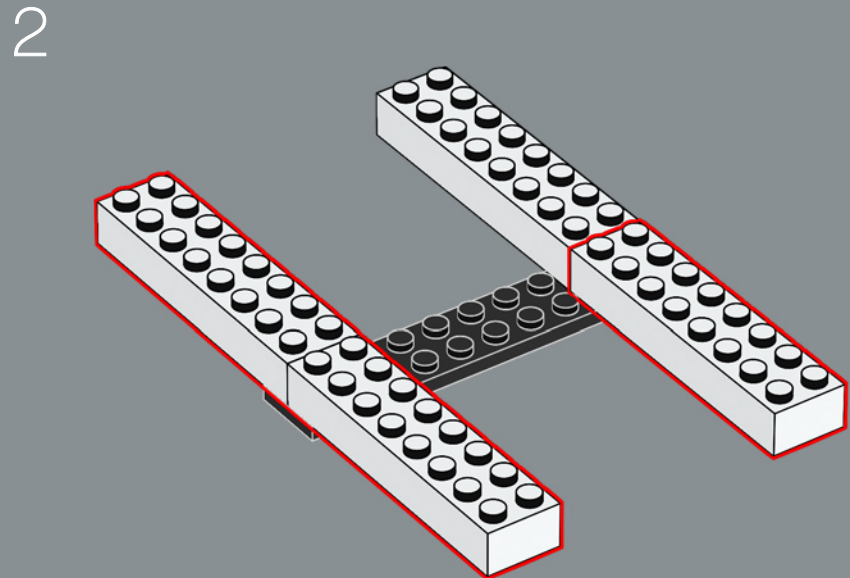
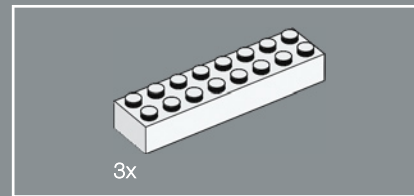
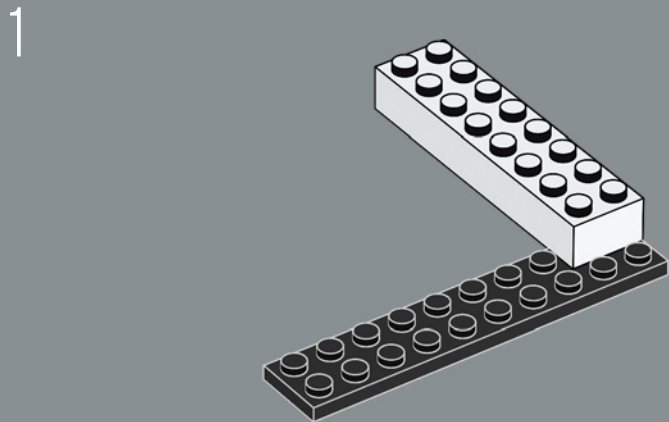
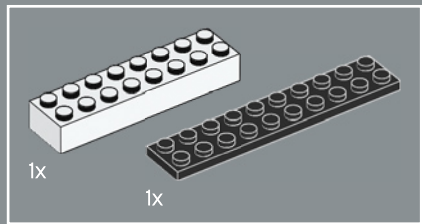
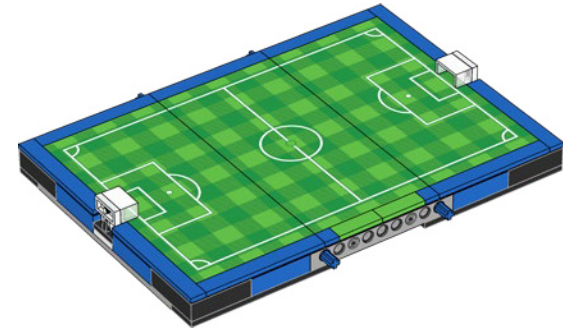
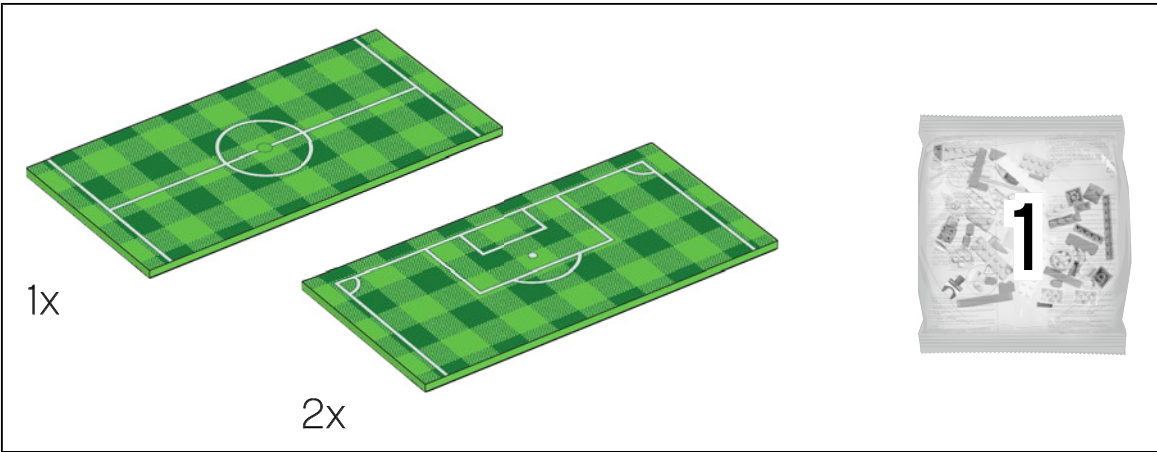

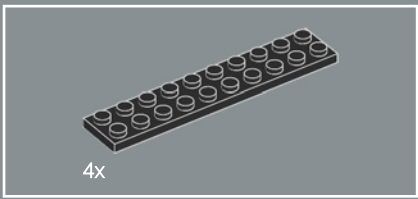

3

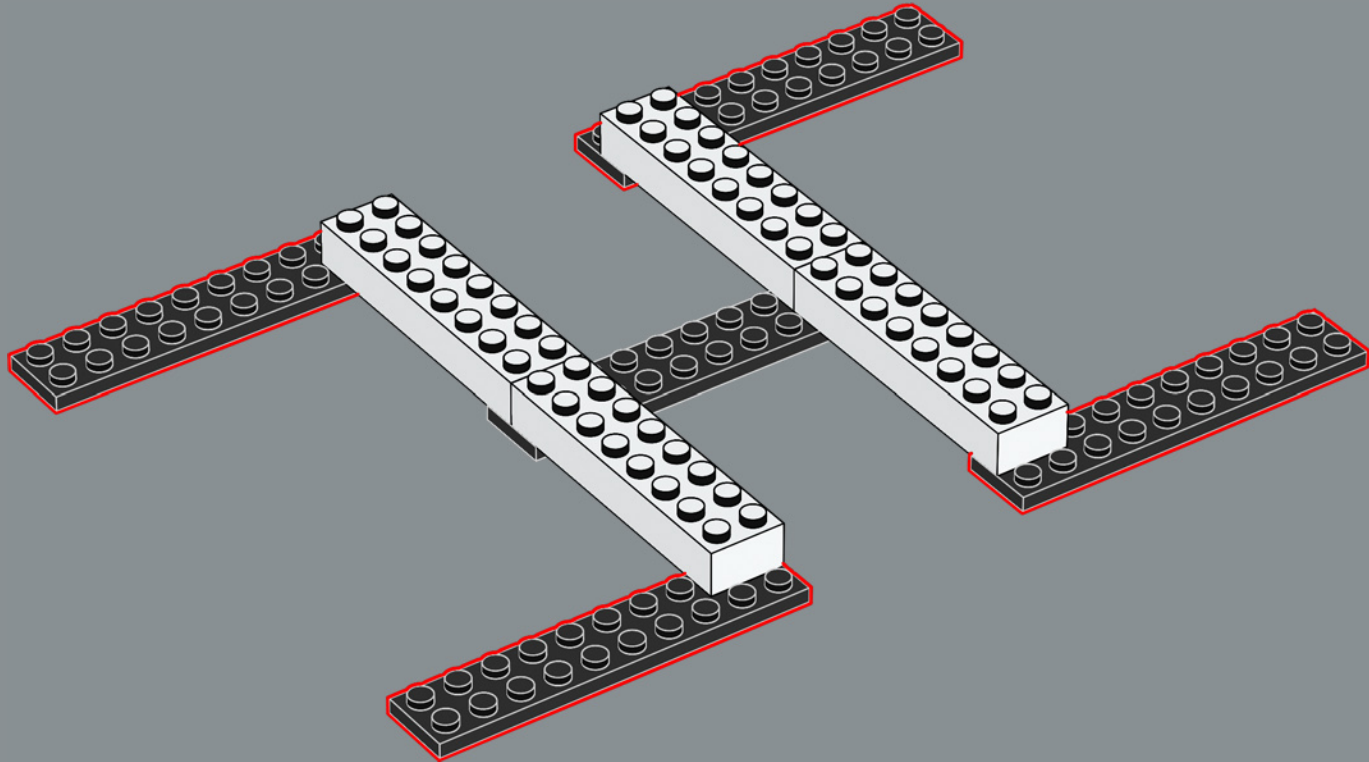

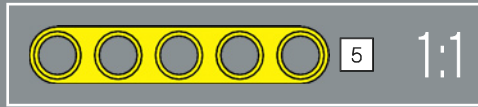
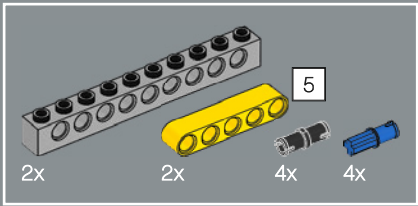

4

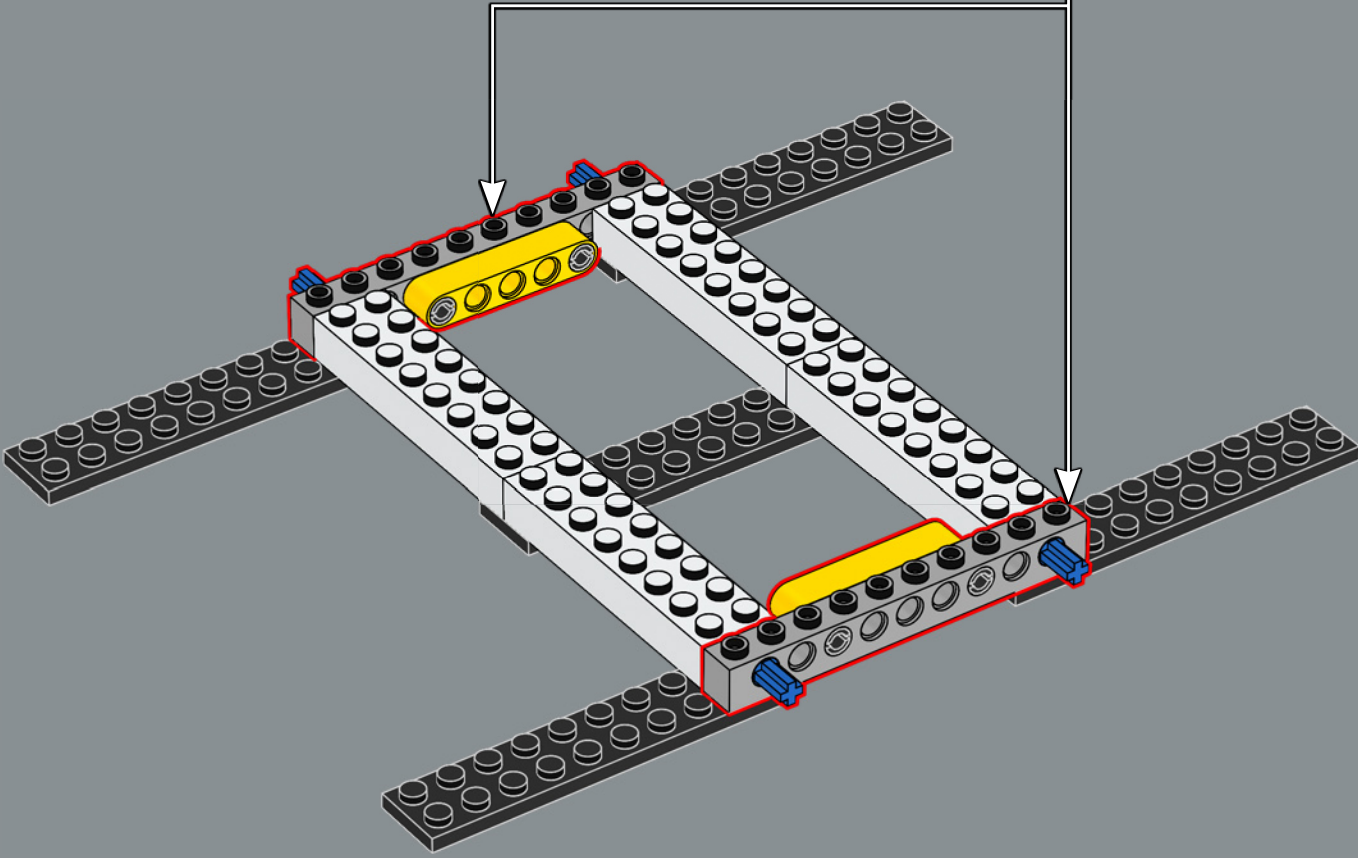
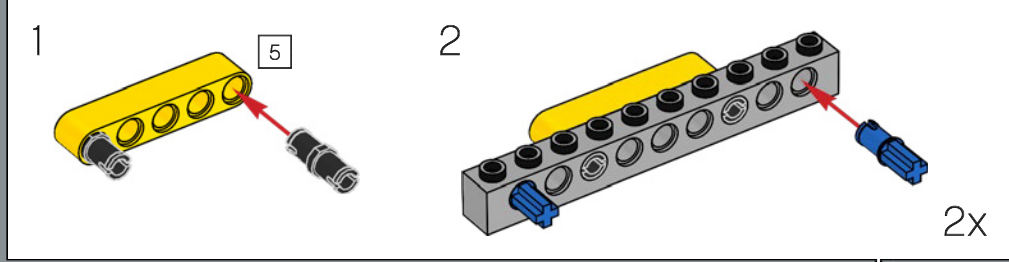

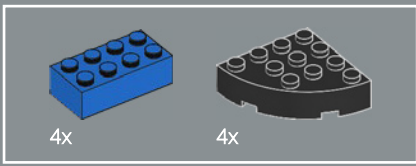

5

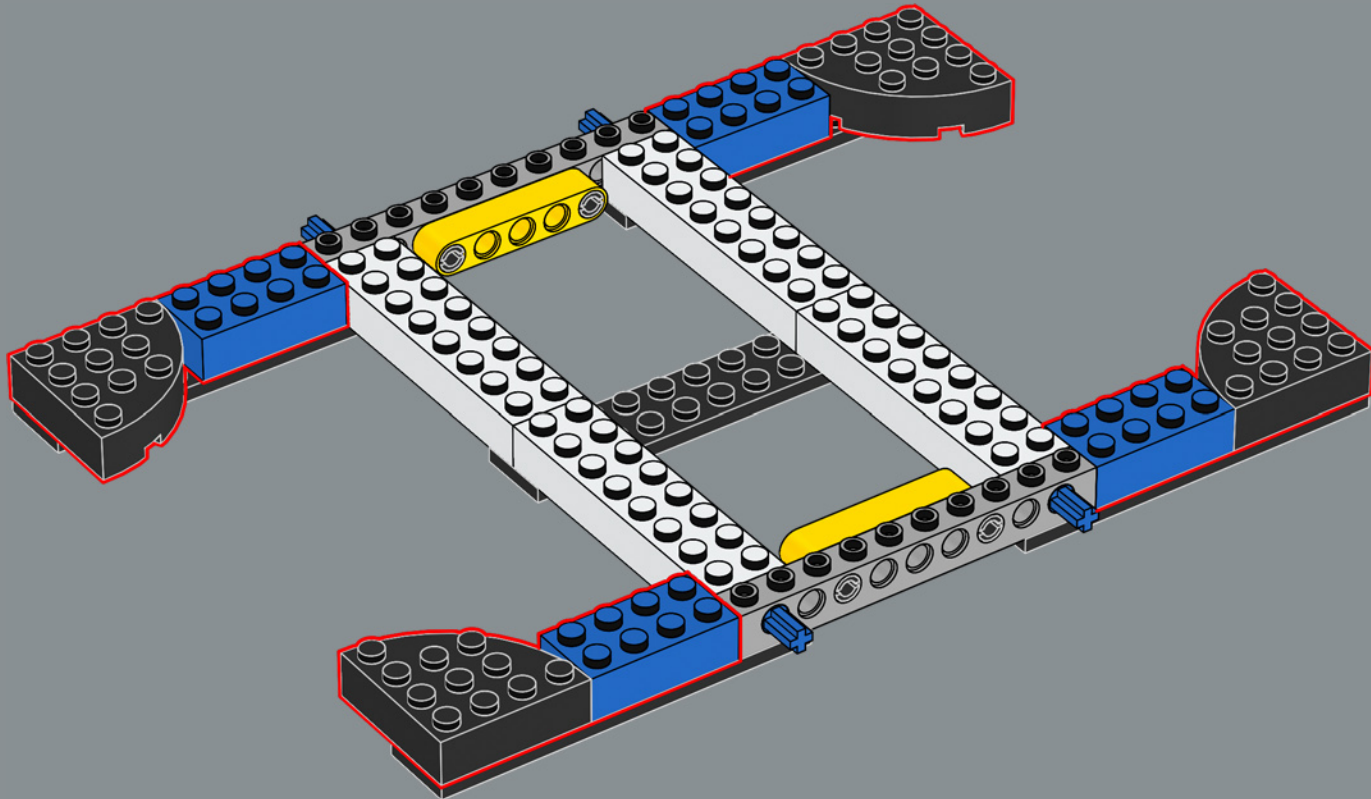

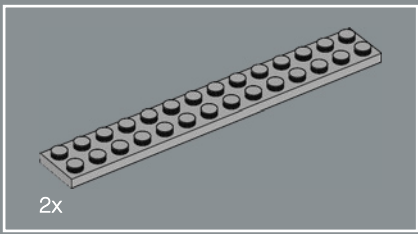

6

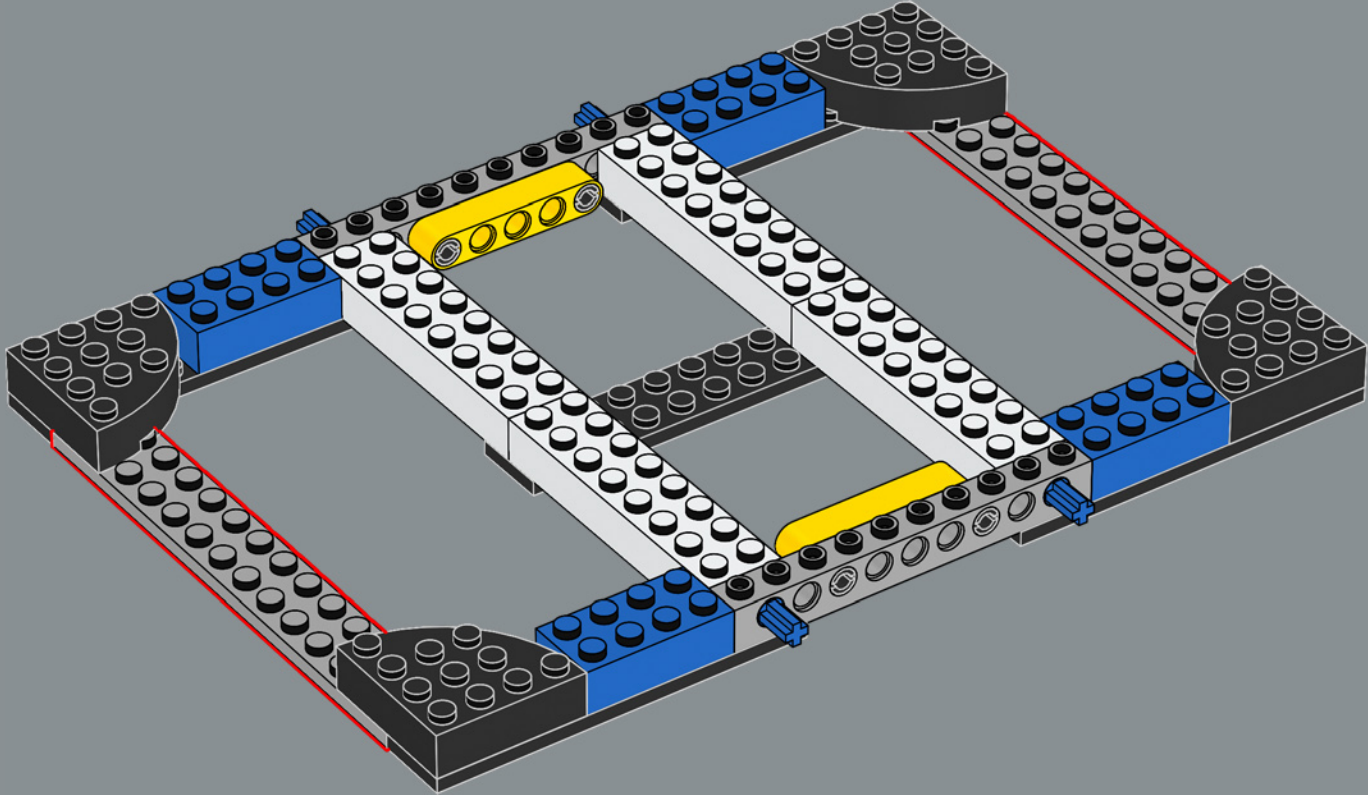

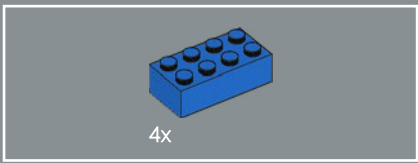

7

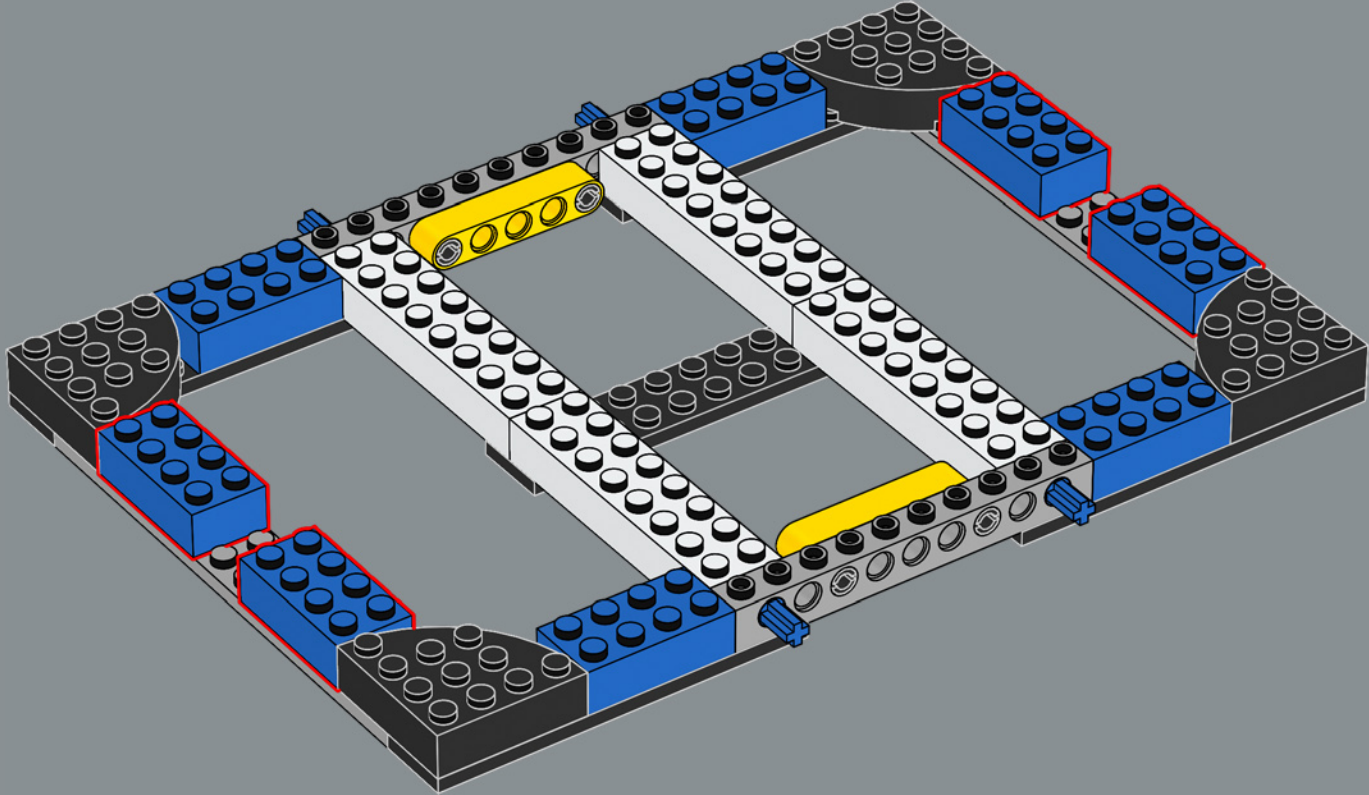

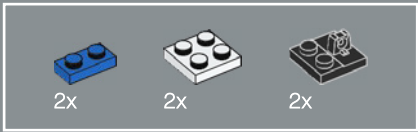

8

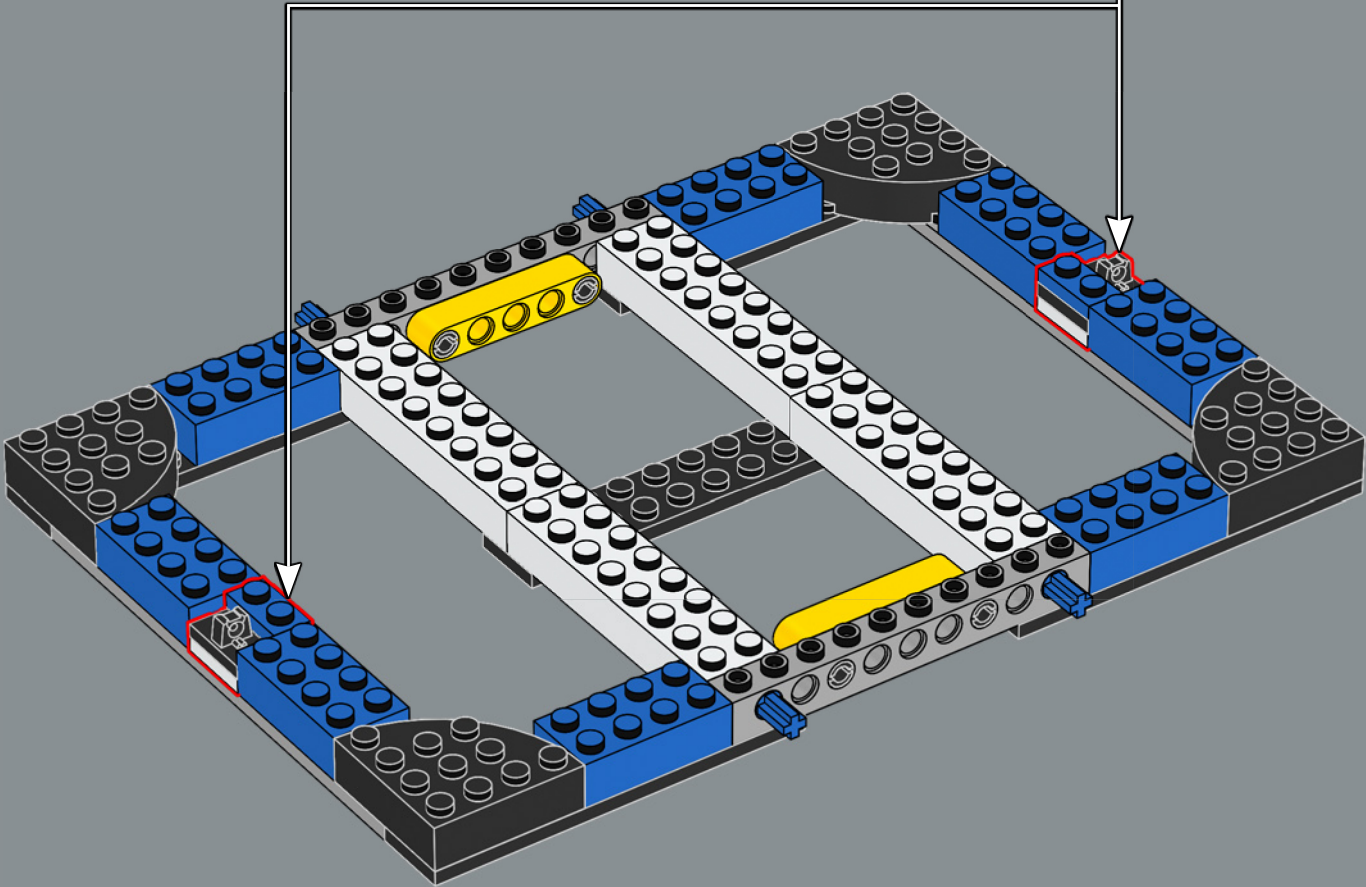
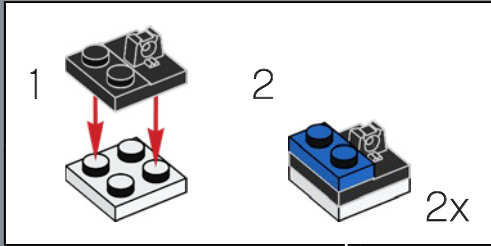

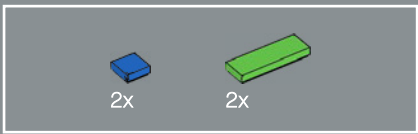

9

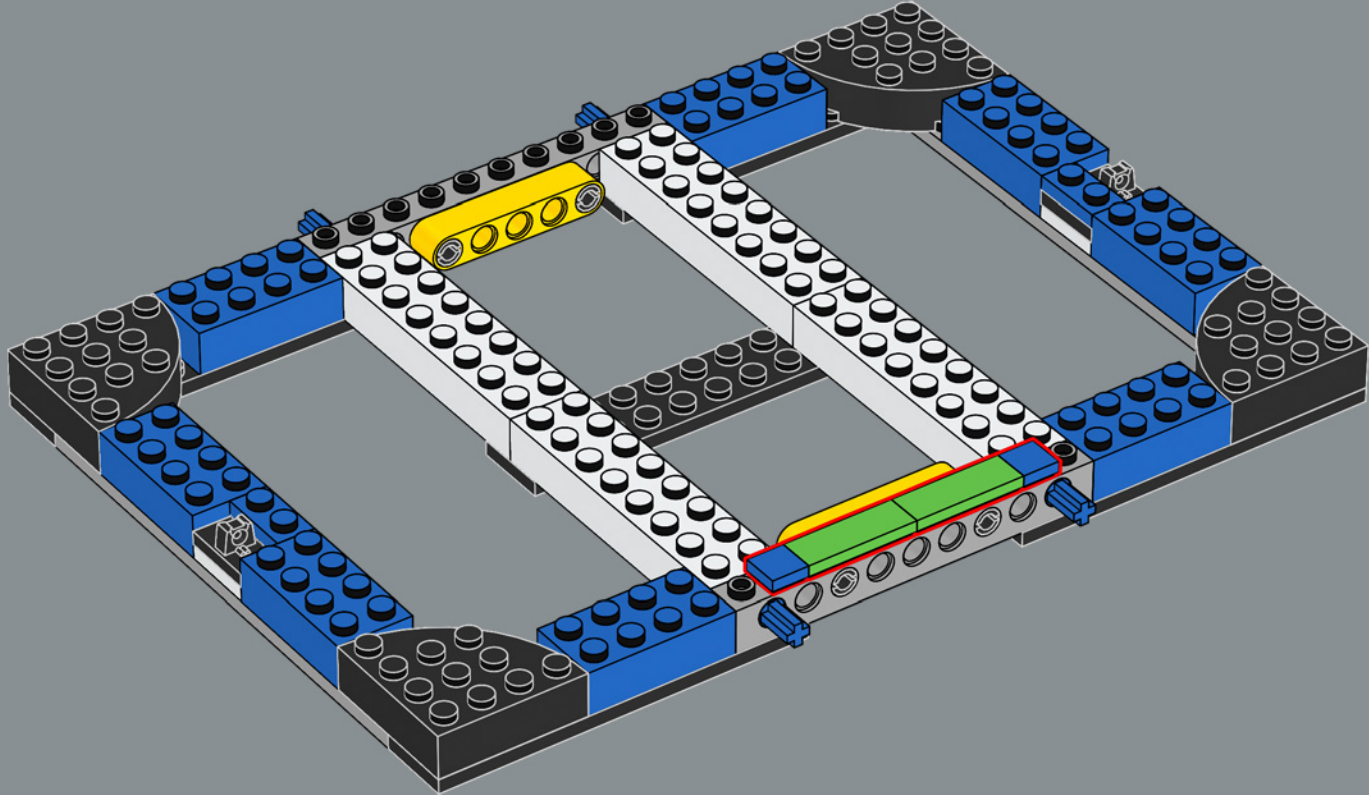

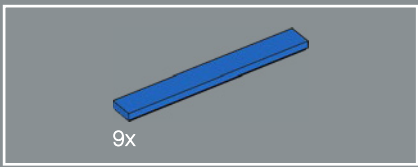

10

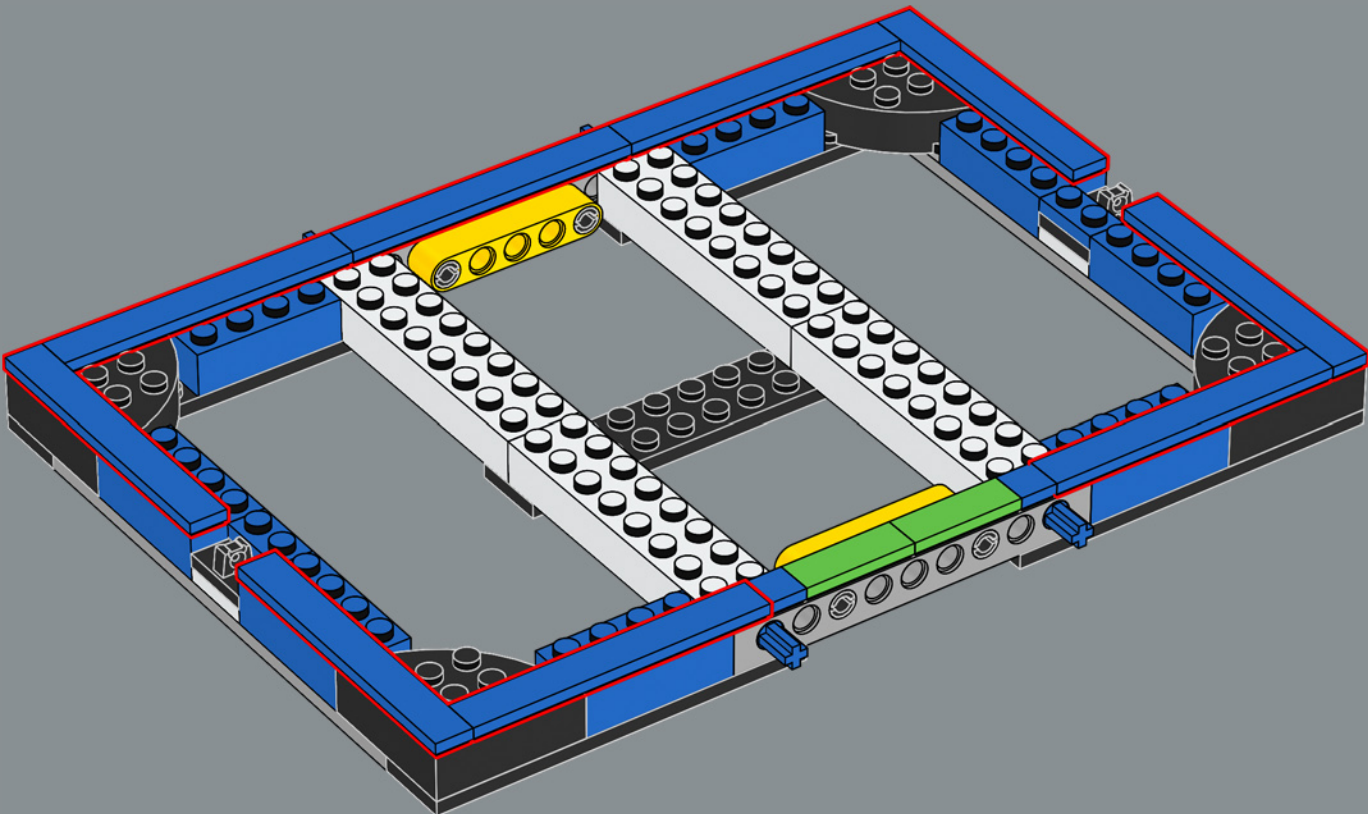

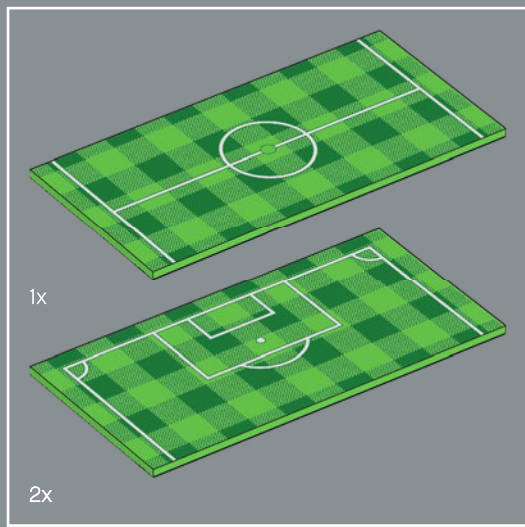

11

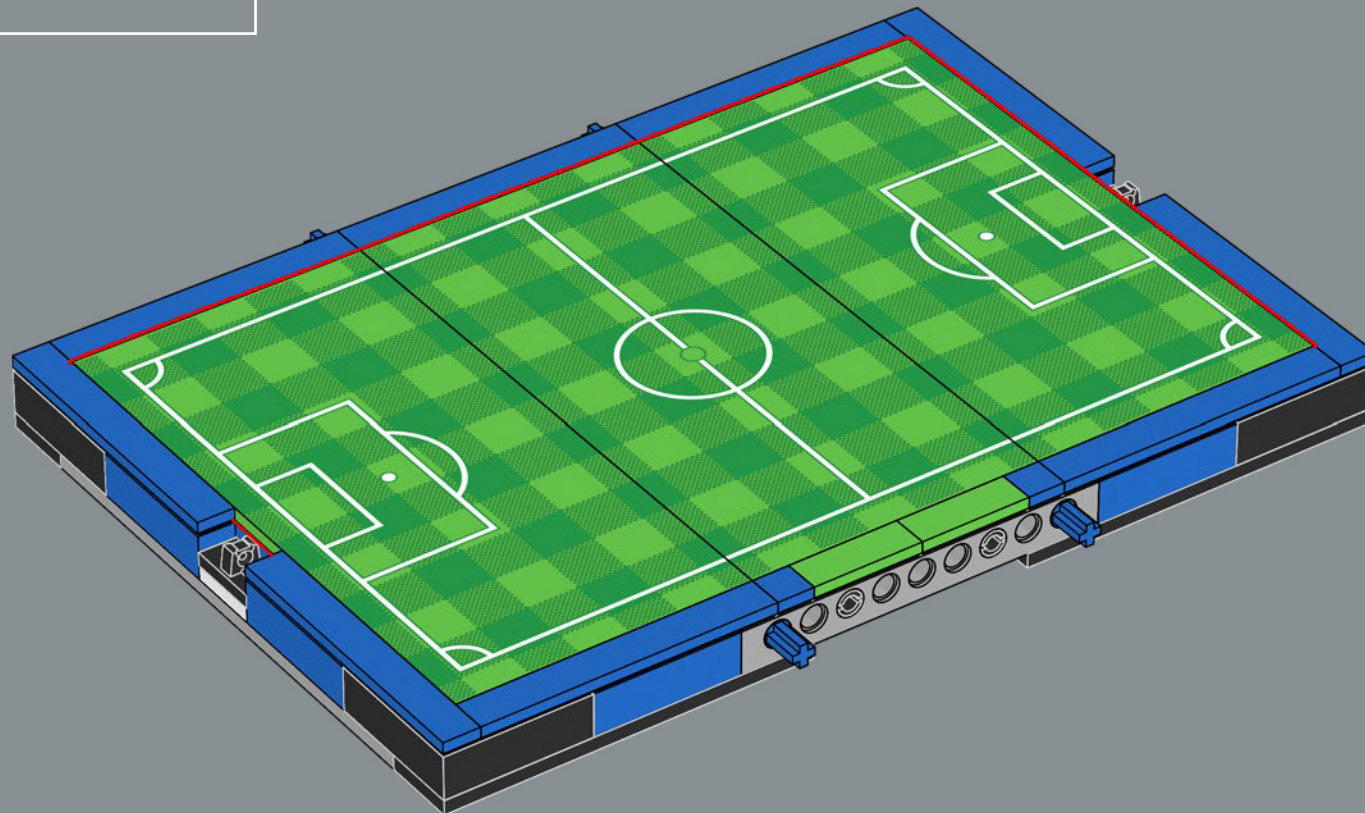

Each LEGO® pitch piece represents the Stadium's blend of natural grass with 17 million synthetic grass fibers - 5.6 million fibers per LEGO Brick!

Les pièces du terrain LEGO® recréent le mélange d'herbe naturelle et de 17 millions de fibres d'herbe synthétique du stade, à une échelle de 5,6 millions de fibres par brique LEGO !

Cada pieza LEGO® del campo de juego representa una porción de la mezcla de césped natural con 17 millones de fibras sintéticas que hay en el estadio, es decir, ¡5,6 millones de fibras por cada brick LEGO!

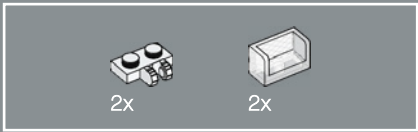

12

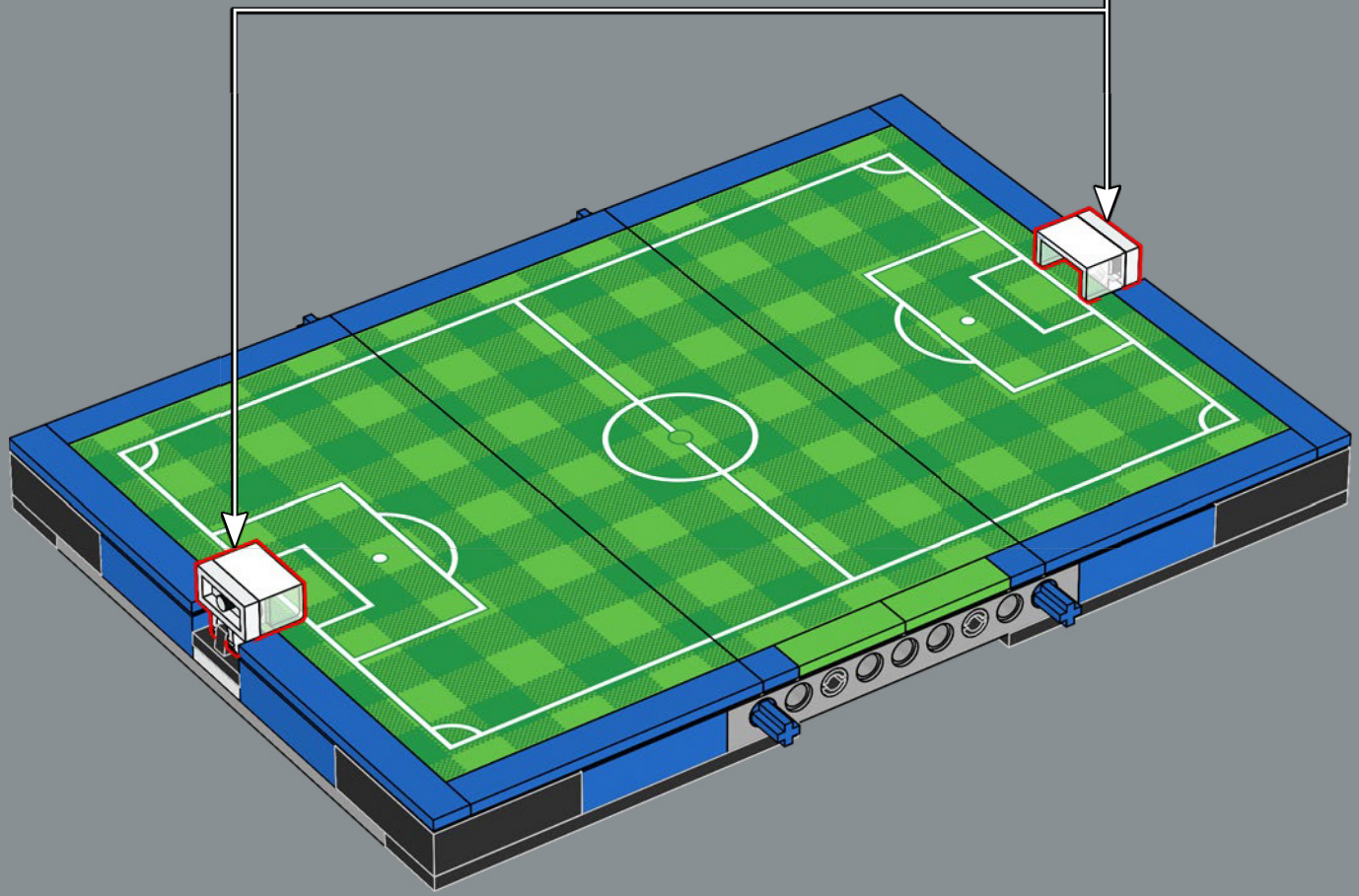
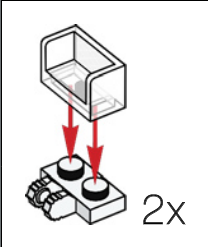

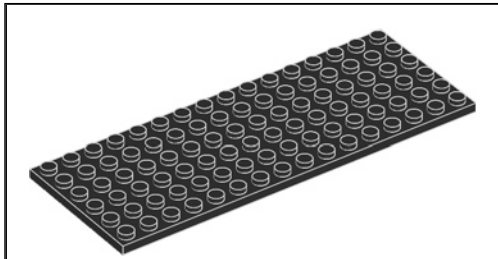

2x

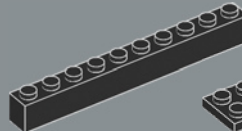
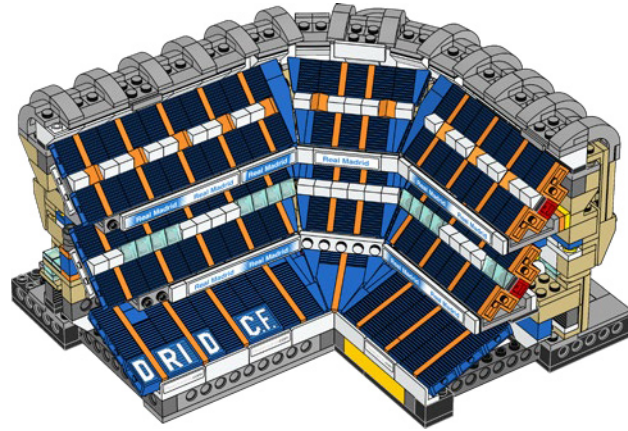
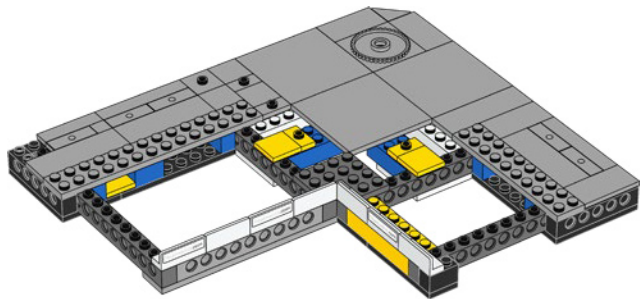
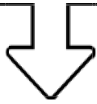

1x

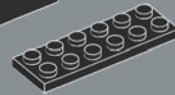

1x

13

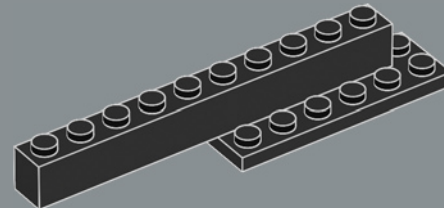

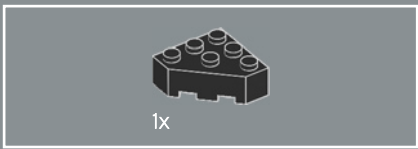

14

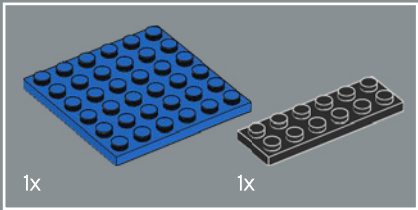
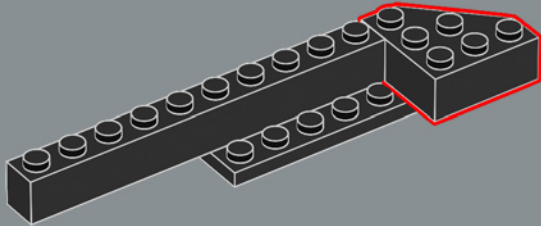

15

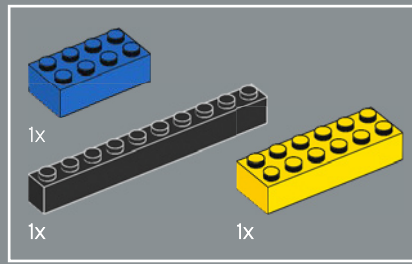
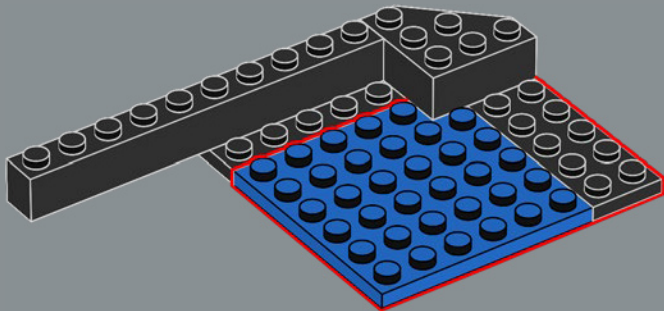

16

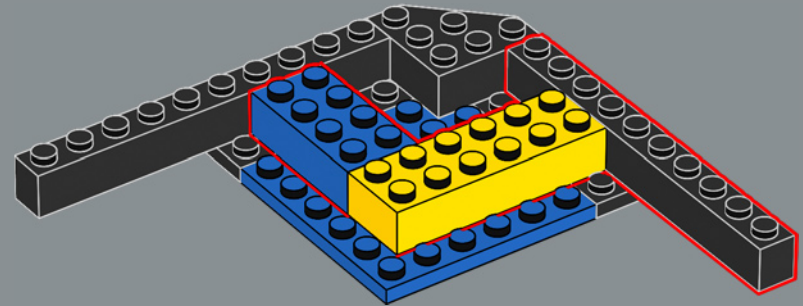

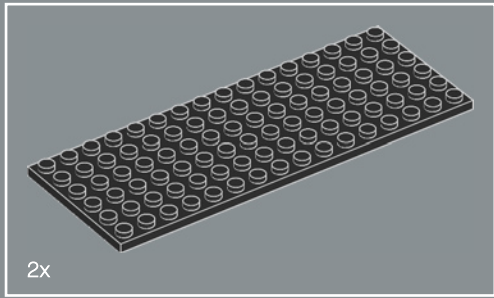

17

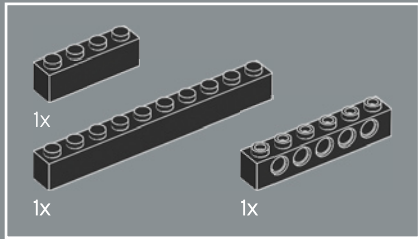
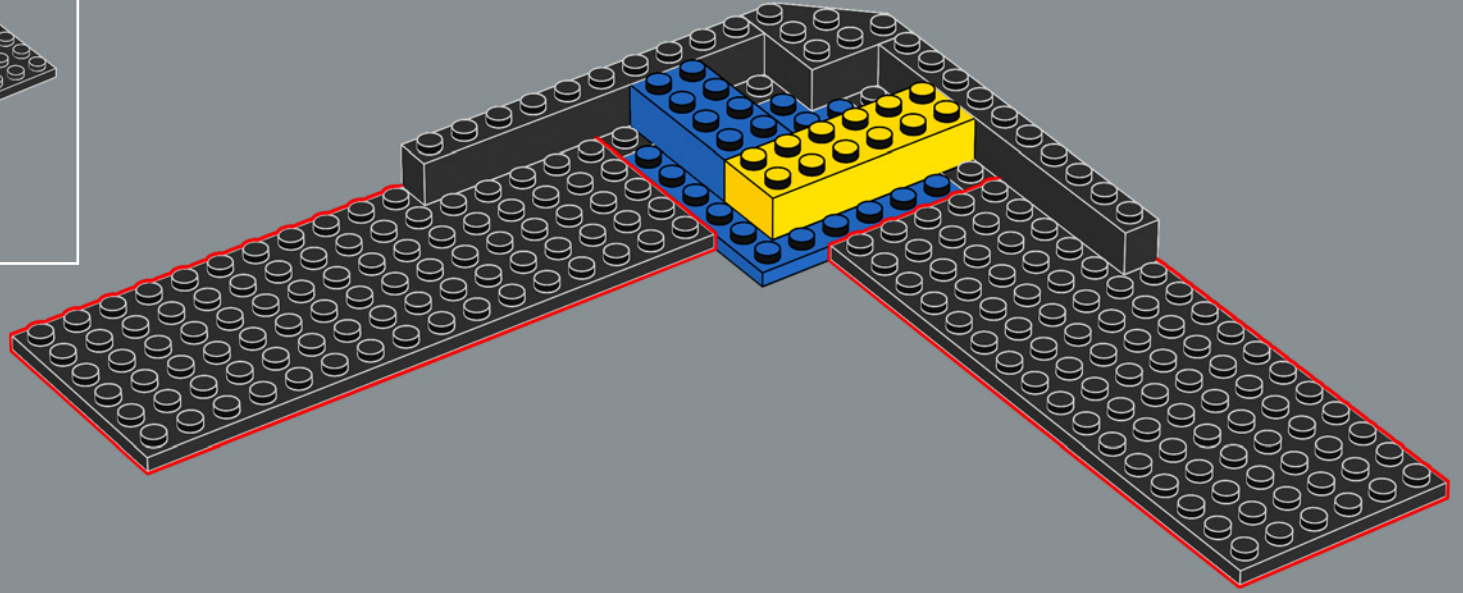

18

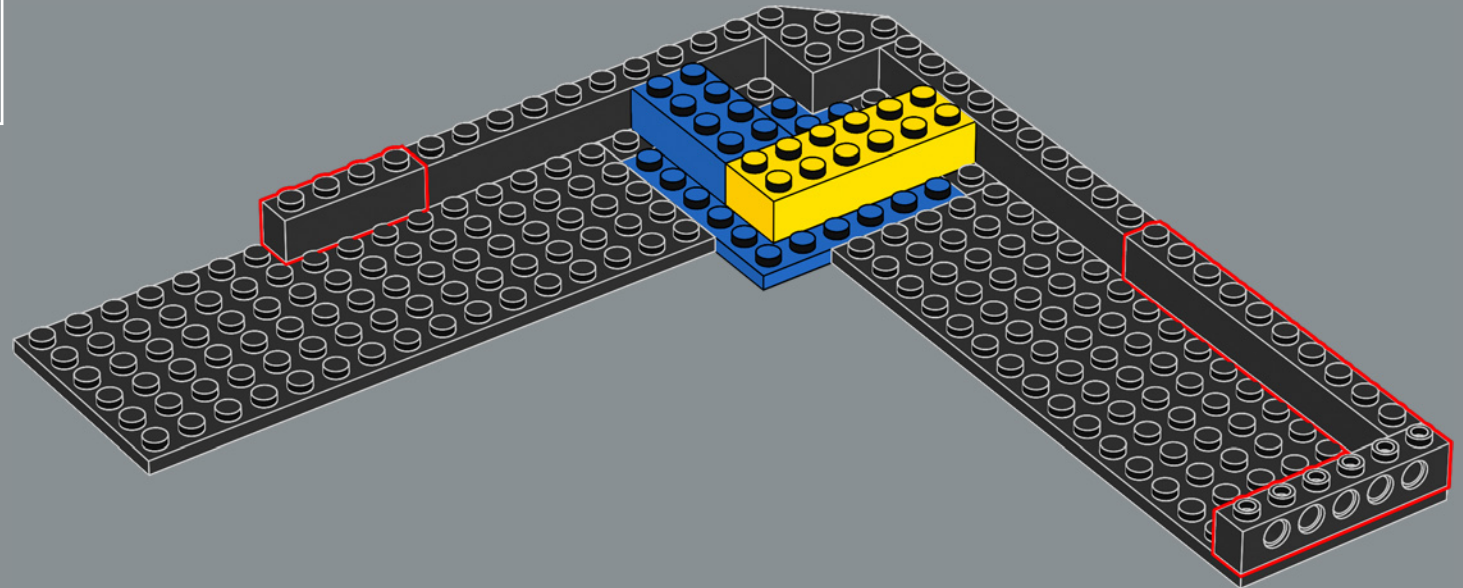

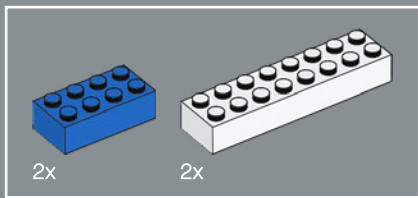

19

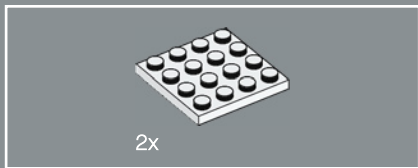
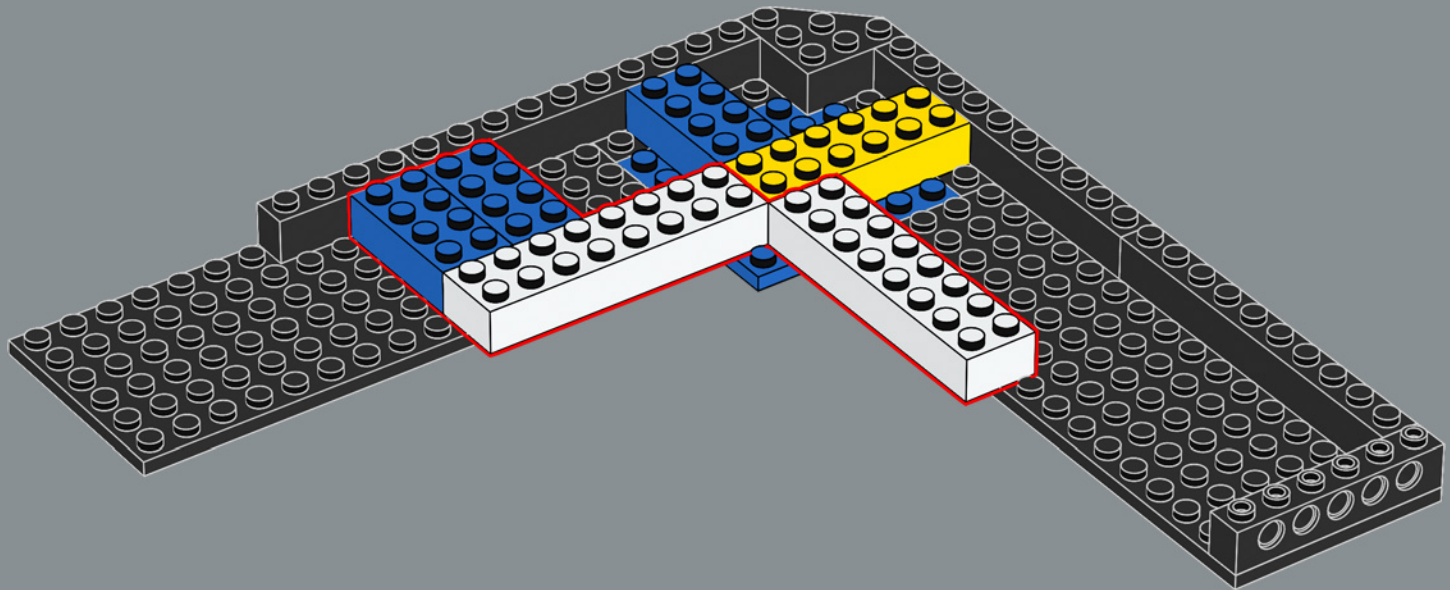

20

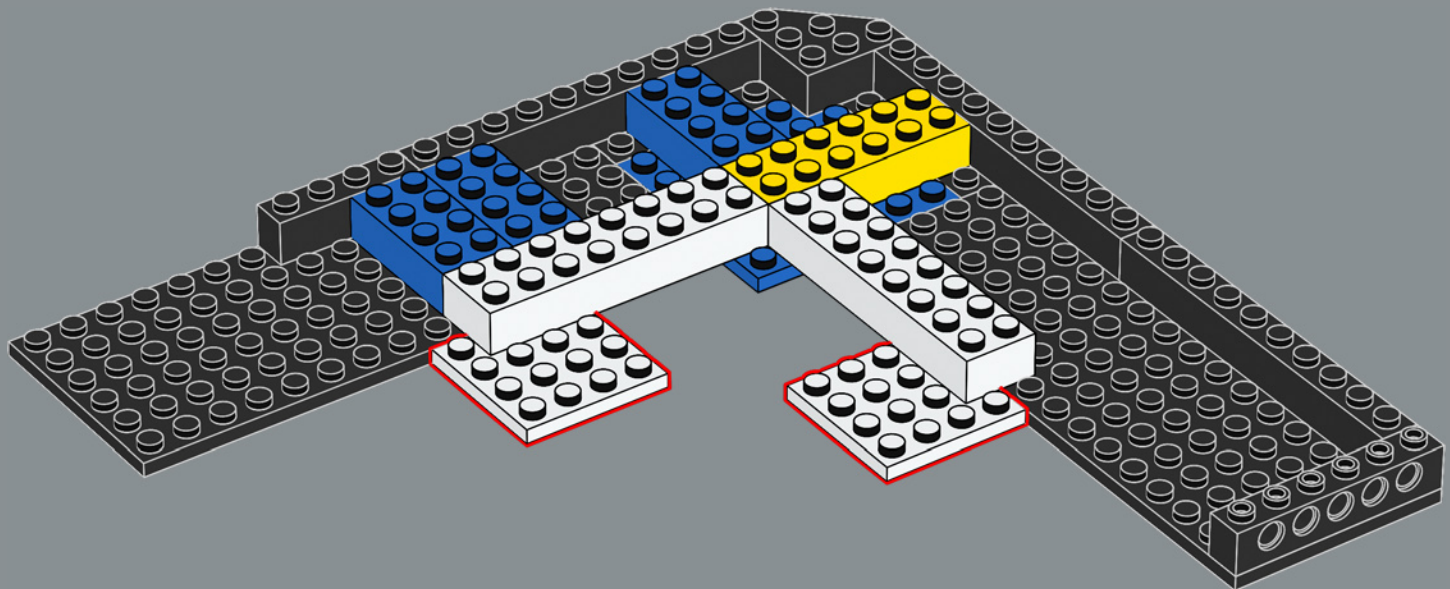

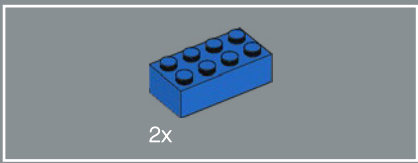

21

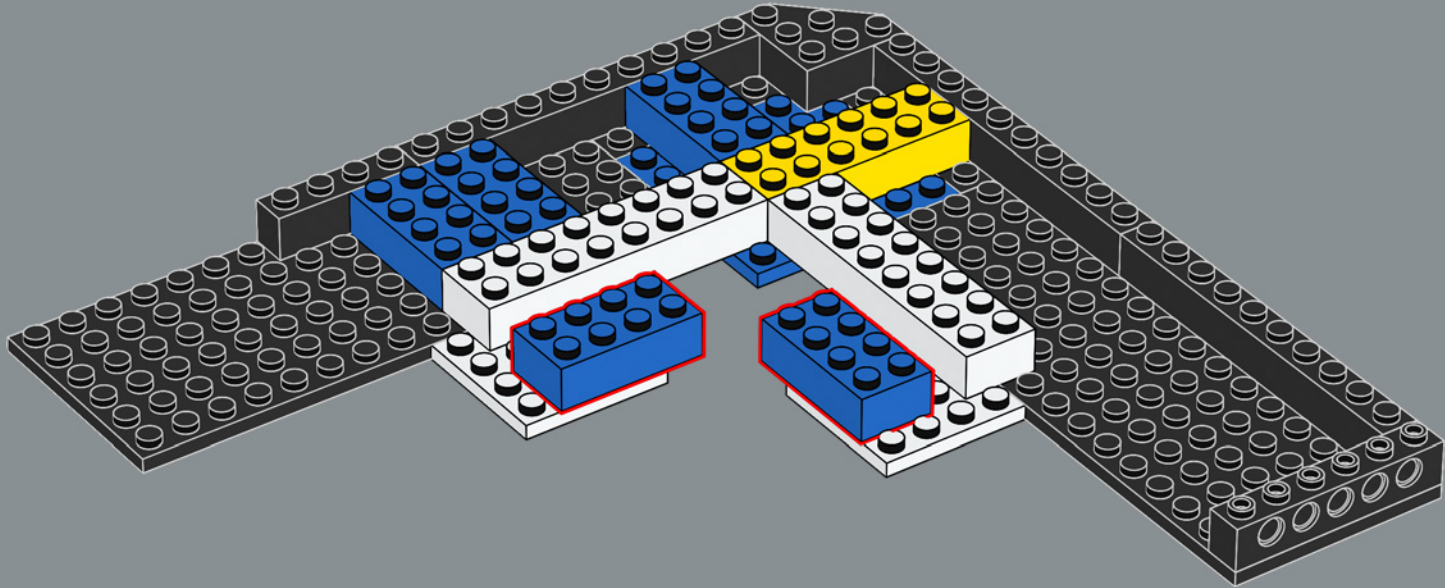

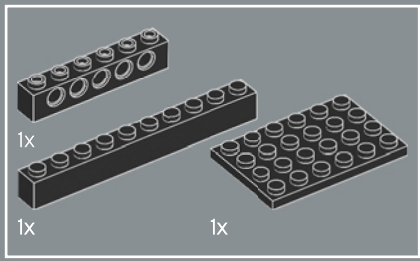

22

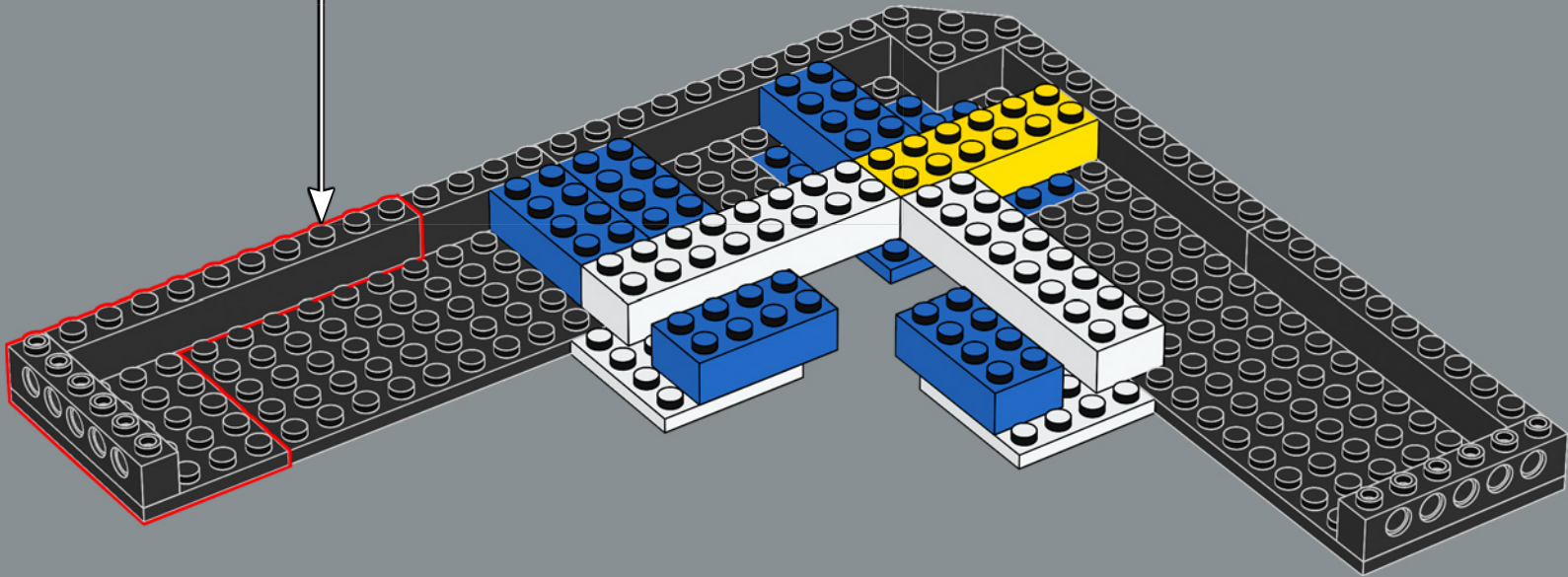
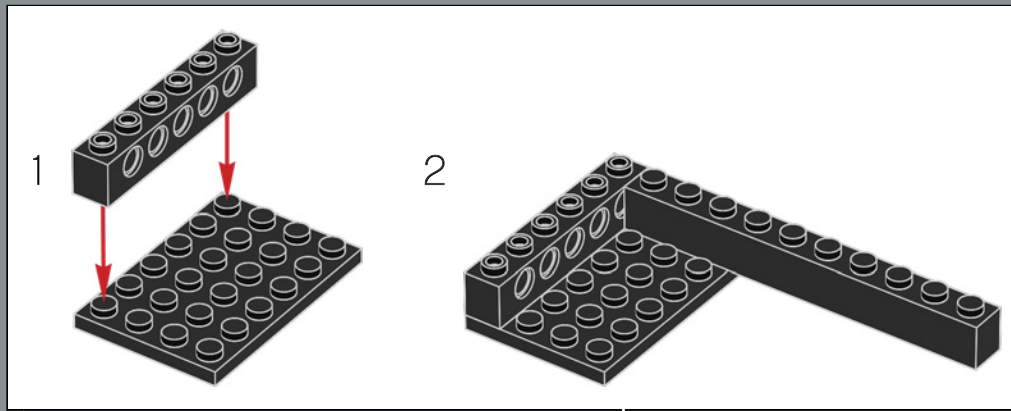

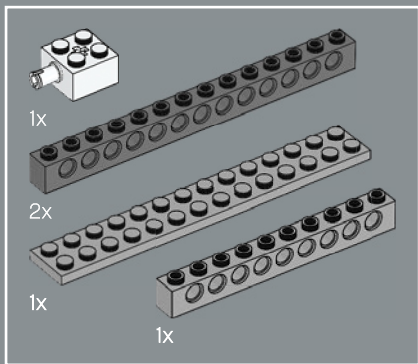

23

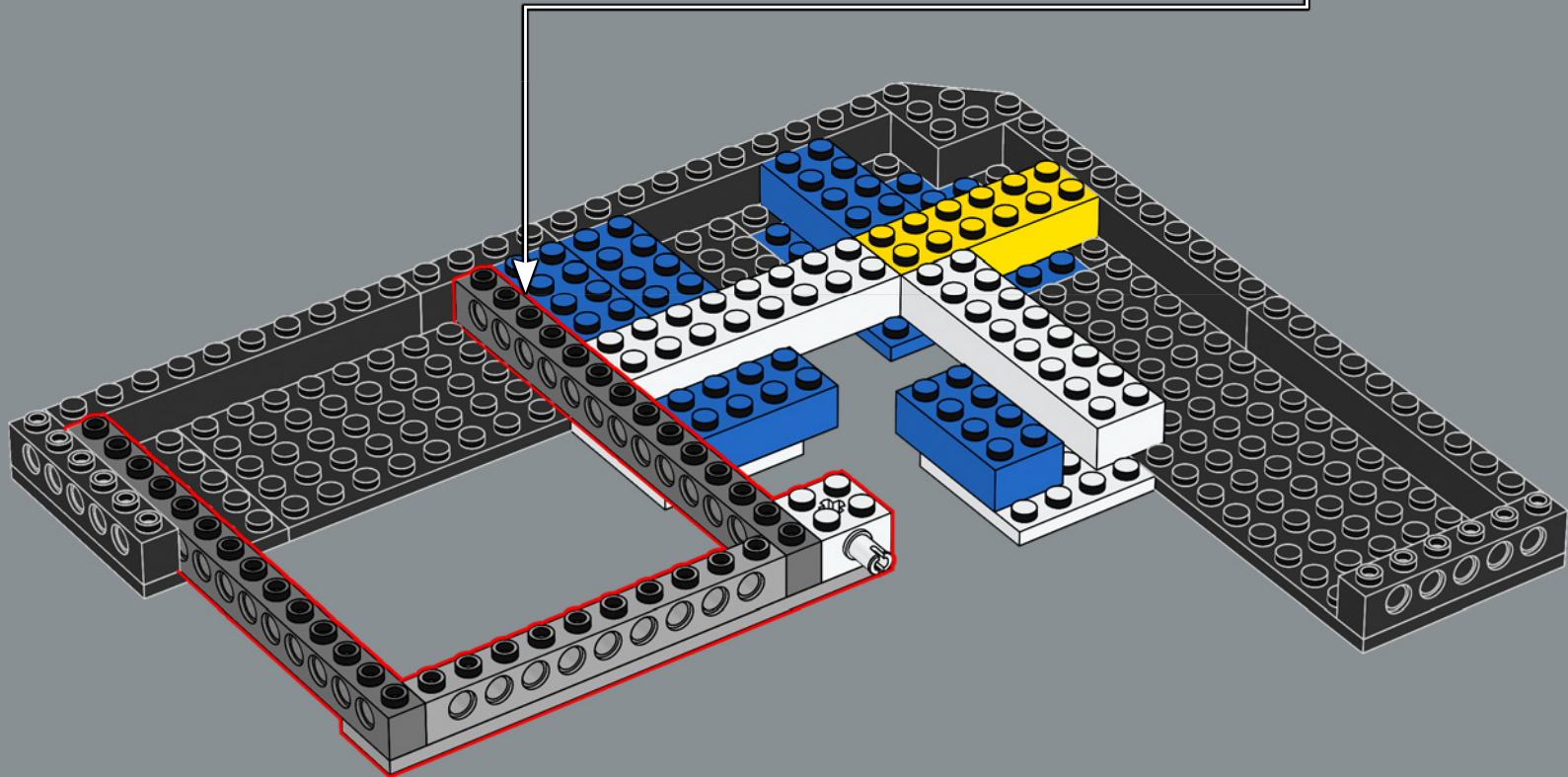
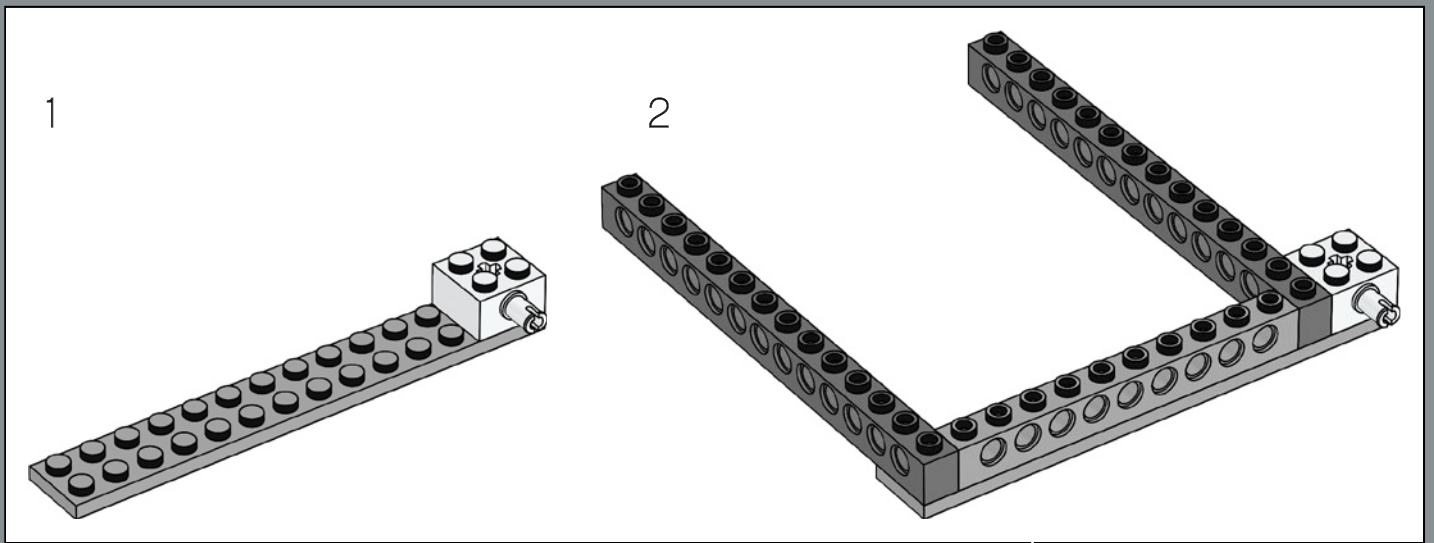

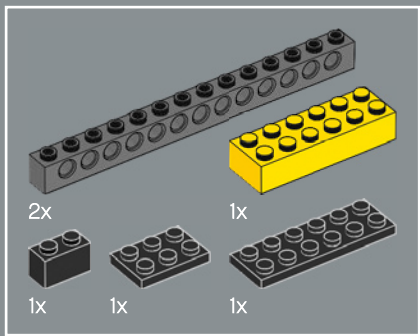

24

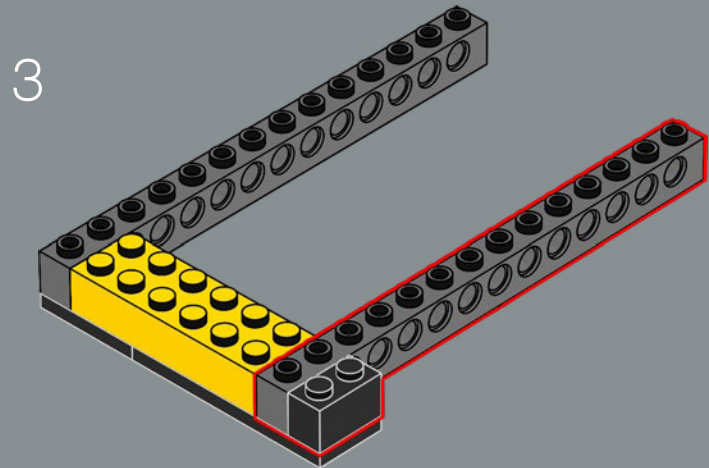
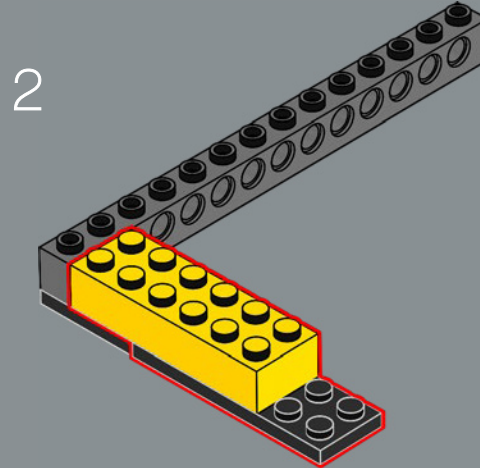
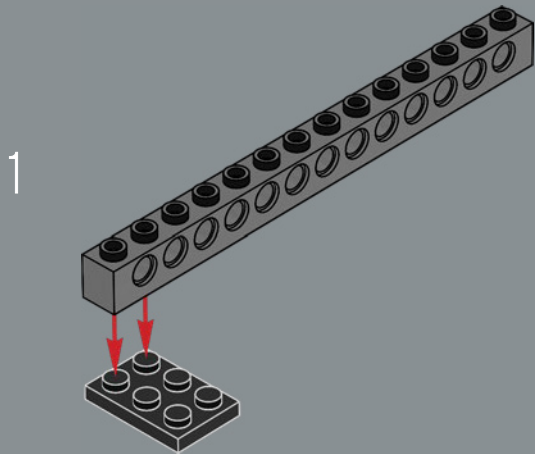

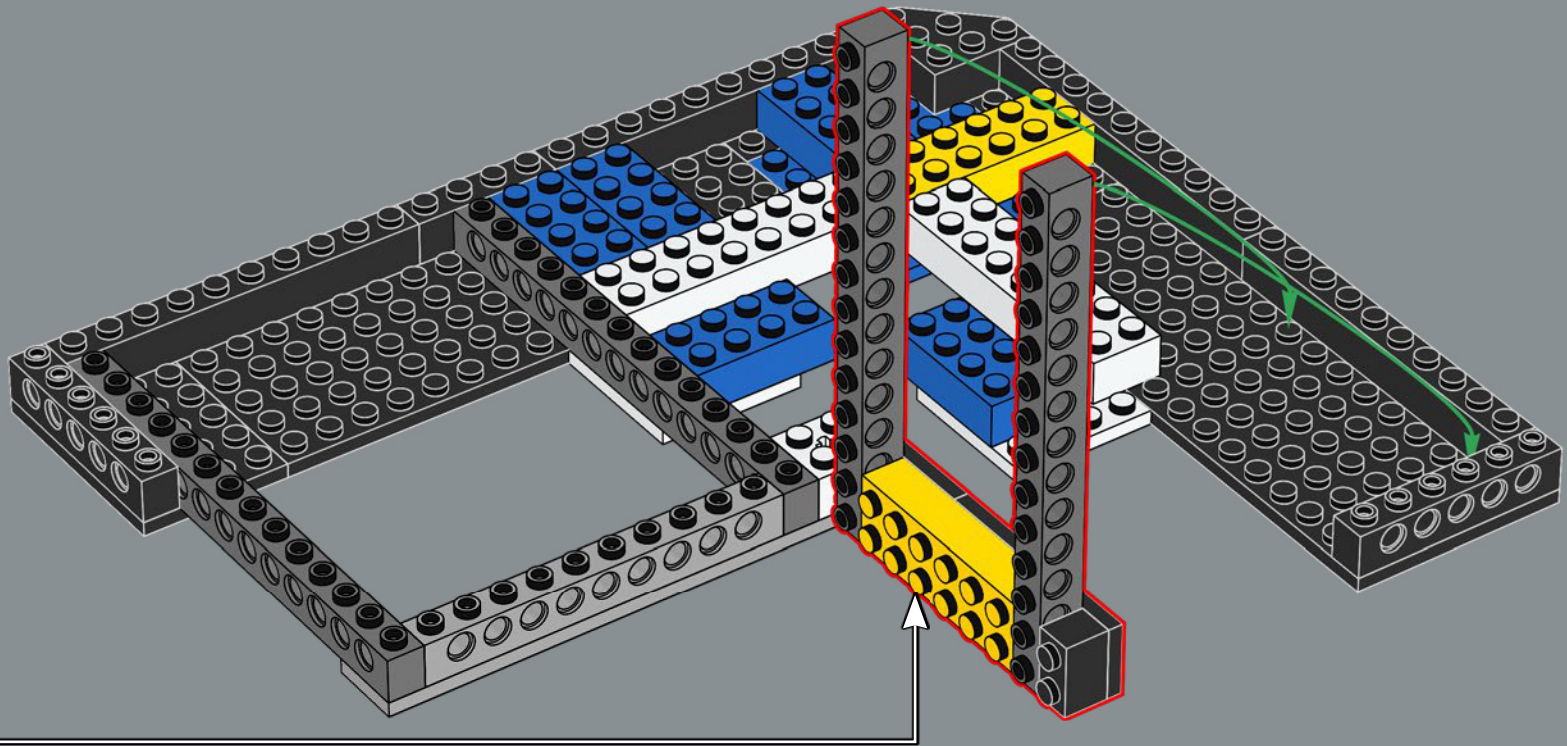

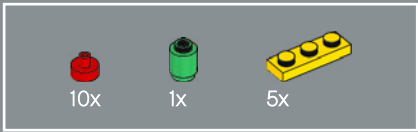

25

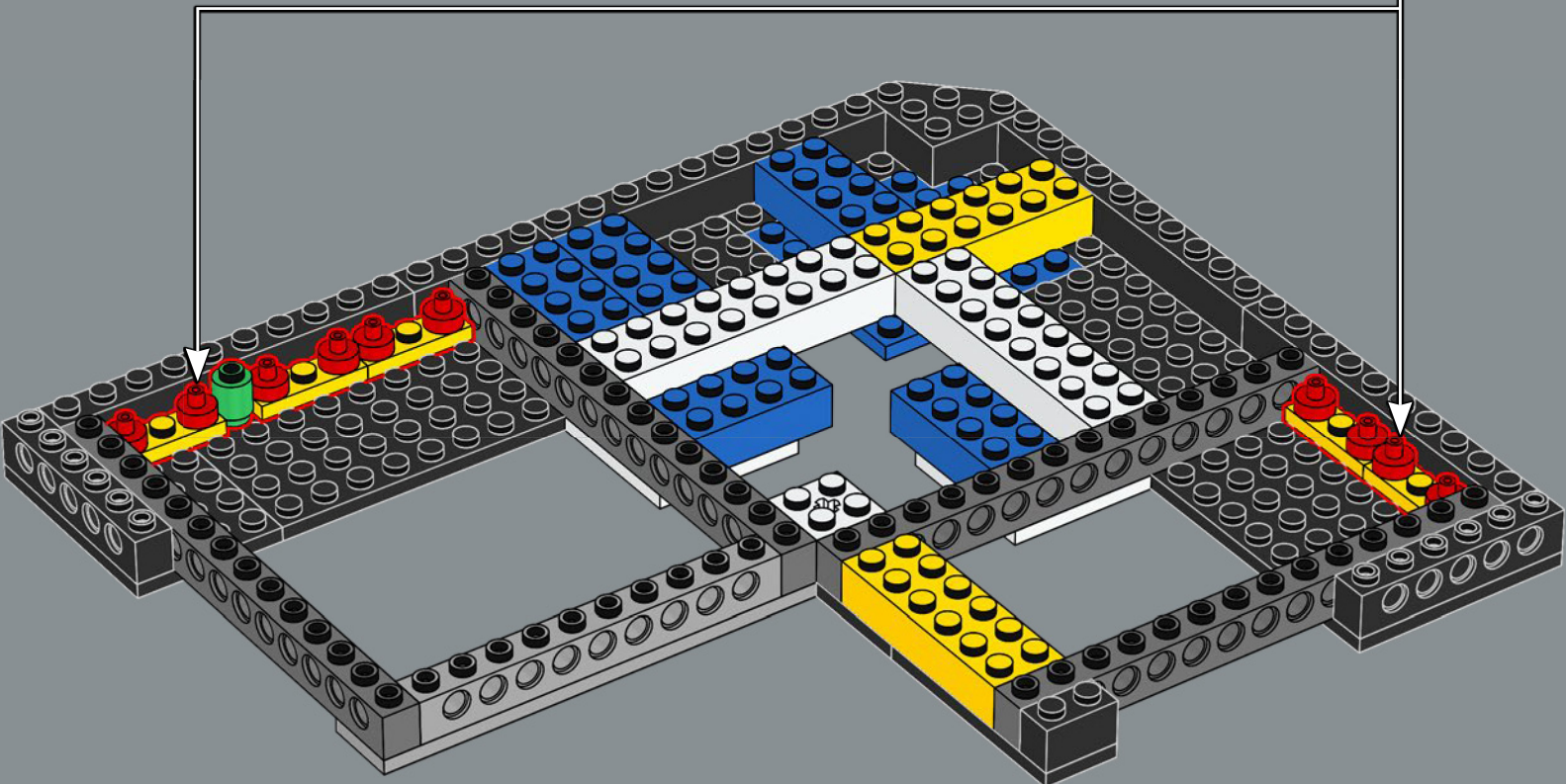
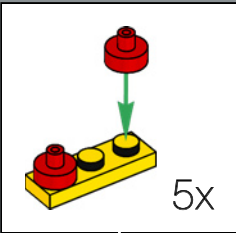

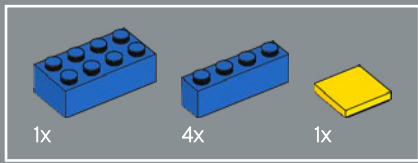

26

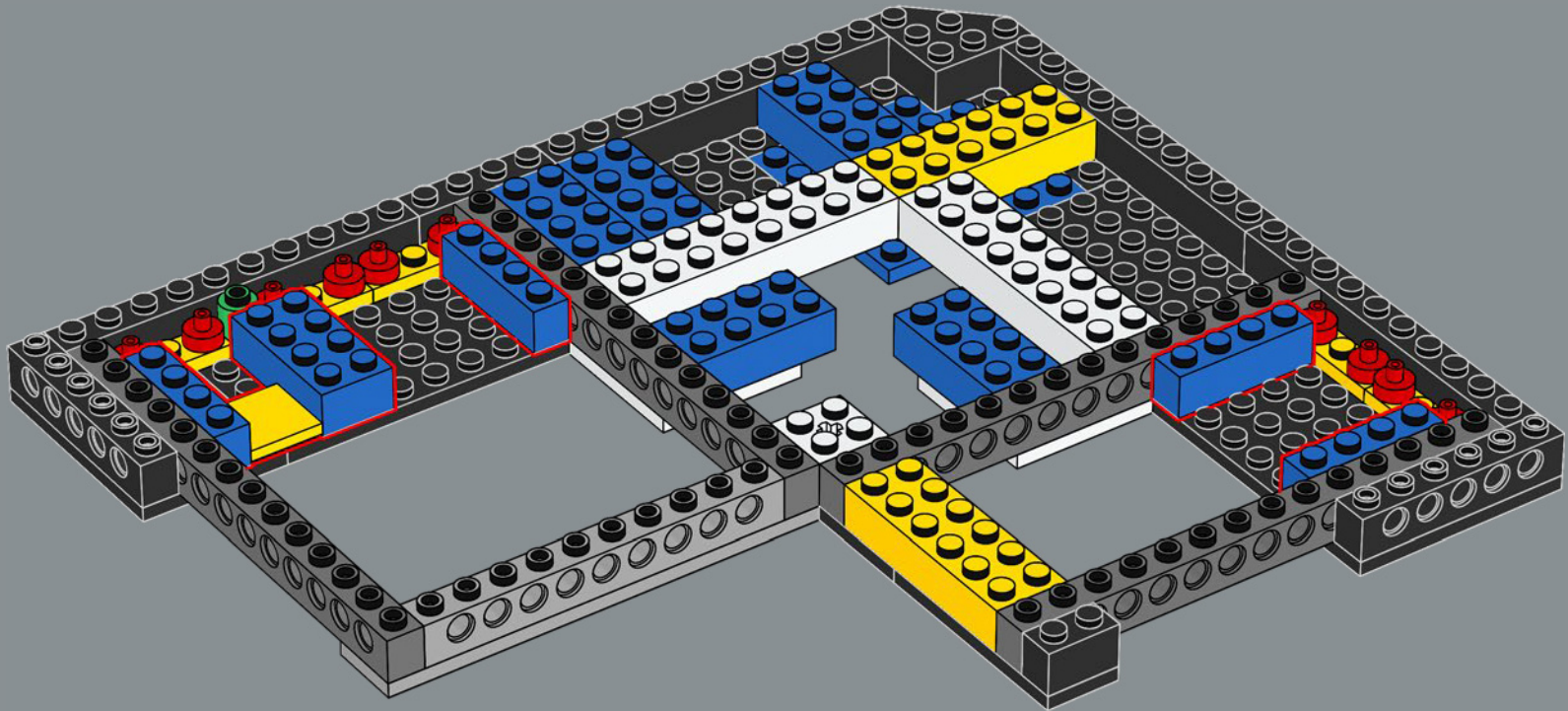

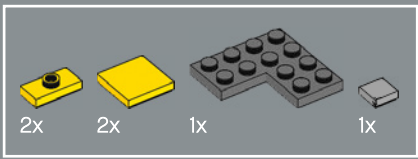

27

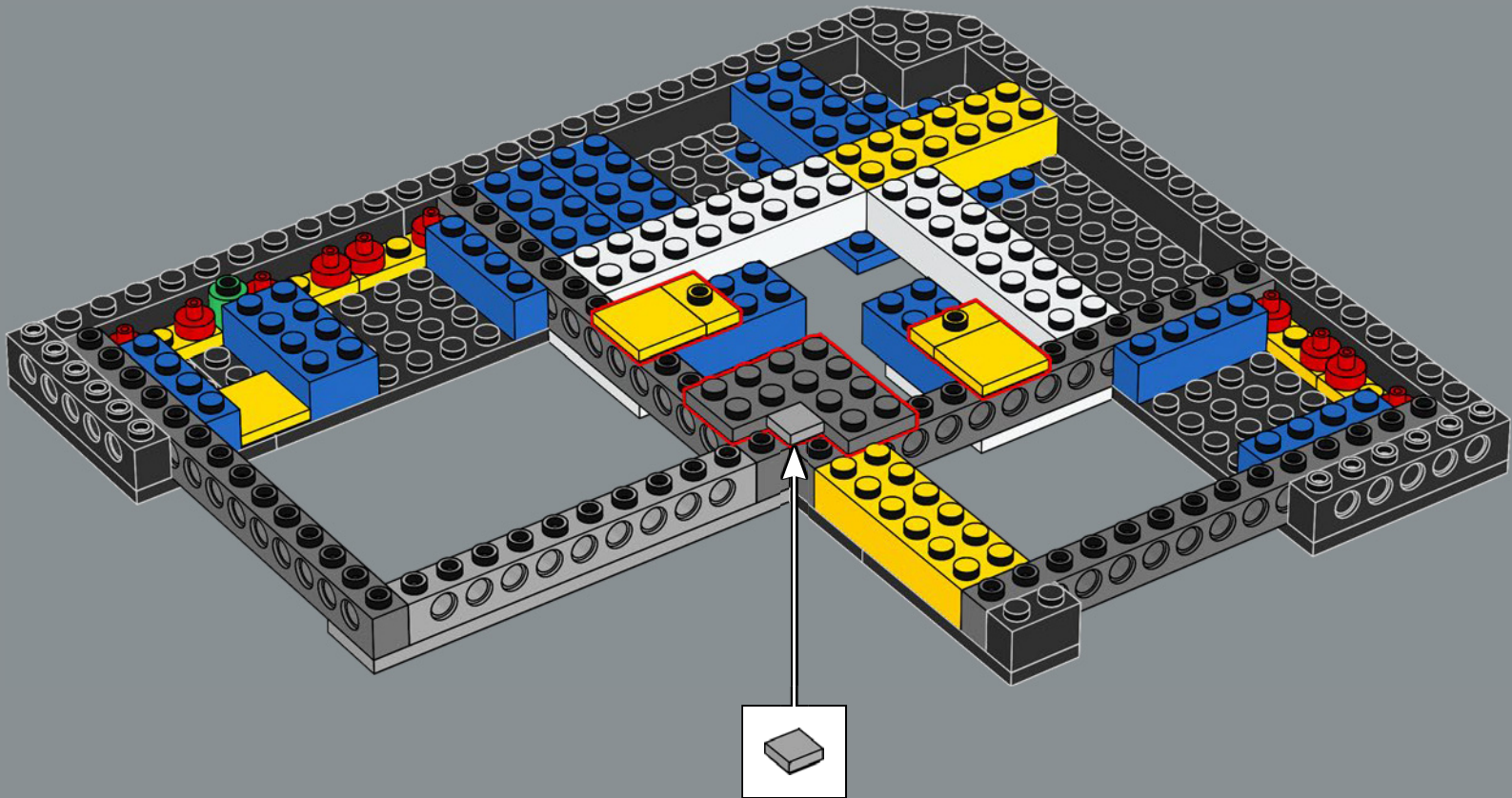

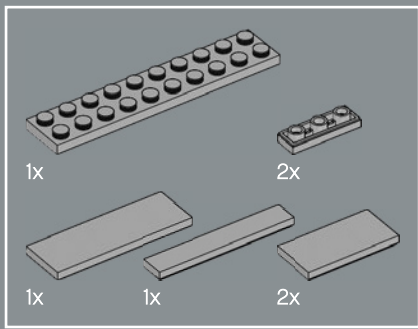

28

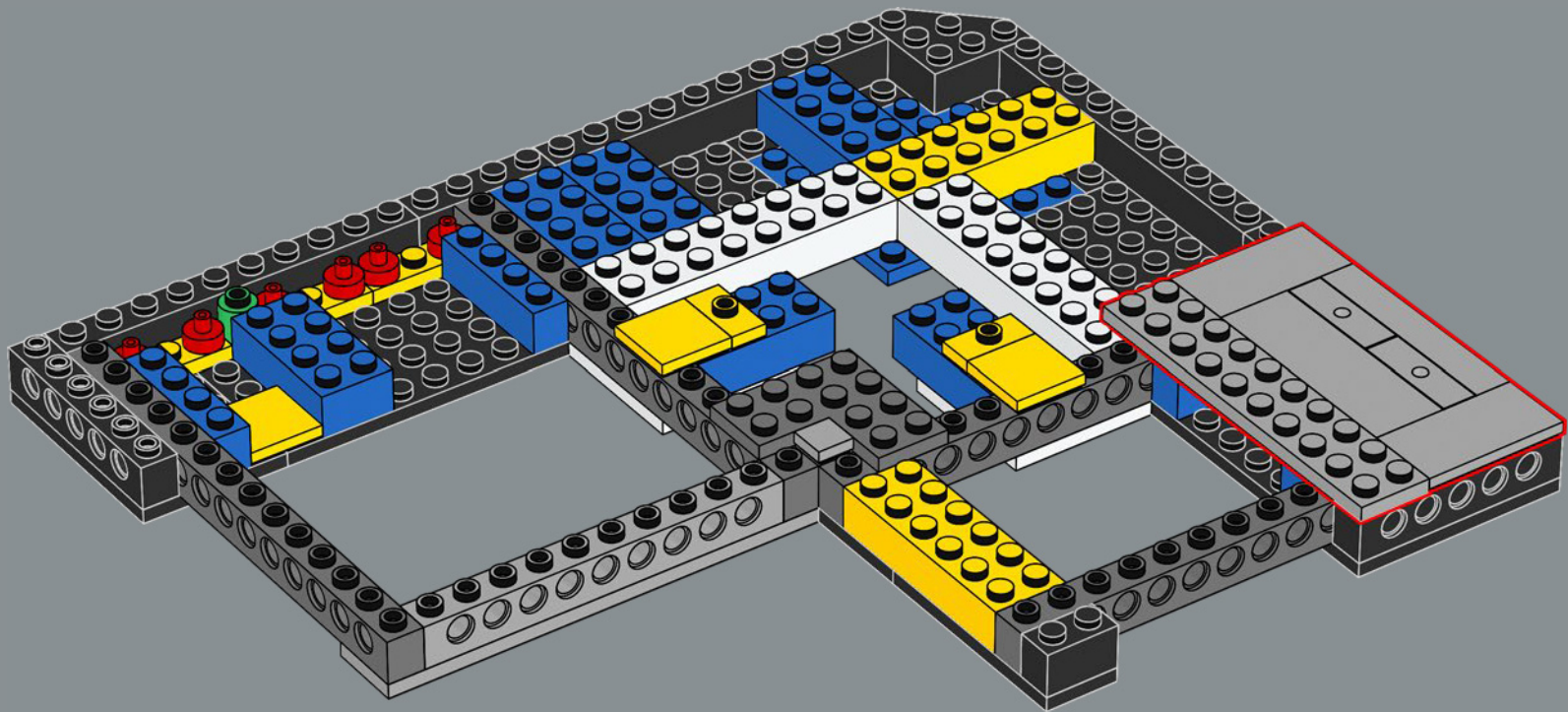

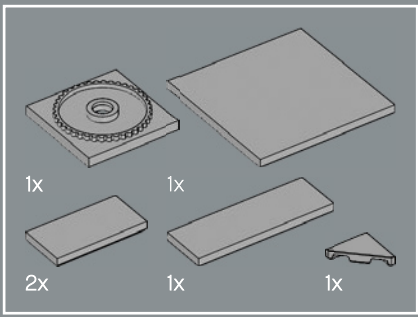

29

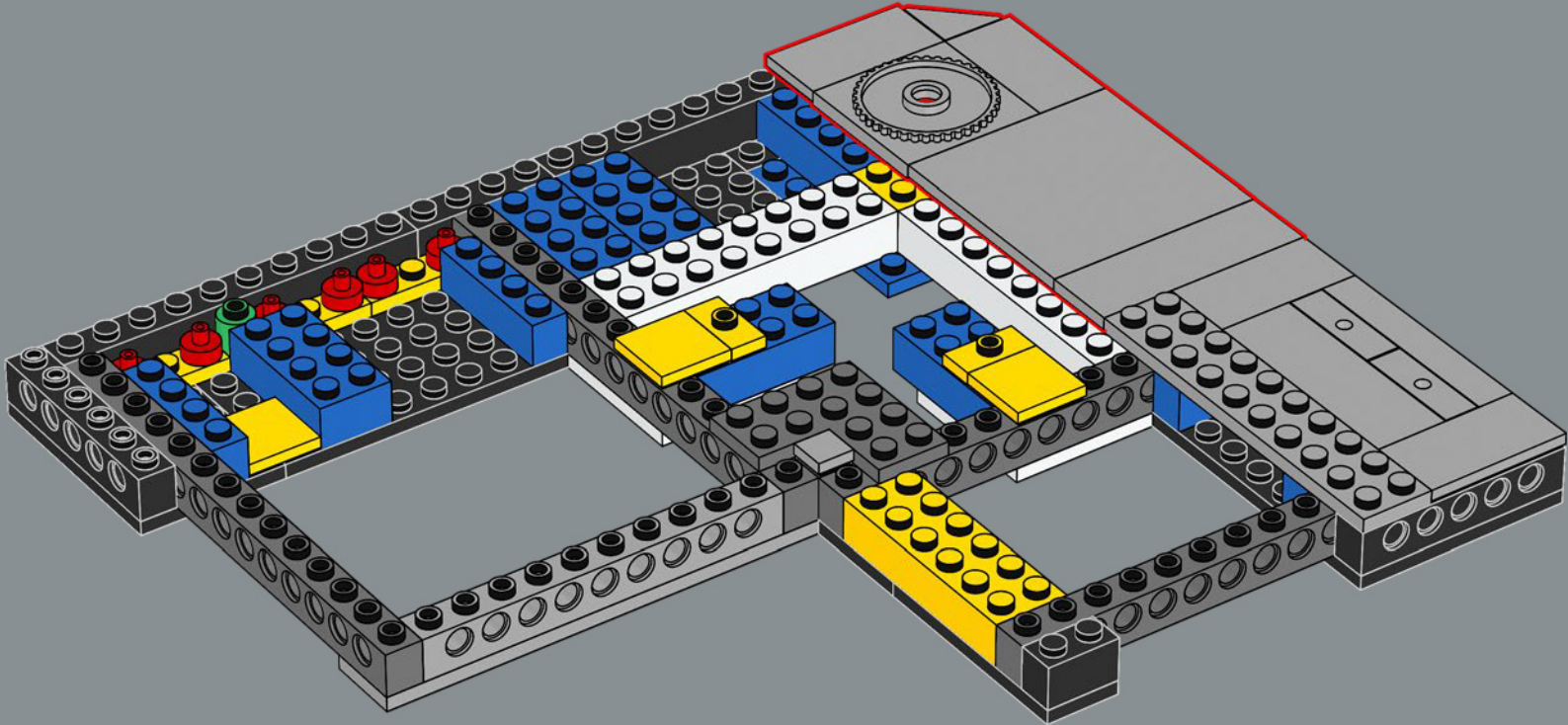

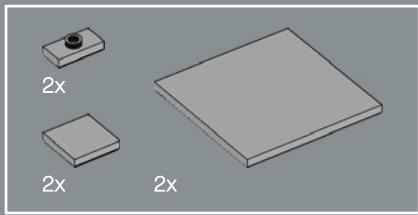

30

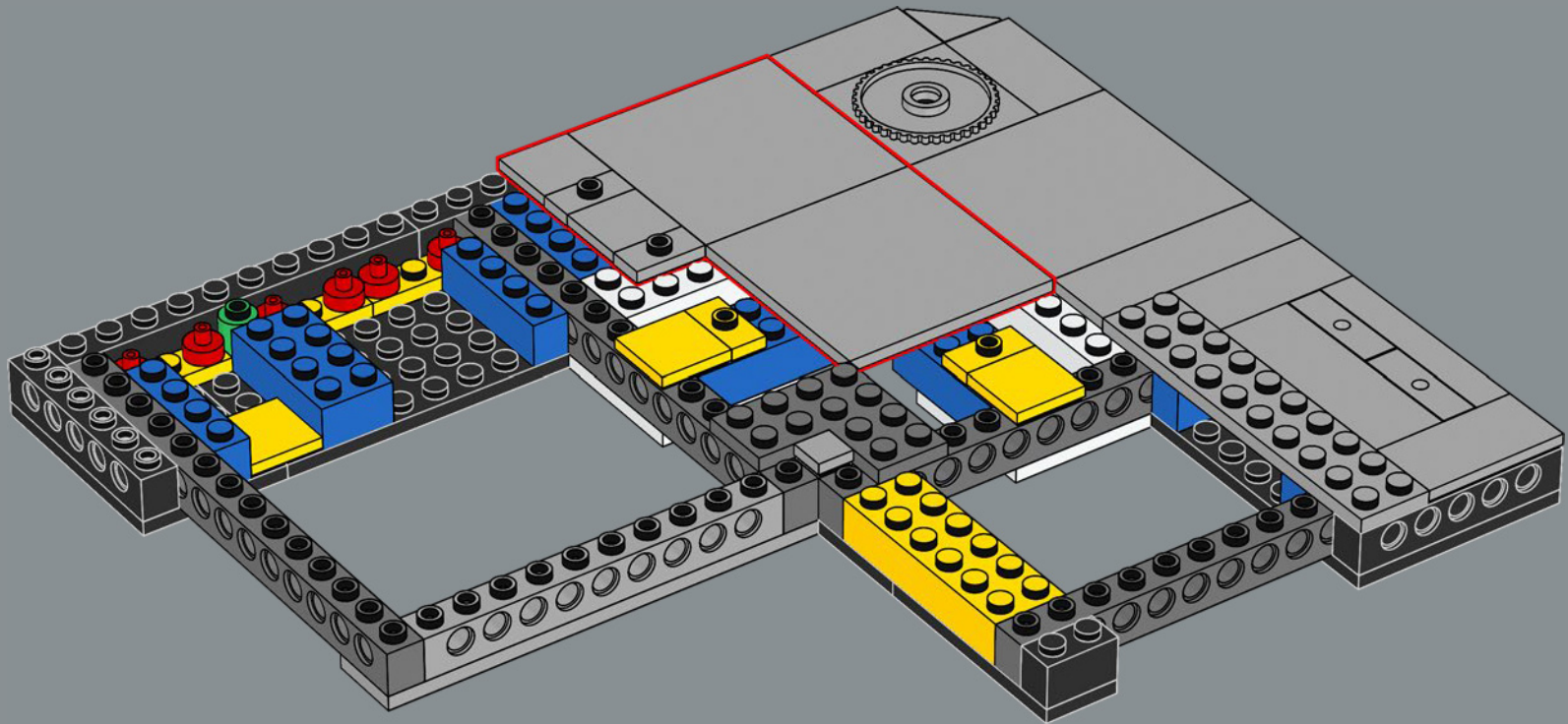

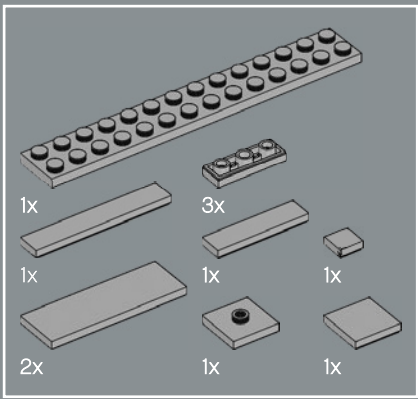

31

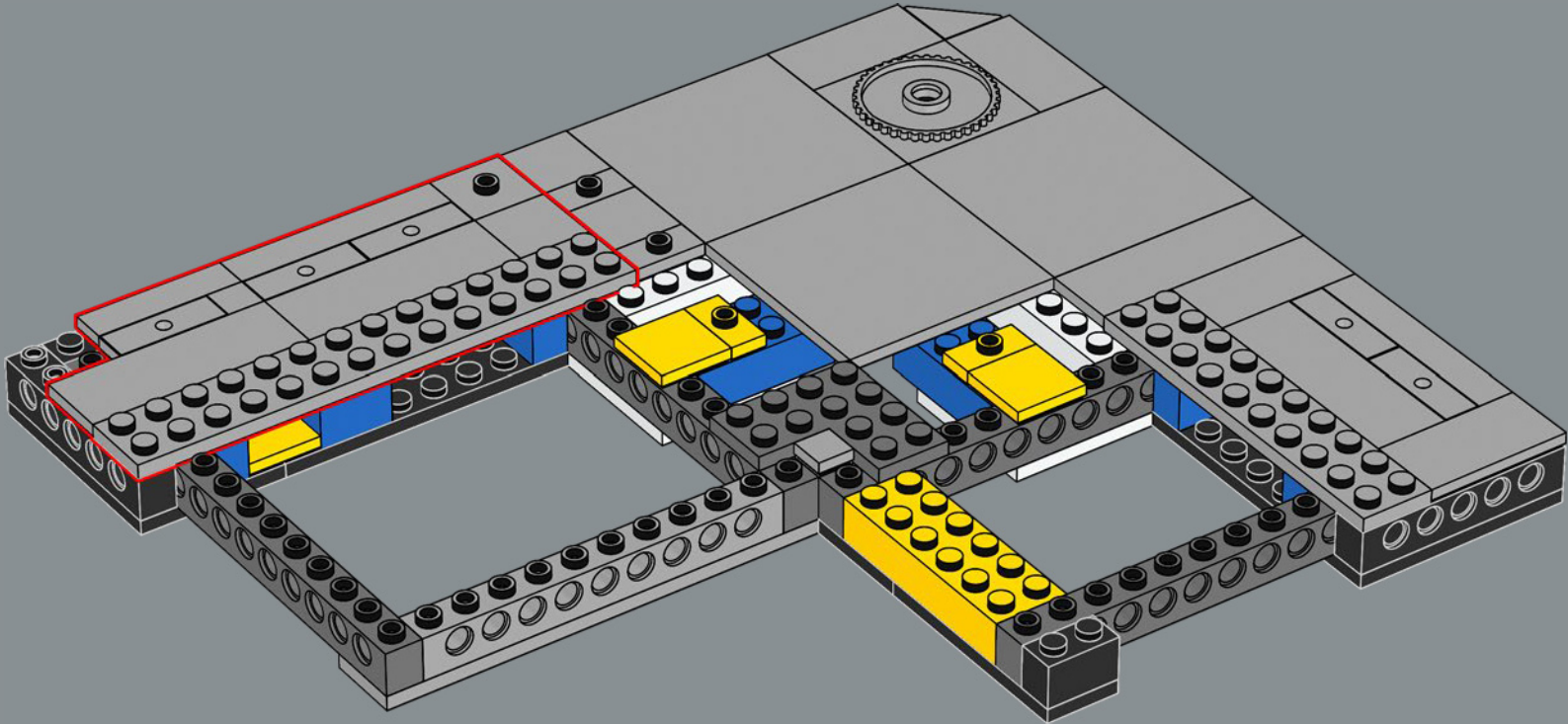

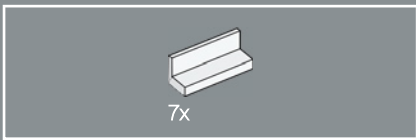

32

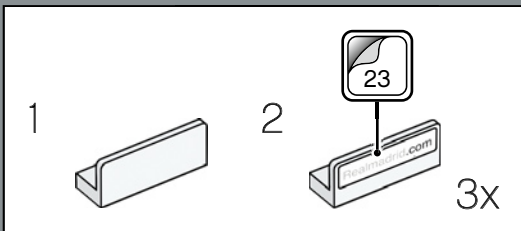
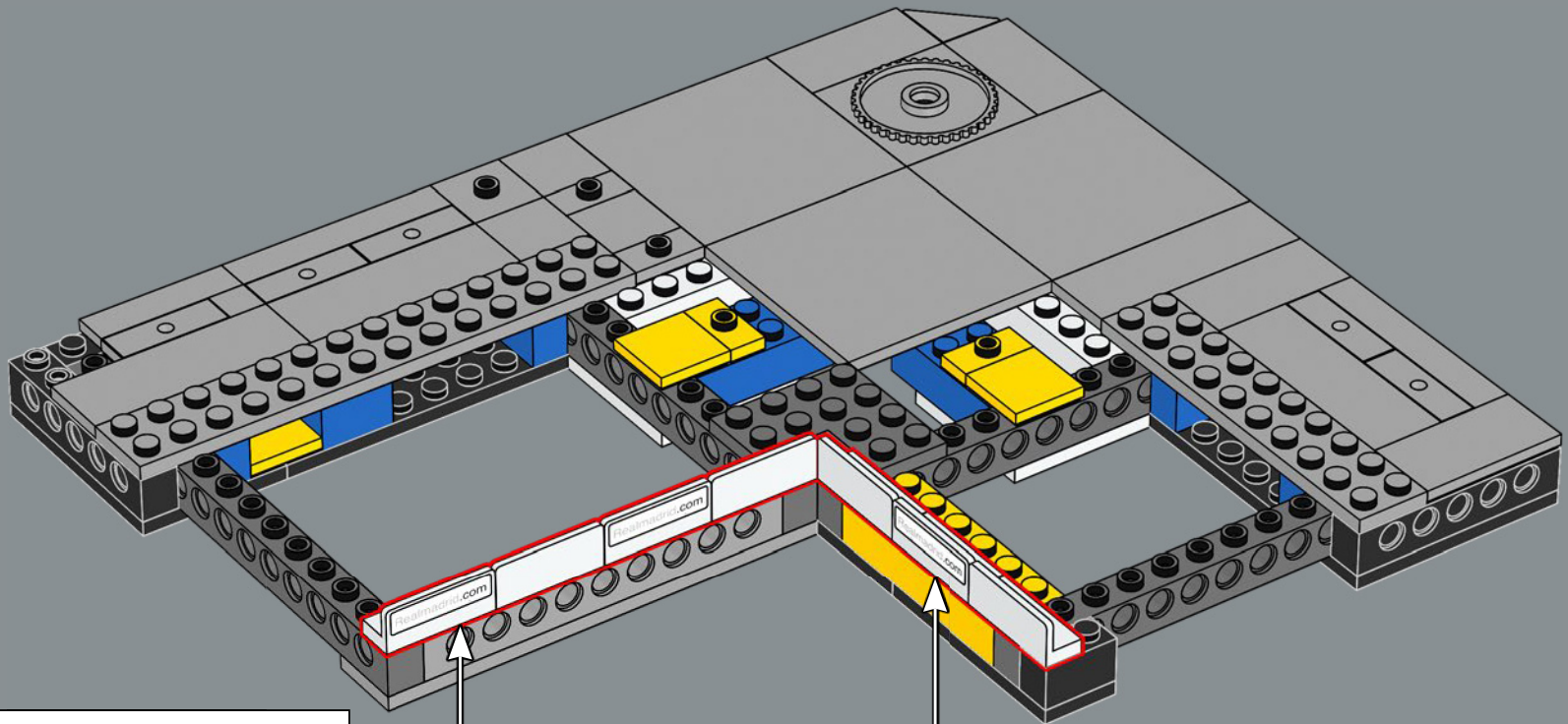

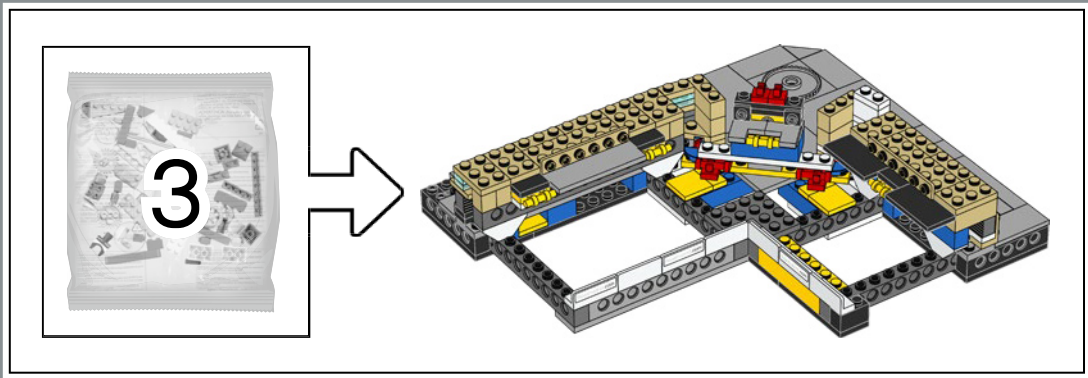

33

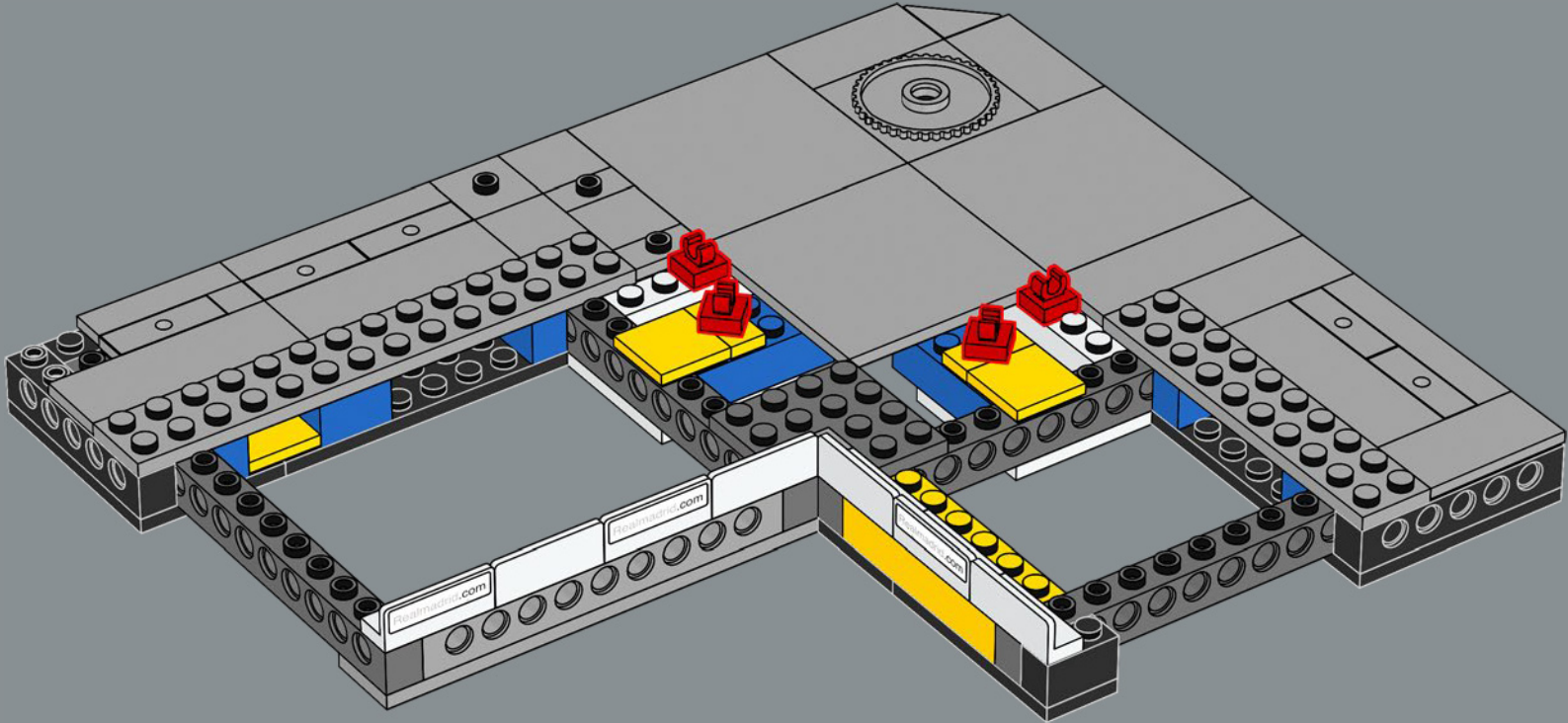

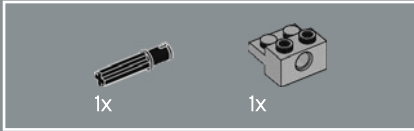
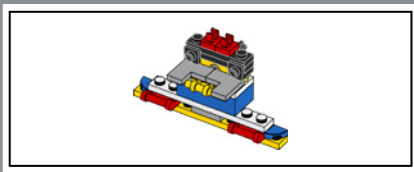

34

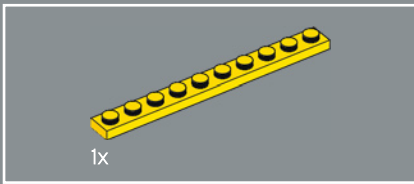
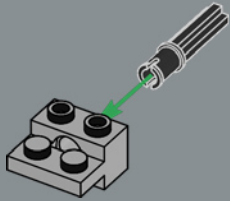

35

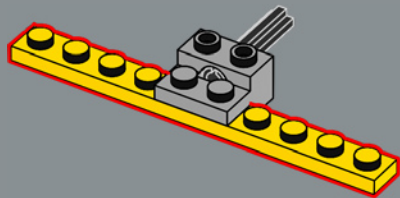

36

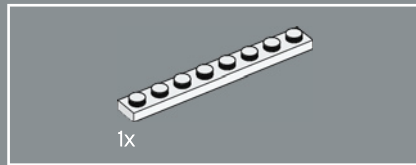
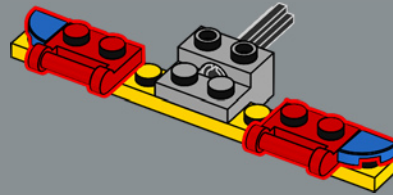

37

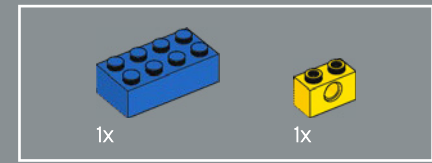
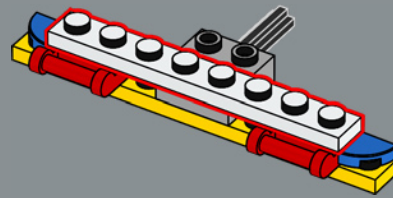

38

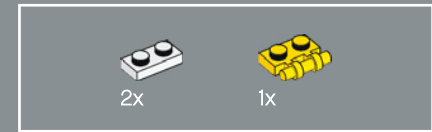
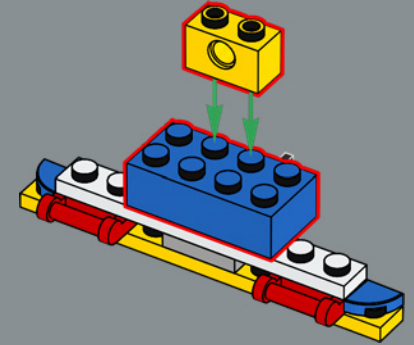

39

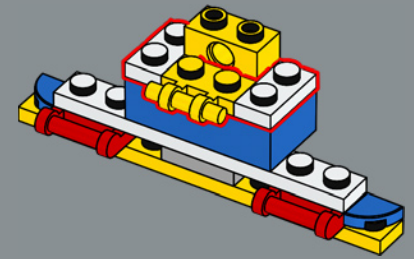

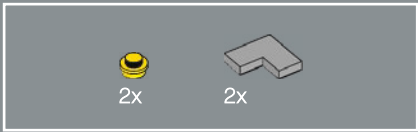

40

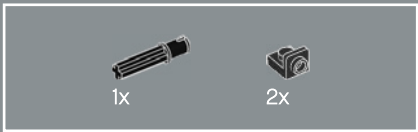
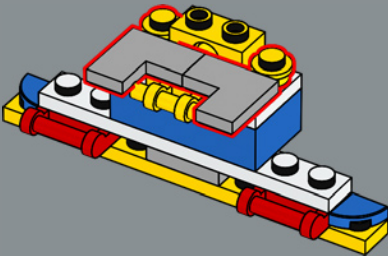

41

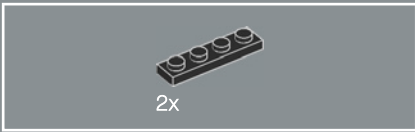
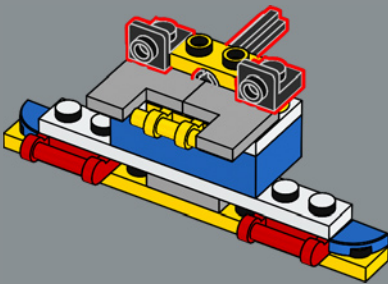

42

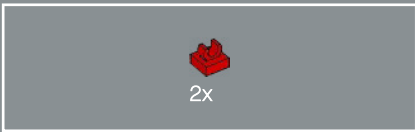
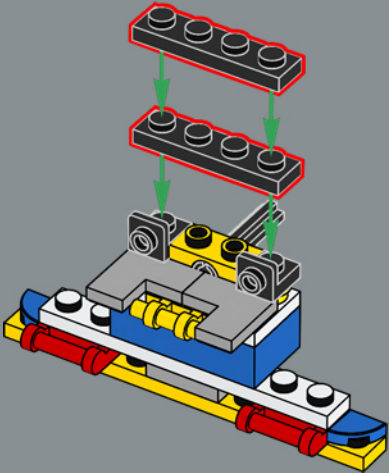

43

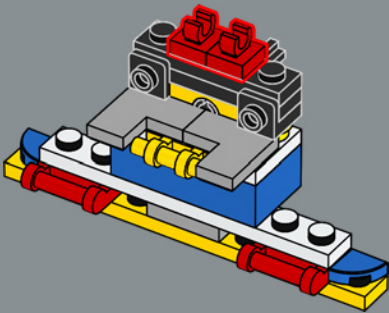

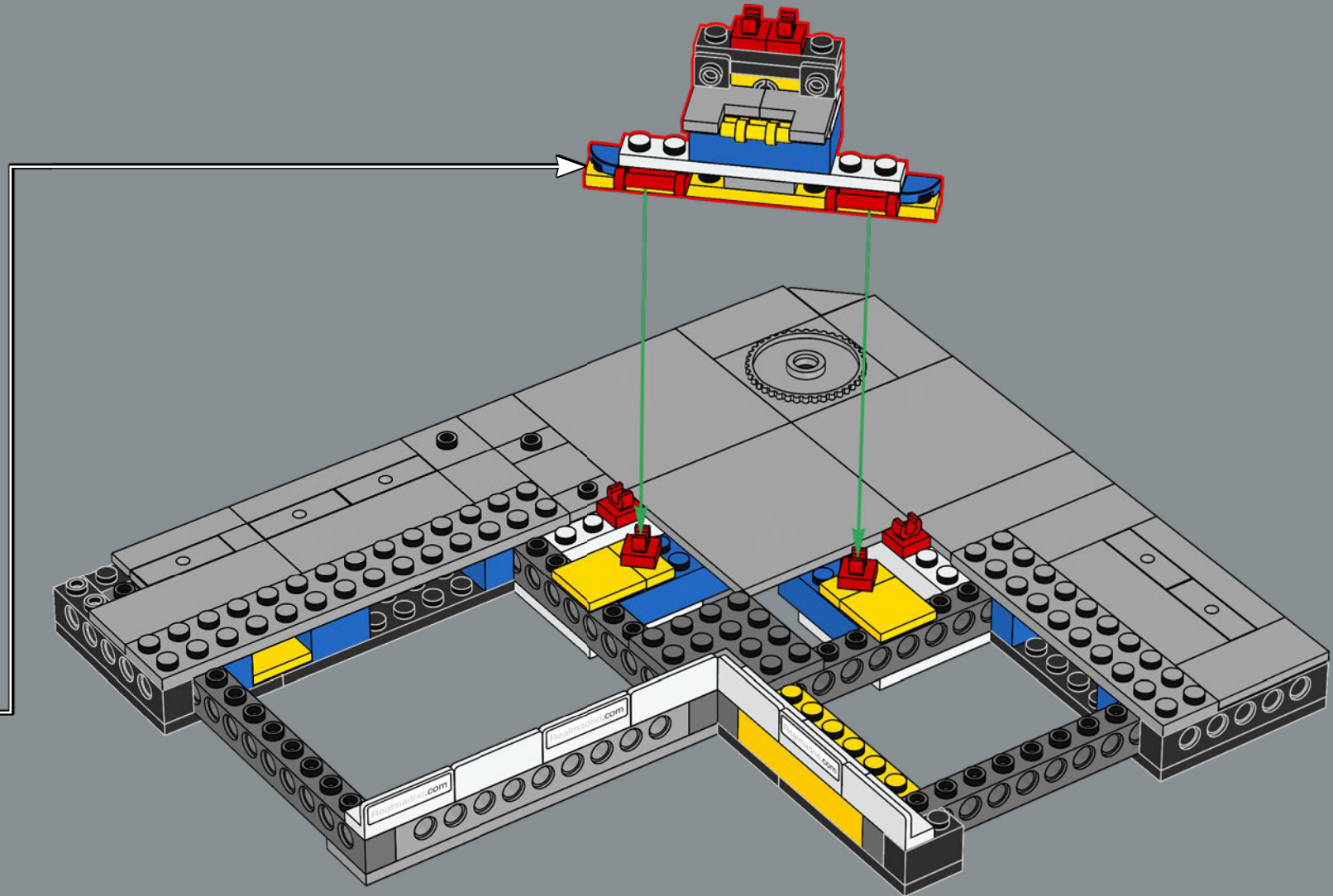

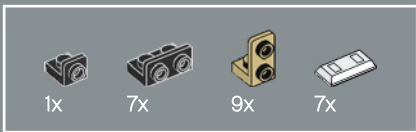

45

The LEGO® pieces used here for the Bernabéu's gates were originally developed as gold ingots for LEGO minifigures!

Les pièces LEGO® utilisées ici pour les portes du Bernabéu étaient au départ des lingots d'or pour les figurines LEGO !

¡Las piezas LEGO® utilizadas para las puertas del Bernabéu se diseñaron originalmente como lingotes de oro para minifiguras LEGO!

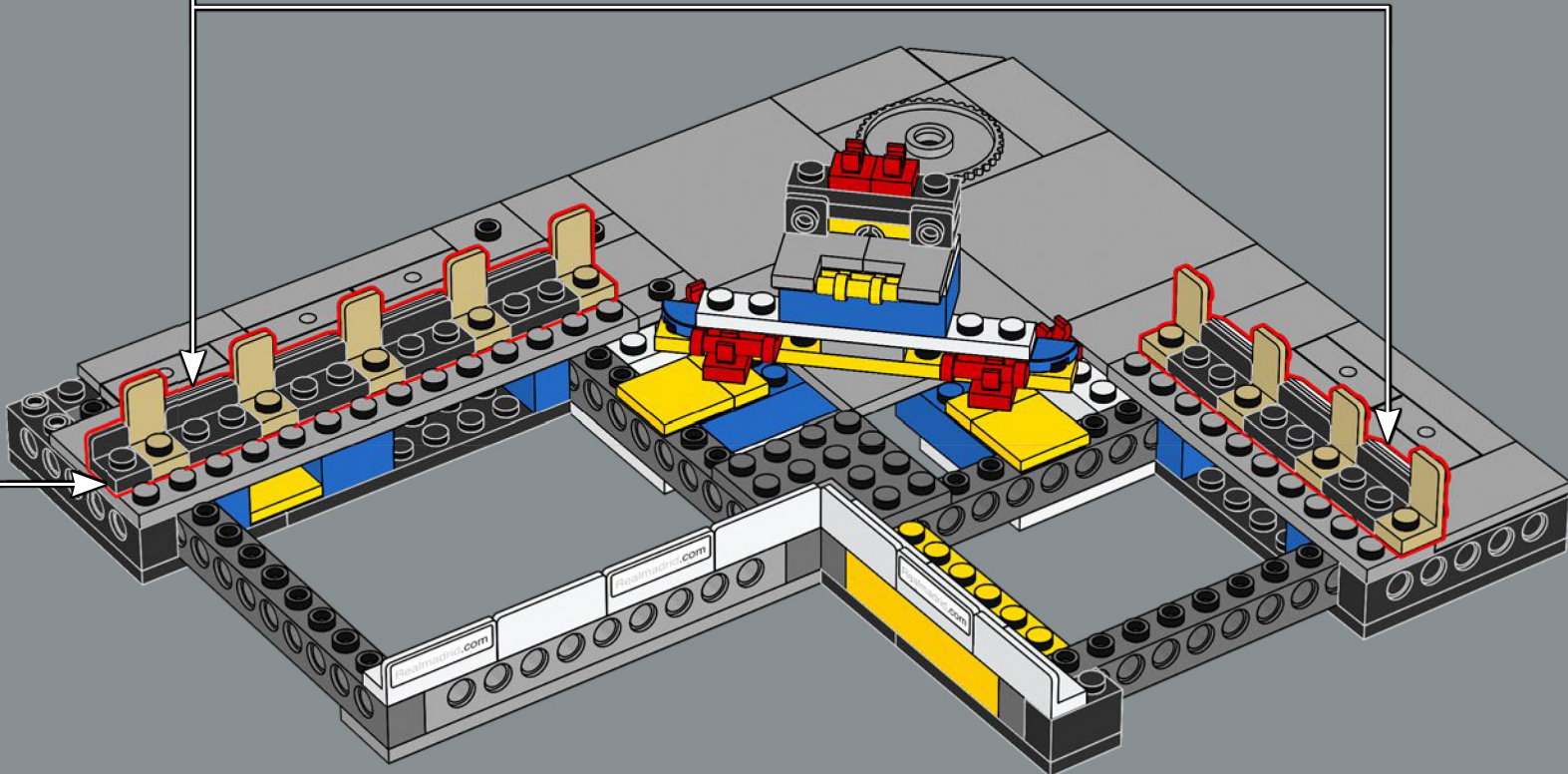
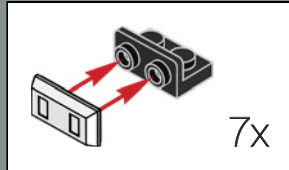

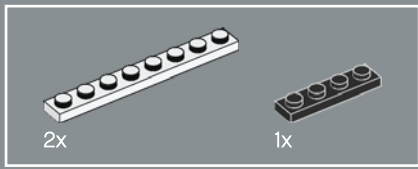

46

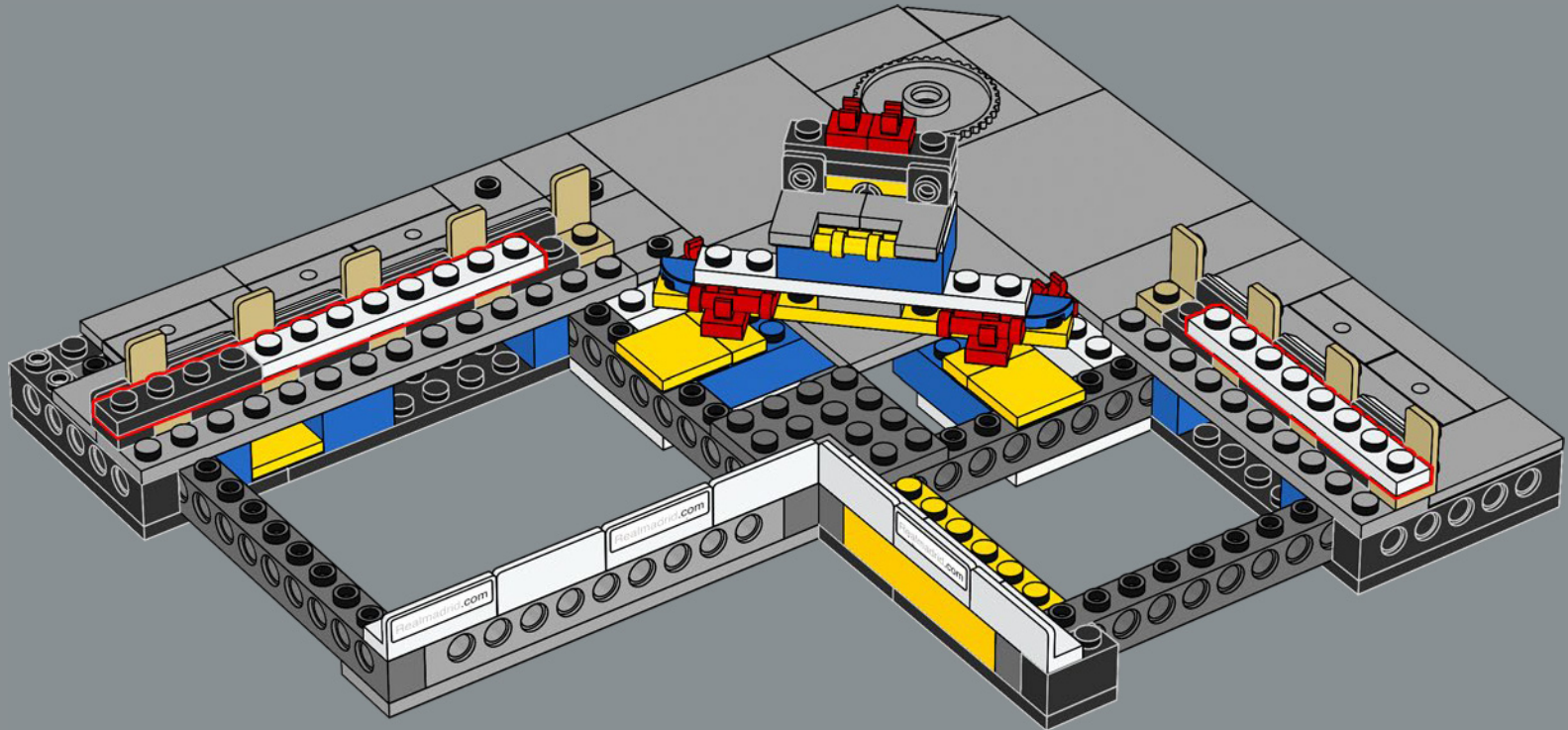

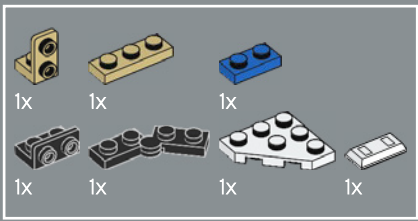

47

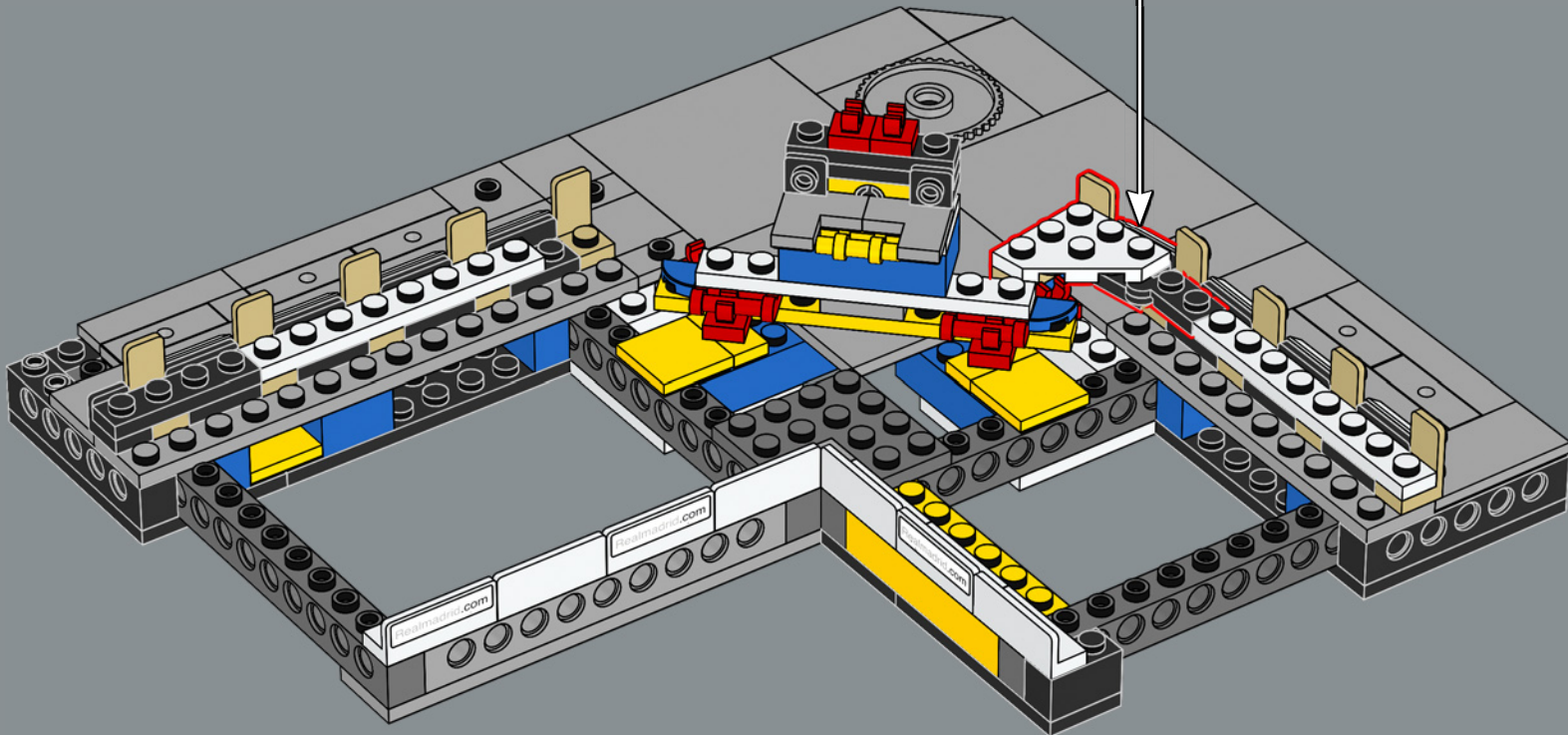
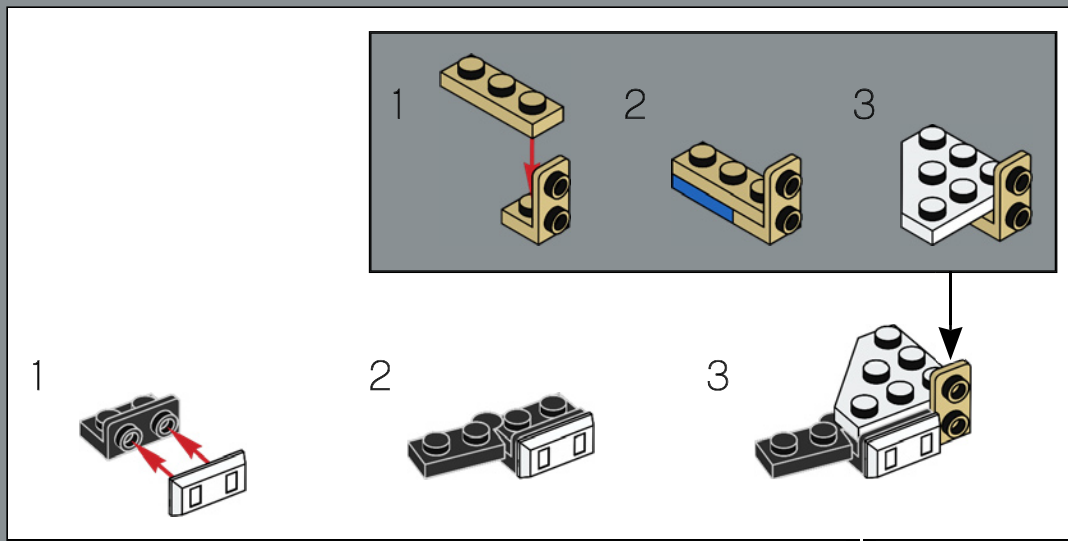

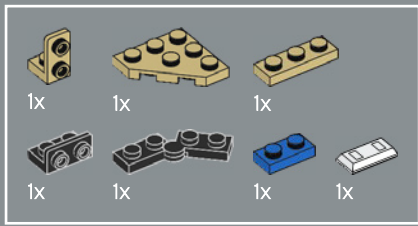

48

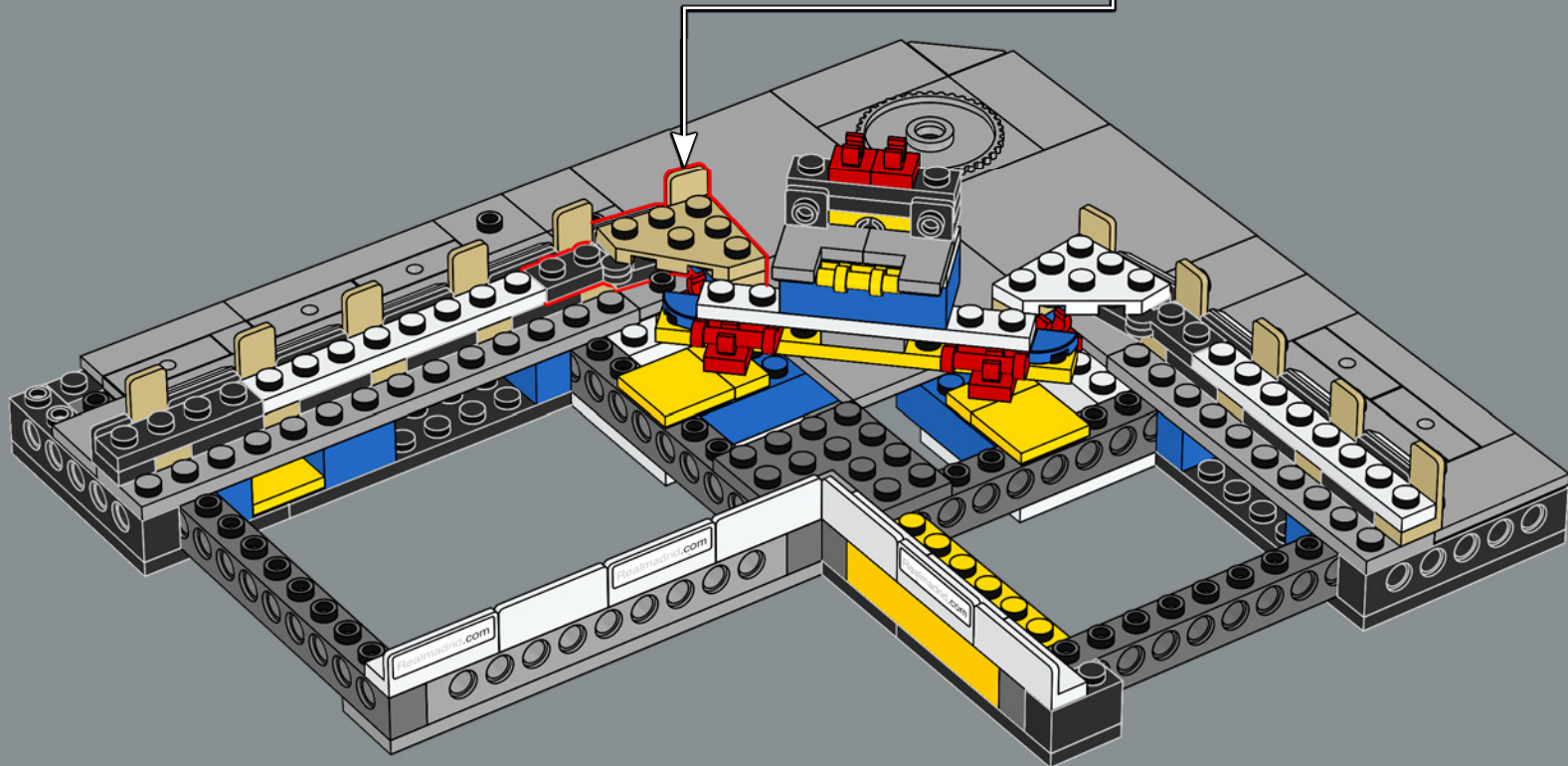
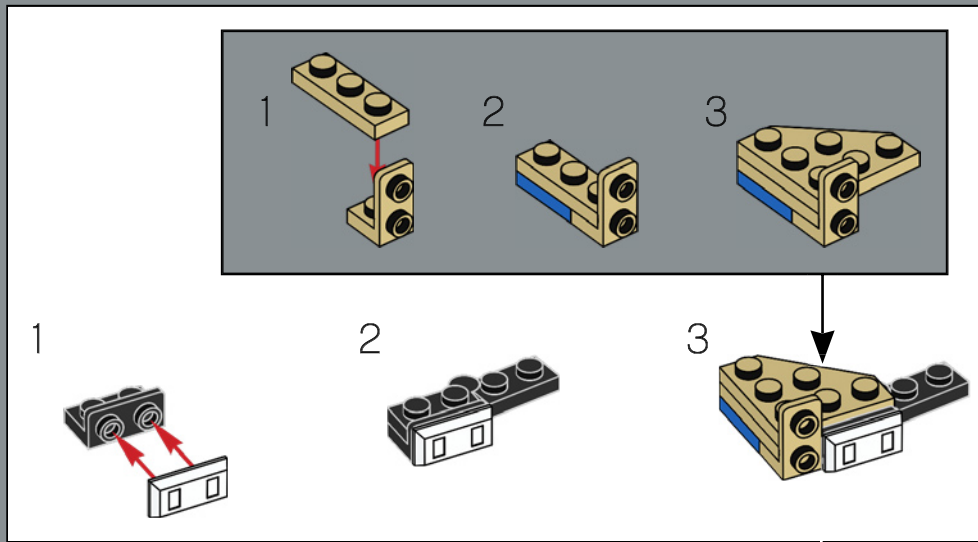



12x

49

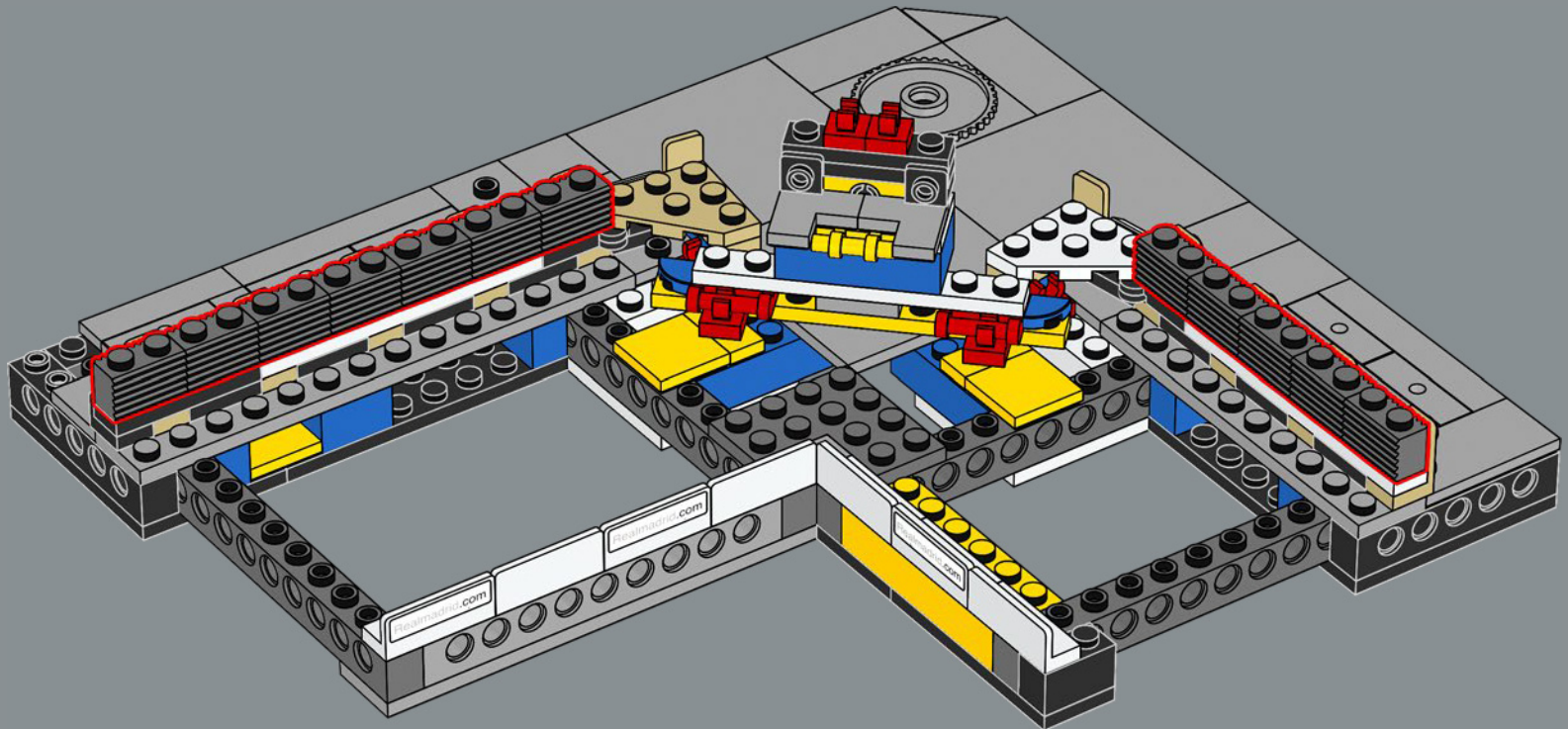

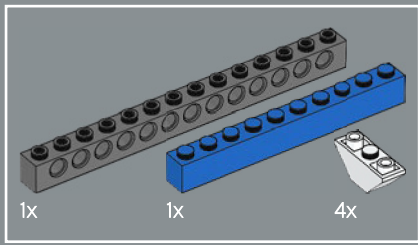

50

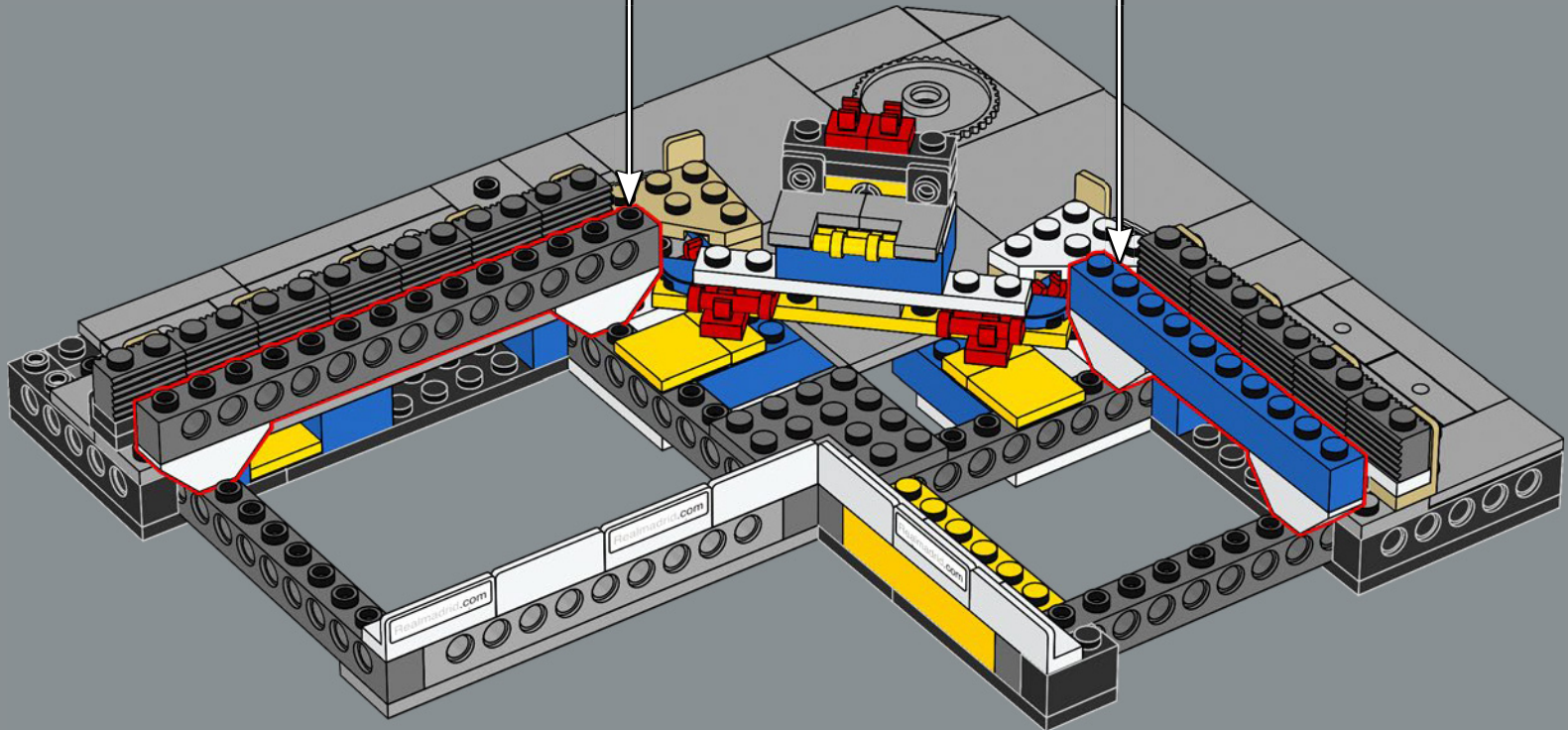
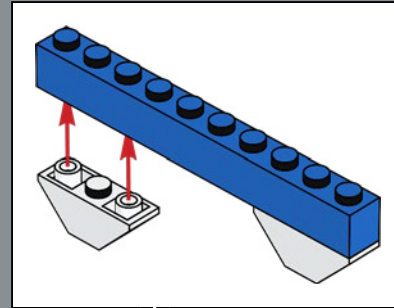
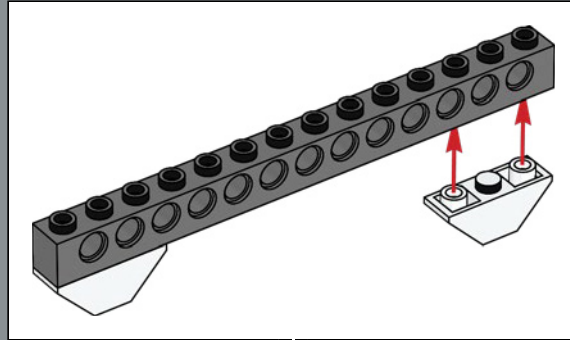

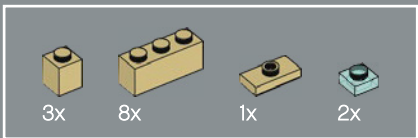

51

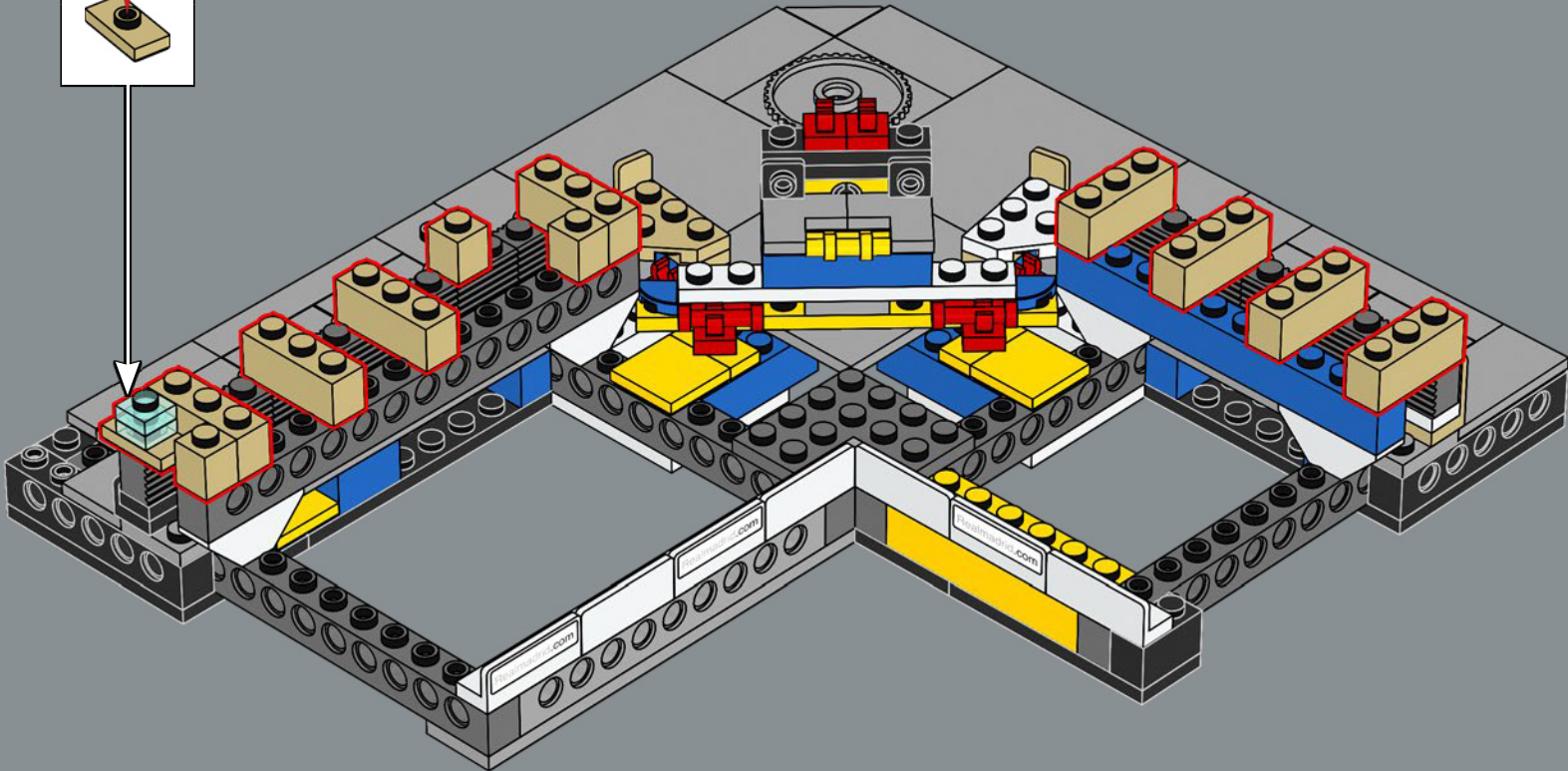
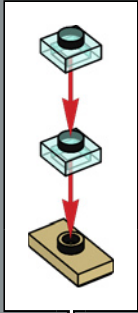



52

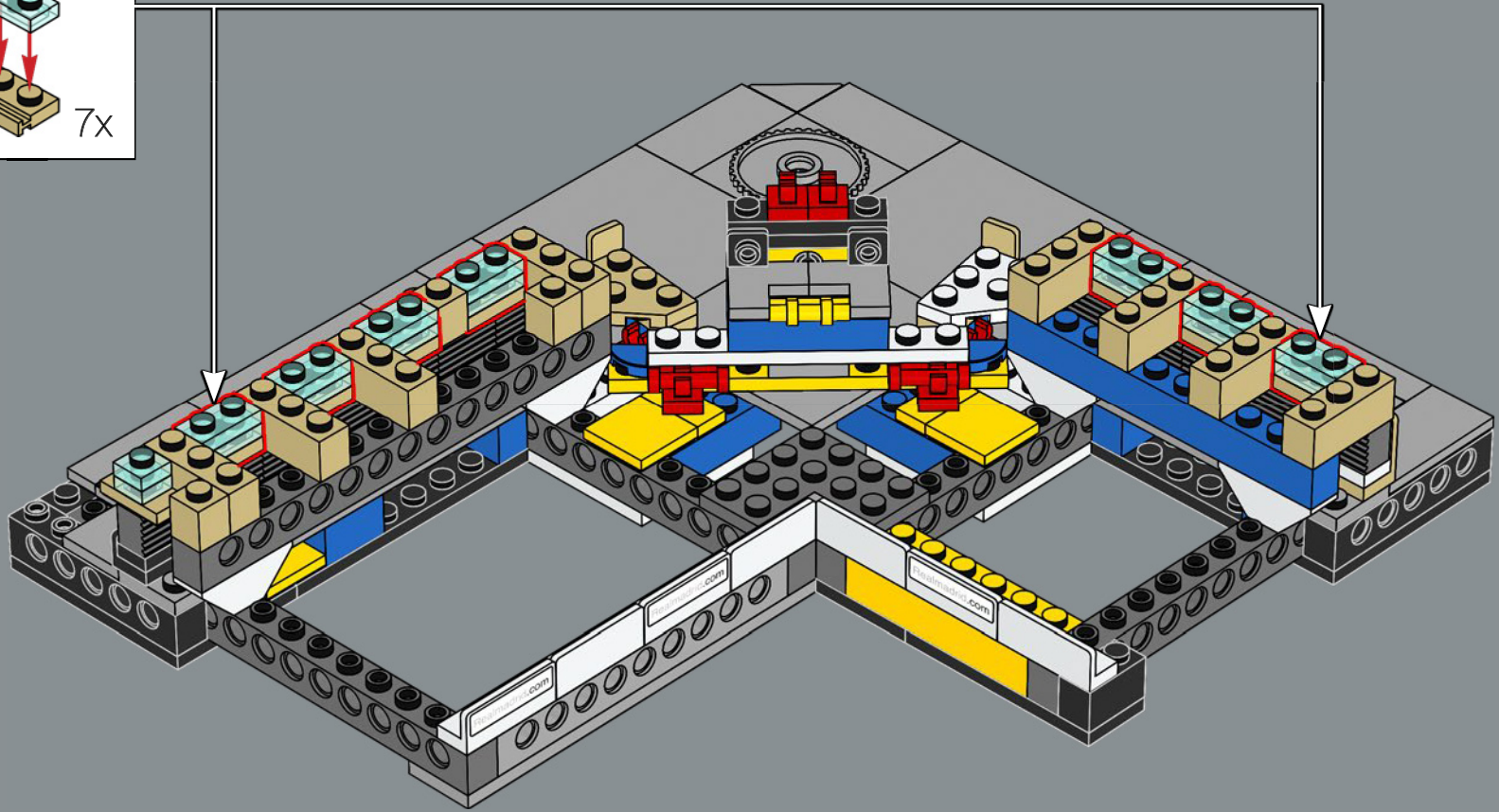
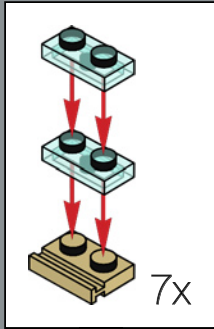

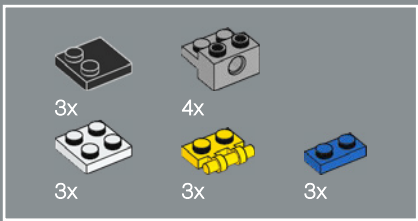

53

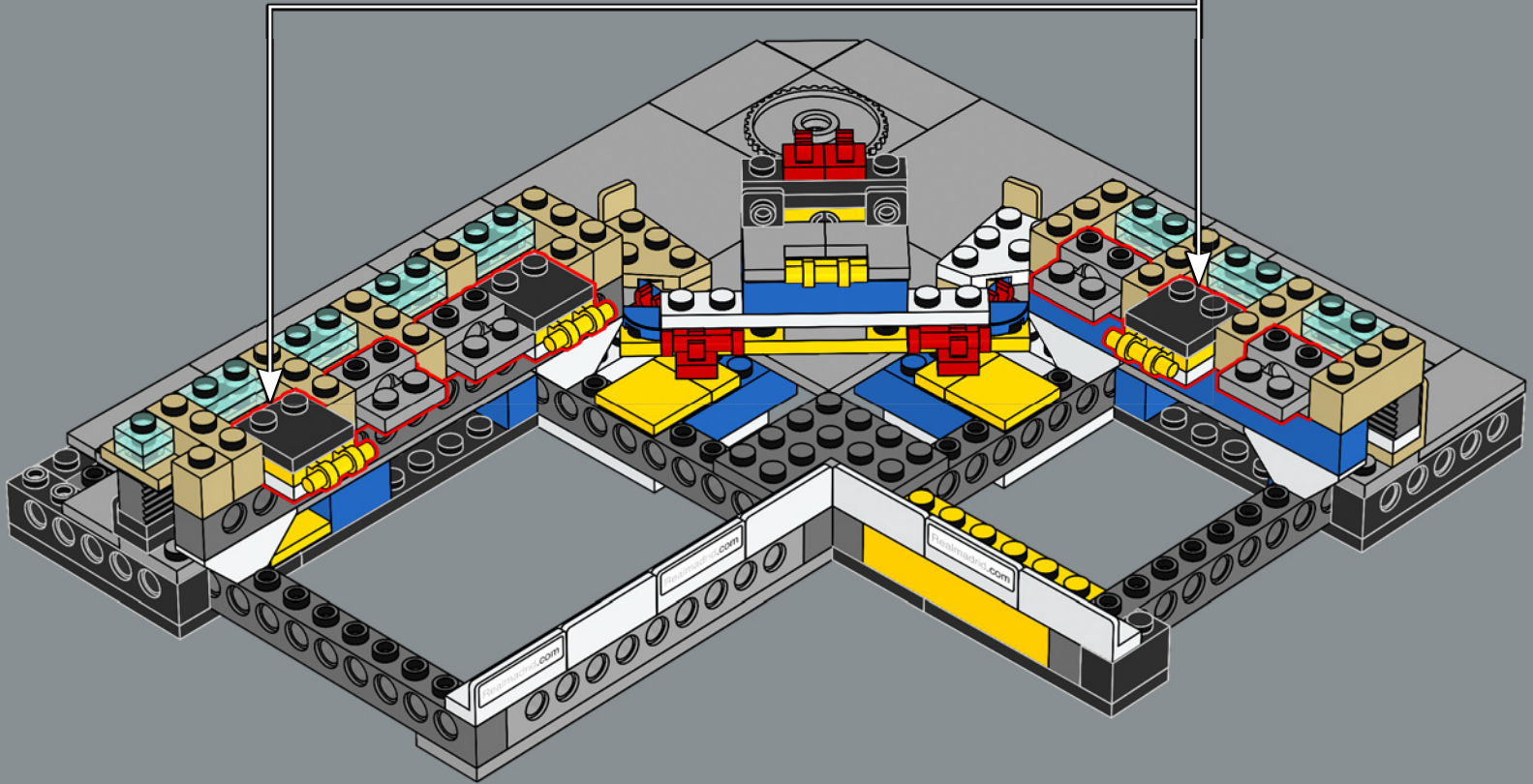
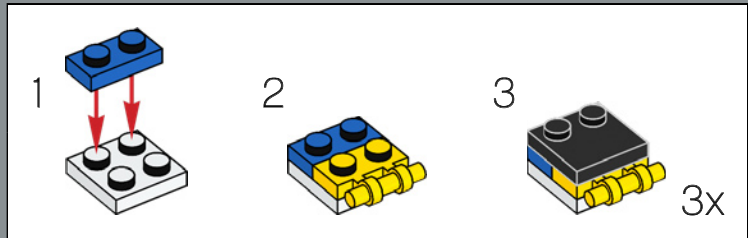

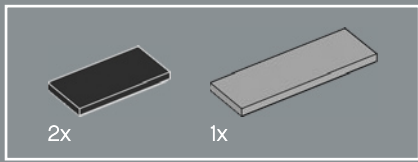

54

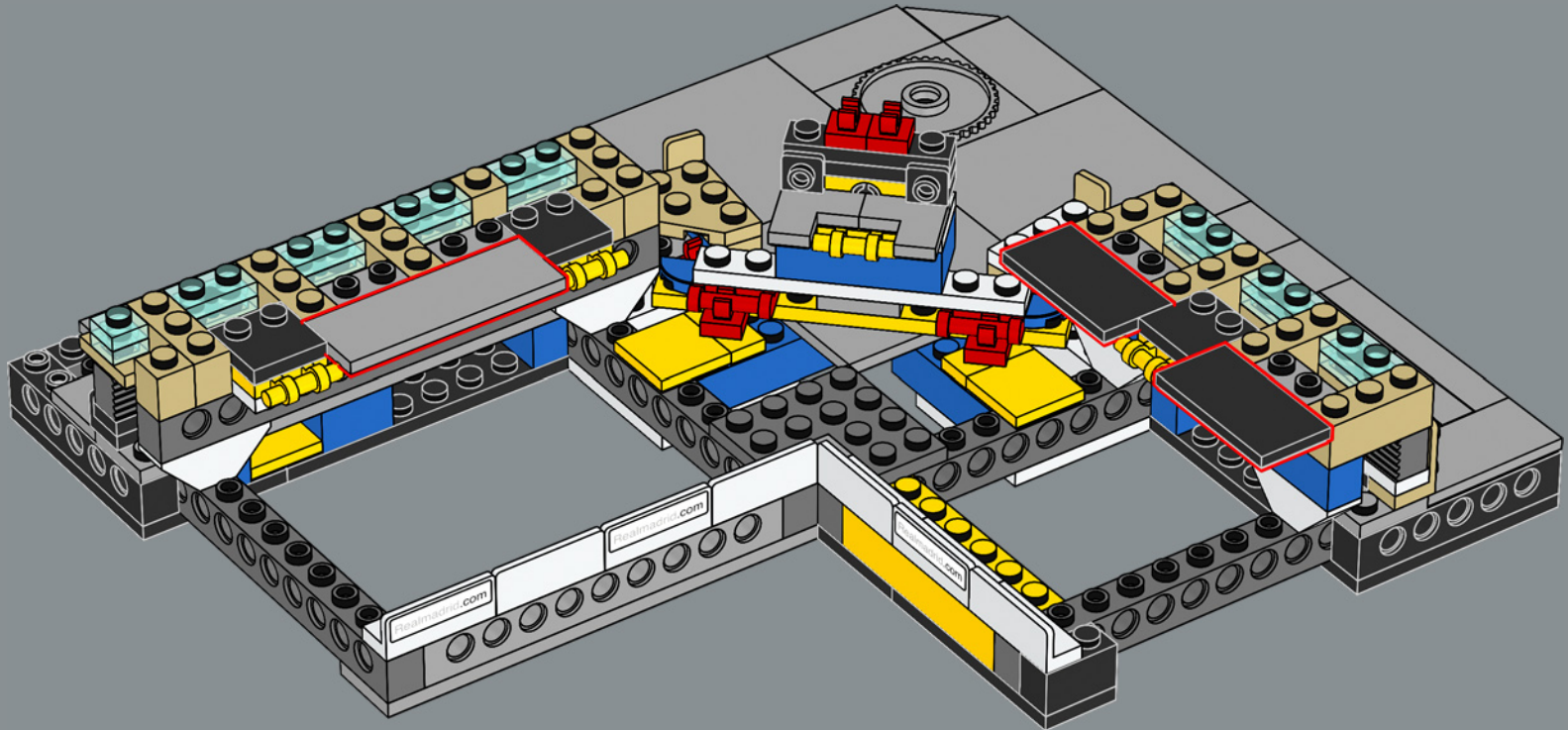

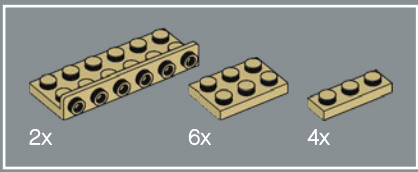

55

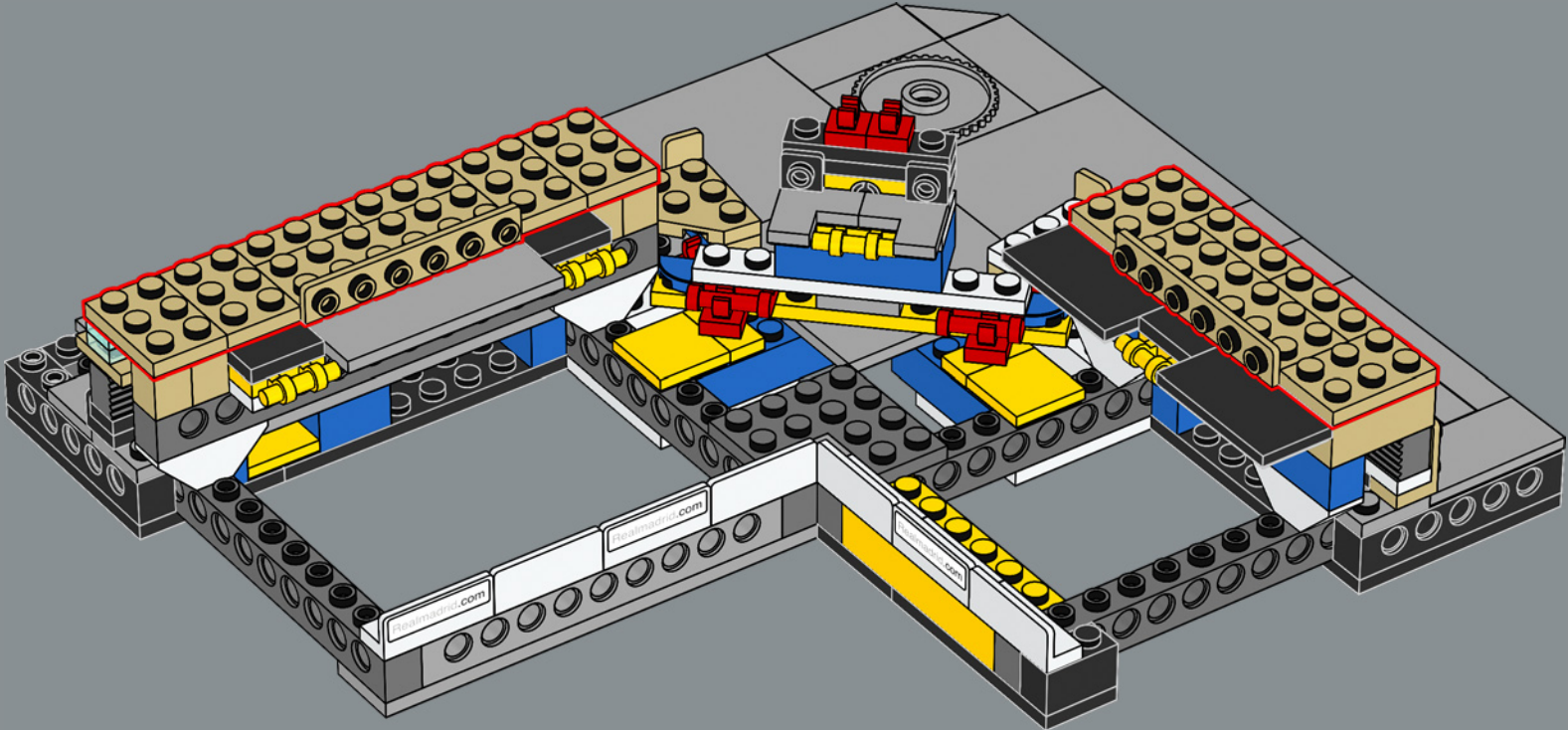

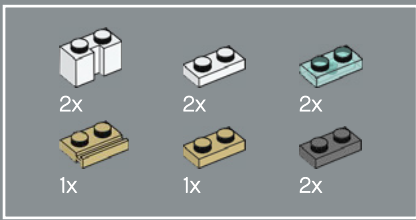

56

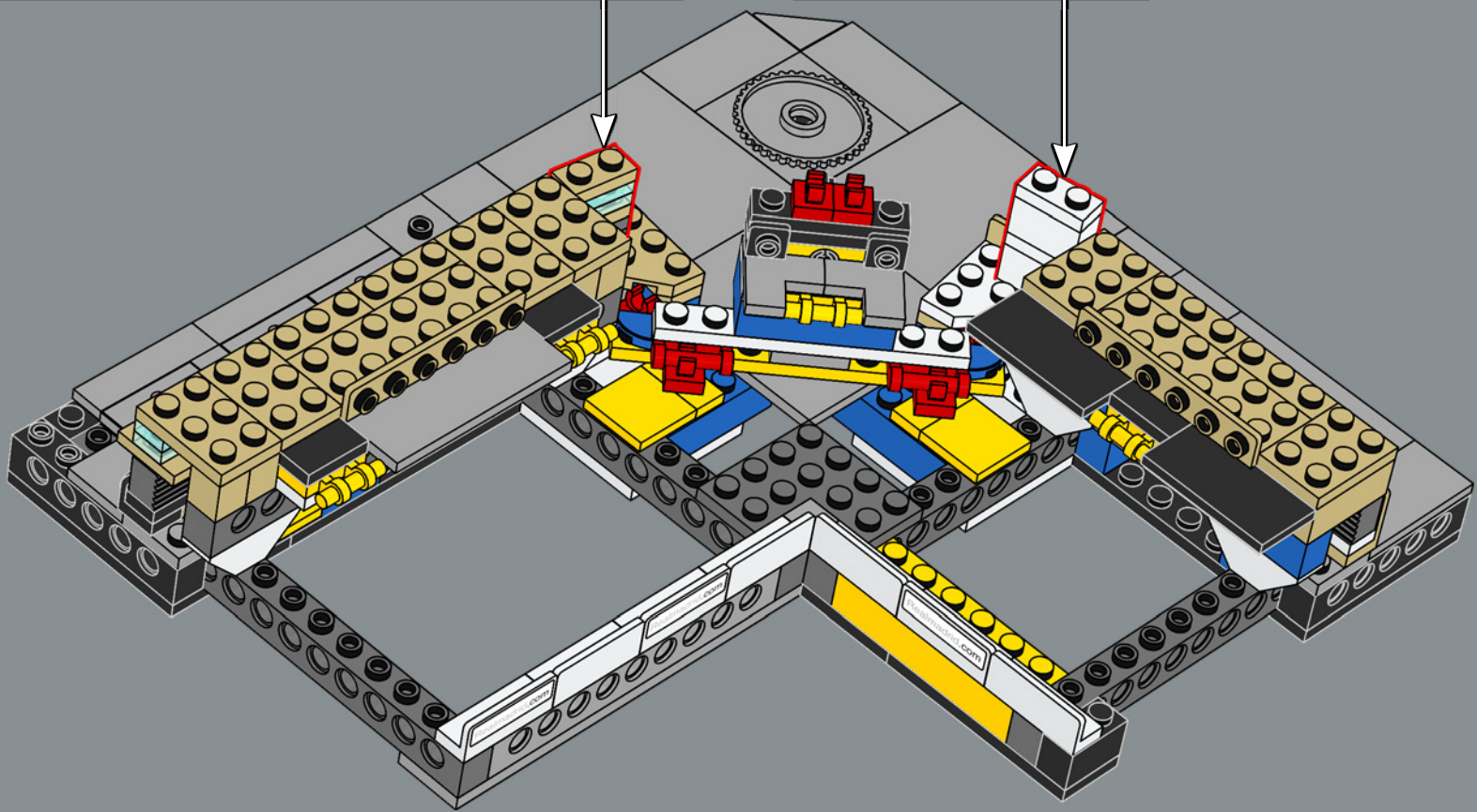
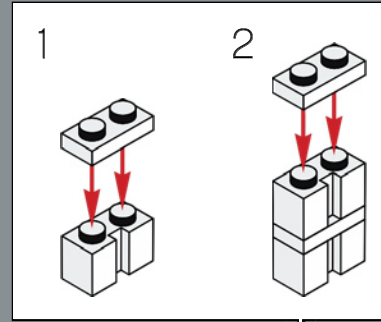
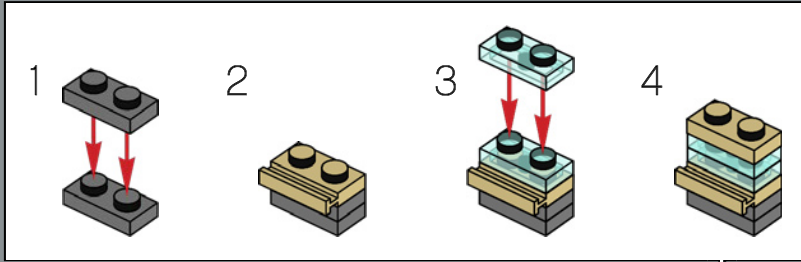

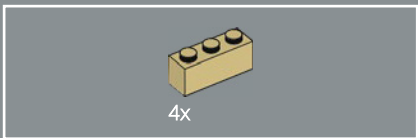

57

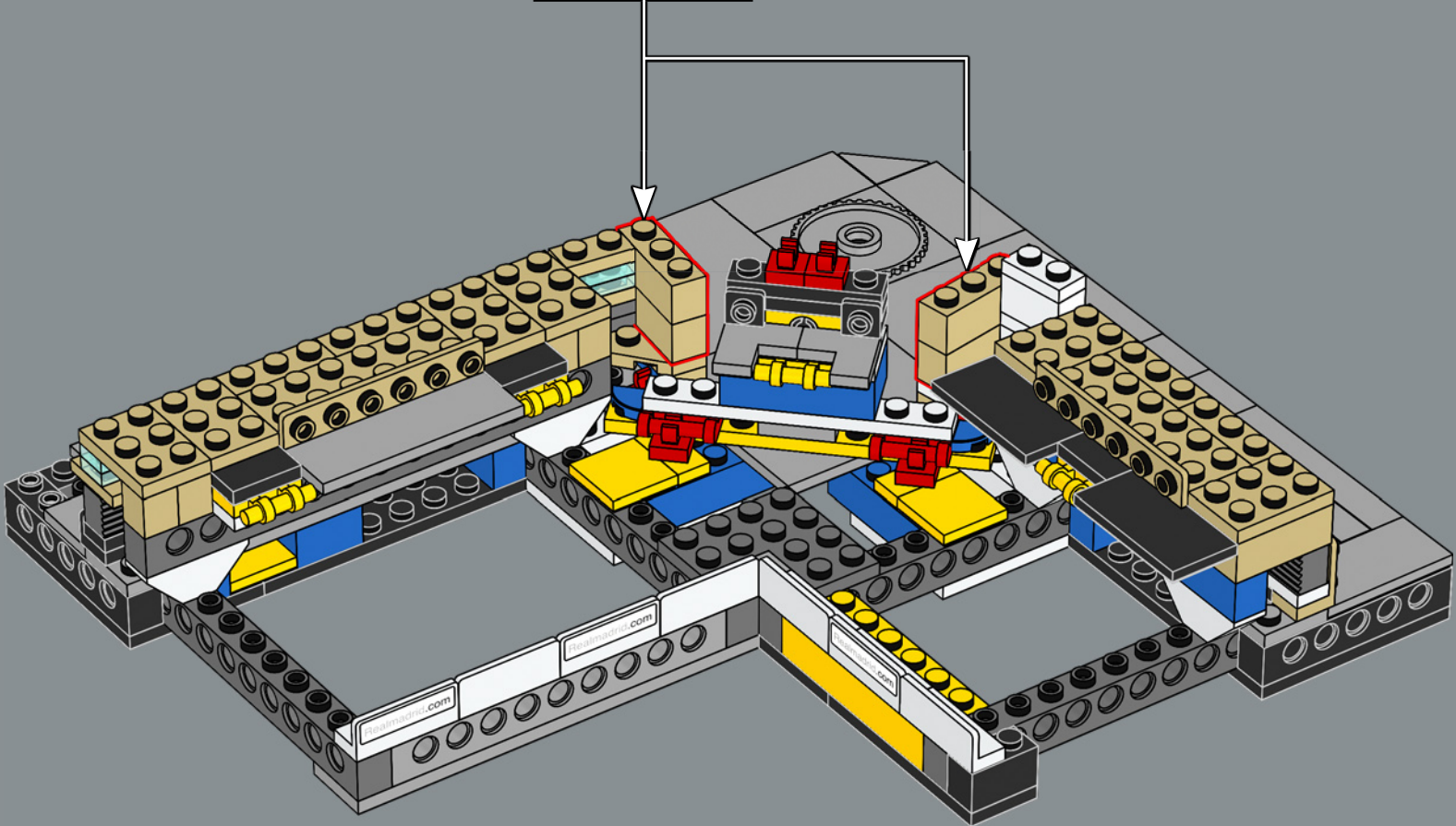
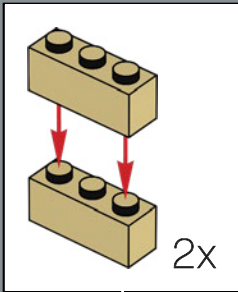

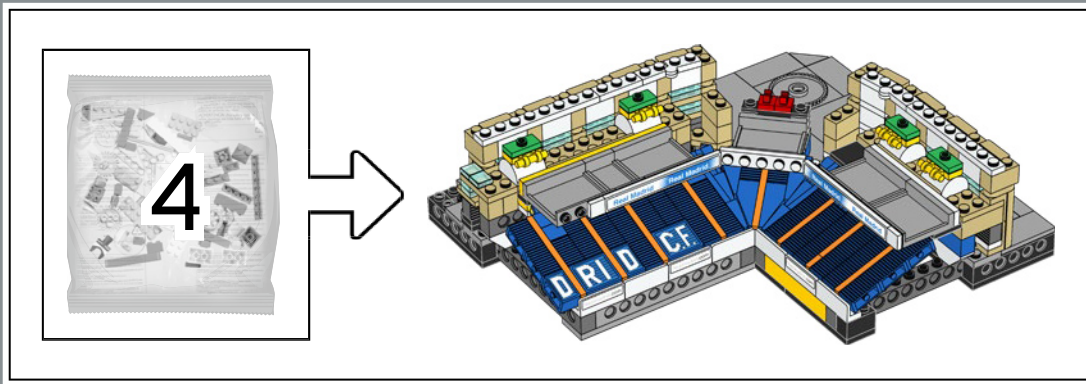

58

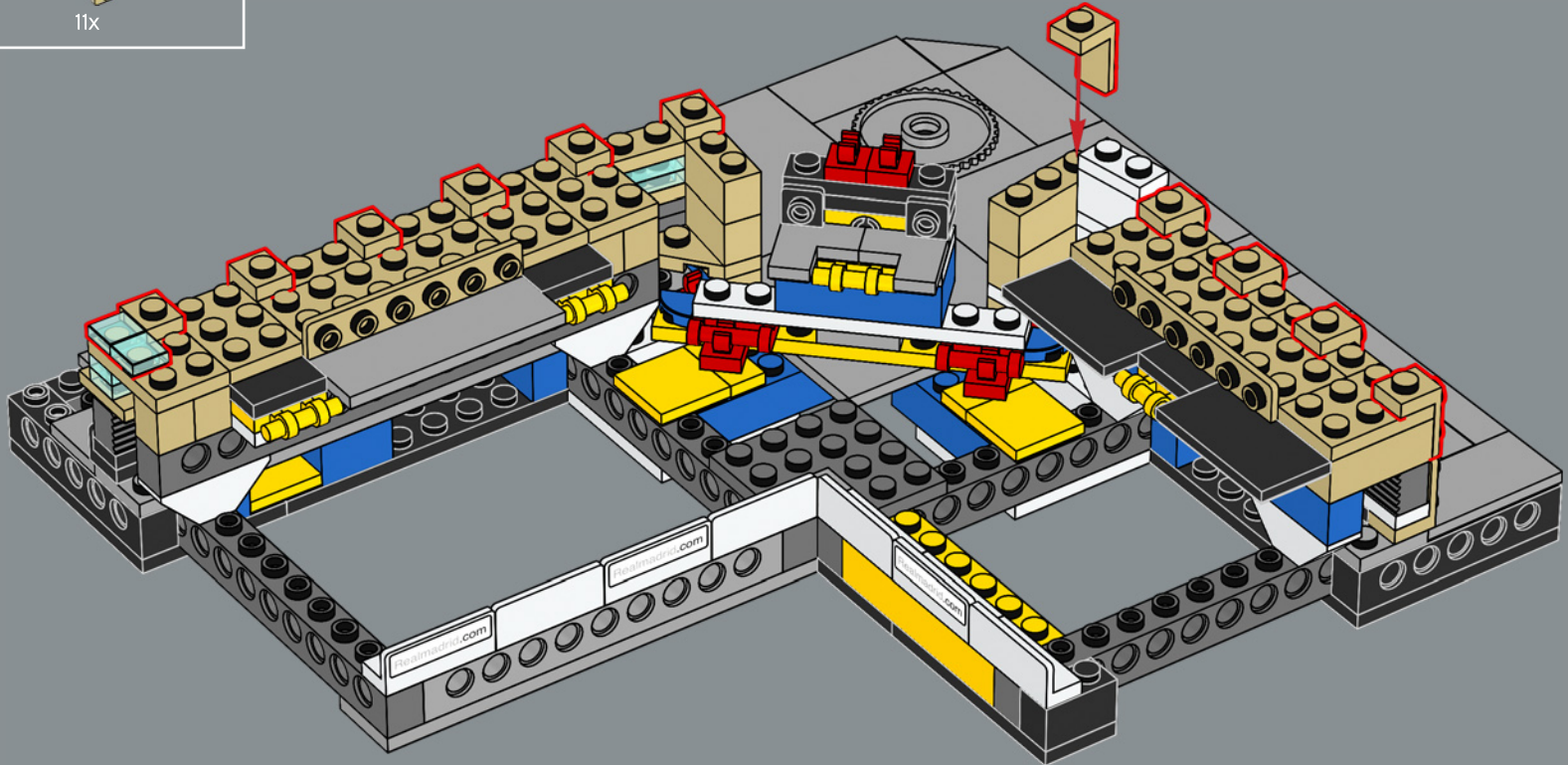



59

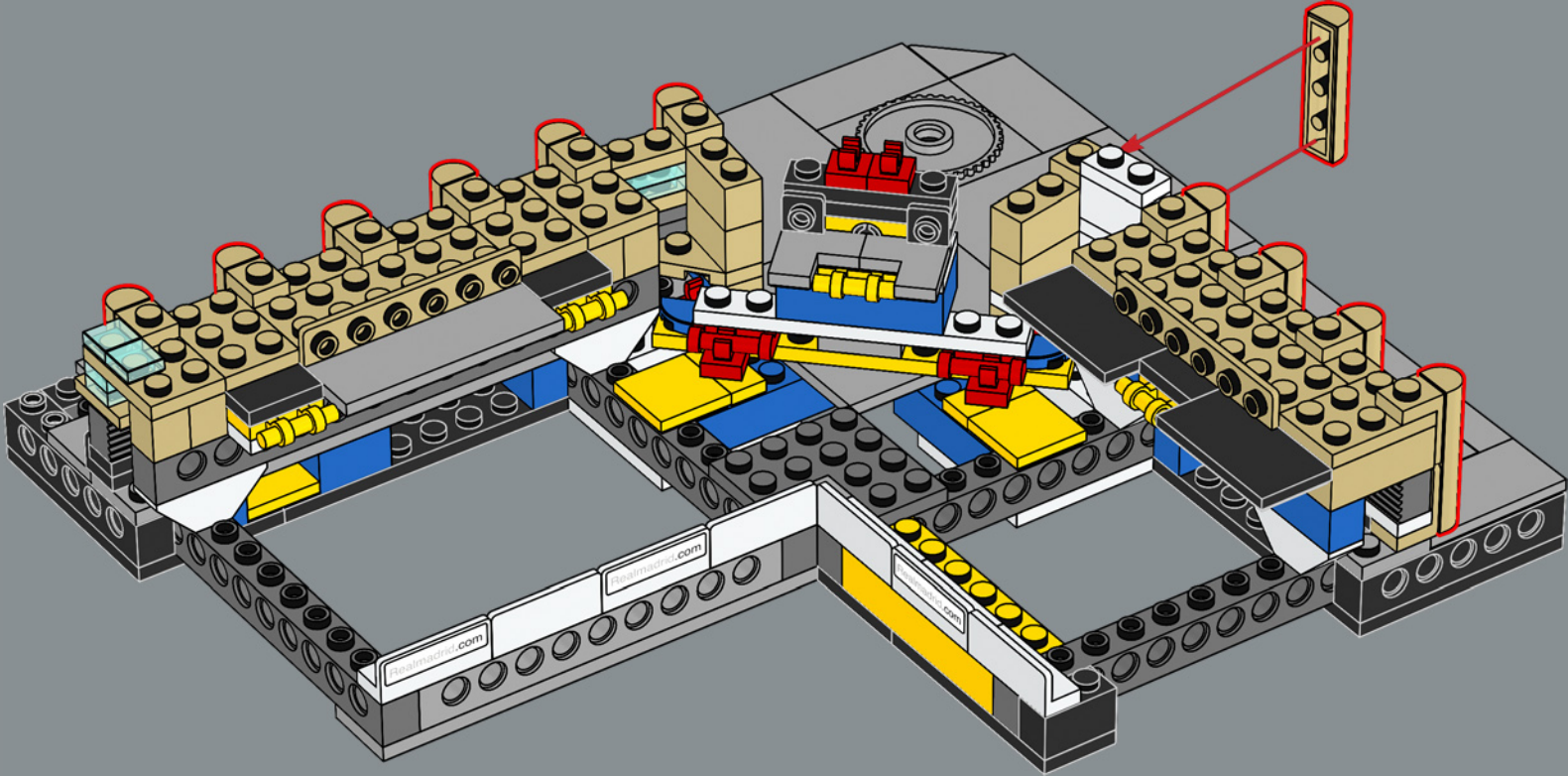



60

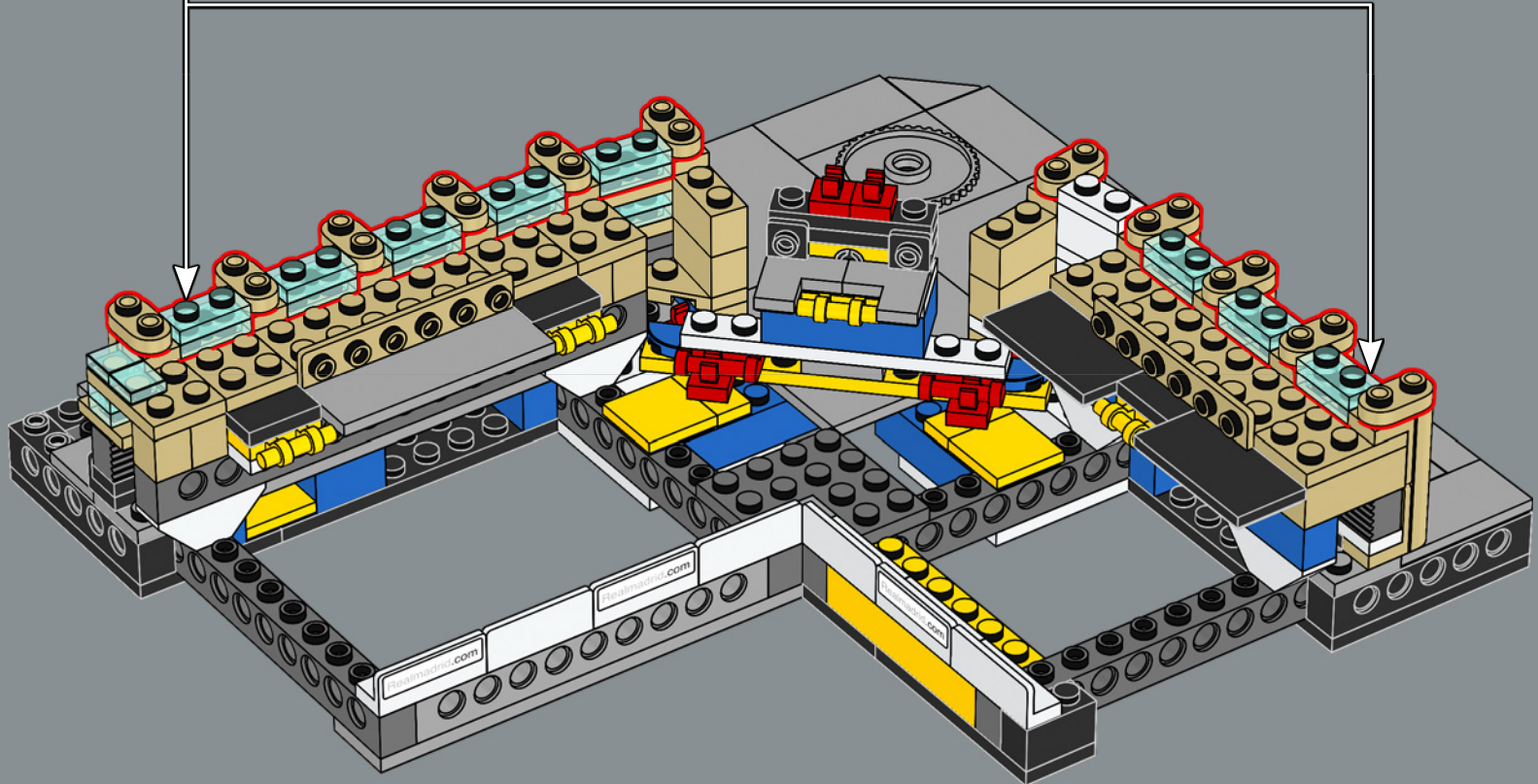
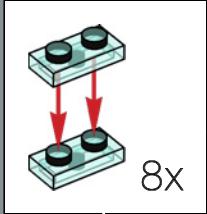



11x

61

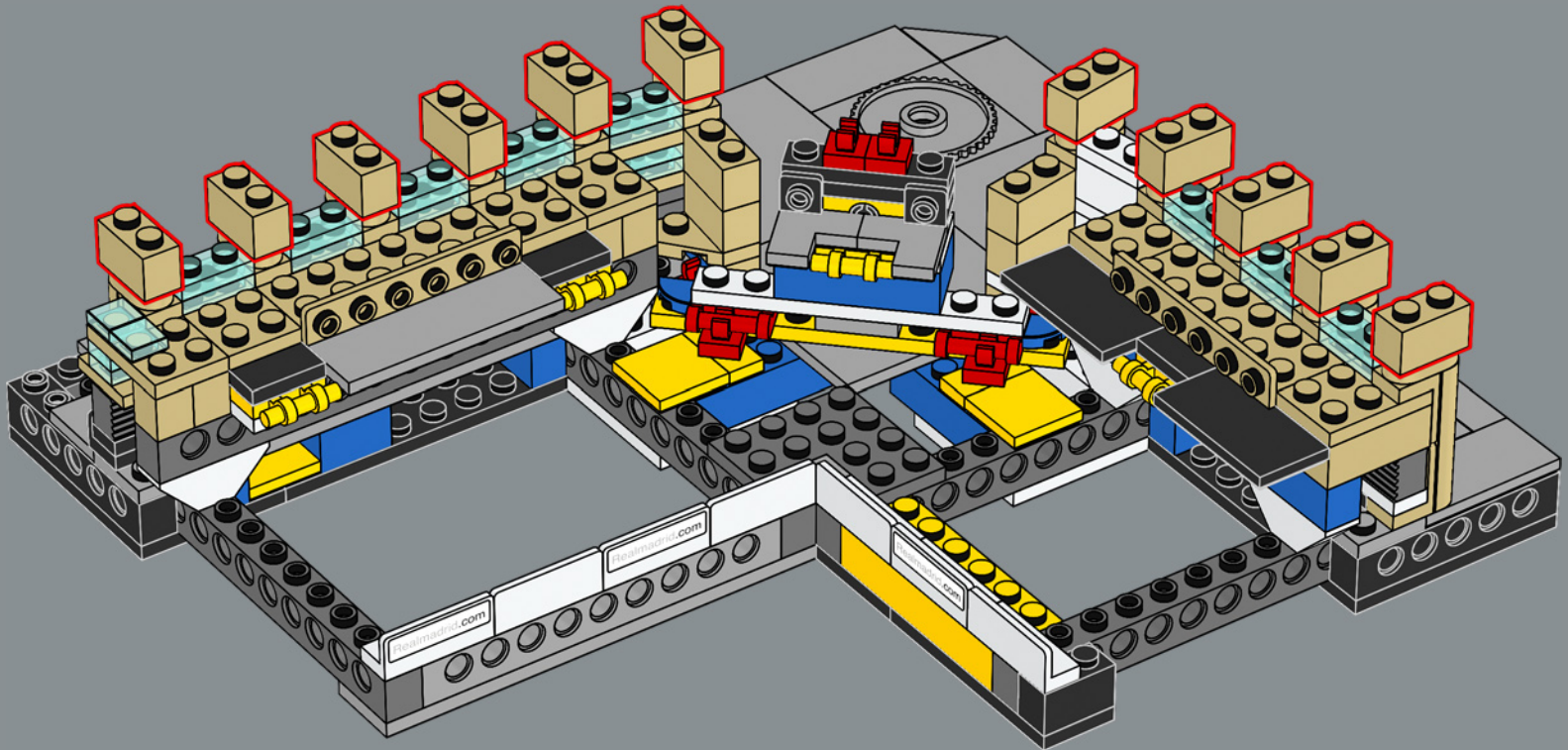

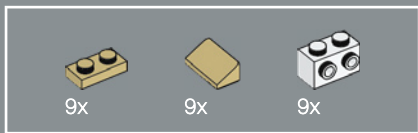

62

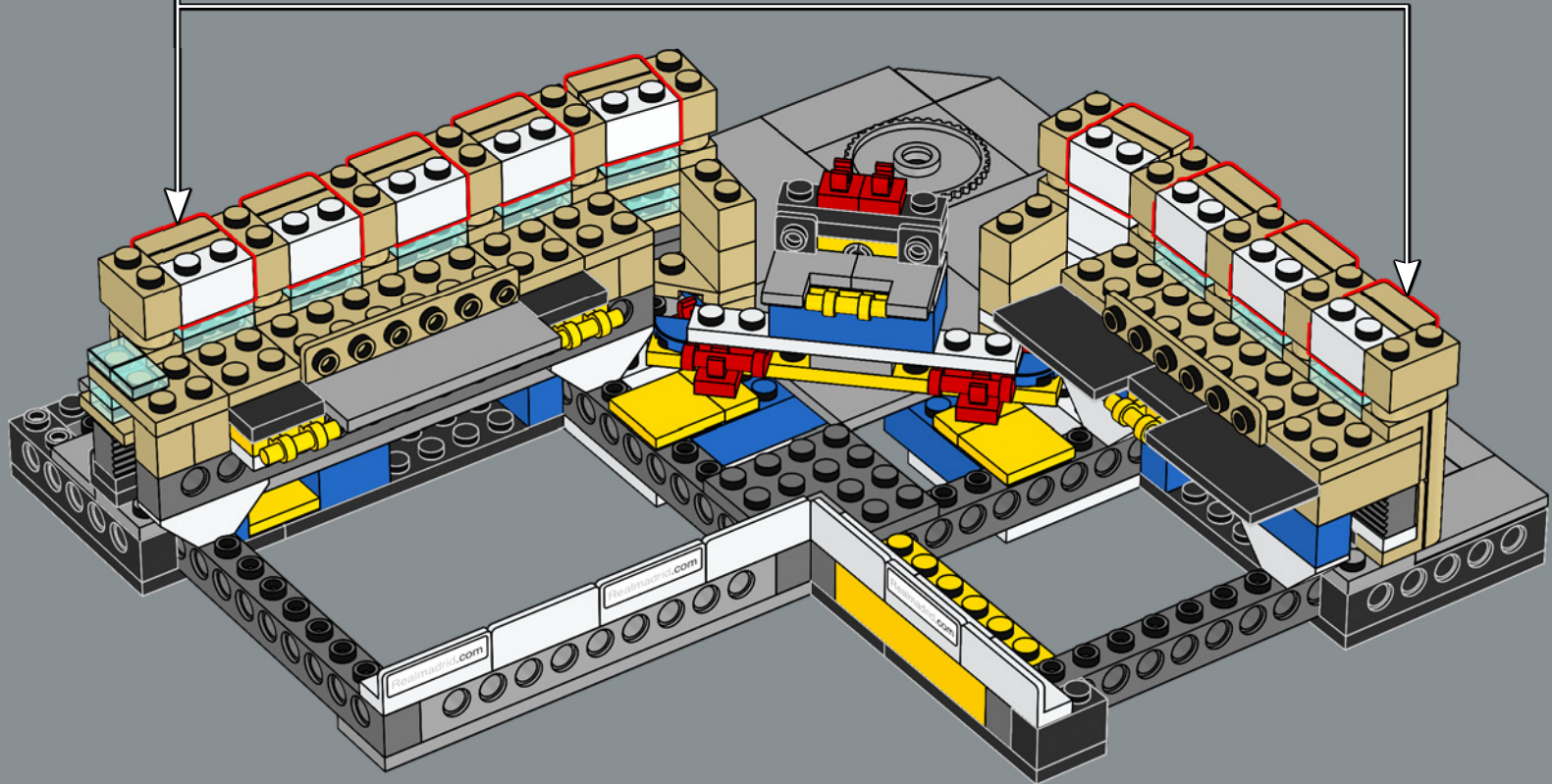
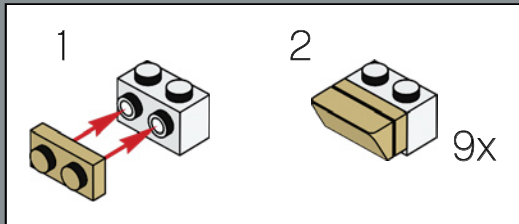

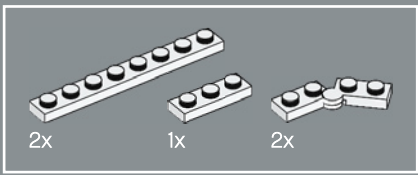

63

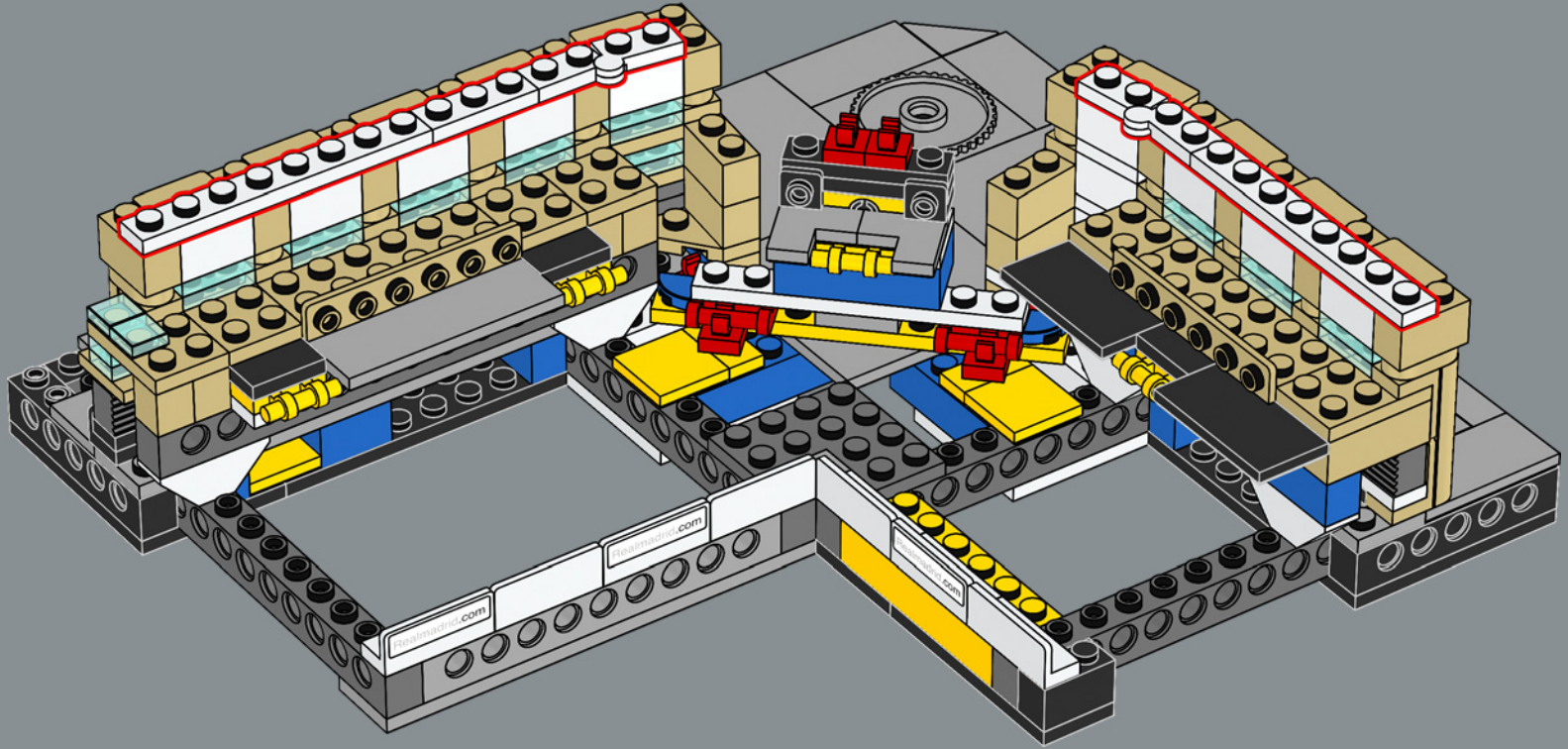



64

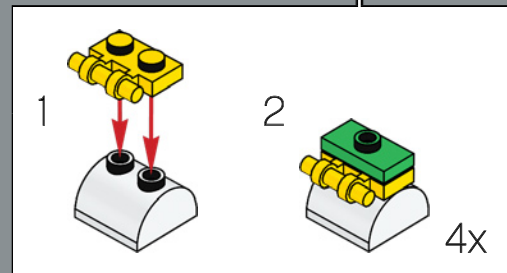
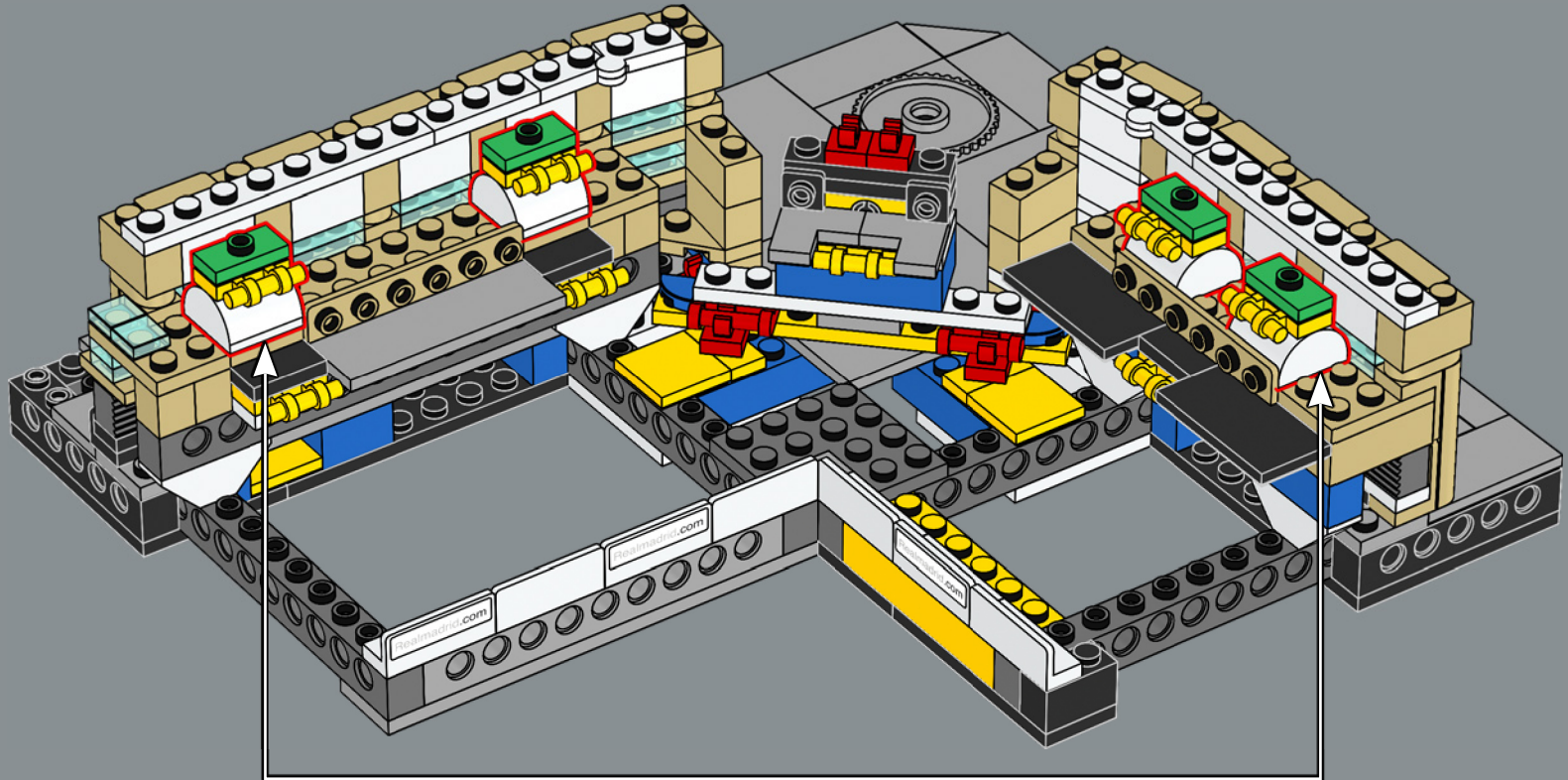

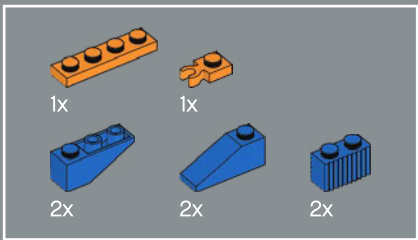

65

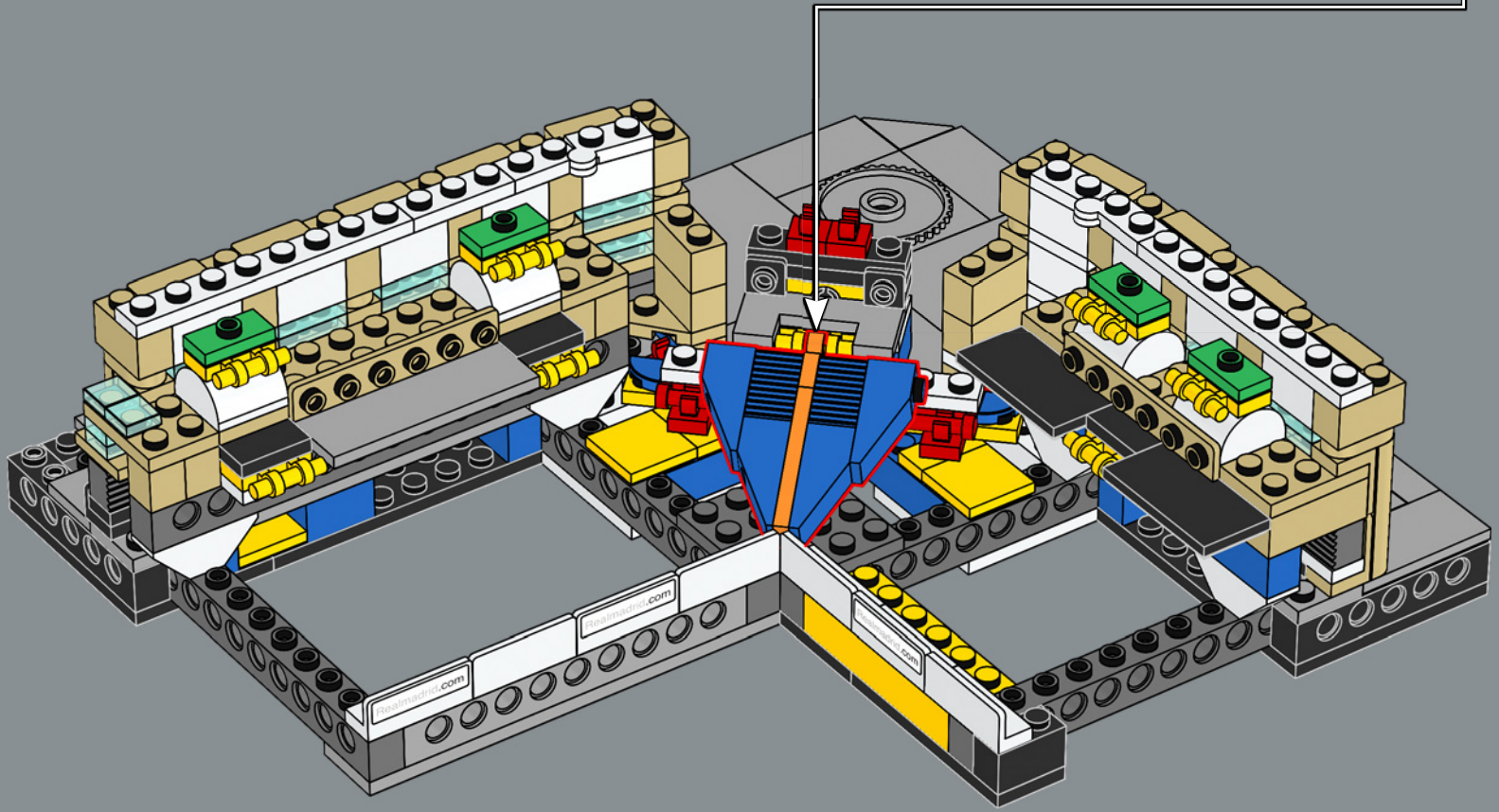
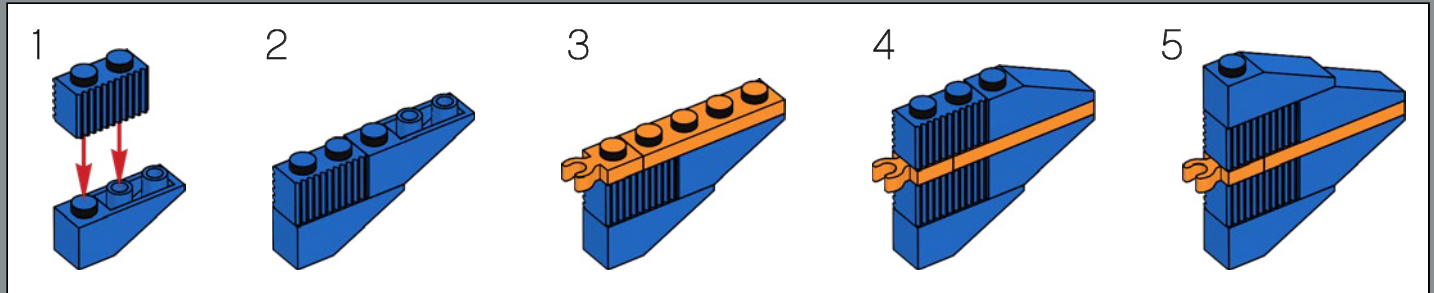

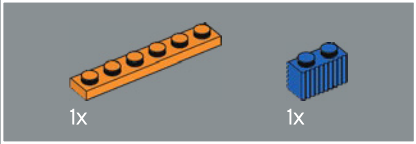
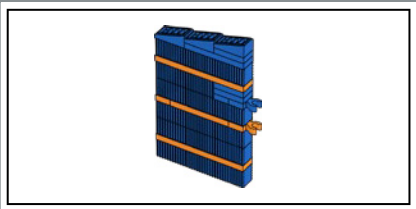

66

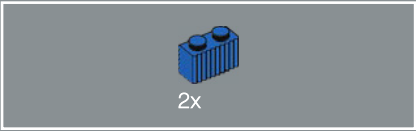
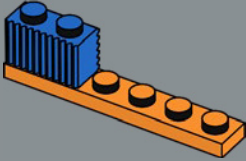

67

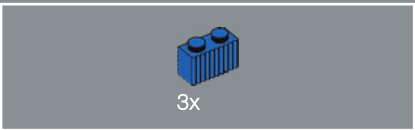
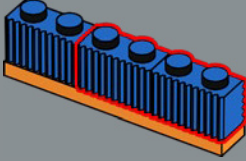

68

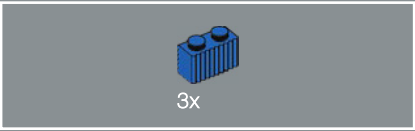
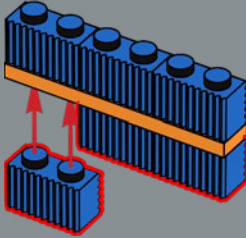

69

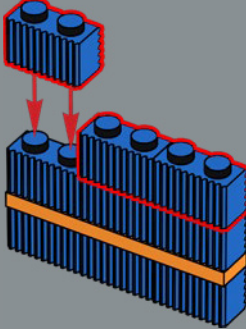

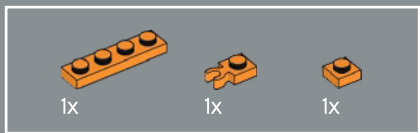

70

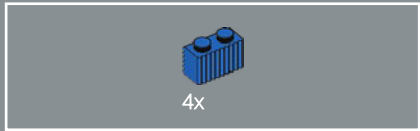
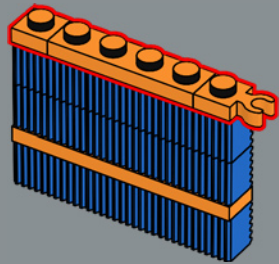

71

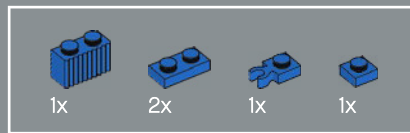
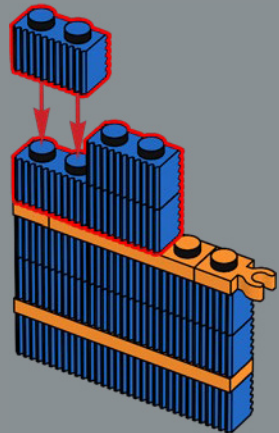

72

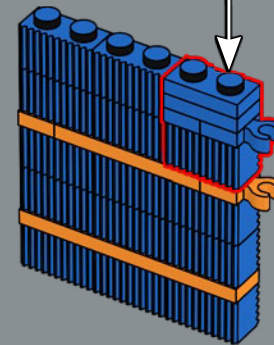
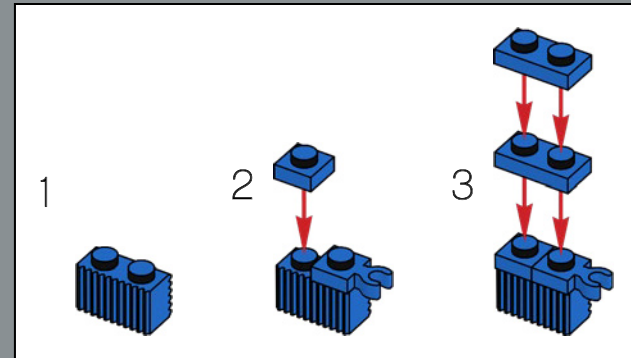

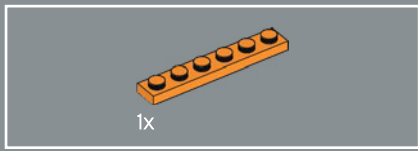

73

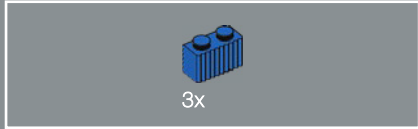
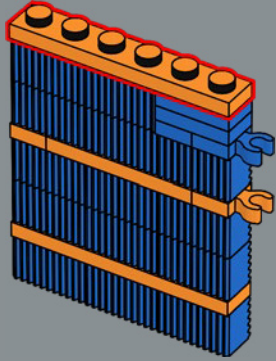

74

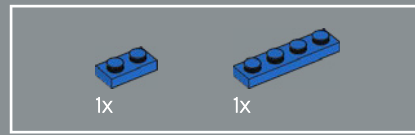
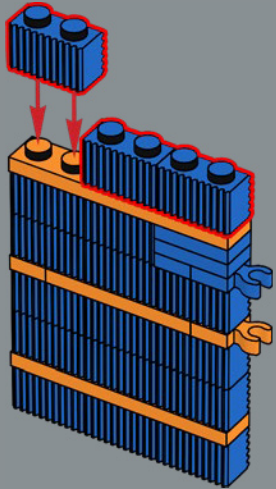

75

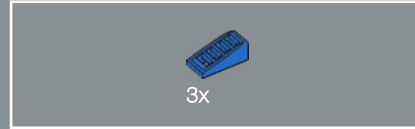
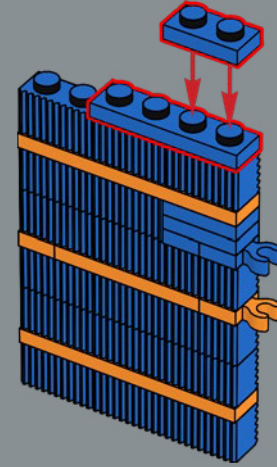

76

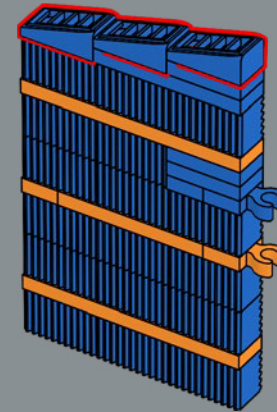

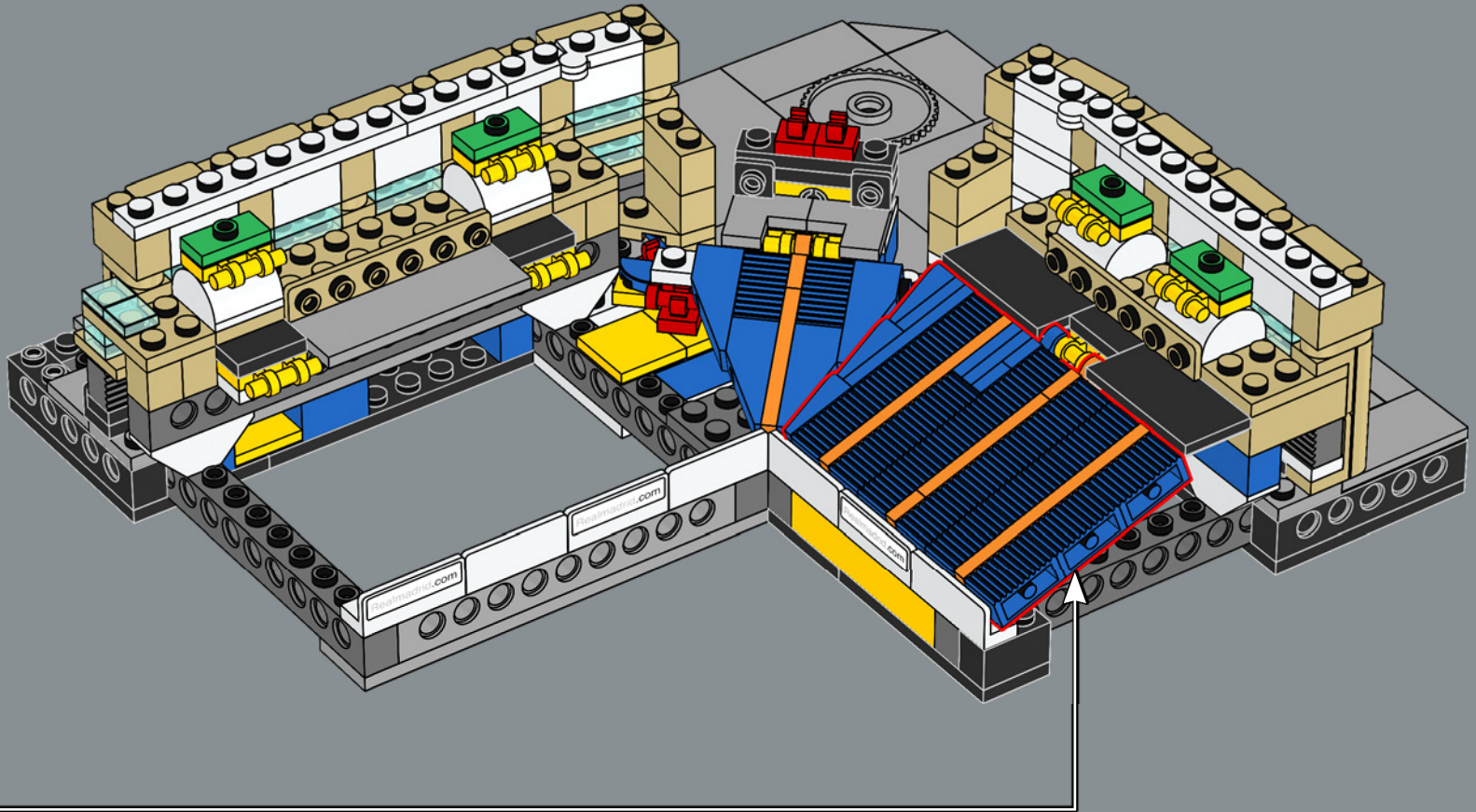

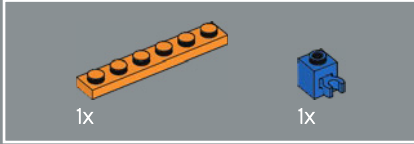
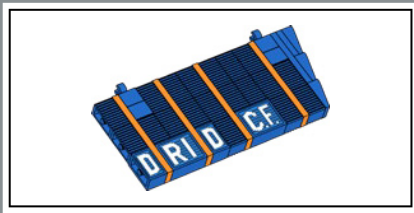

78

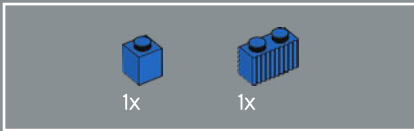
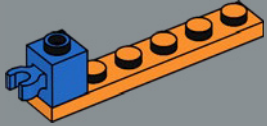

79

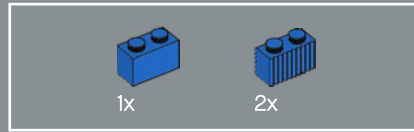
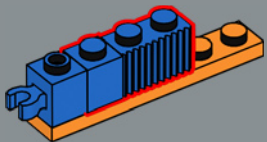

80

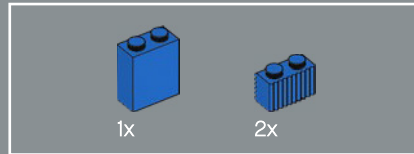
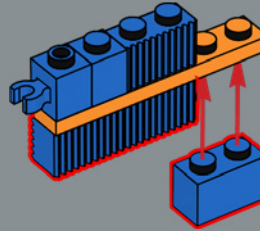

81

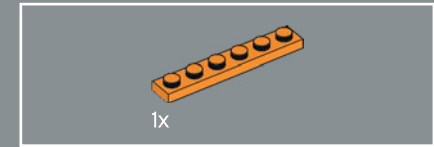
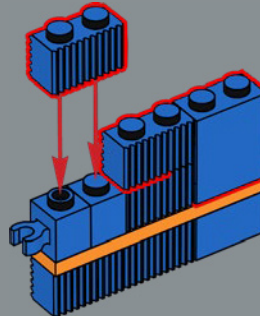

82

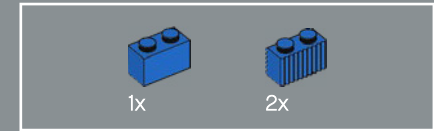
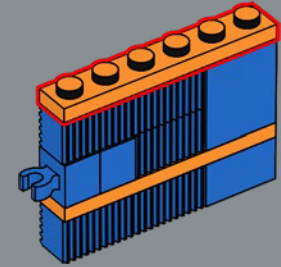

83

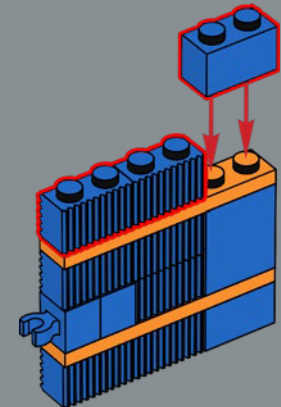



3x

84

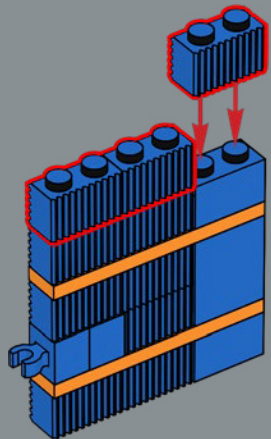

1x



2x

86

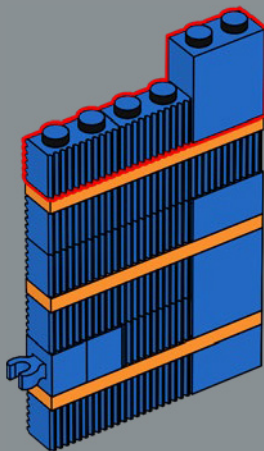

3x

88

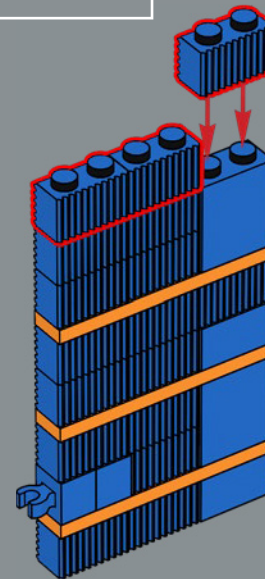

1x

85

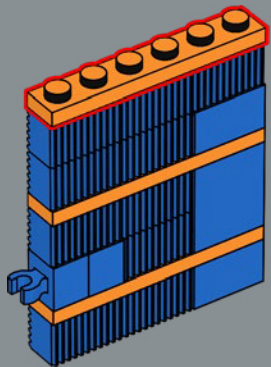

2x

87

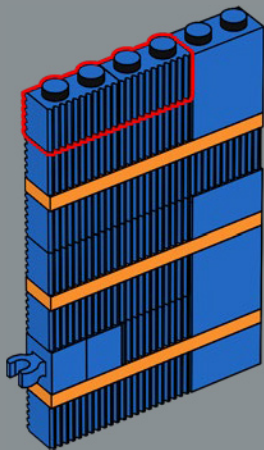

1x

89

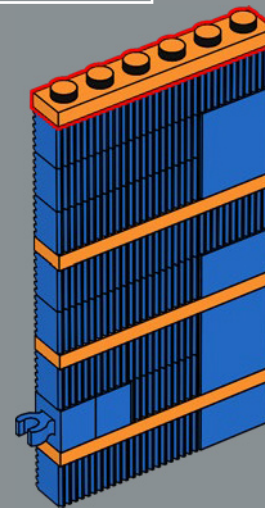

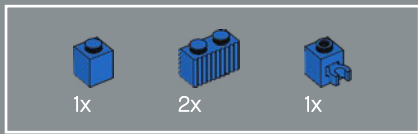

90

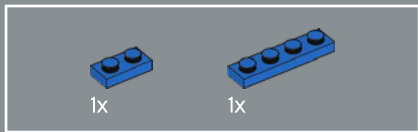
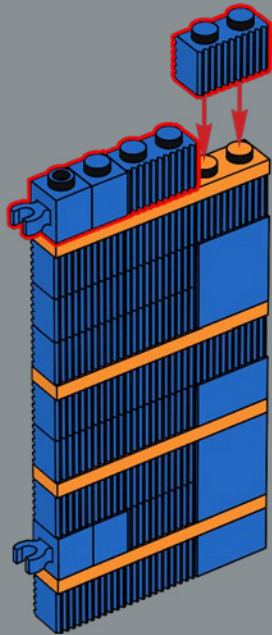

91

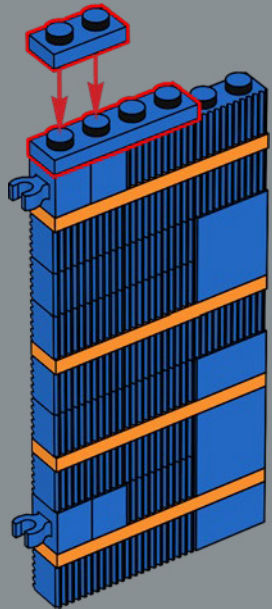

92

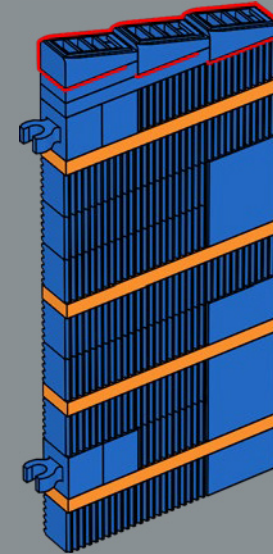

93

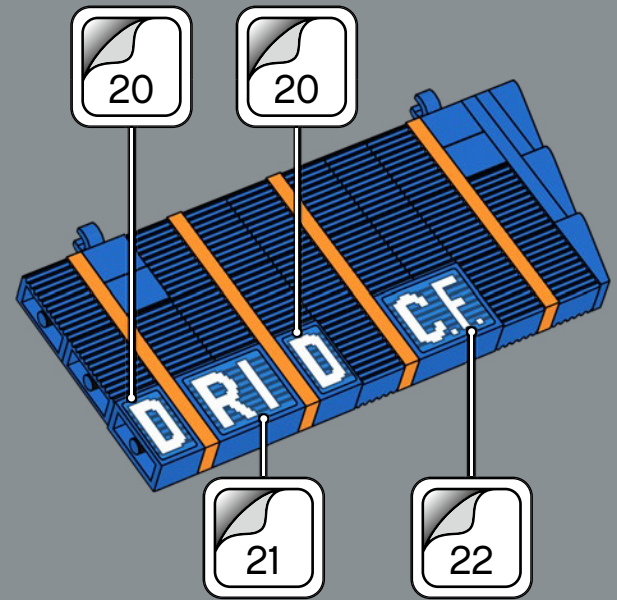

Each of these 1x2 blue textured bricks represents approximately 180 seats in the real stadium!

Chacune de ces briques bleues texturées 1x2 représente environ 180 sièges dans le vrai stade !

¡Cada uno de estos bricks 1x2 azules con textura representa cerca de 180 localidades del estadio de verdad!

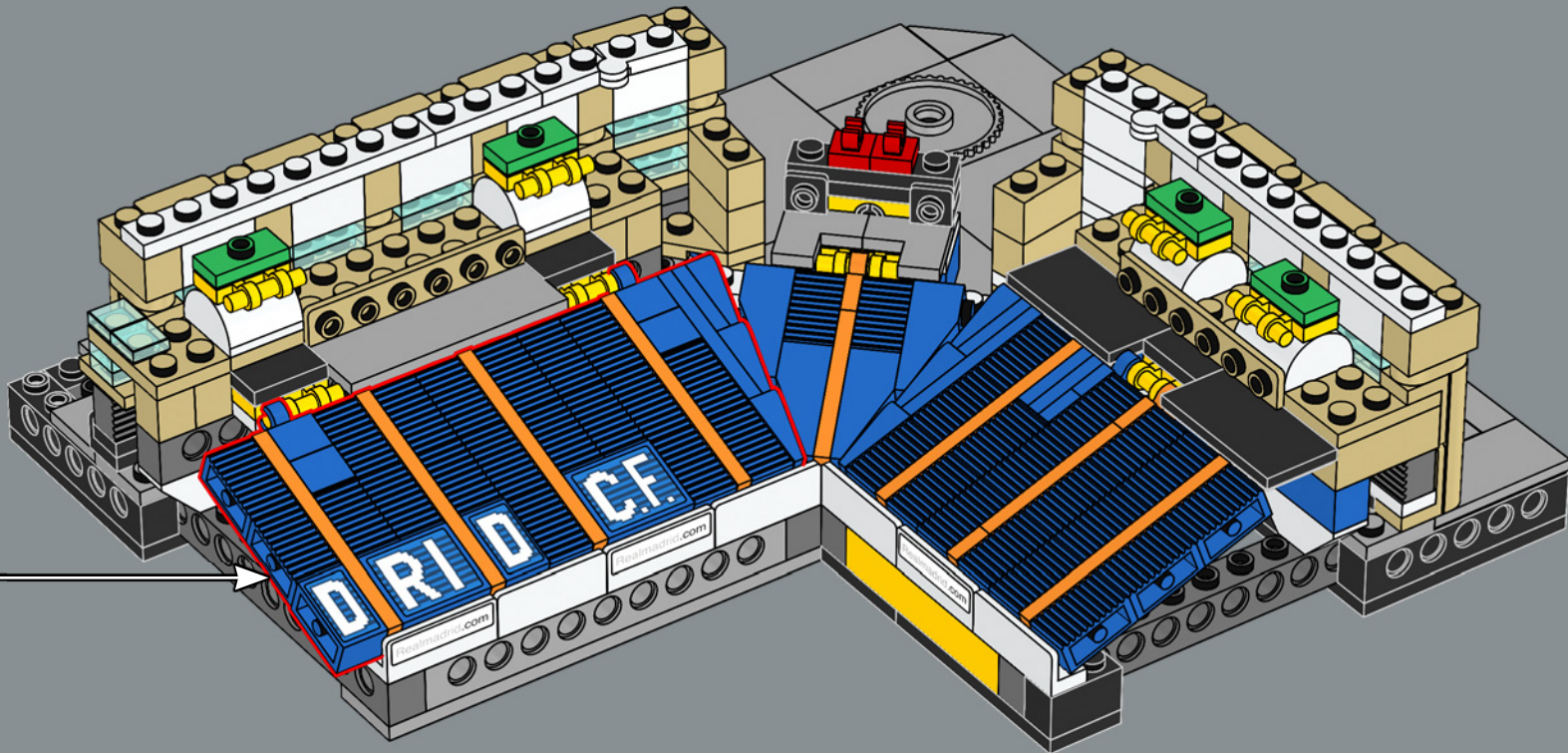

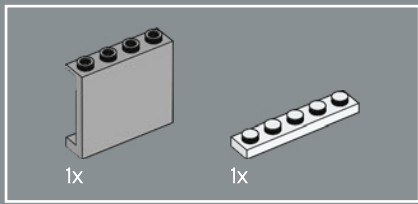

95

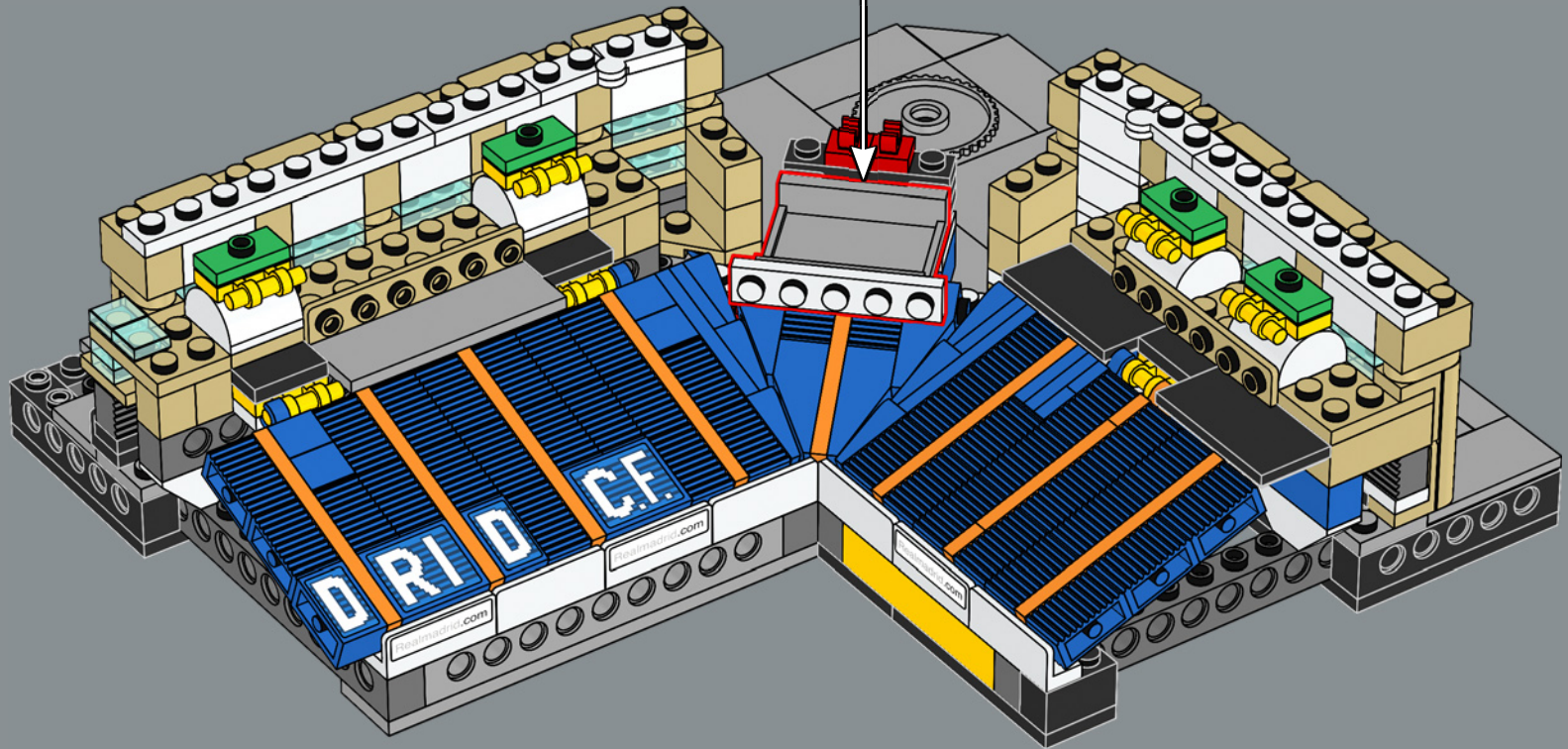
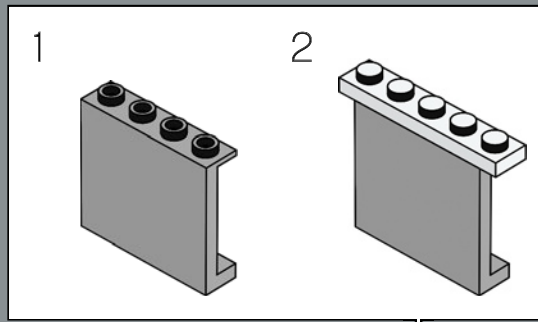

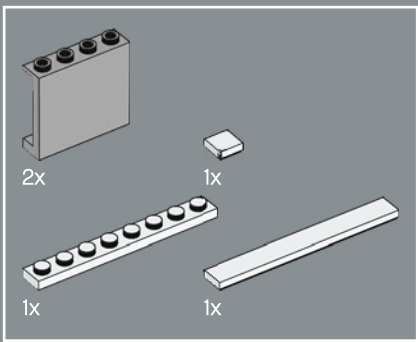

96

1

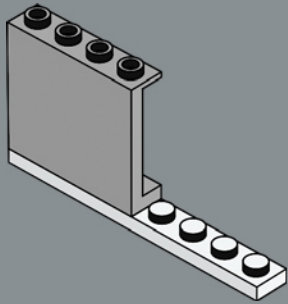

2

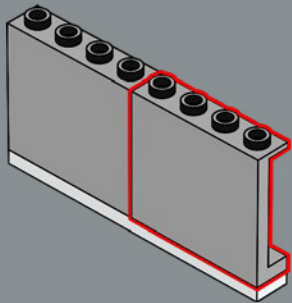

3

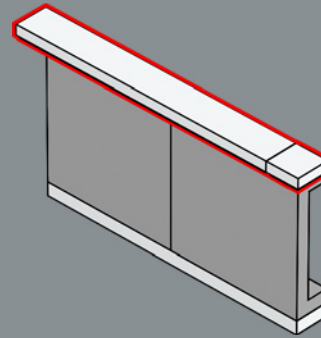

4

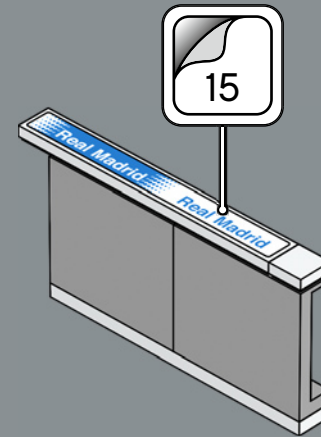

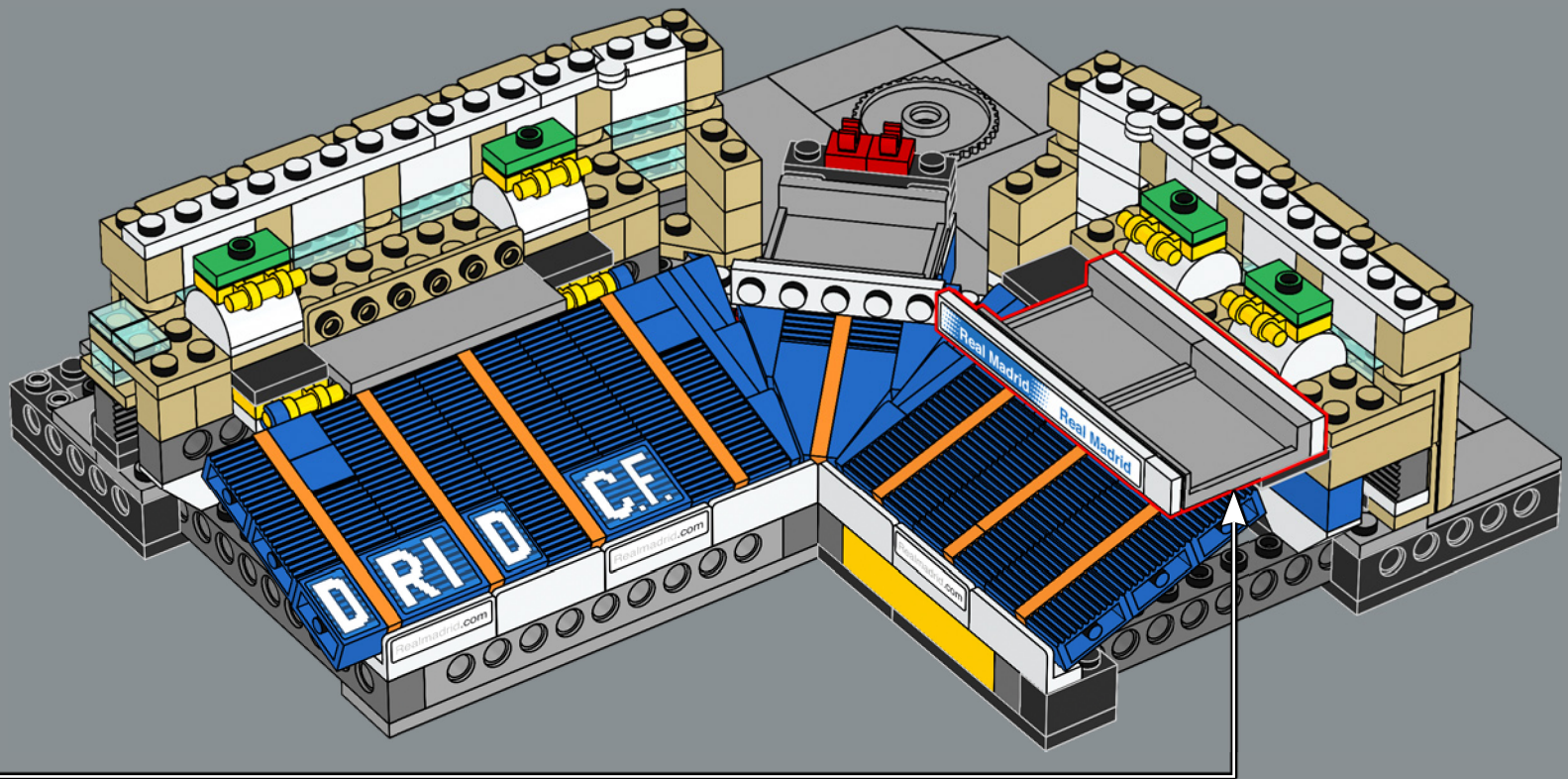

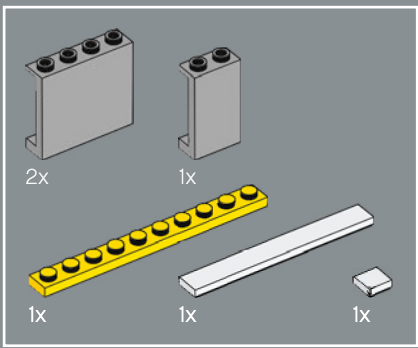

97

1

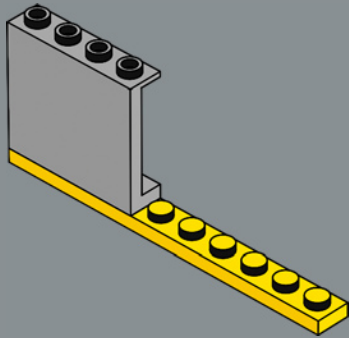

2

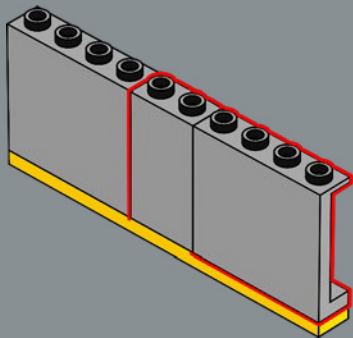

3

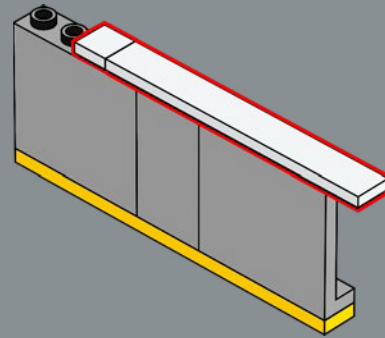

4

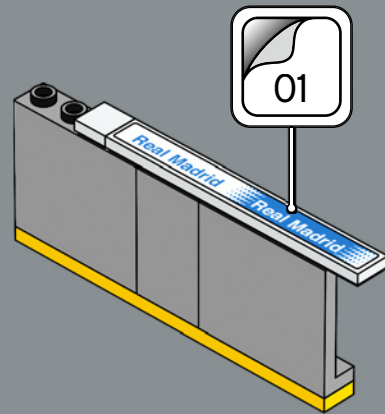

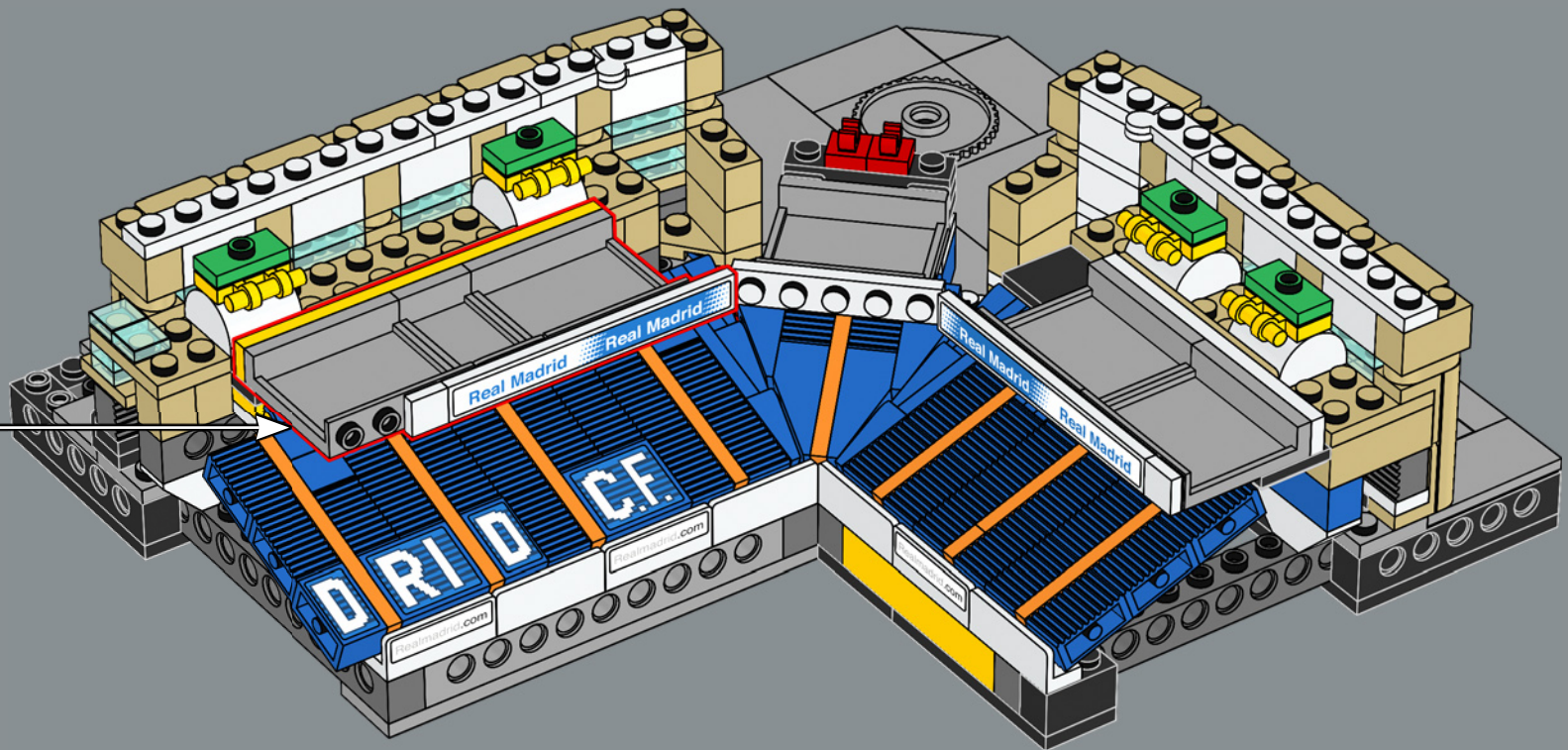

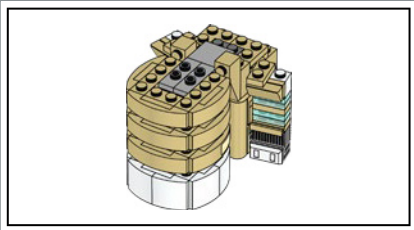
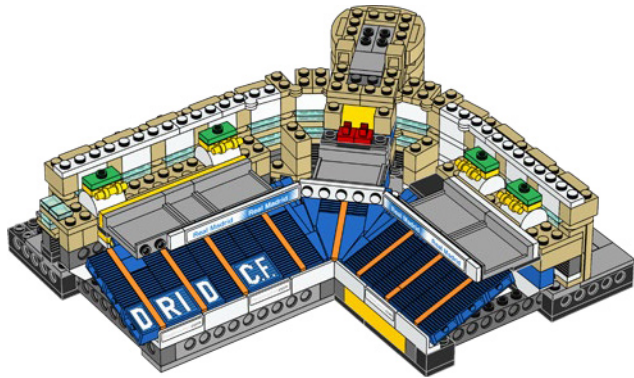
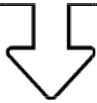

98

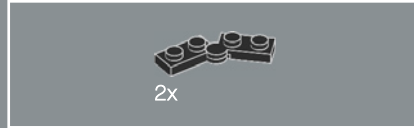
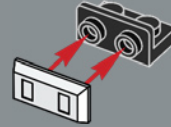

99

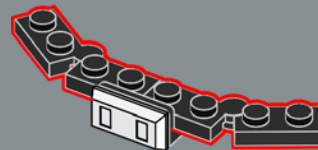

100

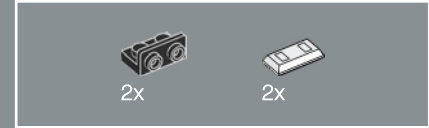
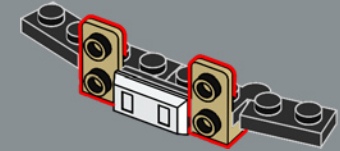

101

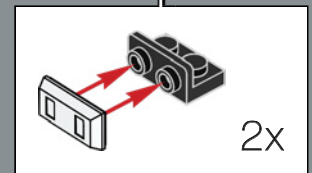
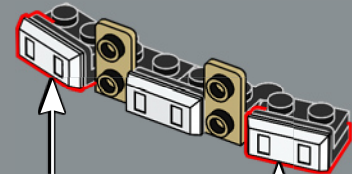

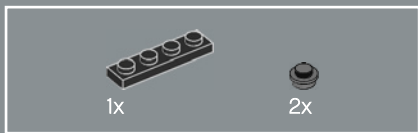

102

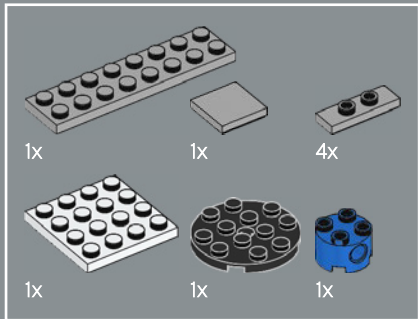
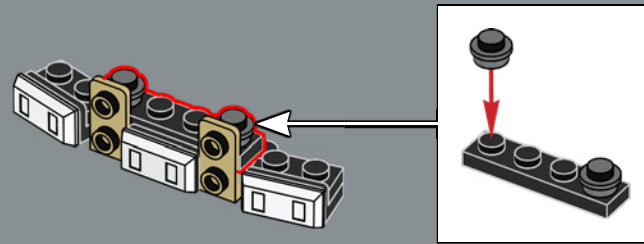

103

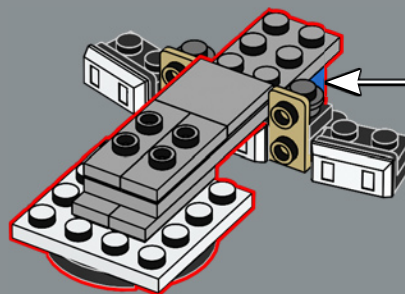
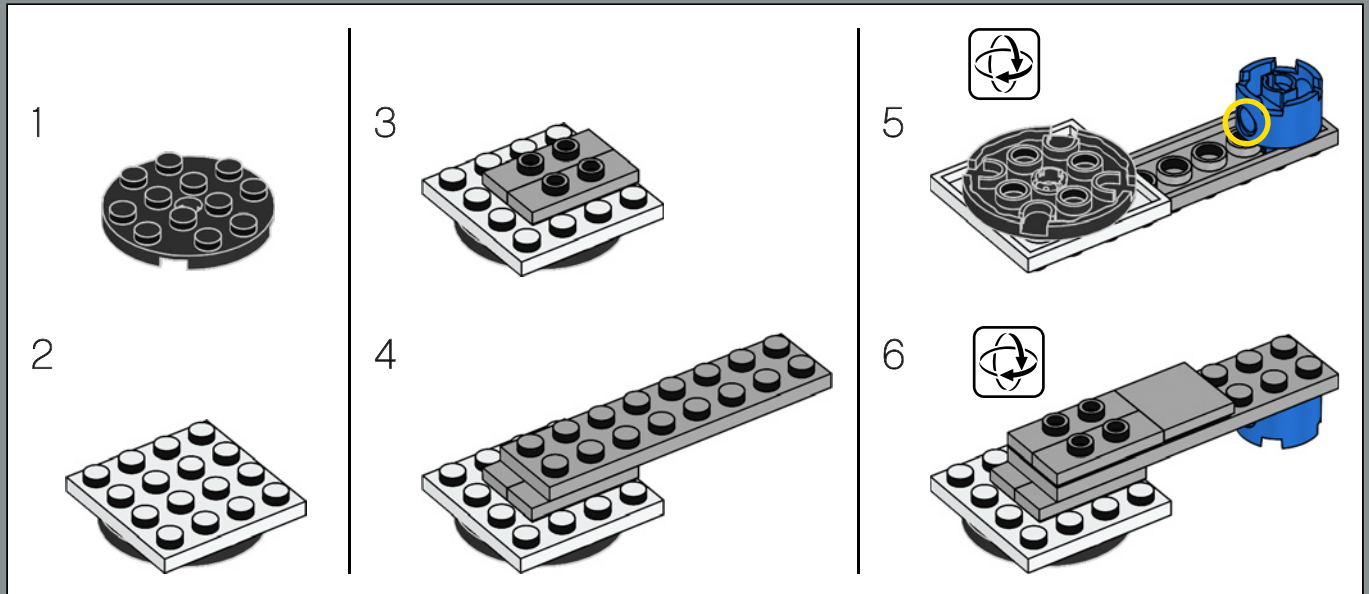

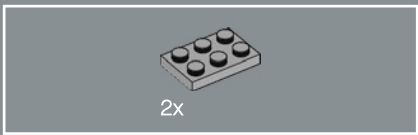

104

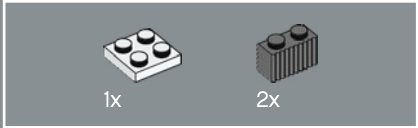
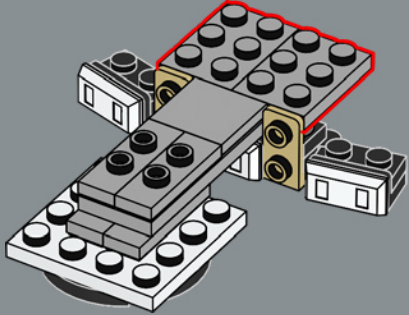

105

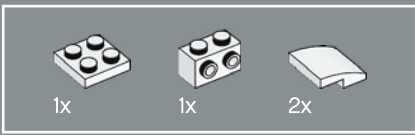
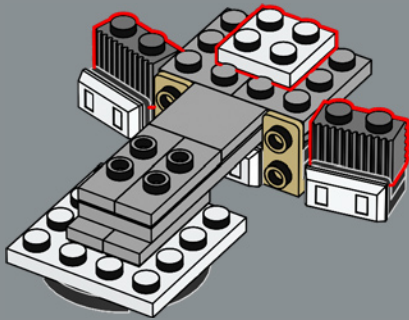

106

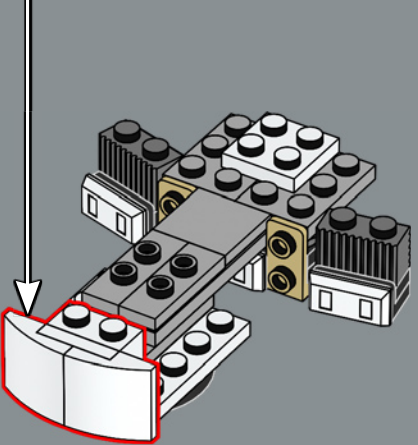
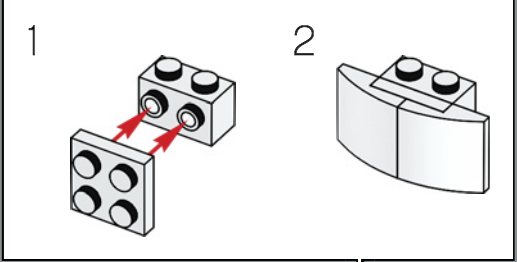

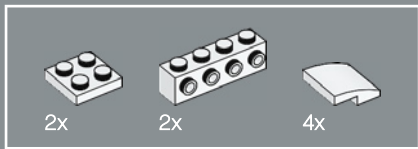

107

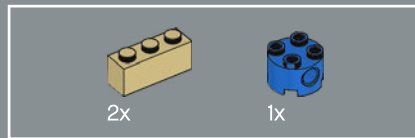
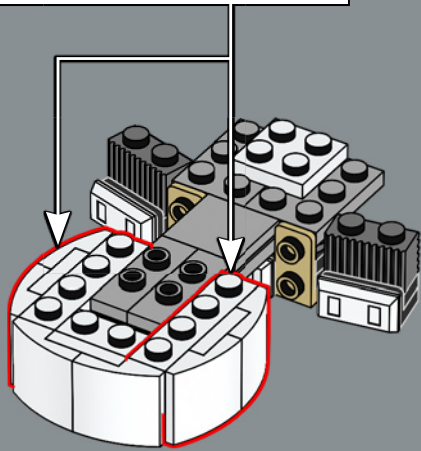
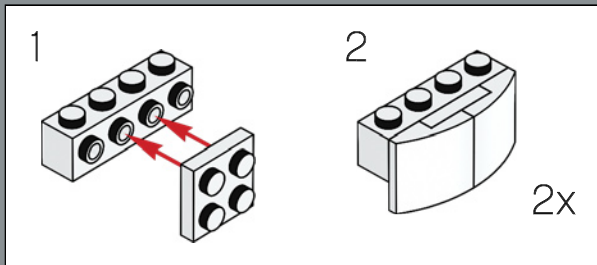

108

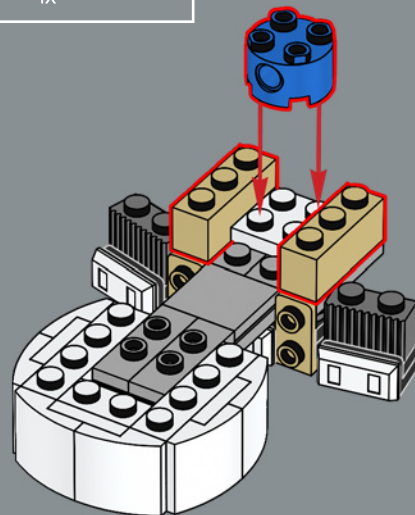

109

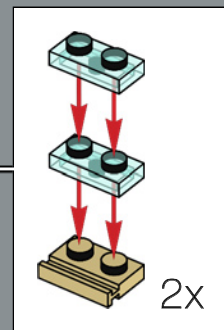
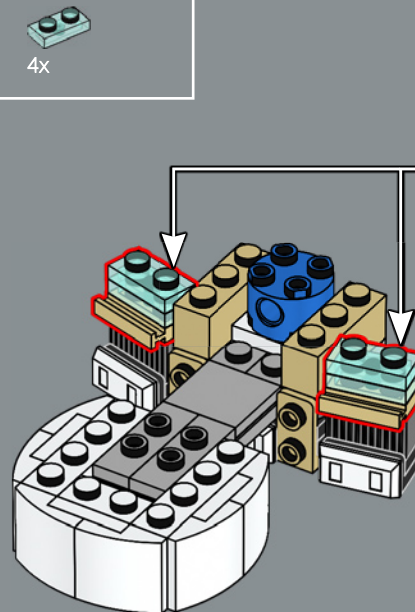

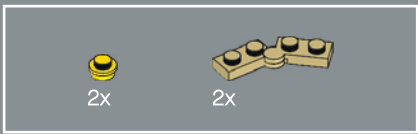

110

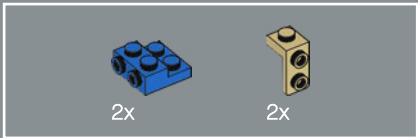
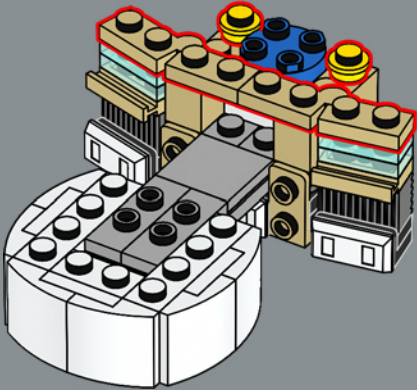

111

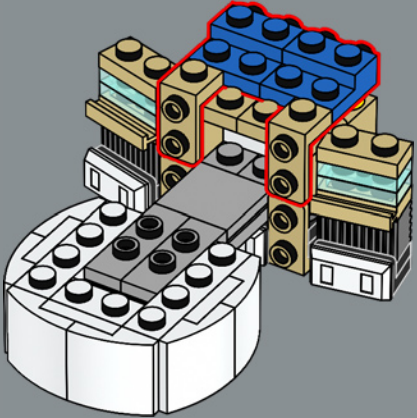

112

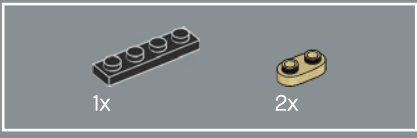
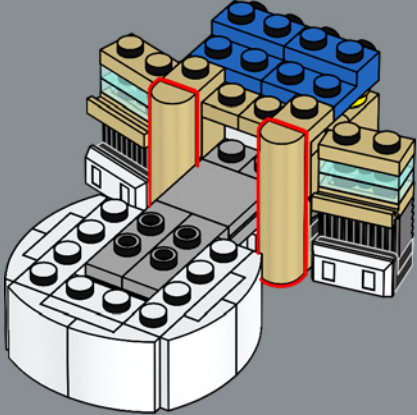

113

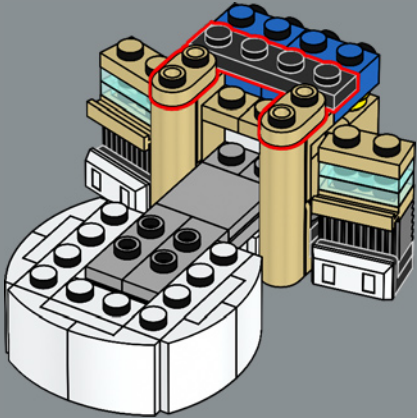



114

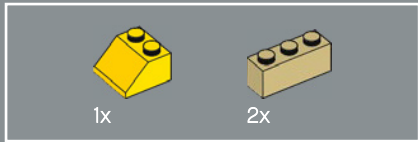
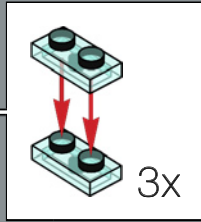
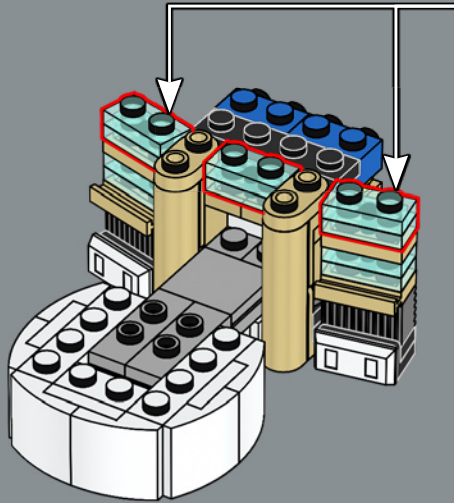

115

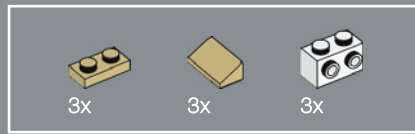
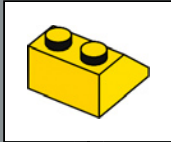
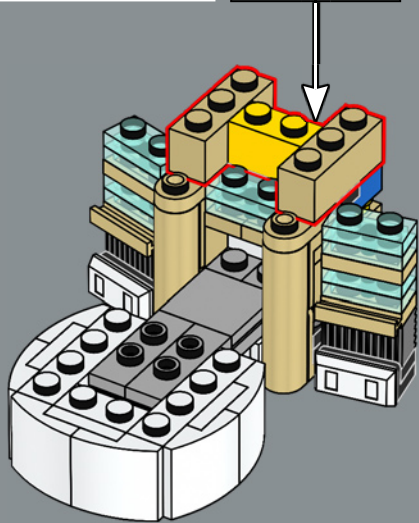

116

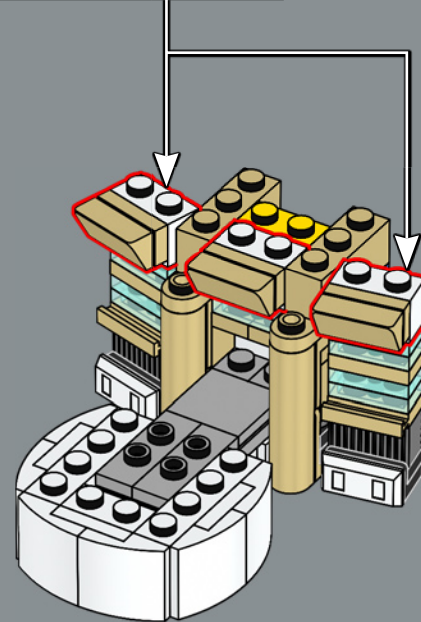
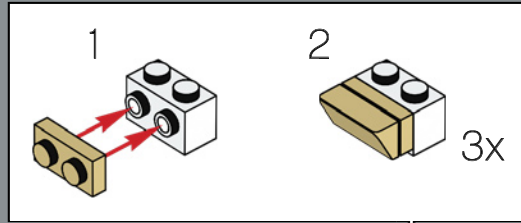



117

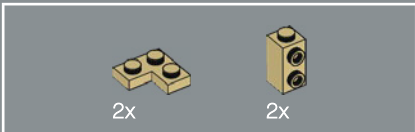
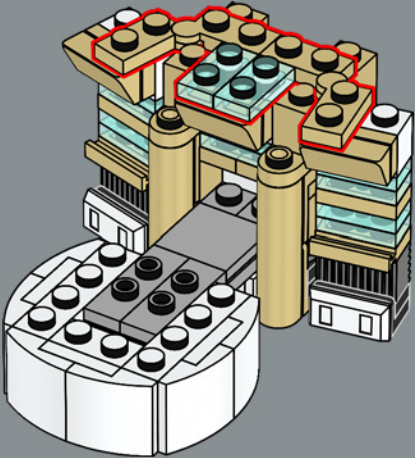

118

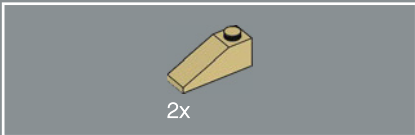
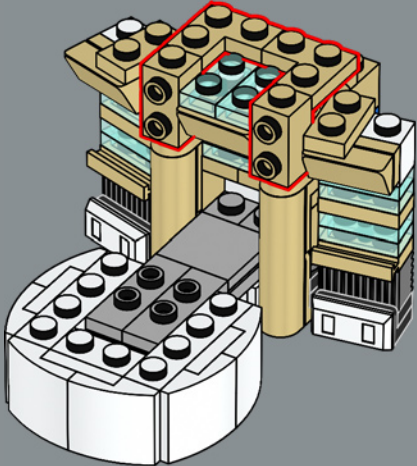

119

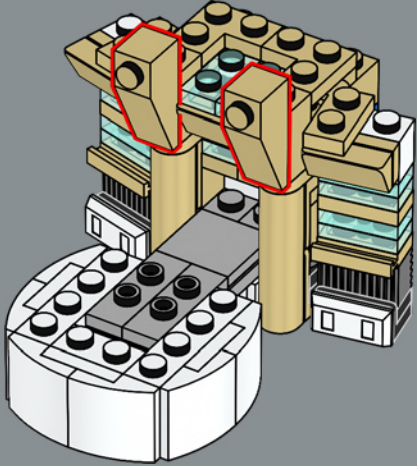

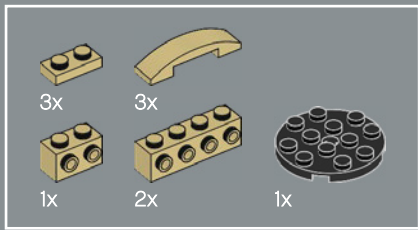

120

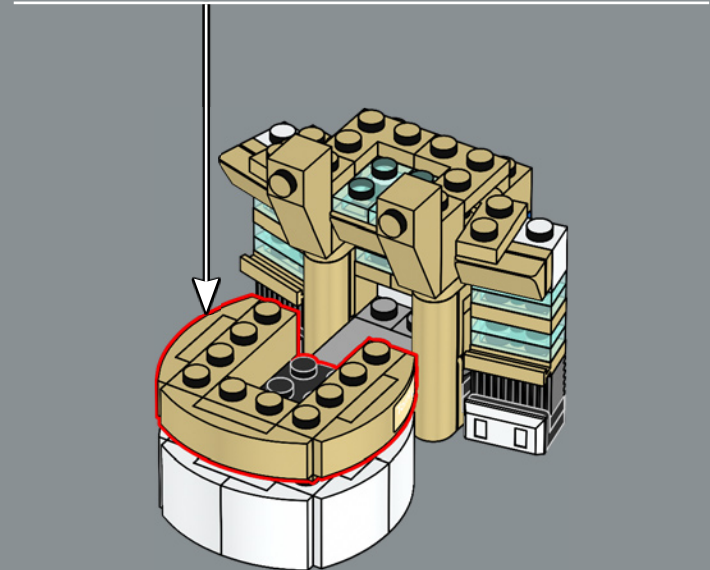
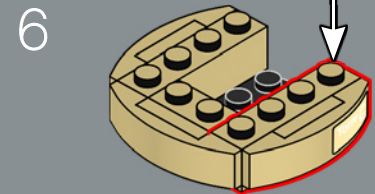
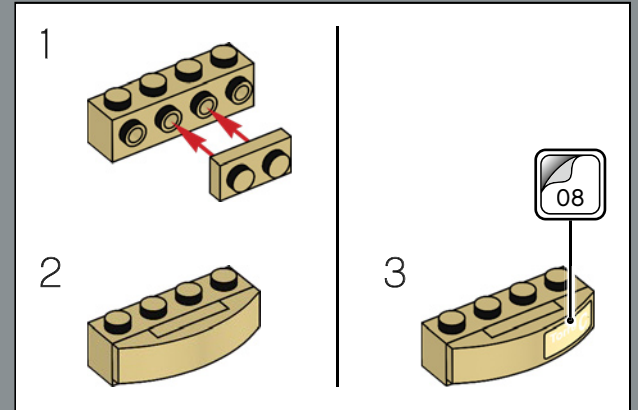
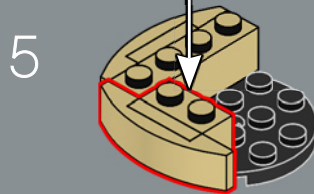
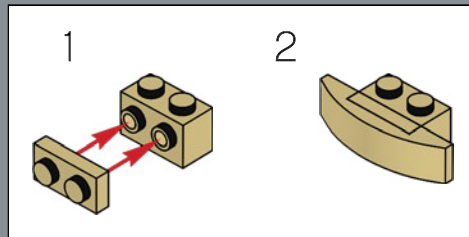
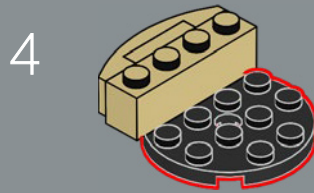
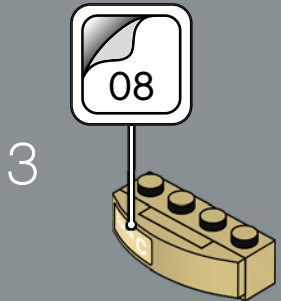
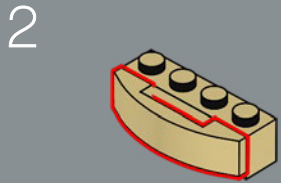
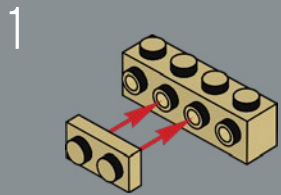

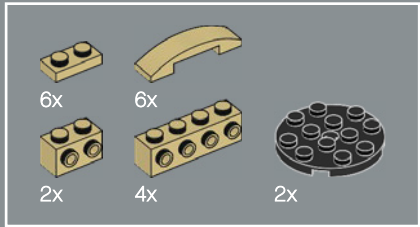
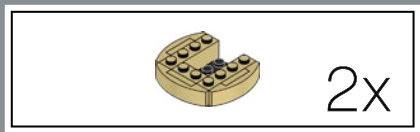

121

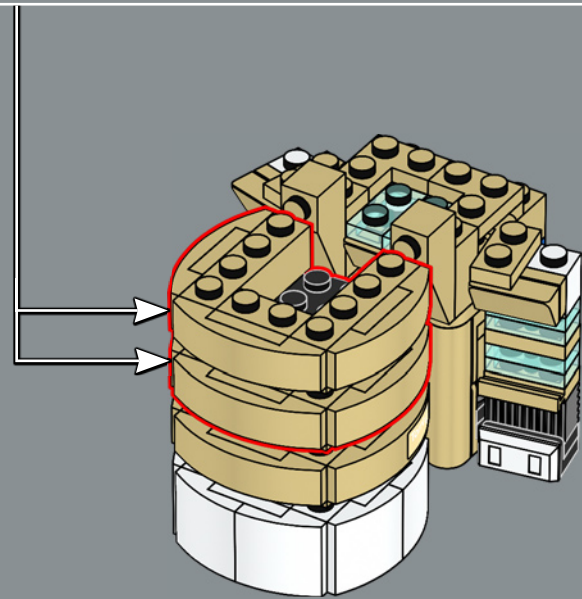
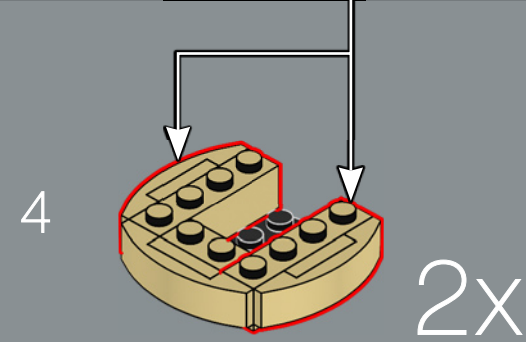
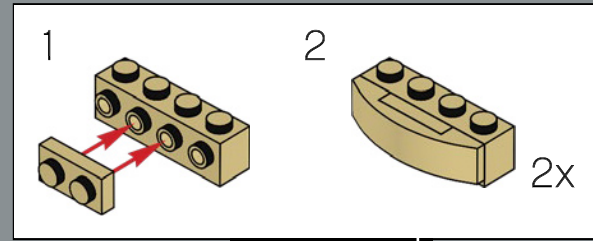
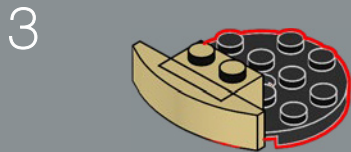
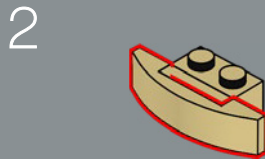
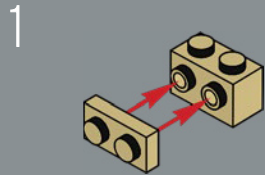

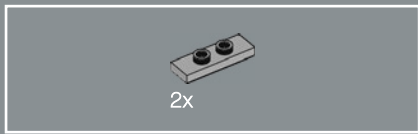

122

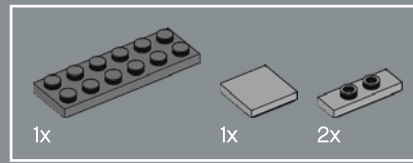
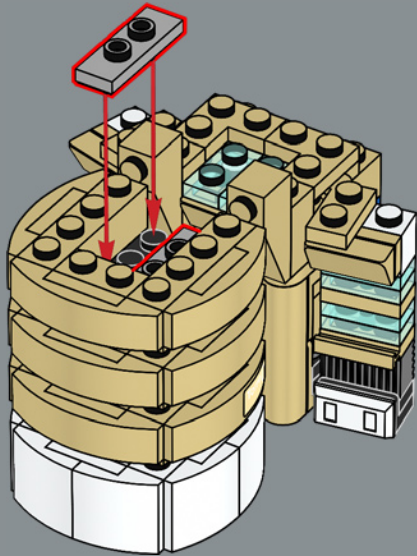

123

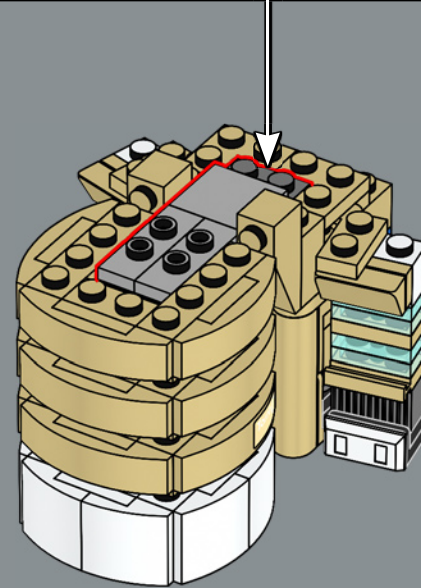
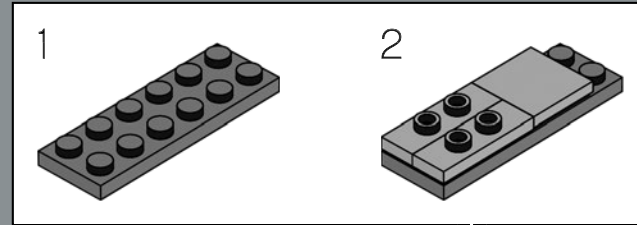

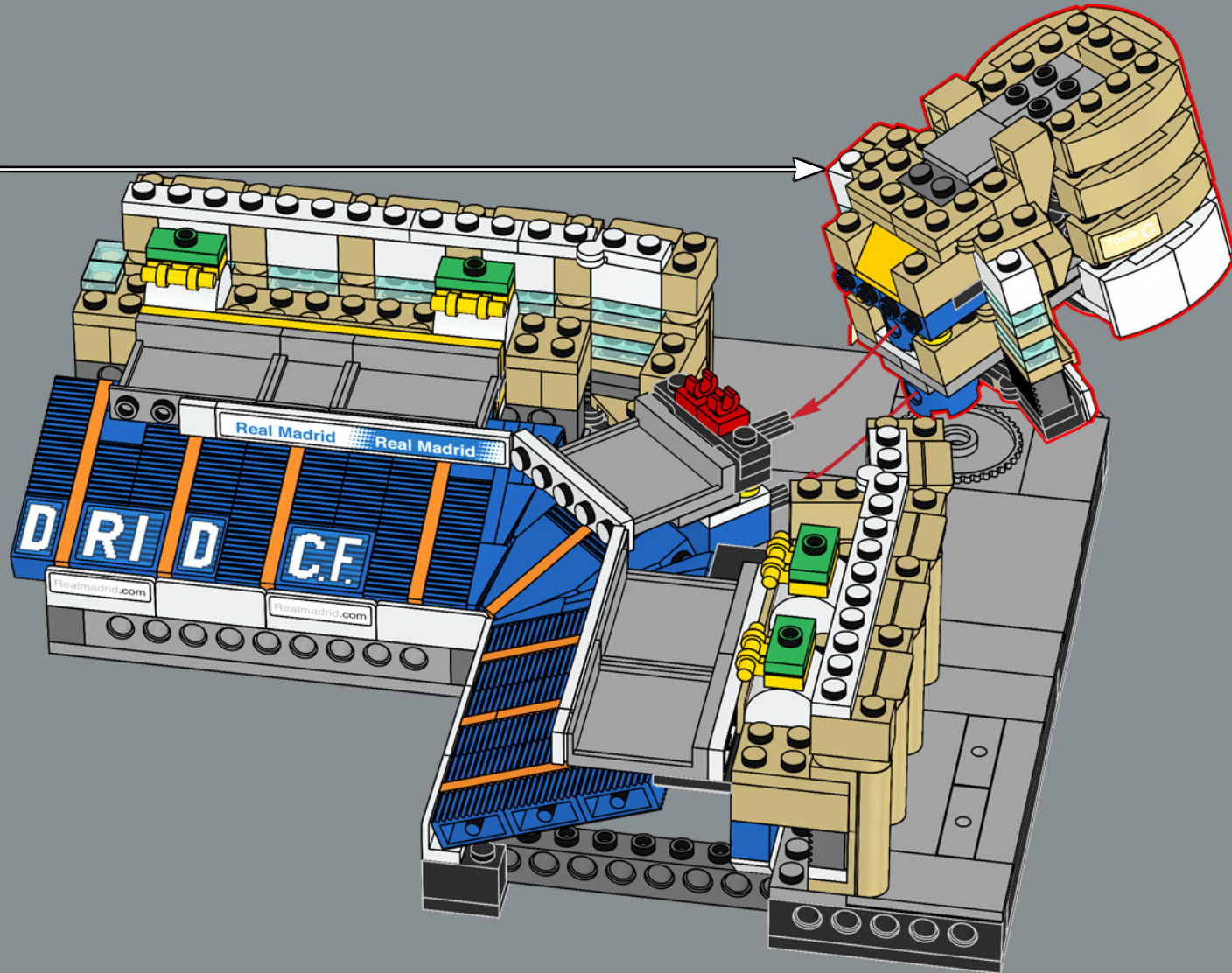

125

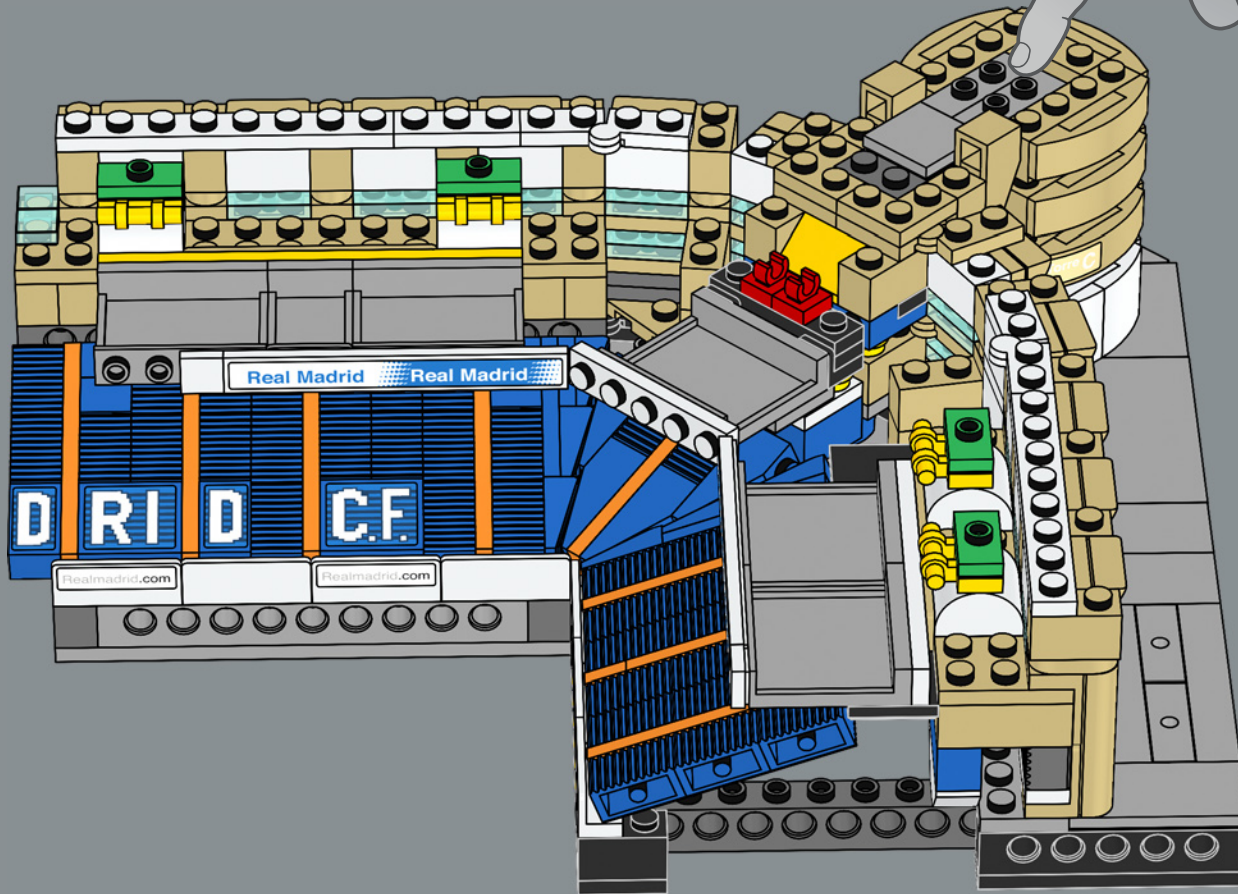



126

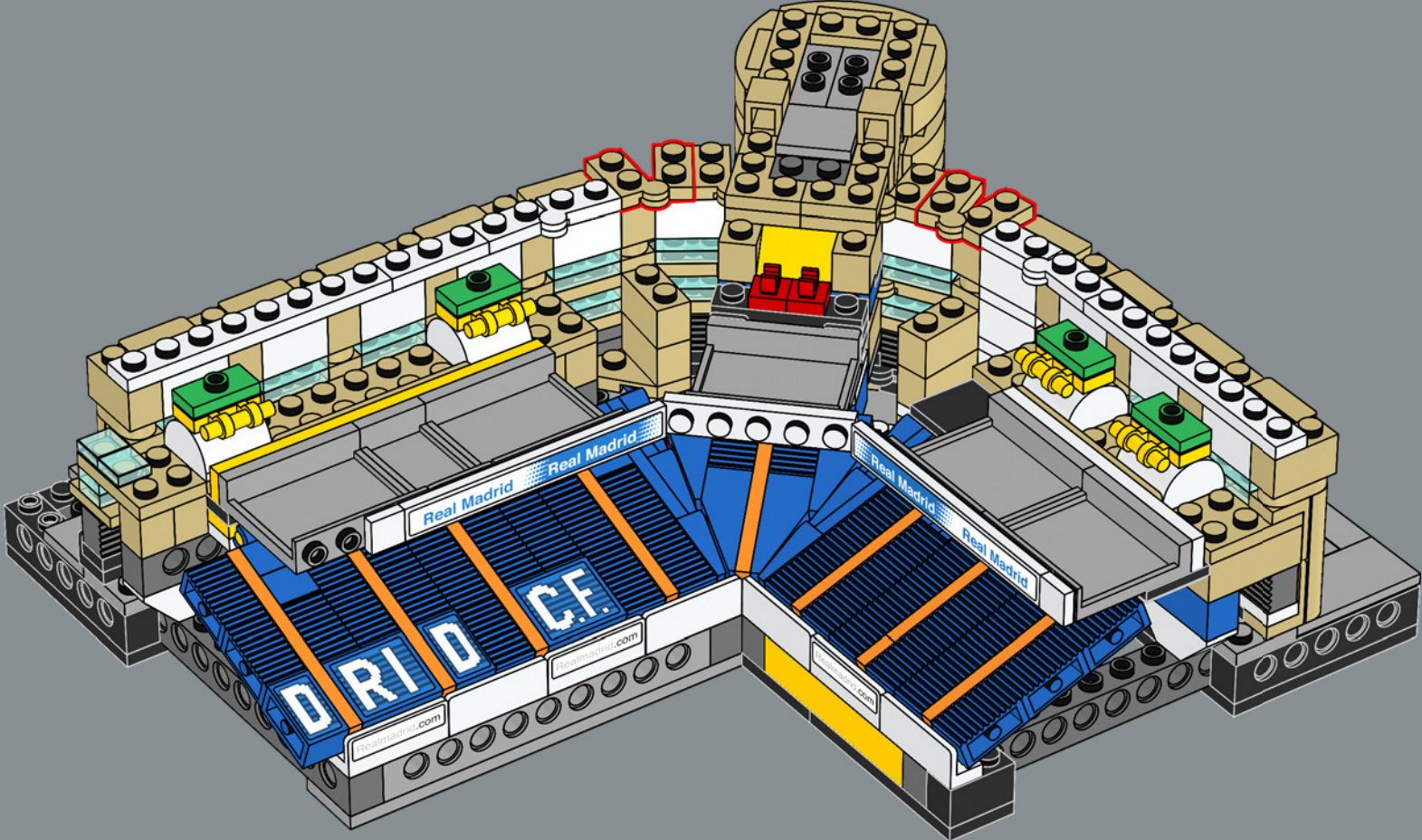

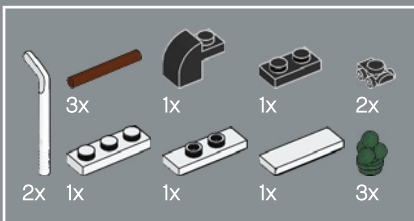

127

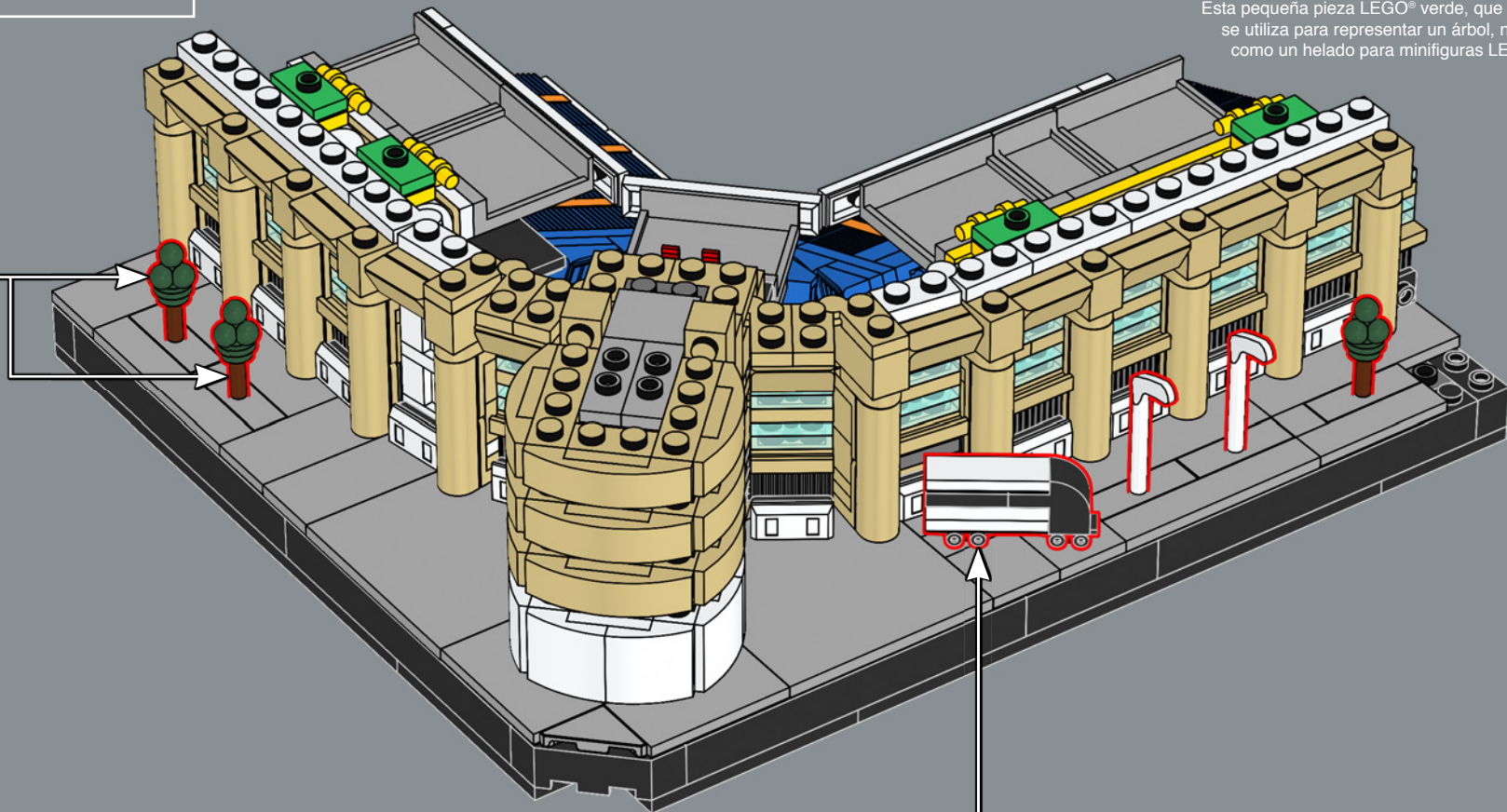
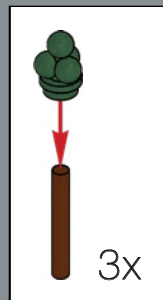

This little green LEGO® piece, used here to represent a tree, was developed as an ice cream scoop for LEGO minifigures.

Cette petite pièce LEGO® verte, utilisée ici pour représenter un arbre, était à l'origine une boule de crème glacée pour les figurines LEGO.

Esta pequeña pieza LEGO® verde, que aquí se utiliza para representar un árbol, nació como un helado para minifiguras LEGO.

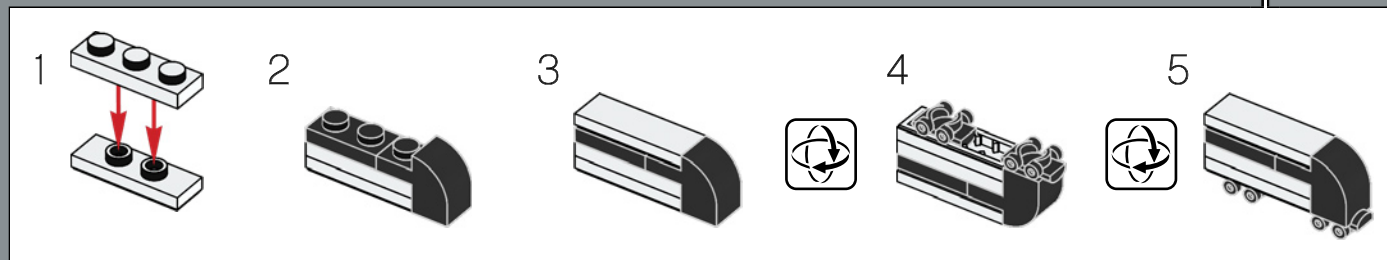

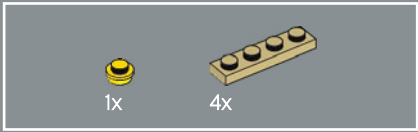
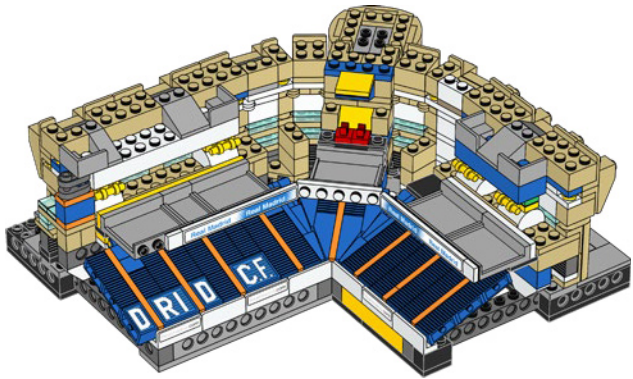

128

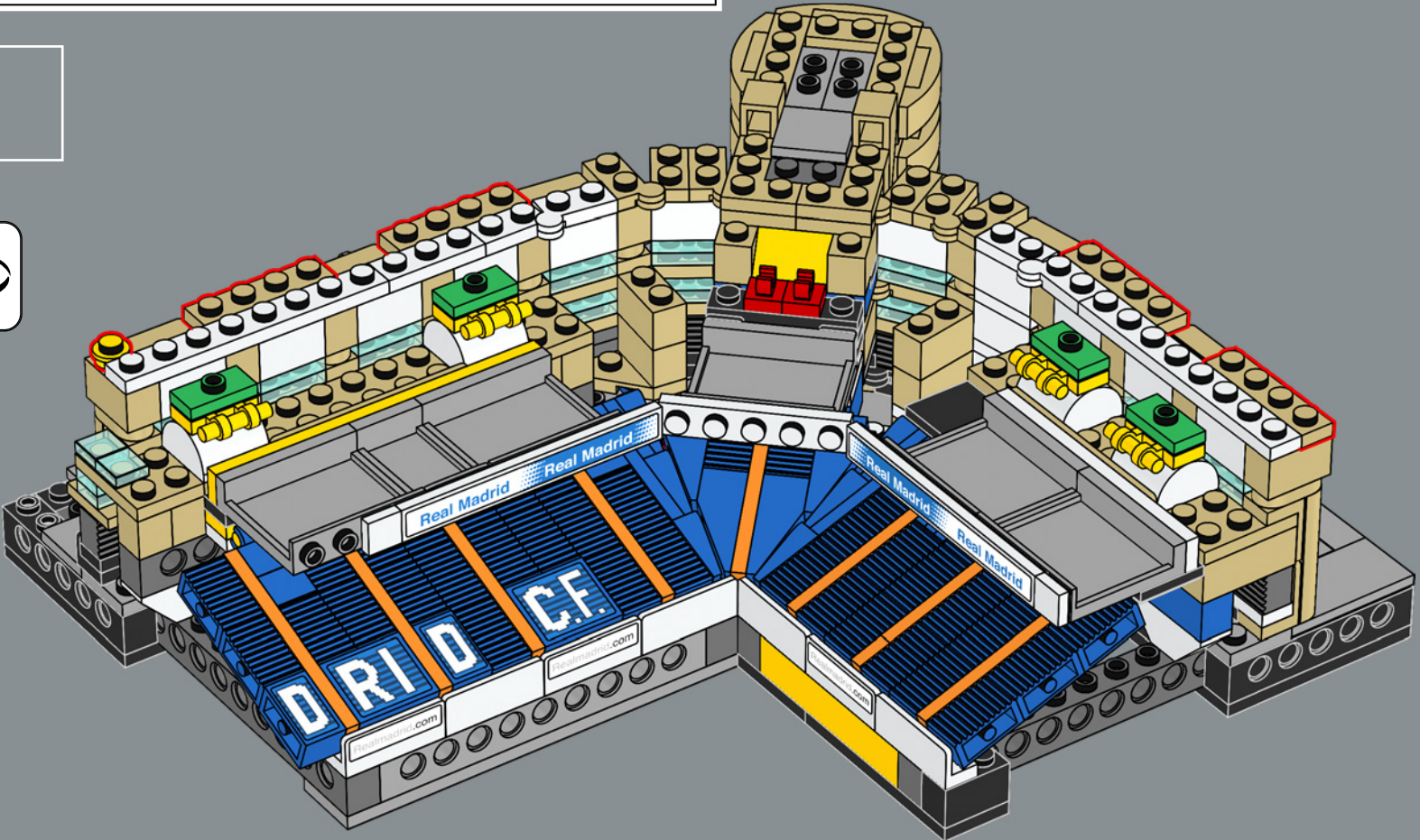

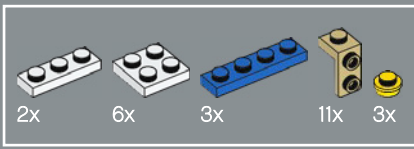

129

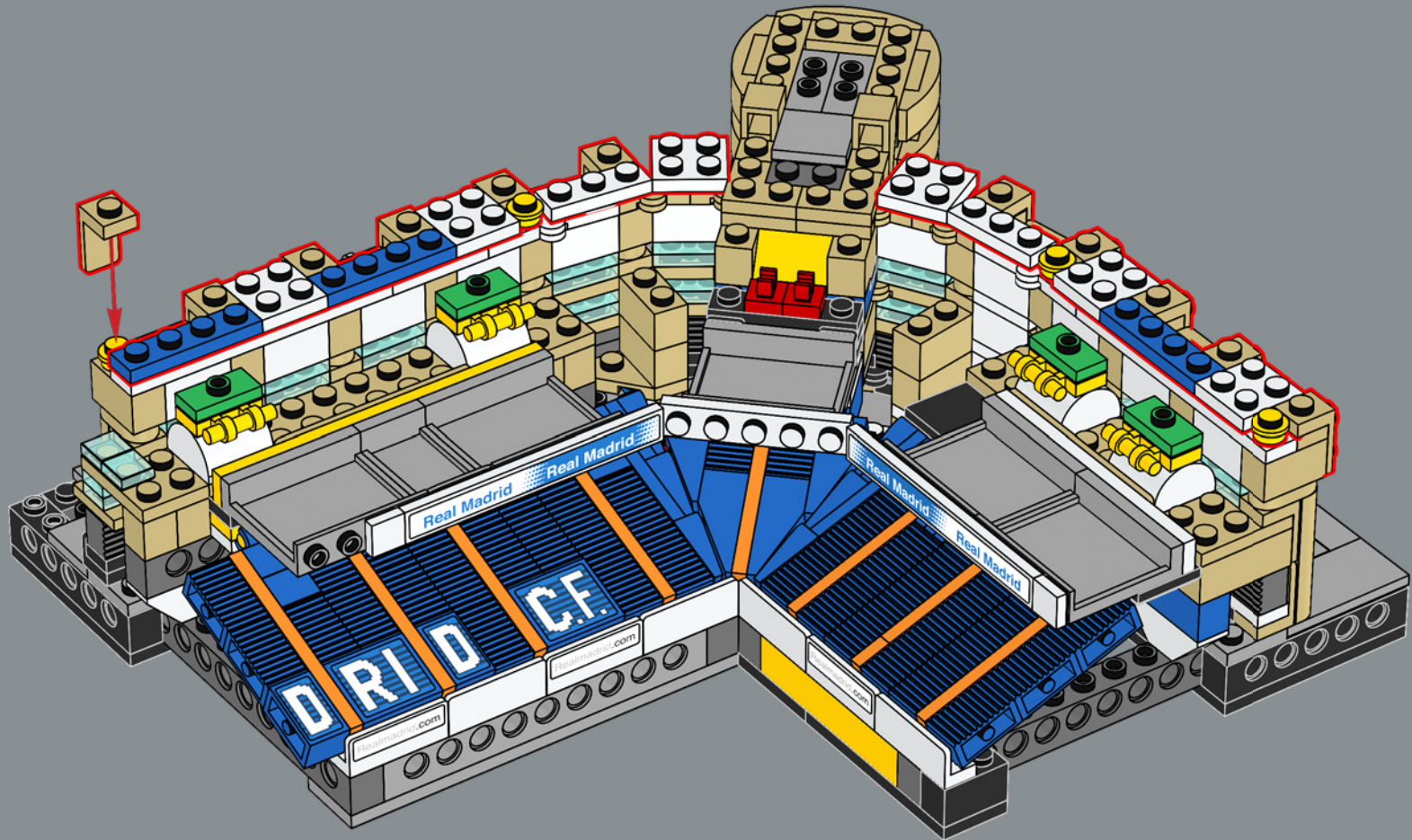

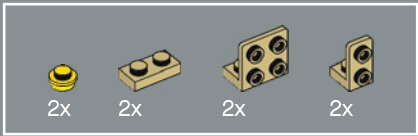

130

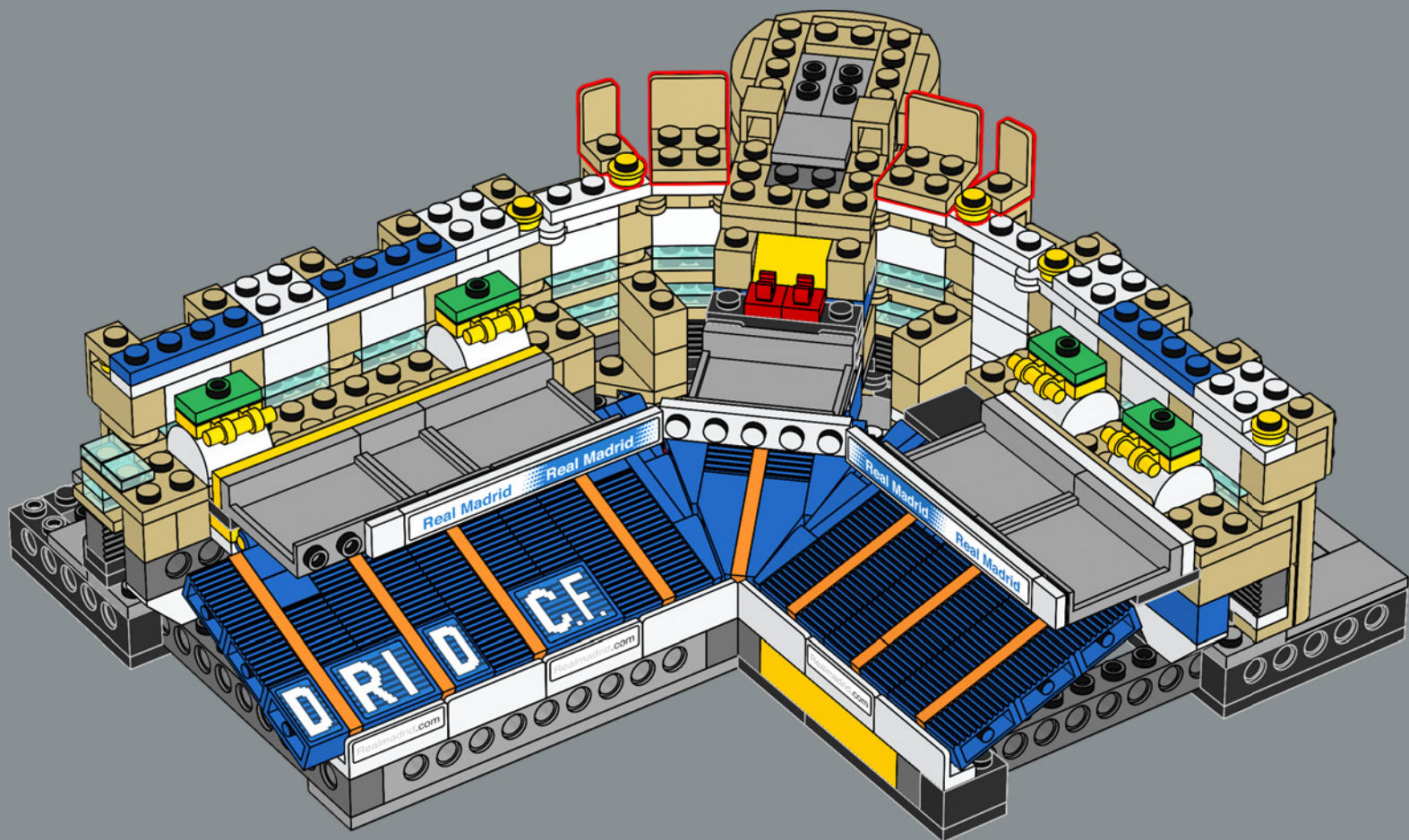

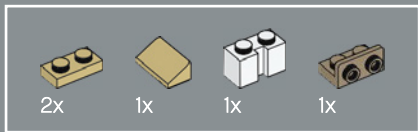

131

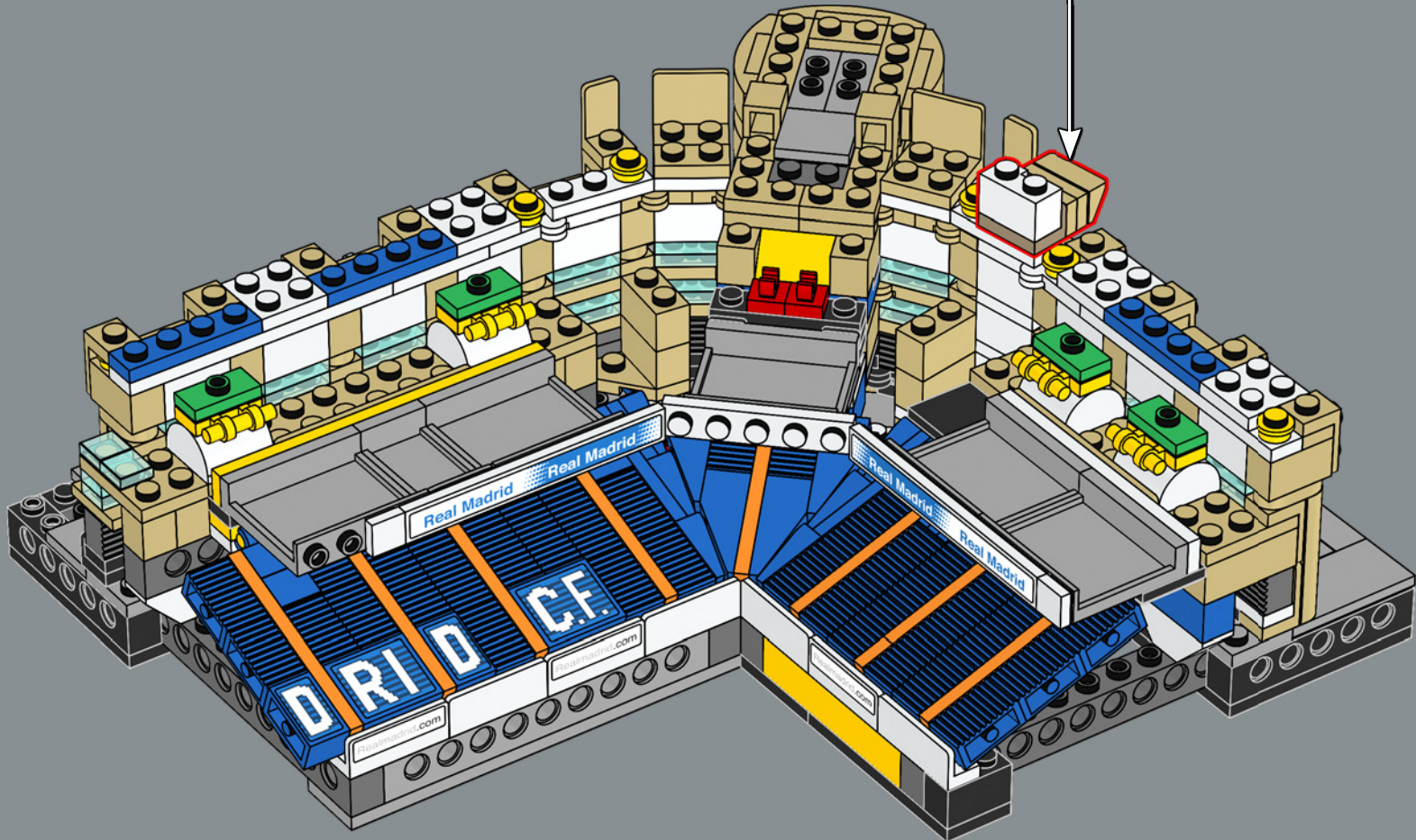
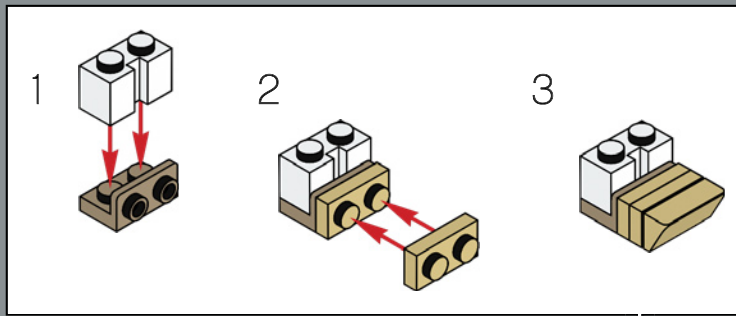



132

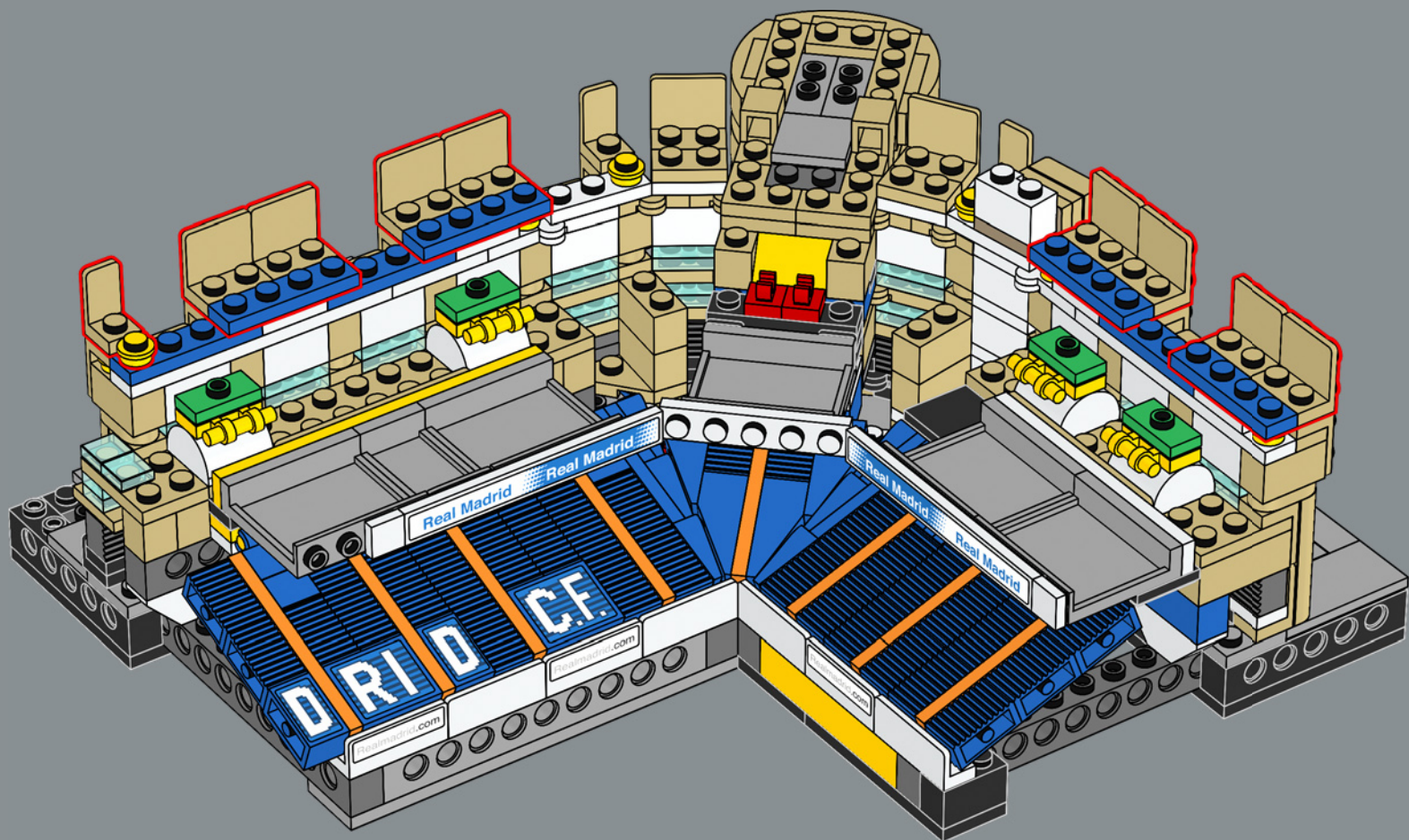

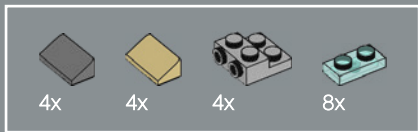

133

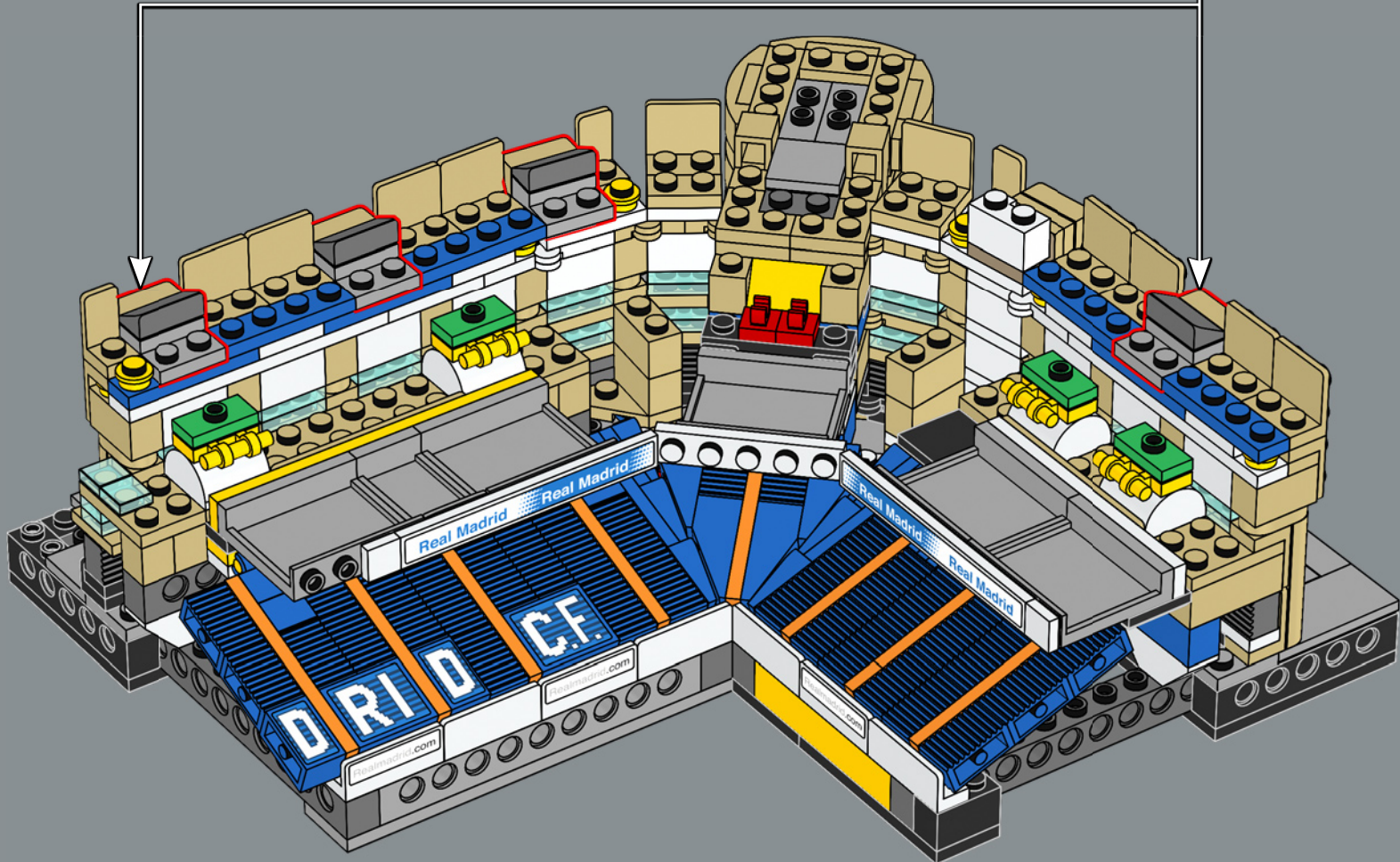
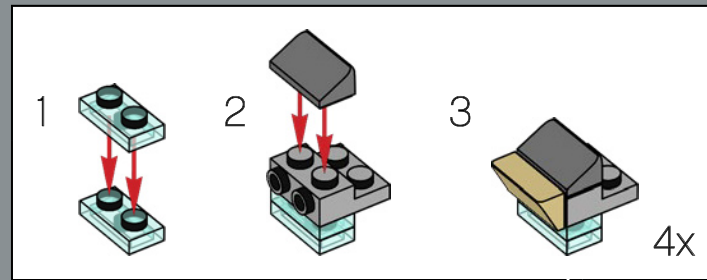

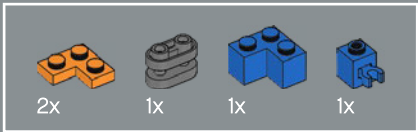

134

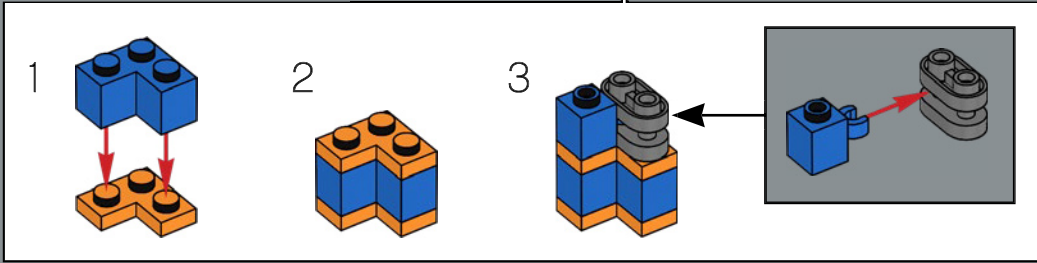
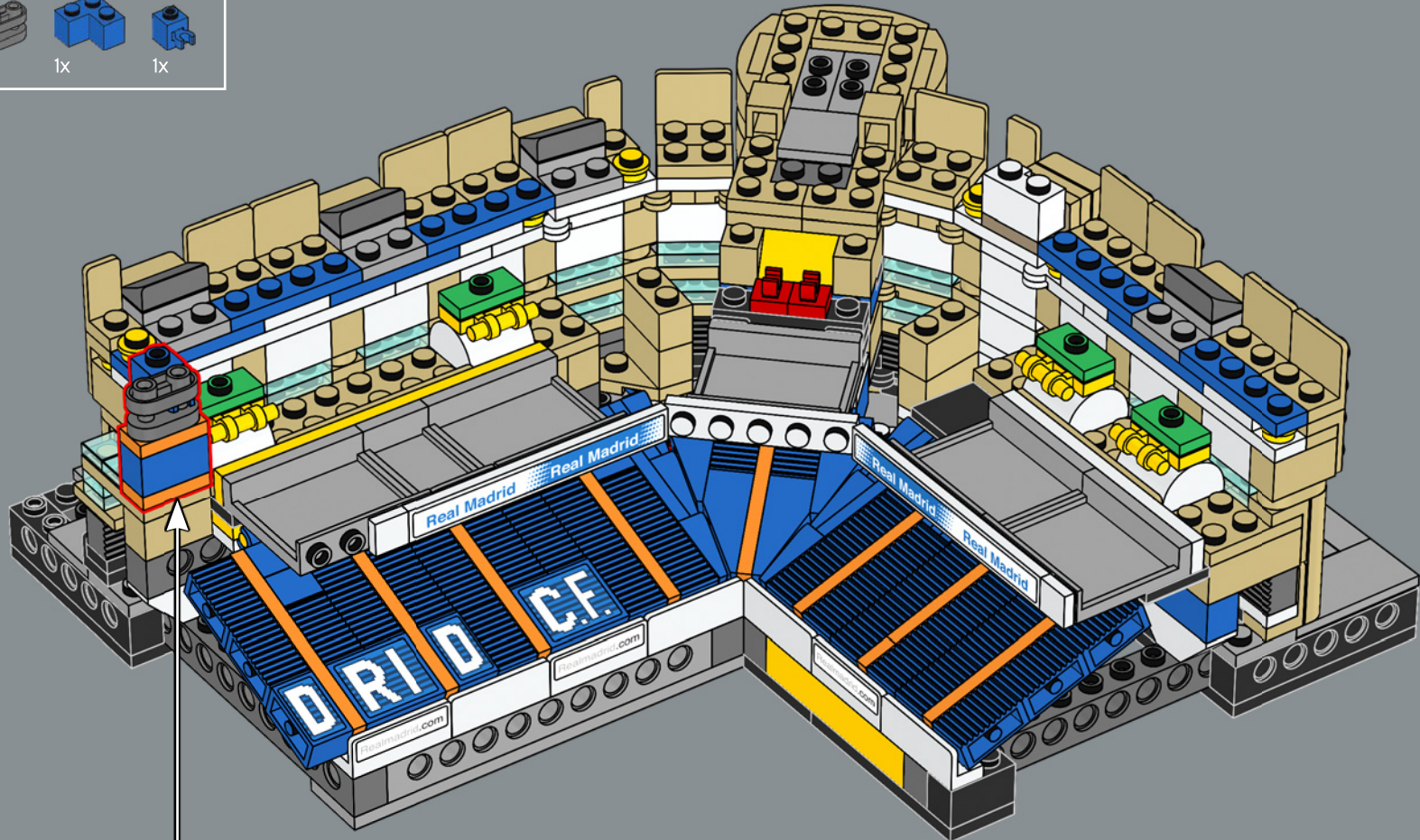

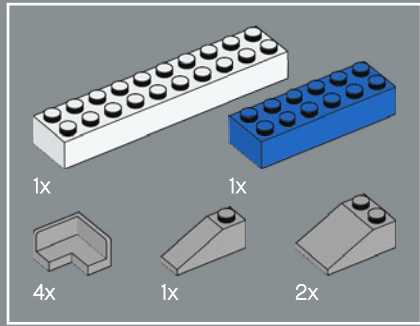

135

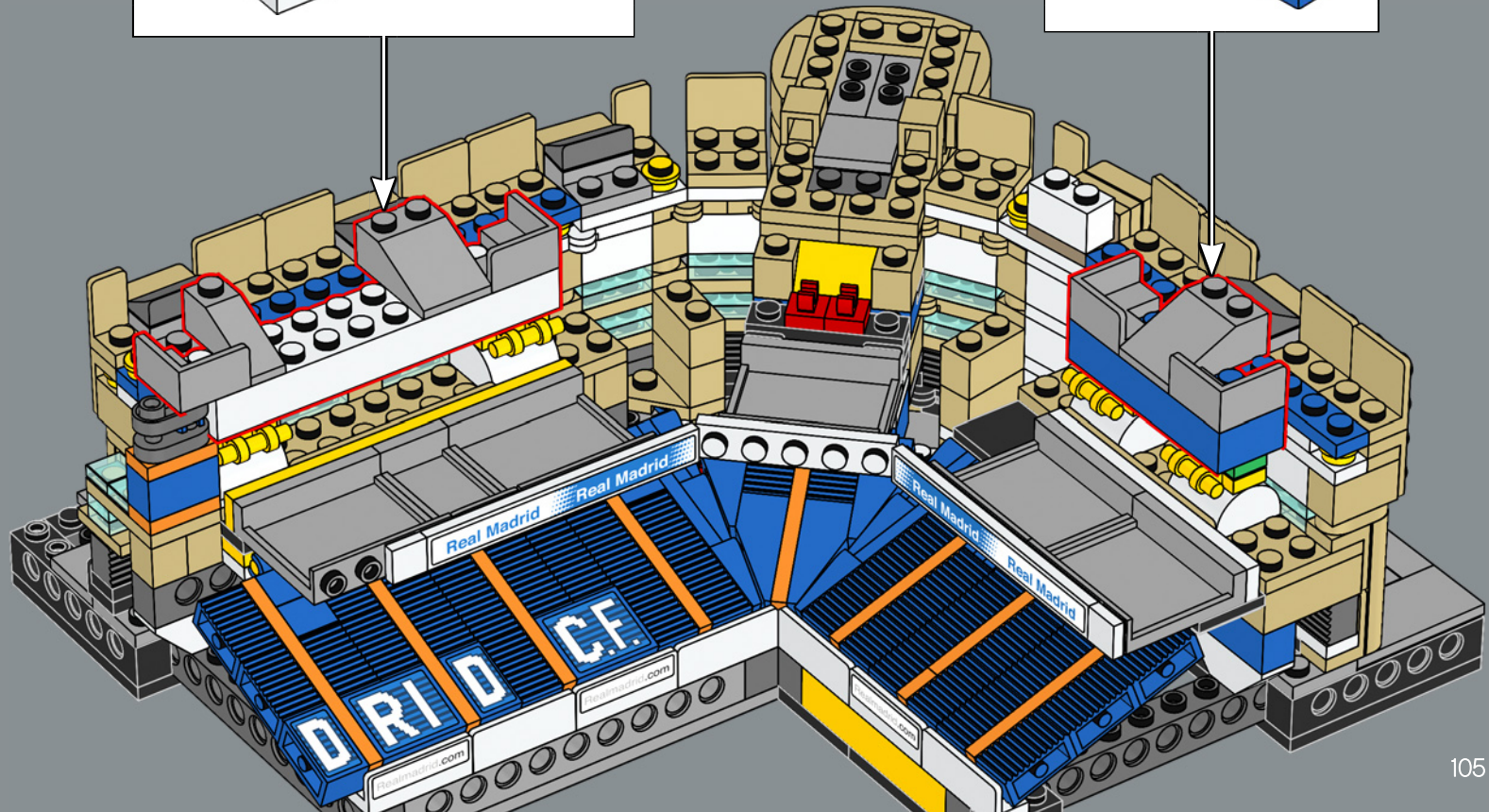
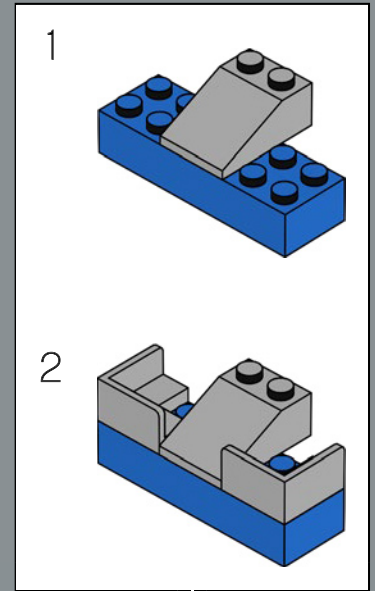
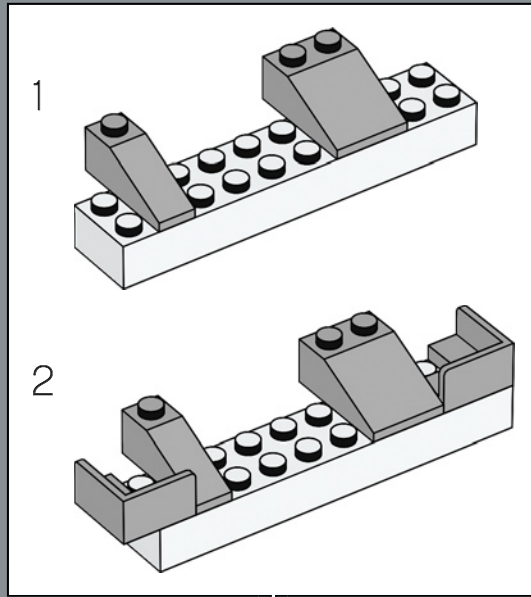

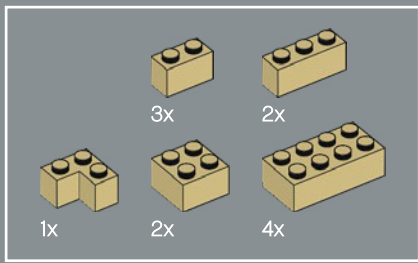

136

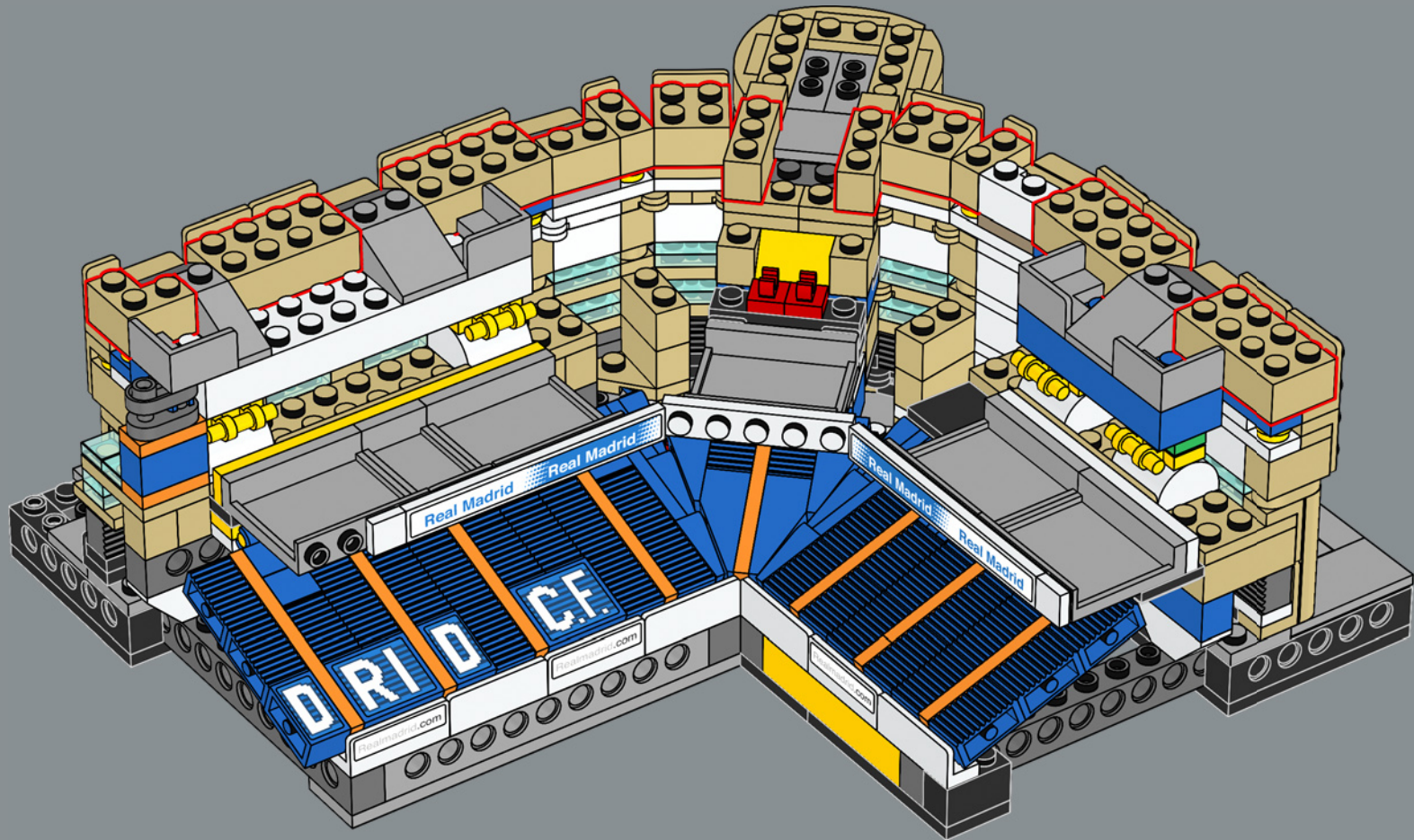

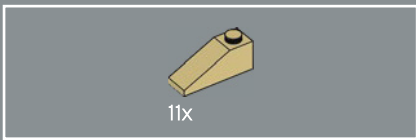

137

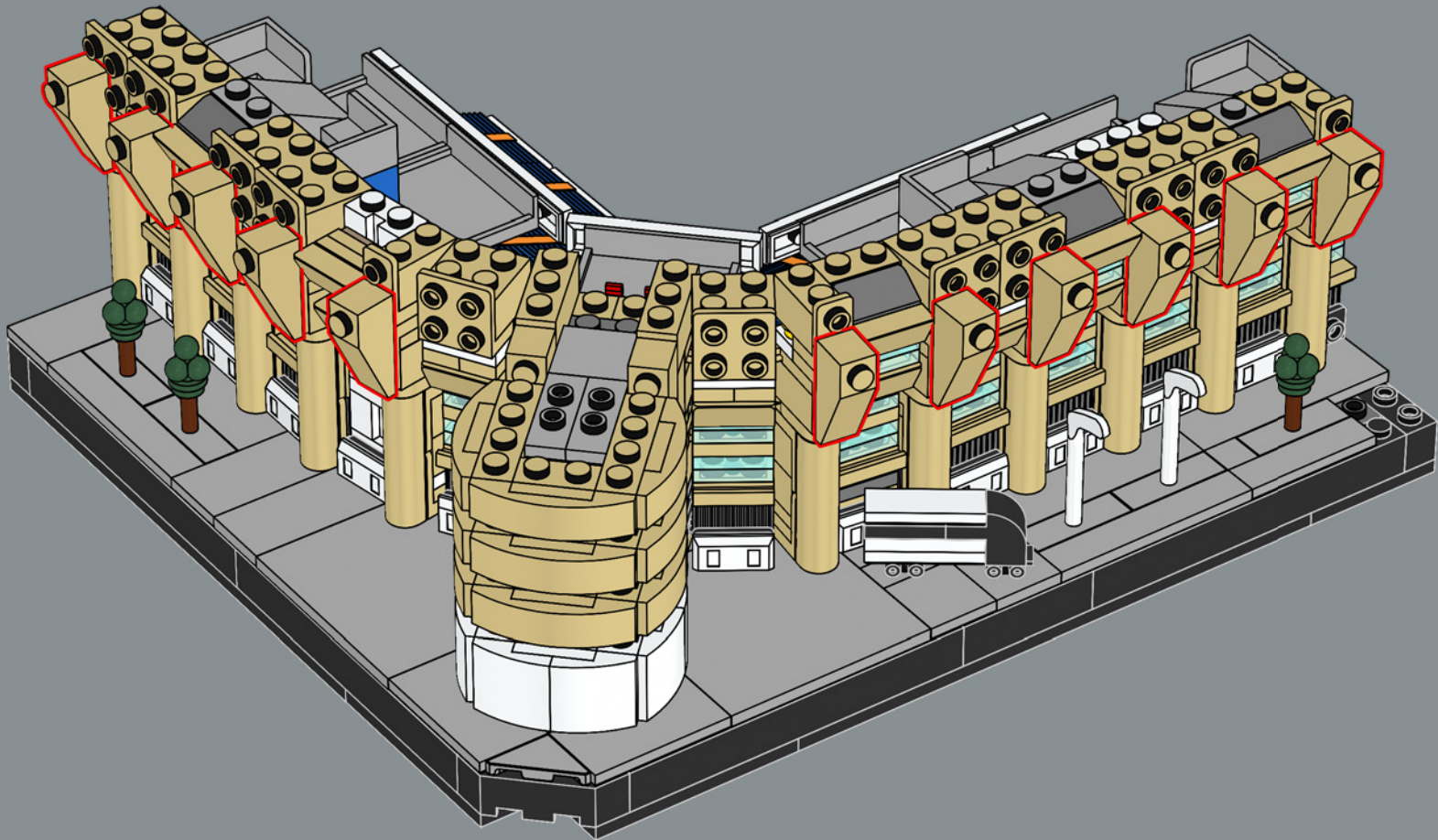

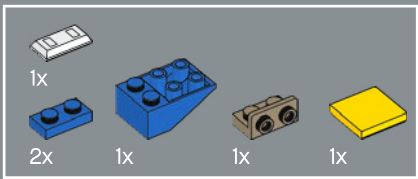

138

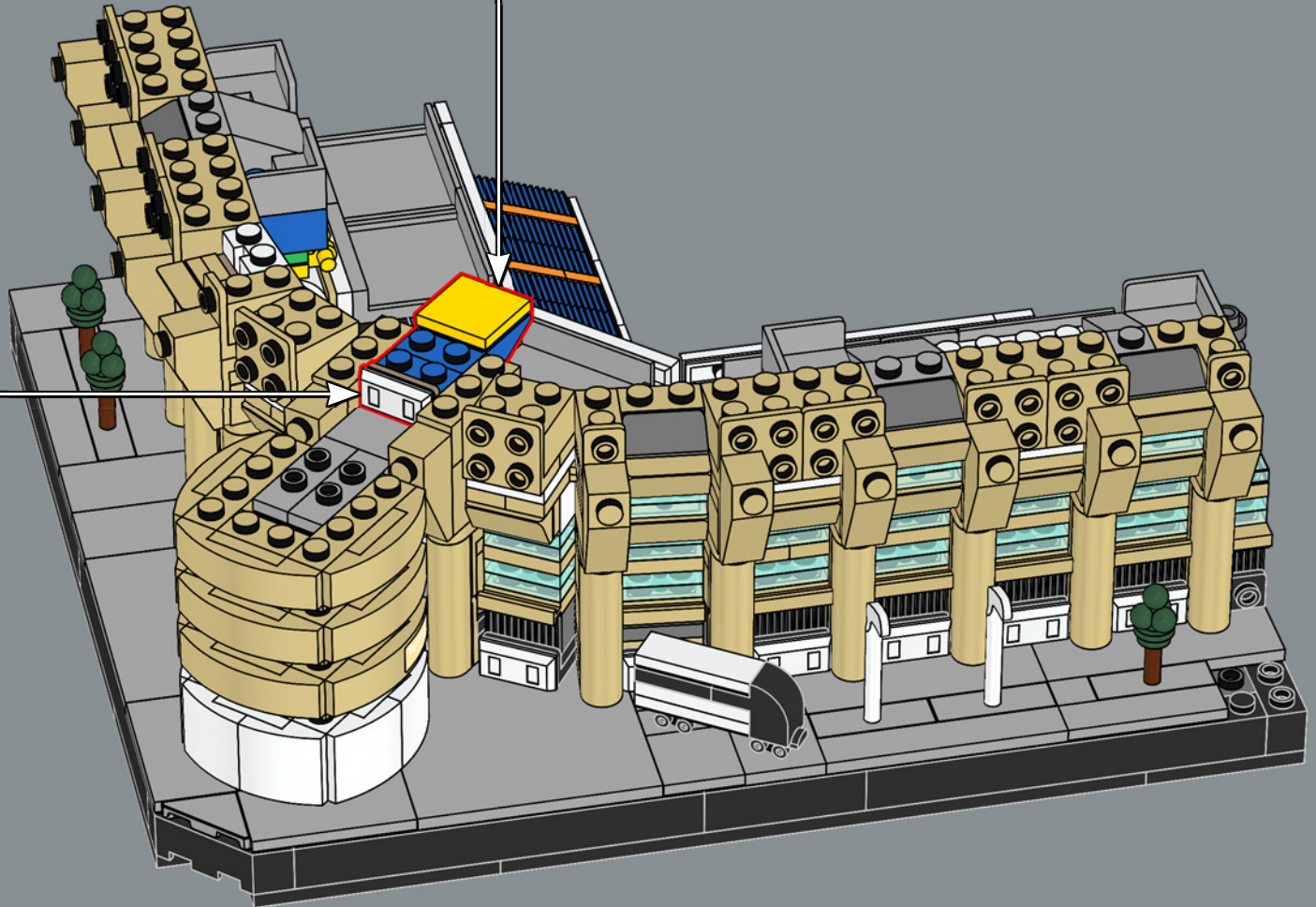
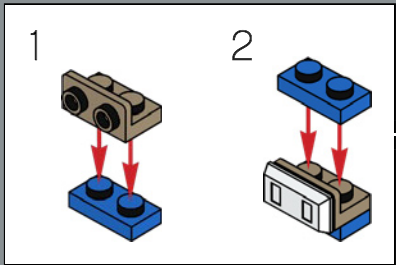
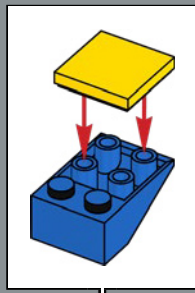

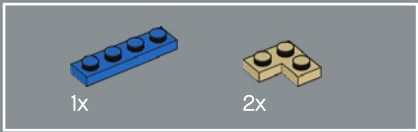

139

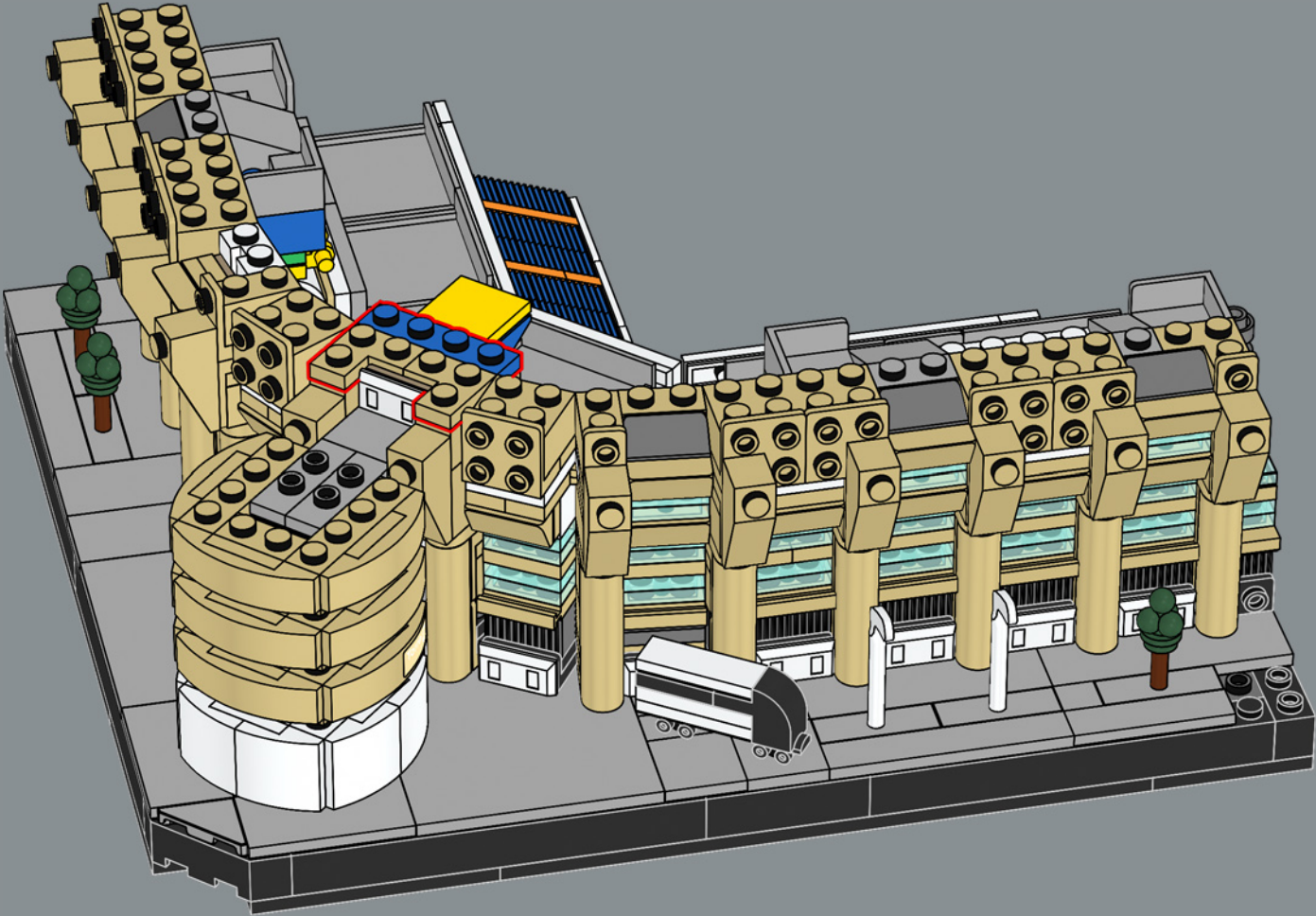

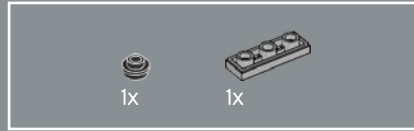
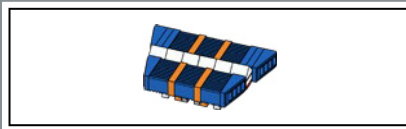
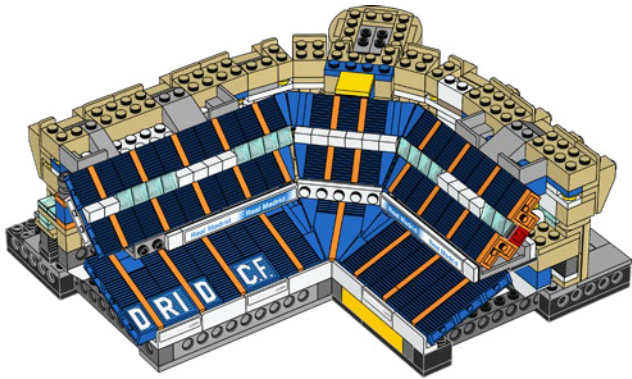
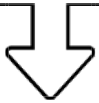

140

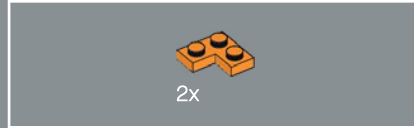
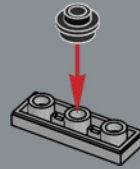

141

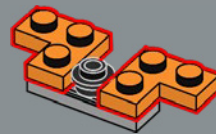

142

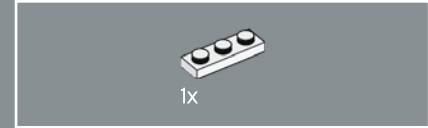
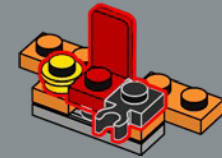

143

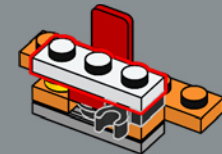

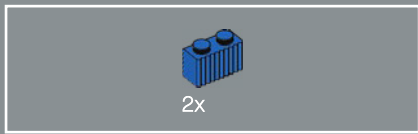

144

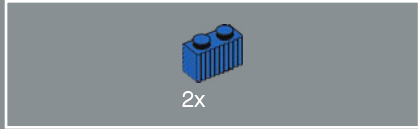
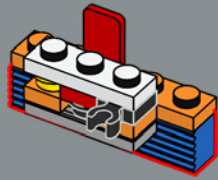

145

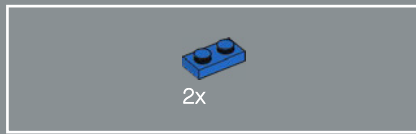
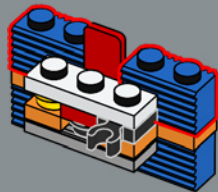

146

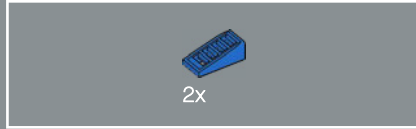
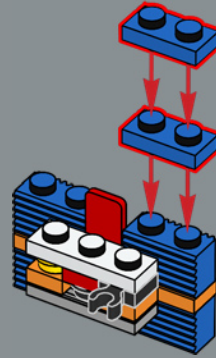

147

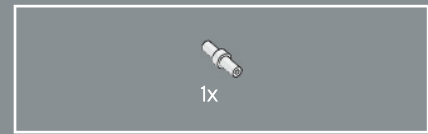
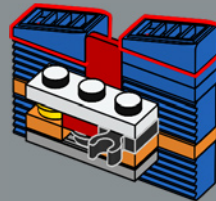

148

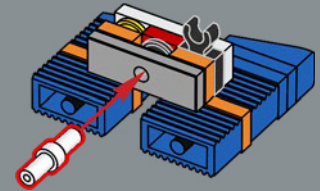

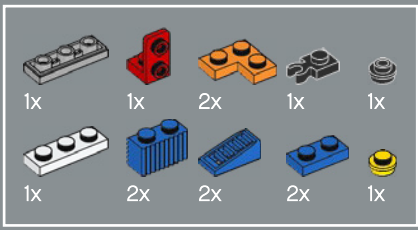

149

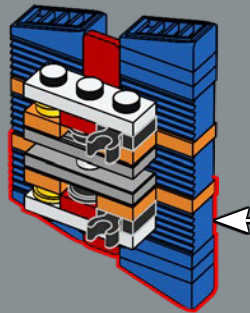
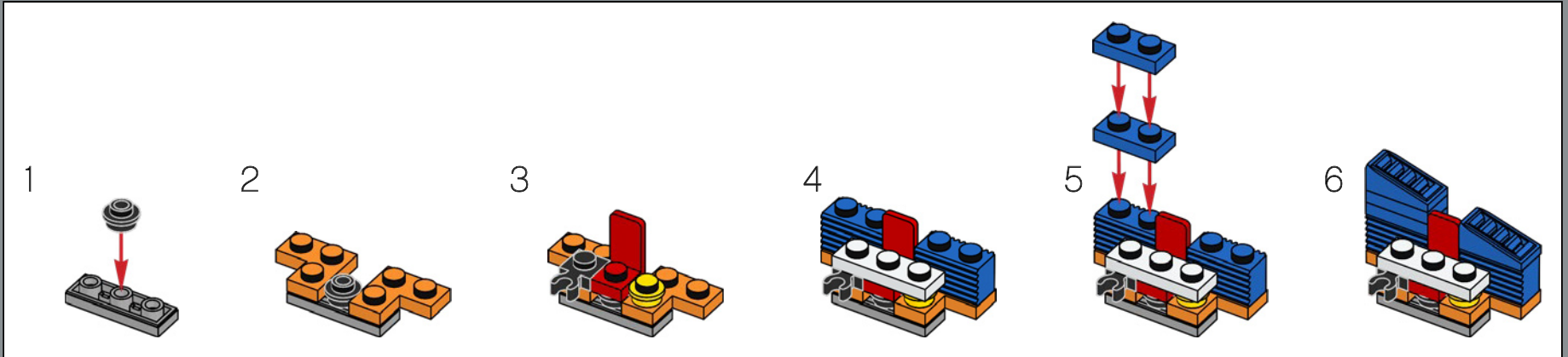

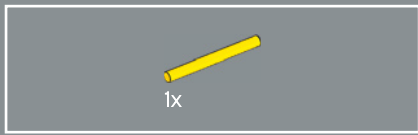

1x

150

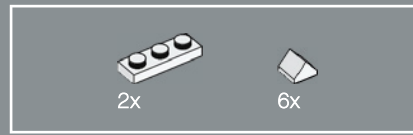
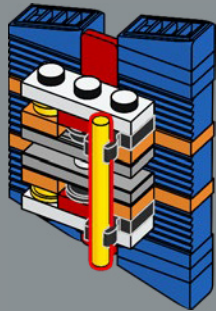

2x

6x

151

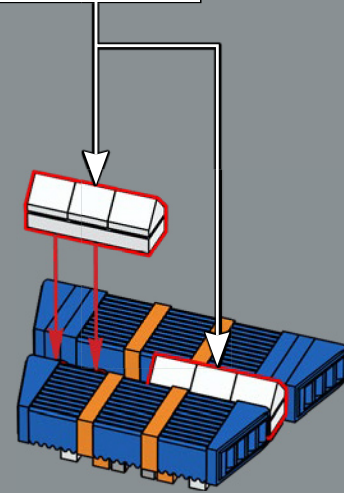
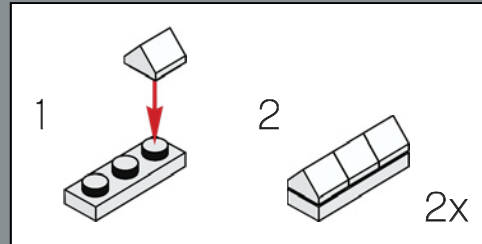

152

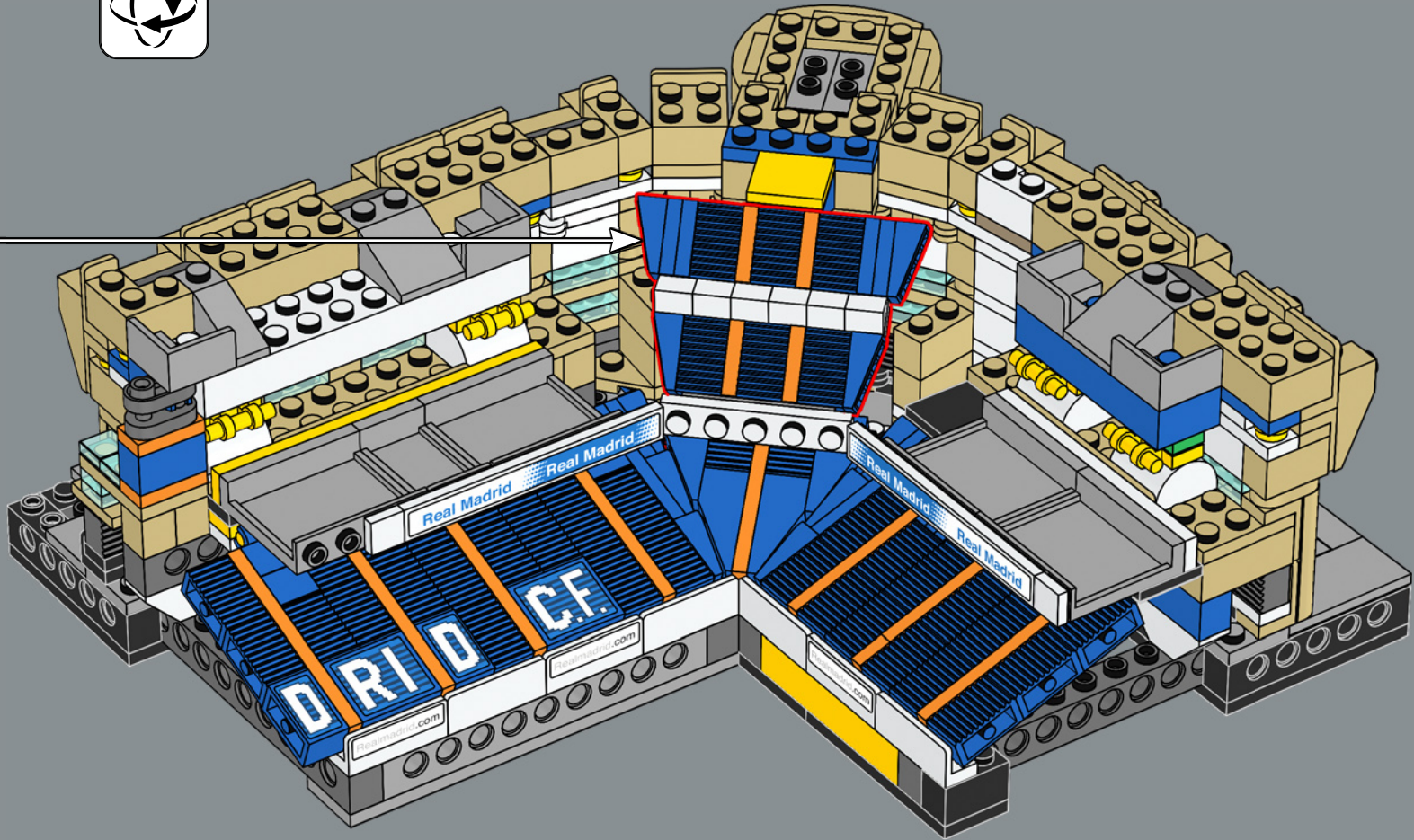

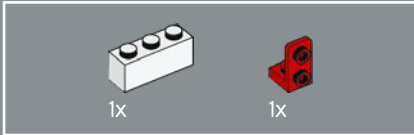
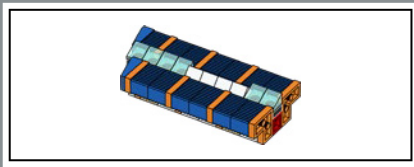

153

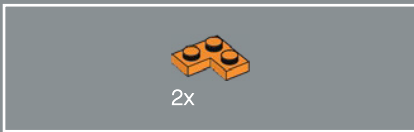
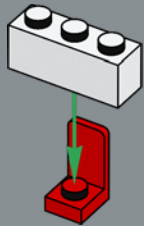

154

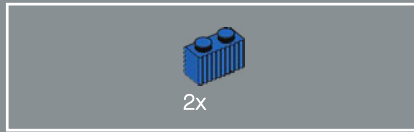
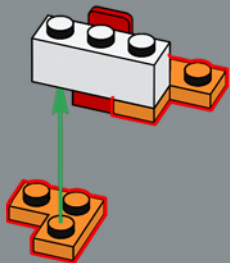

155

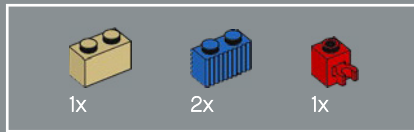
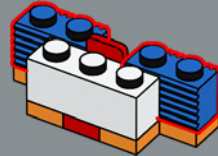

156

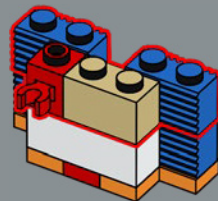

157

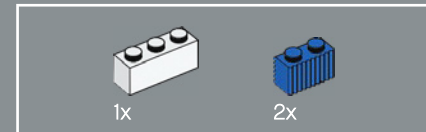
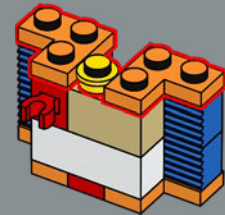

158

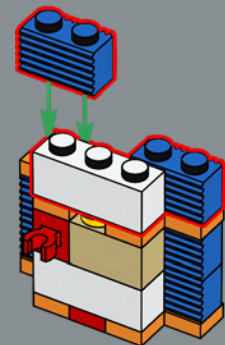

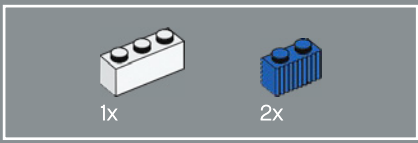

159

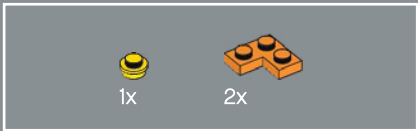
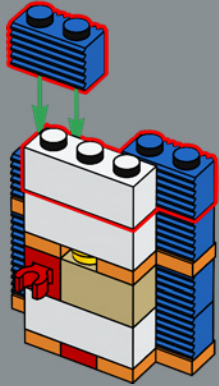

160

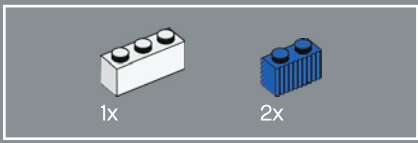
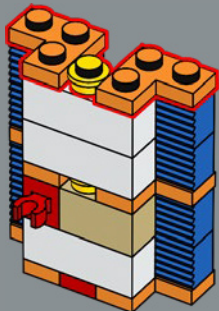

161

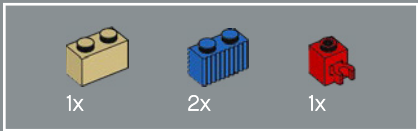
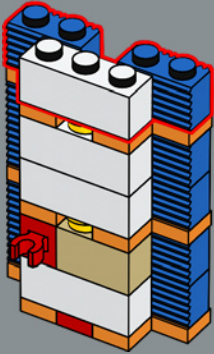

162

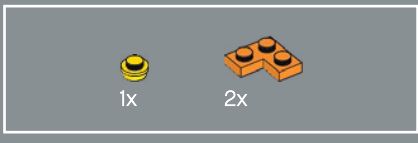
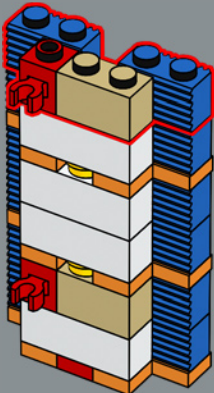

163

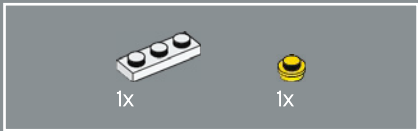
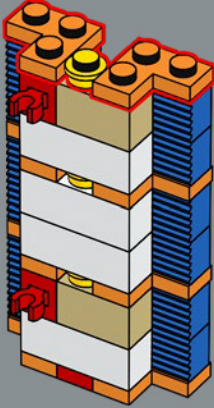

164

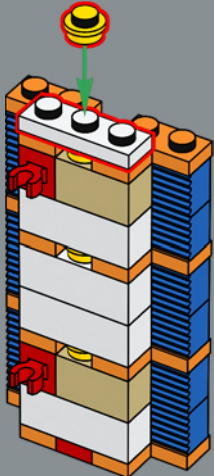

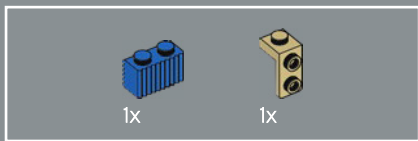

165

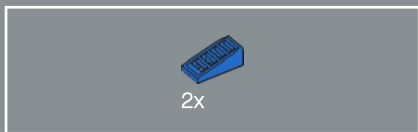
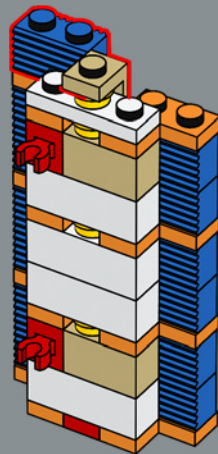

166

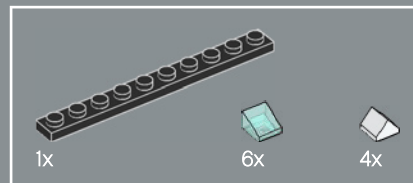
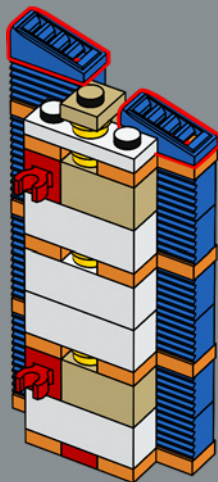

167

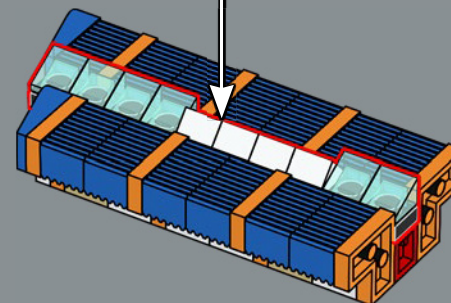
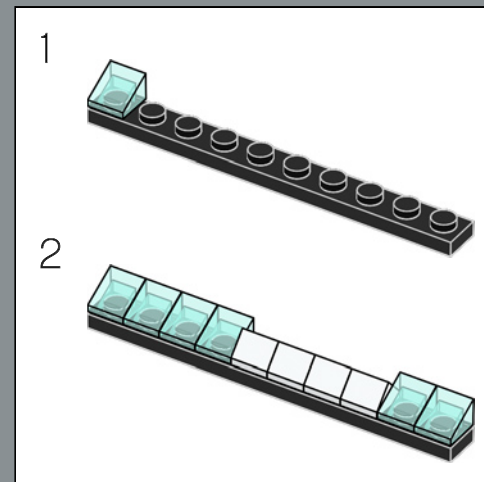

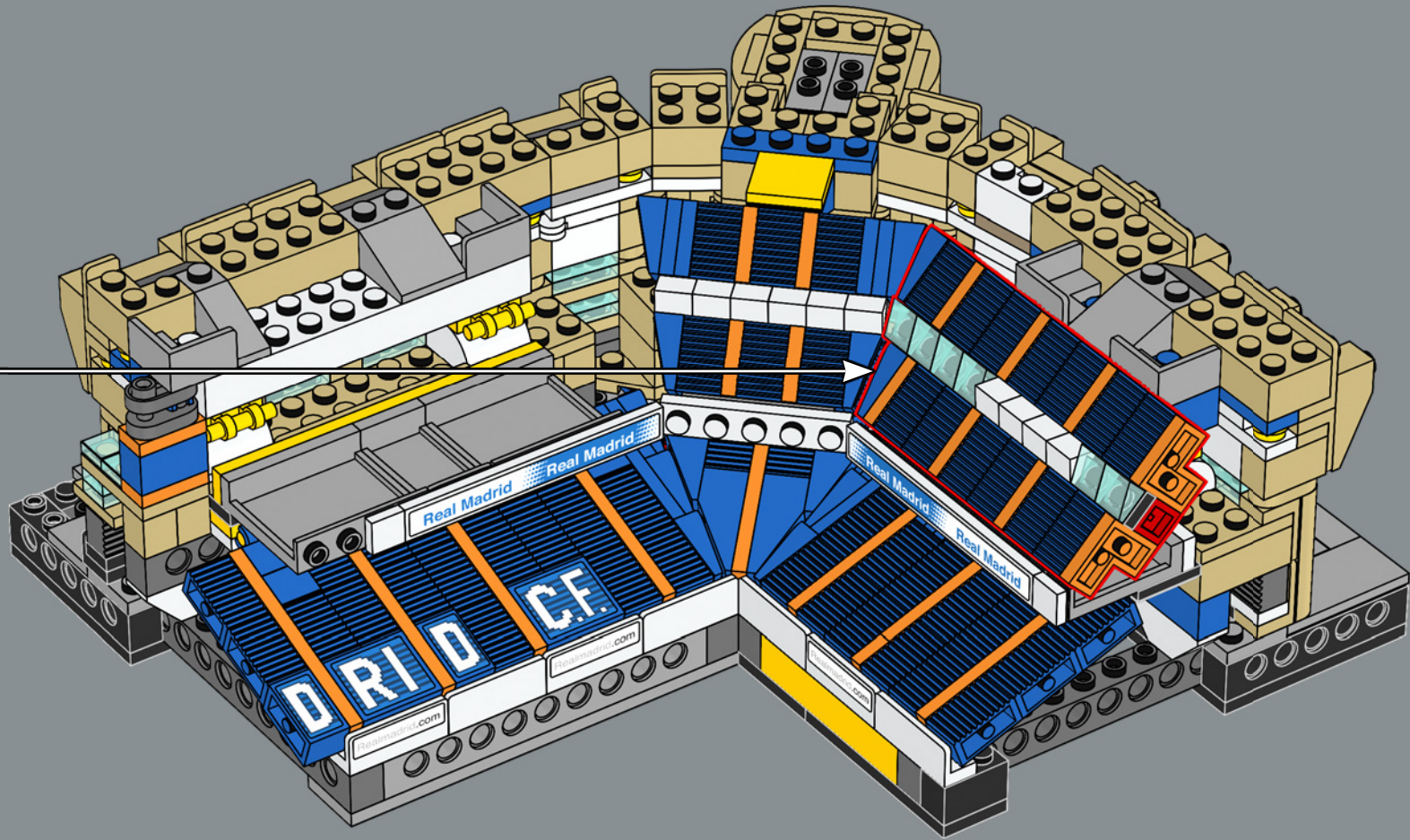

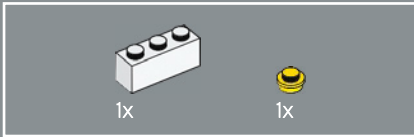
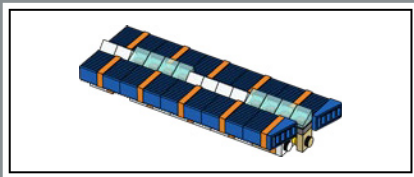

169

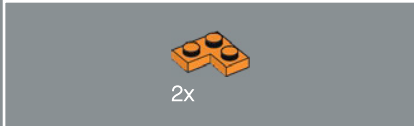
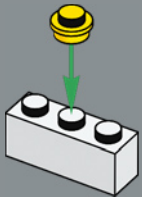

170

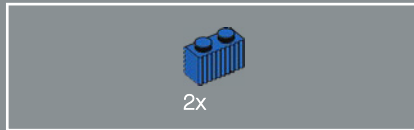
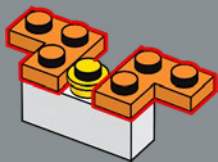

171

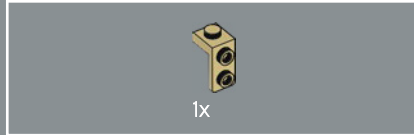
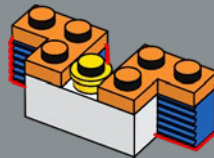

172

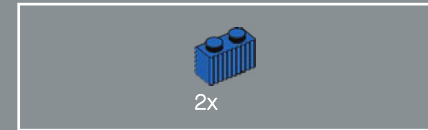
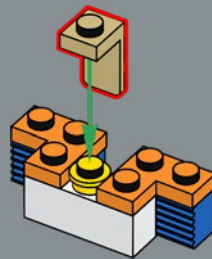

173

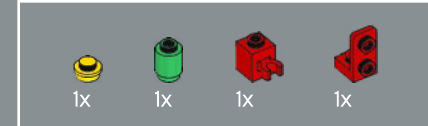
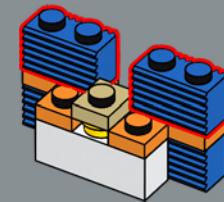

174

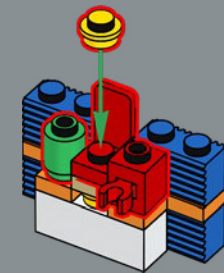

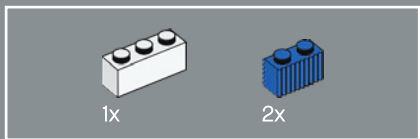

175

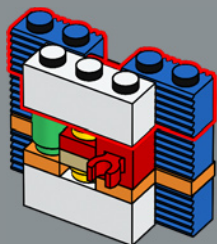

176

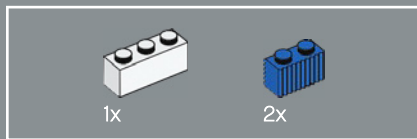
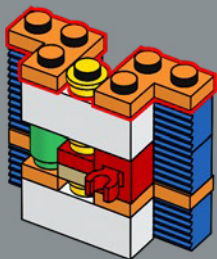

177

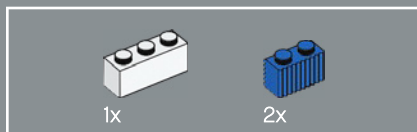
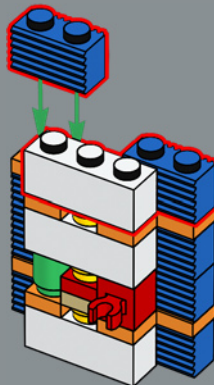

178

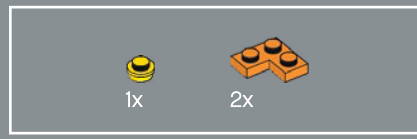
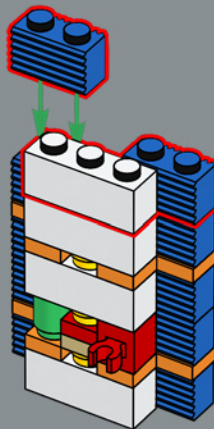

179

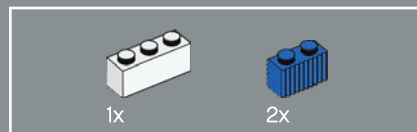
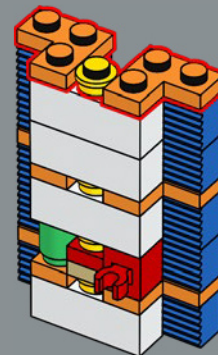

180

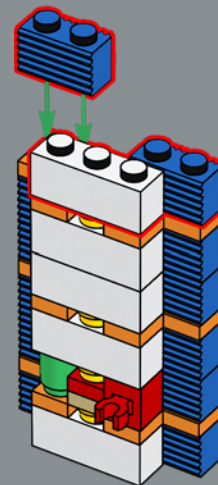

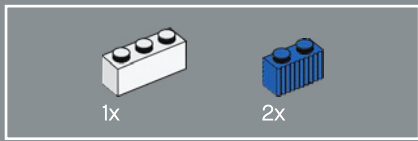

181

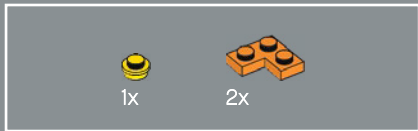
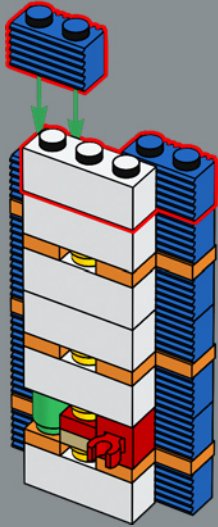

182

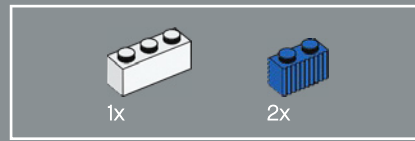
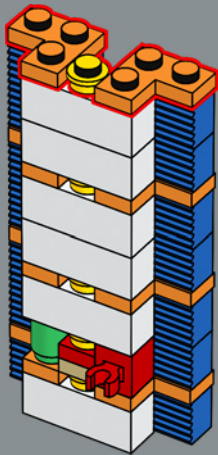

183

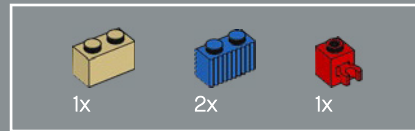
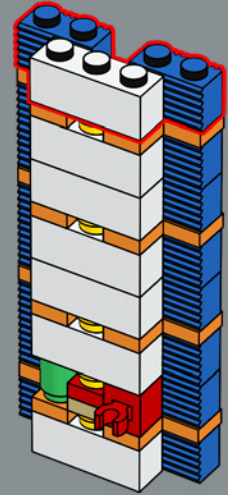

184

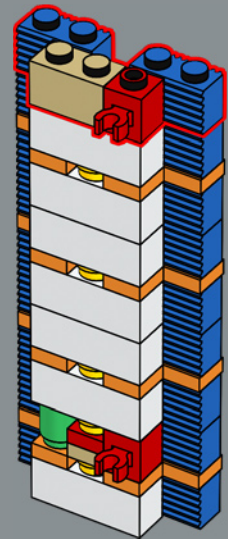



185

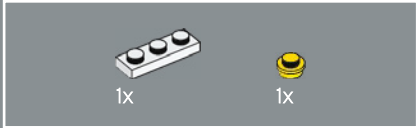
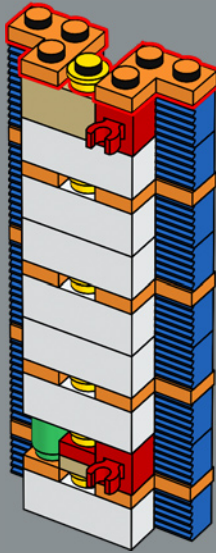

186

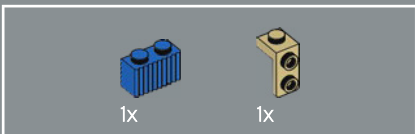
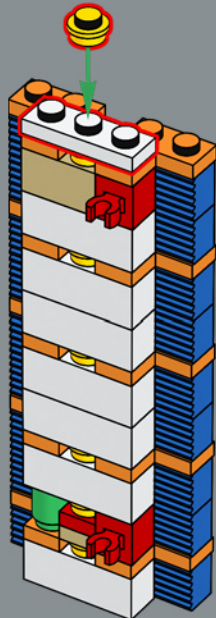

187

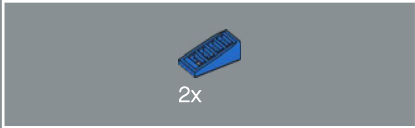
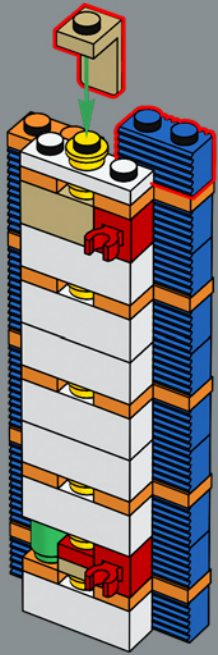

188

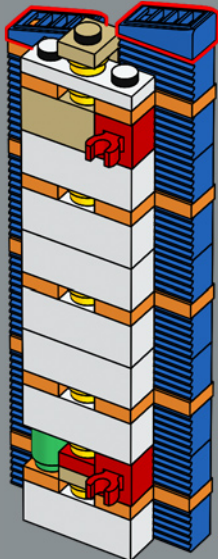

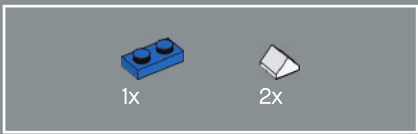

189

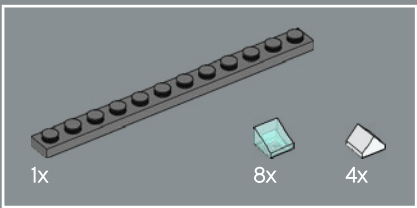
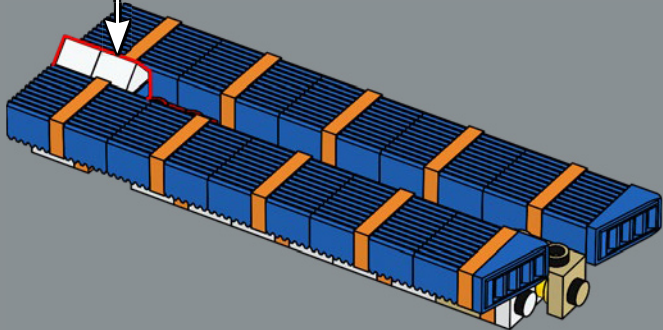
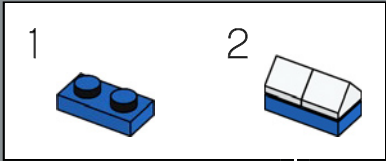

190

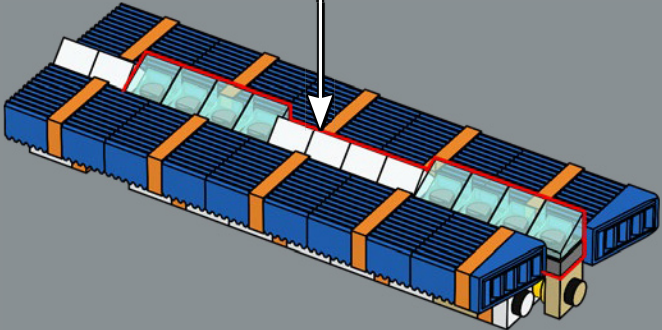
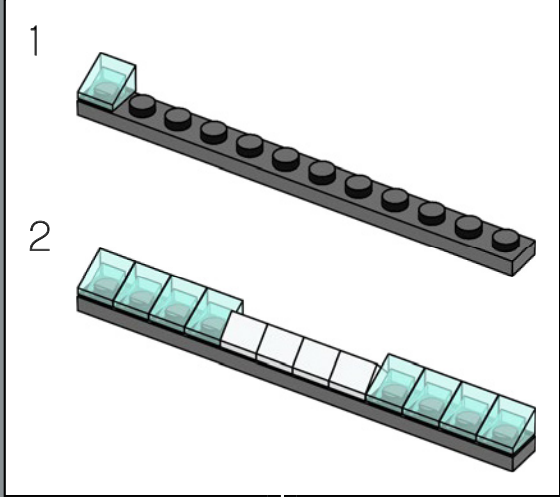

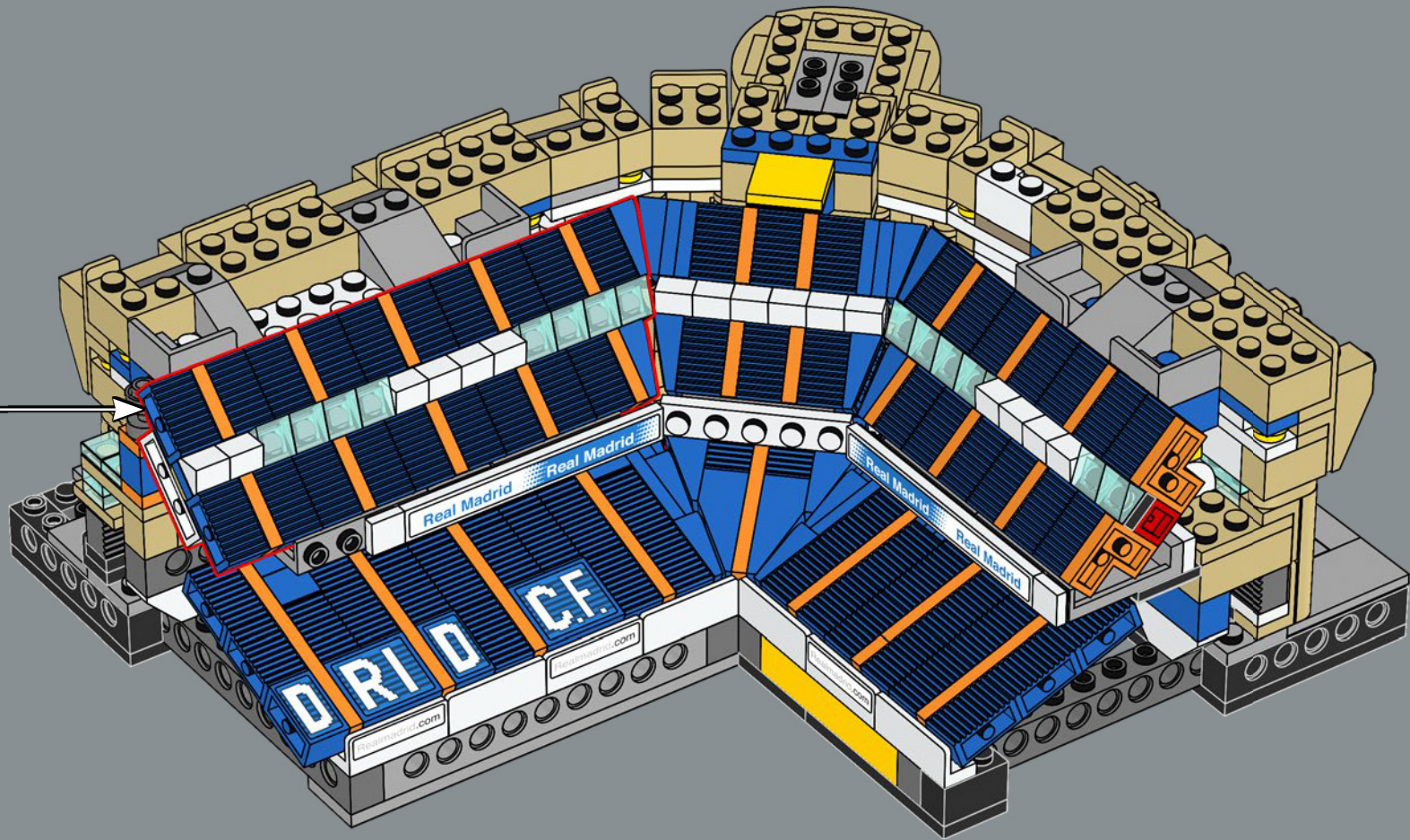

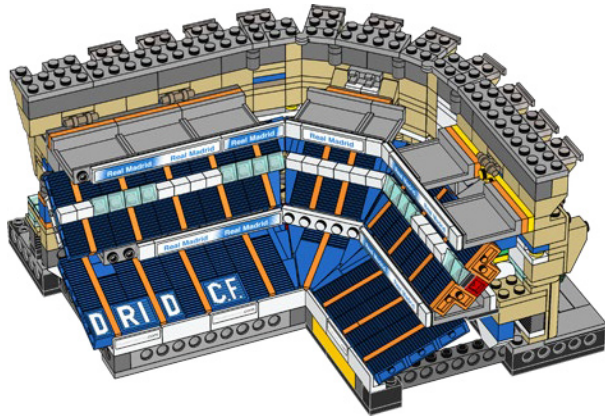
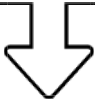

192

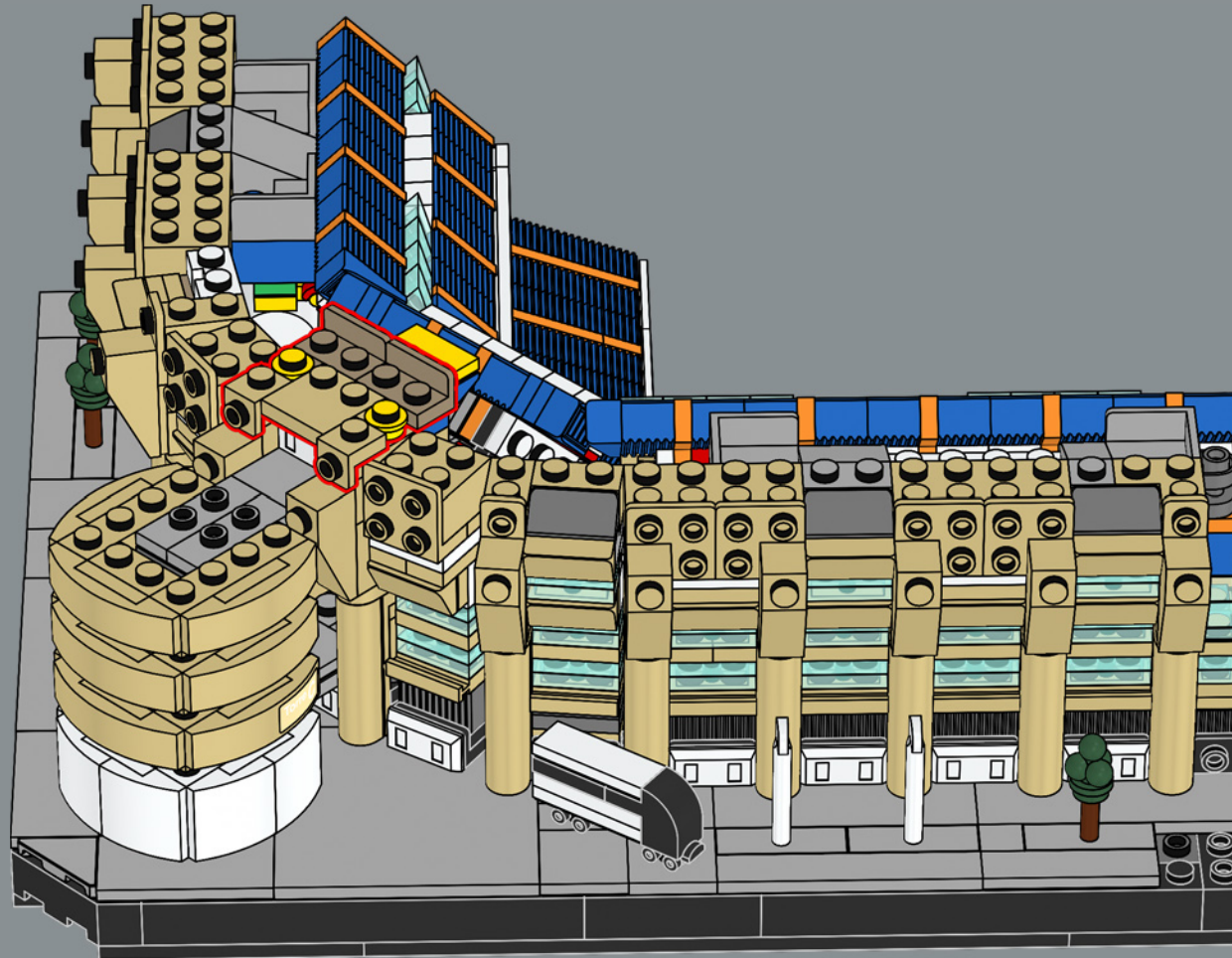



2x

193

In the decade between 1920 and 1930, the club had to relocate twice to accommodate its growing fanbase.

Entre 1920 et 1930, le club a dû déménager deux fois pour accueillir ses partisans de plus en plus nombreux.

En la década comprendida entre 1920 y 1930, el club tuvo que cambiar de sede dos veces con el fin de dar cabida a su creciente base de seguidores.

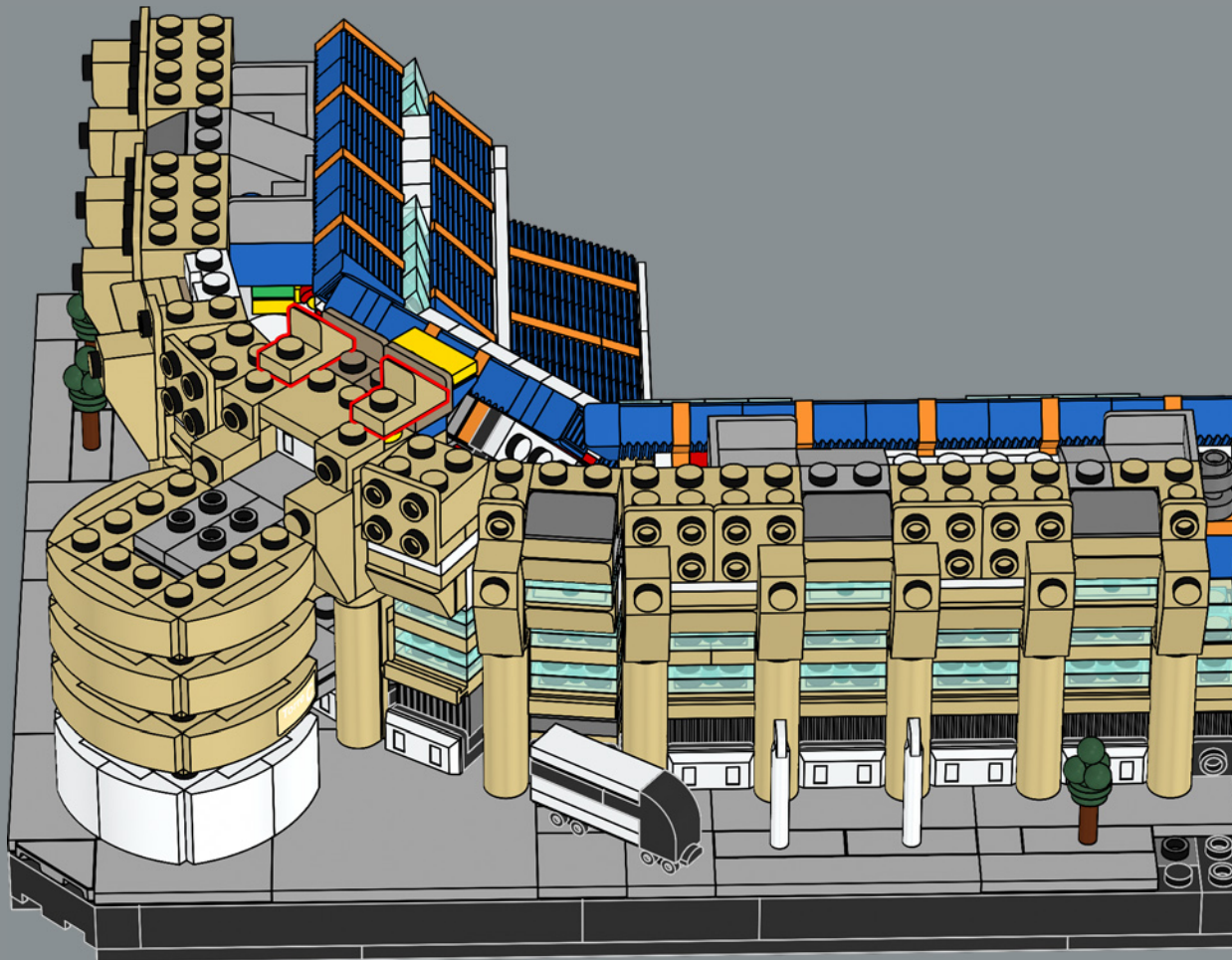

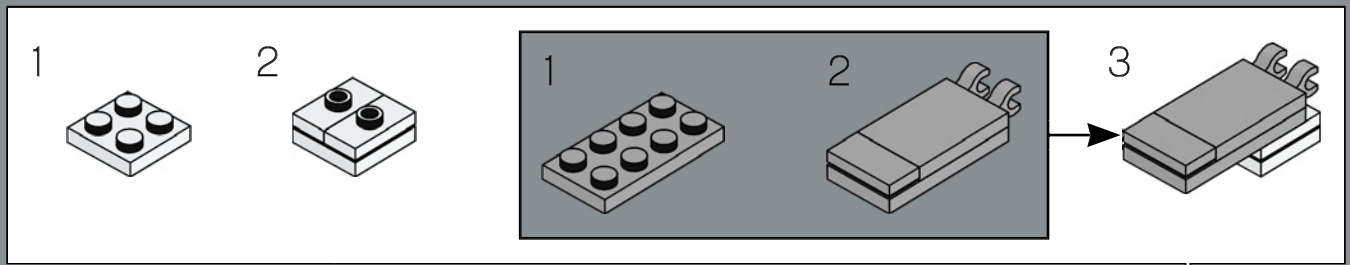
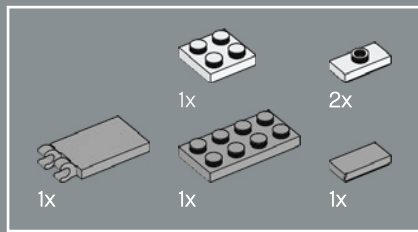

194

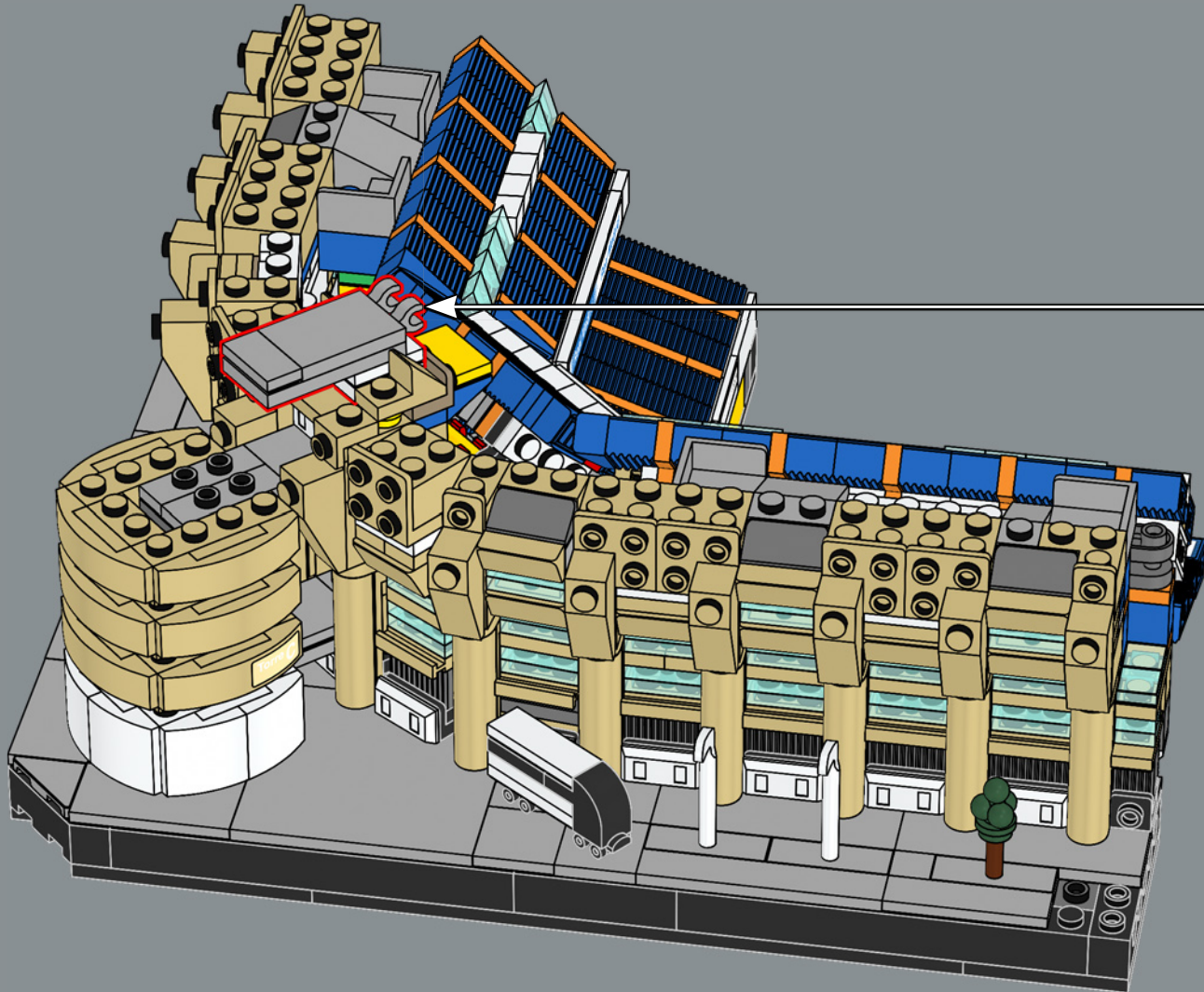

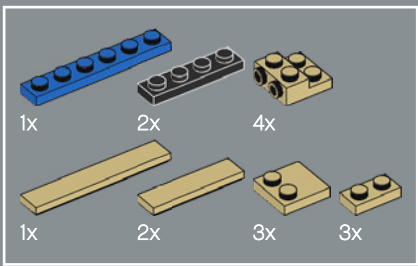

195

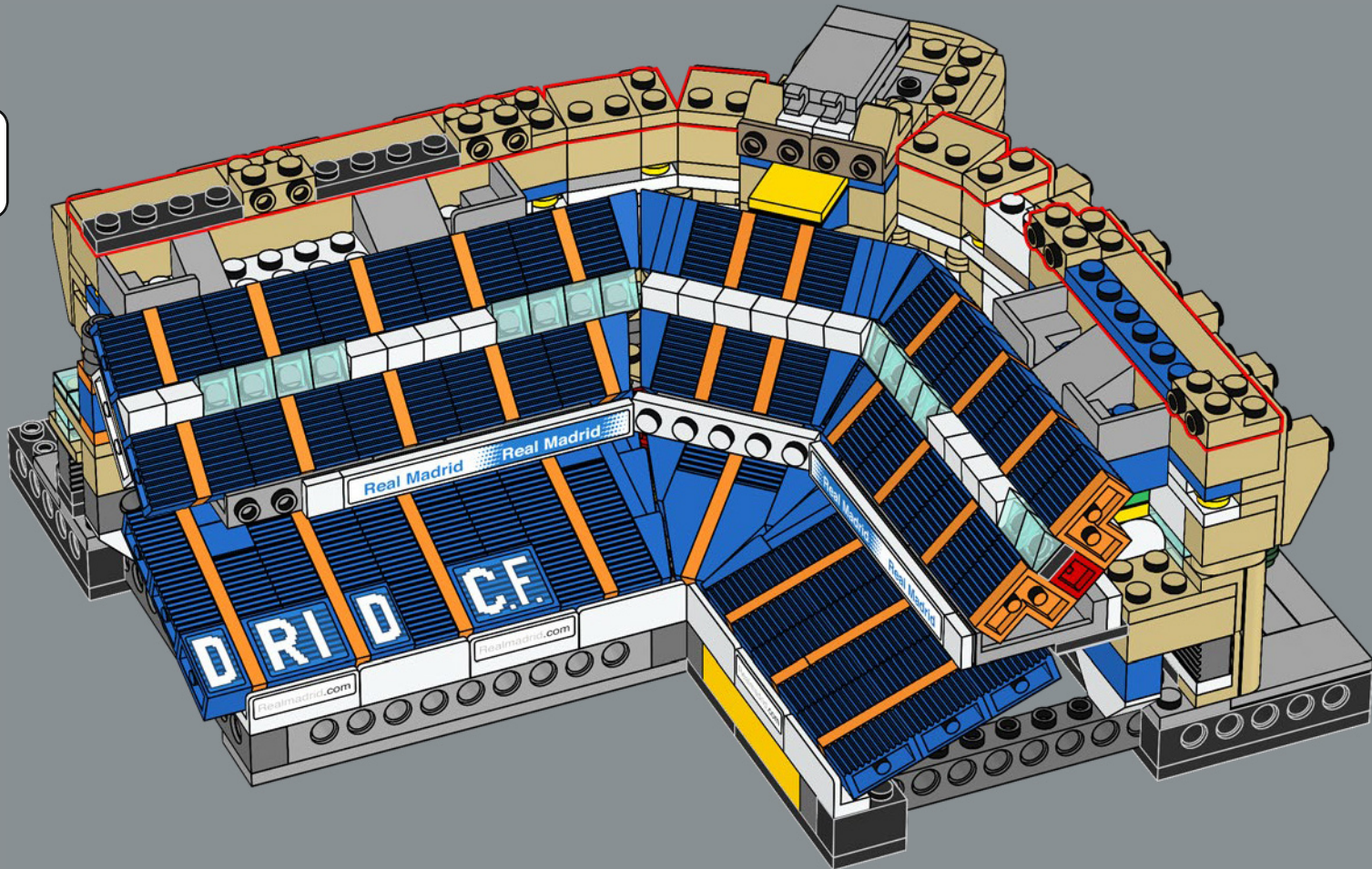

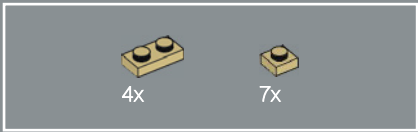

196

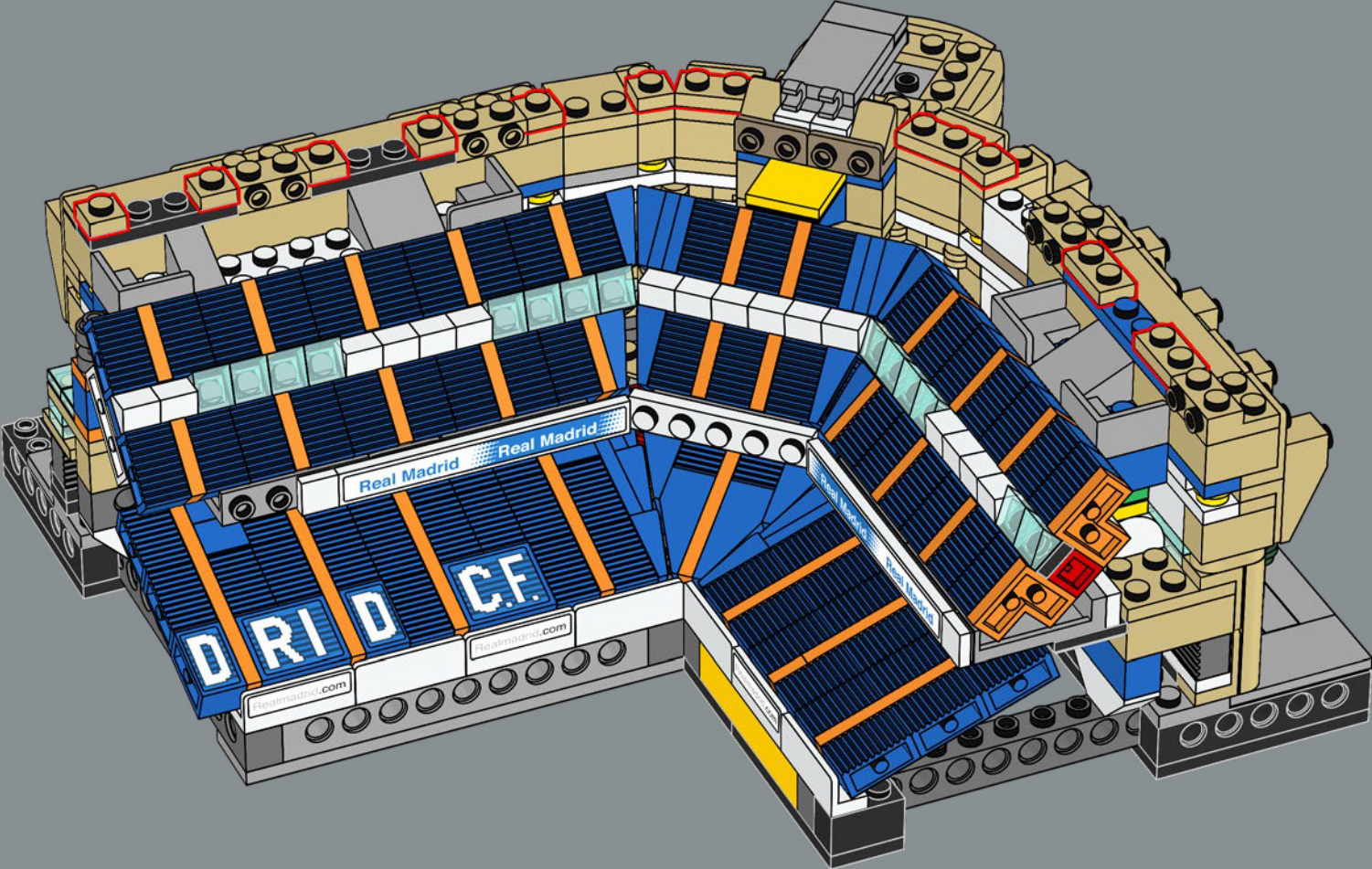

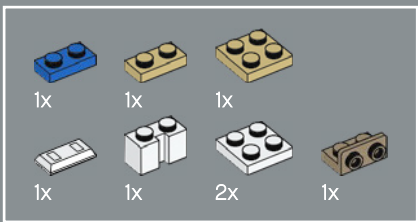

197

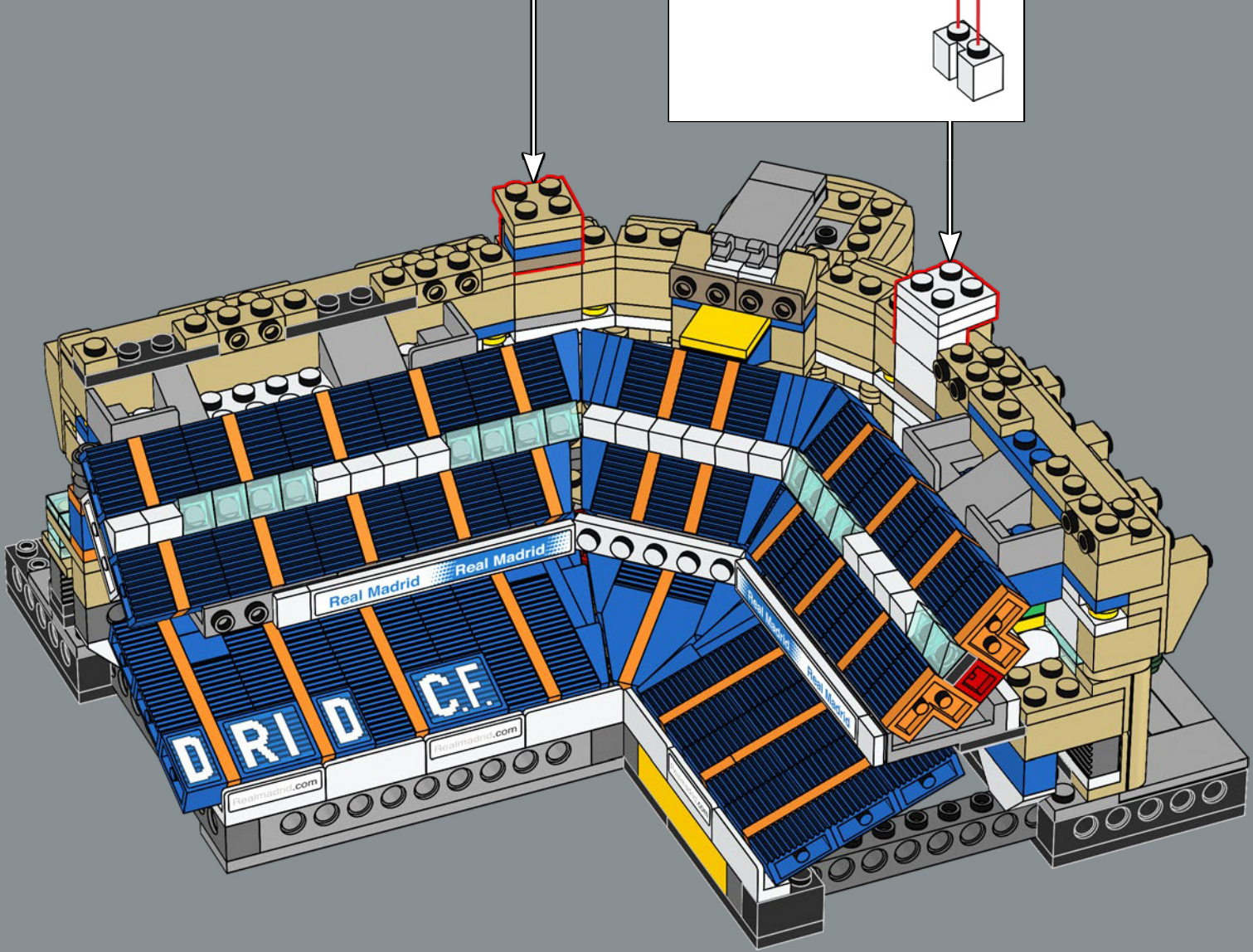
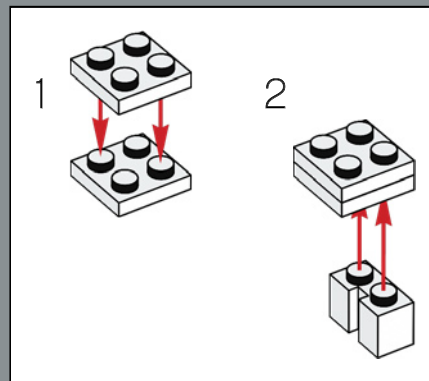
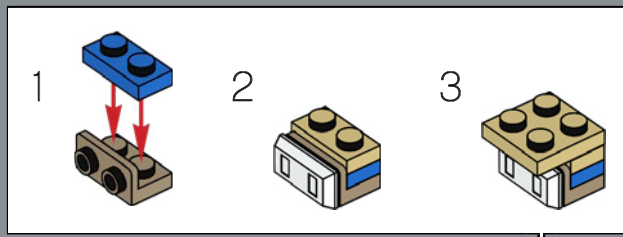



198

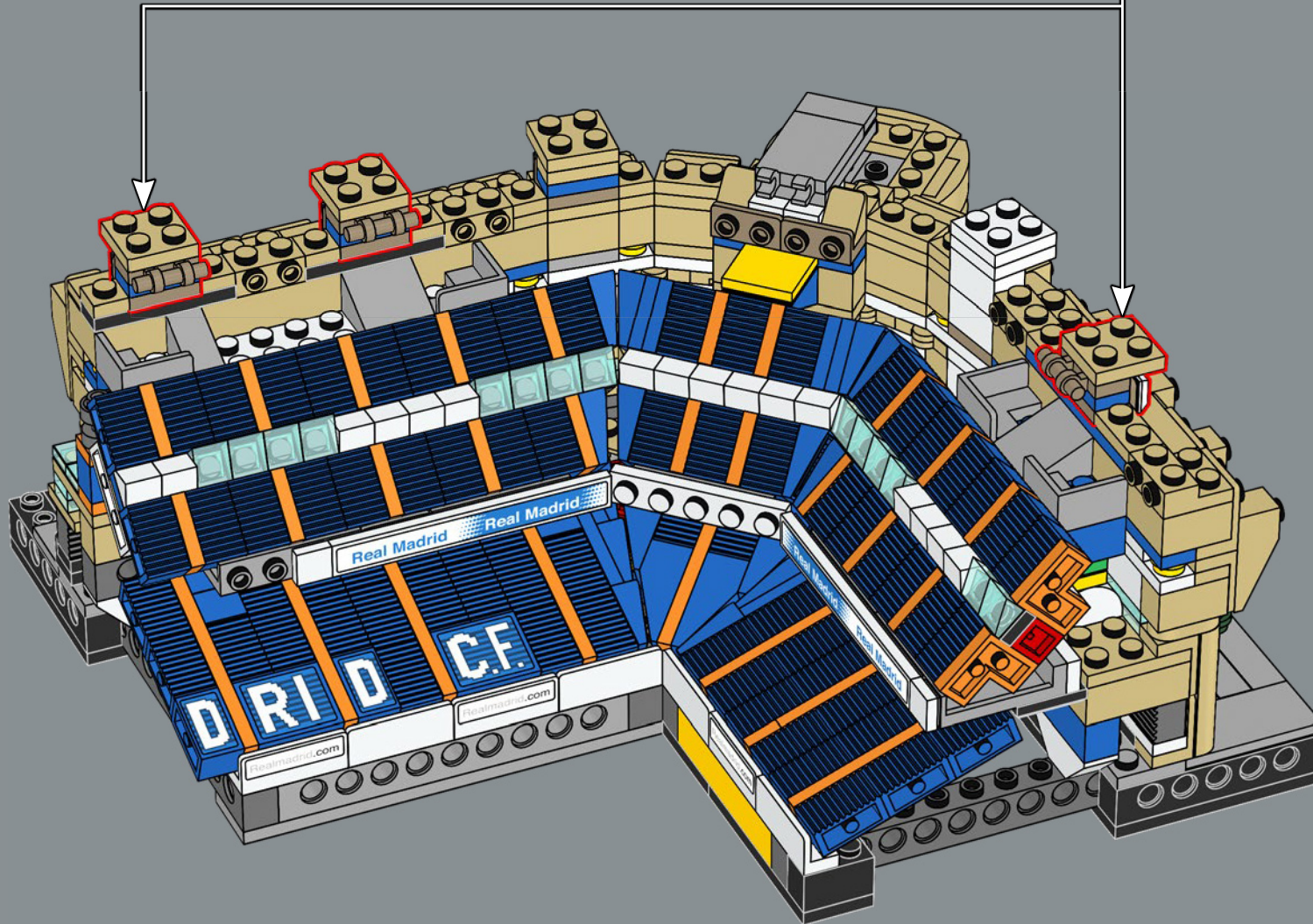
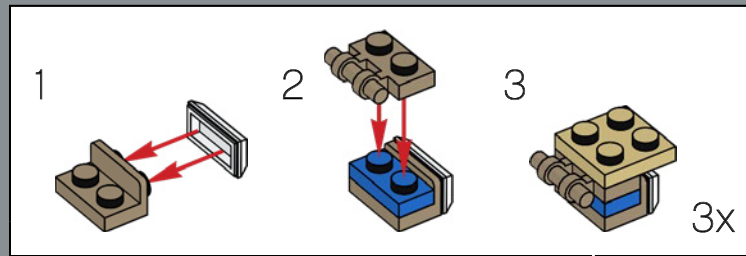

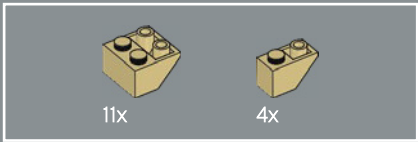

199

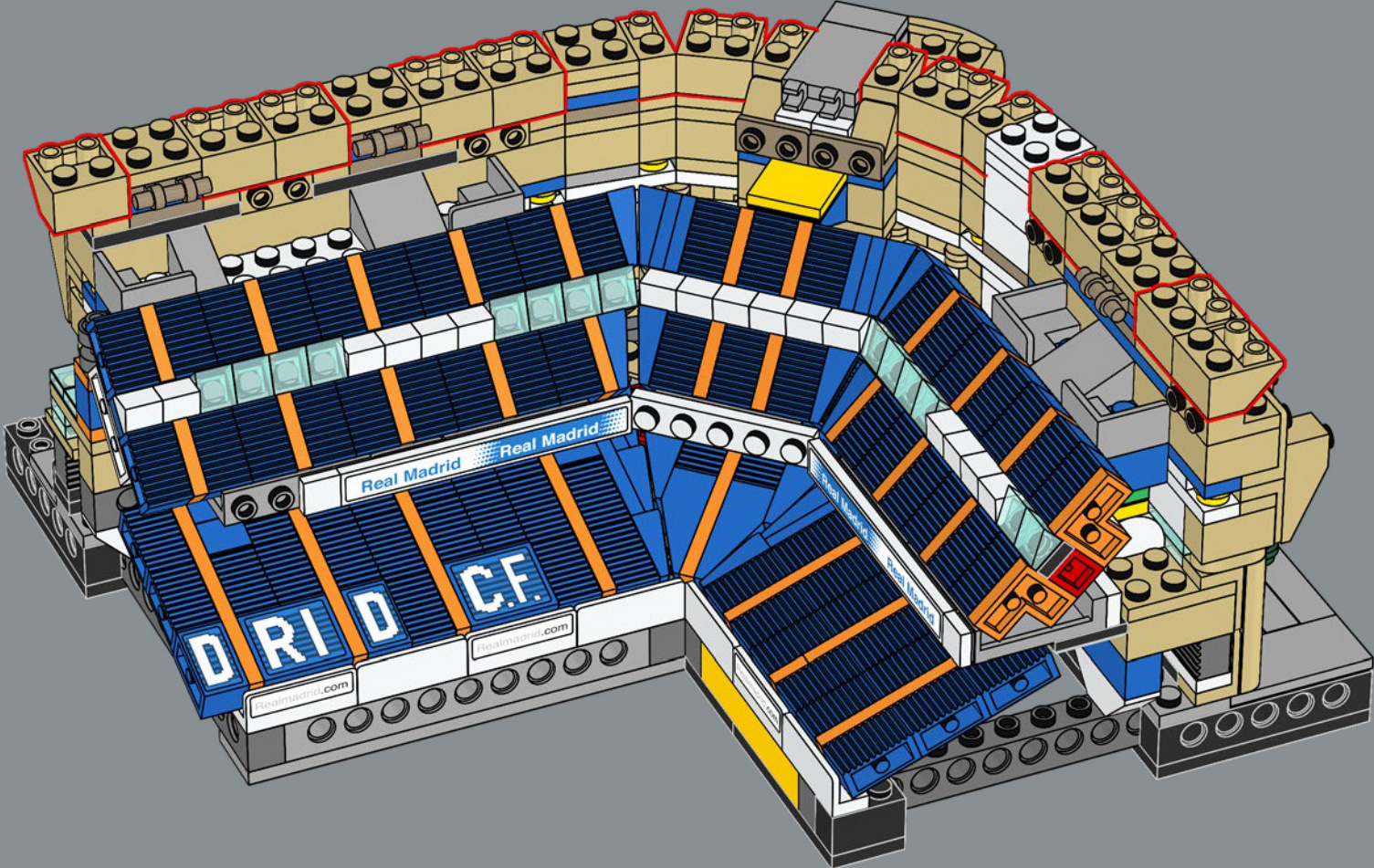

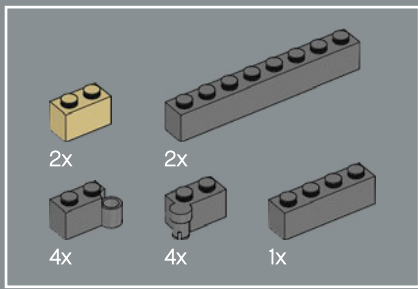

200

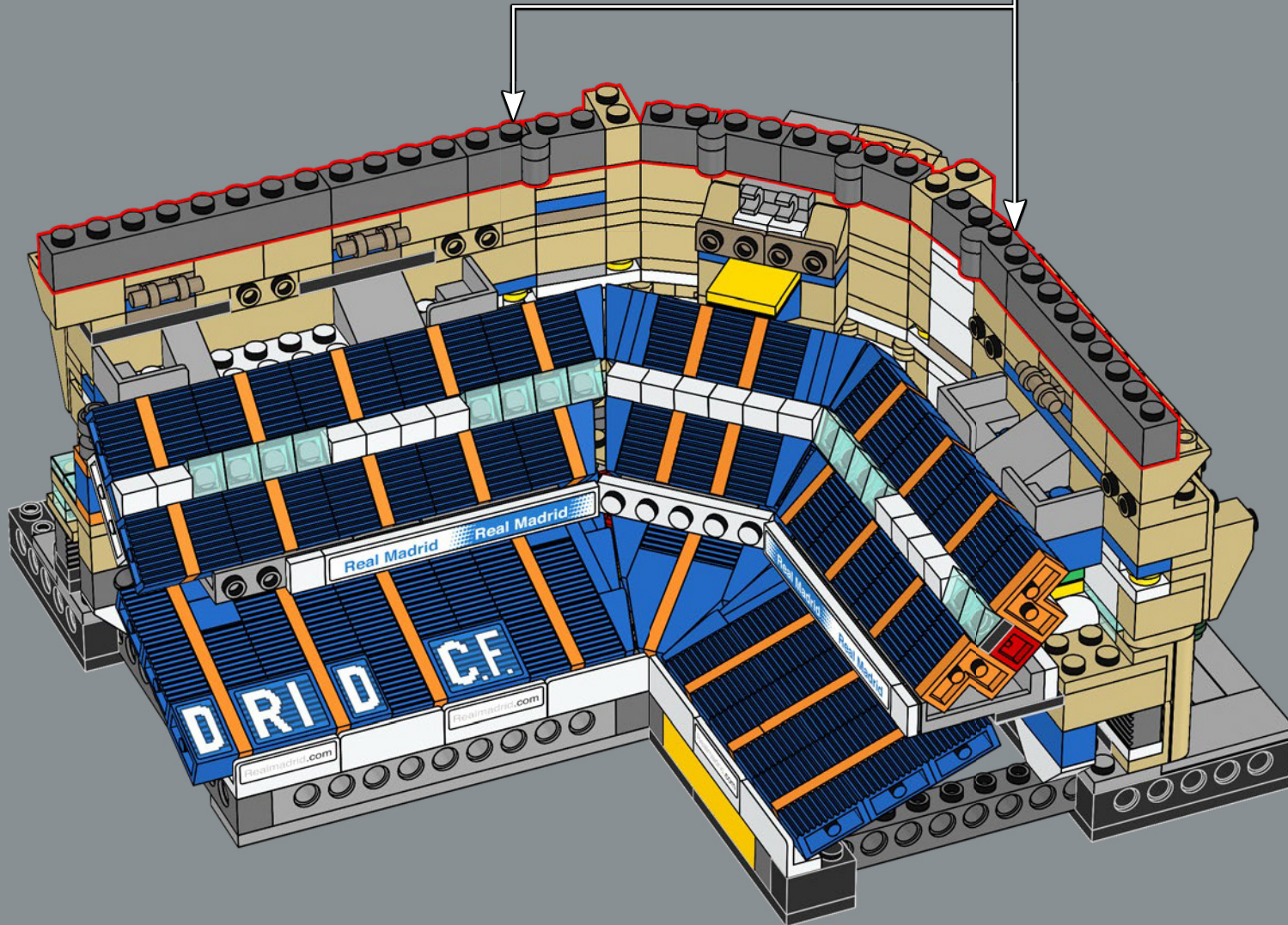
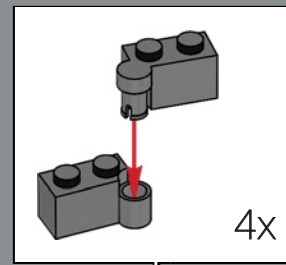

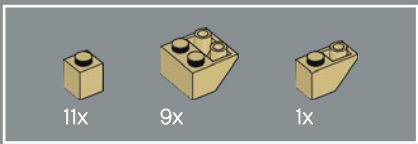

201

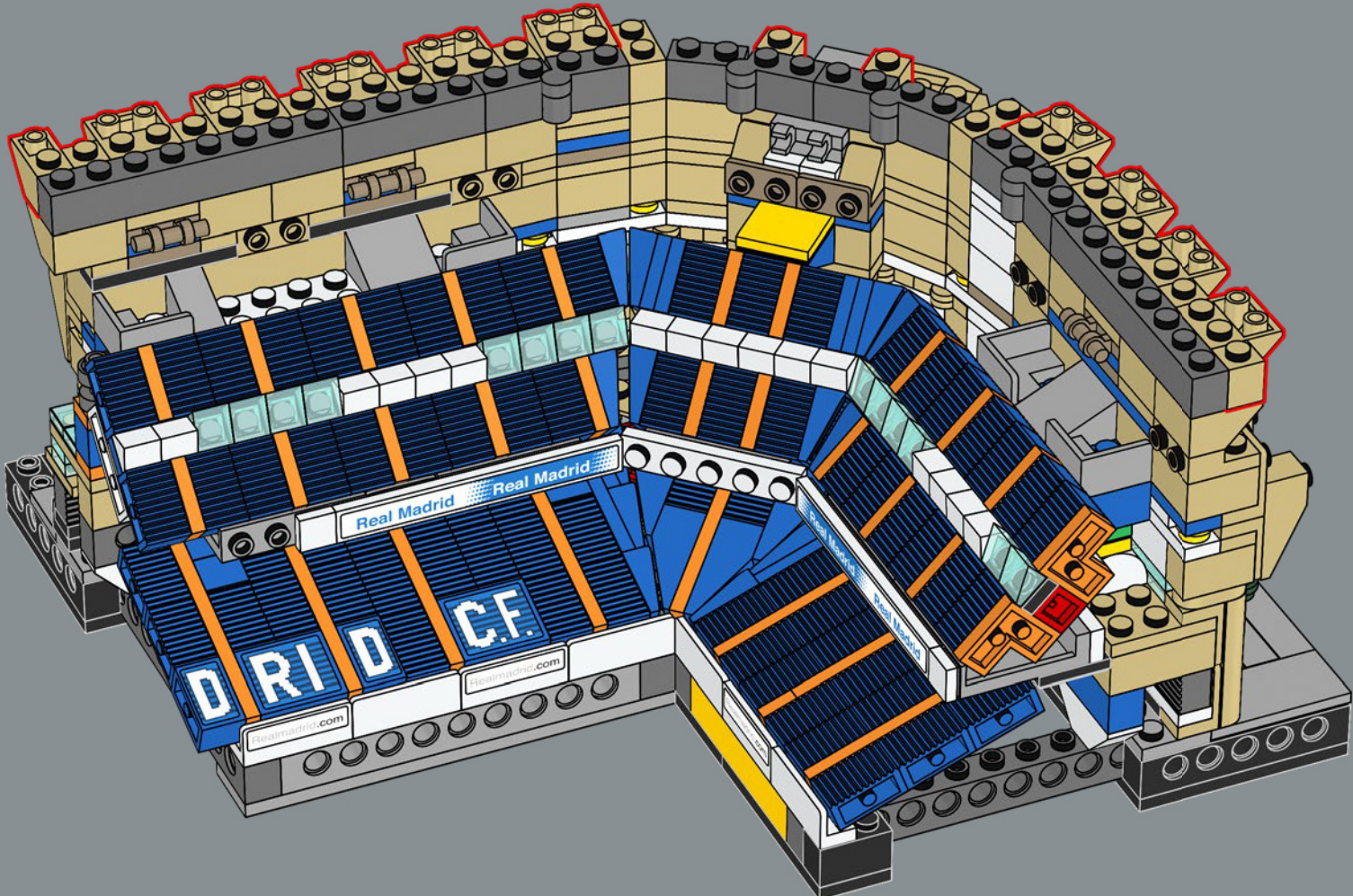

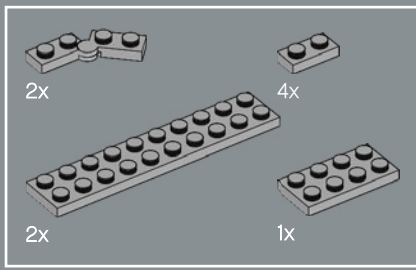

202

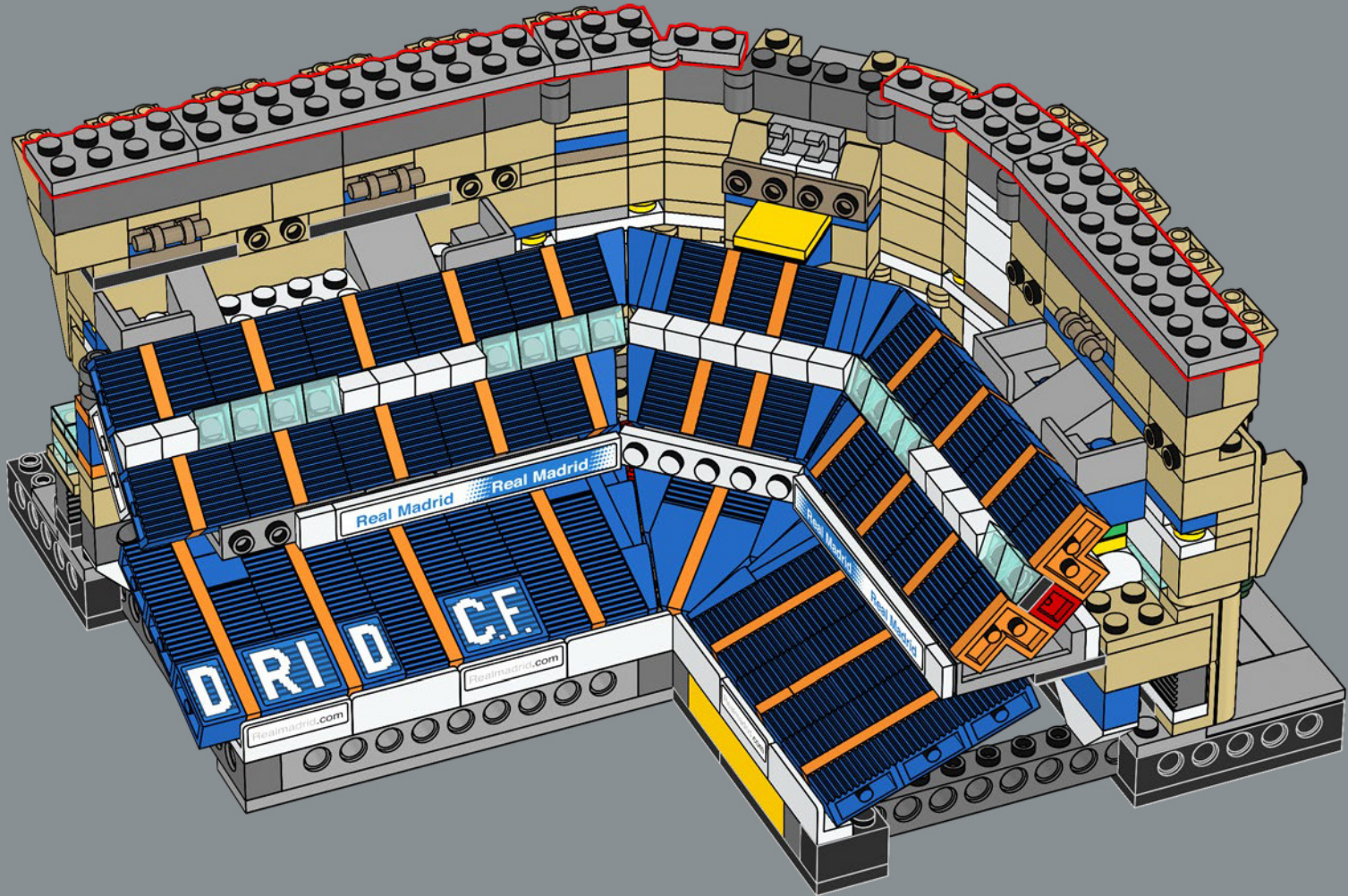

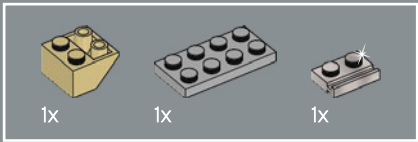

203

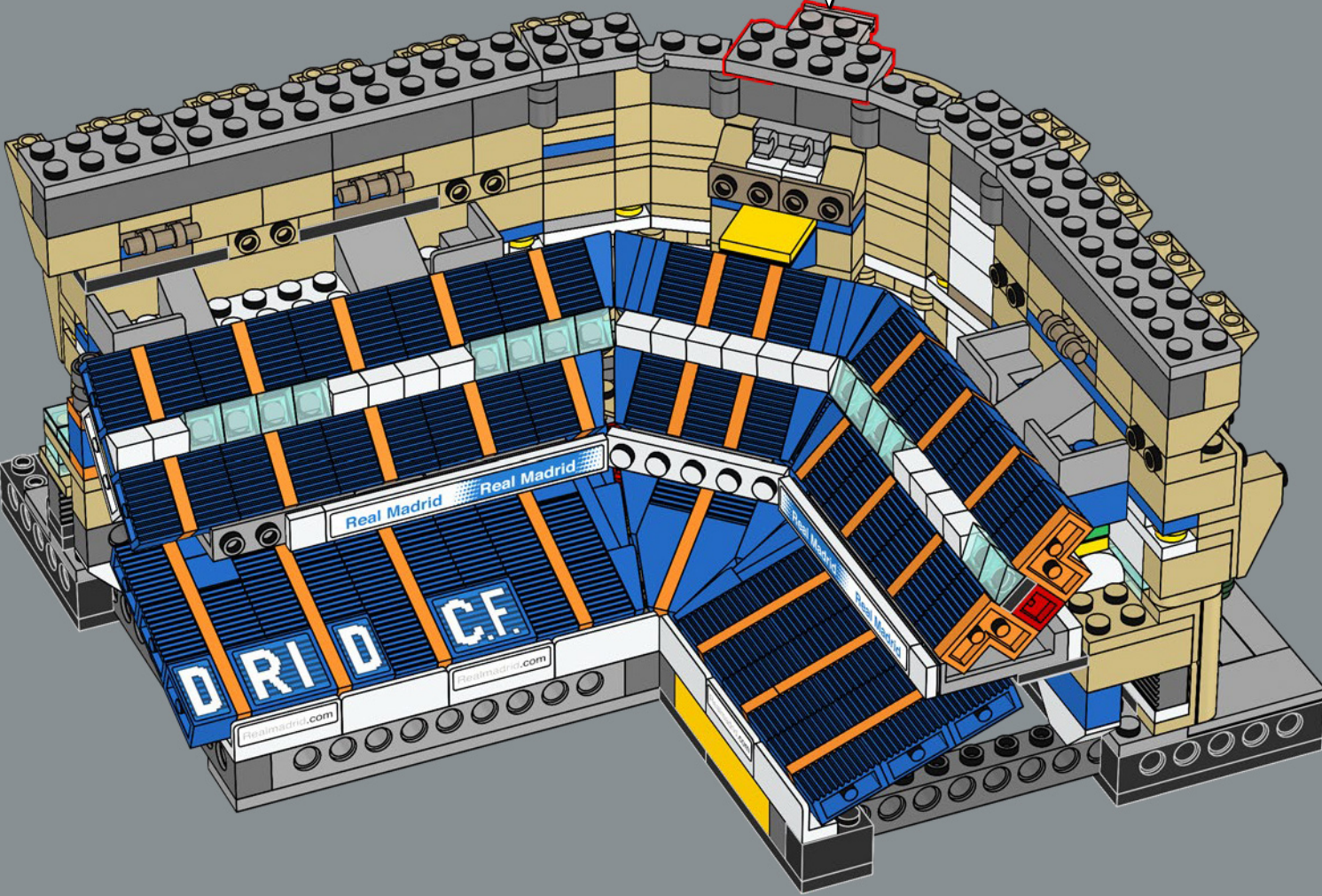
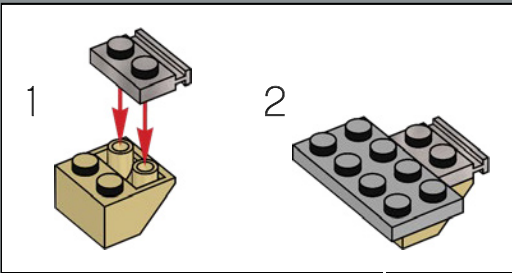

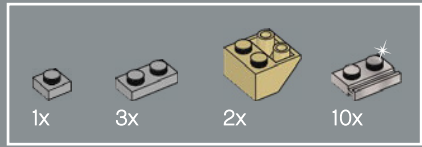

204

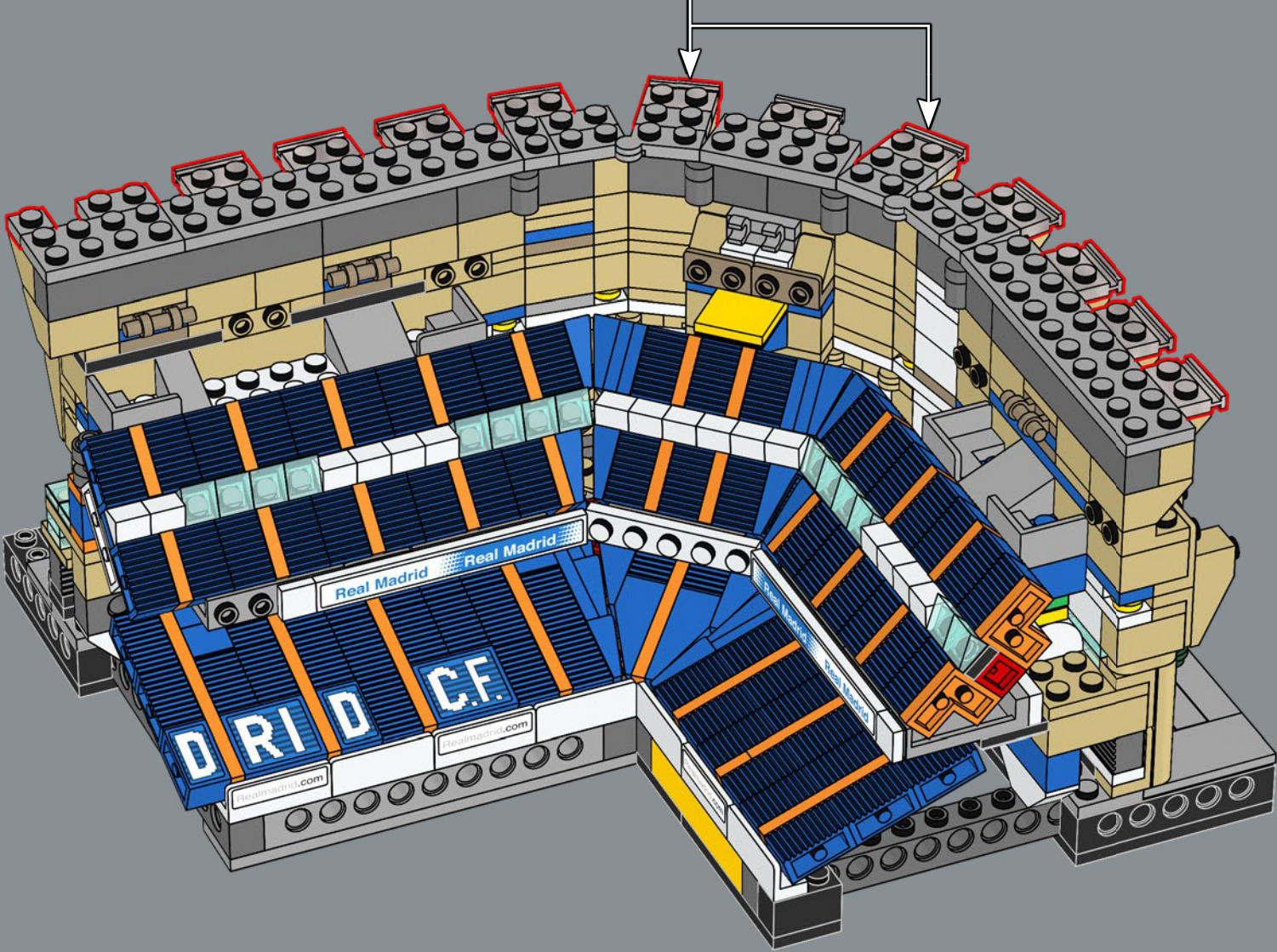
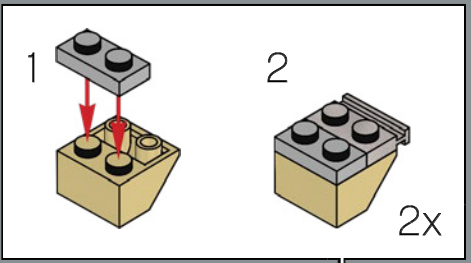

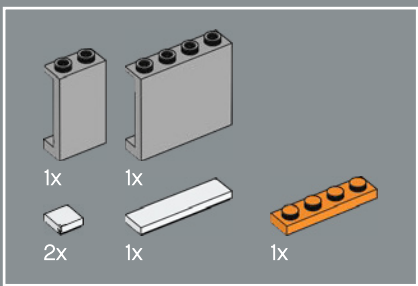

205

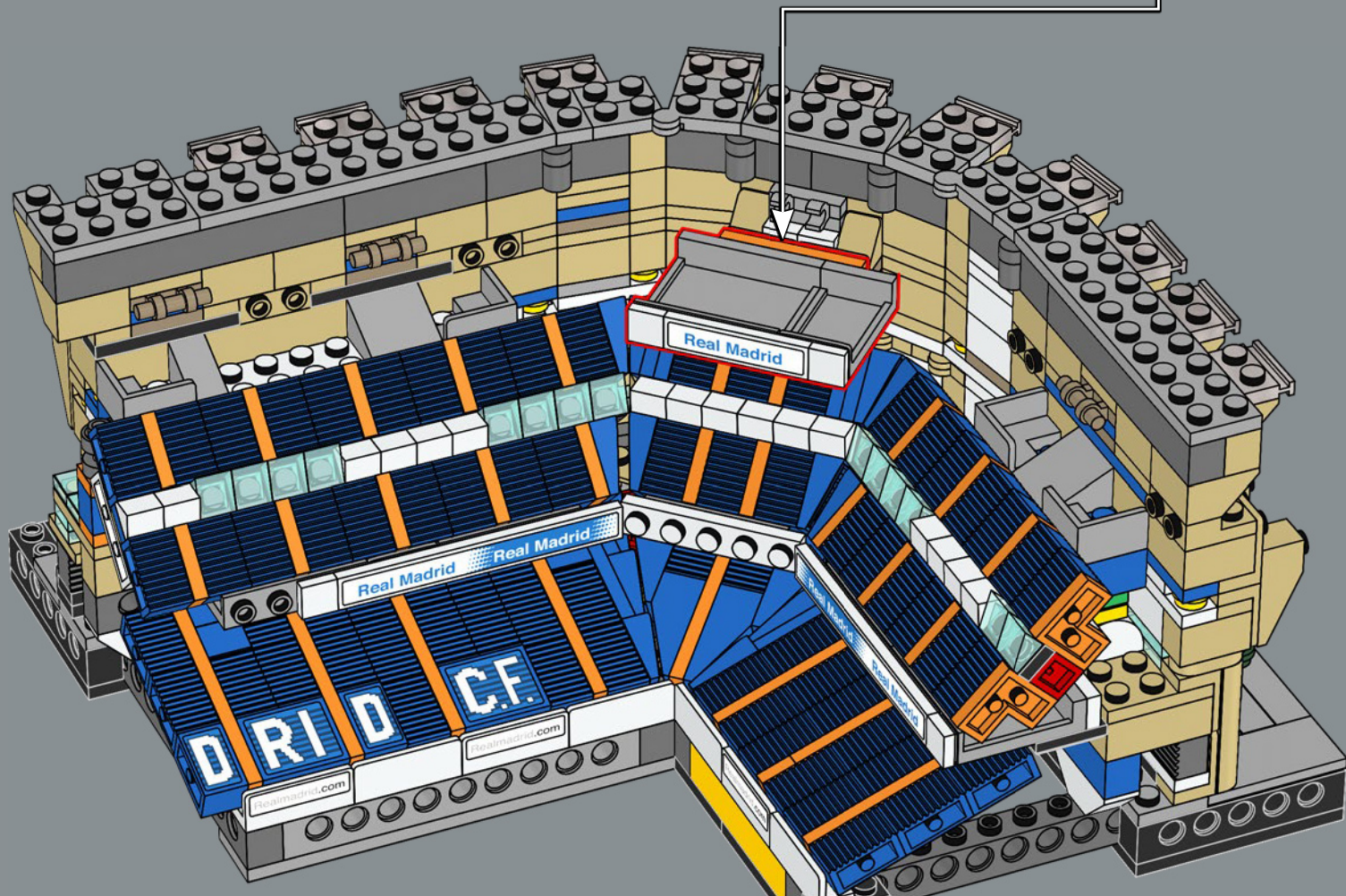
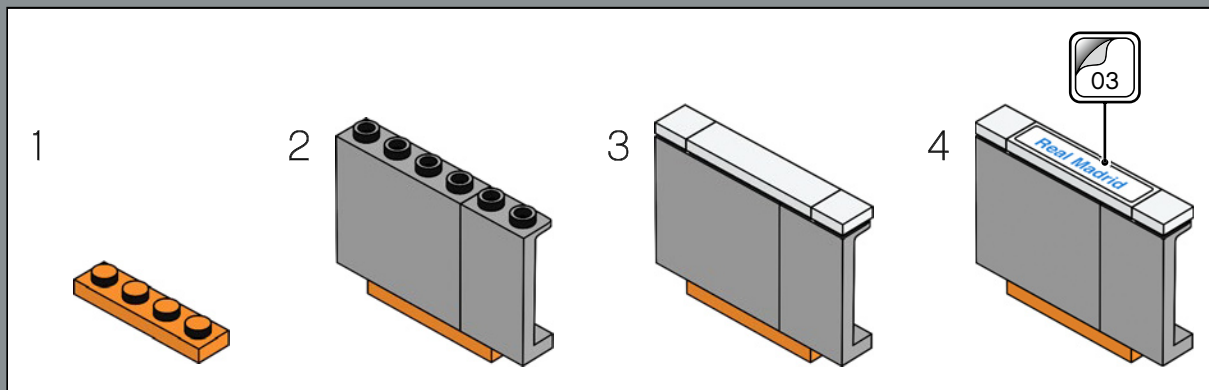

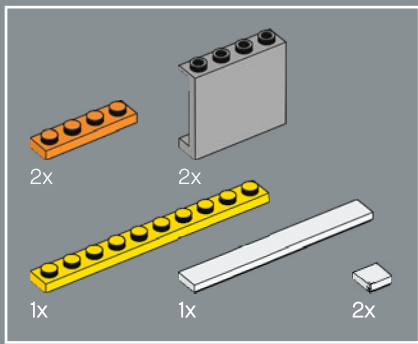

206

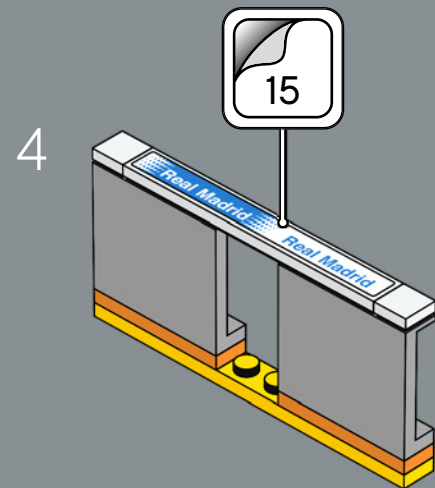
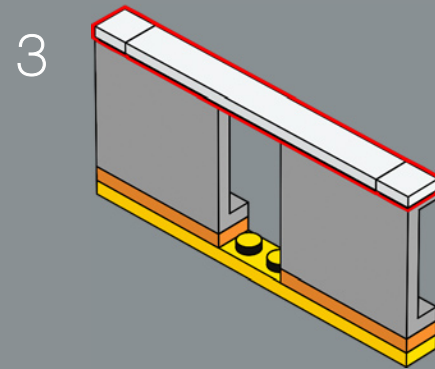
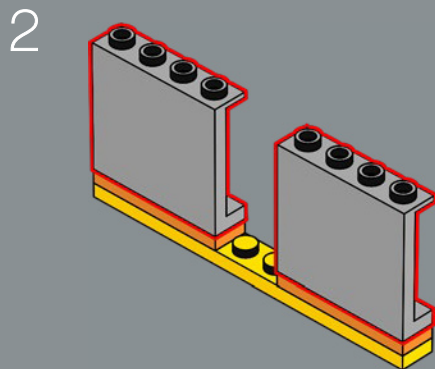
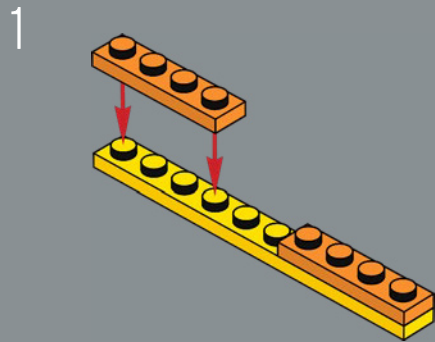

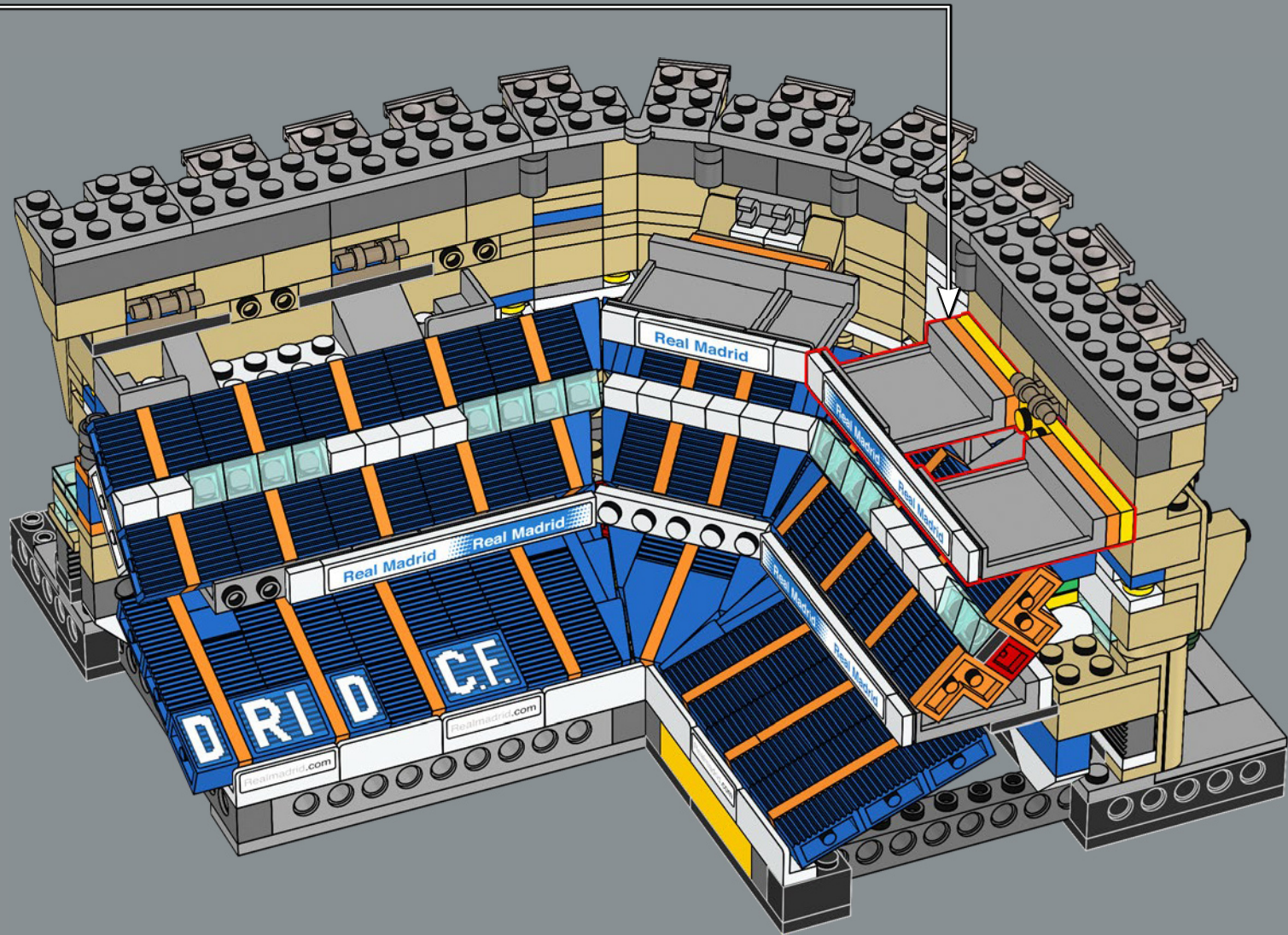

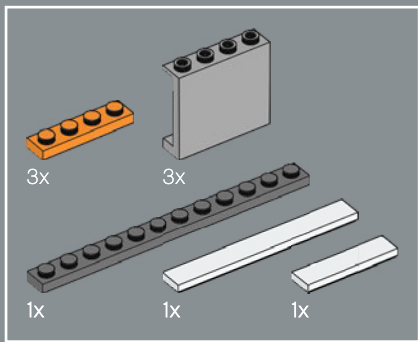

207

1

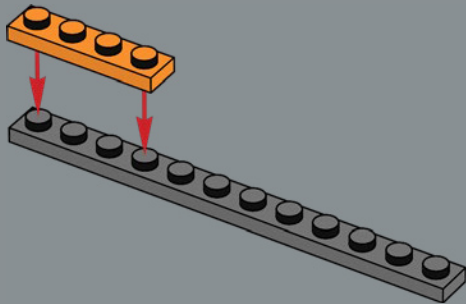

2

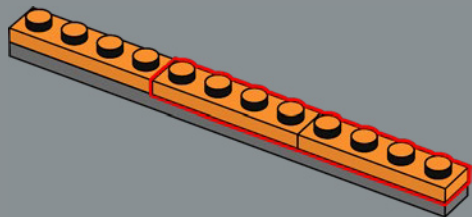

3

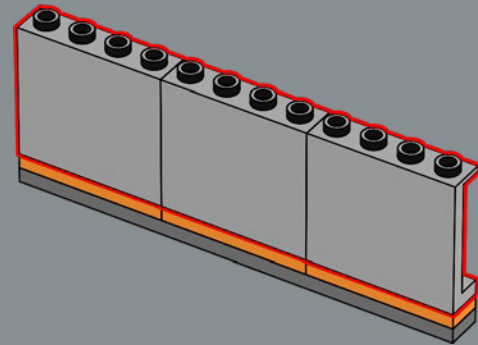

4

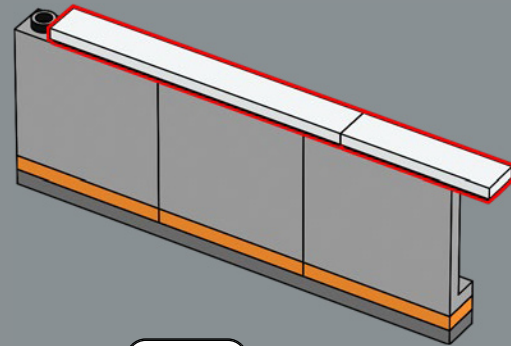

5

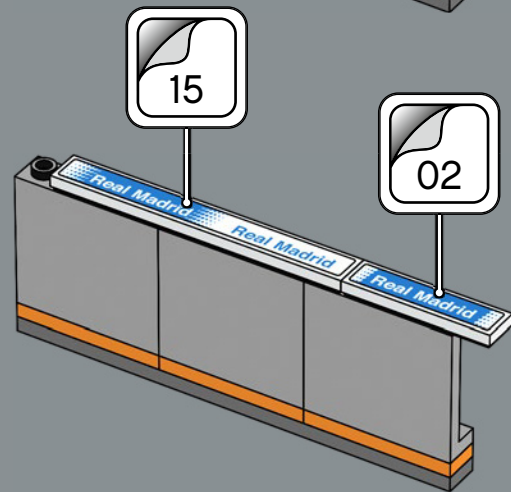

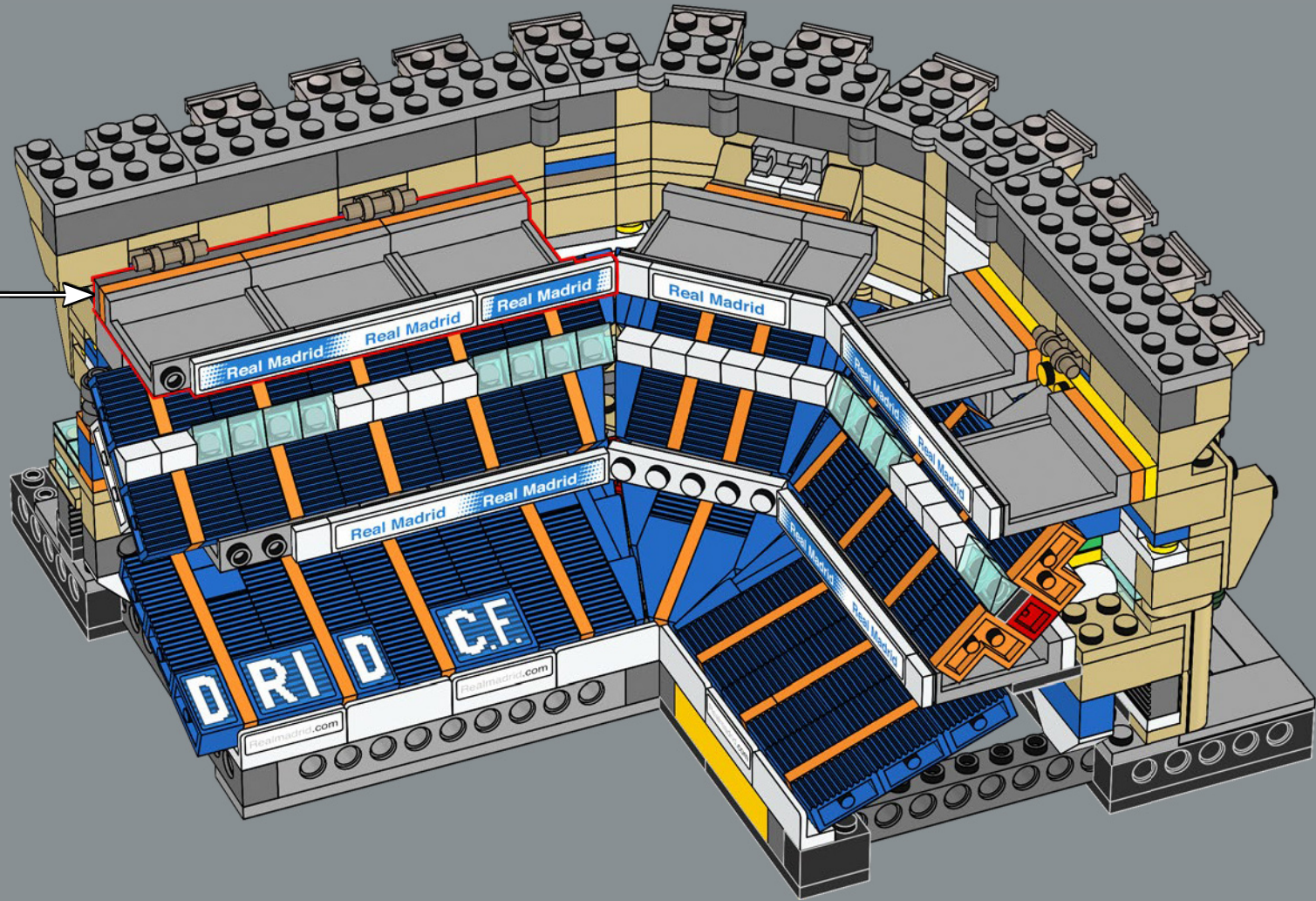

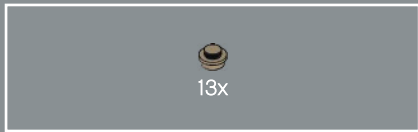
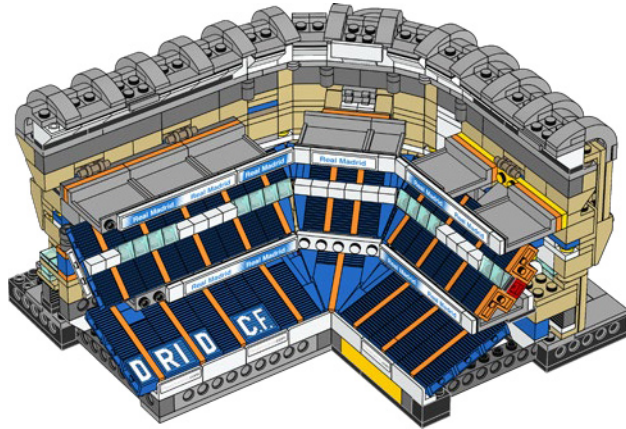
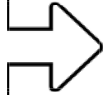

13x

208

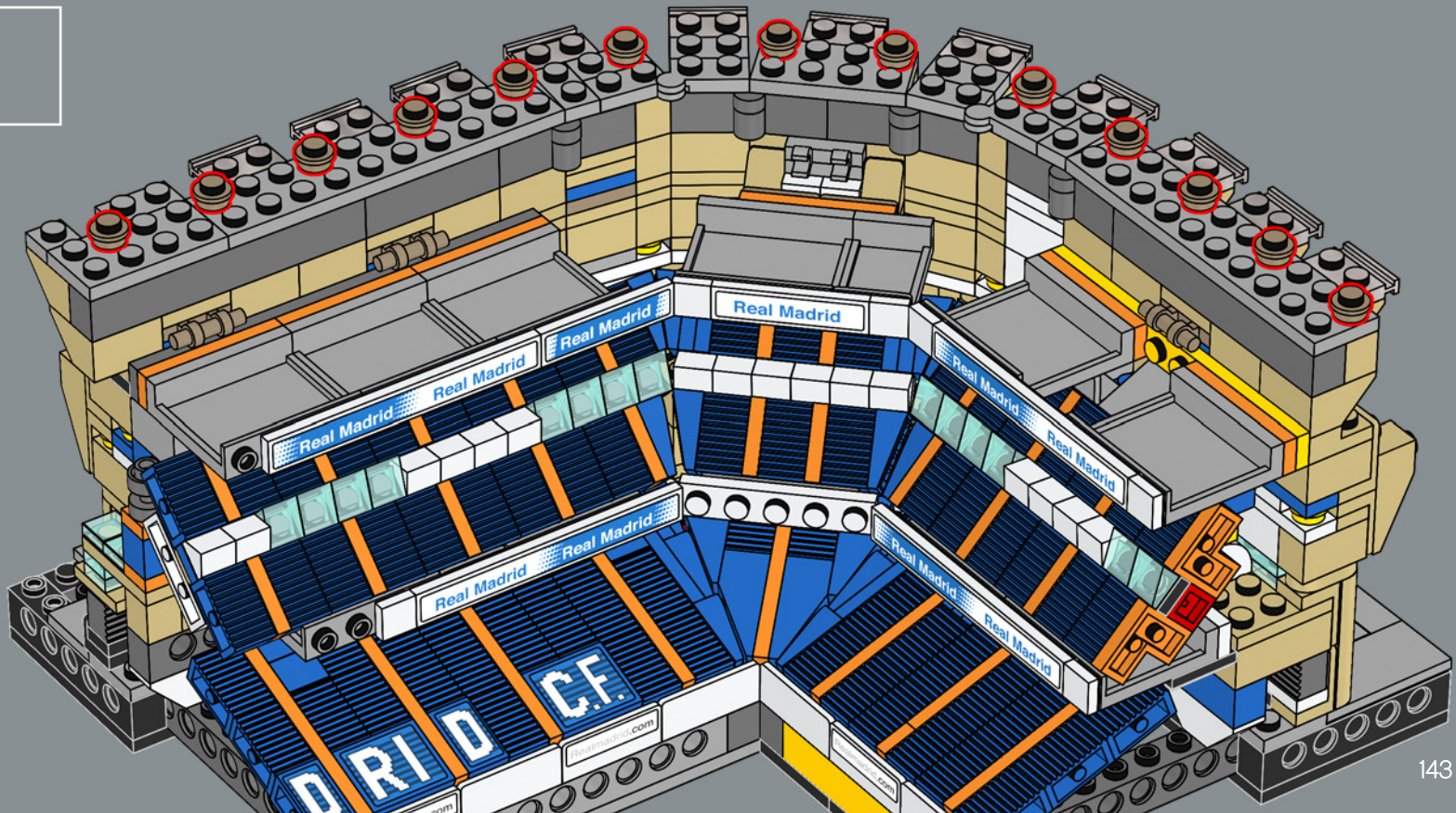



13x

209

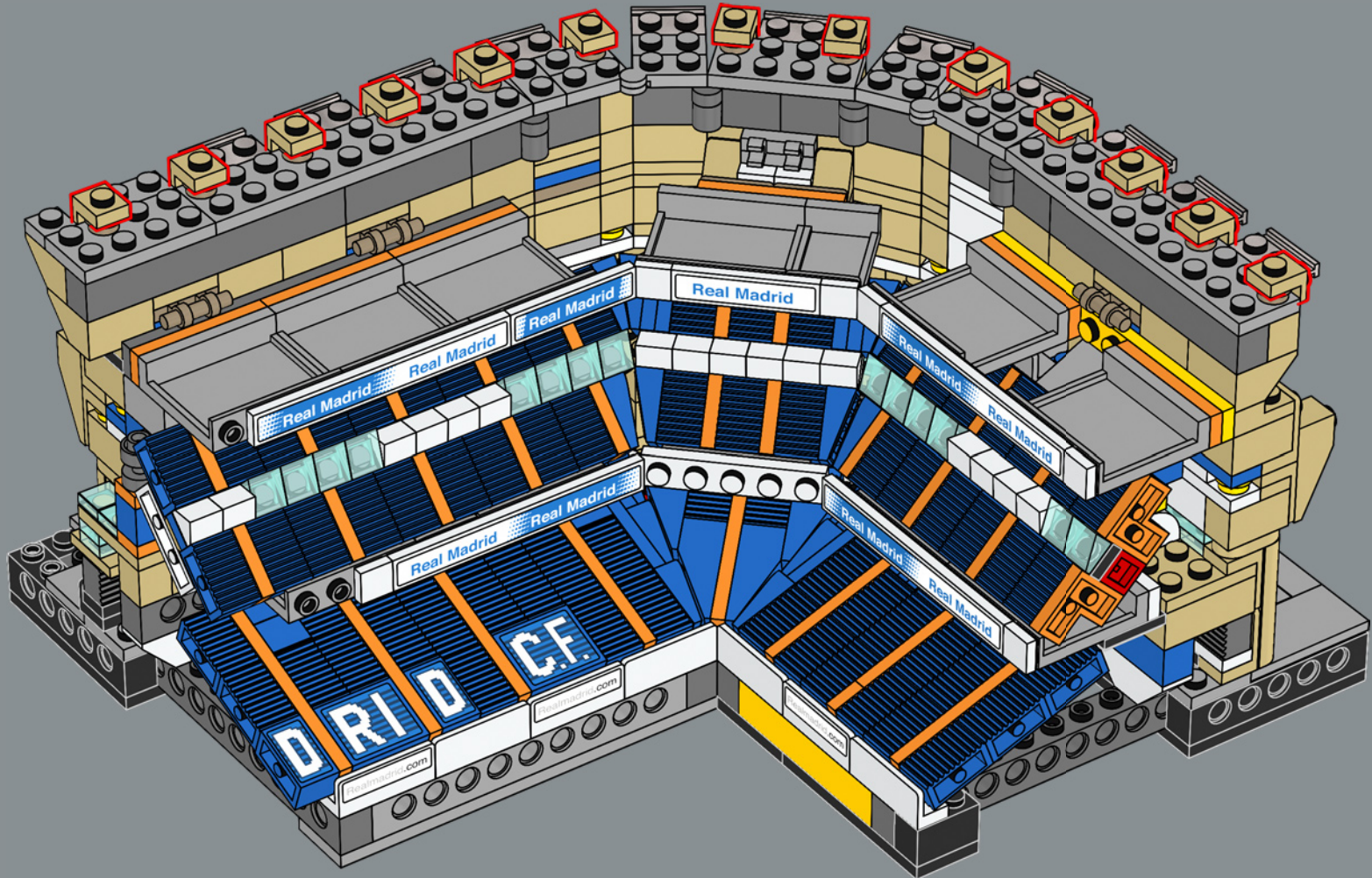

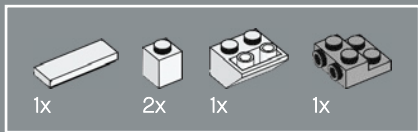

210

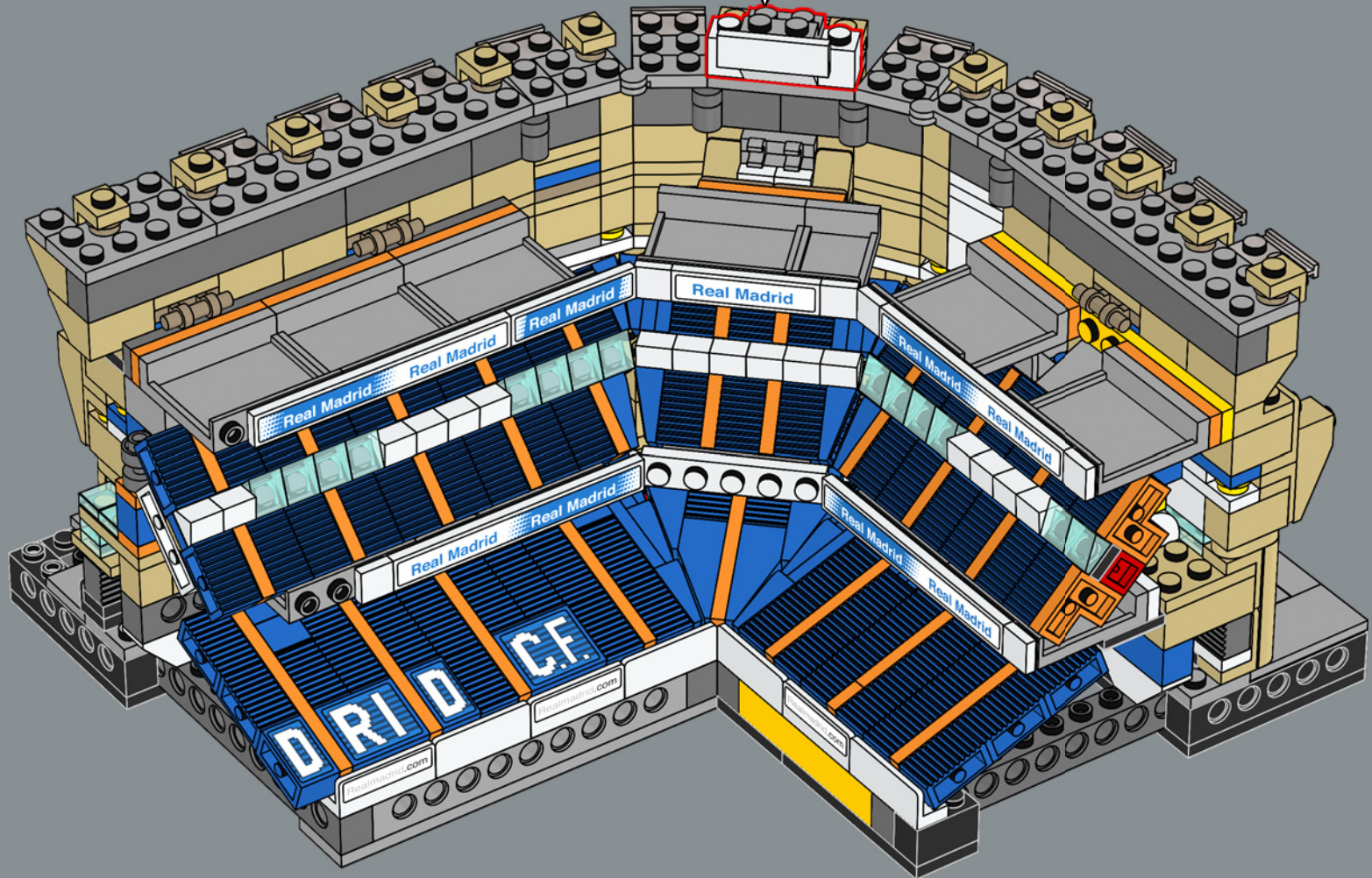
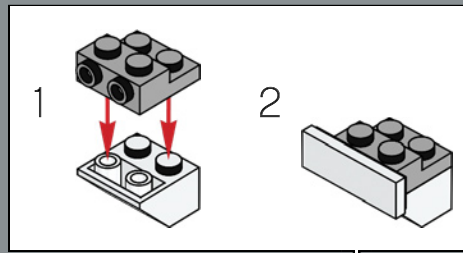

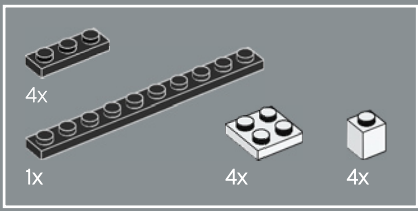

211

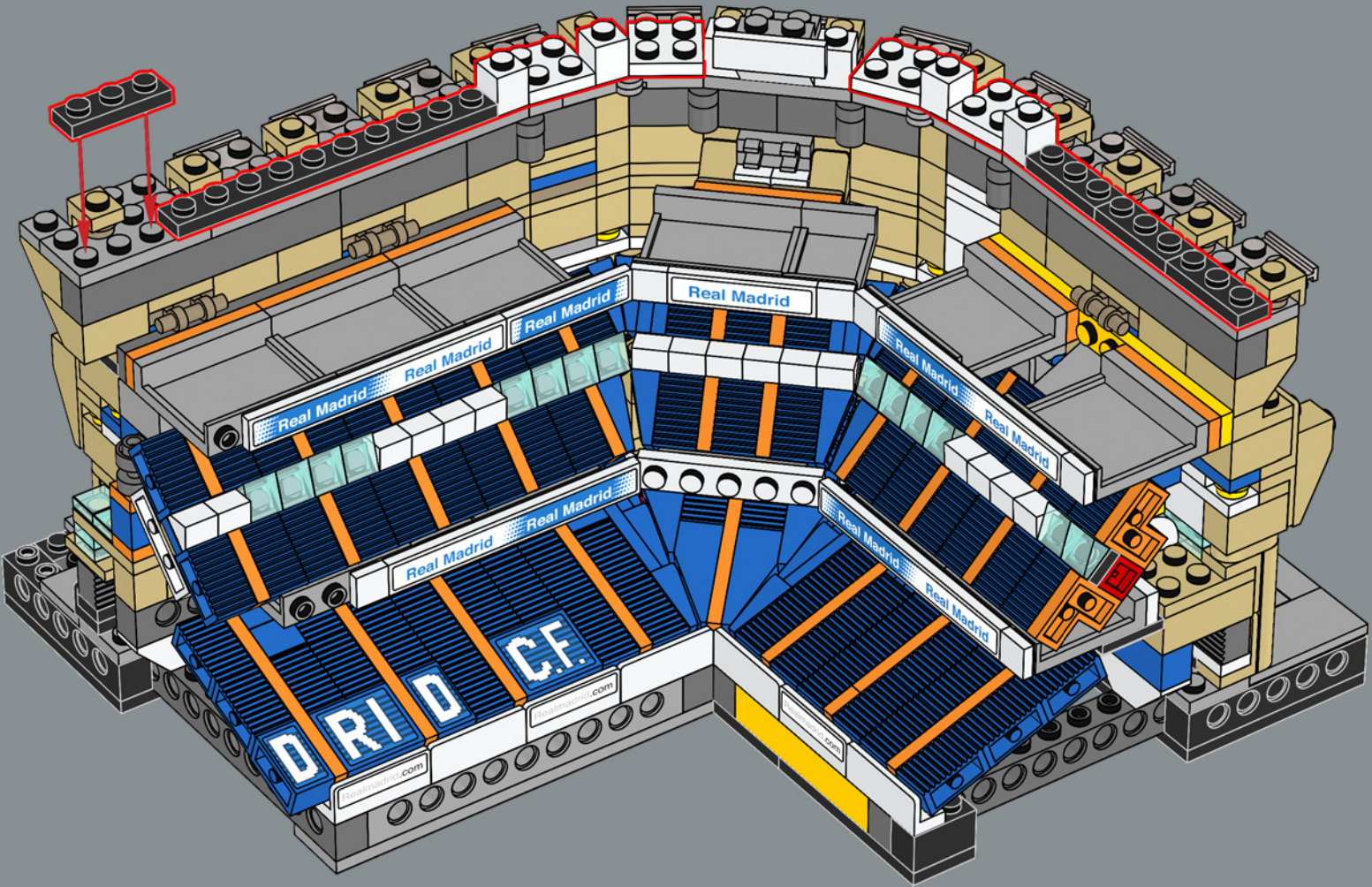

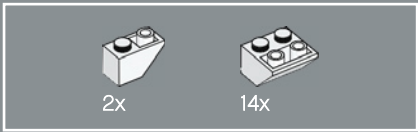

212

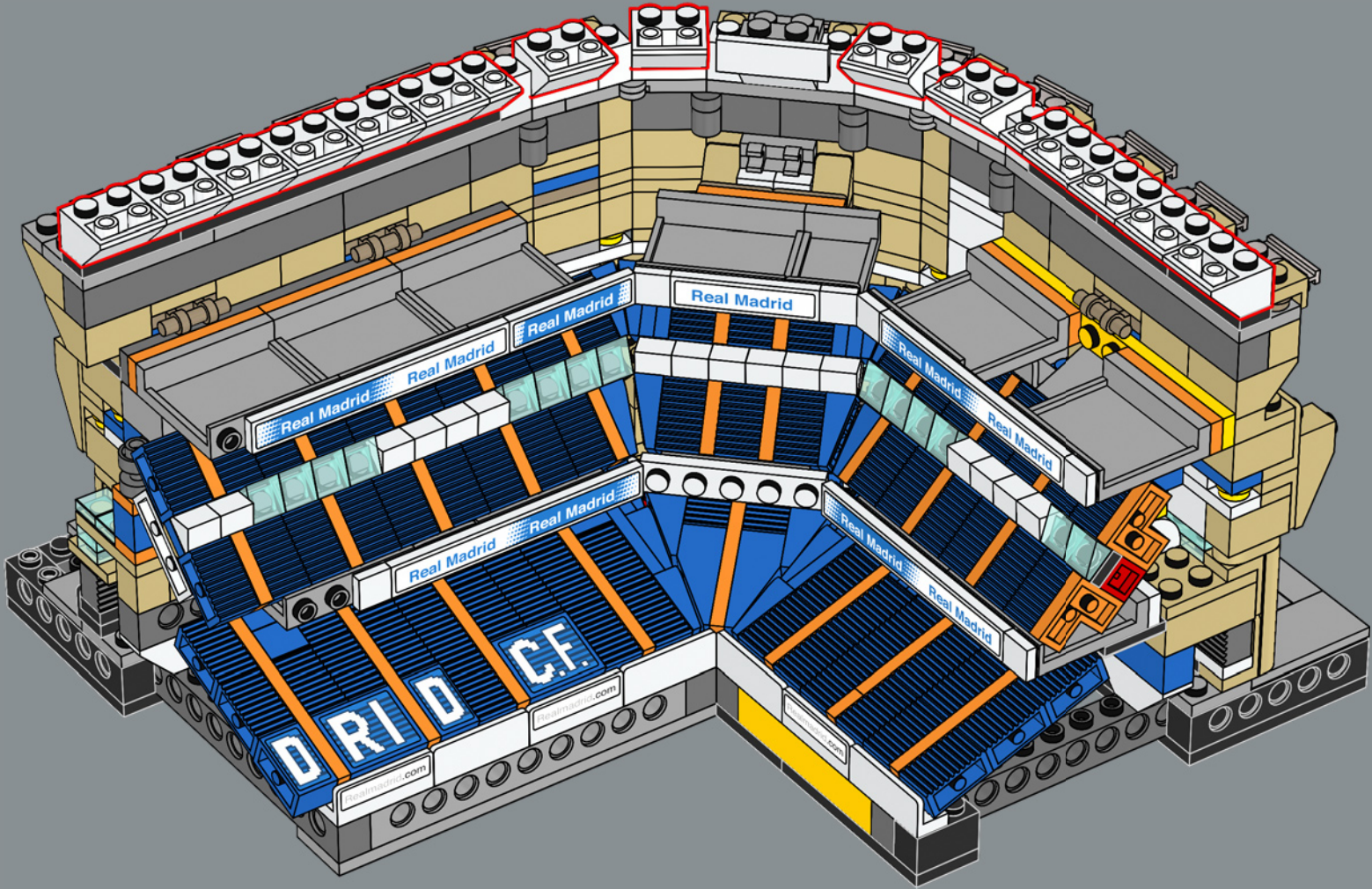



25x

213

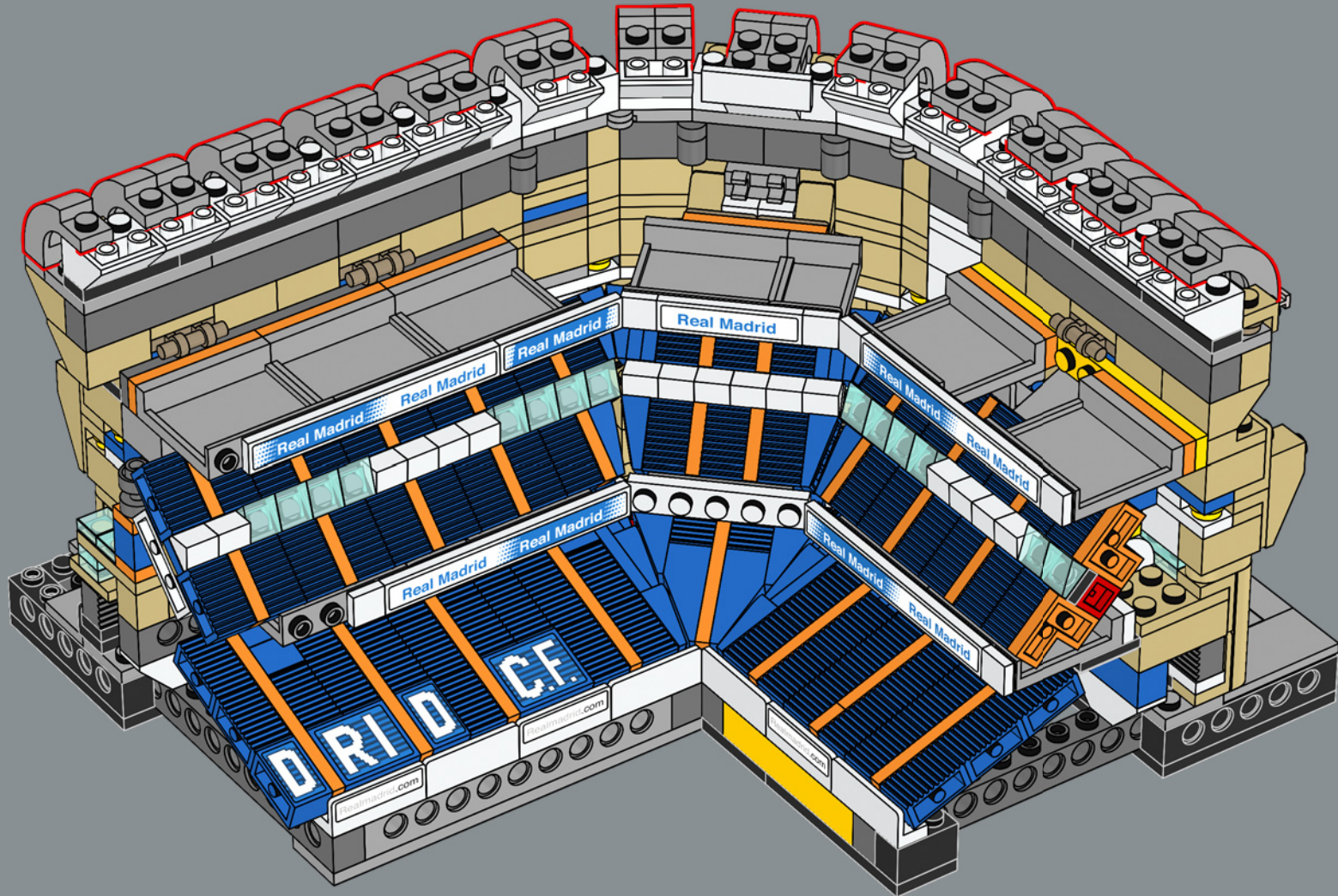



214

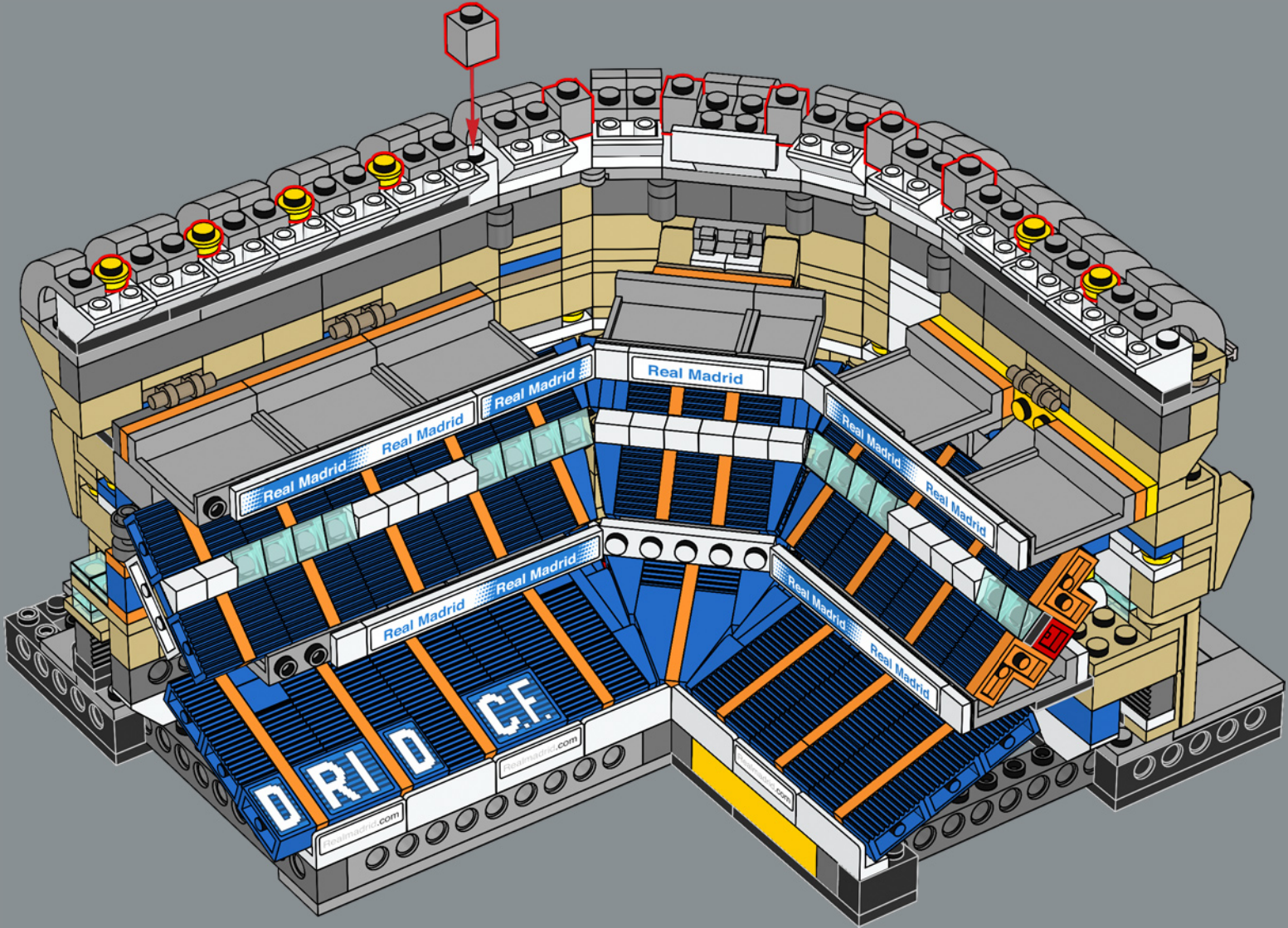

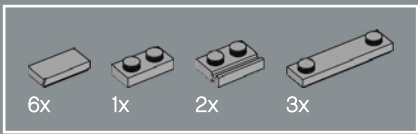

215

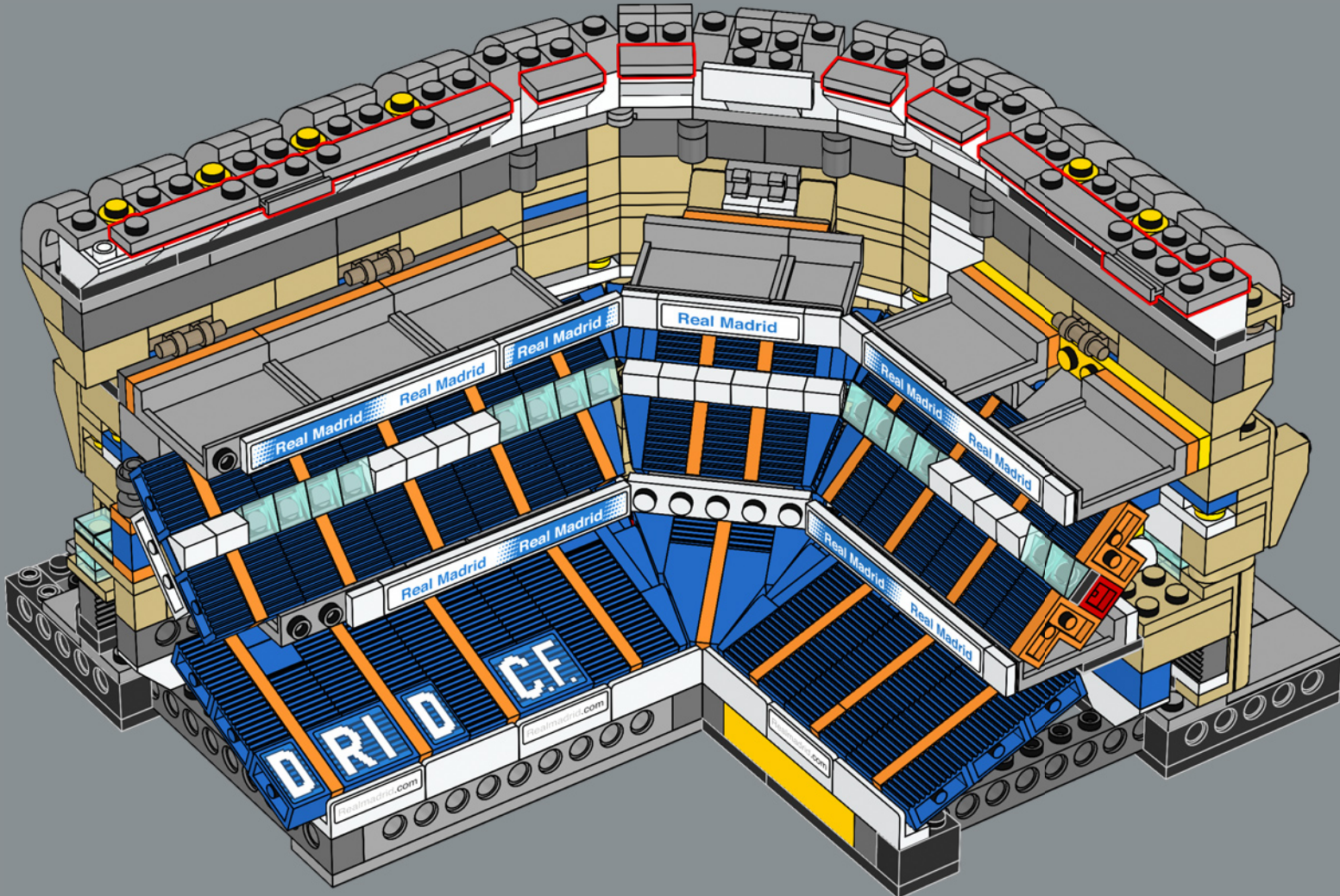



216

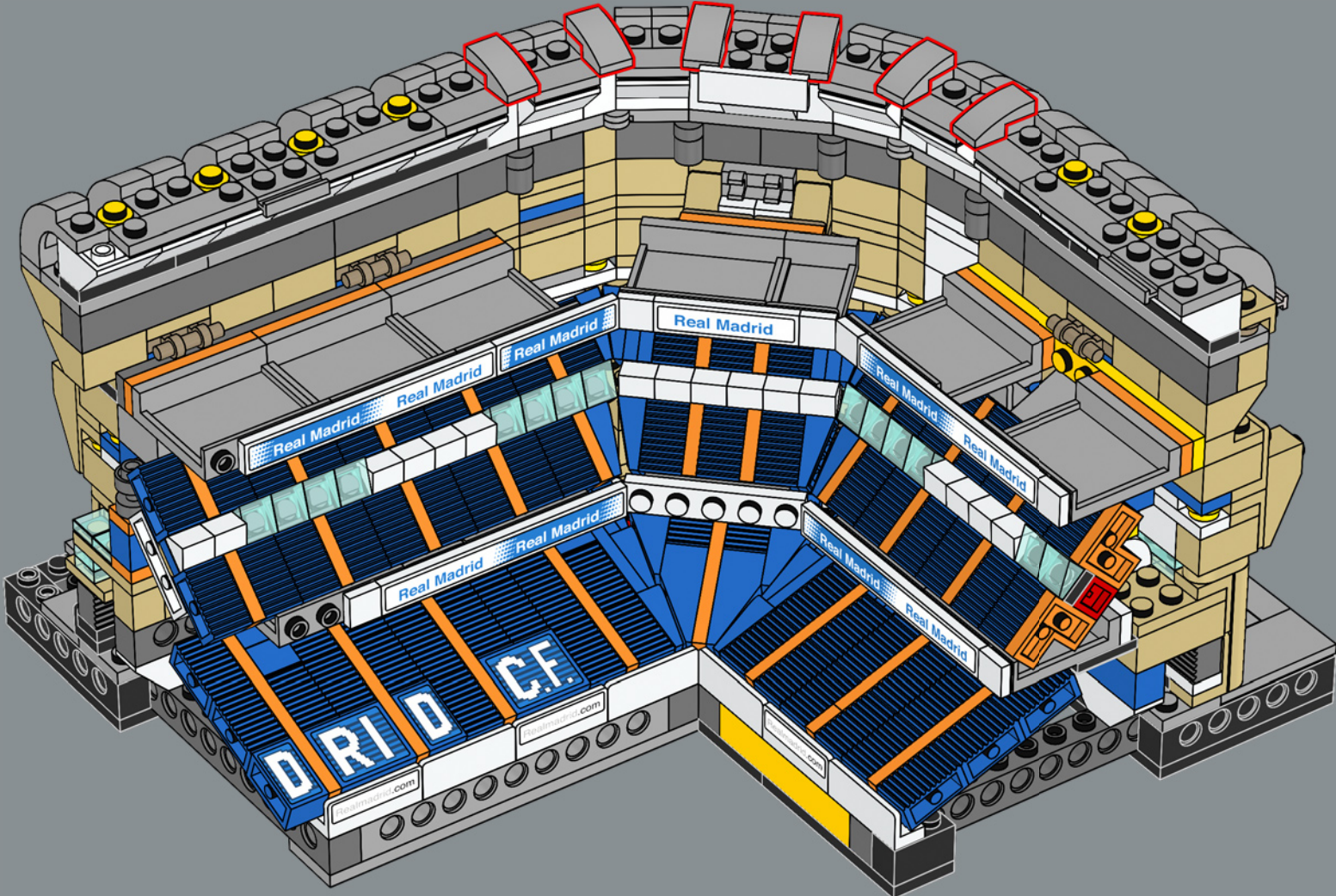

7x

7x

217

7x

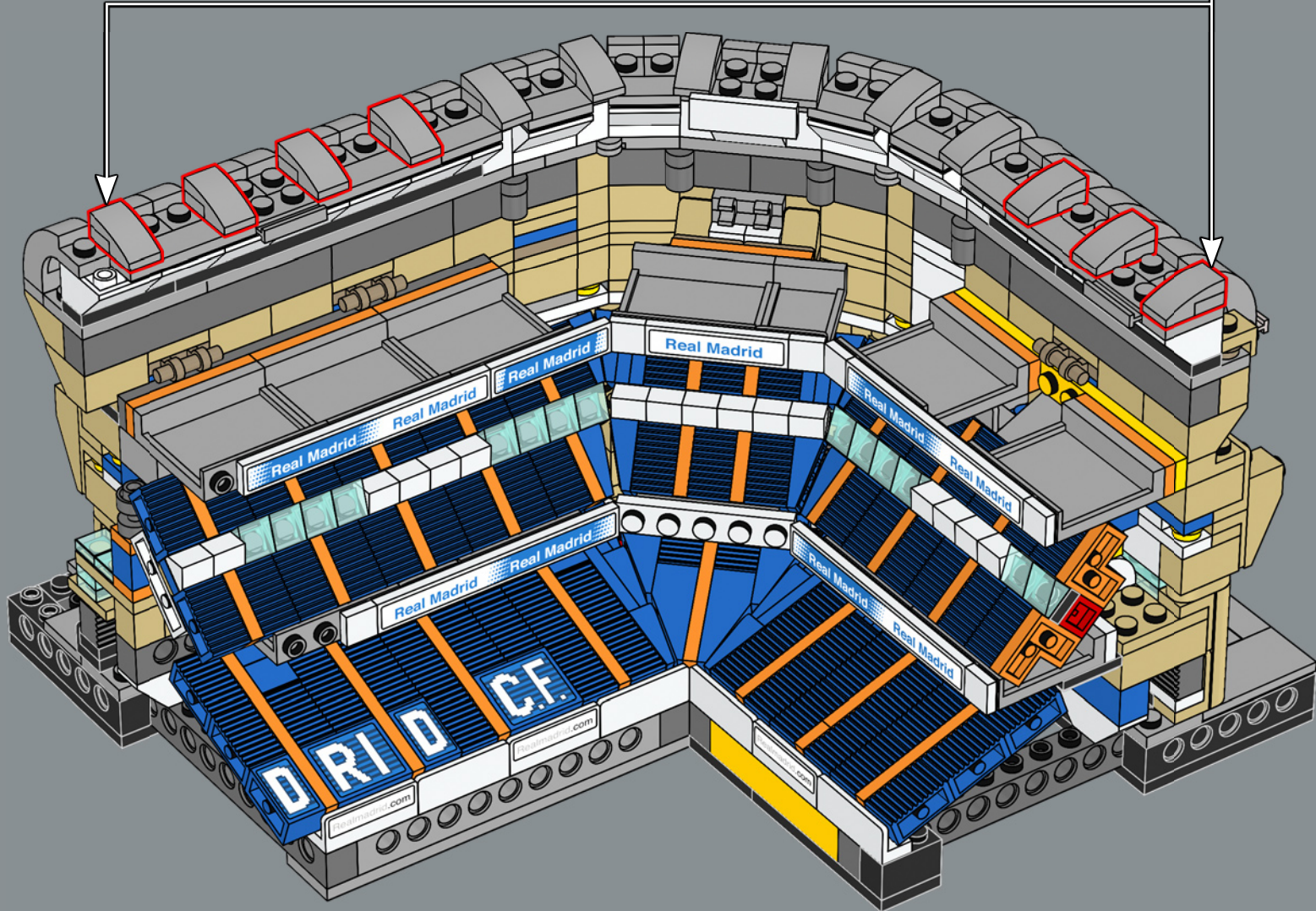

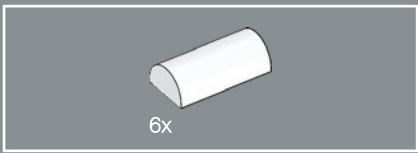

218

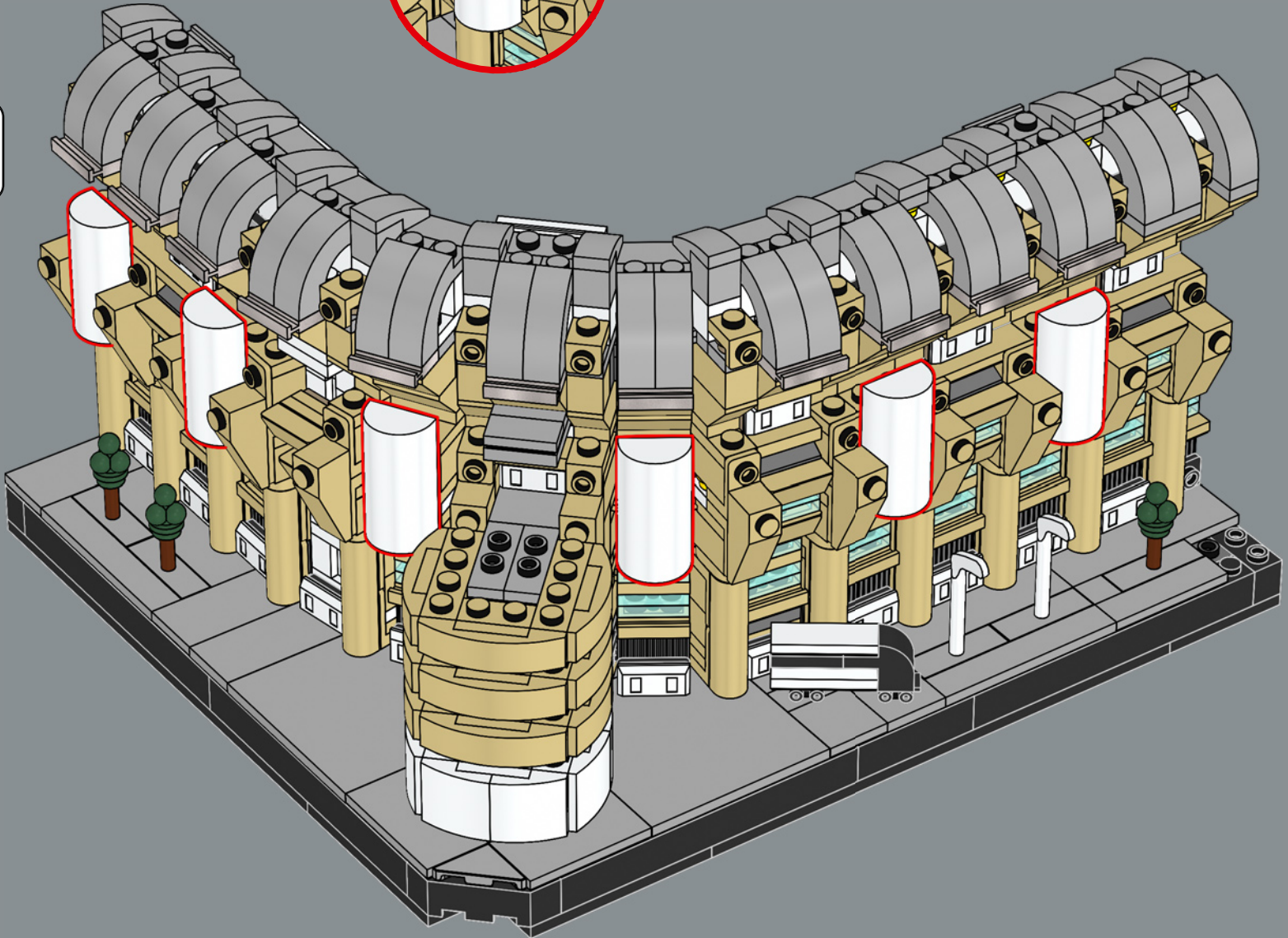
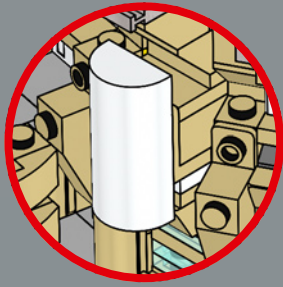

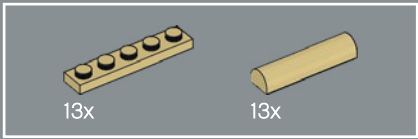

219

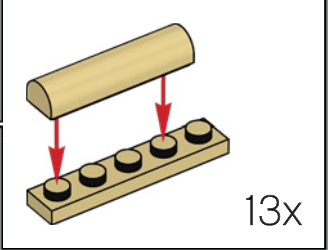
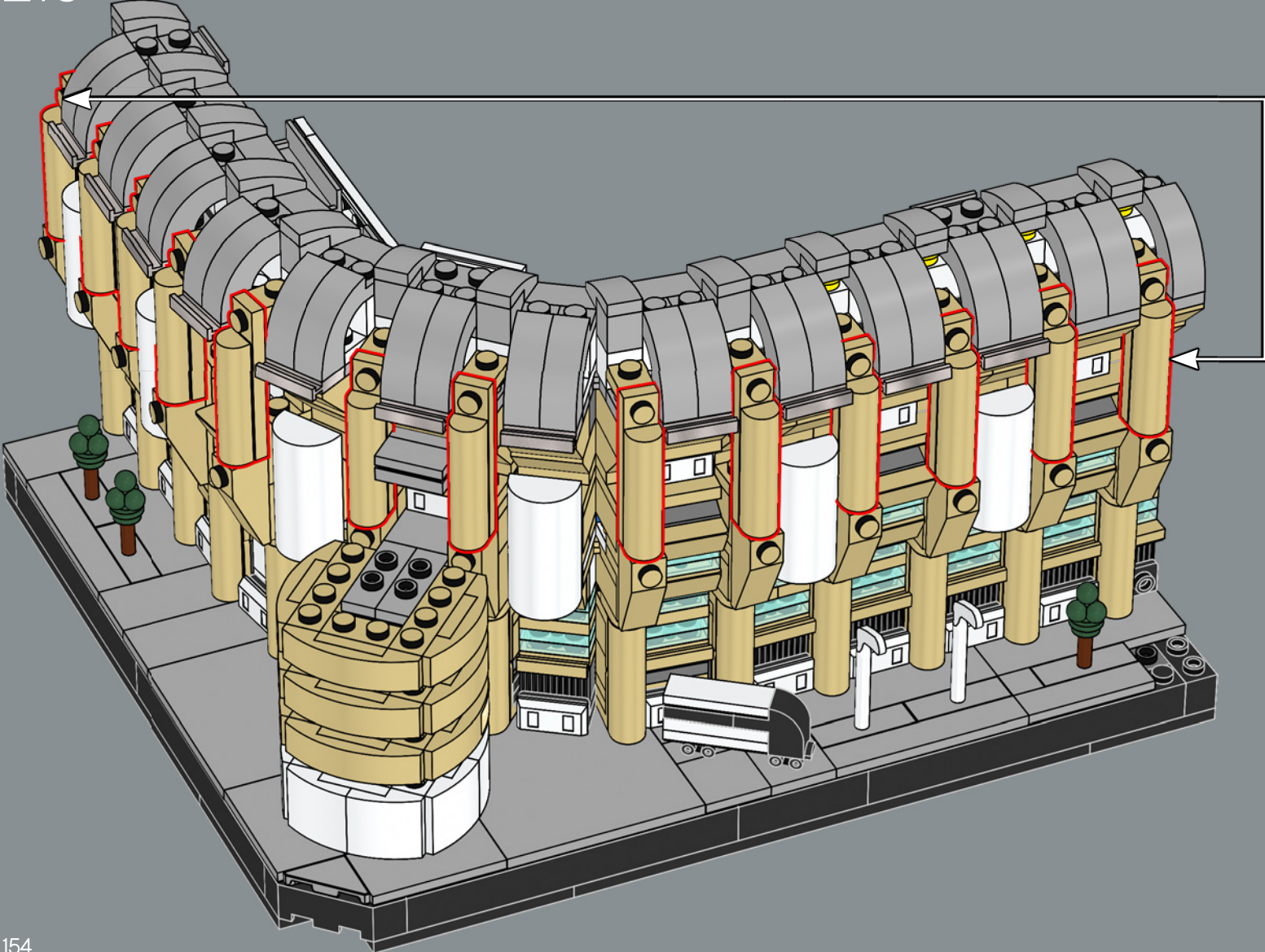

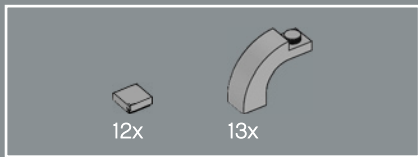

220

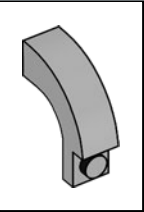
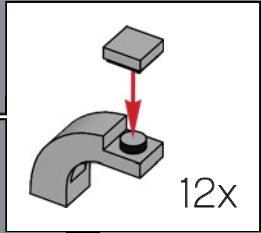
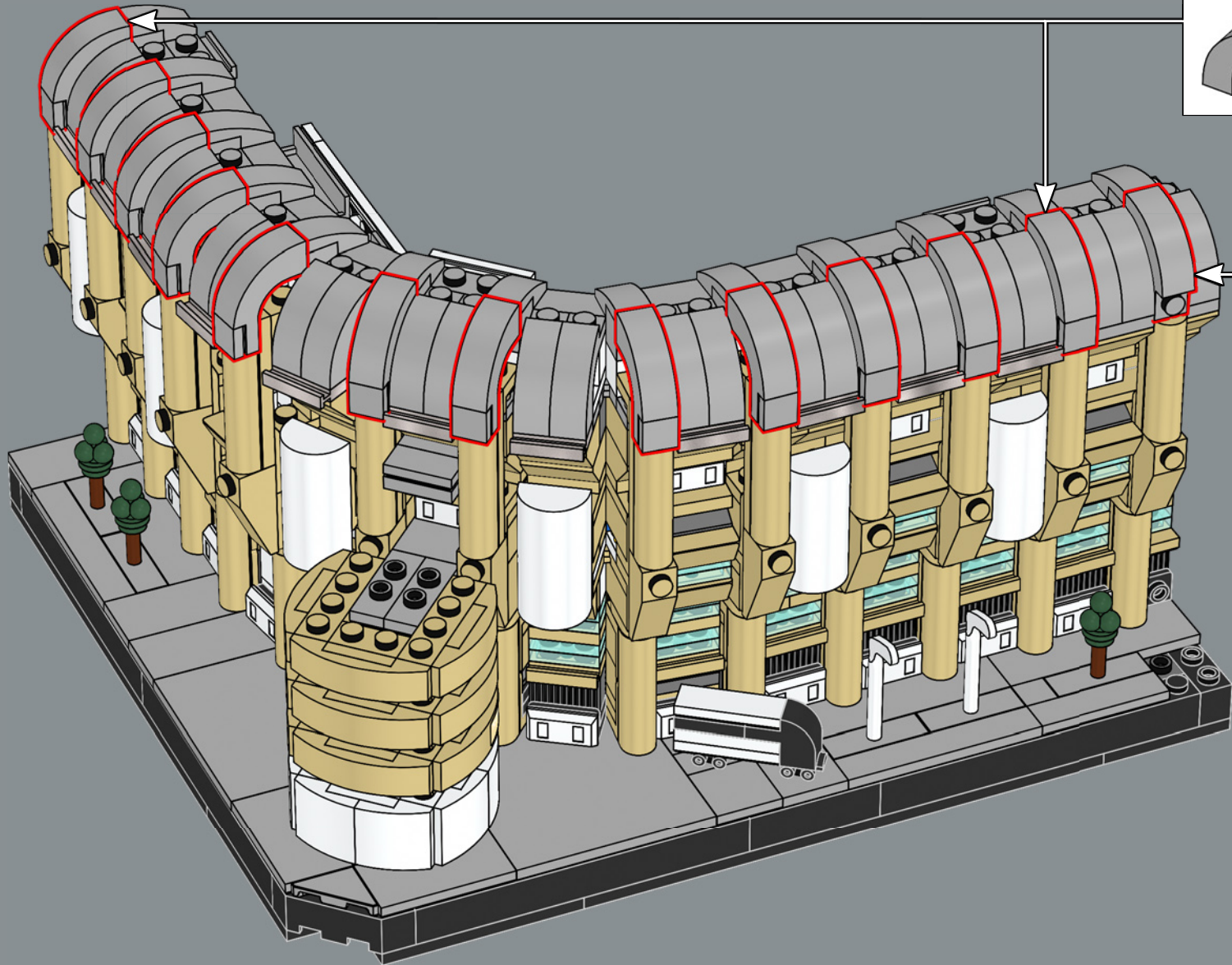

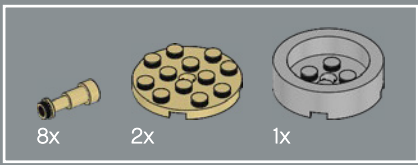

221

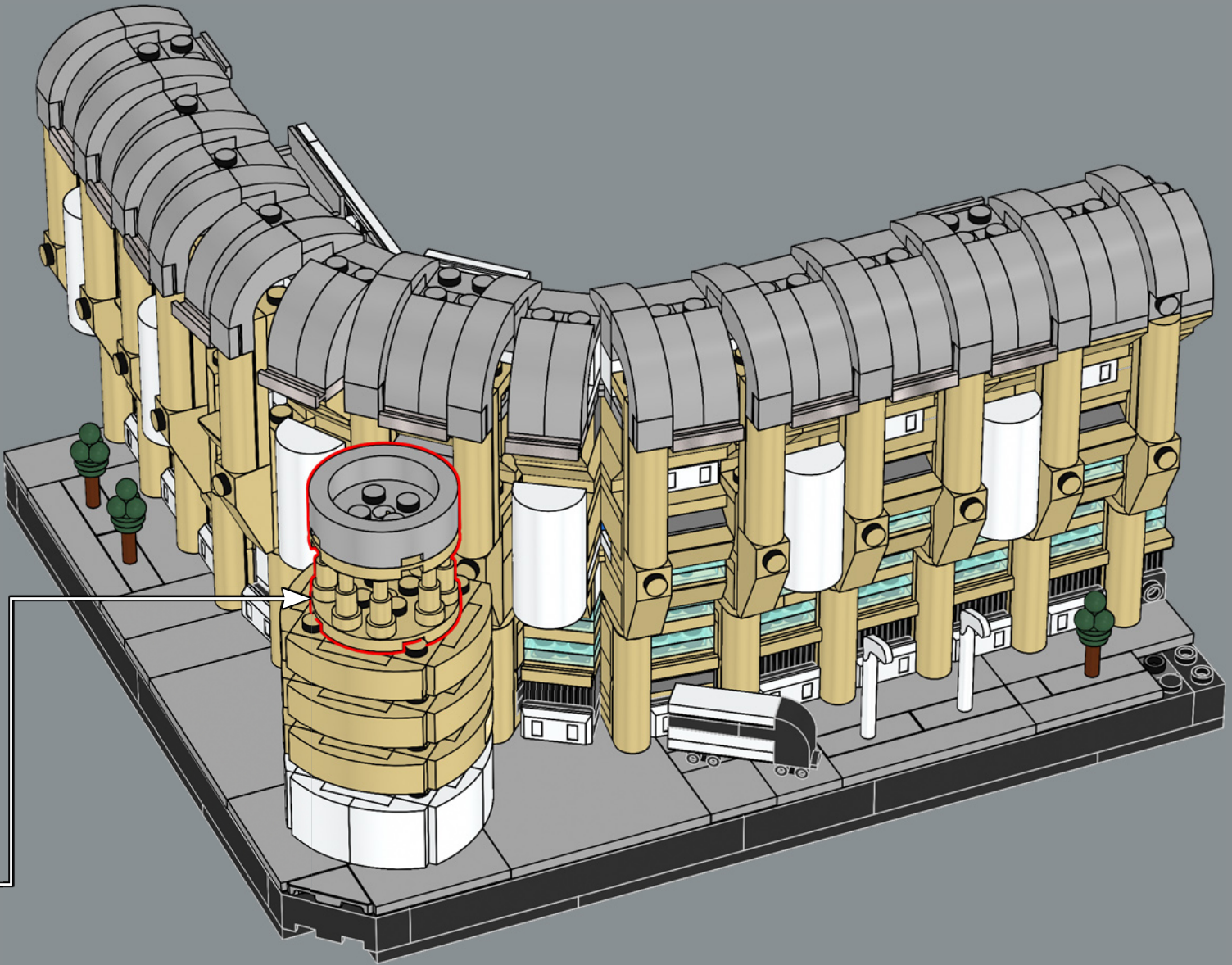
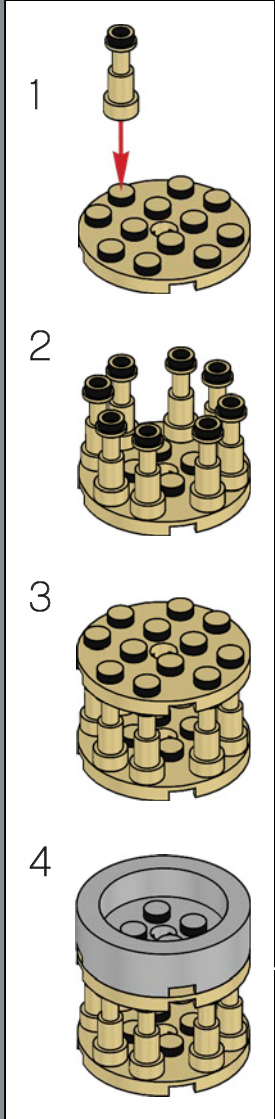

Real Madrid won the inaugural European Cup in 1956.

Le Real Madrid remporte la première Coupe d'Europe en 1956.

El Real Madrid ganó la Copa de Europa inaugural en 1956.

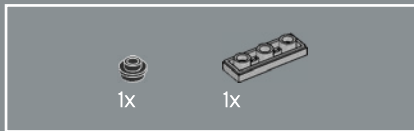
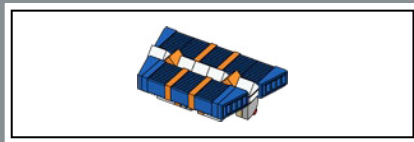
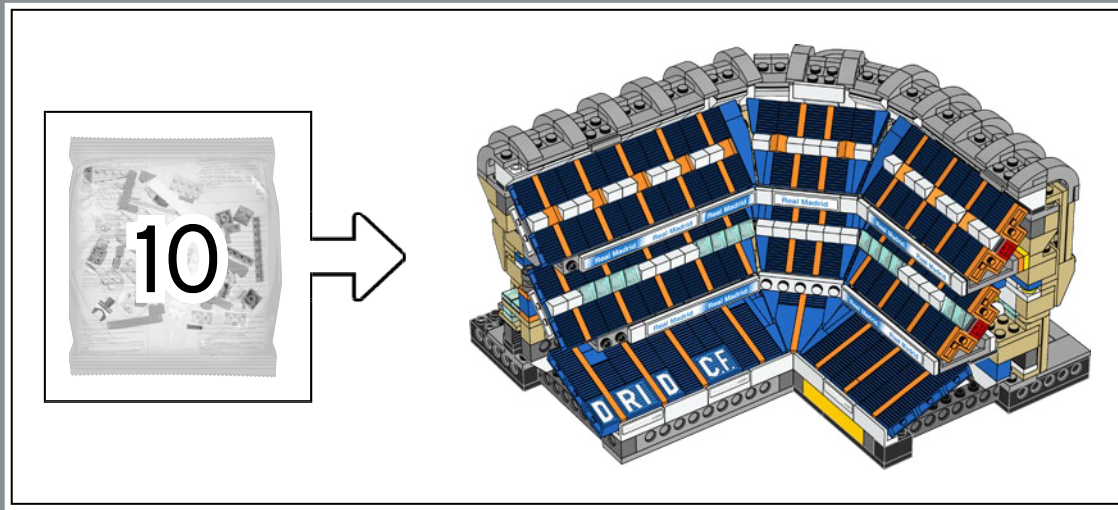

222

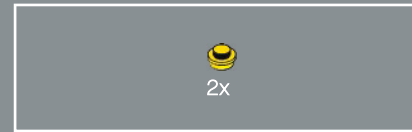
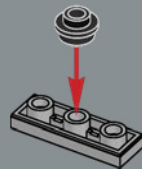

223

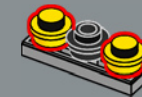



224

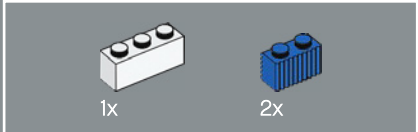
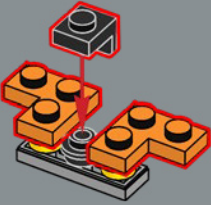

225

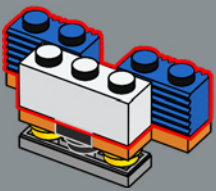

226

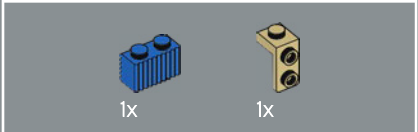
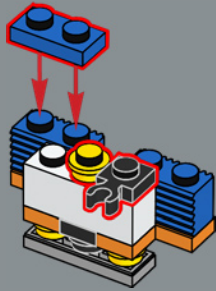

227

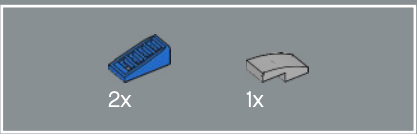
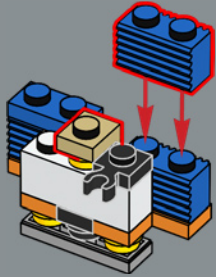

228

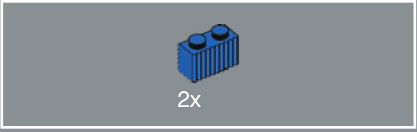
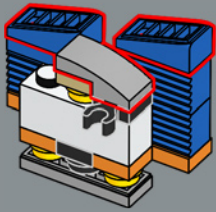

229

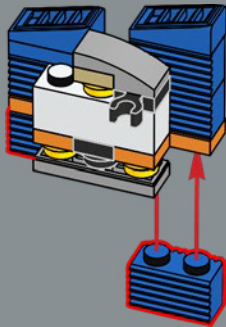

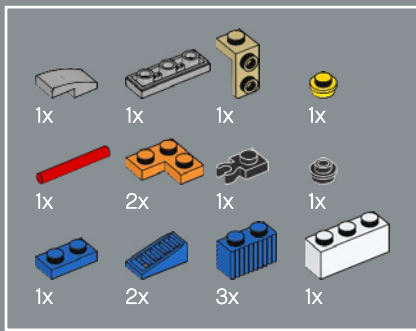

230

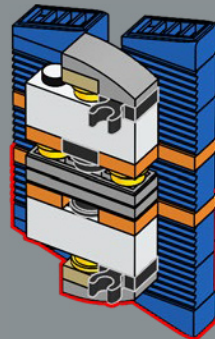
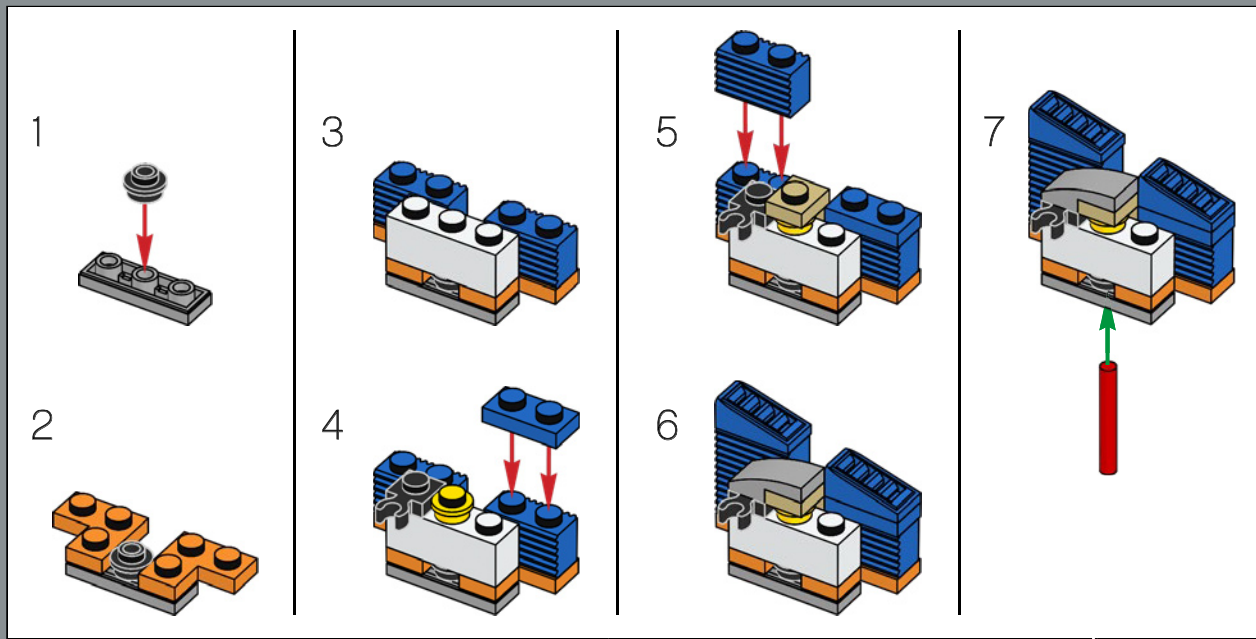

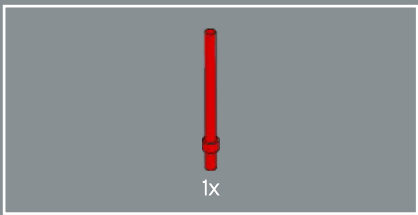

231

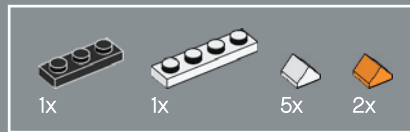
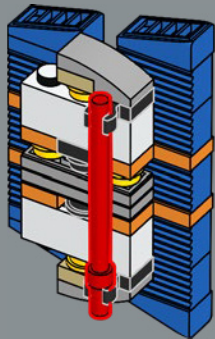

232

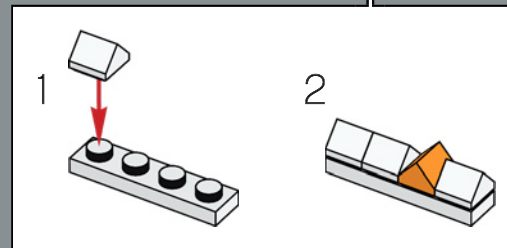
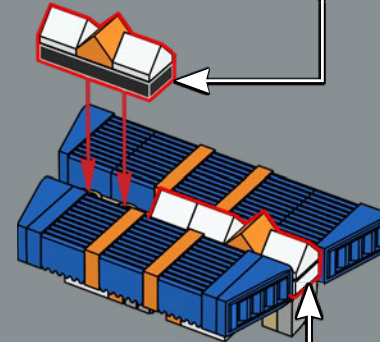
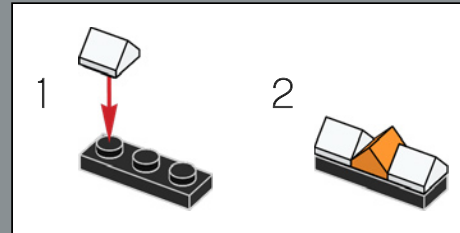

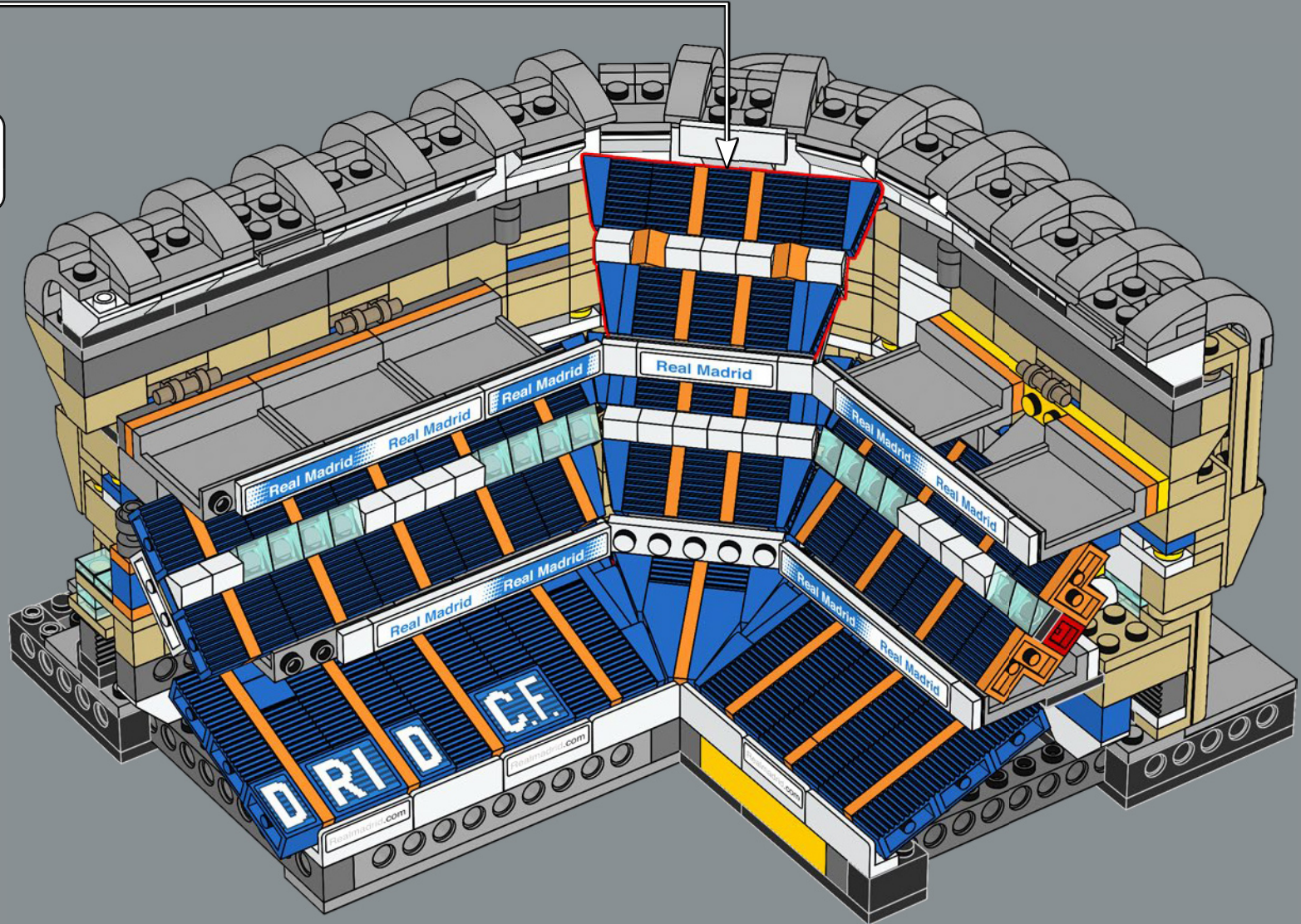

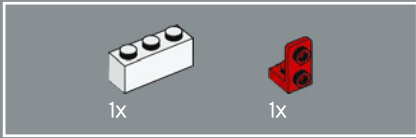
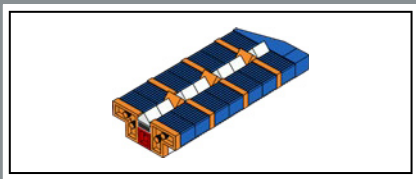

234

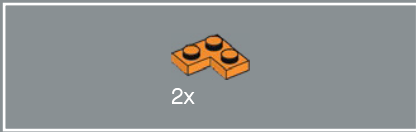
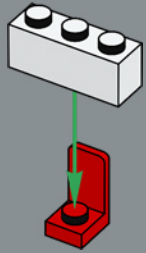

235

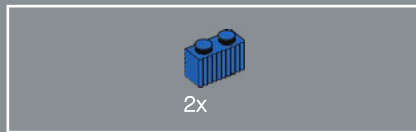
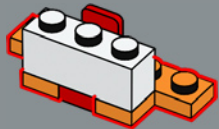

236

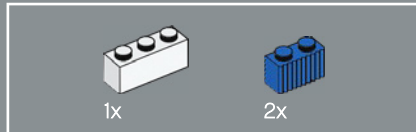

237

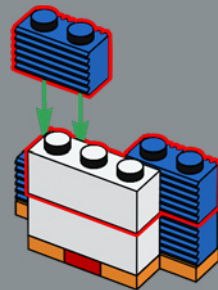

238

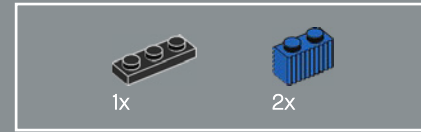
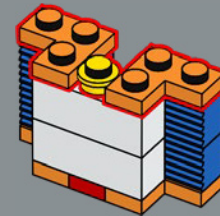

239

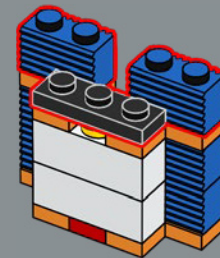

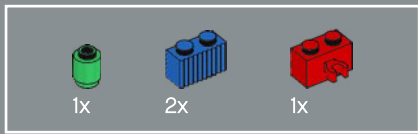

240

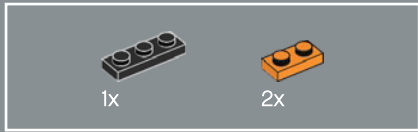
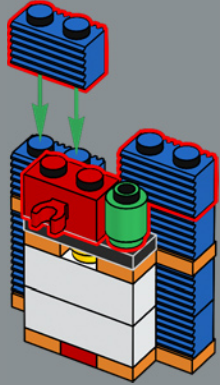

241

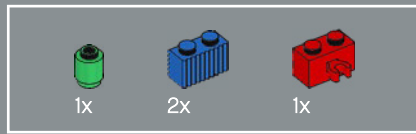
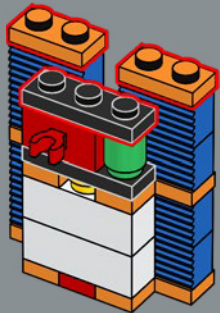

242

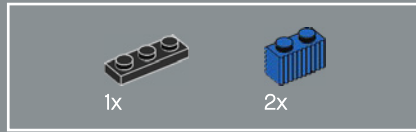
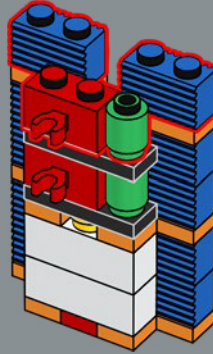

243

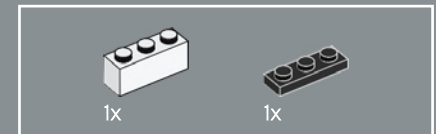
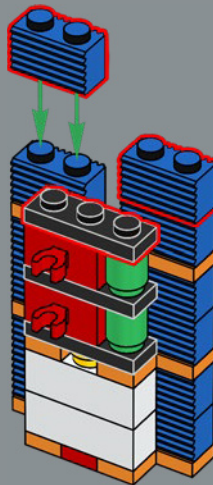

244

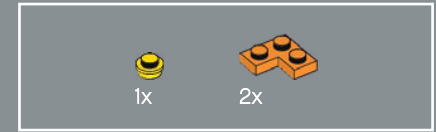
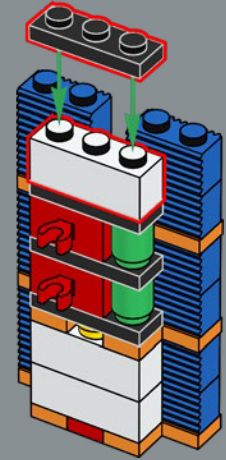

245

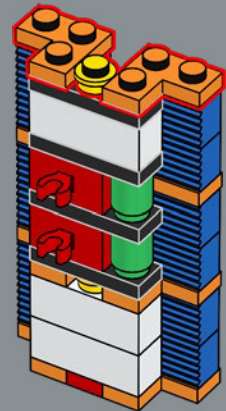

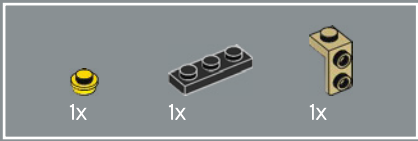

246

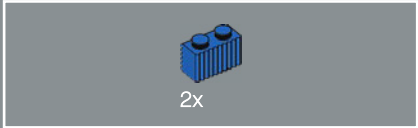
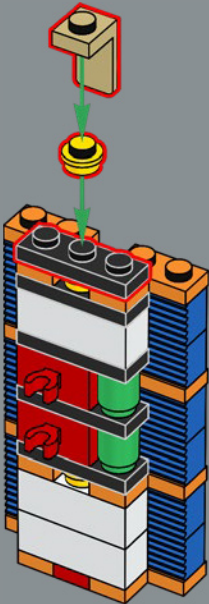

247

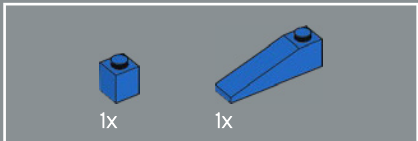
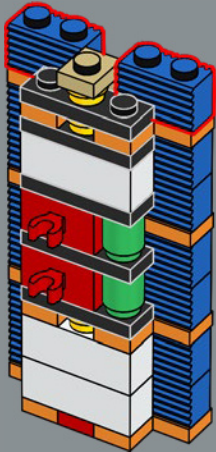

248

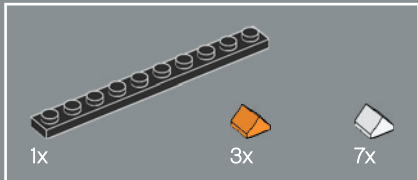
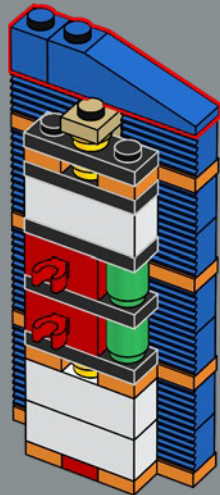

249

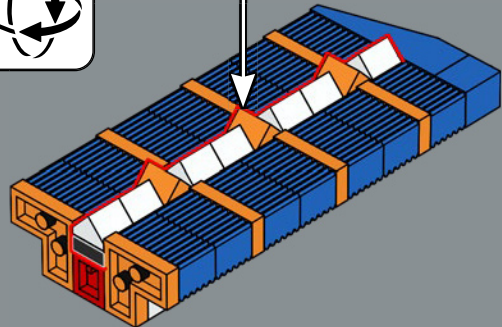
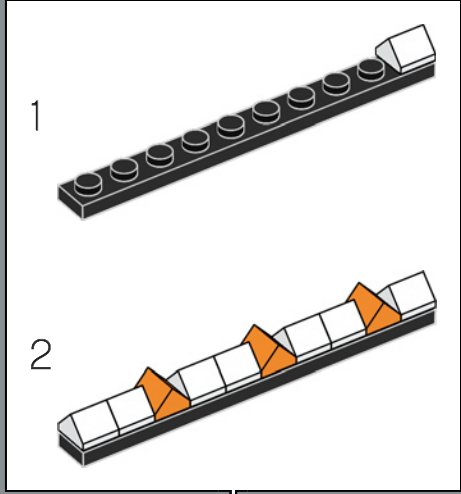

250

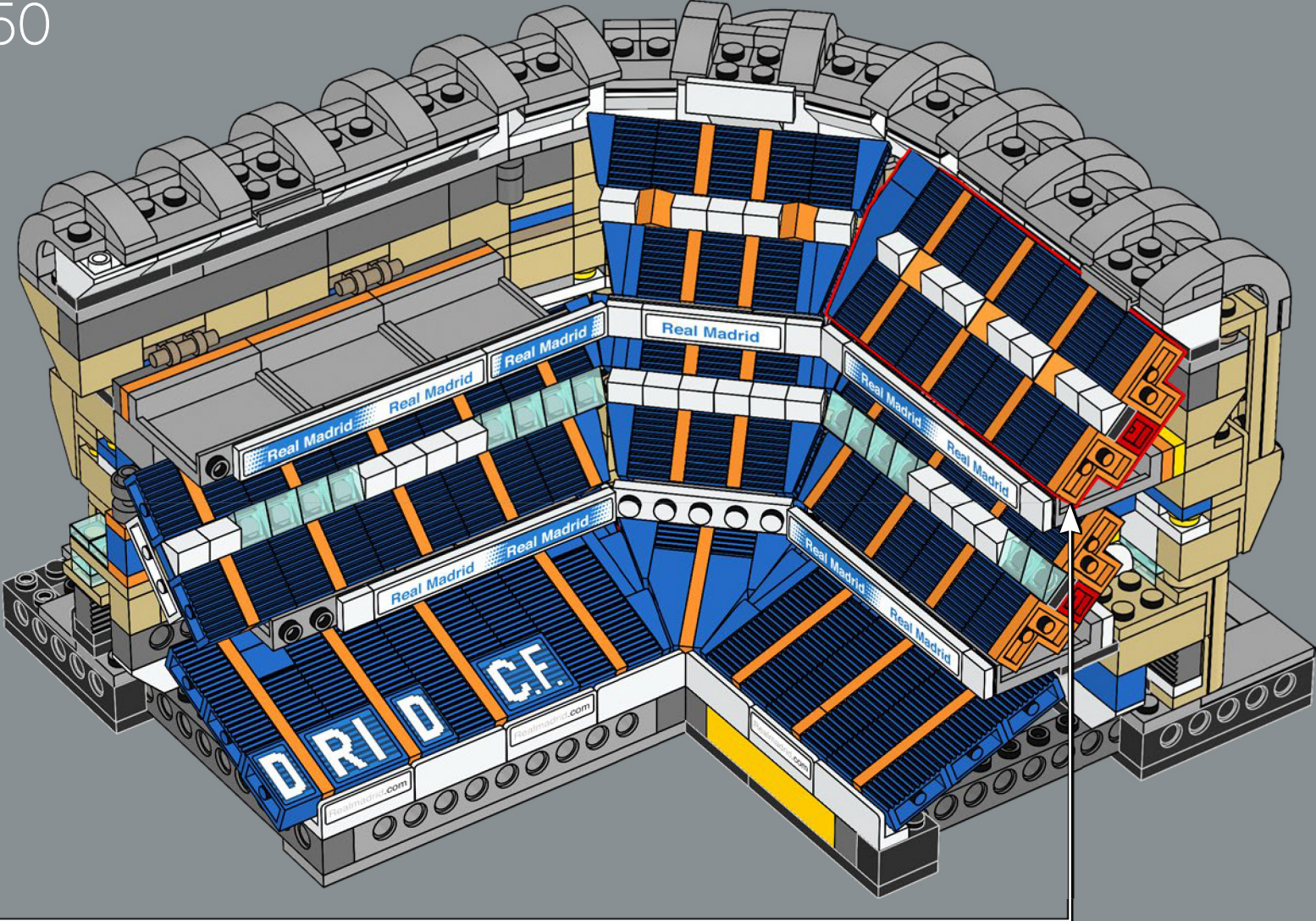

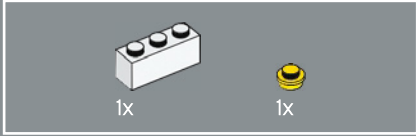
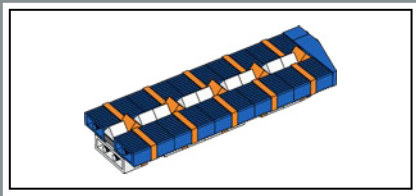

251

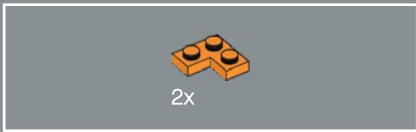
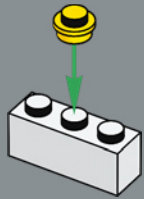

252

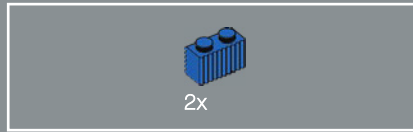
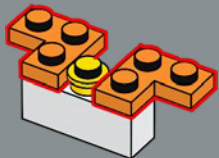

253

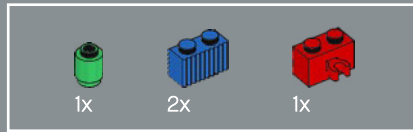
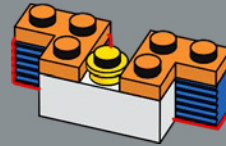

254

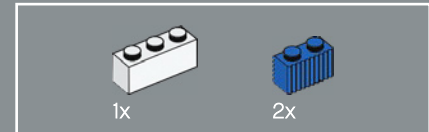
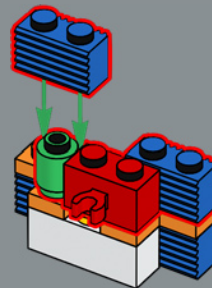

255

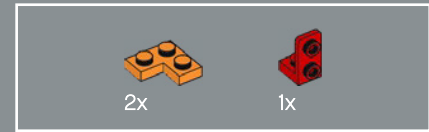
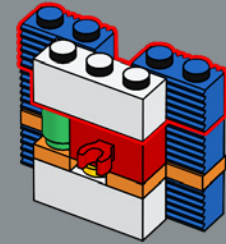

256

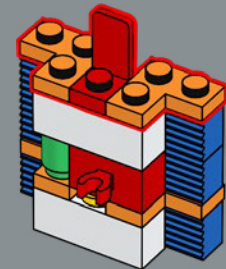

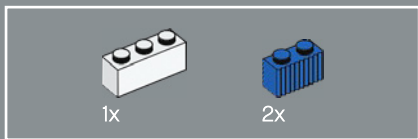

257

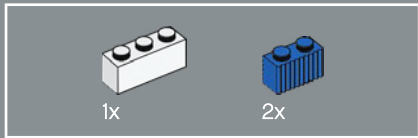
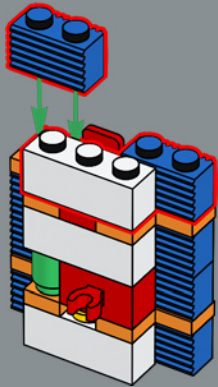

258

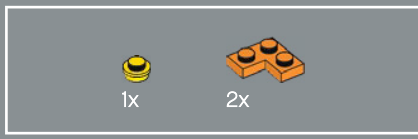
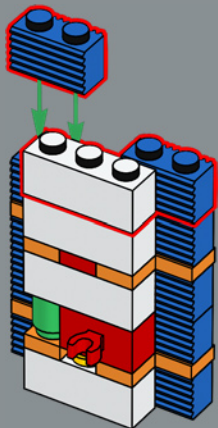

259

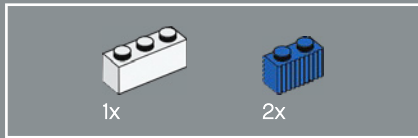
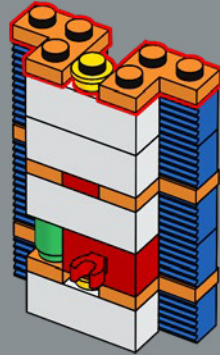

260

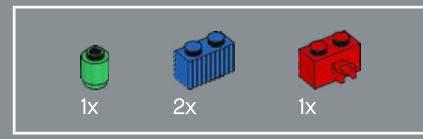
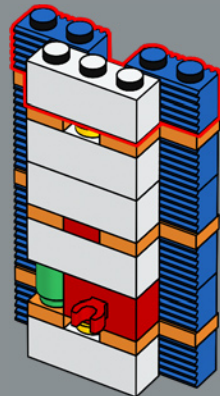

261

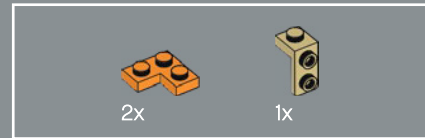
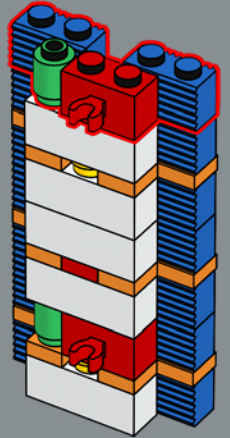

262

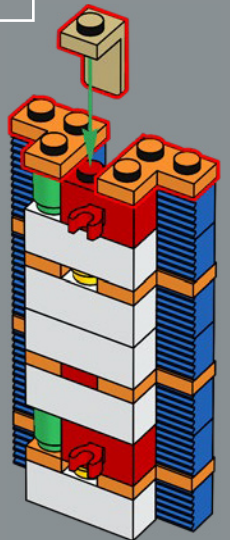

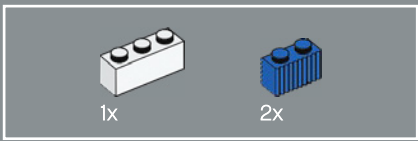

263

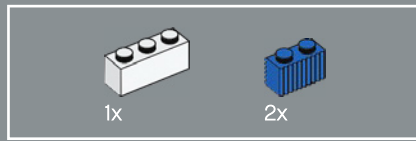
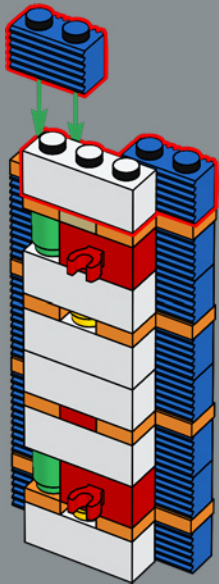

264

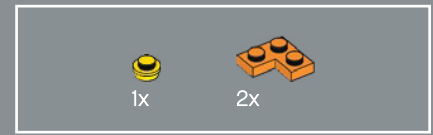
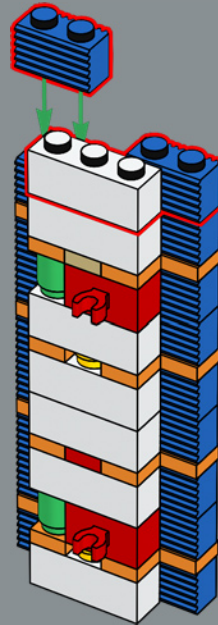

265

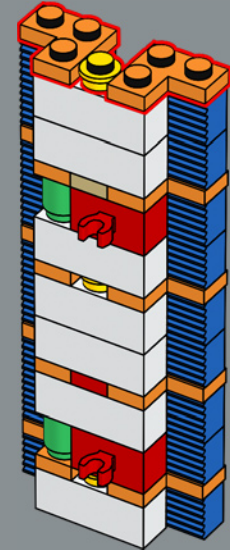

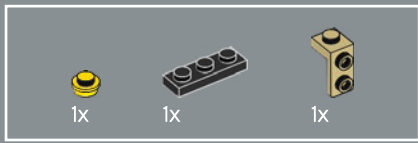

266

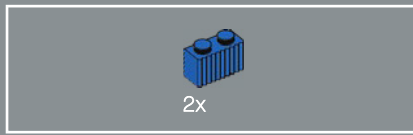
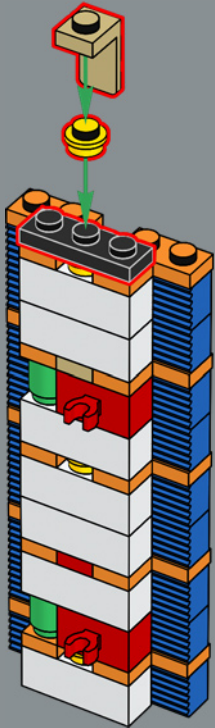

267

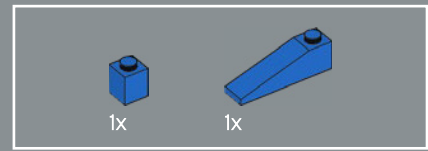
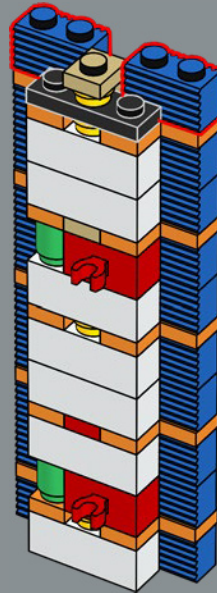

268

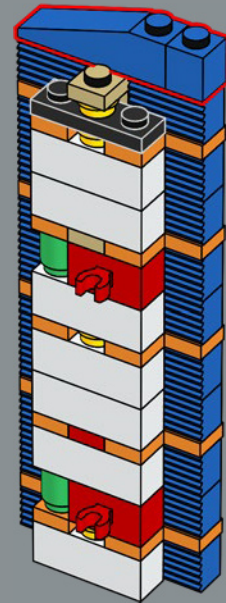

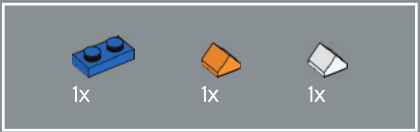

269

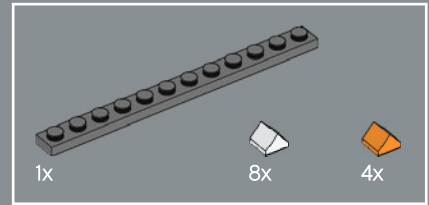
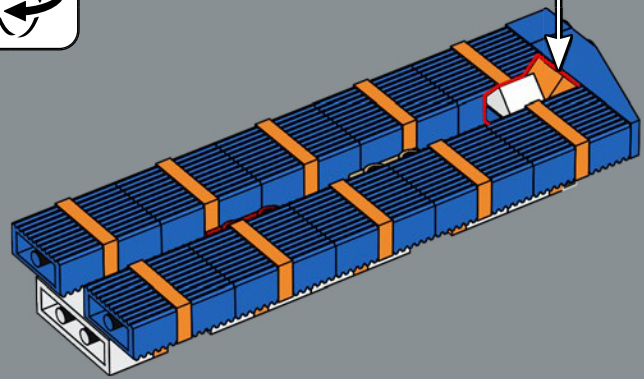
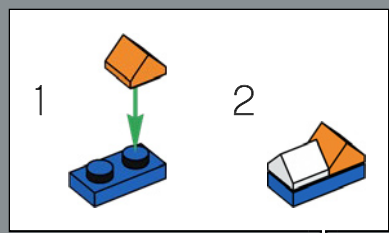

270

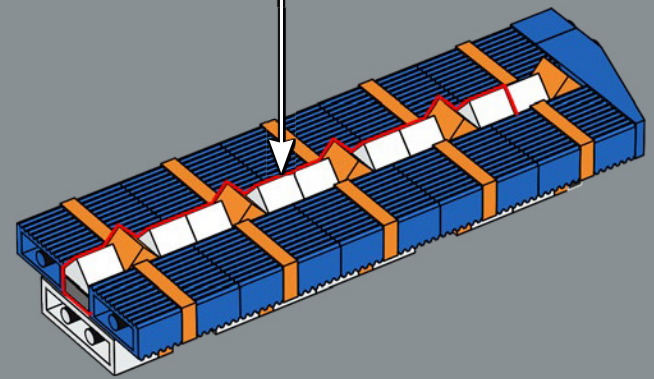
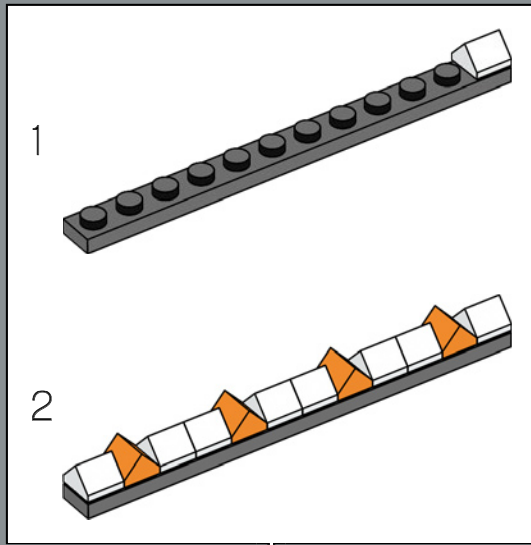

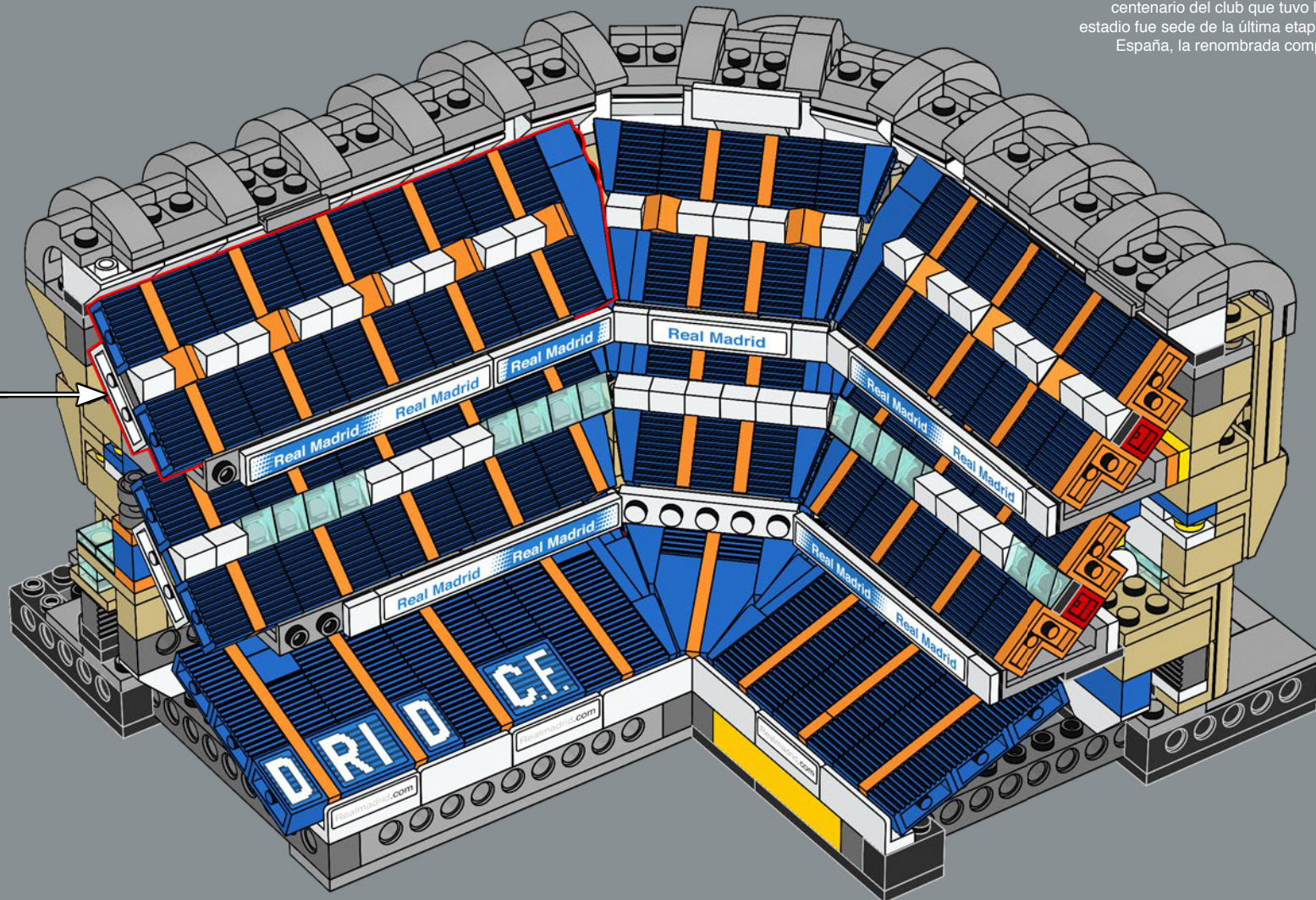

In 2002 the stadium hosted the end of the cycling competition La Vuelta España, as part of the club's Centenary celebrations that year.

En 2002, le stade accueille la fin de la compétition de cyclisme La Vuelta España, dans le cadre des célébrations du centenaire du club.

En 2002, como parte de las celebraciones del centenario del club que tuvo lugar ese año, el estadio fue sede de la última etapa de La Vuelta a España, la renombrada competencia ciclista.

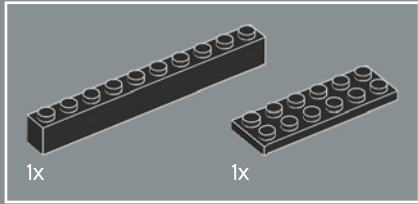
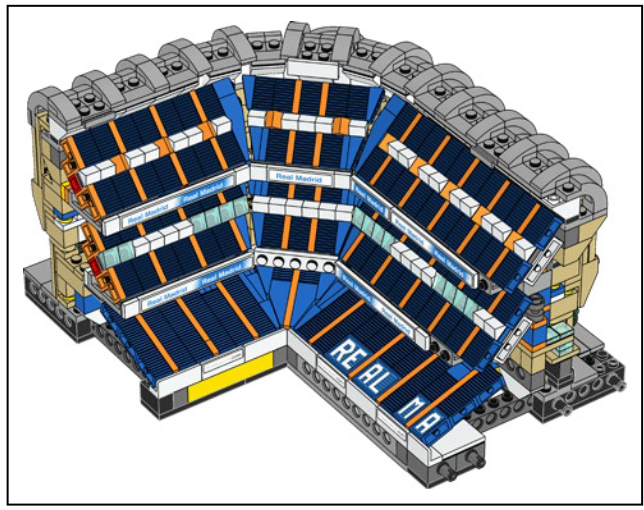
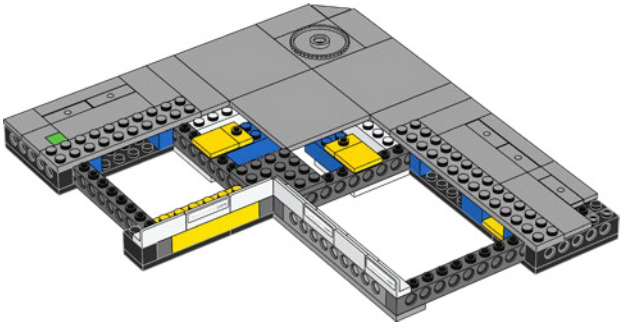
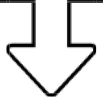
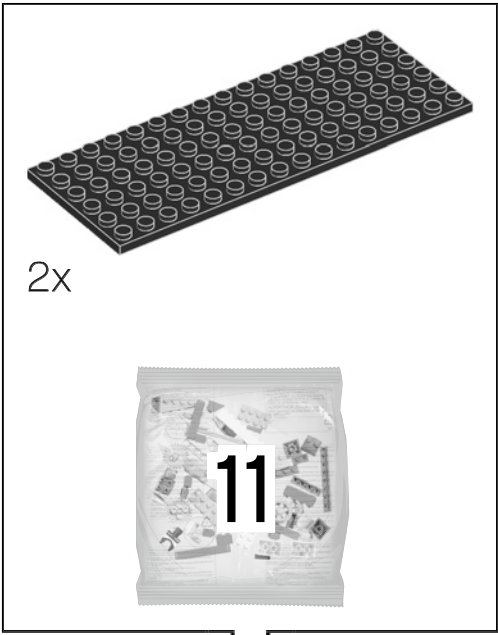

272

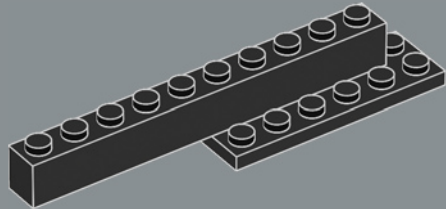

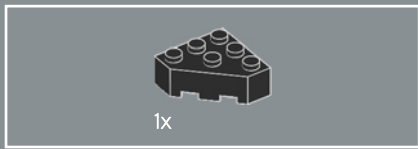

273

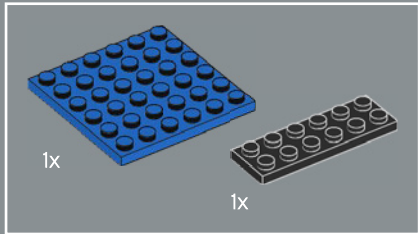
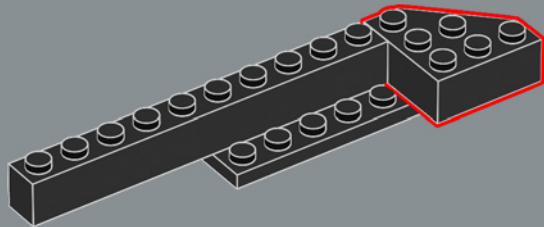

274

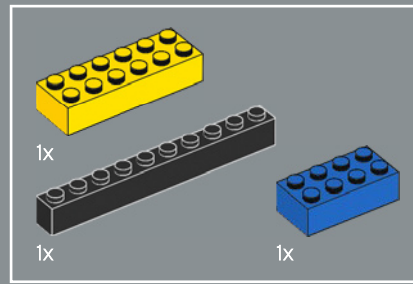
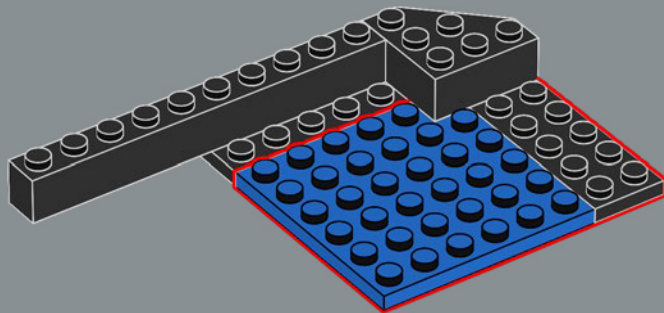

275

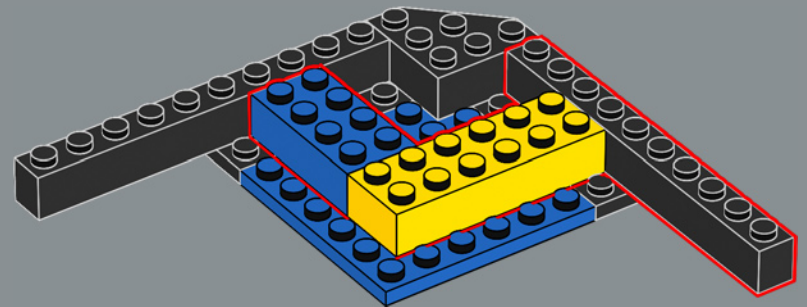

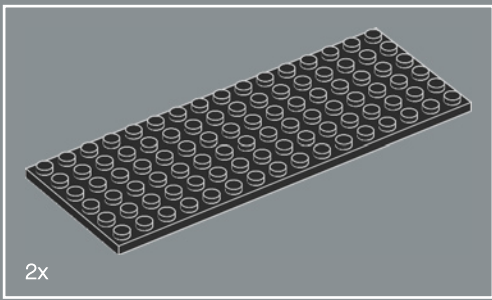

2x

276

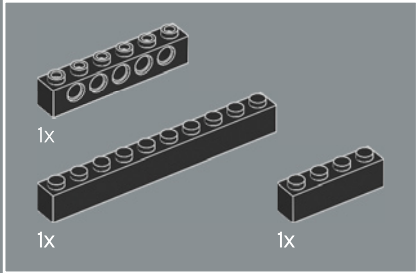
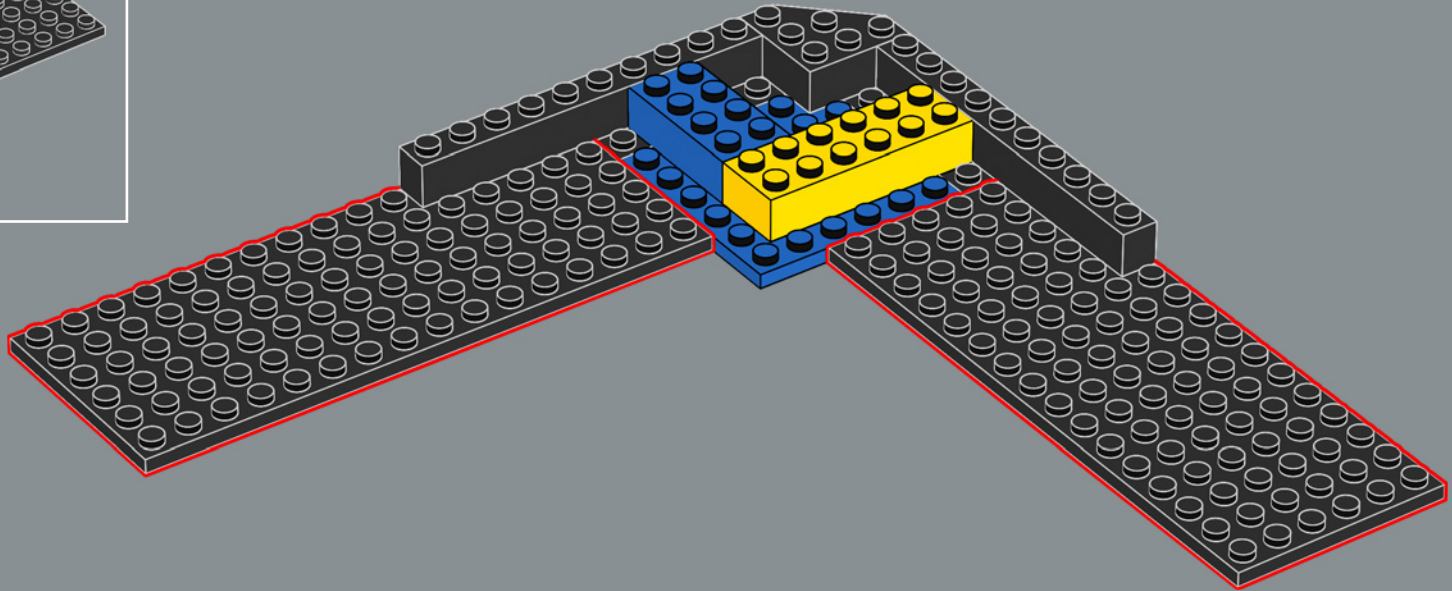

1x

1x

1x

277

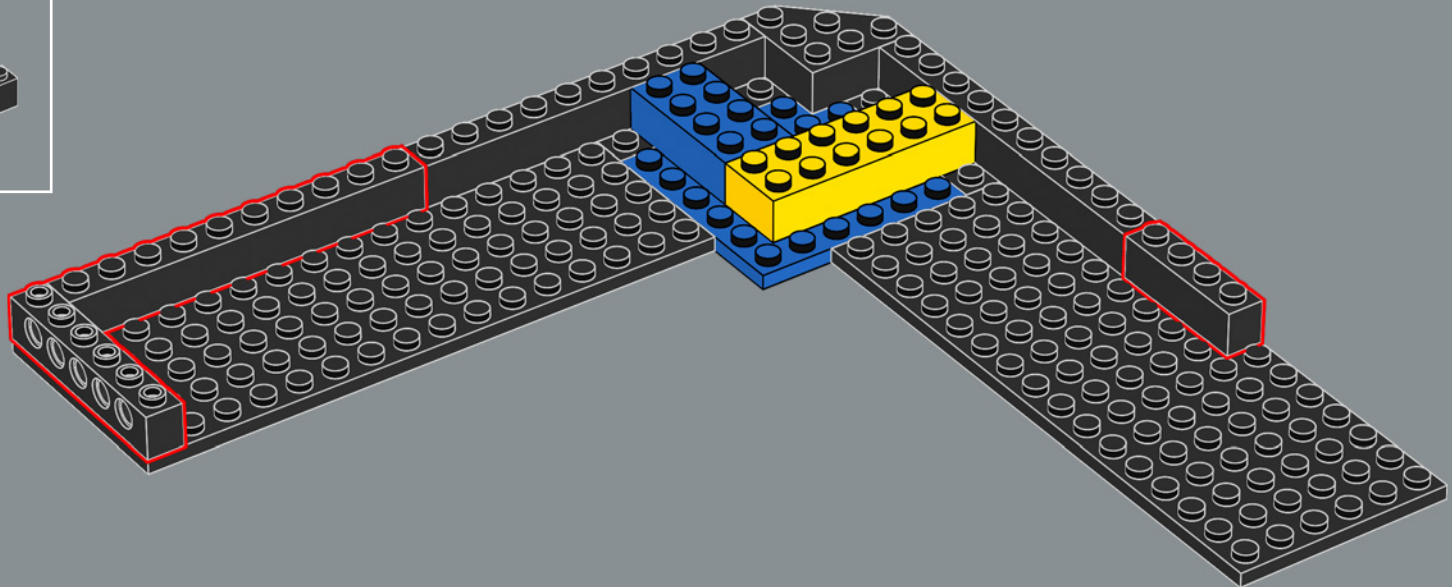

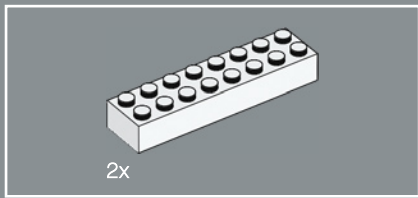

278

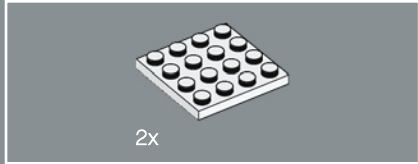
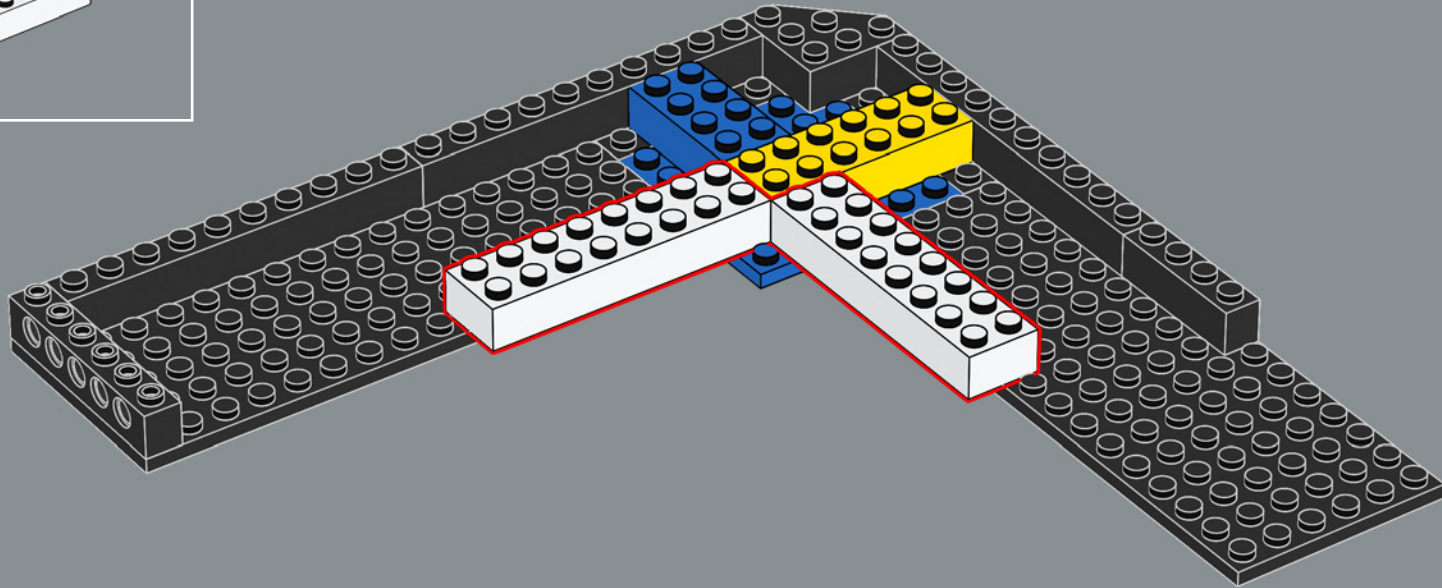

279

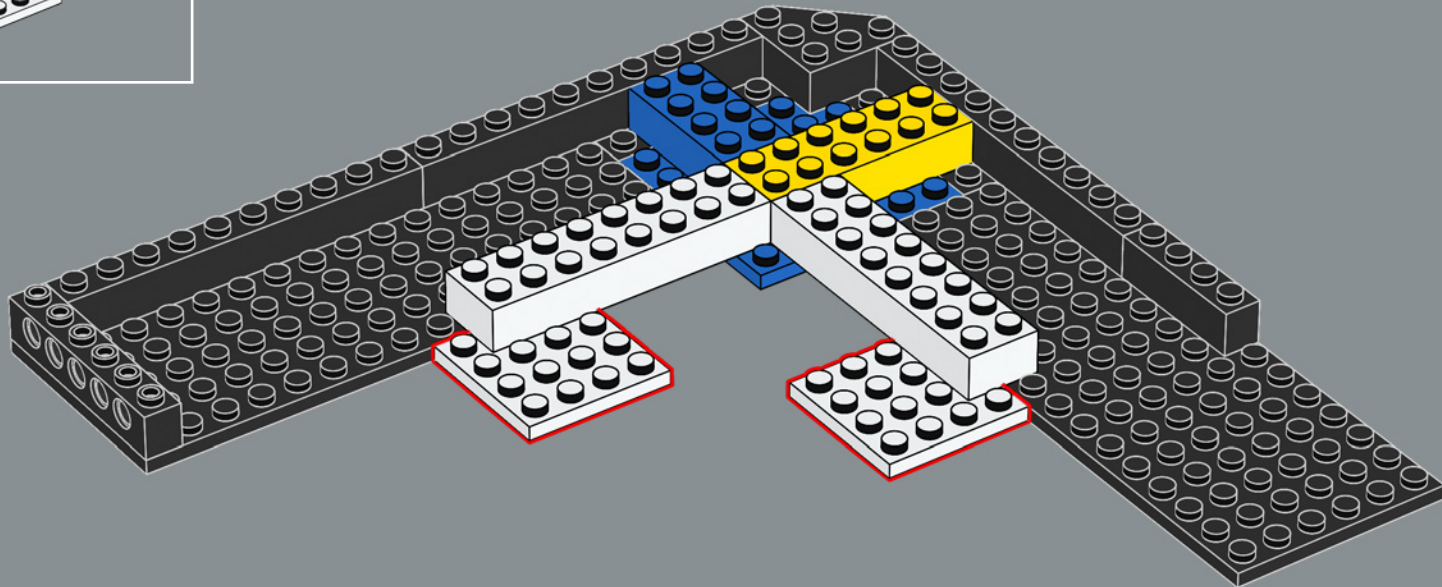

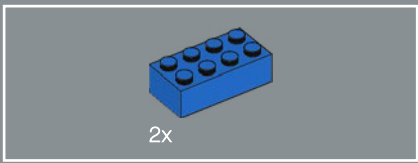

280

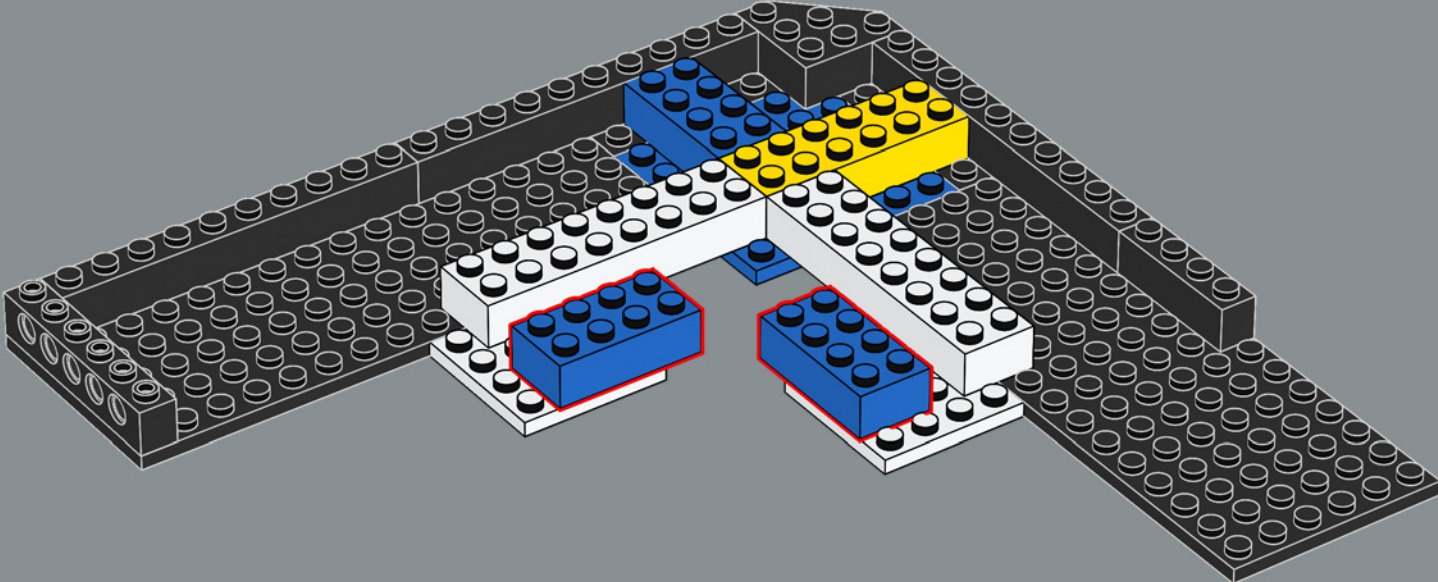

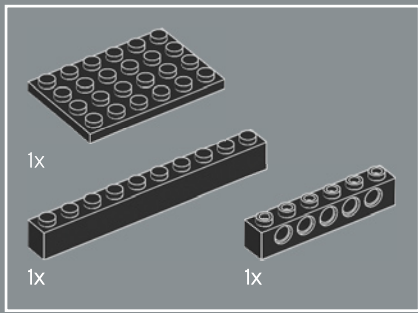

281

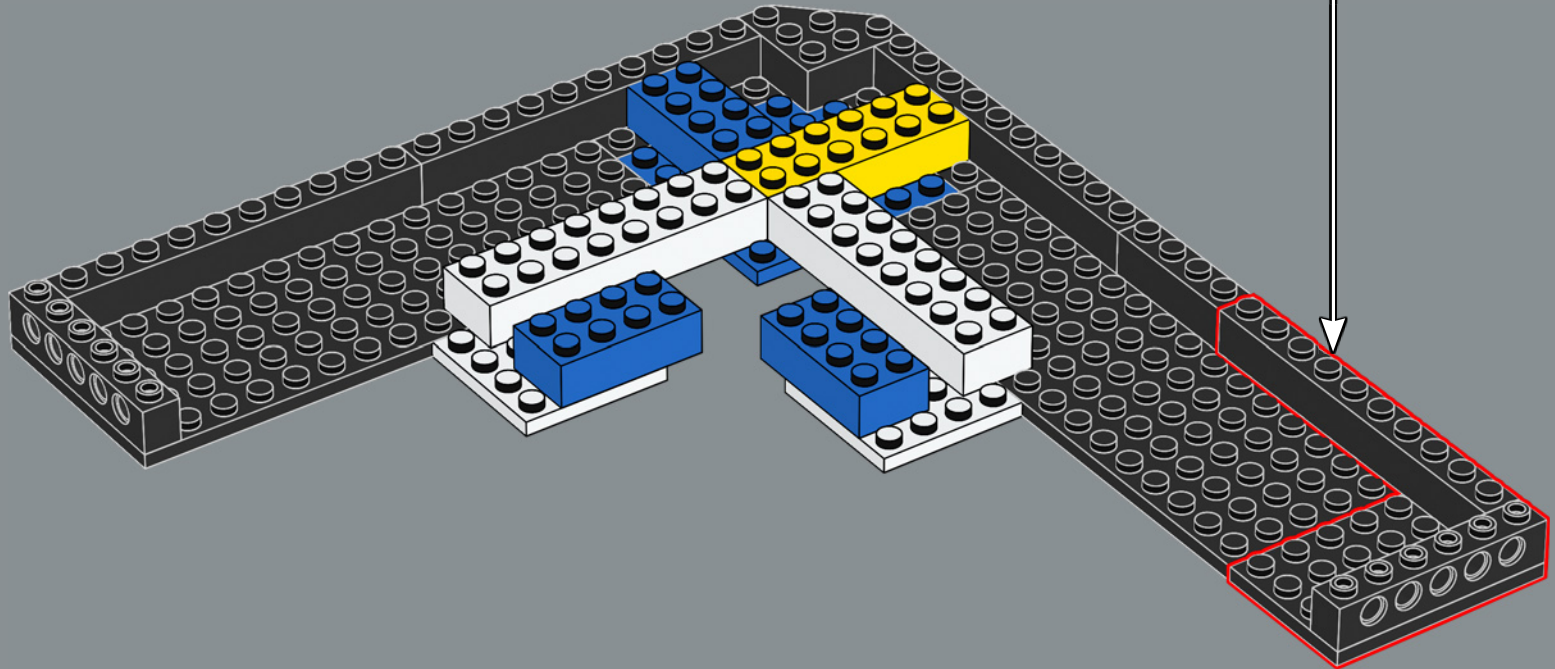
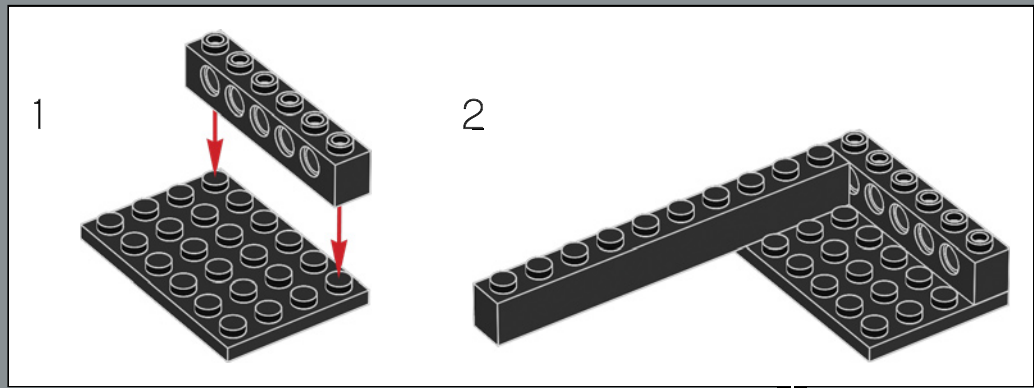

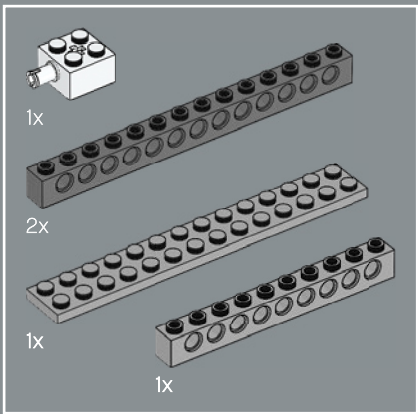

282

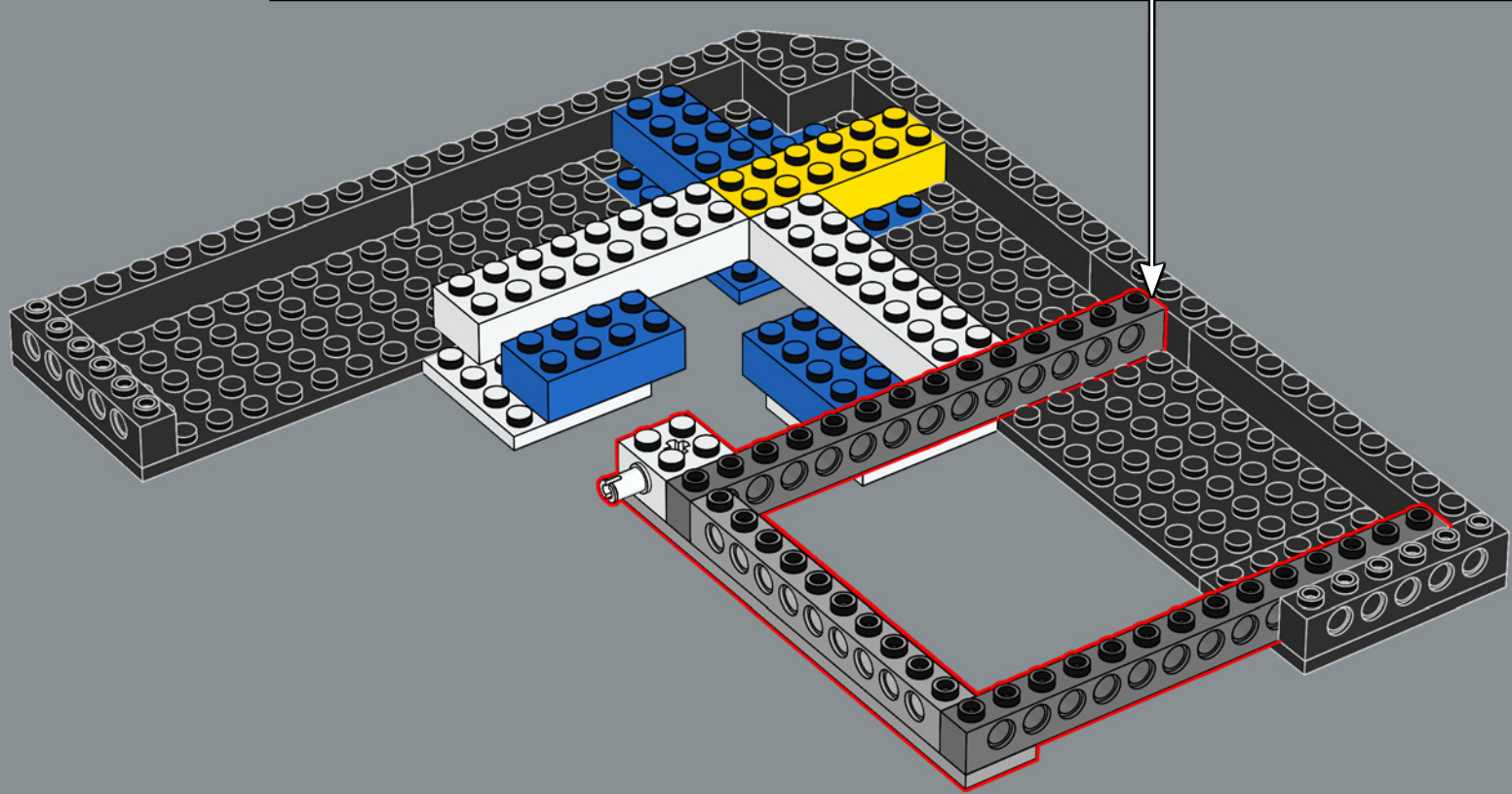
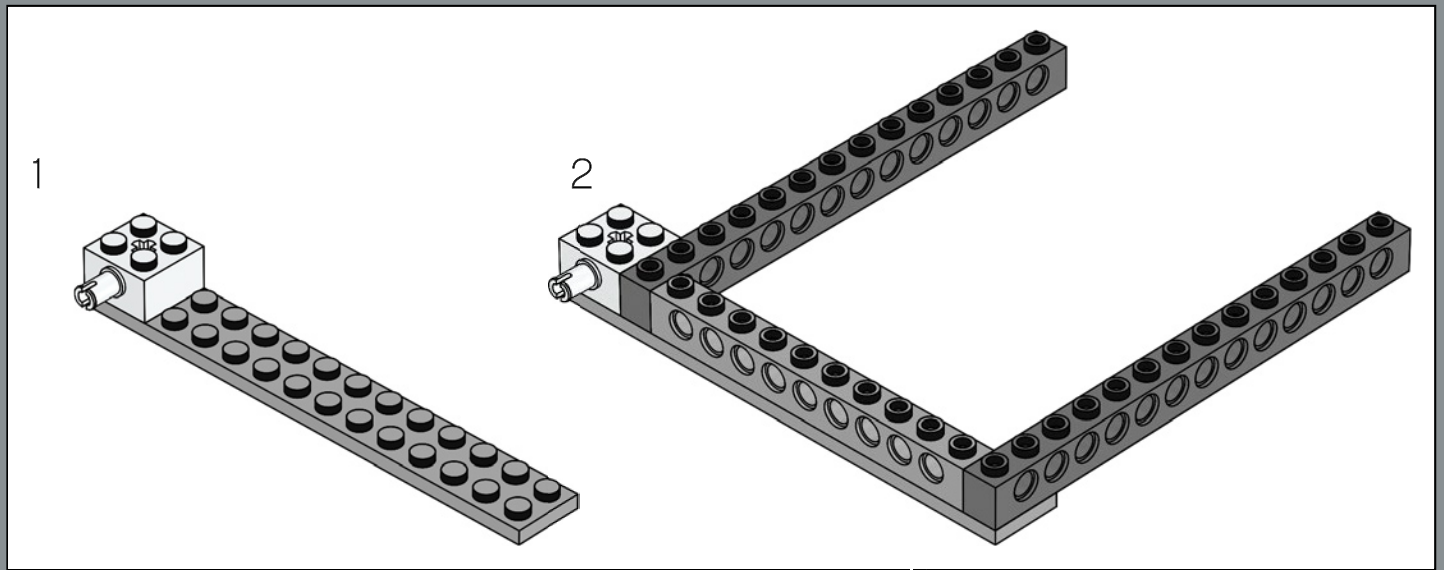

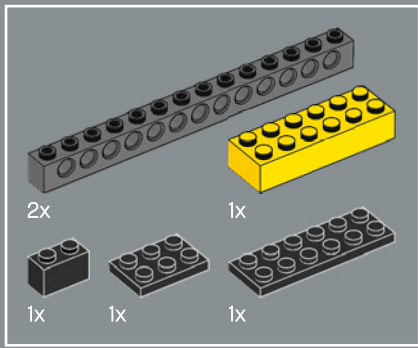

283

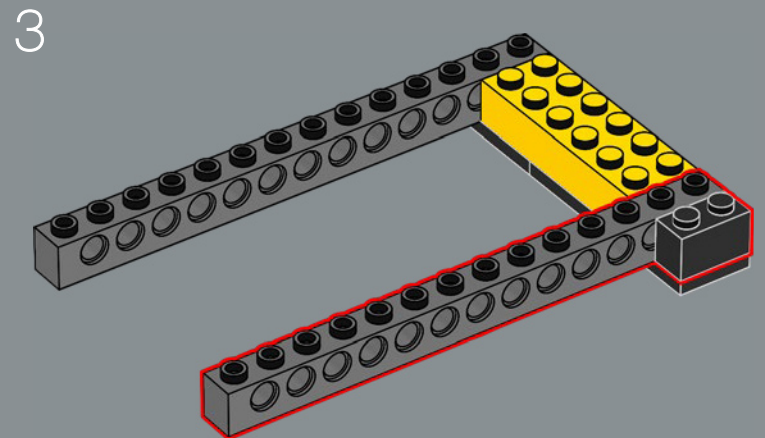
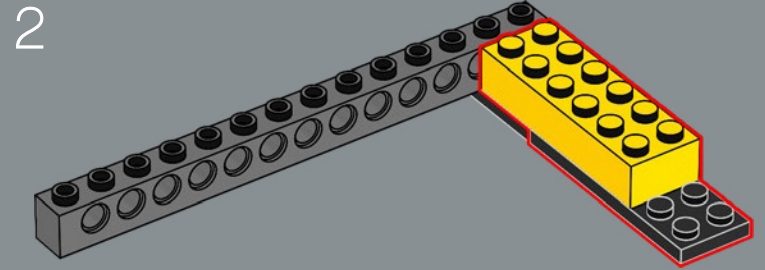
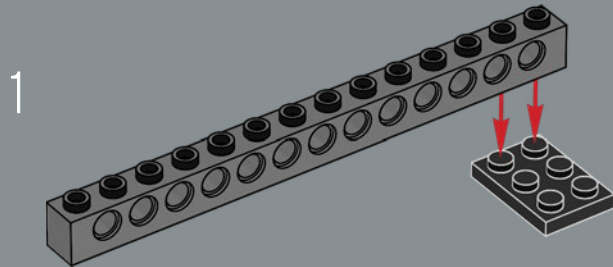

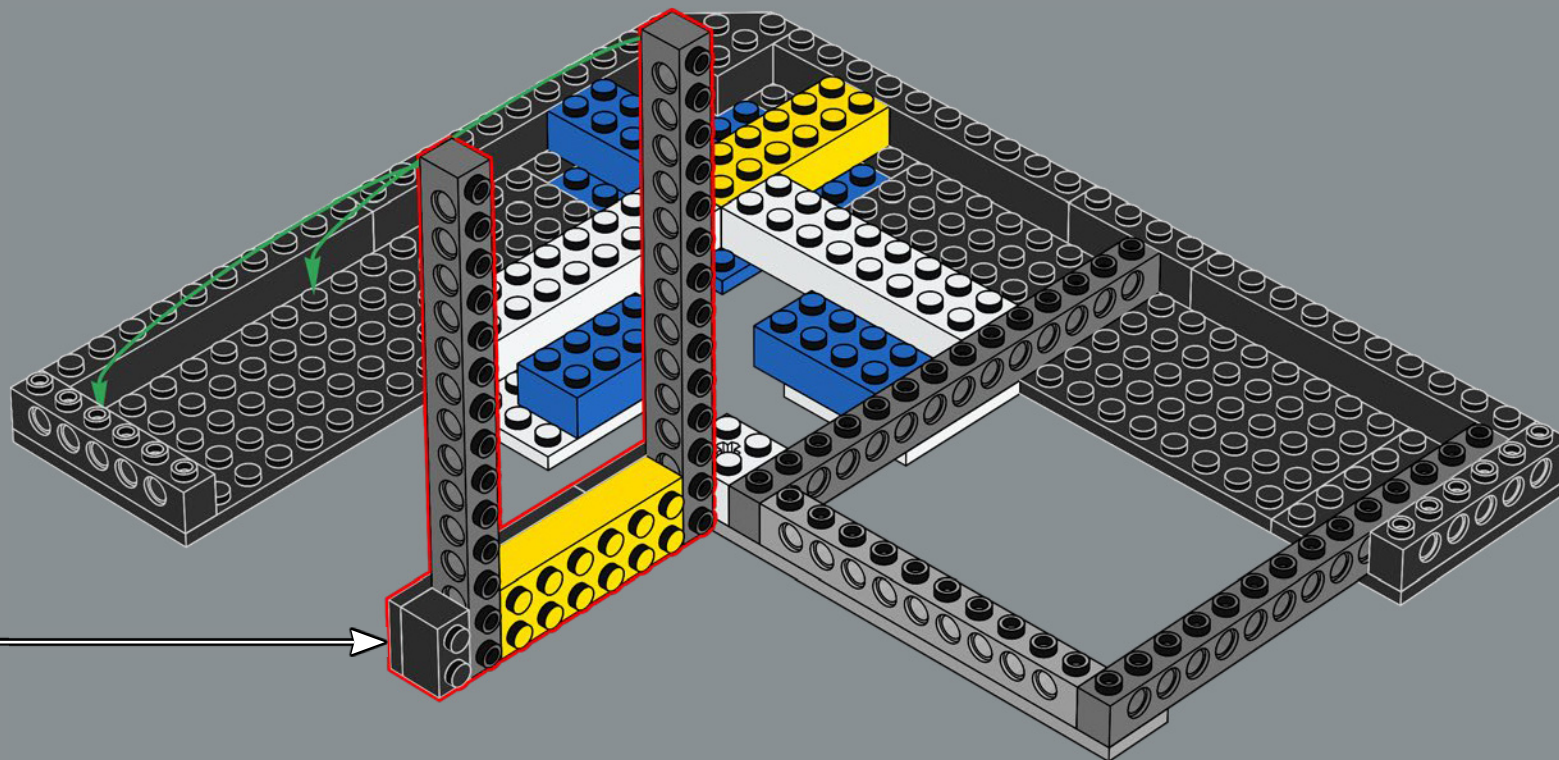

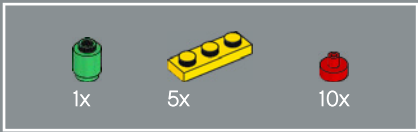

284

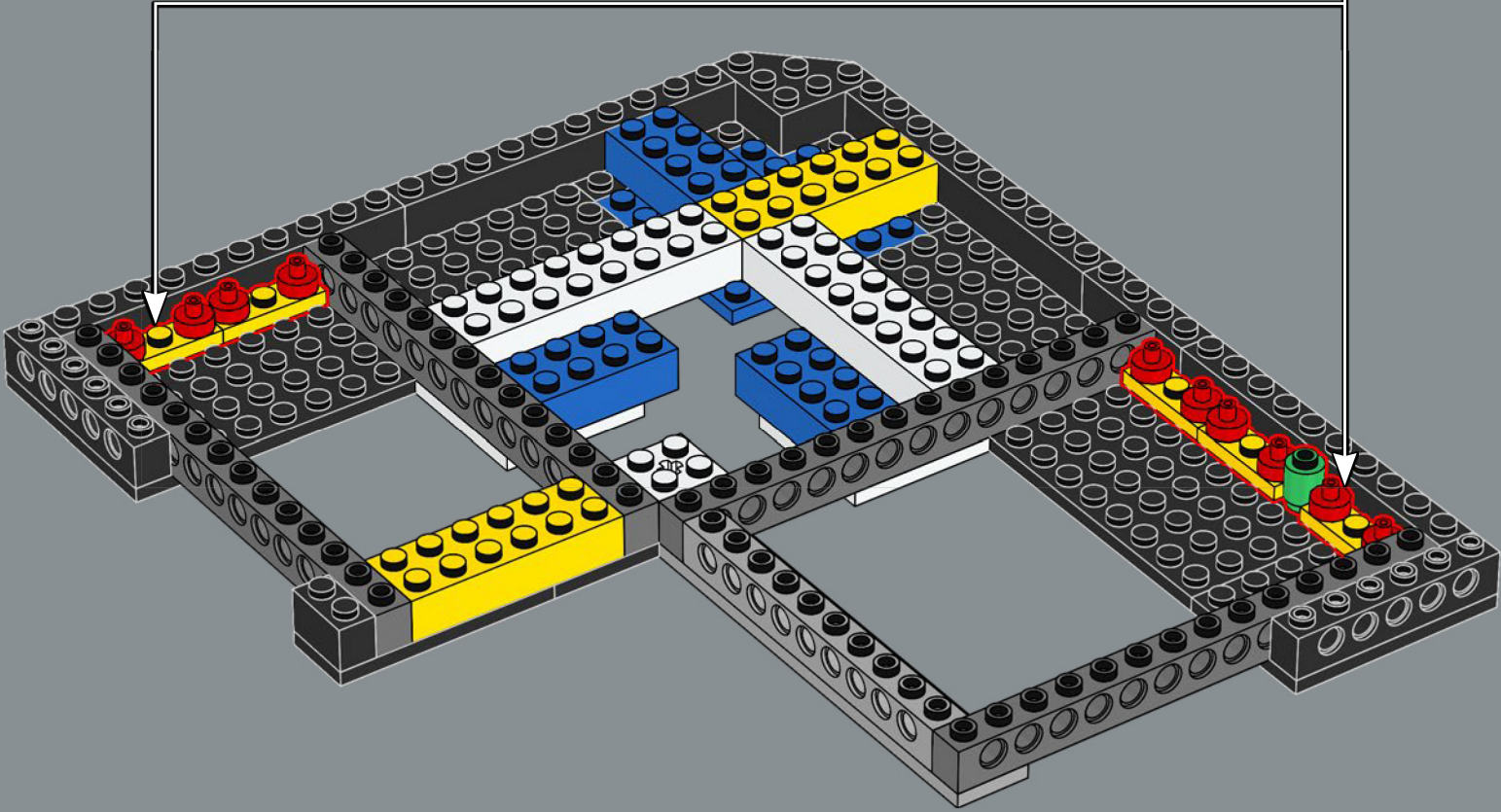
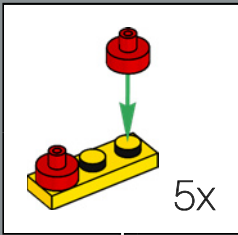

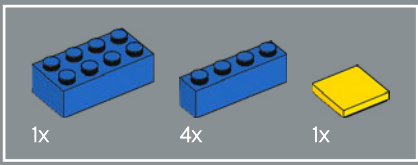

285

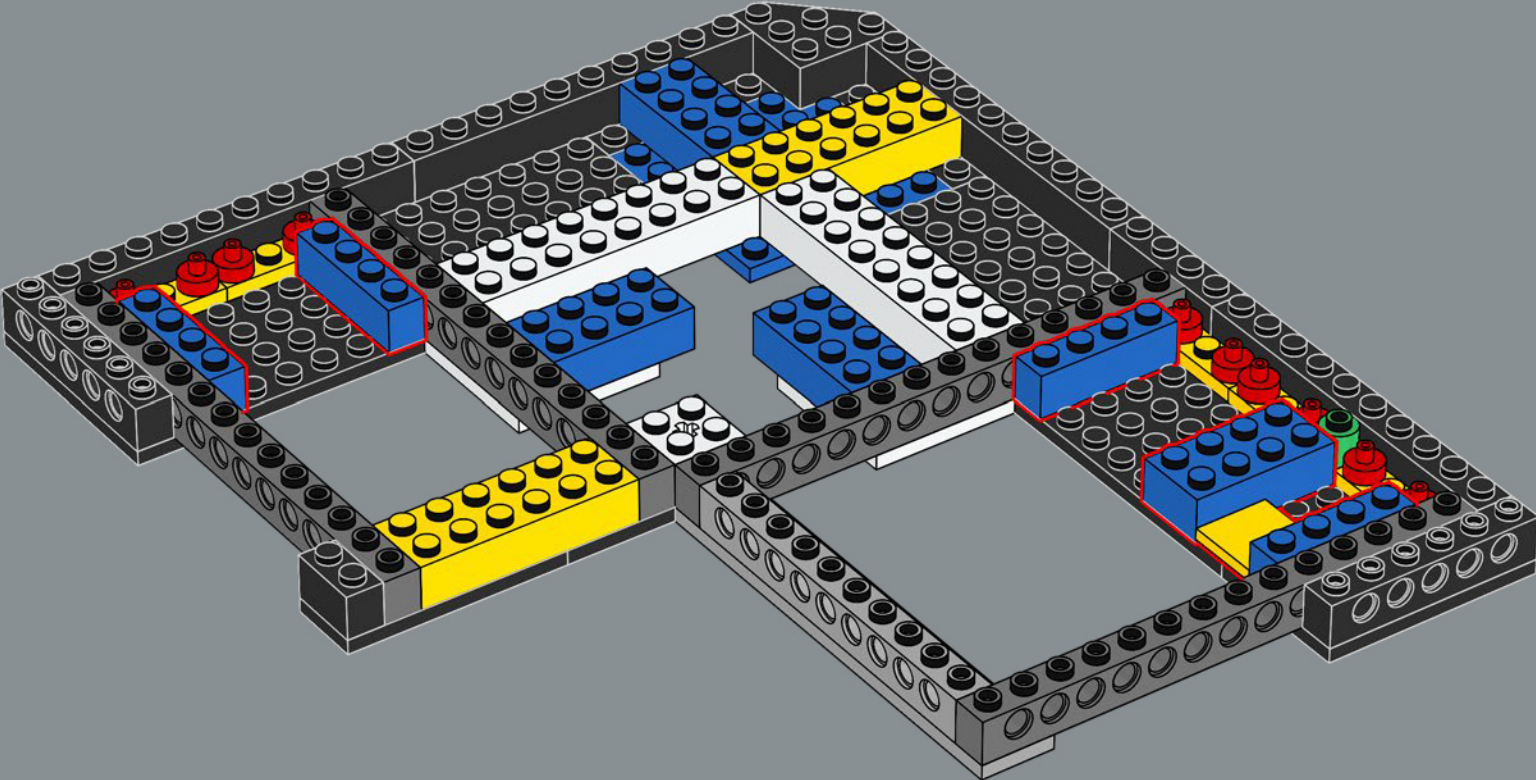

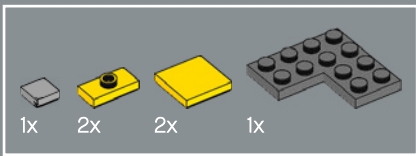

286

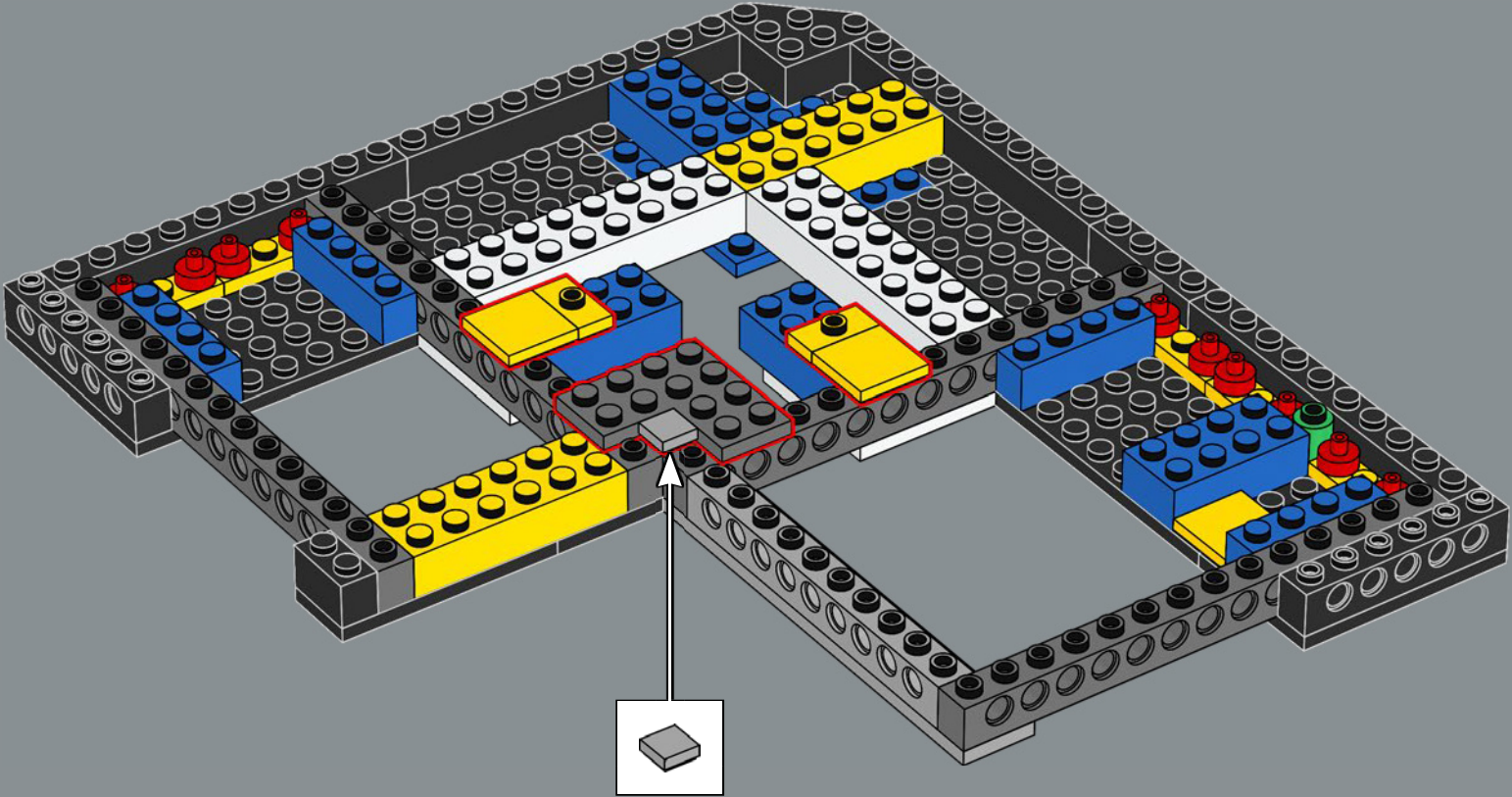

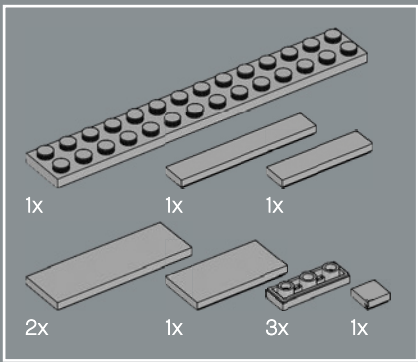

287

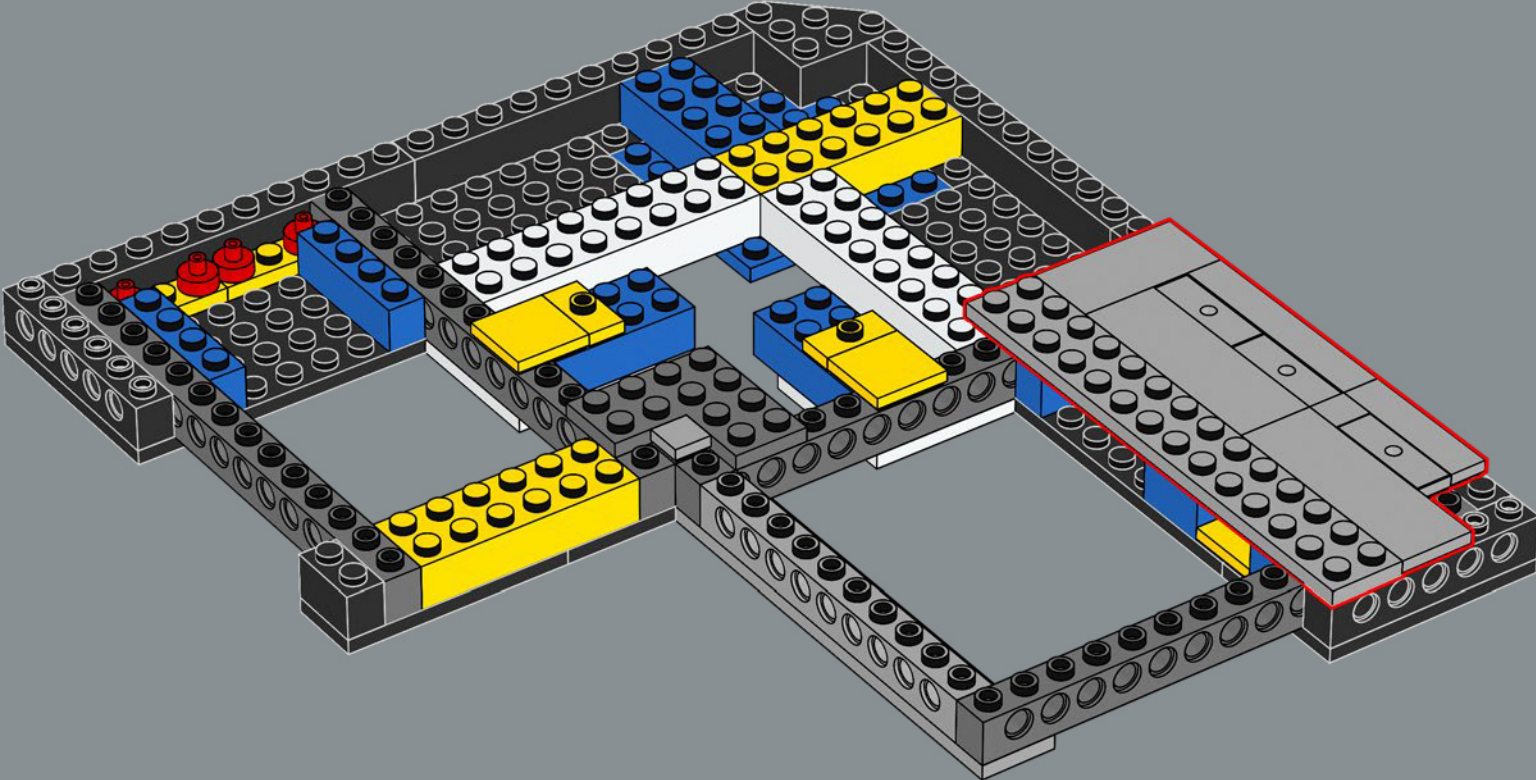

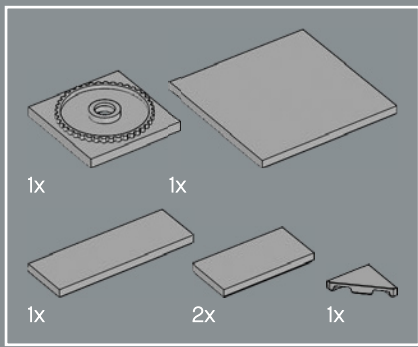

288

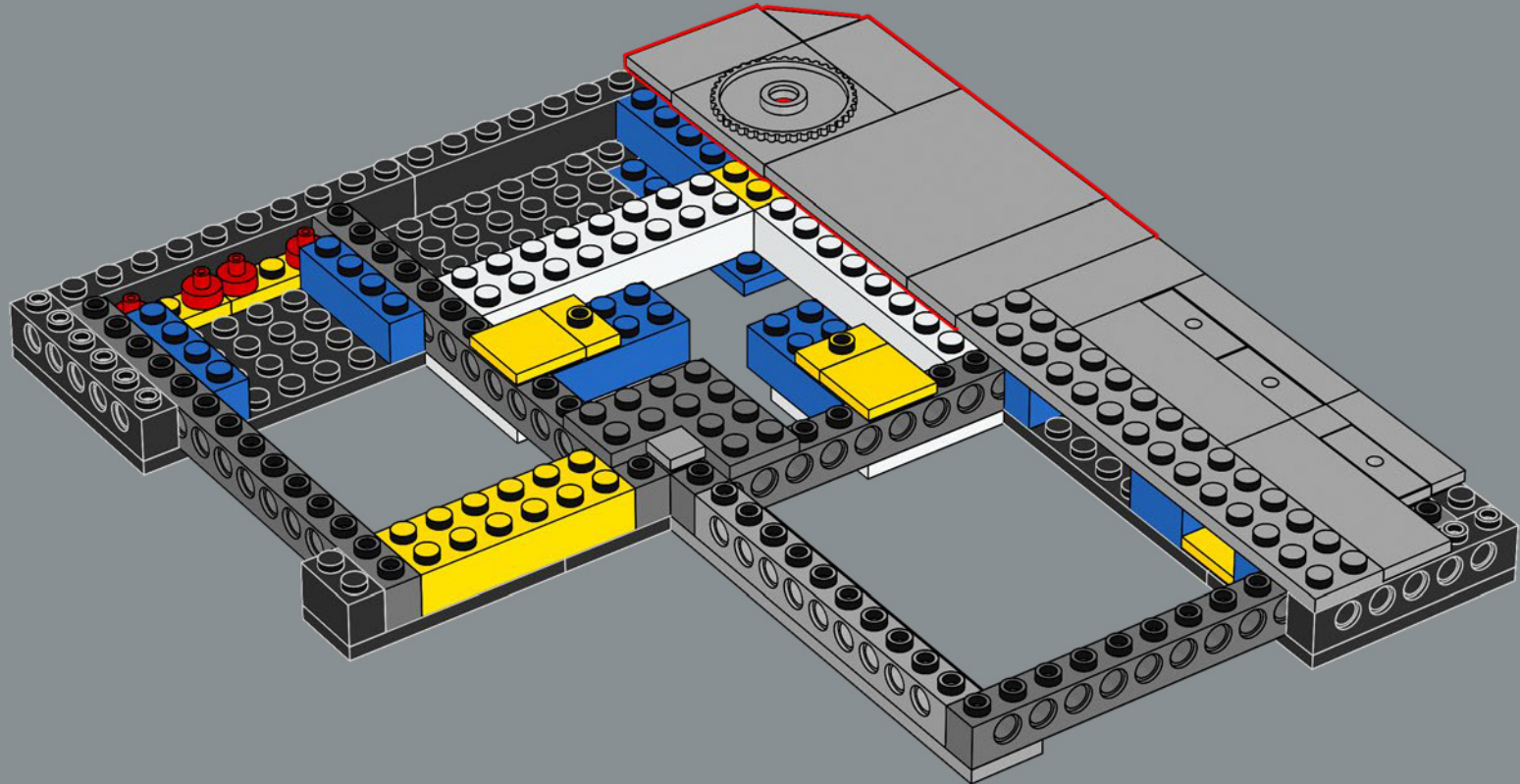

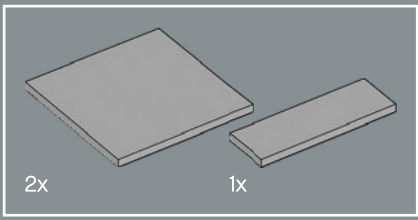

289

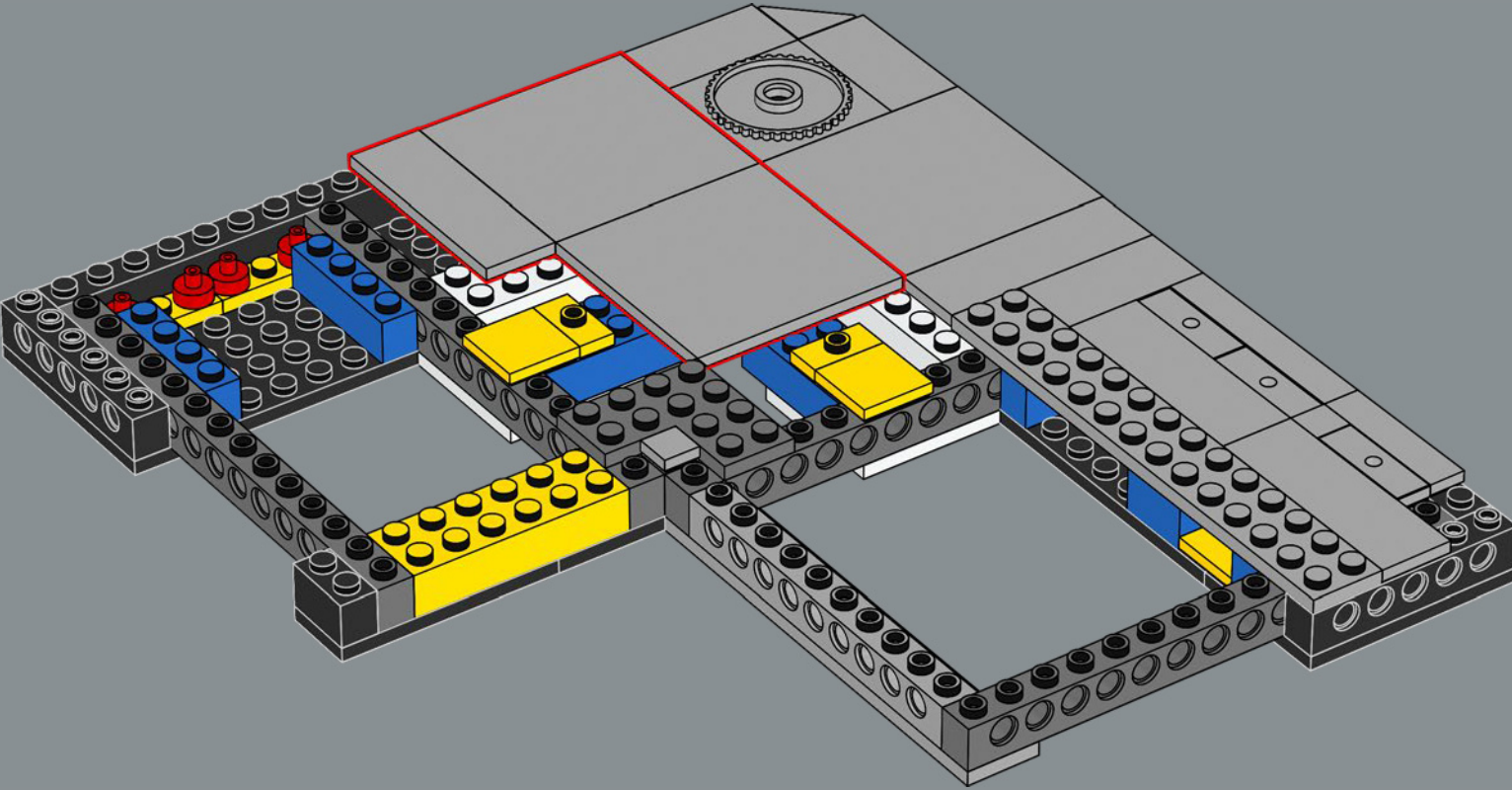

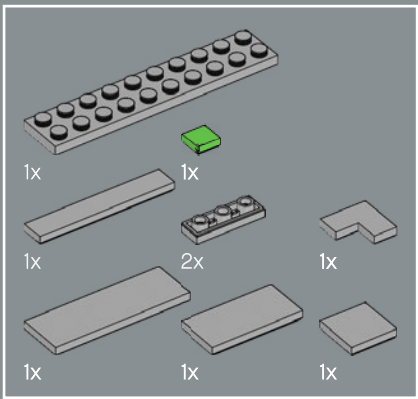

290

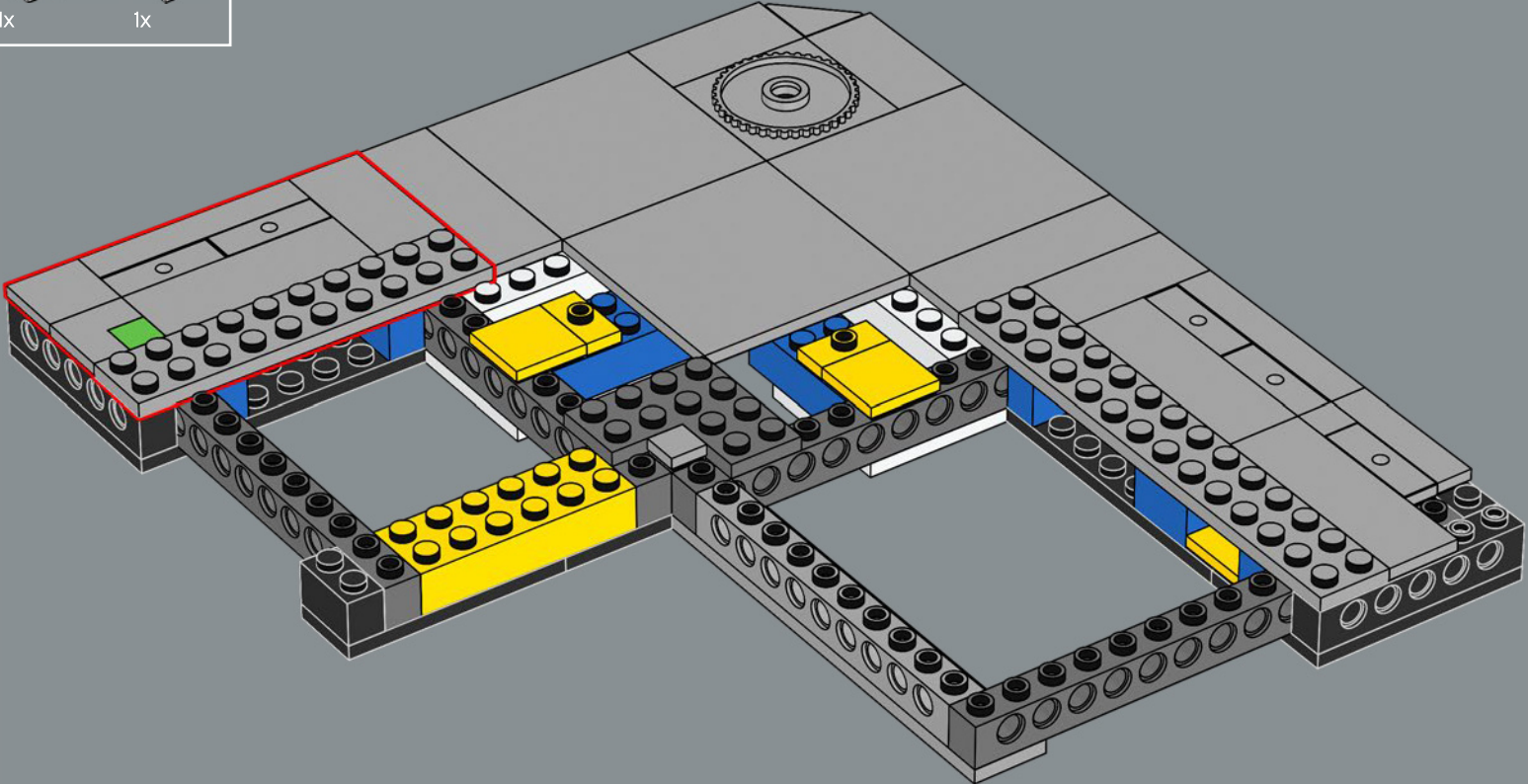

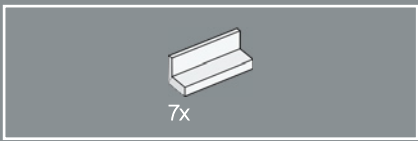

291

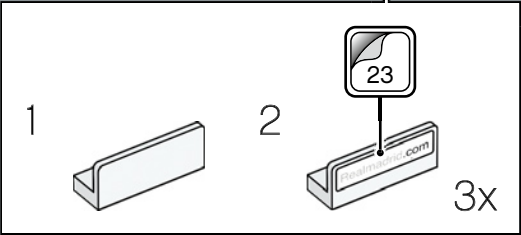
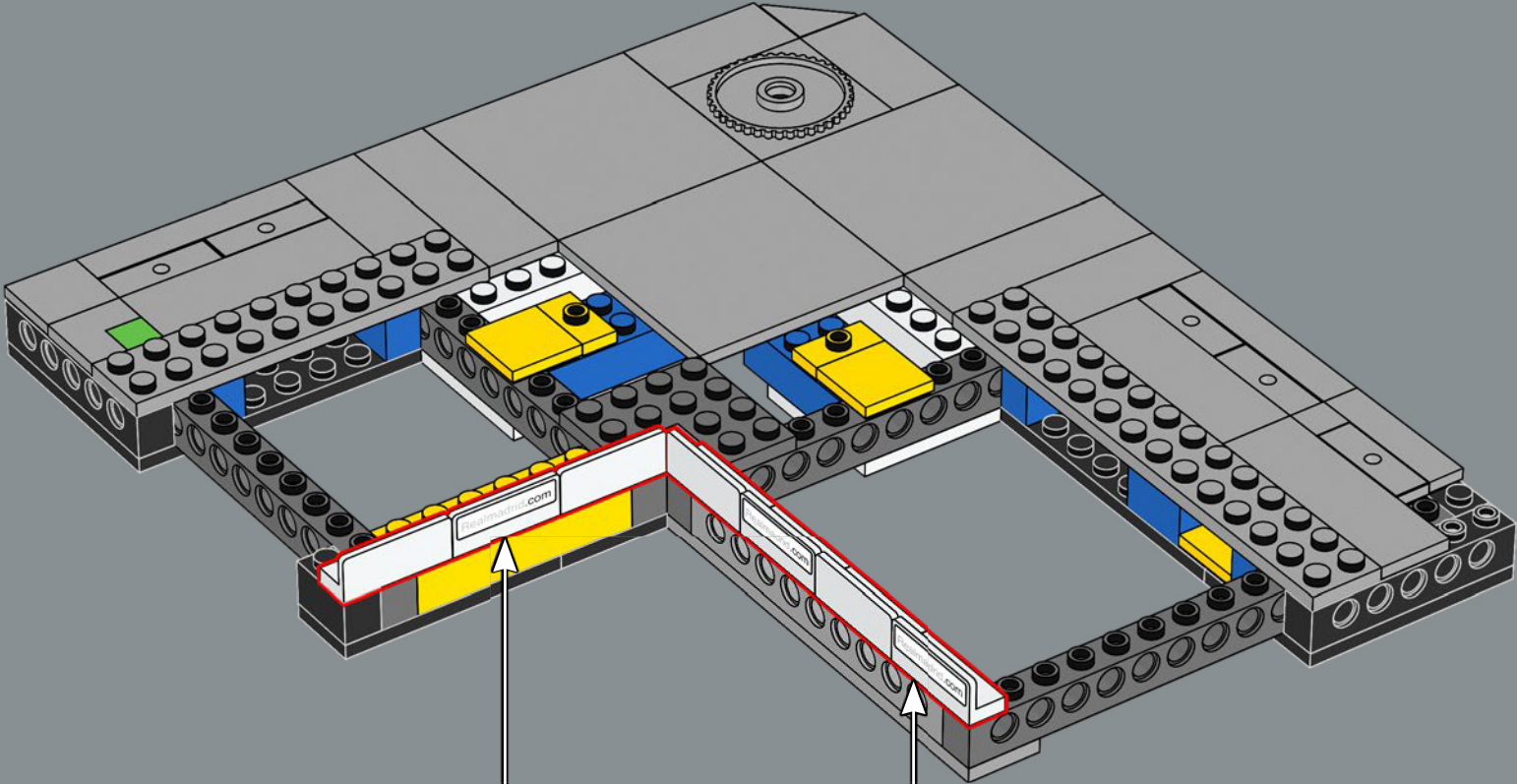

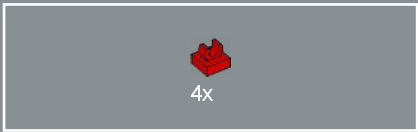
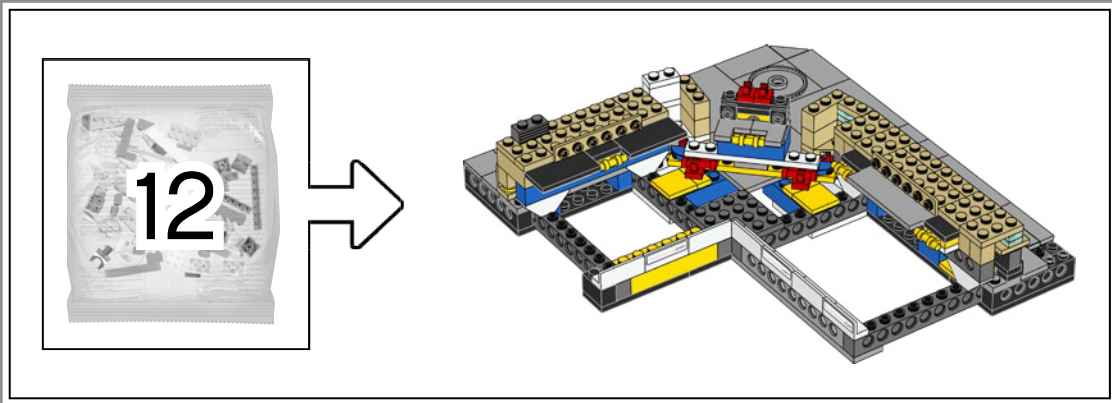

292

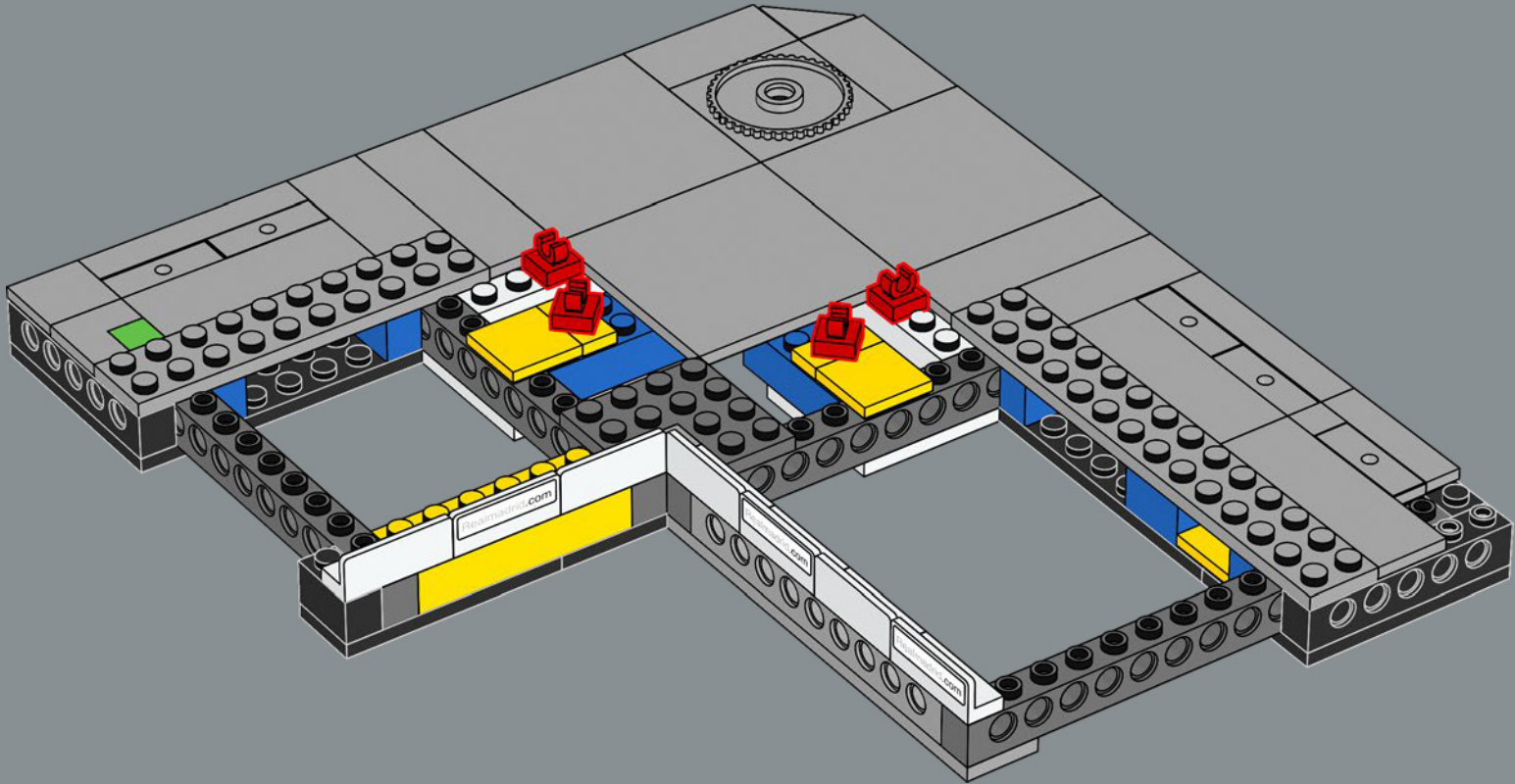

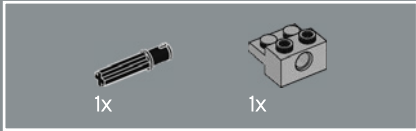
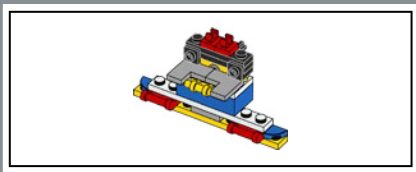

293

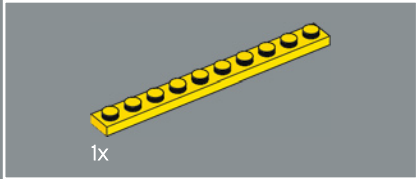
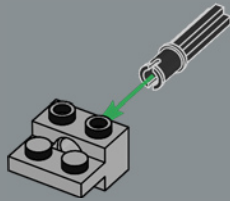

294

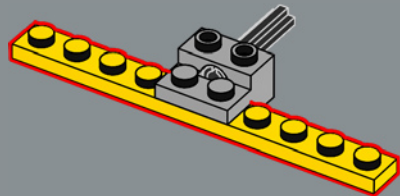

295

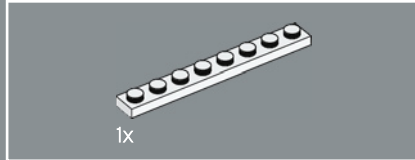
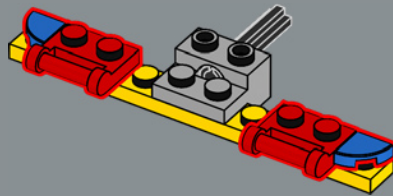

296

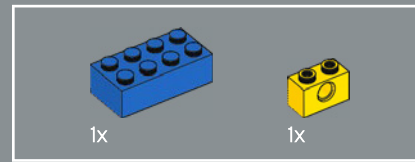
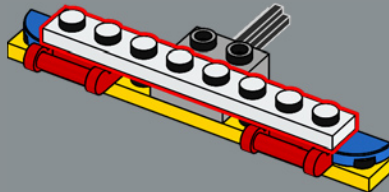

297

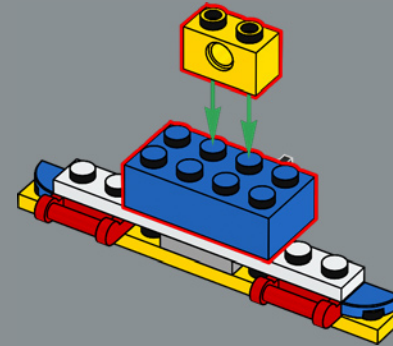

298

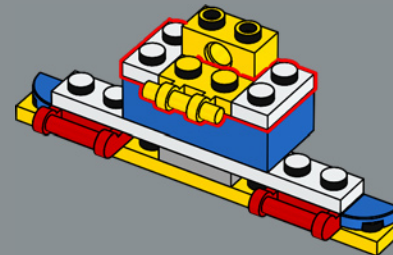

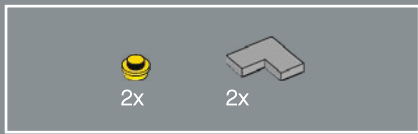

299

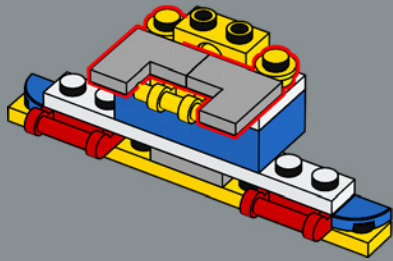

300

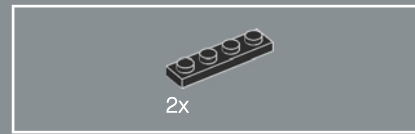
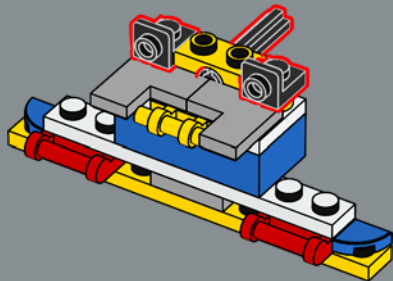

301

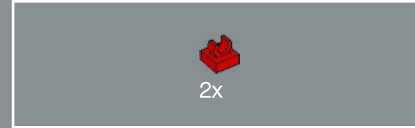
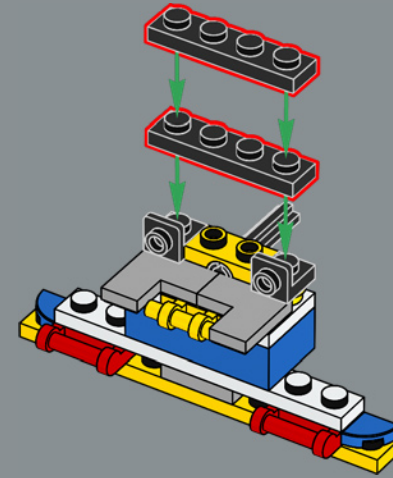

302

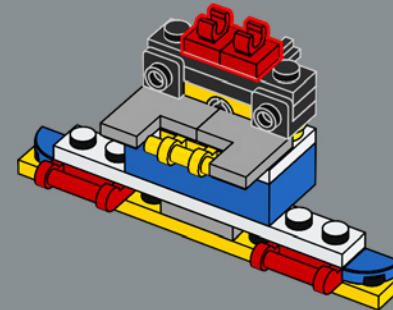

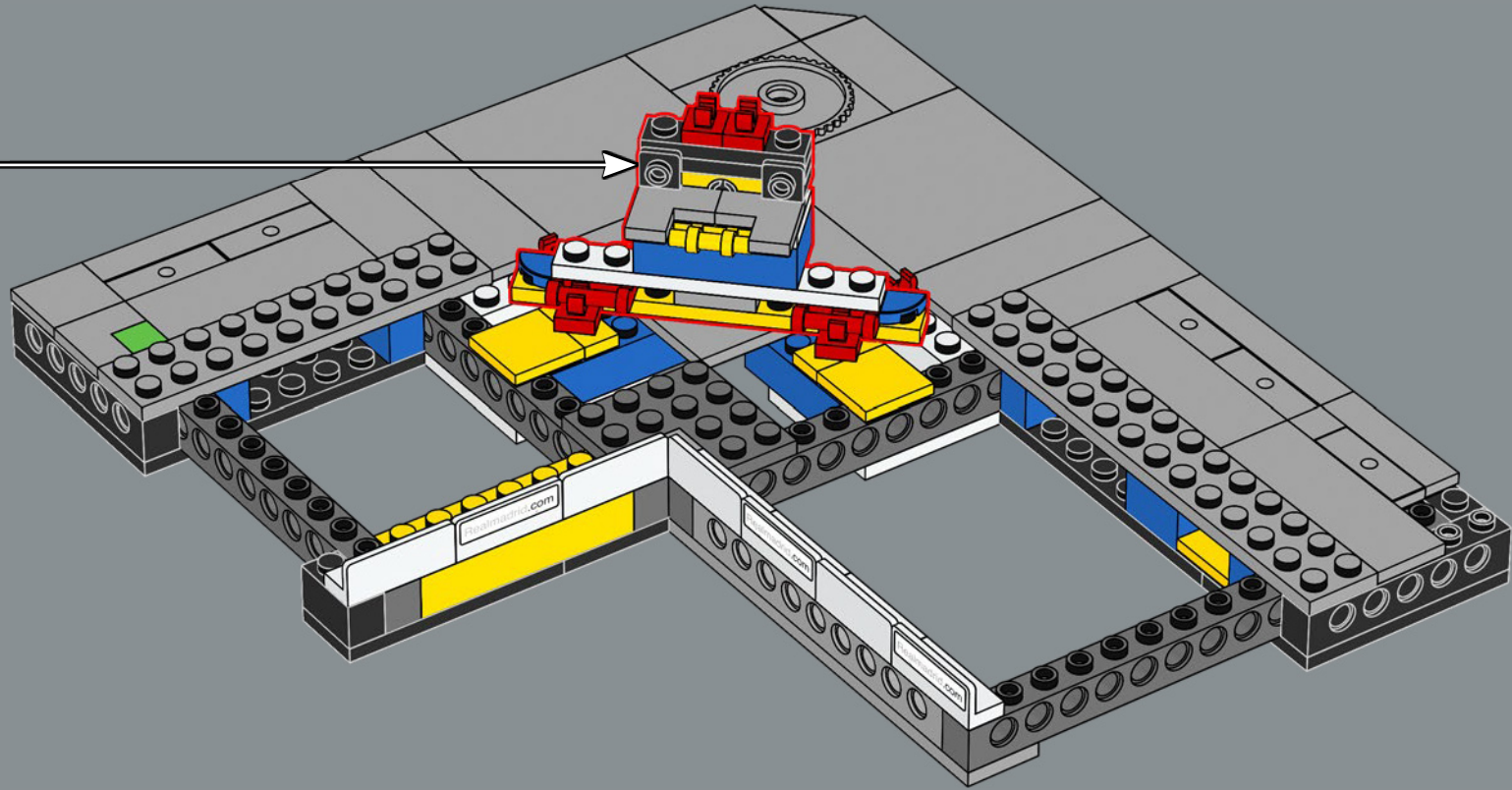

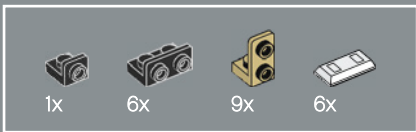

304

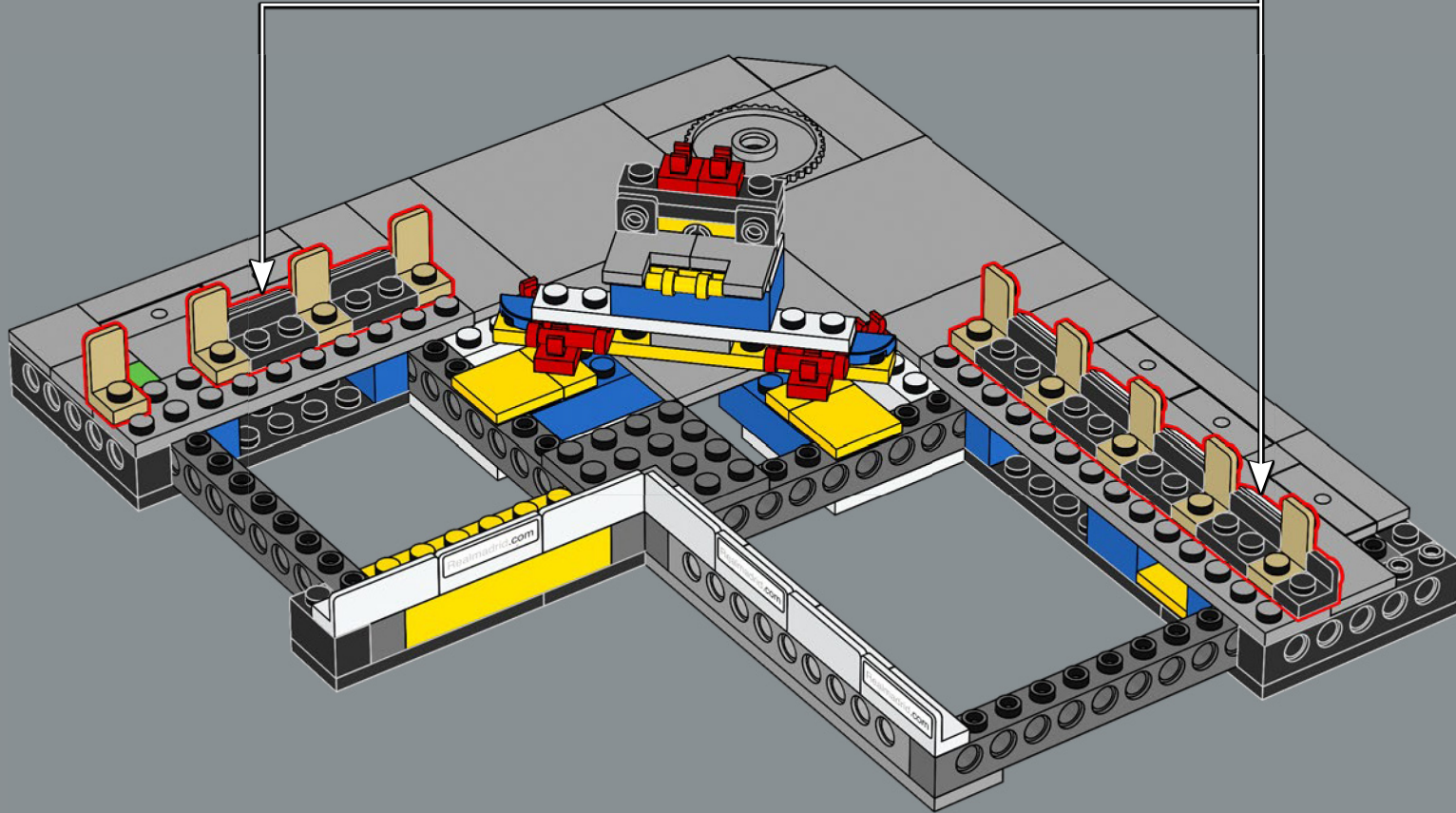
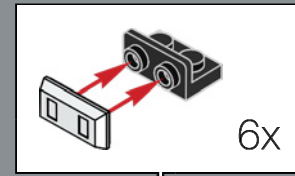

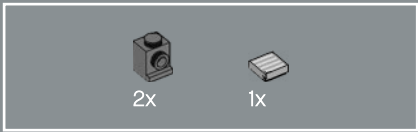

305

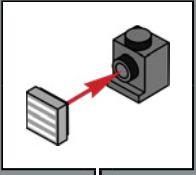
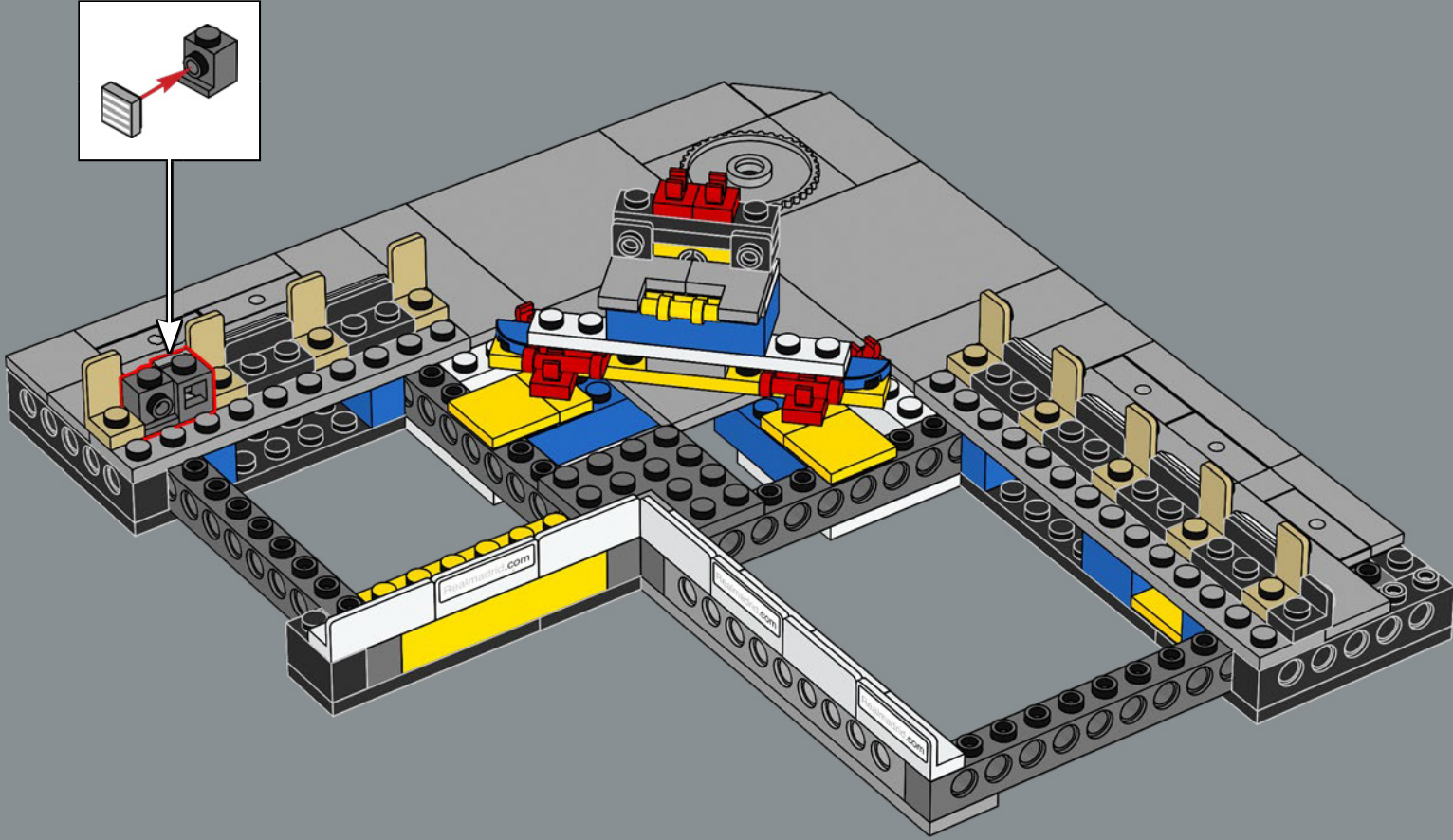

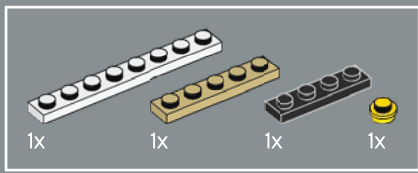

306

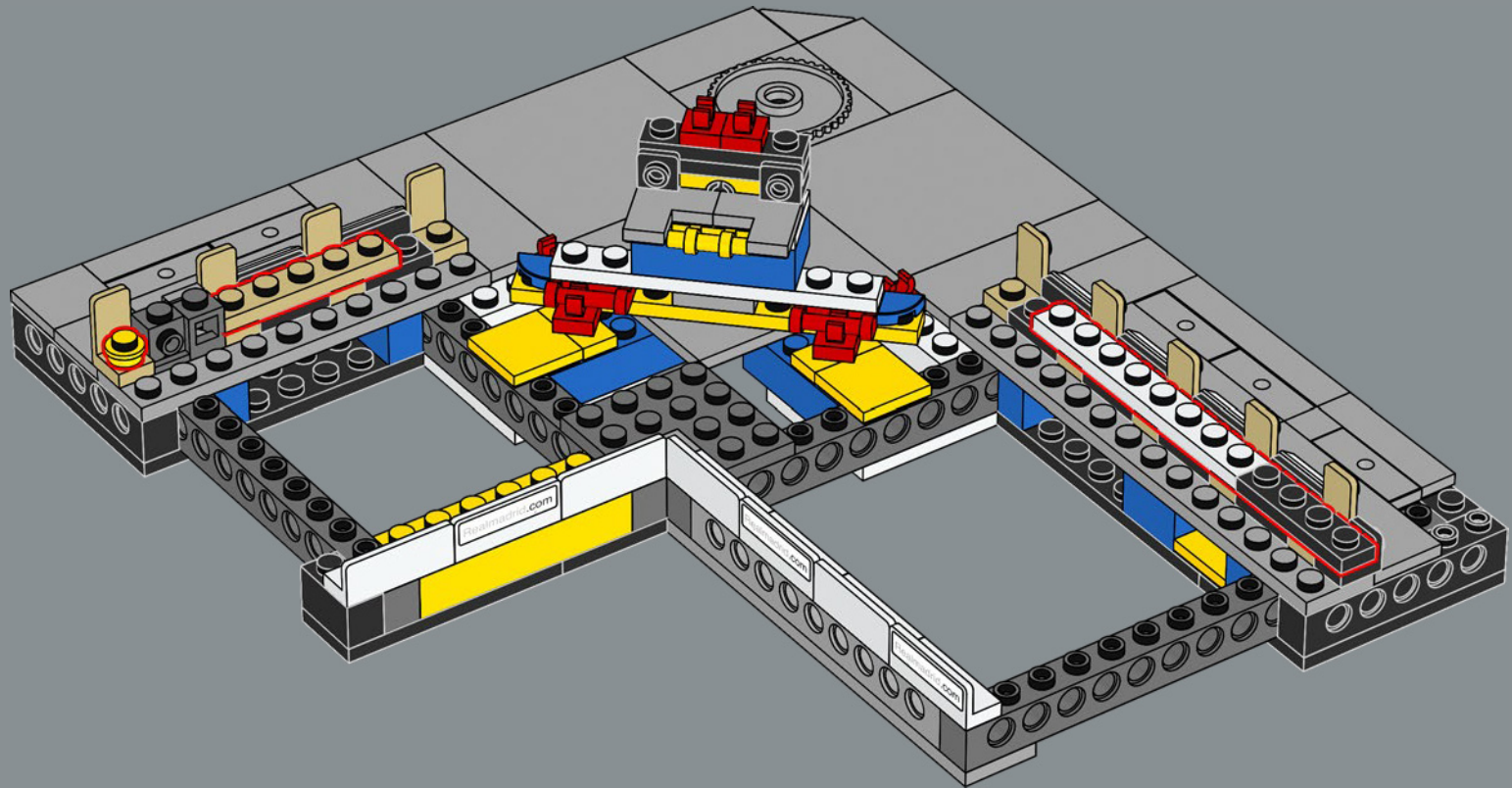

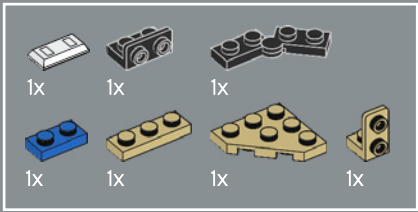

307

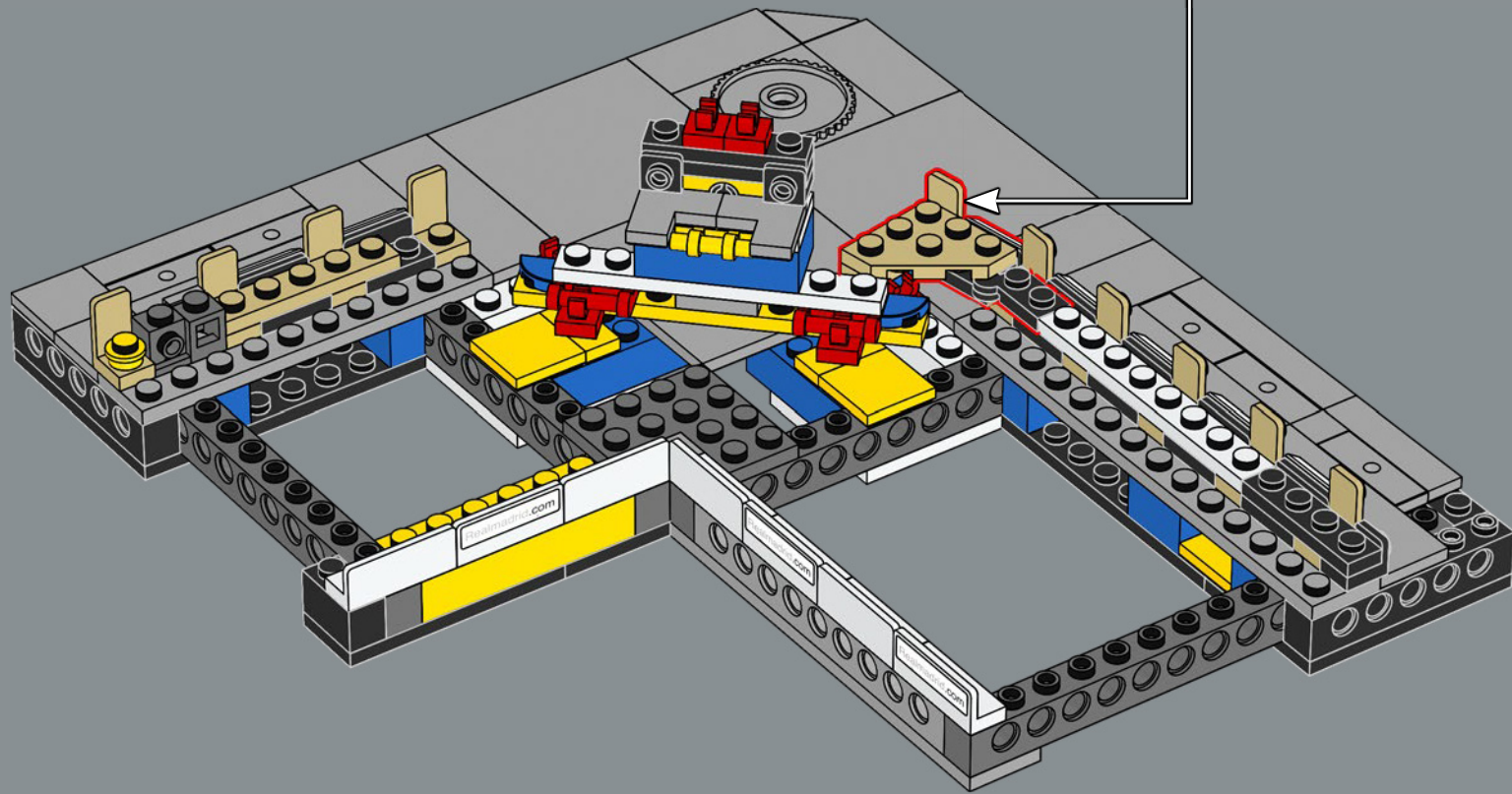
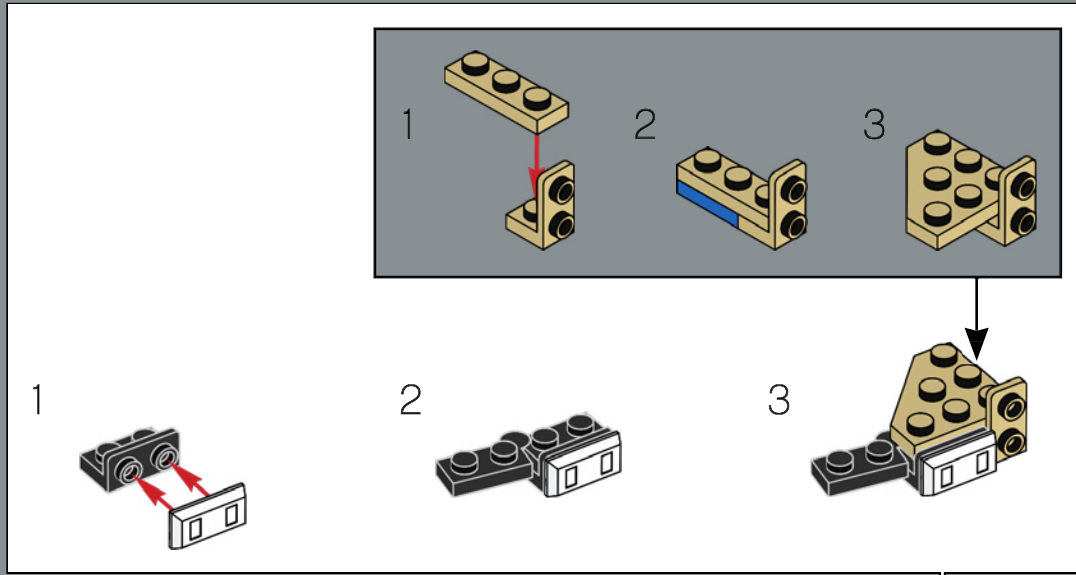

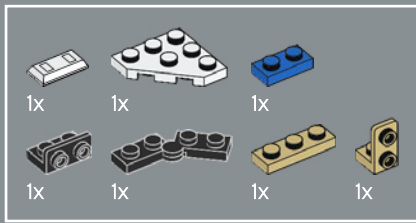

308

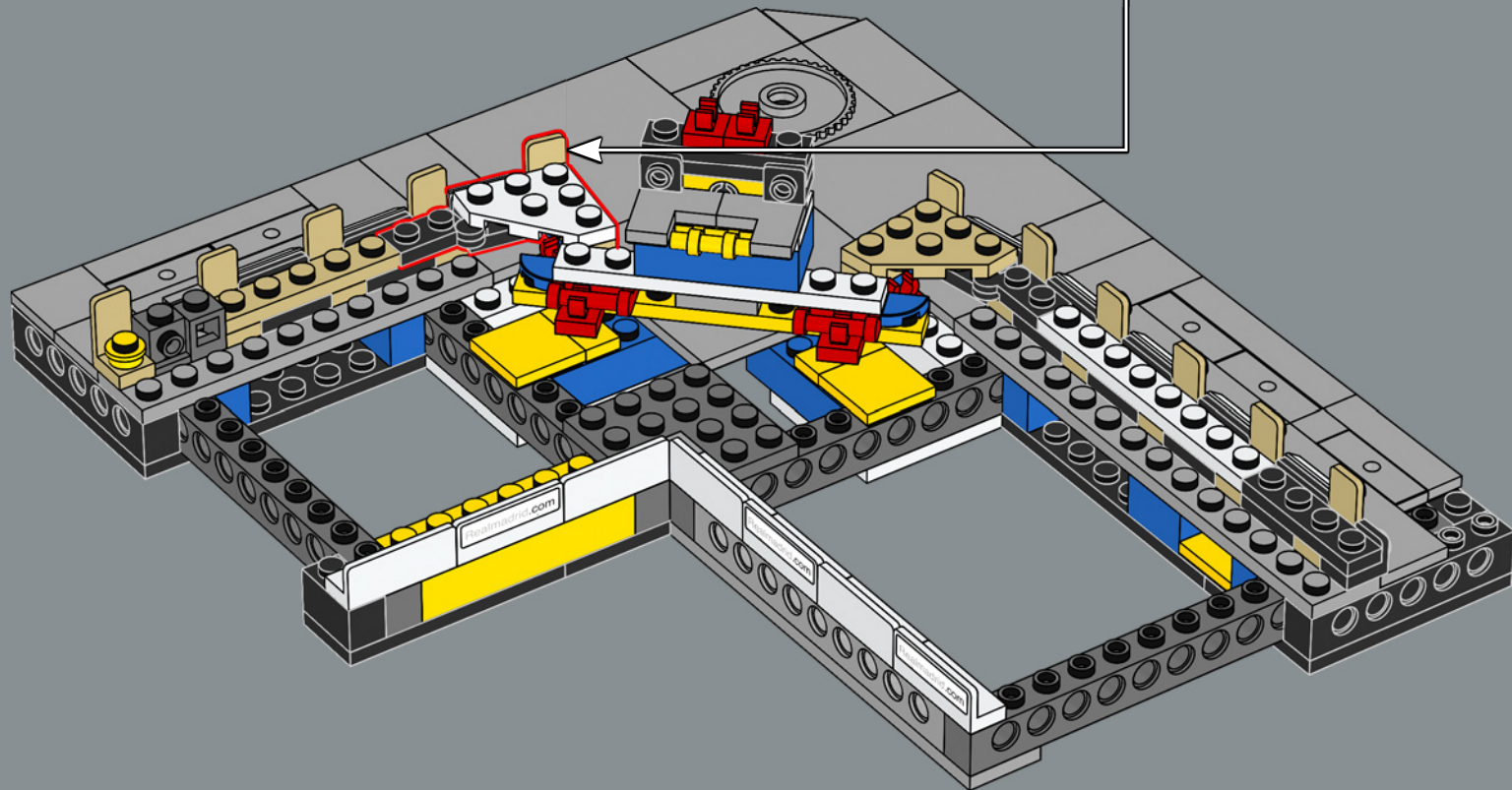
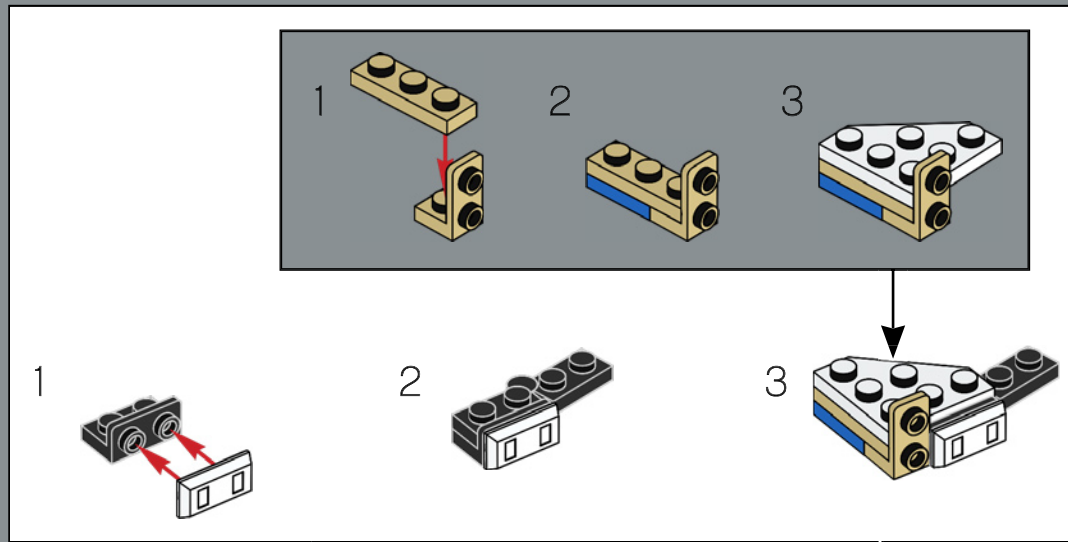

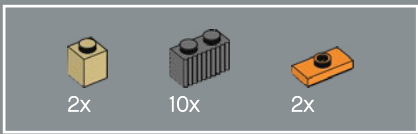

309

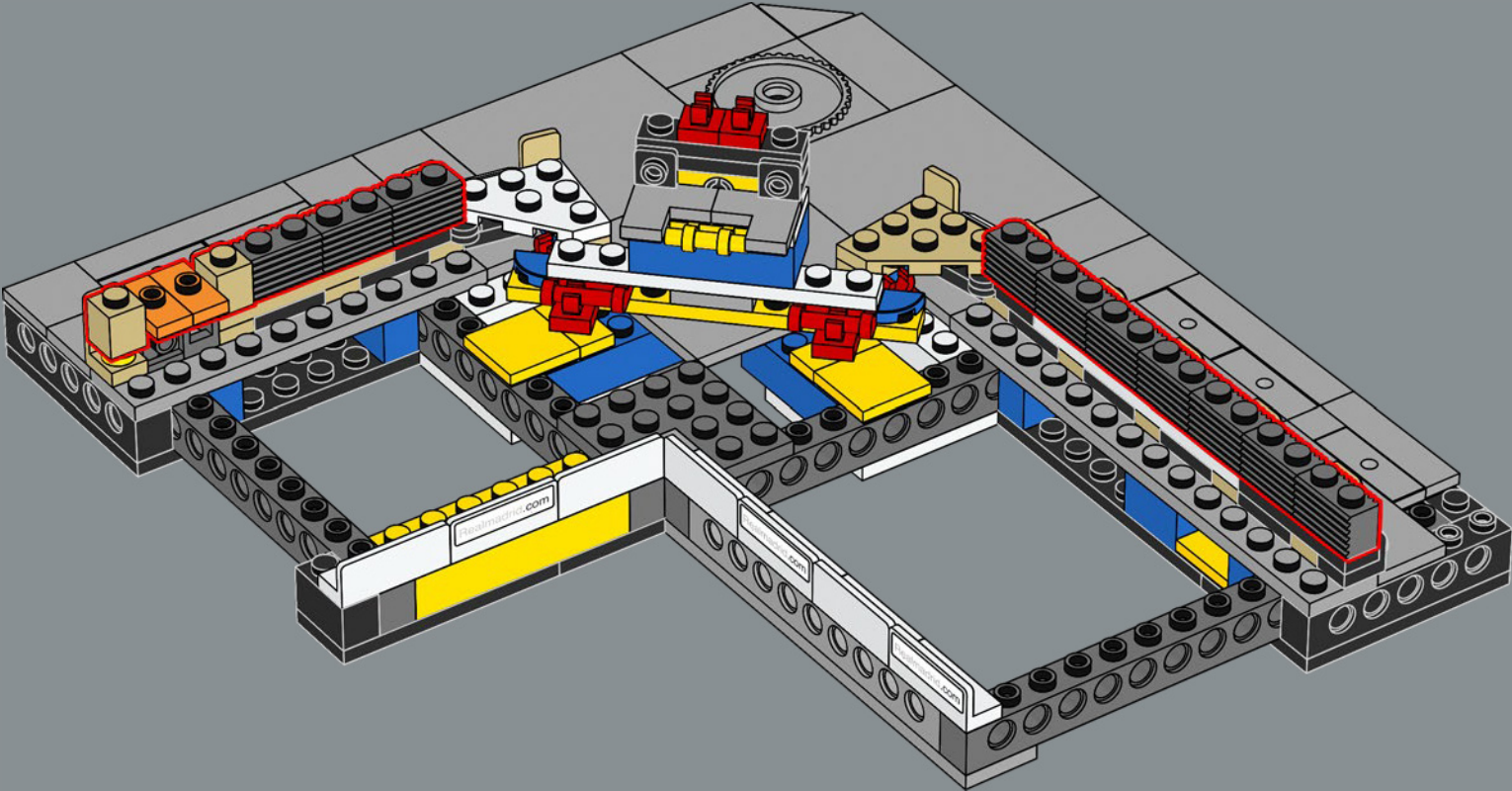

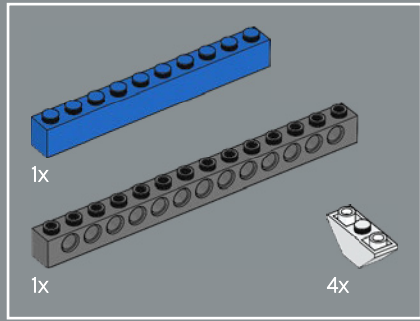

310

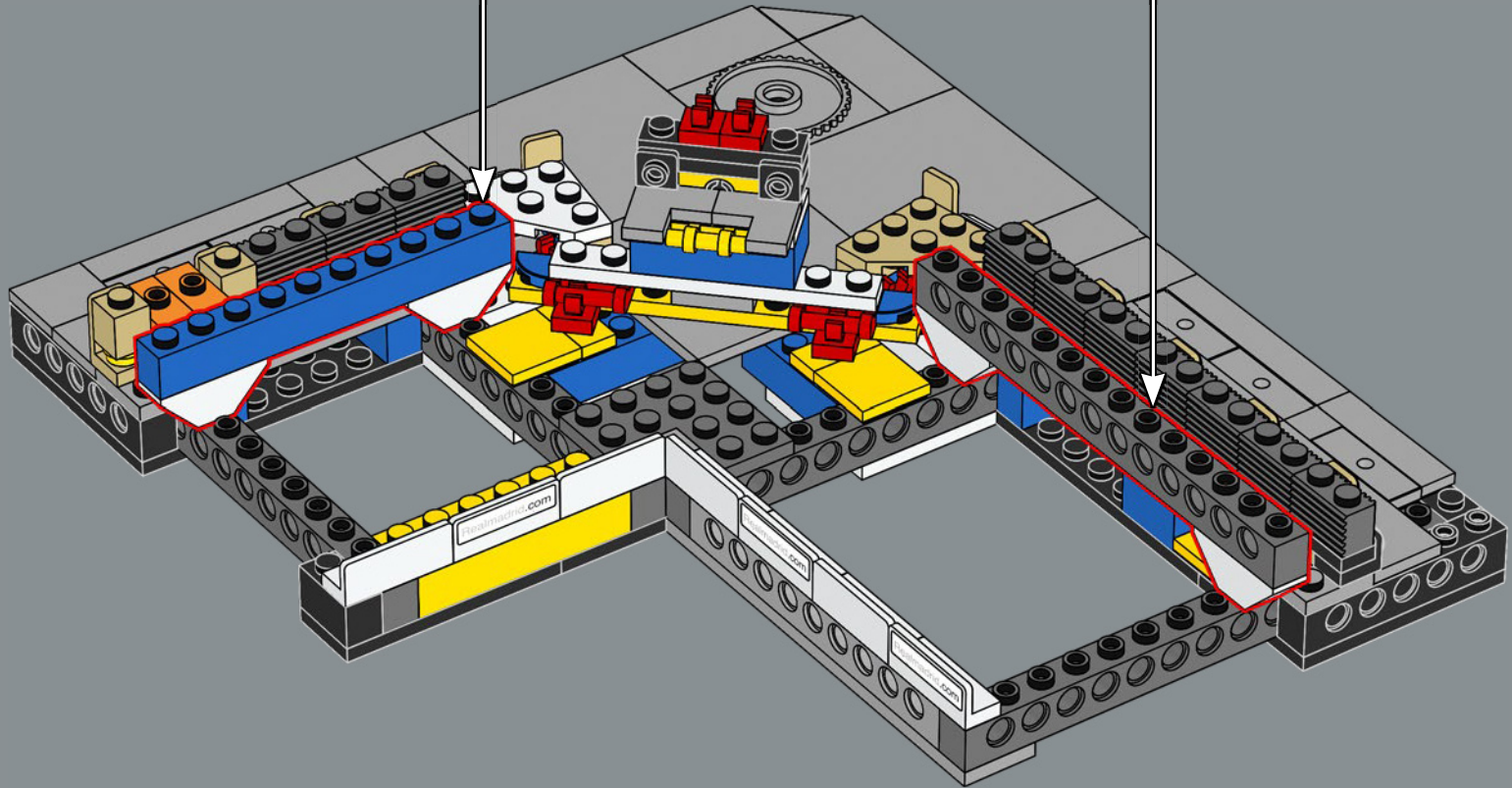
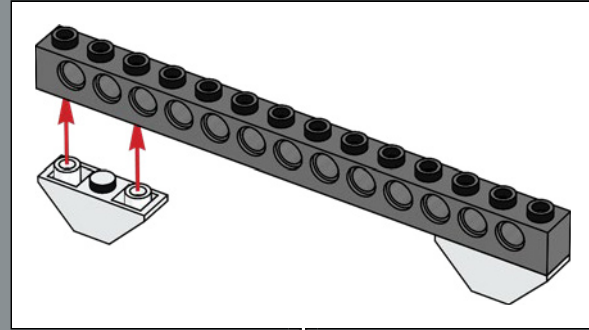
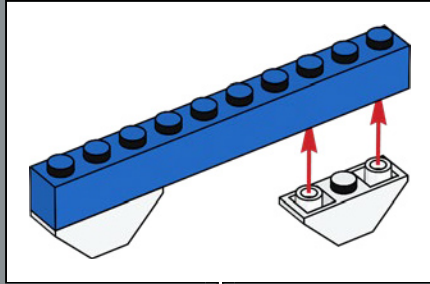

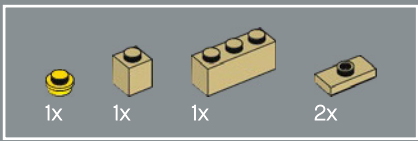

311

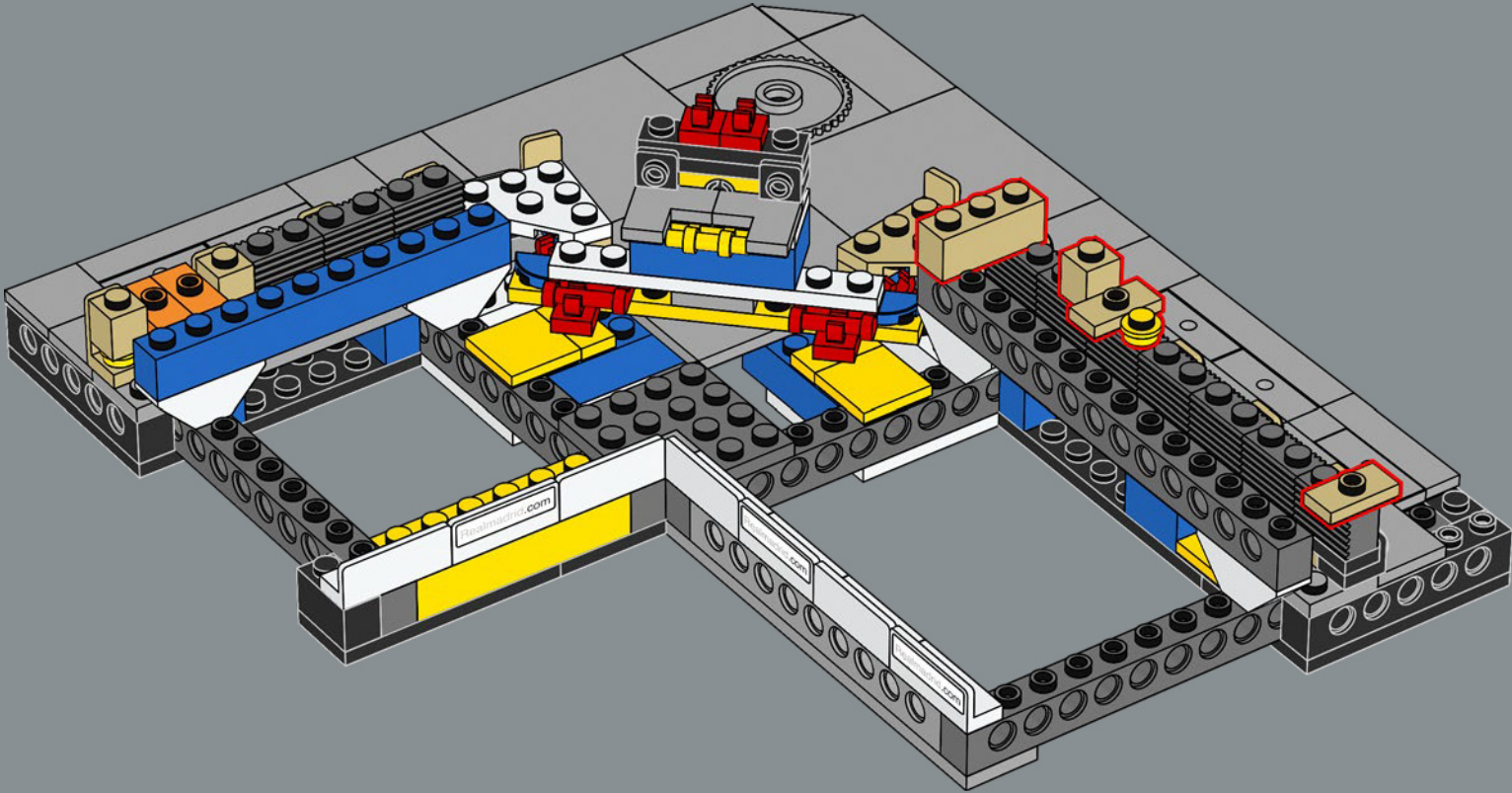

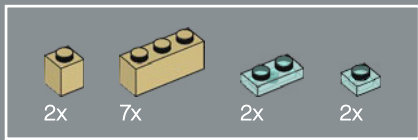

312

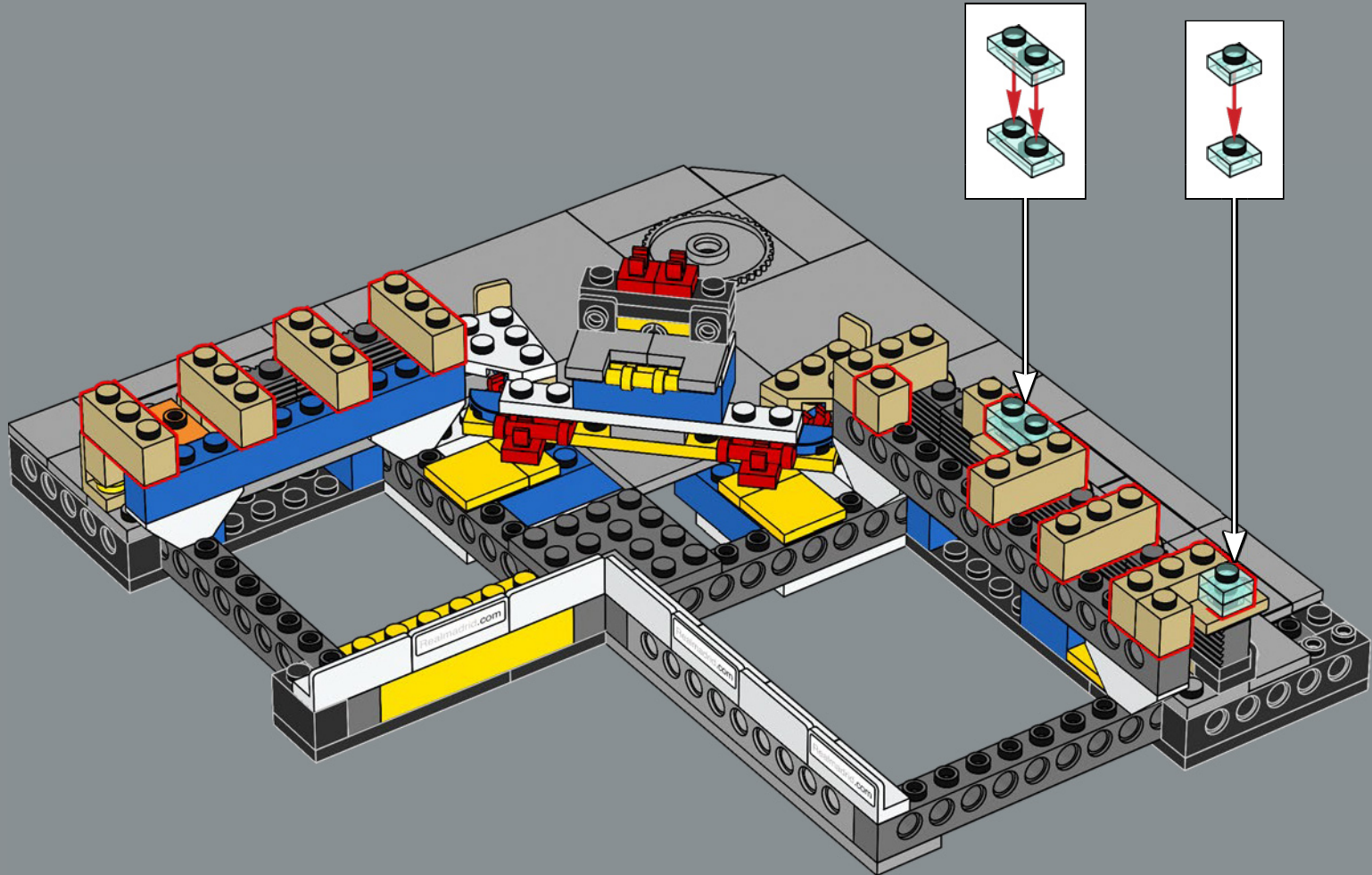

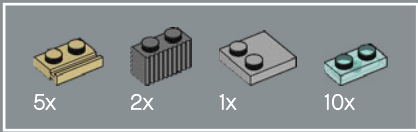

313

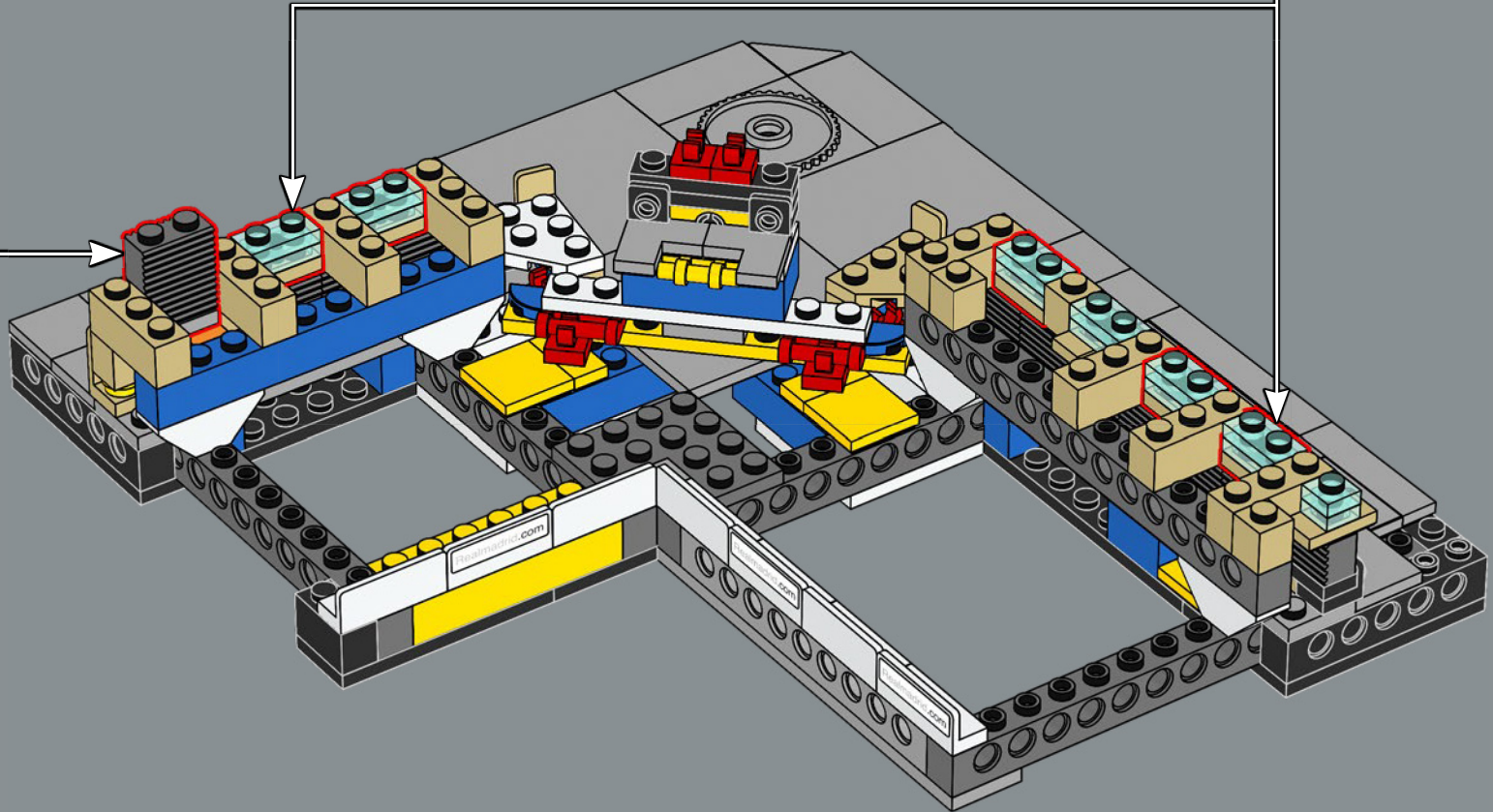
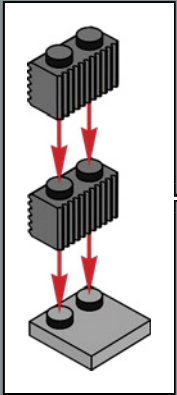
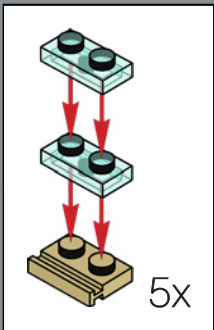

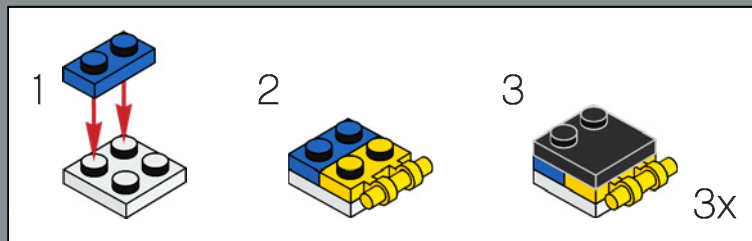
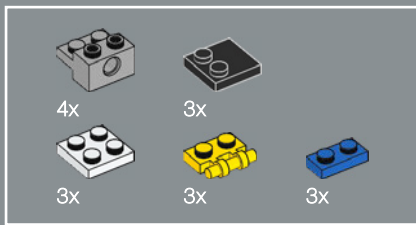

314

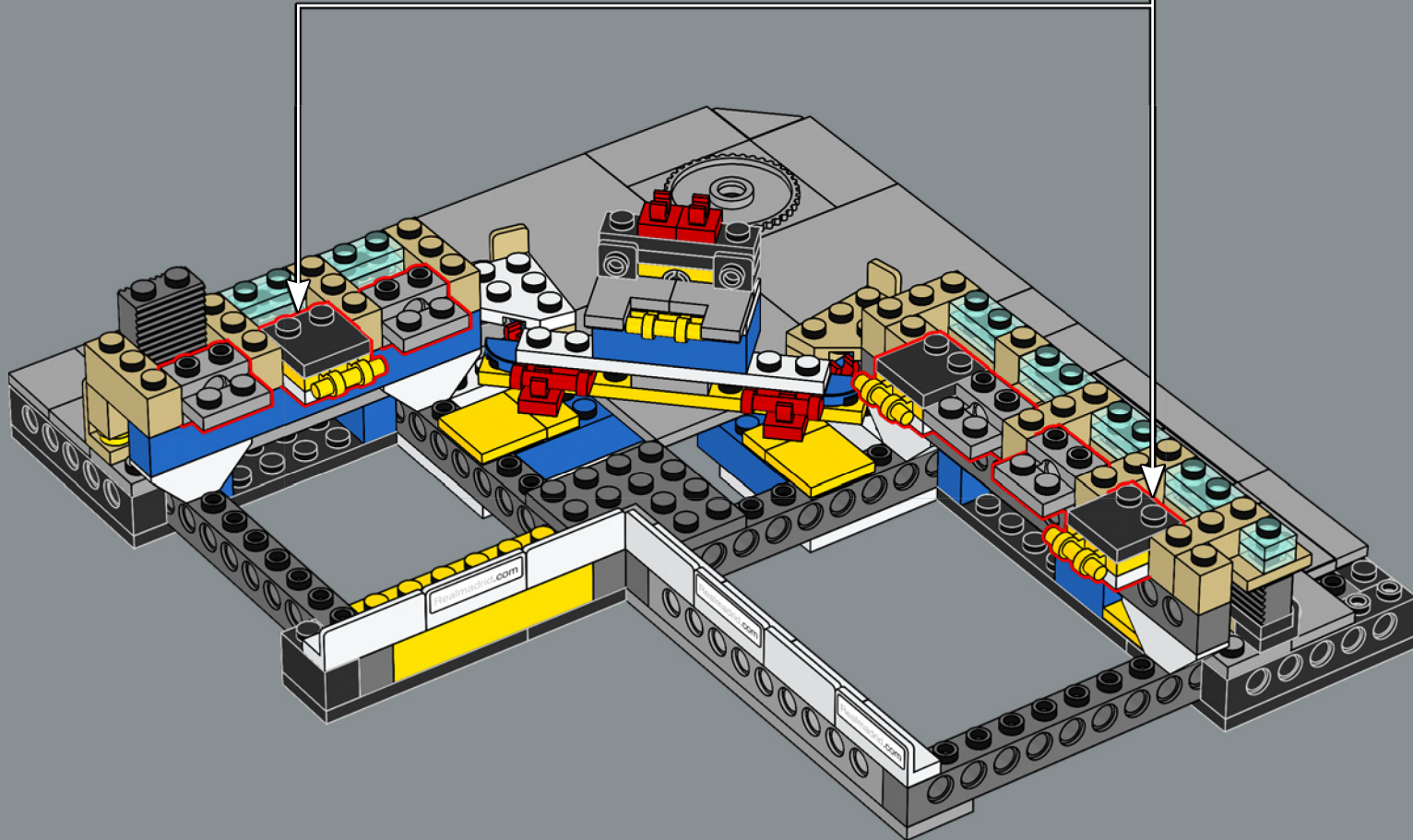

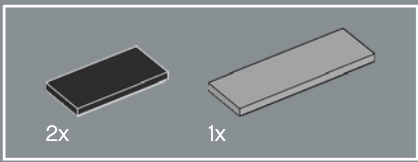

315

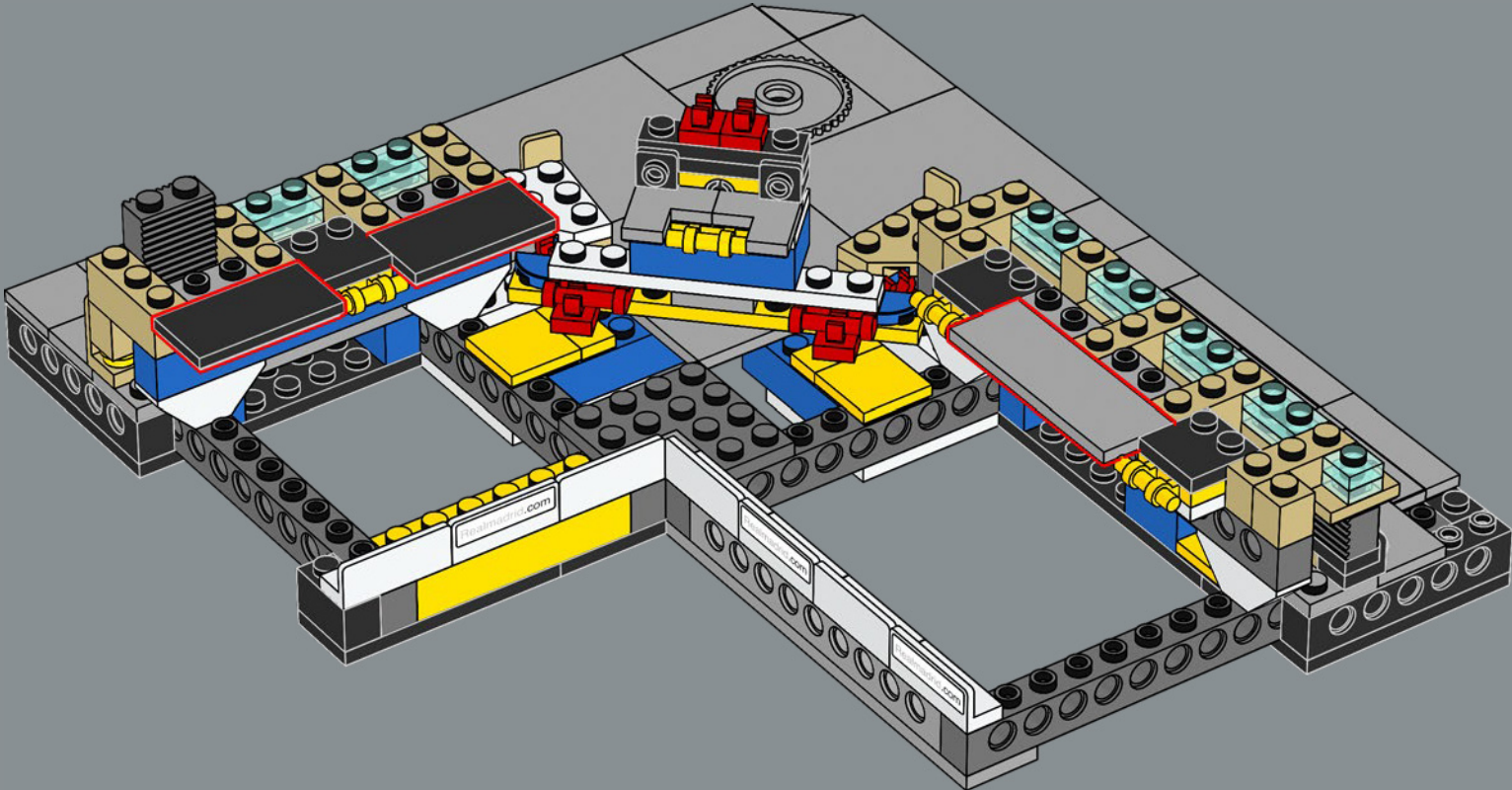

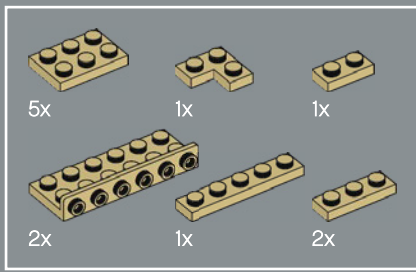

316

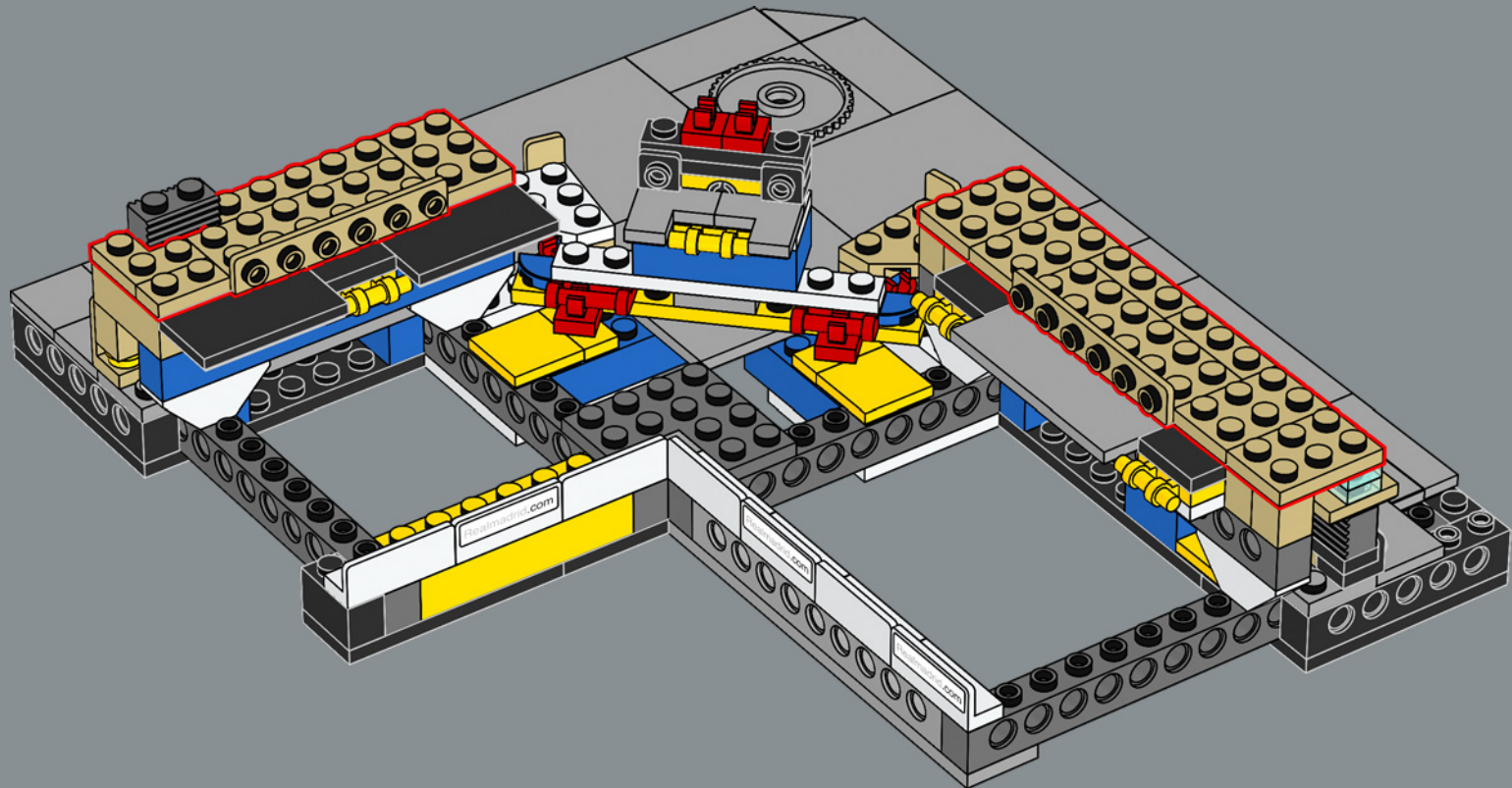

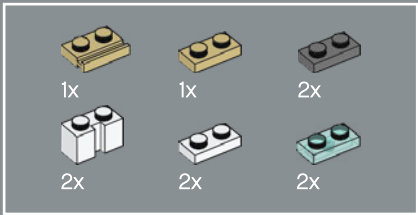

317

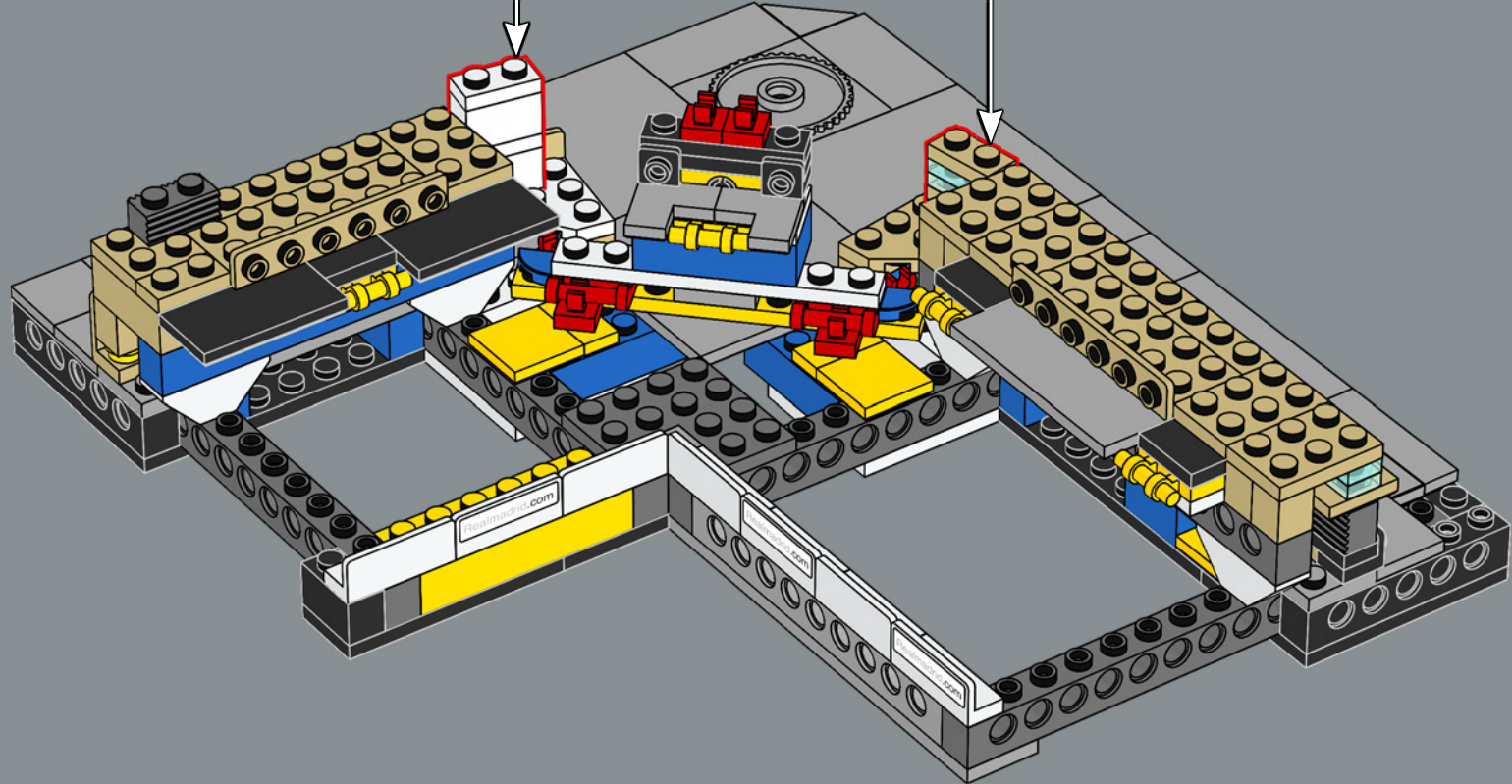
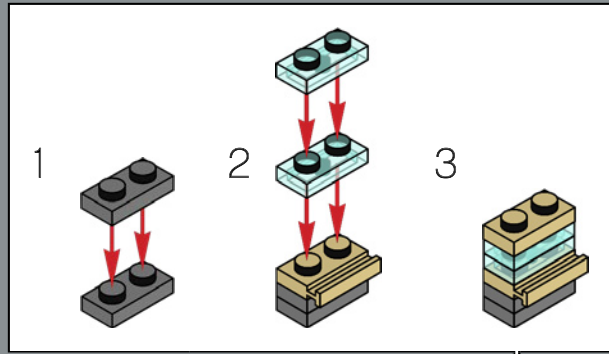
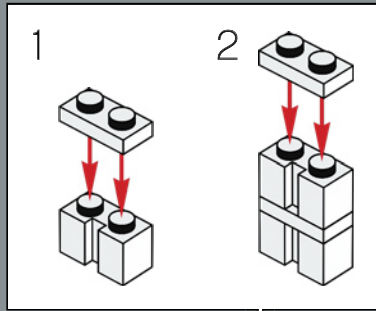

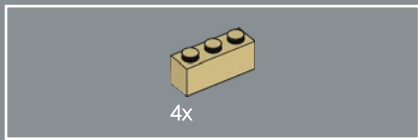

318

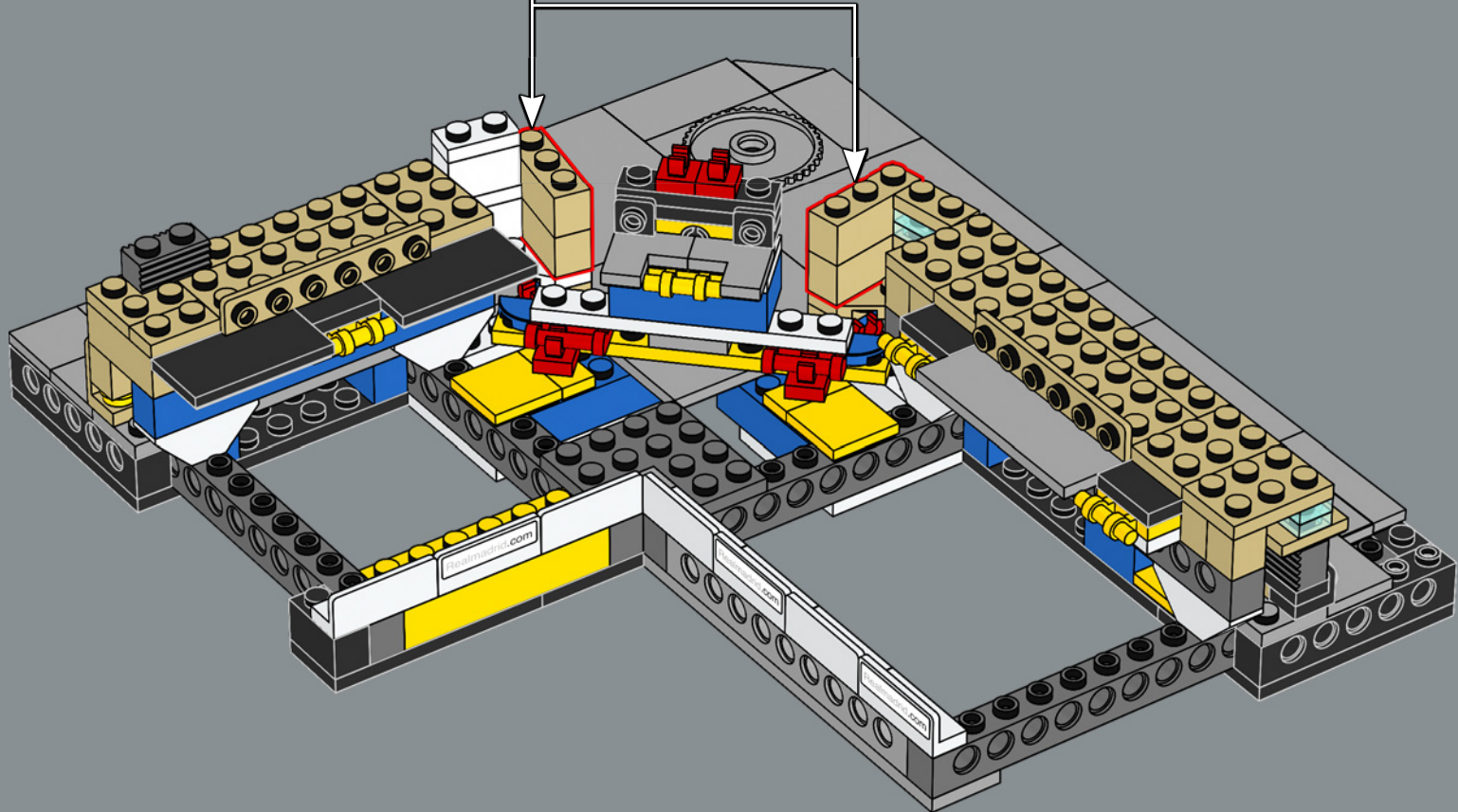
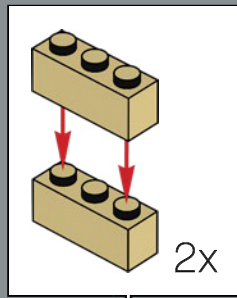

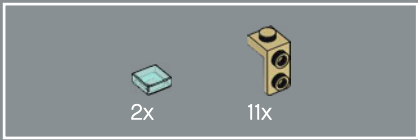
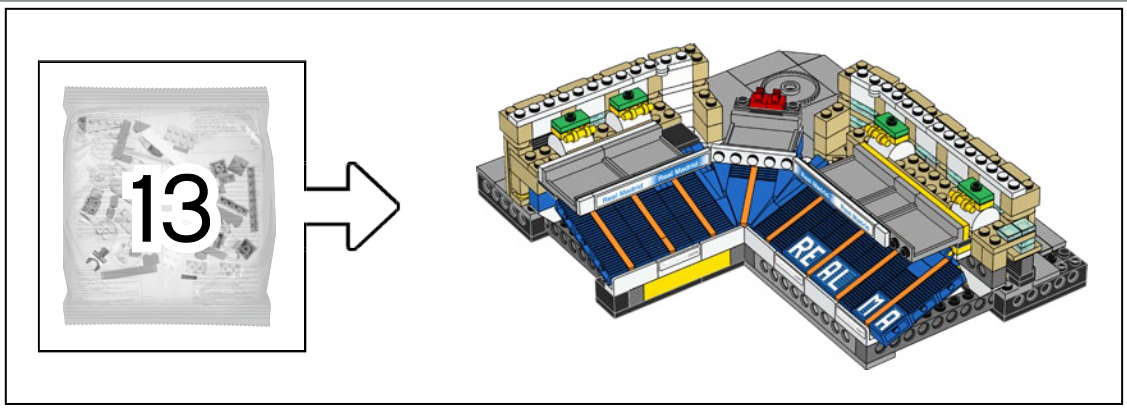

319

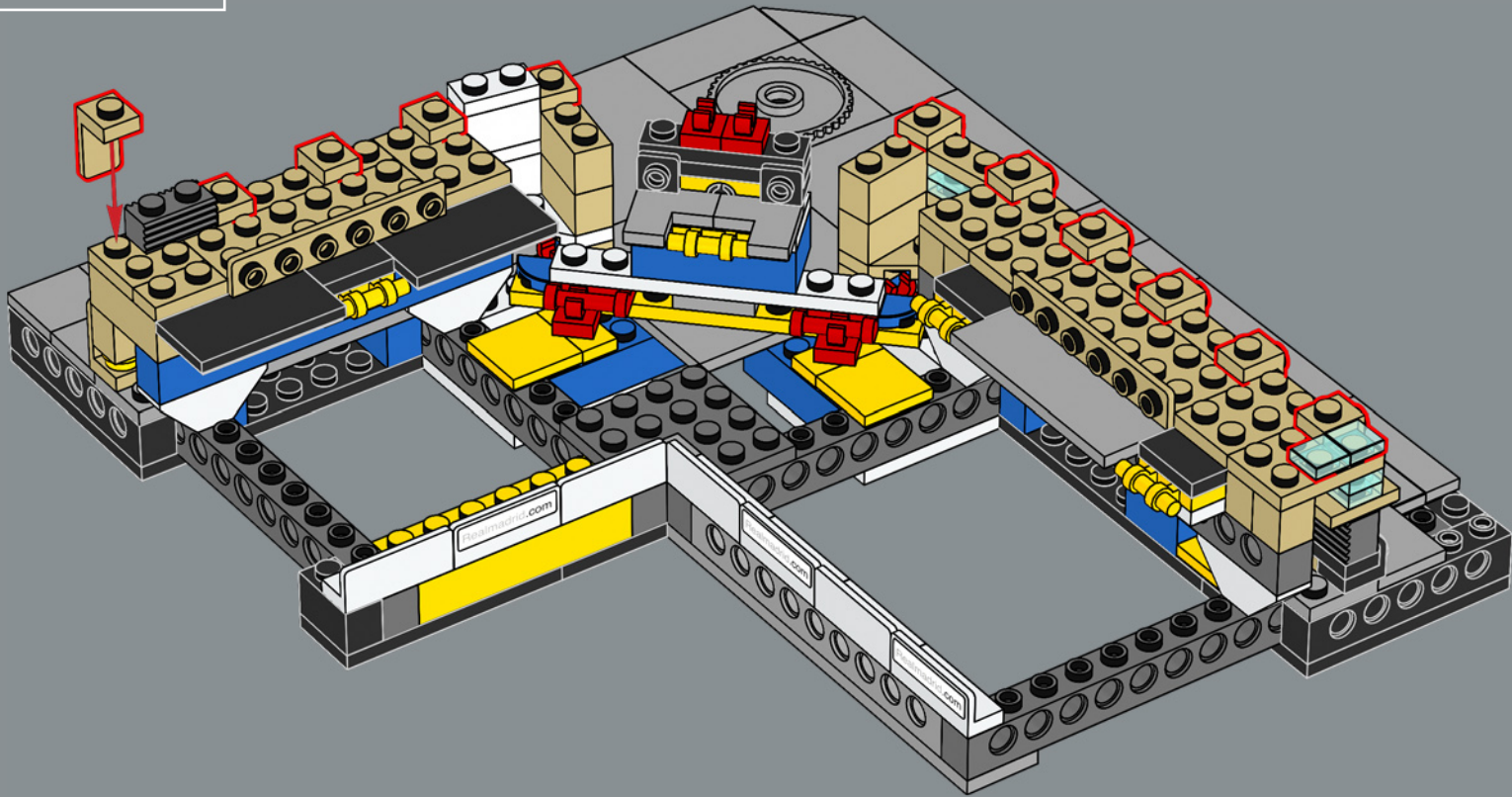

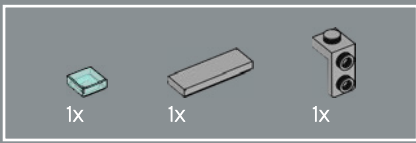

320

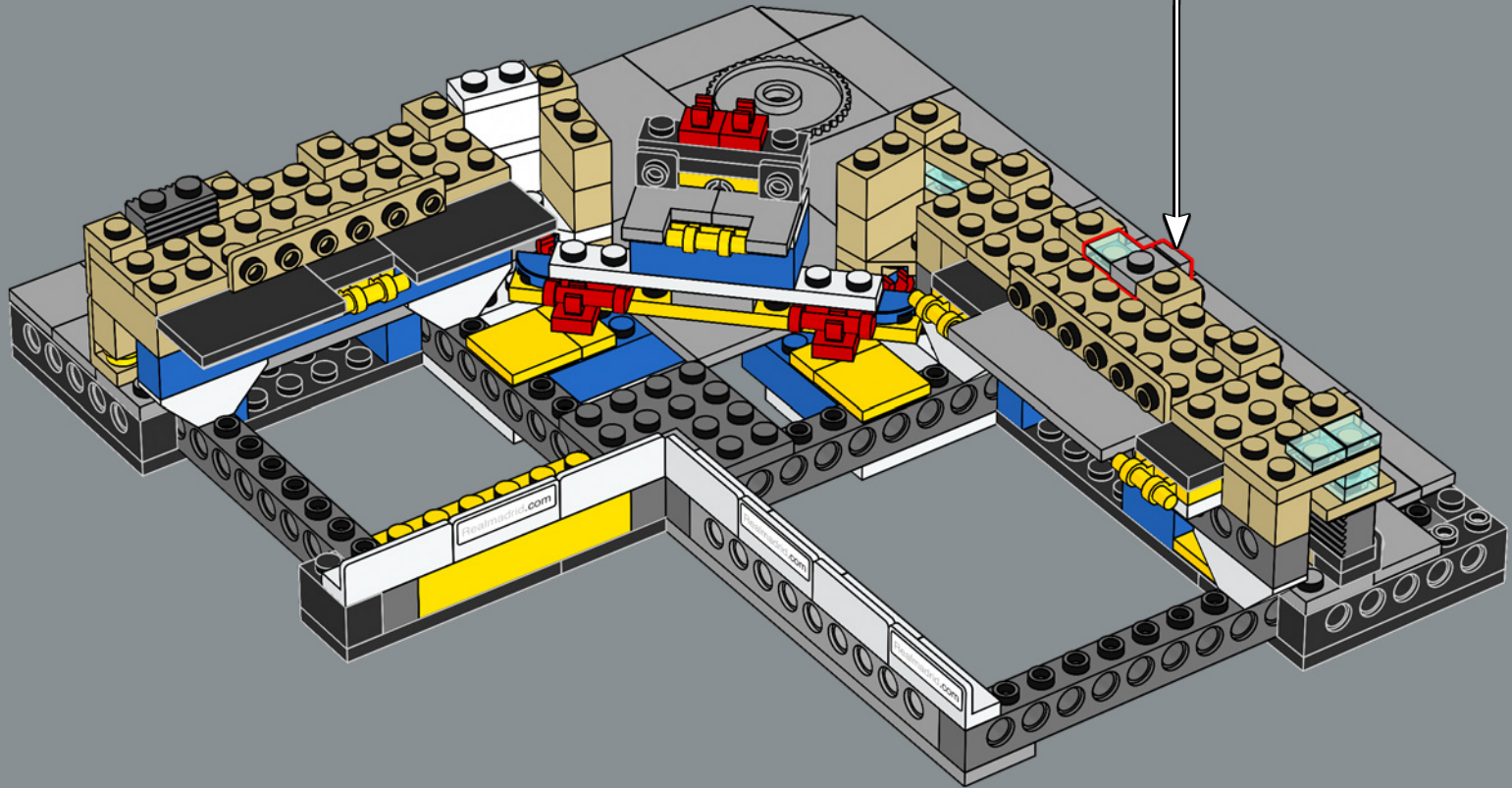
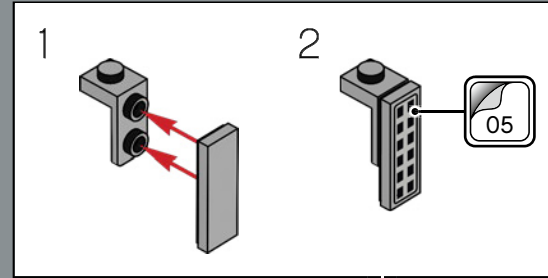



321

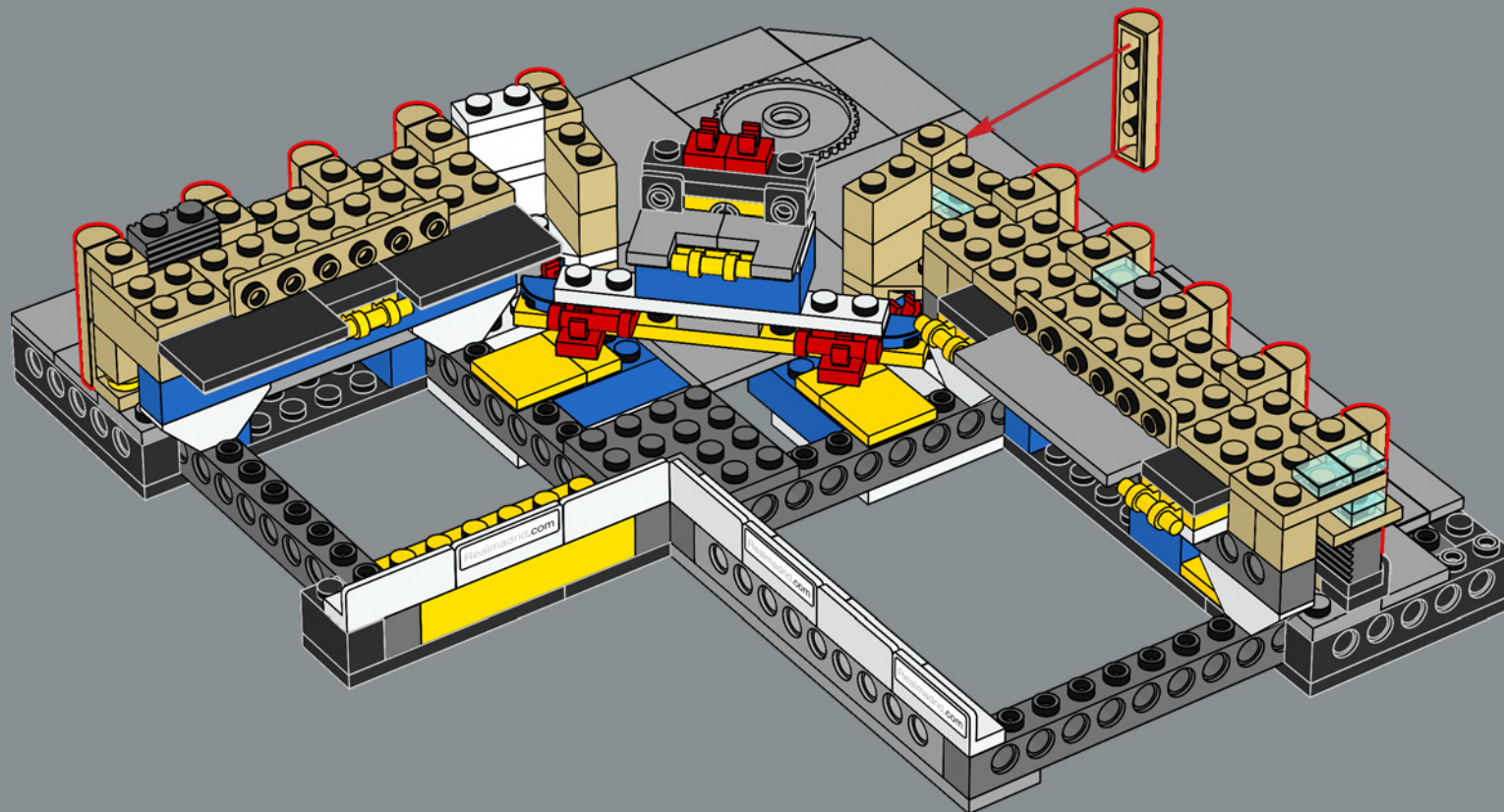

At the start of the 1960s, Real Madrid won five consecutive league titles.

Au début des années 1960, le Real Madrid remporte cinq titres de champion consécutifs.

A principios de los años 60, el Real Madrid ganó cinco títulos de liga consecutivos.



322

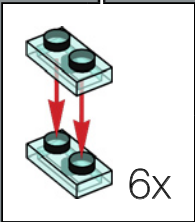
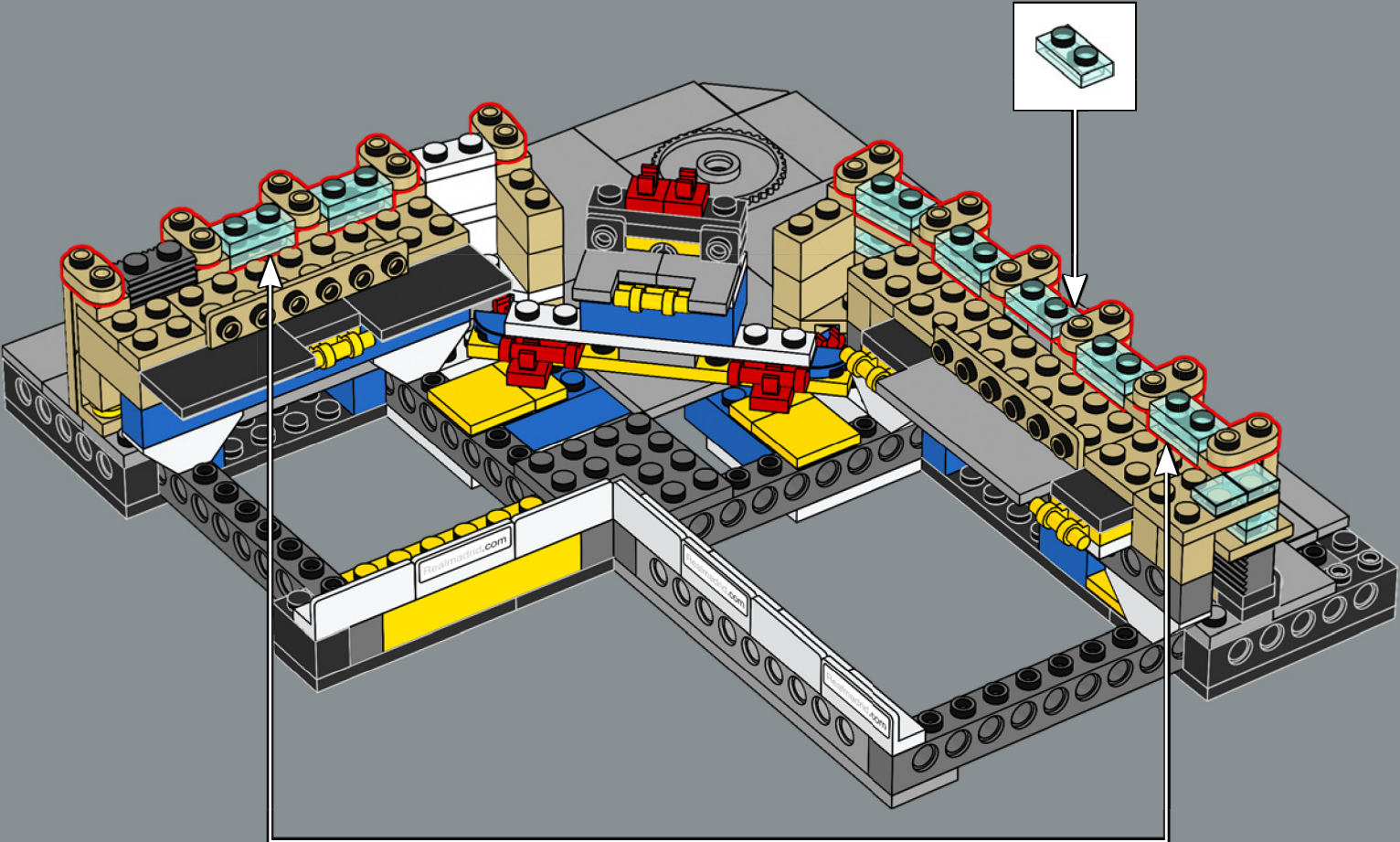

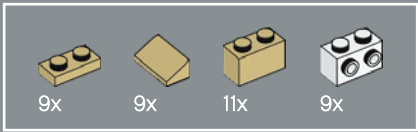

323

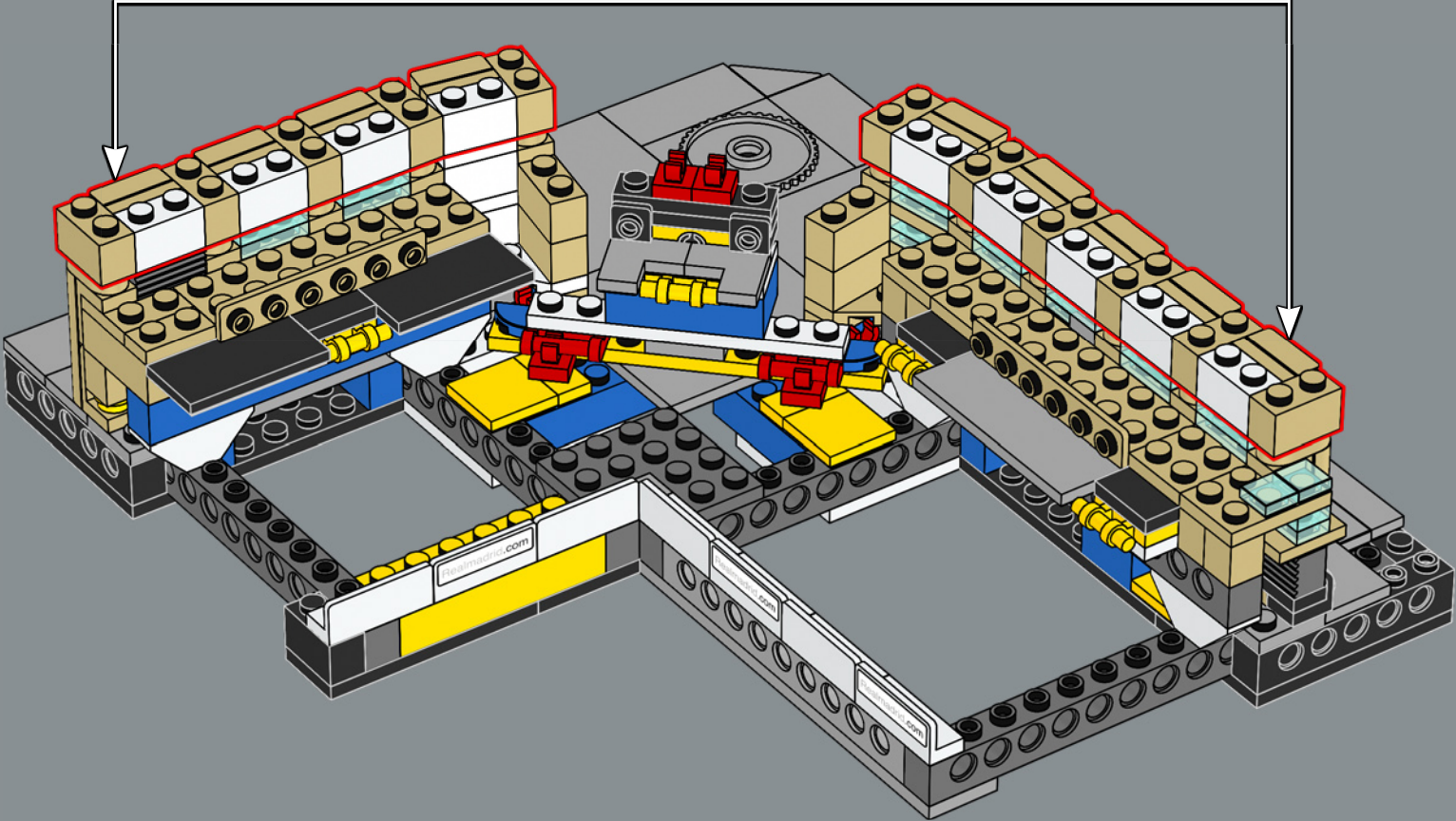
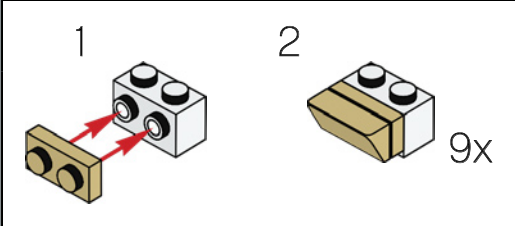

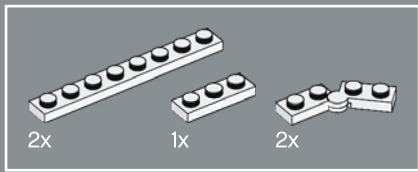

324

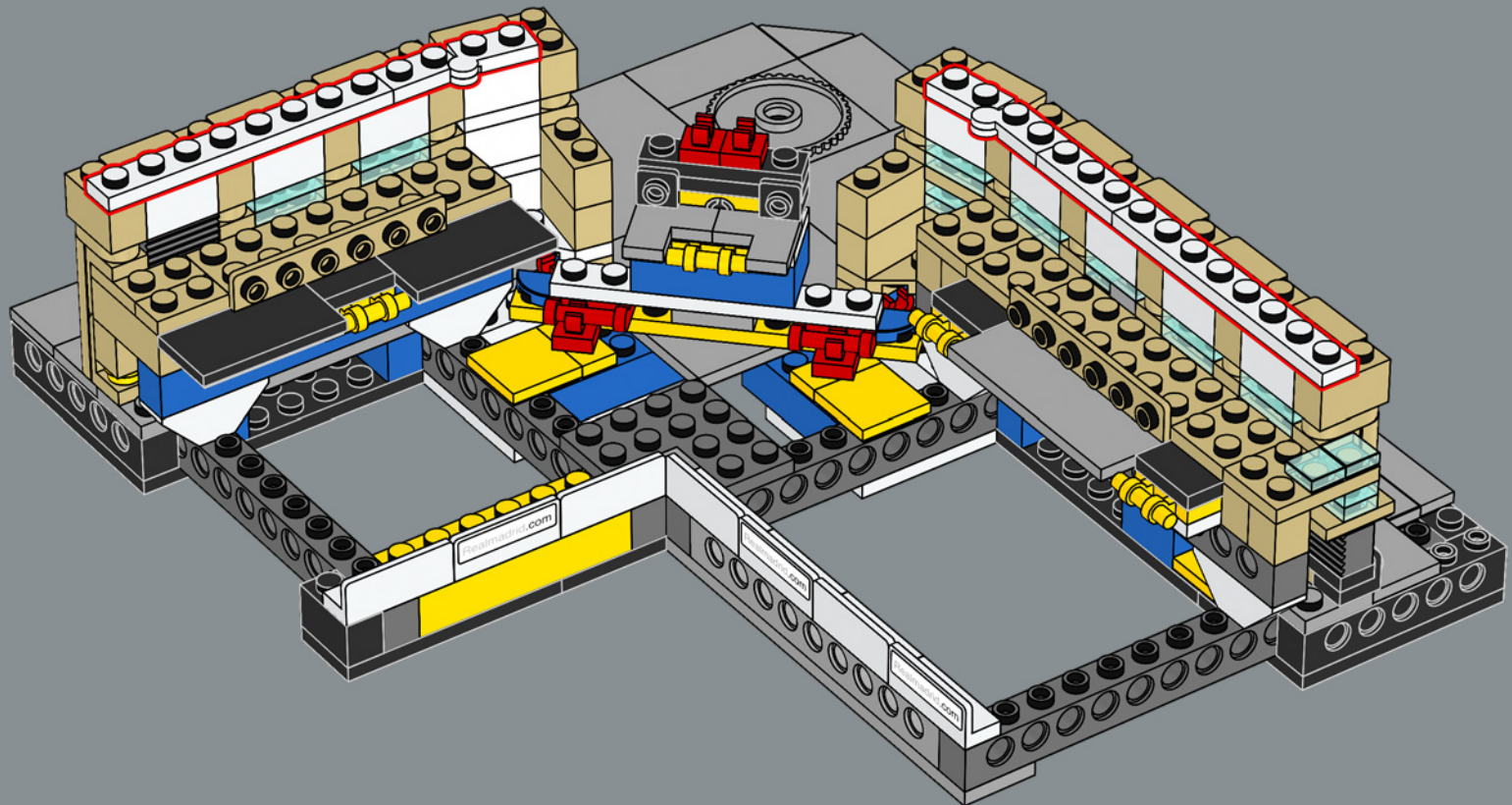



325

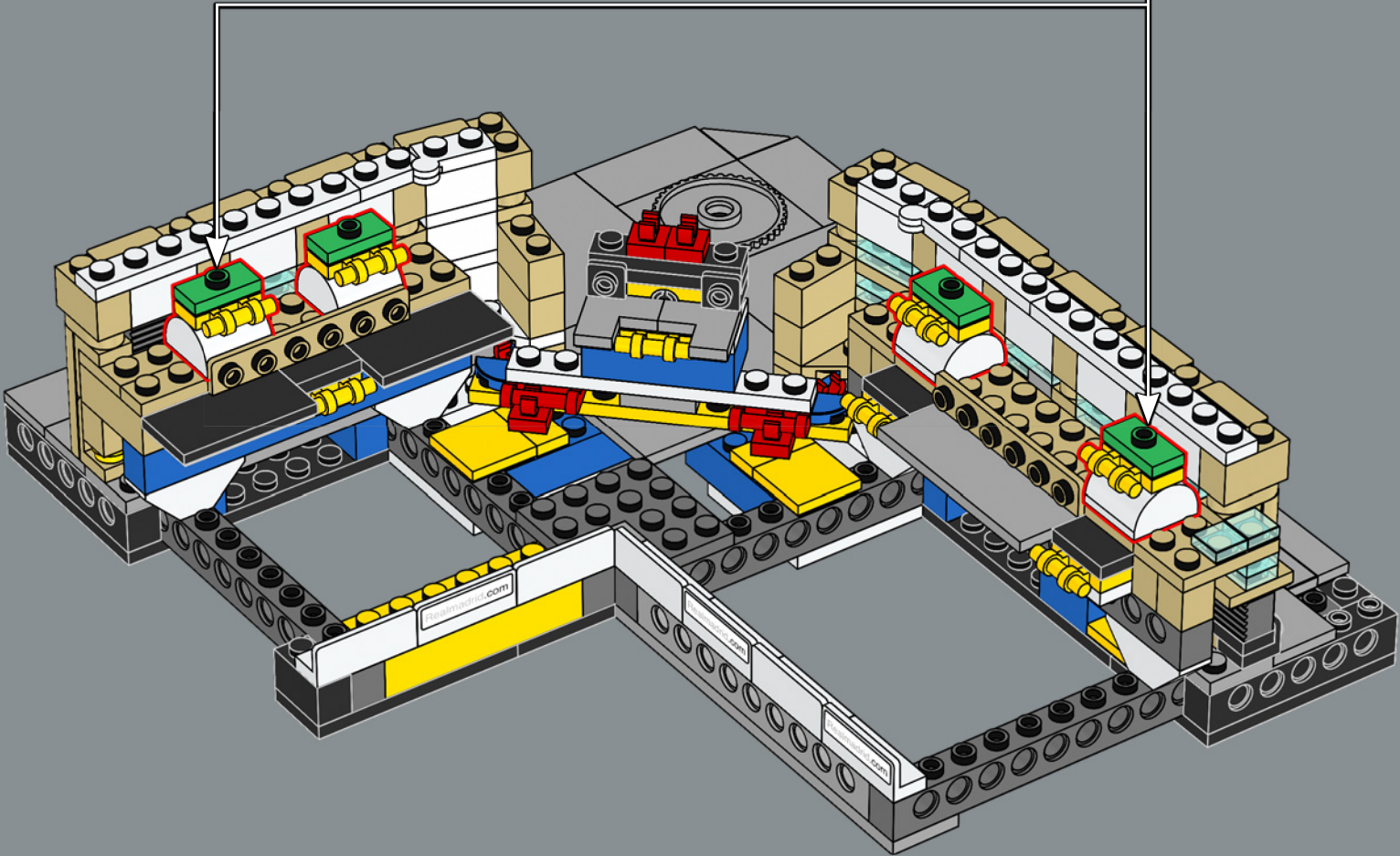
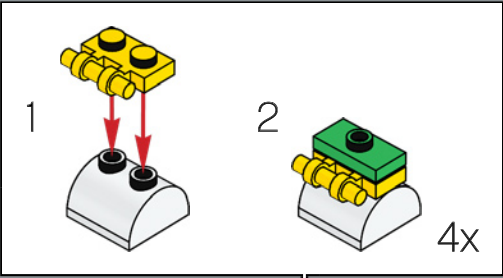

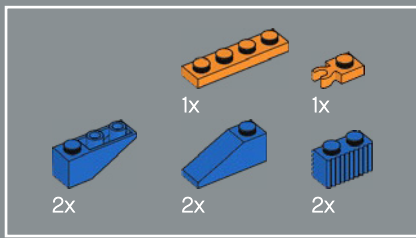

326

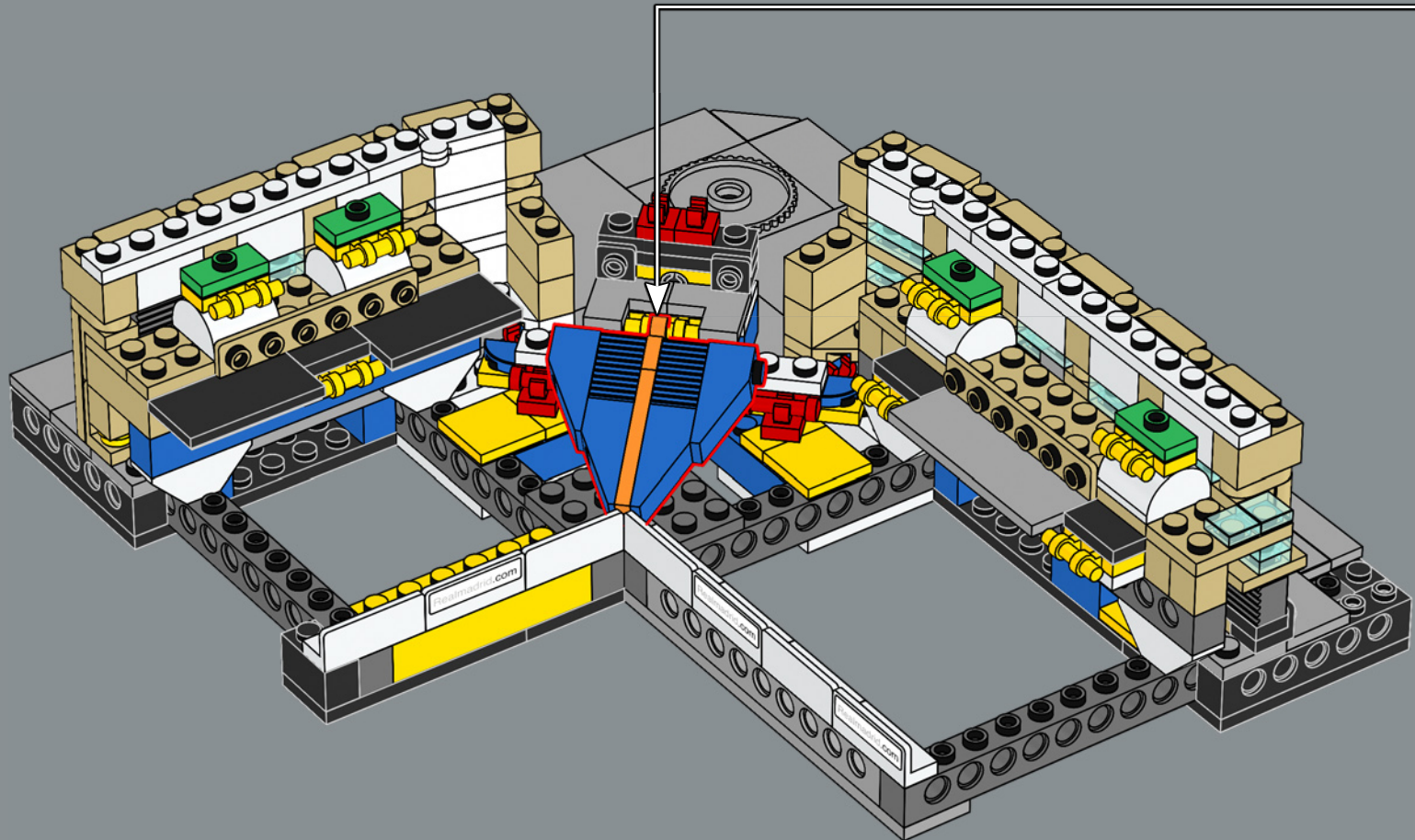
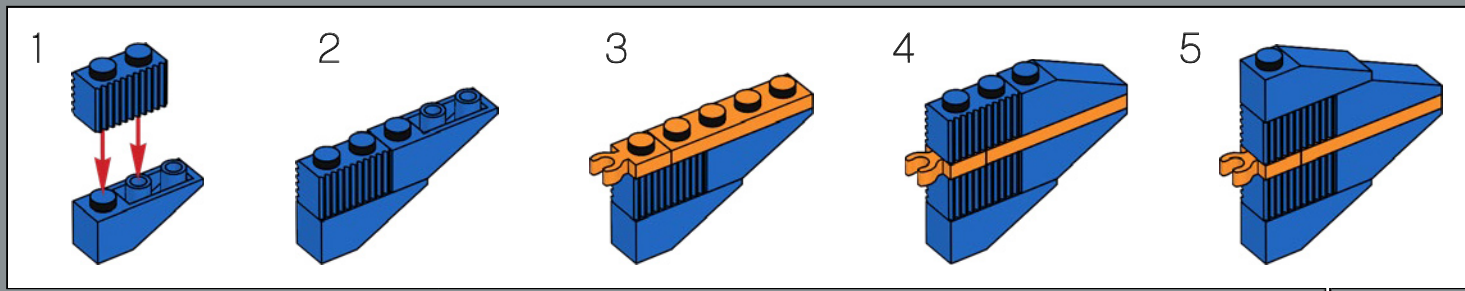

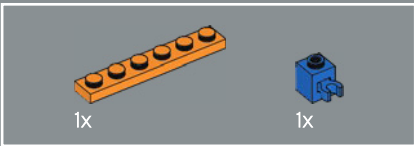
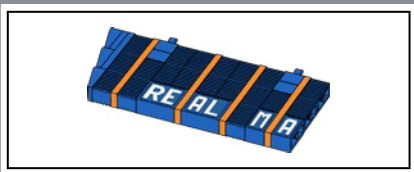

327

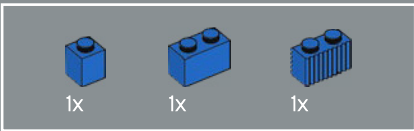
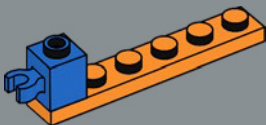

328

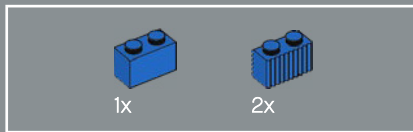
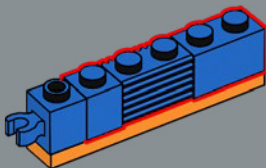

329

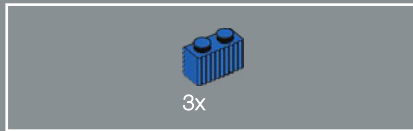
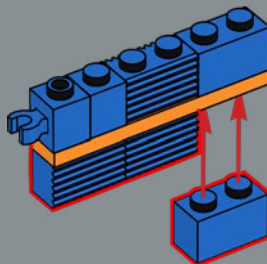

330

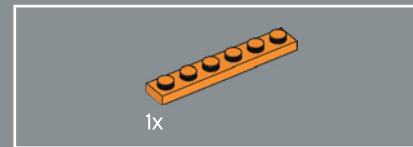
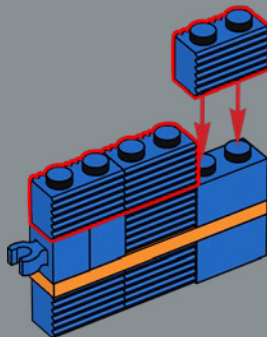

331

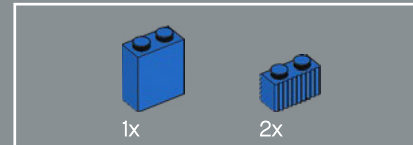
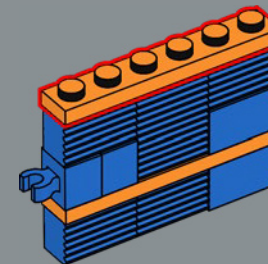

332

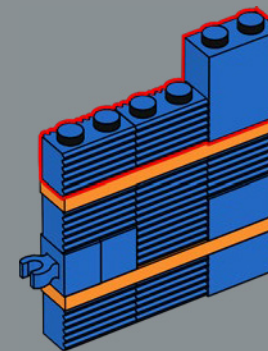

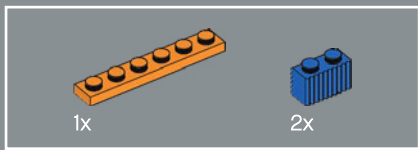

333

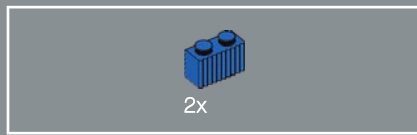
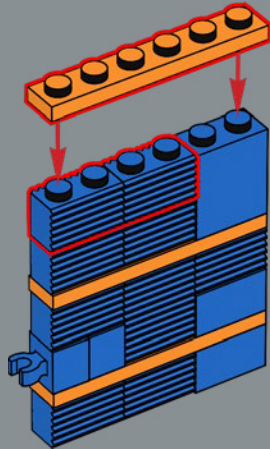

335

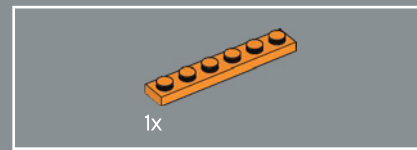
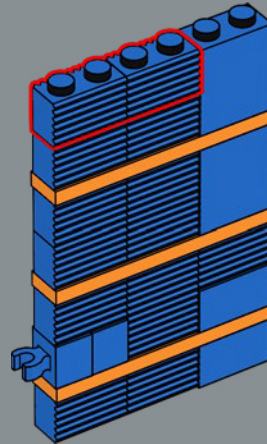

337

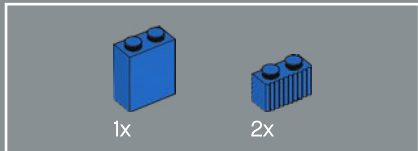
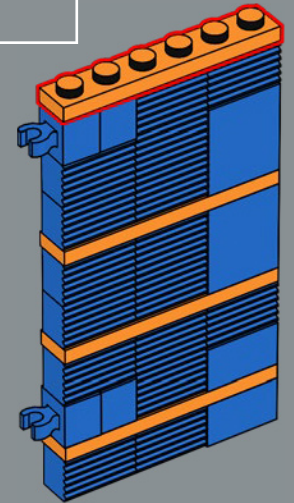

334

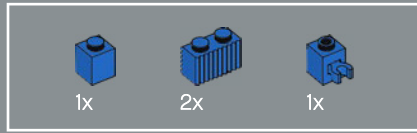
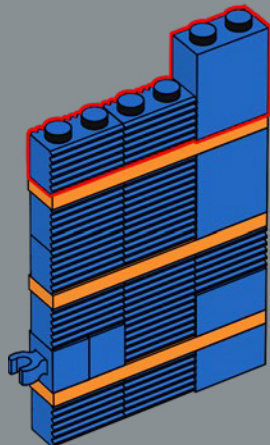

336

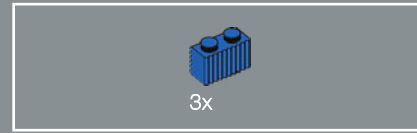
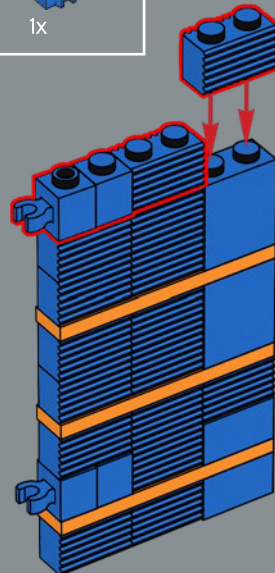

338

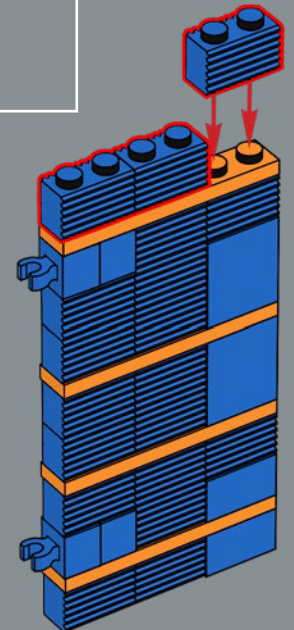

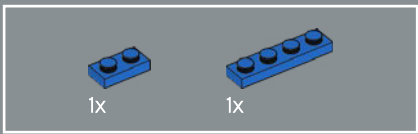

339

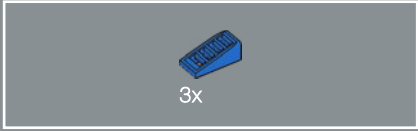
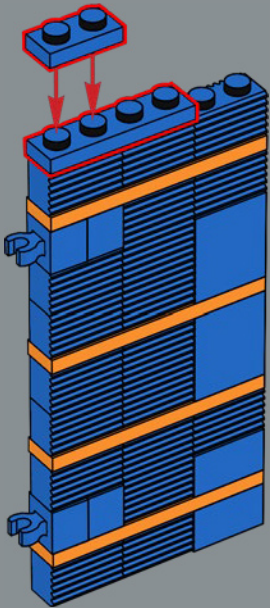

340

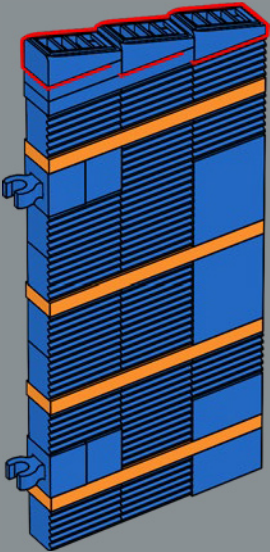

341

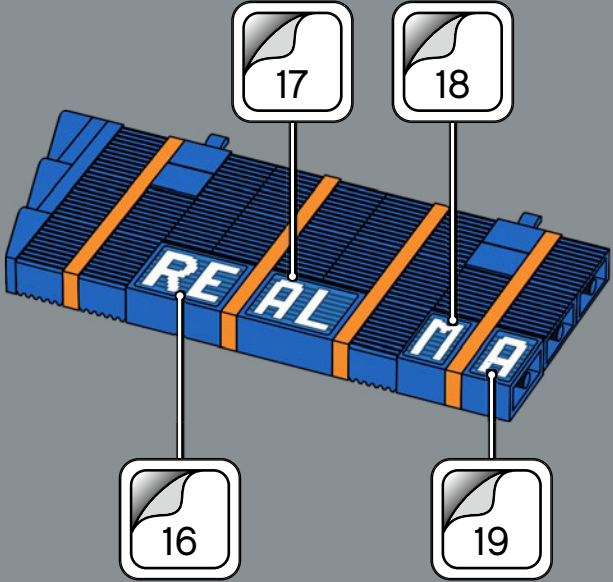

342

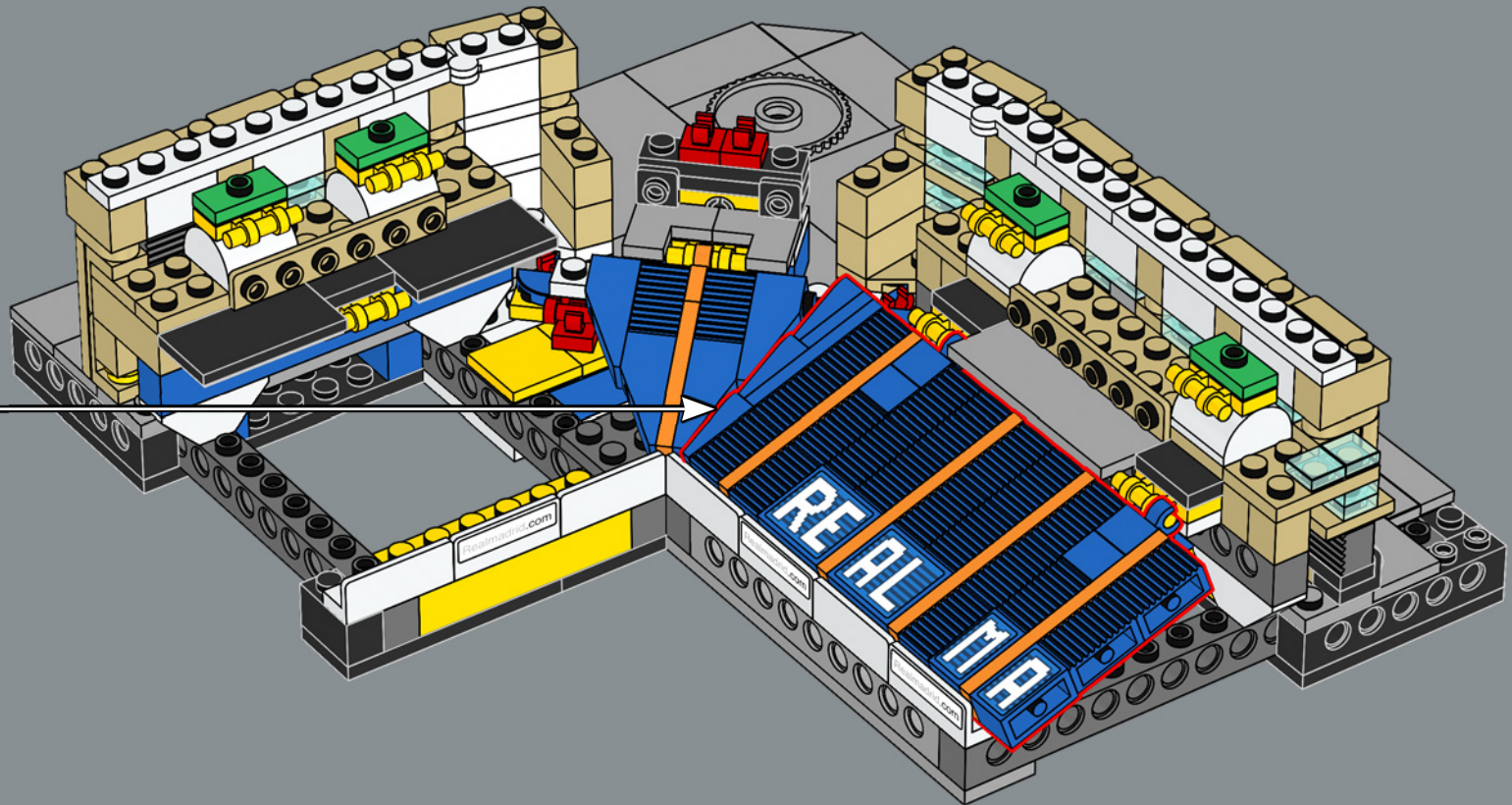

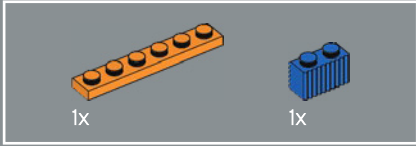

343

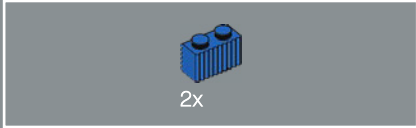
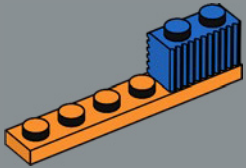

344

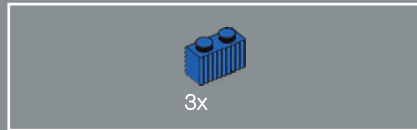
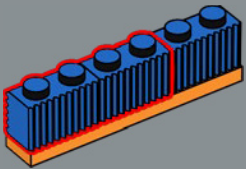

345

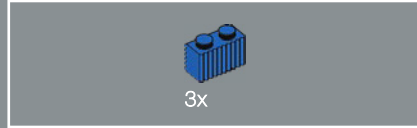
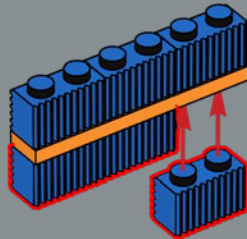

346

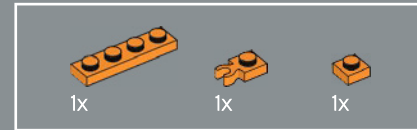
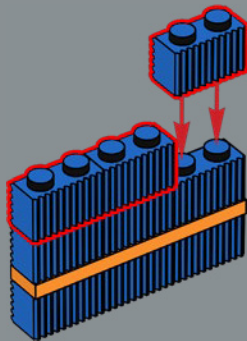

347

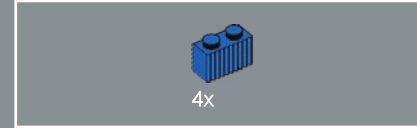
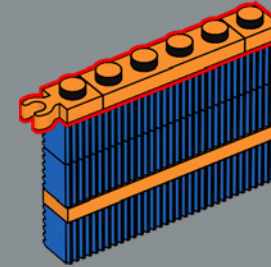

348

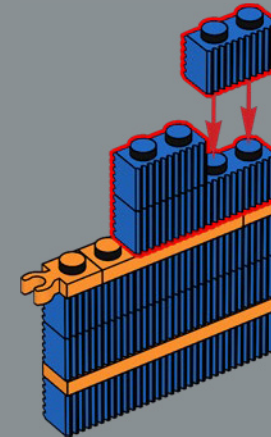

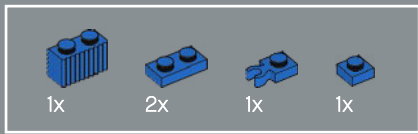

349

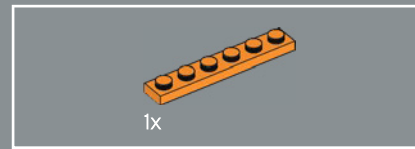
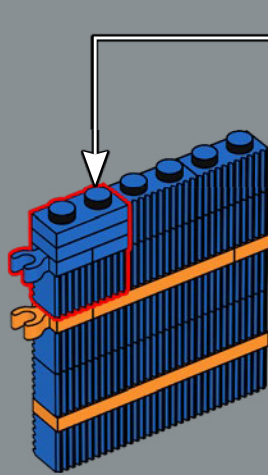
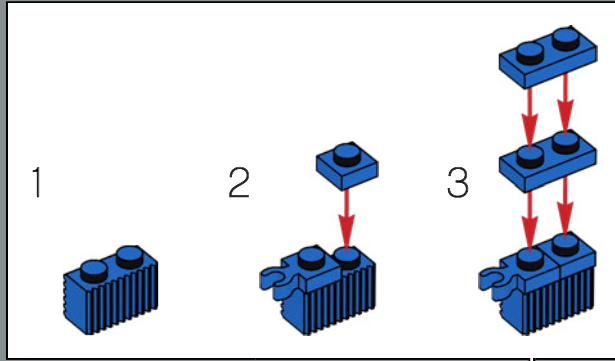

350

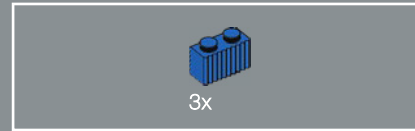
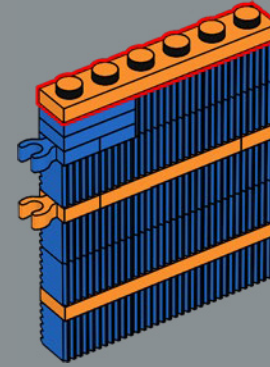

351

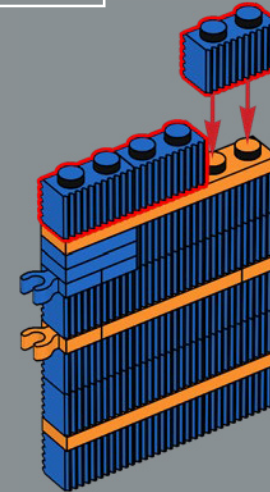

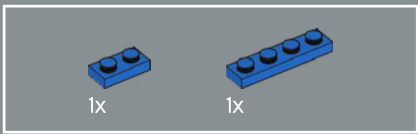

352

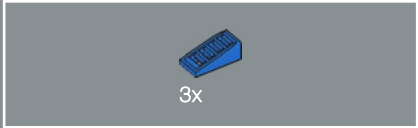
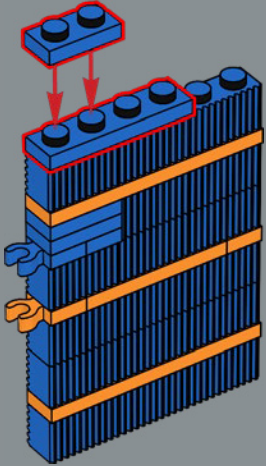

353

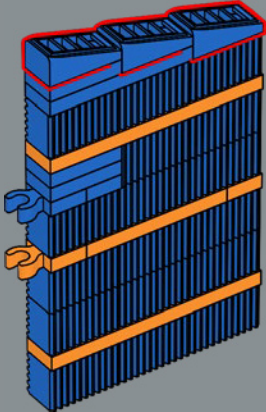

354

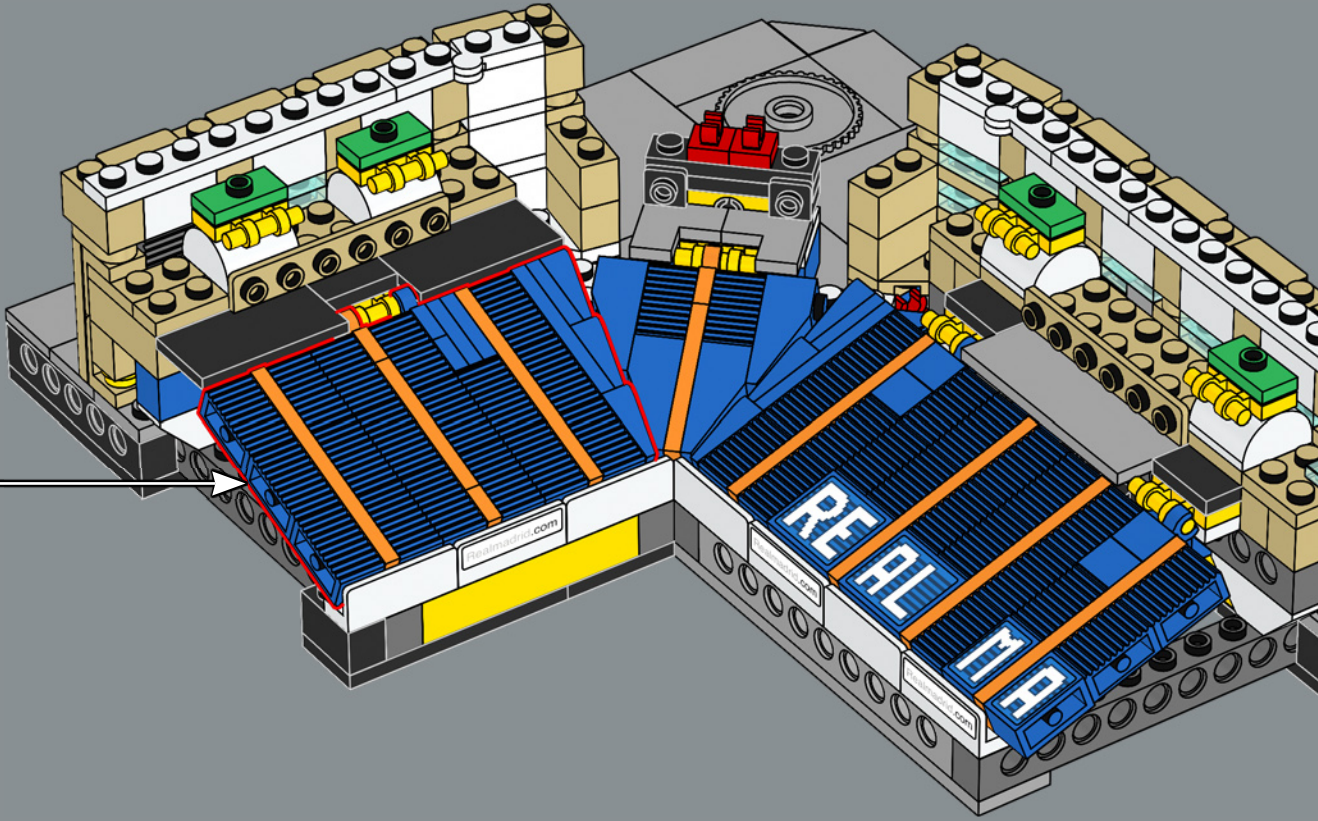

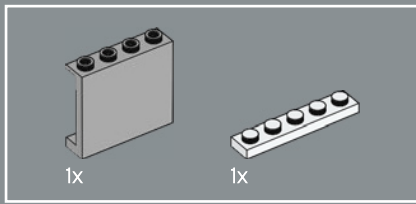

355

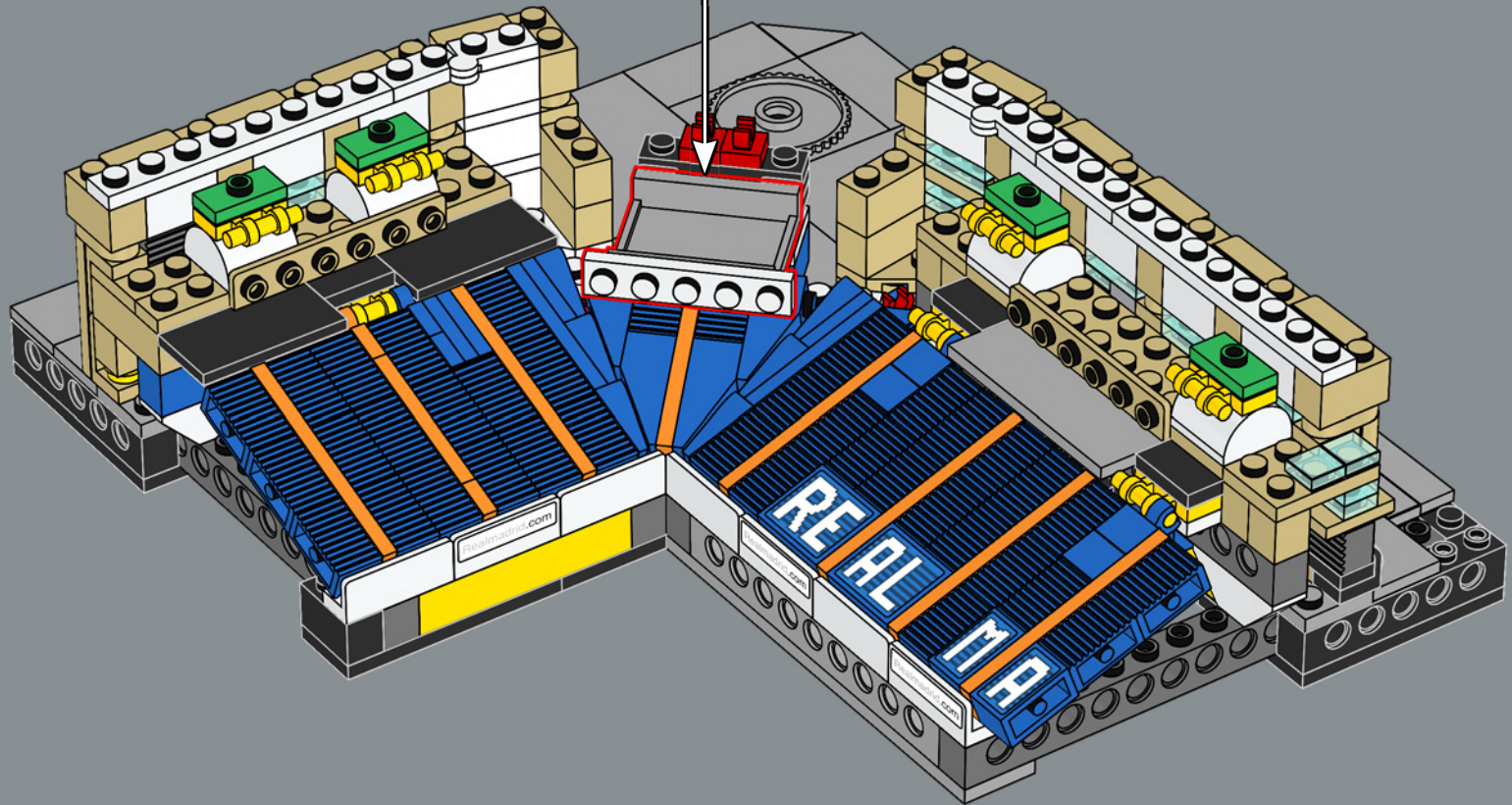
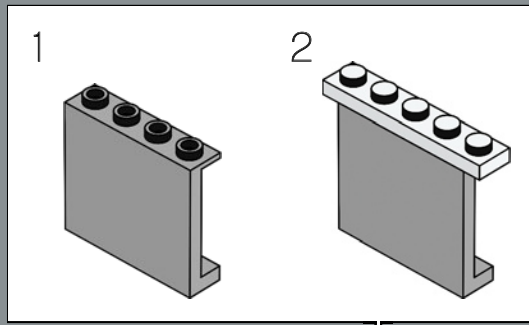

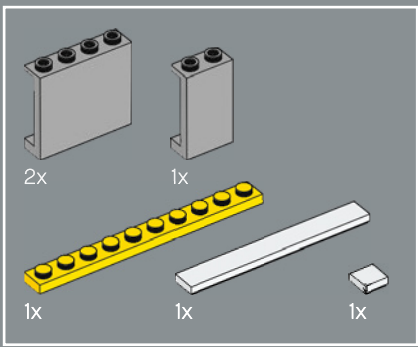

356

1

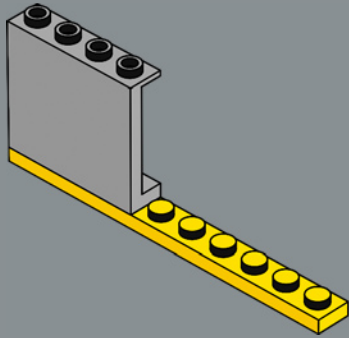

2

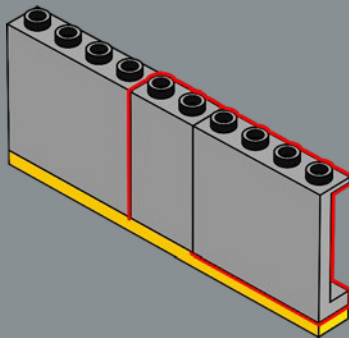

3

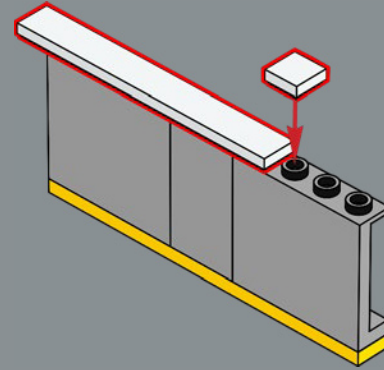

4

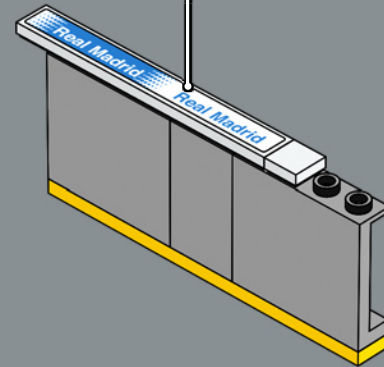

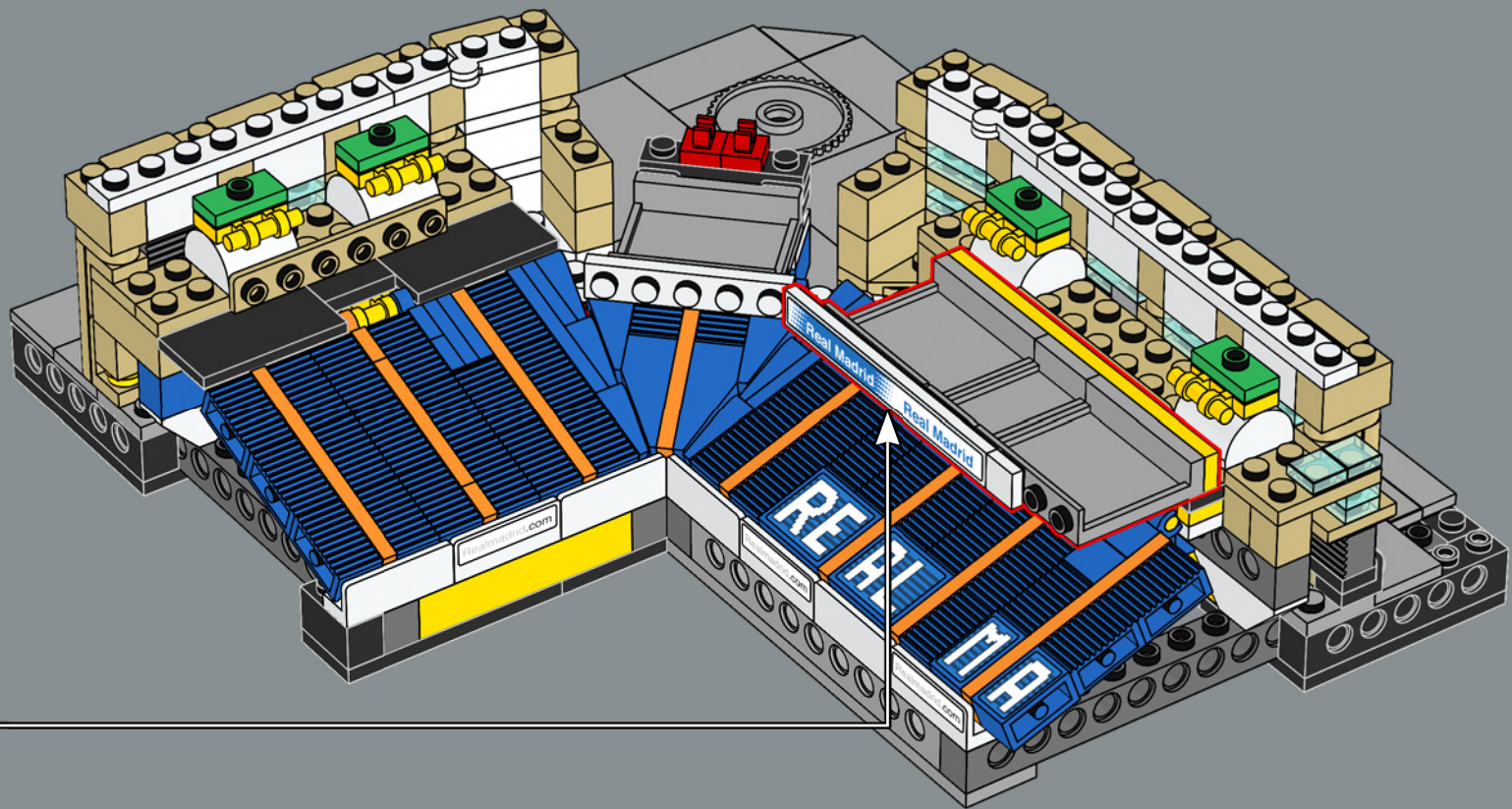

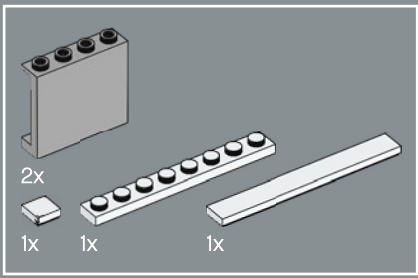

357

1

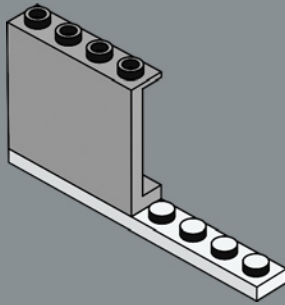

2

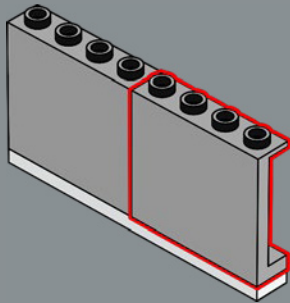

3

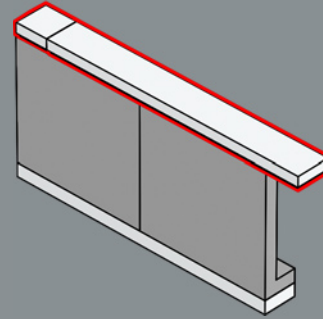

4

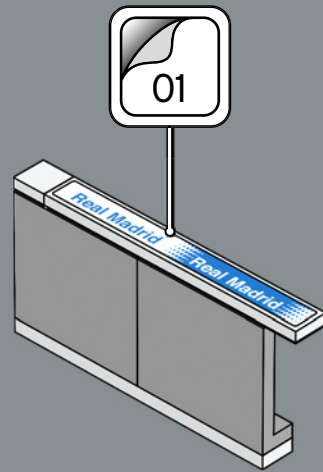

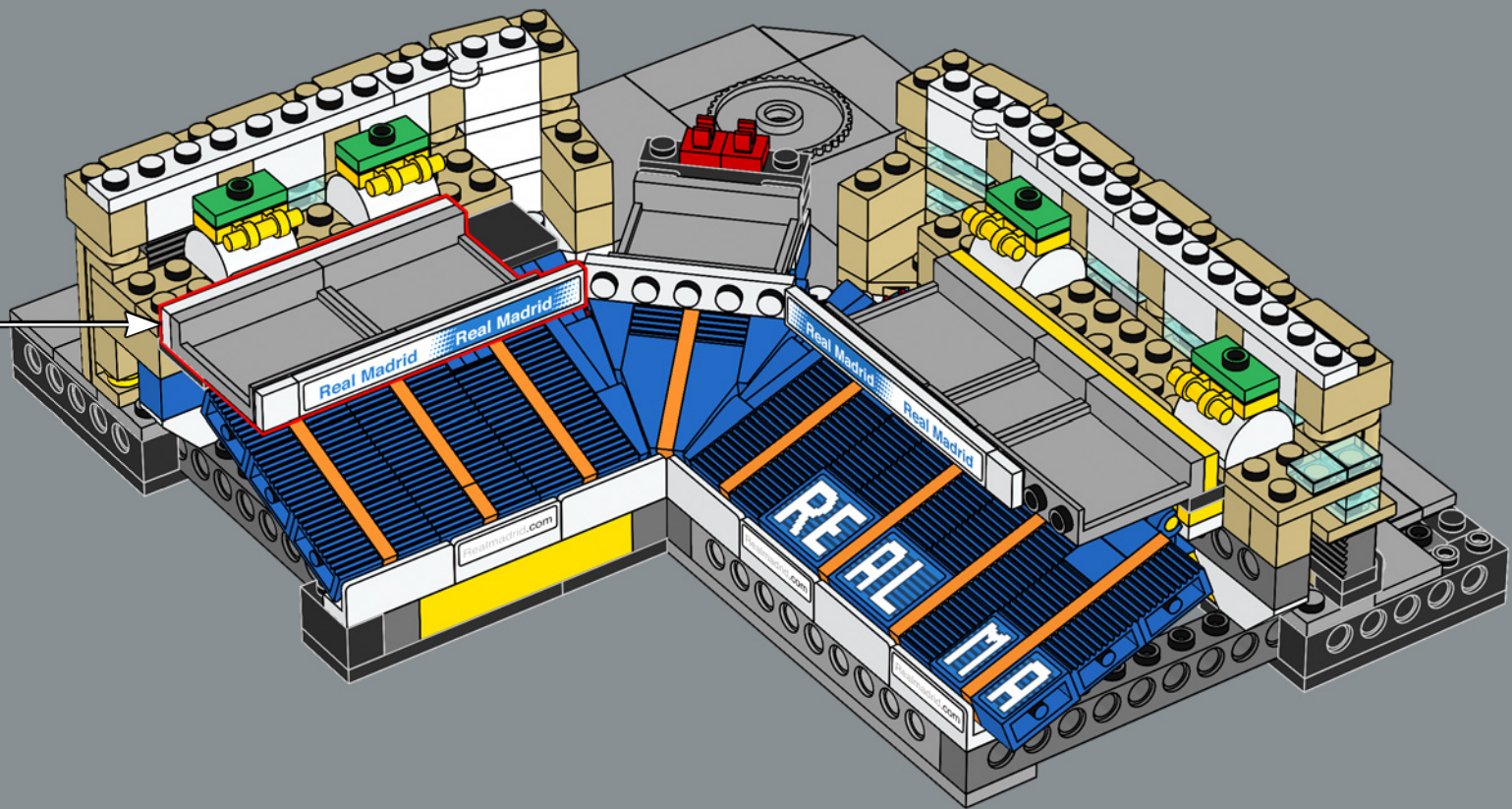

14

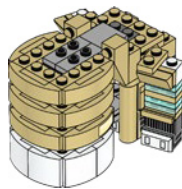
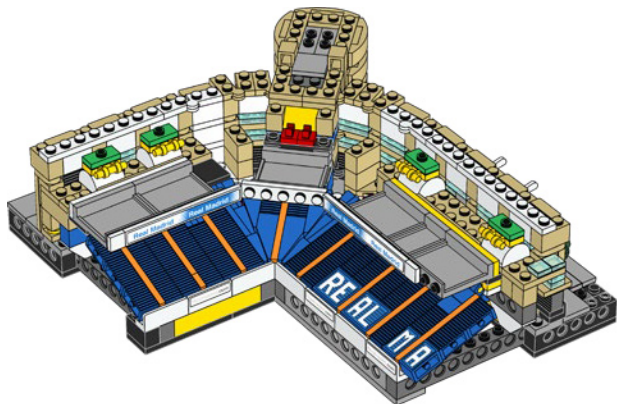

1x



1x

358

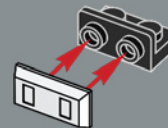

2x

359

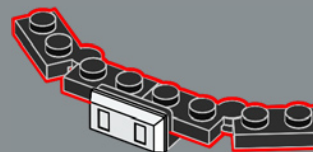



360

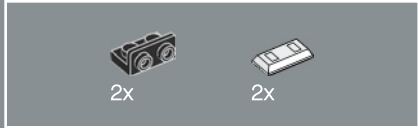
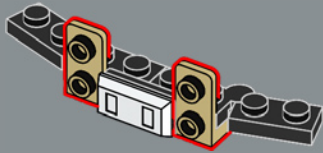

361

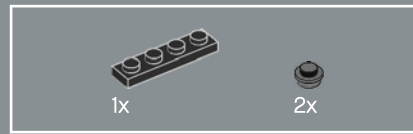
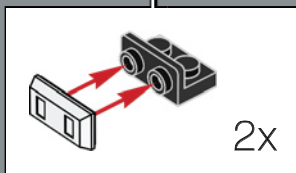
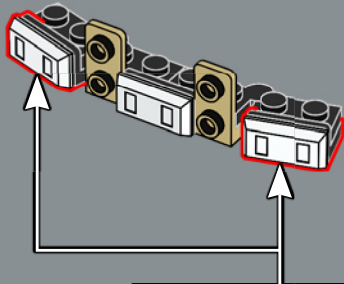

362

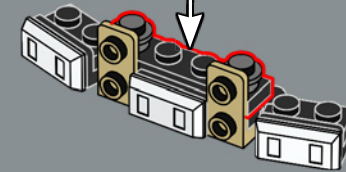
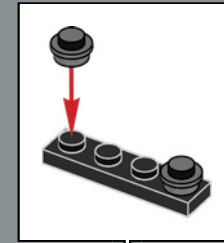

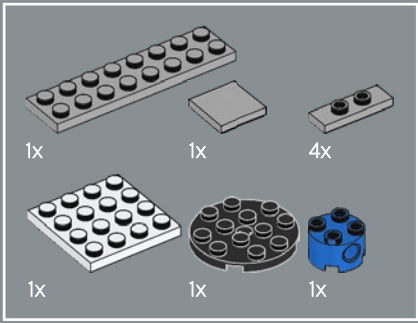

363

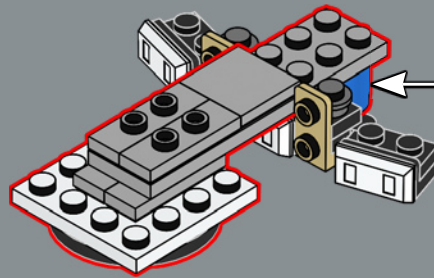
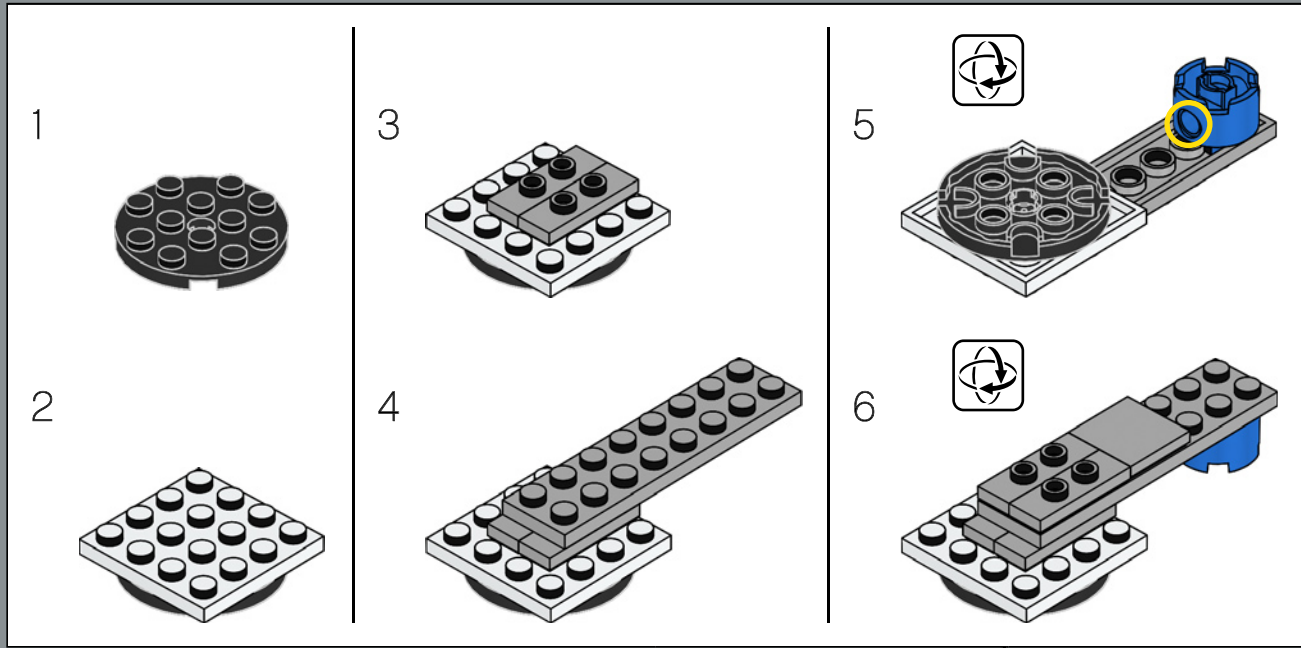

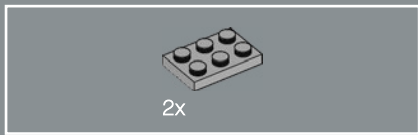

364

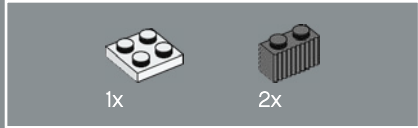
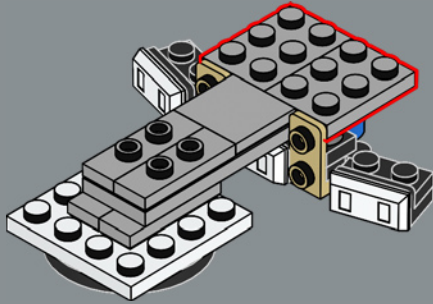

365

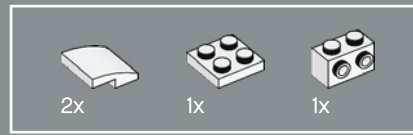
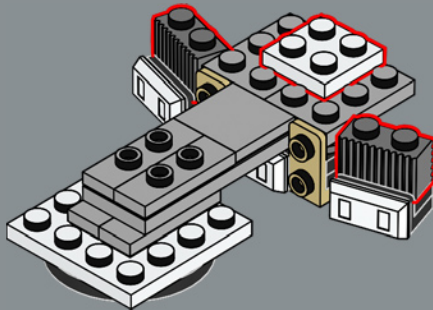

366

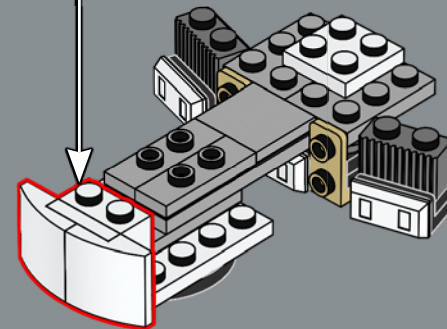
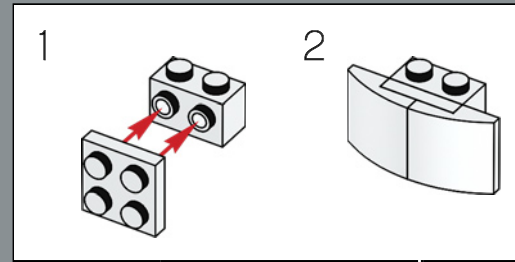

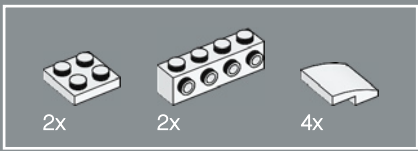

367

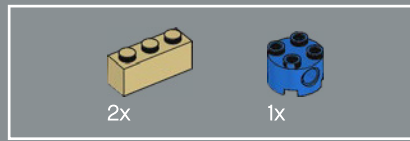
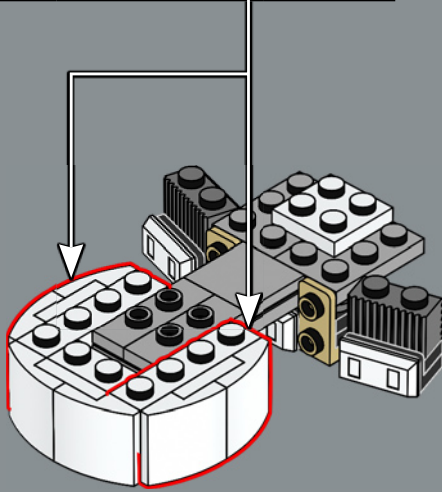
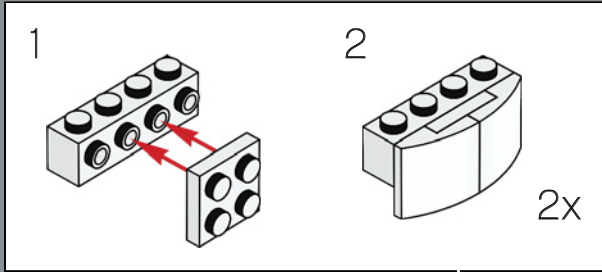

368

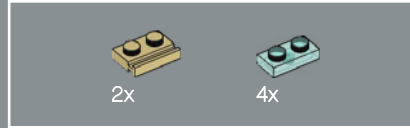
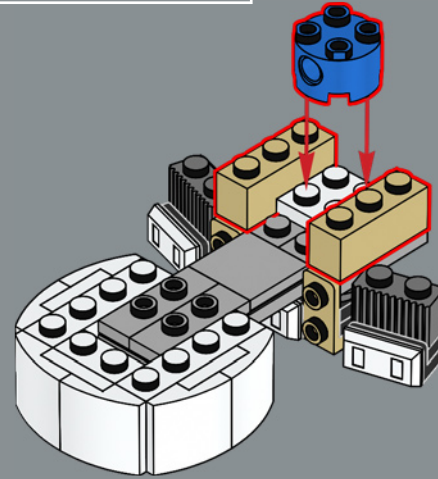

369

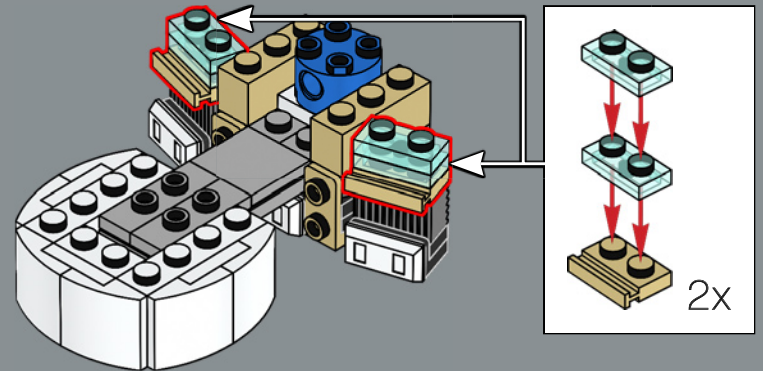

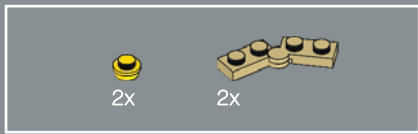

370

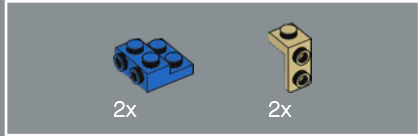
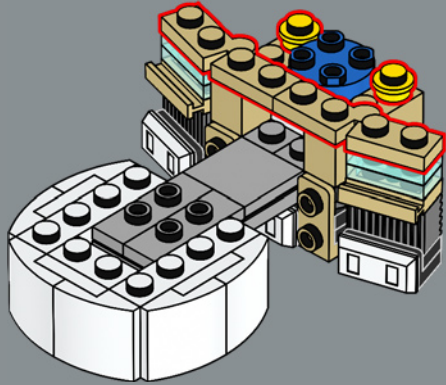

371

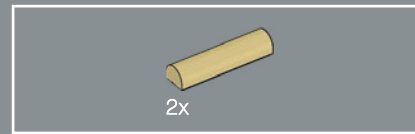
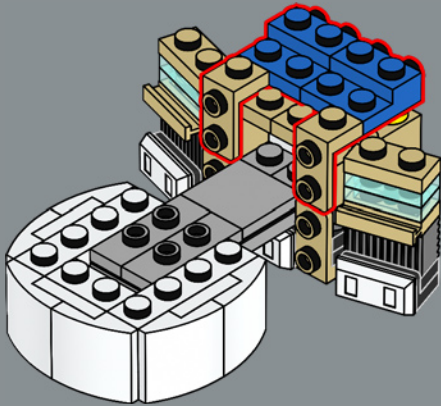

372

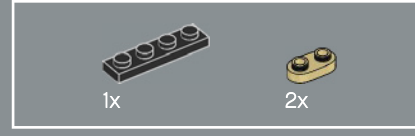
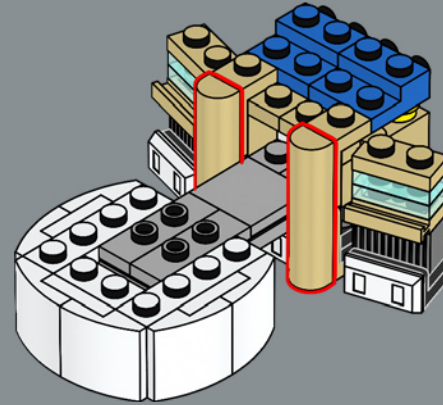

373

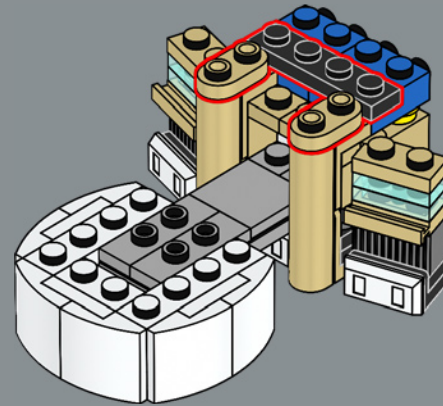



6x

374

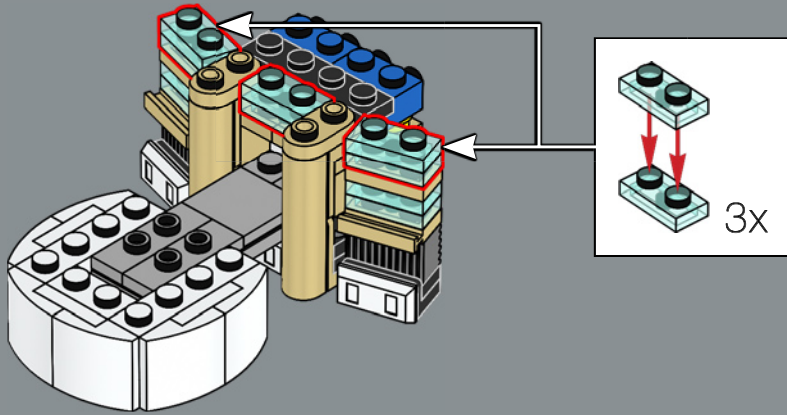

1x

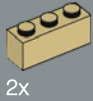

2x

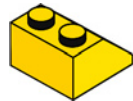

375

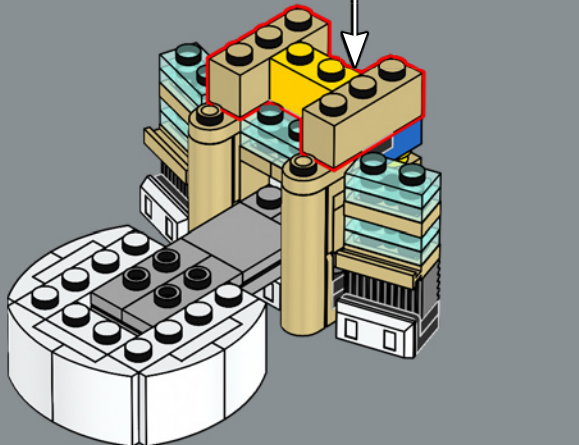

3x



3x



3x

376

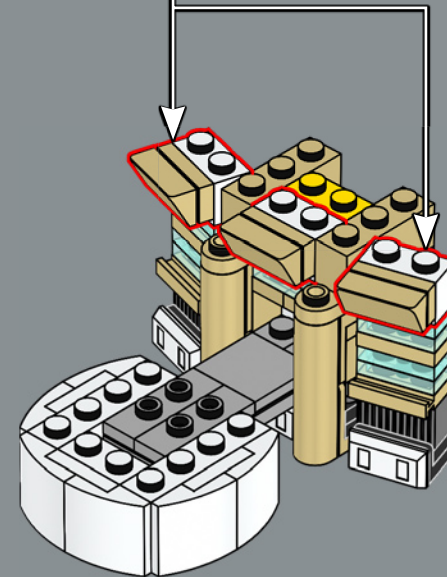
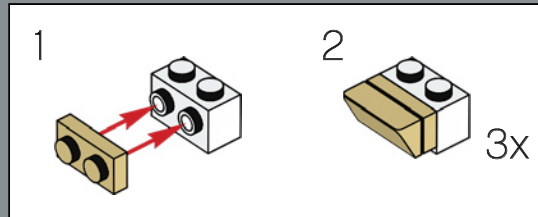



377

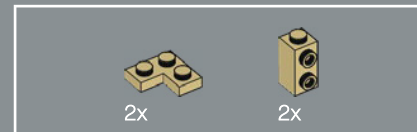
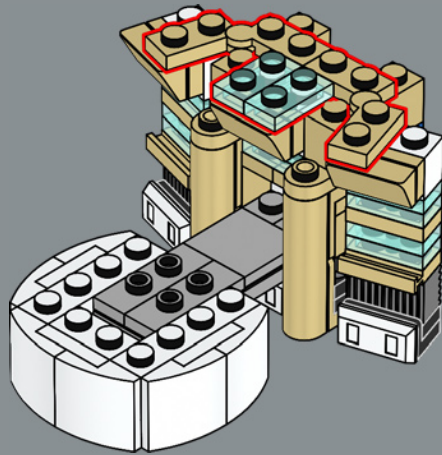

378

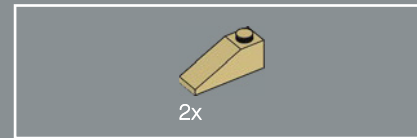
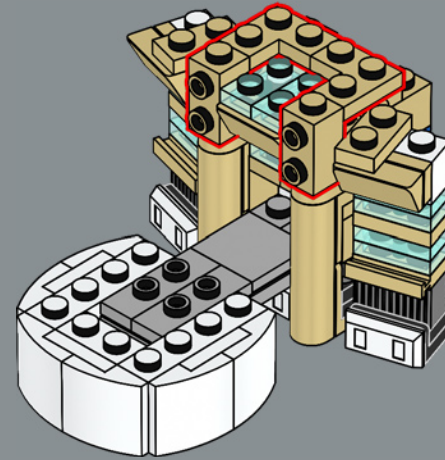

379

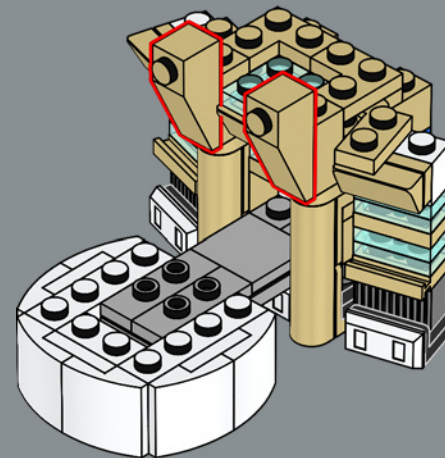

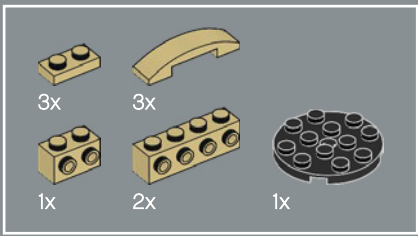

380

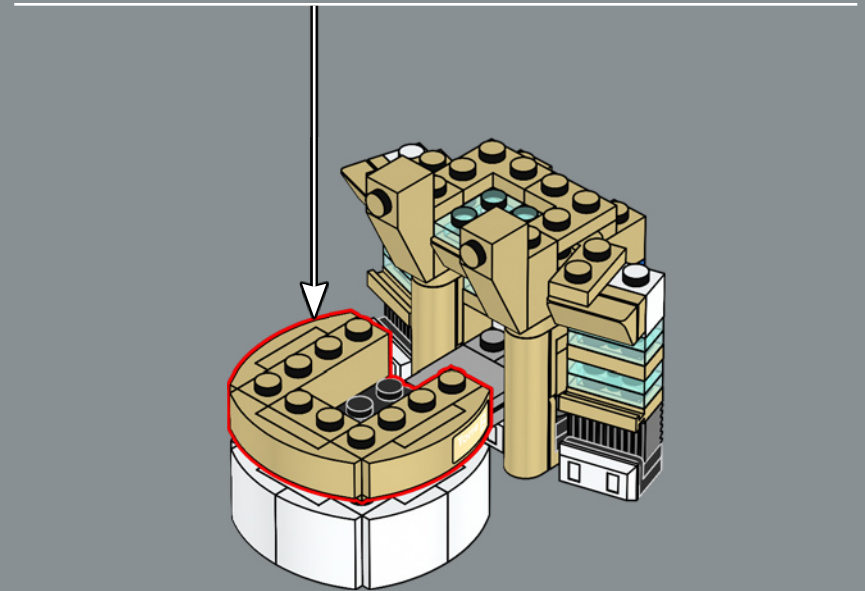
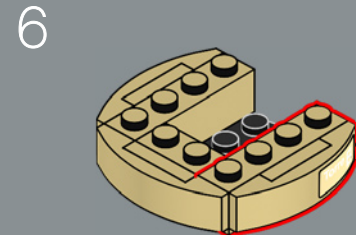
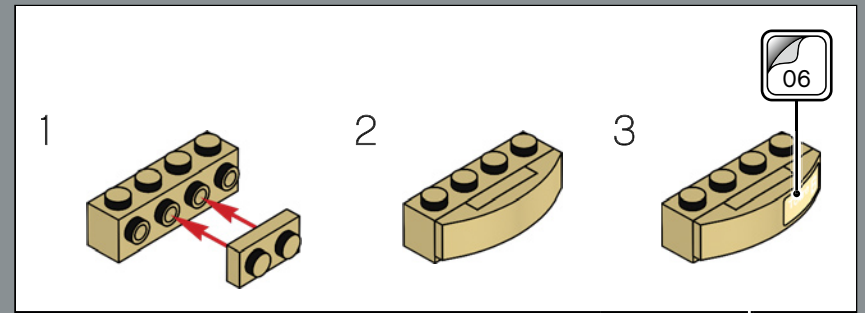
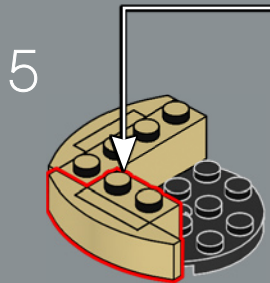
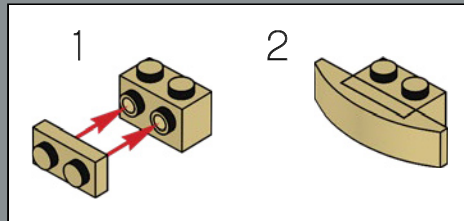
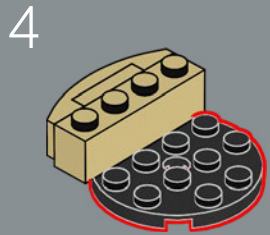
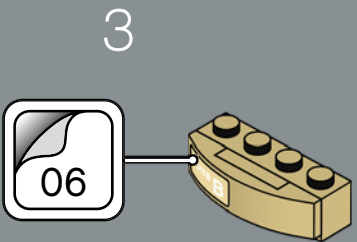
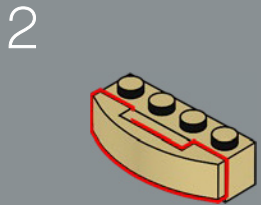
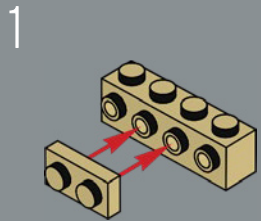

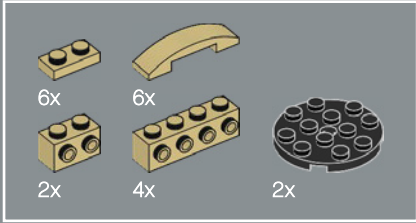
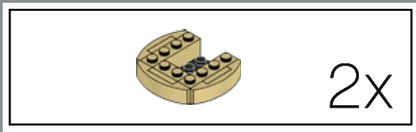

381

1

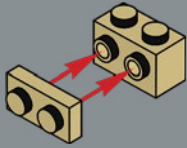

2



3

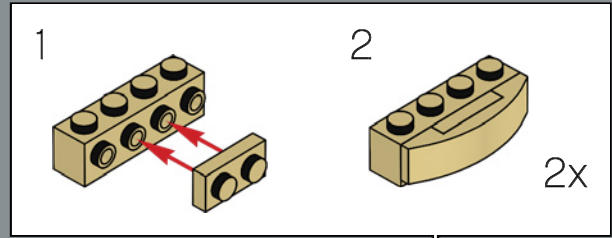
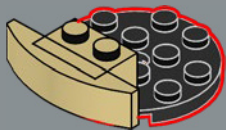

4

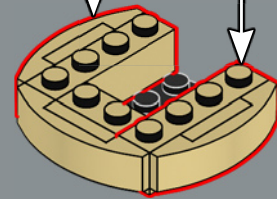

2x

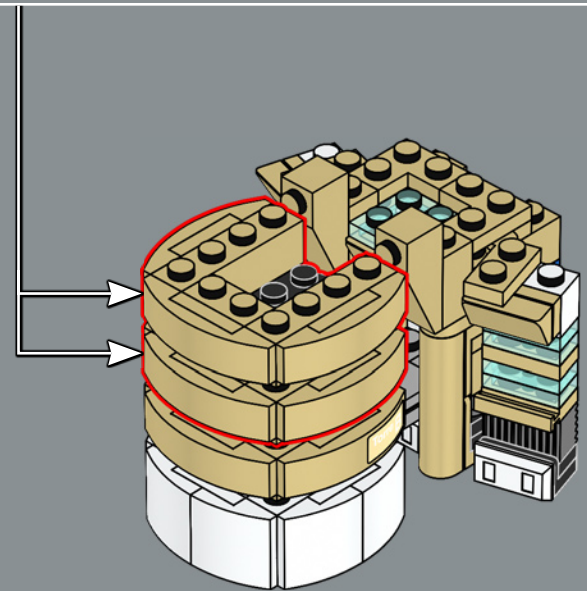

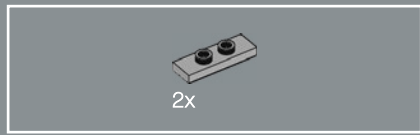

382

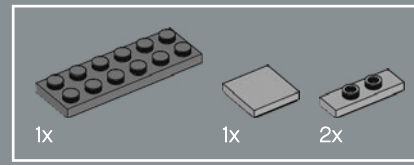
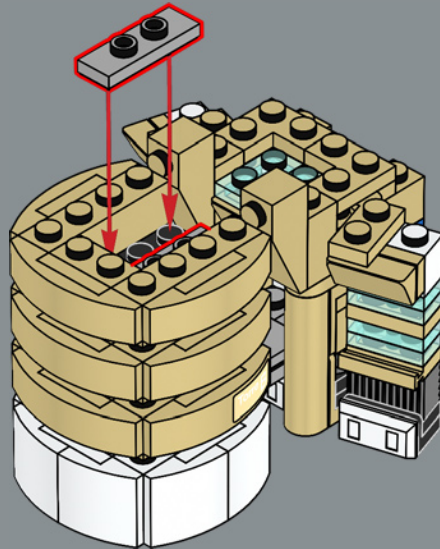

383

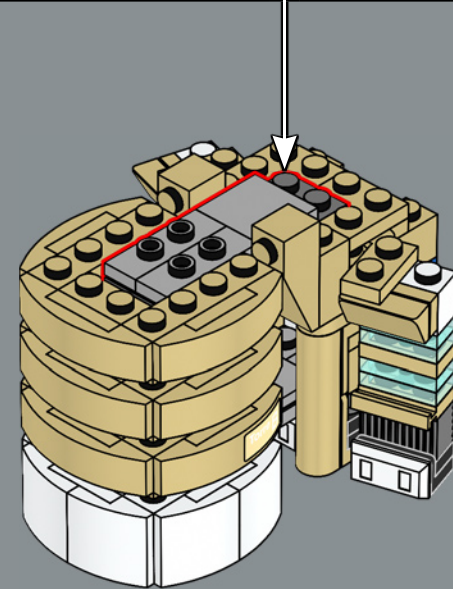
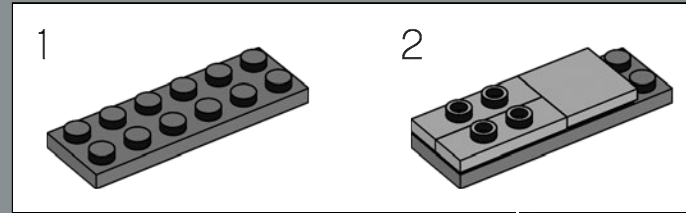

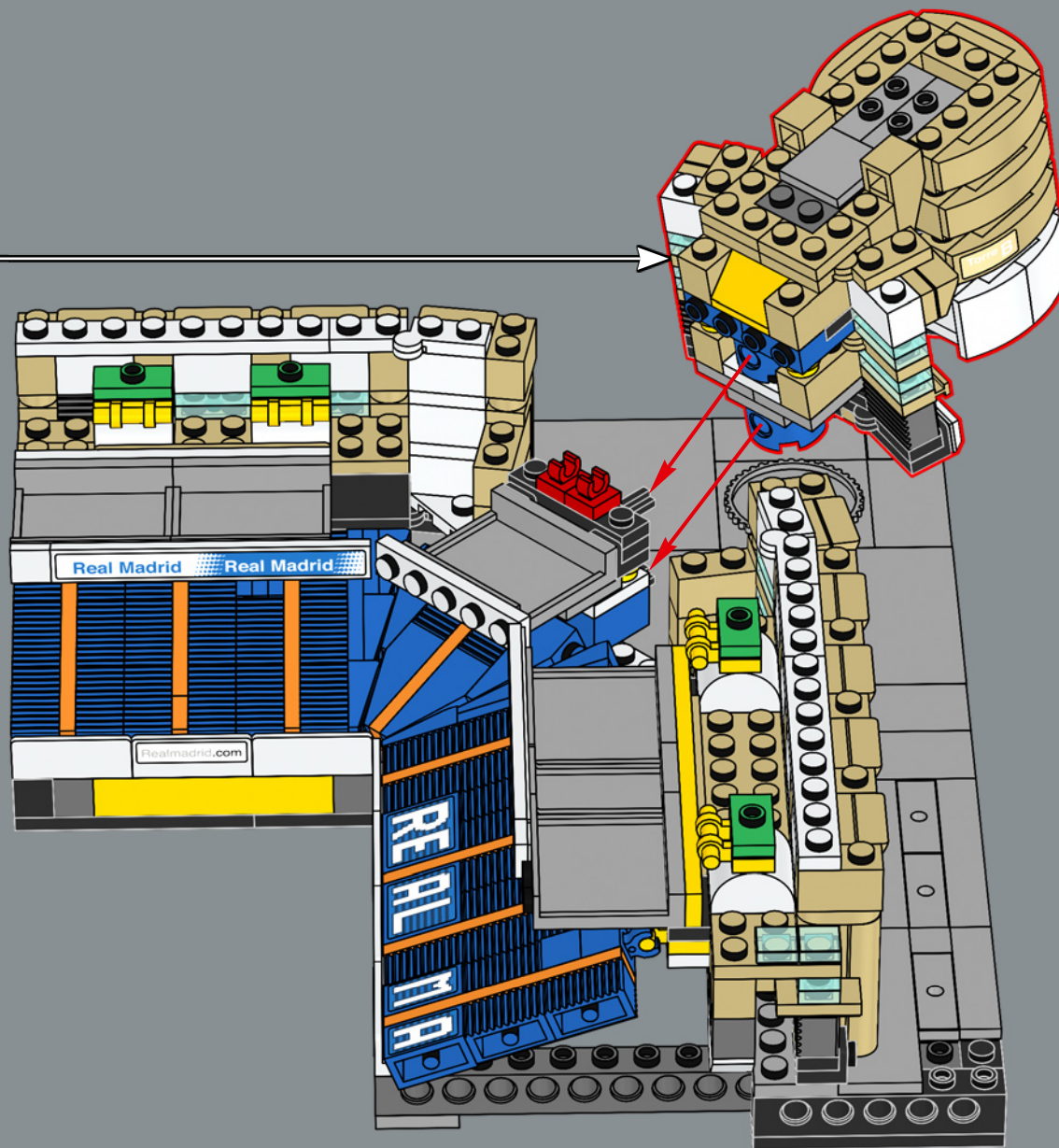

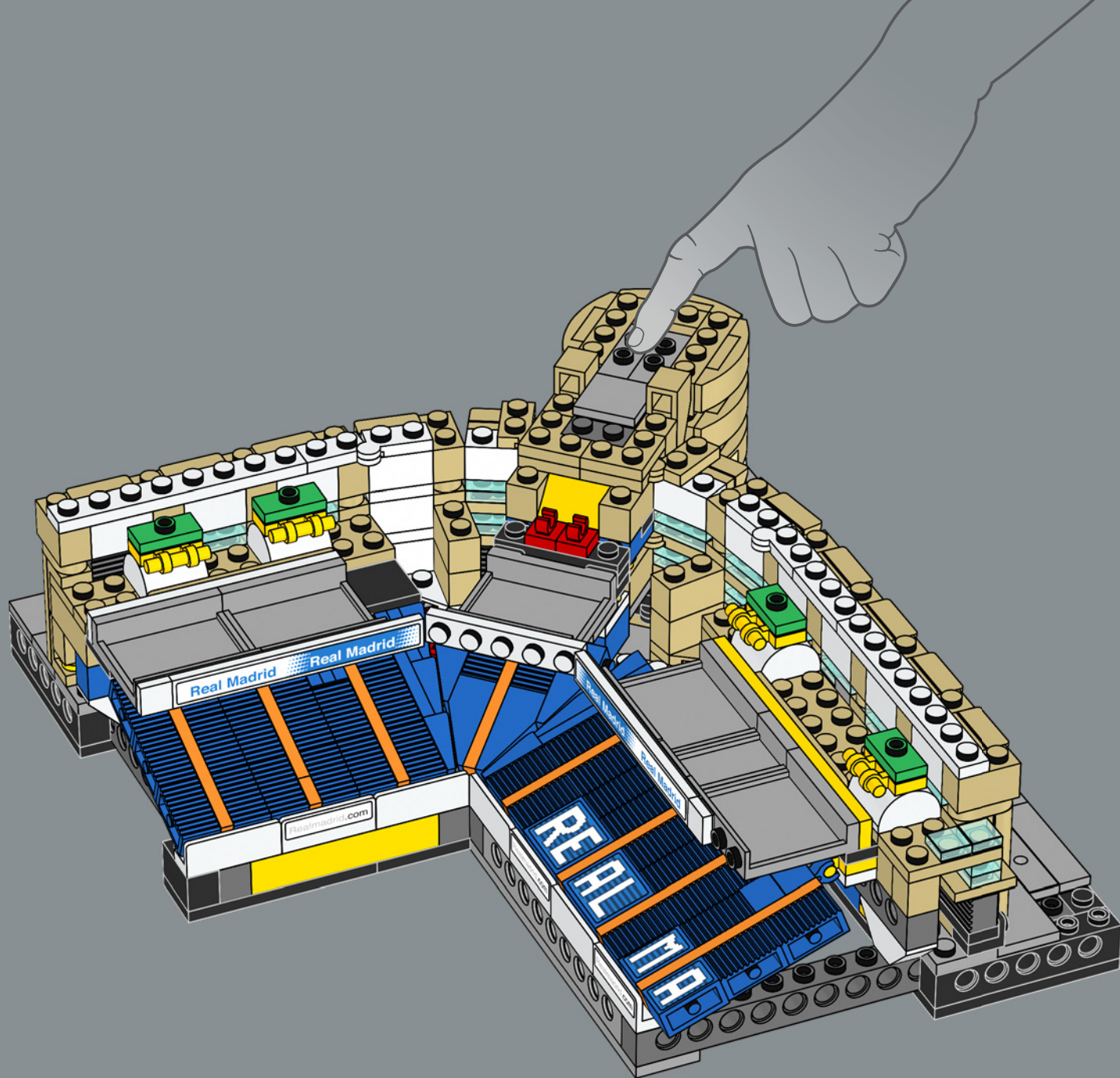



2x

386

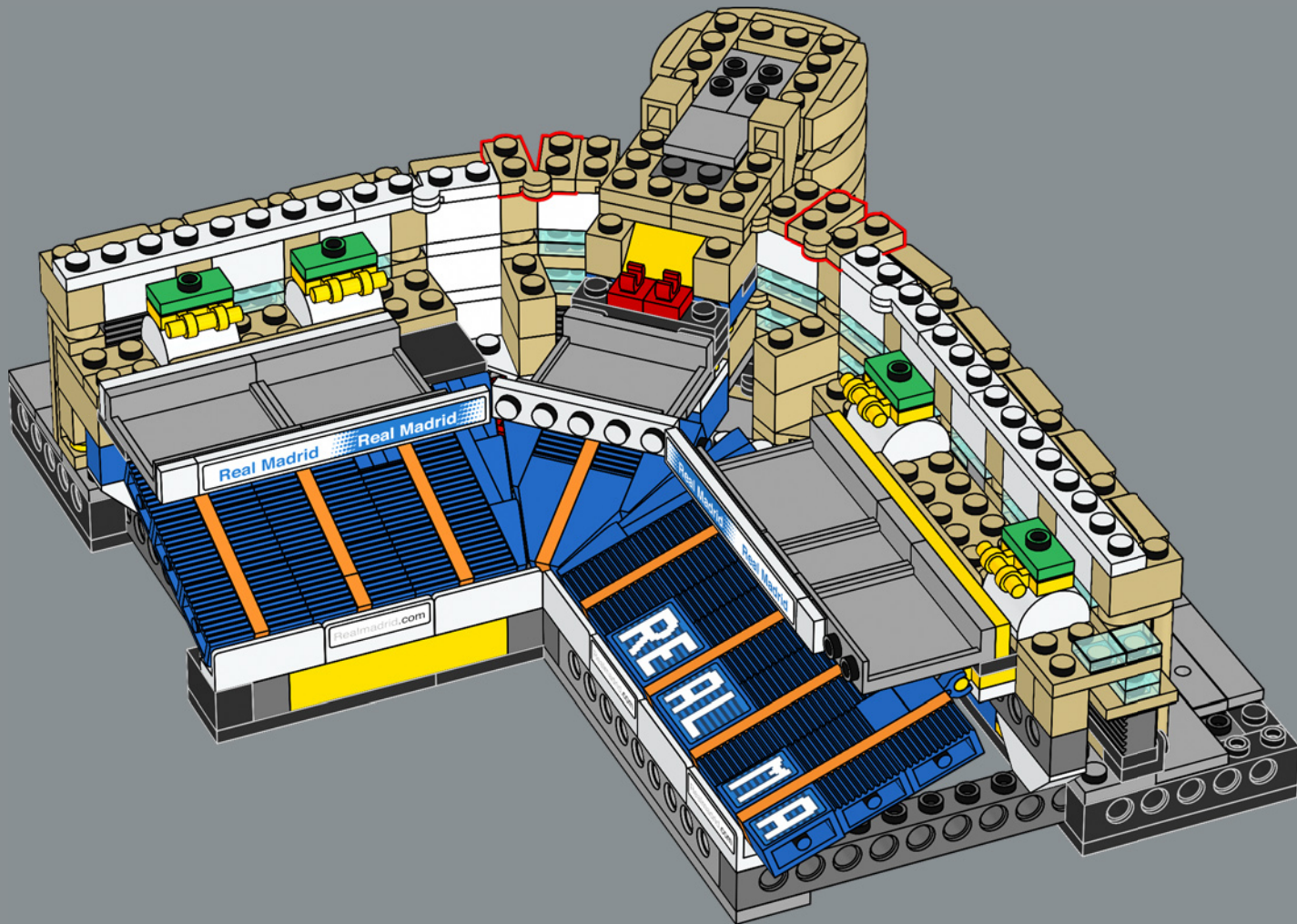

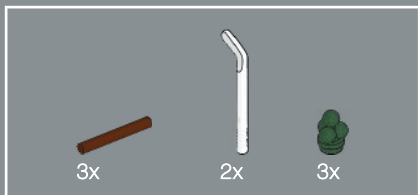

The LEGO® hockey stick was first introduced in Series 4 Collectible Minifigures.

Le bâton de hockey LEGO® a été vu pour la première fois dans la série 4 des figurines à collectionner.

El palo de hockey LEGO® se introdujo en la serie 4 de la colección LEGO Minifigures.

387

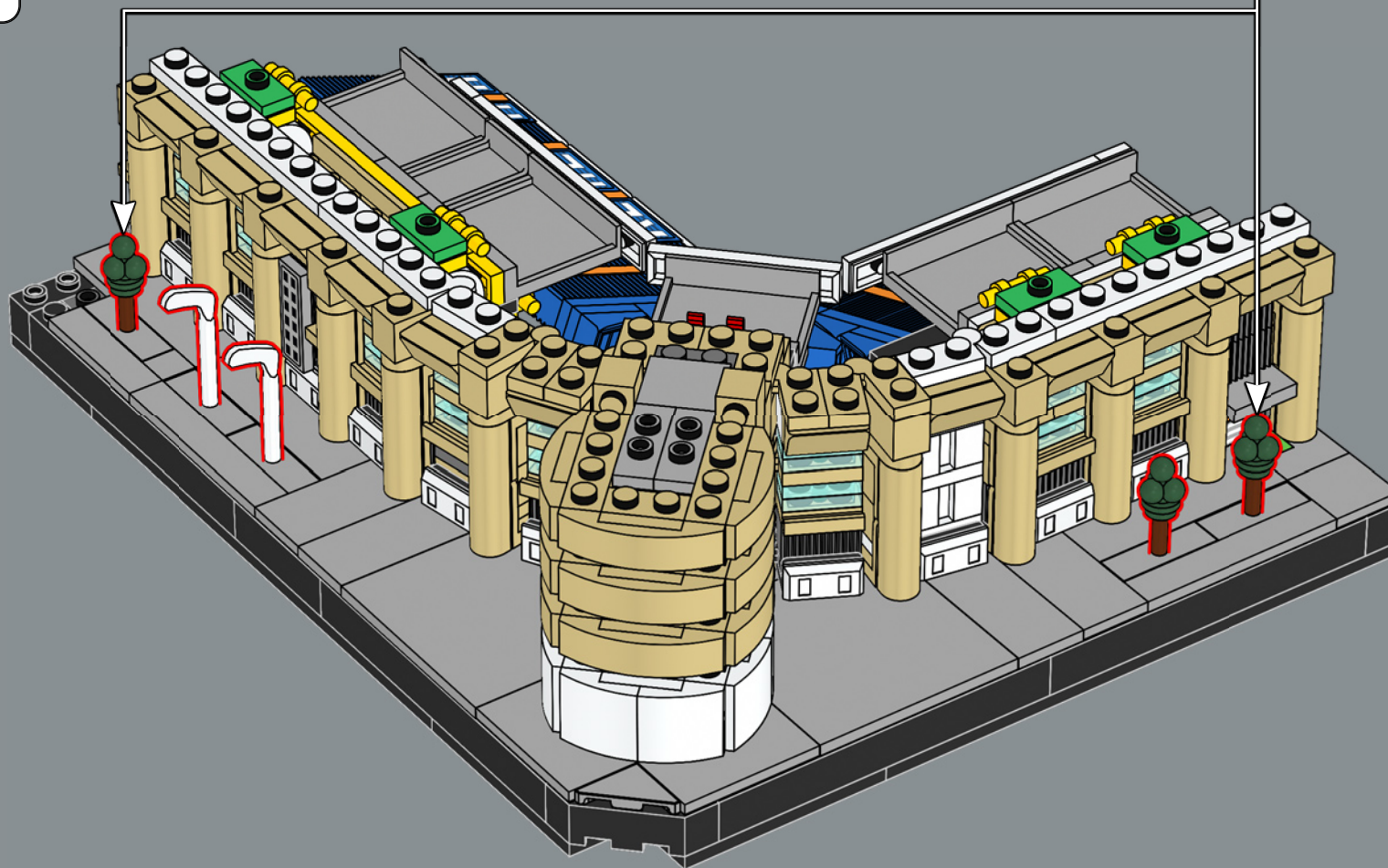
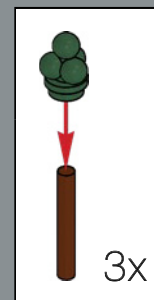

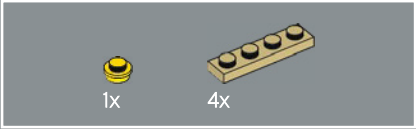
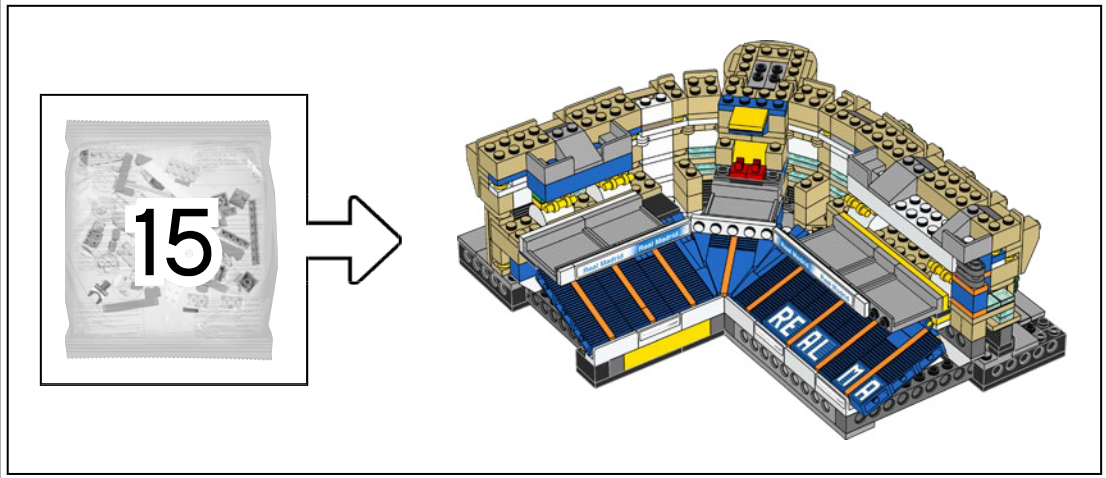

388

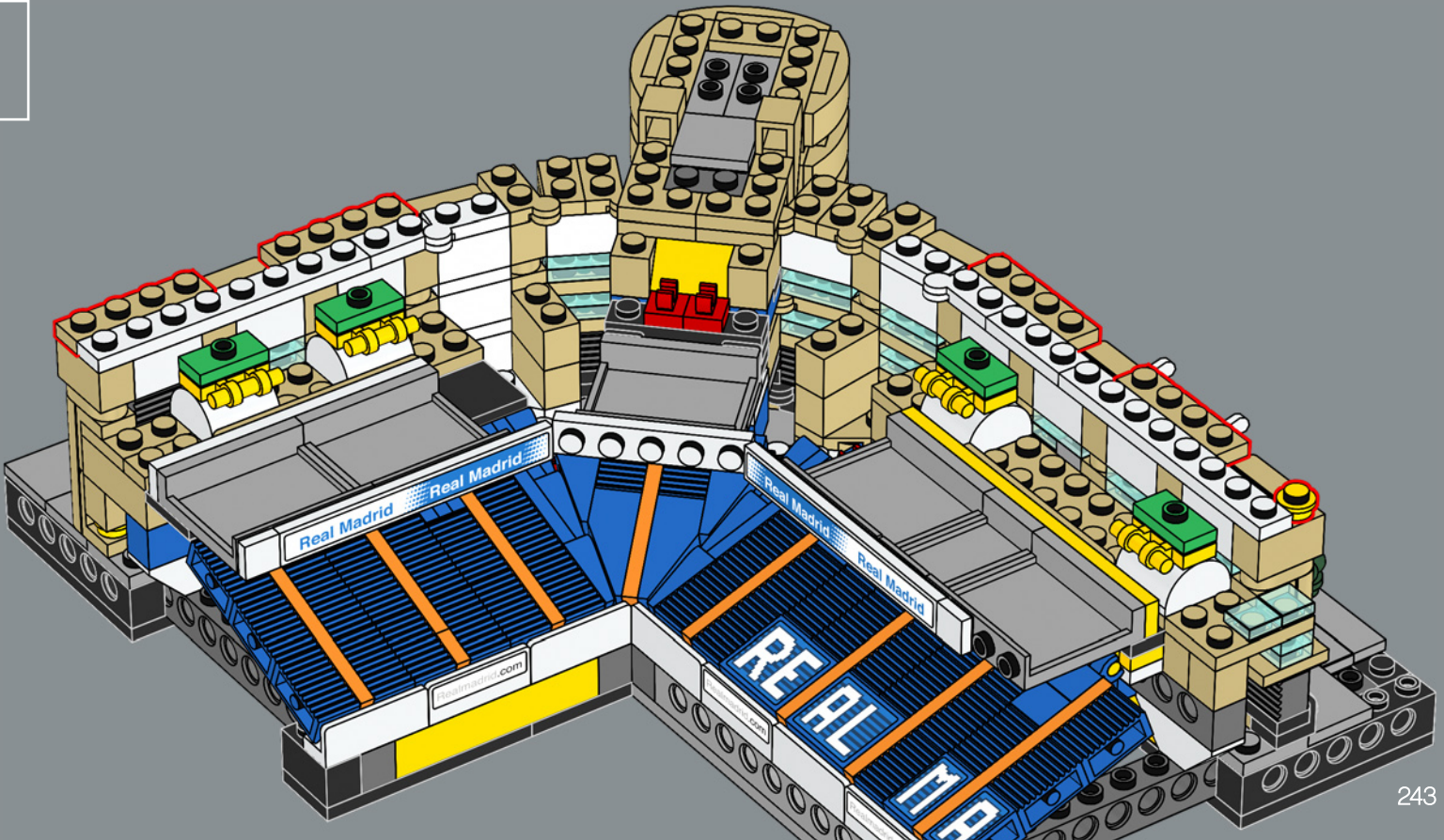

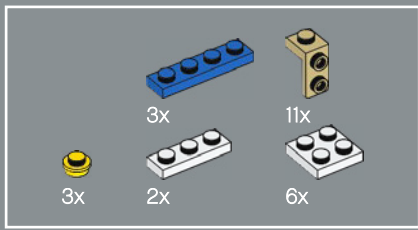

389

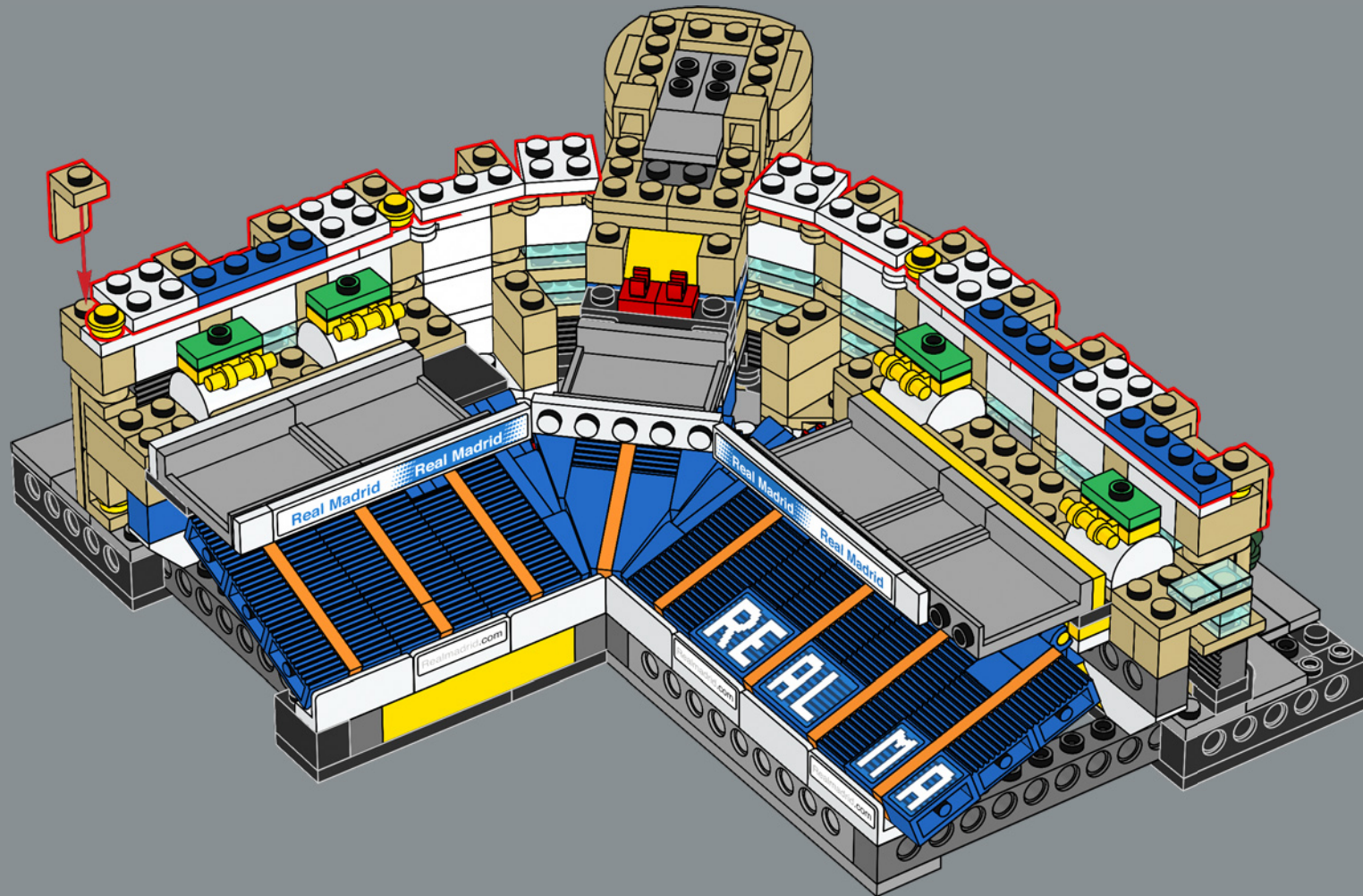

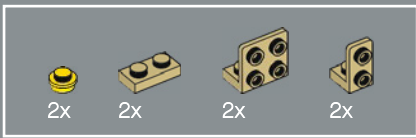

390

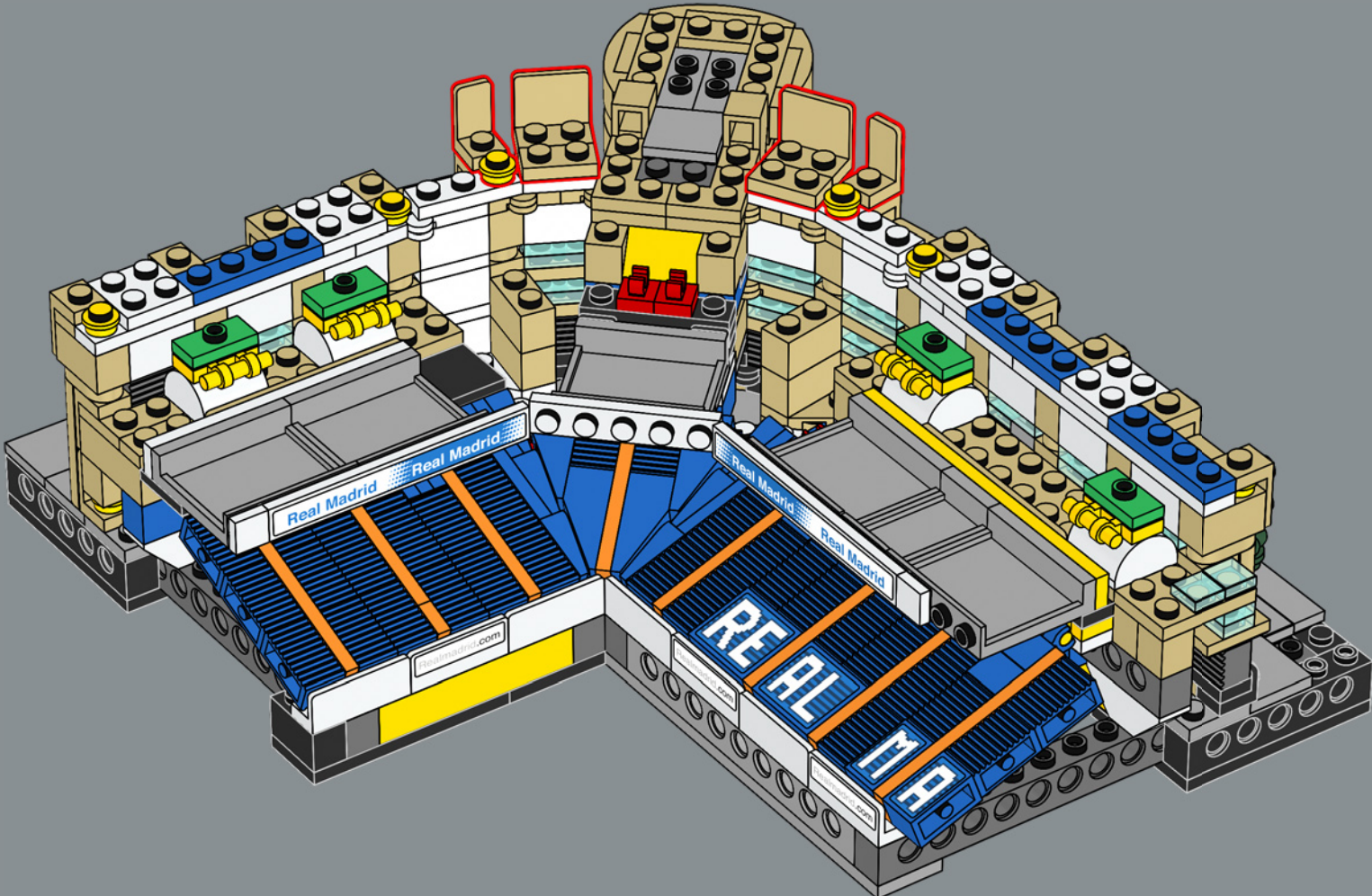

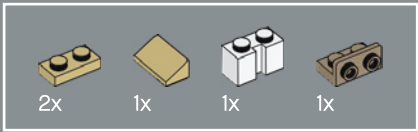

391

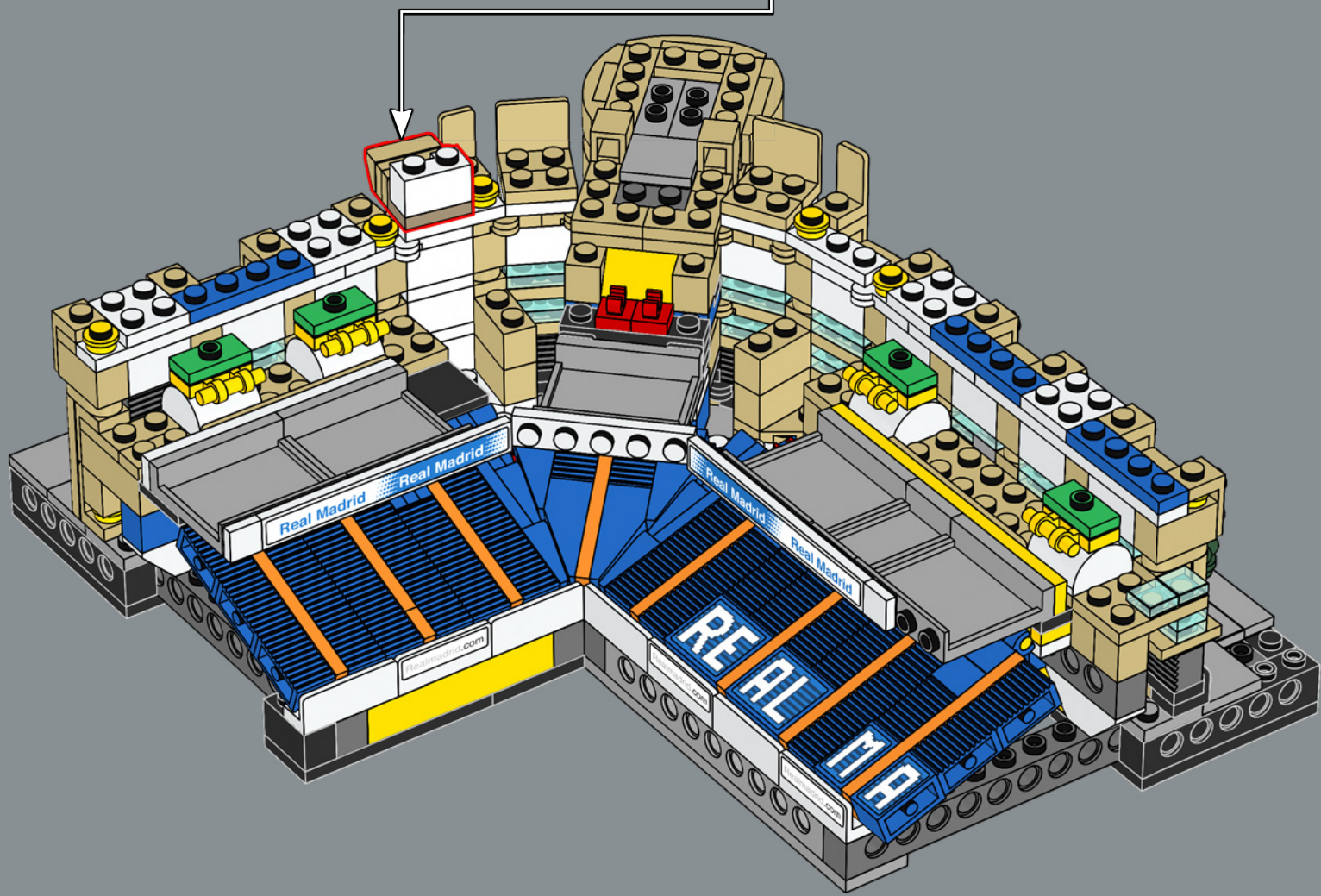
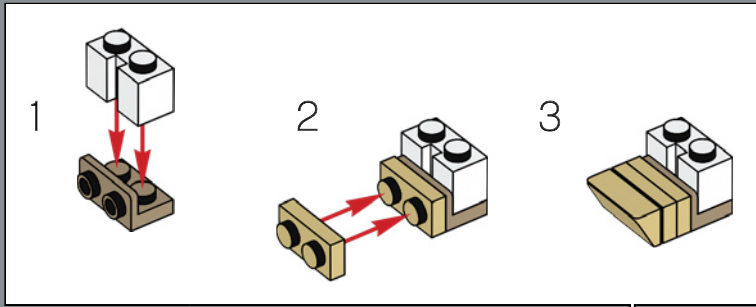



392

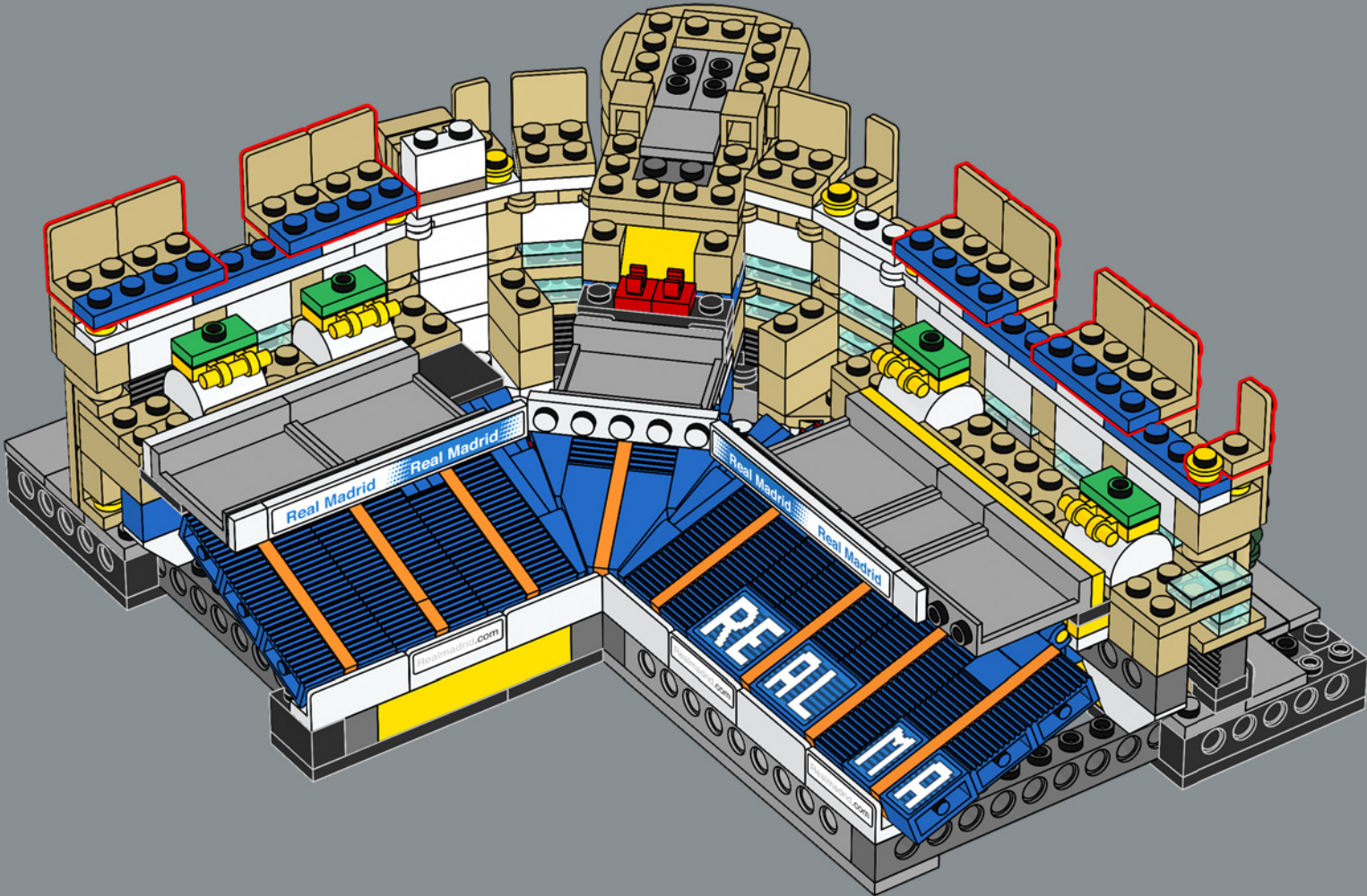

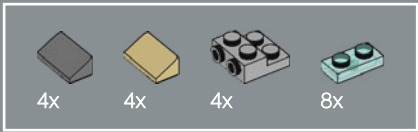

393

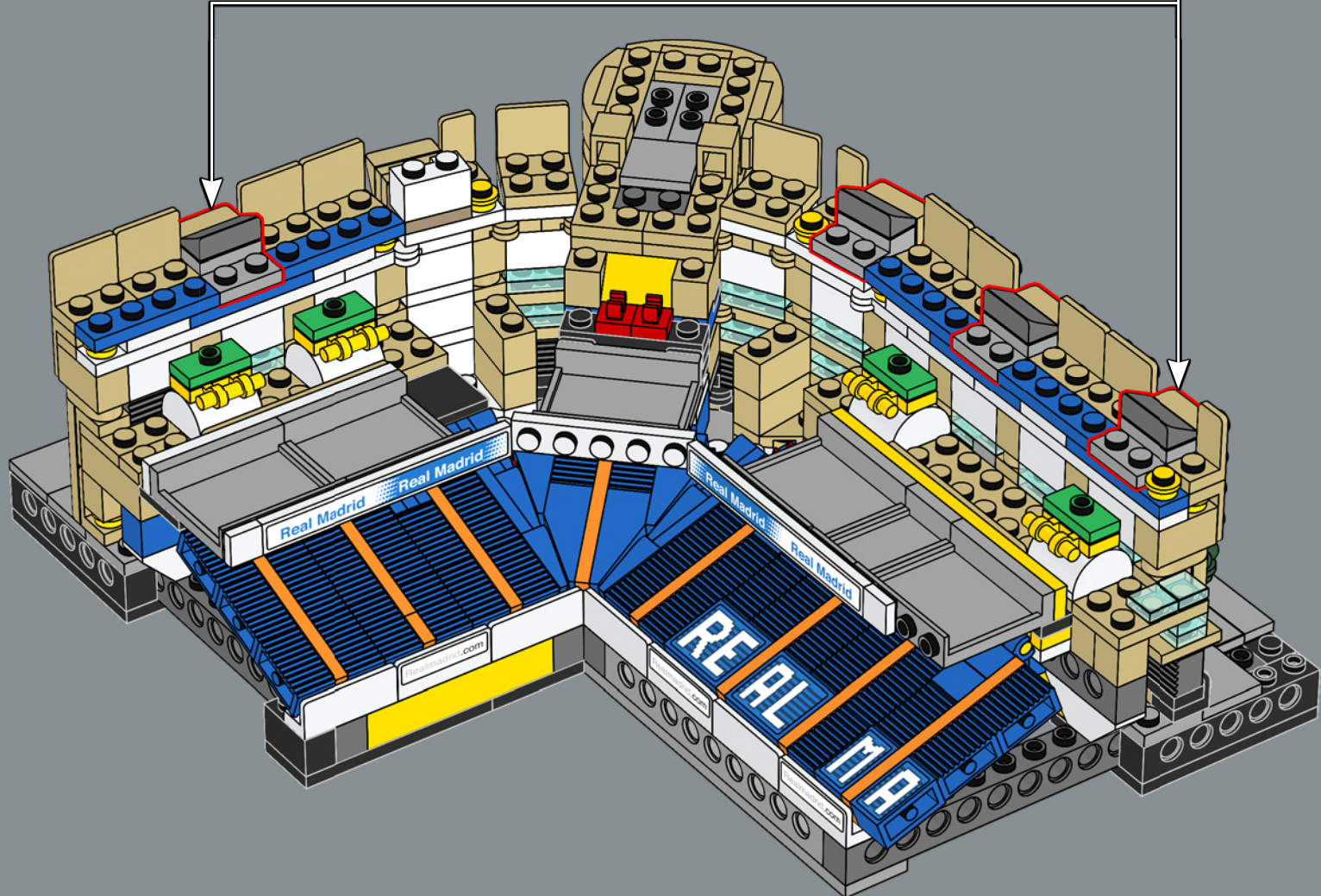
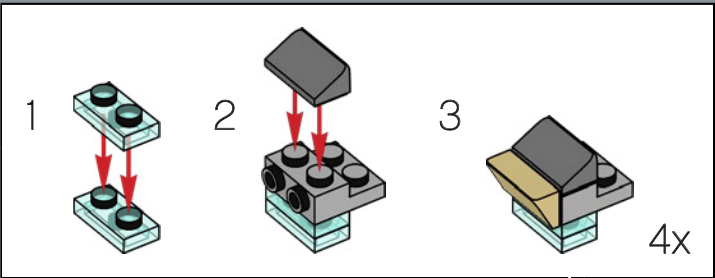

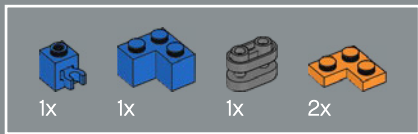

394

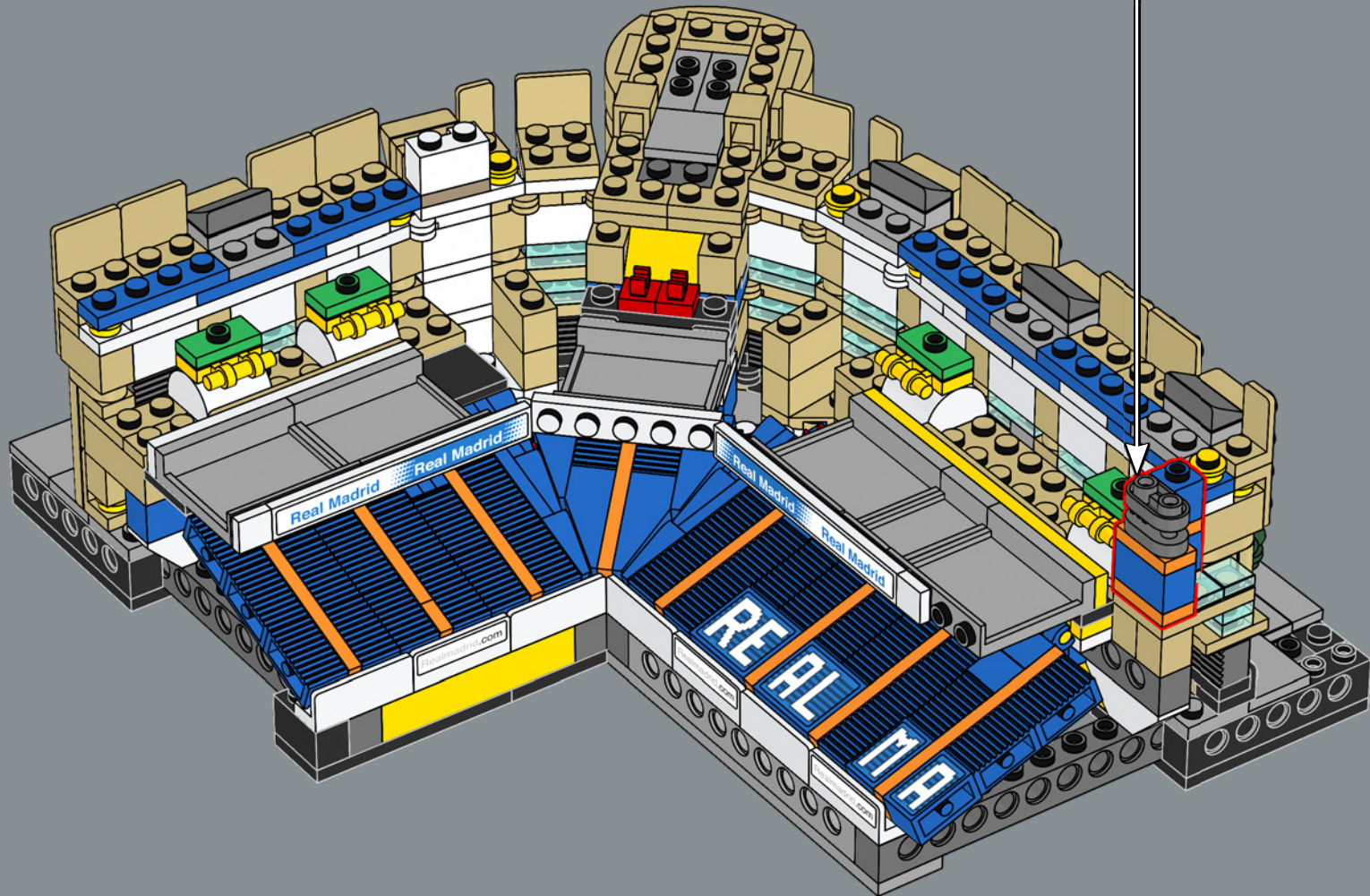
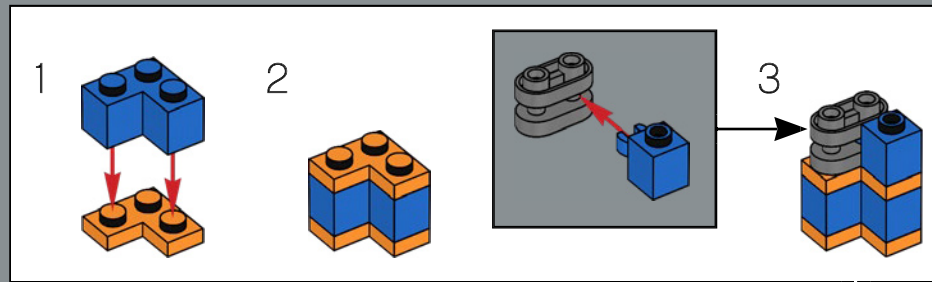

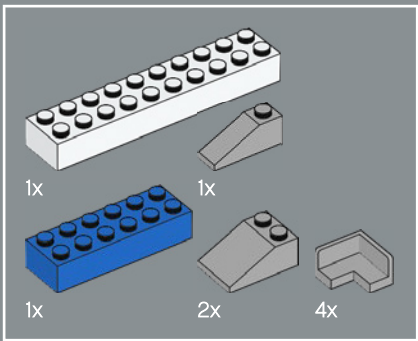

395

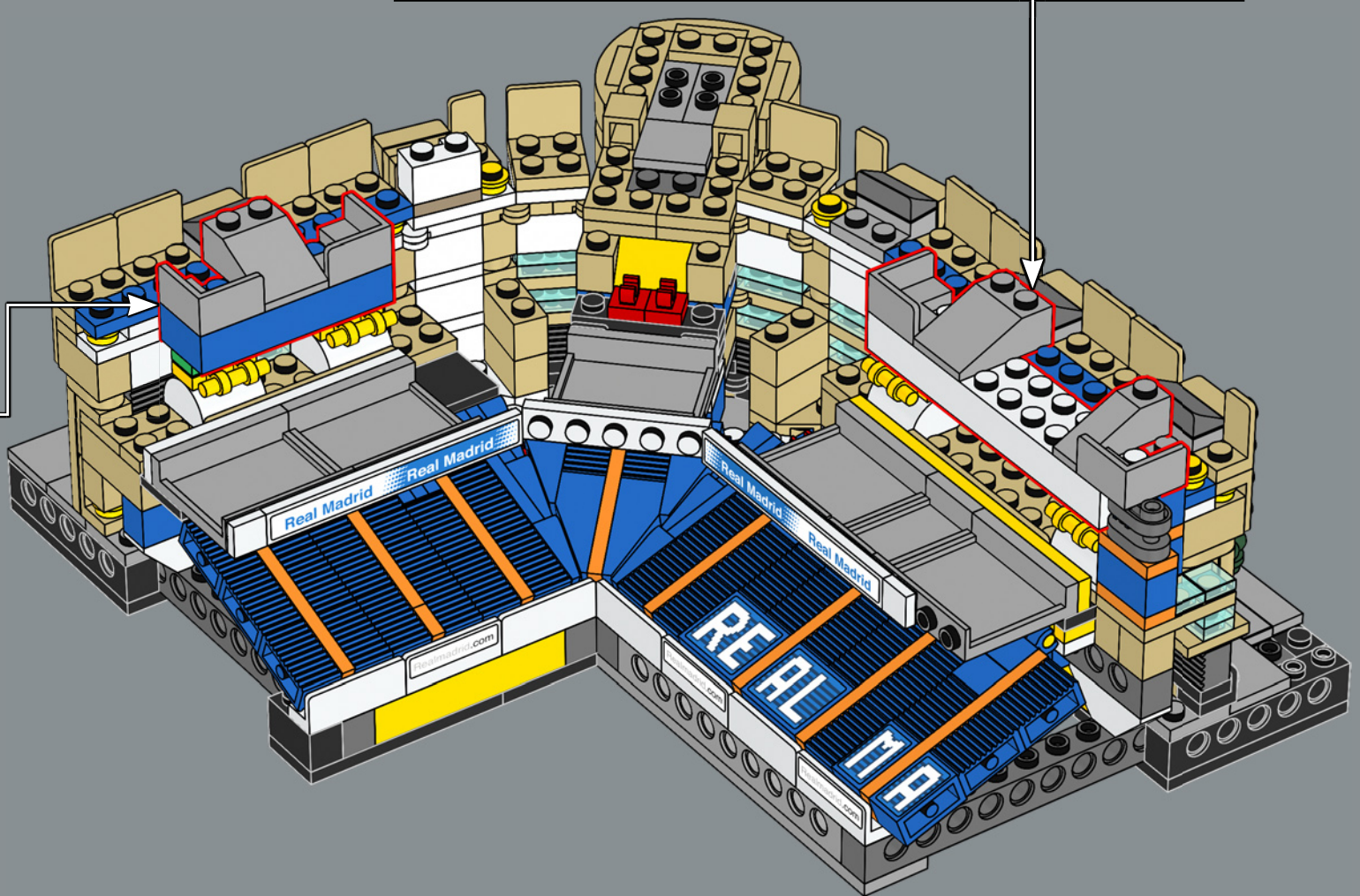
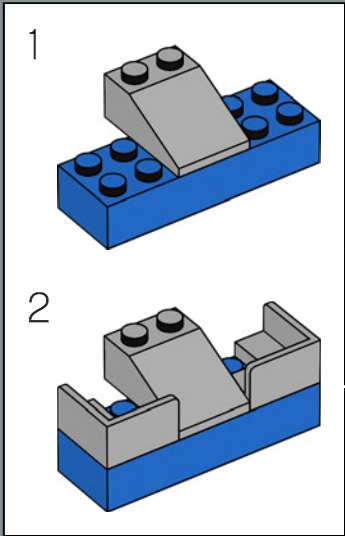
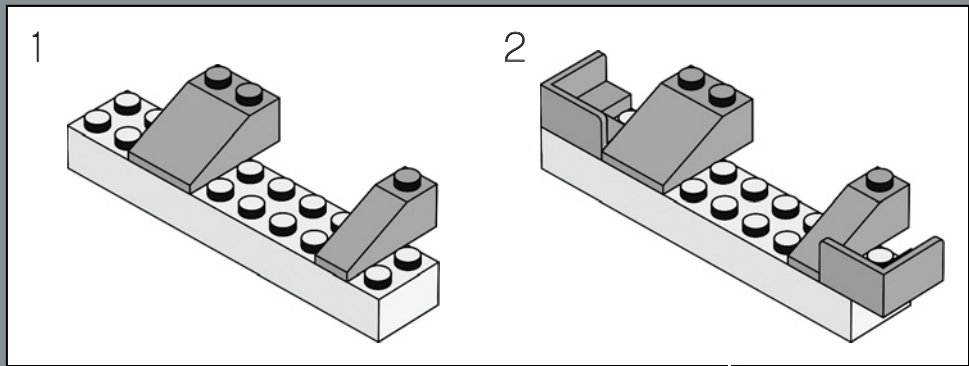

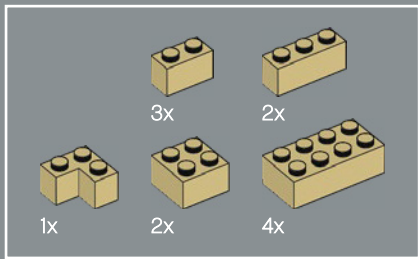

396

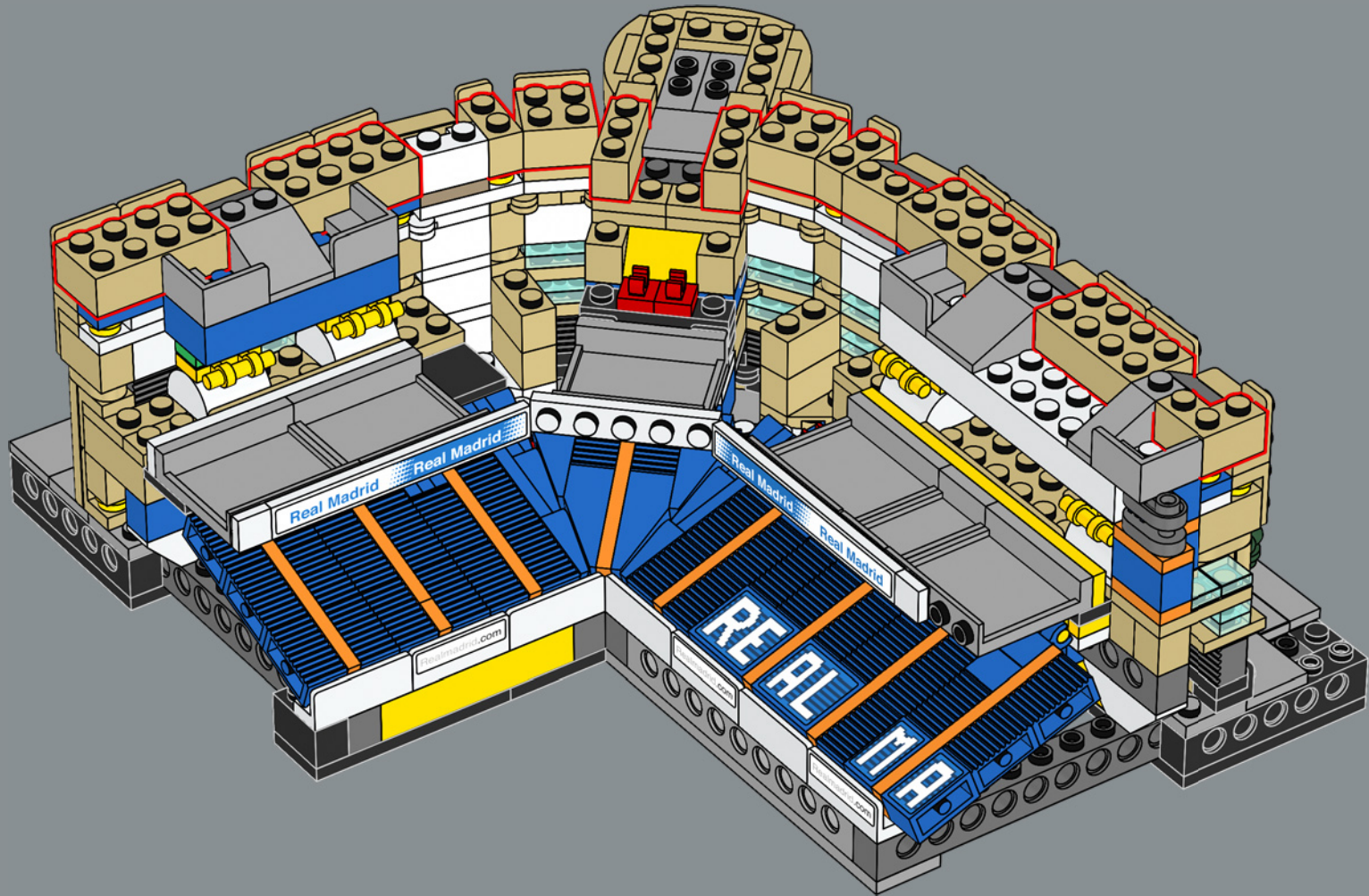

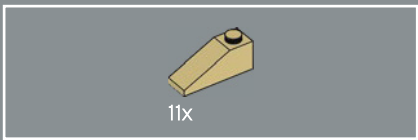

397

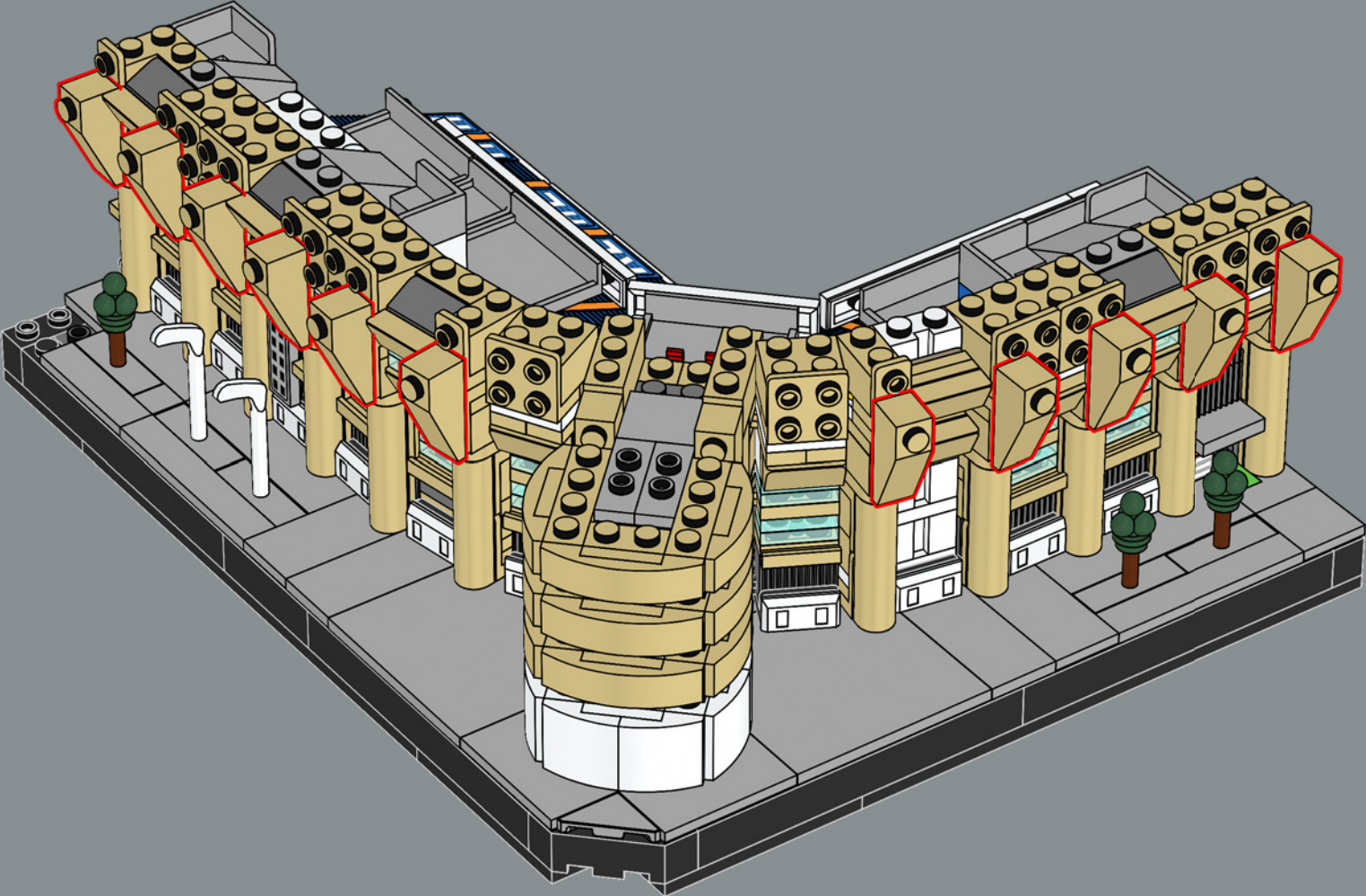

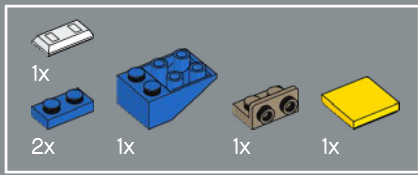

398

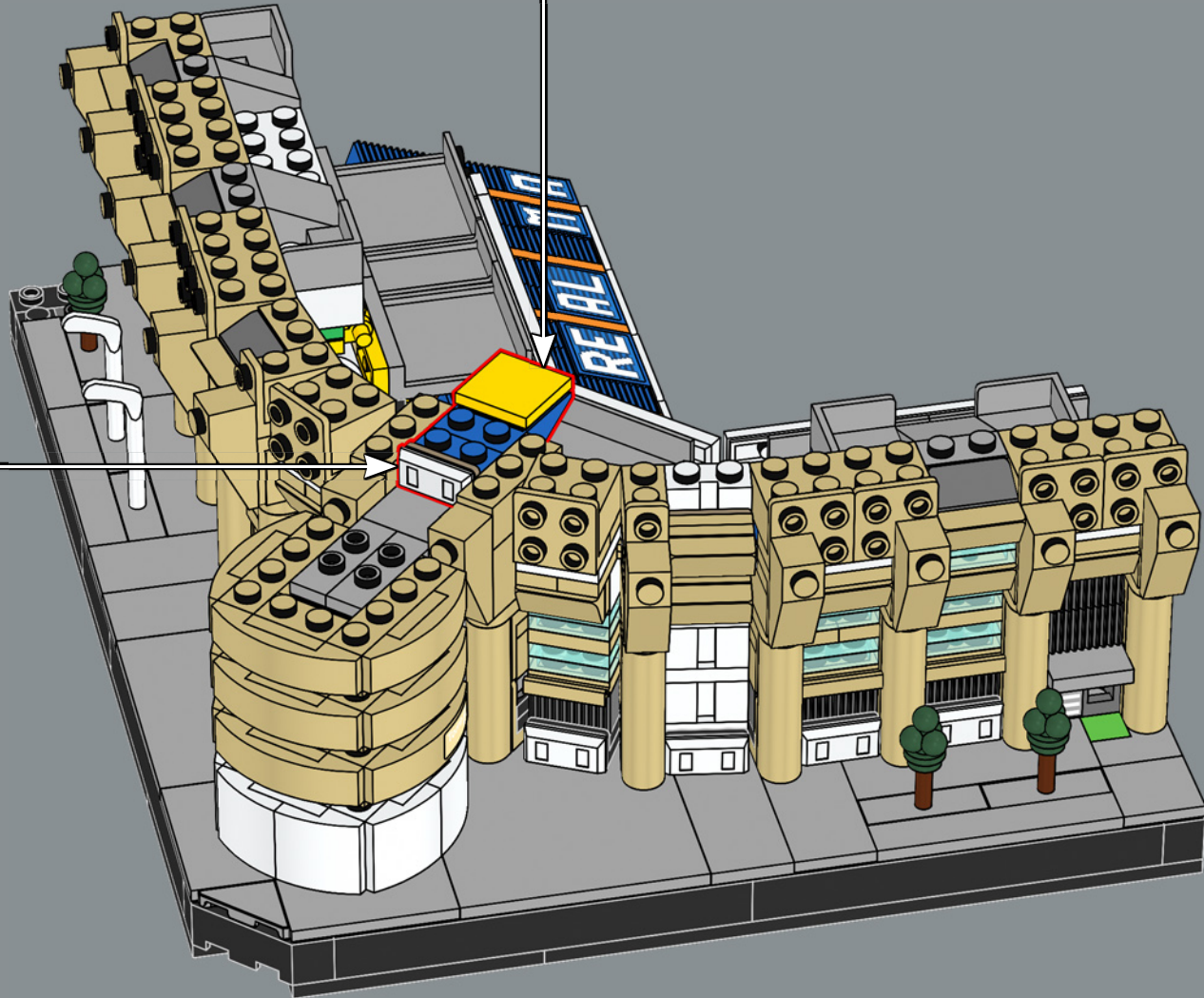
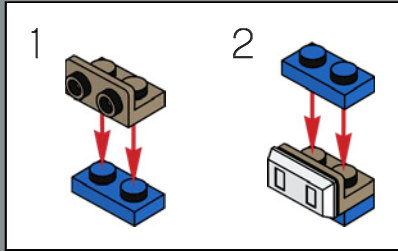
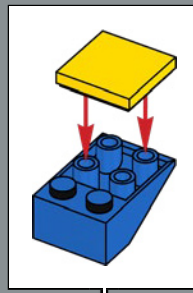

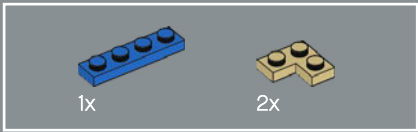

399

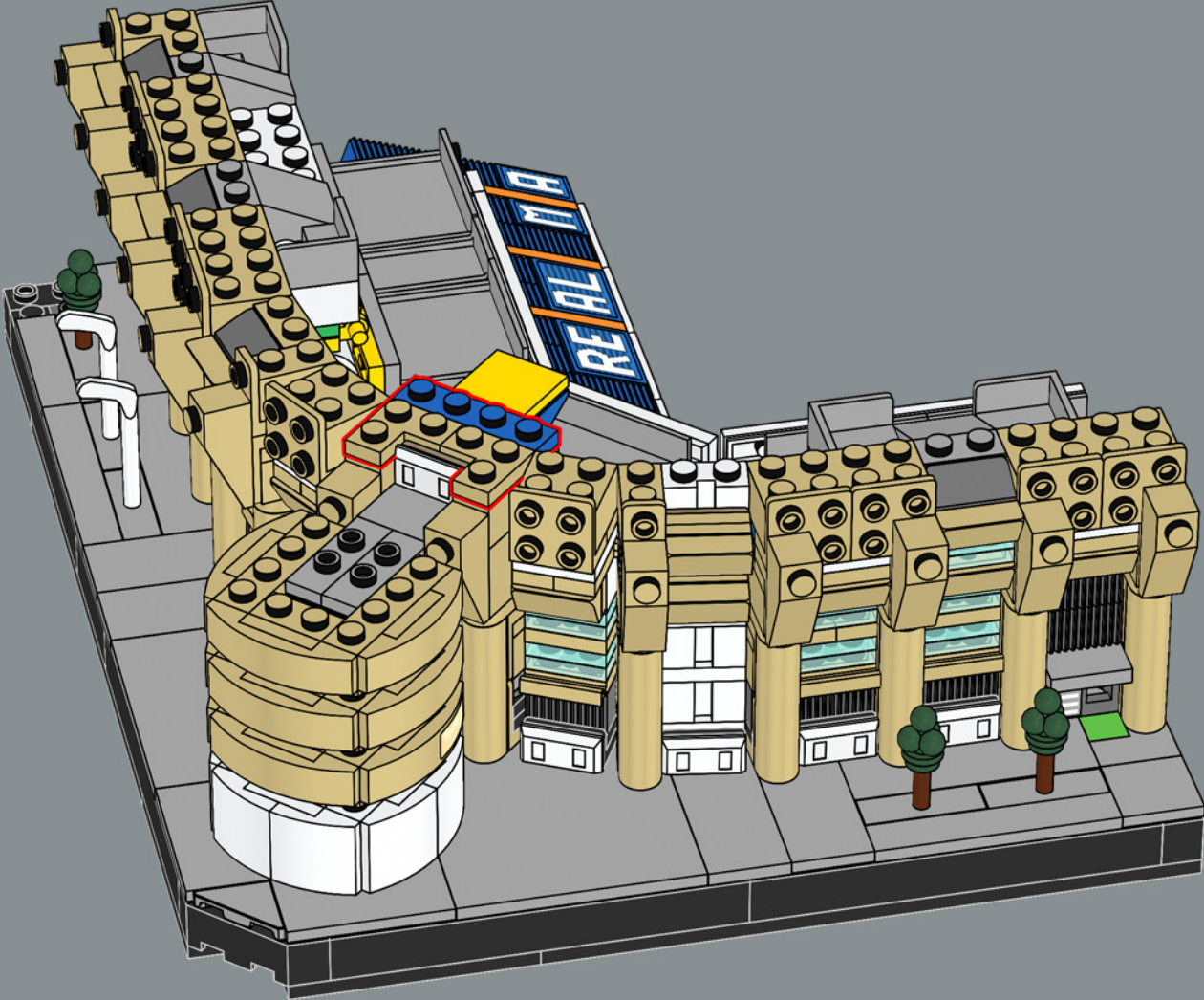

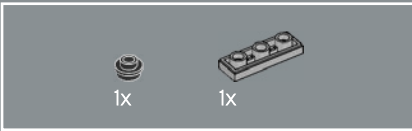
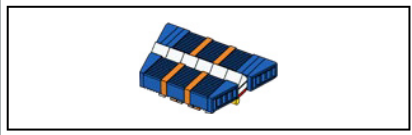
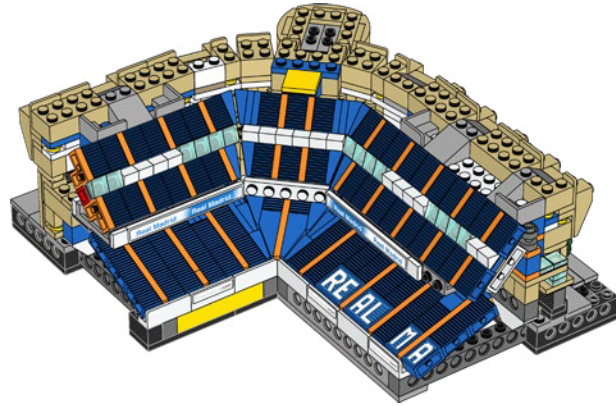
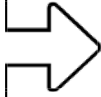

1x

1x

400

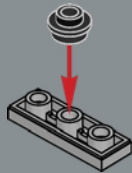

2x

401

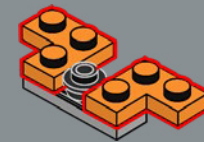



402

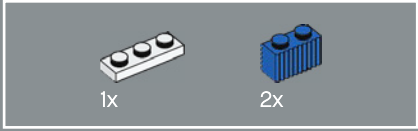
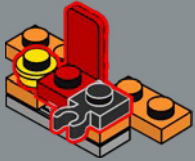

403

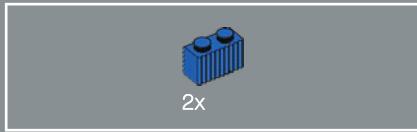
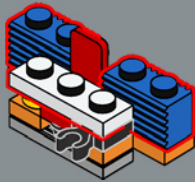

404

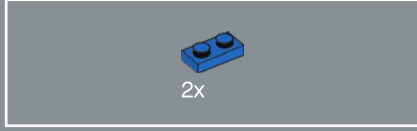
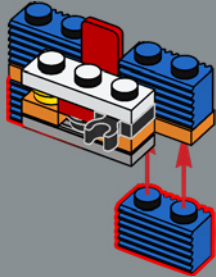

405

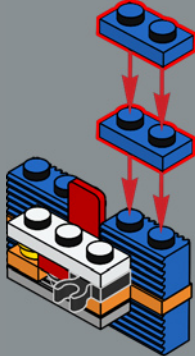

406

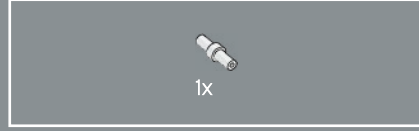
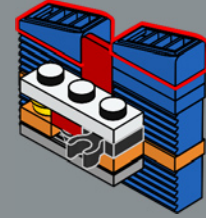

407

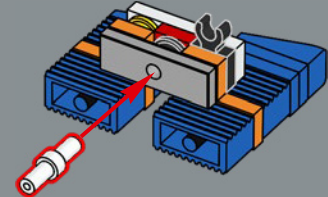

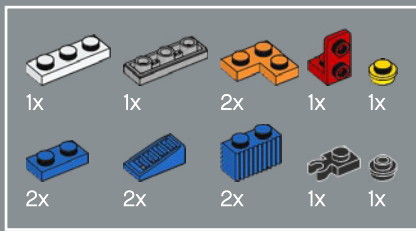

408

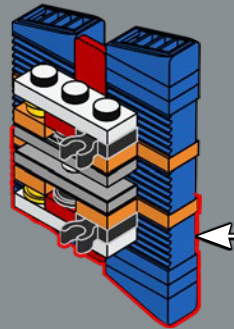
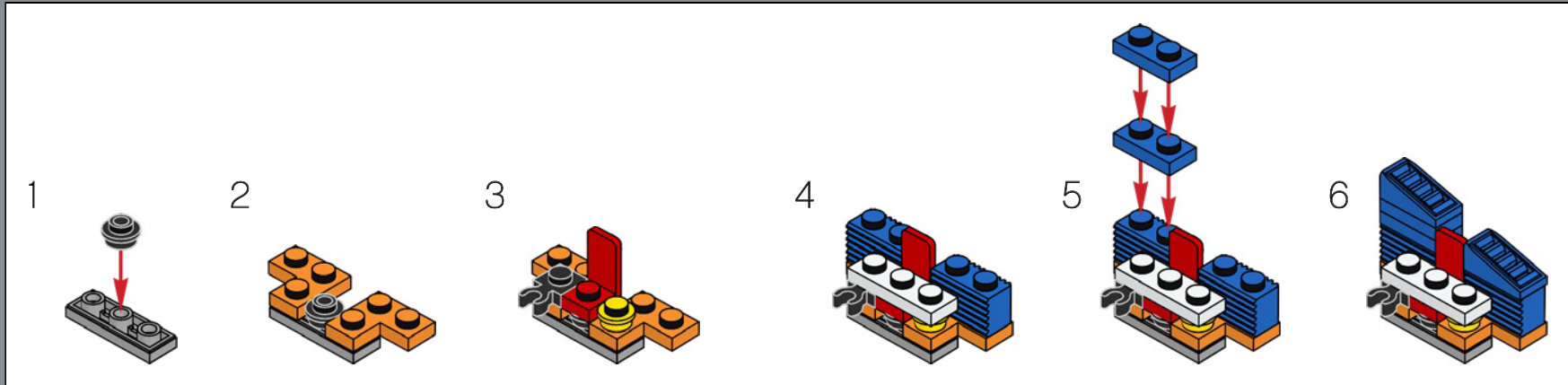

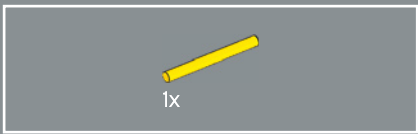

409

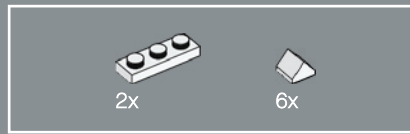
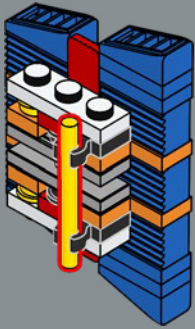

410

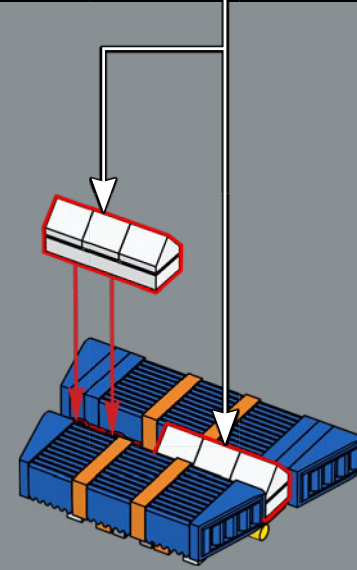
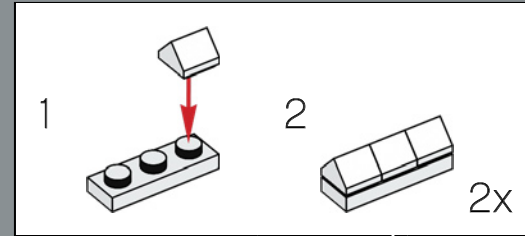

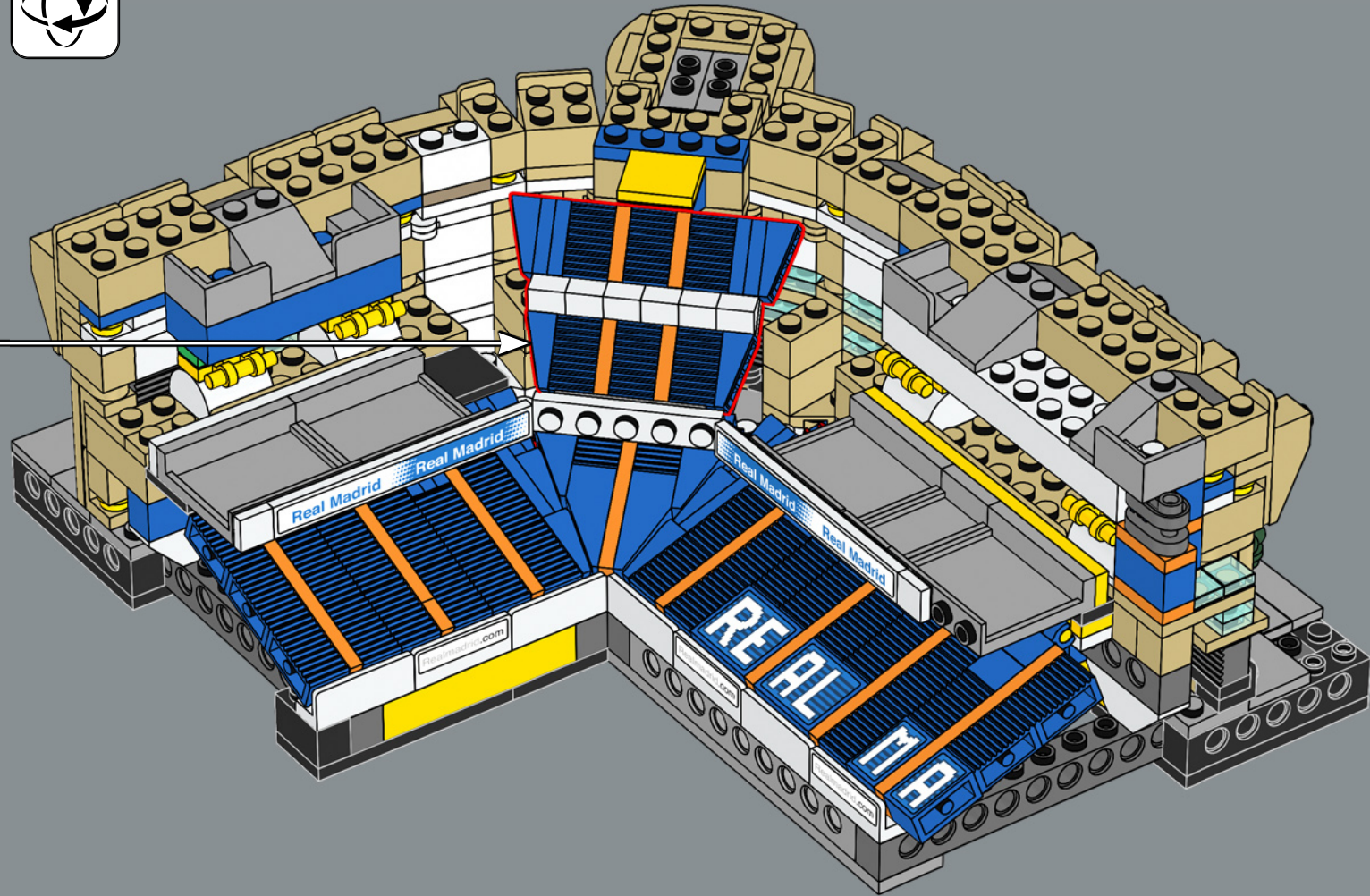

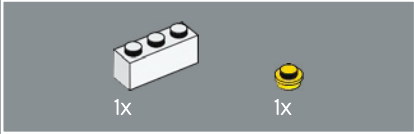
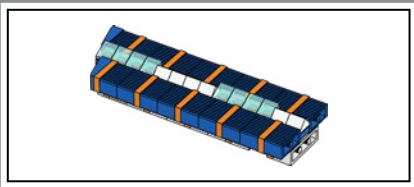

412

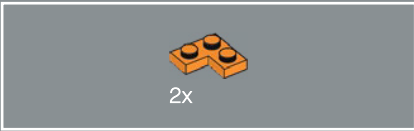
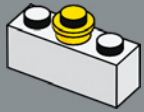

413

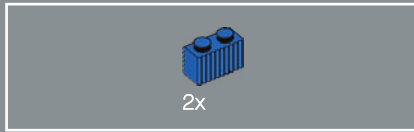
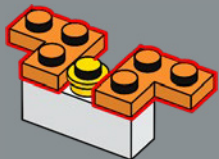

414

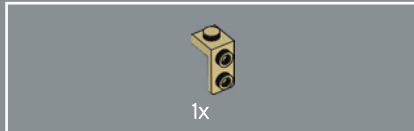
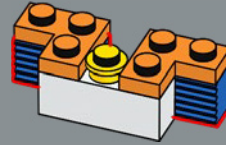

415

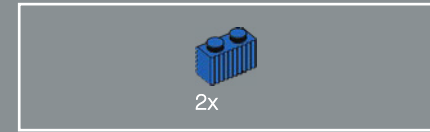
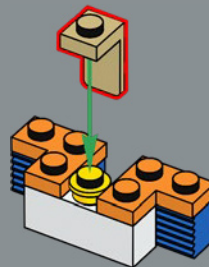

416

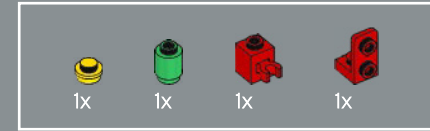
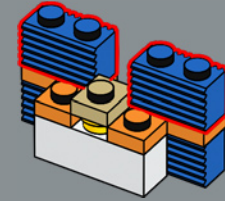

417

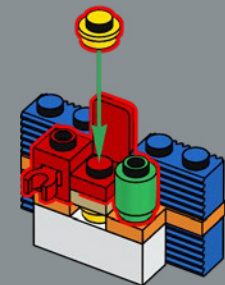

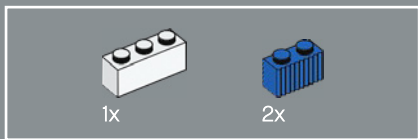

418

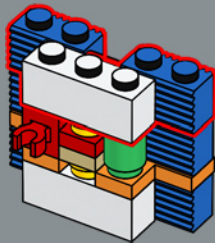

419

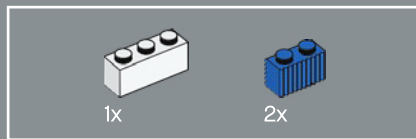
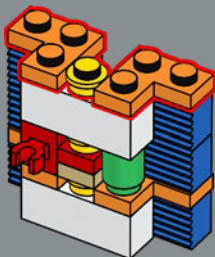

420

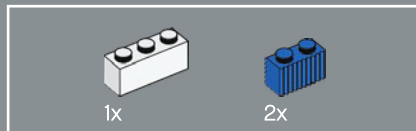
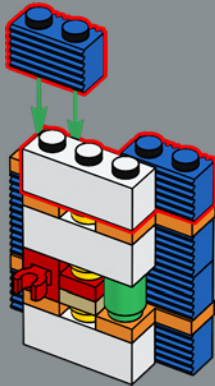

421

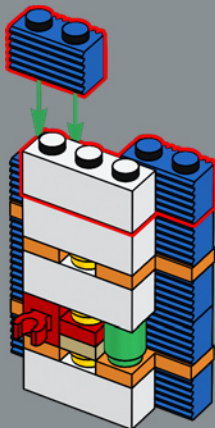

422

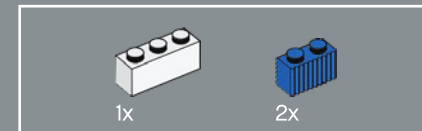
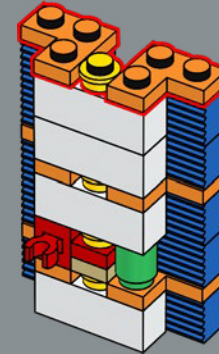

423

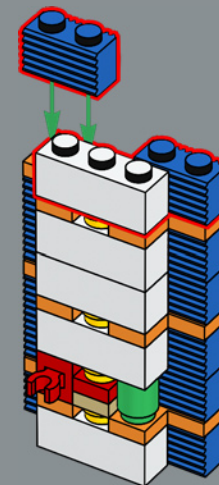

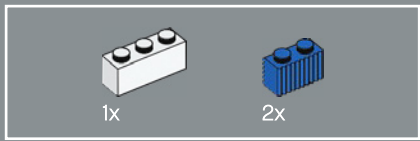

424

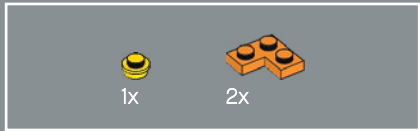
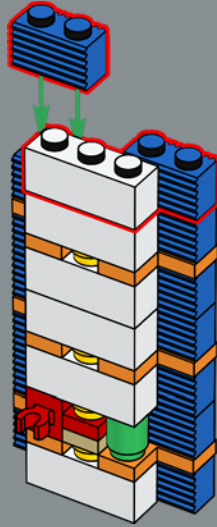

425

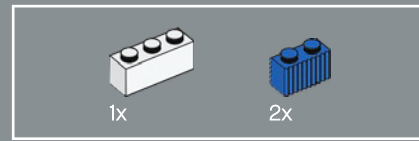
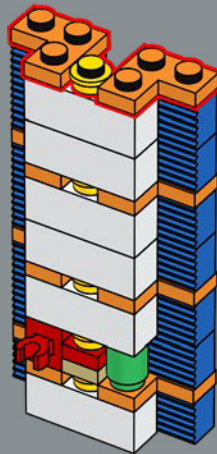

426

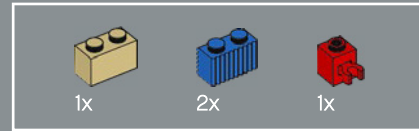
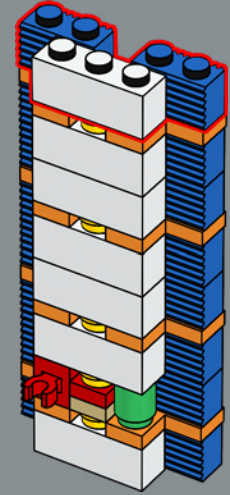

427

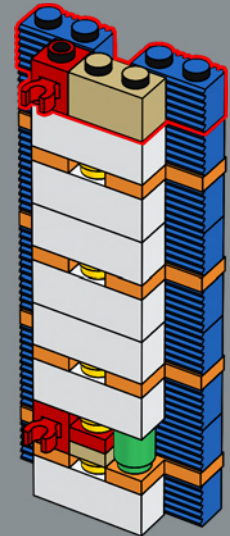

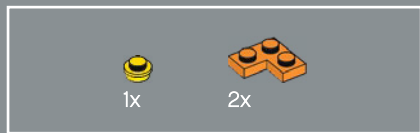

428

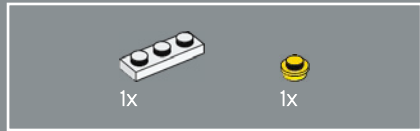
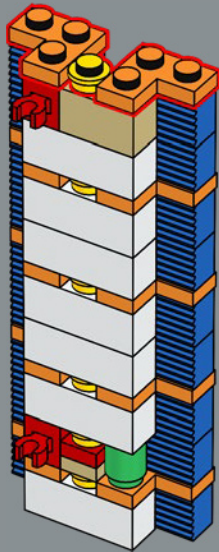

429

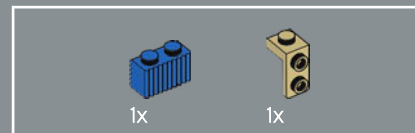
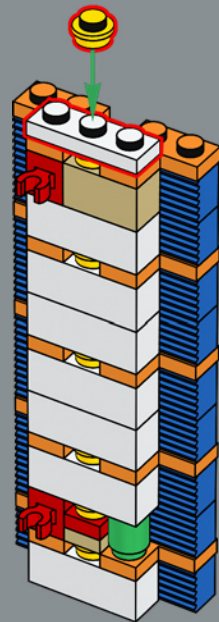

430

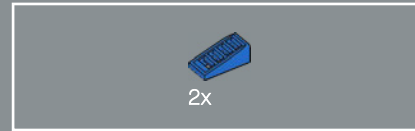
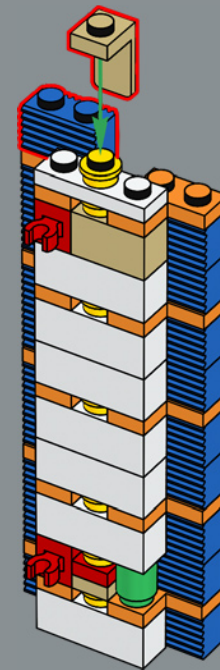

431

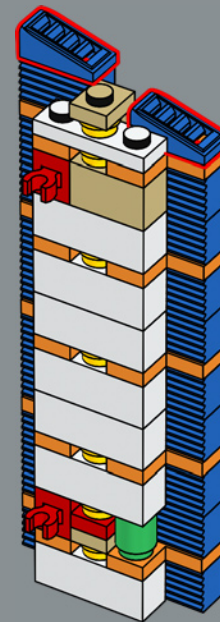

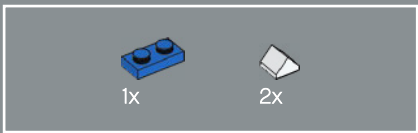

432

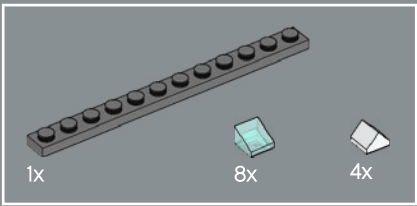
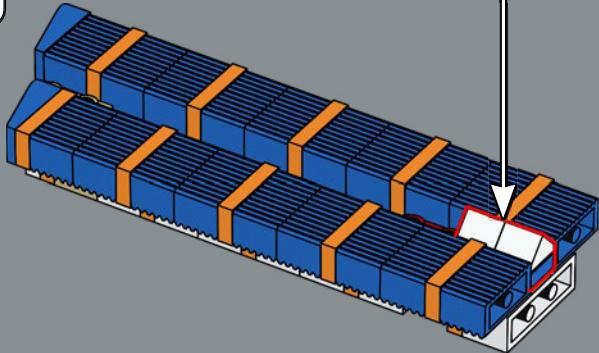
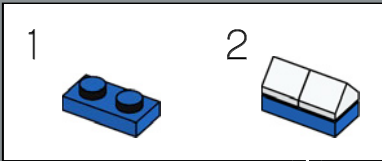

433

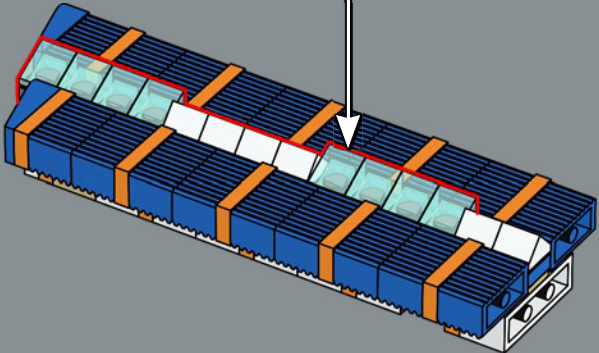
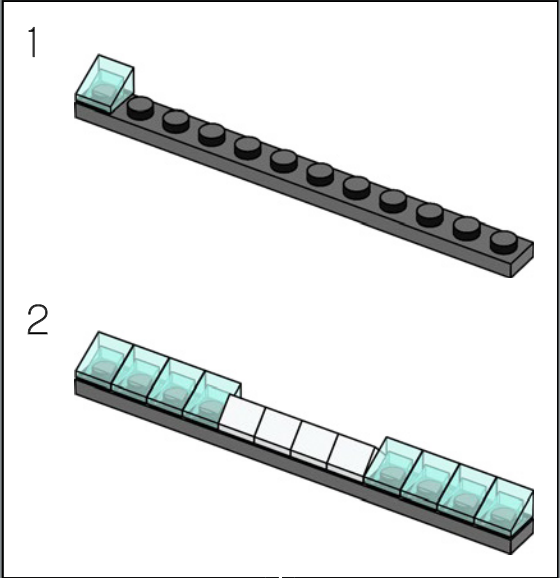

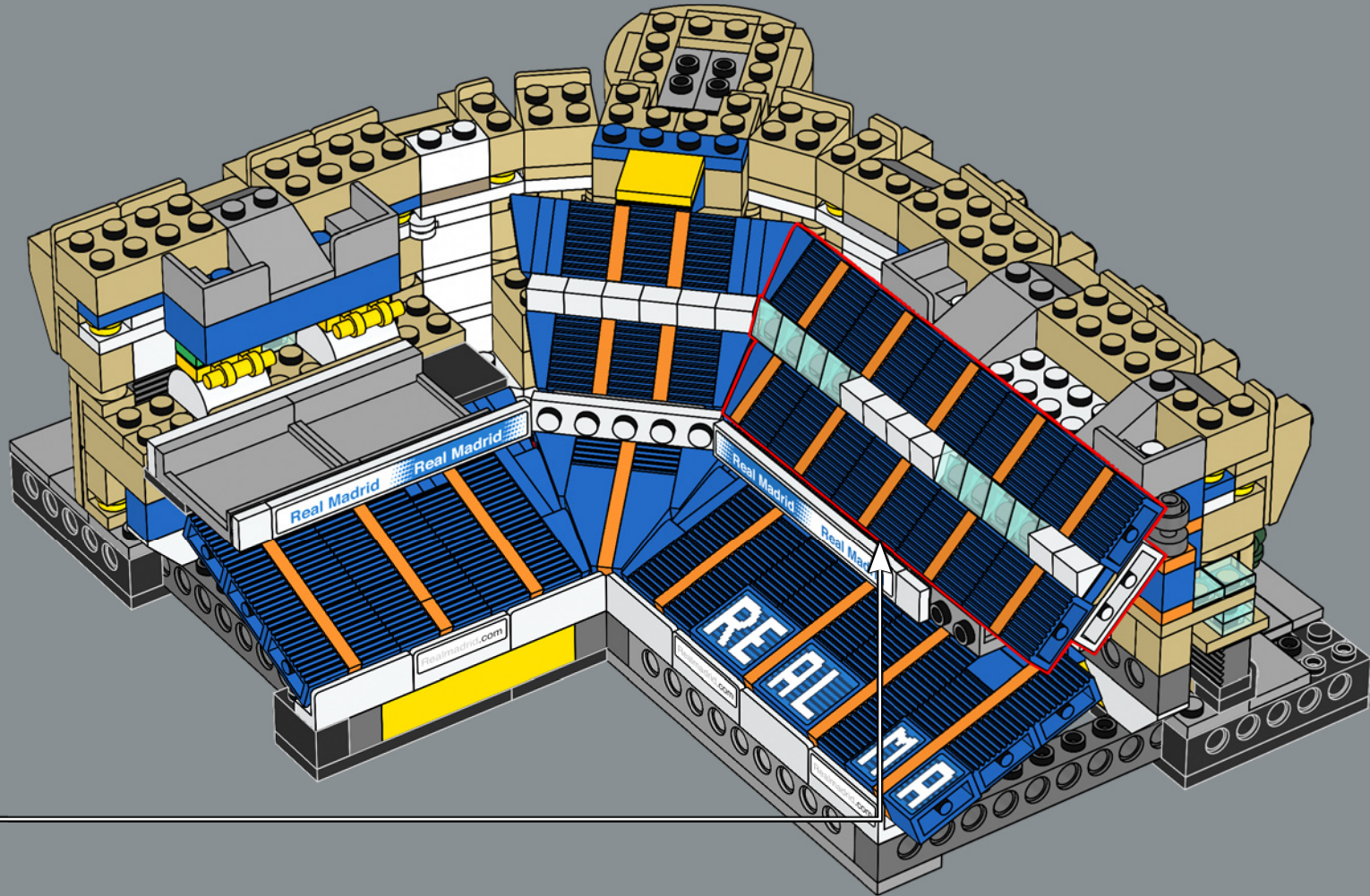

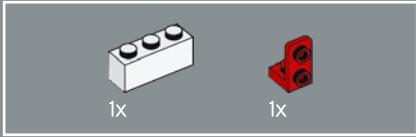
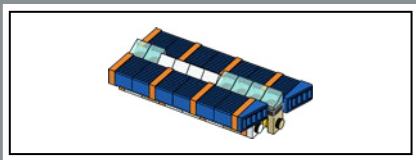

435

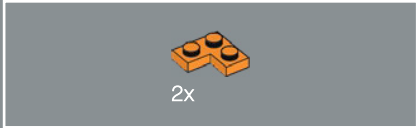
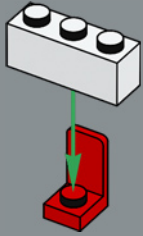

436

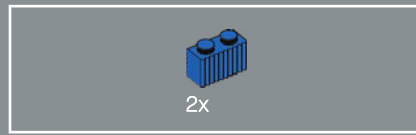
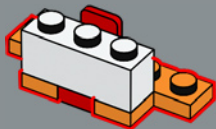

437



2x

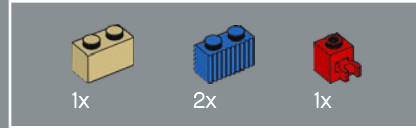
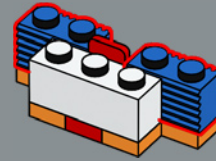

438



1x



2x



1x

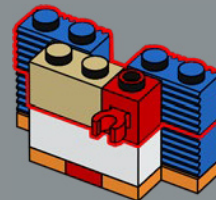

439



1x



2x

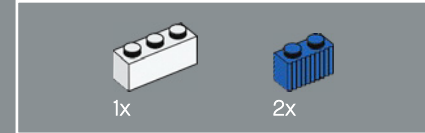
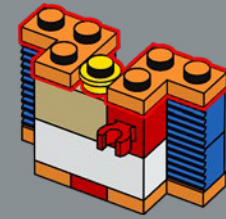

440



1x



2x

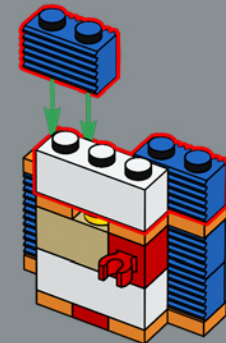

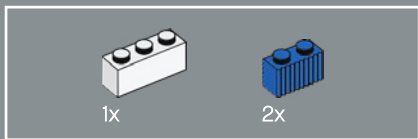

441

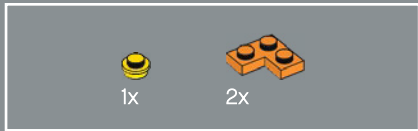
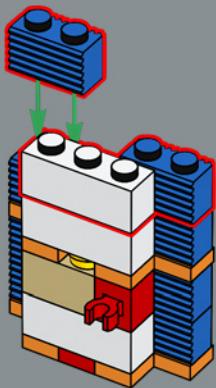

442

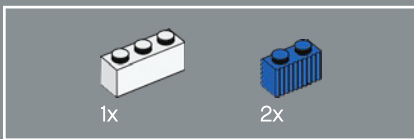
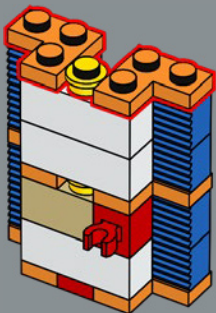

443

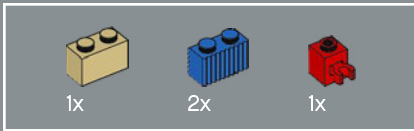
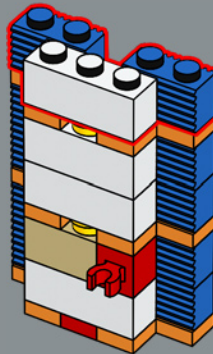

444

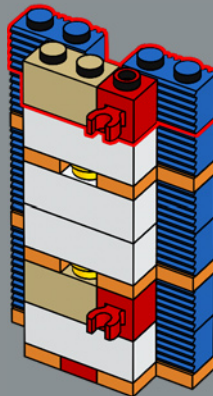

445

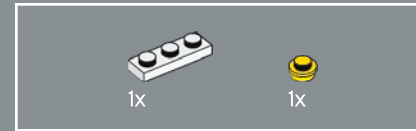
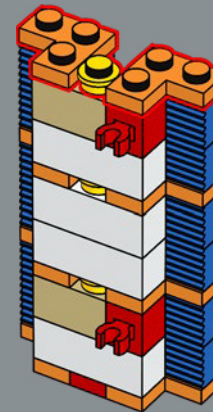

446



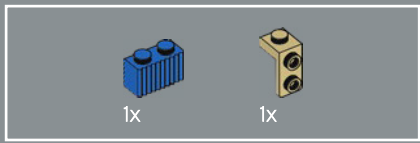

447

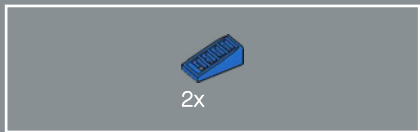
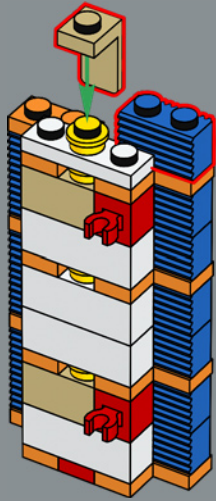

448

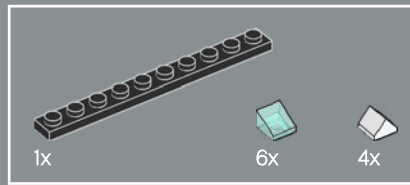
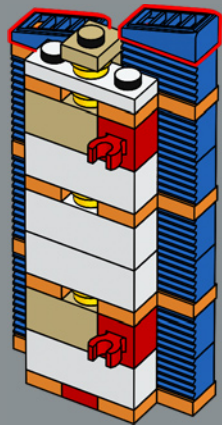

449

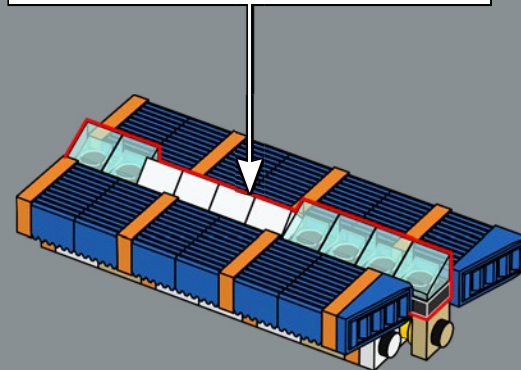
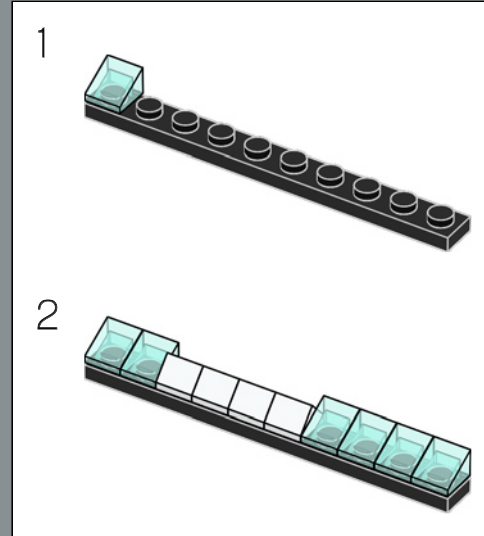

450

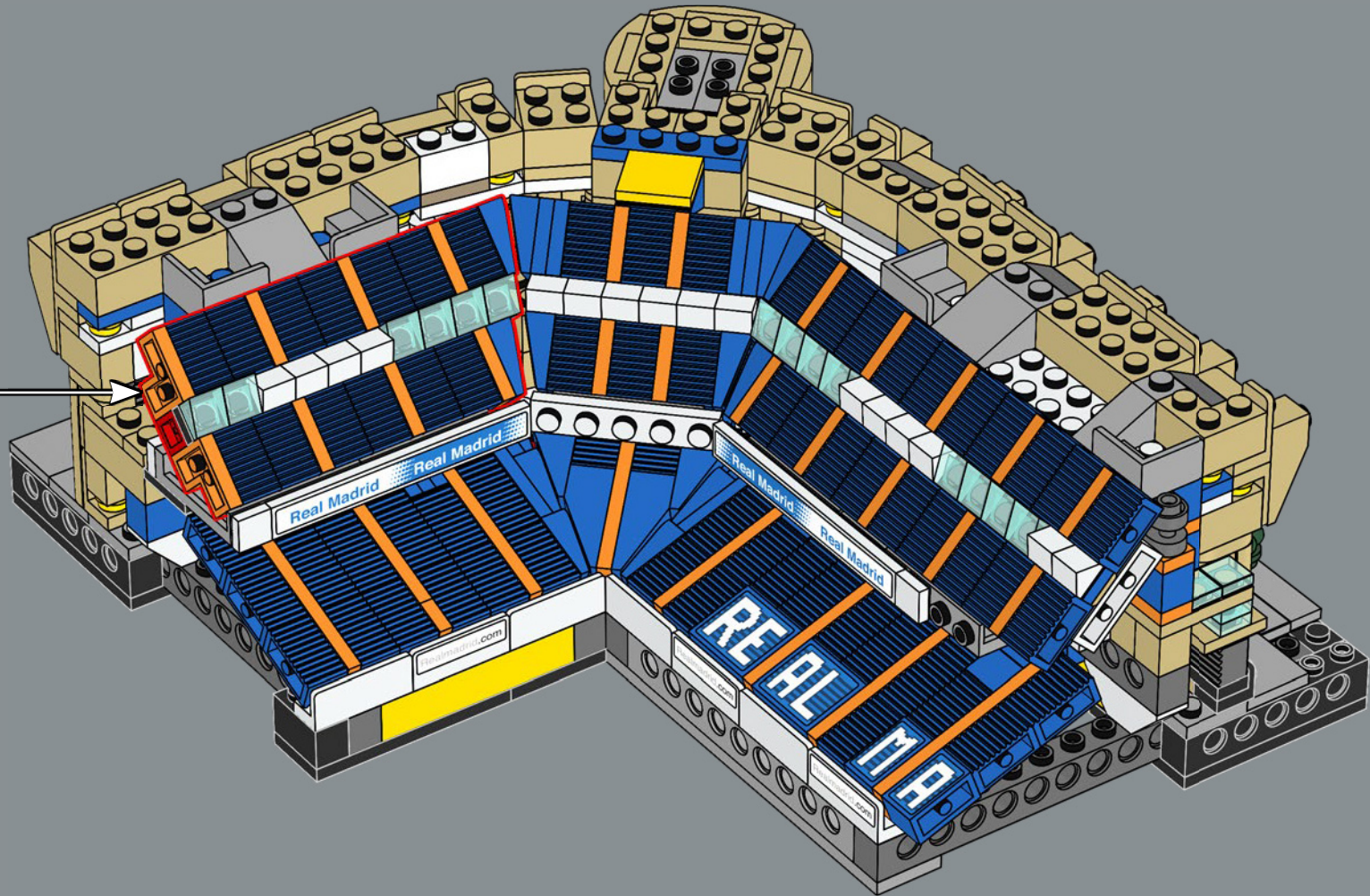

17

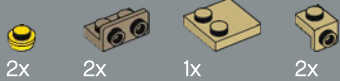
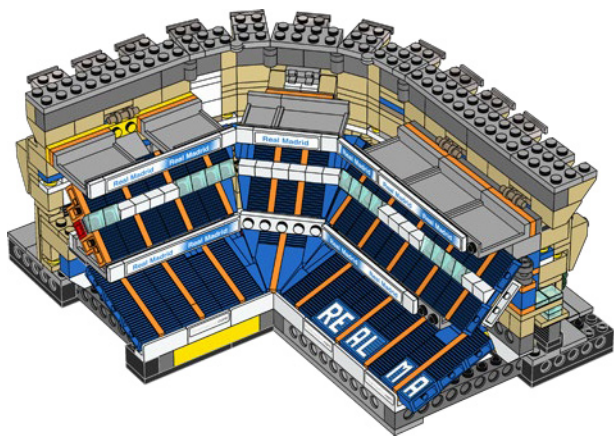
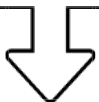

2x

2x

1x

2x

451

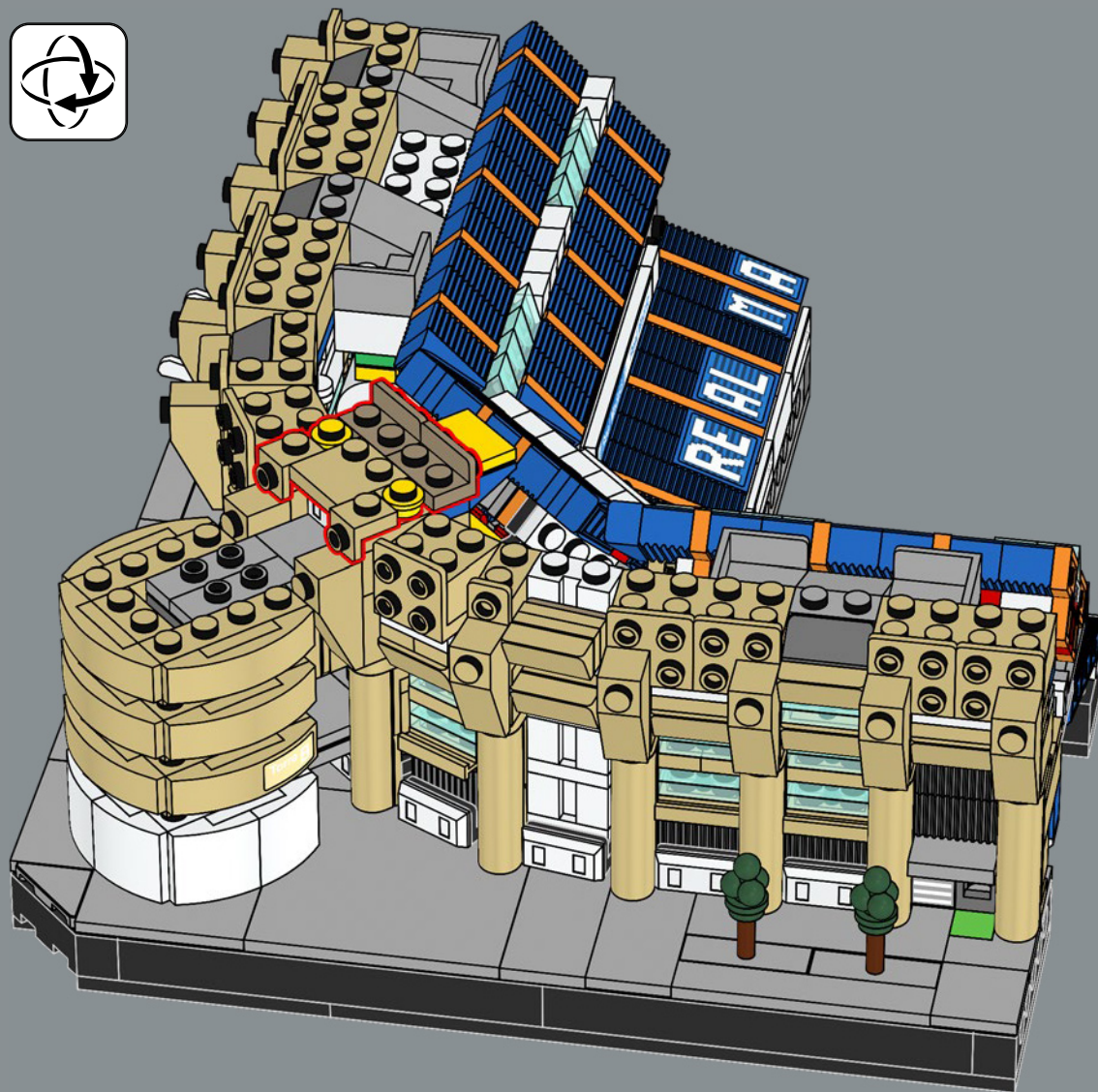



2x

452

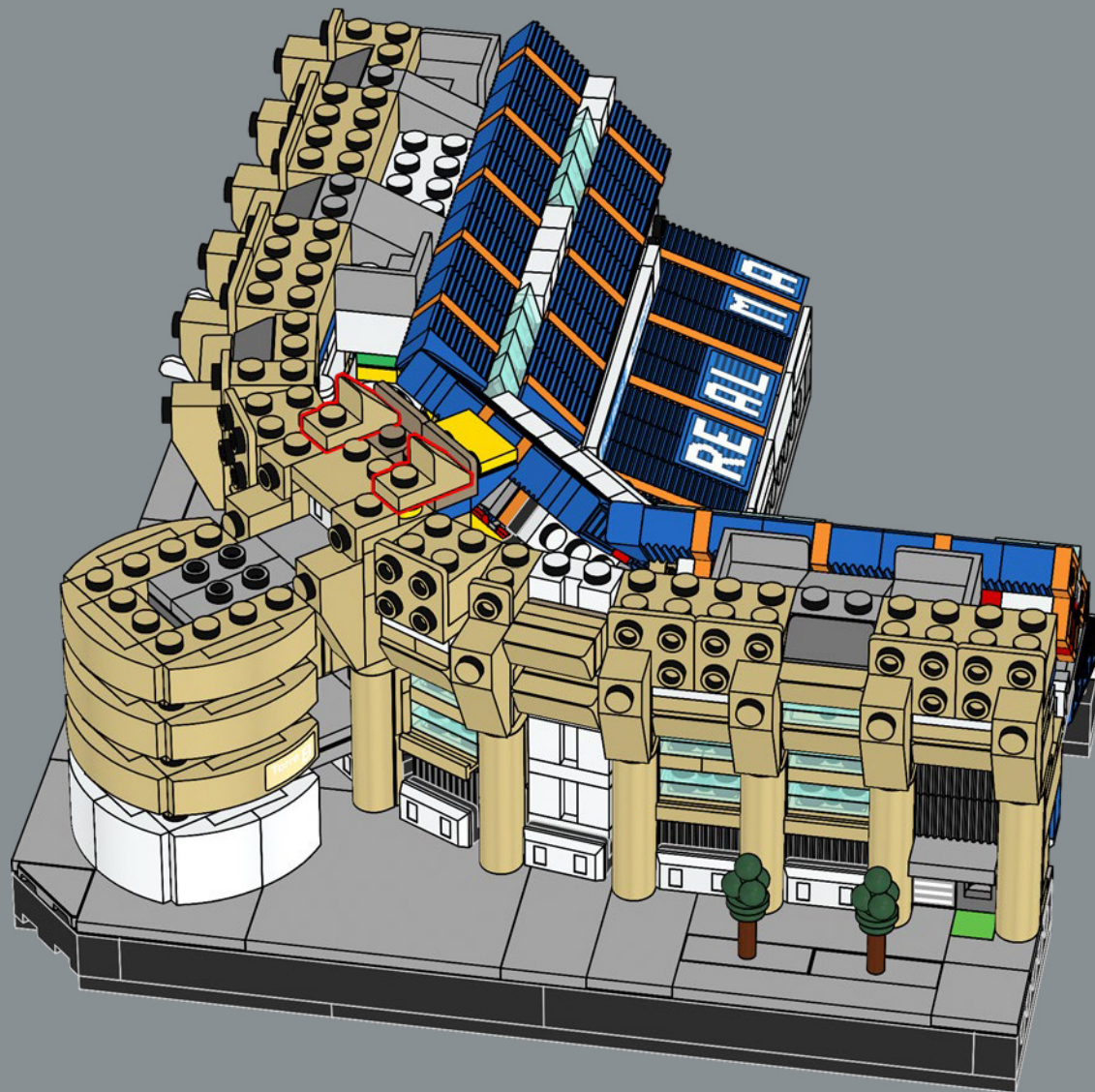

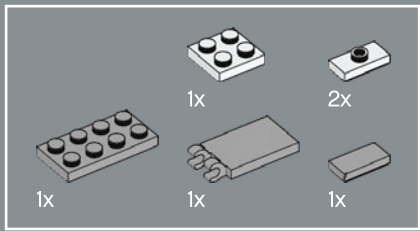

453

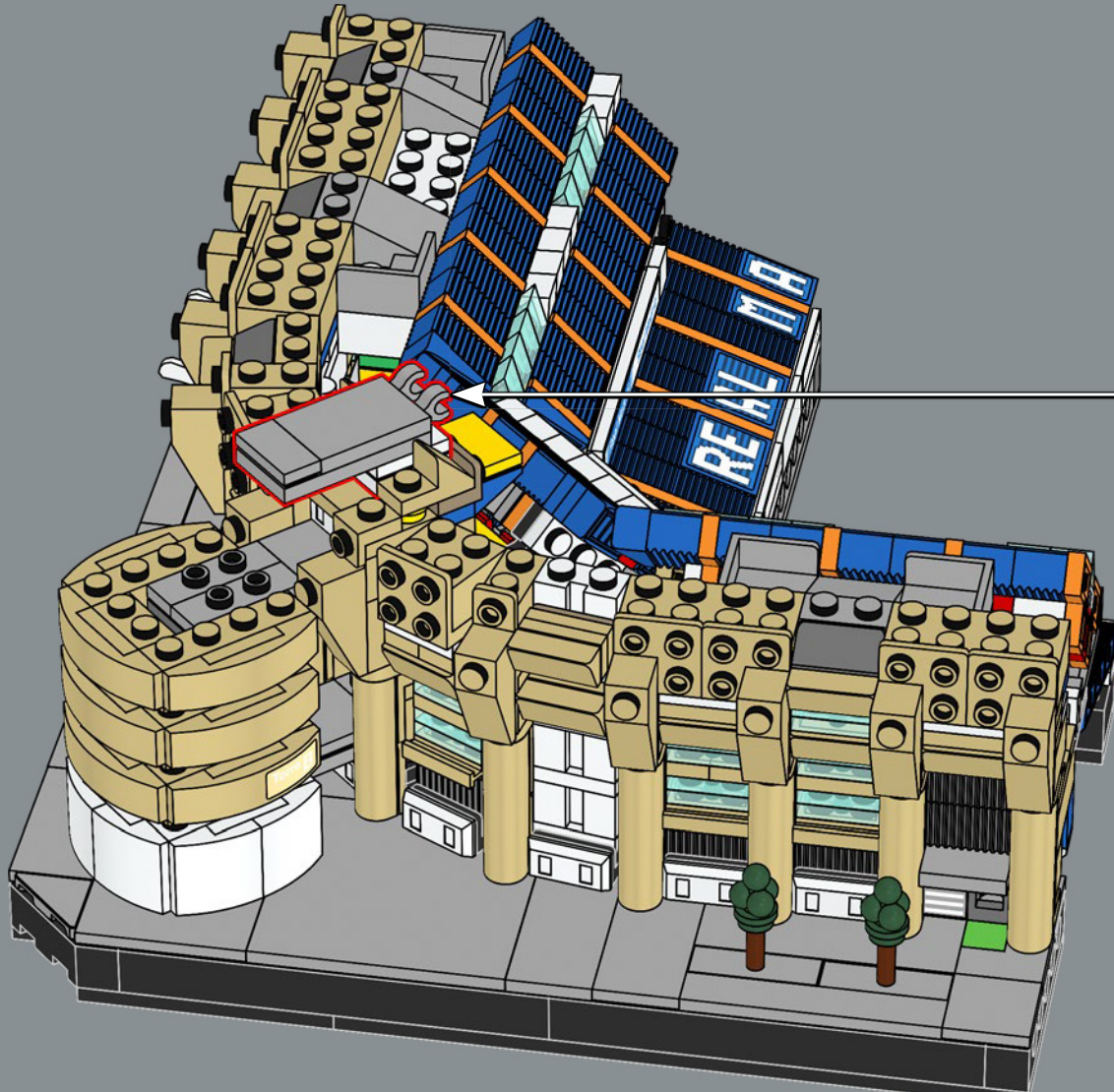
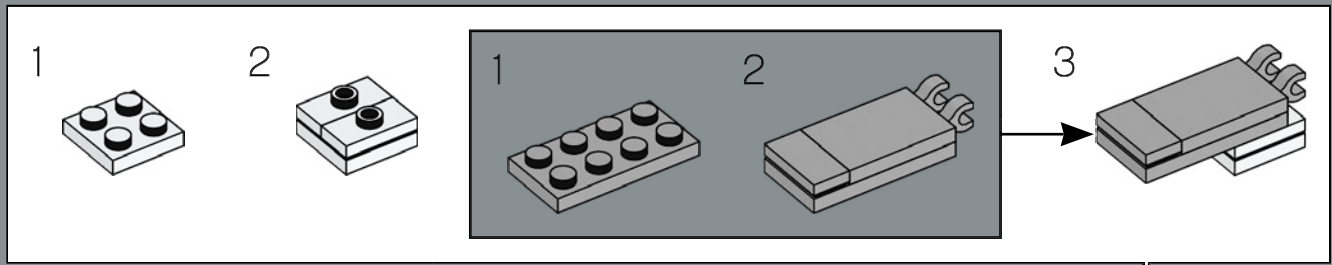

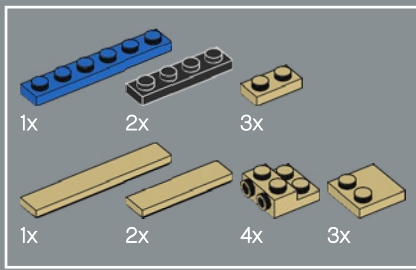

454

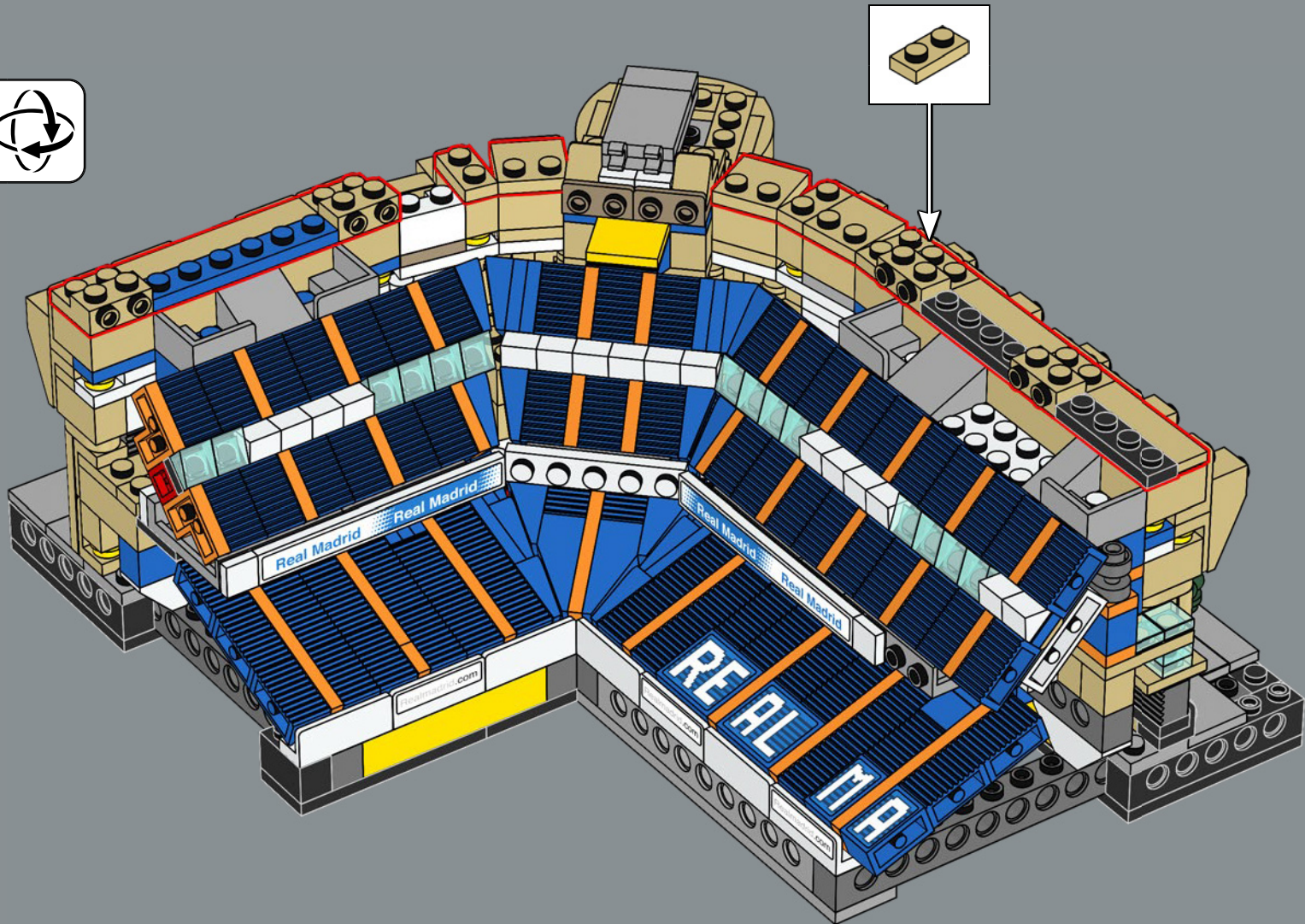

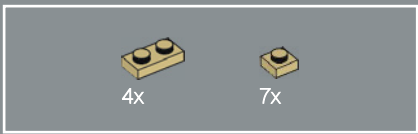

455

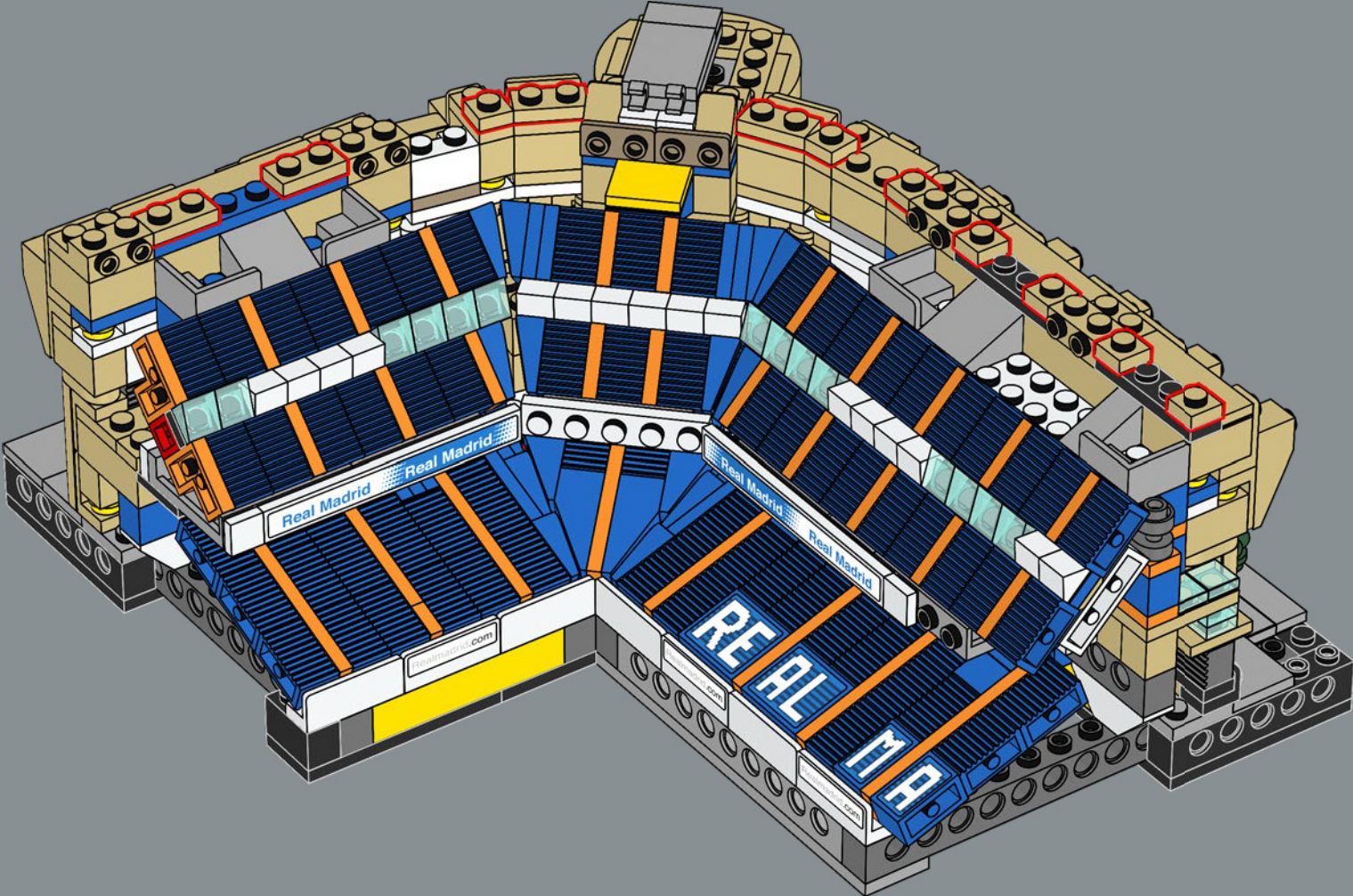

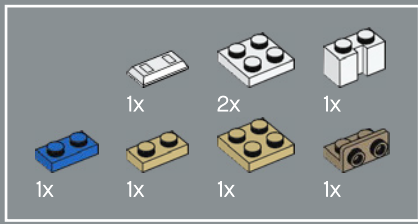

456

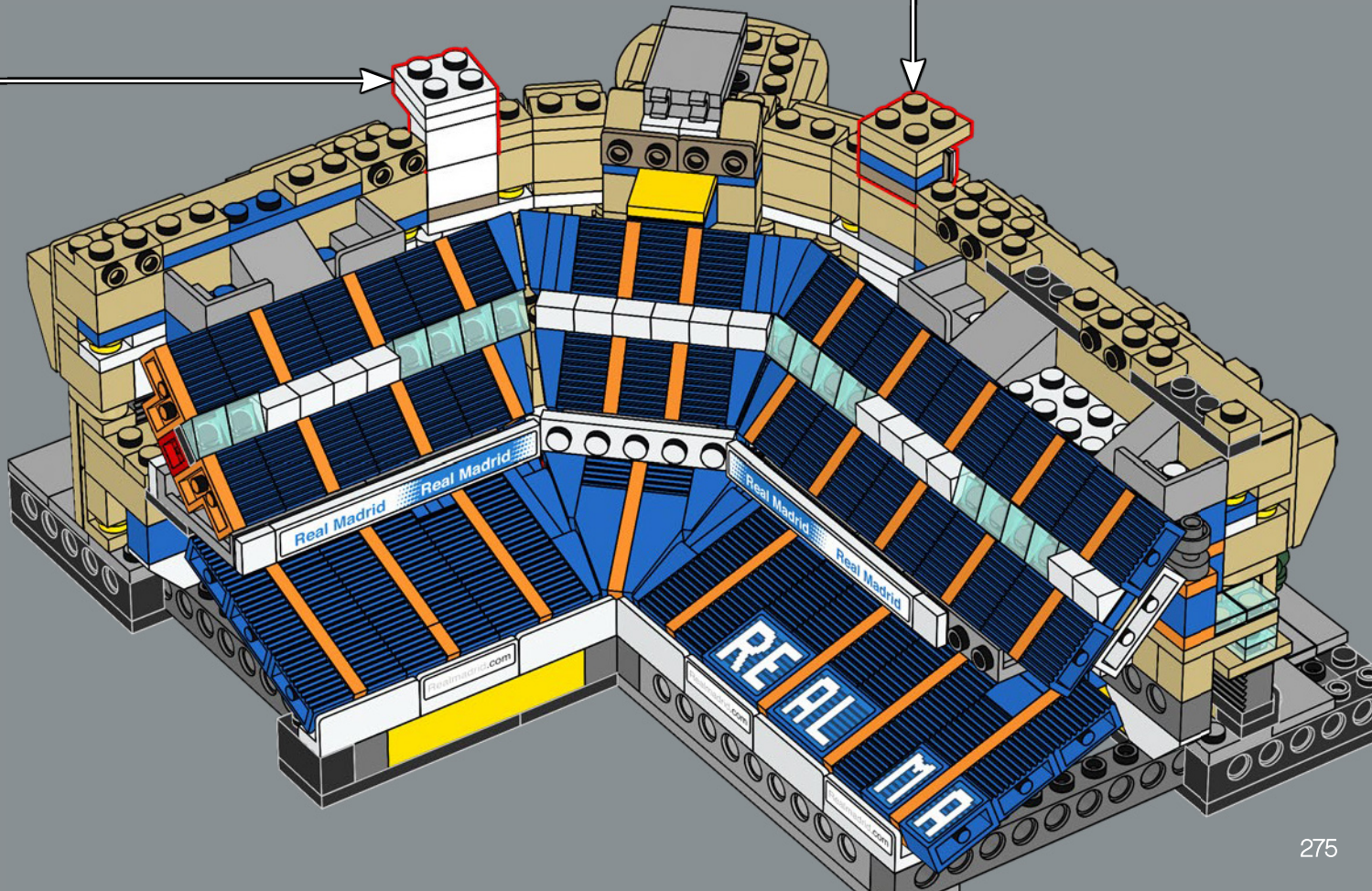
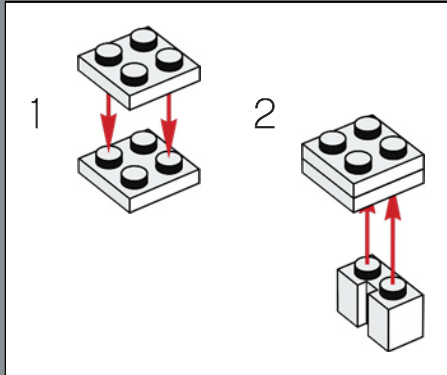
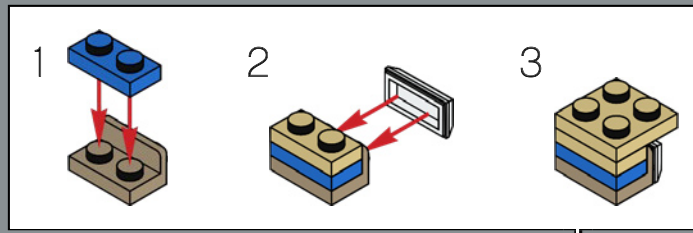

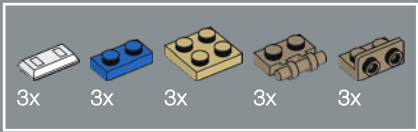

457

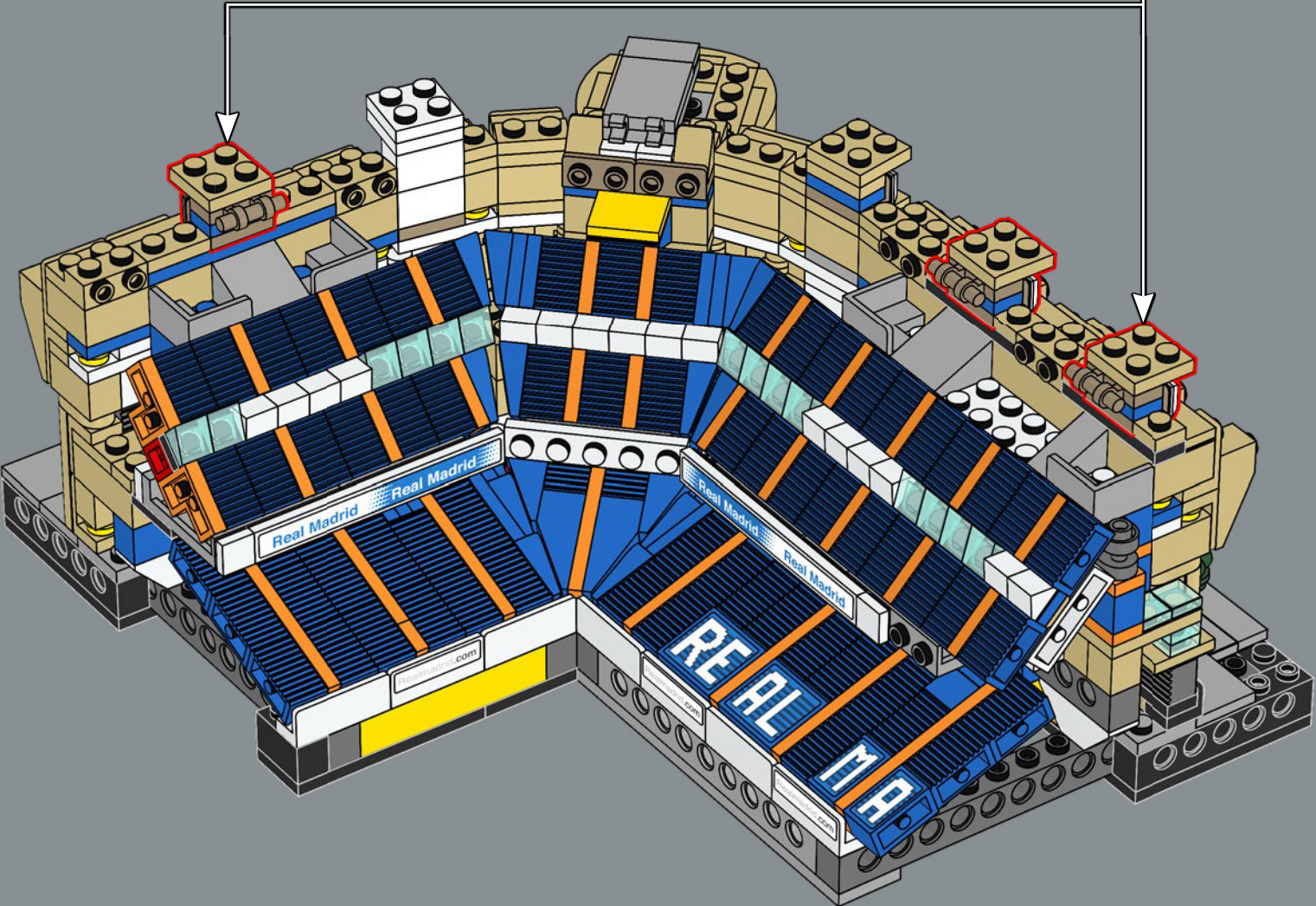
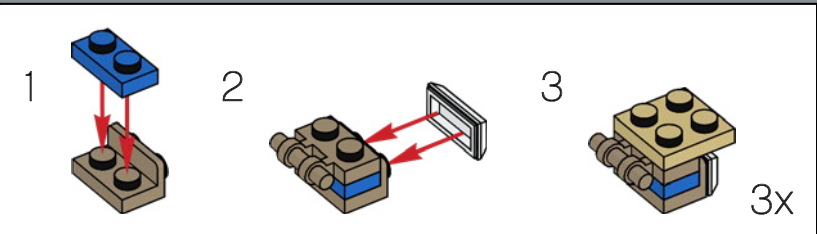

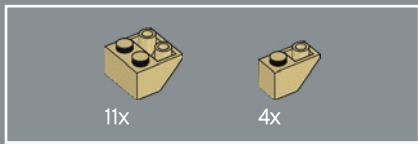

458

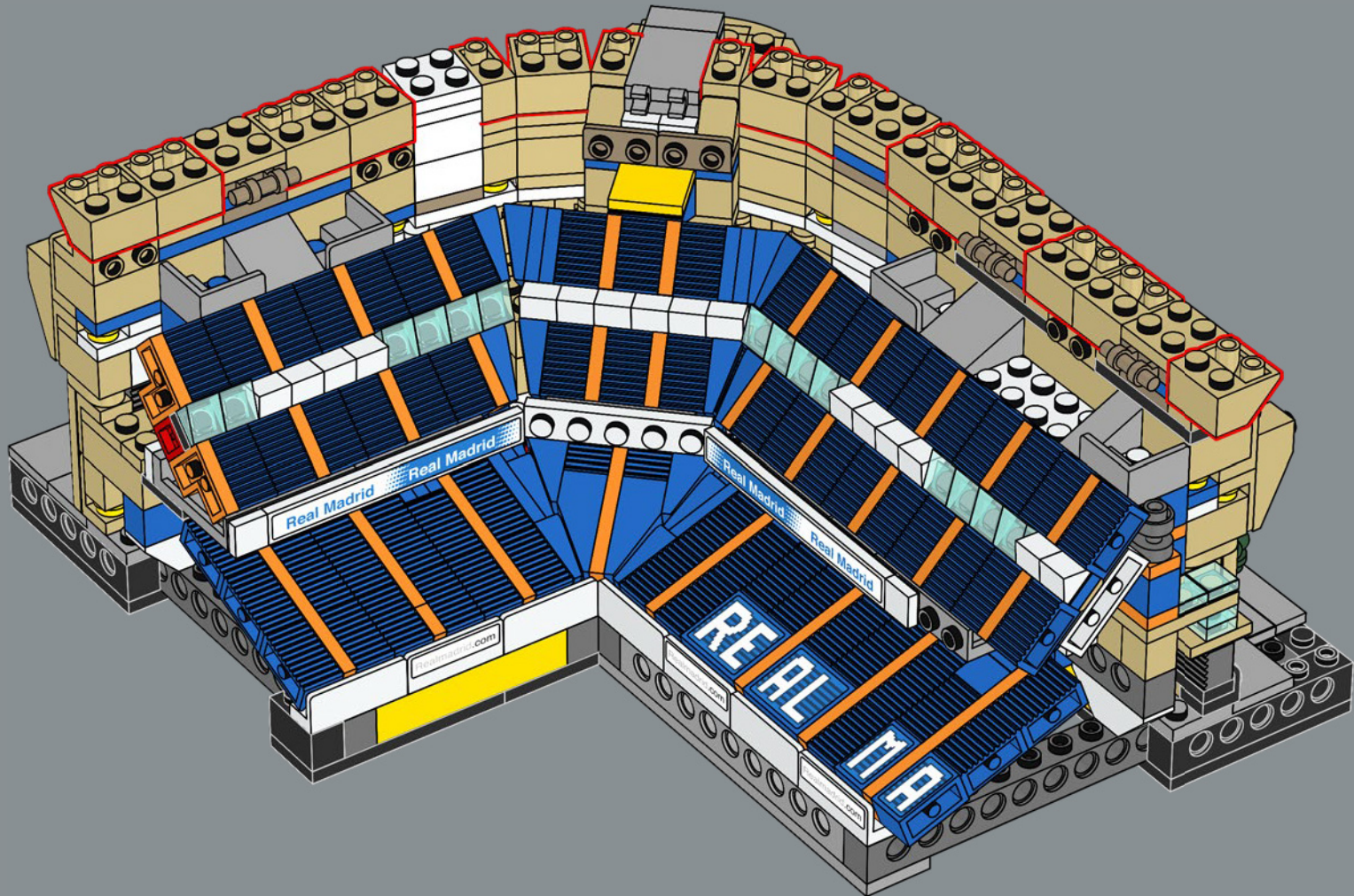

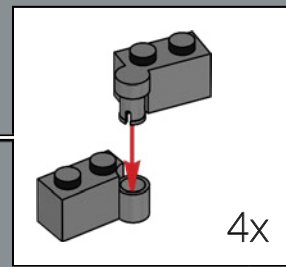
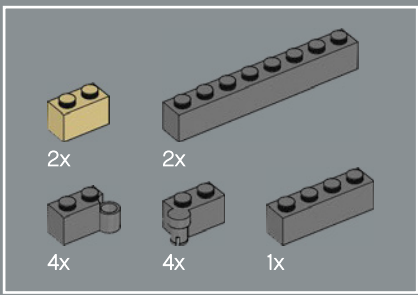

459

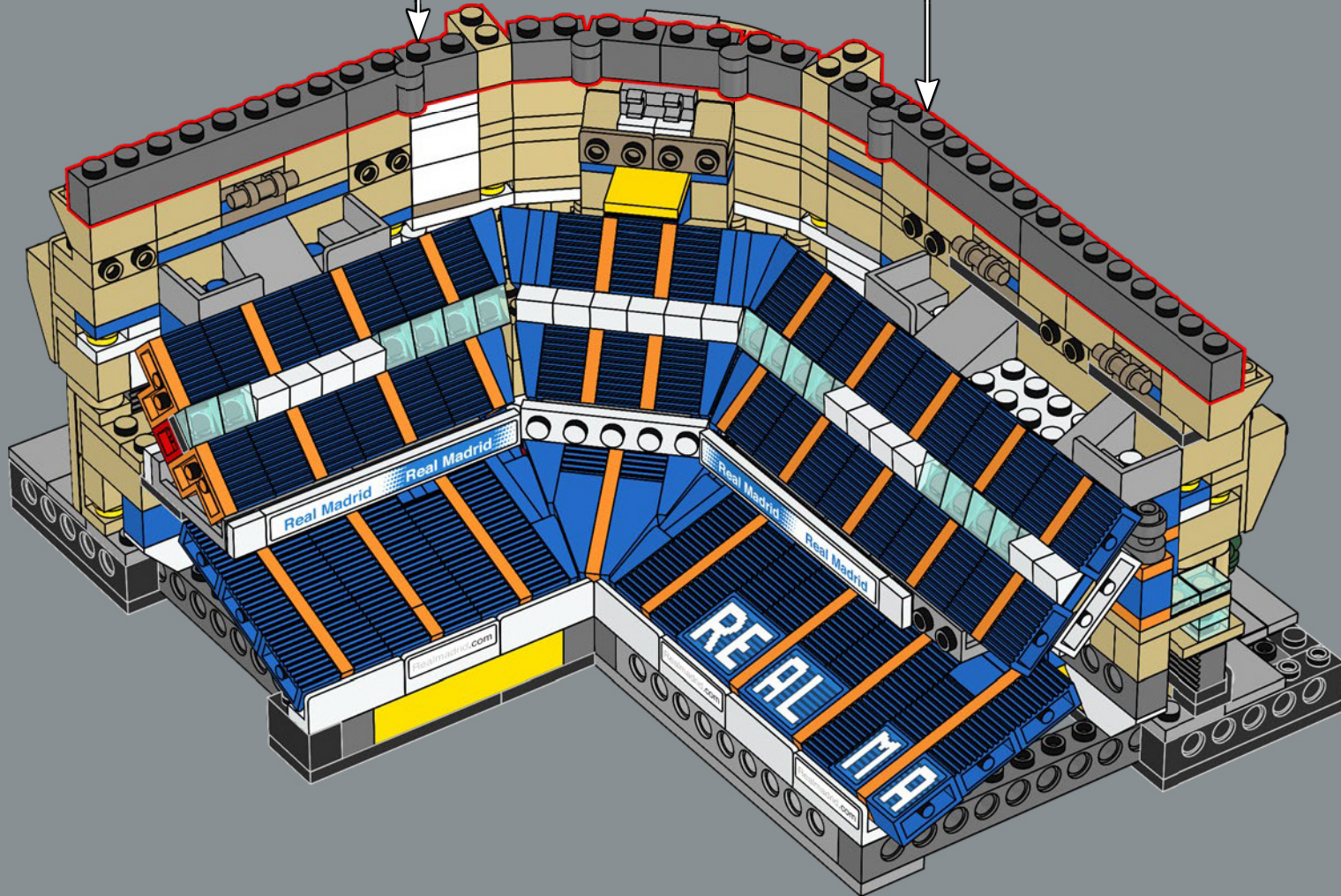

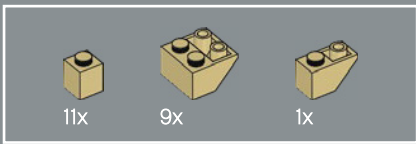

460

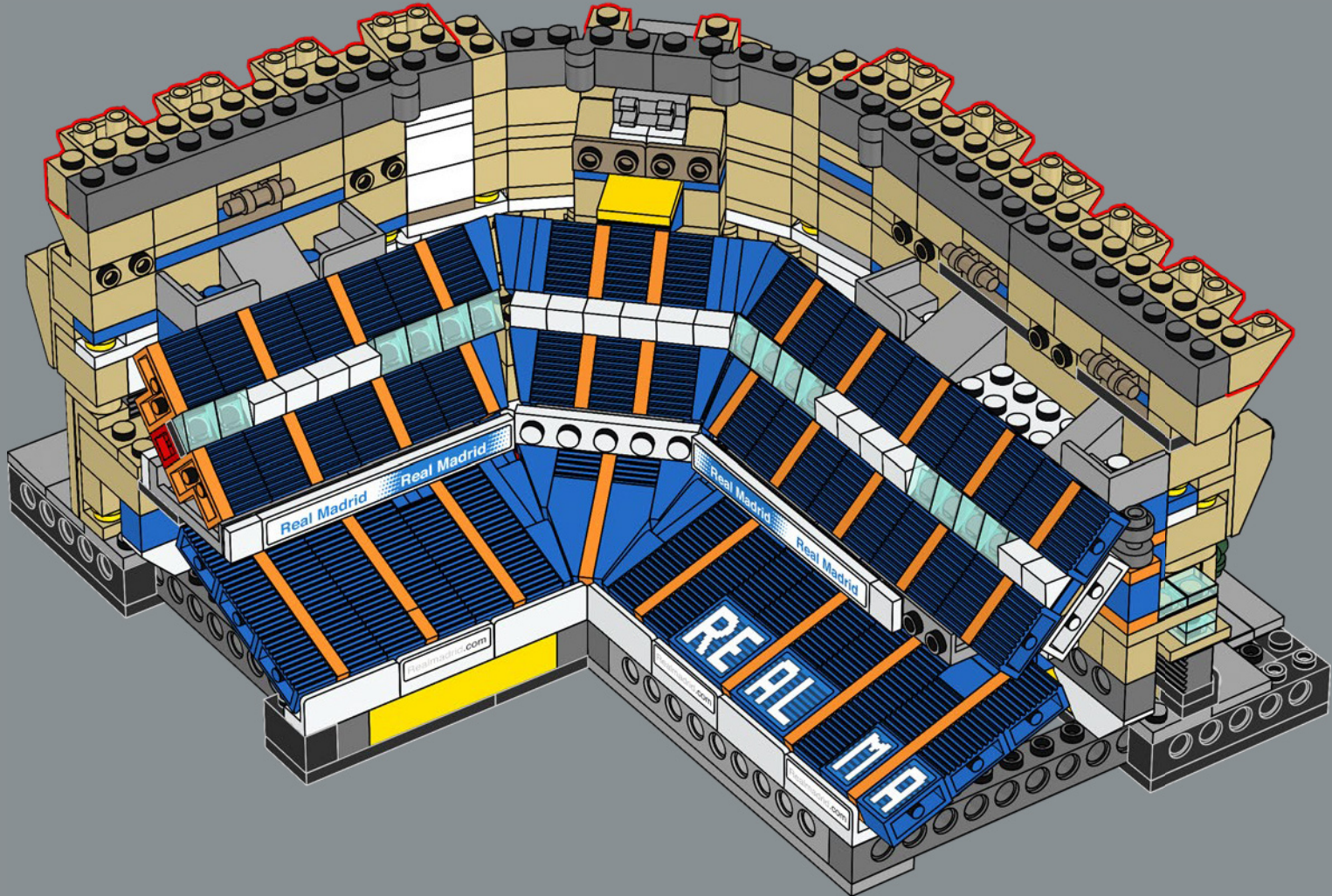

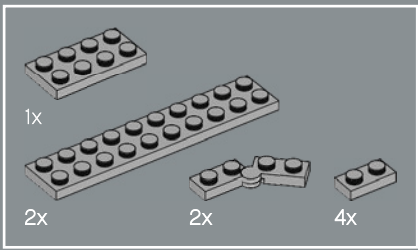

461

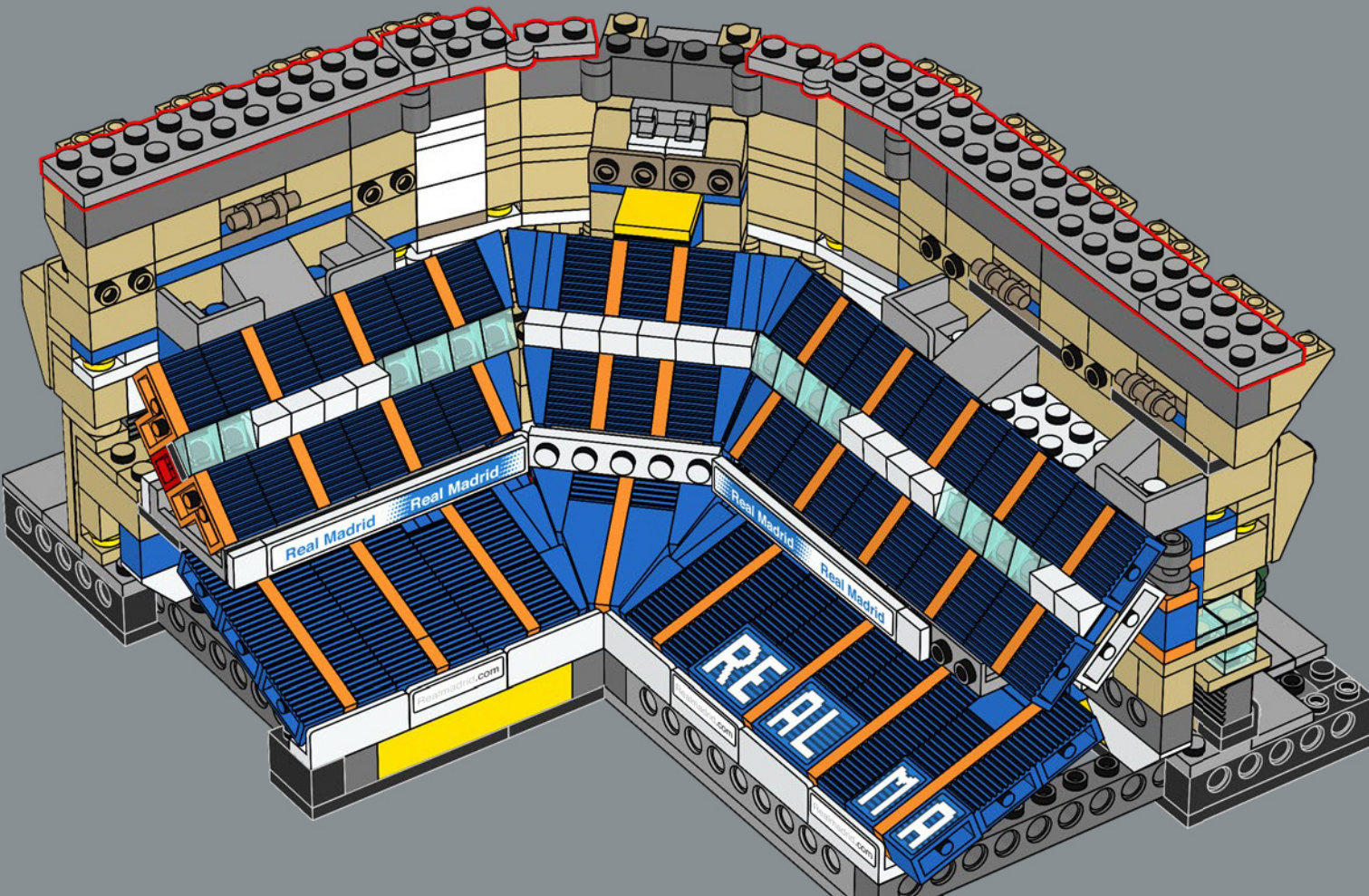

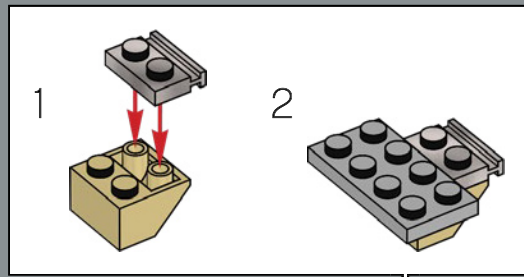
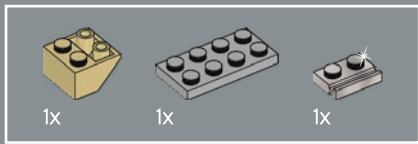

462

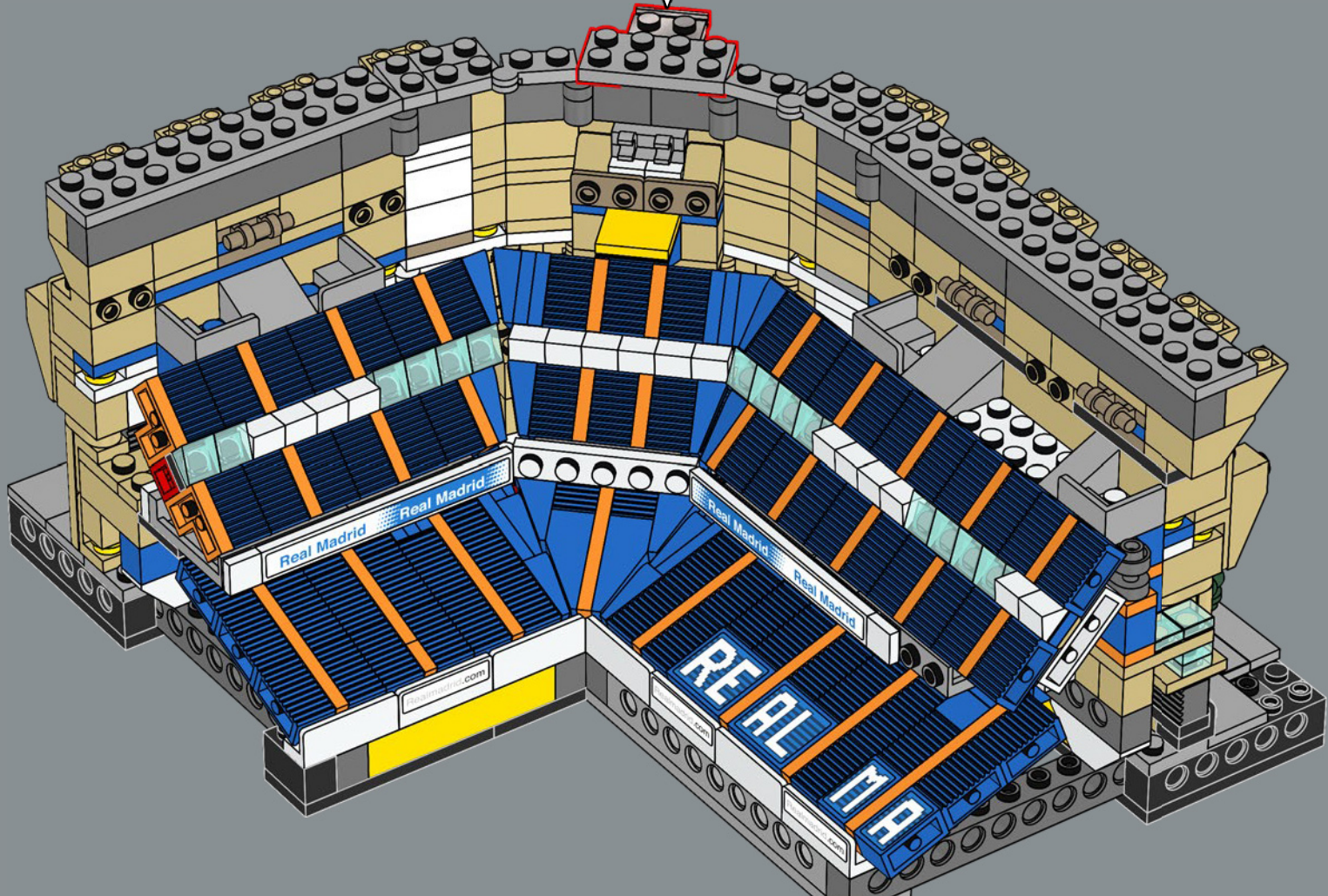

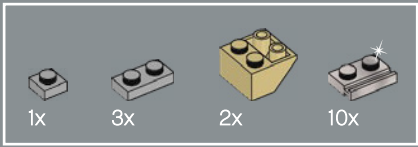

463

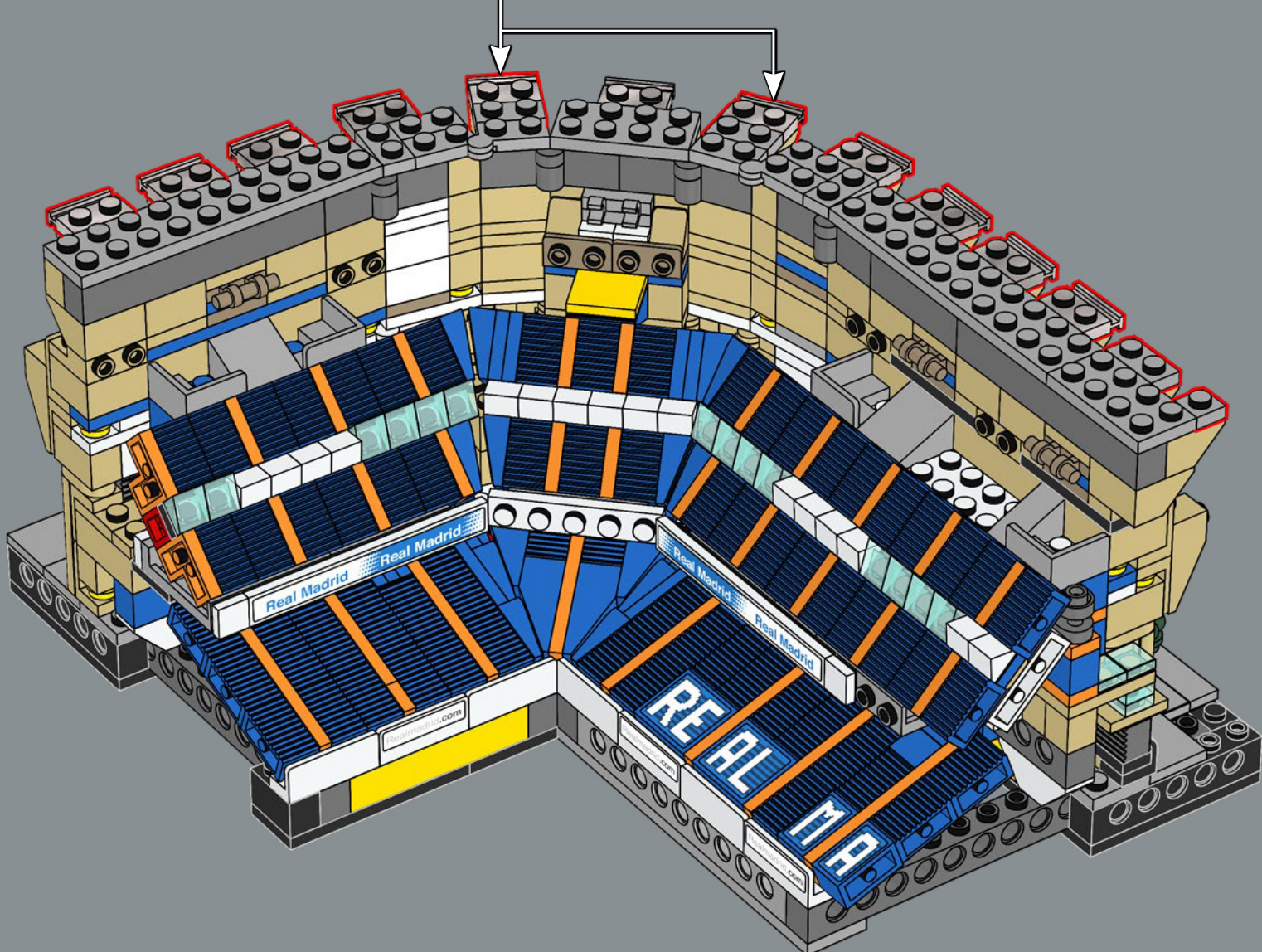
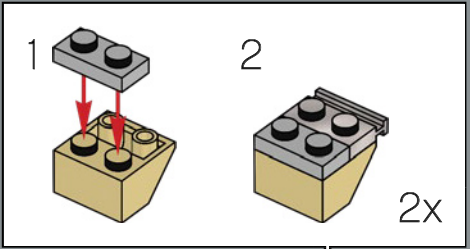

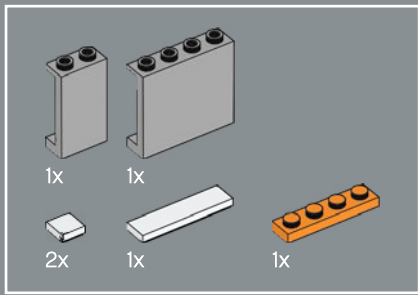

464

1

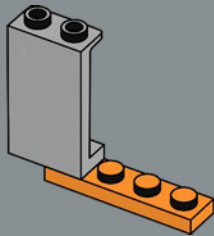

2

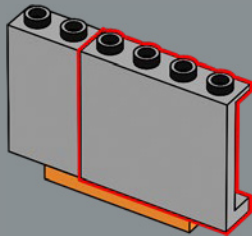

3

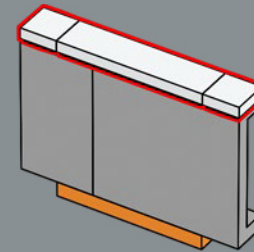

4

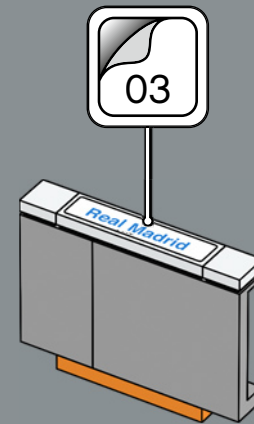

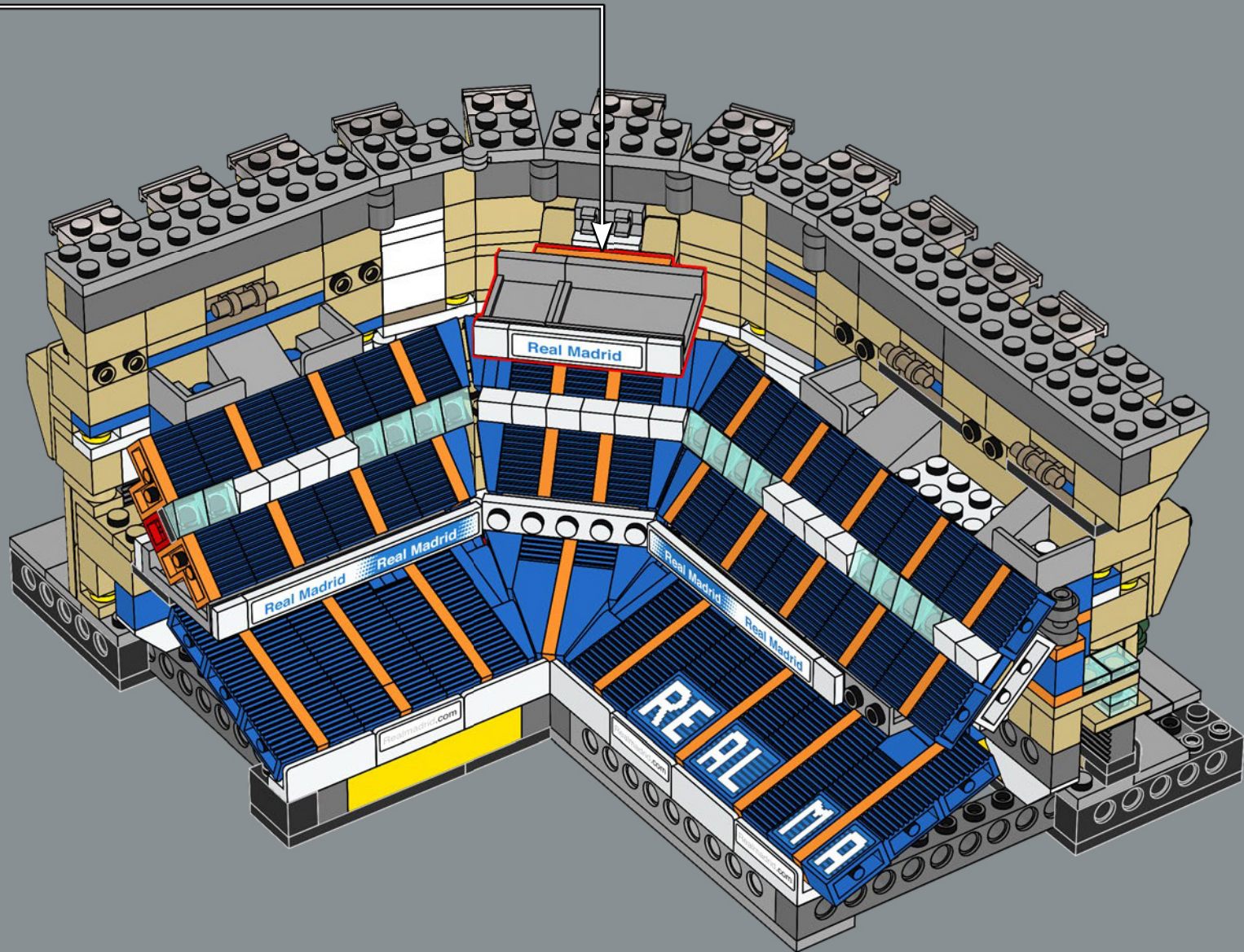

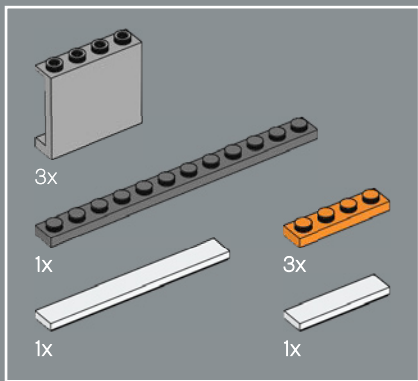

465

1

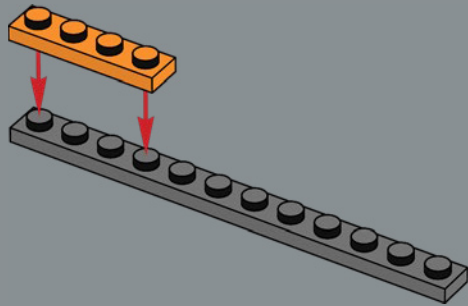

2

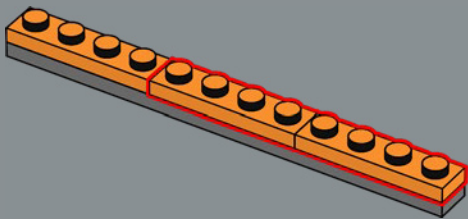

3

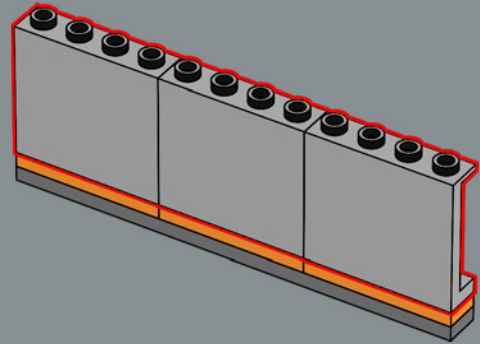

4

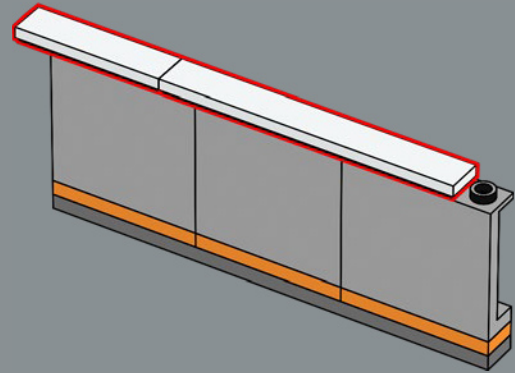

5

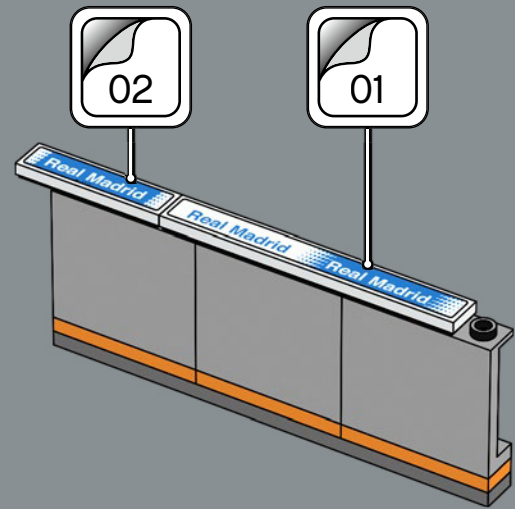

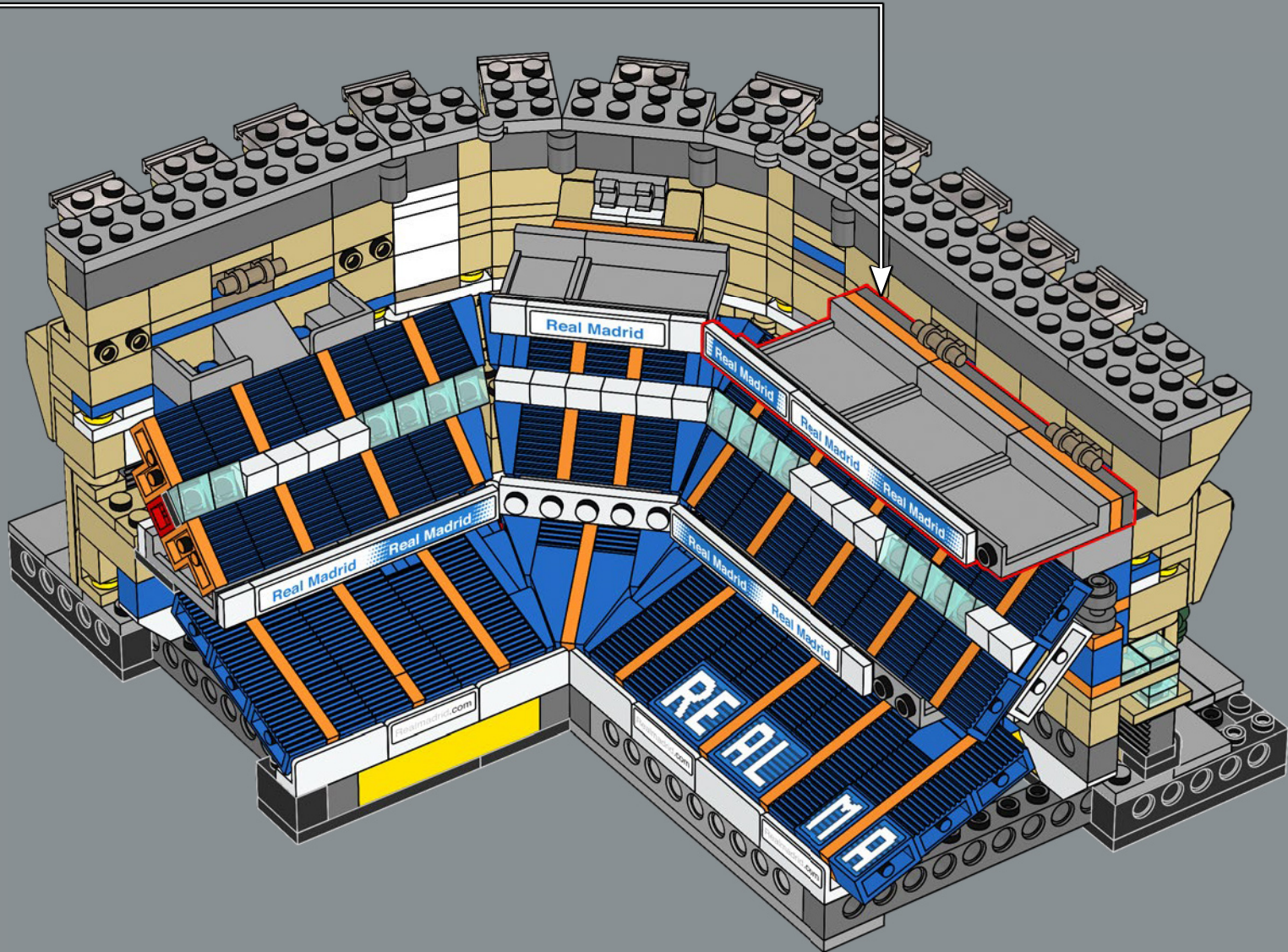

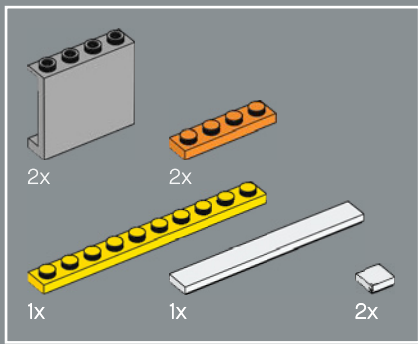

466

1

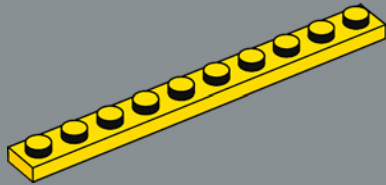

2

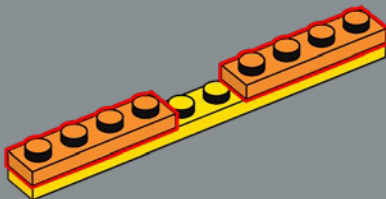

3

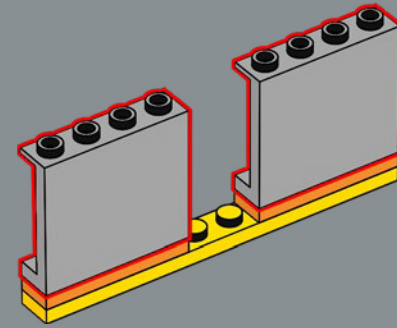

4

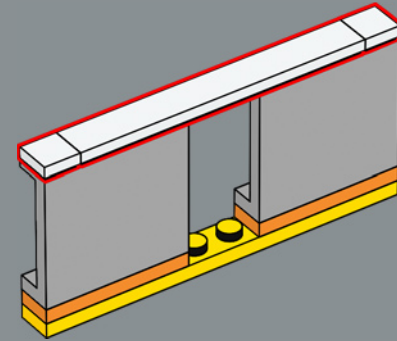

5

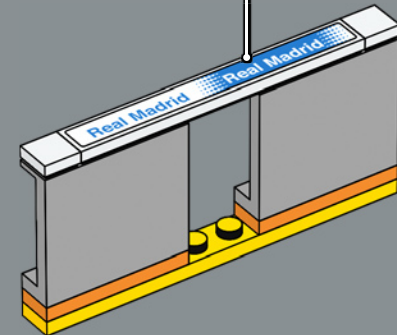

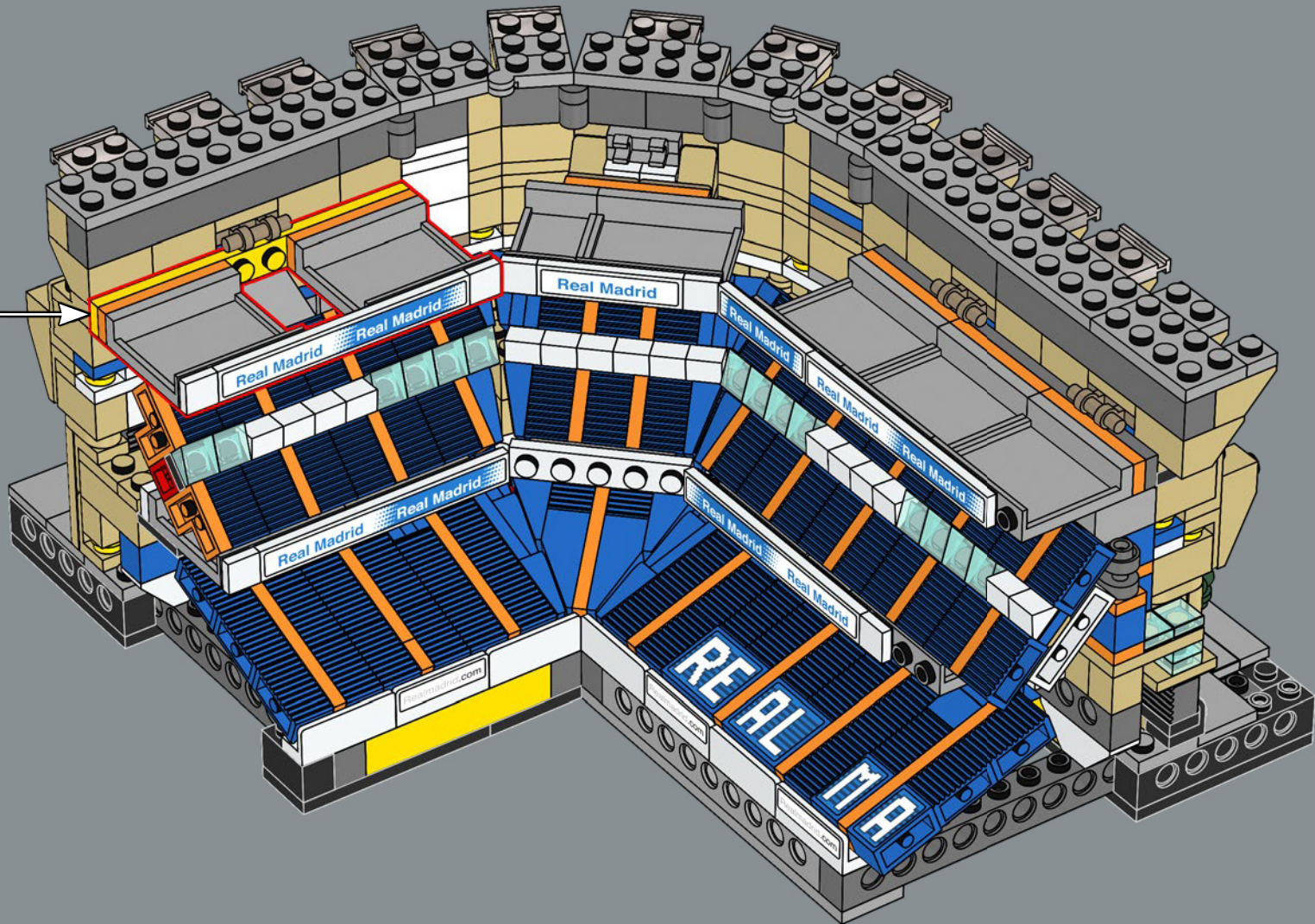

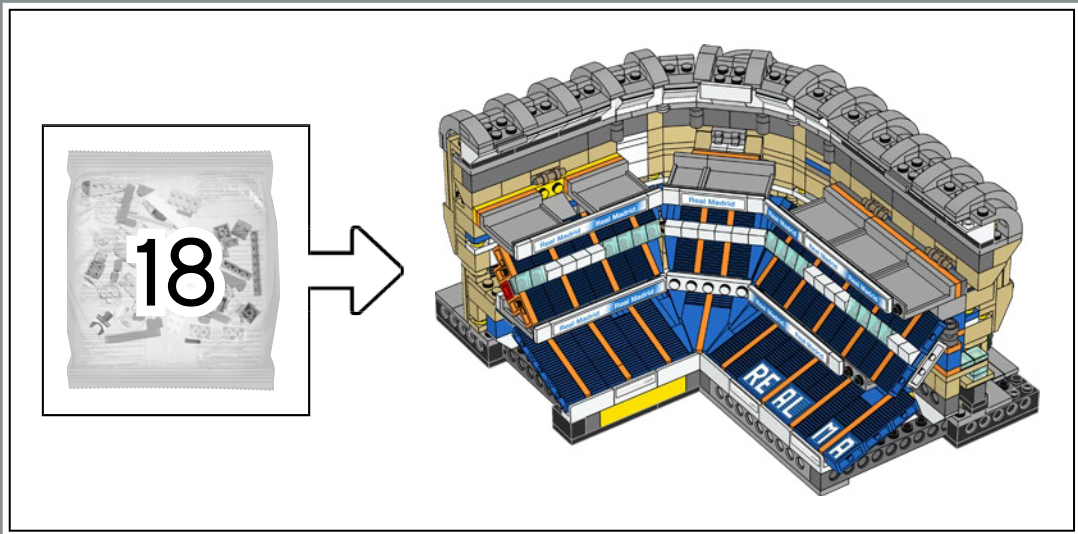

467

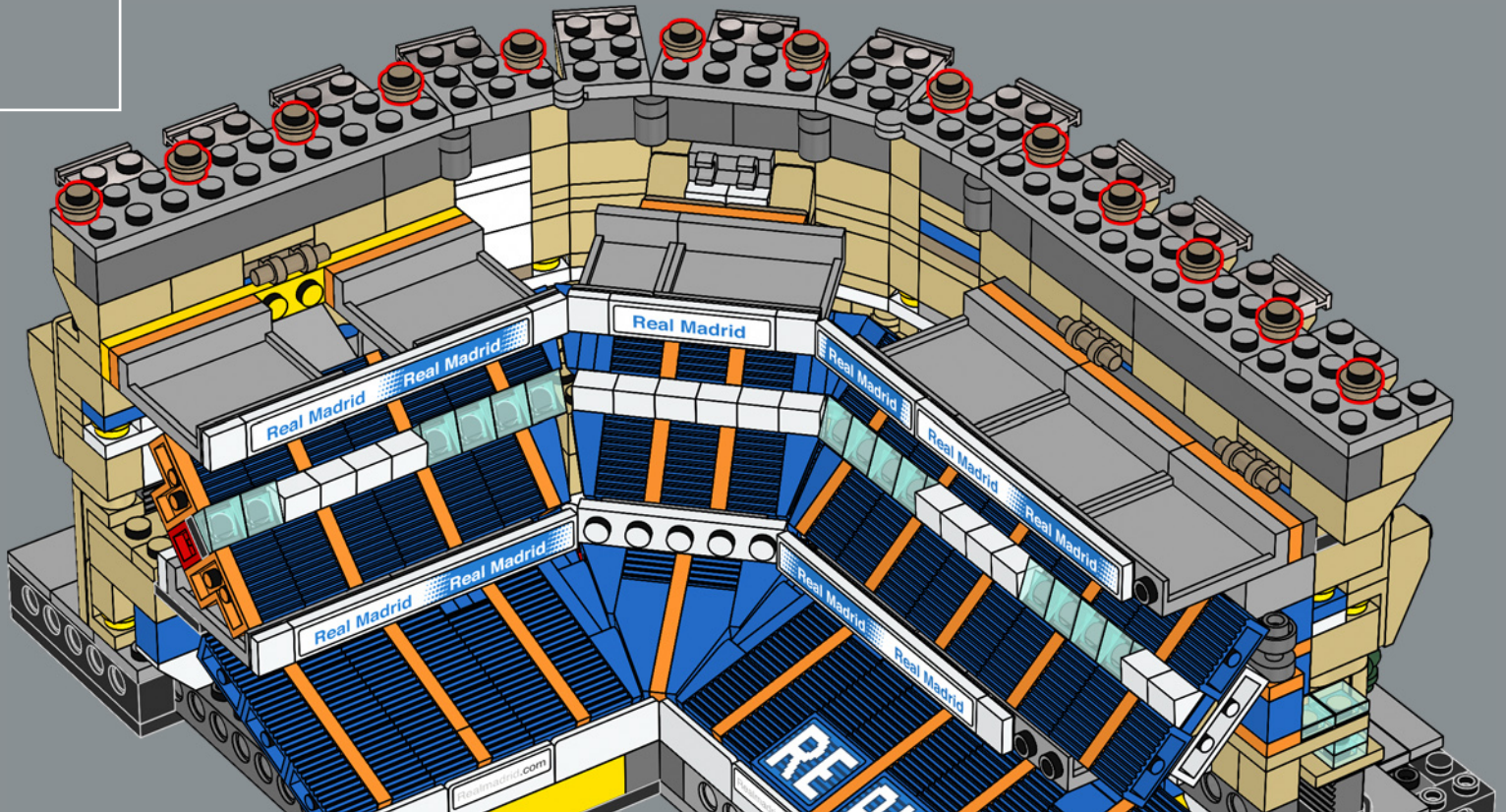



13x

468

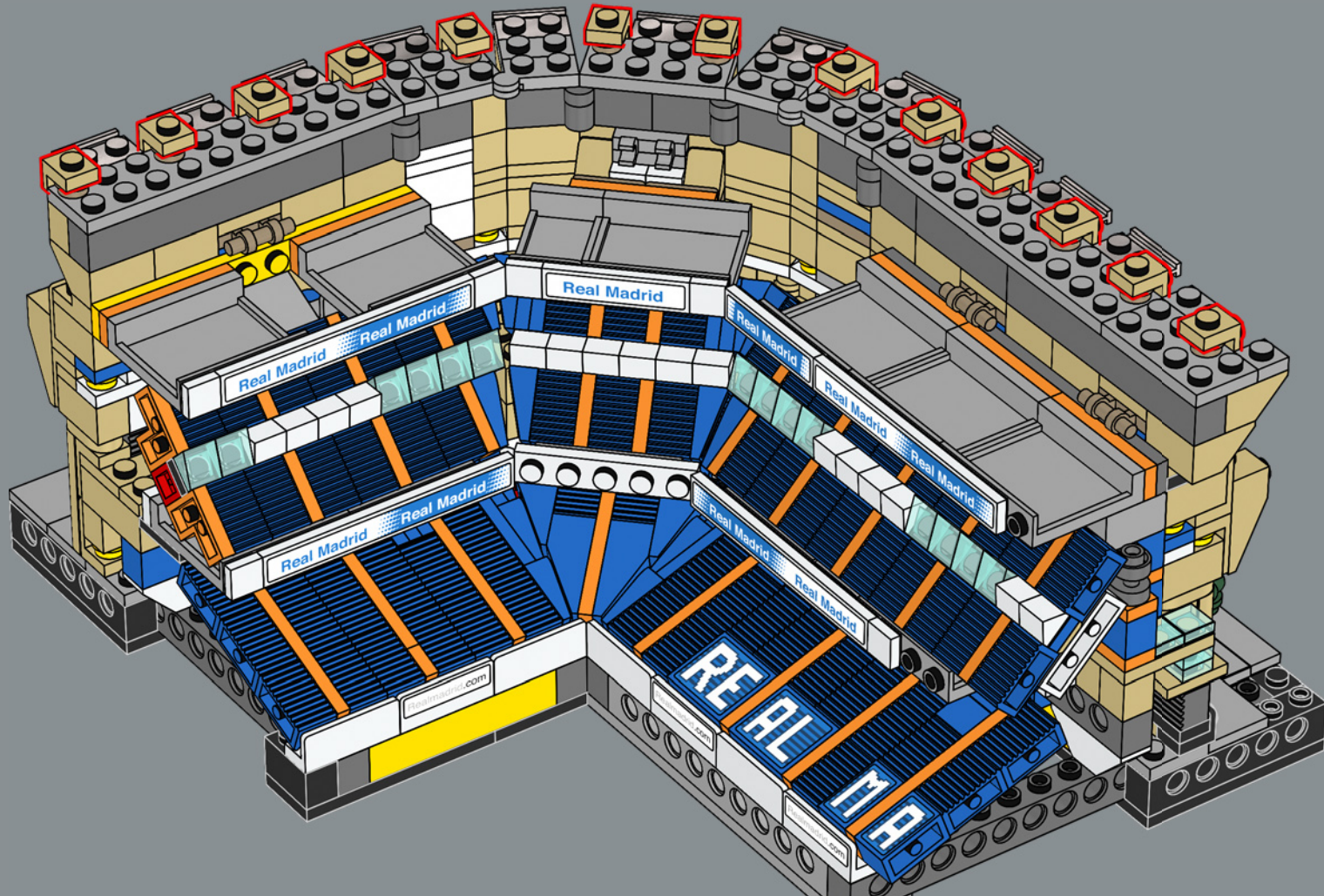

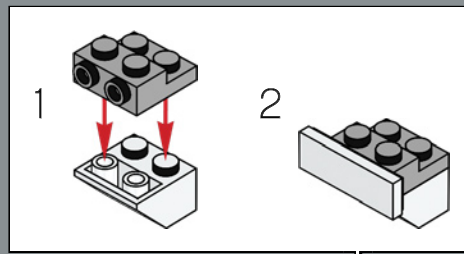
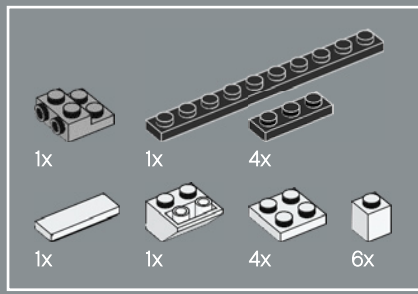

469

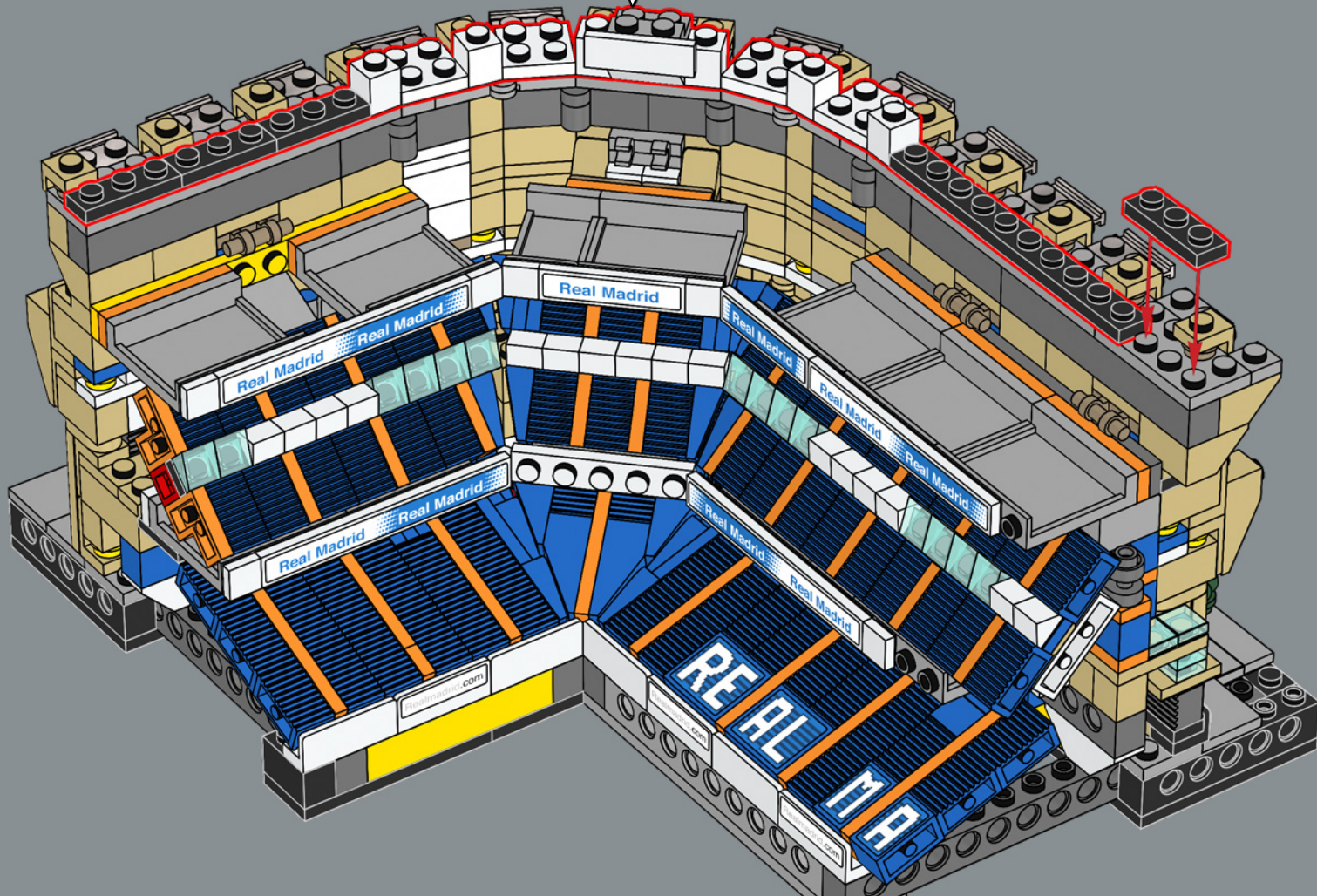



2x



14x

470

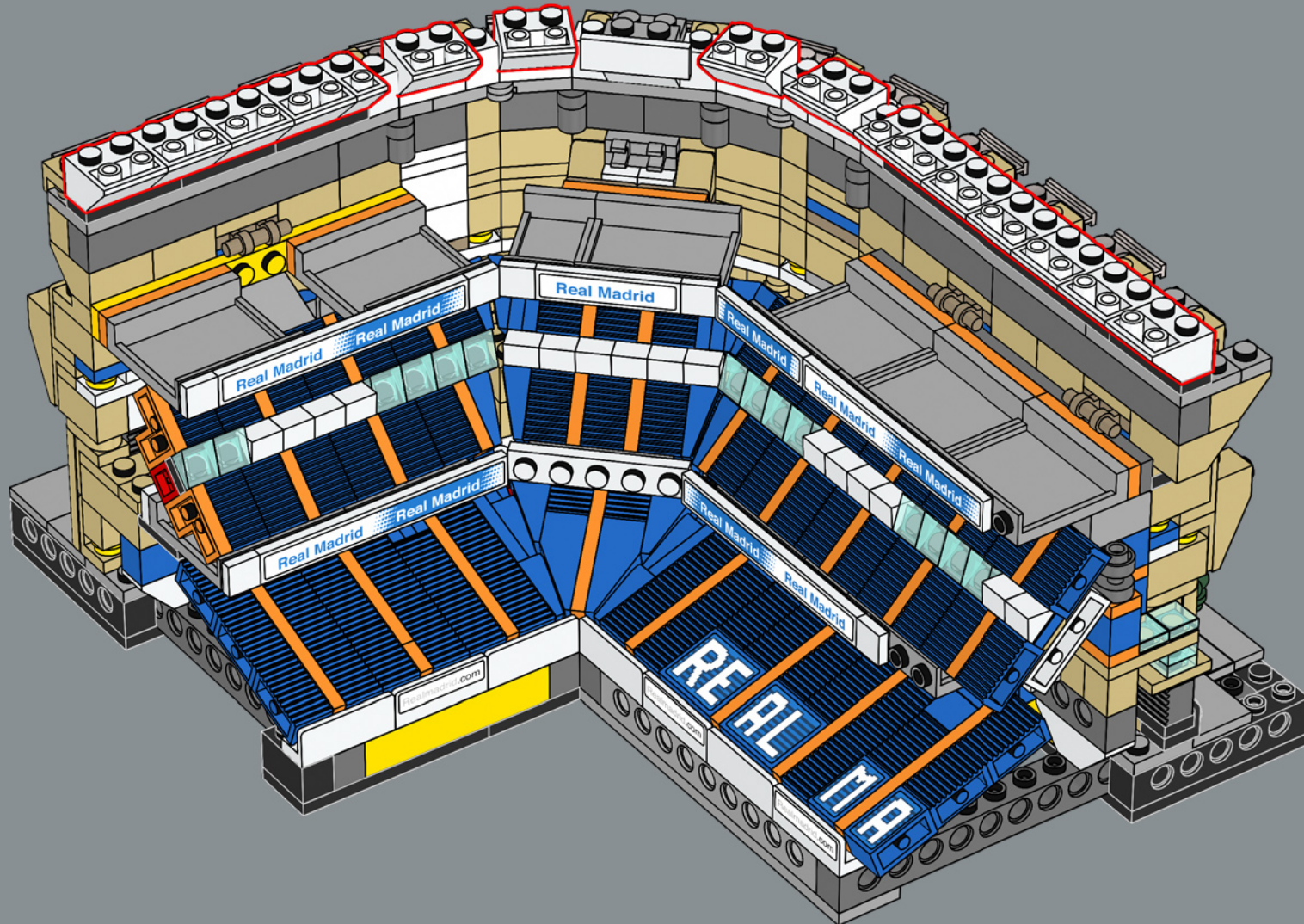



471

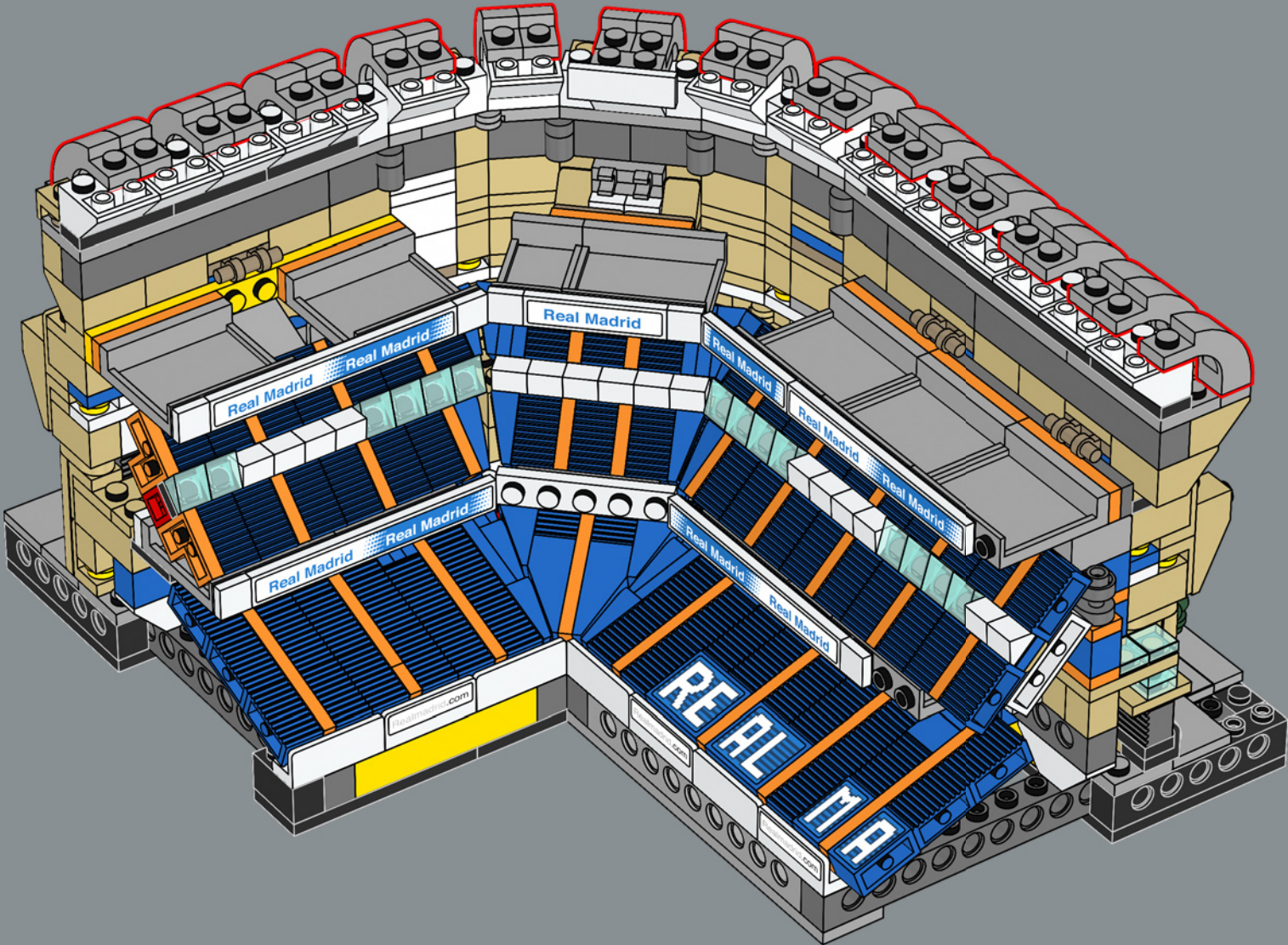



472

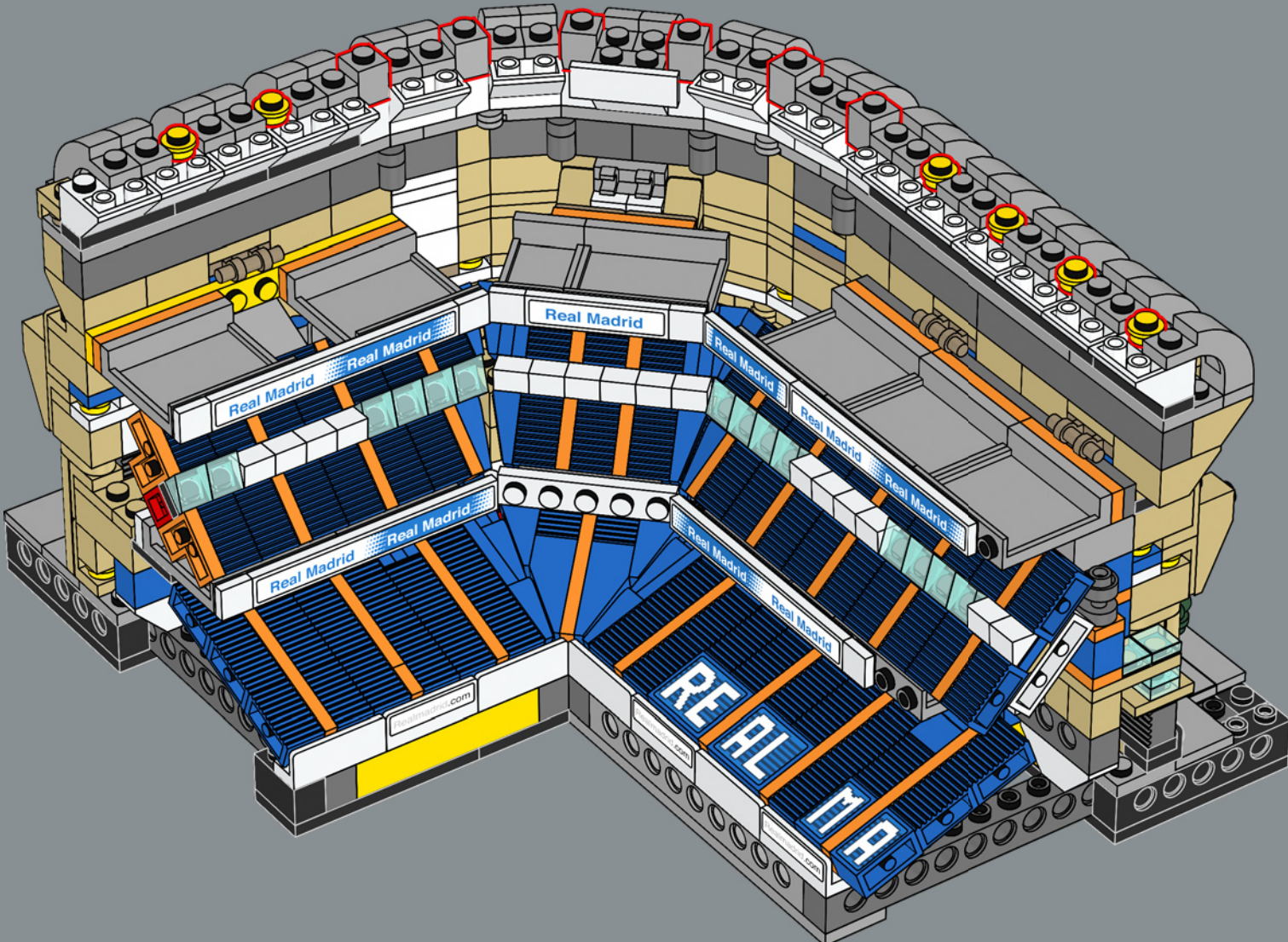

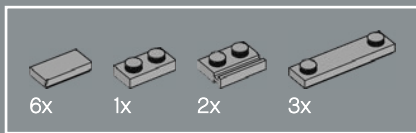

473

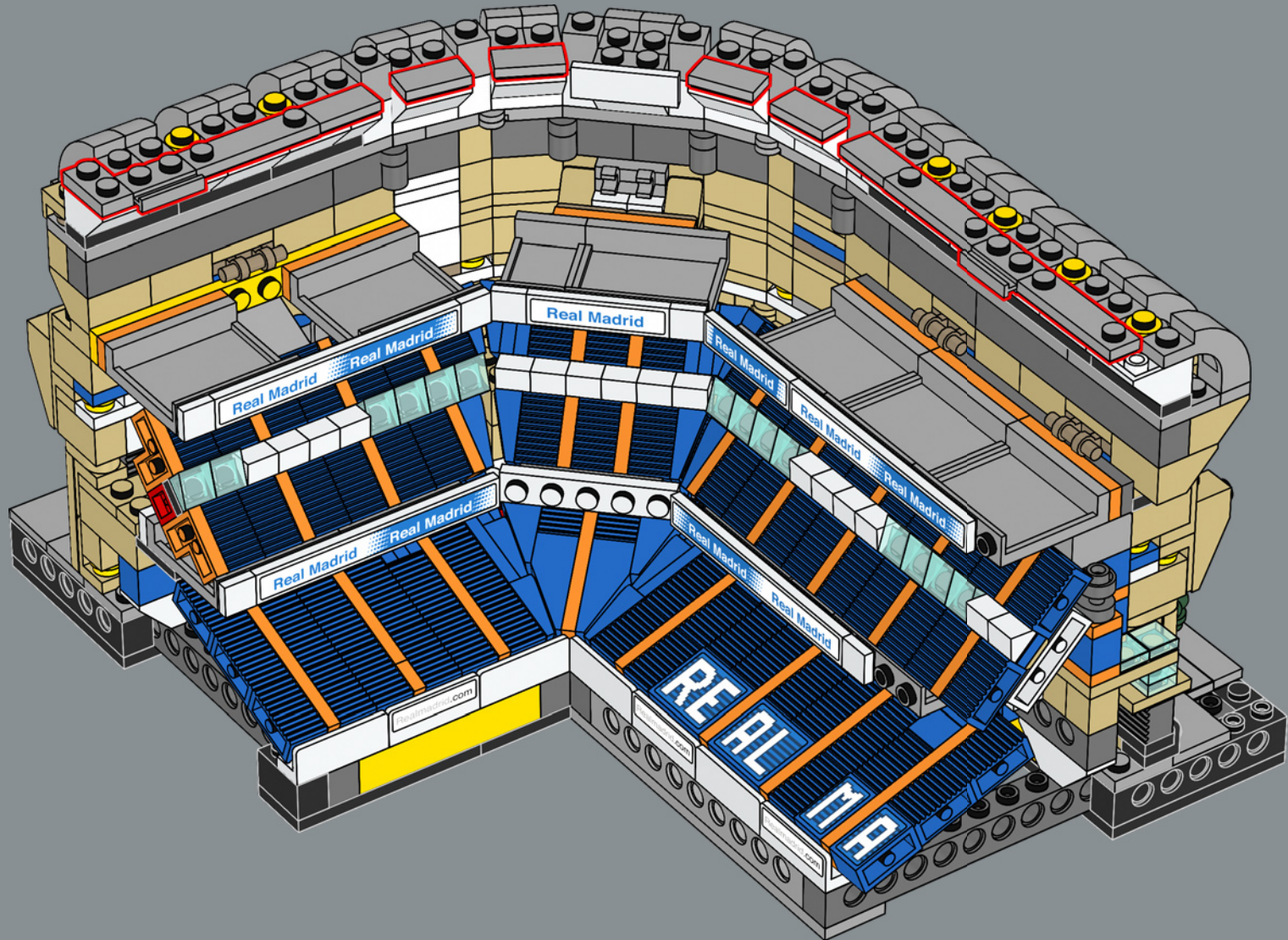



6x

474

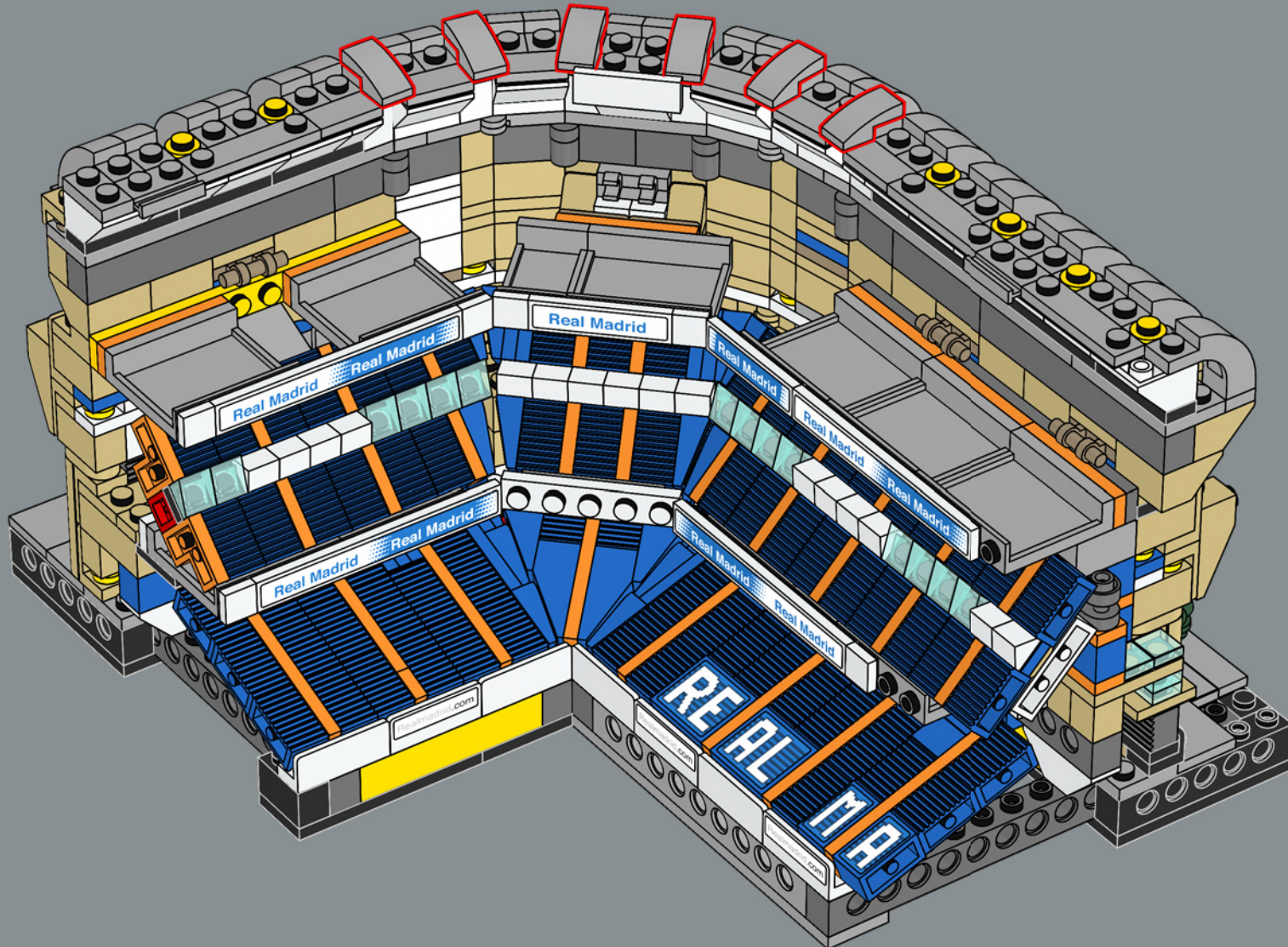

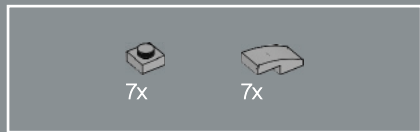

475

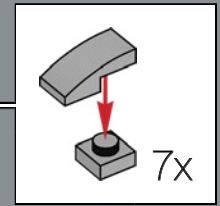
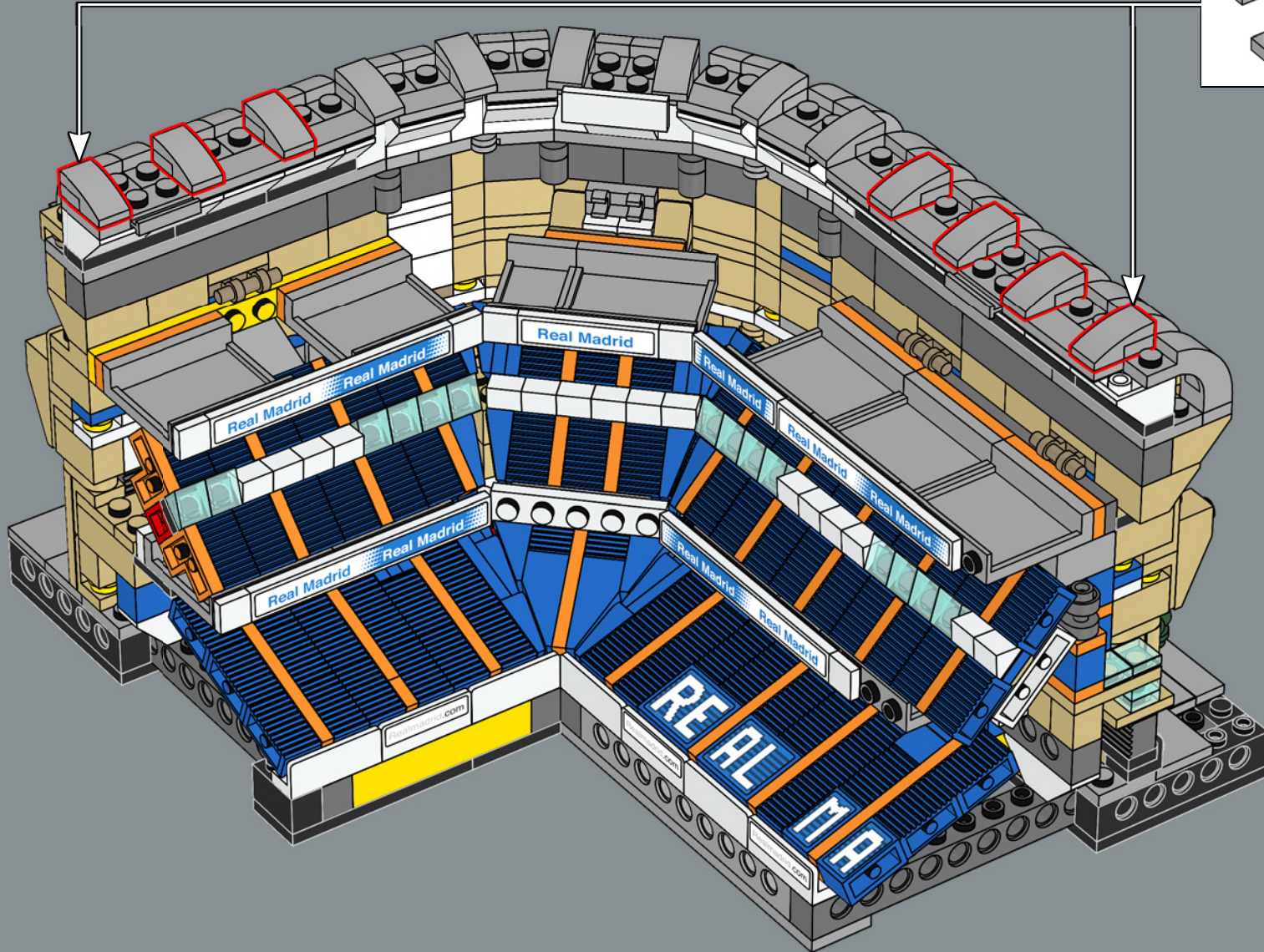

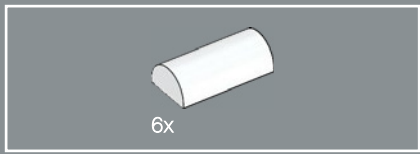

476

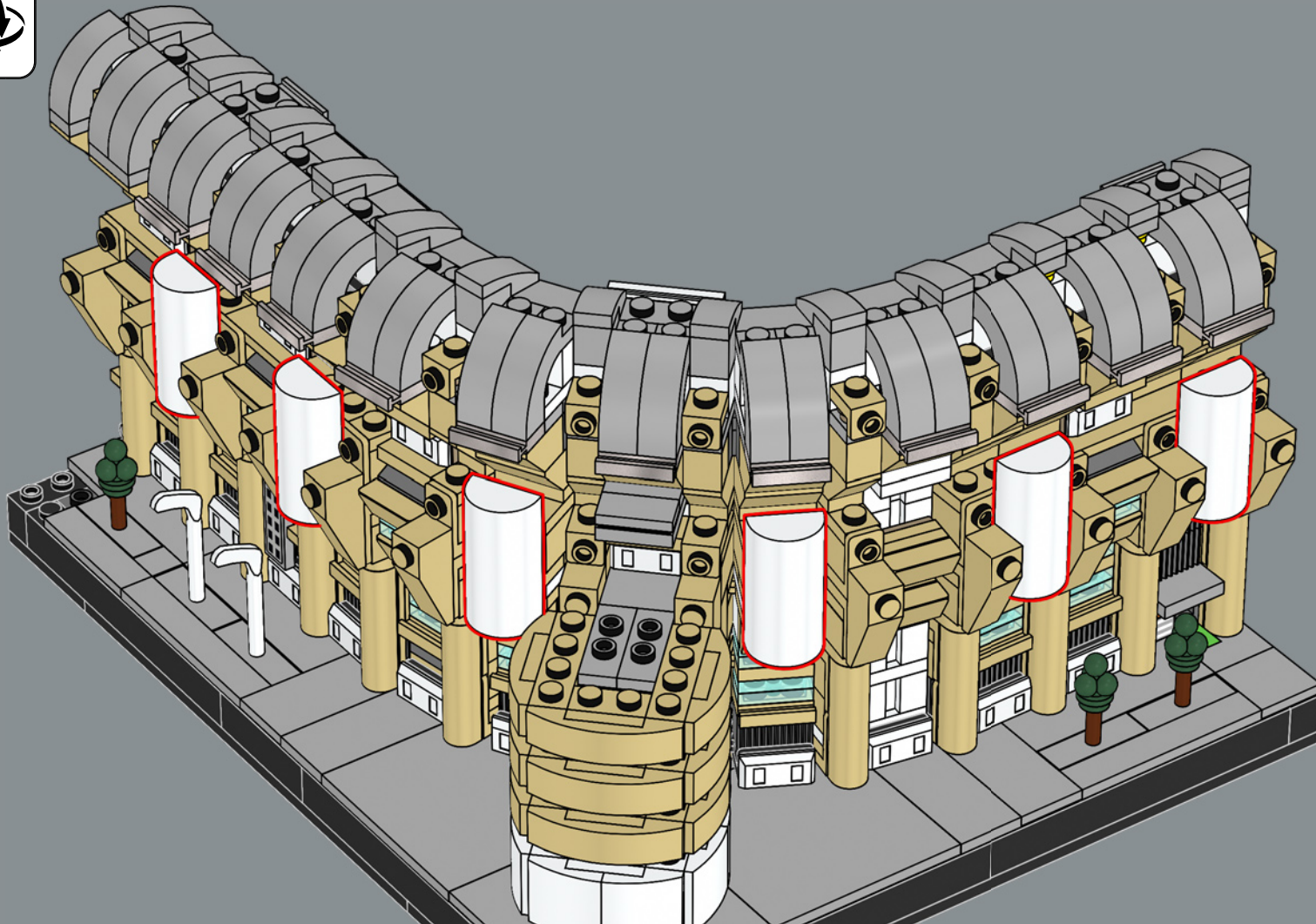
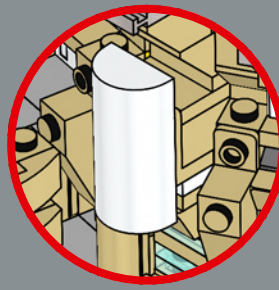

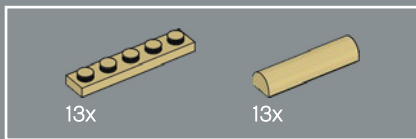

LEGO® fans have been waiting for a 1x5 plate for a very long time. This model includes 48 of this rare LEGO piece, the most in any LEGO model to date!

Les amateurs de LEGO® attendent une plaque 1x5 depuis très longtemps. Ce modèle comprend 48 exemplaires de cette pièce LEGO rare, le plus grand nombre dans un modèle LEGO à ce jour !

Los fans de LEGO® han esperado por mucho tiempo la incorporación de una placa 1x5. Este modelo incluye 48 de estas inusuales piezas LEGO, ¡más que cualquier otro set hasta la fecha!

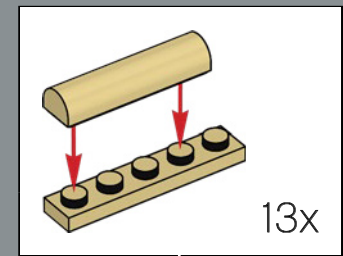

477

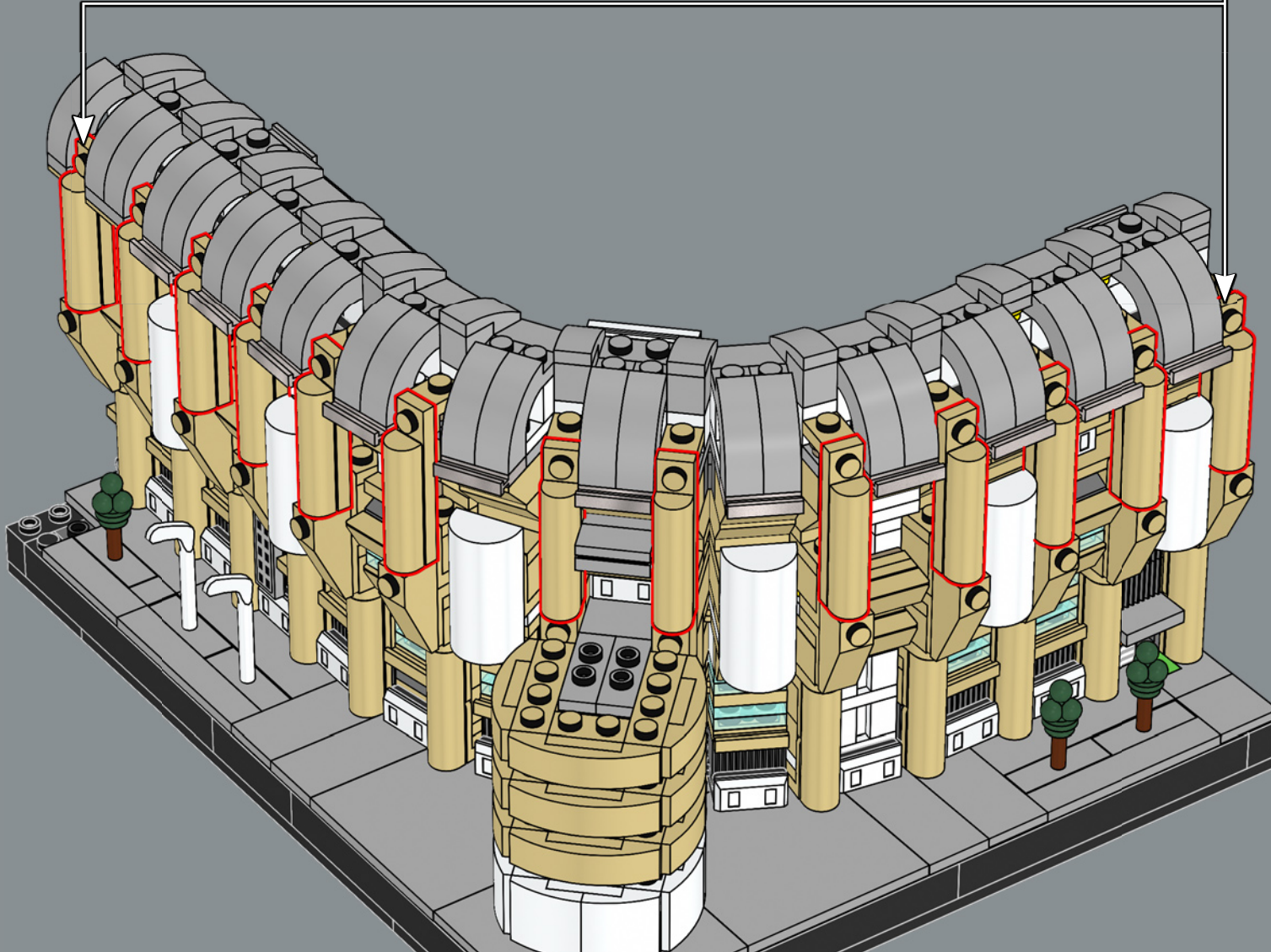

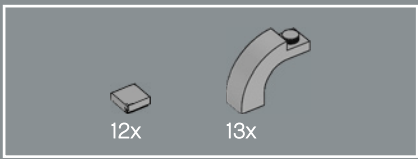

478

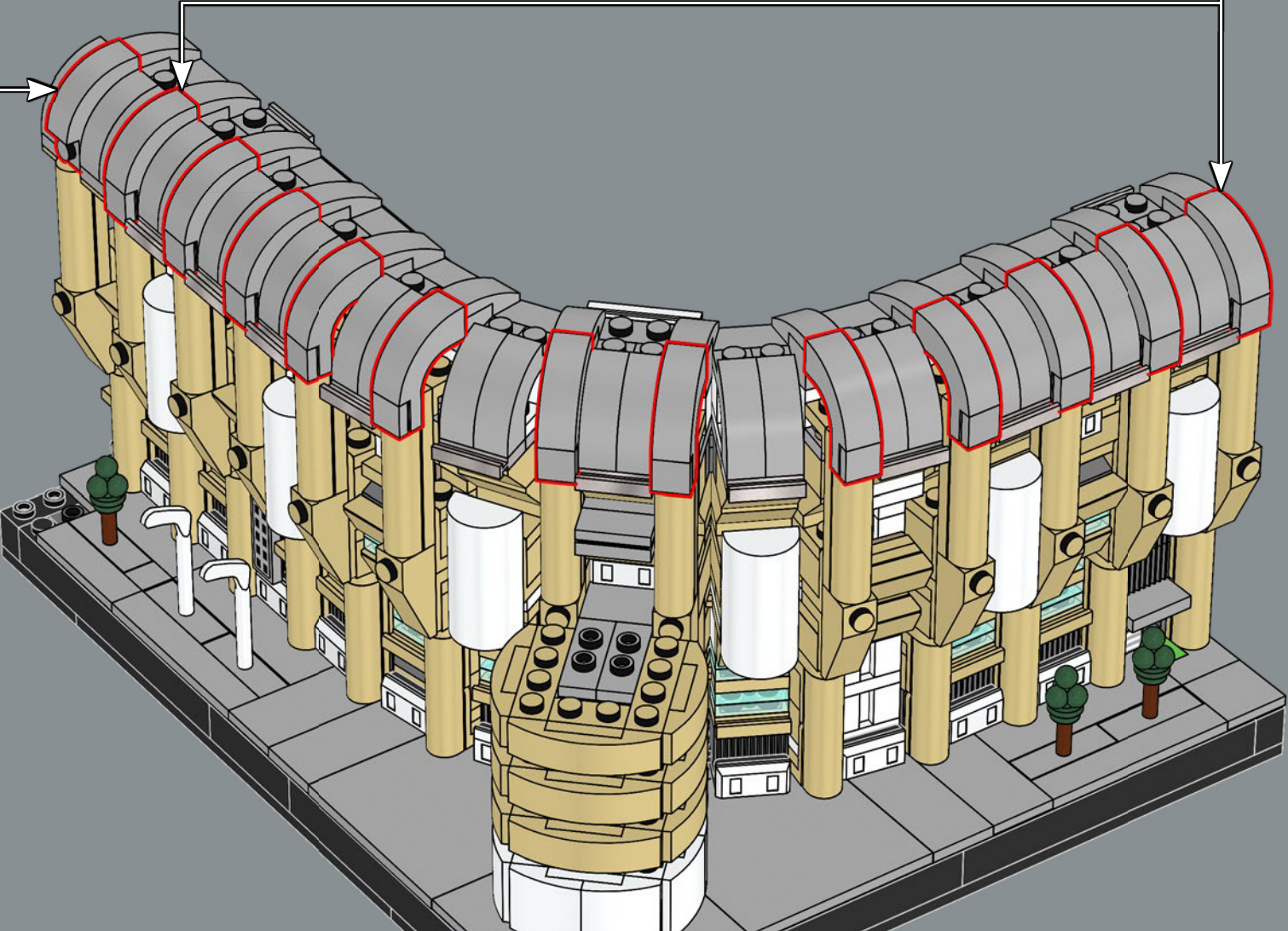
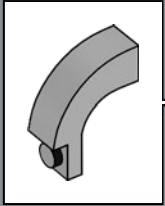
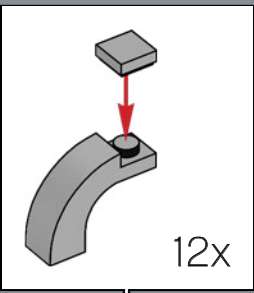

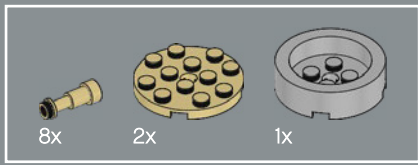

479

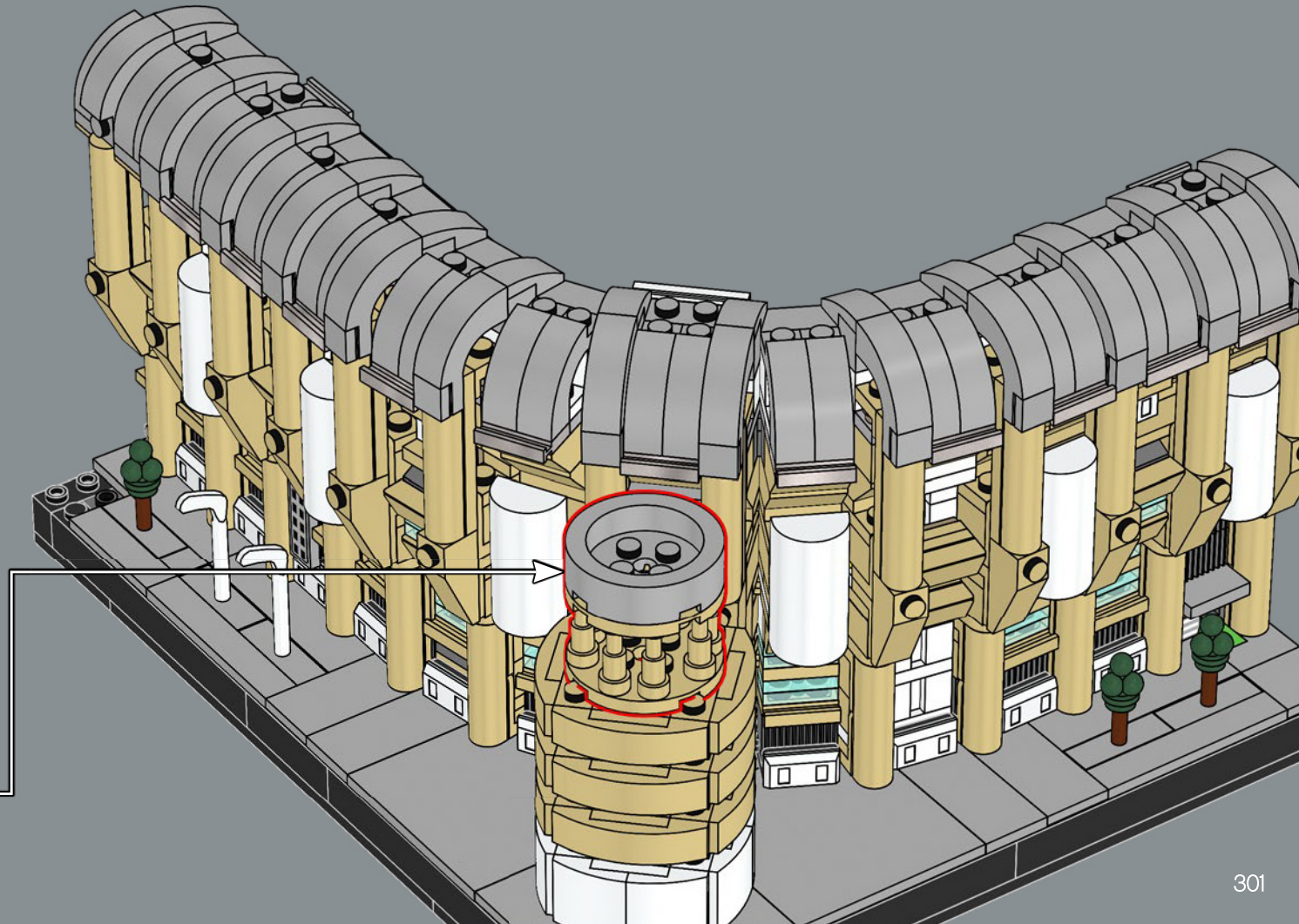
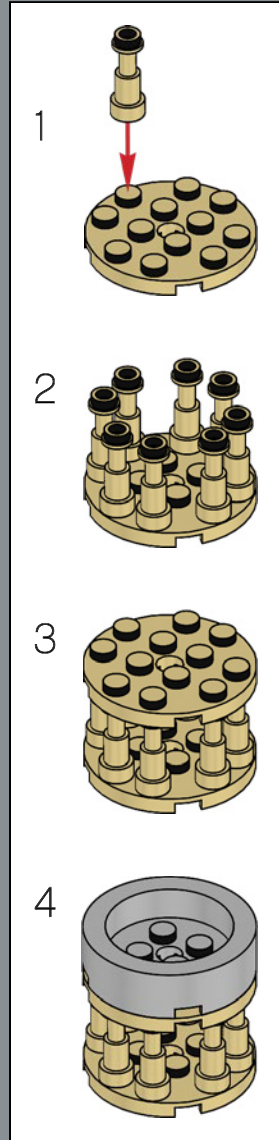

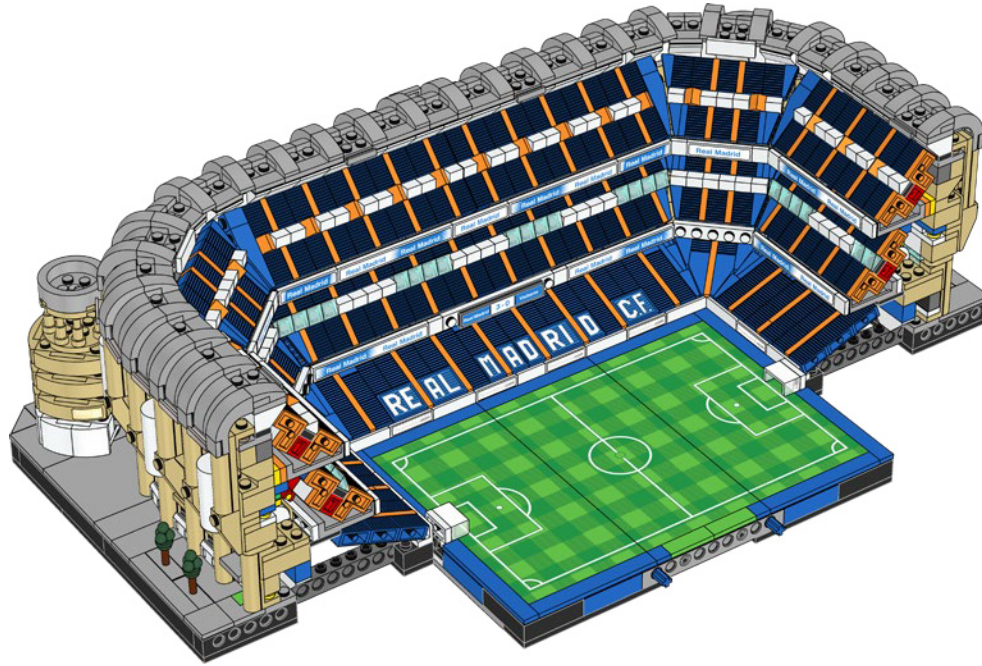
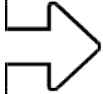

2x



2x



1x



1x



1x

480

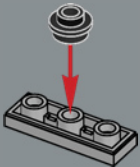

481

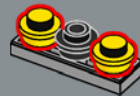

482

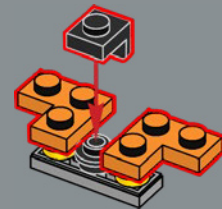

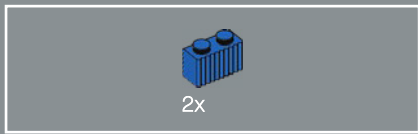

483

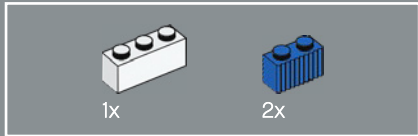
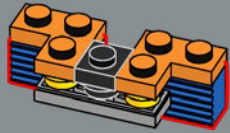

484

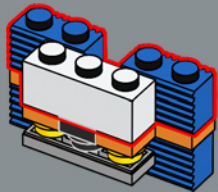

485

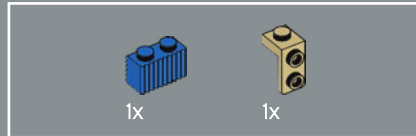
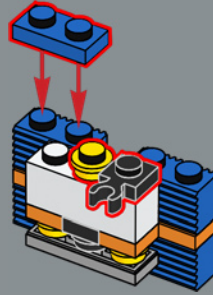

486

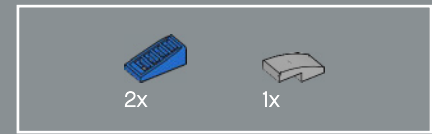
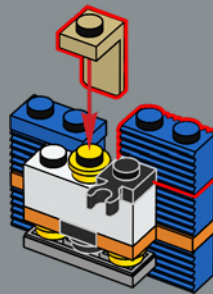

487

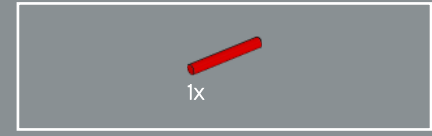
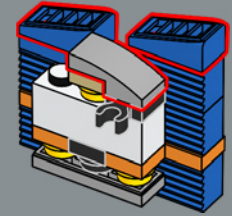

488

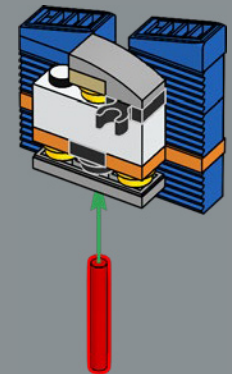

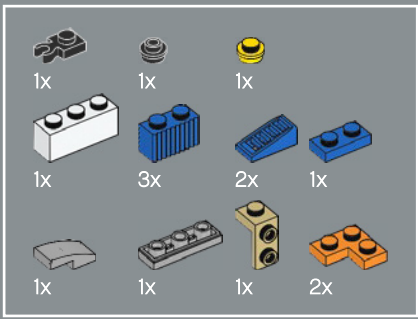

489

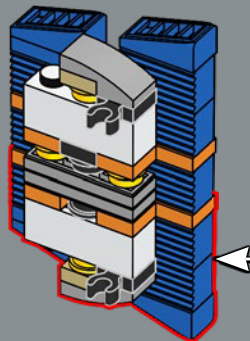
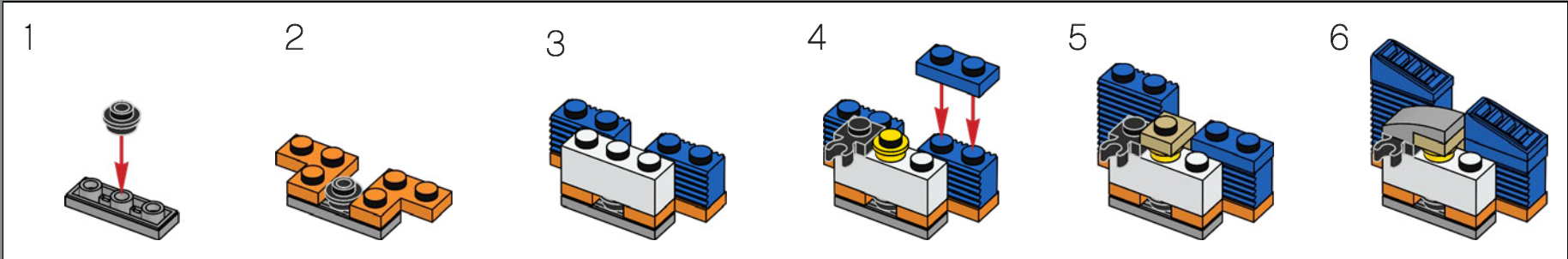

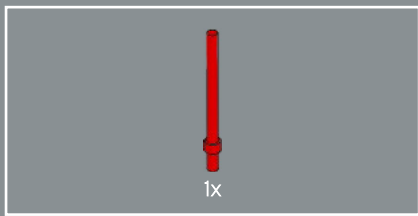

490

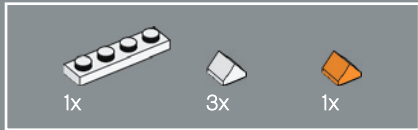
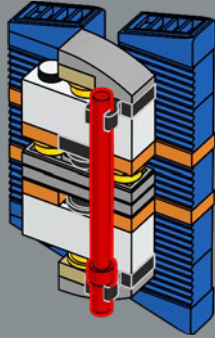

491

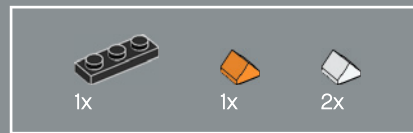
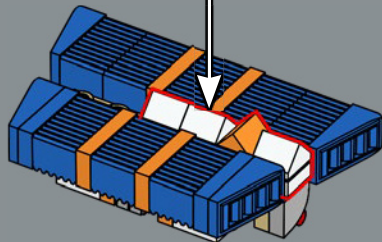
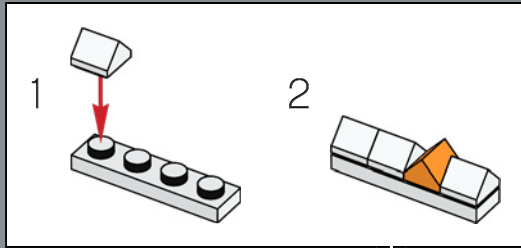

492

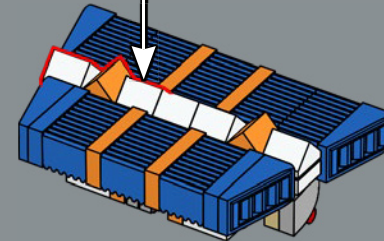
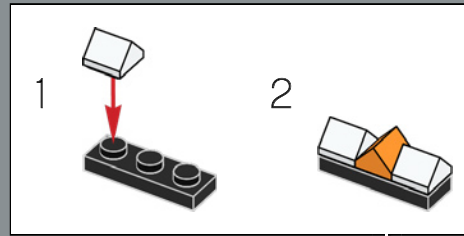

493

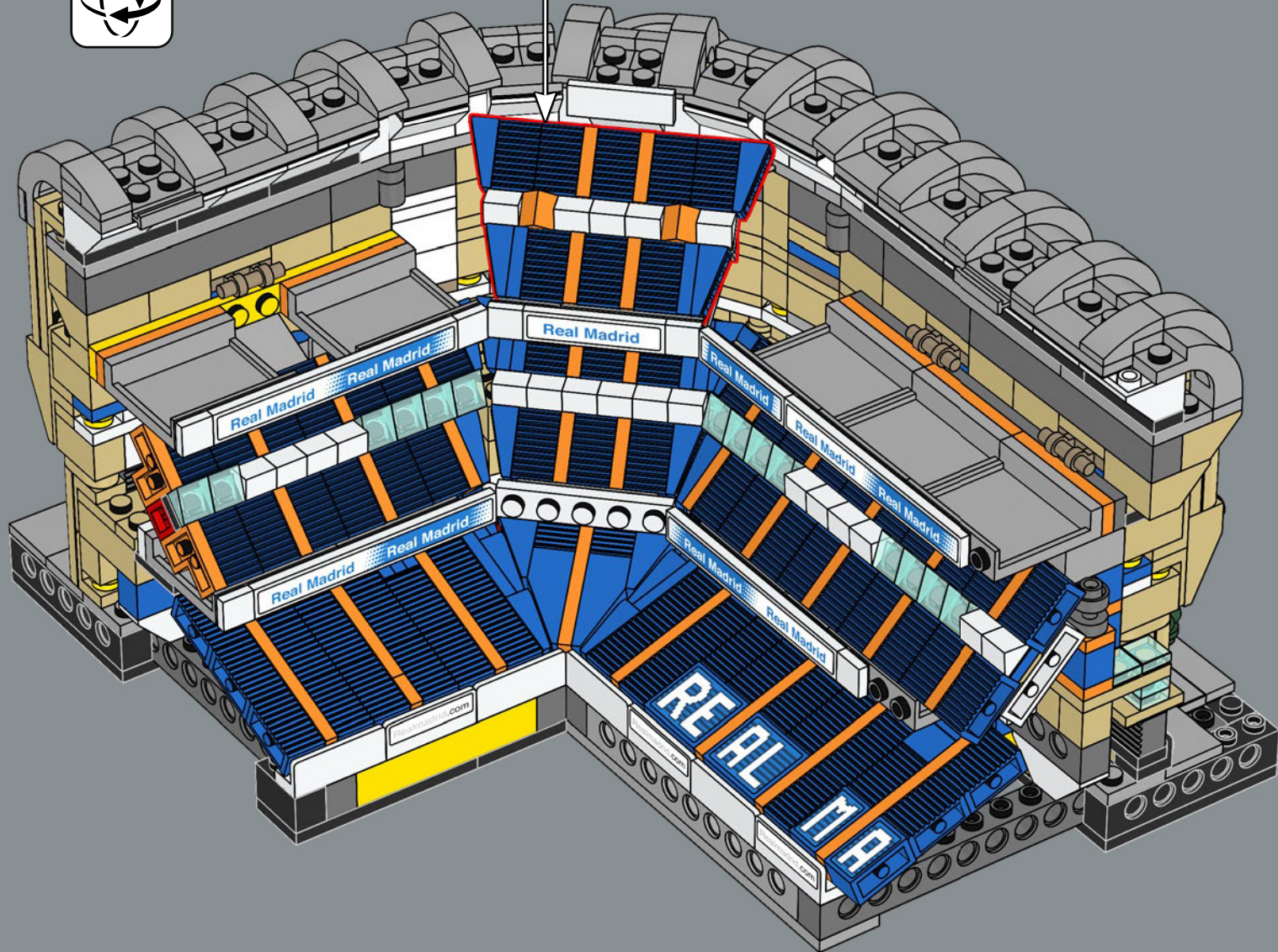

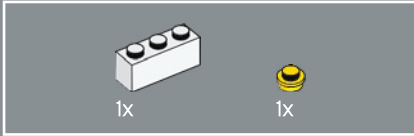
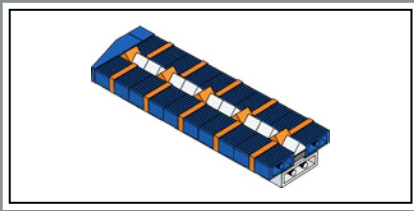

494

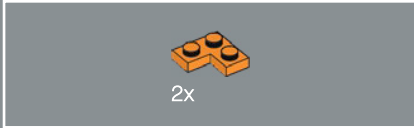
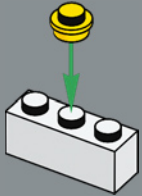

495

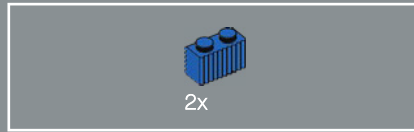
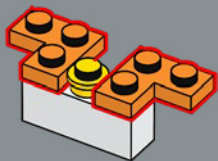

496



2x

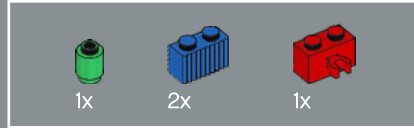
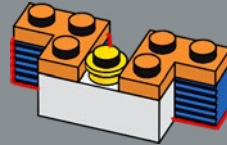

497



1x



2x



1x

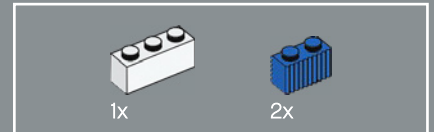
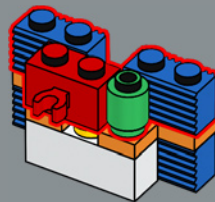

498



1x



2x

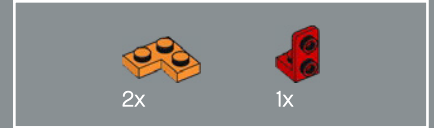
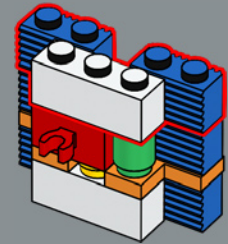

499



2x



1x

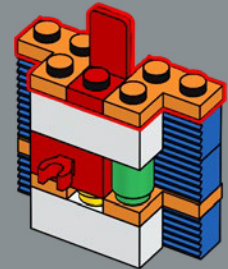

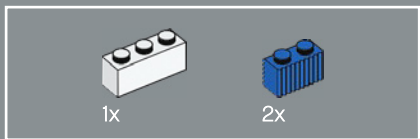

500

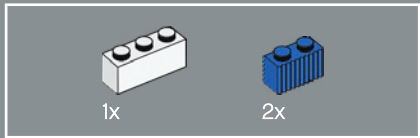
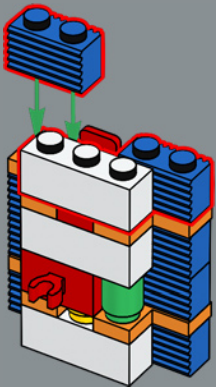

501

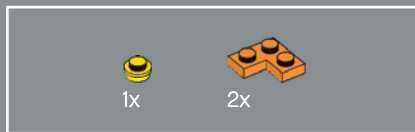
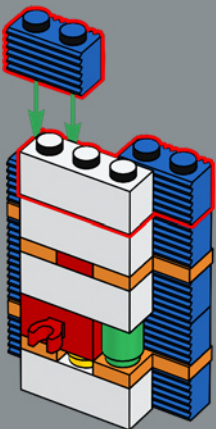

502

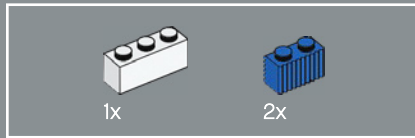
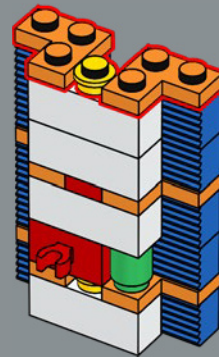

503

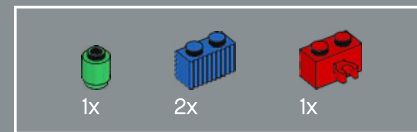
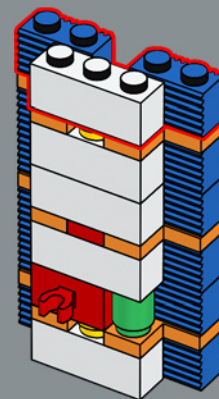

504

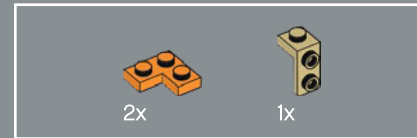
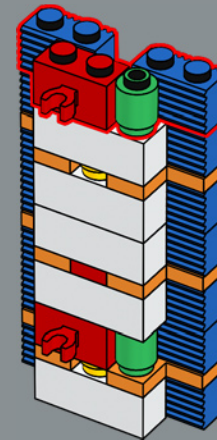

505

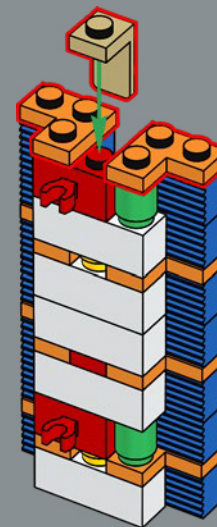

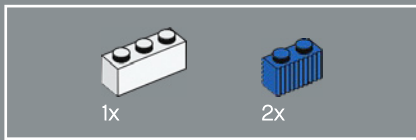

506

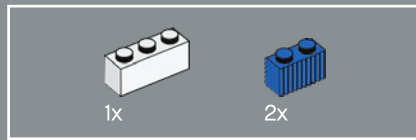
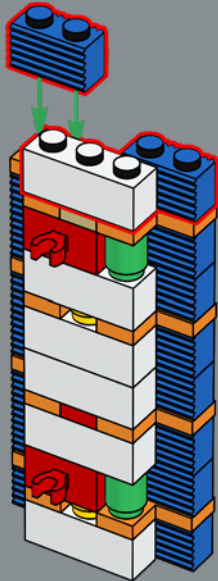

507

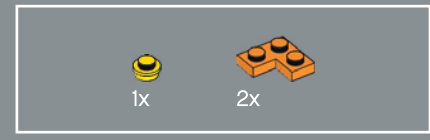
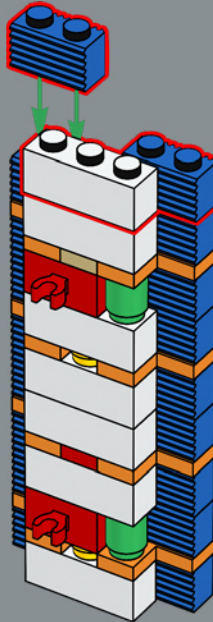

508

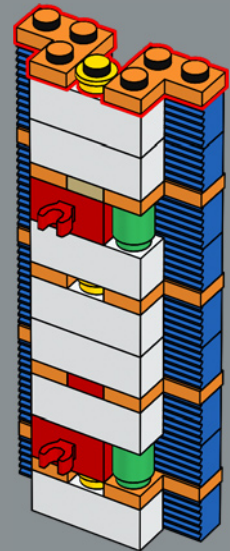



509

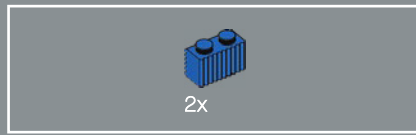
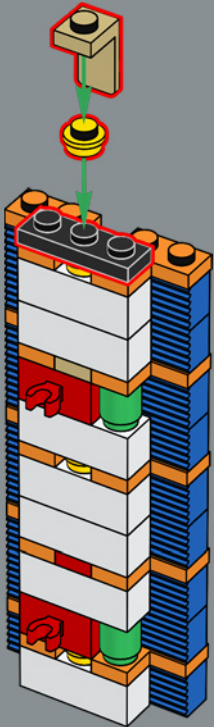

510

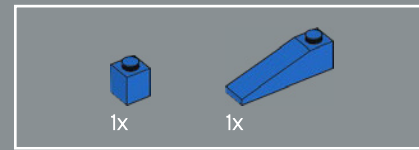
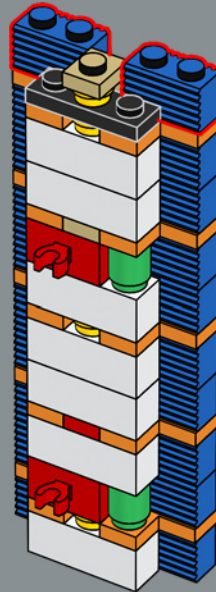

511

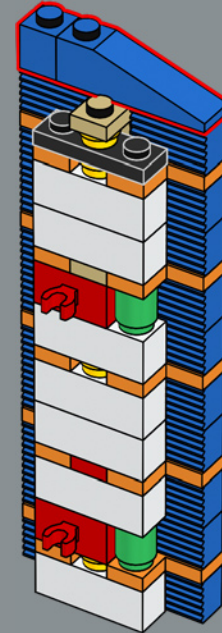

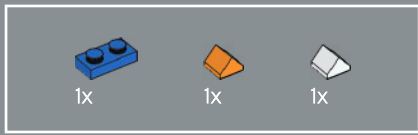

512

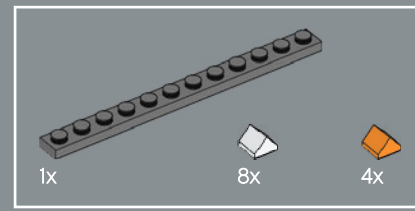
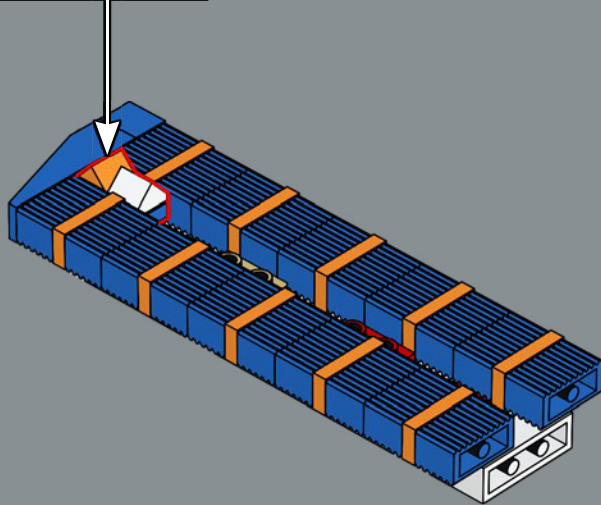
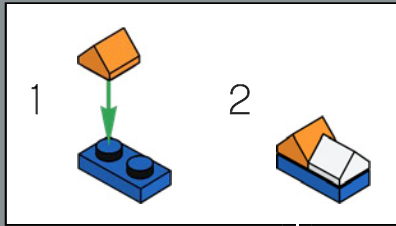

513

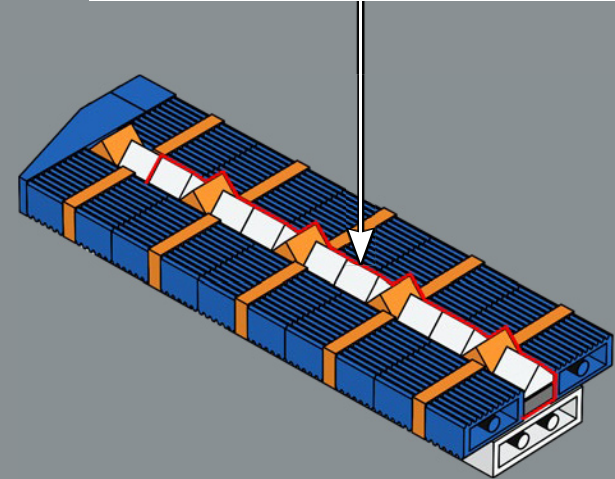
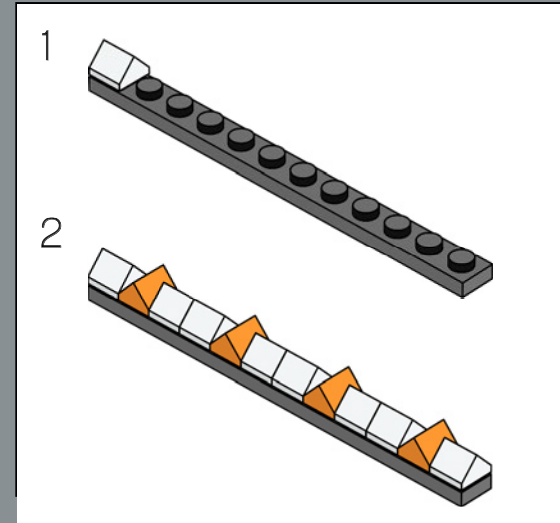

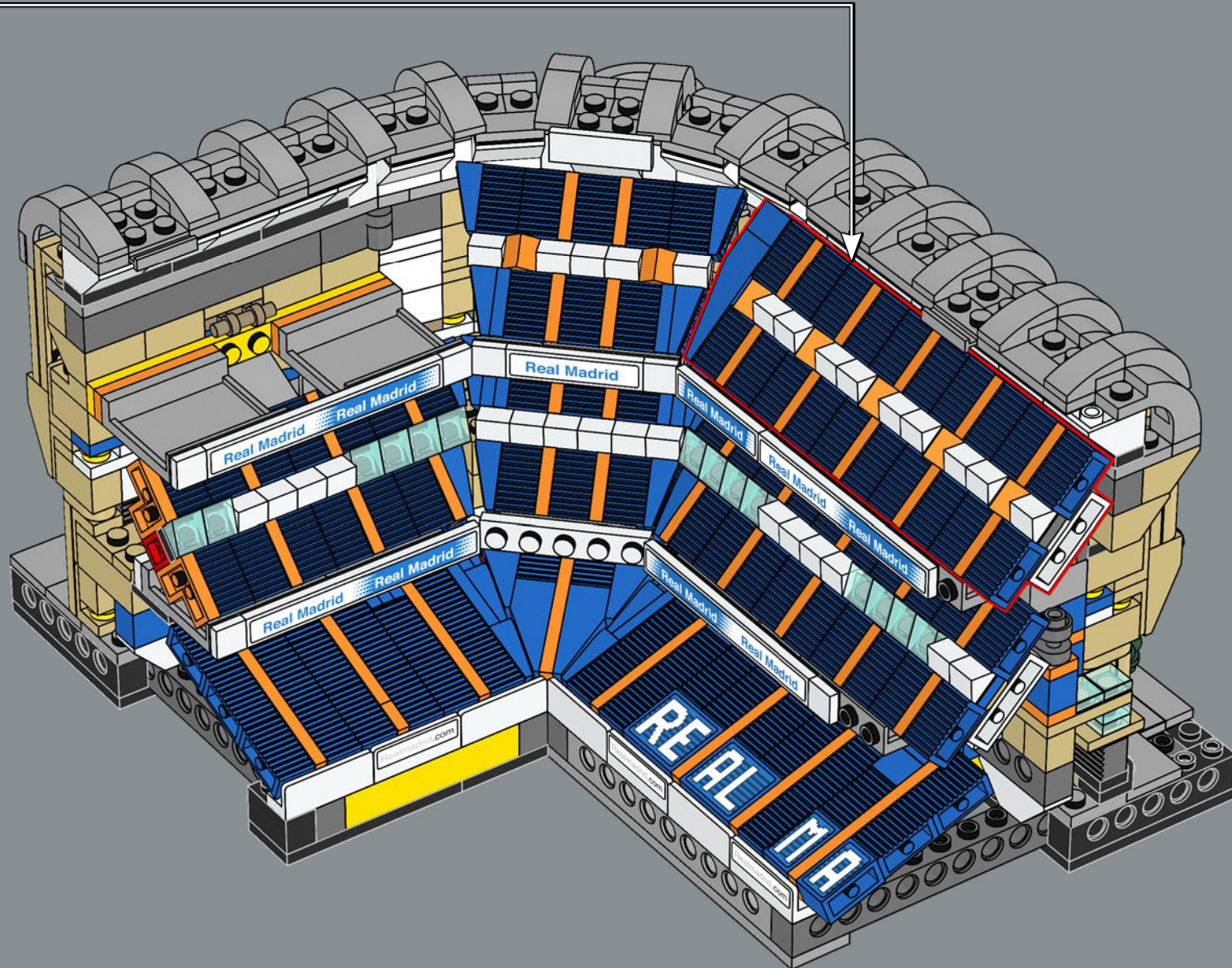

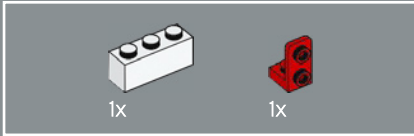
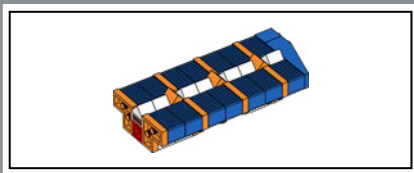

515

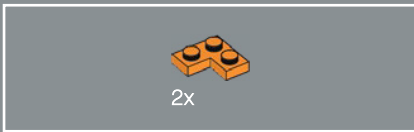
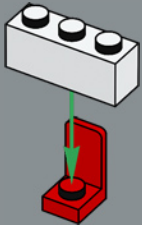

516

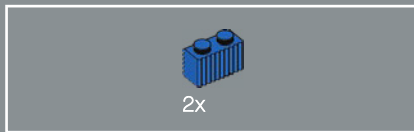
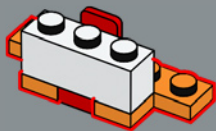

517



2x

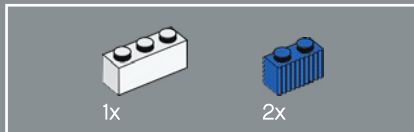
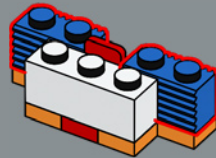

518



1x



2x

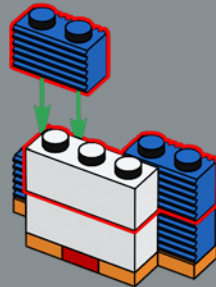

519



1x



2x

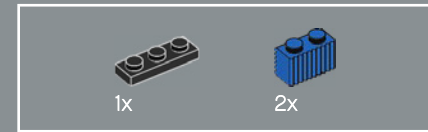
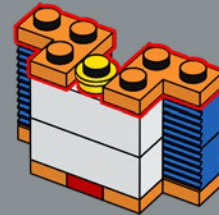

520



1x



2x

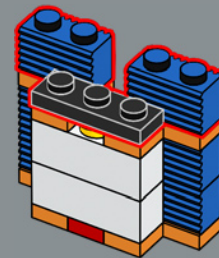

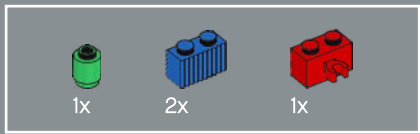

521

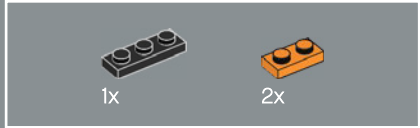
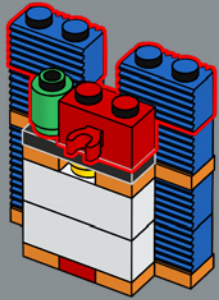

522

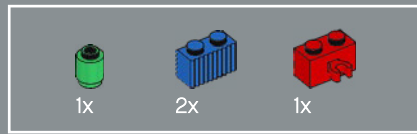
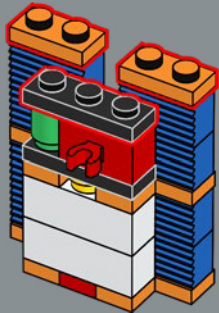

523

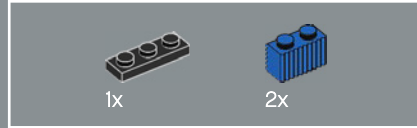
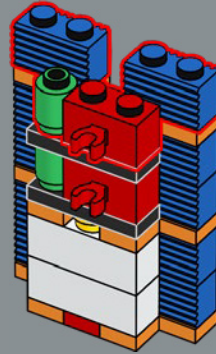

524

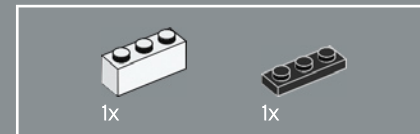
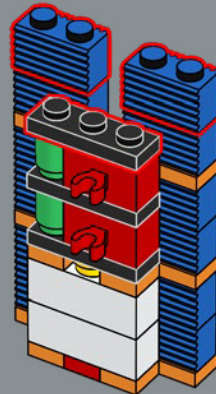

525

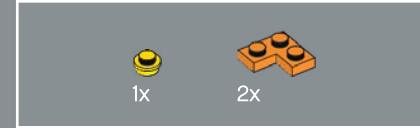
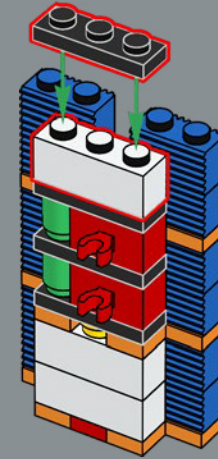

526

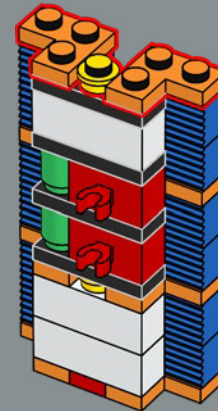

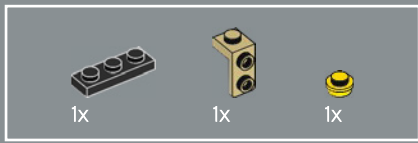

527

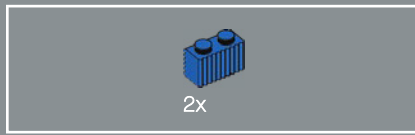
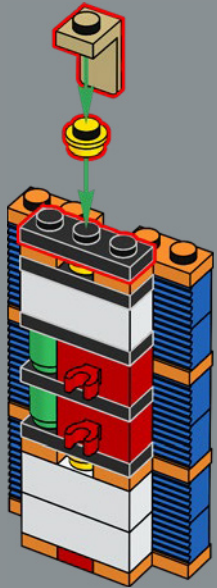

528

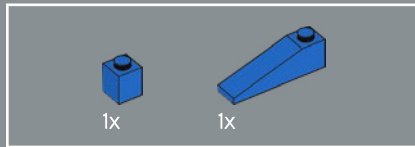
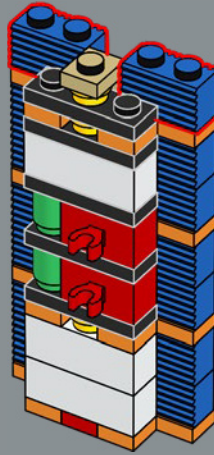

529

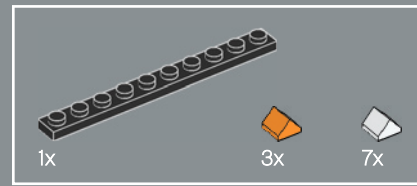
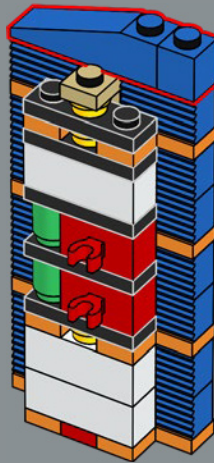

530

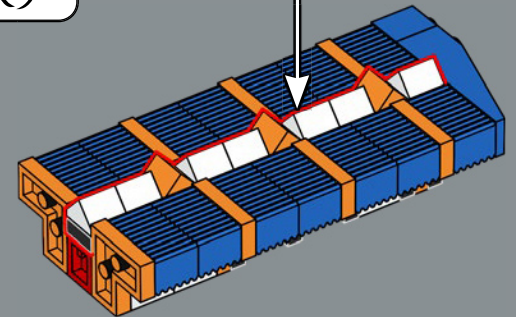
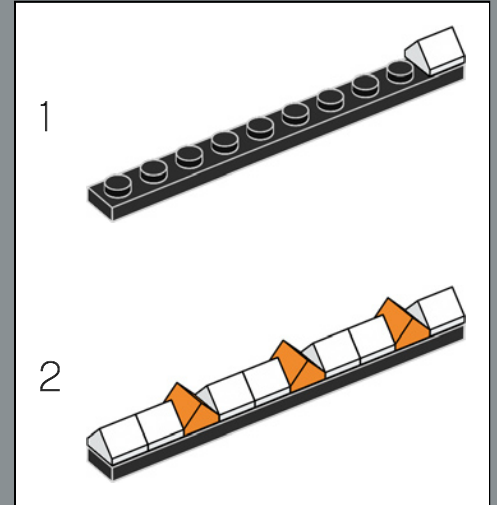

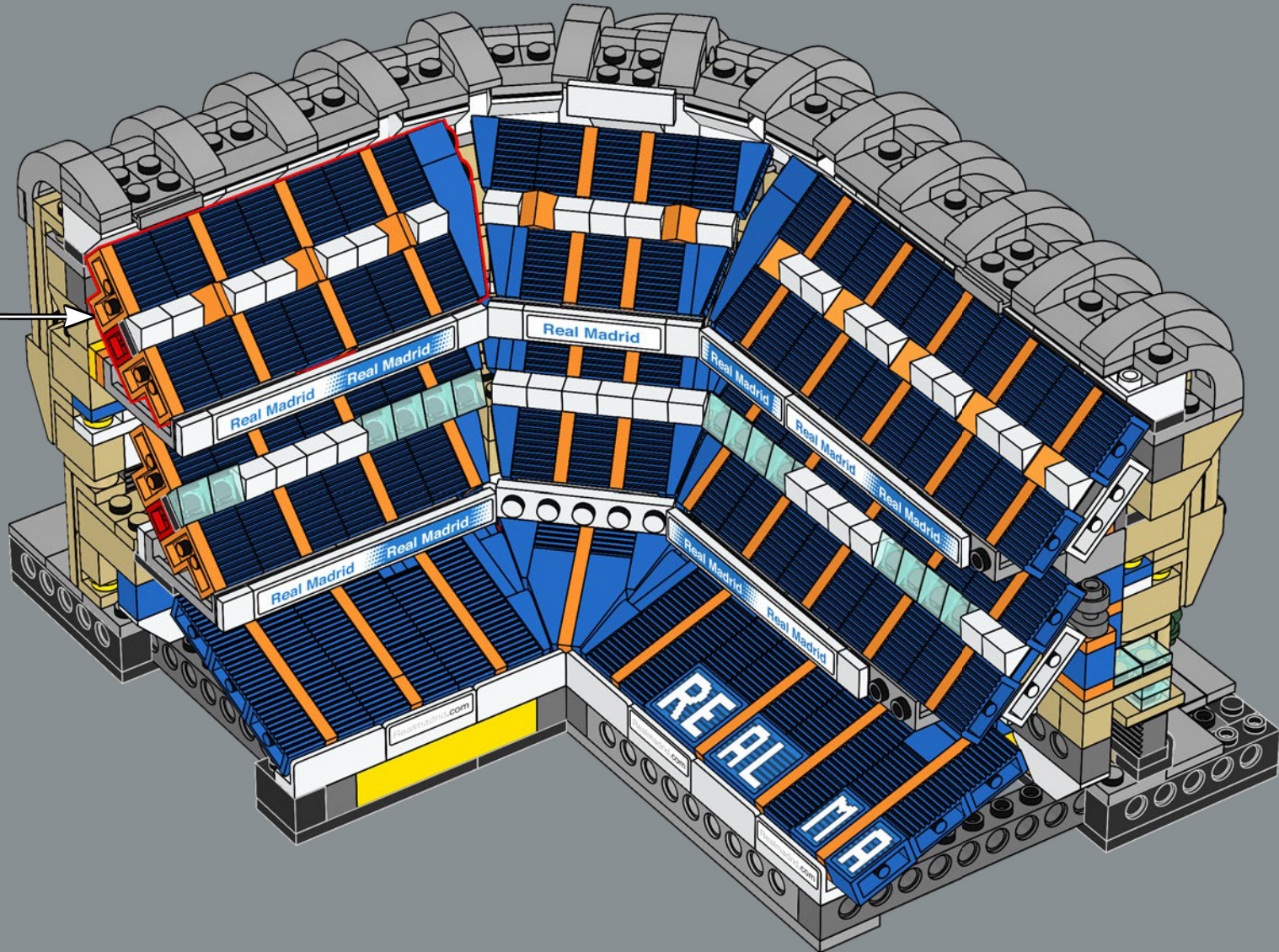



532

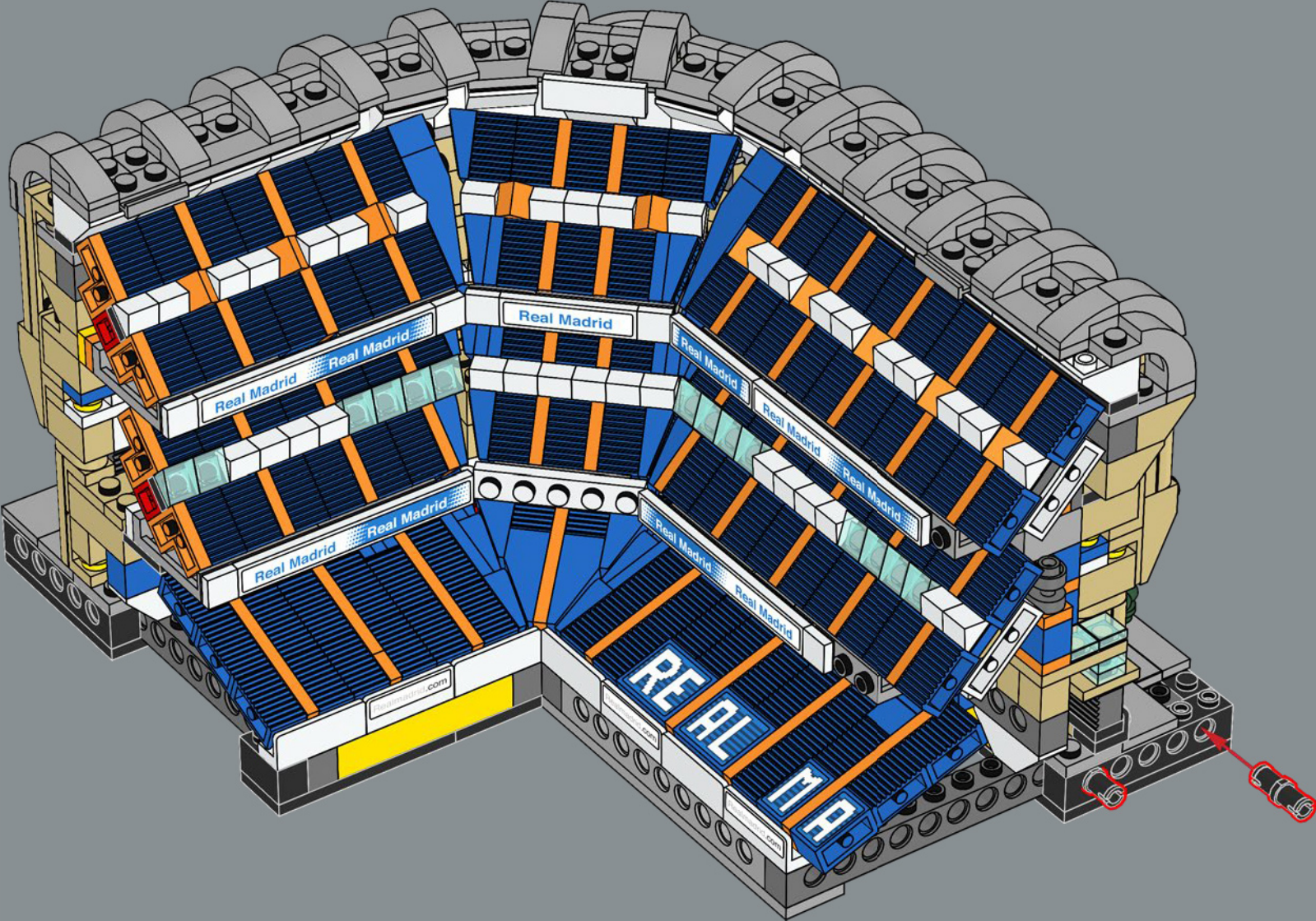

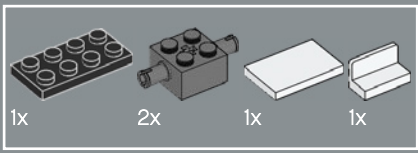

533

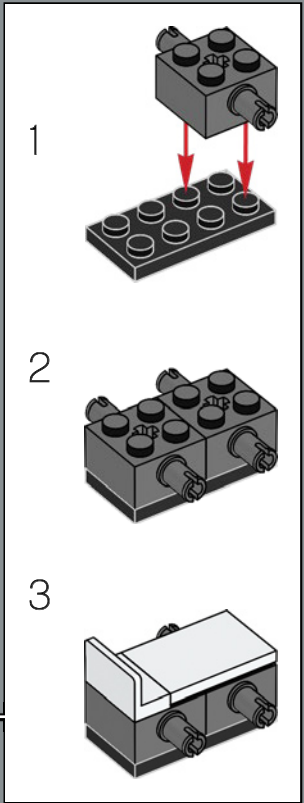
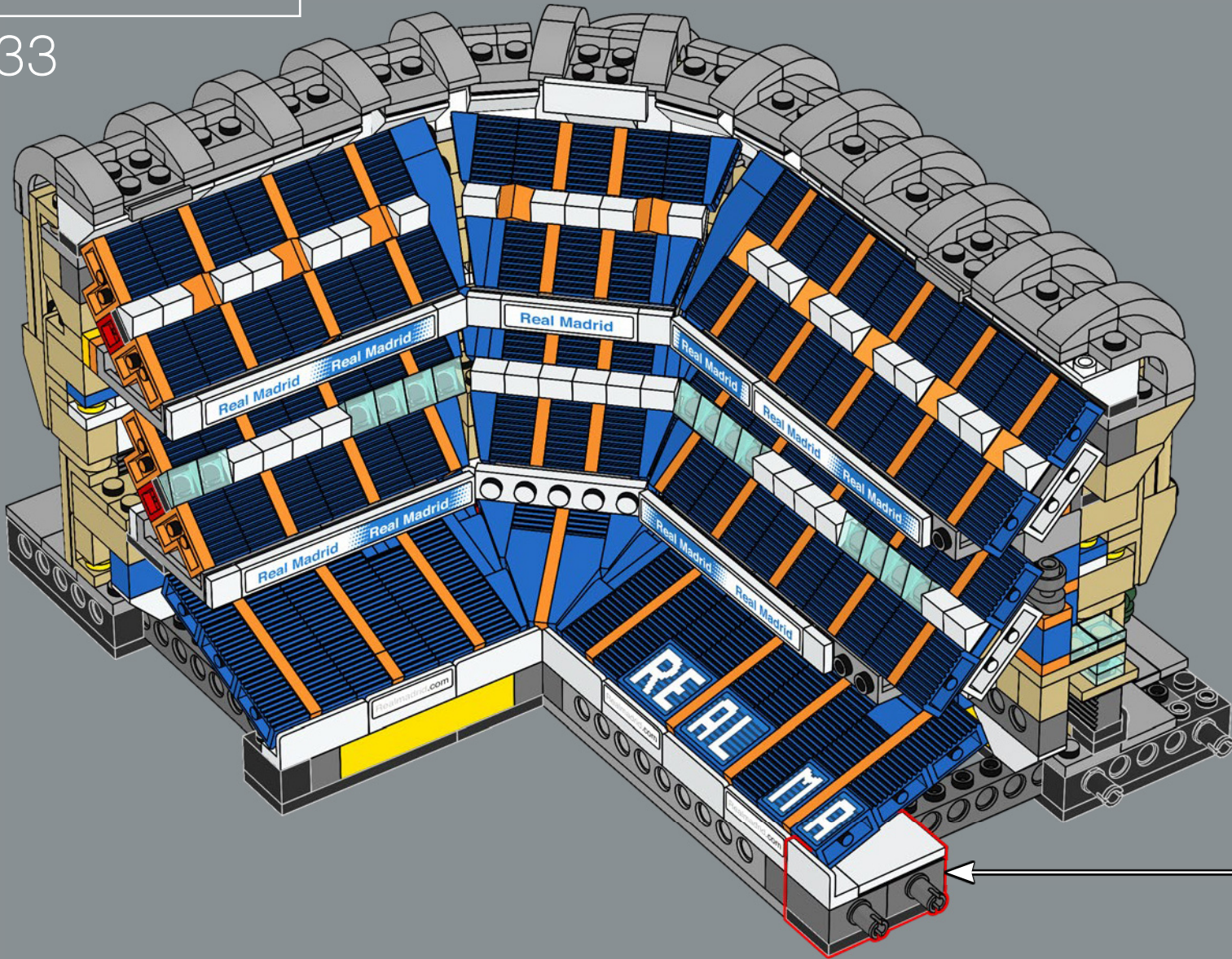

534

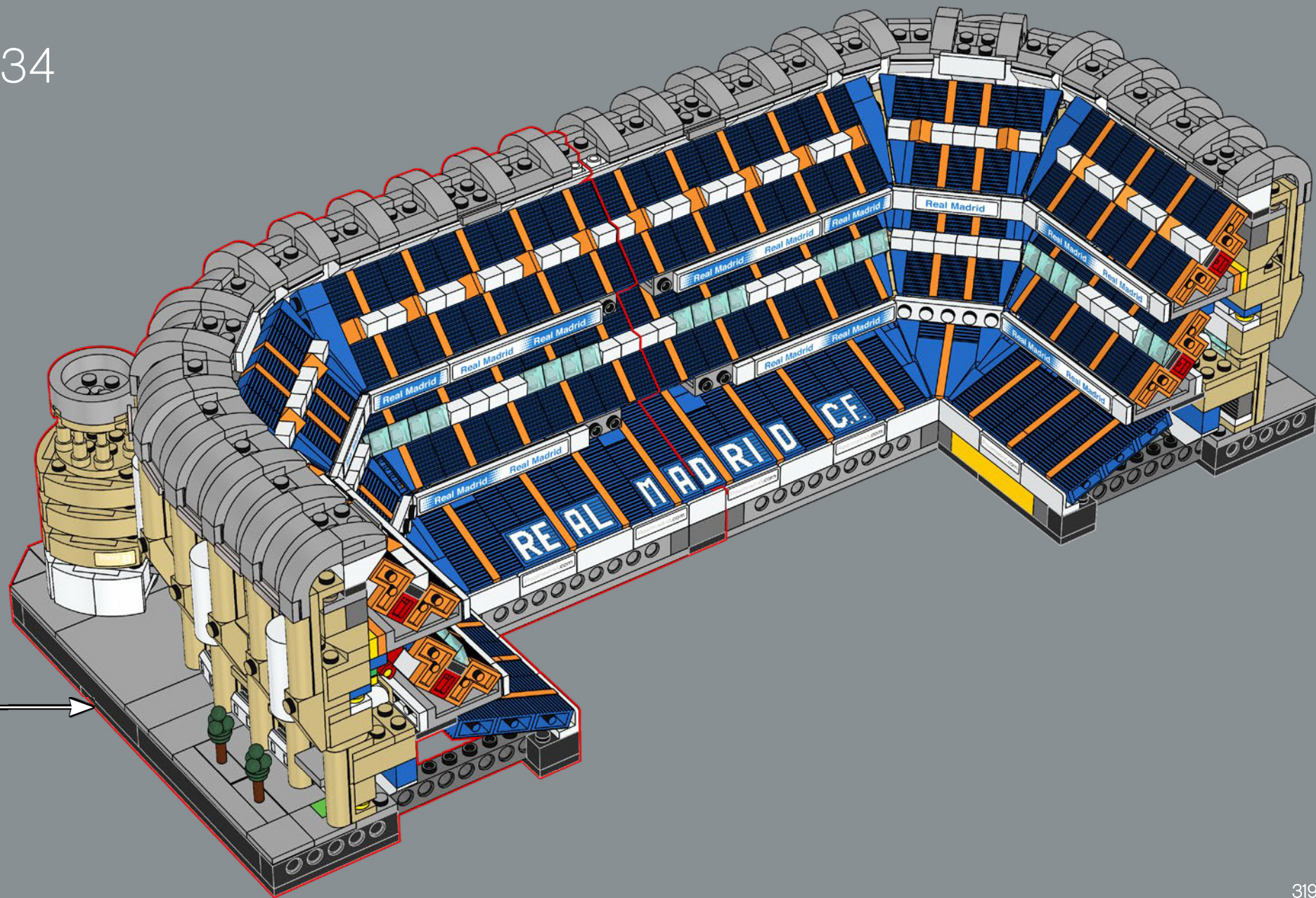

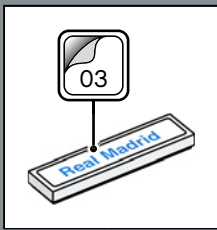
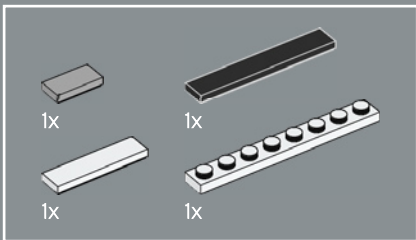

535

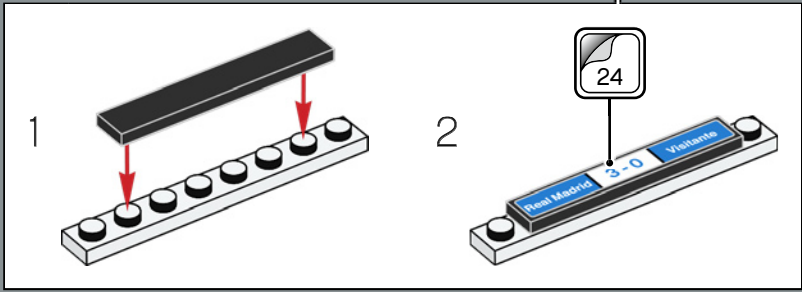
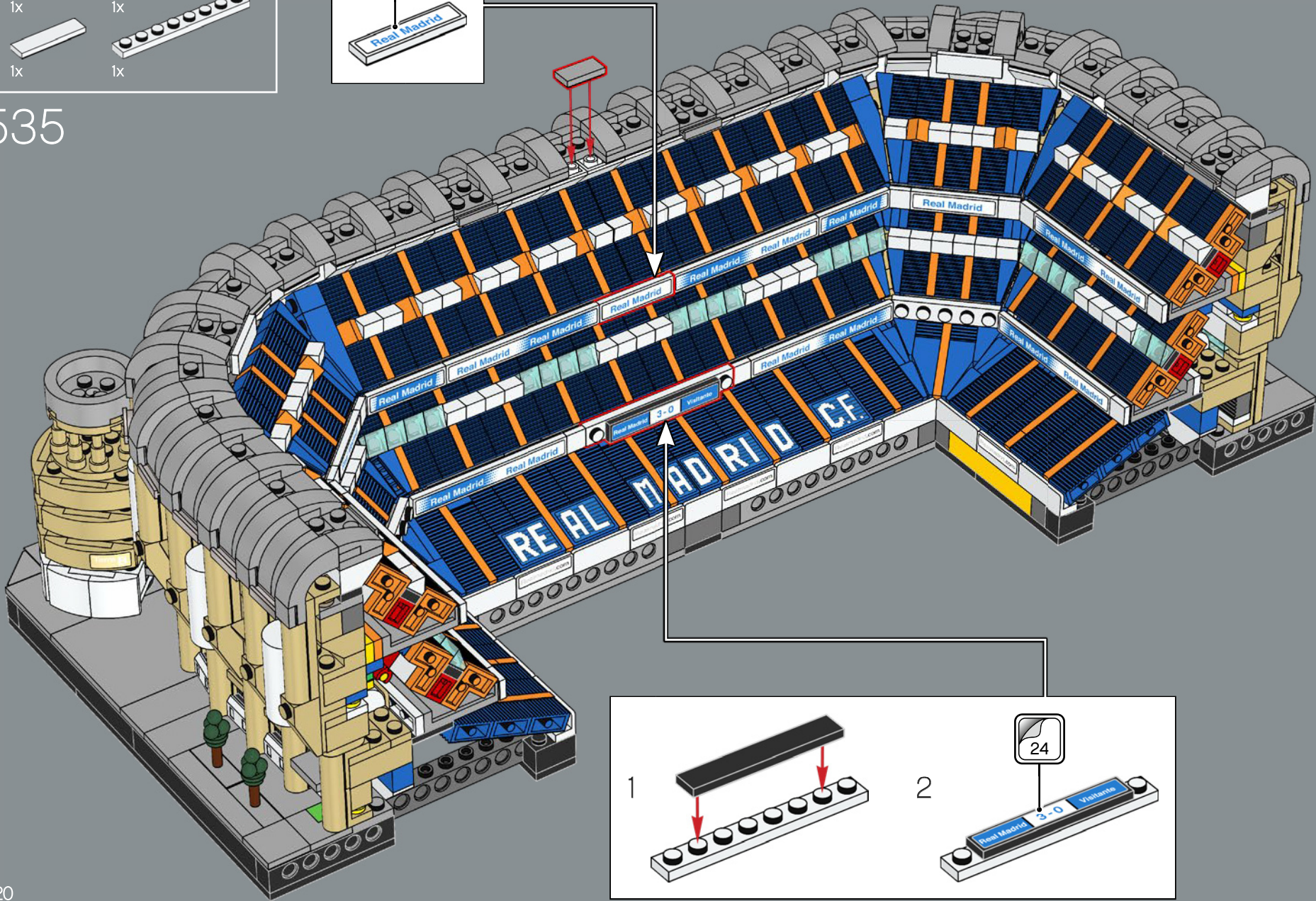

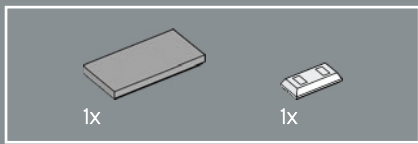

536

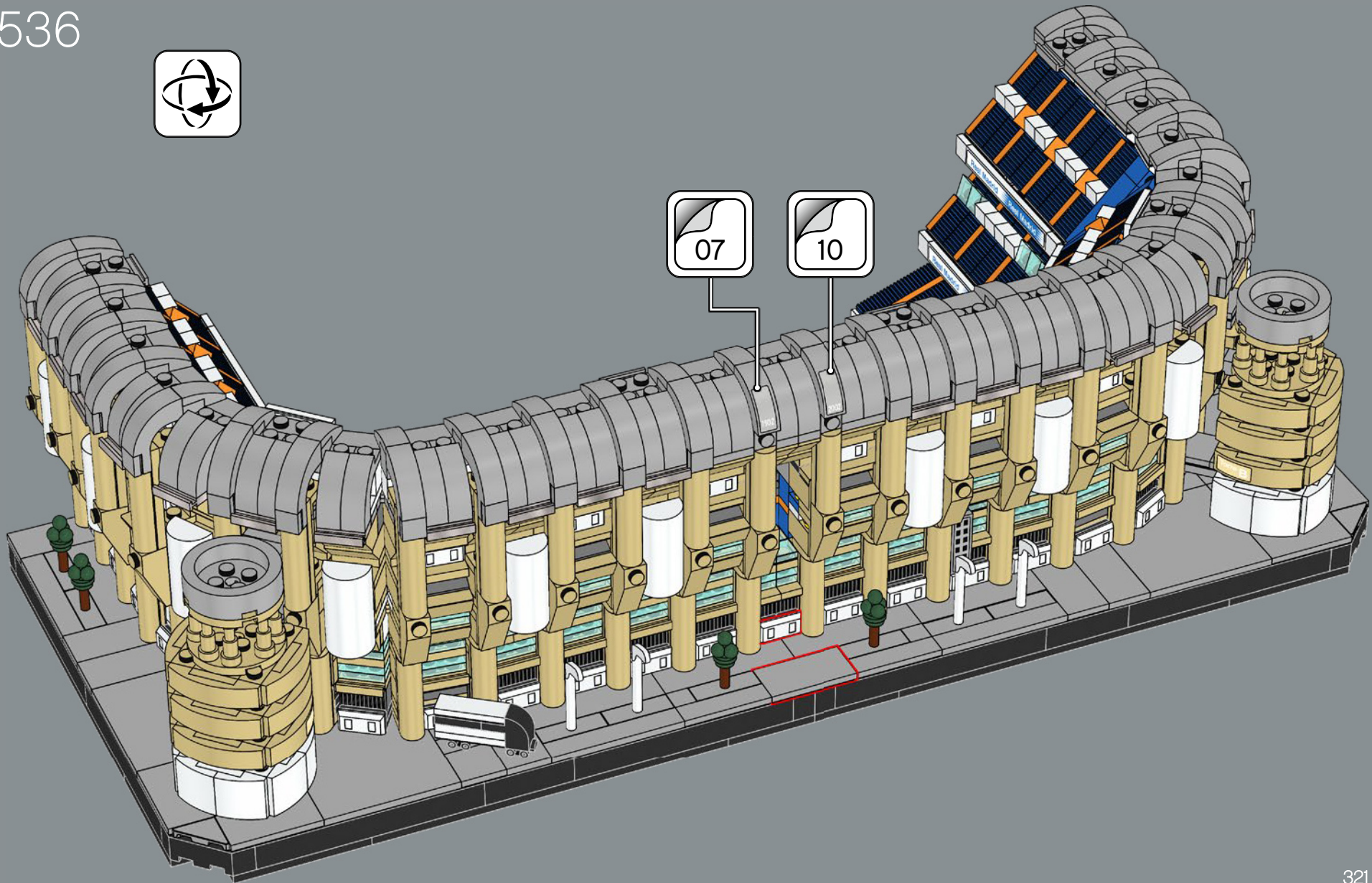

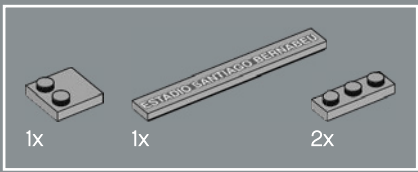

537

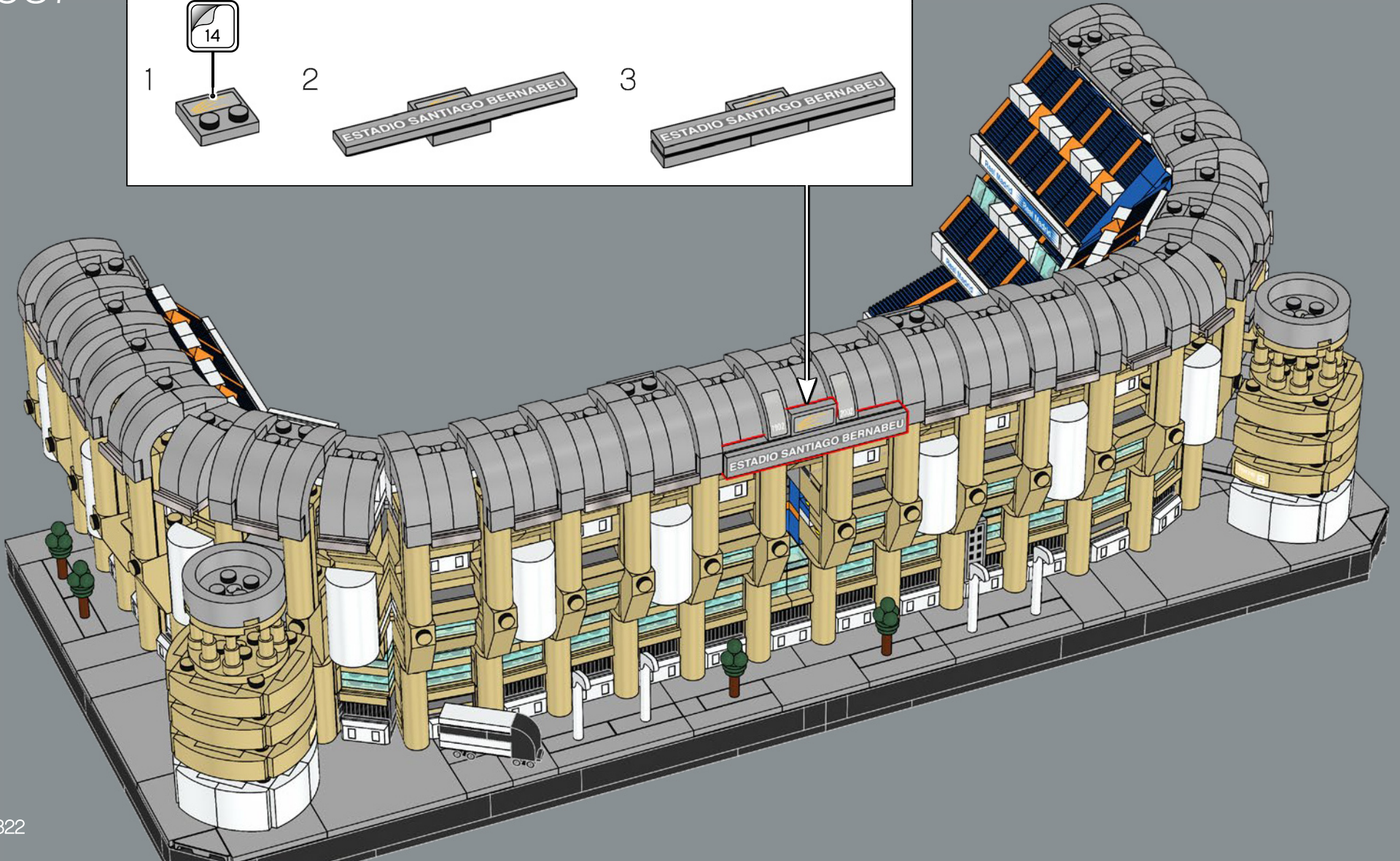

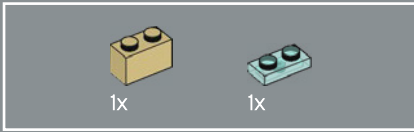
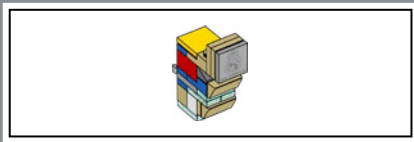

538

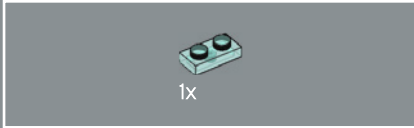
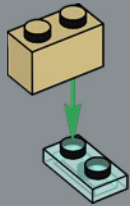

539

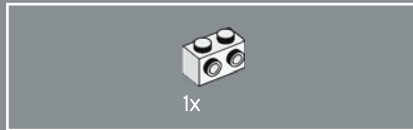
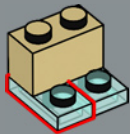

540

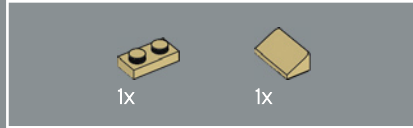
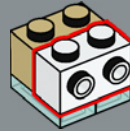

541

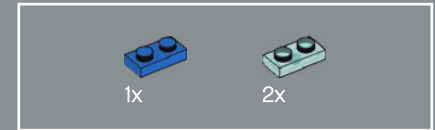
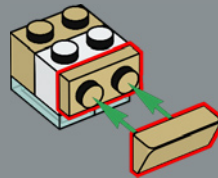

542

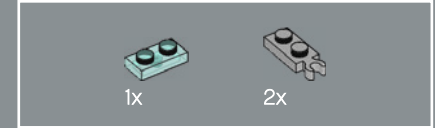

543

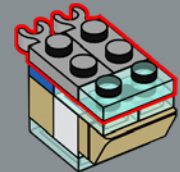

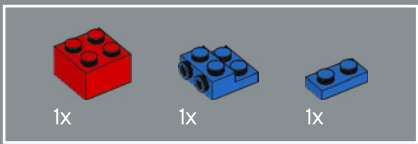

544

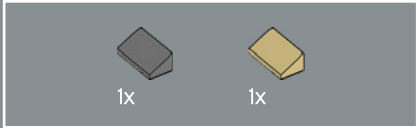
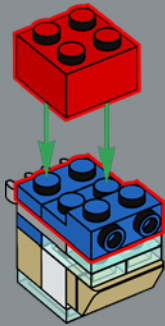

545

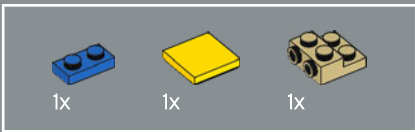
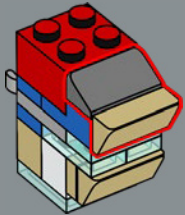

546

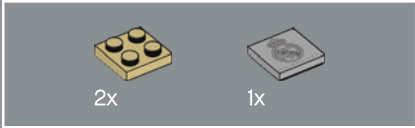
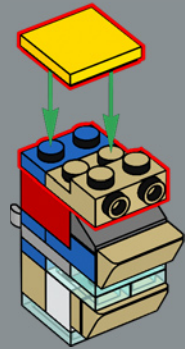

547

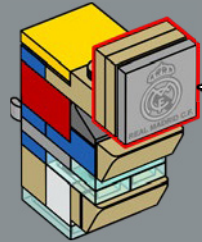
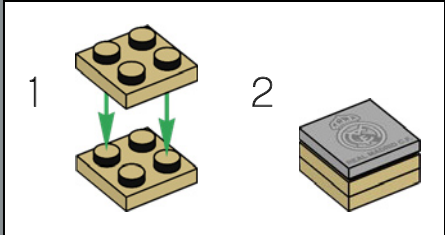

548

A crown was added to the club badge when the club became Real Madrid in 1920.

Une couronne a été ajoutée à l'insigne du club lorsqu'il a été rebaptisé Real Madrid en 1920.

Se añadió una corona a su insignia en 1920, cuando el club se convirtió en Real Madrid.

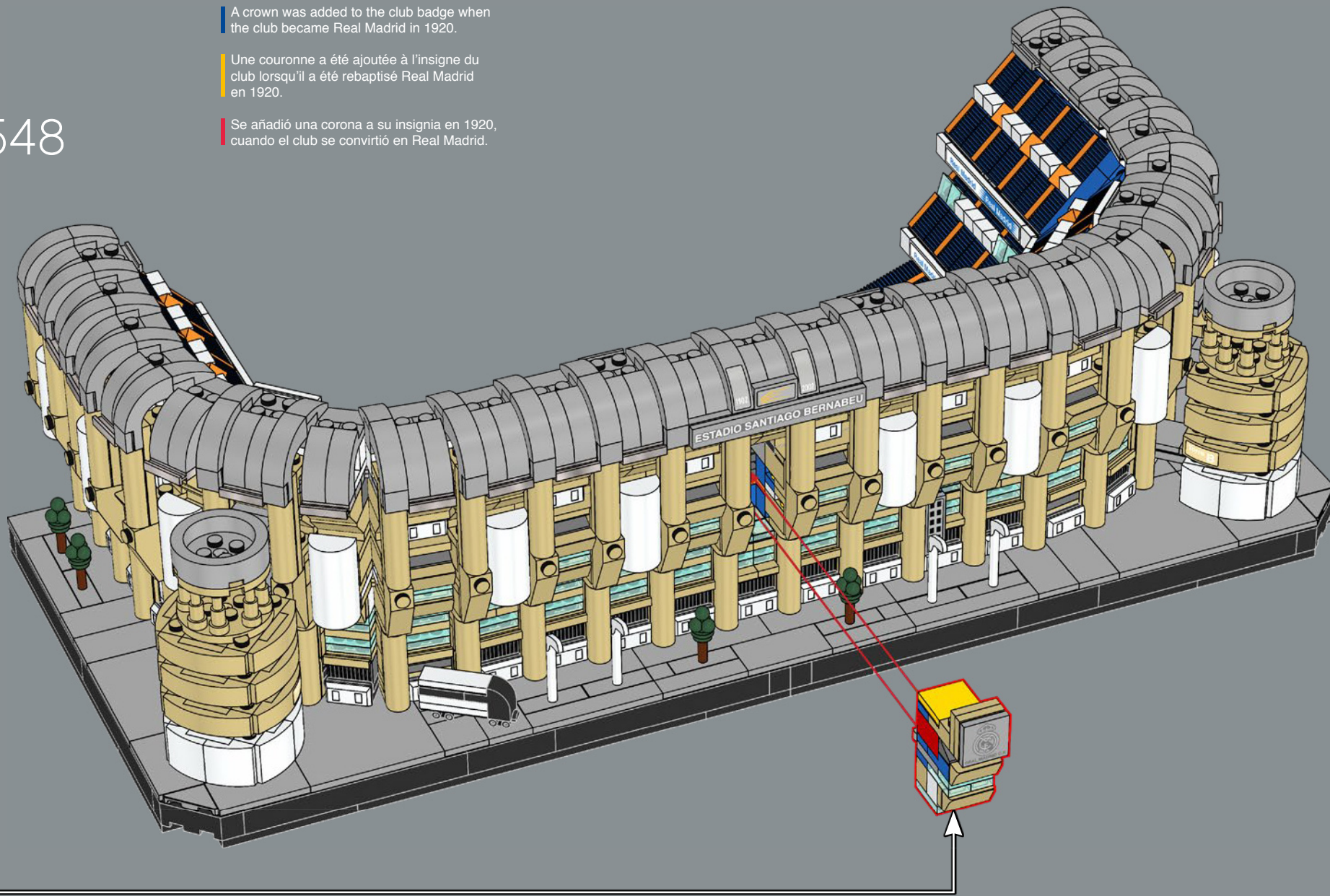

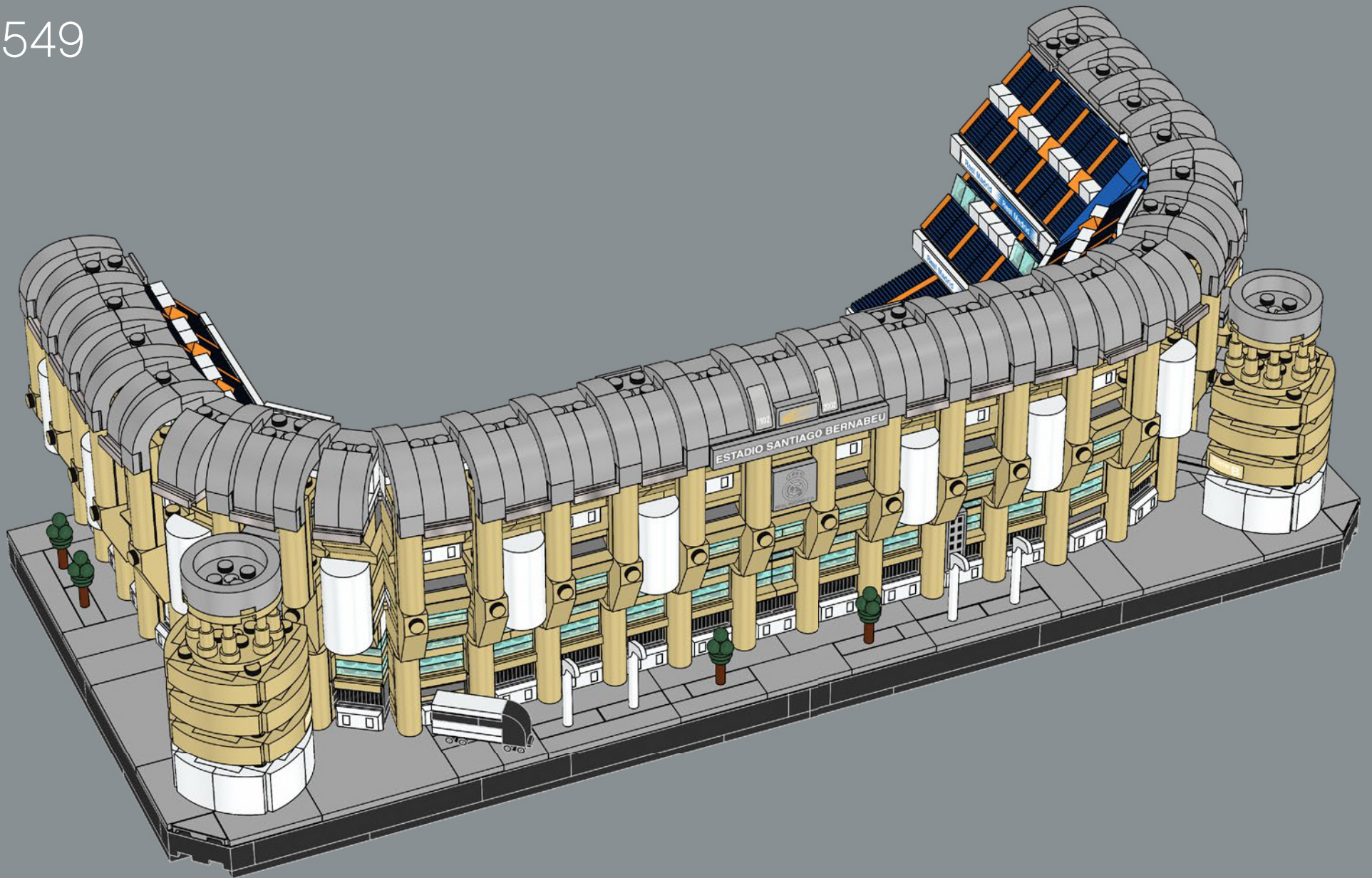

550

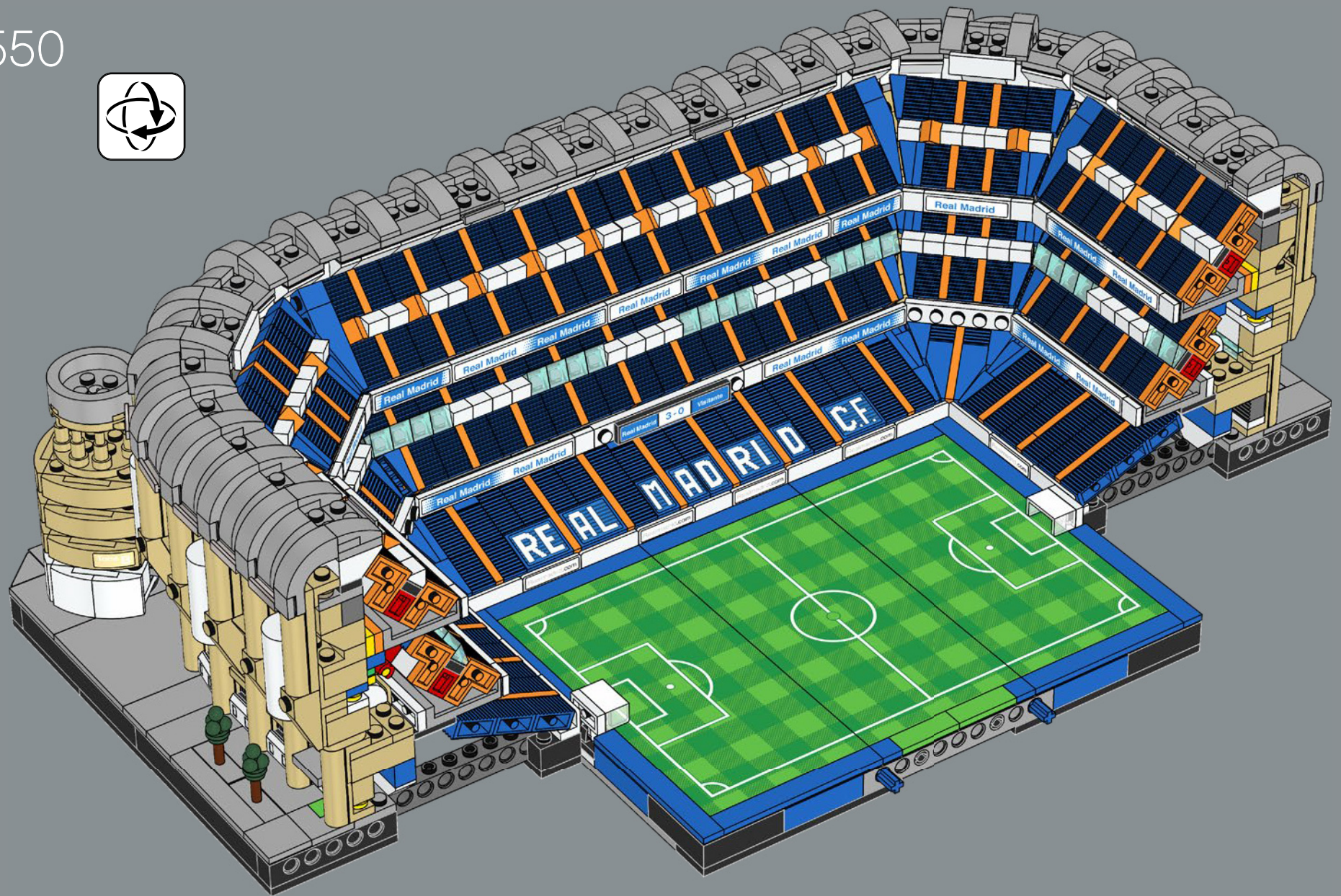

Real Madrid
Le stade
Santiago
Bernabéu

Real Madrid
Estadio
Santiago
Bernabéu

