





# 欢迎光临

2007 年, 我们的设计师们开始着手一种适合晚上和周末拼搭和玩乐的项目, 而现在, 这种项目已经演变成充满活力的市中心, 满是精美的建筑、丰富多样的内饰、许多快乐的小人仔, 以及精妙的积木运用技巧。还有什么比设计粉丝们呼声最高的模型更好的方式来庆祝模块化建筑 (Modular Building) 系列推出 15 周年呢?

欢迎来到精美且历史悠久的**精品酒店**! 这种独特的楔形结构展现了无数优雅的外观和精致的细节, 其设计灵感源自世纪之交的欧洲建筑。酒店还充满了小故事和模块化建筑系列之前模型中不易察觉的物品。看你能发现多少!





从左至右：

Michael Psiaki  
Astrid Graabæk  
Wesley Alan Talbott  
Torben Kidde Skov  
Anderson Ward Grubb  
Chris McVeigh  
Jamie Berard

模块化建筑系列已走过激动人心的 15 年！这里所有的模型和实现这一切的设计师。



Anderson Ward Grubb  
10297 精品酒店设计师



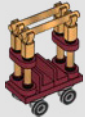
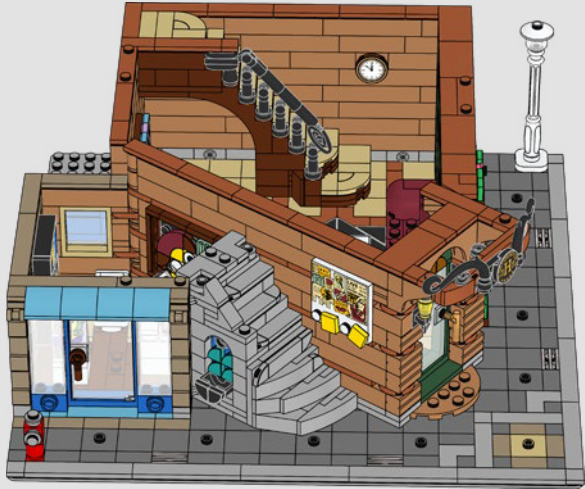
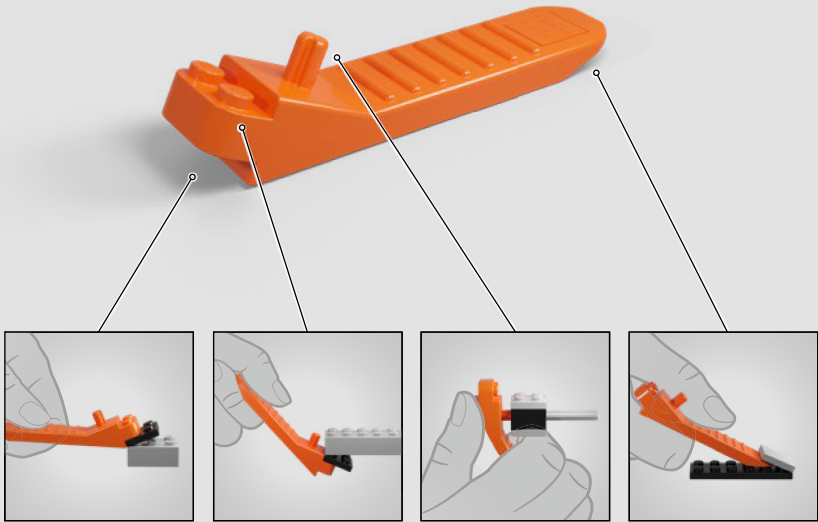
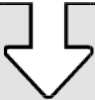
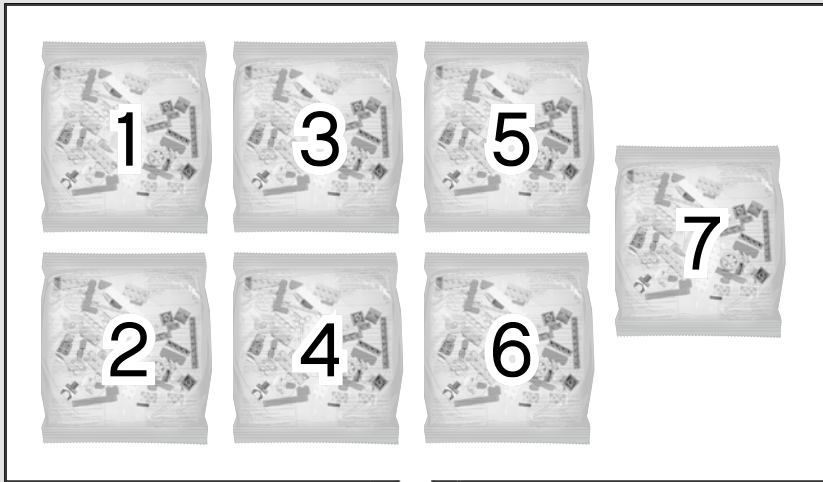

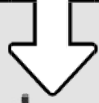
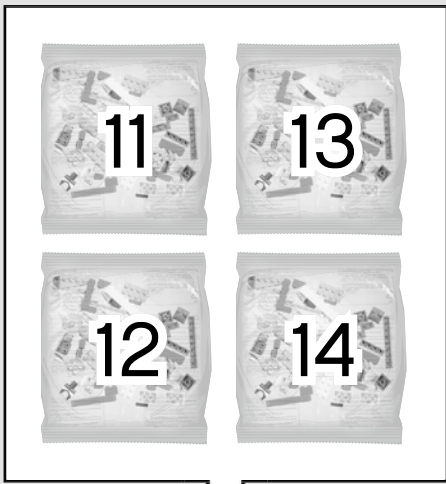
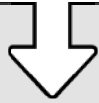

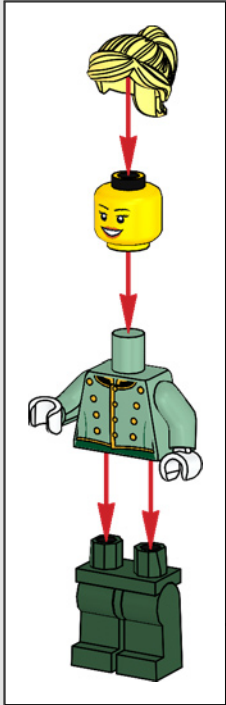
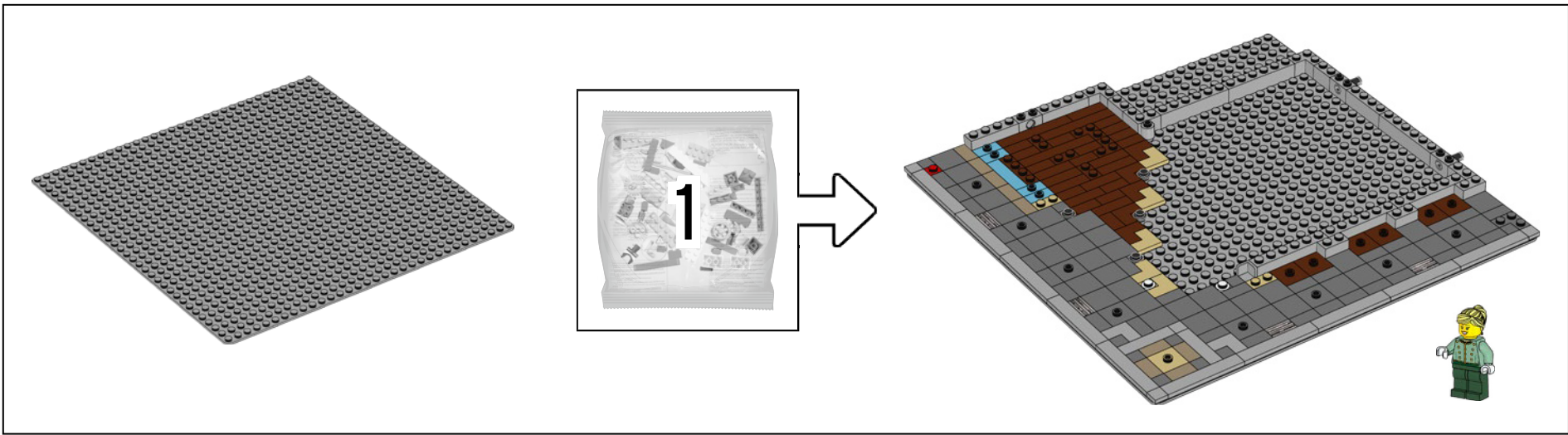

★★★★★  
想在逗留期间找些事情做吗?只需询问接待员  
在 10211 大型百货商场 (Grand Emporium) 中她  
最喜欢的商店或 Chez Albert 美食即可。

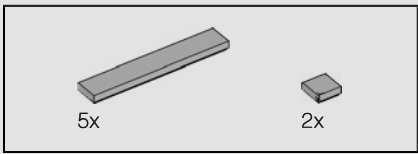

1

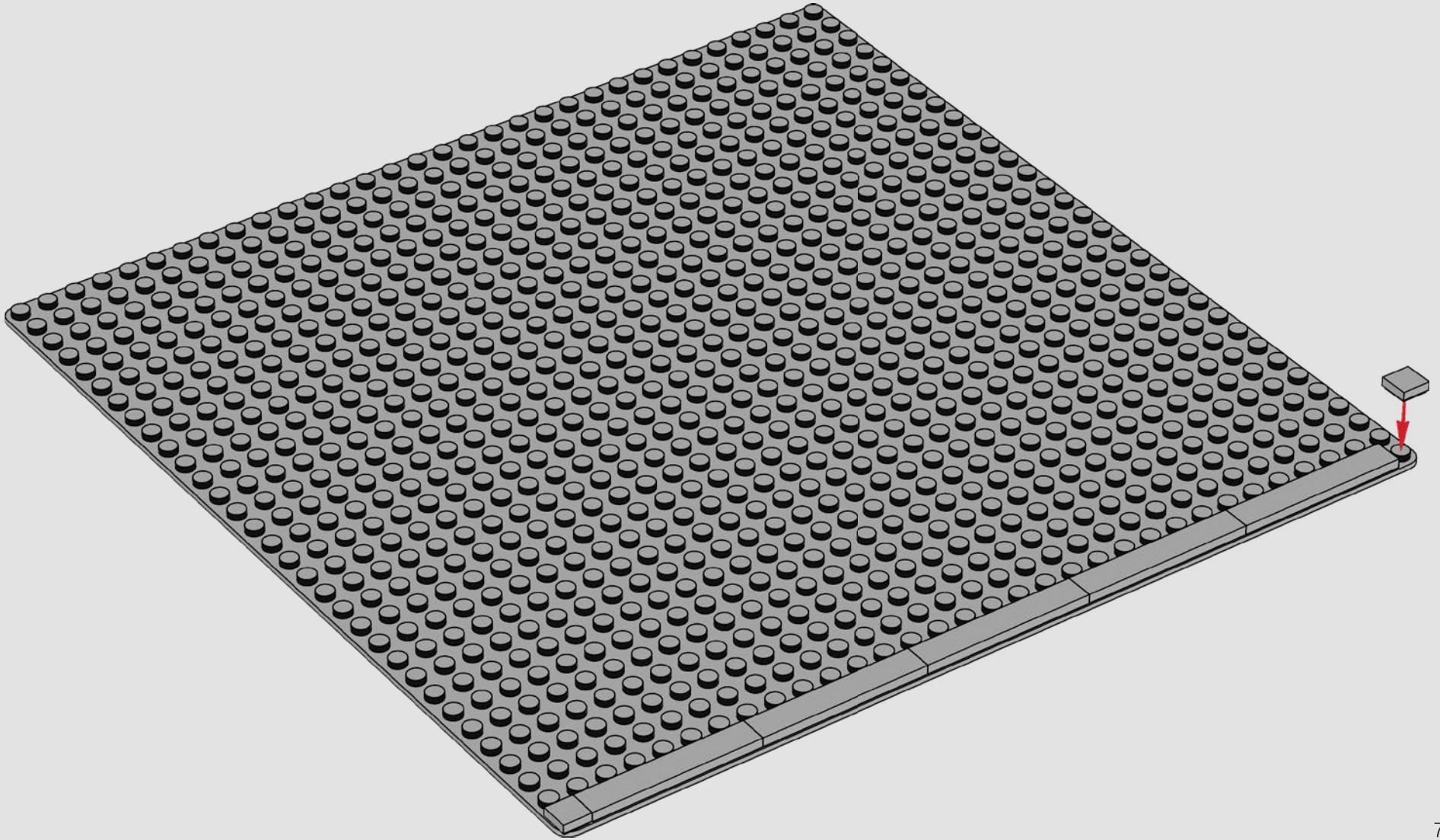

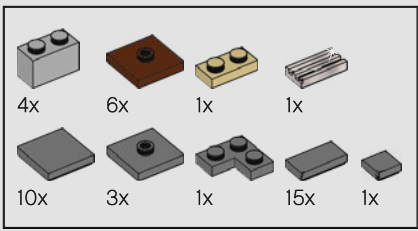

2

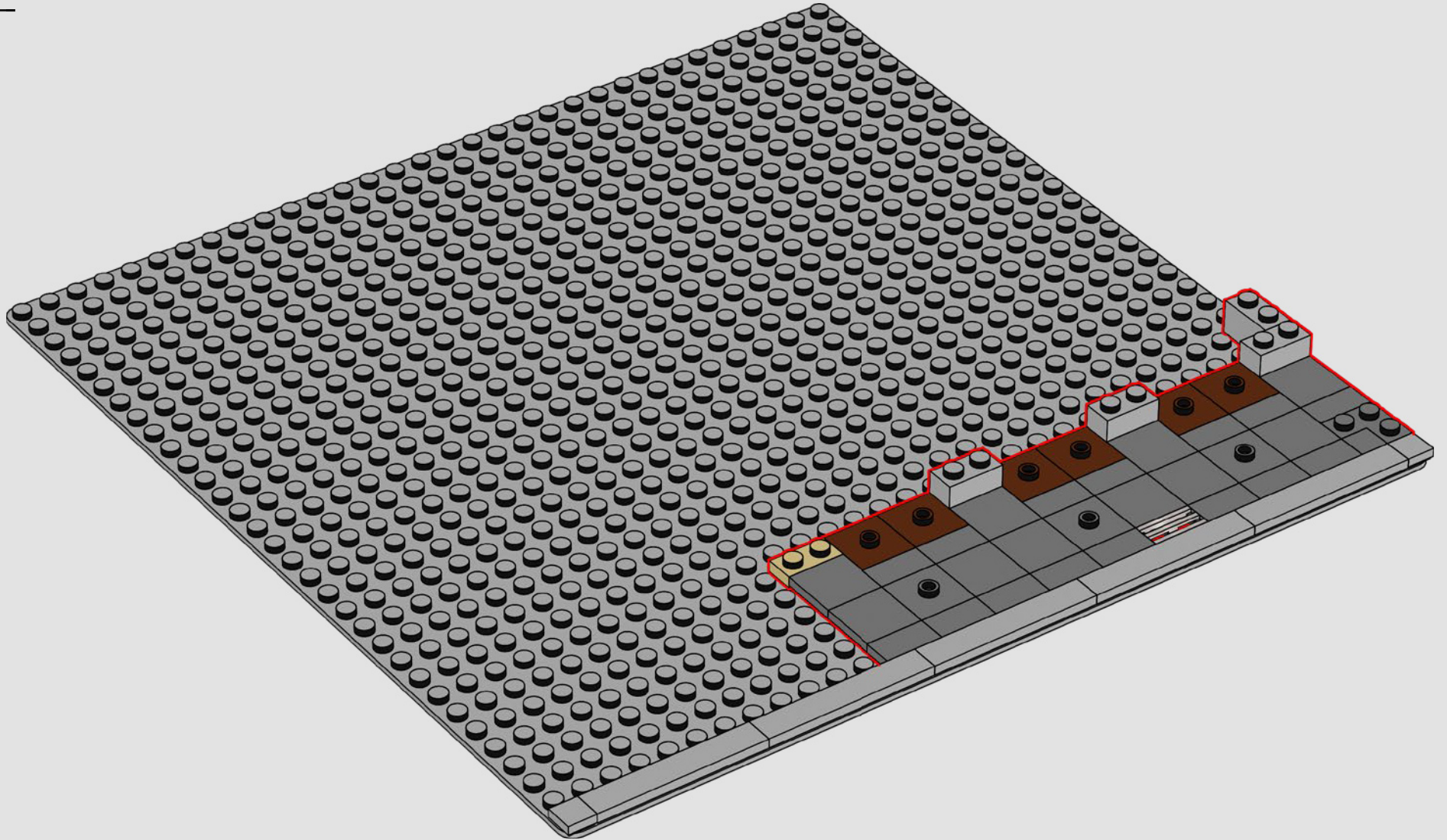



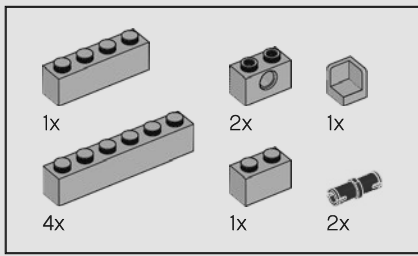

3

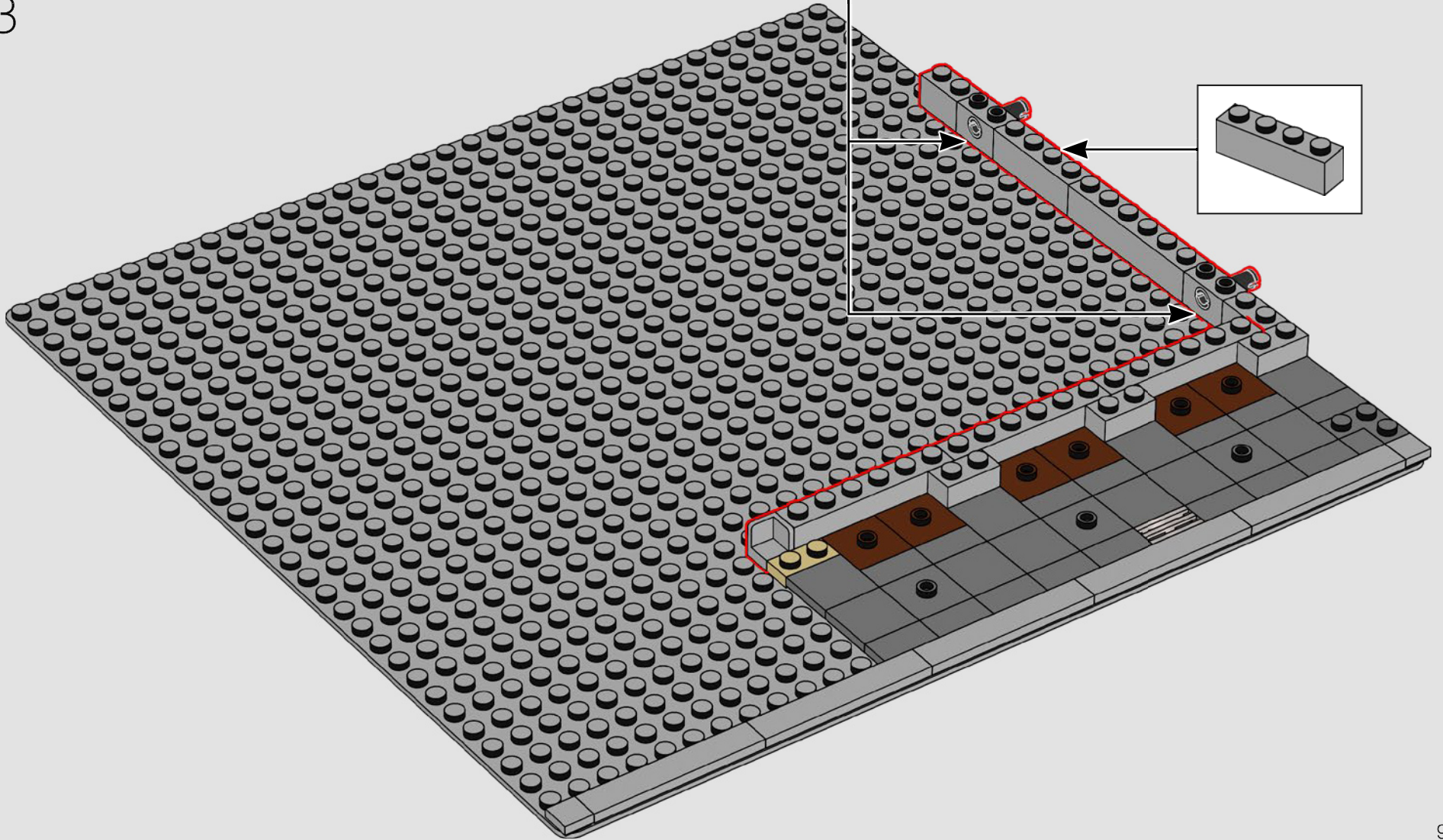
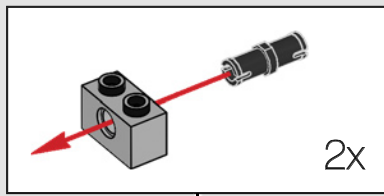

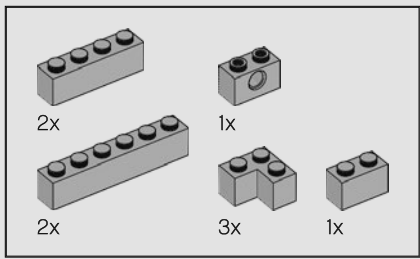

4

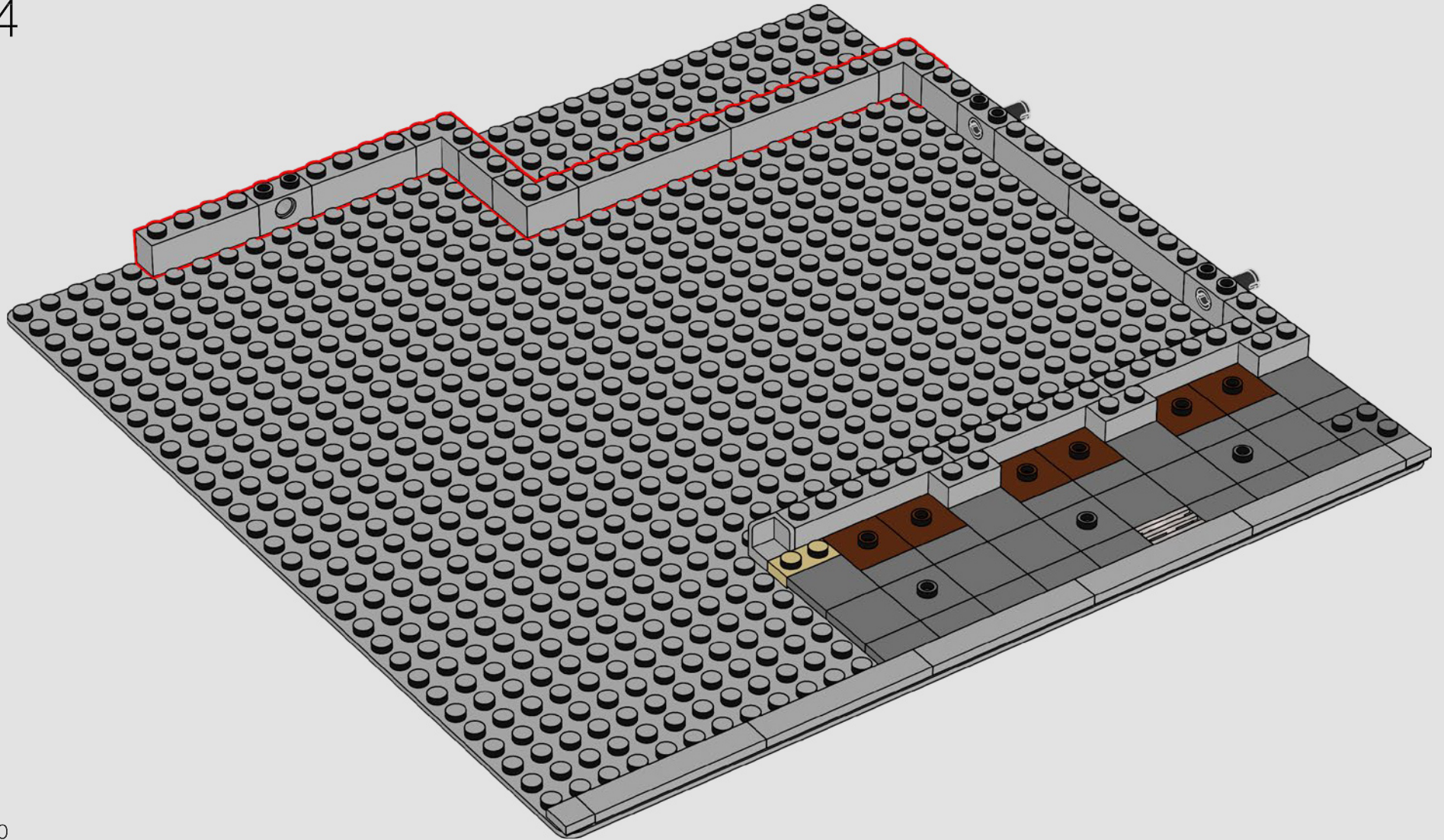

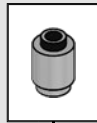
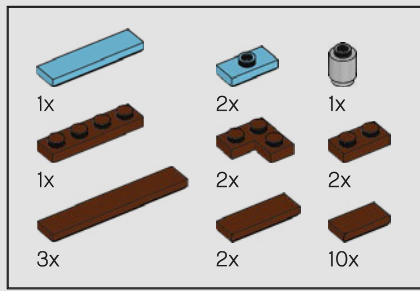

5

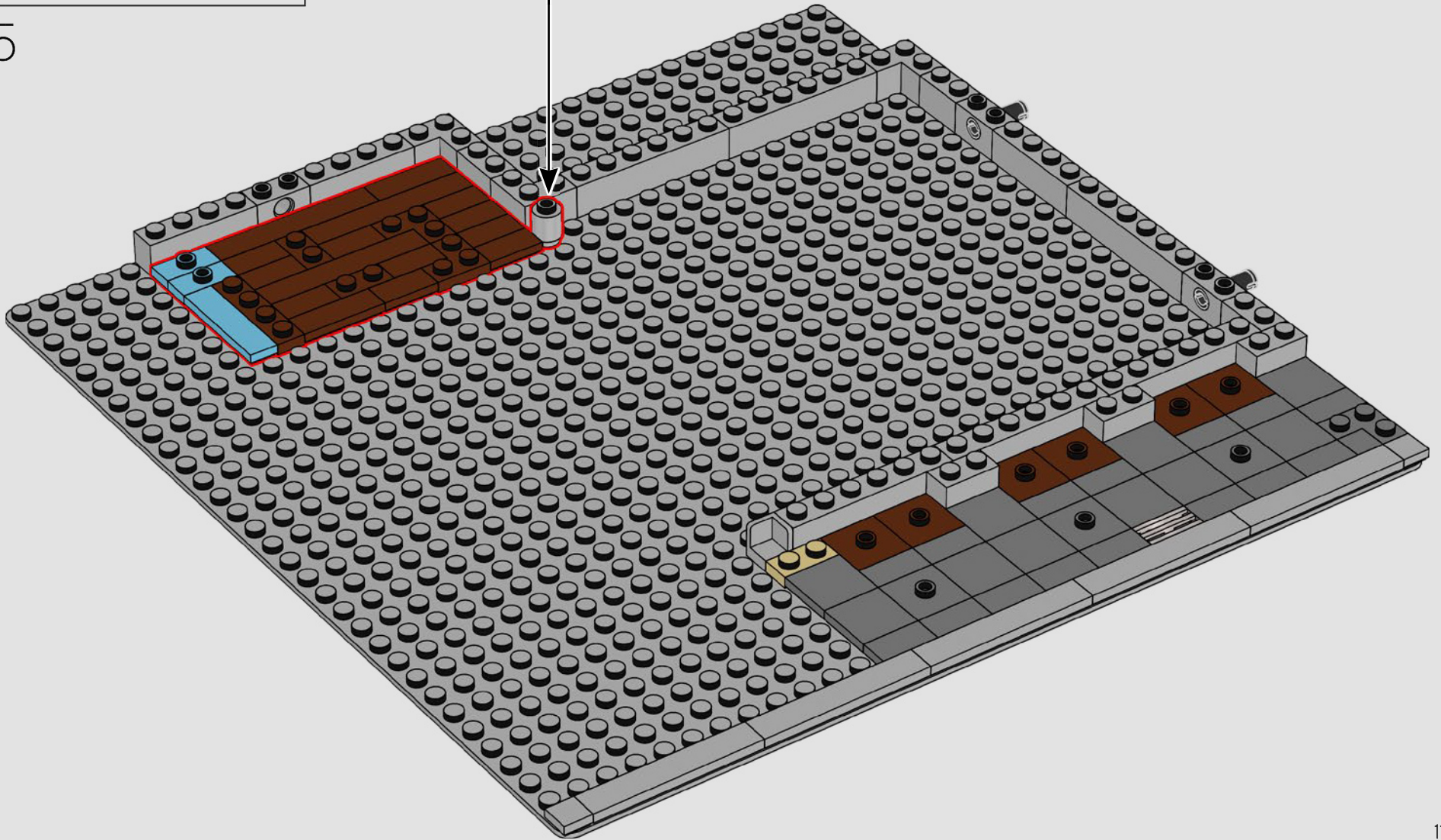

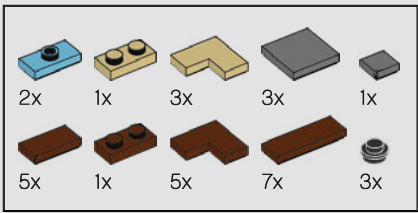

6

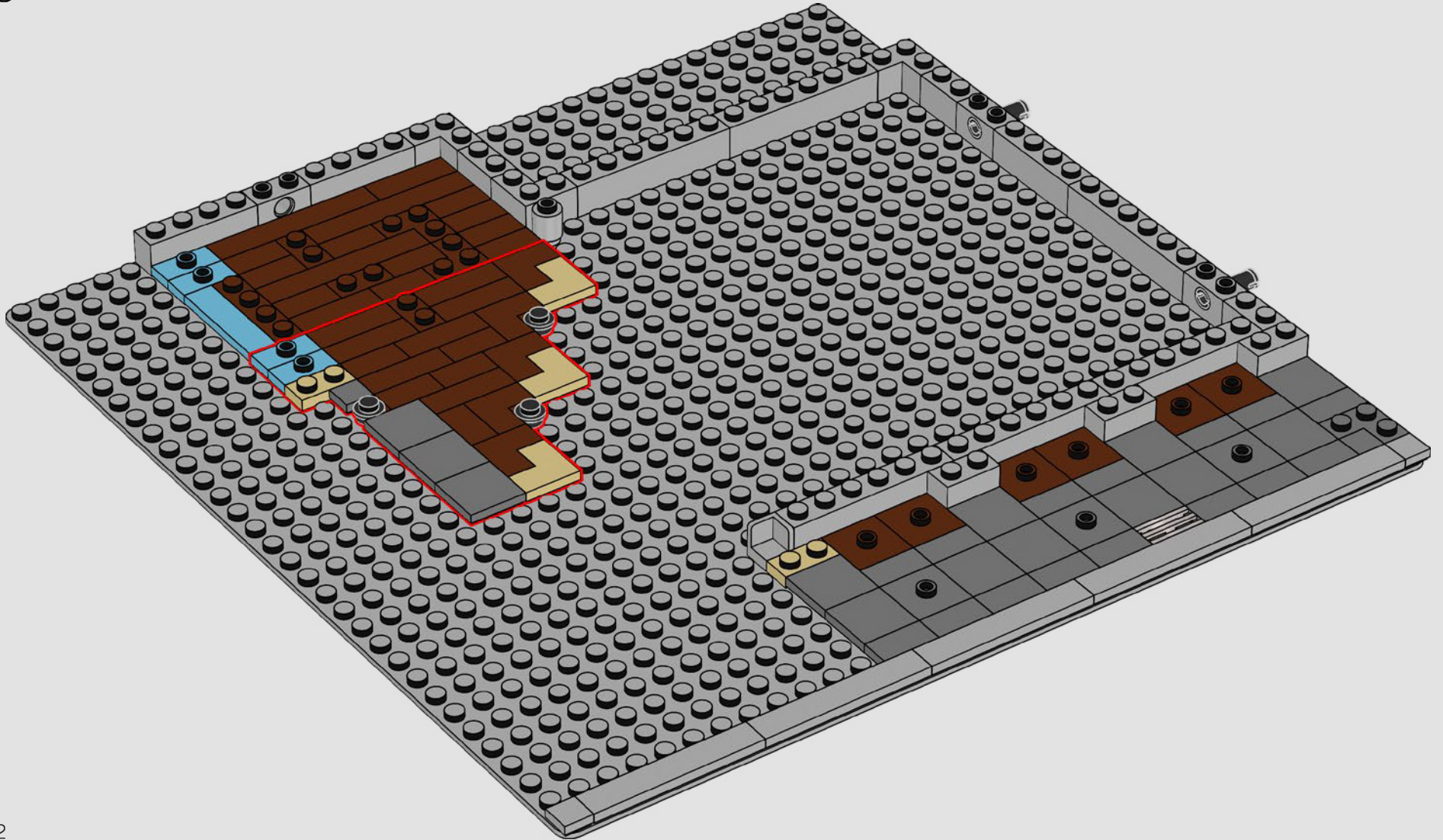

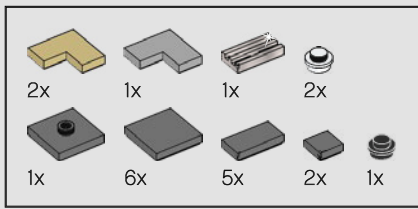

7

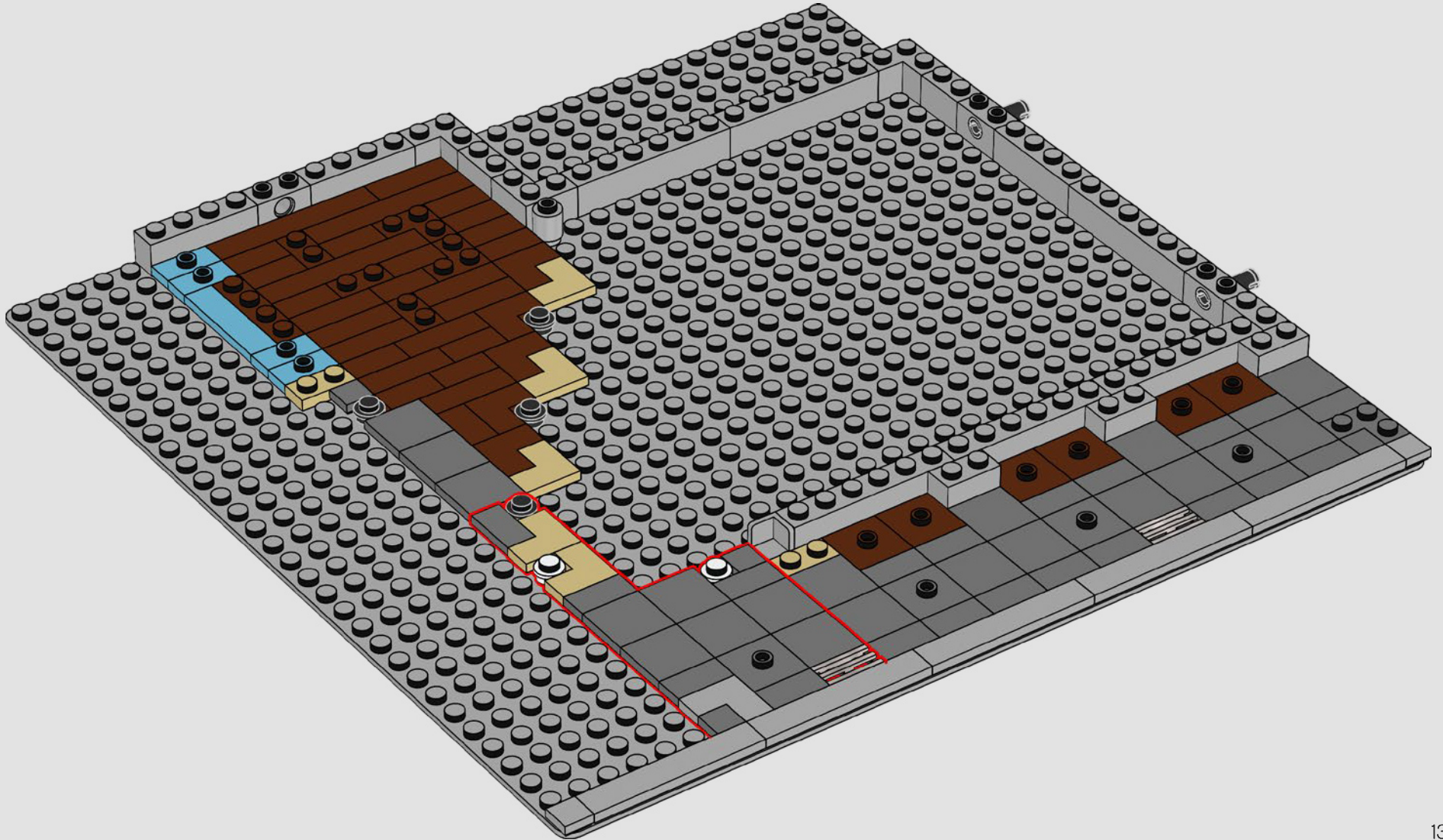

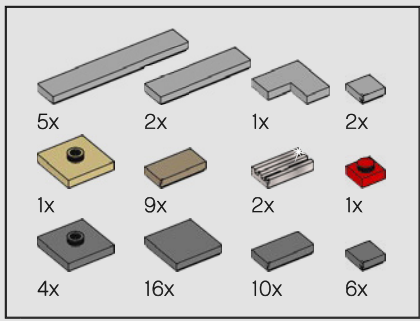

8

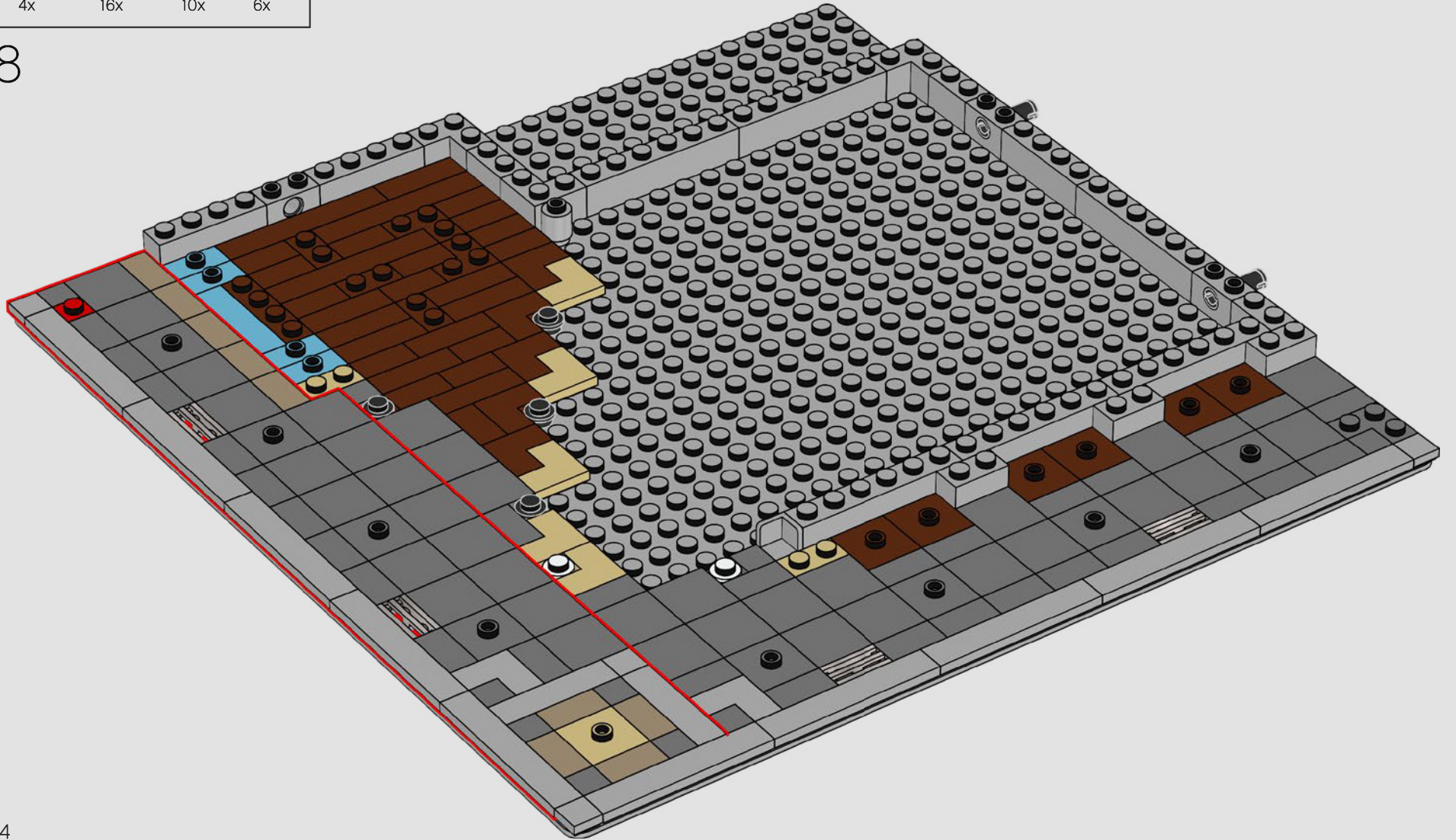

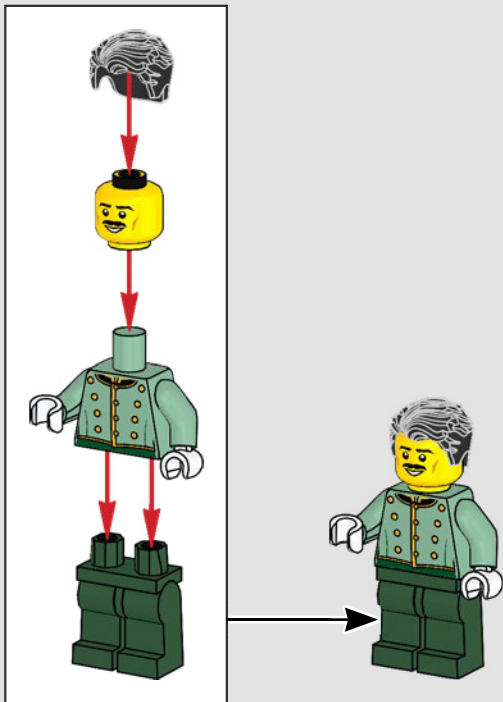
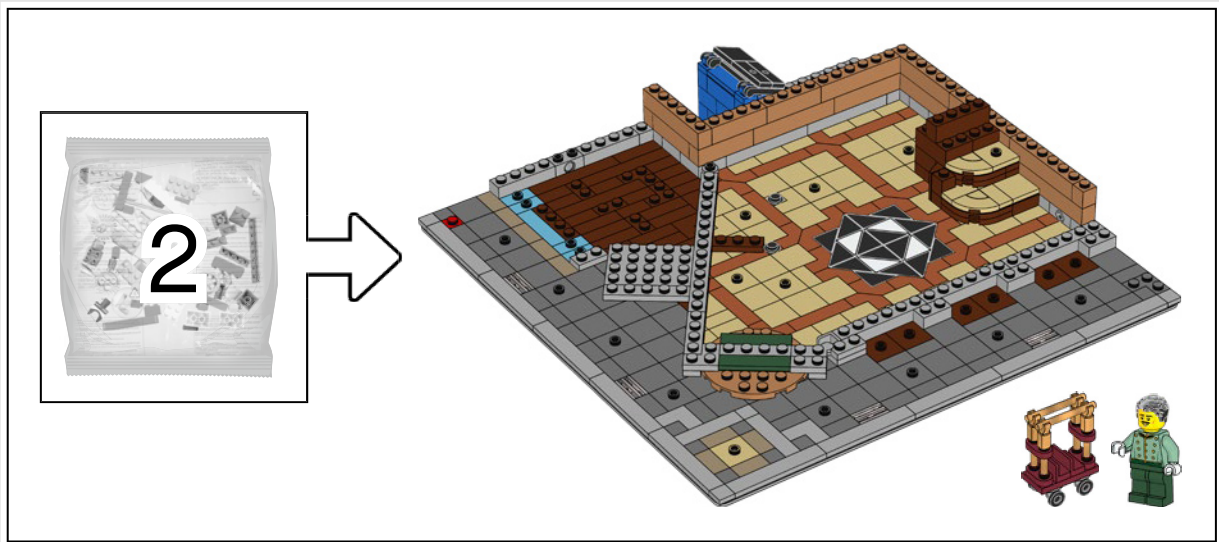

★★★★★  
行李员会很乐意帮助你把行李搬到楼上的房间。  
别忘了给他小费哟！ 15

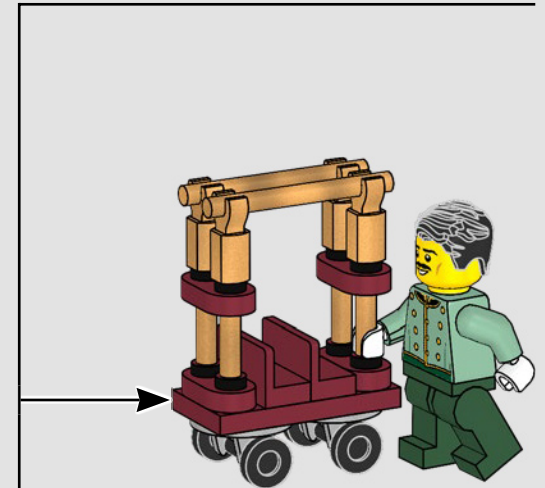
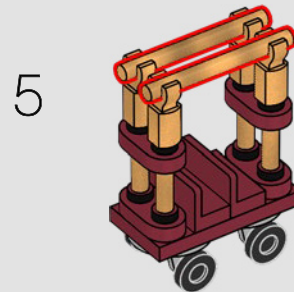
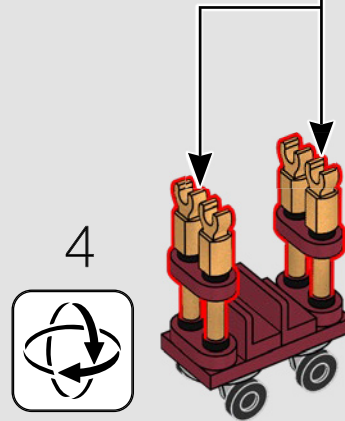
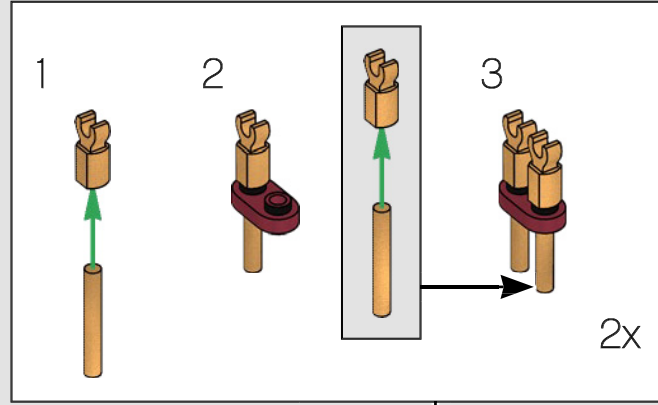
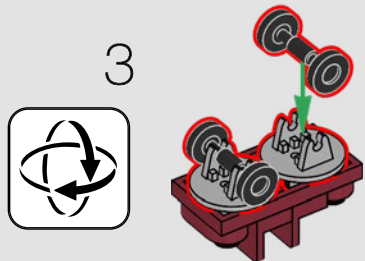
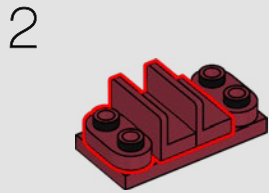
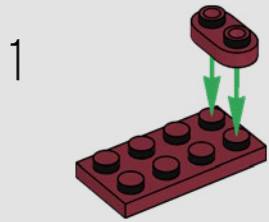
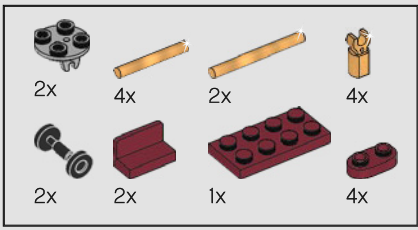



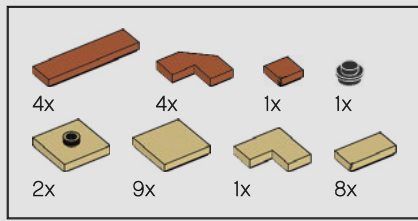

9

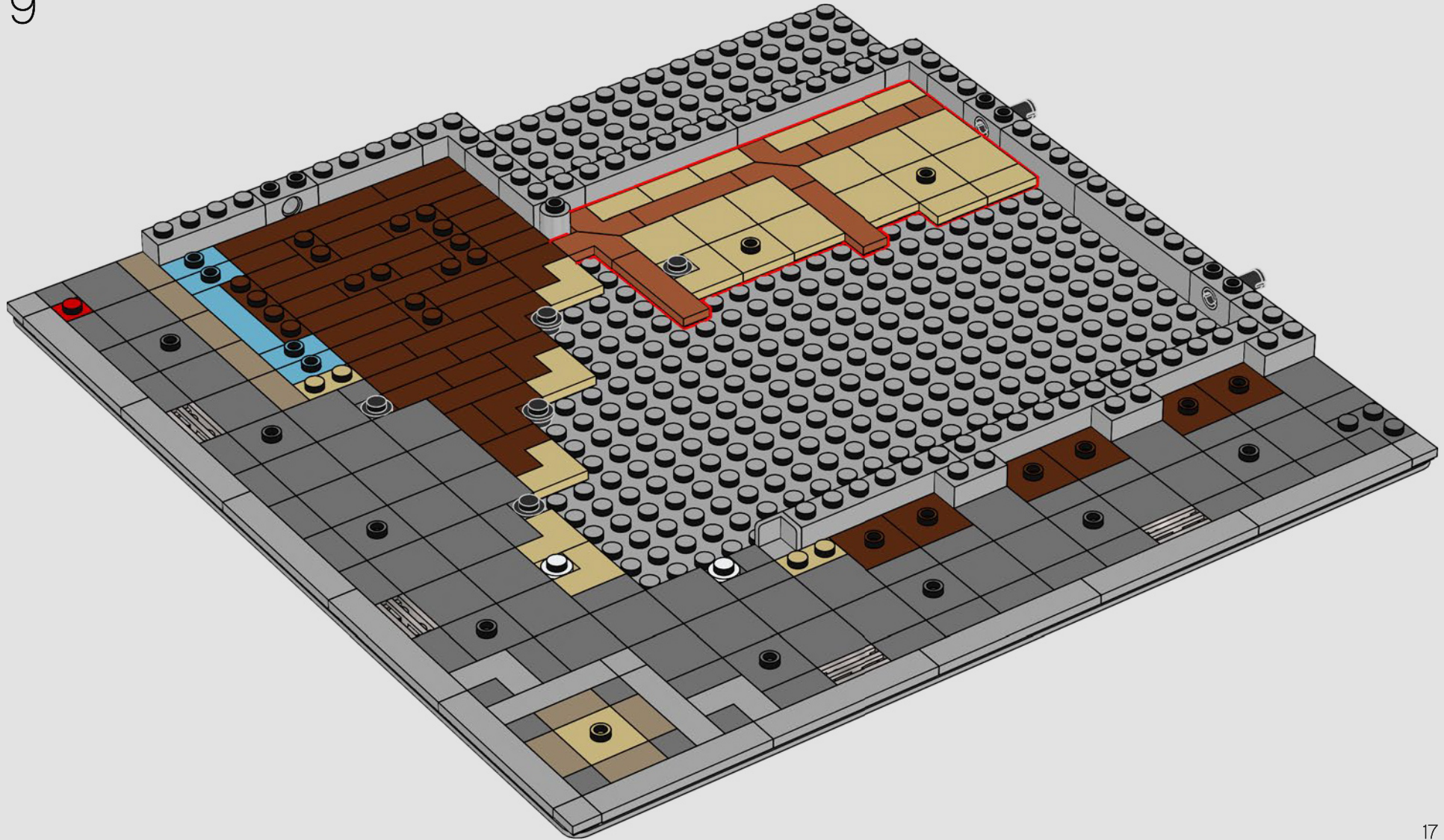

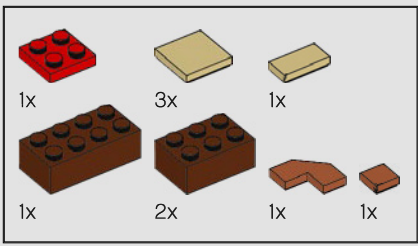

10

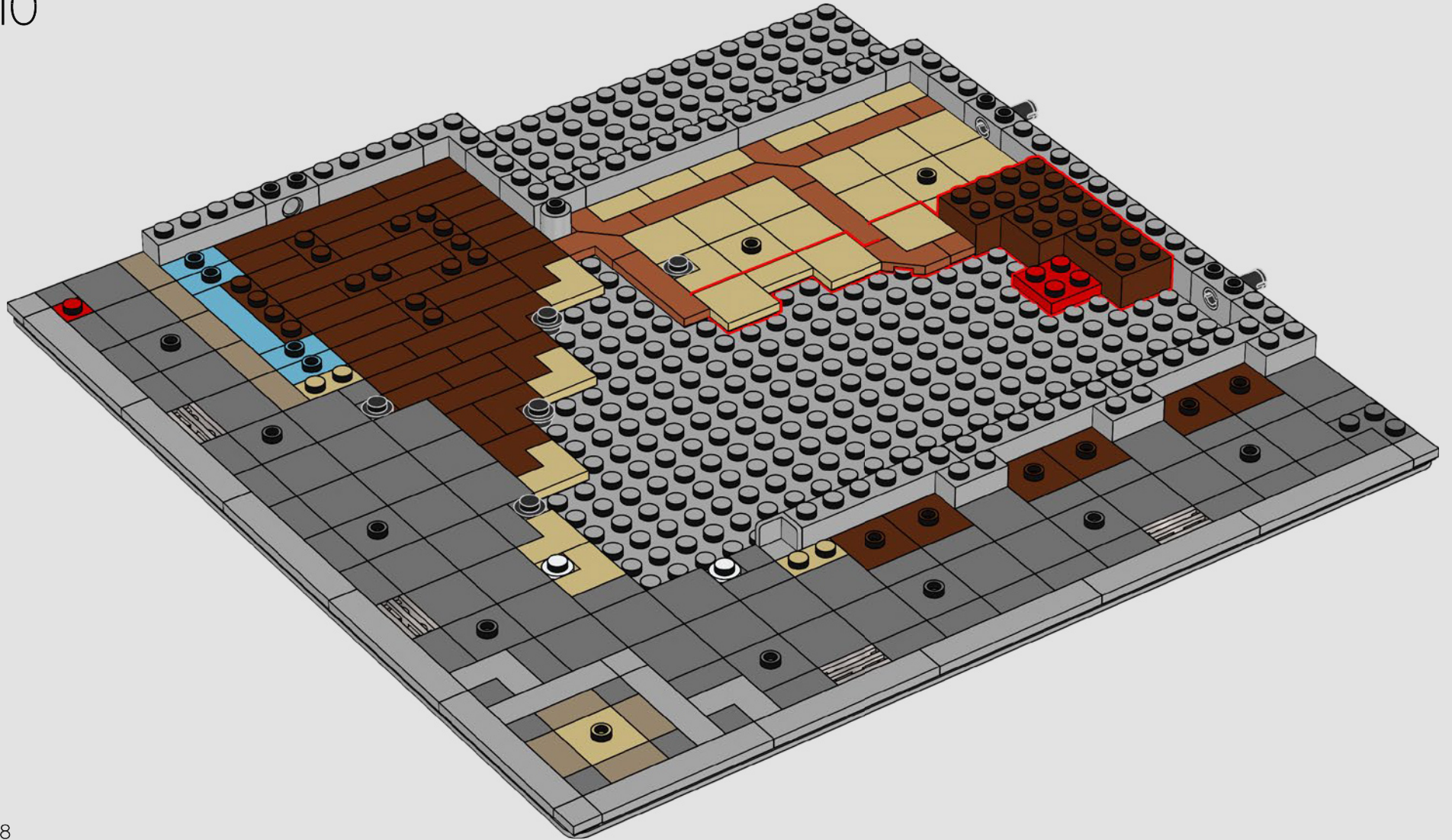

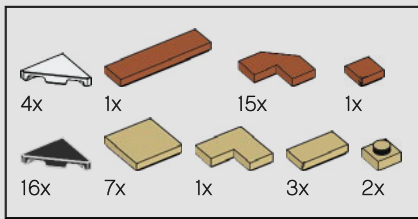

11

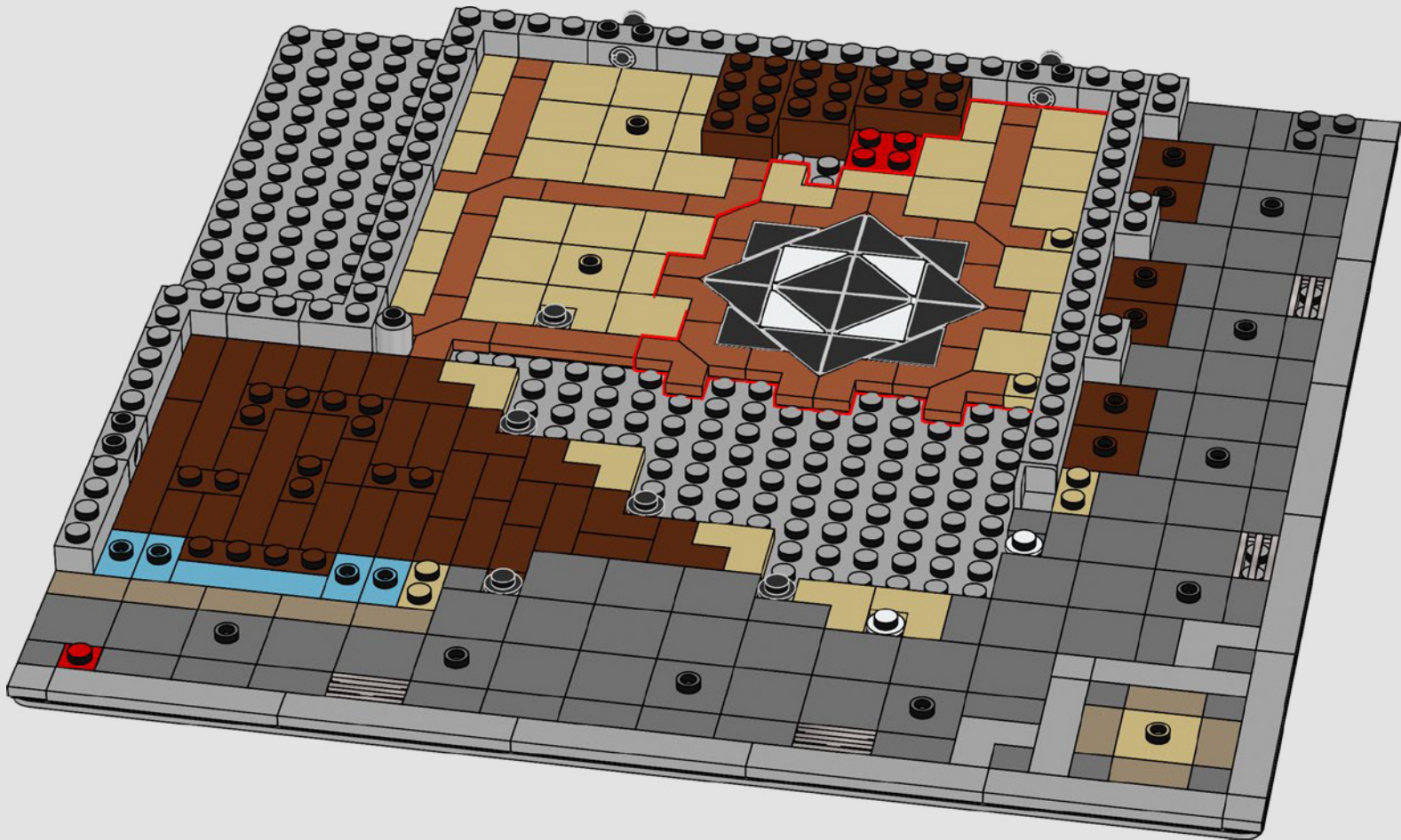

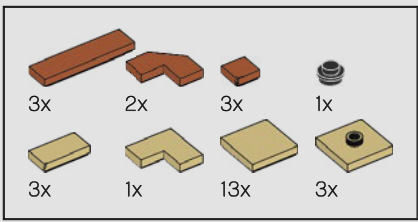

12

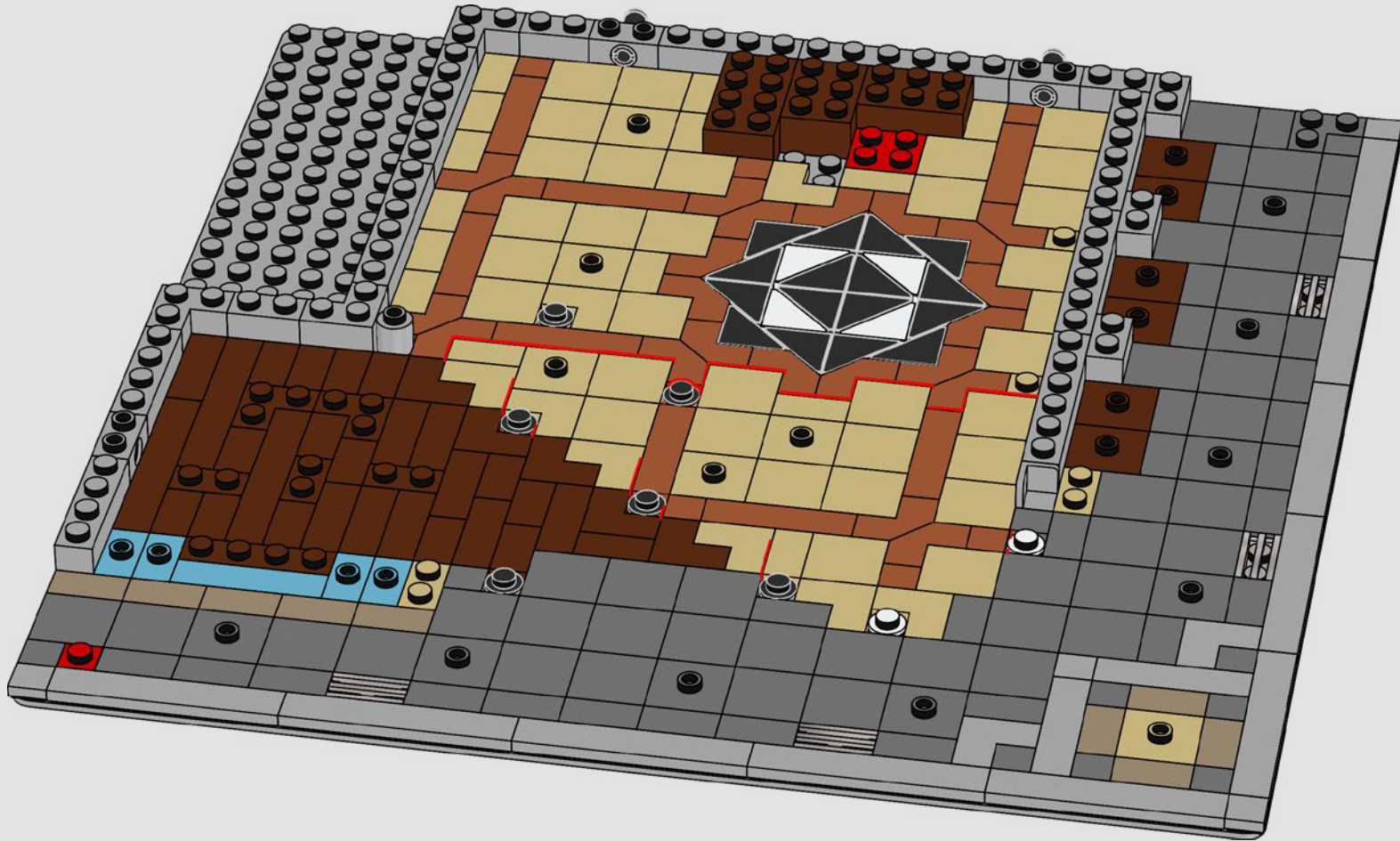

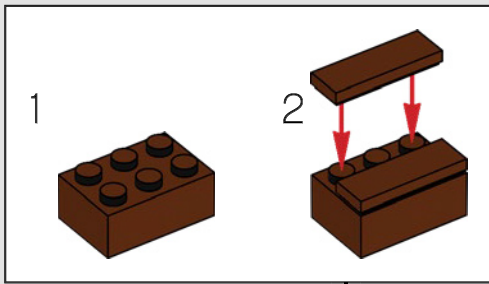
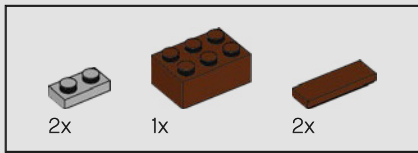

13

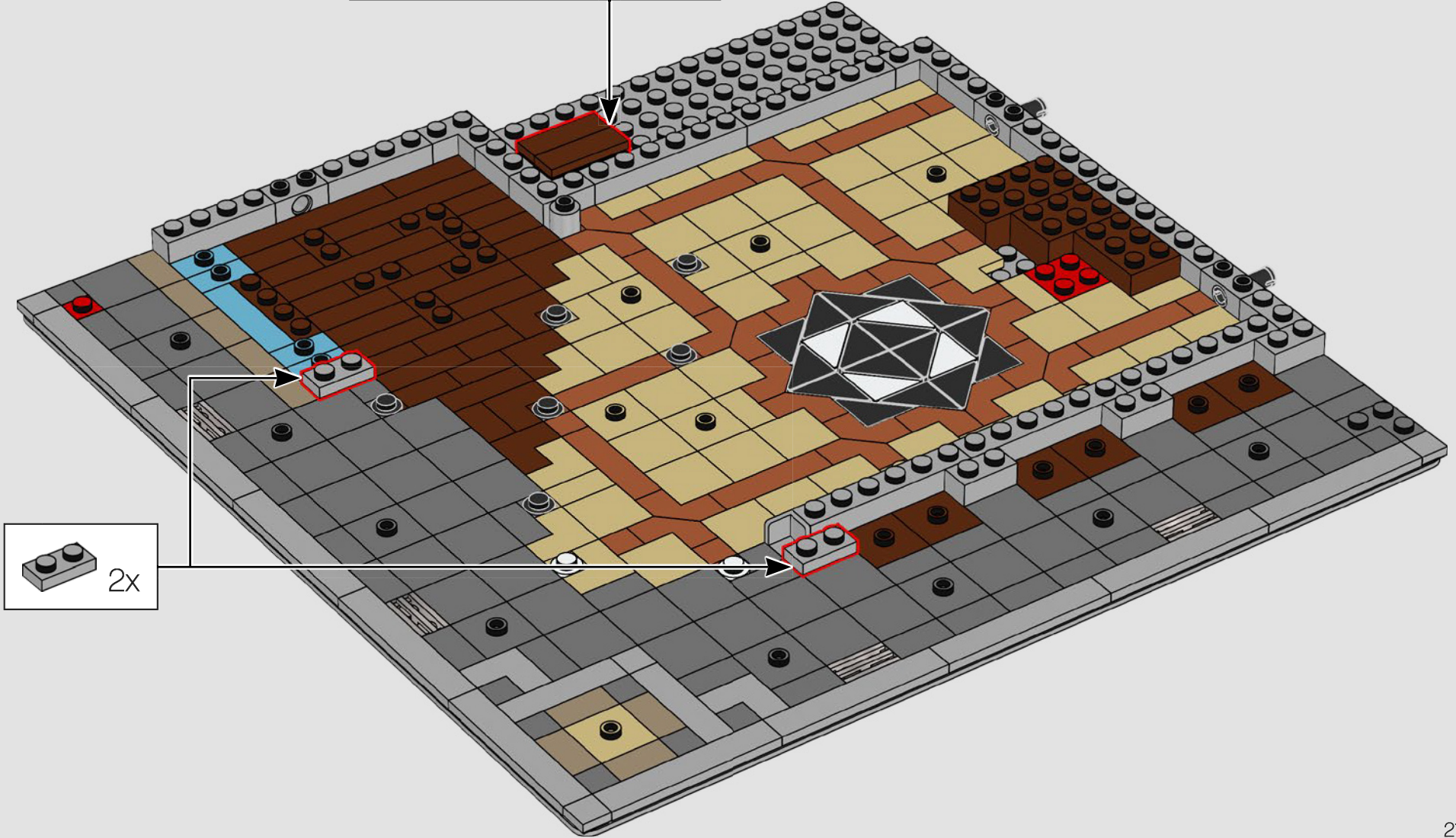

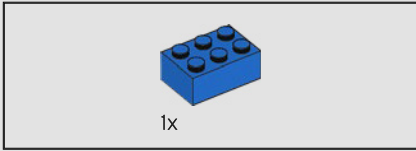
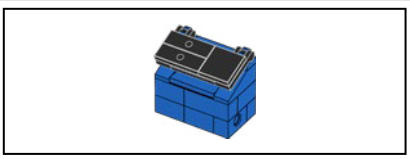

14

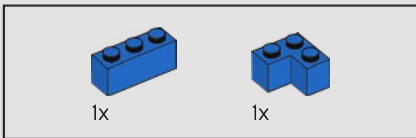
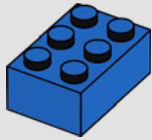

15

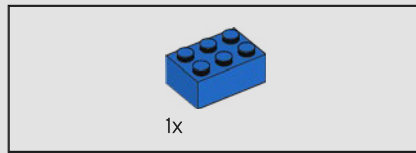
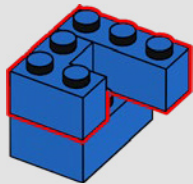

16

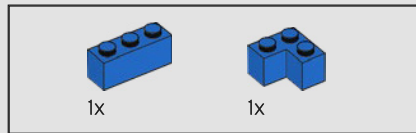
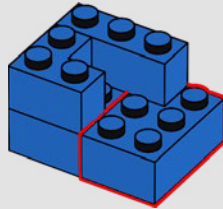

17

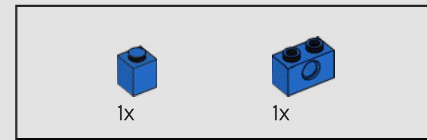
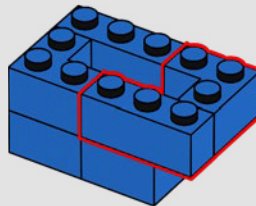

18

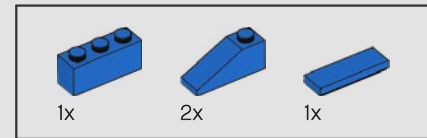
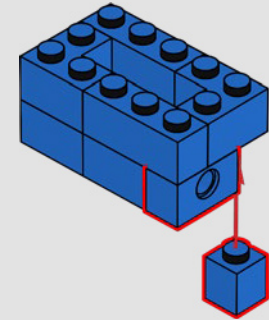

19

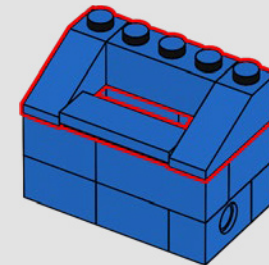

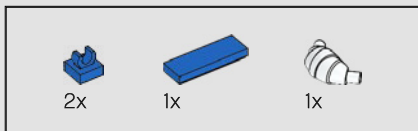

20

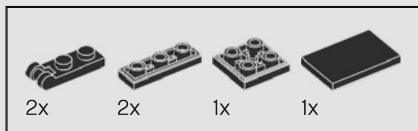
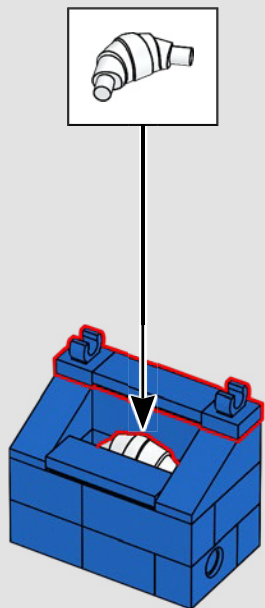

21

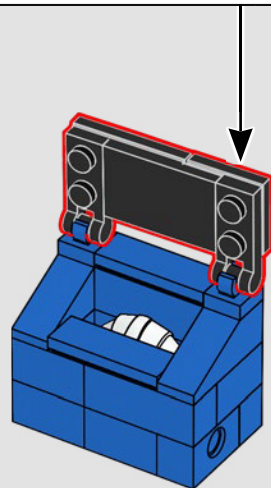
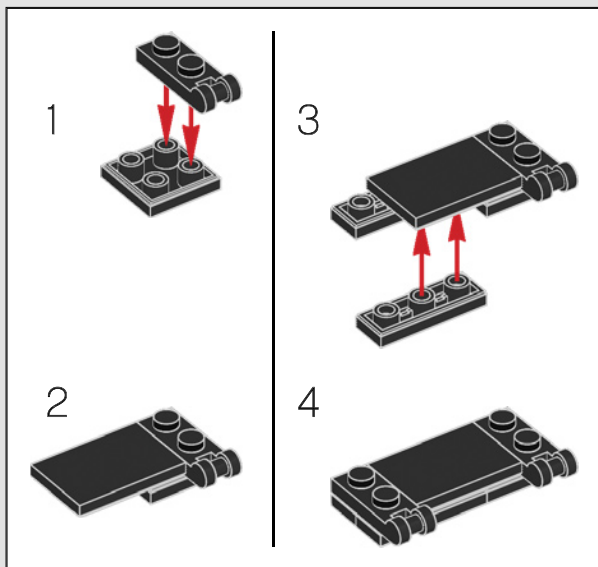

22

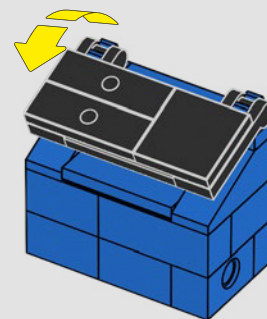

这个羊角面包曾出现在 10243 套装的巴黎餐厅中.....但为什么会有人想要发霉的白羊角面包呢?

23

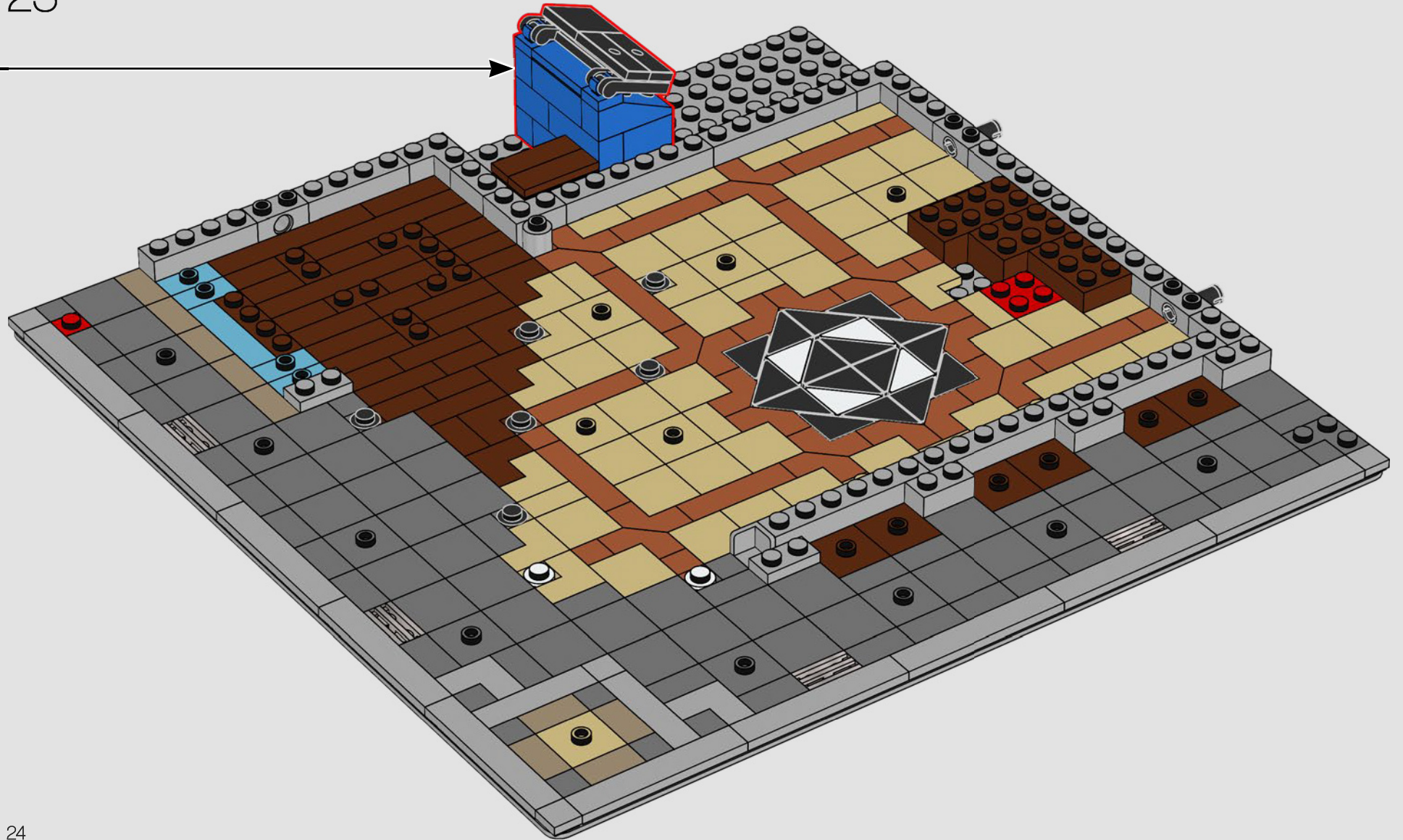

24



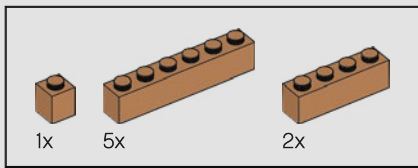

24

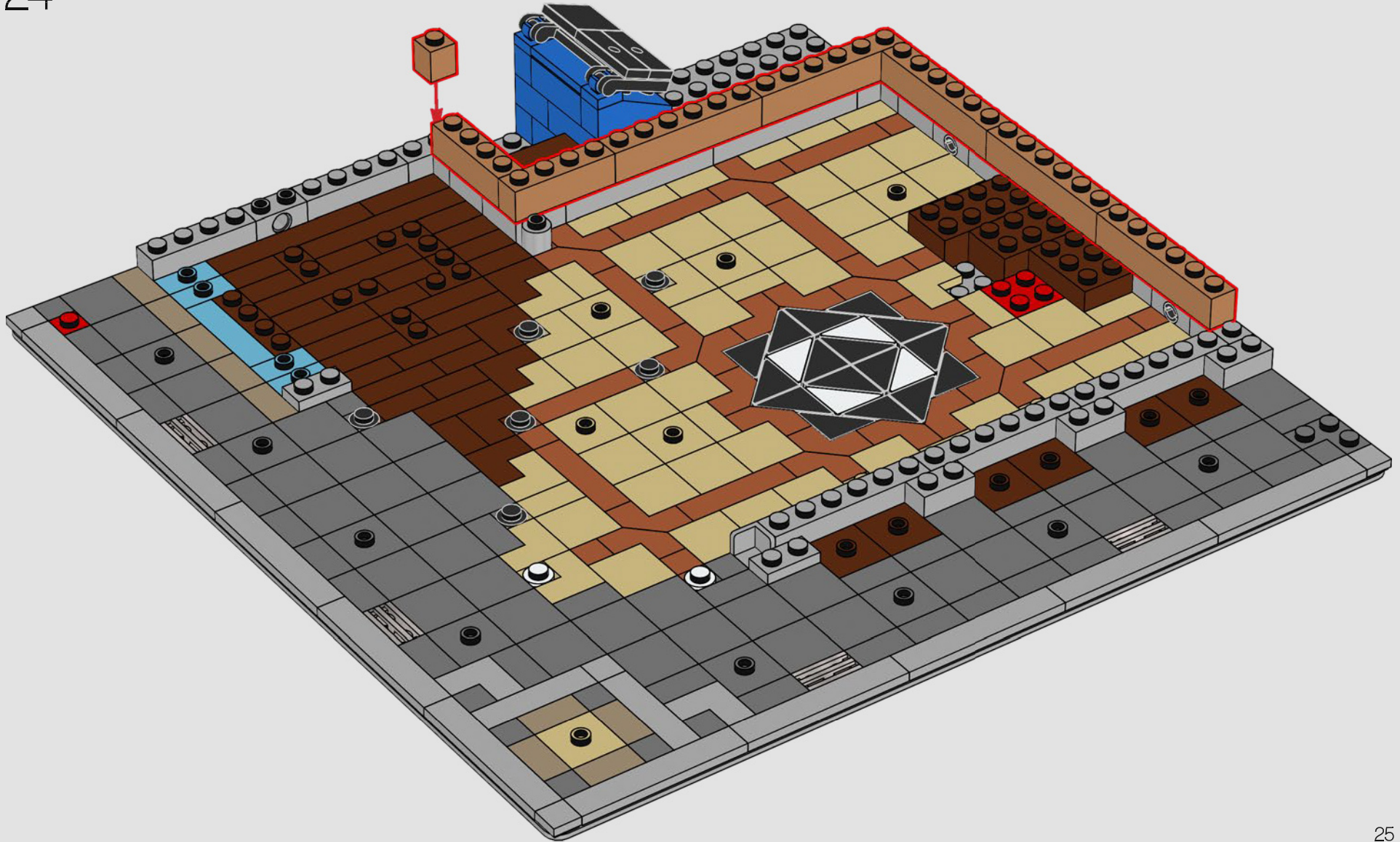

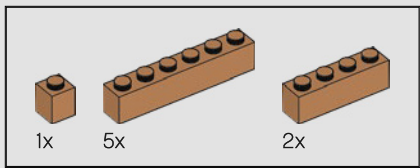

25

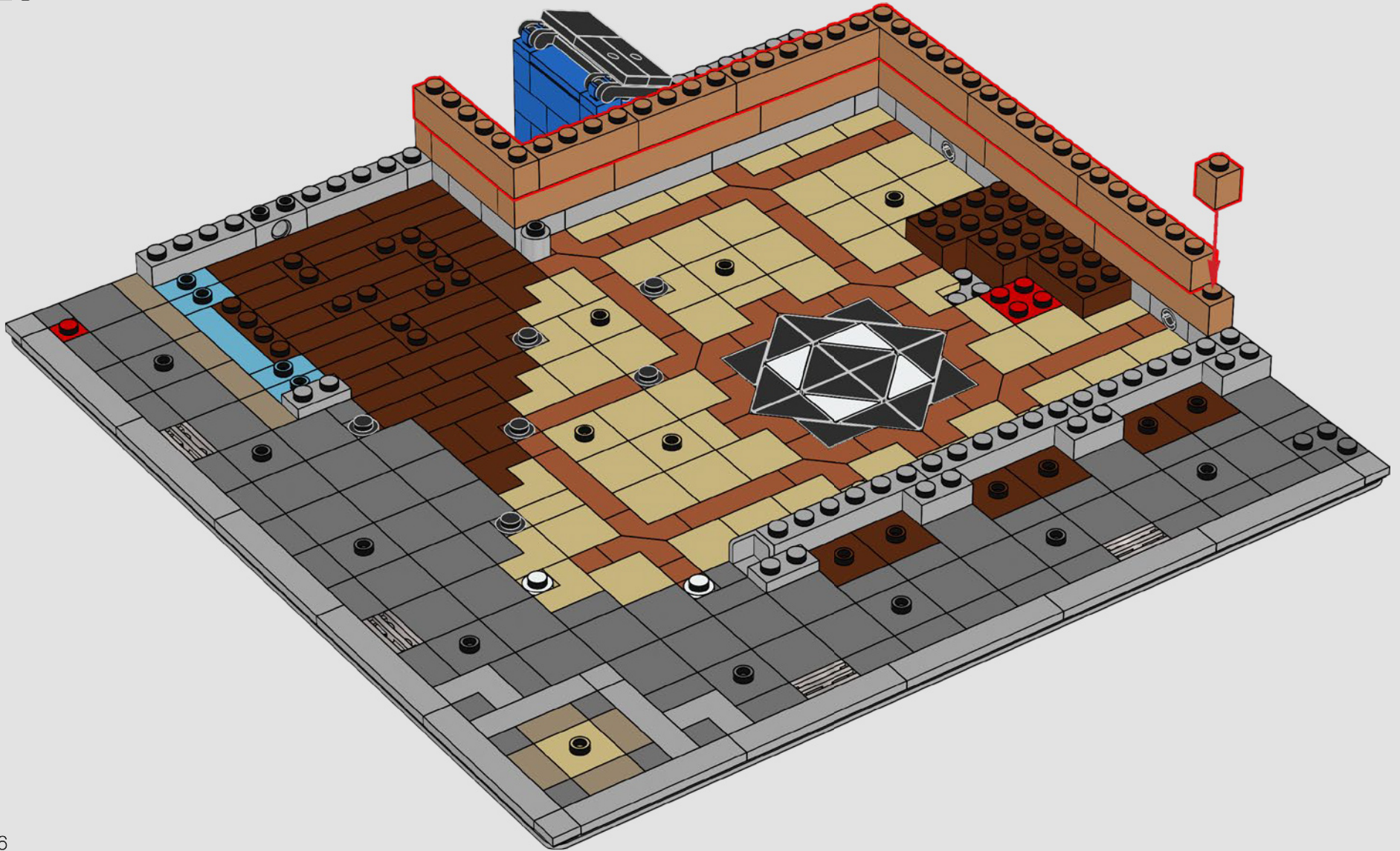

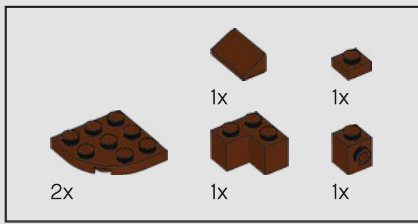

26

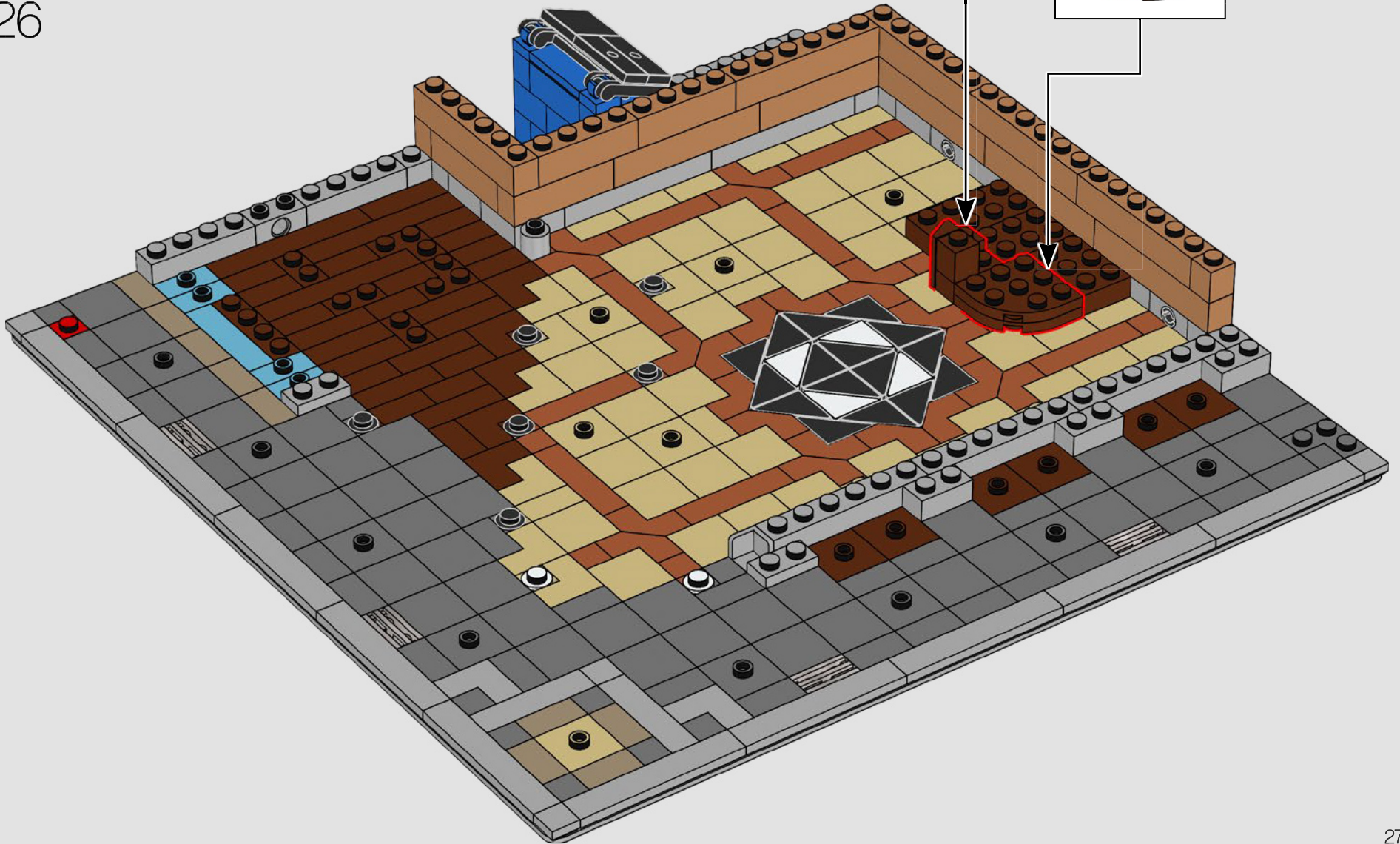
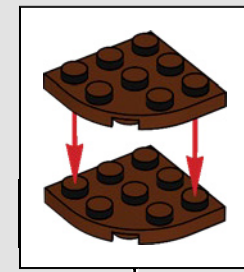
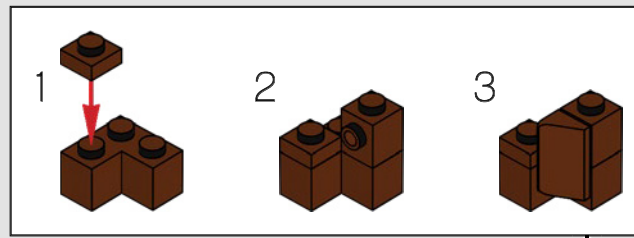

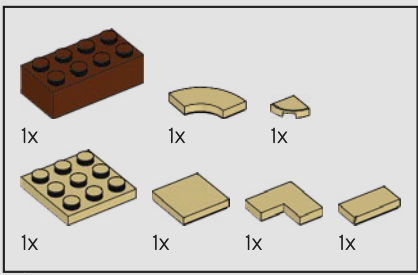

27

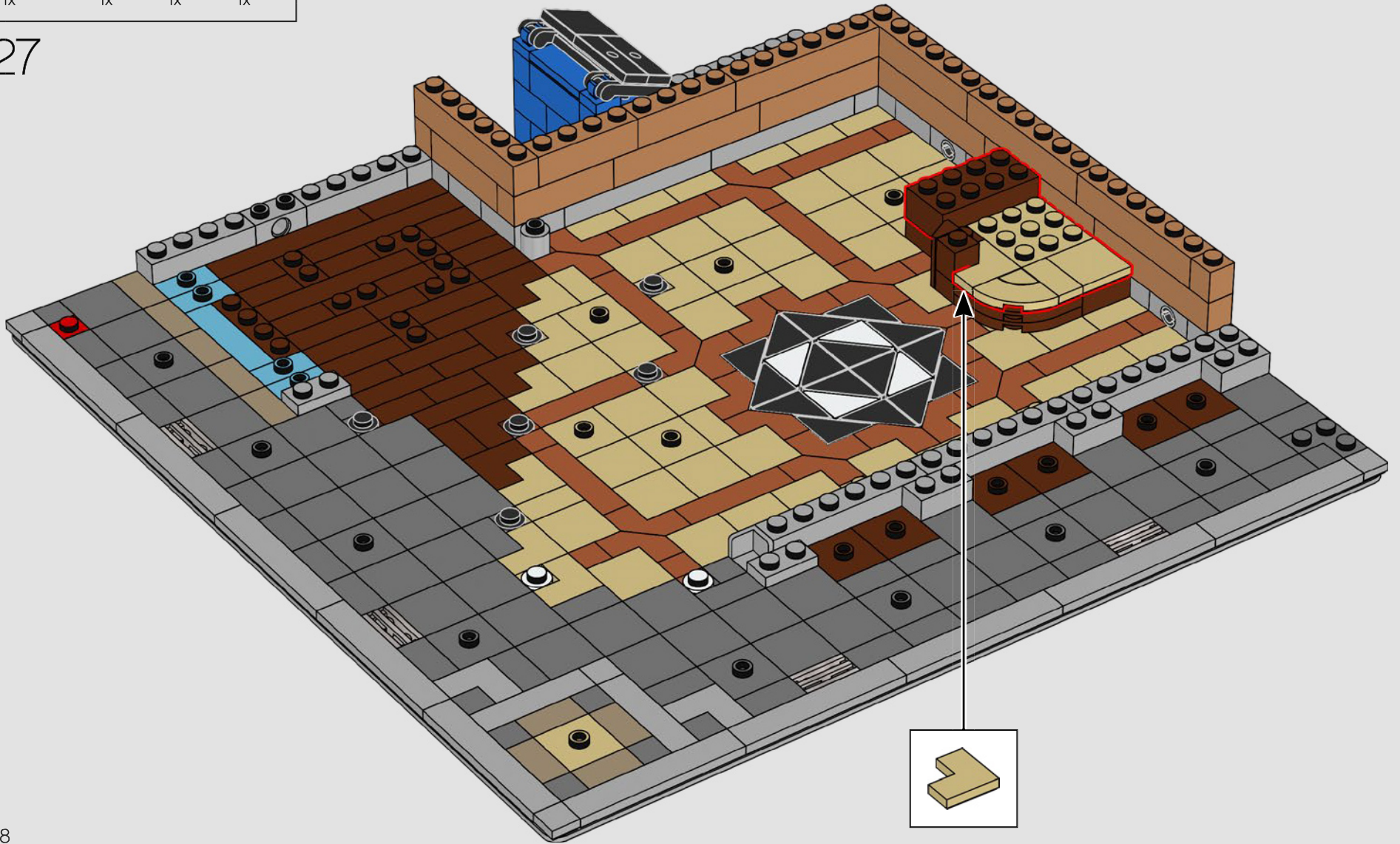

28

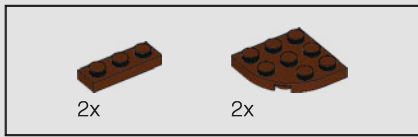

28

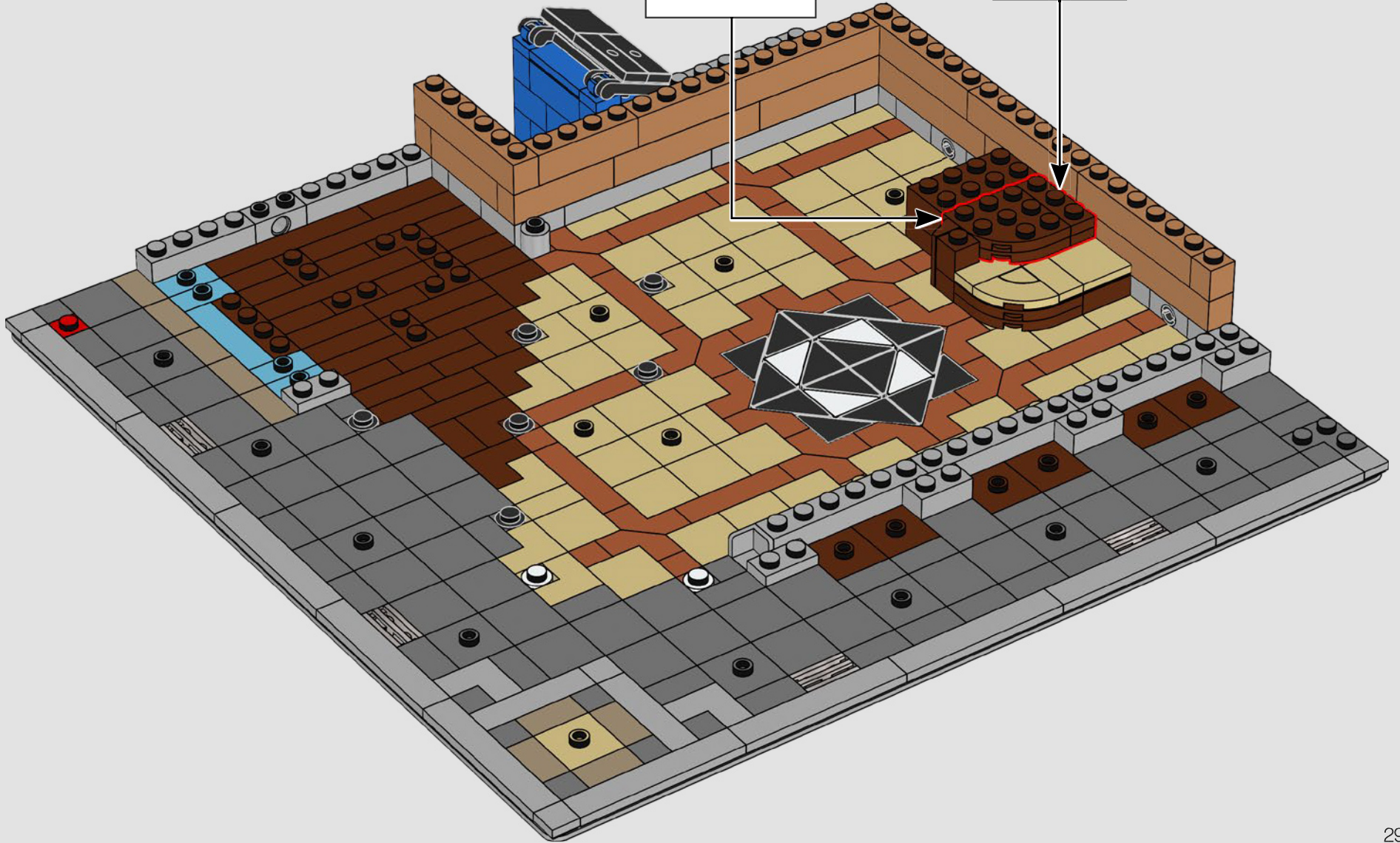
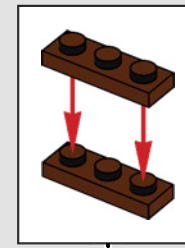
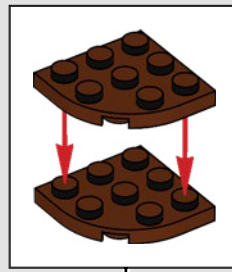

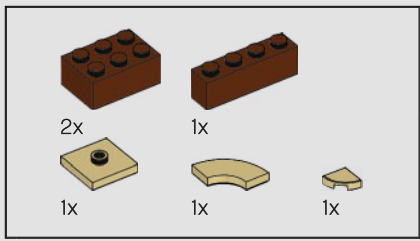

29

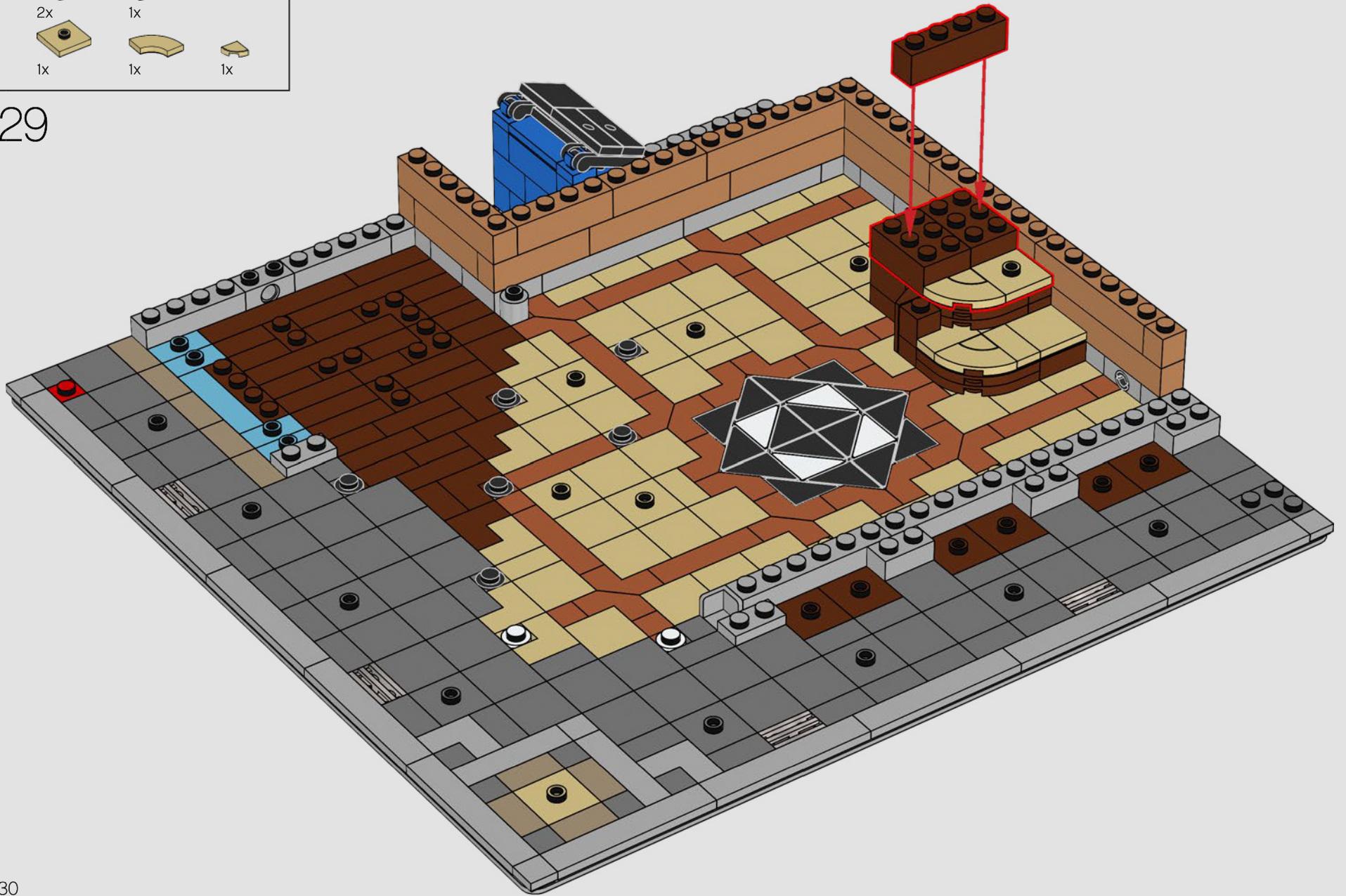

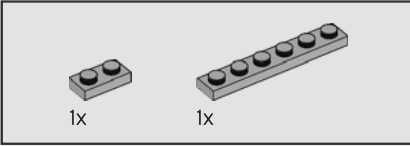
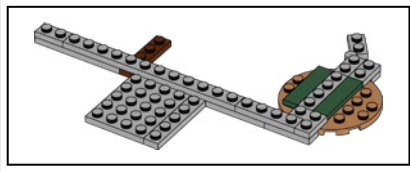

30

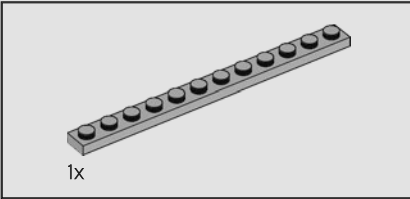
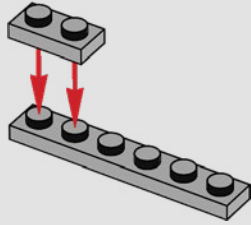

31

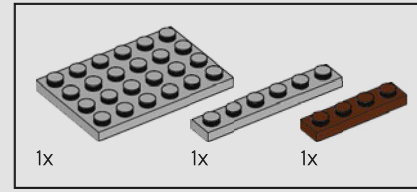
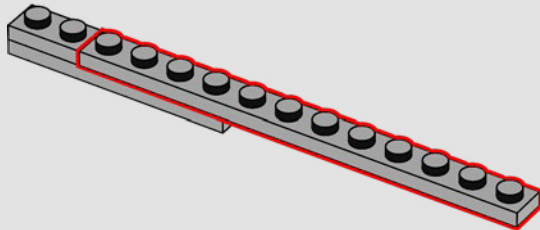

32

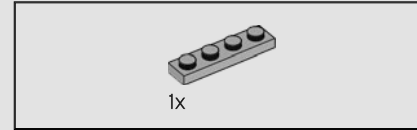
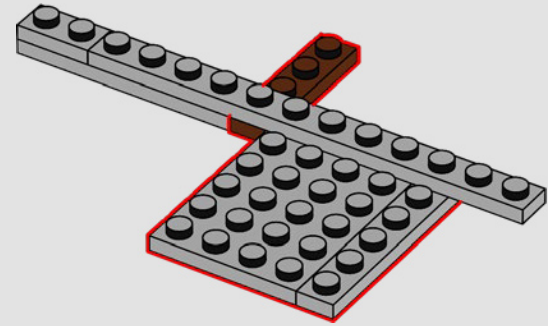

33

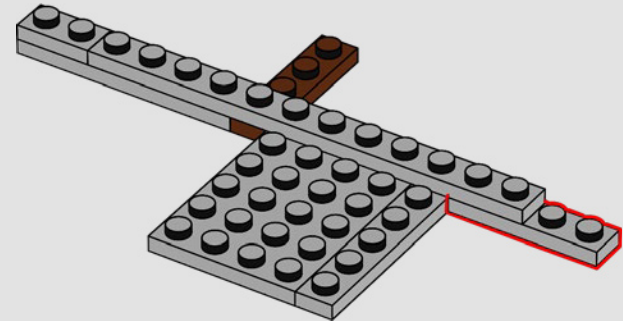

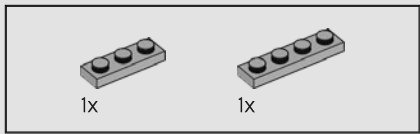

34

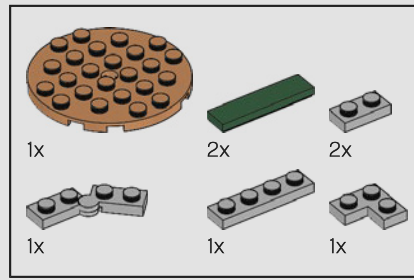
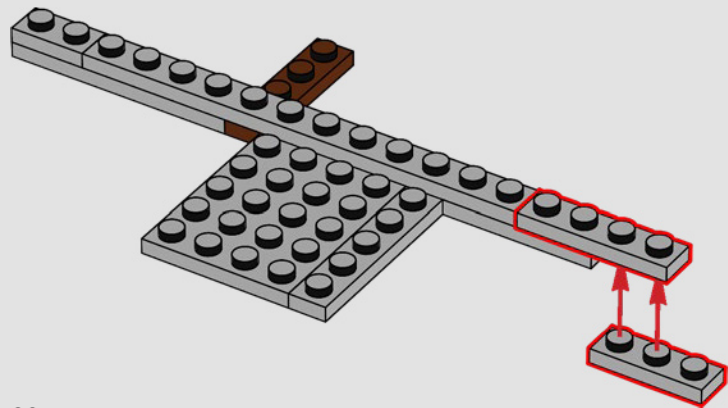

35

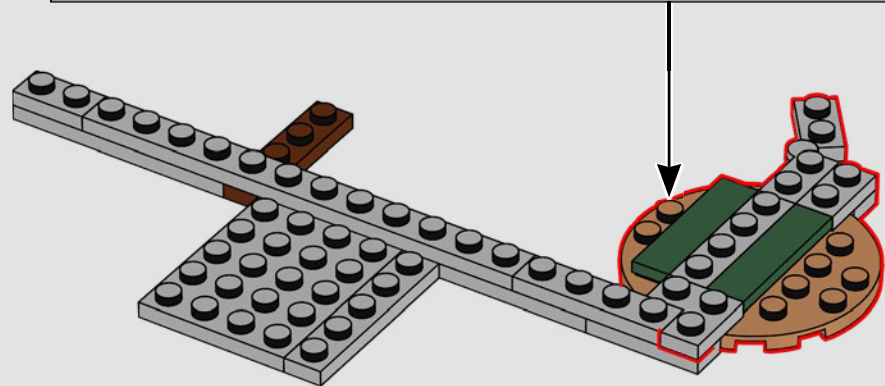
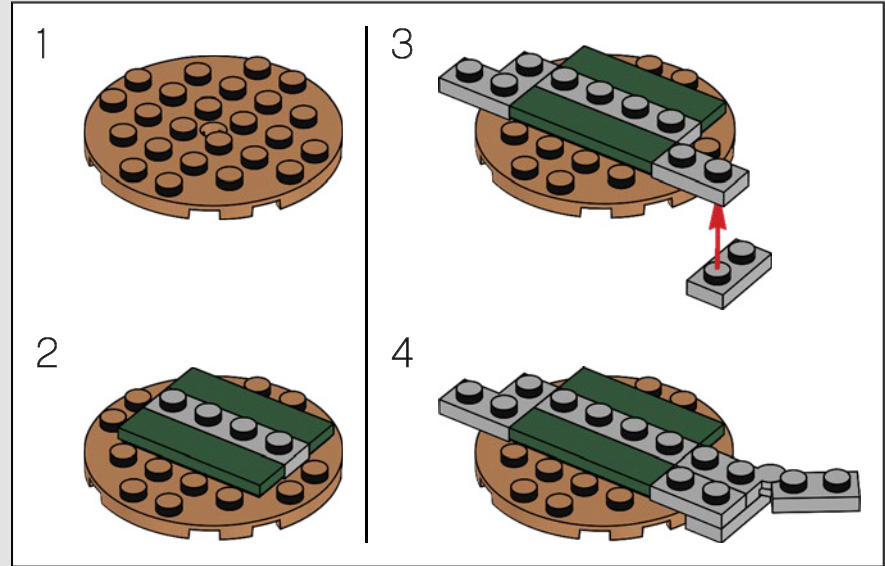



36

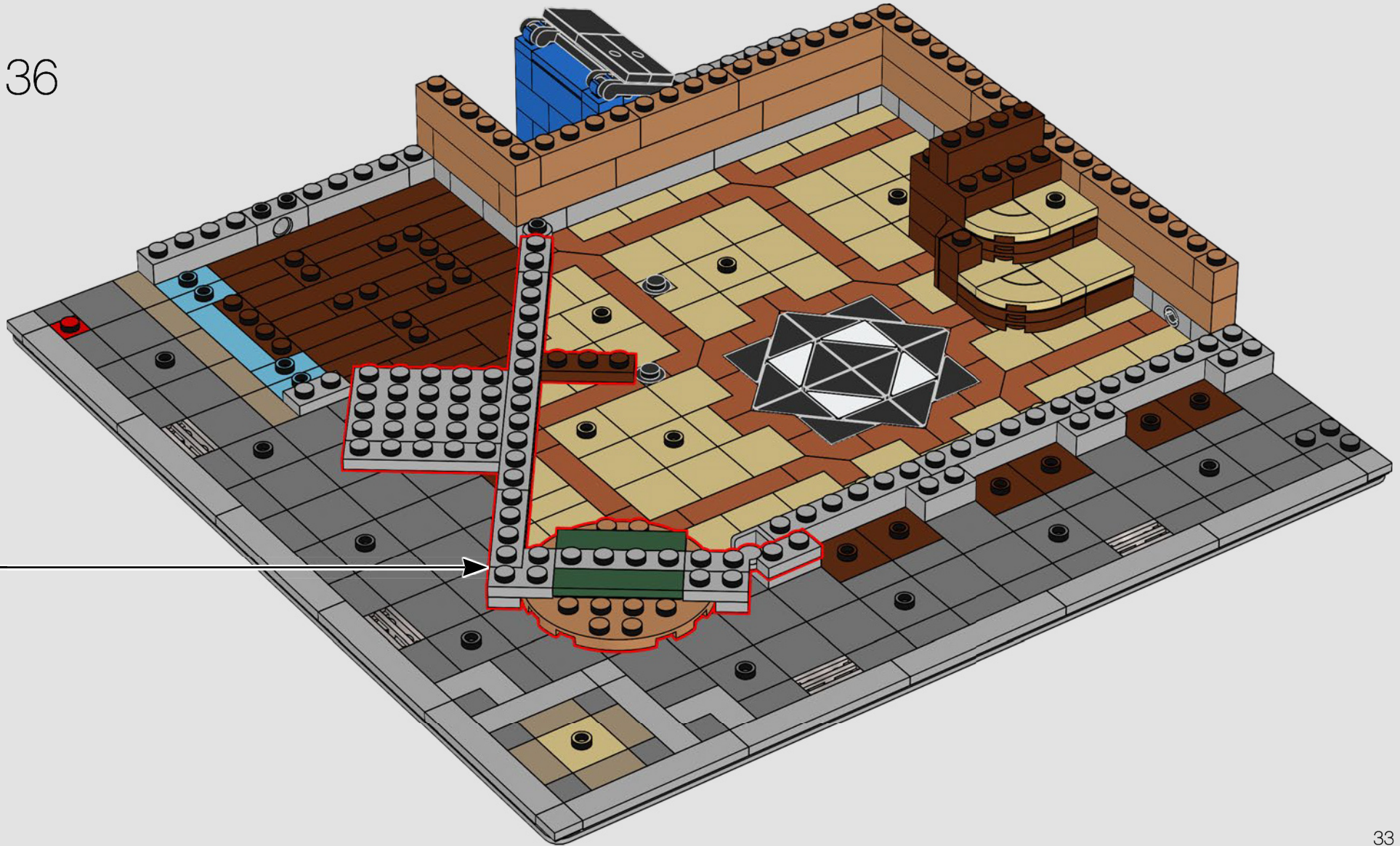

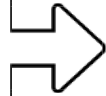

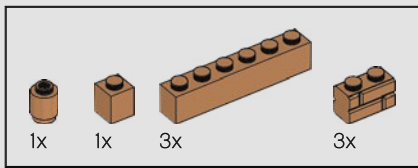

37

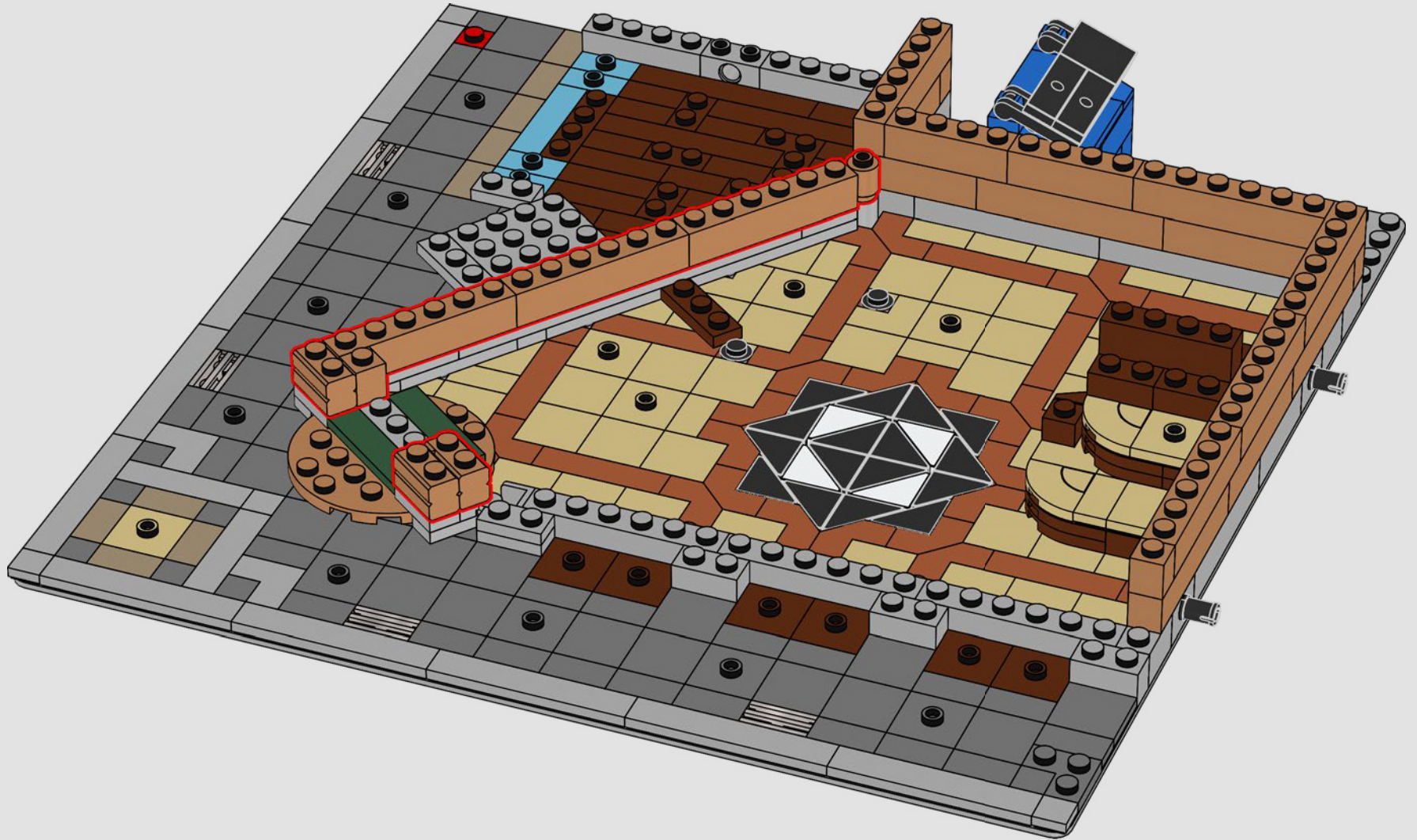

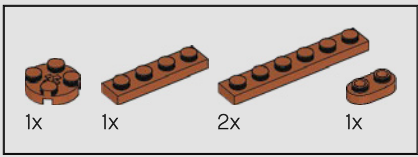

38

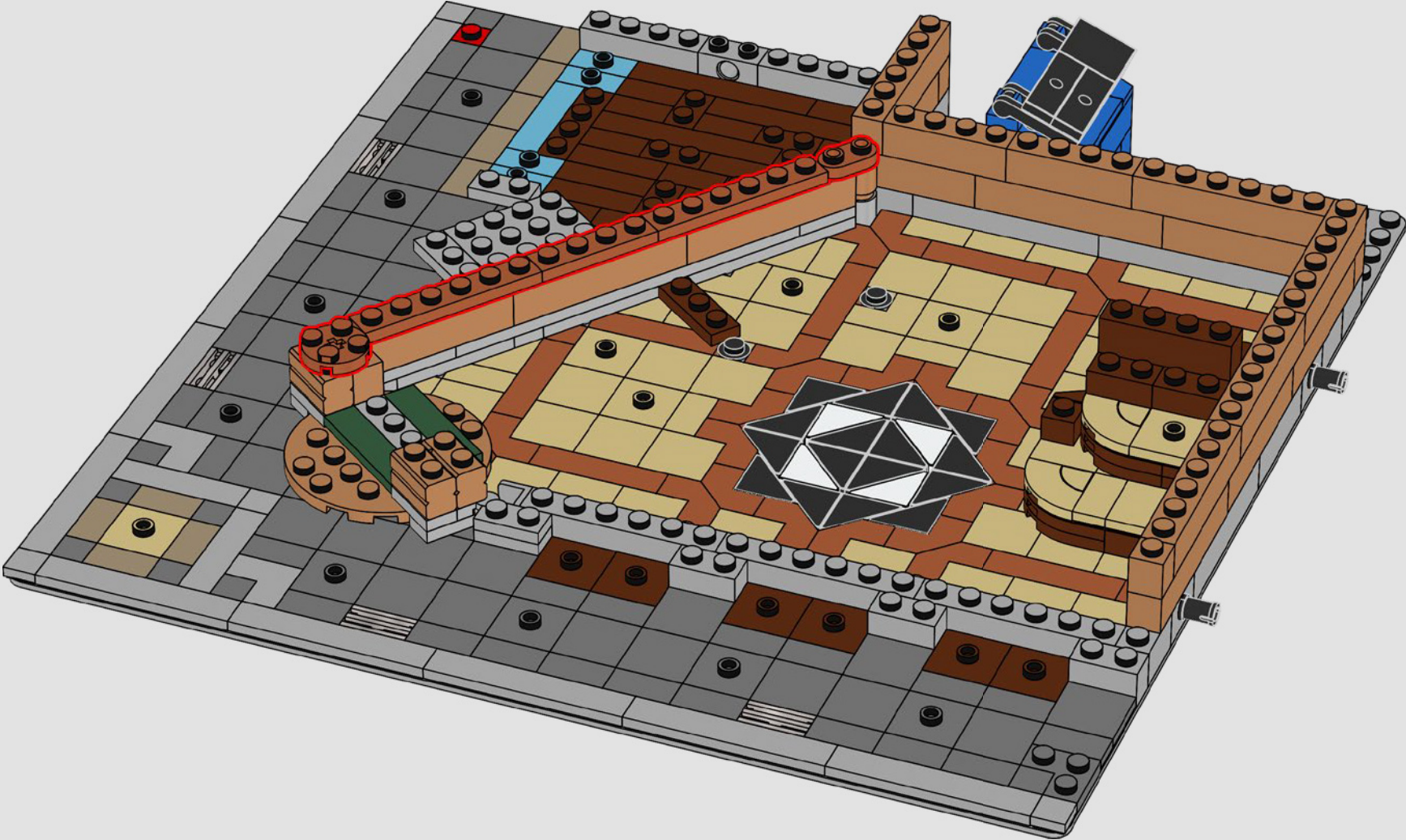

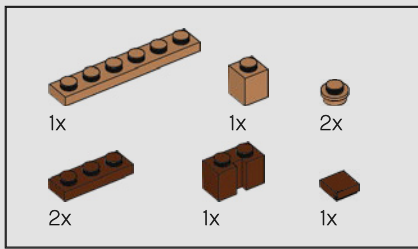

39

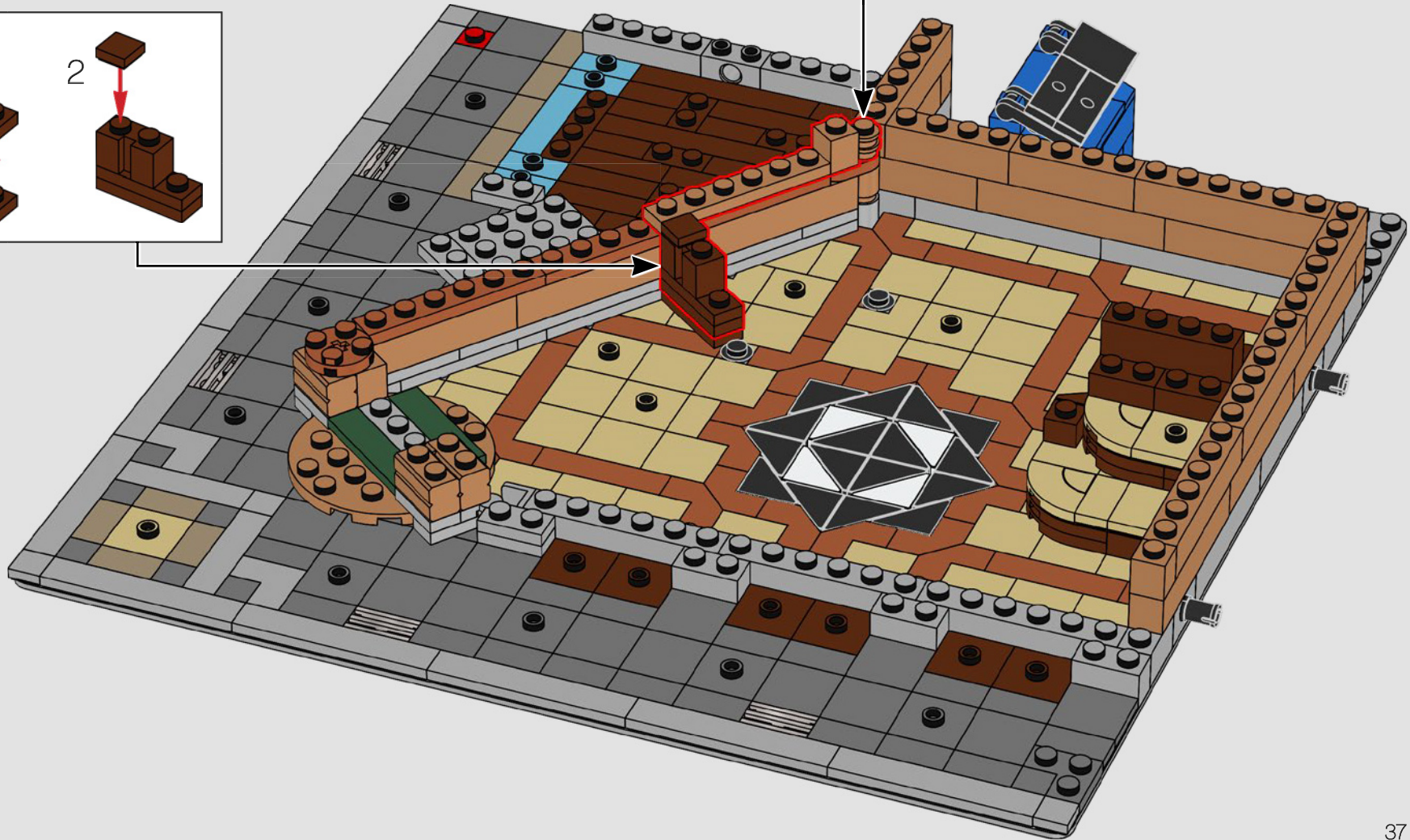
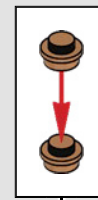
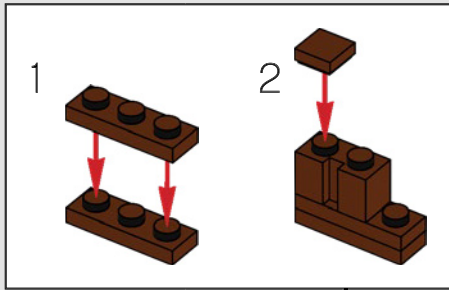

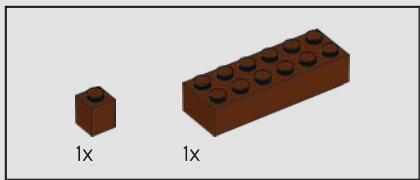

40

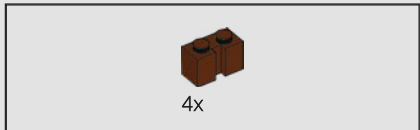
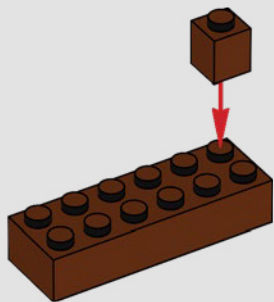

41

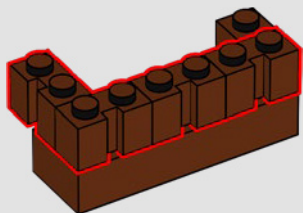

42

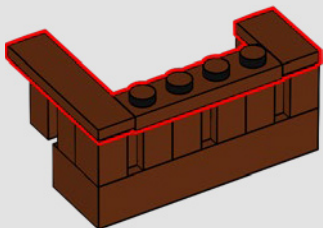

入住这家酒店的许多客人都是以前模块化套装的居民!你能认出他们吗?

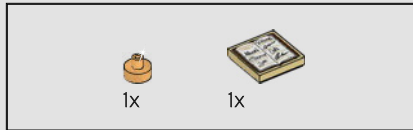

43

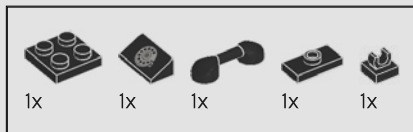
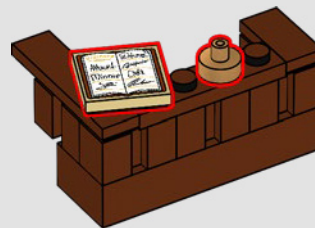

44

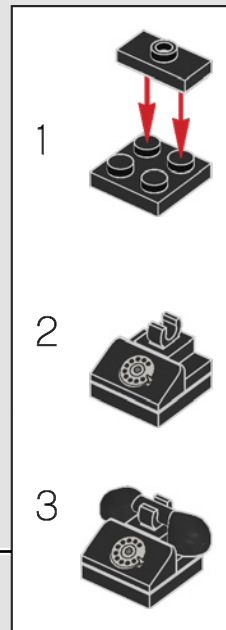
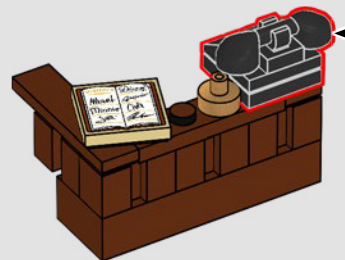



接待员喜欢用这部电话向她的警官朋友 (10278 警察局) 打电话。

45

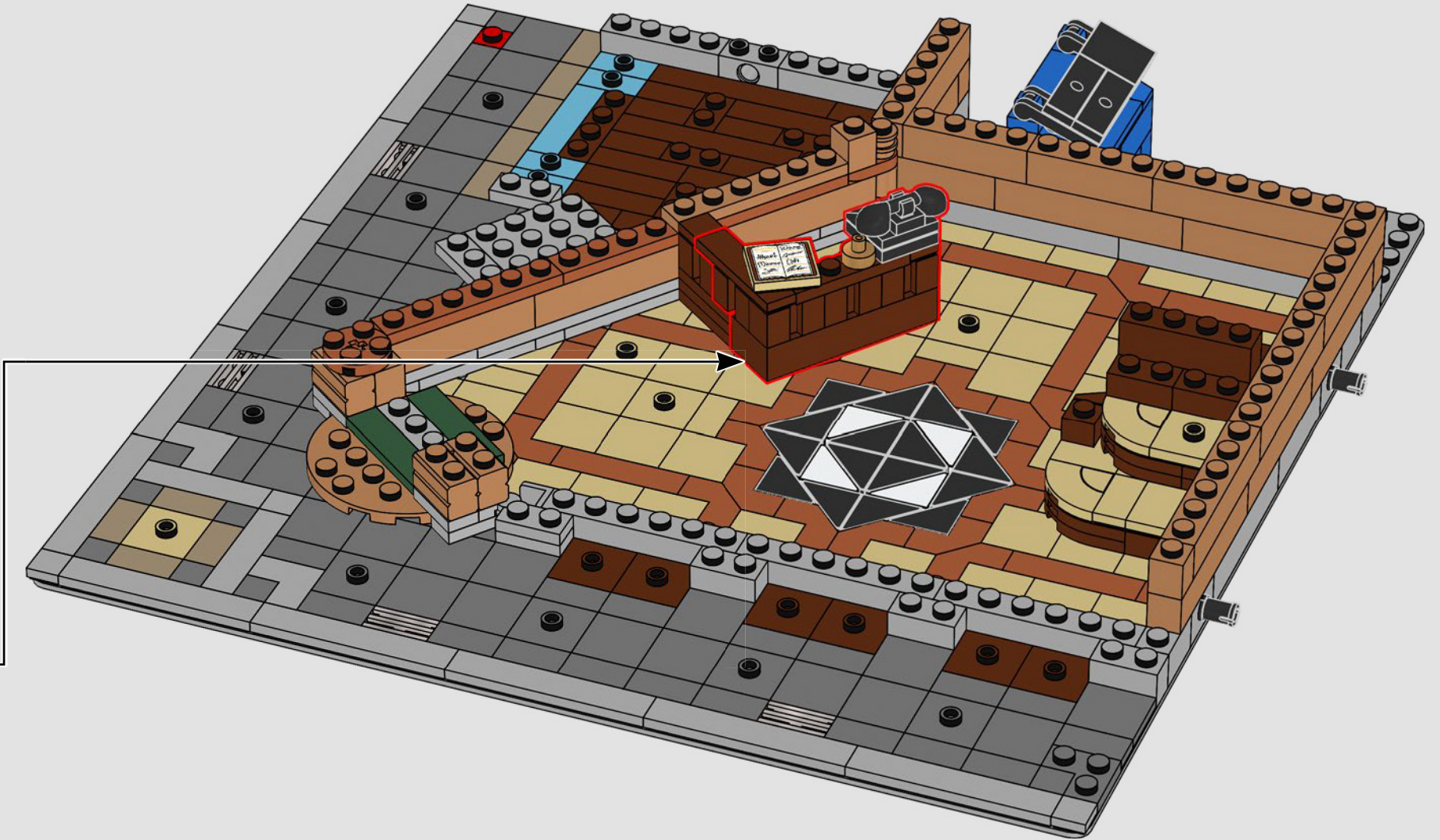

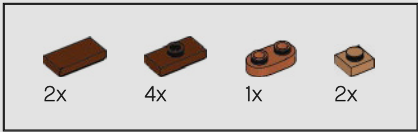

46

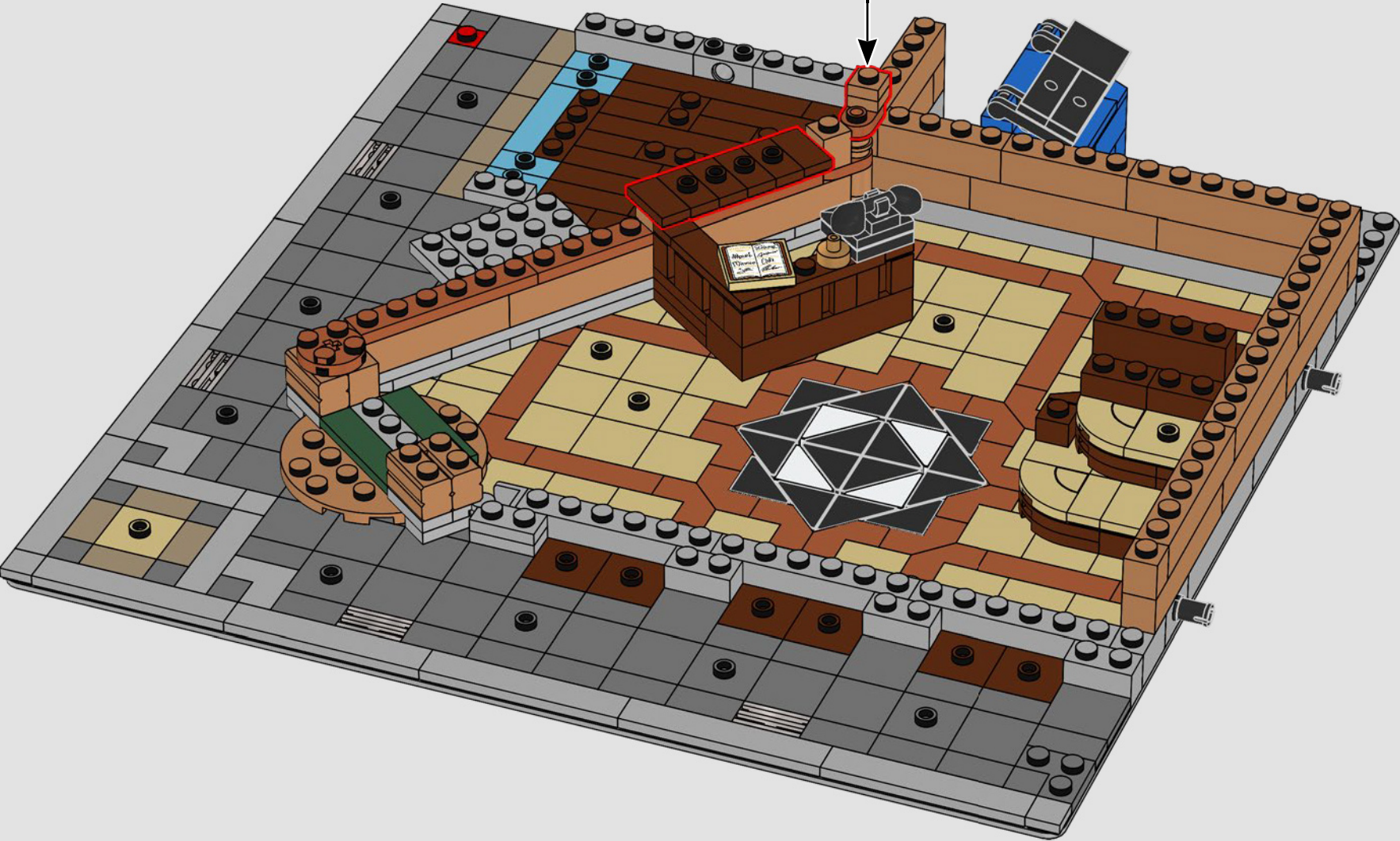
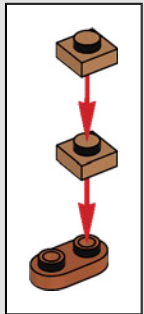



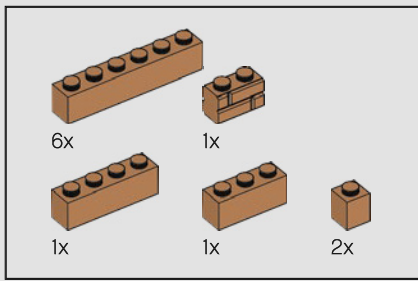

47

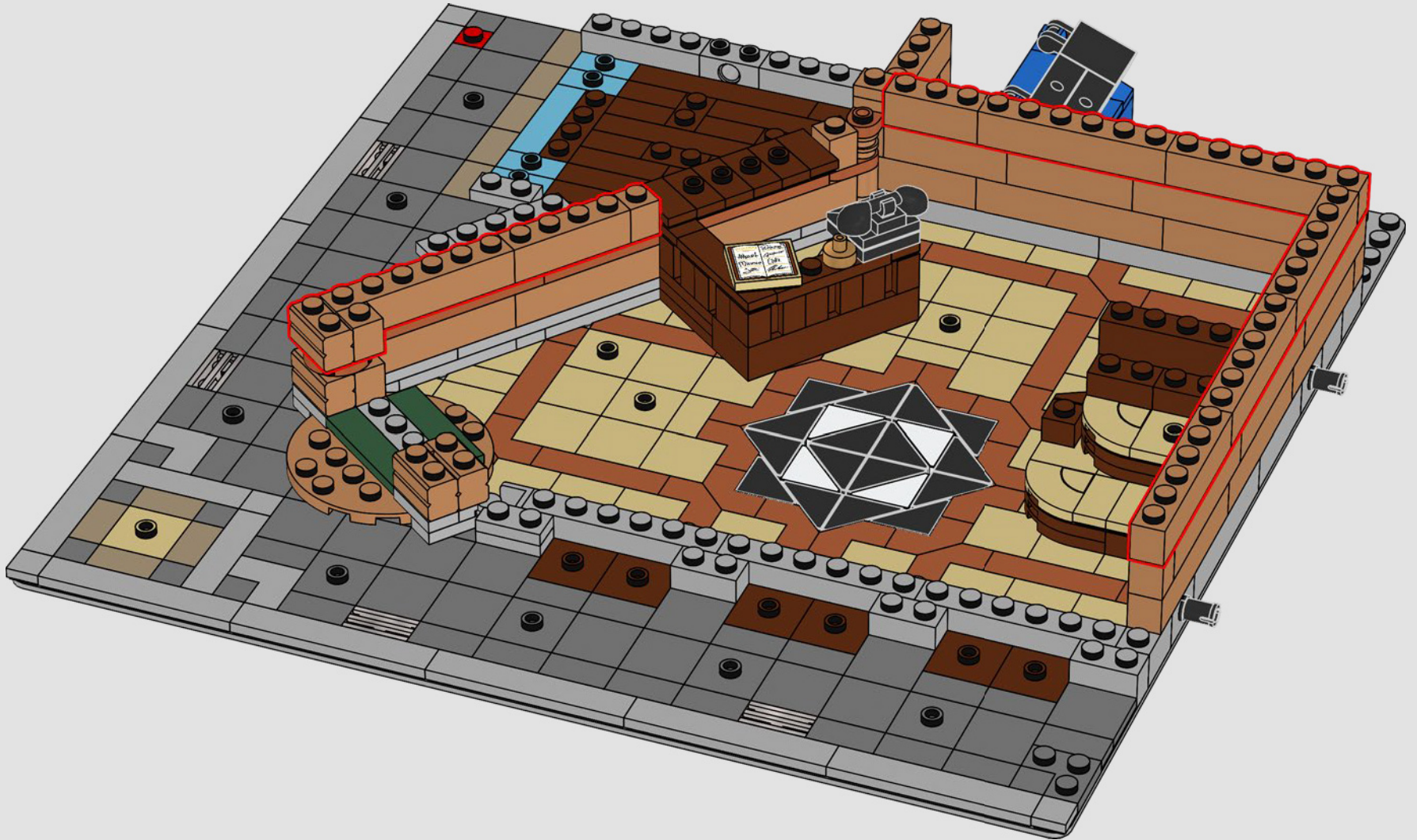

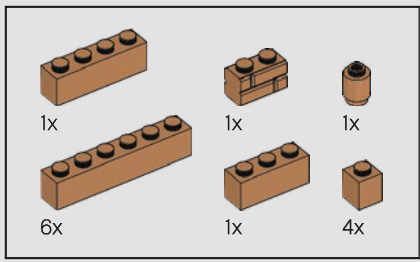

48

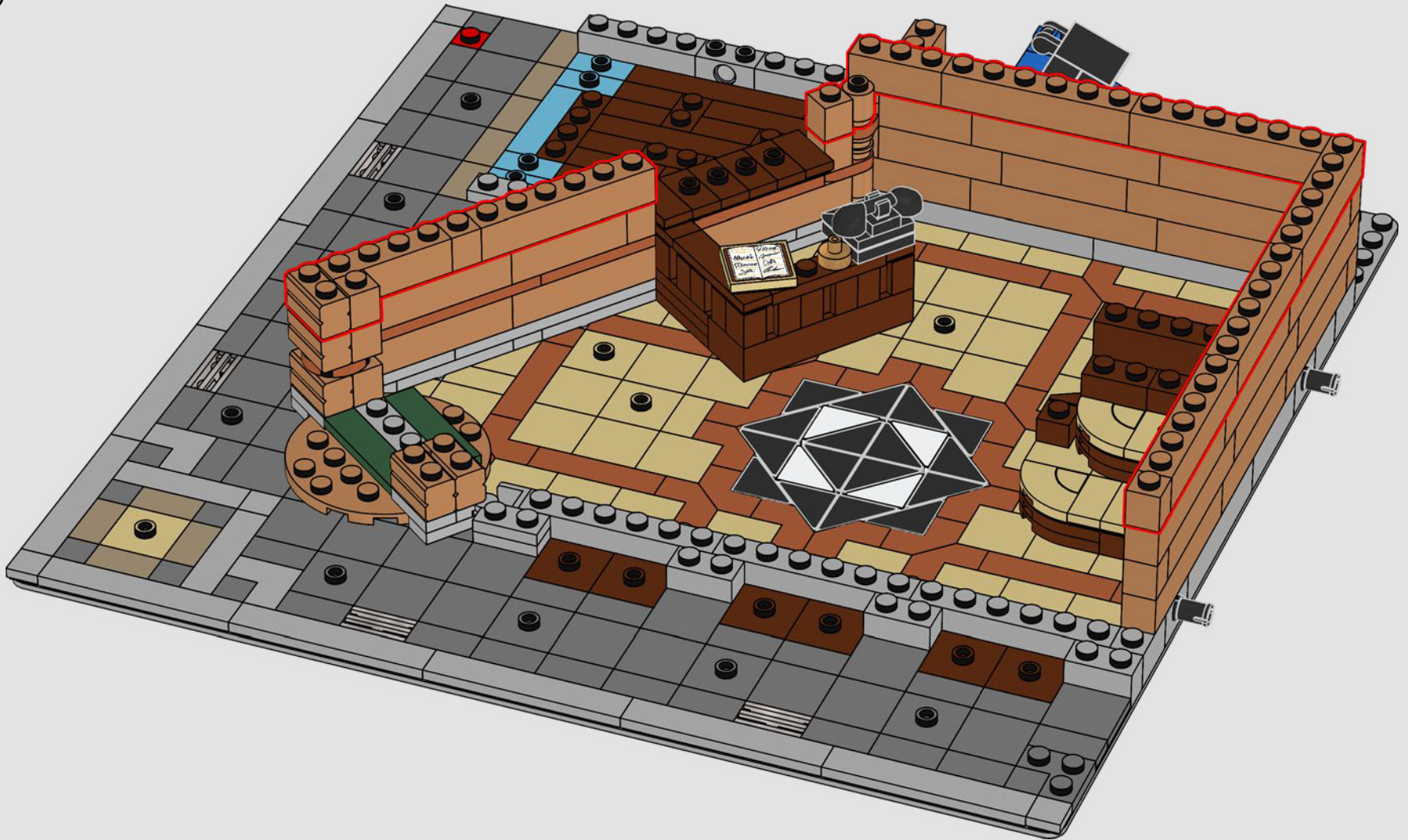

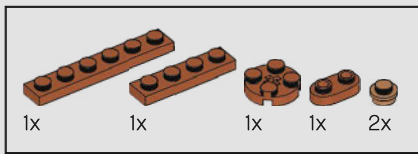

49

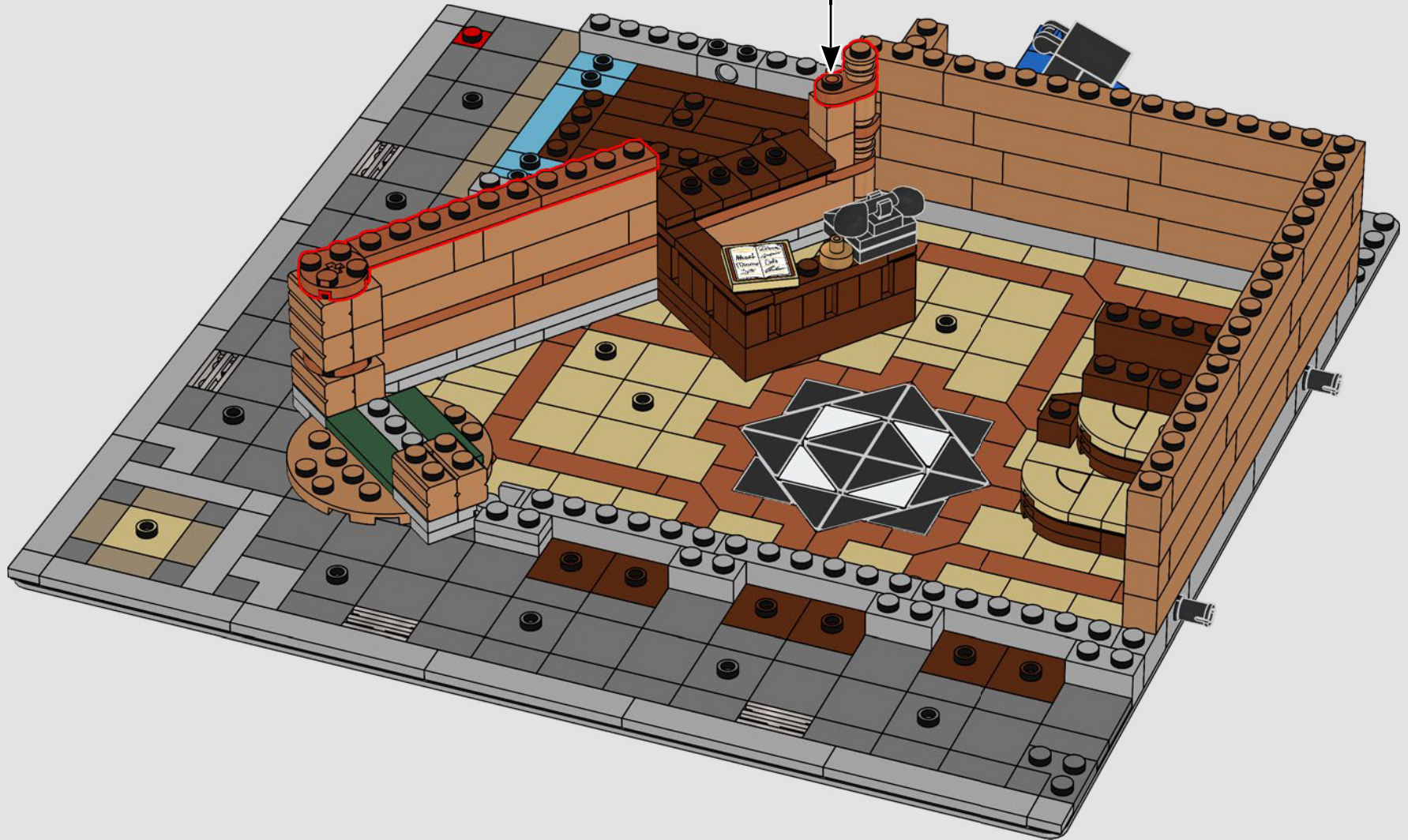
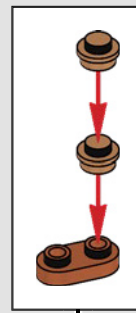

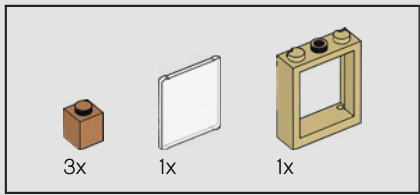

50

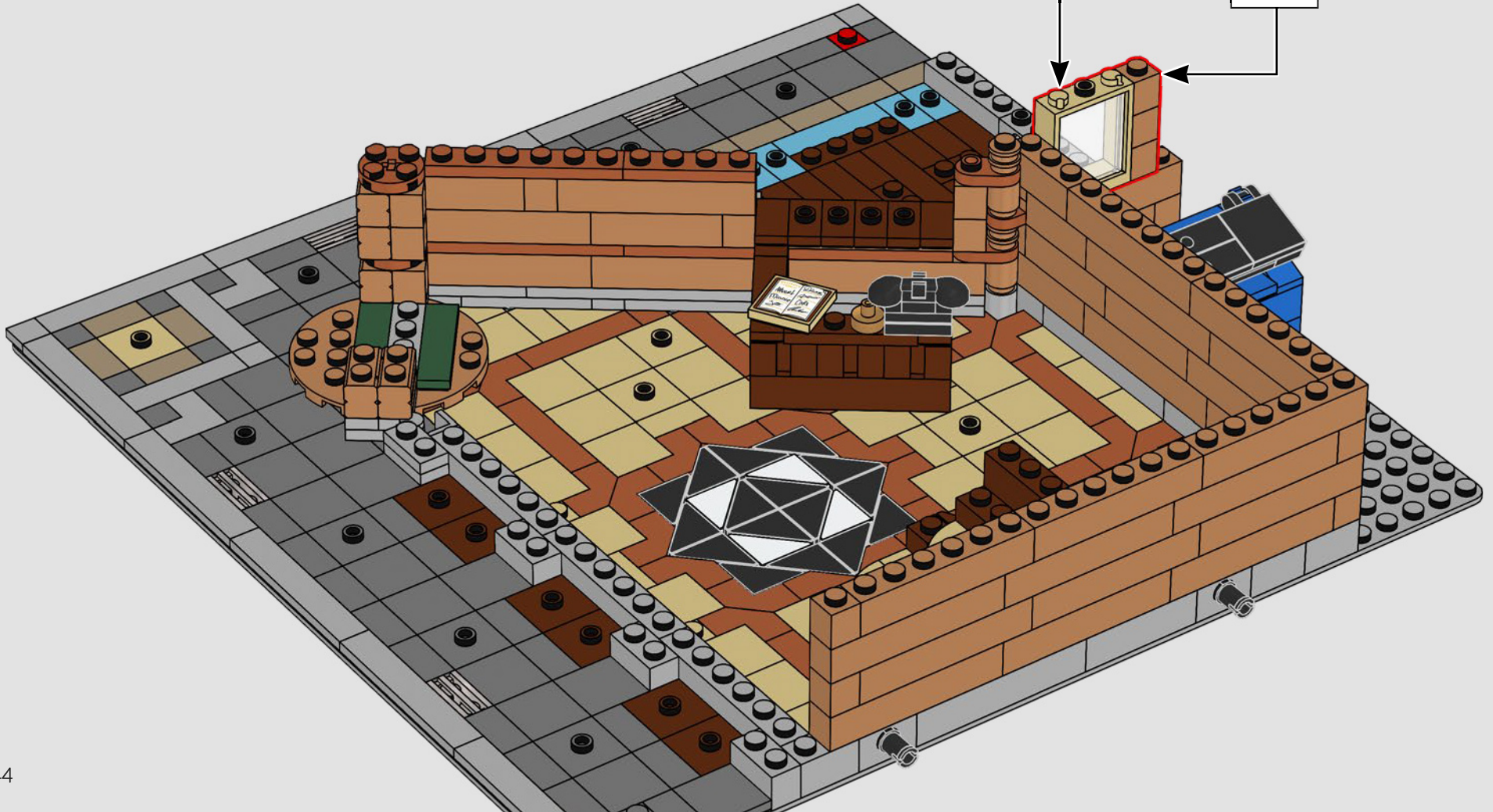
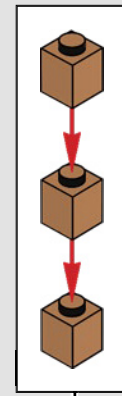
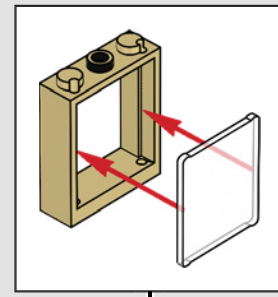

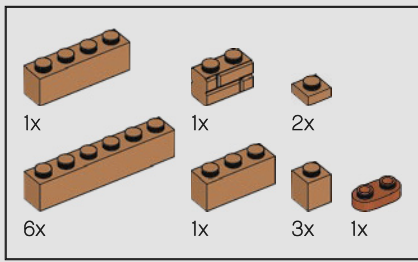

51

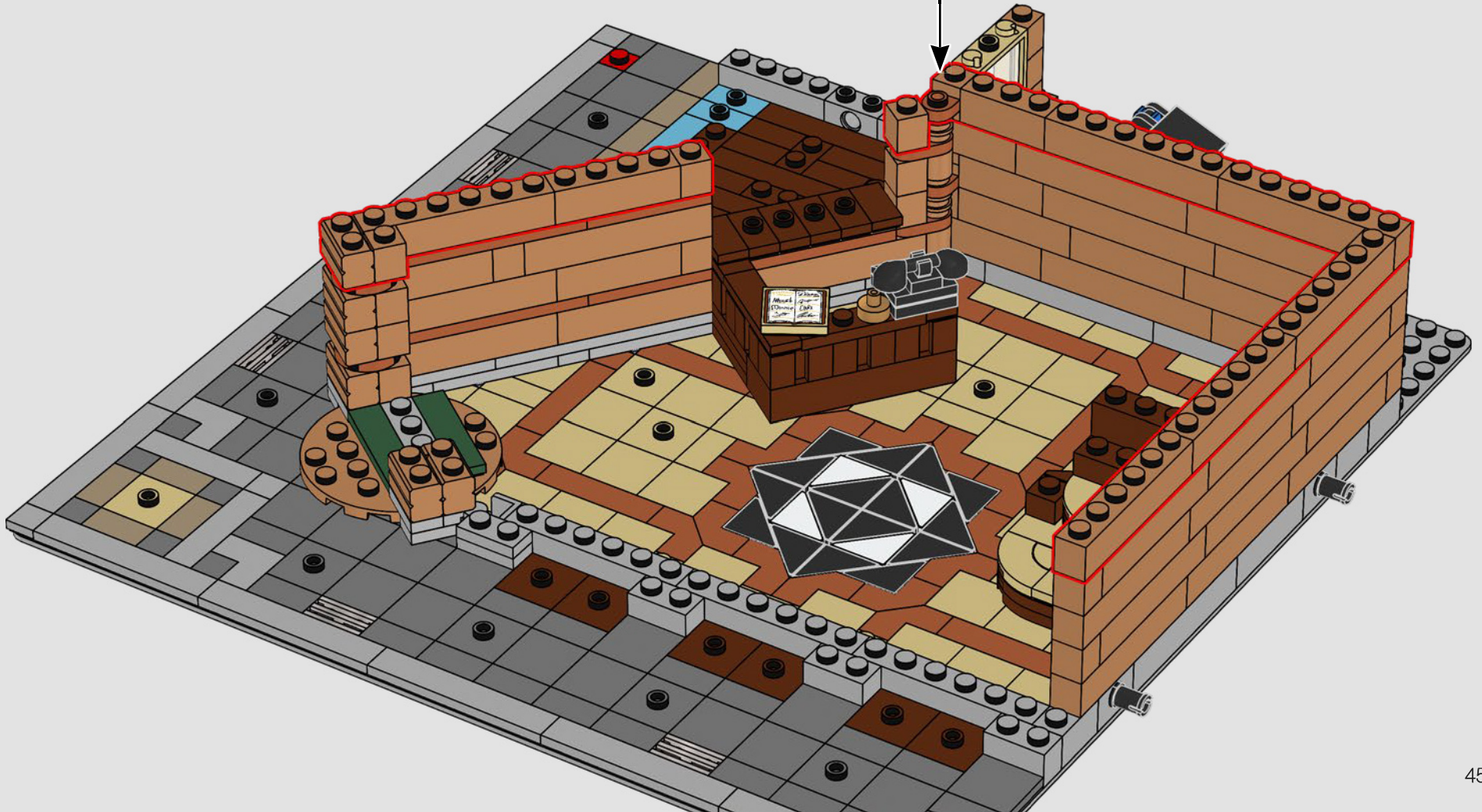
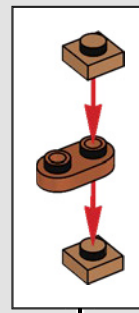

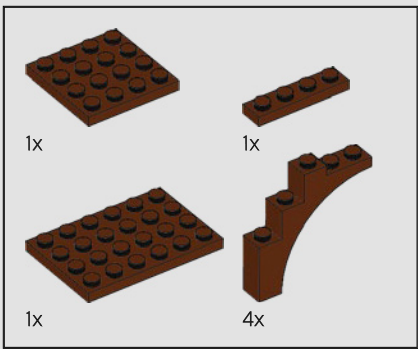

52

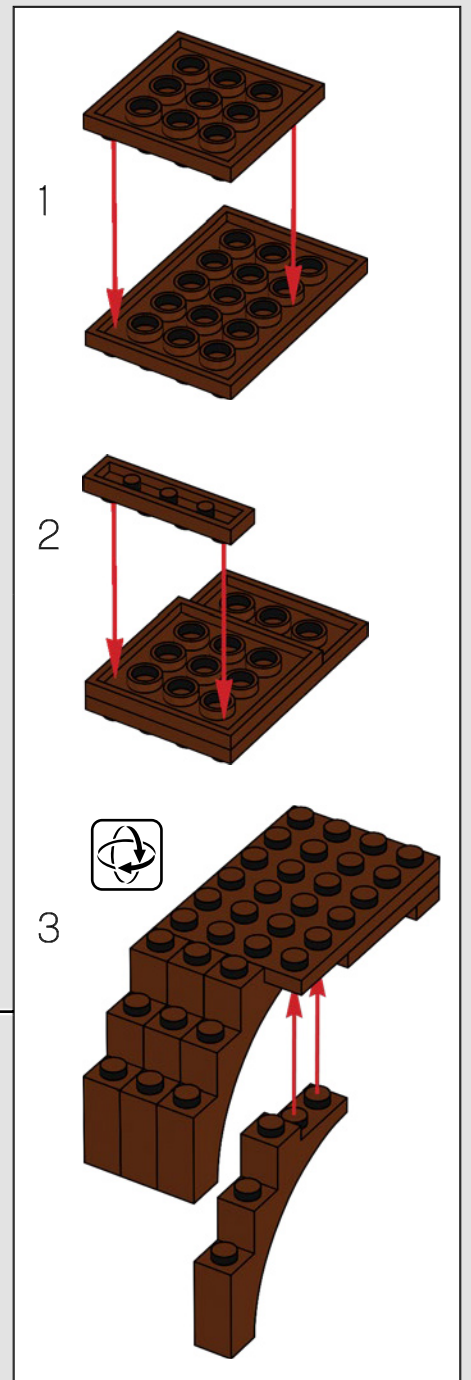
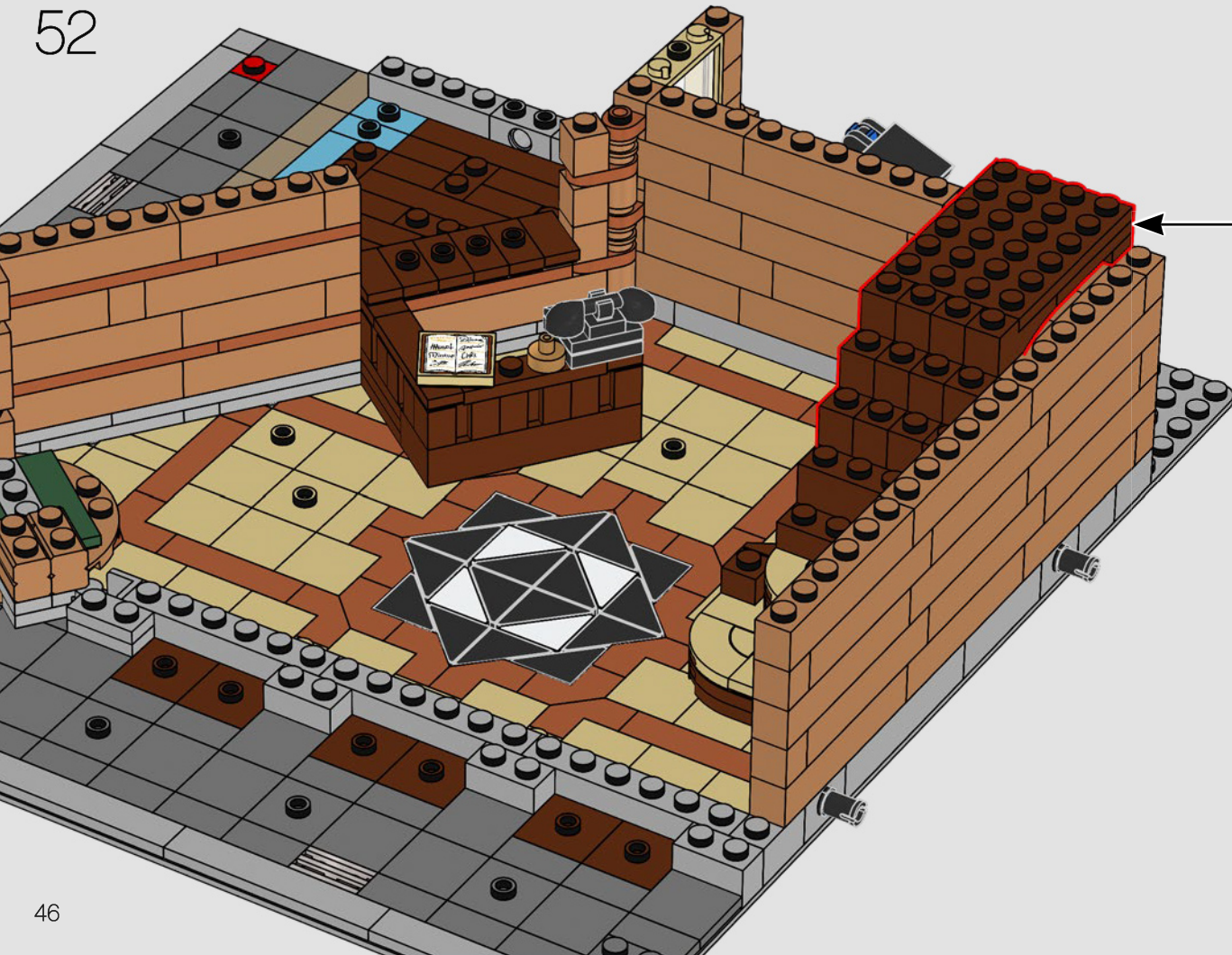

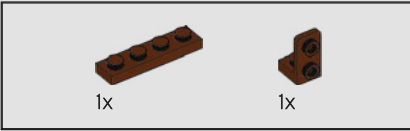

53

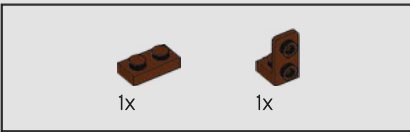
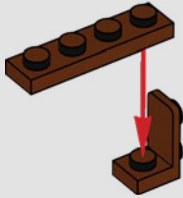

54

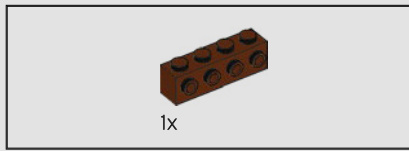
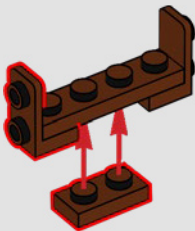

55

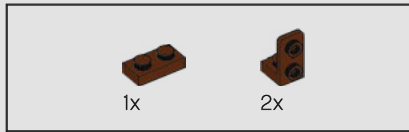
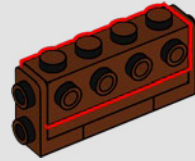

56

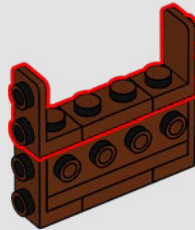

57

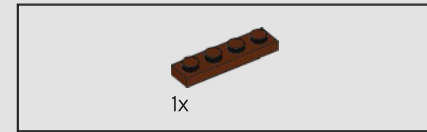
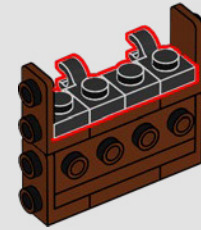

58

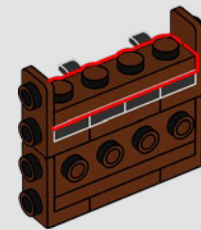



59



60

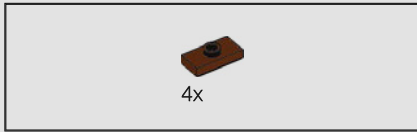
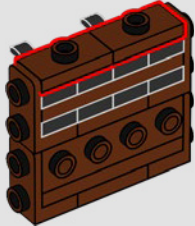

61

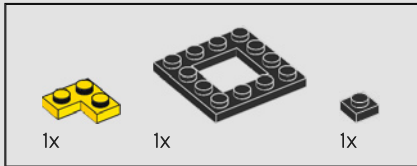
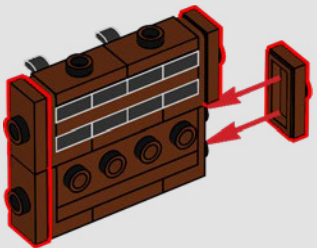

62

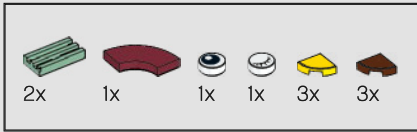
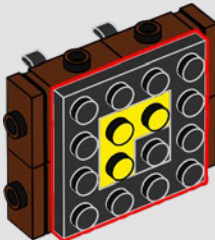

63

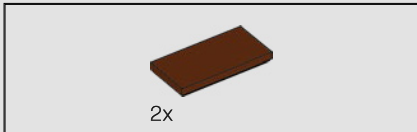
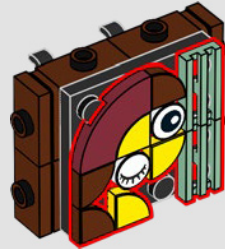

64

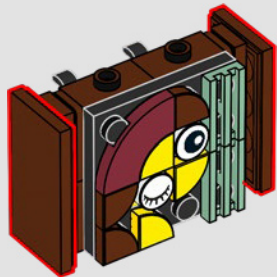



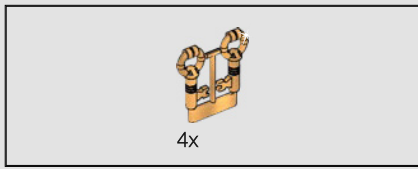

65

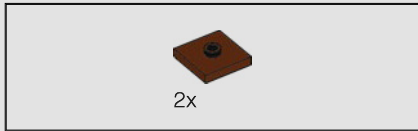
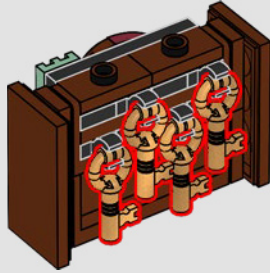

66

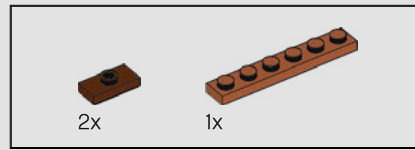
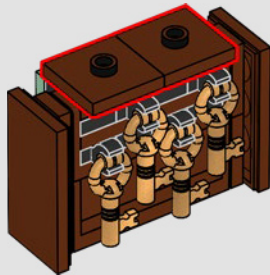

67

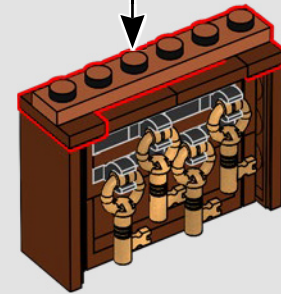
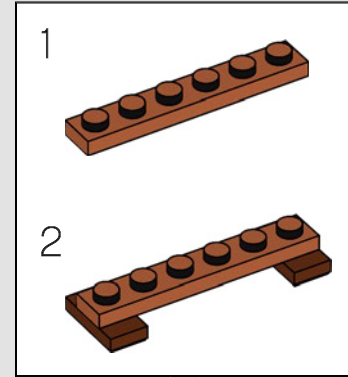

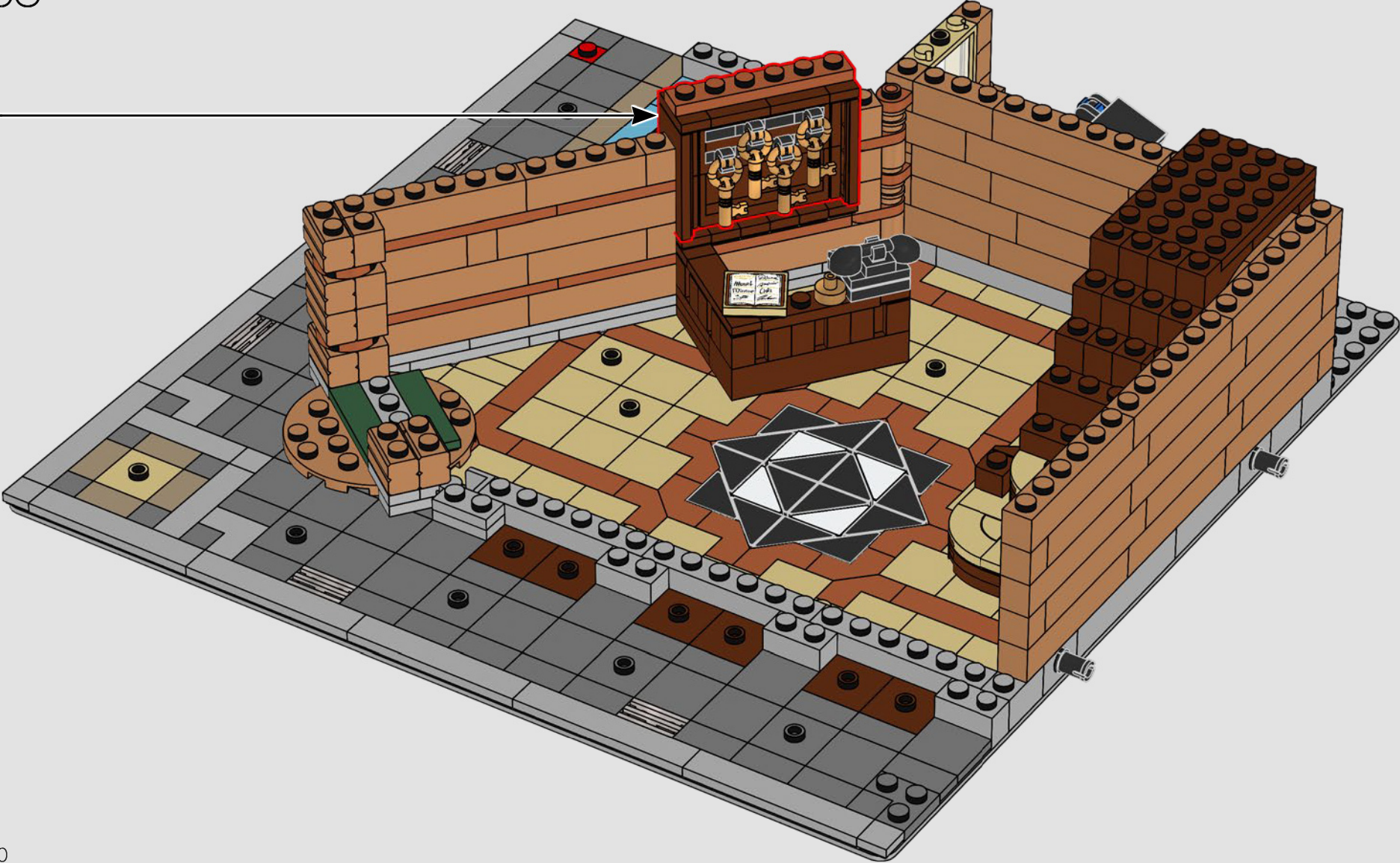

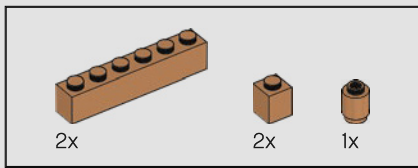

69

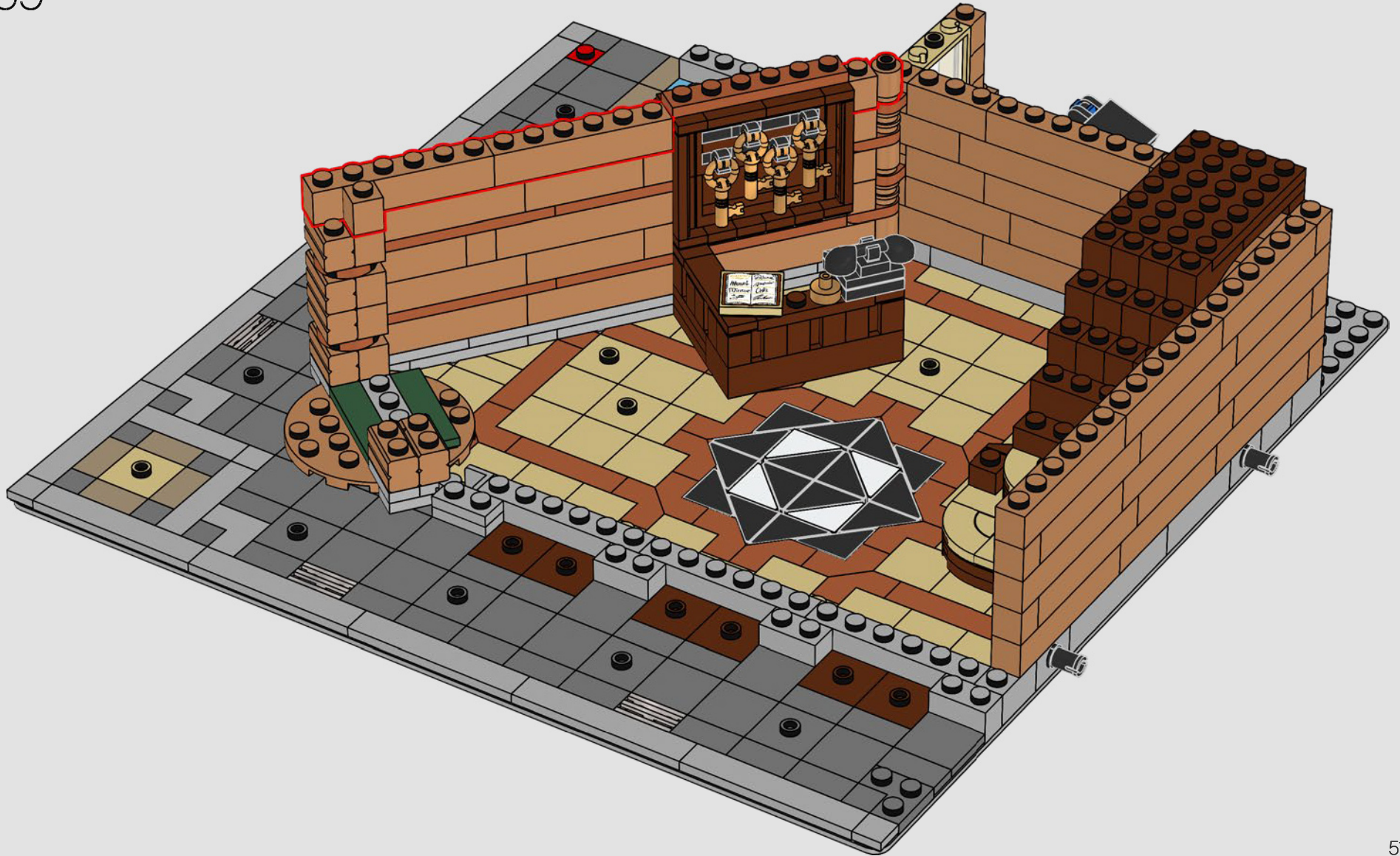

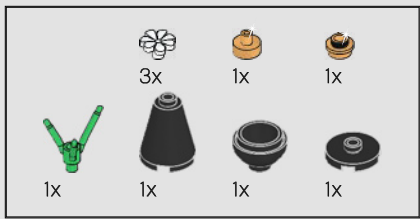

70

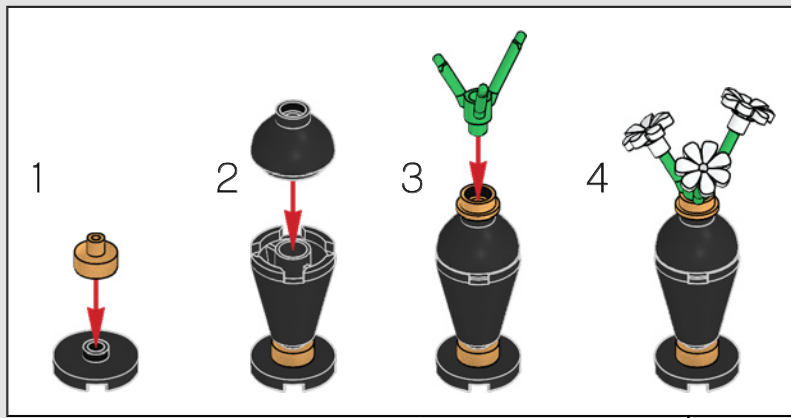

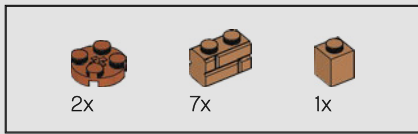

71

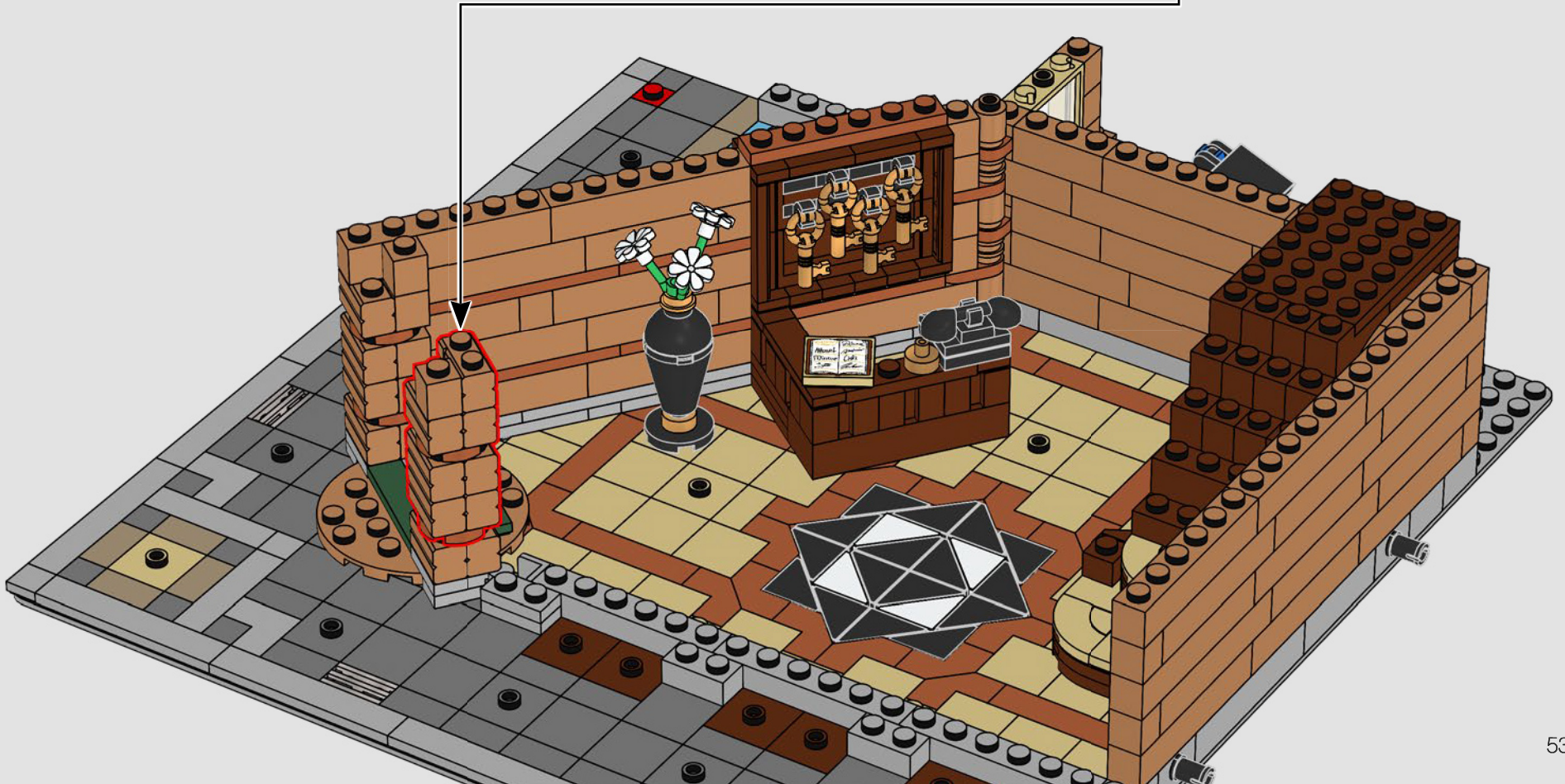
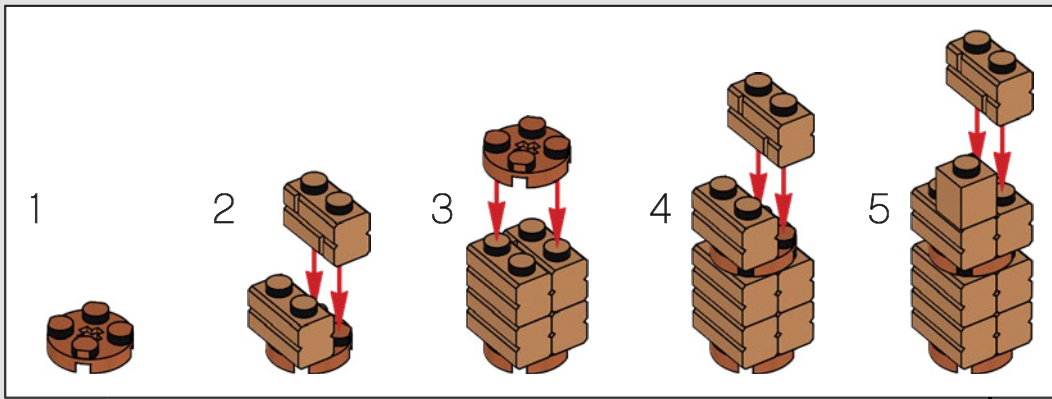

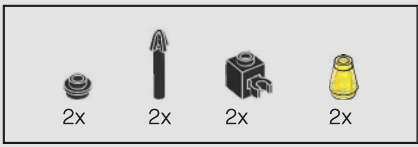

72

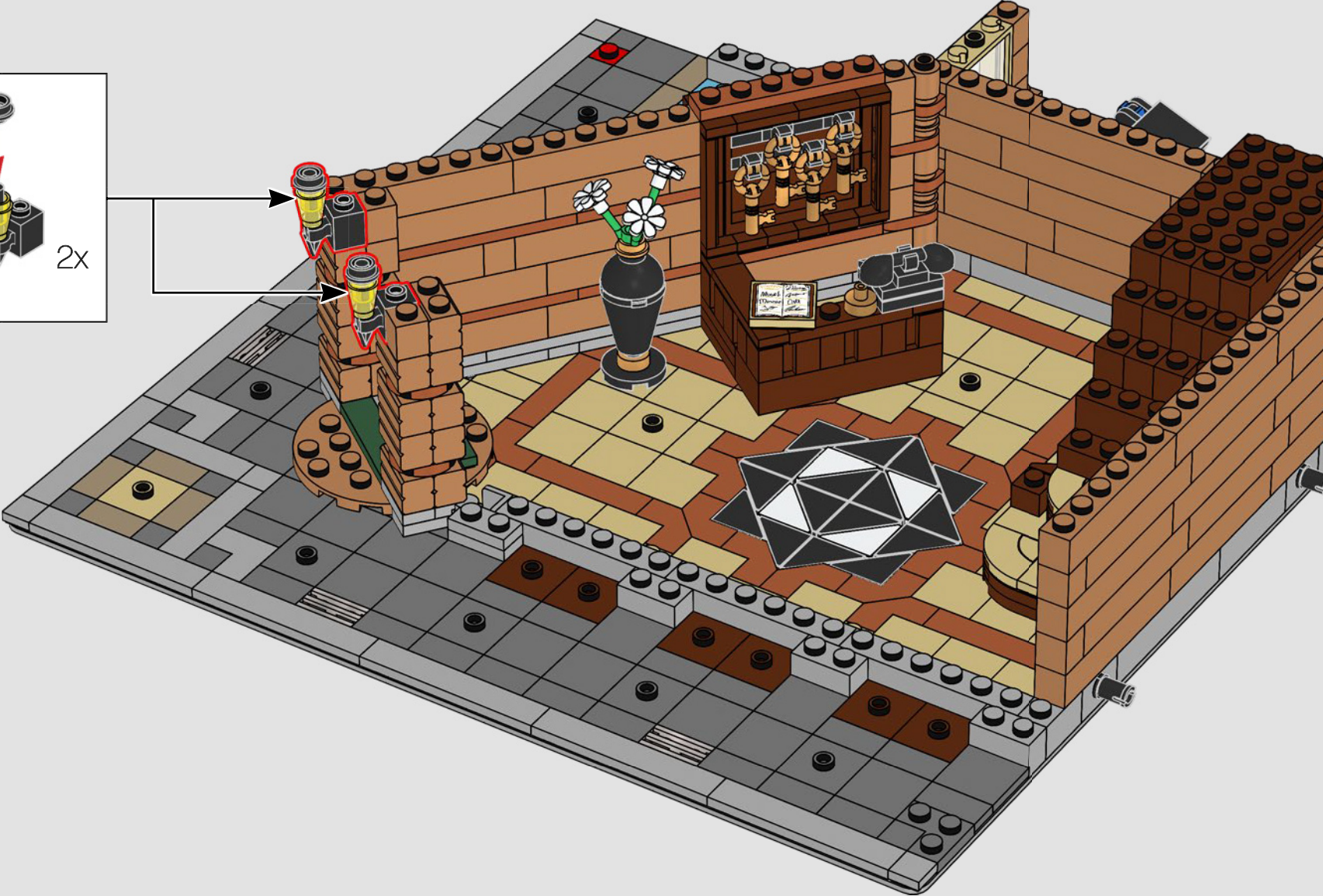
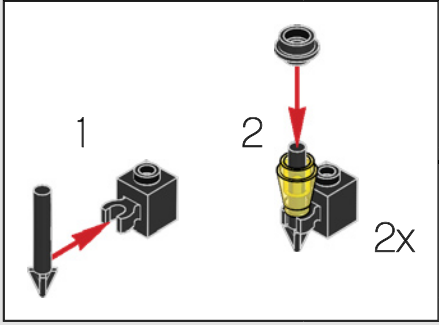

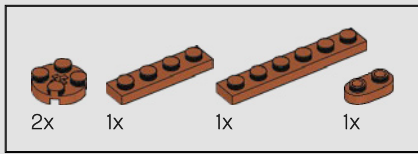

73

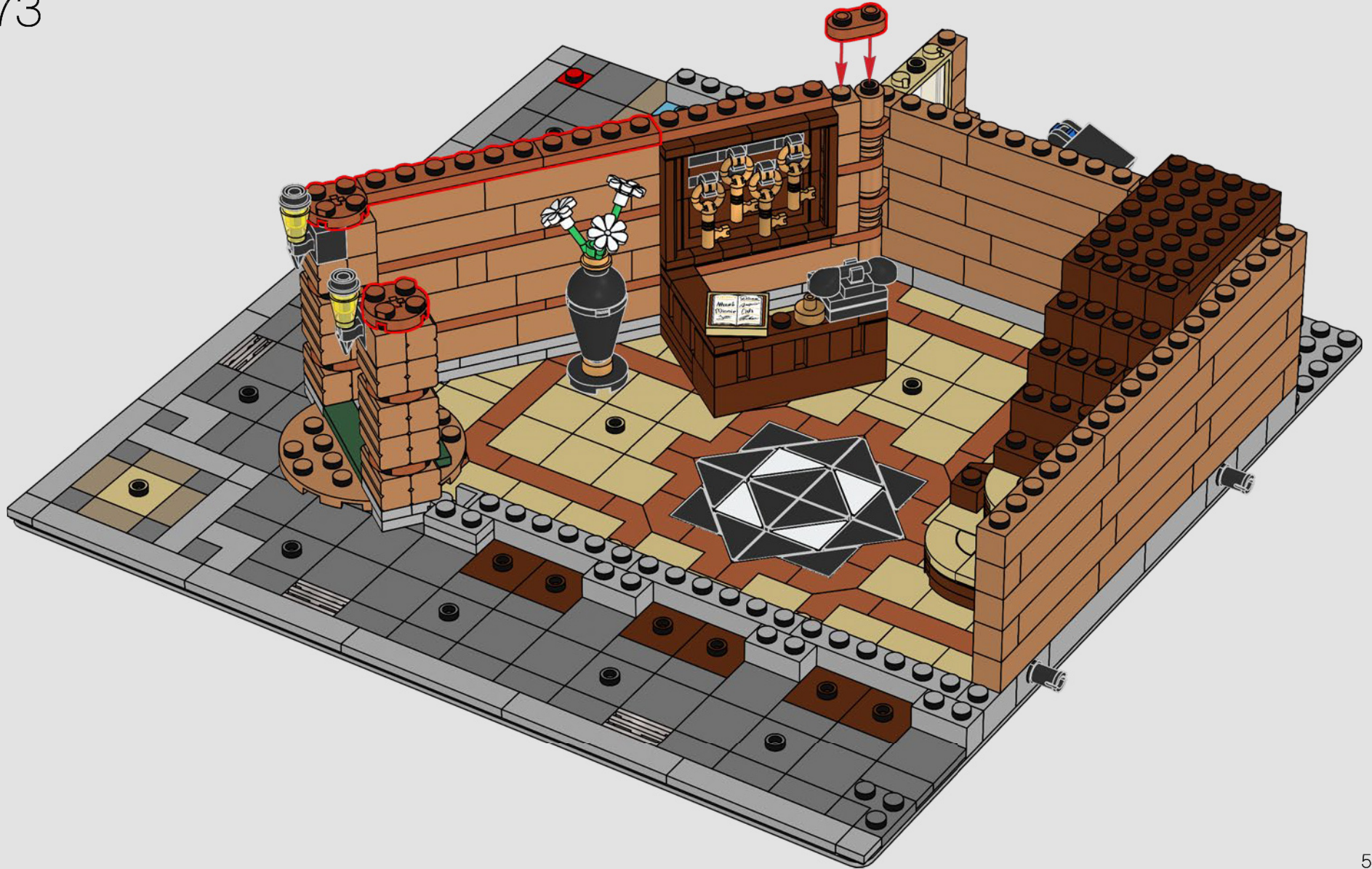

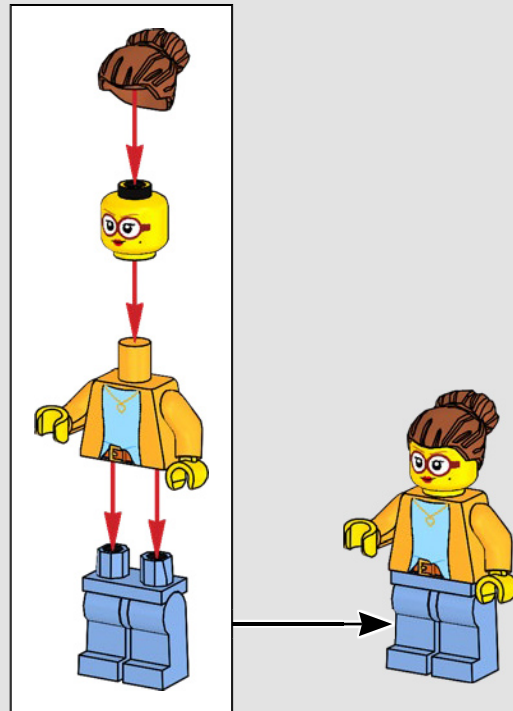



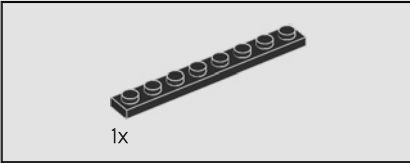
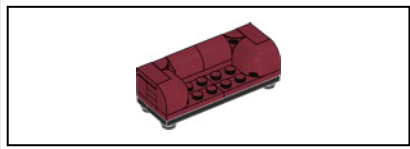

74

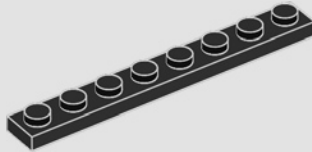

75

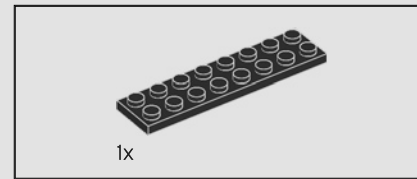
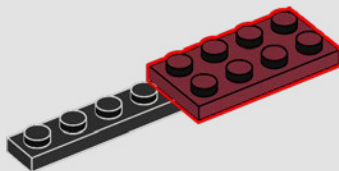

76

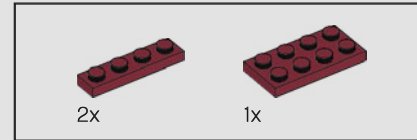
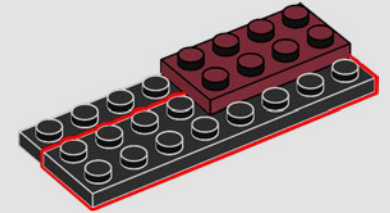

77

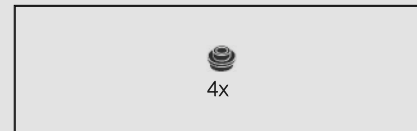
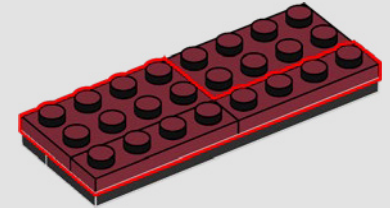

78

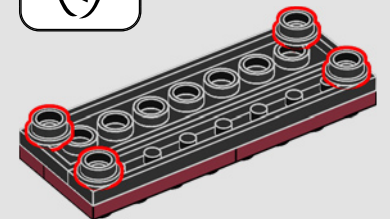
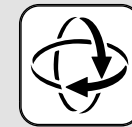

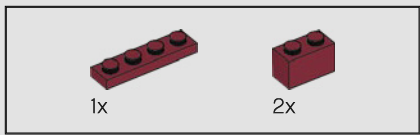

79

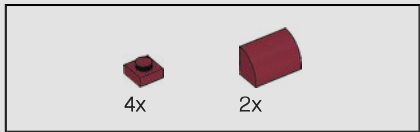
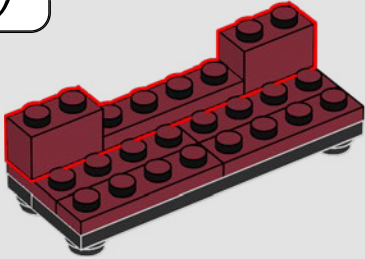

80

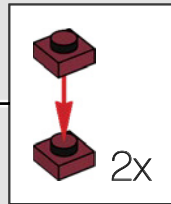
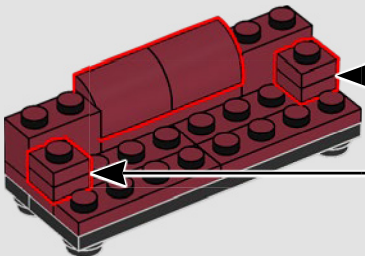

81

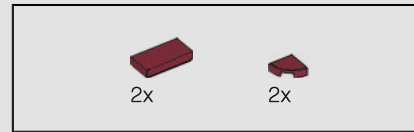
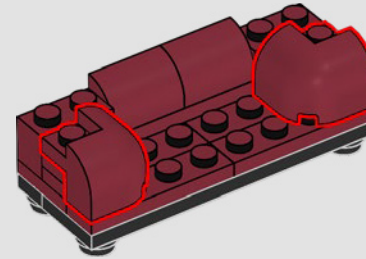

82

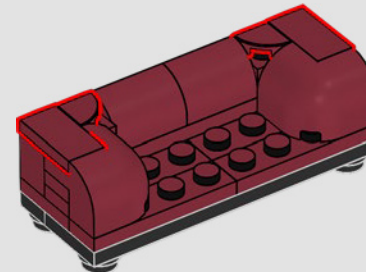



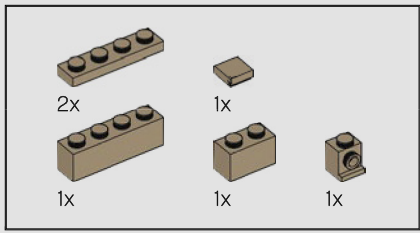

84

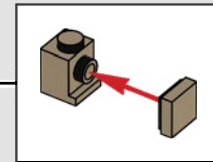
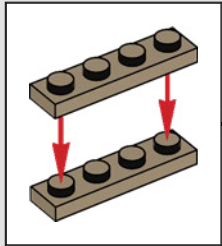
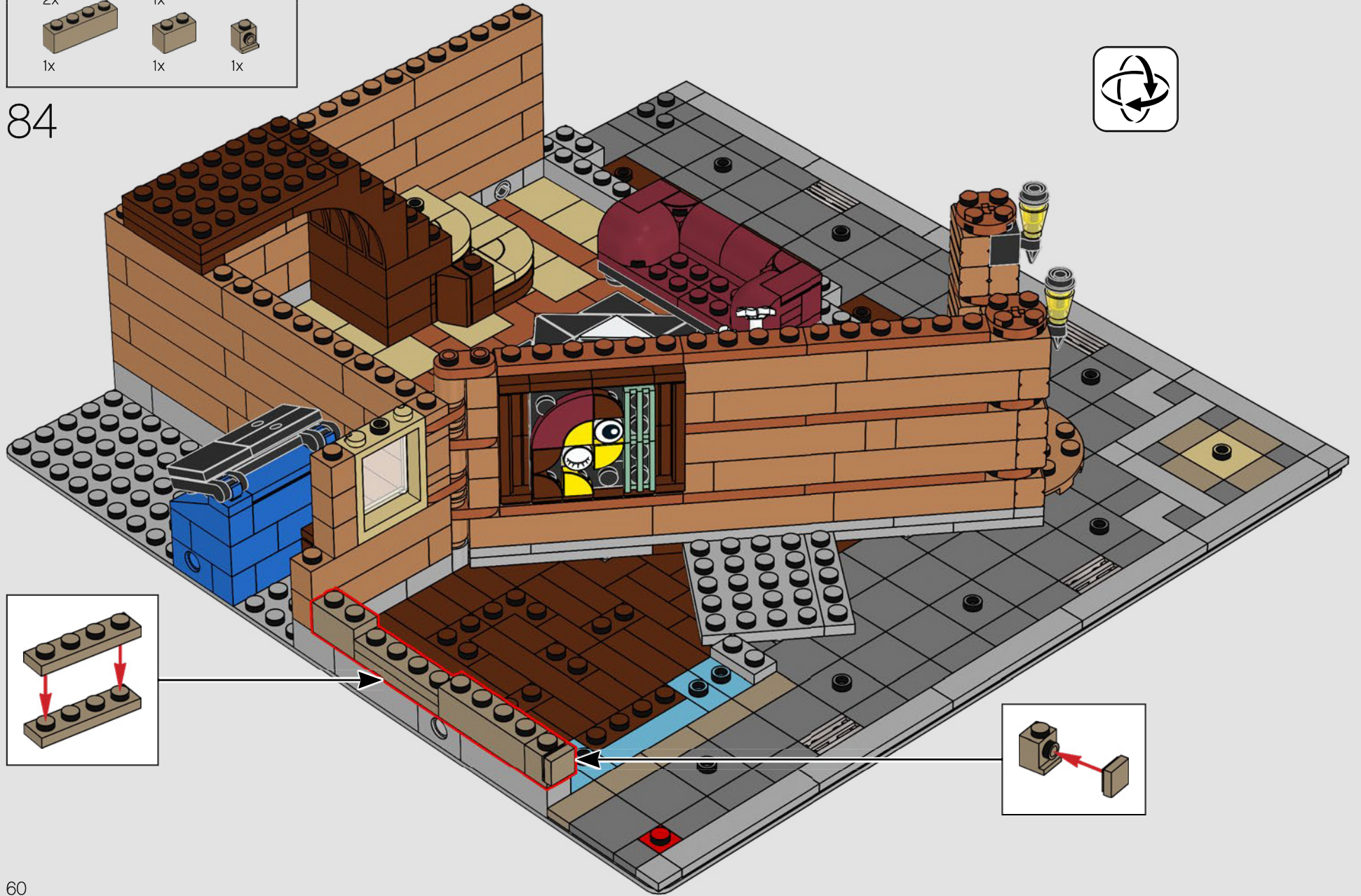

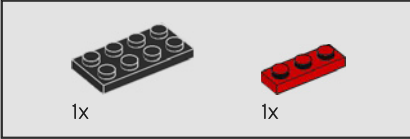

85

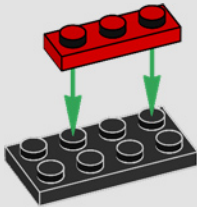

86

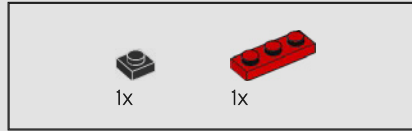
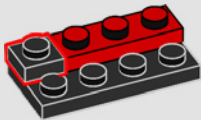

87

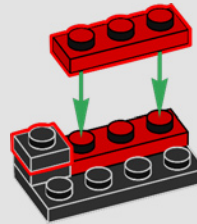

88

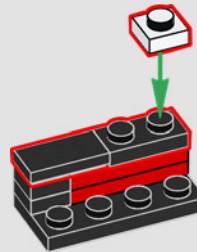

89

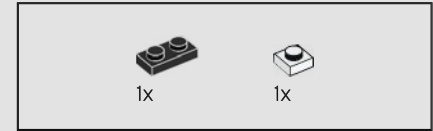
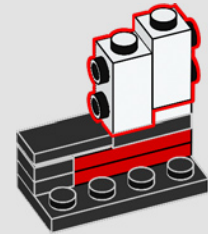

90

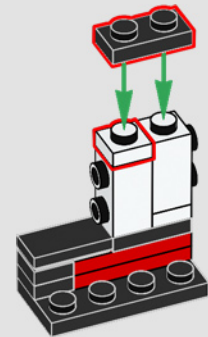

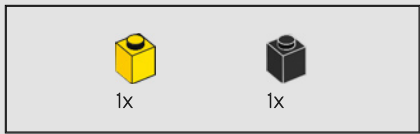

91

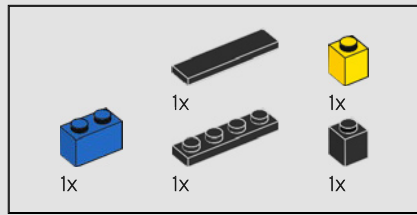
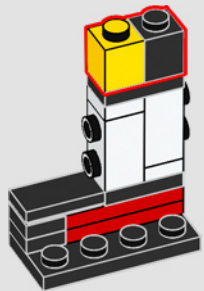

92

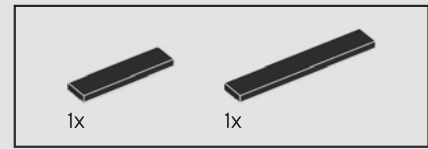
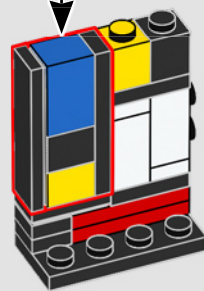
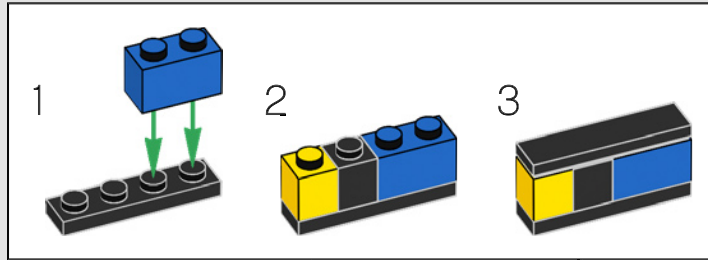

93

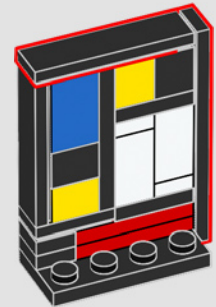

94

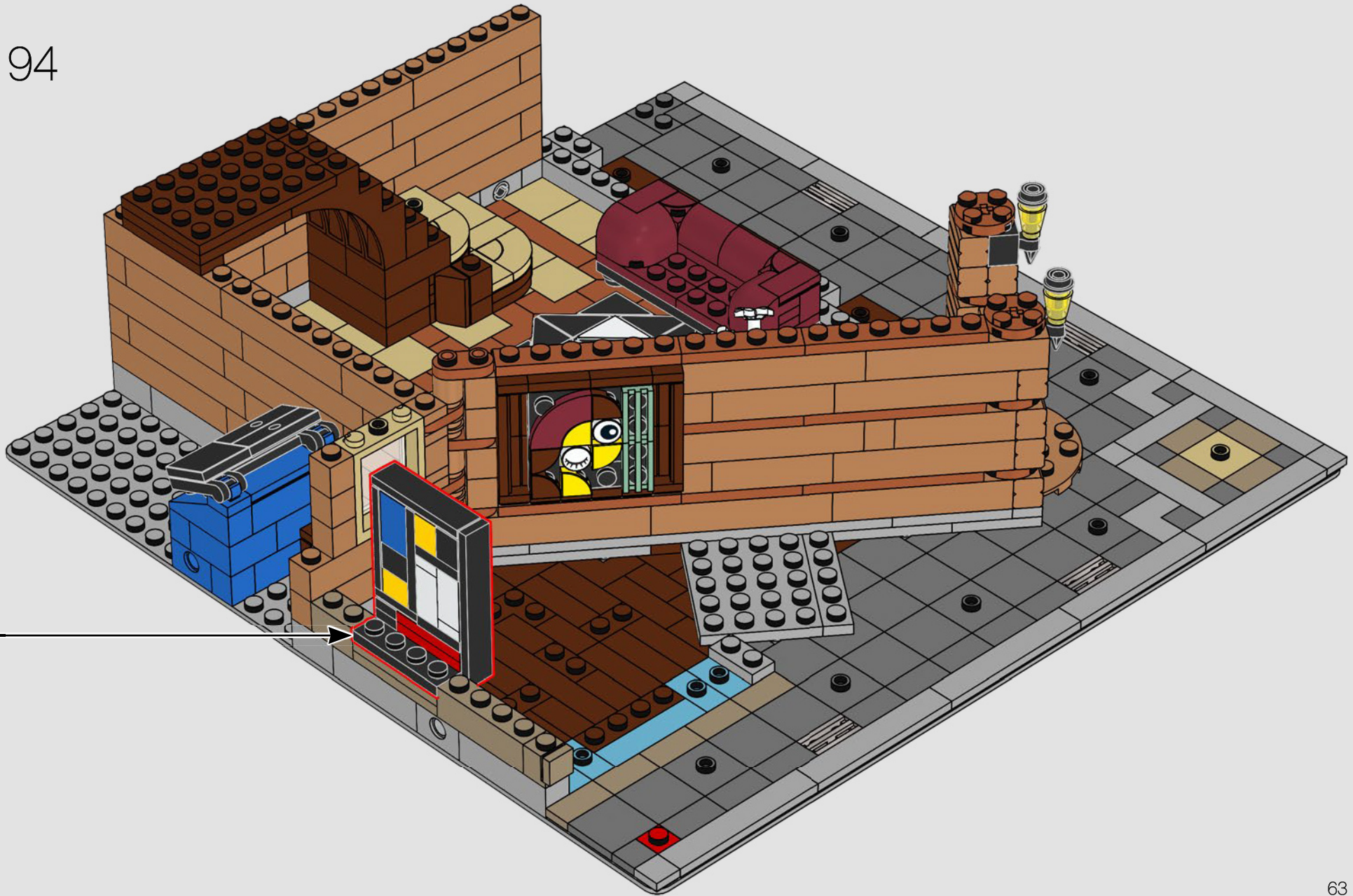

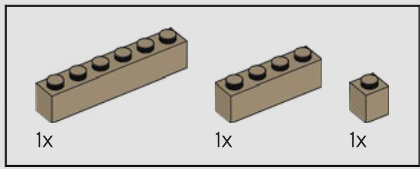

95

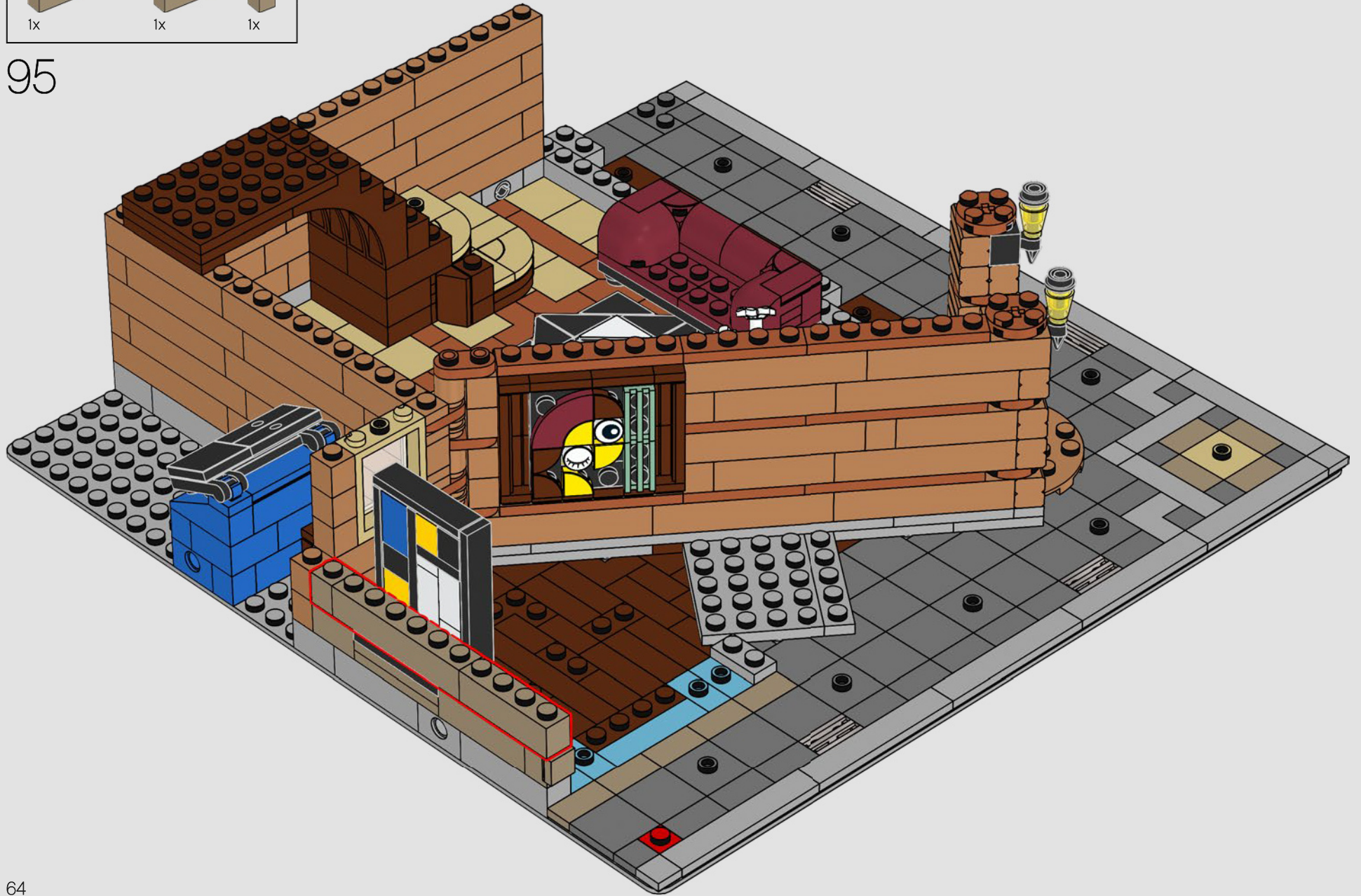



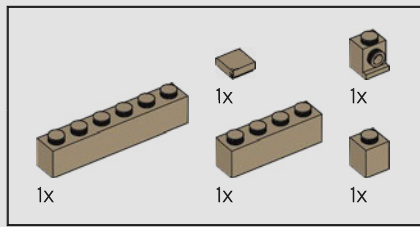

96

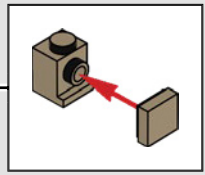
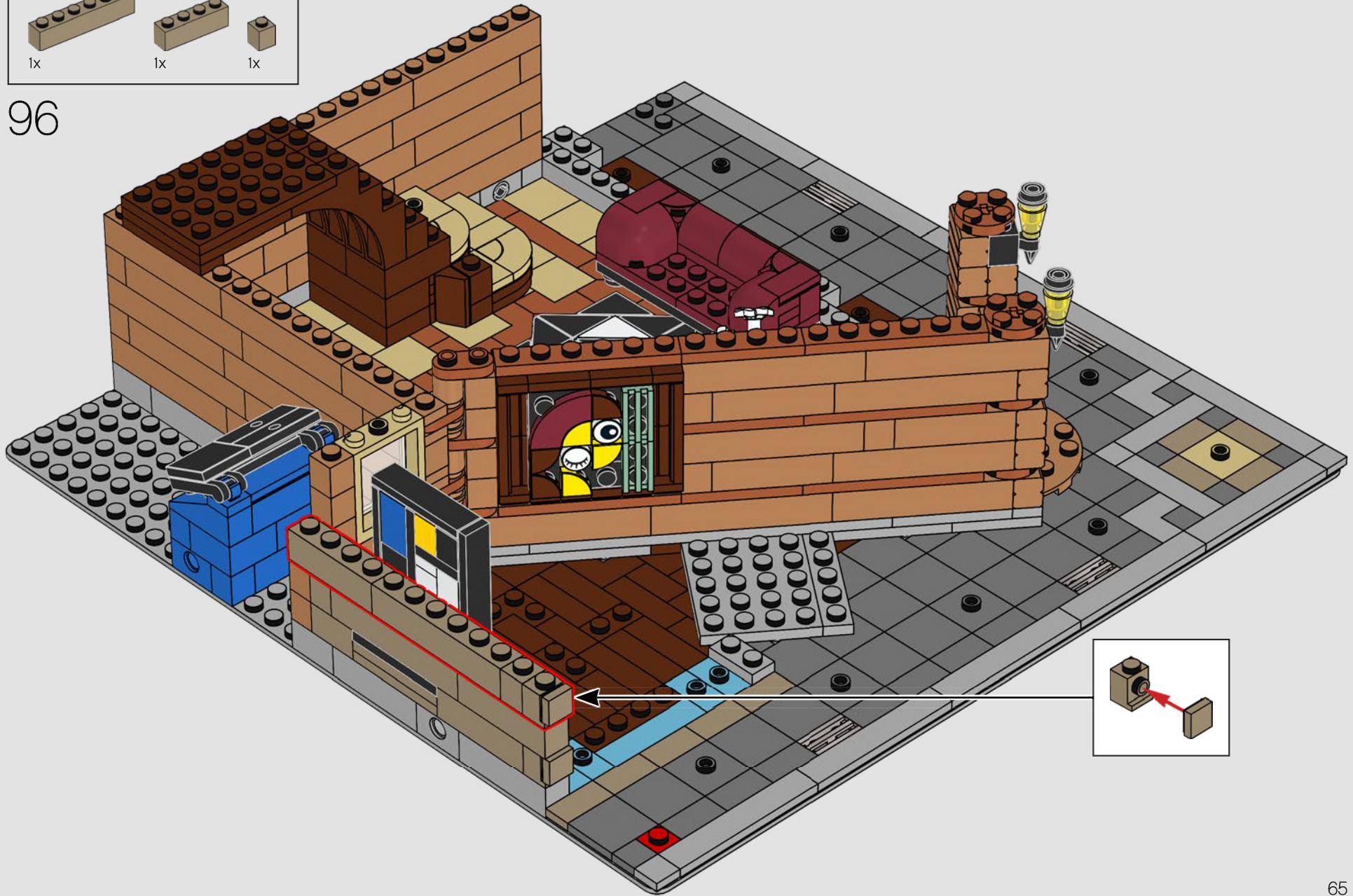

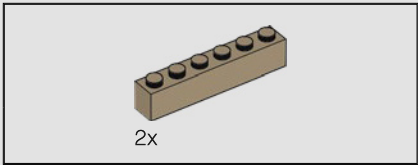

97

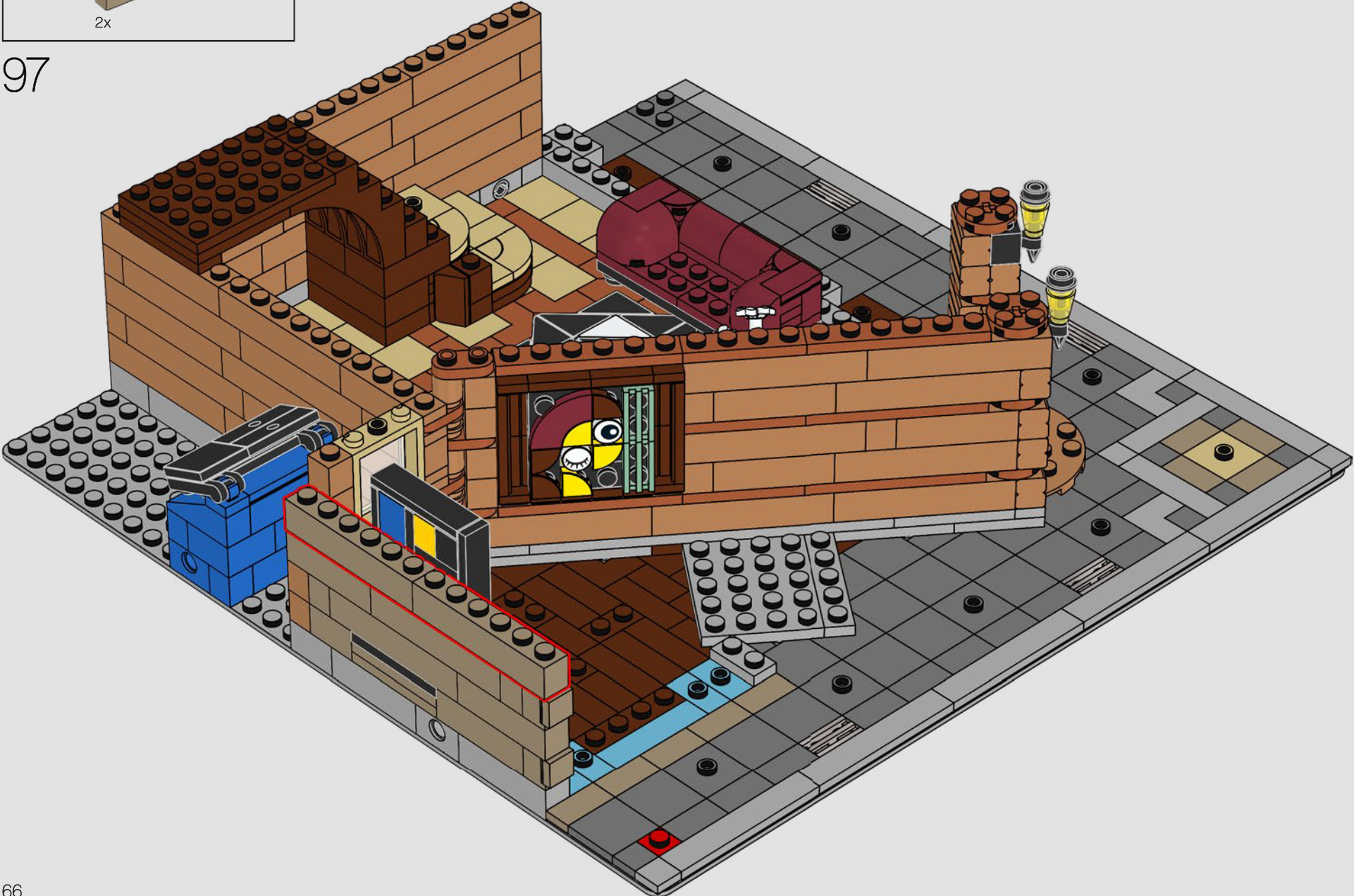

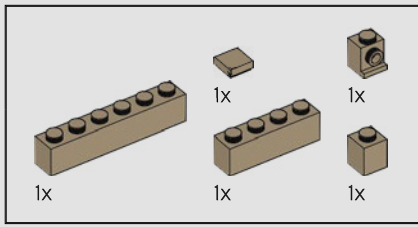

98

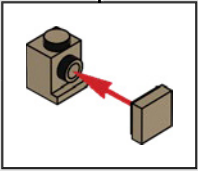
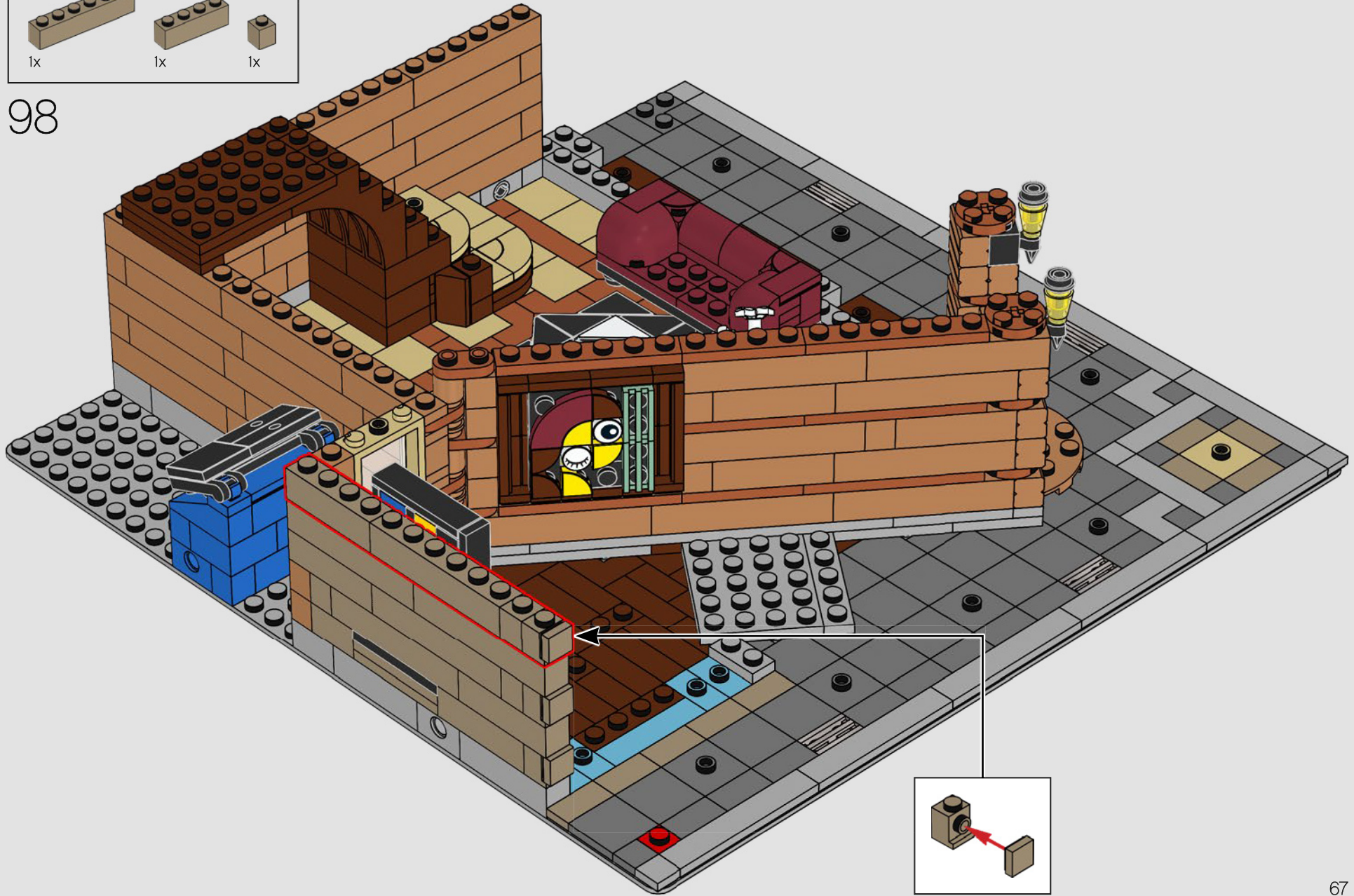

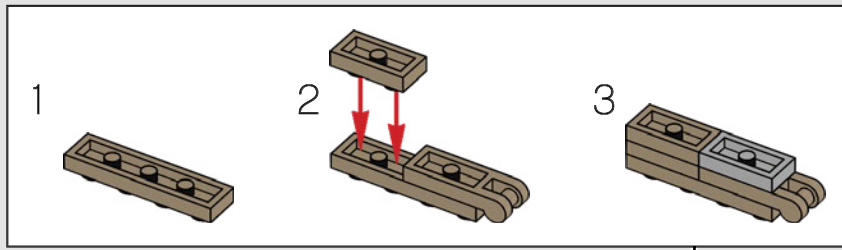
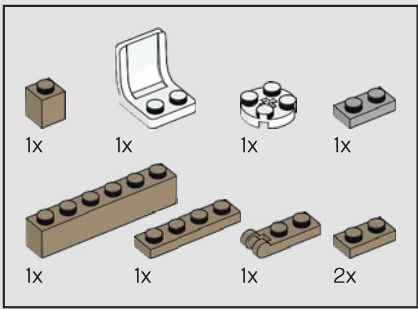

99



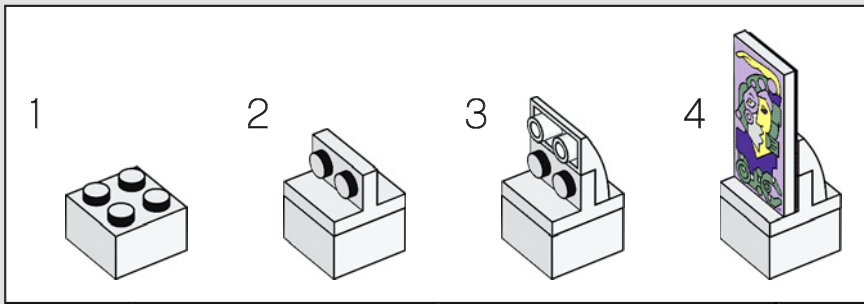
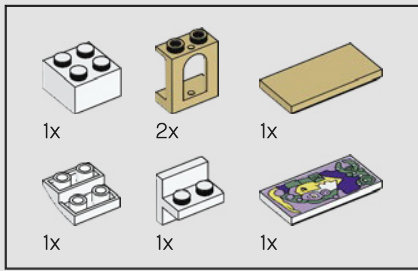

100

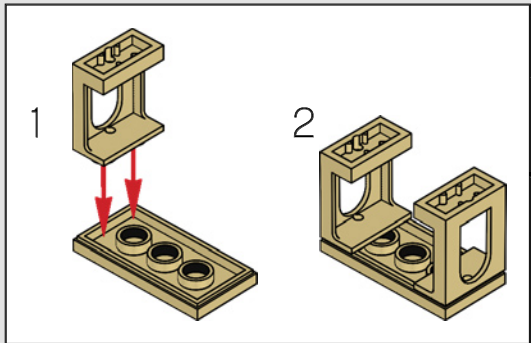

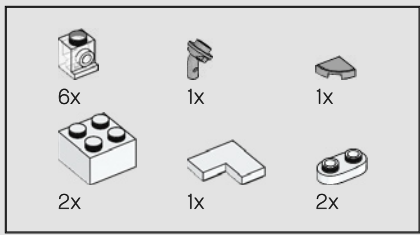

101

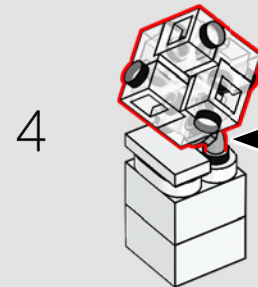
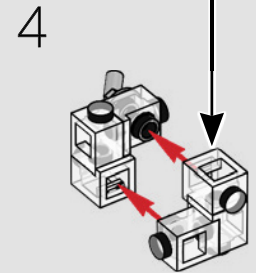
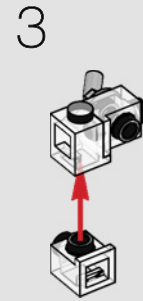
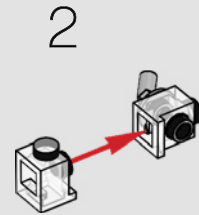
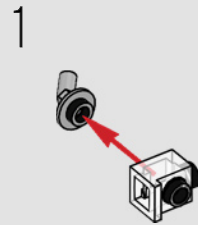
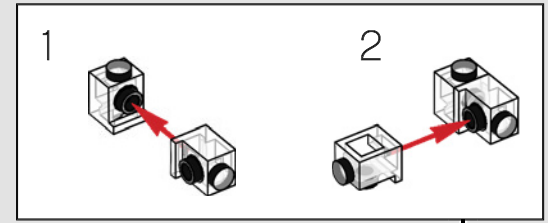
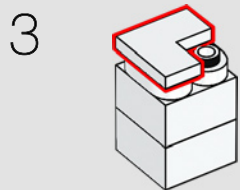
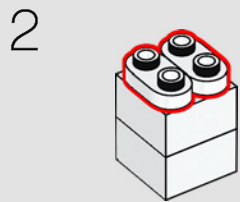
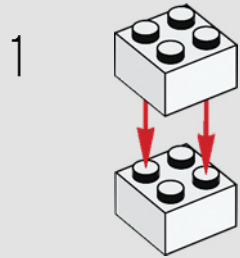

画廊老板首次展示她的立体派艺术品，显得异常激动！不过，她最喜欢的作品不是立体派，而是一个专门制作的立方体。

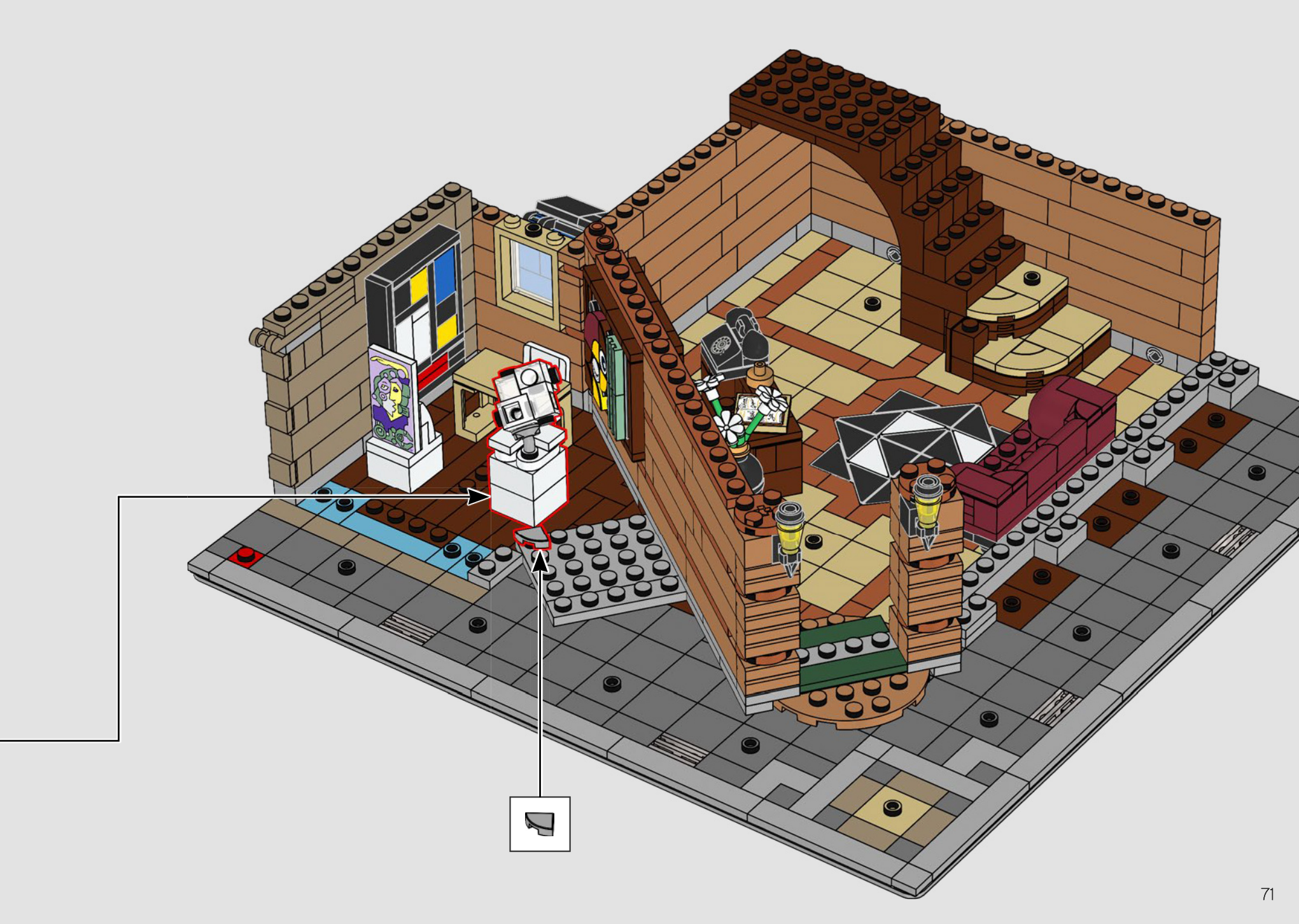

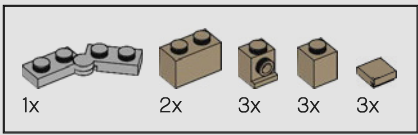

102

1

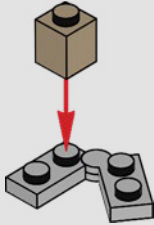

2

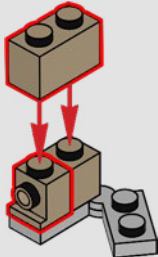

3

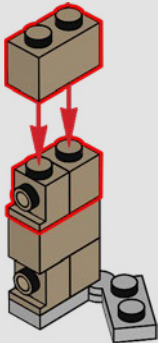

4

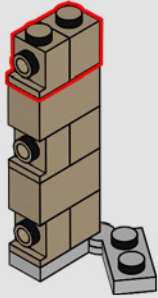

5

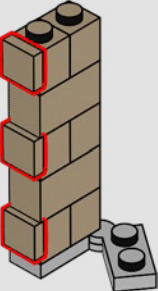



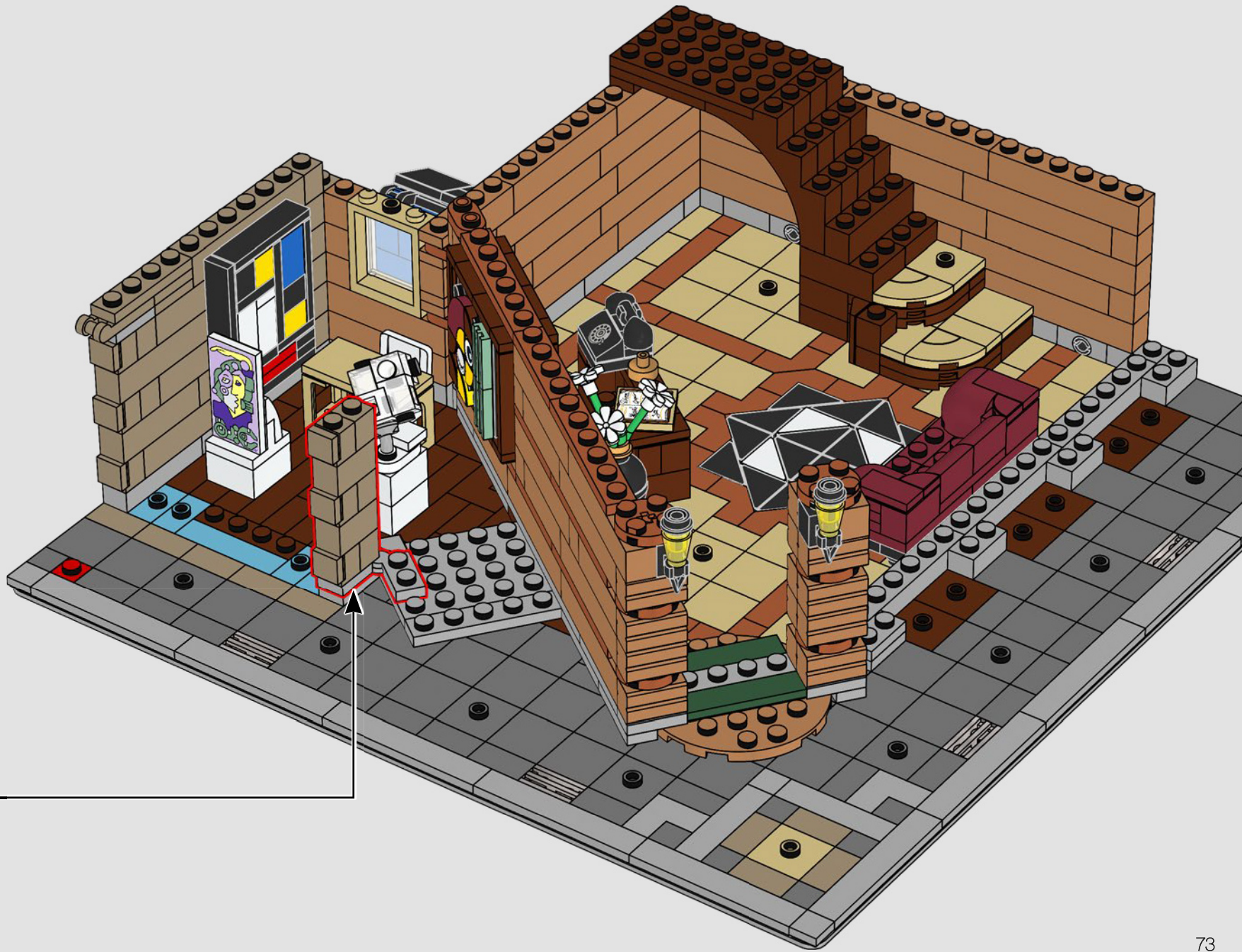

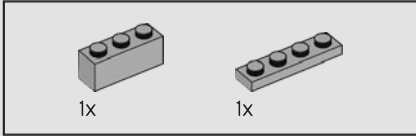
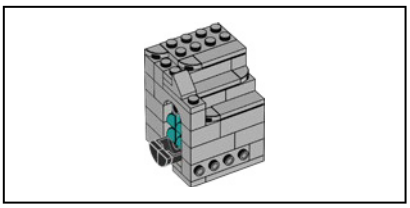

103

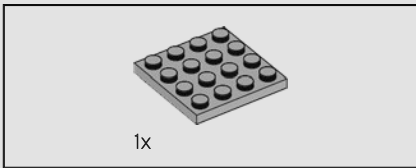
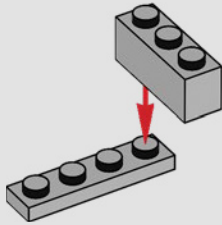

104

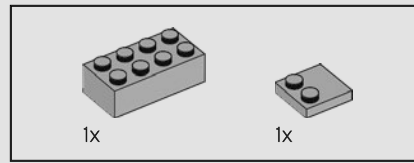
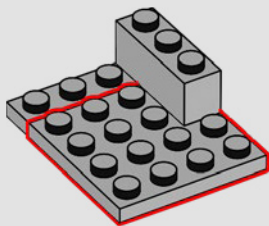

105

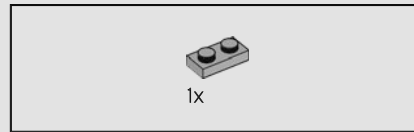
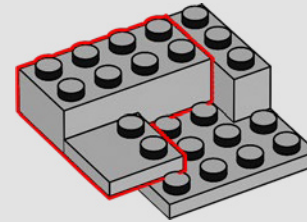

106

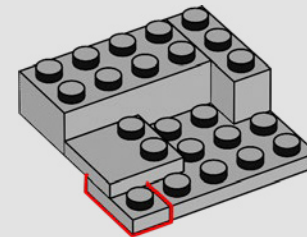

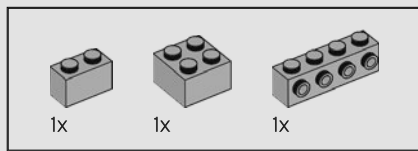

107

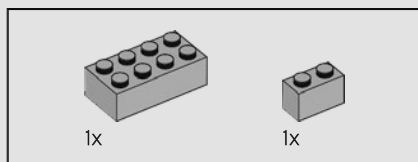
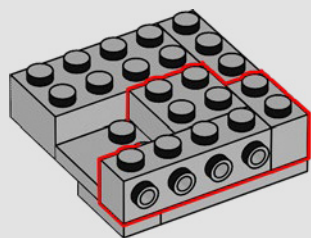

108

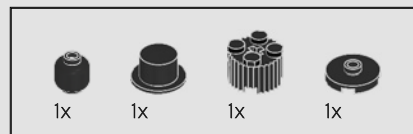
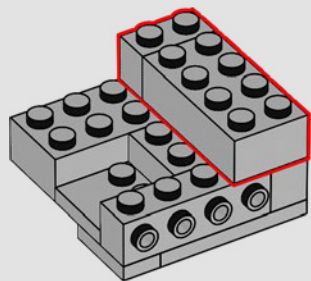

109

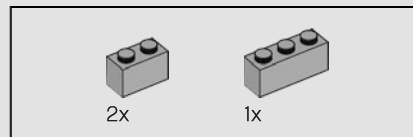
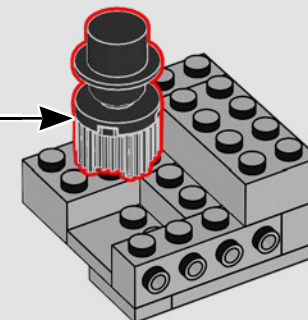
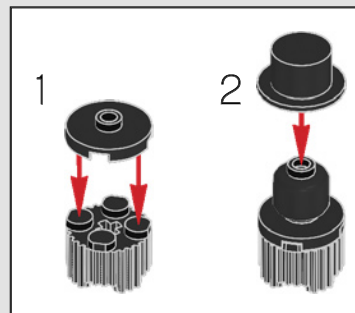

110

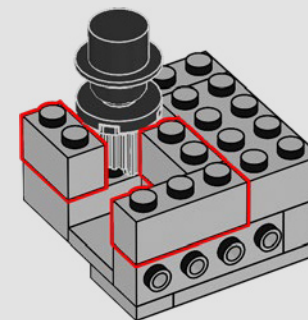

雕刻这座半身像的艺术家还制作了 10224 市政厅套装大厅中的白色半身像。 75

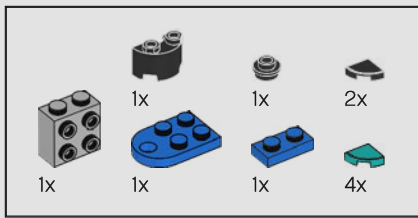

111

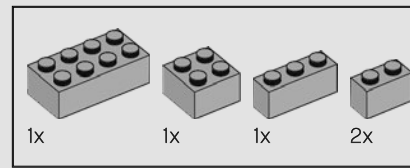
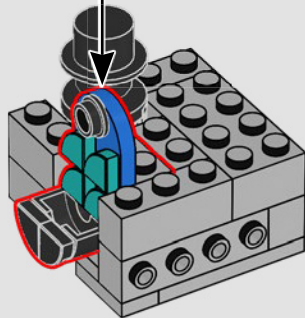
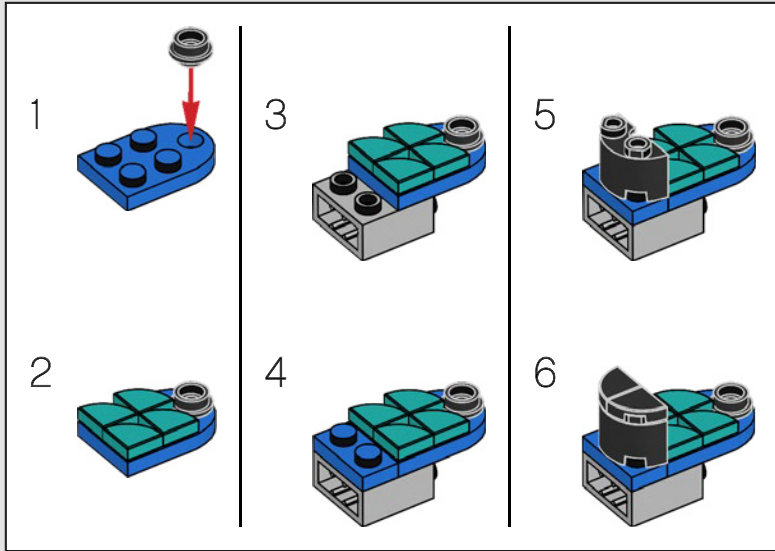

112

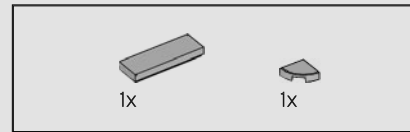
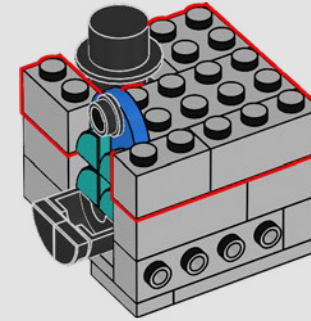

113

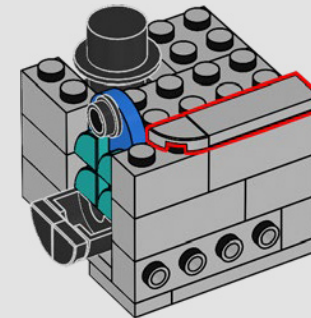

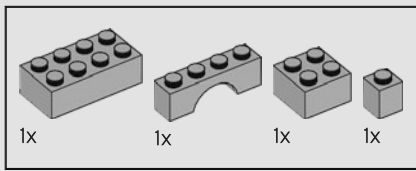

114

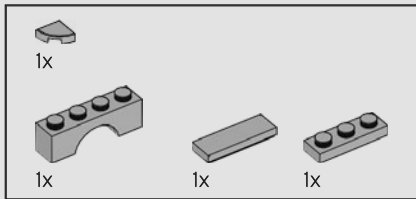
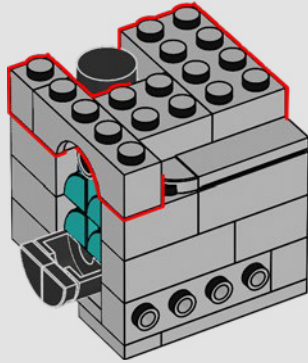

115

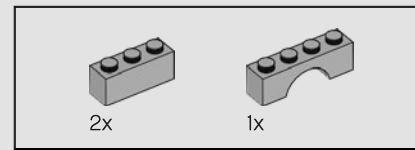
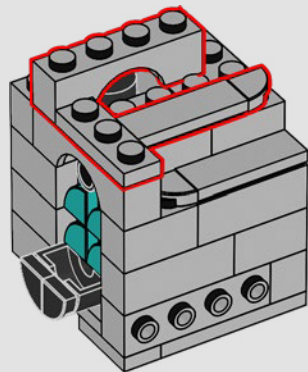

116

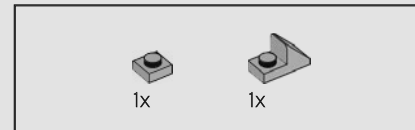
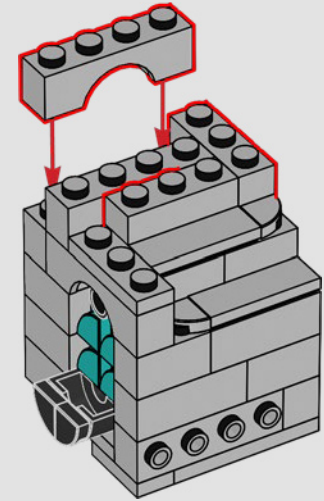

117

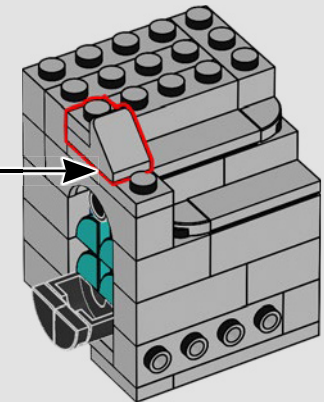
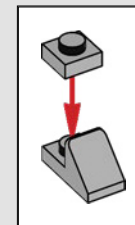

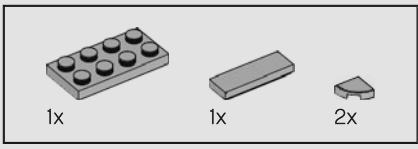

118

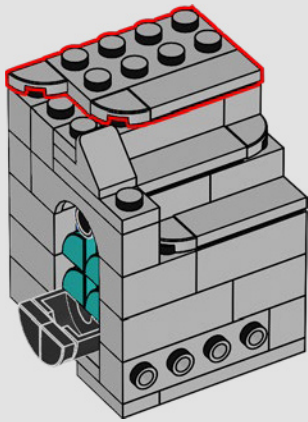

119

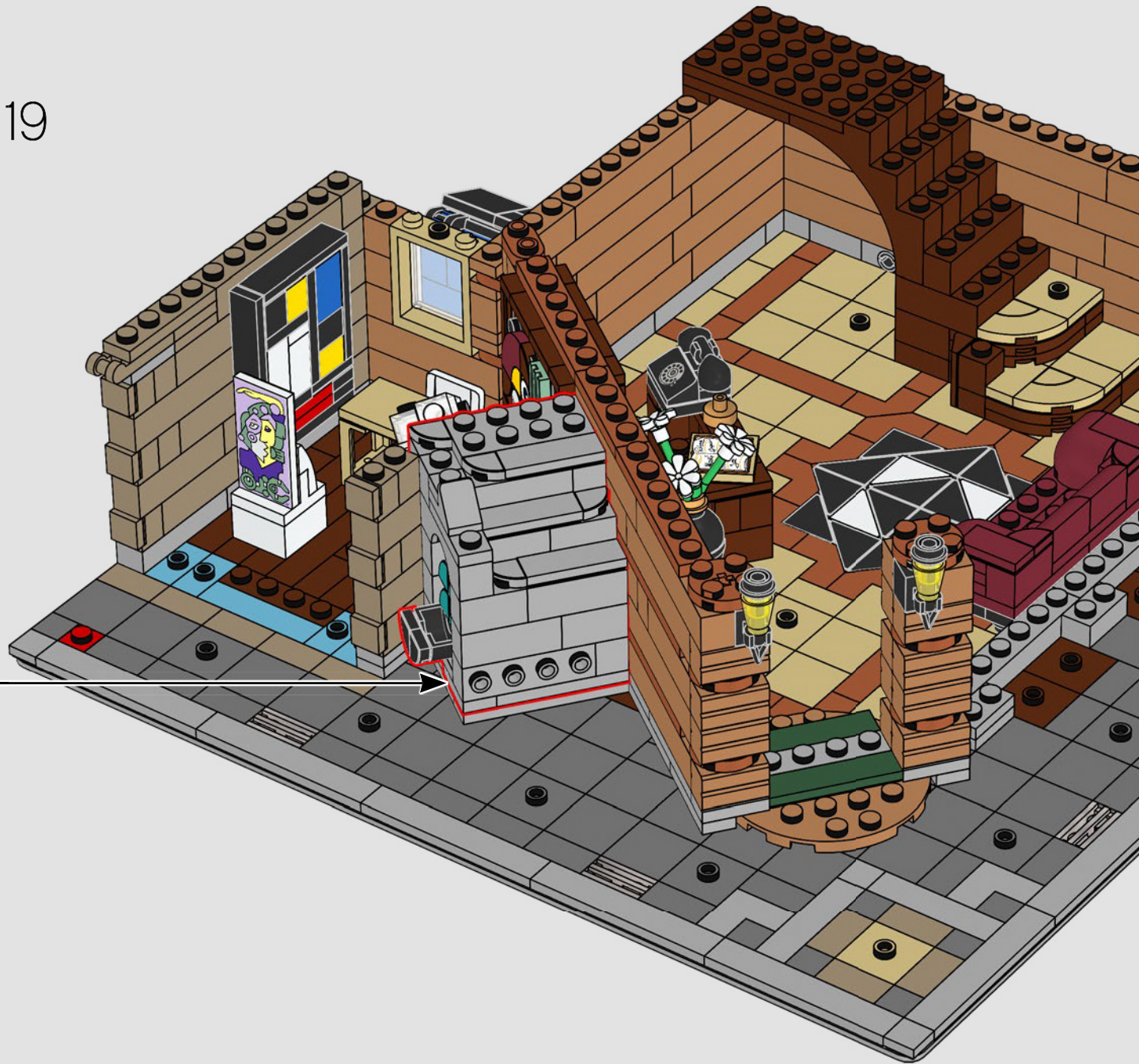

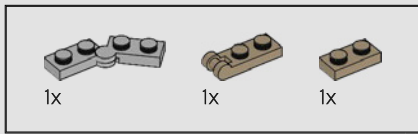

120

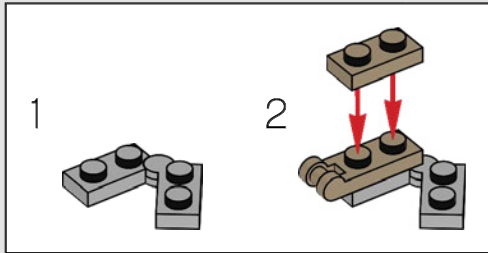

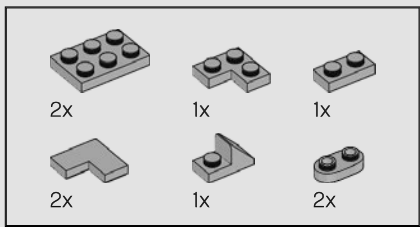

121

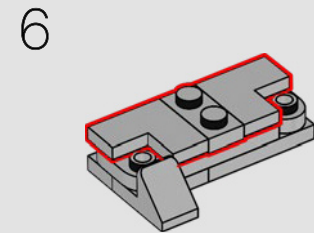
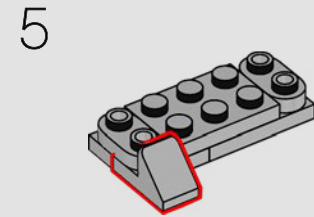
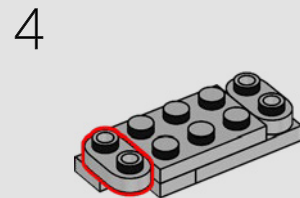
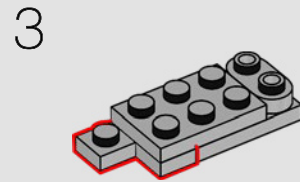
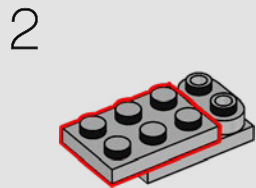
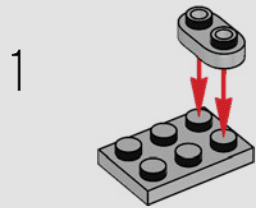





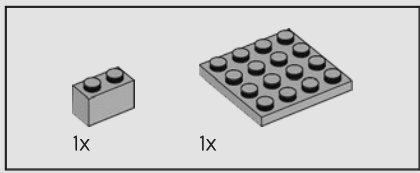

122

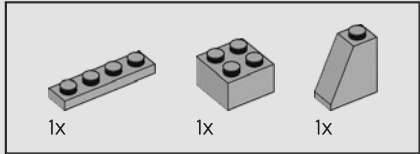
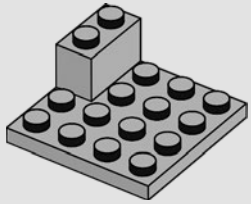

123

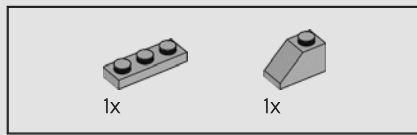
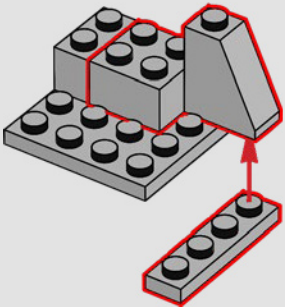

124

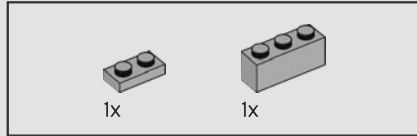
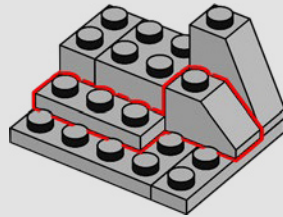

125

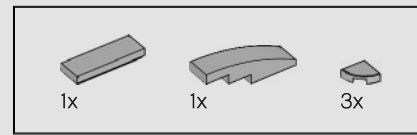
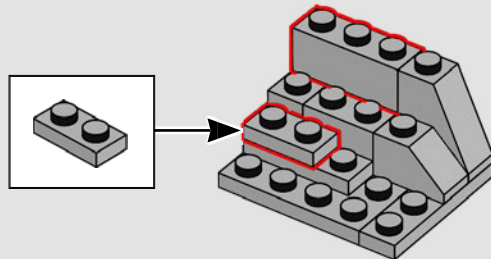

126

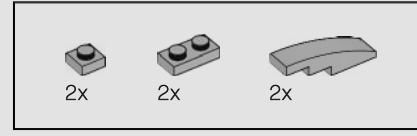
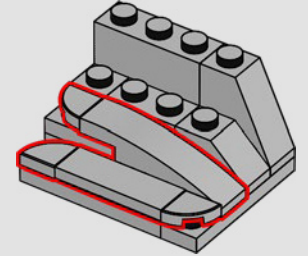

127

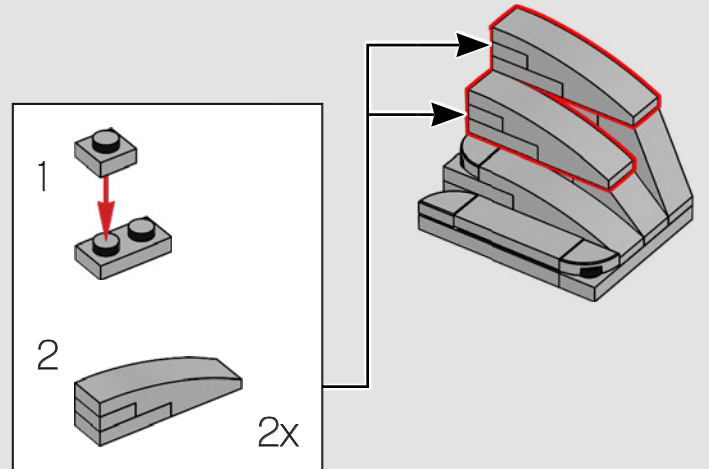

128

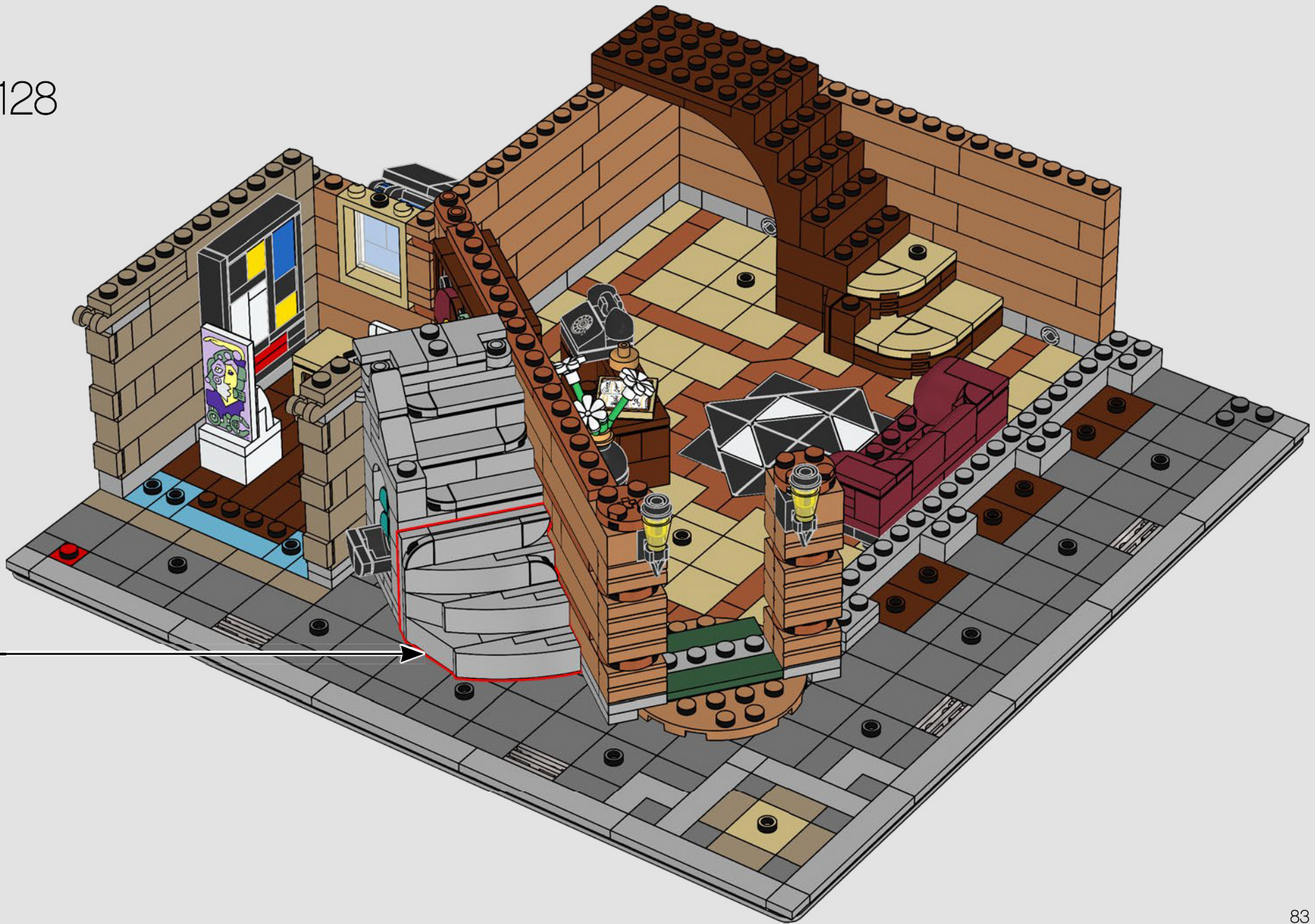

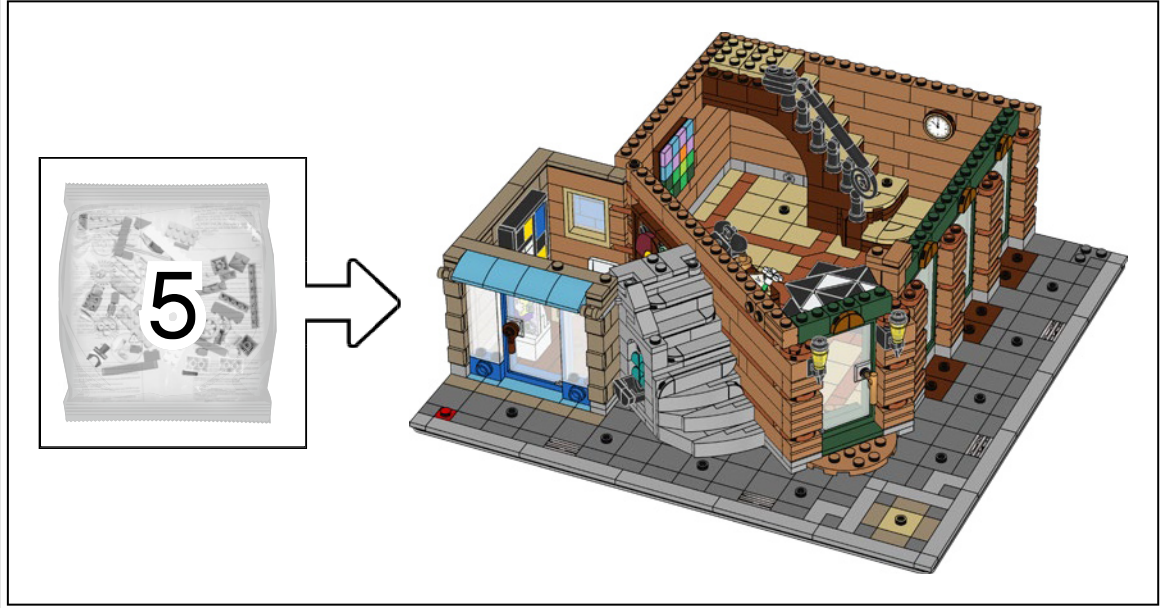

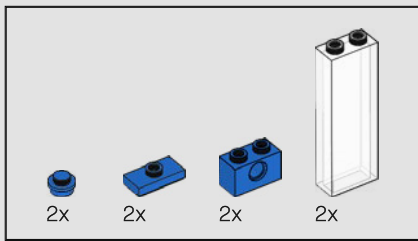

129

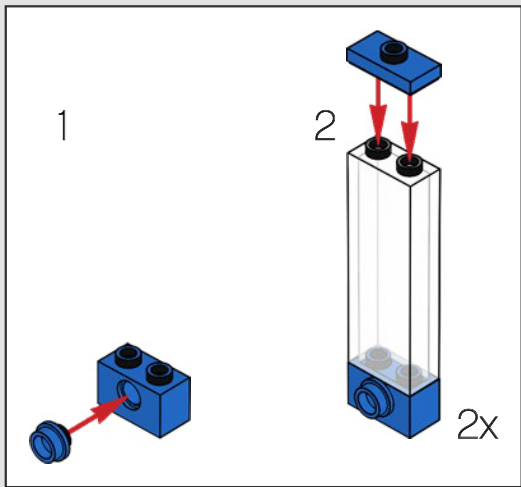

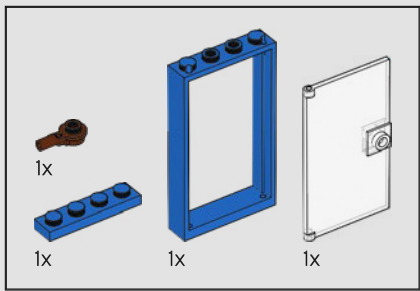

130

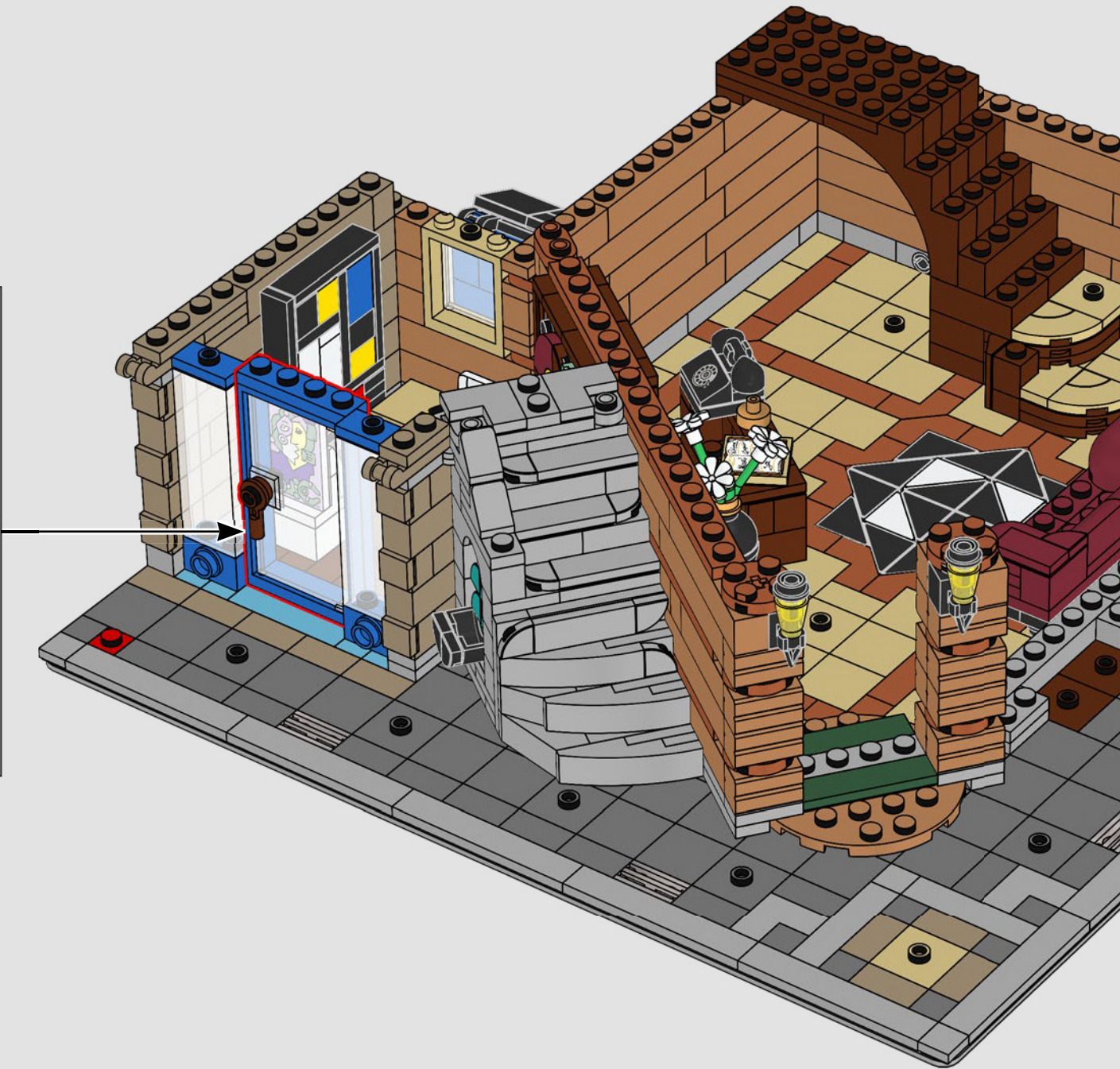
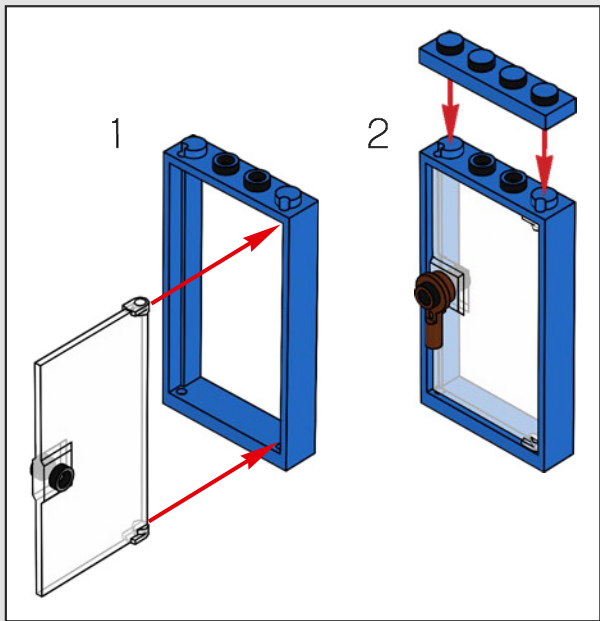

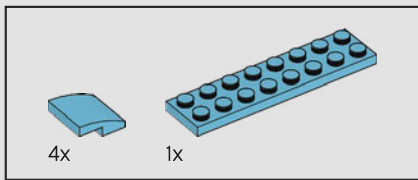

131

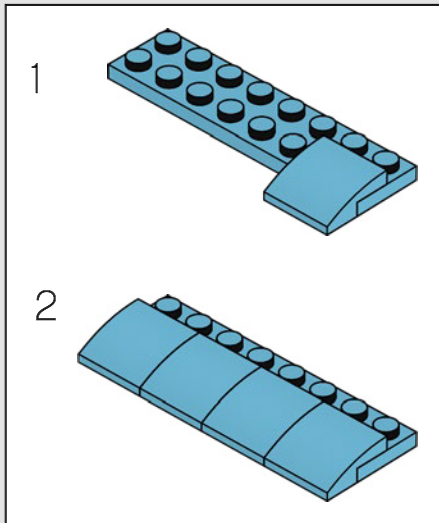

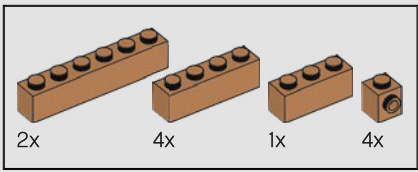

132





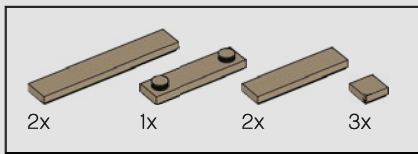

133



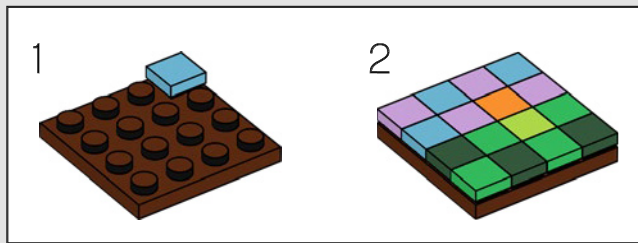
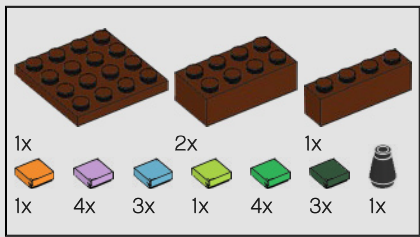

绘制这幅画的艺术家的工作室位于  
10243 巴黎餐厅套装的阁楼中。

134



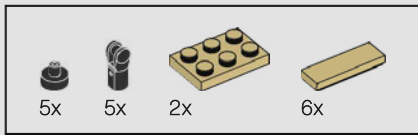

135

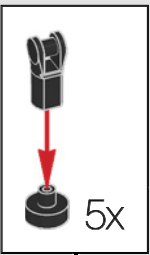



136

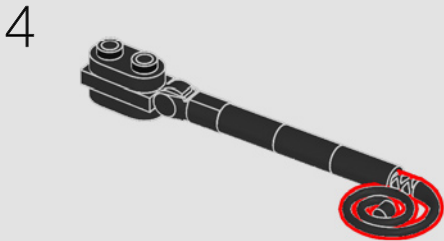
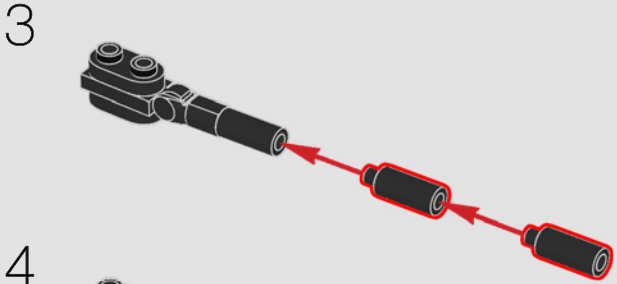
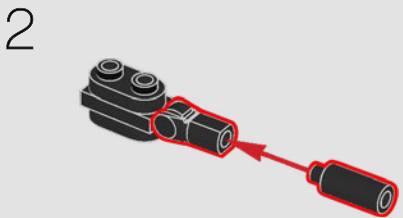
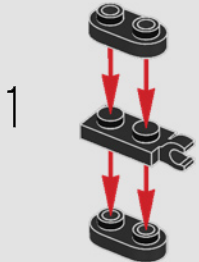

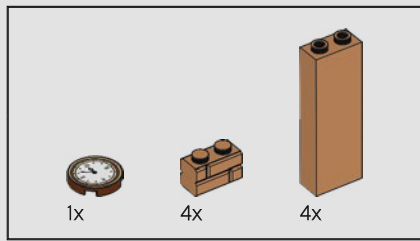

137

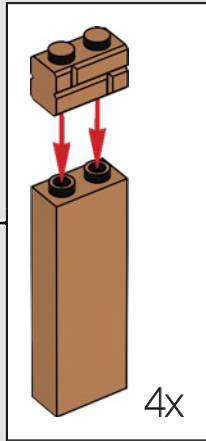

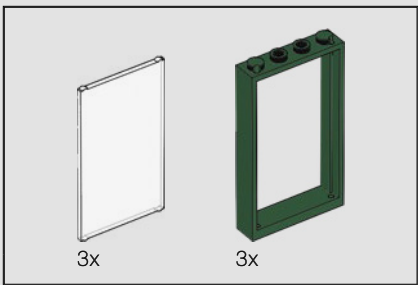

138

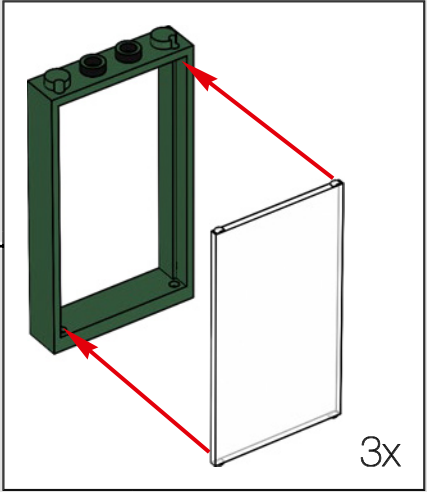

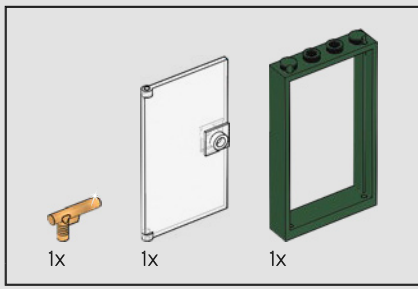

139

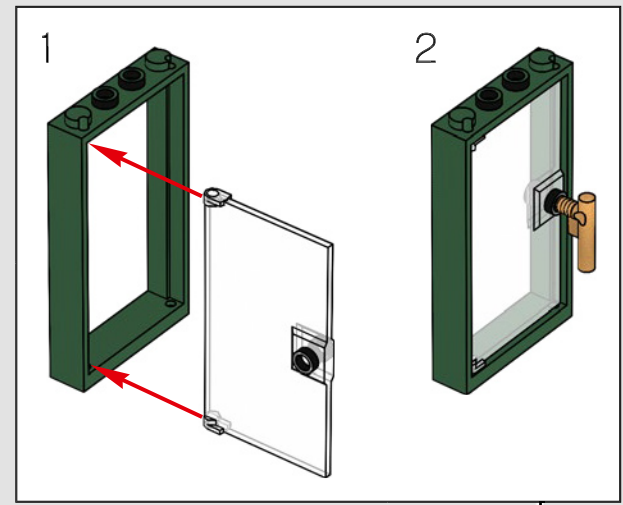

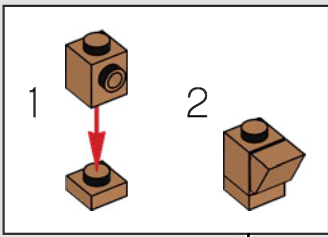
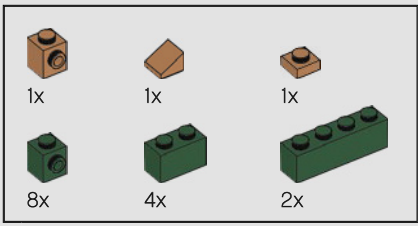

140







141



- 12x
- 20x
- 1x
- 1x
- 1x

142

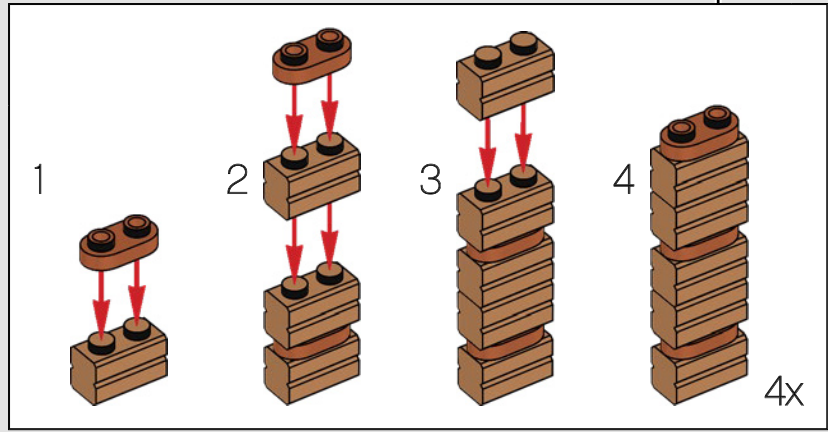
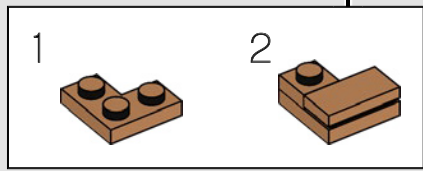

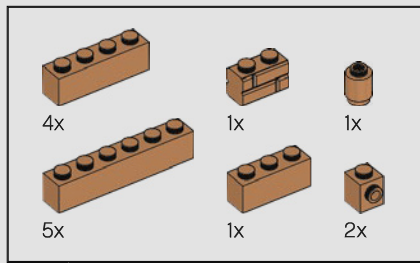

143



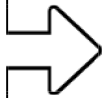

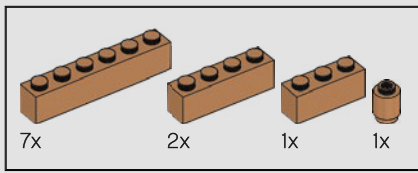

144



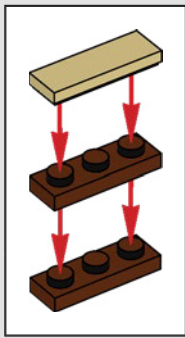
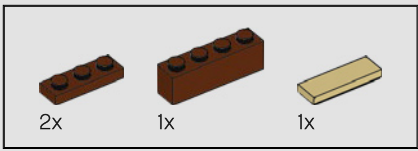

145



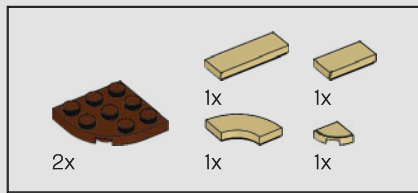

146

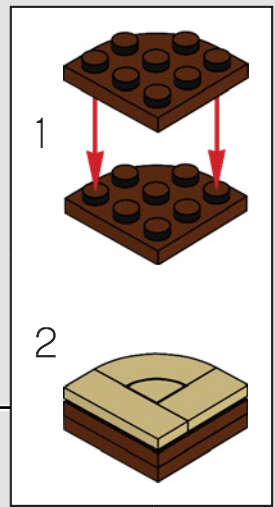

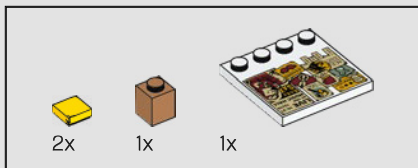

147

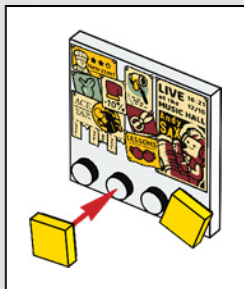

★★★★★  
 这块布告栏上贴满了商品和服务广告信息，  
 而这些商品和服务均来自之前的模块化套  
 装。看你能否认出这些物品！

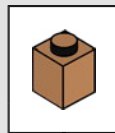



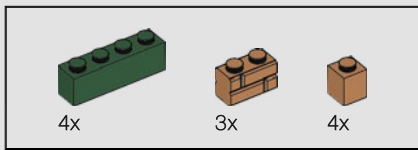

148

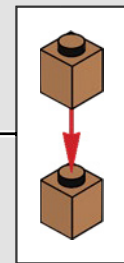

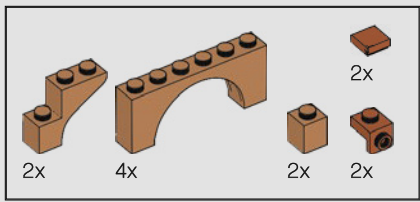

149

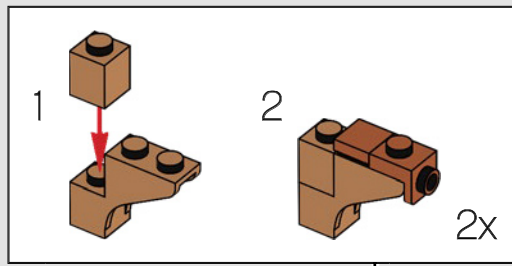

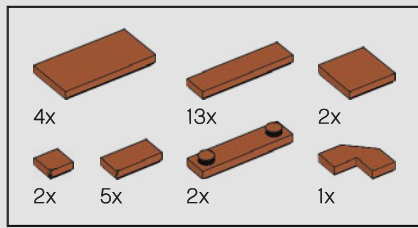

150



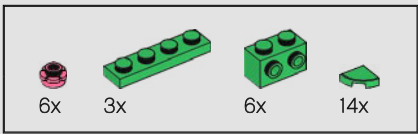

151

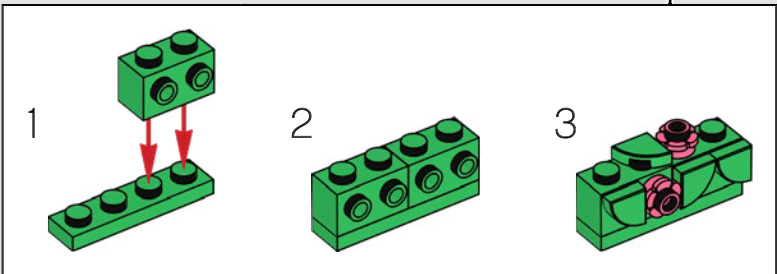
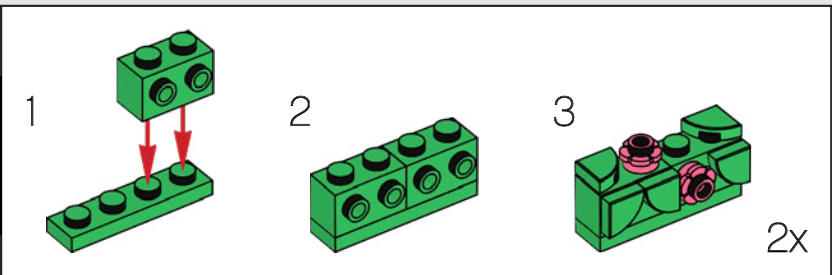

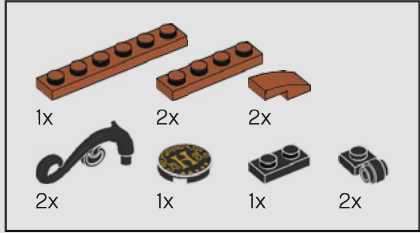
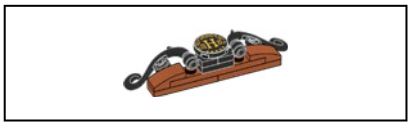

152

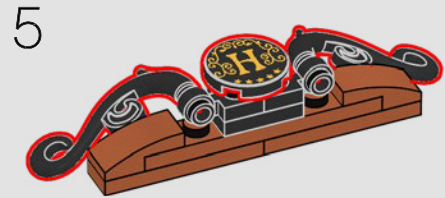
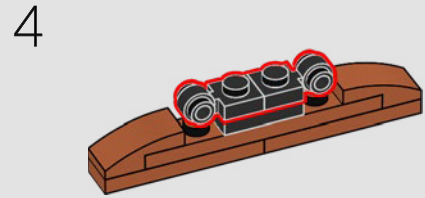
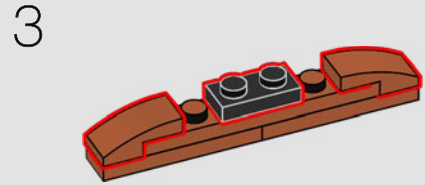
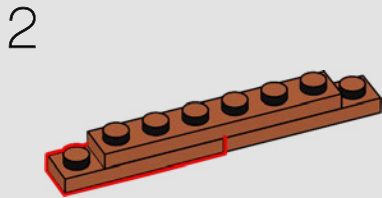
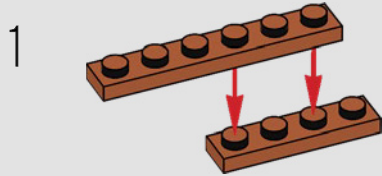



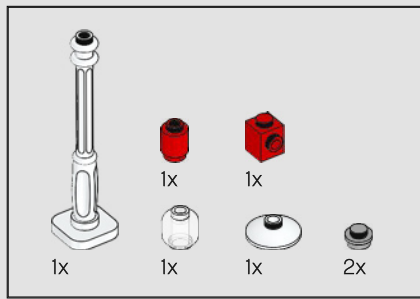

153

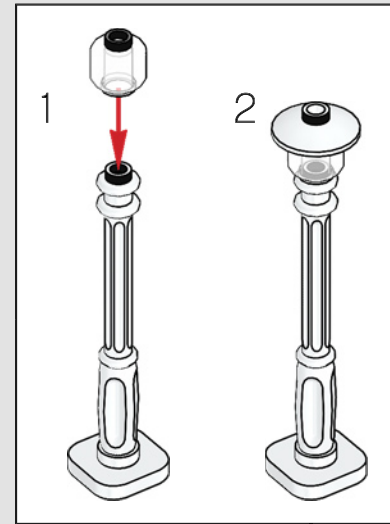
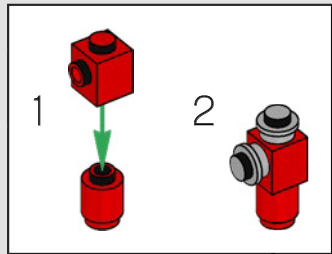

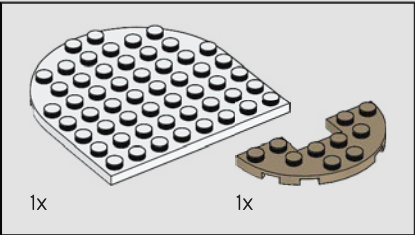
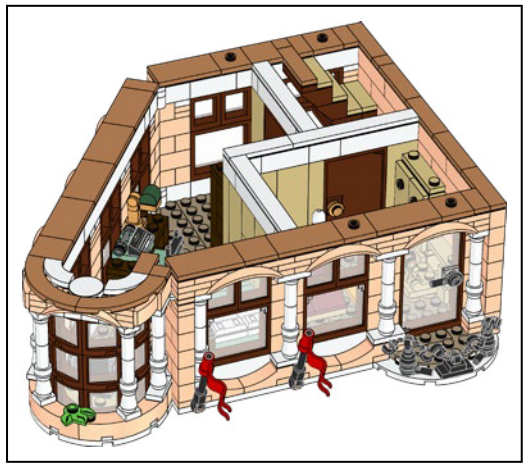
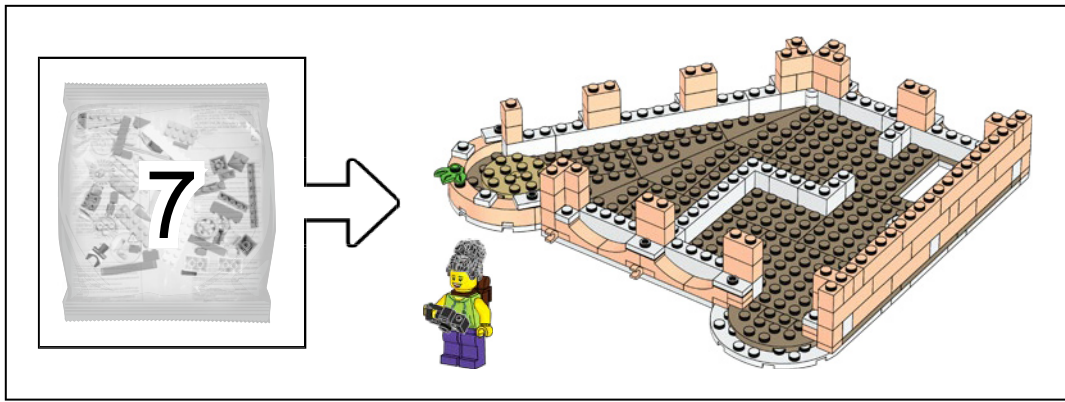

154

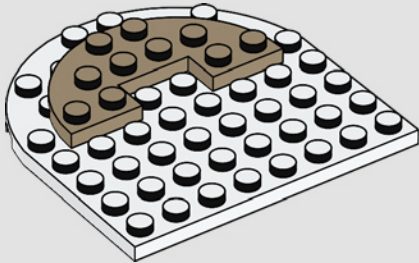

背包客正在环游世界!她这样做是有预算的,住在酒店的经济间也是如此。

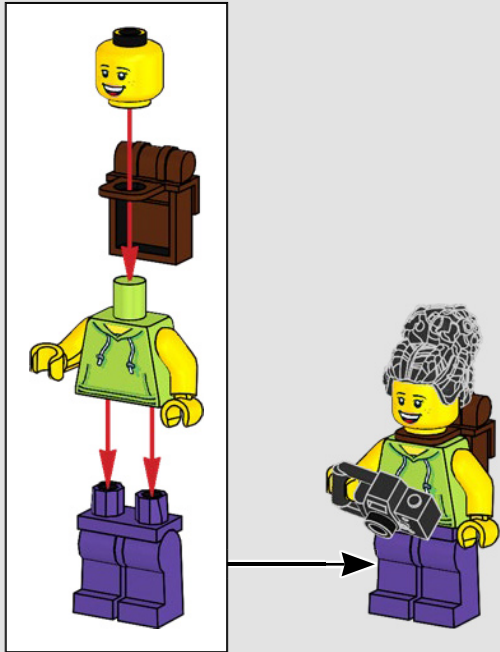



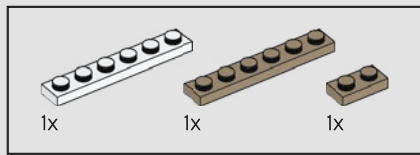

155

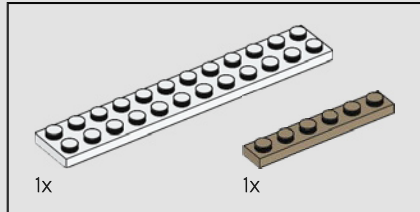
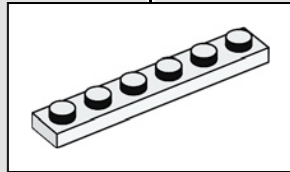
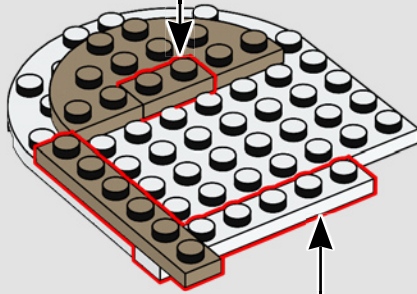
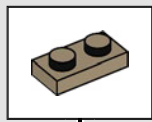

156

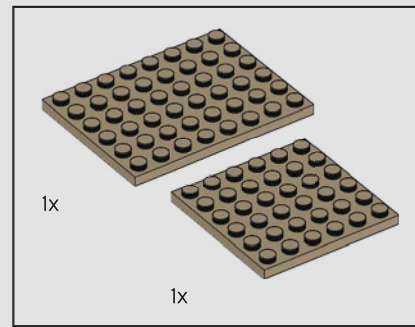
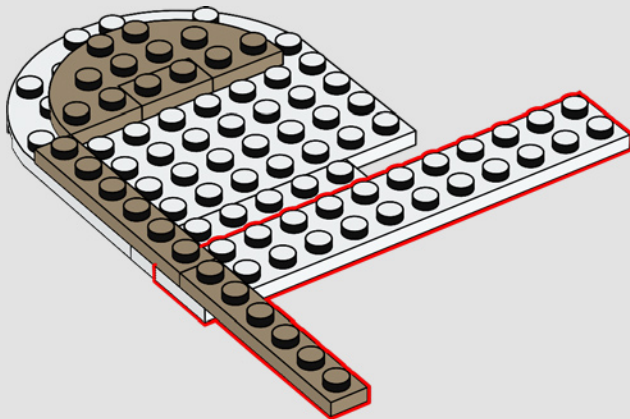

157

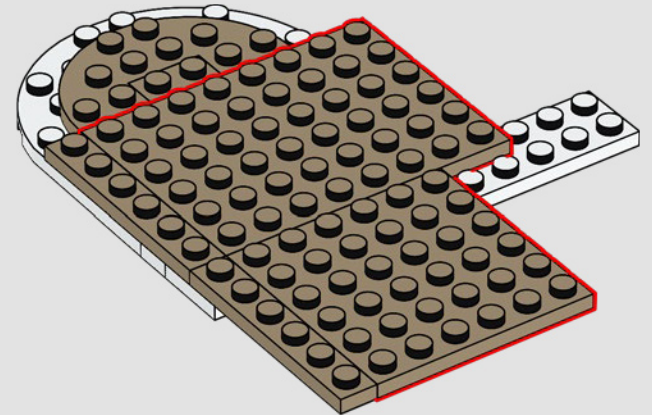

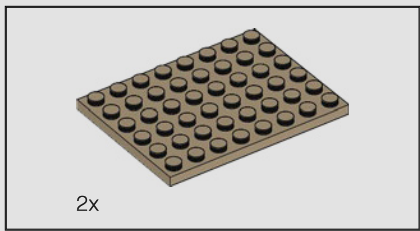

158

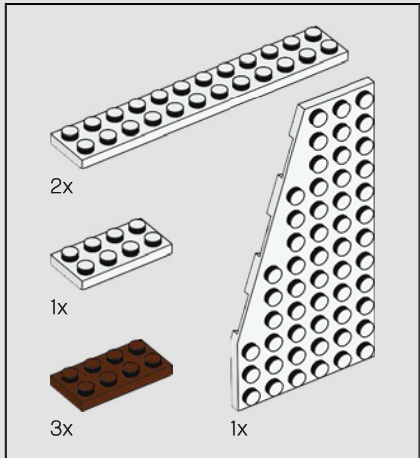
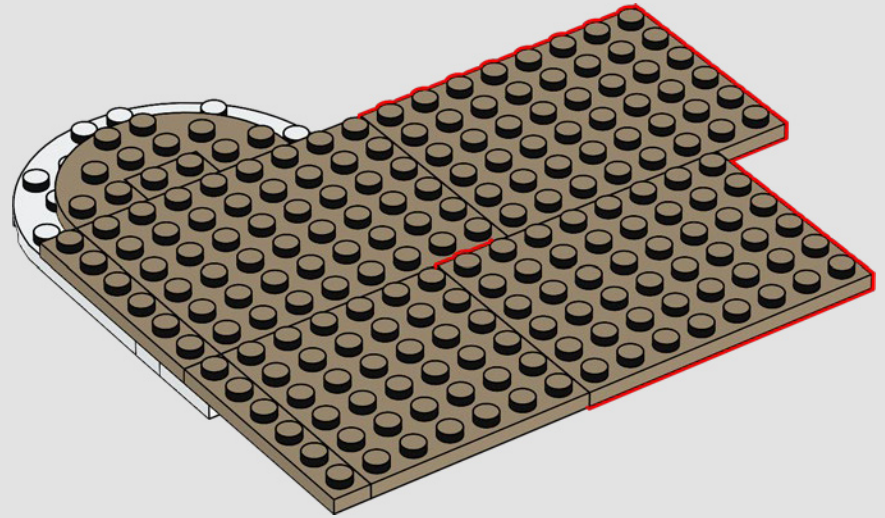

159

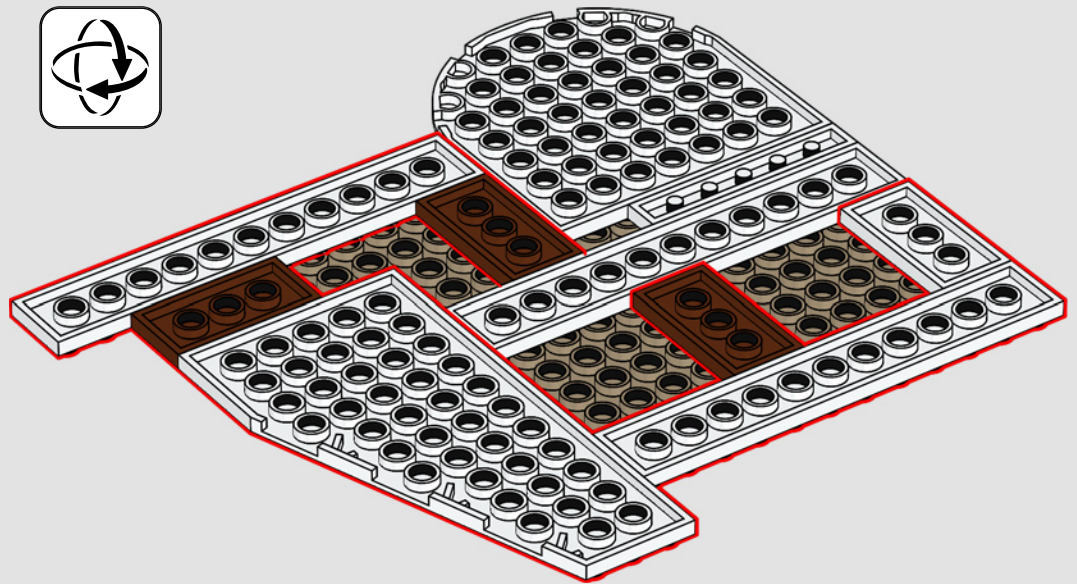
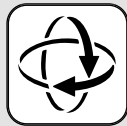

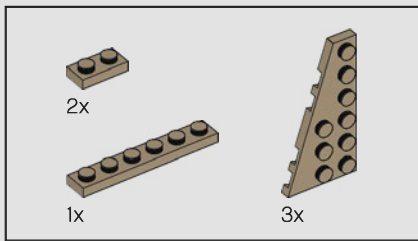

160

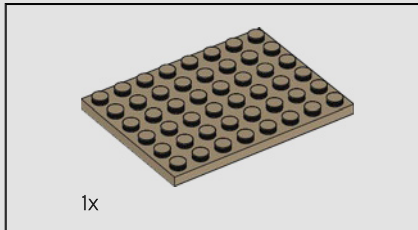
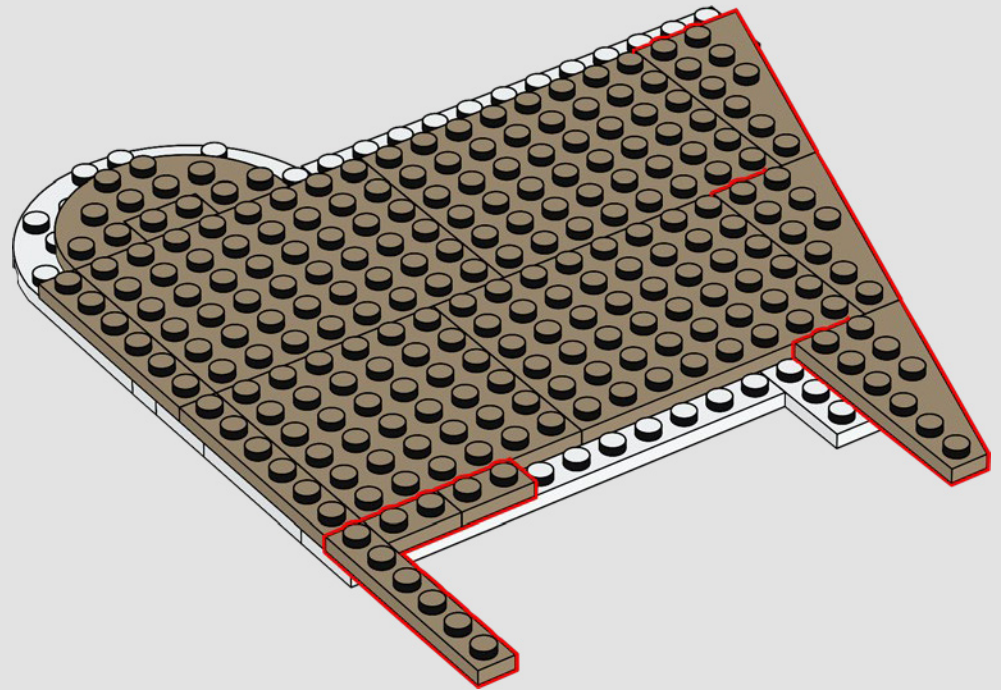

161

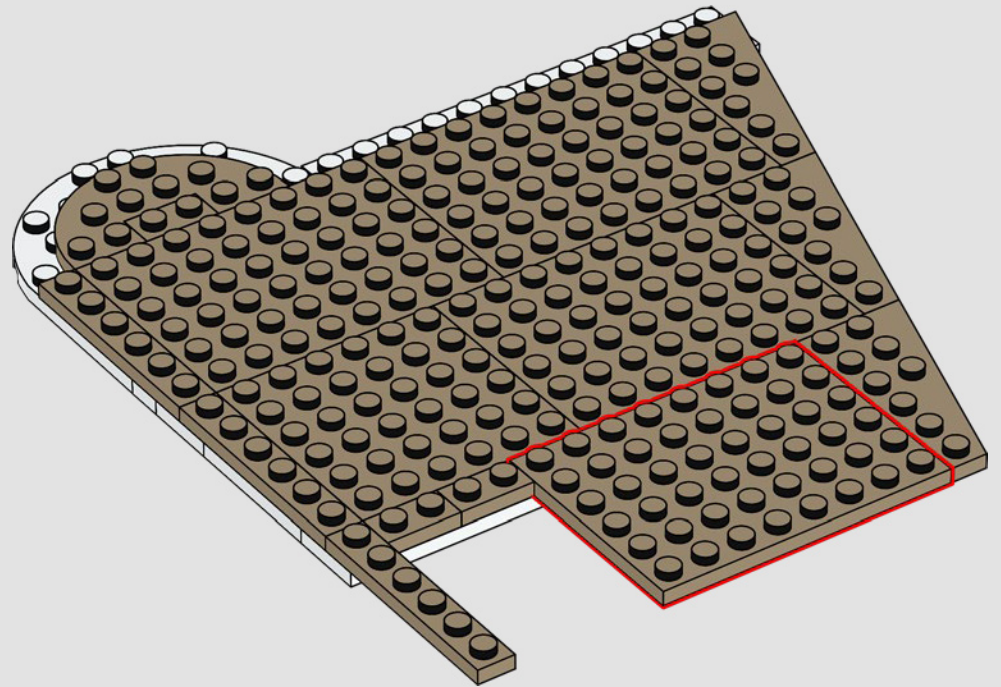

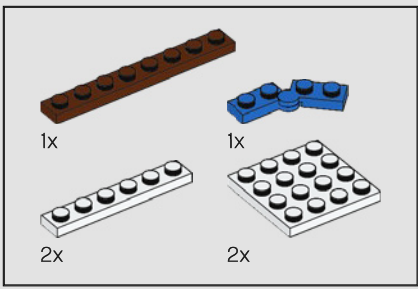

162

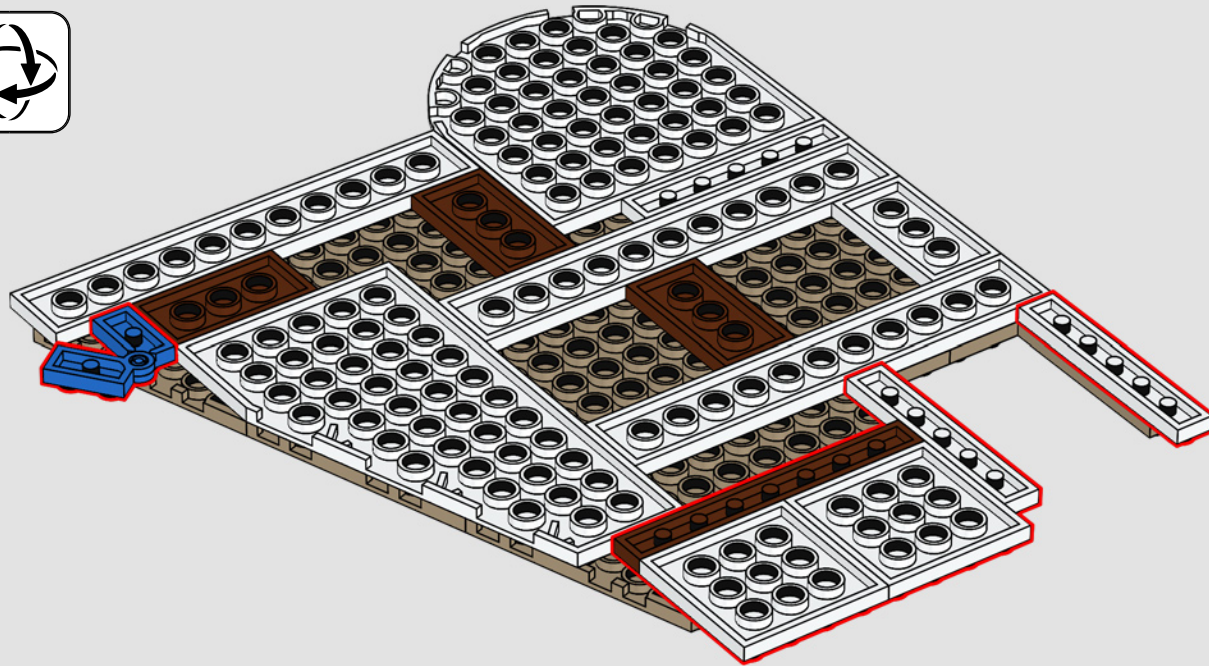

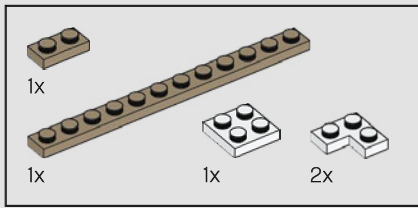

163

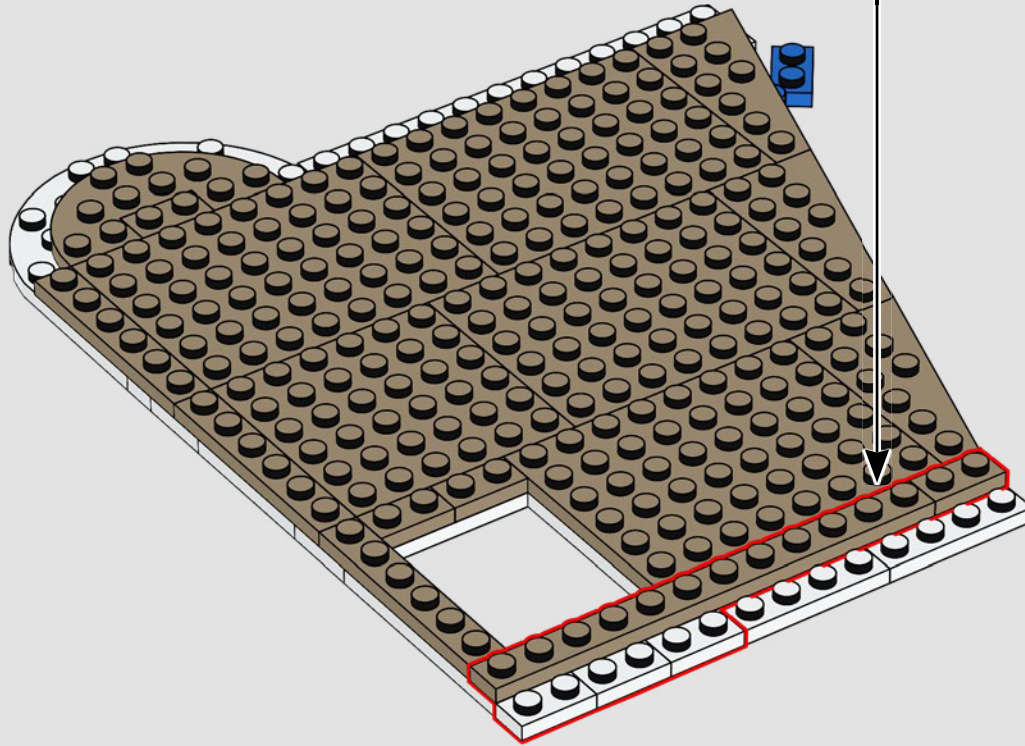
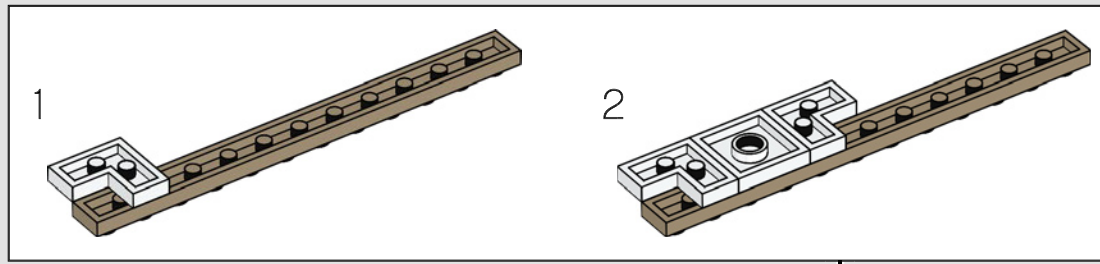

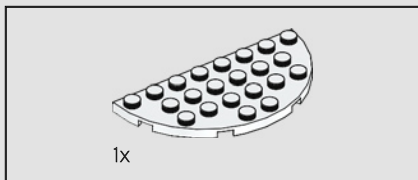

164

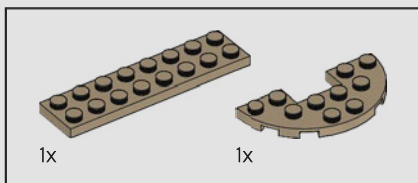
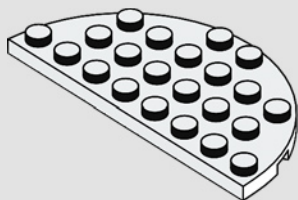

165

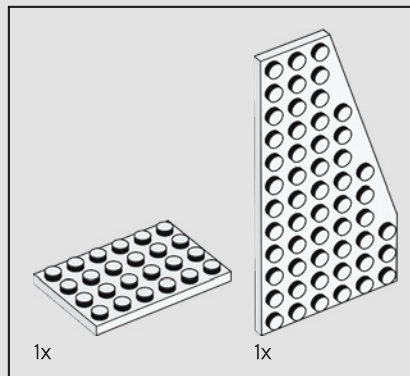
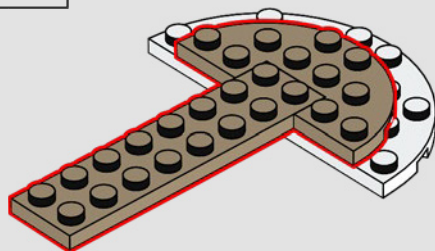

166

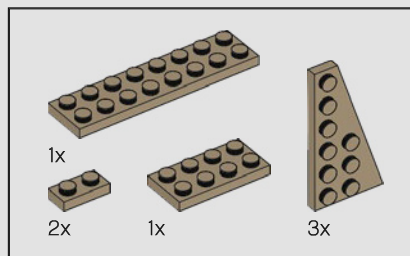
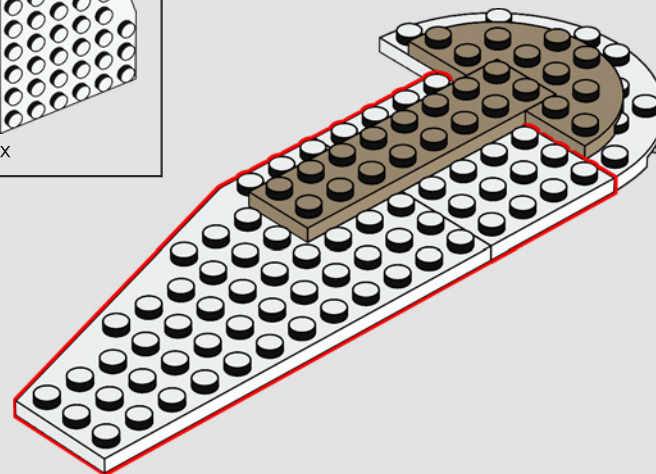

167

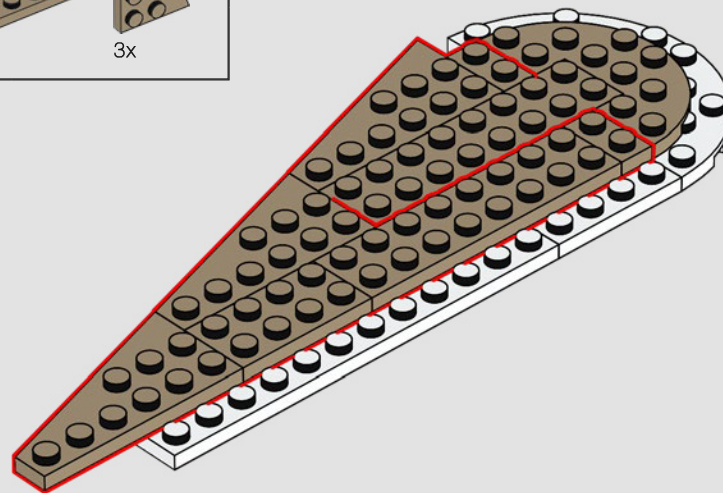

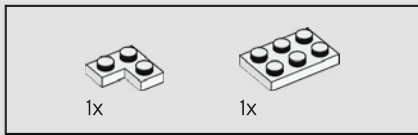

168

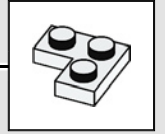
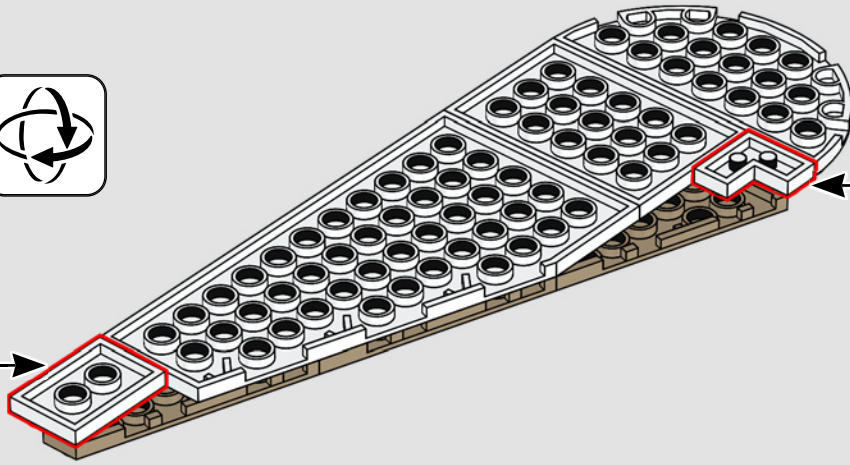
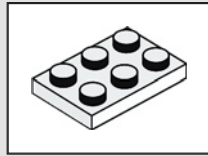

169

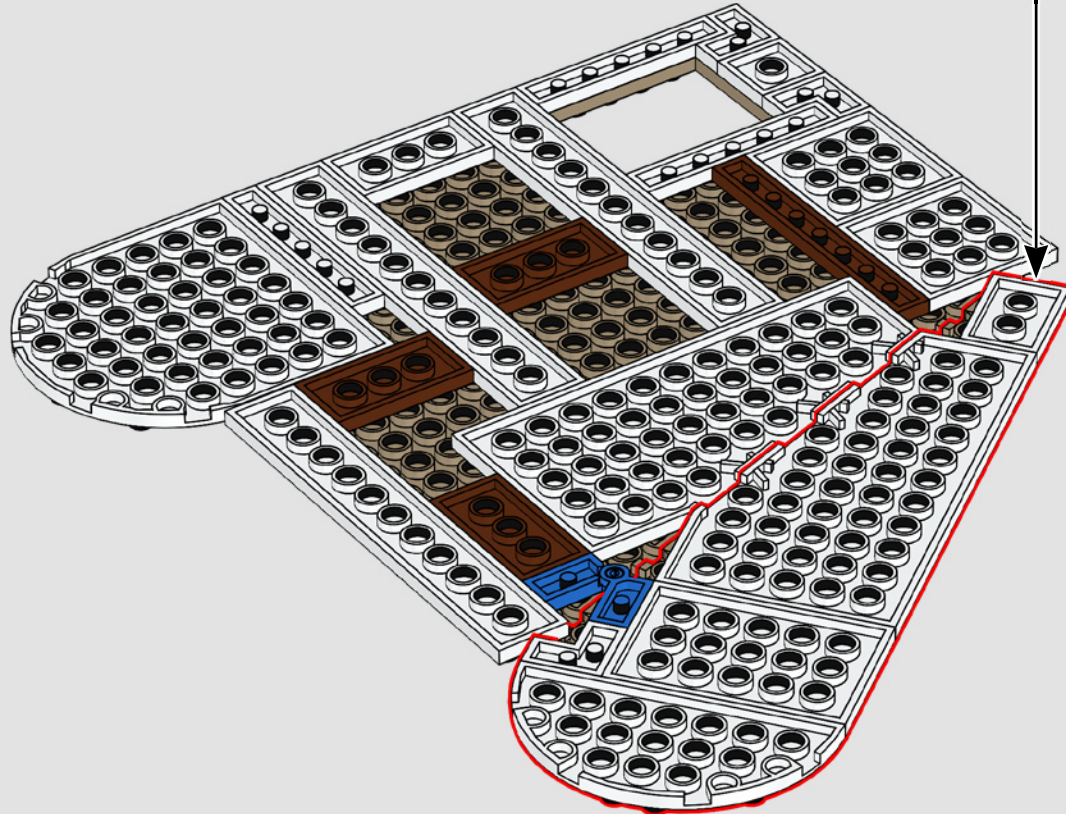

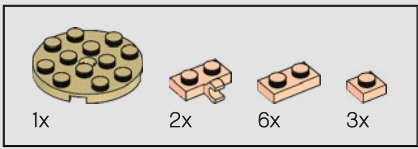

170

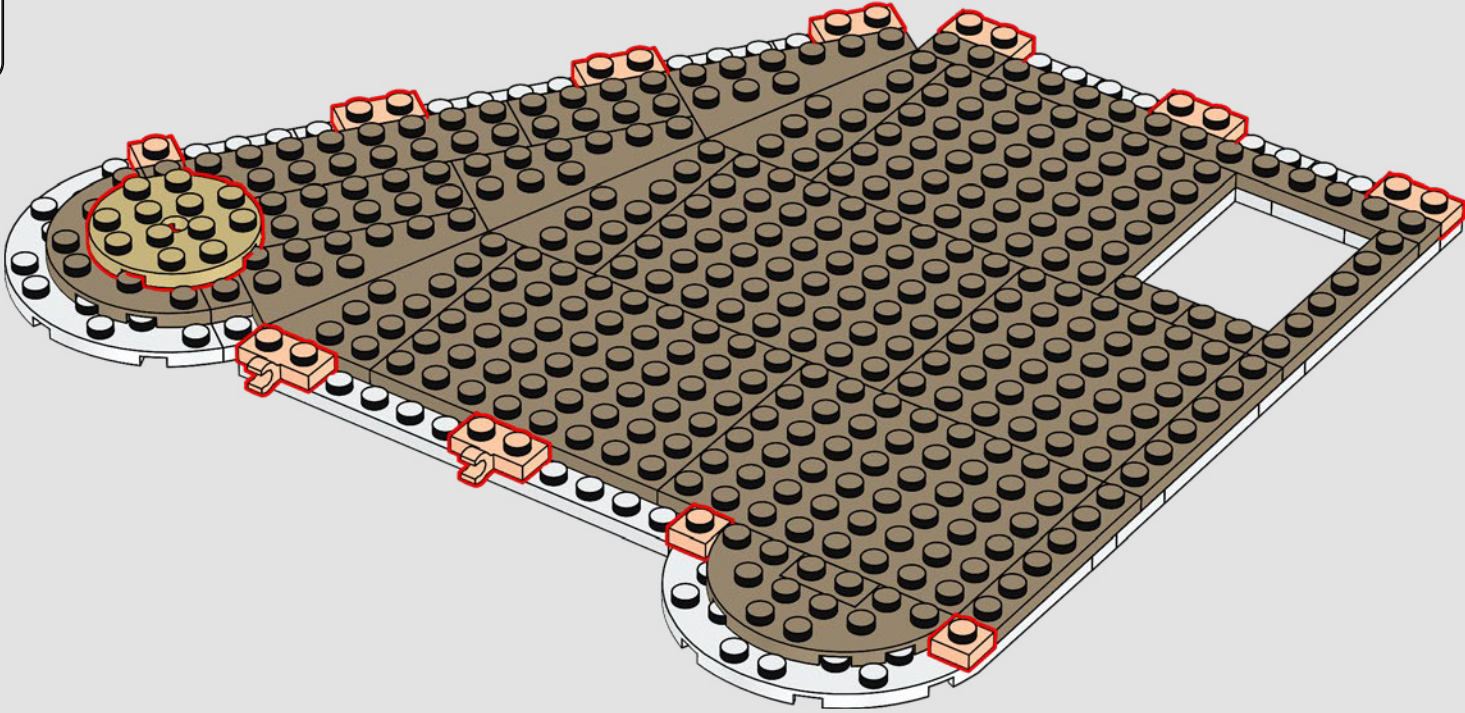



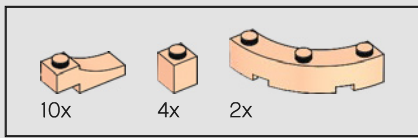

171

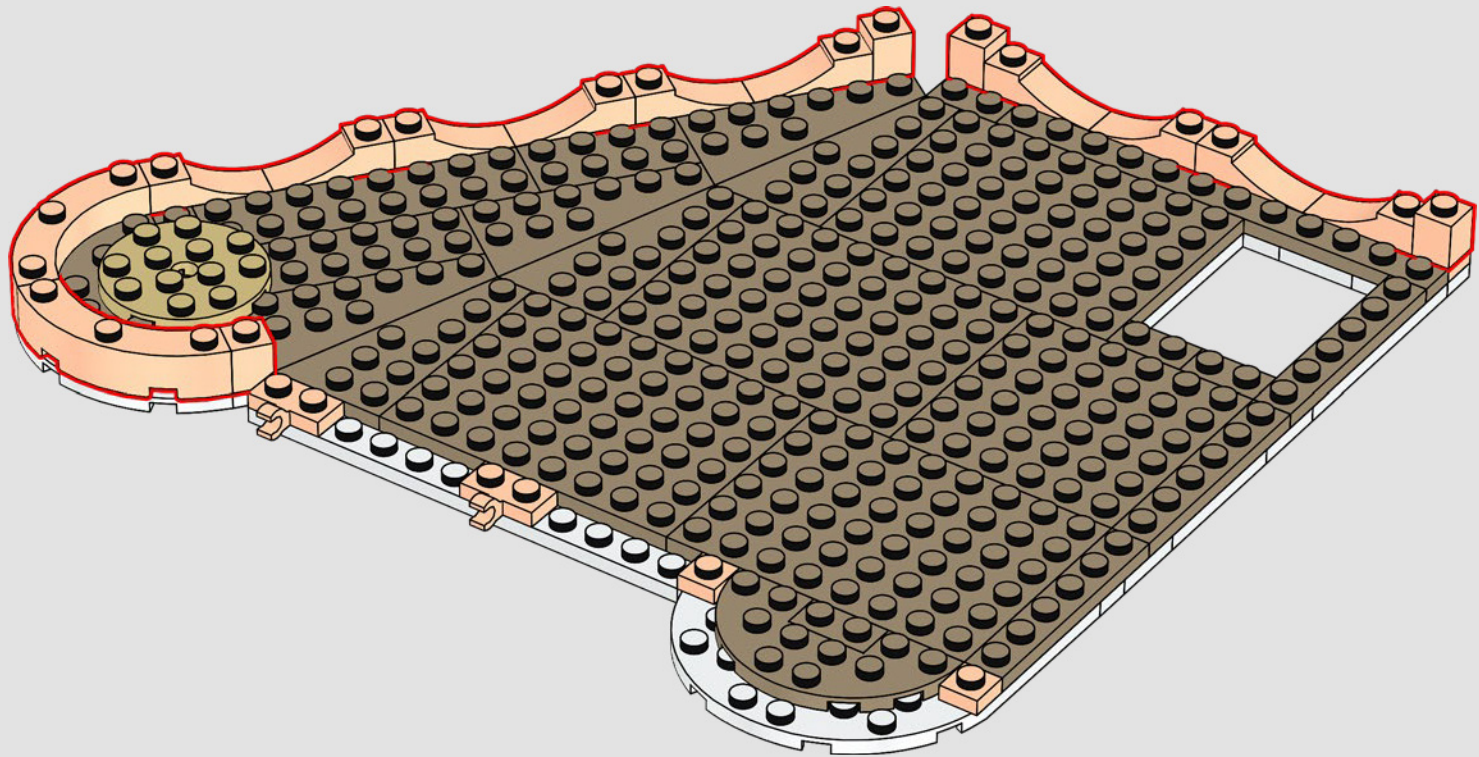



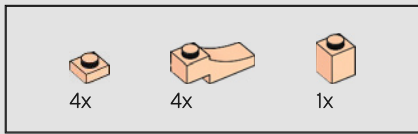

173

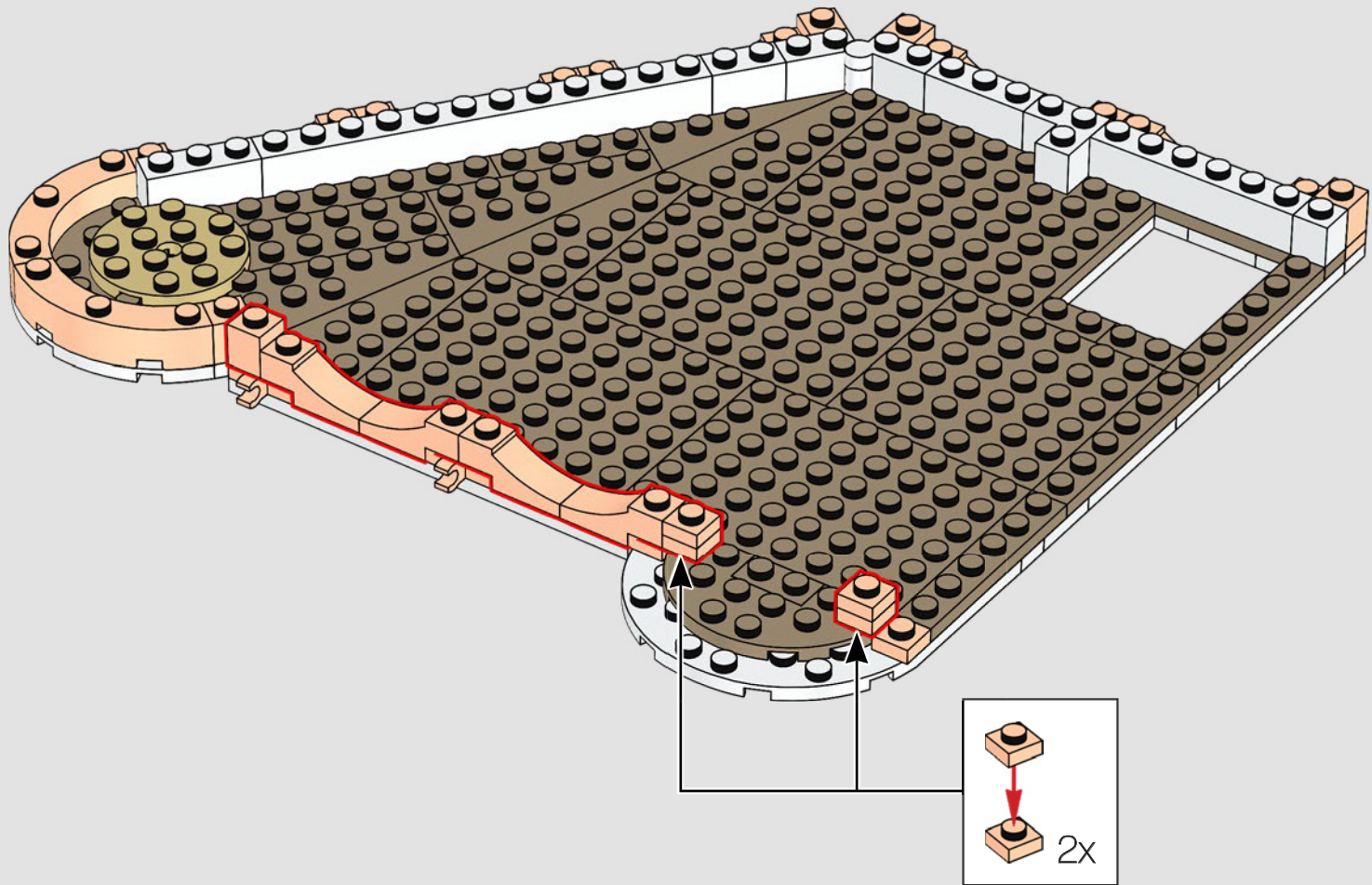

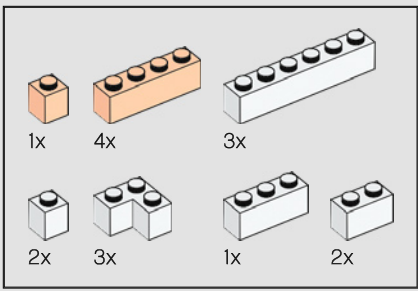

174

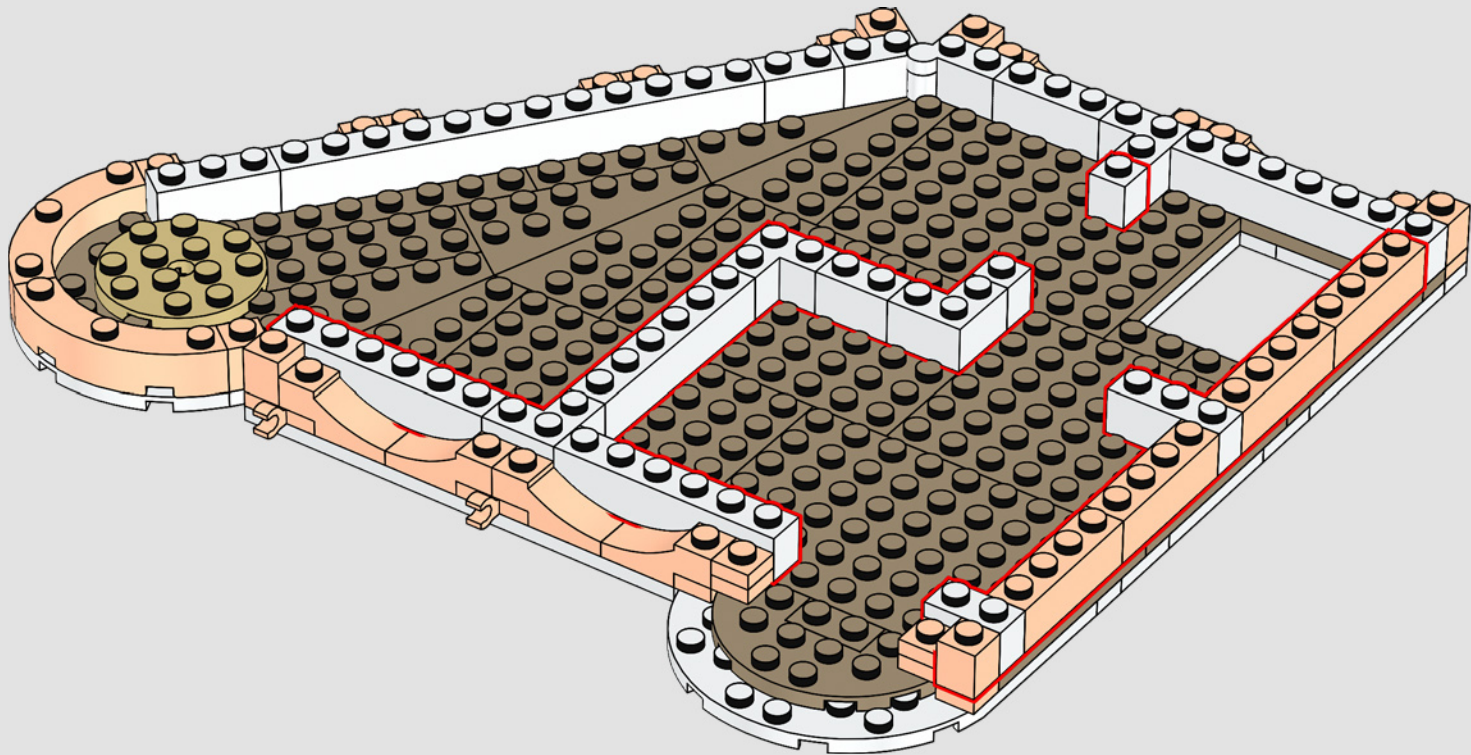

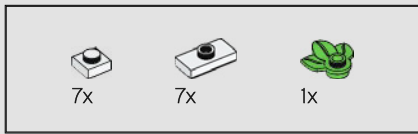

175

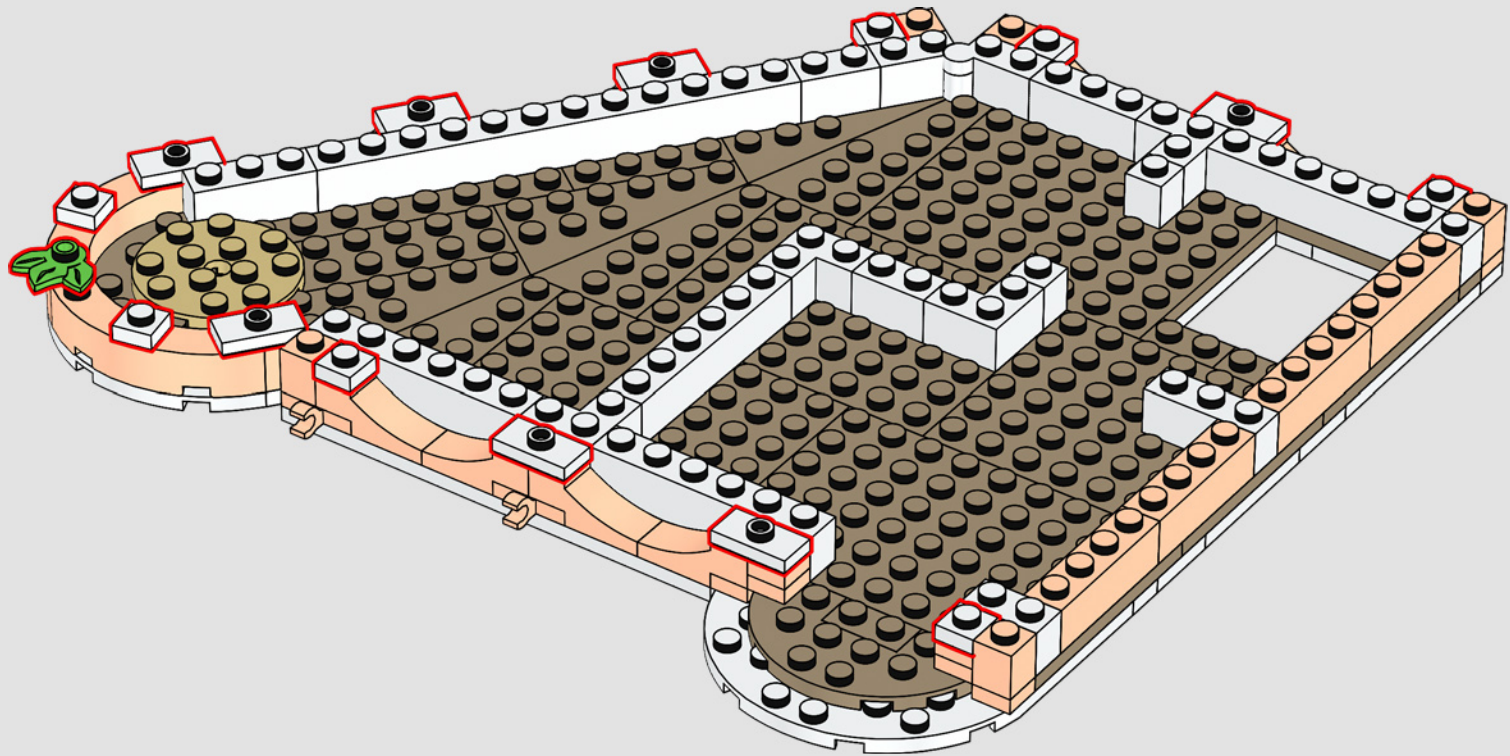

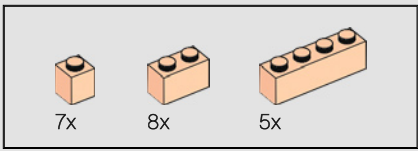

176

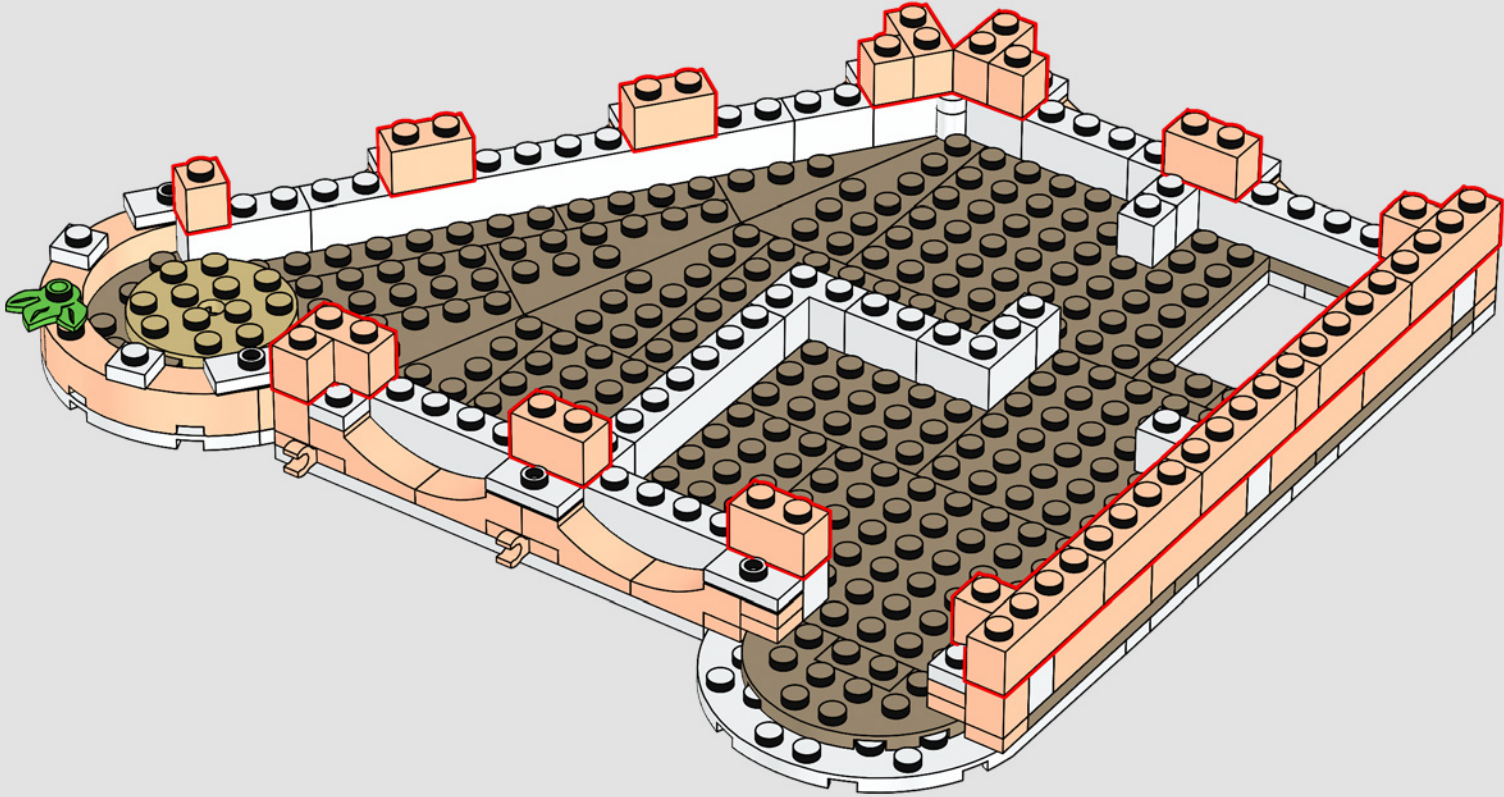

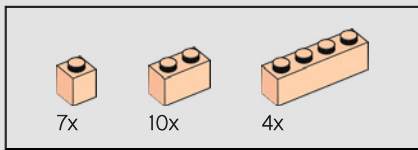

177

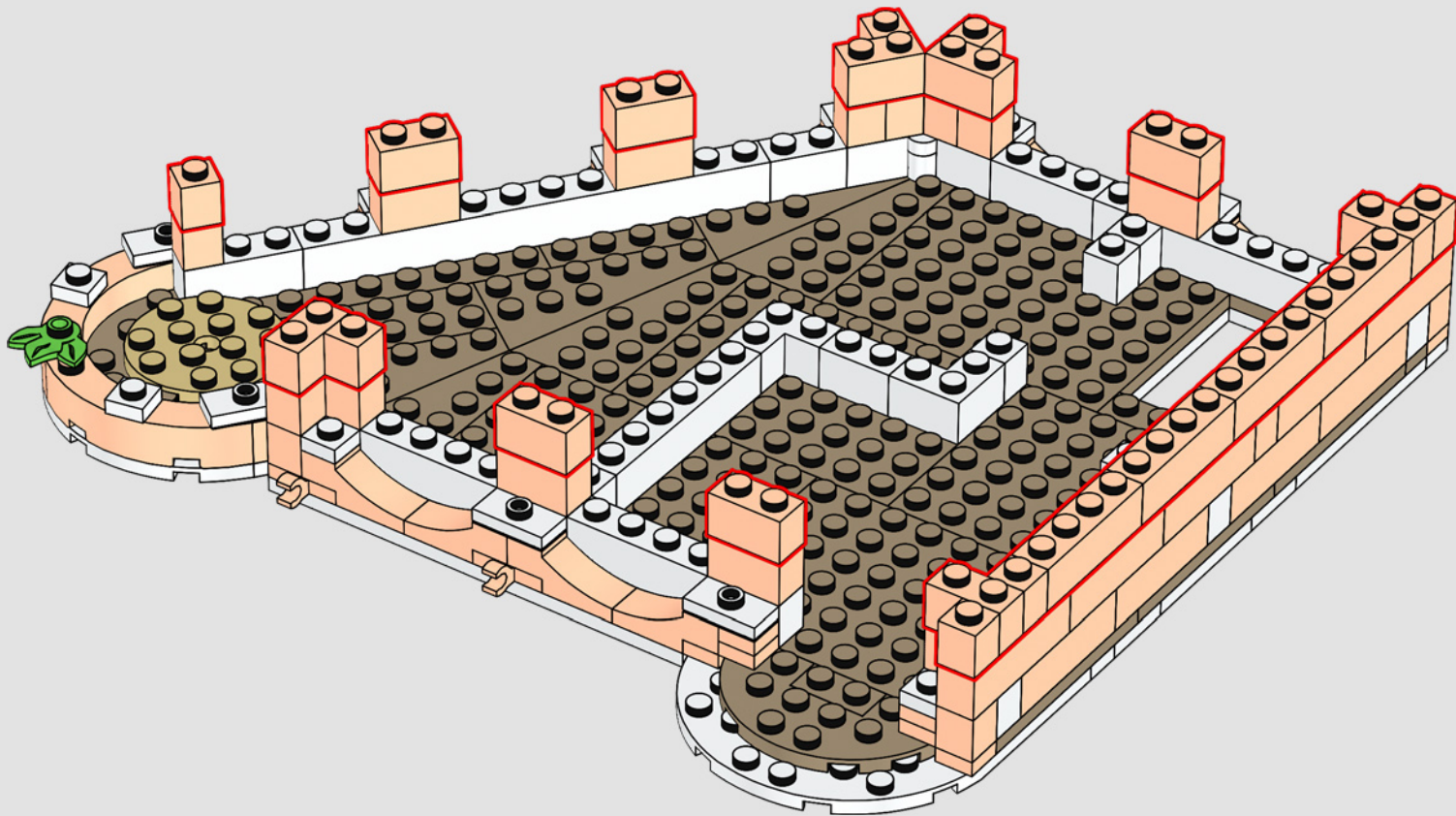

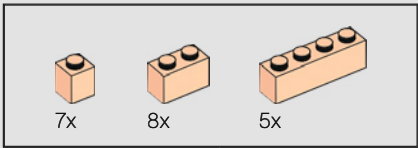
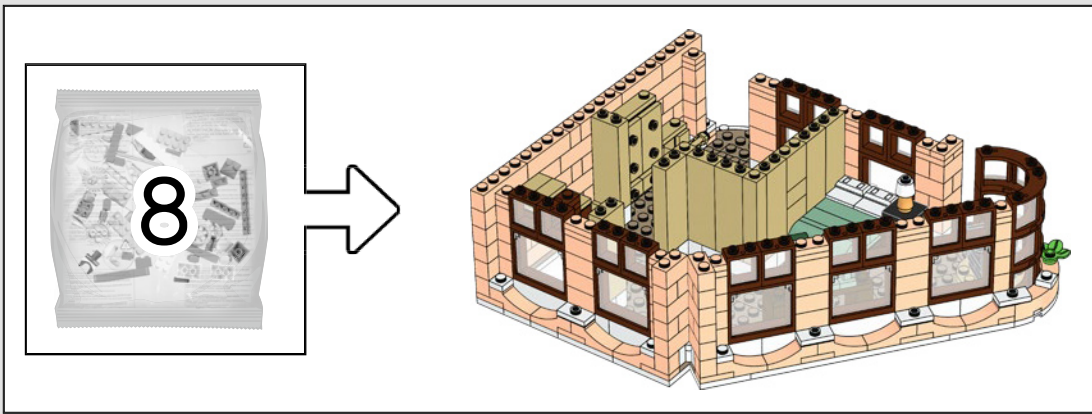

178

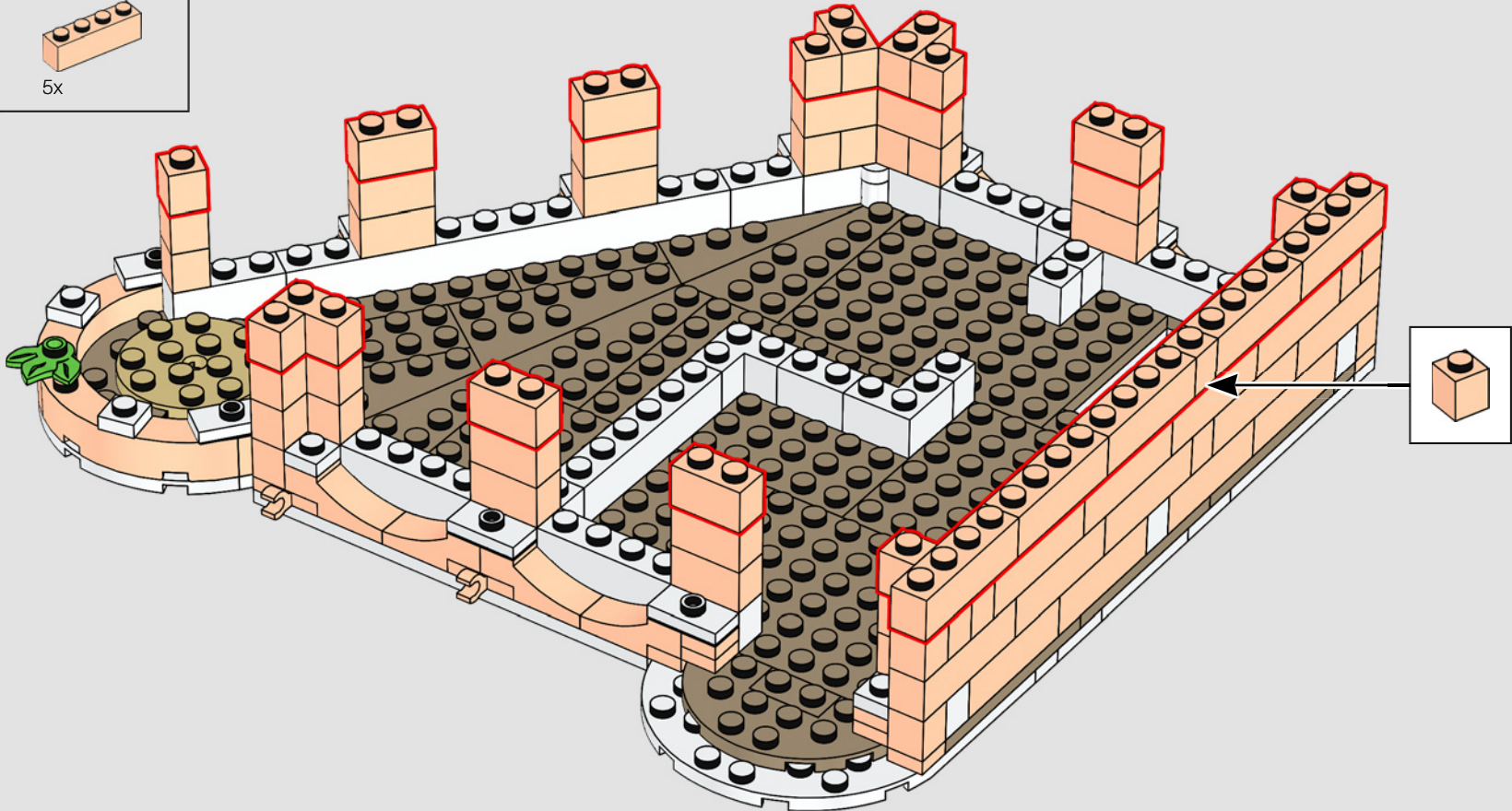



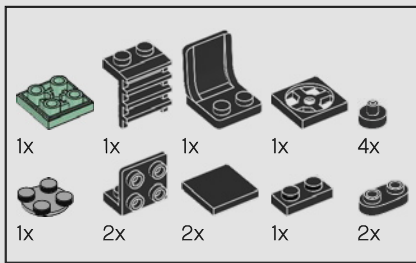

179

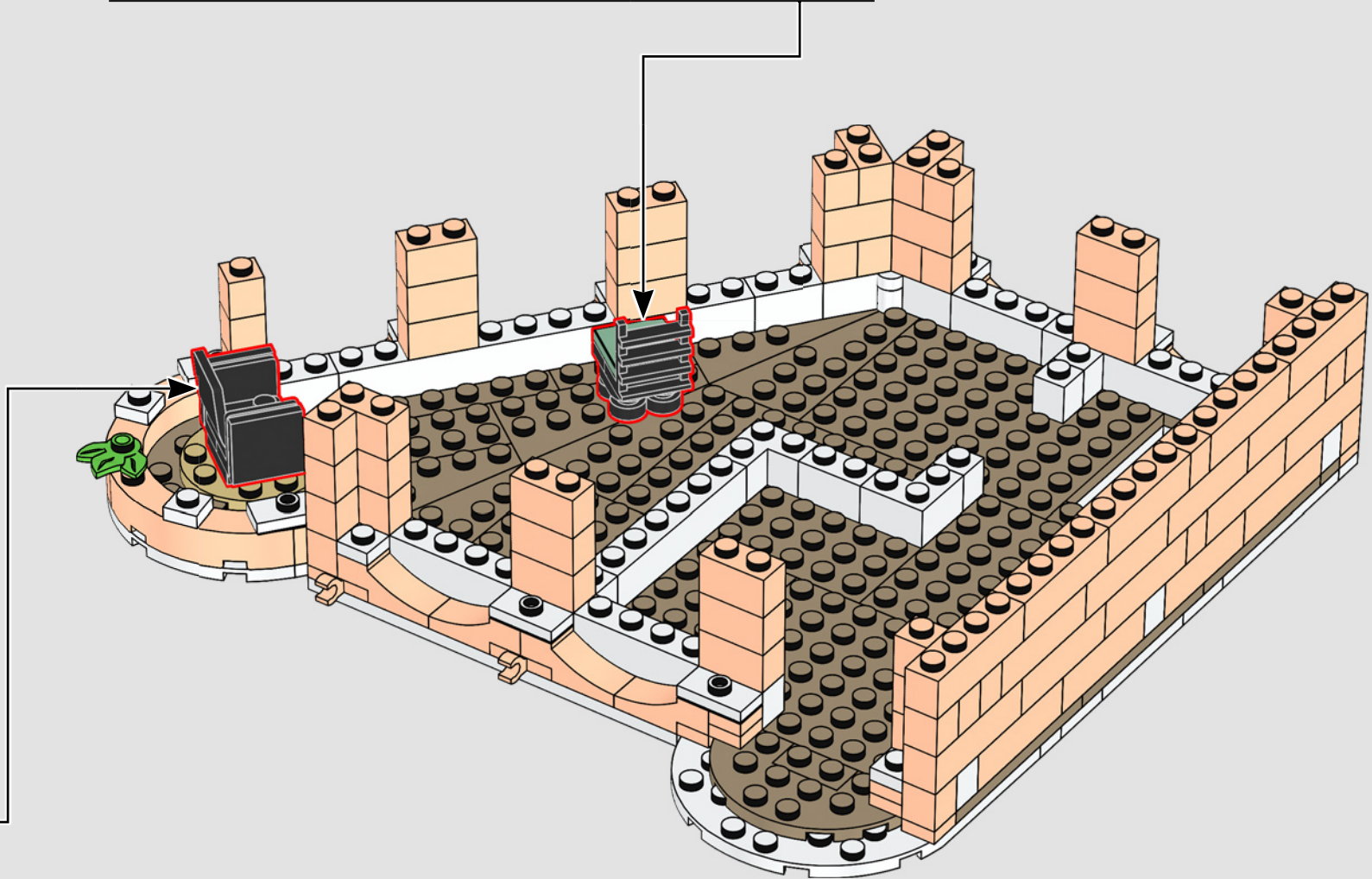
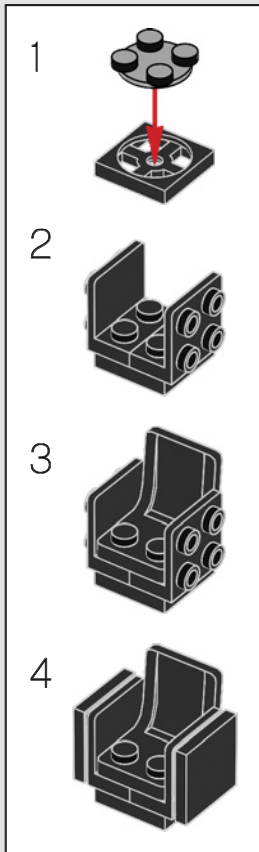
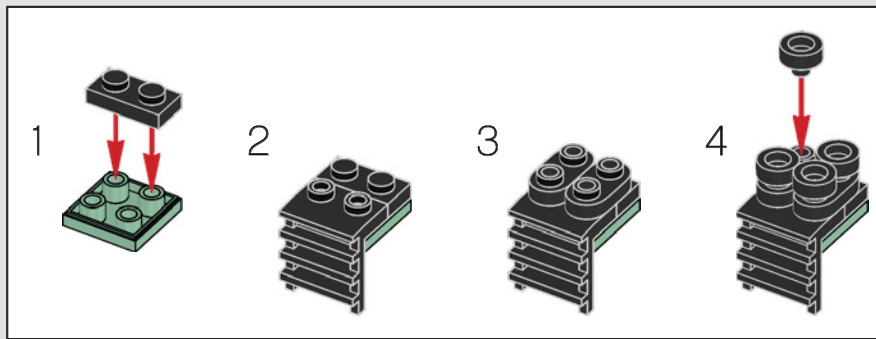

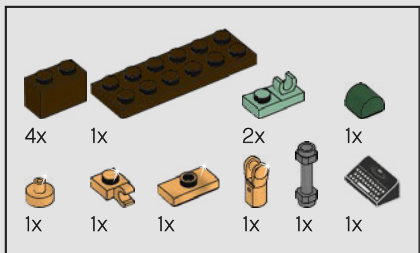

180

1

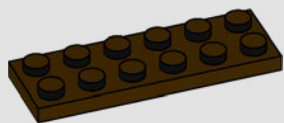

2

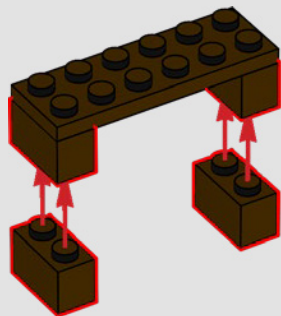

3

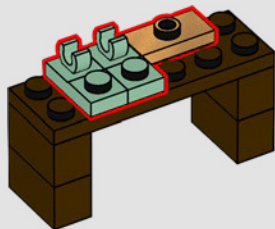

4

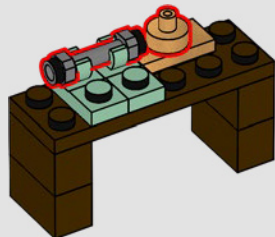

5

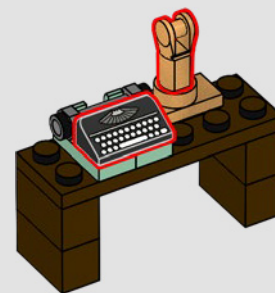

6

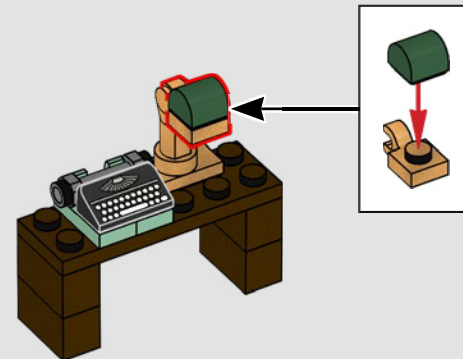

这家本地的打字机公司最近已开始向酒店和 10278 警察局销售产品。

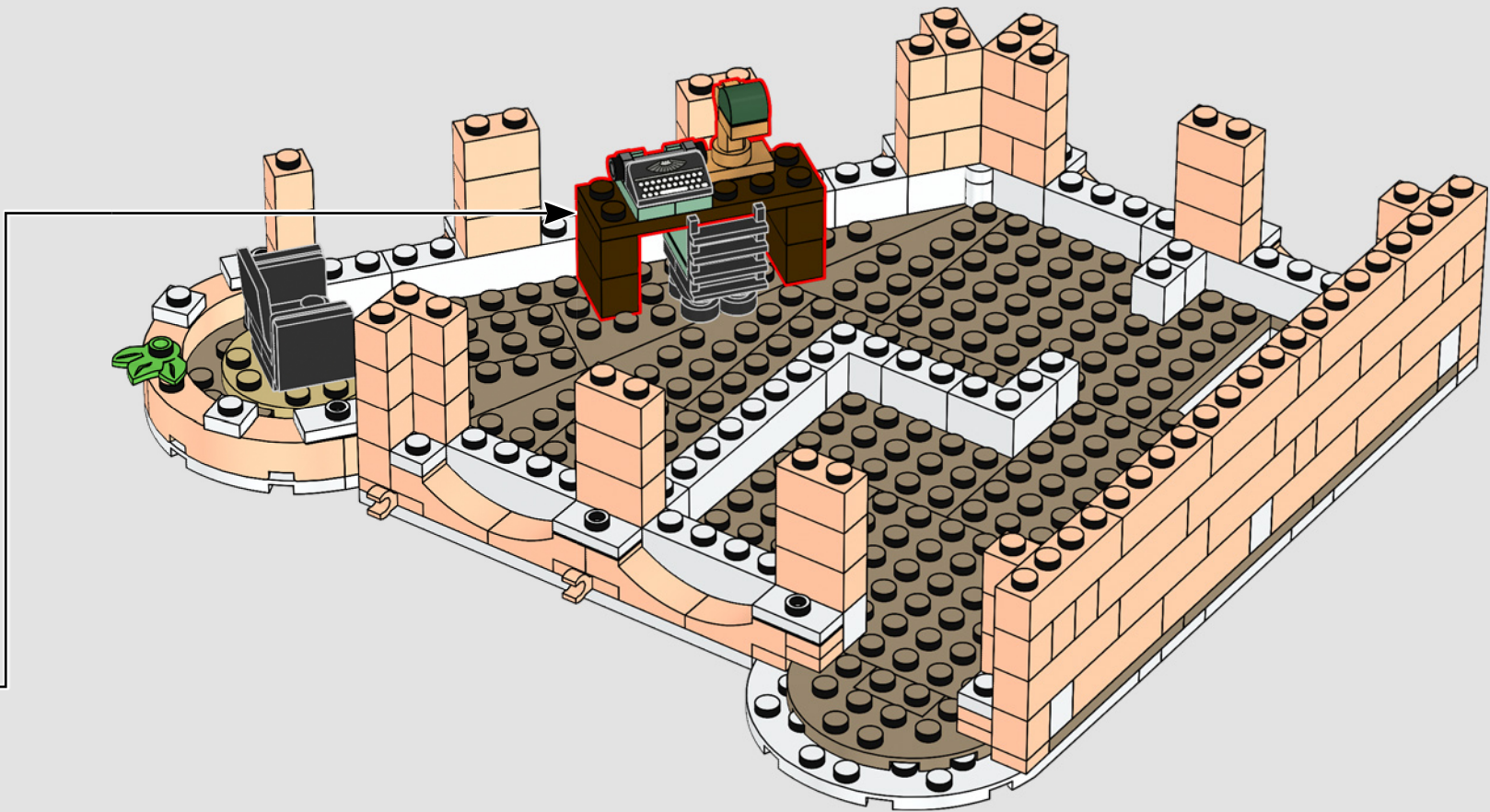

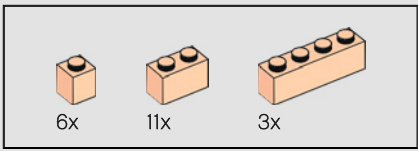

181

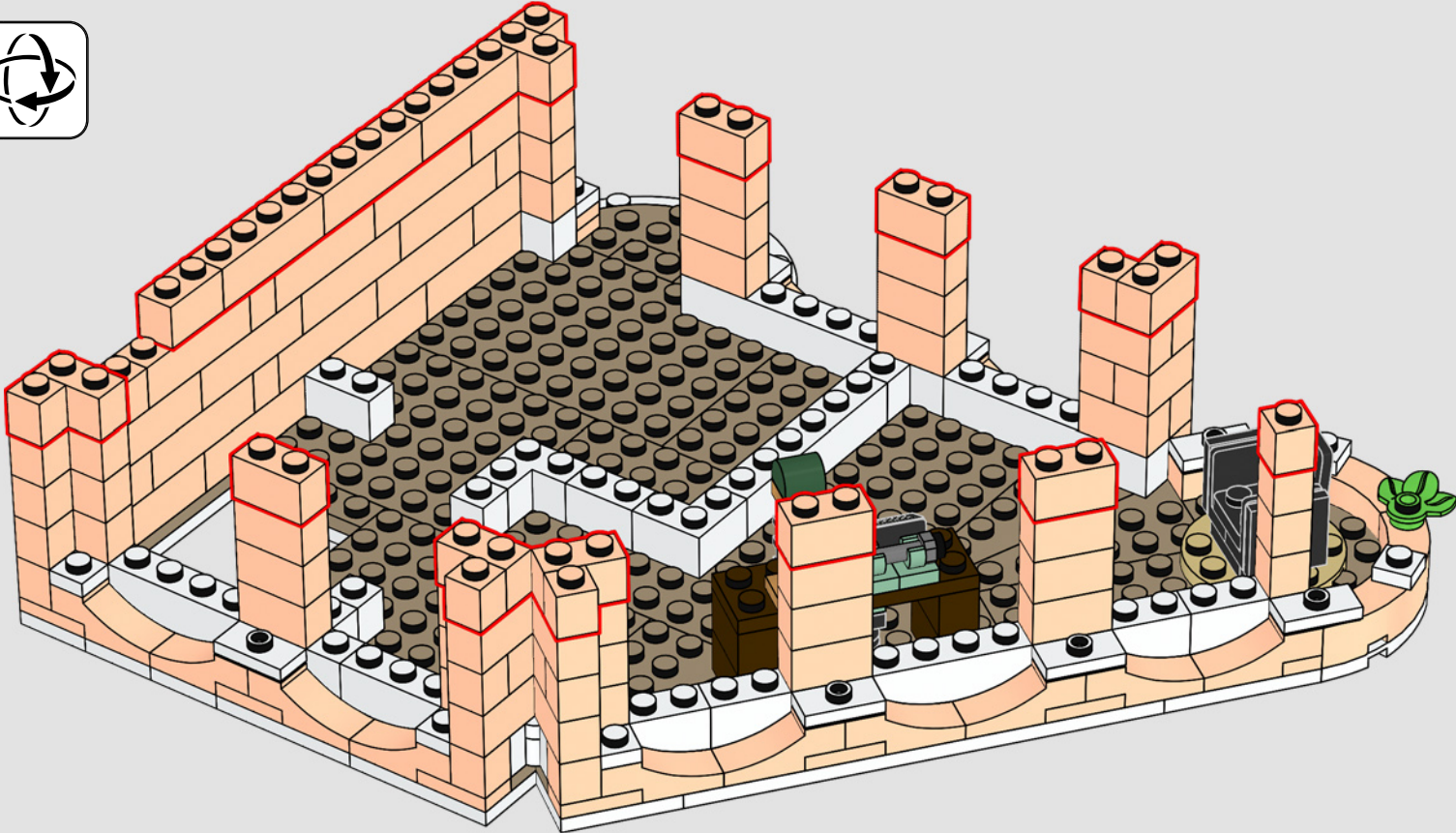

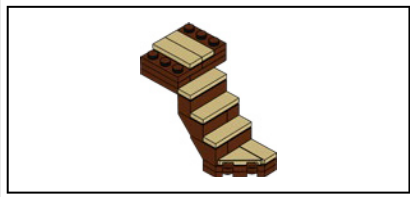

182

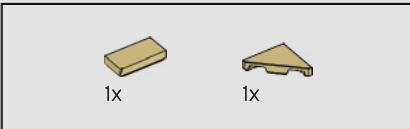
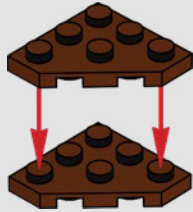

183

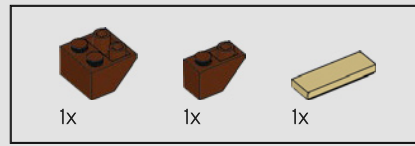

184

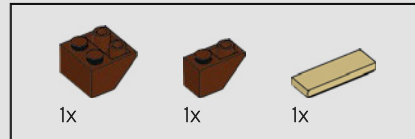
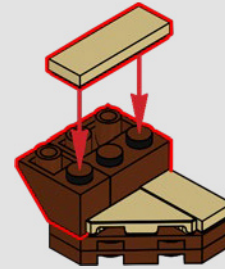

185

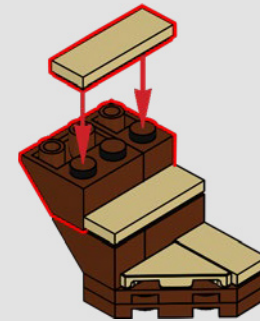

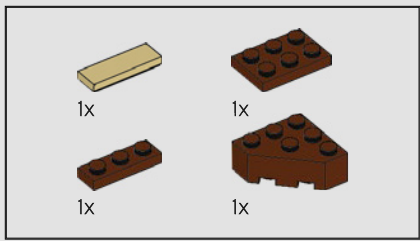

186

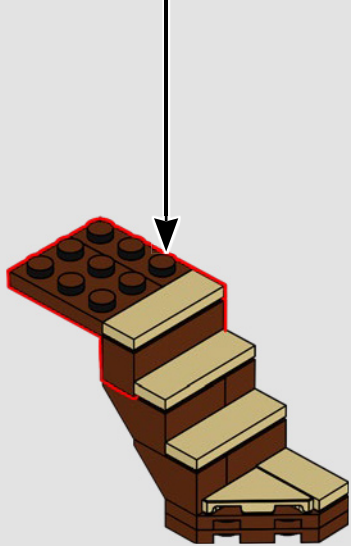
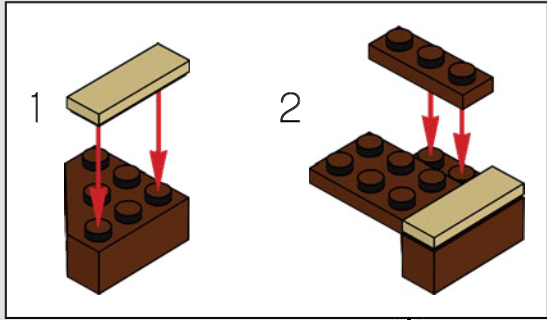

187

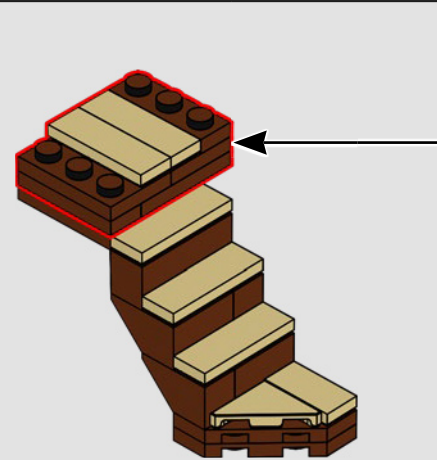
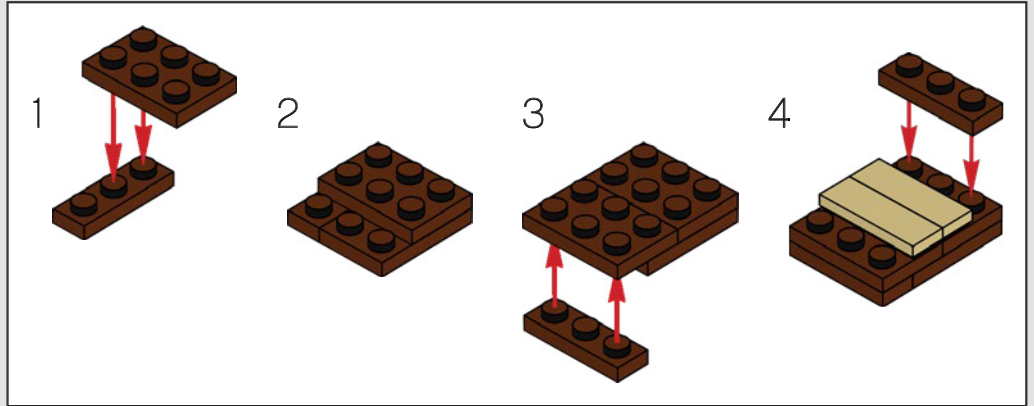

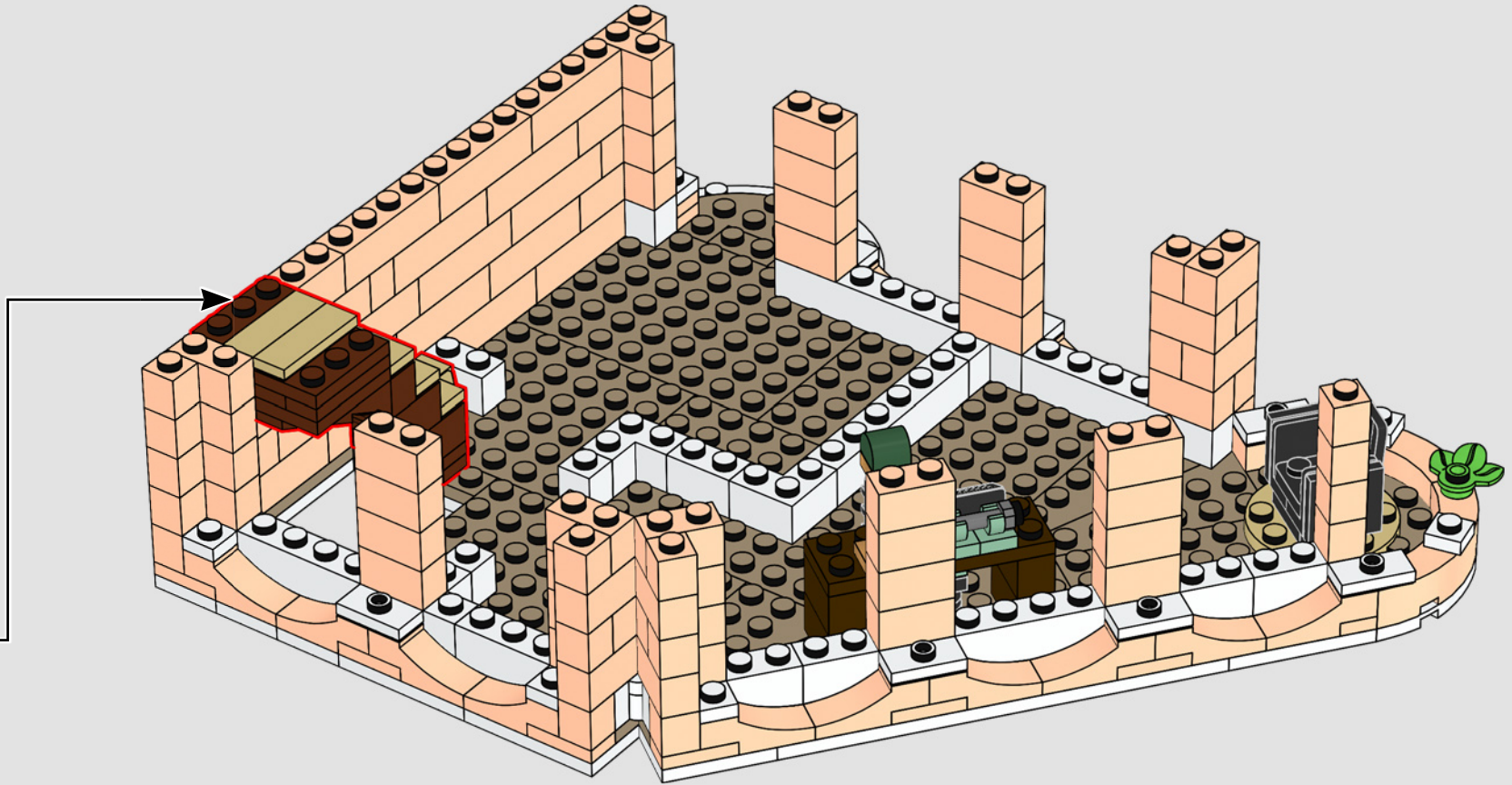

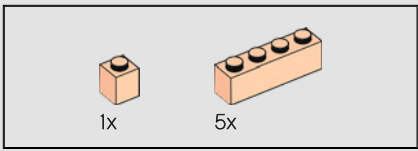

189

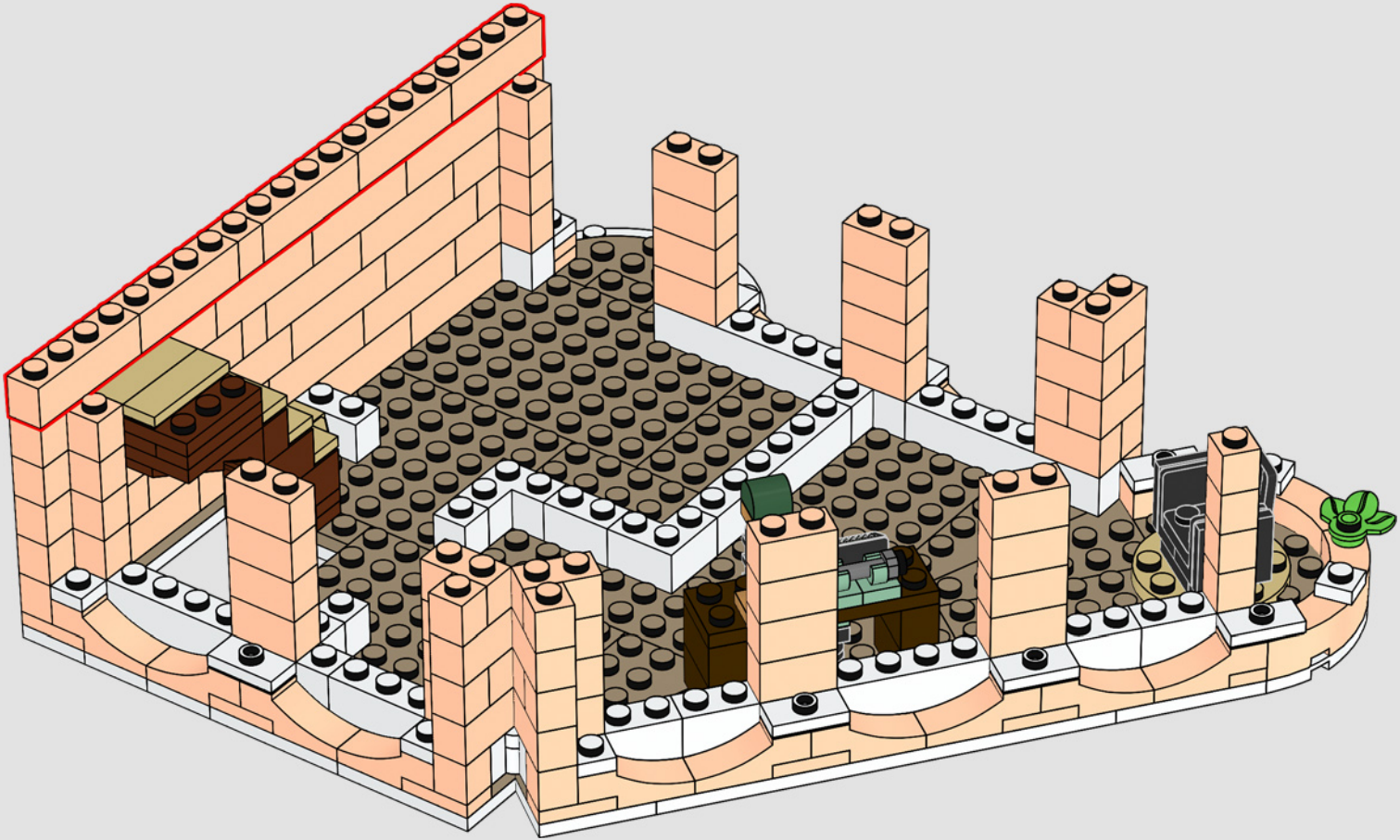



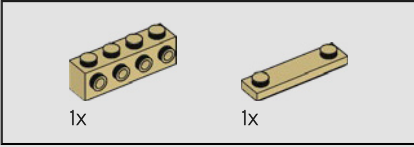
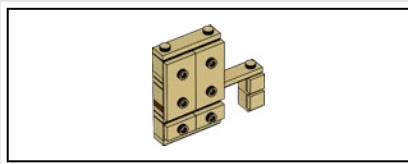

190

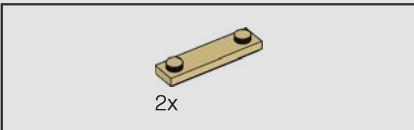
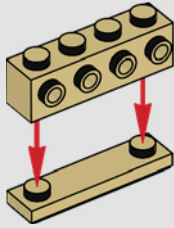

191

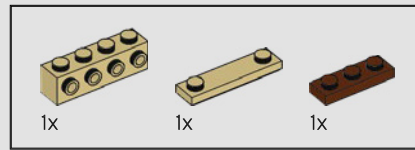
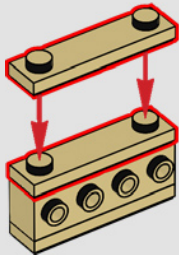

192

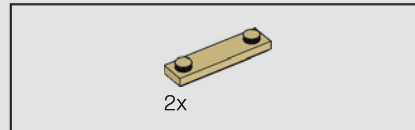
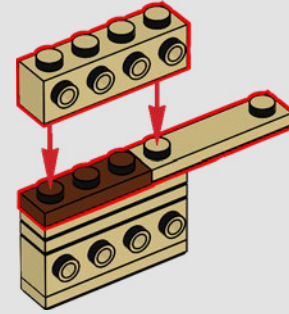

193

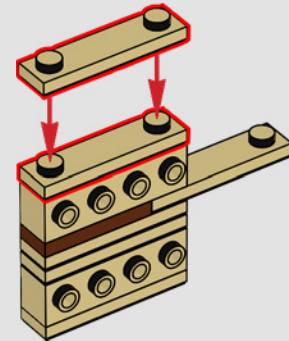

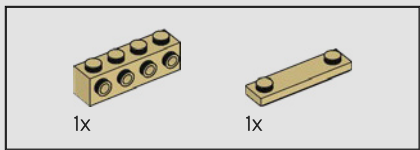

194

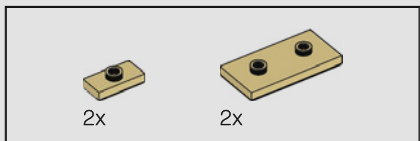
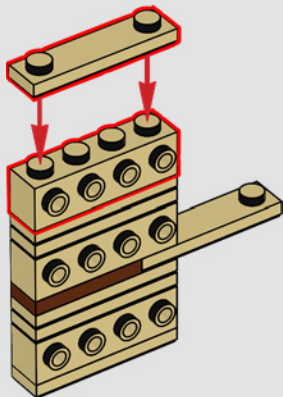

195

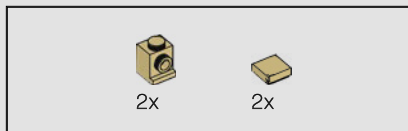
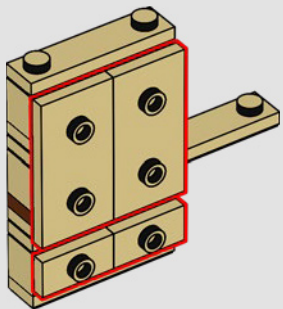

196

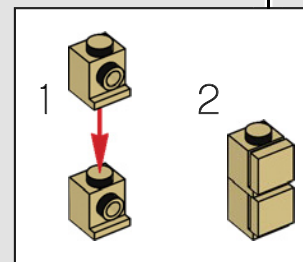
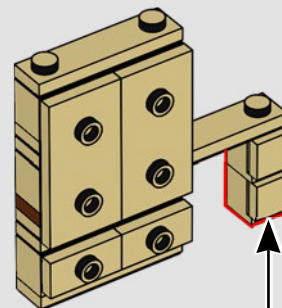

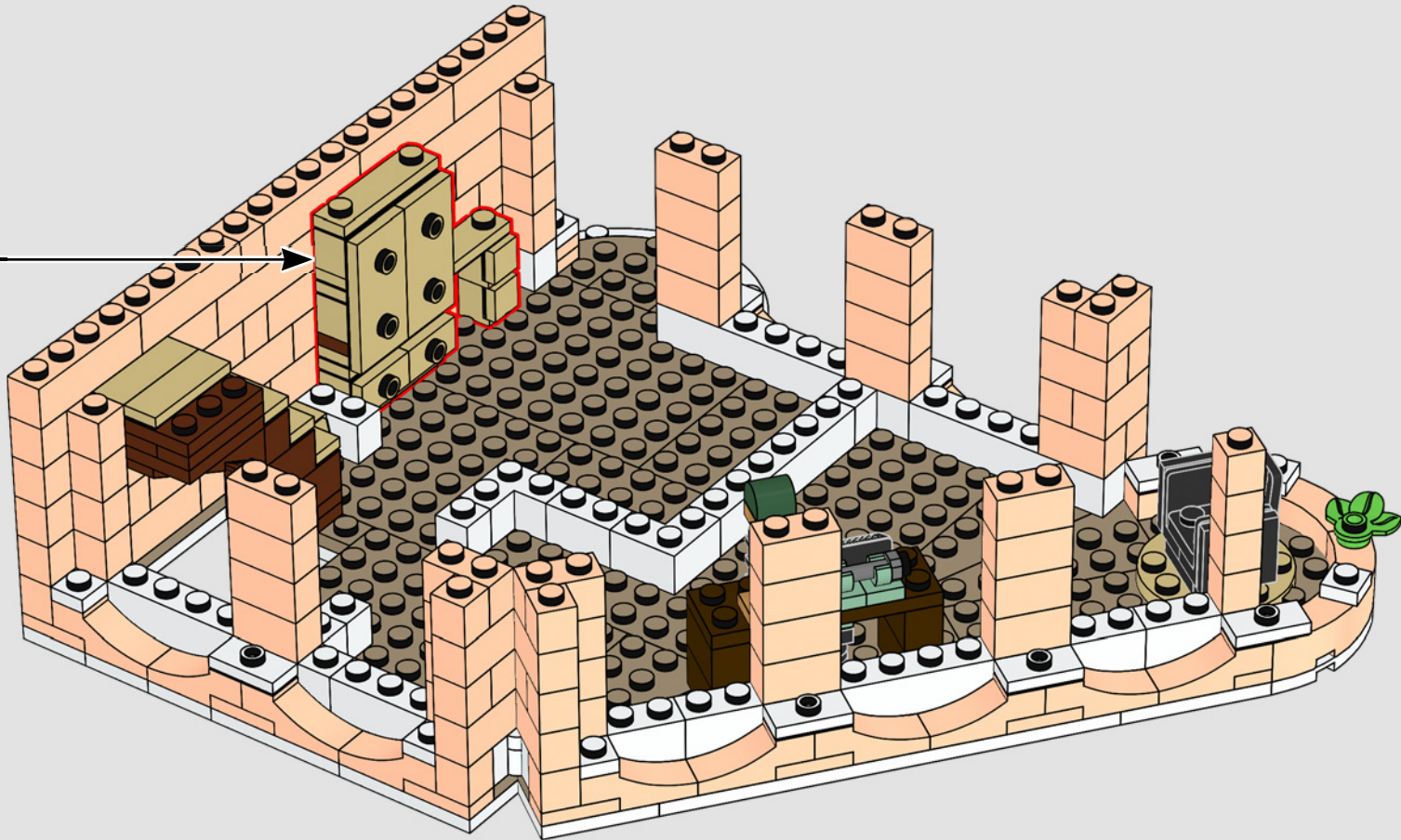

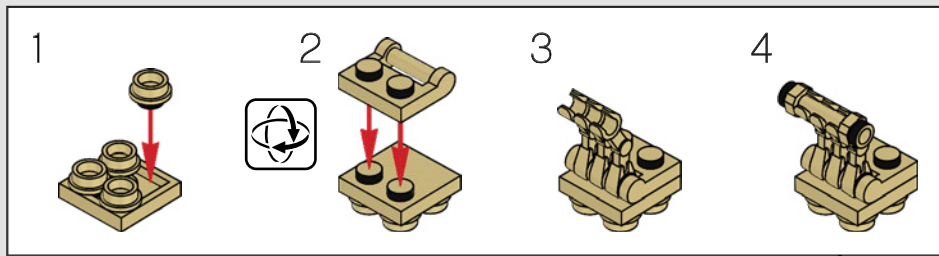
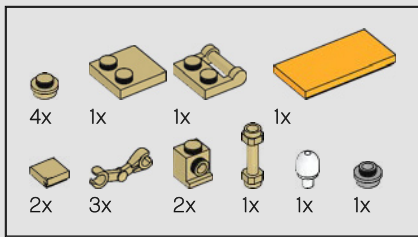

198

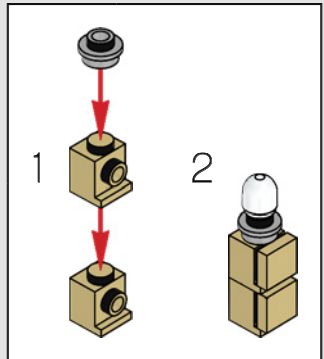
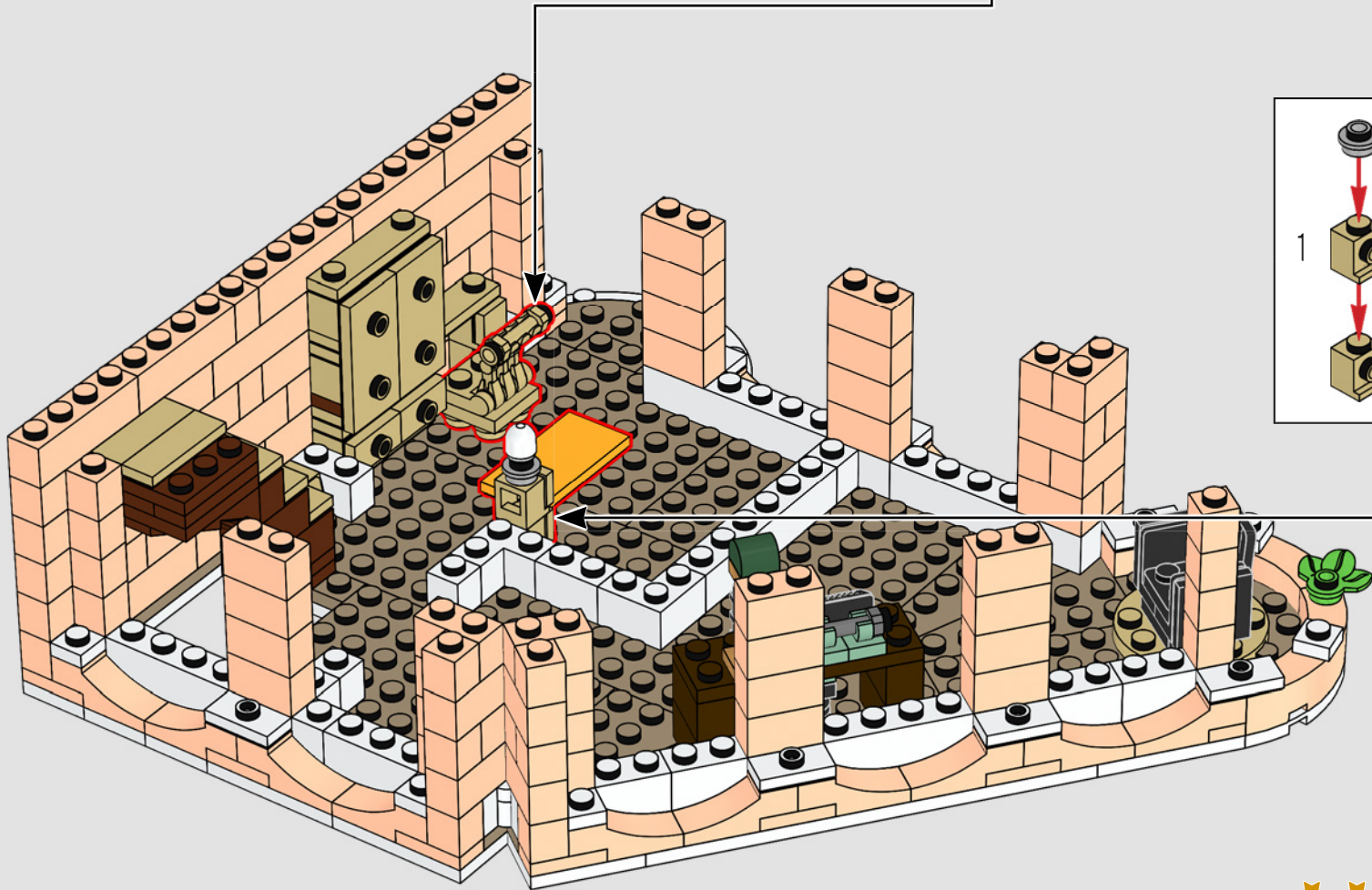

这不是第一次在模块化模型中使用这些机器人手臂.....你还可以从 10190 商业街 (Market Street) 套装的阳台栏杆中找到它们。

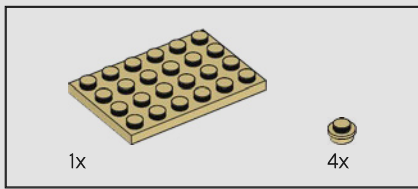

199

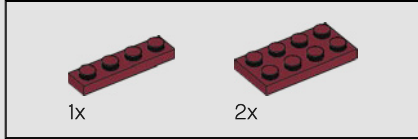
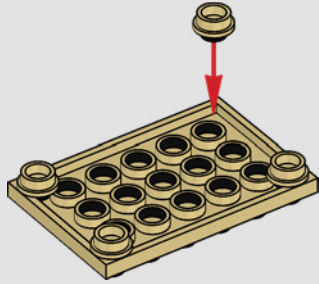

200

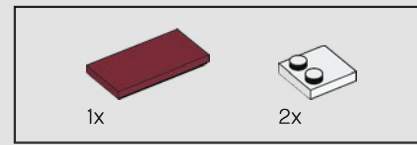
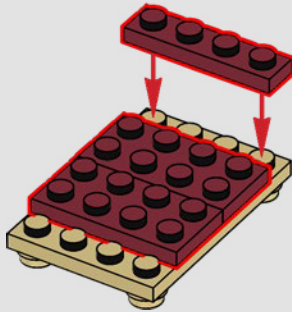

201

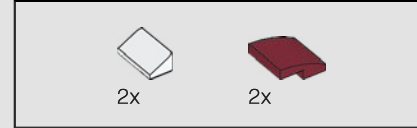
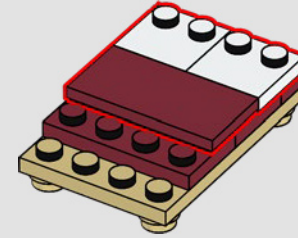

202

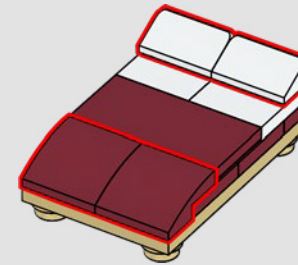

203

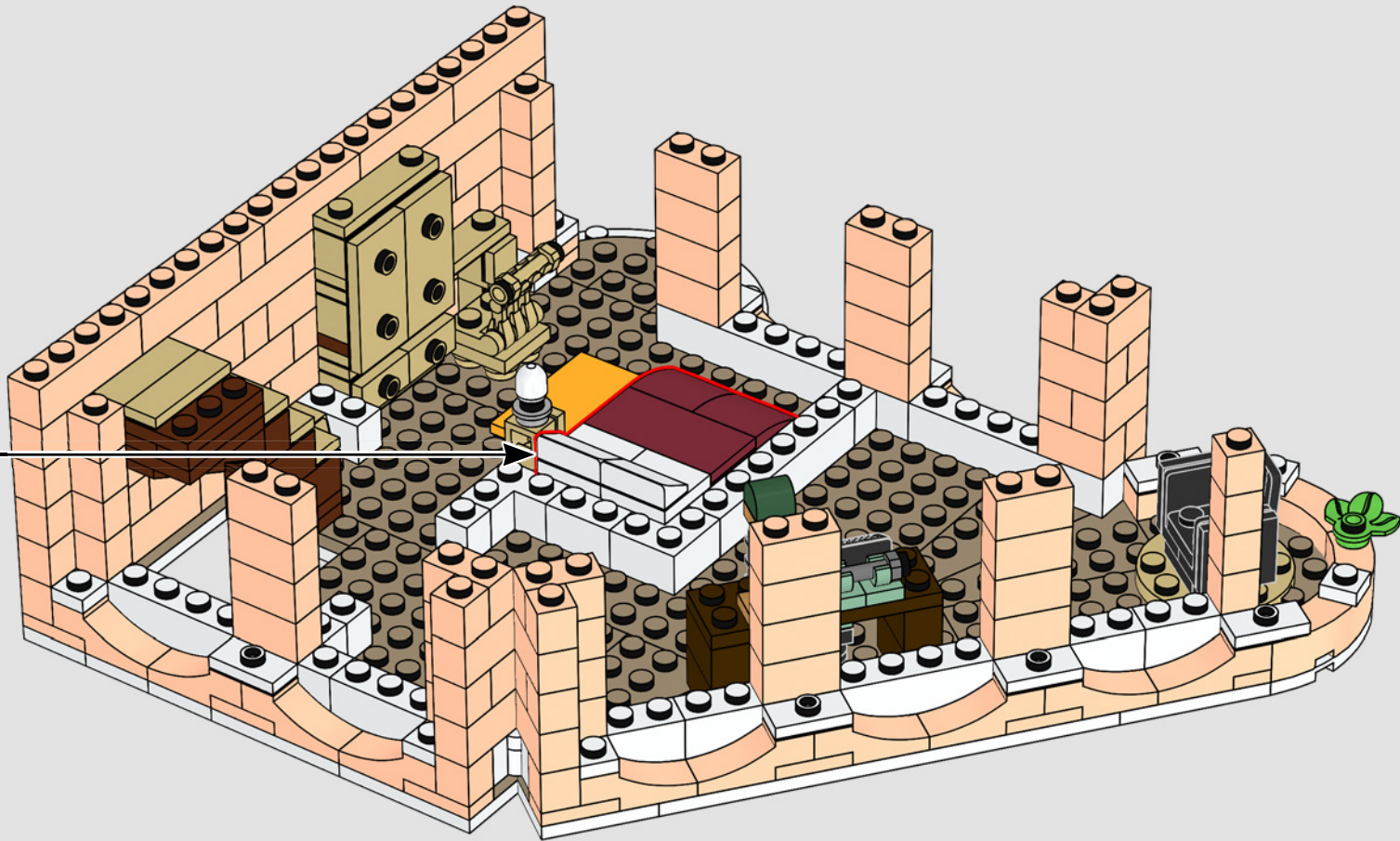

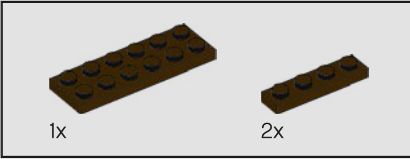
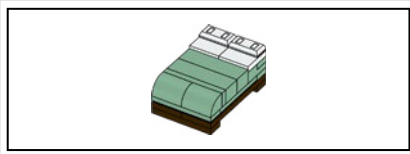

204

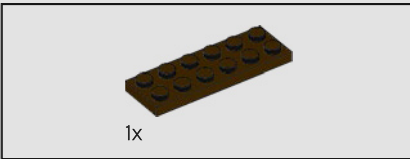
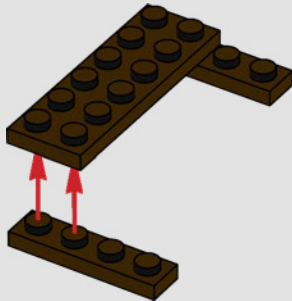

205

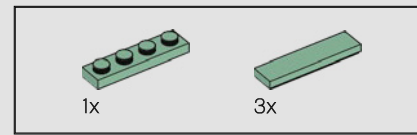
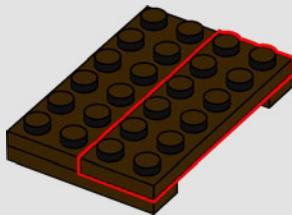

206

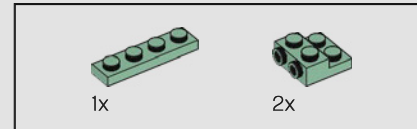
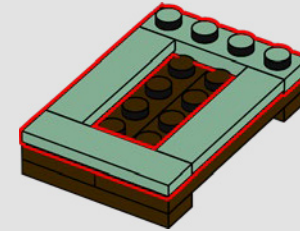

207

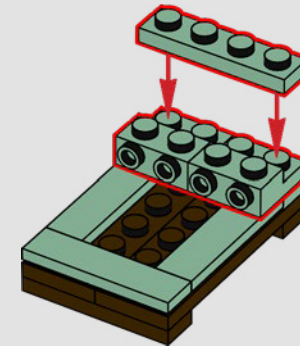





211

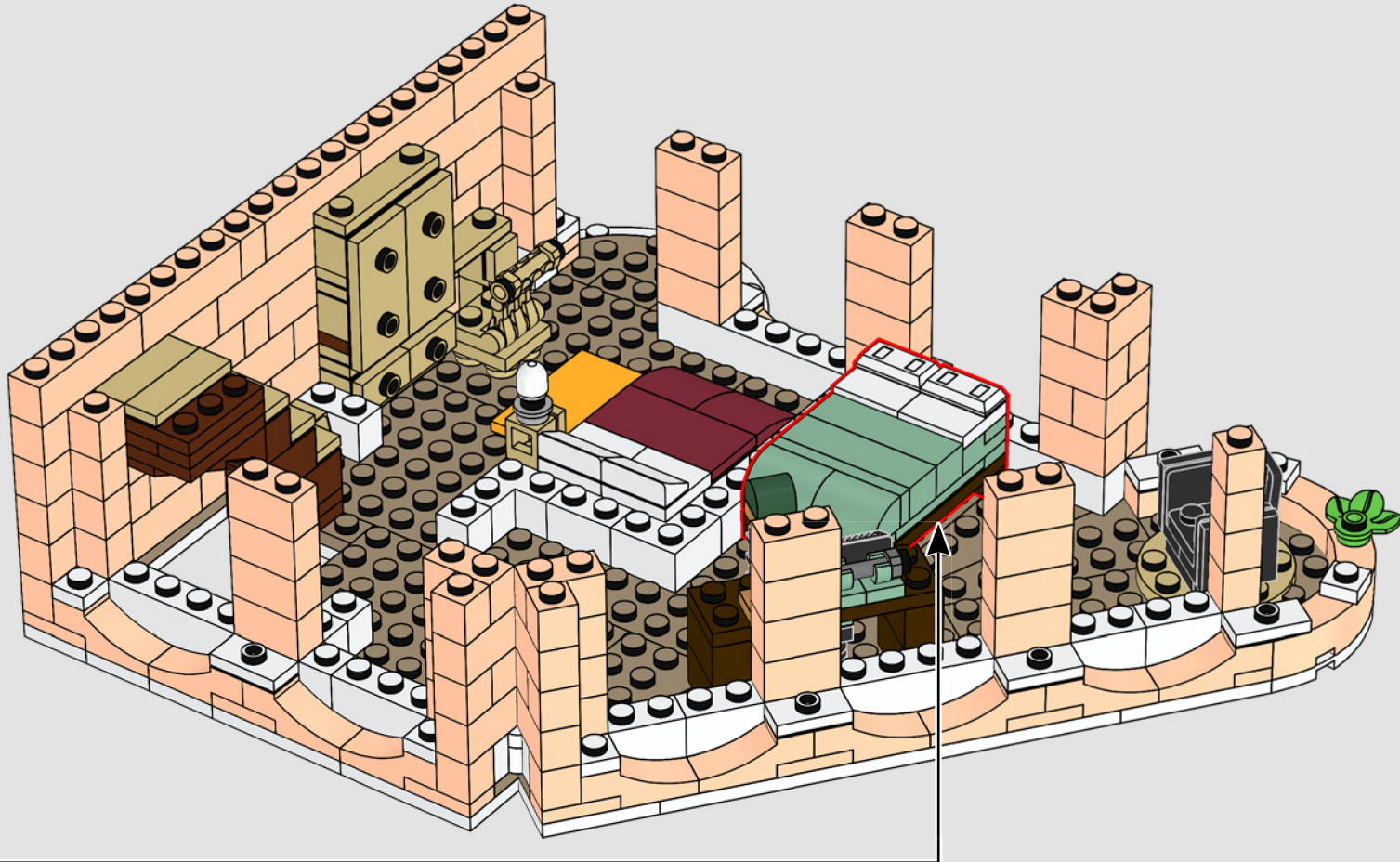

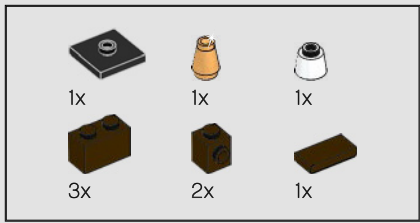

212

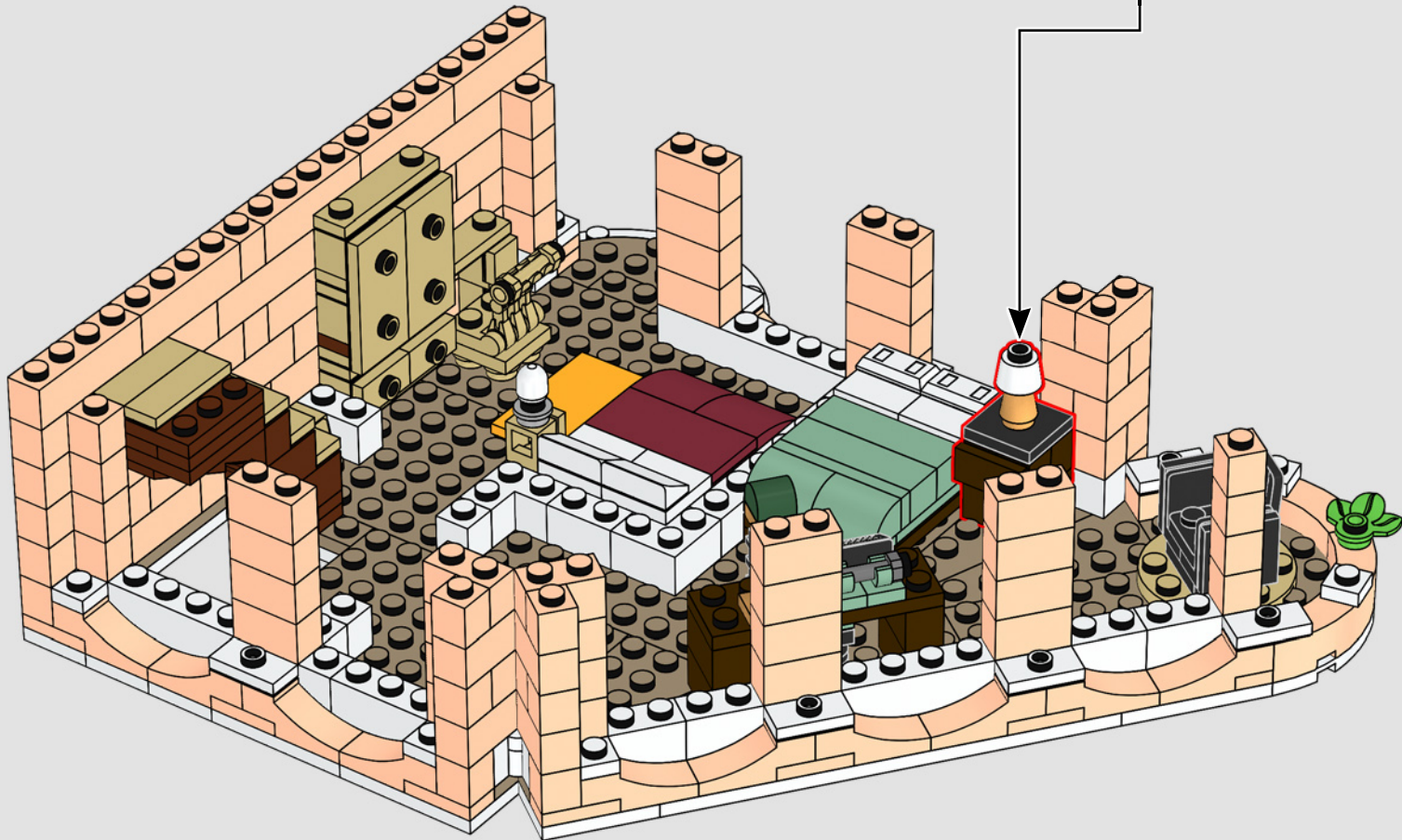
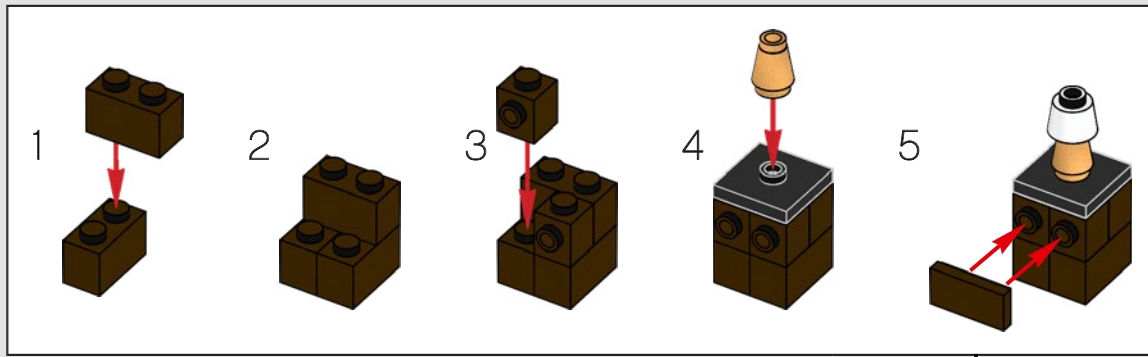

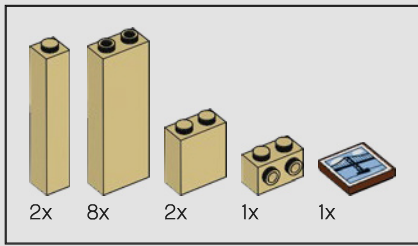

213

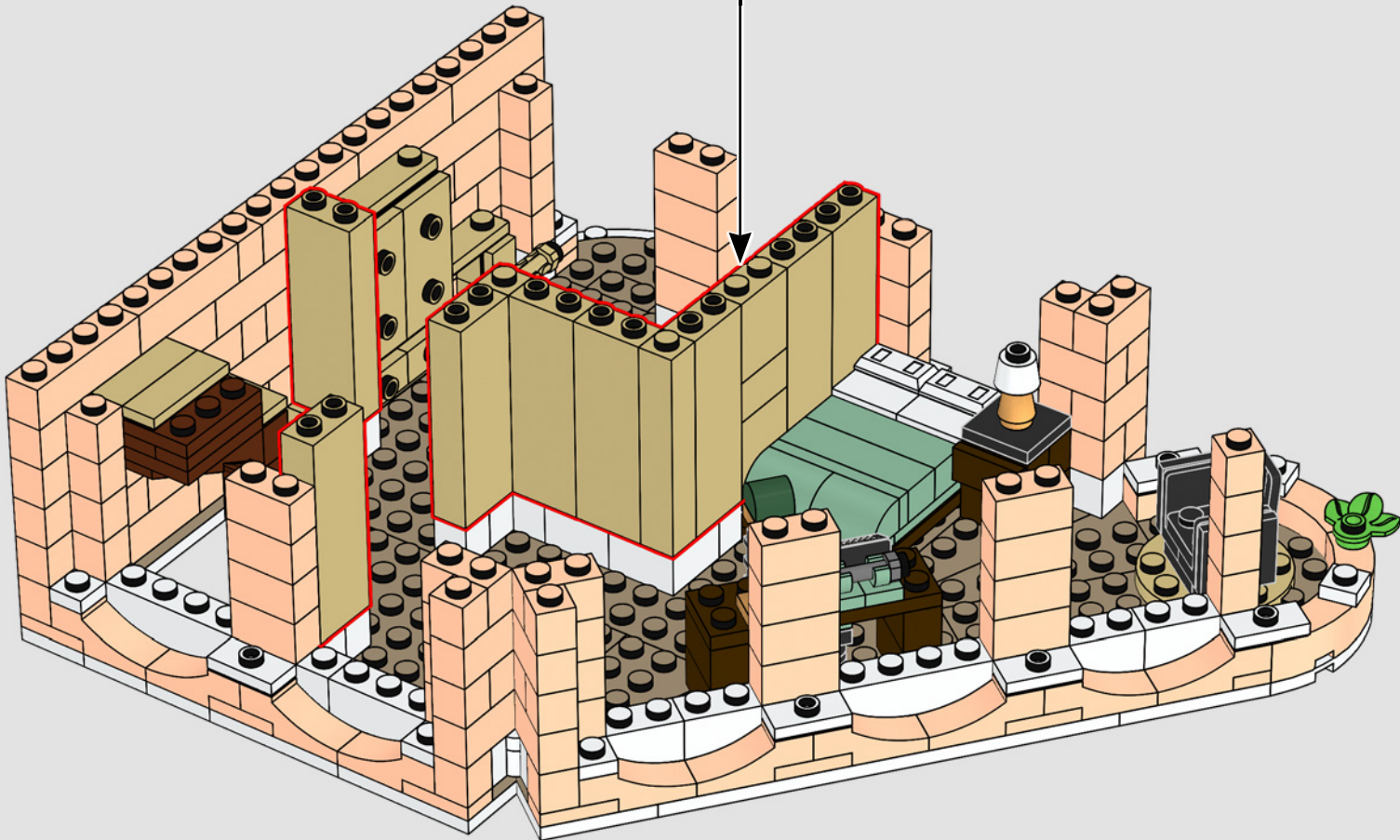
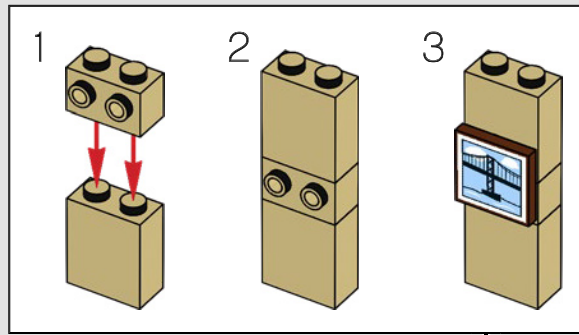

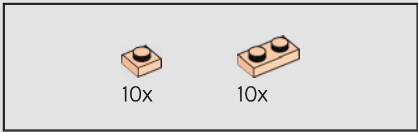

214

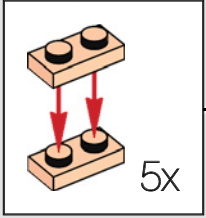
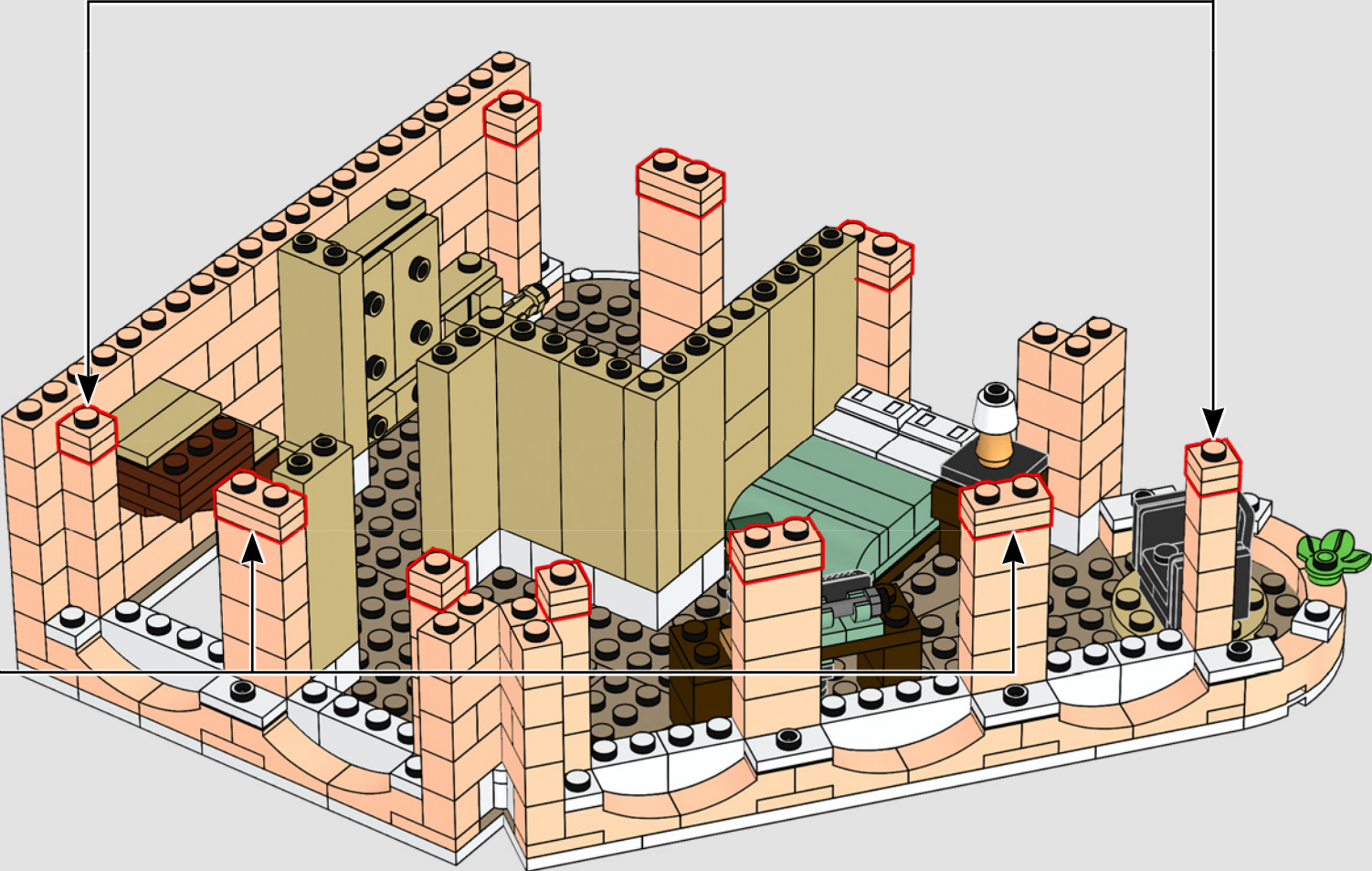
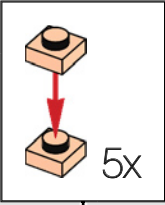

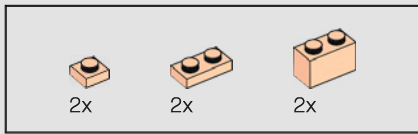

215

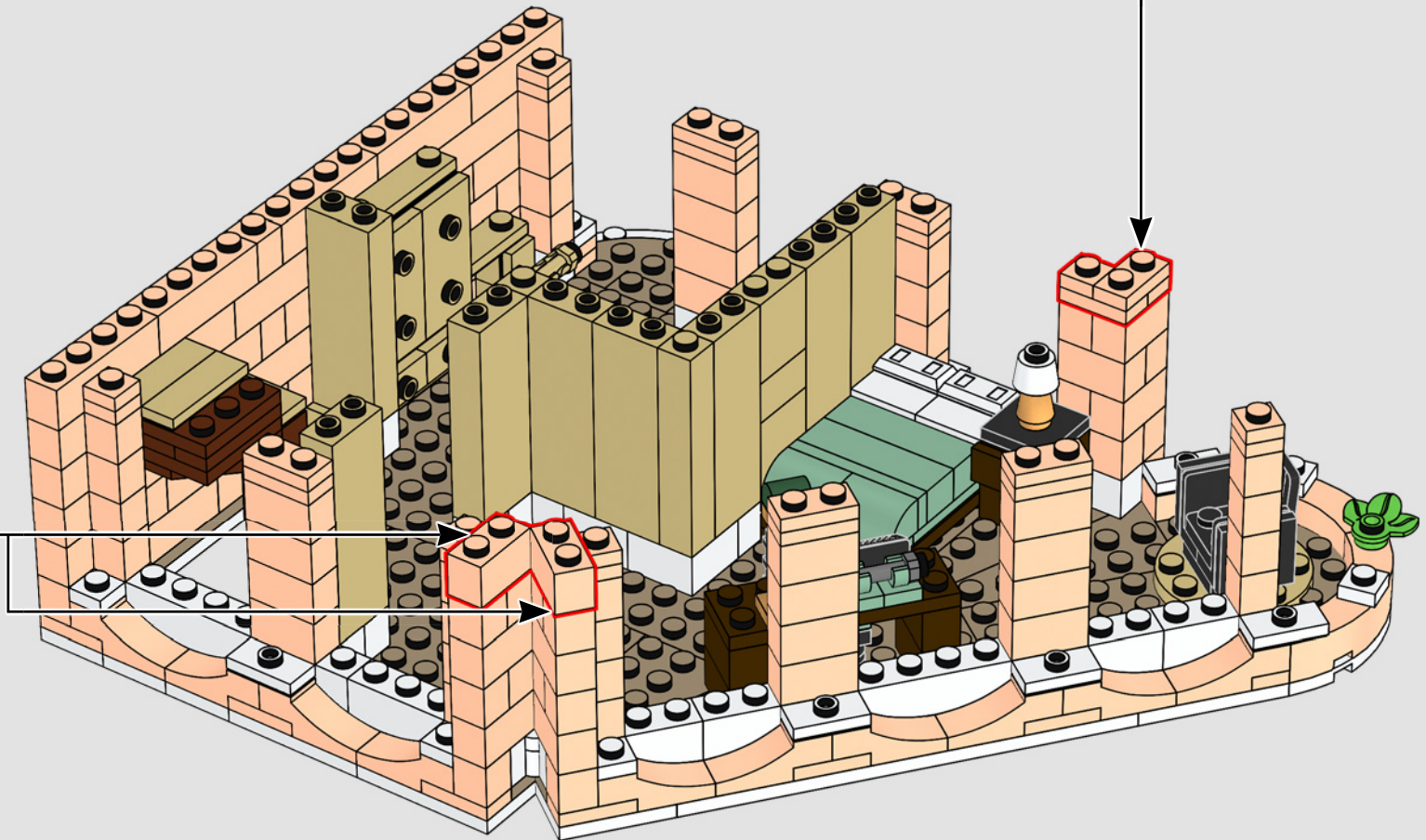
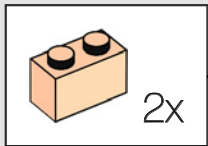
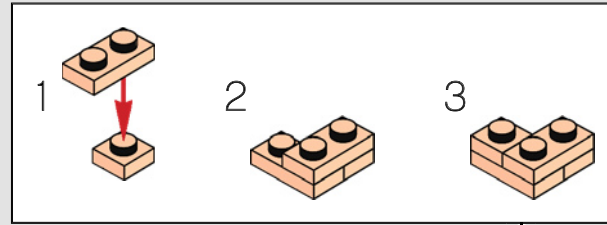

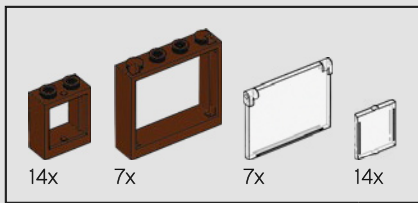

216

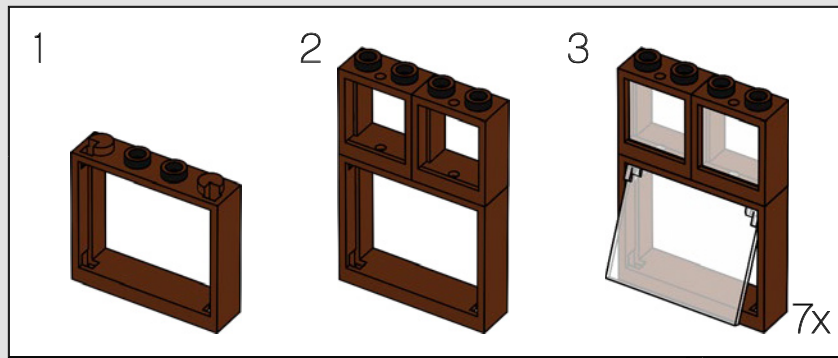

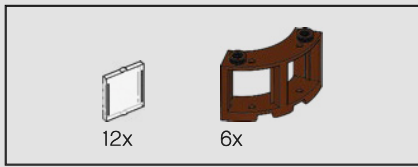

217

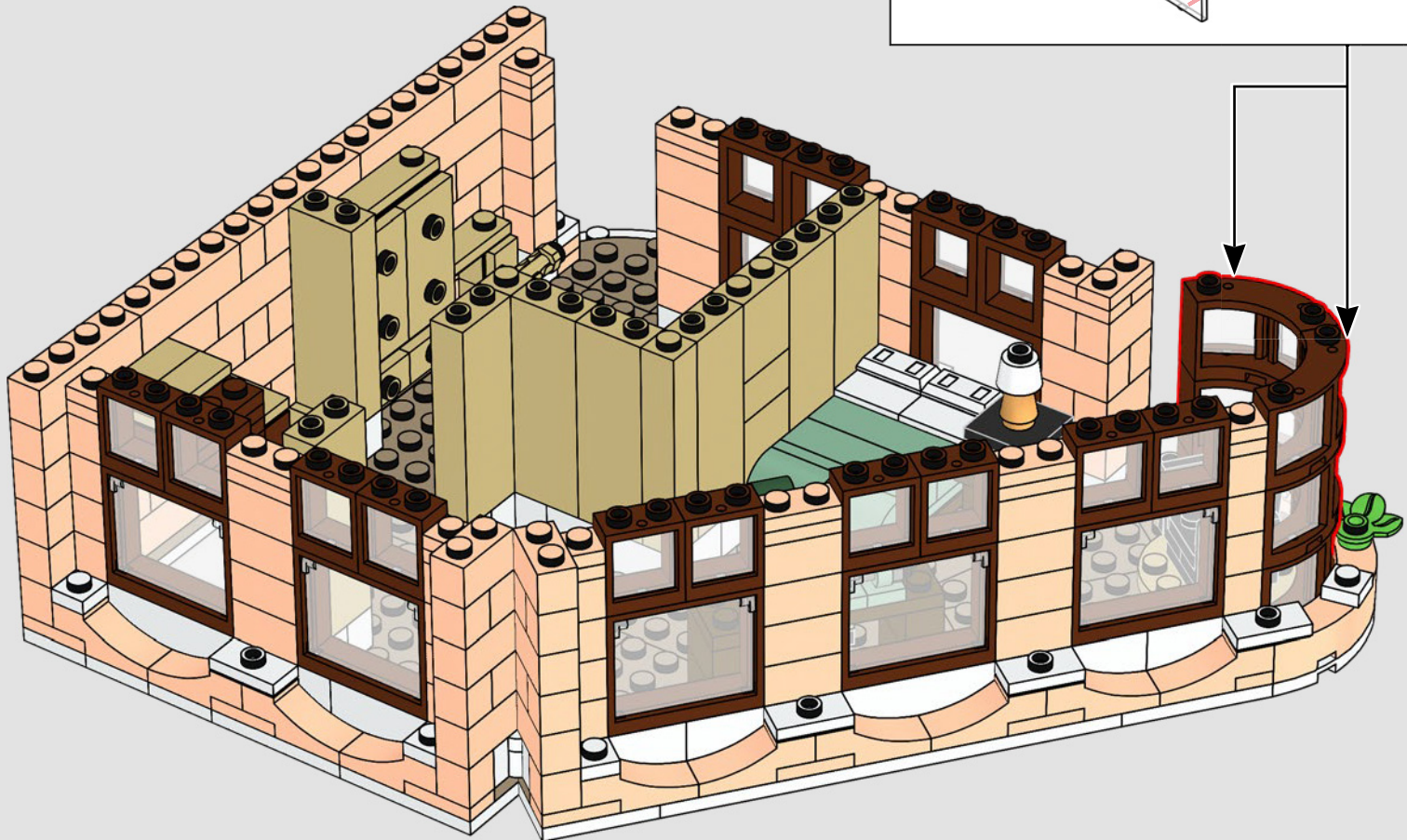
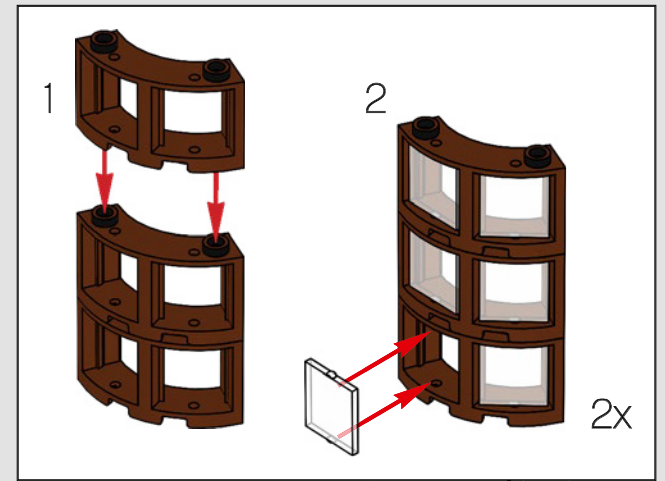

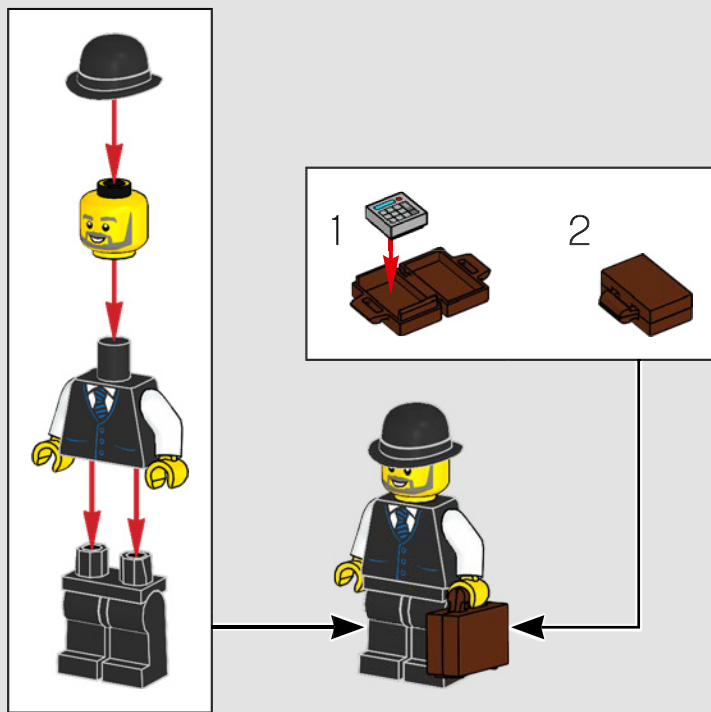
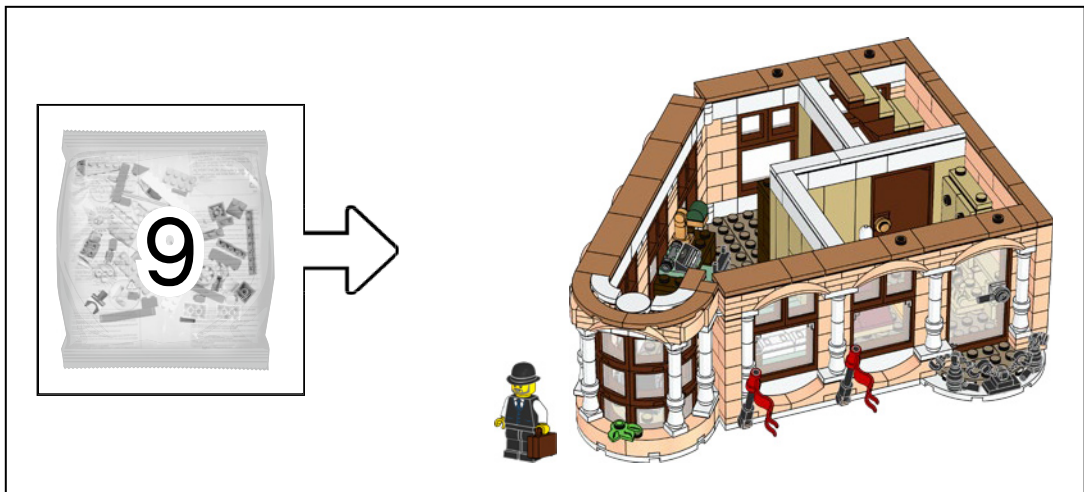



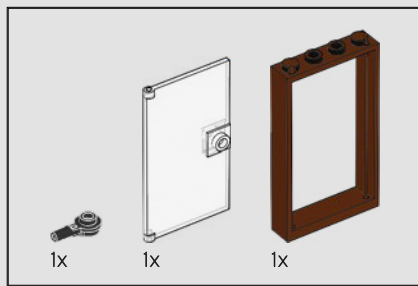

218

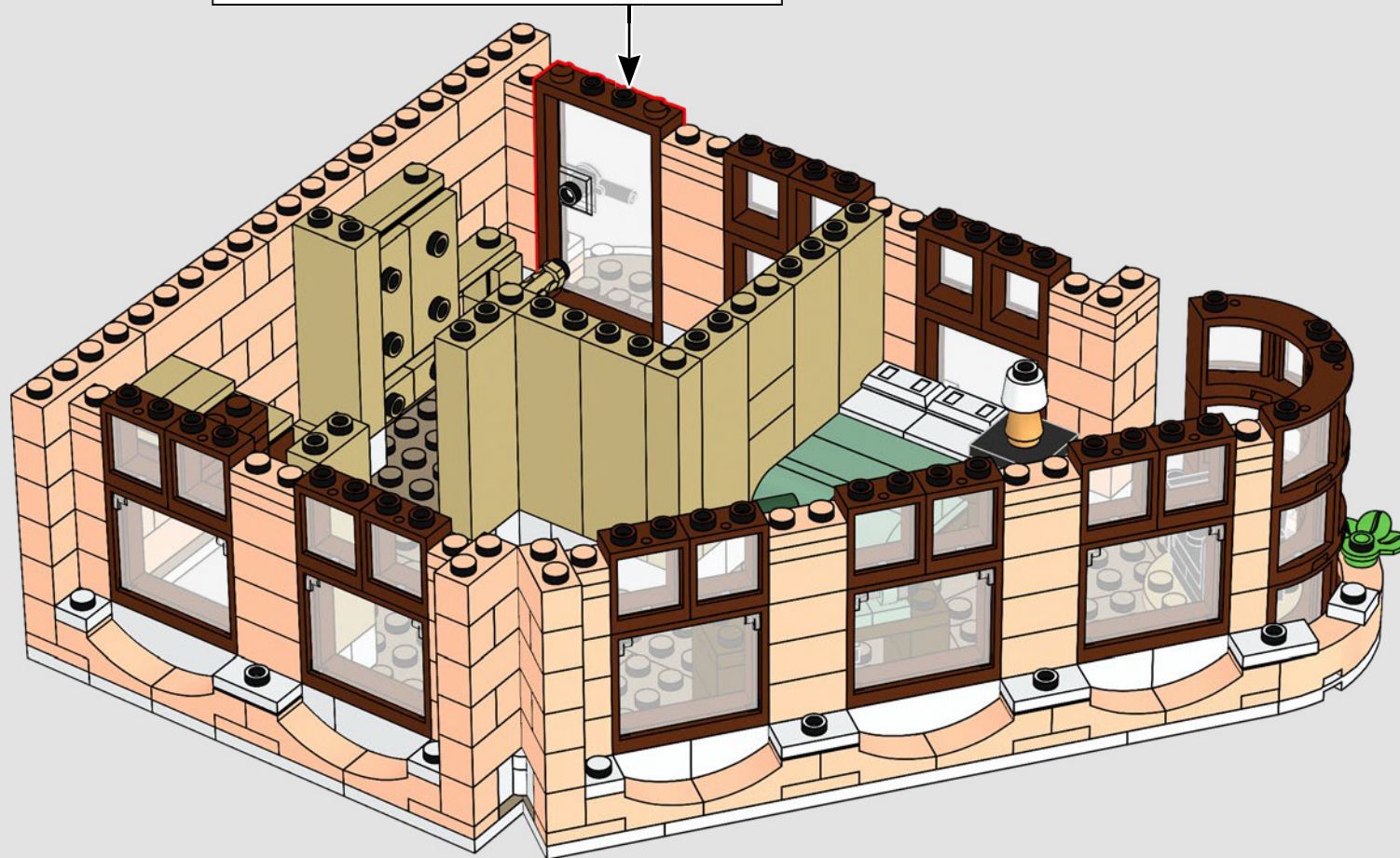
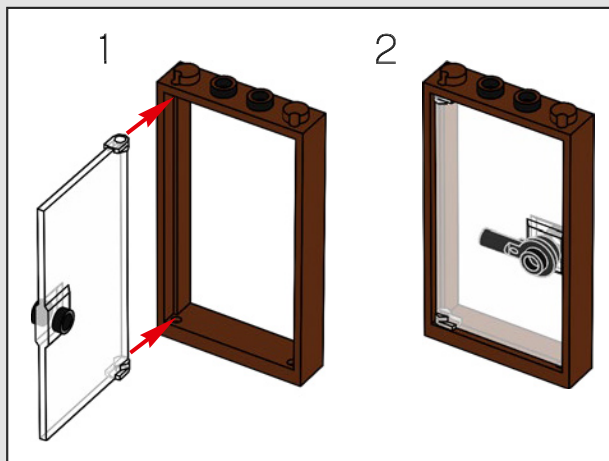

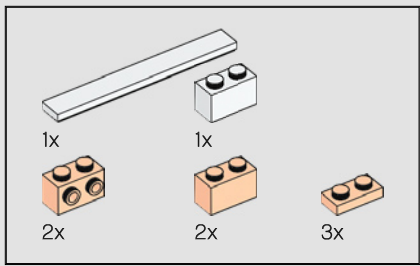

219

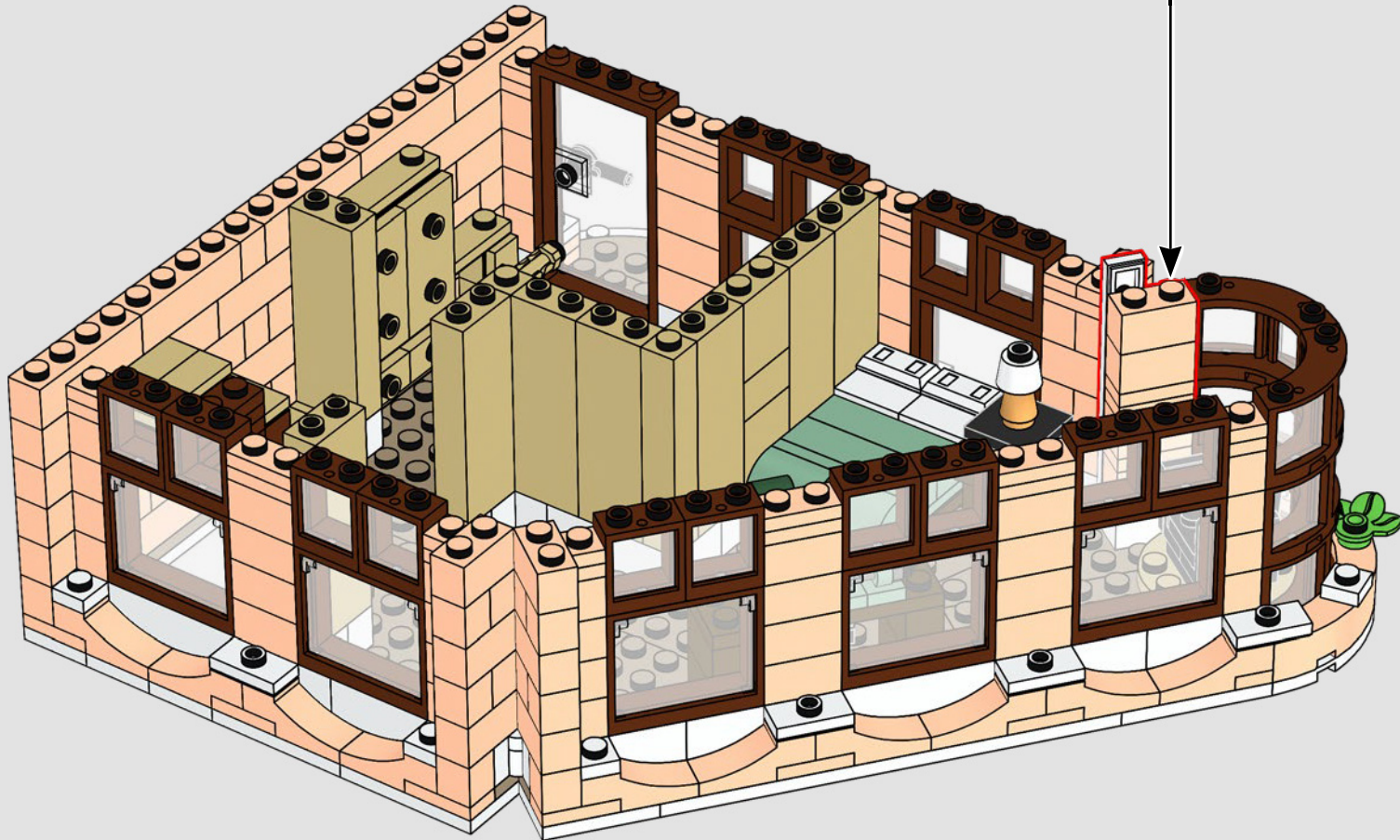
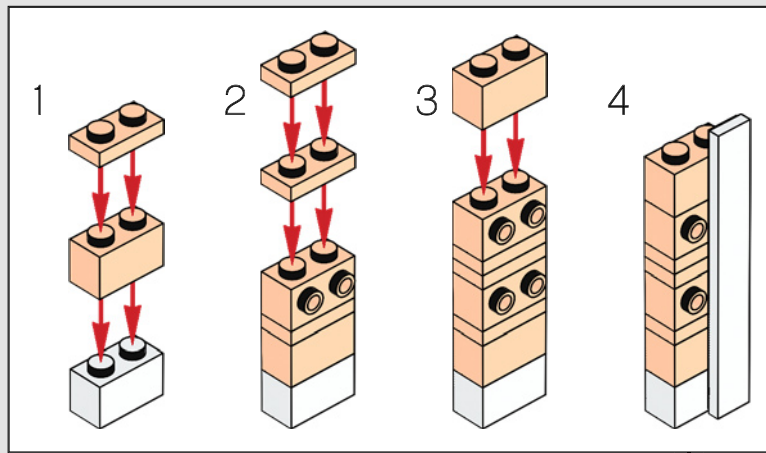

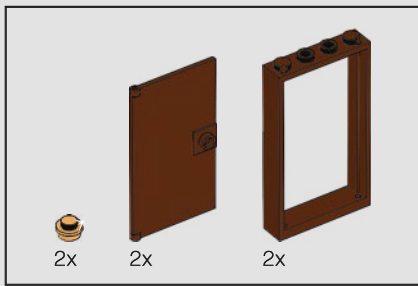

220

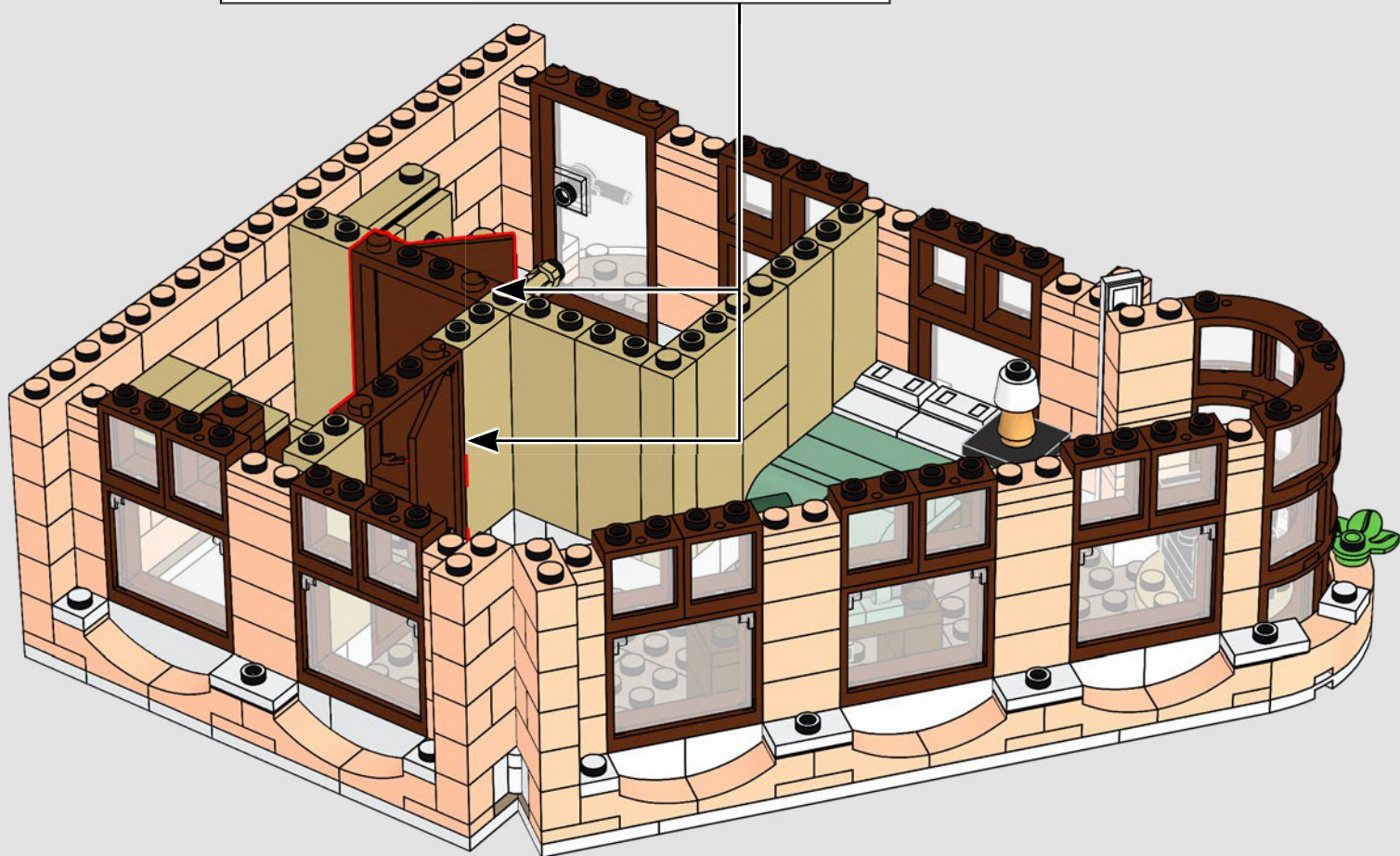
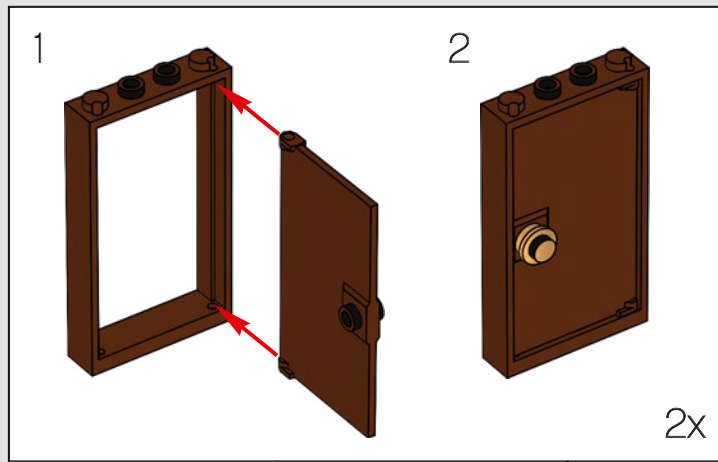

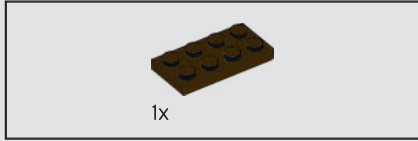
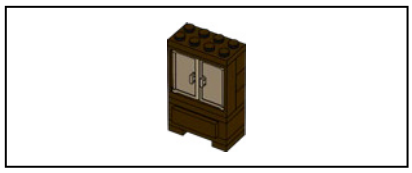

221

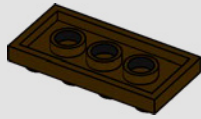

222

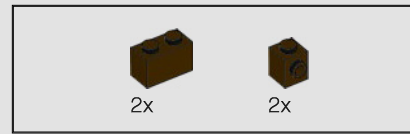
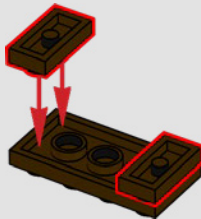

223

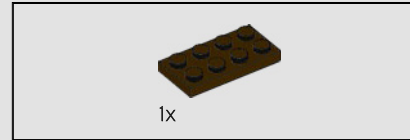
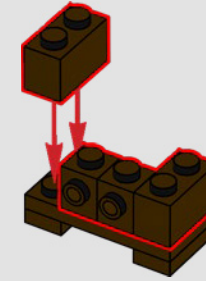
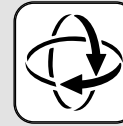

224

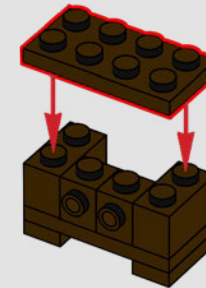

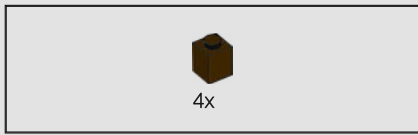

225

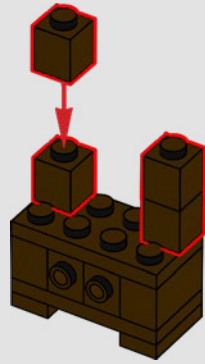

226

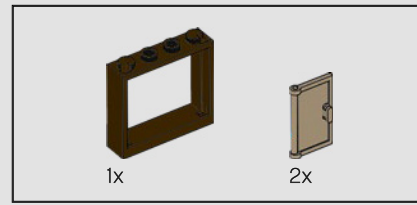
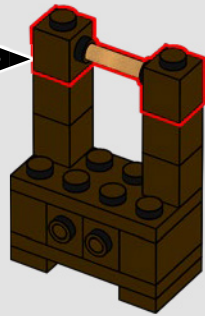
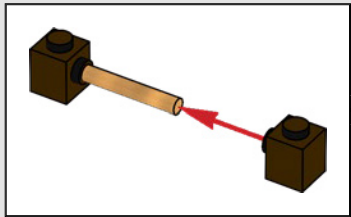

227

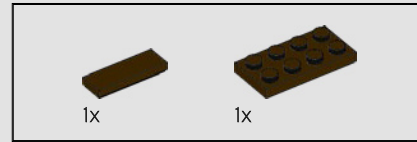
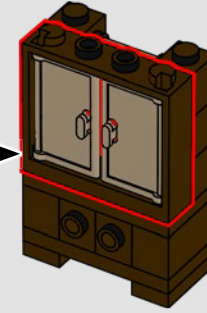
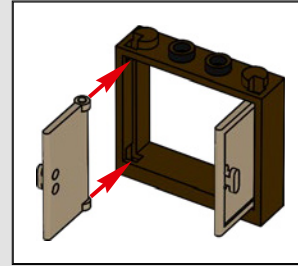

228

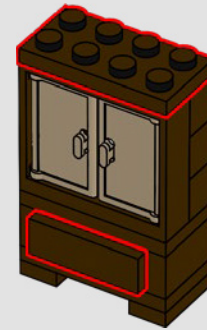

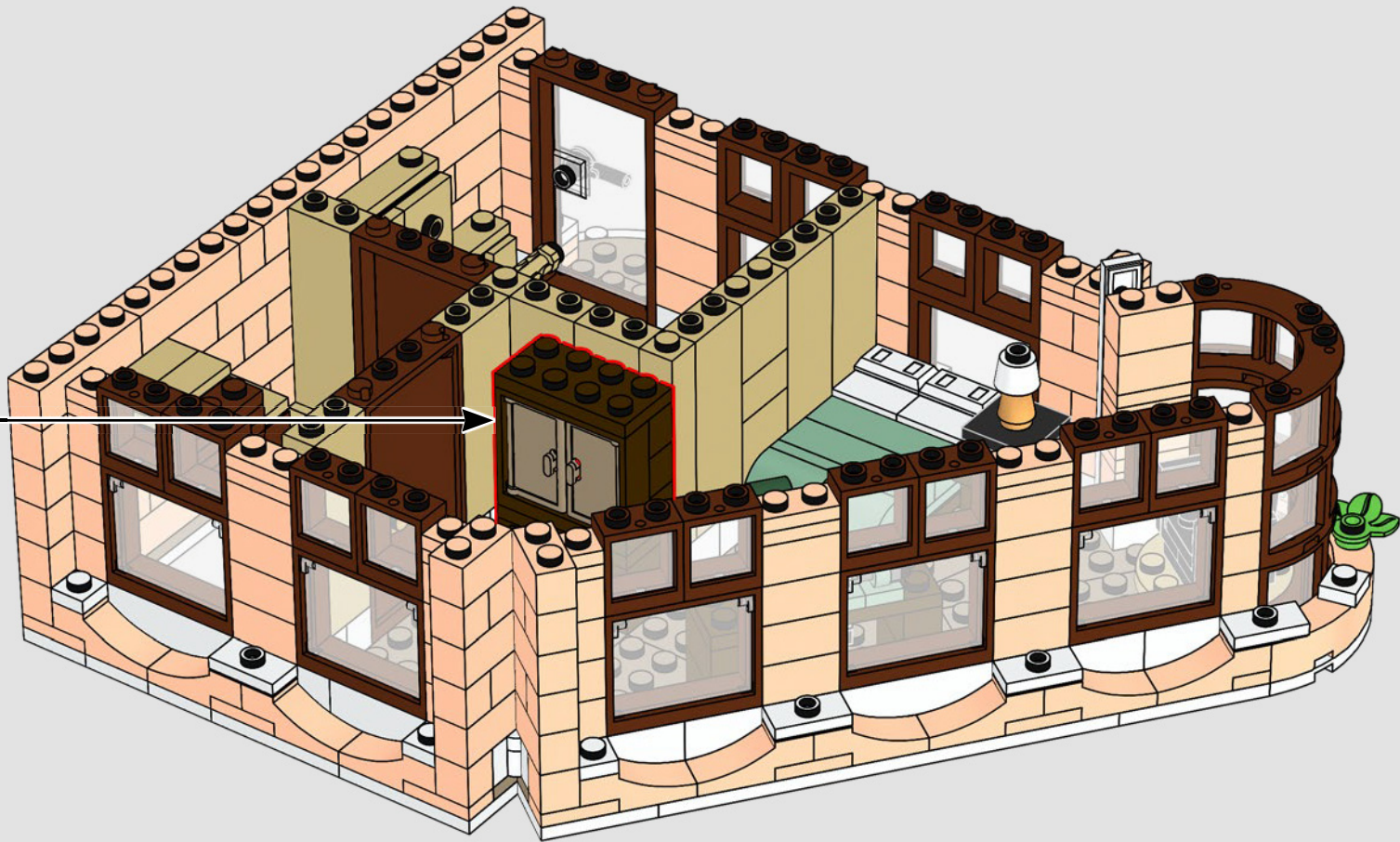



230

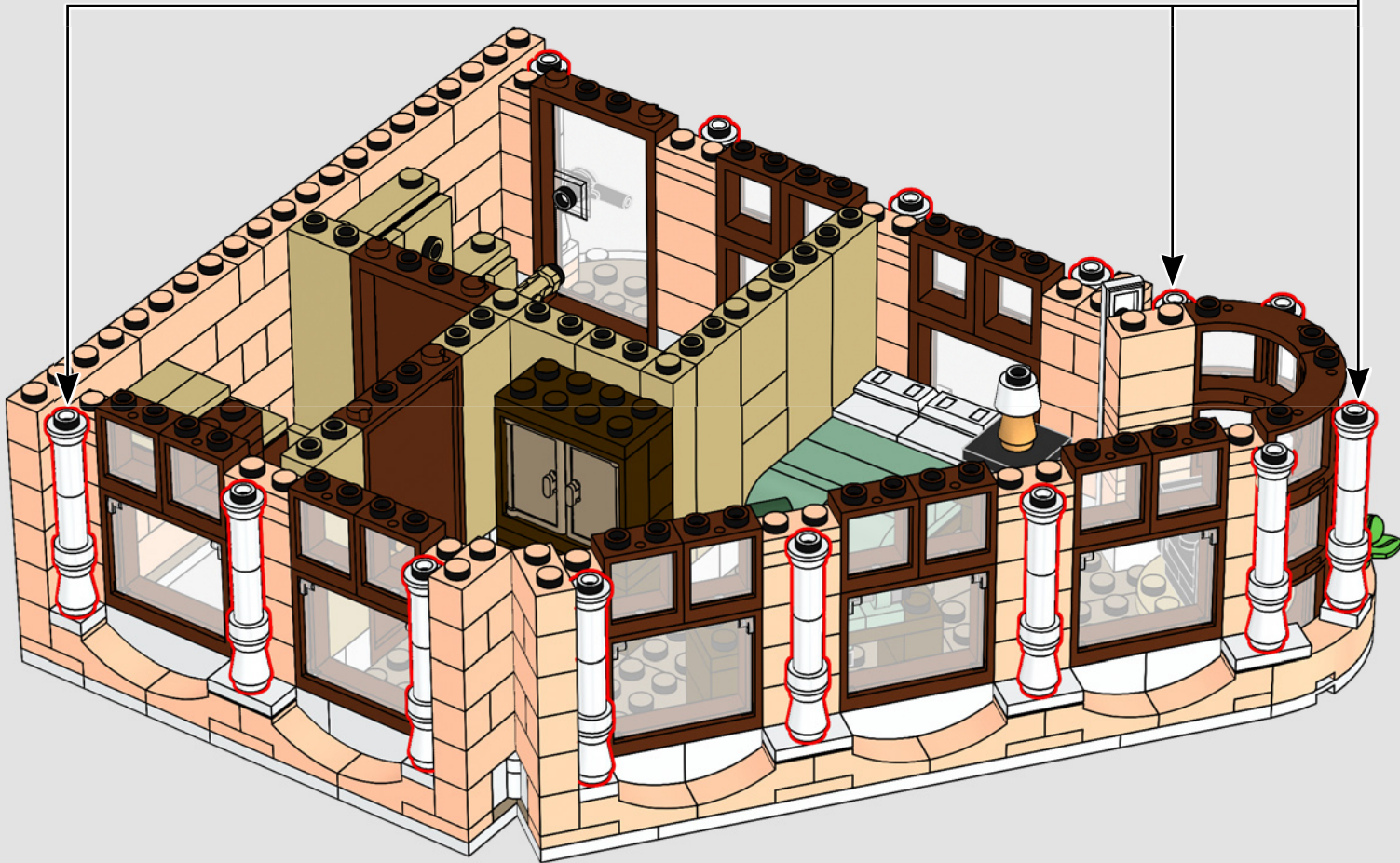
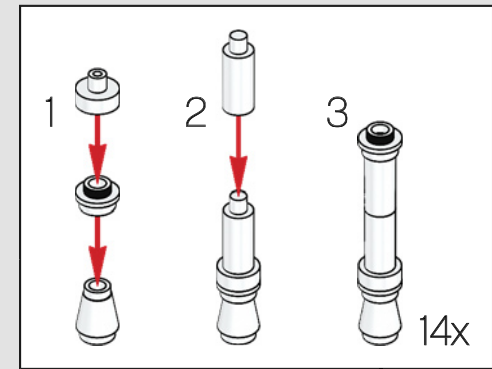

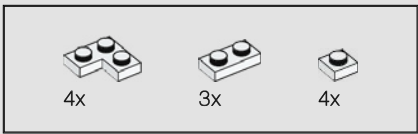

231

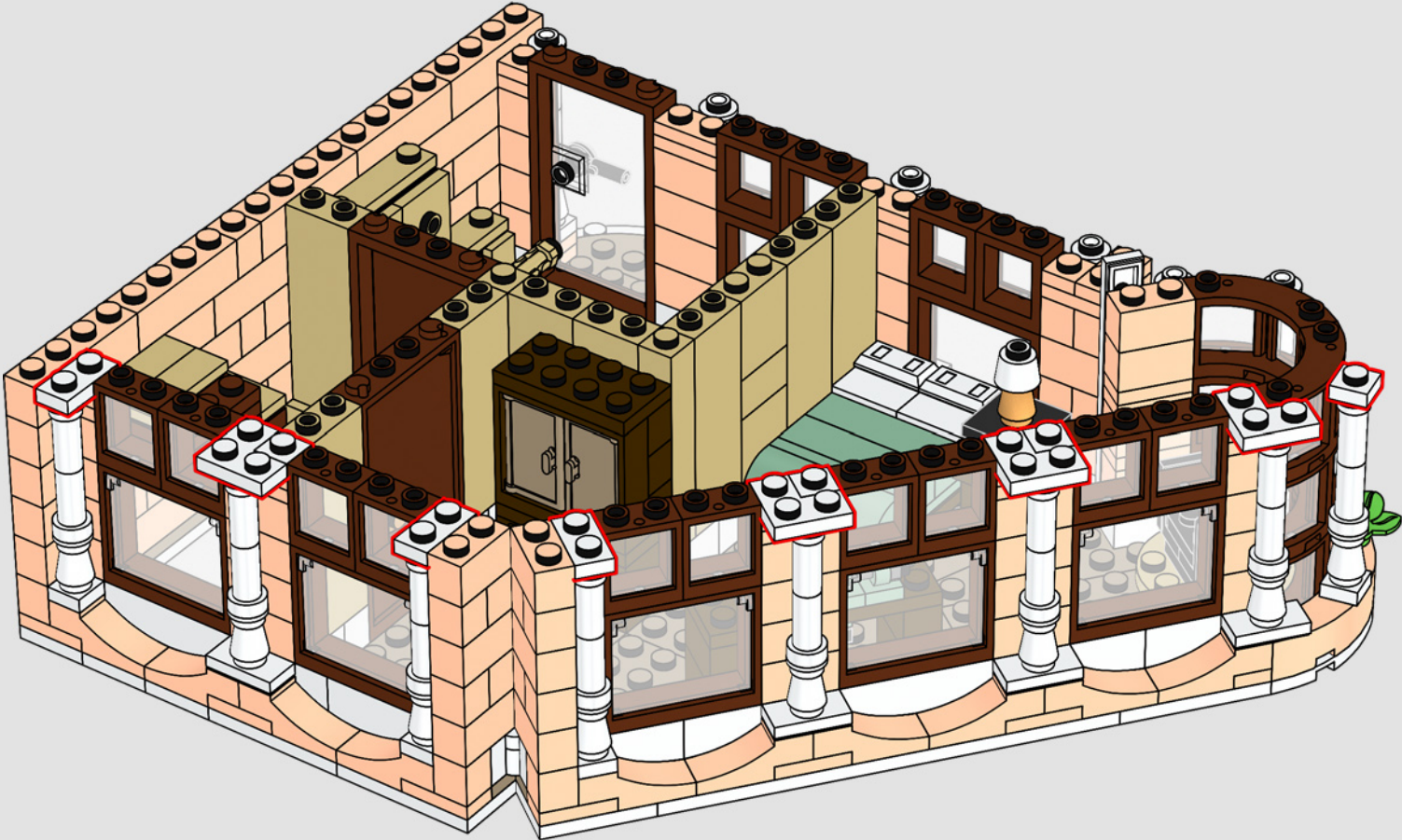



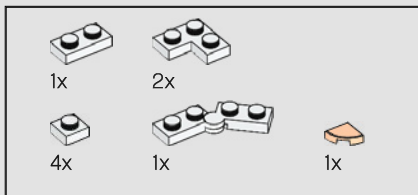

232

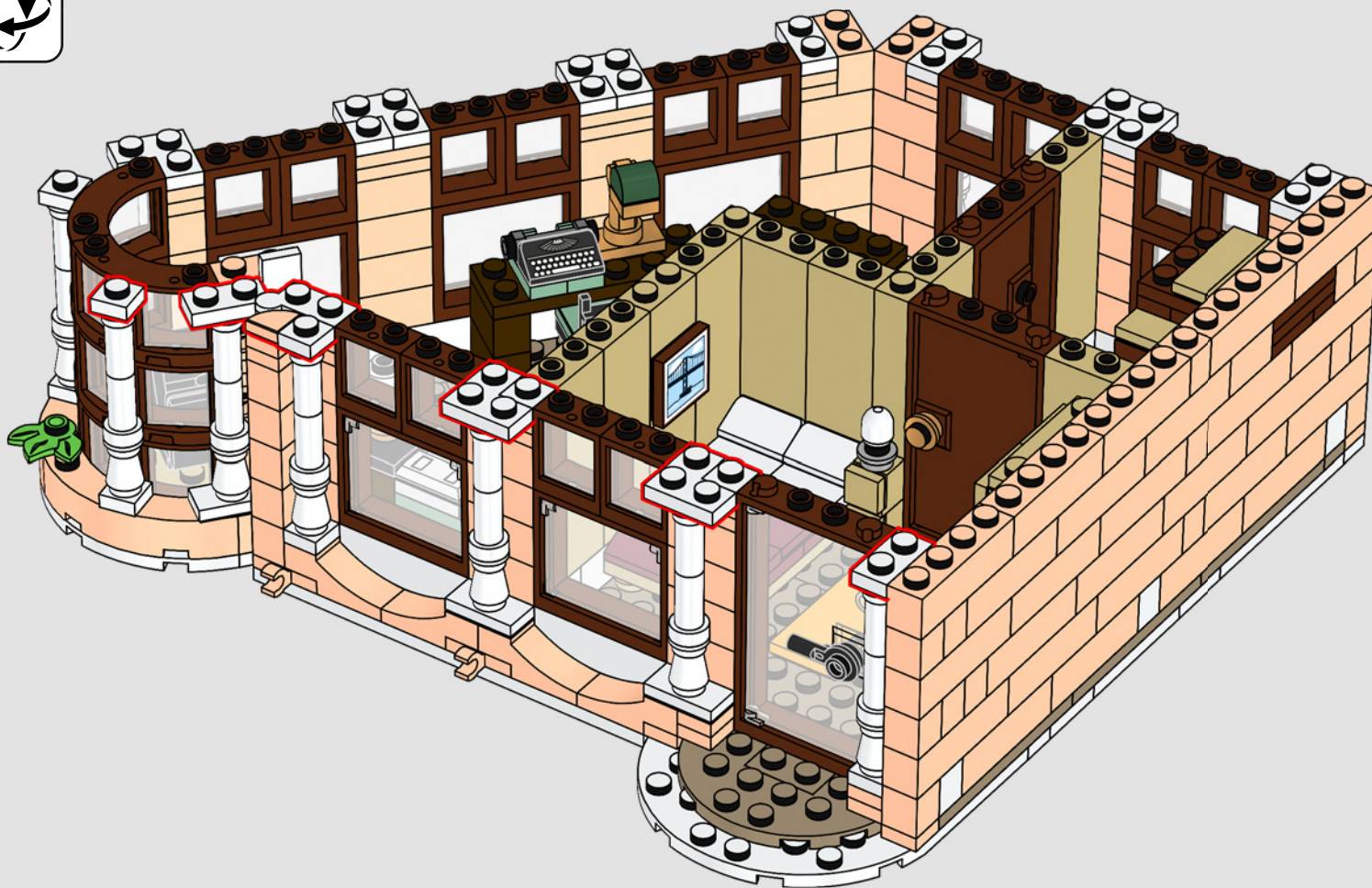



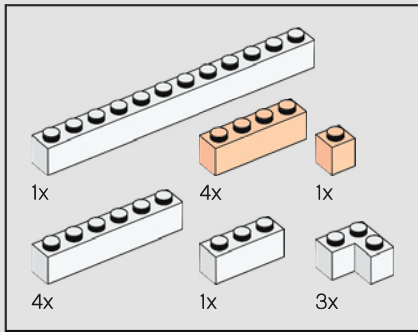

234

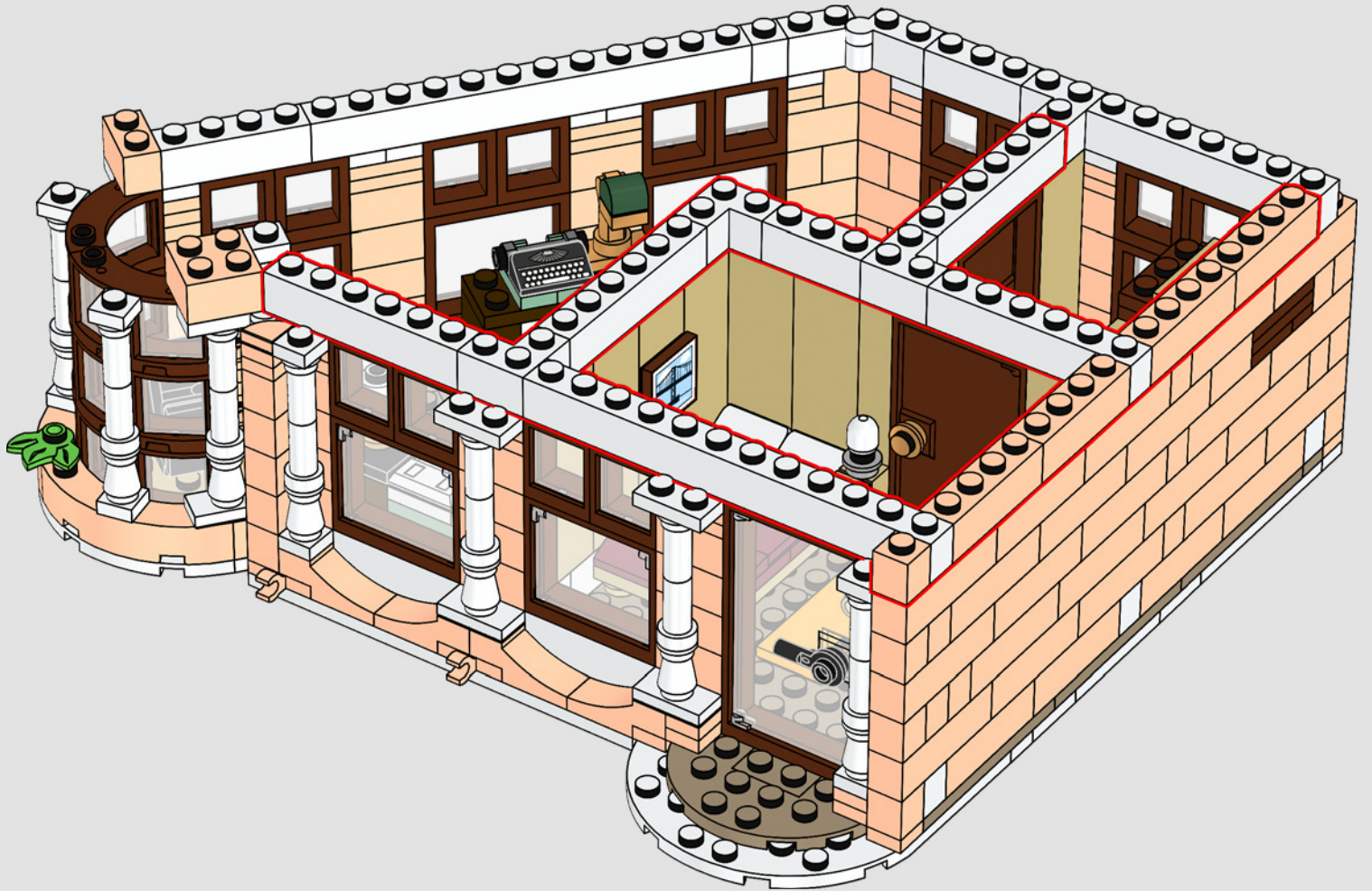

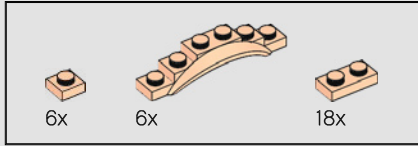
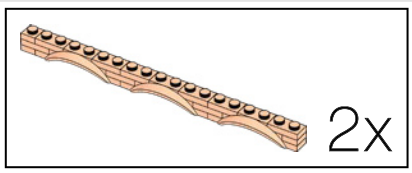

235

1

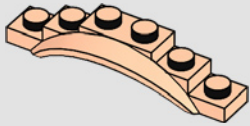

2

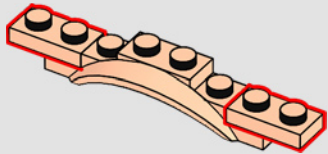

3

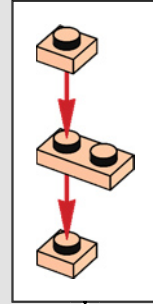
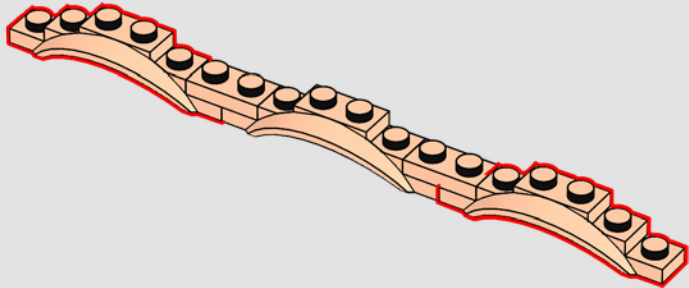

4

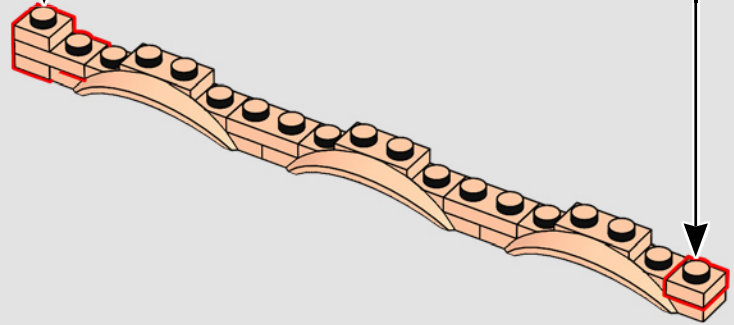

5

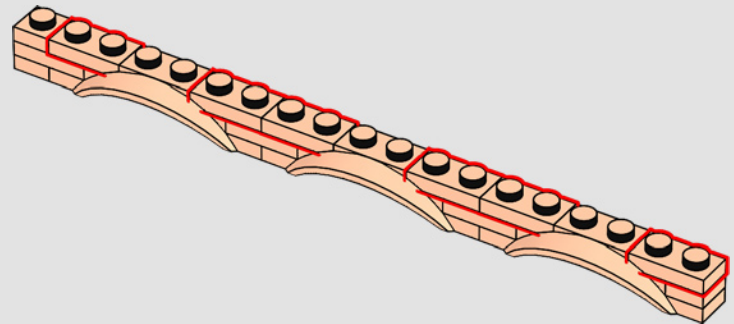

2x

236



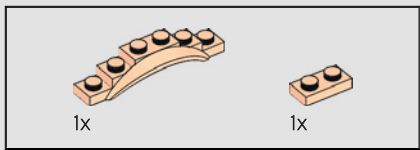

237

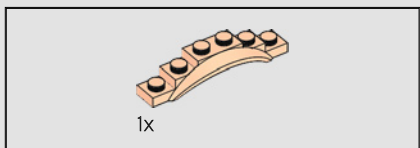
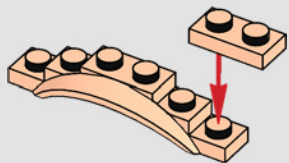

238

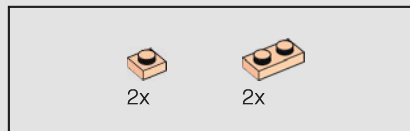
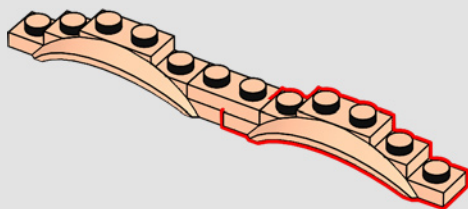

239

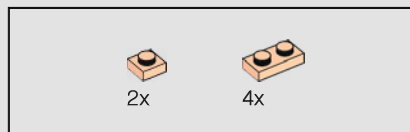
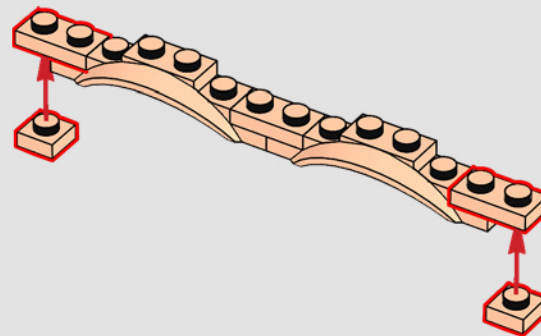

240

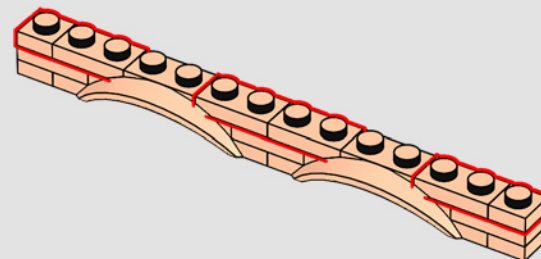

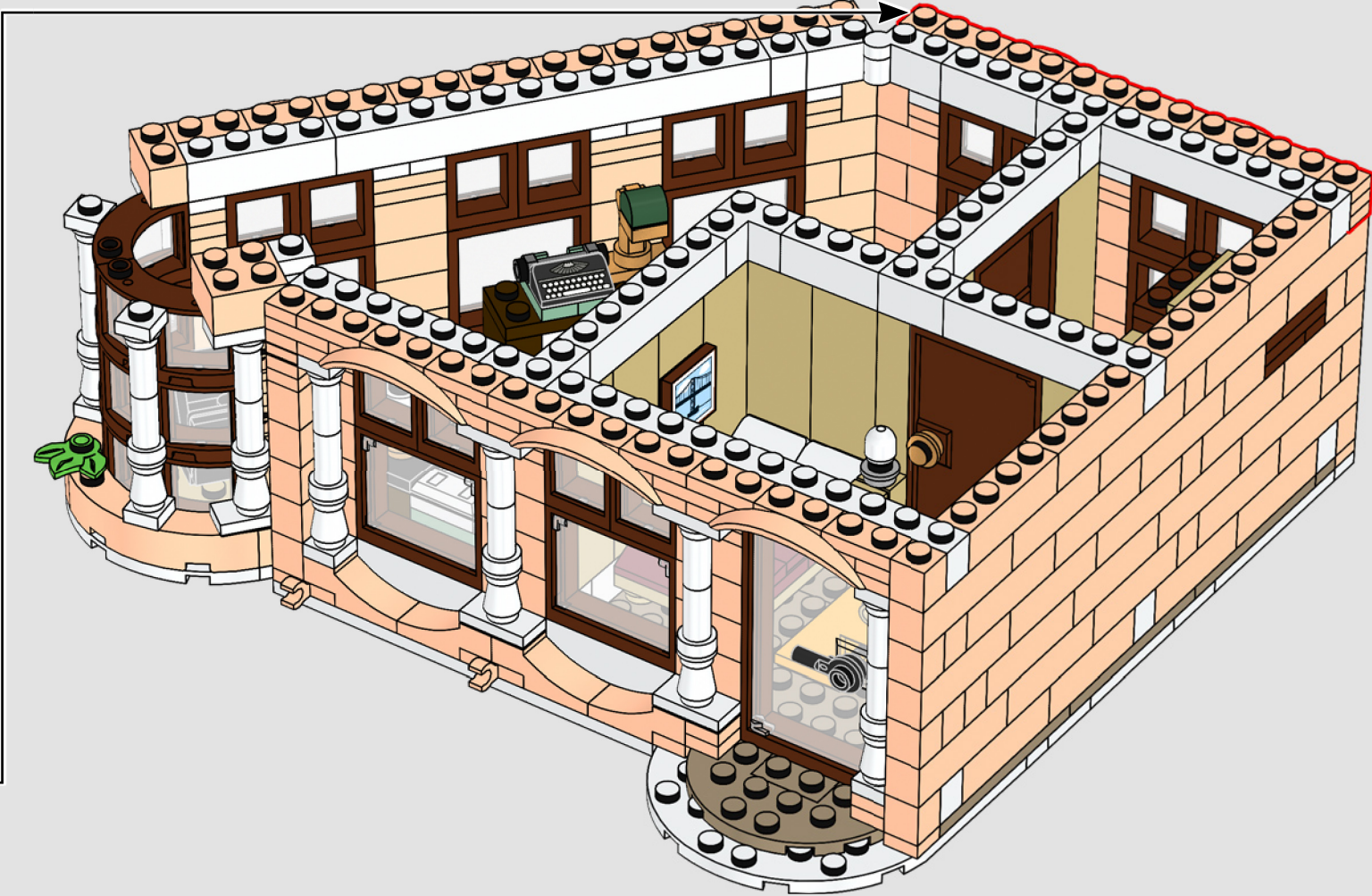

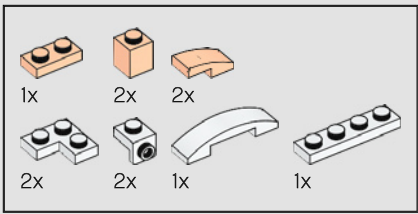

242

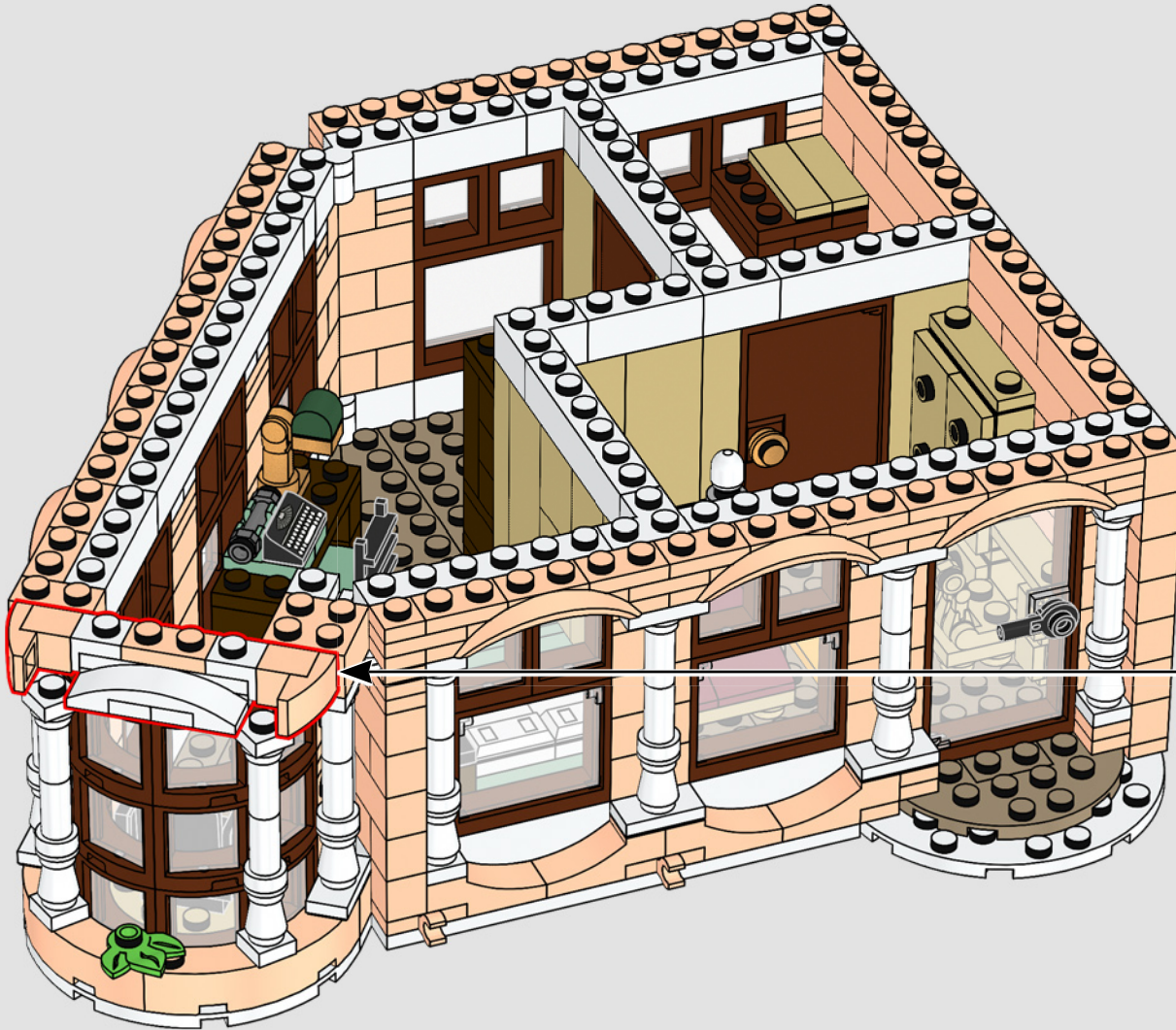
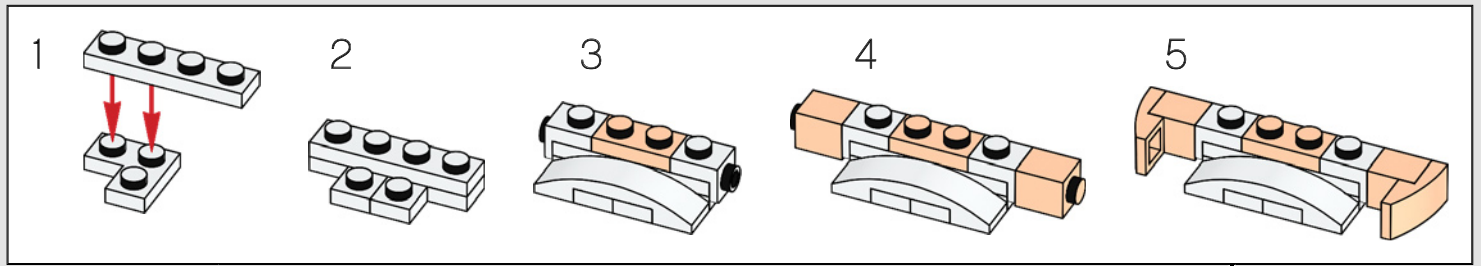



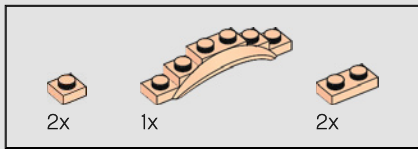

243

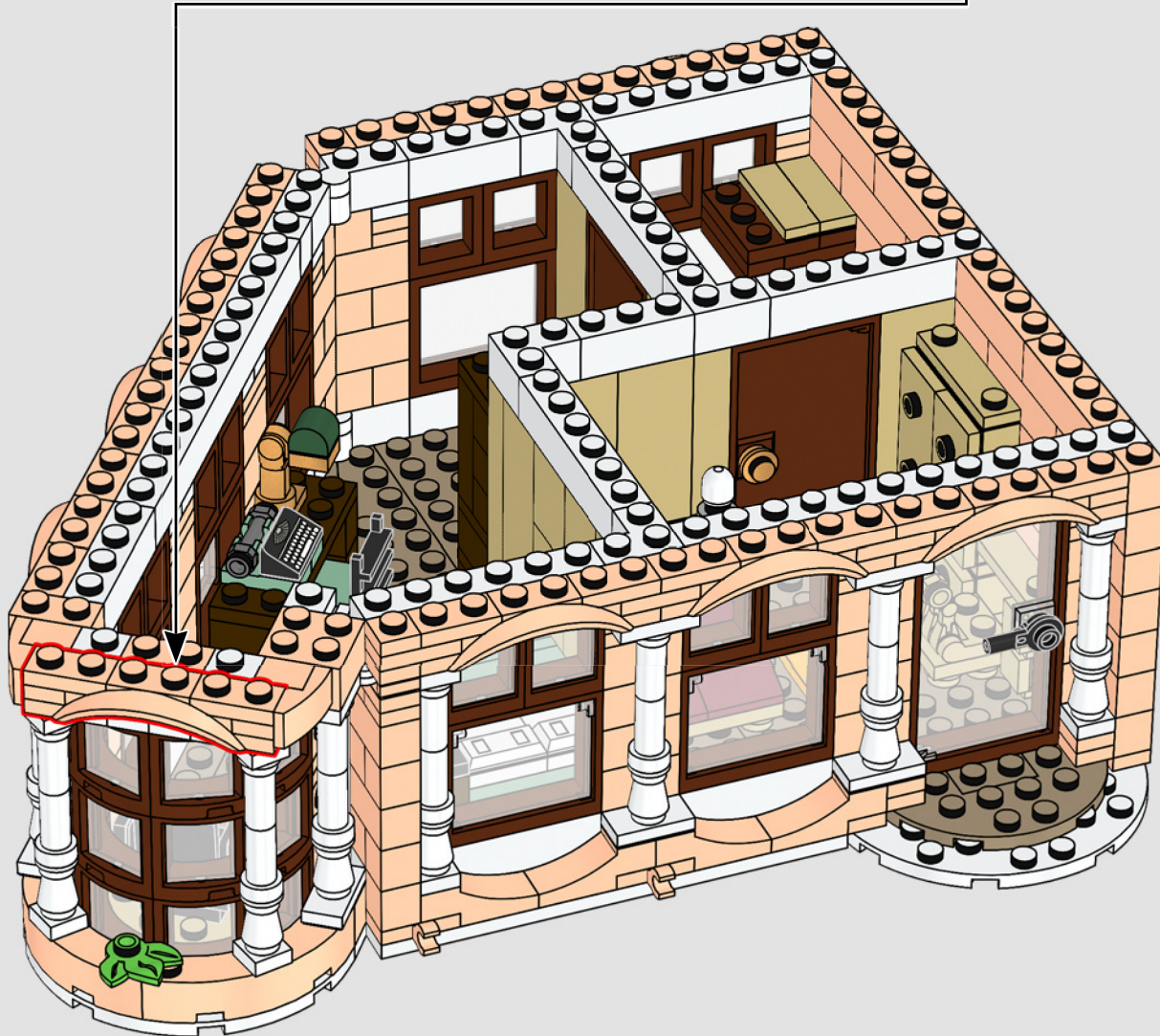
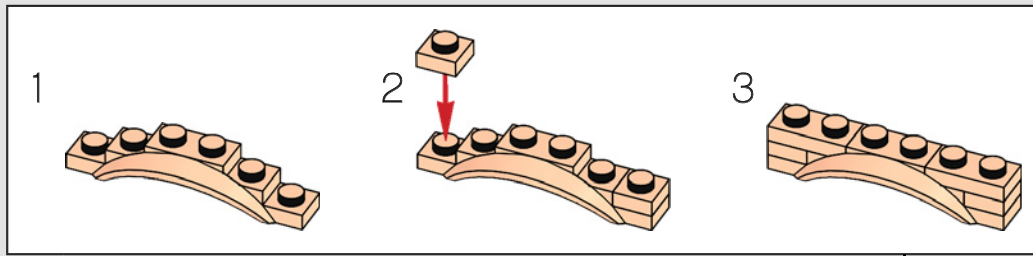

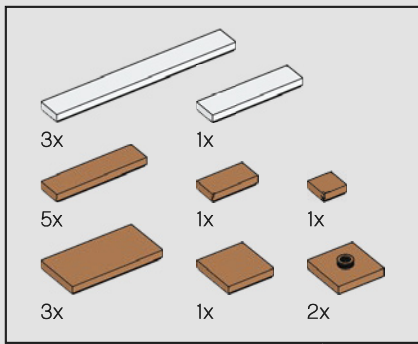

244



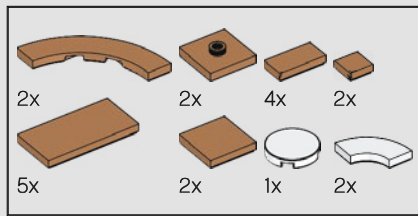

245

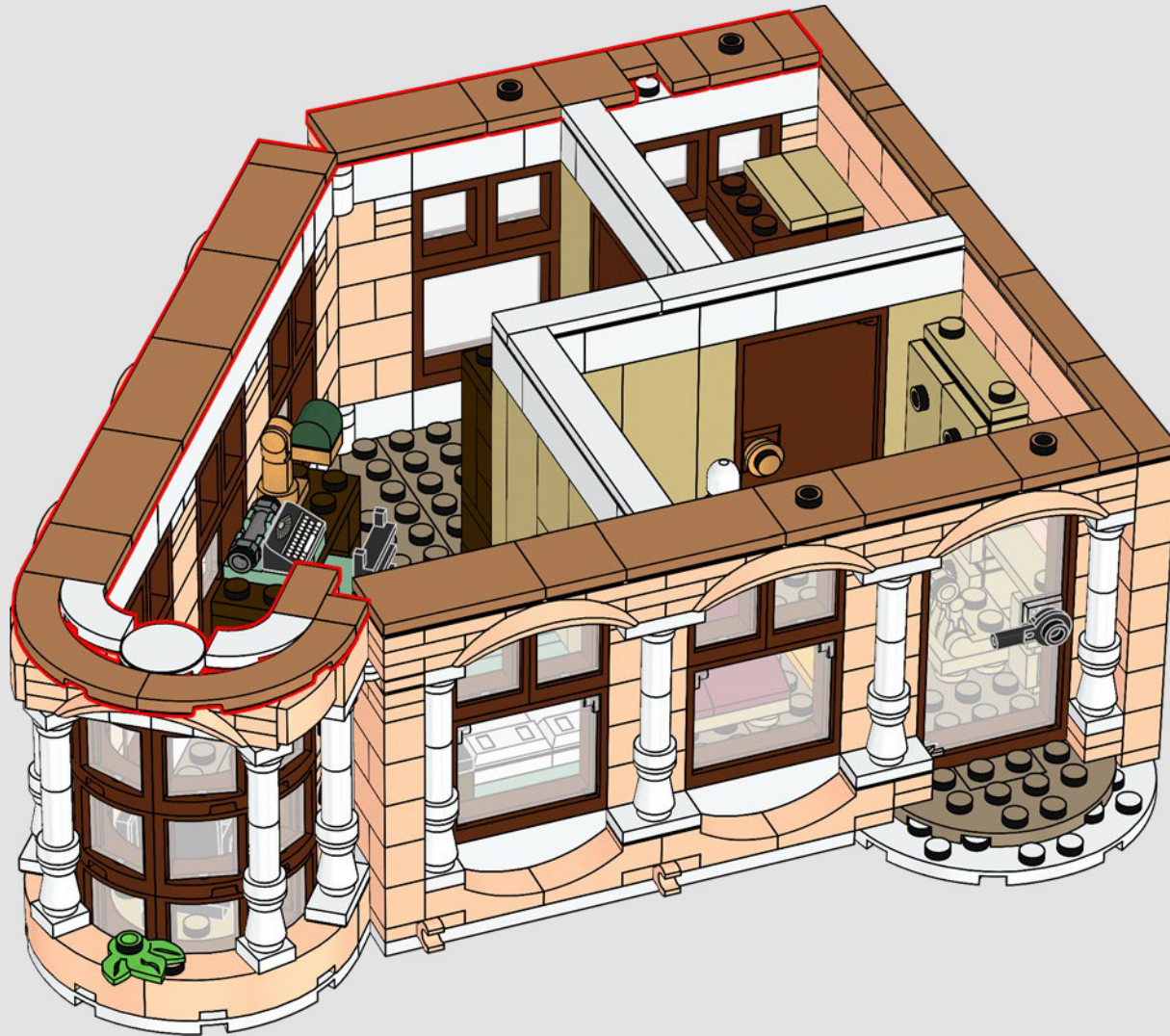

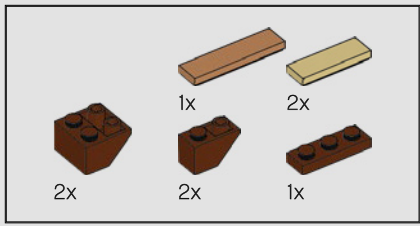

246

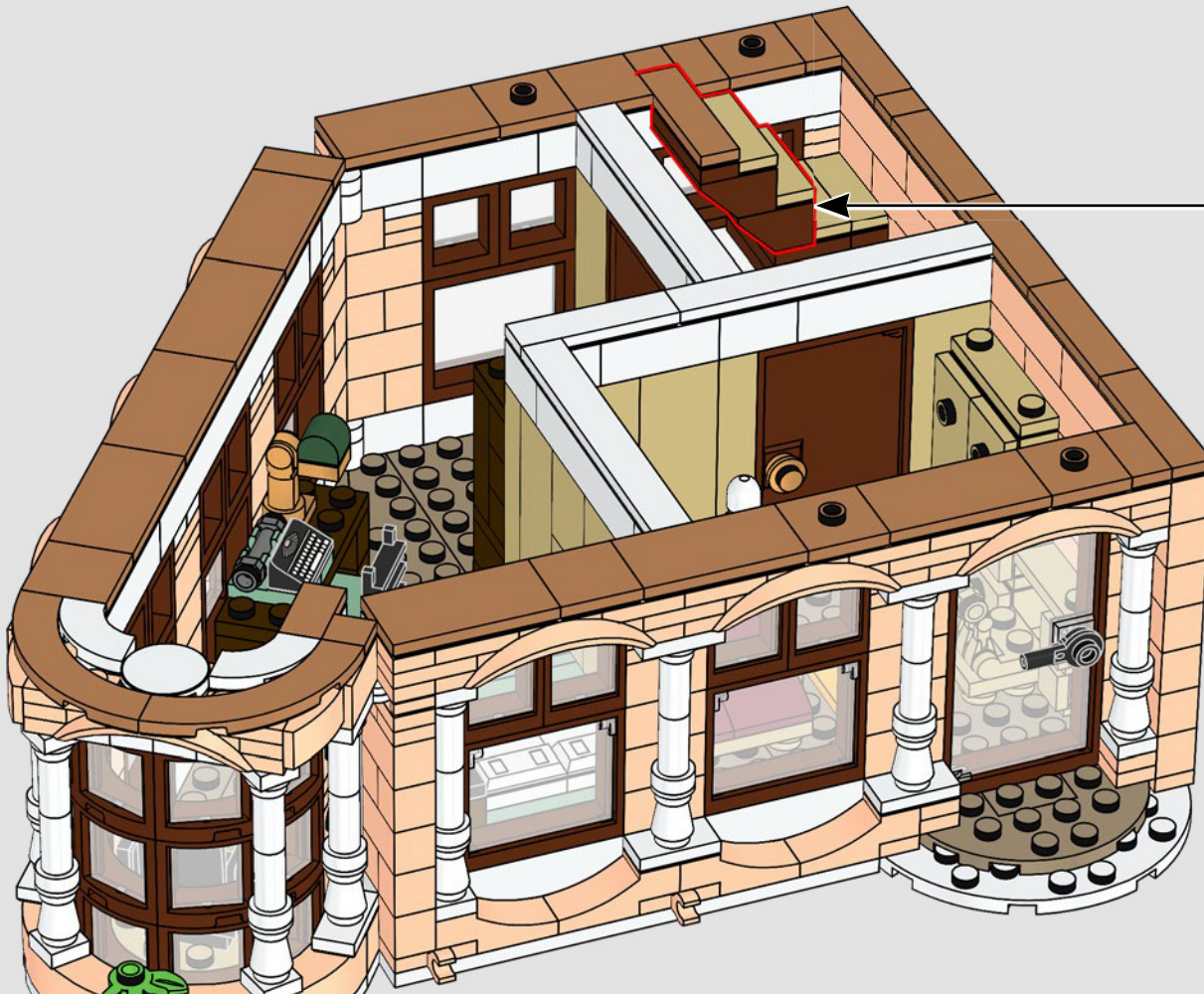
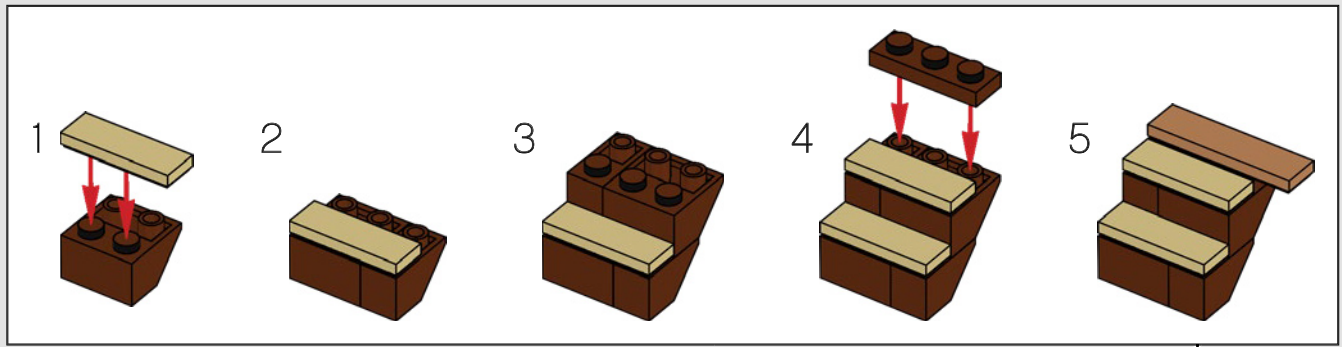

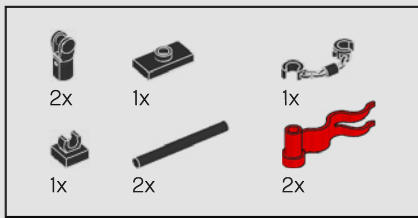

247

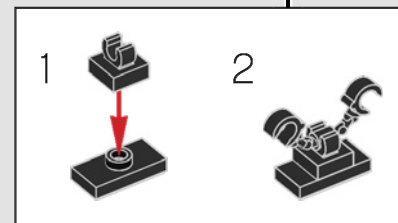
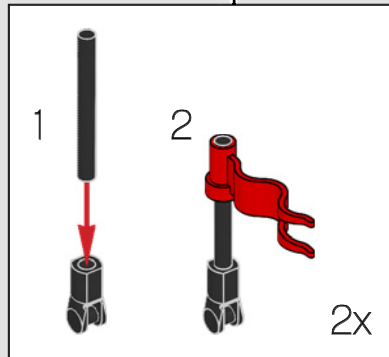



小人仔的骷髅腿部在 10185 蔬菜水果店 (Greengrocer) 套装中首次用于阳台。

248

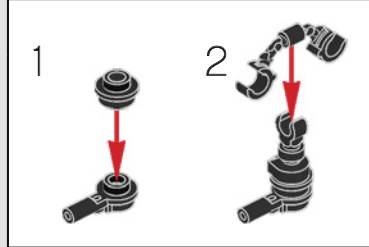
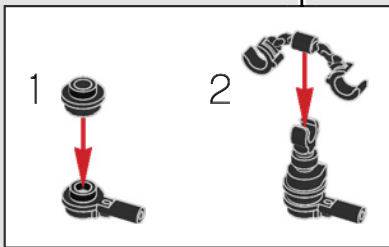
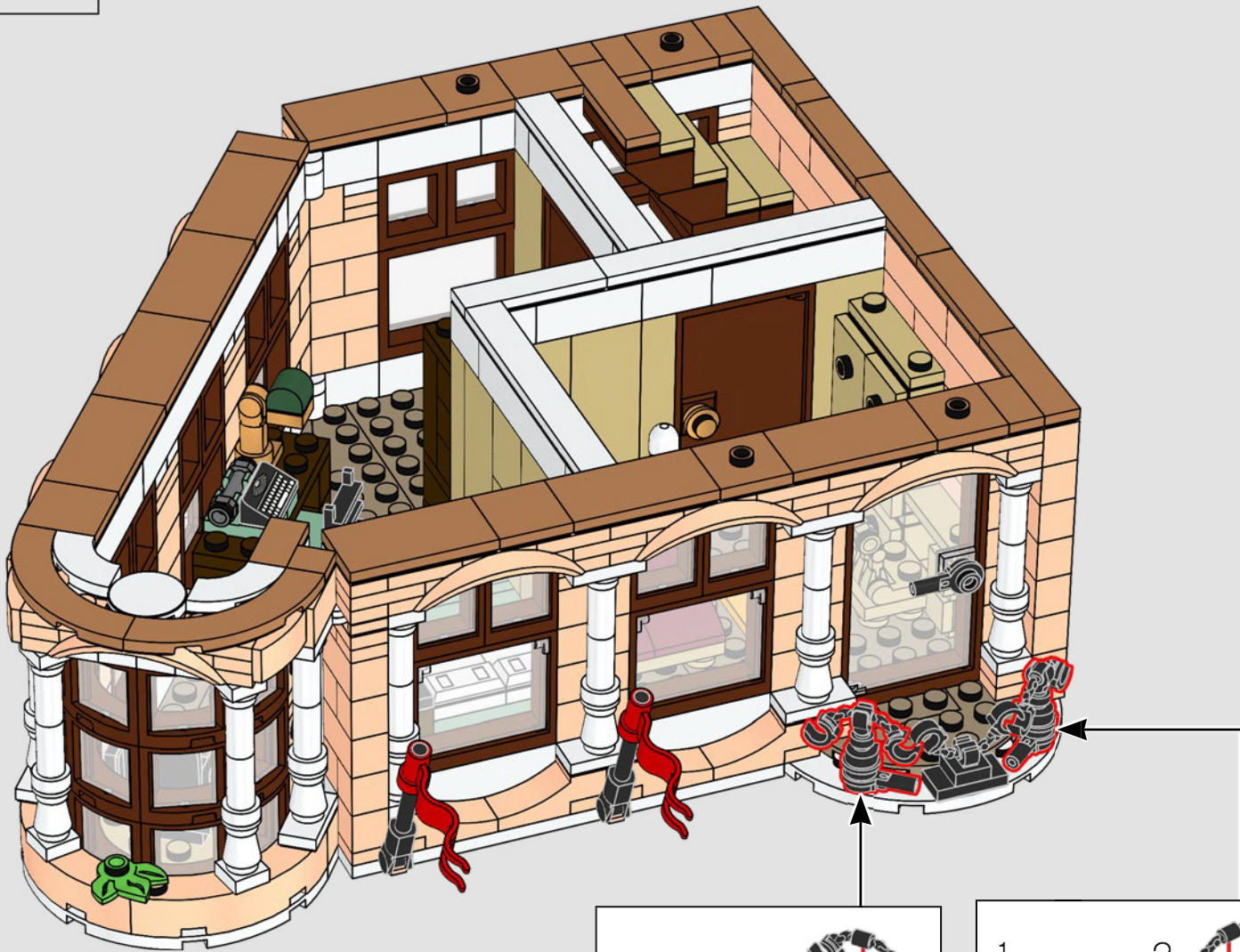



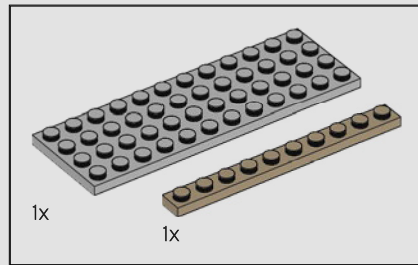
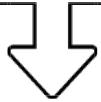

250

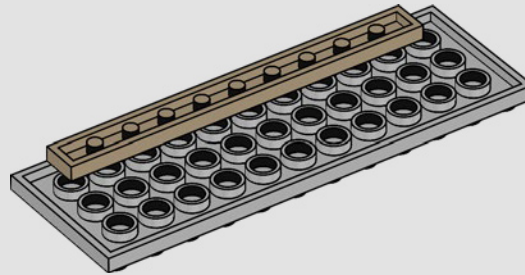



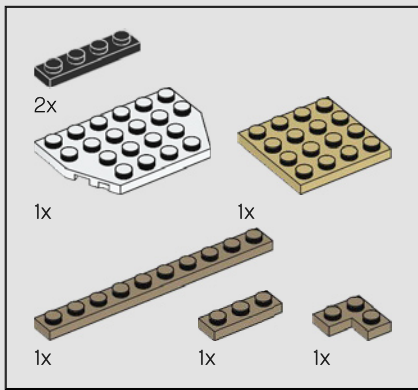

251

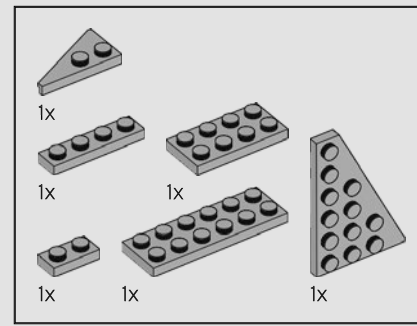
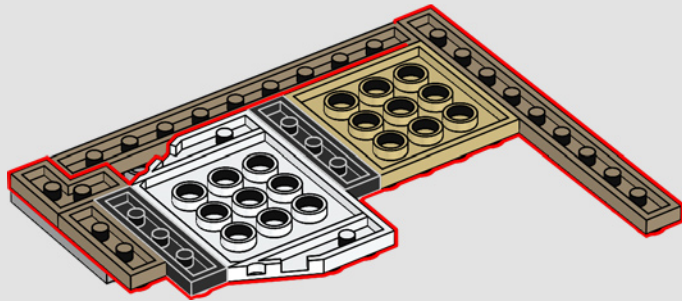

252

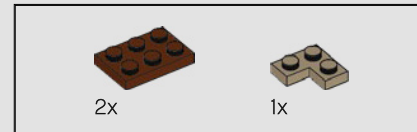
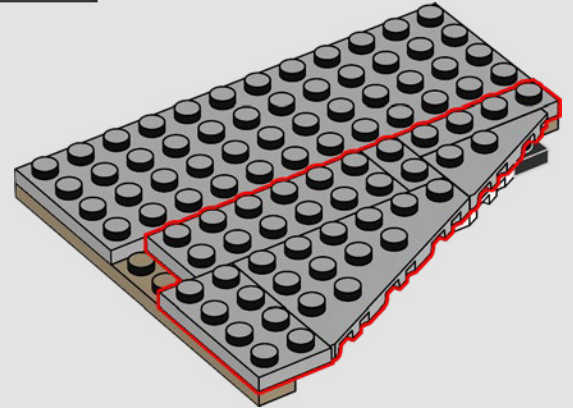
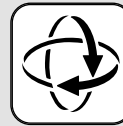

253

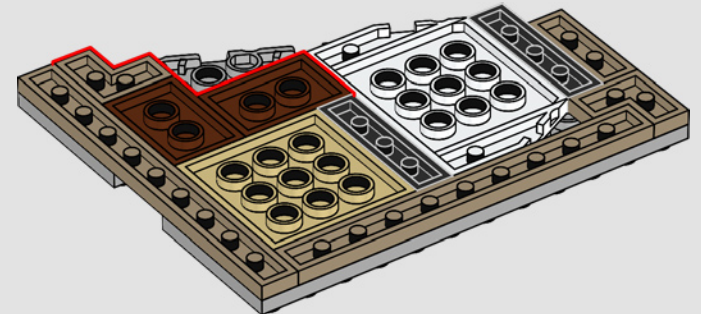
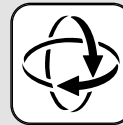

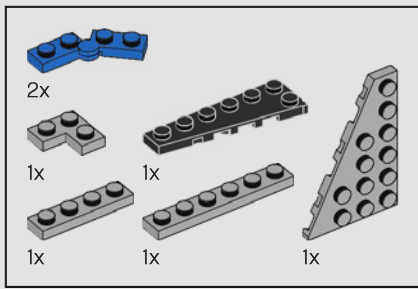

254

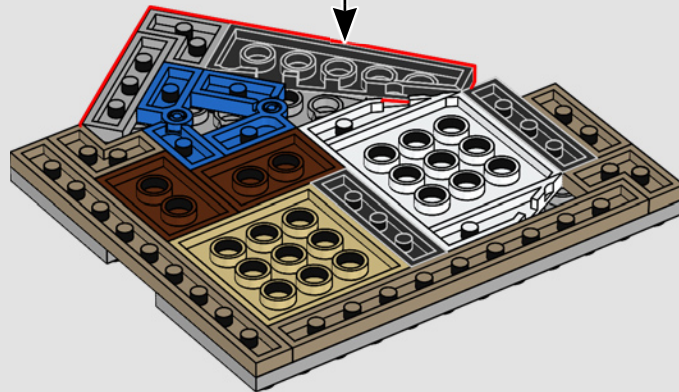
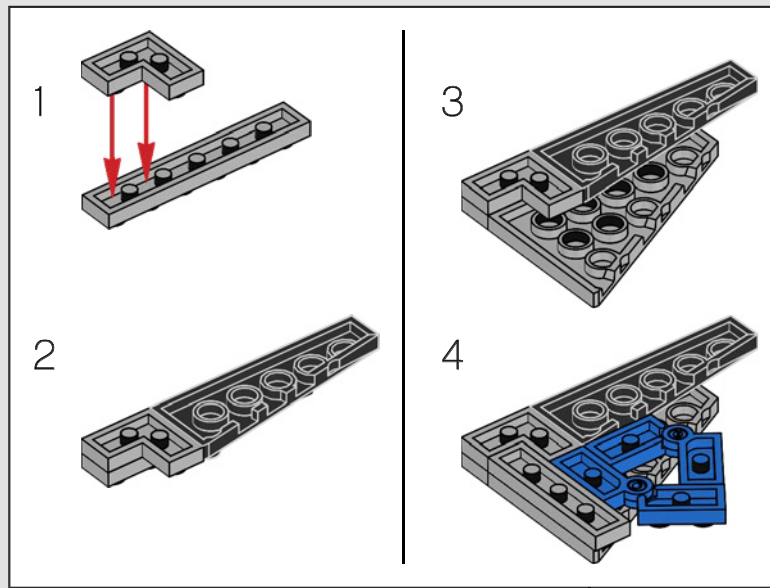

露台采用三角形结构。这种结构与酒店建筑本身结合，就构成了毕达哥拉斯三角形，与乐高®产品系统完美对接。

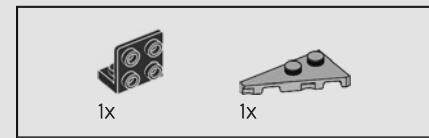

255

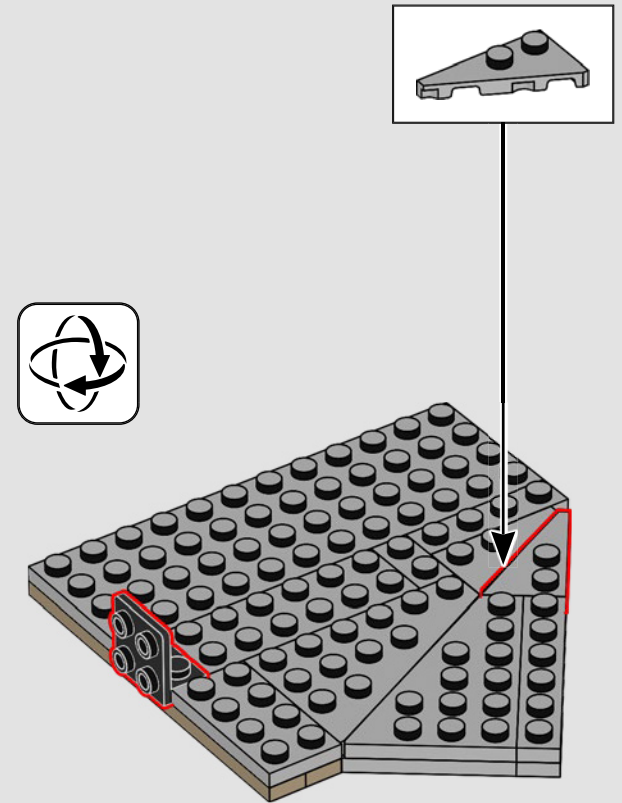

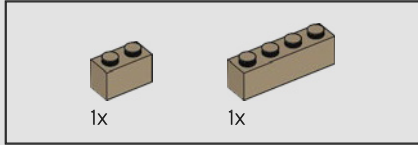
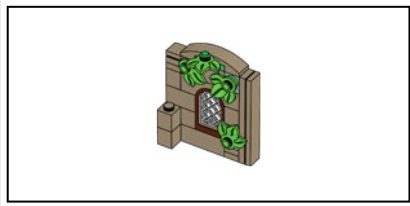

256

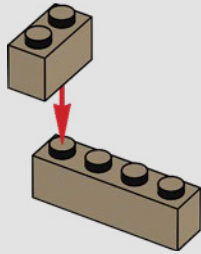

257

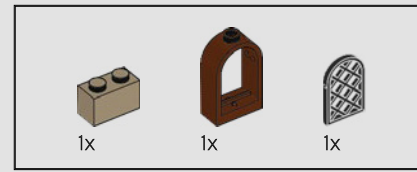
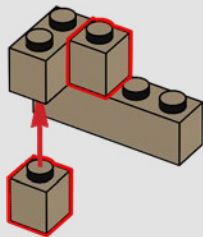

258

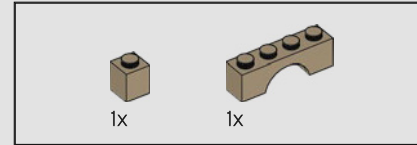
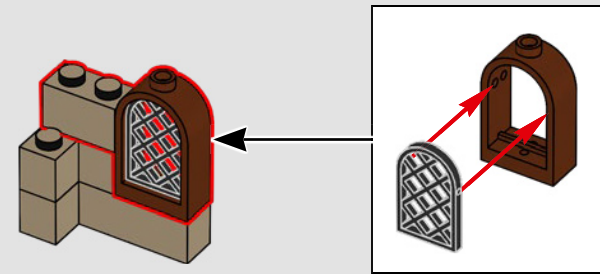

259

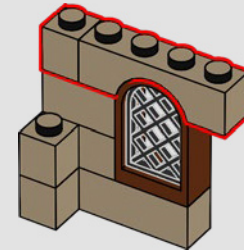

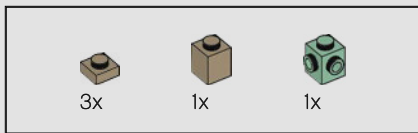

260

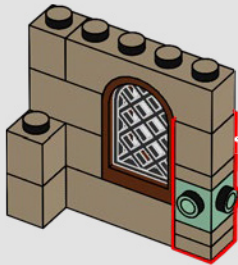
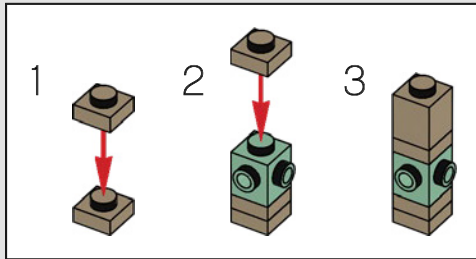

261

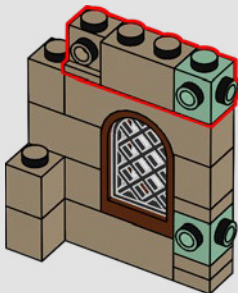

262

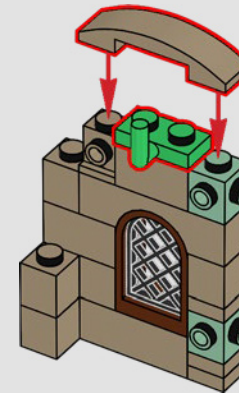

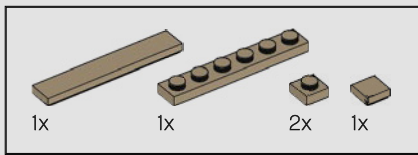

263

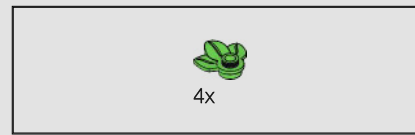
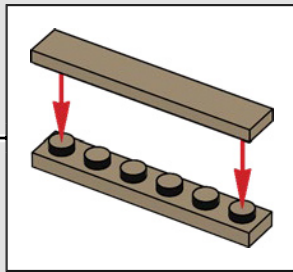
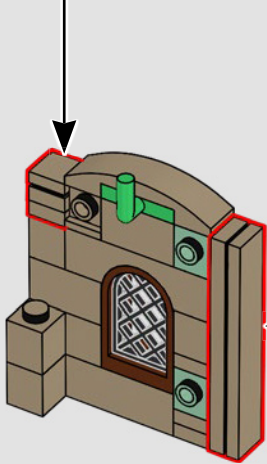
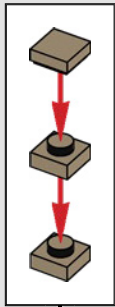

264

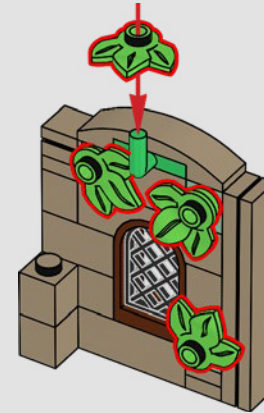

265

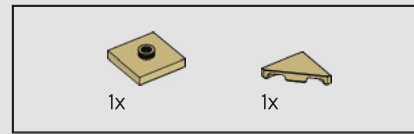
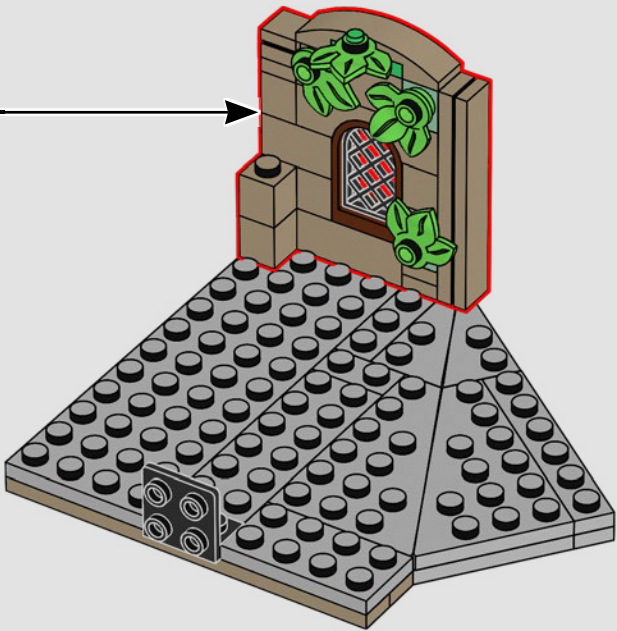

266

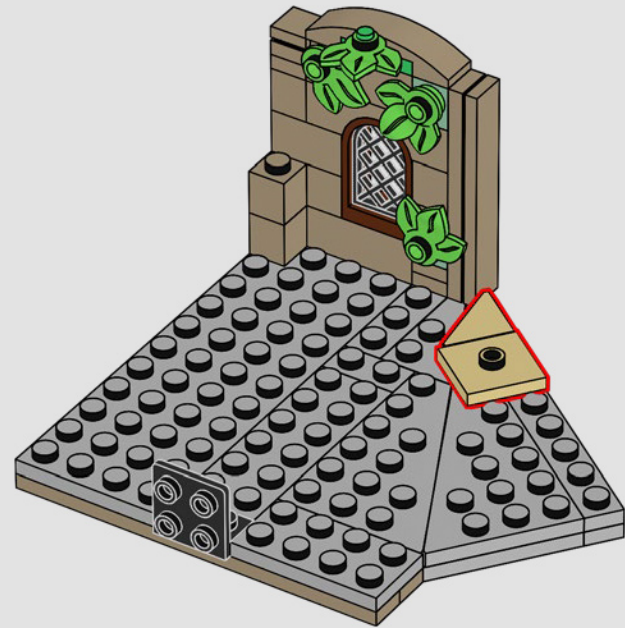

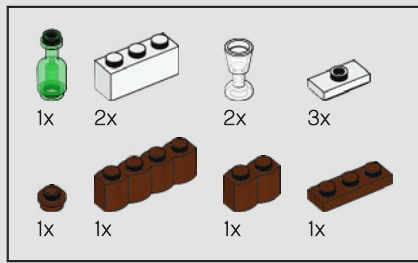

267

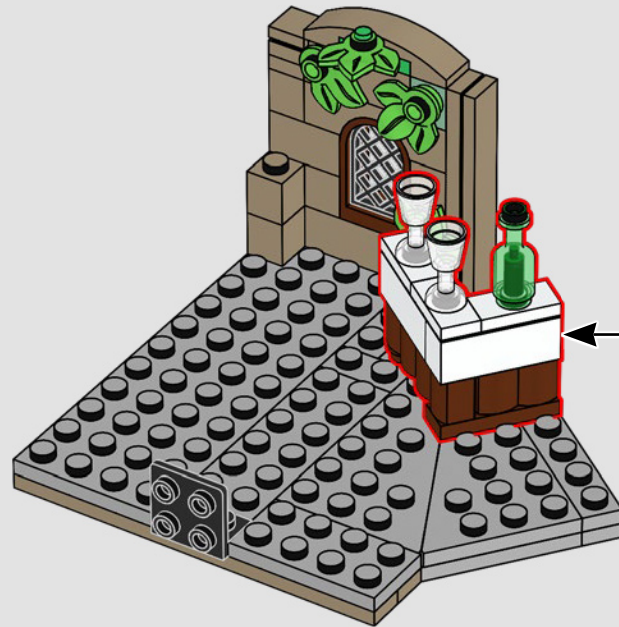
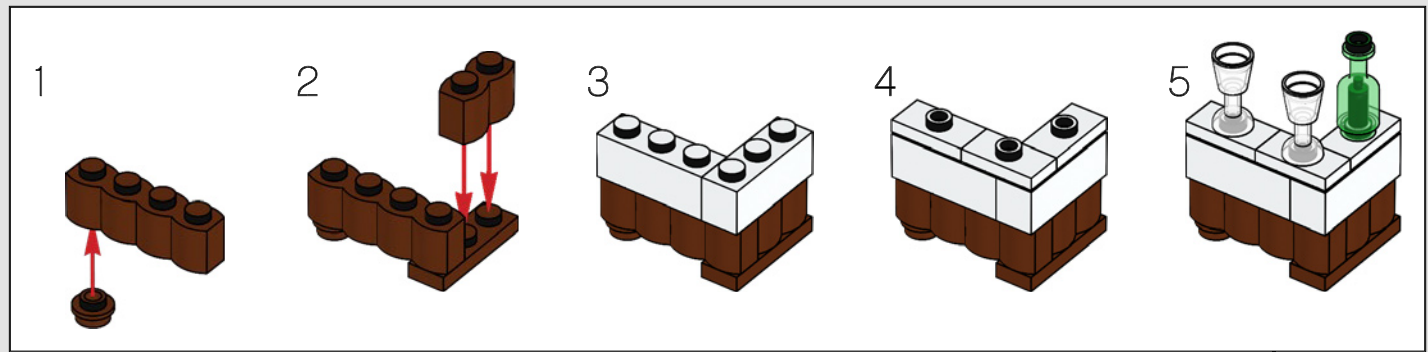

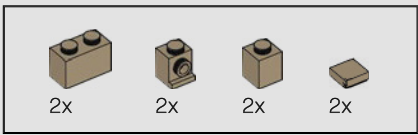

268

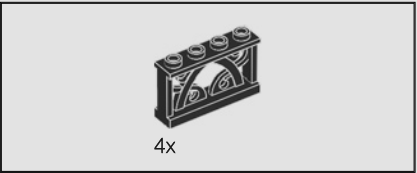
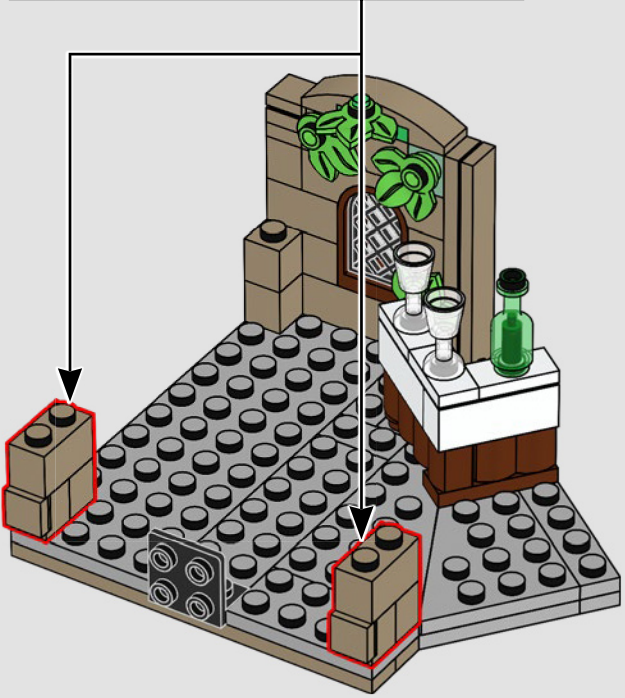
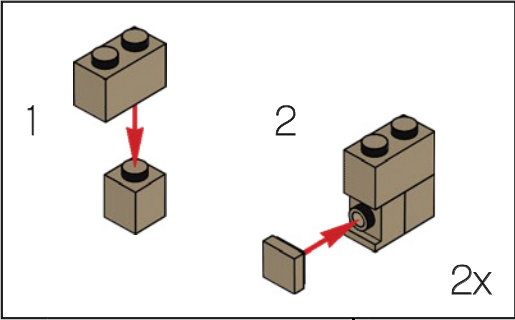

269





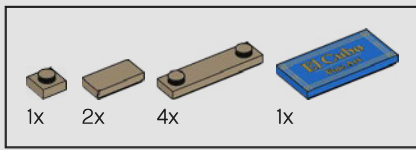

270

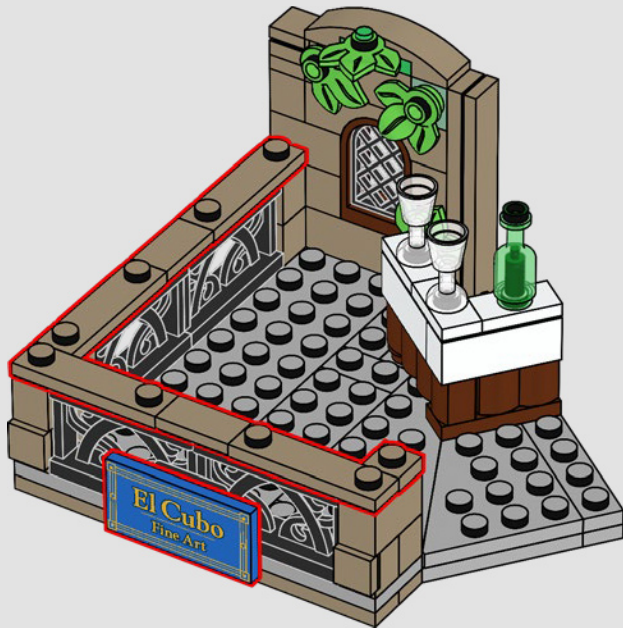

271

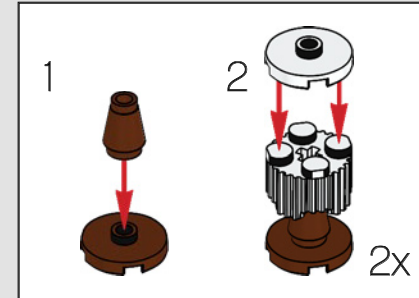

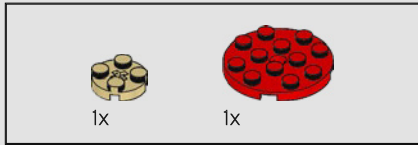

272

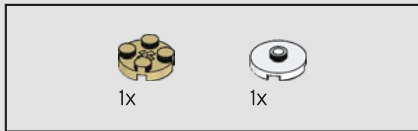

273

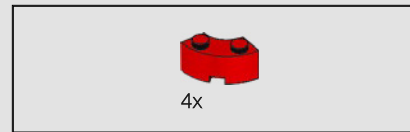
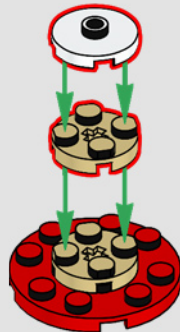

274

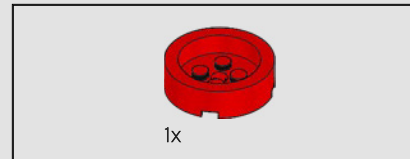
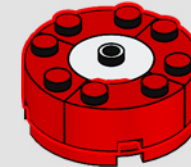

275

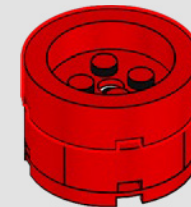

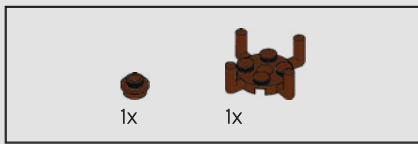

276

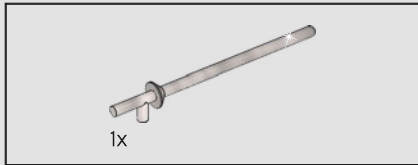
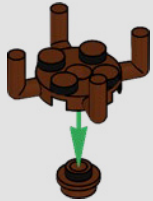

277

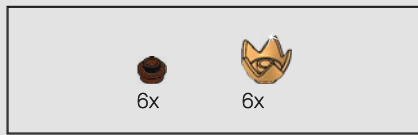

278

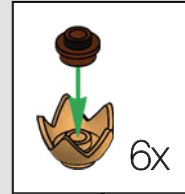

279

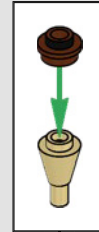

280



5x

281

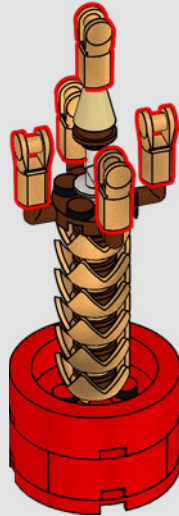

5x

282

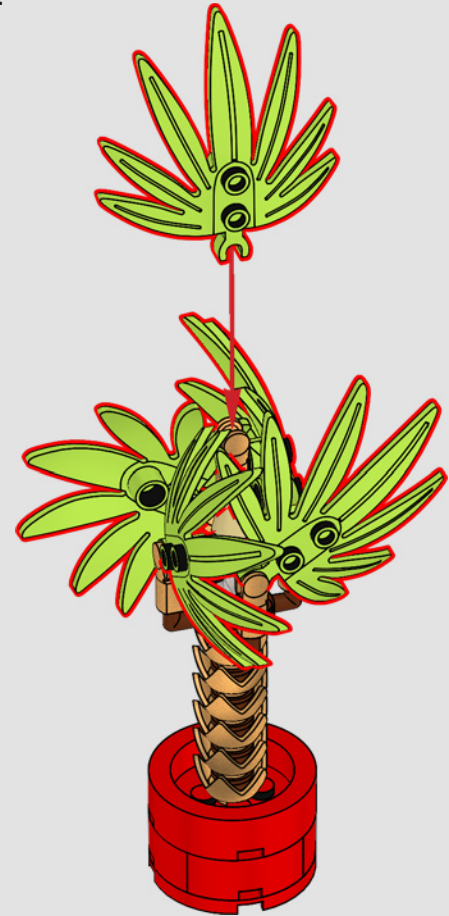

用来拼搭棕榈树树干的元件首次出现在  
《乐高®大电影 2》瓦特弗拉·瓦纳比女  
王的王冠上。

283

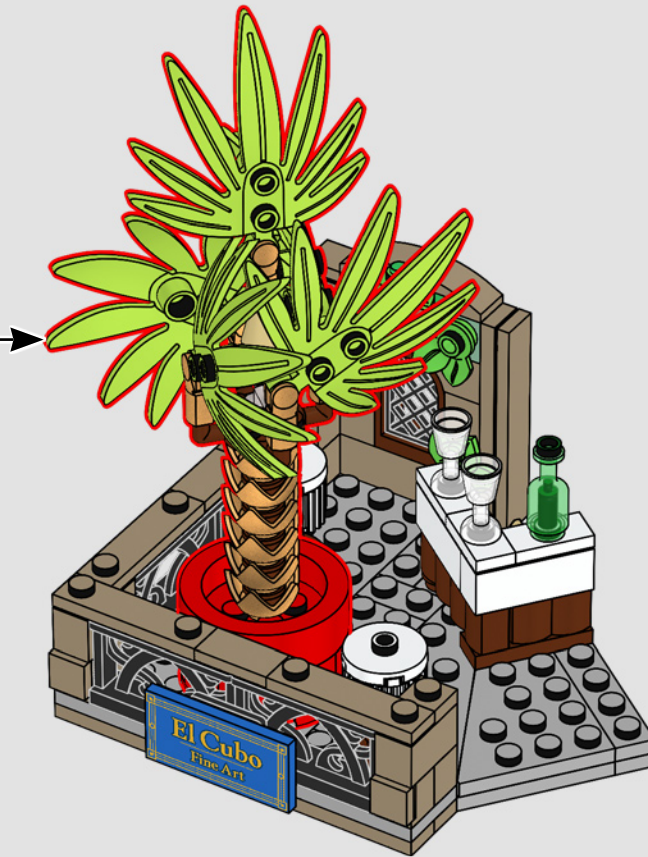

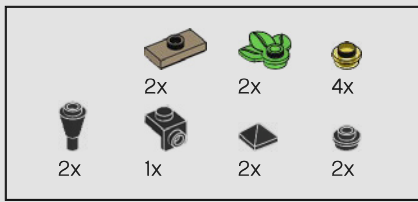

284

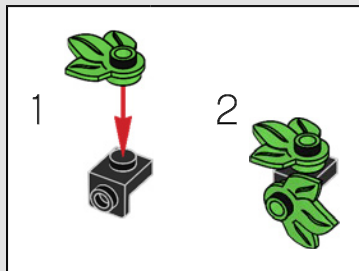
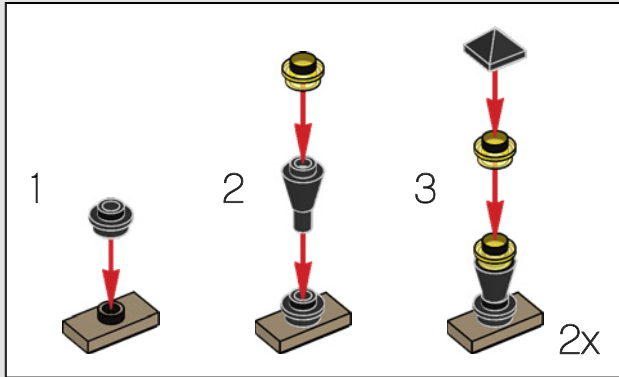

285



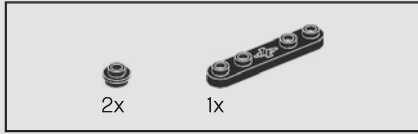
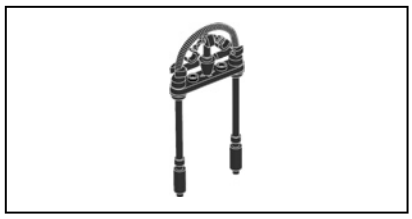

286

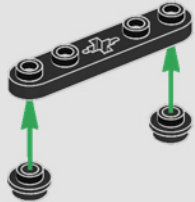

287

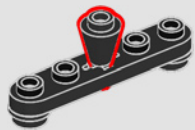

288

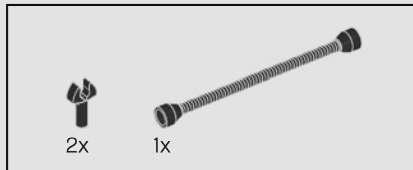
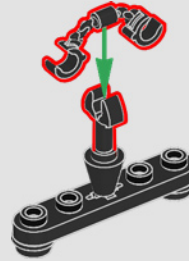

289

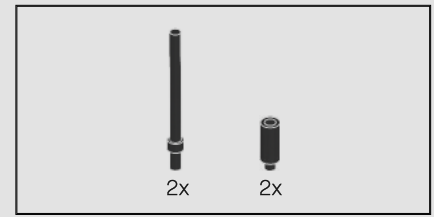
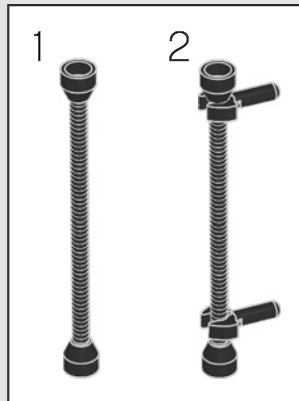

290

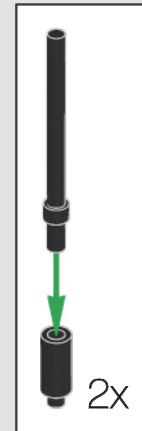
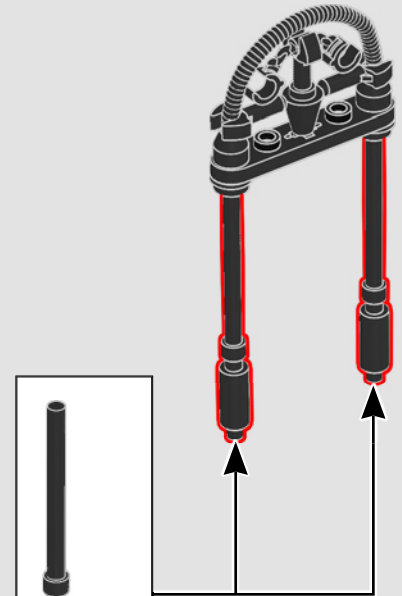





熟铁门首次出现在 10190 商业街套装中。  
小人仔的鞭子因被用于展现有机体的曲线细节而闻名。

291



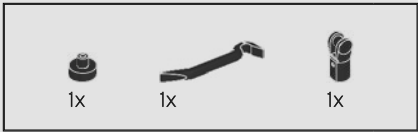

292

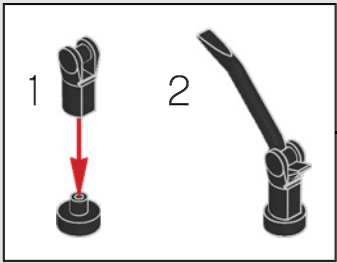

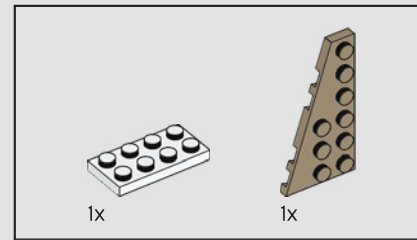
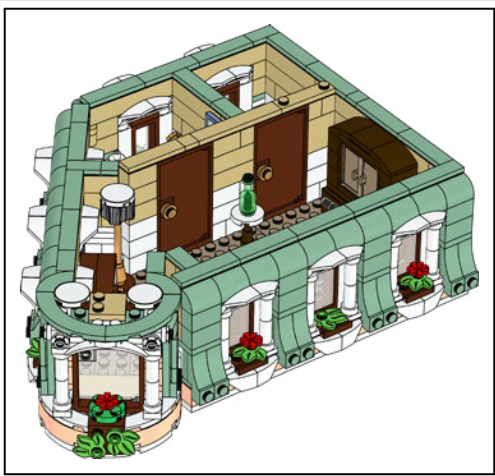
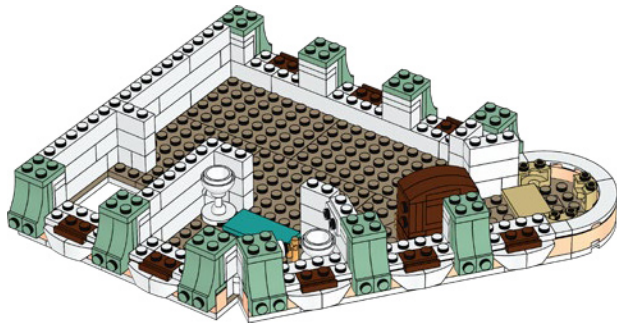
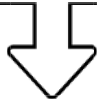

293

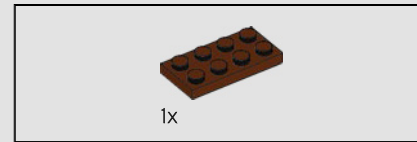
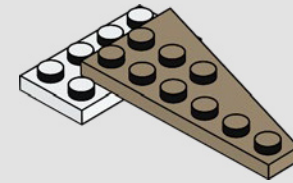

294

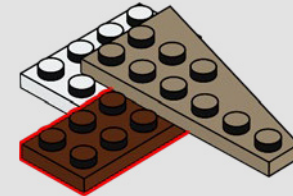

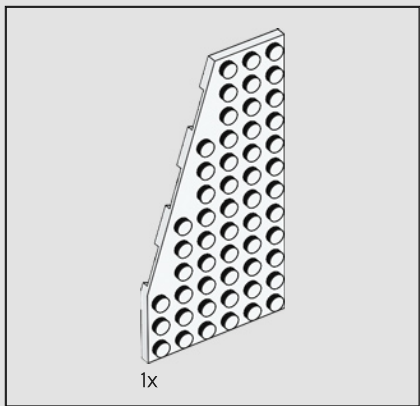

295

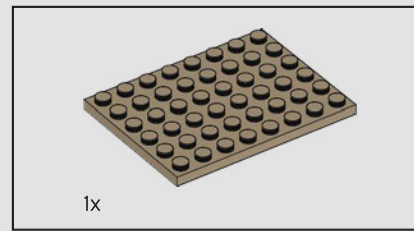
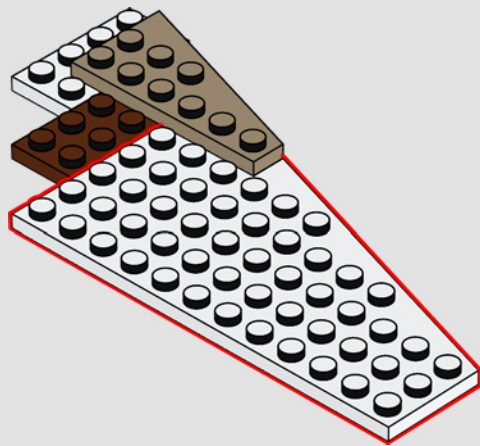

296

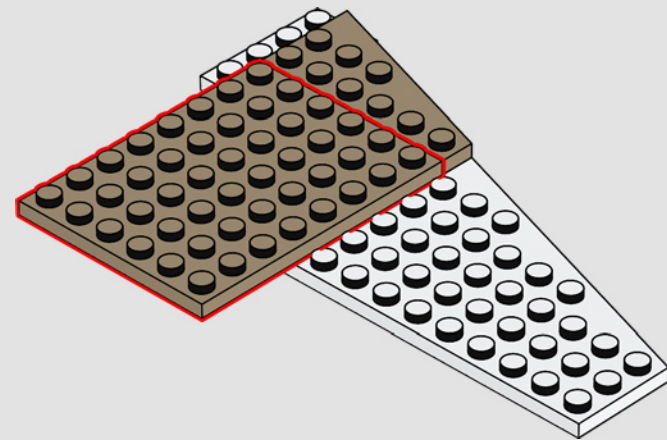

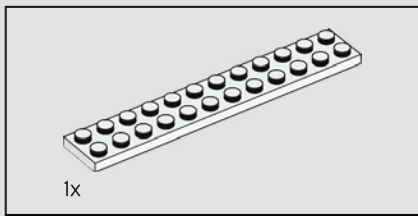

297

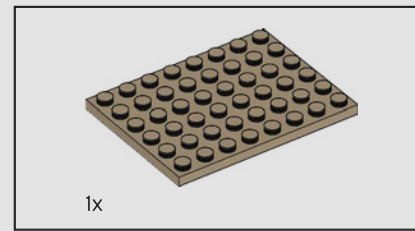
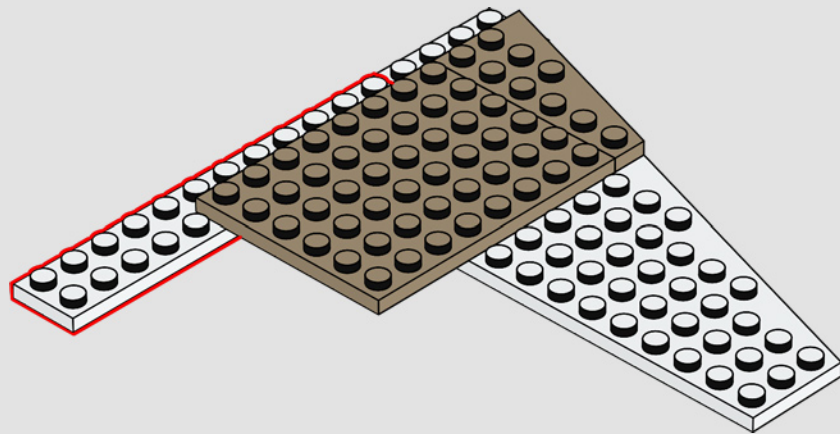

298

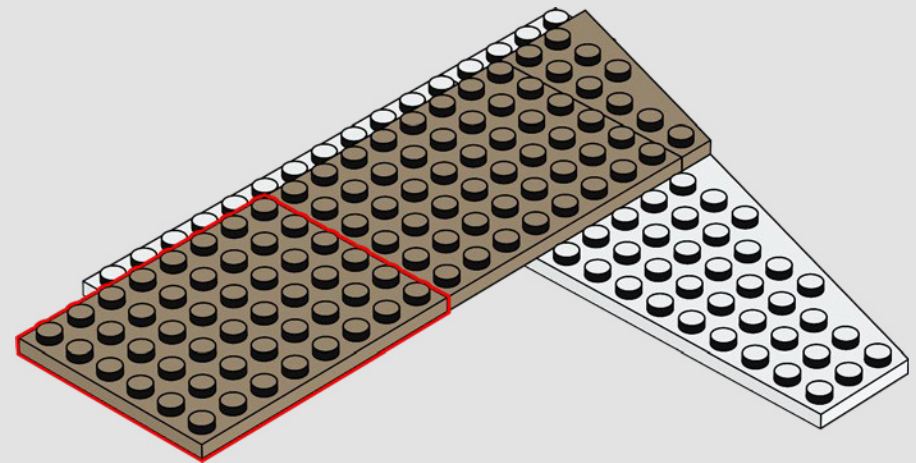

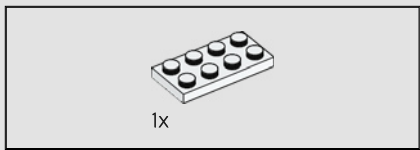

299

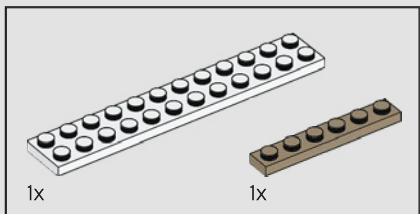
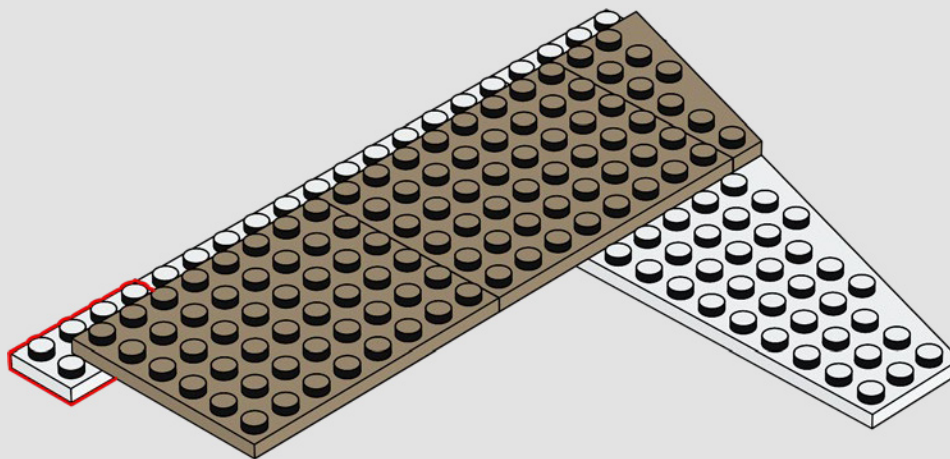

300

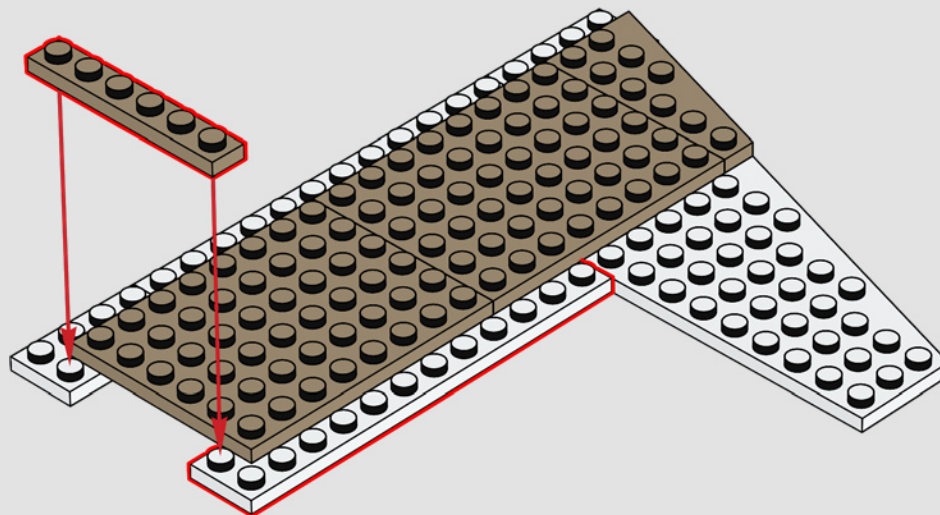



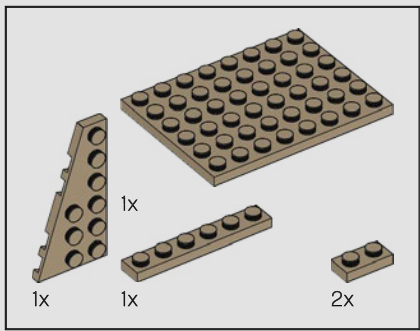

303

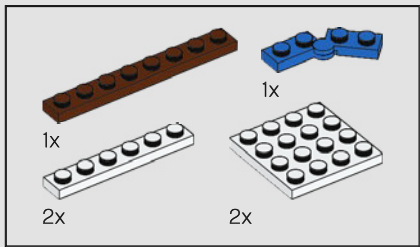
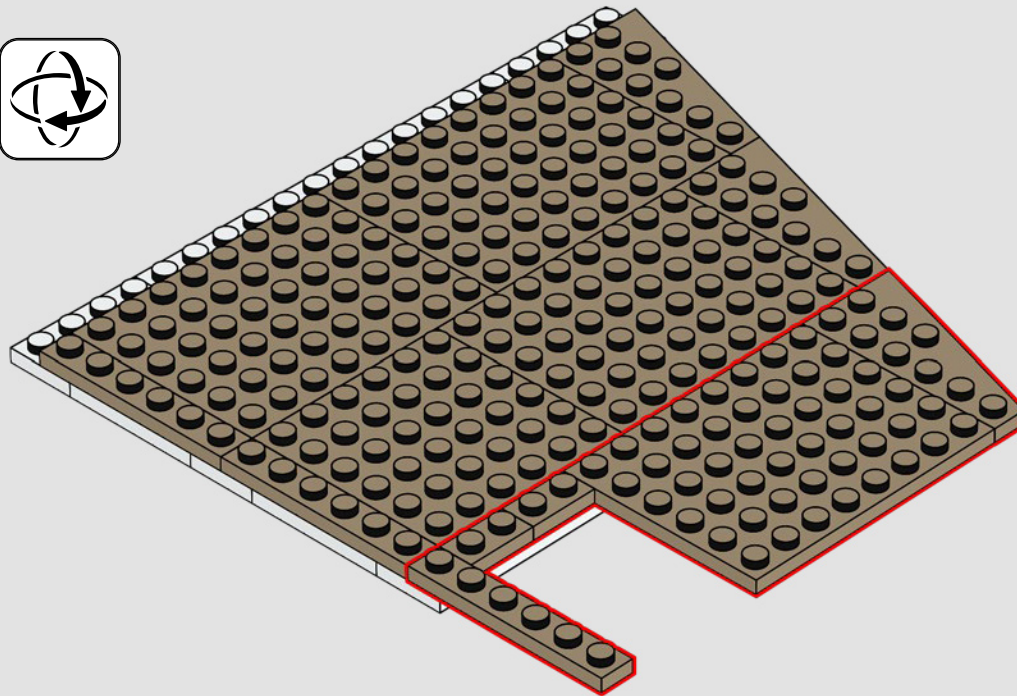

304

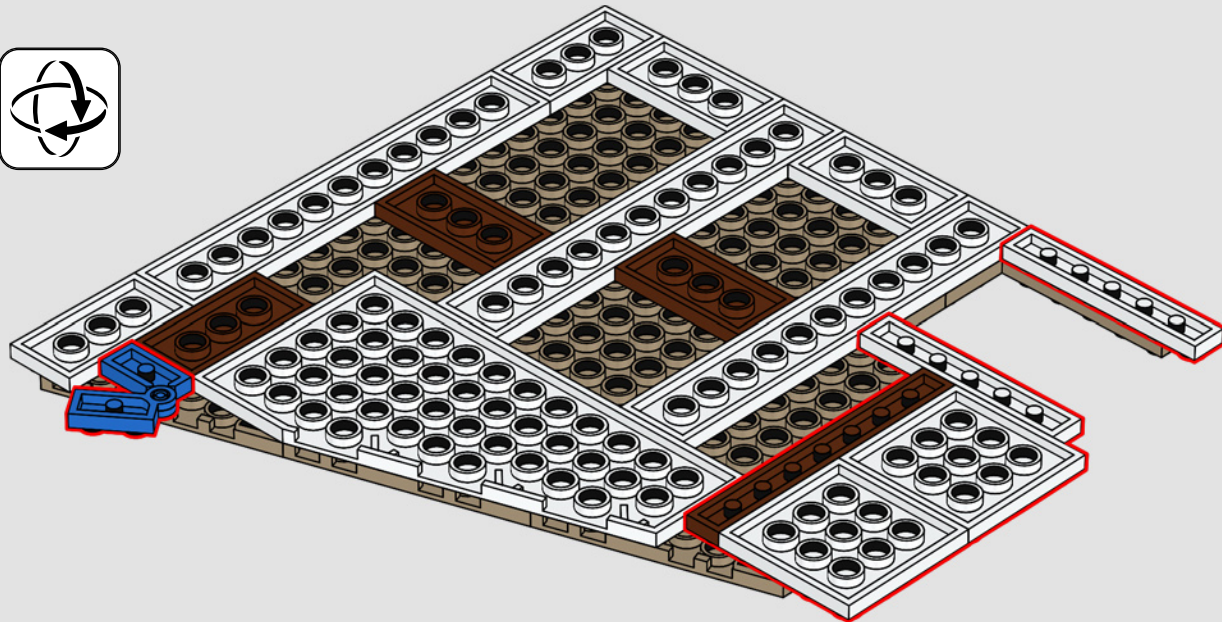
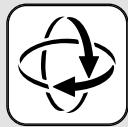



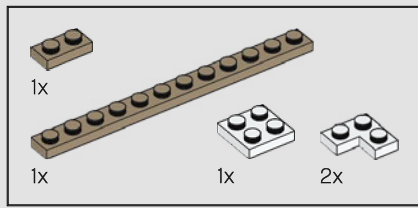

305

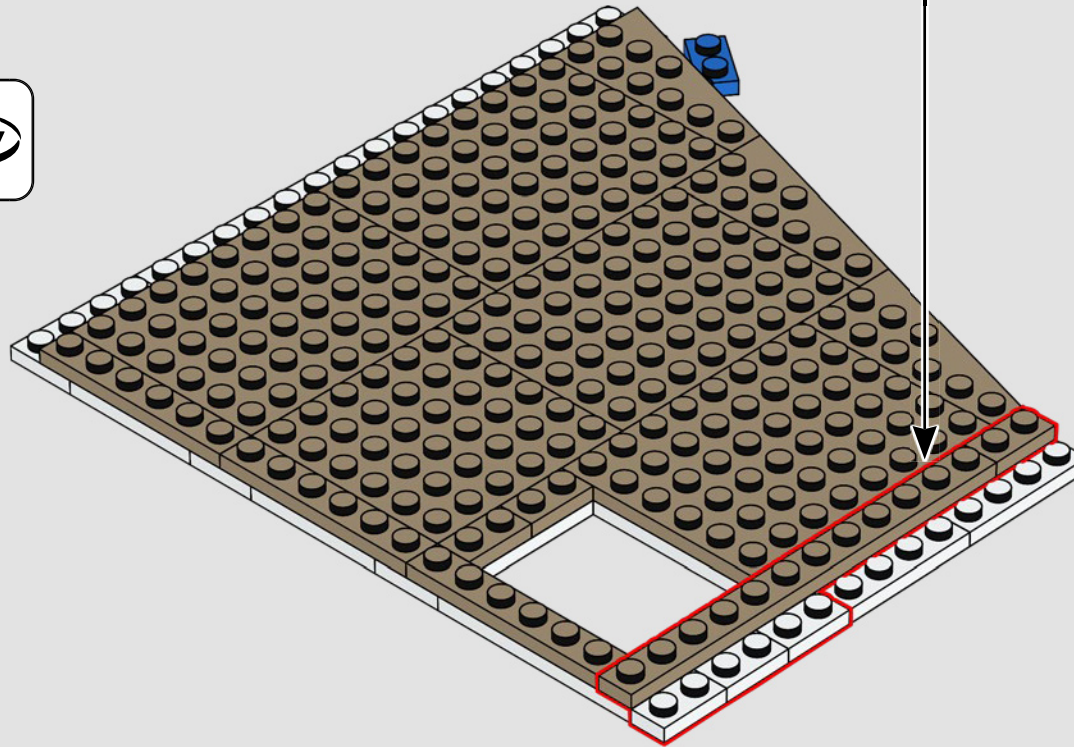
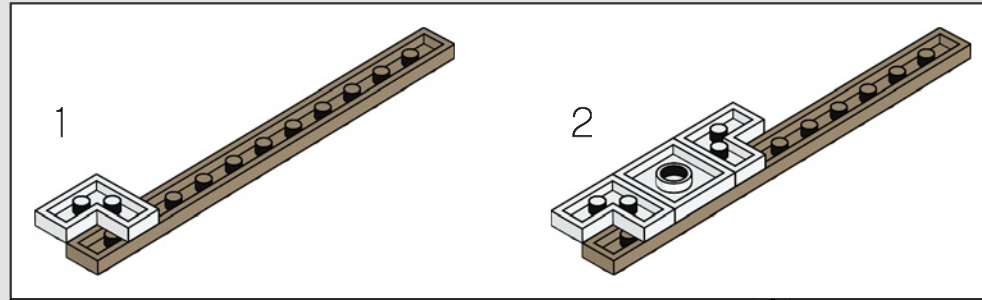

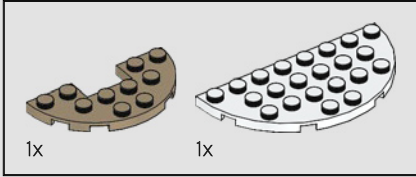
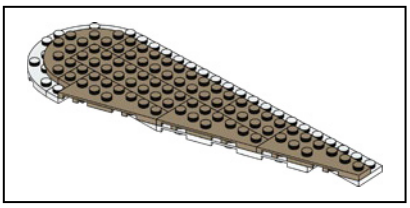

306

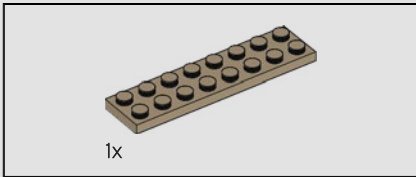
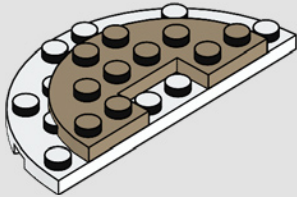

307

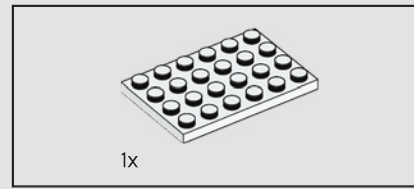
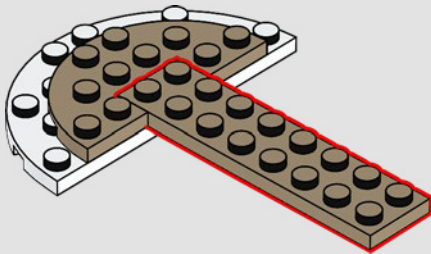

308

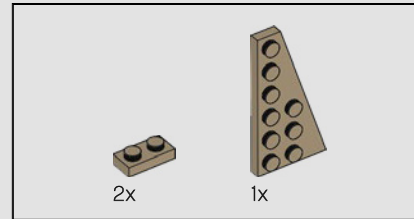
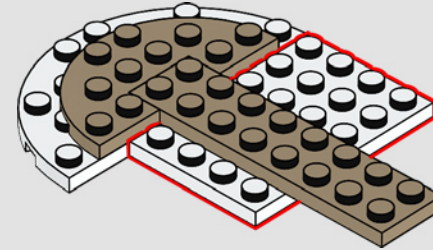

309

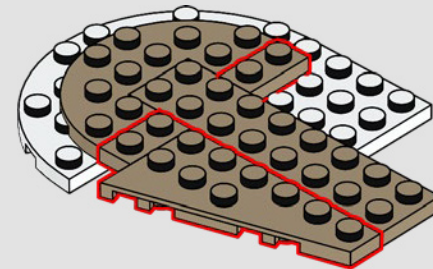

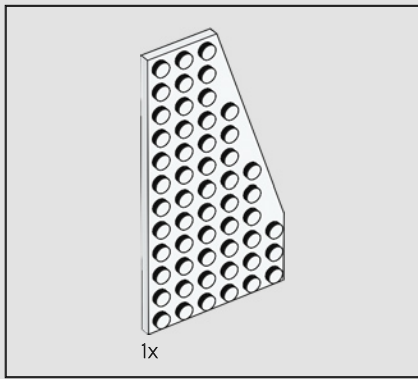

310

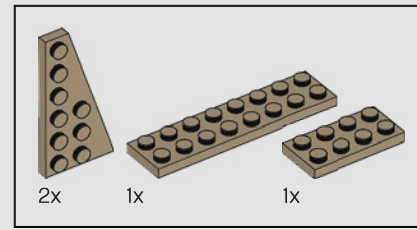
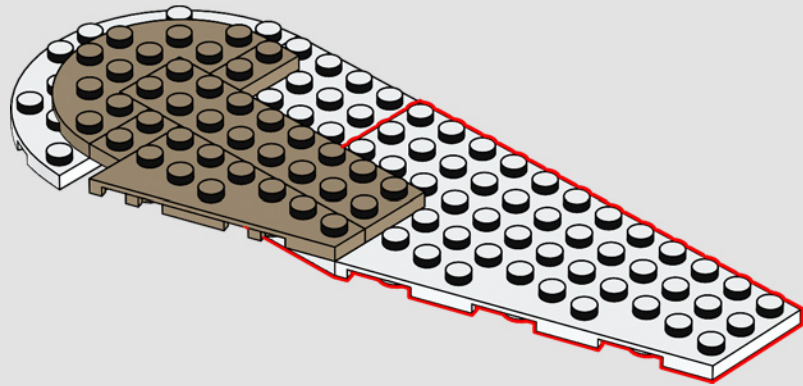

311

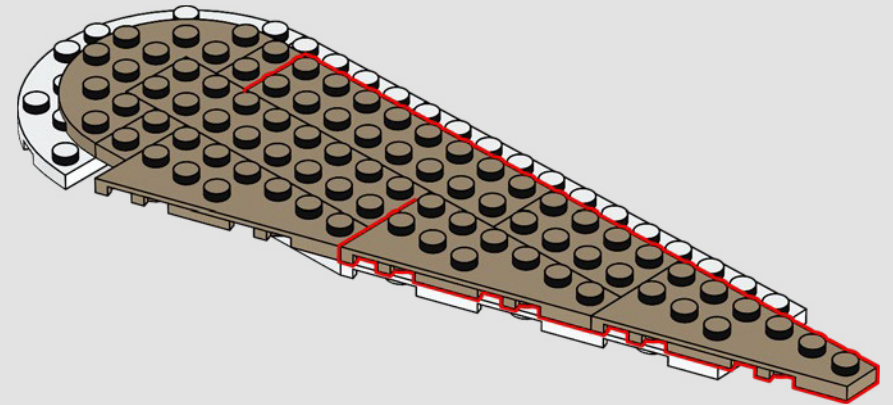

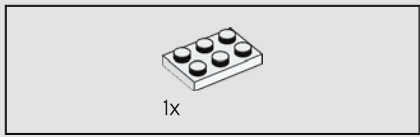

312

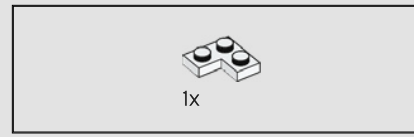
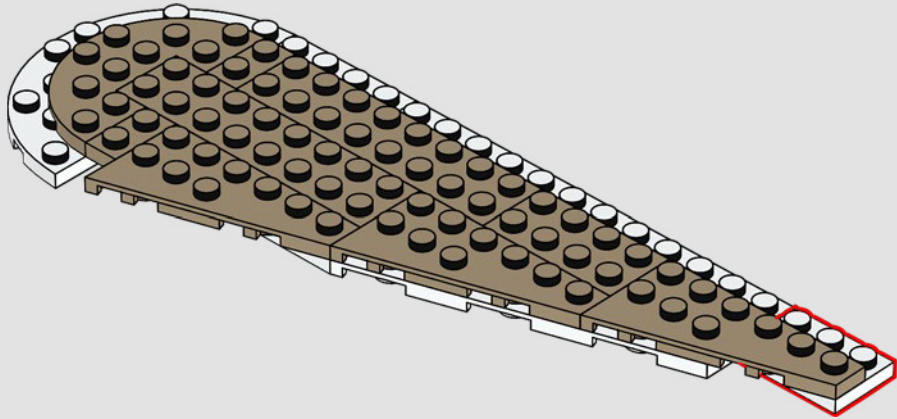

313

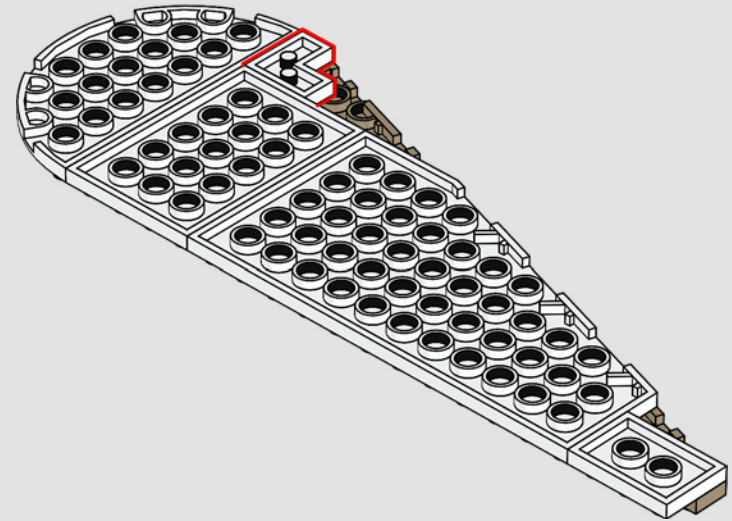
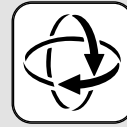

314

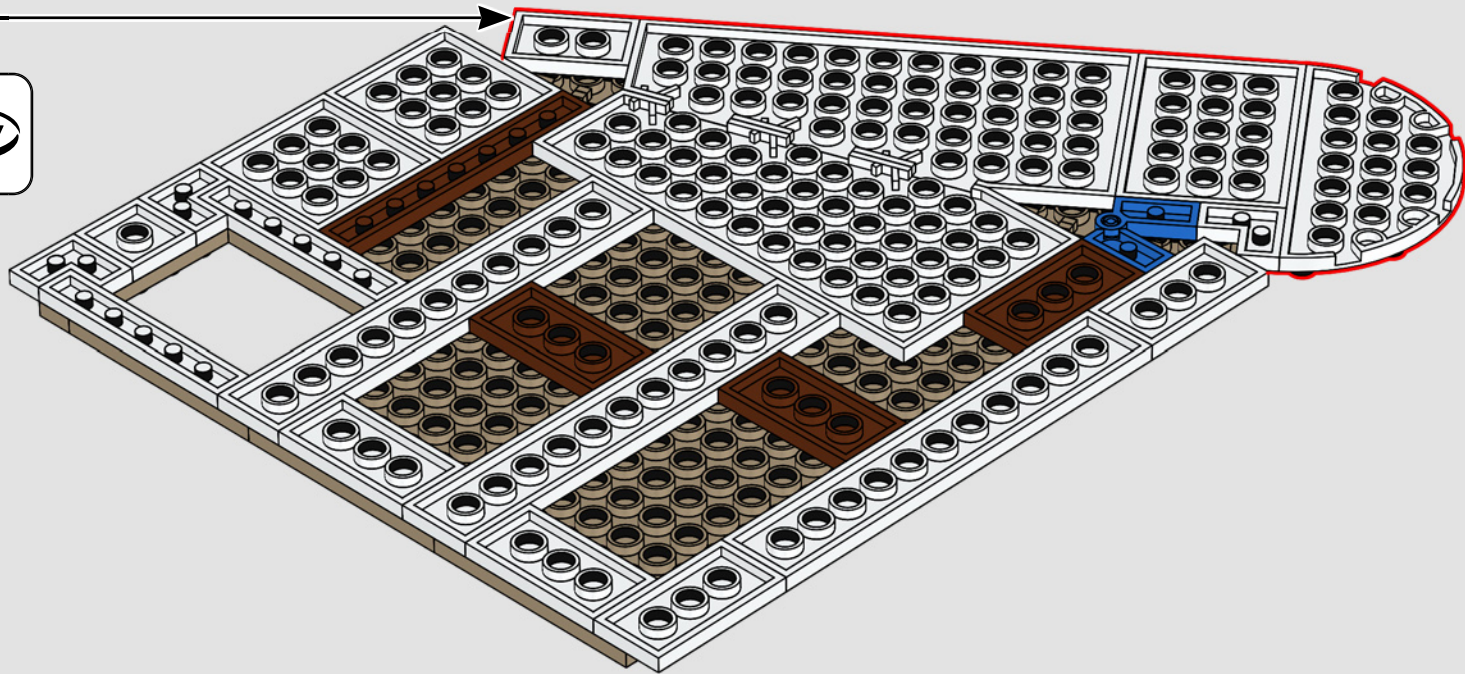

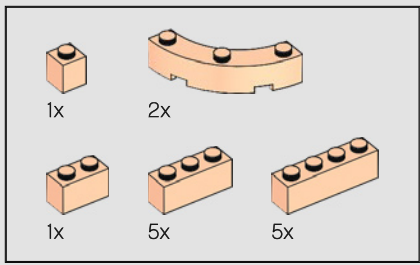

315

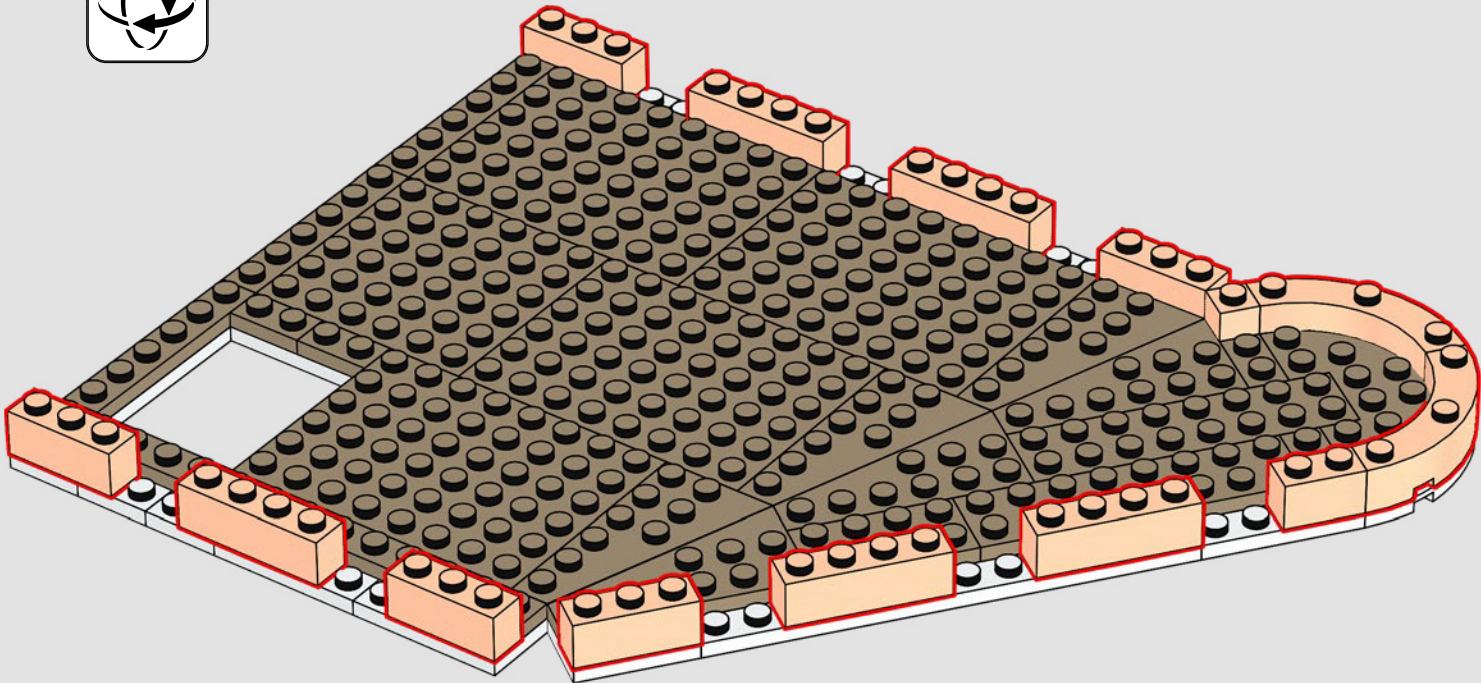

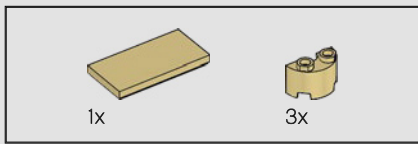

316

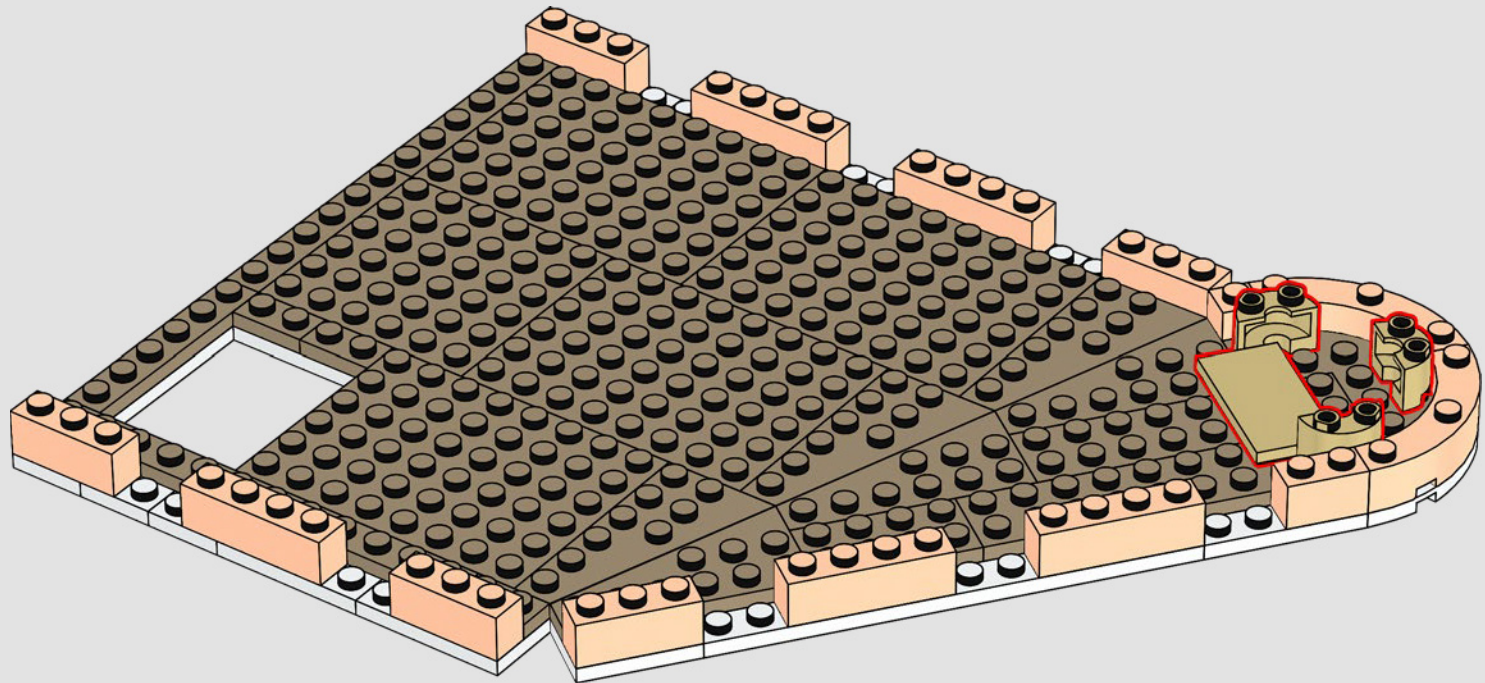

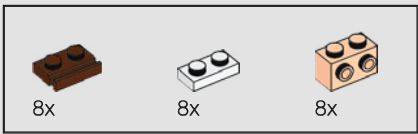

317

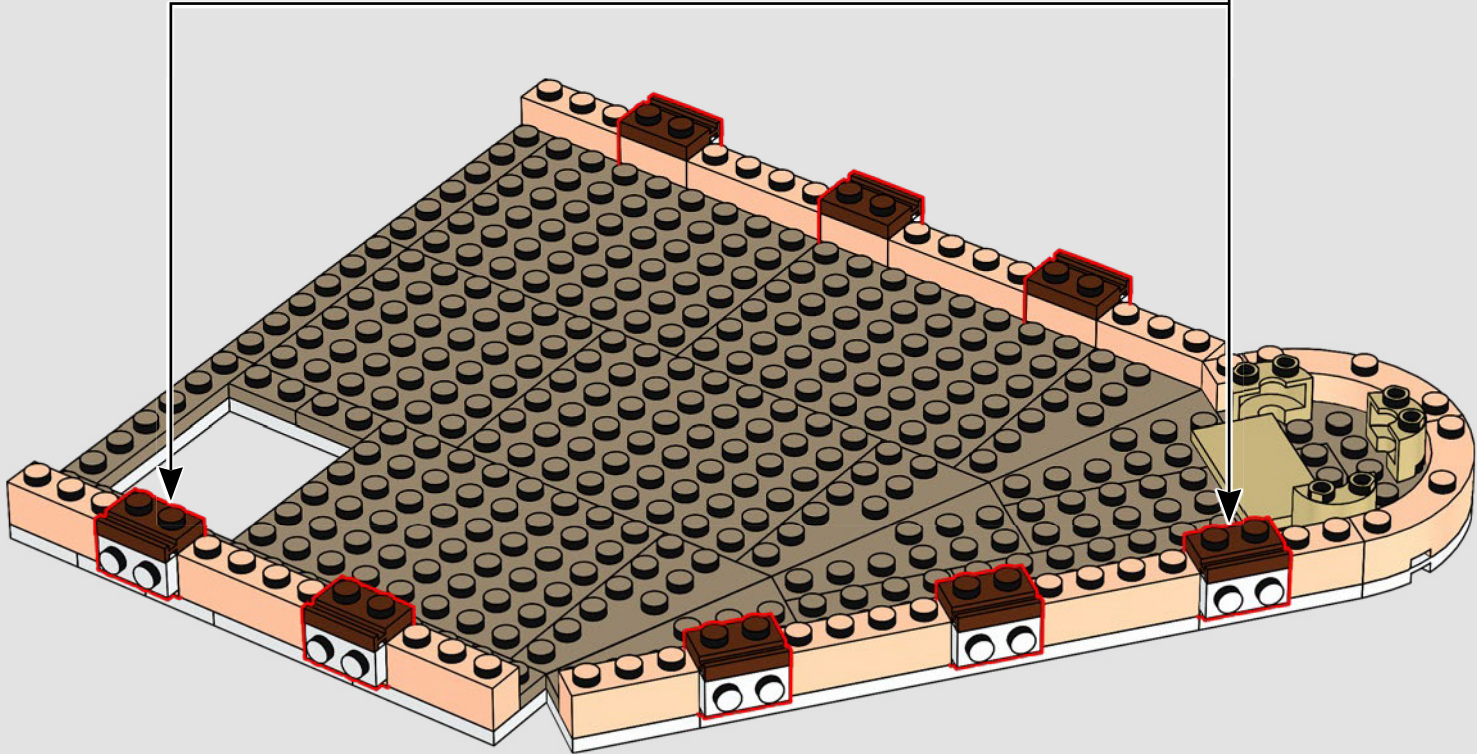
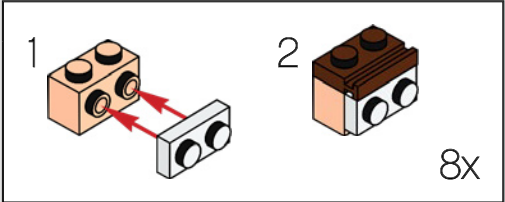



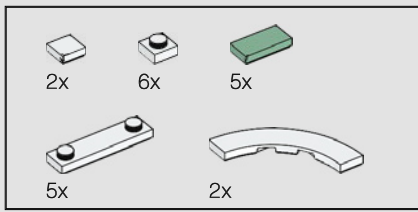

318

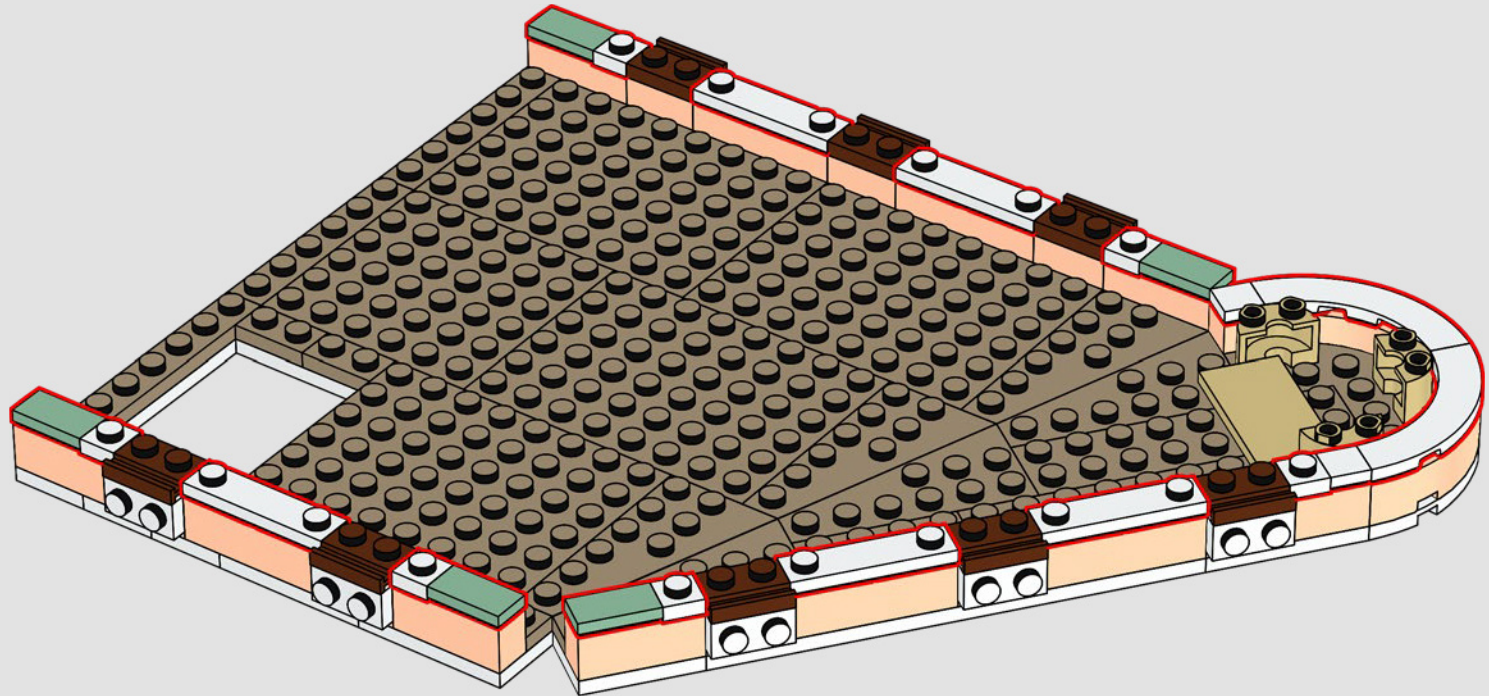

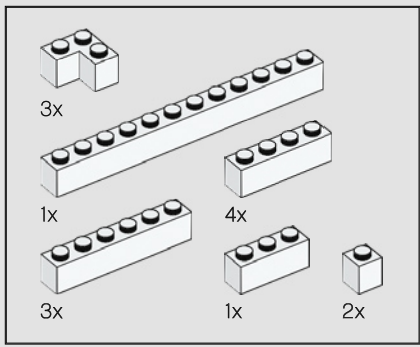

319

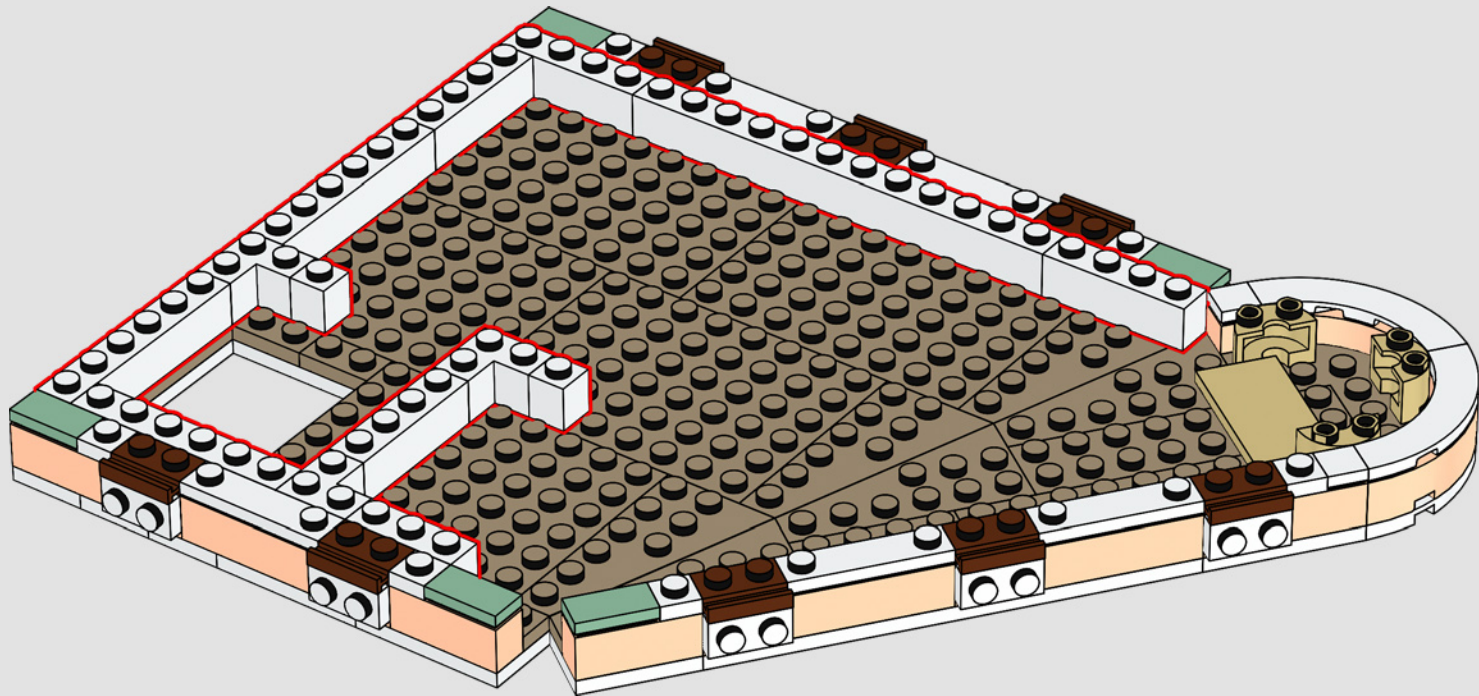

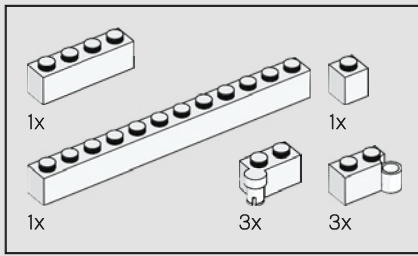

320

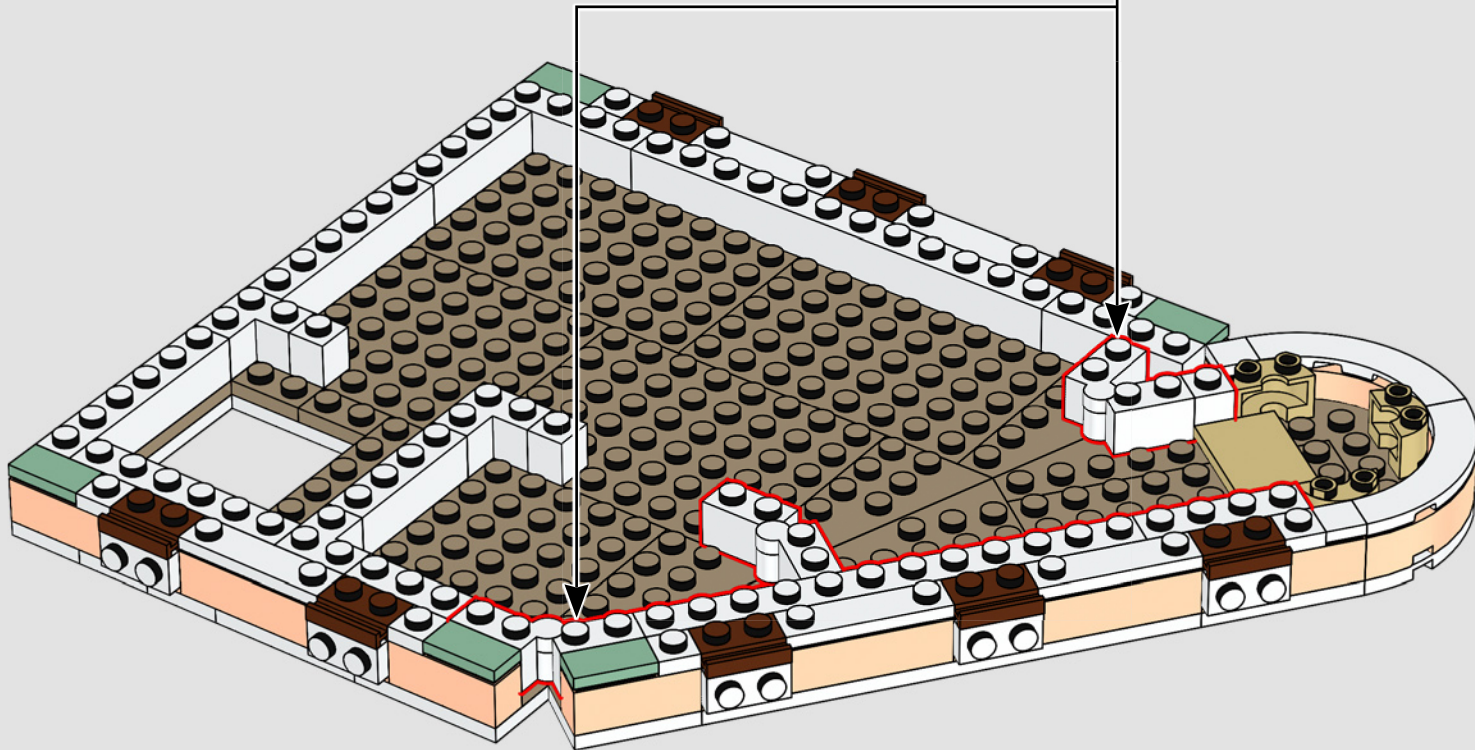
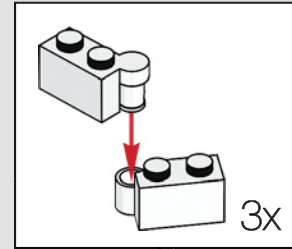

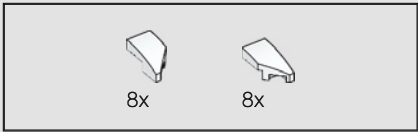

321

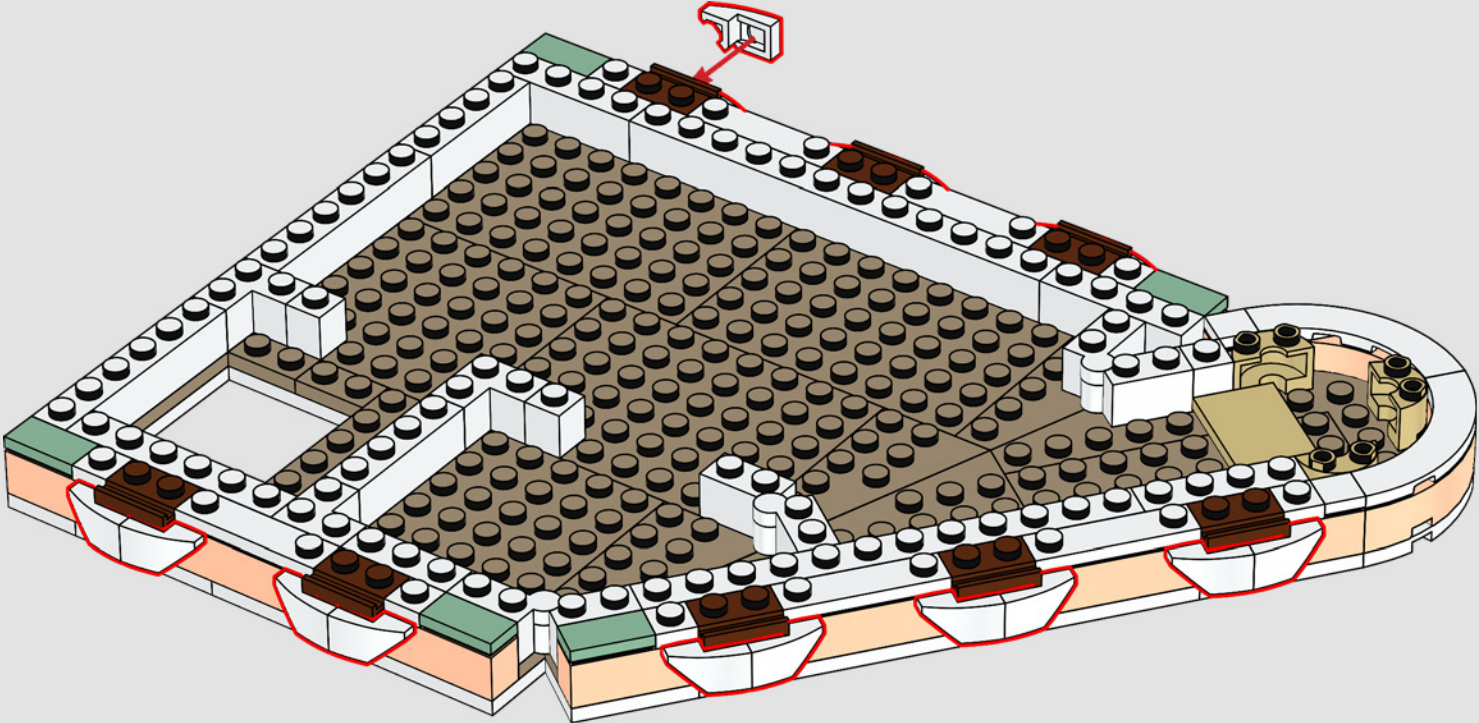

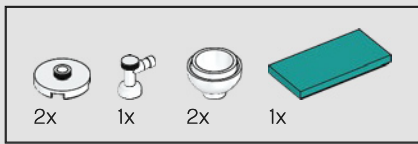

322

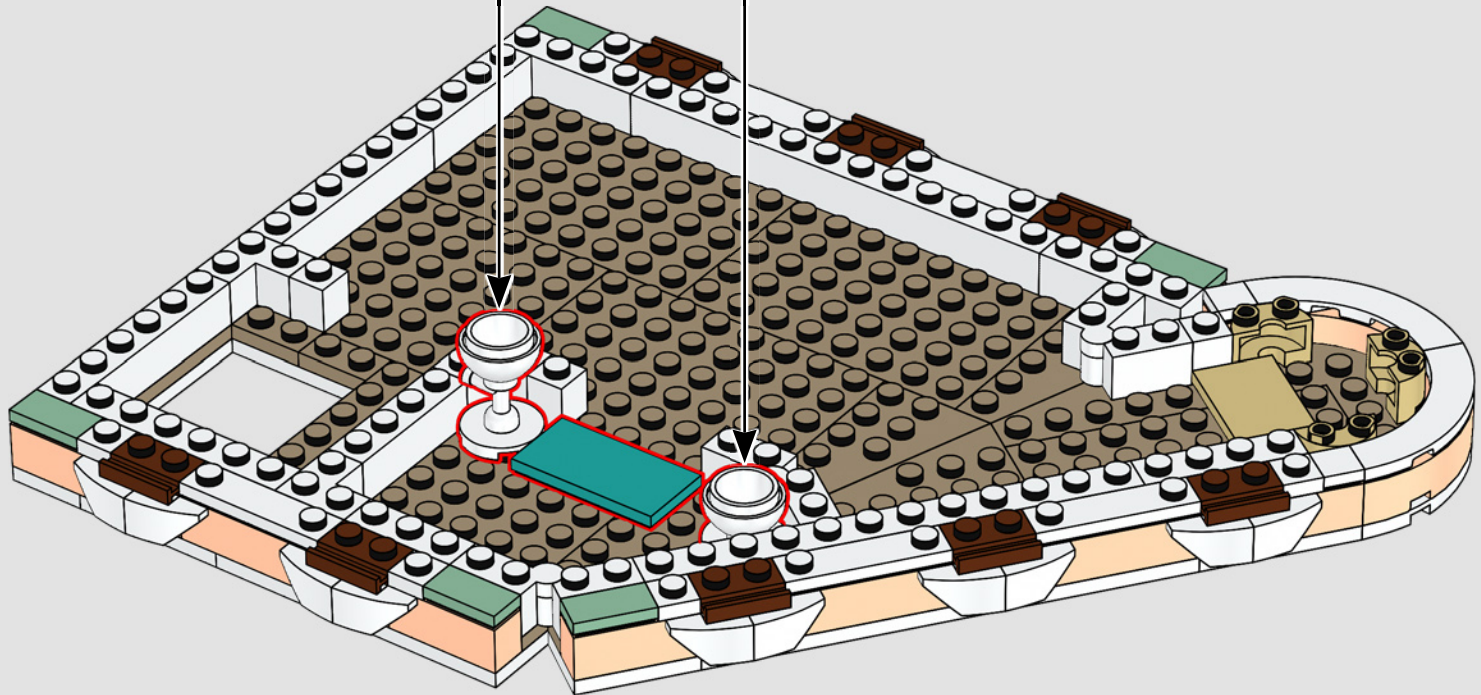
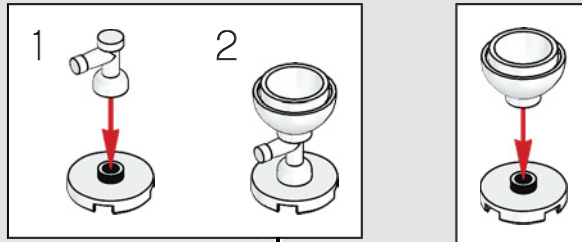

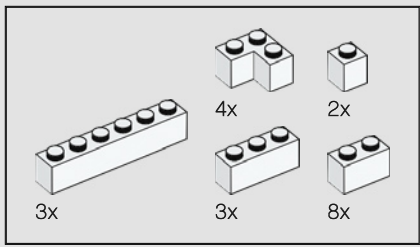

323

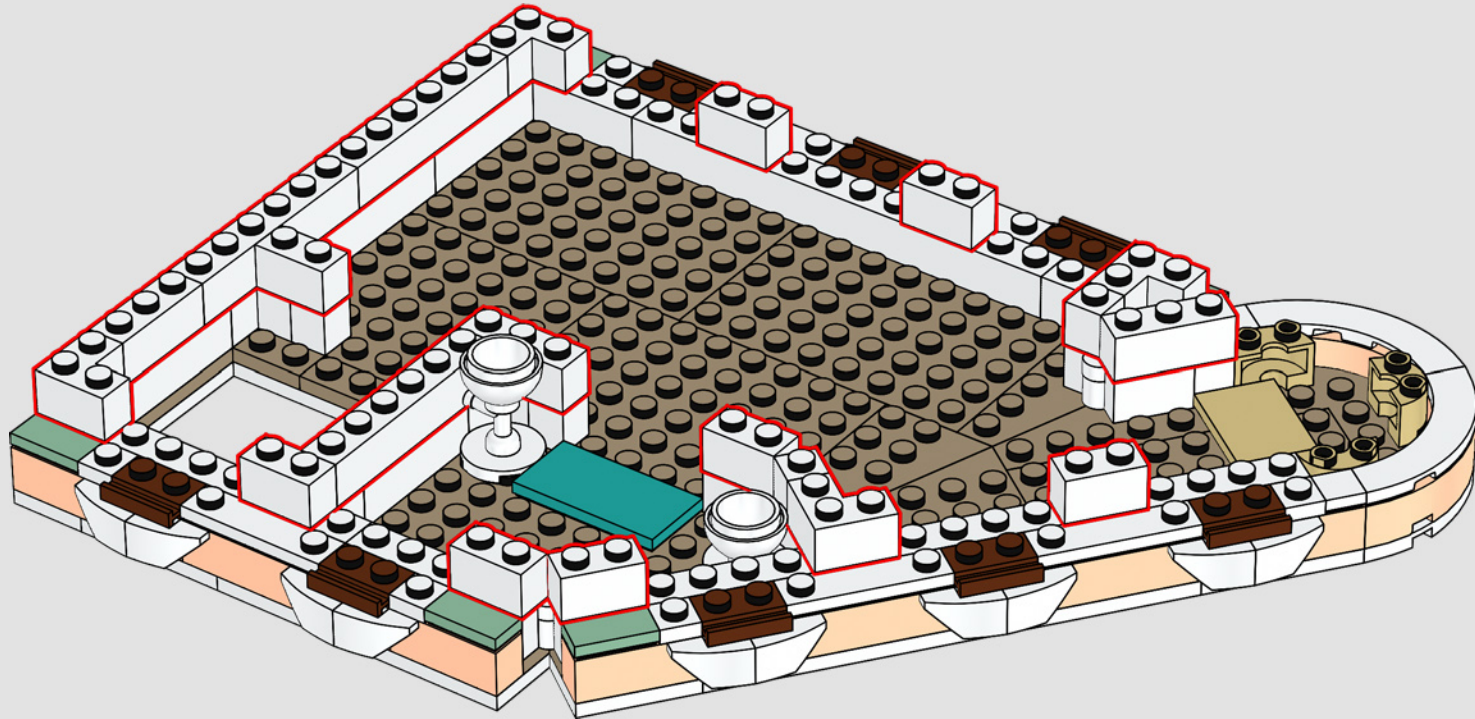

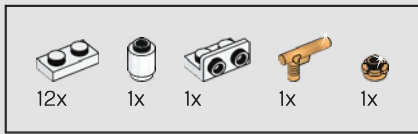

324

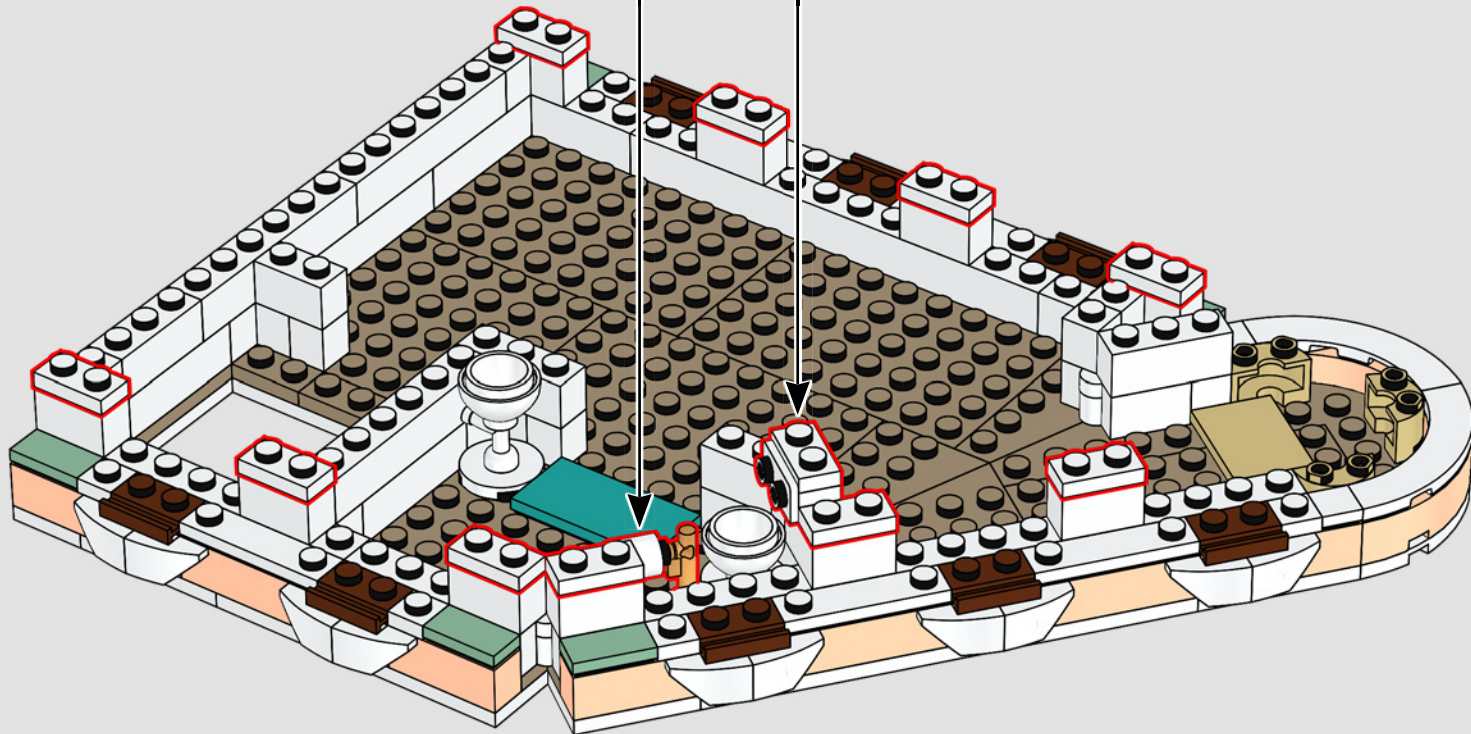
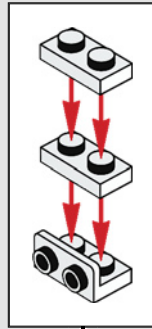
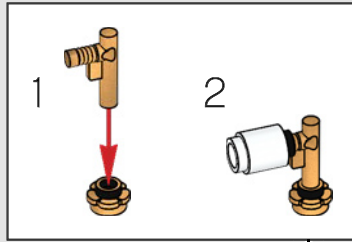

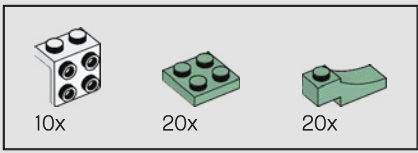

325

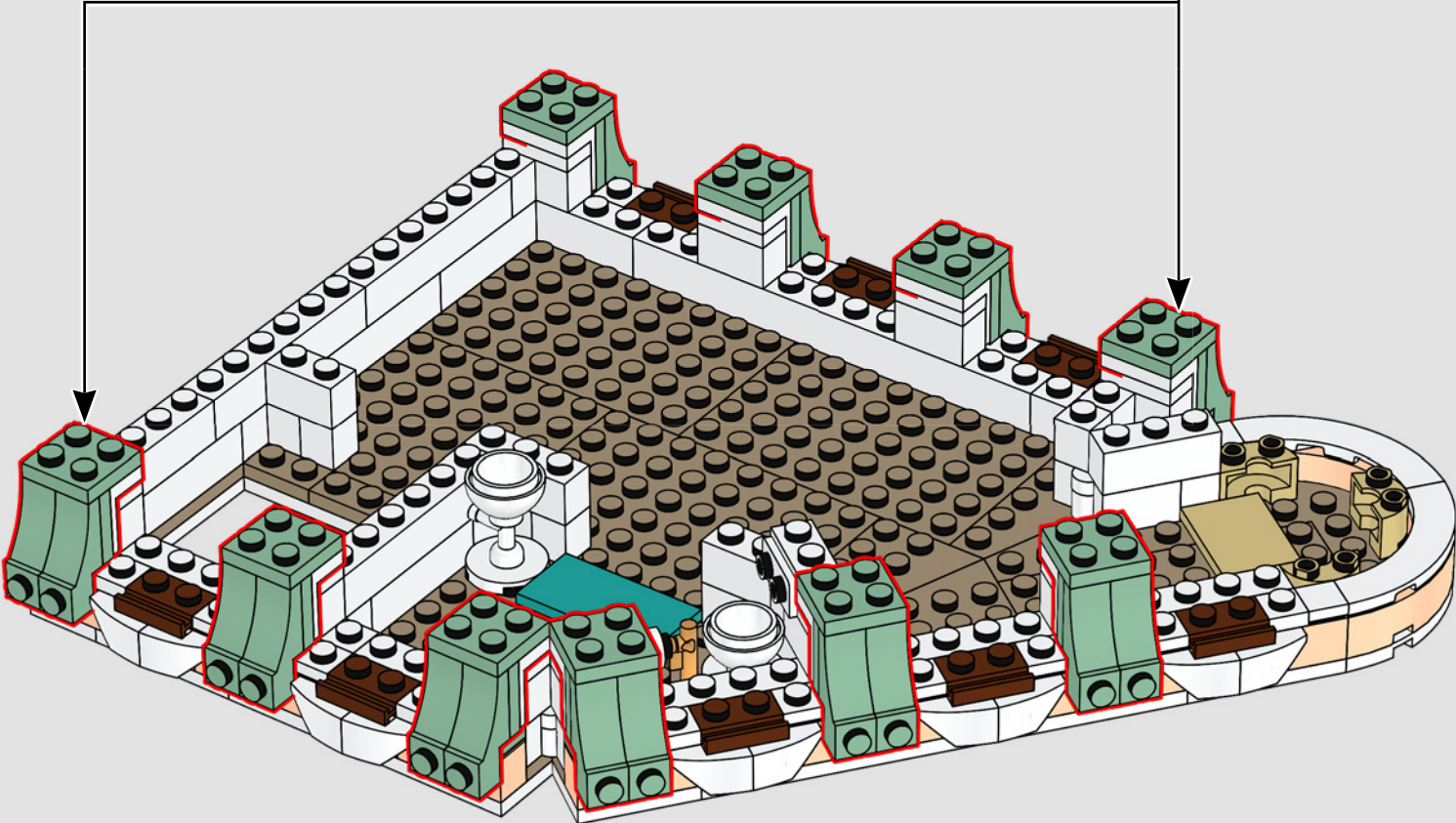
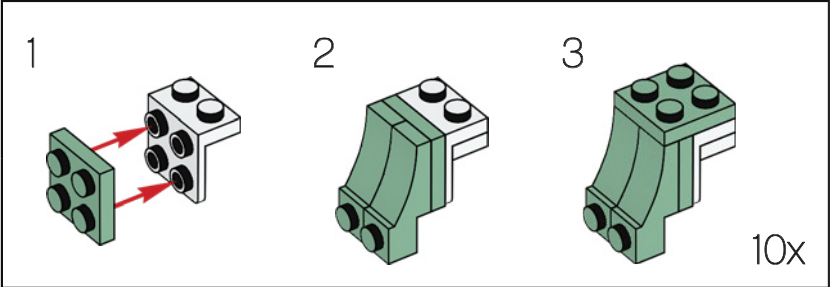



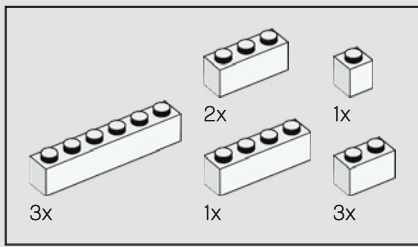

326

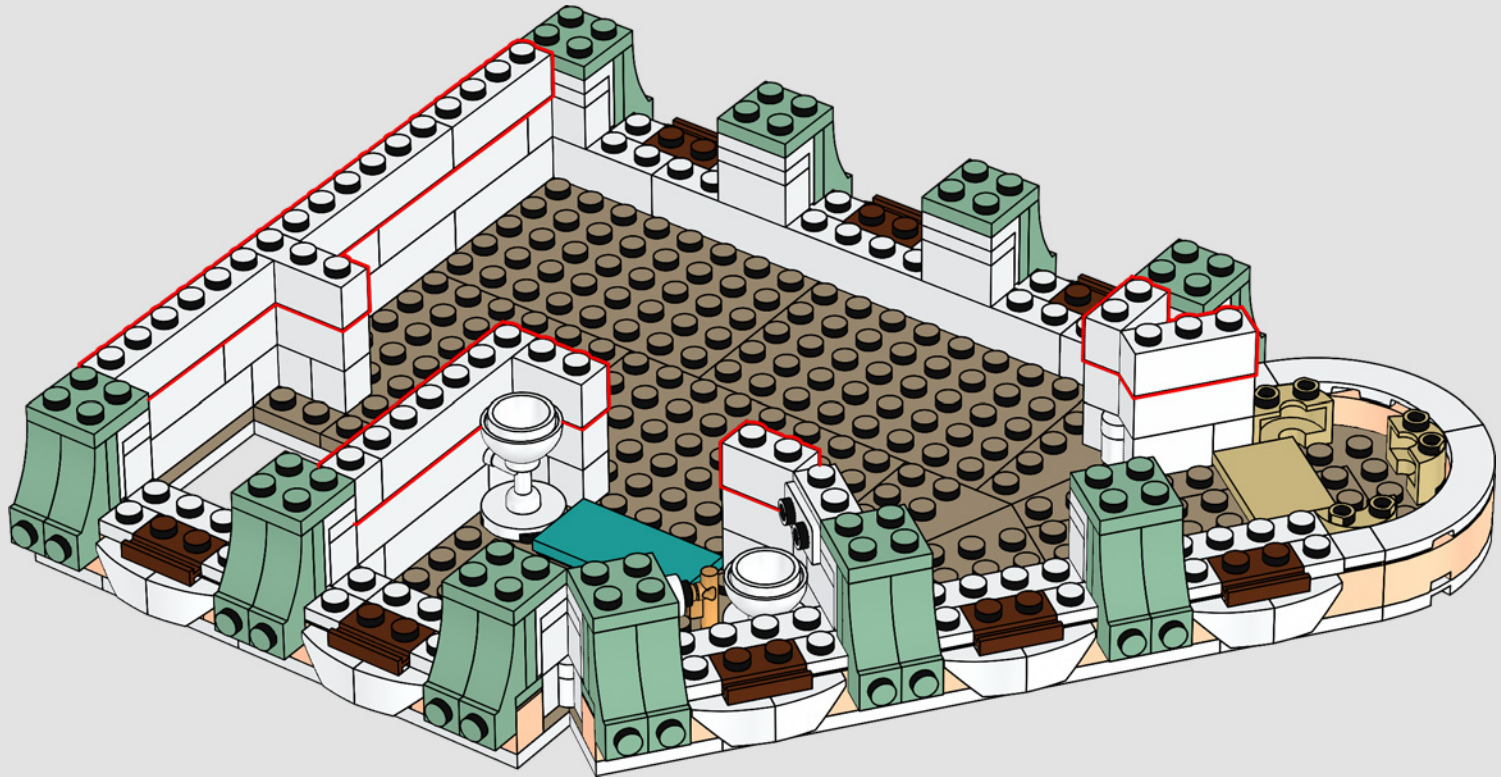

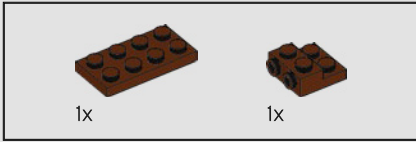

327

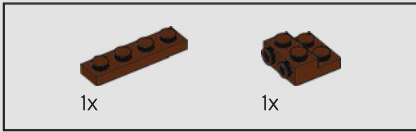
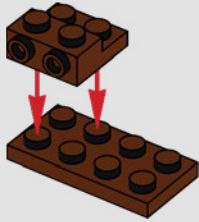

328

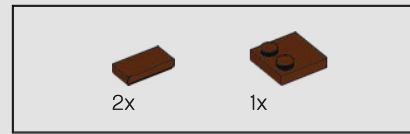
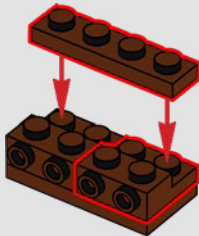

329

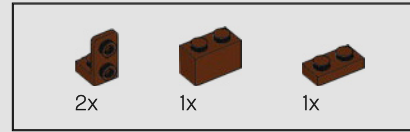
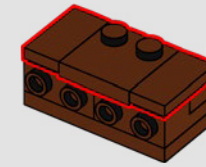

330

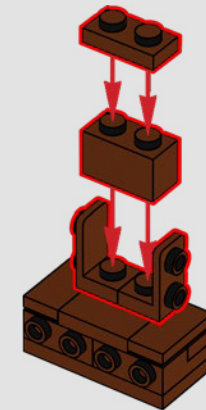

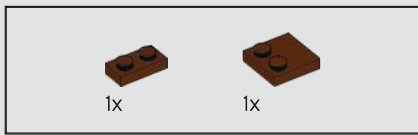

331

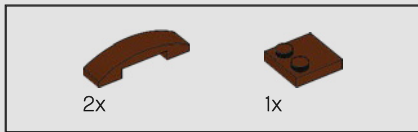
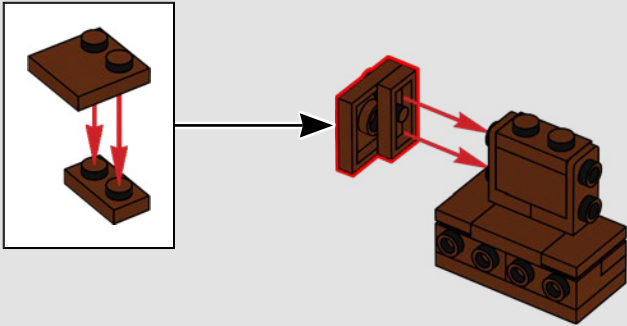

332

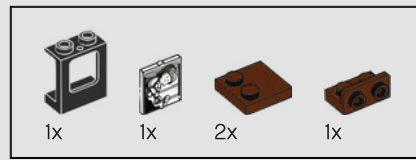
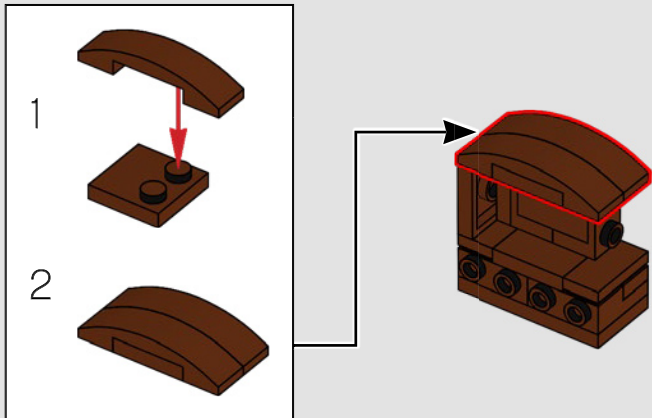

333

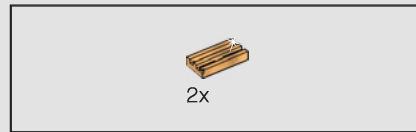
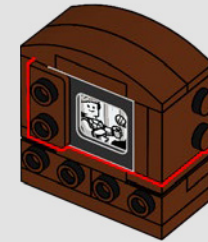
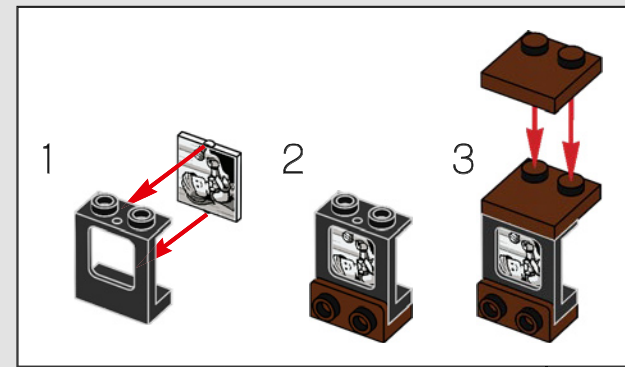

334



335

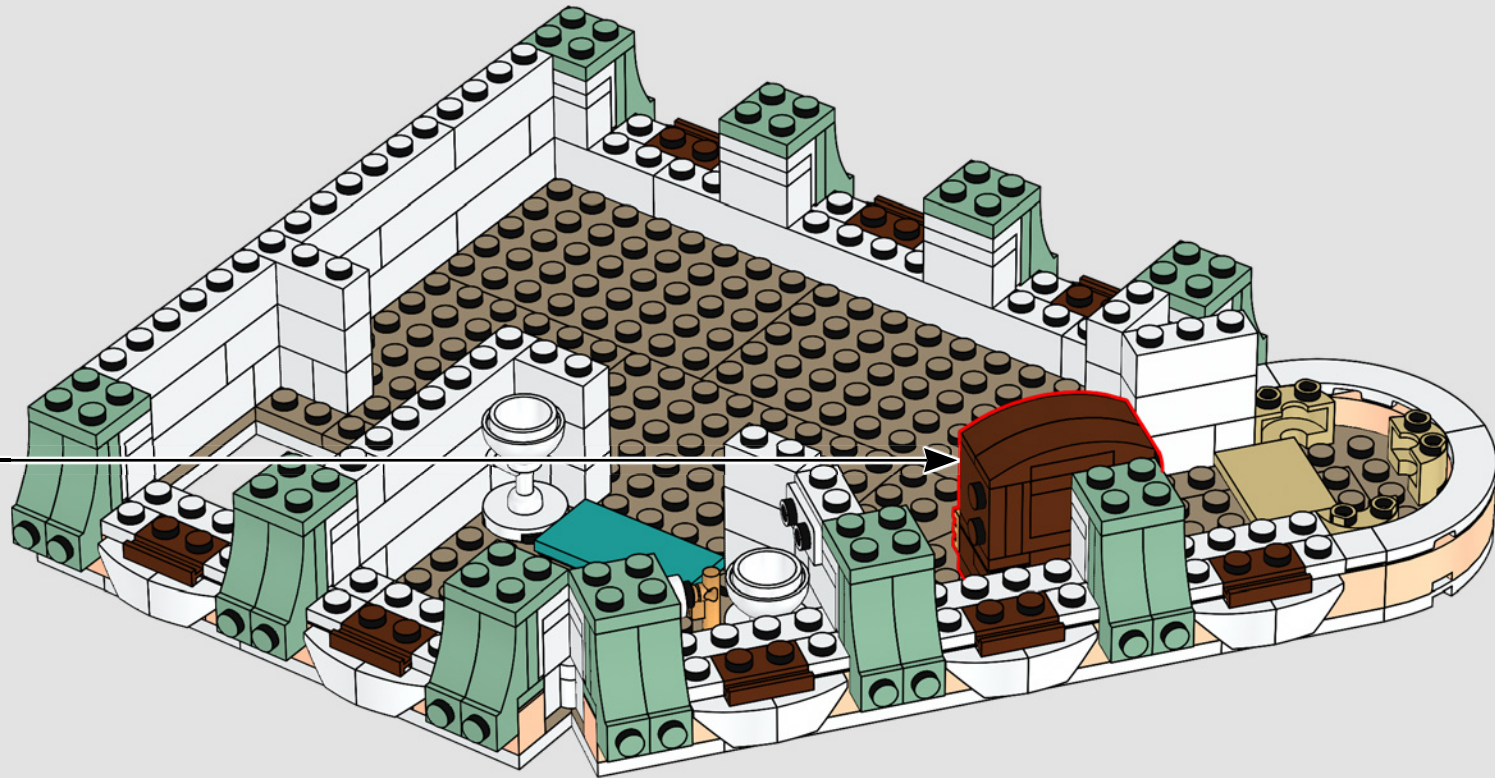



虽然环球旅行家已踏遍世界各地，  
但总喜欢回到精品酒店小歇。

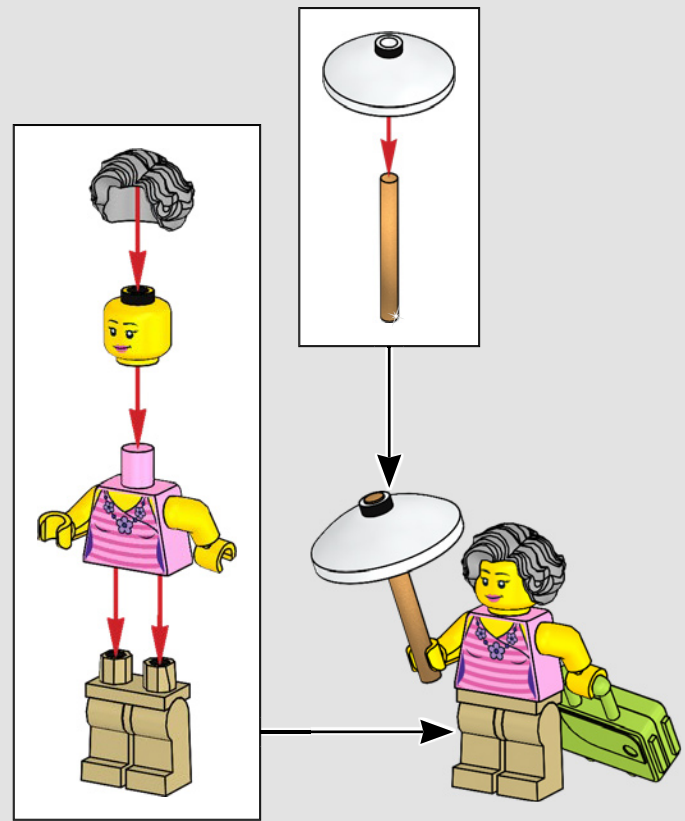
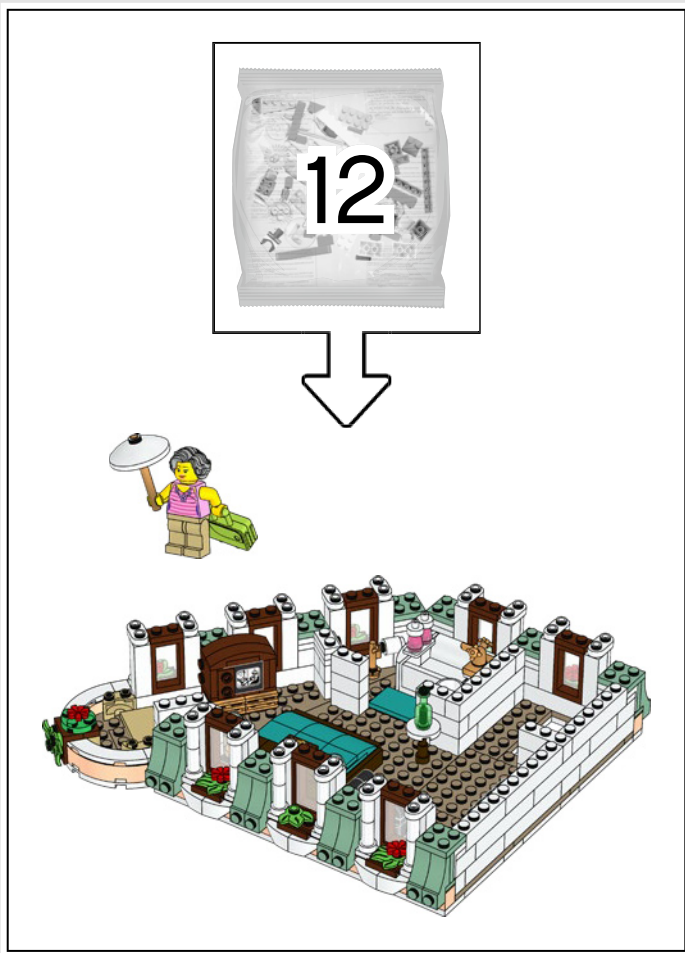

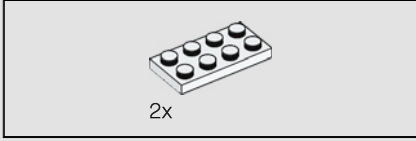
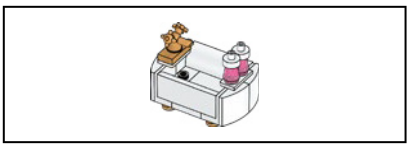

2x

336

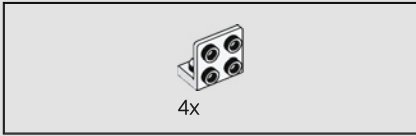
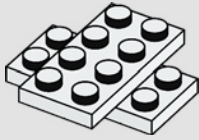

4x

337

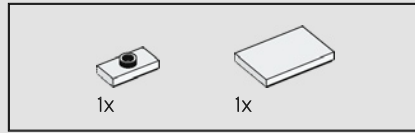
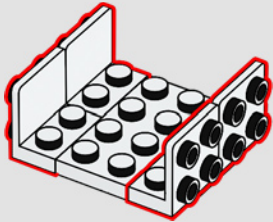

1x

1x

338

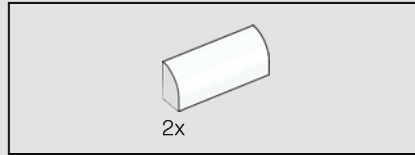
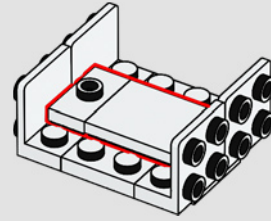

2x

339

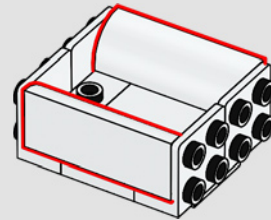

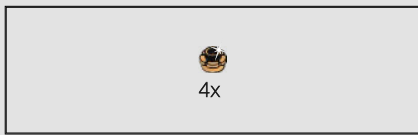

340

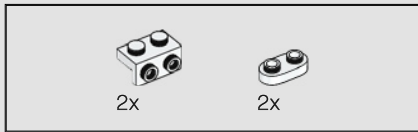
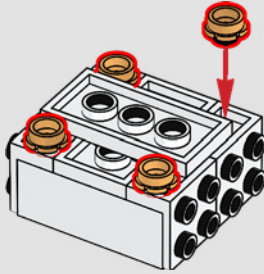

341

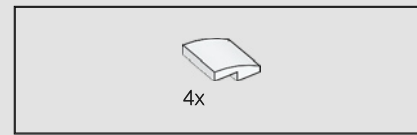
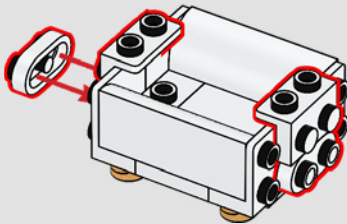

342

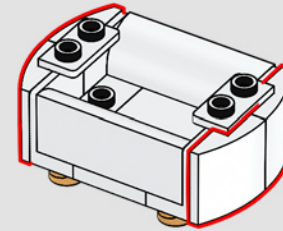

343

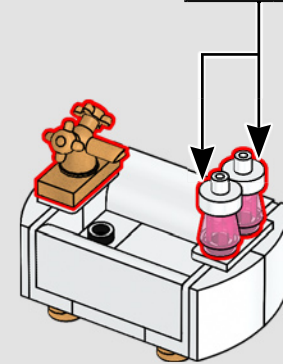
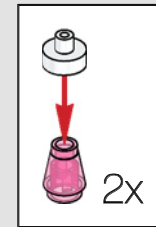

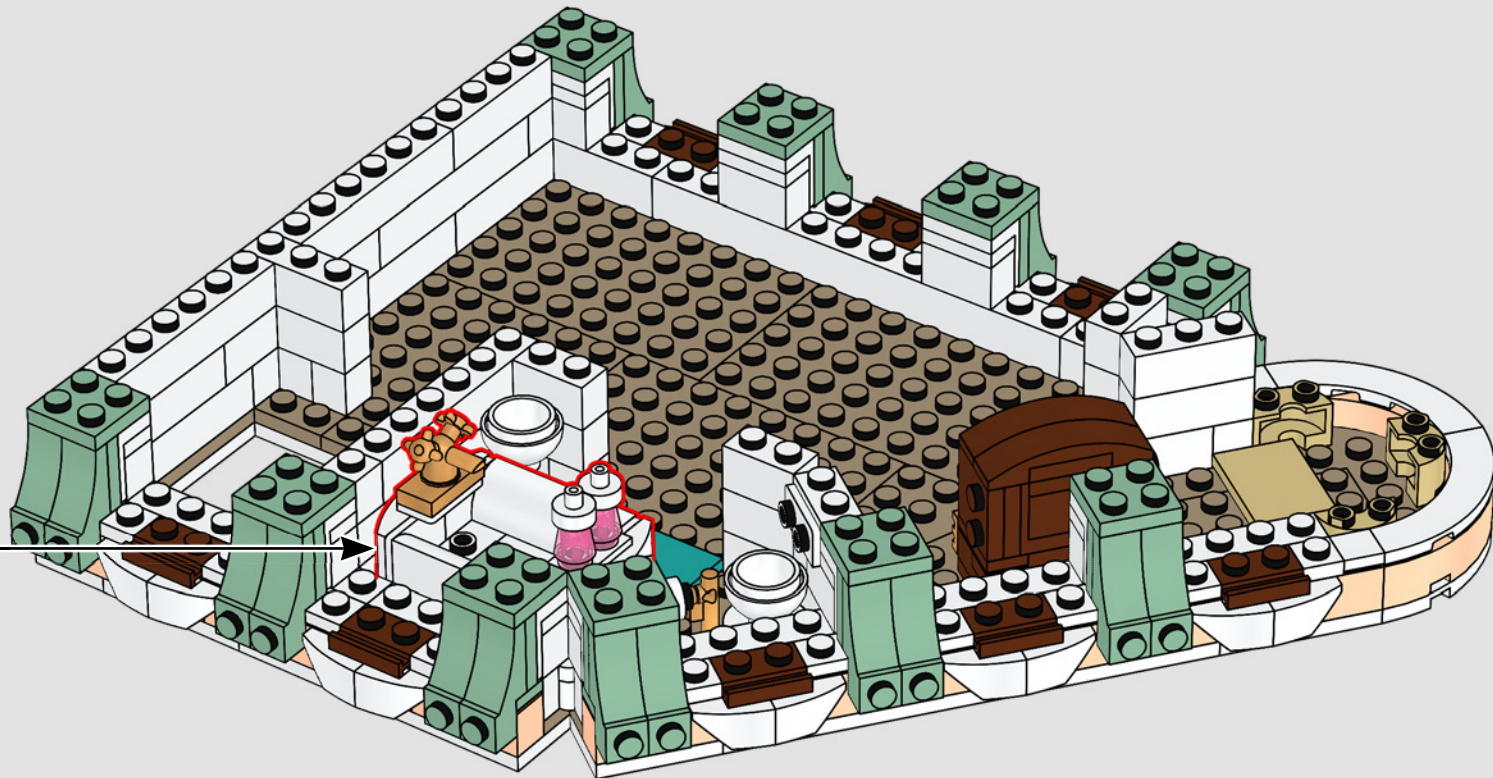



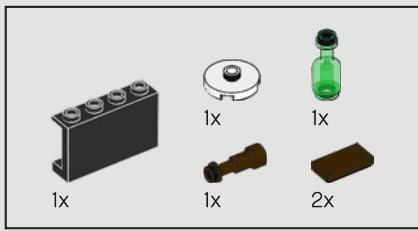

345

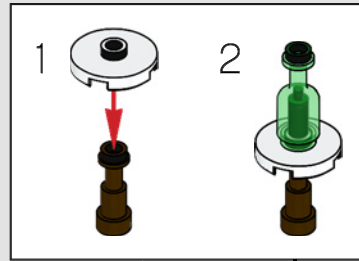

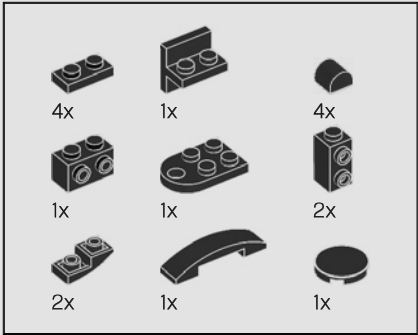

346

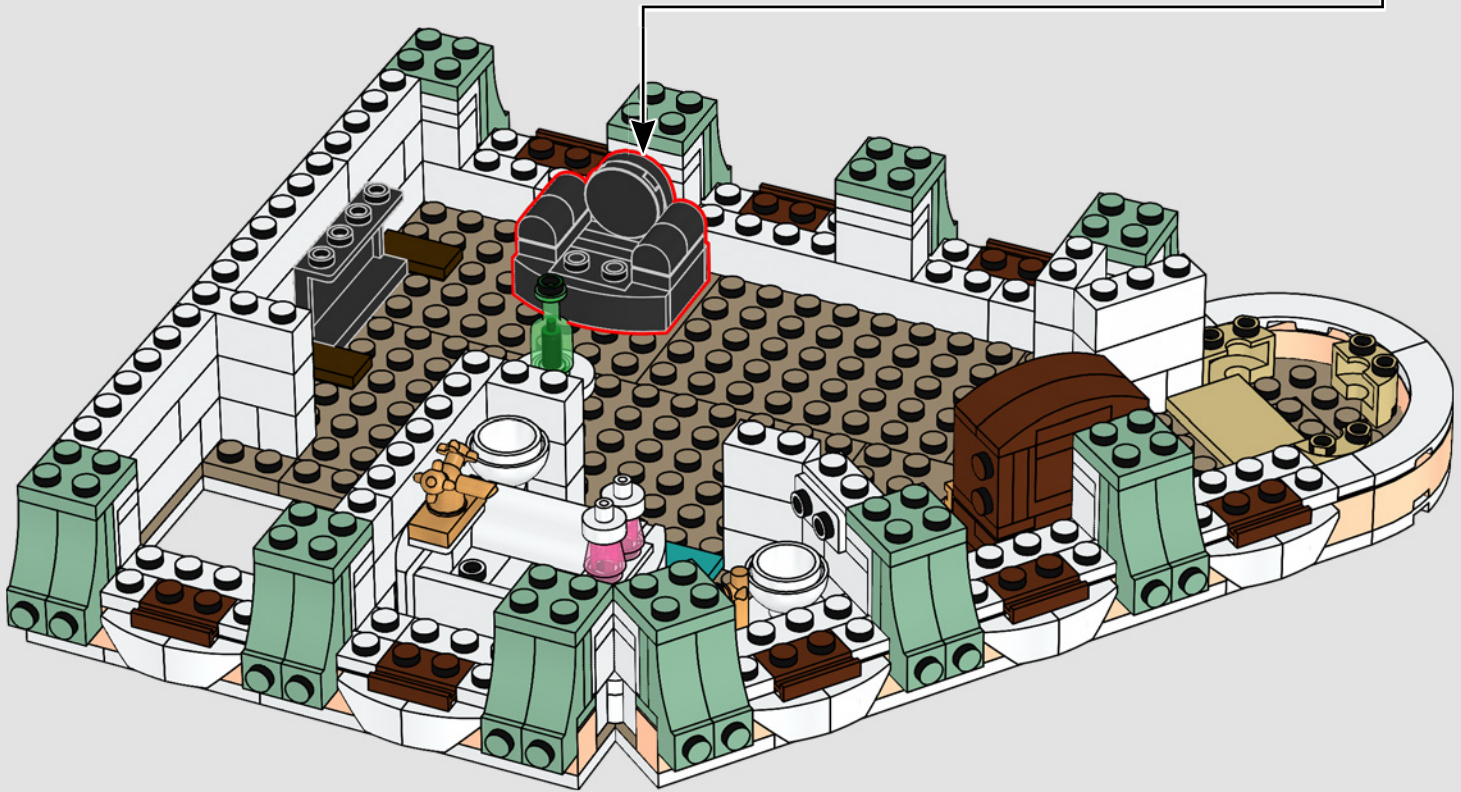
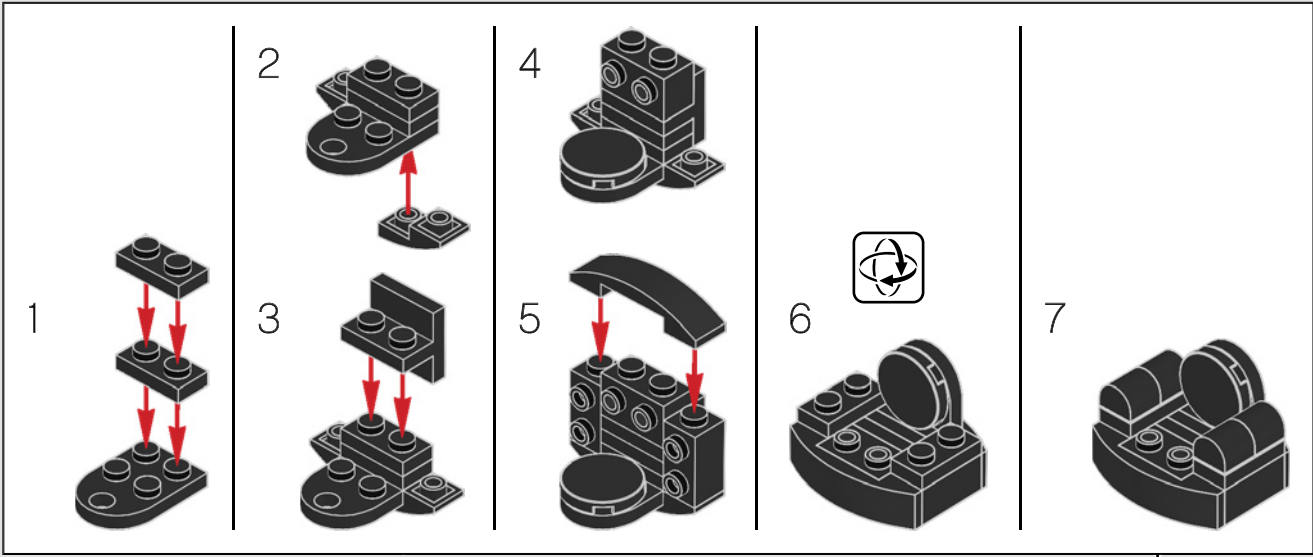

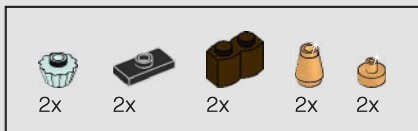

☆☆☆☆☆  
这里的灯罩元件实际上是乐高®好朋友系列套装中的纸杯蛋糕元件。

347

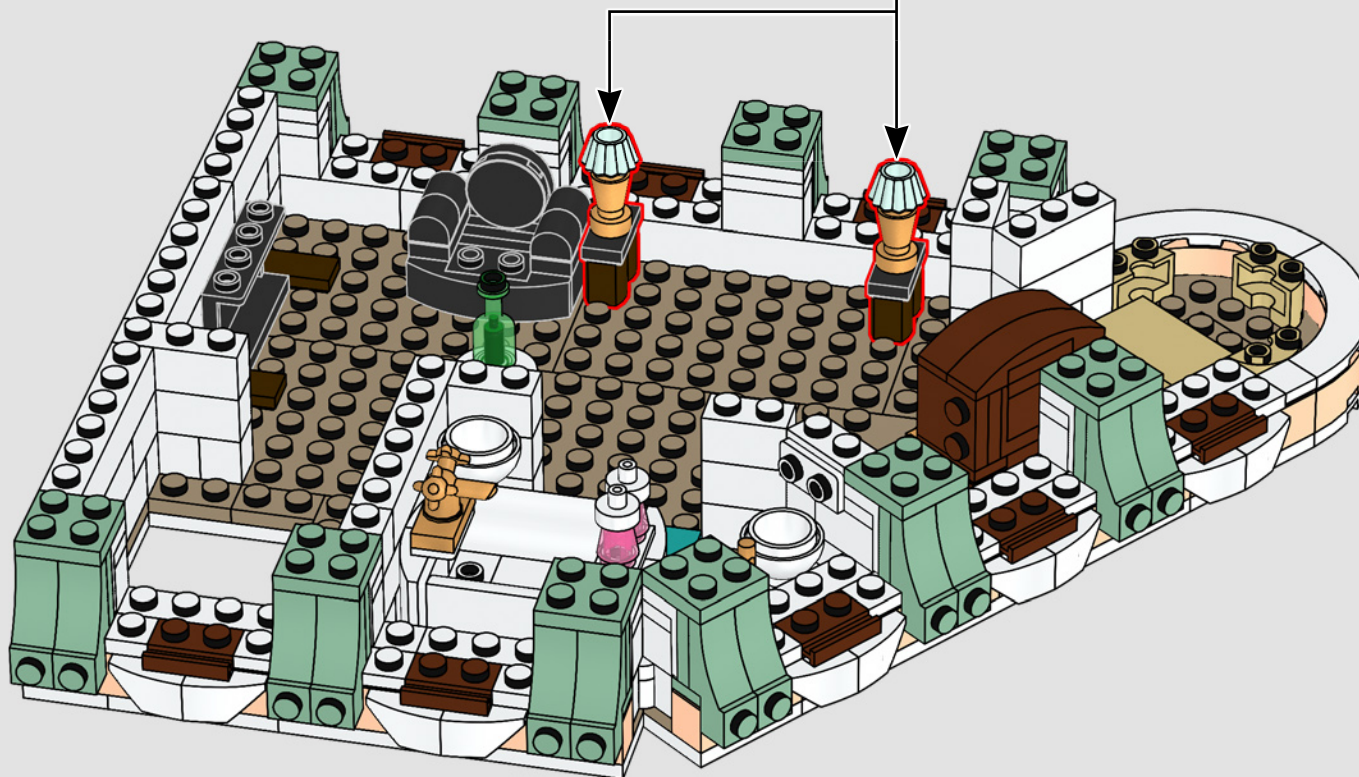
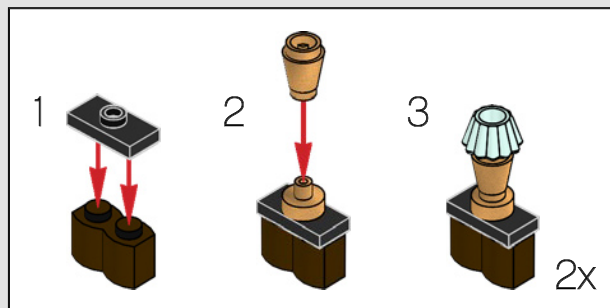

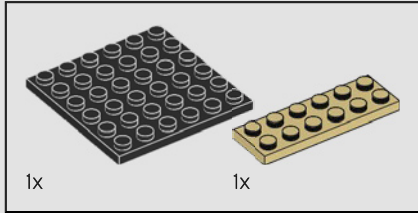
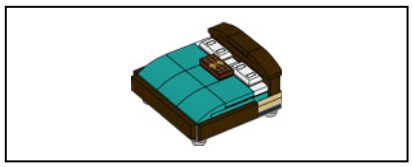

348

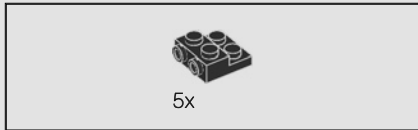
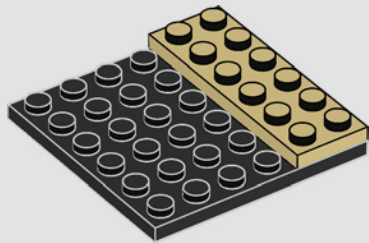

349

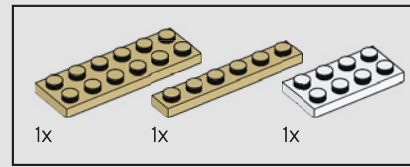
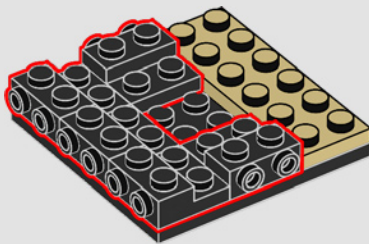

350

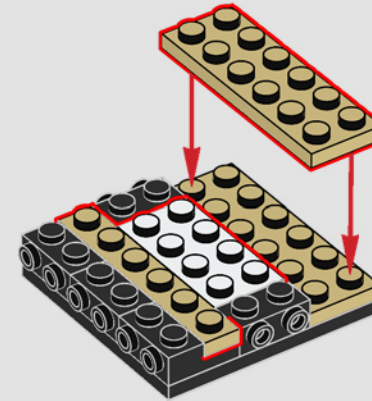

351

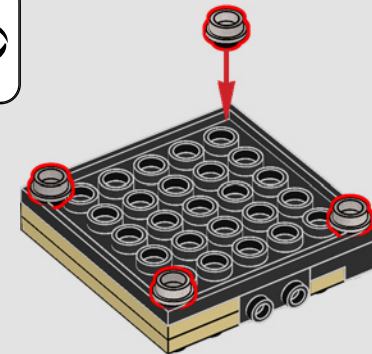
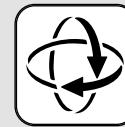

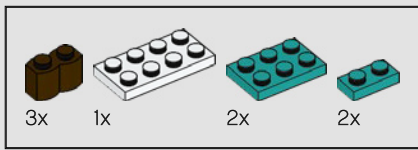

352

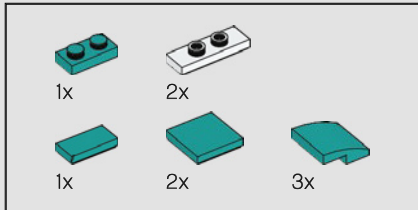
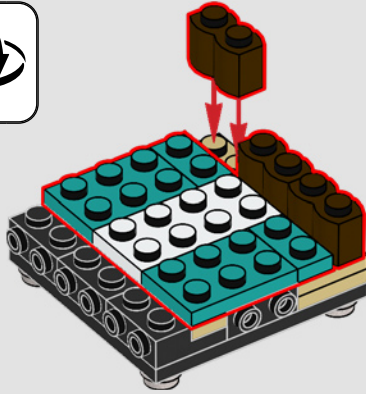

353

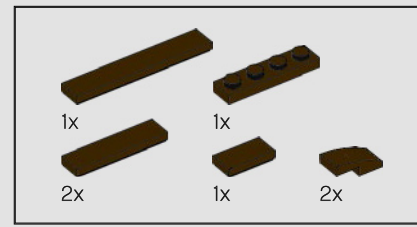
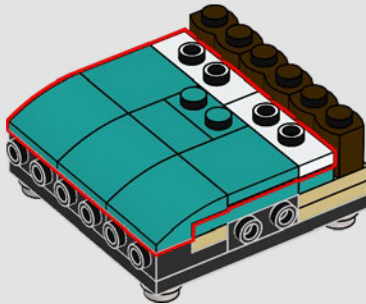

354

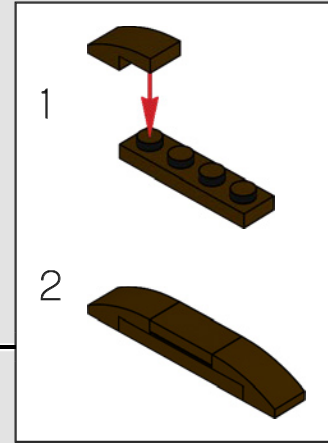
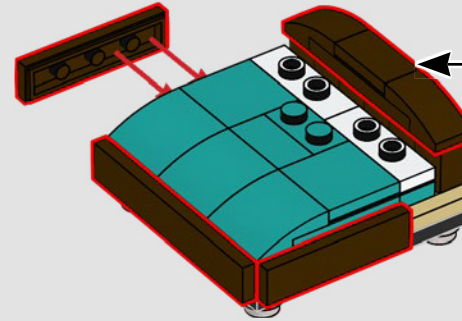

355

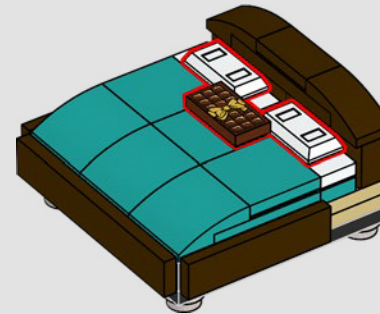

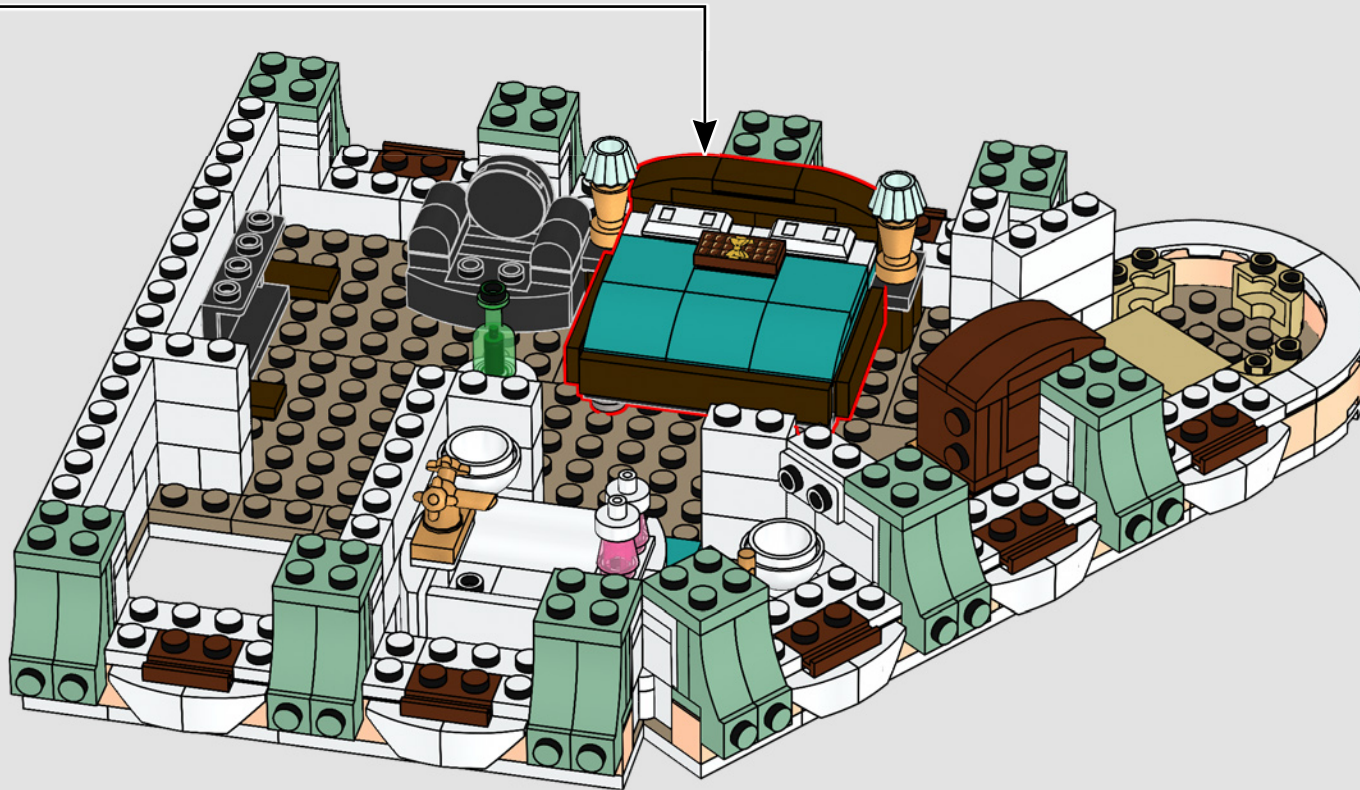

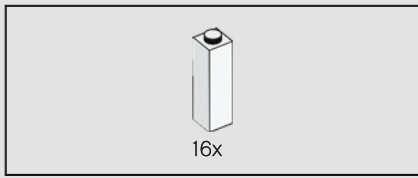

357

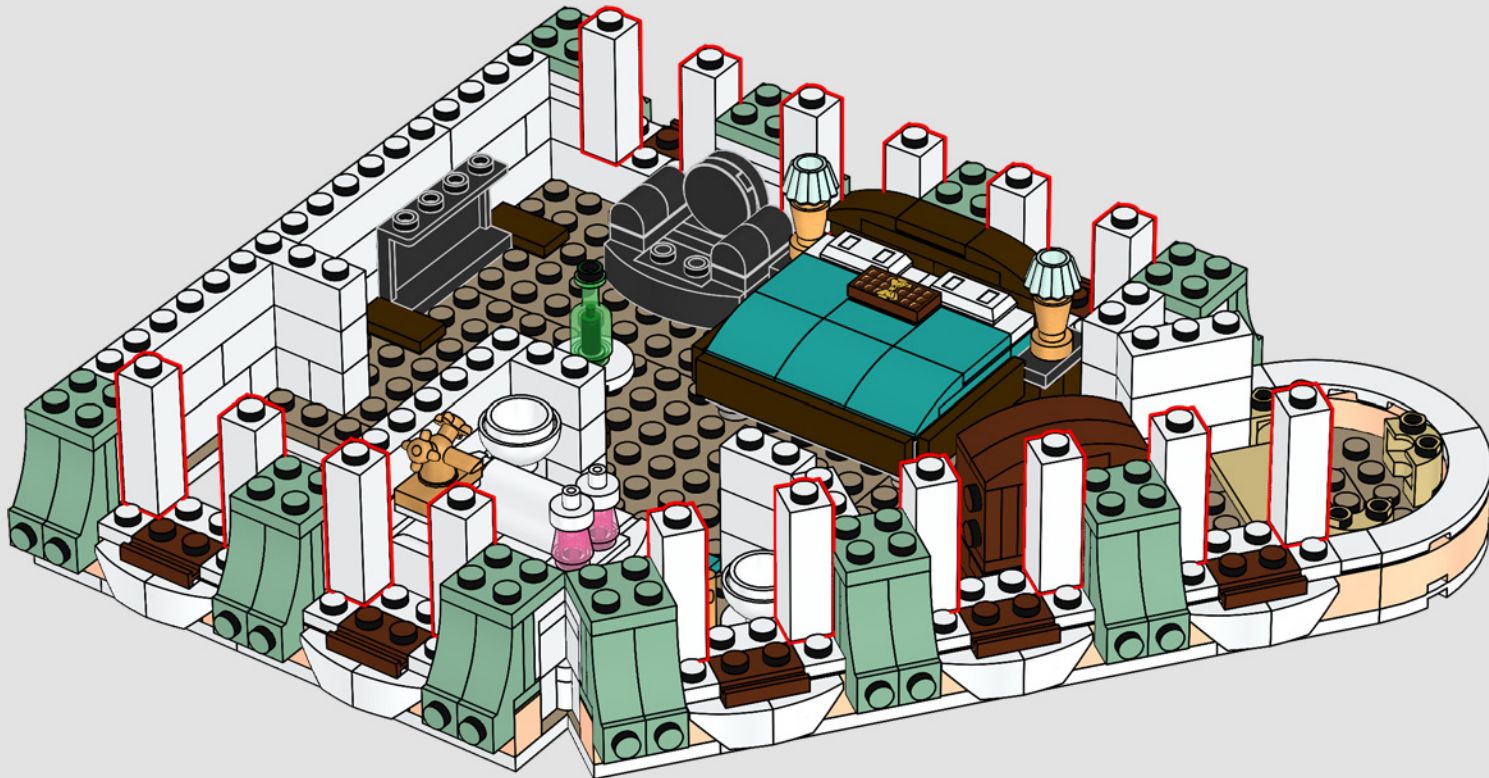

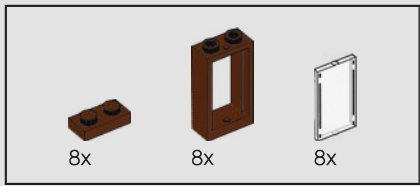

358

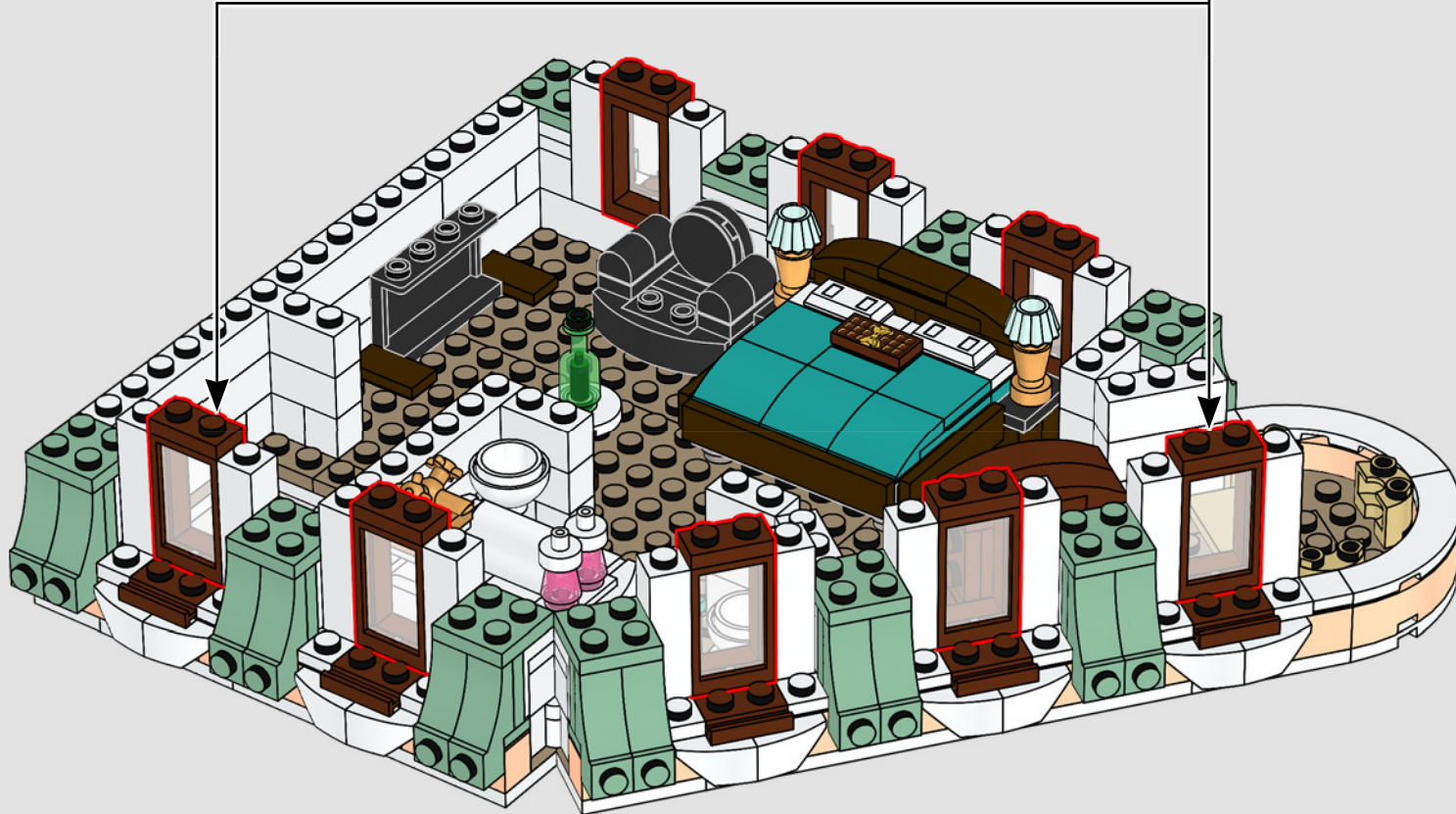
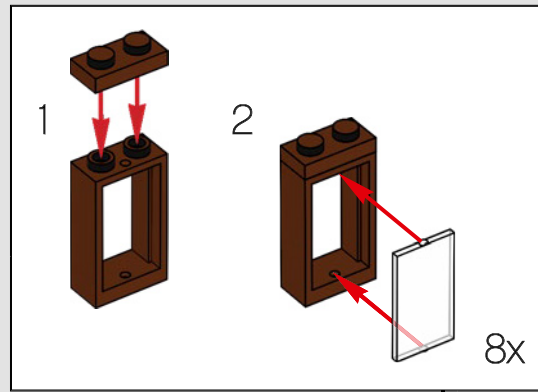



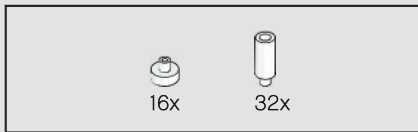

359

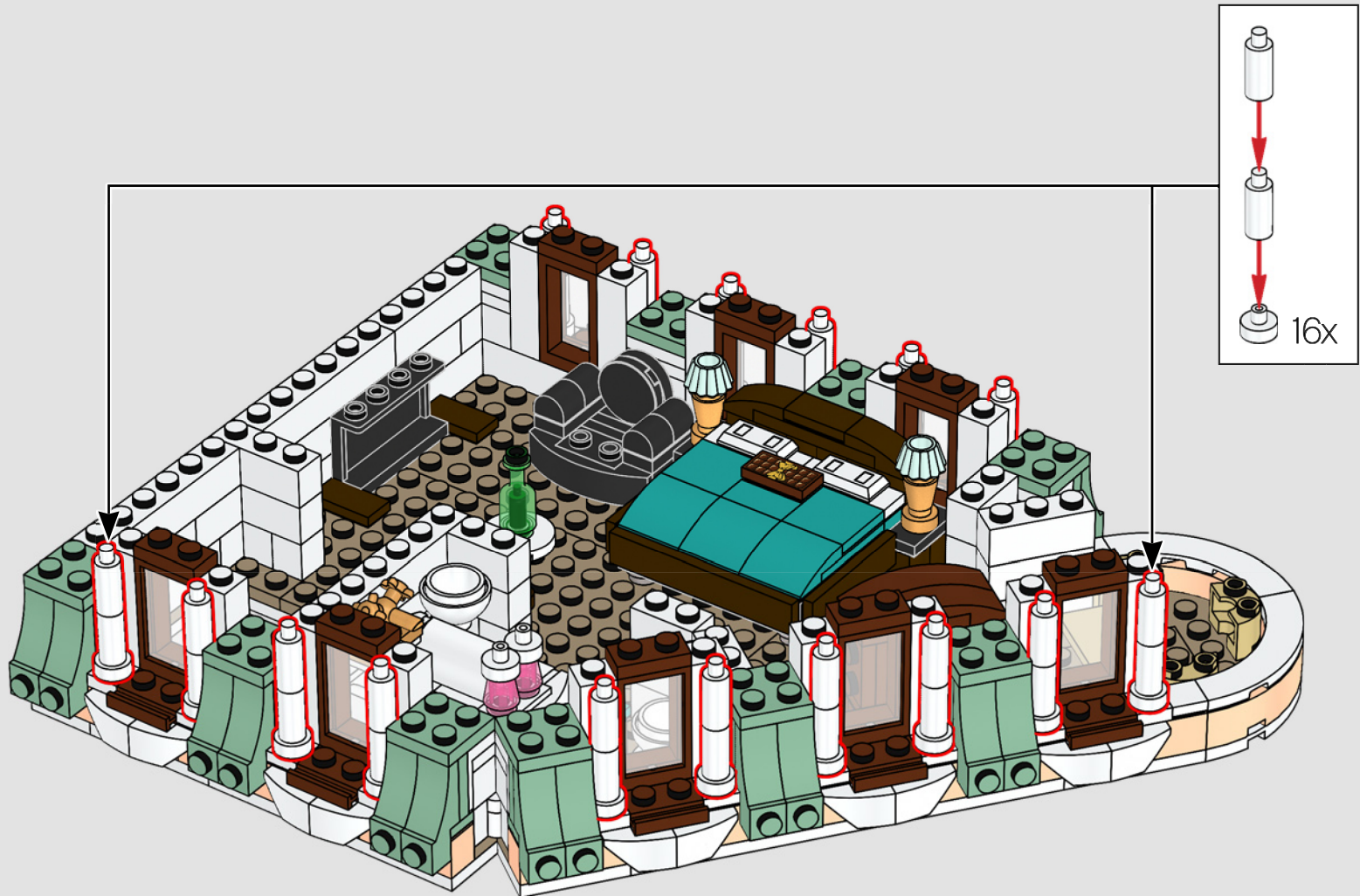



16x

360

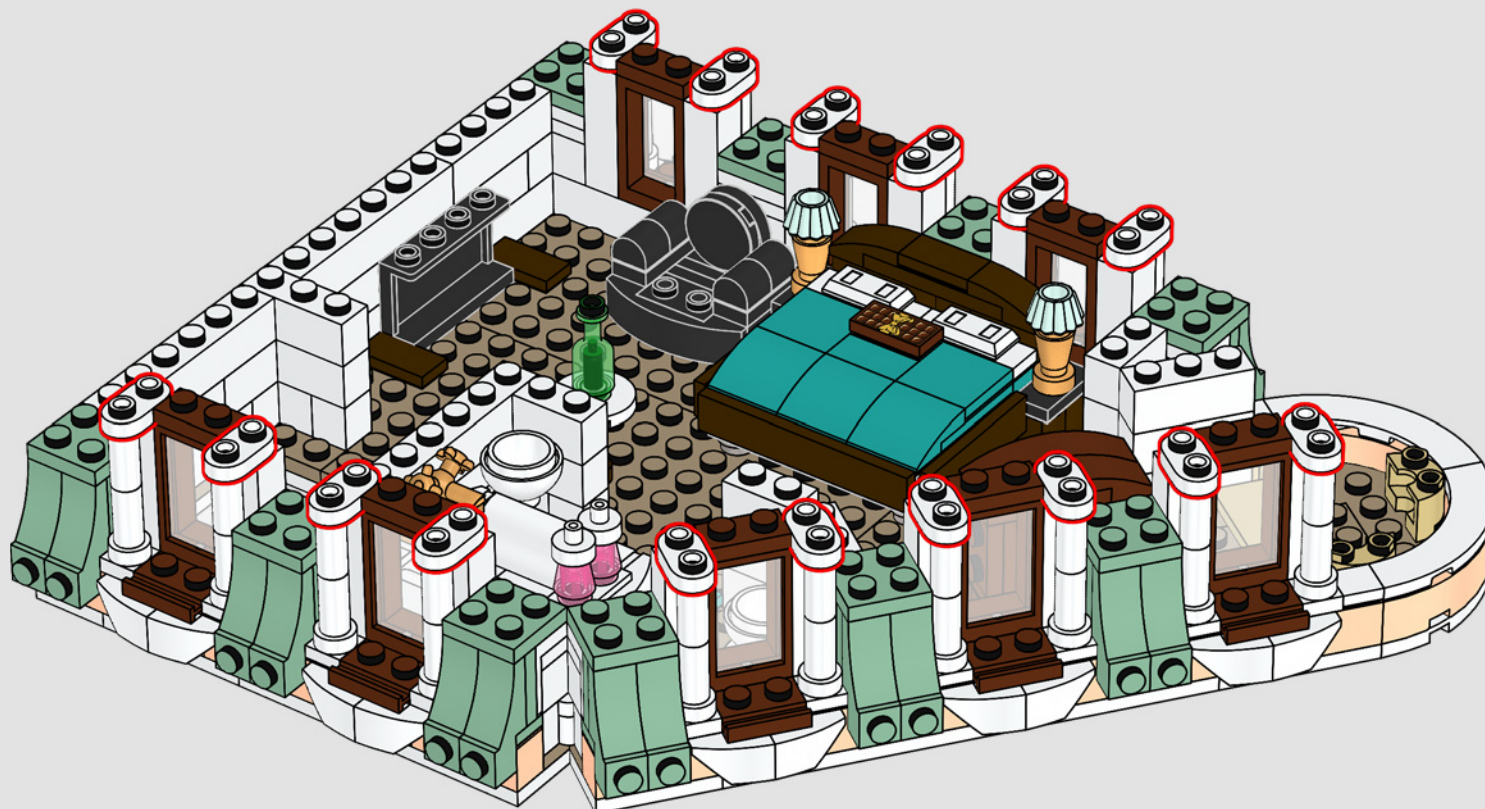

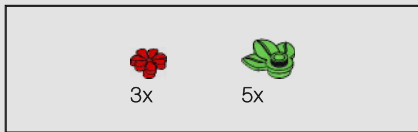

361

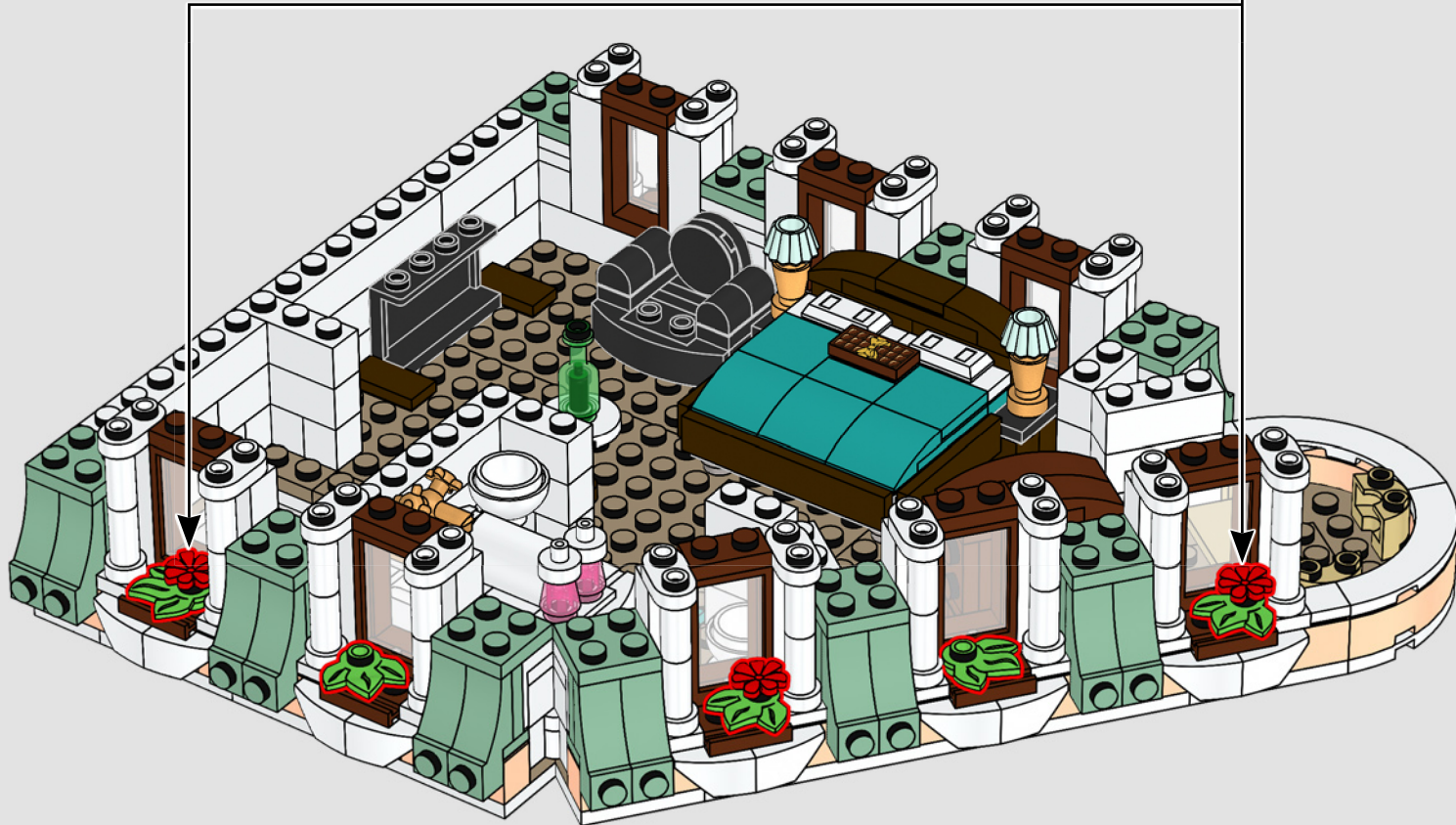
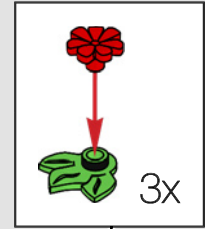

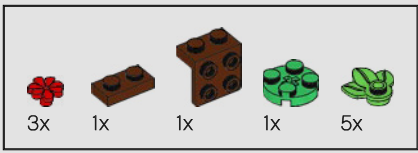

362

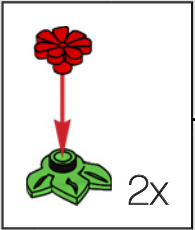
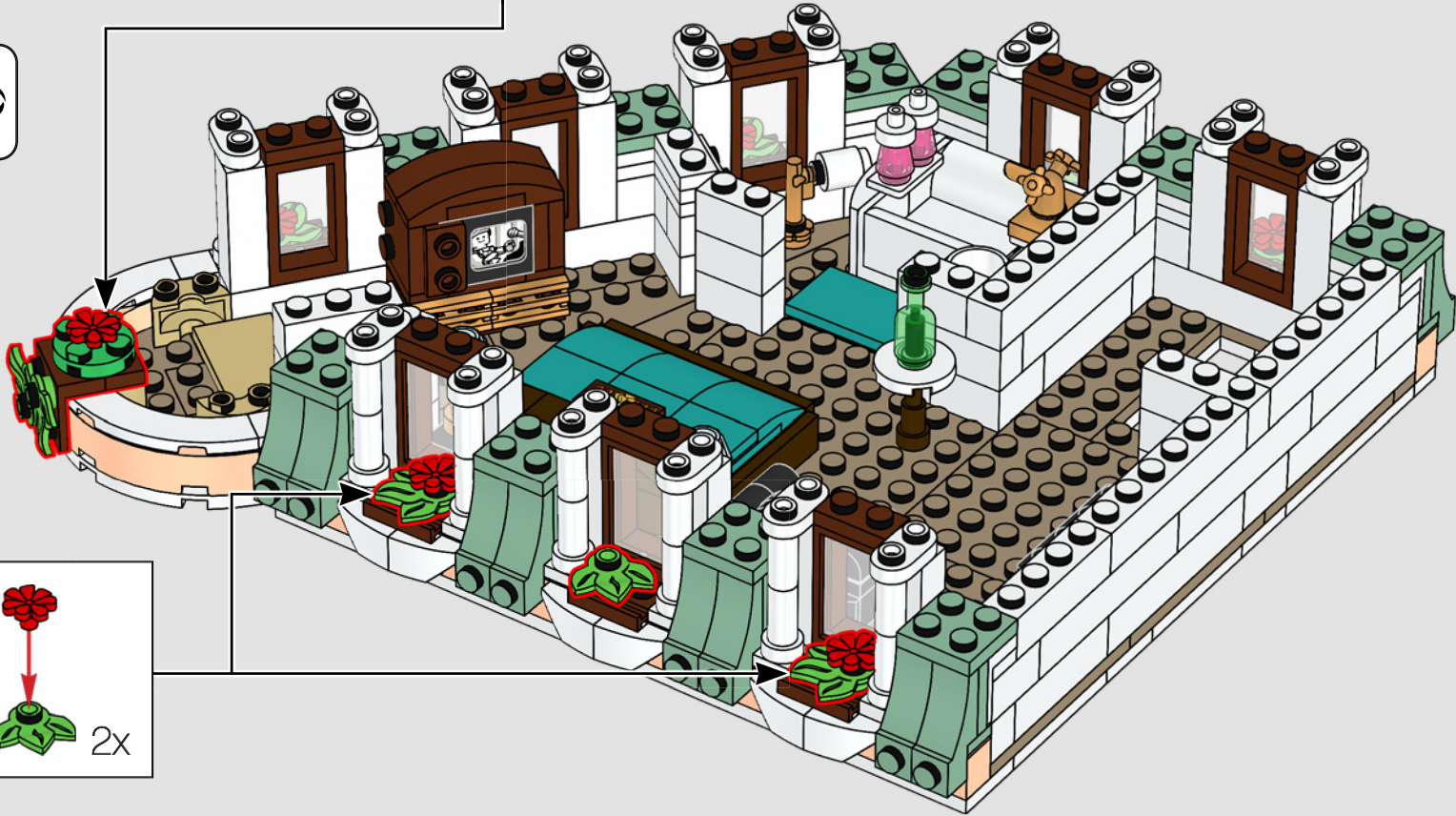
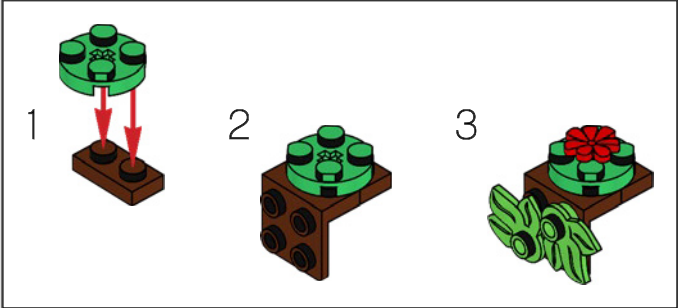

13

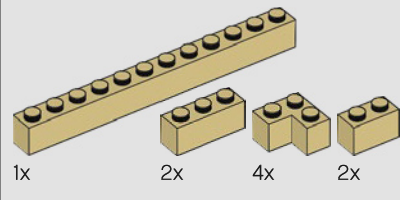

363

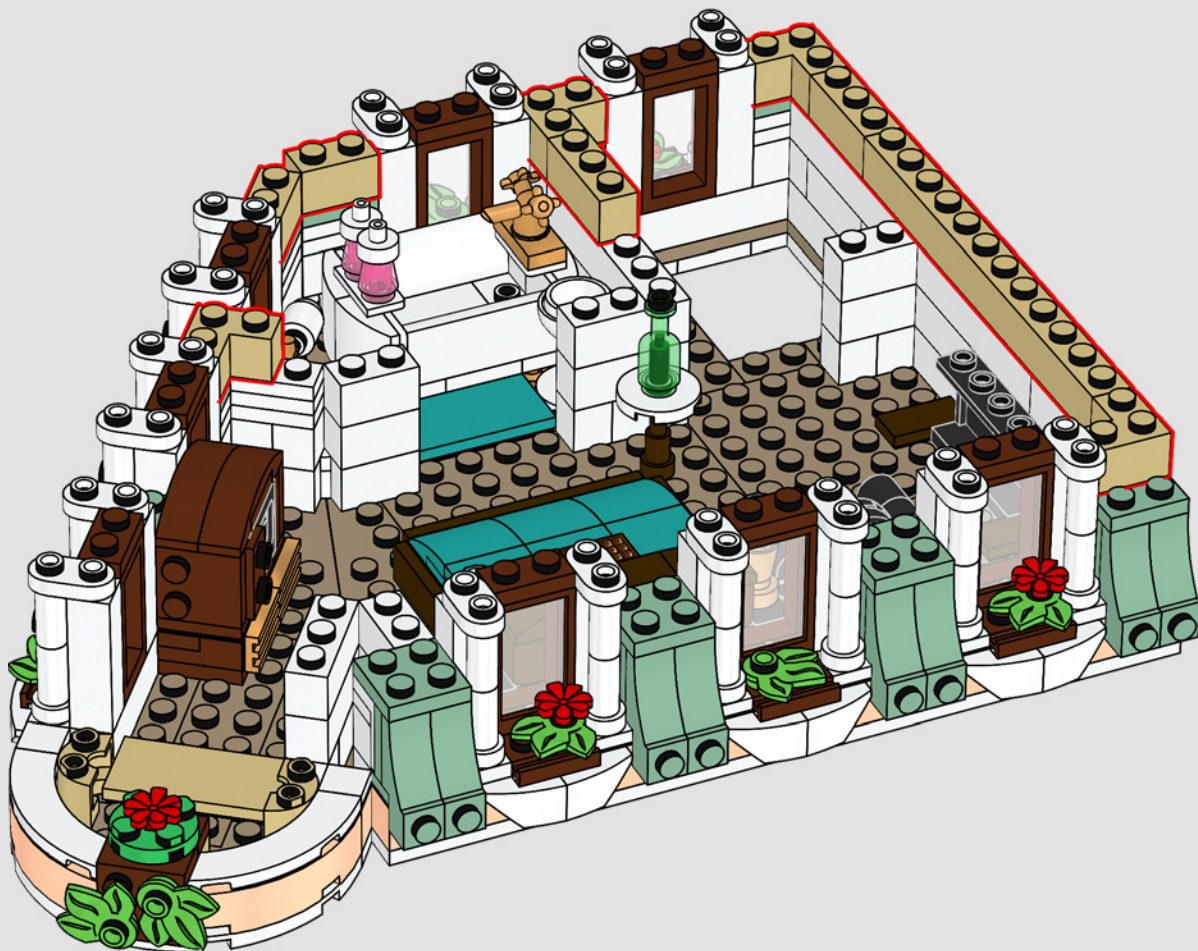

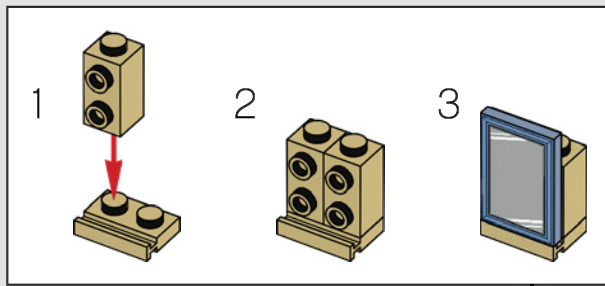
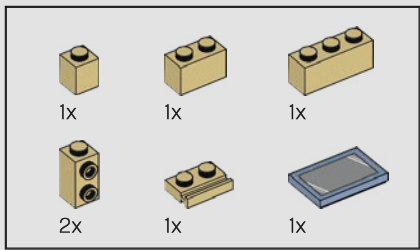

364

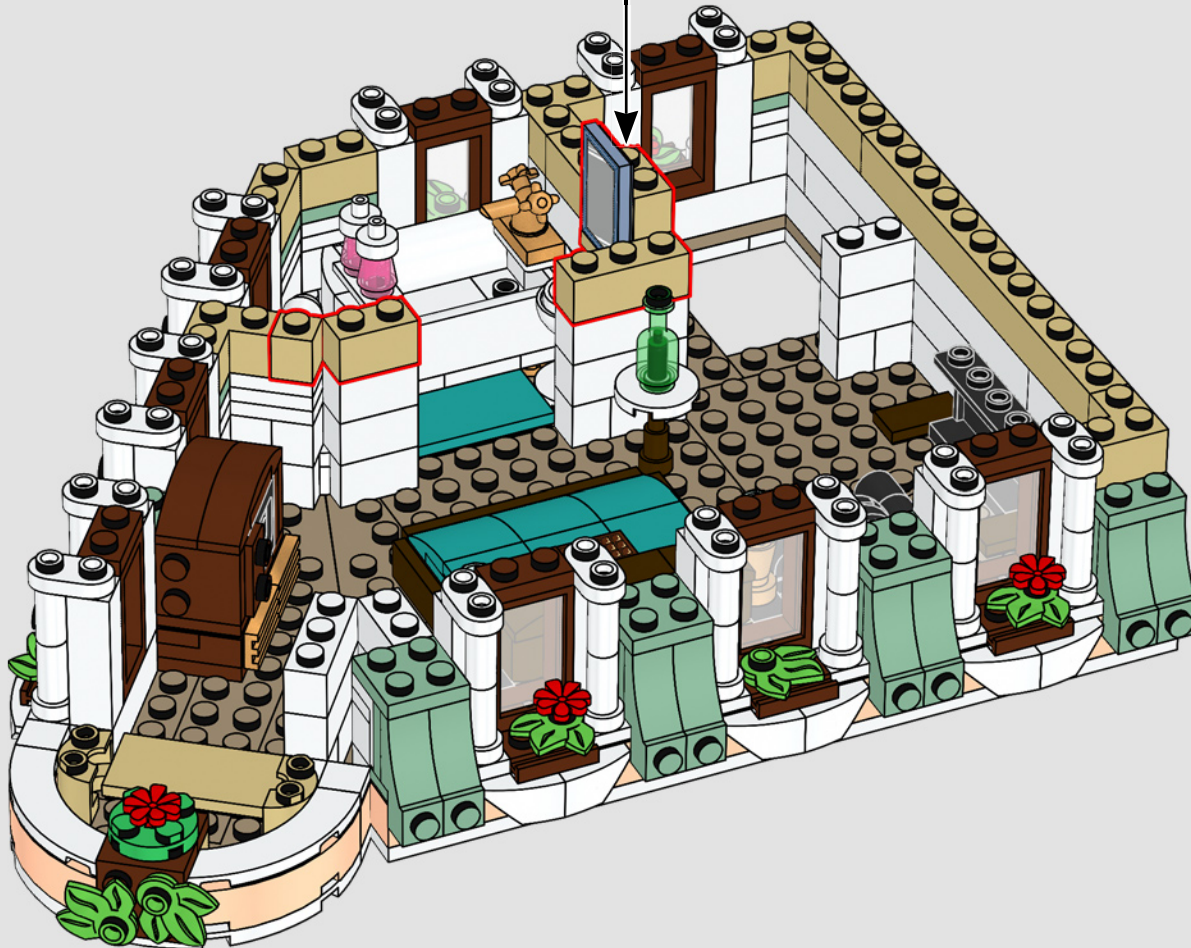

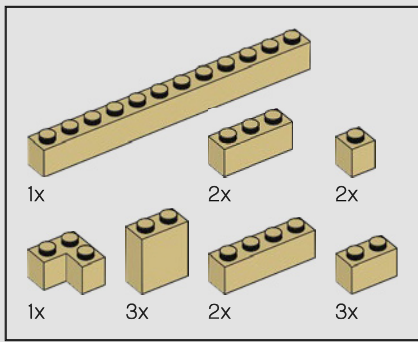

365



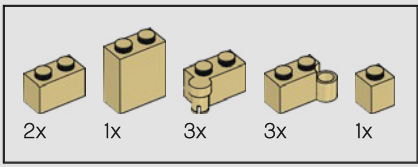

366

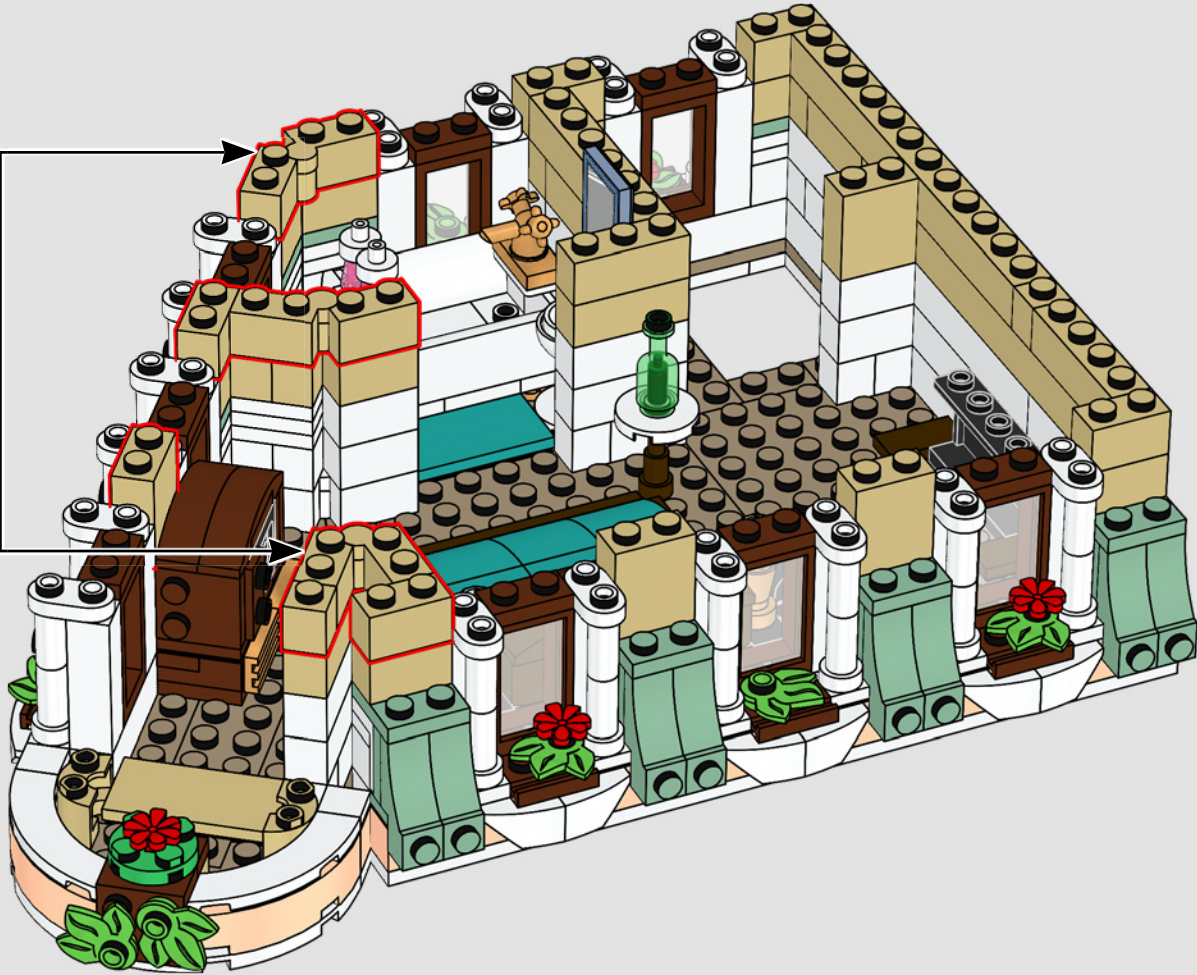
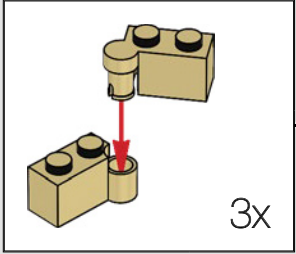



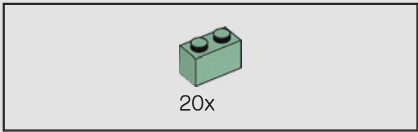

367

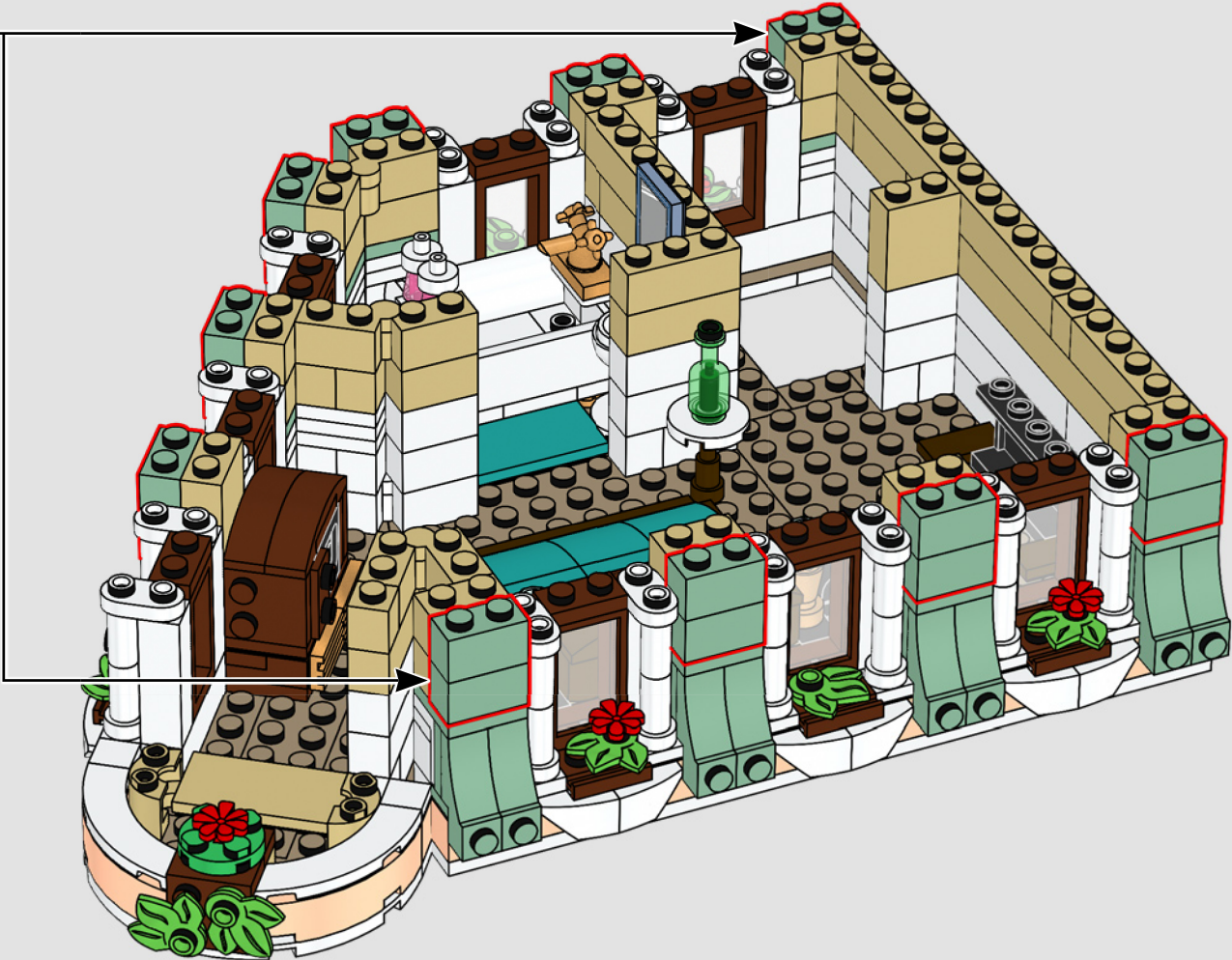
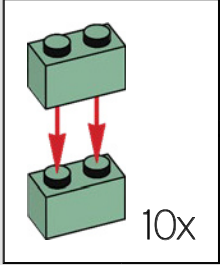

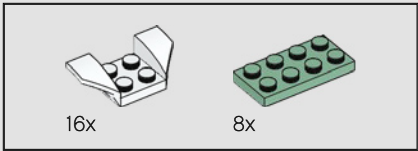

368

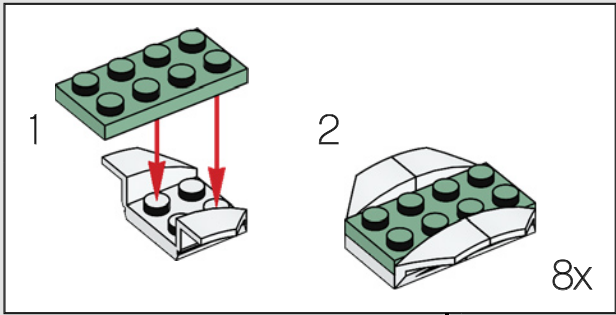

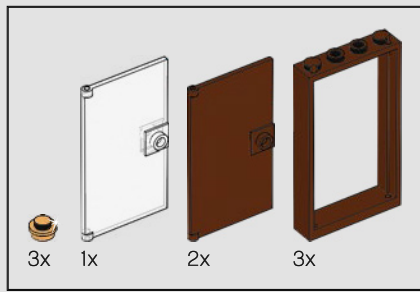

369

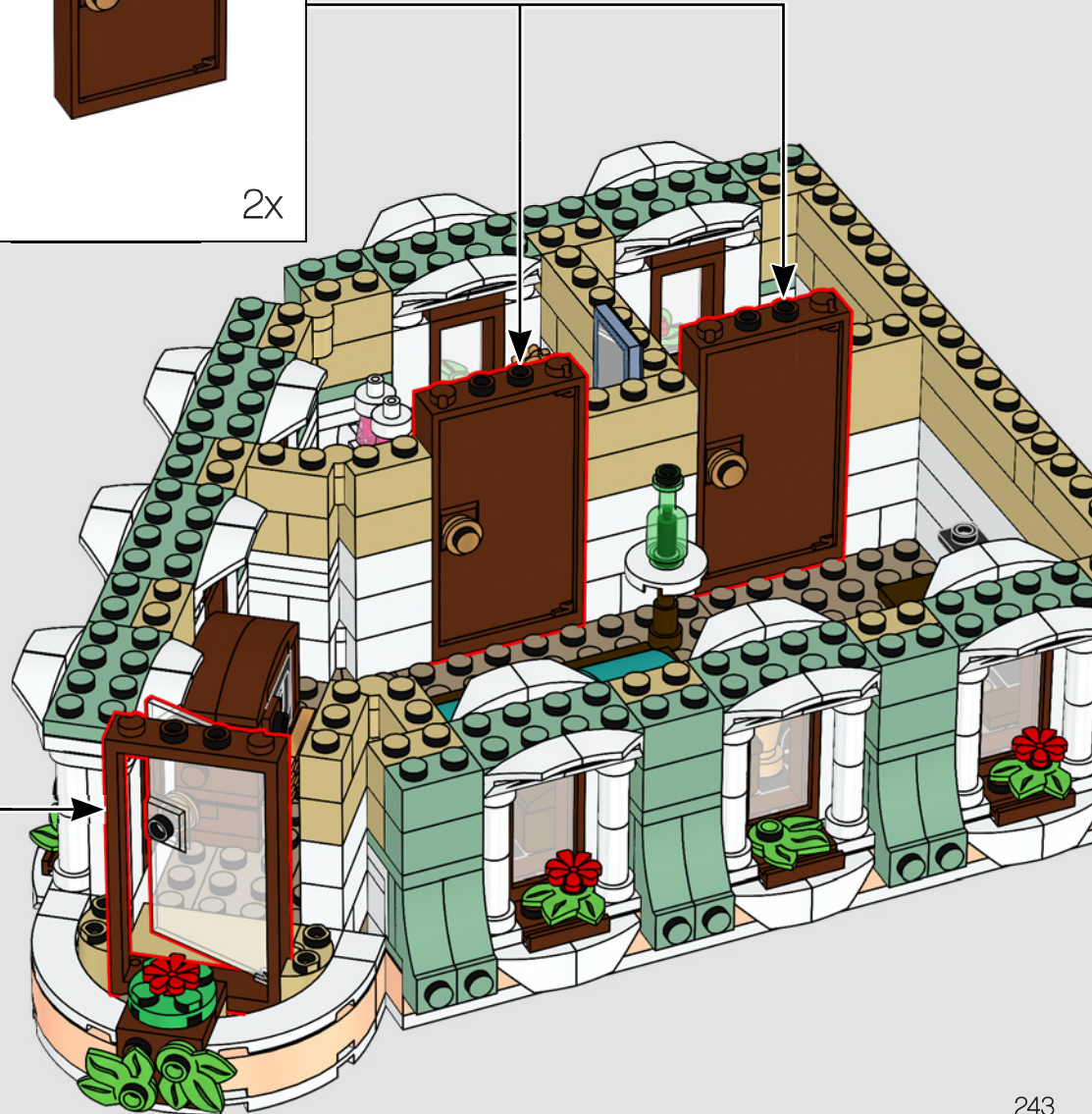
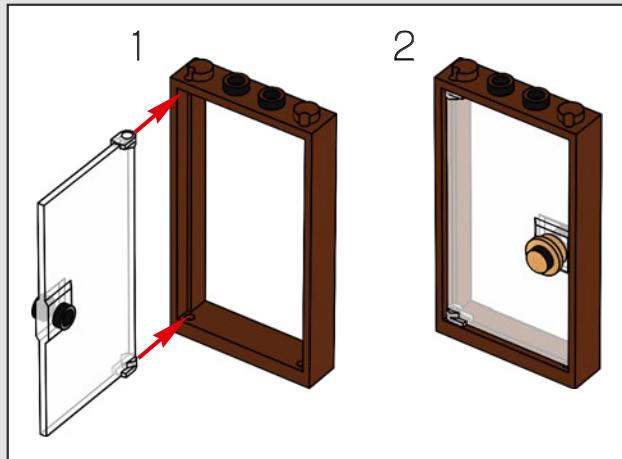
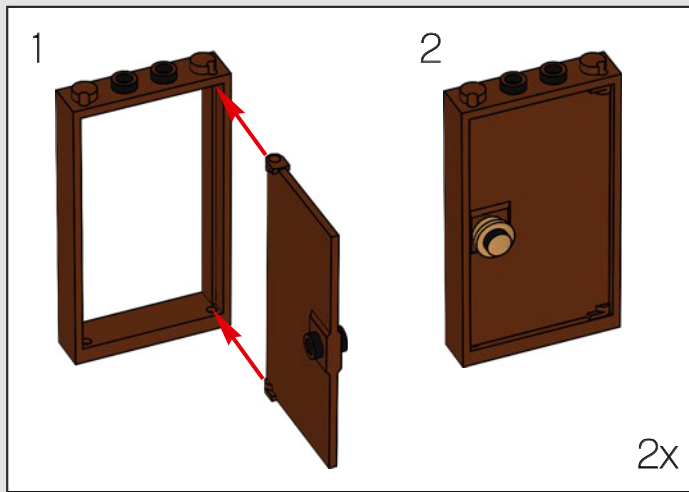

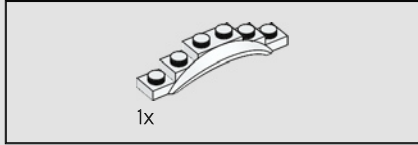
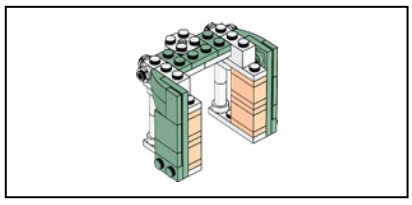

370

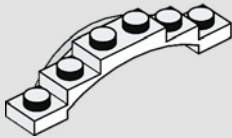

371

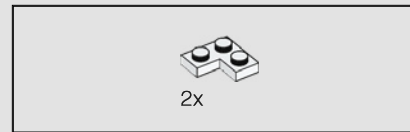
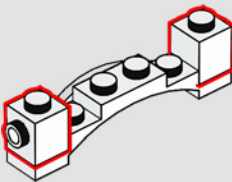

372

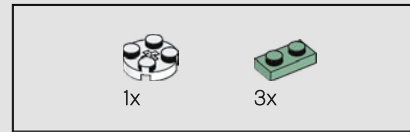
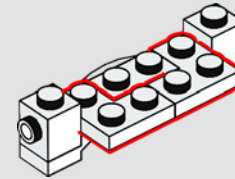

373

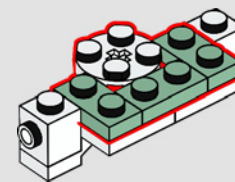



374

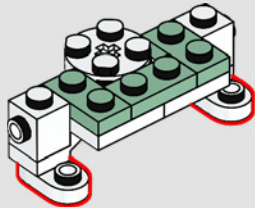

375

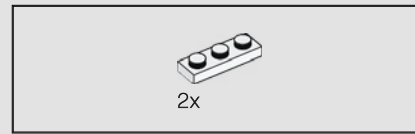
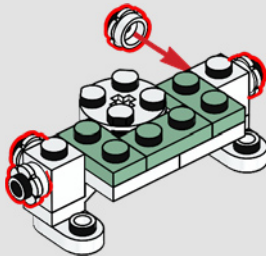

376

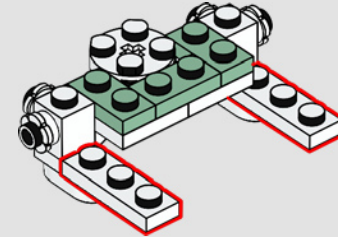

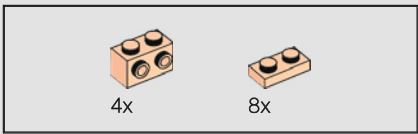

377

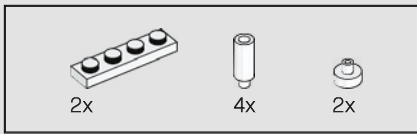
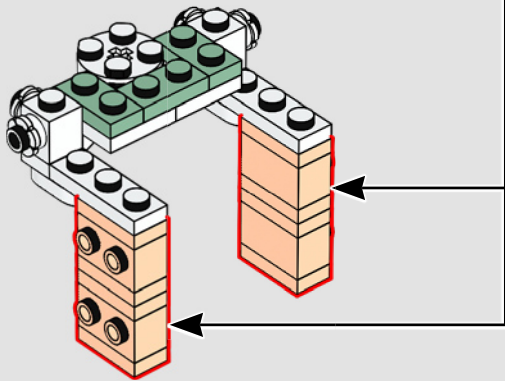
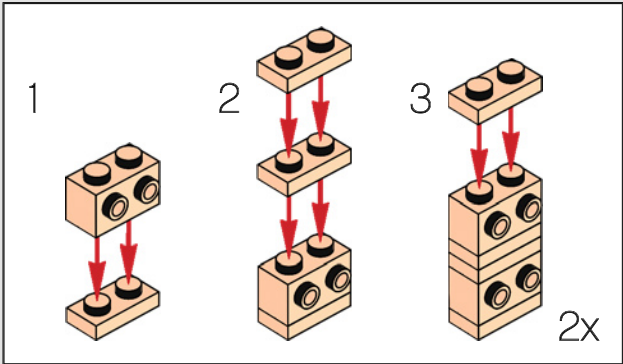

378

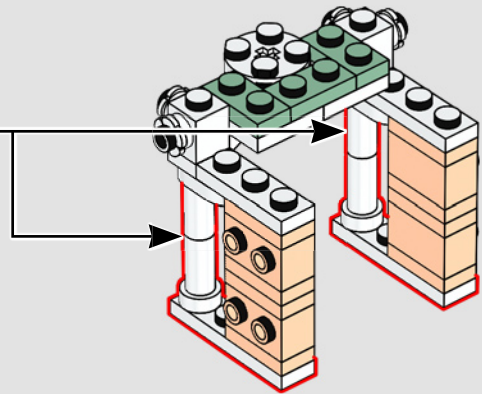
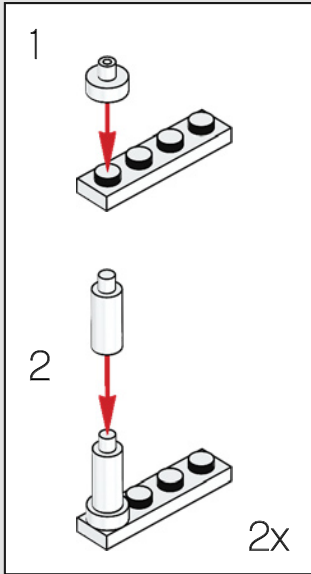

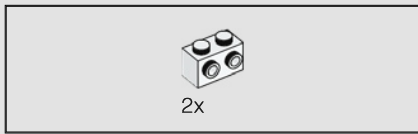

379

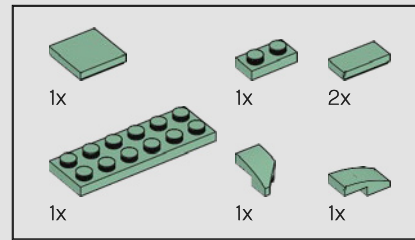
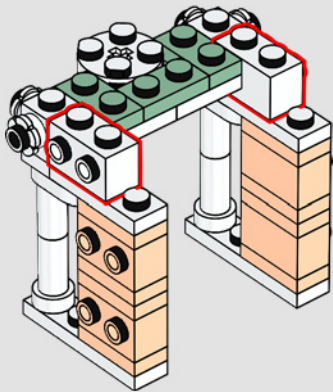

380

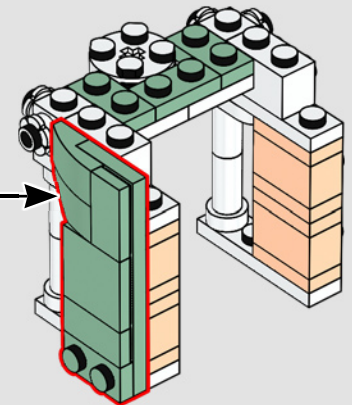
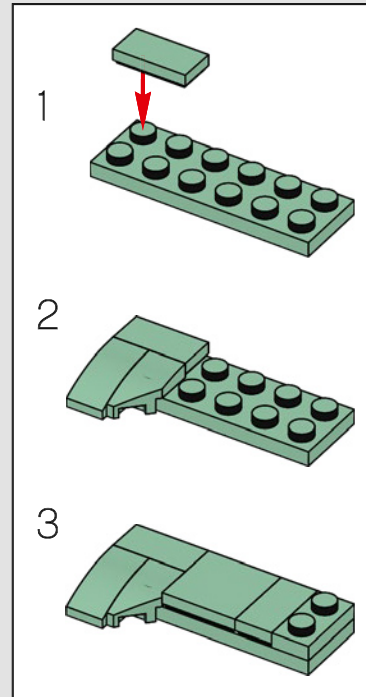

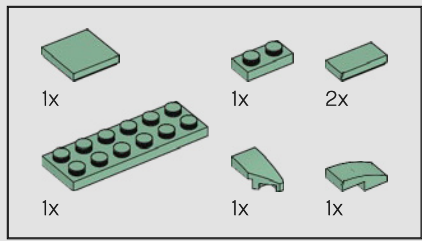

381

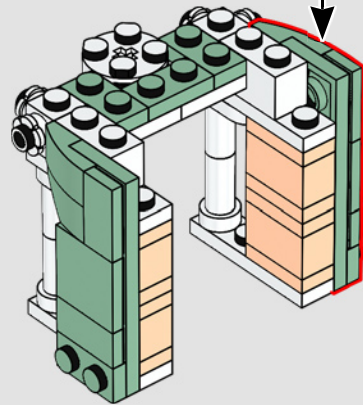
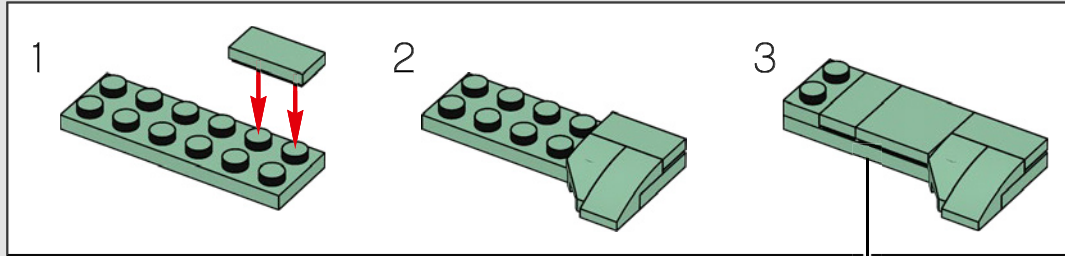



382



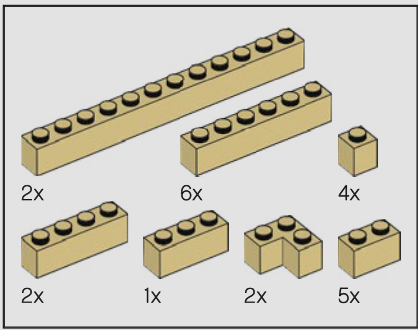

383

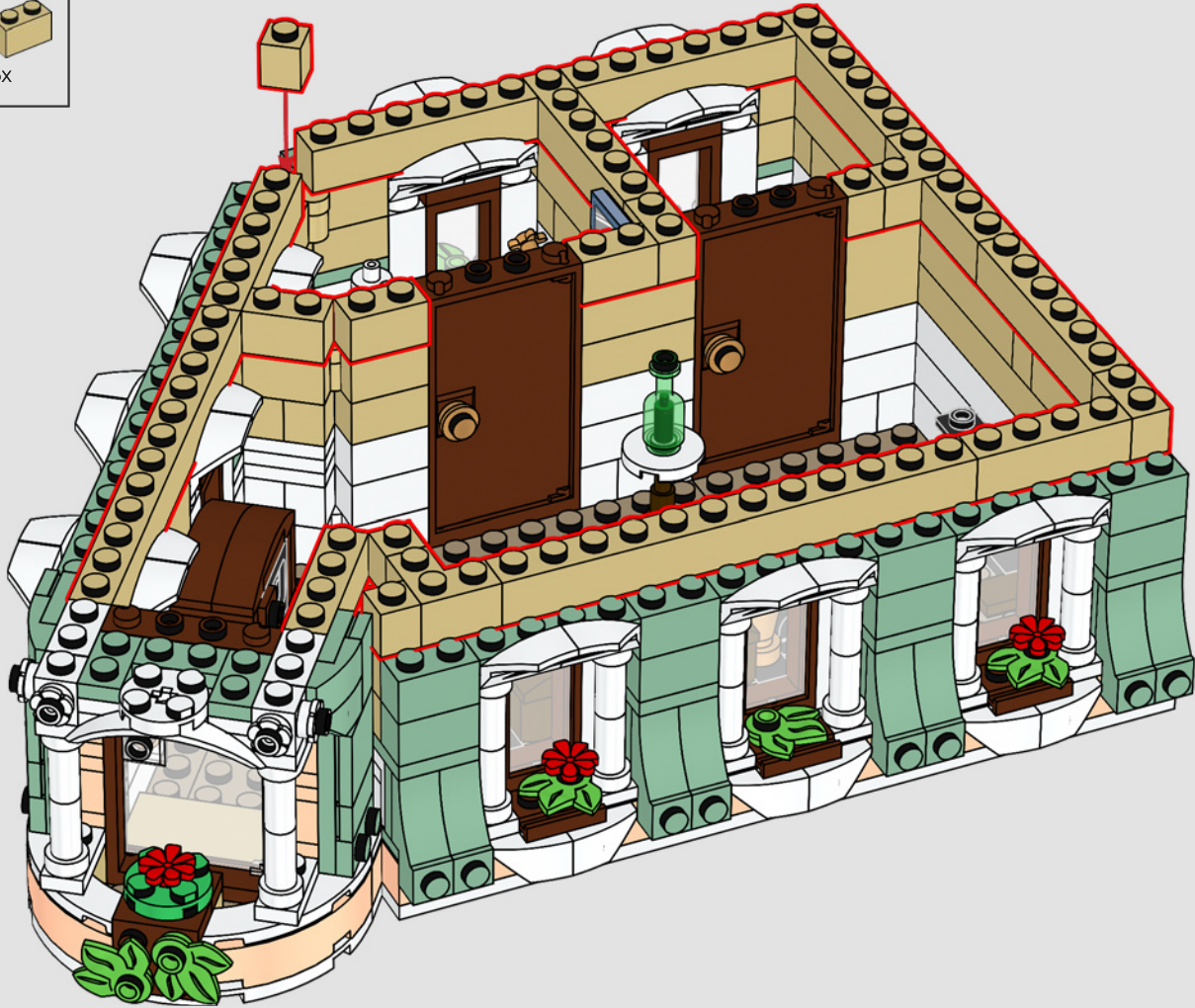

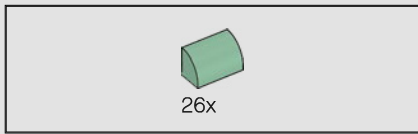

384



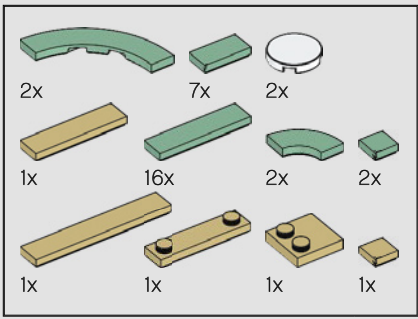

385

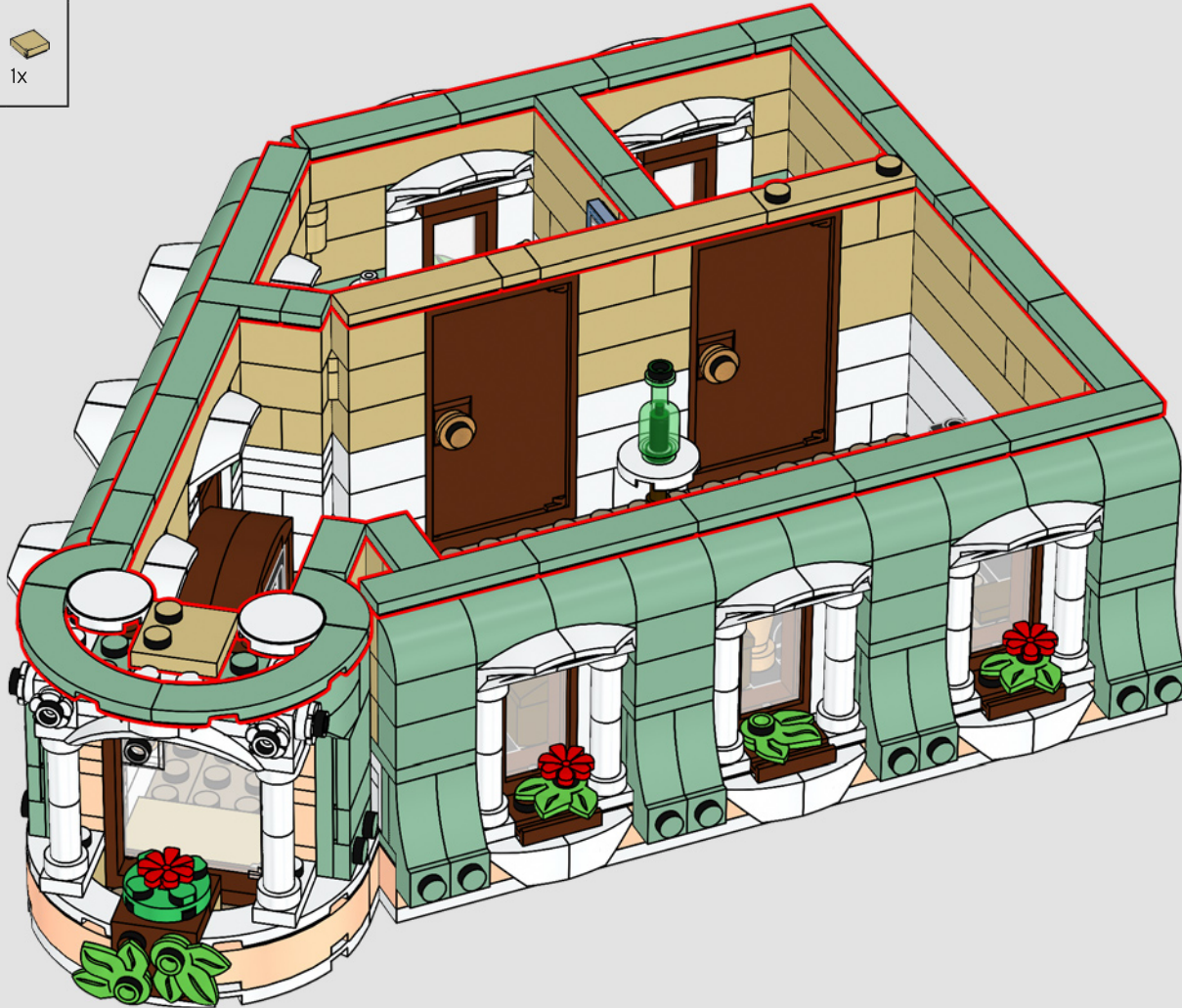

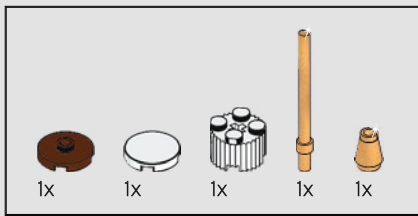

386

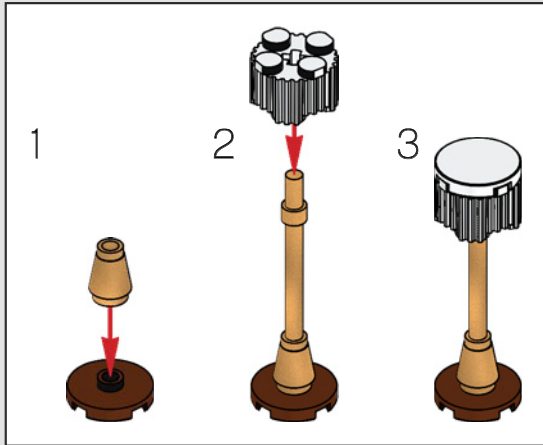

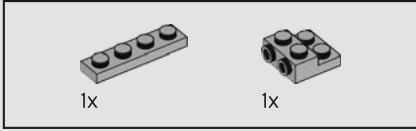
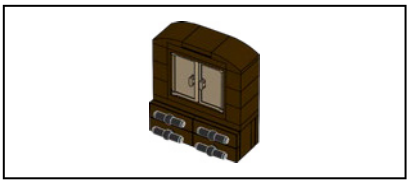

387

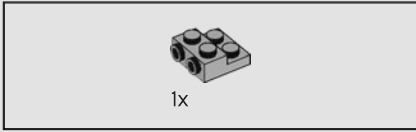
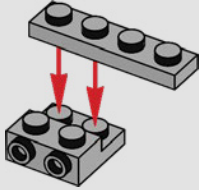

388

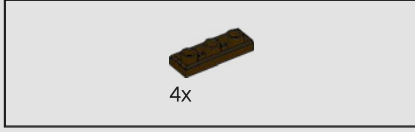
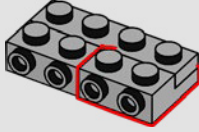

389

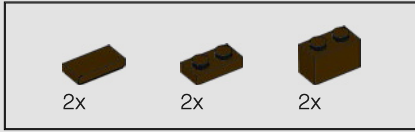
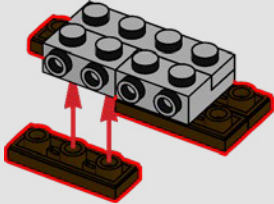

390

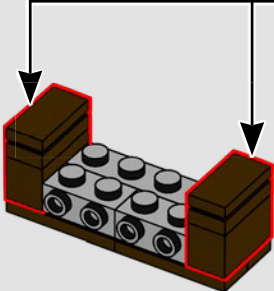
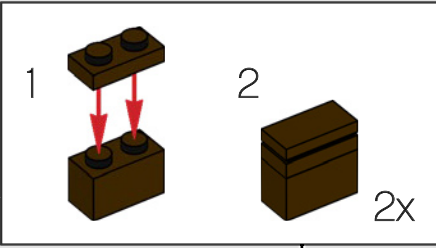

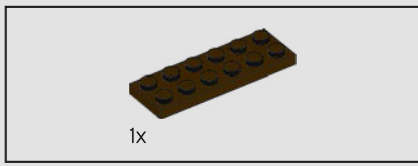

391

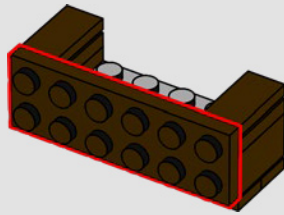

392

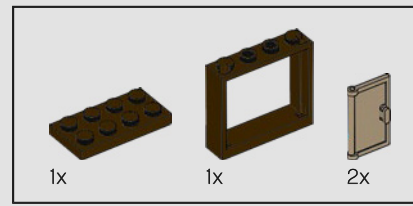
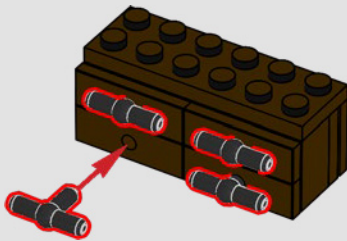

393

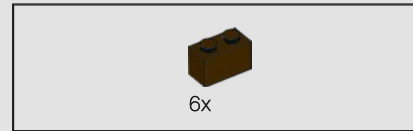
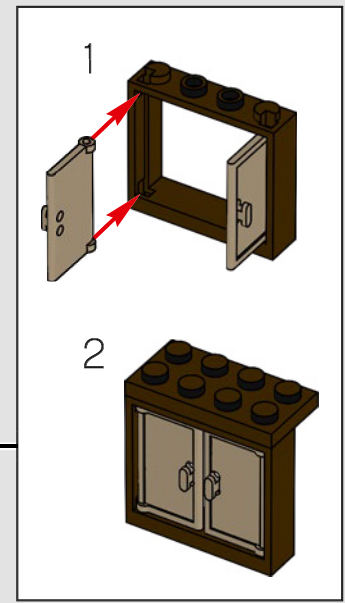
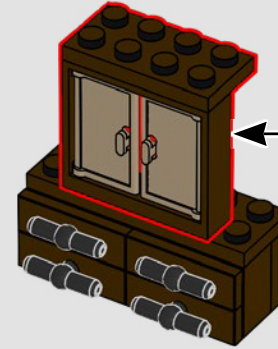

394

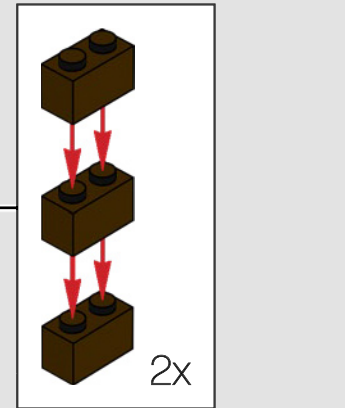
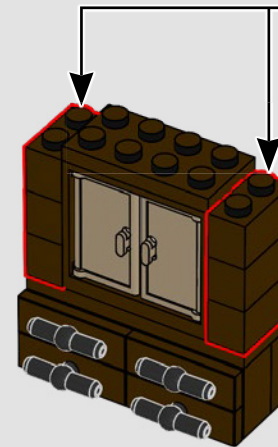

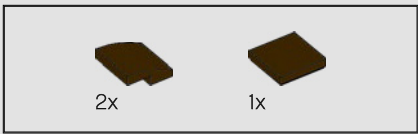

395

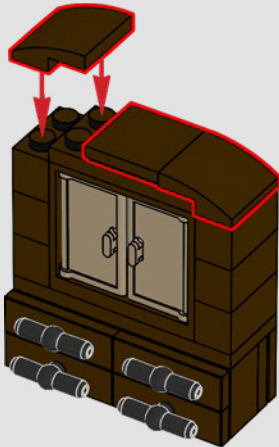

396





397

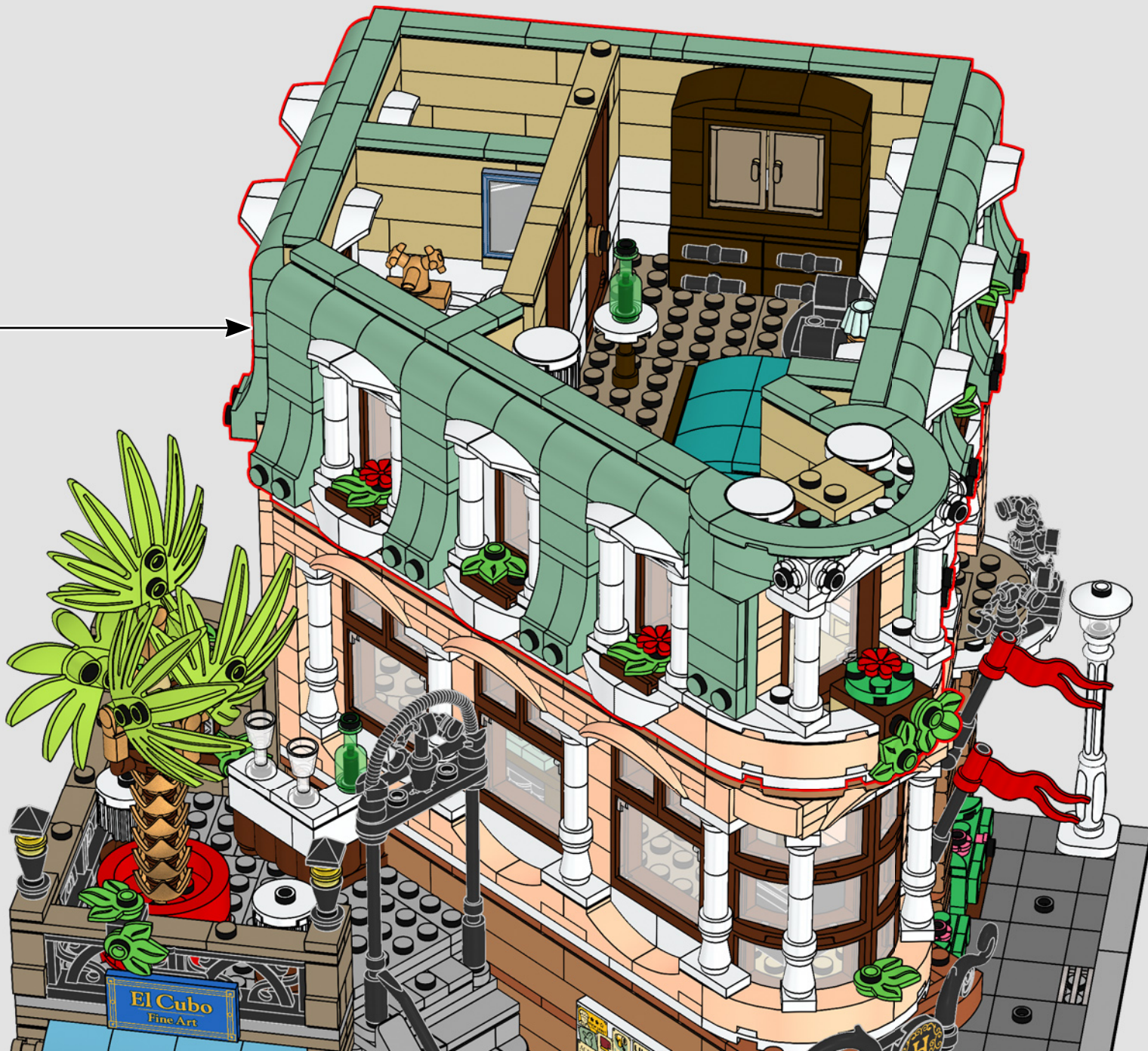

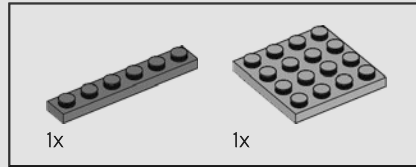
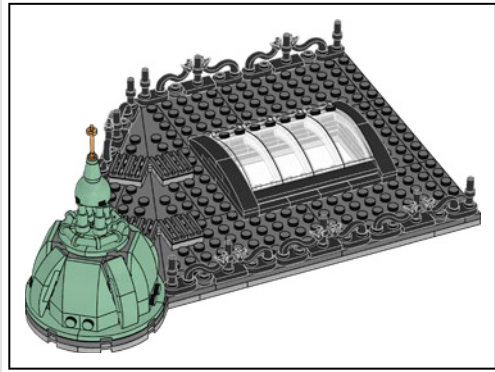
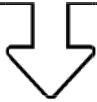

398

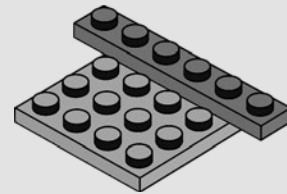

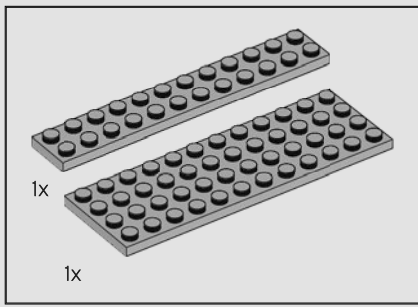

399

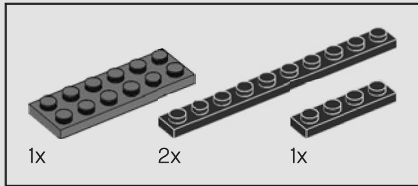
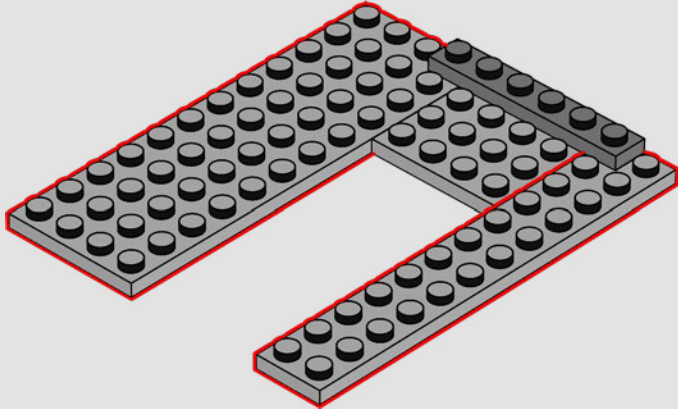

400

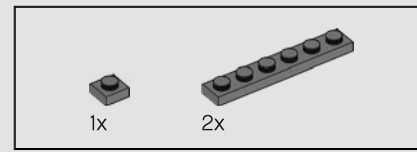
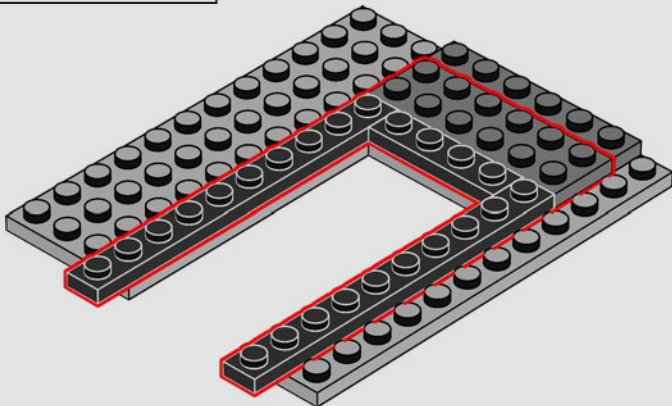

401

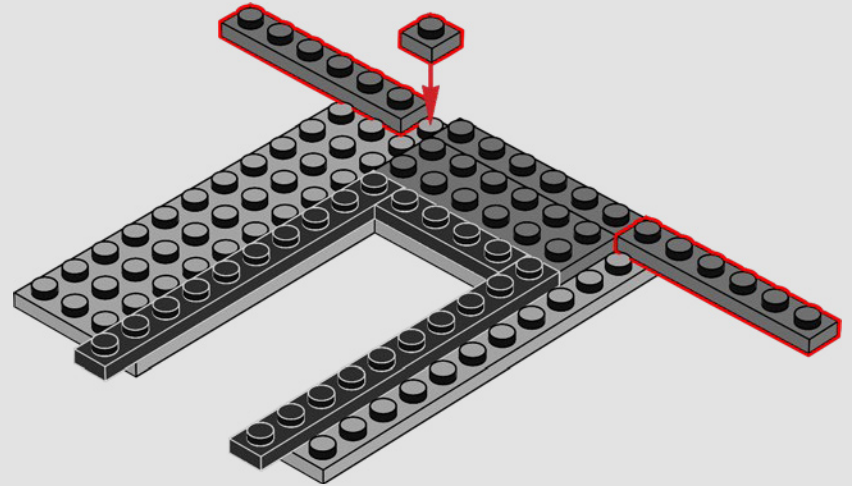

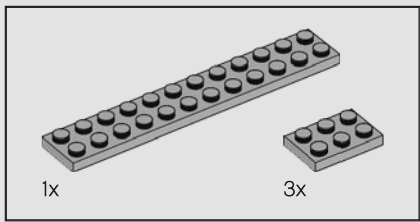

402

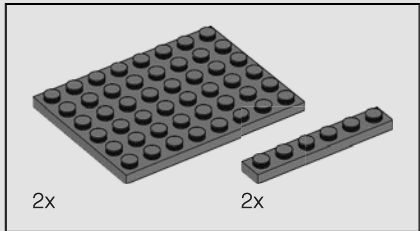
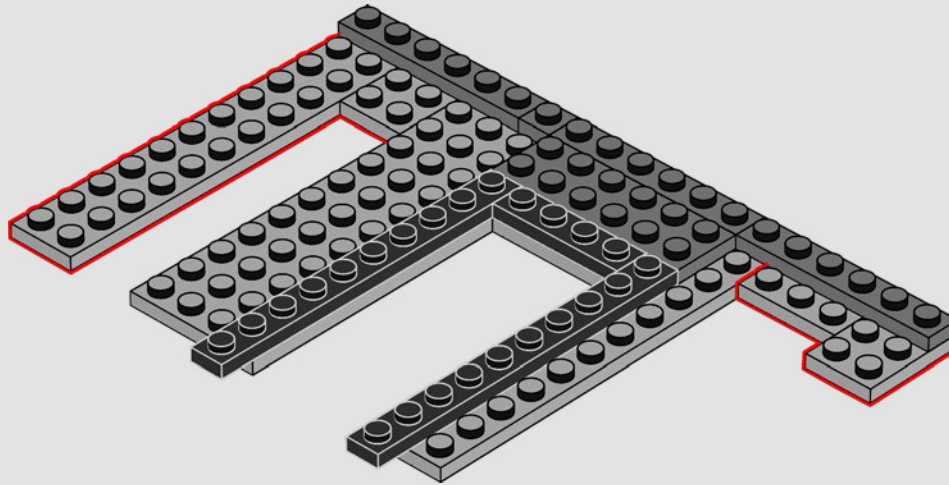

403

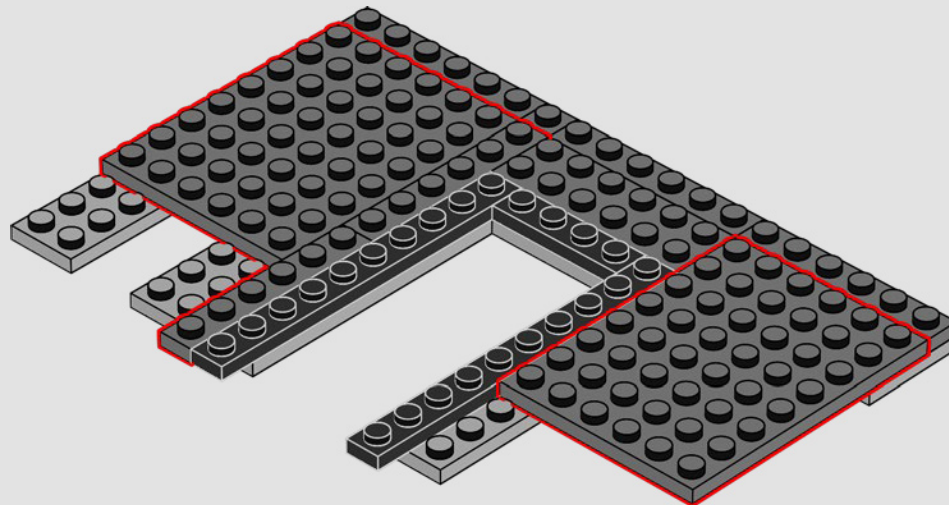

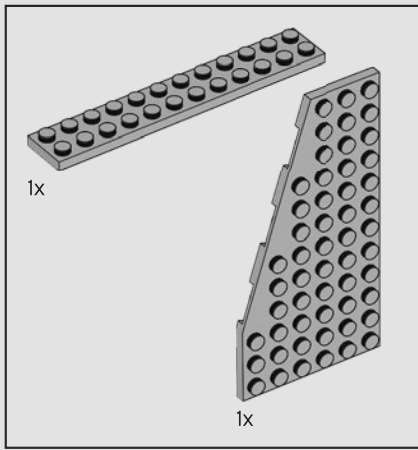

404

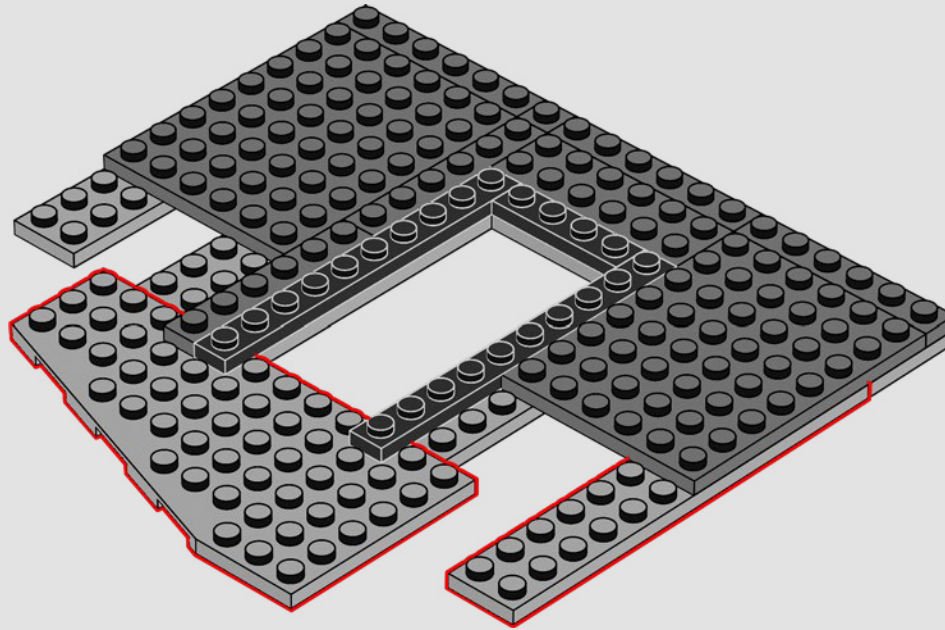

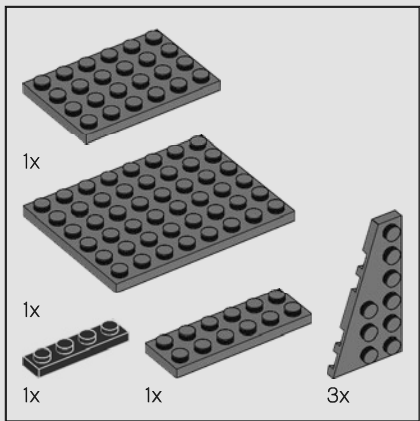

405

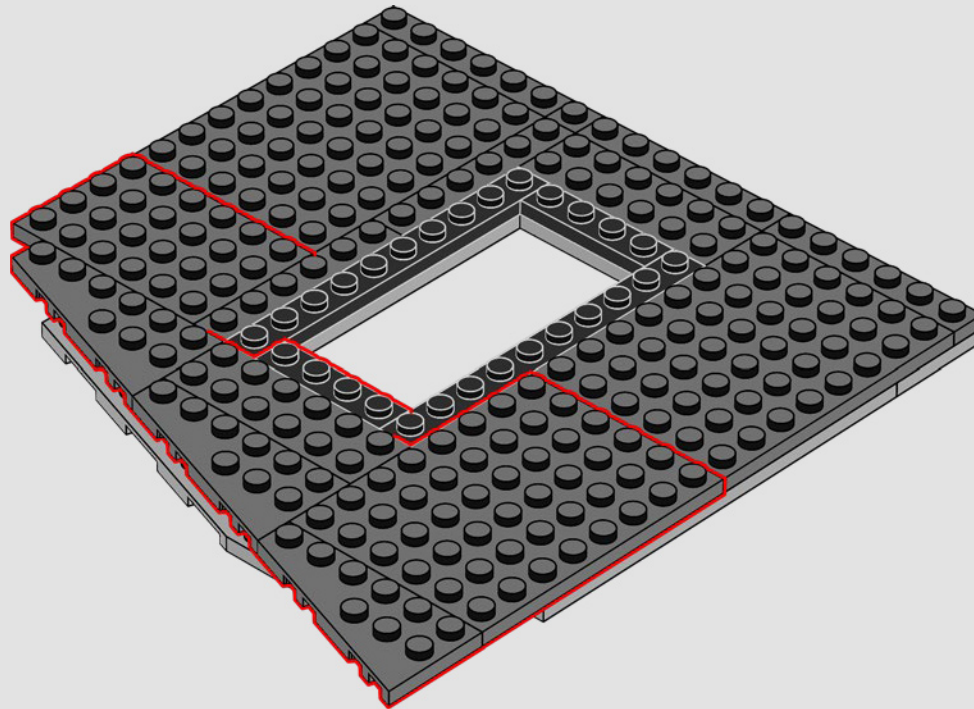

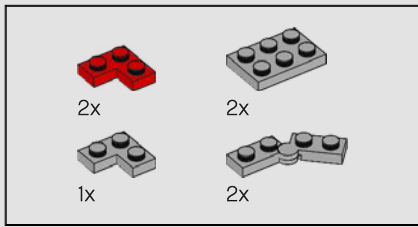

406

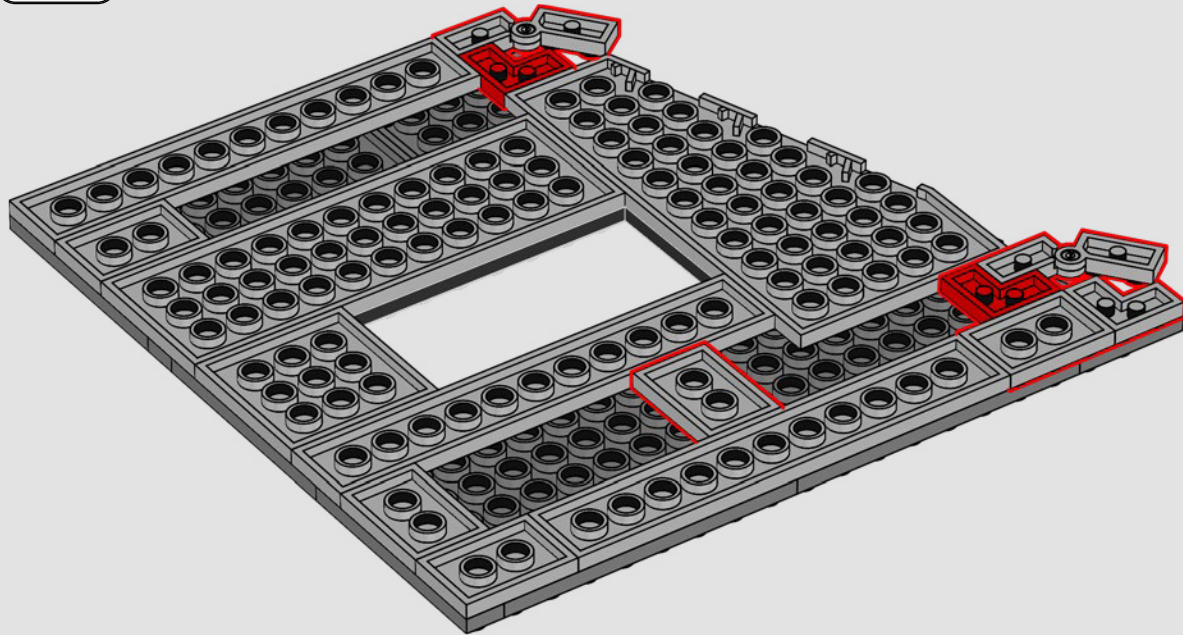



1x

407

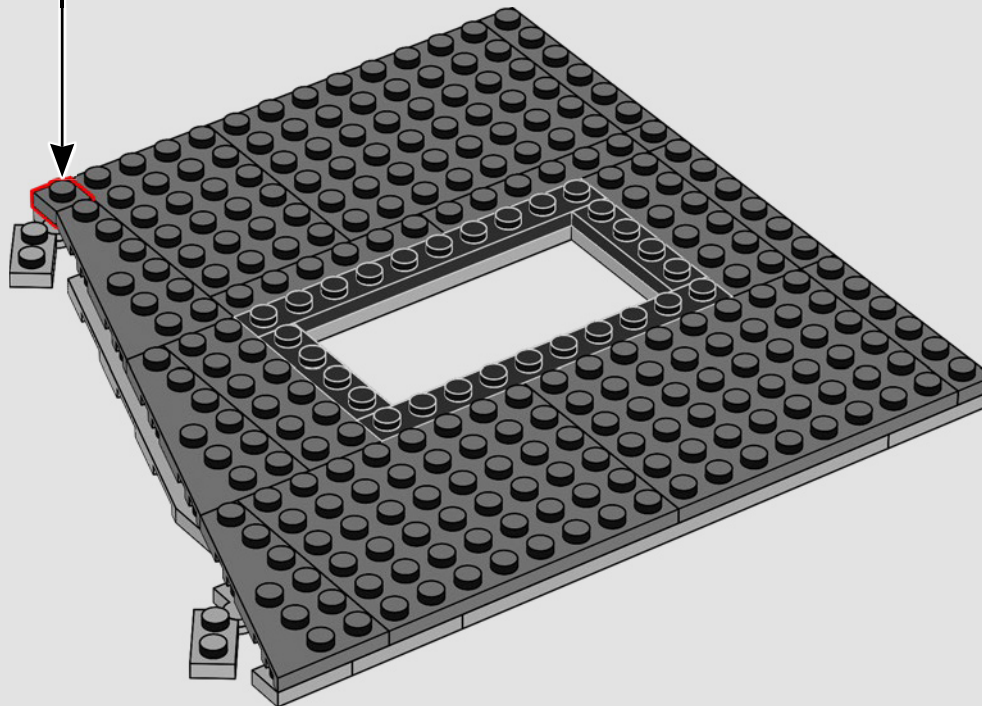
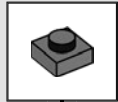



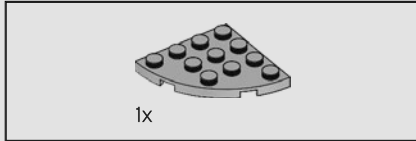
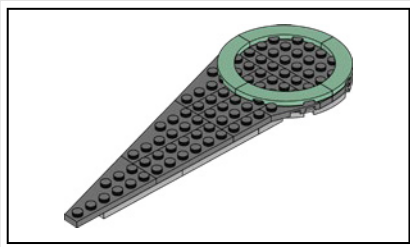

408

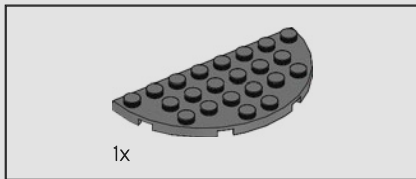
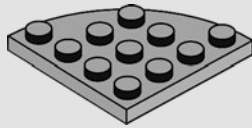

409

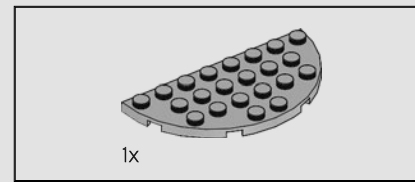
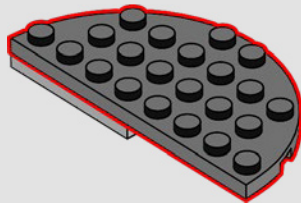

410

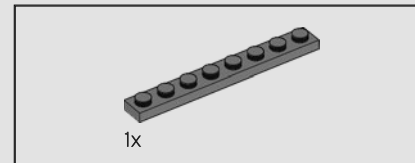
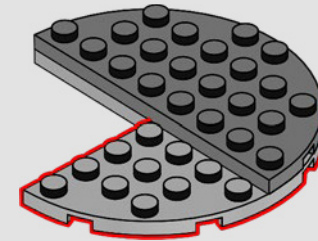

411

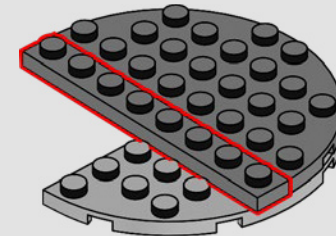

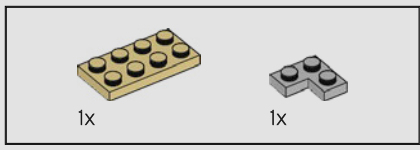

412

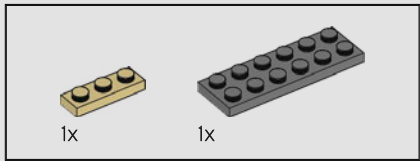
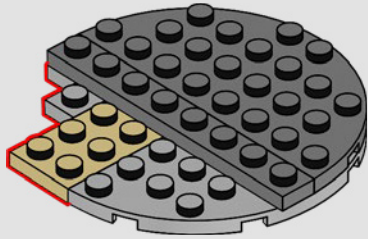

413

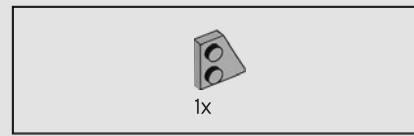
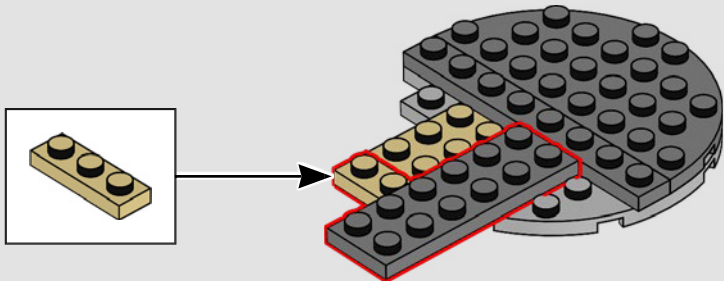

414

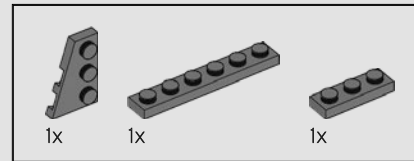
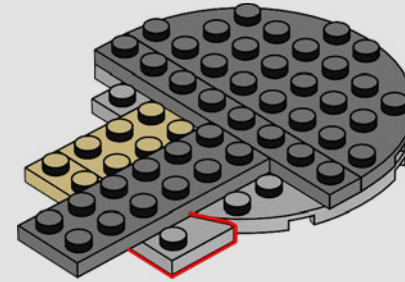

415

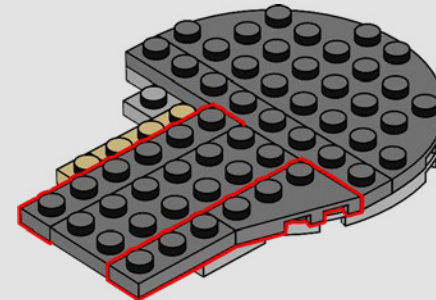

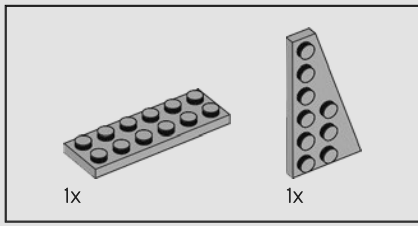

416

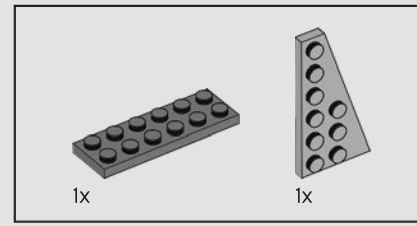
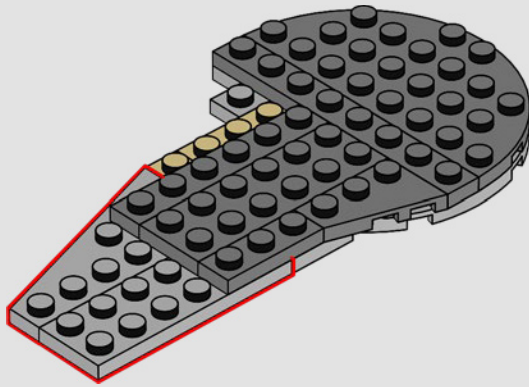

417

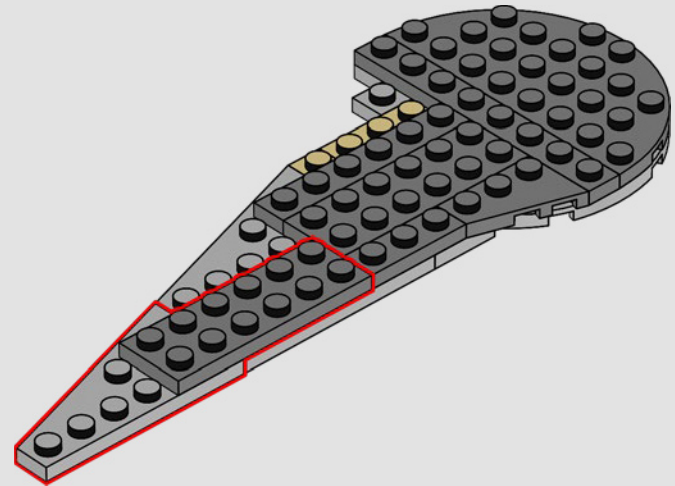

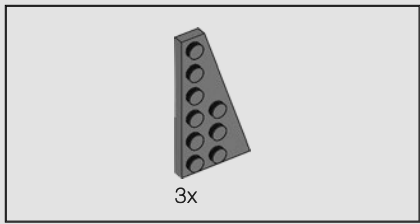

418

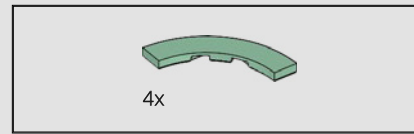
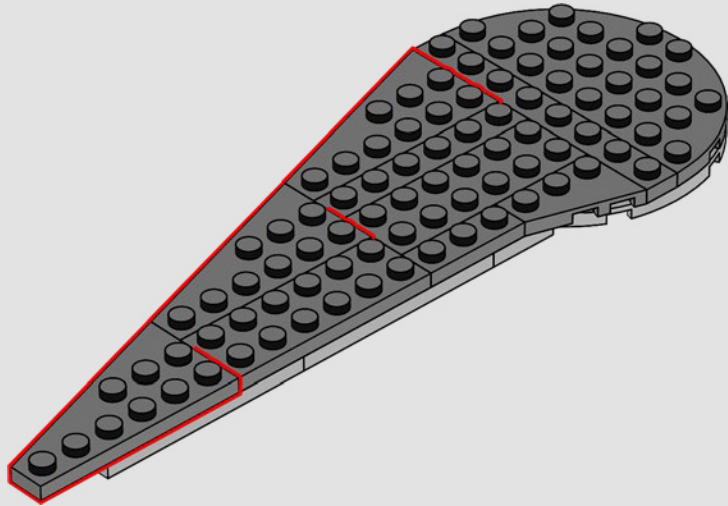

419

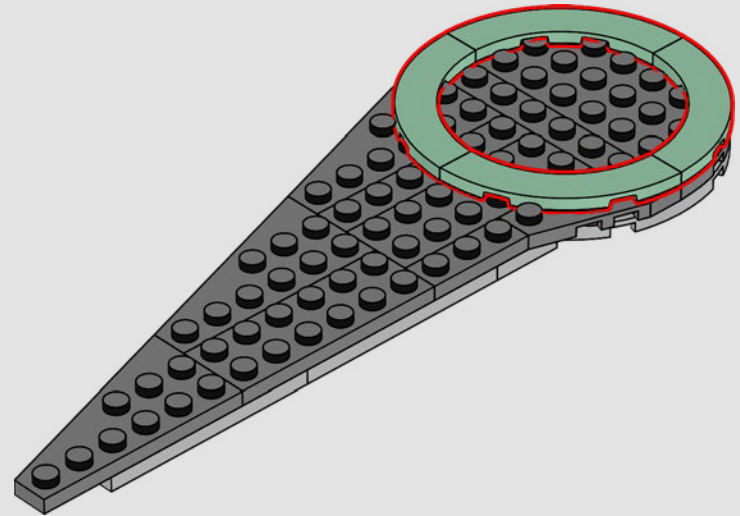

420

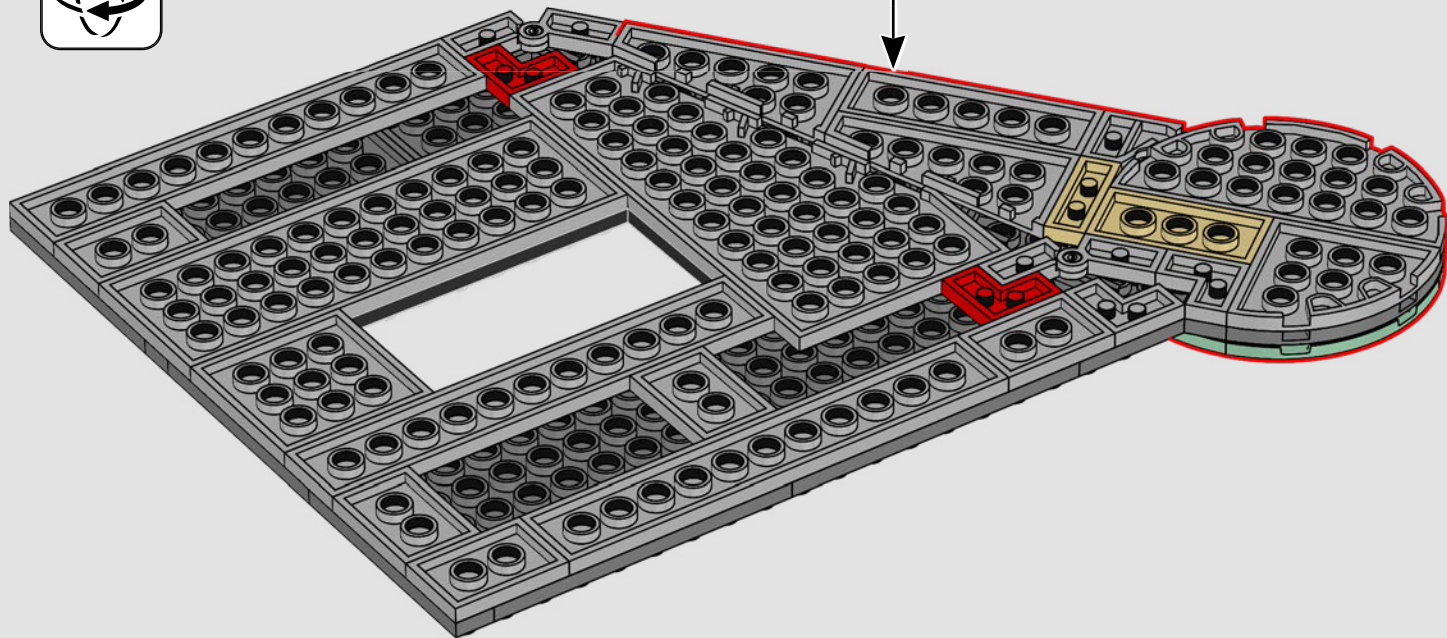



421

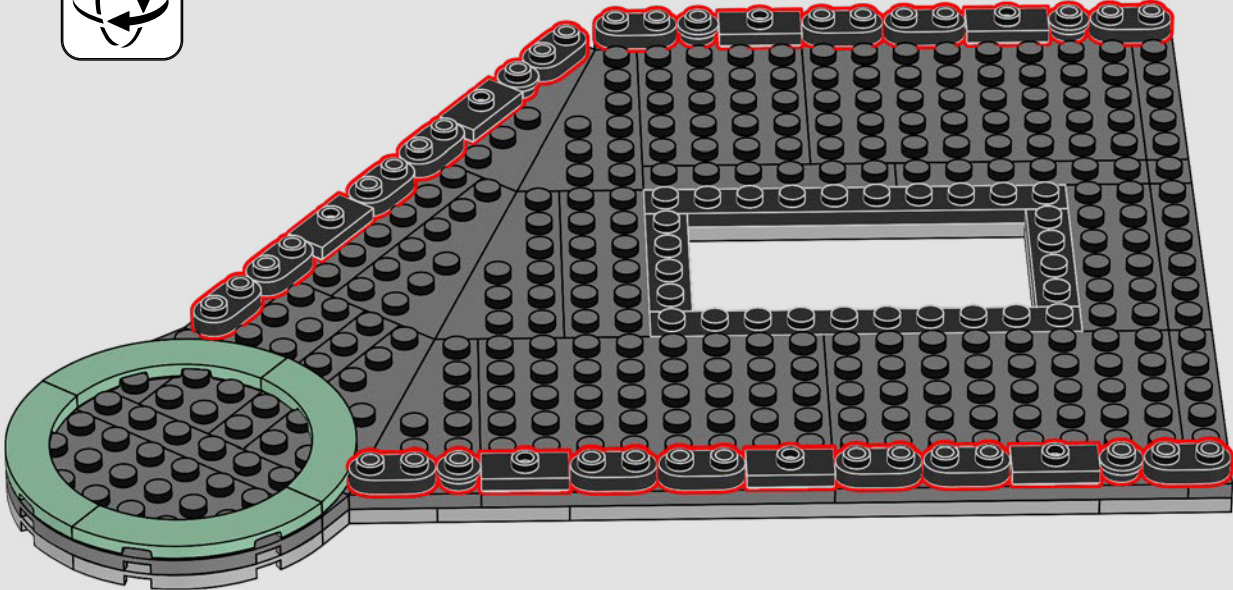

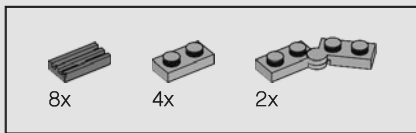

422

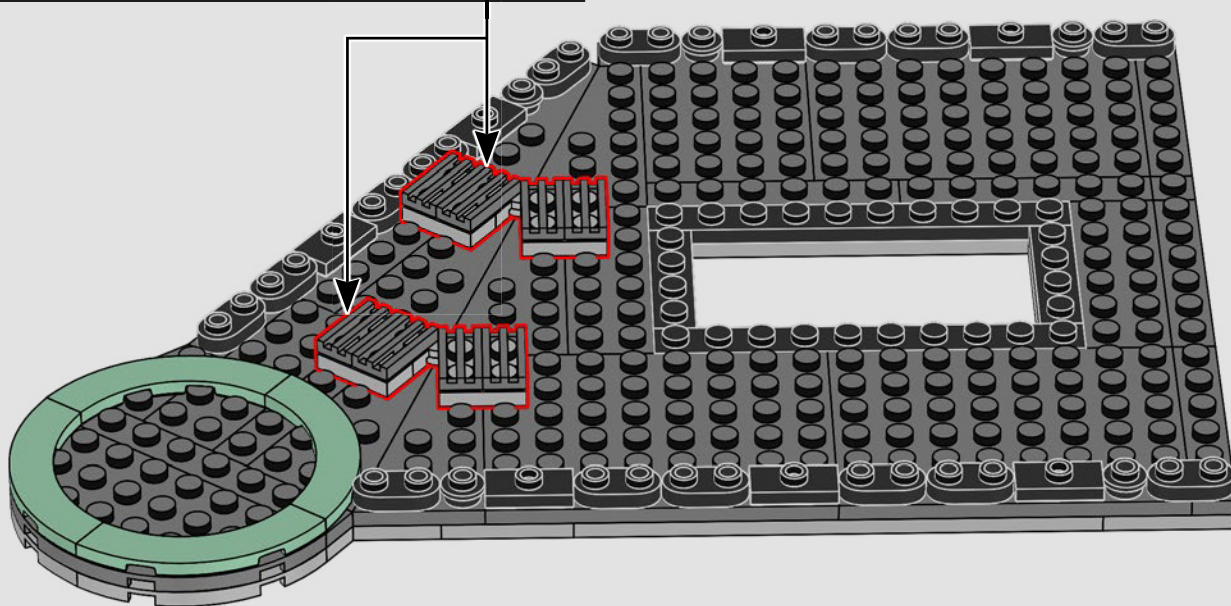
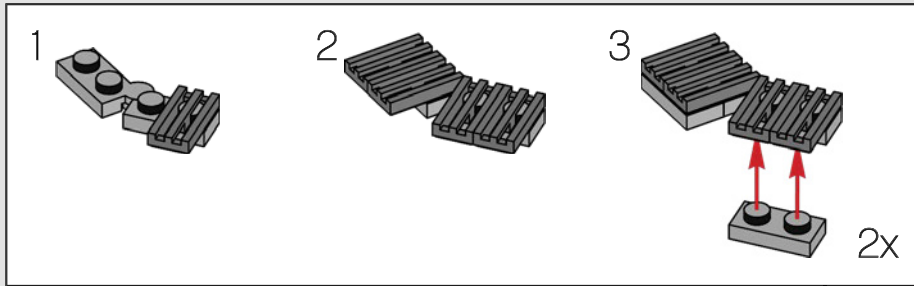



12x

423

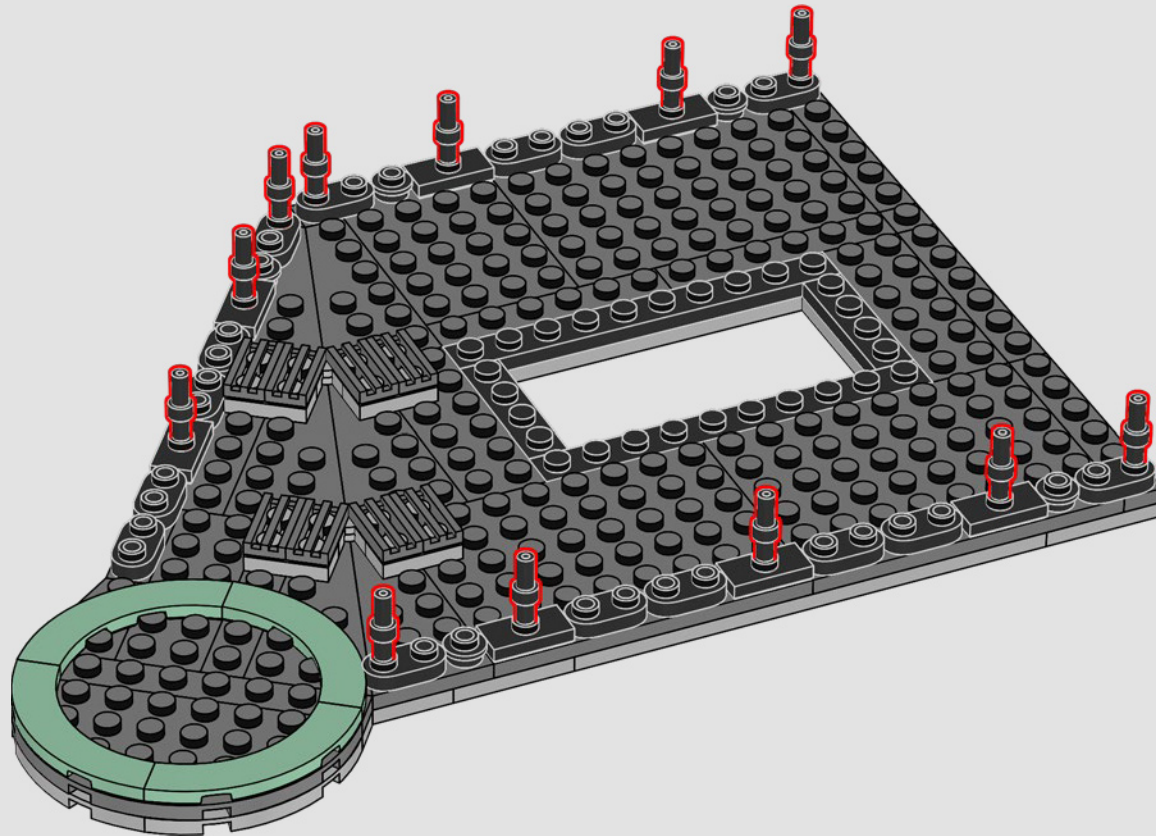





424



用来制作这种弯曲的熟铁细节的元件首次出现在幻影忍者系列套装中, 用作蛇头。

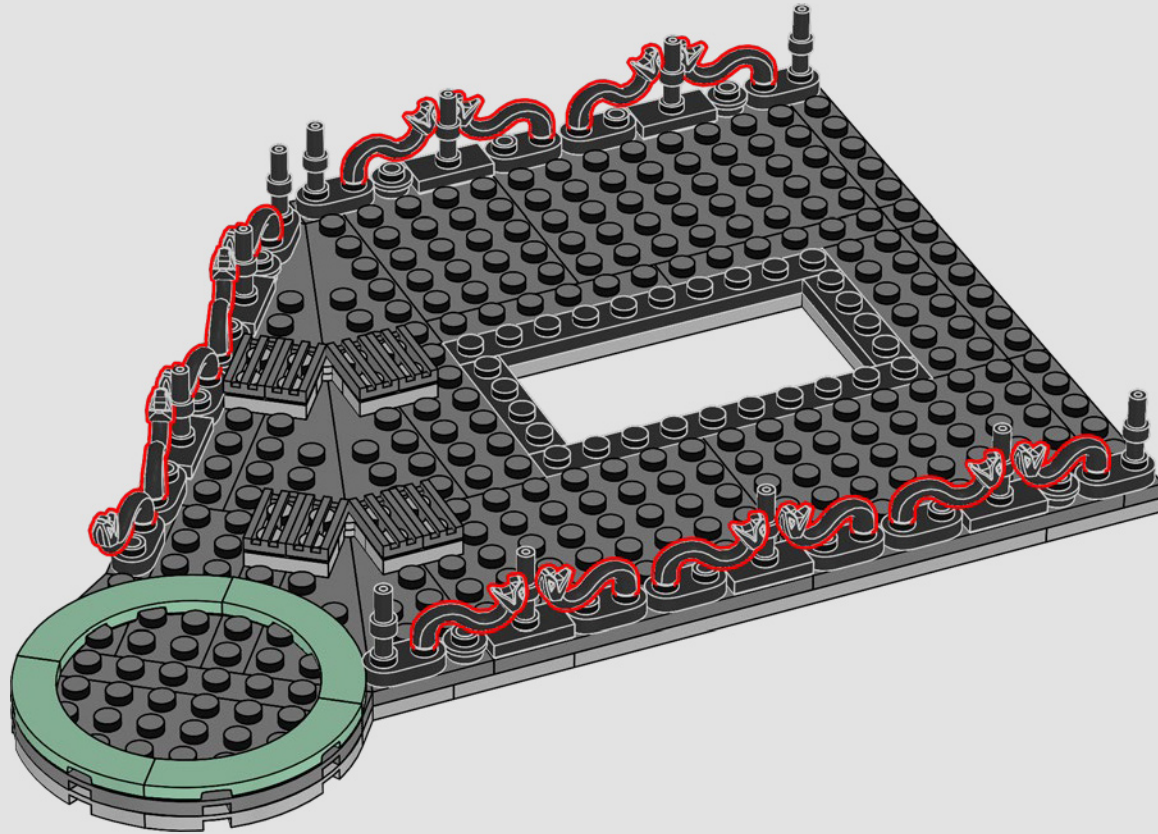

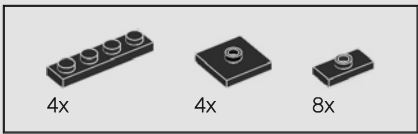

425

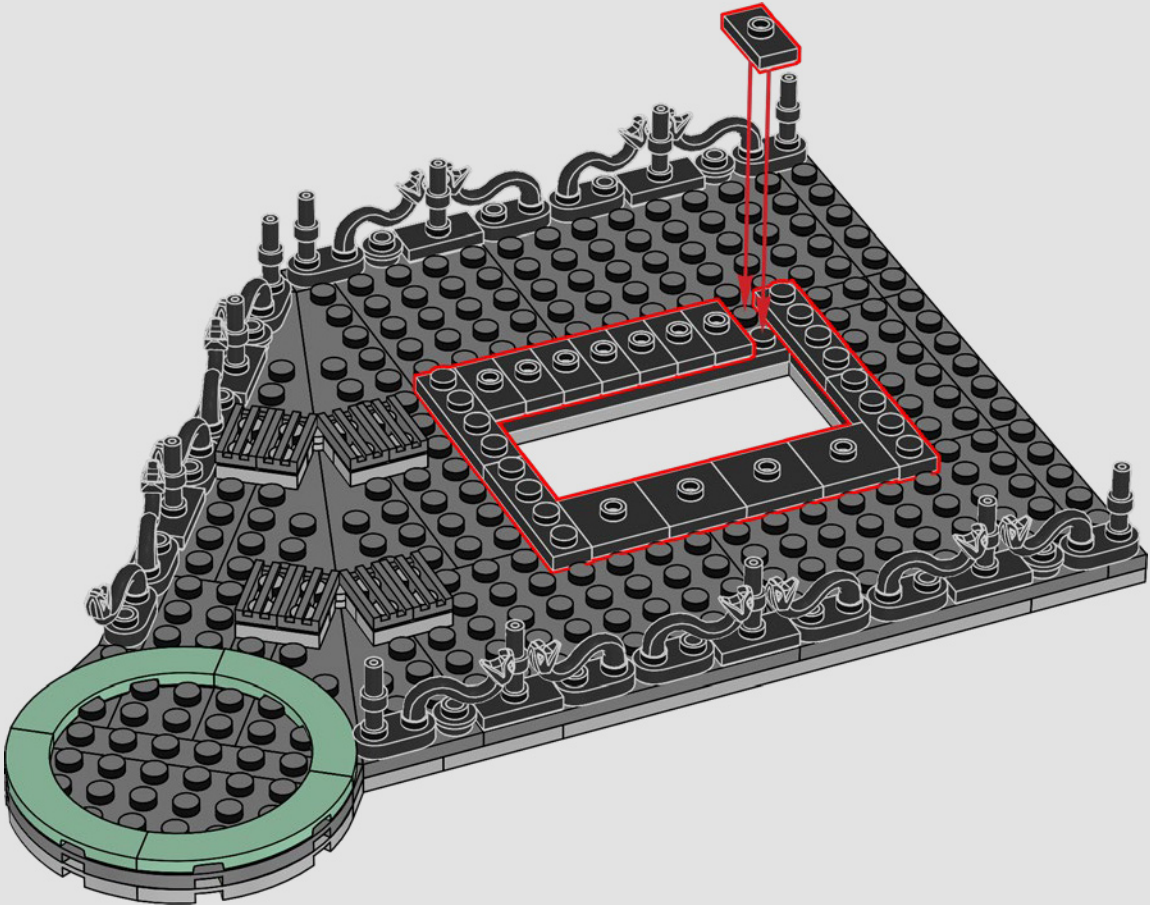

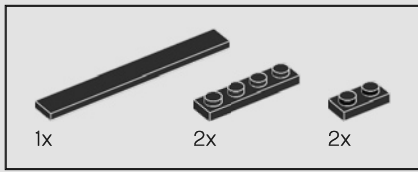

426

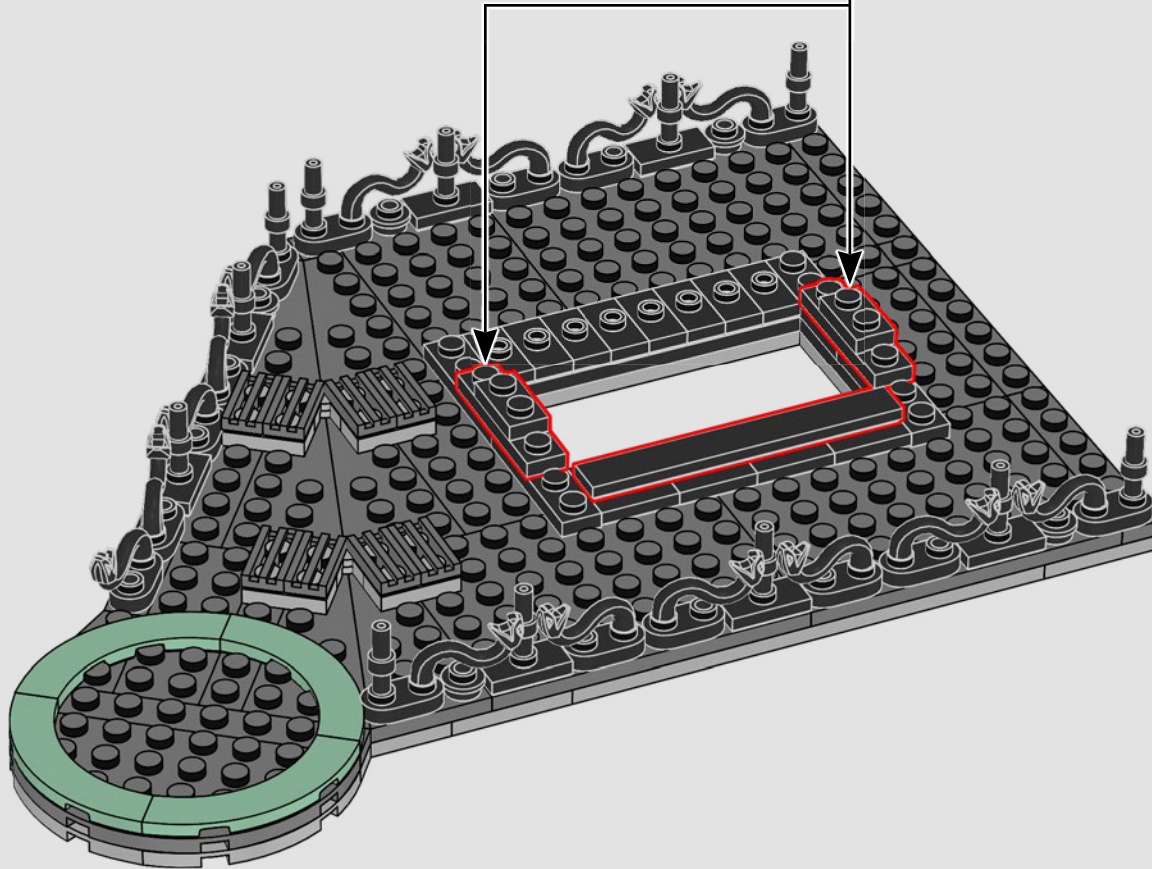
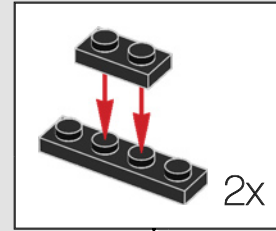



427

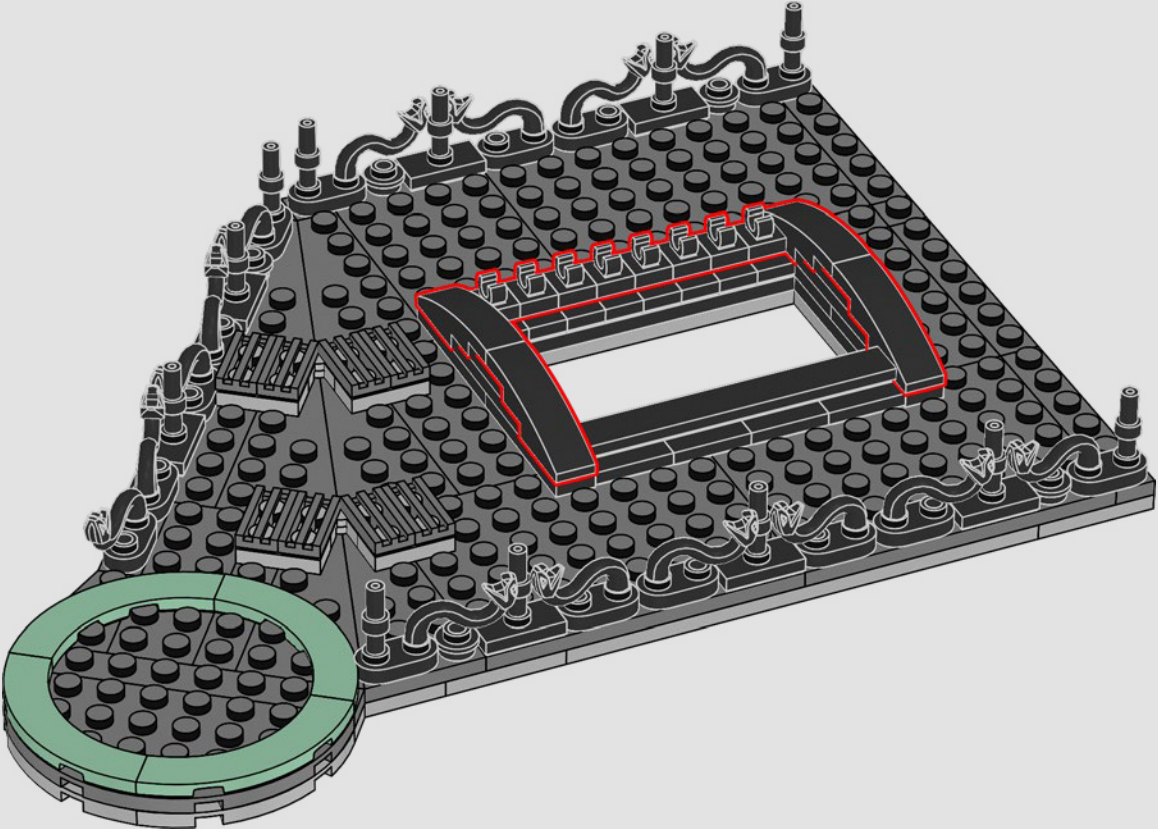

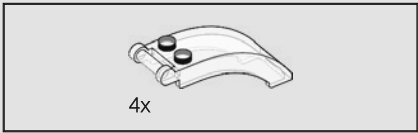

428

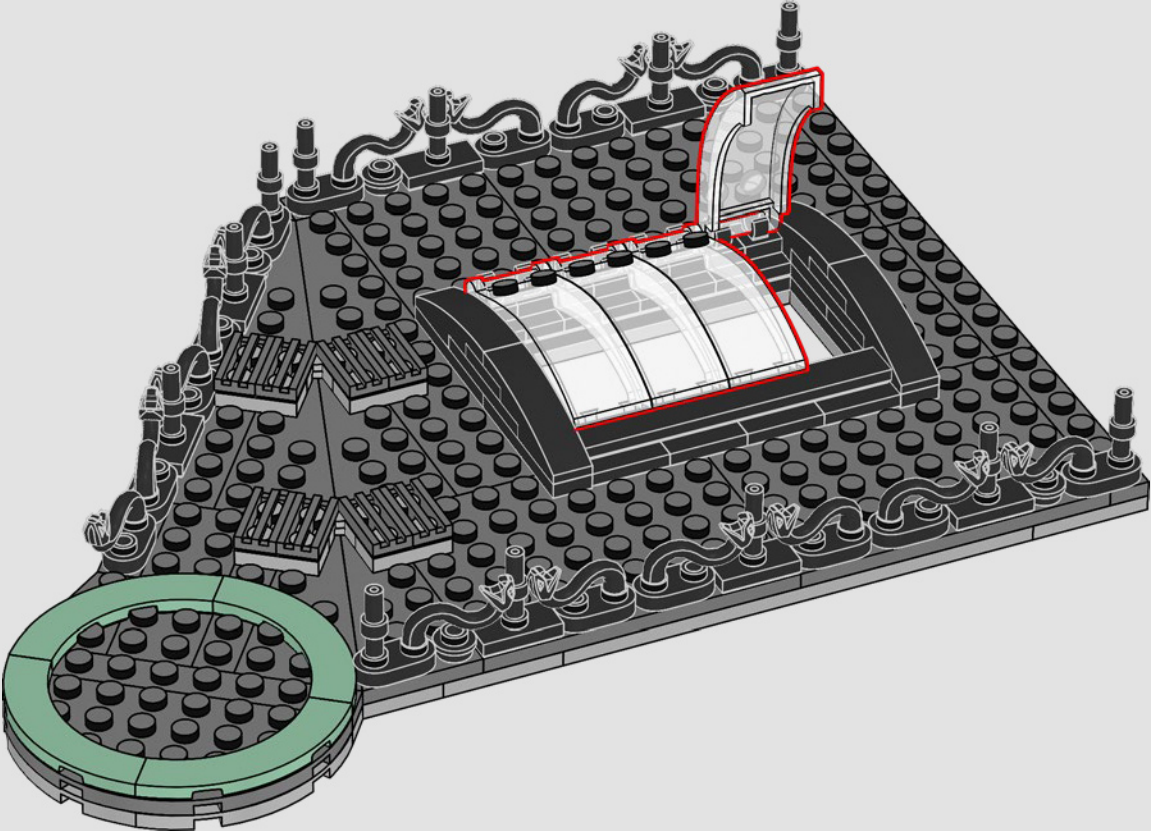

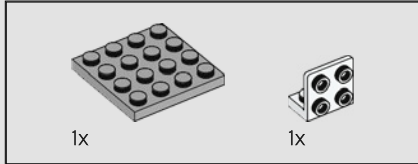
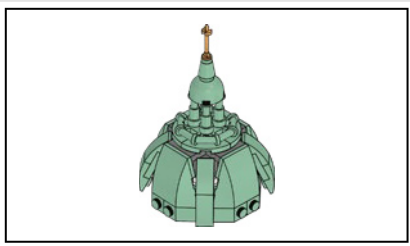

429

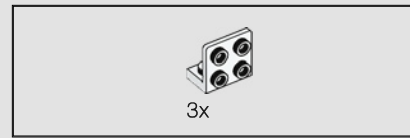
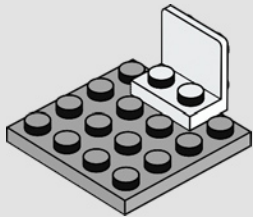

430

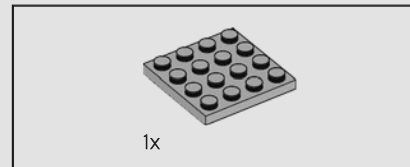
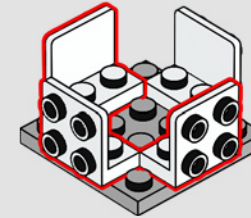

431

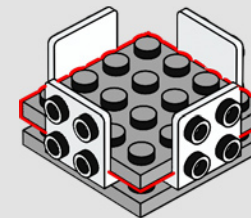

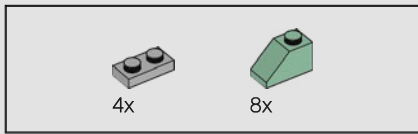

432

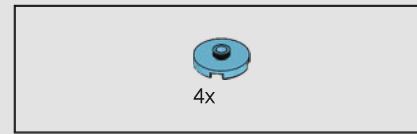
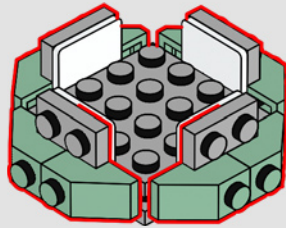

433

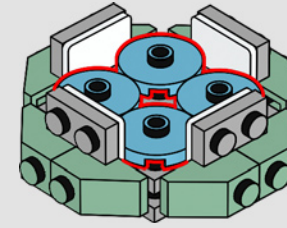

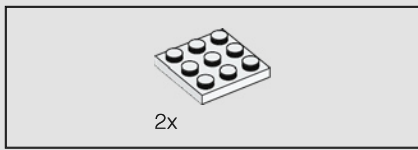

434

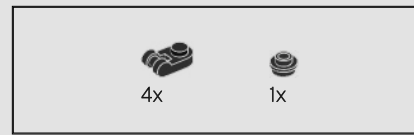
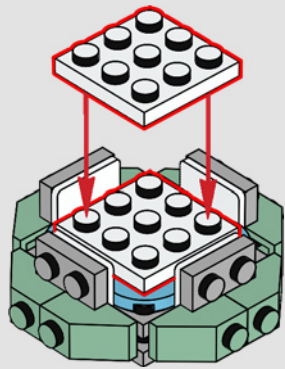

435

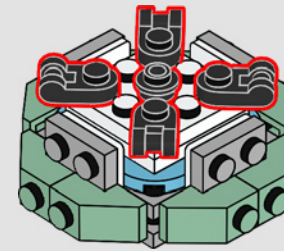



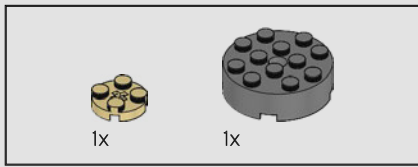

436

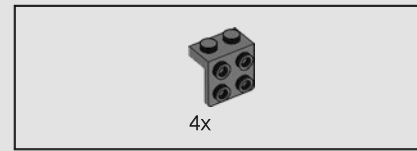
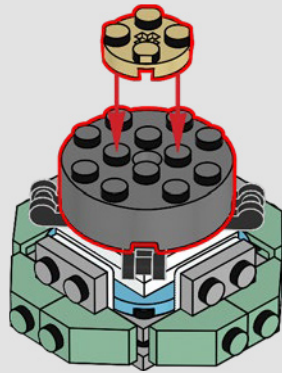

437

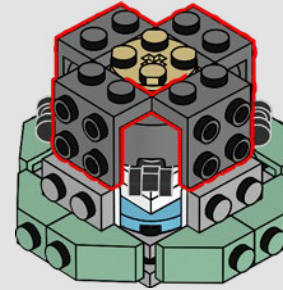

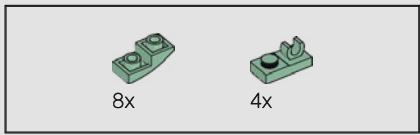

438

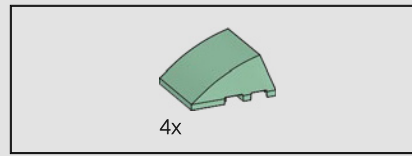
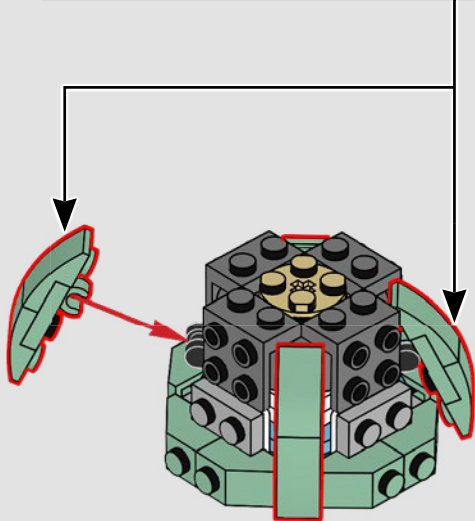
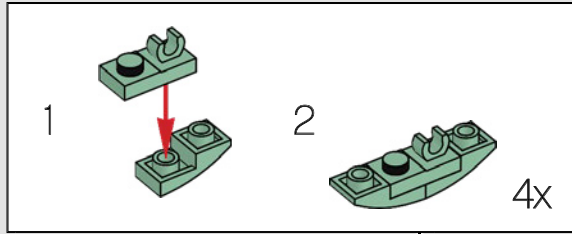

439

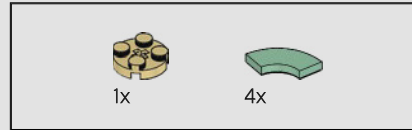
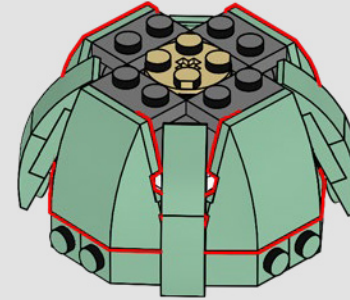

440

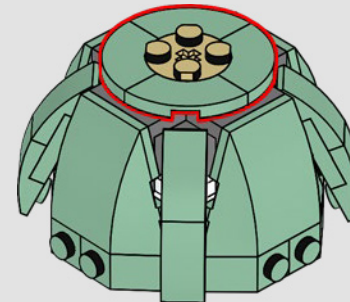

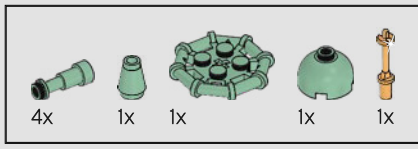

441

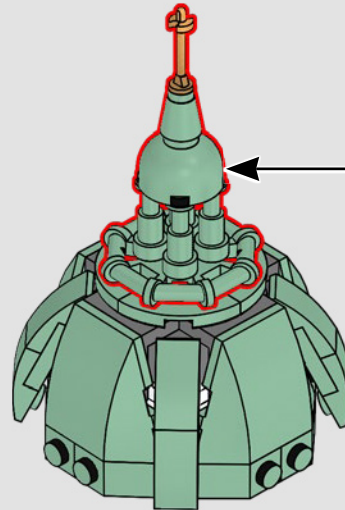
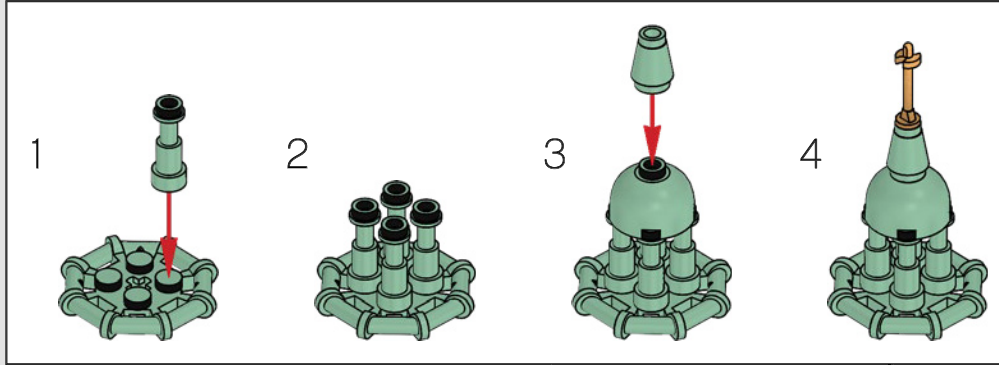

442

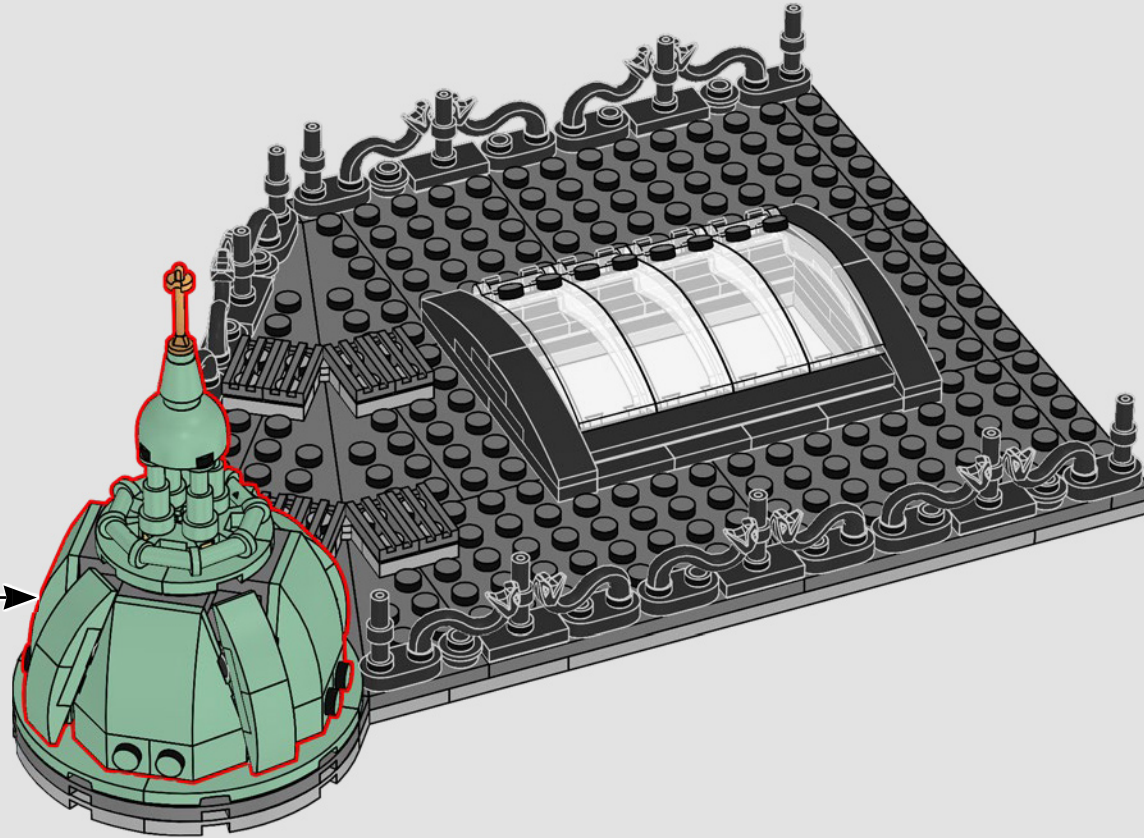

443

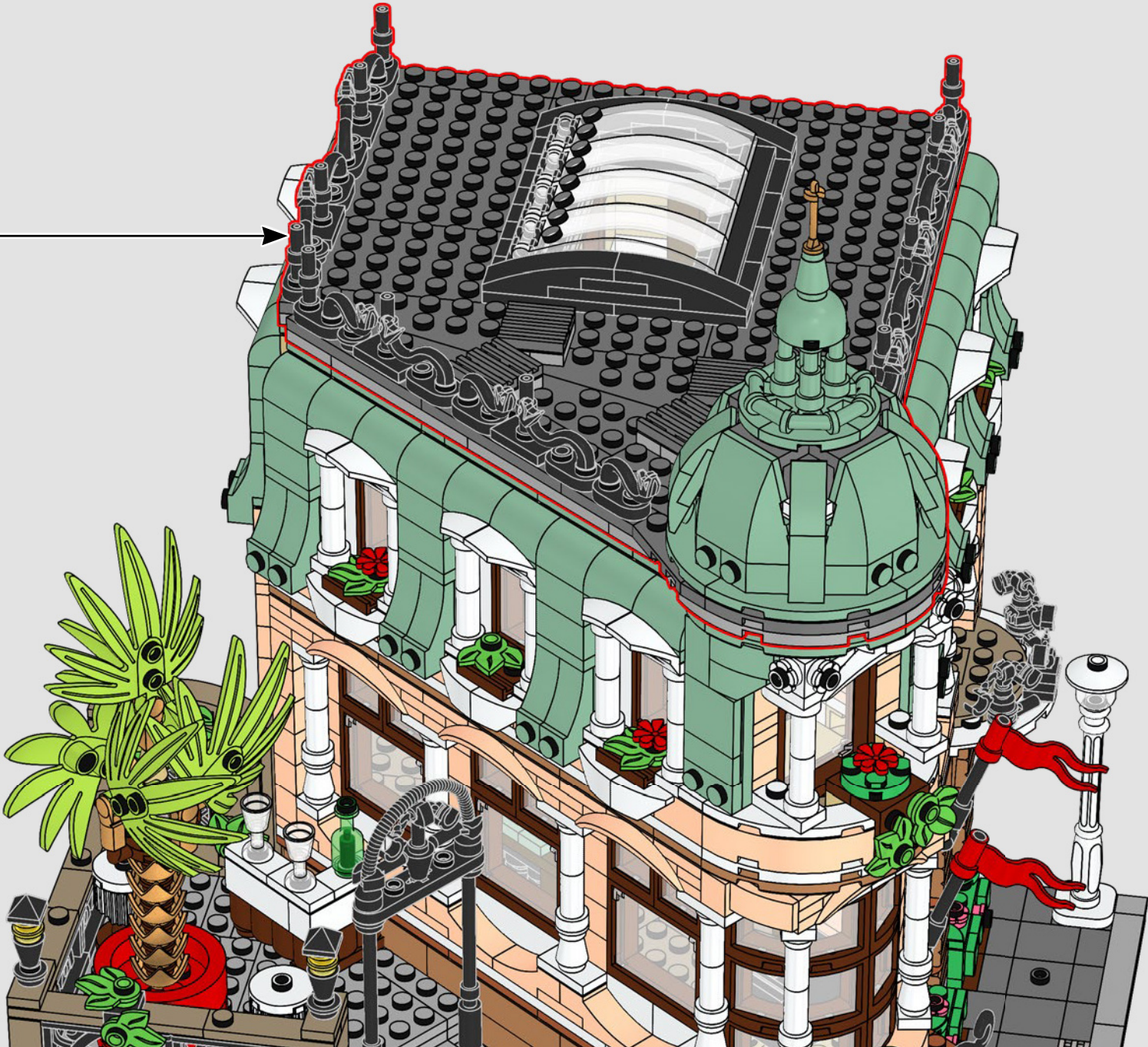

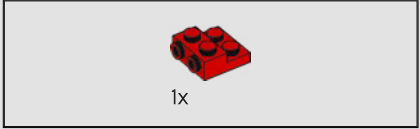
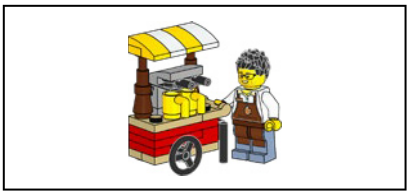

1

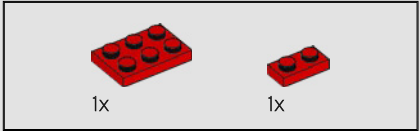
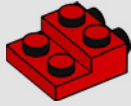

2

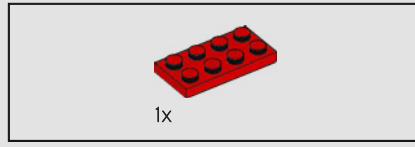
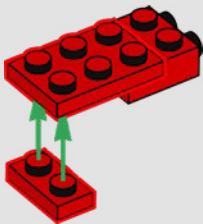

3

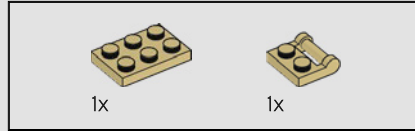
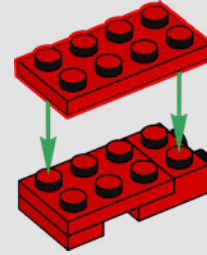

4

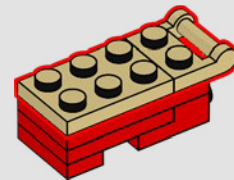



5

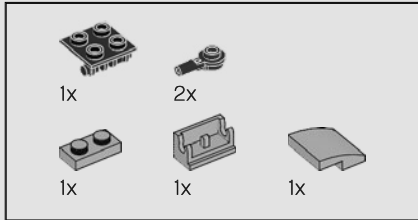
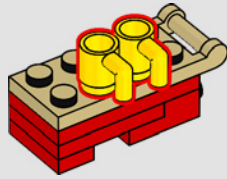

6

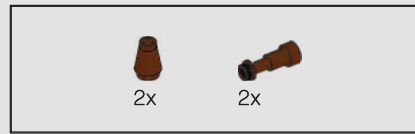
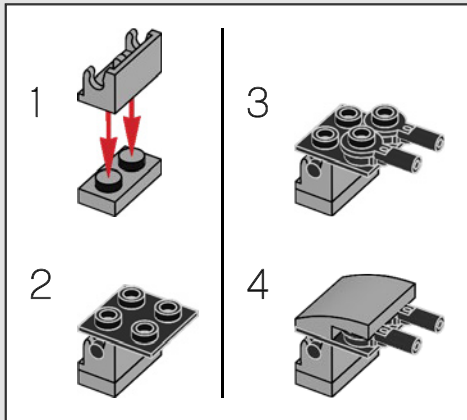

7

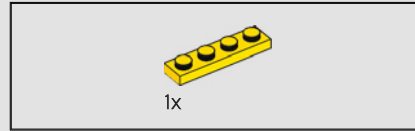
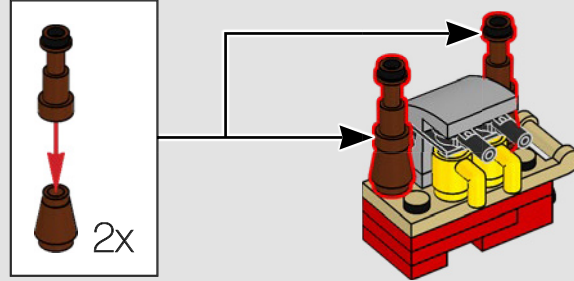

8

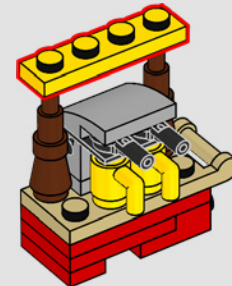

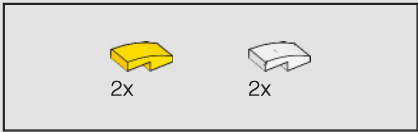

9

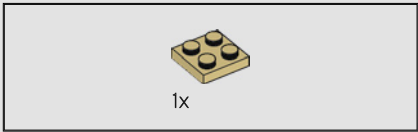
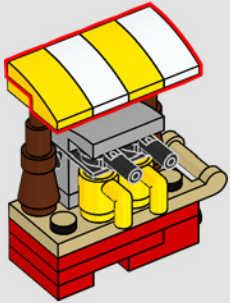

10

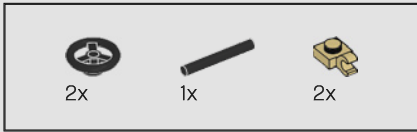
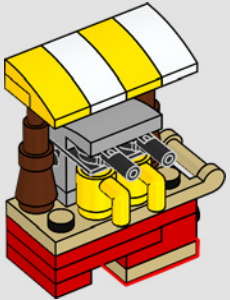

11

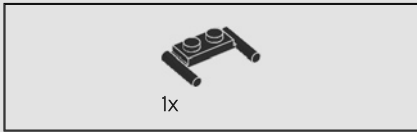
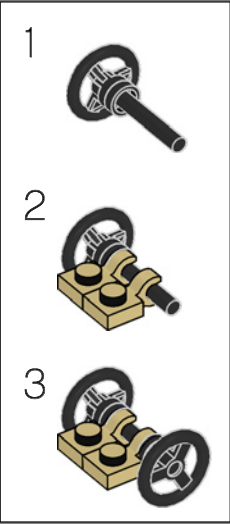
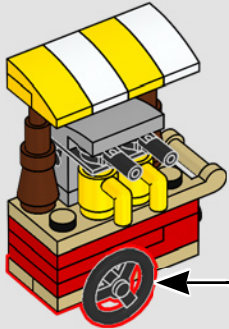

12

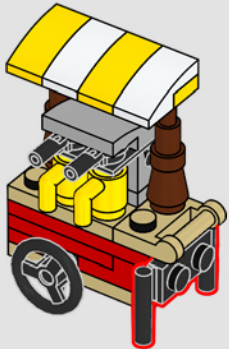

这辆咖啡车是首款模块化建筑套装——10182 转角咖啡厅 (Café Corner) 的移动式扩展。它的遮阳篷和黄色咖啡杯与原建筑的物品一致。

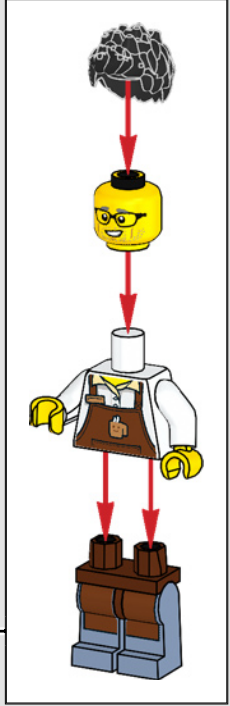







# FEEDBACK AND WIN



## FEEDBACK AND WIN

Your feedback will help shape the future development of this product series.

Please visit:

## FEEDBACK UND GEWINNEN

Dein Feedback trägt zur Weiterentwicklung dieser Produktreihe bei.

Geh auf:

## COMMENTEZ ET GAGNEZ

Vos commentaires nous aideront à concevoir les futurs produits de cette gamme.

Rendez-vous sur :

## COMENTA Y GANA

Tu opinión nos ayudará a dar forma al desarrollo de esta serie de productos en el futuro.

Visita:

## 反馈有奖

您的反馈将有助于我们在今后改进本系列产品。

请访问：

---

[LEGO.com/productfeedback](https://www.lego.com/productfeedback)

---

By completing, you will automatically enter a drawing to win a LEGO® set.

Terms & Conditions apply.

Durch Ausfüllen nimmst du automatisch an der Verlosung eines LEGO® Preises teil.

Es gelten die Teilnahmebedingungen.

En envoyant vos commentaires, vous serez automatiquement inscrit(e) à un tirage au sort qui vous permettra de remporter un prix LEGO®.

Offre soumise à conditions.

Al contestar, participarás automáticamente en el sorteo y podrás ganar un set LEGO®.

Sujeto a Términos y Condiciones.

完成我们的反馈调查,即可自动进入抽奖环节,赢取乐高®套装。

适用《条款和条件》。

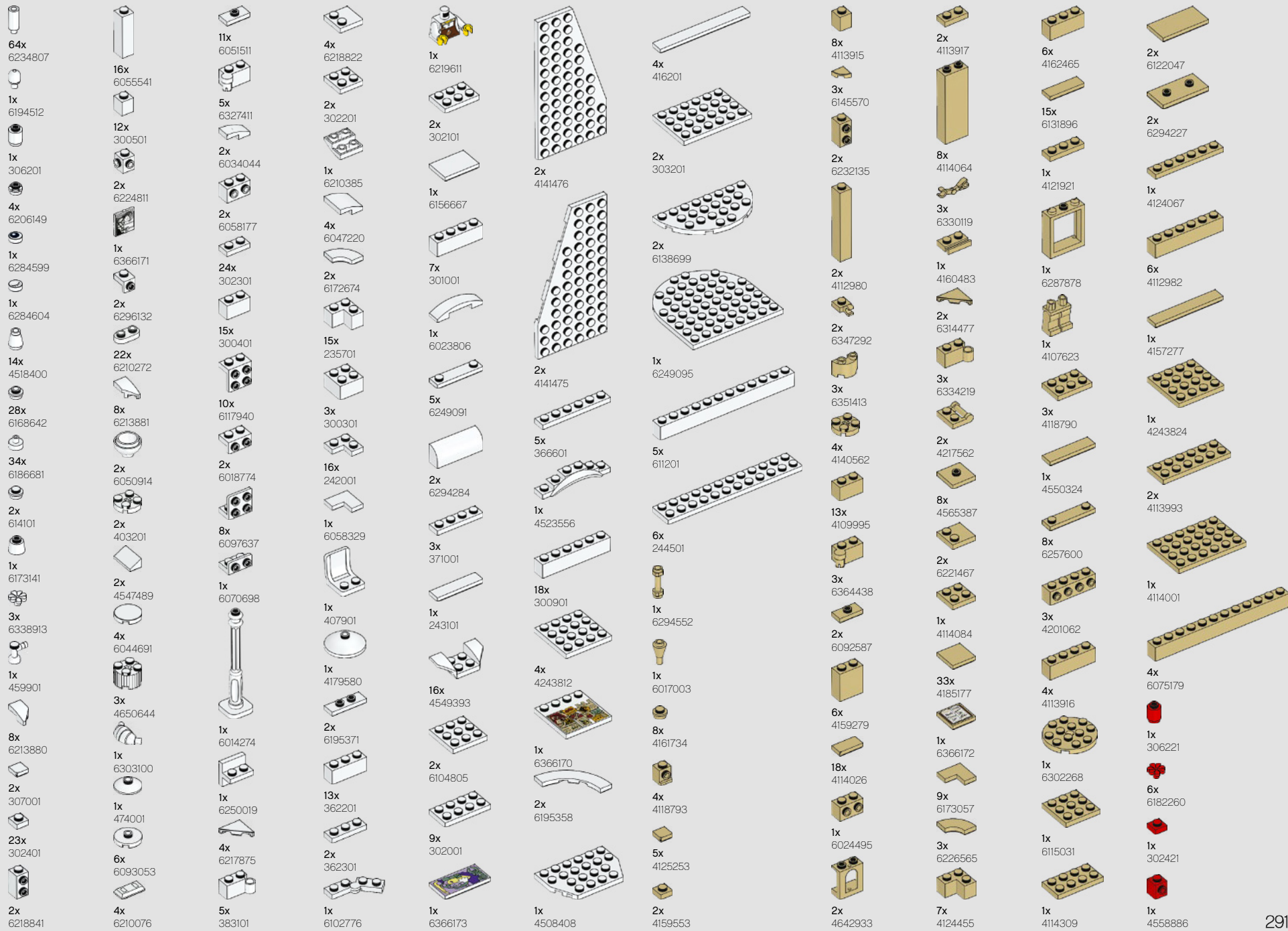

- 1x 302321
- 2x 6092582
- 1x 302221
- 2x 242021
- 4x 4567445
- 1x 6061711
- 2x 362321
- 2x 6268946
- 1x 302121
- 1x 4515348
- 1x 6313597
- 1x 302021
- 2x 614123
- 2x 6344028
- 1x 300523
- 3x 370023
- 2x 6092582
- 1x 300423
- 1x 302323
- 2x 4558606
- 3x 362223
- 2x 4587840
- 2x 428623
- 1x 317623
- 4x 6102759
- 2x 300223
- 1x 371023
- 1x 6262960
- 1x 6366175
- 1x 6218235
- 1x 4651443
- 1x 6116616
- 1x 6103171
- 1x 6329613
- 1x 6288015
- 1x 6211710
- 2x 307024
- 2x 300524
- 3x 6195183
- 2x 389924
- 2x 6029947
- 1x 242024
- 1x 371024
- 7x 302426
- 10x 6335388
- 2x 6172383
- 5x 6290456
- 2x 6210496
- 9x 6321194
- 2x 6240496
- 1x 4529236
- 3x 6056234
- 19x 6168646
- 10x 6186675
- 6x 614126
- 3x 6278152
- 1x 362626
- 2x 6312449
- 4x 6273589
- 2x 300526
- 2x 6170421
- 2x 6228987
- 1x 6224071
- 12x 6371584
- 1x 6173105
- 1x 6299338
- 4x 6308000
- 15x 6380639
- 1x 6134617
- 2x 6336977
- 4x 6104209
- 2x 6281993
- 1x 6079896
- 19x 6210270
- 1x 6308032
- 4x 6157554
- 5x 6196548
- 1x 6210307
- 2x 6279875
- 1x 6323420
- 1x 6323421
- 1x 6024730
- 1x 6269081
- 1x 6102341
- 1x 6092664
- 1x 6070695
- 2x 6057397
- 1x 4105175
- 1x 6366174
- 2x 6195325
- 1x 4106552
- 2x 249626
- 1x 9339
- 10x 302326
- 1x 4539128
- 19x 6092585
- 1x 6138173
- 1x 306926
- 2x 6147050
- 3x 6000650
- 1x 6250020
- 1x 6285241
- 16x 6214807
- 4x 6252201
- 1x 6336989
- 1x 6151289
- 1x 6093525
- 2x 306826
- 1x 302226
- 5x 4565323
- 1x 368026
- 1x 6013867
- 1x 4124096
- 5x 6052126
- 2x 4515368
- 1x 407926
- 2x 6272184
- 1x 6219624
- 1x 317626
- 2x 6116604
- 1x 6162892
- 2x 6286835
- 1x 383926
- 1x 6186698
- 1x 4613153
- 11x 371026
- 4x 6037746
- 2x 243126
- 1x 6115117
- 4x 6138726
- 1x 6280168
- 1x 302026
- 1x 663626
- 1x 6058118
- 1x 6344427
- 1x 346026
- 1x 416226
- 1x 6327402
- 1x 303426
- 1x 395826
- 2x 447726
- 4x 4558593
- 14x 6150607
- 1x 403228
- 1x 6269971
- 1x 6261358
- 6x 6129807
- 3x 371028
- 17x 6182261
- 10x 6143431
- 17x 6369194
- 2x 6248949
- 1x 6357937
- 6x 4616027
- 5x 4614158
- 2x 6186009
- 2x 6186423
- 23x 6253425
- 2x 6257603
- 5x 6074892
- 21x 6074893
- 4x 6058089
- 6x 6253418
- 2x 6166107
- 1x 6168665
- 6x 6244796
- 8x 6252258
- 26x 6254552
- 1x 6278710
- 2x 6251285
- 3x 6256058
- 4x 6247362
- 7x 6253734
- 4x 6244793
- 4x 6240216
- 2x 6337597
- 2x 6247364

1x 6047056	12x 6055172	1x 6167936	2x 4530712	1x 6134280	8x 6083976	4x 4539114	1x 6335285	4x 4211222	8x 4565394	5x 4216668
1x 4558595	9x 6273590	5x 6001822	2x 6232137	2x 6223913	4x 4649065	2x 6311890	1x 4621543	14x 6382102	1x 6122977	1x 4211181
4x 6240467	6x 4549436	1x 6310832	8x 4251796	1x 6221730	2x 6133896	4x 6212040	4x 4529242	5x 6103004	1x 4211200	1x 4211181
1x 6213779	13x 6001824	2x 6175927	2x 6232137	2x 6223225	20x 6186823	2x 6341767	9x 6215659	1x 6139435	4x 4211221	6x 6343651
3x 6213777	4x 6334209	5x 6257599	2x 6275088	1x 6221729	1x 6186828	2x 4539090	1x 4211242	12x 6092590	5x 6221608	3x 4211225
3x 6223665	2x 6092591	3x 4626904	1x 6312450	1x 6278544	6x 6299637	2x 6274681	1x 4212744	1x 4542131	2x 4211257	2x 4658005
								1x 421149	2x 6146301	1x 4211194
3x 6223665	2x 6273853	11x 4496699	3x 6055171	16x 4616578	2x 6223171	2x 6274681	1x 421288	1x 6146301	1x 4211257	1x 4211194
		14x 4528604	8x 6055222	20x 4616581	20x 6369375	2x 4539102	3x 6149677	16x 421150	1x 6313506	7x 4211190
2x 6273853		8x 4521914	4x 4245570	6x 6360075	2x 6385228	2x 6107758	1x 6062574	20x 421151	11x 6100769	1x 6153594
		11x 4496699	28x 6278541	20x 4616581	1x 6223219	1x 6172632	6x 6341553	1x 421149	13x 4211152	7x 4595889
2x 6249417		8x 4521914	4x 4245570	20x 4616581	2x 6385228	1x 6172632	1x 6306775	16x 421150	8x 6058084	1x 6262952
		11x 4496699	28x 6278541	20x 4616581	1x 6223219	1x 6172632	1x 6306775	20x 421151	2x 6310449	6x 4283660
1x 6223065		14x 4528604	4x 4245570	6x 6360075	2x 6385228	1x 6172632	1x 6306775	1x 421149	1x 6310449	2x 6075207
		14x 4528604	4x 4245570	6x 6360075	2x 6385228	1x 6172632	1x 6306775	16x 421150	2x 6310449	2x 6075207
2x 6337637		6x 6002849	2x 4226869	28x 6278541	1x 6223219	1x 6172632	1x 6306775	20x 421151	11x 6100769	1x 6153594
		6x 6002849	2x 4226869	28x 6278541	1x 6223219	1x 6172632	1x 6306775	1x 421149	13x 4211152	7x 4595889
1x 4537251		6x 6002849	2x 4226869	28x 6278541	1x 6223219	1x 6172632	1x 6306775	16x 421150	8x 6058084	1x 6262952
		6x 6002849	2x 4226869	28x 6278541	1x 6223219	1x 6172632	1x 6306775	20x 421151	2x 6310449	6x 4283660
1x 6192789		6x 6002849	2x 4226869	28x 6278541	1x 6223219	1x 6172632	1x 6306775	1x 421149	1x 6310449	2x 6075207
		6x 6002849	2x 4226869	28x 6278541	1x 6223219	1x 6172632	1x 6306775	16x 421150	2x 6310449	2x 6075207
1x 6226630		6x 6002849	2x 4226869	28x 6278541	1x 6223219	1x 6172632	1x 6306775	20x 421151	11x 6100769	1x 6153594
		6x 6002849	2x 4226869	28x 6278541	1x 6223219	1x 6172632	1x 6306775	1x 421149	13x 4211152	7x 4595889
1x 6226630		6x 6002849	2x 4226869	28x 6278541	1x 6223219	1x 6172632	1x 6306775	16x 421150	2x 6310449	6x 4283660
		6x 6002849	2x 4226869	28x 6278541	1x 6223219	1x 6172632	1x 6306775	20x 421151	11x 6100769	1x 6153594
1x 6192789		6x 6002849	2x 4226869	28x 6278541	1x 6223219	1x 6172632	1x 6306775	1x 421149	13x 4211152	7x 4595889
		6x 6002849	2x 4226869	28x 6278541	1x 6223219	1x 6172632	1x 6306775	16x 421150	2x 6310449	6x 4283660
1x 6226630		6x 6002849	2x 4226869	28x 6278541	1x 6223219	1x 6172632	1x 6306775	20x 421151	11x 6100769	1x 6153594
		6x 6002849	2x 4226869	28x 6278541	1x 6223219	1x 6172632	1x 6306775	1x 421149	13x 4211152	7x 4595889
1x 6192789		6x 6002849	2x 4226869	28x 6278541	1x 6223219	1x 6172632	1x 6306775	16x 421150	2x 6310449	6x 4283660
		6x 6002849	2x 4226869	28x 6278541	1x 6223219	1x 6172632	1x 6306775	20x 421151	11x 6100769	1x 6153594
1x 6226630		6x 6002849	2x 4226869	28x 6278541	1x 6223219	1x 6172632	1x 6306775	1x 421149	13x 4211152	7x 4595889
		6x 6002849	2x 4226869	28x 6278541	1x 6223219	1x 6172632	1x 6306775	16x 421150	2x 6310449	6x 4283660
1x 6192789		6x 6002849	2x 4226869	28x 6278541	1x 6223219	1x 6172632	1x 6306775	20x 421151	11x 6100769	1x 6153594
		6x 6002849	2x 4226869	28x 6278541	1x 6223219	1x 6172632	1x 6306775	1x 421149	13x 4211152	7x 4595889
1x 6226630		6x 6002849	2x 4226869	28x 6278541	1x 6223219	1x 6172632	1x 6306775	16x 421150	2x 6310449	6x 4283660
		6x 6002849	2x 4226869	28x 6278541	1x 6223219	1x 6172632	1x 6306775	20x 421151	11x 6100769	1x 6153594
1x 6192789		6x 6002849	2x 4226869	28x 6278541	1x 6223219	1x 6172632	1x 6306775	1x 421149	13x 4211152	7x 4595889
		6x 6002849	2x 4226869	28x 6278541	1x 6223219	1x 6172632	1x 6306775	16x 421150	2x 6310449	6x 4283660
1x 6226630		6x 6002849	2x 4226869	28x 6278541	1x 6223219	1x 6172632	1x 6306775	20x 421151	11x 6100769	1x 6153594
		6x 6002849	2x 4226869	28x 6278541	1x 6223219	1x 6172632	1x 6306775	1x 421149	13x 4211152	7x 4595889
1x 6192789		6x 6002849	2x 4226869	28x 6278541	1x 6223219	1x 6172632	1x 6306775	16x 421150	2x 6310449	6x 4283660
		6x 6002849	2x 4226869	28x 6278541	1x 6223219	1x 6172632	1x 6306775	20x 421151	11x 6100769	1x 6153594
1x 6226630		6x 6002849	2x 4226869	28x 6278541	1x 6223219	1x 6172632	1x 6306775	1x 421149	13x 4211152	7x 4595889
		6x 6002849	2x 4226869	28x 6278541	1x 6223219	1x 6172632	1x 6306775	16x 421150	2x 6310449	6x 4283660
1x 6192789		6x 6002849	2x 4226869	28x 6278541	1x 6223219	1x 6172632	1x 6306775	20x 421151	11x 6100769	1x 6153594
		6x 6002849	2x 4226869	28x 6278541	1x 6223219	1x 6172632	1x 6306775	1x 421149	13x 4211152	7x 4595889
1x 6226630		6x 6002849	2x 4226869	28x 6278541	1x 6223219	1x 6172632	1x 6306775	16x 421150	2x 6310449	6x 4283660
		6x 6002849	2x 4226869	28x 6278541	1x 6223219	1x 6172632	1x 6306775	20x 421151	11x 6100769	1x 6153594
1x 6192789		6x 6002849	2x 4226869	28x 6278541	1x 6223219	1x 6172632	1x 6306775	1x 421149	13x 4211152	7x 4595889
		6x 6002849	2x 4226869	28x 6278541	1x 6223219	1x 6172632	1x 6306775	16x 421150	2x 6310449	6x 4283660
1x 6226630		6x 6002849	2x 4226869	28x 6278541	1x 6223219	1x 6172632	1x 6306775	20x 421151	11x 6100769	1x 6153594
		6x 6002849	2x 4226869	28x 6278541	1x 6223219	1x 6172632	1x 6306775	1x 421149	13x 4211152	7x 4595889
1x 6192789		6x 6002849	2x 4226869	28x 6278541	1x 6223219	1x 6172632	1x 6306775	16x 421150	2x 6310449	6x 4283660
		6x 6002849	2x 4226869	28x 6278541	1x 6223219	1x 6172632	1x 6306775	20x 421151	11x 6100769	1x 6153594
1x 6226630		6x 6002849	2x							

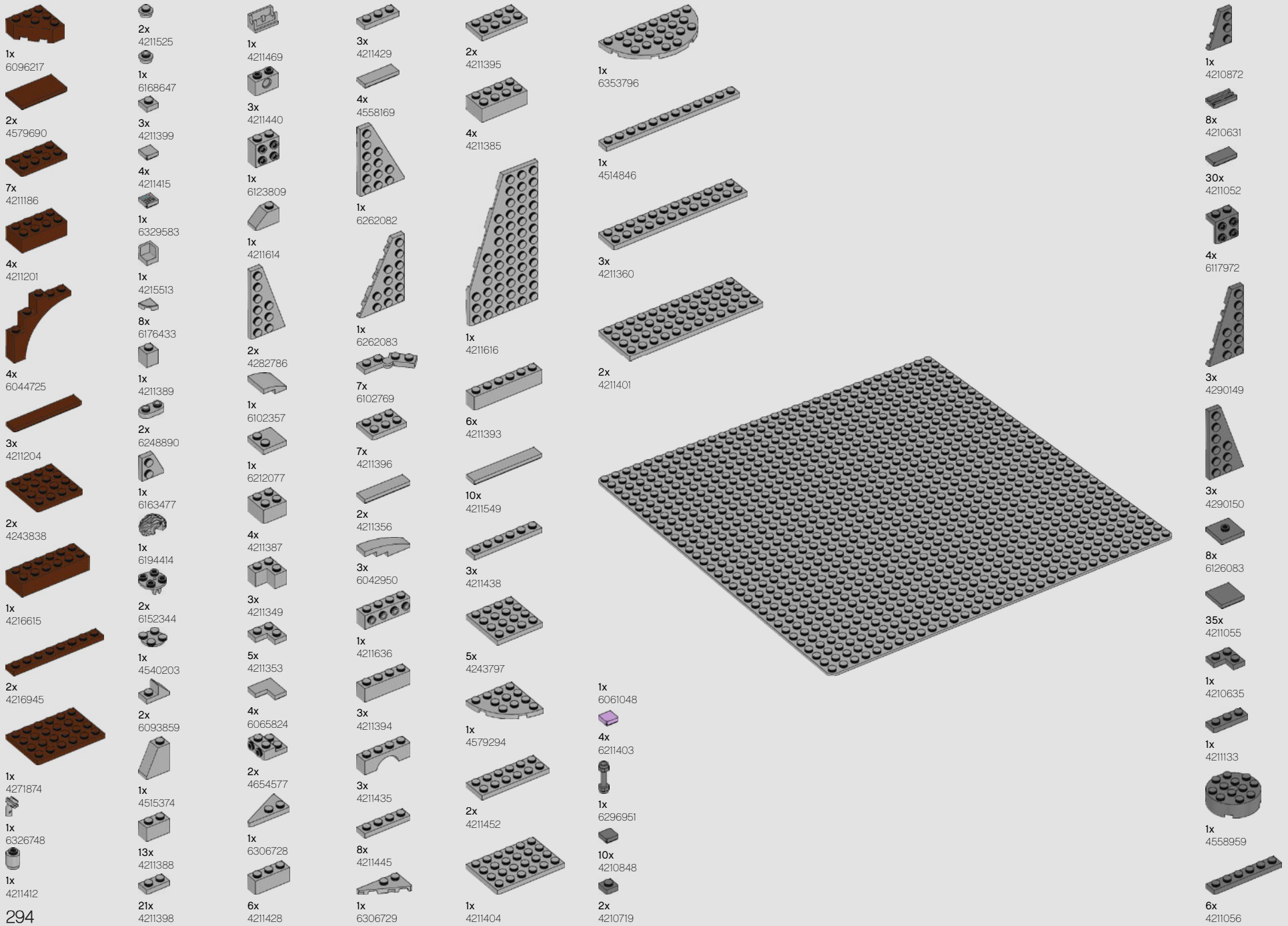

- 1x 6096217
- 2x 4579690
- 7x 4211186
- 4x 4211201
- 4x 6044725
- 3x 4211204
- 2x 4243838
- 1x 4216615
- 2x 4216945
- 1x 4271874
- 1x 6326748
- 1x 4211412

- 2x 4211525
- 1x 6168647
- 3x 4211399
- 4x 4211415
- 1x 6329583
- 1x 4215513
- 8x 6176433
- 1x 4211389
- 2x 6248890
- 1x 6163477
- 1x 6194414
- 2x 6152344
- 1x 4540203
- 2x 6093859
- 1x 4515374
- 13x 4211388
- 21x 4211398

- 1x 4211469
- 3x 4211440
- 1x 6123809
- 1x 4211614
- 2x 4282786
- 1x 6102357
- 1x 6212077
- 4x 4211387
- 3x 4211349
- 5x 4211353
- 4x 6065824
- 2x 4654577
- 4x 606728
- 6x 4211428

- 3x 4211429
- 4x 4558169
- 1x 6262082
- 1x 6262083
- 7x 6102769
- 7x 4211396
- 2x 4211356
- 3x 6042950
- 1x 4211636
- 3x 4211394
- 3x 4211435
- 8x 4211445
- 1x 6306729

- 2x 4211395
- 4x 4211385
- 1x 4211616
- 6x 4211393
- 10x 4211549
- 3x 4211438
- 5x 4243797
- 1x 4579294
- 2x 4211452
- 1x 4211404

- 1x 6353796
- 1x 4514846
- 3x 4211360
- 2x 4211401
- 1x 6061048
- 4x 6211403
- 1x 6296951
- 10x 4210848
- 2x 4210719

- 1x 4210872
- 8x 4210631
- 30x 4211052
- 4x 6117972
- 3x 4290149
- 3x 4290150
- 8x 6126083
- 35x 4211055
- 1x 4210635
- 1x 4211133
- 1x 4558959
- 6x 4211056

4x 4211002  
 1x 4210998  
 1x 4211115  
 1x 6141856  
 3x 4210794  
 1x 6107399  
 1x 6092833  
 1x 4586410  
 38x 6369191  
 31x 6357797  
 1x 6275872  
 57x 6369188  
 43x 6369189

2x 6357796  
 2x 6343511  
 14x 6325881  
 1x 6297283  
 5x 6357794  
 14x 6369190  
 35x 6378419  
 9x 6369187  
 4x 6369192  
 1x 6170470  
 1x 6292254  
 4x 6252838  
 6x 6296657  
 5x 6209691

4x 4529247  
 1x 6190252  
 5x 6186672  
 5x 4523159  
 1x 6284379  
 6x 6257048  
 2x 6167585  
 2x 4490599  
 1x 6245261  
 1x 6092594  
 2x 6022033  
 5x 6093529  
 3x 6147169  
 4x 6226437  
 6x 6251021  
 5x 4519970

6x 4566688  
 2x 6046943  
 4x 6058221  
 17x 6058257  
 1x 4538950  
 1x 6179803  
 2x 6047037  
 4x 6272145  
 1x 6167928  
 2x 6313874  
 3x 6252667  
 2x 6328181  
 4x 6226792  
 1x 6295366  
 4x 4518687

5x 6300103  
 4x 6167641  
 26x 6057986  
 1x 6167690  
 7x 6215606  
 3x 6177146  
 7x 6314190  
 41x 4656783  
 6x 6021997  
 4x 6186400  
 2x 4568955

17x 6223183  
 6x 6102998  
 8x 6218359  
 47x 6099341  
 1x 6295464  
 4x 6106193  
 2x 6387478  
 1x 6345302  
 3x 6102990  
 4x 6102994  
 1x 6177535  
 6x 6192922

4x 4633691  
 4x 4619636  
 1x 4611884  
 3x 4655243  
 4x 6136419  
 4x 6331949

4x 6119126  
 1x 4624705  
 1x 6253666  
 2x 6361352  
 8x 6251591  
 6x 6295242  
 1x 6240515

Customer Service  
 Kundenservice  
 Service Consommateurs  
 Servicio Al Consumidor  
 LEGO.com/service or dial  
 : 00800 5346 5555  
 : 1-800-422-5346

