

# TITANIC

BOOK 1

LIVRE 1

LIBRO 1

Booklet available in English on  
Livret disponible en français sur  
Folleto disponible en español en

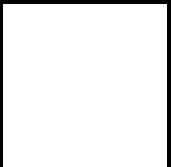

---

# THE QUEEN OF THE OCEANS

When the RMS *Titanic* left the port of Southampton, England, on April 10<sup>th</sup>, 1912, on her maiden voyage bound for New York City, she was not only the largest ship afloat at the time but also the most luxurious. She was the second of three state-of-the-art Olympic-class ocean liners commissioned by the White Star Line in an effort to maintain the company's dominant position in the highly competitive trans-Atlantic passenger route. The Belfast-based shipbuilders, Harland and Wolff, had been authorized to spend what was needed to ensure the *Titanic* had a level of comfort and luxury never seen before.

---

# LE ROI DE L'OCÉAN

Lorsque le RMS *Titanic* quitte le port de Southampton, en Angleterre, le 10 avril 1912, pour son voyage inaugural à destination de New York, il est non seulement le plus grand paquebot à flot de l'époque, mais aussi le plus luxueux. Il est le deuxième de trois paquebots ultramodernes de la classe Olympic construits à la demande de la White Star Line dans le but d'assurer à l'entreprise de conserver sa position dominante au sein de la très compétitive ligne transatlantique. Les constructeurs du chantier naval Harland and Wolff, basé à Belfast, reçoivent l'autorisation de dépenser ce qu'il faut pour procurer au *Titanic* un niveau de confort et de luxe jamais vu auparavant.

---

# EL REY DE LOS OCÉANOS

Cuando el RMS *Titanic* zarpó del puerto de Southampton (Inglaterra) el 10 de abril de 1912 en su viaje inaugural con destino a la ciudad de Nueva York, no solo era el barco más grande del mundo y de la época, sino también el más lujoso. Emprendía la navegación como segundo de un trío de innovadores buques de la clase Olympic encargados por la naviera White Star Line en su esfuerzo por mantener la supremacía en la competitiva ruta transatlántica de transporte de pasajeros. La compañía había autorizado a la constructora naval Harland and Wolff de Belfast a gastar todo lo que fuera necesario para garantizar que el *Titanic* contara con un nivel de confort y lujo nunca vistos.

---

→ A White Star Line postcard depicting the *Titanic*.

→ Une carte postale de la White Star Line montrant le *Titanic*.

→ Postal de la naviera White Star Line con una ilustración del *Titanic*.





↑ The RMS Titanic departing  
Southampton on April 10<sup>th</sup>, 1912.

↑ Le RMS Titanic à son départ de  
Southampton le 10 avril 1912.

↑ Buque RMS Titanic partiendo de  
Southampton el 10 de abril de 1912.

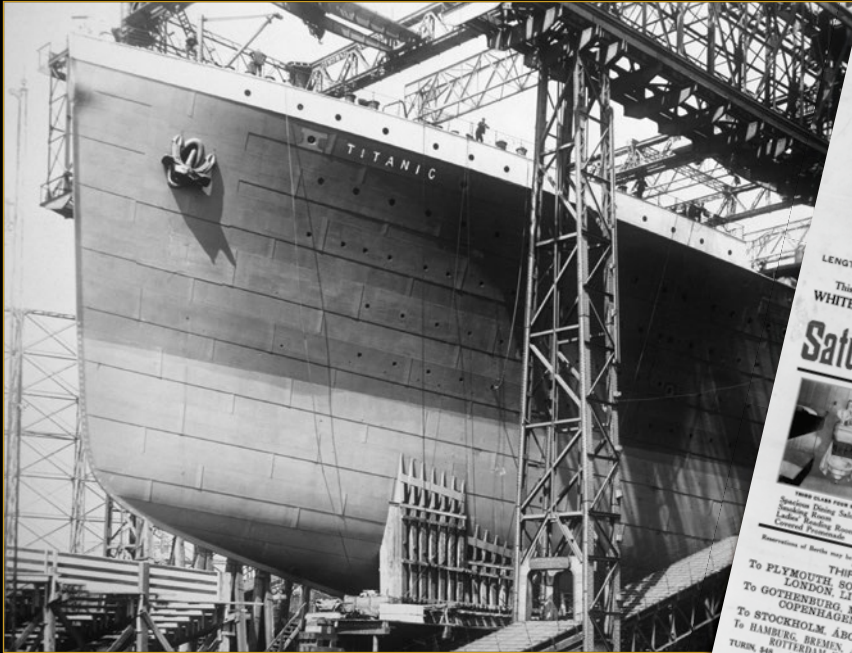

**WHITE STAR LINE**  
 ROYAL & UNITED STATES MAIL STEAMERS  
 FIRST SAILING OF THE LATEST ADDITION TO THE WHITE STAR FLEET  
 The Queen of the Ocean  
**TITANIC**

LENGTH 852 FT. OVER 45,000 TONS TRIPLE-SCREWS BEAM 92 FT.  
 This, the Largest, Largest and Finest Steamer Afloat, will sail from  
**WHITE STAR LINE, PIER 59 North River, NEW YORK**  
**Saturday, April 20th** At 12 Noon

THIRD CLASS CABIN DECK FROM  
 Spacious Dining Saloons  
 Smoking Room  
 Ladies' Smoking Room  
 General Promenade

All passengers berthed in closed rooms  
 ber equipped with washbasins, etc.

THIRD CLASS DINING SALOON

Remuneration of Berths may be made direct with the Office or through any of our accredited Agents

**THIRD CLASS RATES ARE:**  
 To PLYMOUTH, SOUTHAMPTON,  
 LONDON, LIVERPOOL and GLASGOW.  
 To GOTHENBURG, MALMÖ, CHRISTIANIA,  
 COPENHAGEN, ESBJERG, Etc. **\$36.25**  
 To STOCKHOLM, ÅBO, HANGÖ, HELSINGFORS,  
 HAMBURG, BREMEN, ANTWERP, AMSTERDAM,  
 ROTTERDAM, HAVRE, CHERBOURG,  
 TURIN, etc. **41.50**  
 DO NOT DEPART. **44.50**  
**45.00**  
 WHITE STAR LINE, 9 Broadway, New York

**TICKETS FOR SALE HERE**

← 1912: An advertisement for the luxury passenger liner Titanic, announcing the time of the ship's maiden voyage departure. Ticket prices and berth descriptions are provided.

← 1912 : Une publicité pour le paquebot de luxe Titanic, annonçant l'heure du départ inaugural du navire. Le prix des billets et une description des cabines sont fournis.

← 1912: Cartel publicitario del transatlántico de lujo Titanic anunciando la fecha de partida del buque en su viaje inaugural. Incluye los precios de los pasajes y la descripción de los camarotes.

↑ The prow of the Titanic under construction at Harland and Wolff shipyard in Belfast, Ireland.

↑ La proue du Titanic en cours de construction au chantier naval Harland and Wolff à Belfast, en Irlande.

↑ Proa del Titanic durante su construcción en los astilleros Harland and Wolff de Belfast (Irlanda).

→ Two White Star Liners, RMS Titanic and RMS Olympic, seen together for the last time, 3 February 1912.

→ Le RMS Titanic et le RMS Olympic, deux paquebots de la White Star Line, vus ensemble pour la dernière fois le 3 février 1912.

→ Dos barcos de la naviera White Star Line, el RMS Titanic y el RMS Olympic, la última vez que pudieron verse juntos: el 3 de febrero de 1912.



---

# THE TRIPLE SCREW OLYMPIC-CLASS LINER

The *Titanic* was powered by three powerful engines, each driving its own propeller. The two outer steam engines were 63 ft. (19 meters) long, weighed 793.6 tons (720 metric tonnes) and created a combined output of 30,000 hp. The central, low-pressure turbine added a further 16,000 hp. It took 29 boilers, 534.6 tons (484.5 metric tonnes) of water and 661.3 tons (600 metric tonnes) of coal a day to power the steam engines. All three engines connected directly to propellers via long shafts. The two outer propellers were a massive 23.5 ft. (7.2 meters) in diameter, while the smaller middle one had a diameter of 17 ft. (5.2 meters). All this power gave the *Titanic* a top speed of more than 26 miles per hour (23 knots).

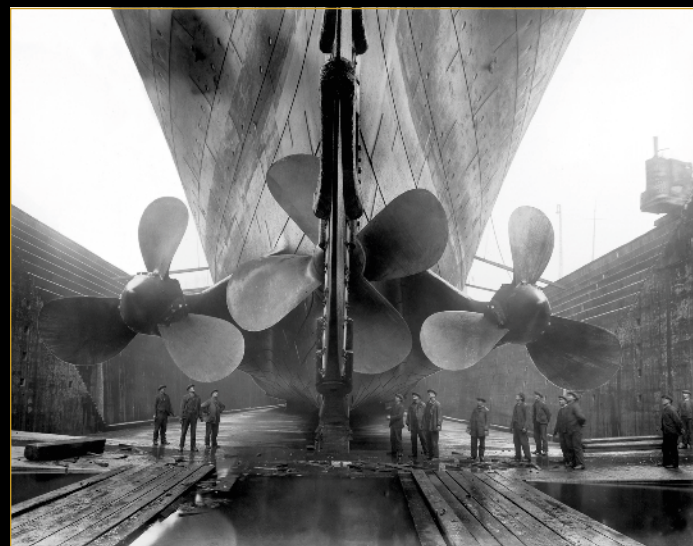

↑ The huge propellers of the RMS *Titanic* as the mighty ship sat in dry dock.

↑ Les énormes hélices du RMS *Titanic*, alors que le navire est immobilisé en cale sèche.

↑ Vista de las inmensas hélices del RMS *Titanic* con el imponente buque en dique seco.

---

# LE PAQUEBOT À TROIS HÉLICES DE LA CLASSE OLYMPIC

Le *Titanic* est propulsé par deux machines alternatives et une turbine, chacune actionnant sa propre hélice. Les deux machines à vapeur extérieures mesurent 19 m (63 pi) de long, pèsent 720 tonnes métriques (793,6 tonnes courtes) et produisent une puissance combinée de 30 000 ch. La turbine centrale à basse pression ajoute 16 000 ch supplémentaires. Il faut 29 chaudières, 484,5 tonnes métriques (534,6 tonnes courtes) d'eau et 600 tonnes métriques (661,3 tonnes courtes) de charbon par jour pour alimenter les machines à vapeur. La turbine et les machines sont connectées directement aux hélices grâce à de longs conduits. Les deux hélices extérieures ont un diamètre impressionnant de 7,2 m (23,5 pi), tandis que la plus petite au centre a un diamètre de 5,2 m (17 pi). Grâce à une telle puissance, le *Titanic* a une vitesse de pointe de plus de 23 nœuds (42 km/h / 26 miles/h).

---

# EL BUQUE DE LA CLASE OLYMPIC DE TRIPLE HÉLICE

El *Titanic* avanzaba propulsado por tres potentes motores, y cada uno de ellos movía su propia hélice. Los dos motores de vapor exteriores medían 19 m de longitud, pesaban 720 t y generaban una potencia total de más de 30.000 CV. La turbina de baja presión central agregaba unos 16.000 CV adicionales. Para mantener en funcionamiento los motores de vapor, se usaban 29 calderas y se consumían 484,5 t de agua y 600 t de carbón diarias. Los tres motores estaban conectados directamente a sus respectivas hélices mediante largos ejes. Las dos gigantescas hélices laterales medían 7,2 m de diámetro, mientras que la del medio, más pequeña, tenía un diámetro de 5,2 m. Toda esta potencia permitía al *Titanic* alcanzar una velocidad máxima que superaba los 23 kn (42 km/h).

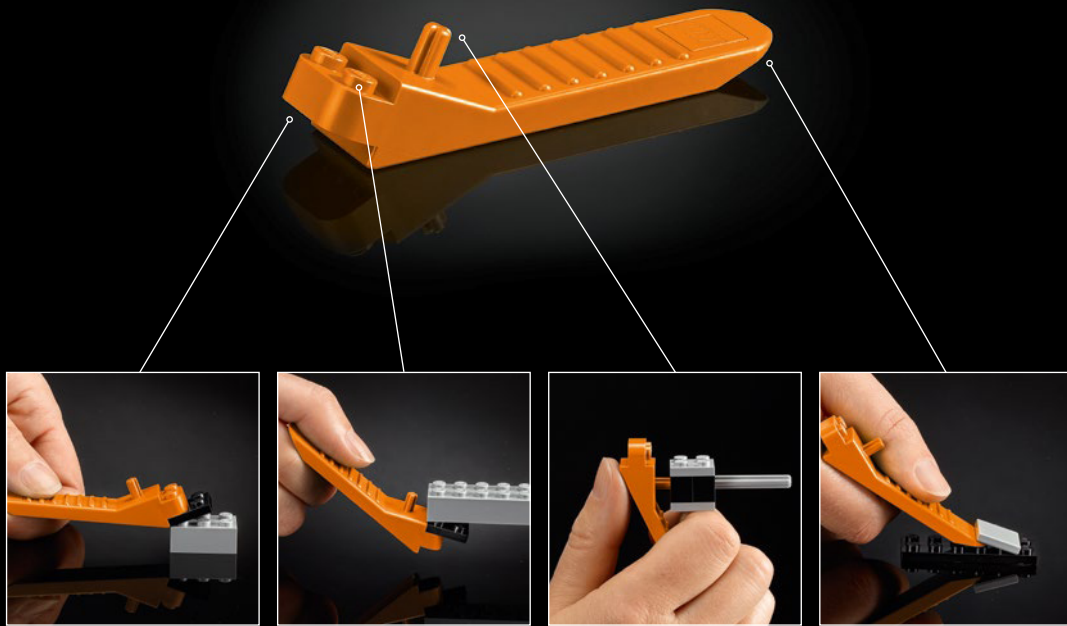

[LEGO.com/brickseparator](https://LEGO.com/brickseparator)

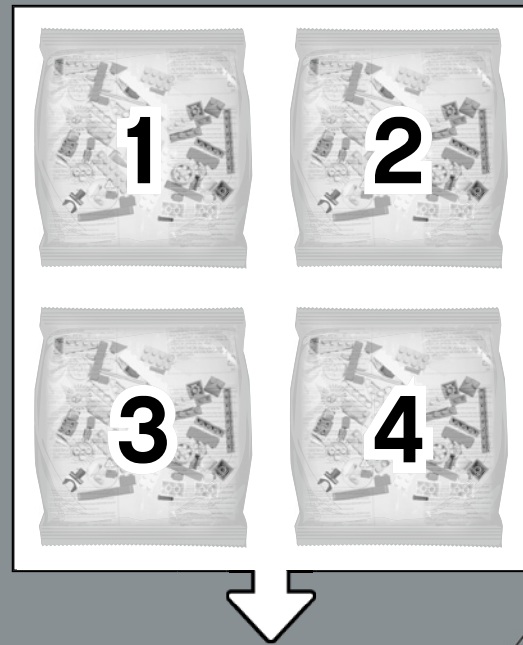

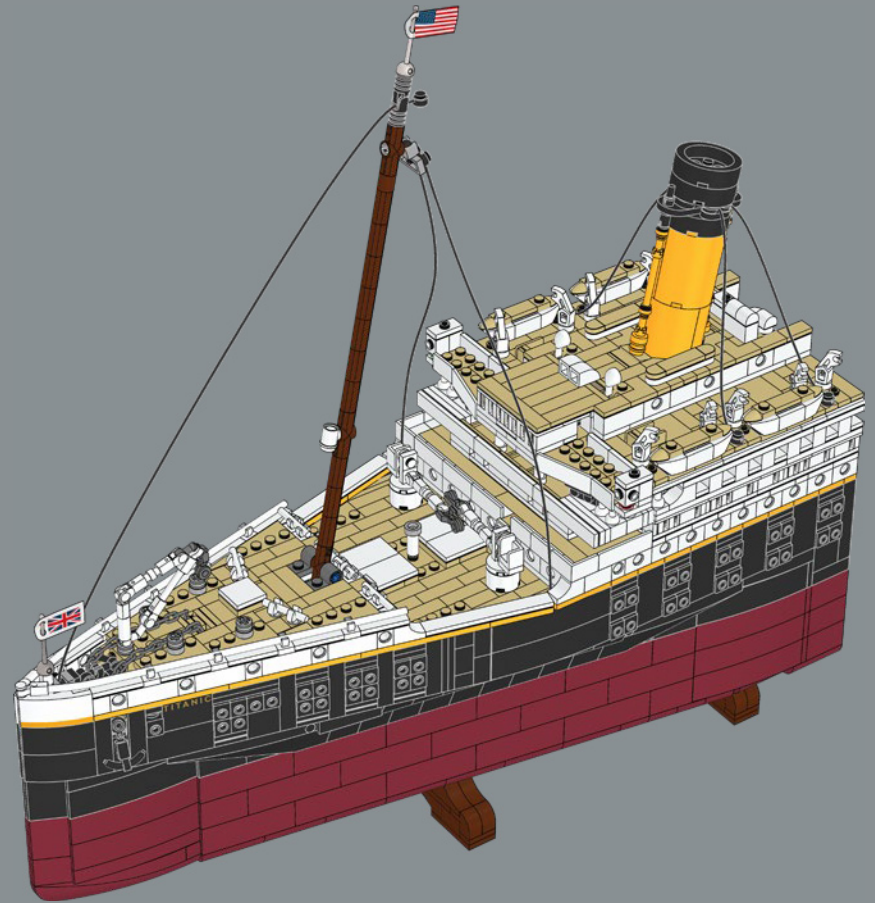
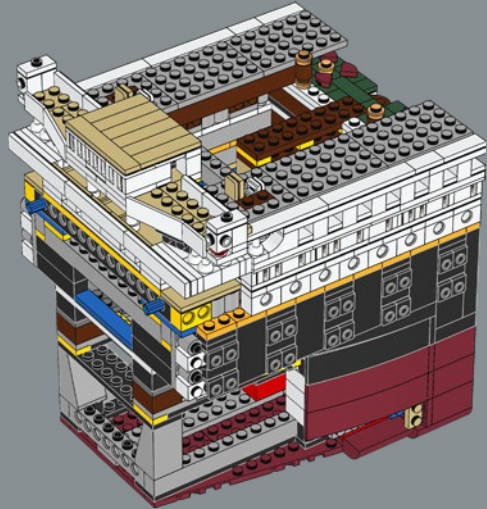
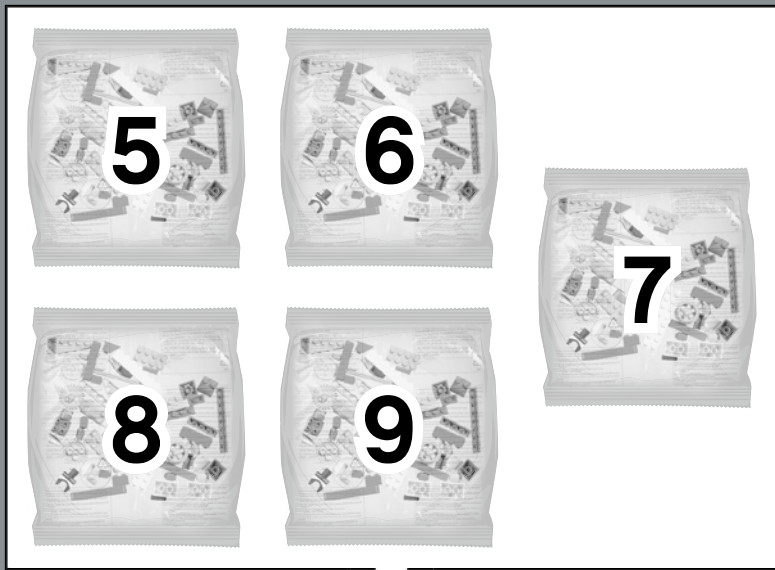

## SECTION 1:

# BOW AND WELL DECK

In this section you will build the bow of the ship along with the anchors, ship name, well deck, cargo hatches and cargo cranes, anchor crane with the 3rd anchor, and forward mast. In the interior of the ship the structures that will support the angled forward hull are also constructed. These will combine with supports in later sections to lock together and finish off the front hull of the model.

## SECTION 1 :

# PROUE ET COFFRE

Dans cette section, vous allez construire la proue ainsi que les ancres, le nom du navire, le coffre, les écoutilles et les grues à crochet, le guindeau avec la 3<sup>e</sup> ancre et le mât avant. À l'intérieur du navire, les structures qui supporteront la coque avant inclinée seront également construites. Celles-ci se raccorderont avec les supports des sections suivantes pour compléter la coque avant du modèle.

## SECCIÓN 1:

# PROA Y CUBIERTA DE POZO

En esta sección, construirás la proa del buque, así como las anclas, el rótulo con el nombre, la cubierta de pozo, las escotillas de carga y las grúas de carga, la grúa de anclas con la tercera ancla, y el trinquete. También te encargarás de la construcción en el interior de las estructuras de soporte del casco de proa con forma de cuña. Estas se combinarán con soportes en secciones posteriores para acoplar y rematar el casco frontal del modelo.

↓ We use the 2x10x2 triple curved bow brick to form the front of the keel of the model.

↓ La brique à trois arcs 2x10x2 est utilisée pour former l'avant de la quille du modèle.

↓ Usamos el arco de triple borde curvado 2x10x2 para formar la parte frontal de la quilla del modelo.

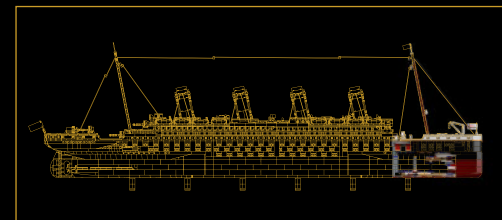



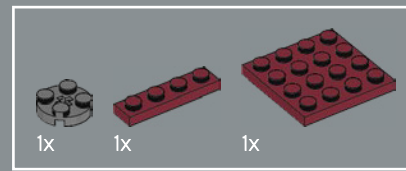
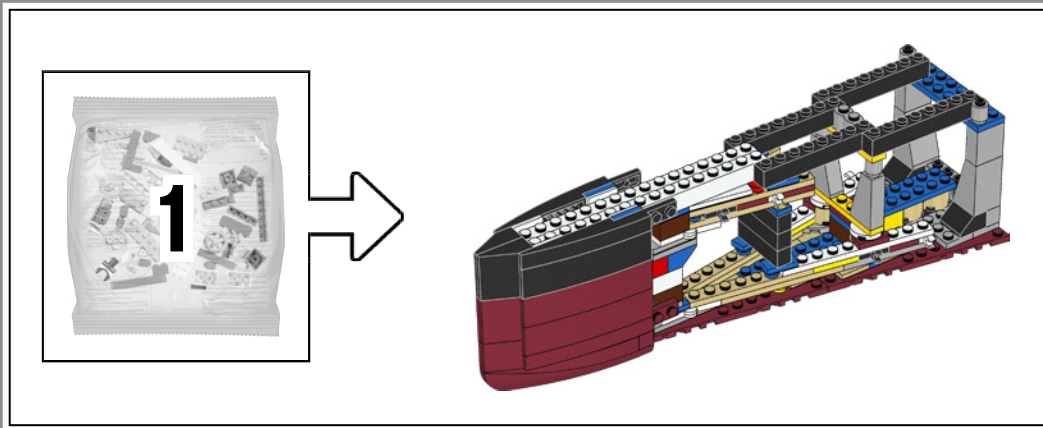

2

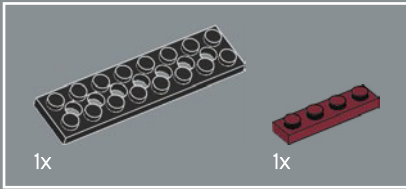

1

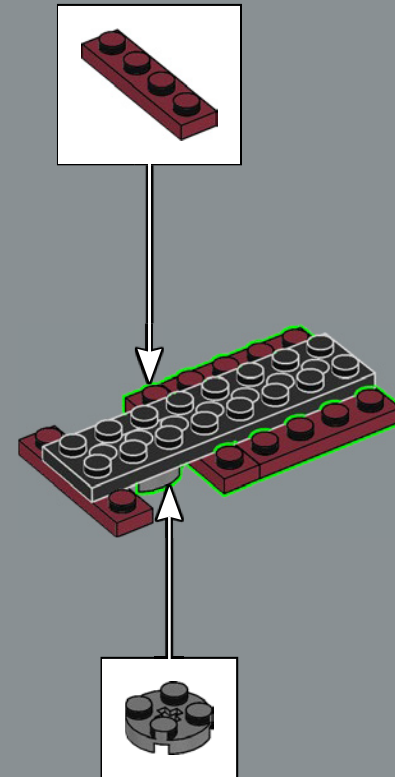
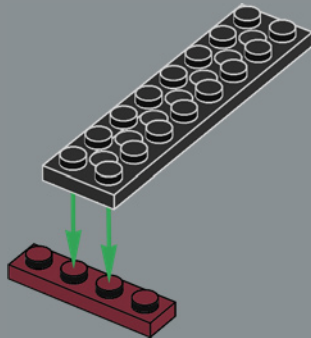

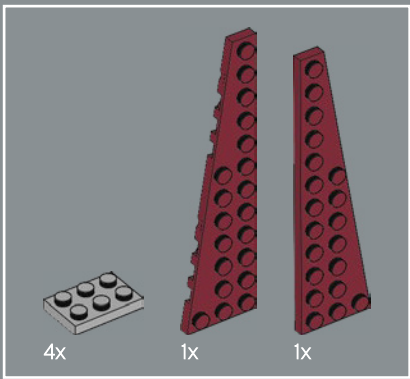

3

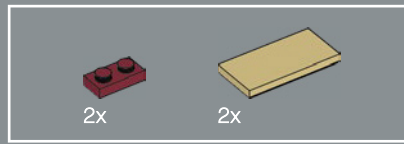
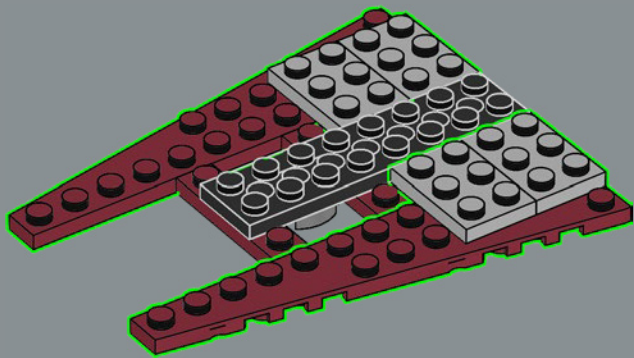

4

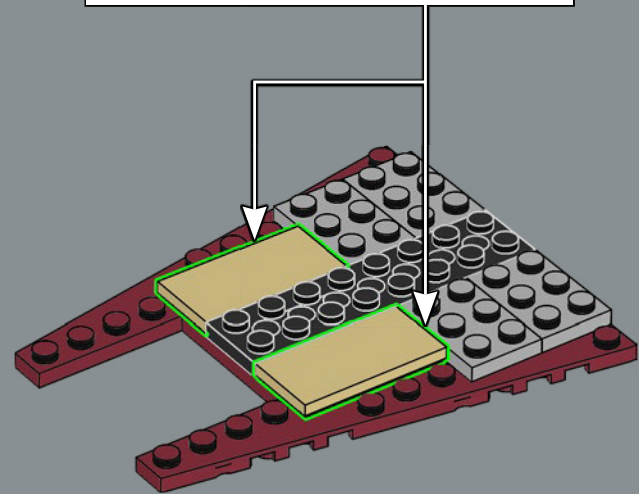
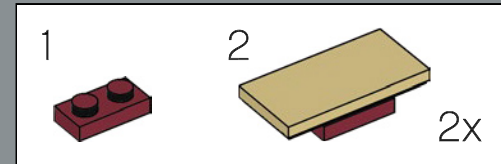

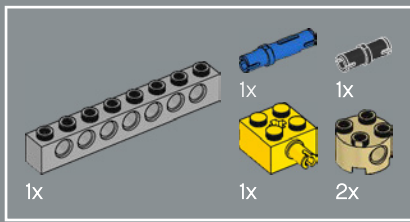

5

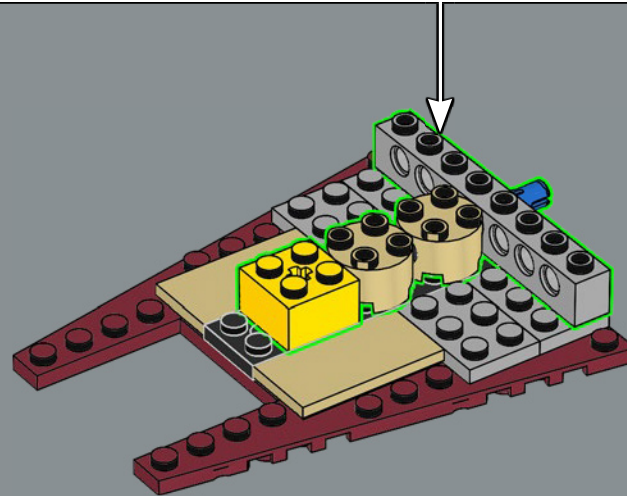
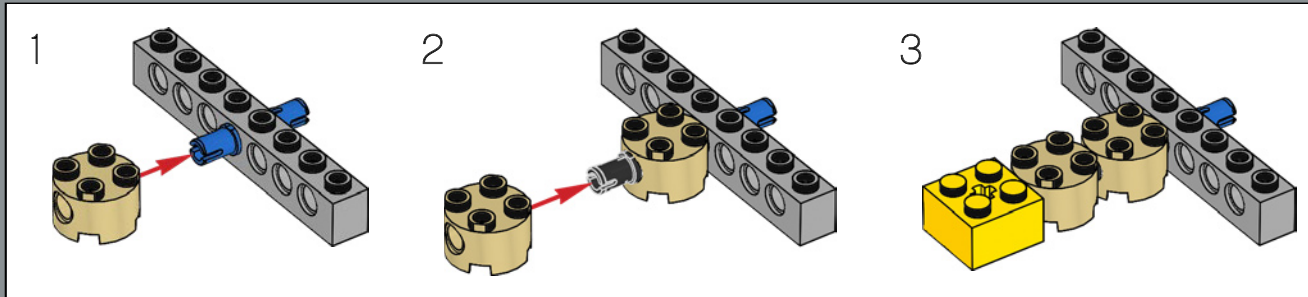

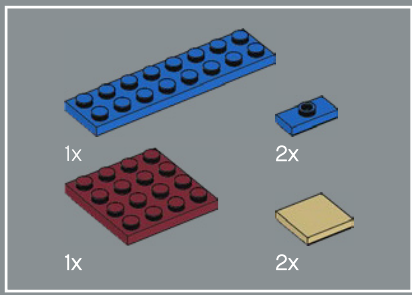

6

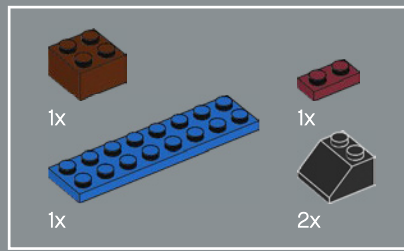
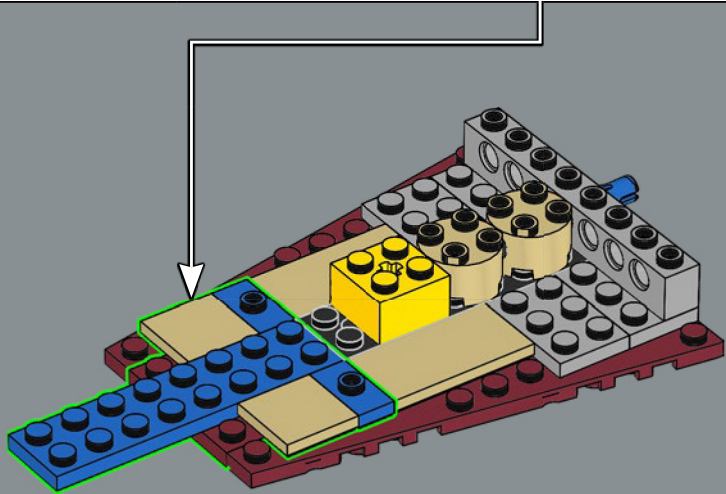
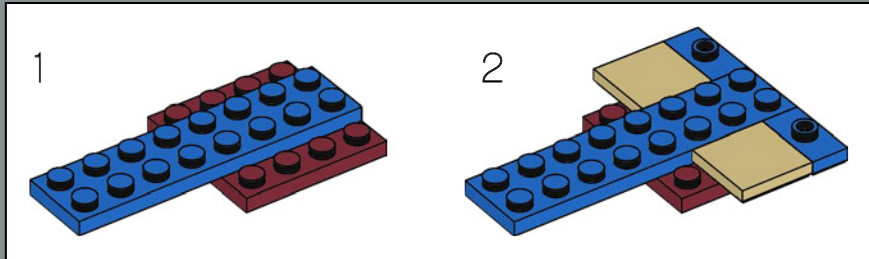

7

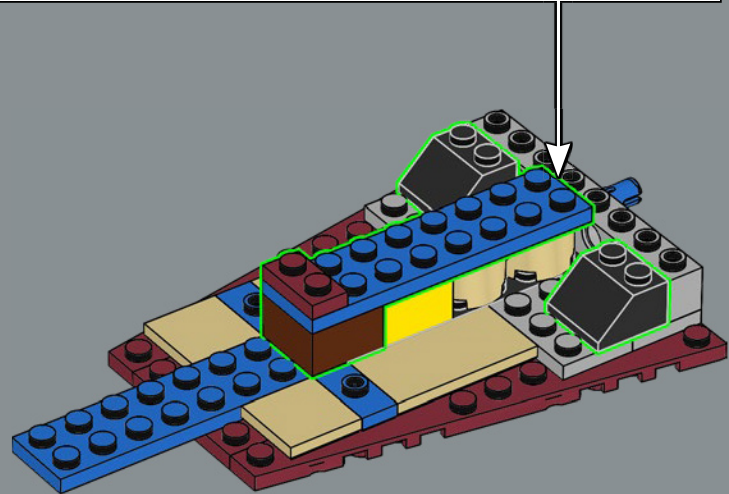
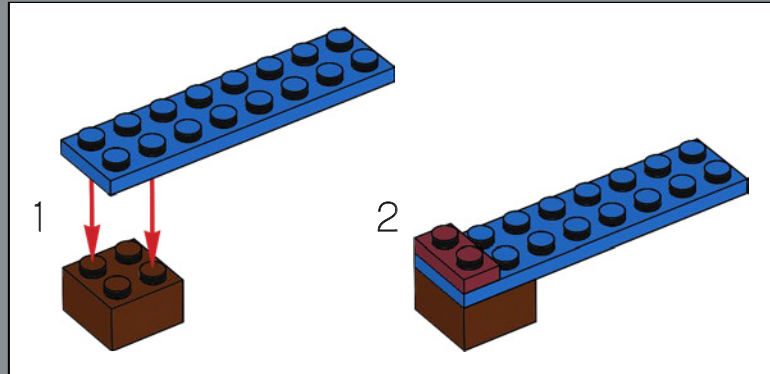

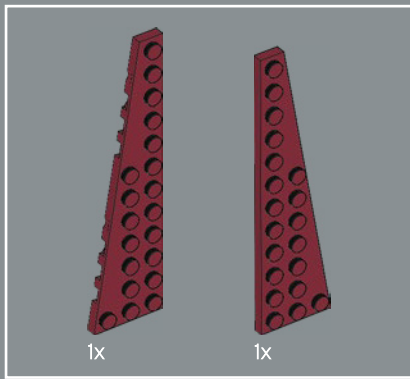

8

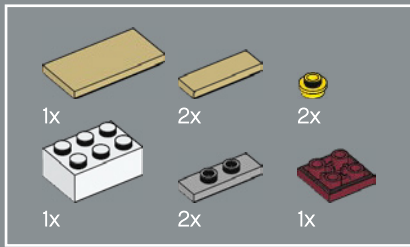
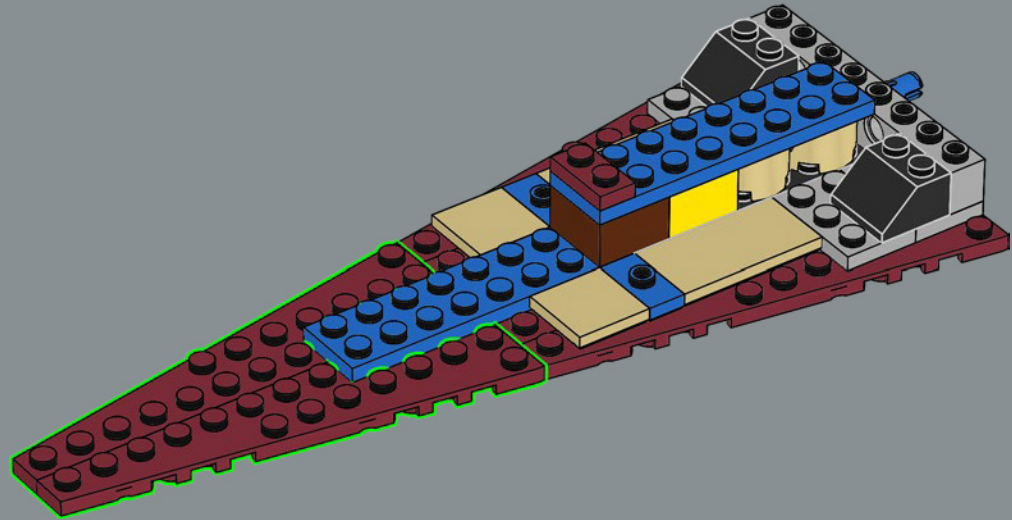

9

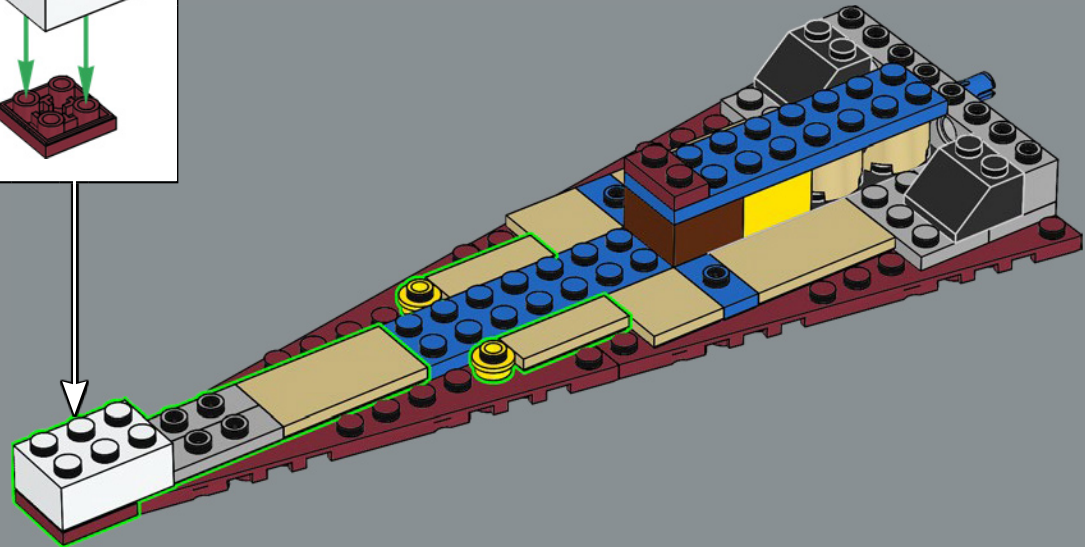
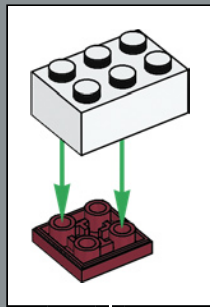



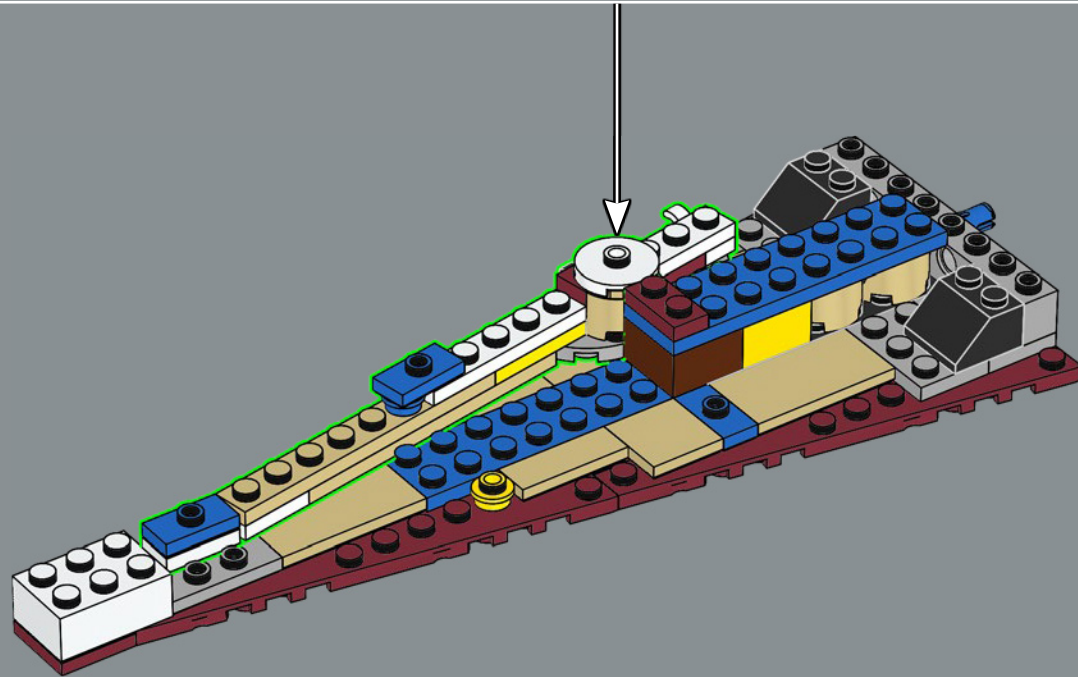
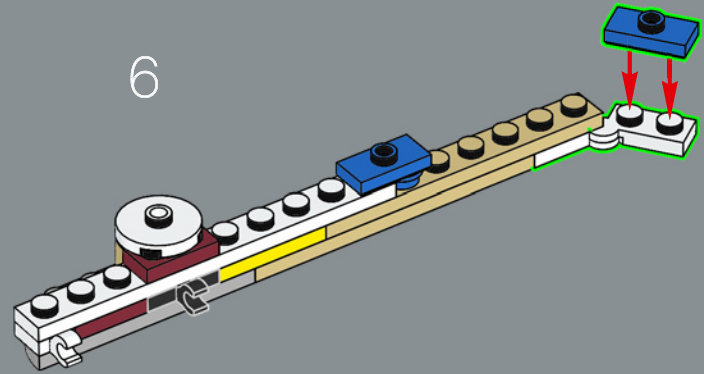
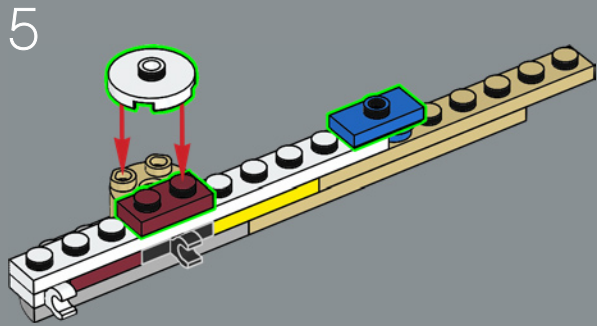

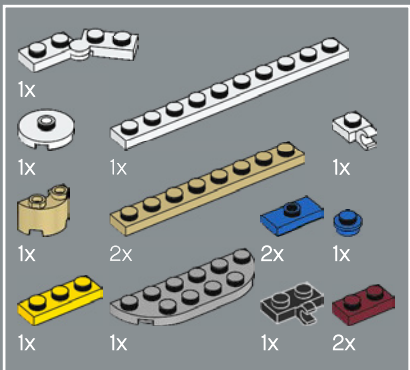

11

1

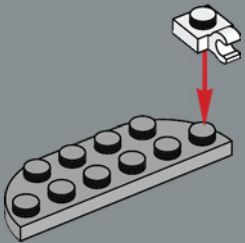

2

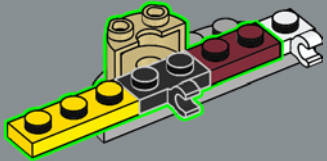

3

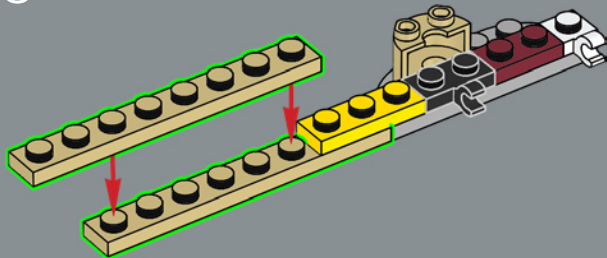

4

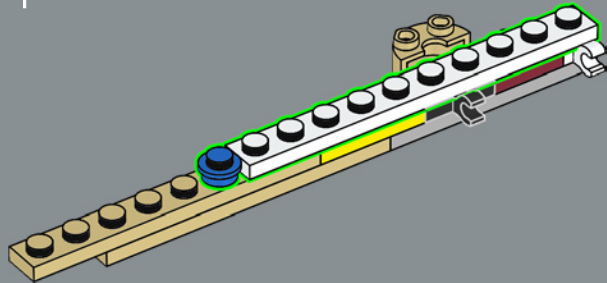



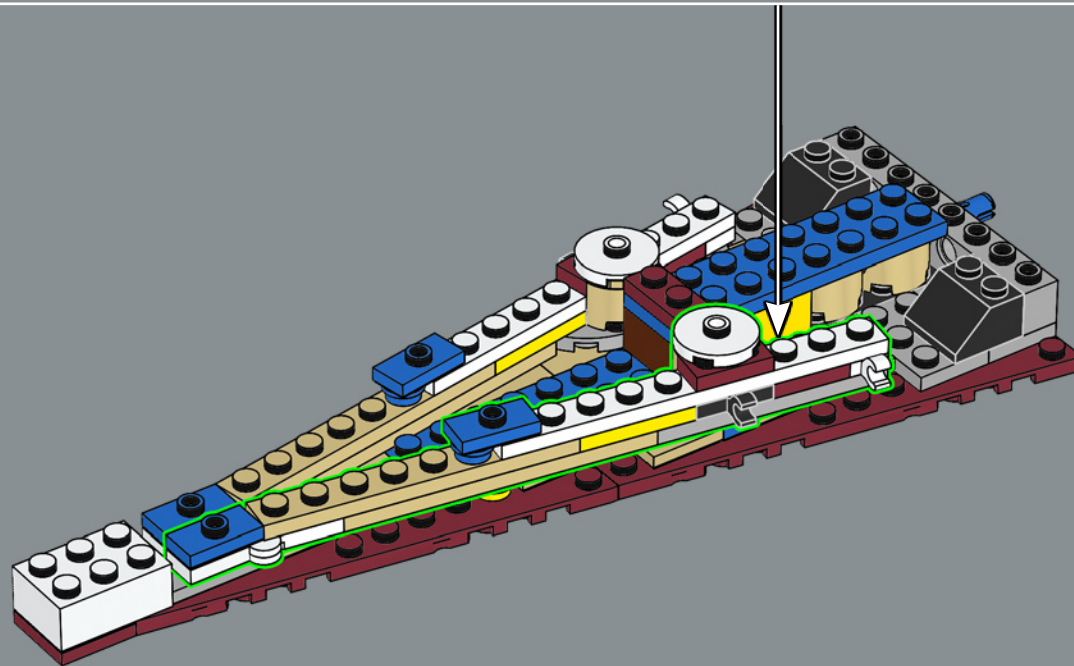
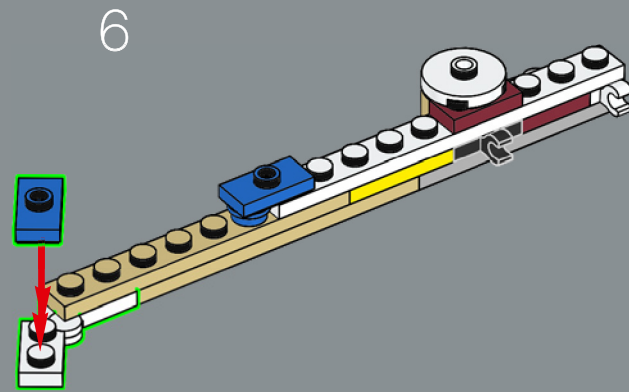
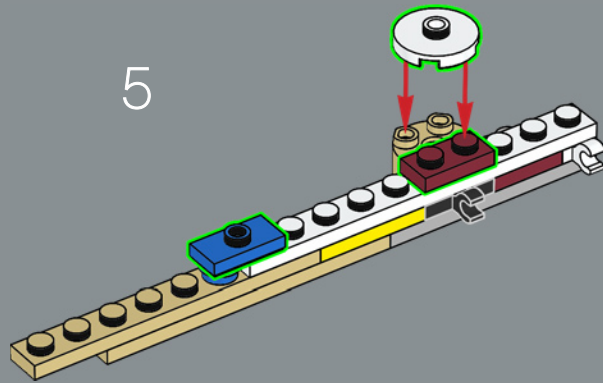

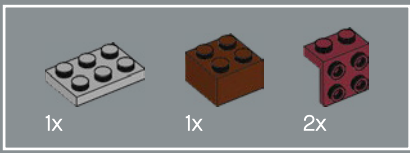

12

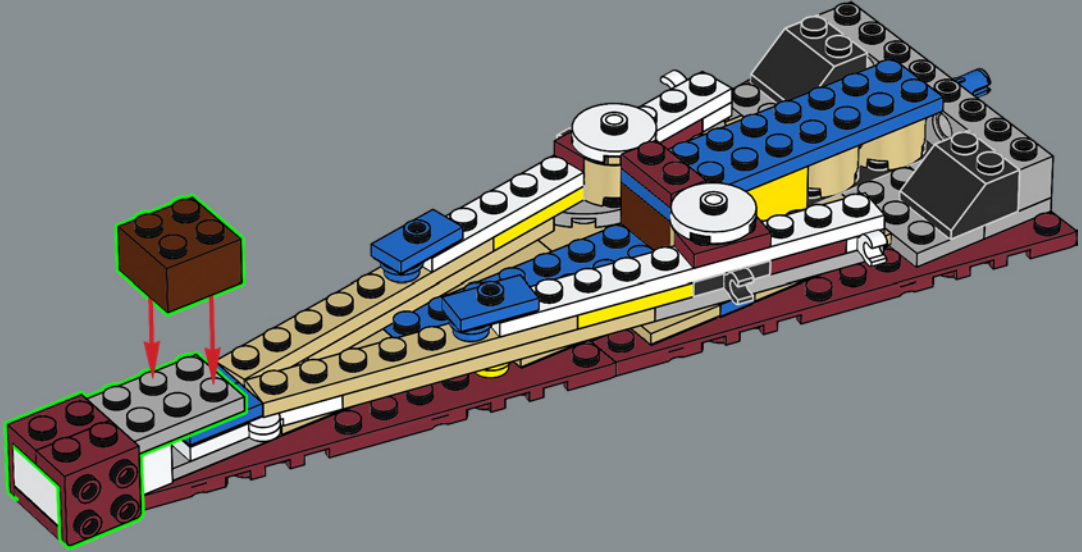

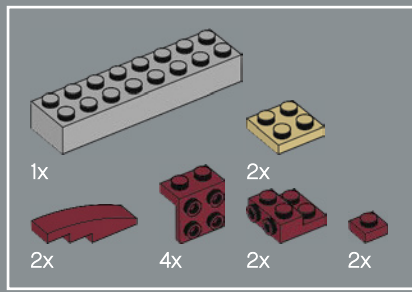

13

1

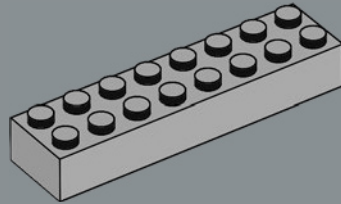

2

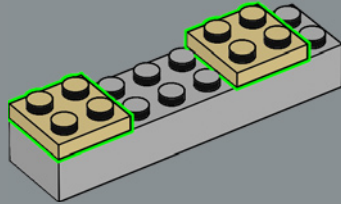

3

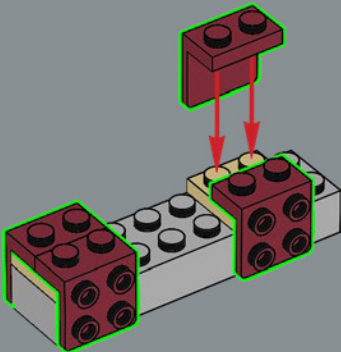

4

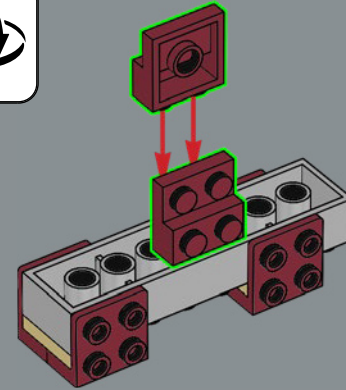

5

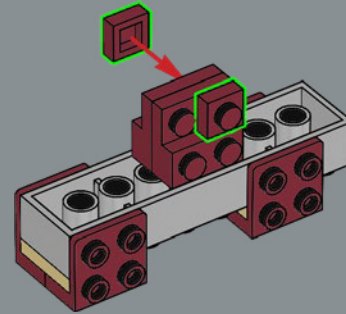

6

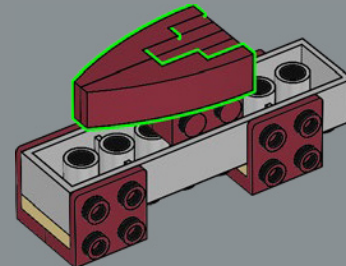

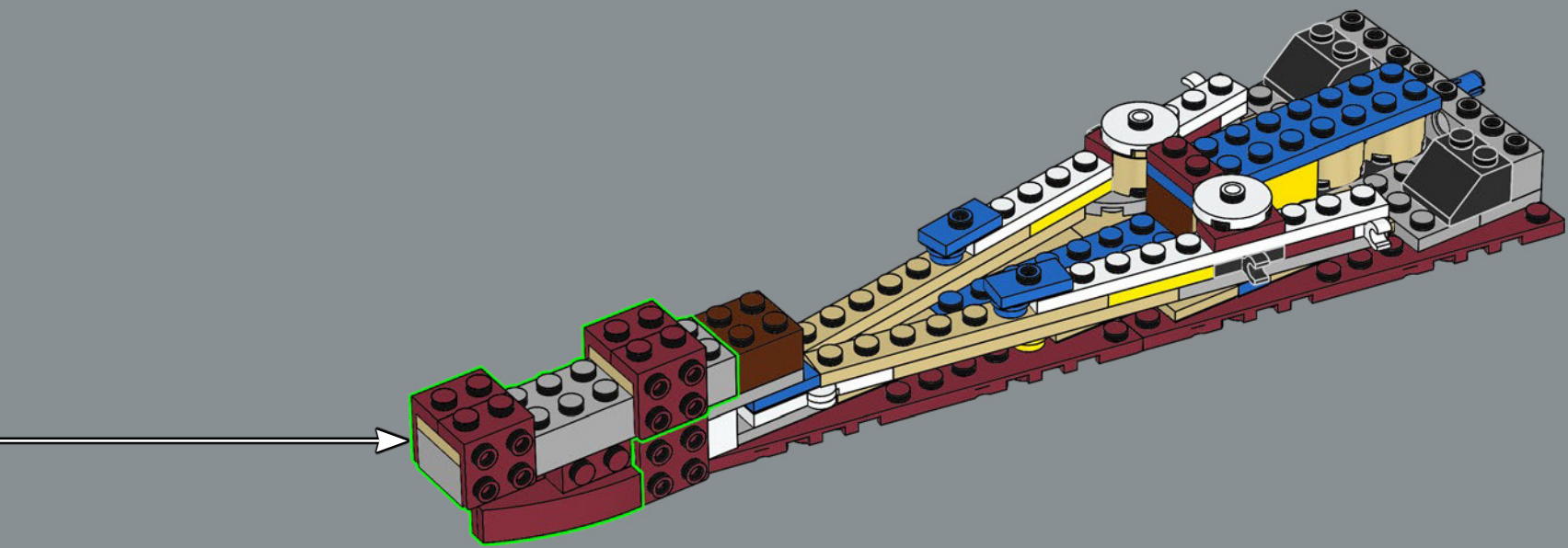

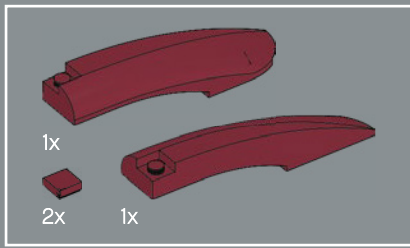

14

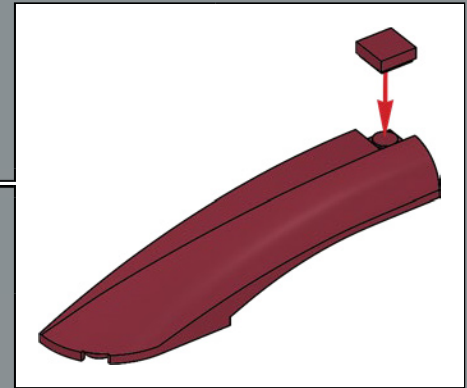
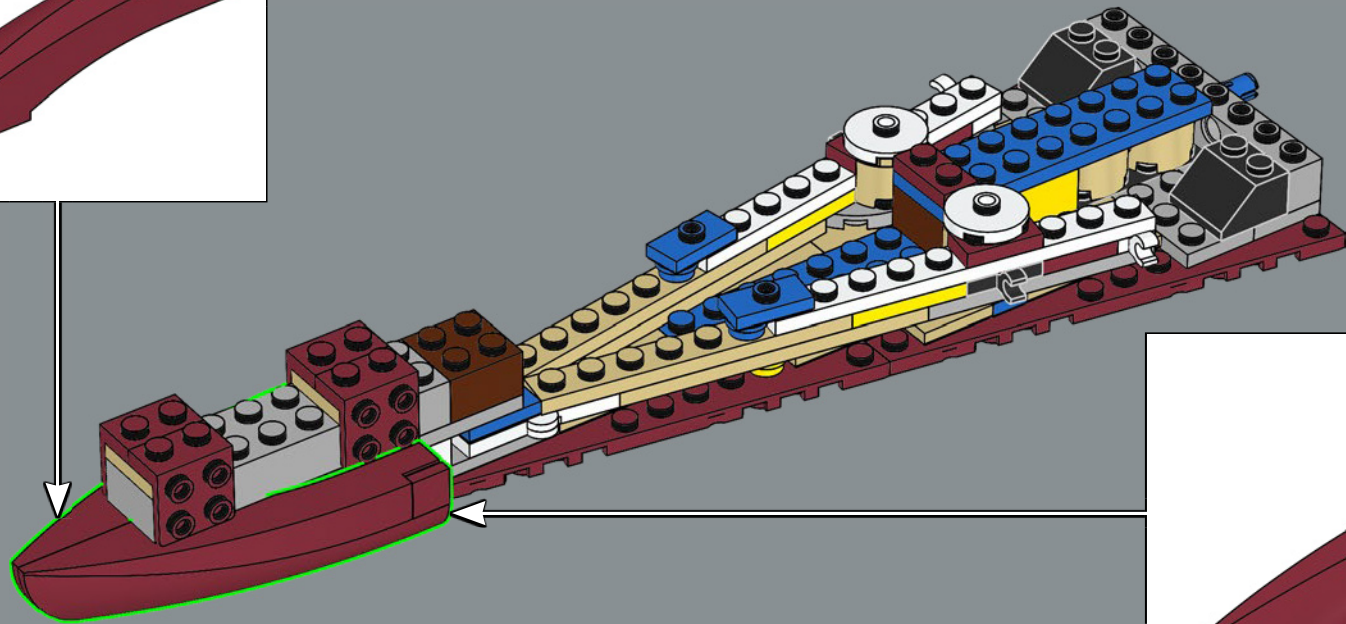
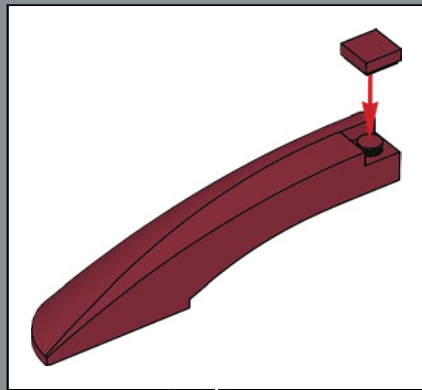

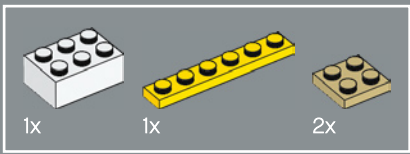

15

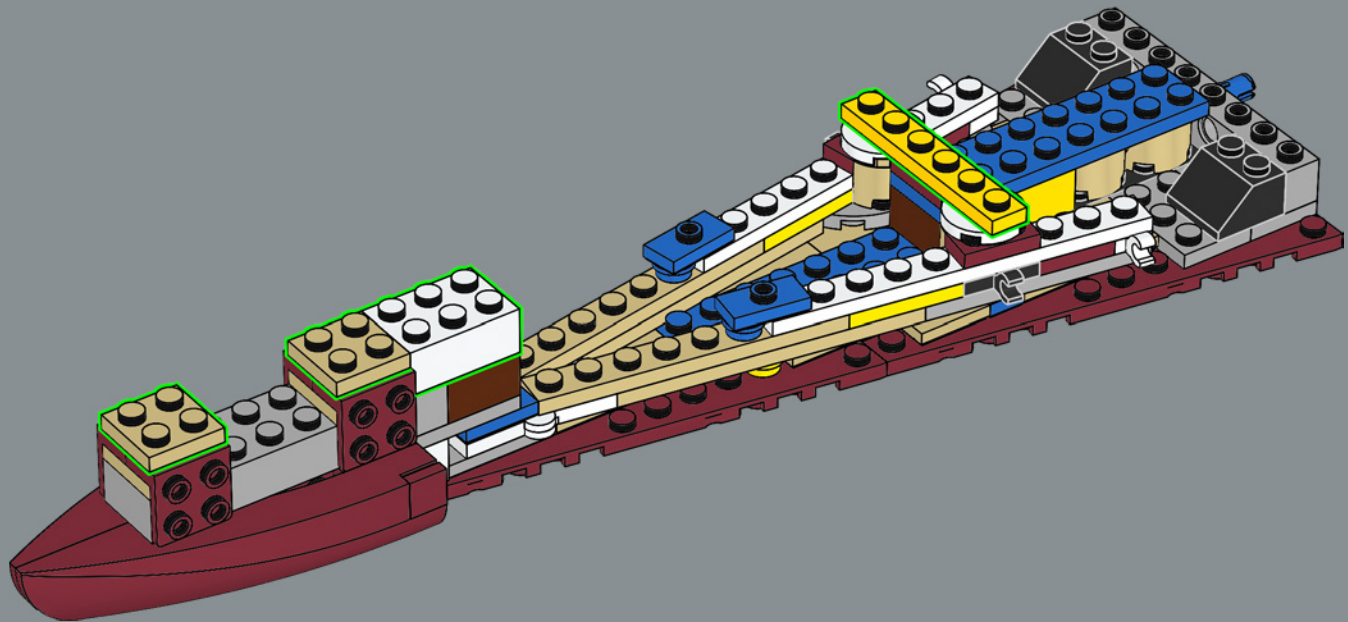

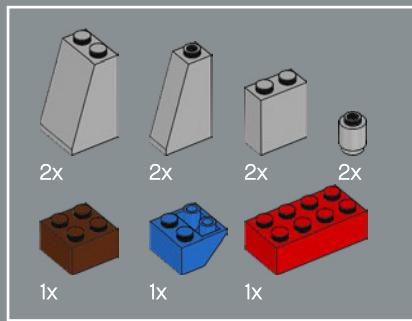

16

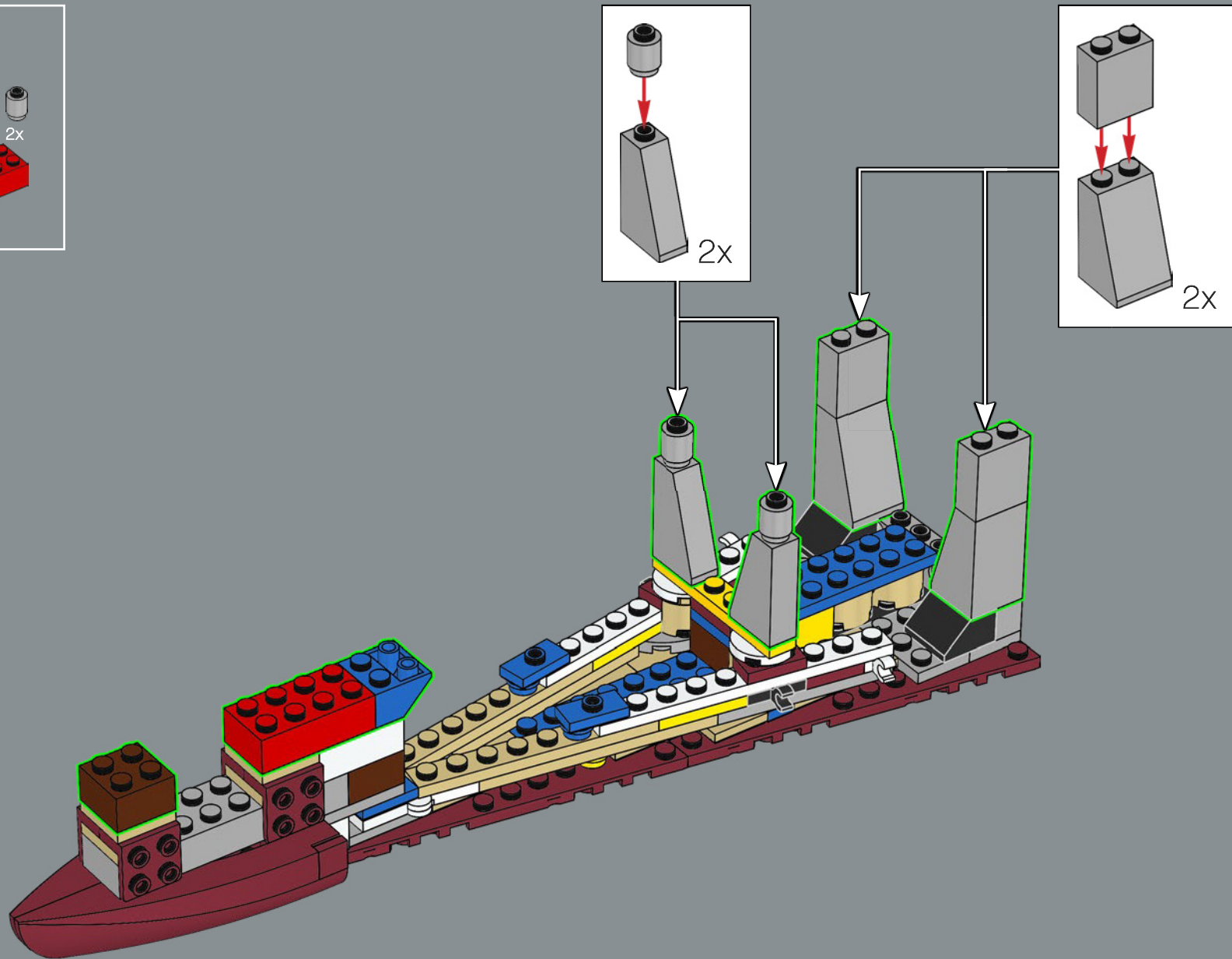

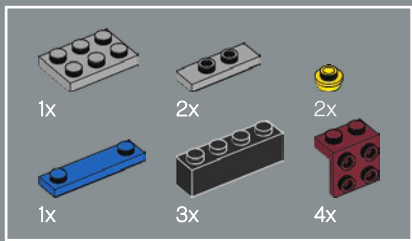

17

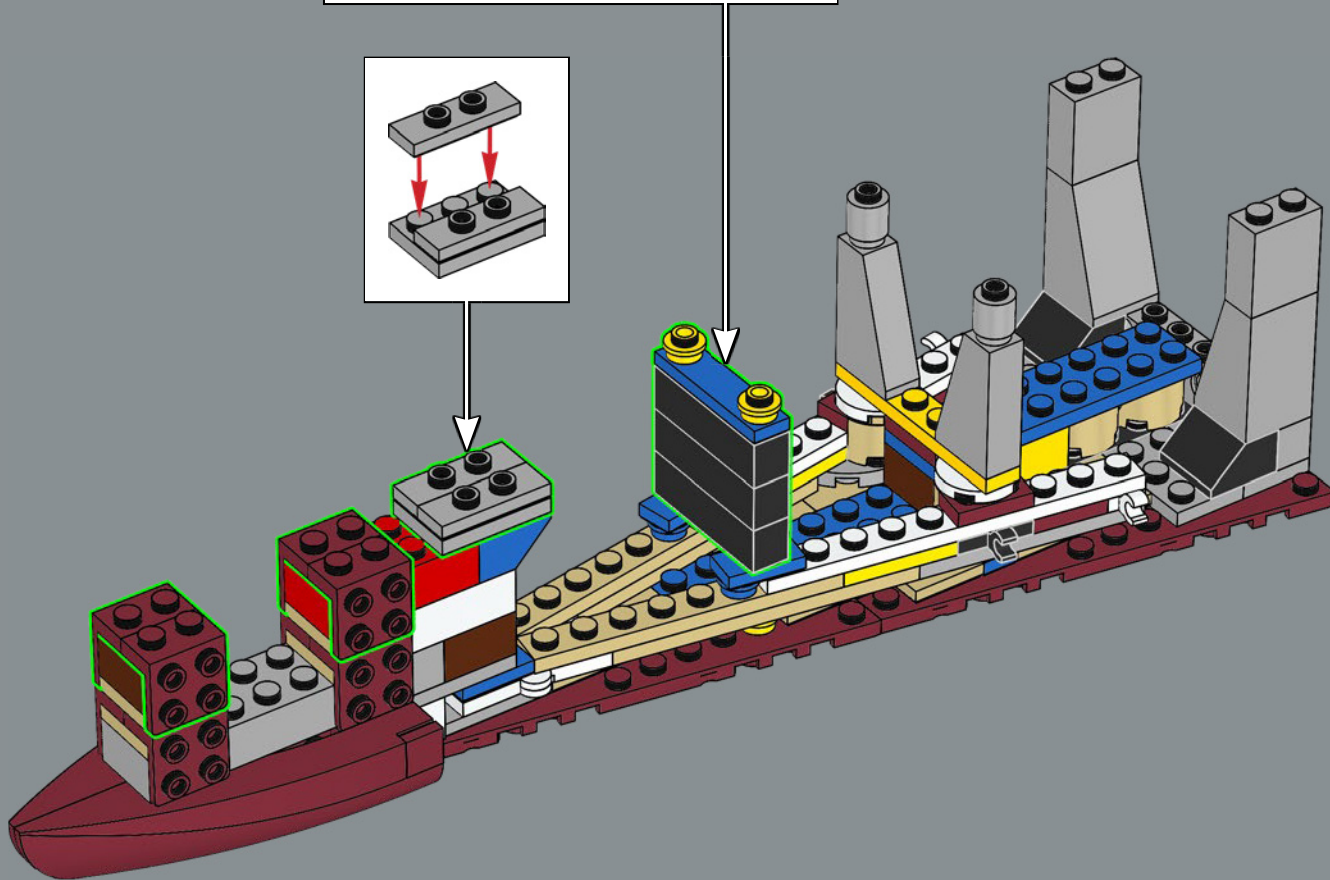
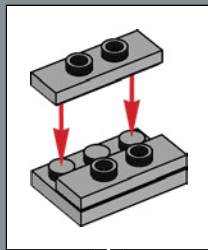
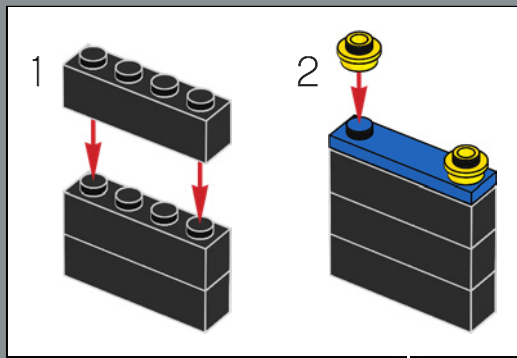



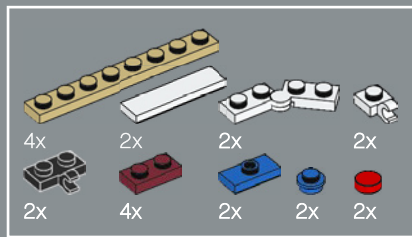

18

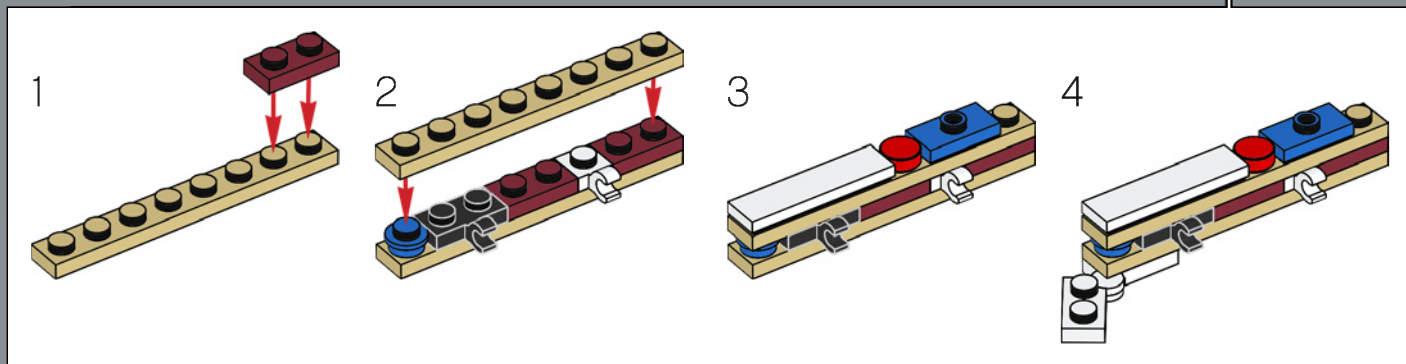
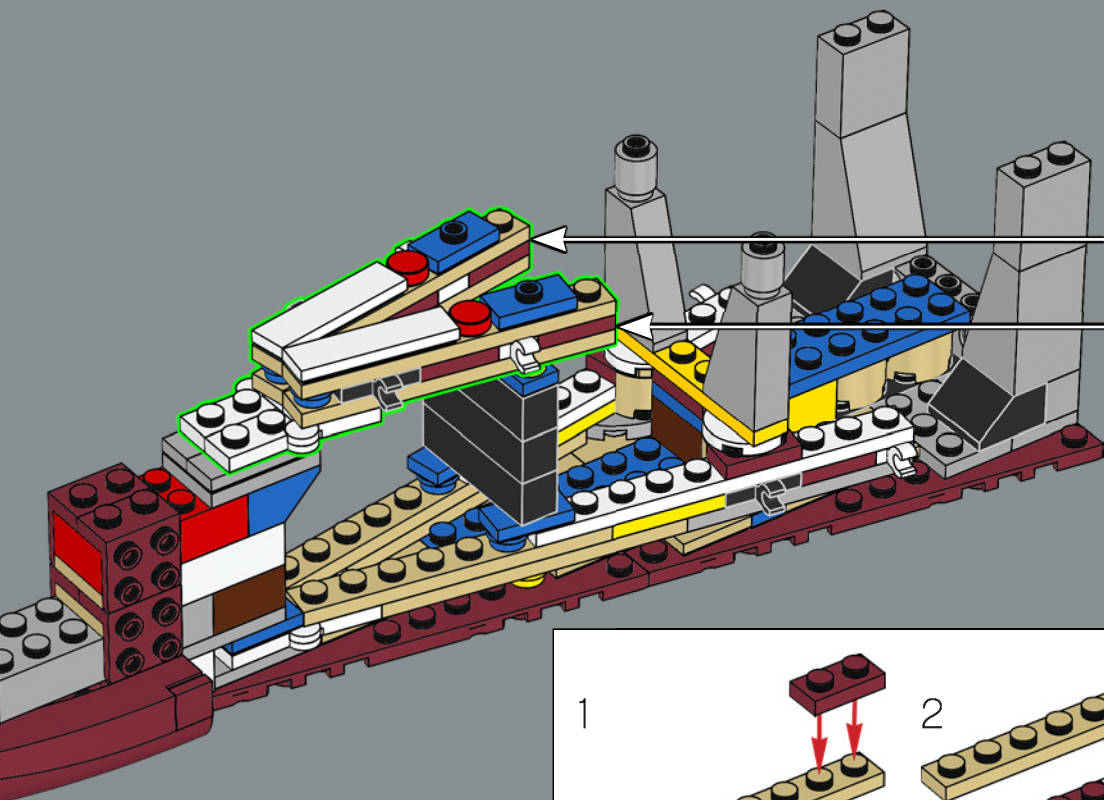
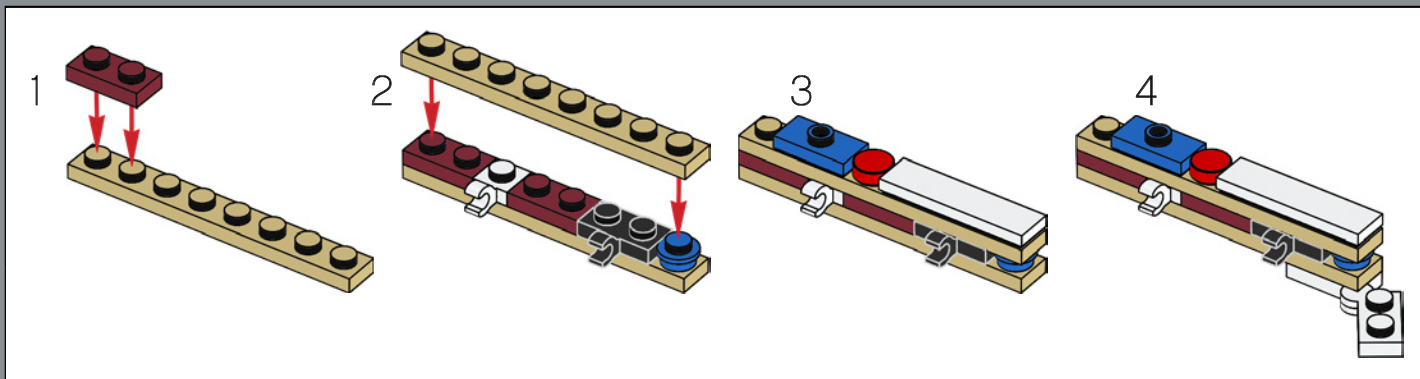

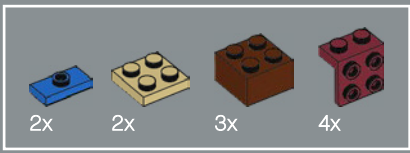

19

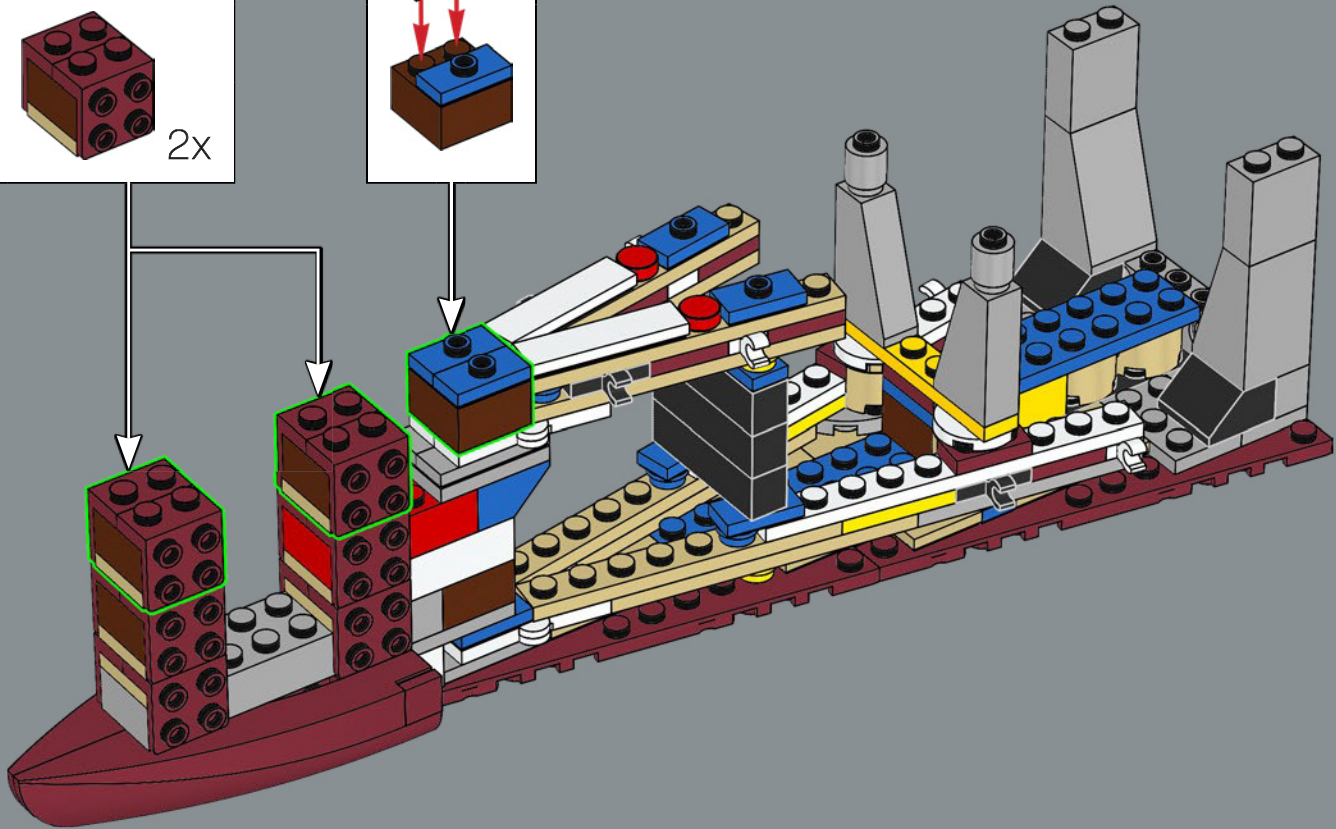
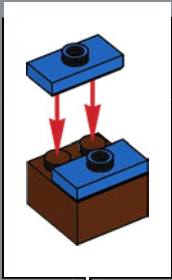
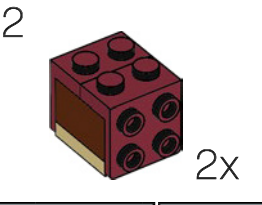
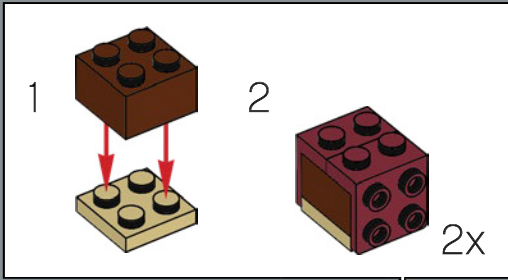

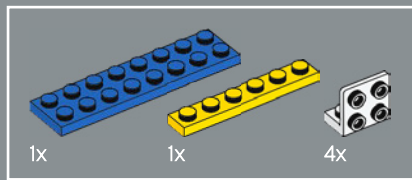

20

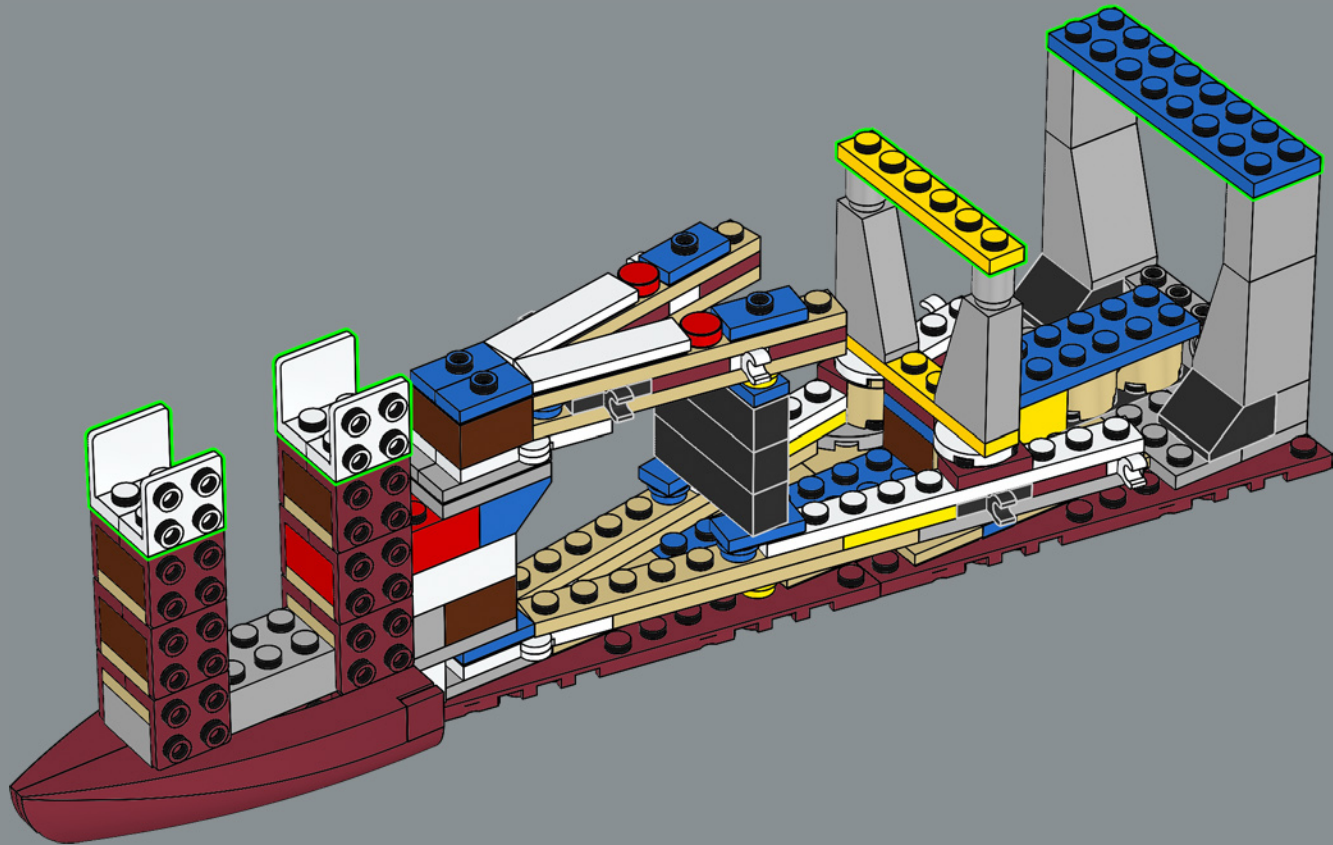

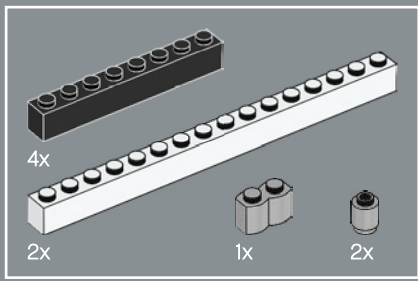

21

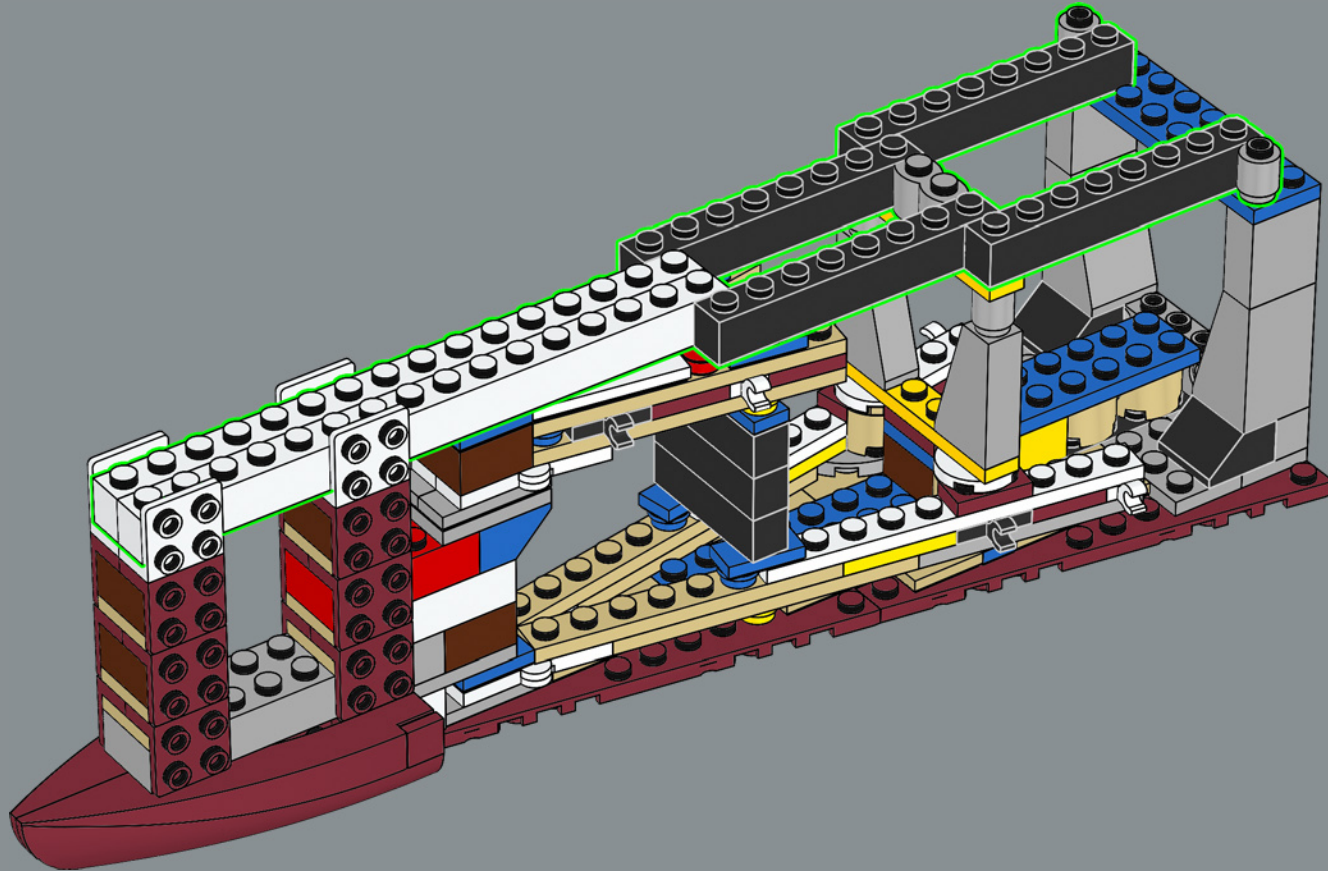

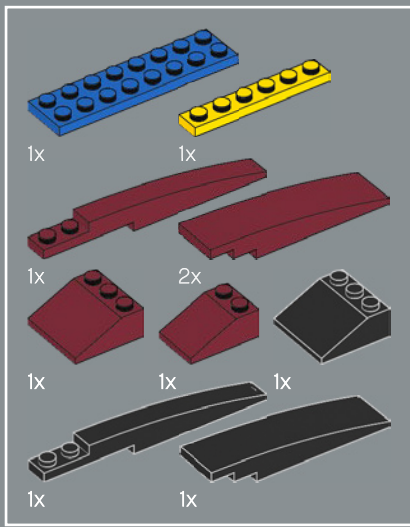

22

1

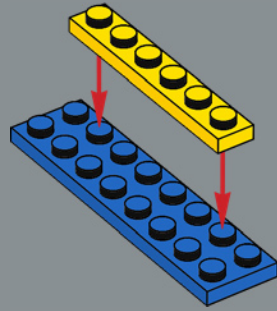

2

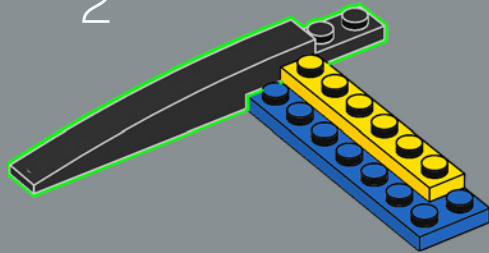

3

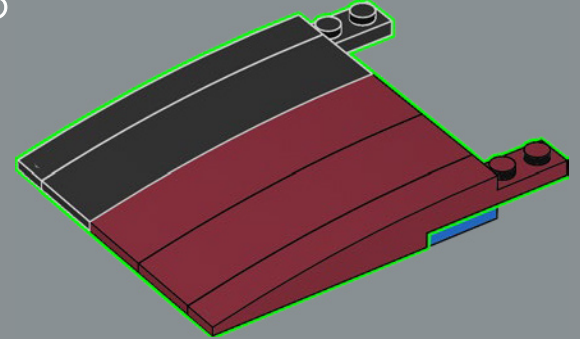

4

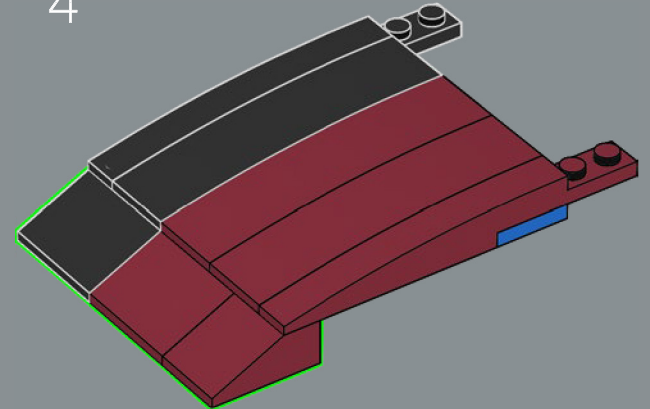

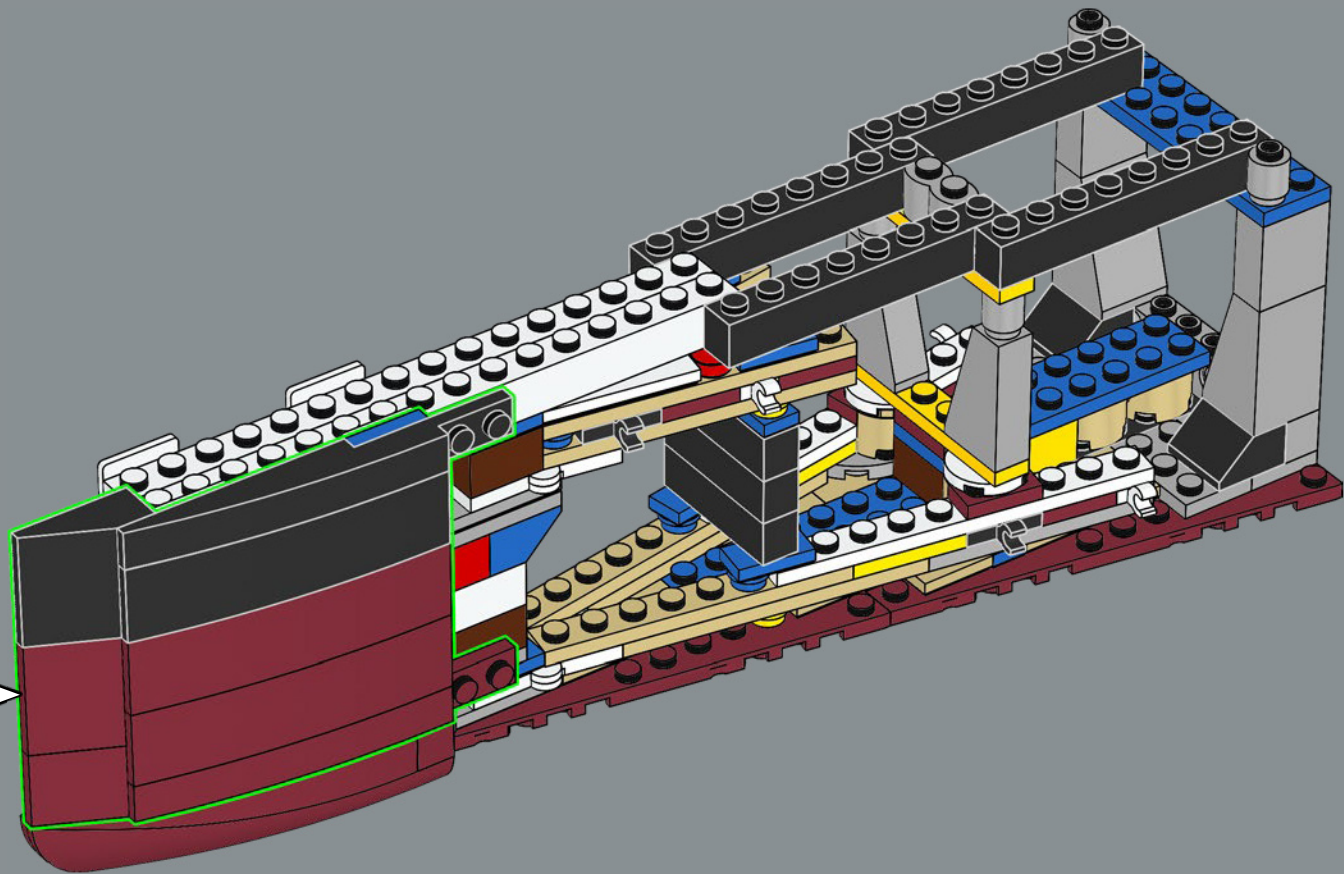

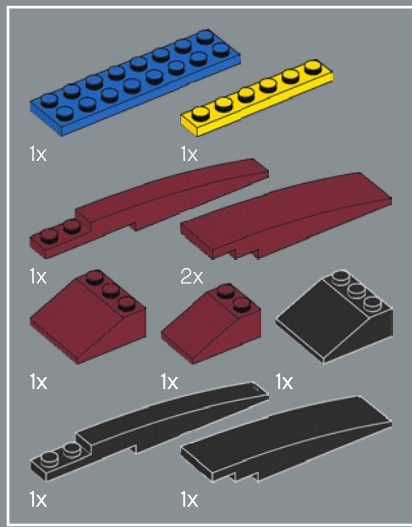

23

1

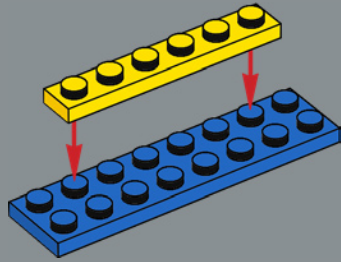

2

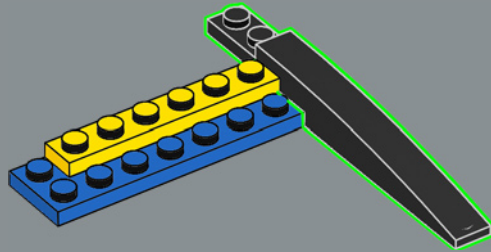

3

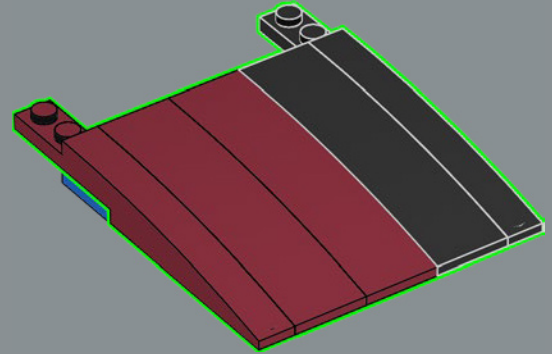

4

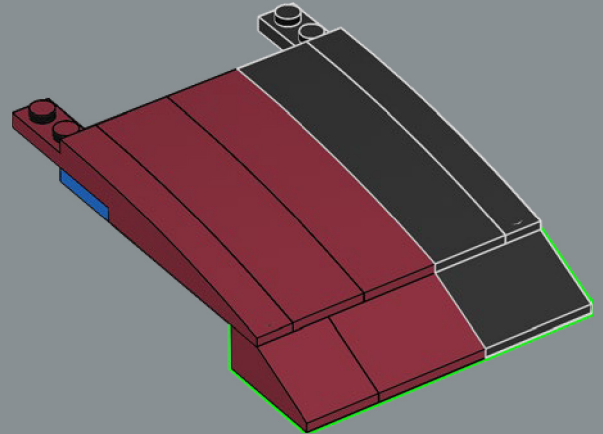

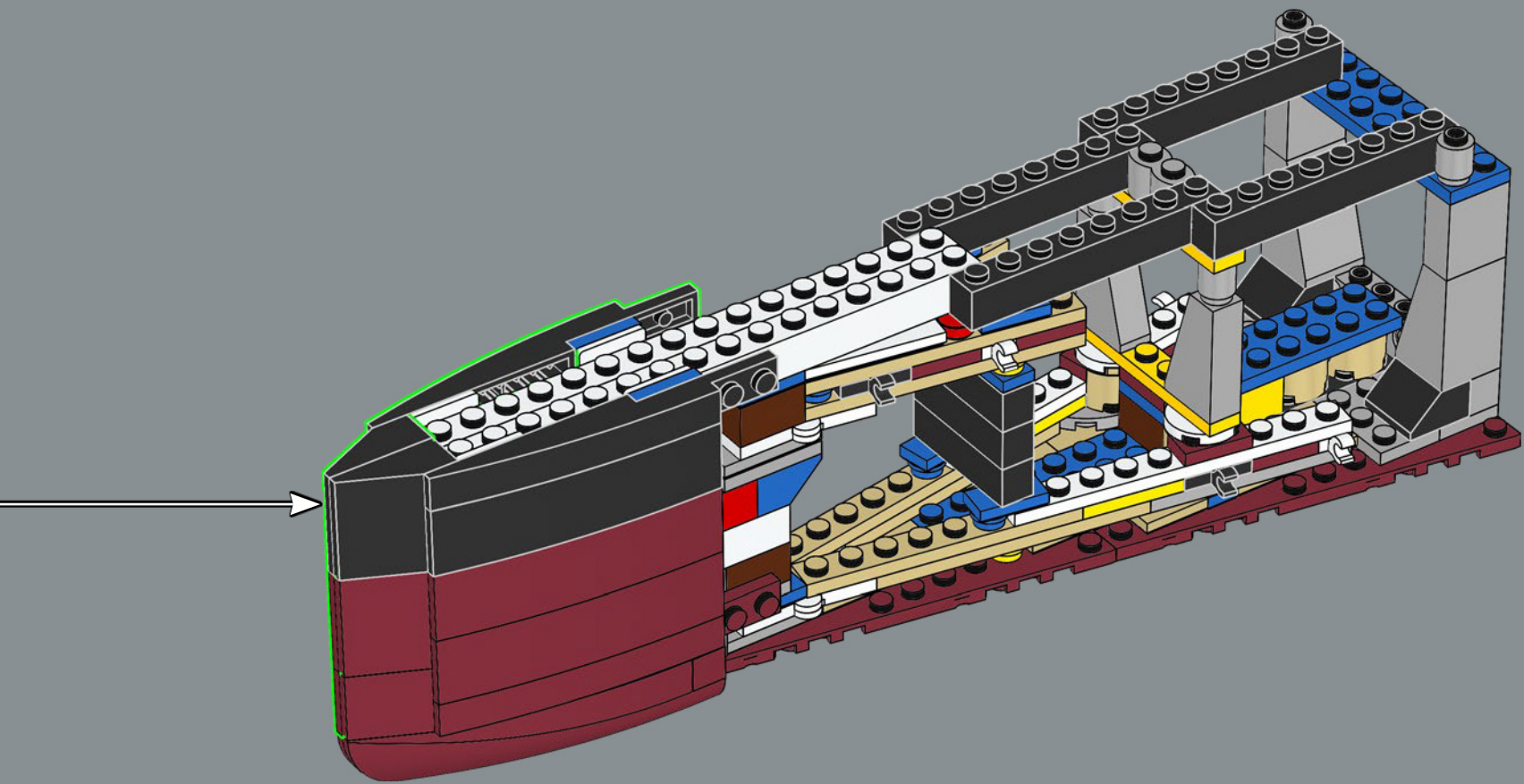



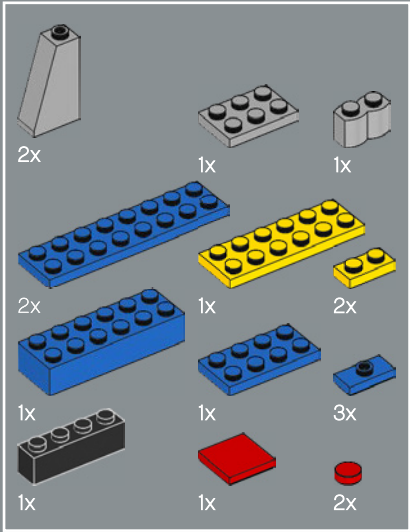
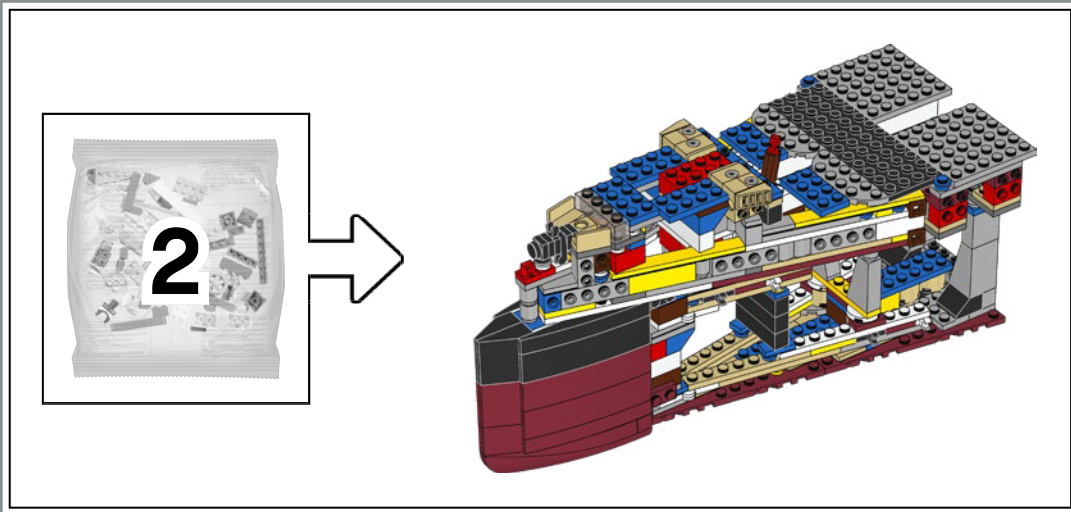

24

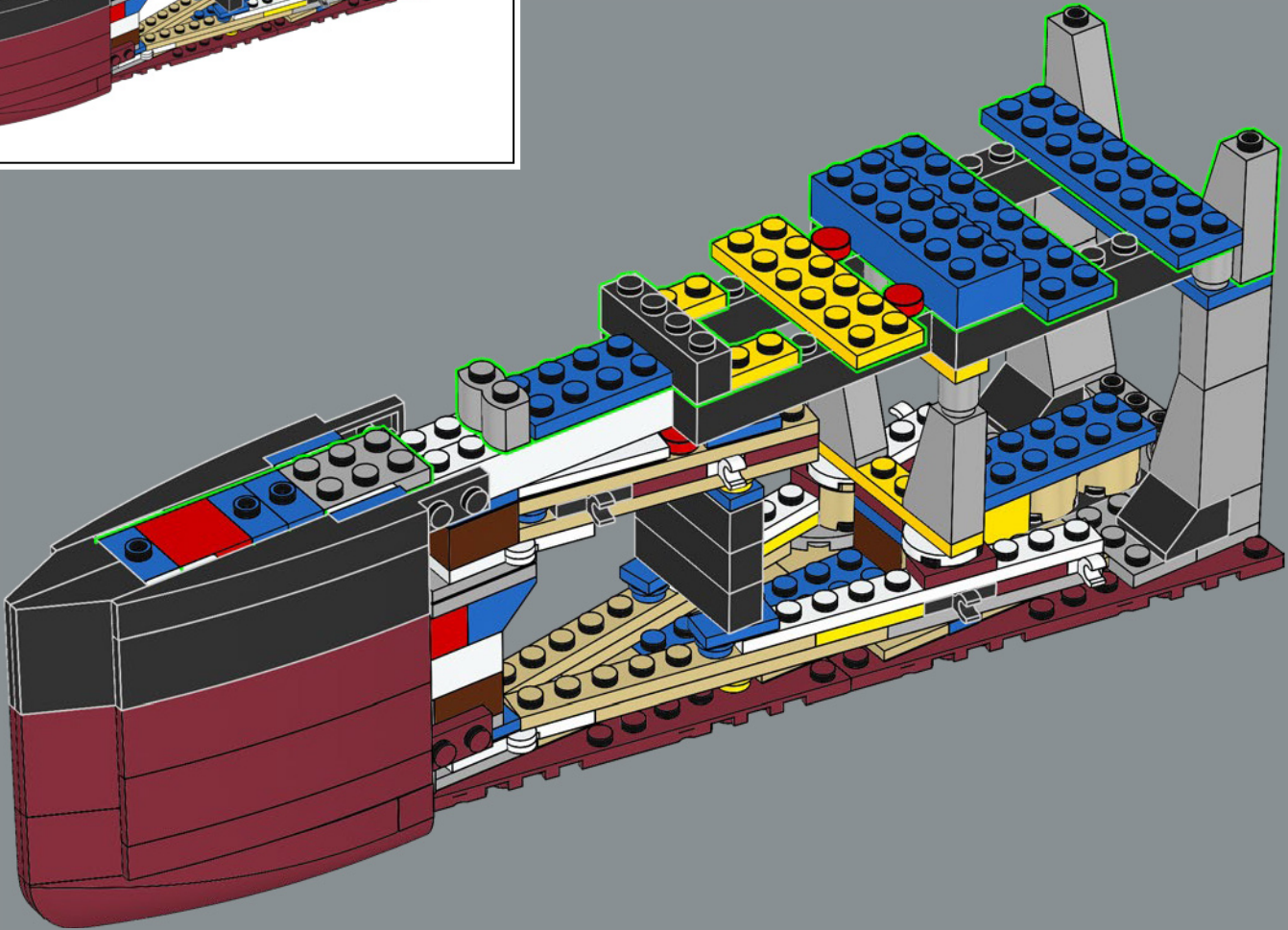

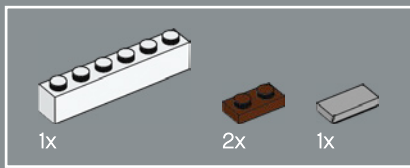

25

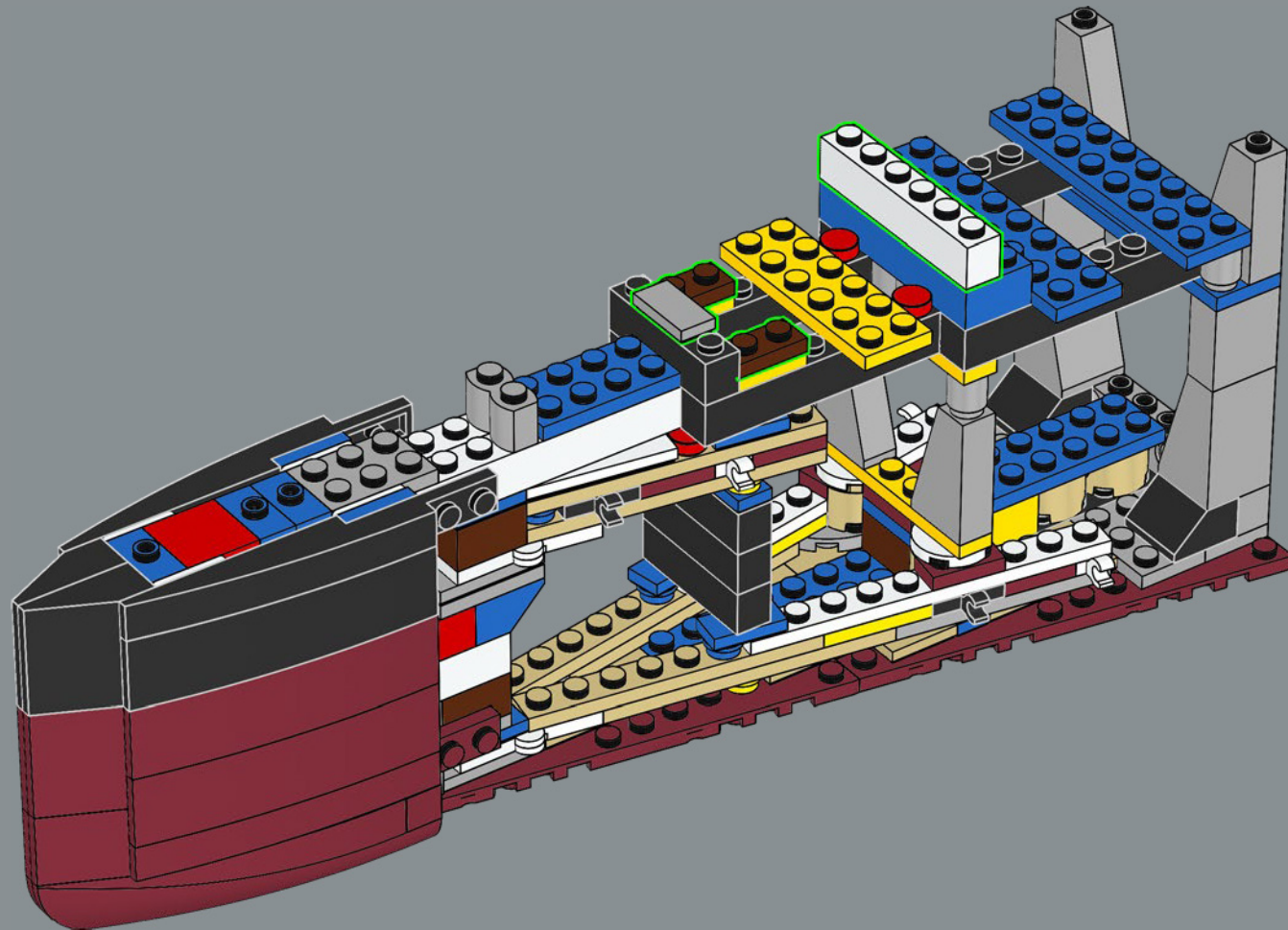

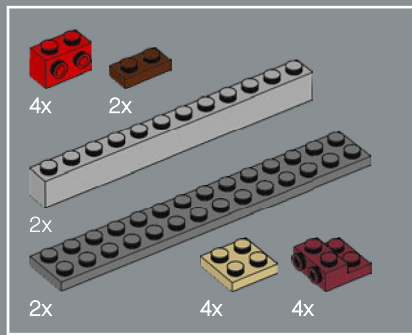

26

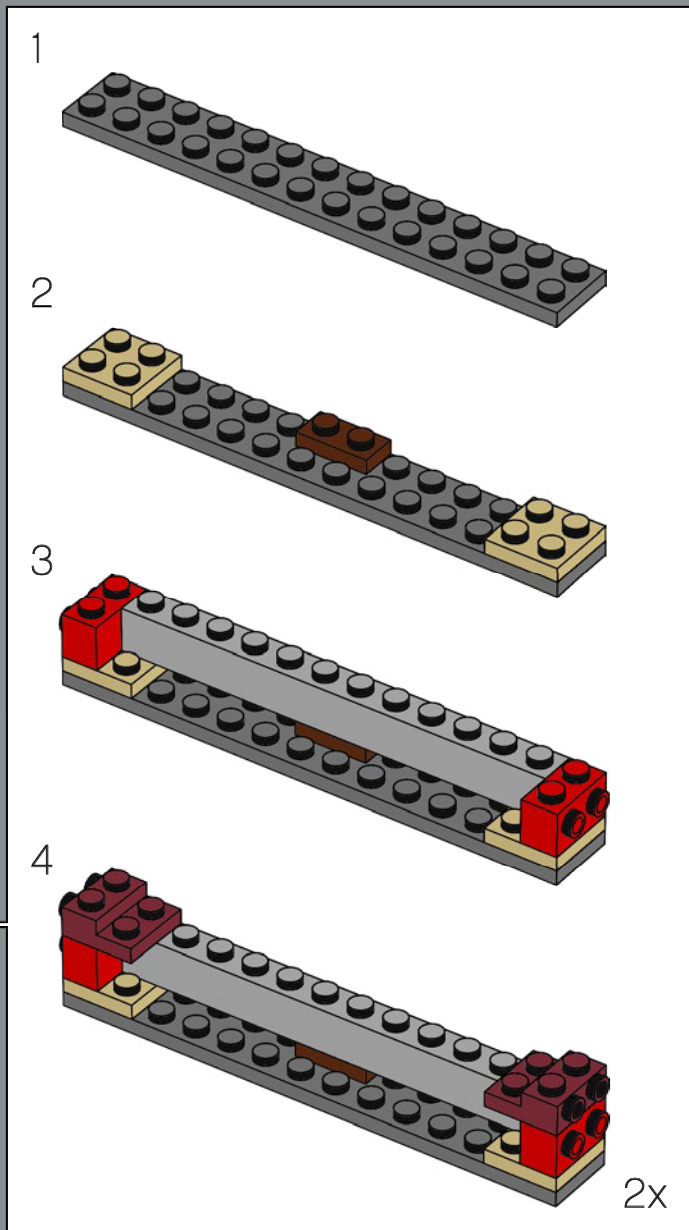
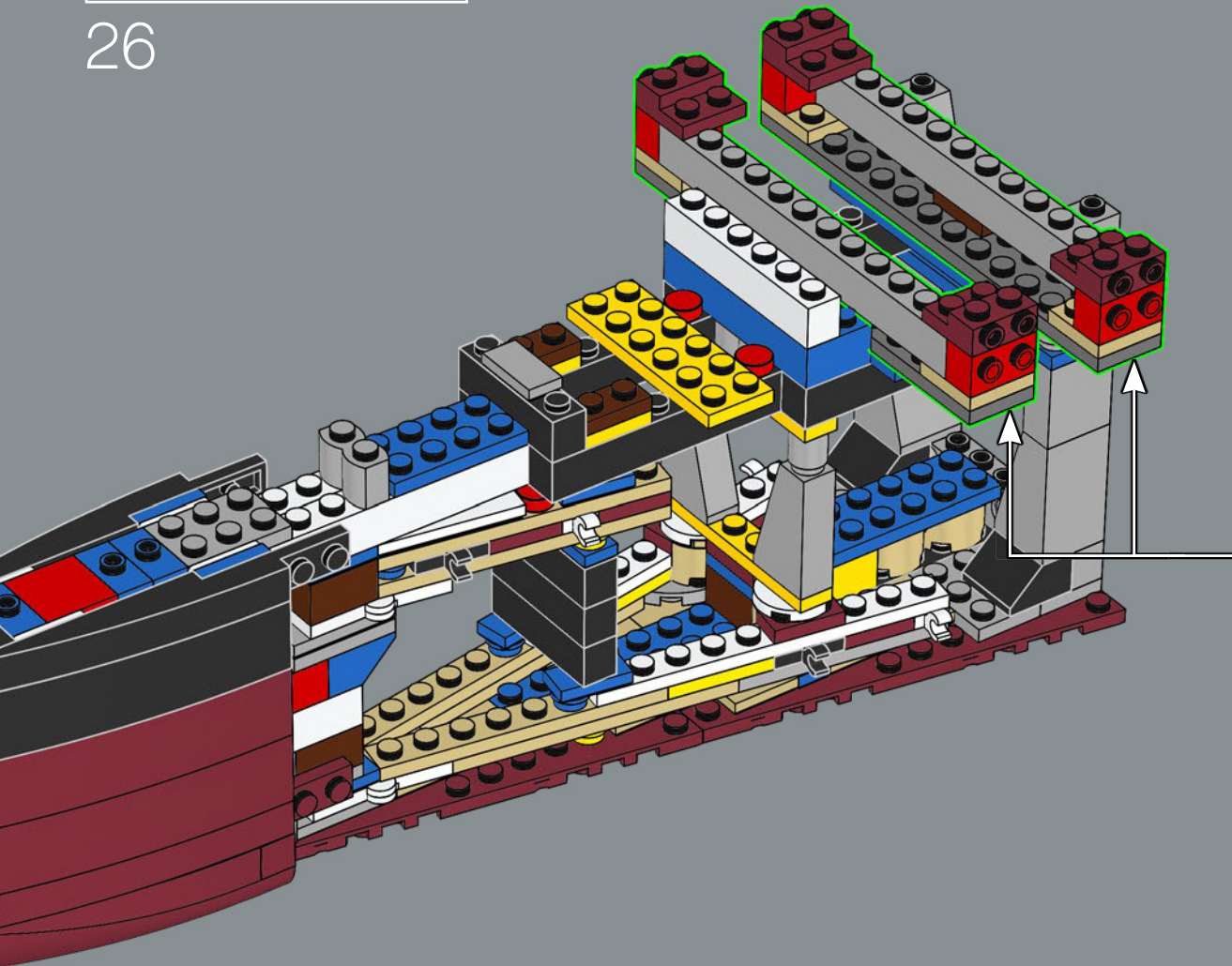

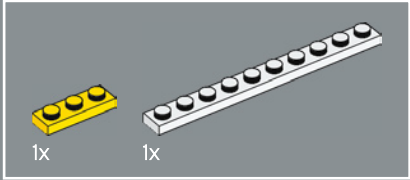
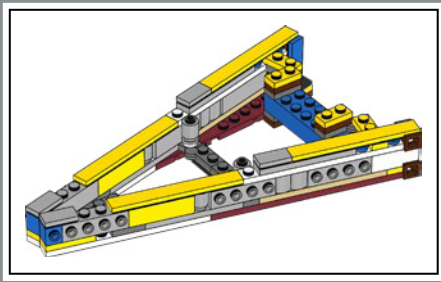

27

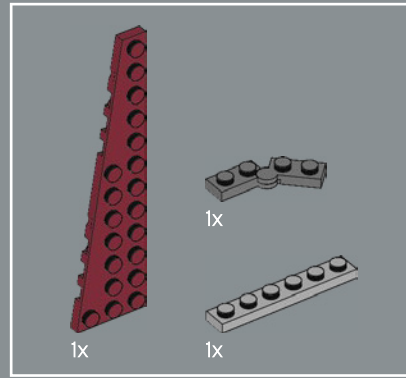
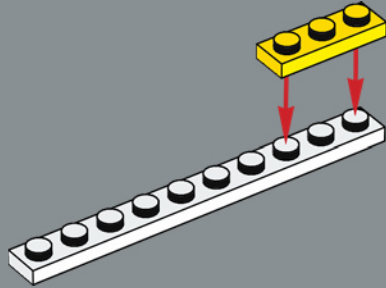

28

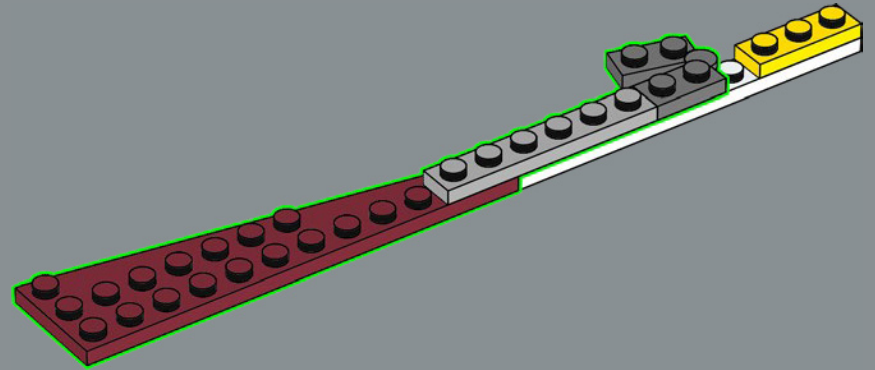

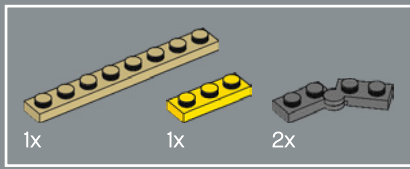

29

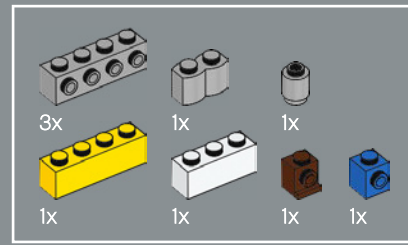
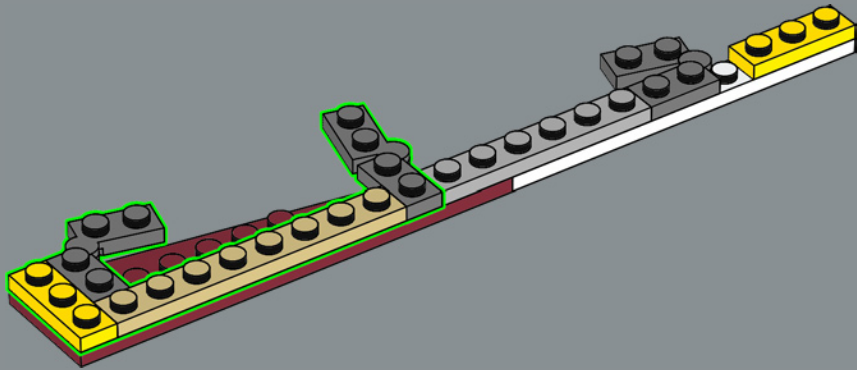

30

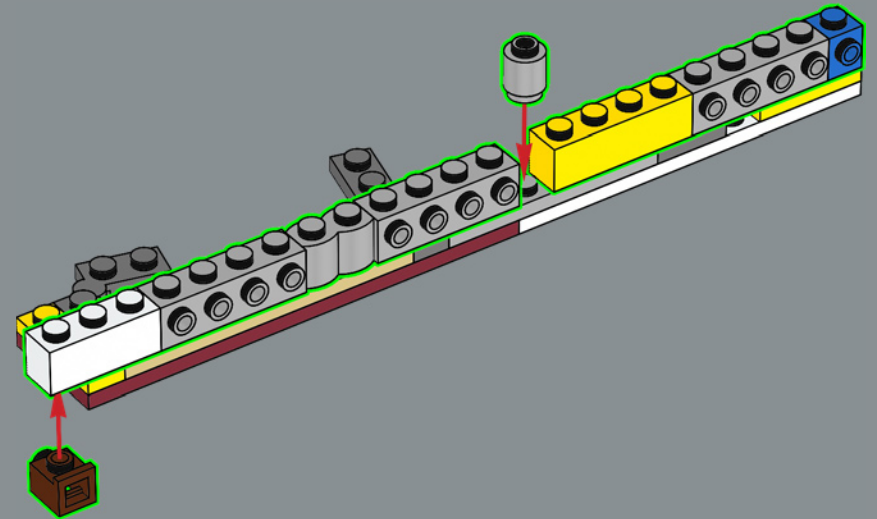

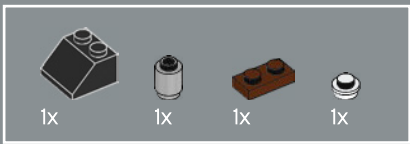

31

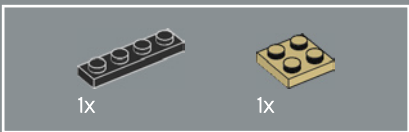
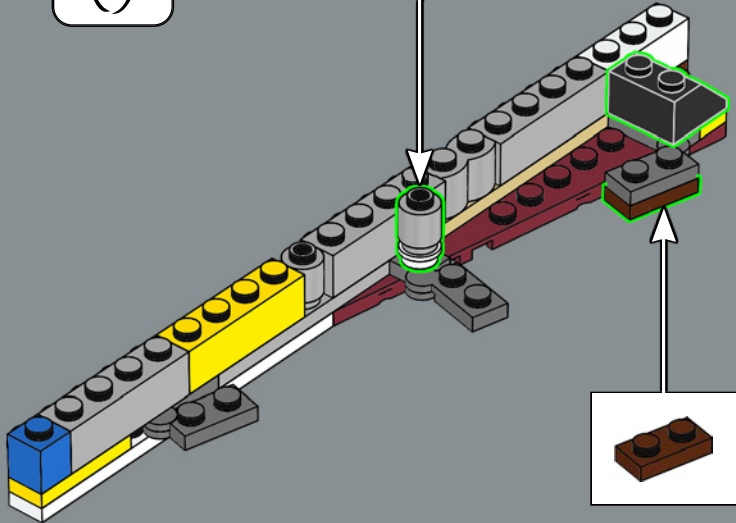
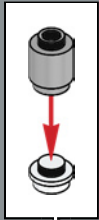

32

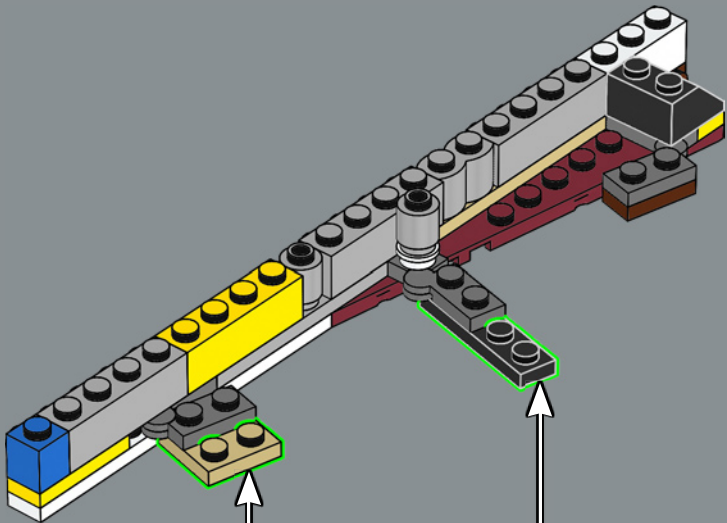

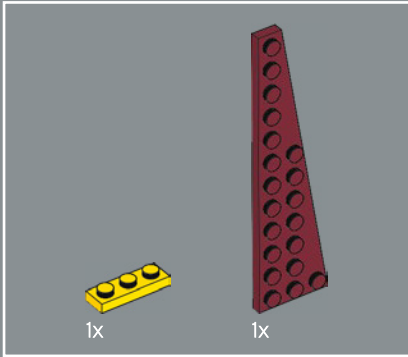
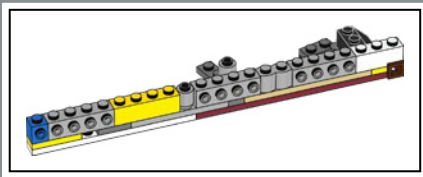

33

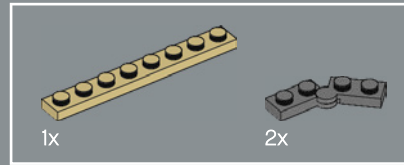
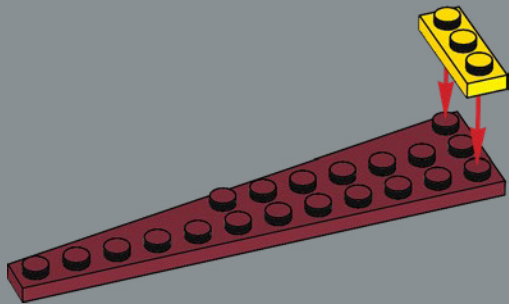

34

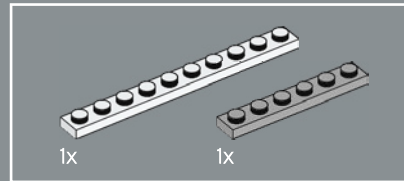
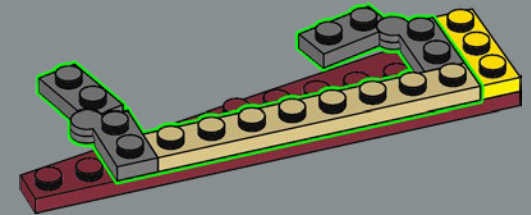

35

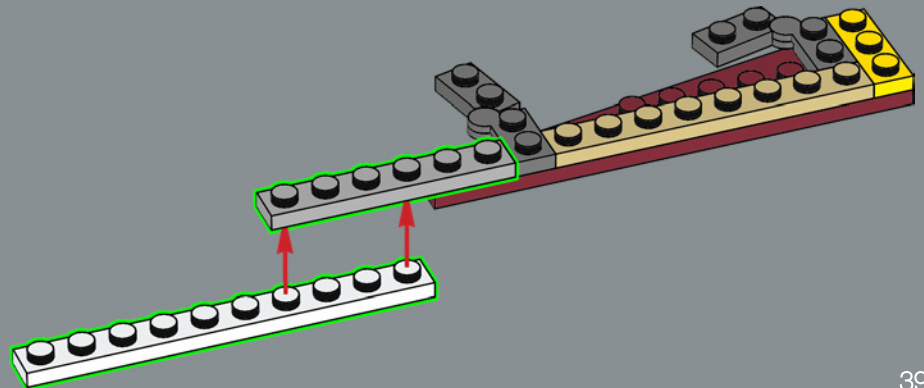

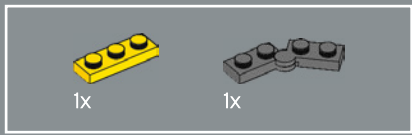

36

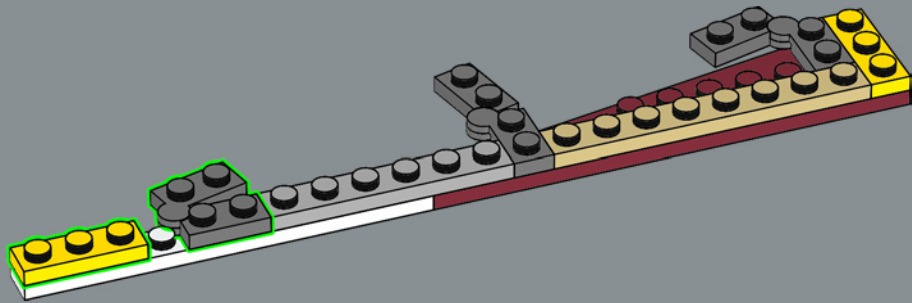

37

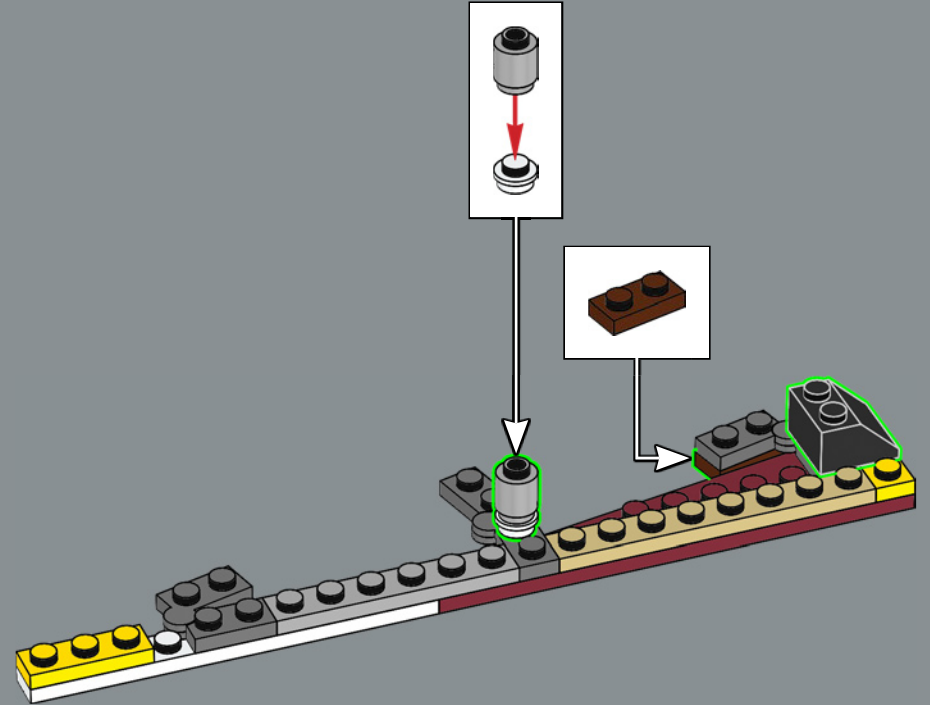



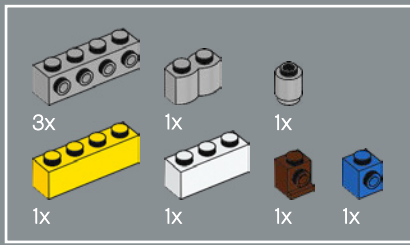

38

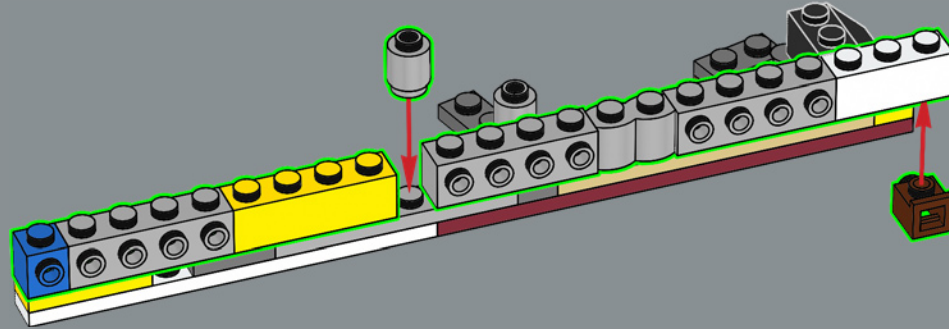

39

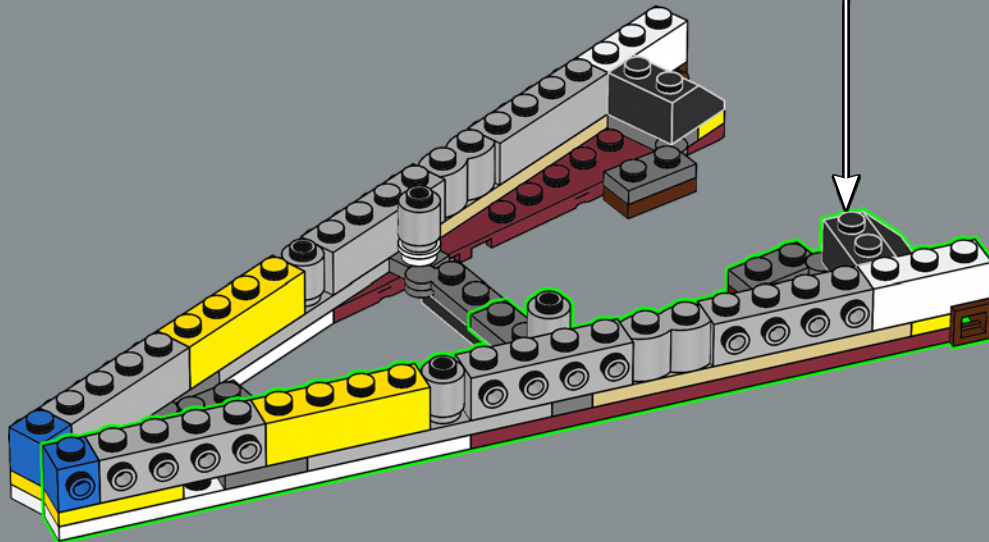

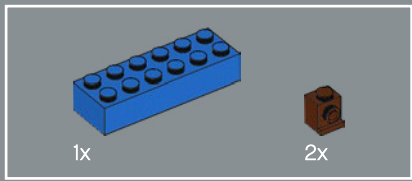

40

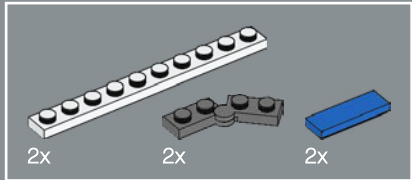
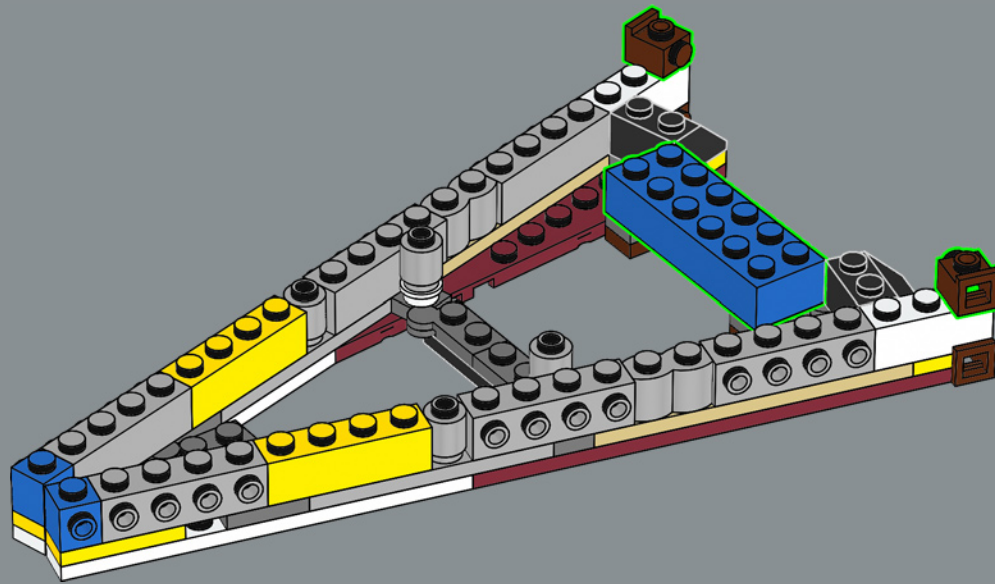

41

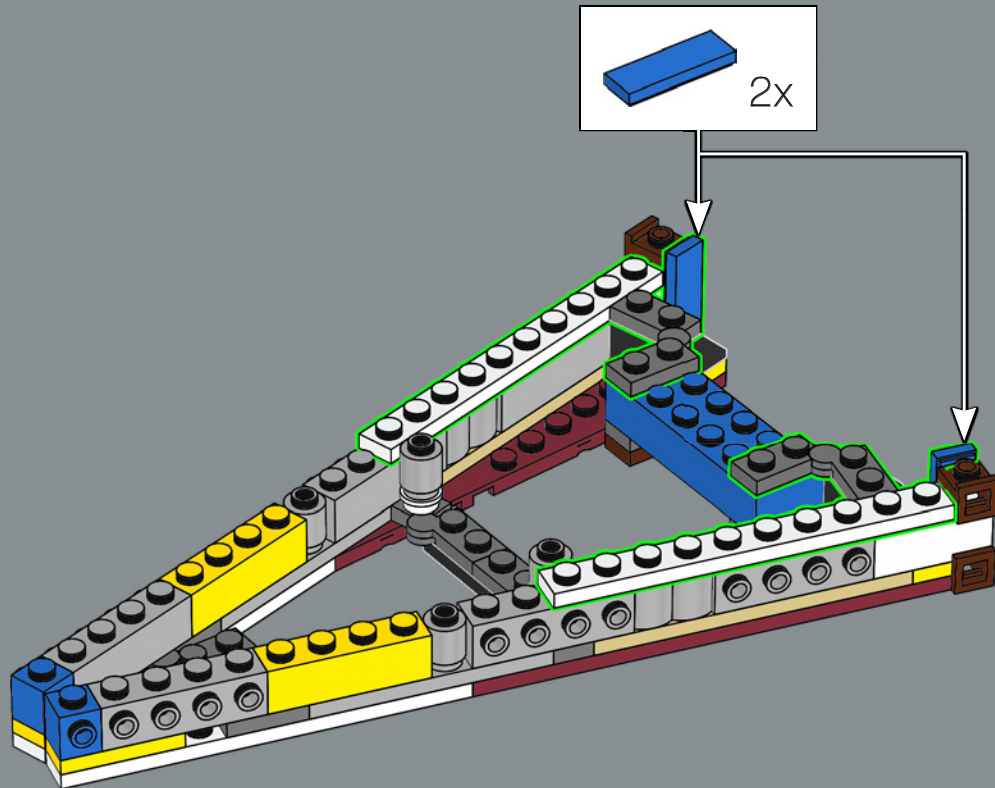

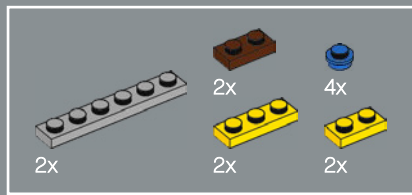

42

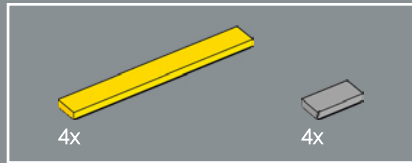
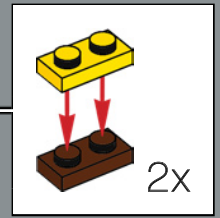
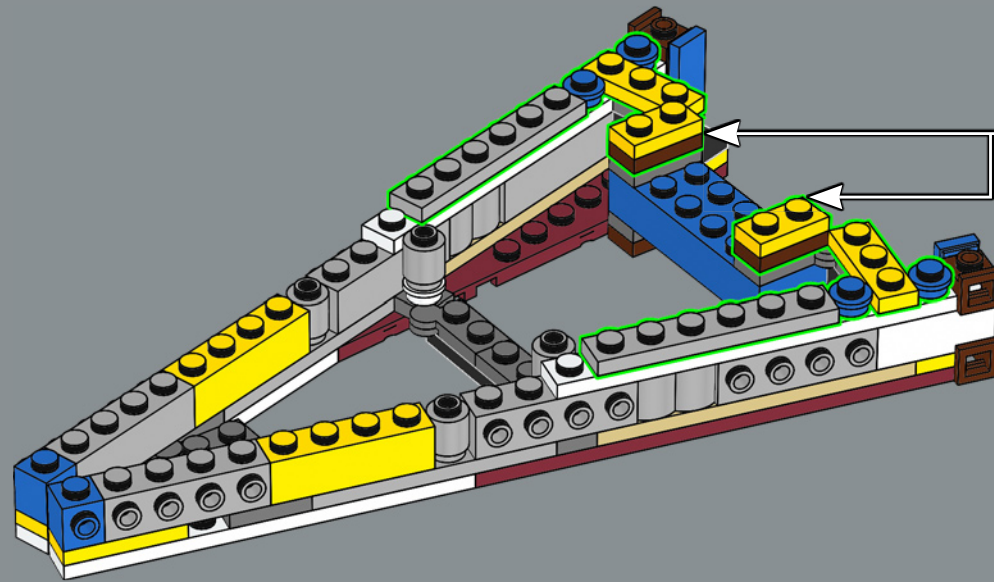

43

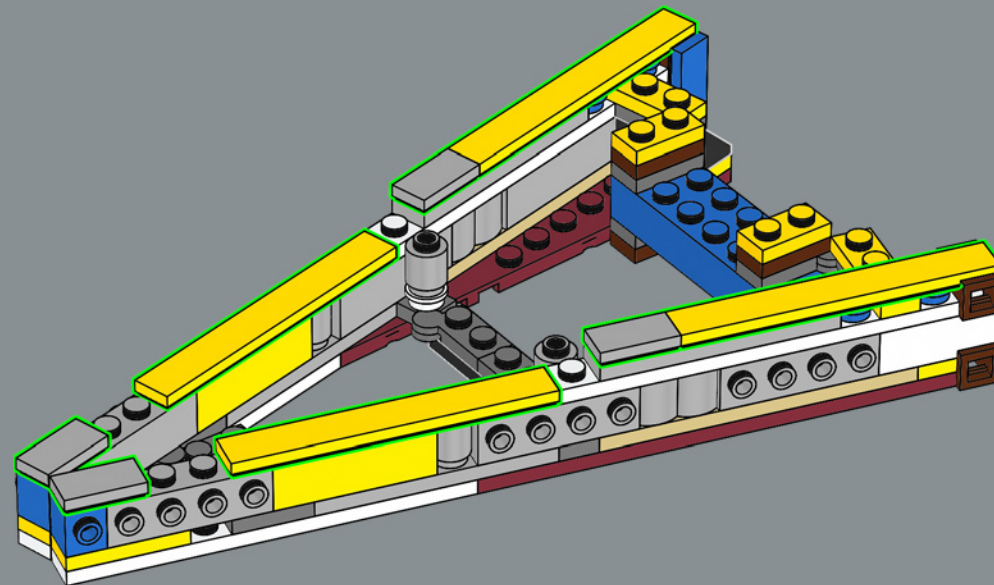

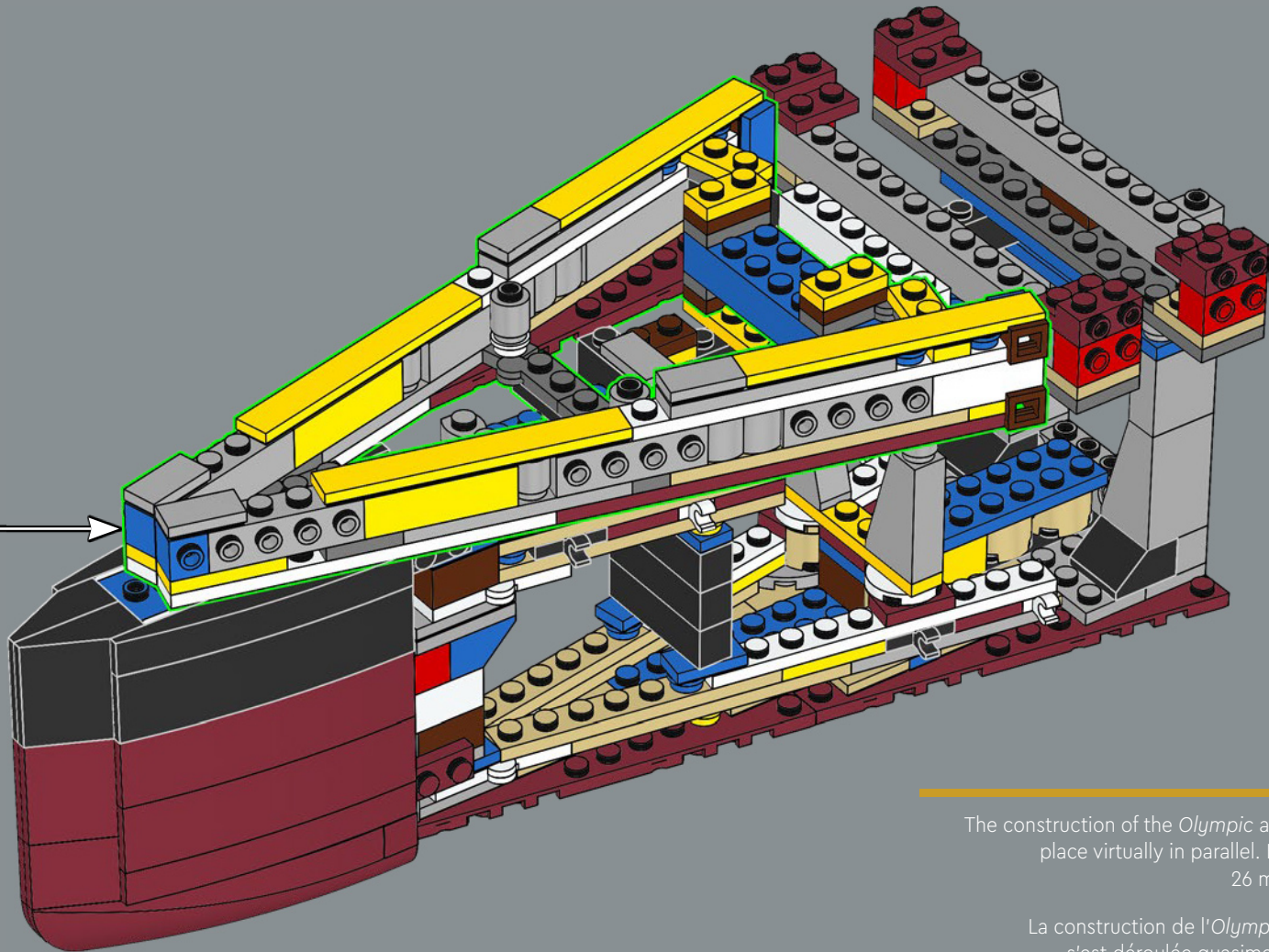

The construction of the *Olympic* and *Titanic* took place virtually in parallel. Both ships took 26 months to build.

La construction de l'*Olympic* et du *Titanic* s'est déroulée quasiment en parallèle. La construction des deux navires a pris 26 mois.

La construcción del *Olympic* y el *Titanic* se desarrolló prácticamente en paralelo. La construcción de ambos buques tardó 26 meses.

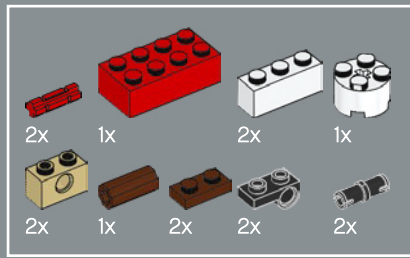

45

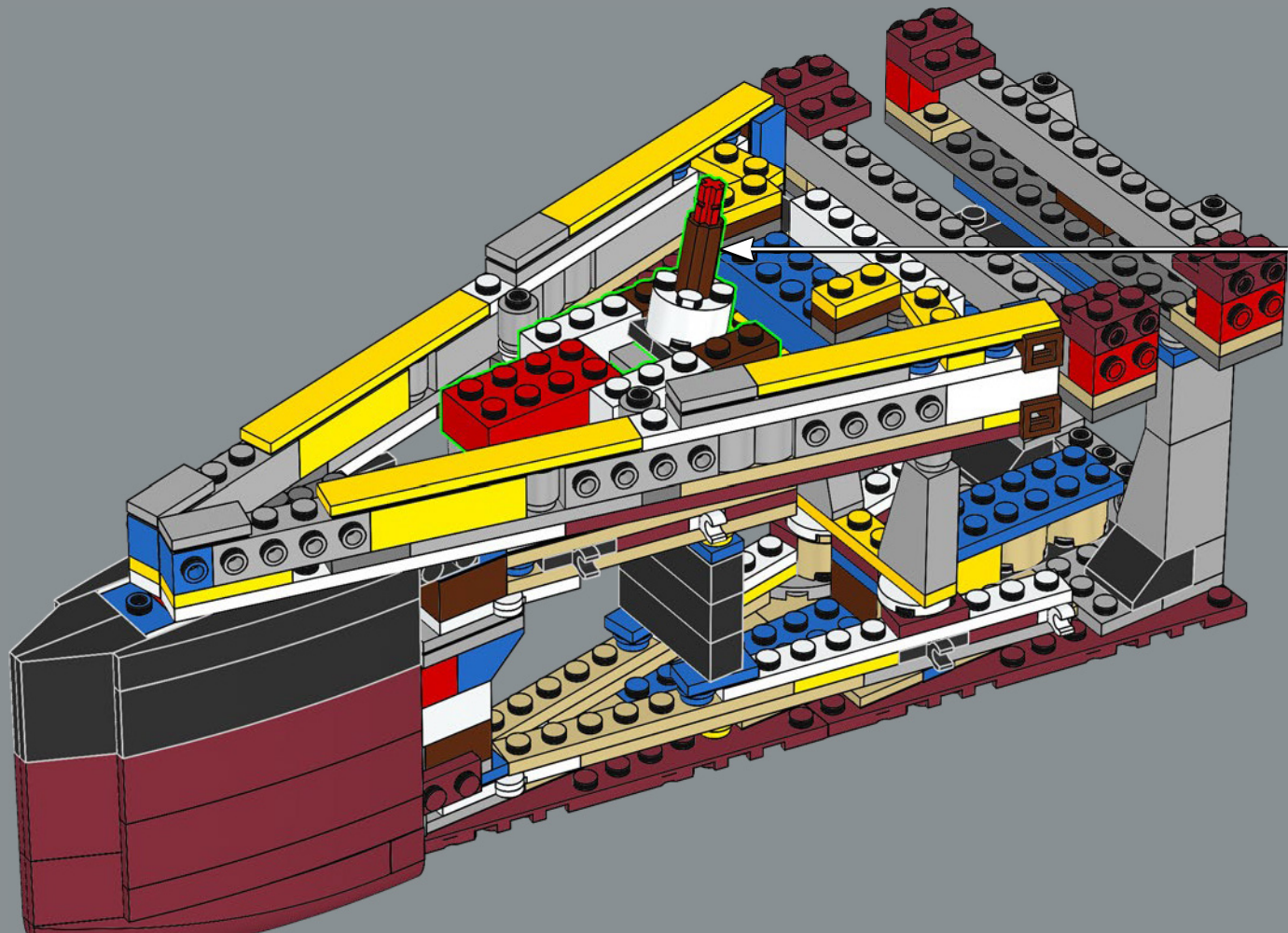
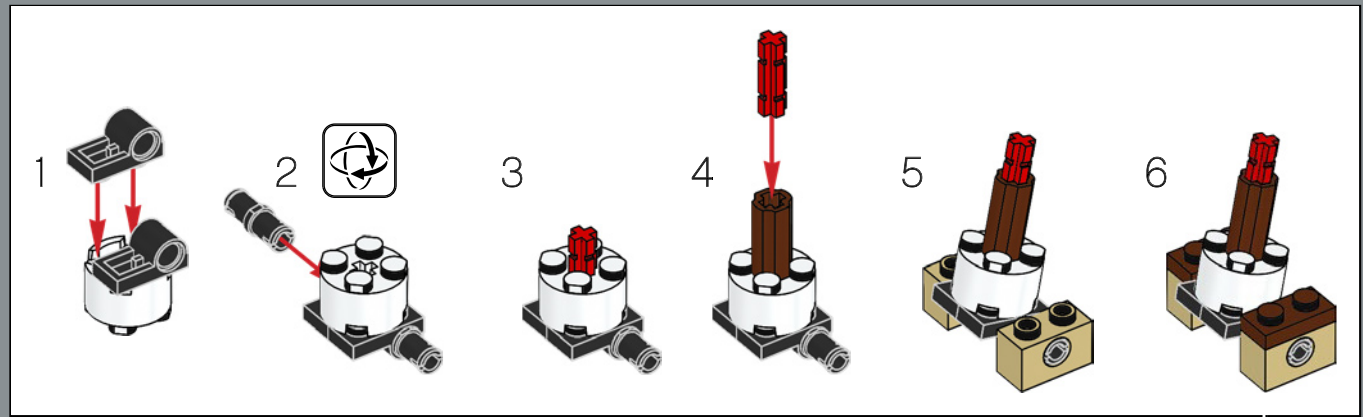

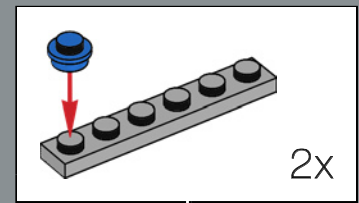
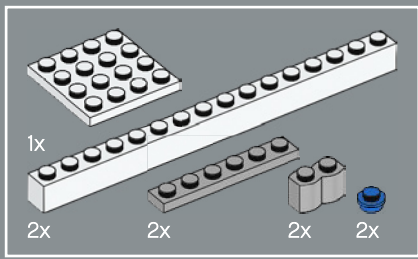

46

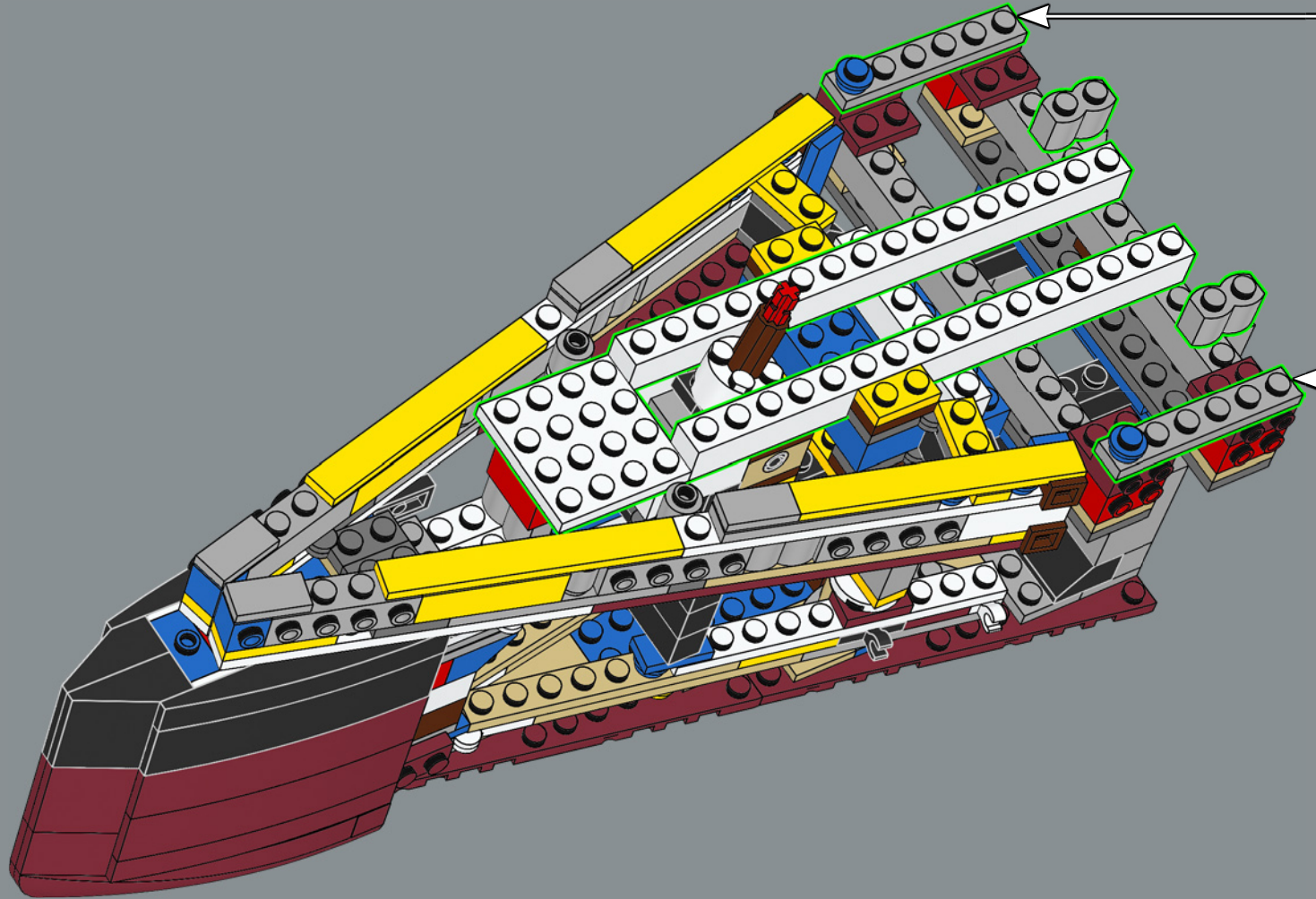

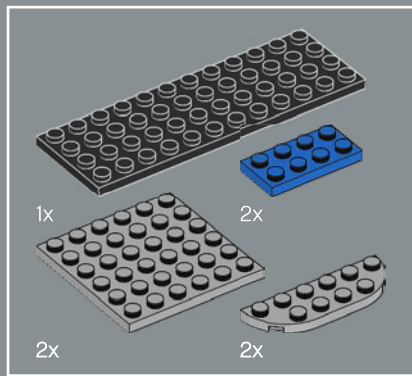

47

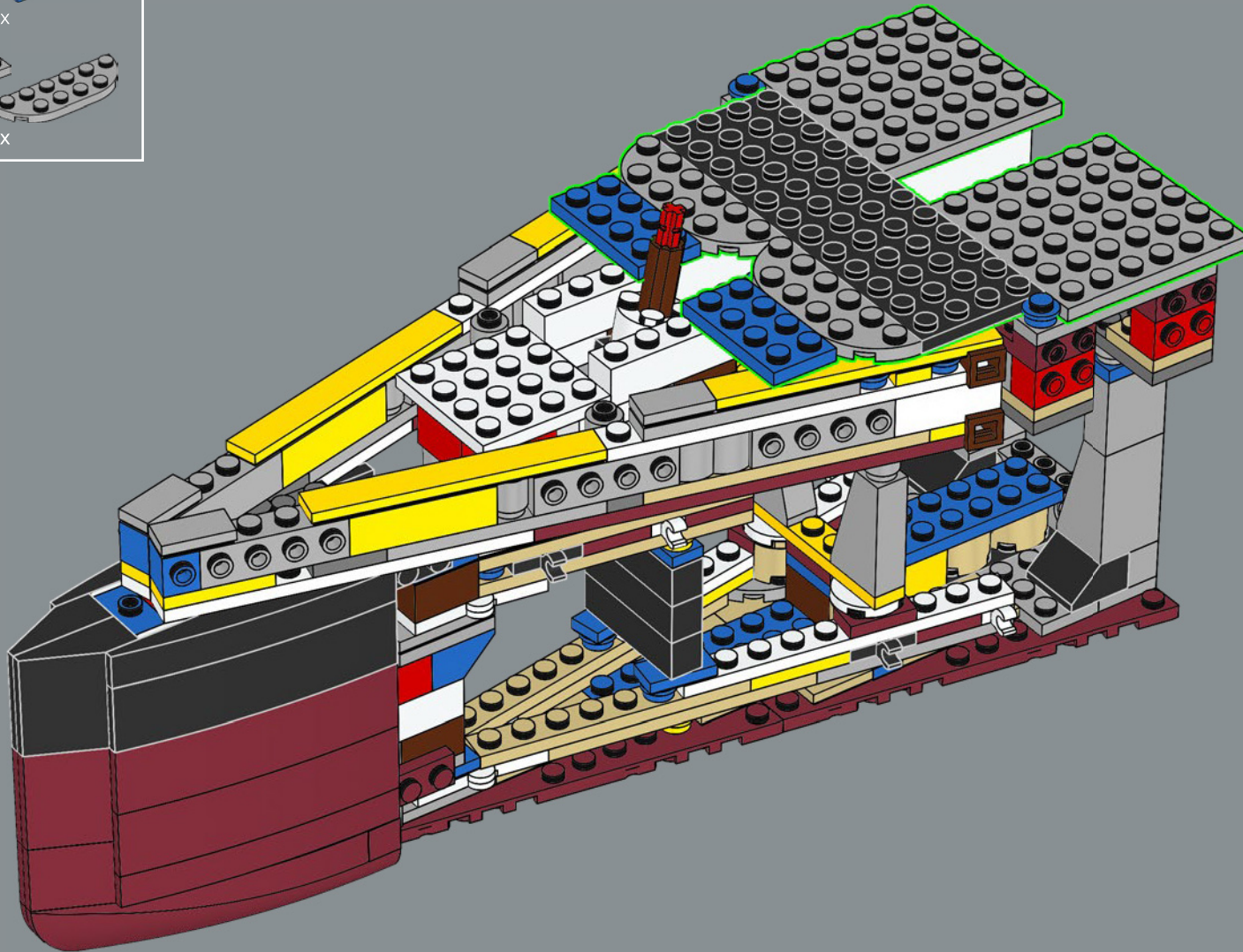

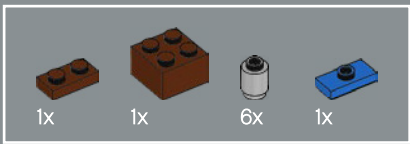

48

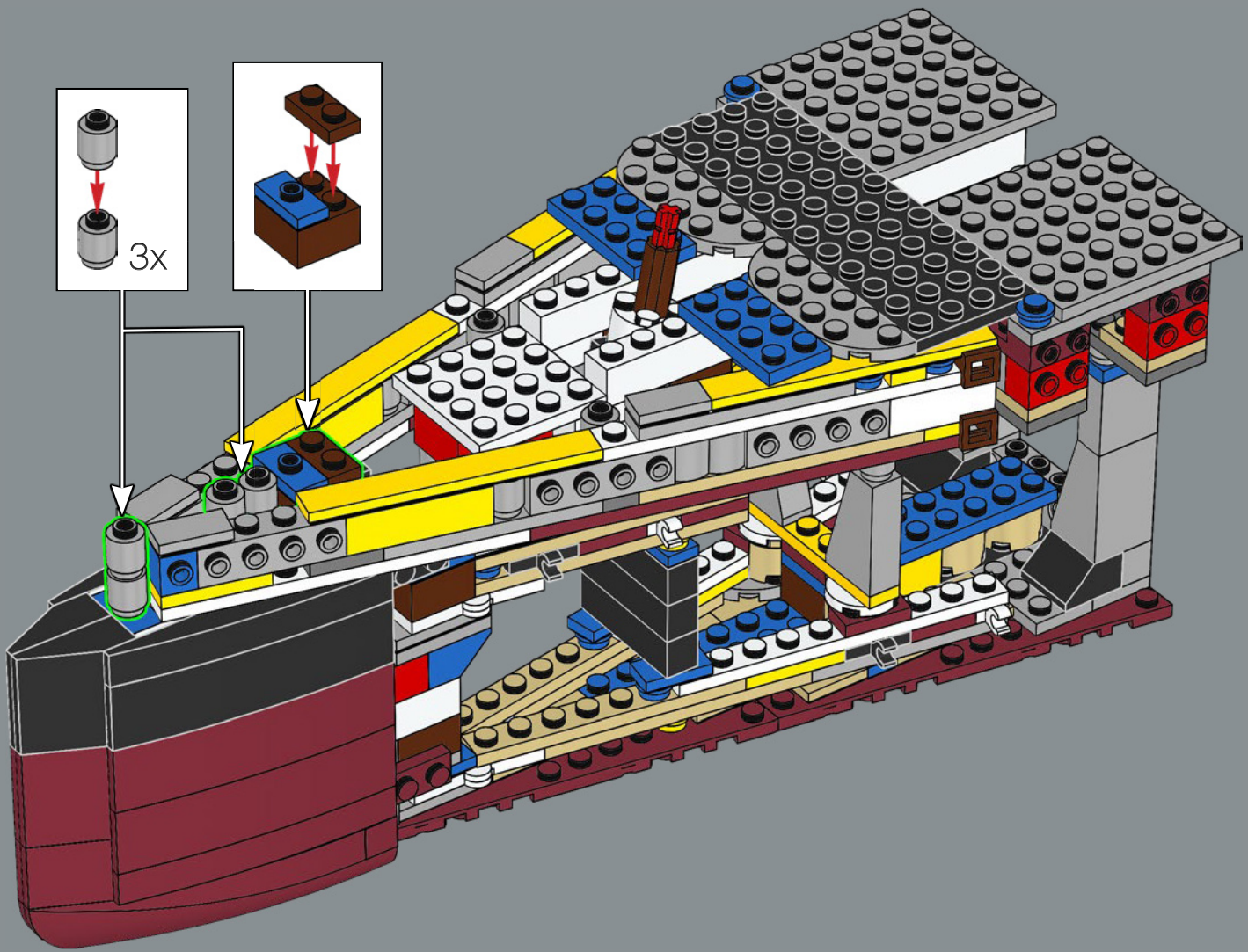



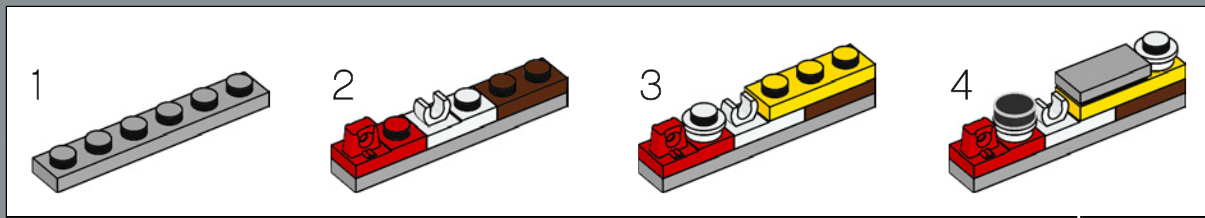
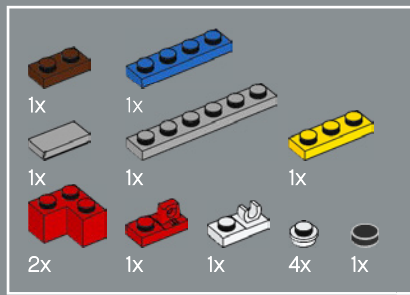

49

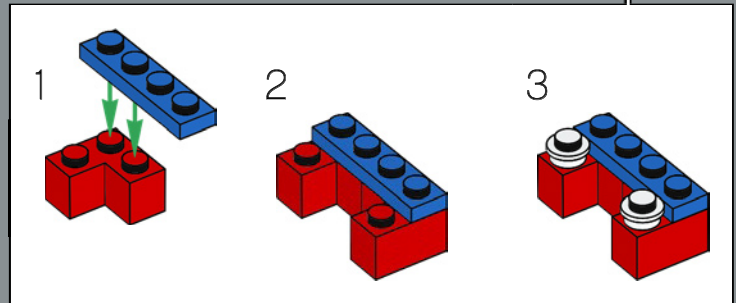
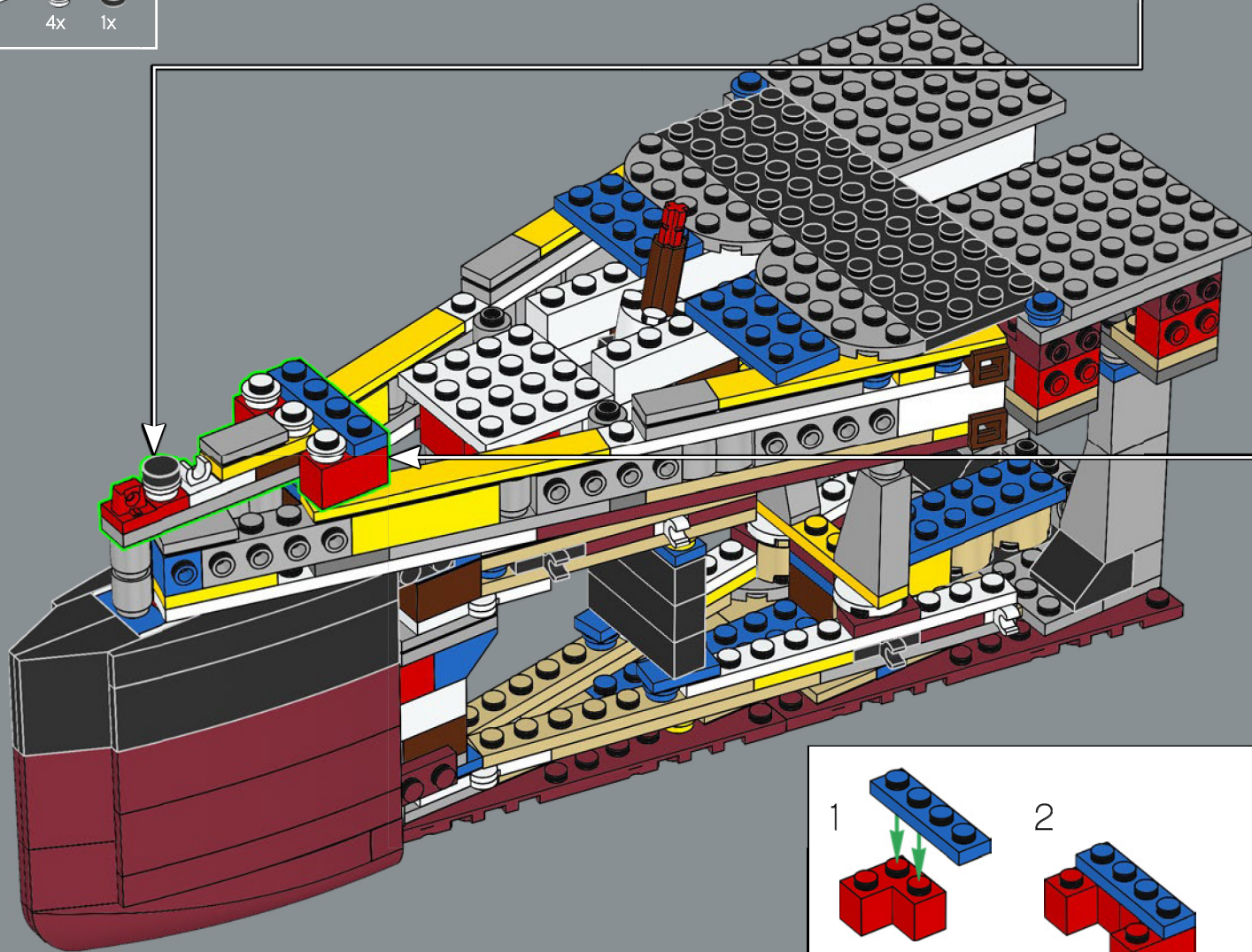

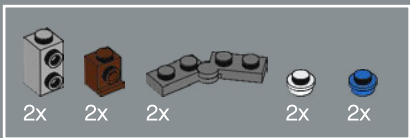

50

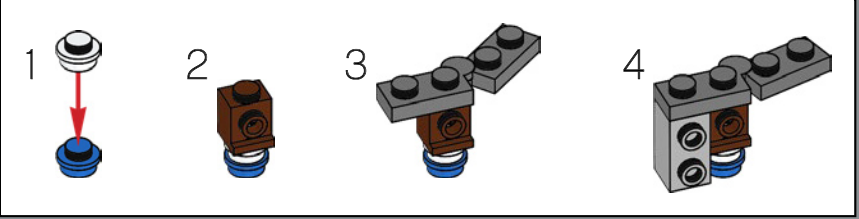
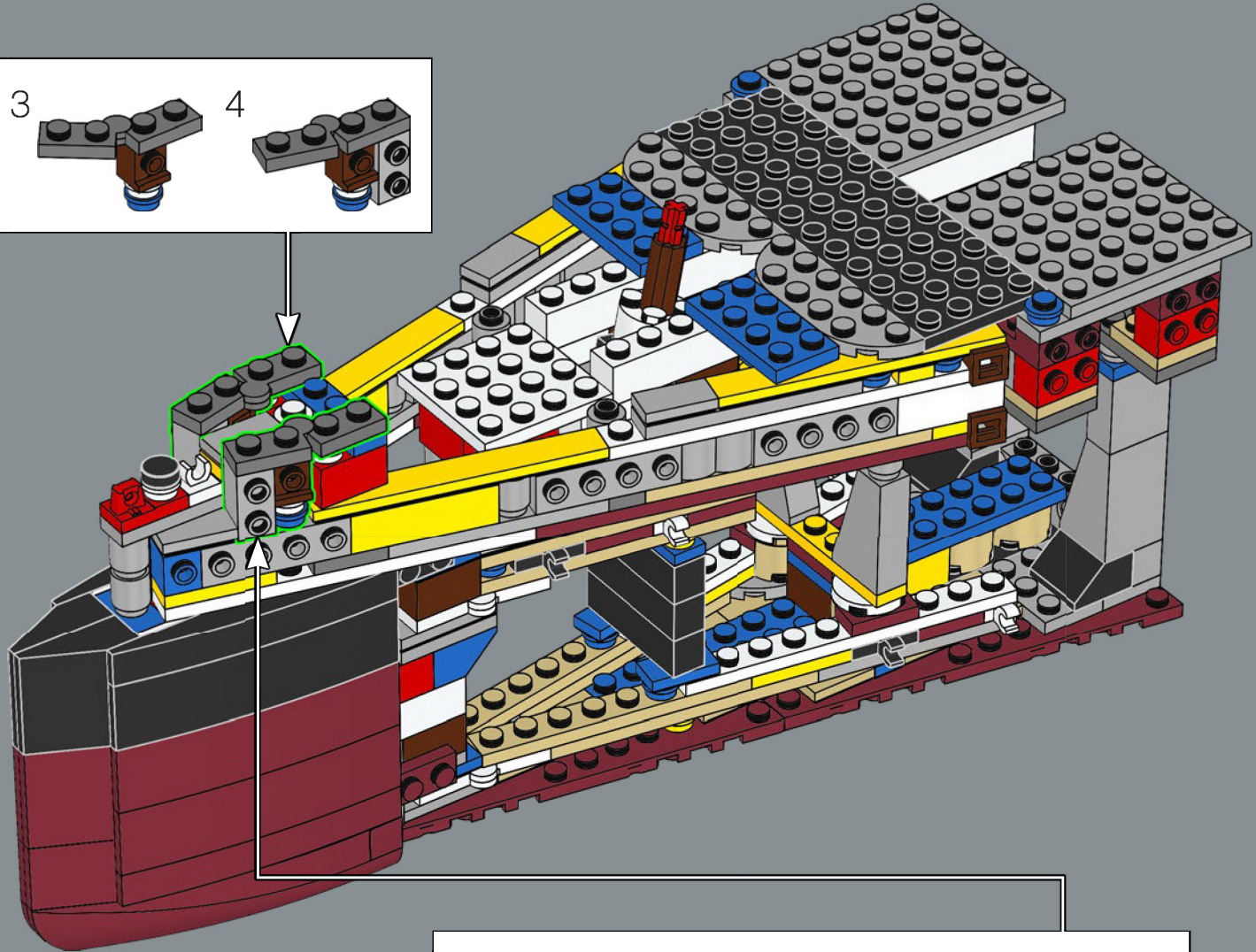
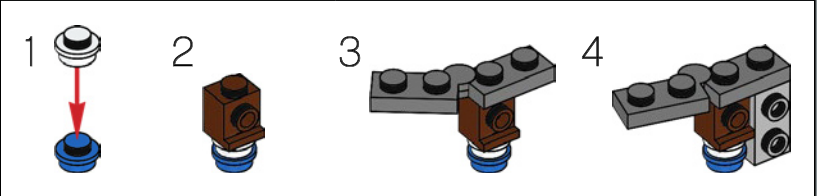

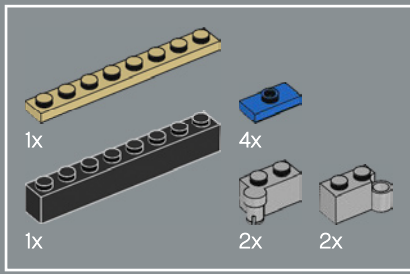

51

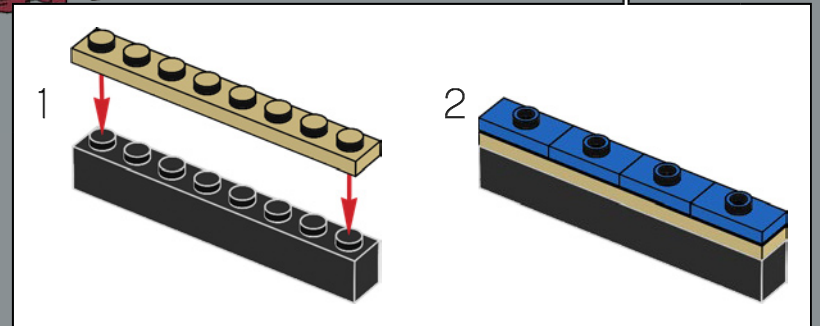
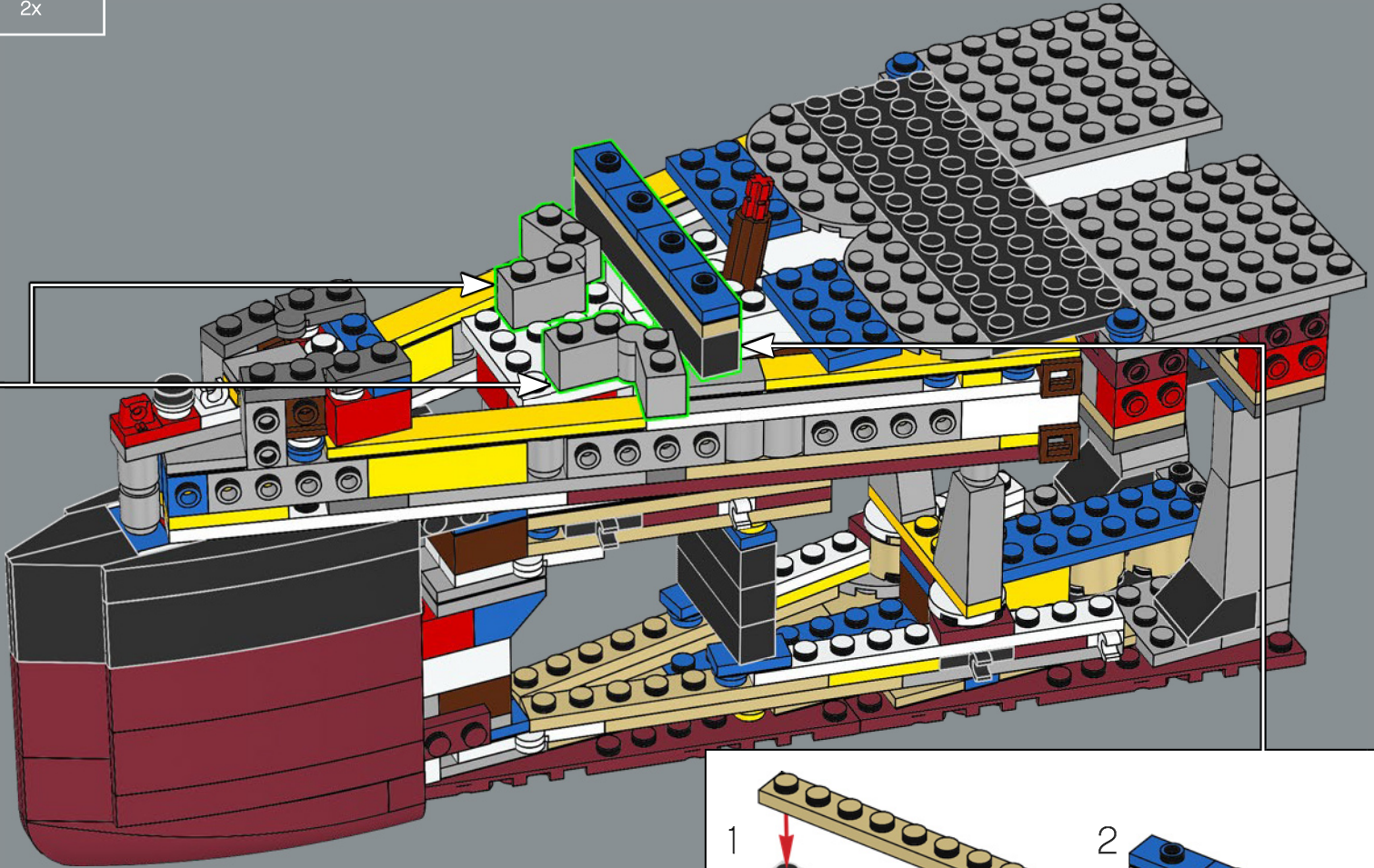
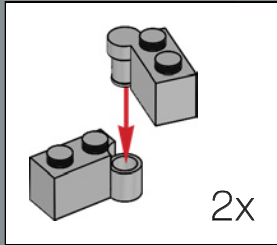

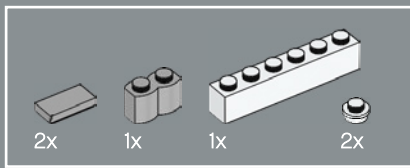

52

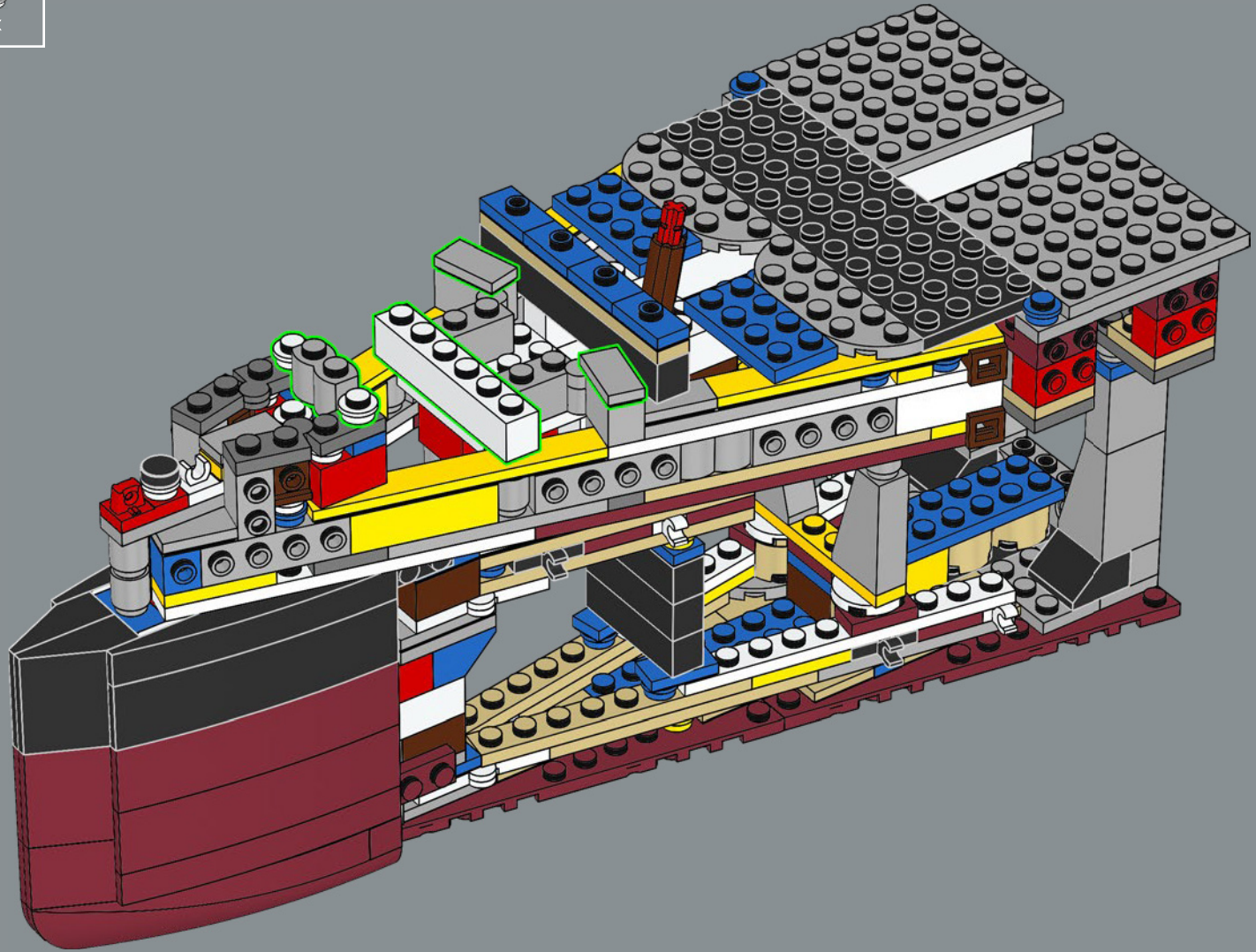

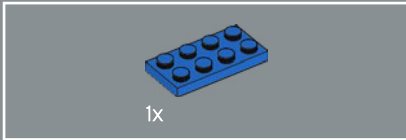
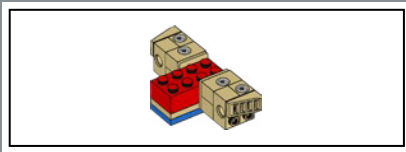

1x

53

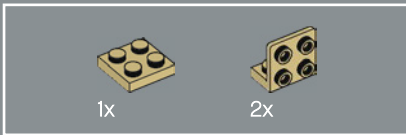
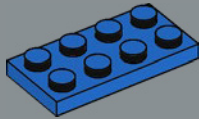

1x

2x

54

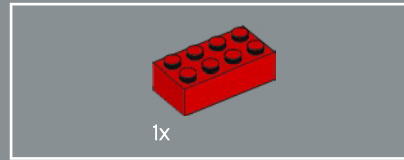
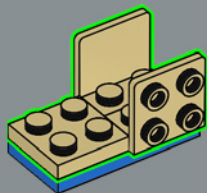

1x

55

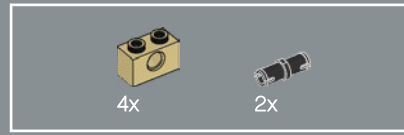
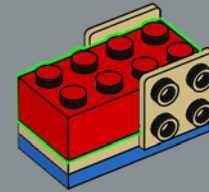

4x

2x

56

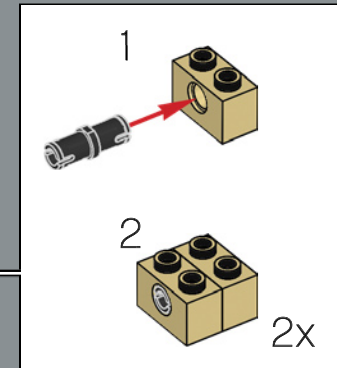

1

2

2x

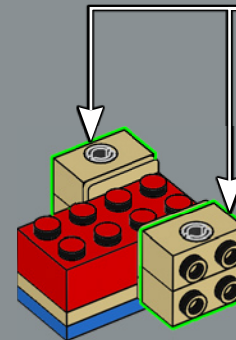



57

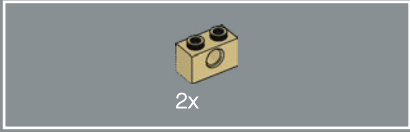
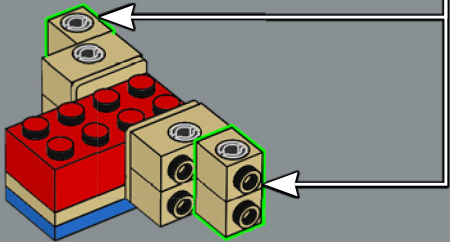
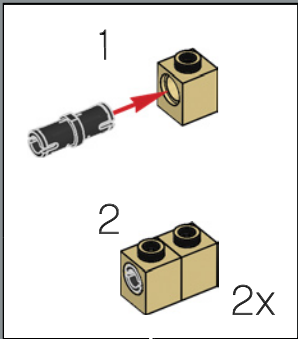

58

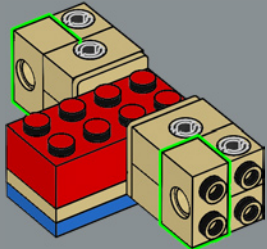

59

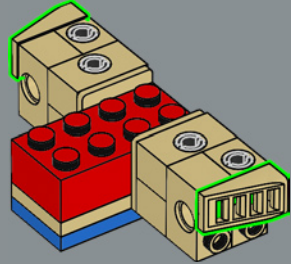

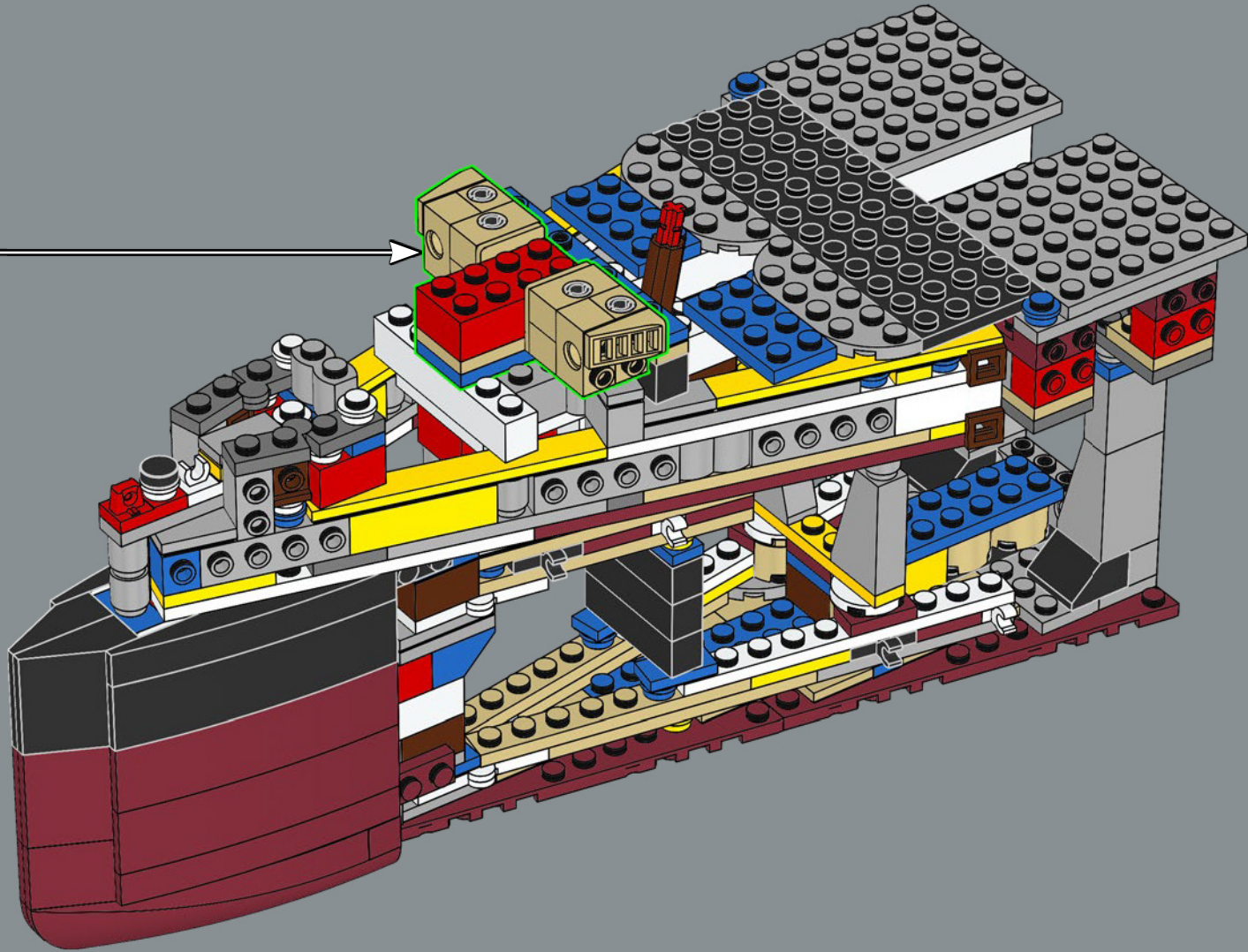

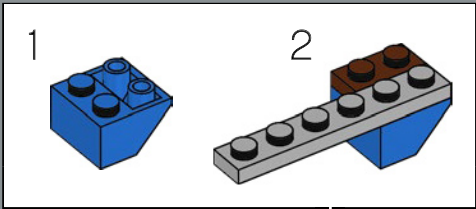
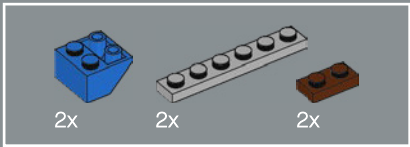

61

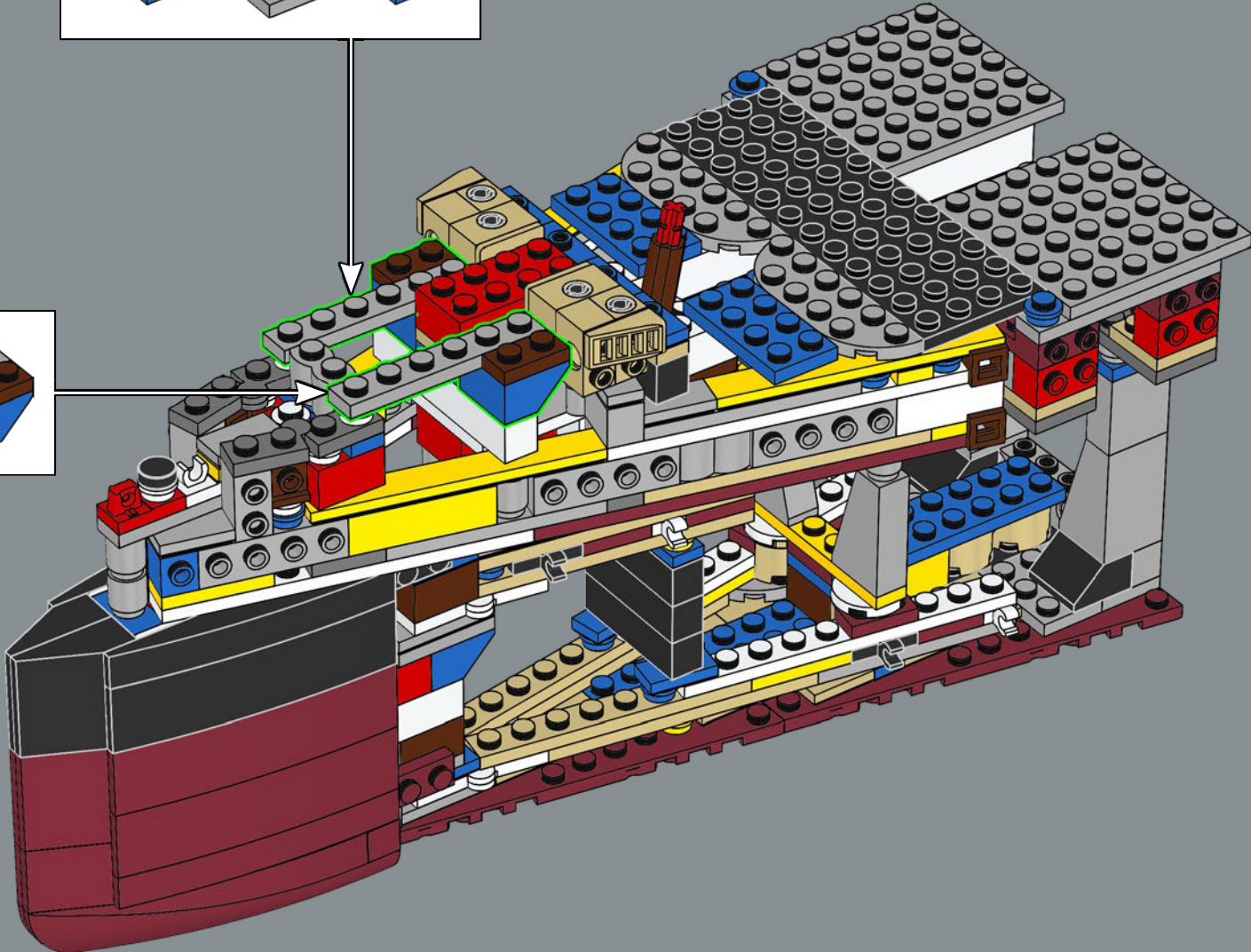
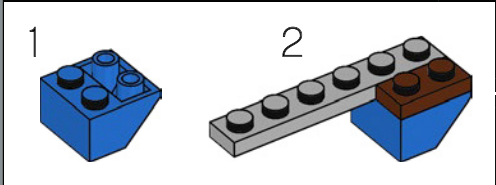



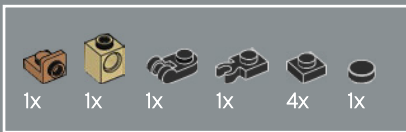

62

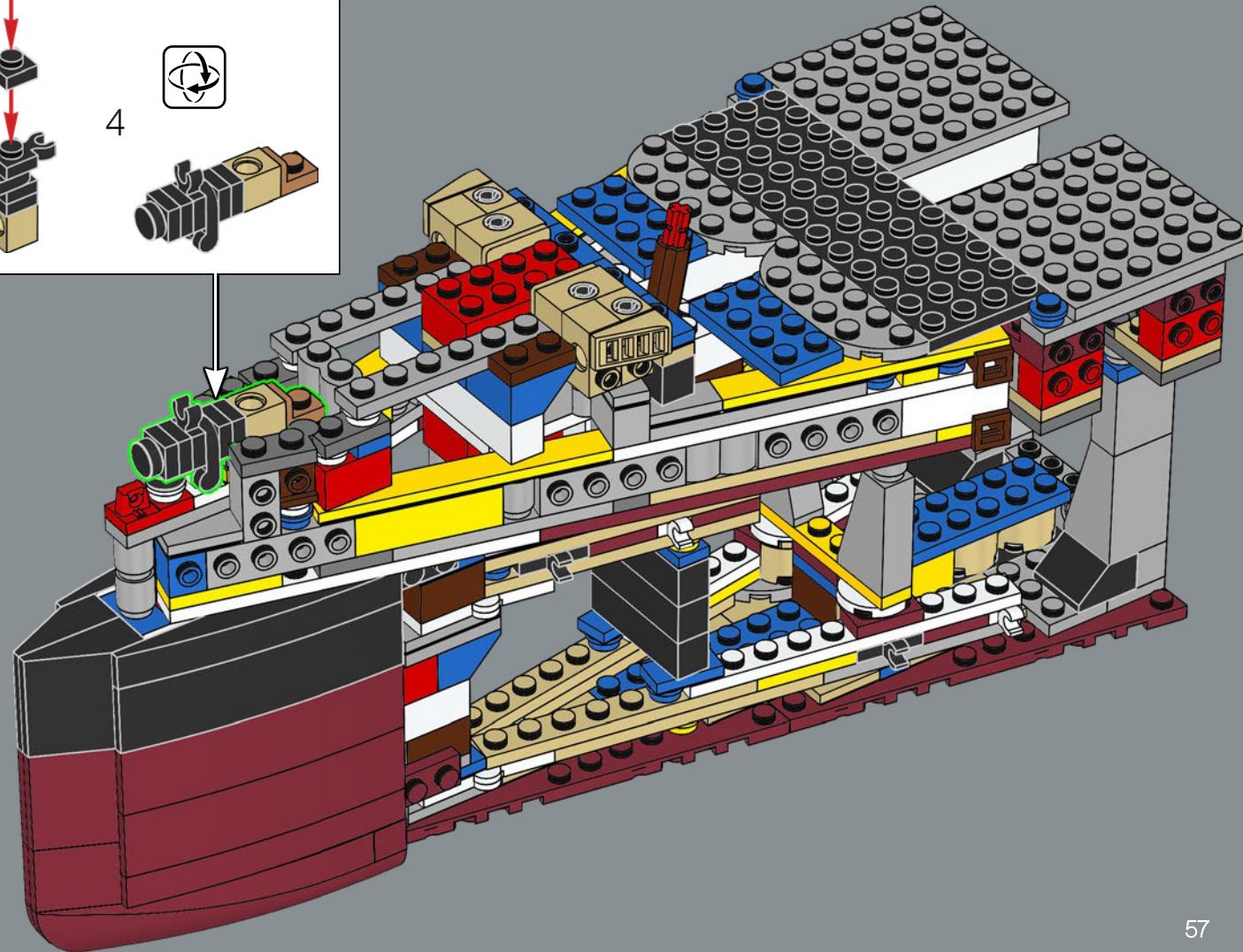
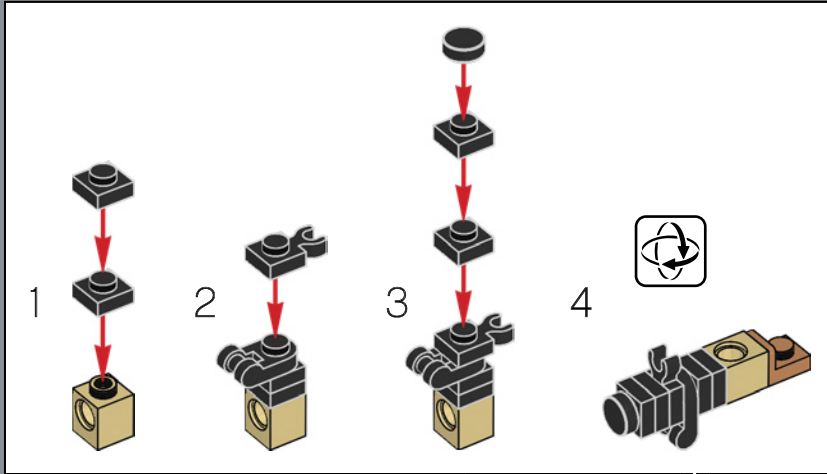

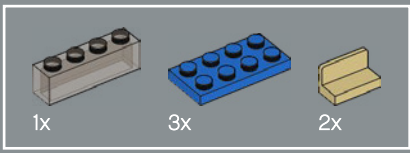

63

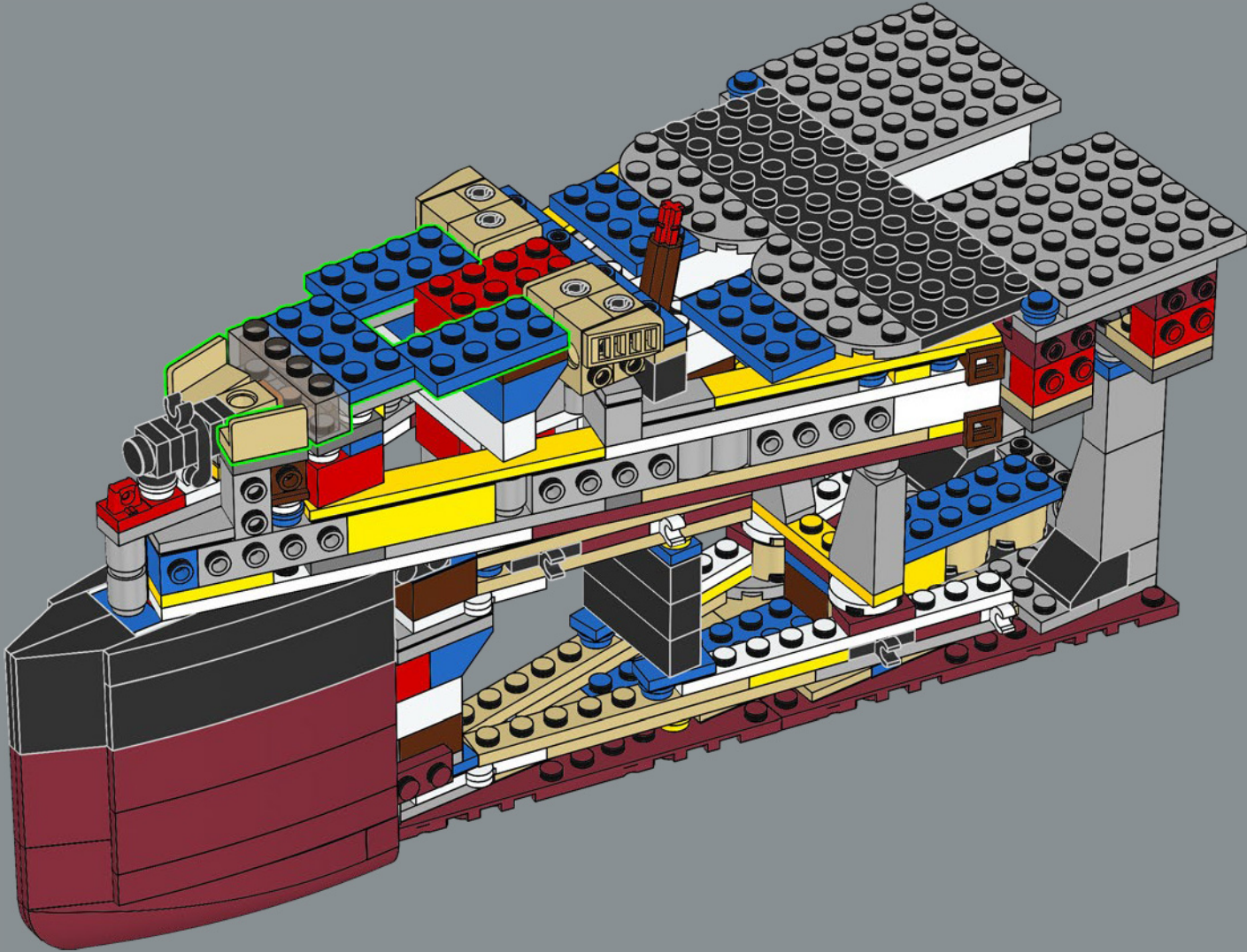

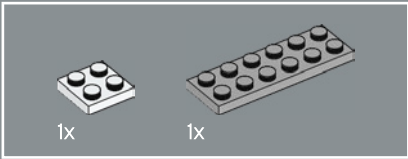
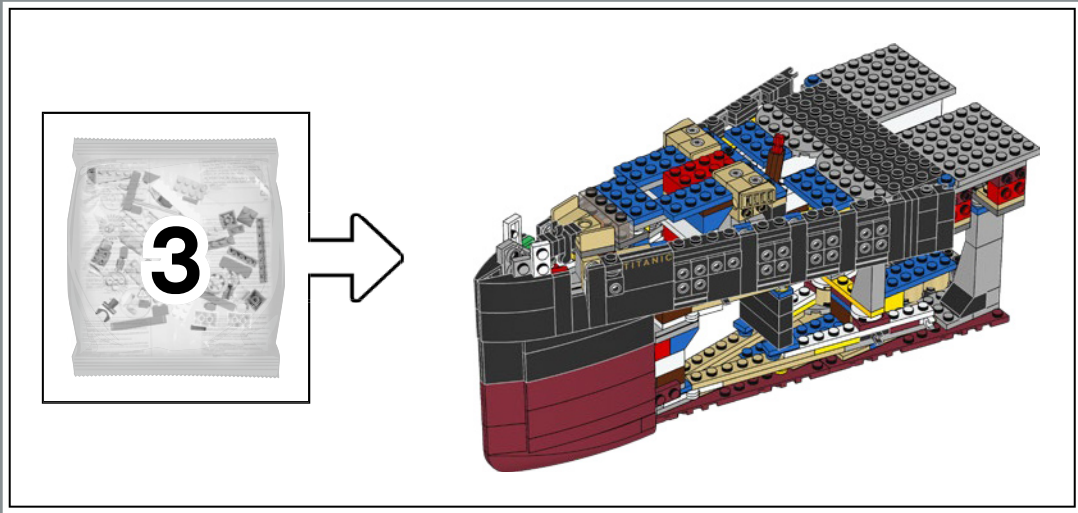

65

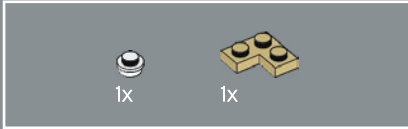
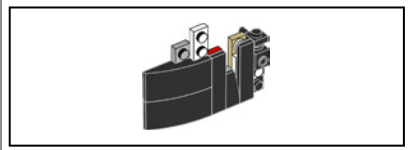

64

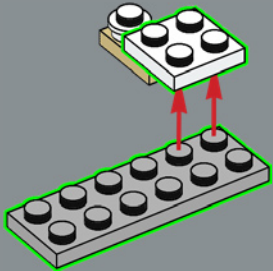
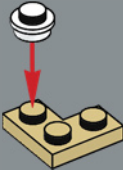

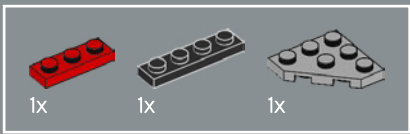

66

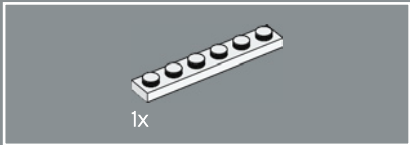
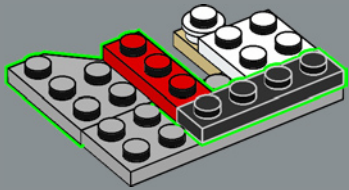

67

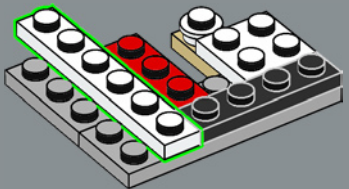

68

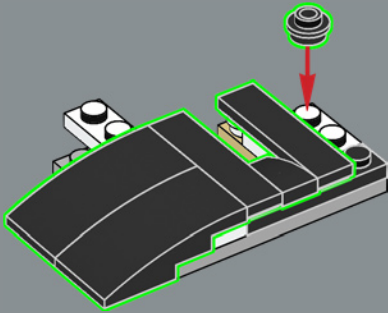

69

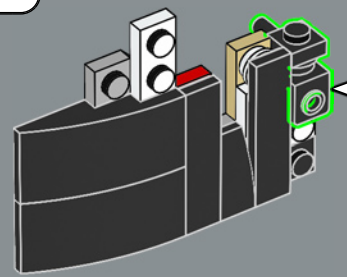
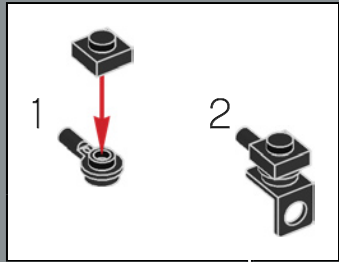

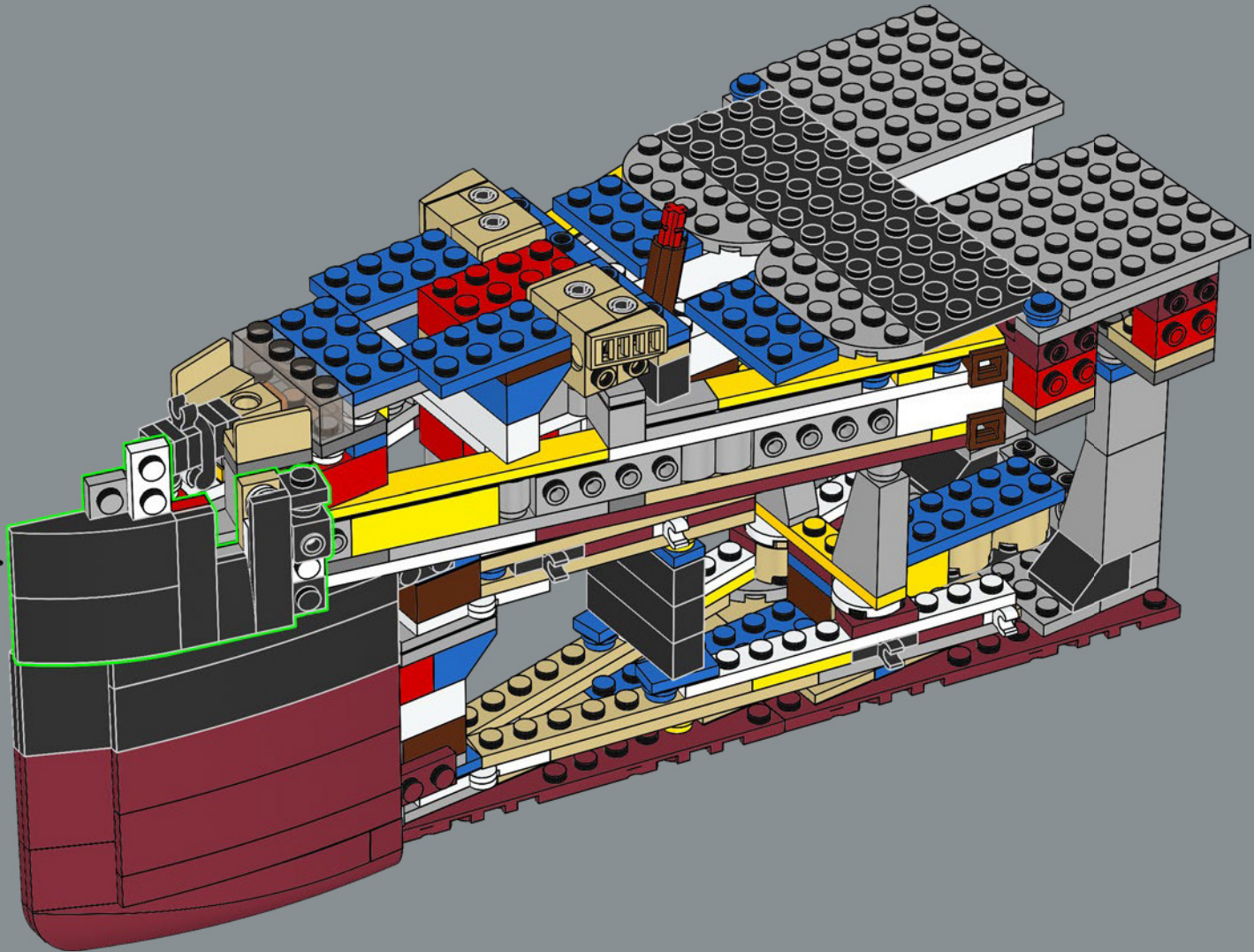

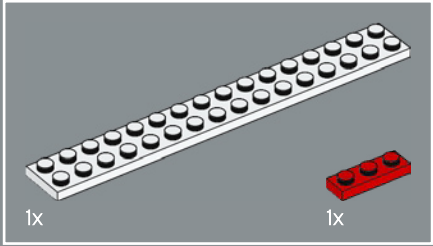
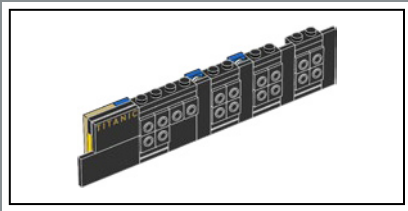

71

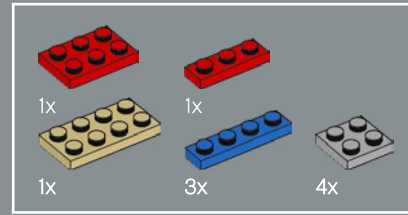
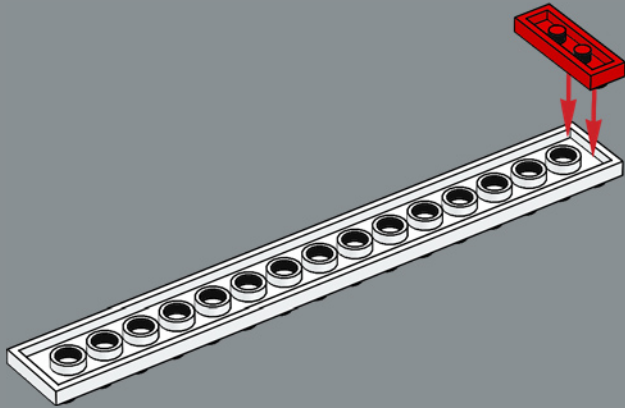

72

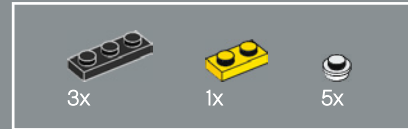
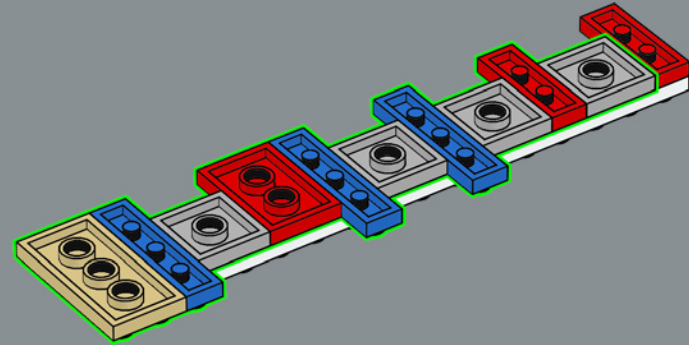

73

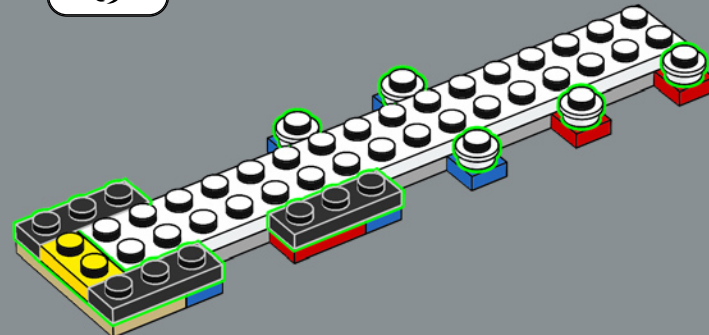

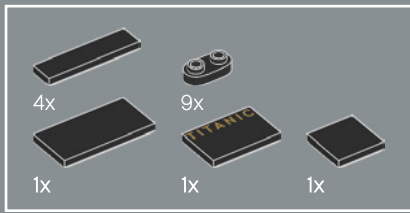

74

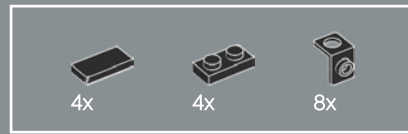
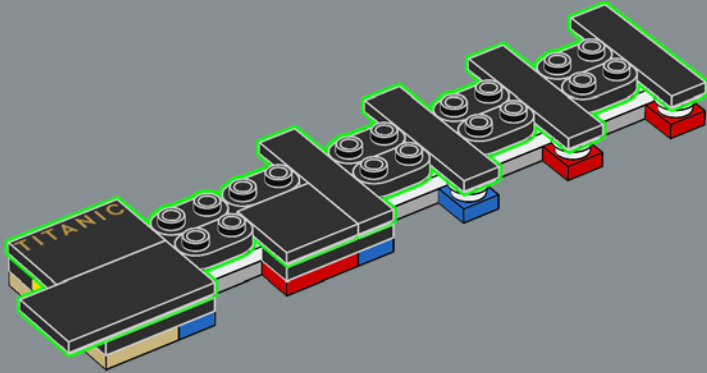

75

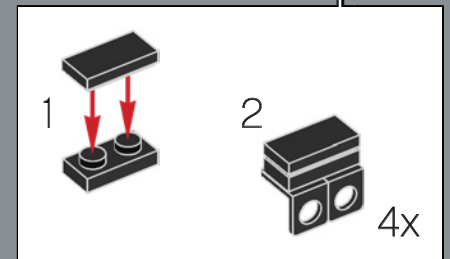
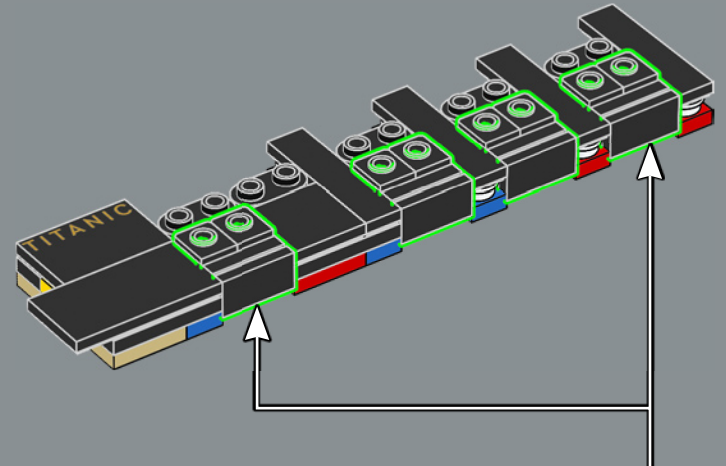

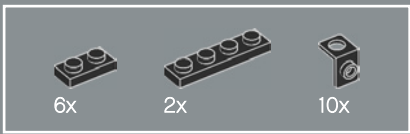

76

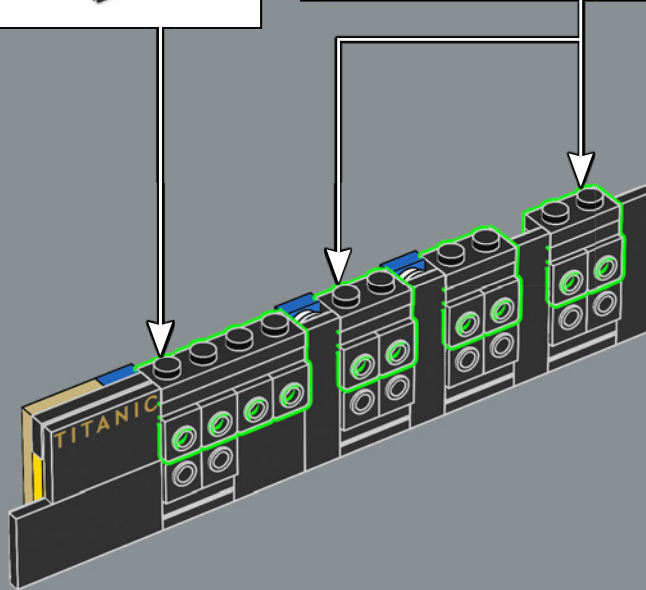
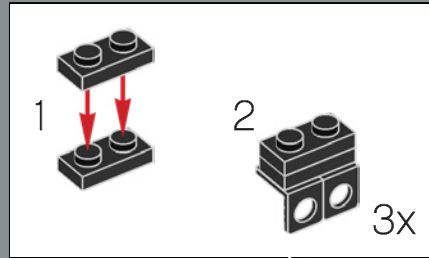
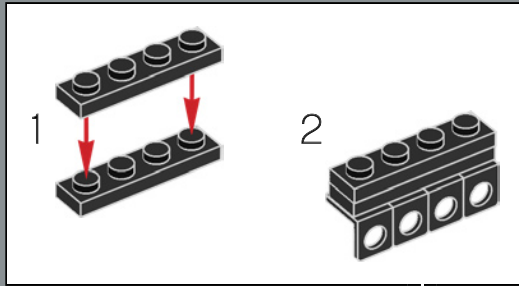



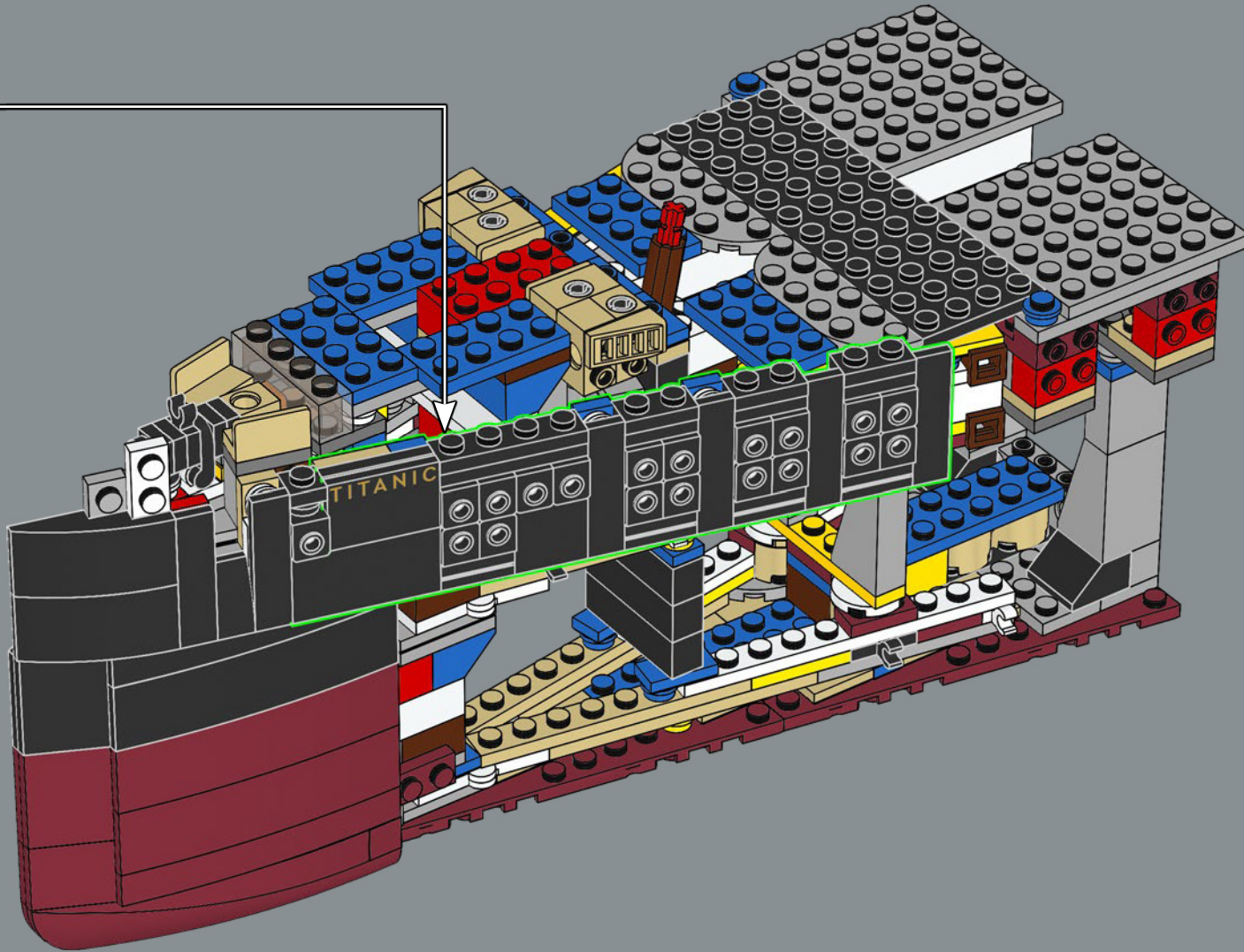

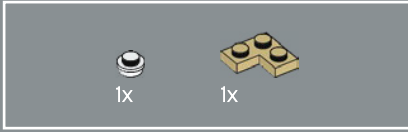
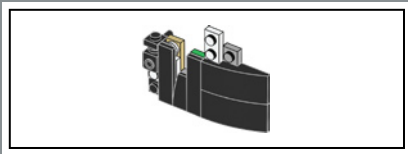

78

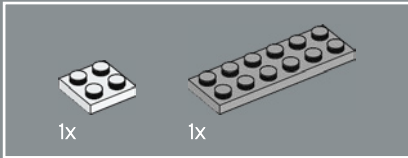
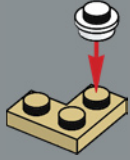

79

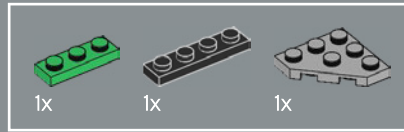
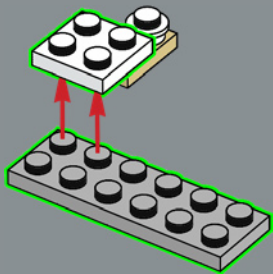

80

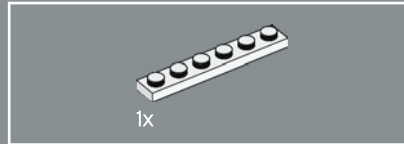
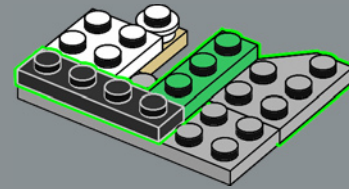

81

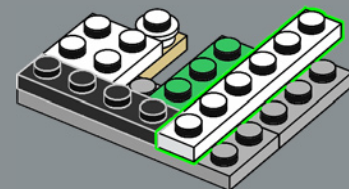



82

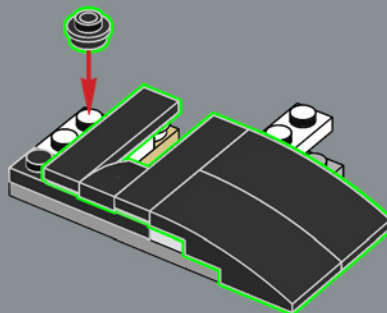

83

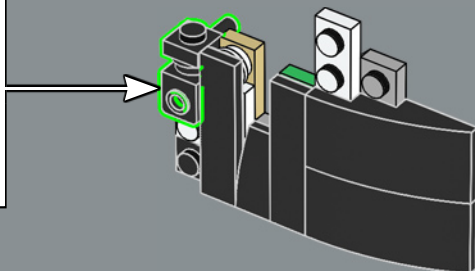
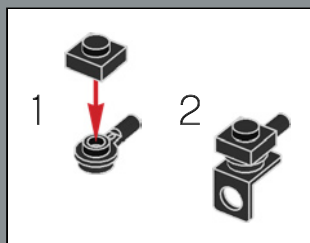

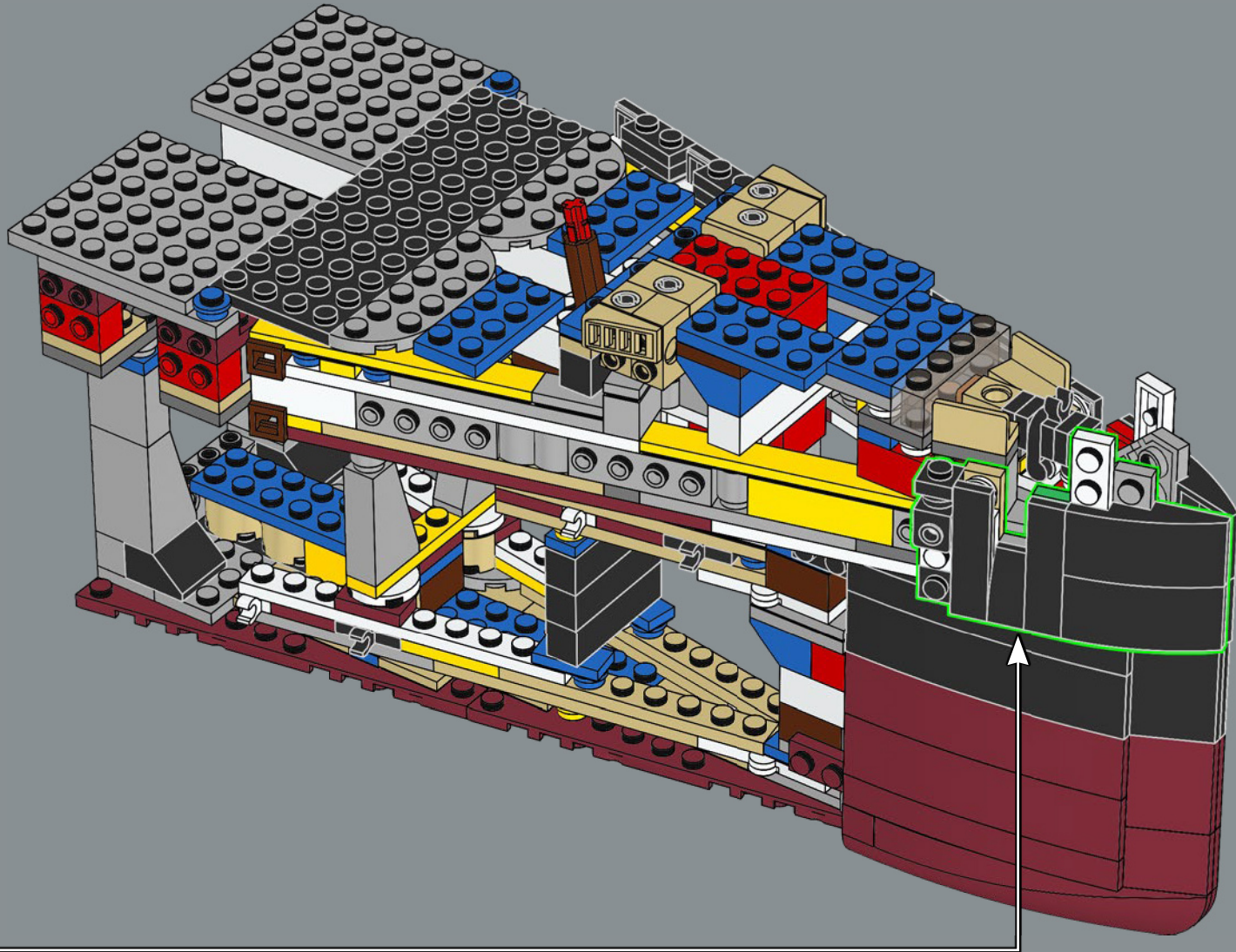

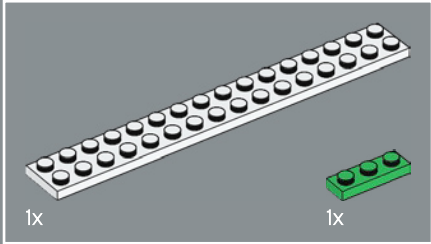
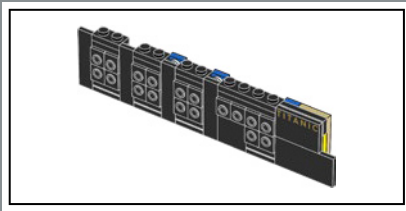

85

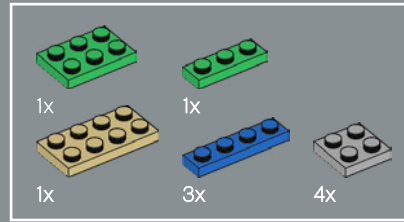
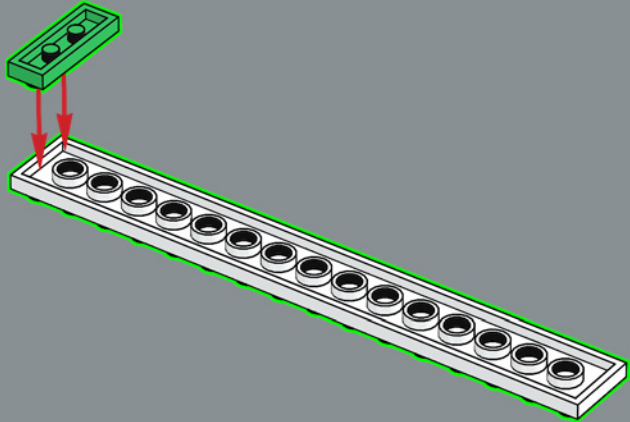

86

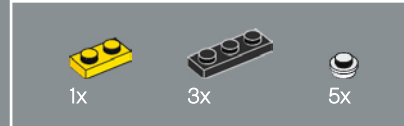
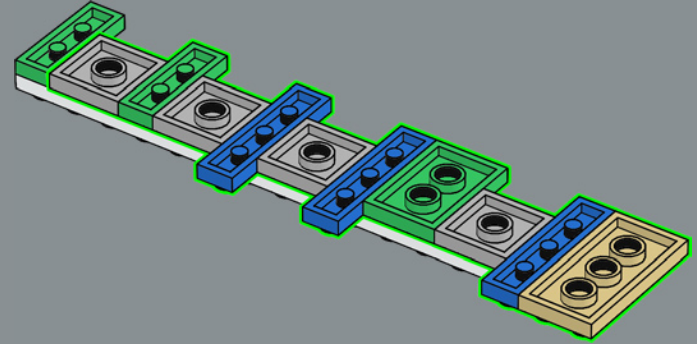

87

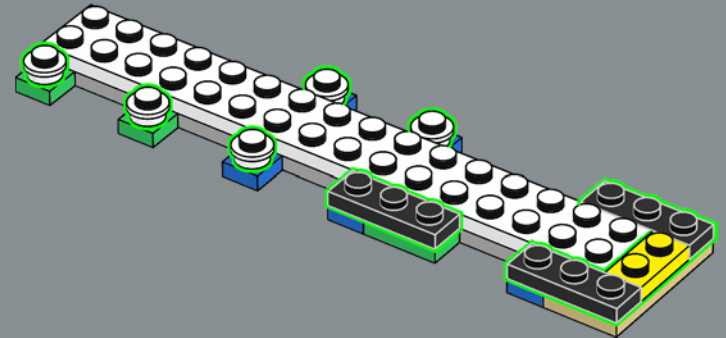

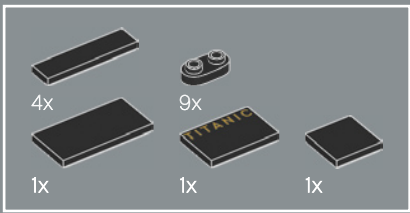

88

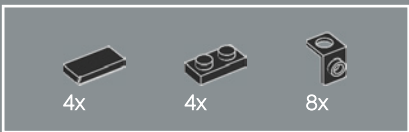
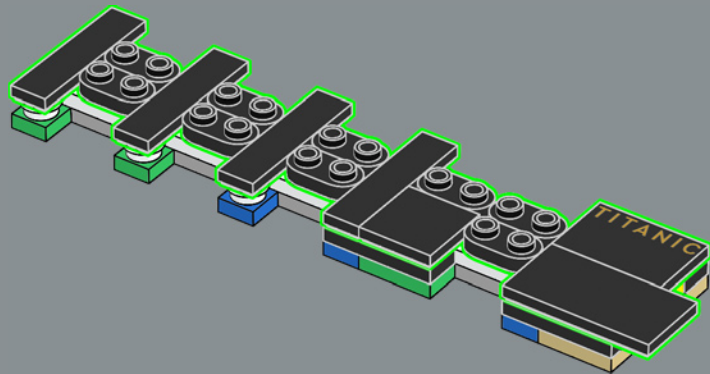

89

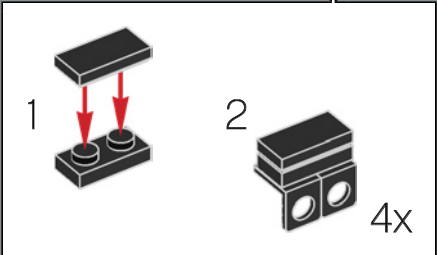
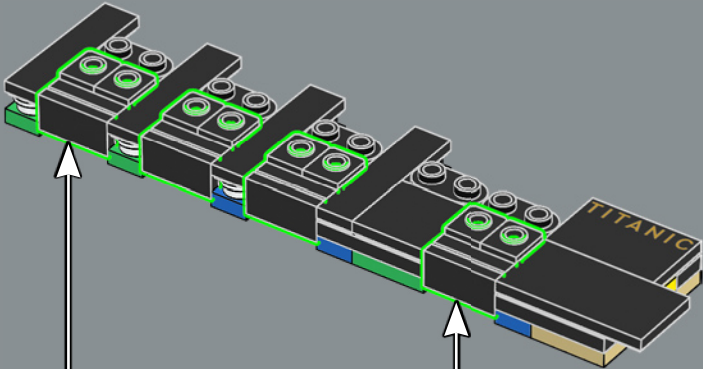

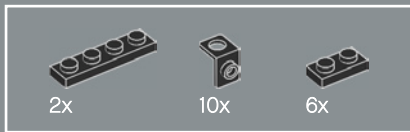

90

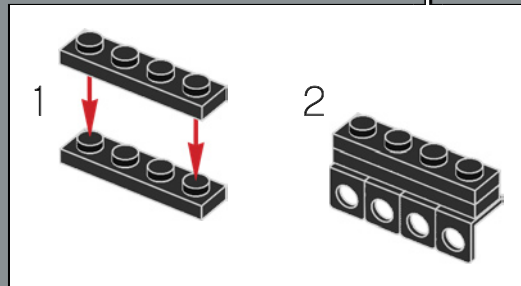
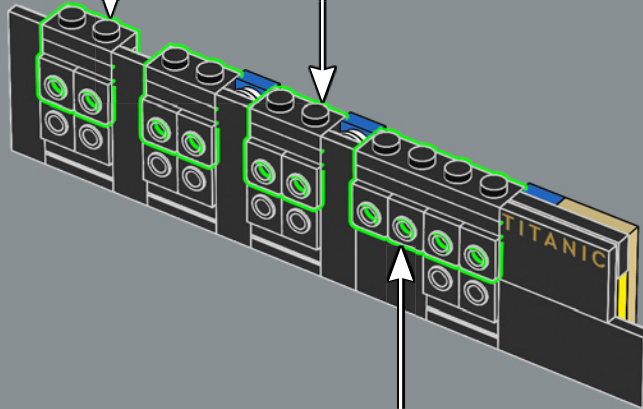
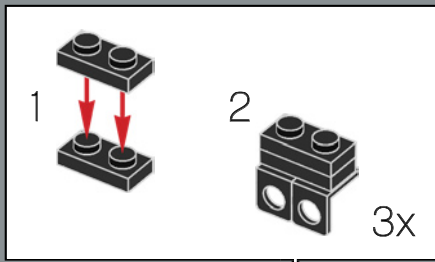

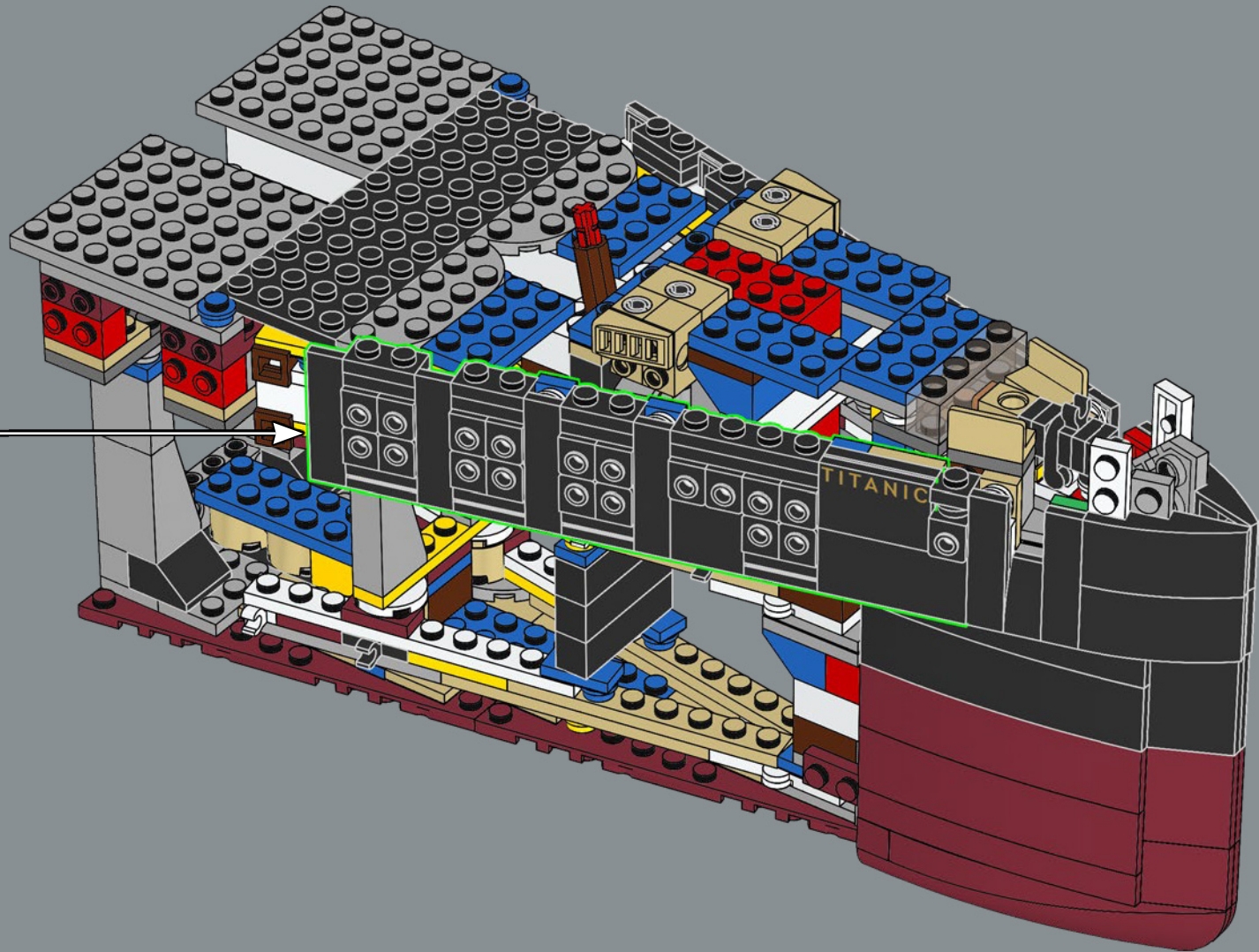



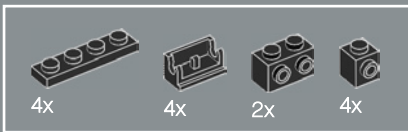

92

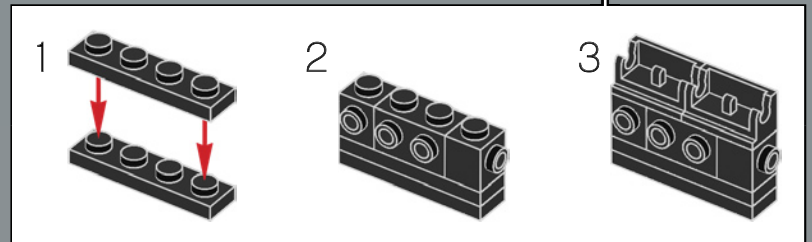
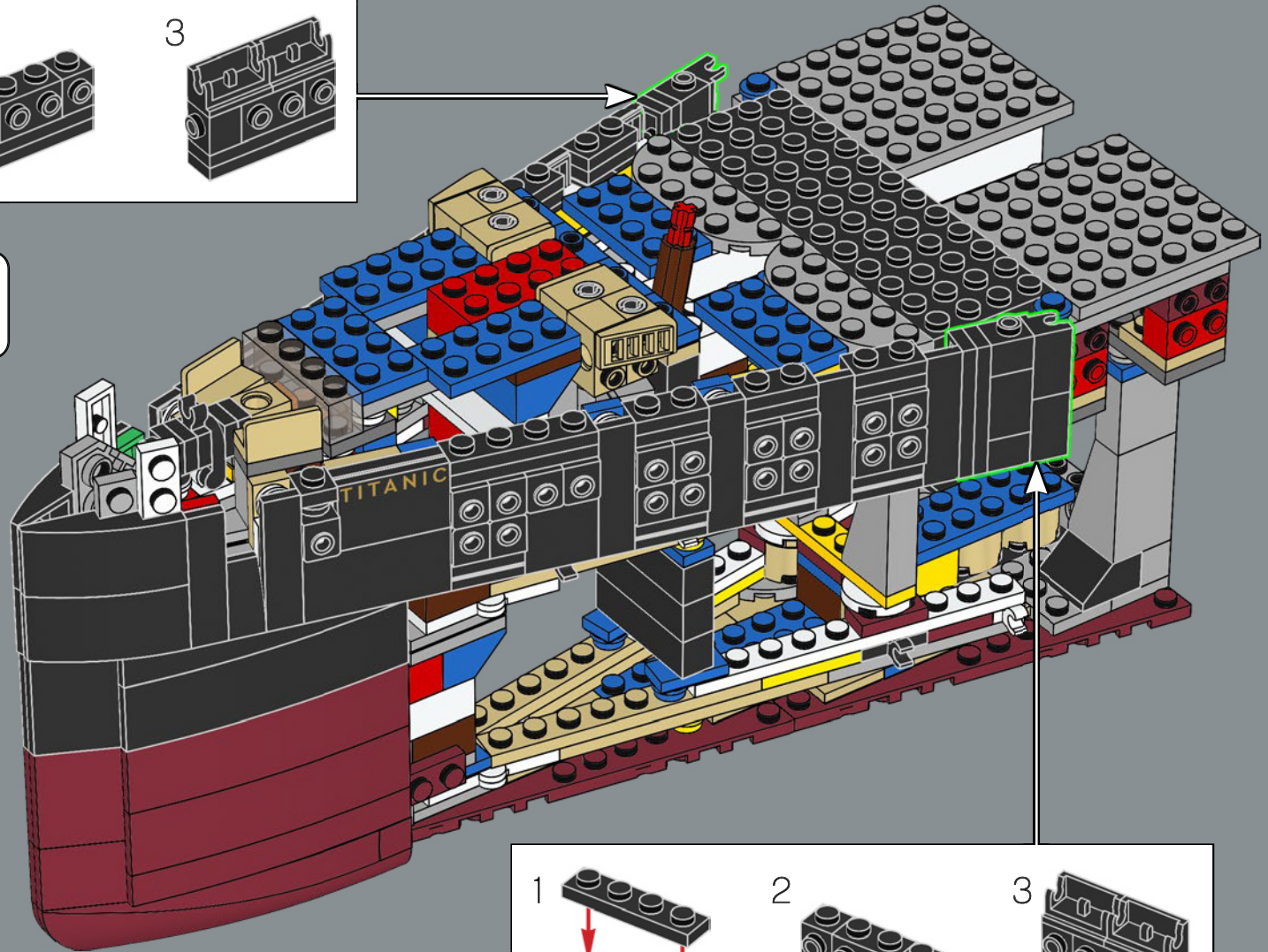
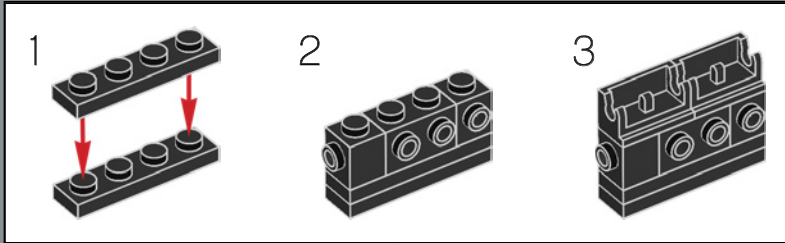

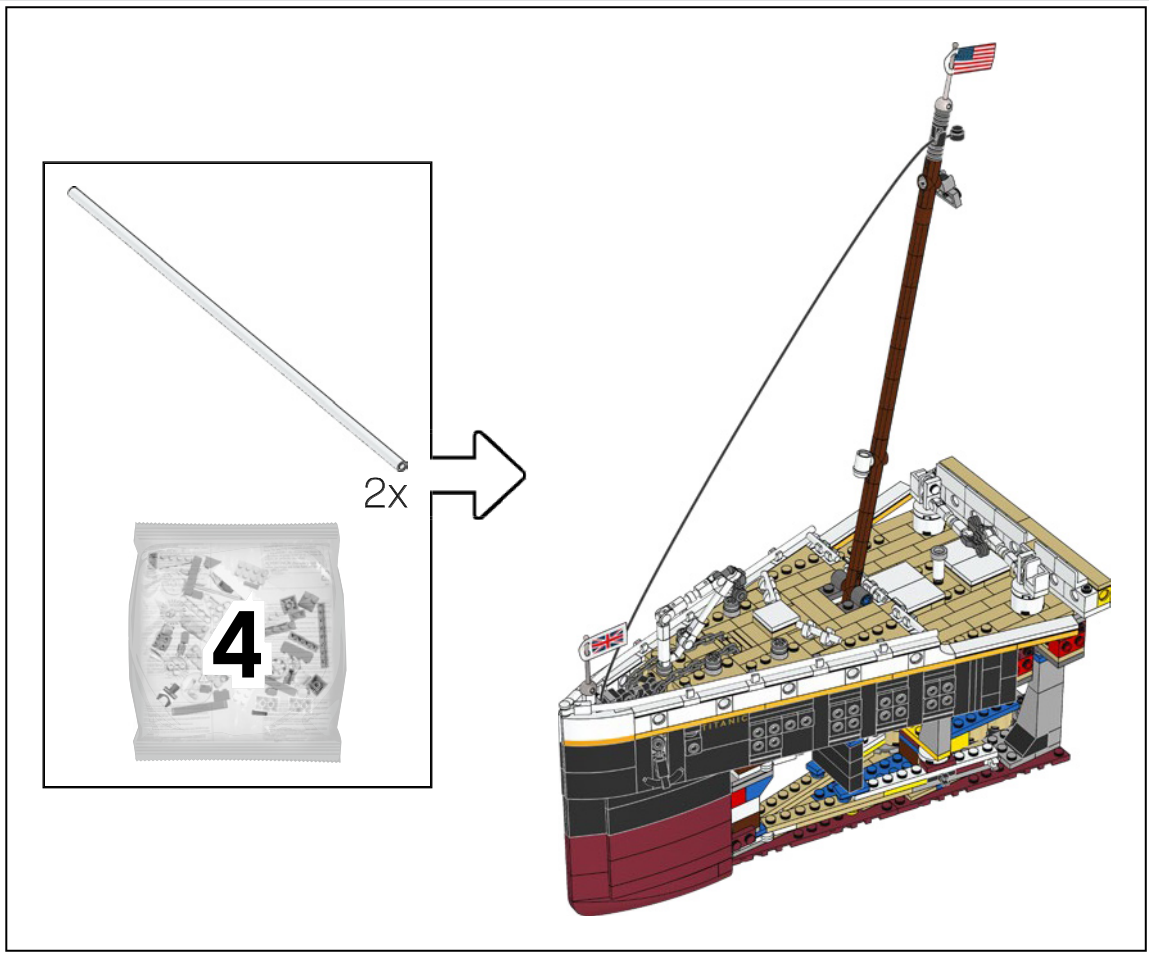

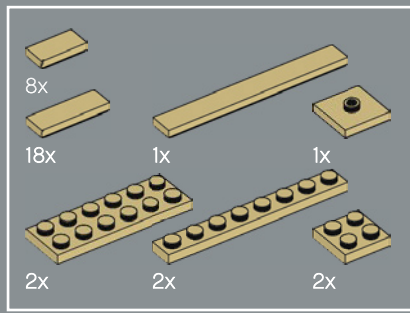

93

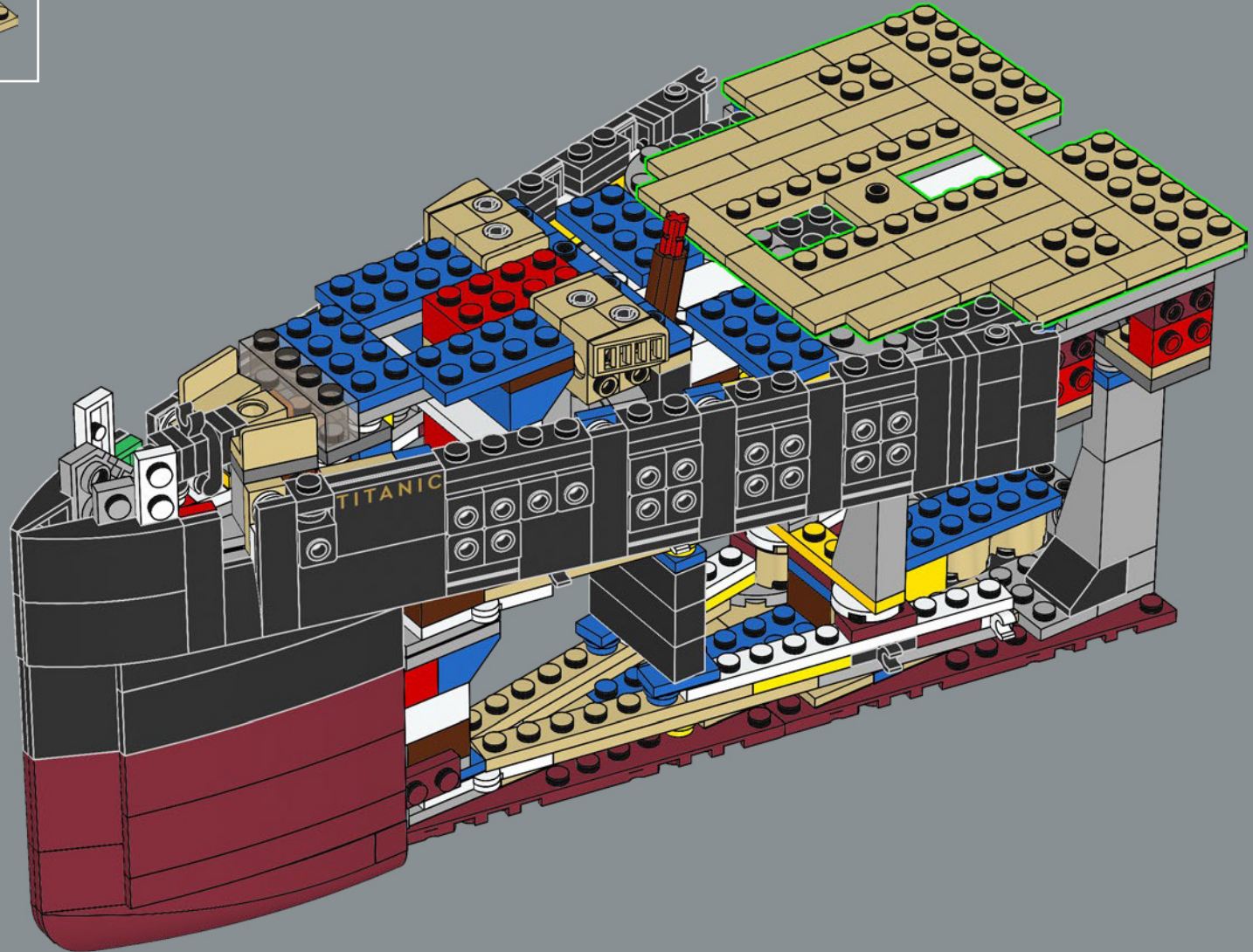

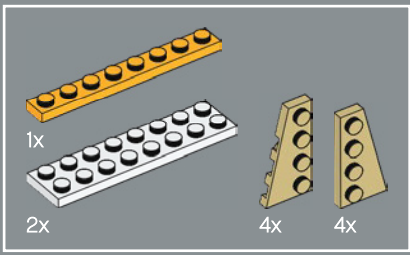

94

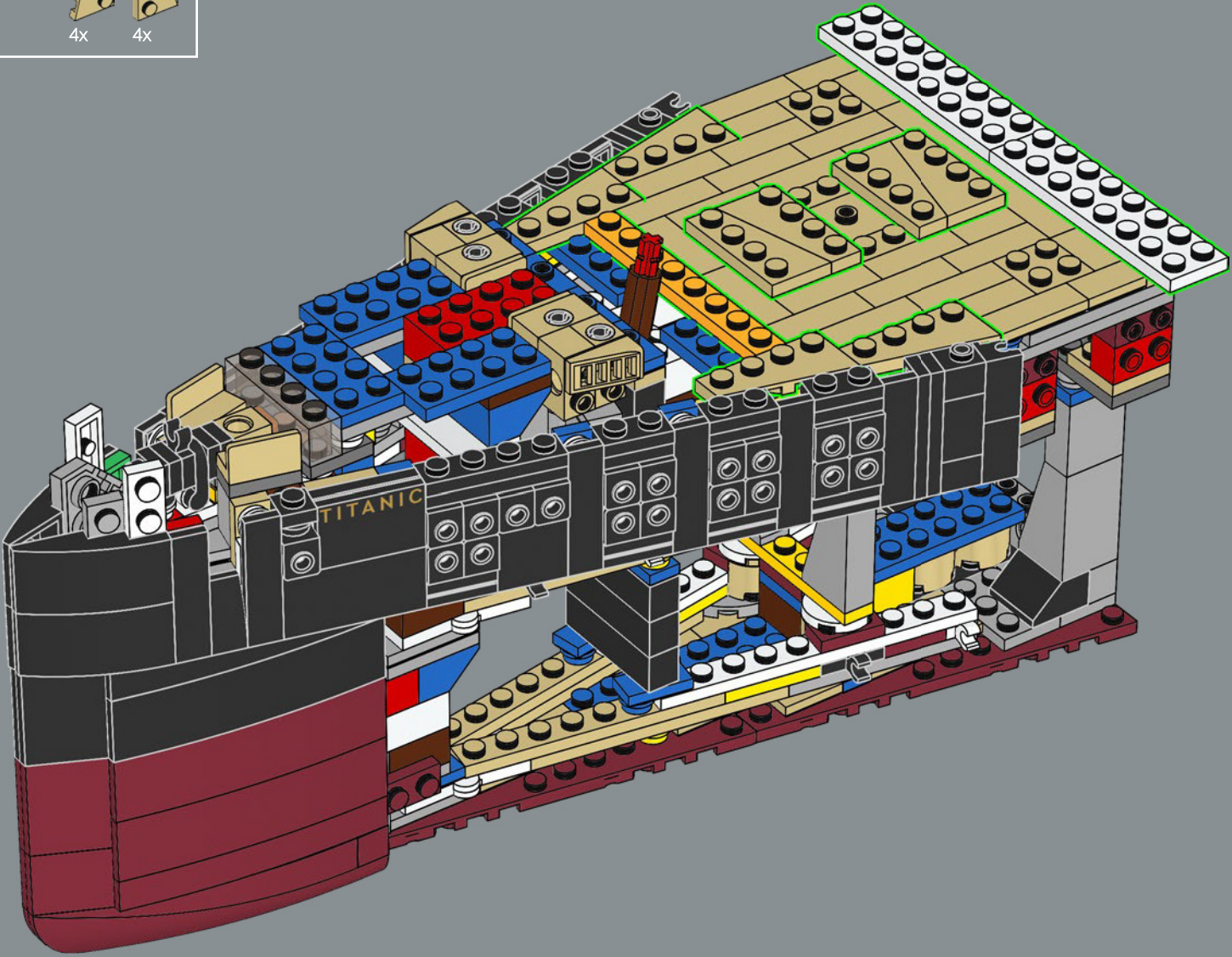

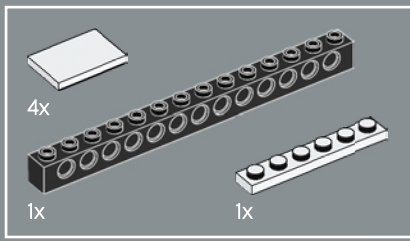

95

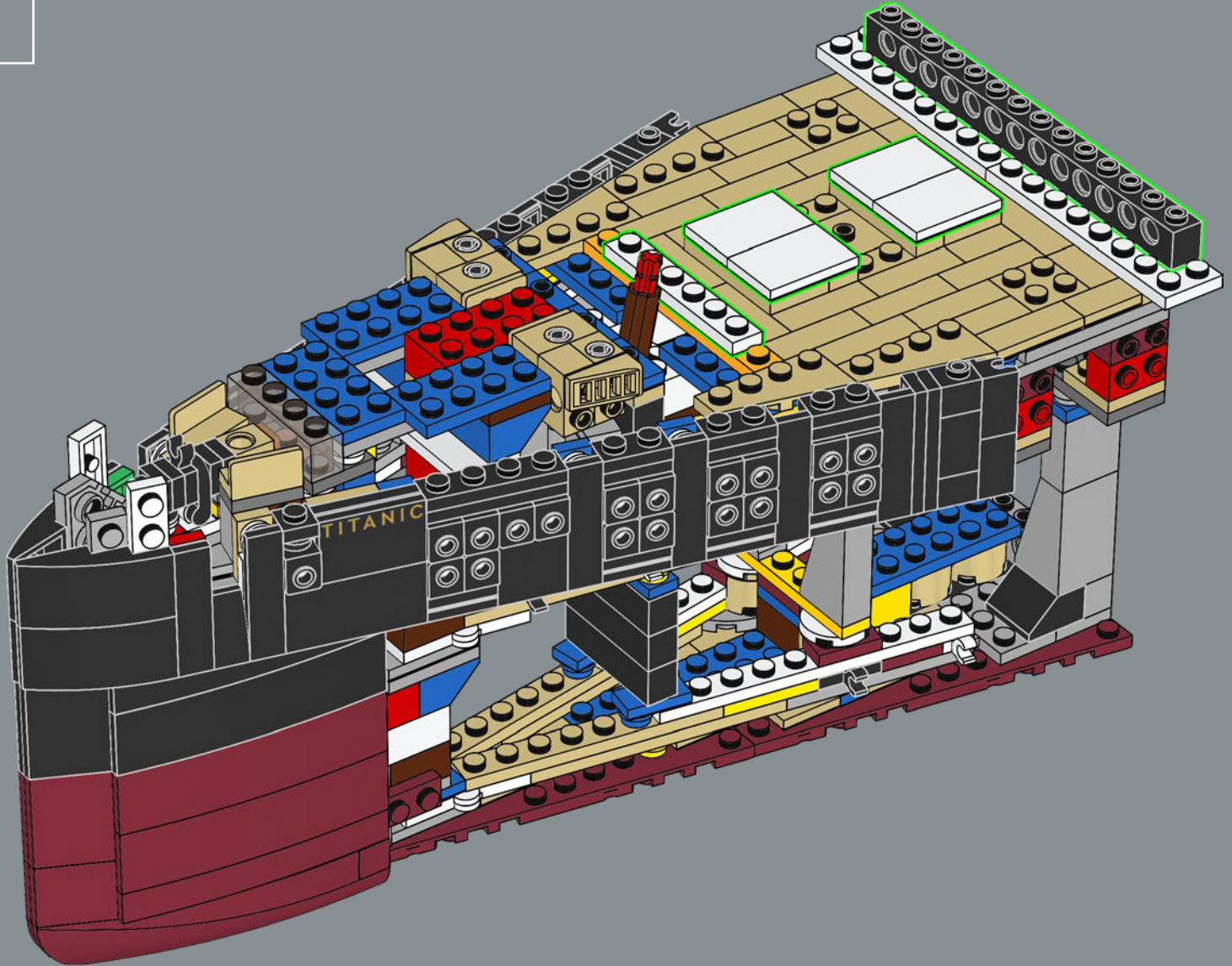

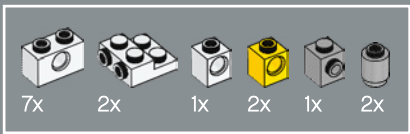

96

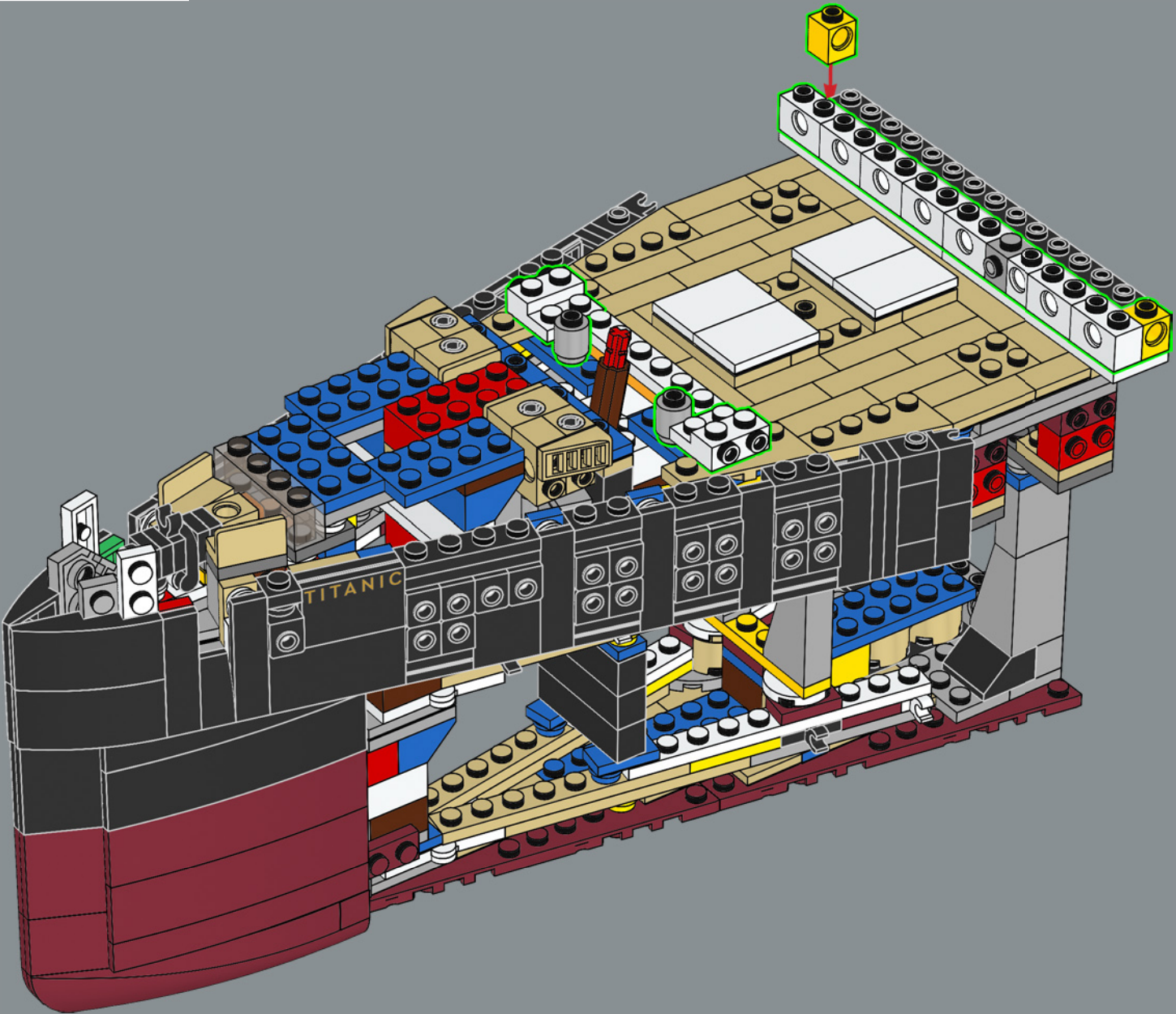

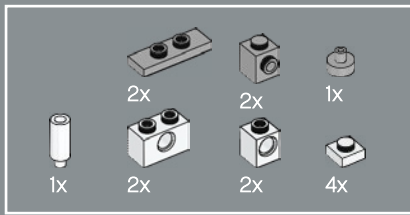

97

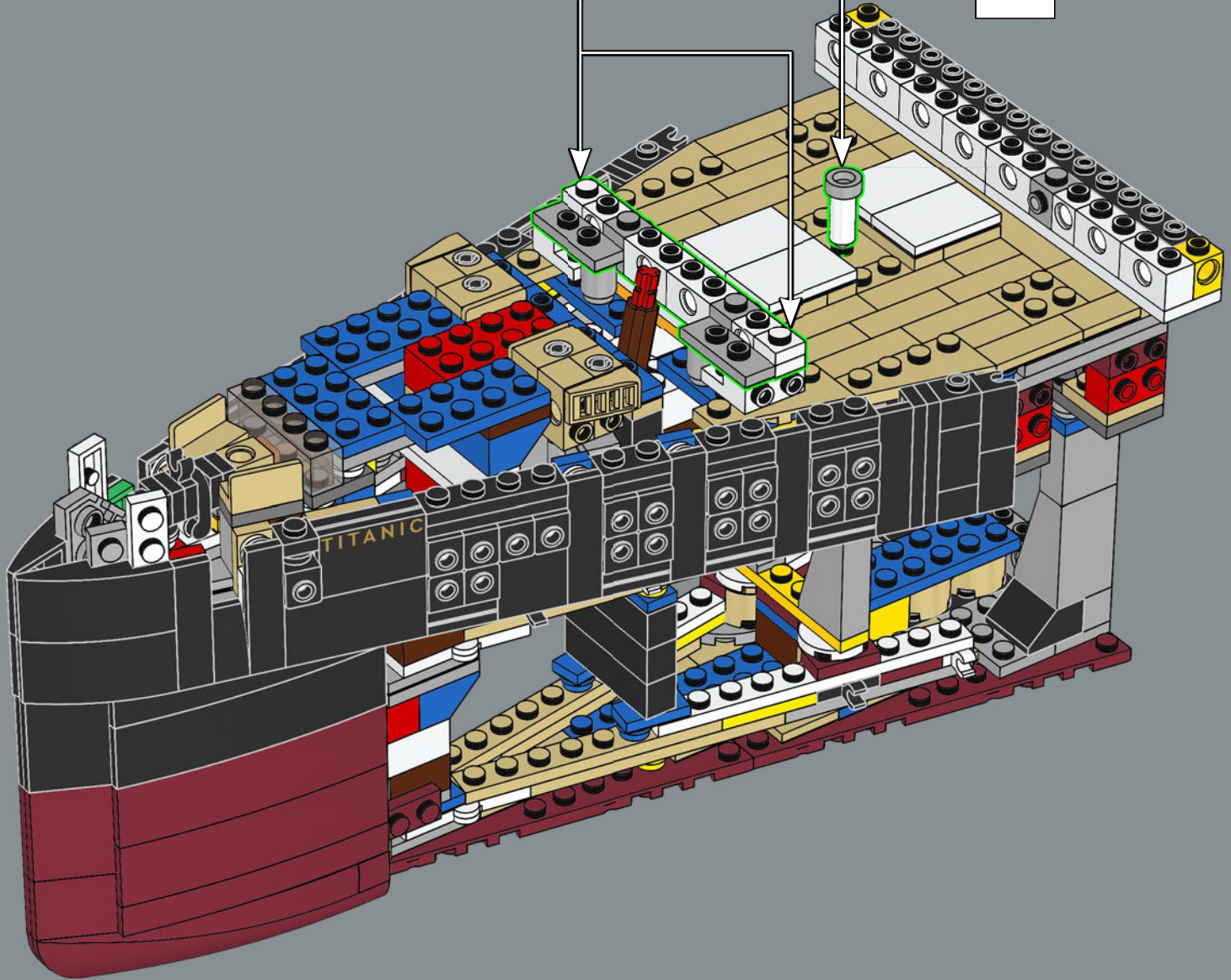
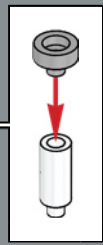
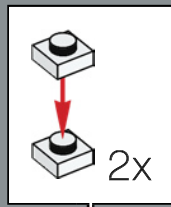

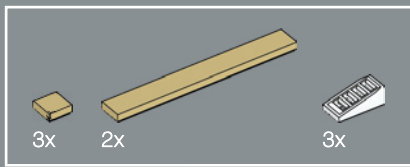

98

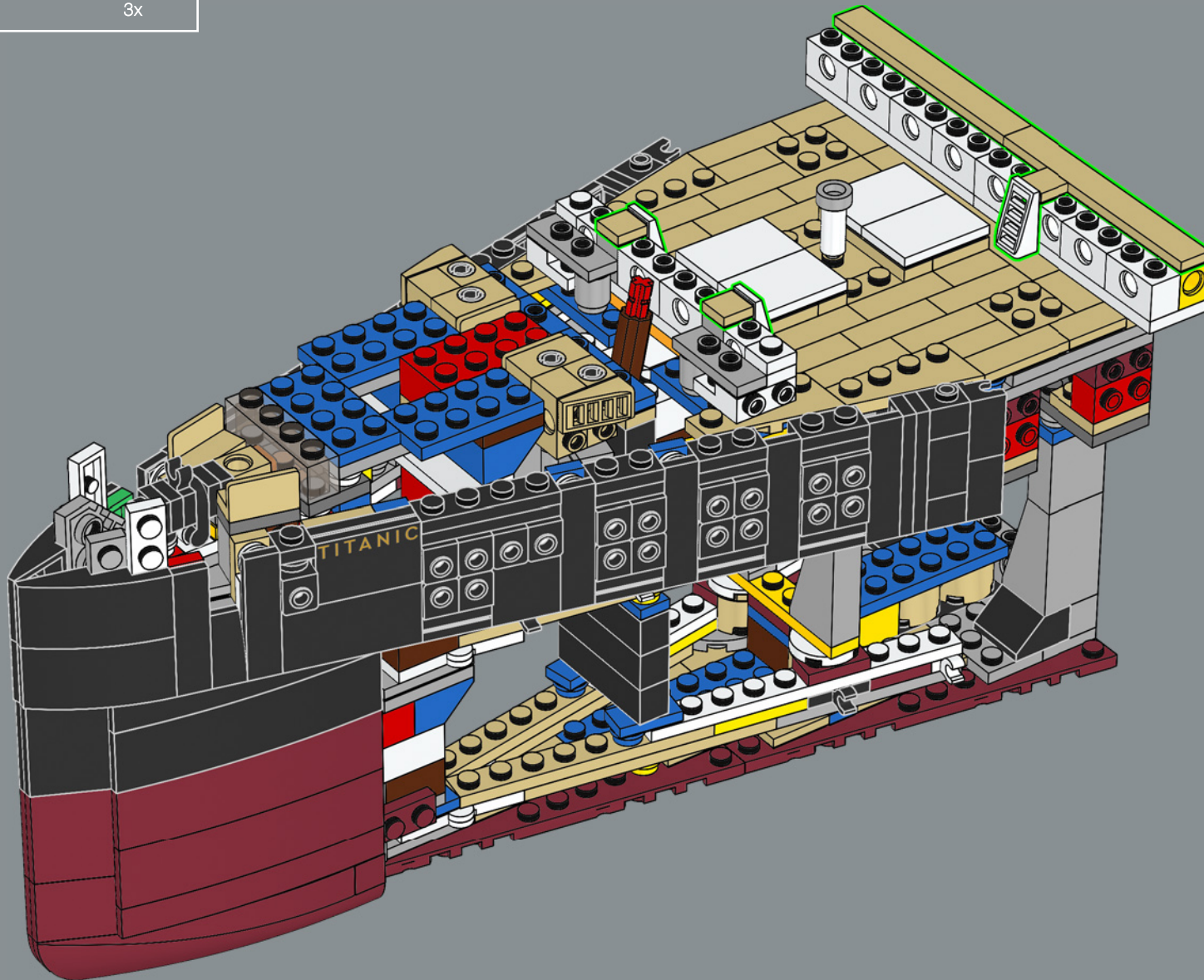



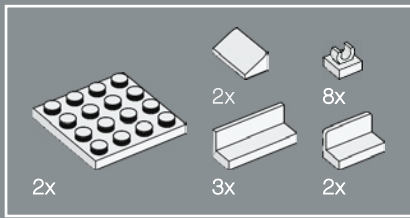

99

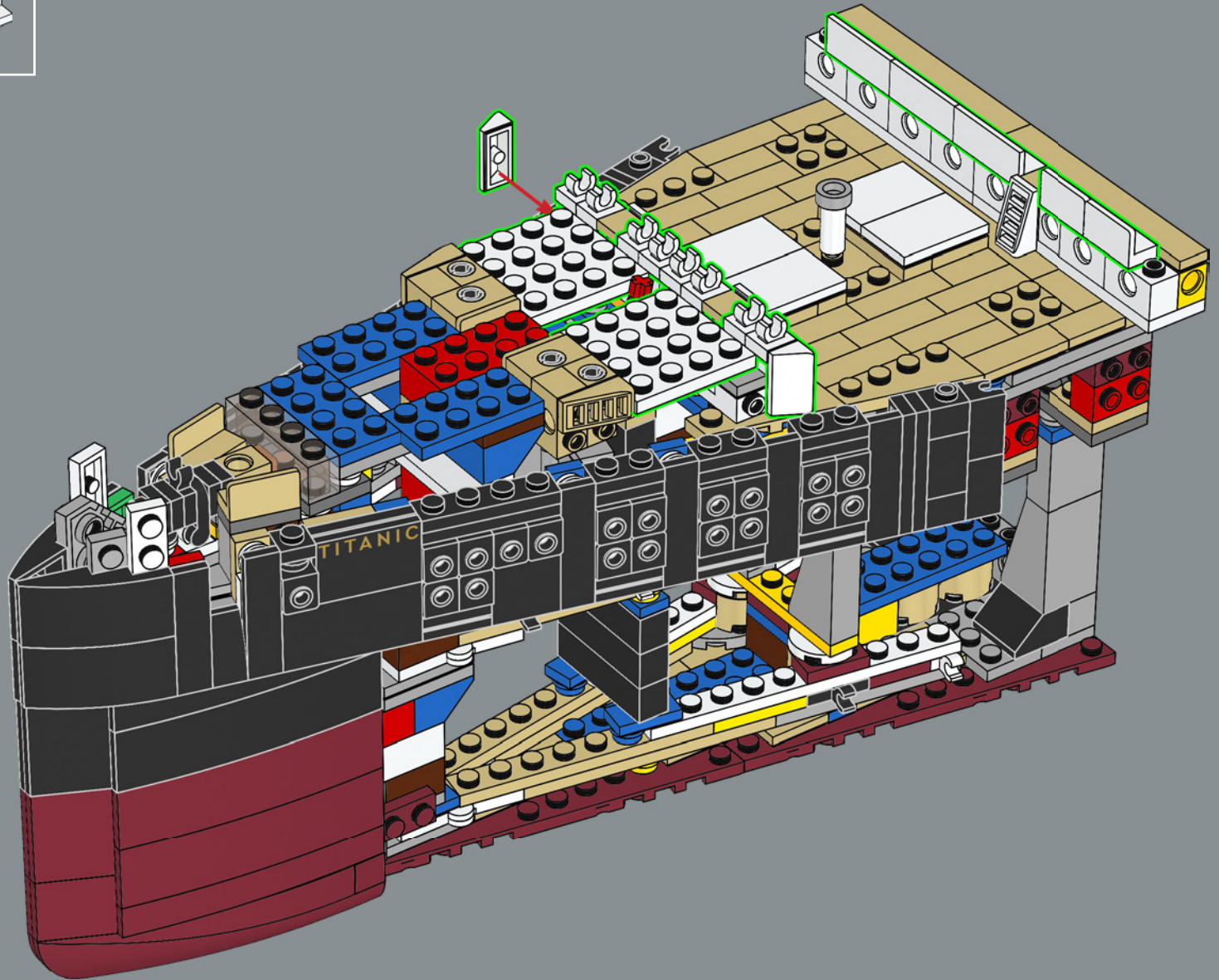

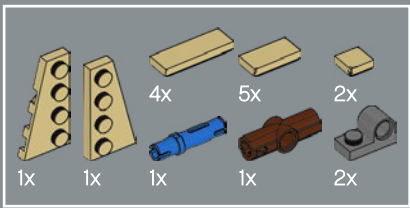

100

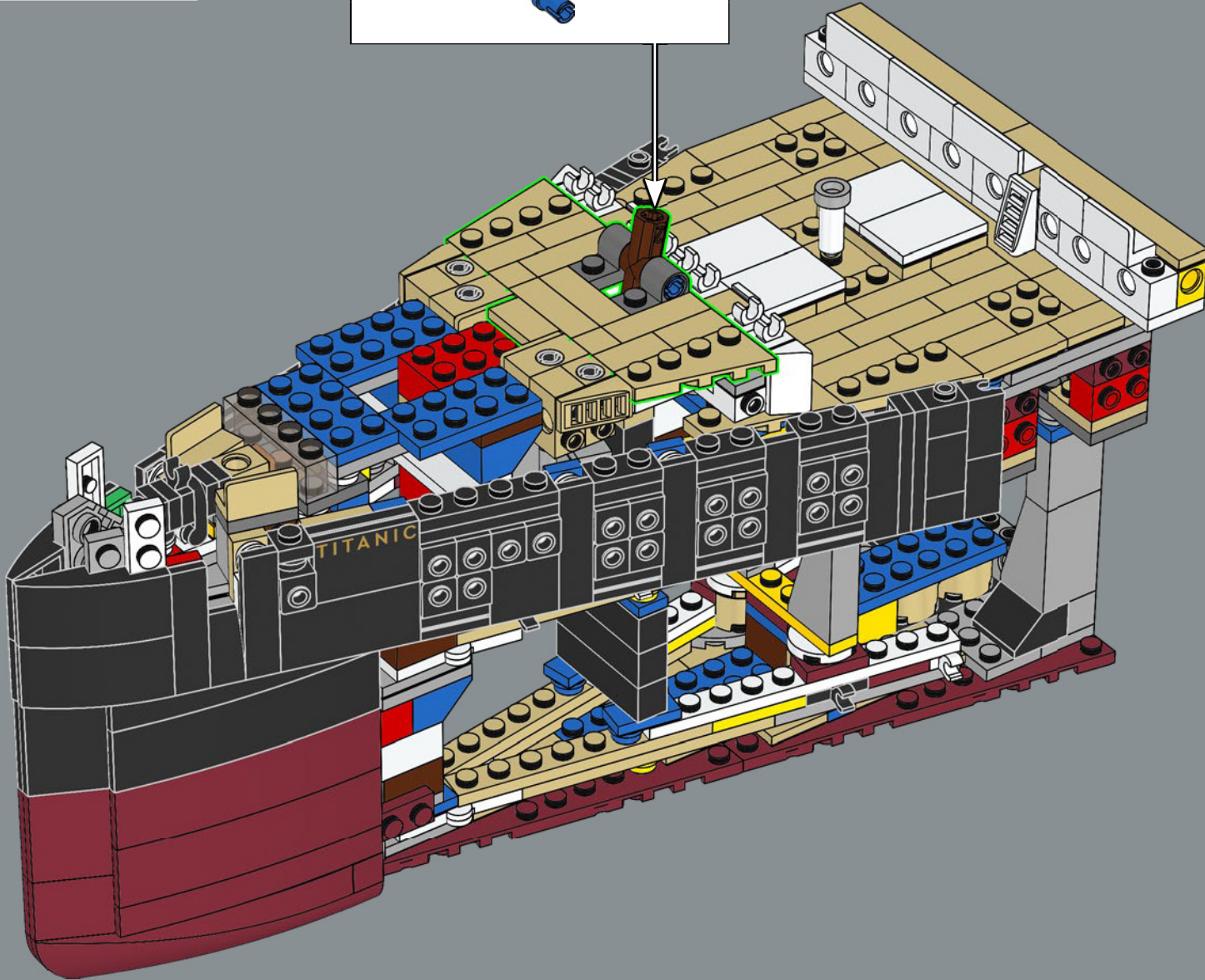
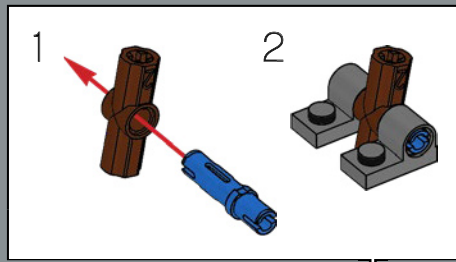



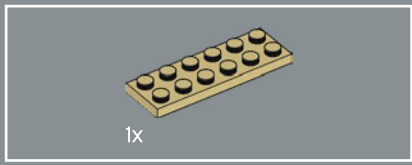

102

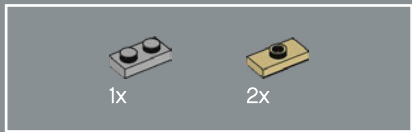
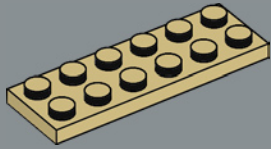

103

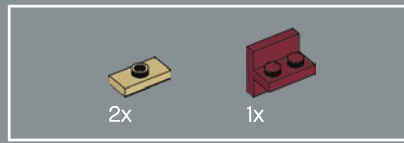
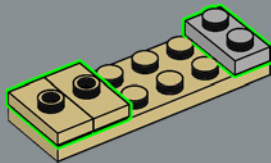

104

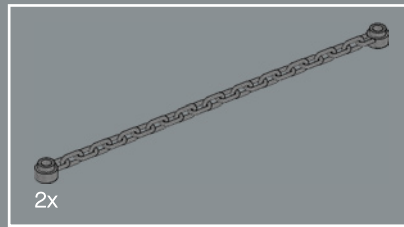
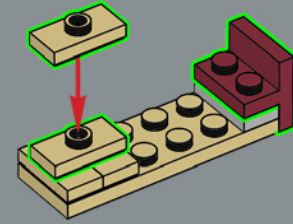

105

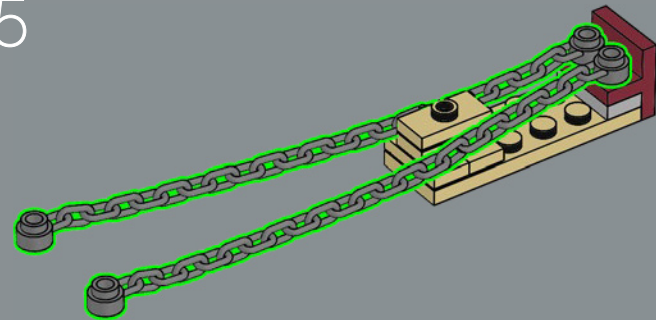

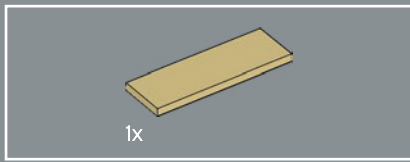

106

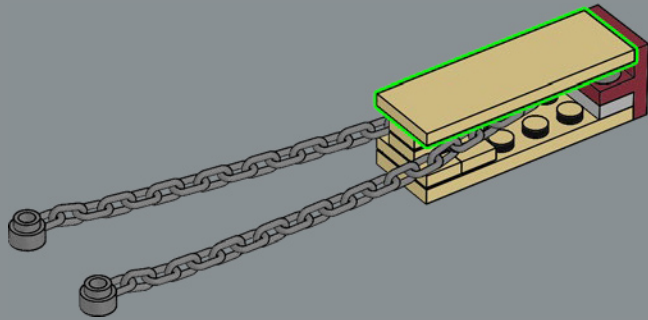

107

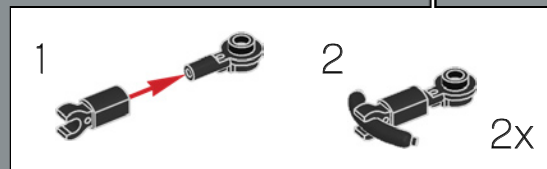
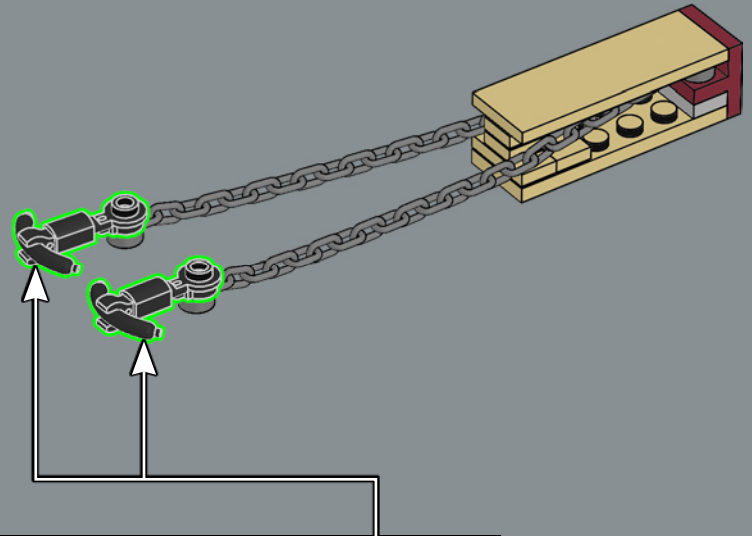

The *Titanic* was fitted with three anchors:  
one on each side and the heaviest in the center.

Le *Titanic* est équipé de trois ancres : une de  
chaque côté, et une plus lourde au centre.

El *Titanic* estaba equipado con tres anclas:  
una en el costado de babor, otra en el costado  
de estribor y la más pesada en el centro.

108

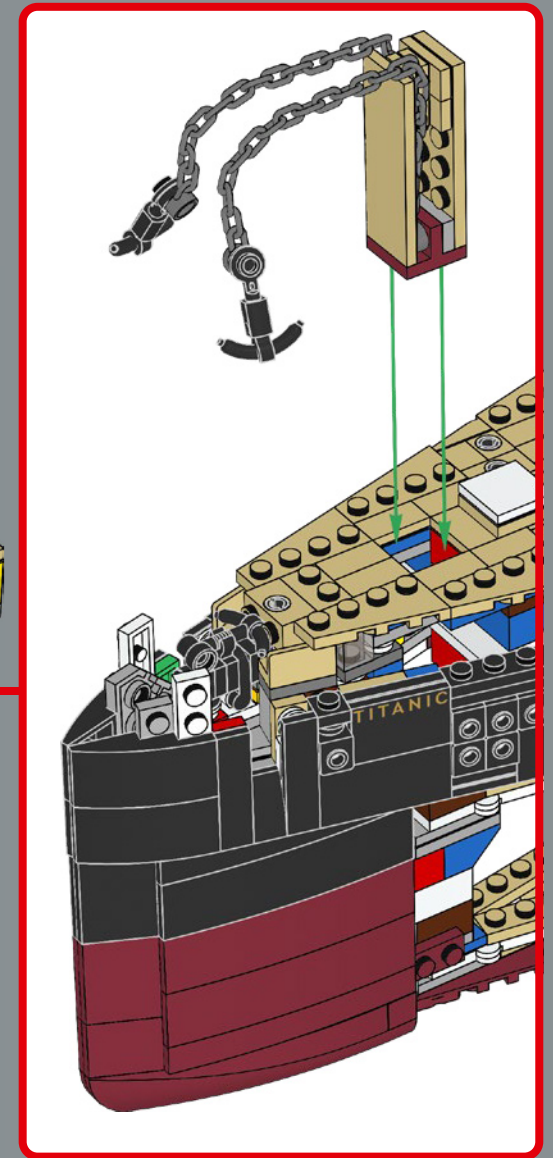
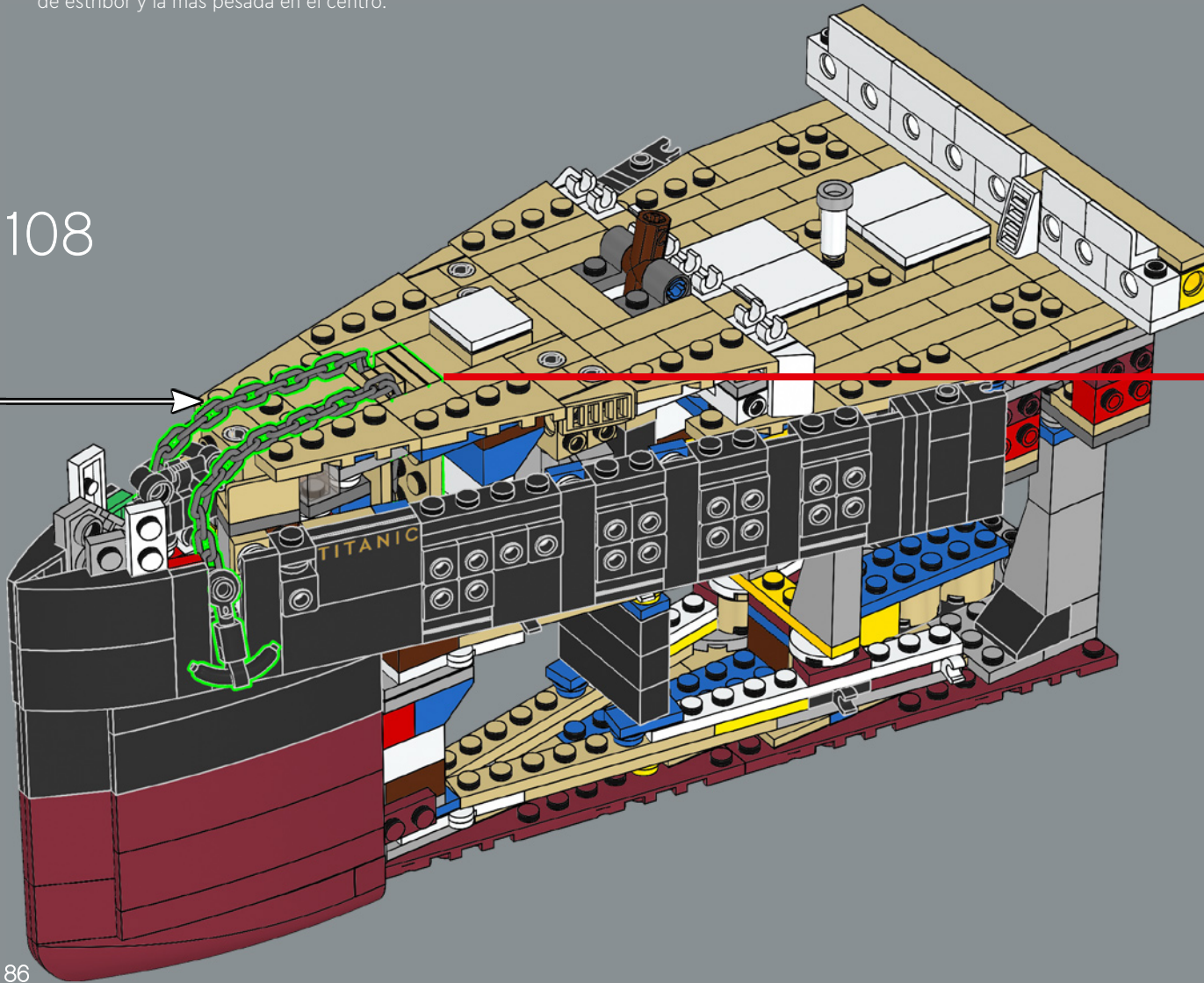

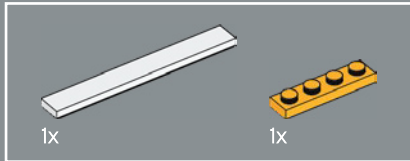
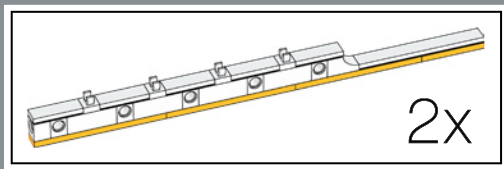

109

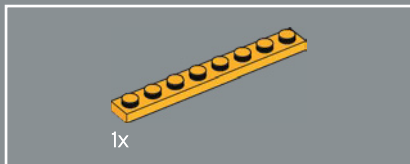
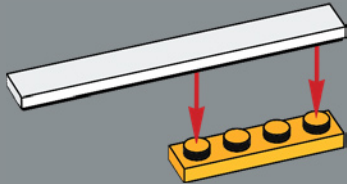

110

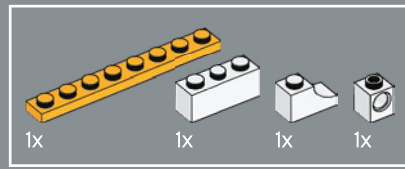
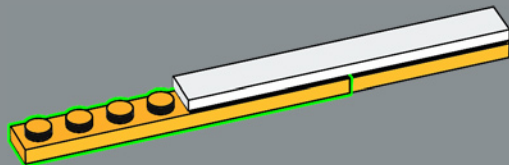

111

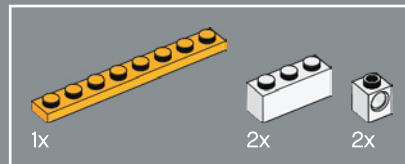
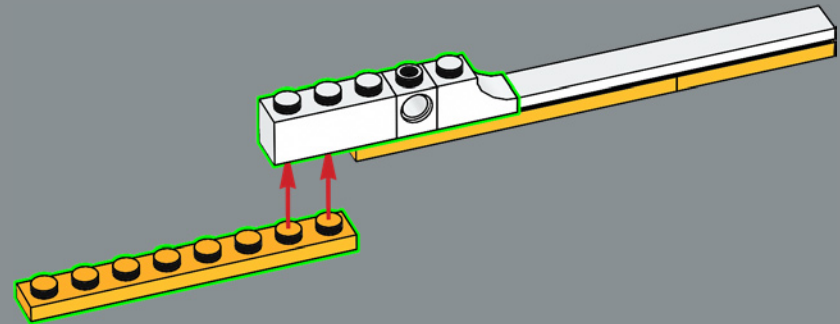

112

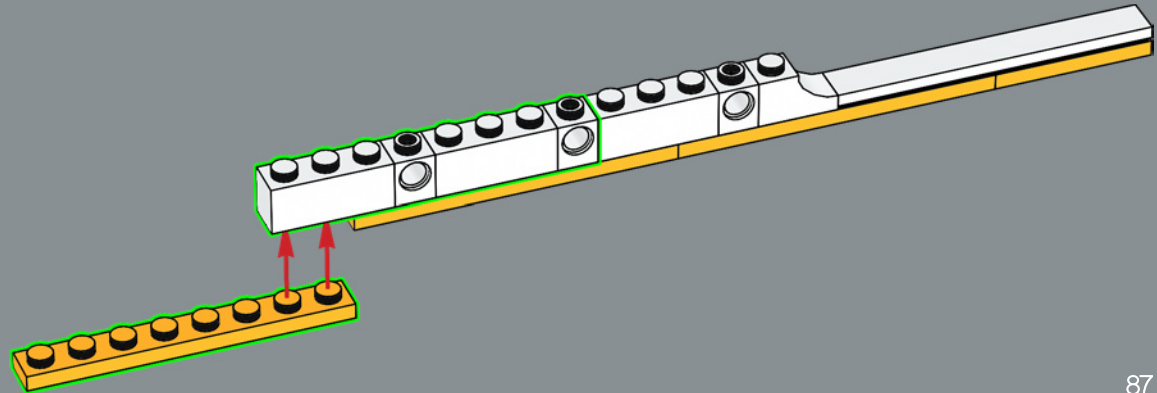

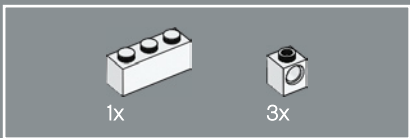

113

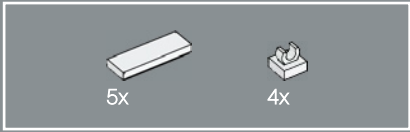
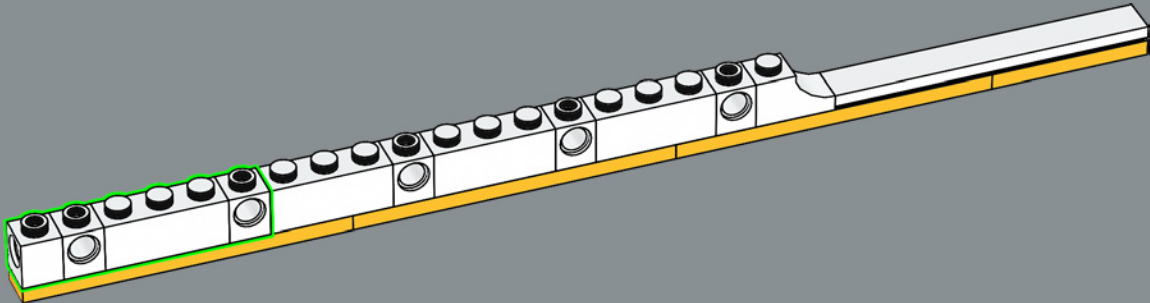

114

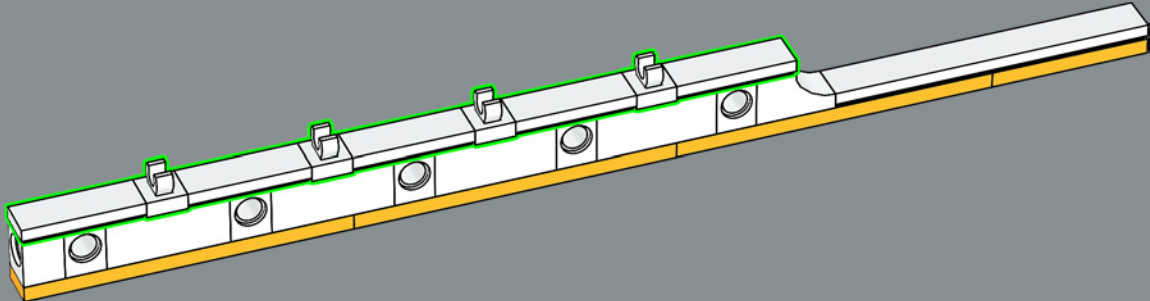

2x



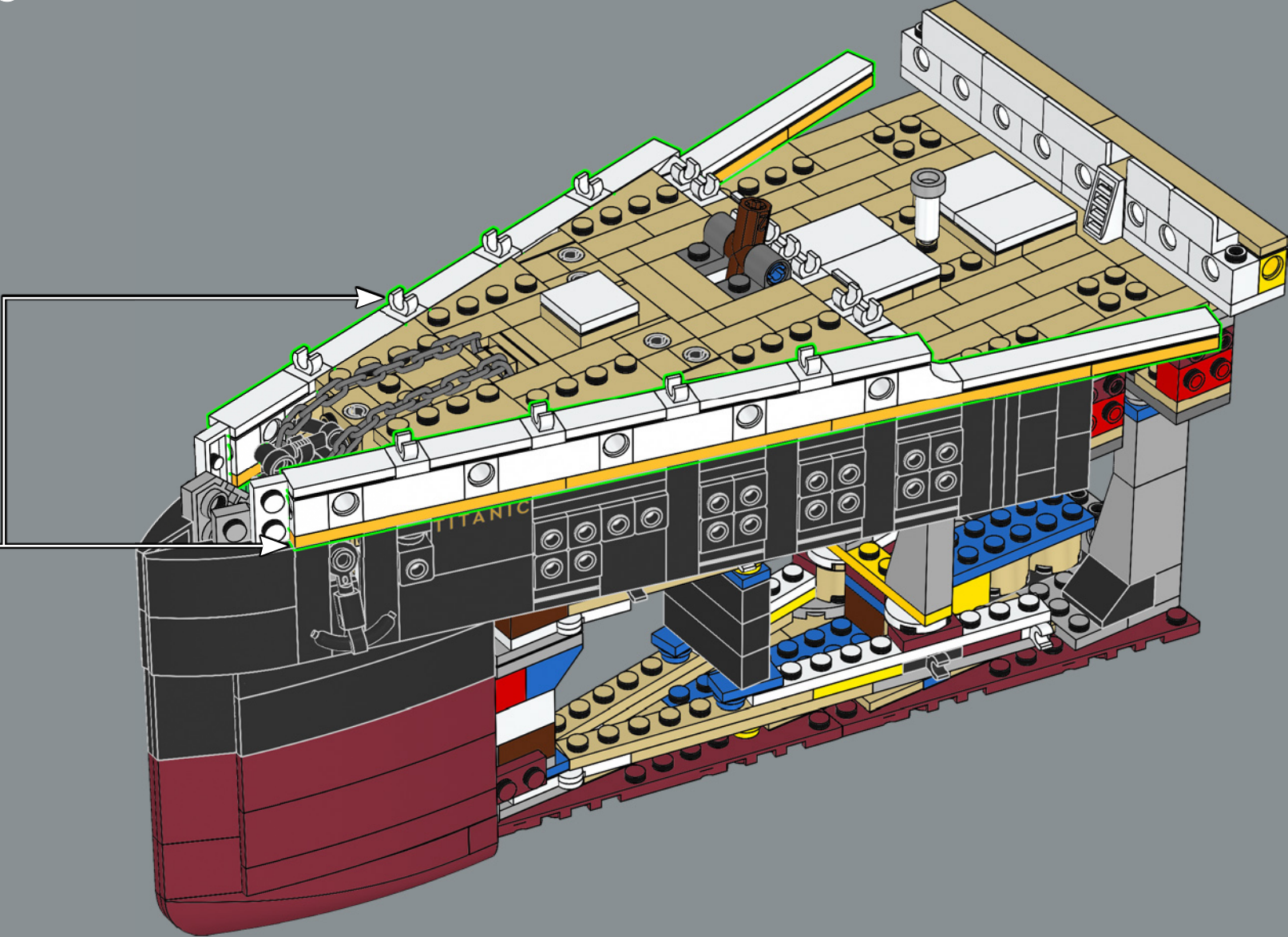

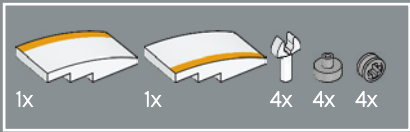

116

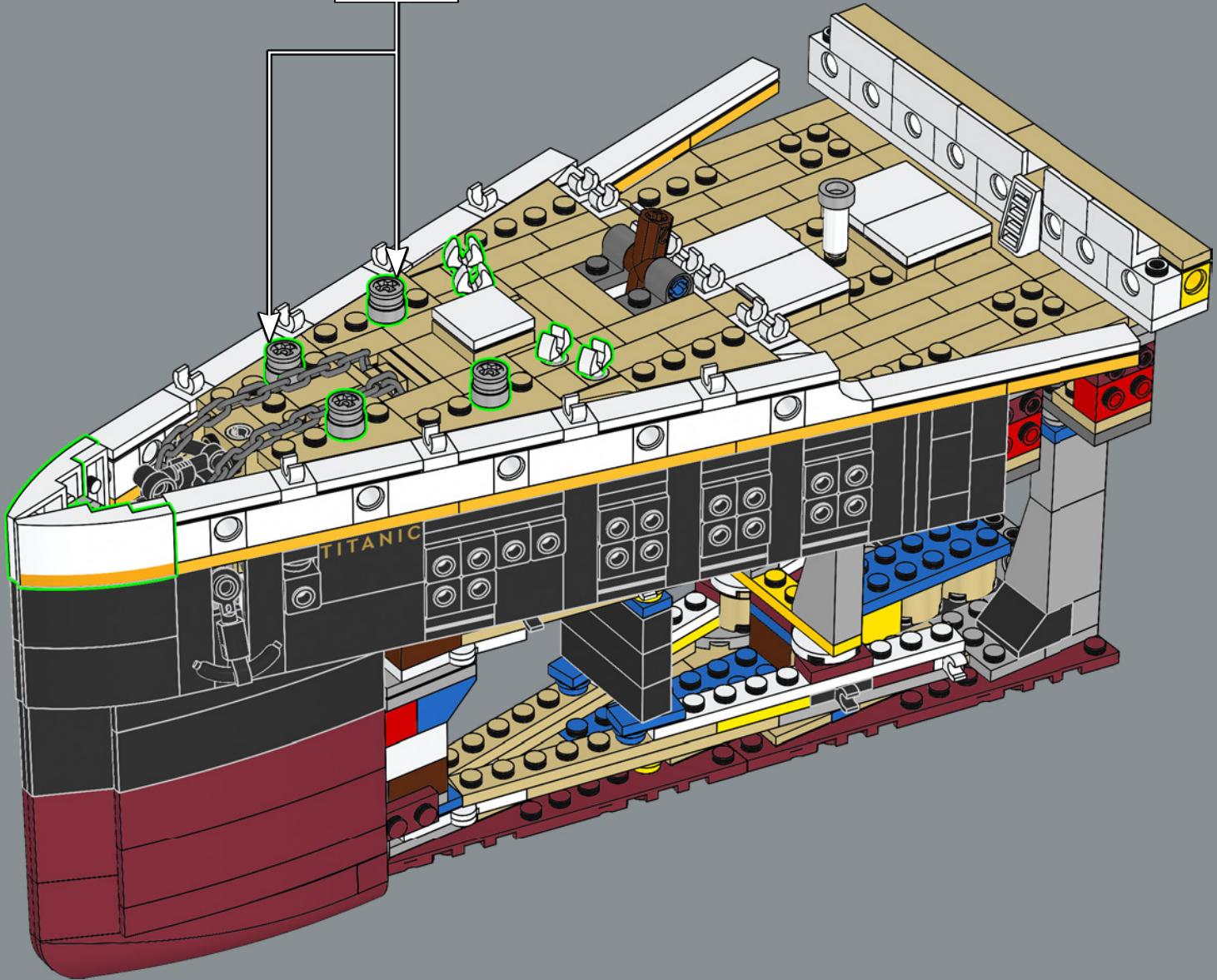
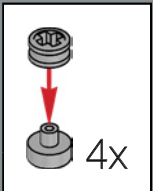

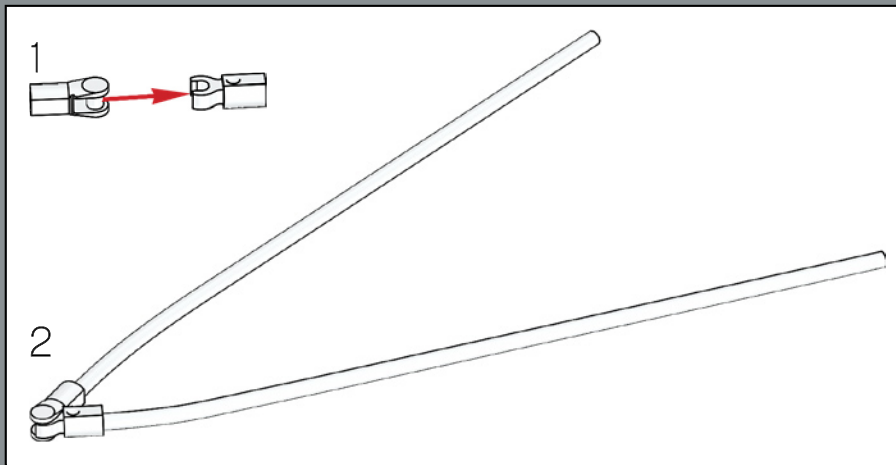
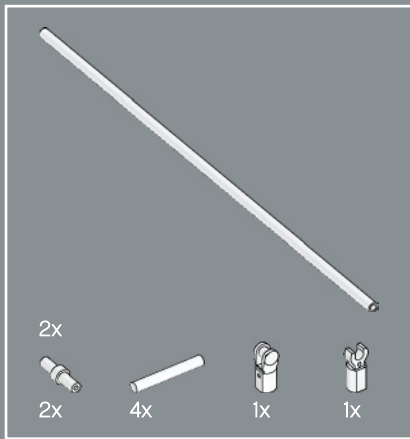

117

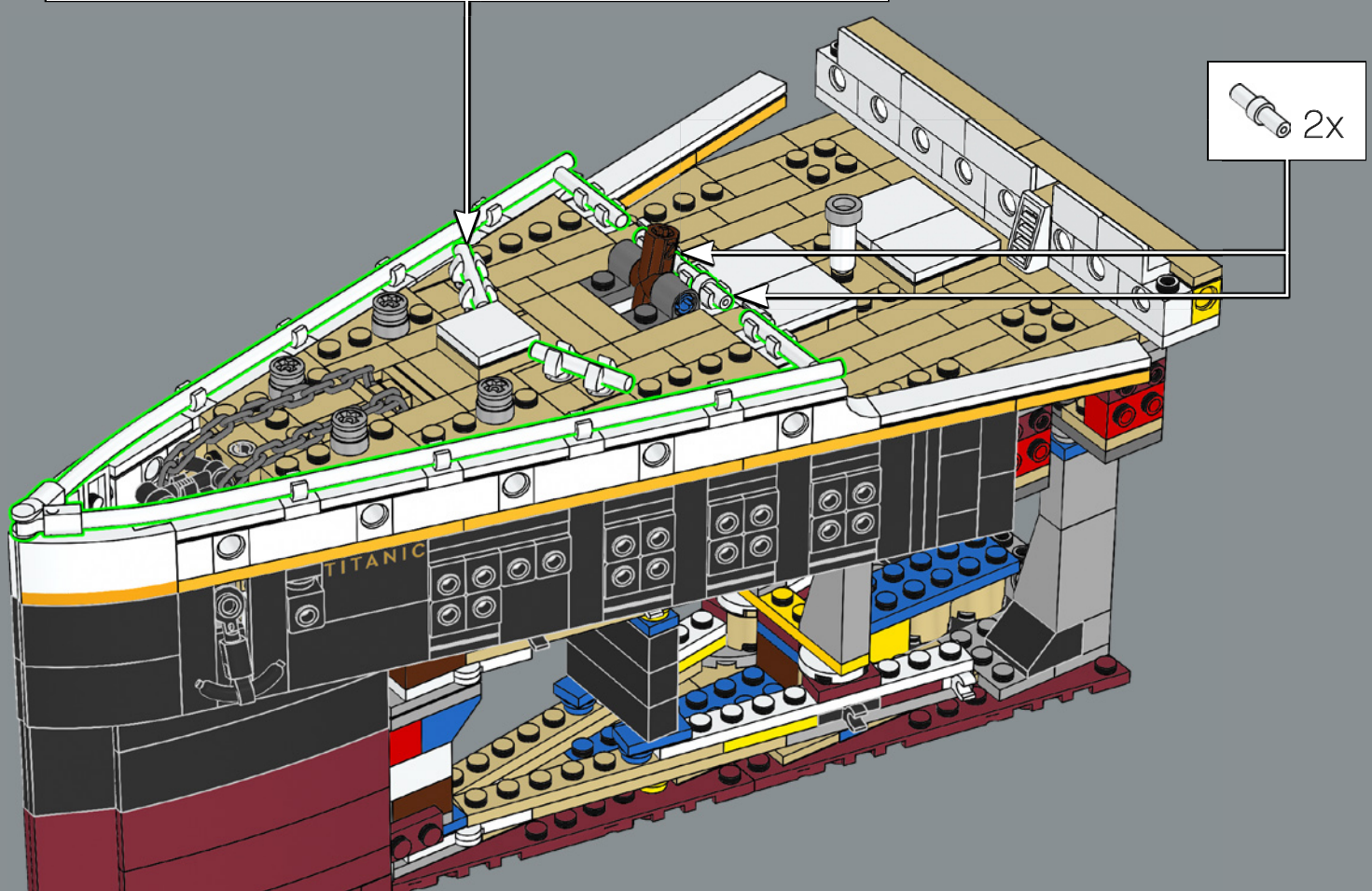
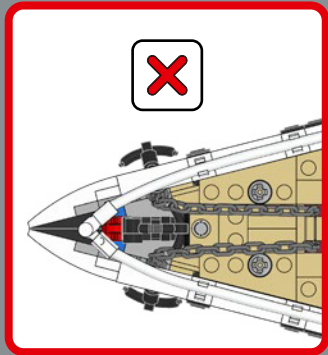
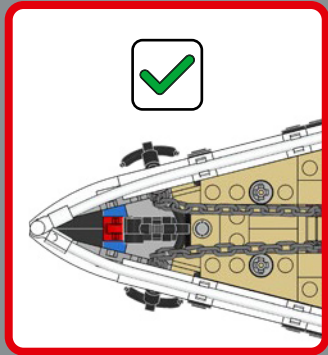



118



119



120

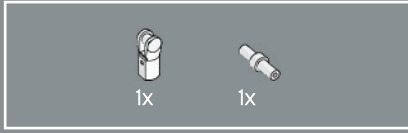
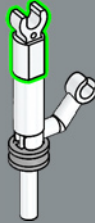

121

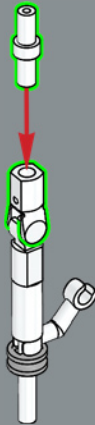



122

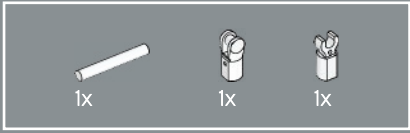
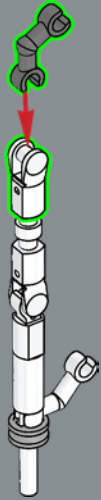

123

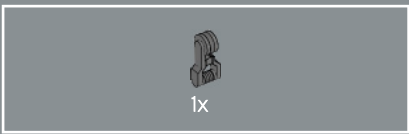
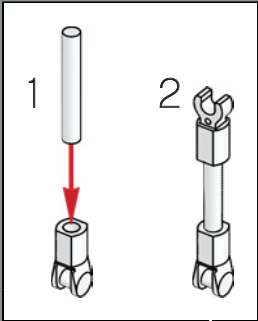
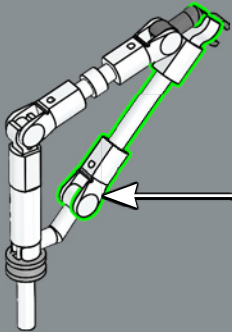

124

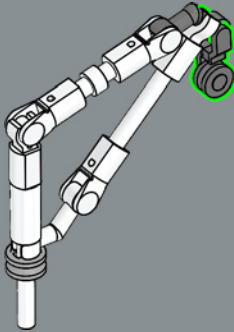

125

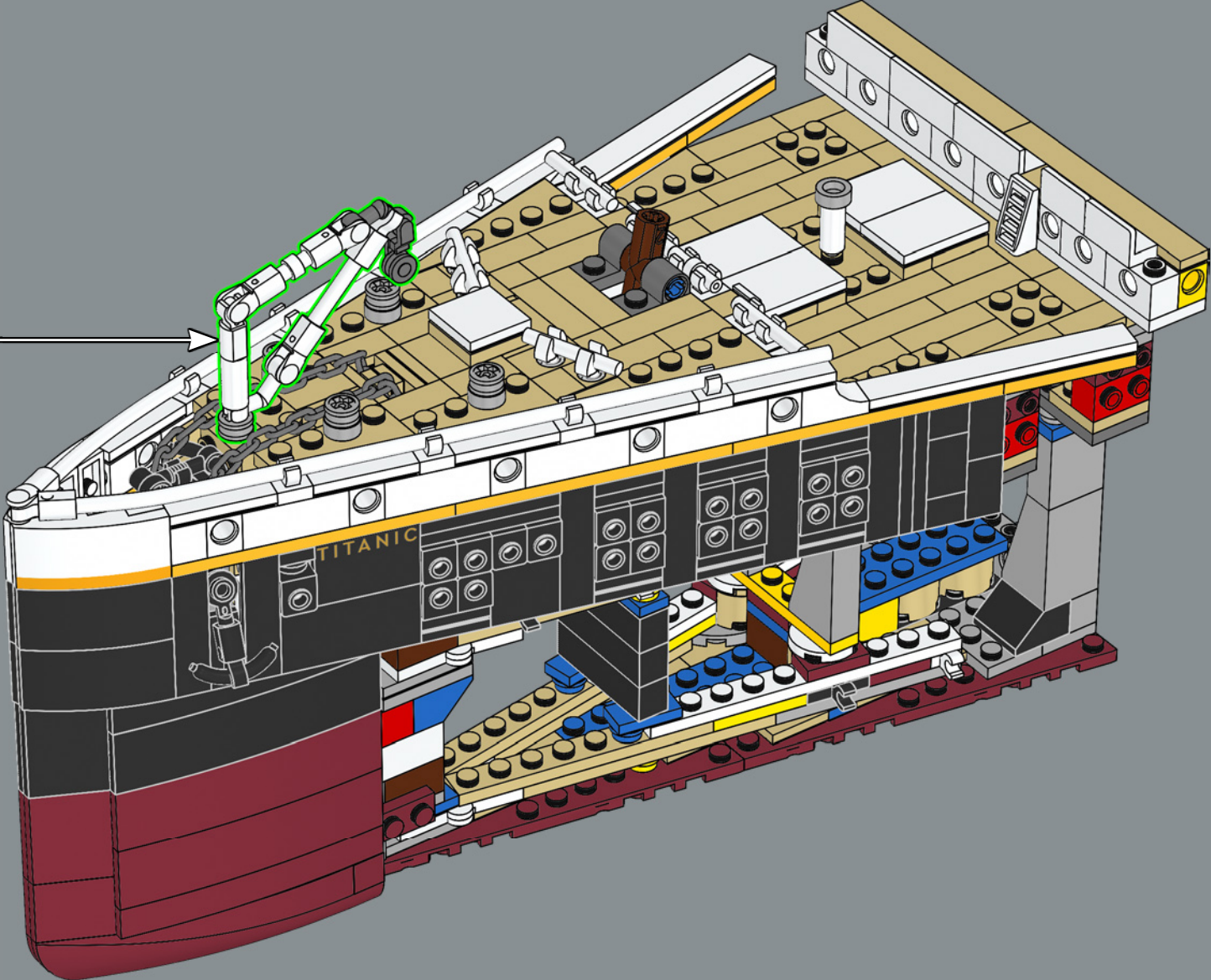

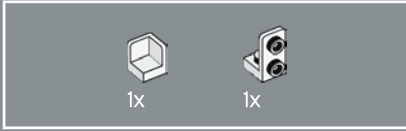
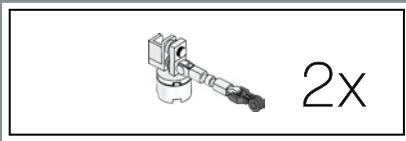

126

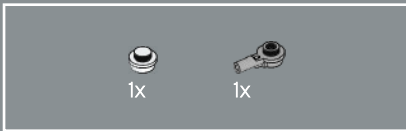

127

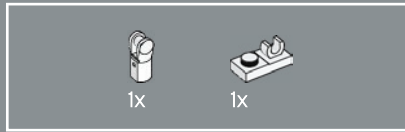

128

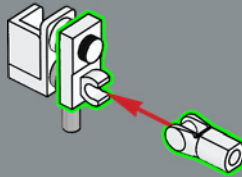

129

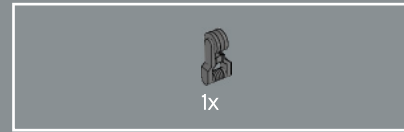
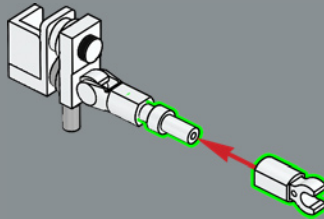

130

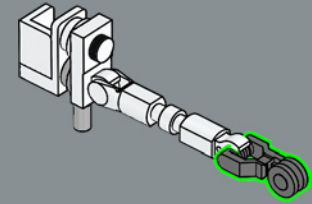

131

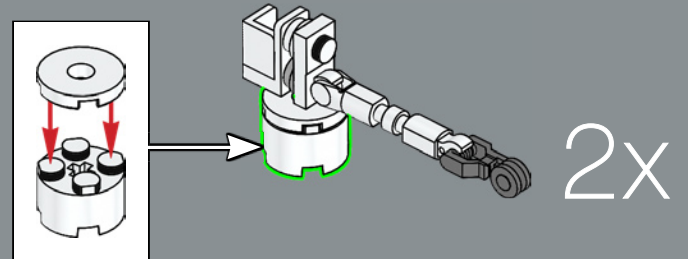

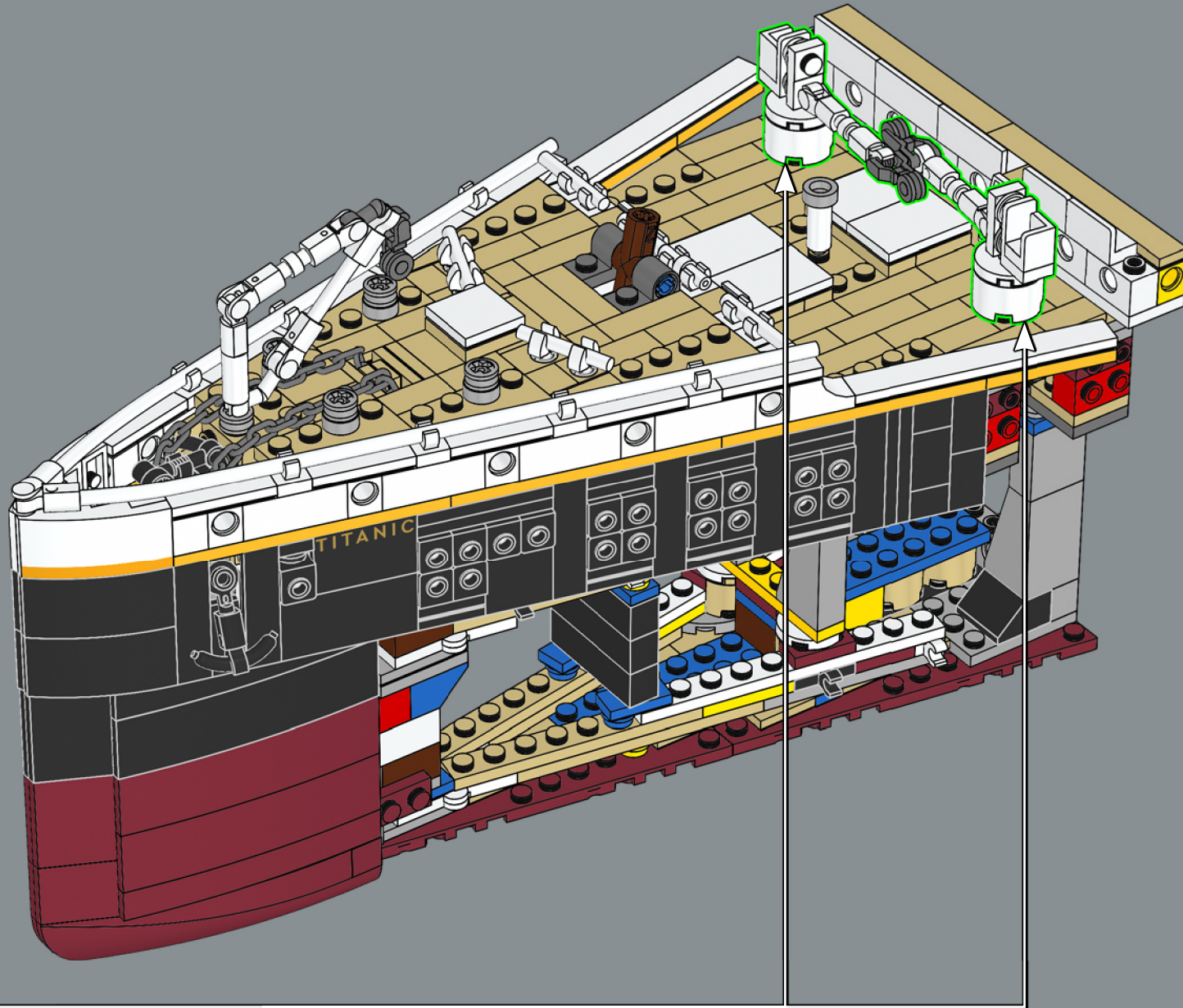



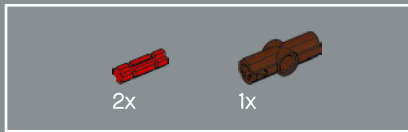
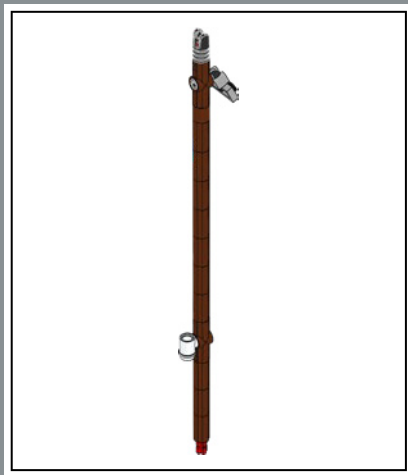

133



134

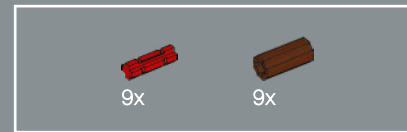

135

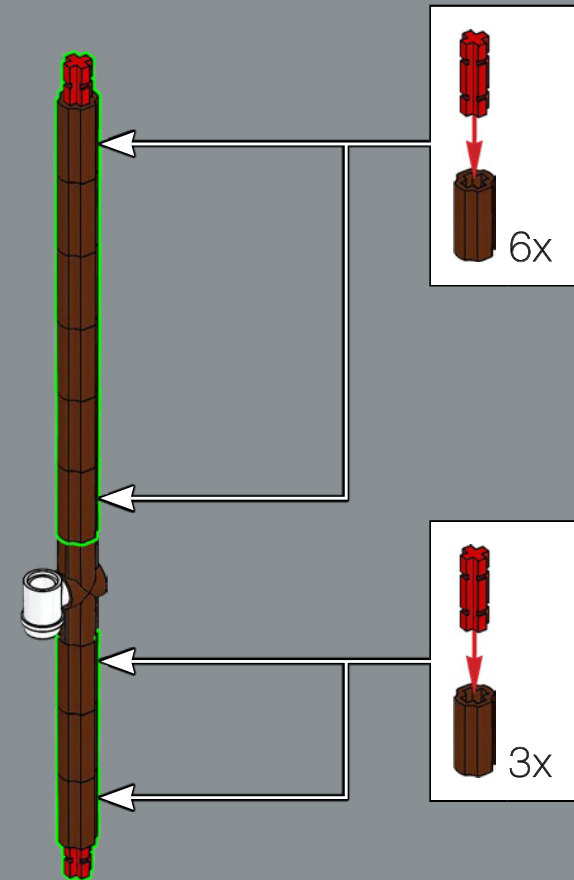

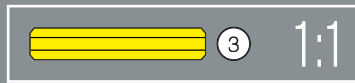
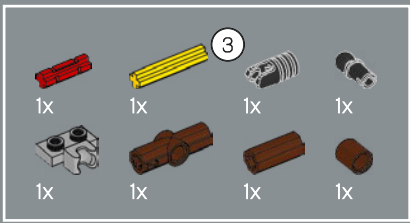

136

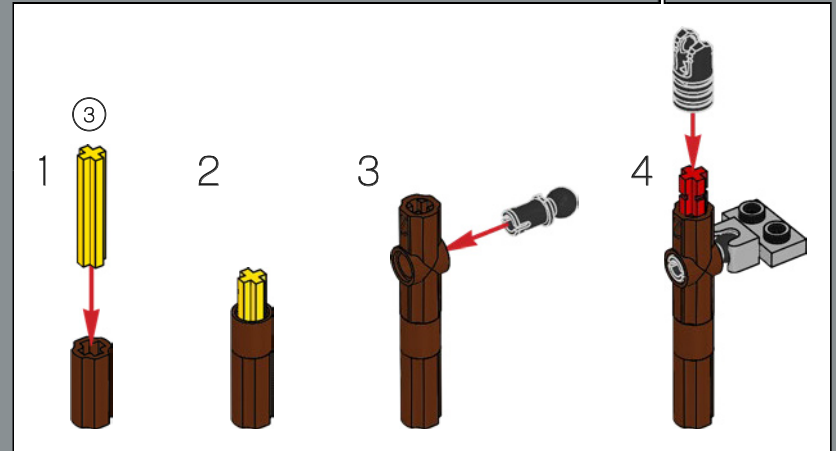

137

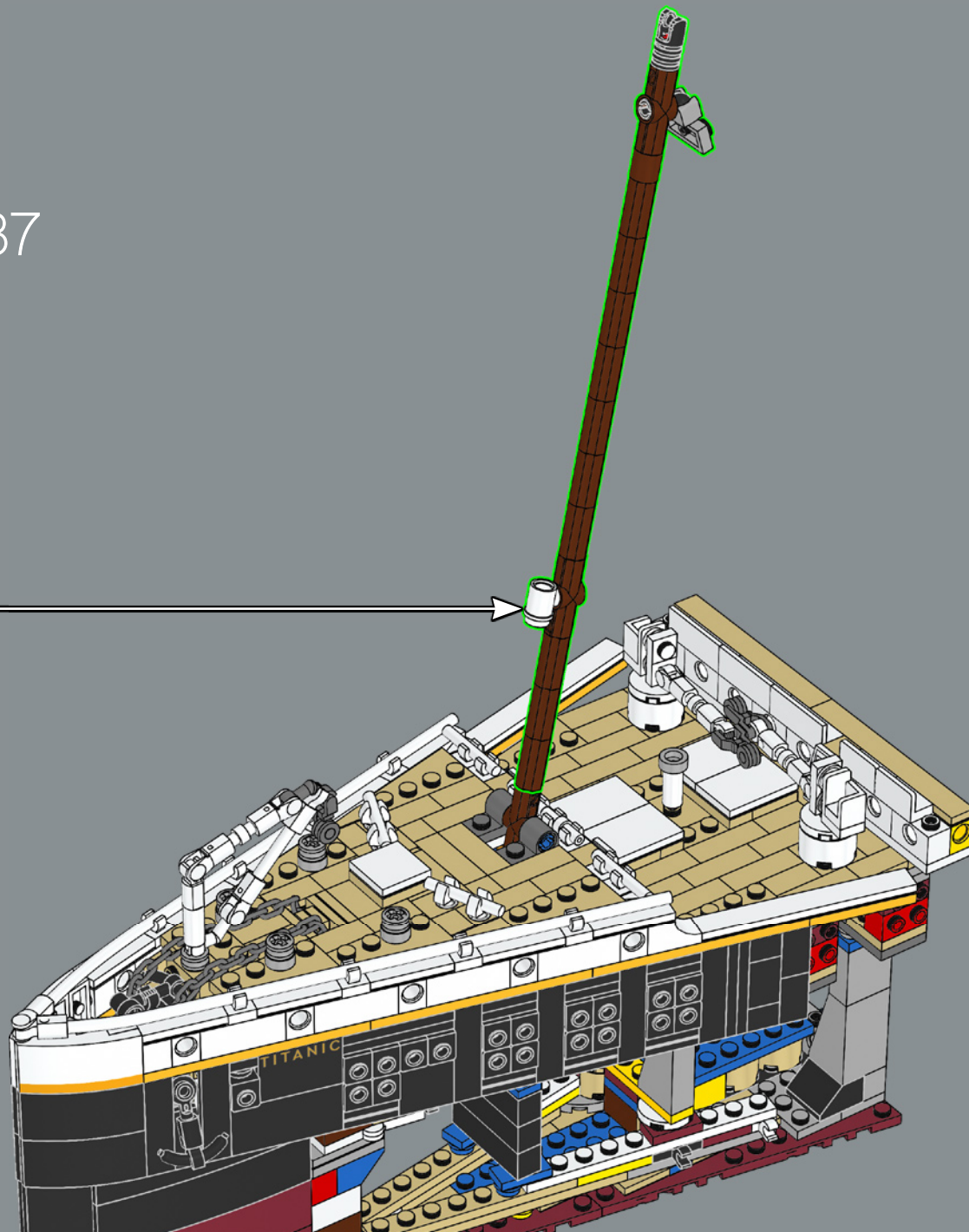

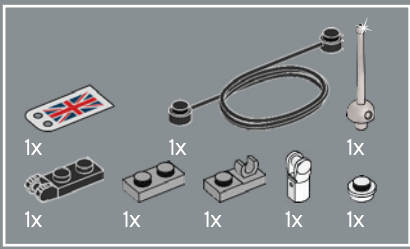

138

1

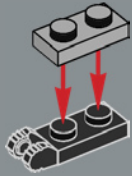

2

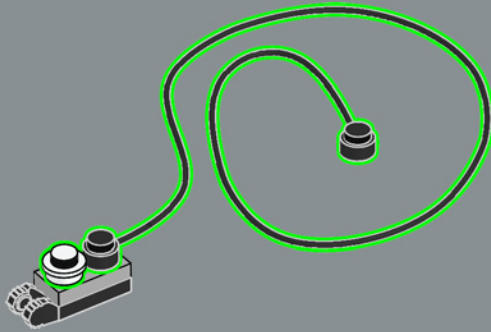

3

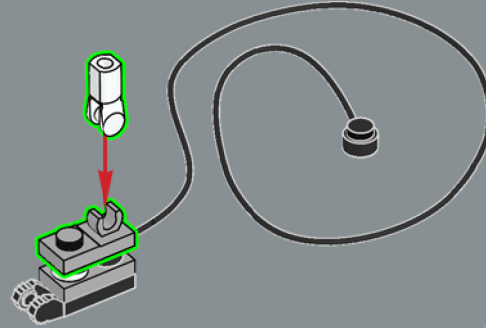

4

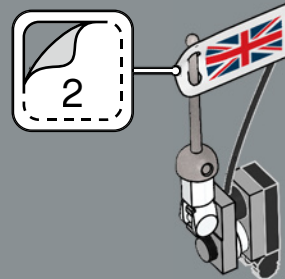

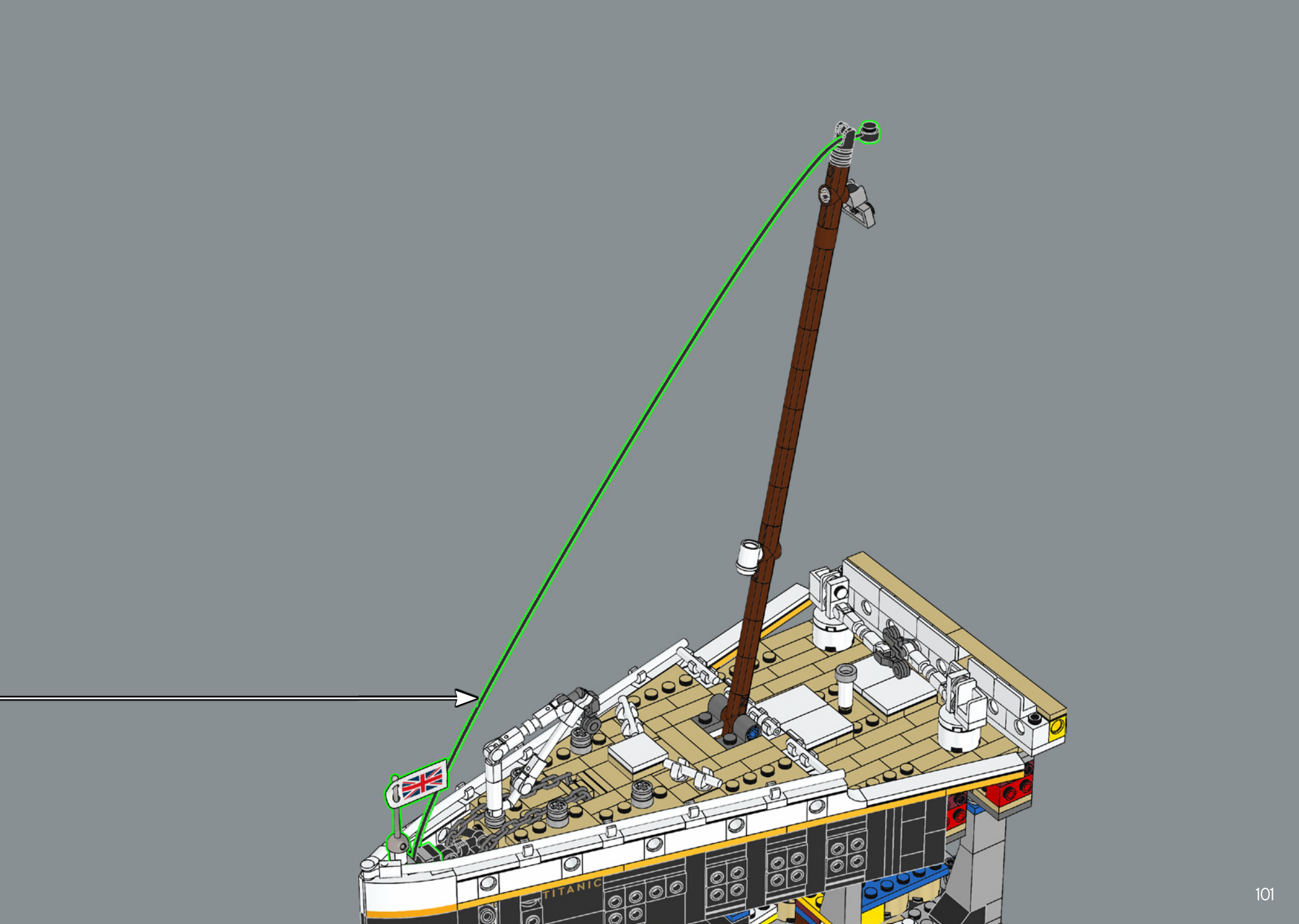

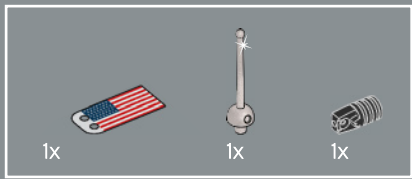

139

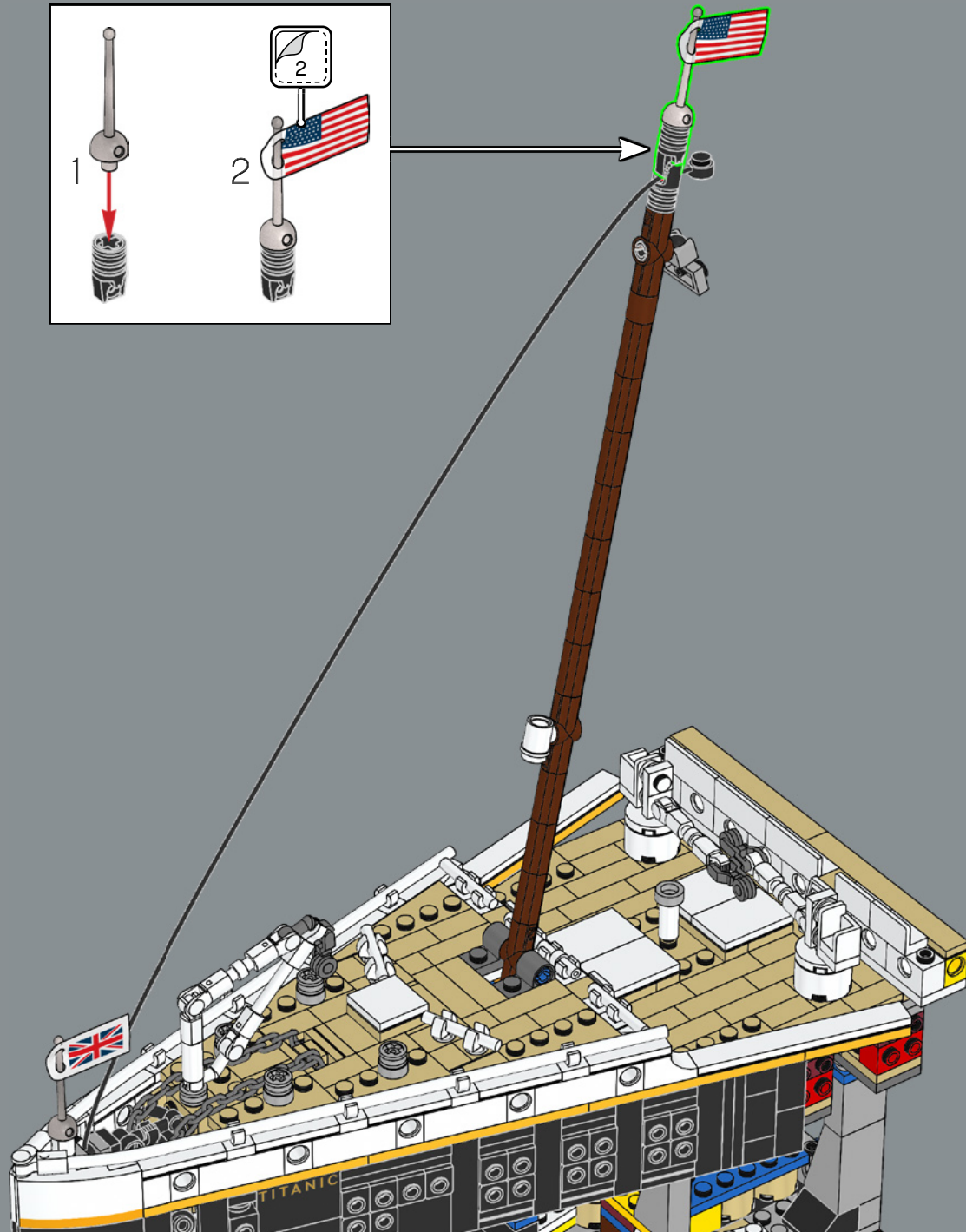
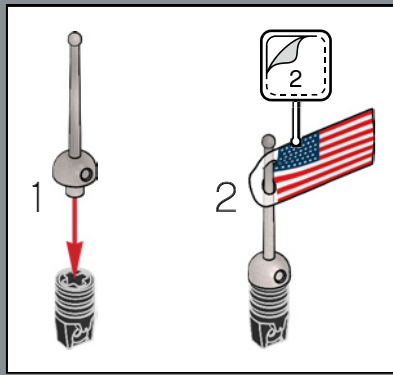

## SECTION 2:

# BRIDGE & FUNNEL

In this second section, the hull reaches its maximum width, 18 modules or roughly 5.6 in. (144 mm). Inside the hull, you will begin construction of the ship's cross section, including part of the swimming pool, the grand staircase and one of *Titanic's* boiler rooms. You will also build the iconic bridge house and the first of four funnels.

## SECTION 2 :

# PONT ET CHEMINÉE

Dans cette deuxième section, la coque atteint sa largeur maximale, soit 18 modules ou environ 144 mm (5,6 po). À l'intérieur de la coque, vous commencerez la construction de la section transversale du navire, dont une partie de la piscine, le Grand Escalier et l'une des salles des chaudières du *Titanic*. Vous construirez également l'emblématique château et la première des quatre cheminées.

## SECCIÓN 2:

# PUENTE Y CHIMENEA

En esta segunda sección, el casco presenta su máxima anchura (18 módulos o, aproximadamente, 144 mm). Adentro del casco, empezarás a construir la sección transversal del barco, incluidas parte de la alberca, la Gran Escalera y una de las salas de calderas del *Titanic*. También construirás la inconfundible caseta del puente y la primera de las cuatro chimeneas.

↓ A hidden locking mechanism inside the grand staircase allows the entire ship to connect securely together.

↓ Un mécanisme de verrouillage caché à l'intérieur du Grand Escalier permet de raccorder l'ensemble du navire en toute sécurité.

↓ El mecanismo de fijación oculto en el interior de la Gran Escalera permite conectar firmemente todo el barco.

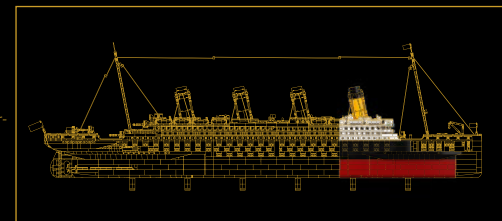

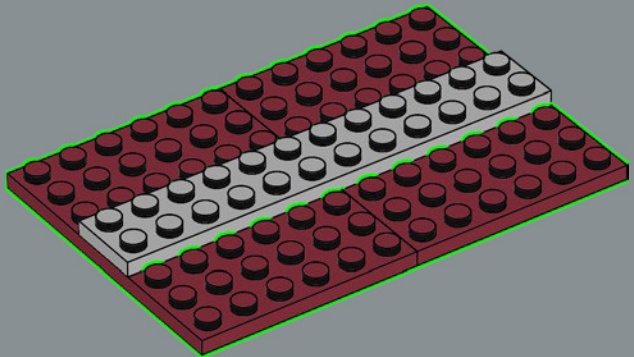
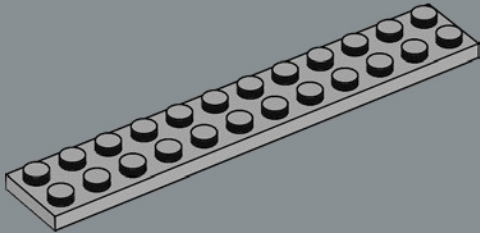
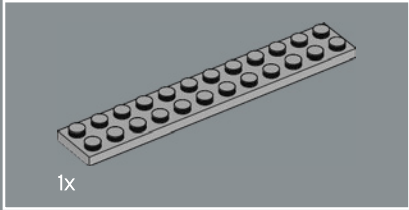
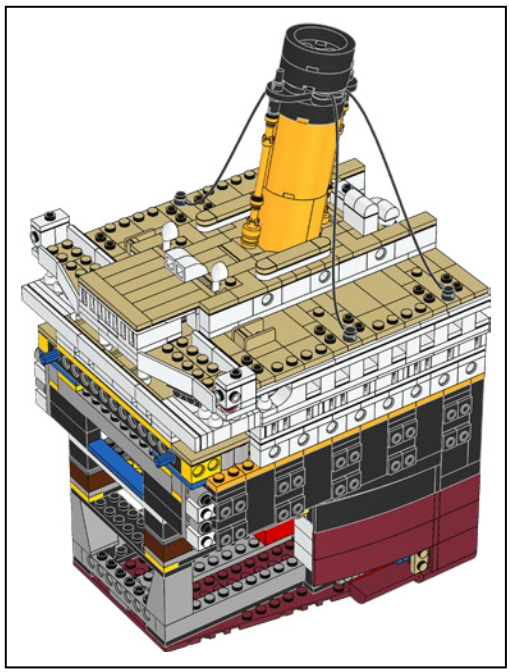
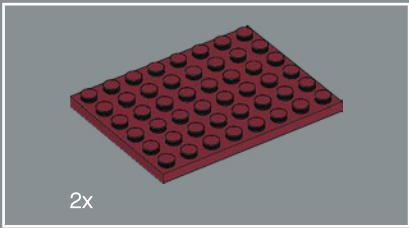
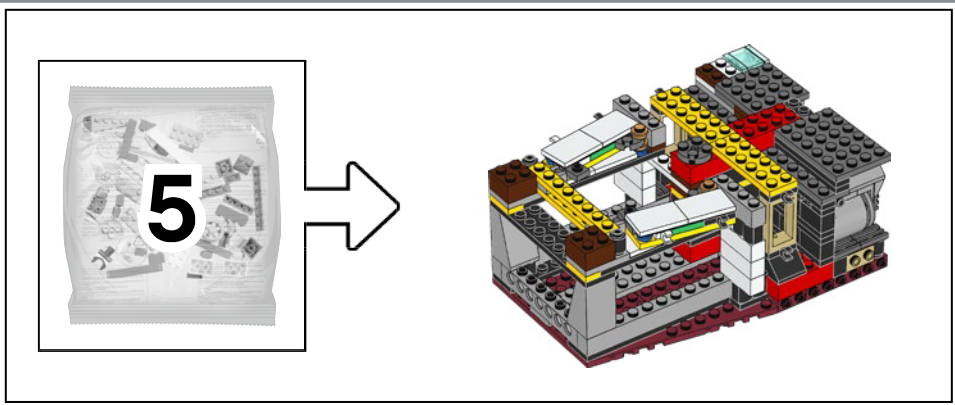



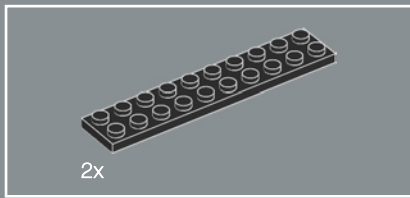

142

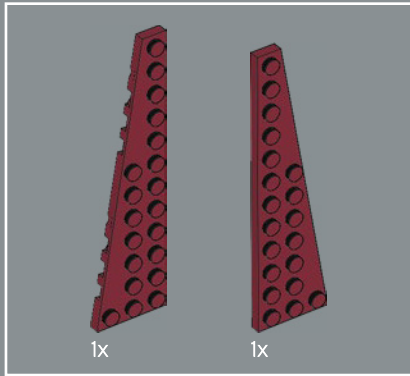
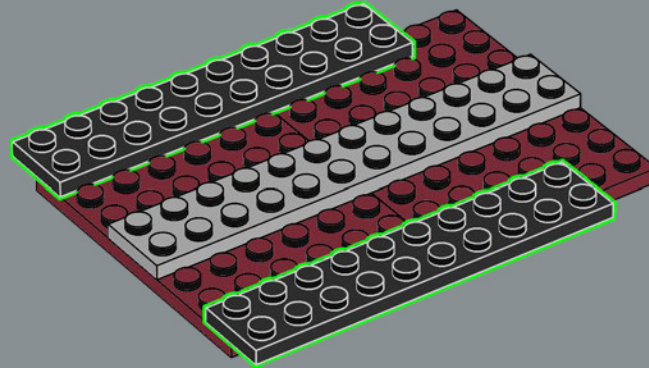

143

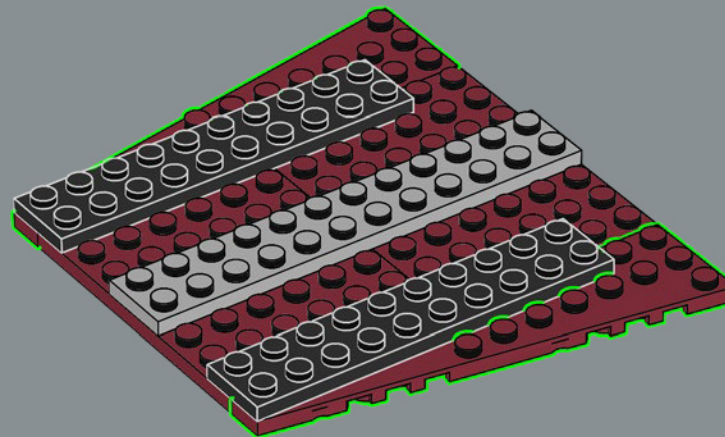

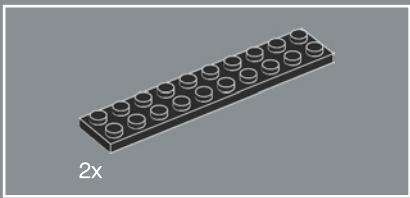

144

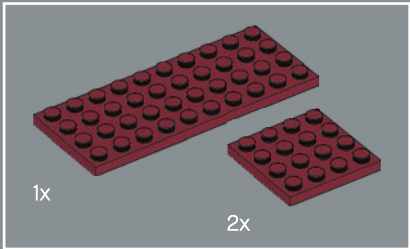
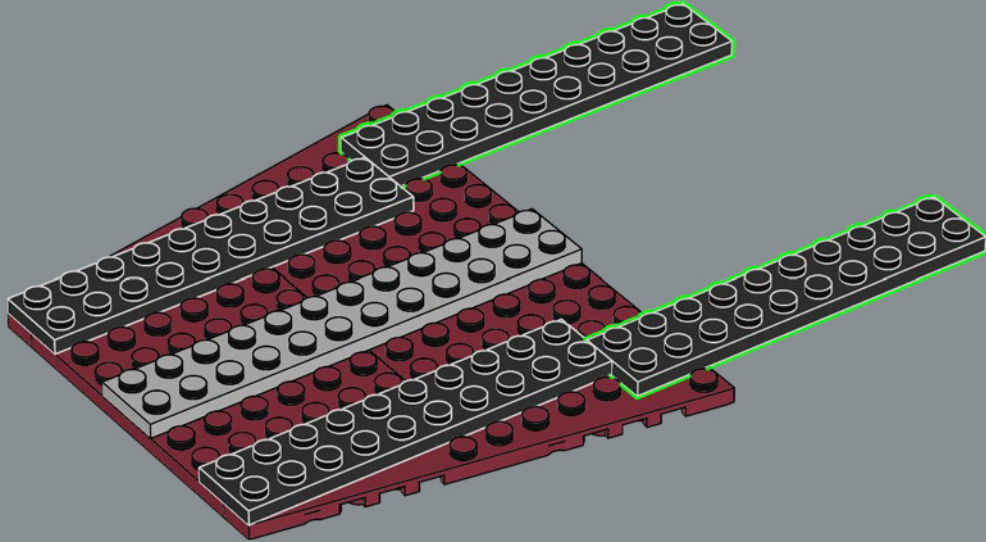

145

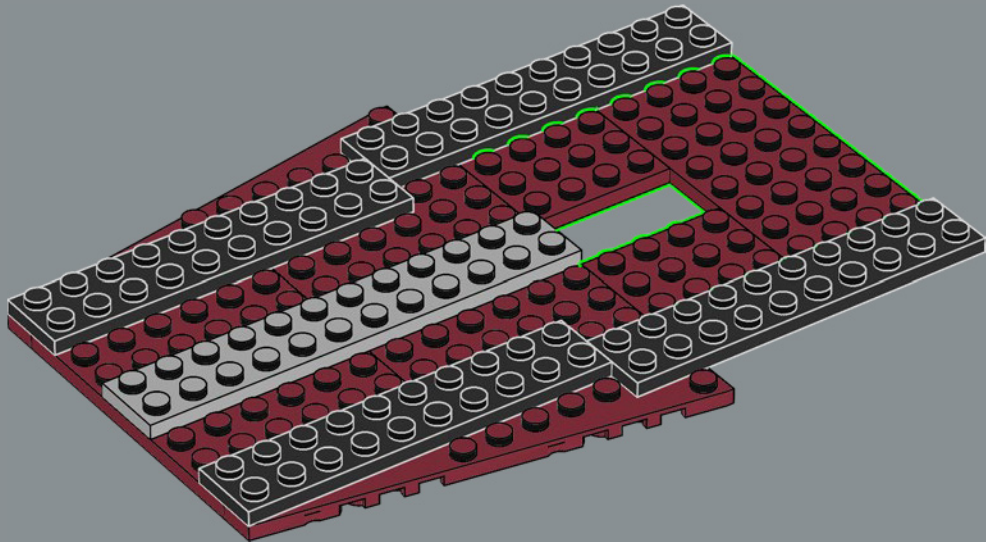

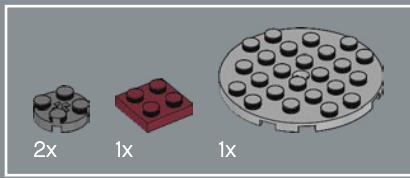

146

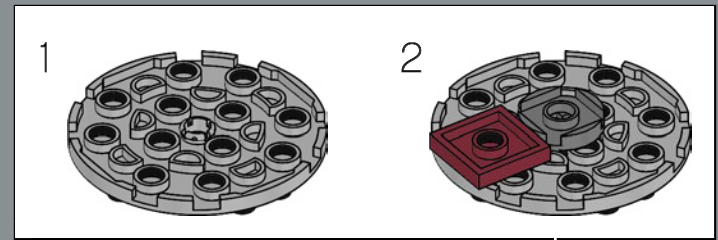
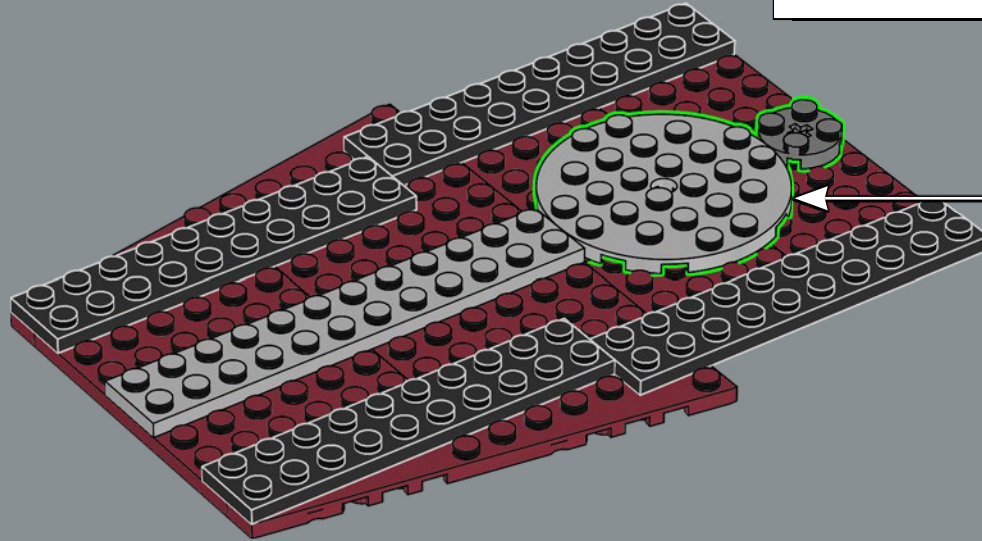

147

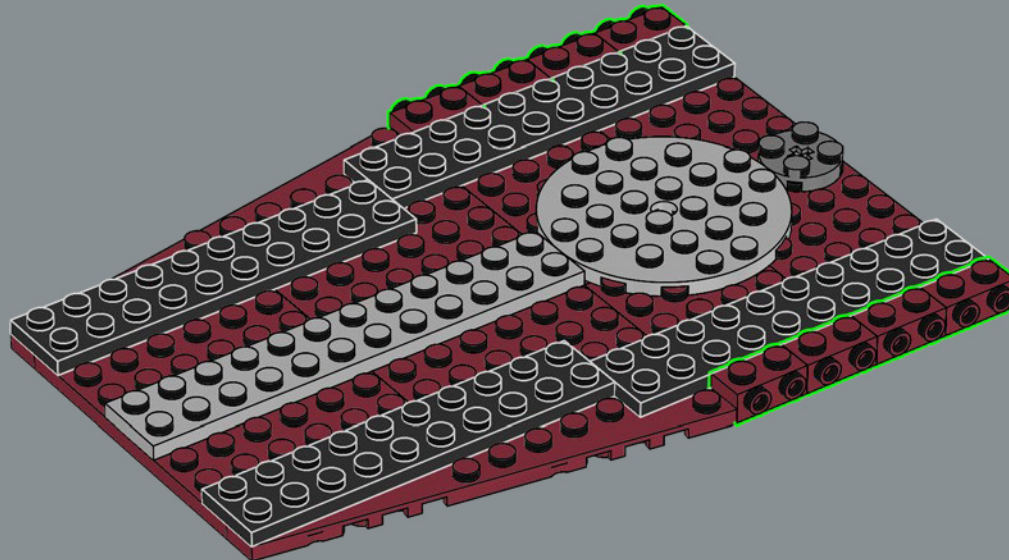

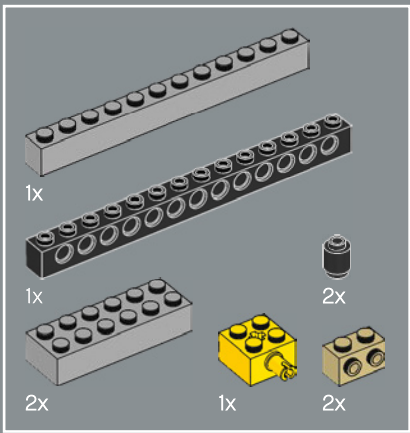

148

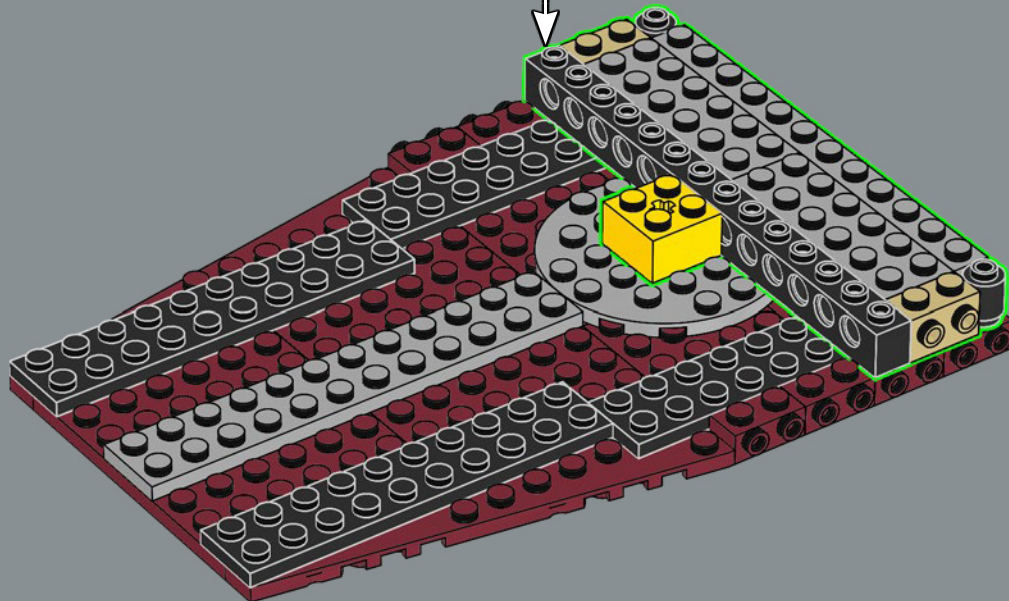
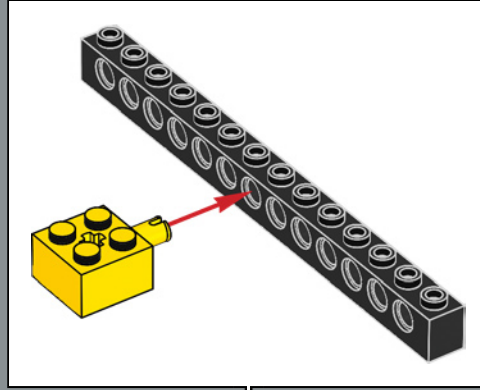

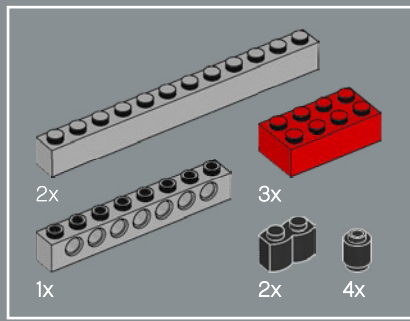

149

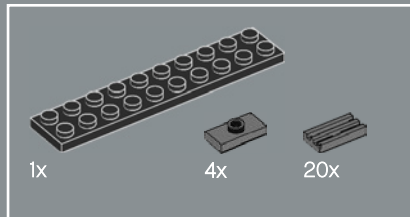
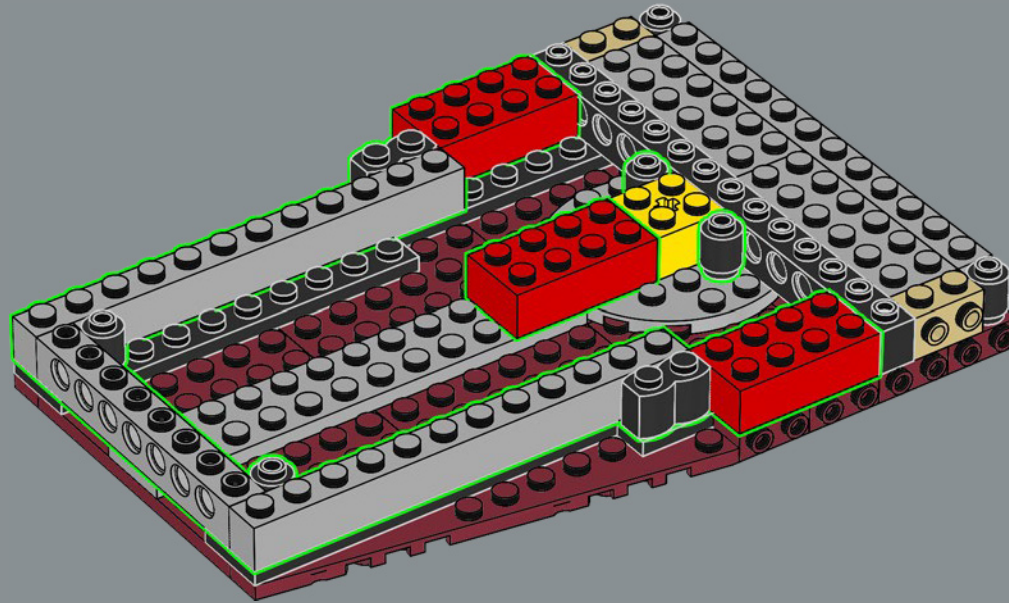

150

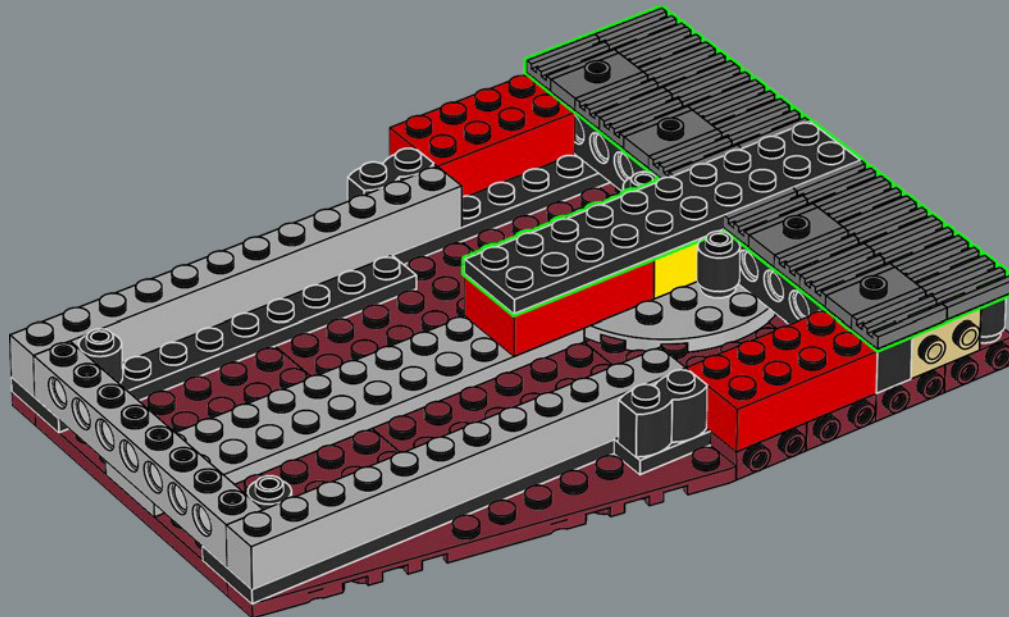

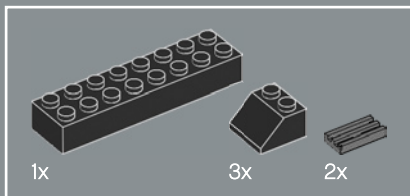

151

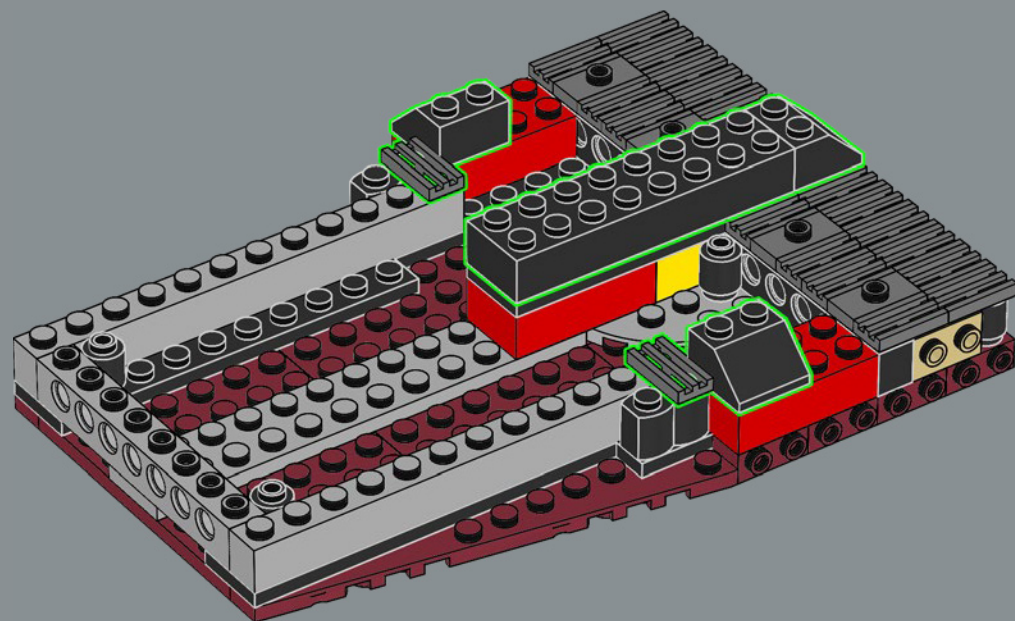

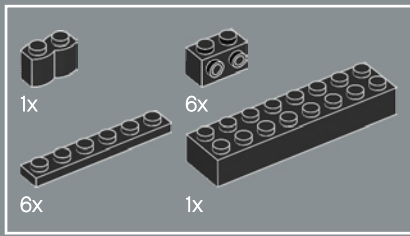

152

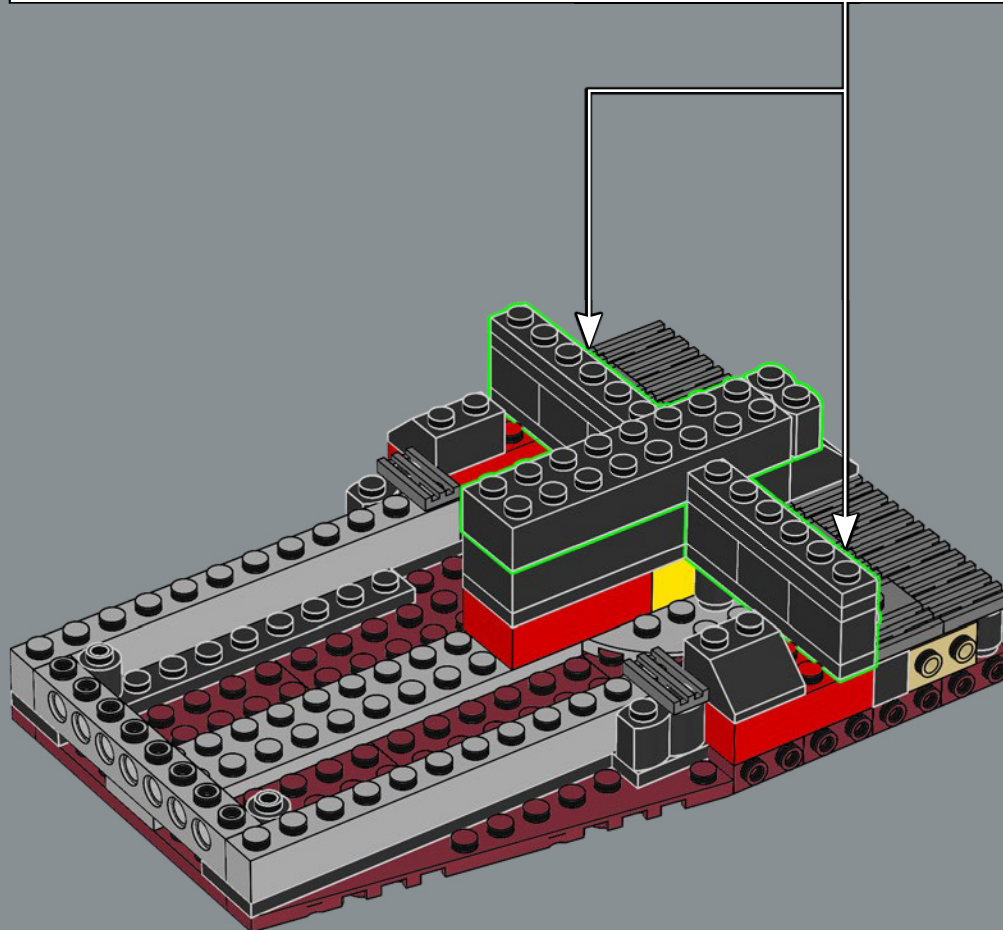
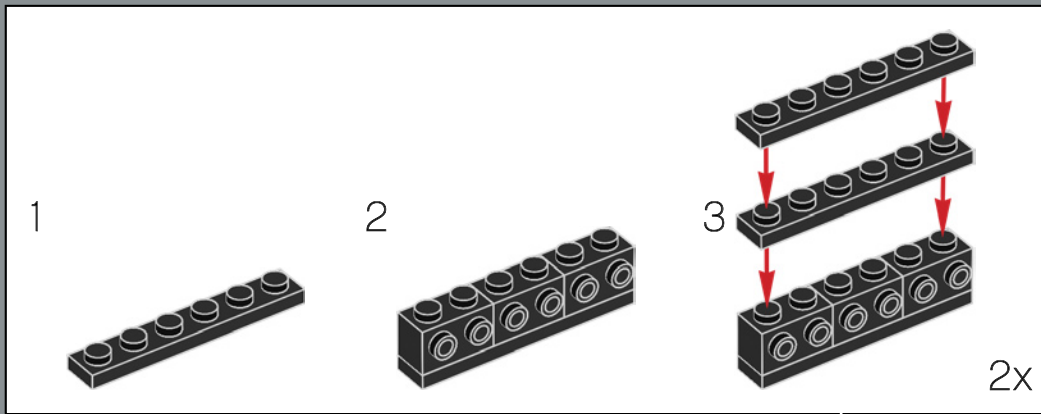

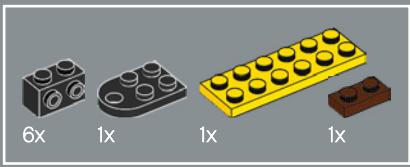

153

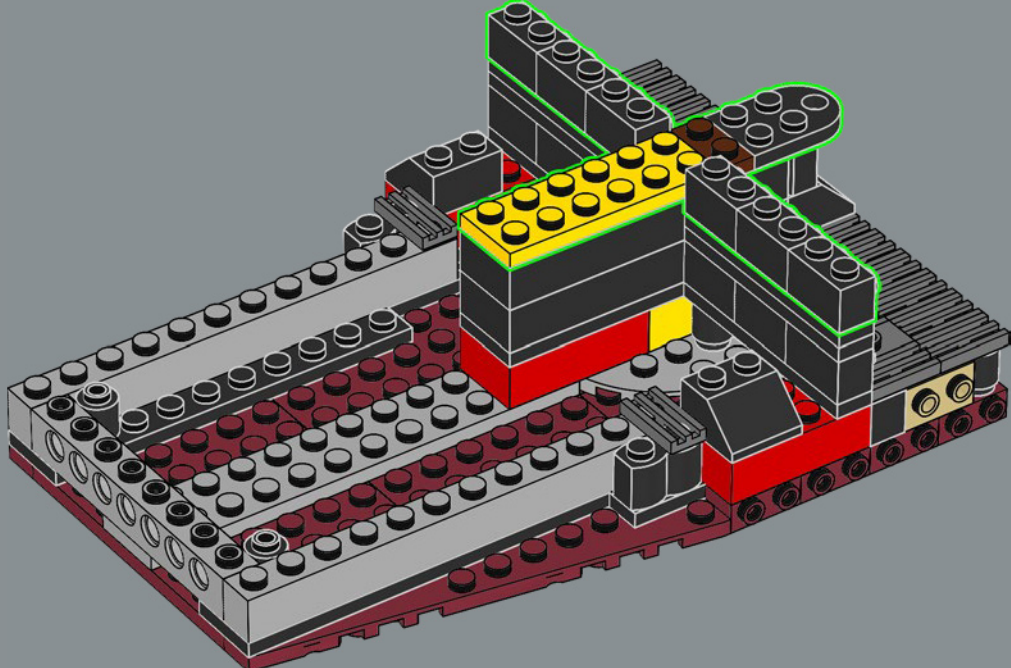



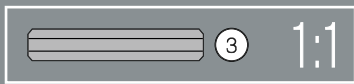
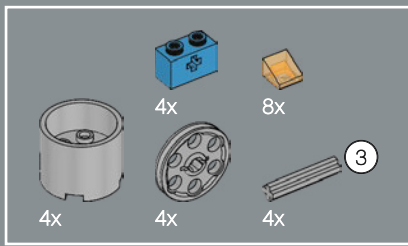

154

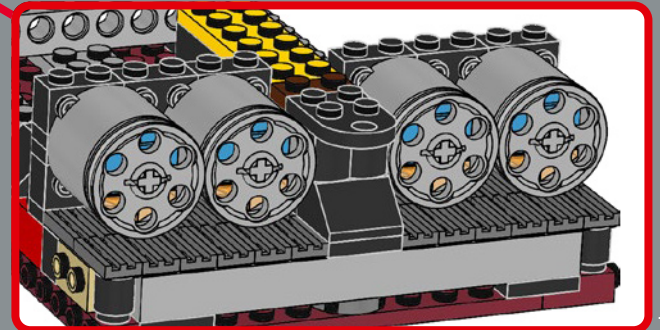
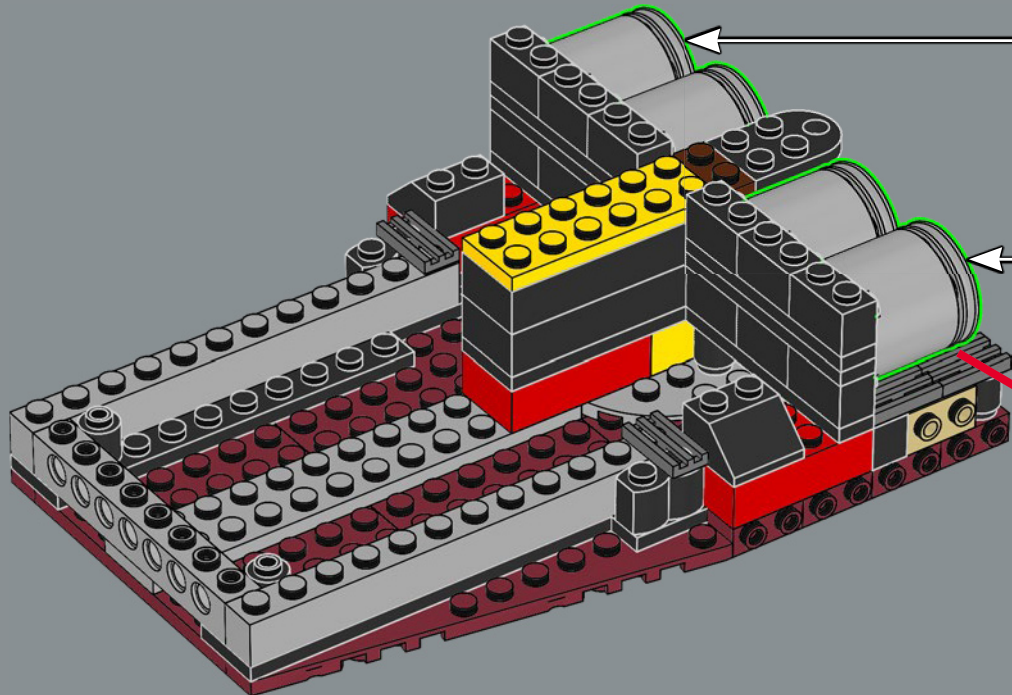
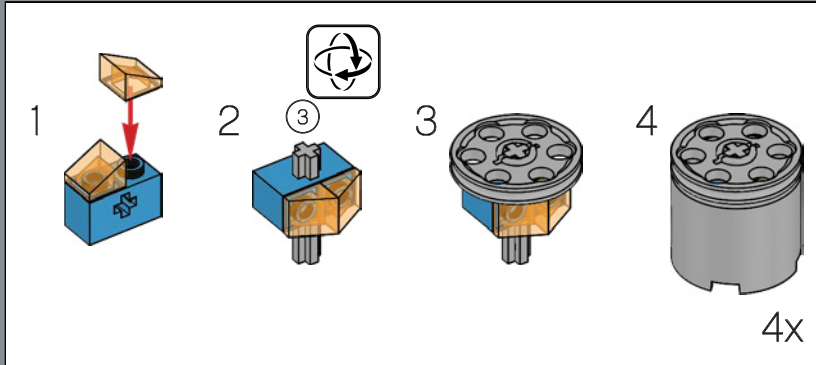

175 firemen worked around the clock shoveling coal into the engines' furnaces.

175 chauffeurs travaillent jour et nuit pour alimenter en charbon les chaudières des machines à vapeur et de la turbine.

175 fogoneros trabajaban día y noche paleando carbón a las calderas de los motores.

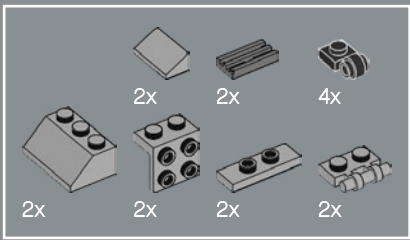

155

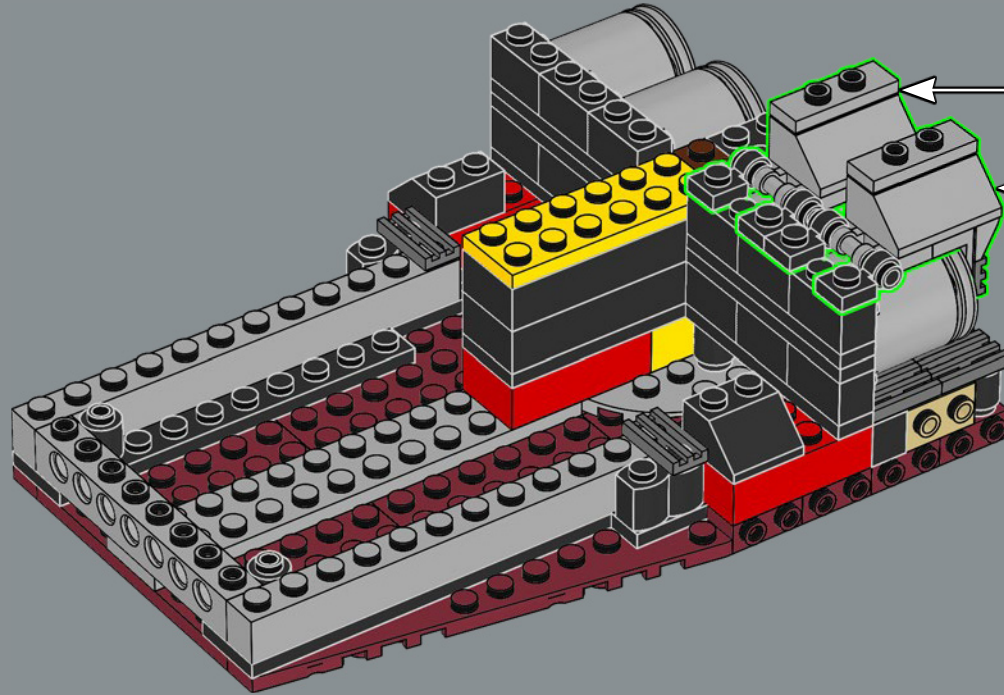
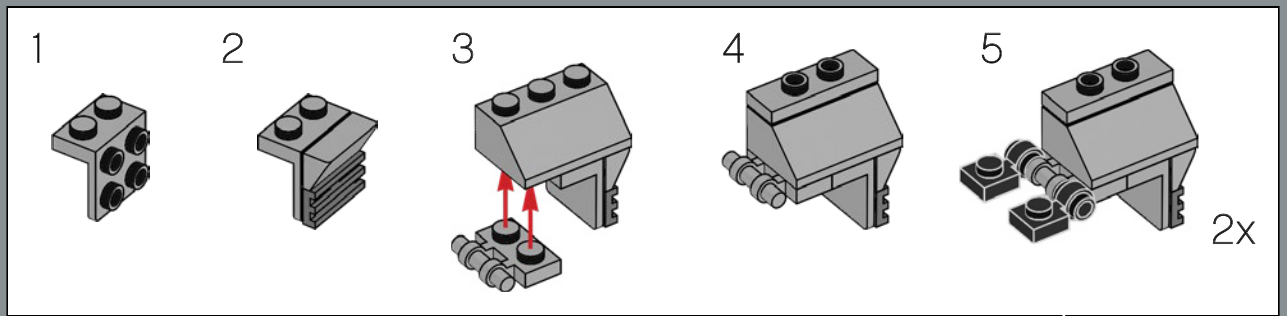

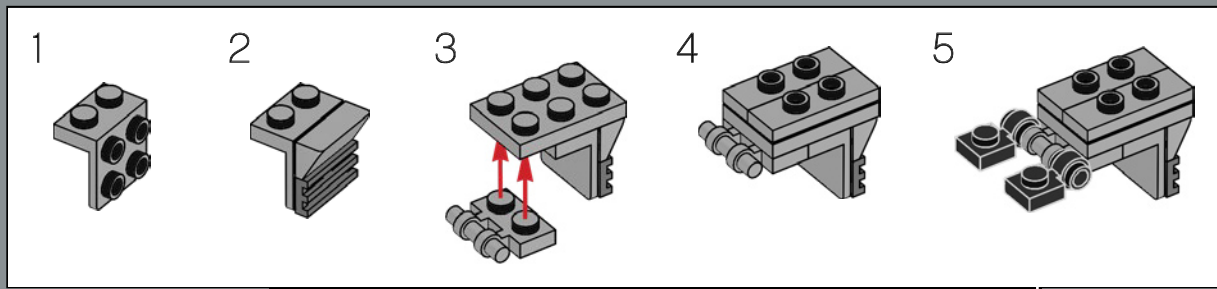
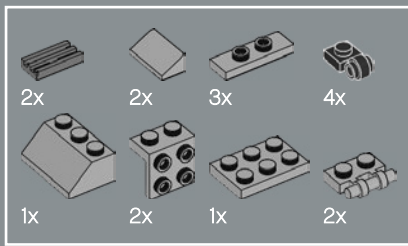

156

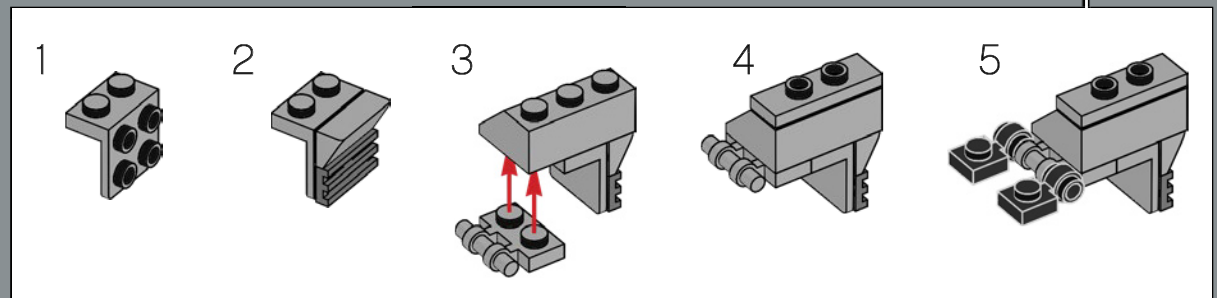
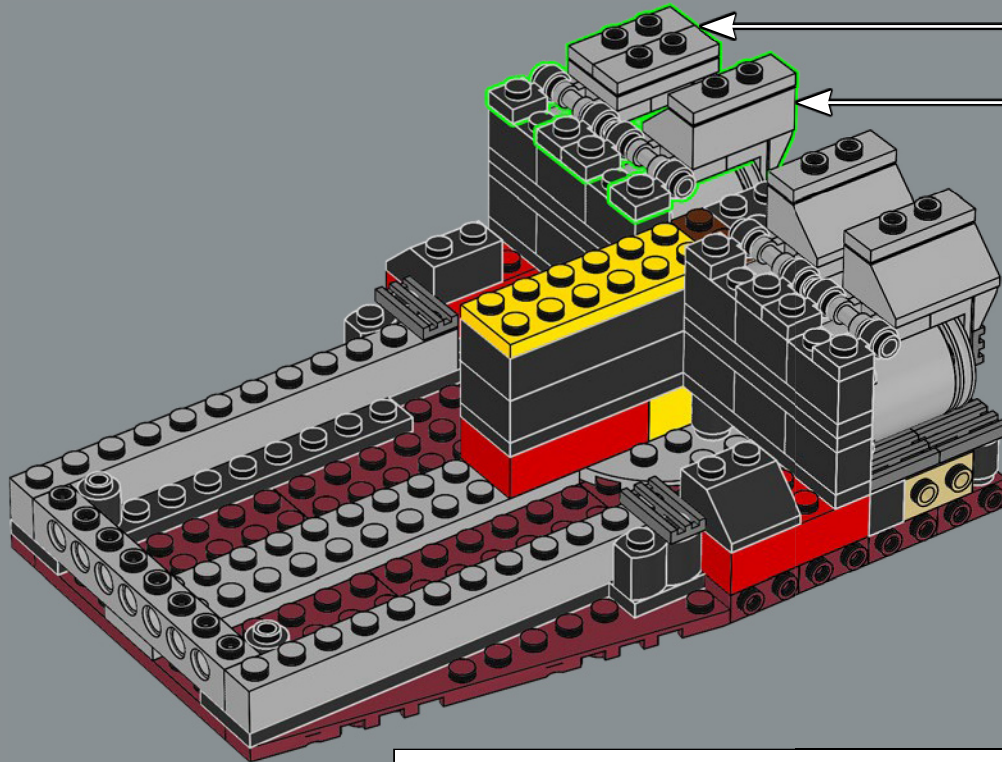

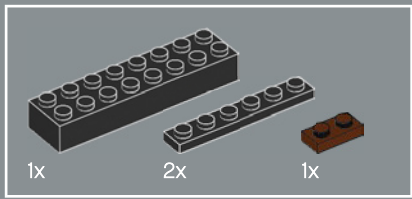

157

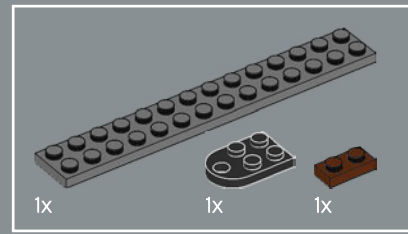
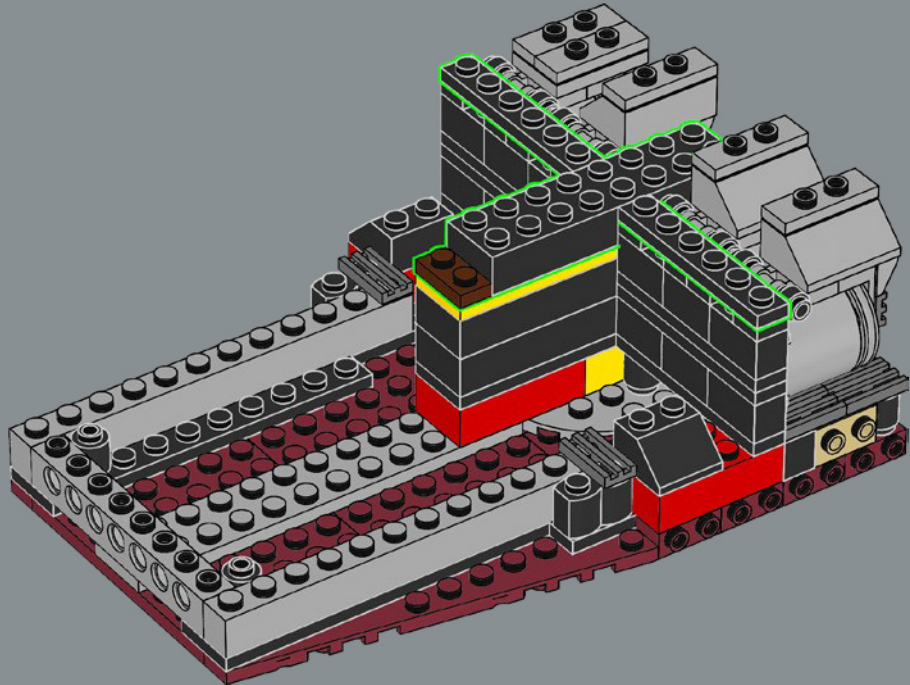

158

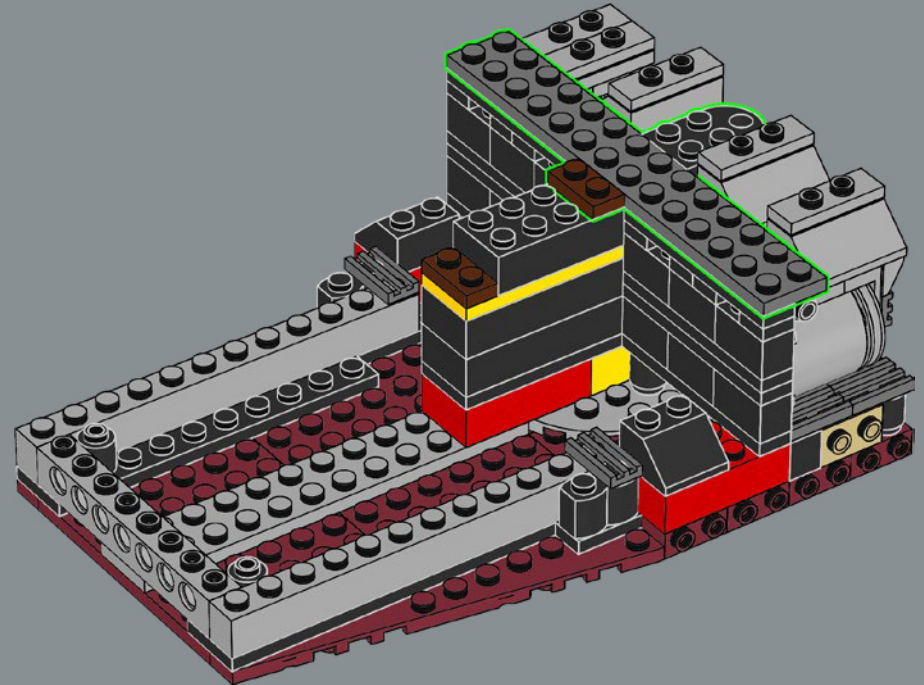

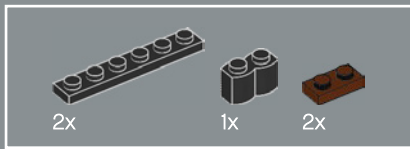

159

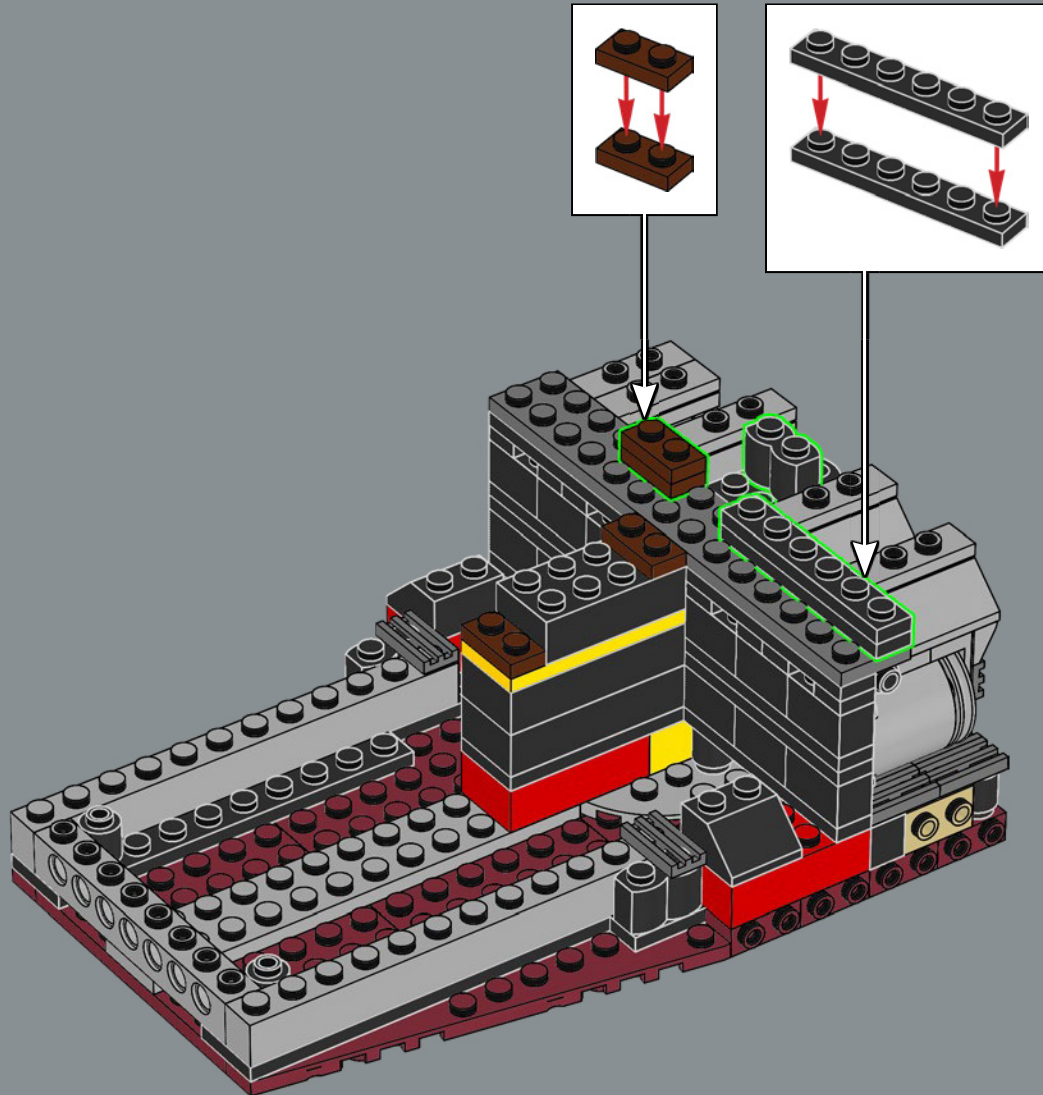

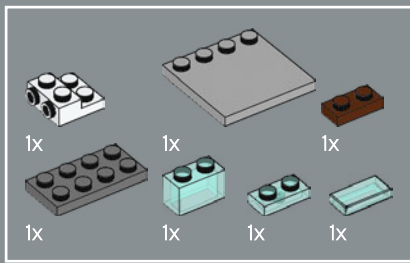

160

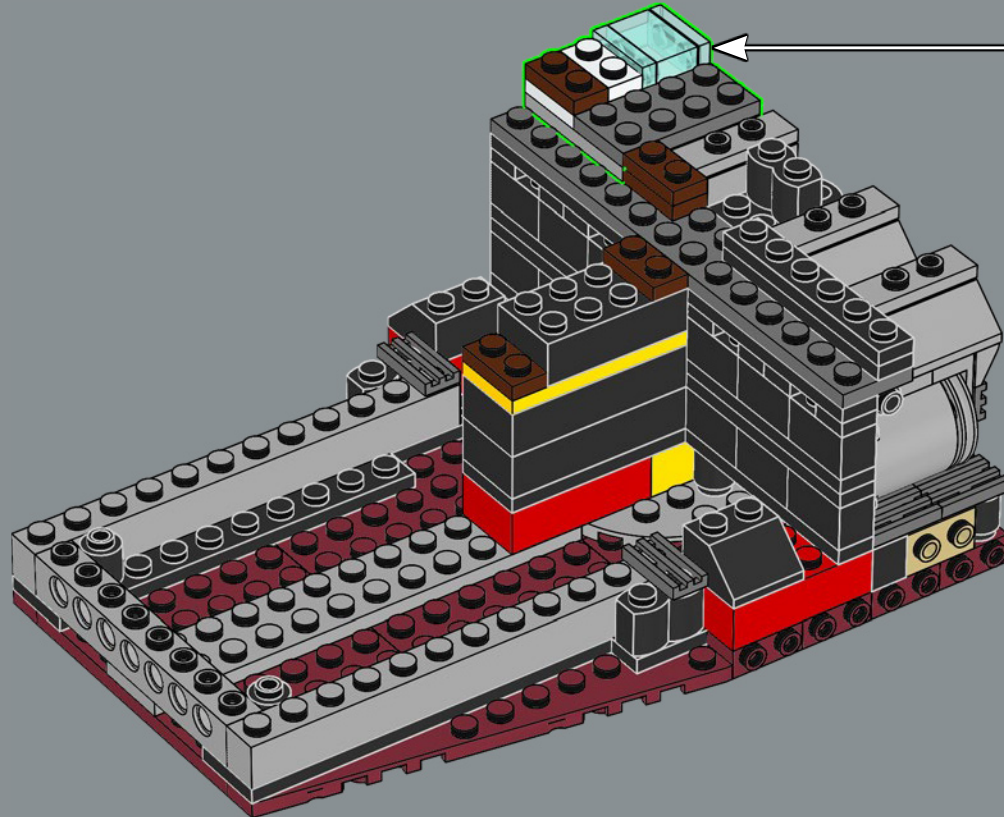
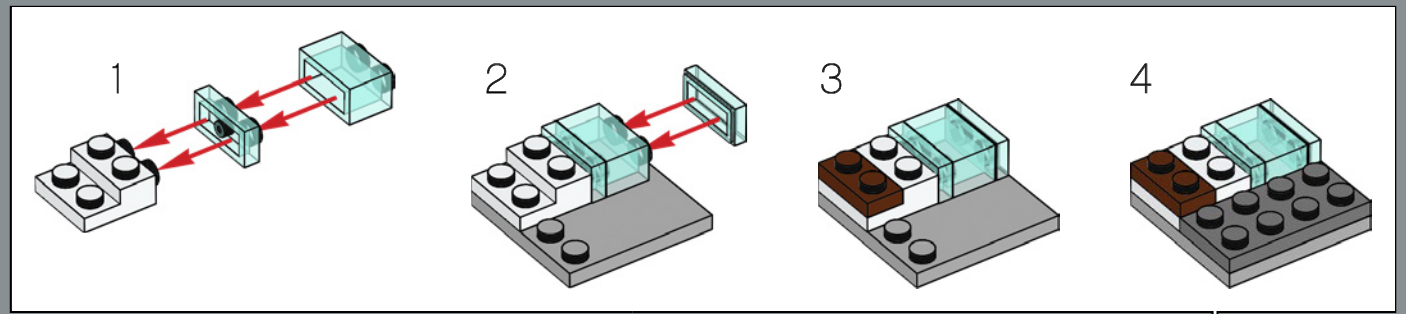

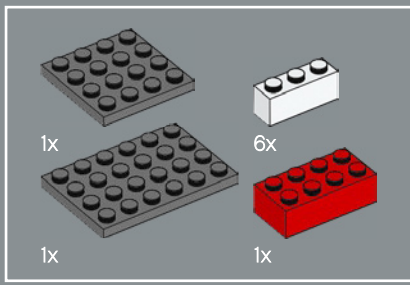

161

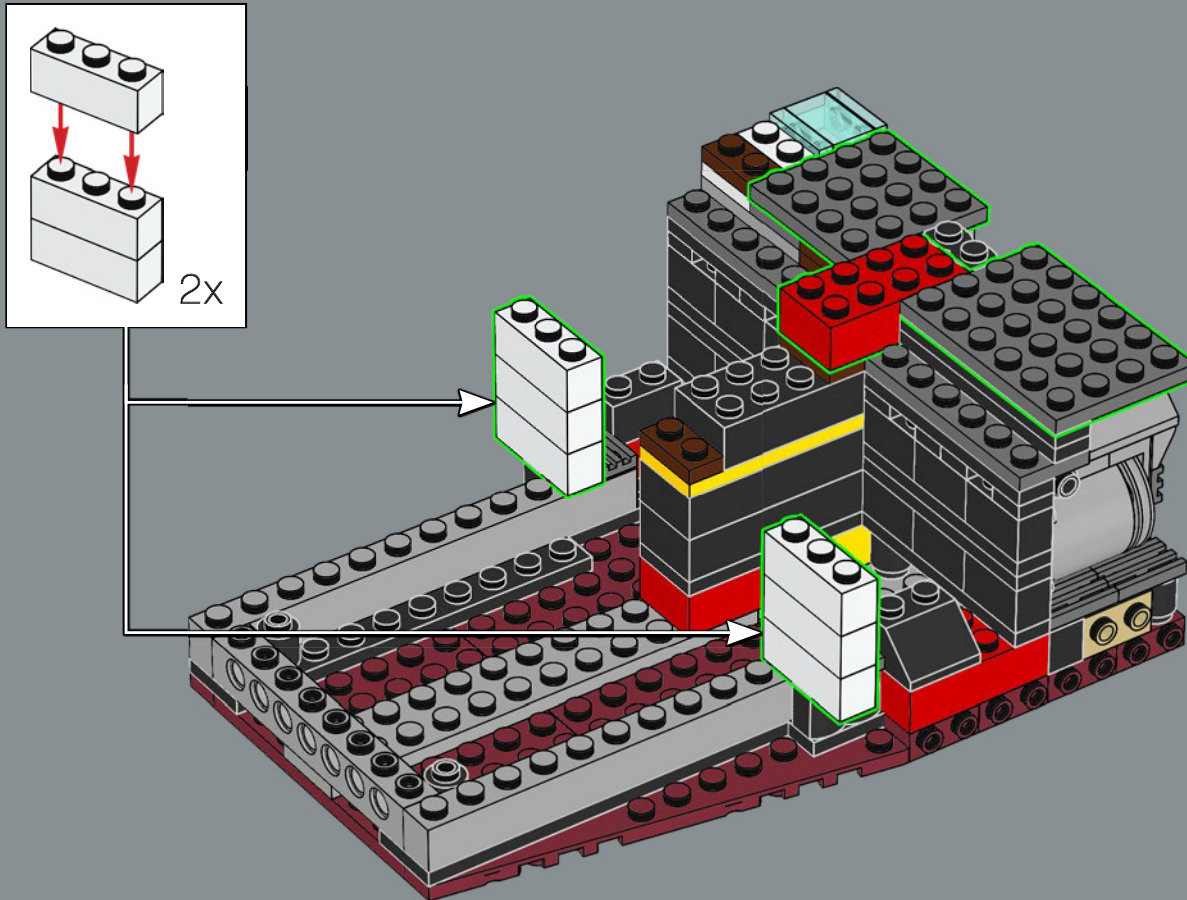

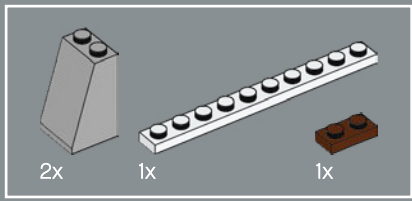

162

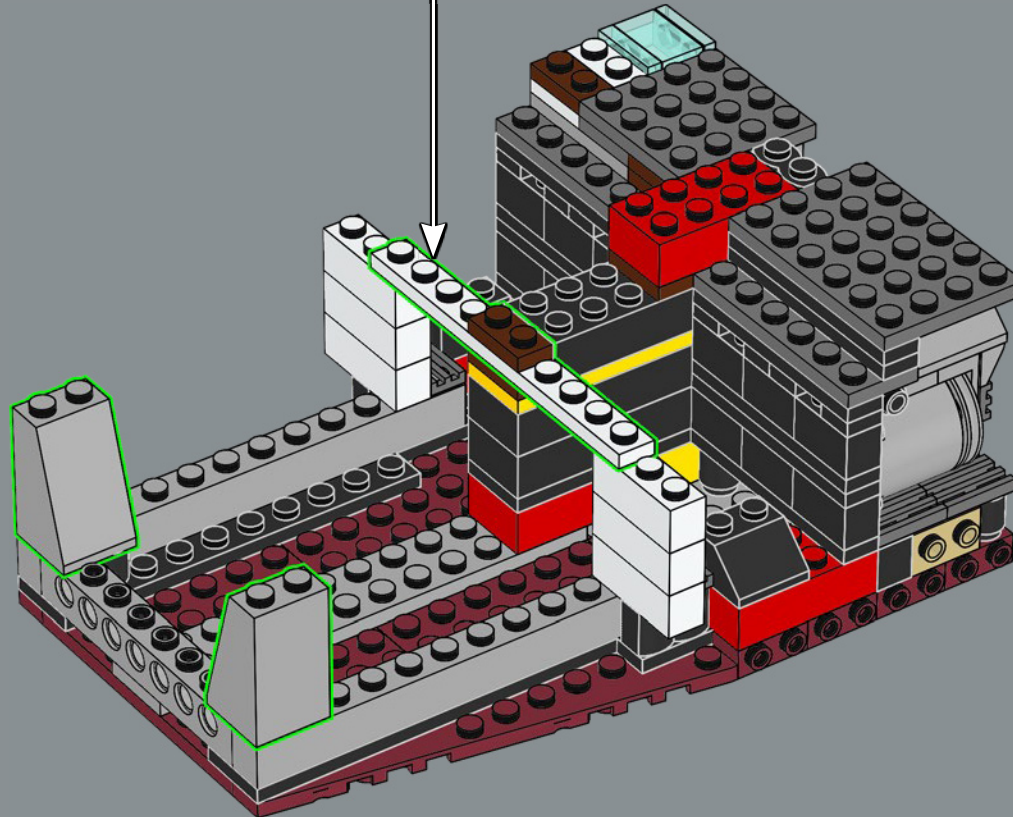
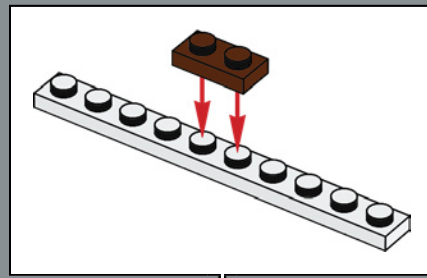



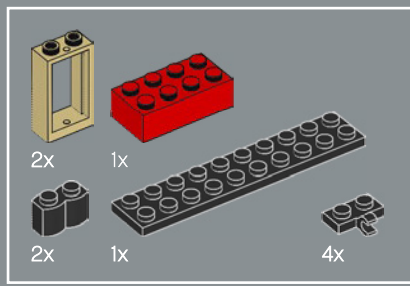

163

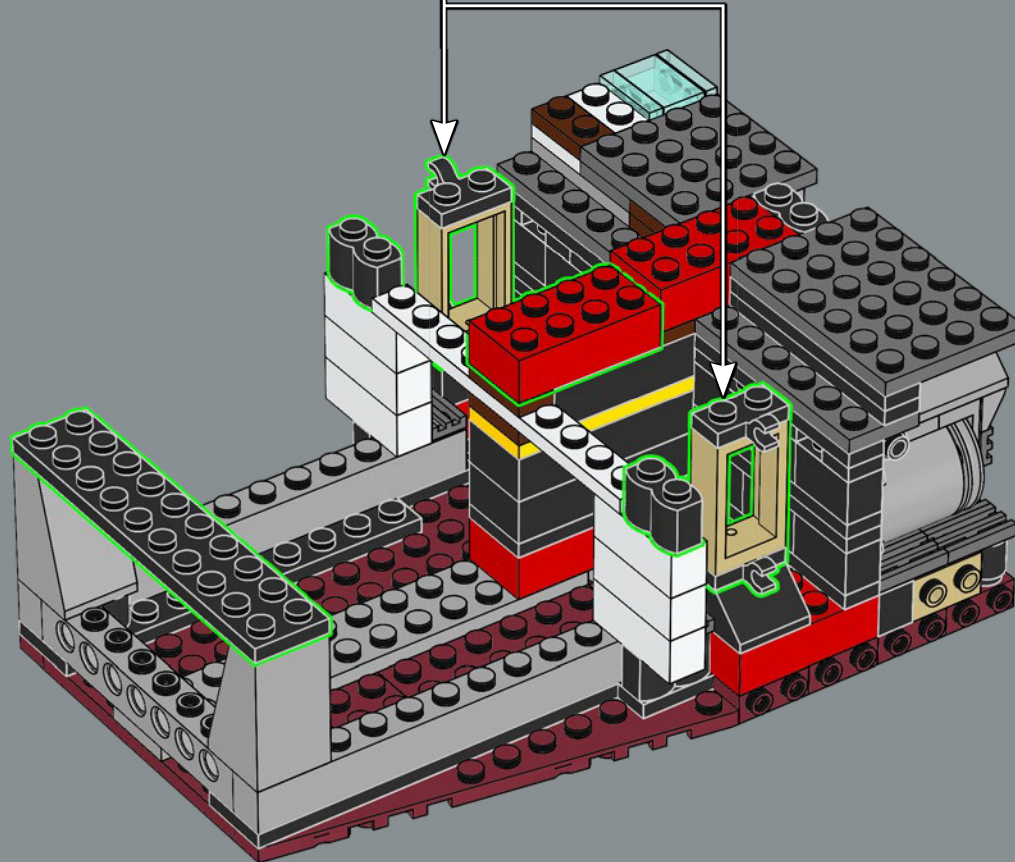
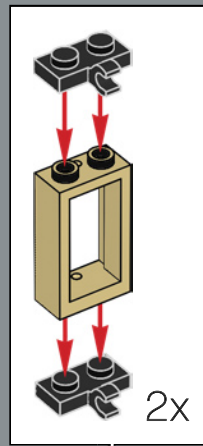

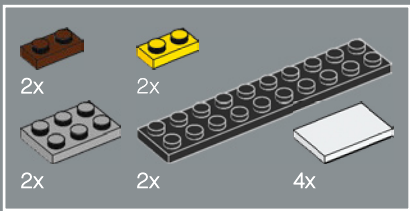

164

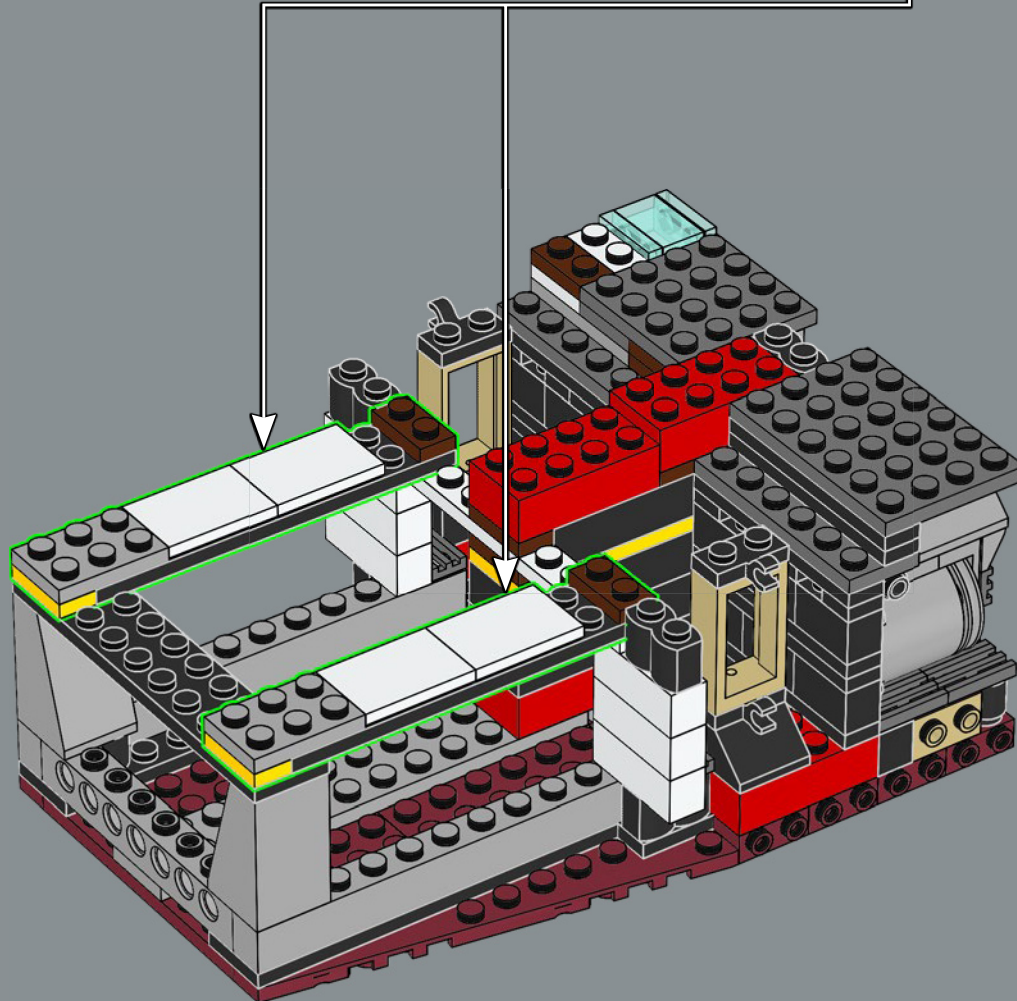
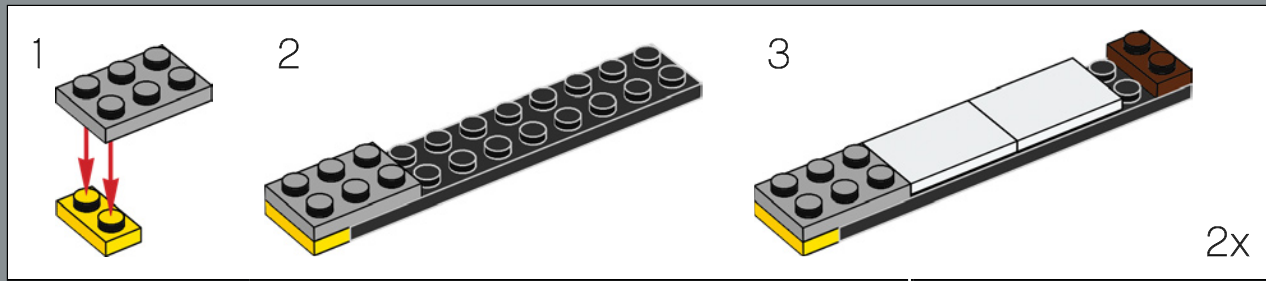

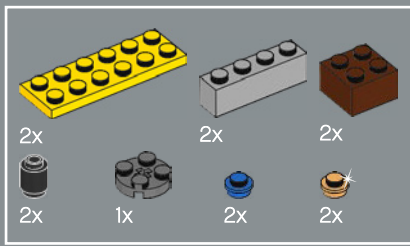

165

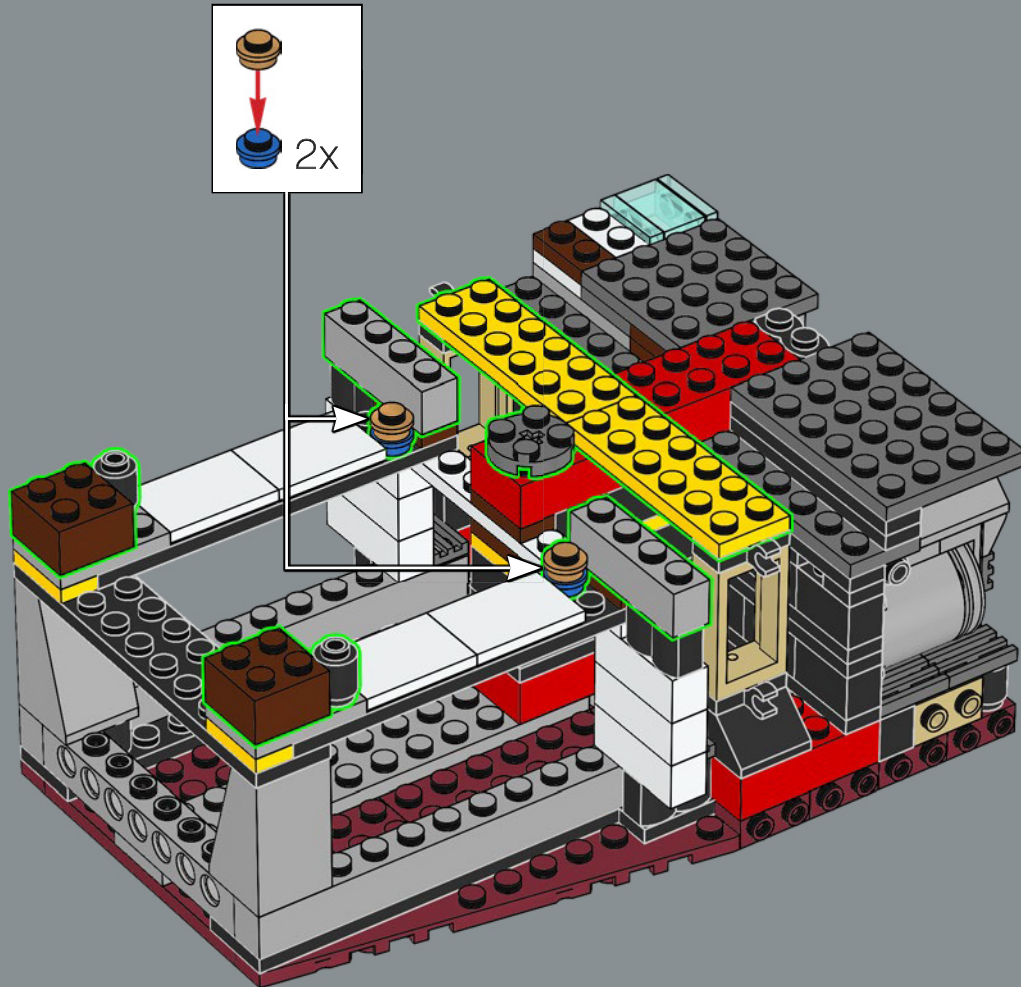

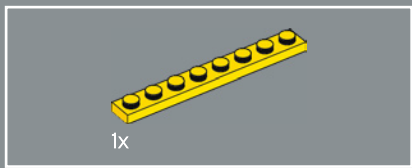

166

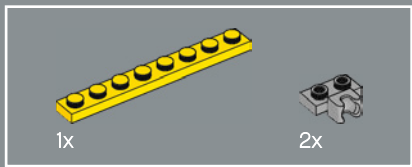
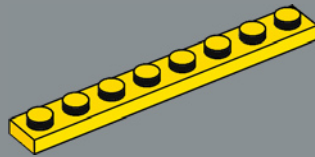

167

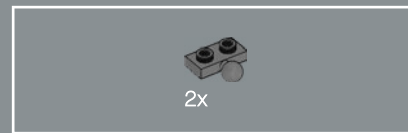
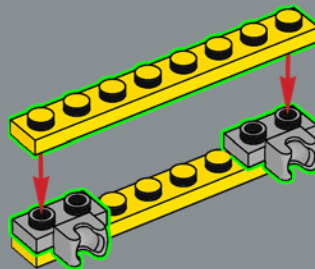

168

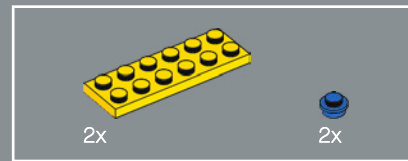
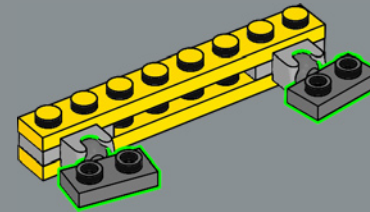

169

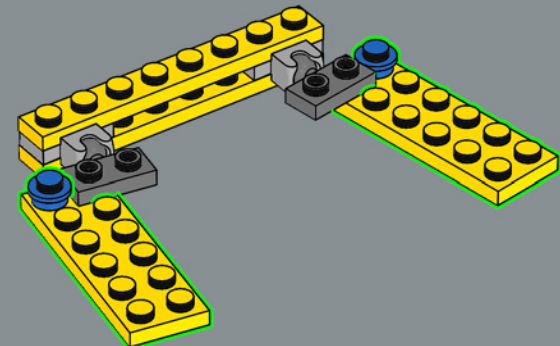

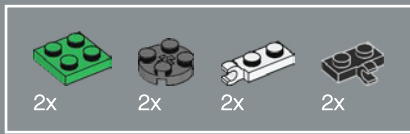

170

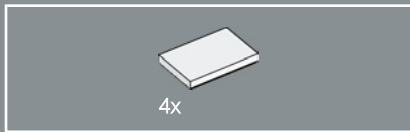
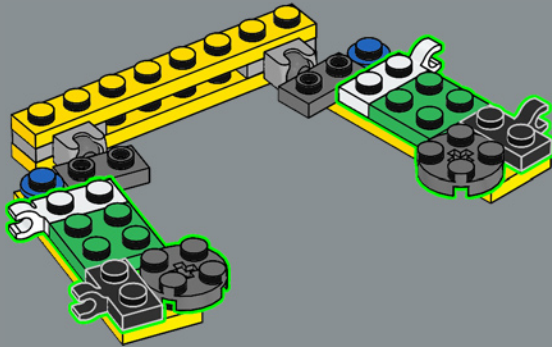

171

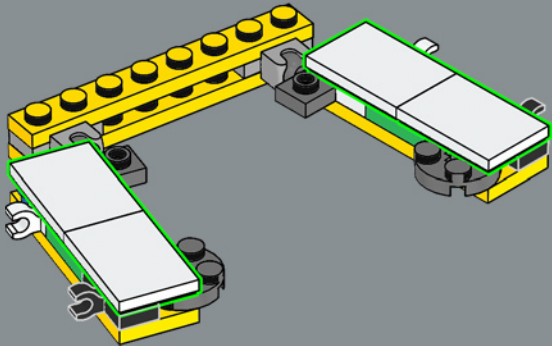

172

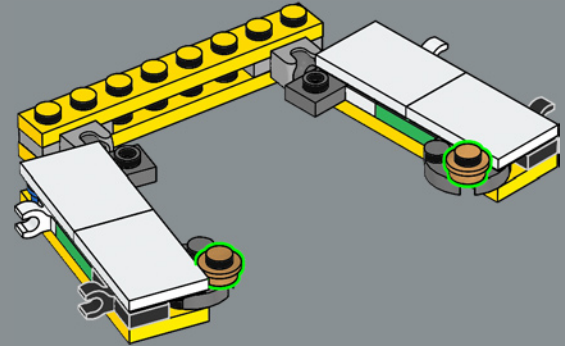

173

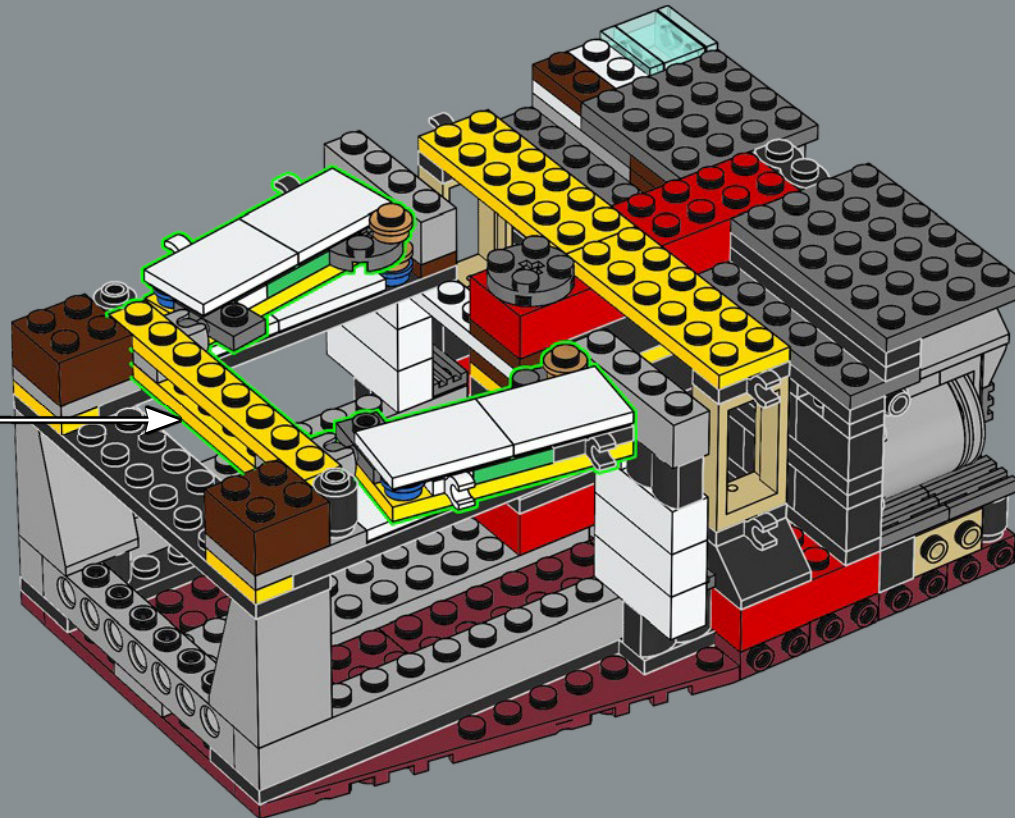

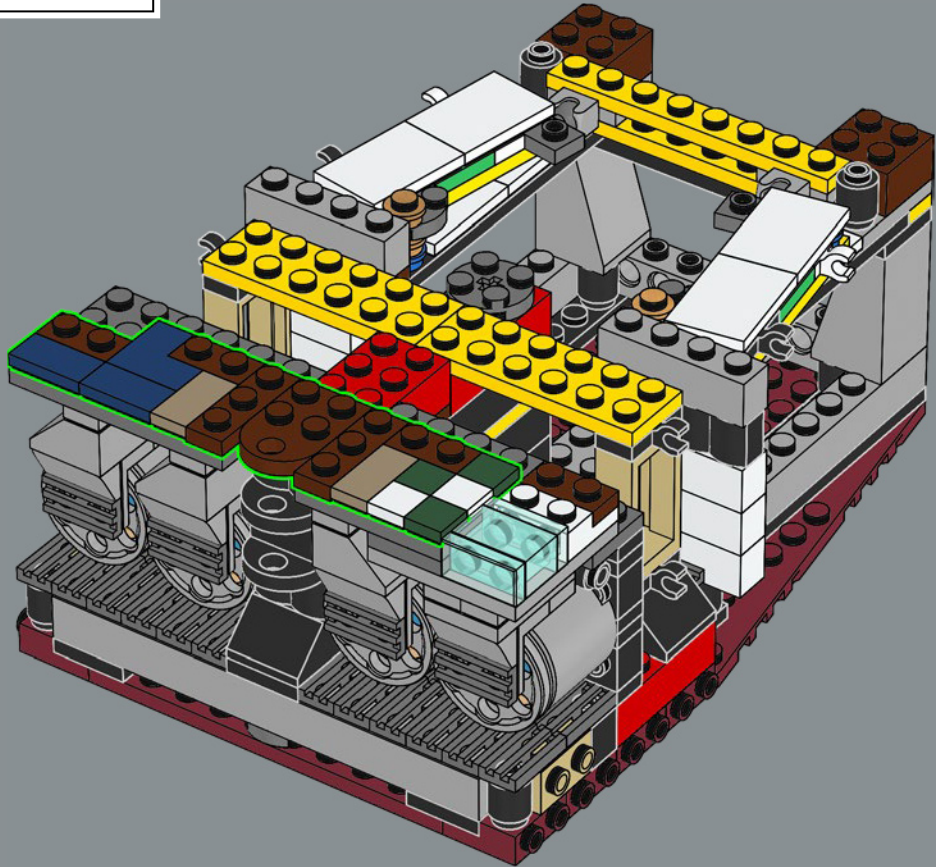
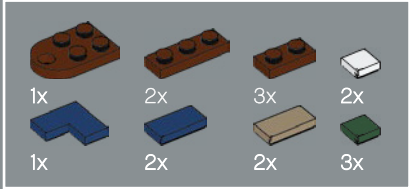
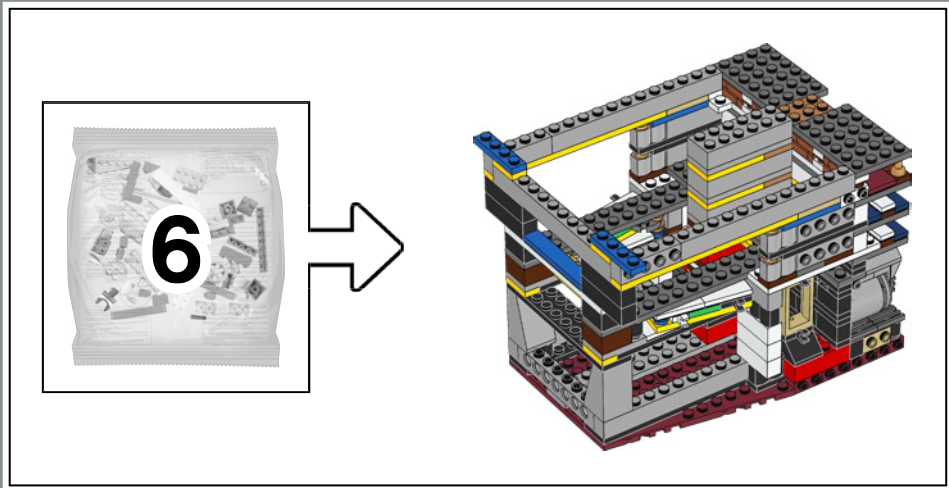

174

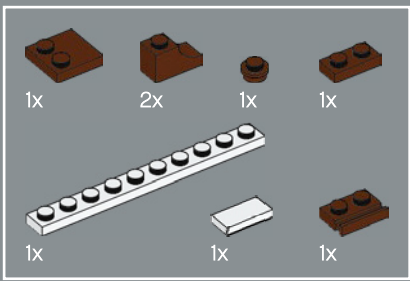

175

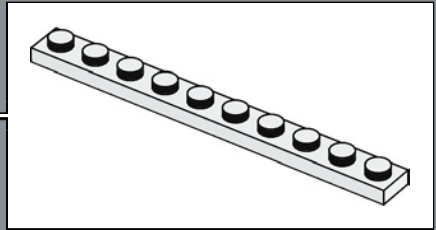
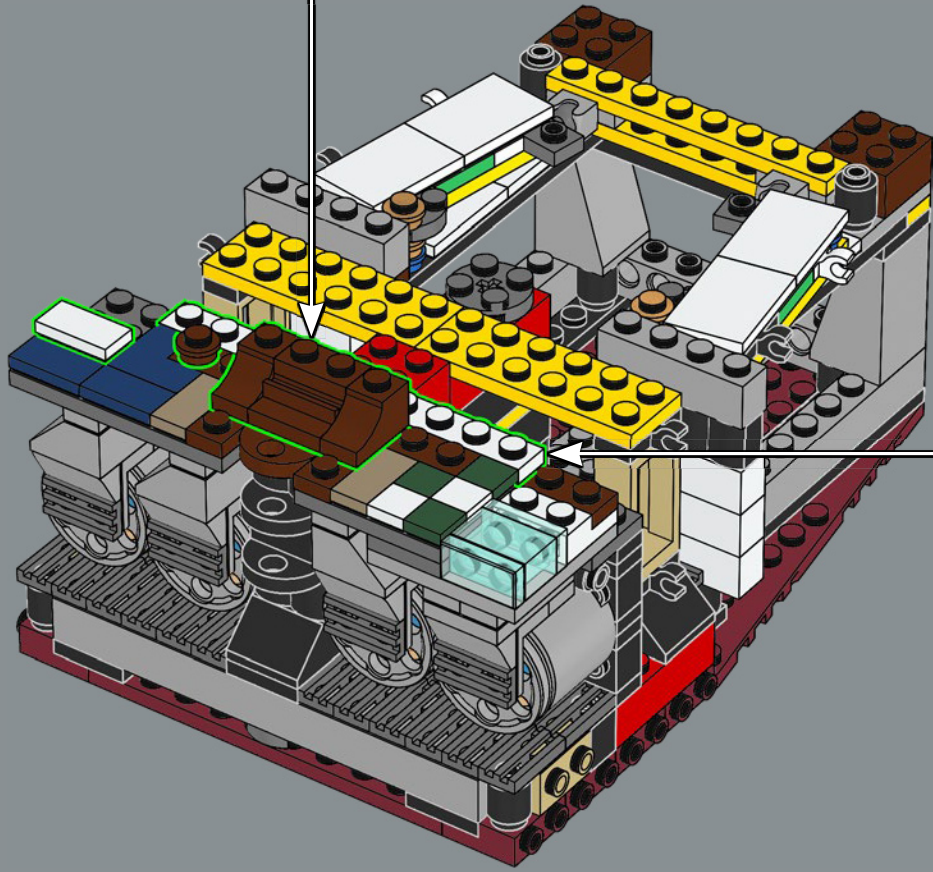
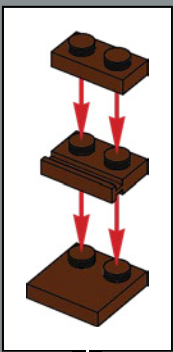





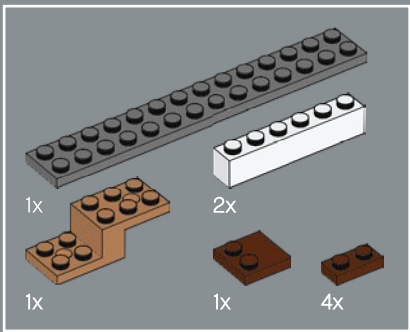

177

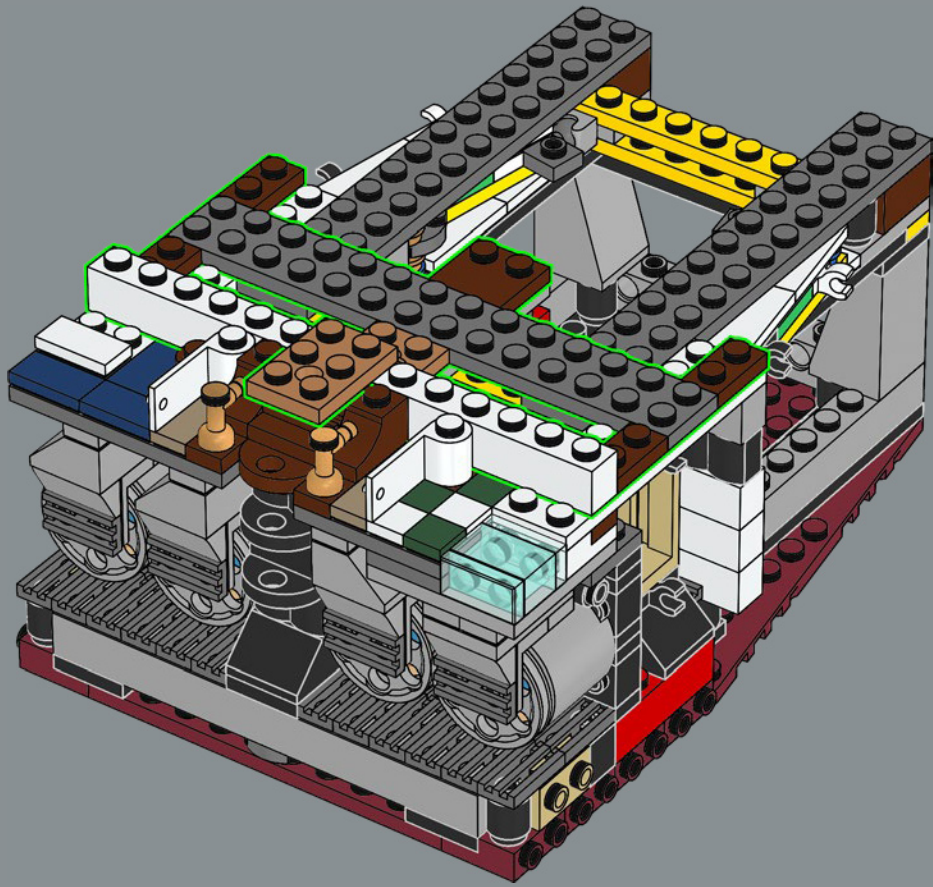

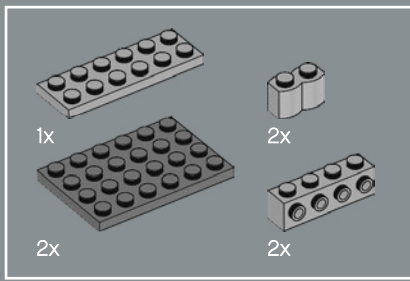

178

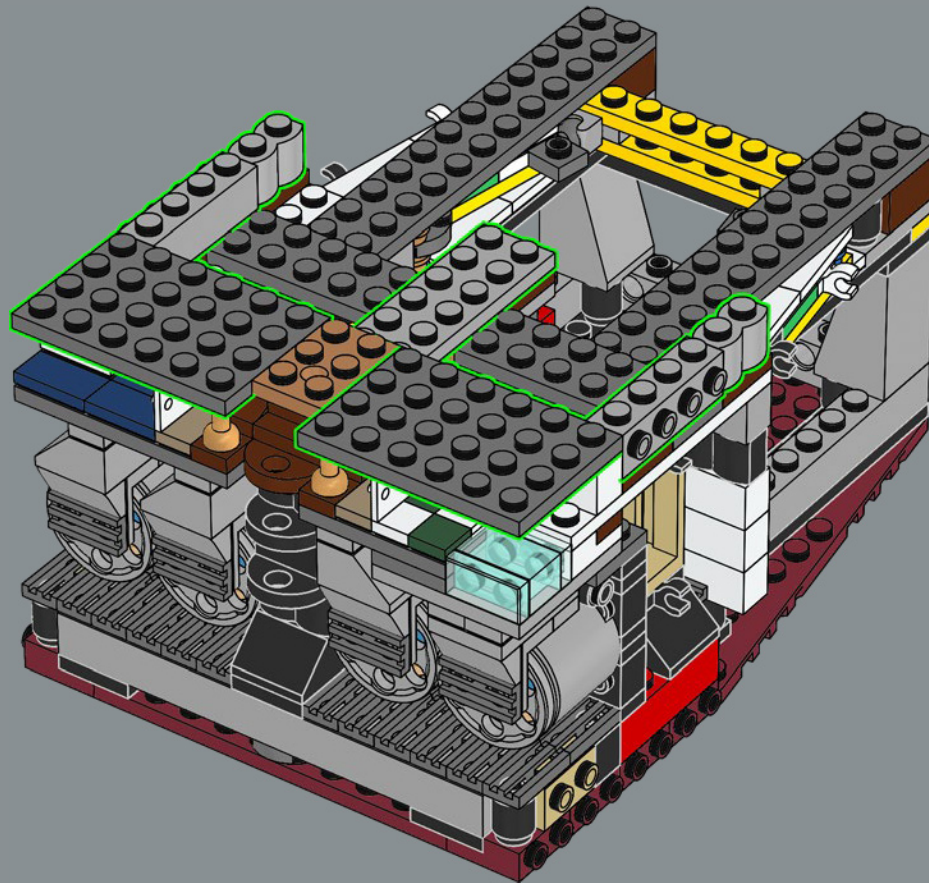

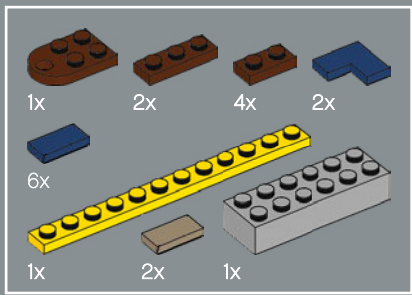

179

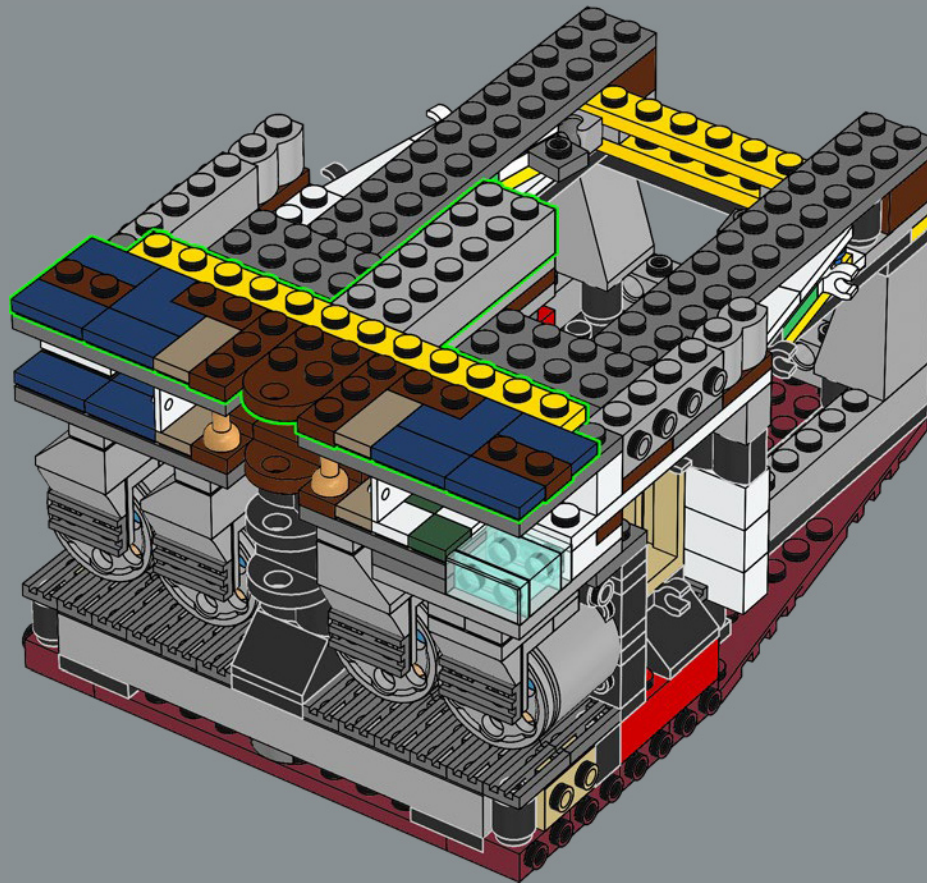

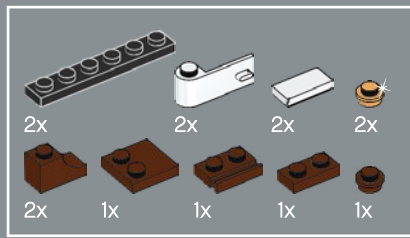

180

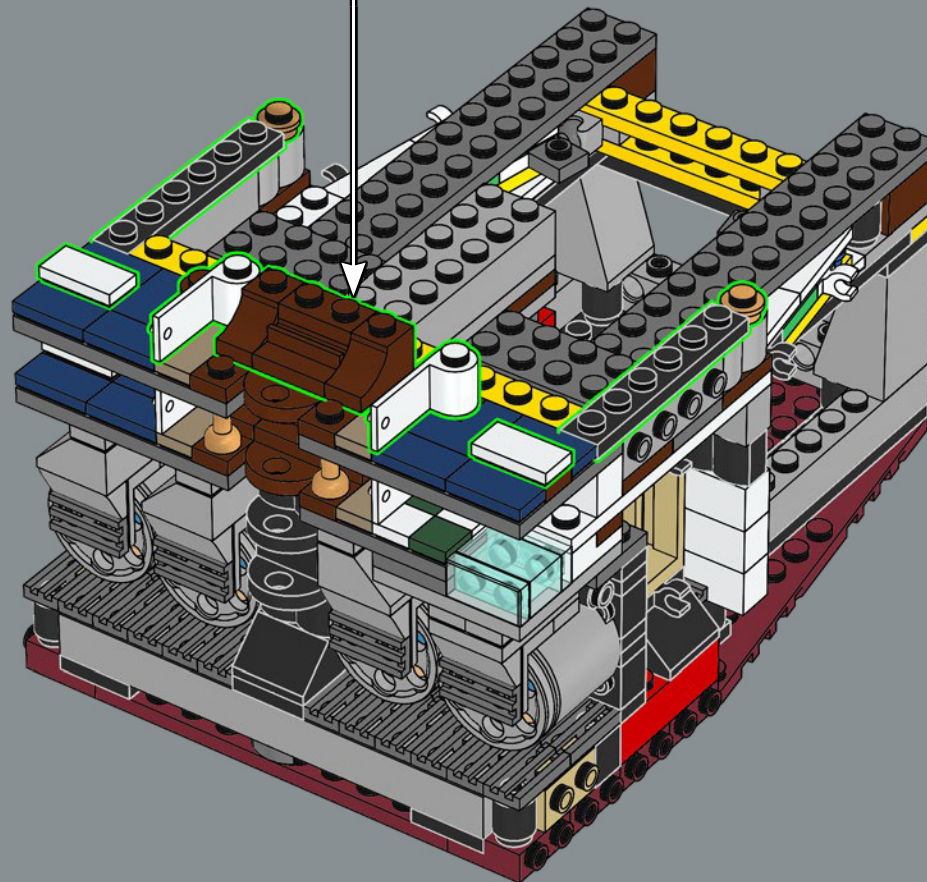
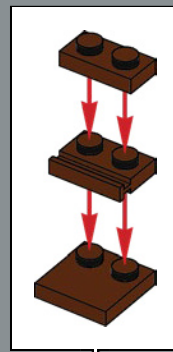

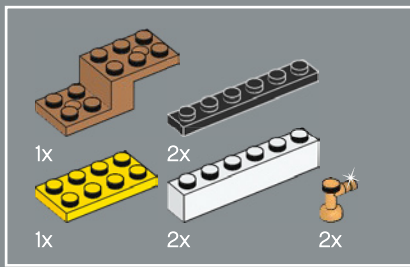

181

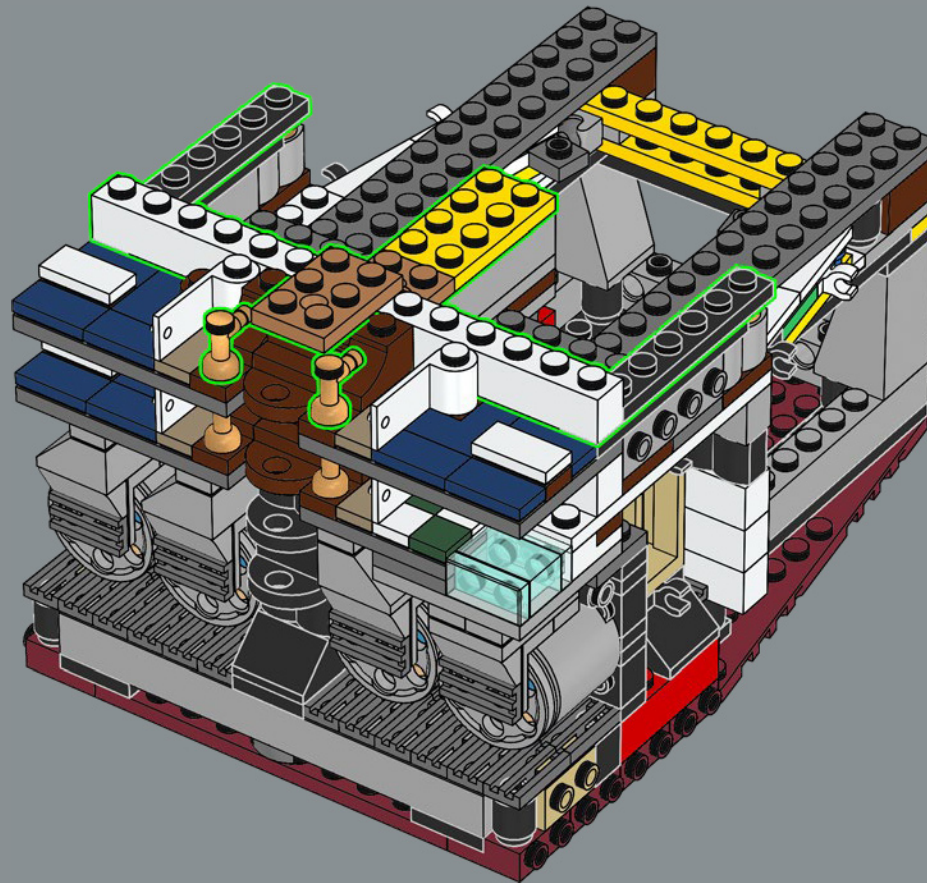

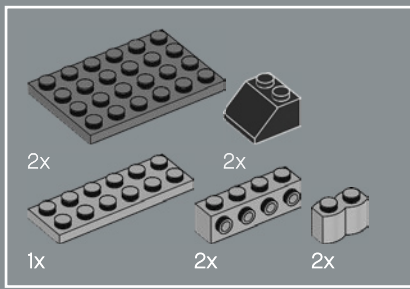

182

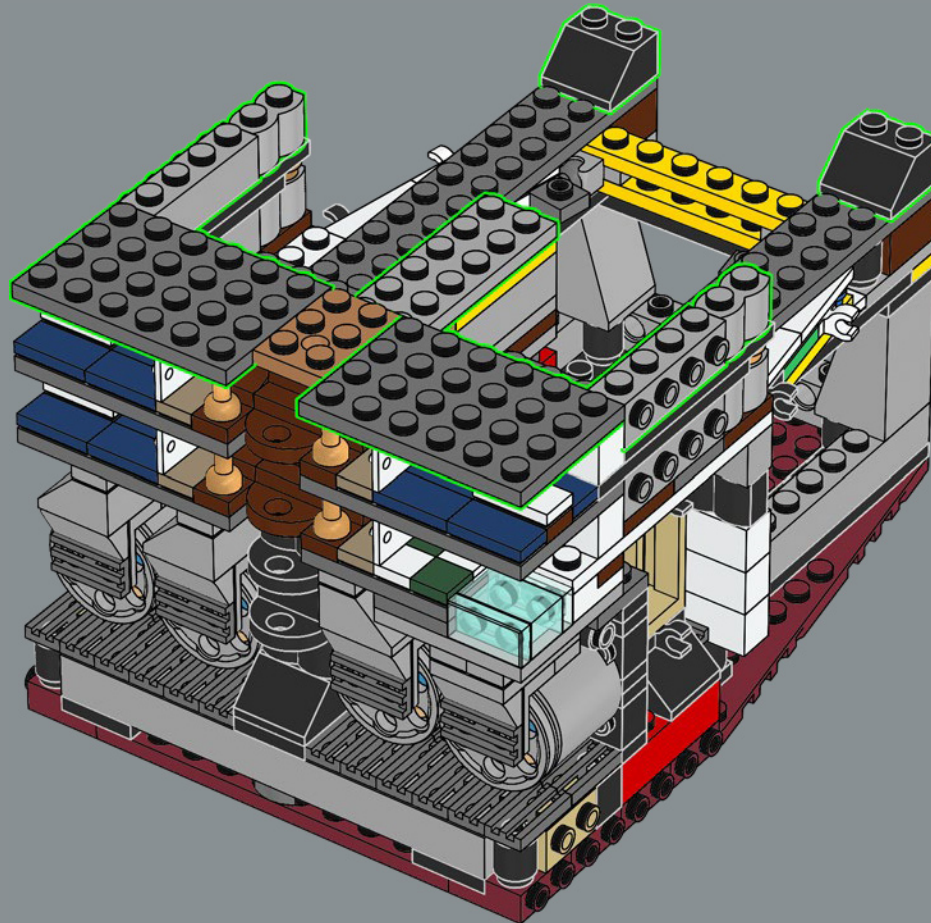

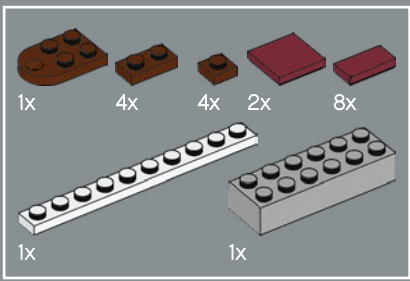

183

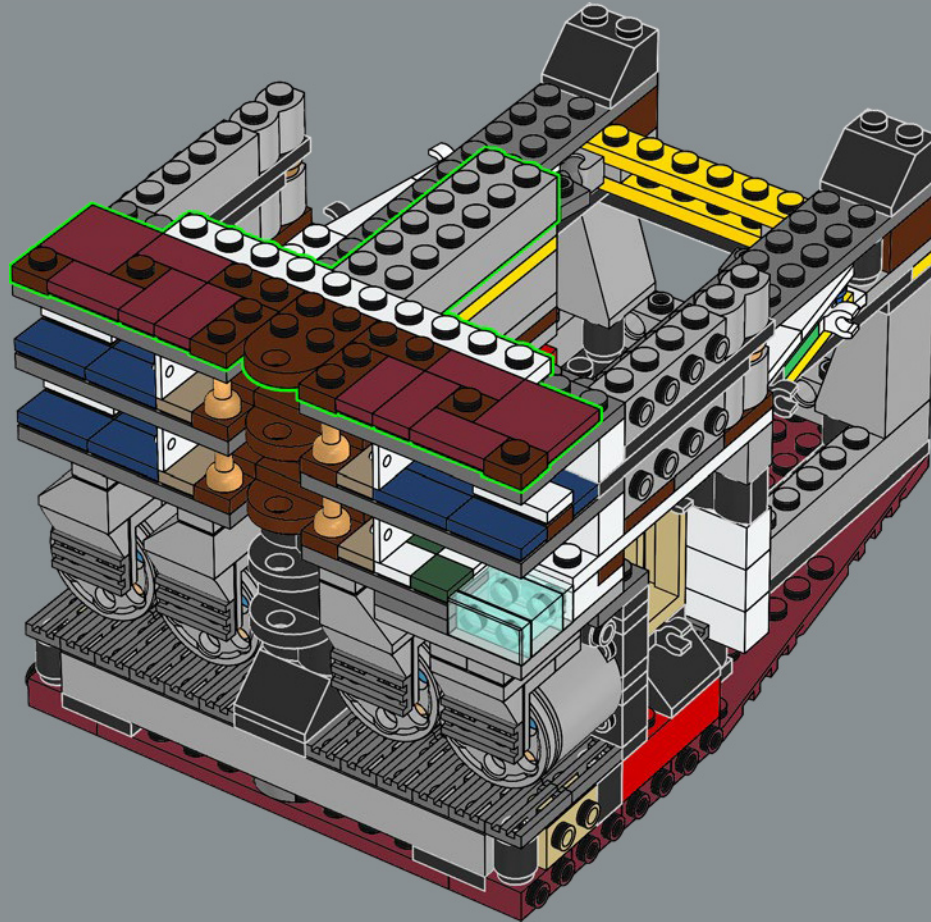



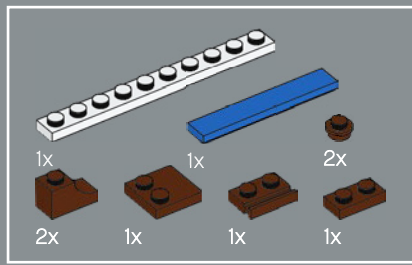

184

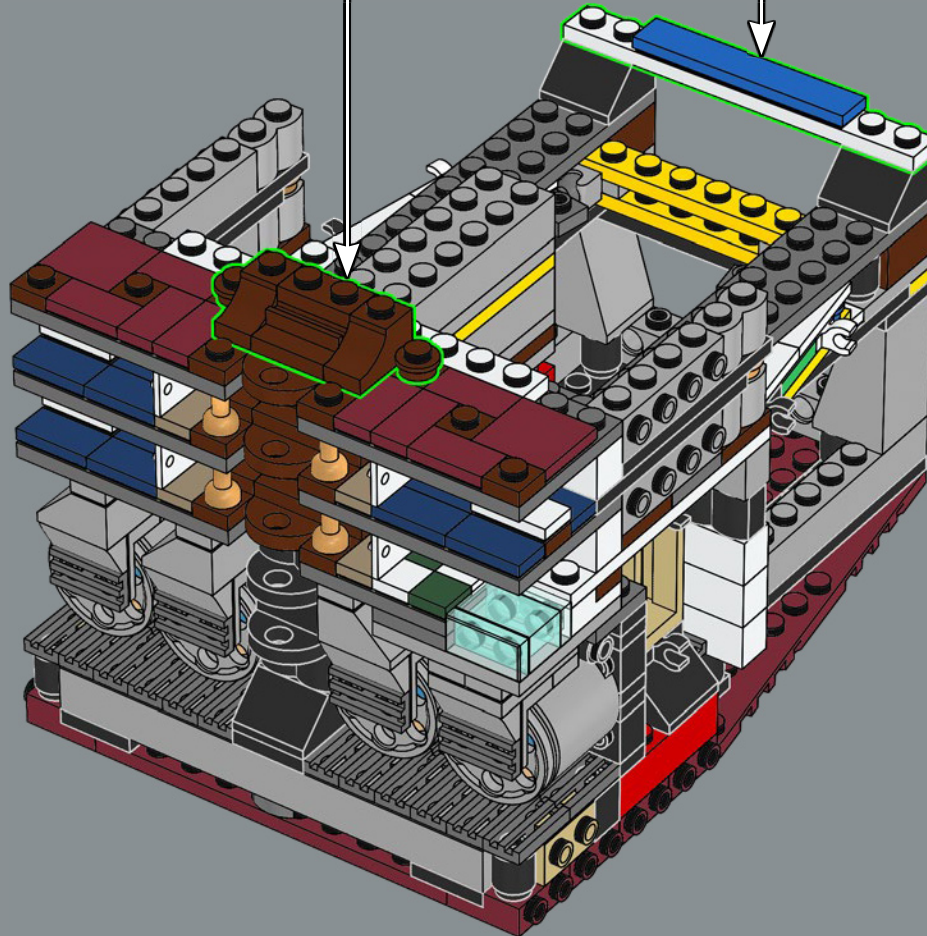
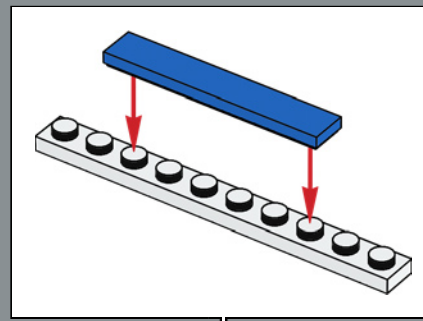
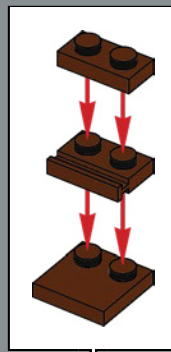

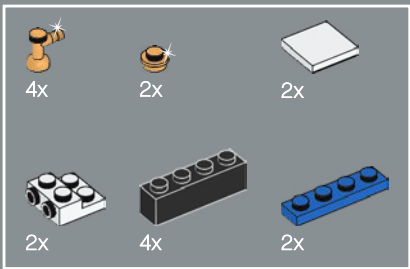

185

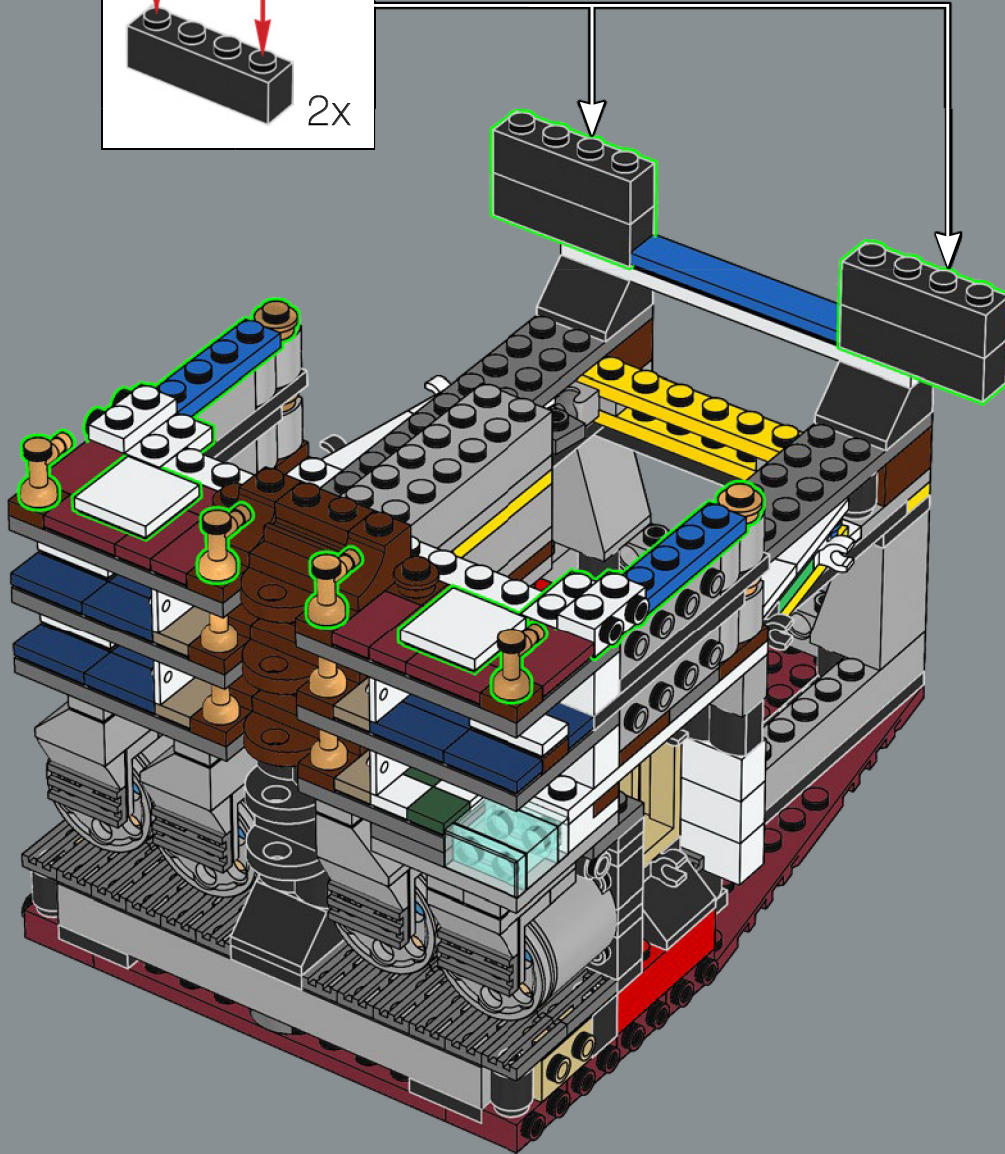
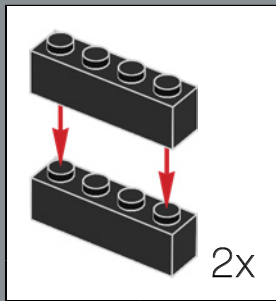

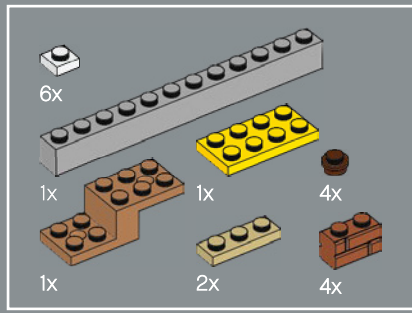

186

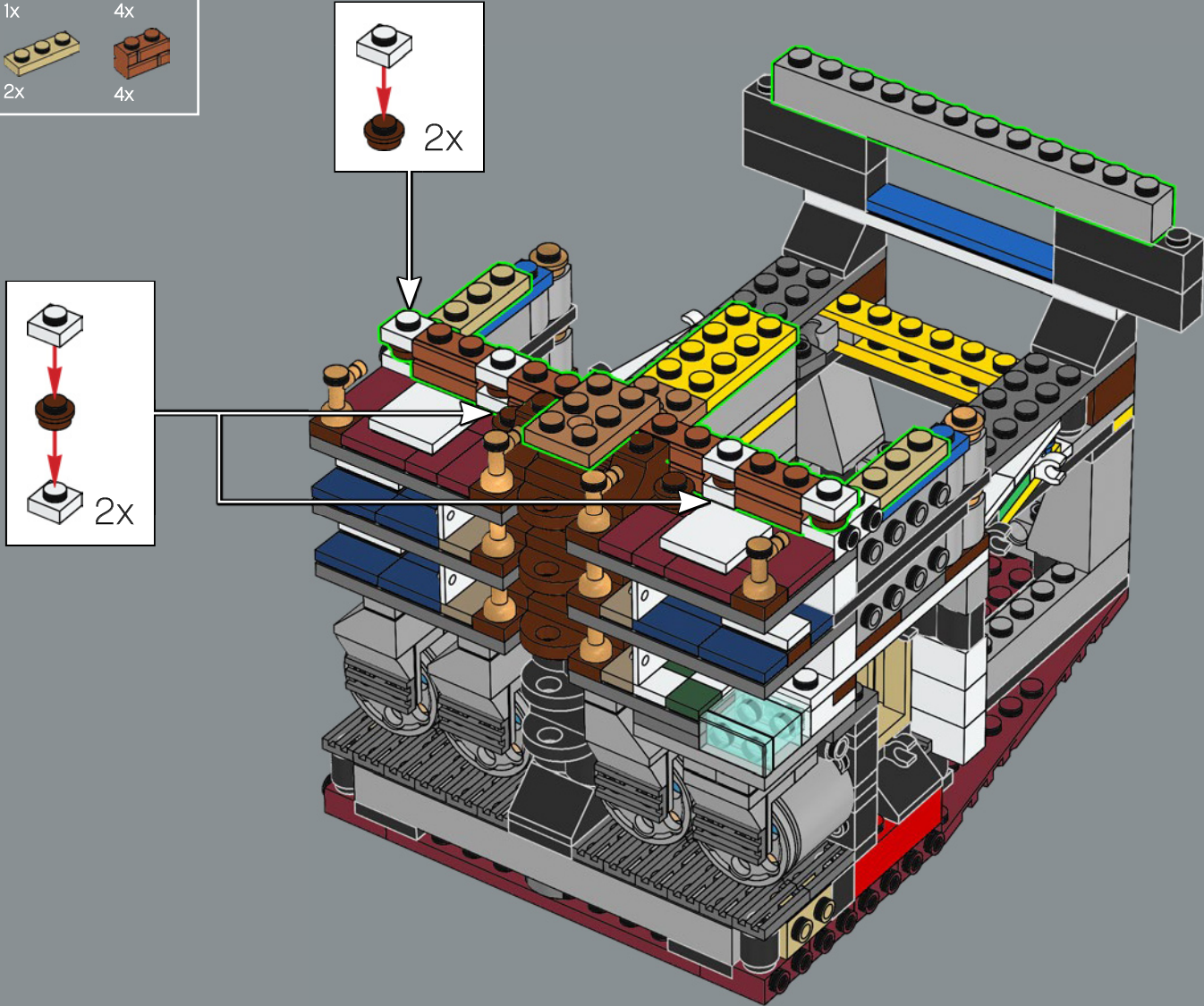

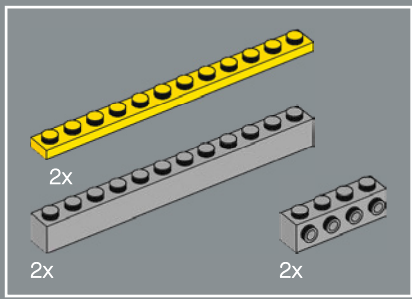

187

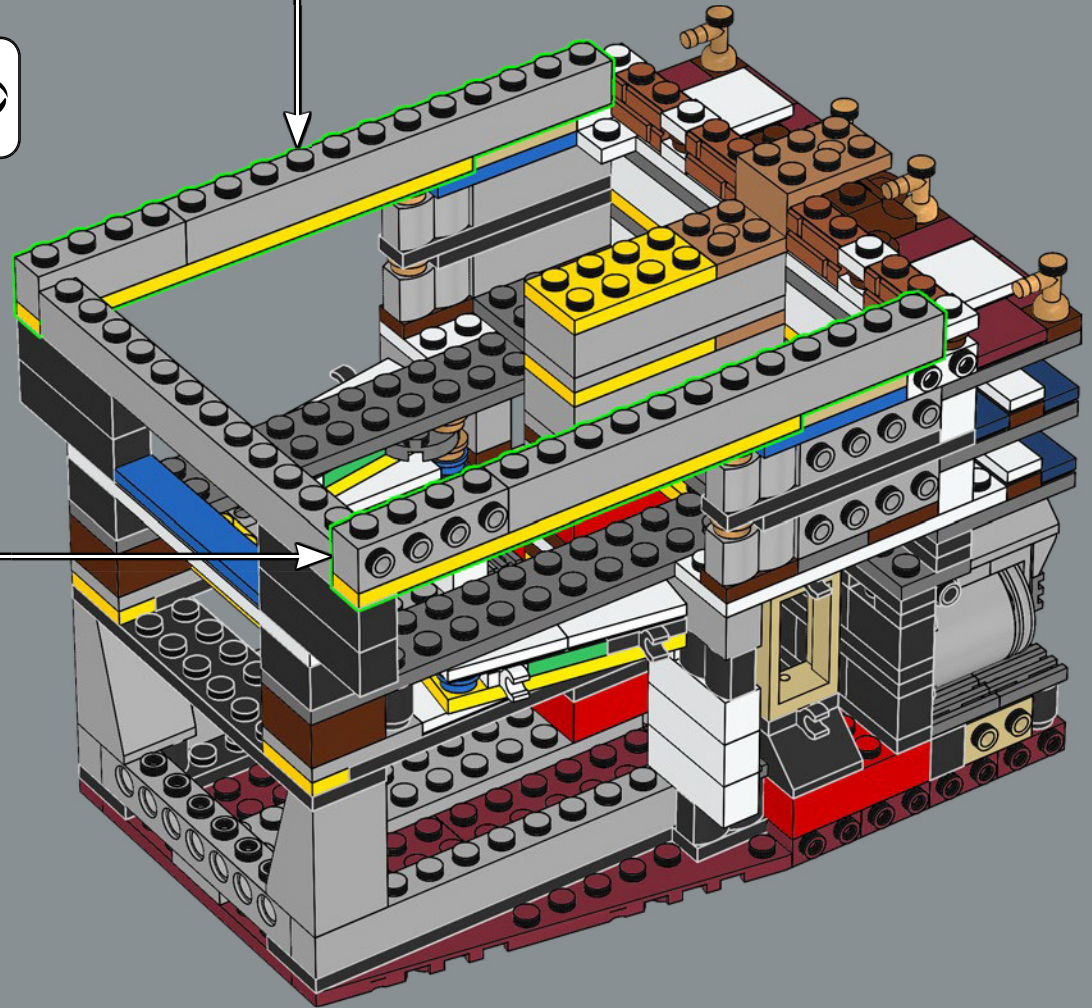
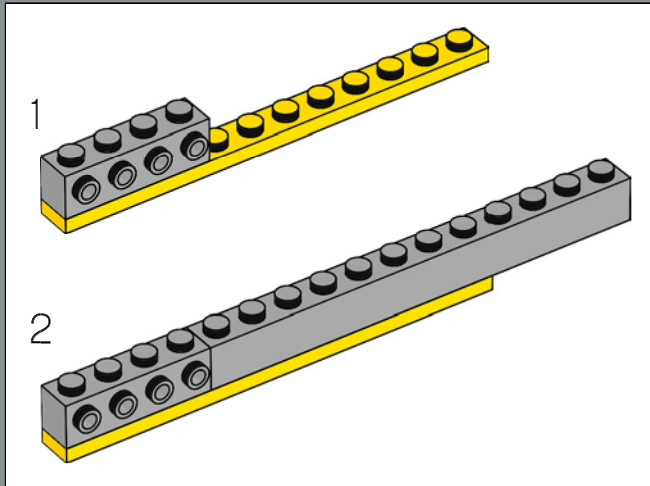
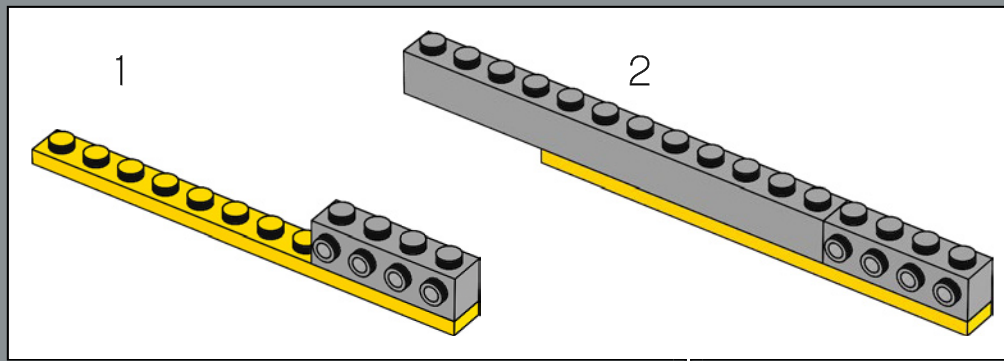

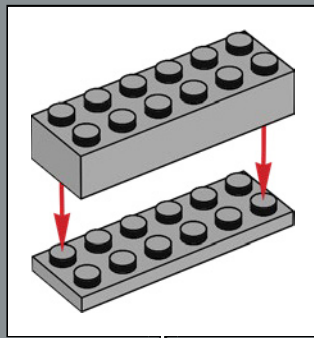
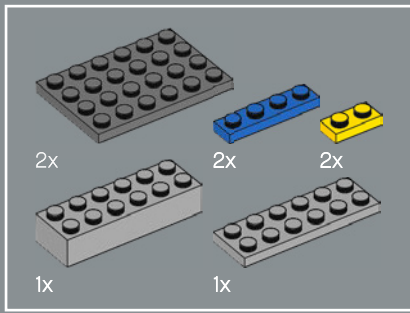

188

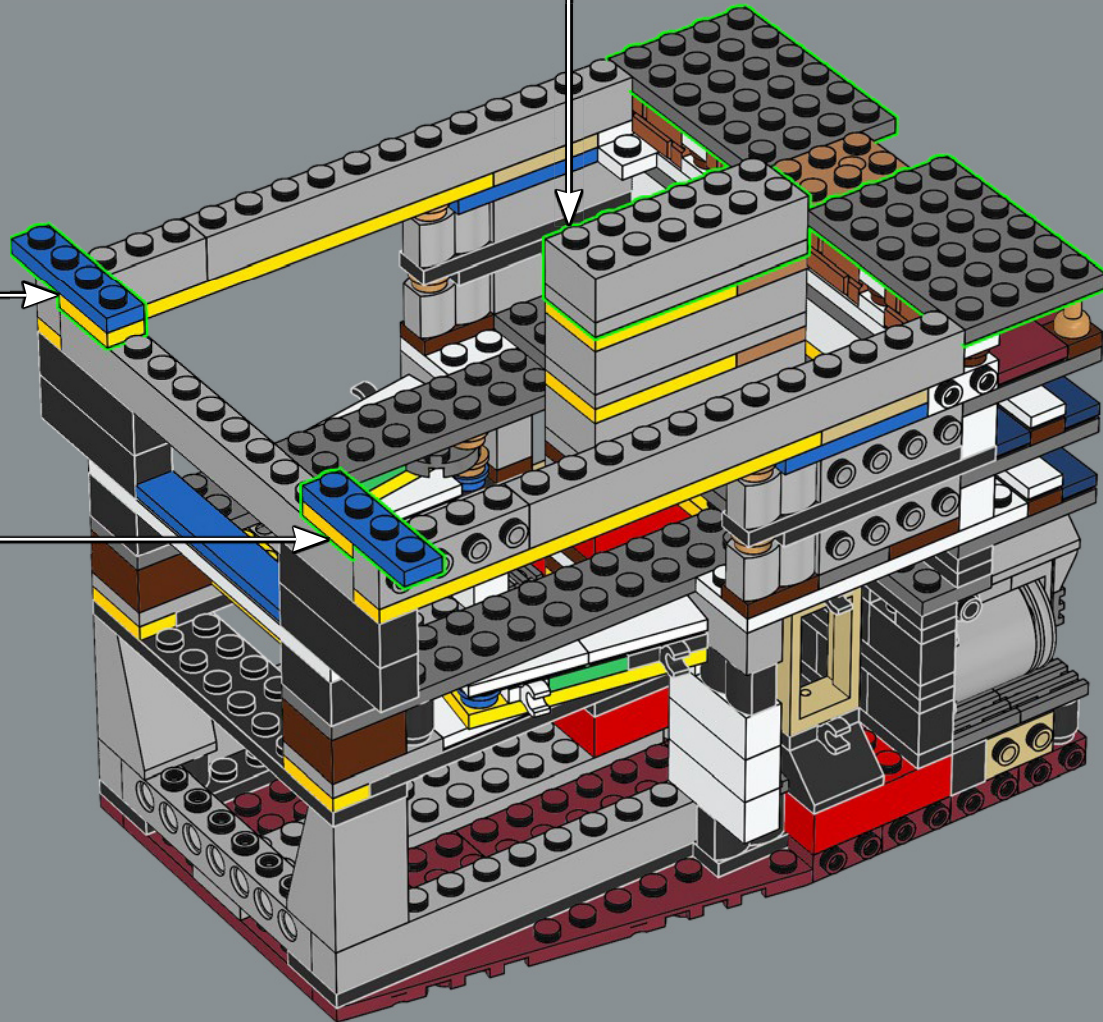
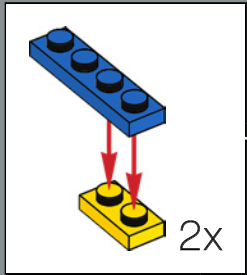

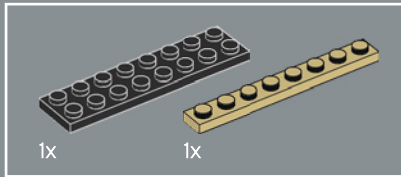
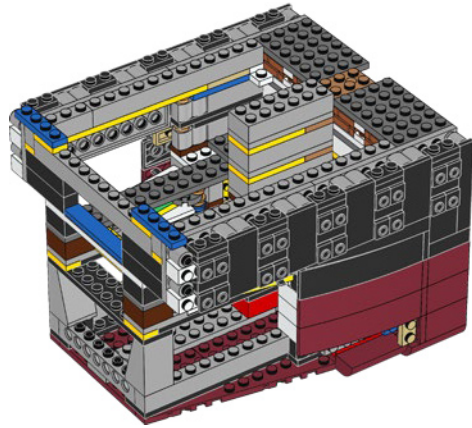
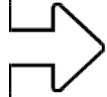

190

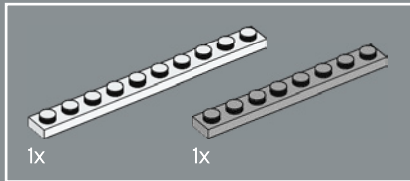
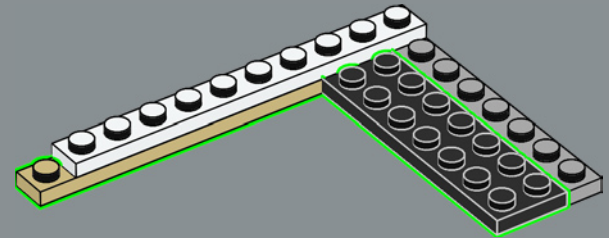

189

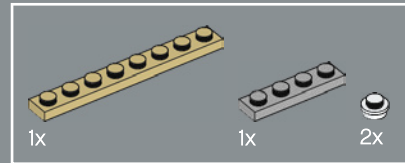
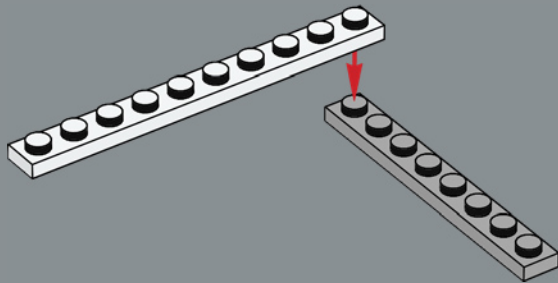

191

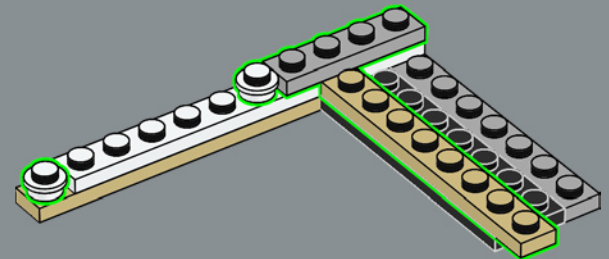

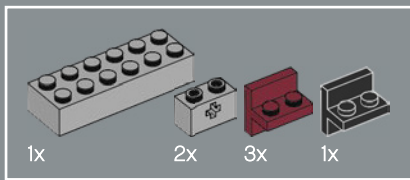

192

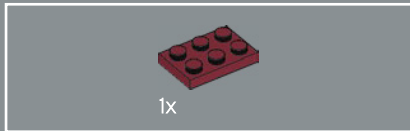
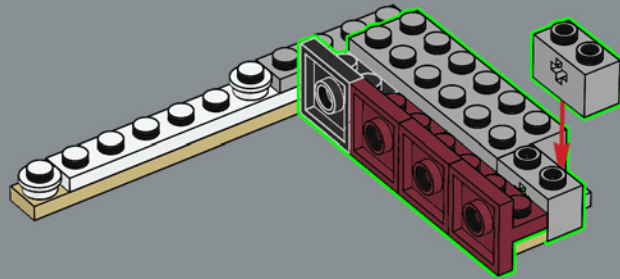

193

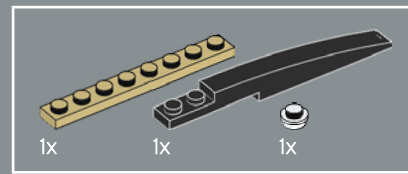
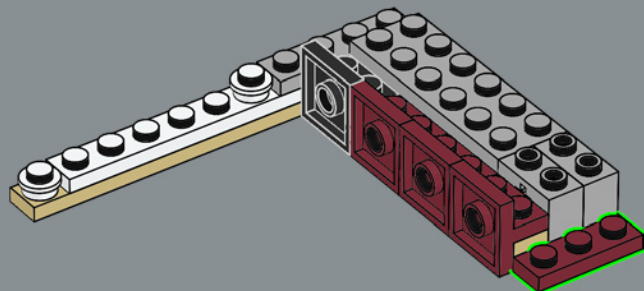

194

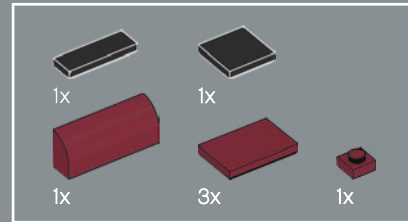
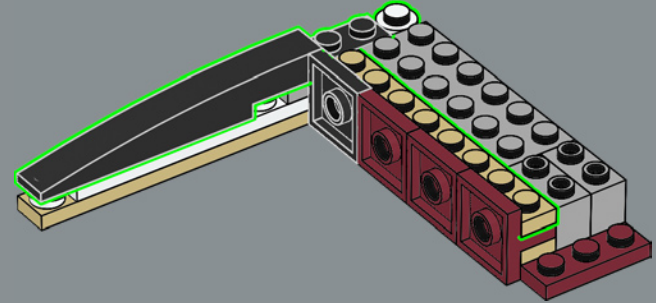

195

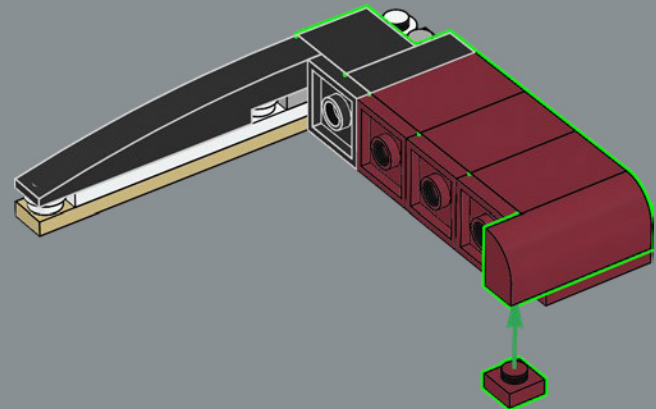

196

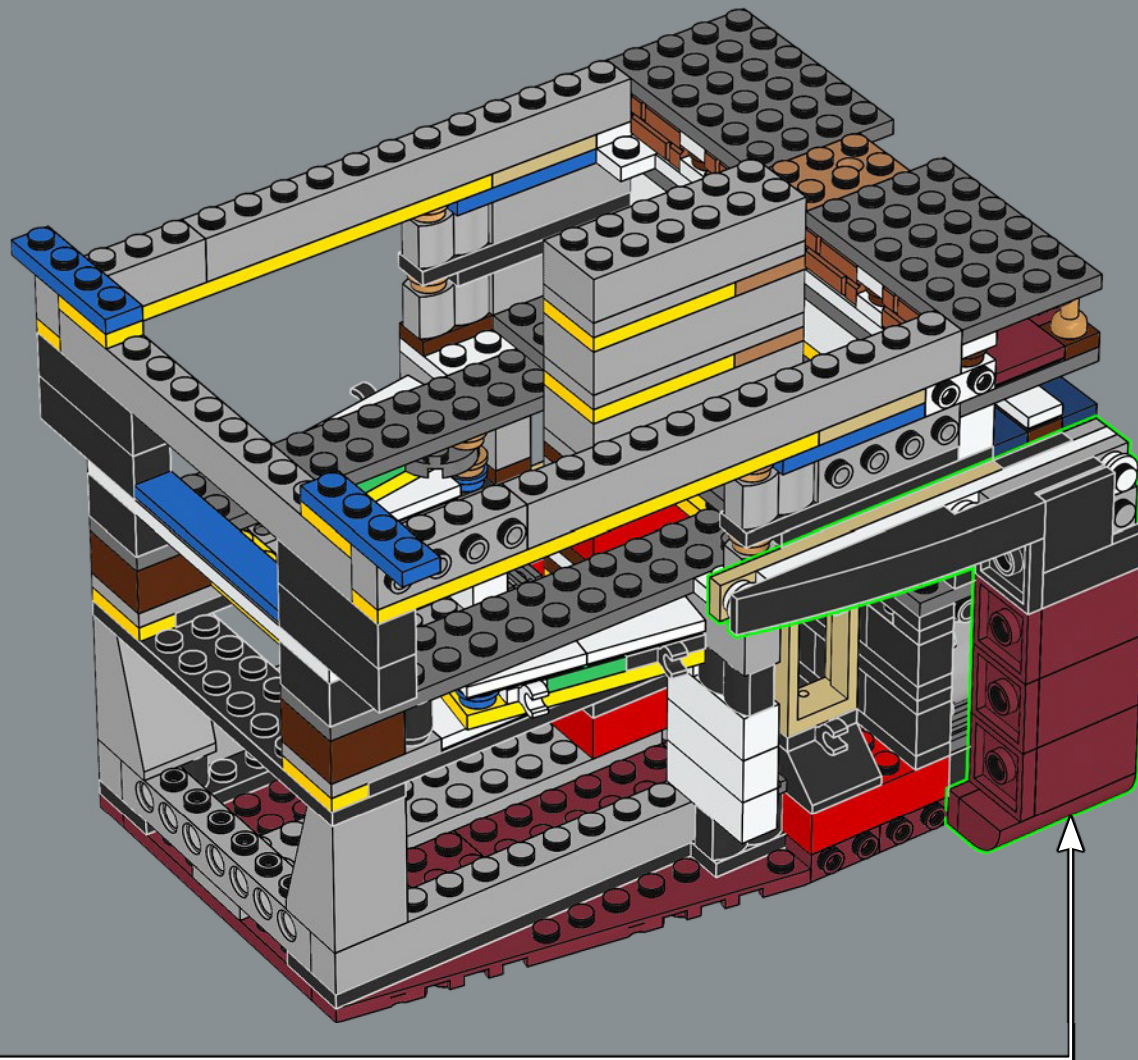



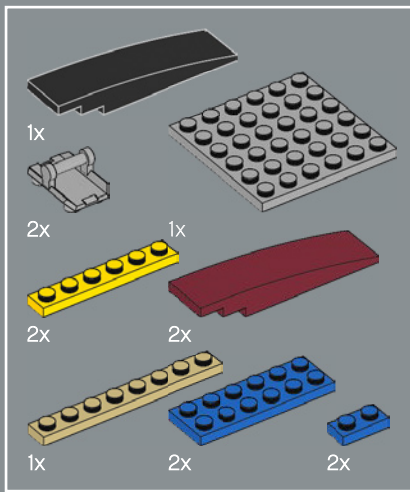

197

1

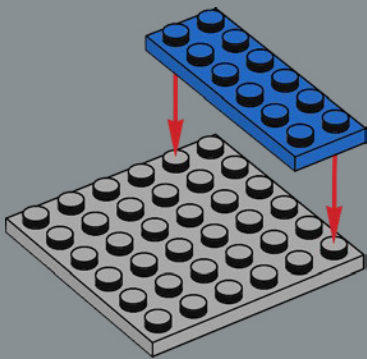

2

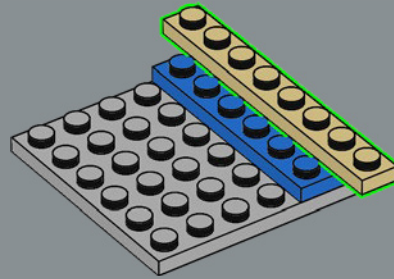

3

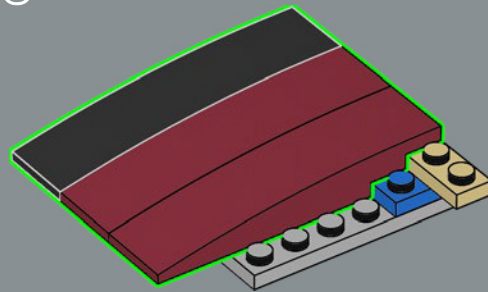

4

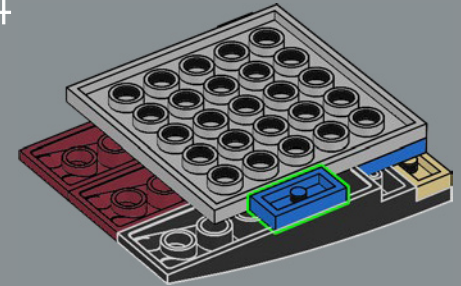
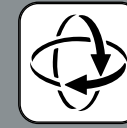

5

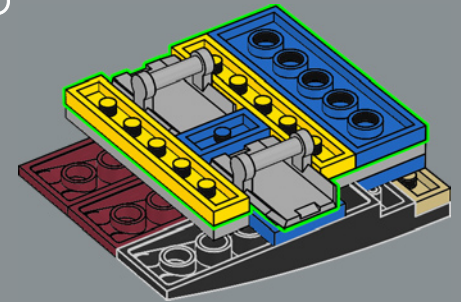

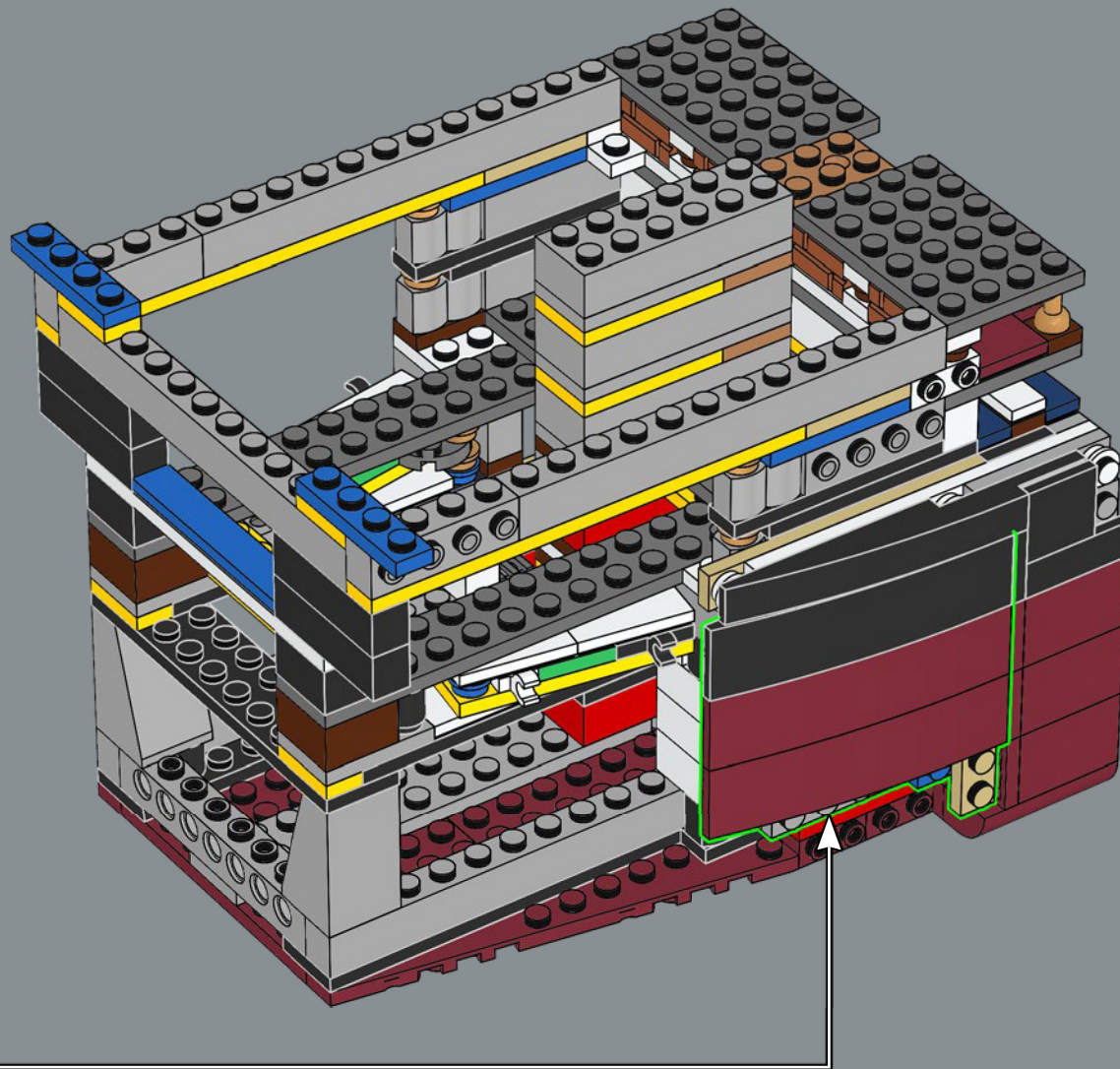

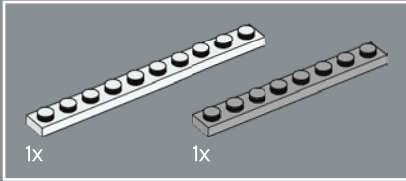
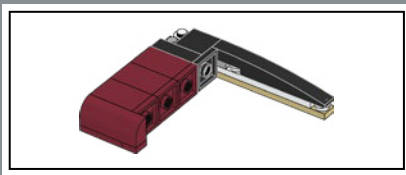

198

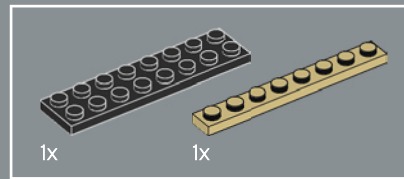
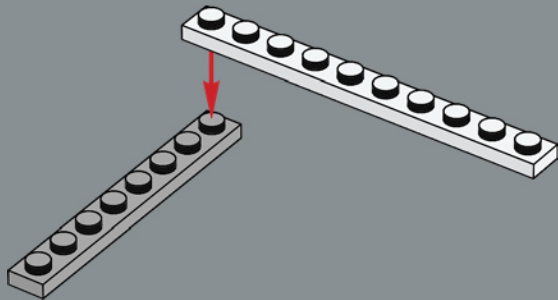

199

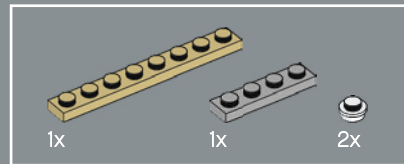
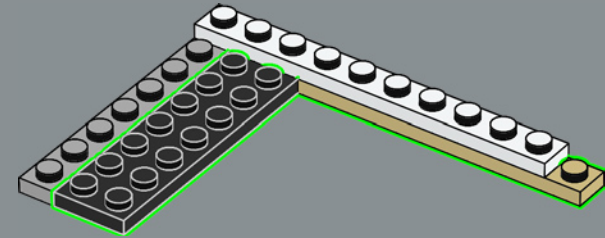

200

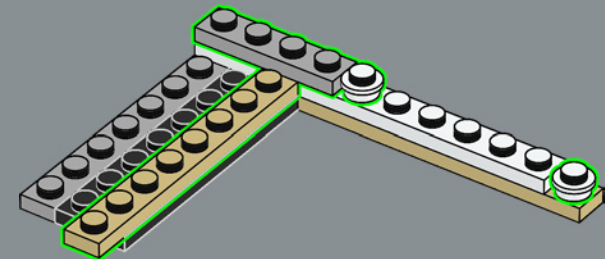

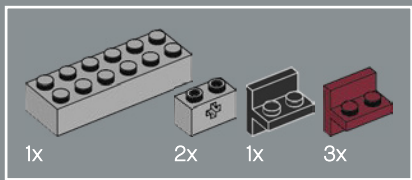

201

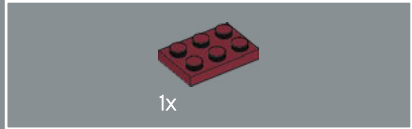
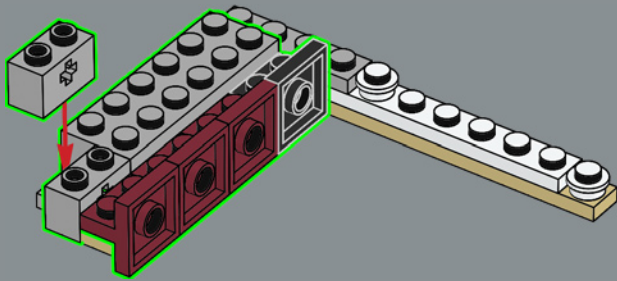

202

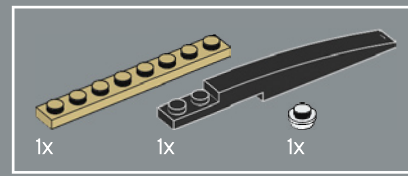
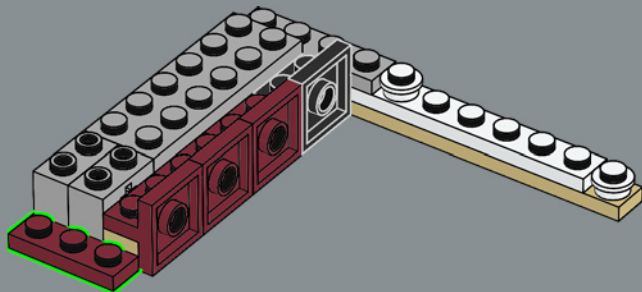

203

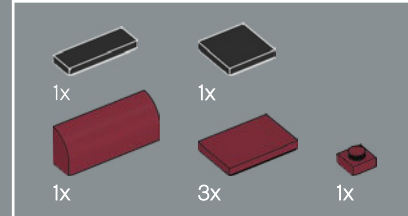
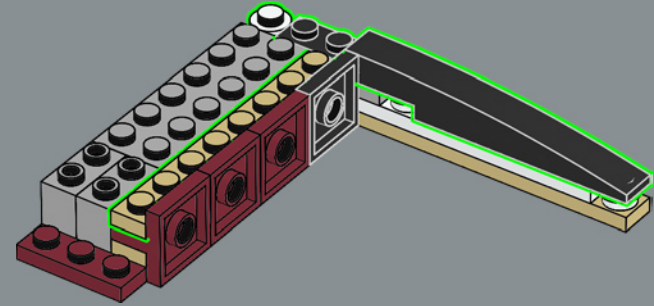

204

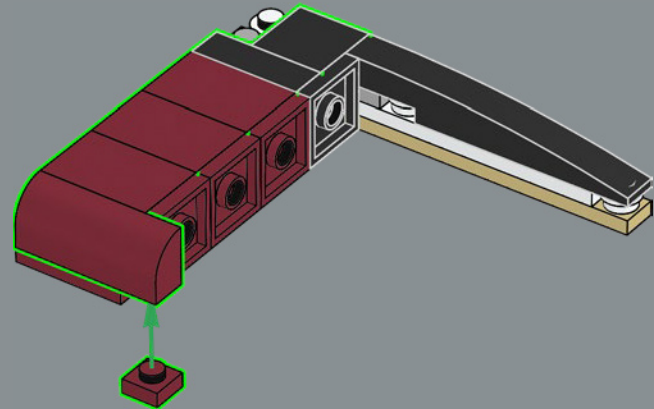

205

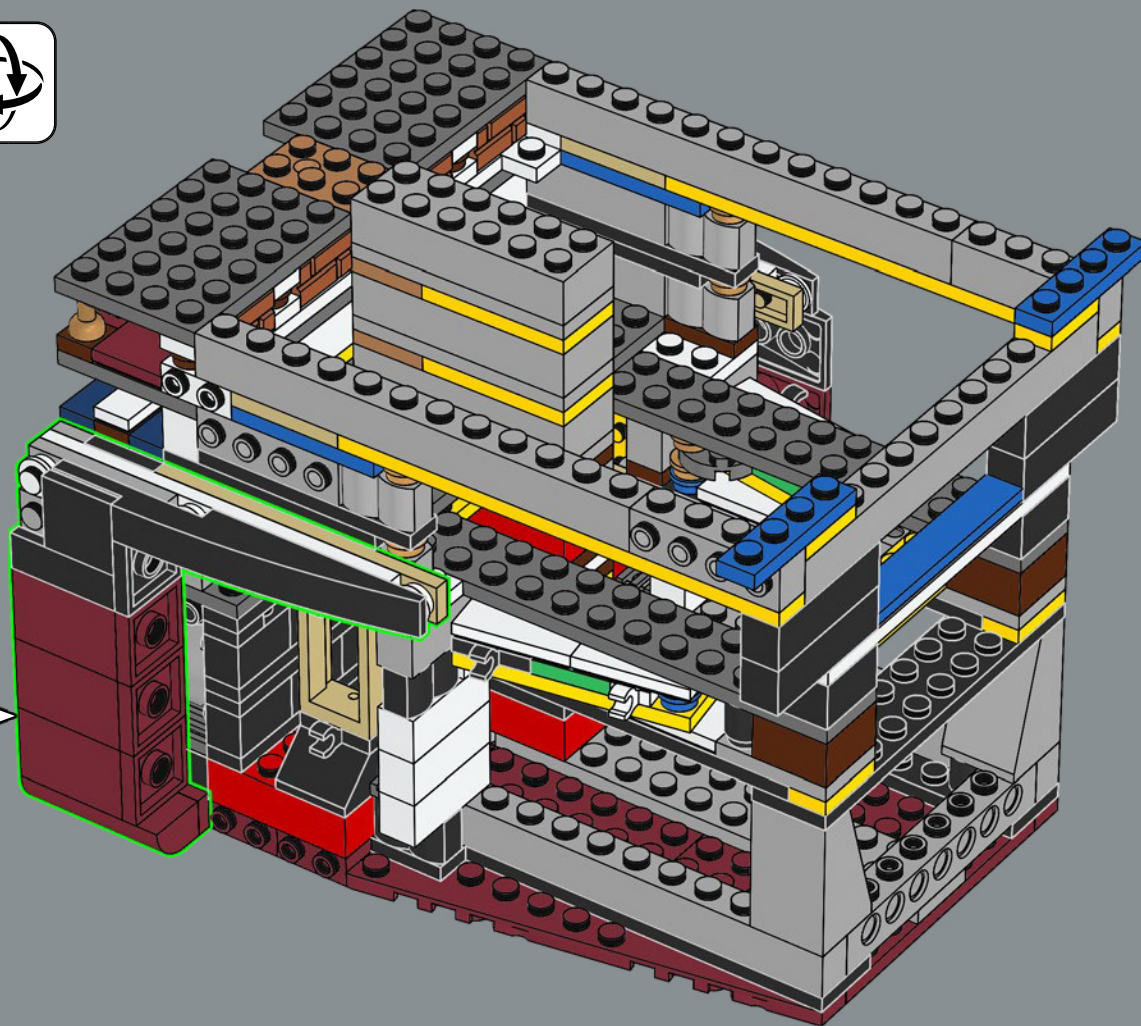

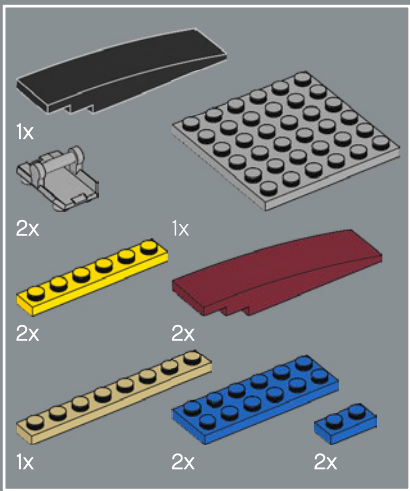

206

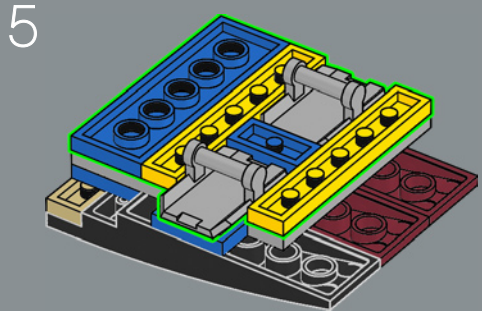
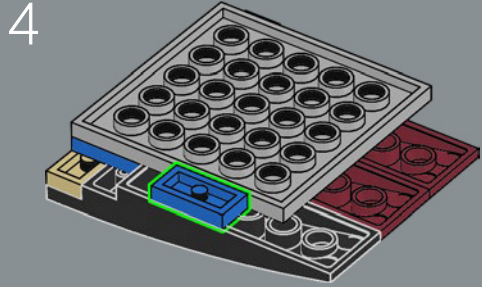
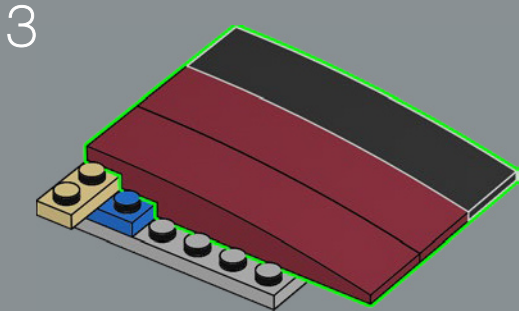
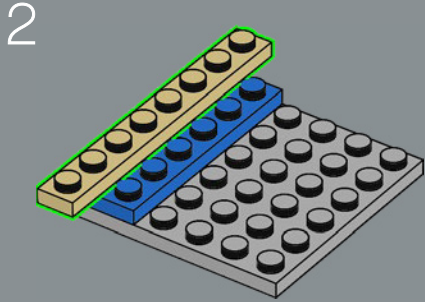
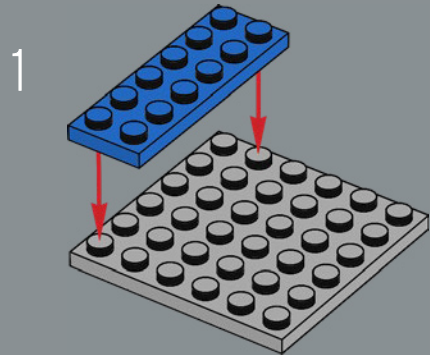

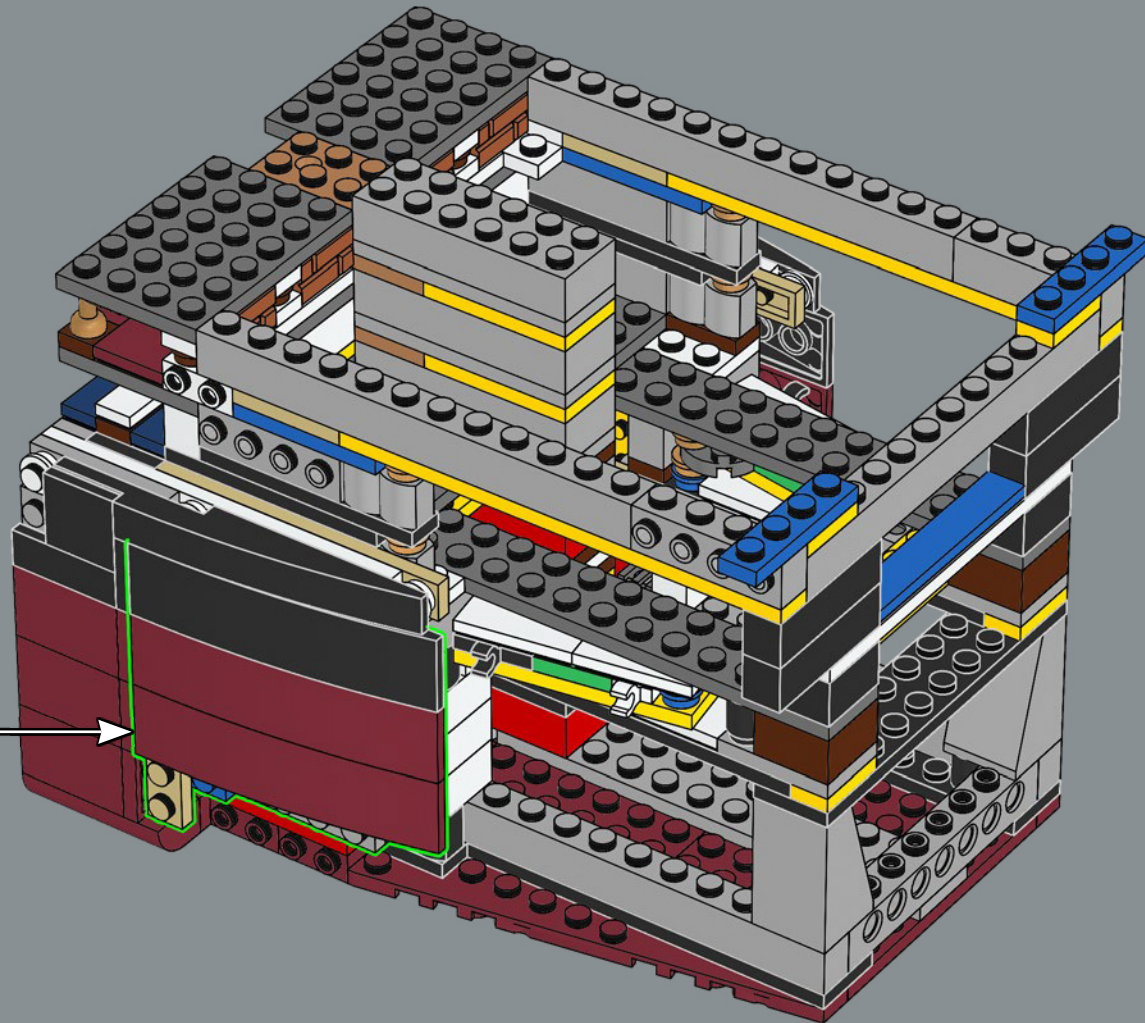

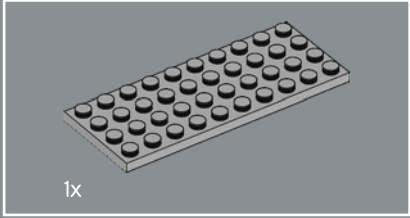
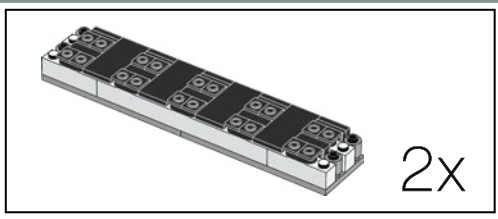

207

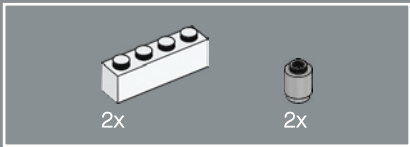
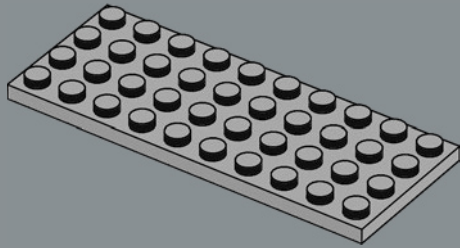

208

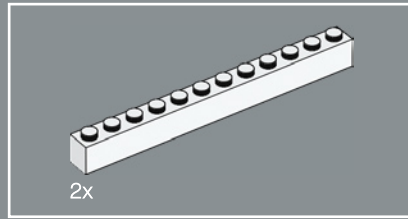
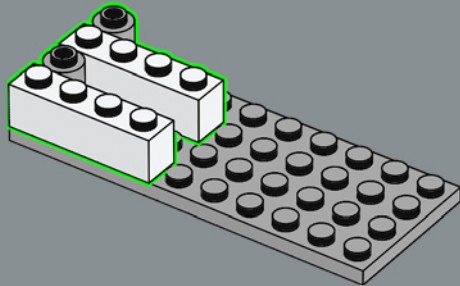

209

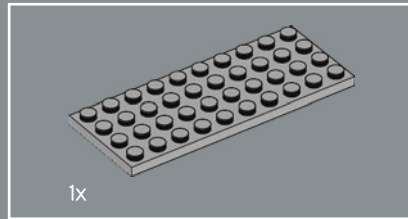
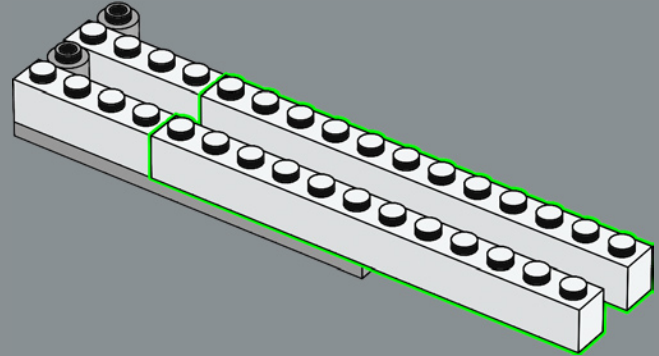

210

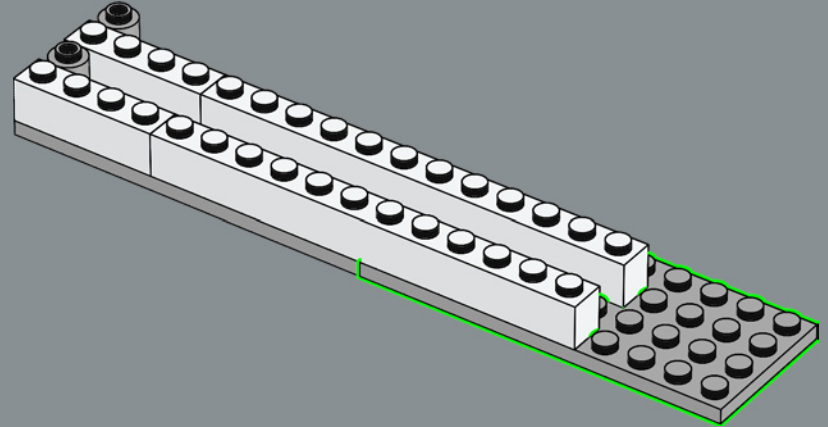



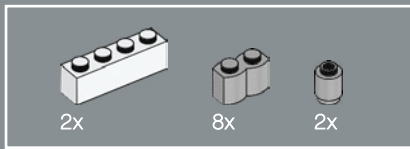

211

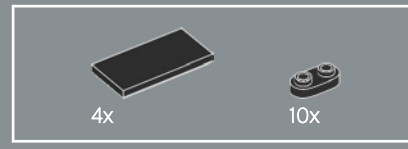
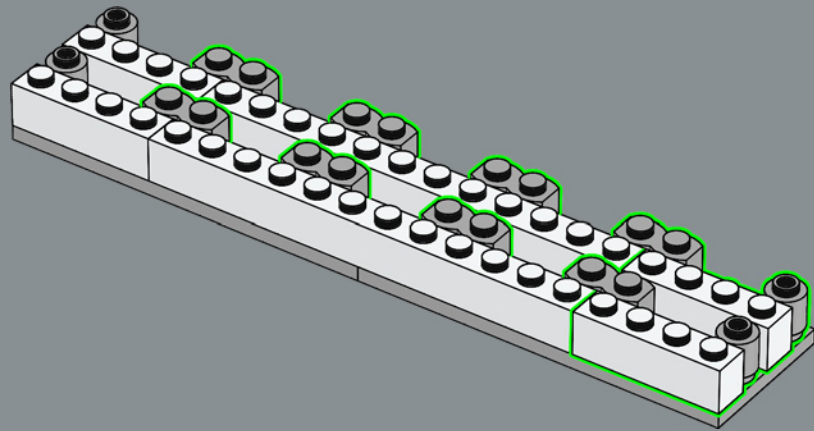

212

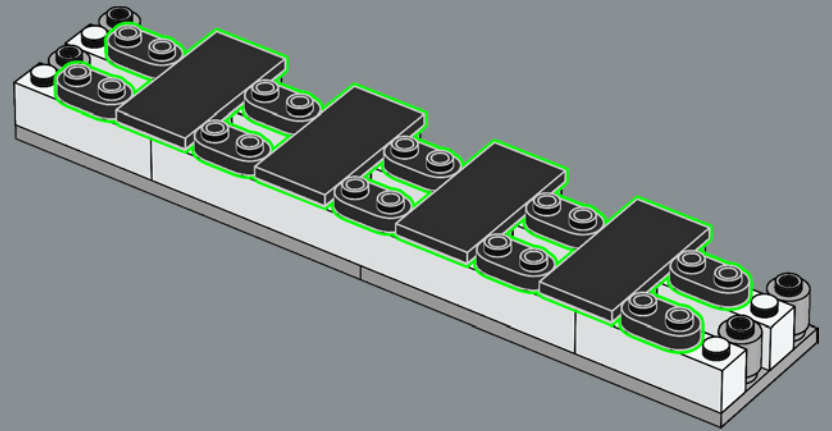

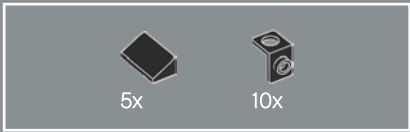

213

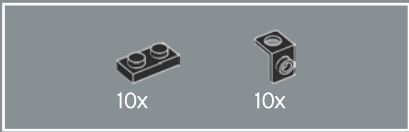
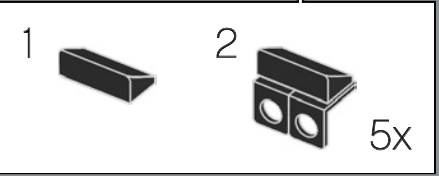
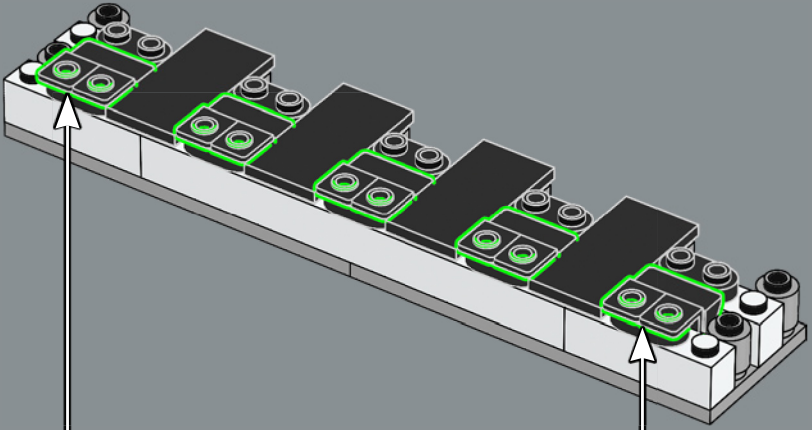

214

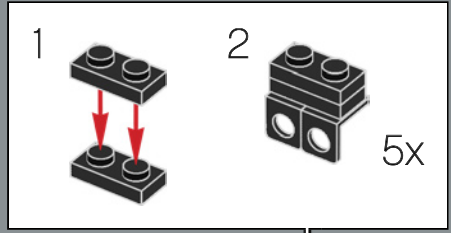
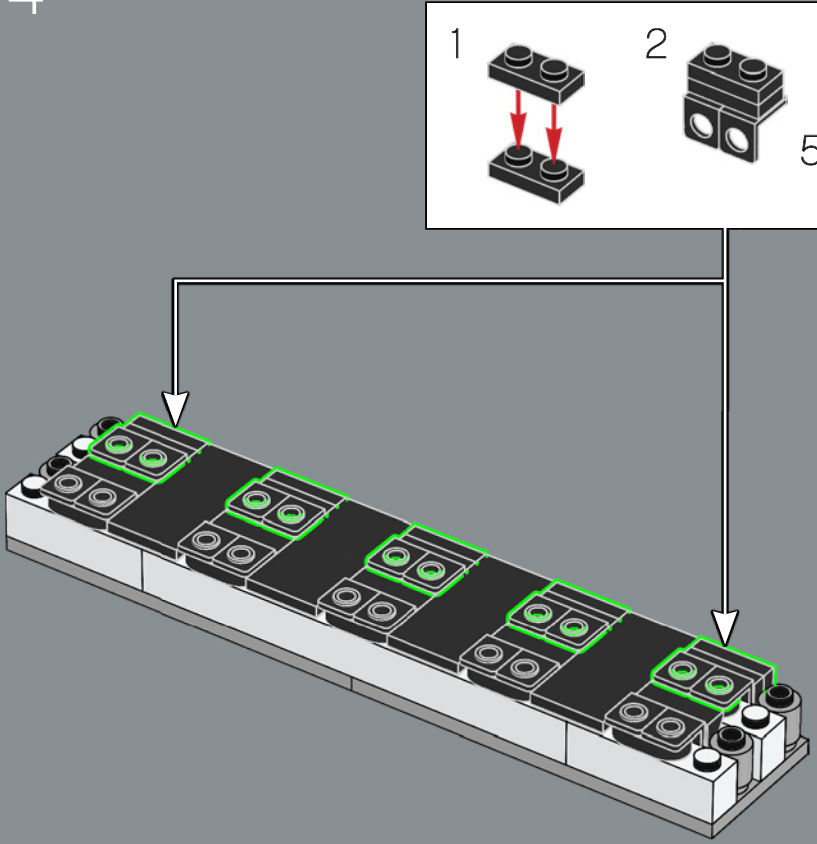

2x

215

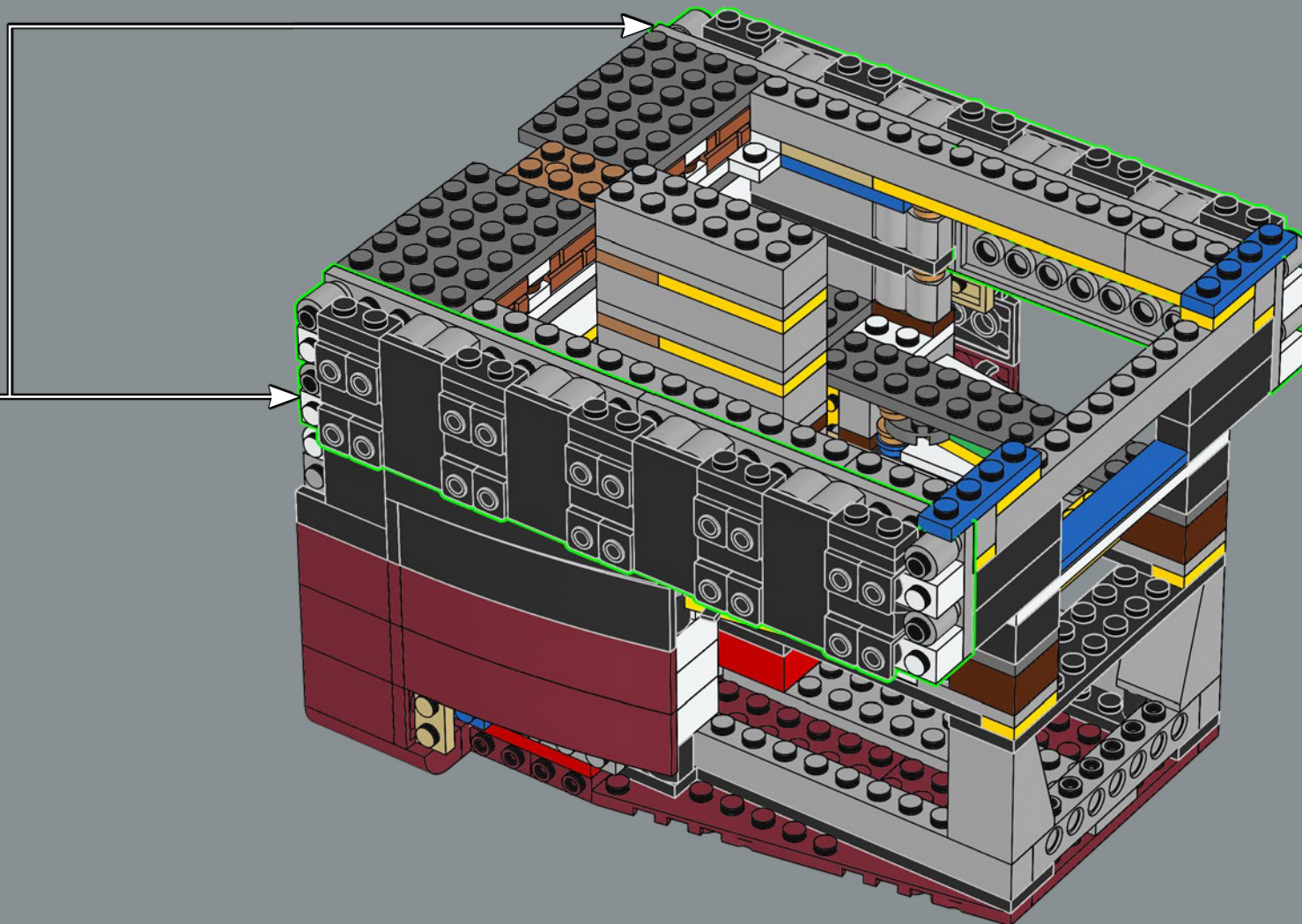

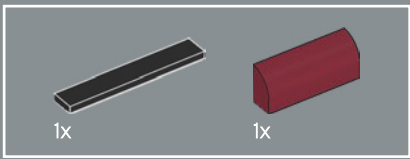

216

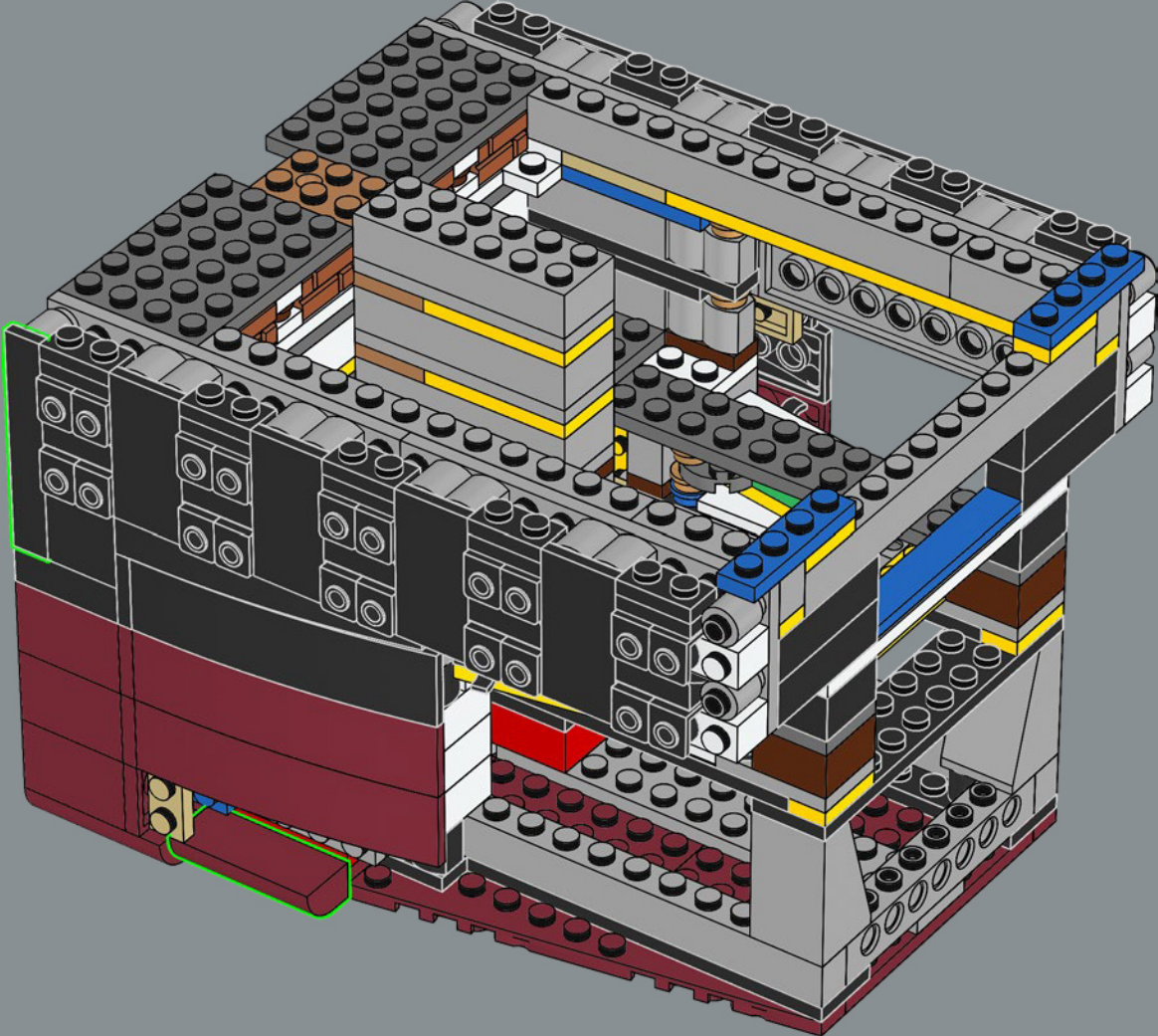

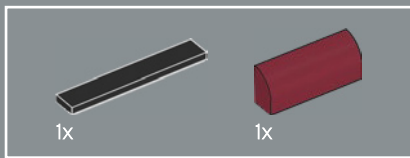

217

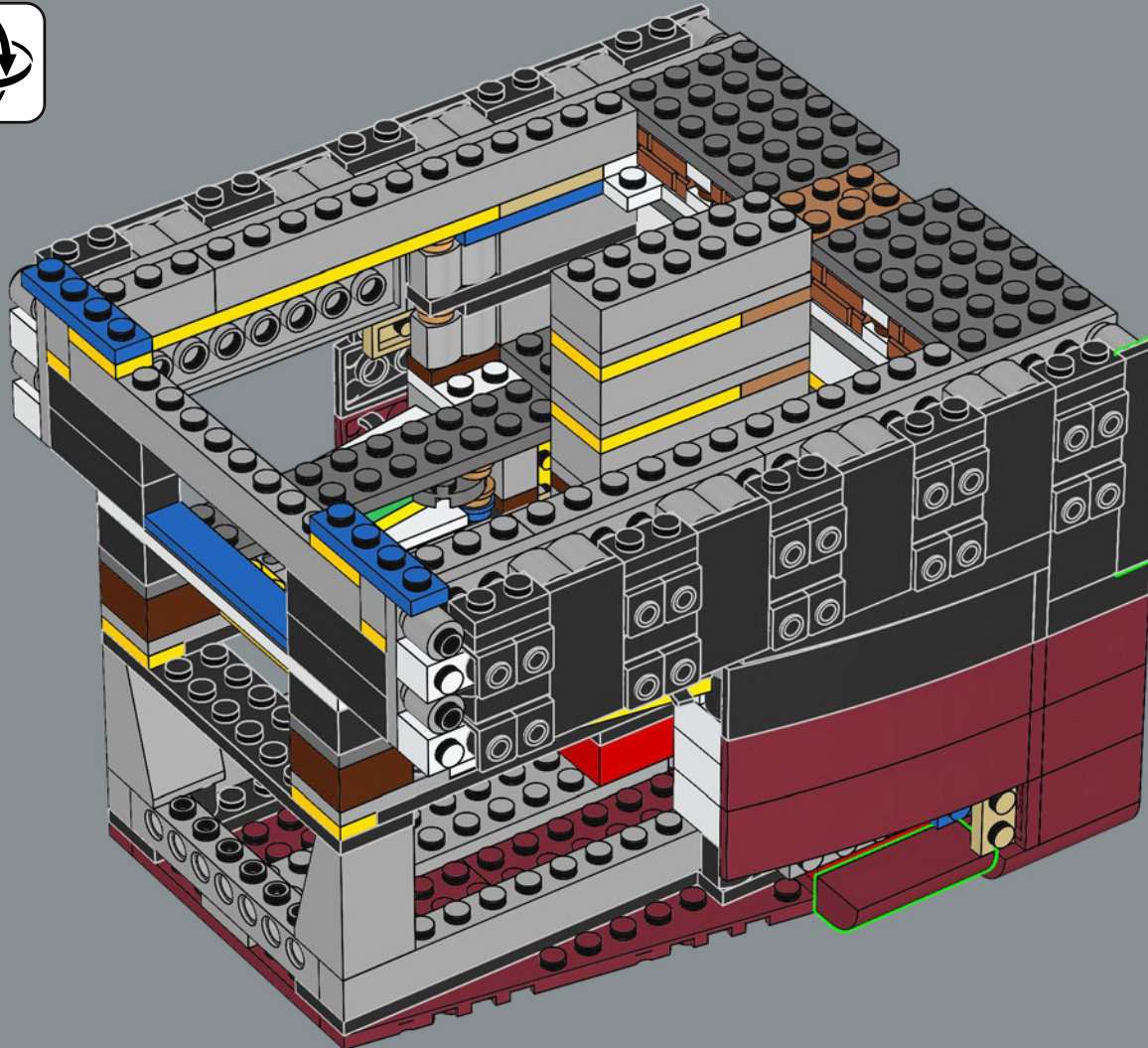

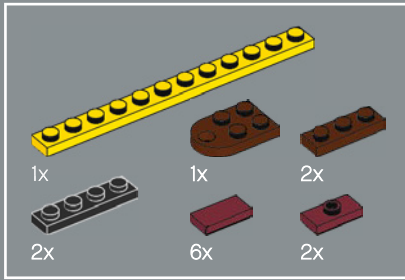
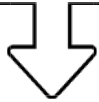

218

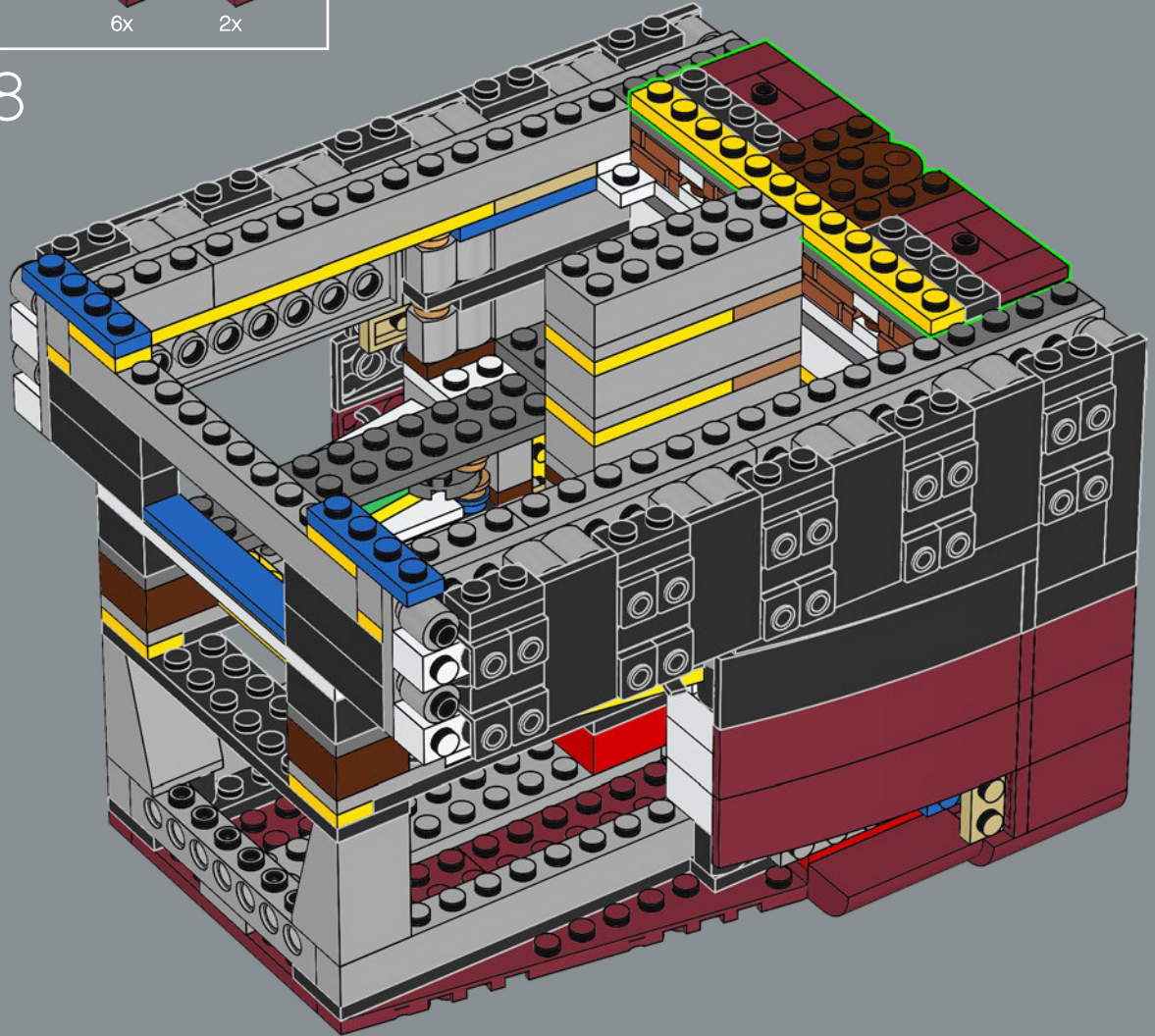



219

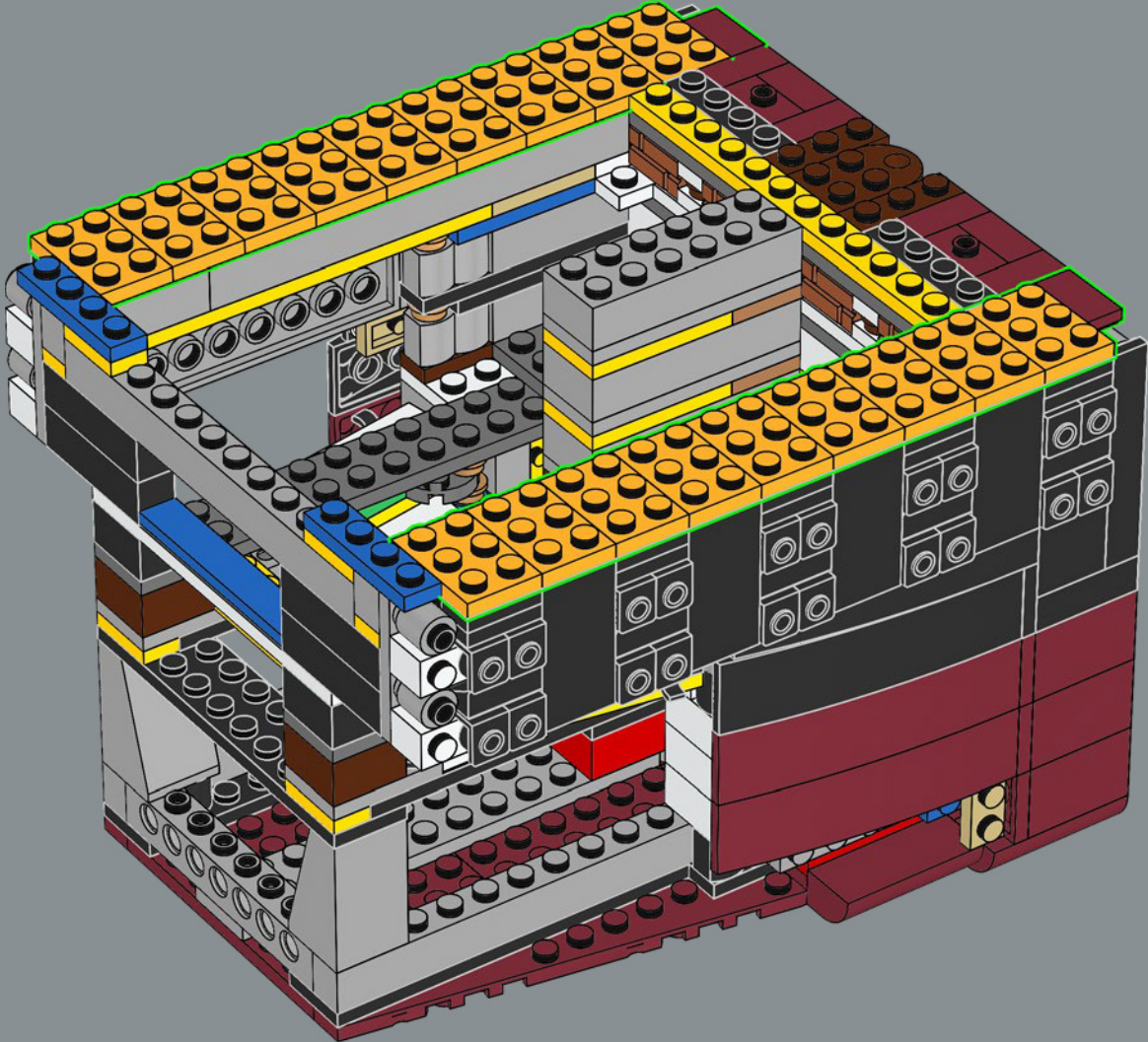

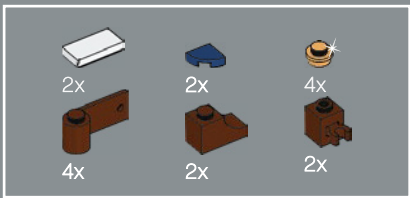

220

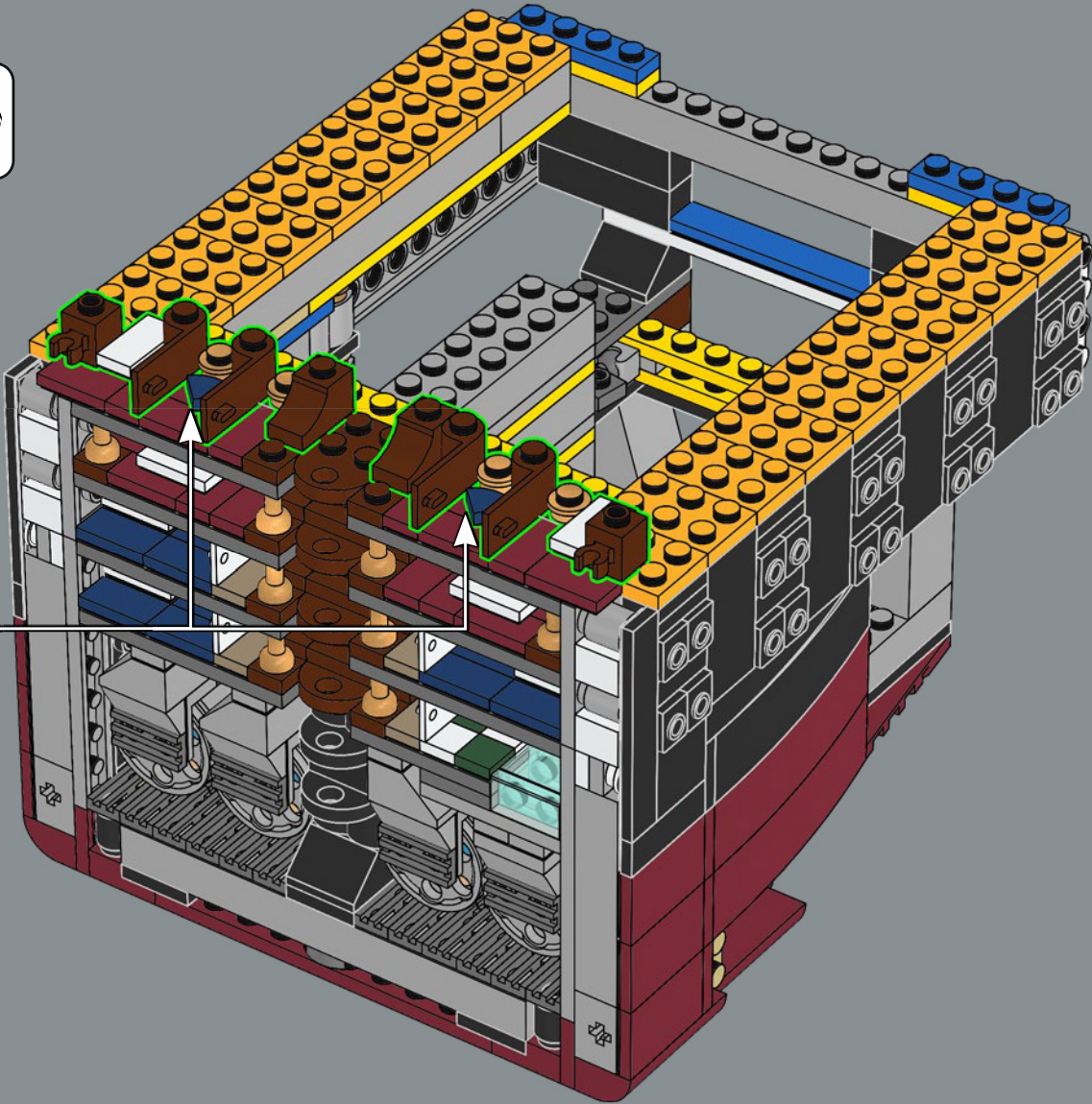



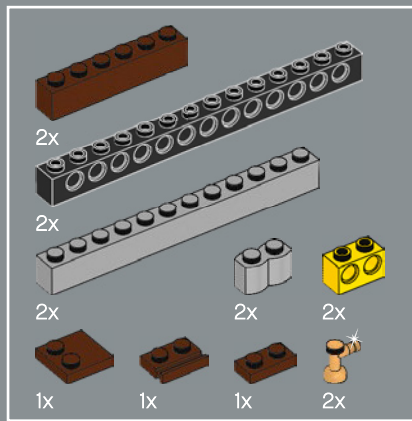

221

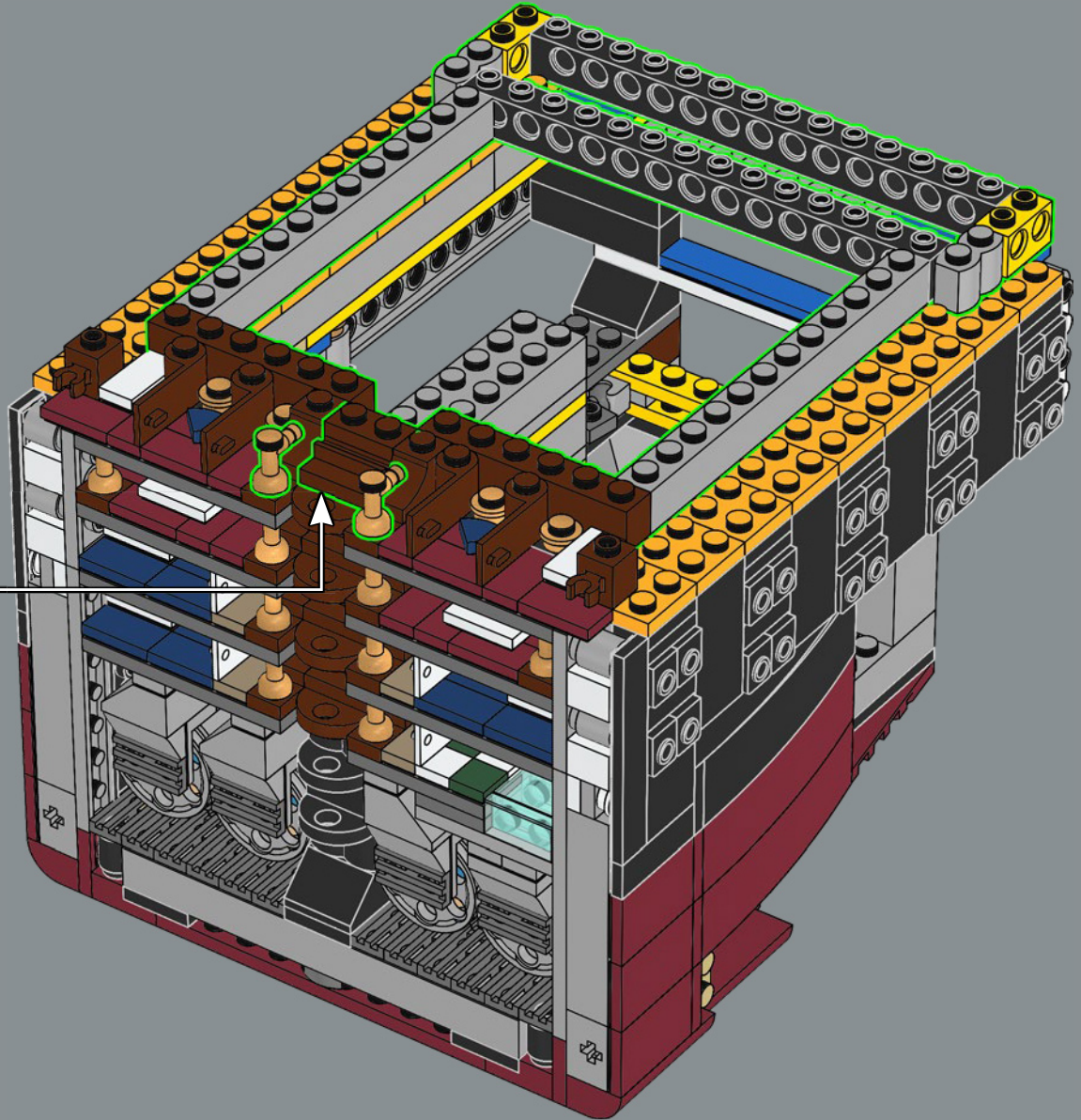
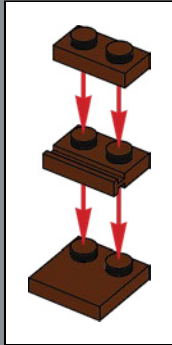

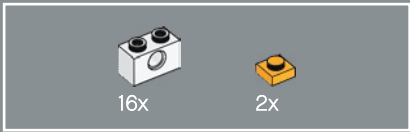

222

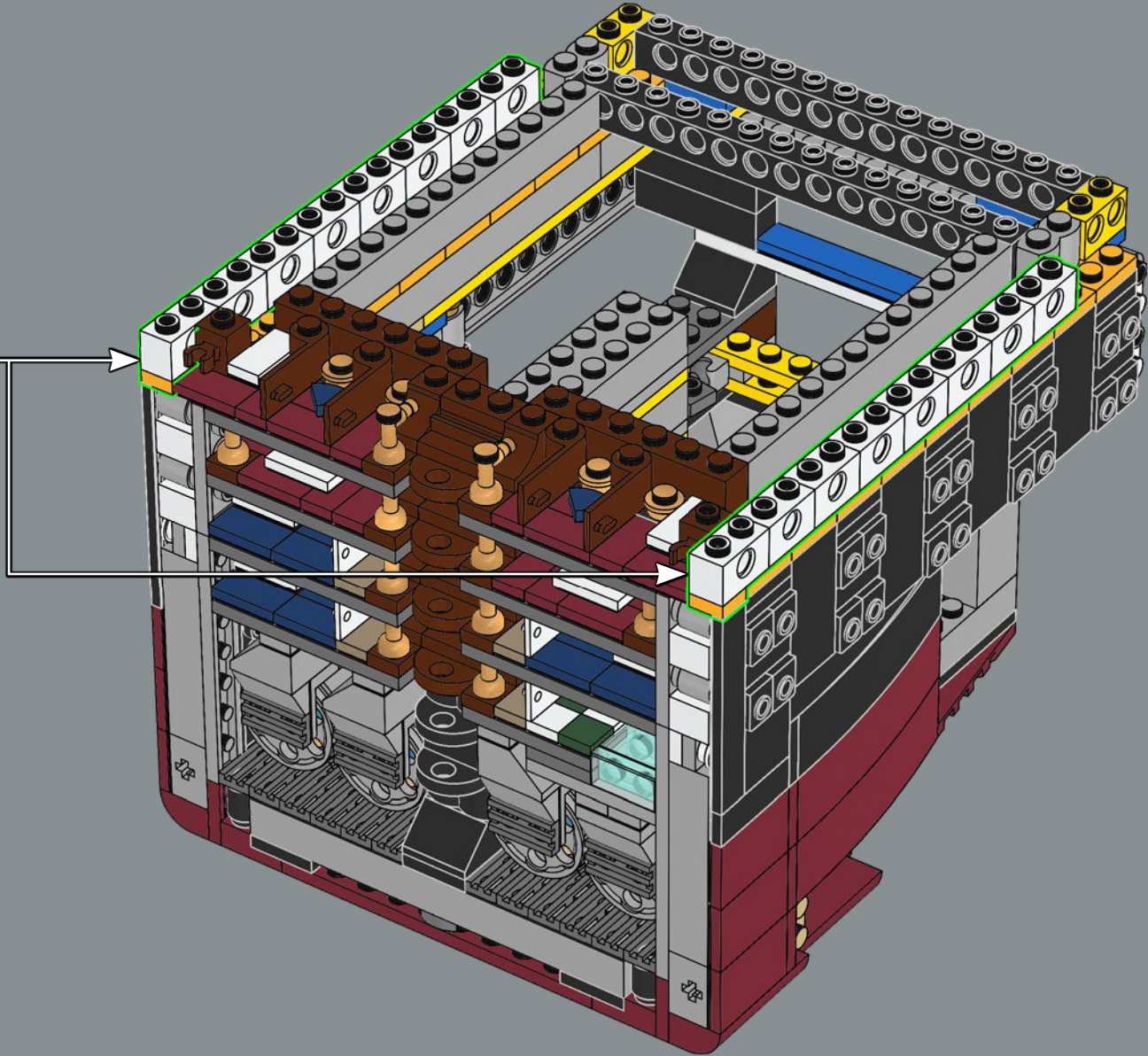
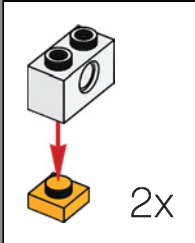

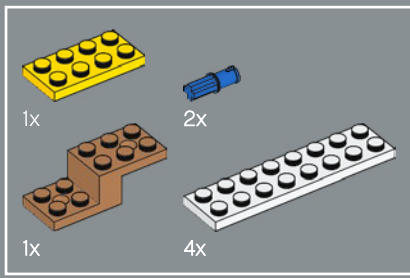

223

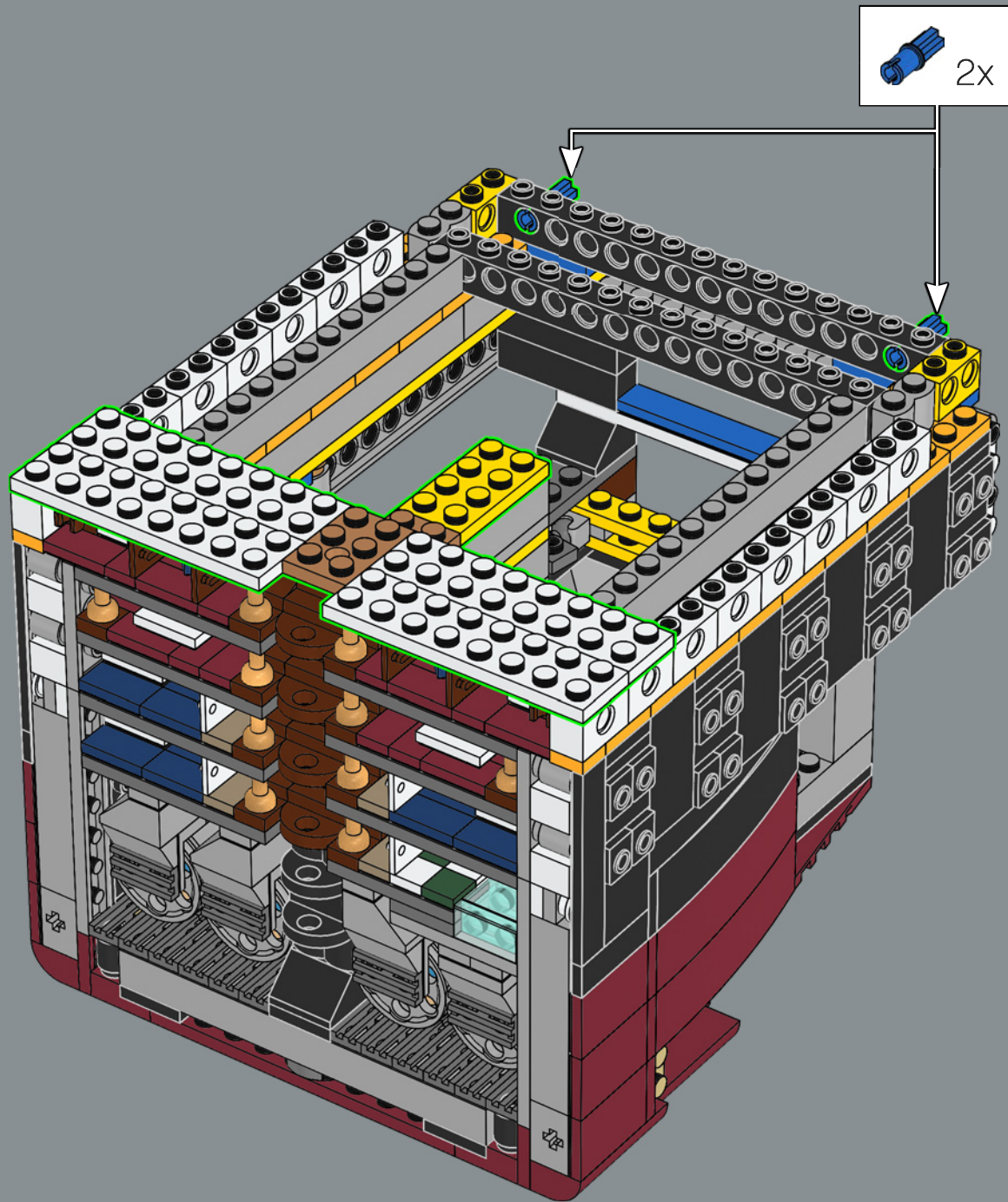

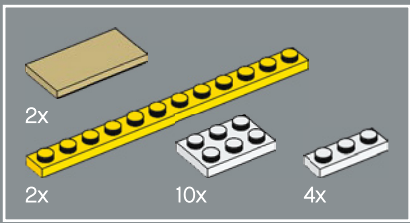

224

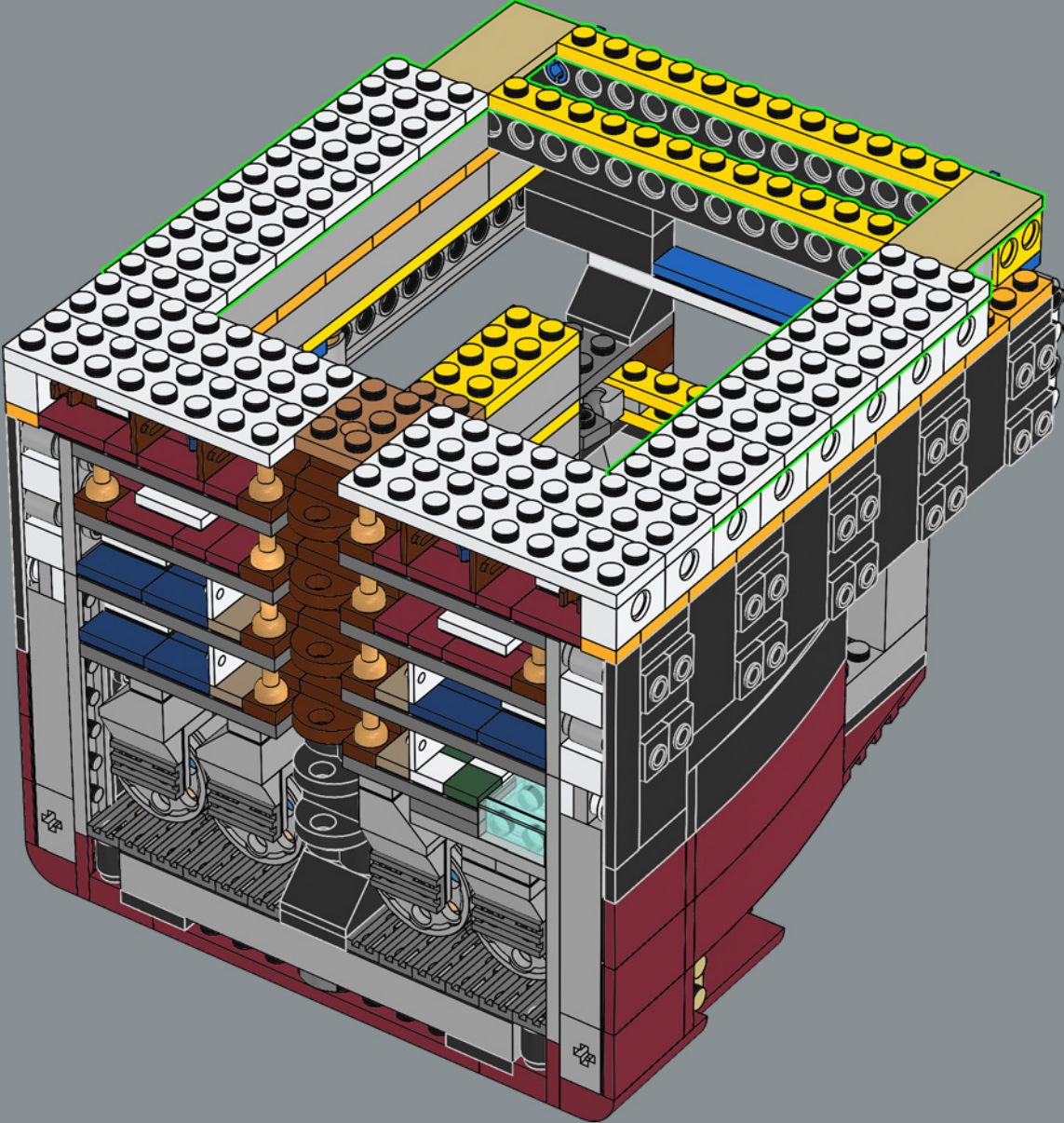

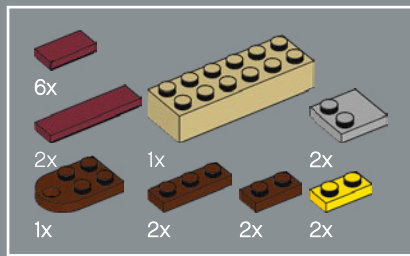

225

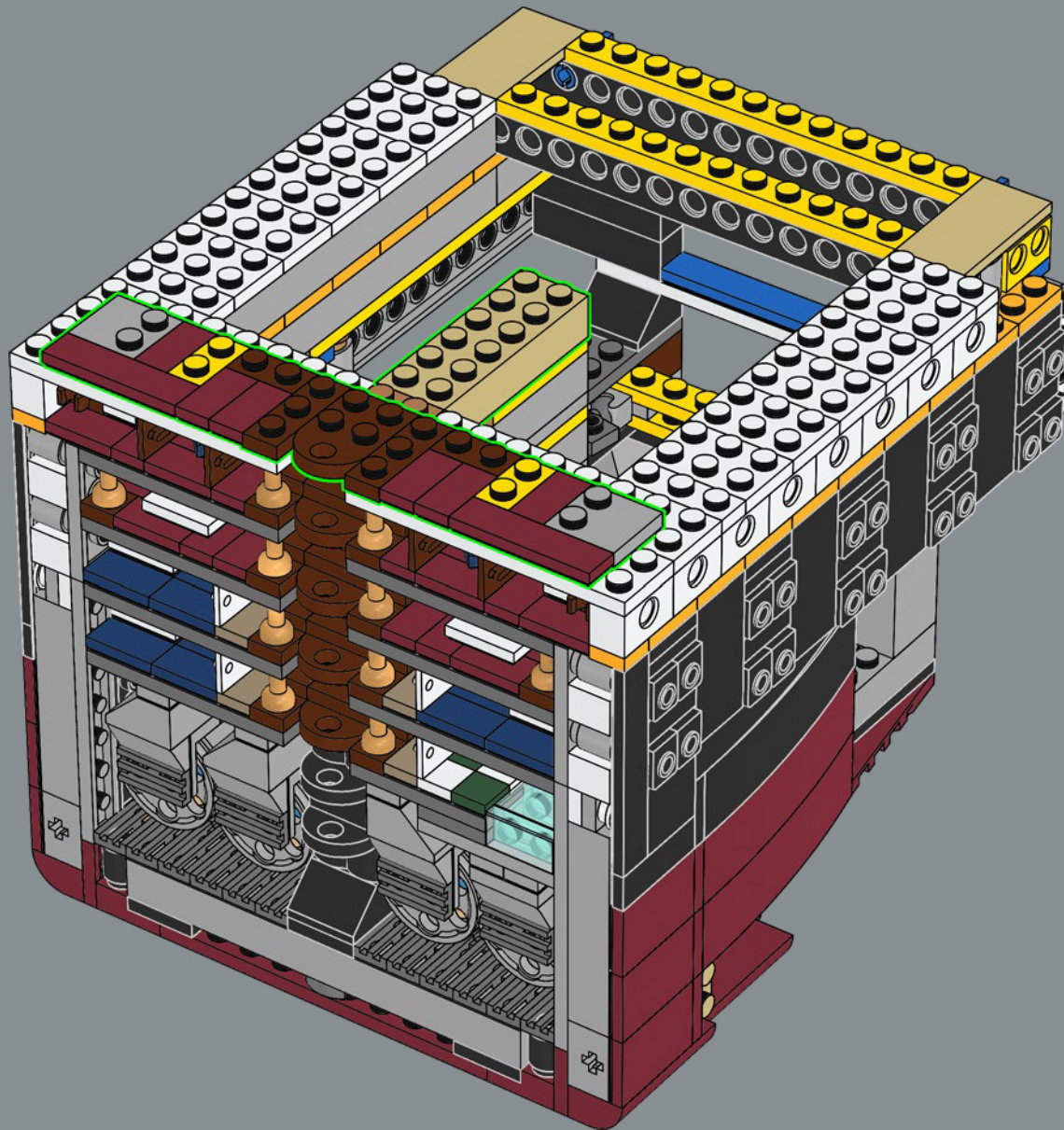

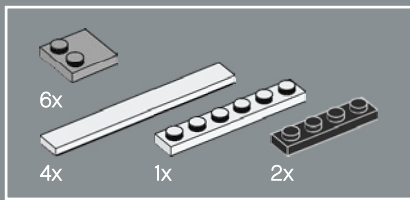

226

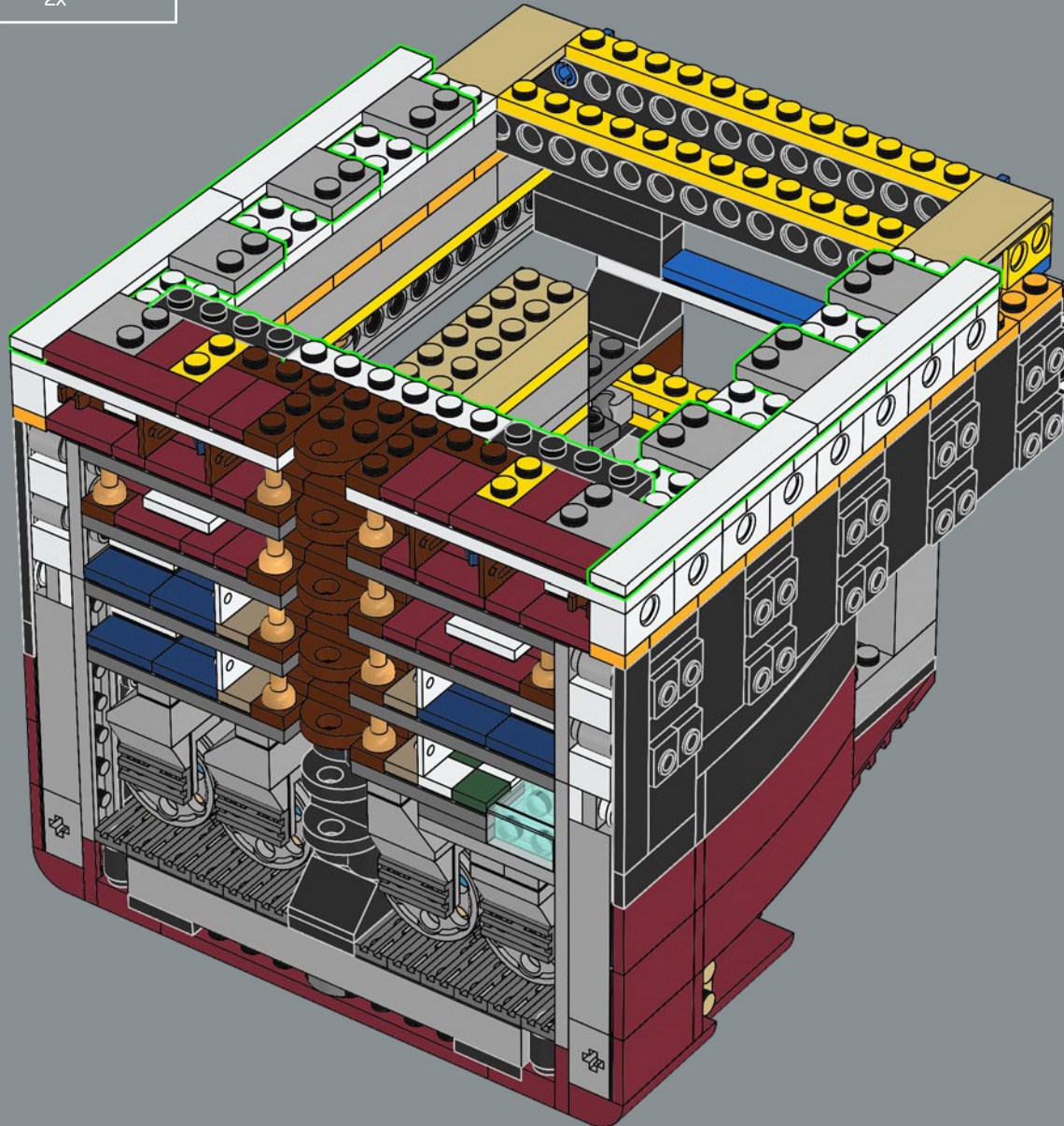

The RMS in RMS *Titanic* stands for Royal Mail Ship and she carried a large amount of cargo for both the Royal Mail and the US Postal Service.

Le RMS *Titanic* transporte une grande quantité de marchandises pour la Royal Mail et le service postal américain, d'où les initiales RMS pour « Royal Mail Ship » (« navire de la poste britannique »).

Las siglas RMS de RMS *Titanic* corresponden a *Royal Mail Ship* ("Buque de Royal Mail"); en este primer viaje, el barco transportaba un gran cargamento de correo para la empresa Royal Mail británica y también para USPS, el servicio postal de los Estados Unidos.

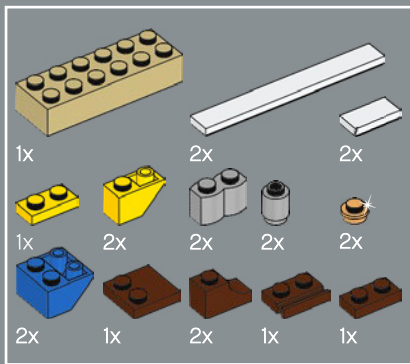

227

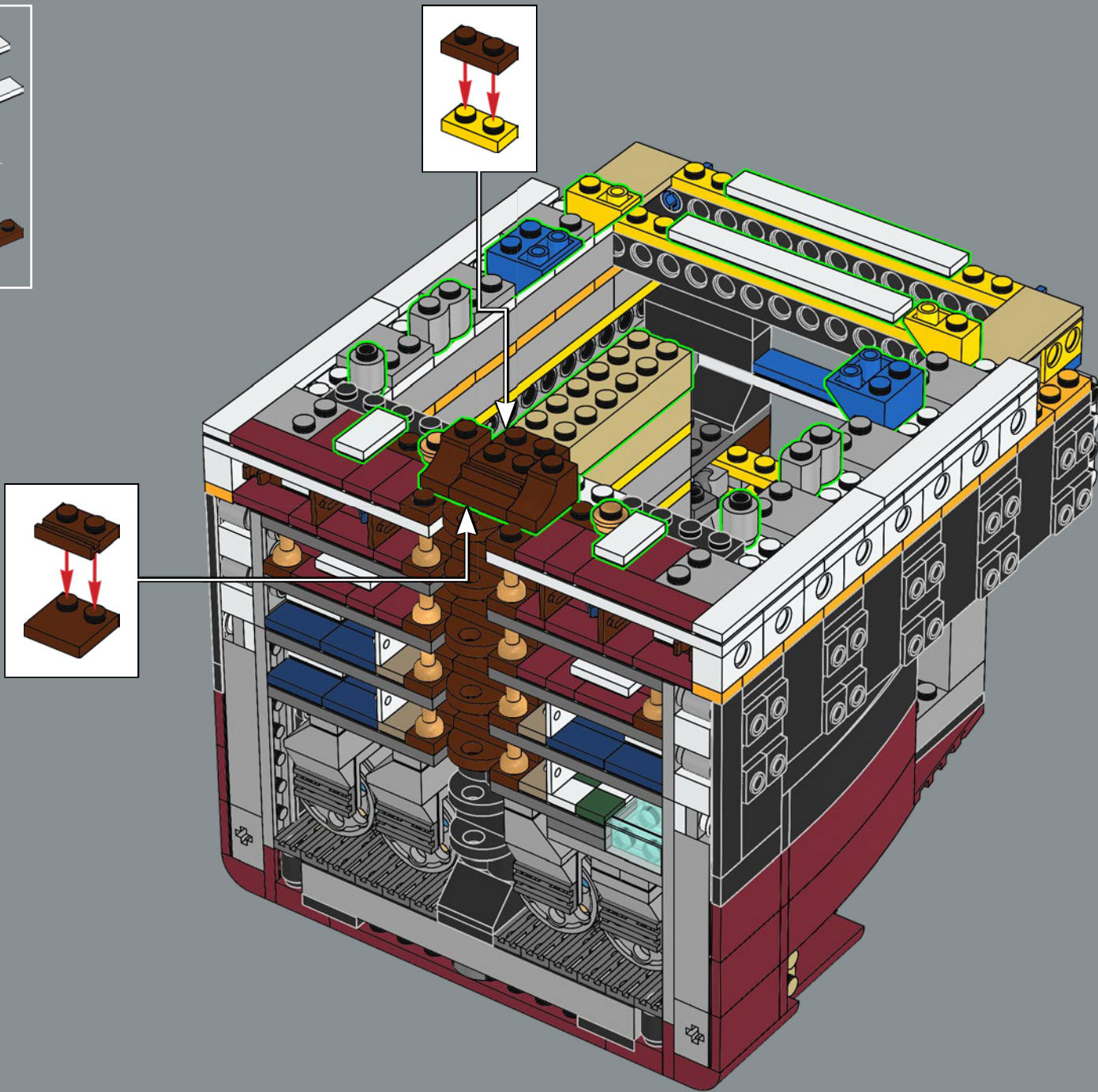

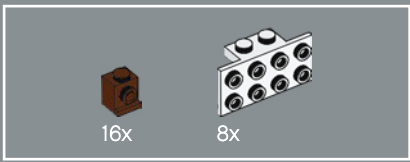

228

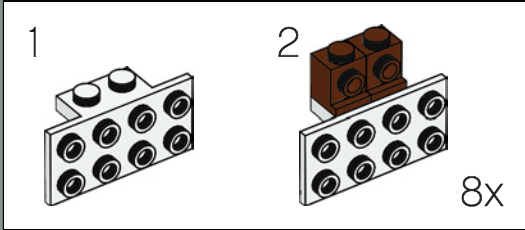
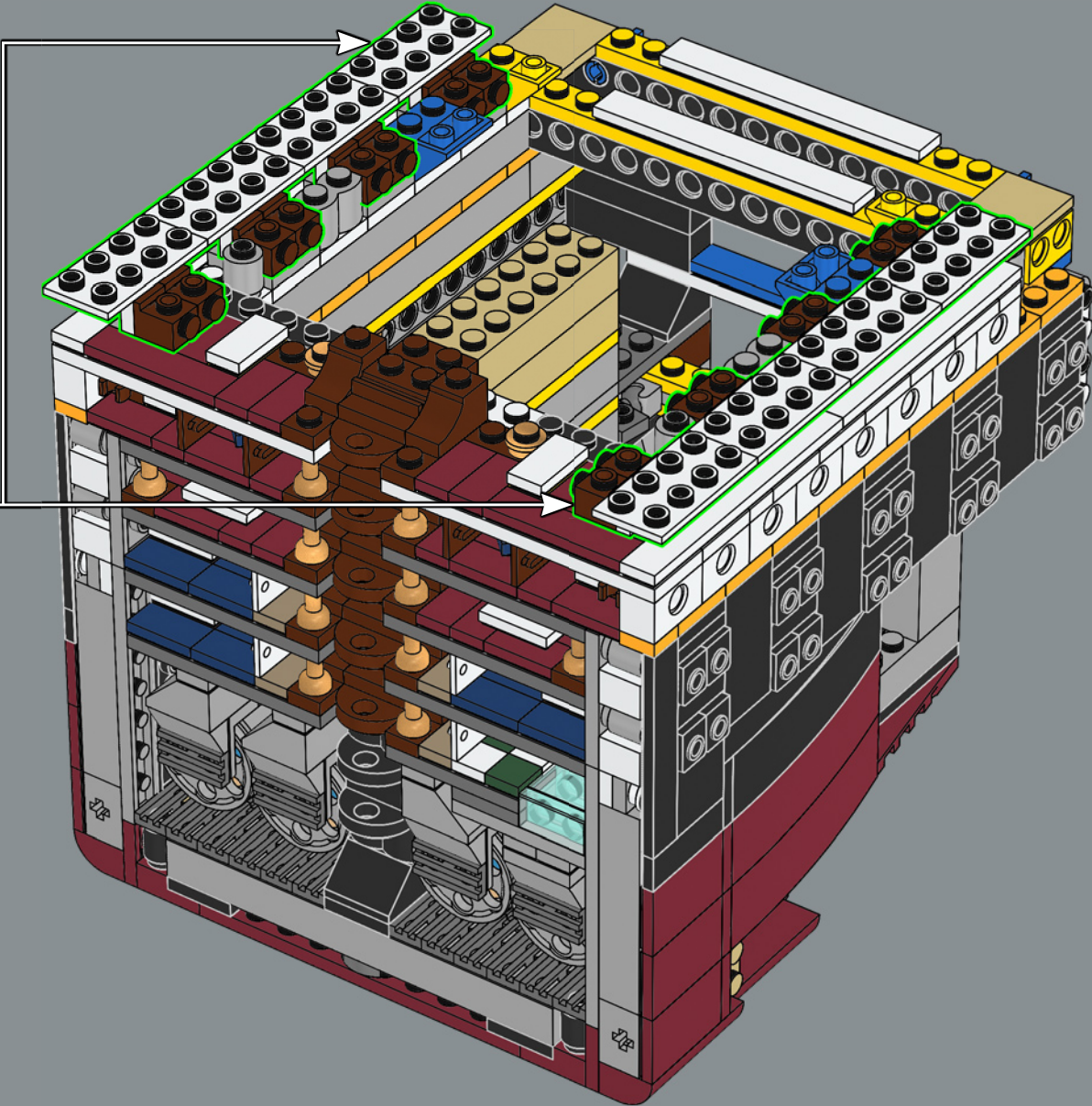



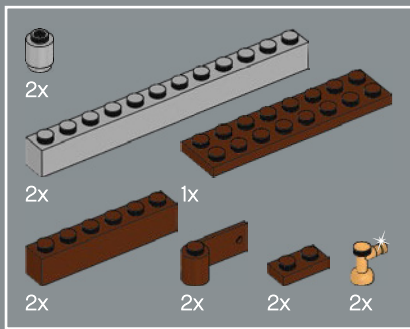

229

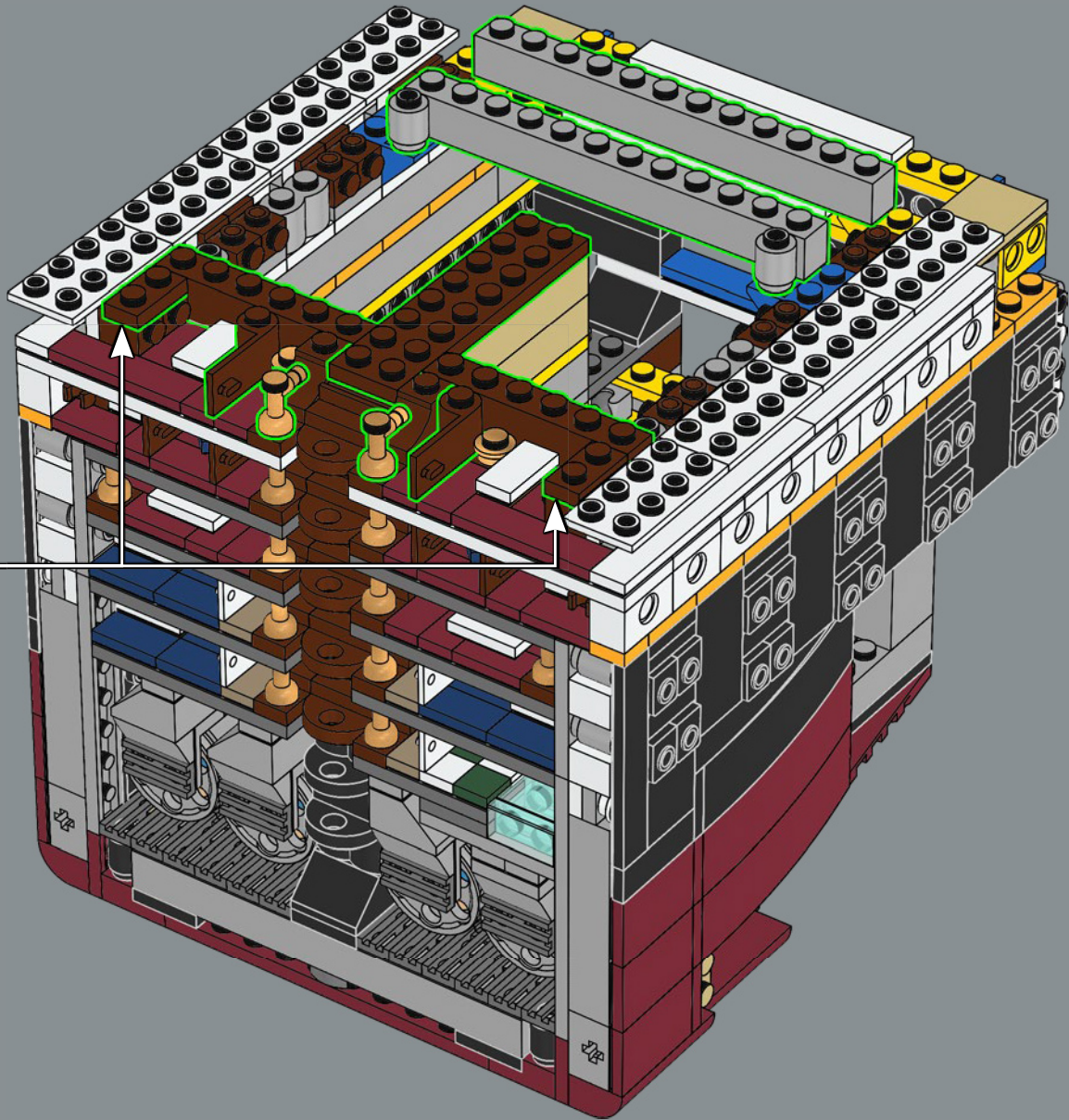

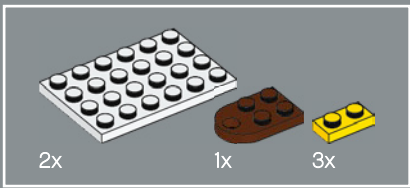

230

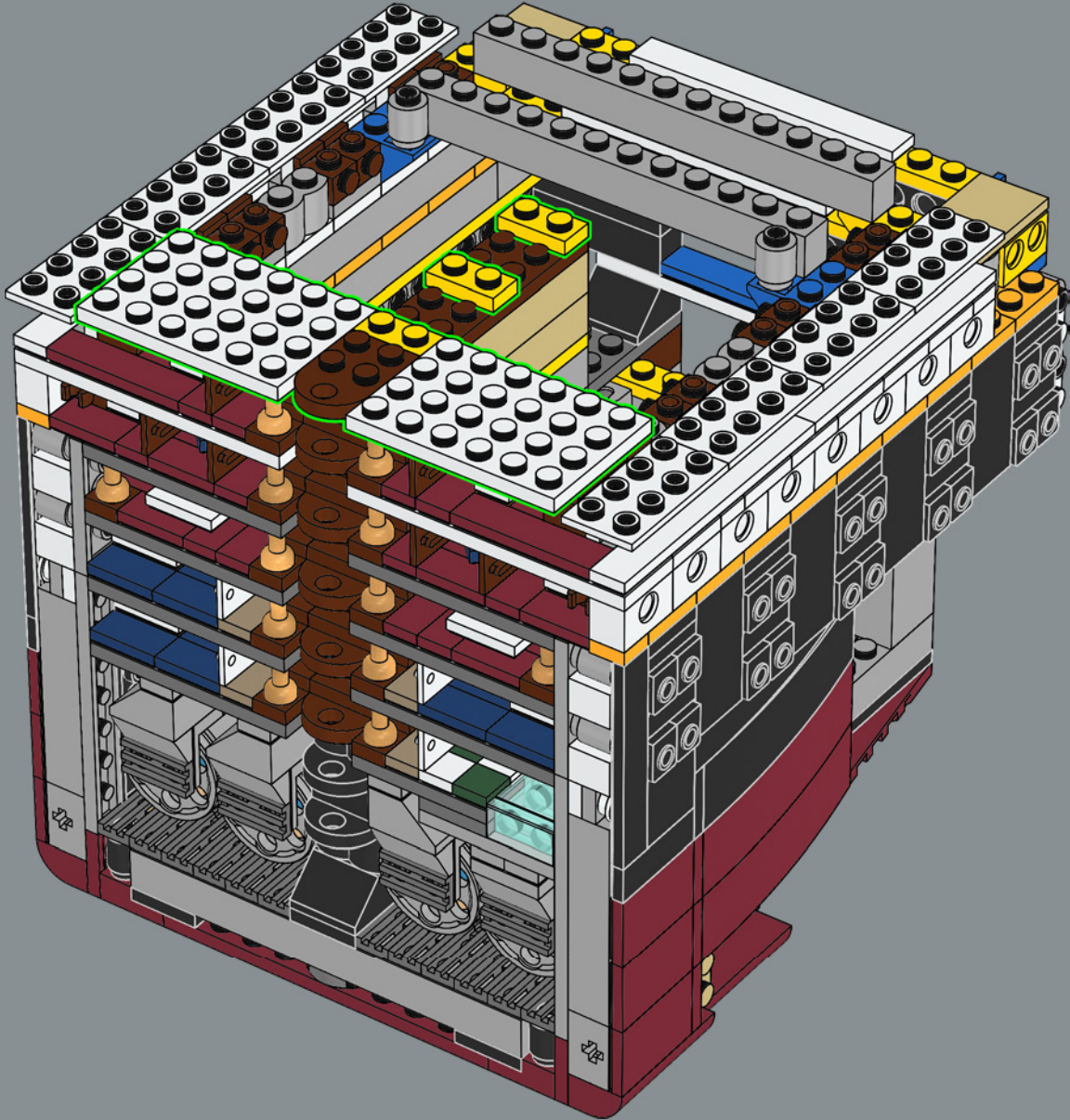

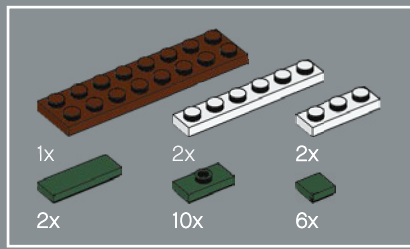

231

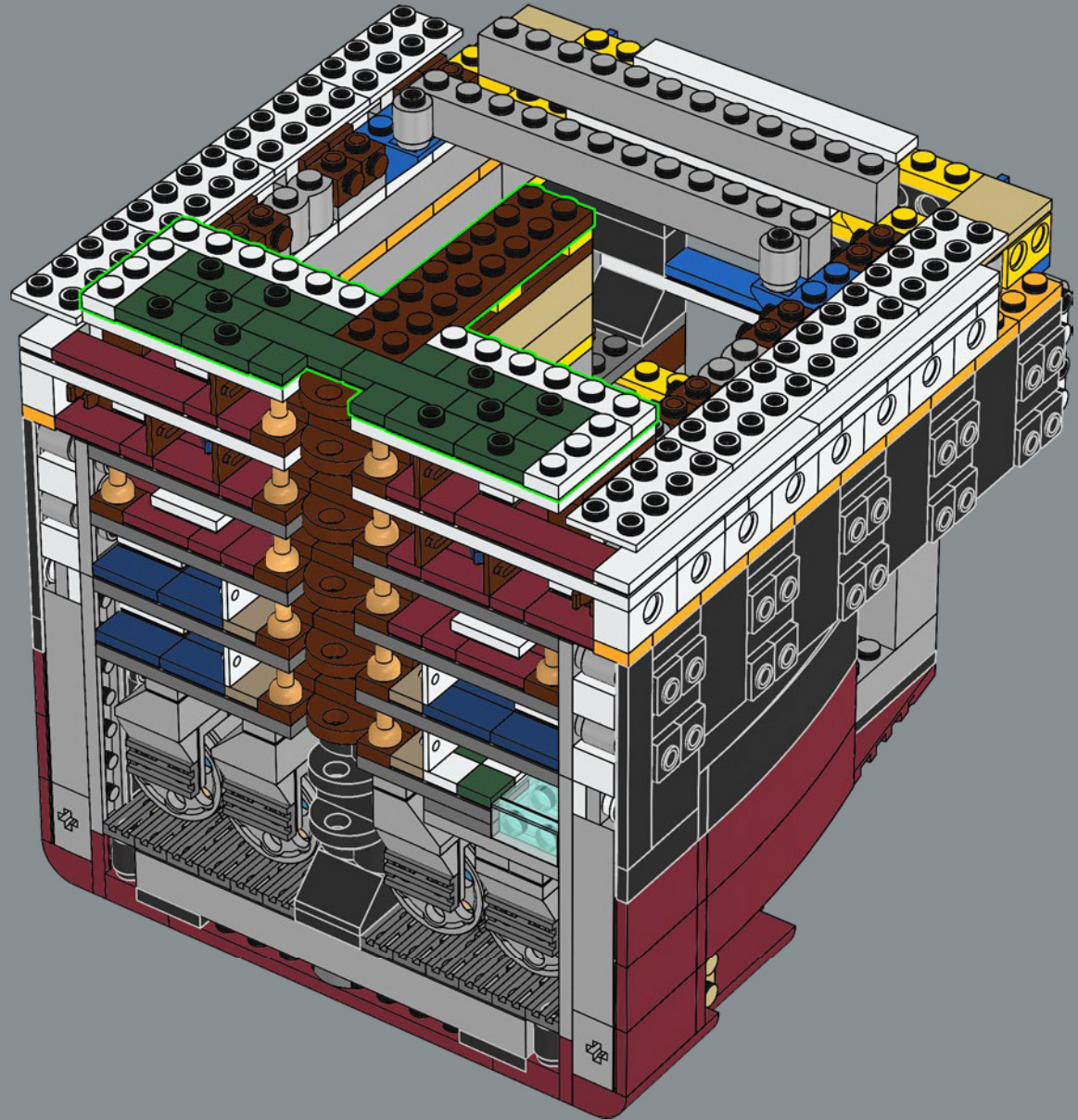

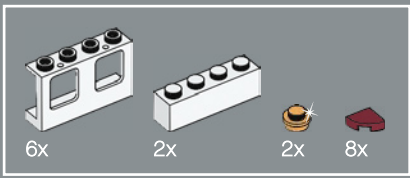

232

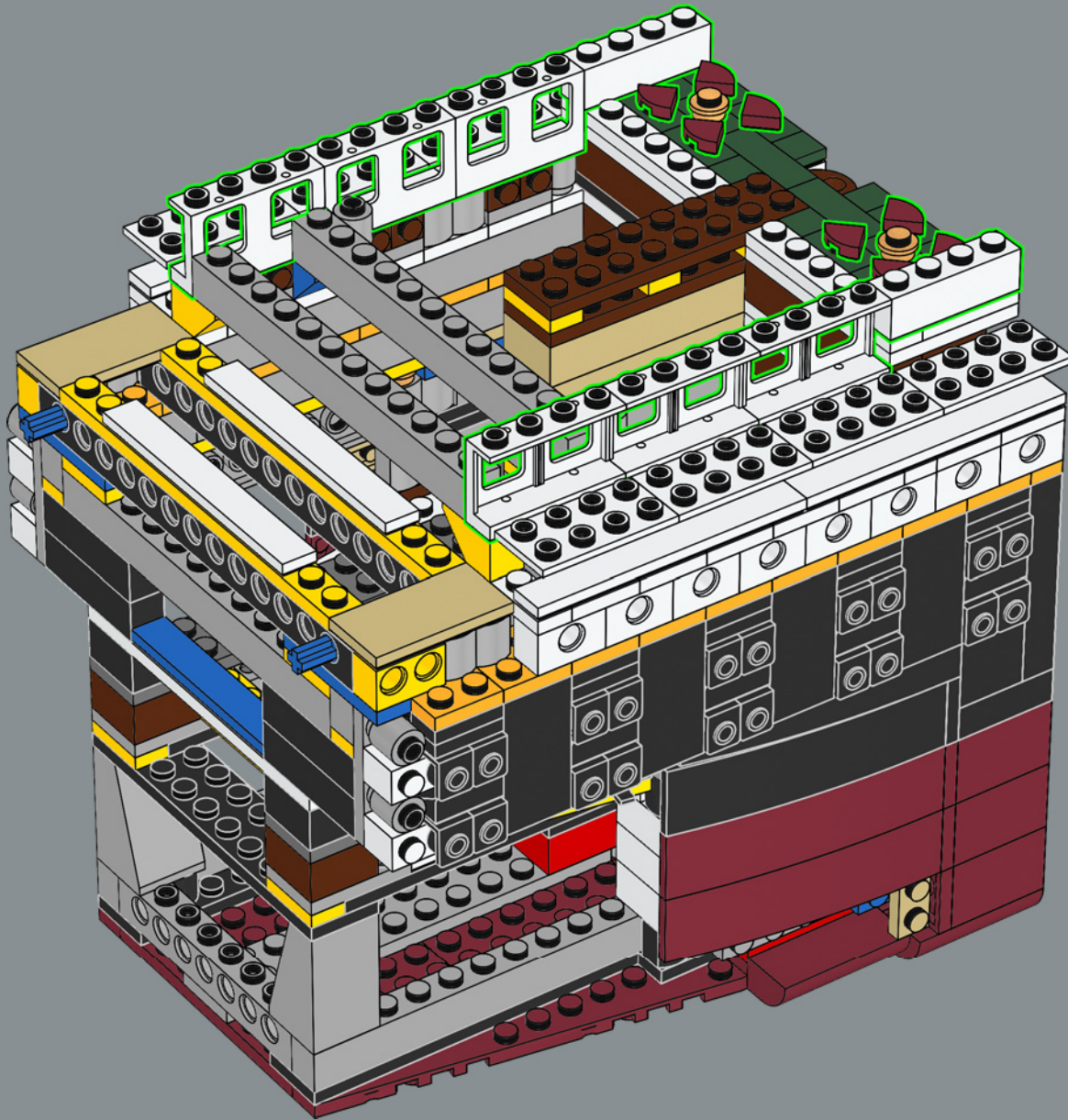

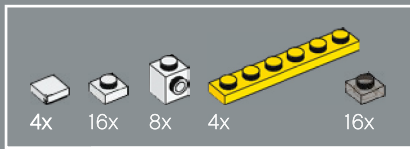

233

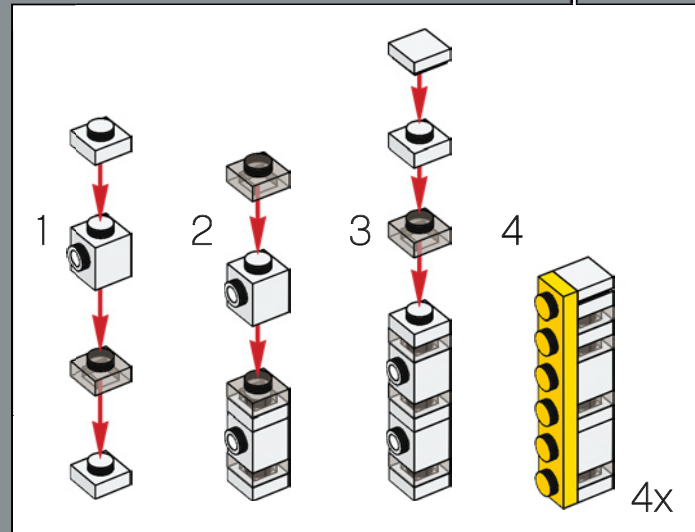
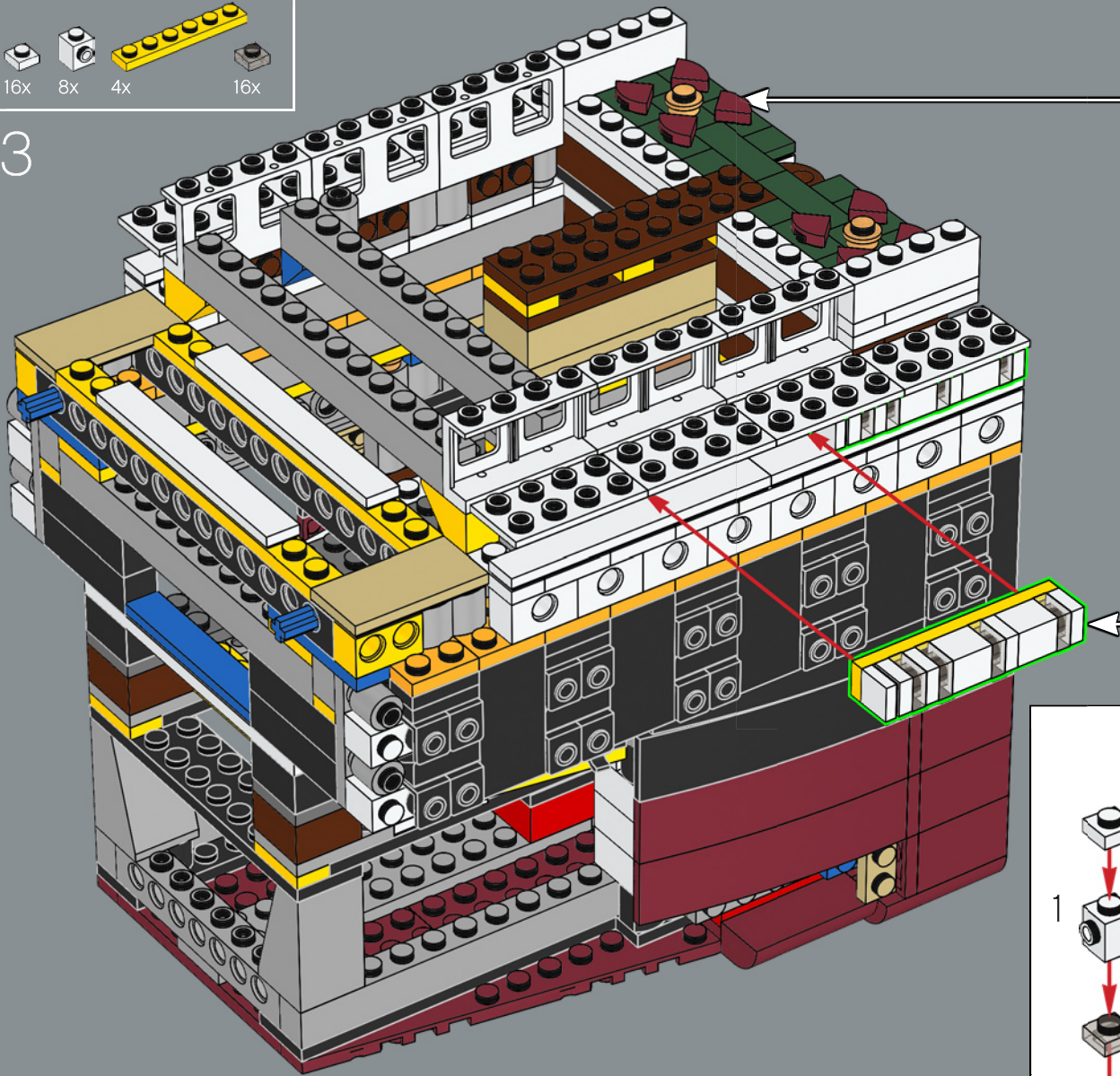

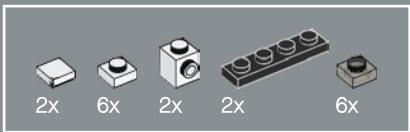

234

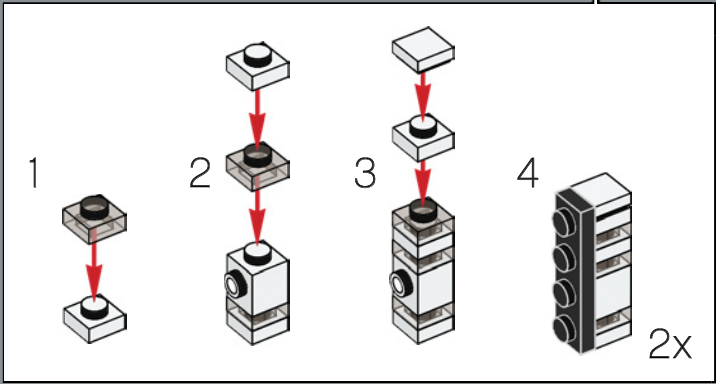
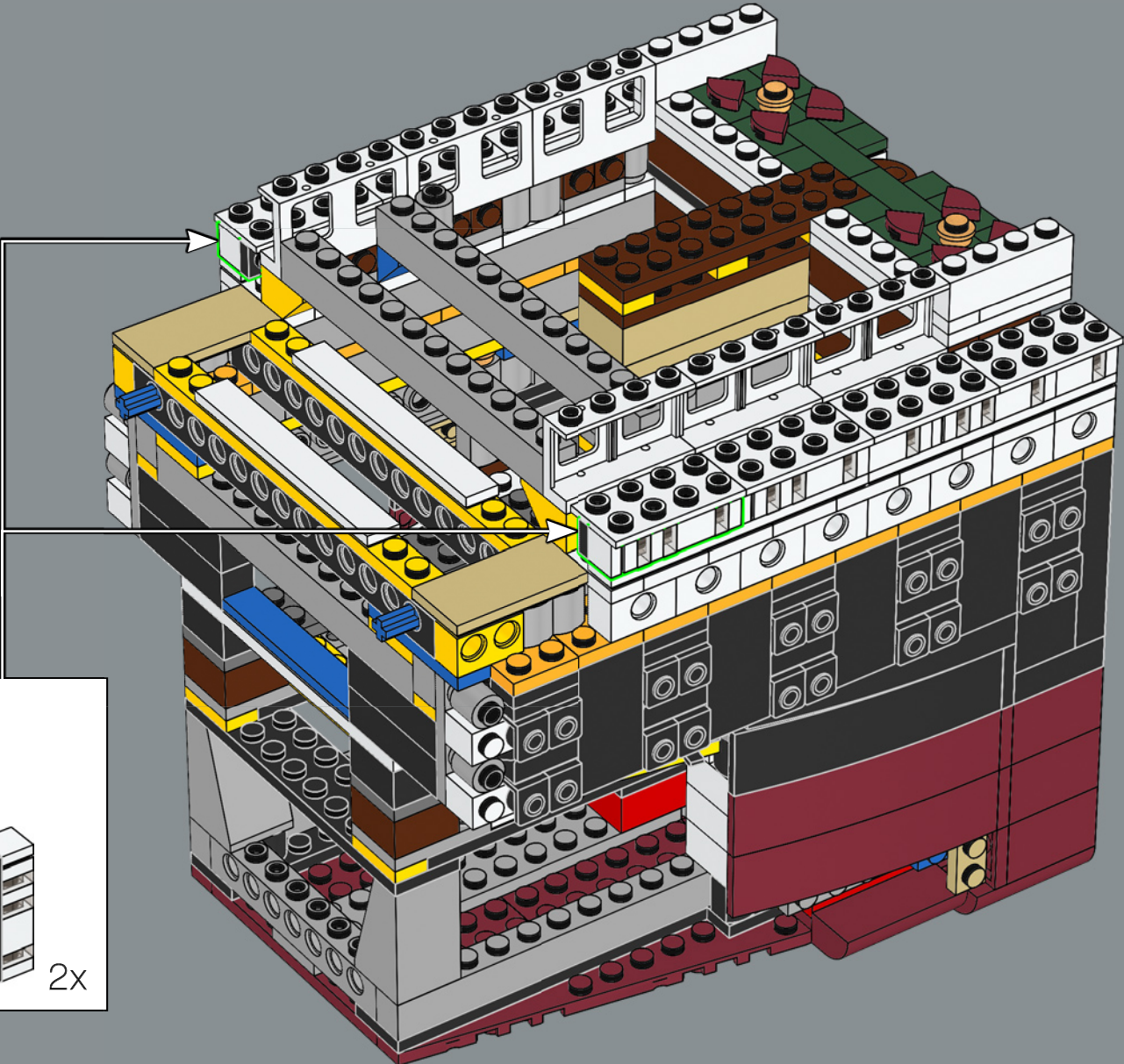

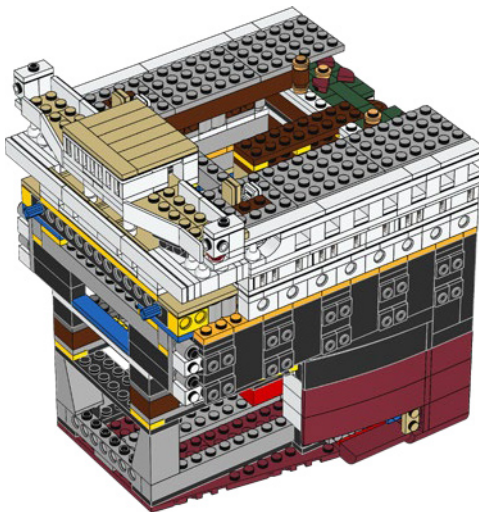
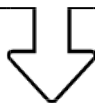

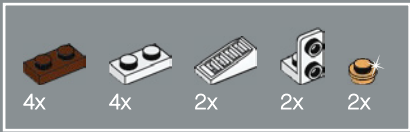

235

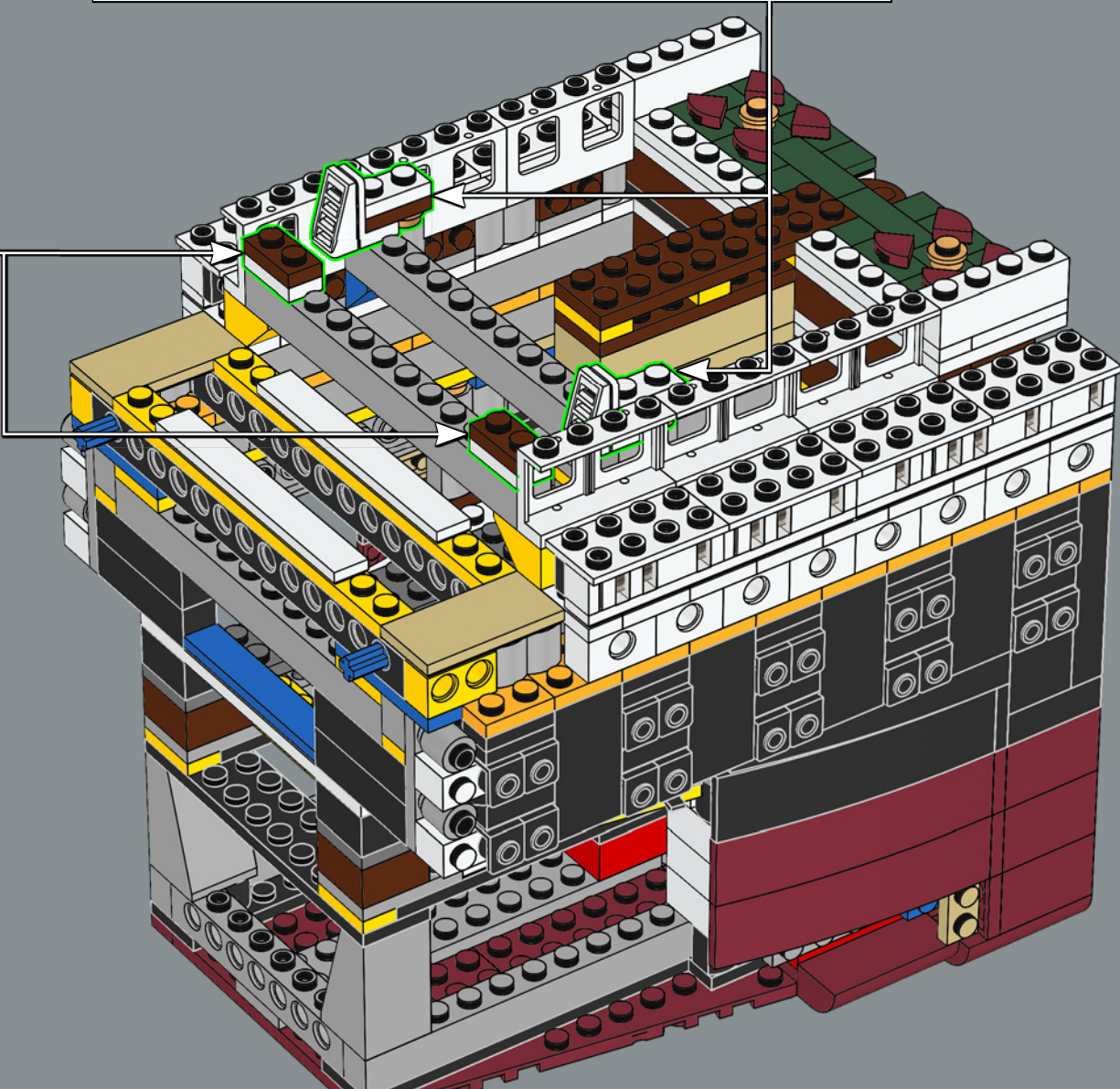
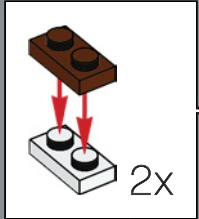
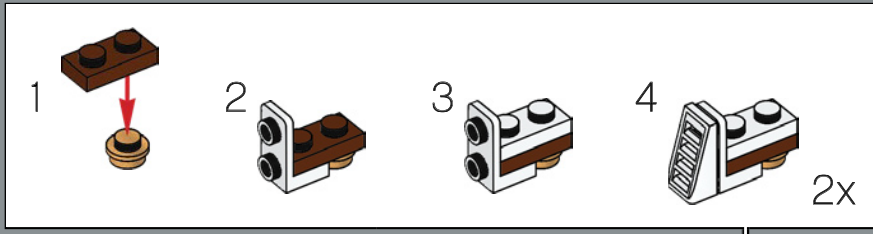



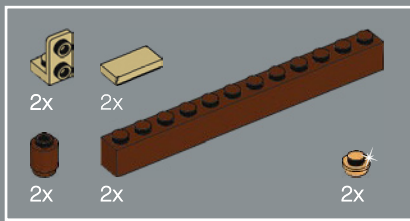

236

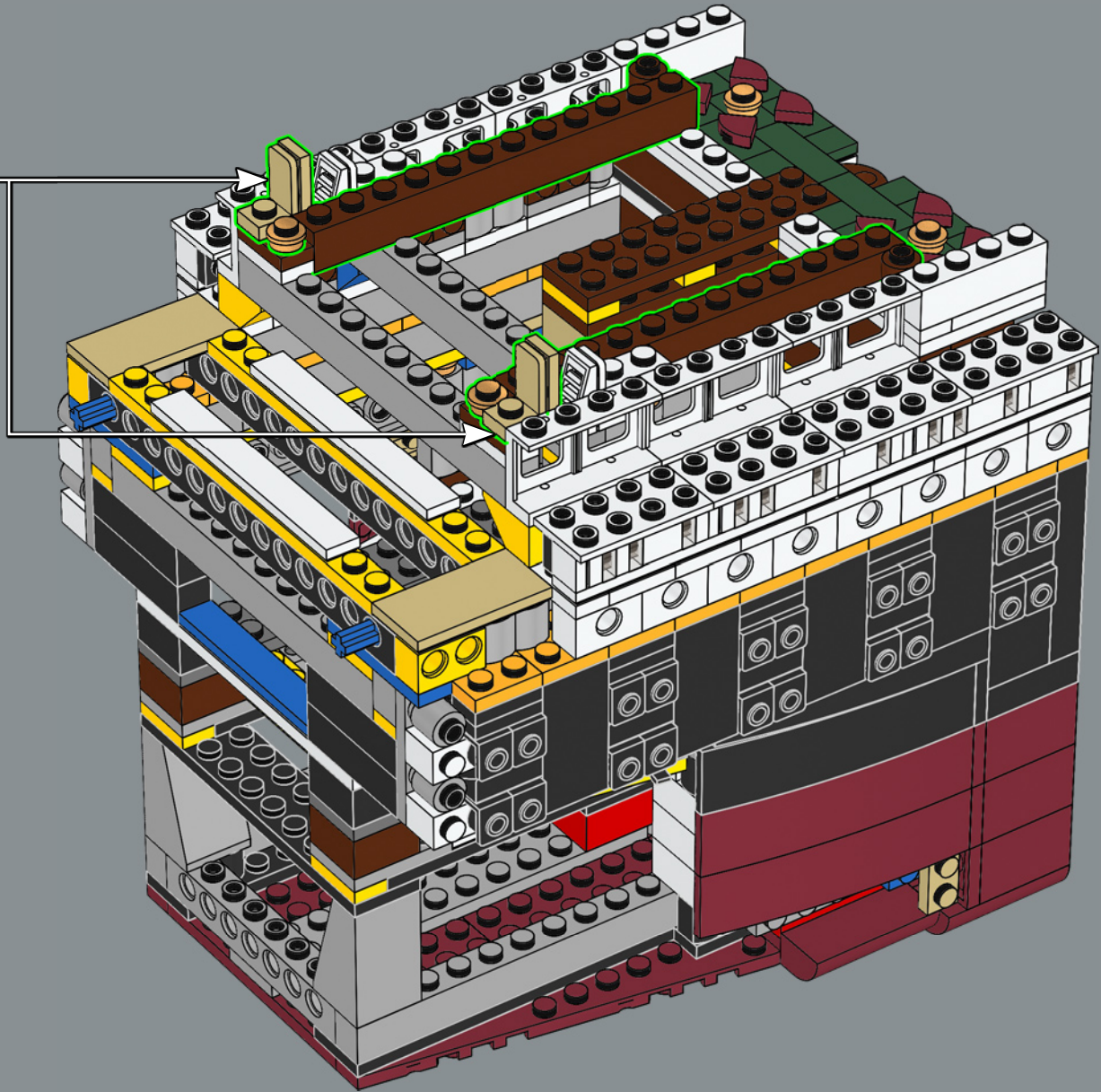
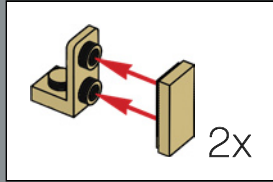

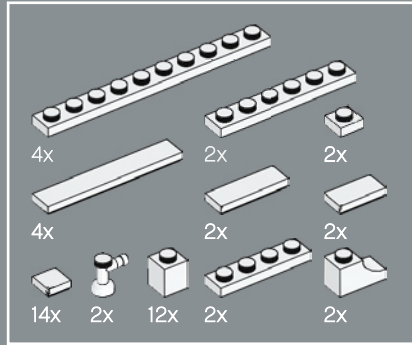
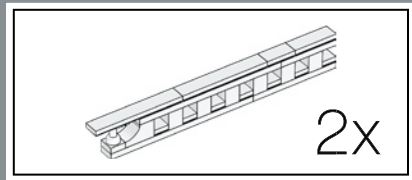

237

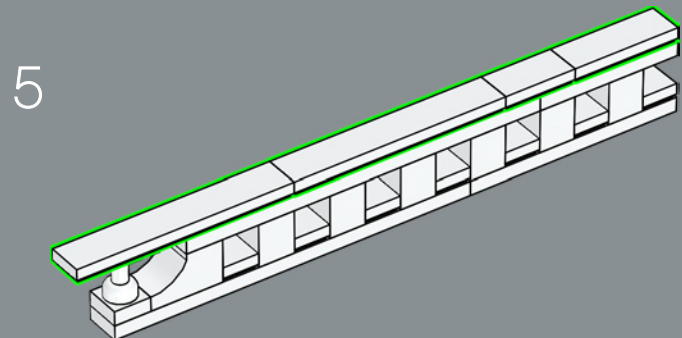
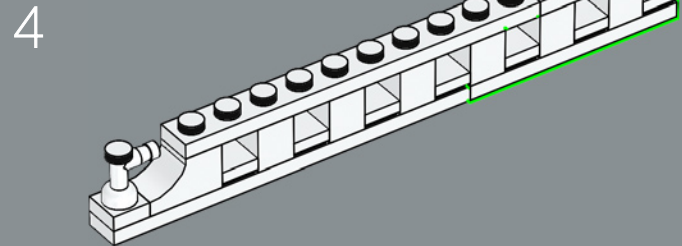
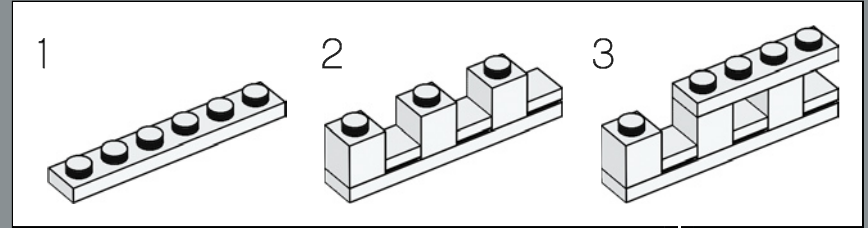
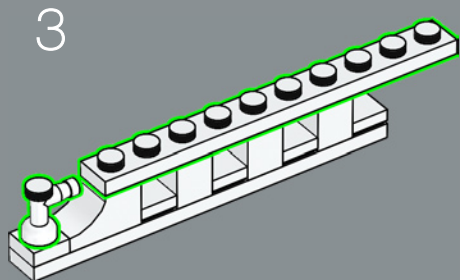
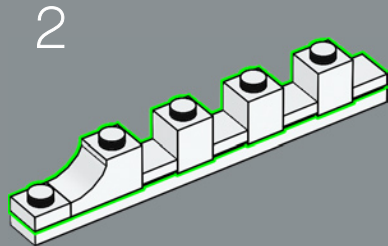
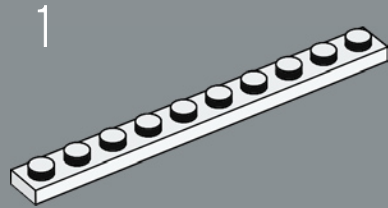

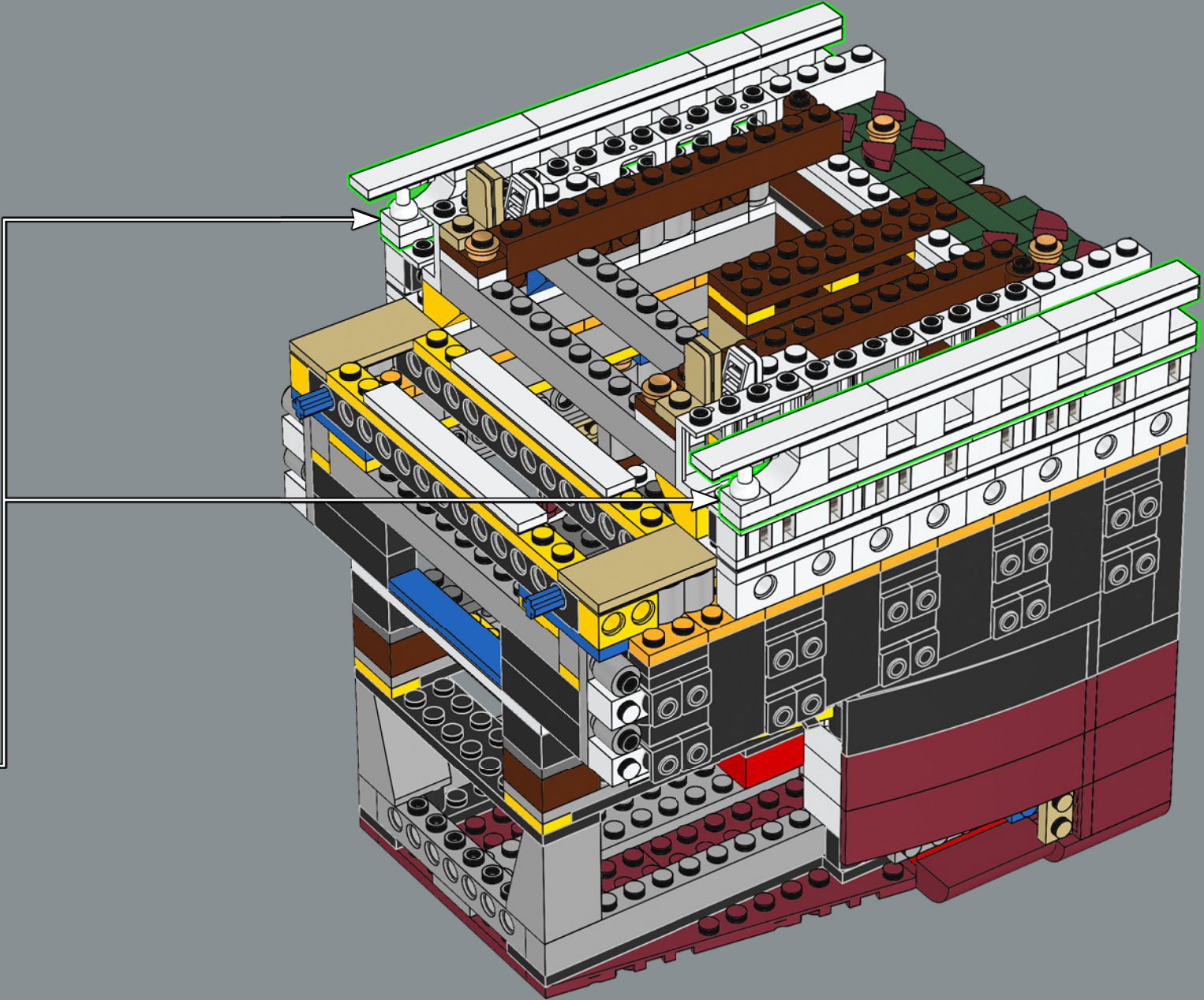

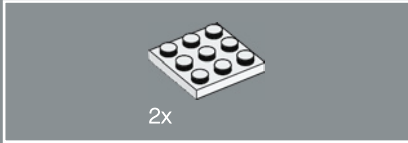
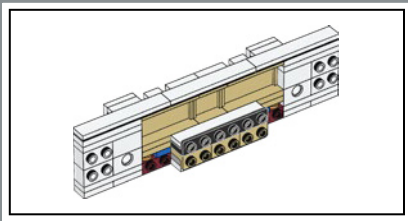

238

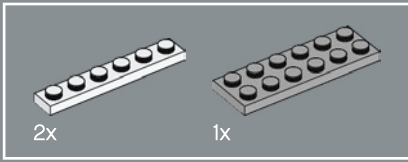
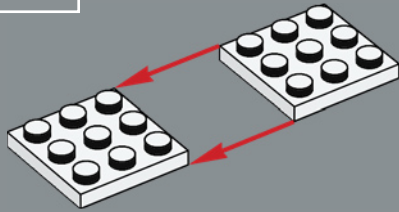

239

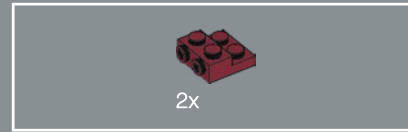
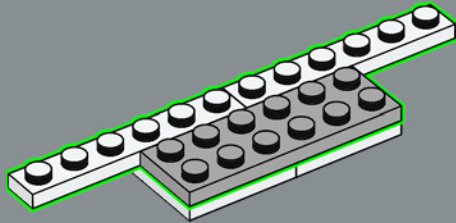

240

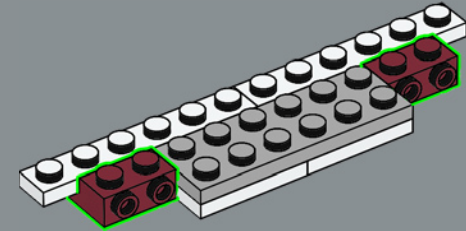

241

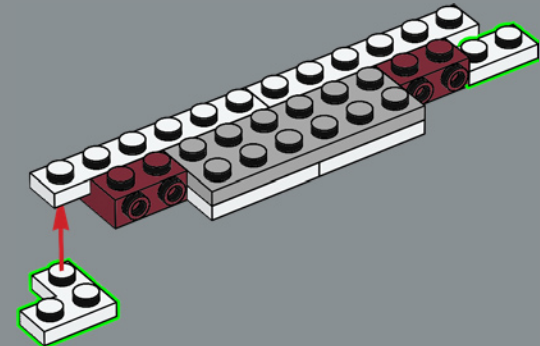

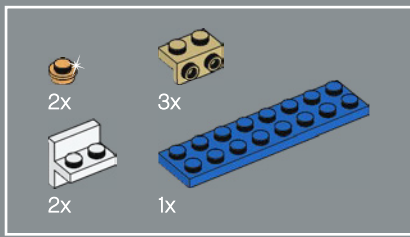

242

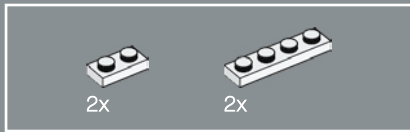
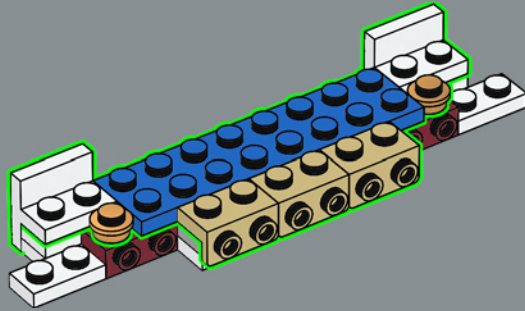

243

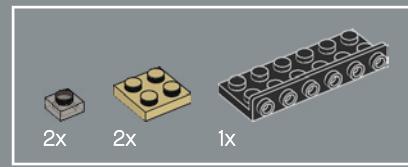
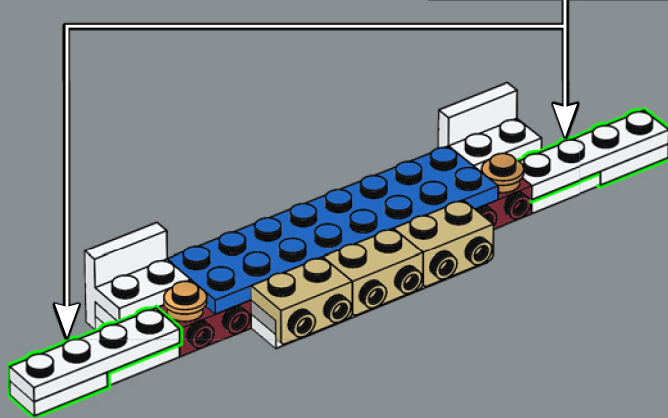
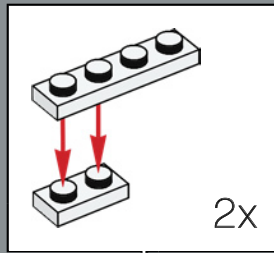

244

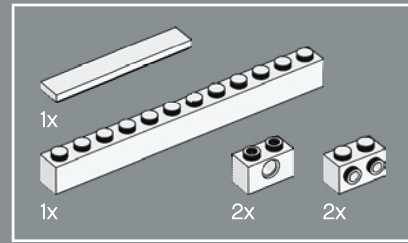
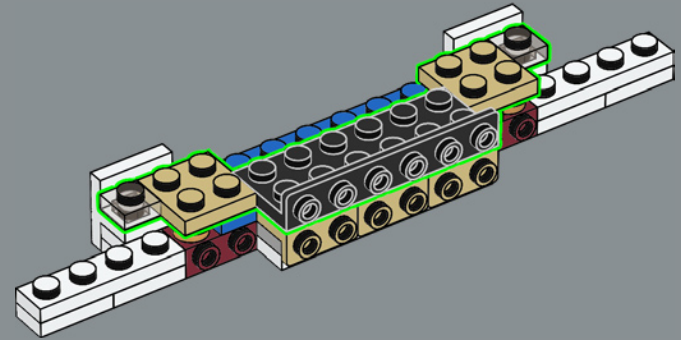

245

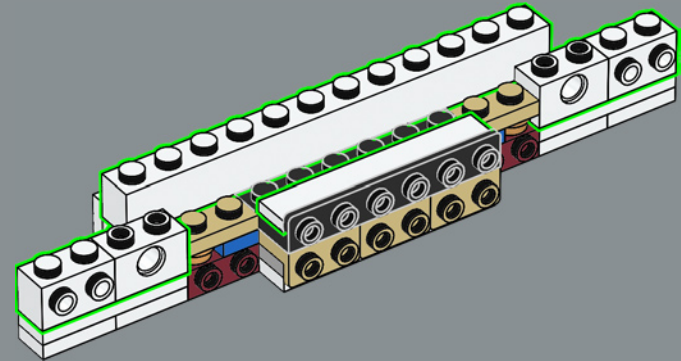

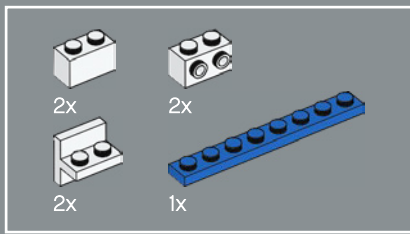

246

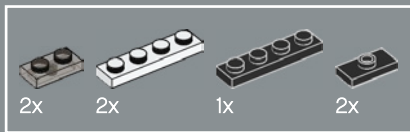
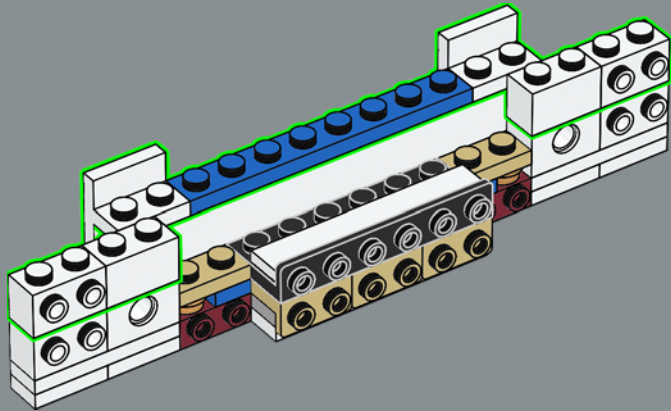

247

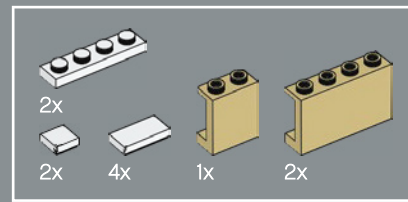
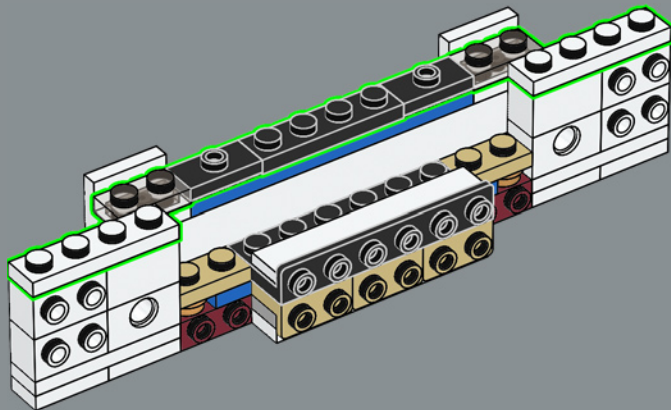

248

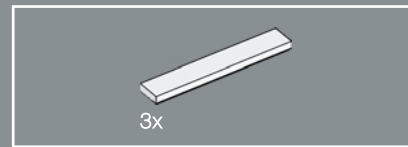
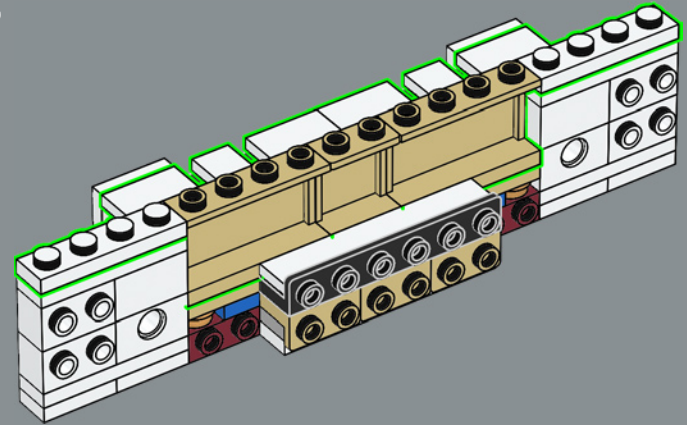

249

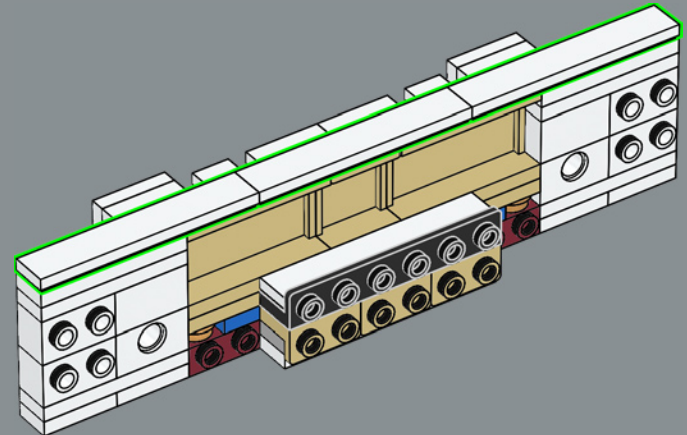

250

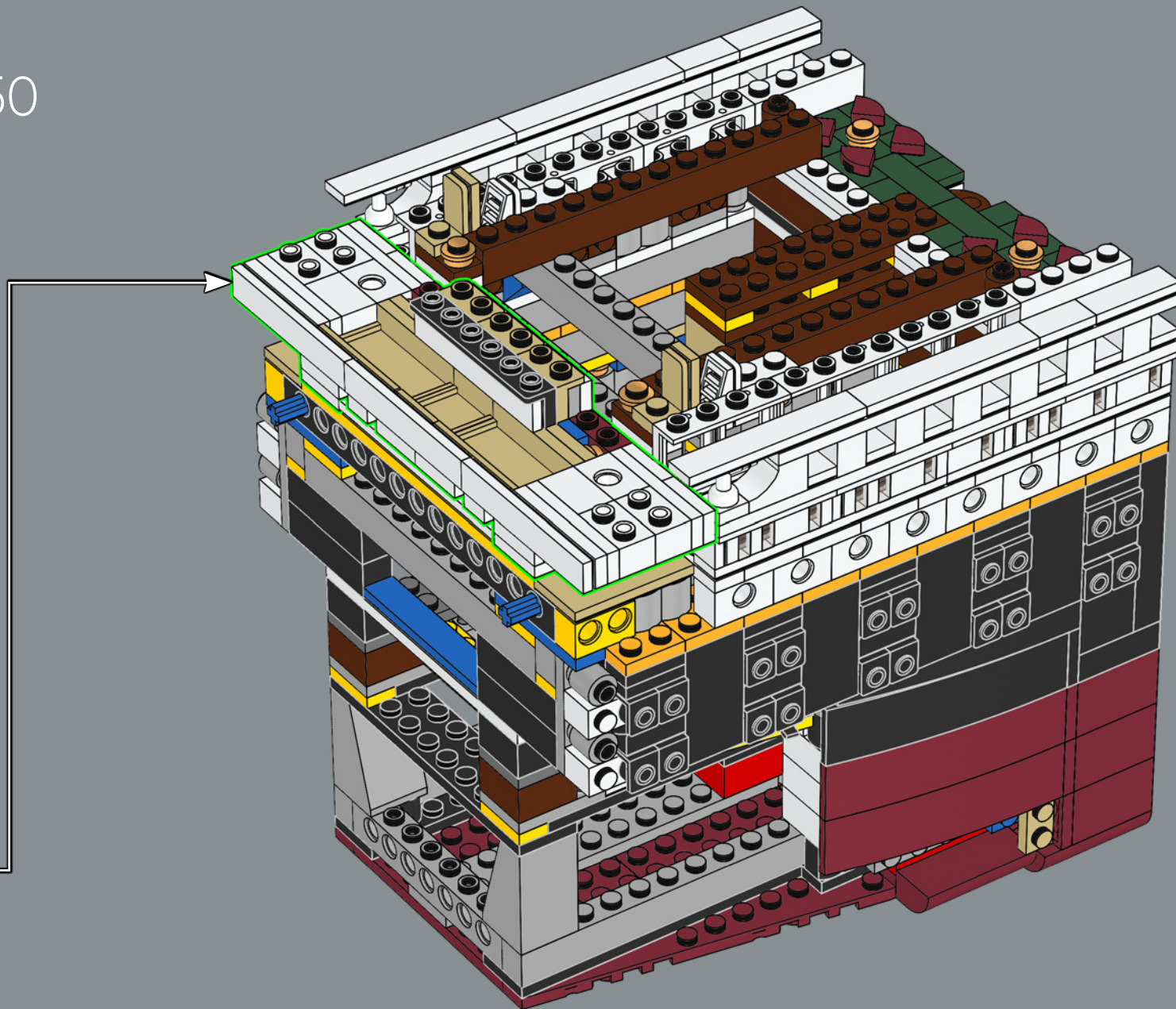

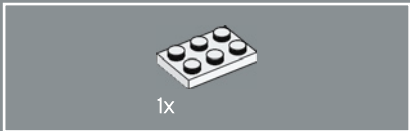
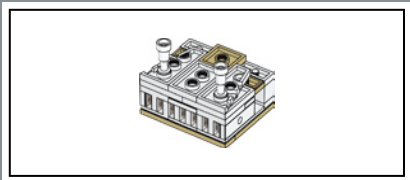

251

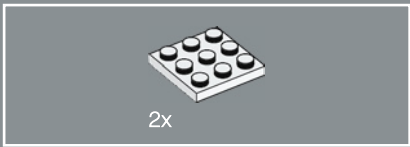

252

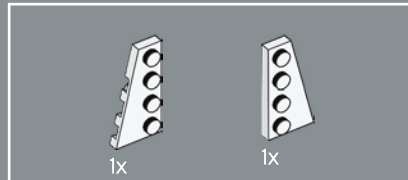
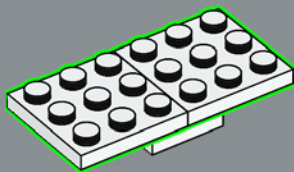

253

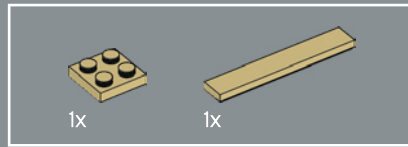
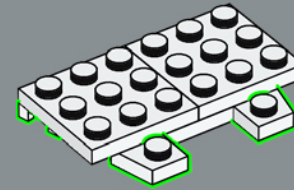

254

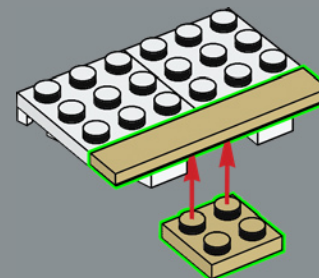



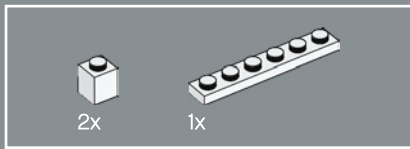

255

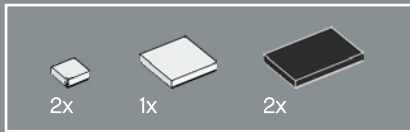
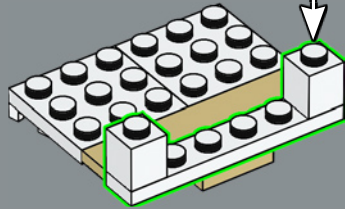
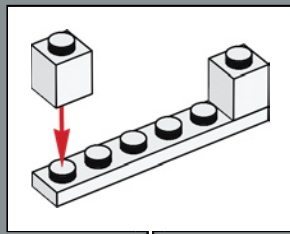

256

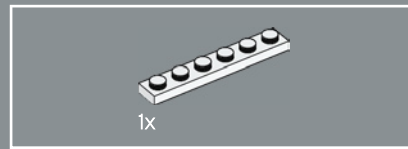
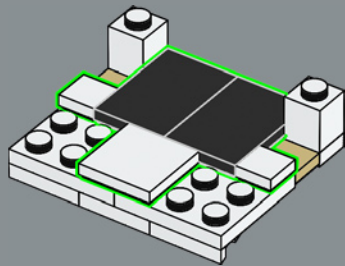

257

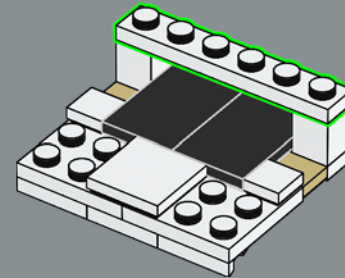



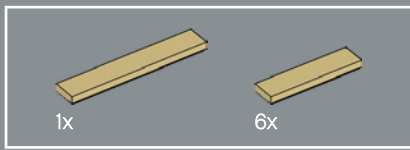

259

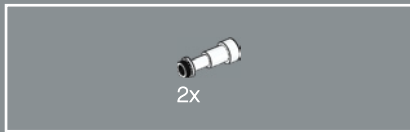
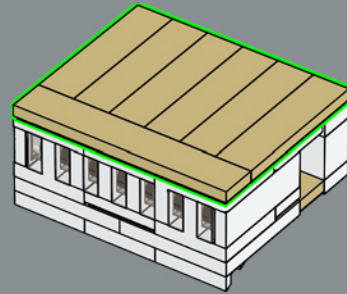

260

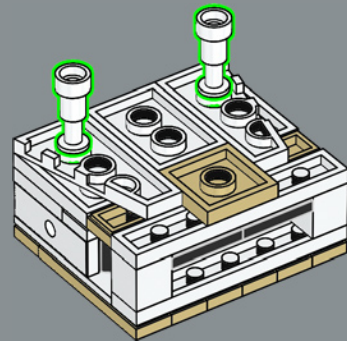

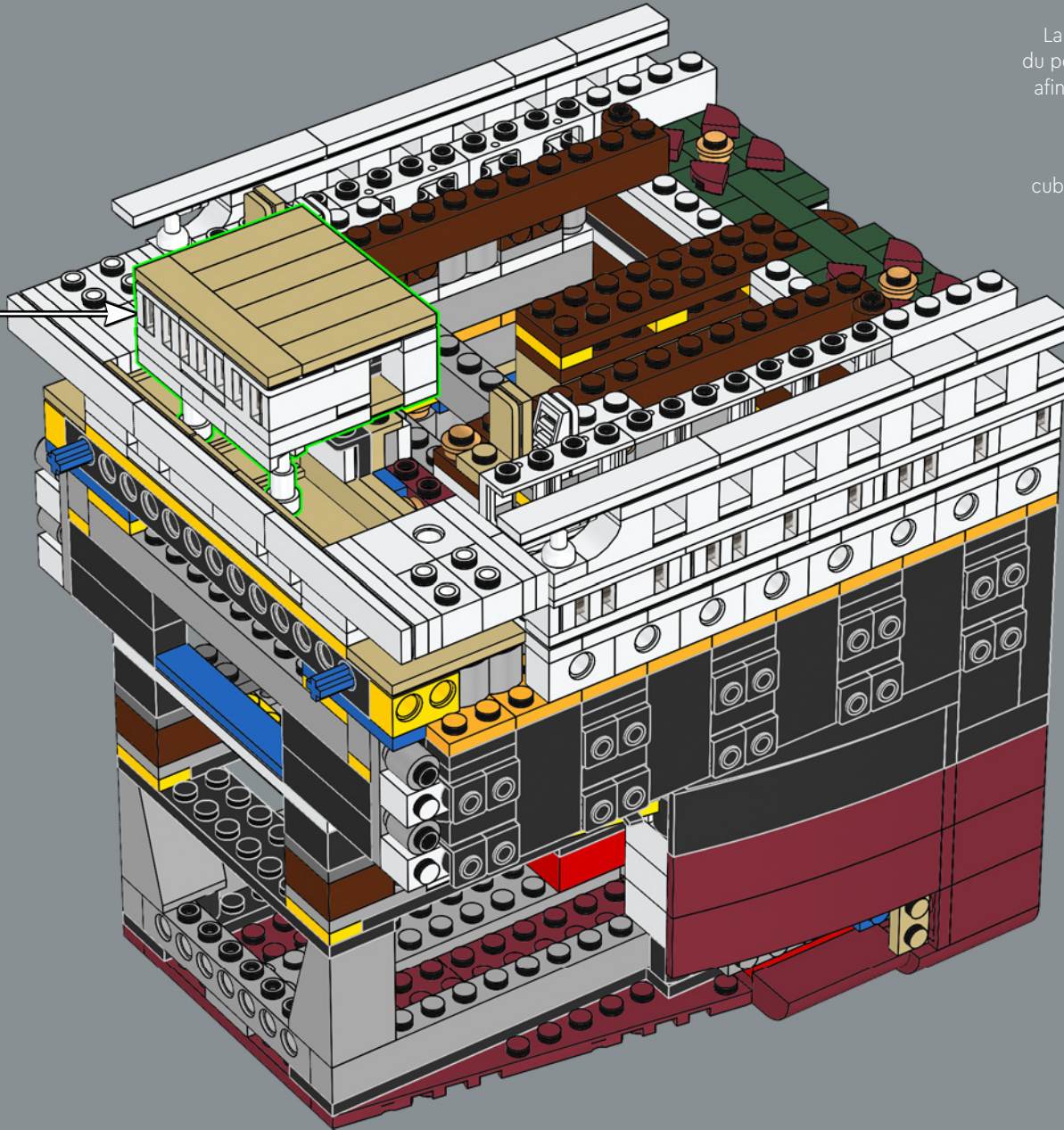

The bridge stood 8 ft. (2.4 meters) above the deck and extended out to either side so that the ship could be controlled while docking.

La passerelle se situe à 2,4 m (8 pi) au-dessus du pont et s'étend des deux côtés du paquebot afin de permettre de contrôler le navire durant la mise à quai.

El puente se alzaba 2,4 m por encima de la cubierta y sobresalía por cada lado para poder controlar el barco durante el atraque.



262

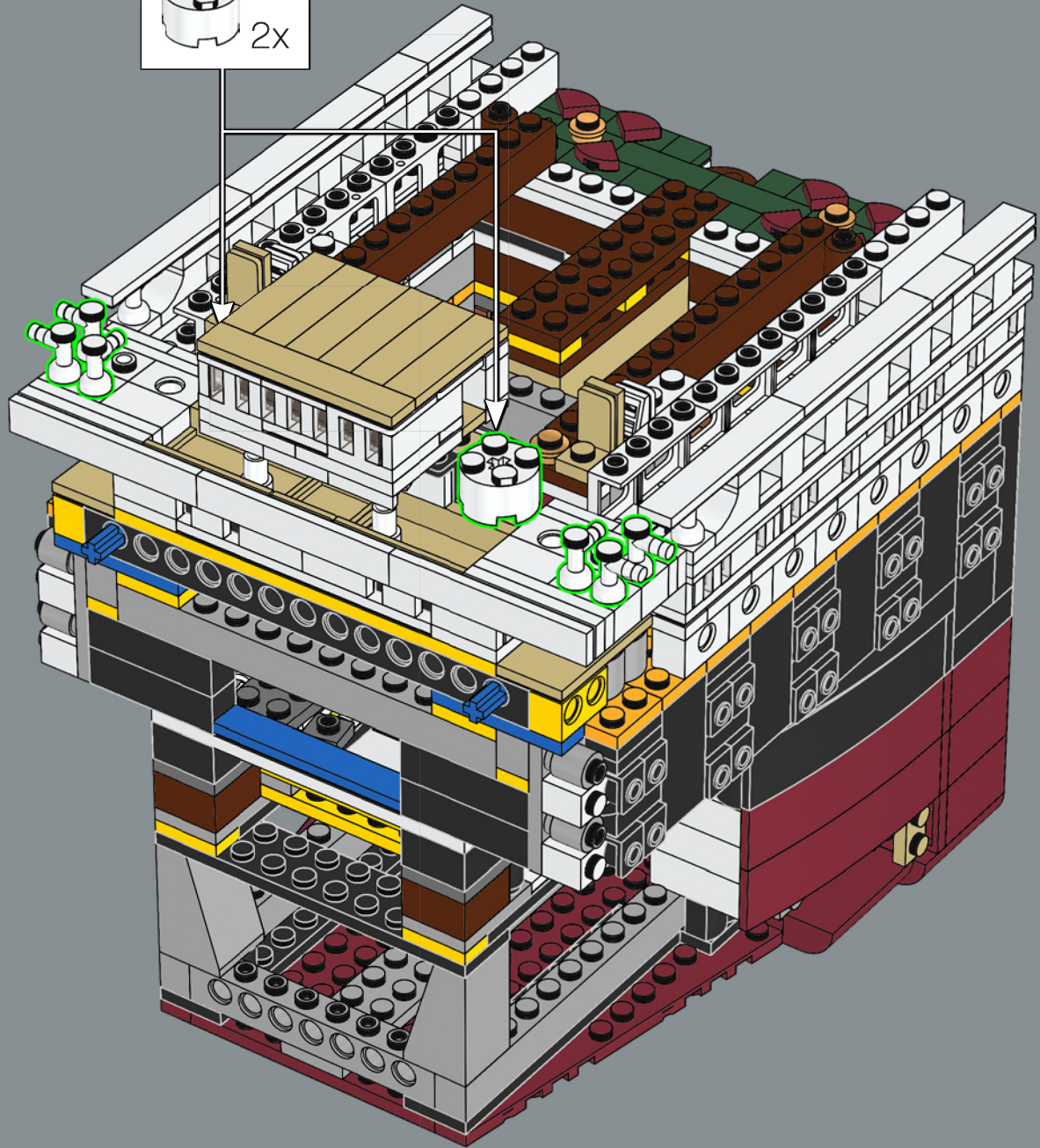
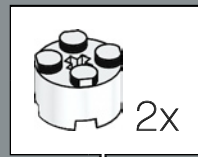

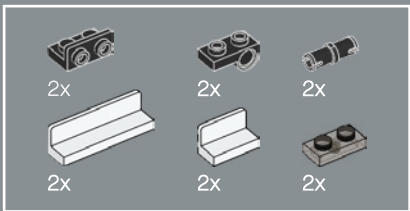

263

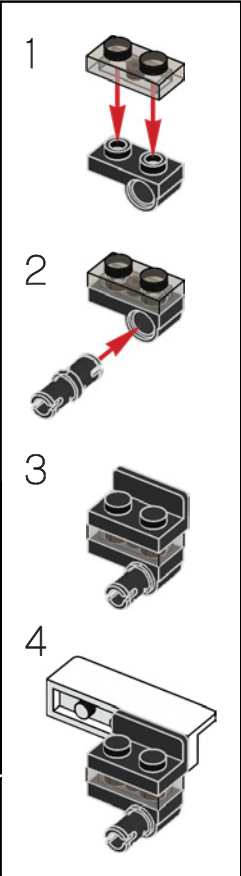
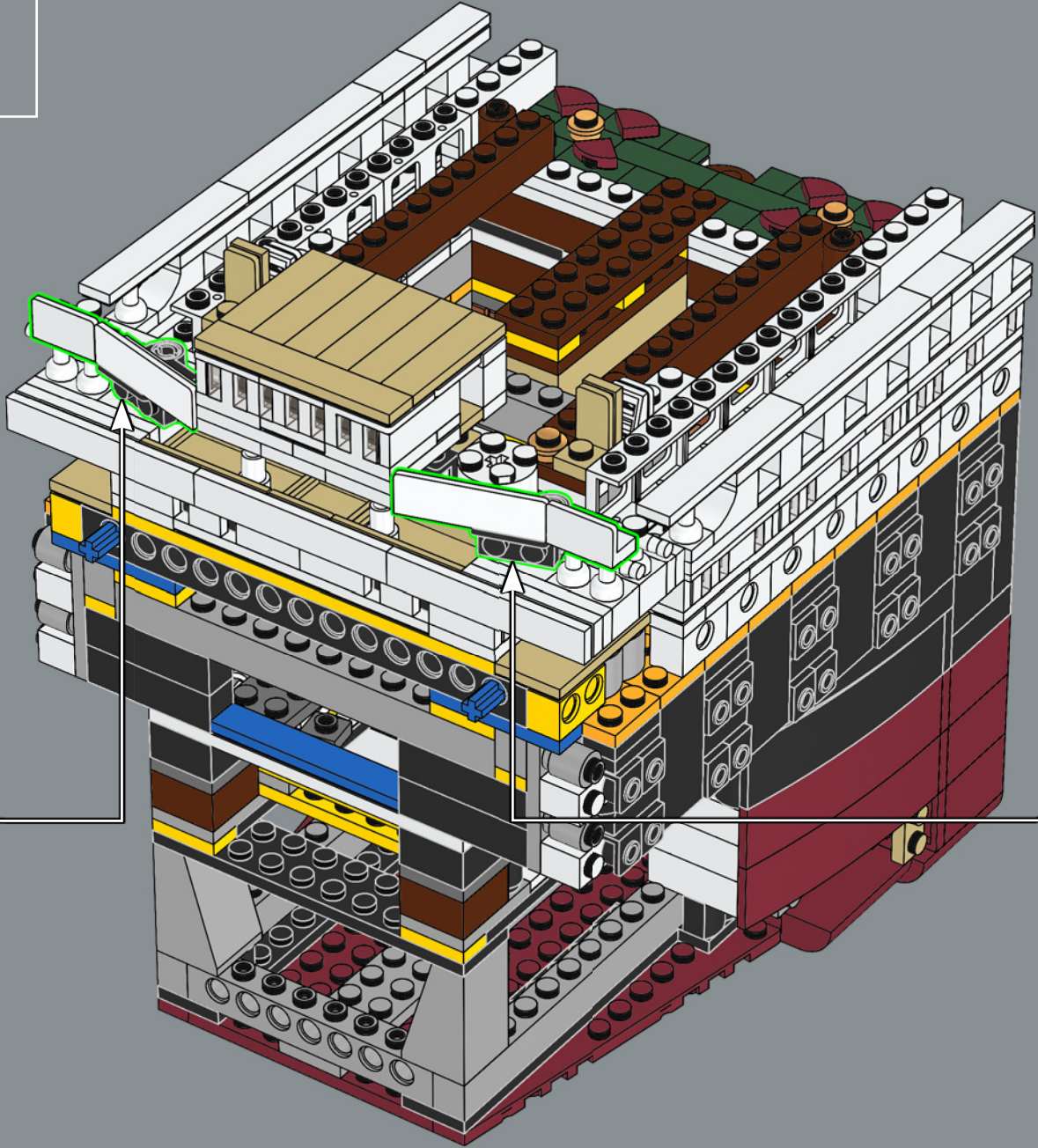
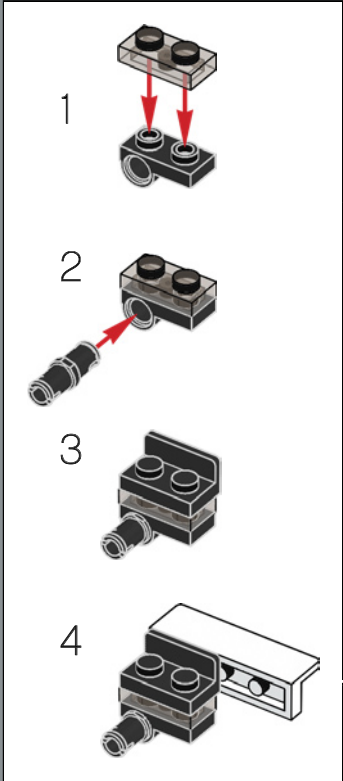

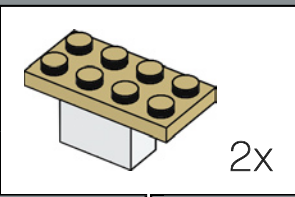
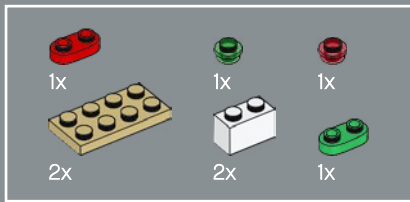

264

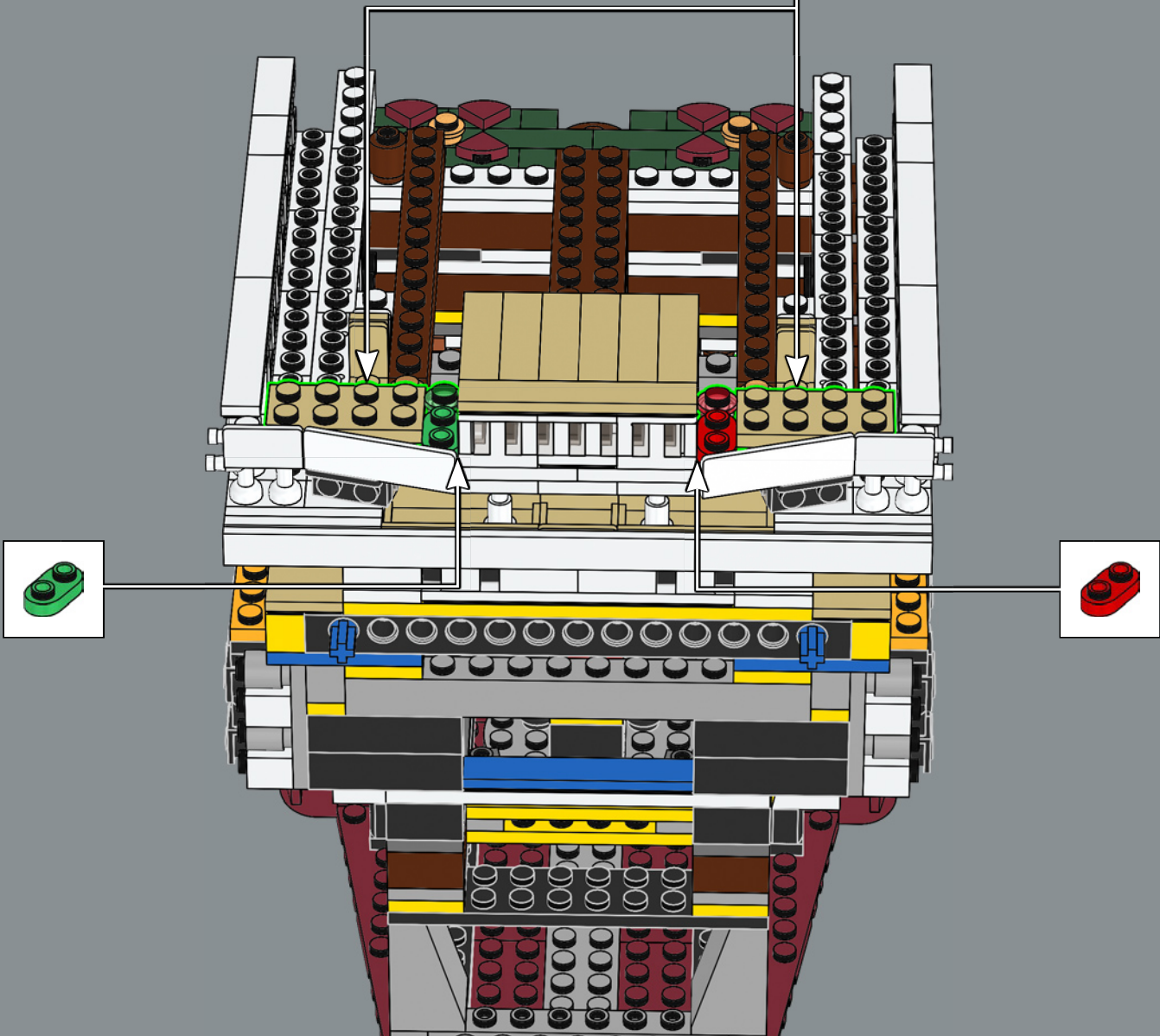

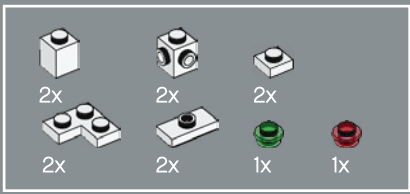

265

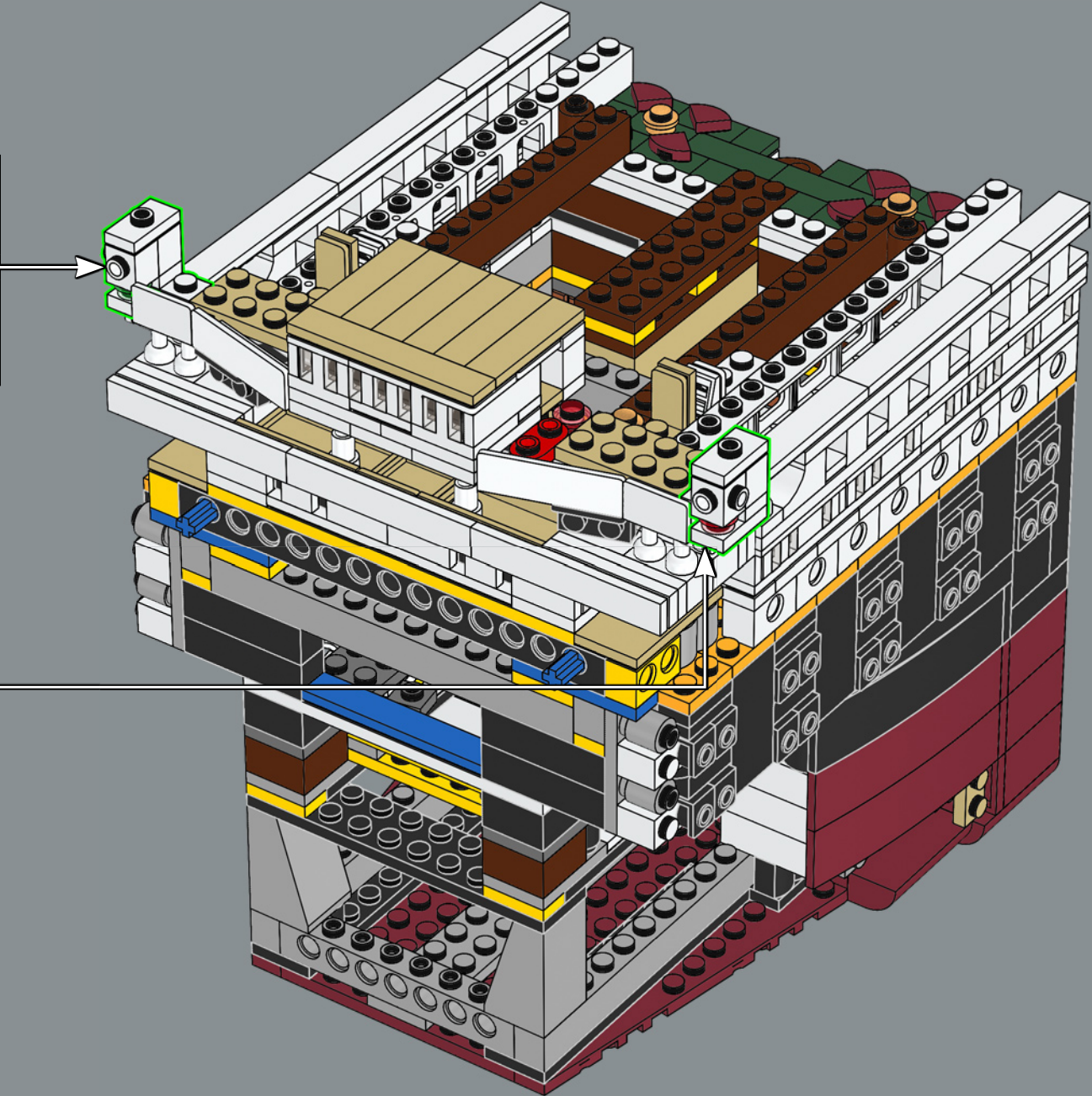
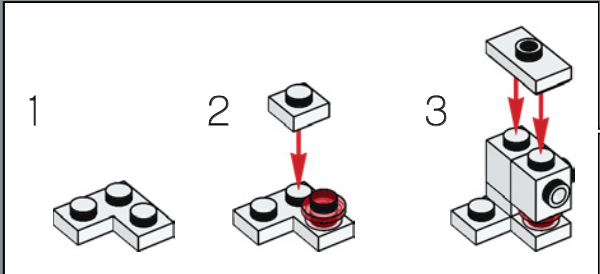
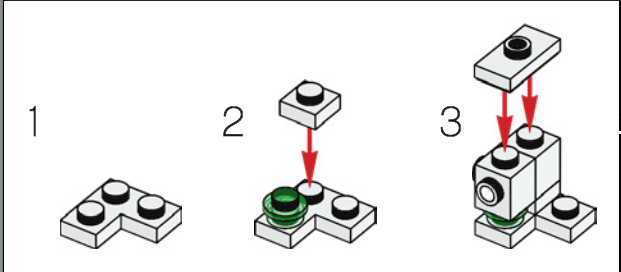



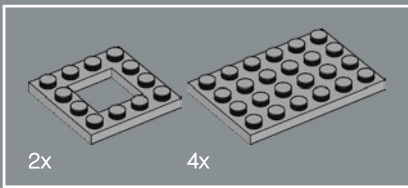

266

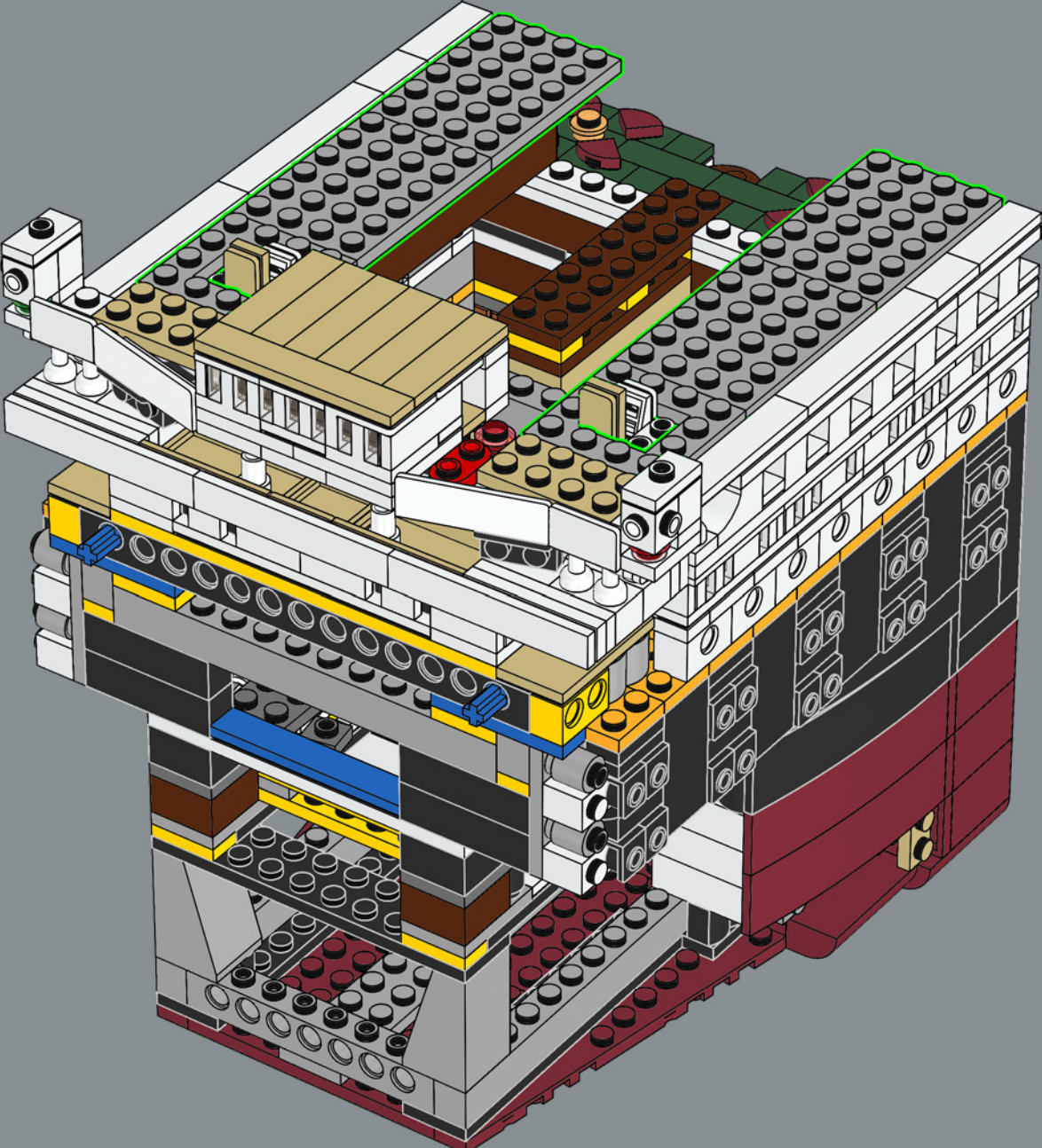

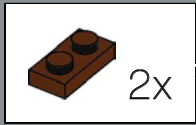
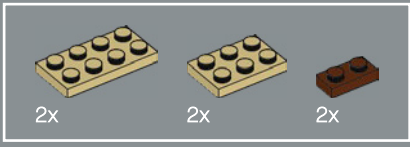

267

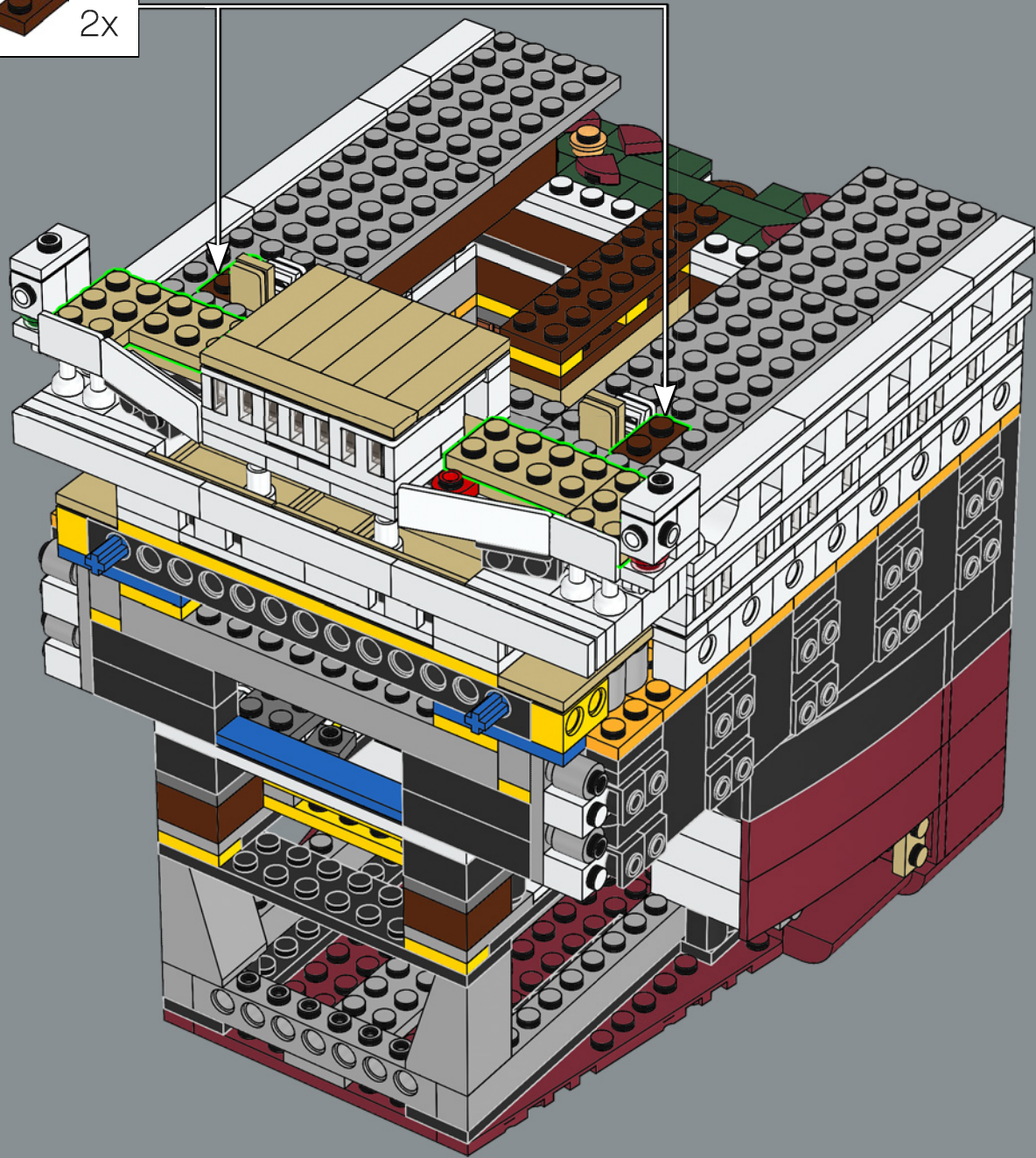

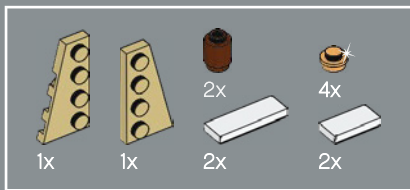

268

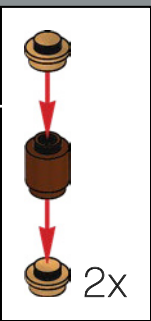
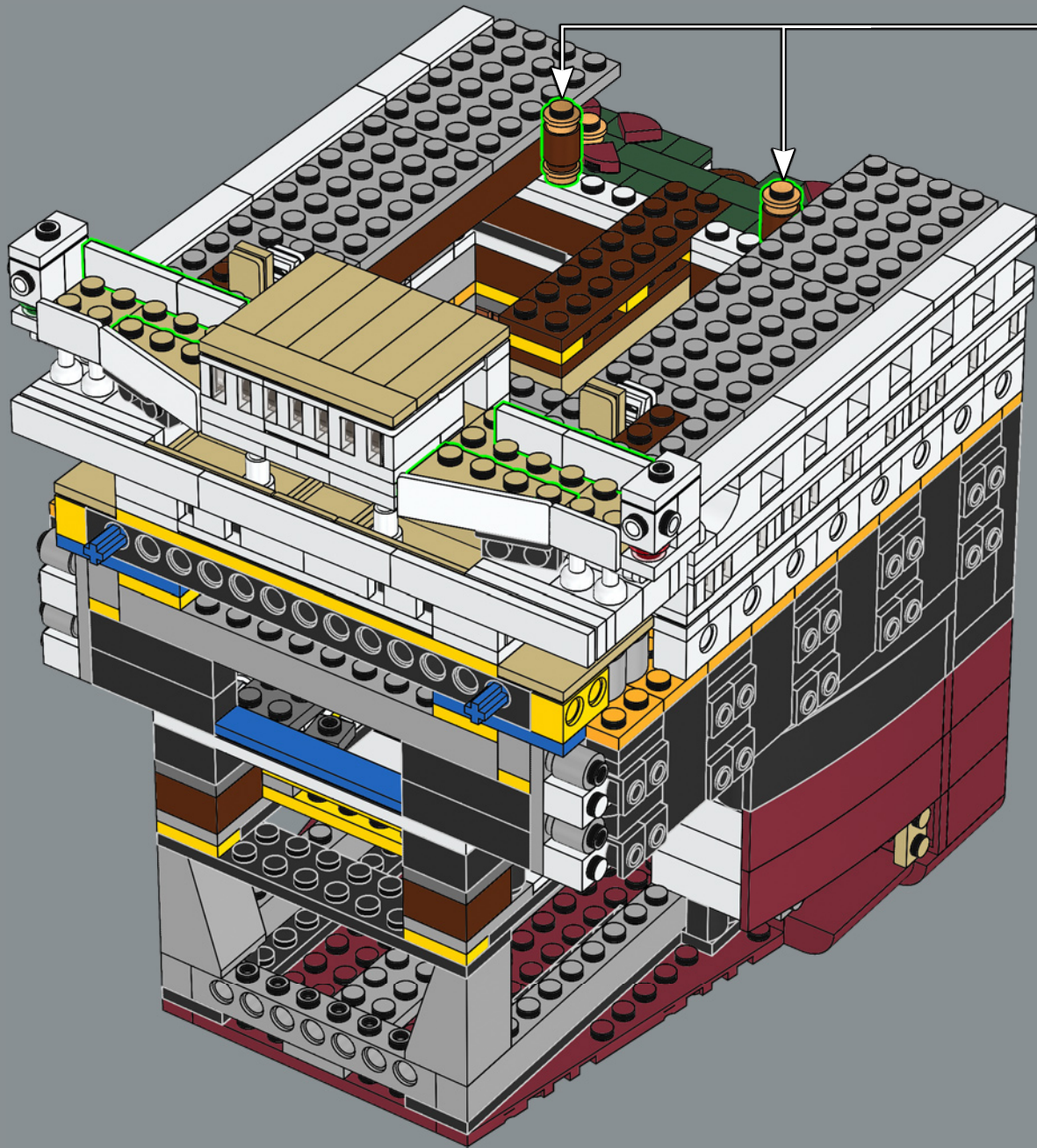
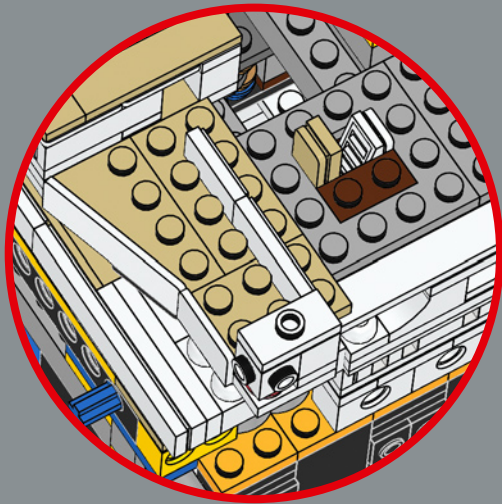
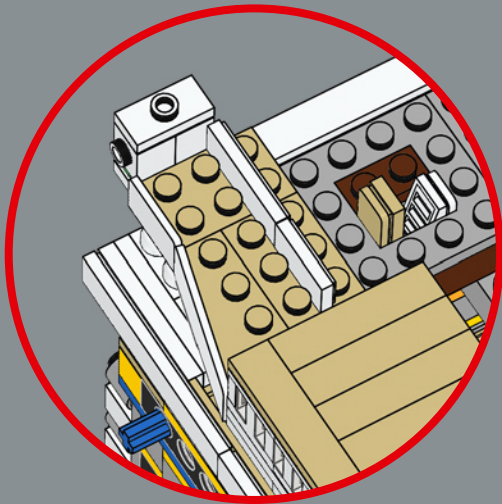

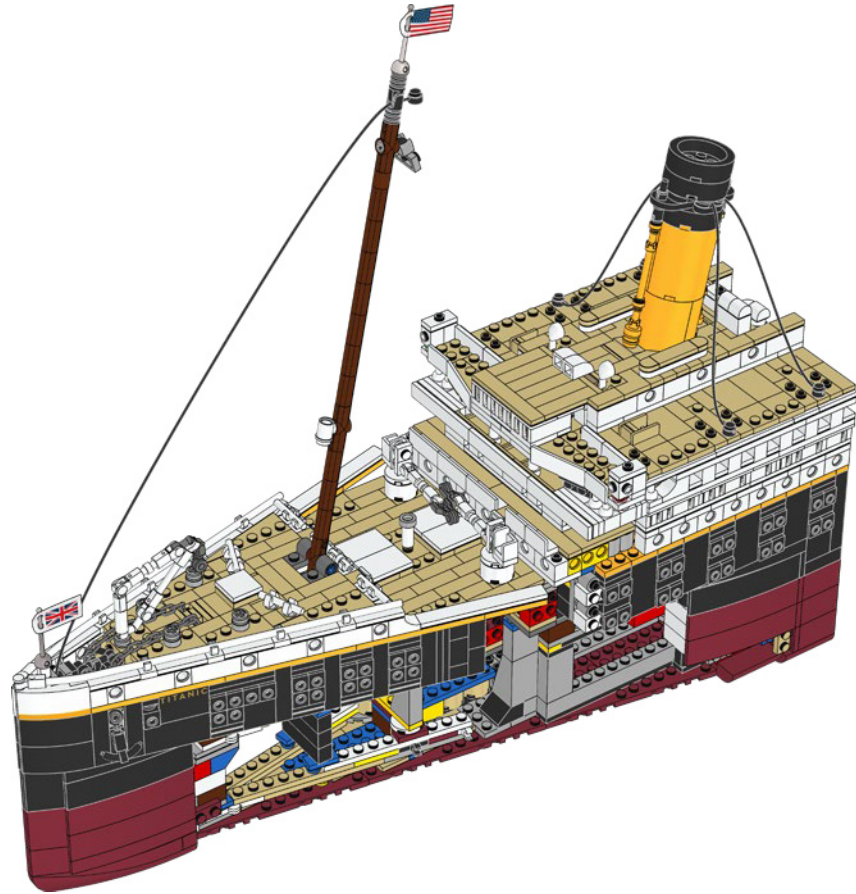
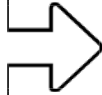

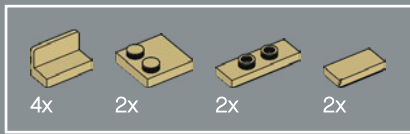

269

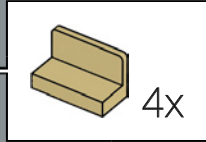
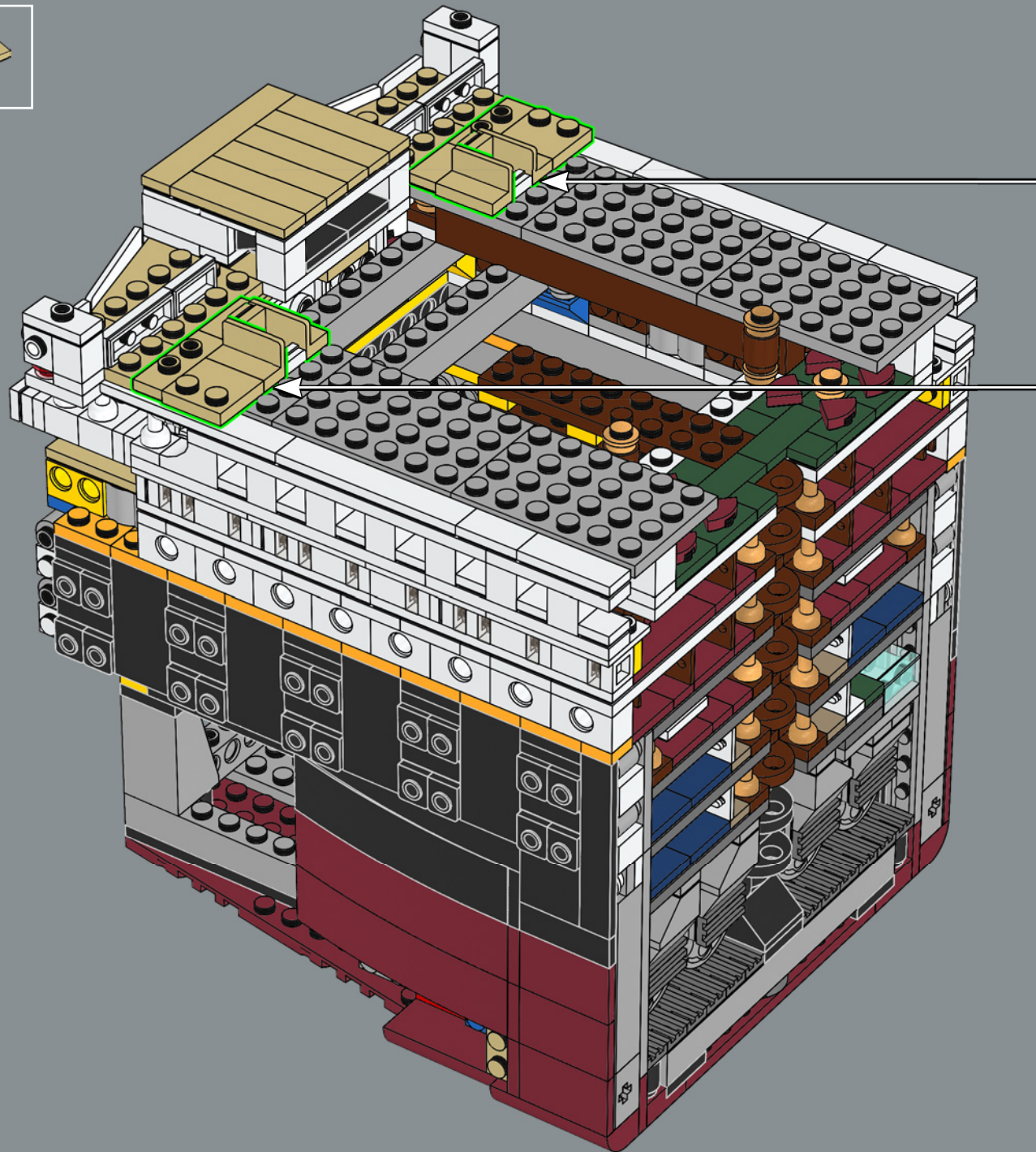

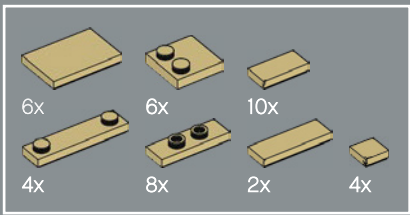

270

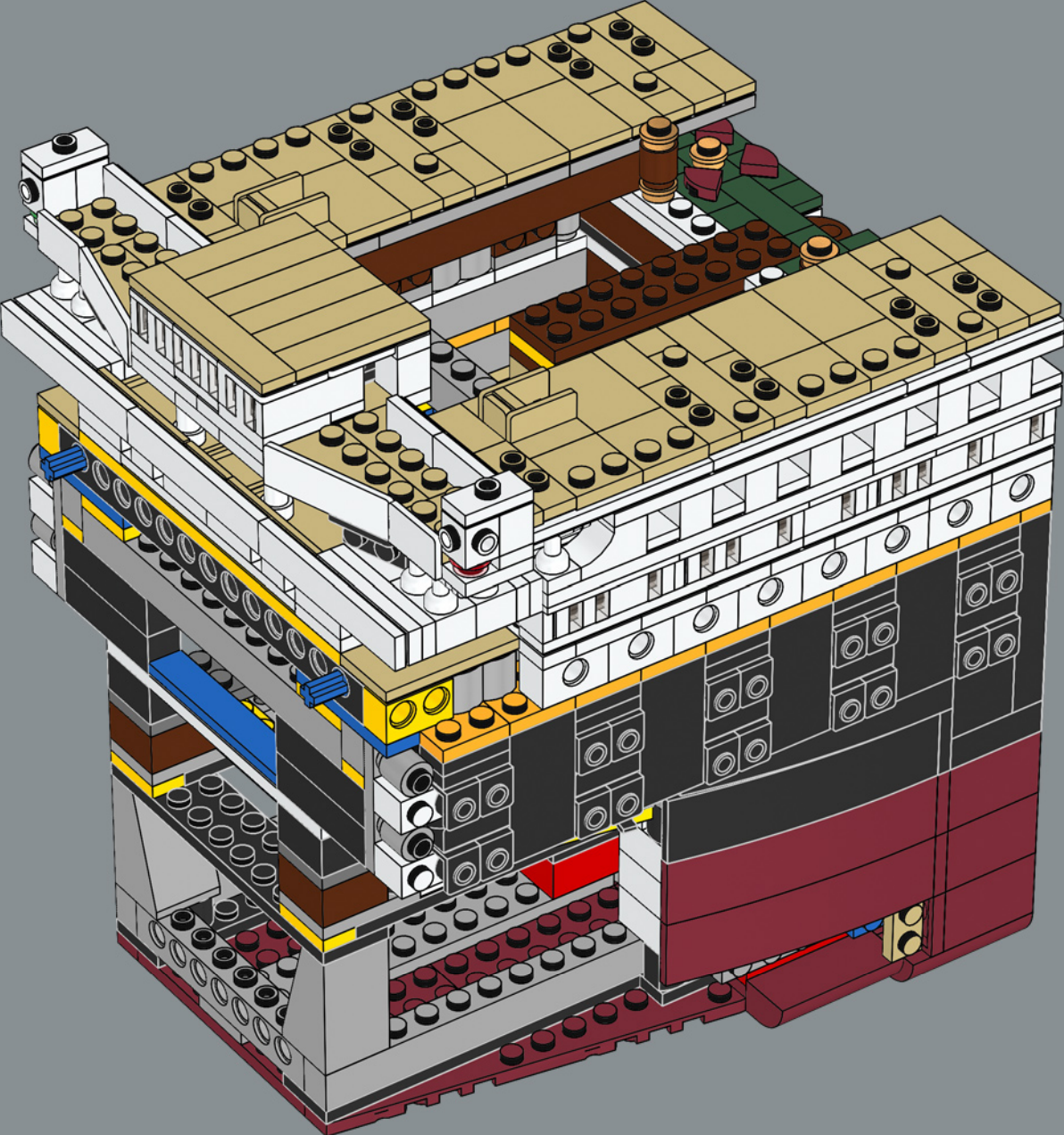

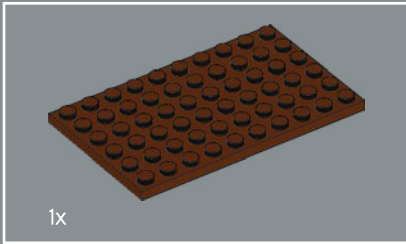
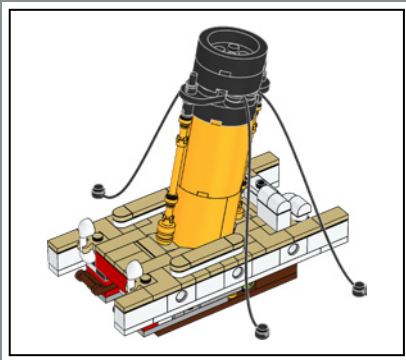

1x

271

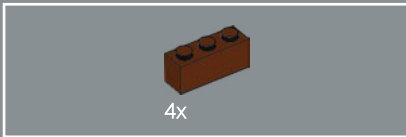
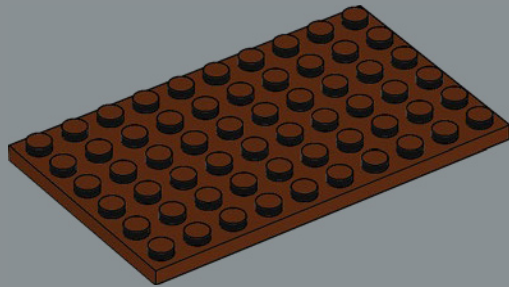

4x

272

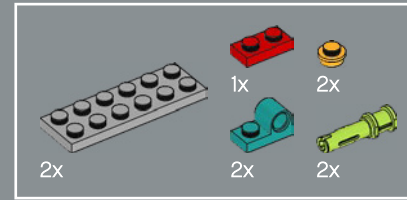
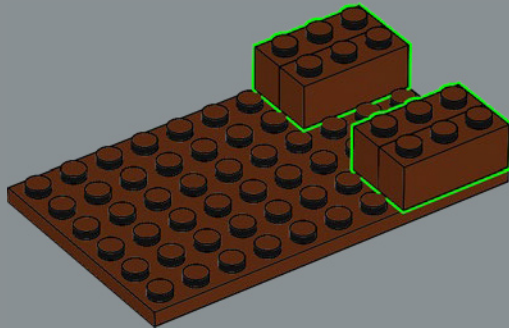

273

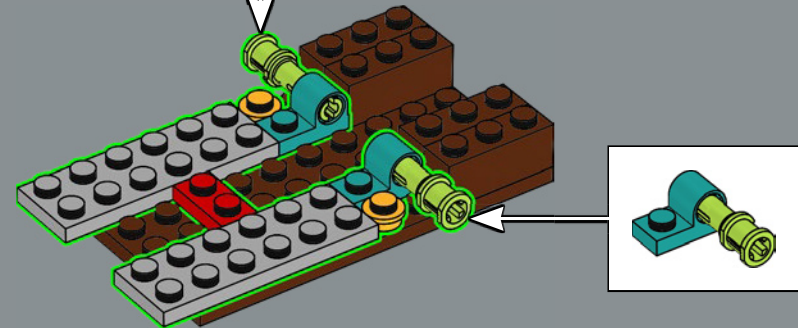
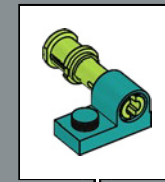

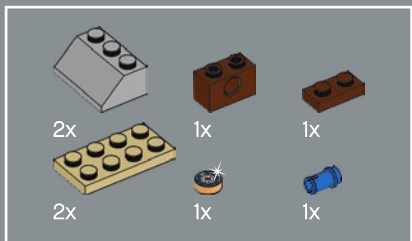

274

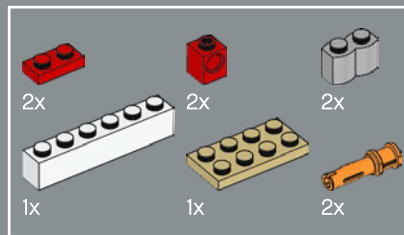
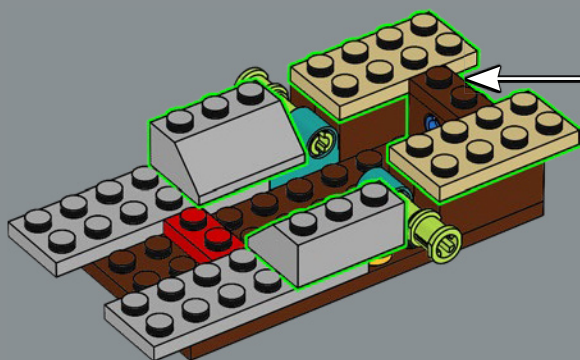
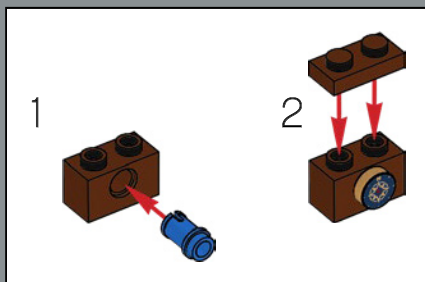

275

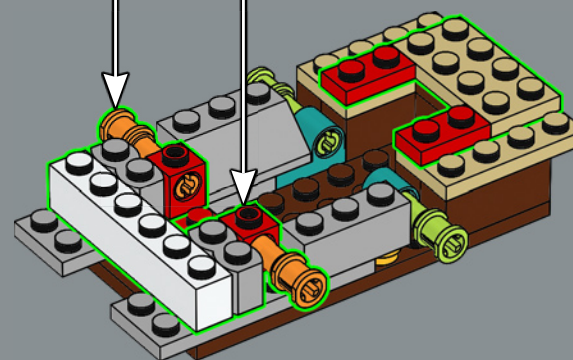
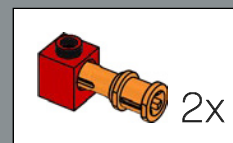



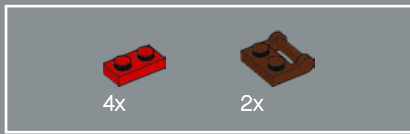

276

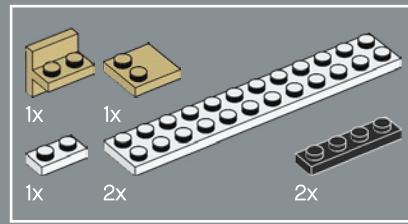
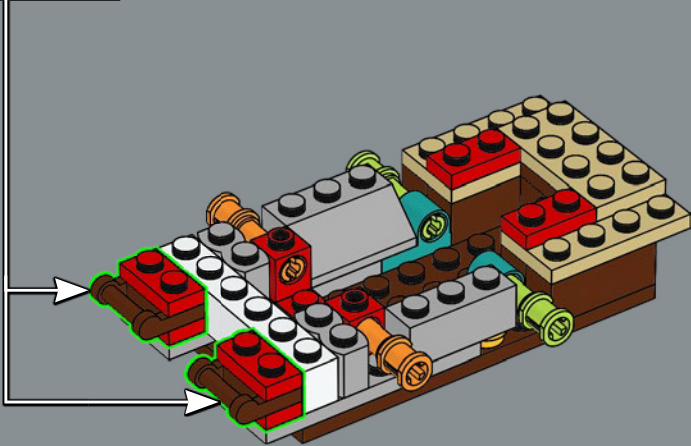
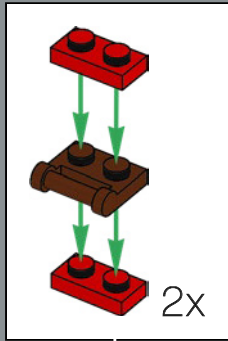

277

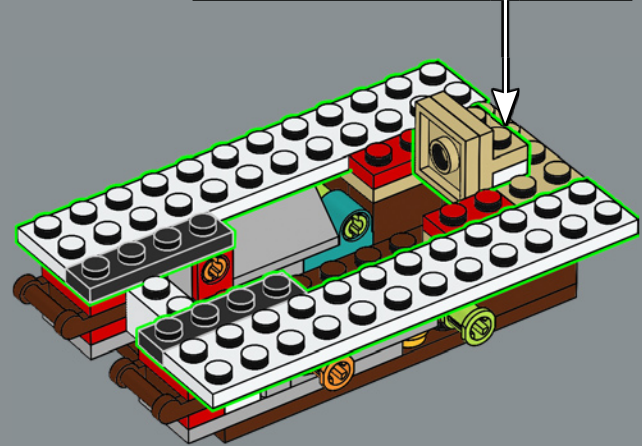
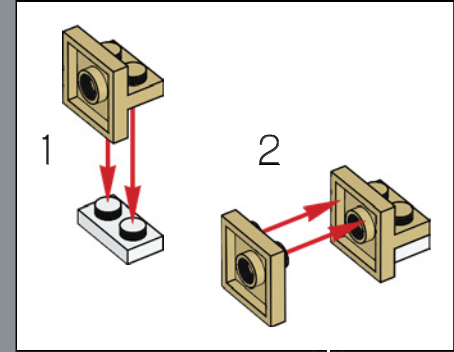

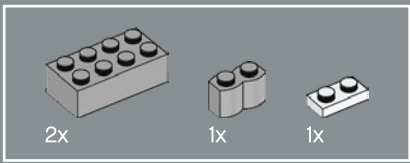

278

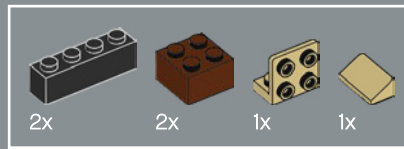
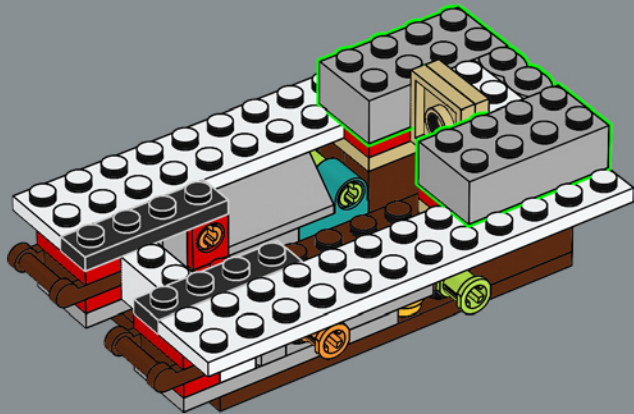

279

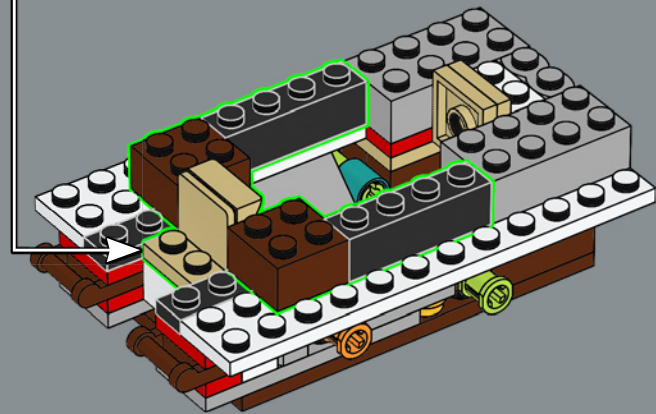
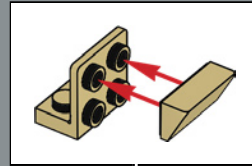

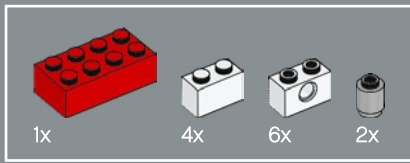

280

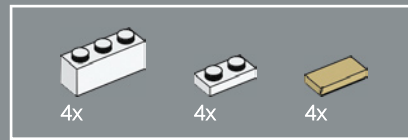
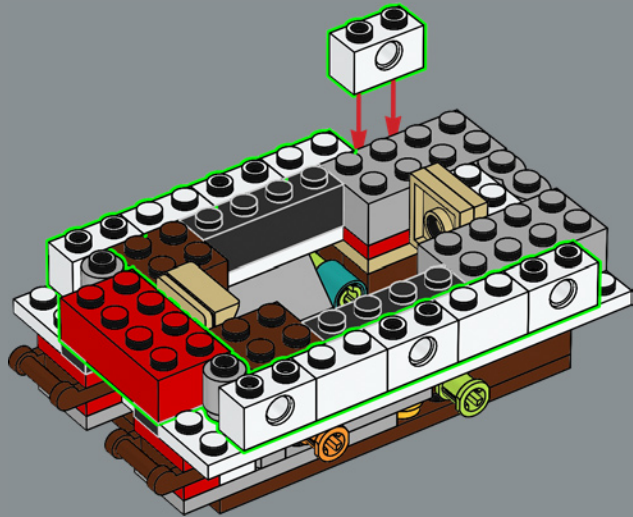

281

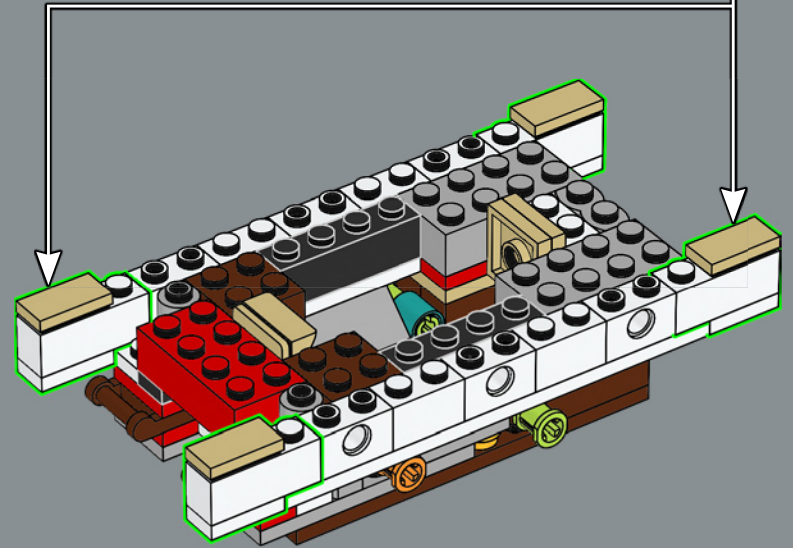
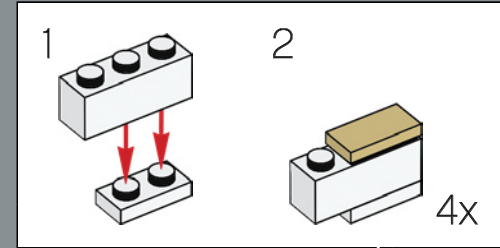

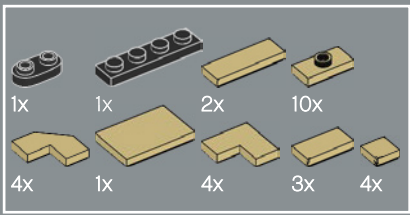

282

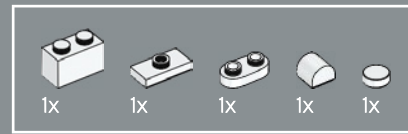
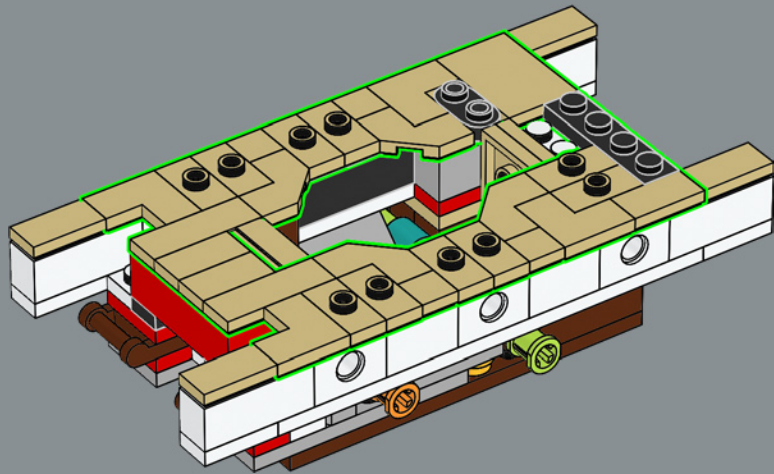

283

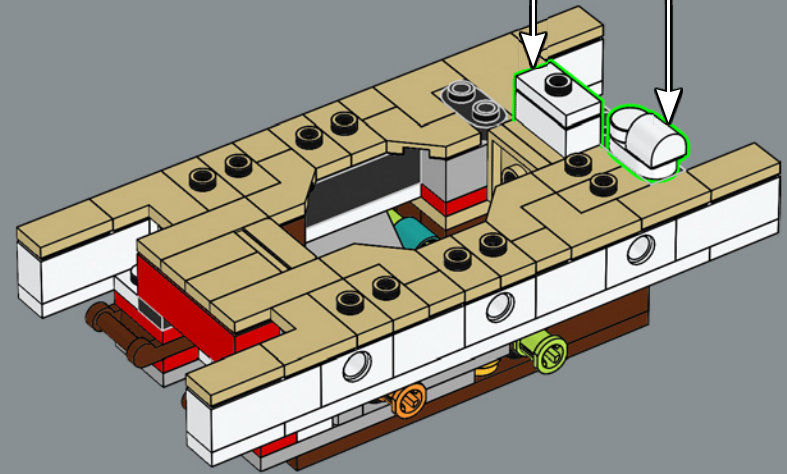
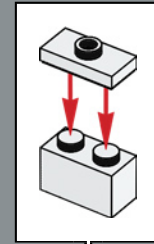
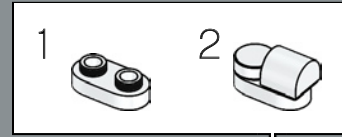

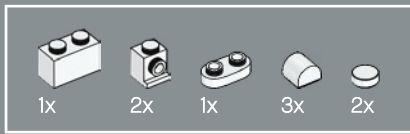

284

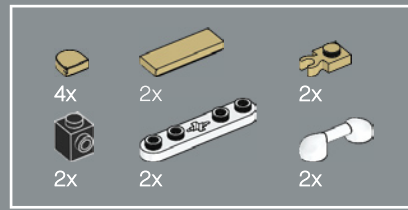
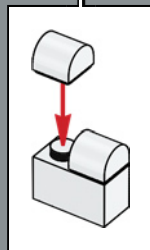
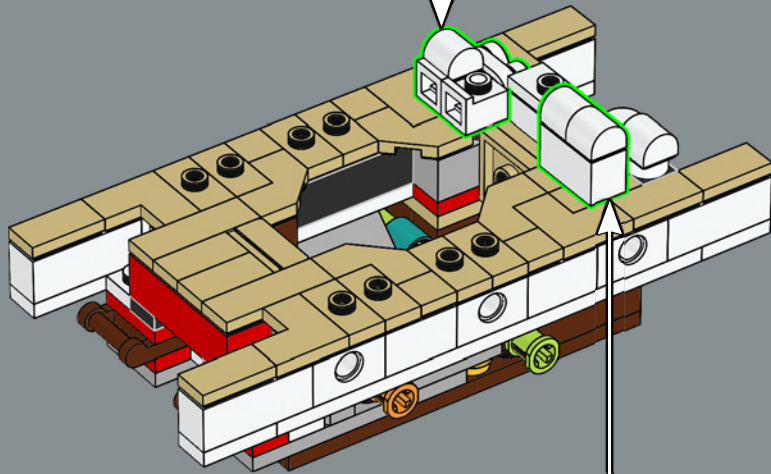
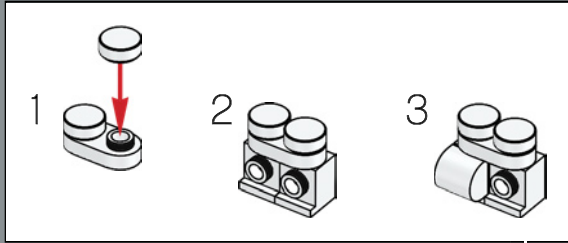

285

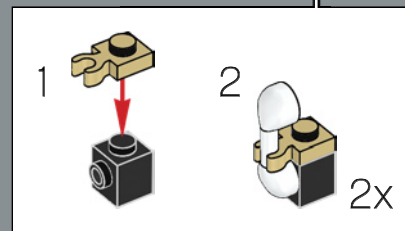
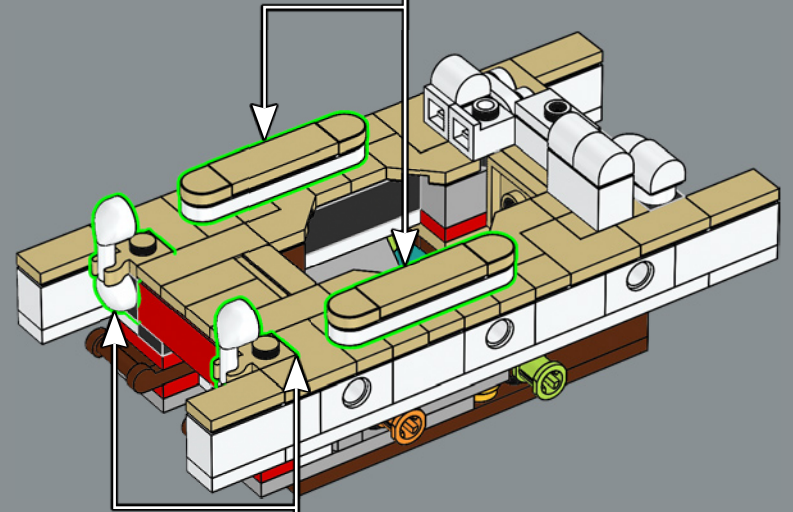
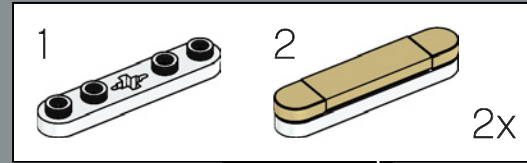

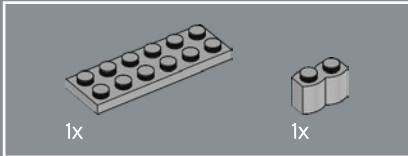
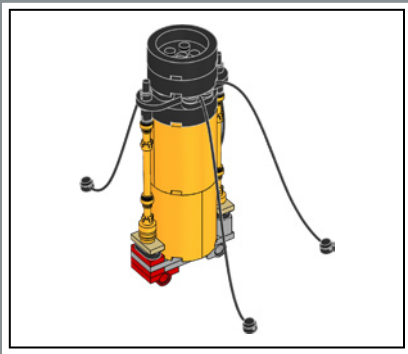

286

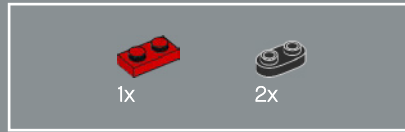
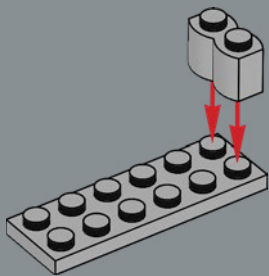

287

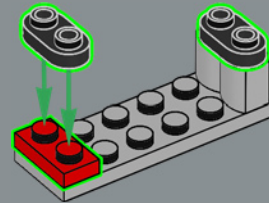

288

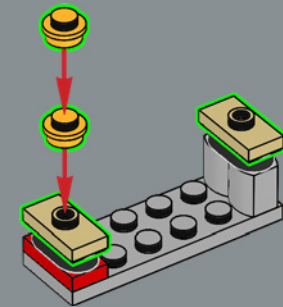

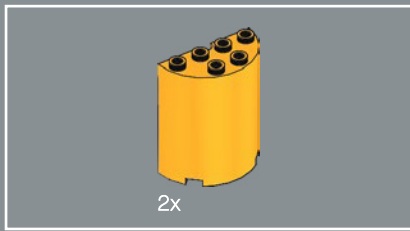

289

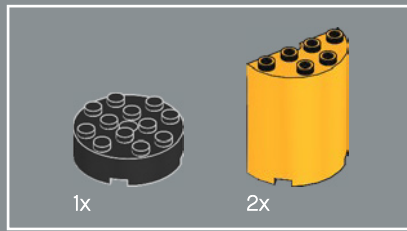
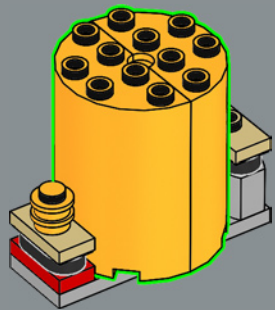

290

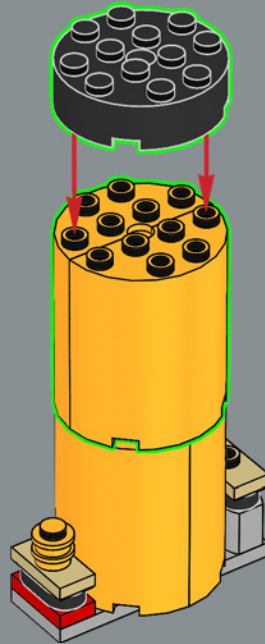

291

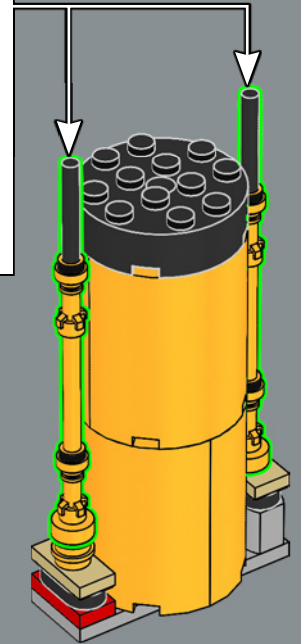
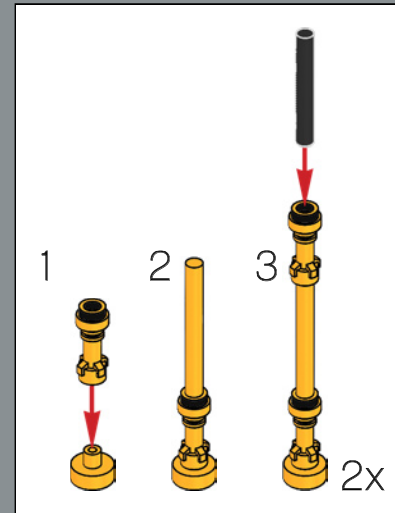

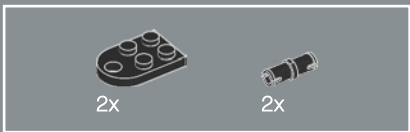

292

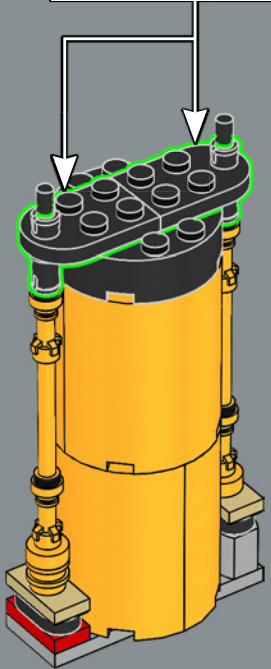
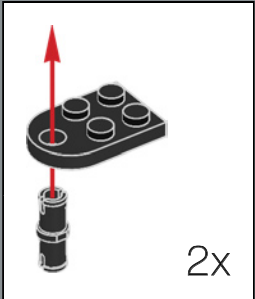

293

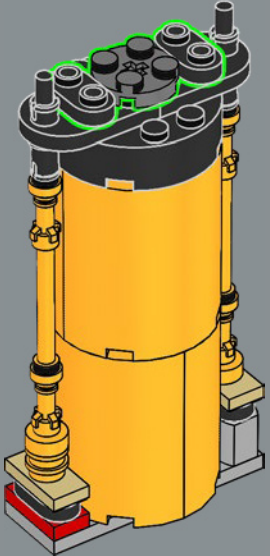



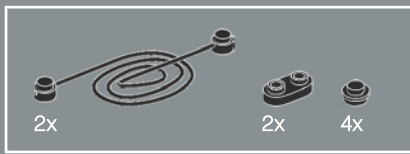

294

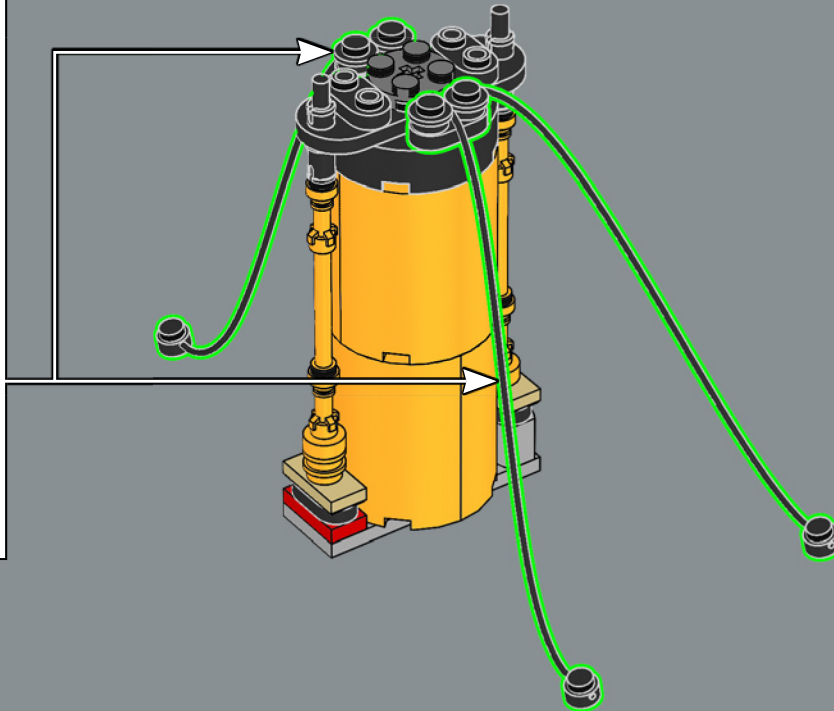
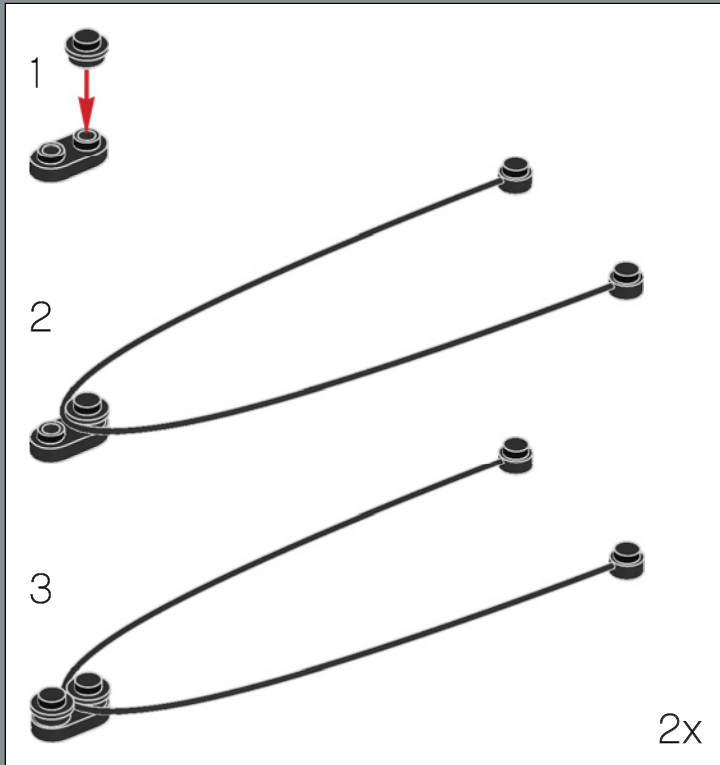

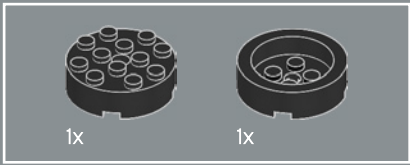

295

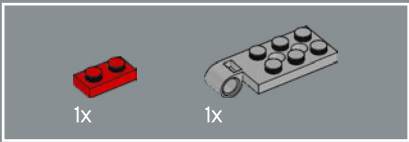
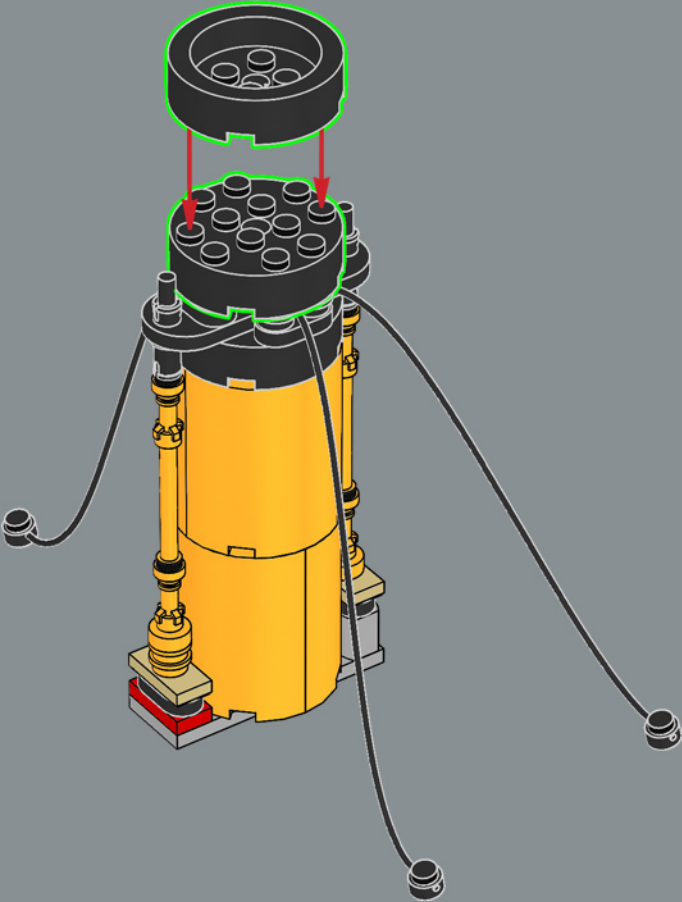

296

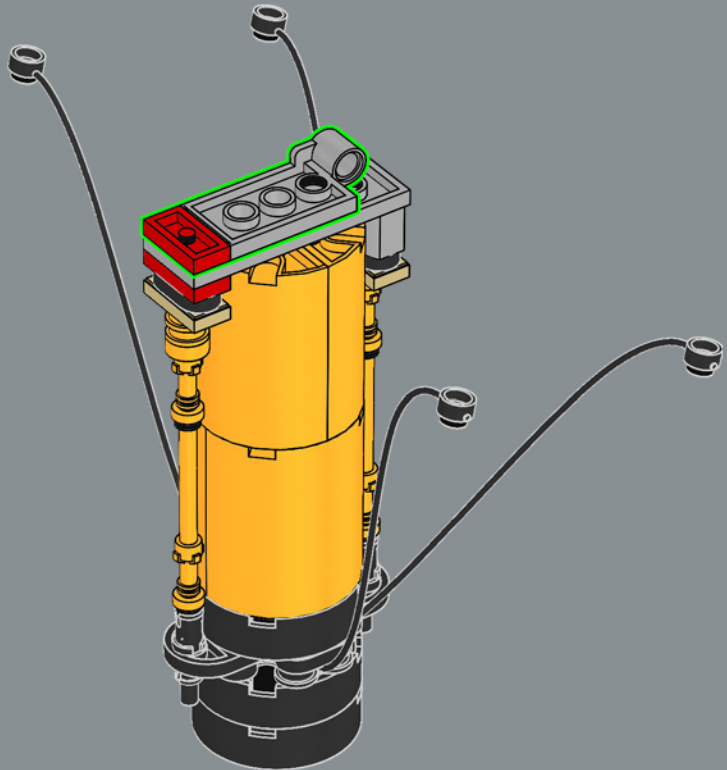

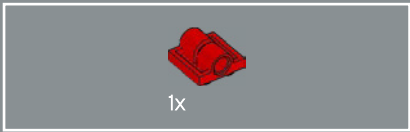

297

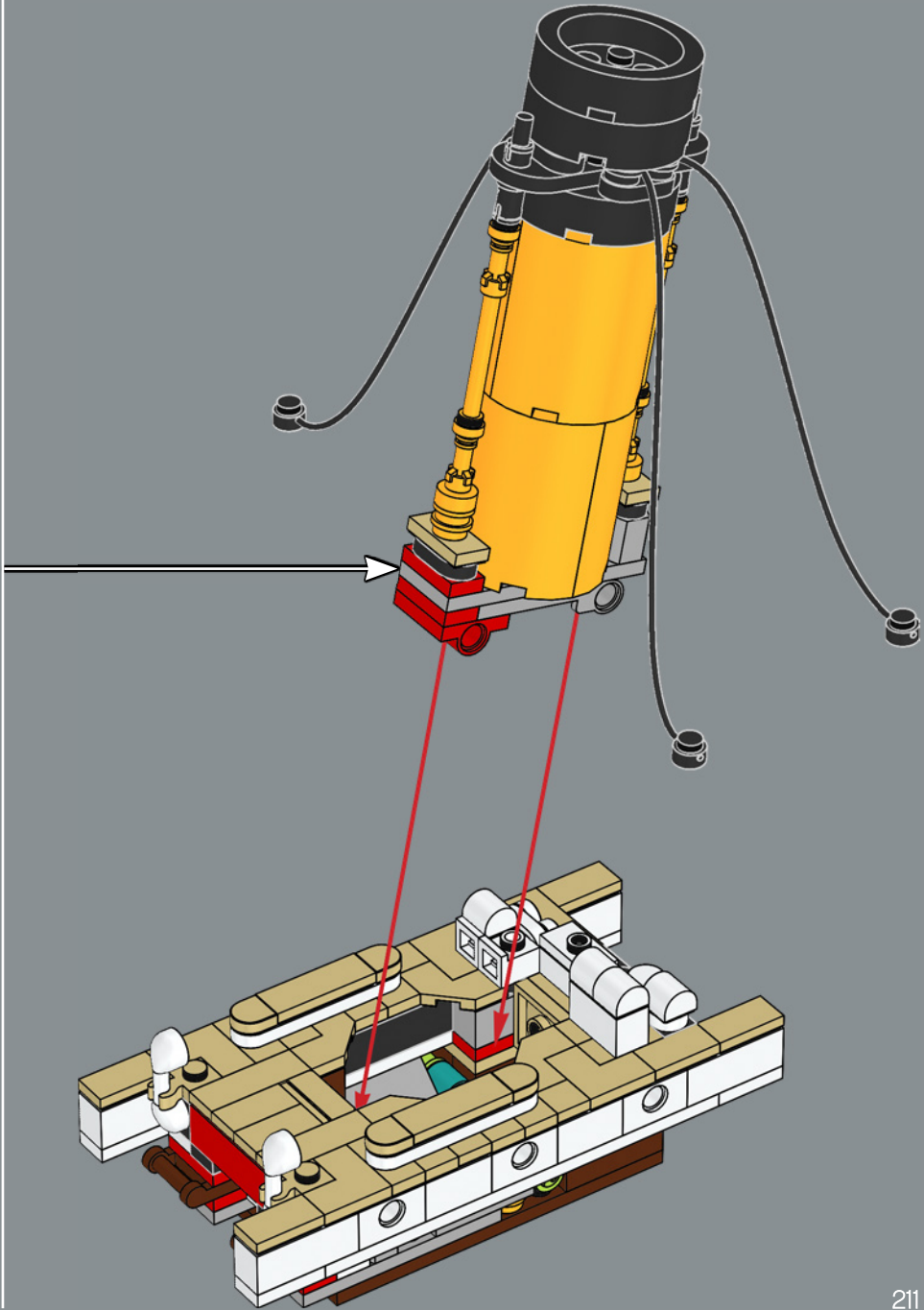
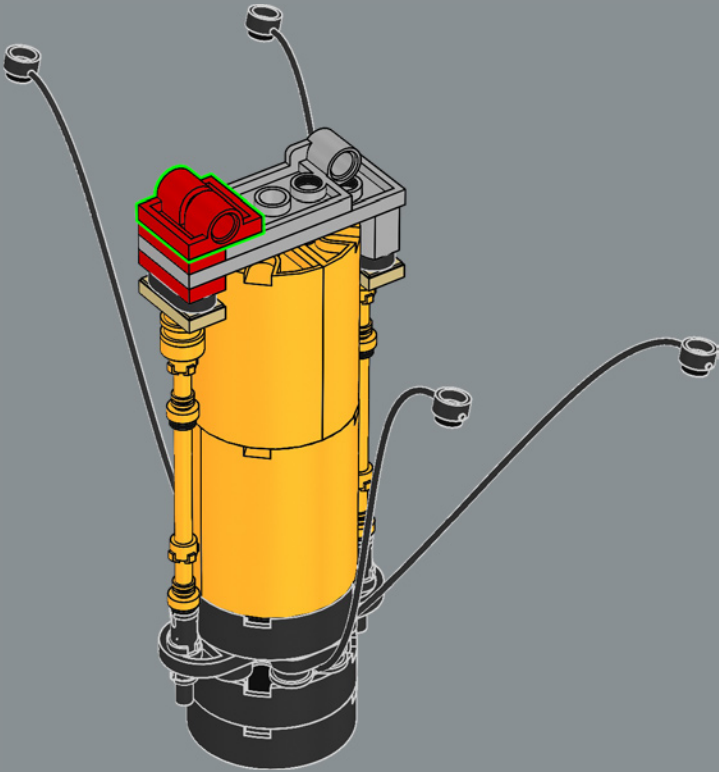

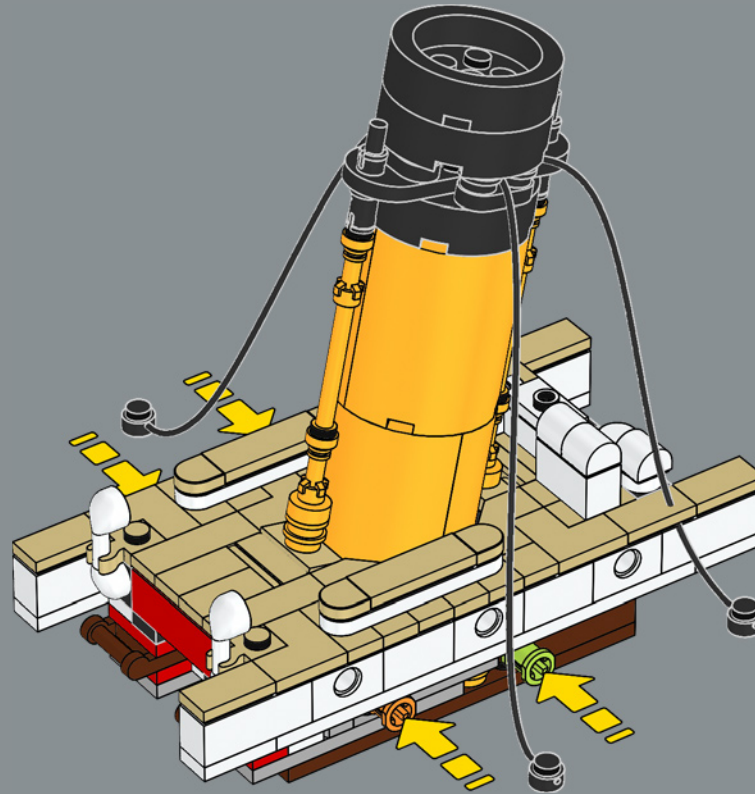

The ship's communication room contained one of the most powerful transmitters in the world, guaranteed to broadcast over a radius of 350 miles (563 km).

La salle de communication du navire contient l'un des plus puissants émetteurs au monde, permettant d'émettre un signal sur un rayon de 563 km (350 mi).

La sala de comunicaciones del barco contenía uno de los transmisores más potentes del mundo, con un radio de alcance garantizado de 563 km.

299

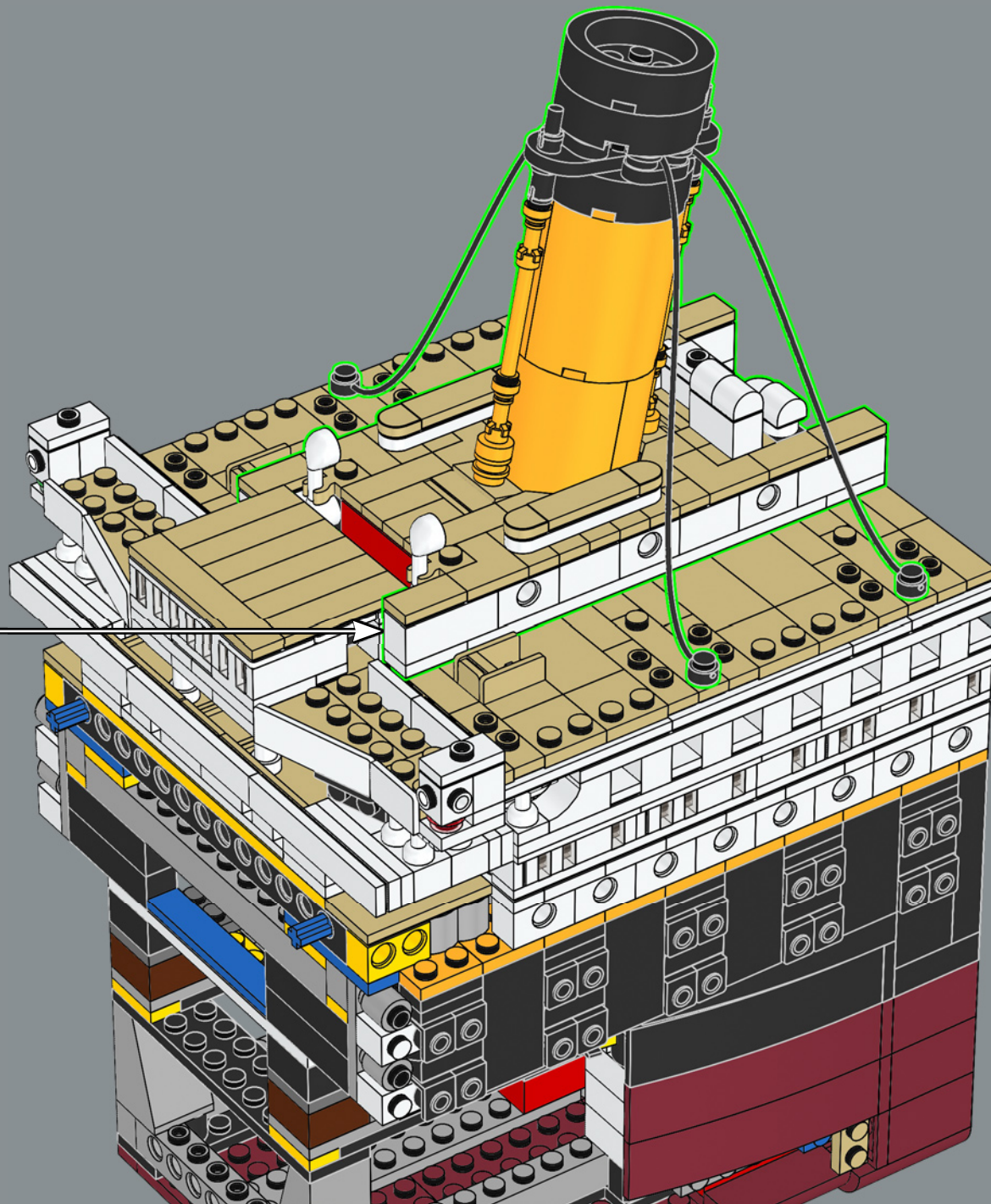

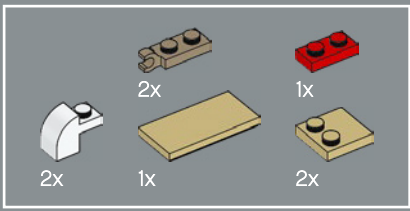

300

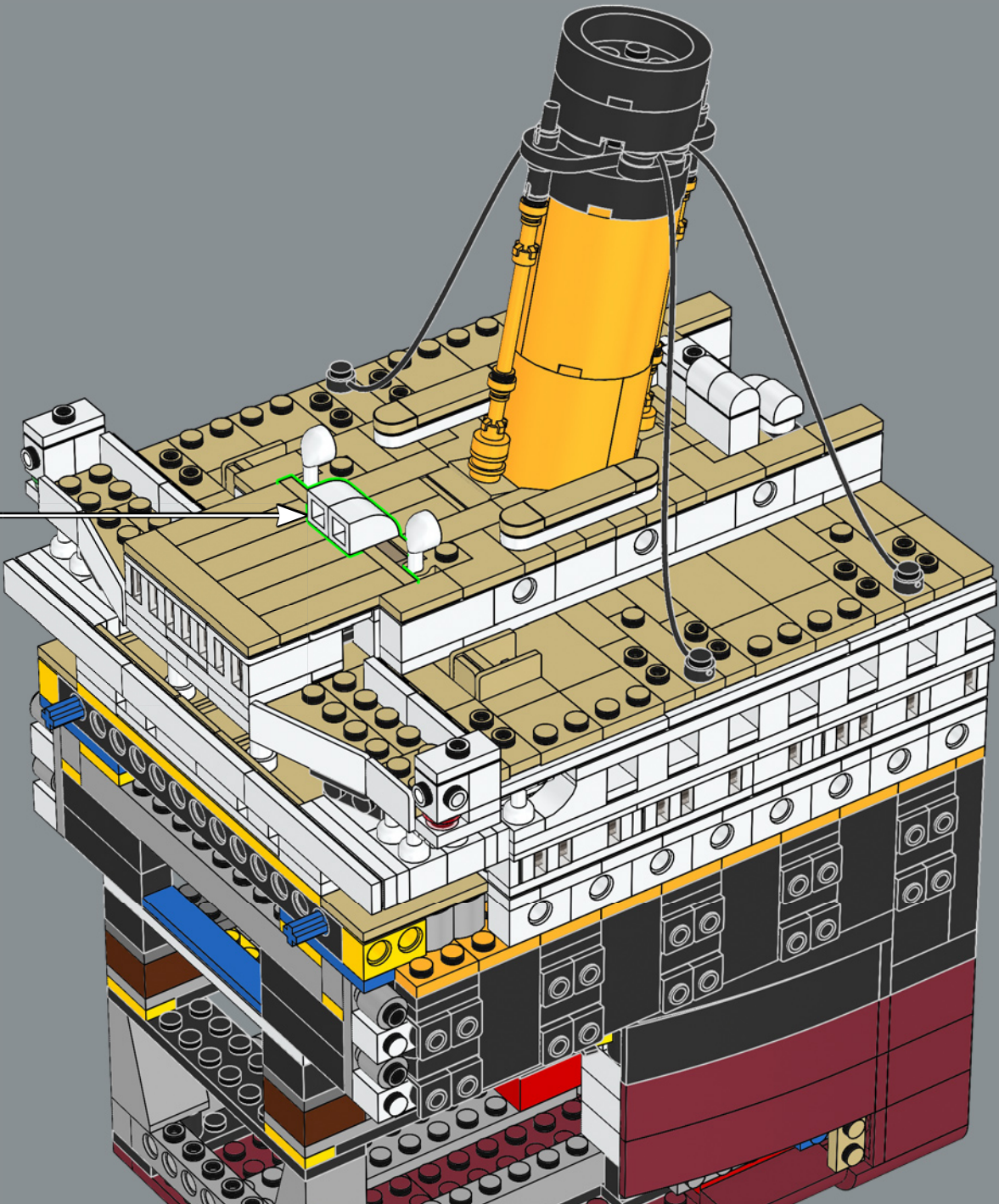
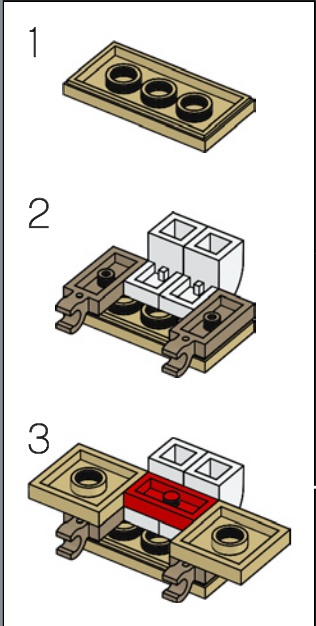

301

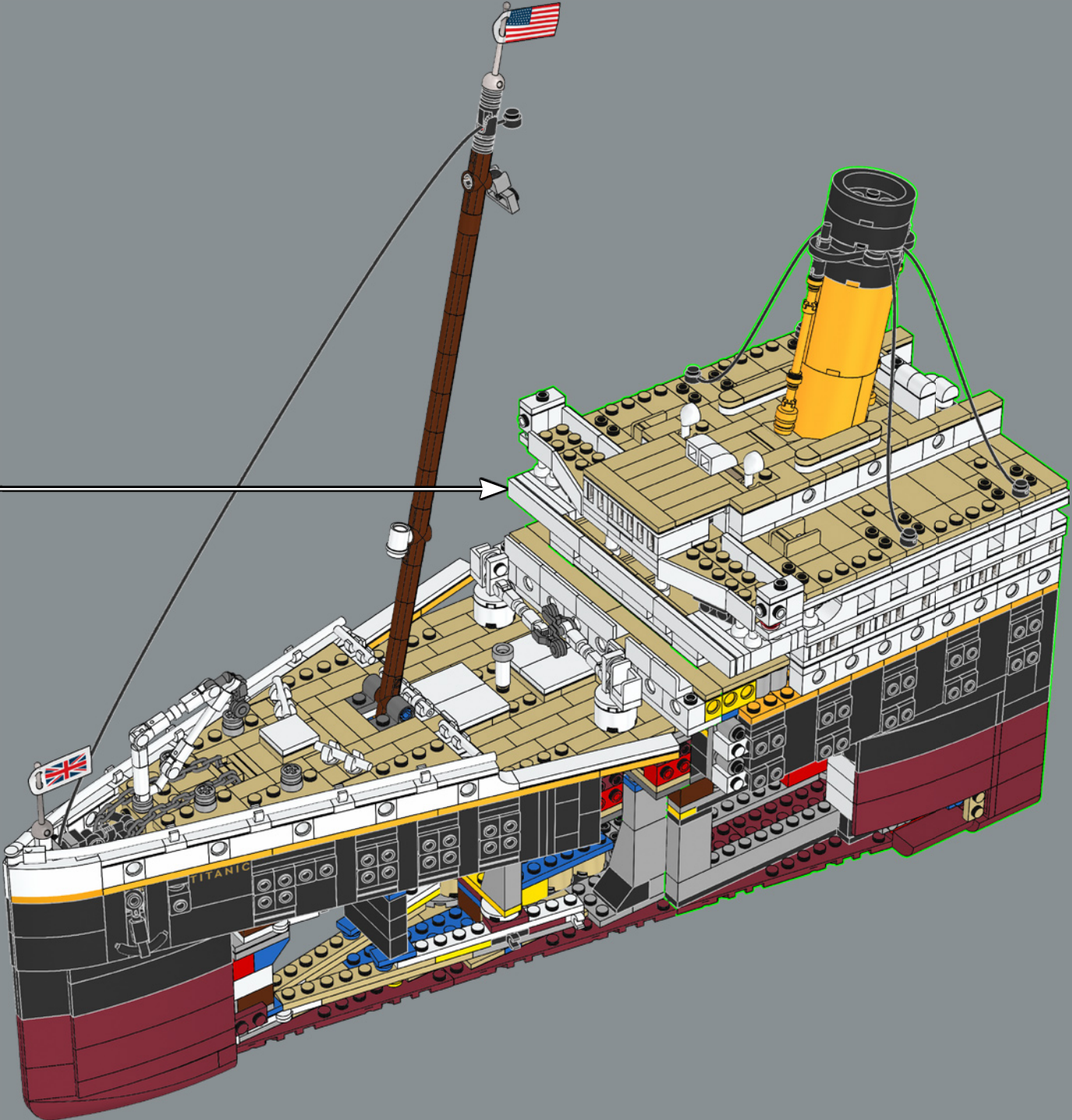

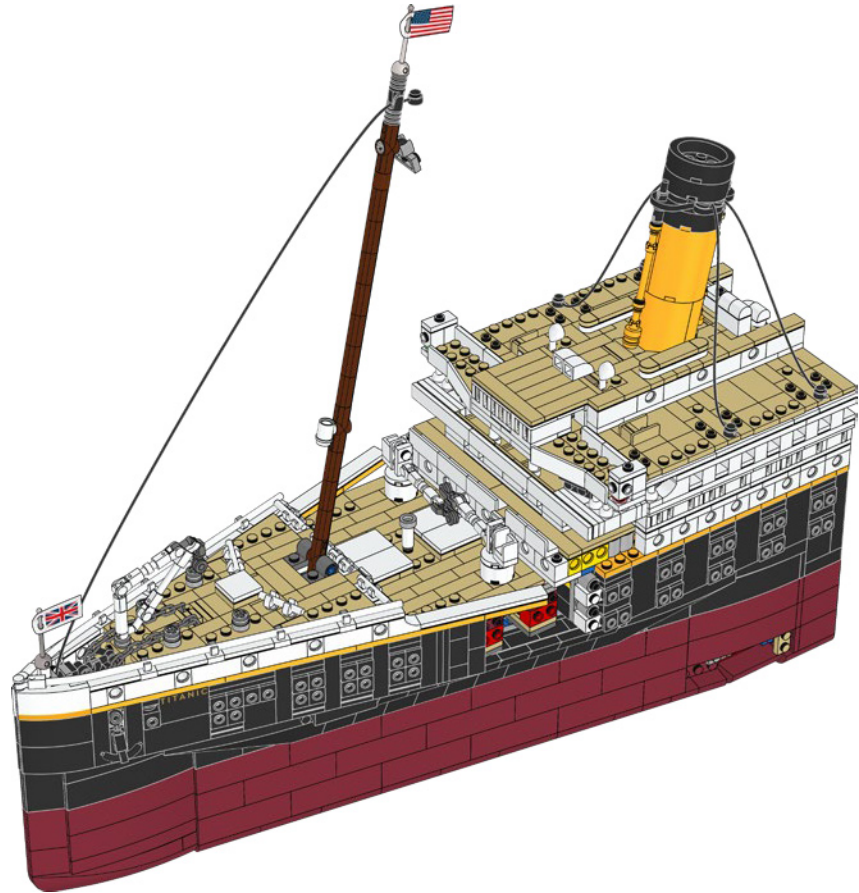
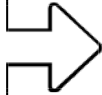



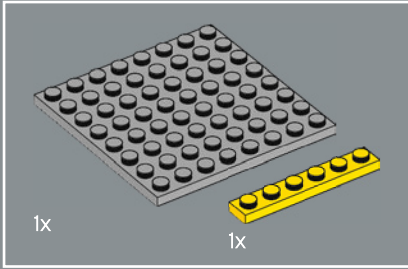
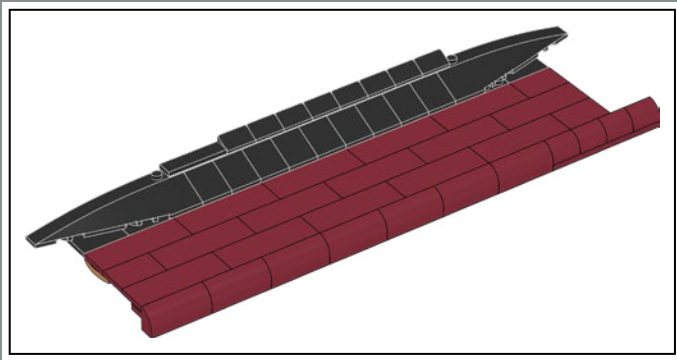

302

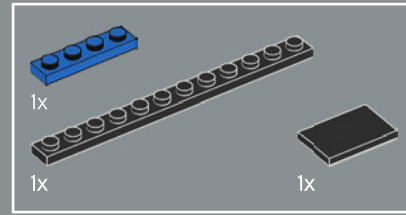
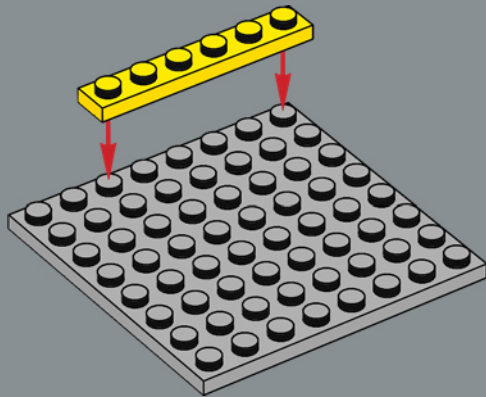

303

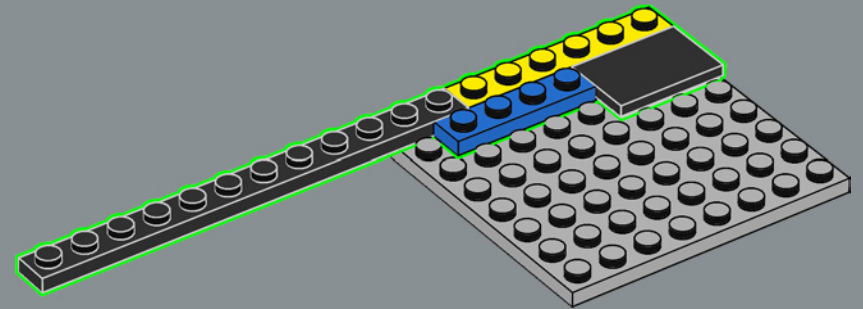

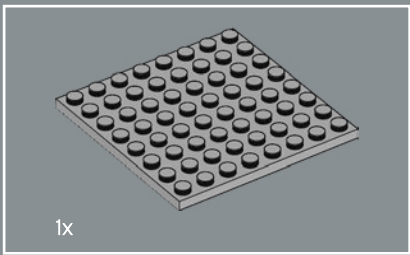

304

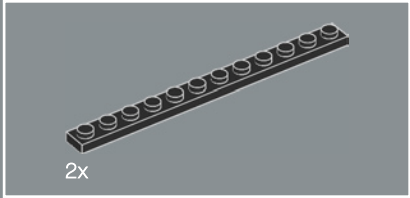
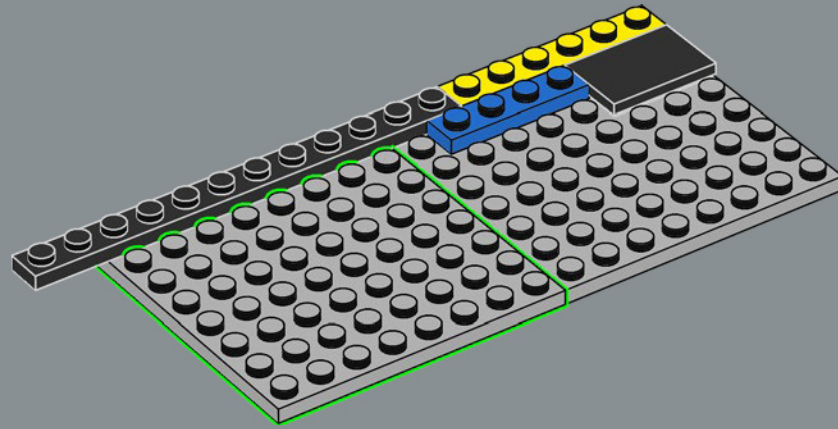

305

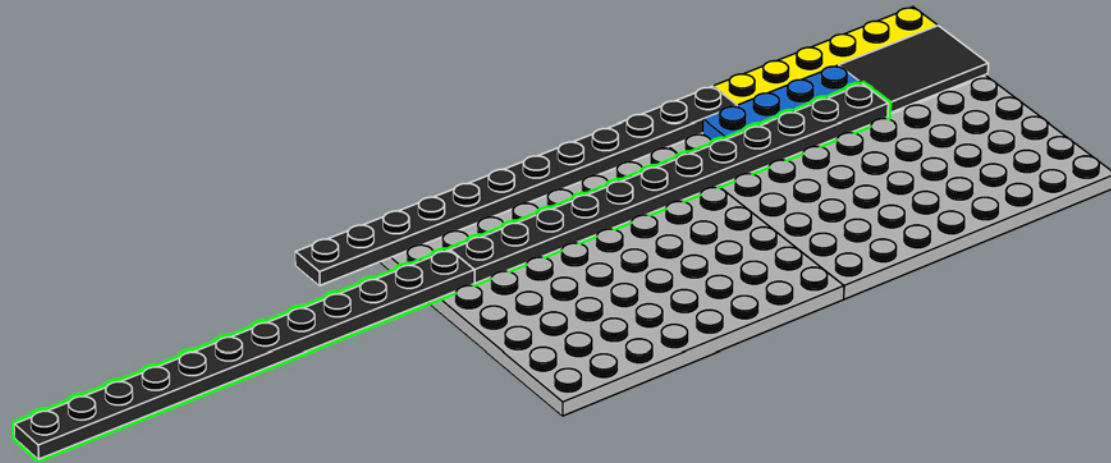

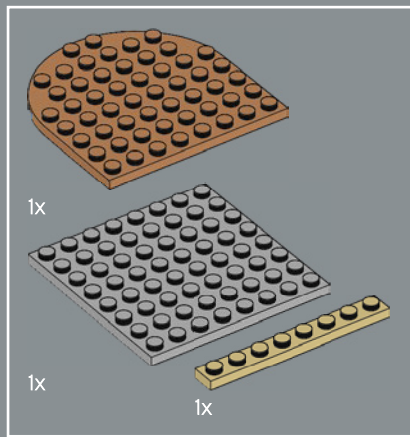

306

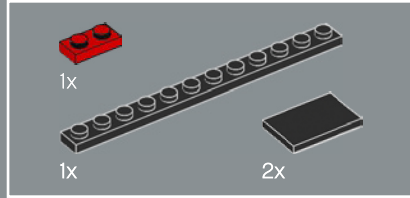
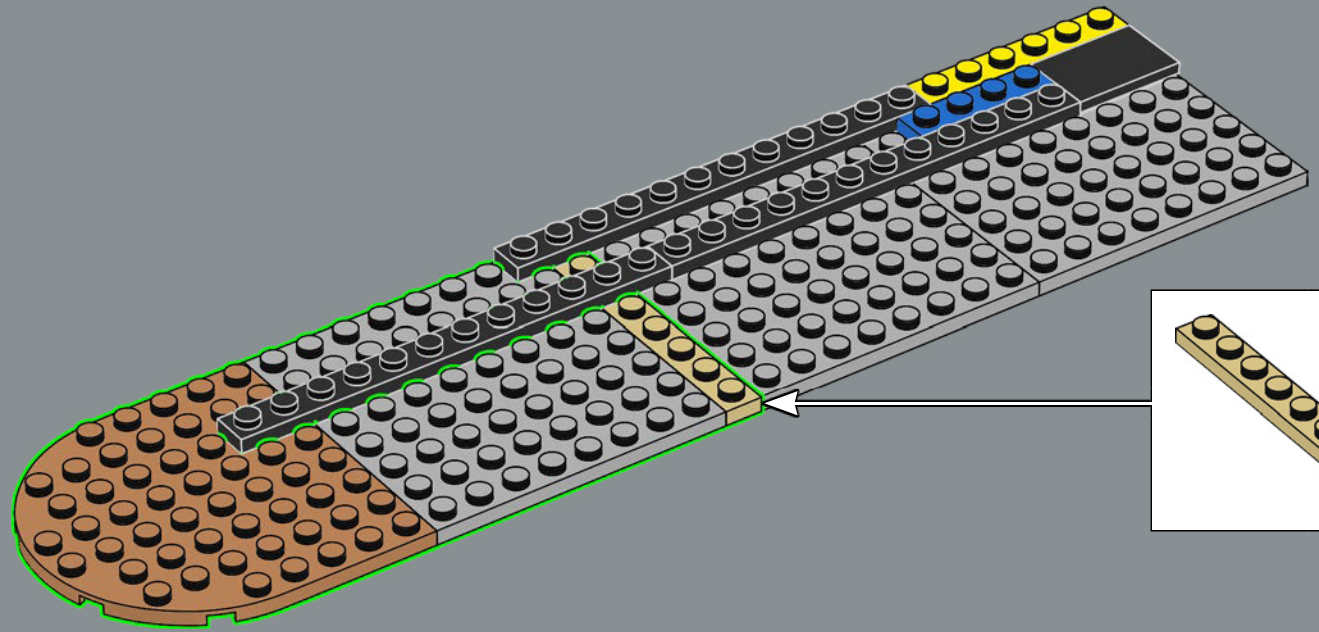

307

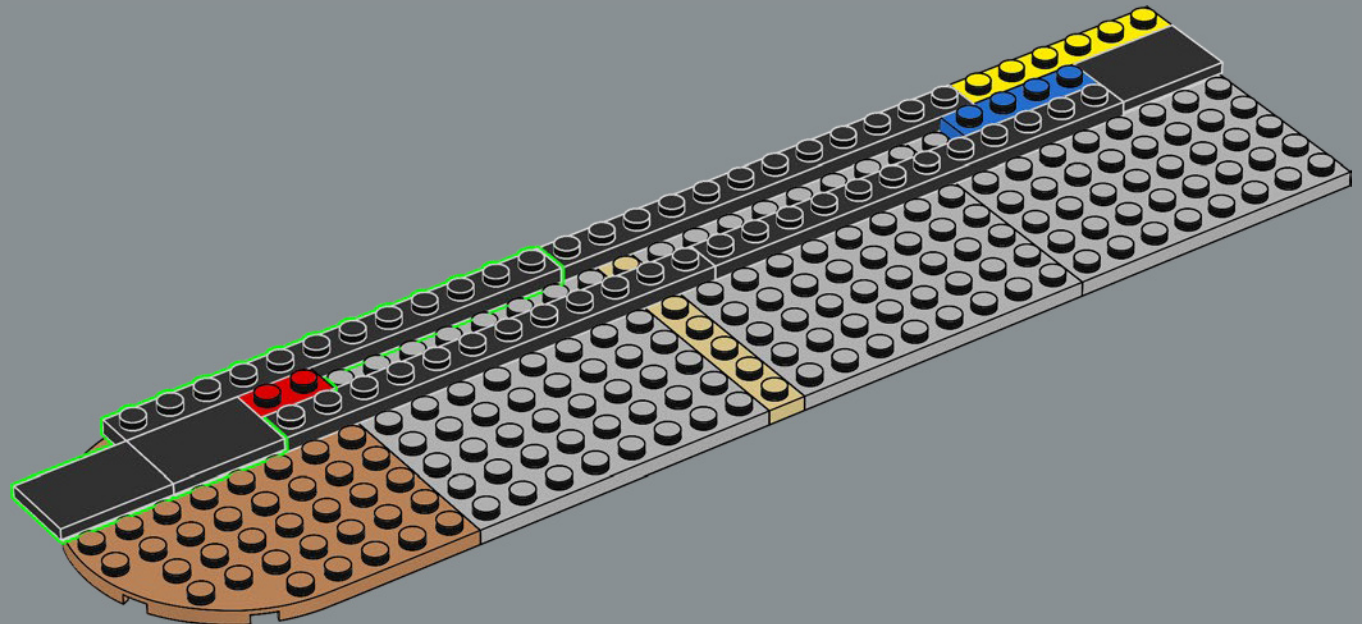

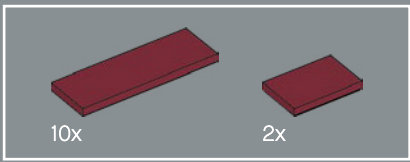

308

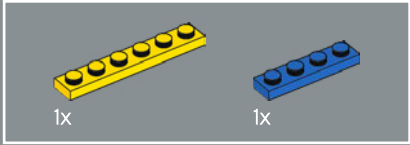
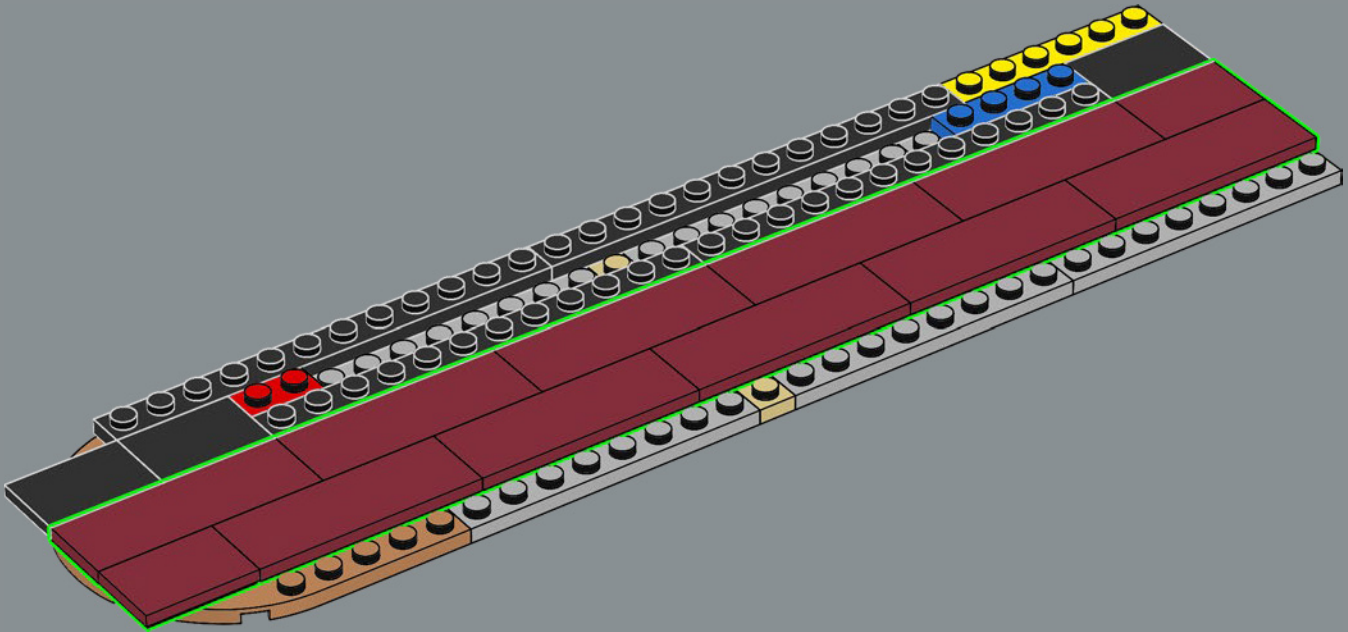

309

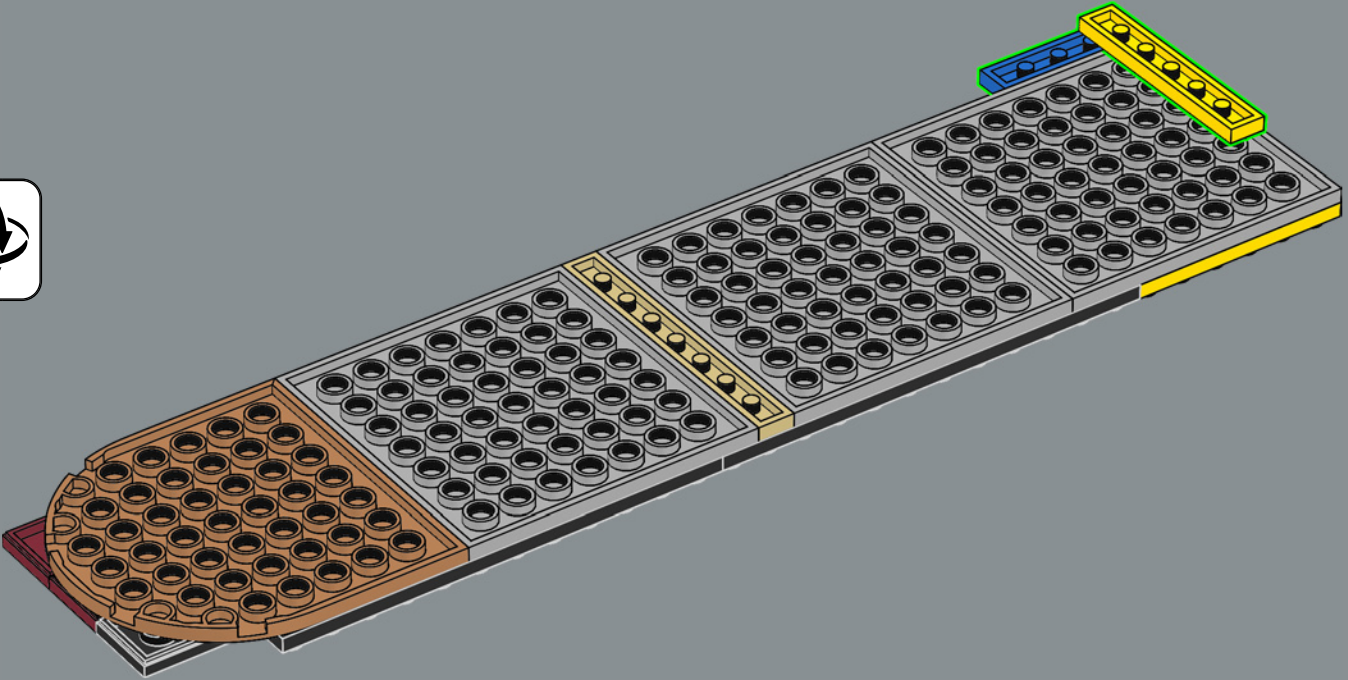

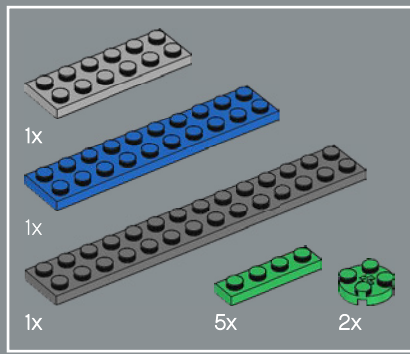

310

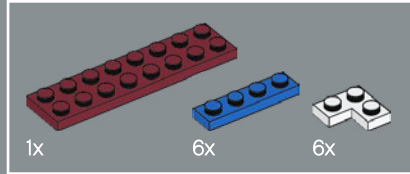
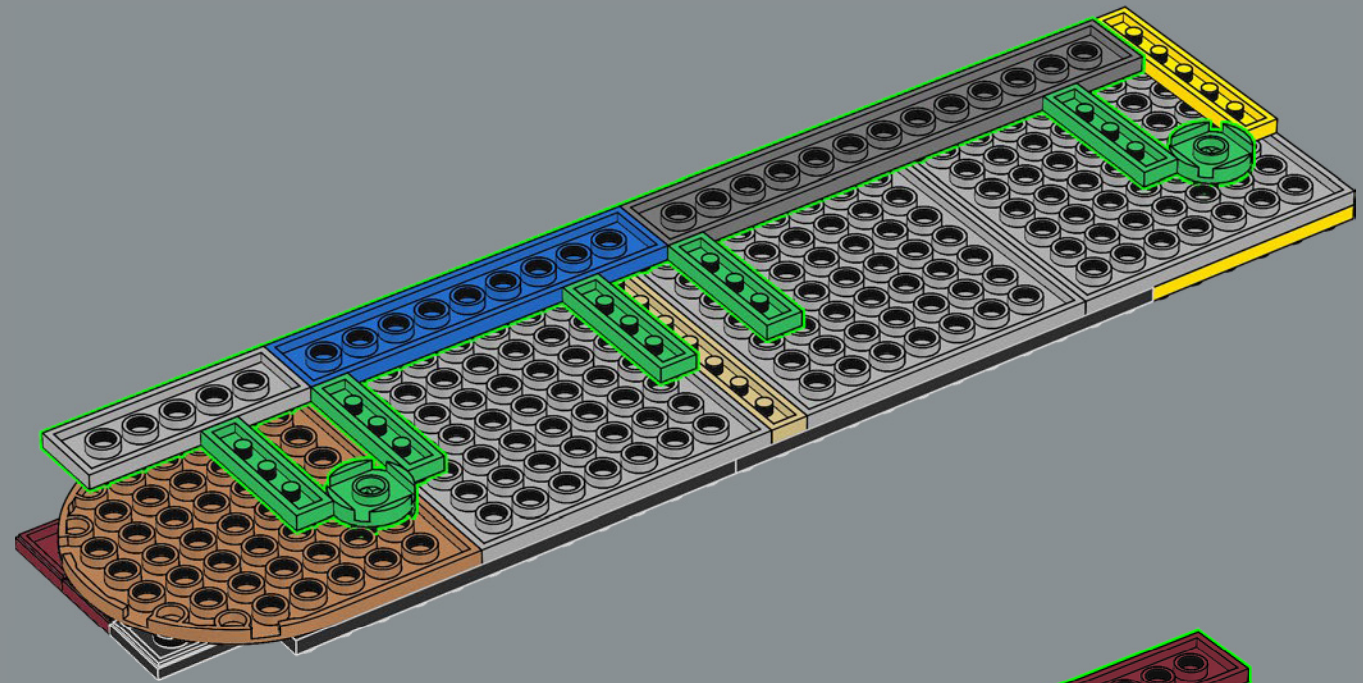

311

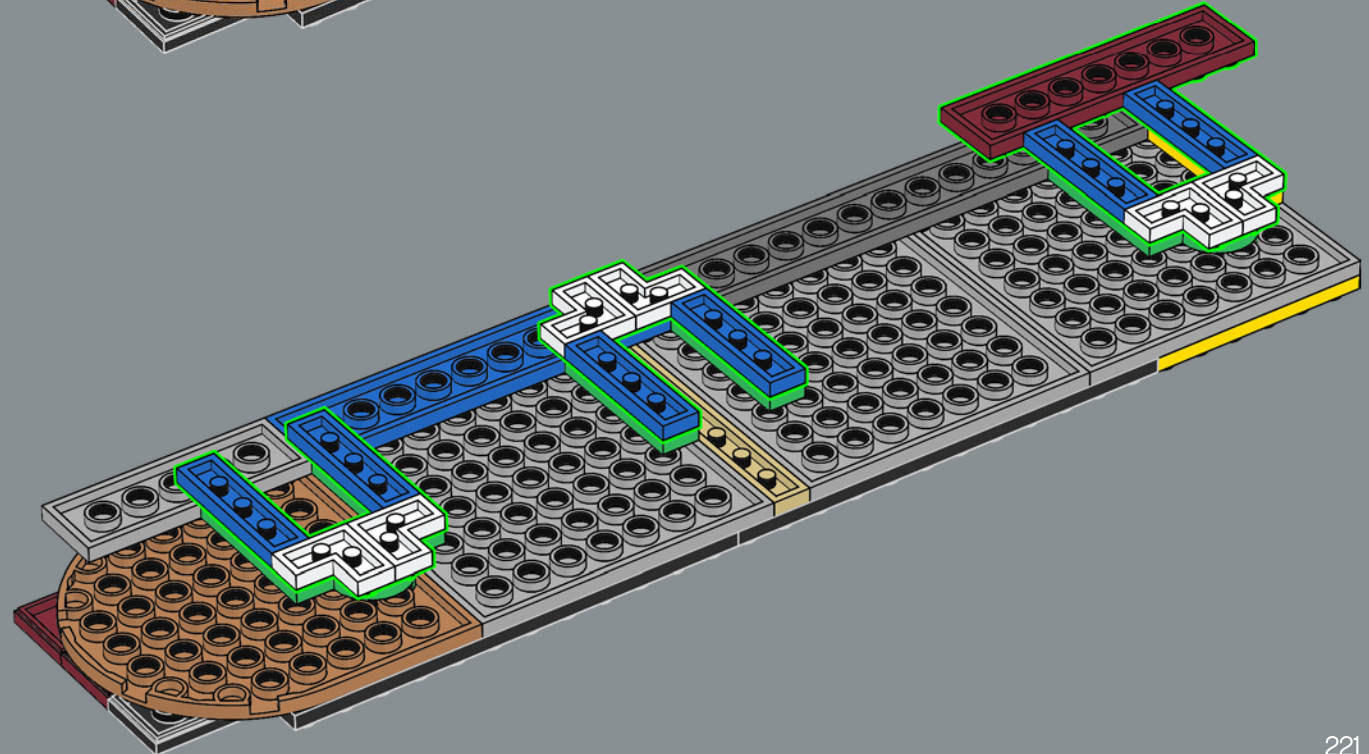

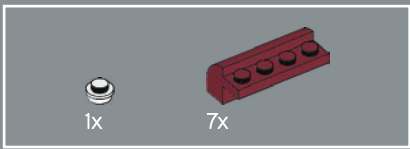

312

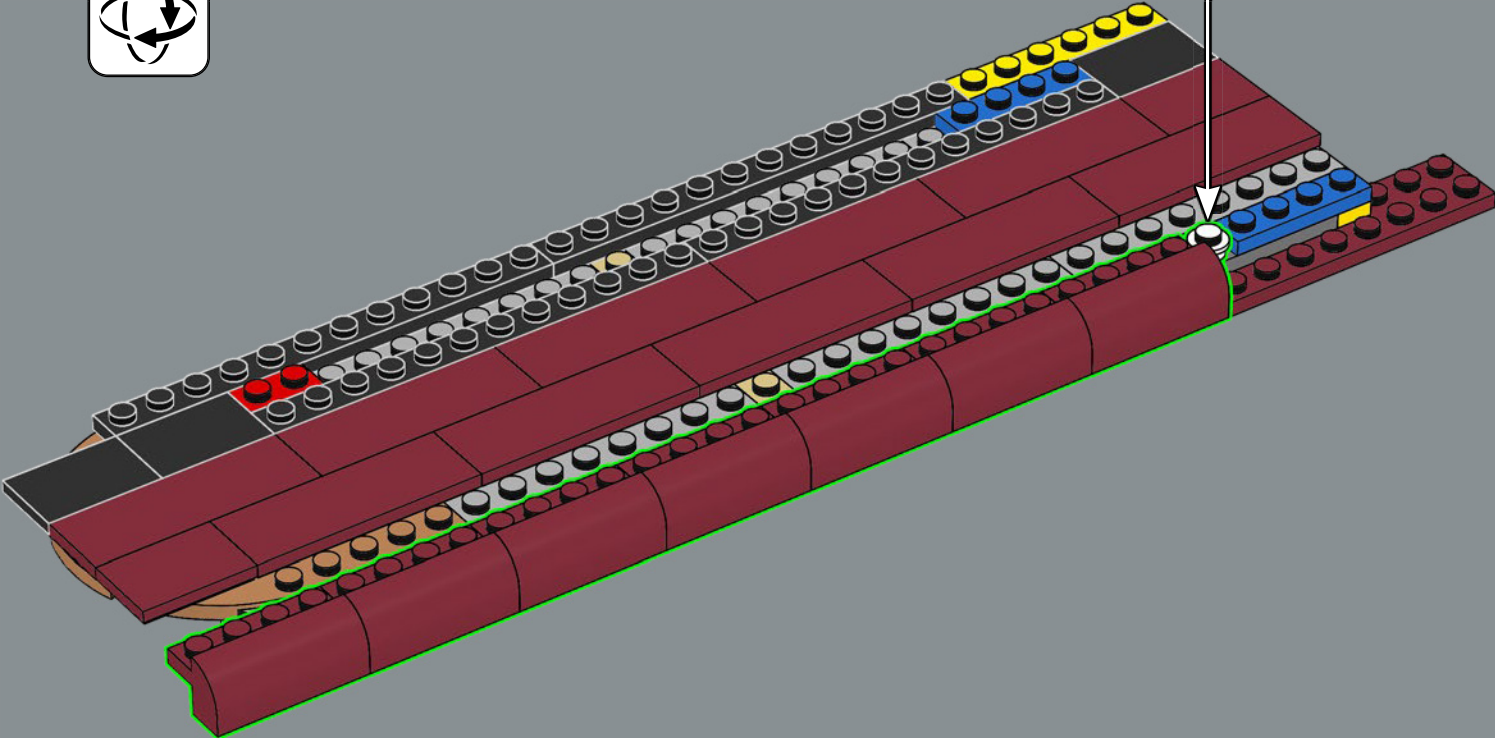

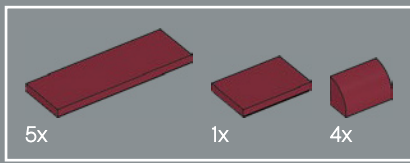

313

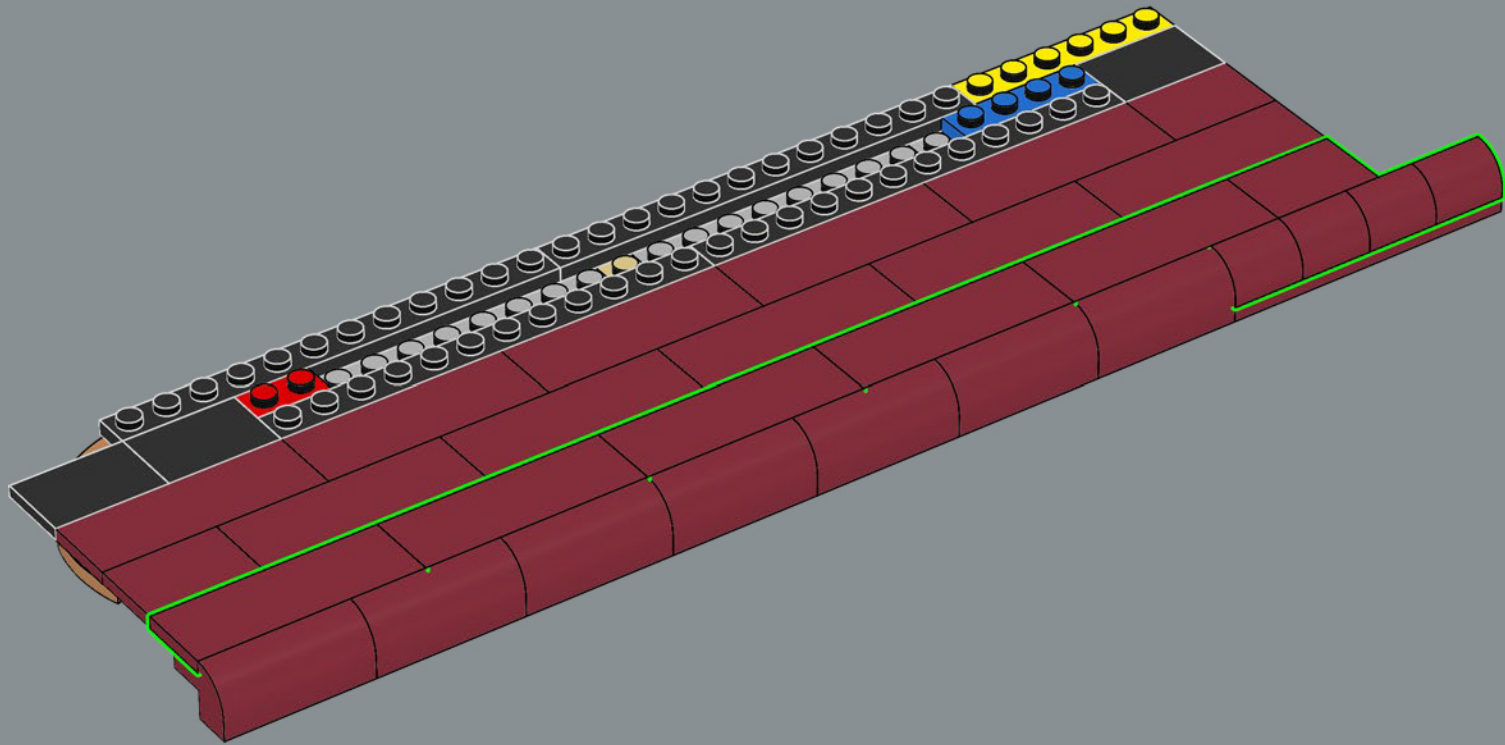



314

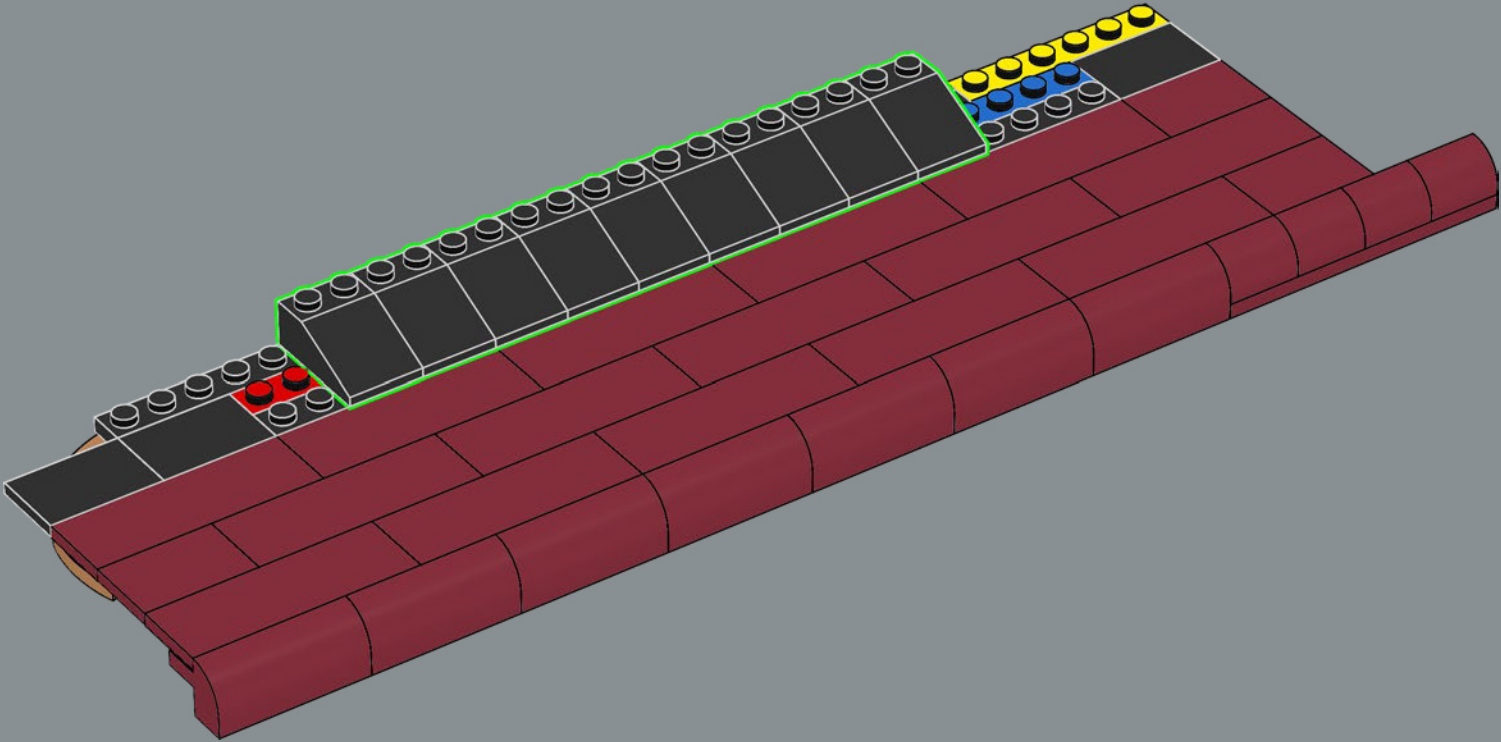



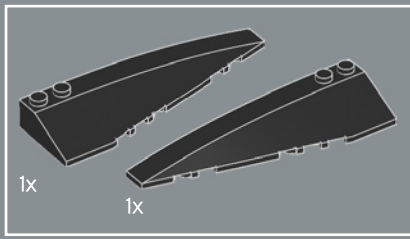

315

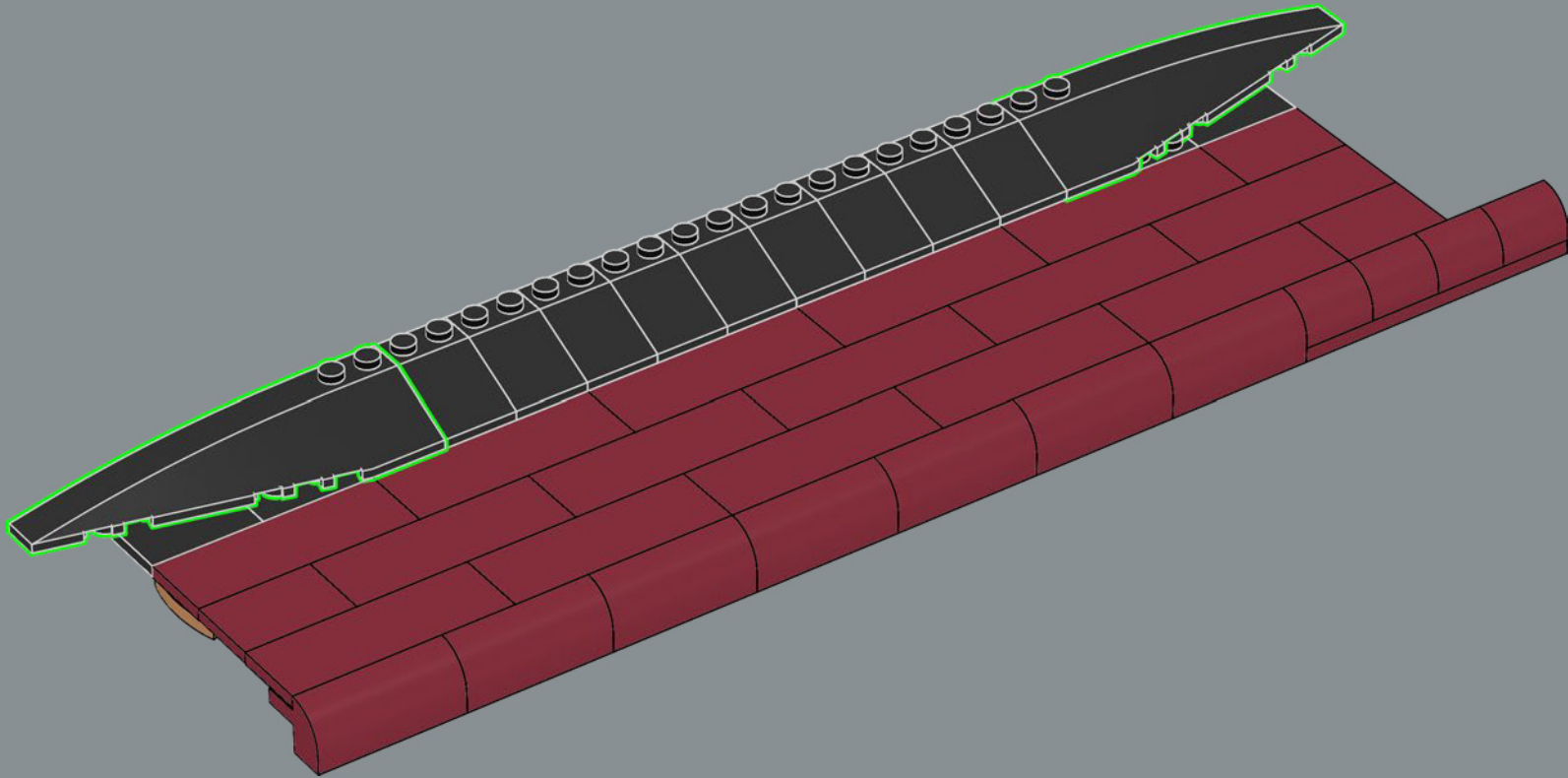

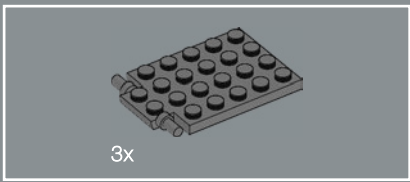

316

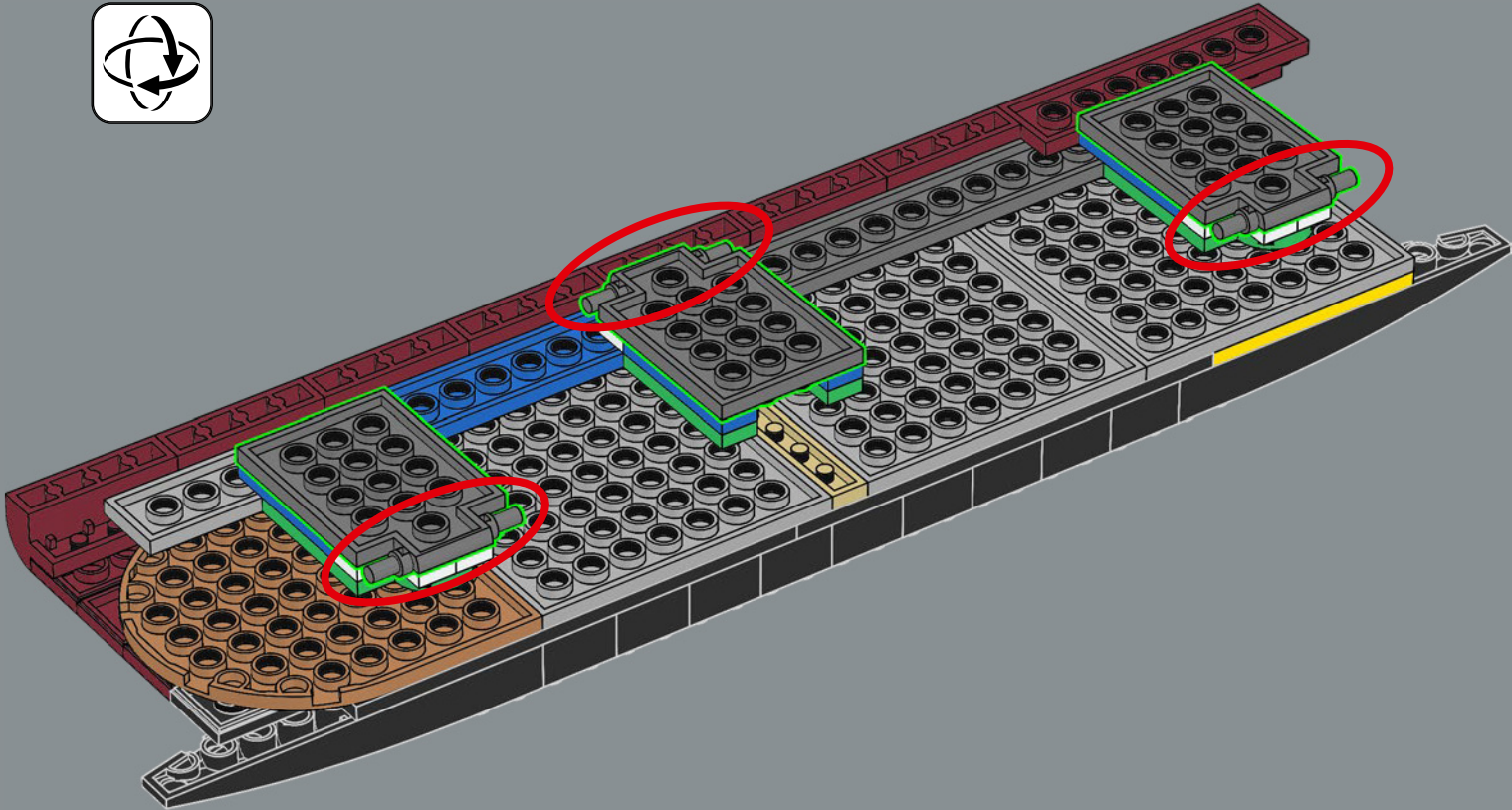



317

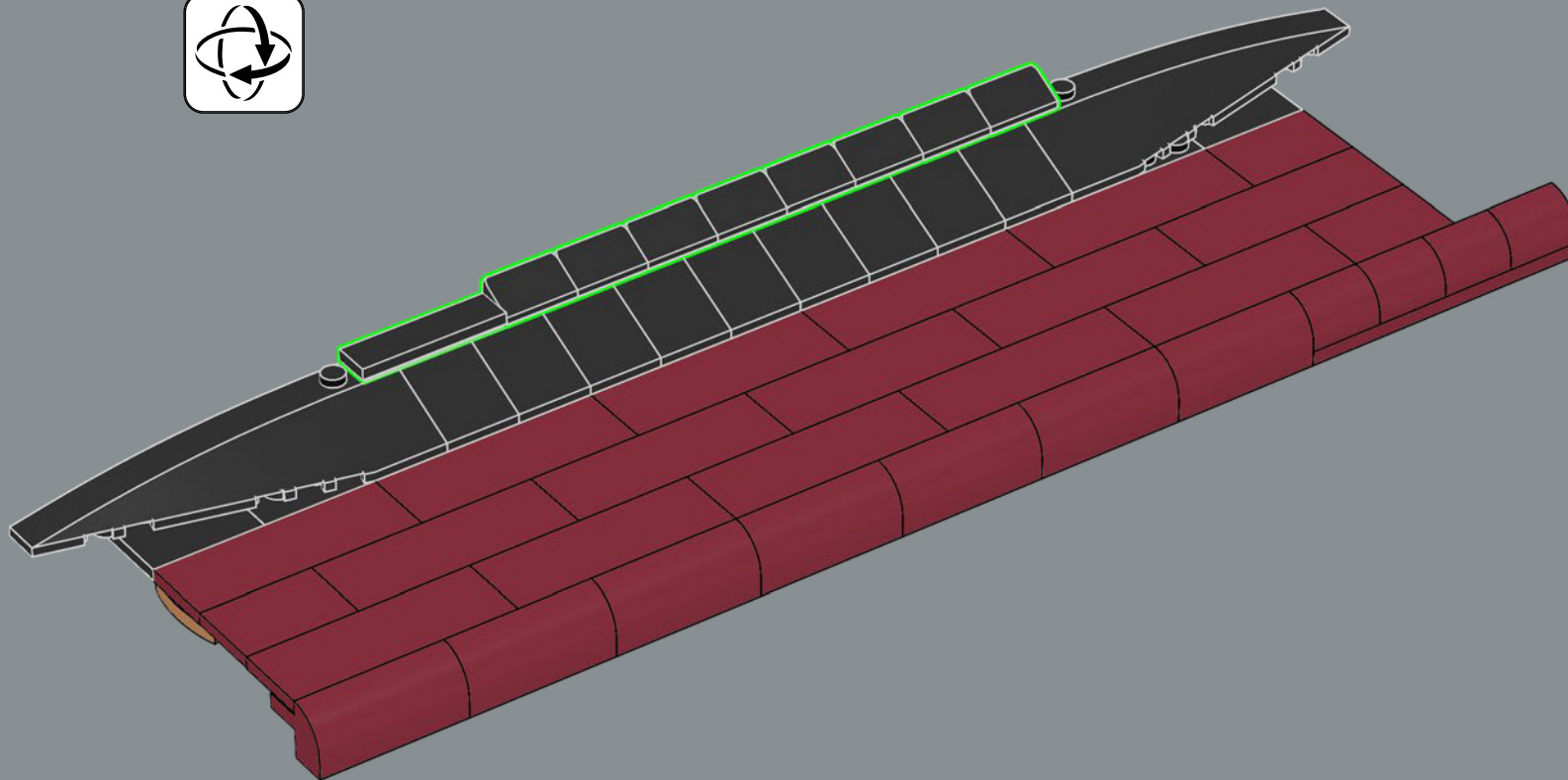

318

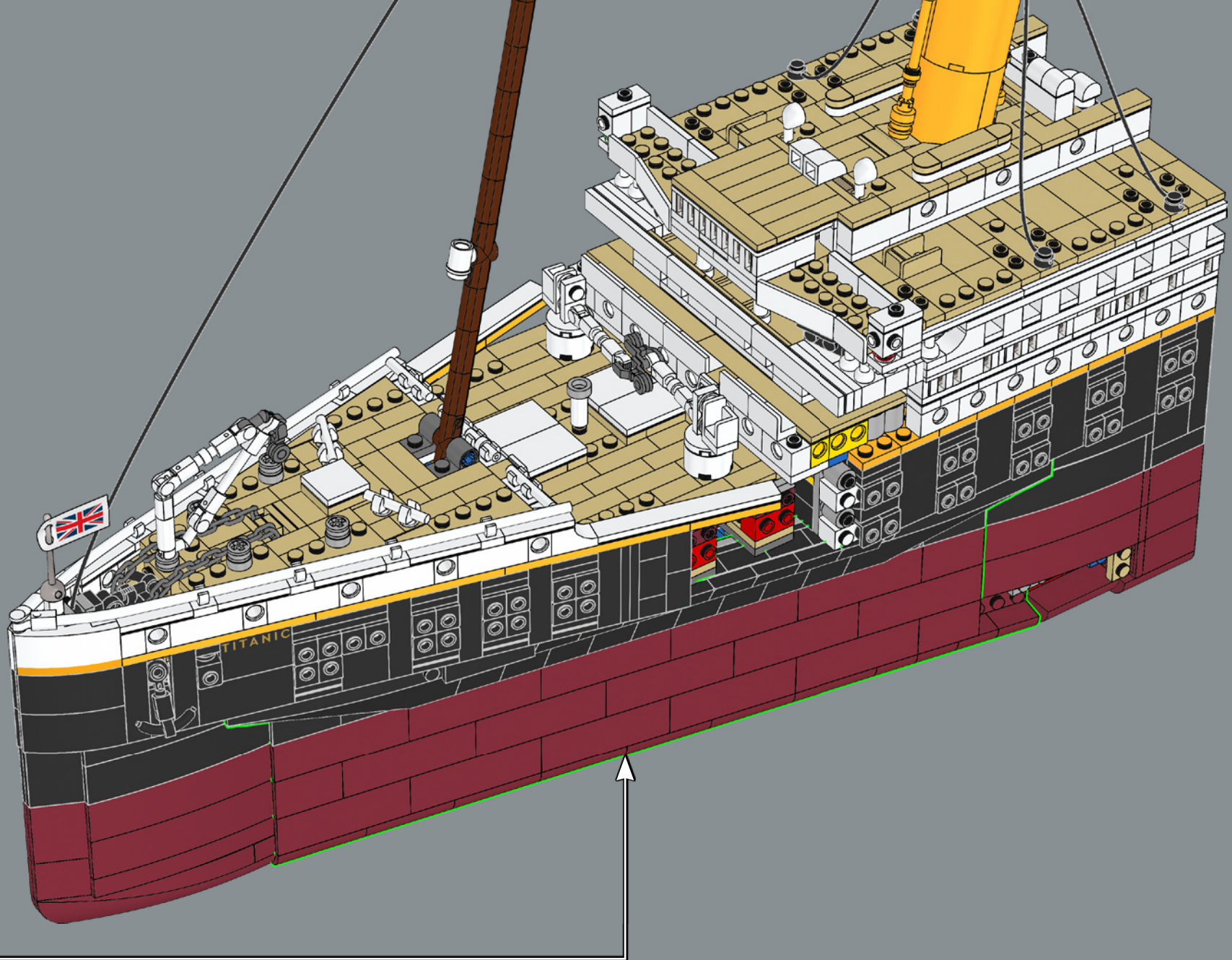

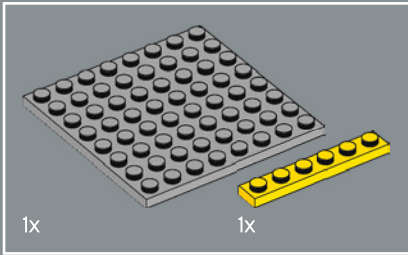
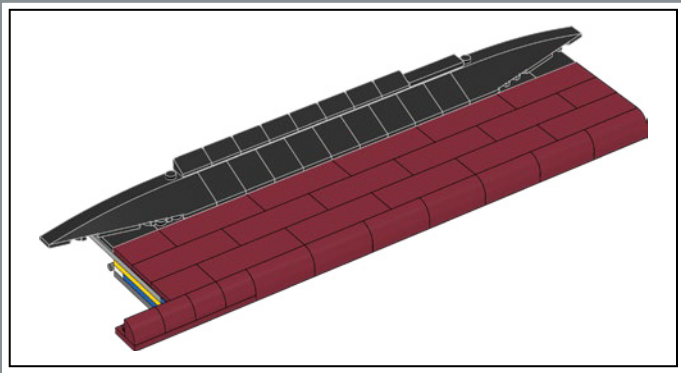

319

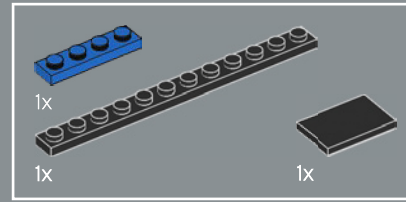
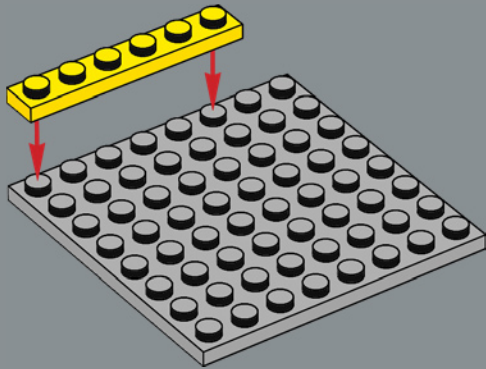

320

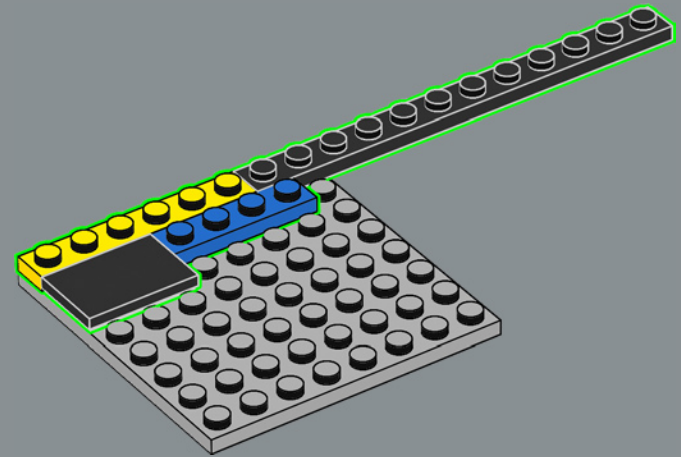

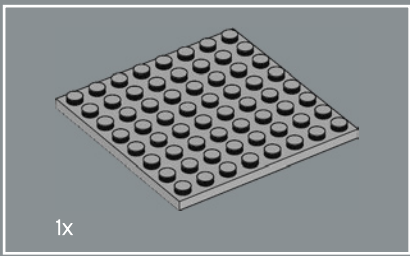

321

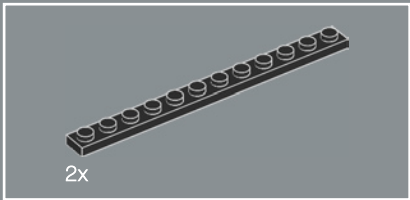
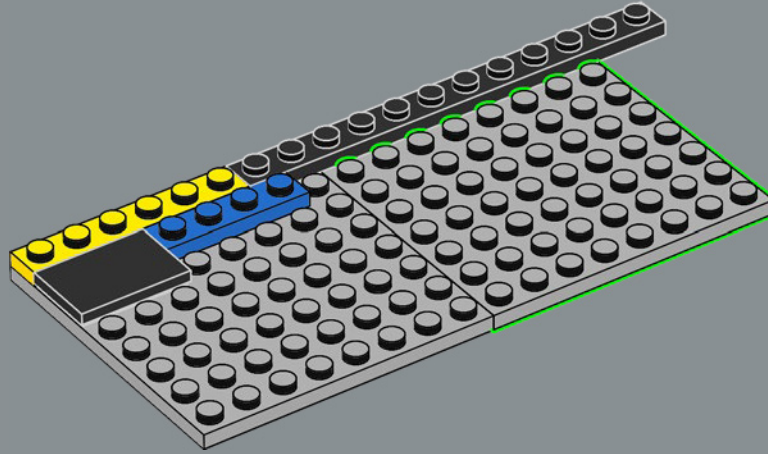

322

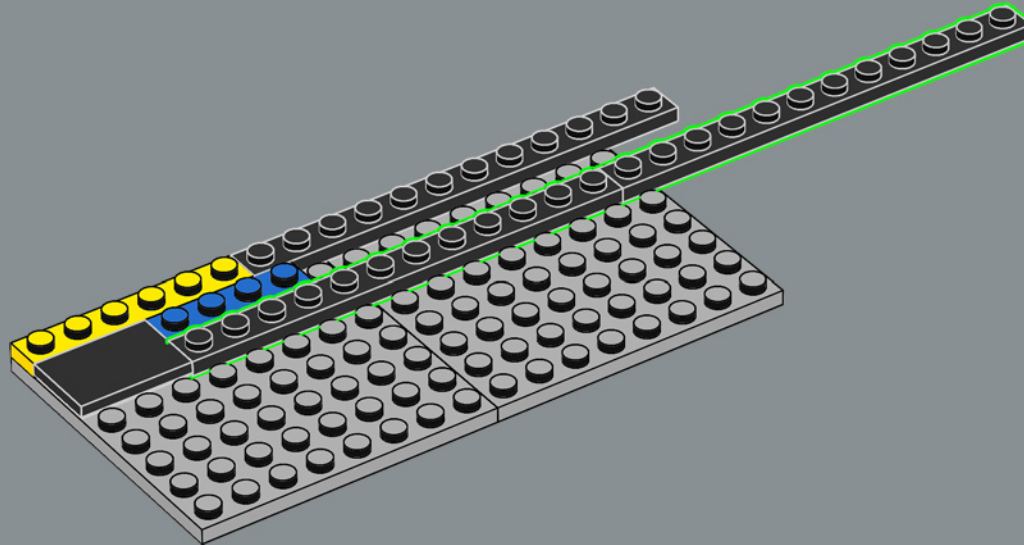

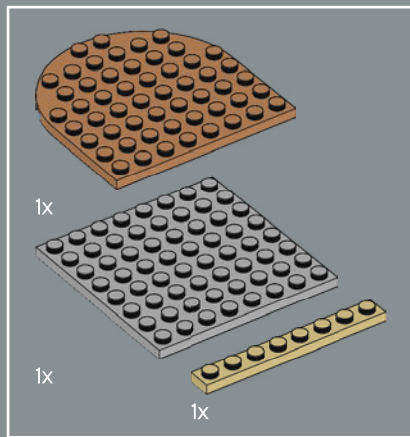

323

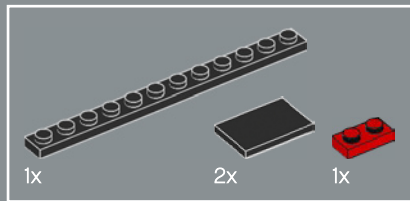
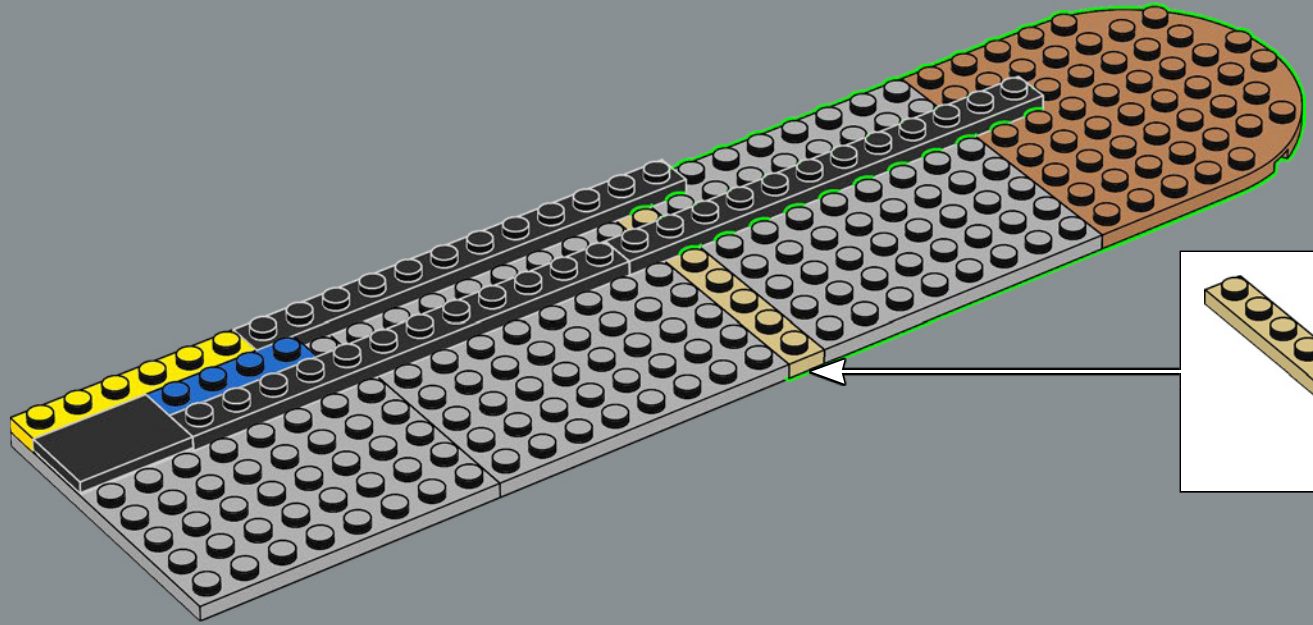

324

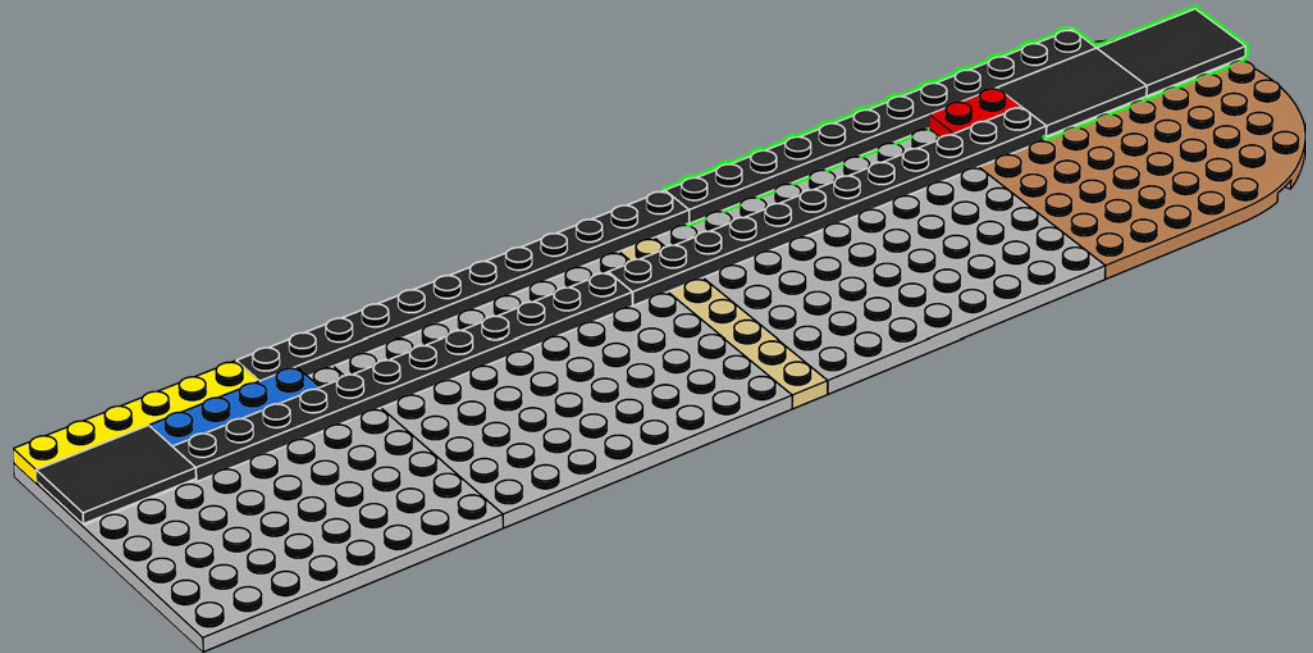

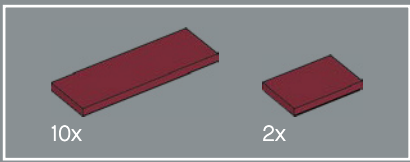

325

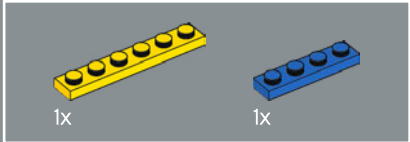
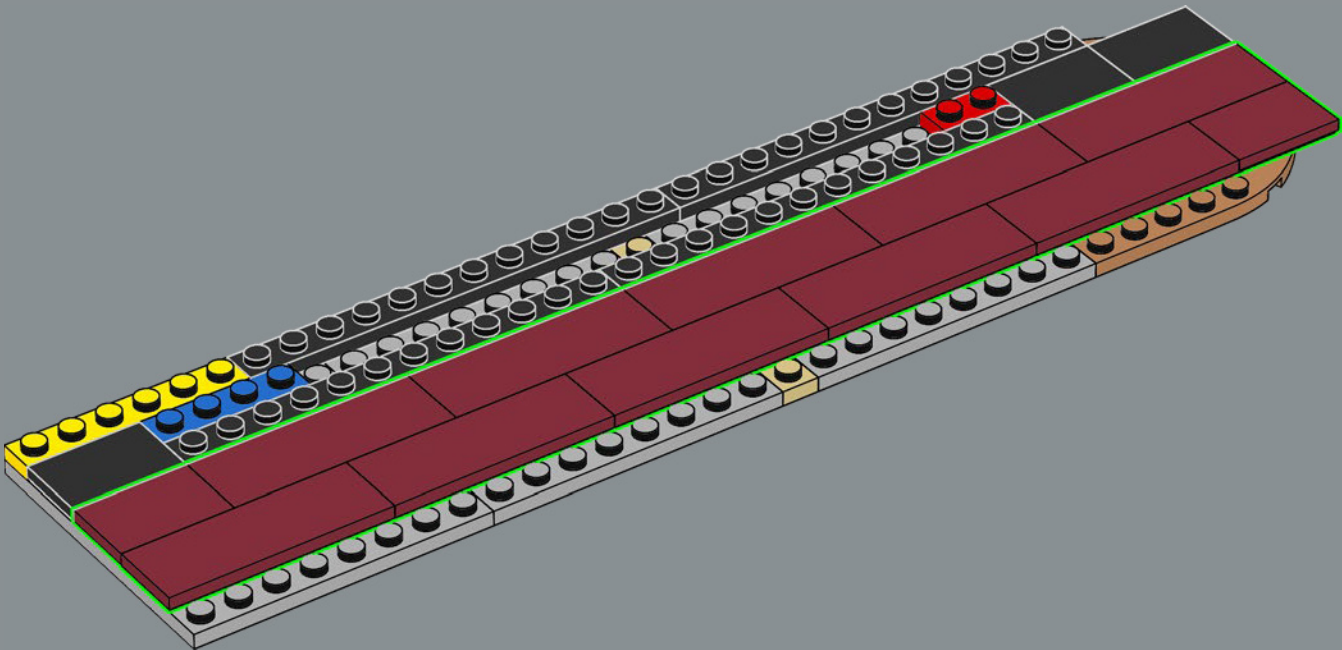

326

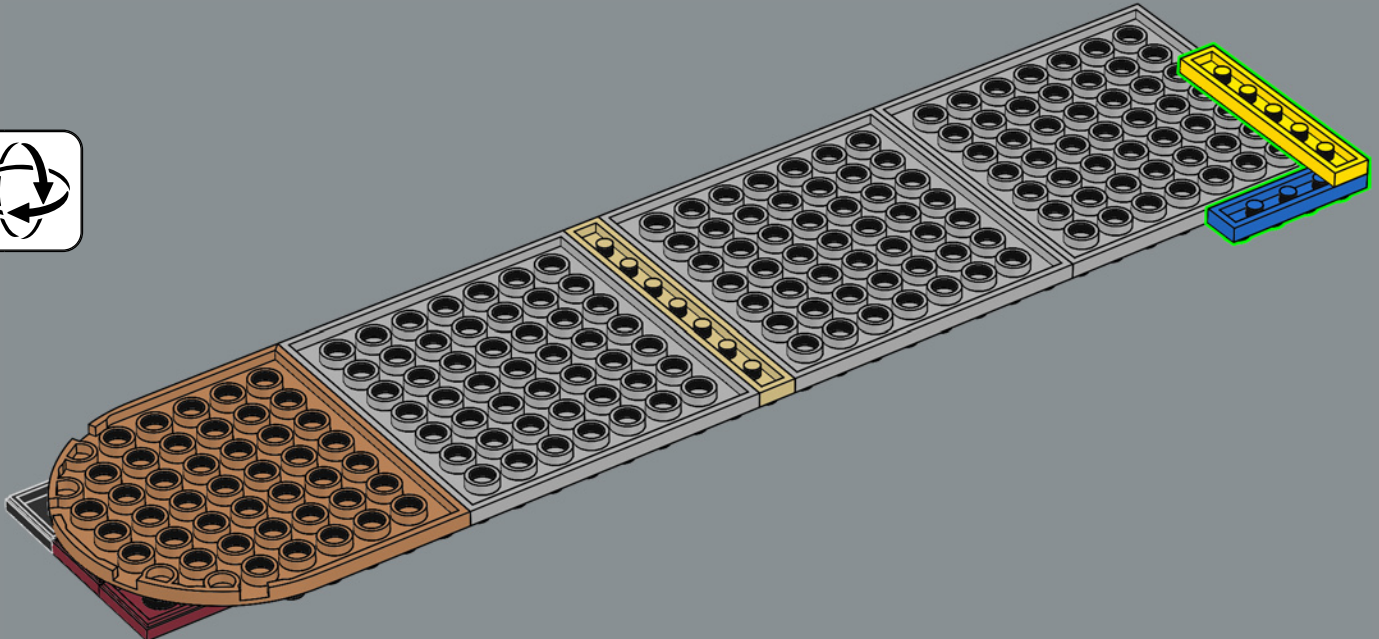



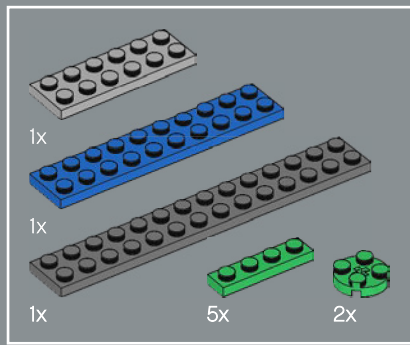

327

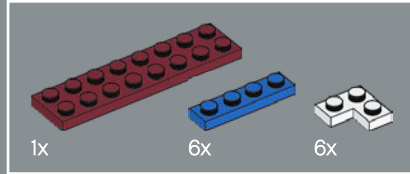
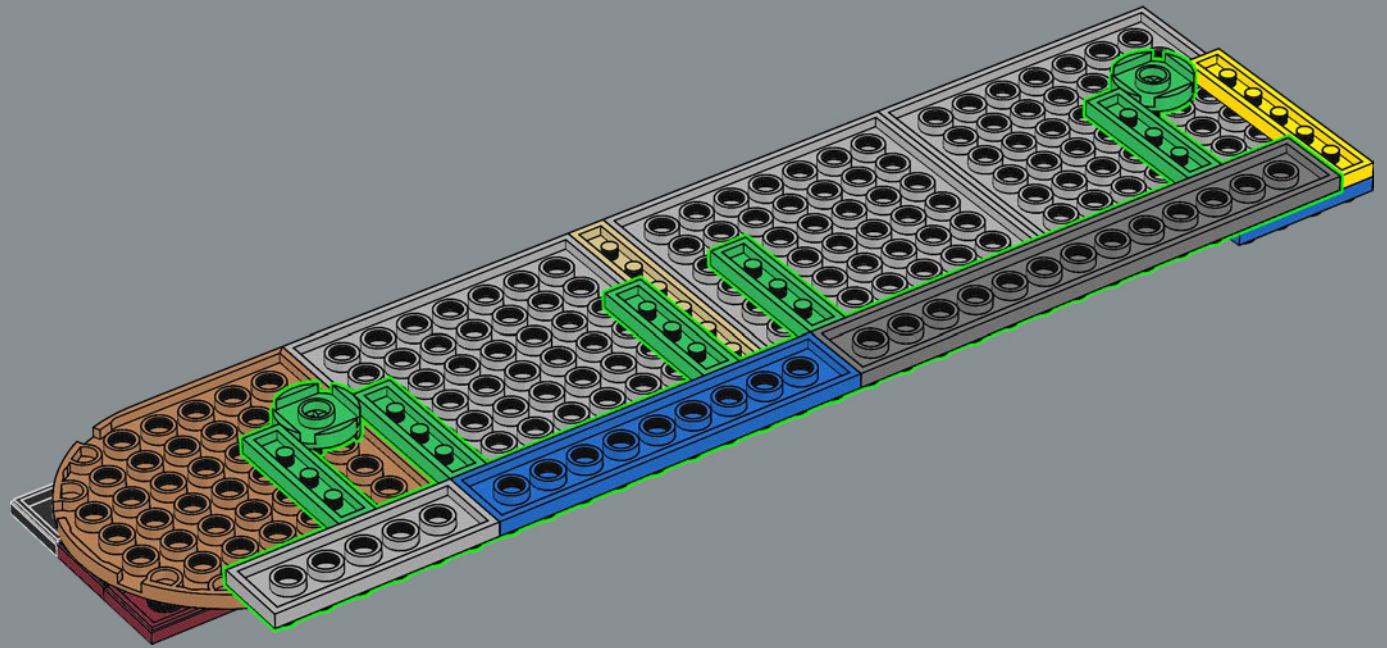

328

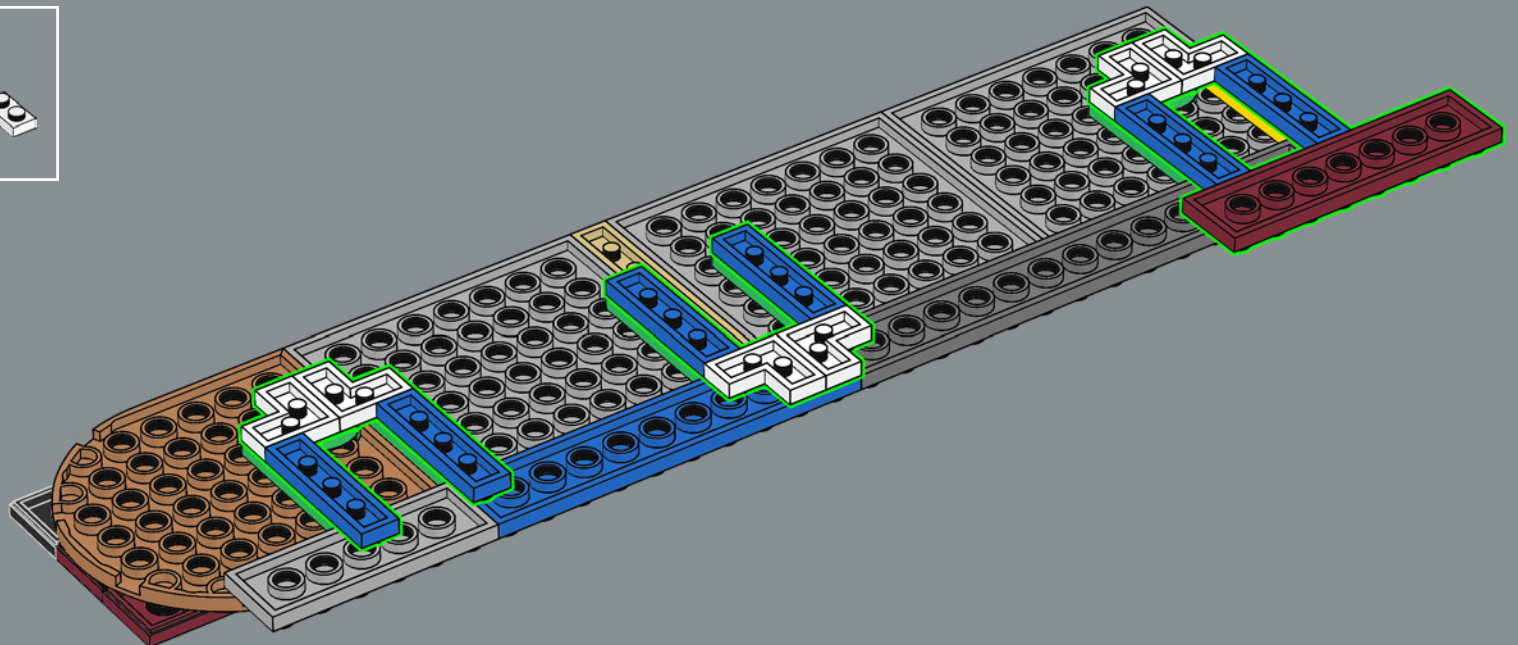

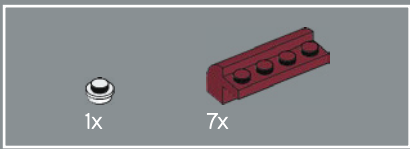

329

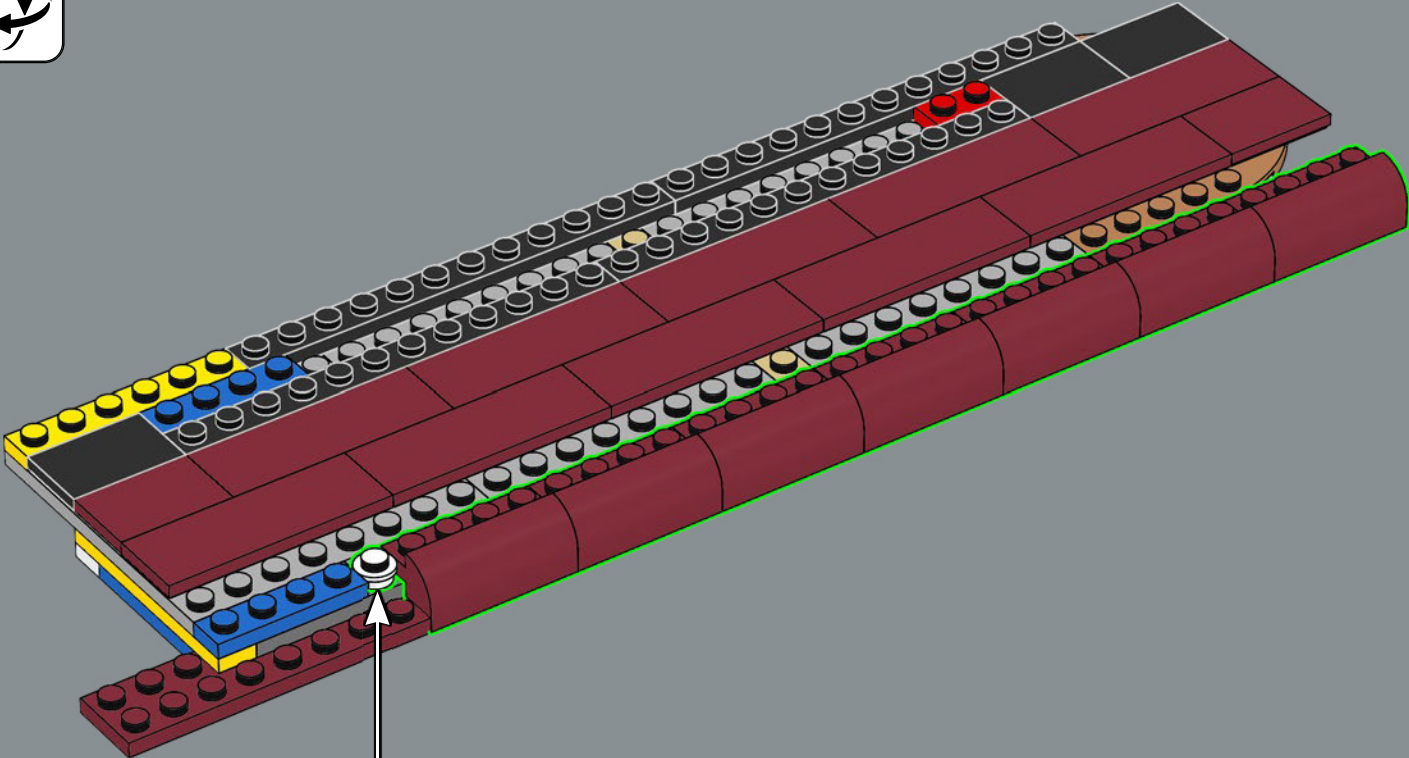

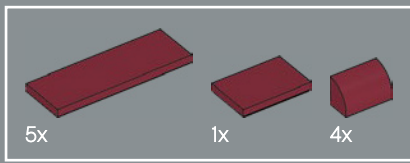

330

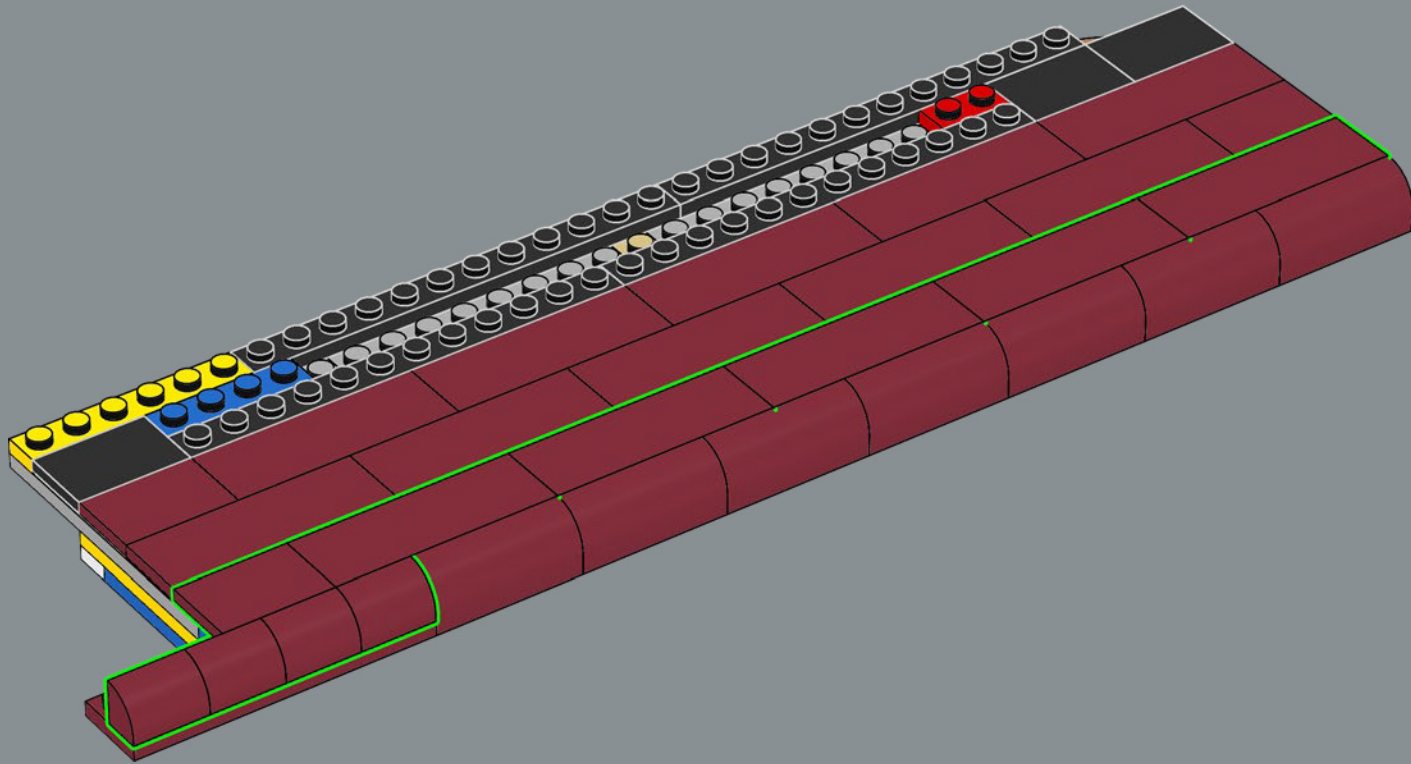



331

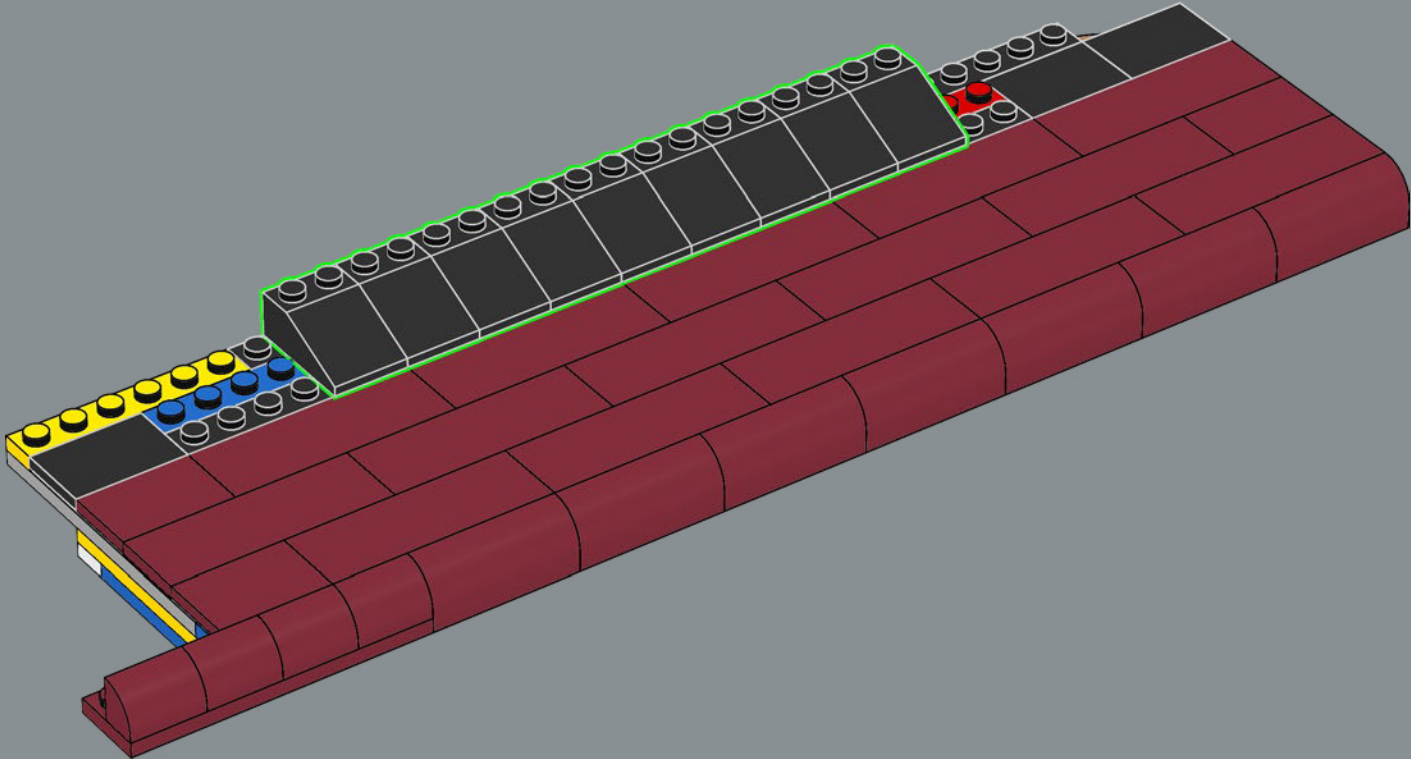



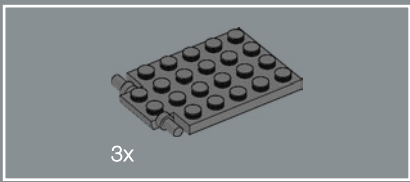

333

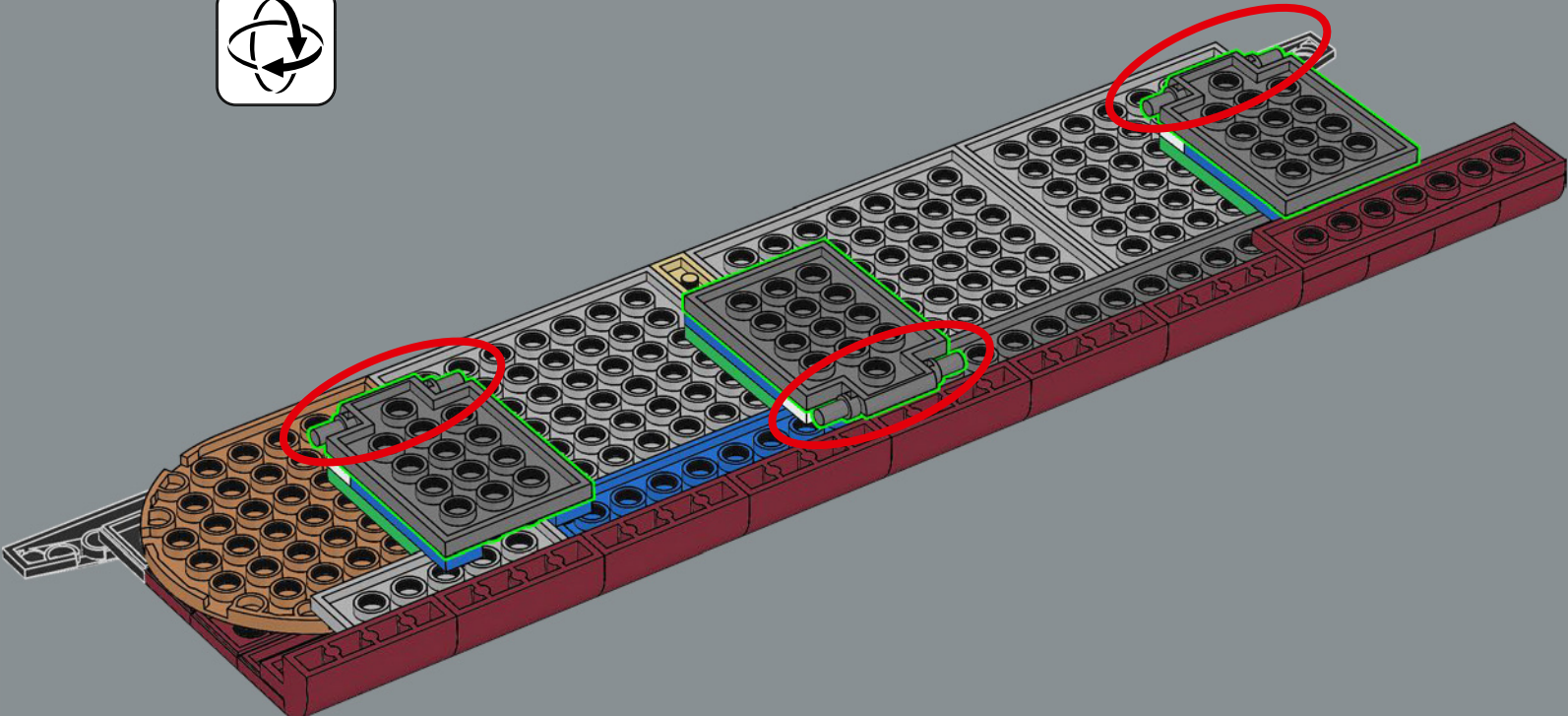



334

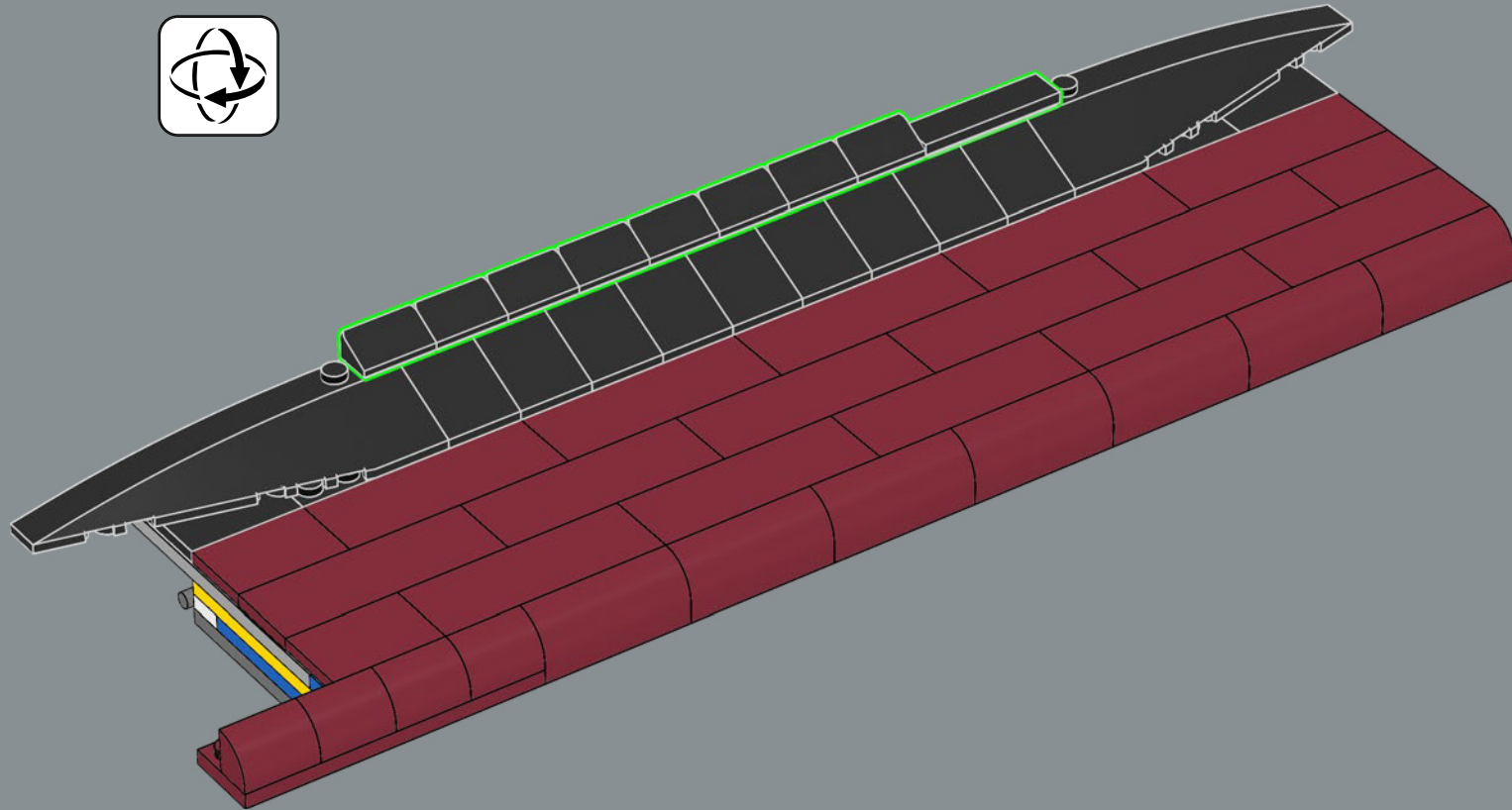

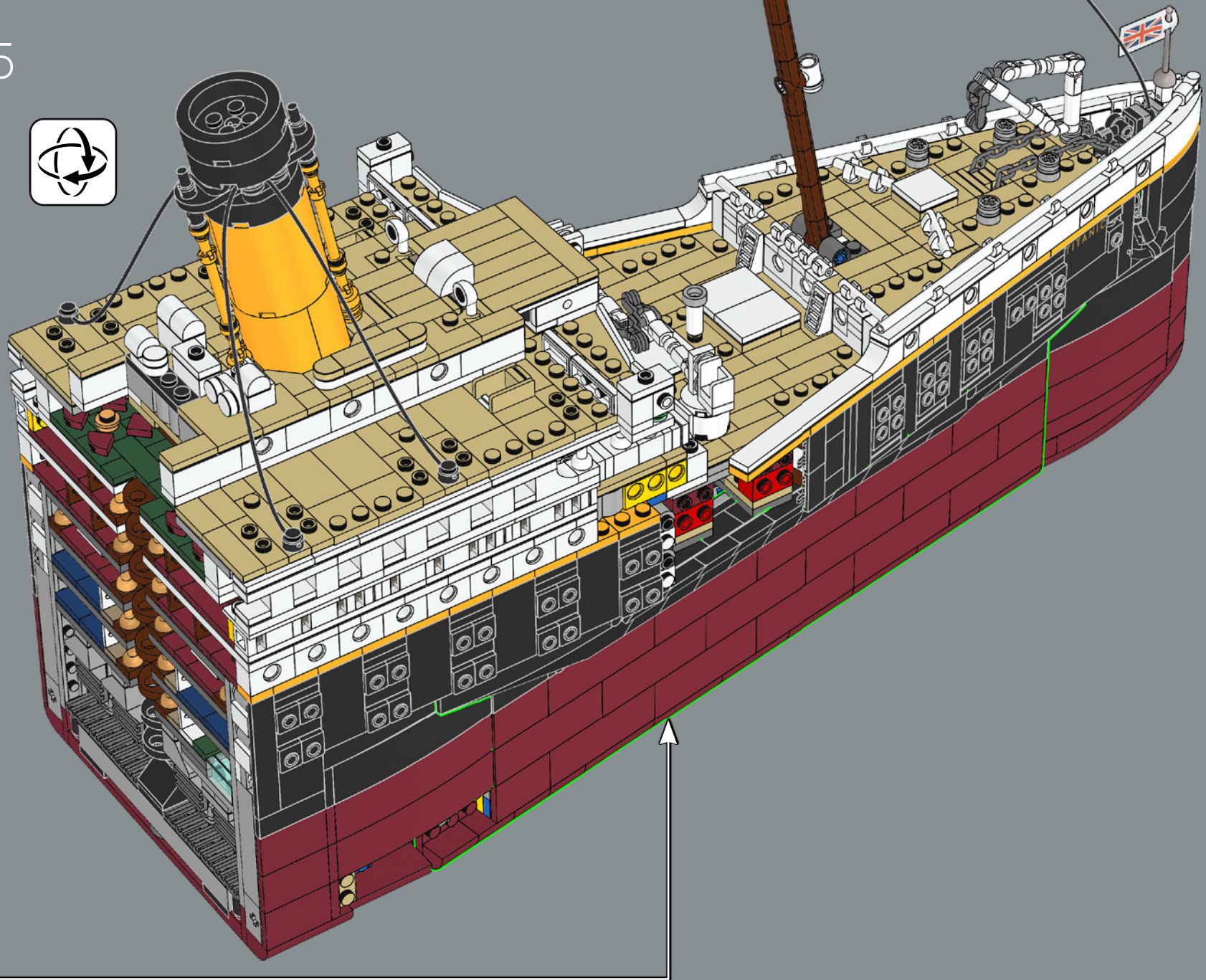



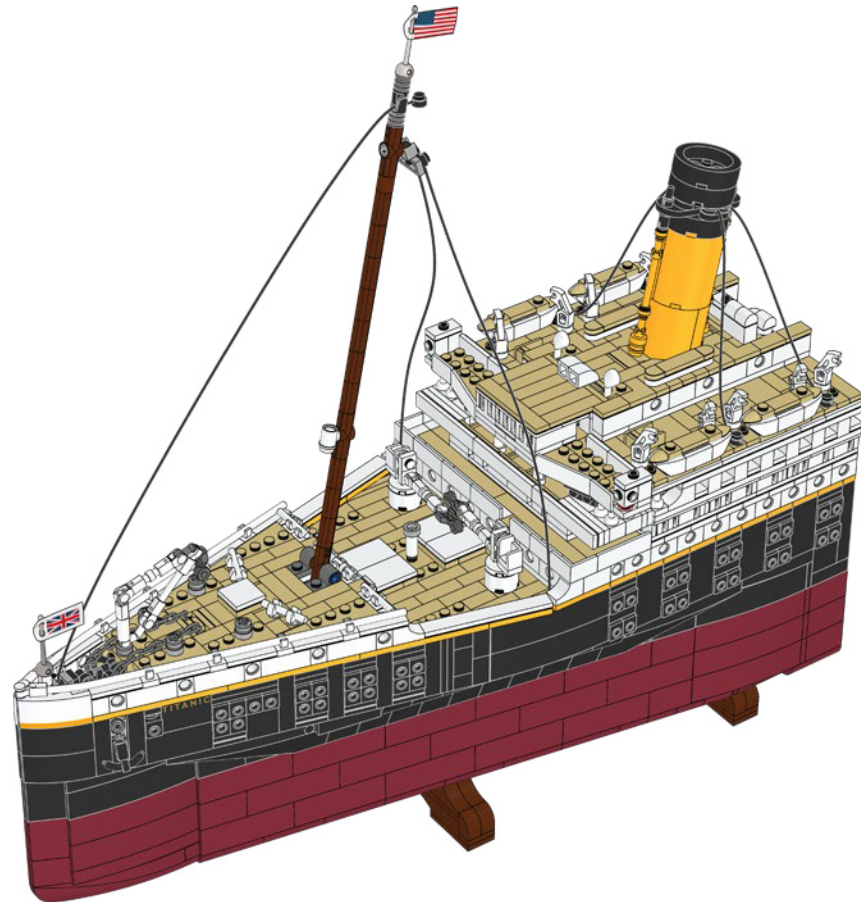
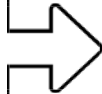



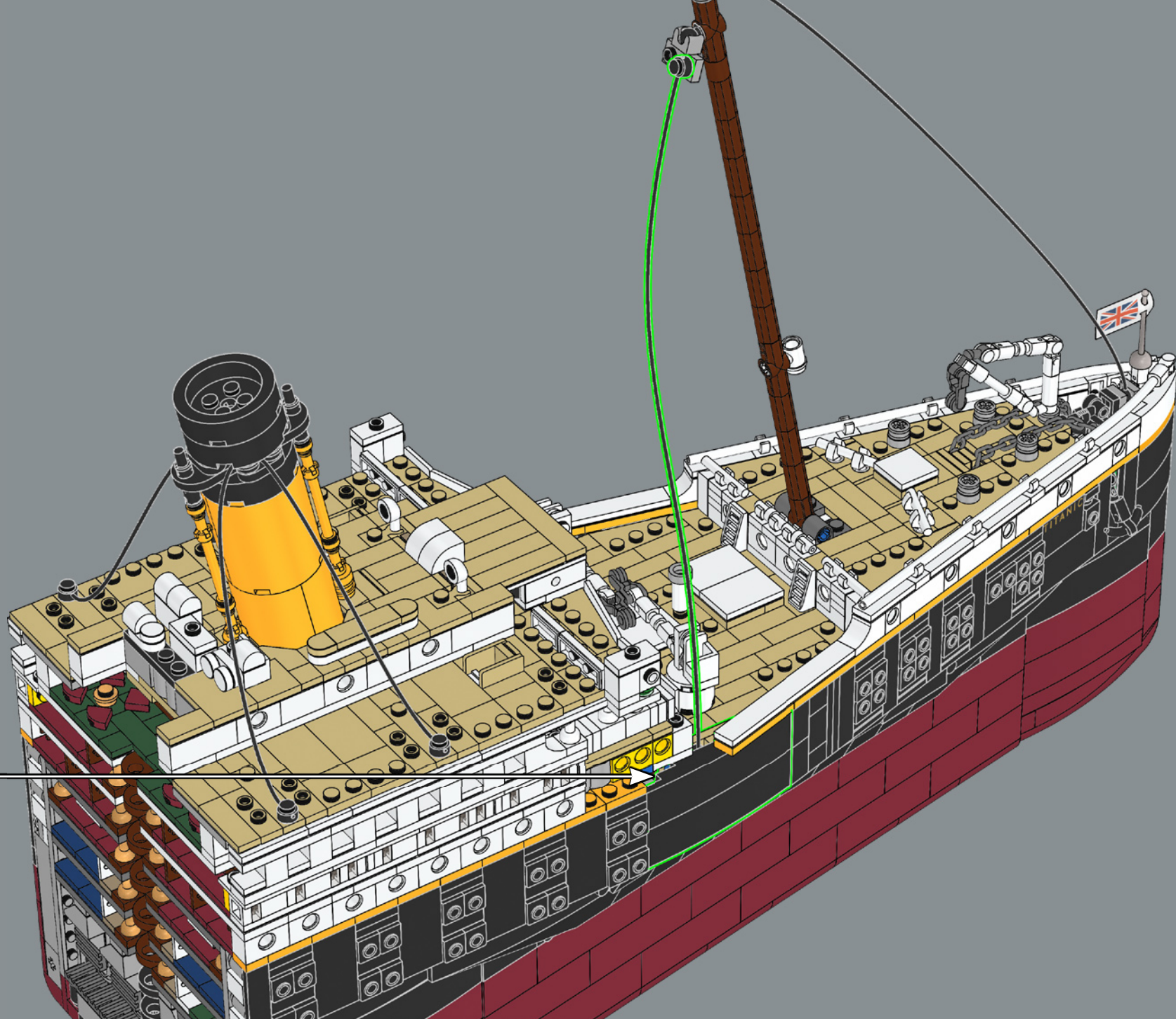

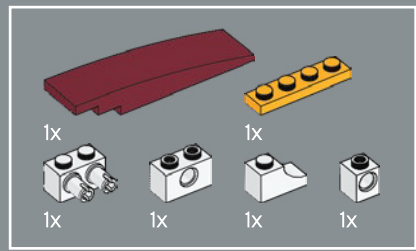

337

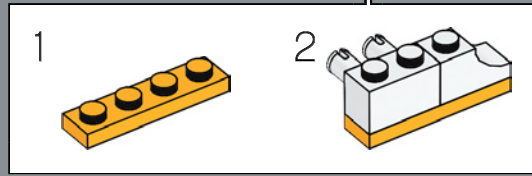
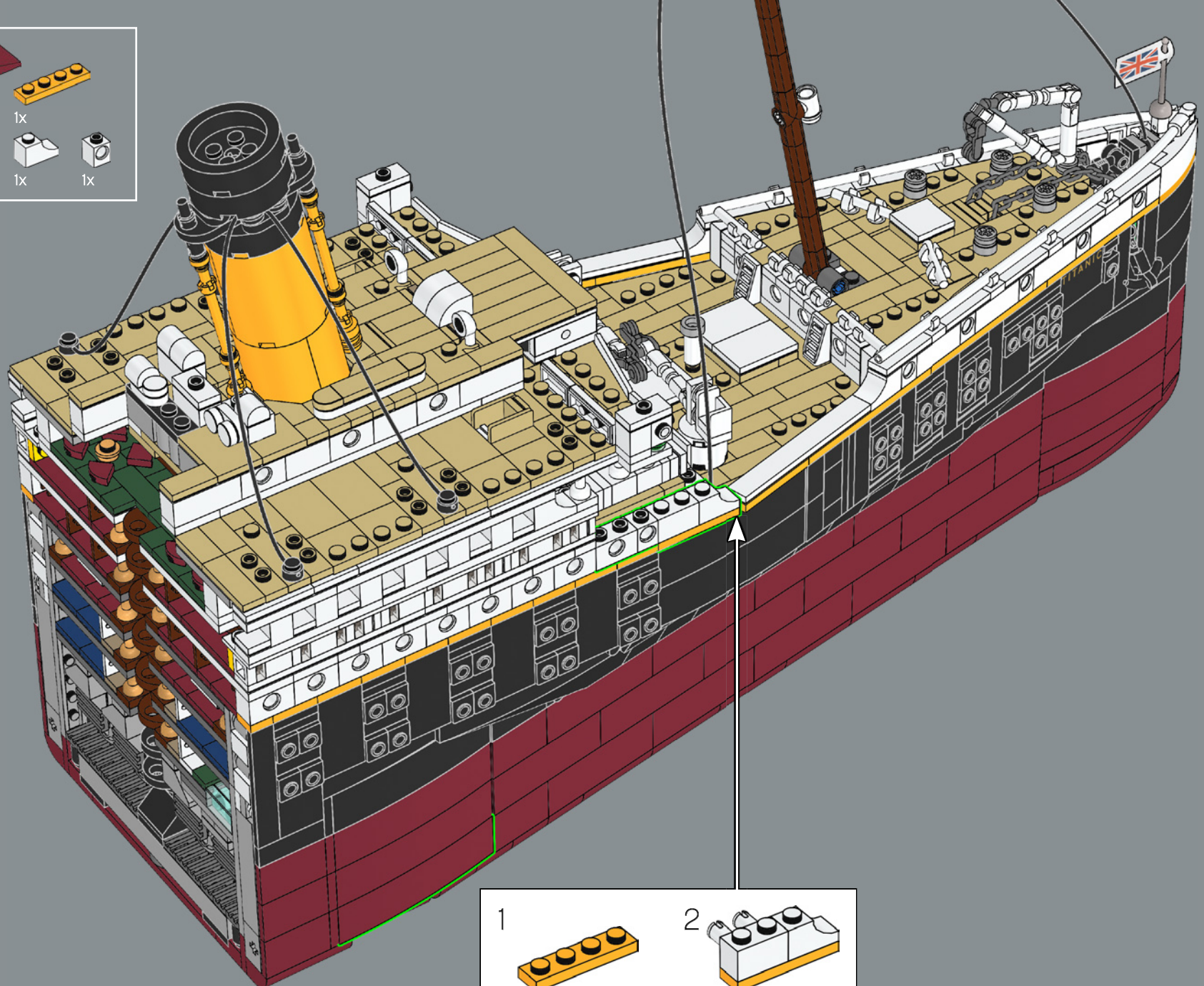



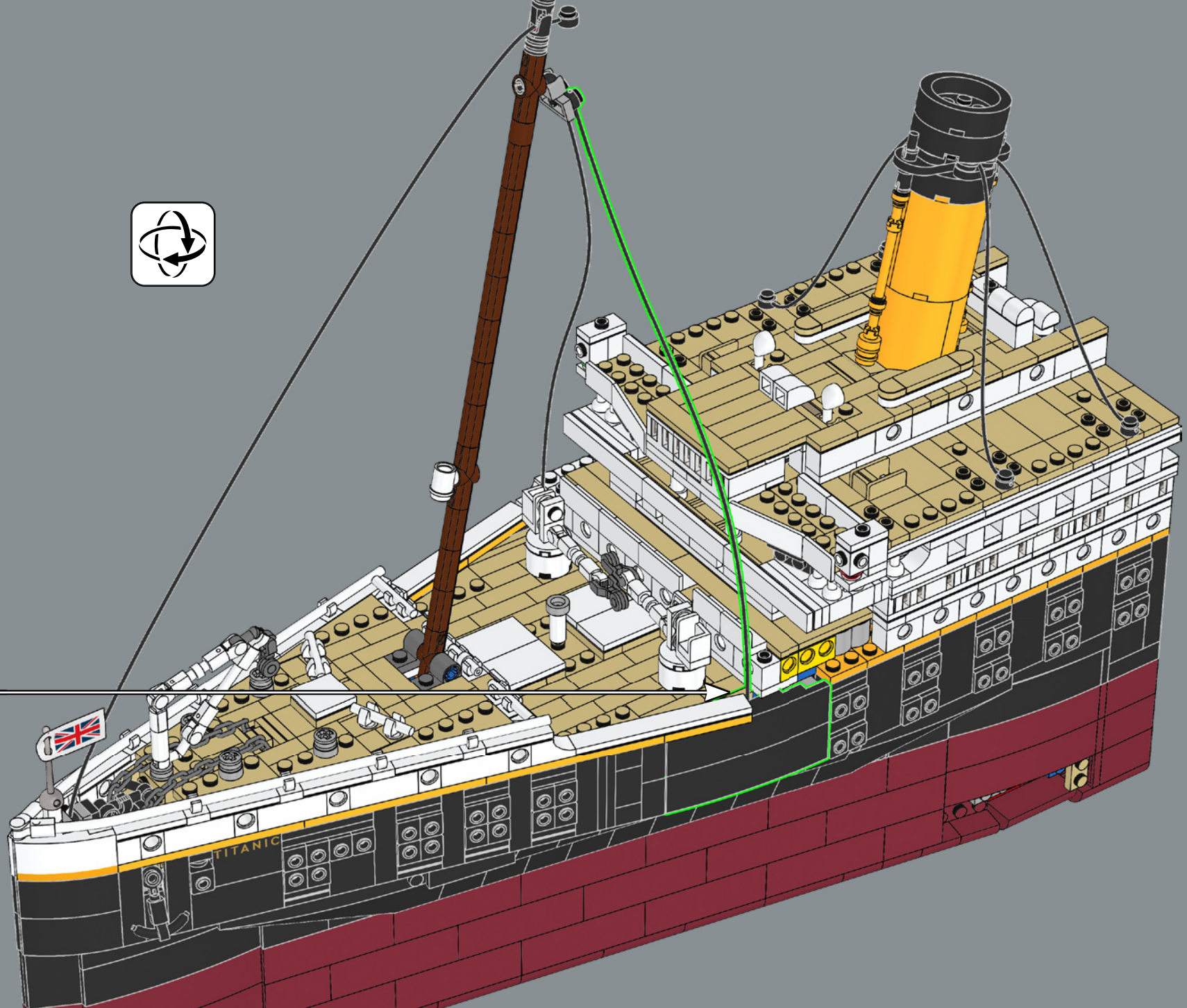

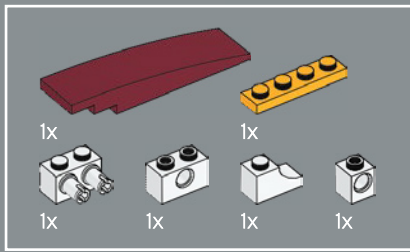

339

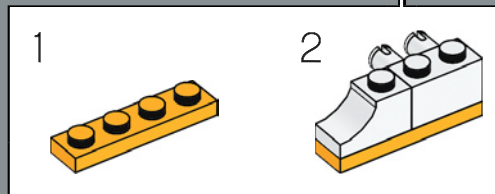
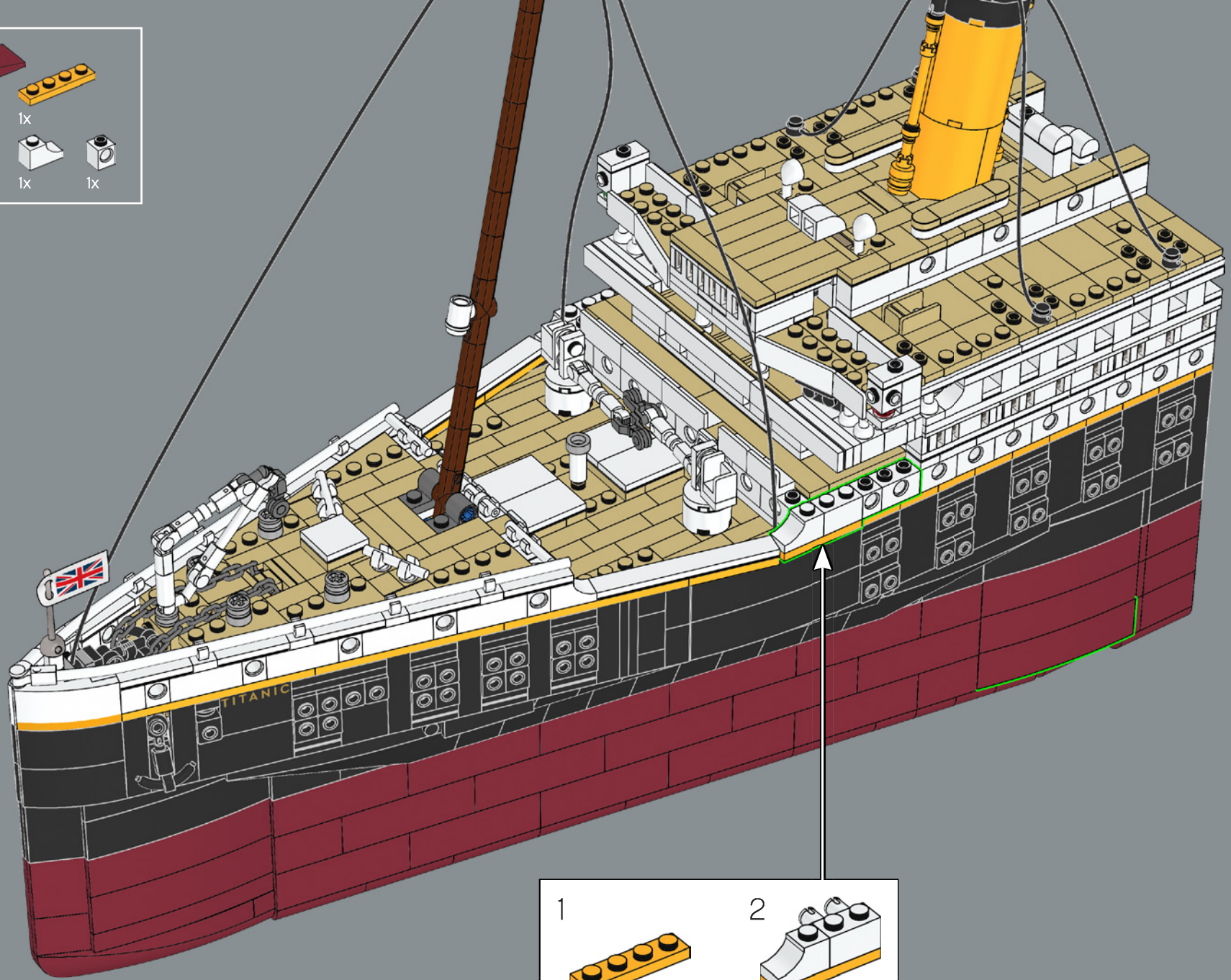

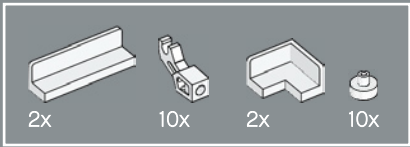

340

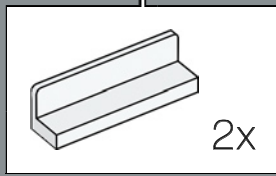
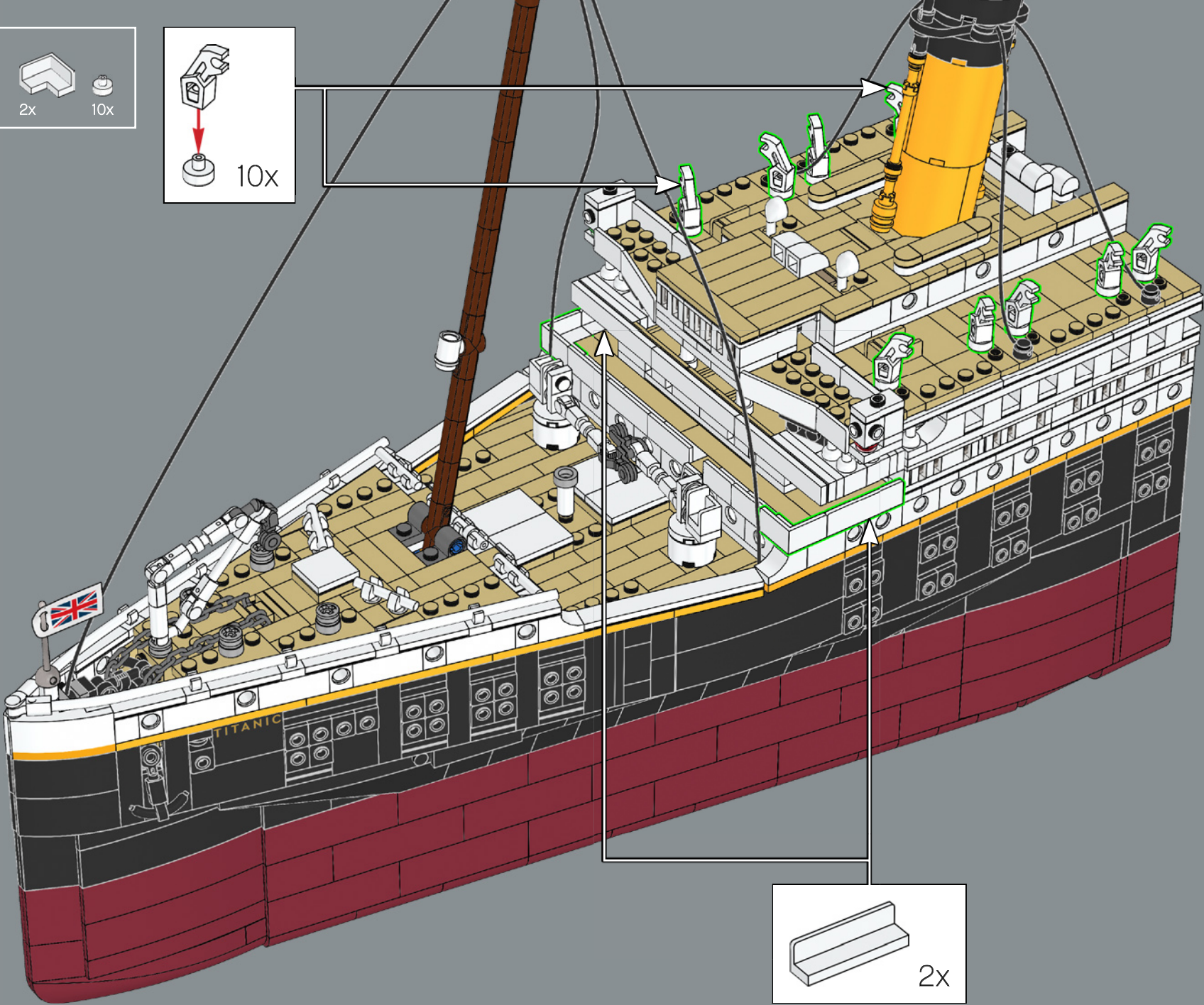
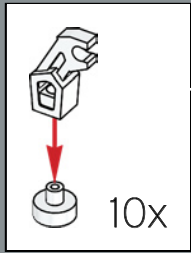



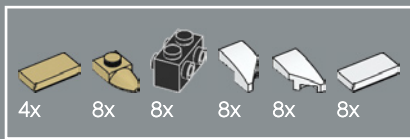

341

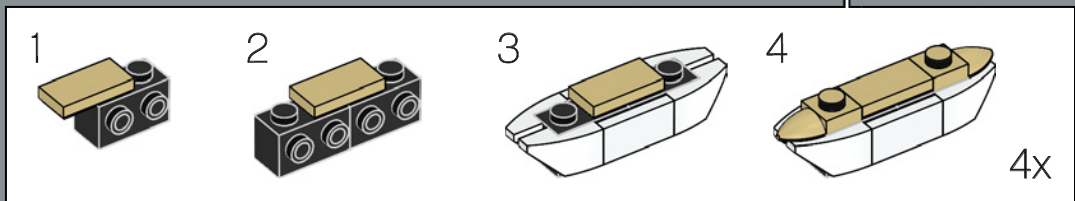
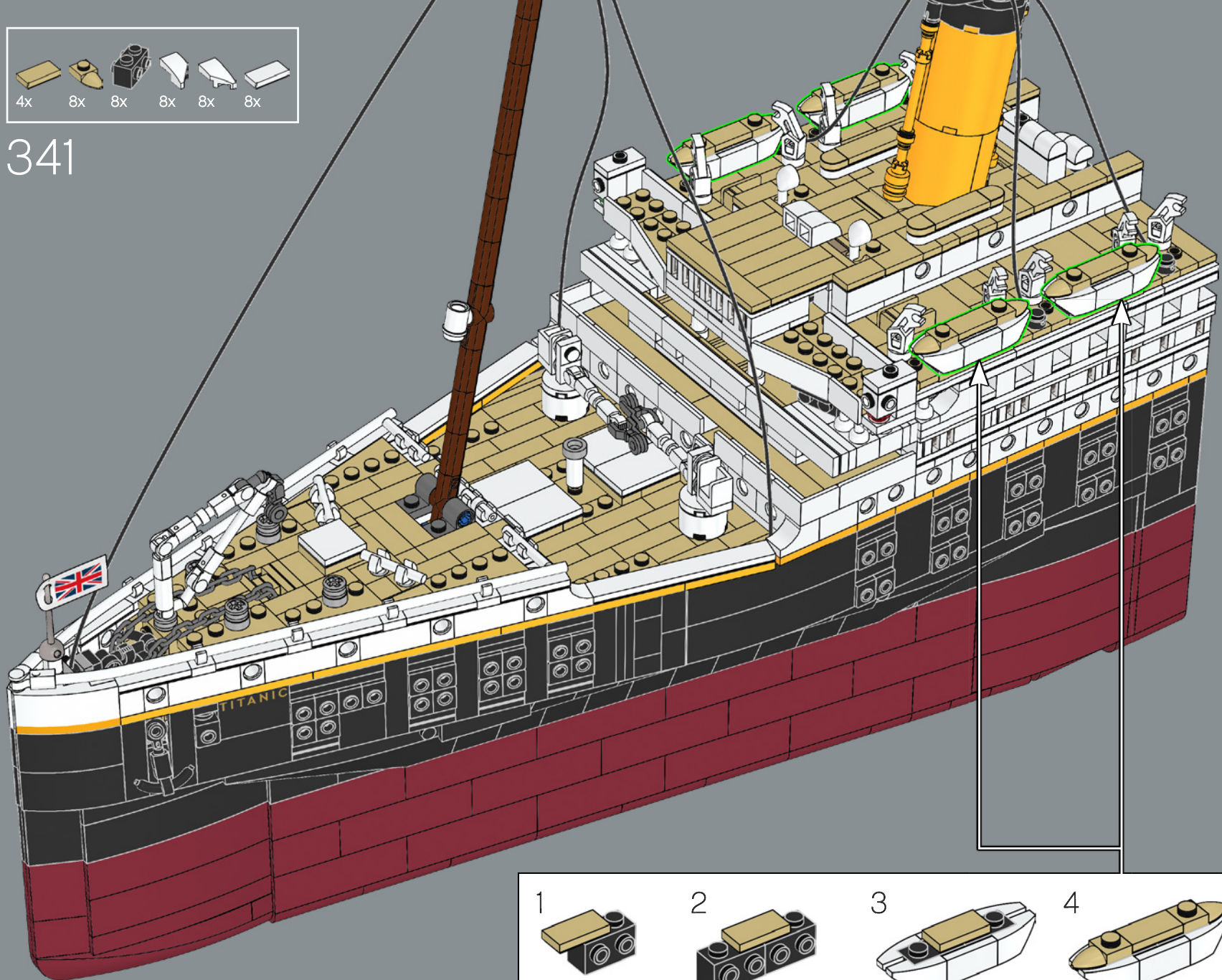

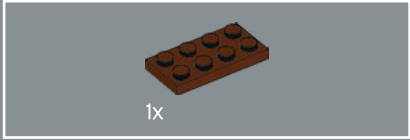
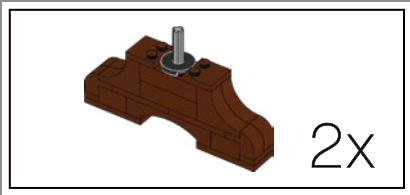

342

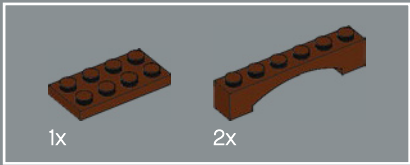
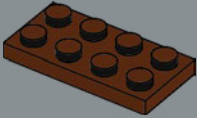

343

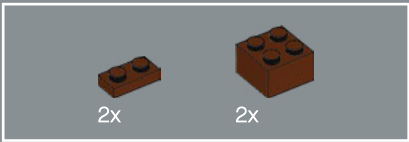
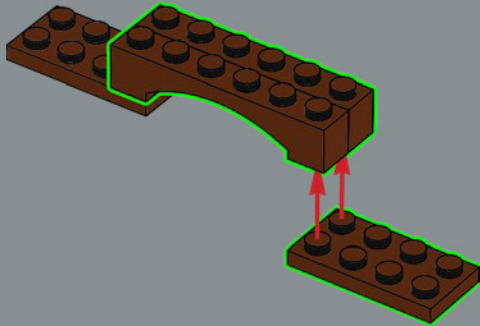

344

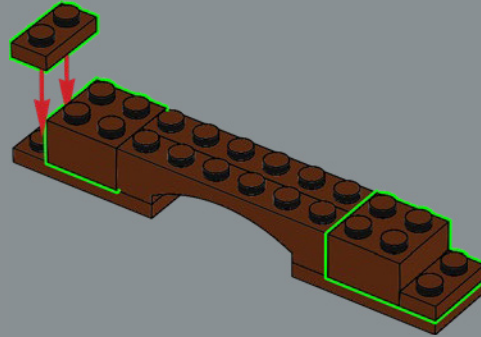

345

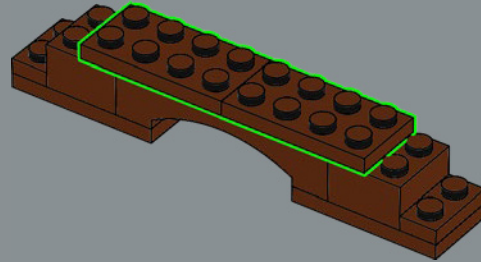

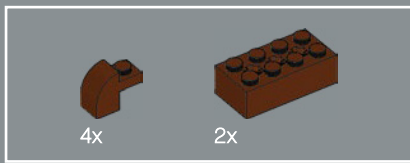

346

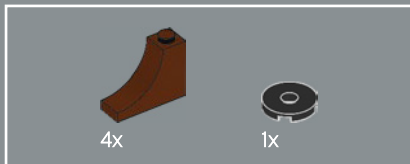
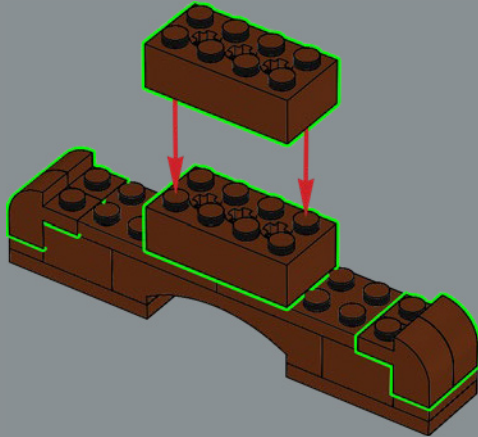

347

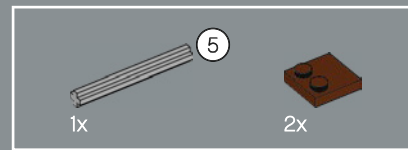
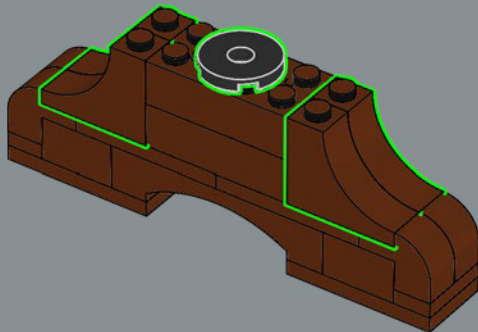

348

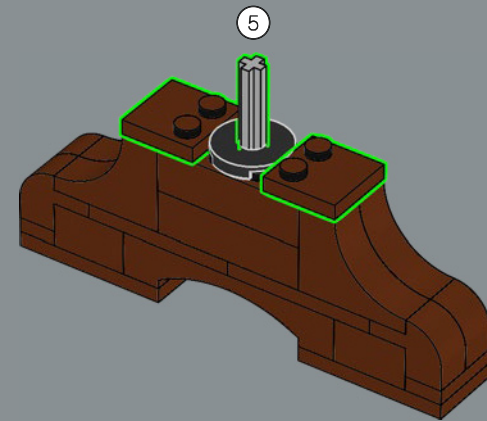

2x

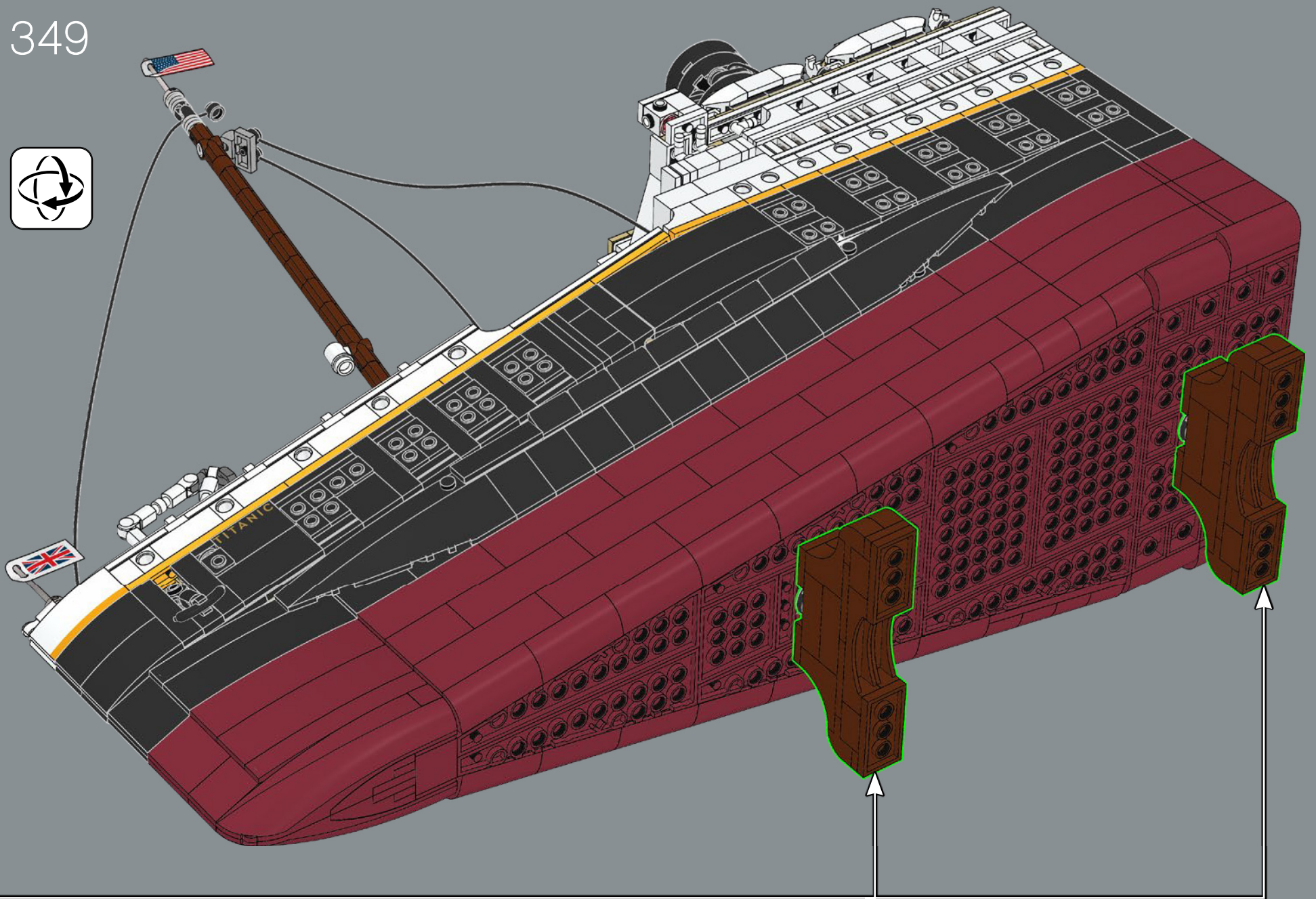

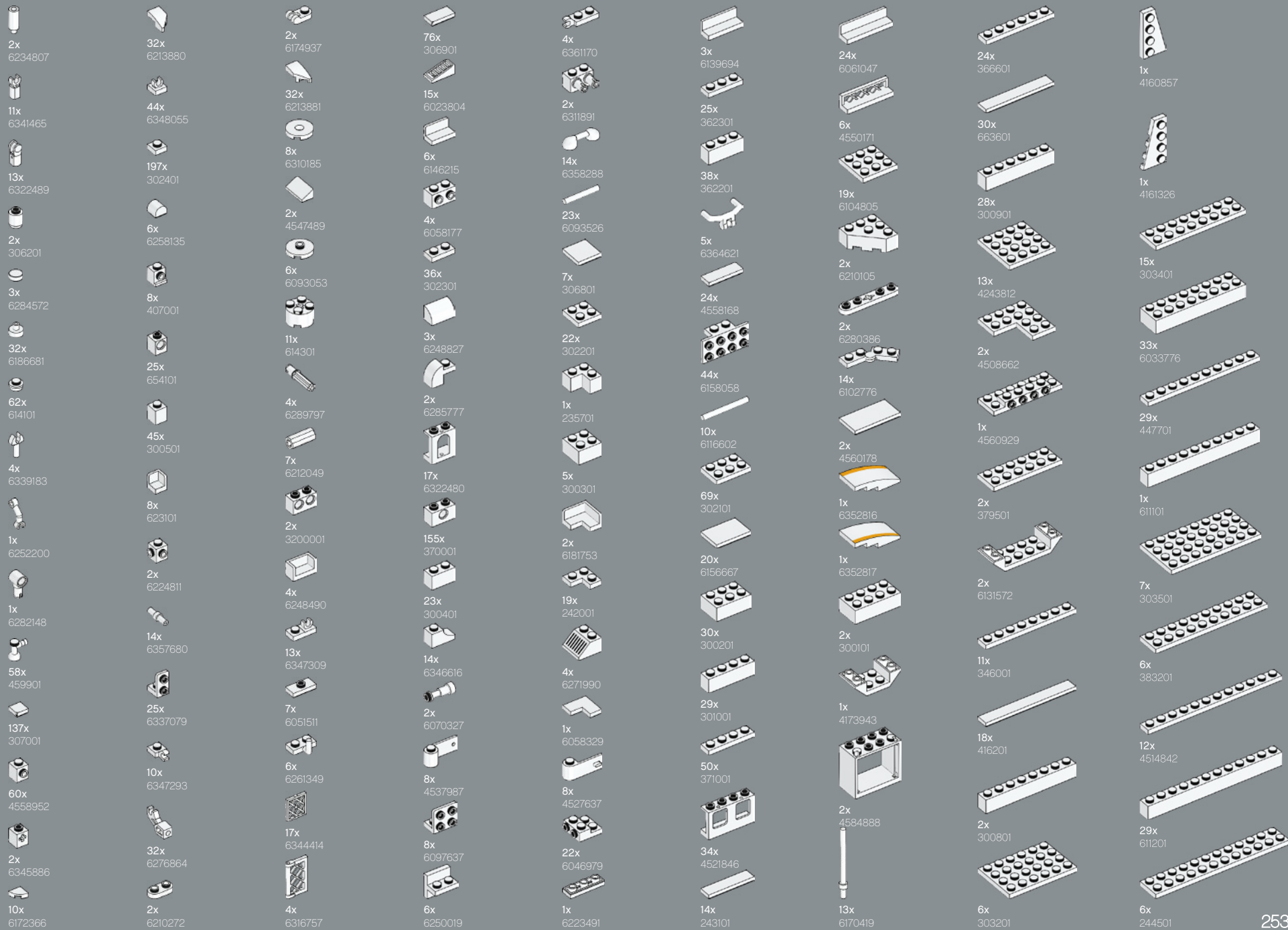

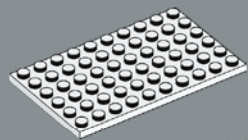

5x  
4528341

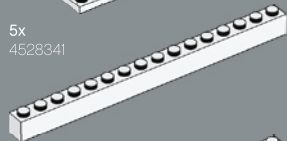

6x  
246501

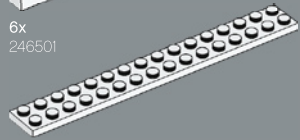

13x  
4119227



2x  
6365707

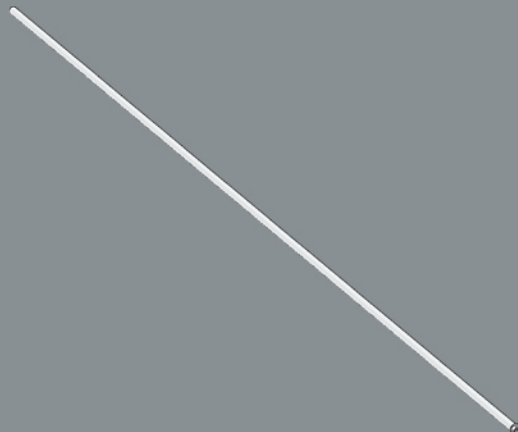

1x  
6364683



1x  
6370720



4x  
6353196



44x  
4118793



83x  
6360078



2x  
4113915



5x  
4179771



54x  
4125253



10x  
4516055



20x  
4159553



2x  
4612603



2x  
6357613



32x  
4224793



4x  
6355727



6x  
6351413



14x  
6352222



8x  
6177890



8x  
6177891



4x  
4624086



4x  
6232037



50x  
4218749



41x  
6092587



2x  
6338180



4x  
6148262



6x  
4109995



6x  
6146221



2x  
6024495



13x  
4205107



4x  
6063943



1x  
6294481



2x  
6103001



2x  
6103001



153x  
4114026



21x  
4113917



20x  
6034929



2x  
4273526



2x  
6214334



4x  
6117975



4x  
6249809



10x  
6174925



5x  
6253003



2x  
6314477



2x  
6358290



2x  
6358290



1x  
4565387



39x  
4185177



44x  
6221467



44x  
4114084



47x  
6173057



18x  
4114077



16x  
6265572



4x  
6211975



96x  
6131896



14x  
4121921



2x  
4624088



34x  
6211966



2x  
6318084



8x  
4118790



9x  
6175367



2x  
4500453



5x  
4666999



2x  
4113233



12x  
4550324



26x  
6257600



2x  
6195544



2x  
6115031



2x  
4208072



33x  
4114309



53x  
6122047



8x  
6351905



2x  
4112982



10x  
4157277



3x  
6331158



4x  
4113993



5x  
4181134



49x  
4114324



11x  
4544139



12x  
4159774



2x  
4114001



2x  
4125217



2x  
4166138



3x  
4509897

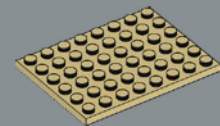

4x  
6070501

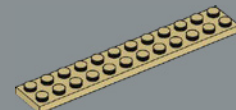

6x  
6093864



6x  
6284574



2x  
306221



8x  
654121



10x  
6345429



1x  
6210269



46x  
4142865



2x  
6168634



4x  
6019155



1x  
6265697



22x  
302321



2x  
245821



2x  
6313831

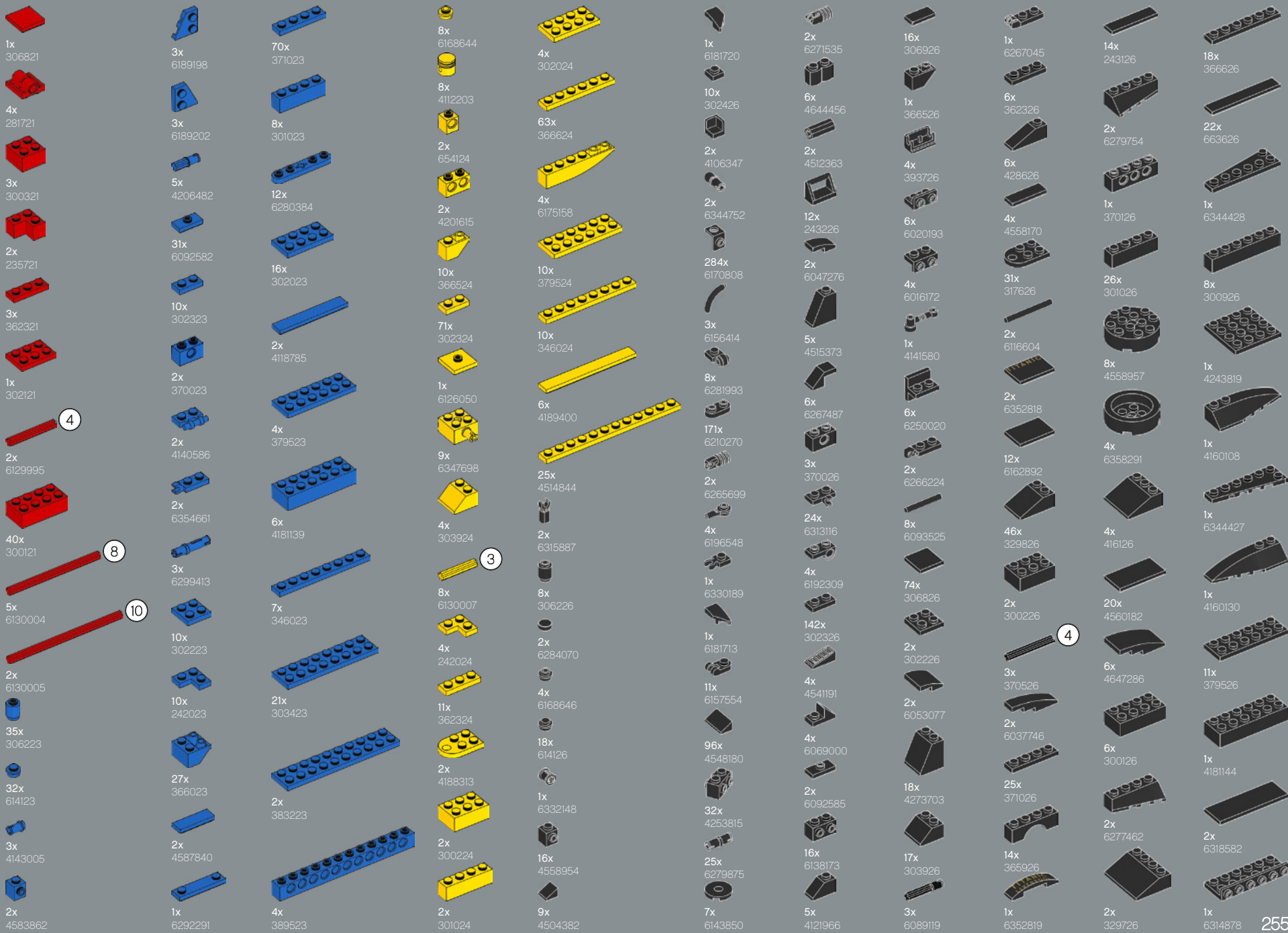

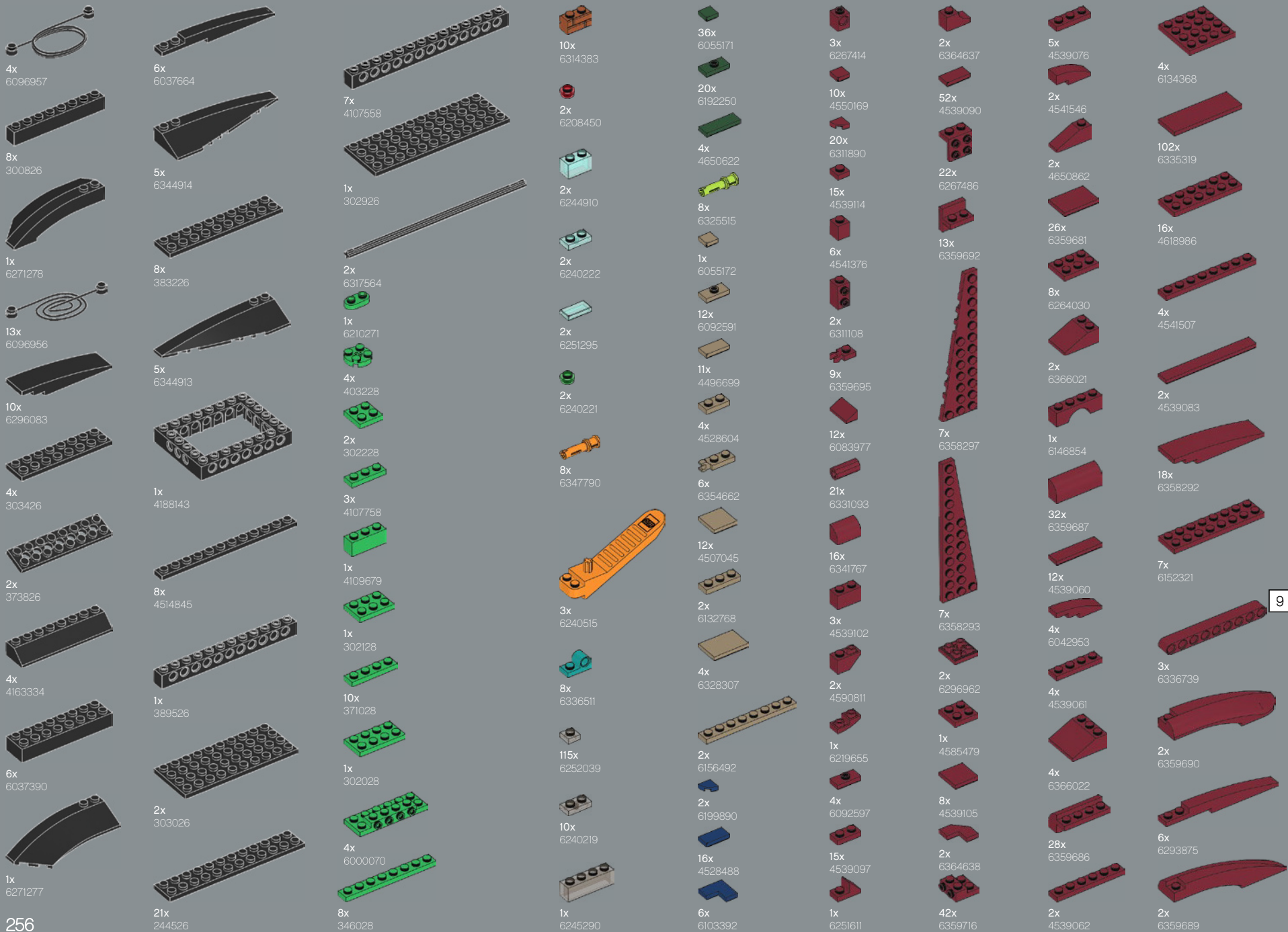



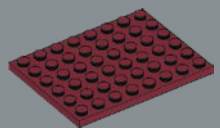

11x  
6028115

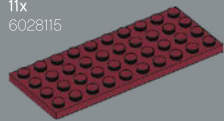

8x  
6186106



8x  
6245265



16x  
6134252



8x  
6223719



16x  
6331261



6x  
6073040



6x  
6028736



91x  
6097503



16x  
6358295



16x  
6020073



4x  
6359223



12x  
6020074



9x  
6192205

6x  
4211183



19x  
4216581



1x  
6170813



2x  
6149677



12x  
4221744



26x  
4211288



46x  
4225469



4x  
6325717



29x  
4531751



2x  
4211222



1x  
4211252



14x  
6365885



105x  
4211150



24x  
6335567



1x  
4211151



10x  
6365884



24x  
4645103



39x  
6236915



20x  
6196221



30x  
4211210



10x  
6365883



5x  
6333110



6x  
4211220



20x  
4211152



24x  
6133833



9x  
6172636



30x  
4211186



14x  
6365882



1x  
4221590



18x  
4211193



12x  
4655611



1x  
4216615



6x  
6313736



2x  
4211211



2x  
4222627



1x  
6338230



88x  
4211412



23x  
6258831



7x  
6372076



1x  
4211483



1x  
4211483



3x  
4558953



12x  
4211399



2x  
6225242



2x  
6345639



8x  
6335378



8x  
4211375



8x  
6227897



4x  
4568637



2x  
6352979



2x  
6352983



1x  
6352986



1x  
6352997



1x  
6353001



155x  
4550325



2x  
6372076



16x  
6093859



4x  
6327412



9x  
6338165



2x  
4211564



20x  
4211398



8x  
4211414



8x  
4211440



10x  
6206249



1x  
6326078



8x  
6146300



8x  
6146300



8x  
4211363



4x  
4211494



2x  
4211614



4x  
6117967



6x  
4654580



8x  
4211609



4x  
6337268



4x  
6078211



4x  
6198932



4x  
4667578



4x  
4211461



4x  
4211632



4x  
6321743



1x  
4208988



1x  
4209006



8x  
4211397



46x  
6212077



6x  
6007894



6x  
4234535



4x  
4211815



4x  
6078212



8x  
6195471



1x  
6346487



4x  
6326483



1x  
6304930



15x  
6211969



8x  
4211419



11x  
4211773



30x  
4211396



1x  
4211386



9x  
4211394



1x  
4211441



2x  
4211445



26x  
4211636



8x  
6230229



2x  
4211361



2x  
4211395



8x  
4211385



6x  
4211639



4x  
6256117



8x  
6105964



6x  
4211393



16x  
4211438



2x  
4612621



2x  
4211837



2x  
4527174



4x  
6015349



35x  
4211452



13x  
4211795



4x  
6225219



4x  
4211425





2x  
4211442

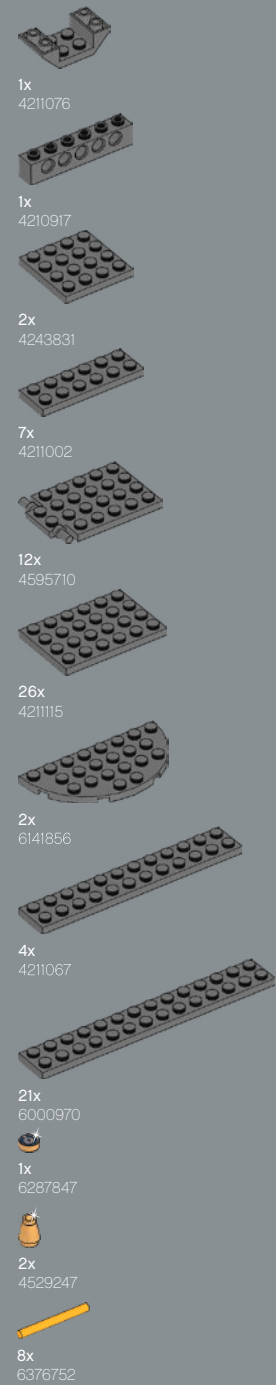
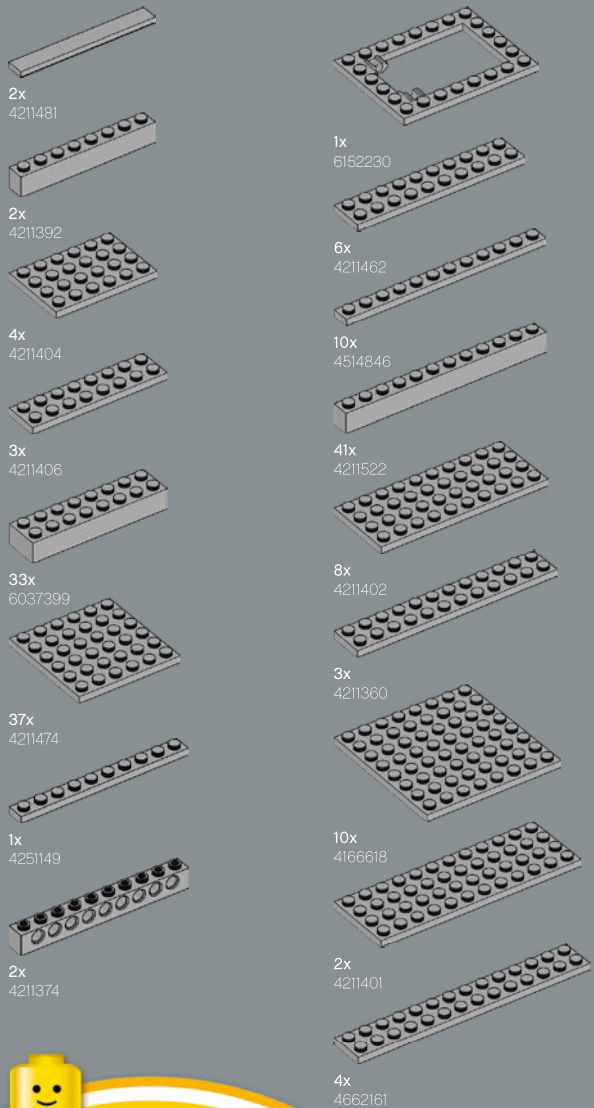

3

5

**Customer Service**  
**Kundenservice**  
**Service Consommateurs**  
**Servicio Al Consumidor**

**LEGO.com/service** or dial

00800 5346 5555 : 

1-800-422-5346 : 



# FEEDBACK AND WIN



## FEEDBACK AND WIN

Your feedback will help shape the future development of this product series.

Please visit:

## FEEDBACK UND GEWINNEN

Dein Feedback trägt zur Weiterentwicklung dieser Produktreihe bei.

Geh auf:

## COMMENTEZ ET GAGNEZ

Vos commentaires nous aideront à concevoir les futurs produits de cette gamme.

Rendez-vous sur :

## COMENTA Y GANA

Tu opinión nos ayudará a dar forma al desarrollo de esta serie de productos en el futuro.

Visita:

## 反馈有奖

您的反馈将有助于我们在今后改进本系列产品。

请访问：

---

[LEGO.com/productfeedback](https://www.lego.com/productfeedback)

---

By completing, you will automatically enter a drawing to win a LEGO® set.

Terms & Conditions apply.

Durch Ausfüllen nimmst du automatisch an der Verlosung eines LEGO® Preises teil.

Es gelten die Teilnahmebedingungen.

En envoyant vos commentaires, vous serez automatiquement inscrit(e) à un tirage au sort qui vous permettra de remporter un prix LEGO®.

Offre soumise à conditions.

Al contestar, participarás automáticamente en el sorteo y podrás ganar un set LEGO®.

Sujeto a Términos y Condiciones.

完成我们的反馈调查，即可自动进入抽奖环节，赢取乐高®套装。

适用《条款和条件》。

