

泰坦尼克号

手册 1

→ 绘有泰坦尼克号的英国白星航运公司信片。

海洋女王

1912年4月10日,泰坦尼克号从英国南安普敦港起航,开启了她前往美国纽约的处女航。她是当时世界上体积最庞大、设施最豪华的游轮。英国白星航运公司(White Star Line)委托建造了三艘最先进的奥林匹克级远洋客轮,泰坦尼克号是其中的第二艘,旨在保持该公司在竞争激烈的跨大西洋客运航线上的主导地位。泰坦尼克号由总部位于贝尔法斯特的哈兰德与沃尔夫造船厂承建,为了确保这艘客轮拥有前所未有的舒适度和奢华度,白星航运公司授权造船厂不必考虑成本。





↑ 1912年4月10日, 泰坦尼克号从南安普敦起航。

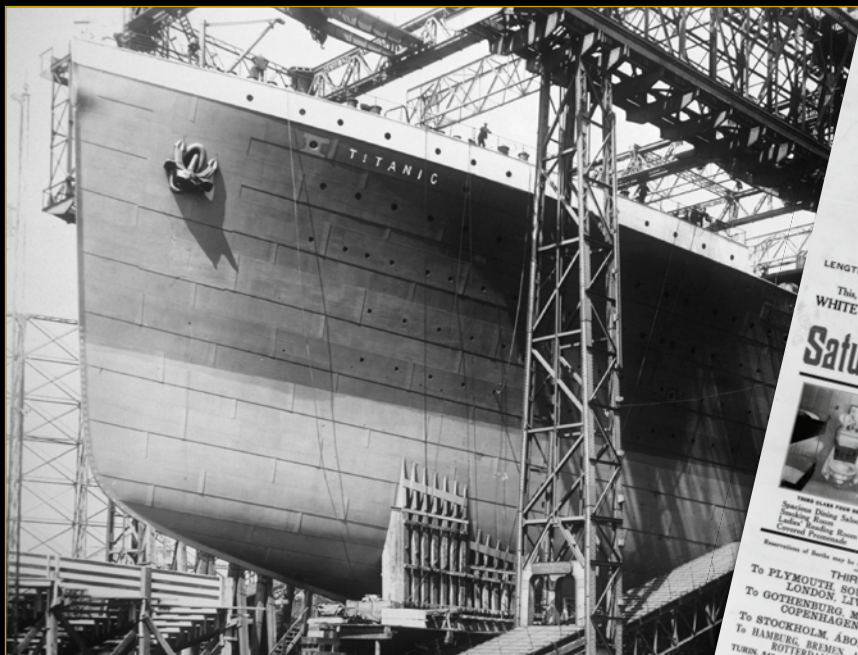

↑ 泰坦尼克号由位于爱尔兰贝尔法斯特的哈兰德与沃尔夫造船厂建造。

WHITE STAR LINE
 ROYAL & UNITED STATES MAIL STEAMERS
 FIRST SAILING OF THE LATEST ADDITION TO THE WHITE STAR FLEET
The Queen of the Ocean
TITANIC
 LENGTH 682 FT. OVER 45,000 TONS TRIPLE-SCREWS BEAM 92 FT.
 This, the Latest, Largest and Finest Steamer Afloat, will sail from
WHITE STAR LINE, PIER 59 (North River), NEW YORK
Saturday, April 20th At 12 Noon

THIRD CLASS CABIN DECK FROM
 Smoking Saloon Saloons
 Ladies' Smoking Room
 General Promenade

All passengers booked in closed rooms
 but equipped with washstands, etc.

THIRD CLASS DINING SALOON

Representatives of Berks may be made direct with the Office at through one of our accredited Agents

THIRD CLASS RATES ARE:
 To PLYMOUTH SOUTHAMPTON
 LONDON LIVERPOOL and GLASGOW.
 To GOTHENBURG MALMÖ CHRISTIANIA,
 COPENHAGEN, ESBJERG, Etc.
 To STOCKHOLM, ÅBO, HANGÖ, HELSINGFORS,
 To HAMBURG, BREMEN, ANTWERP, AMSTERDAM,
 ROTTERDAM, HAVRE, CHERBOURG,
 NANTES, BRISAC, PIRAEUS, ETC.
 BEYROUTH, SUEZ, ETC., ETC.

DO NOT DELAY. Passage and other charges through the White Star Line Agents or direct from
WHITE STAR LINE, 9 Broadway, New York

TICKETS FOR SALE HERE

\$36.25
 41.50
 44.50
 45.00

← 1912年：一则关于豪华客轮泰坦尼克号的广告，宣布了该船处女航的起航时间，还提供了票价和舱位说明。



→ 1912年2月3日，最后一次同时看到白星航运公司的两艘轮船：泰坦尼克号和奥林匹克号。

三螺旋桨 奥林匹克级客轮

泰坦尼克号由三个强大的引擎提供动力，每个引擎都驱动着对应的螺旋桨。两台外部蒸汽机长 19 米（63 英尺），重 720 公吨（793.6 美吨），总输出功率为 3 万马力。中央低压涡轮机又提供了 1.6 万马力。蒸汽机每天需要使用 29 台锅炉、484.5 公吨（534.6 美吨）水和 600 公吨（661.3 美吨）煤。所有三个引擎都通过长轴直接与螺旋桨相连。两个外侧螺旋桨的直径为 7.2 米（23.5 英尺），而中间较小的螺旋桨的直径为 5.2 米（17 英尺）。所有这些装置使泰坦尼克号的最高时速可达 23 节（超过每小时 26 英里）。

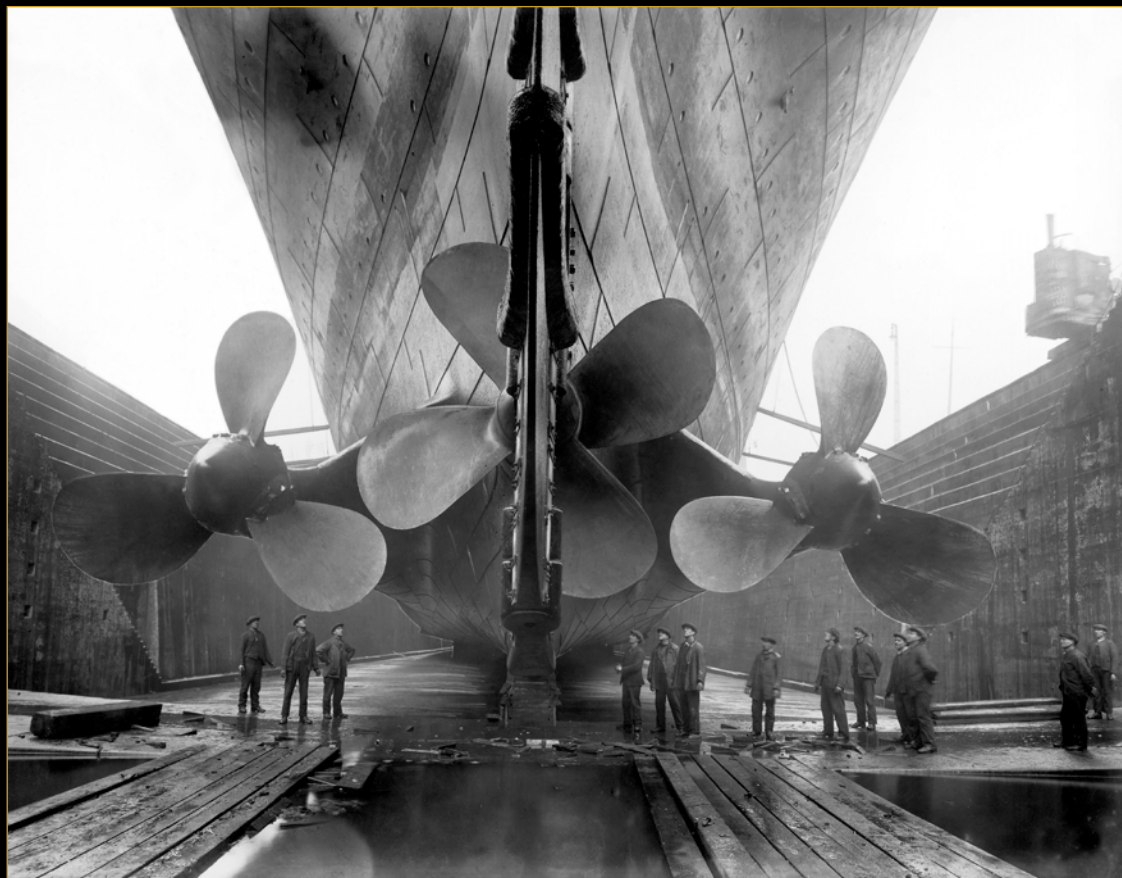

↑ 干船坞中巨型泰坦尼克号的巨大螺旋桨。



LEGO.com/brickseparator

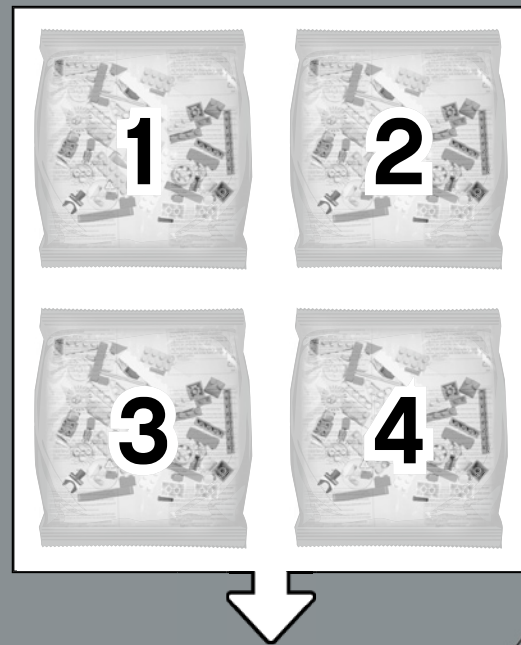

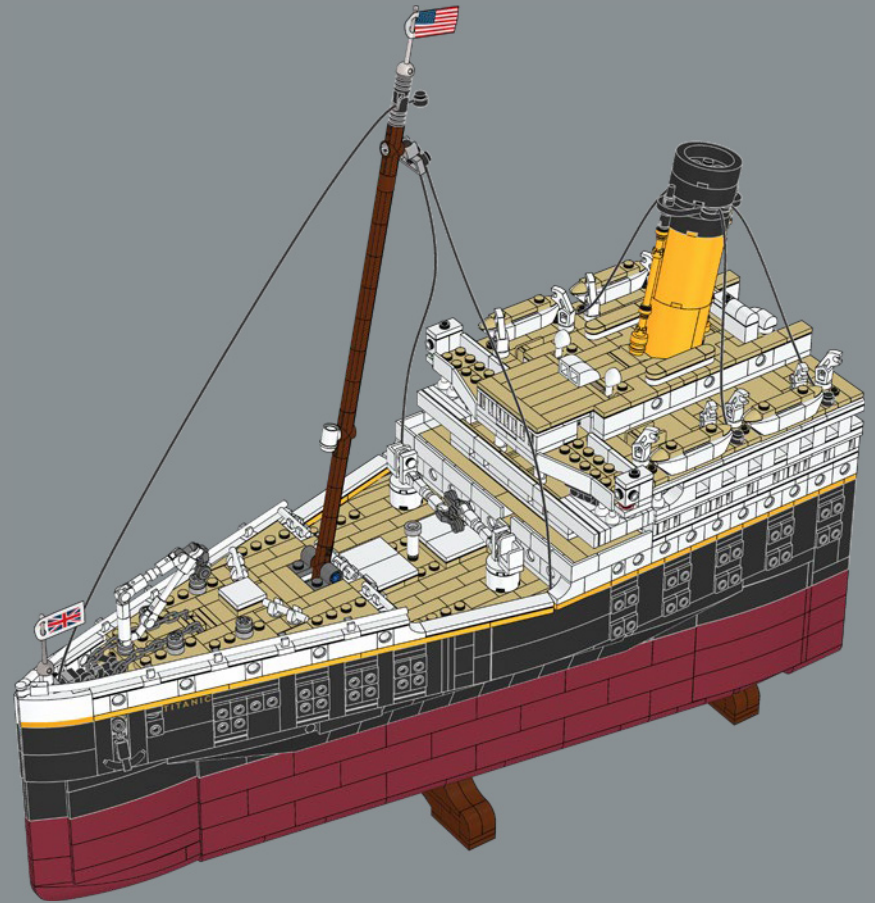
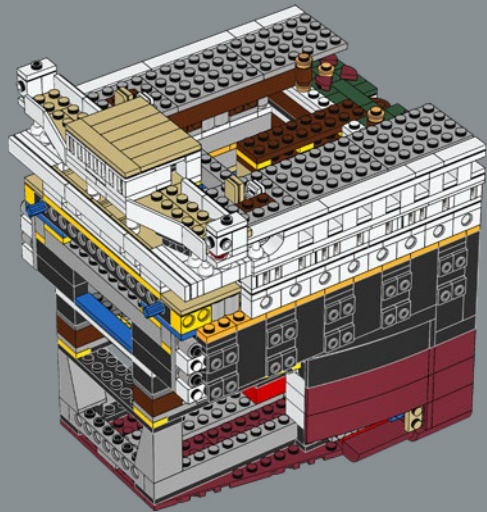

↓ 我们使用 2x10x2 三阶式拱形砖 (triple curved bow) 拼搭模型龙骨的正面。

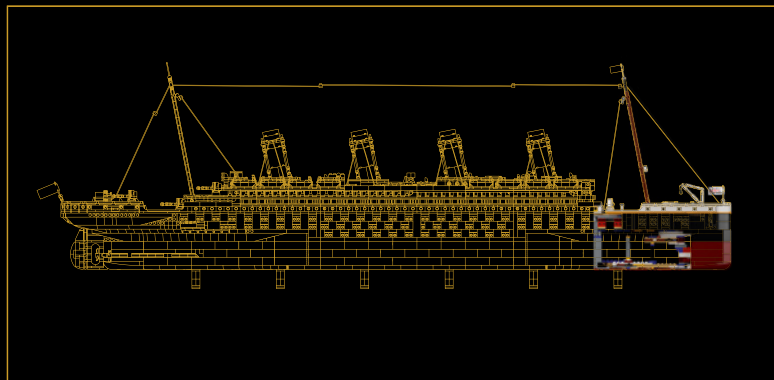

第1部分：

首舷和 井型甲板

在此部分，你将会拼搭带有锚的首舷、船名、井型甲板、舱口、货物起重机、挂有第3个锚的起锚吊车，以及前桅杆。在船的内部，还将拼搭船首部分的支撑结构。这些结构还将与后一部分的支撑结构组合锁定，构成模型的前部船体。



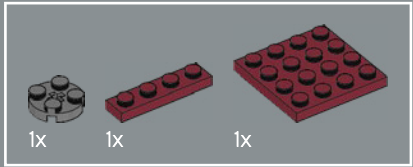
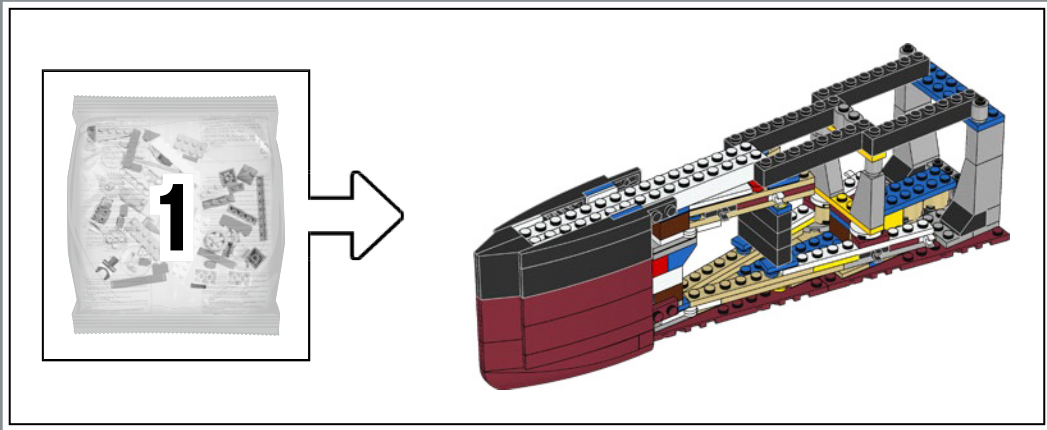

2

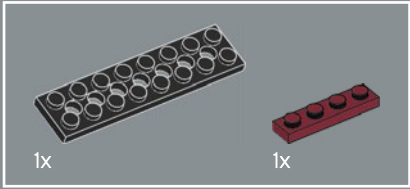

1

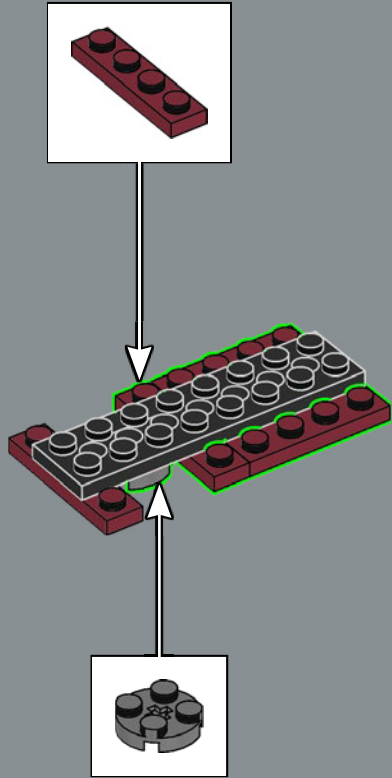
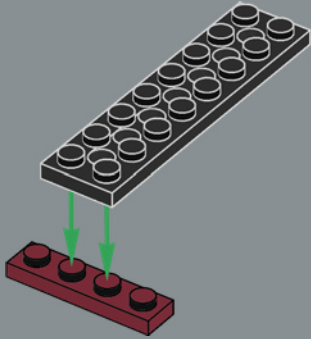

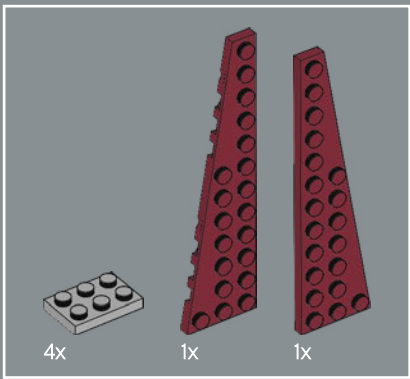

3

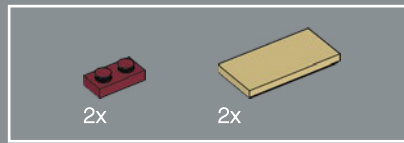
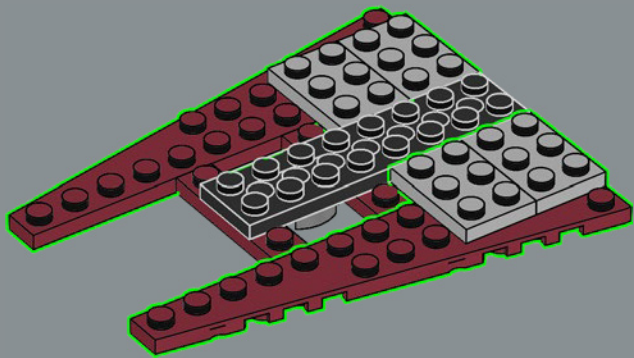

4

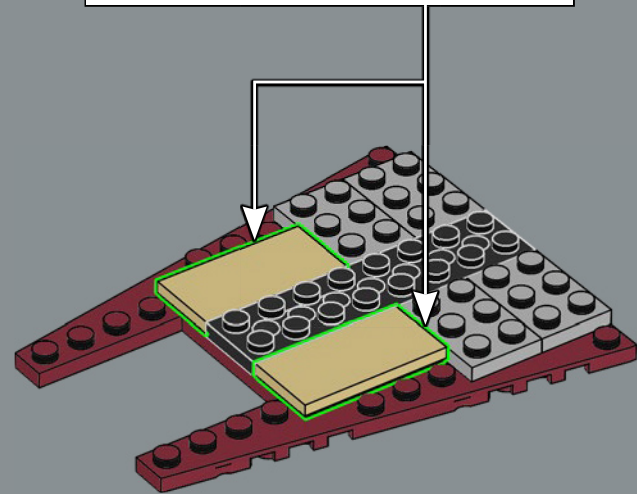
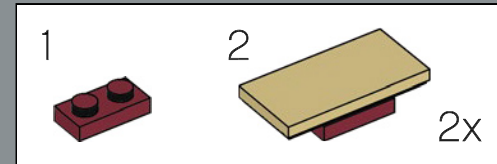

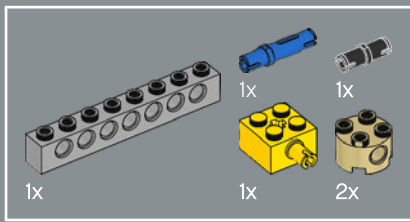

5

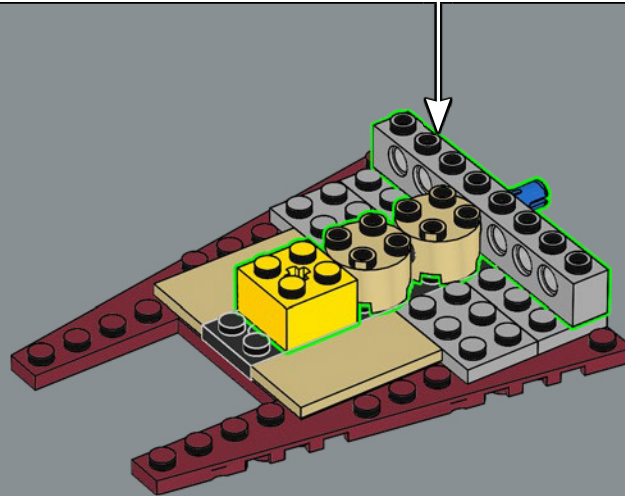
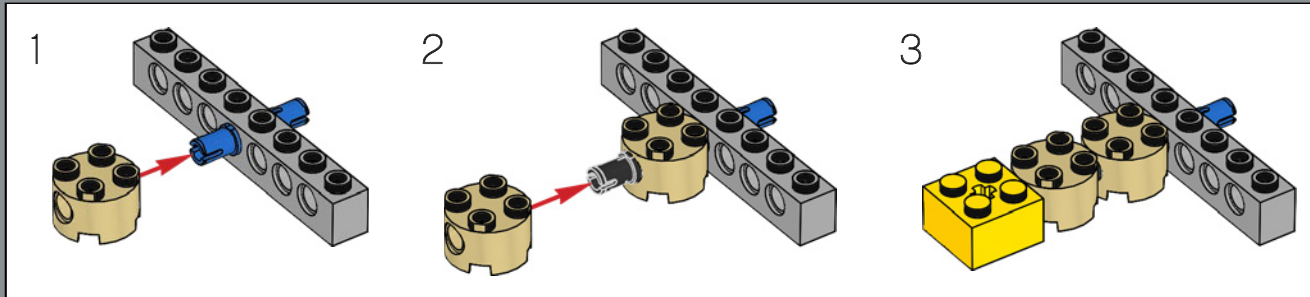

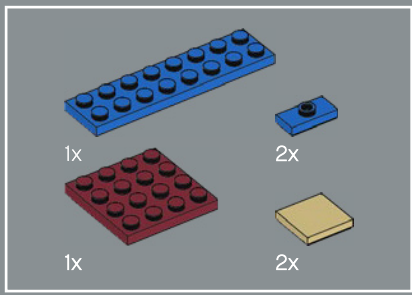

6

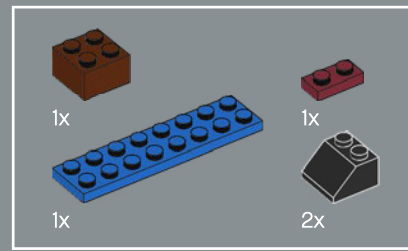
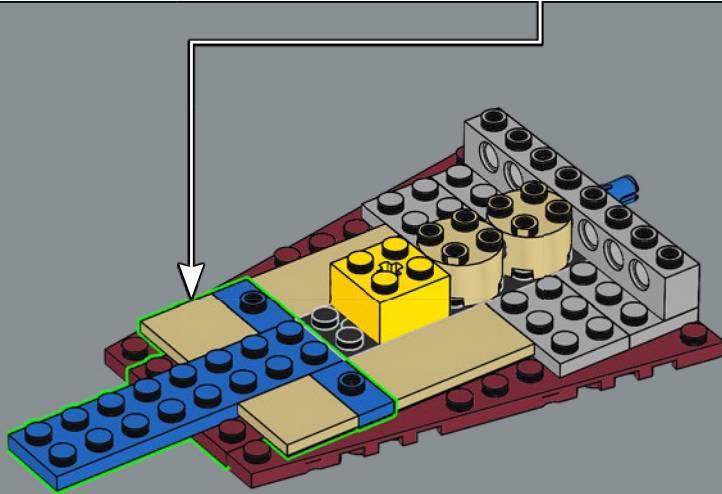
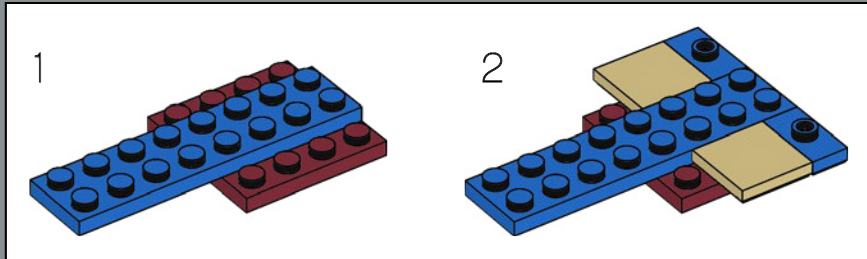

7

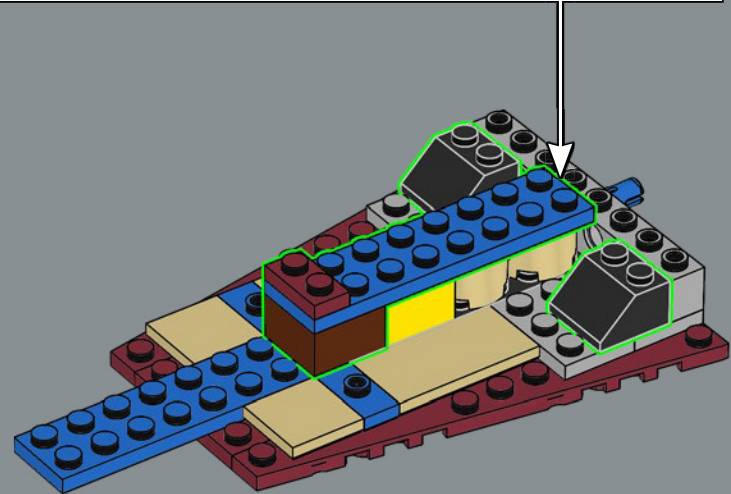
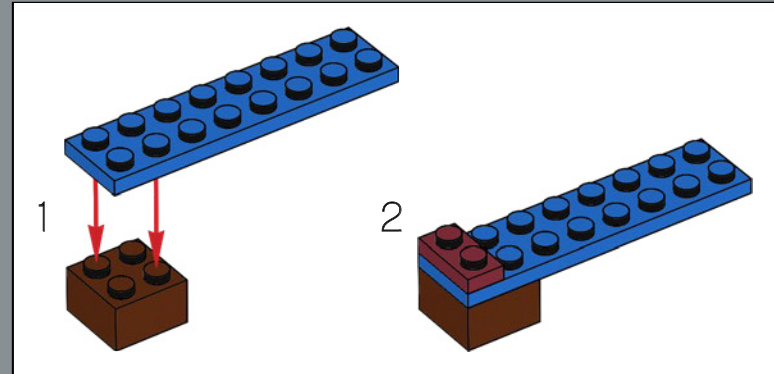

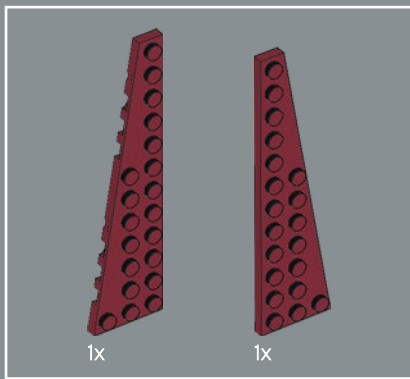

8

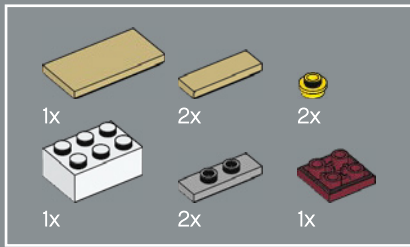
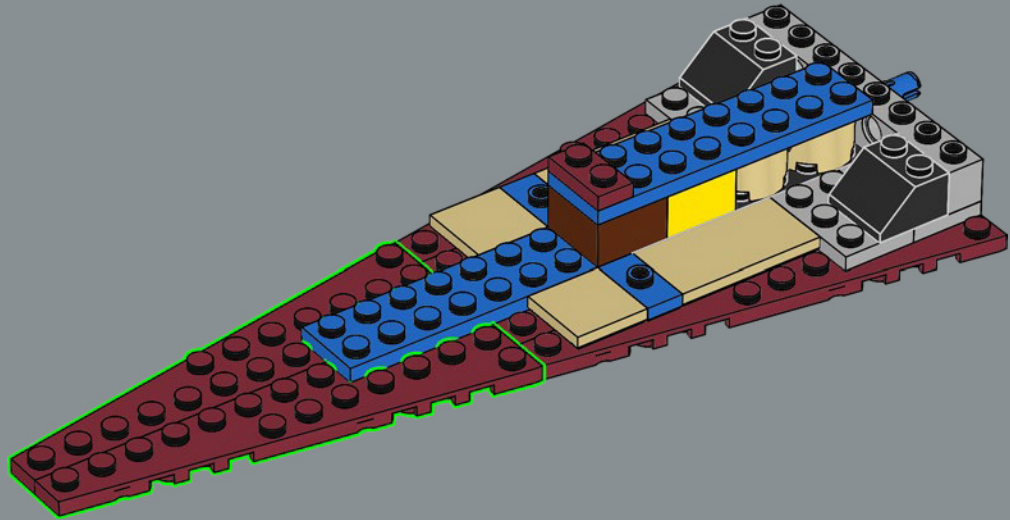

9

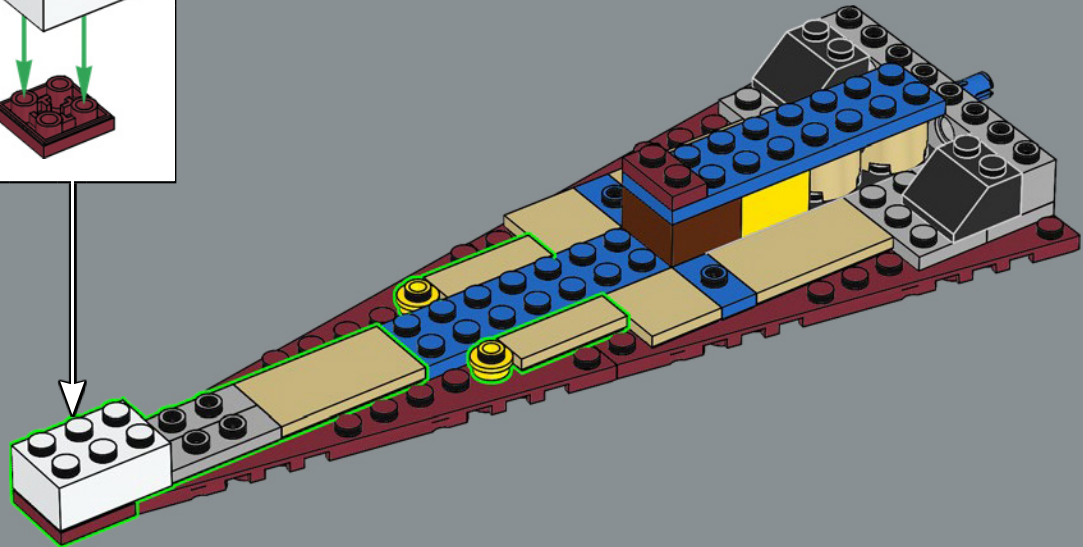
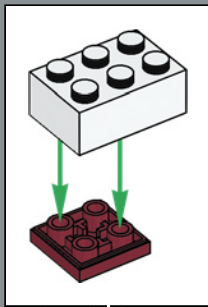

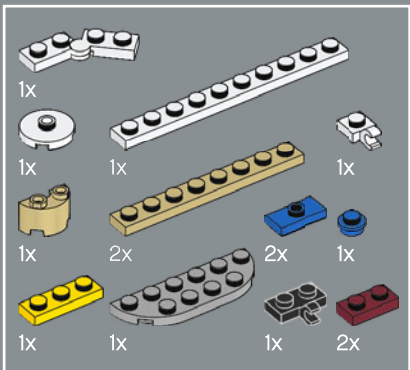

10

1

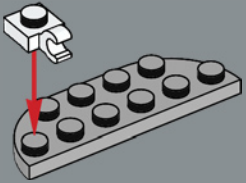

2

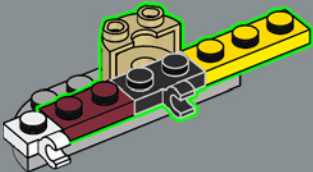

3

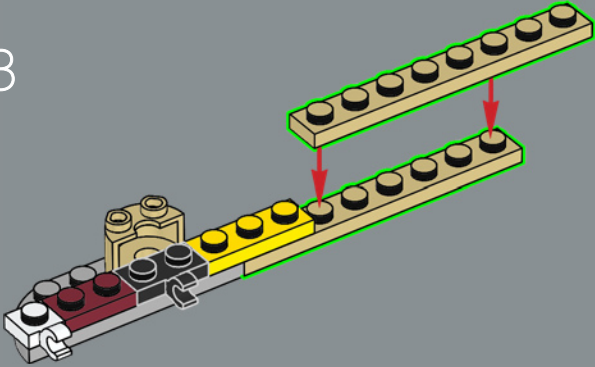

4

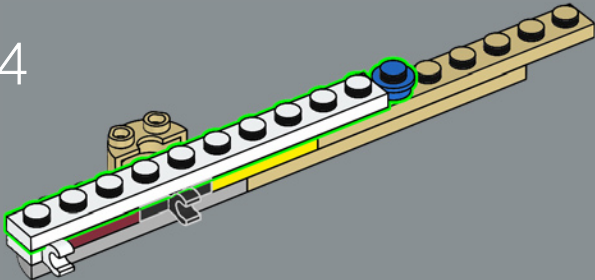

5

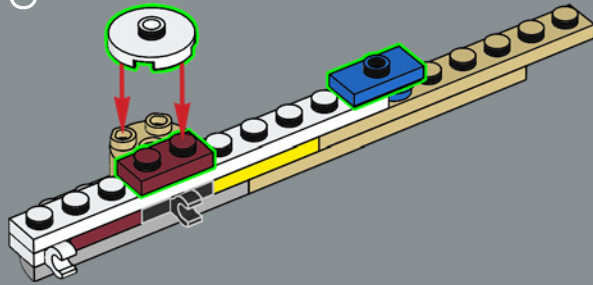

6

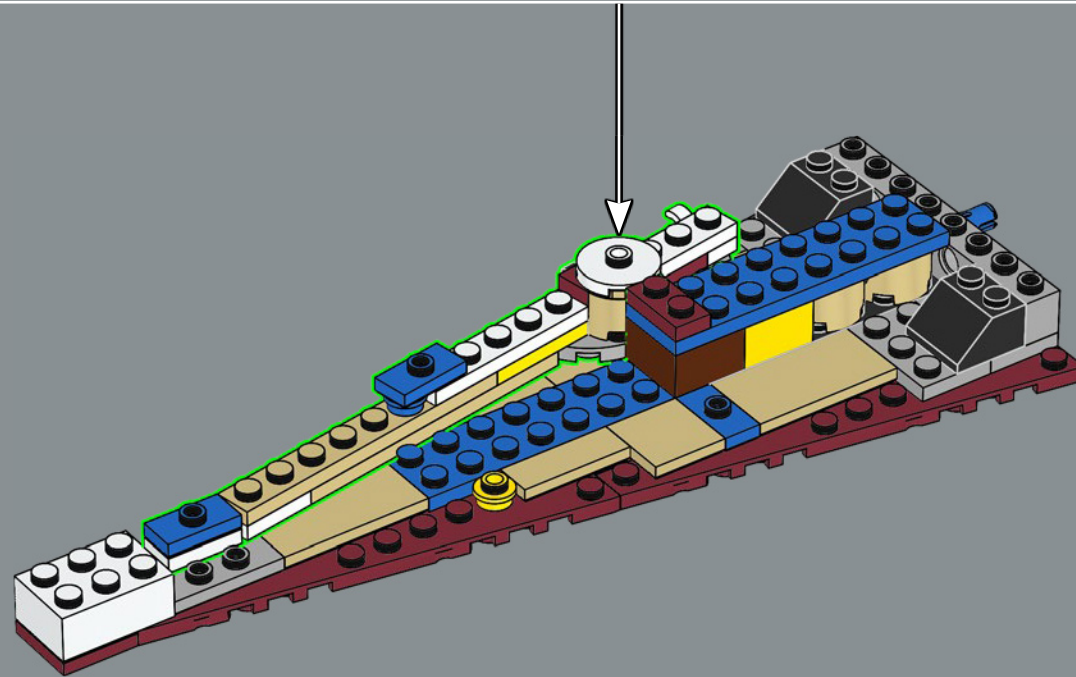
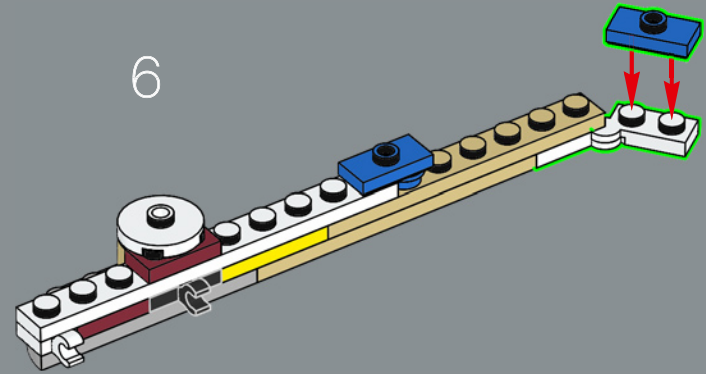

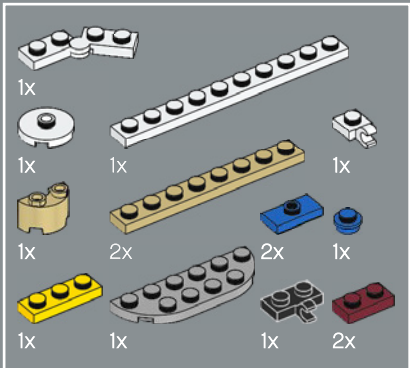

11

1

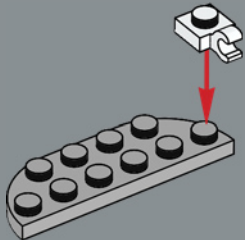

2

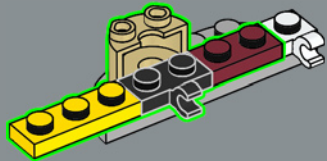

3

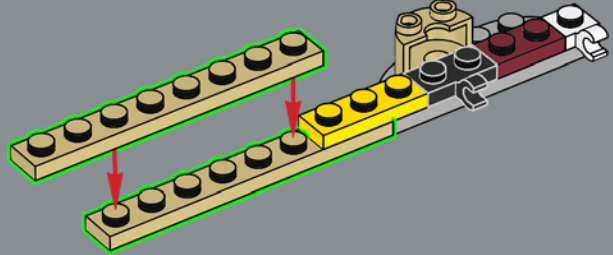

4

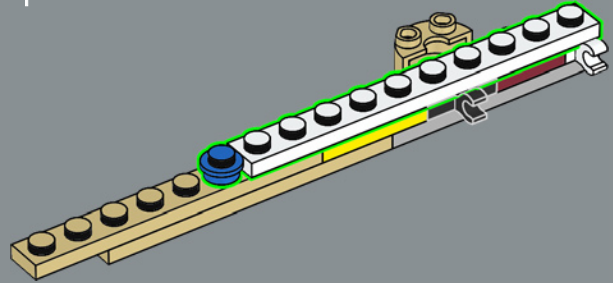

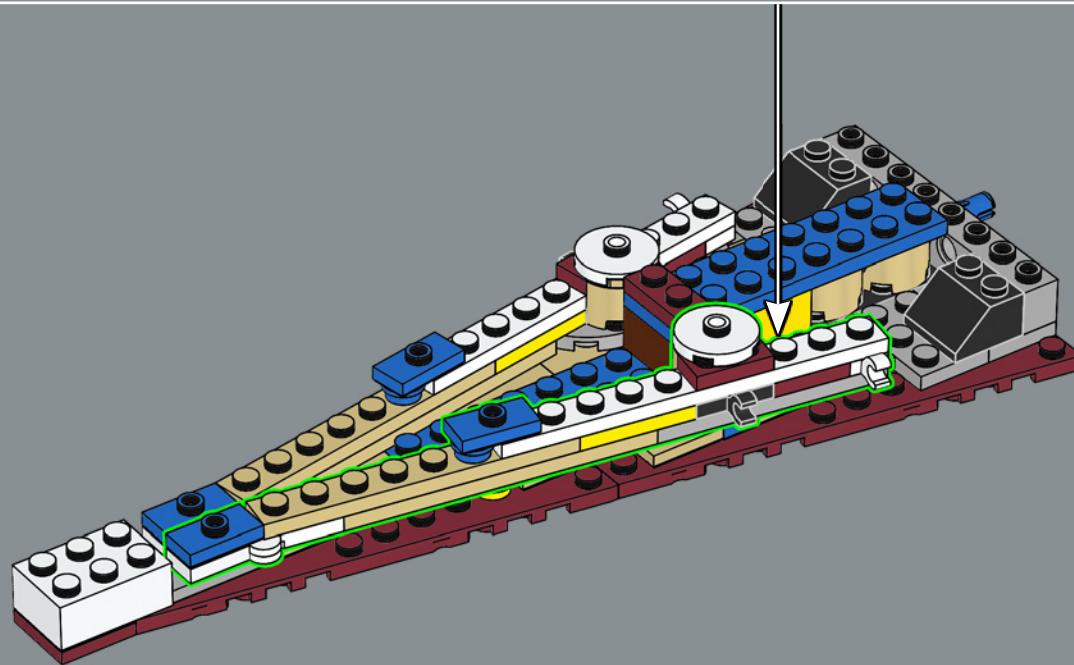
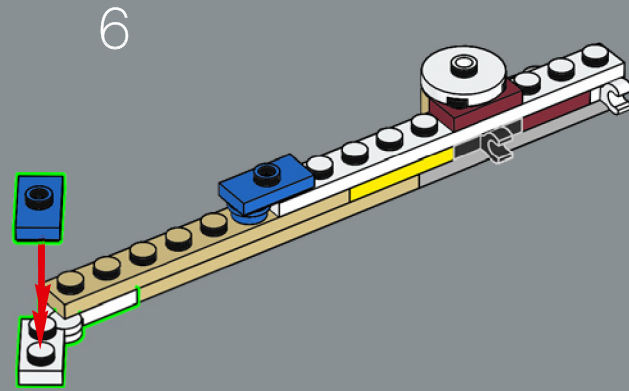
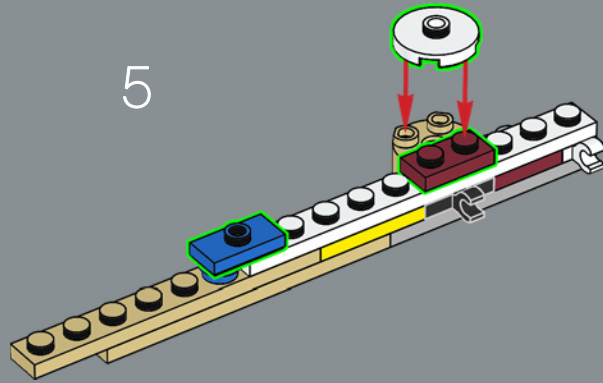

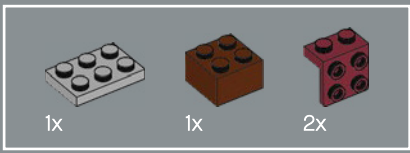

12

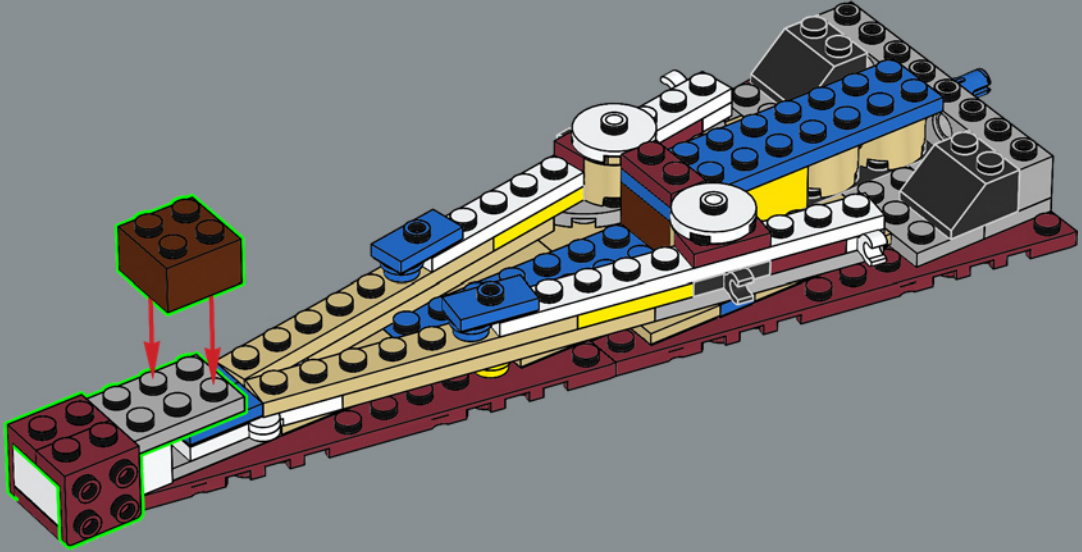

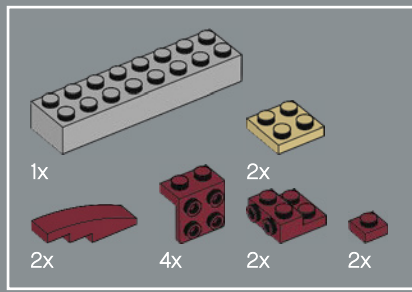

13

1

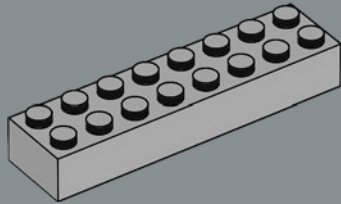

2

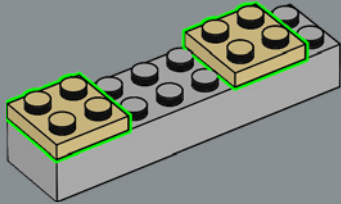

3

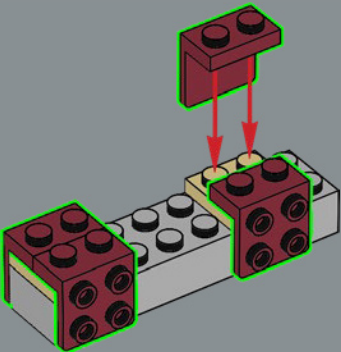

4

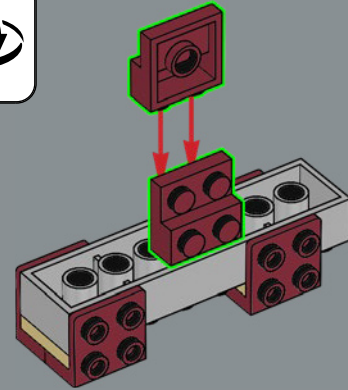

5

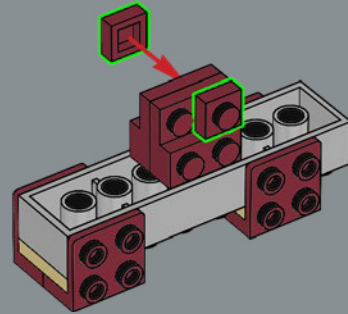

6

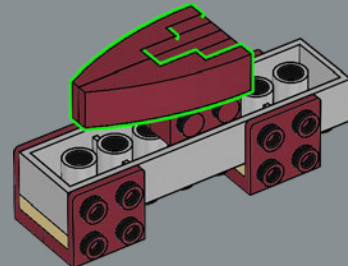

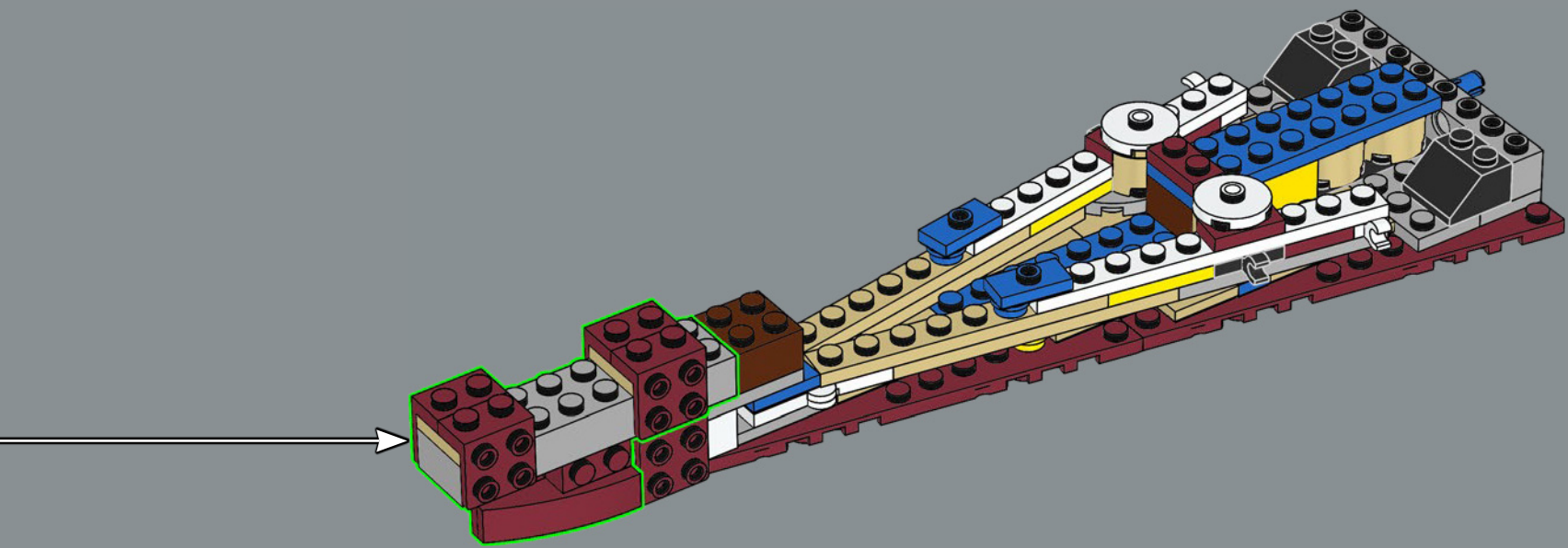

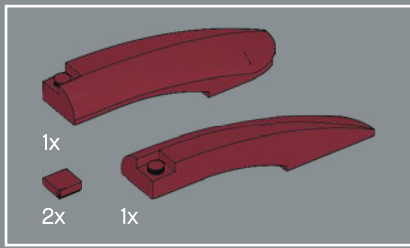

14

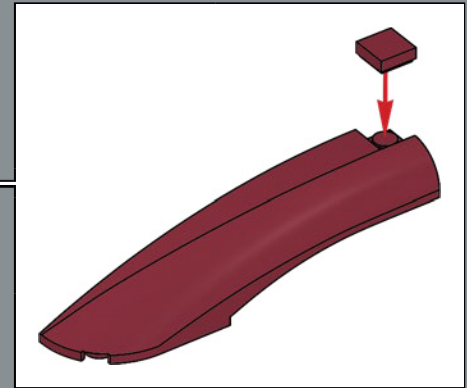
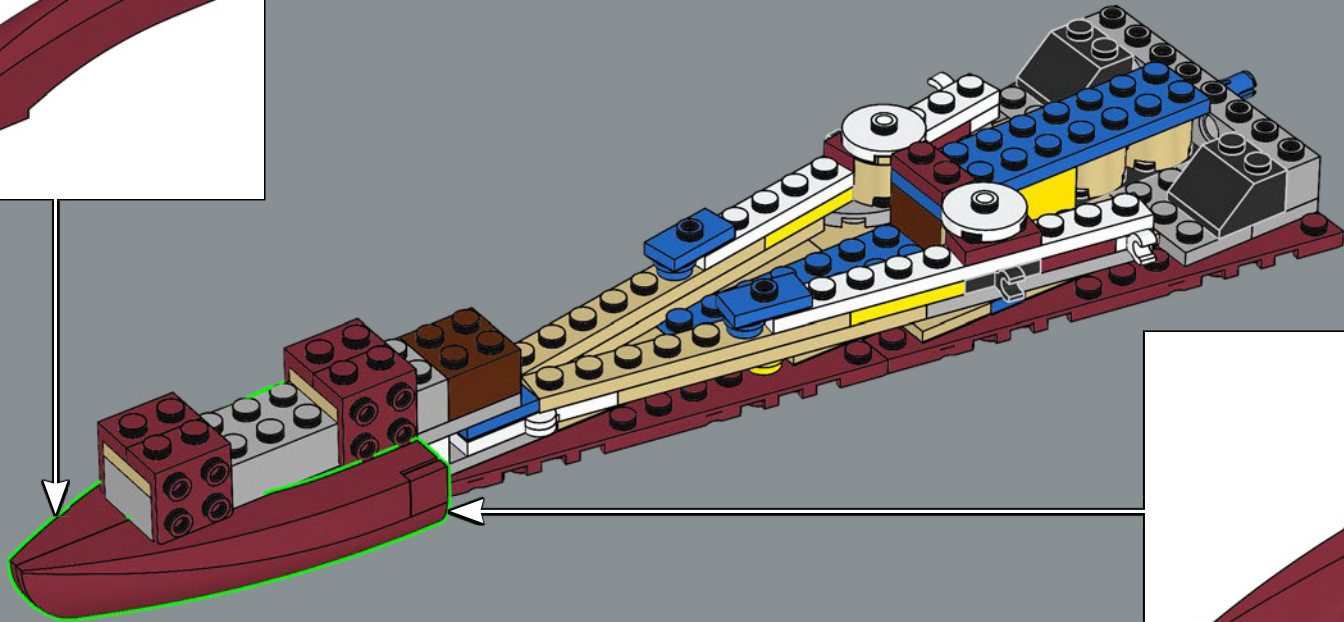
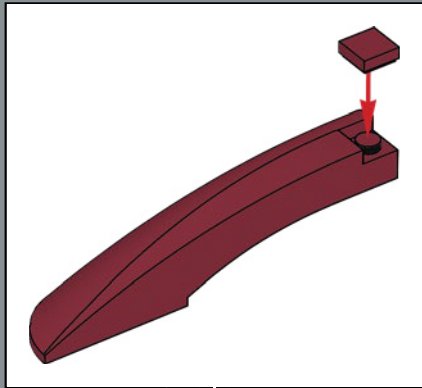

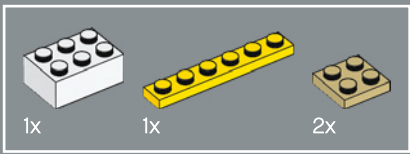

15

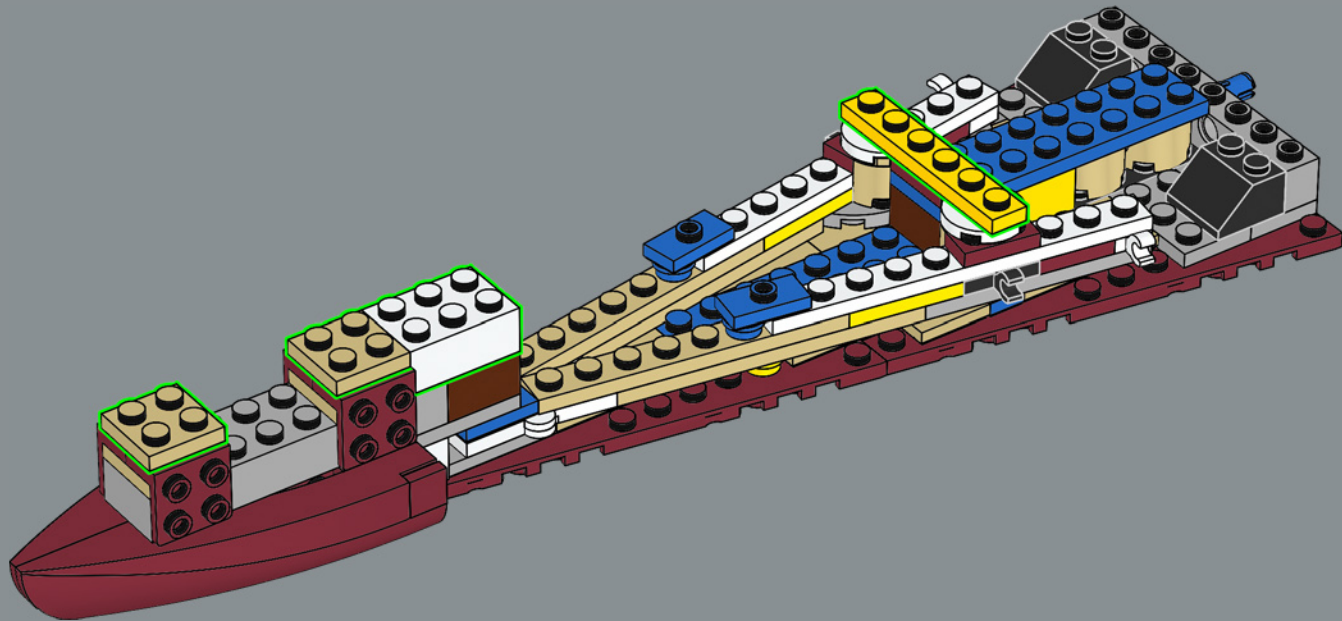

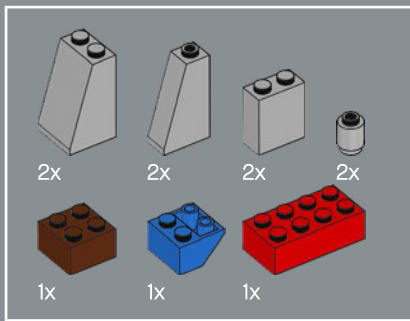

16

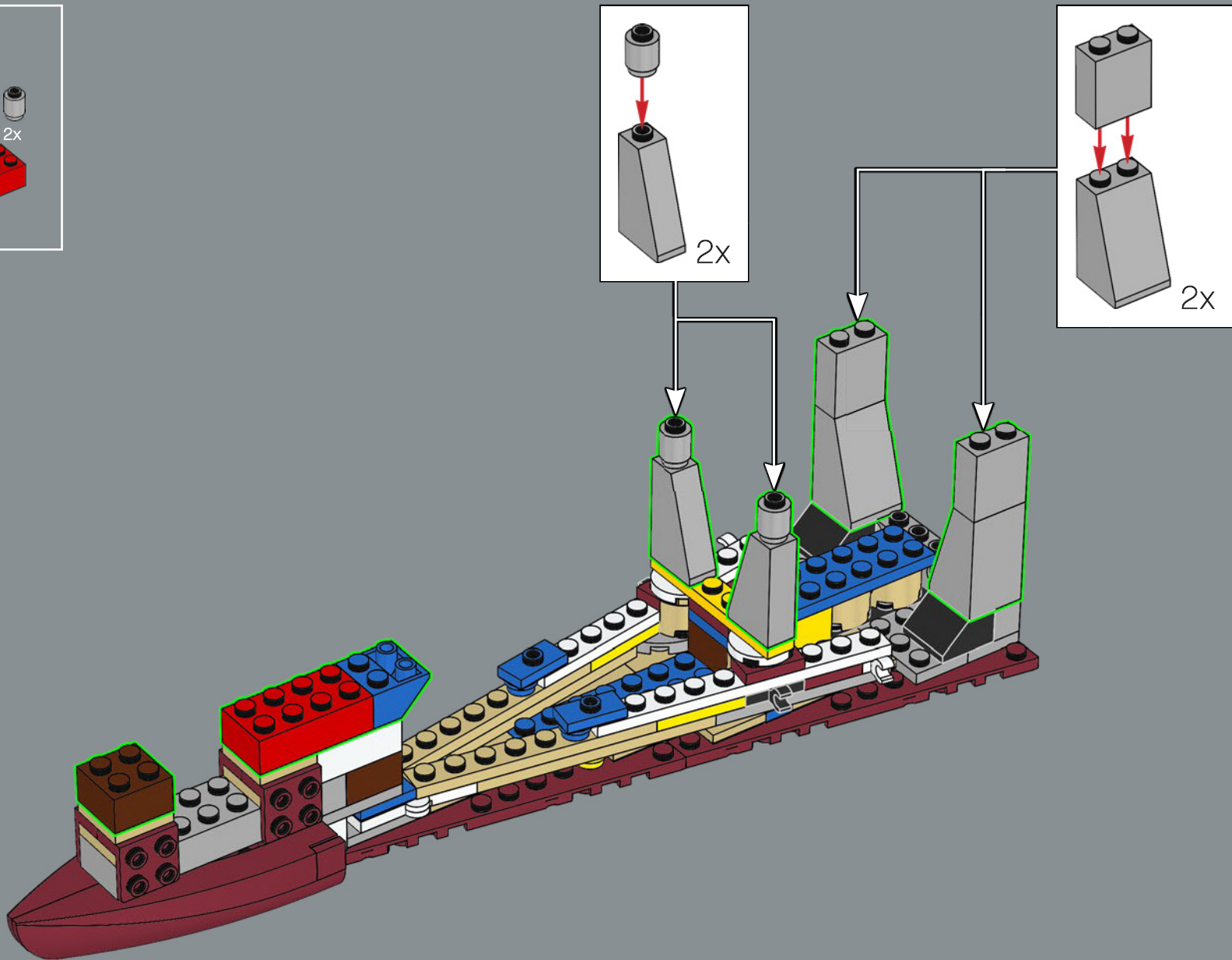

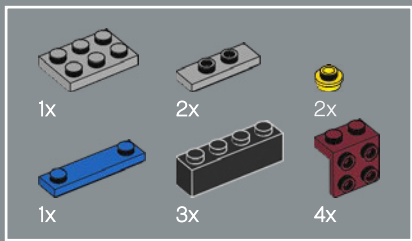

17

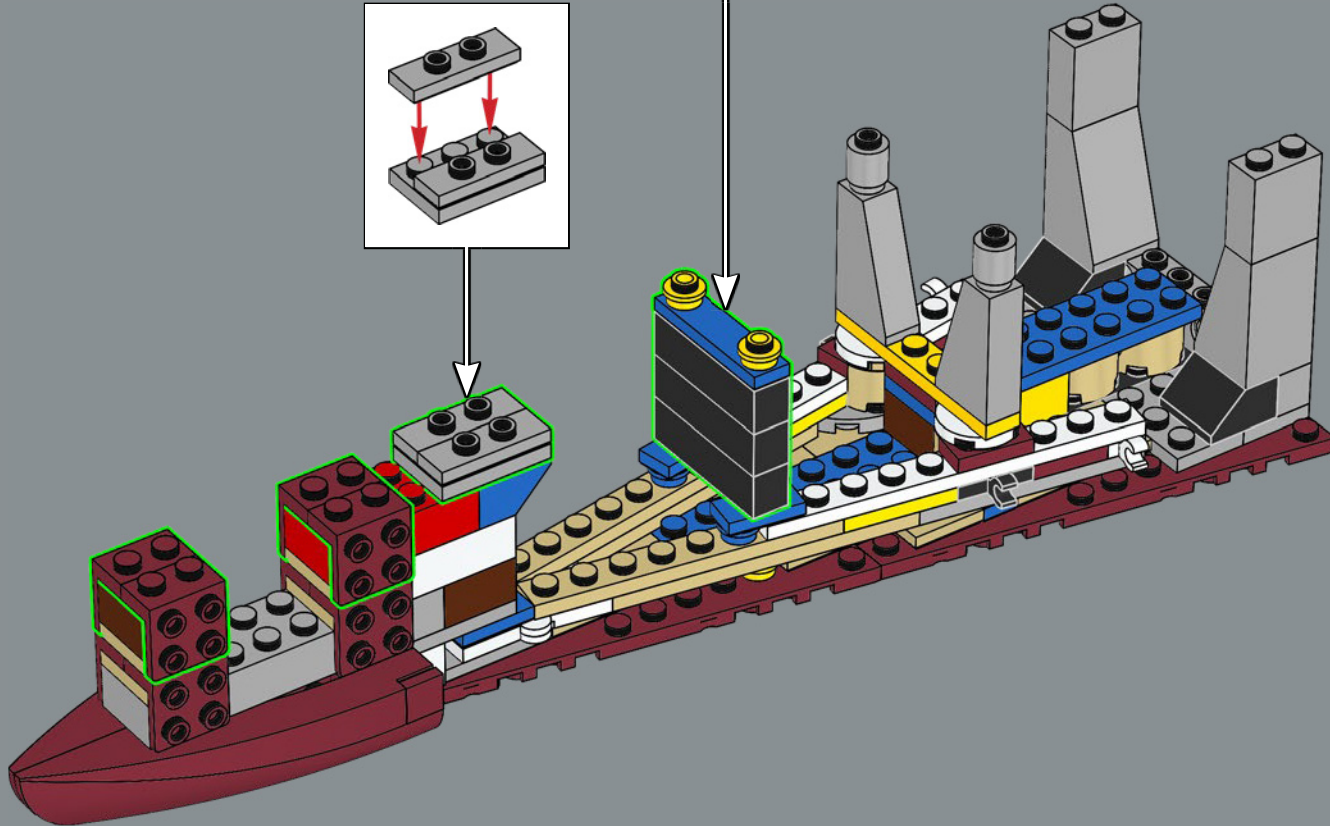
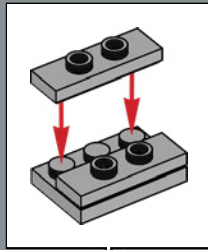
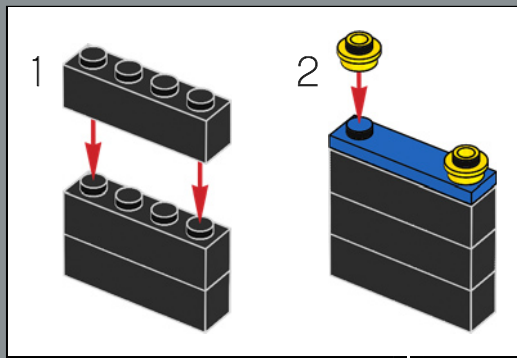

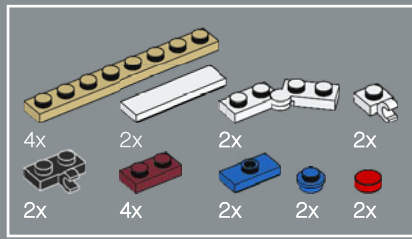

18

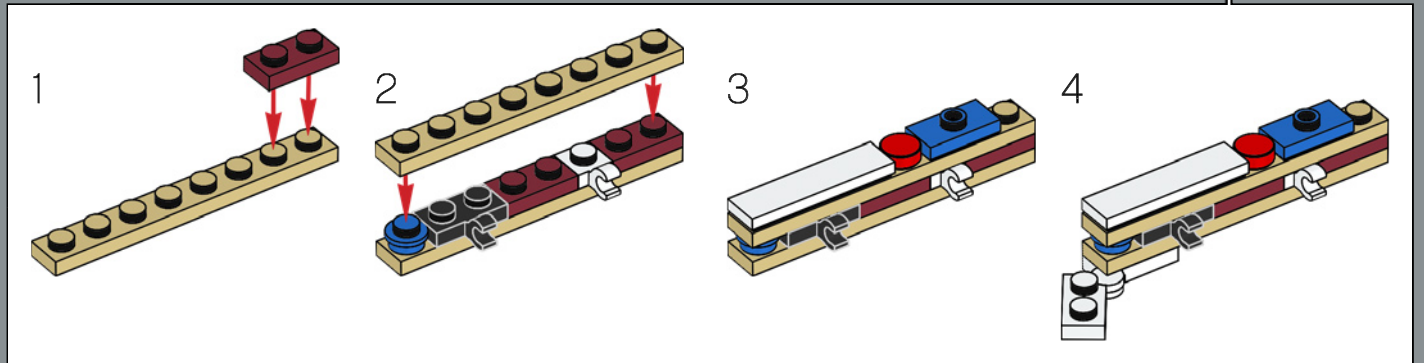
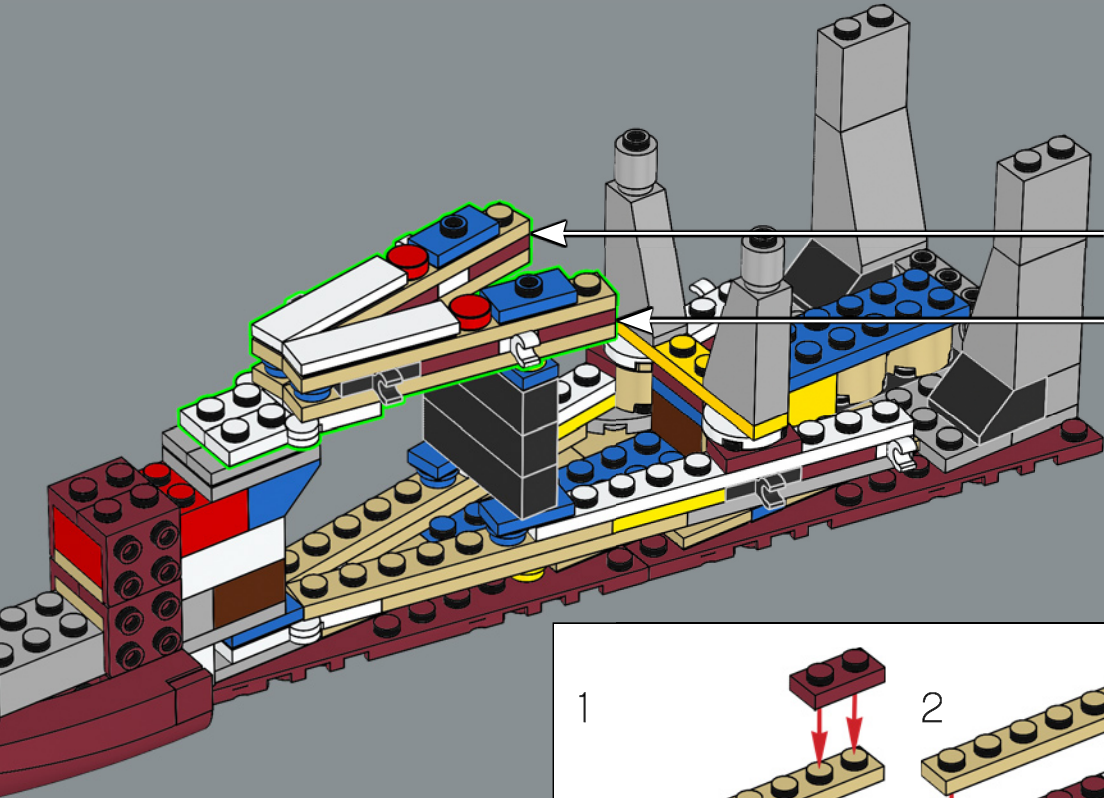
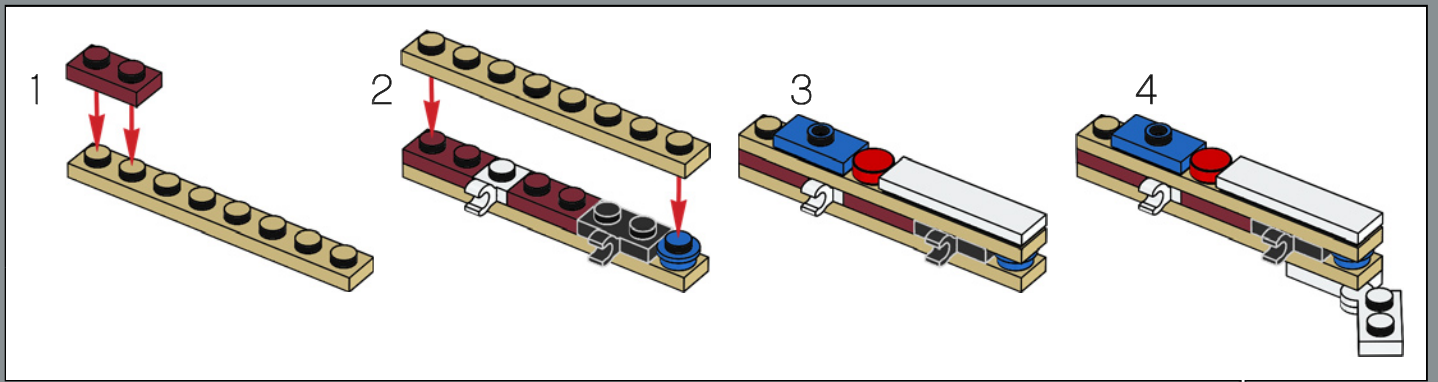

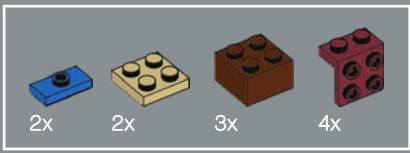

19

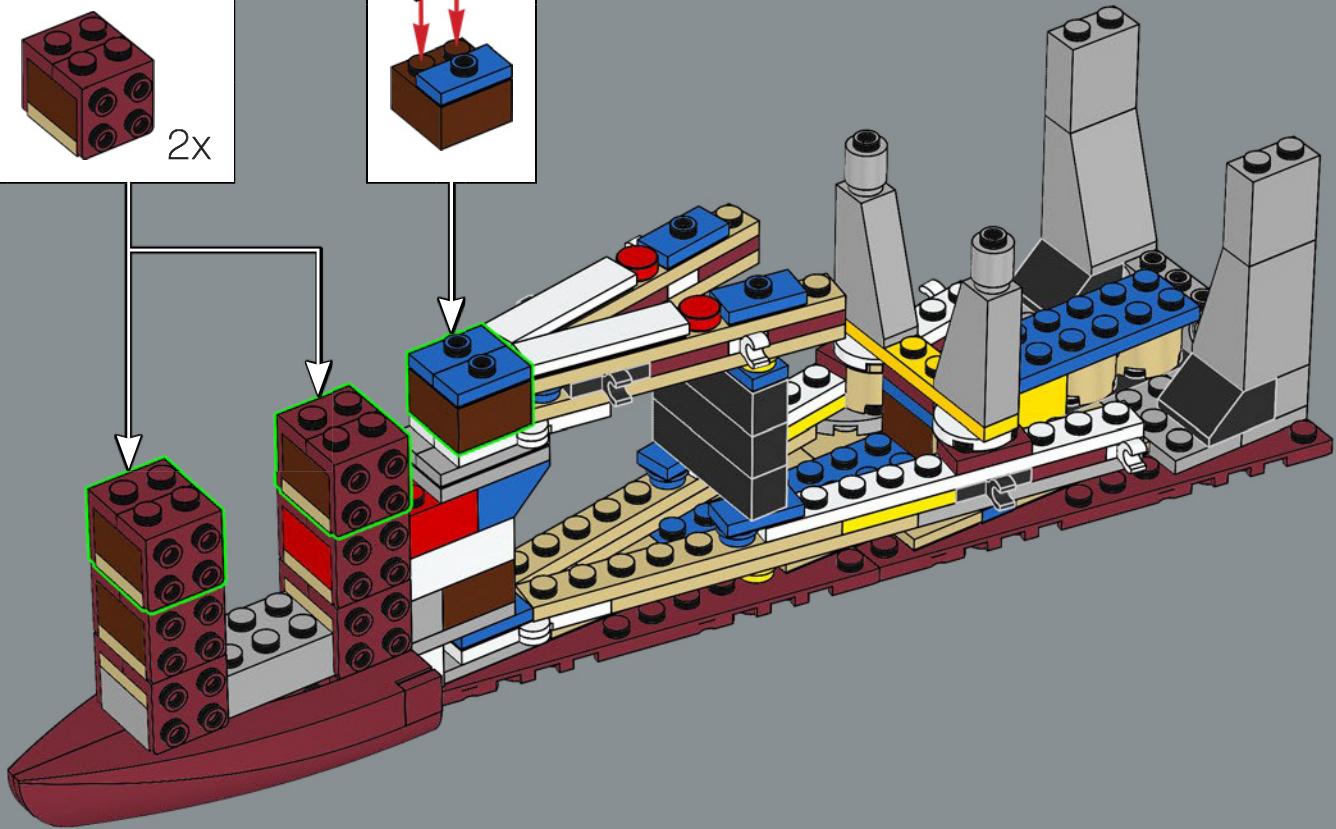
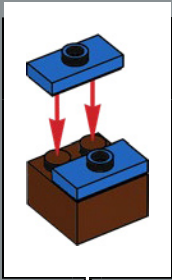
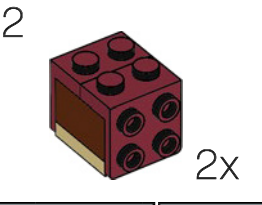
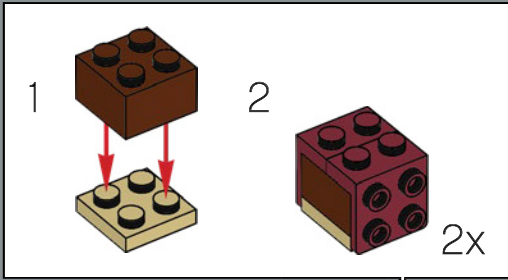

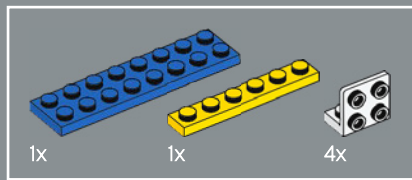

20

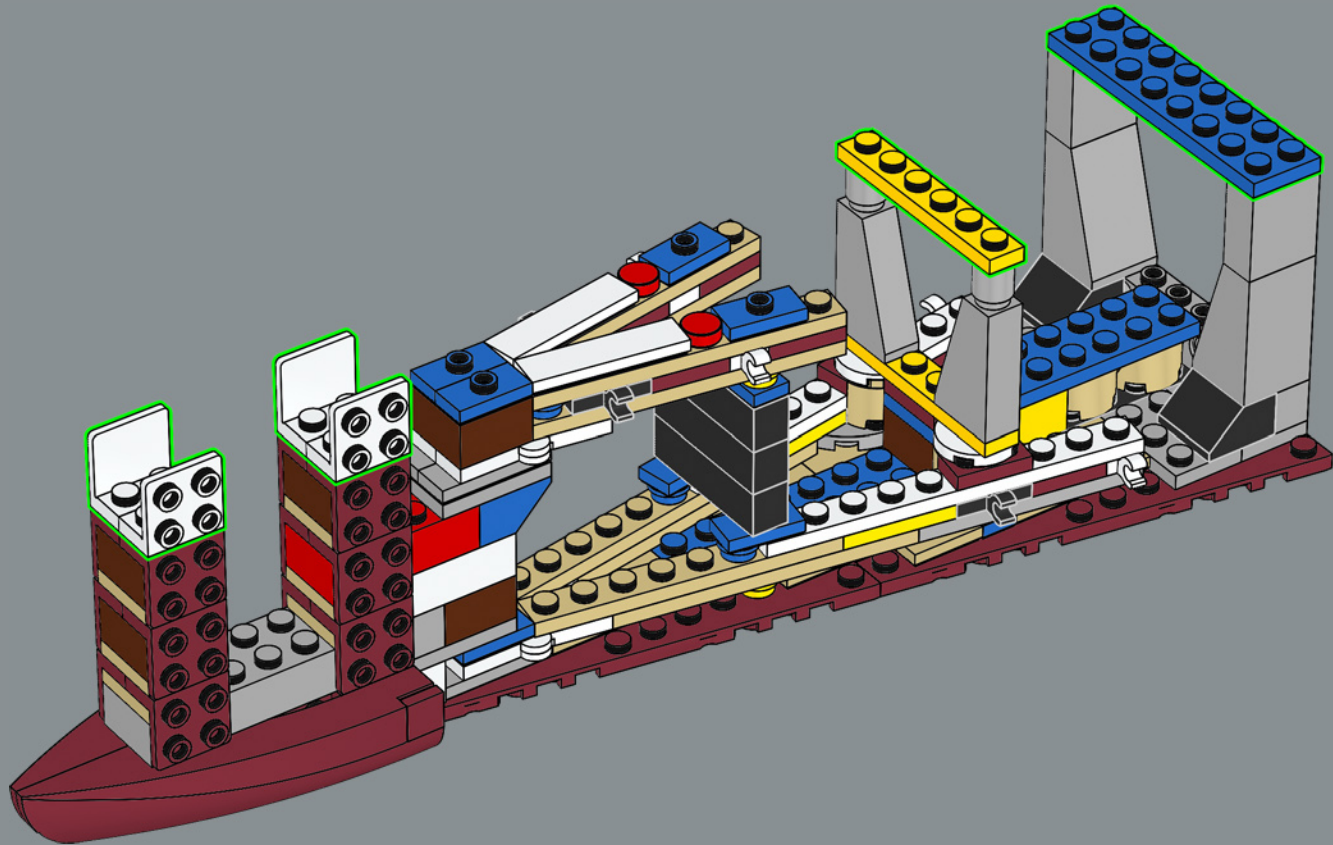

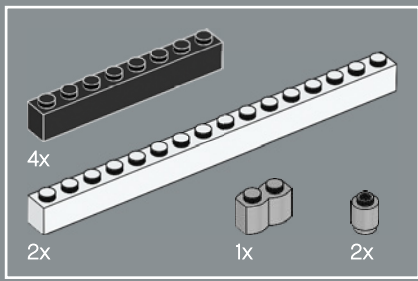

21

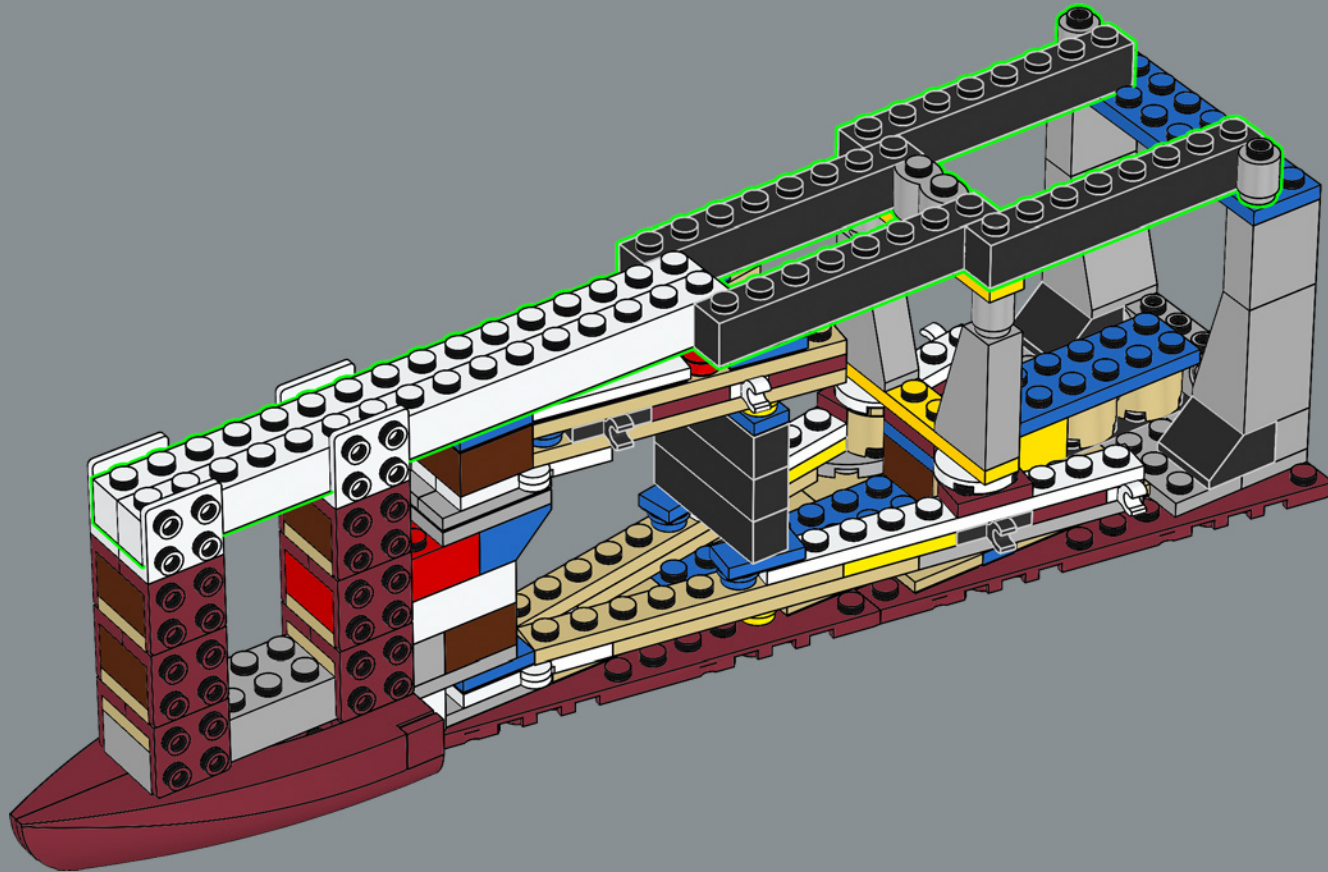

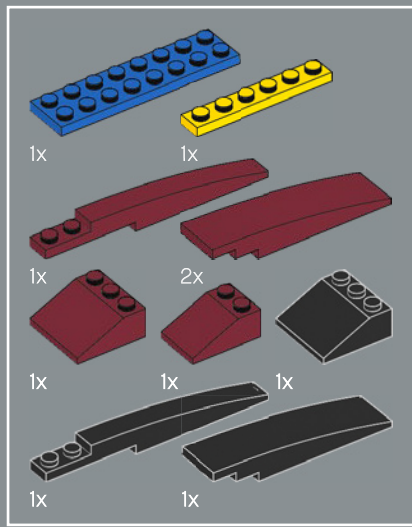

22

1

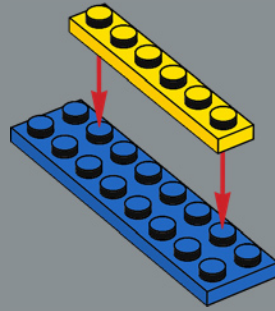

2

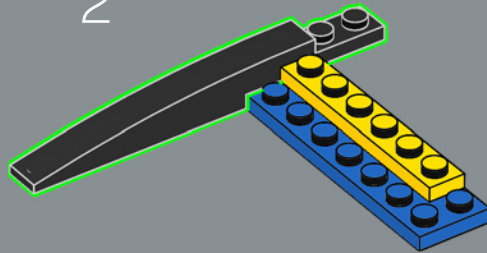

3

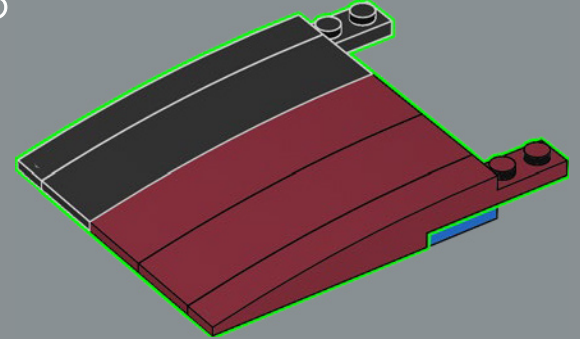

4

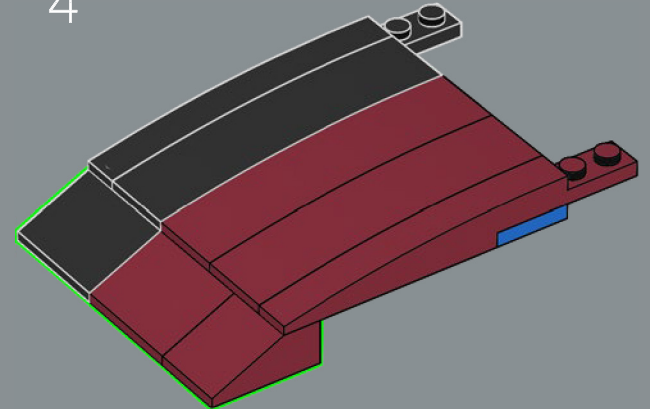

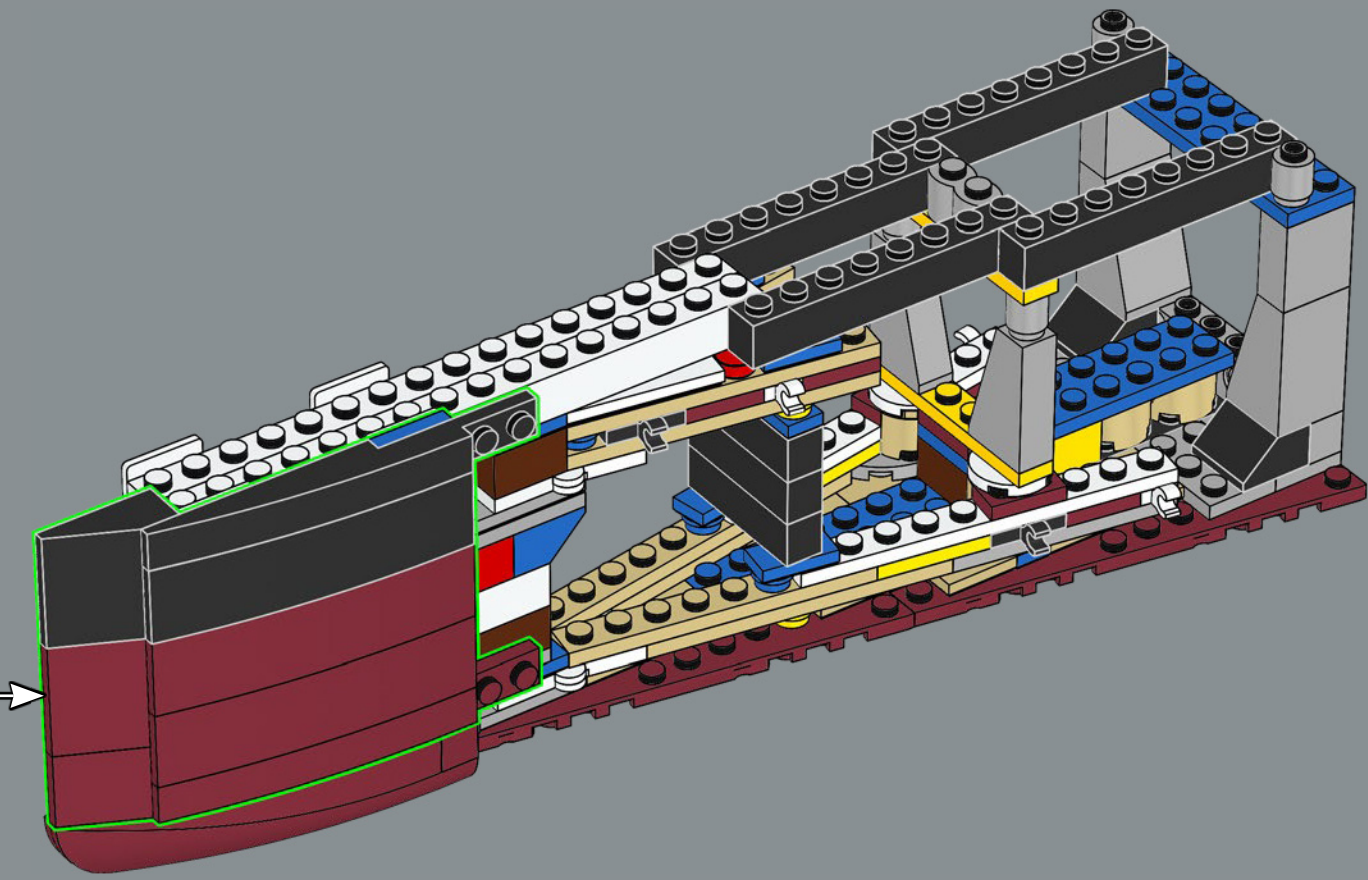

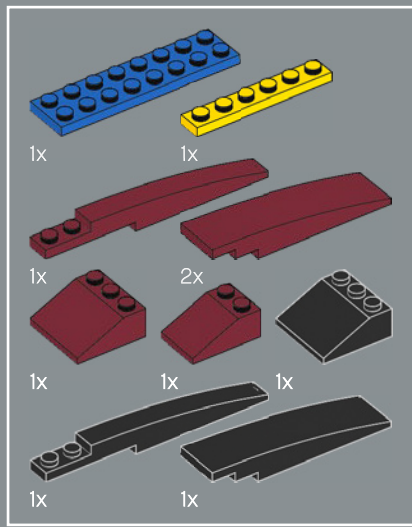

23

1

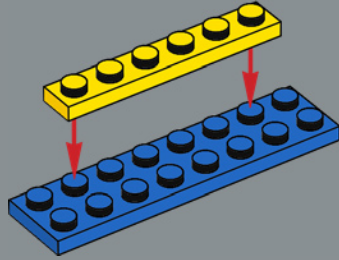

2

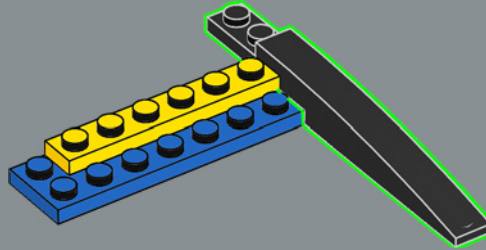

3

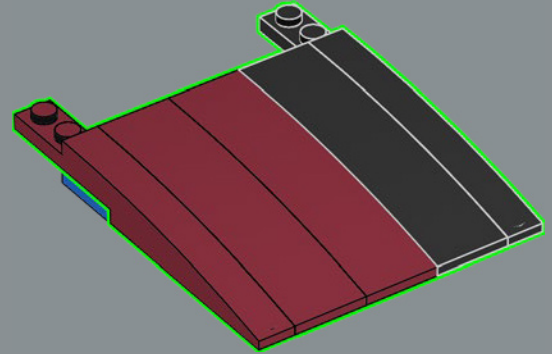

4

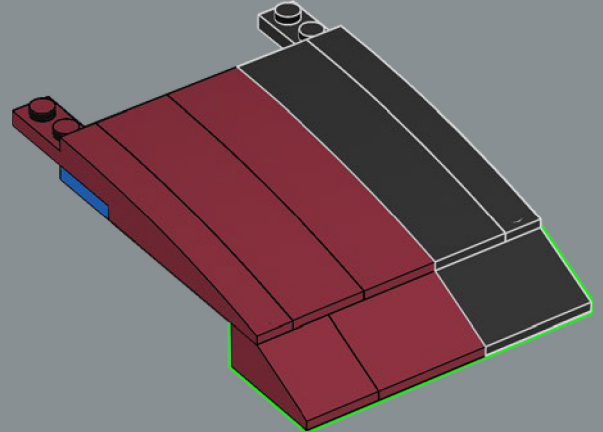

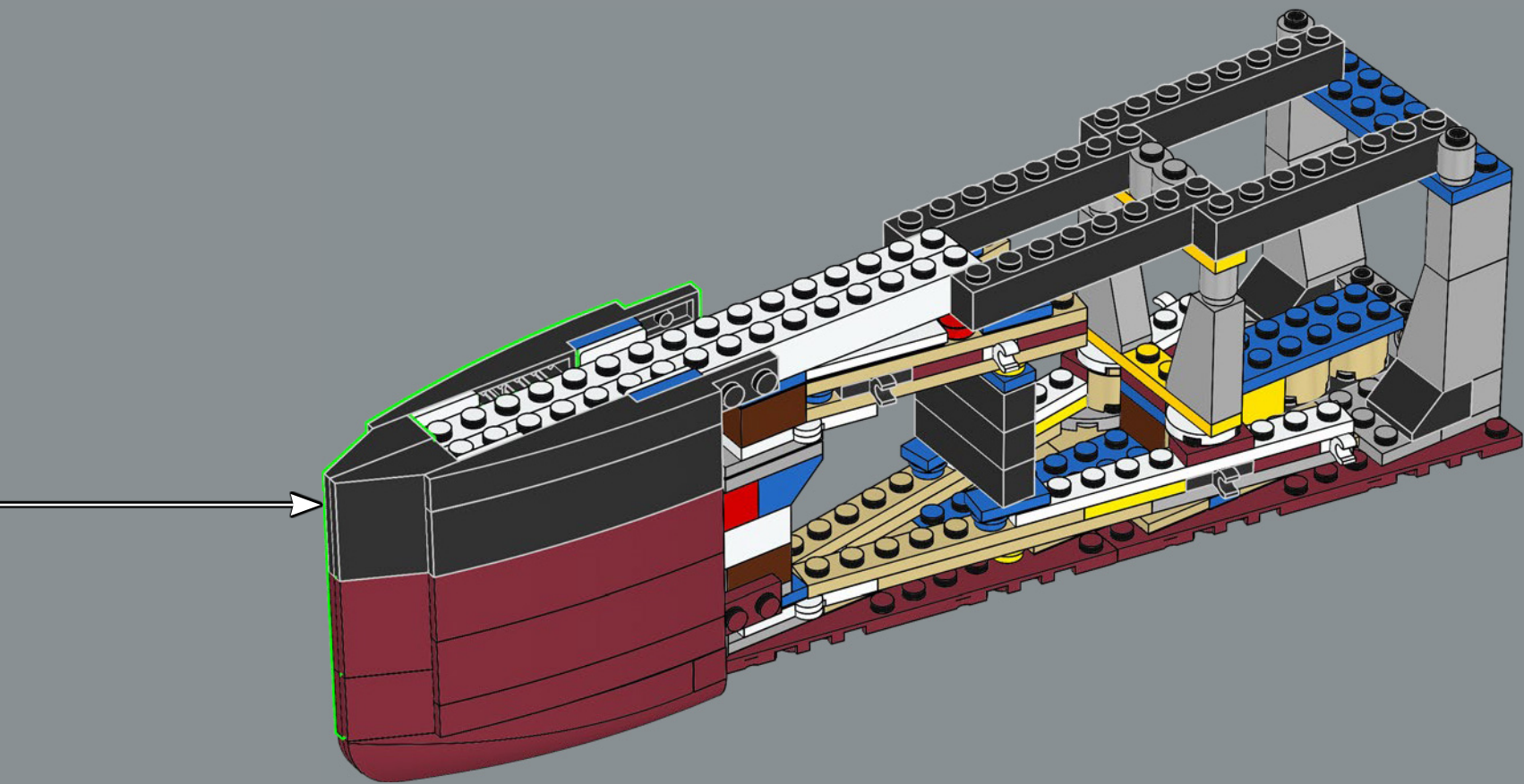

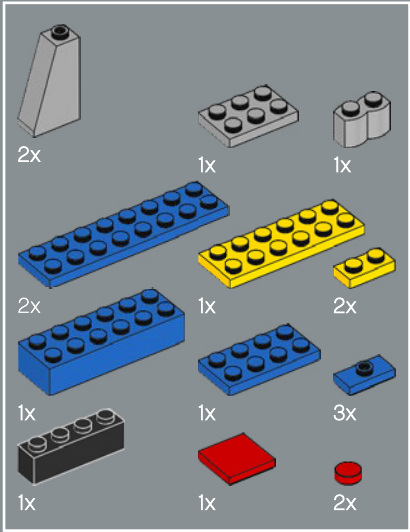
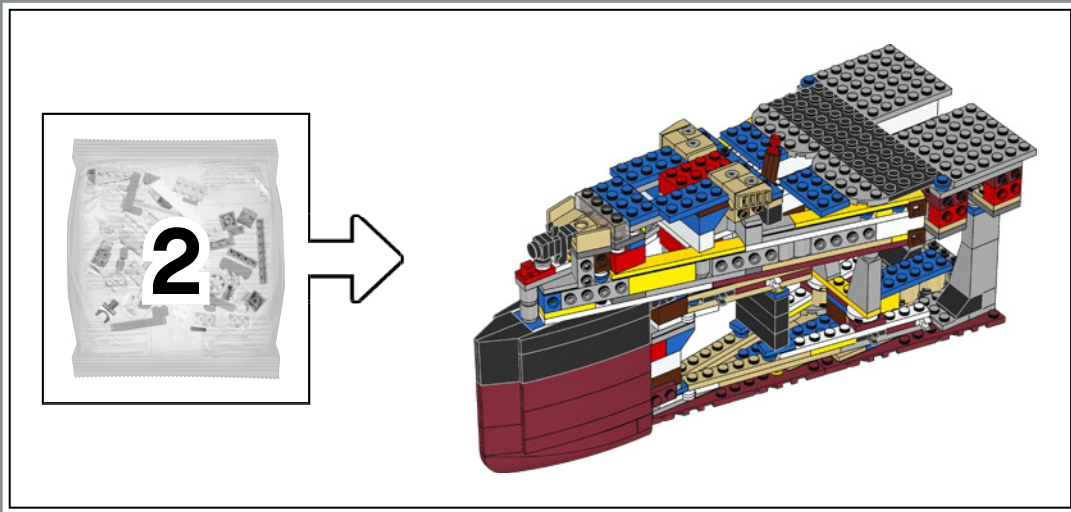

24

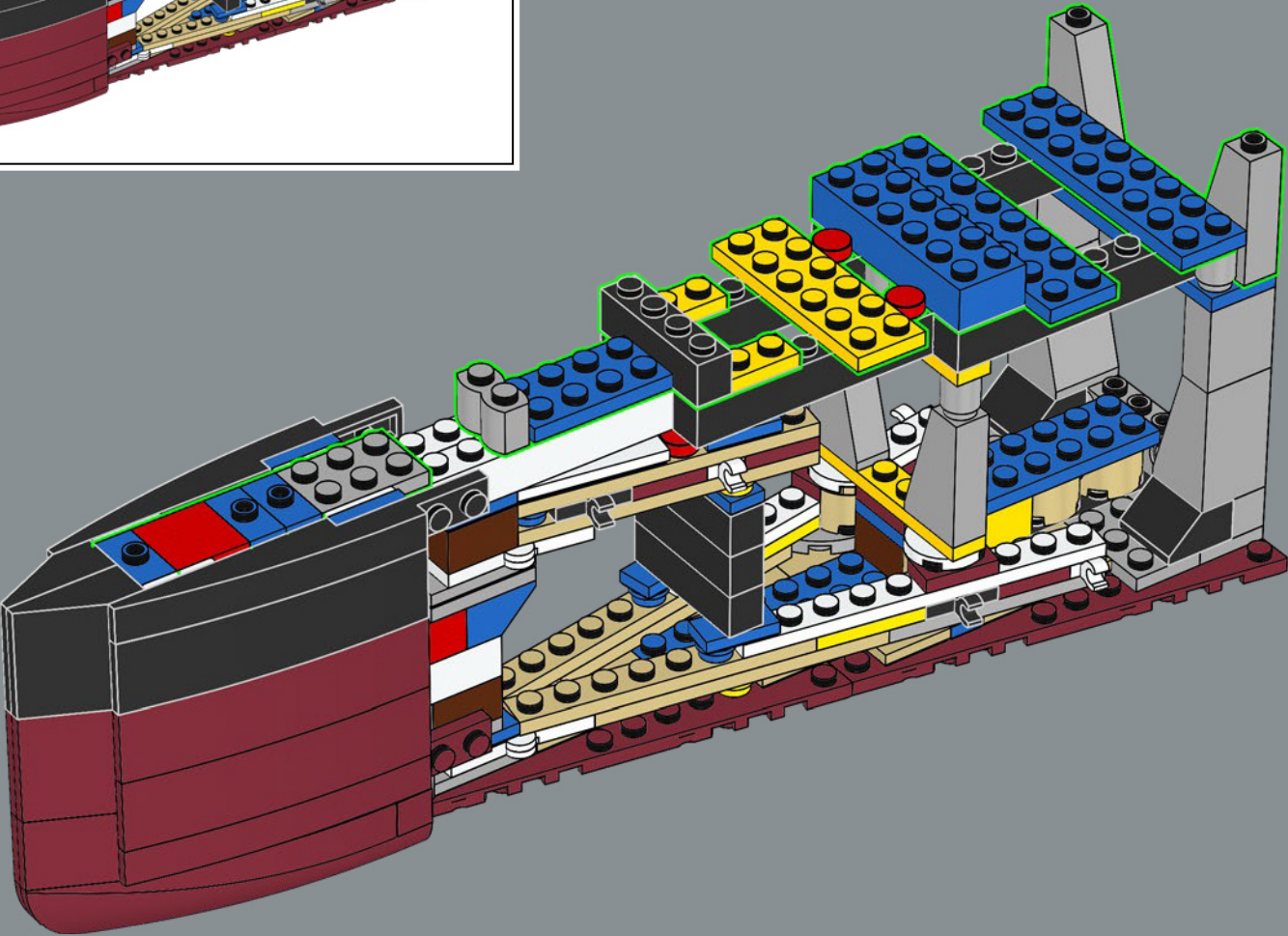

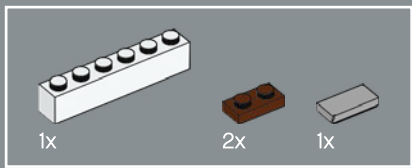

25

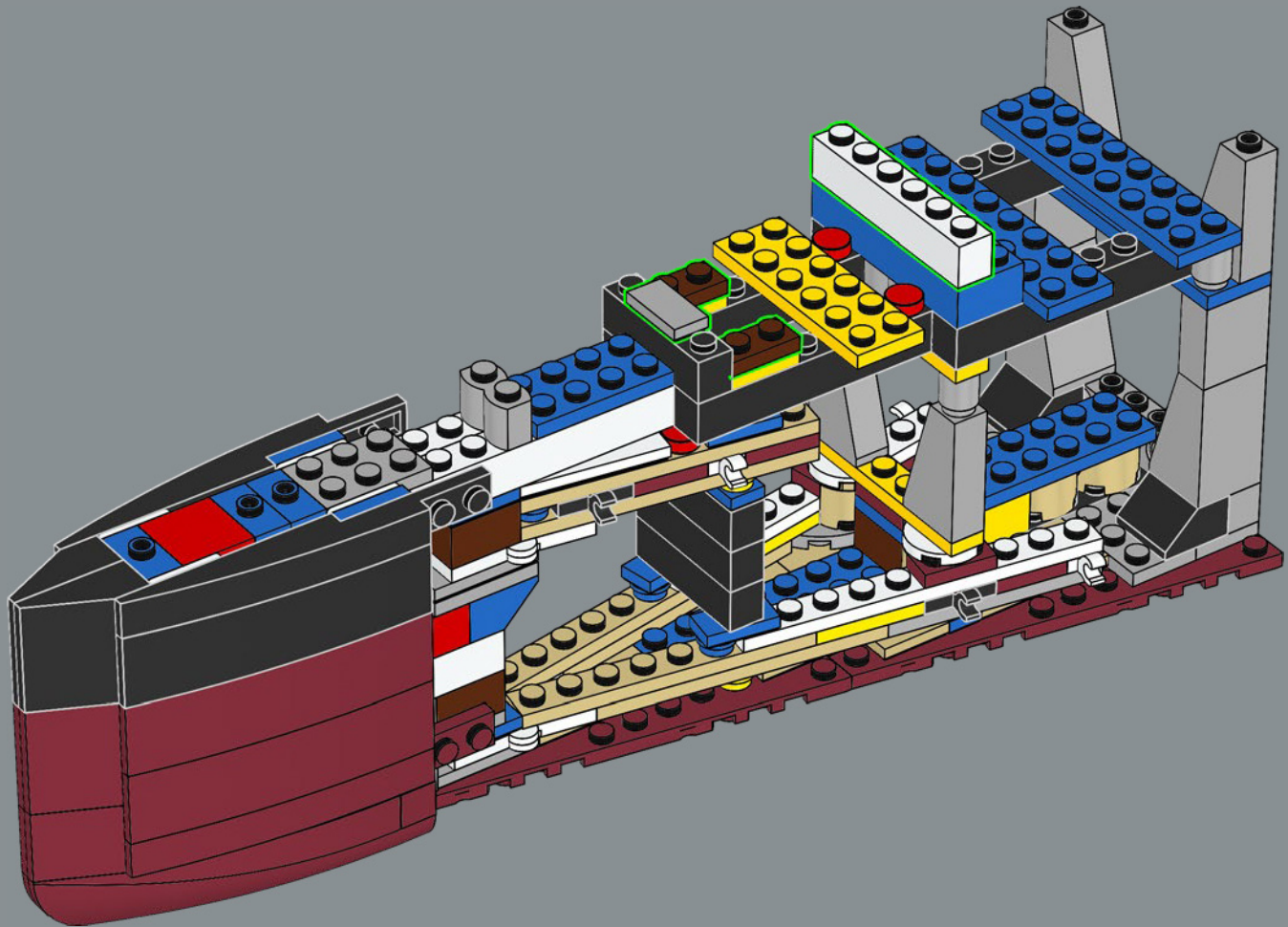

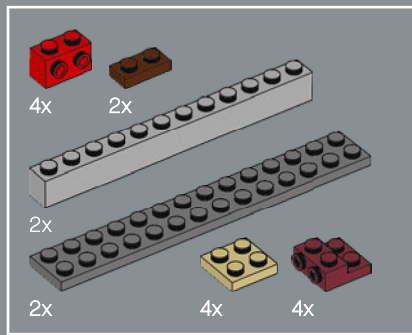

26

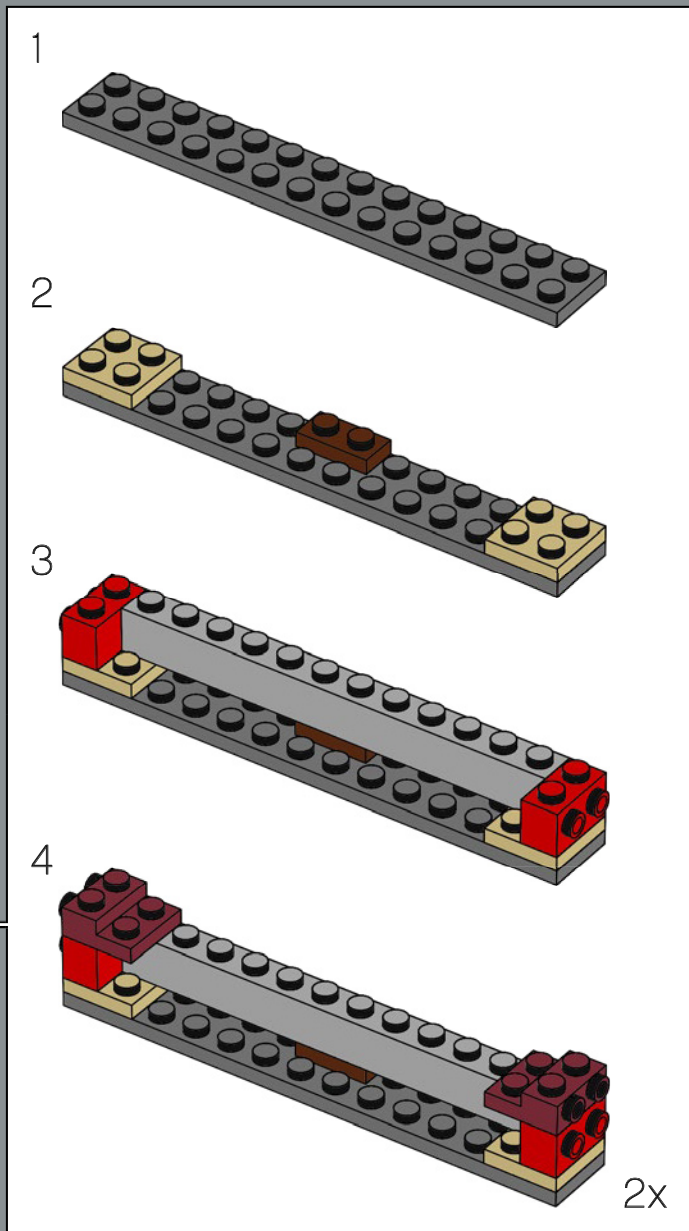
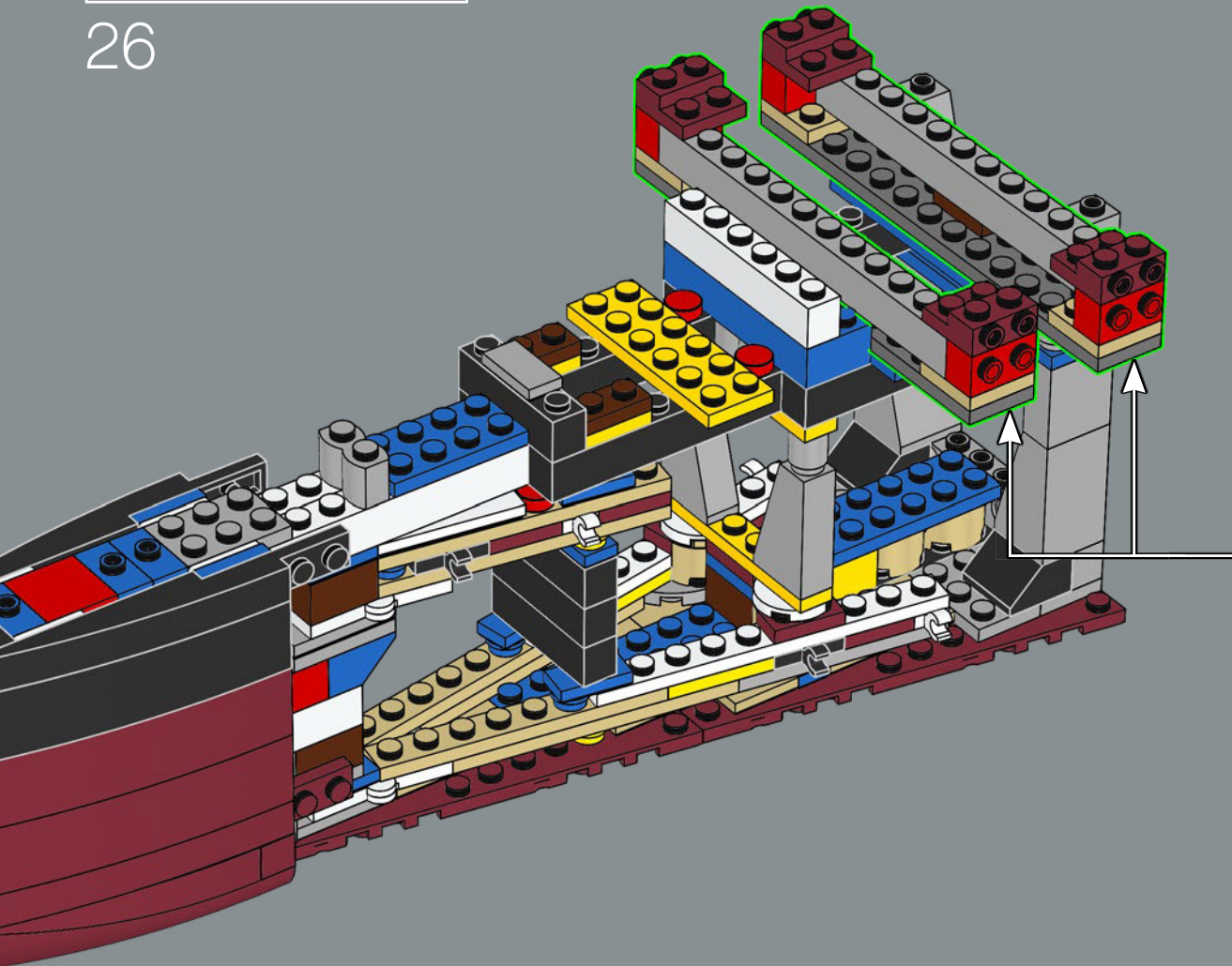

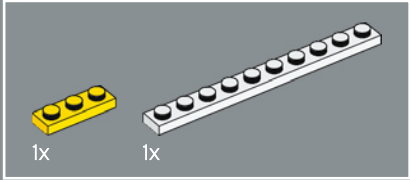
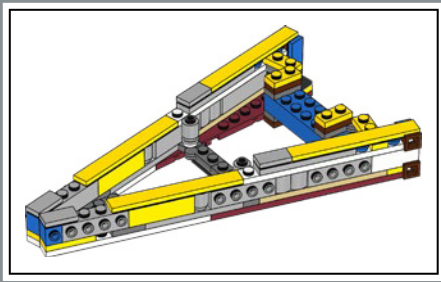

27

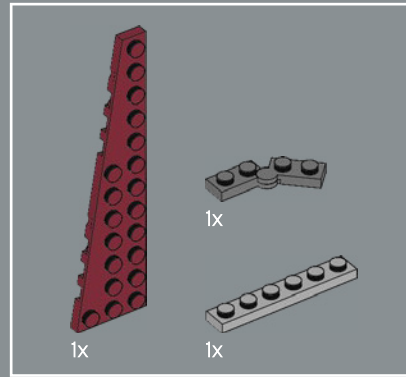
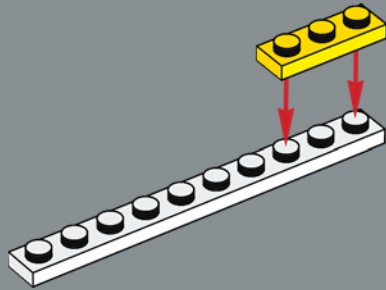

28

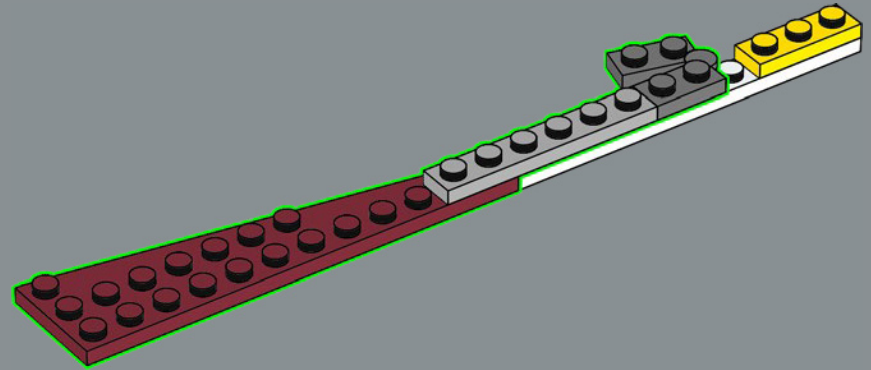

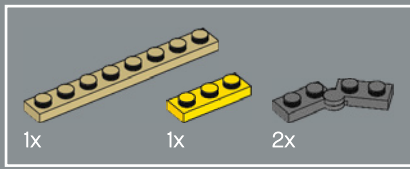

29

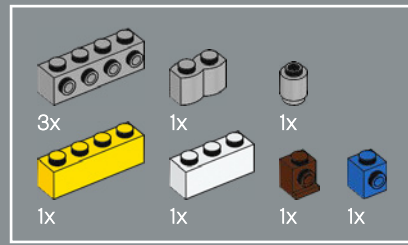
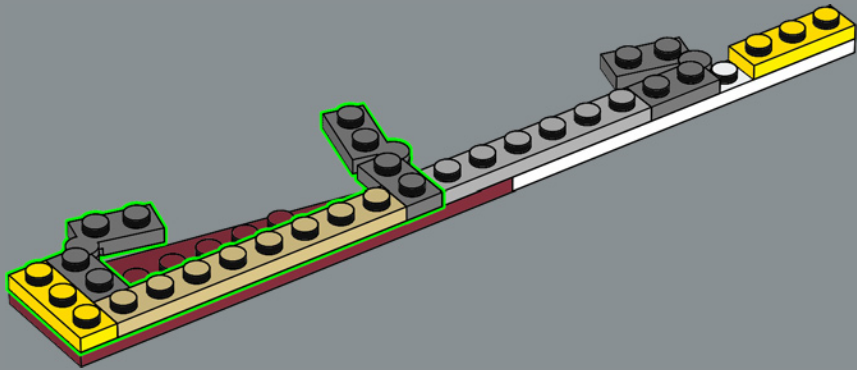

30

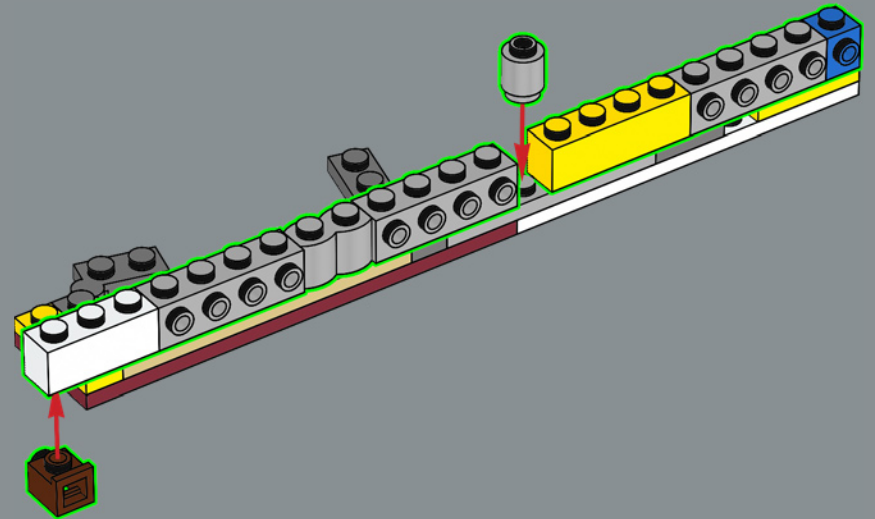

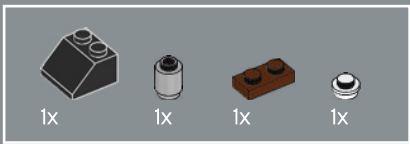

31

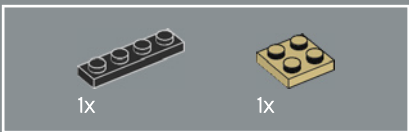
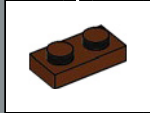
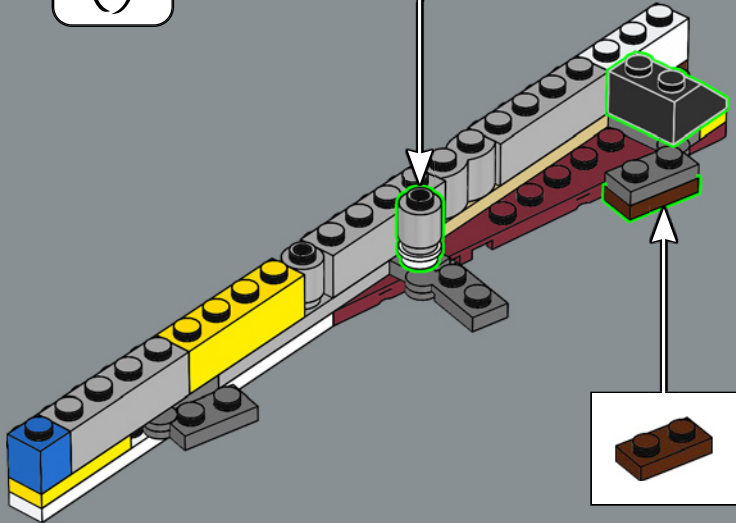
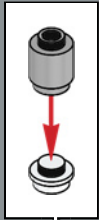

32

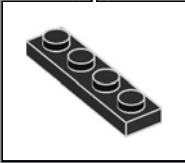
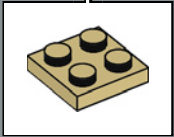
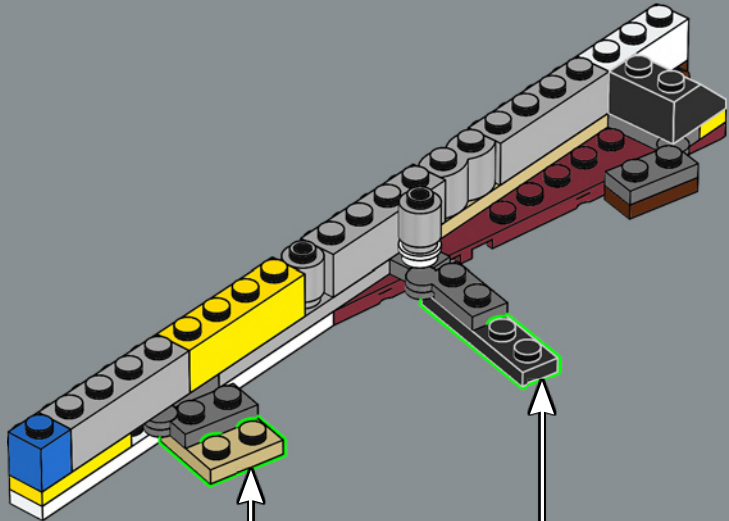

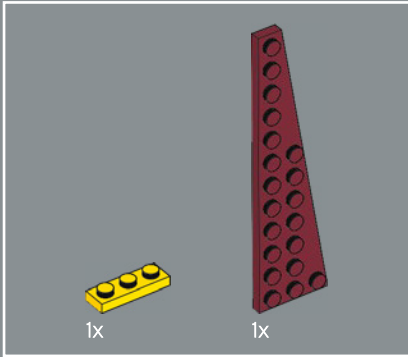
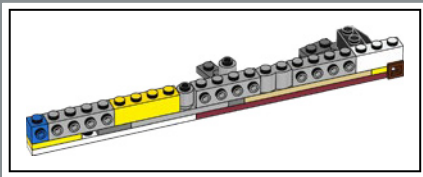

33

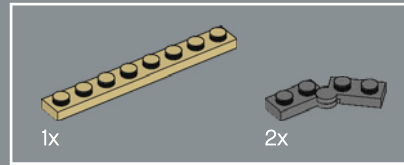
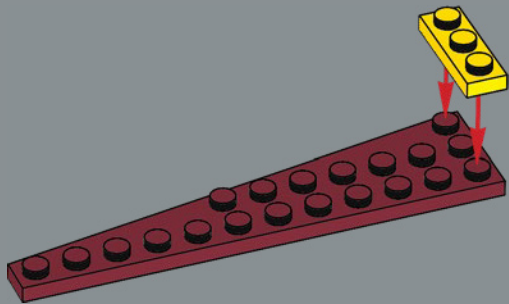

34

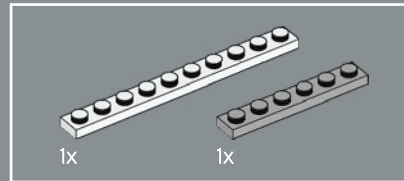
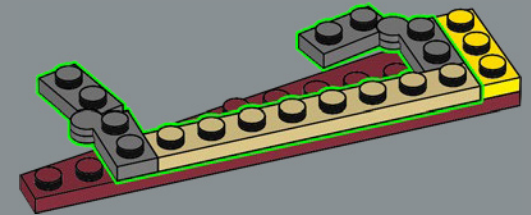

35

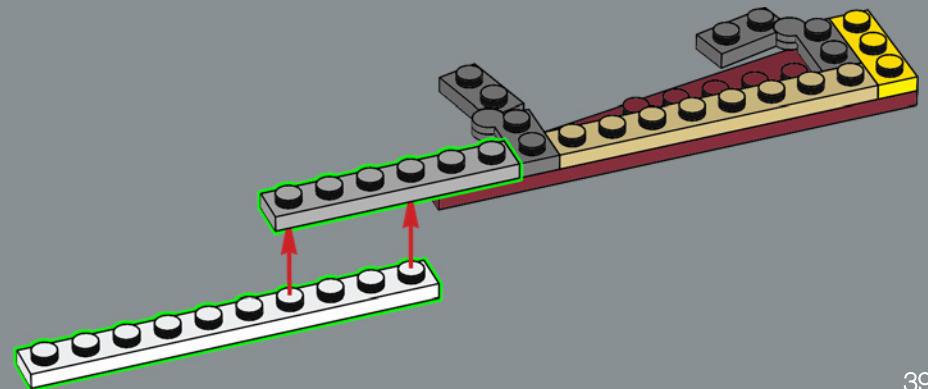

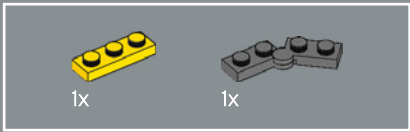

36

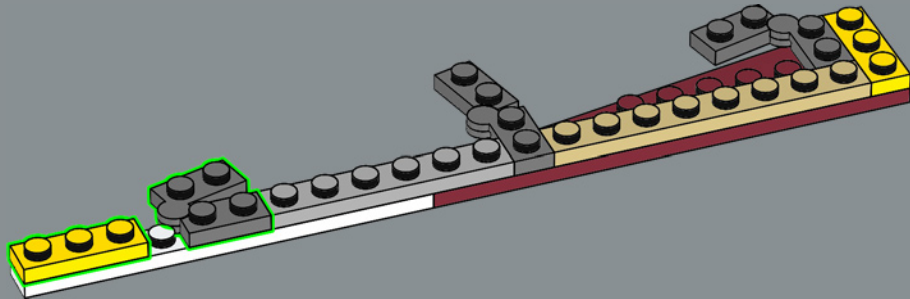

37

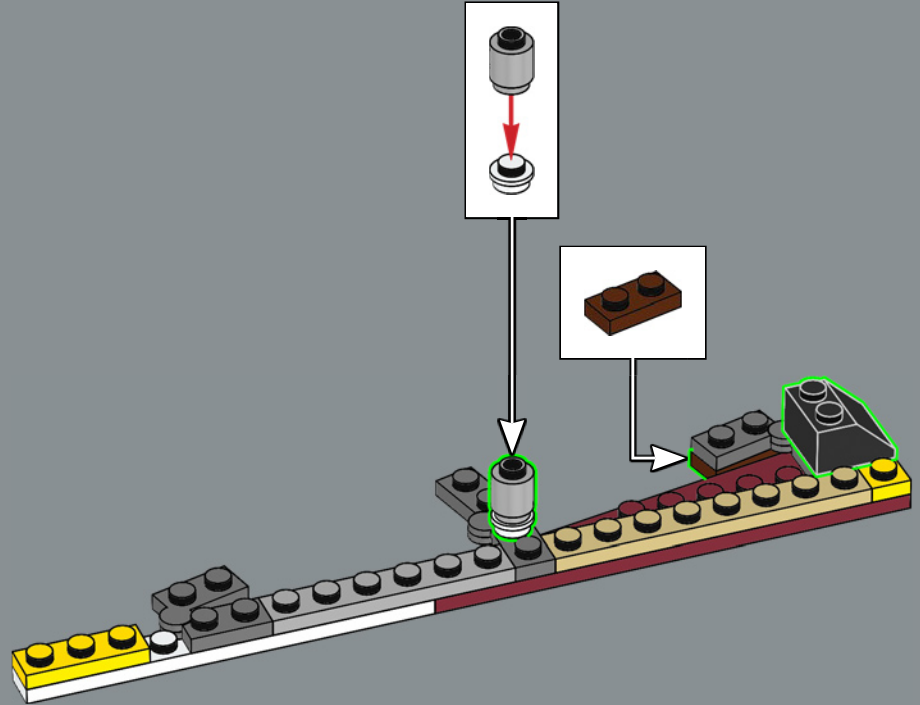

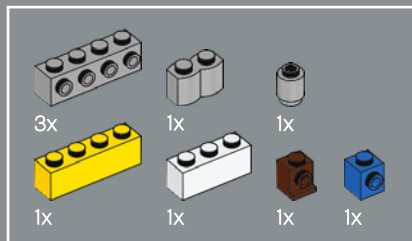

38

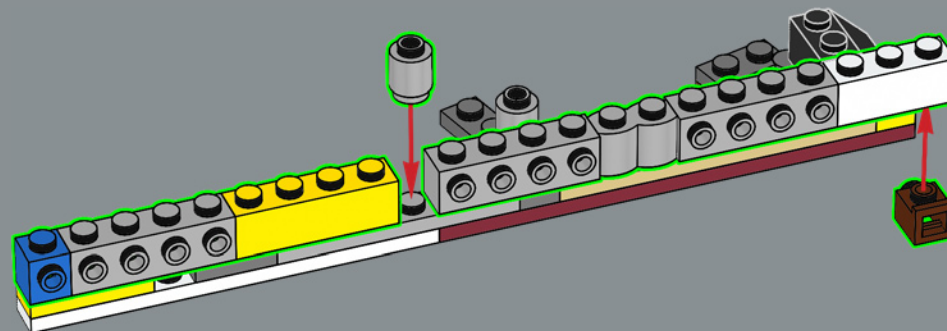

39

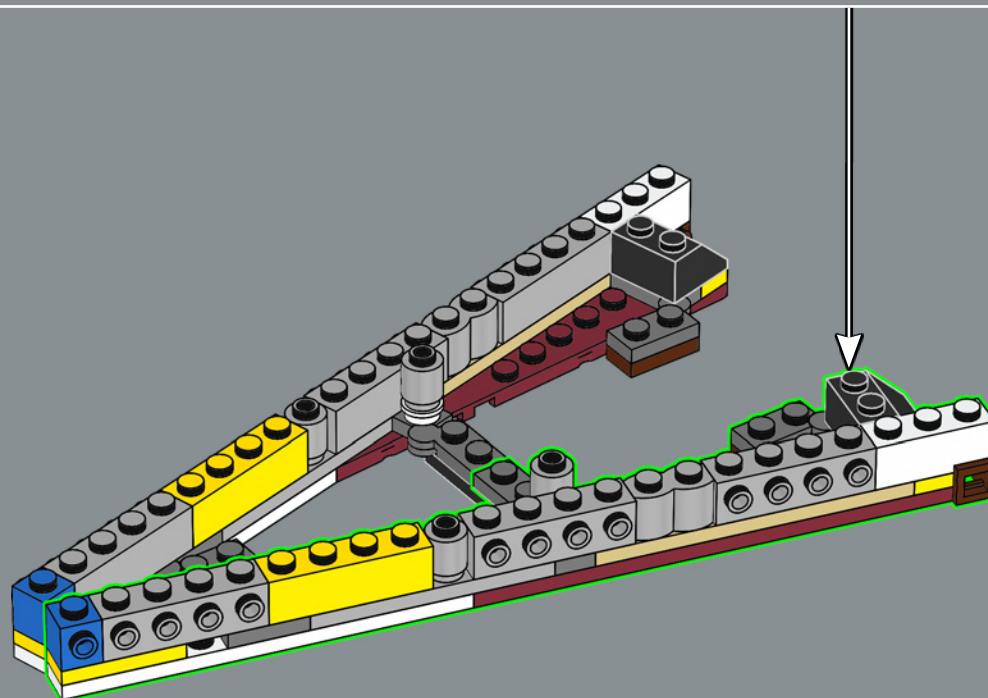

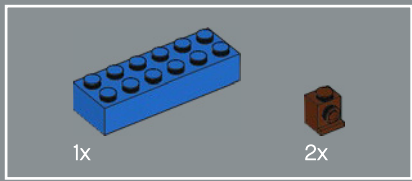

40

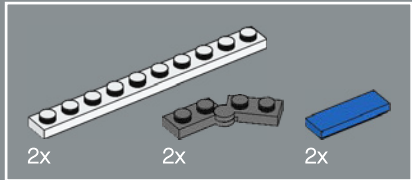
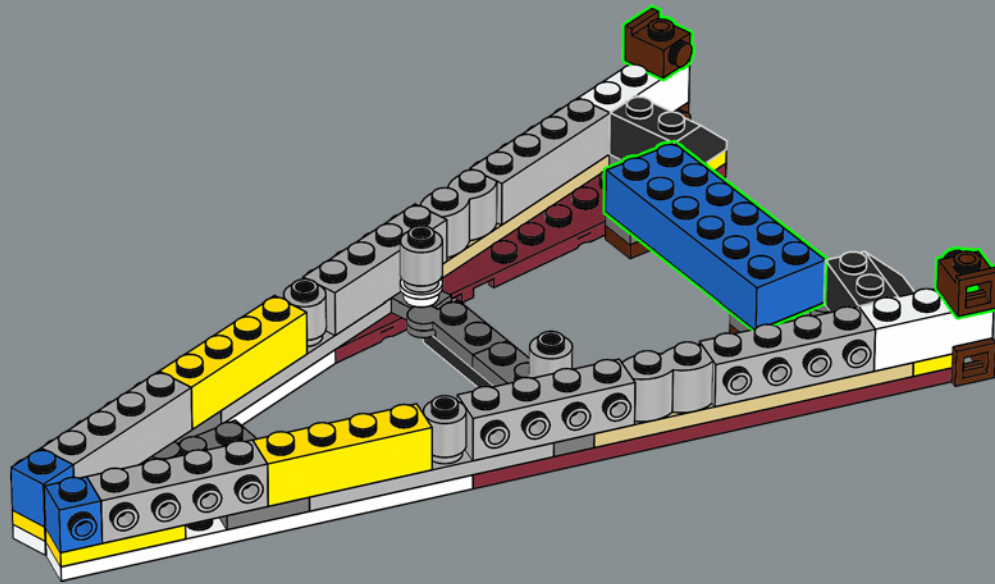

41

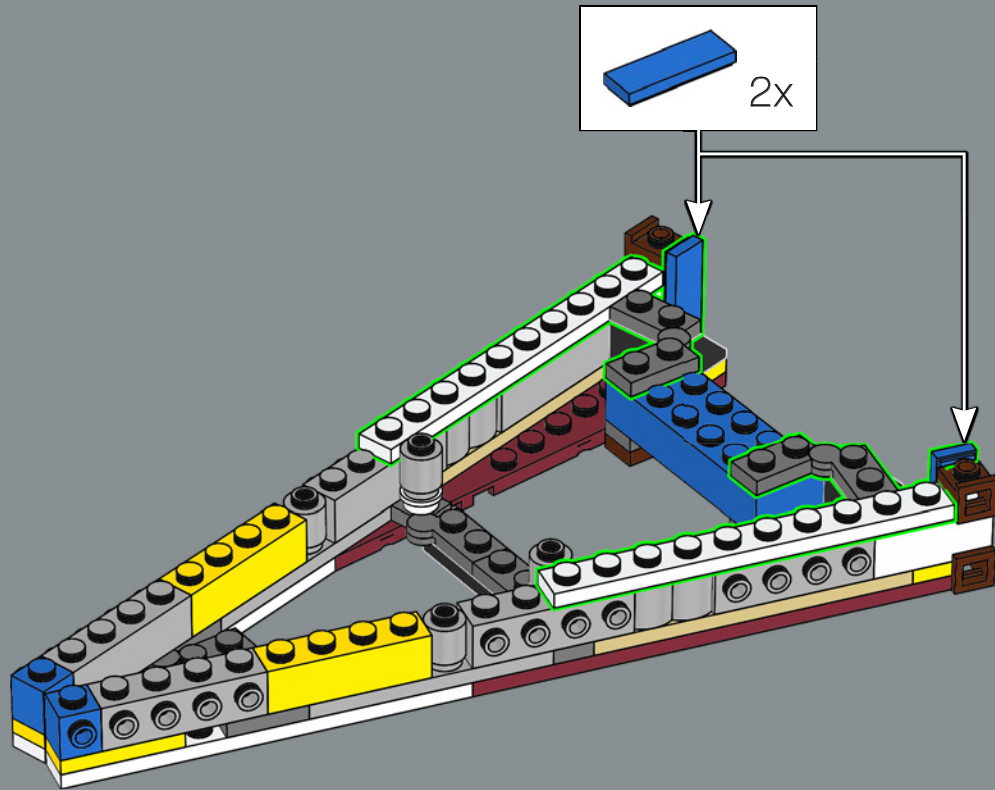

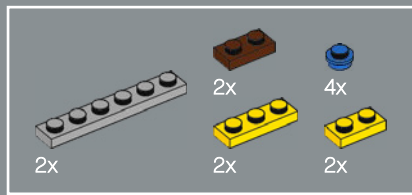

42

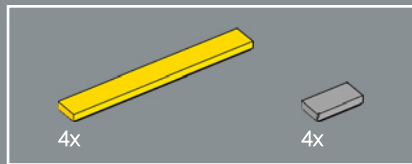
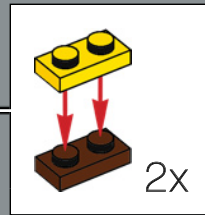
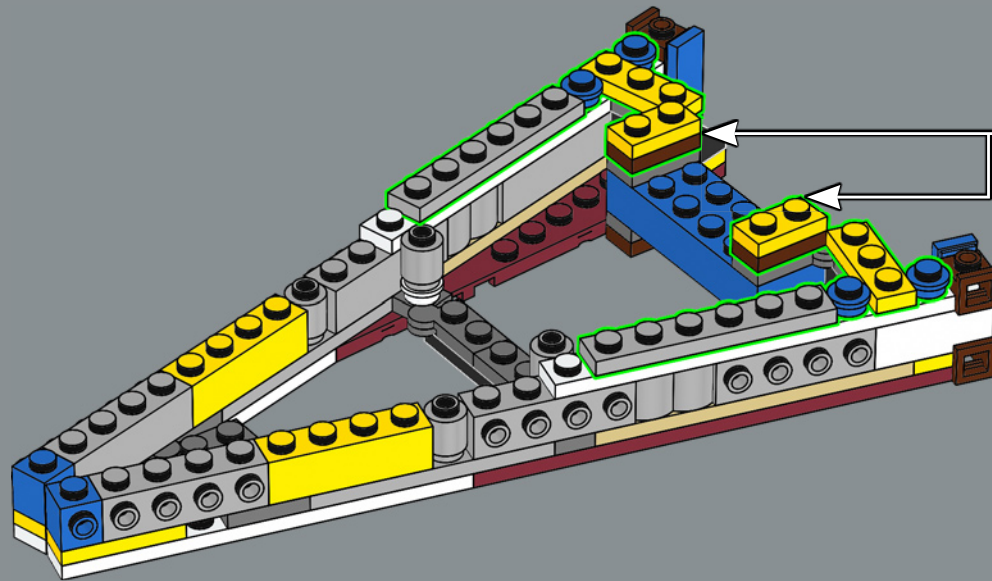

43

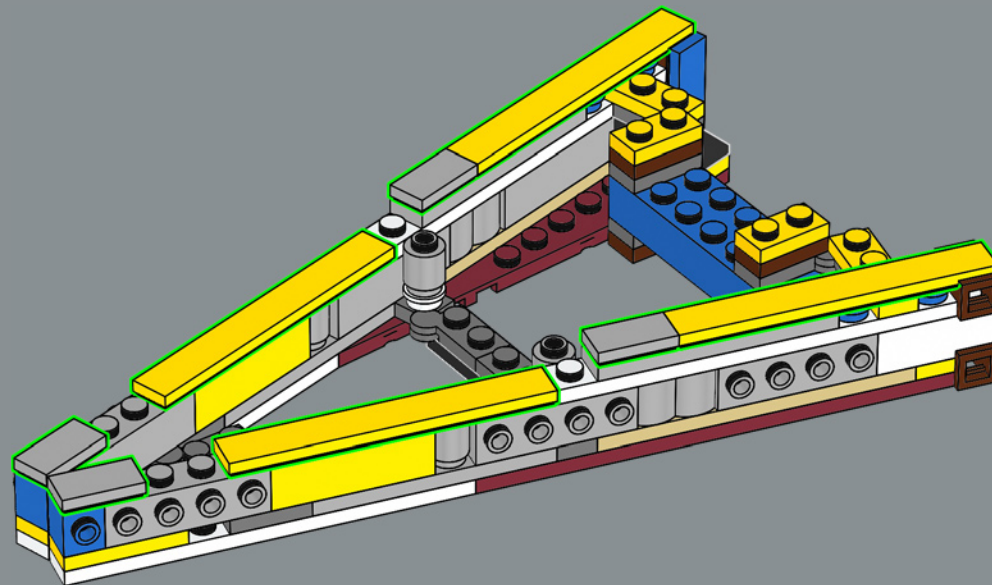

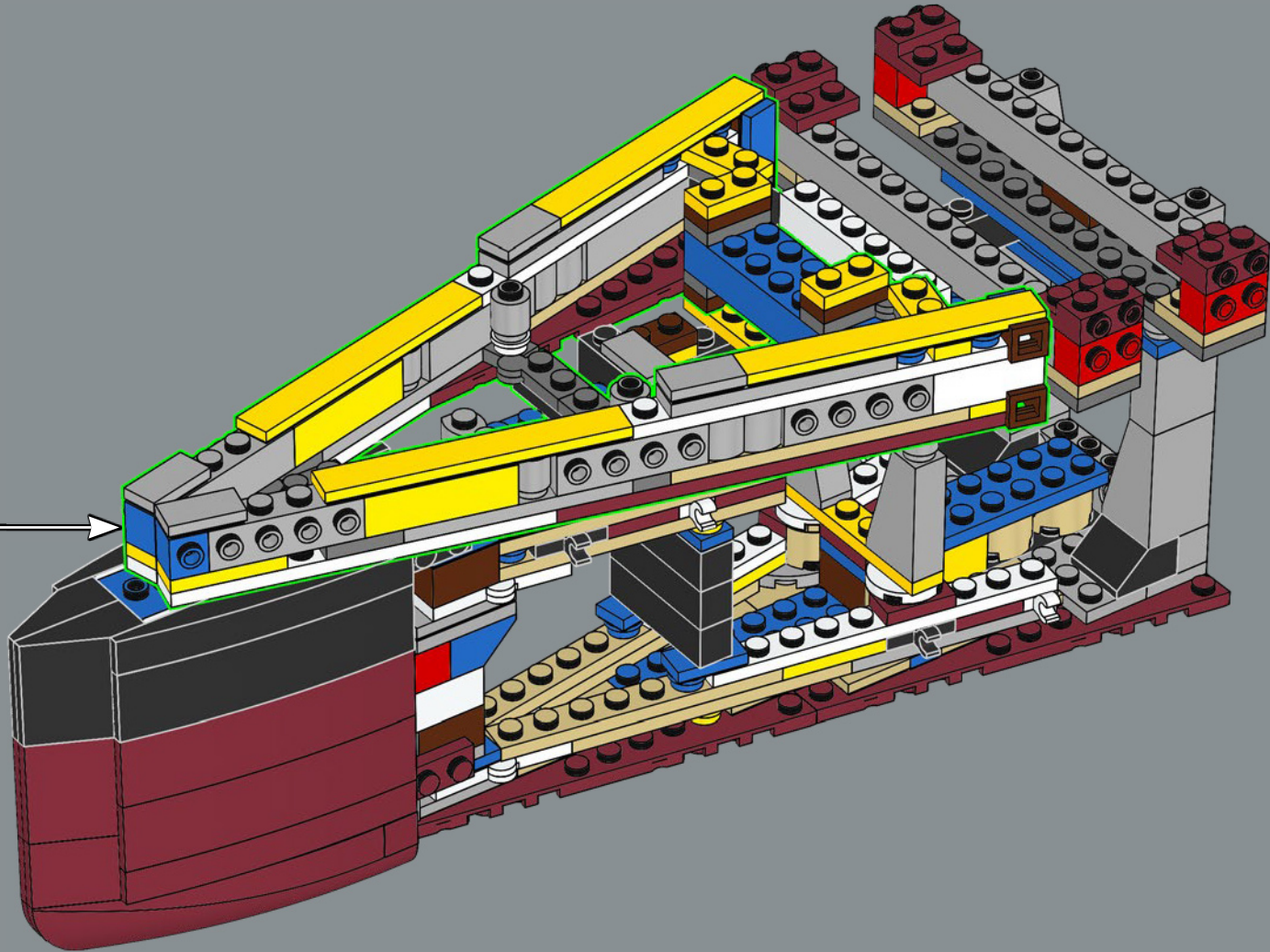

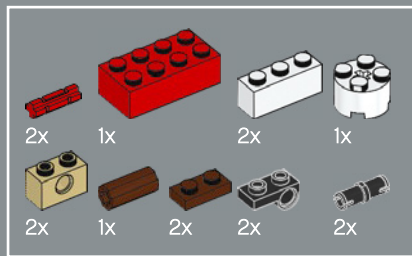

45

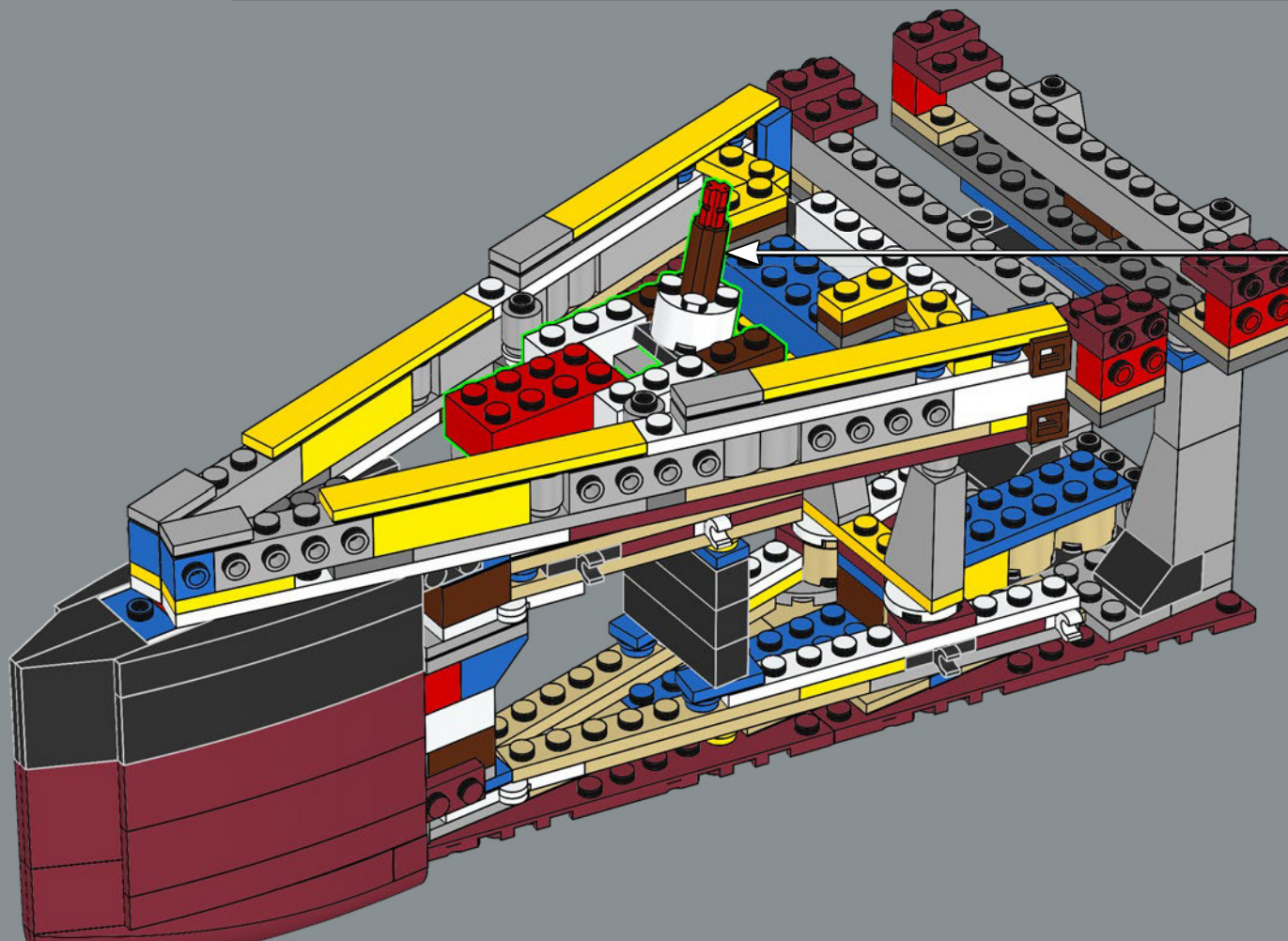
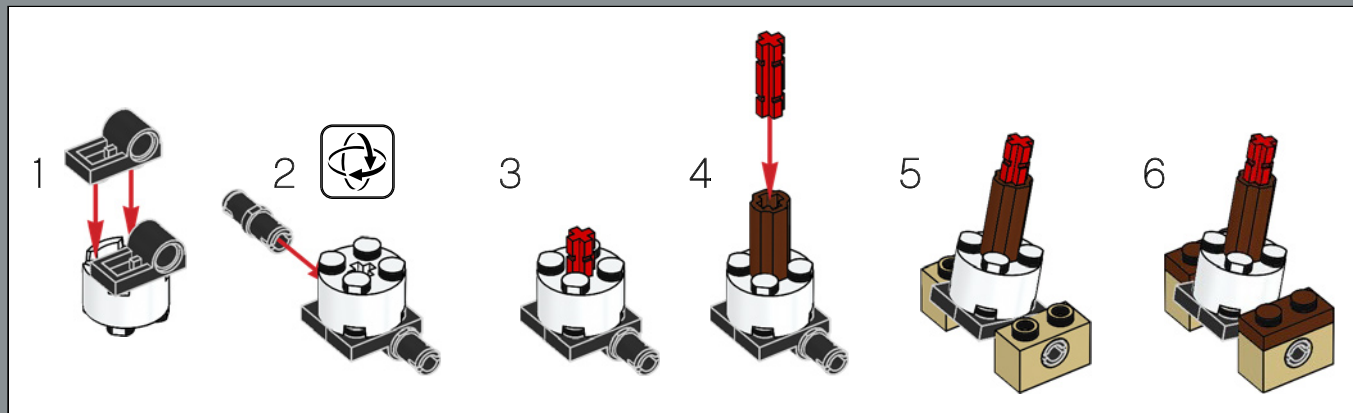

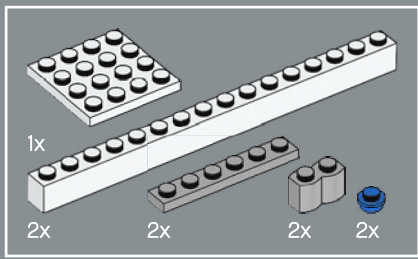

46

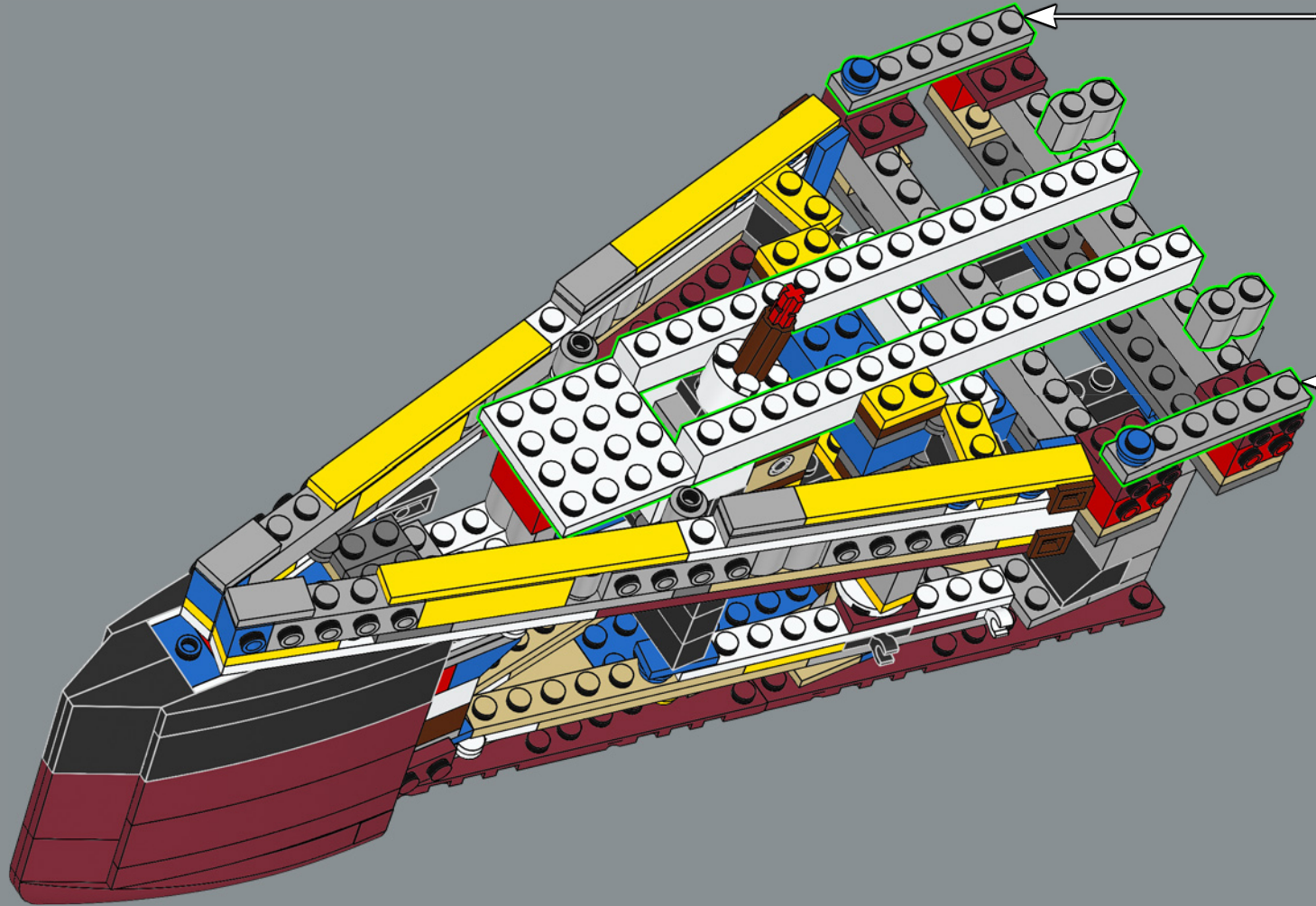
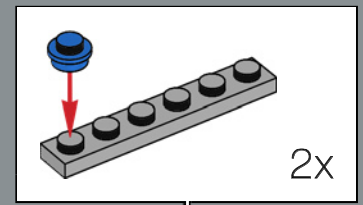

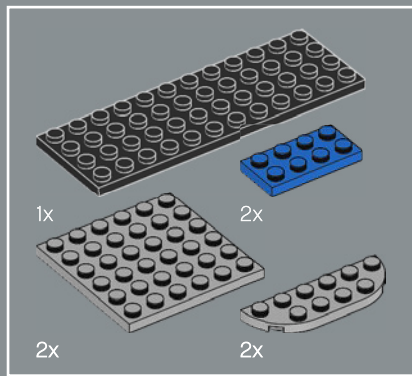

47

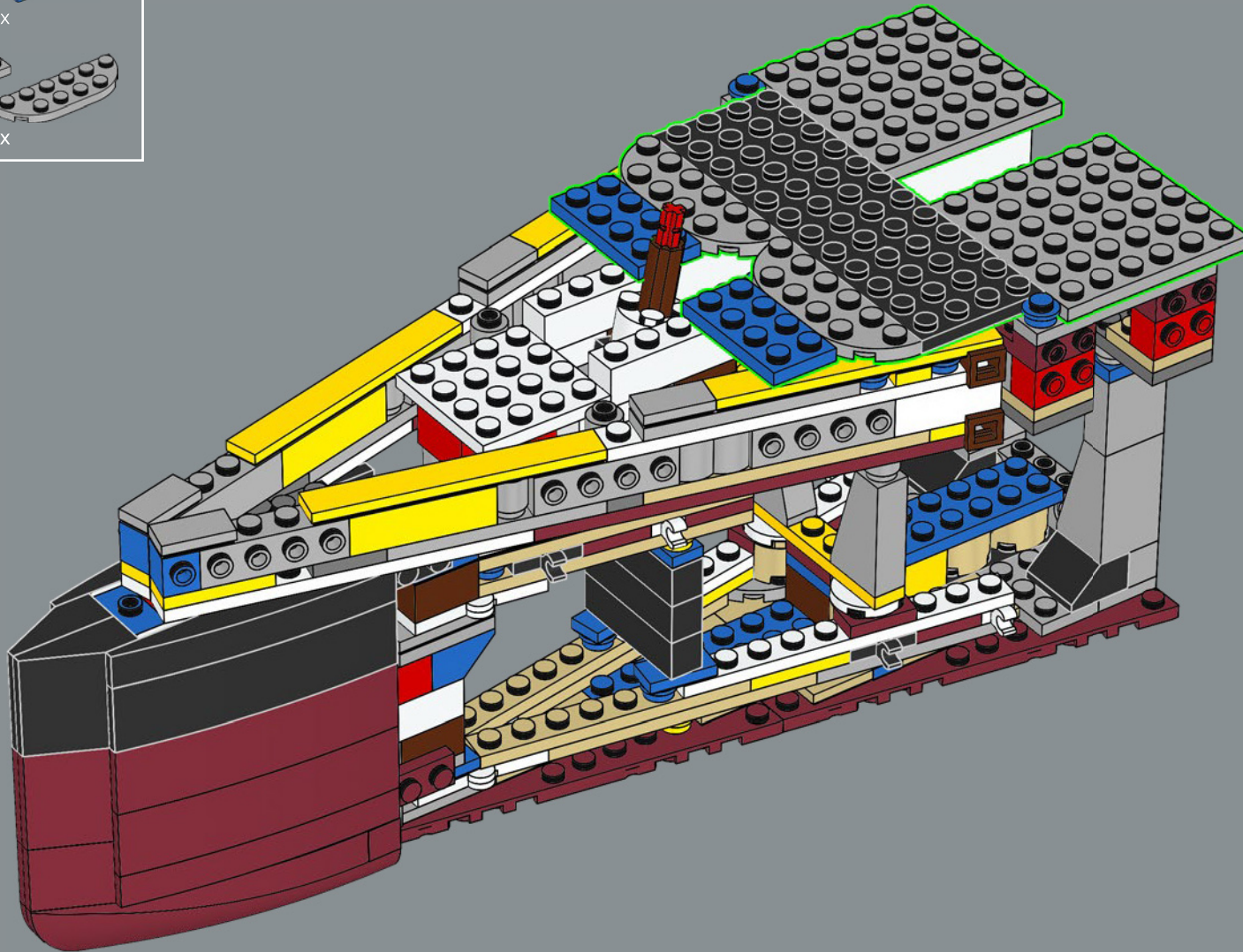

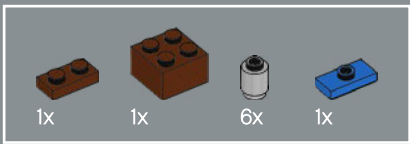

48

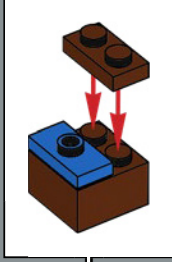
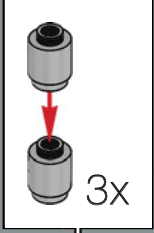
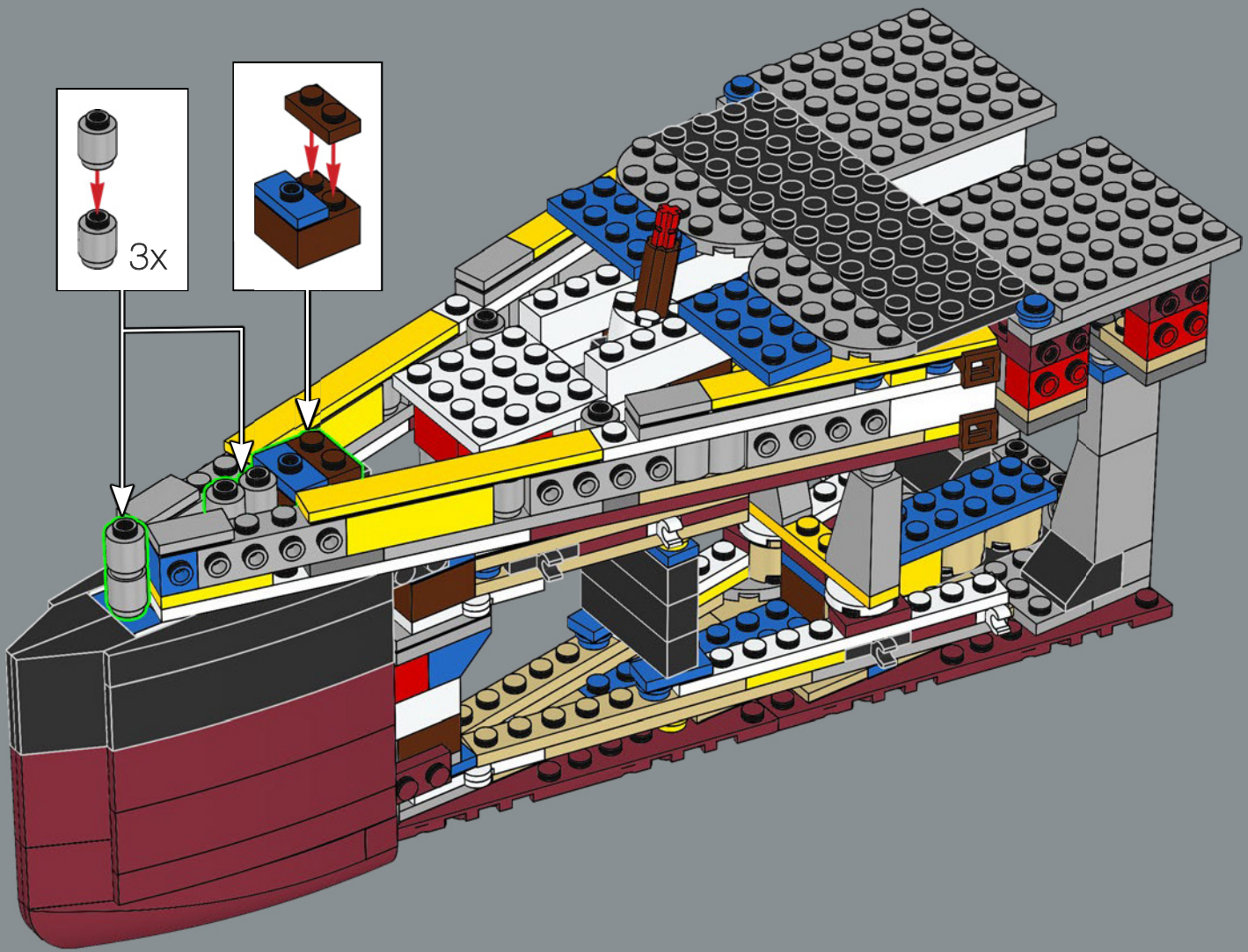

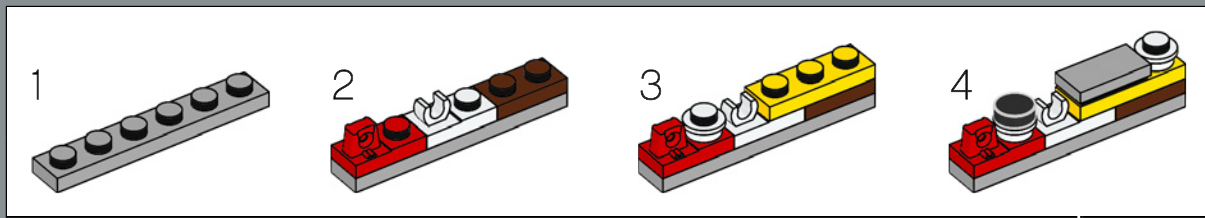
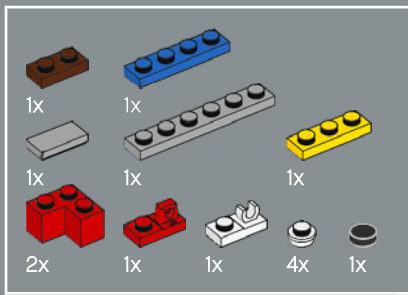

49

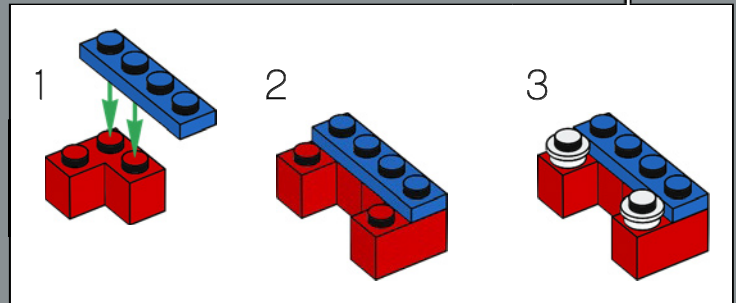
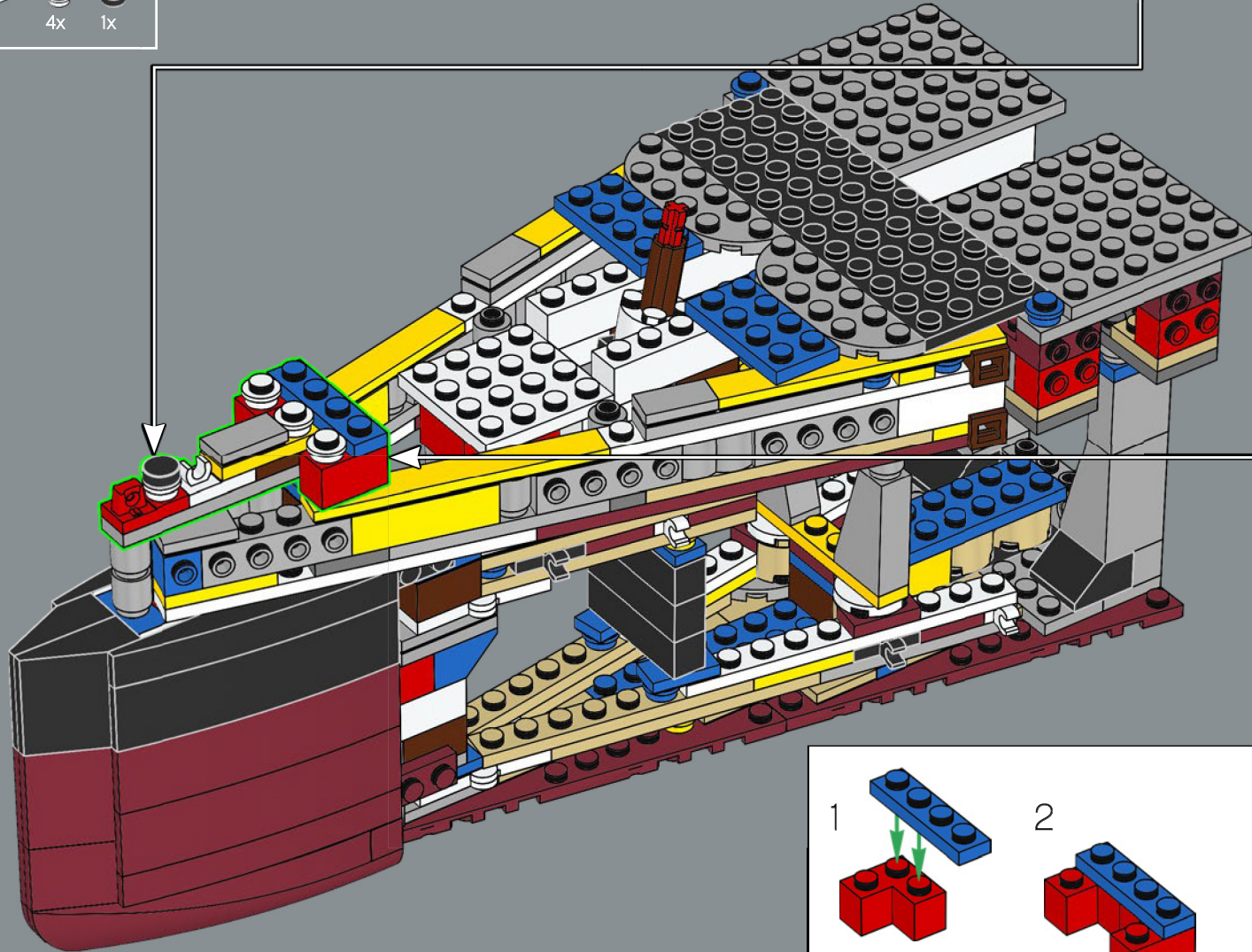

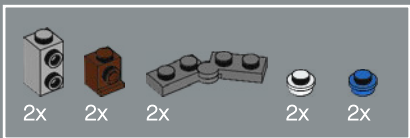

50

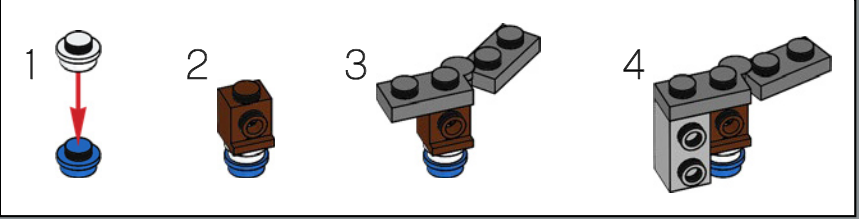
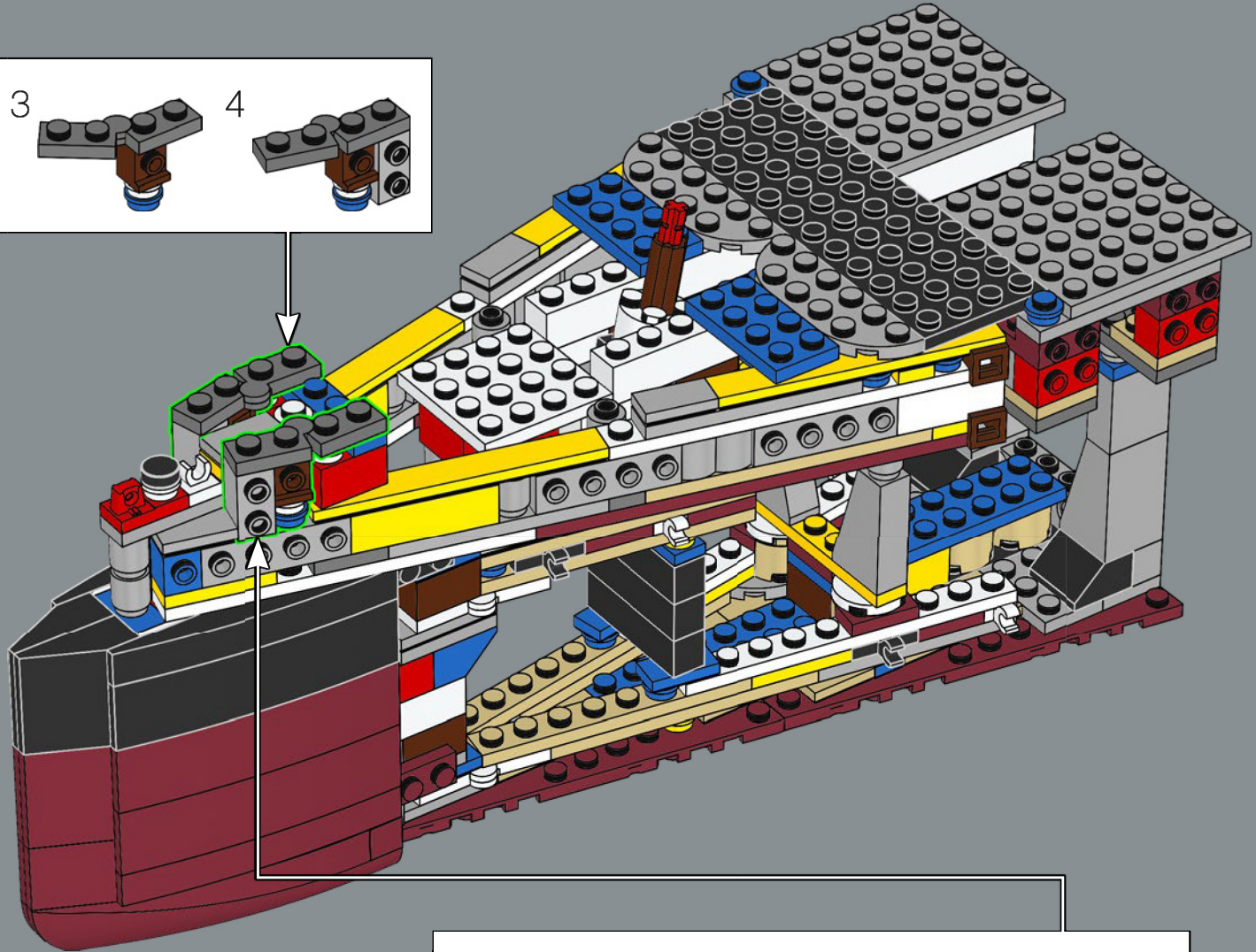
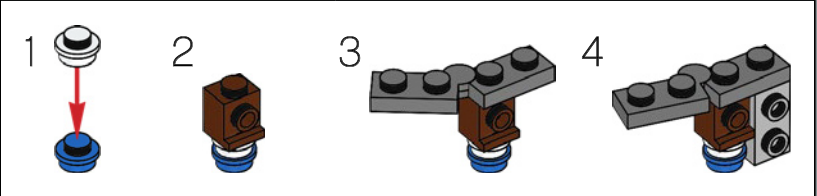

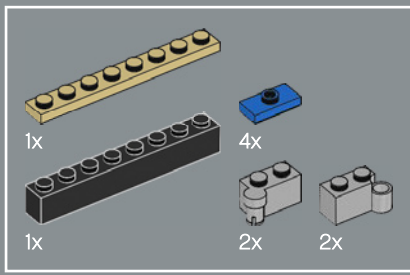

51

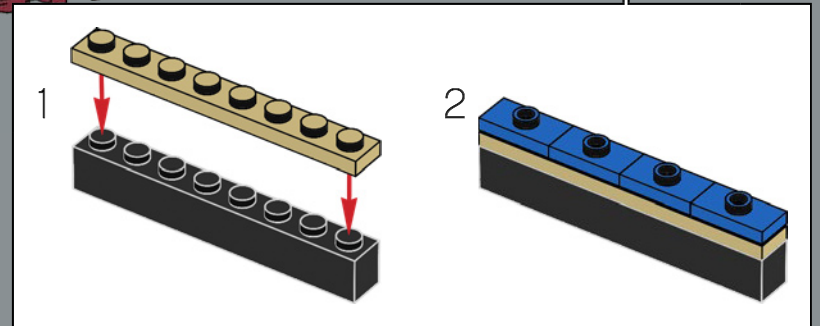
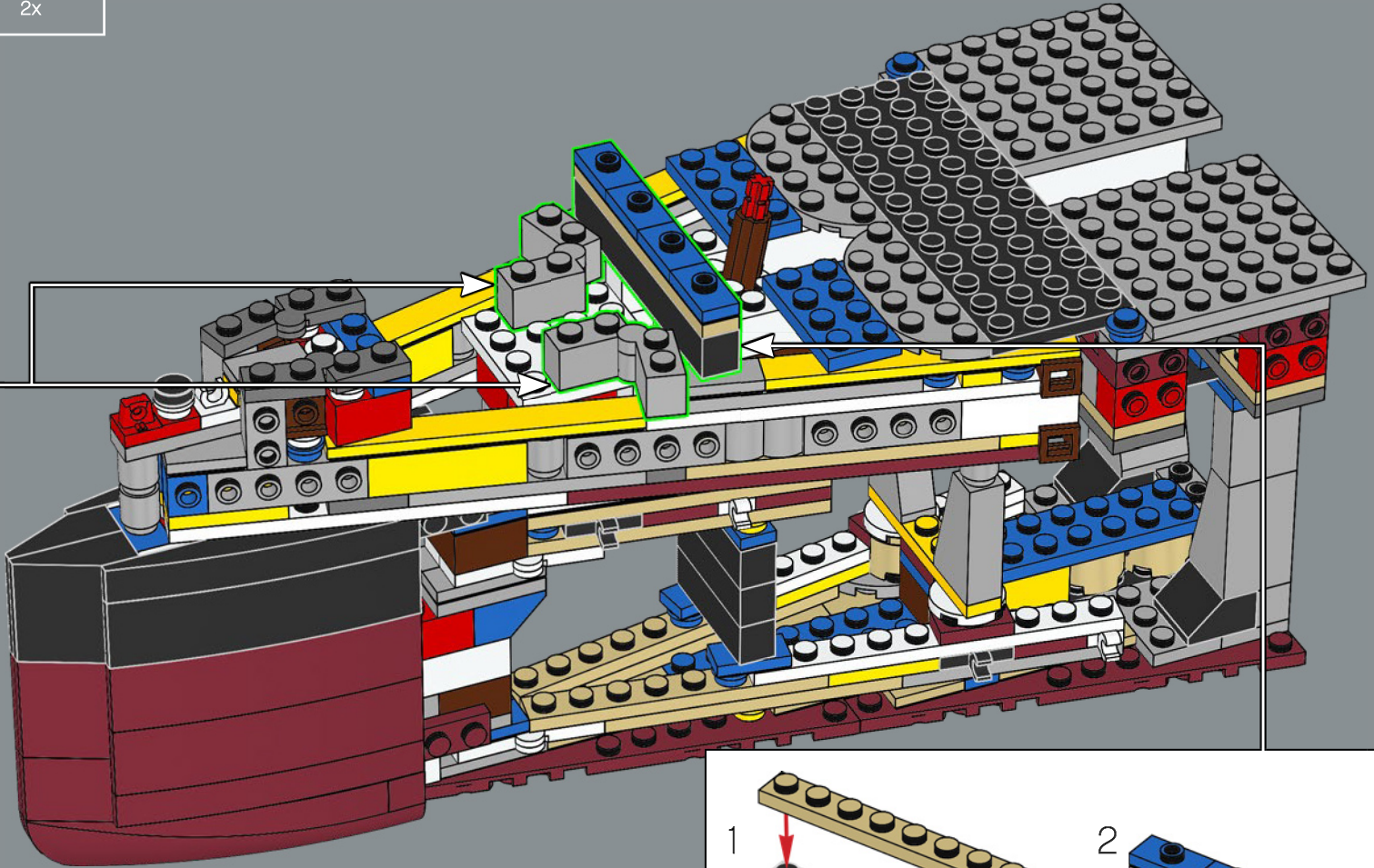
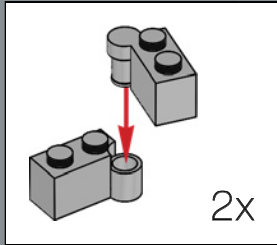

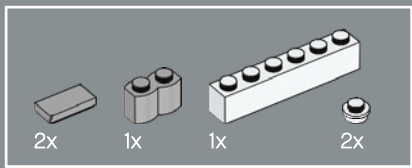

52

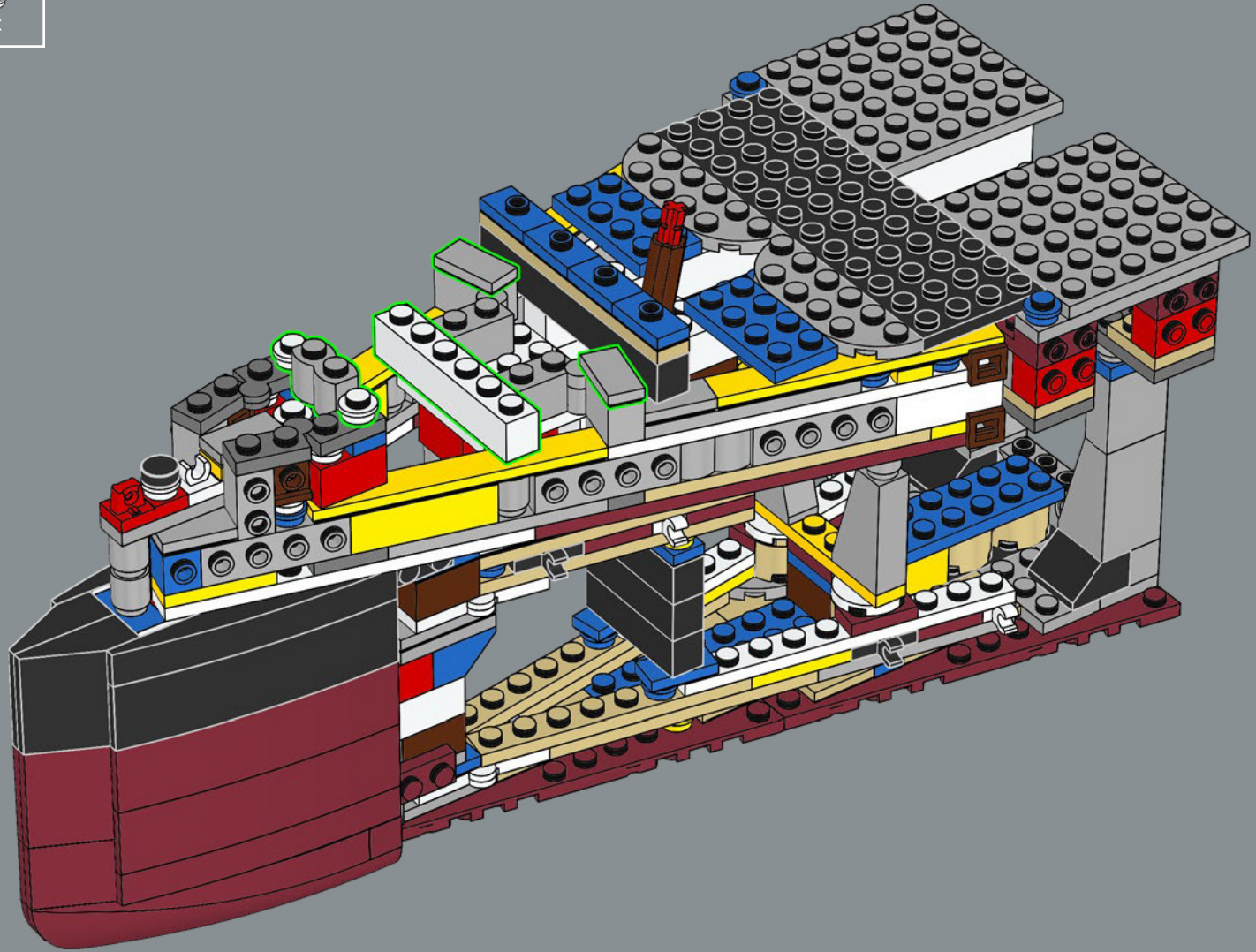

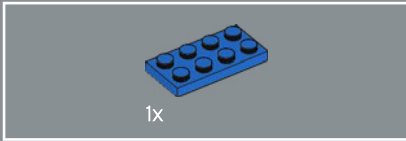
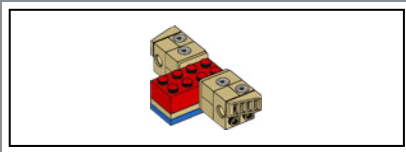

53

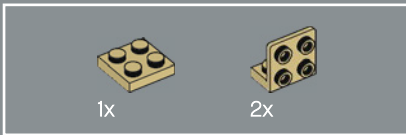
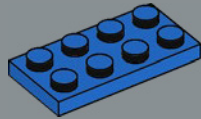

54

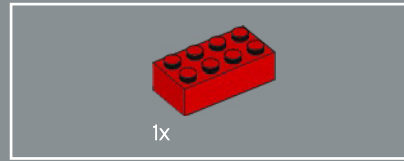
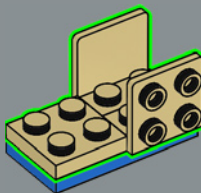

55

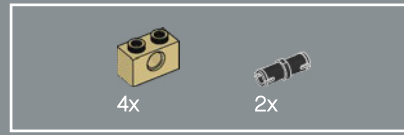
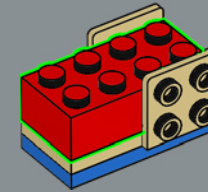

56

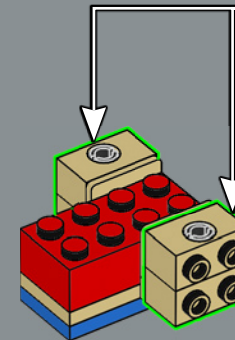
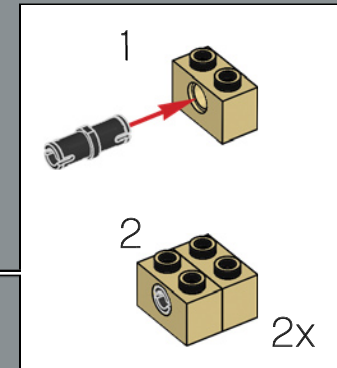

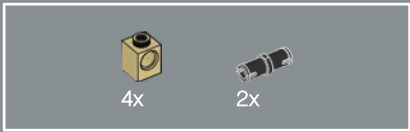

57

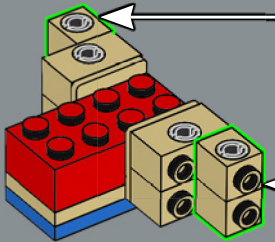
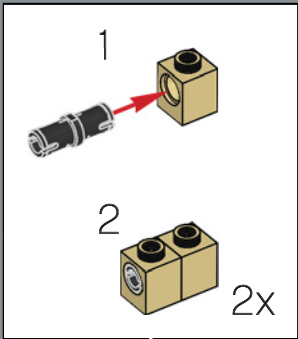

59

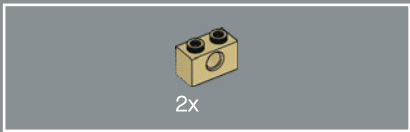
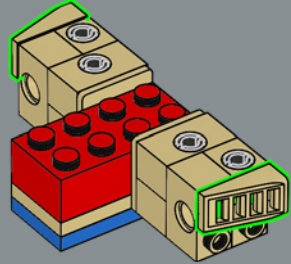

58

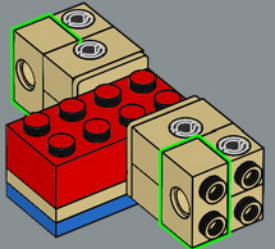

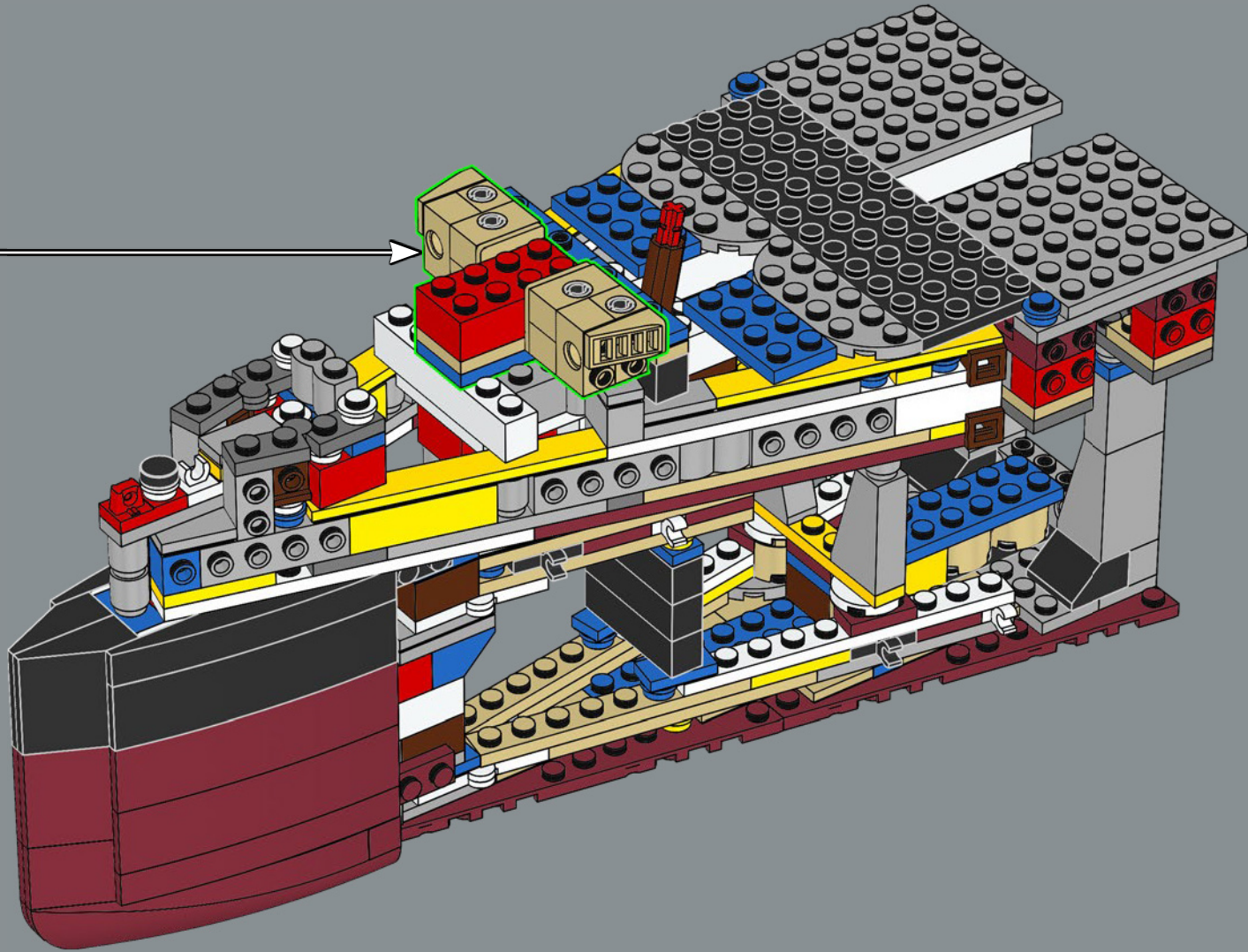

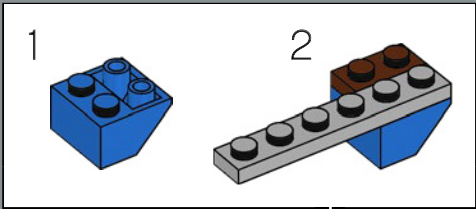
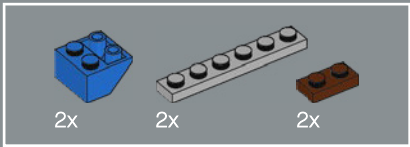



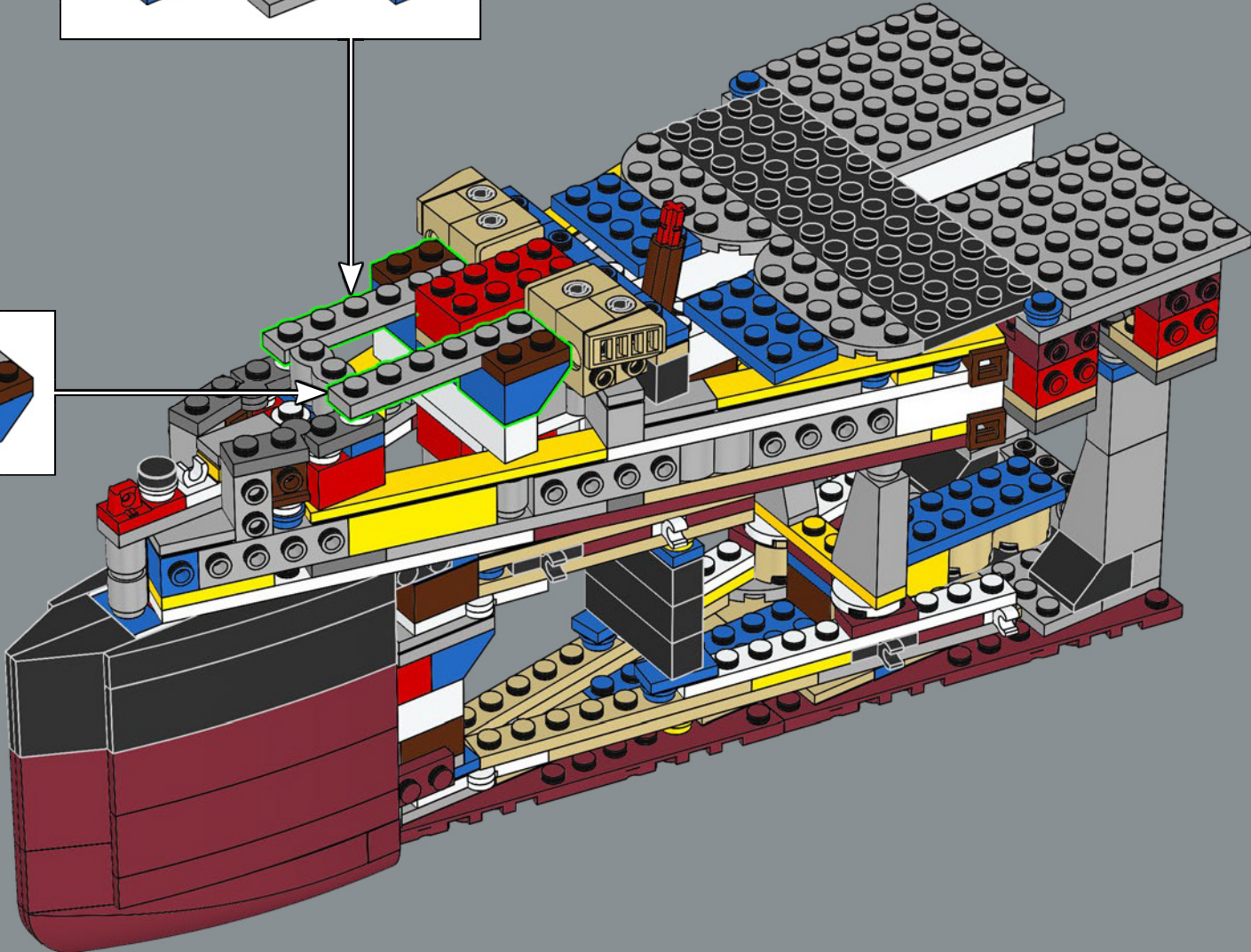
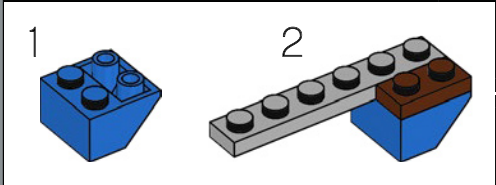



61



-  1x
-  1x
-  1x
-  1x
-  4x
-  1x

62

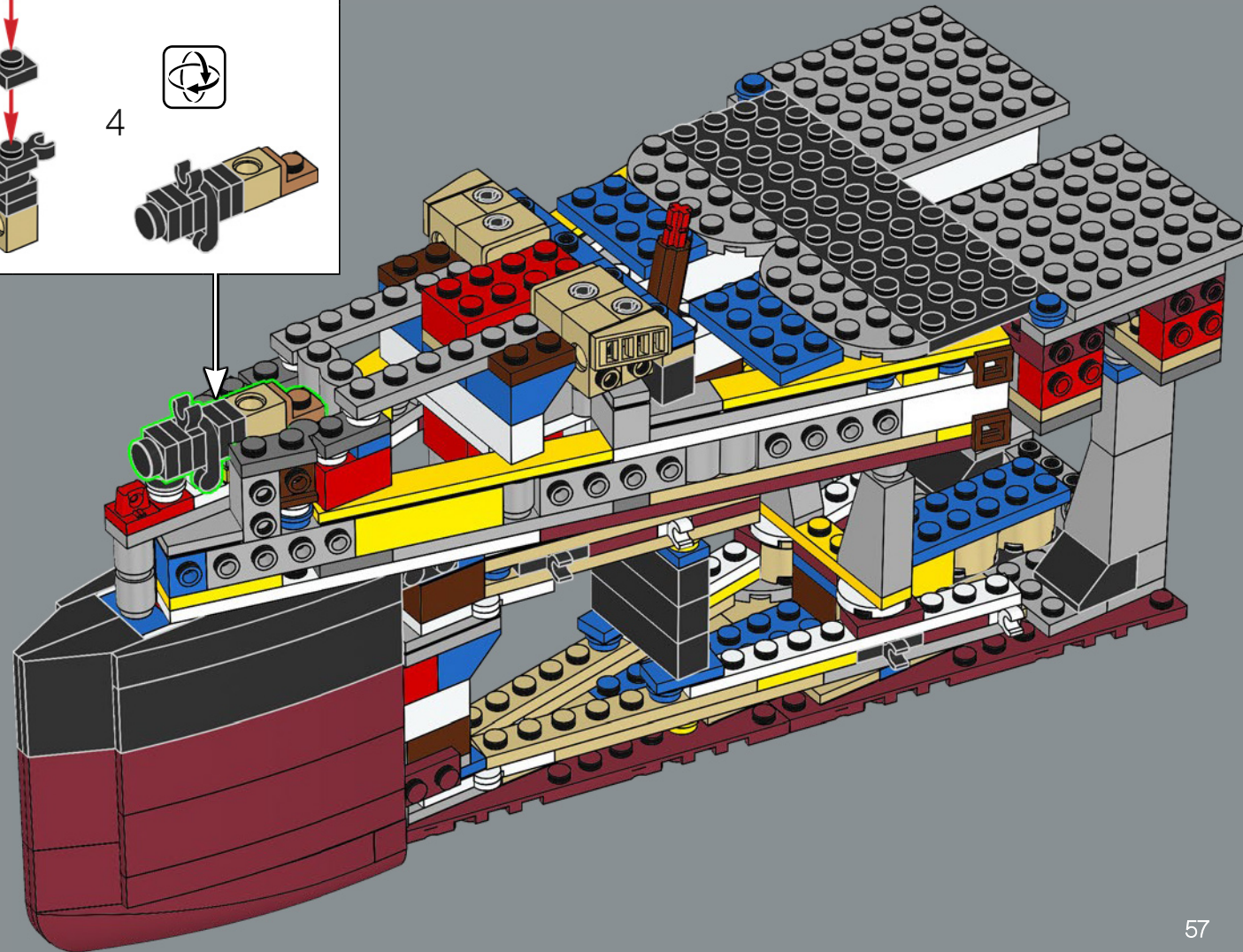
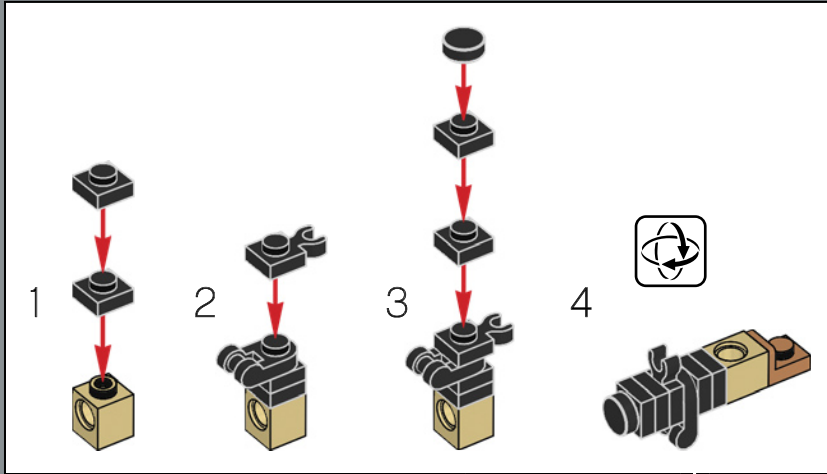

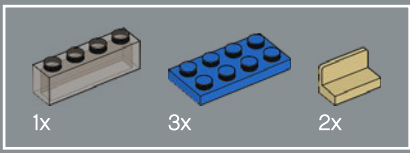

63

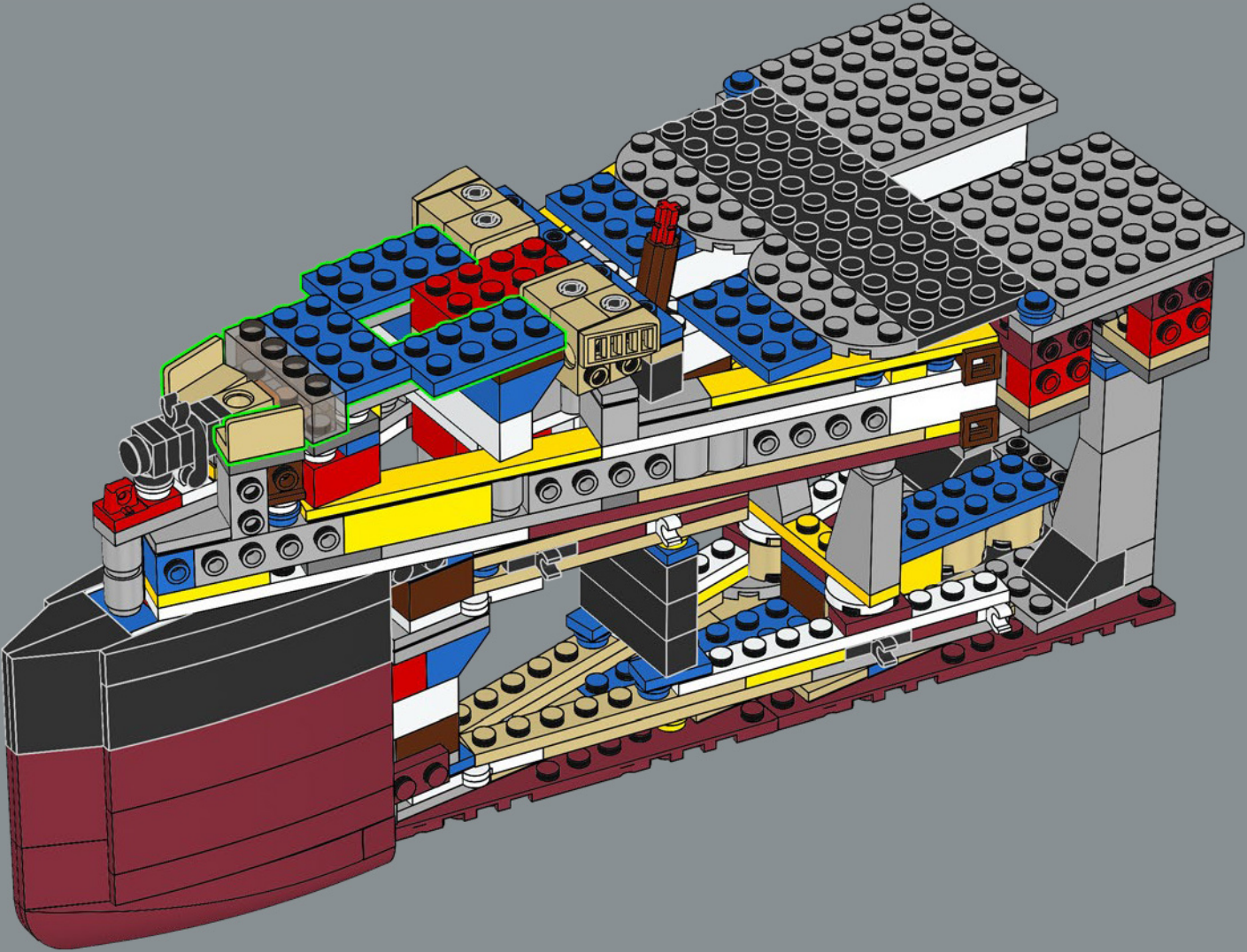

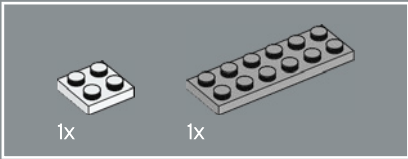
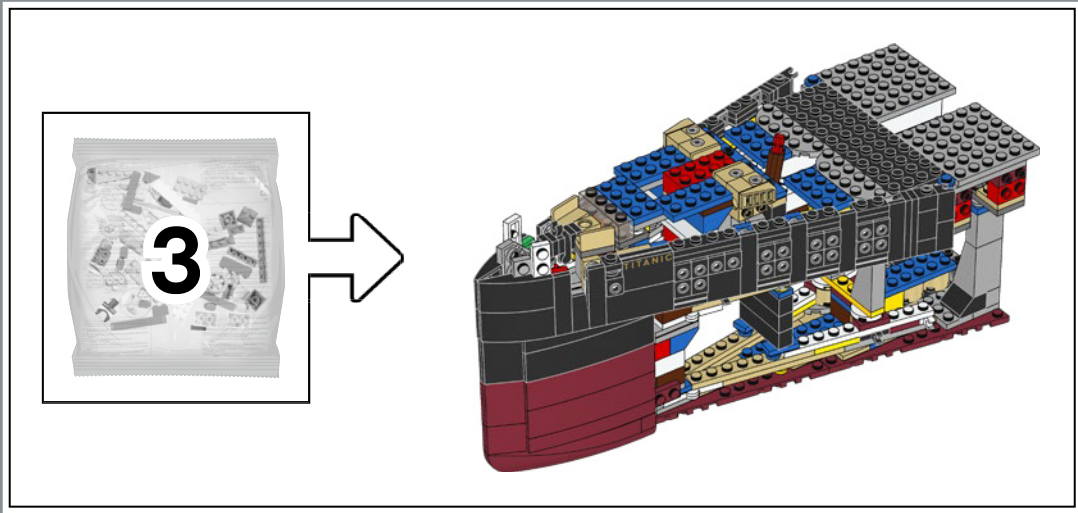

65

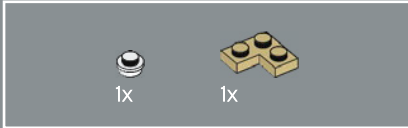
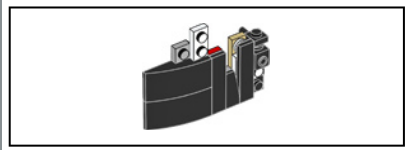

64

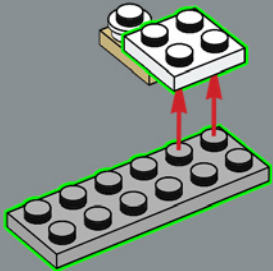
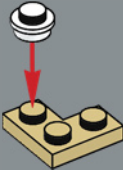

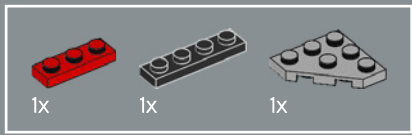

66

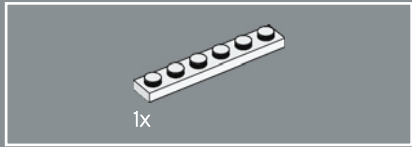
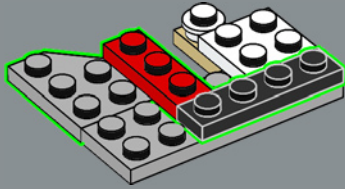

67

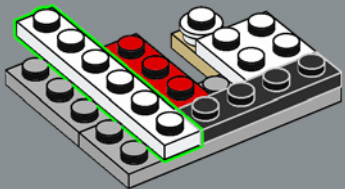

68

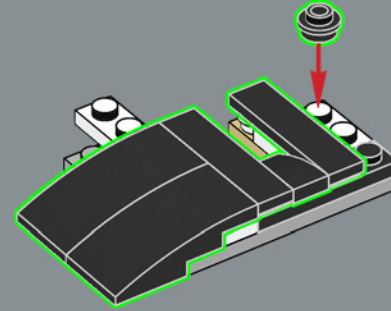

69

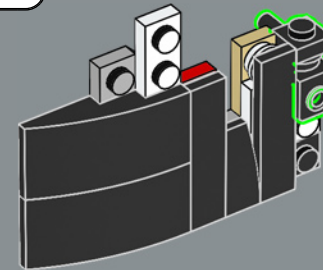
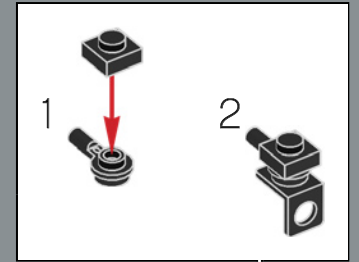

70

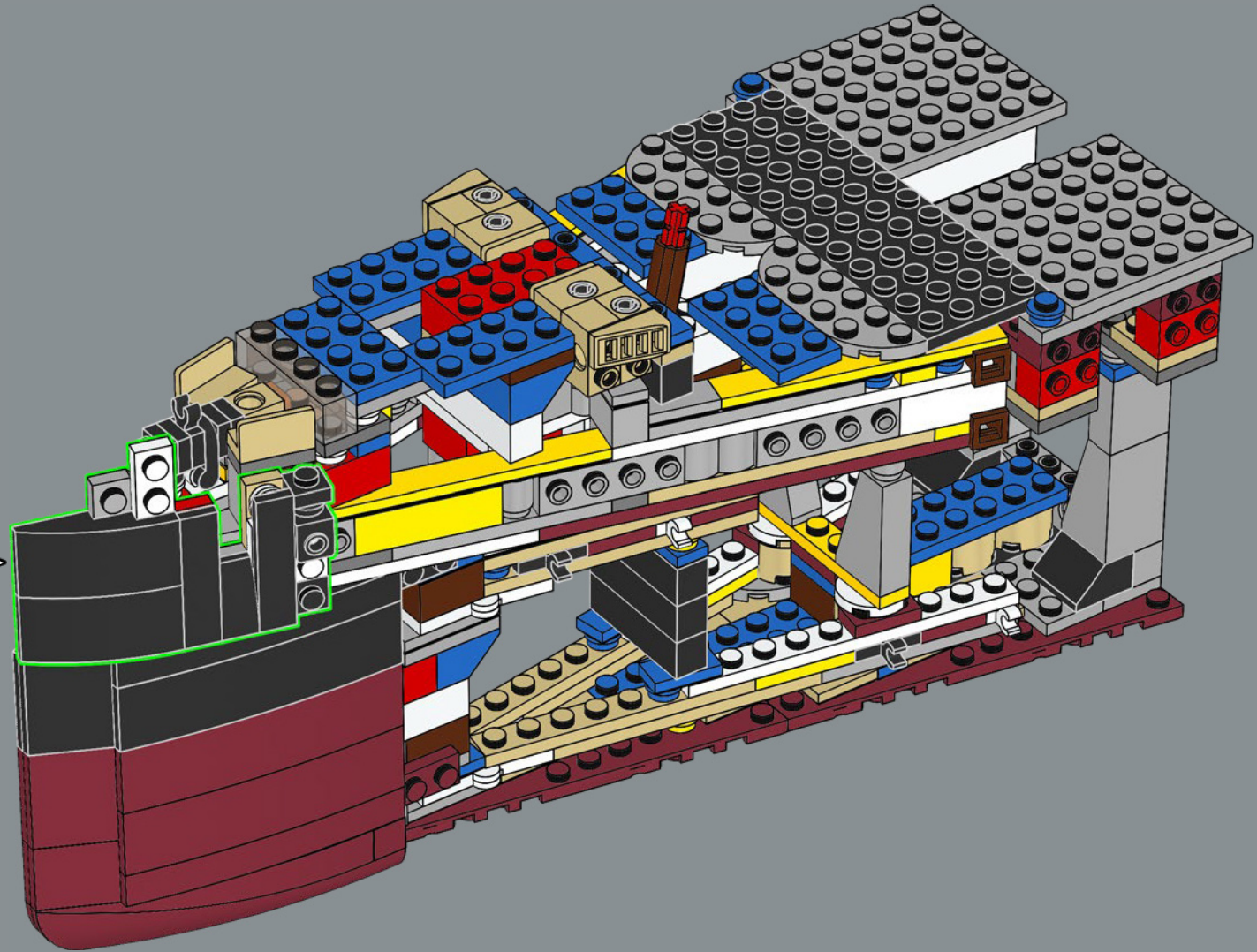

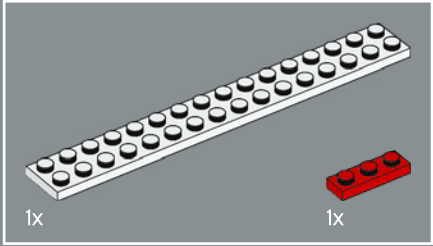
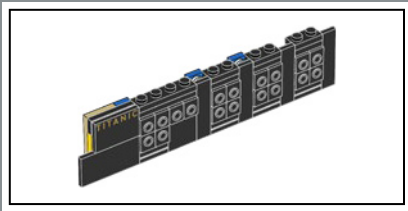

71

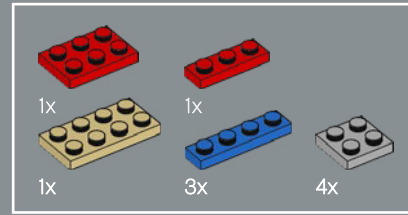
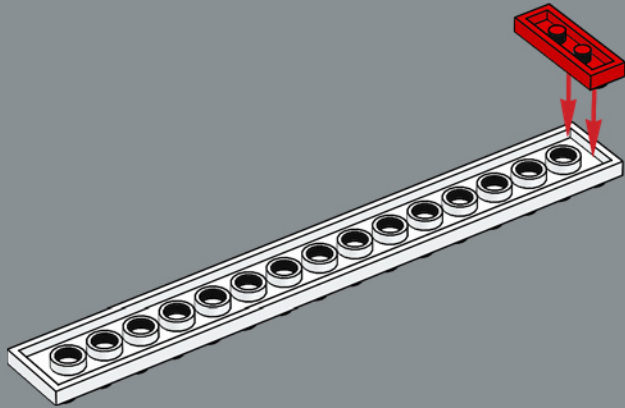

72

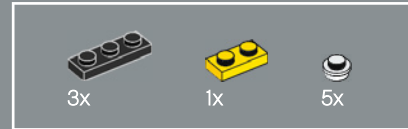
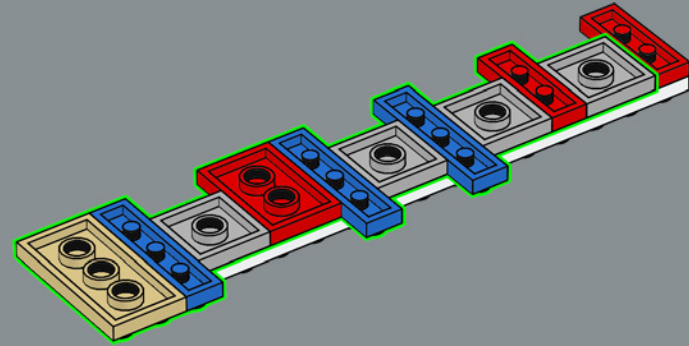

73

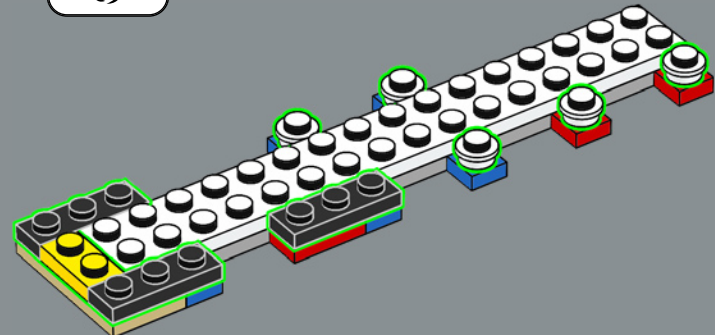

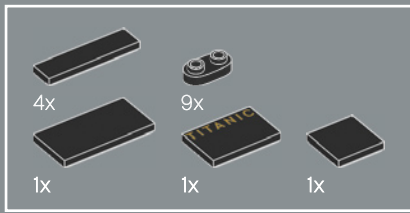

74

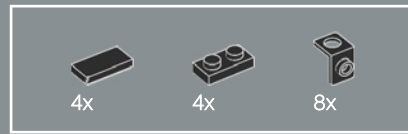
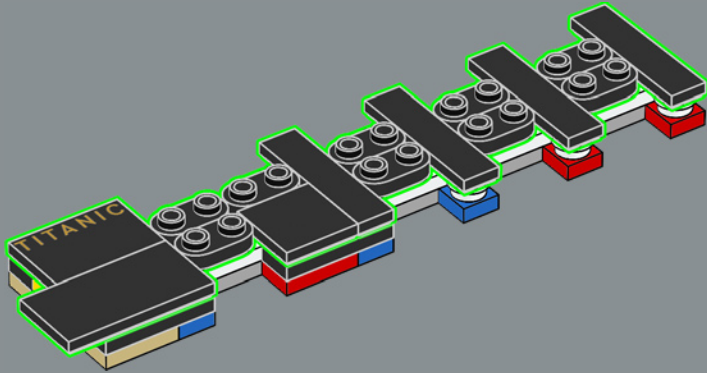

75

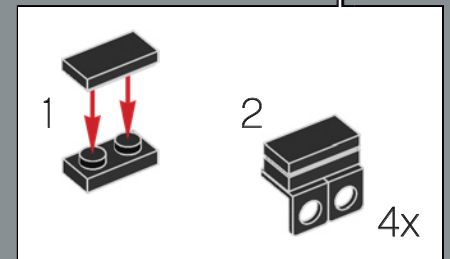
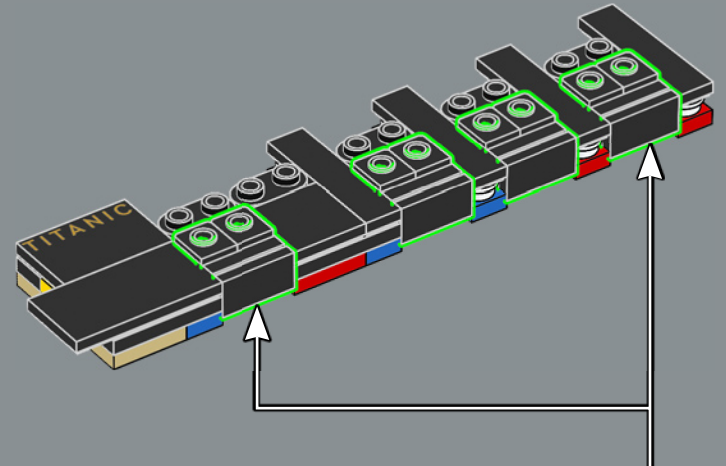

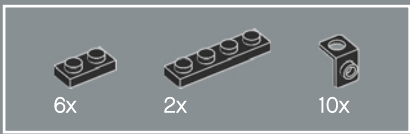

76

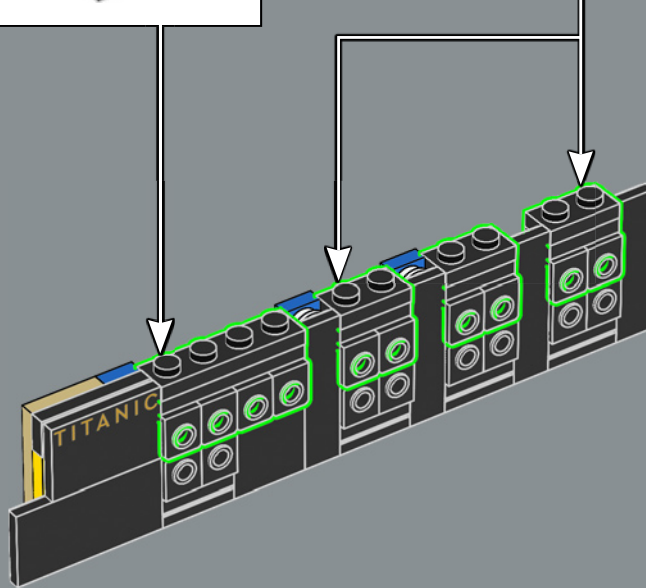
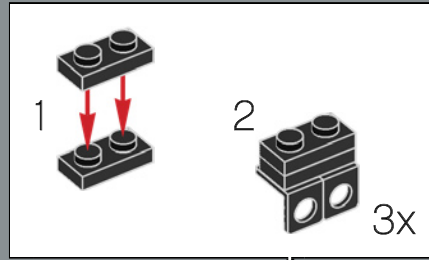
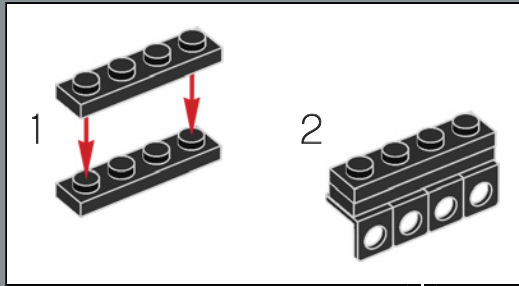

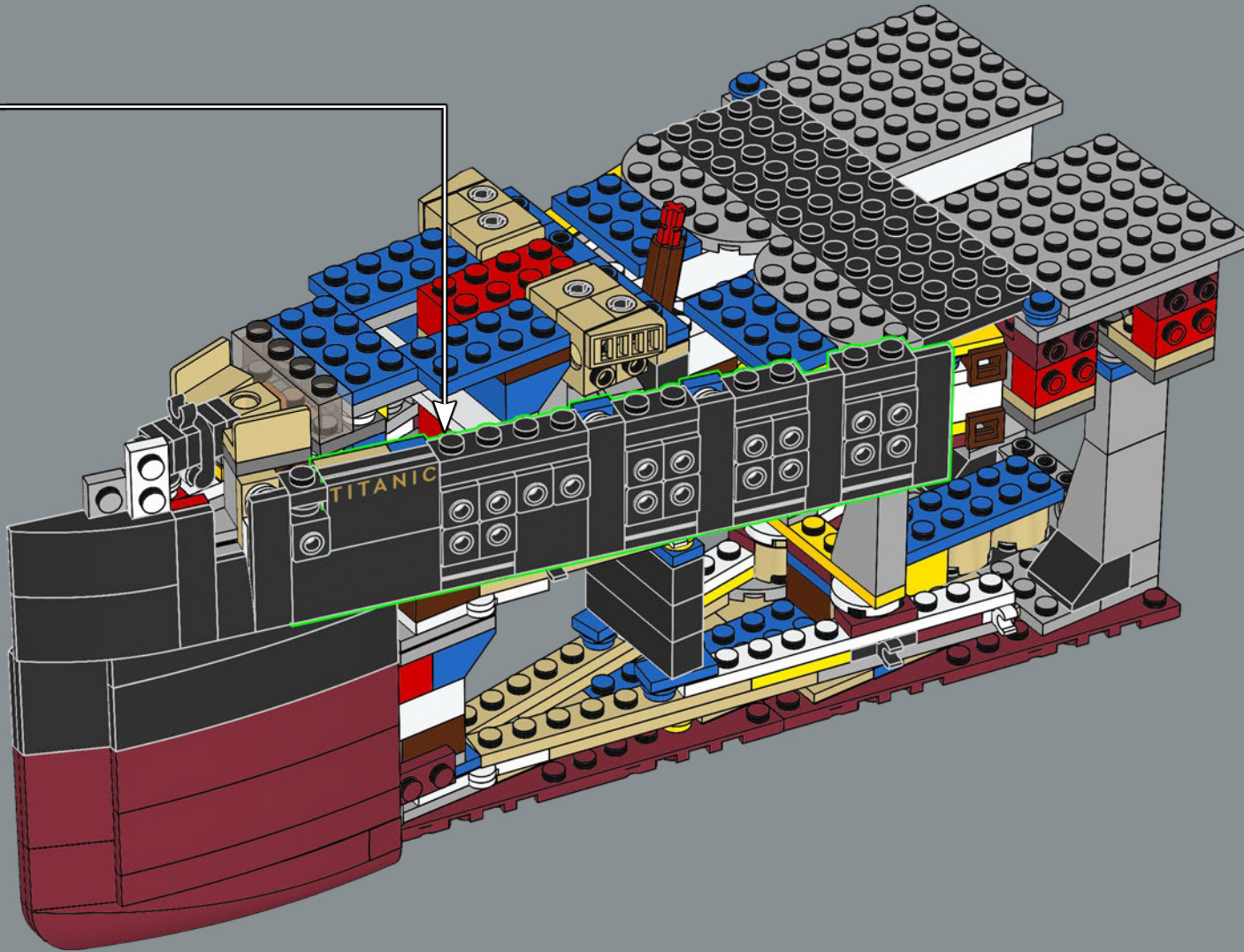

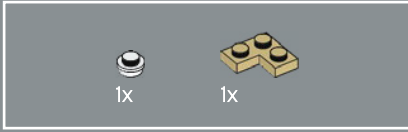
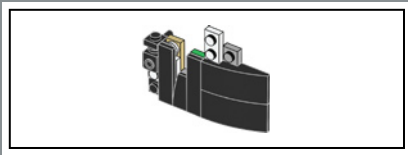

78

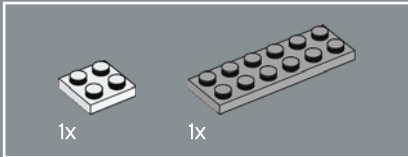
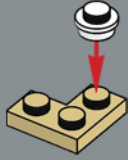

79

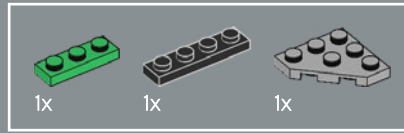
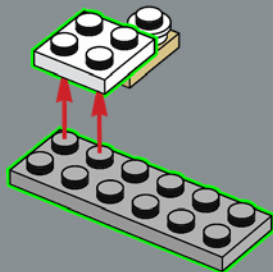

80

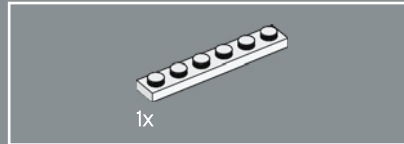
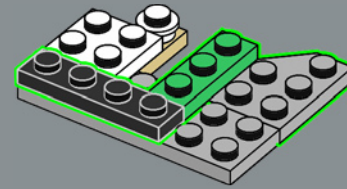

81

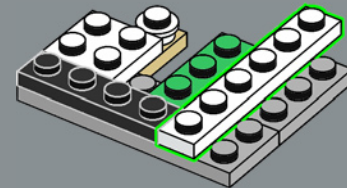



82

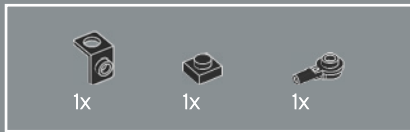
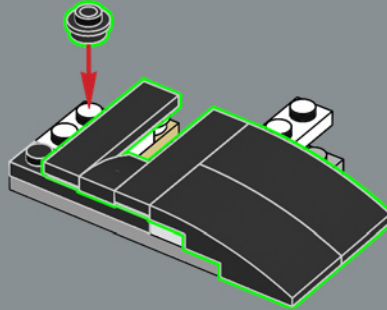

83

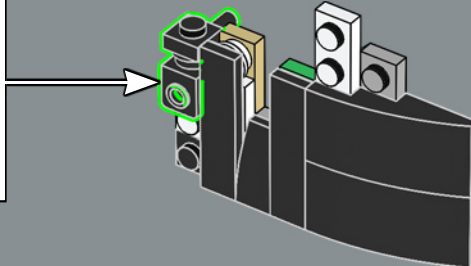
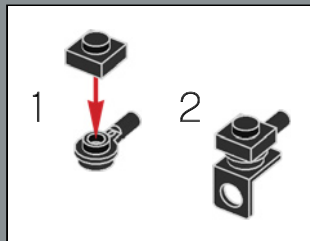

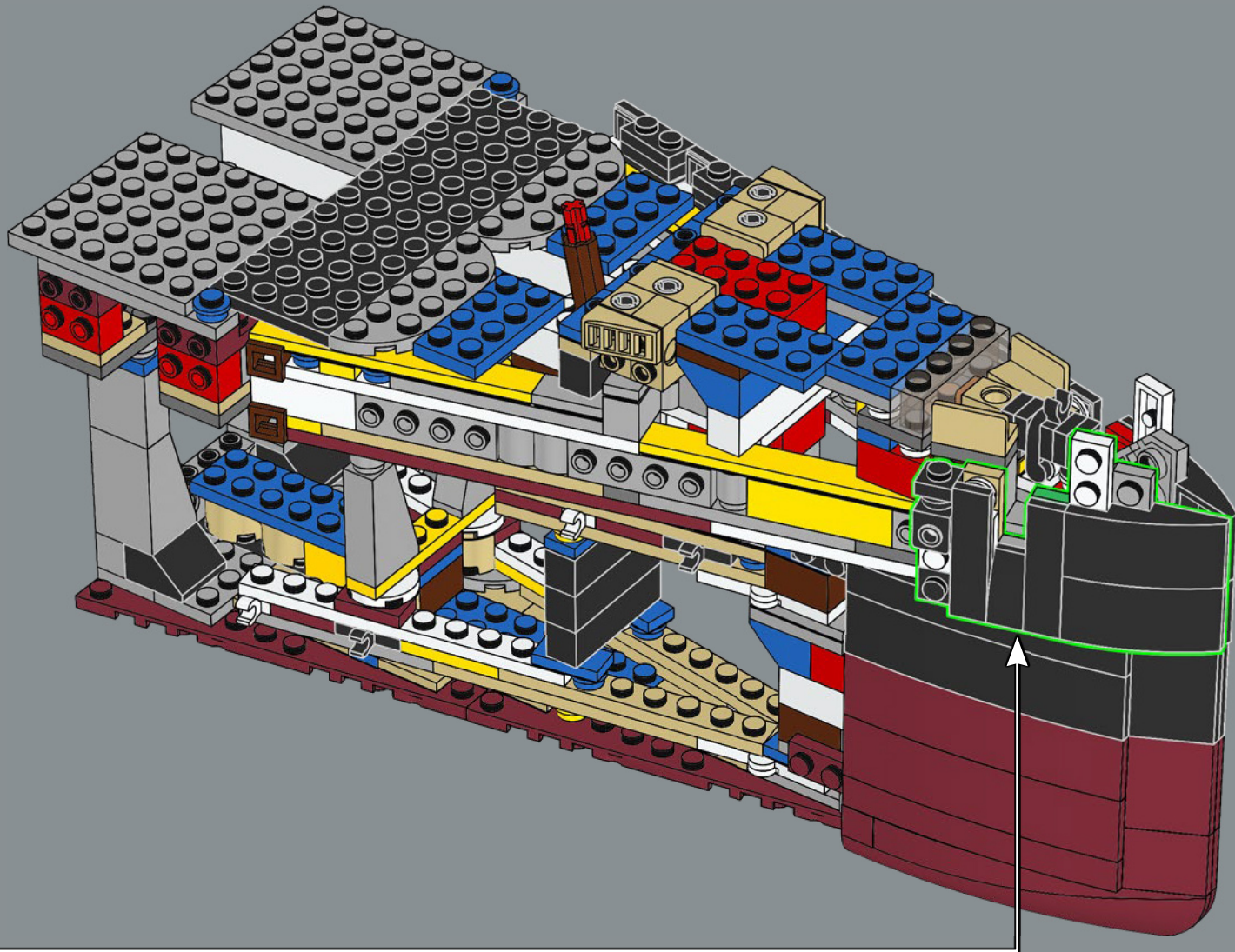

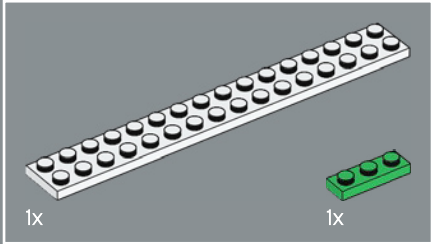
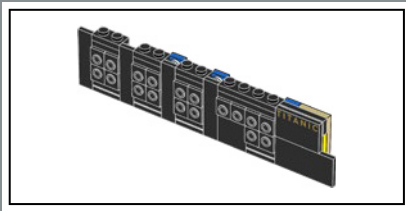

85

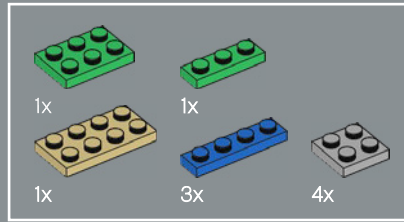
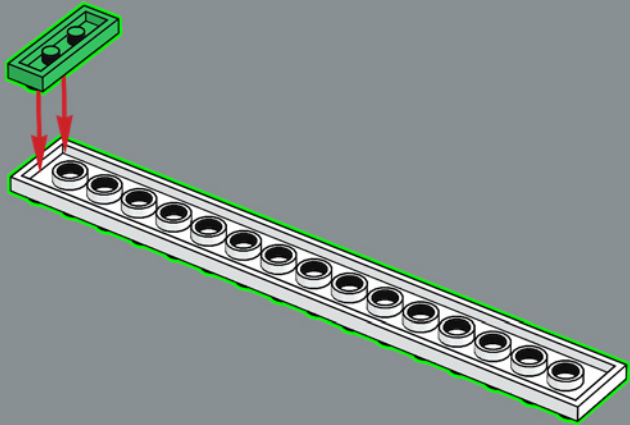

86

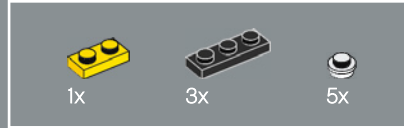
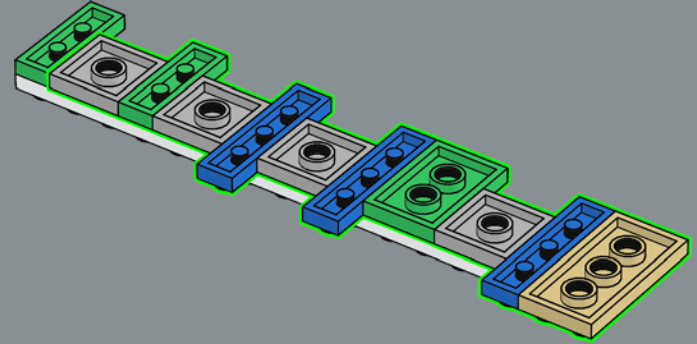

87

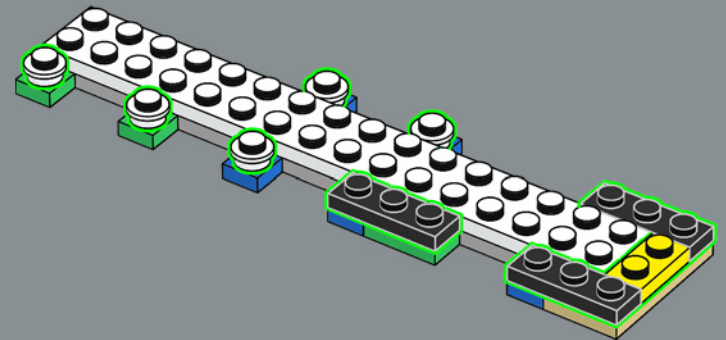

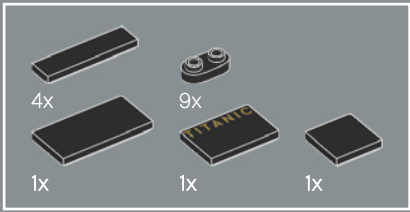

88

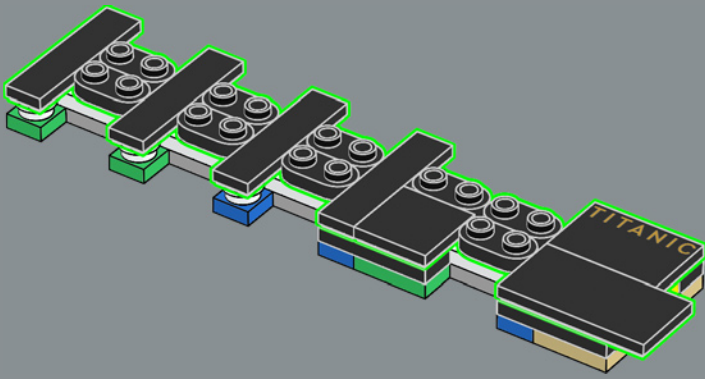

89

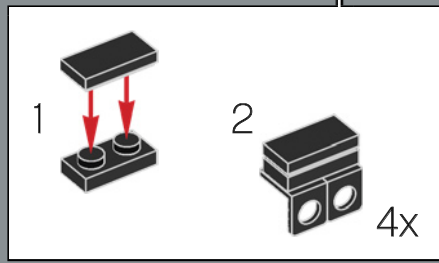
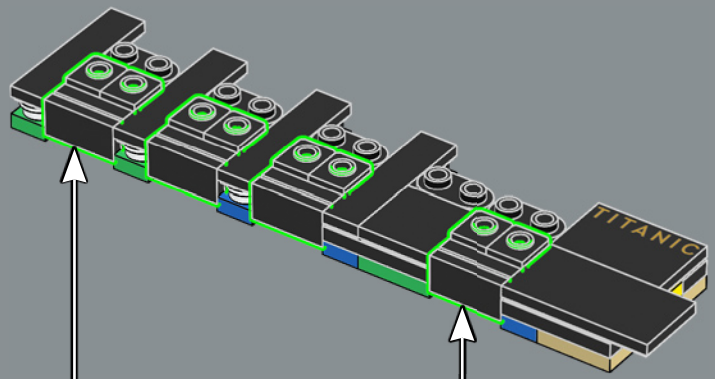

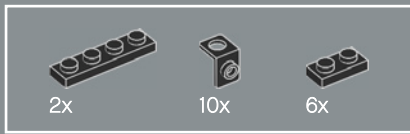

90

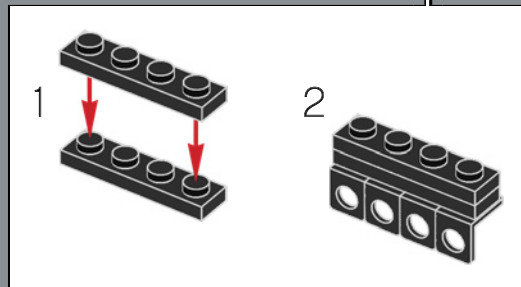
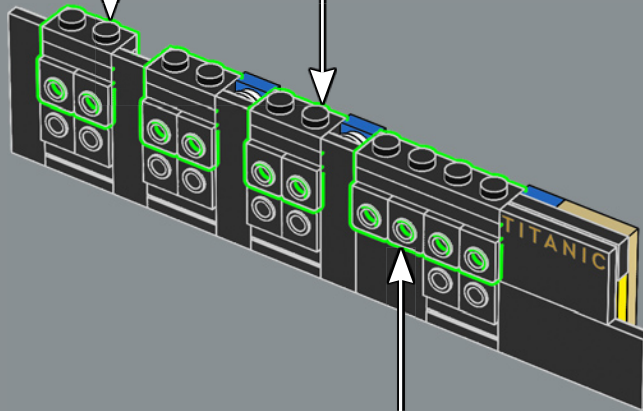
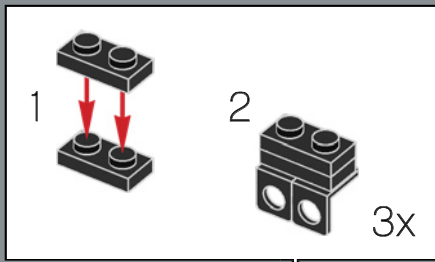

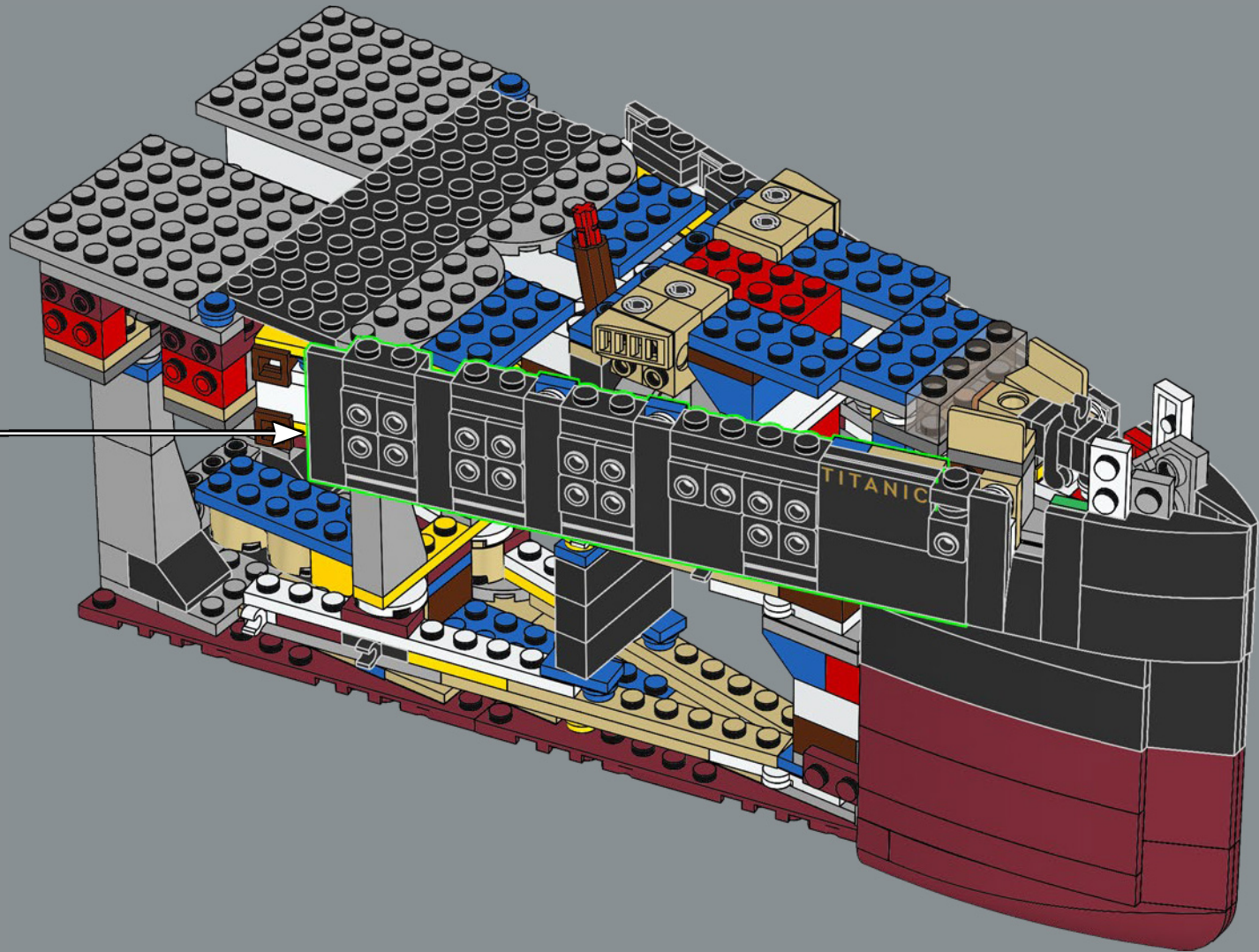

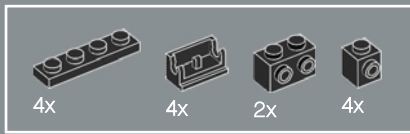

92

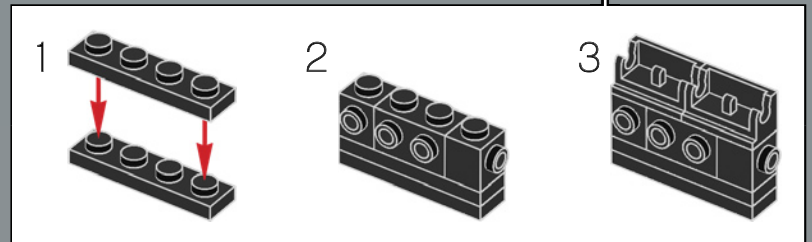
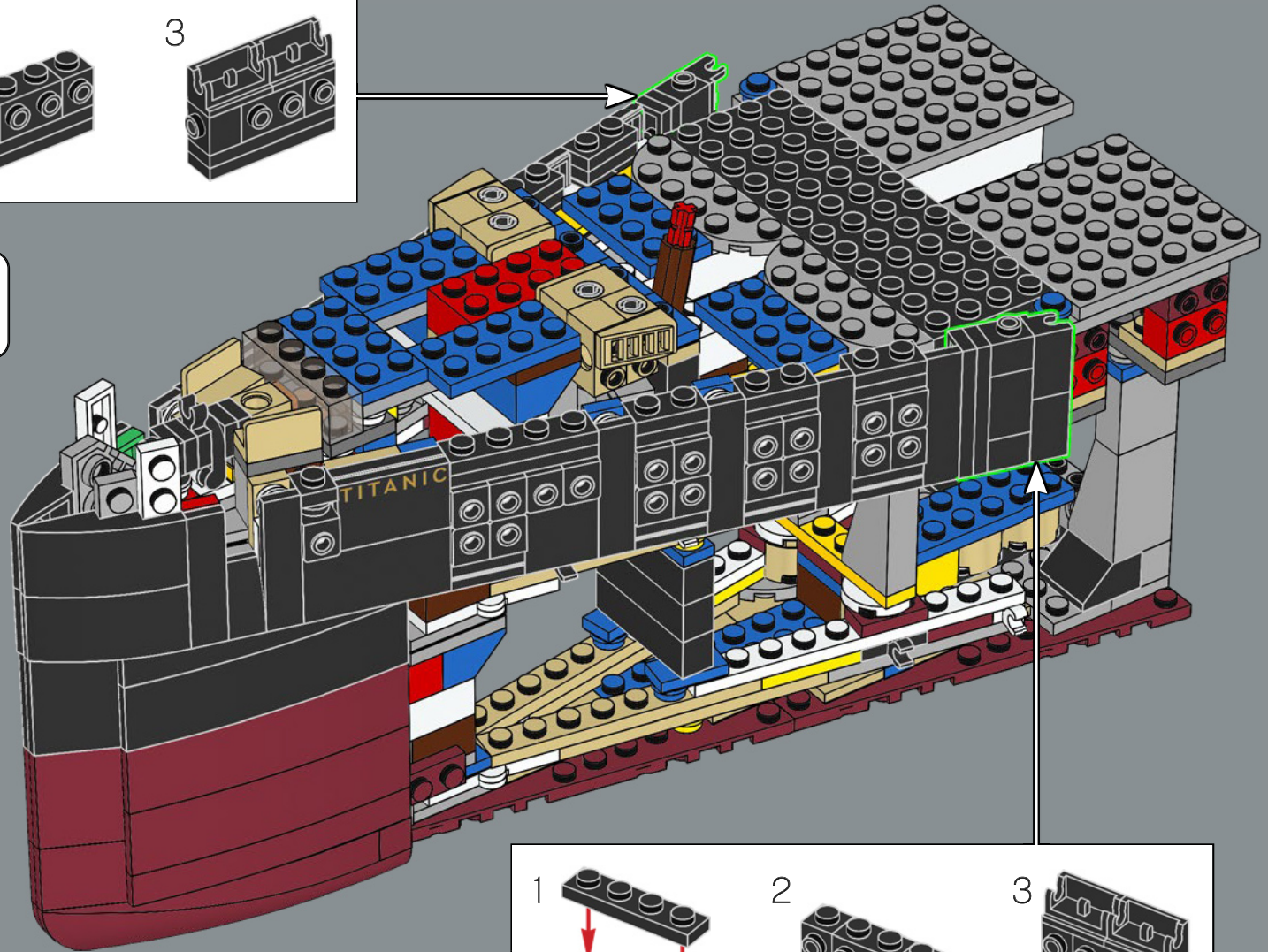
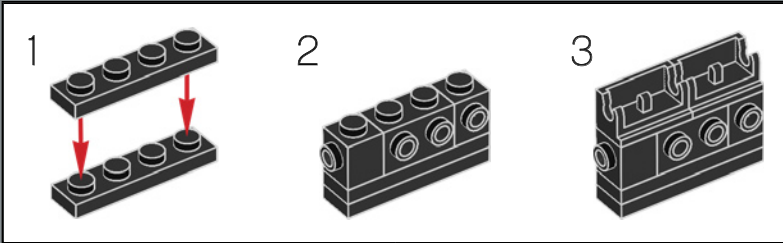

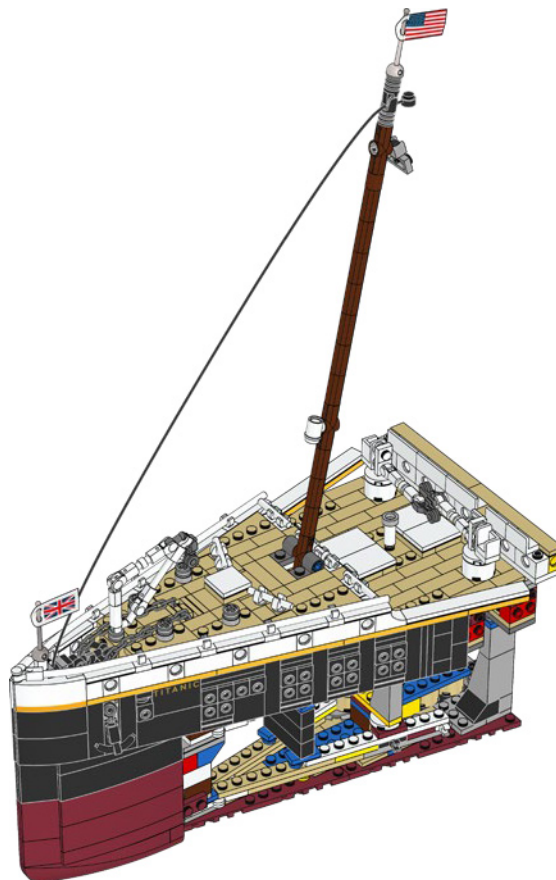

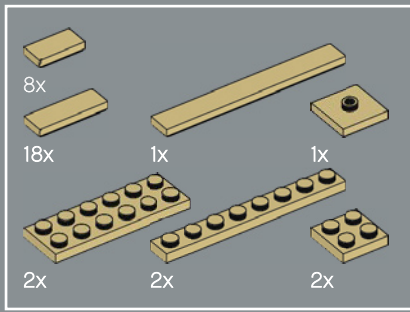

93

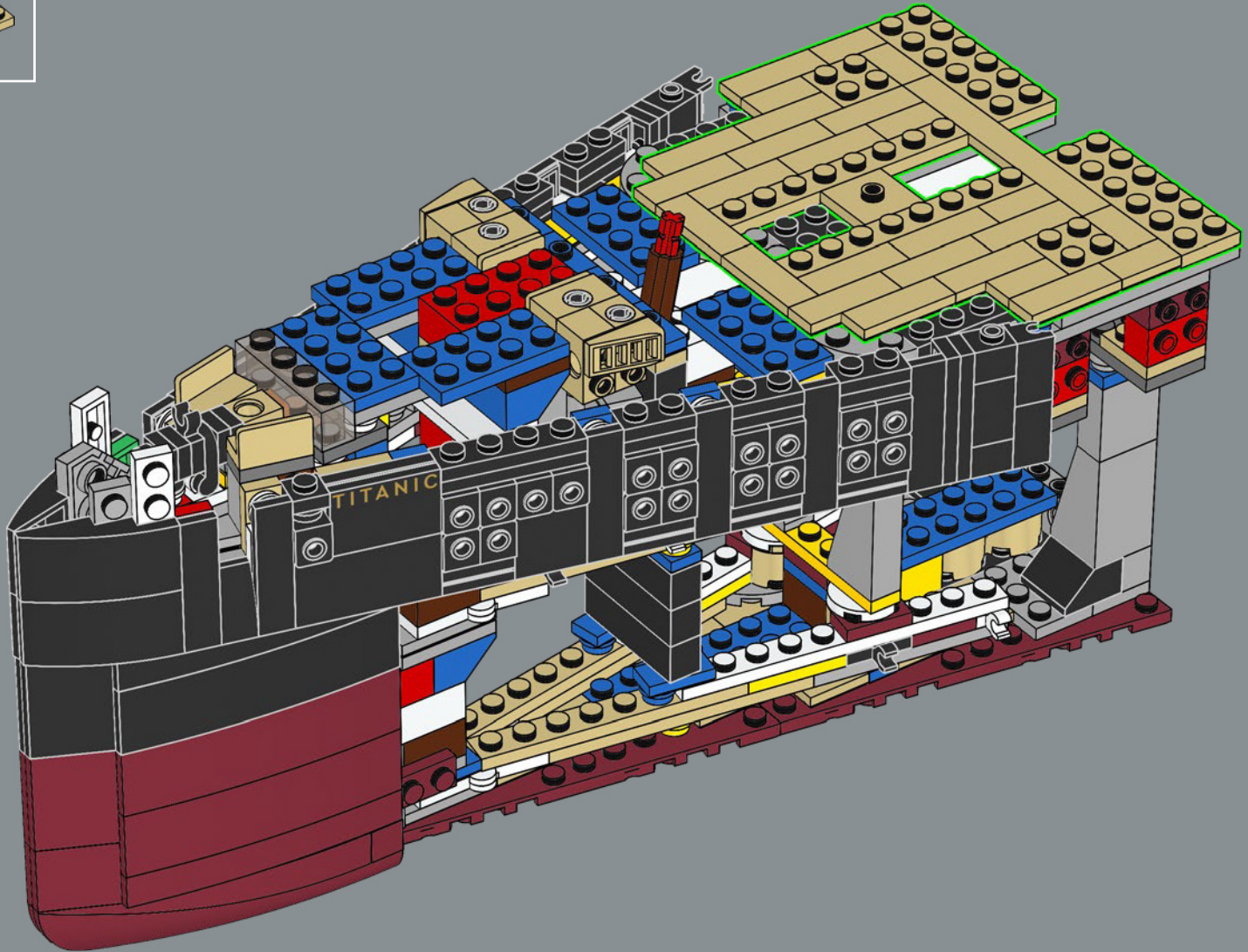

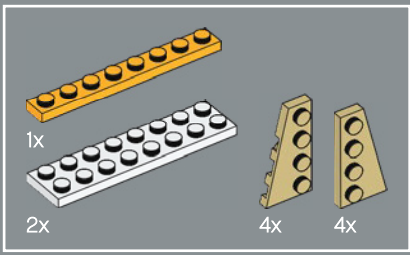

94

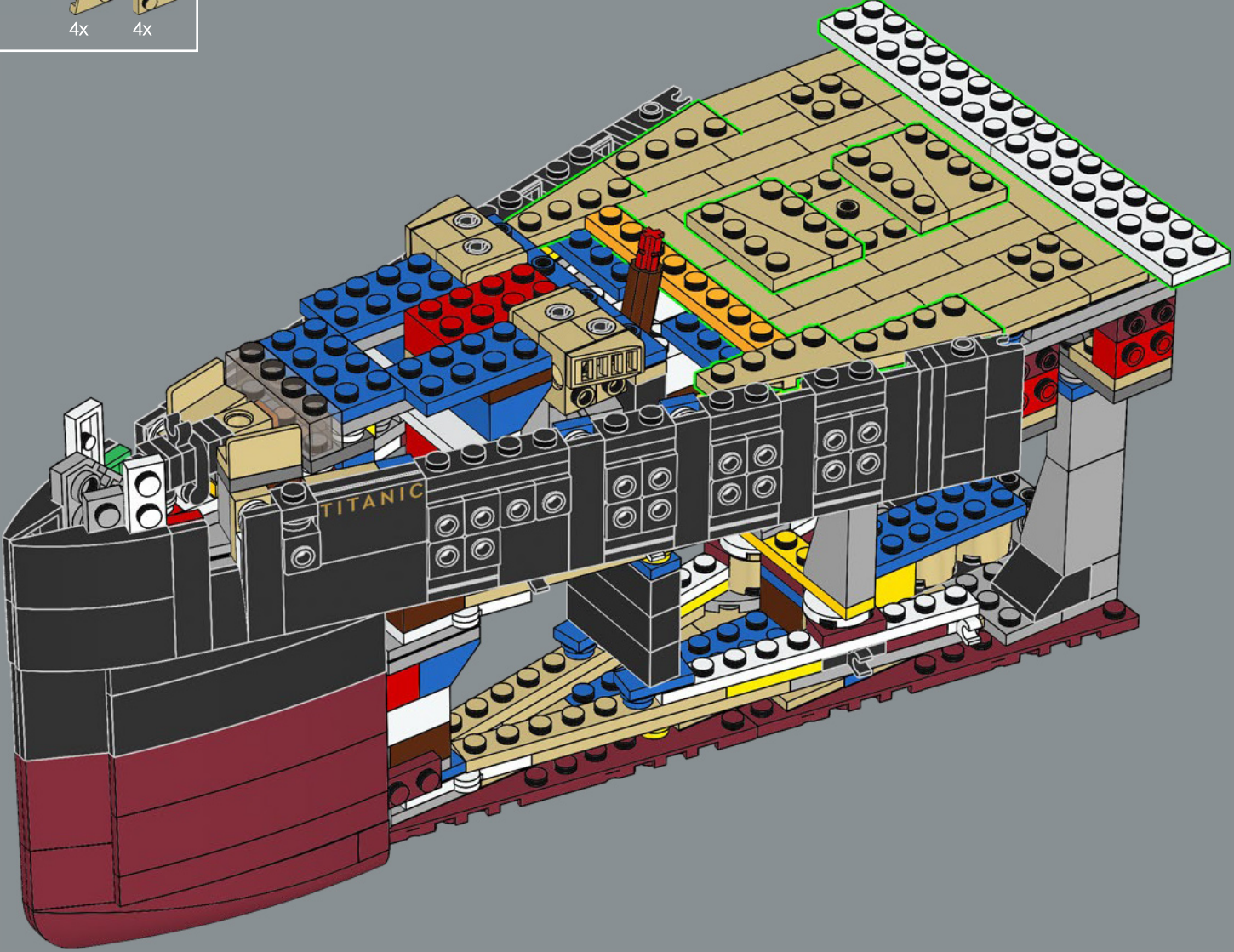

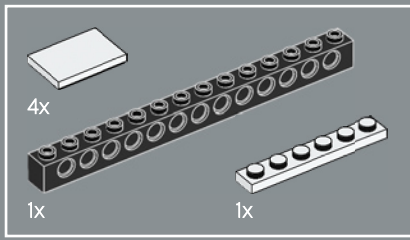

95

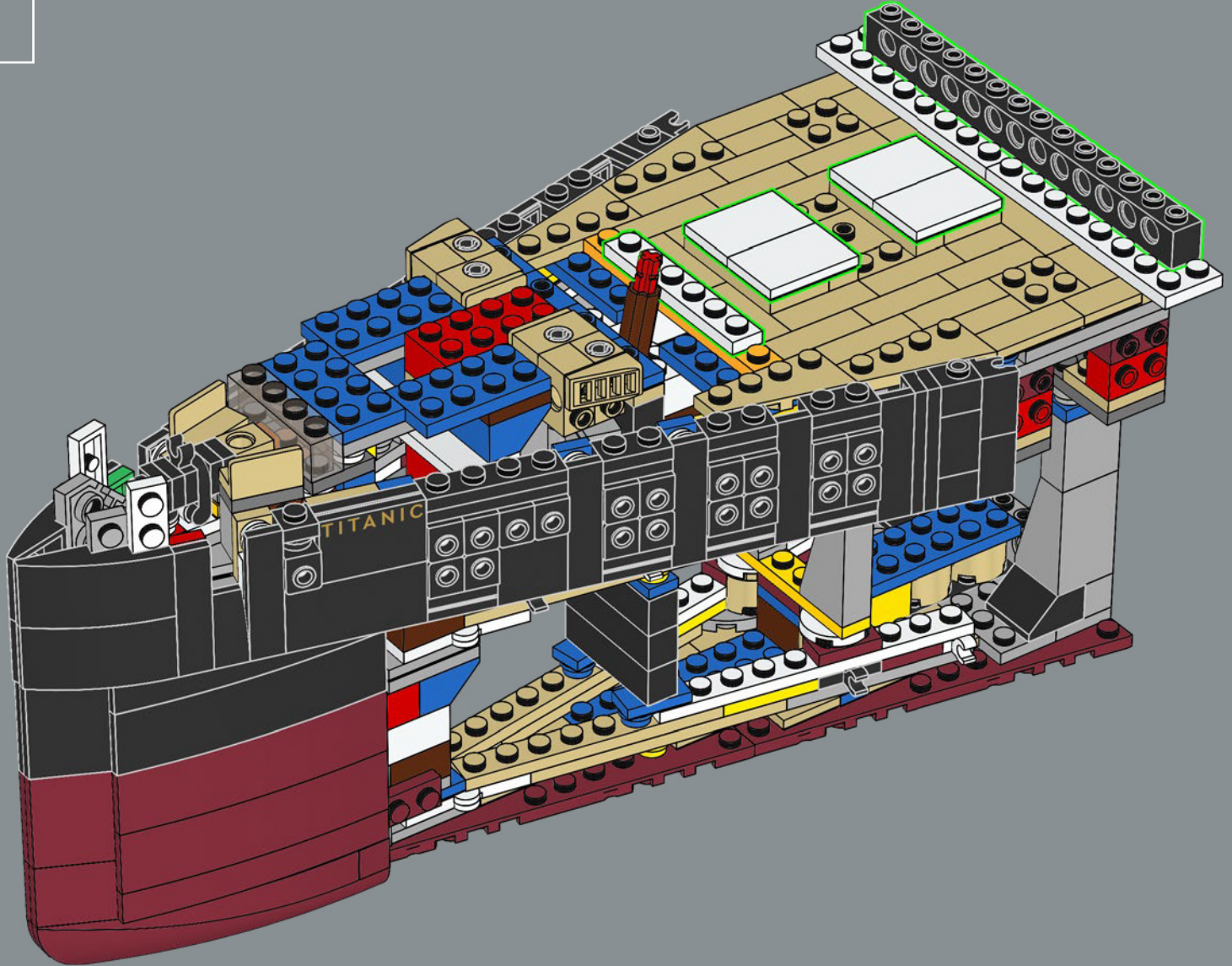

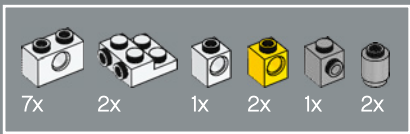

96

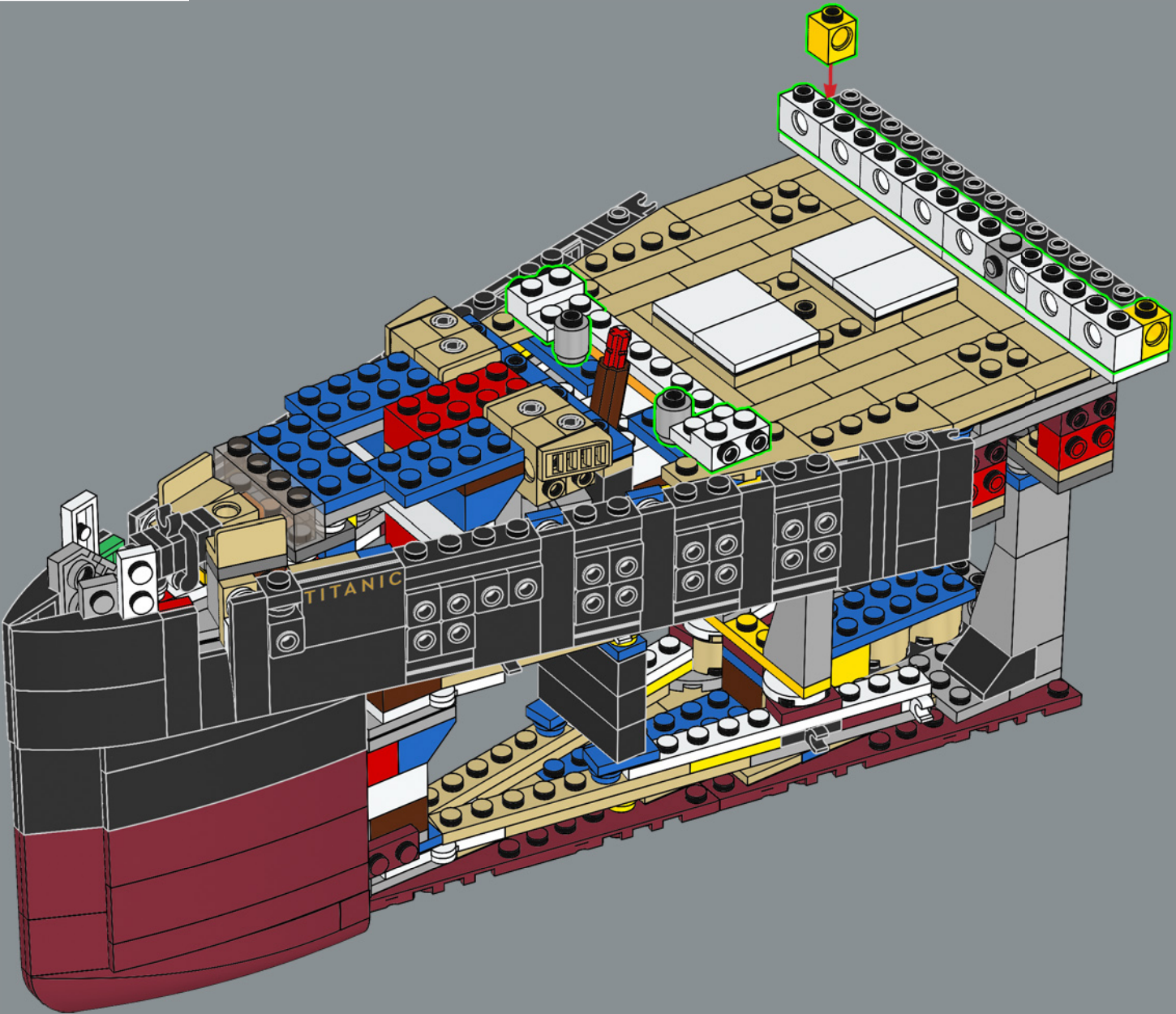

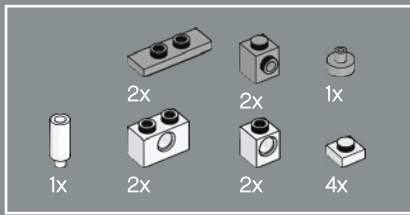

97

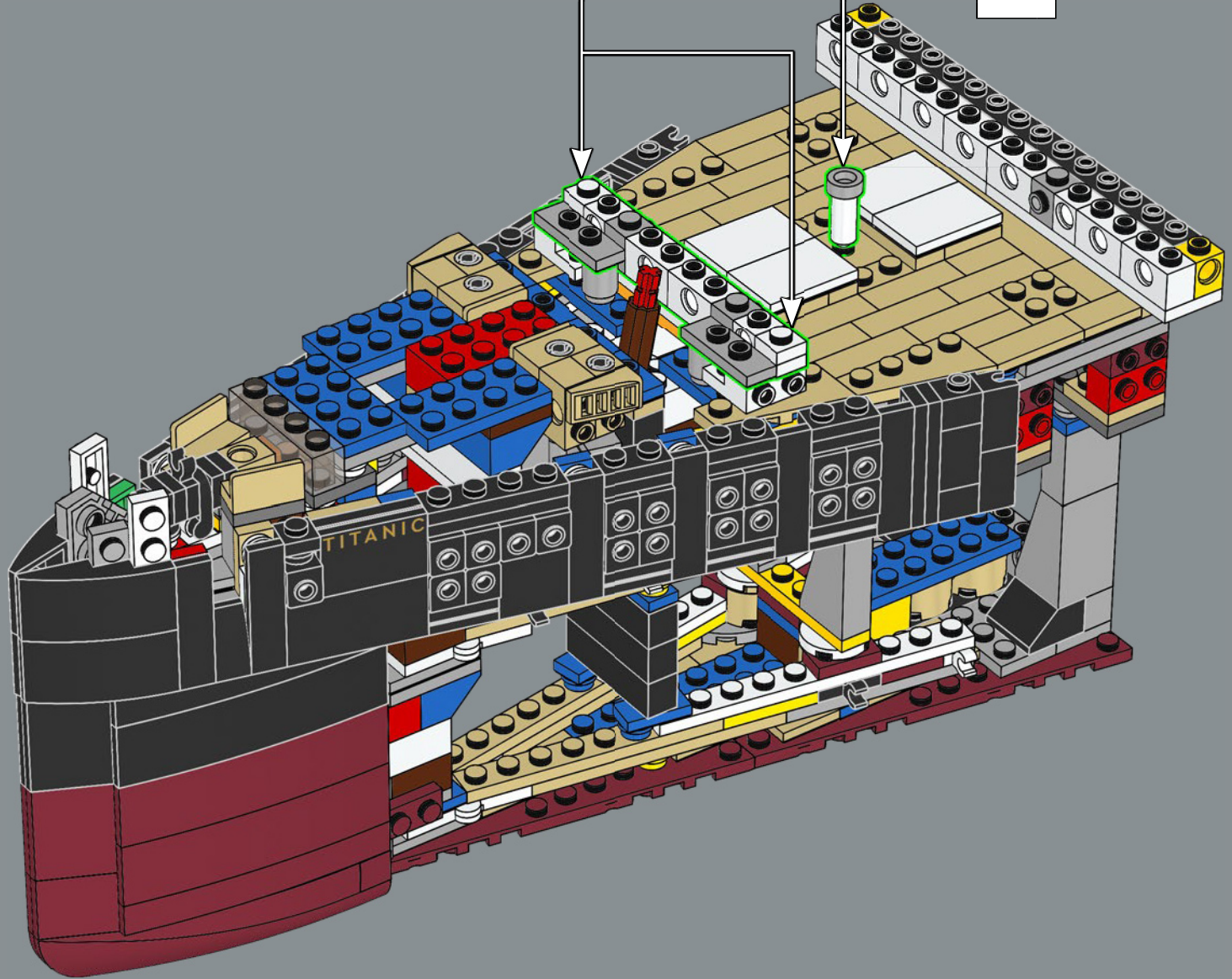
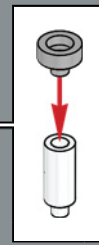
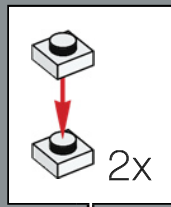

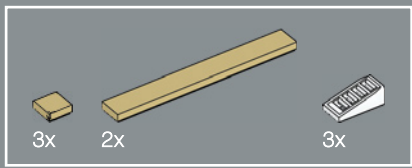

98

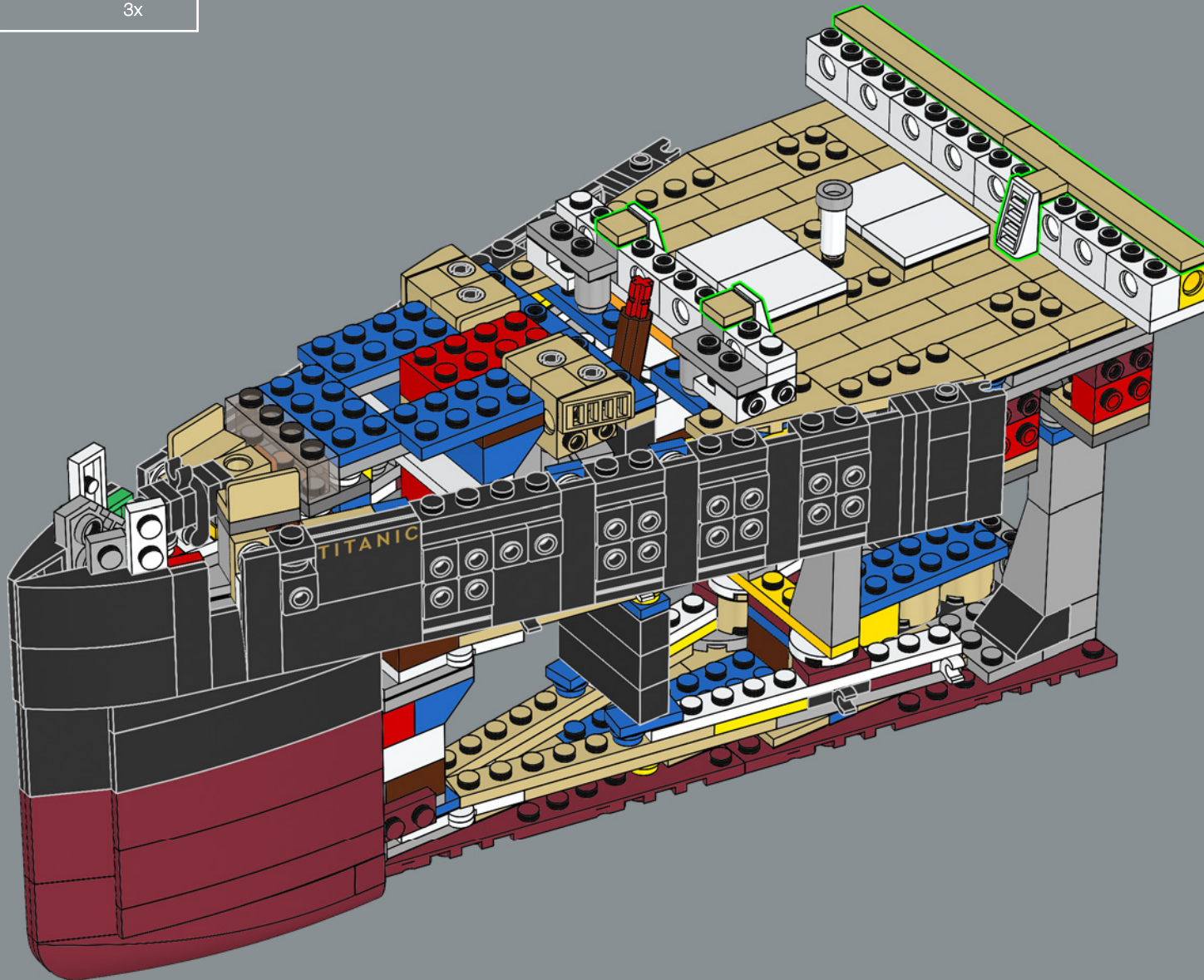

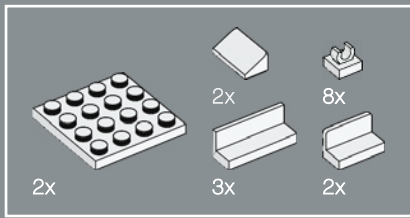

99

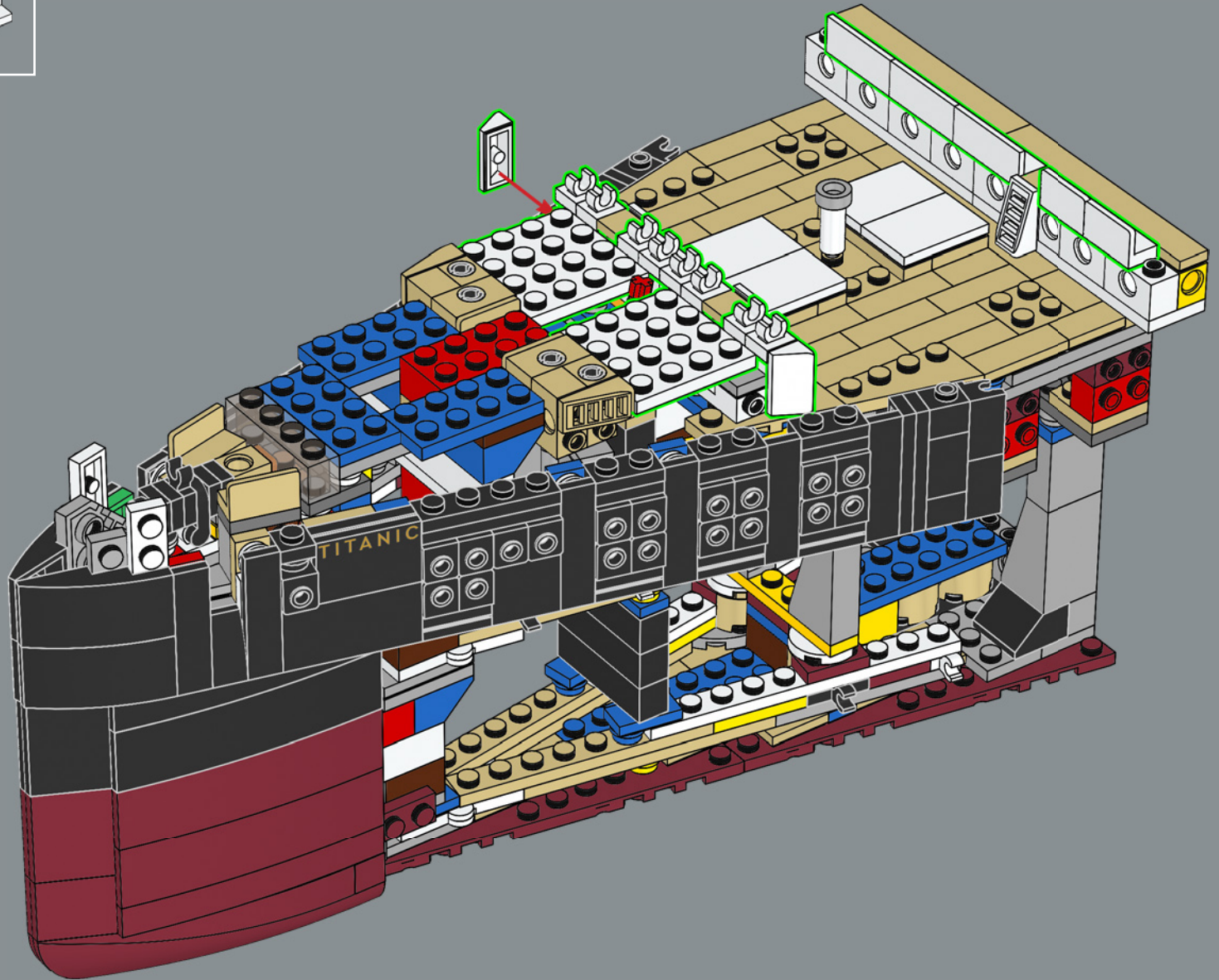

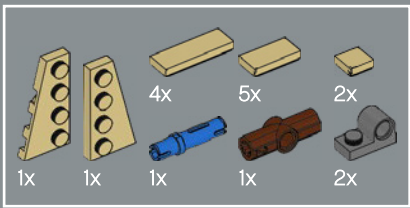

100

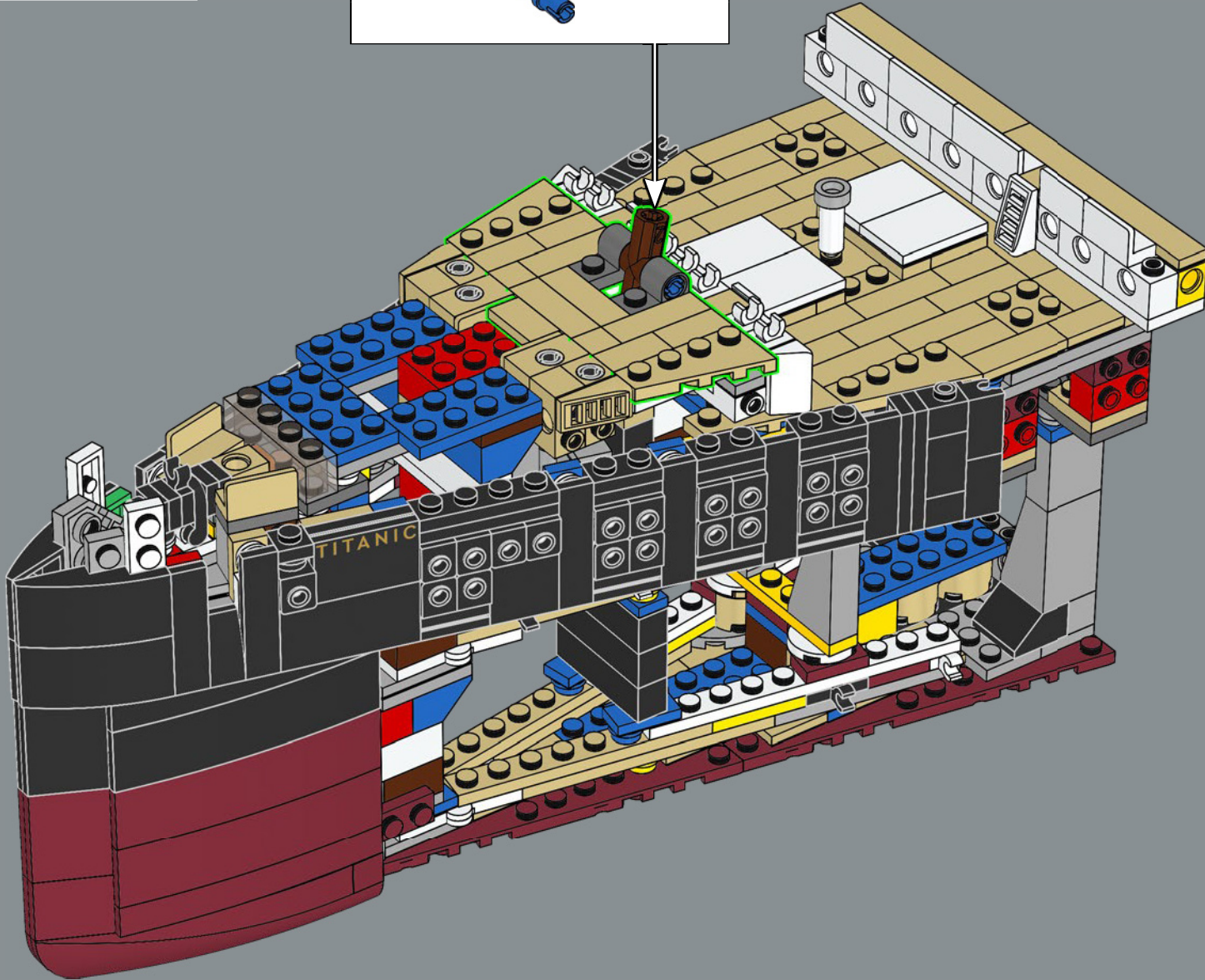
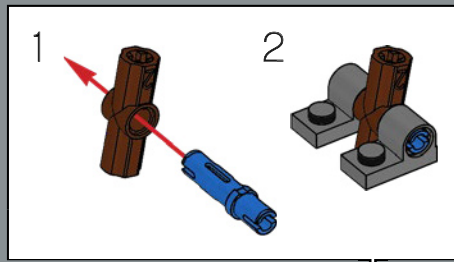

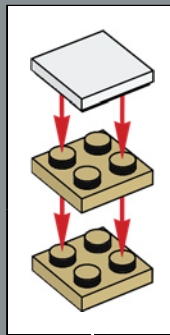
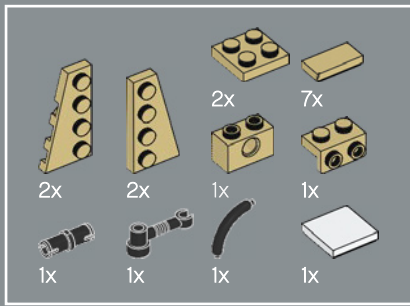

101

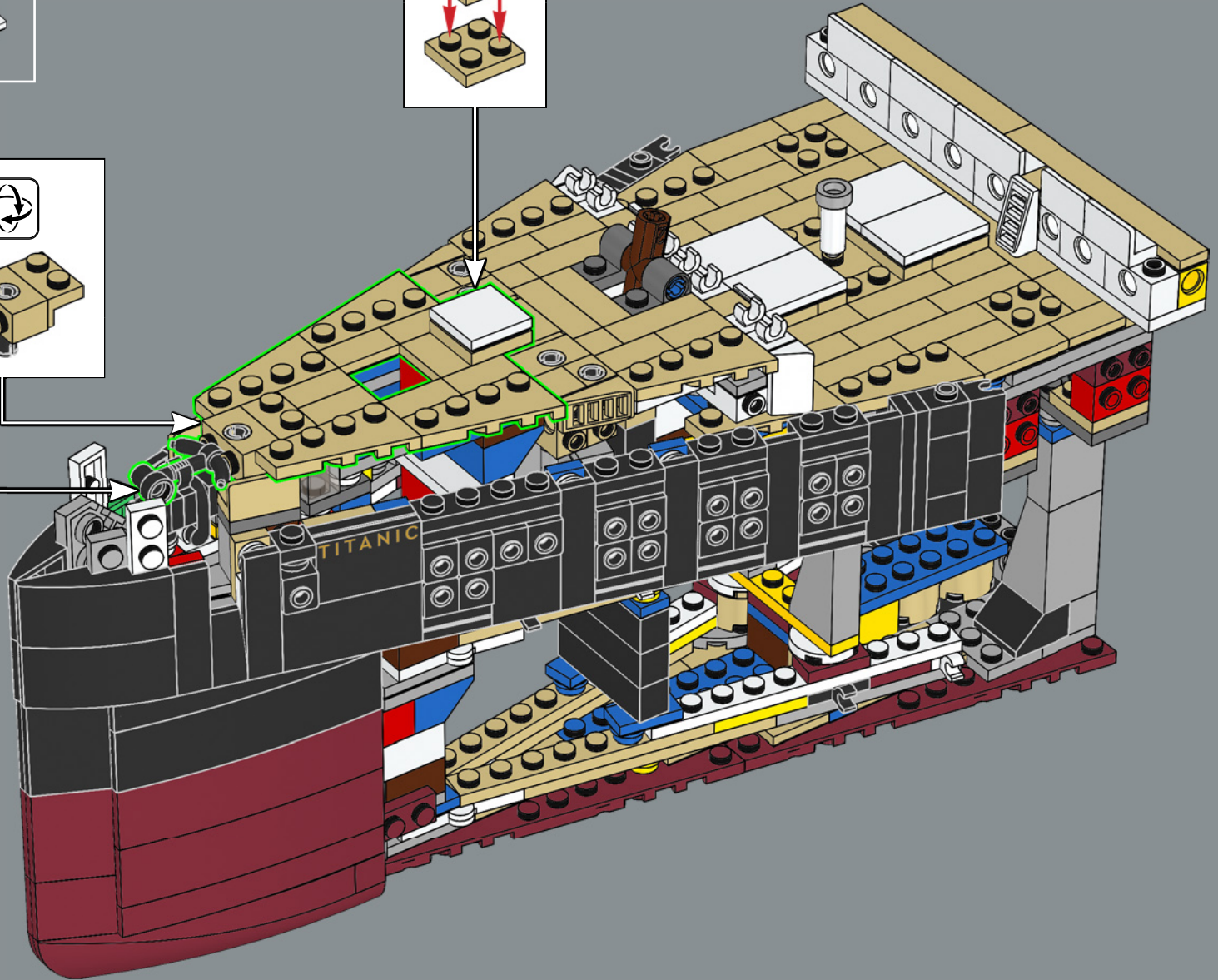
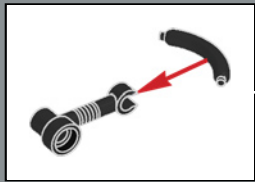
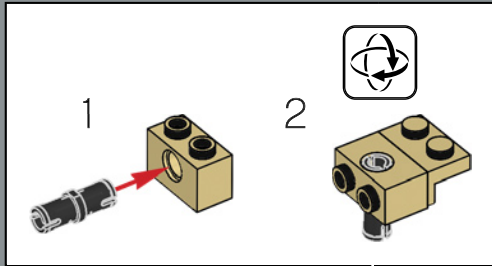

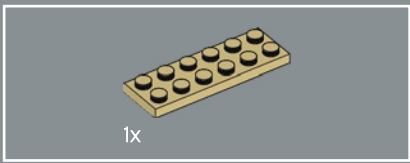

102

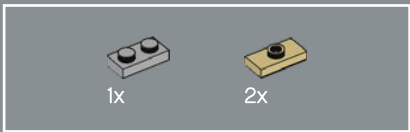
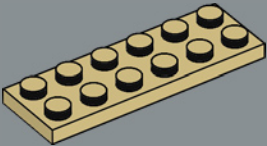

103

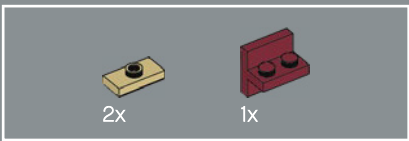
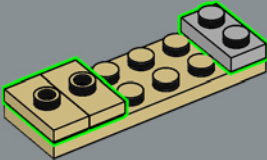

104

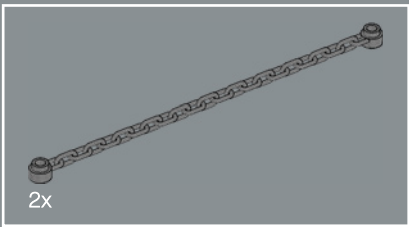
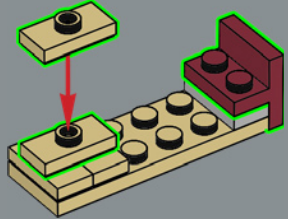

105

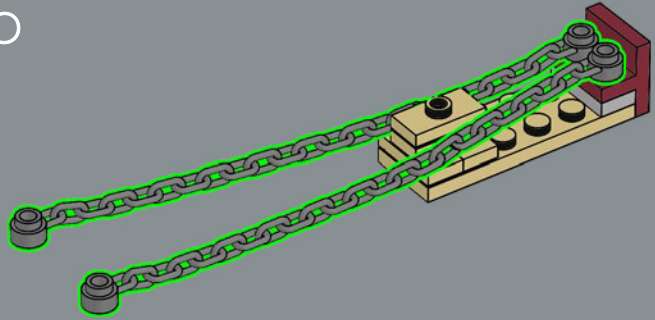

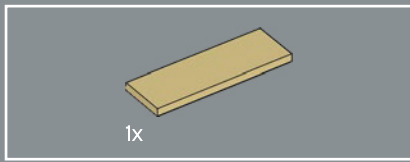

106

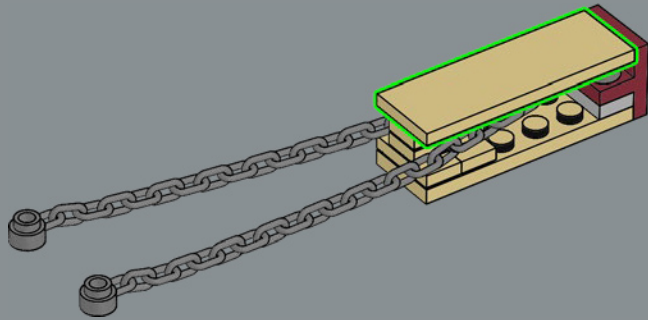

107

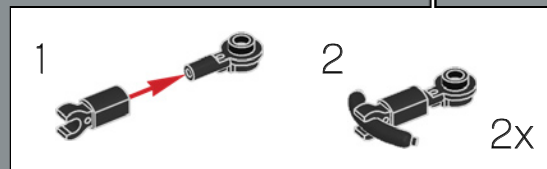
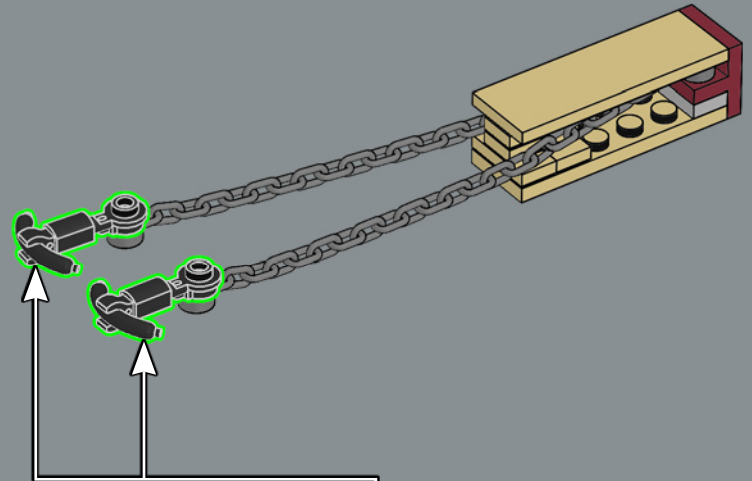

泰坦尼克号配有三个锚：
每侧各一个，最重的一个位于中间。

108

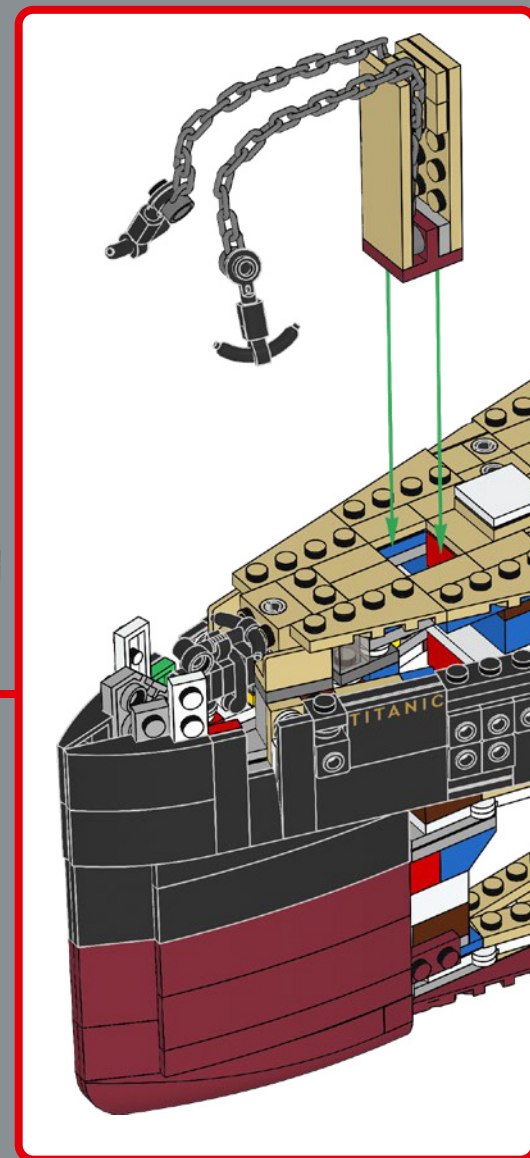
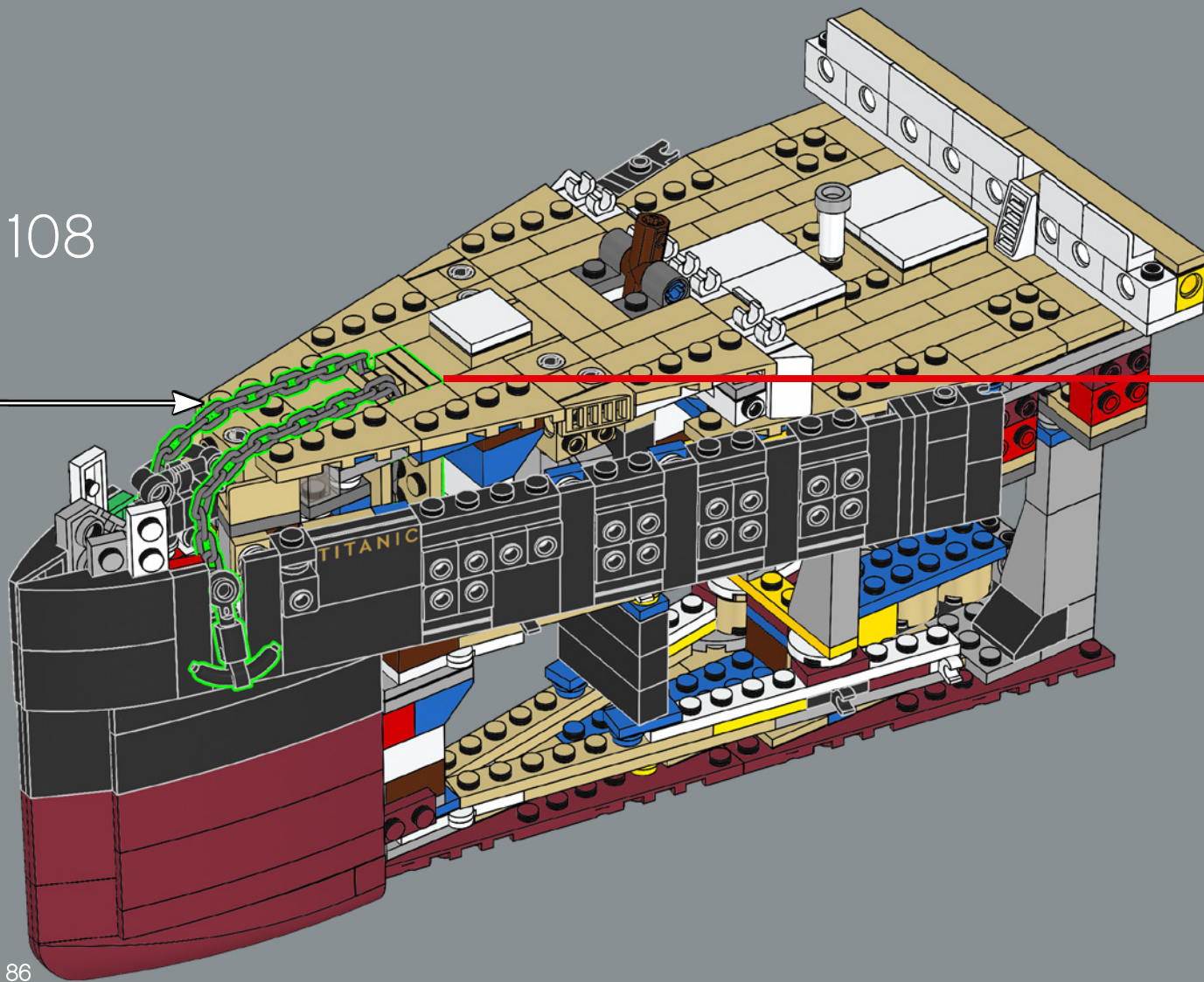

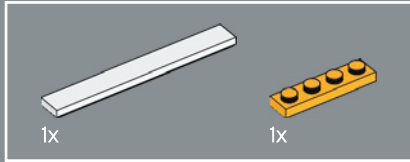
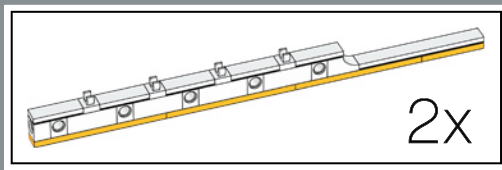

109

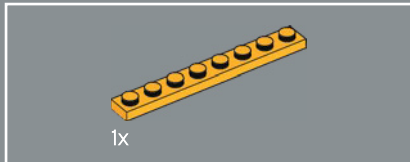
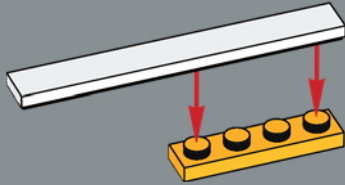

110

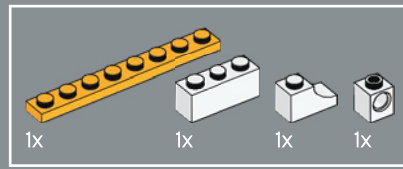
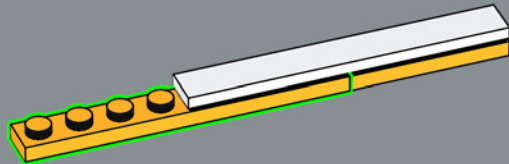

111

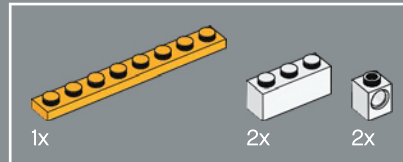
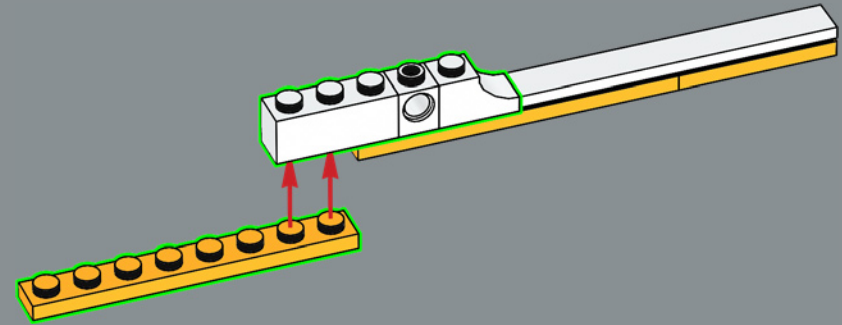

112

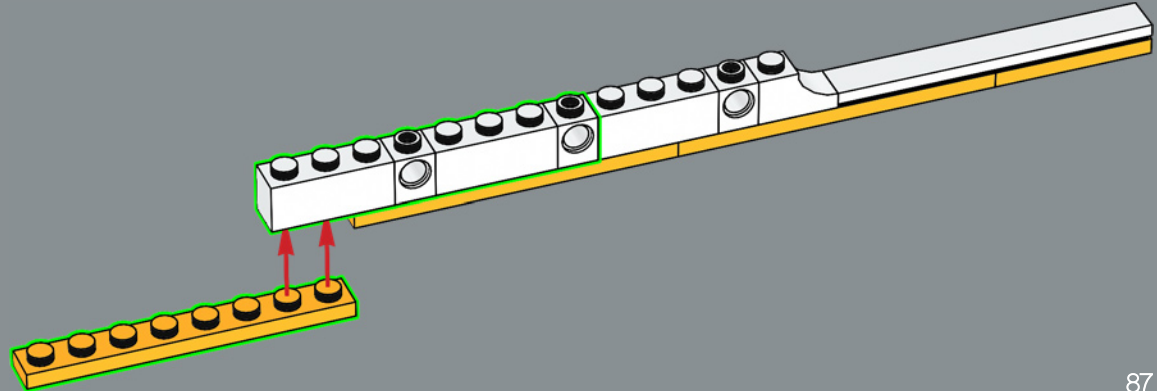

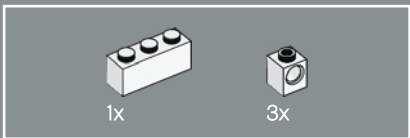

113

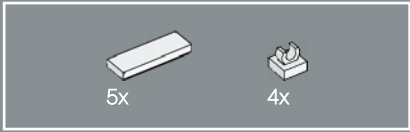
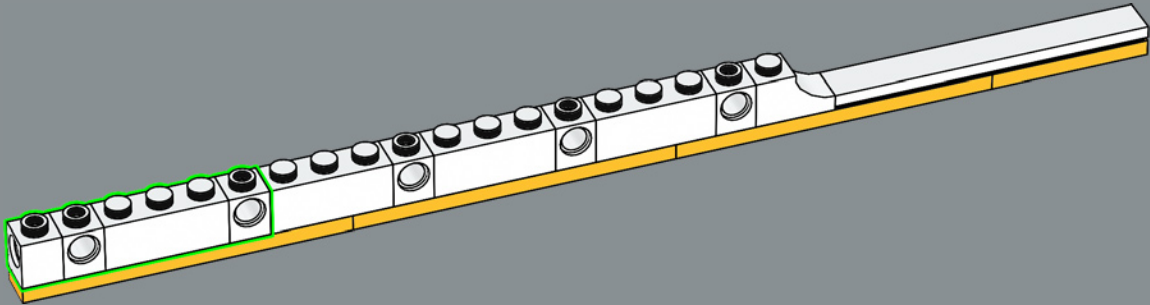

114

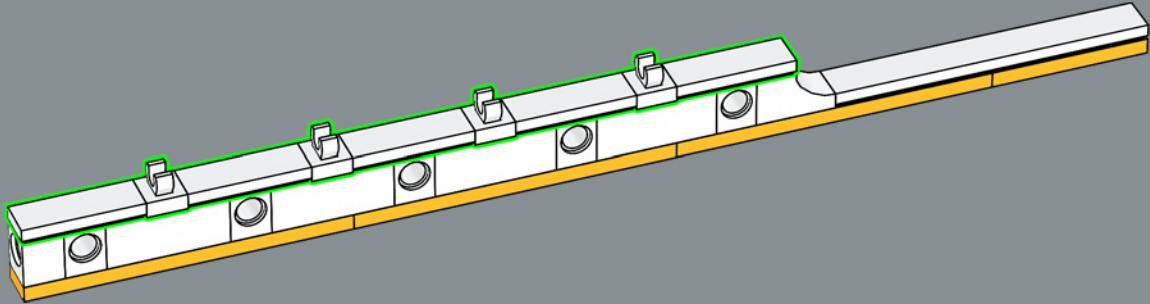

2x

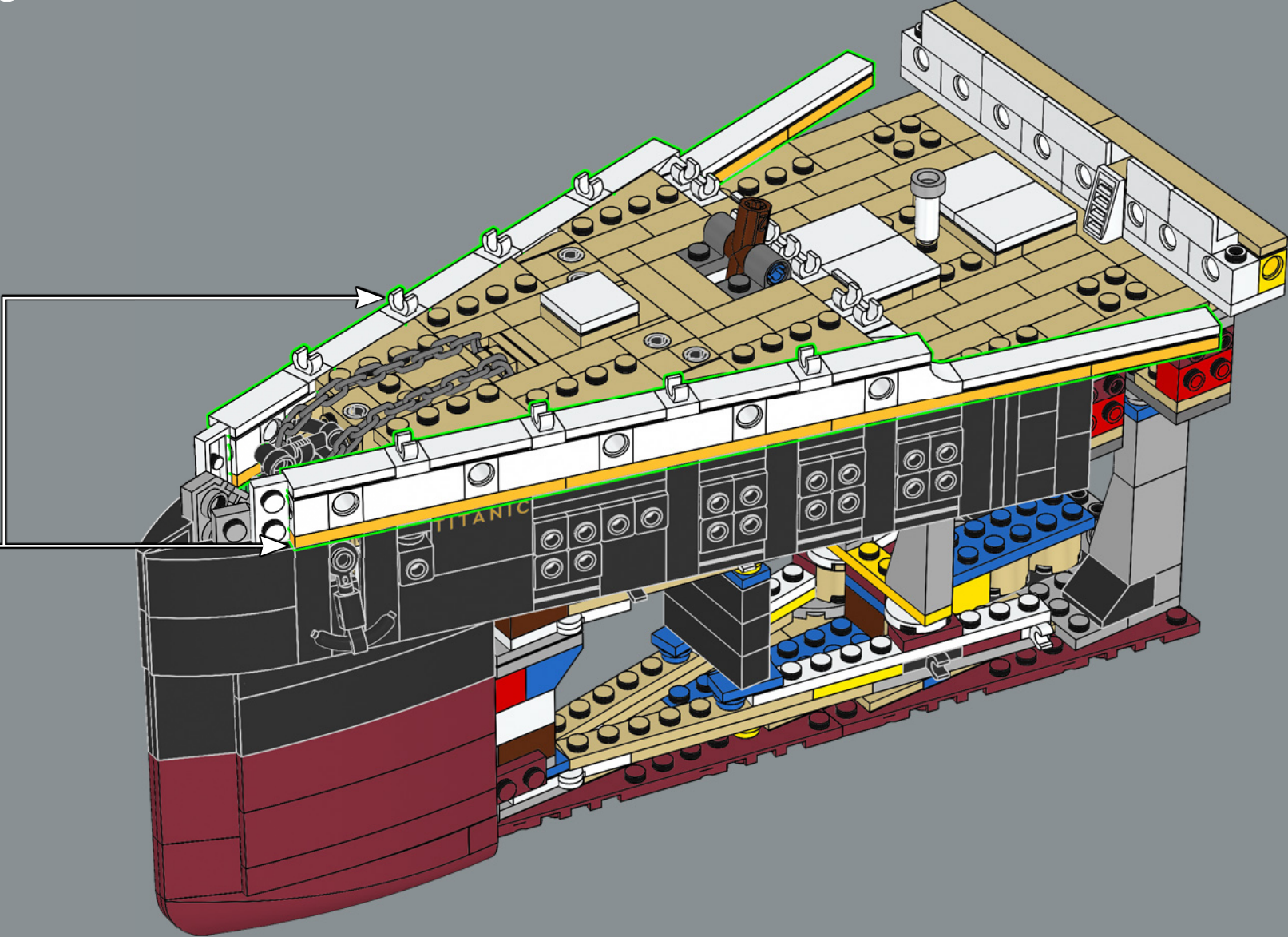

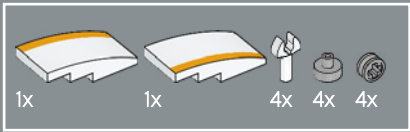

116

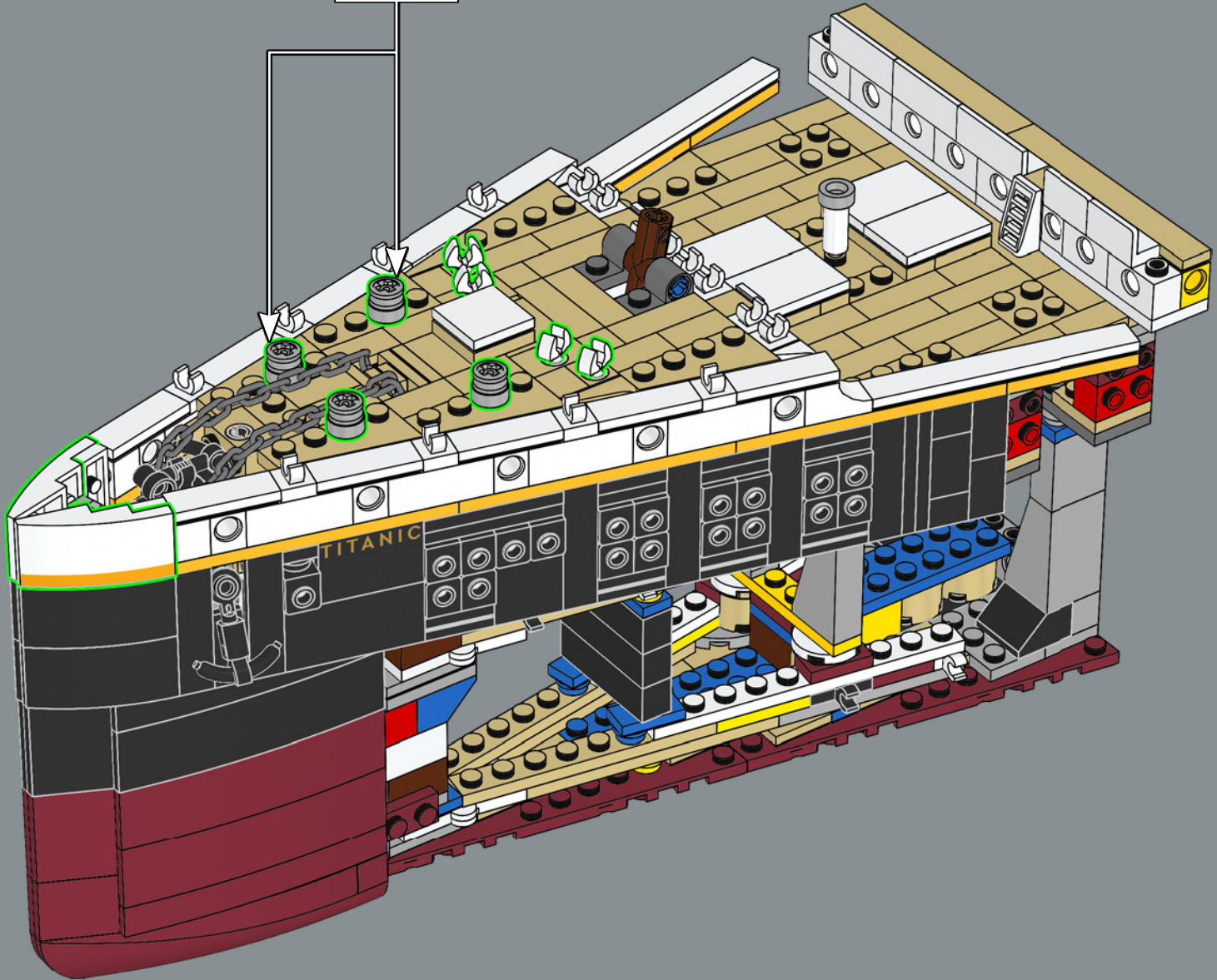
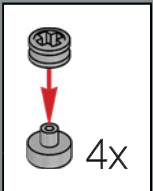

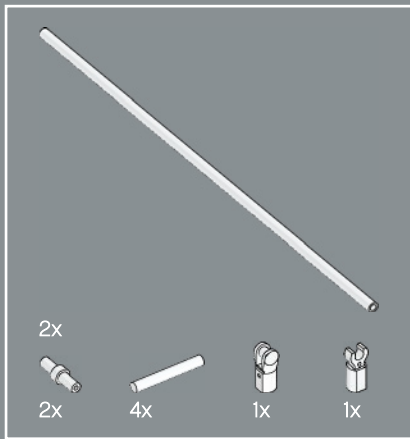

117

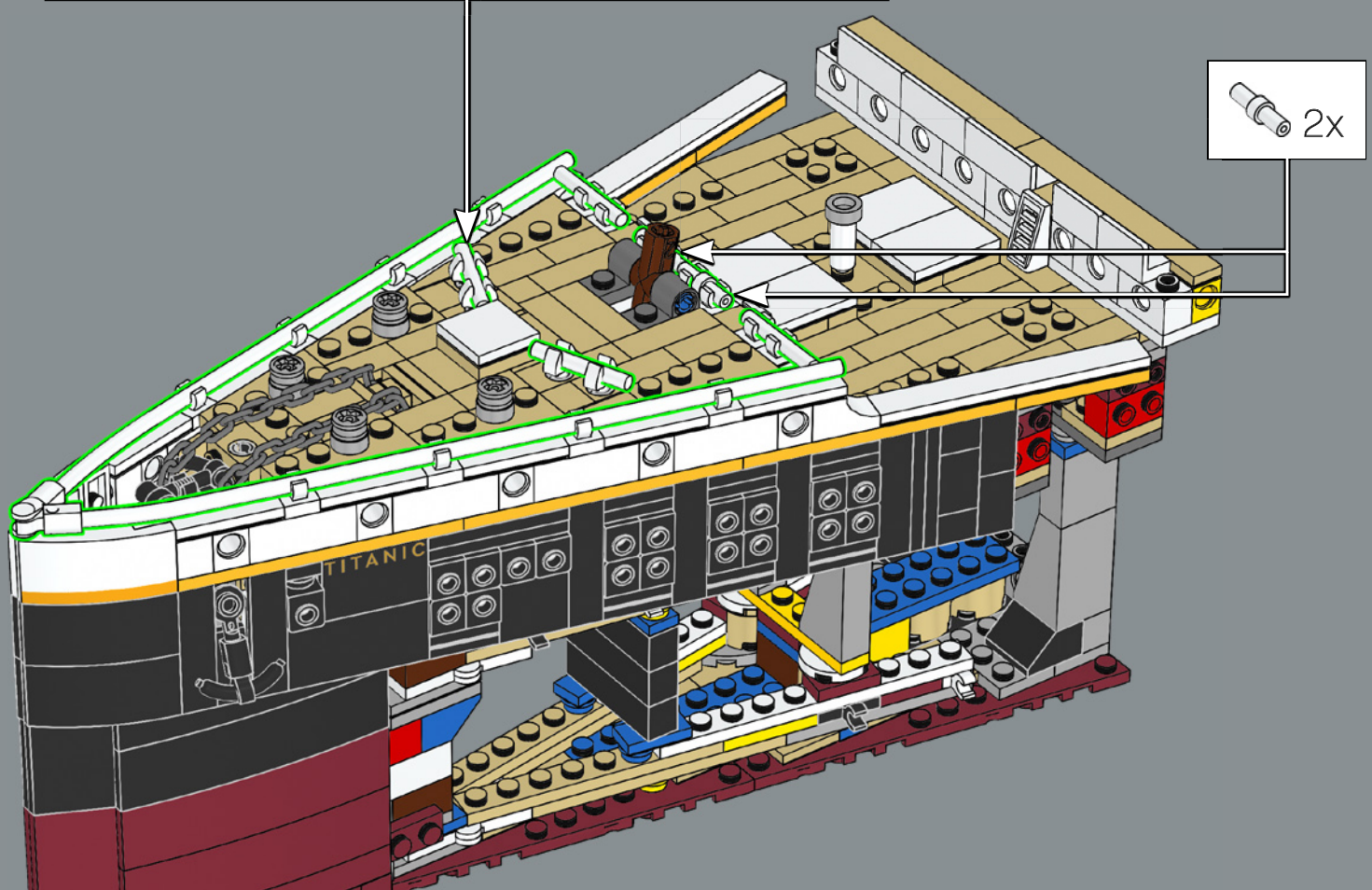
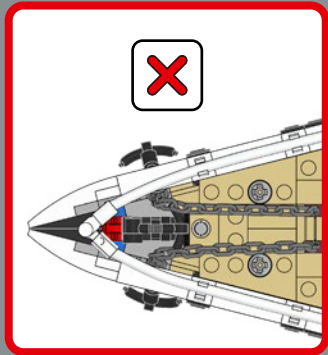
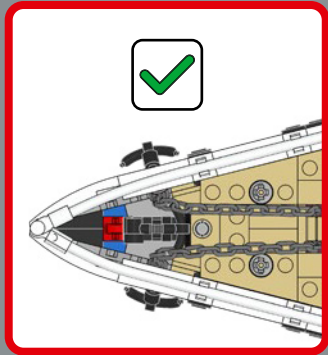
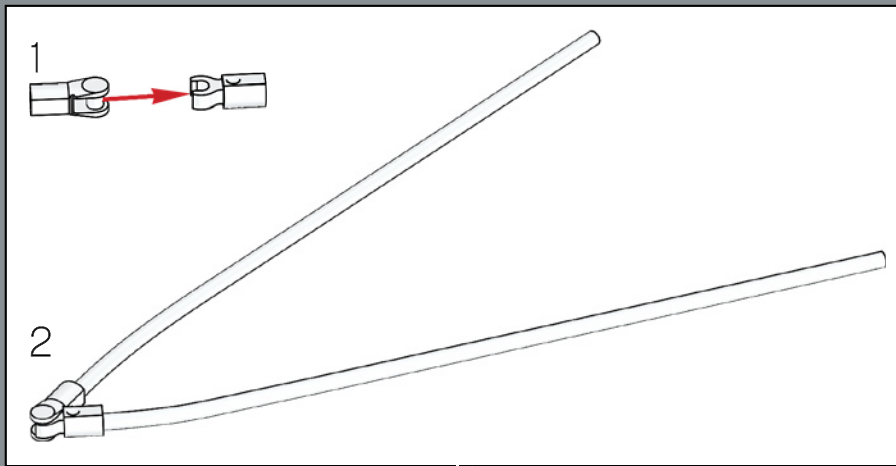



118

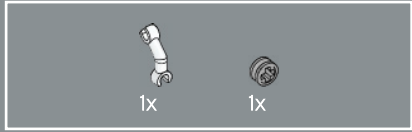

119



120

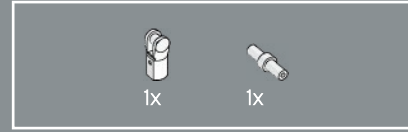
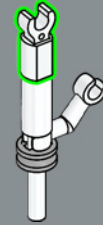

121

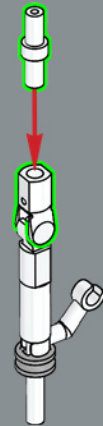



122

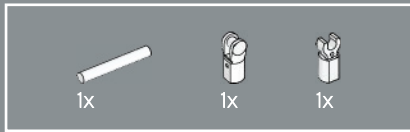
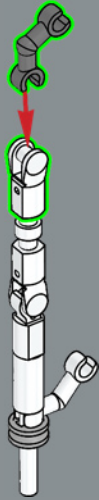

123

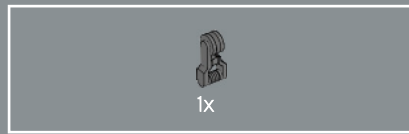
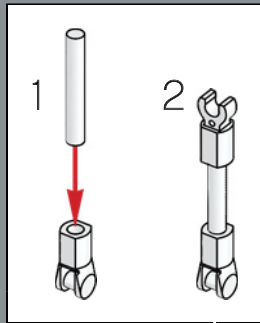
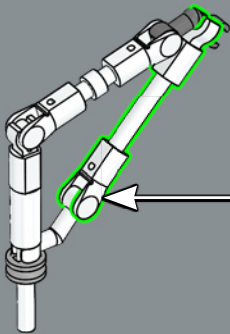

124

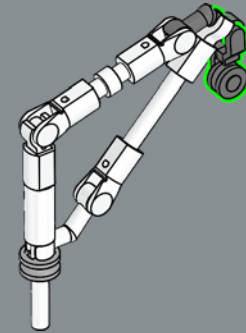

125

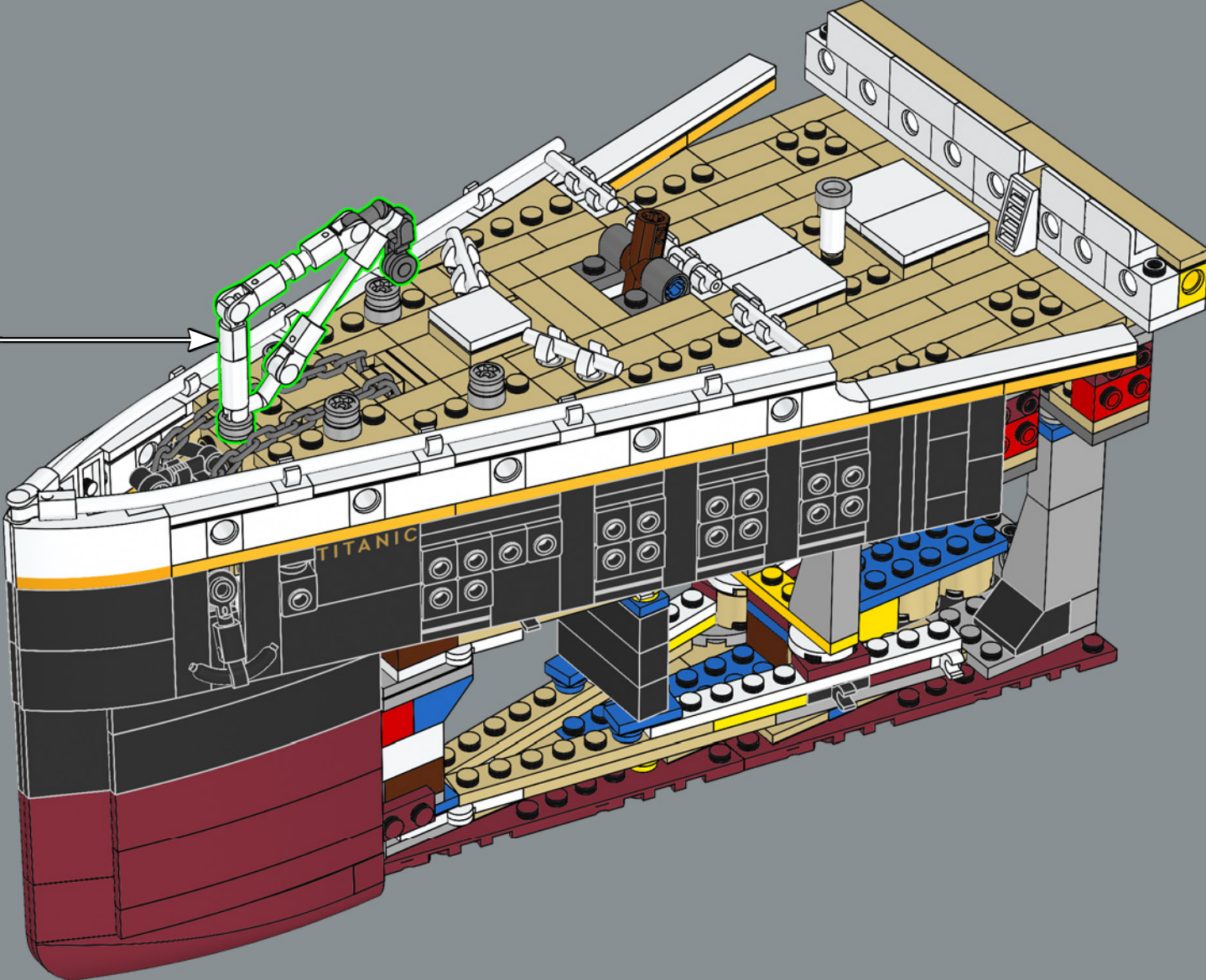

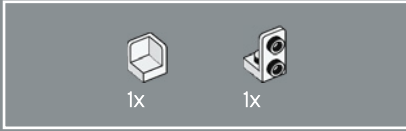
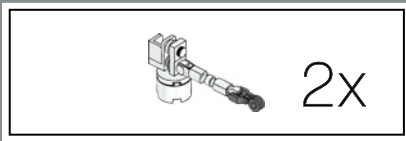

126

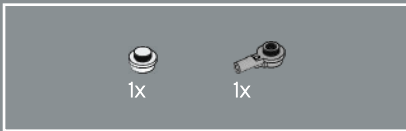

127

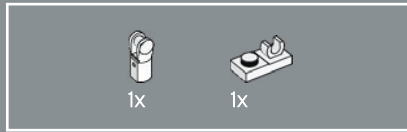
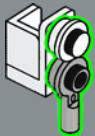

128

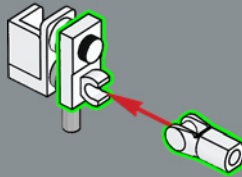

129

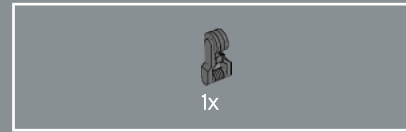
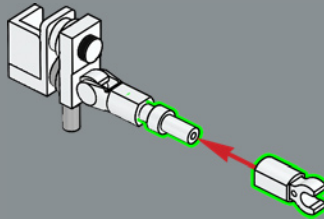

130

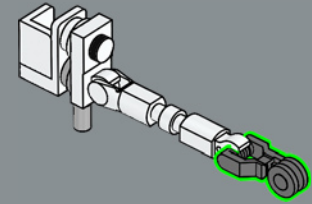

131

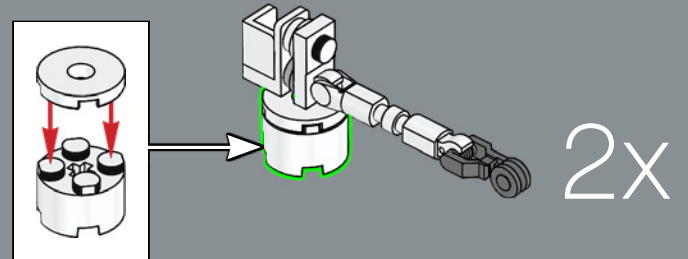

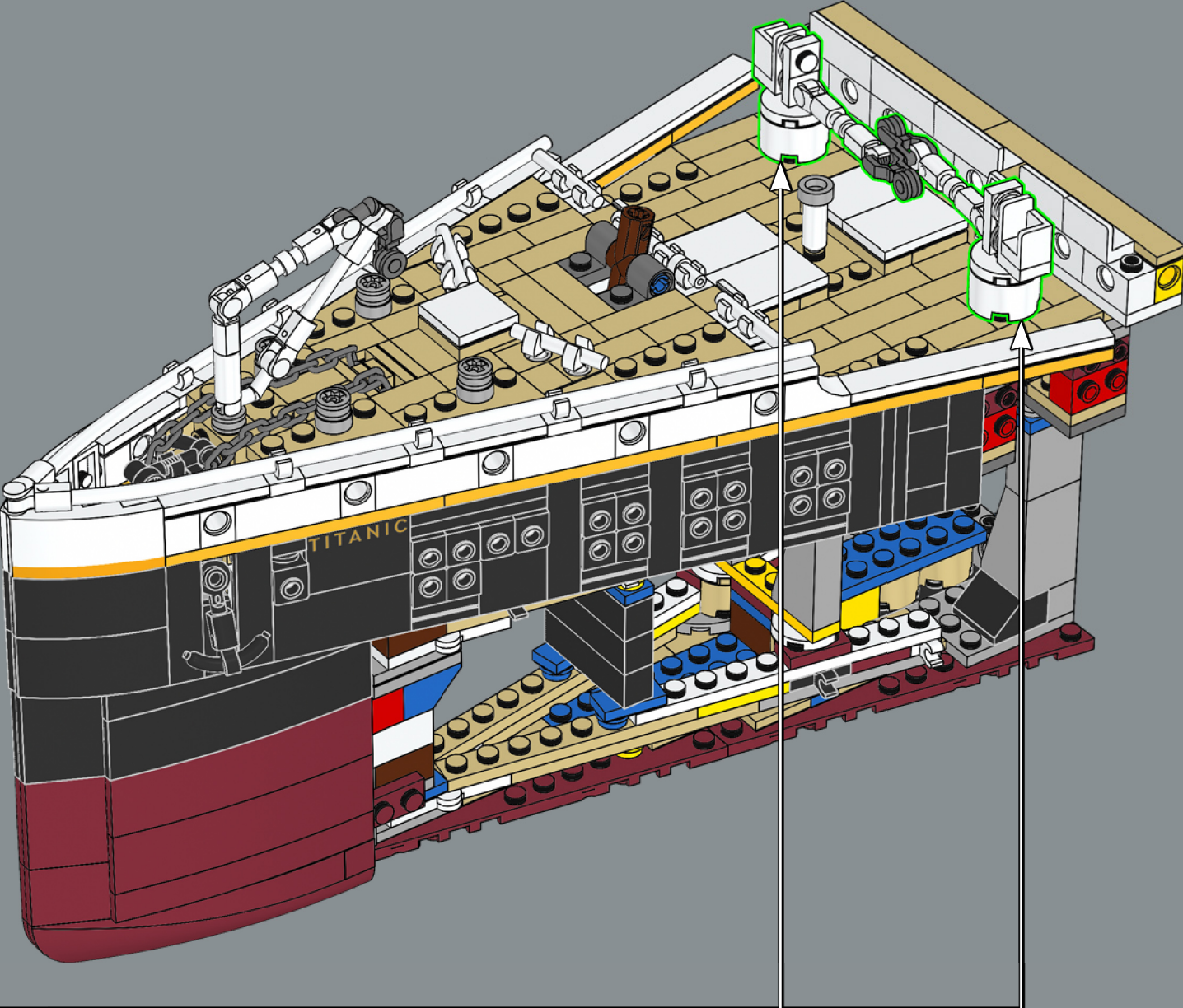

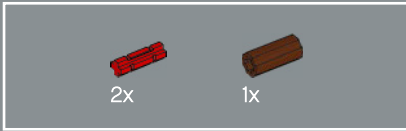
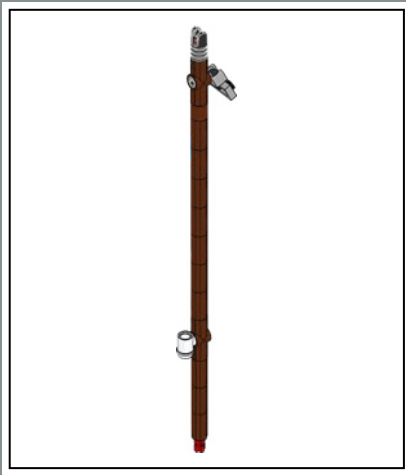

133



134

1x

1x



135

9x

9x

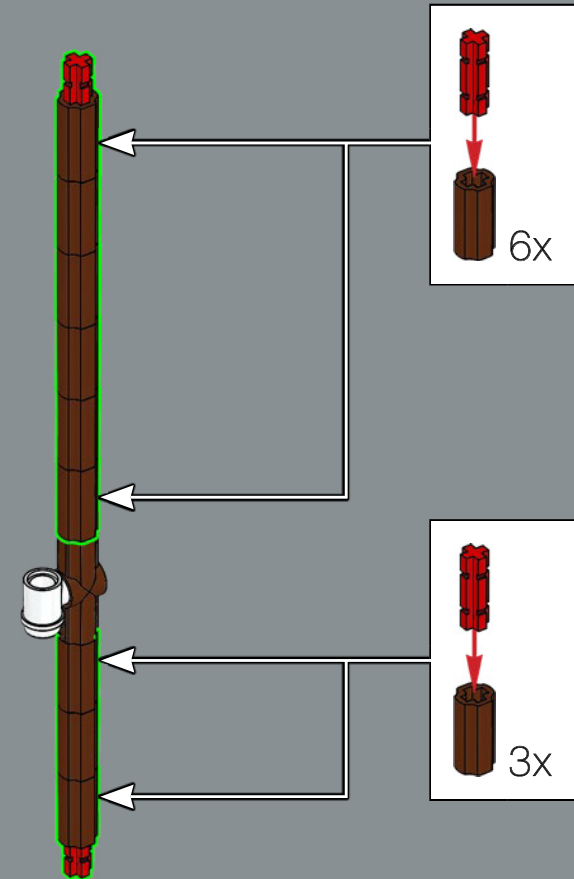

6x

3x

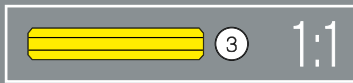
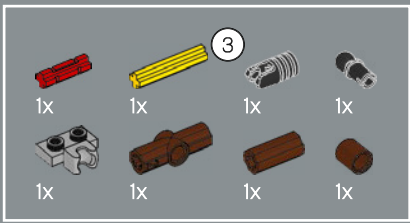

136

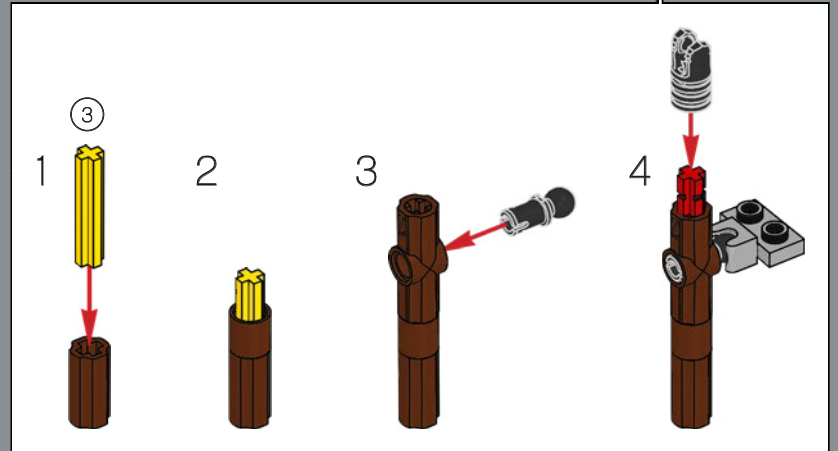

137

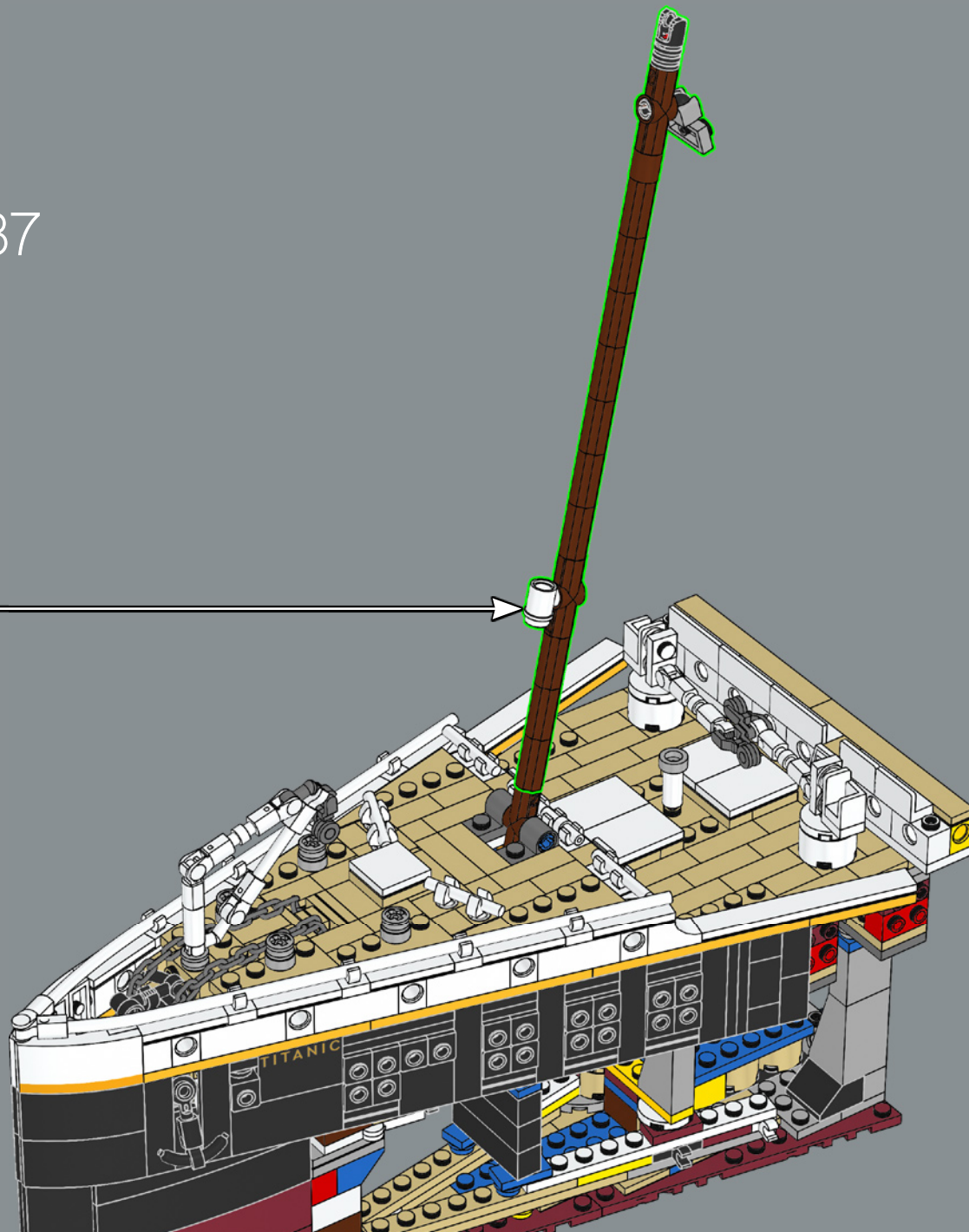

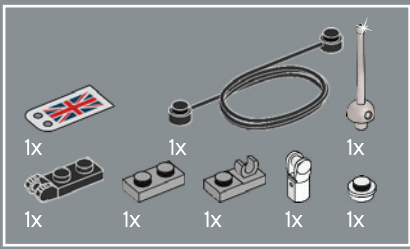

138

1

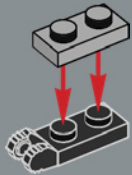

2

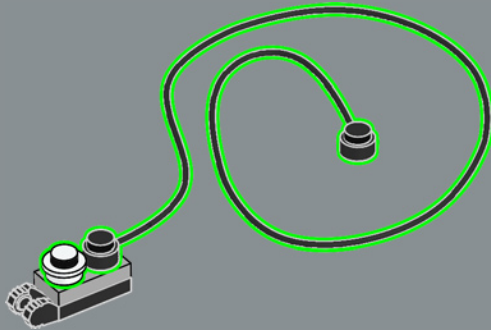

3

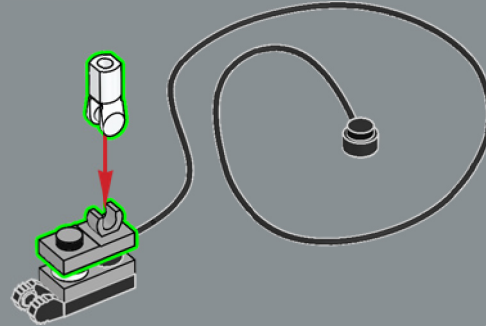

4

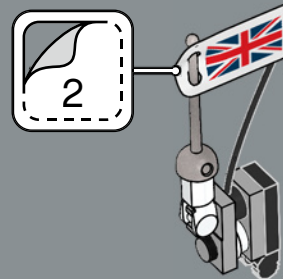

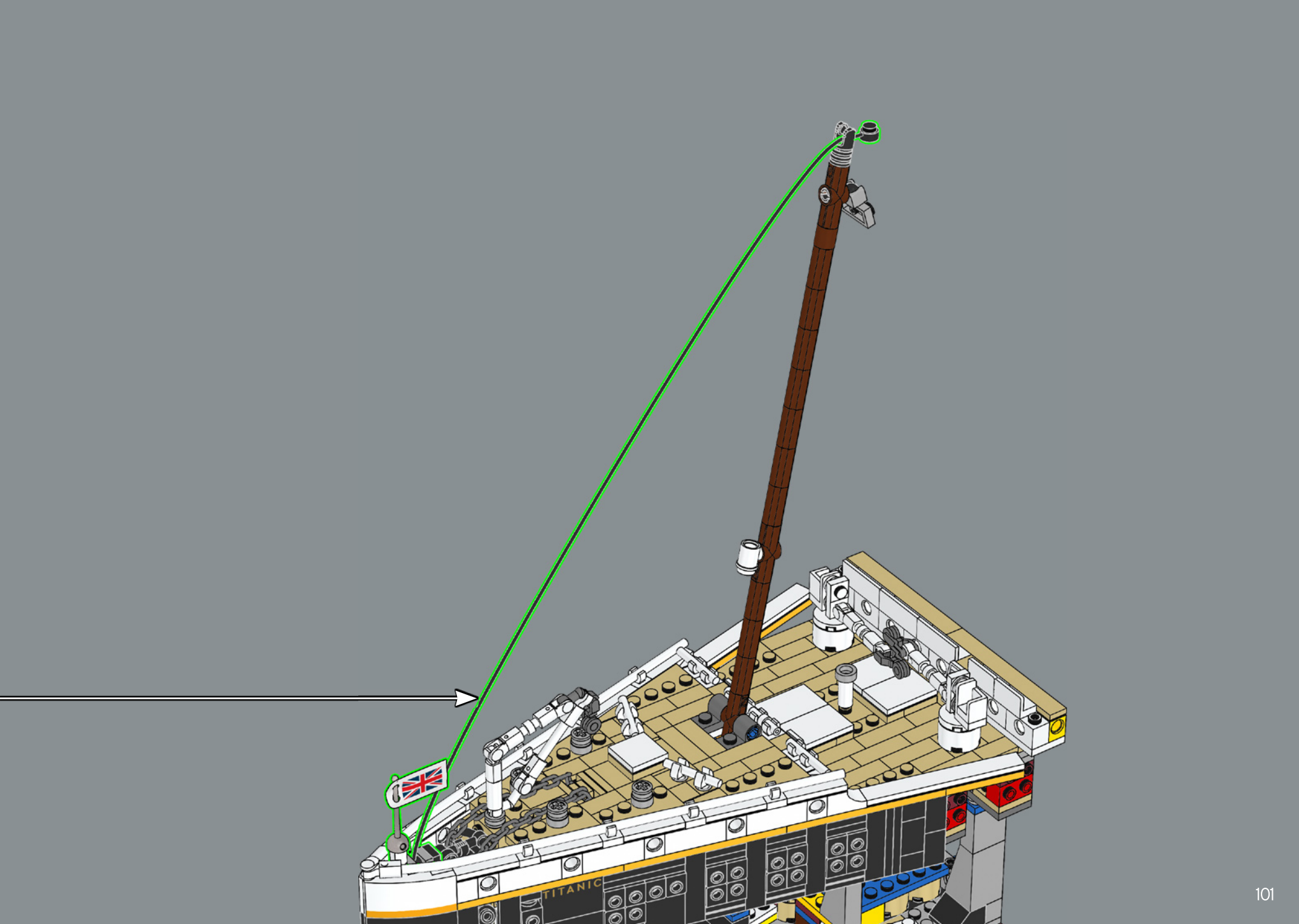

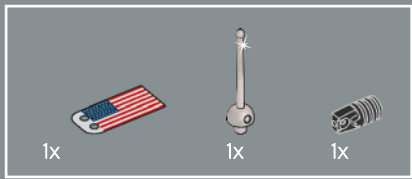

139

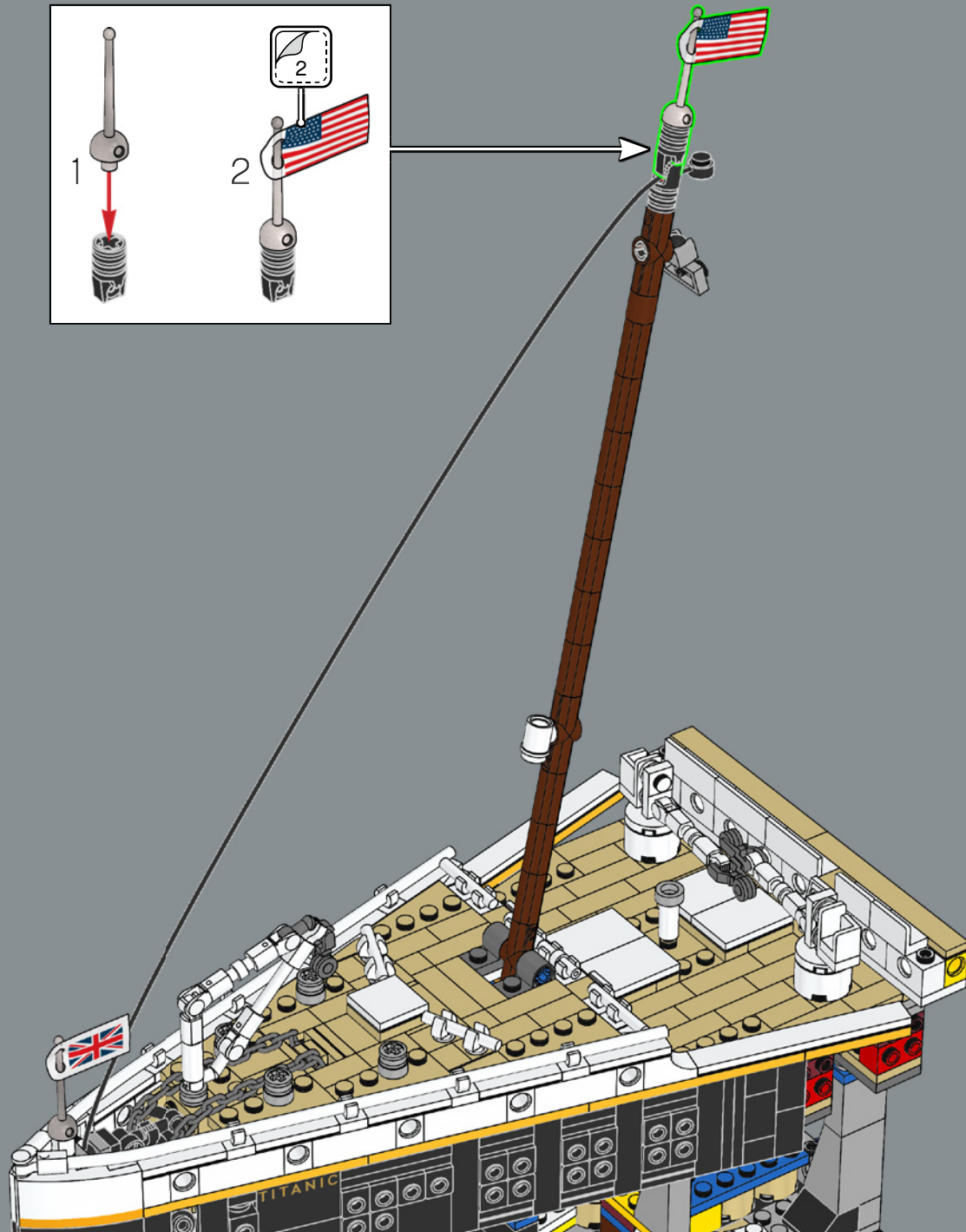
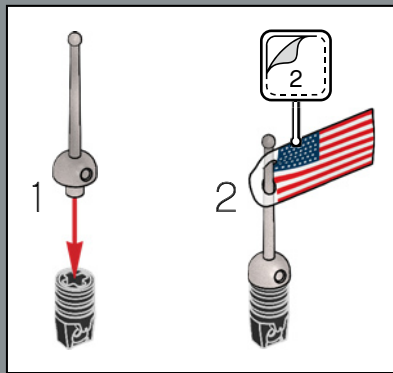

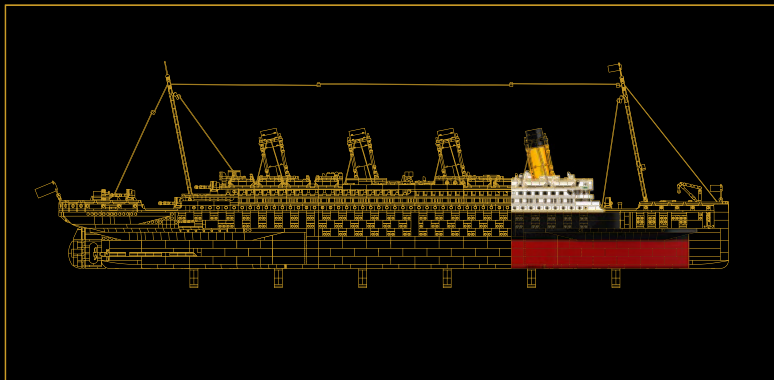

第 2 部分：

桥楼和烟囱

在第二部分中，船体达到其最大宽度，宽达 18 个模块或大约 144 毫米（5.6 英寸）。在船体内，你将开始拼搭船的横截面，其包括部分游泳池、大楼梯和泰坦尼克号的锅炉室。你还将拼搭标志性的桥楼和四根烟囱中的第一根。



↓ 大楼梯内隐藏的锁定装置可使整艘船安全稳固地连接在一起。

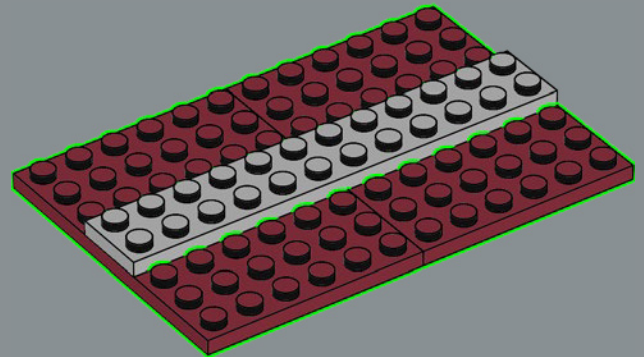
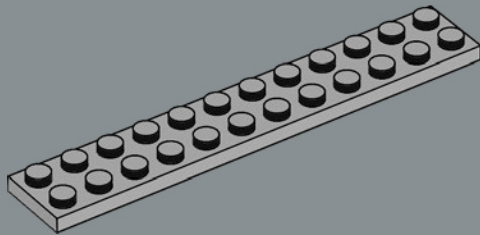
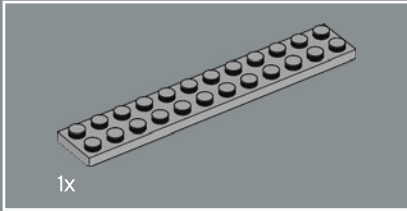
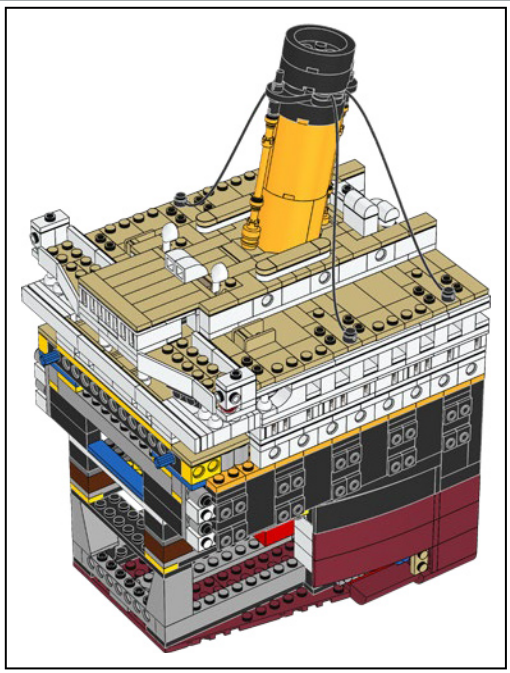
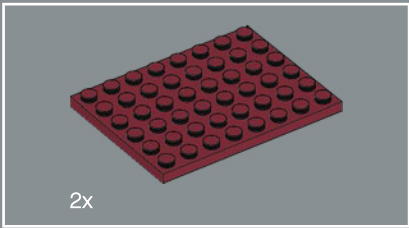
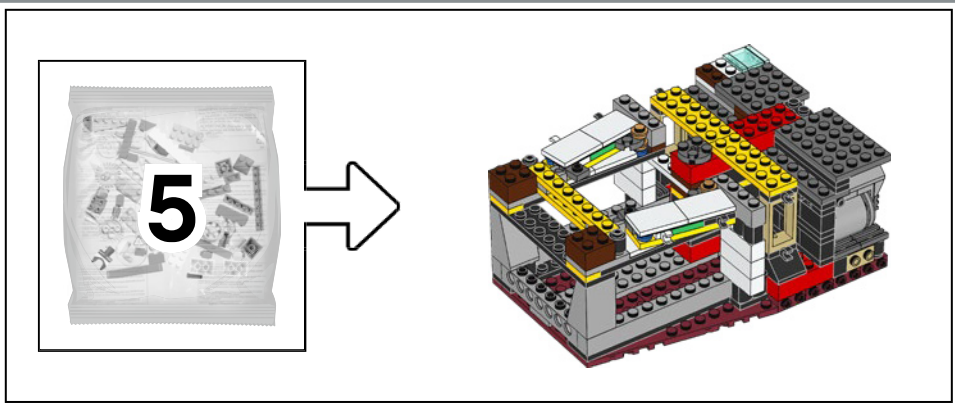

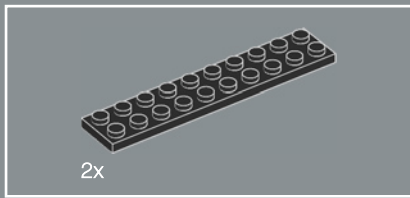

142

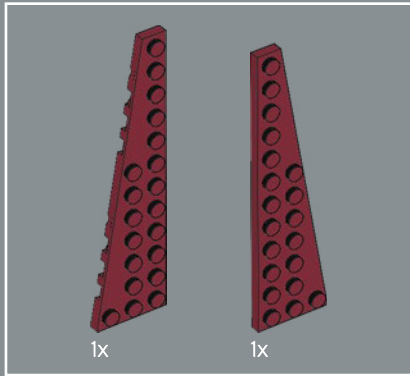
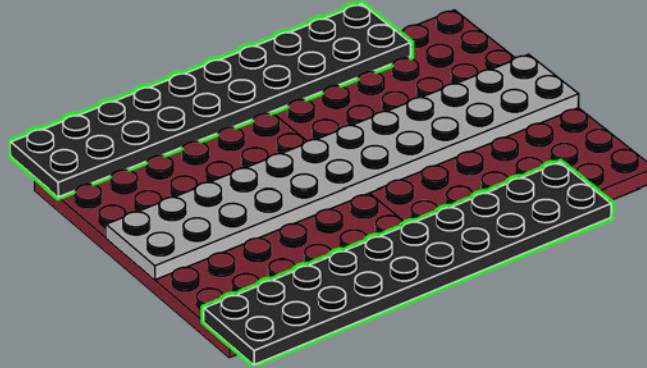

143

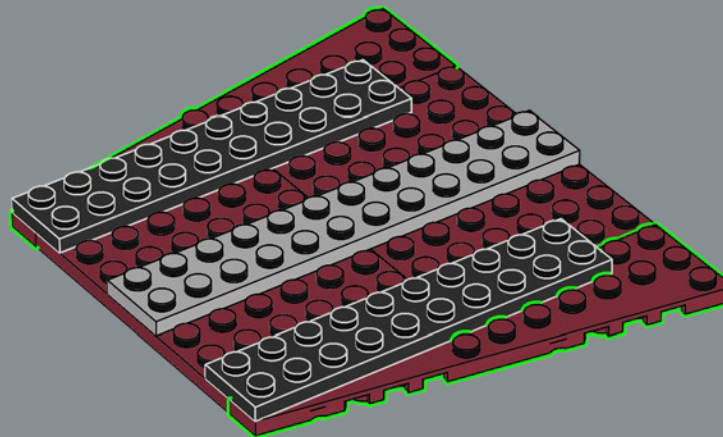

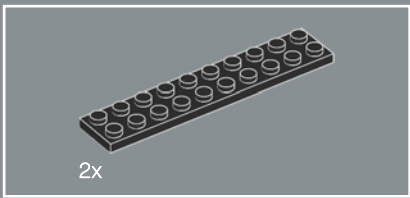

144

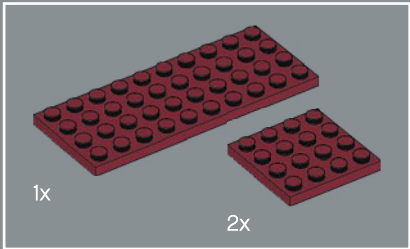
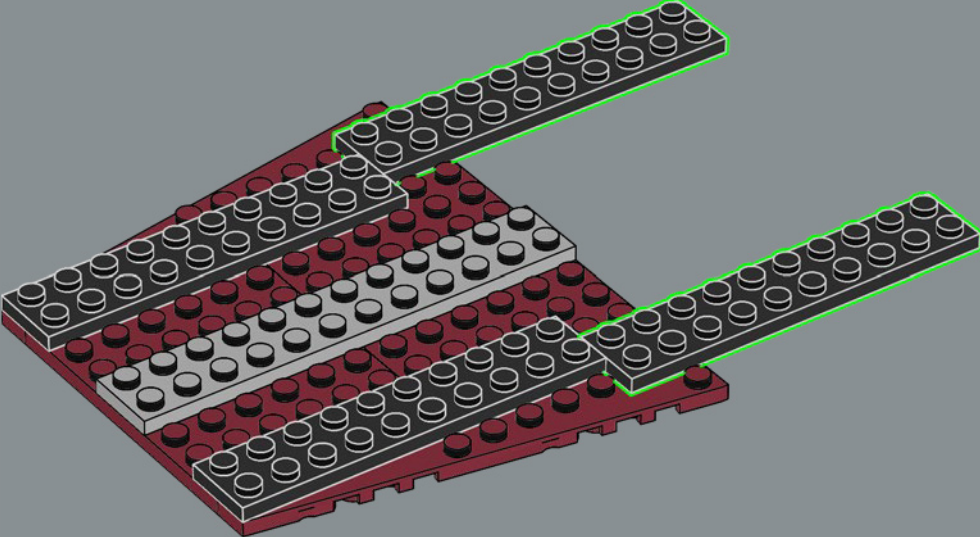

145

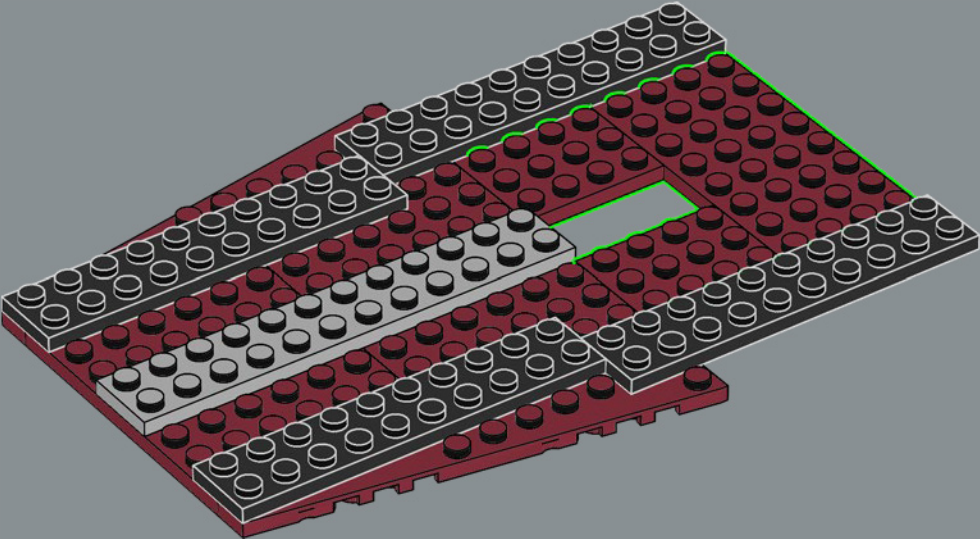

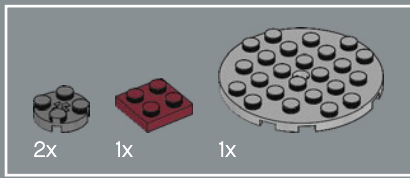

146

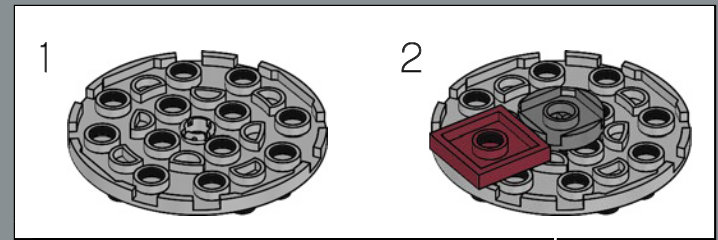
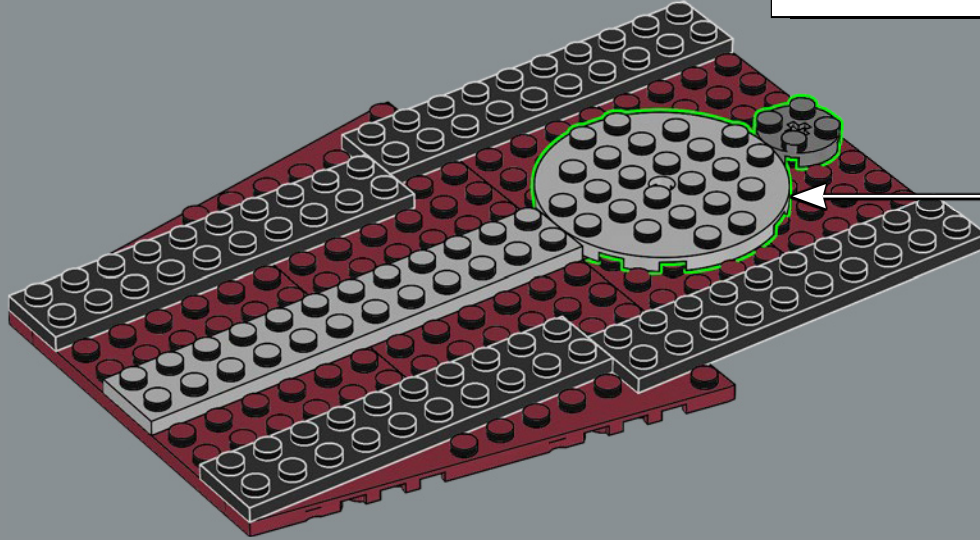

147

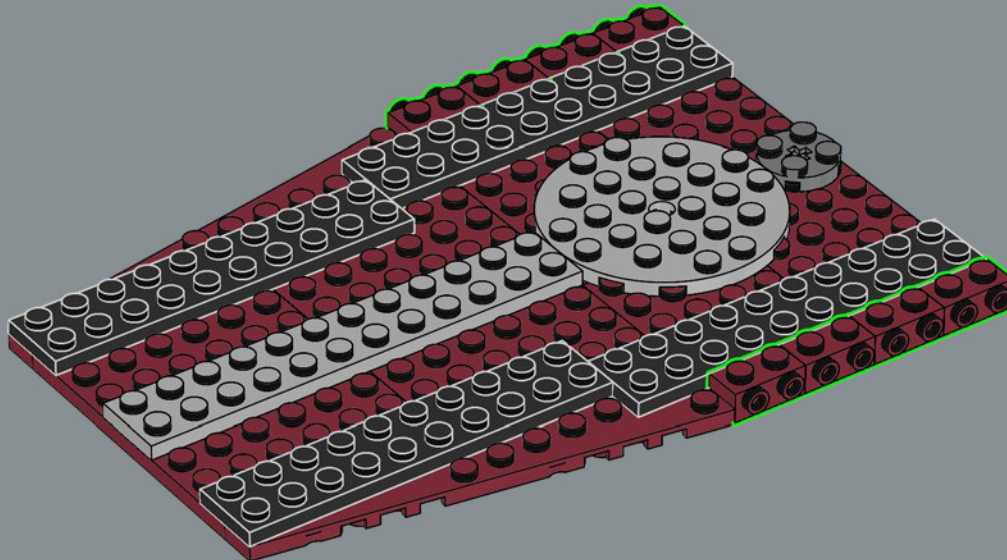

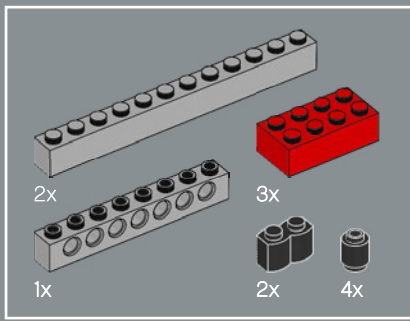

149

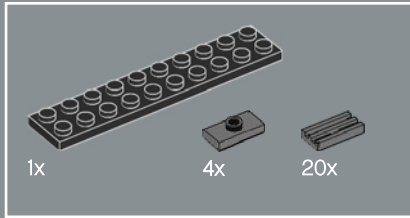
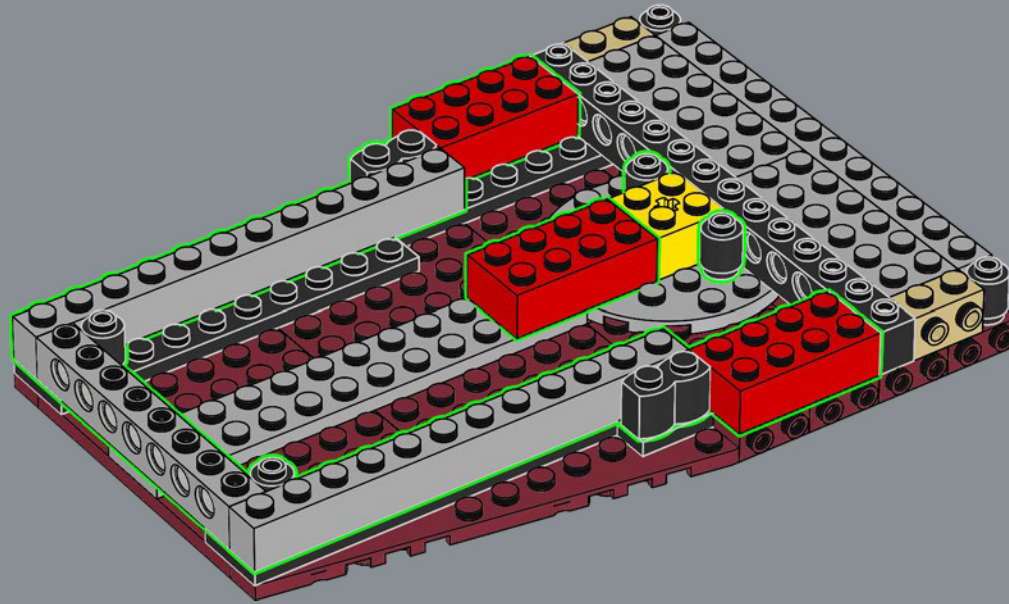

150

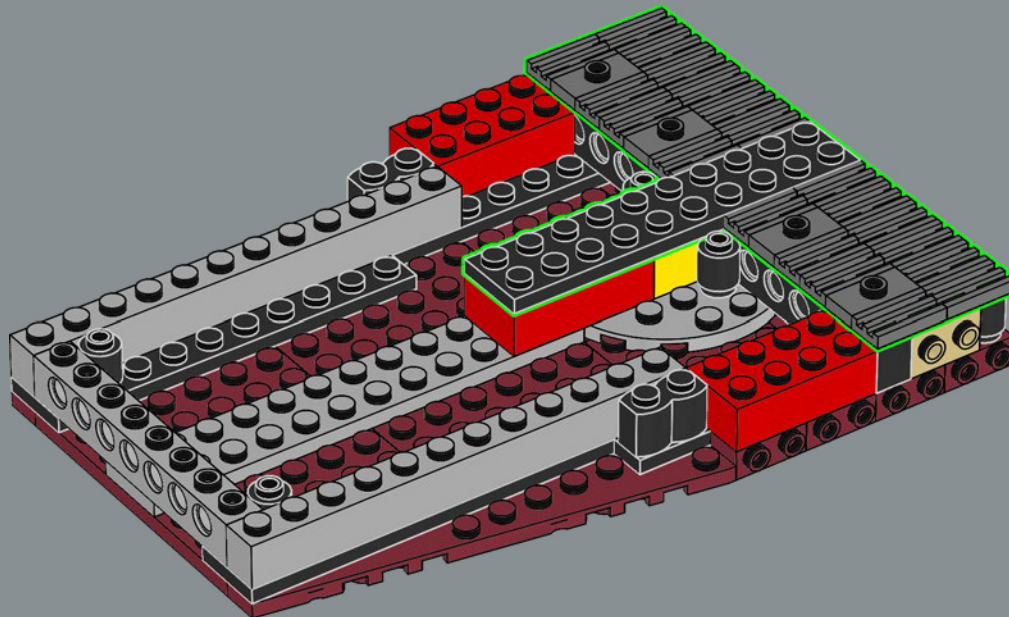

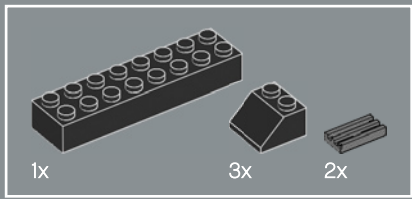

151

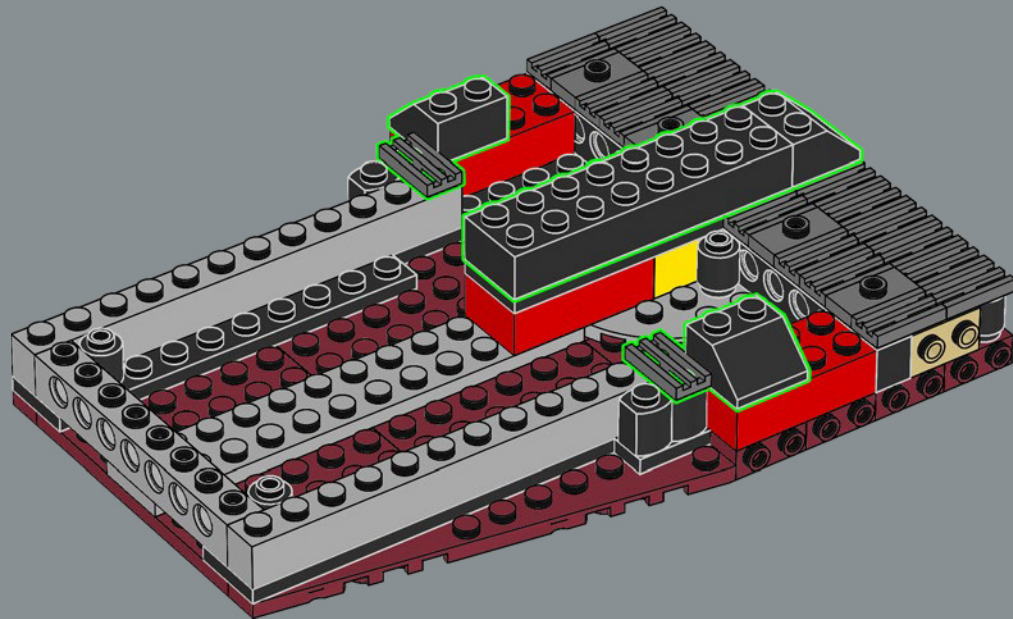

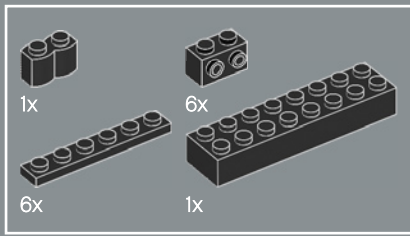

152

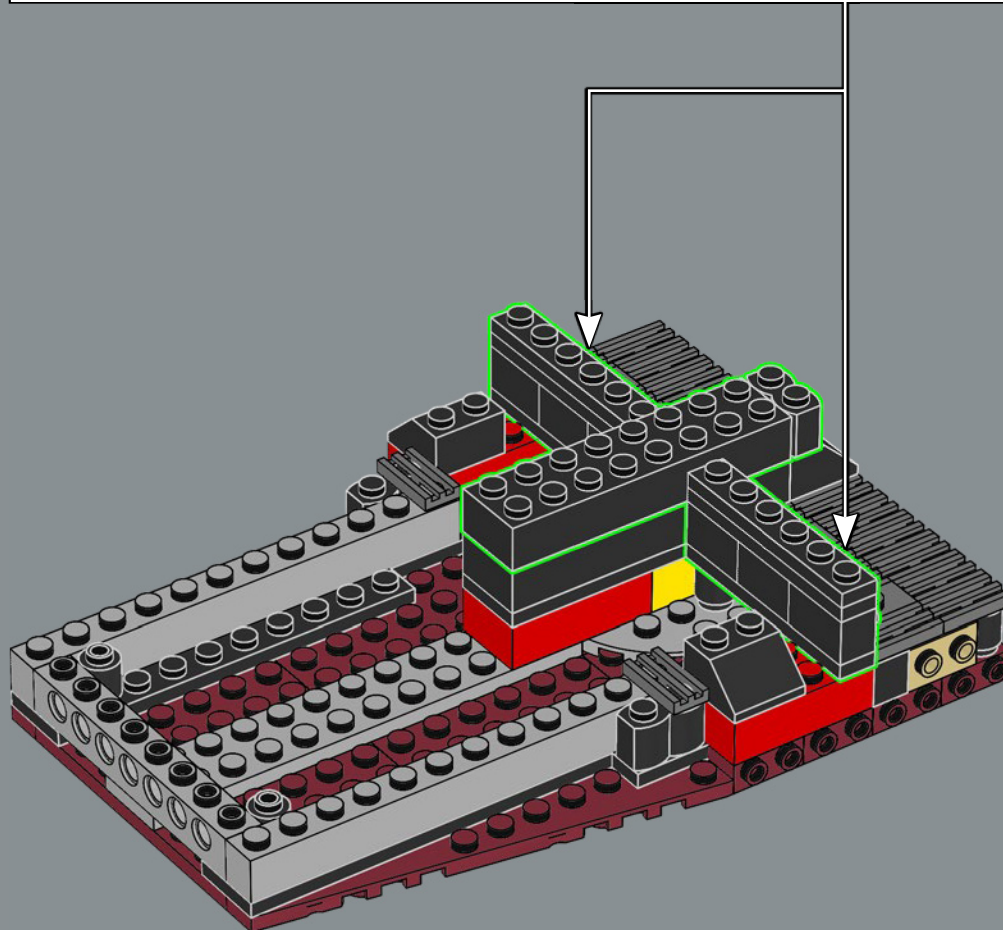
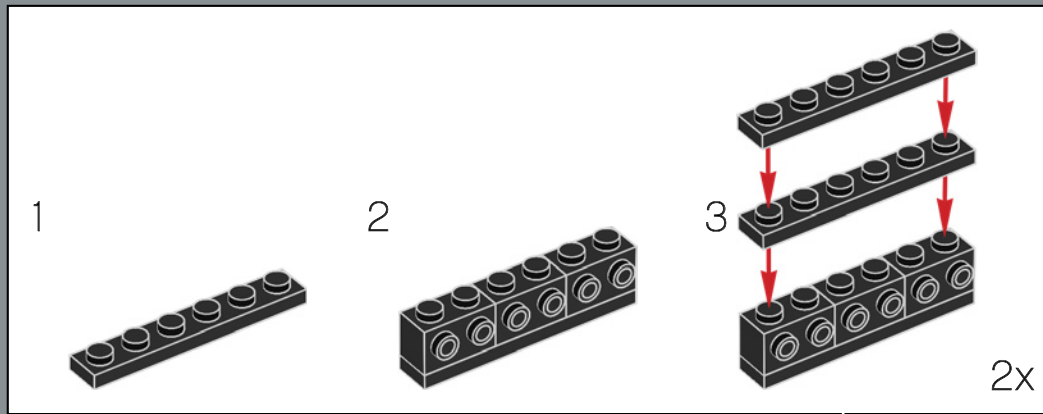

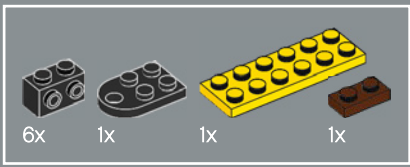

153

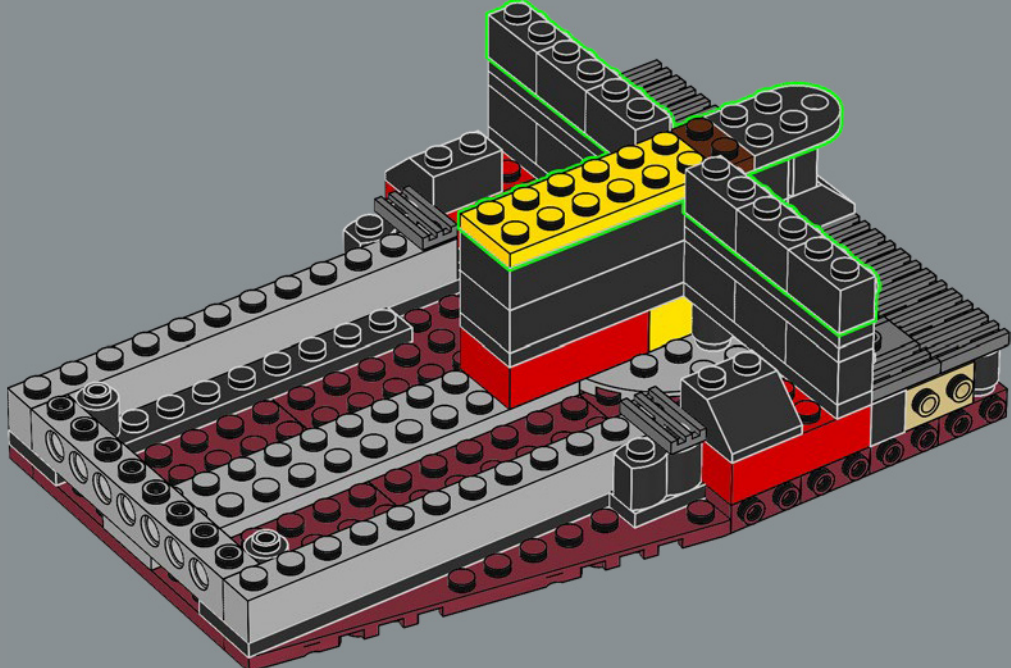

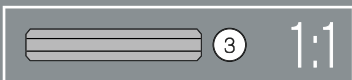
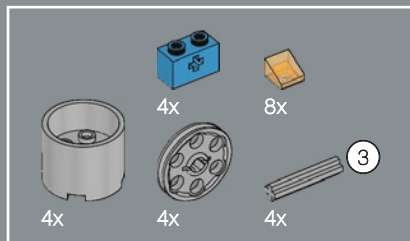

154

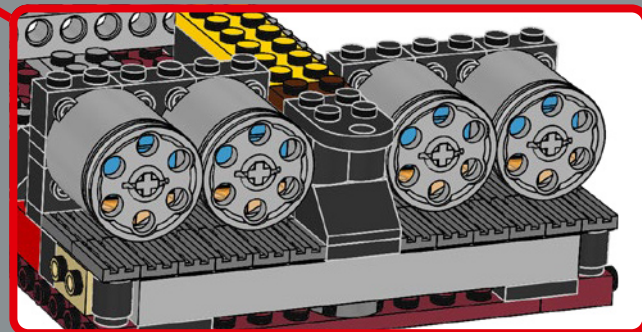
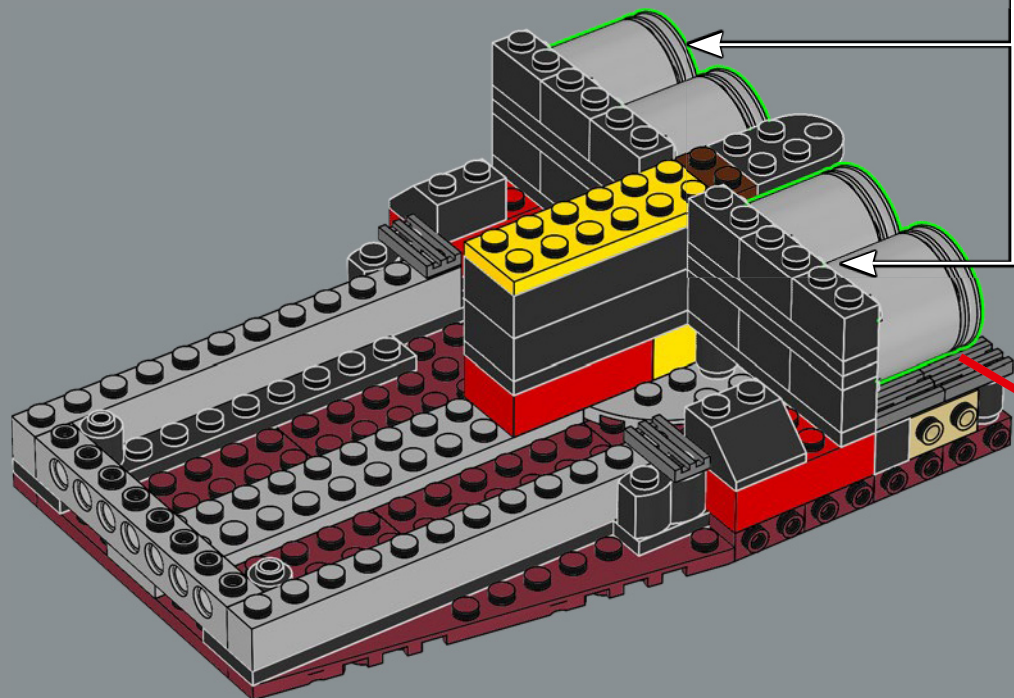
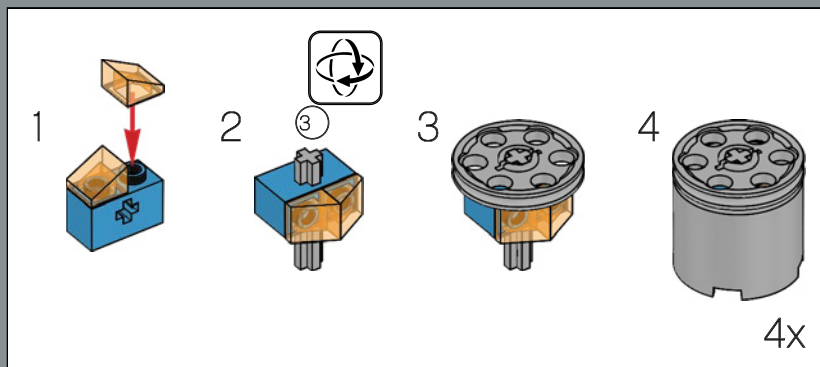

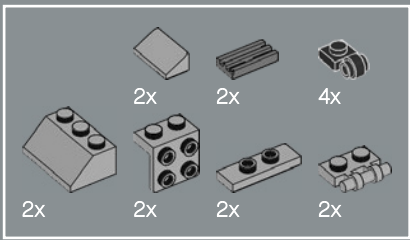

155

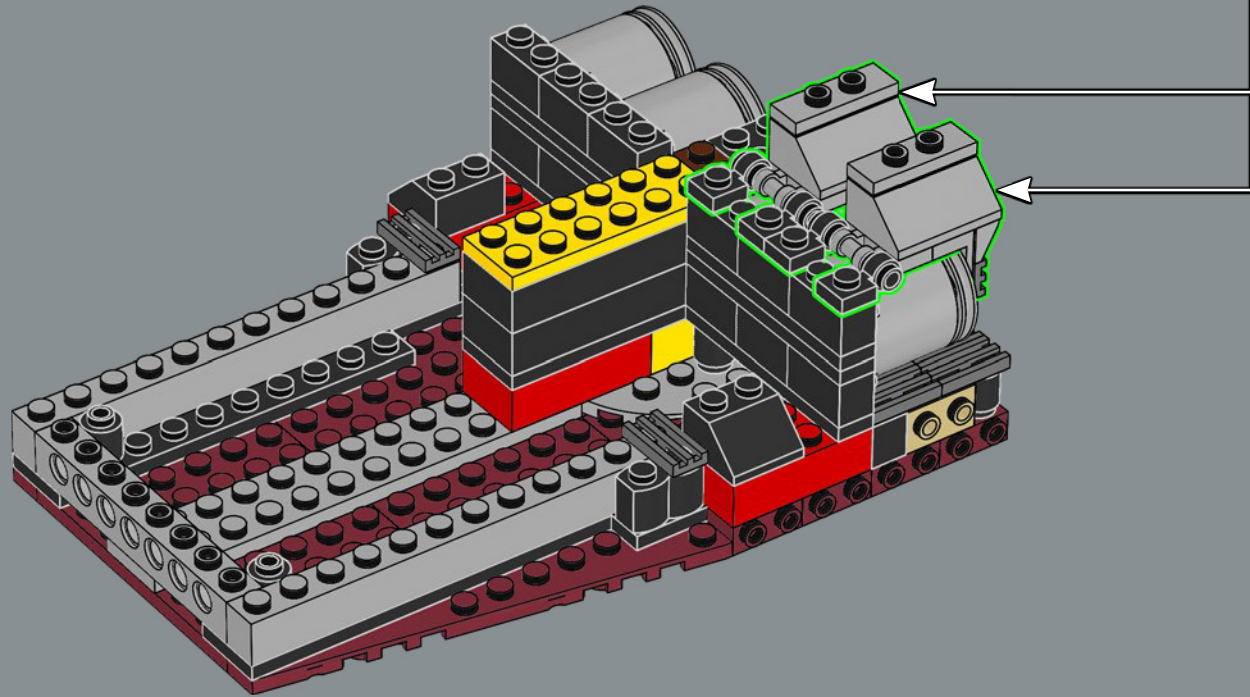
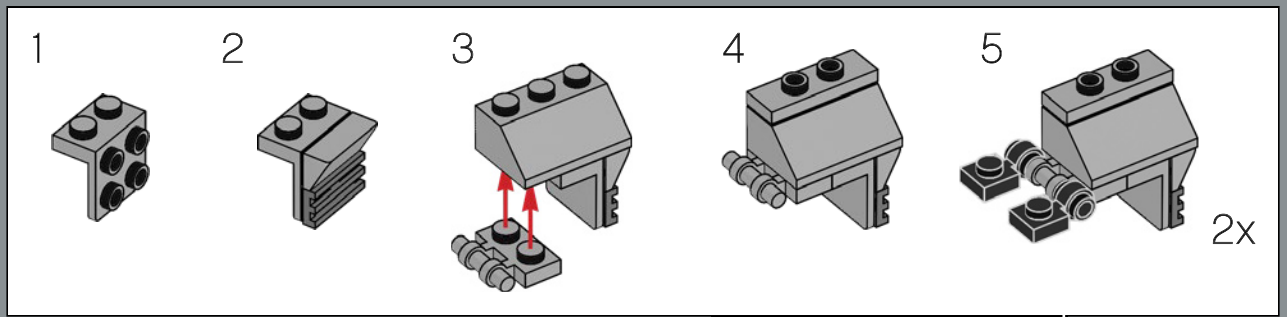

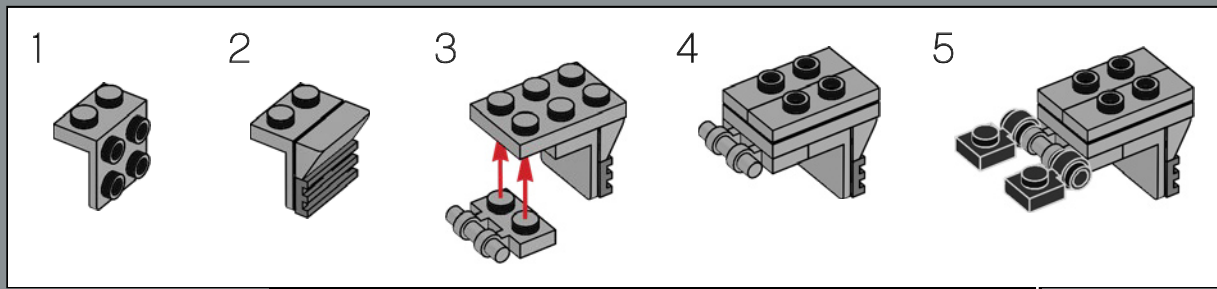
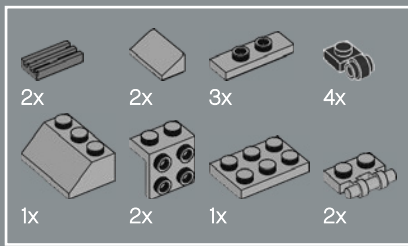

156

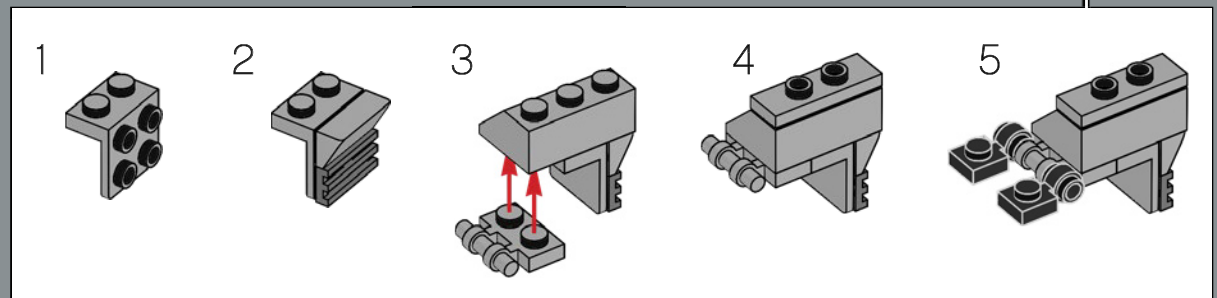
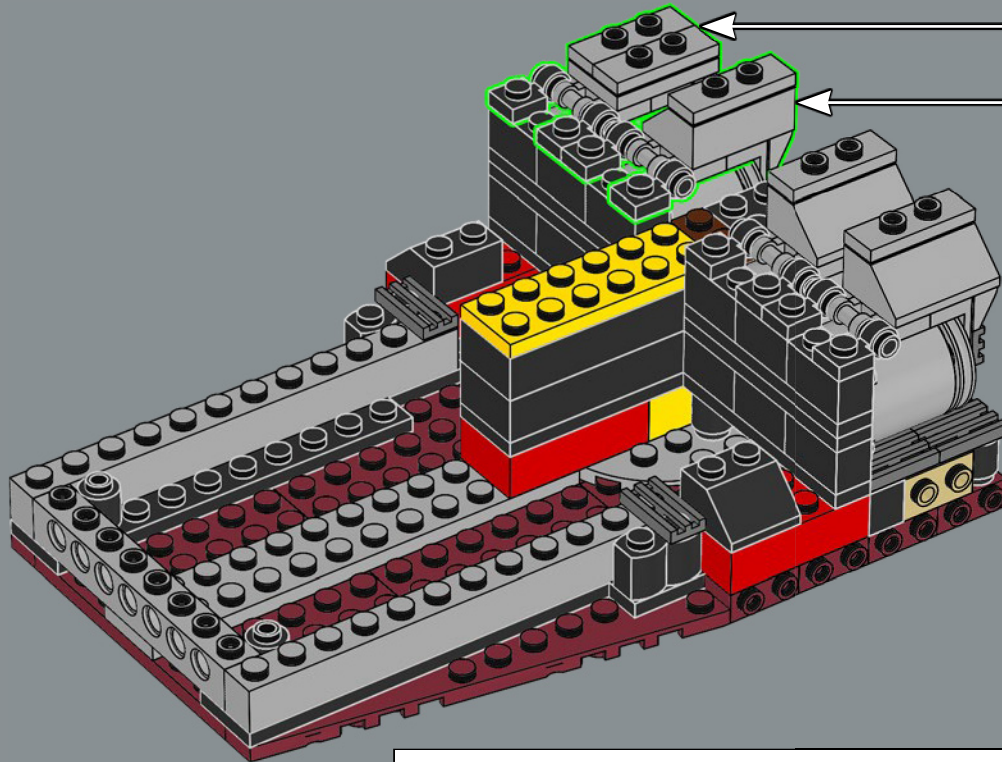

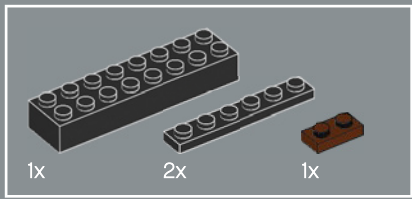

157

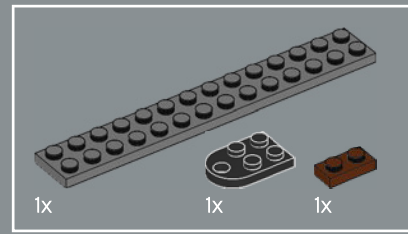
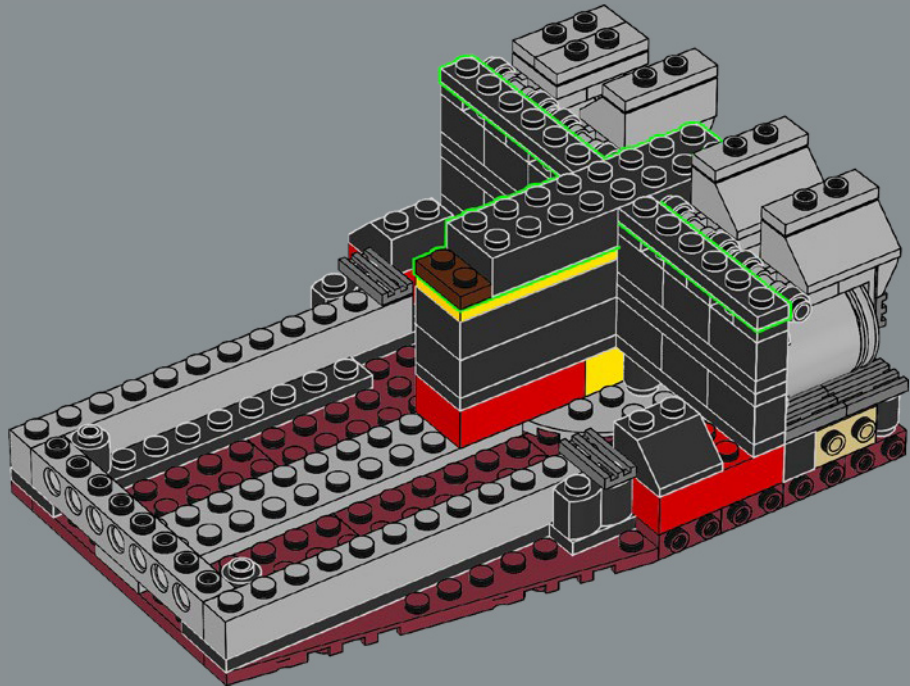

158

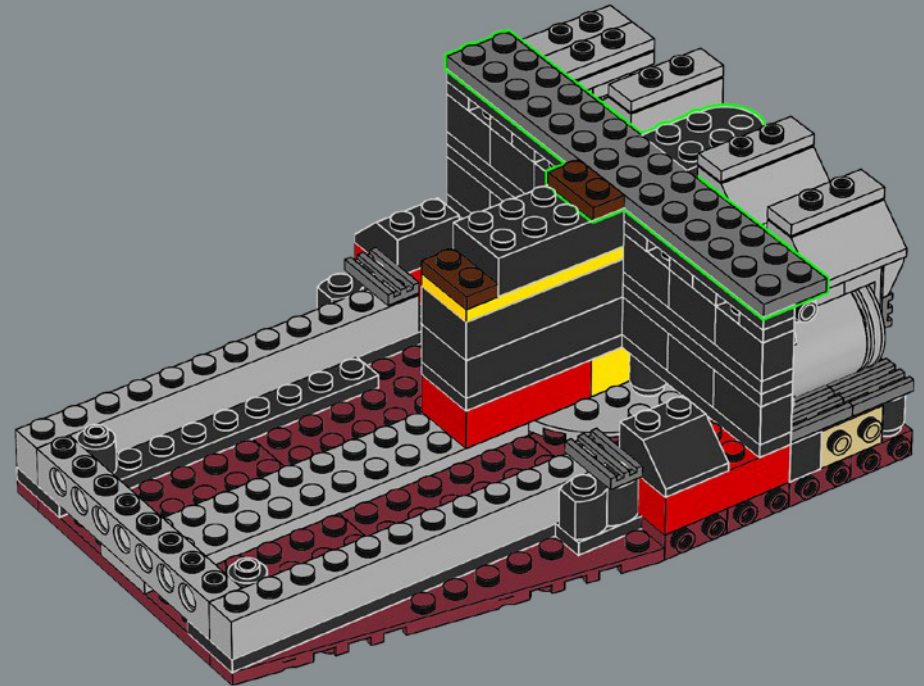

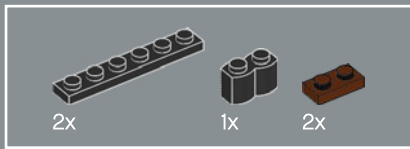

159

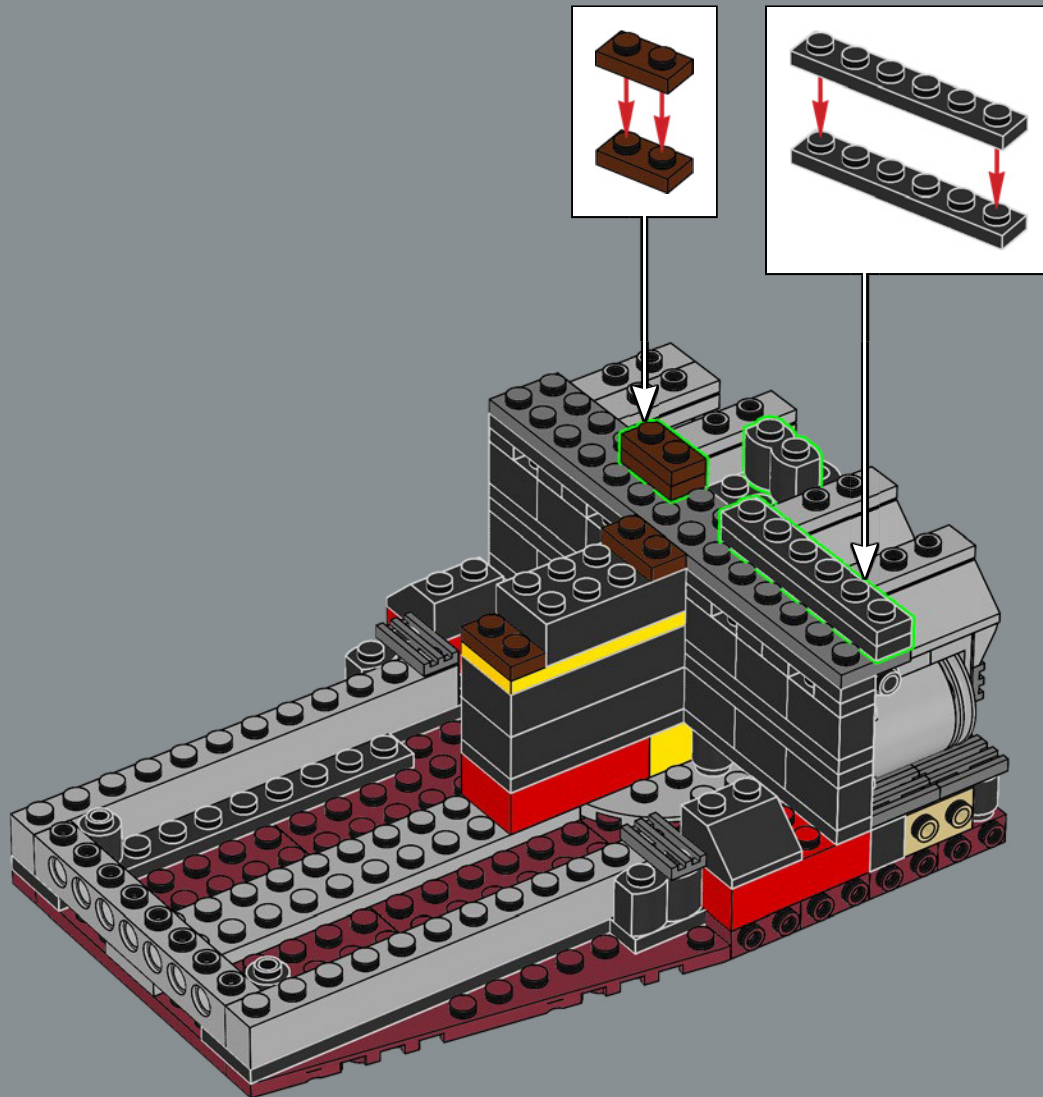

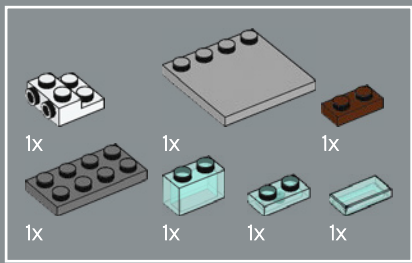

160

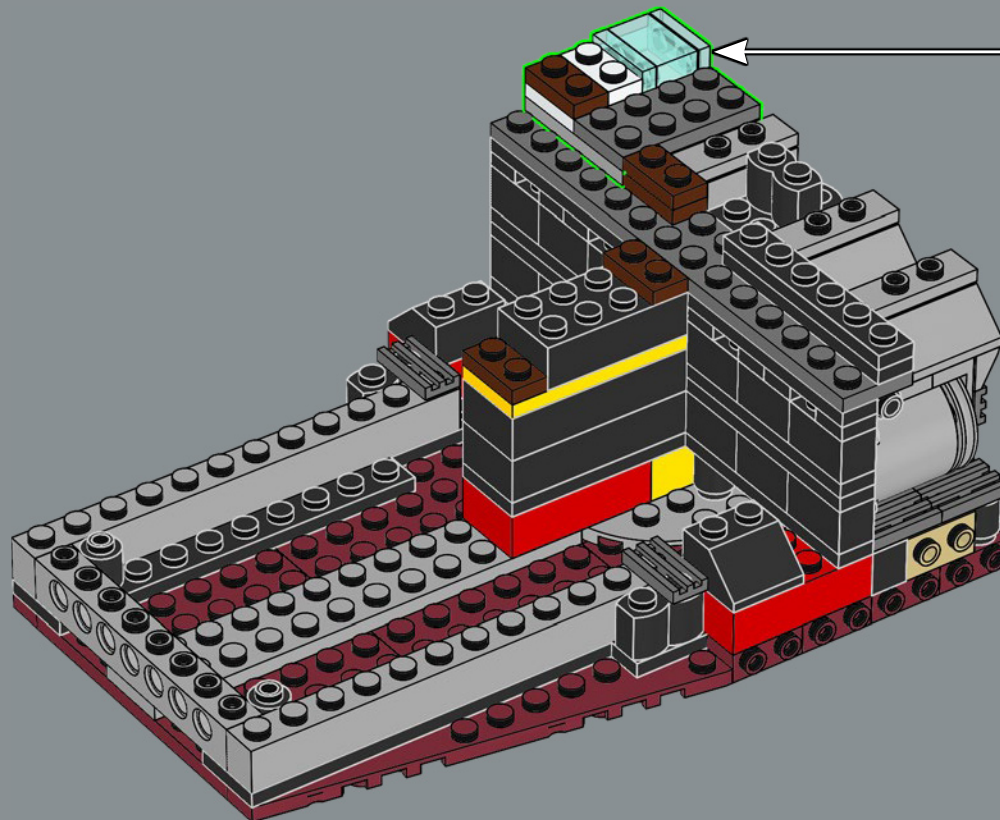
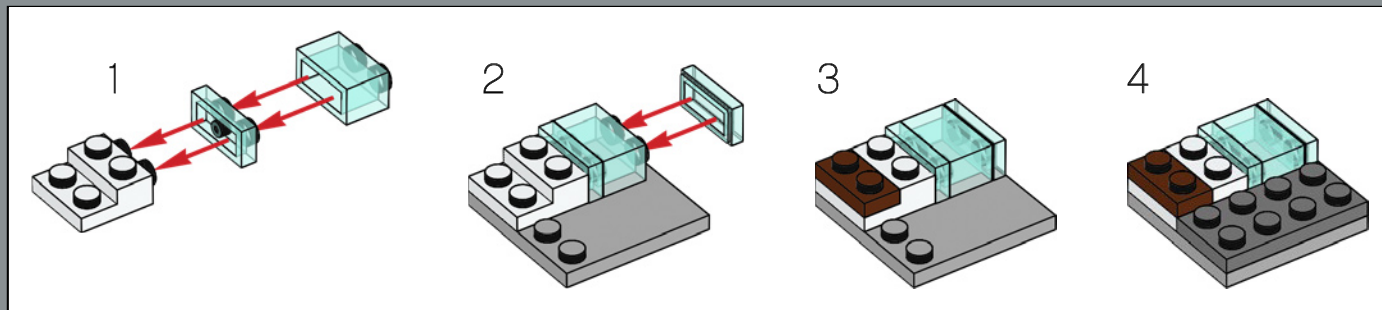

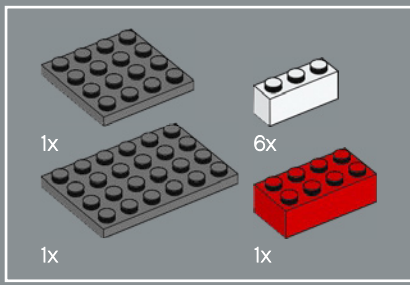

161

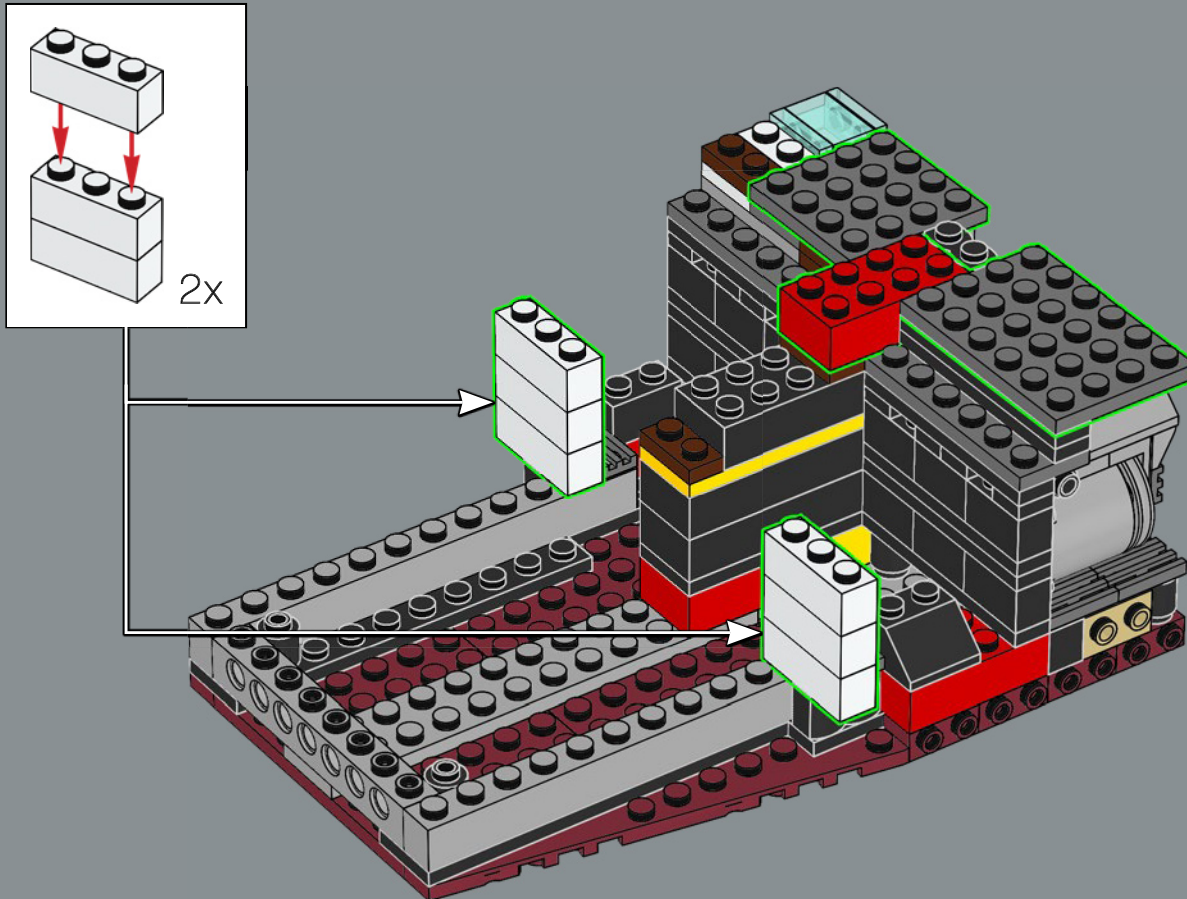

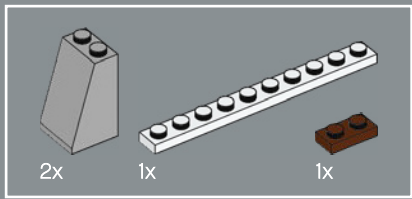

162

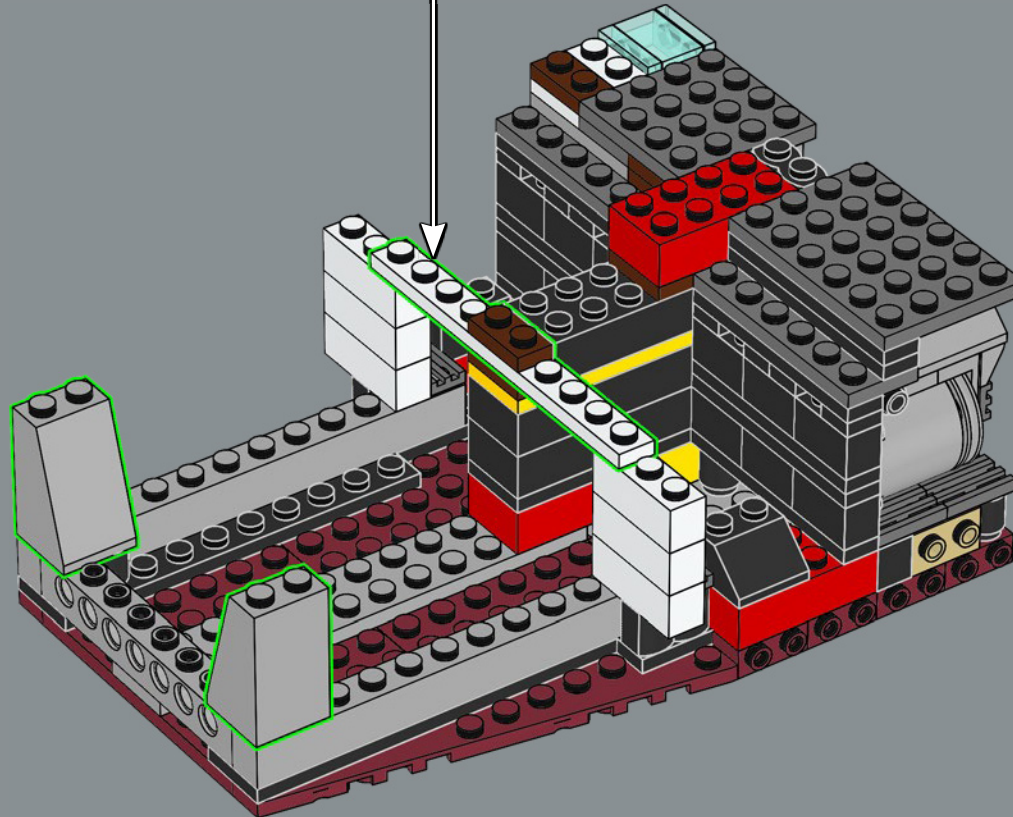
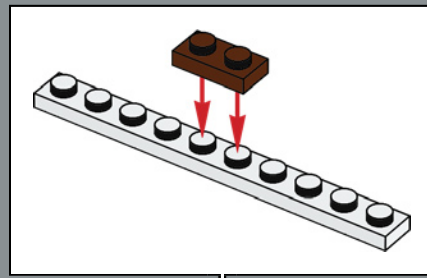

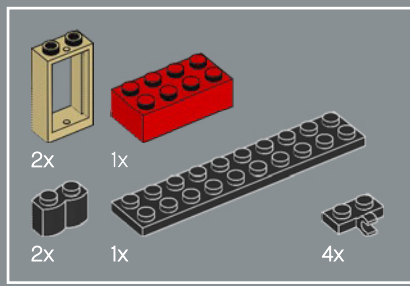

163

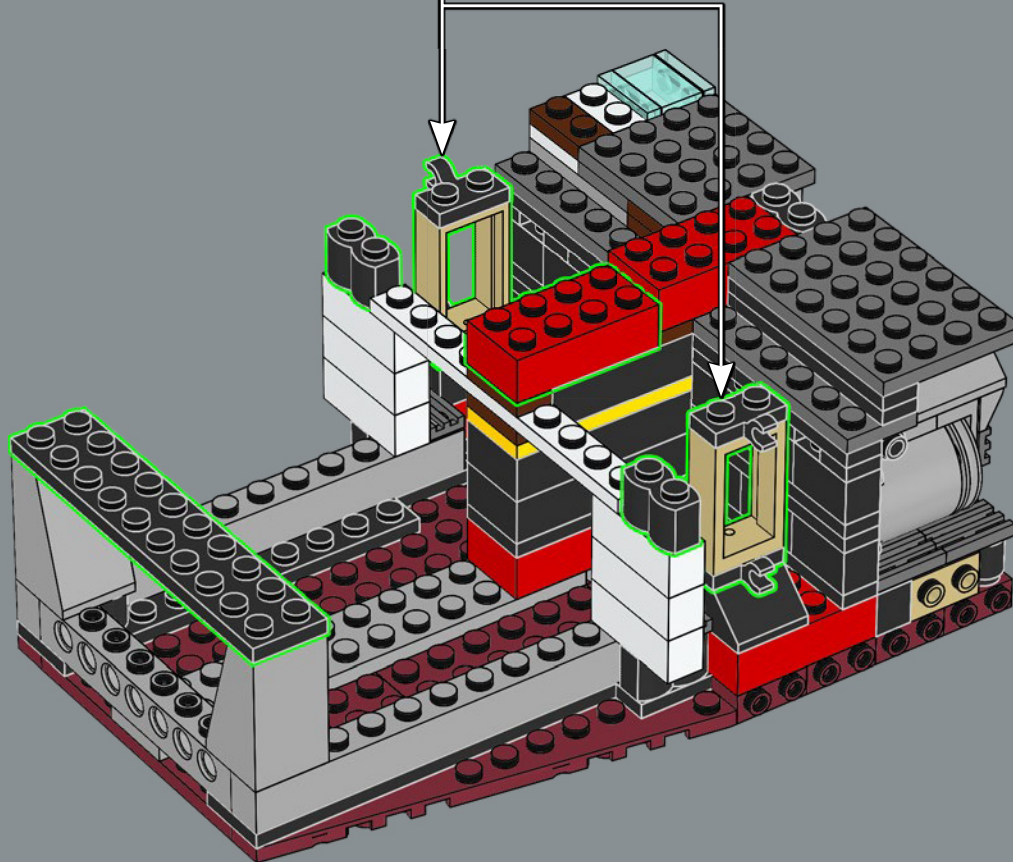
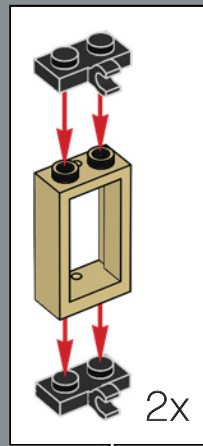

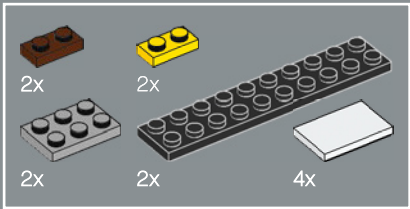

164

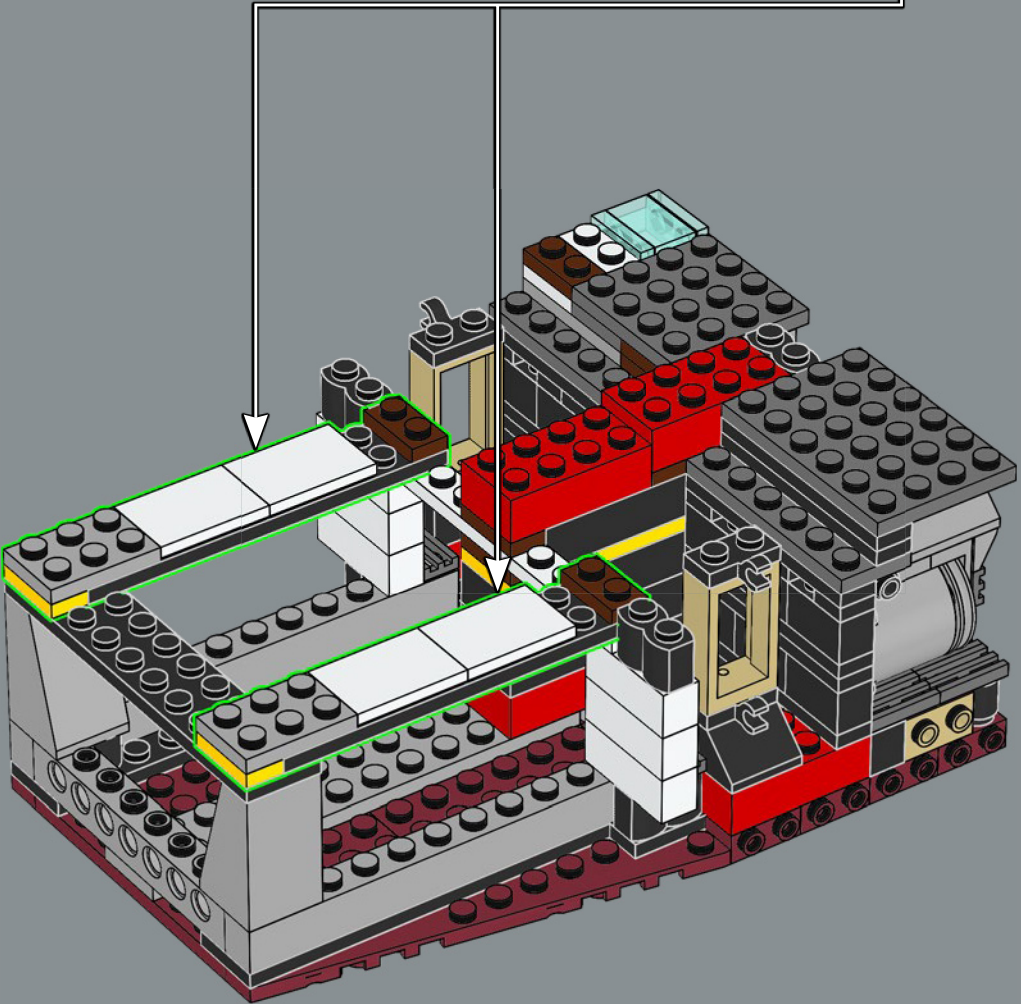
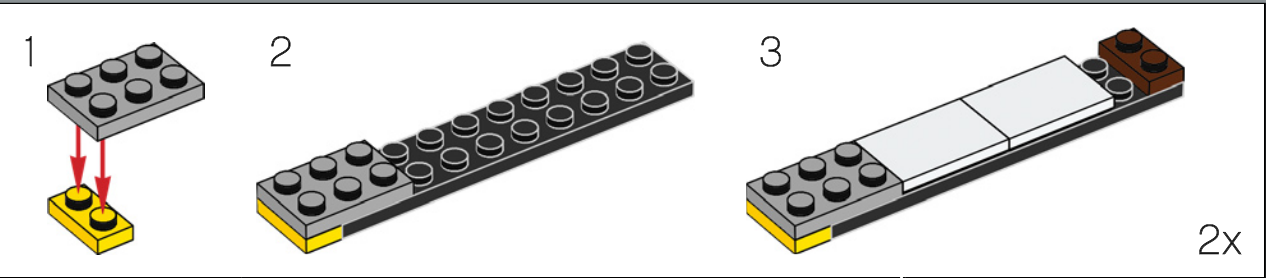

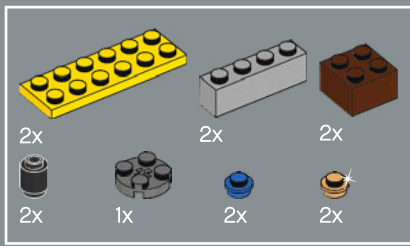

165

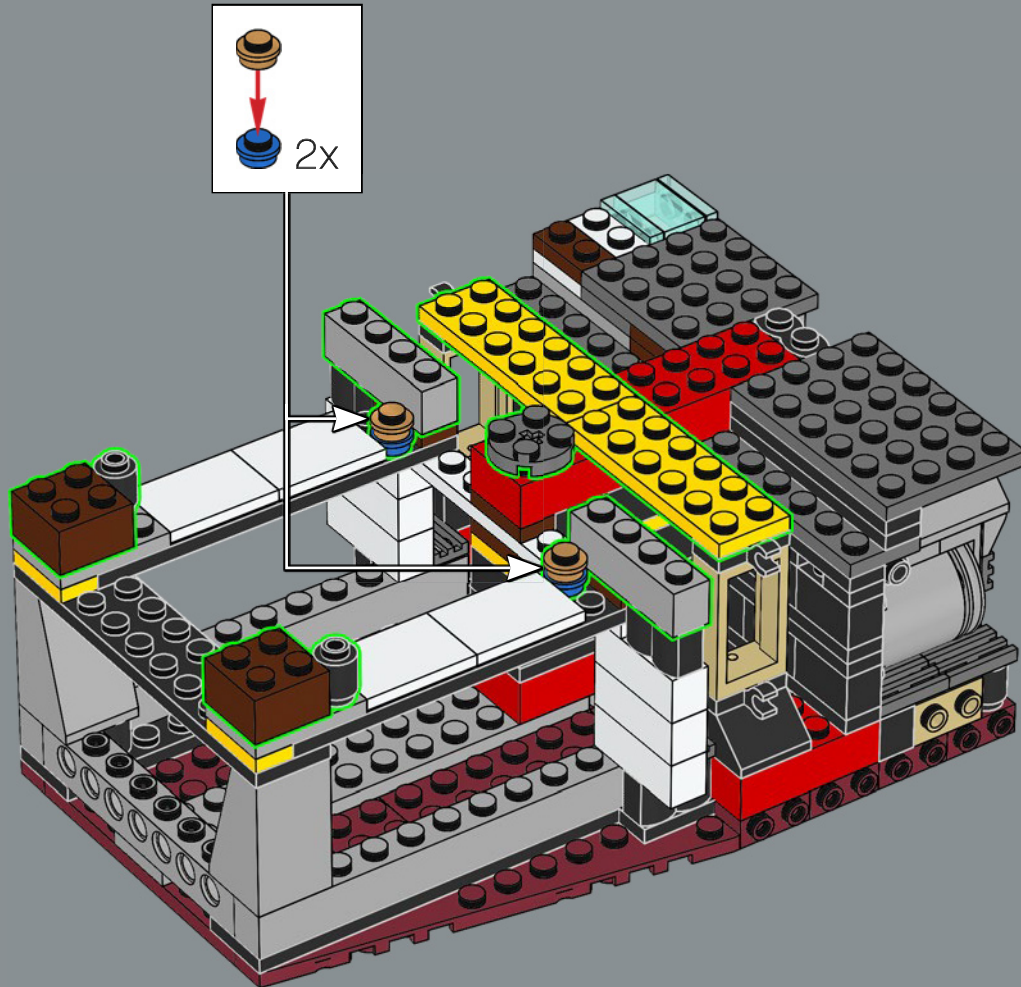

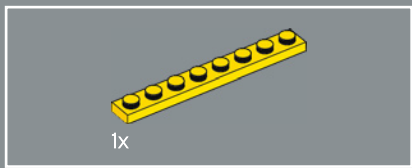

166

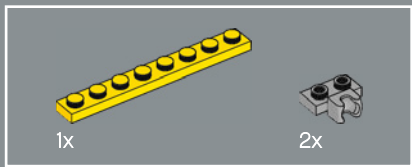
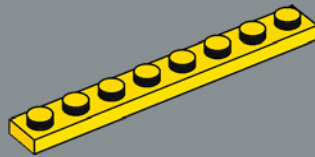

167

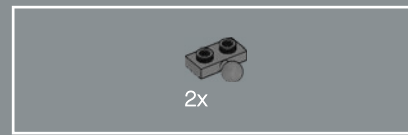
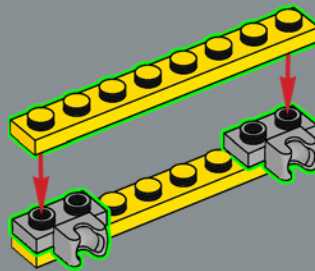

168

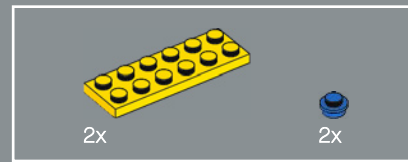
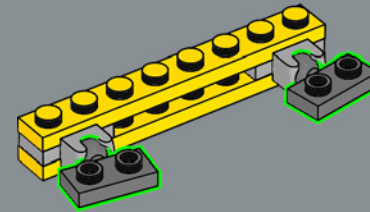

169

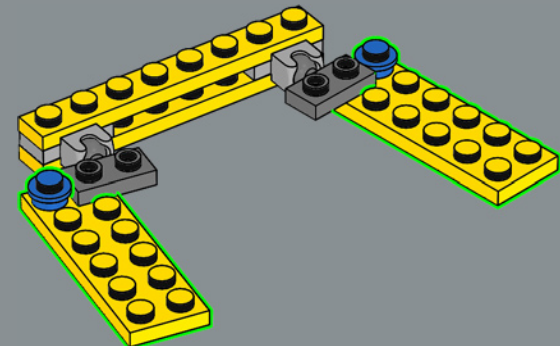

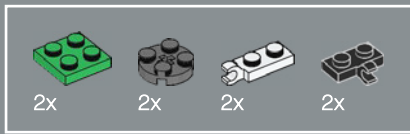

170

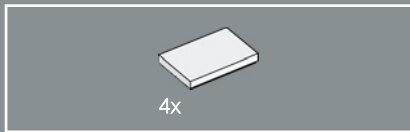
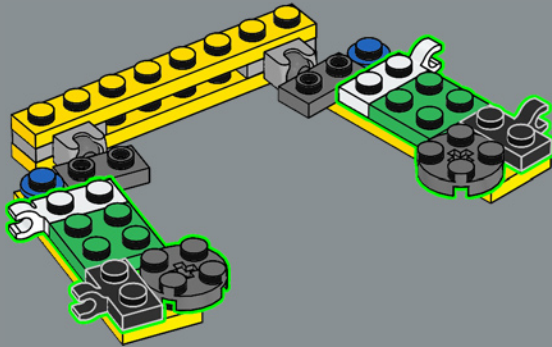

171

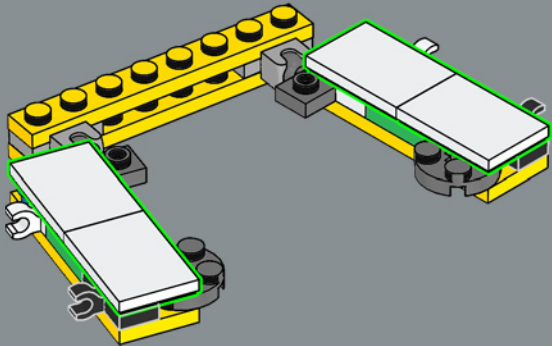

172

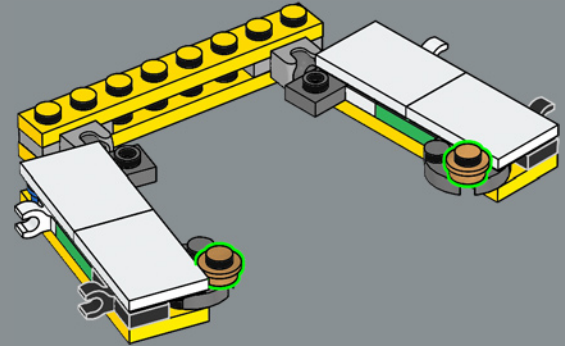

173

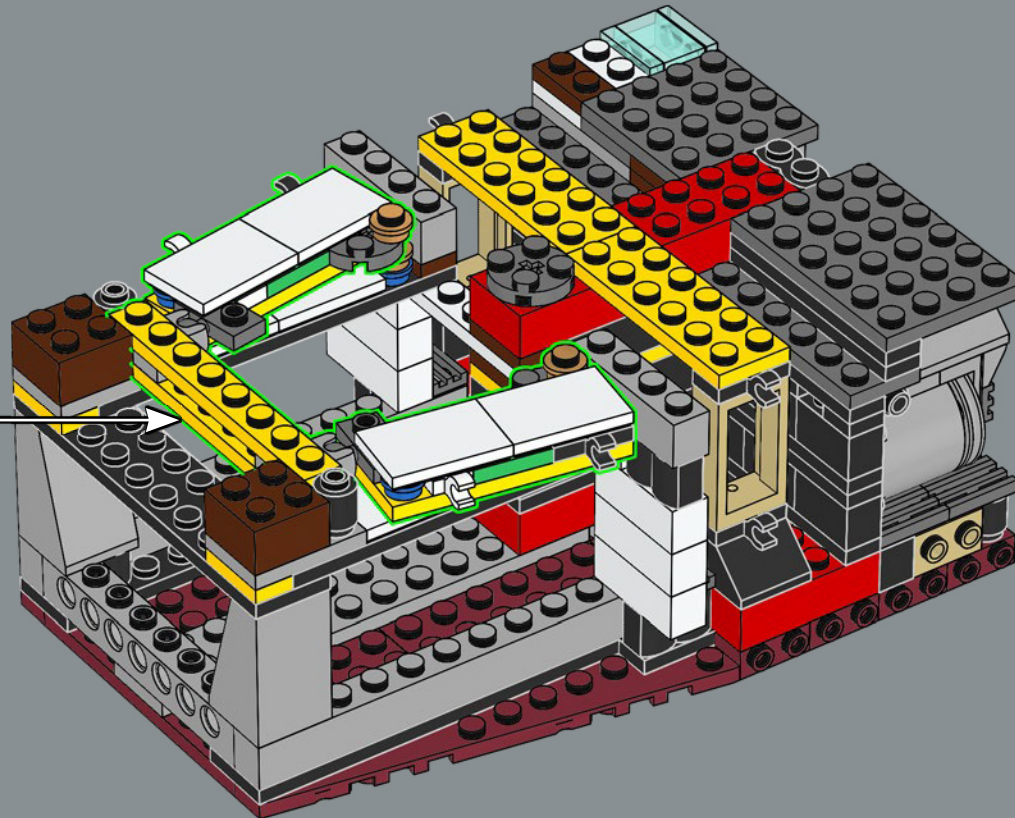

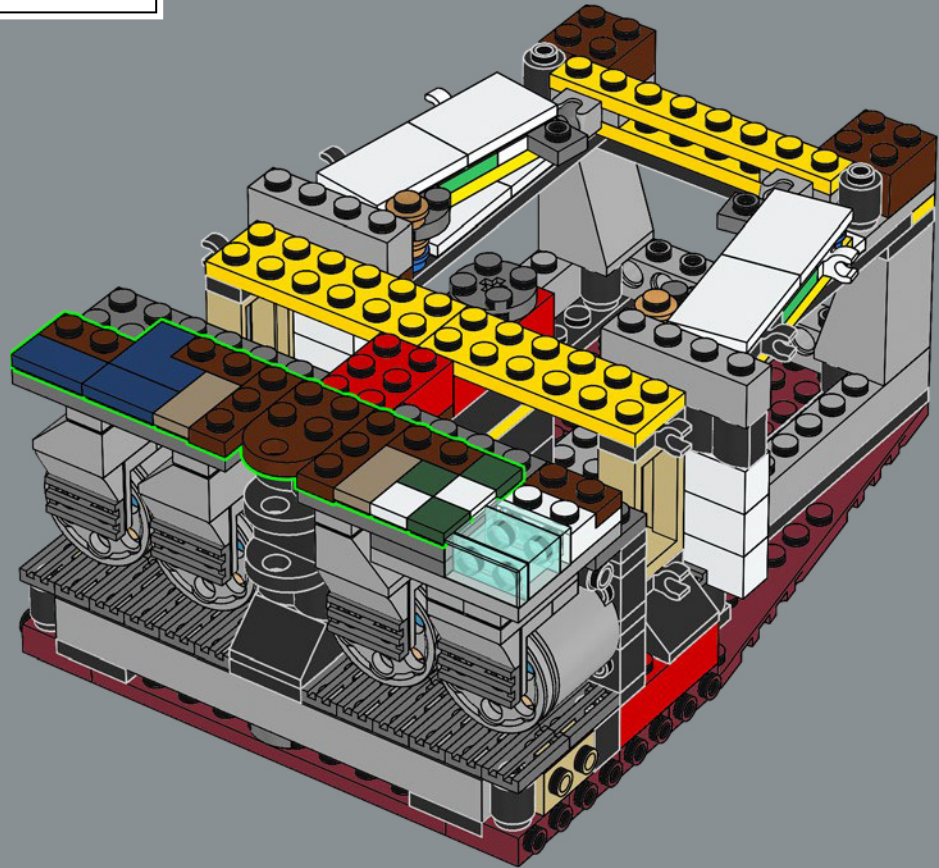
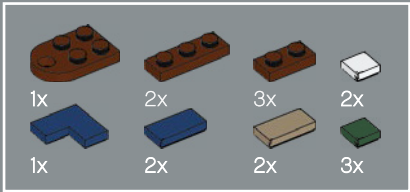
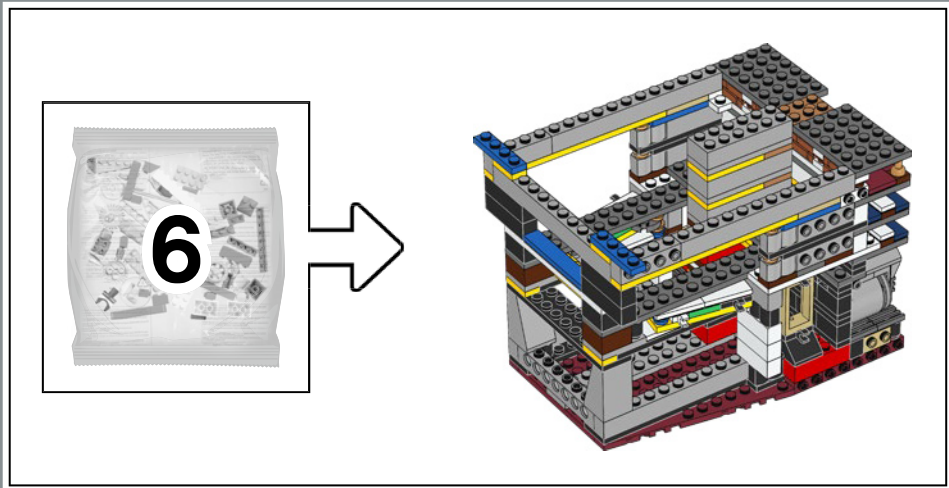

174

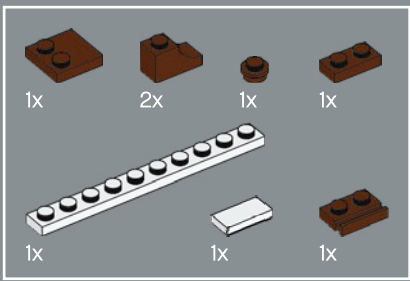

175

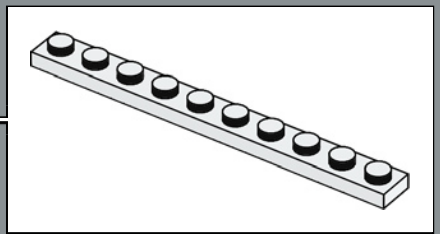
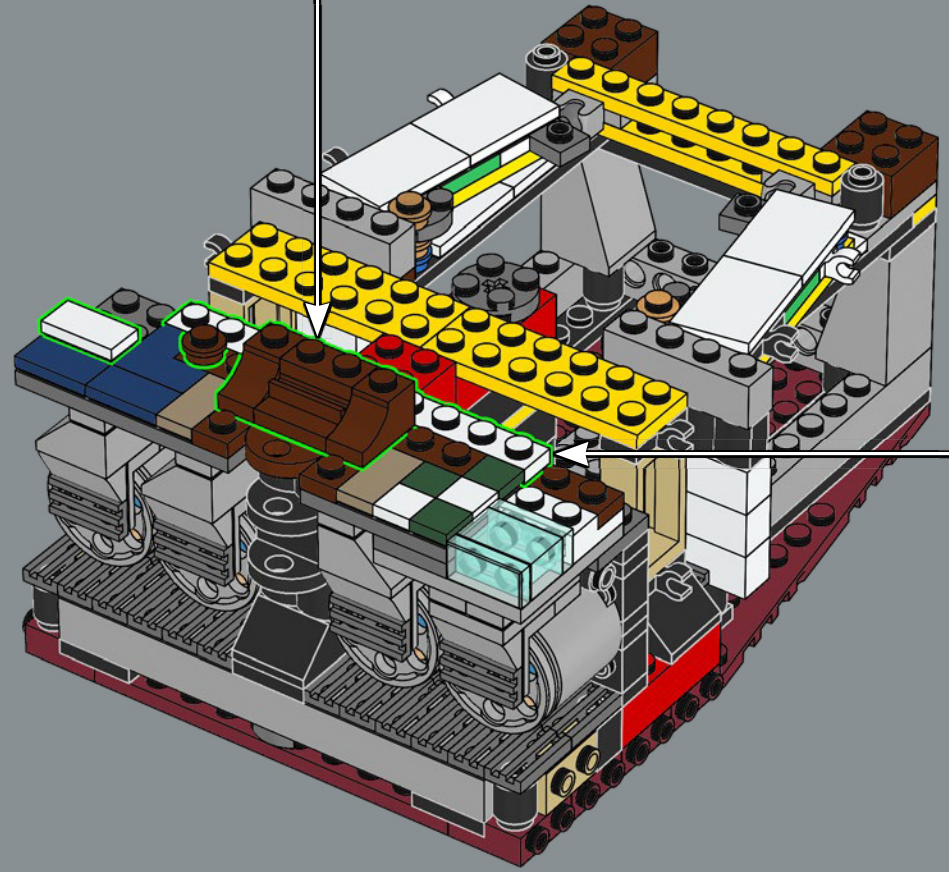
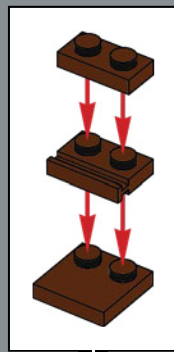

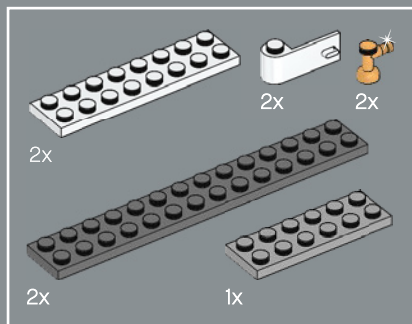

176

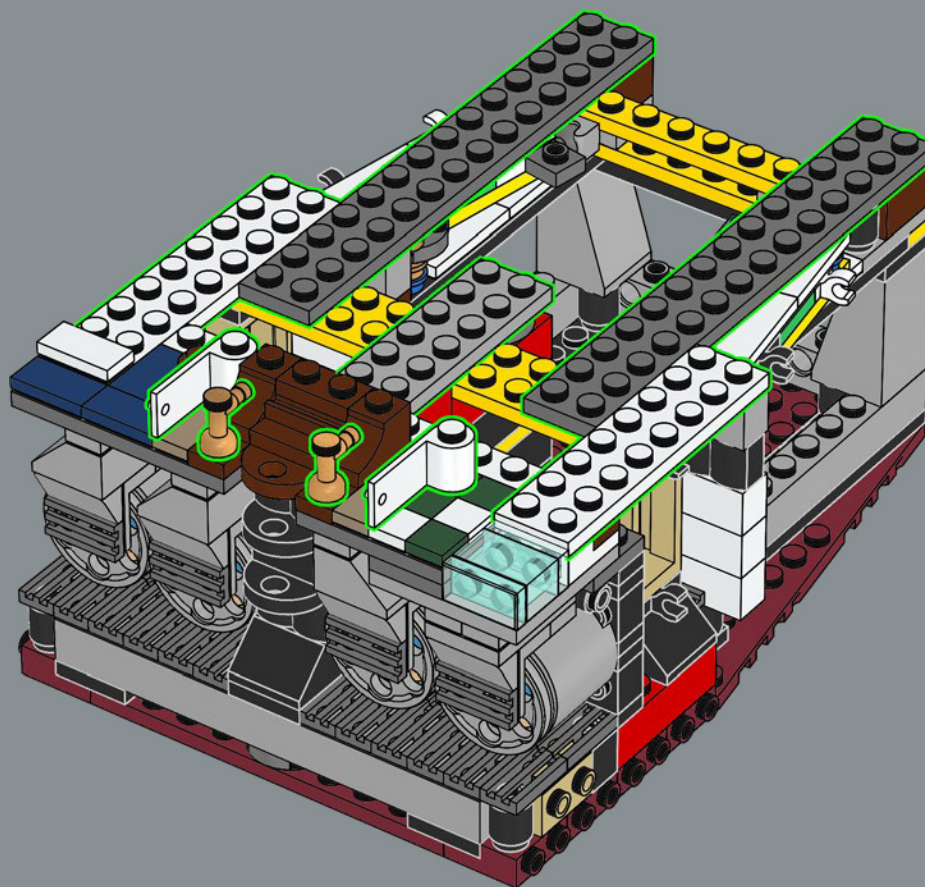

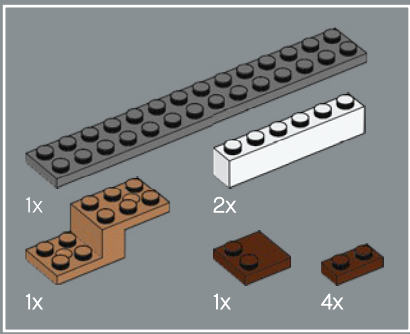

177

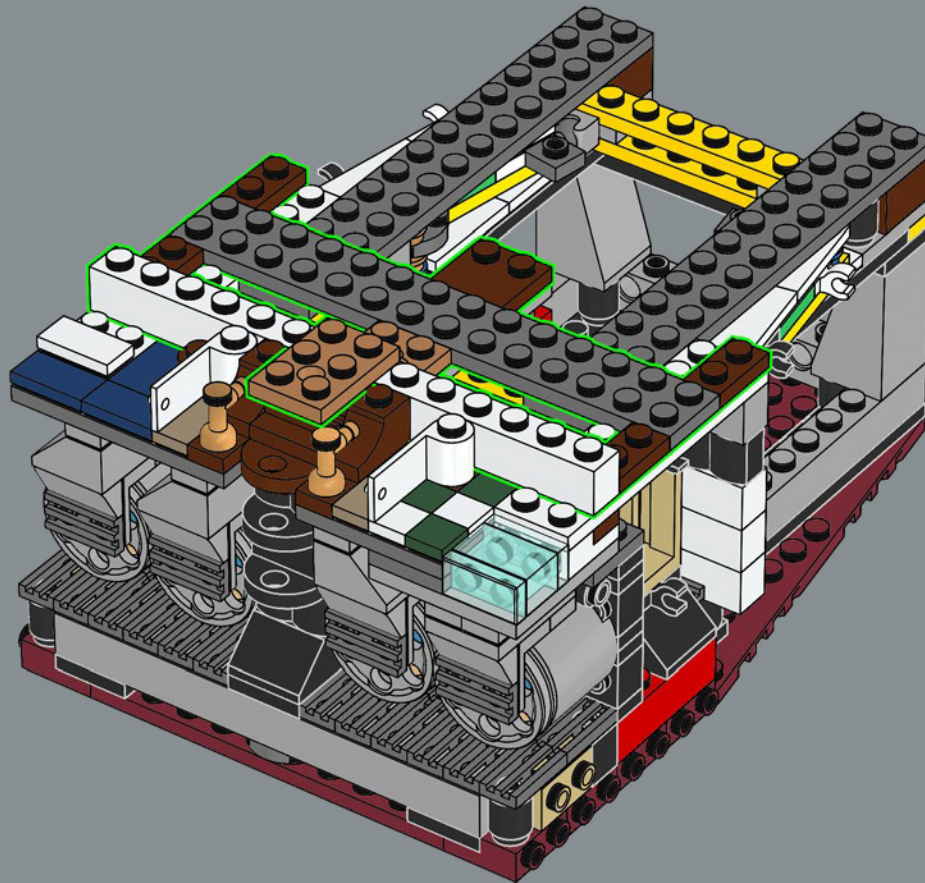

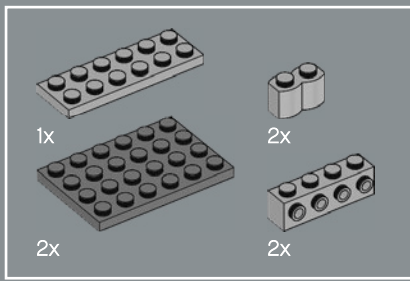

178

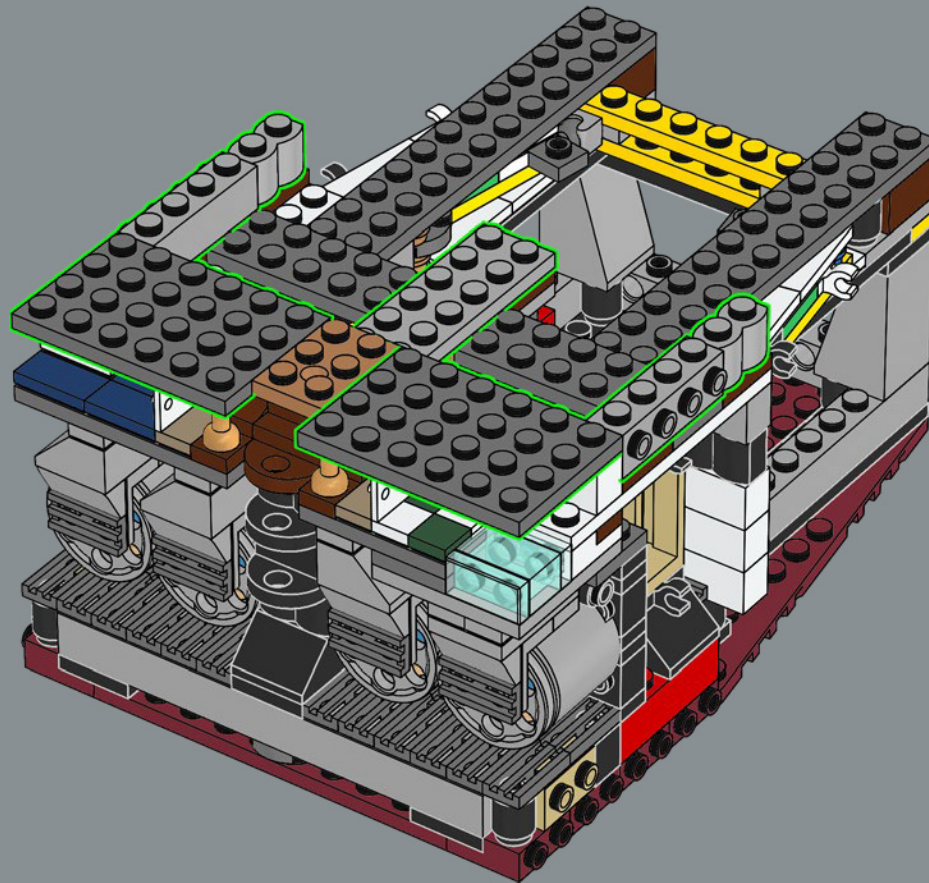

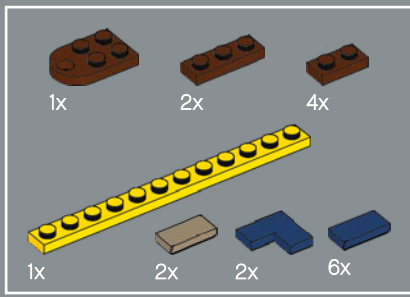

179

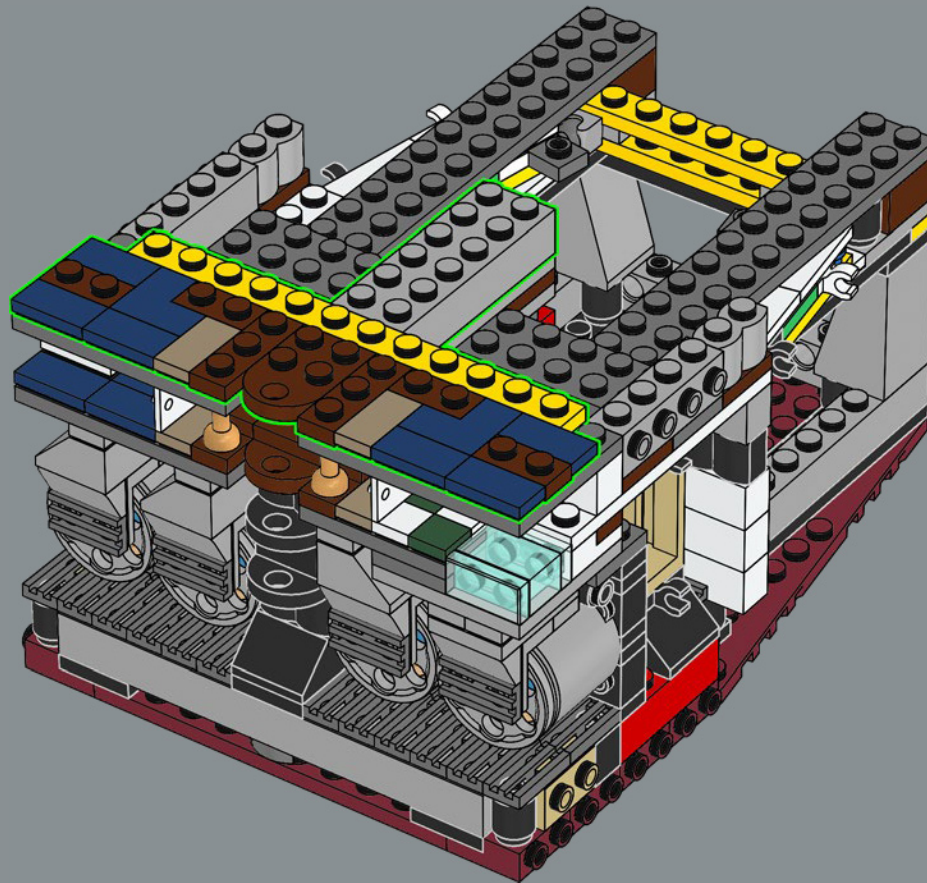

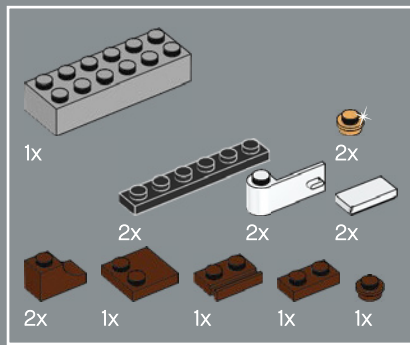

180

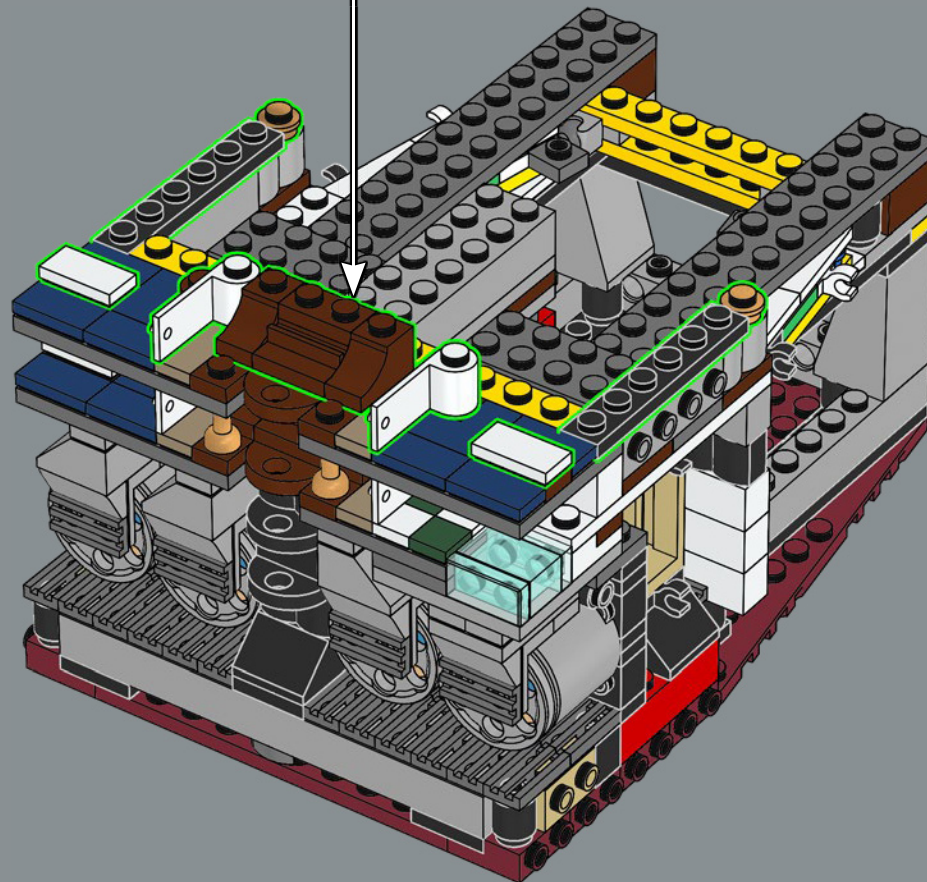
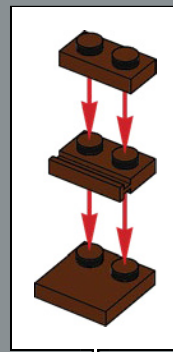

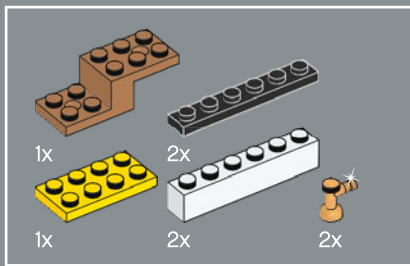

181

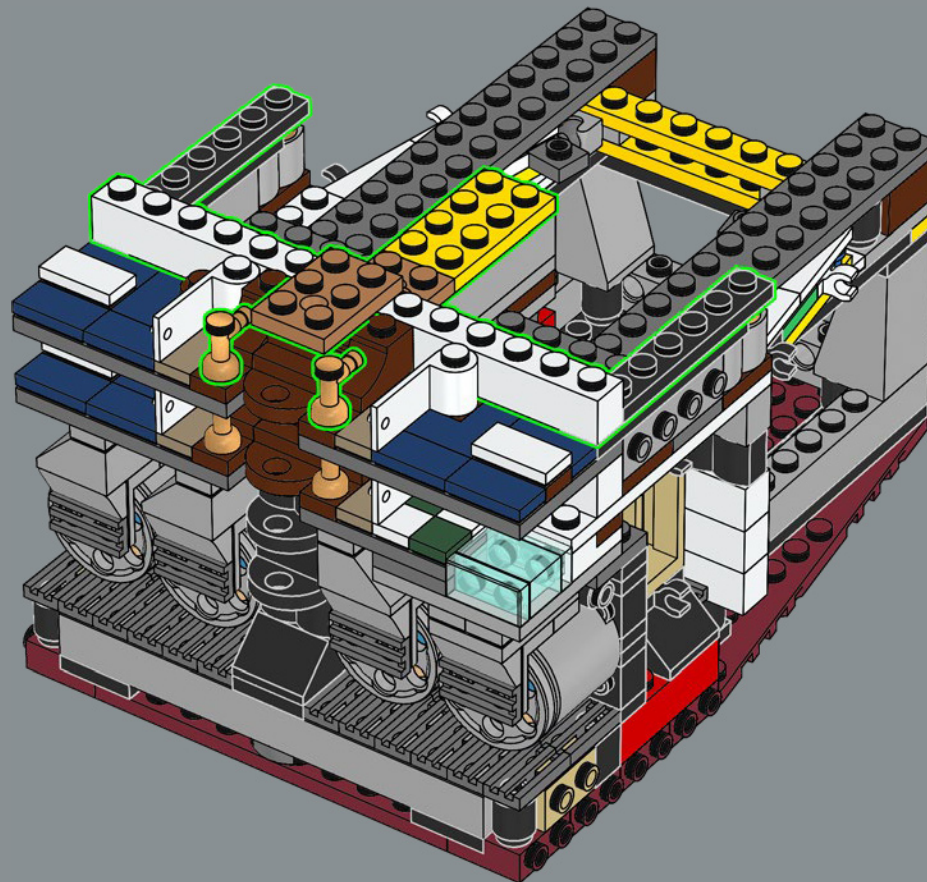

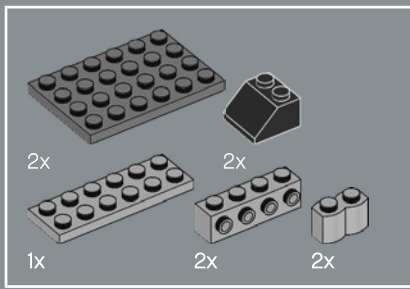

182

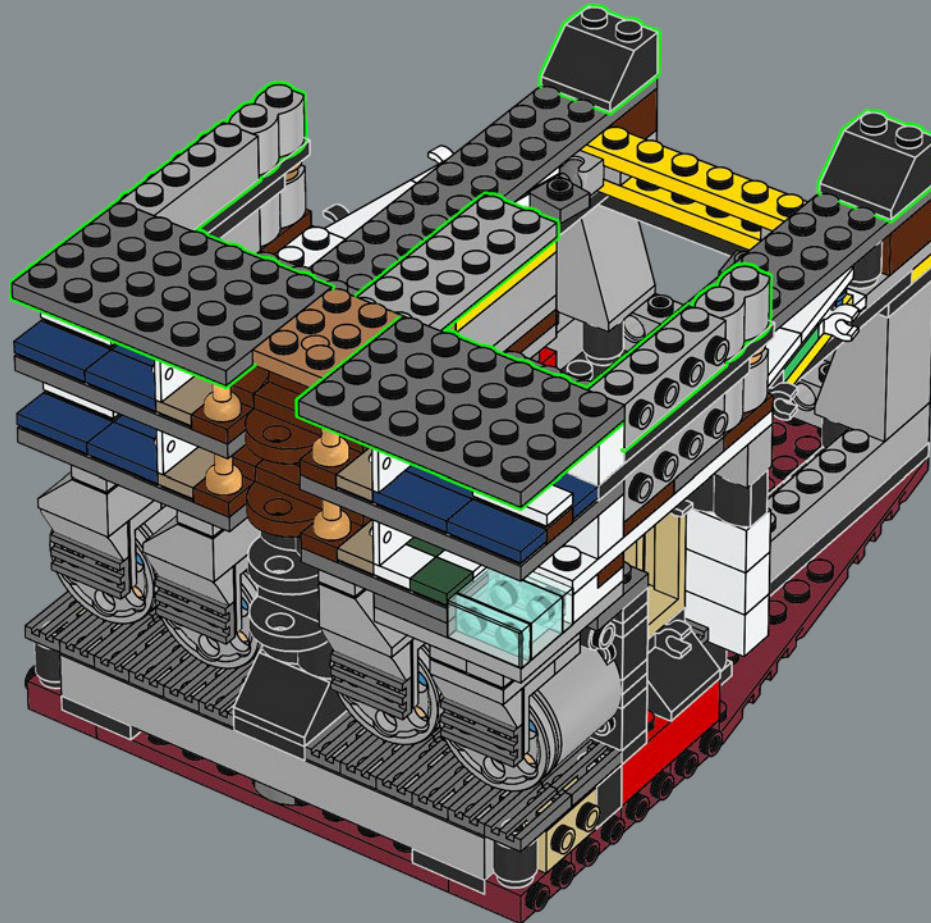

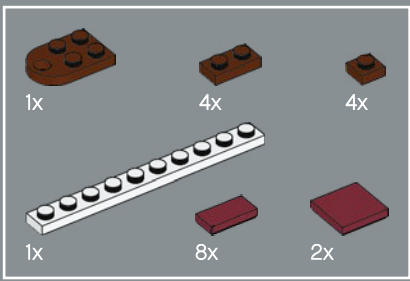

183

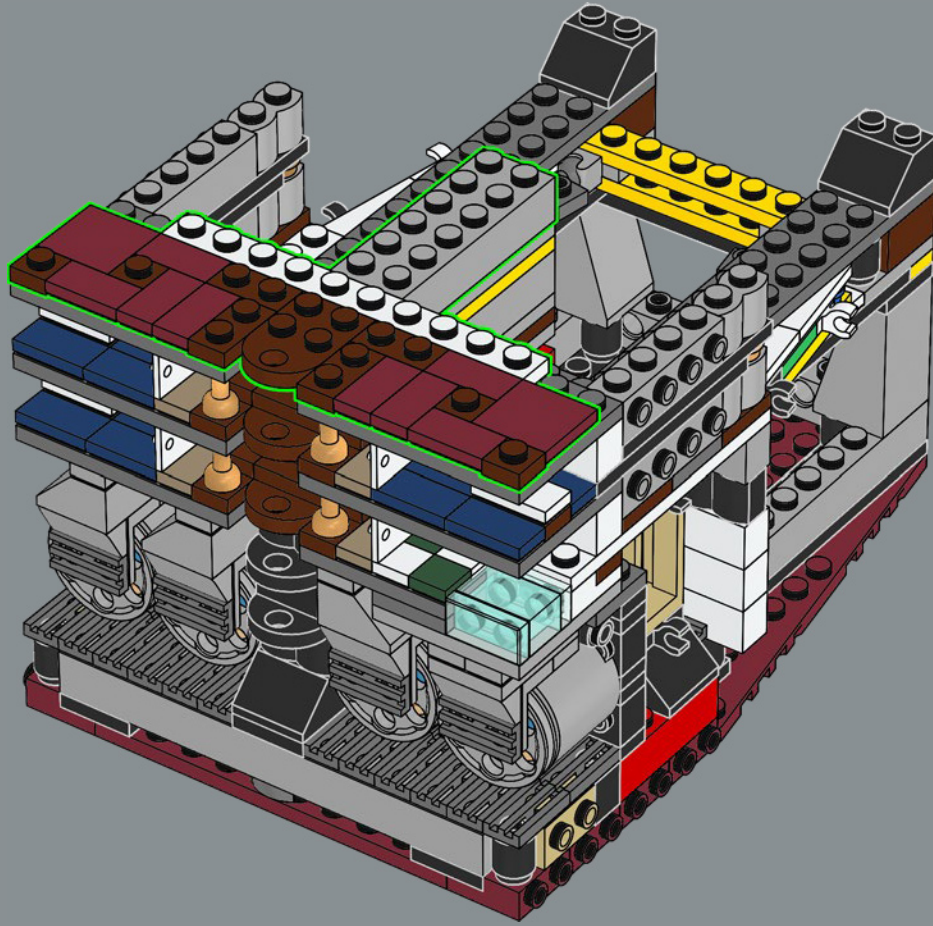

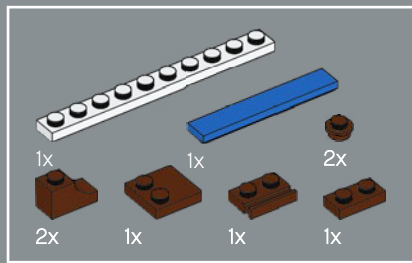

184

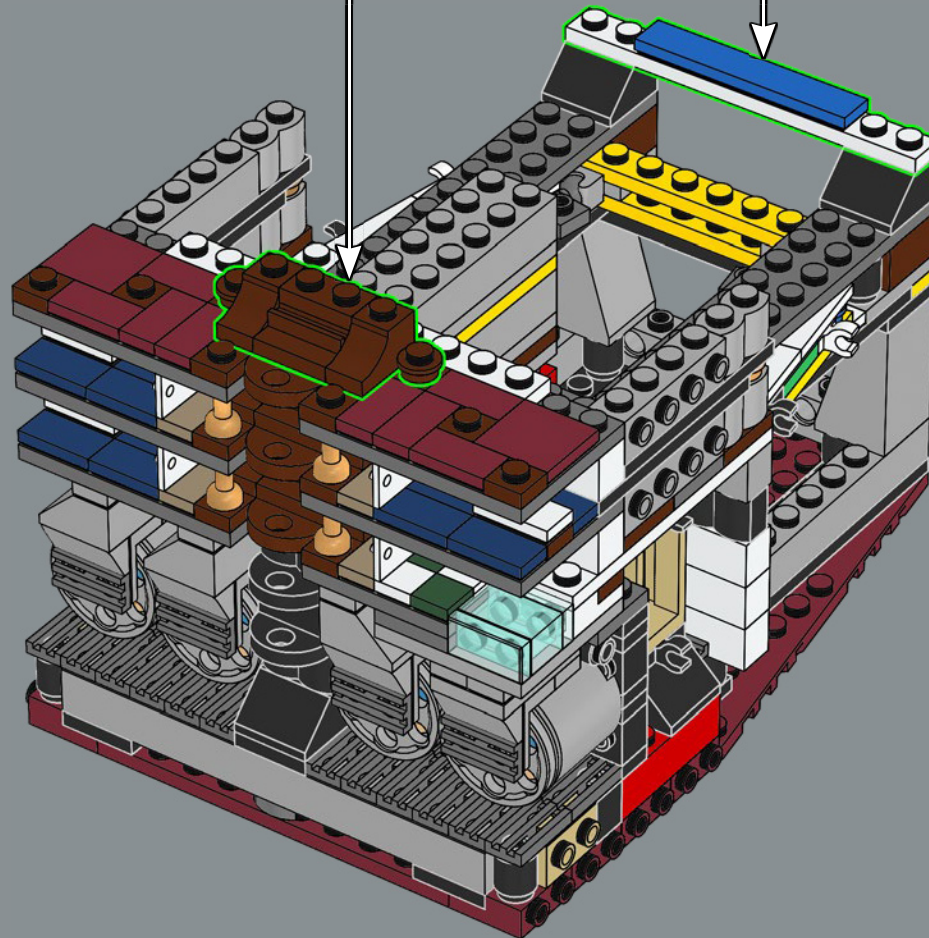
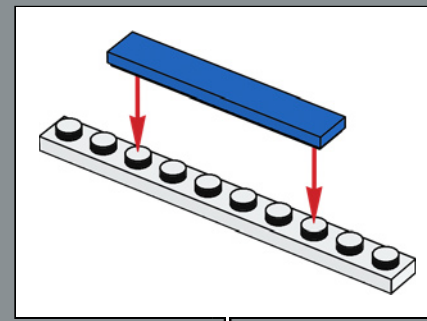
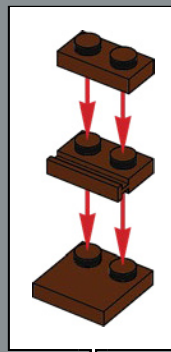

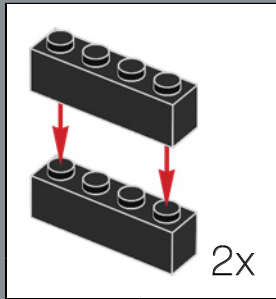
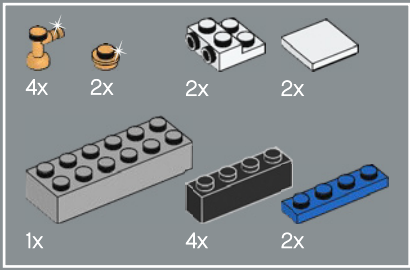

185

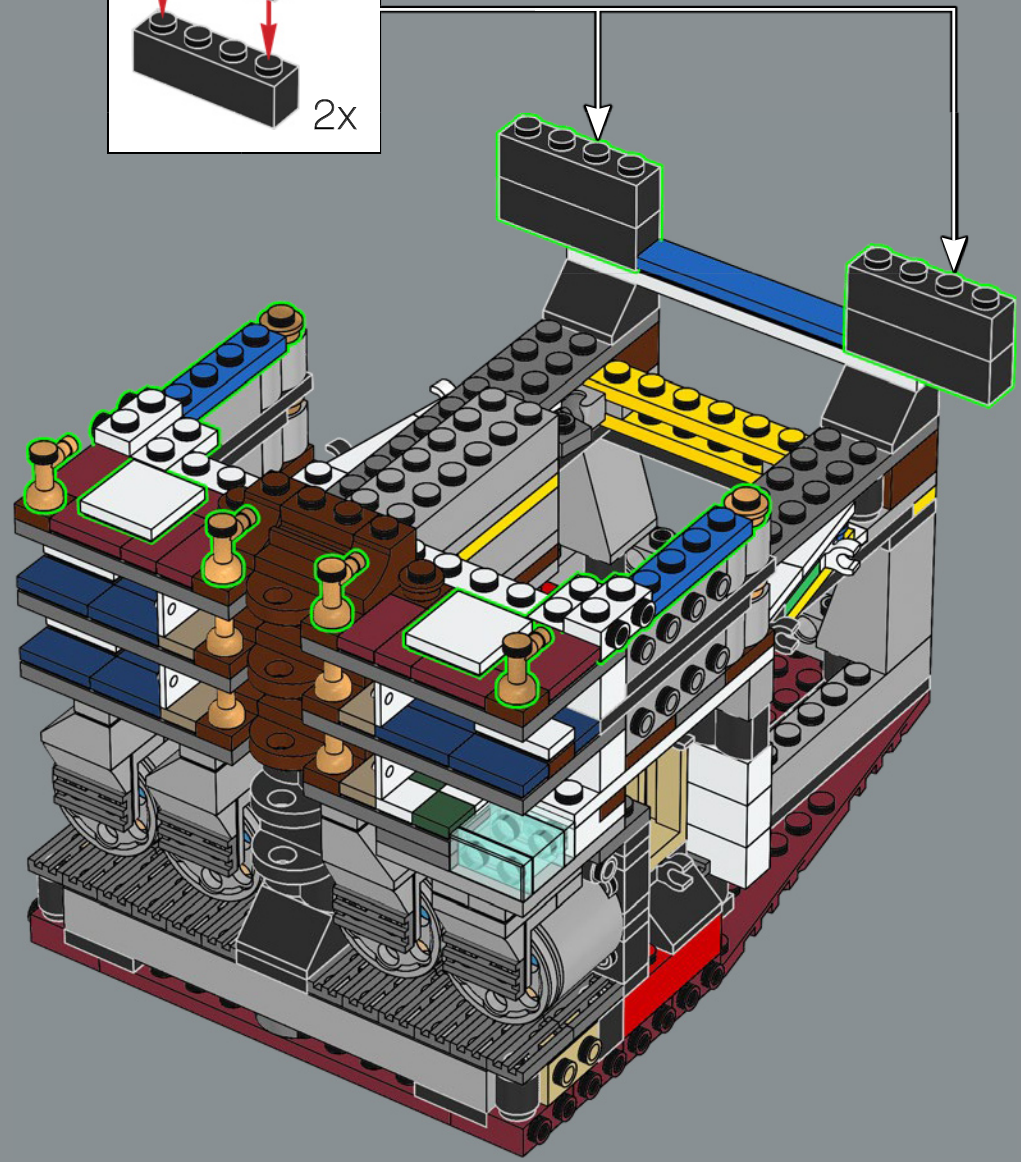

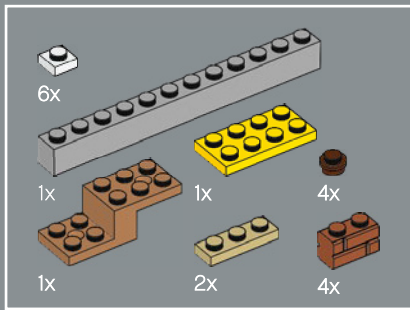

186

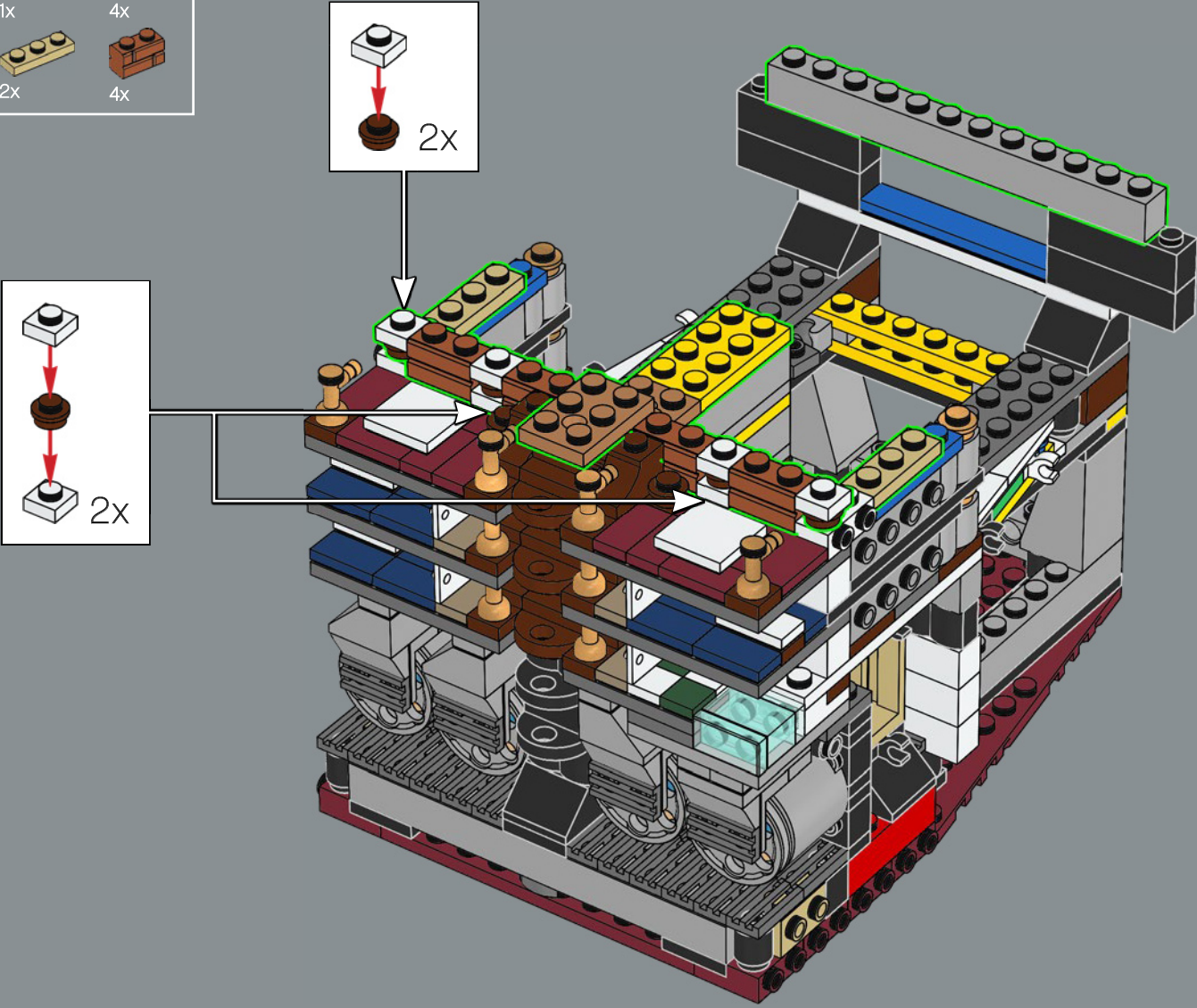

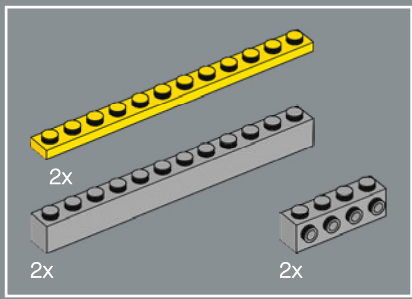

187

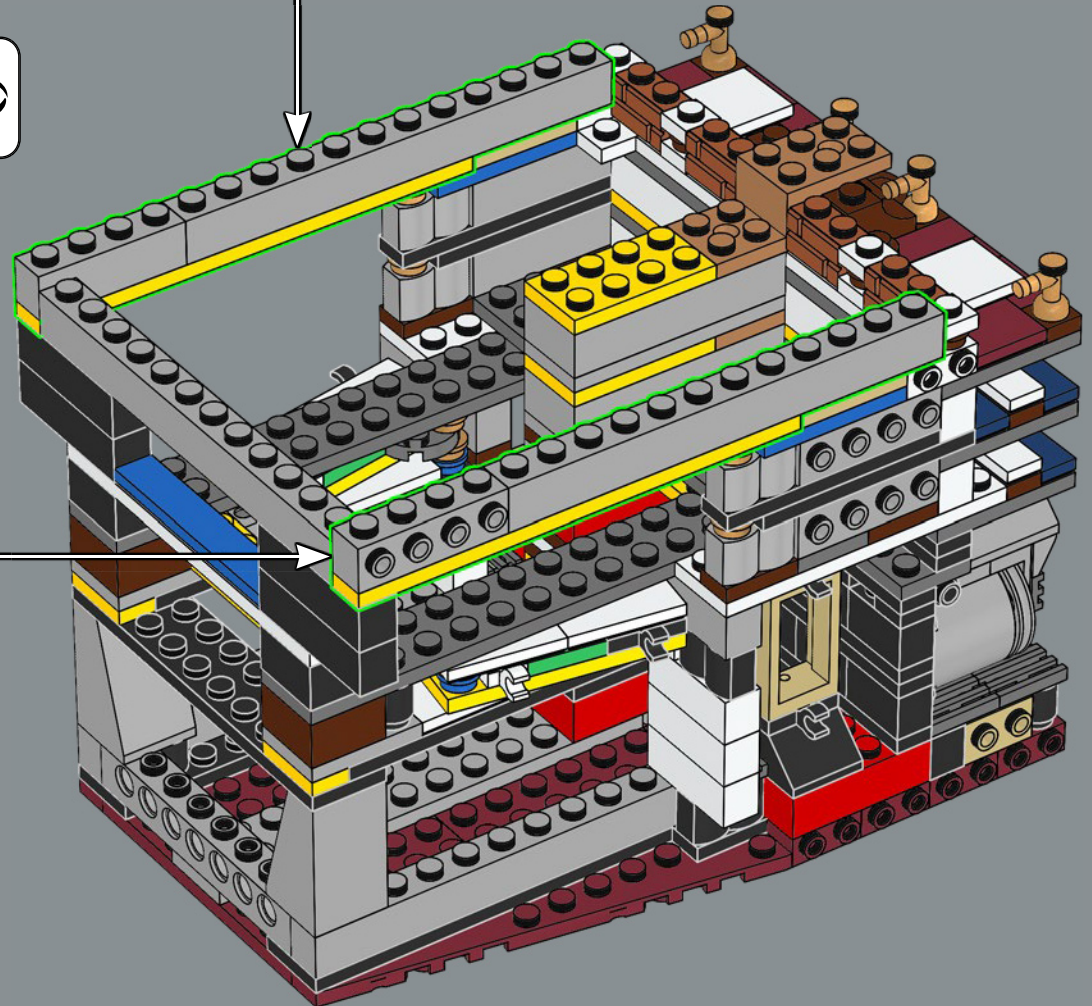
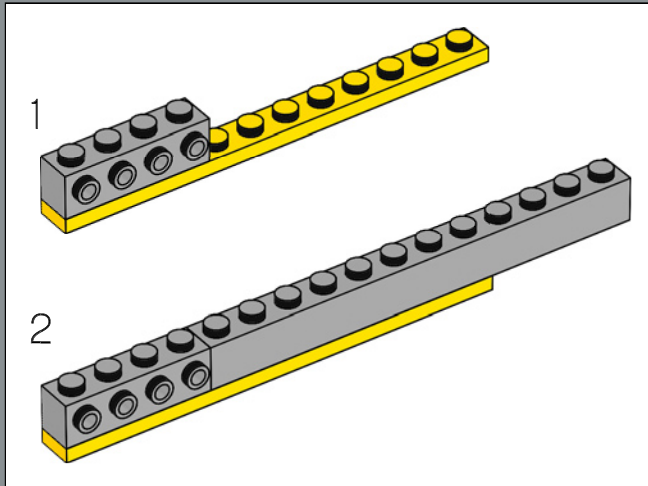
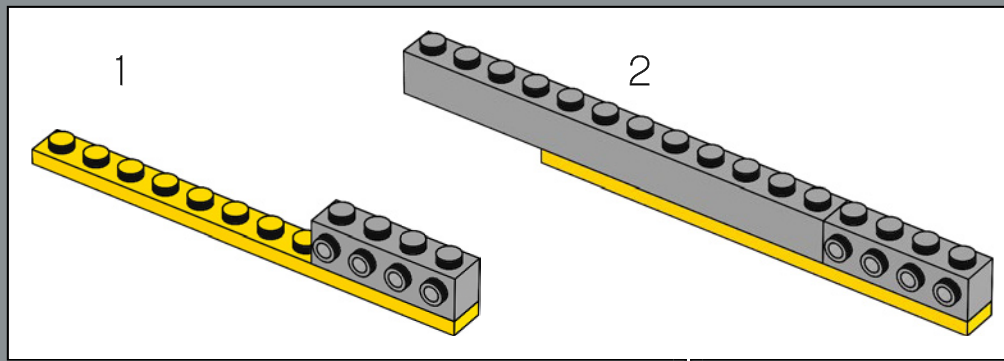

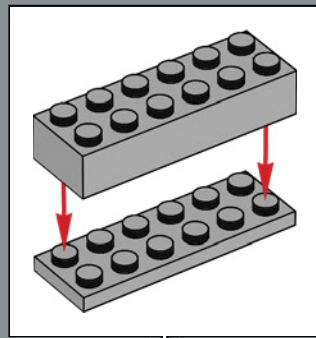
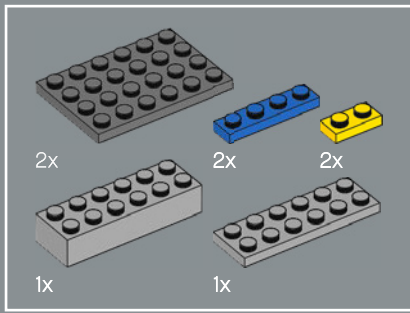

188

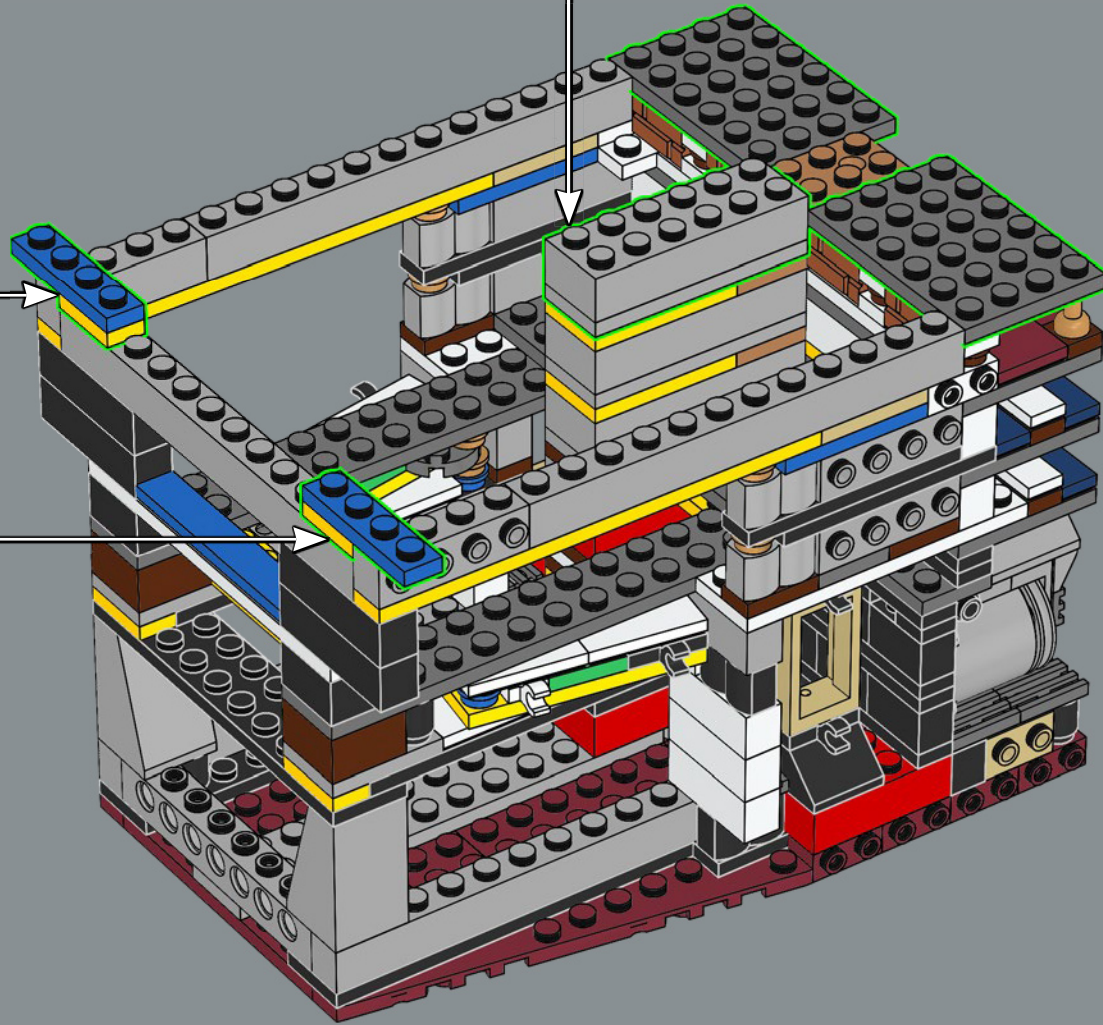
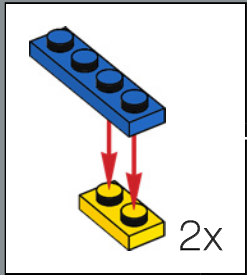

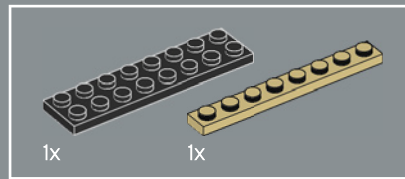
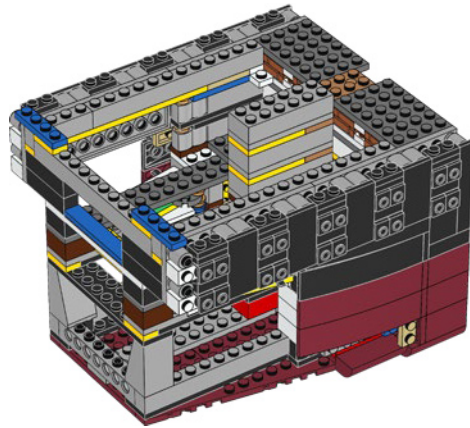
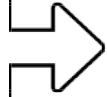

190

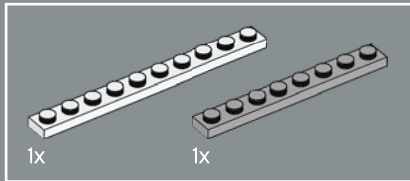
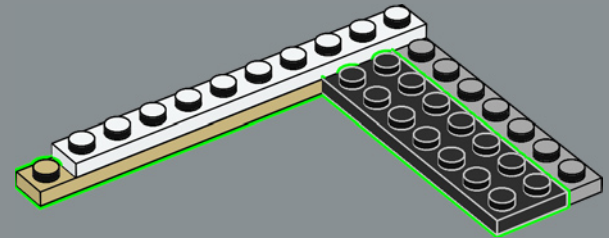

189

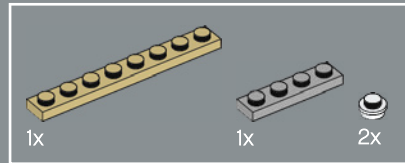
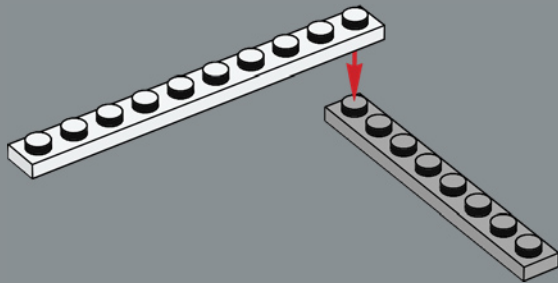

191

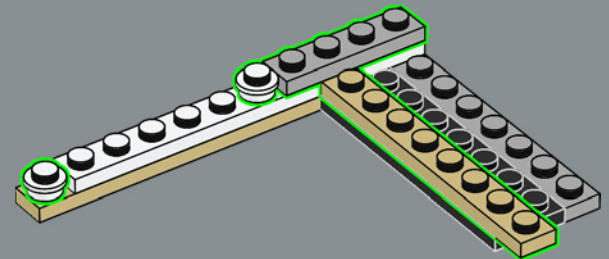

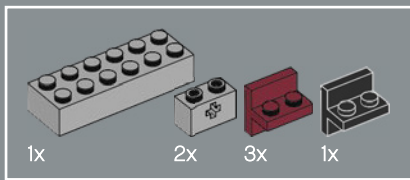

192

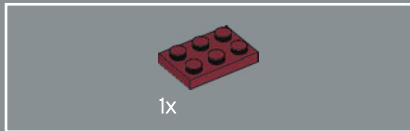
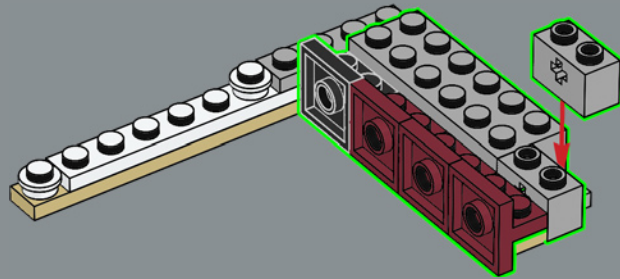

193

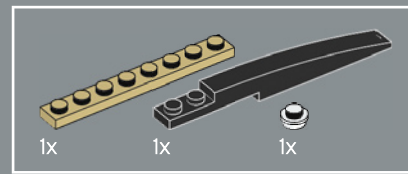
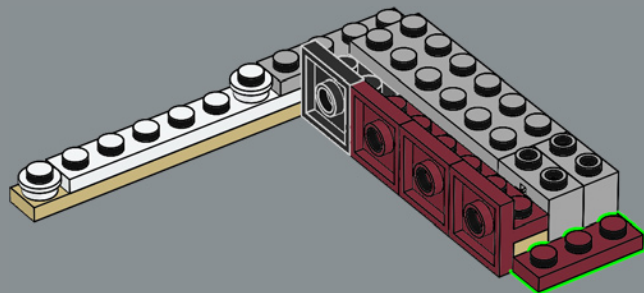

194

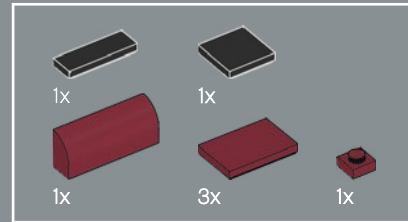
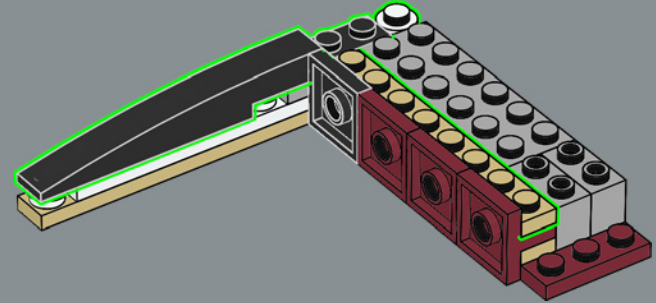

195

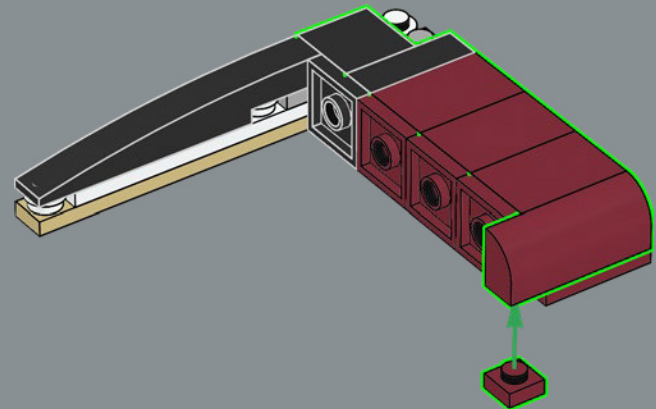

196

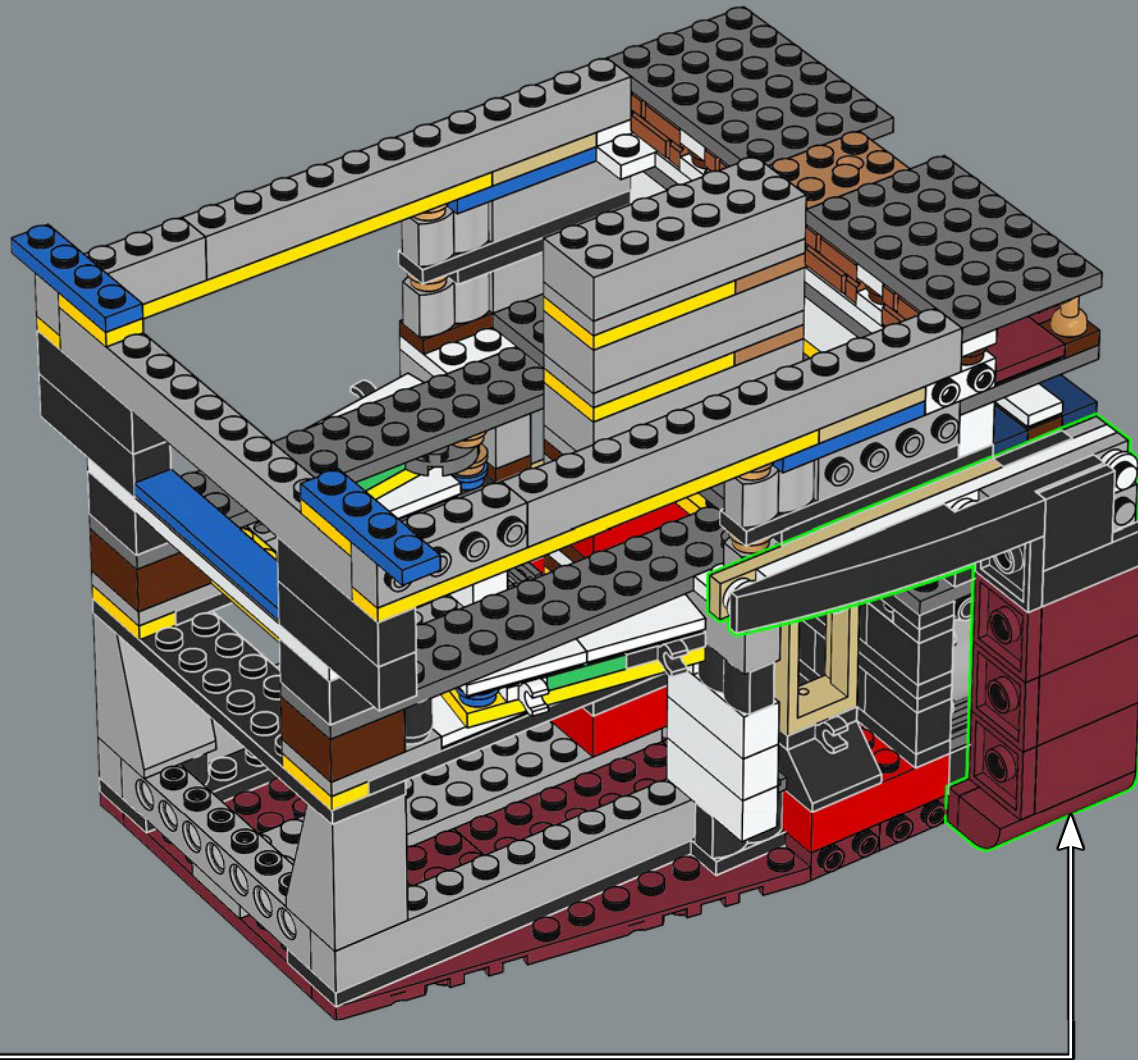

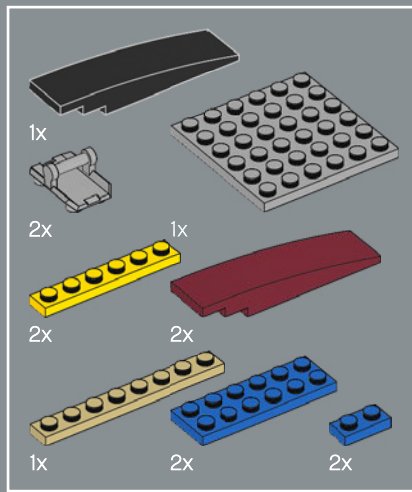

197

1

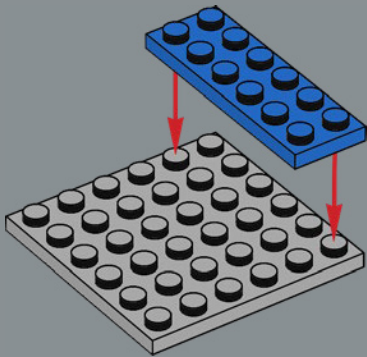

2

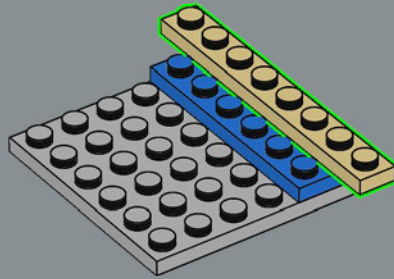

3

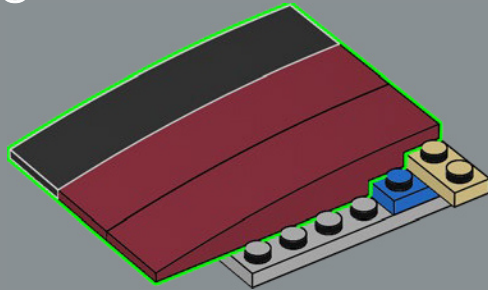

4

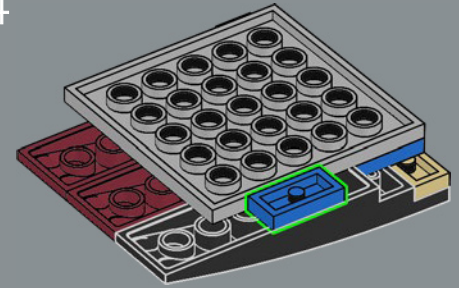

5

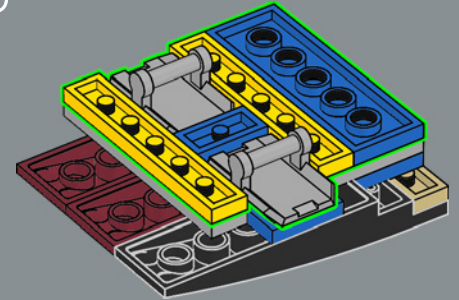

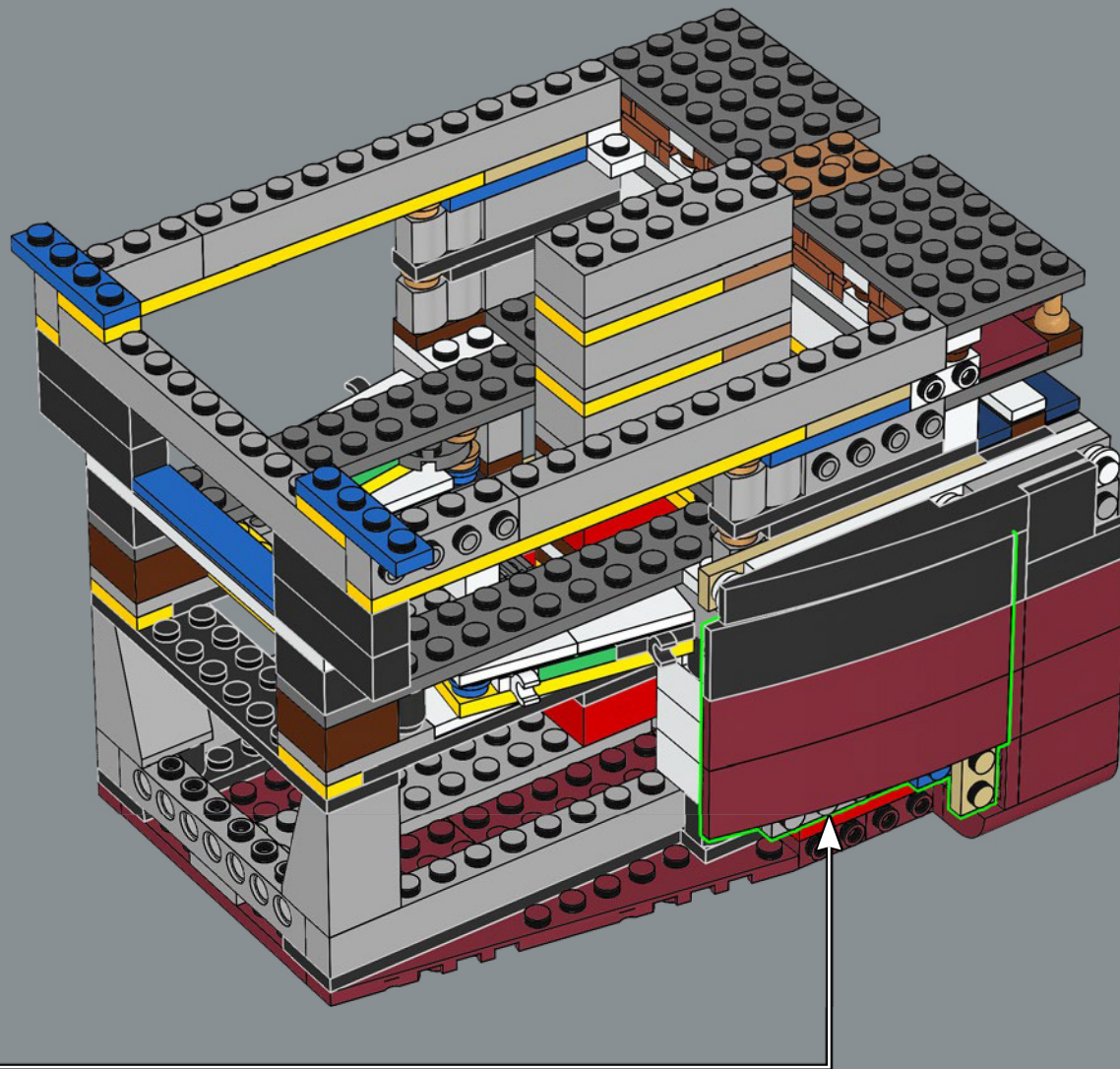

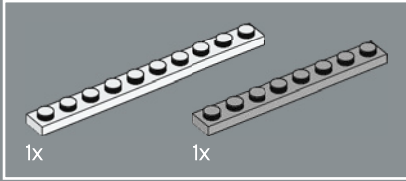
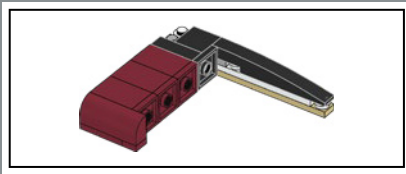

198

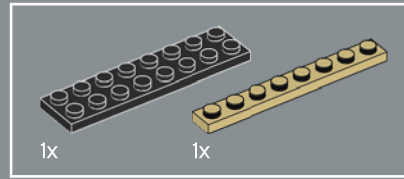
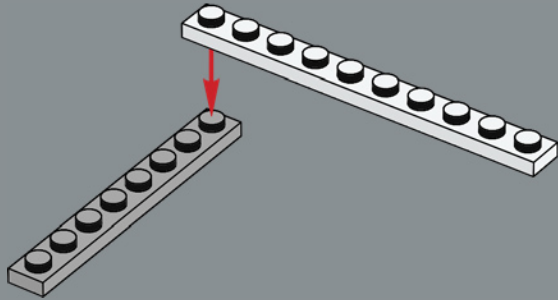

199

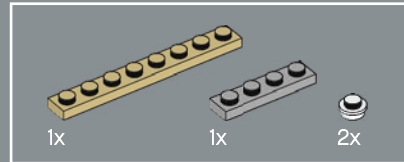
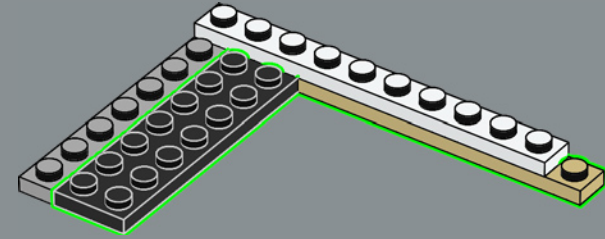

200

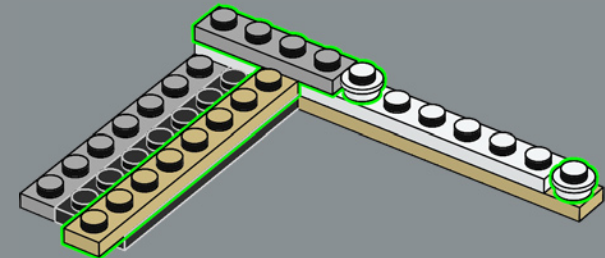

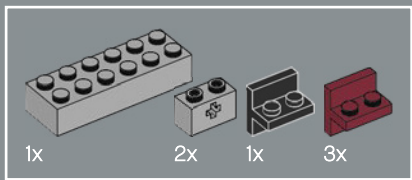

201

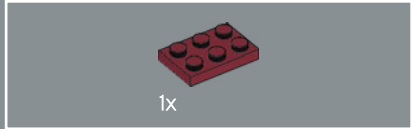
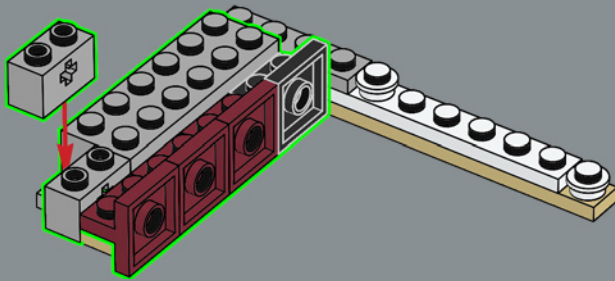

202

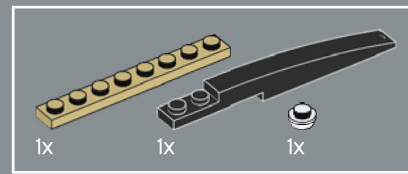
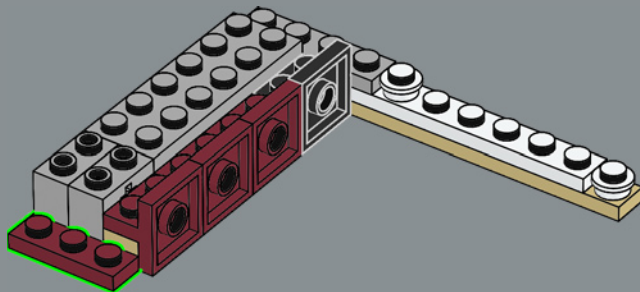

203

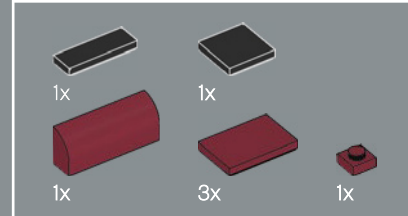
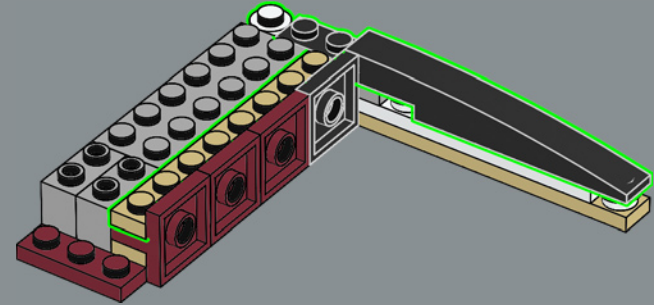

204

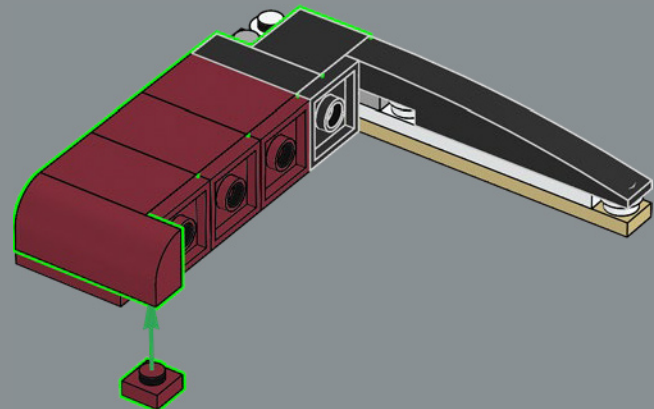

205

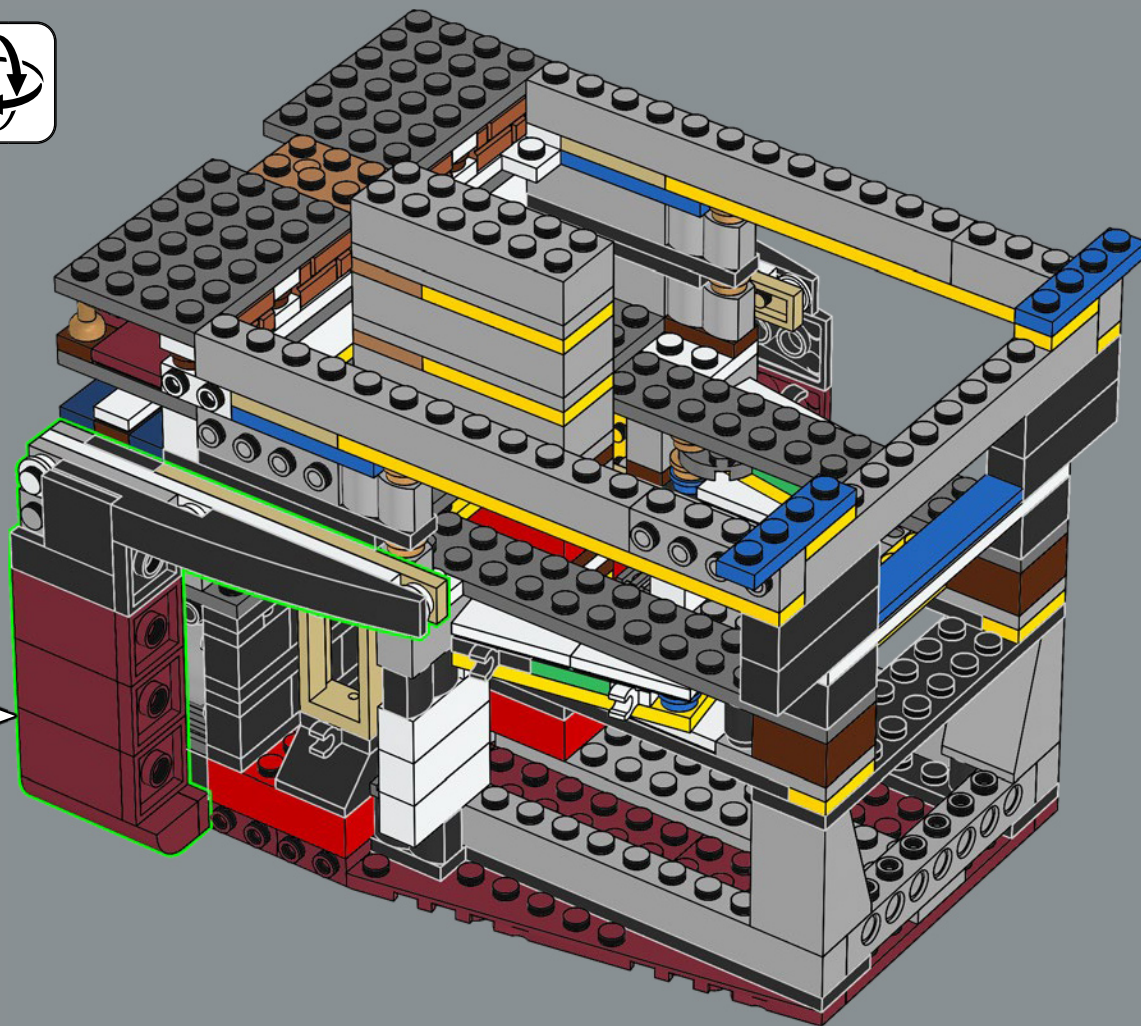

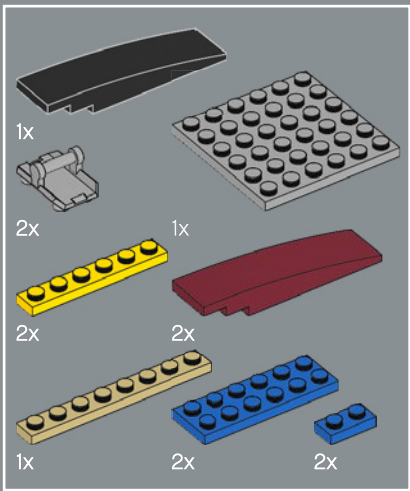

206

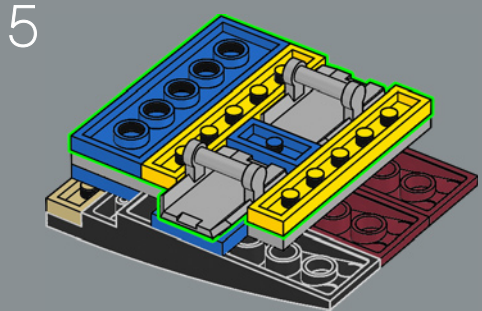
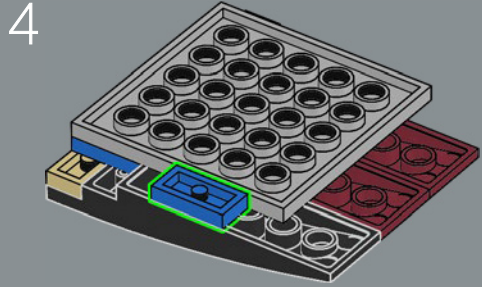
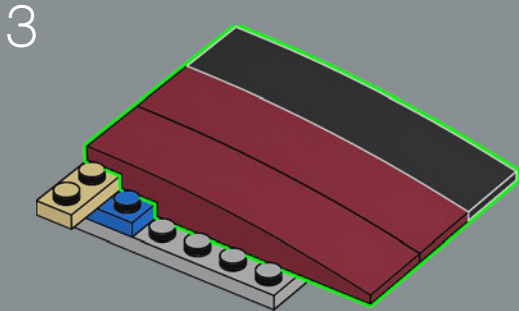
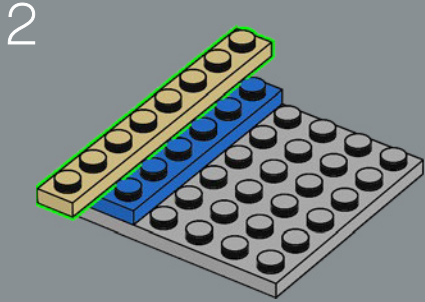
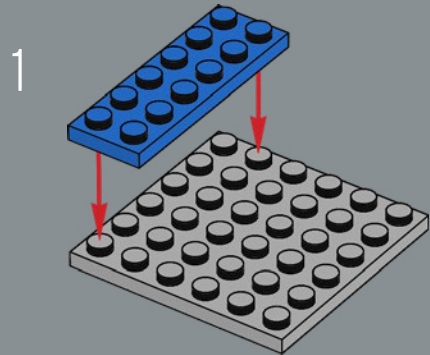

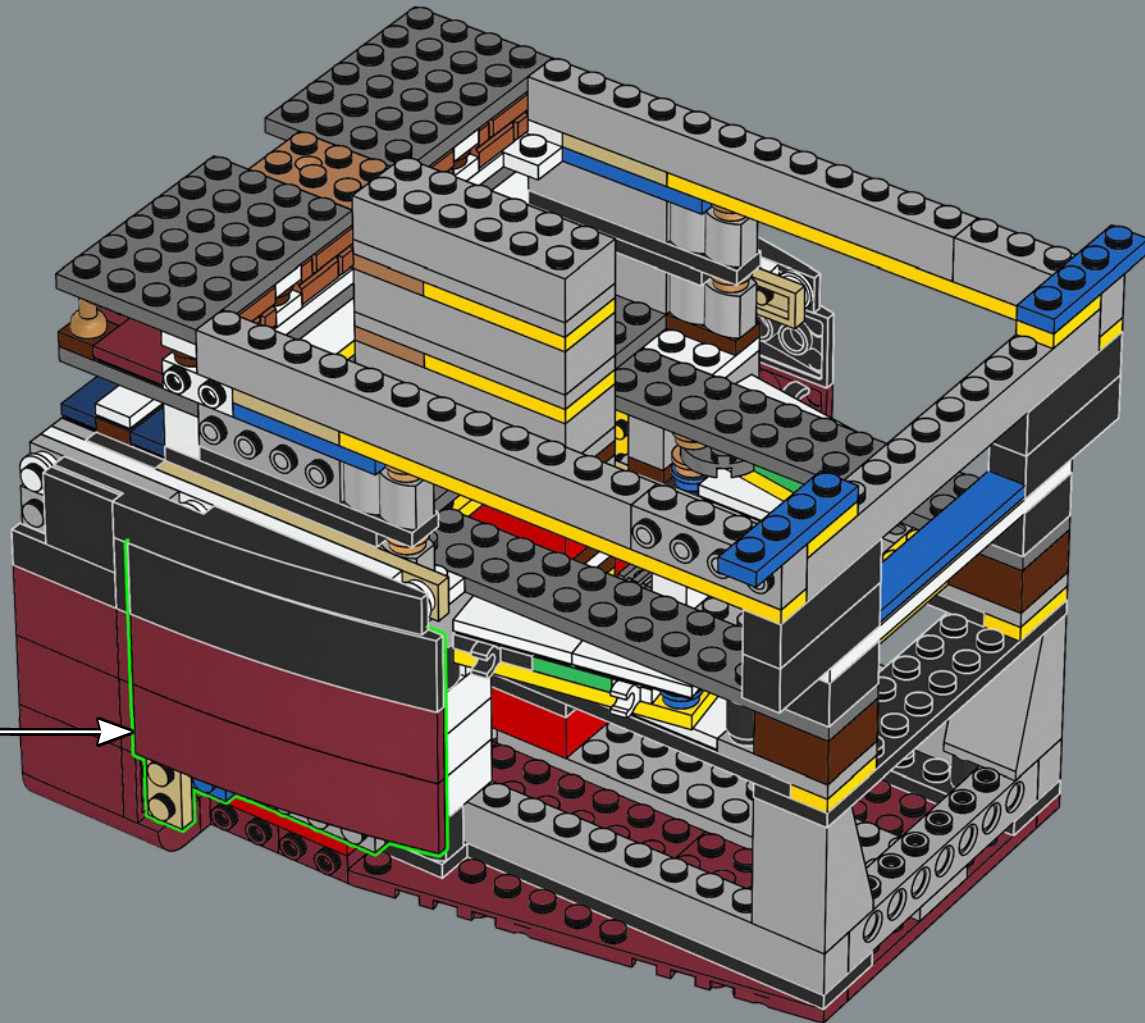

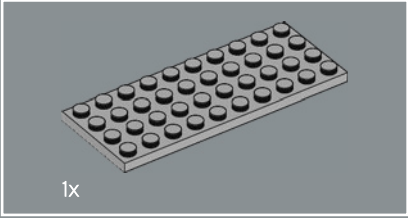
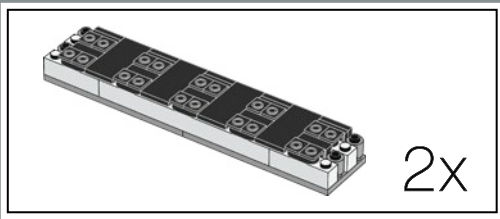

207

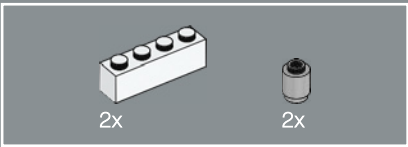
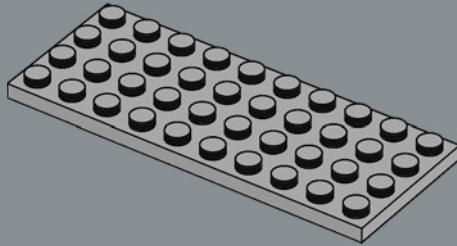

208

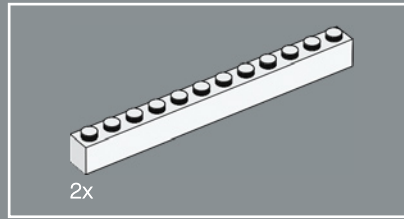
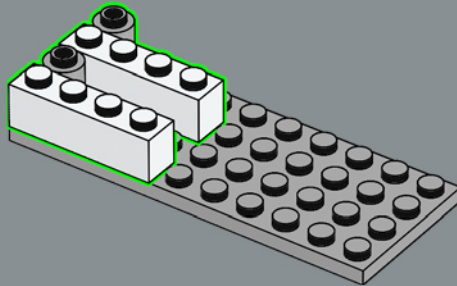

209

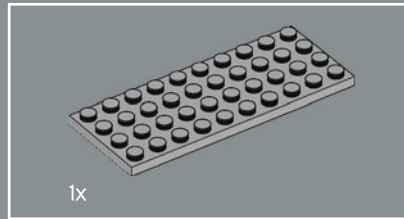
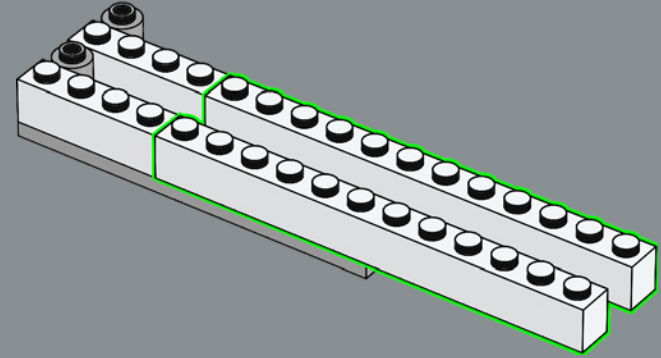

210

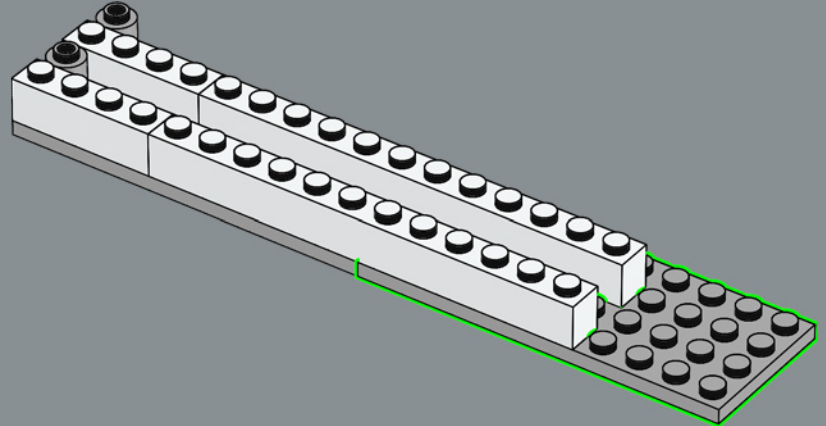

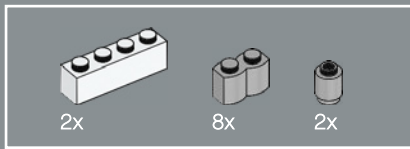

211

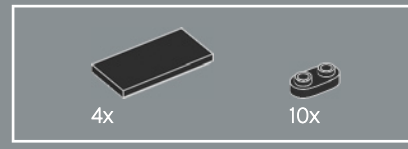
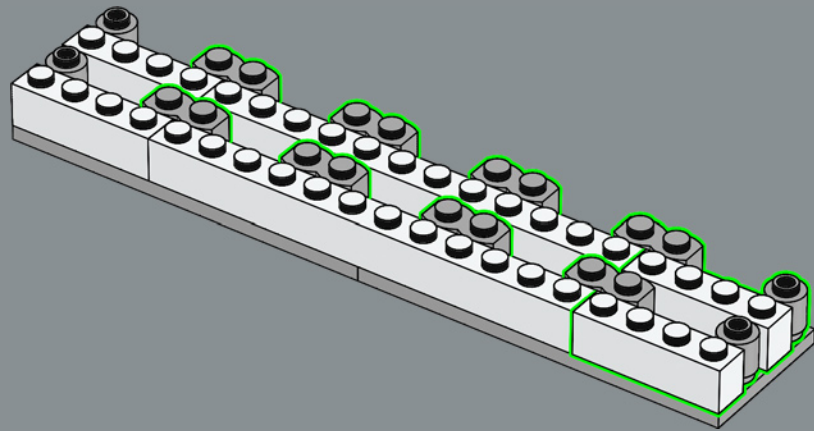

212

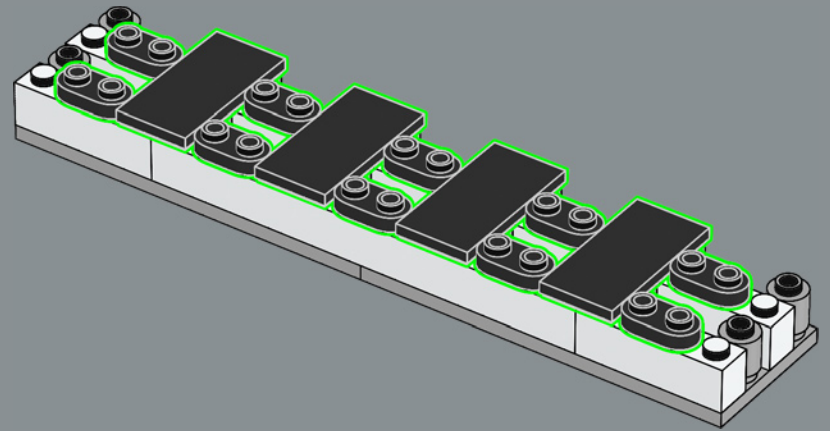

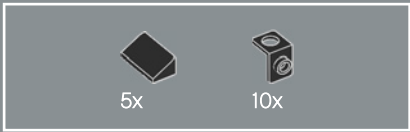

213

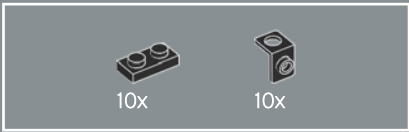
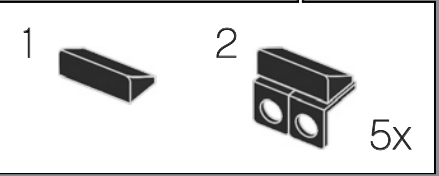
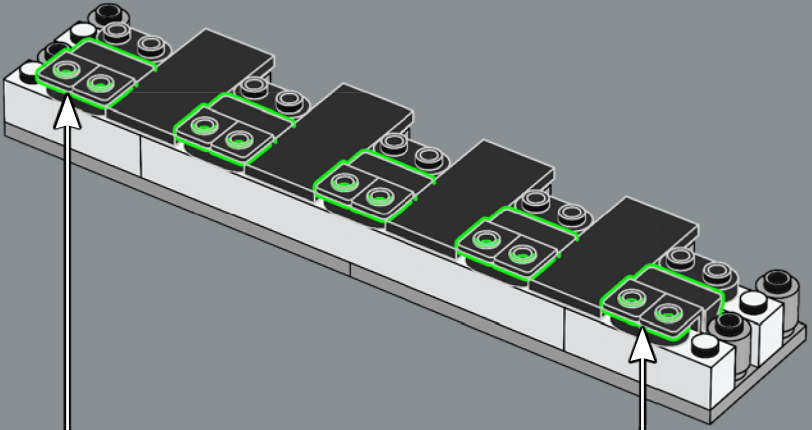

214

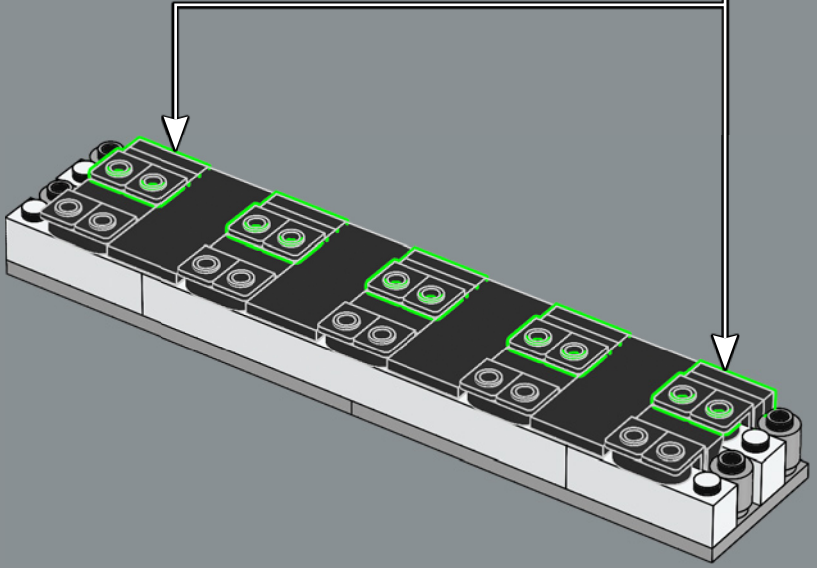
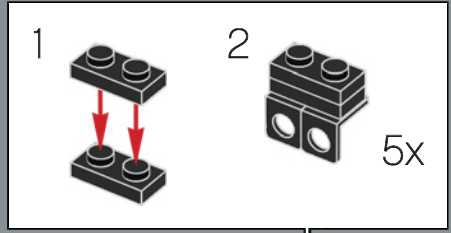

2x

215

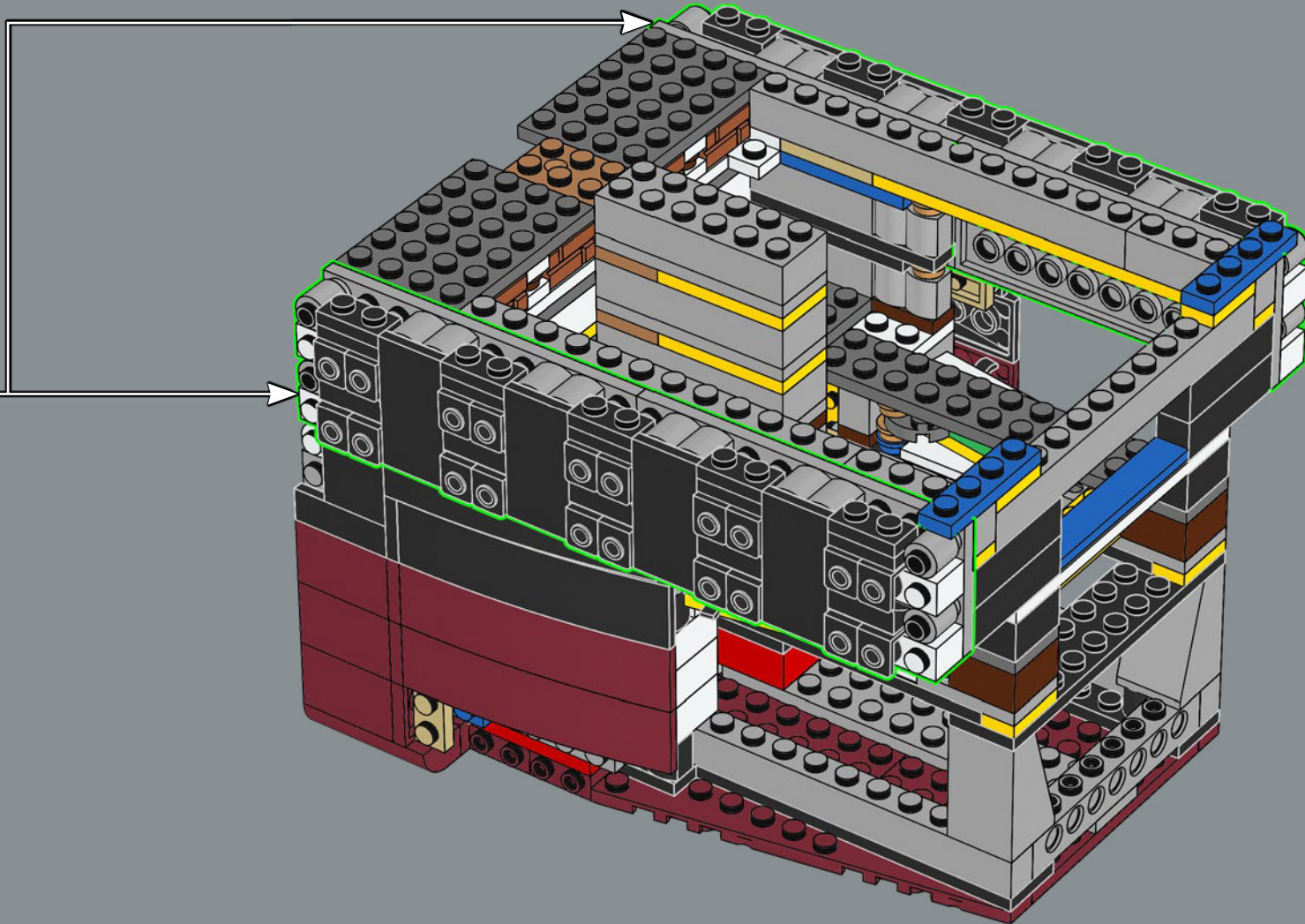

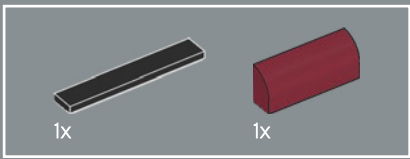

216

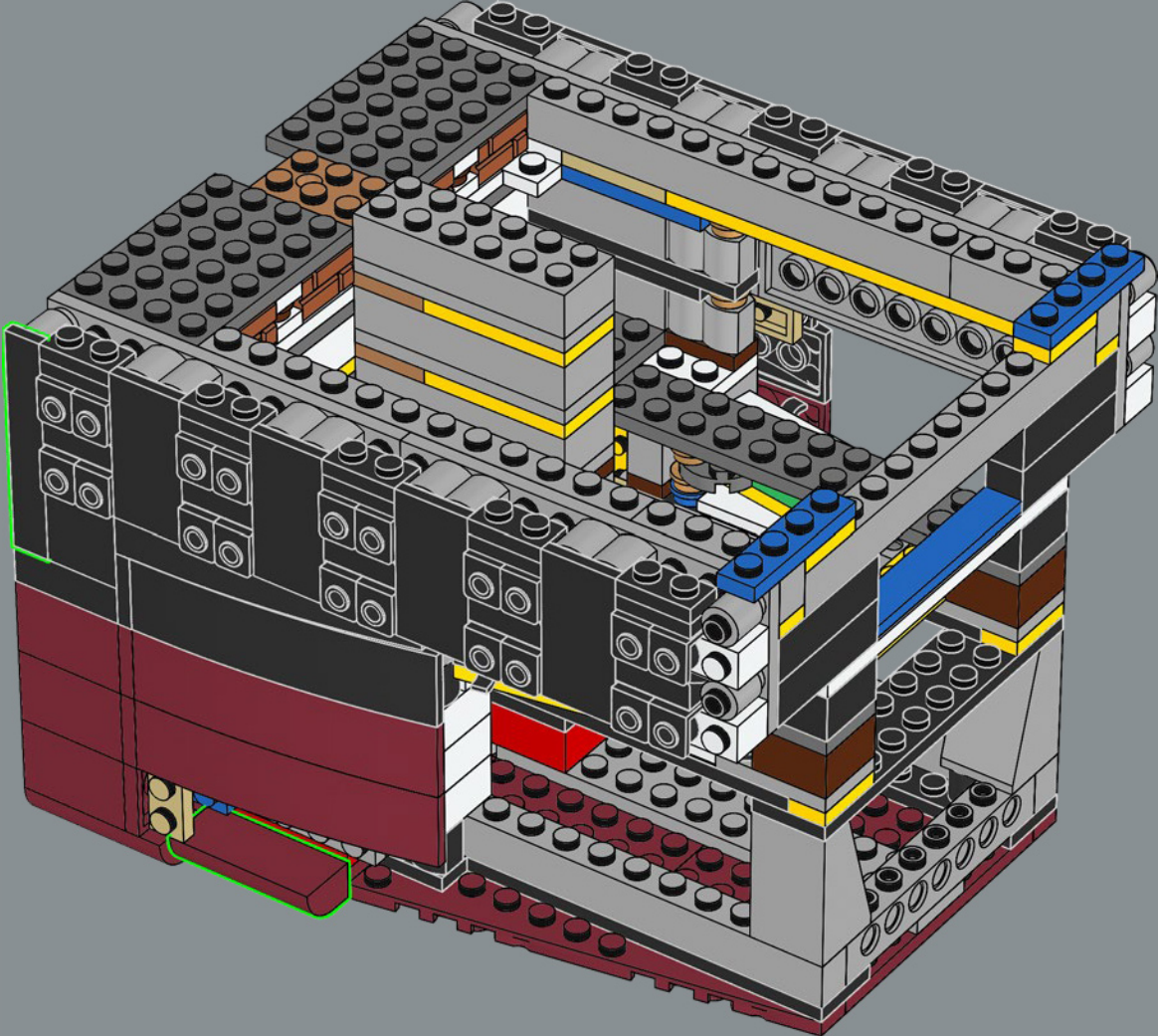

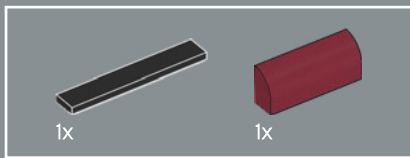

217

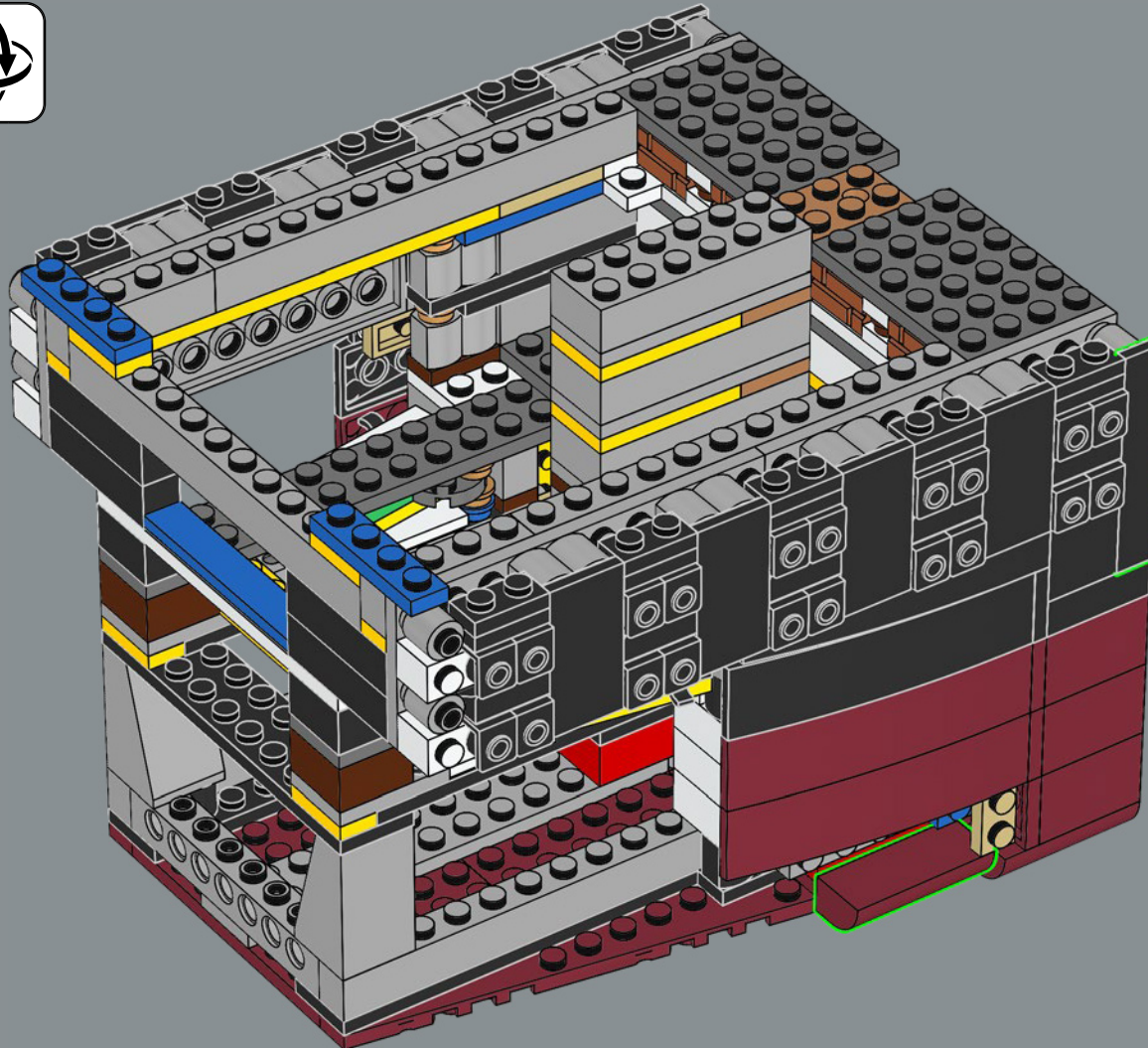

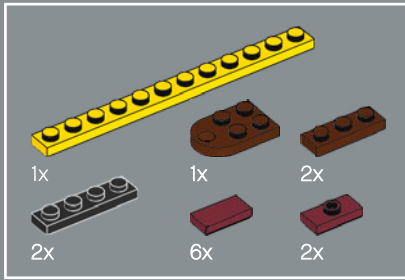
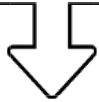

218

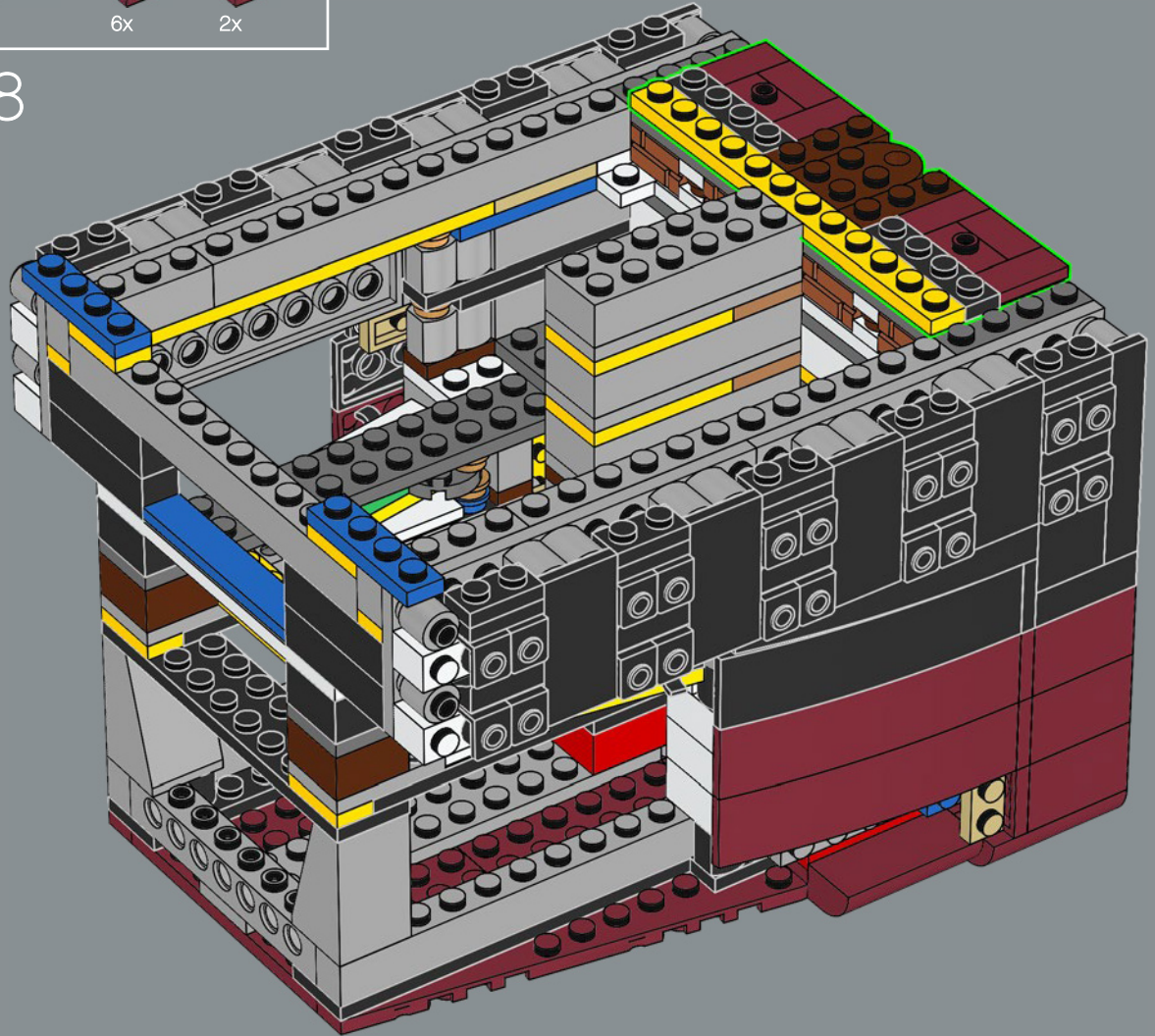



219

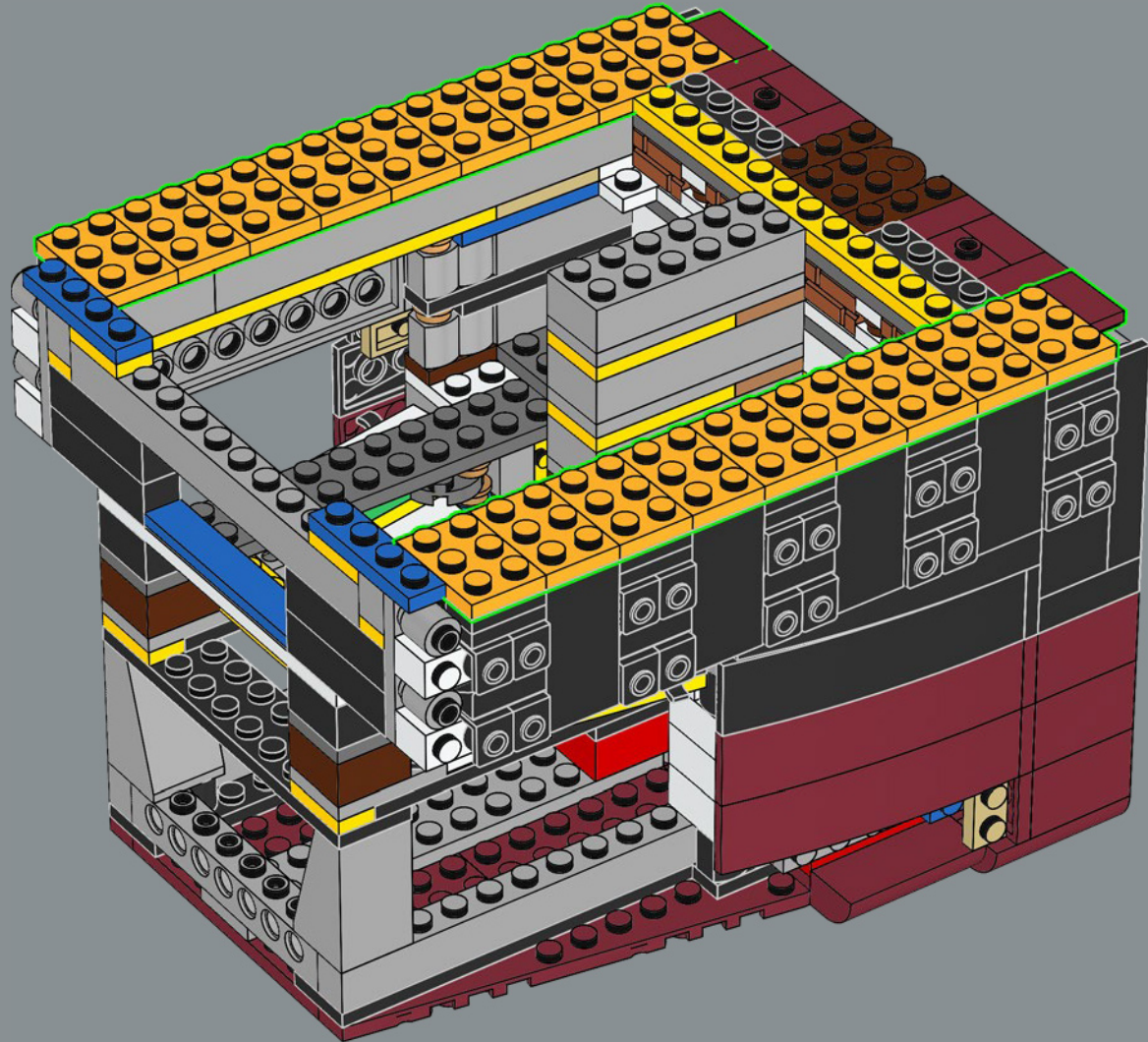

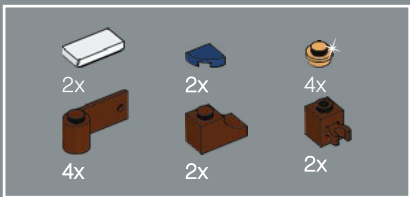

220

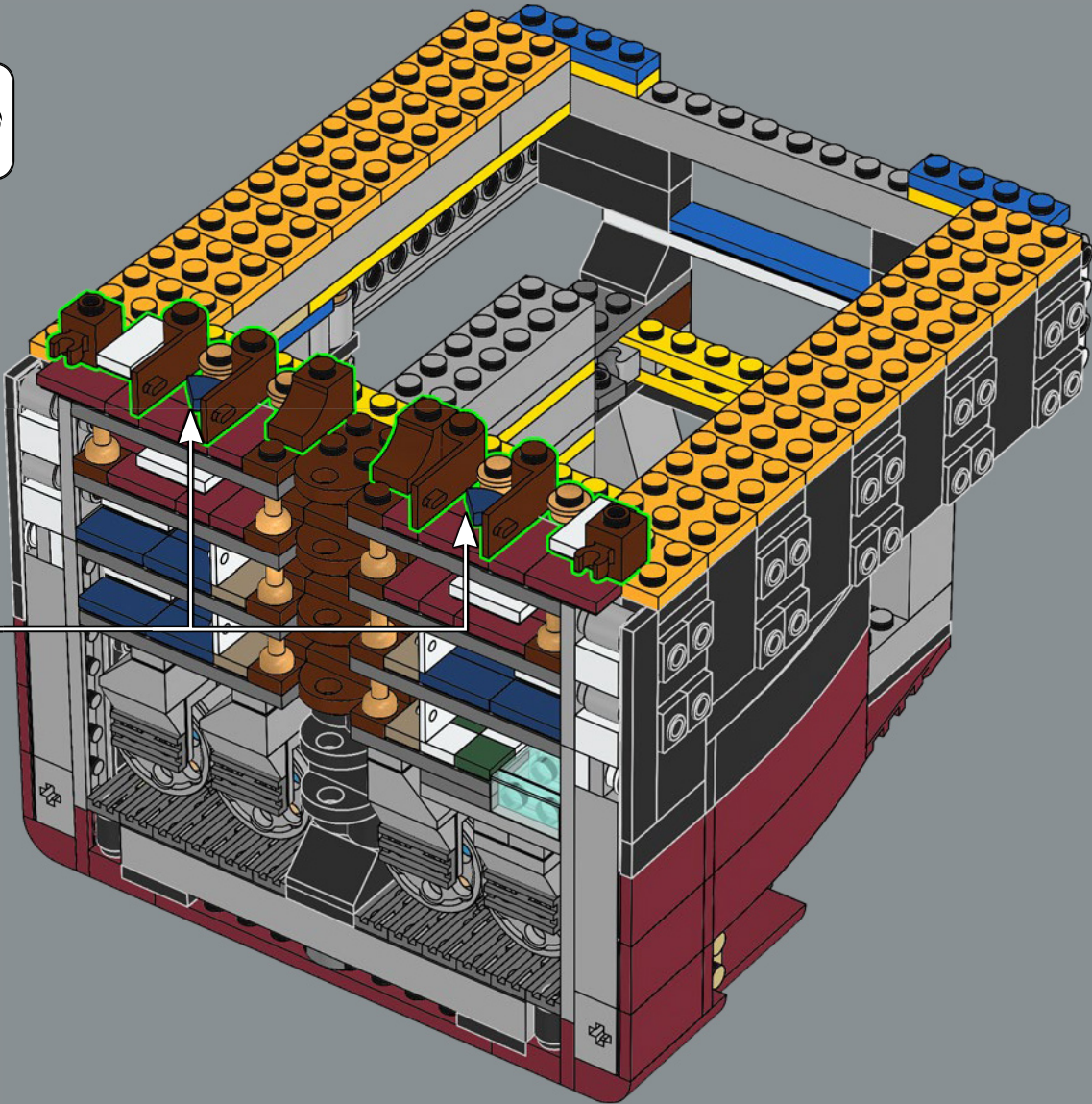

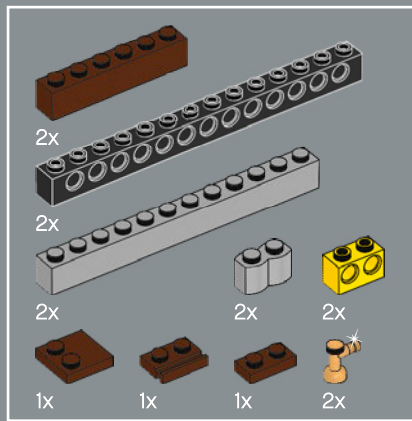

221

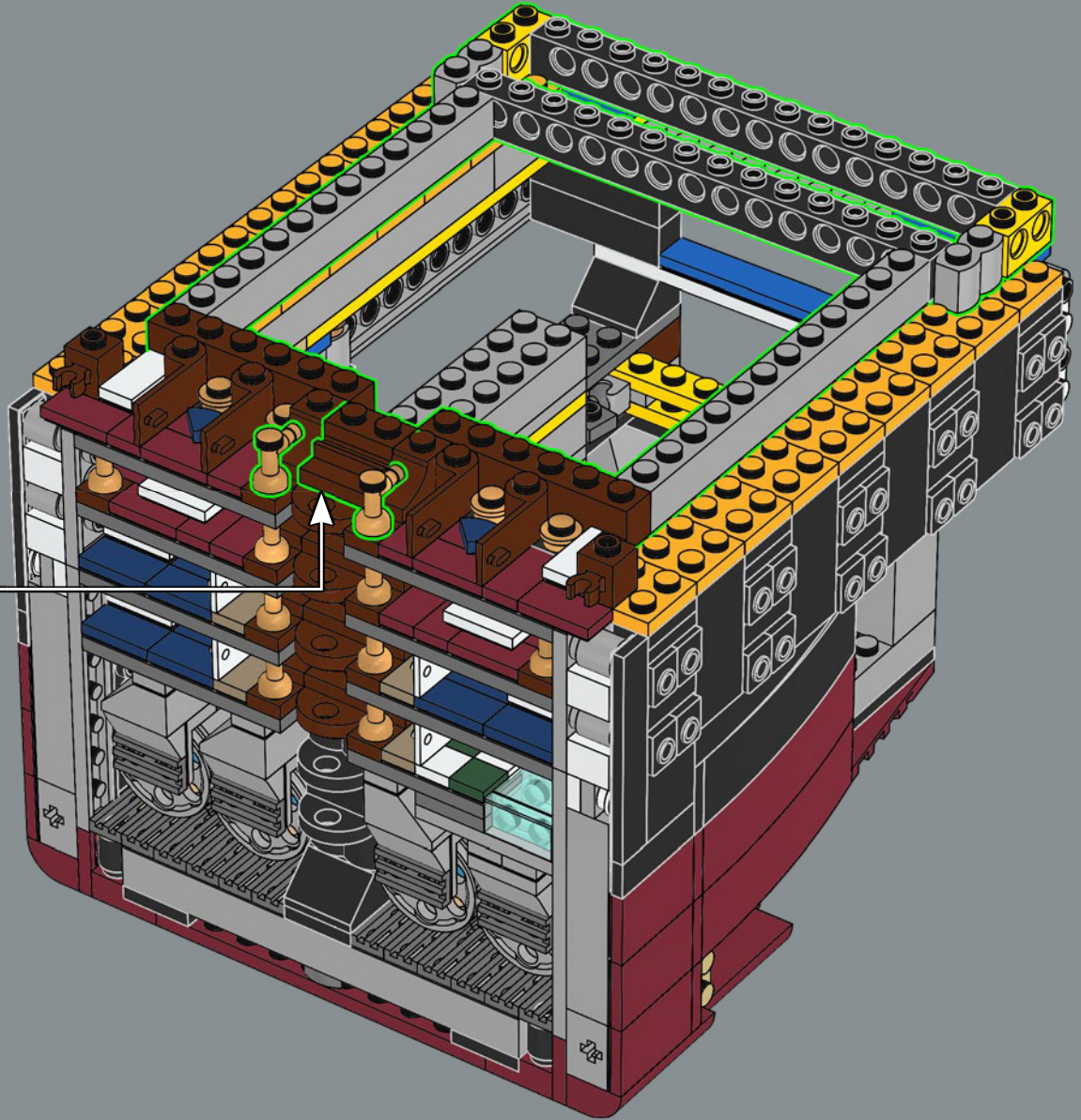
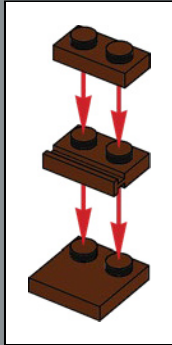

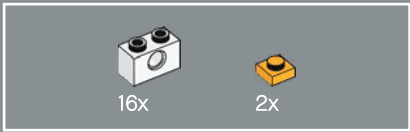

222

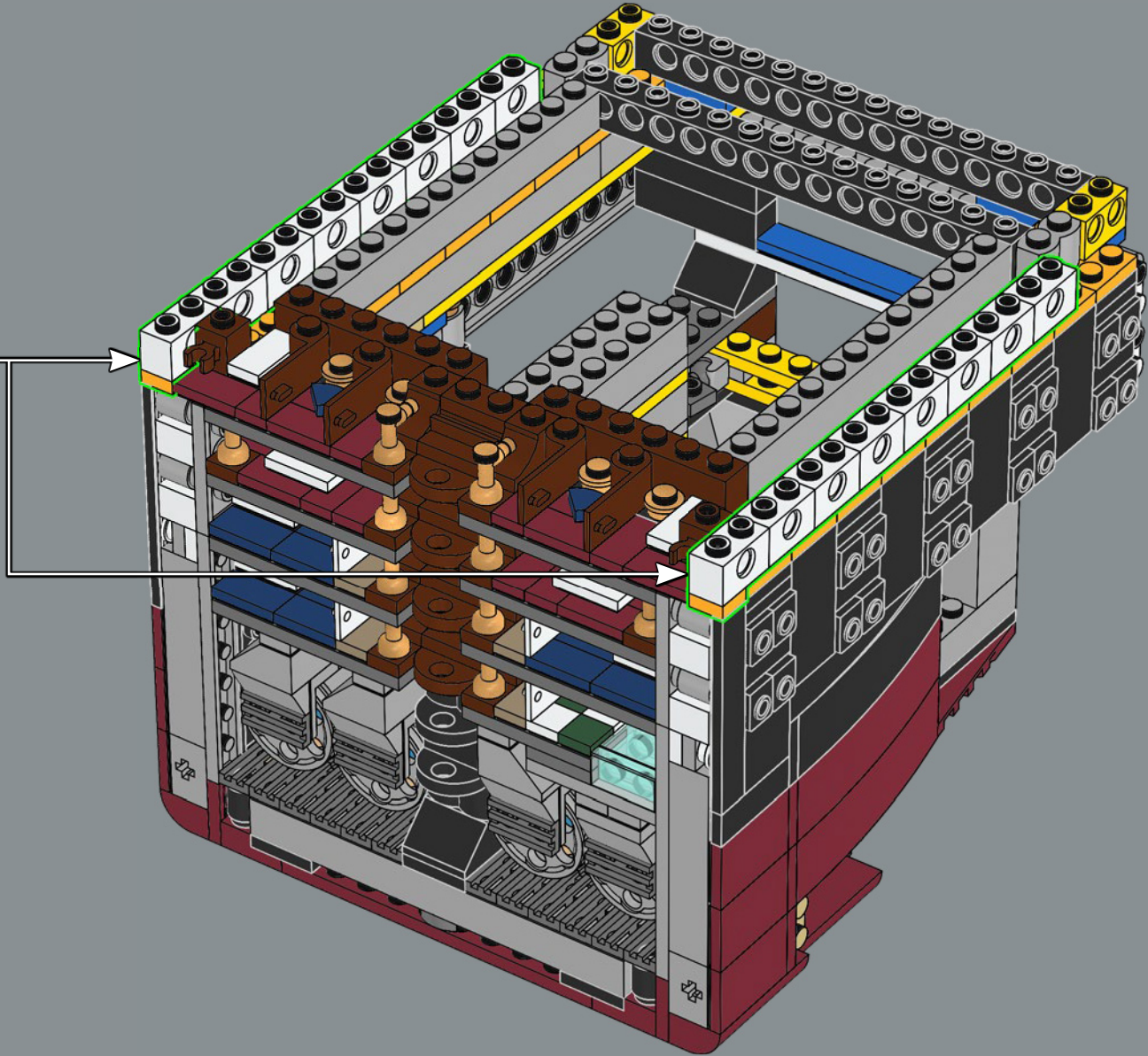
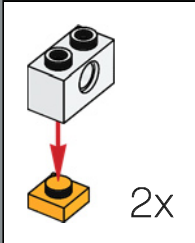

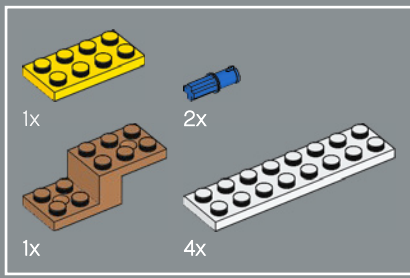

223

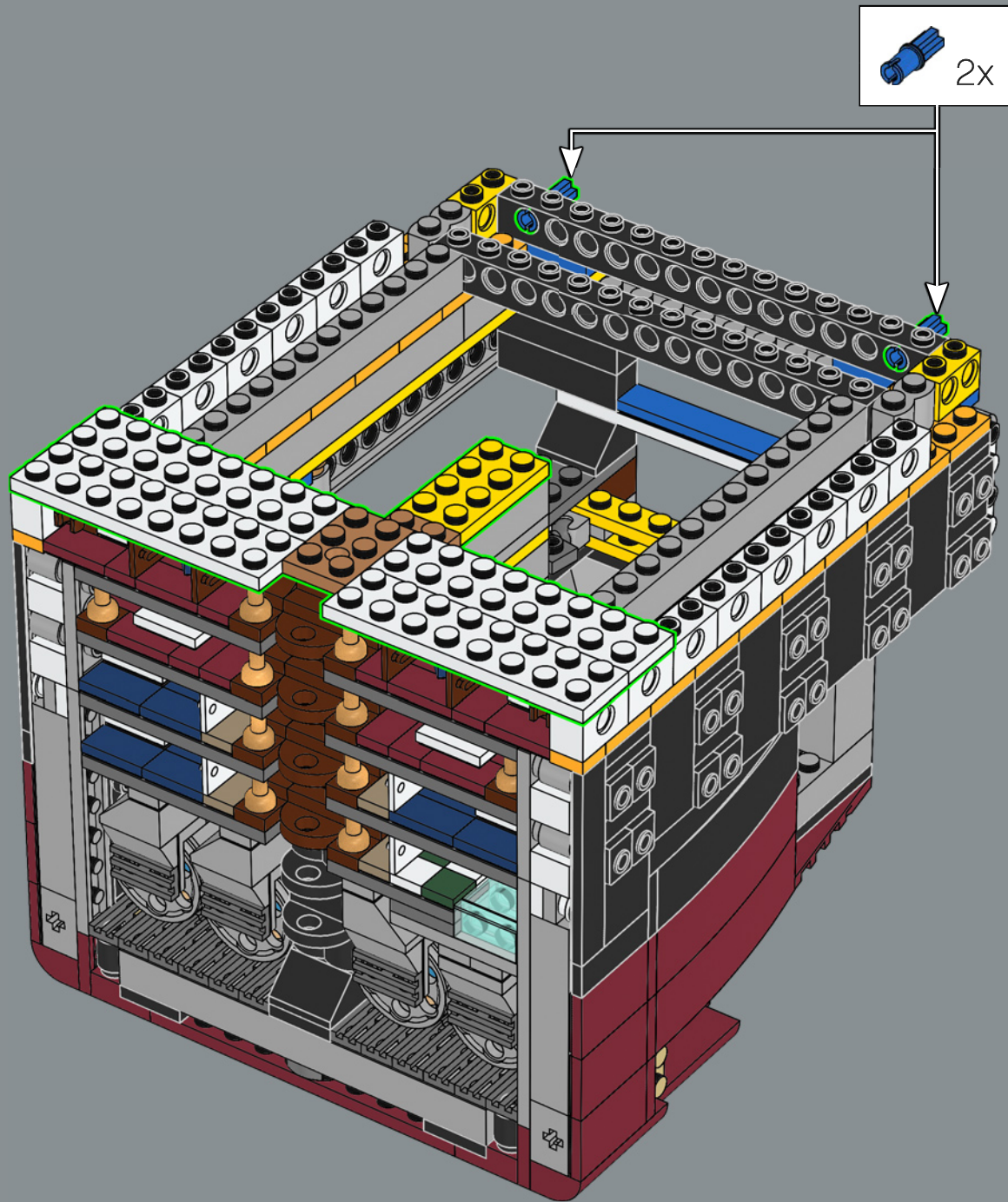

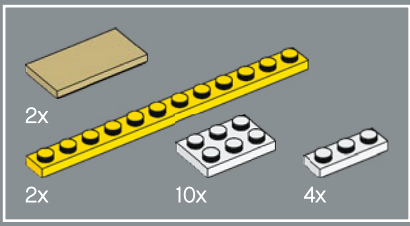

224

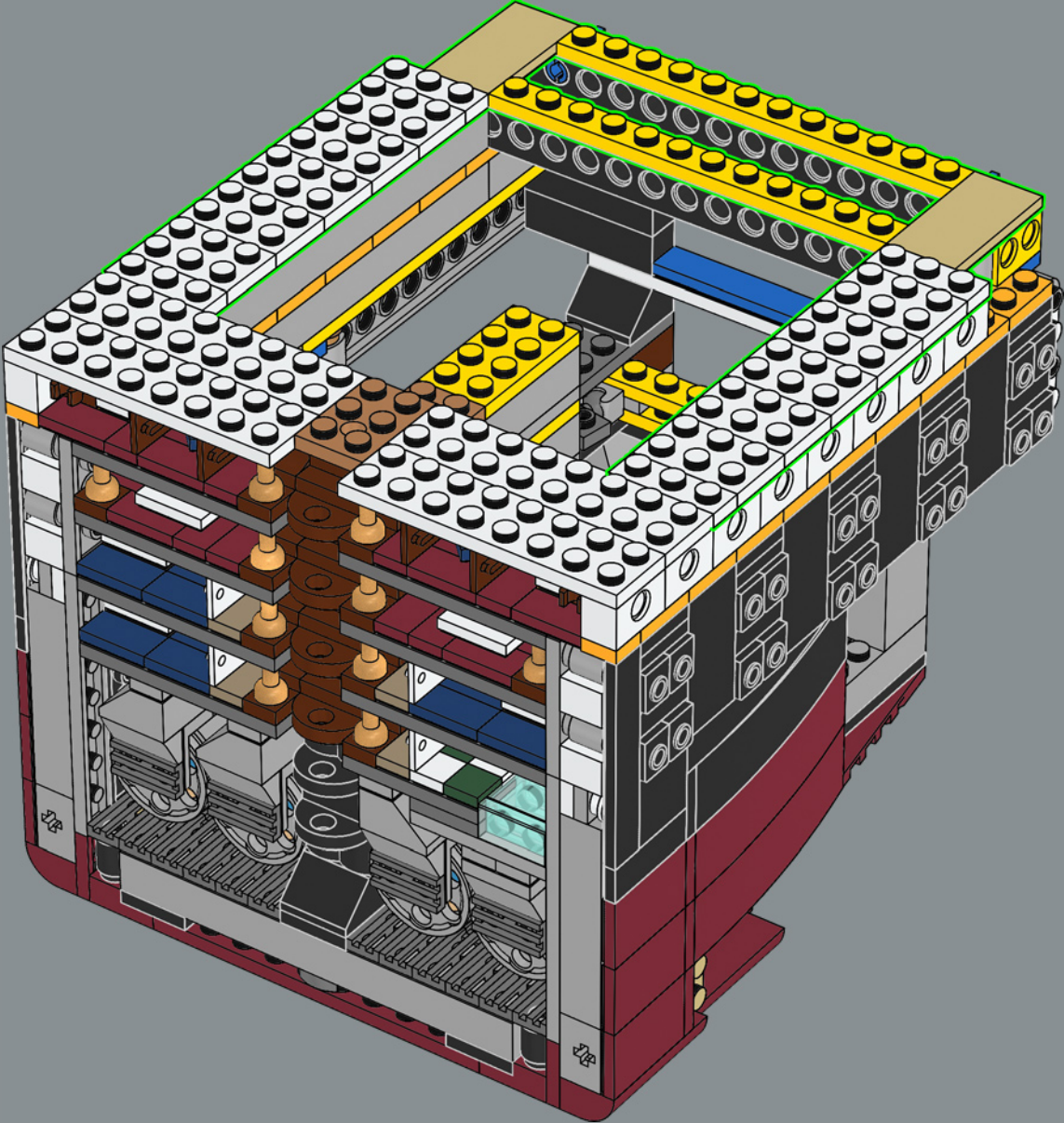

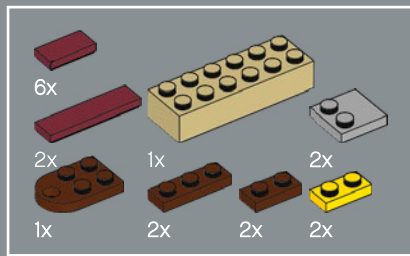

225

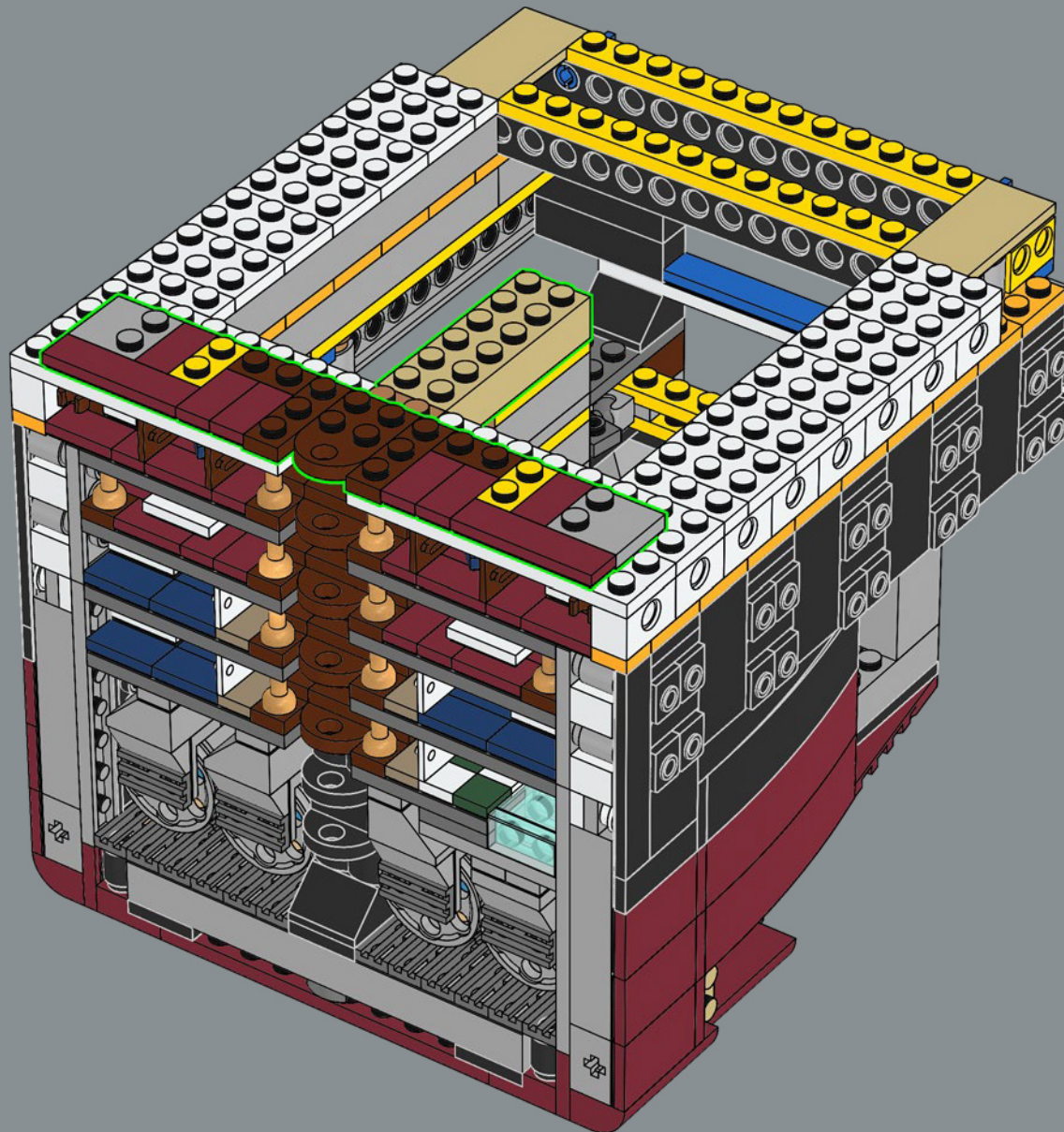

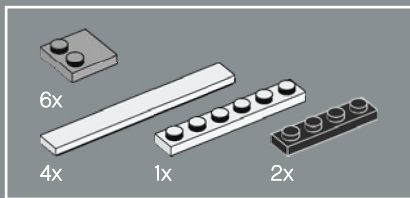

226

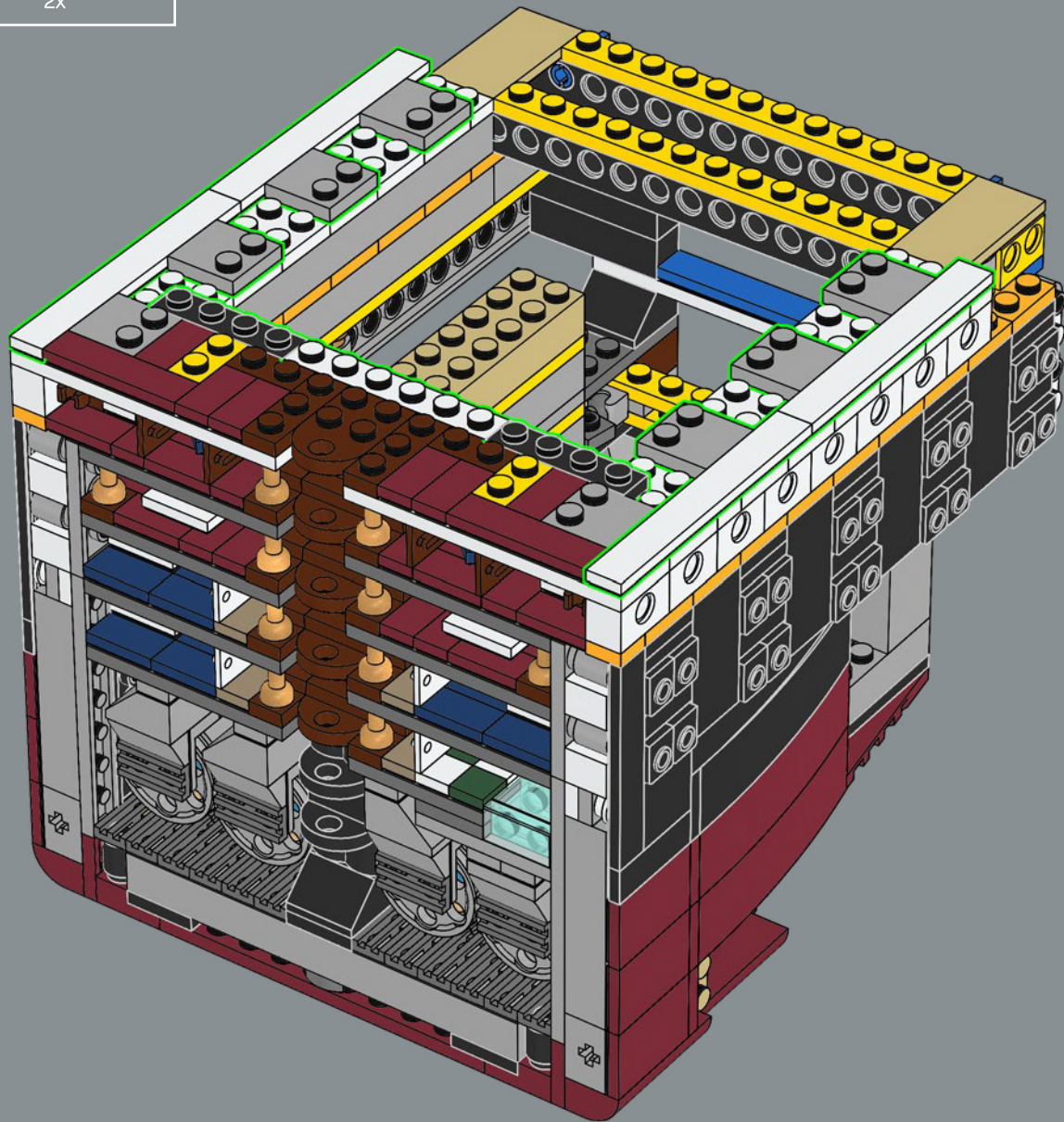

泰坦尼克号英文名称中的 RMS 代表皇家邮轮, 她为皇家邮政 (Royal Mail) 和美国邮政服务 (US Postal Service) 运送了大量货物。

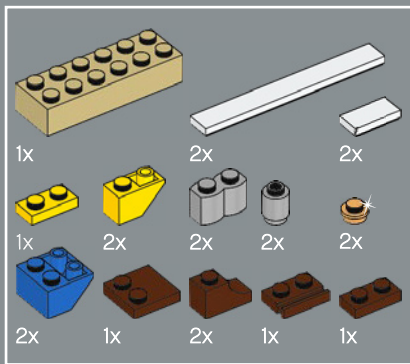

227

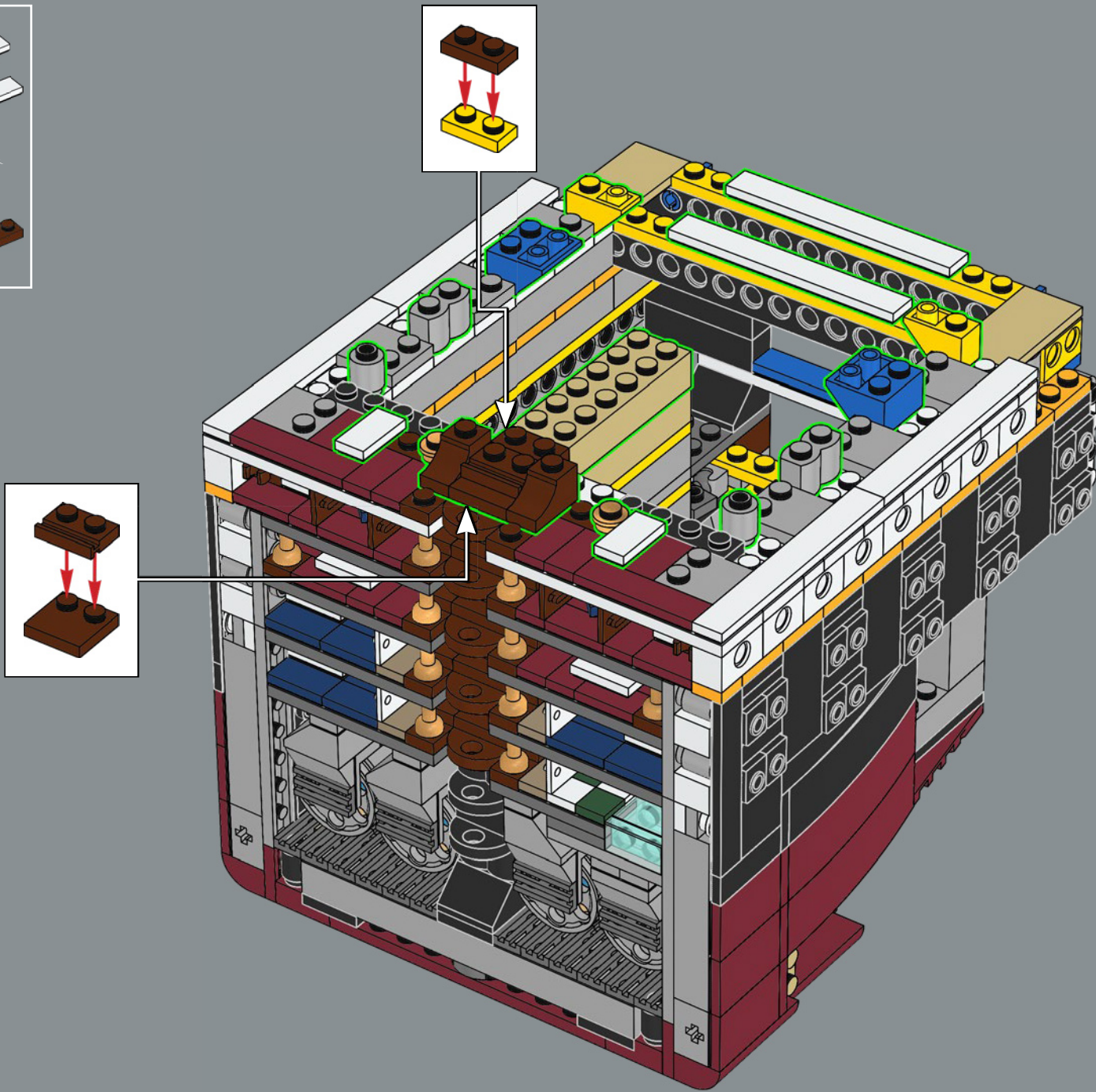

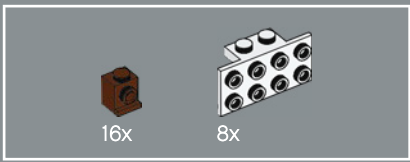

228

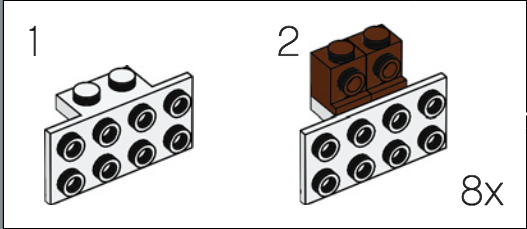
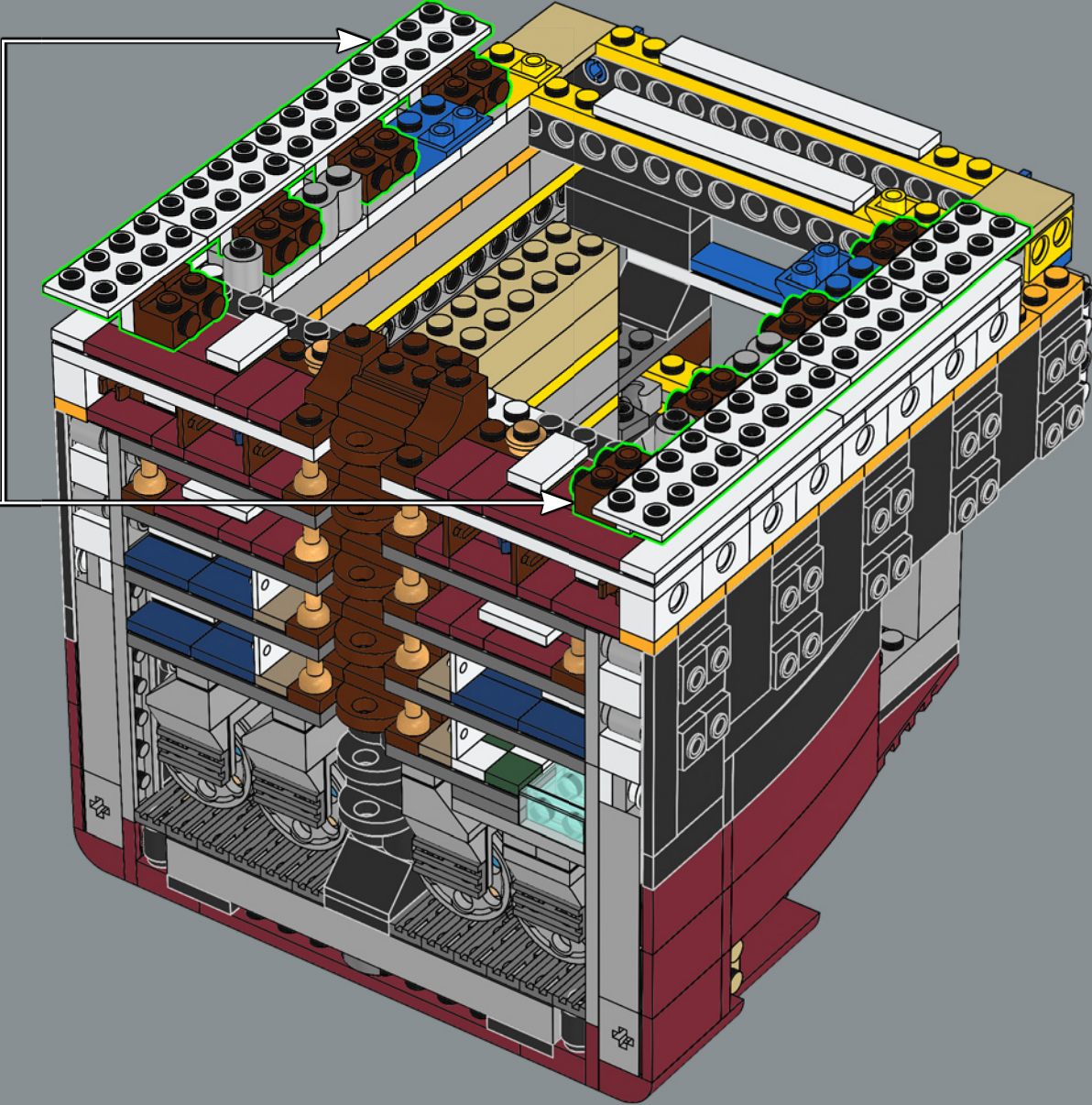

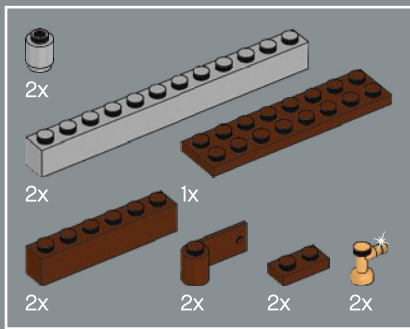

229

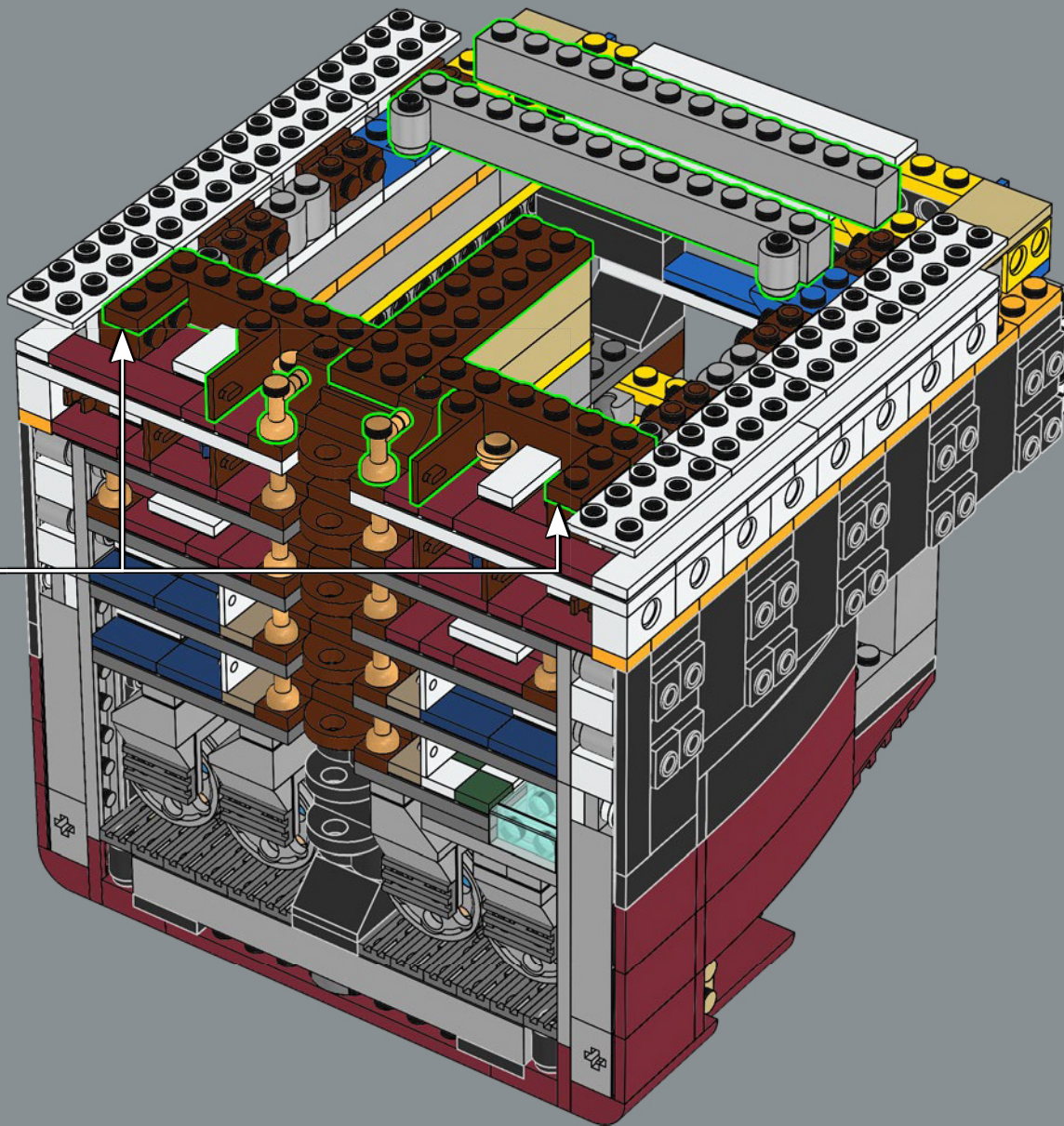

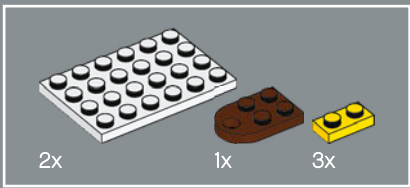

230

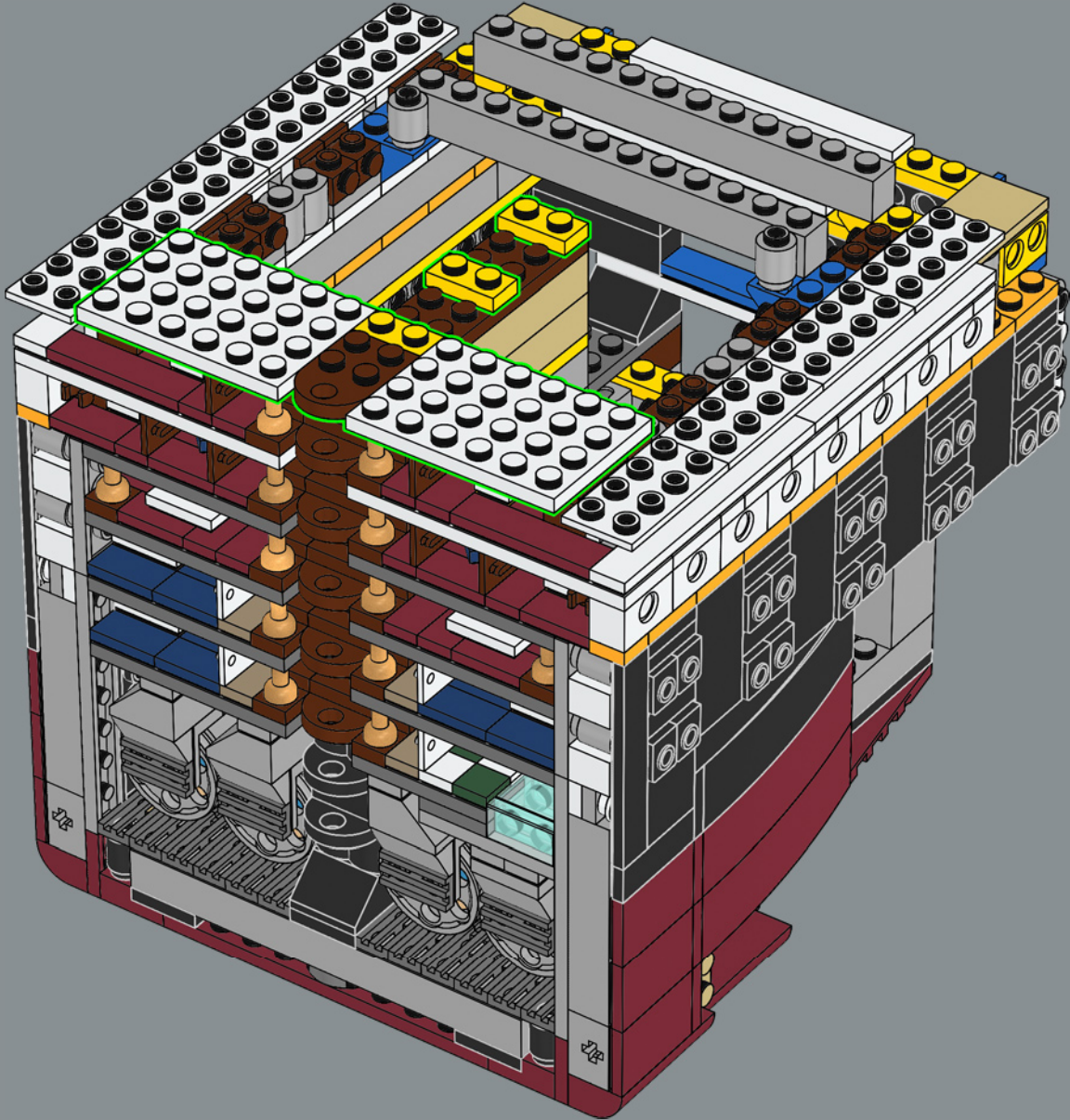

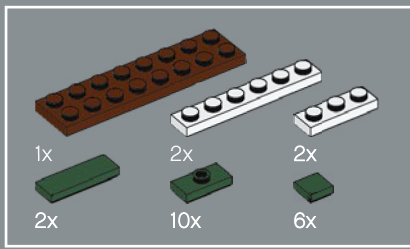

231

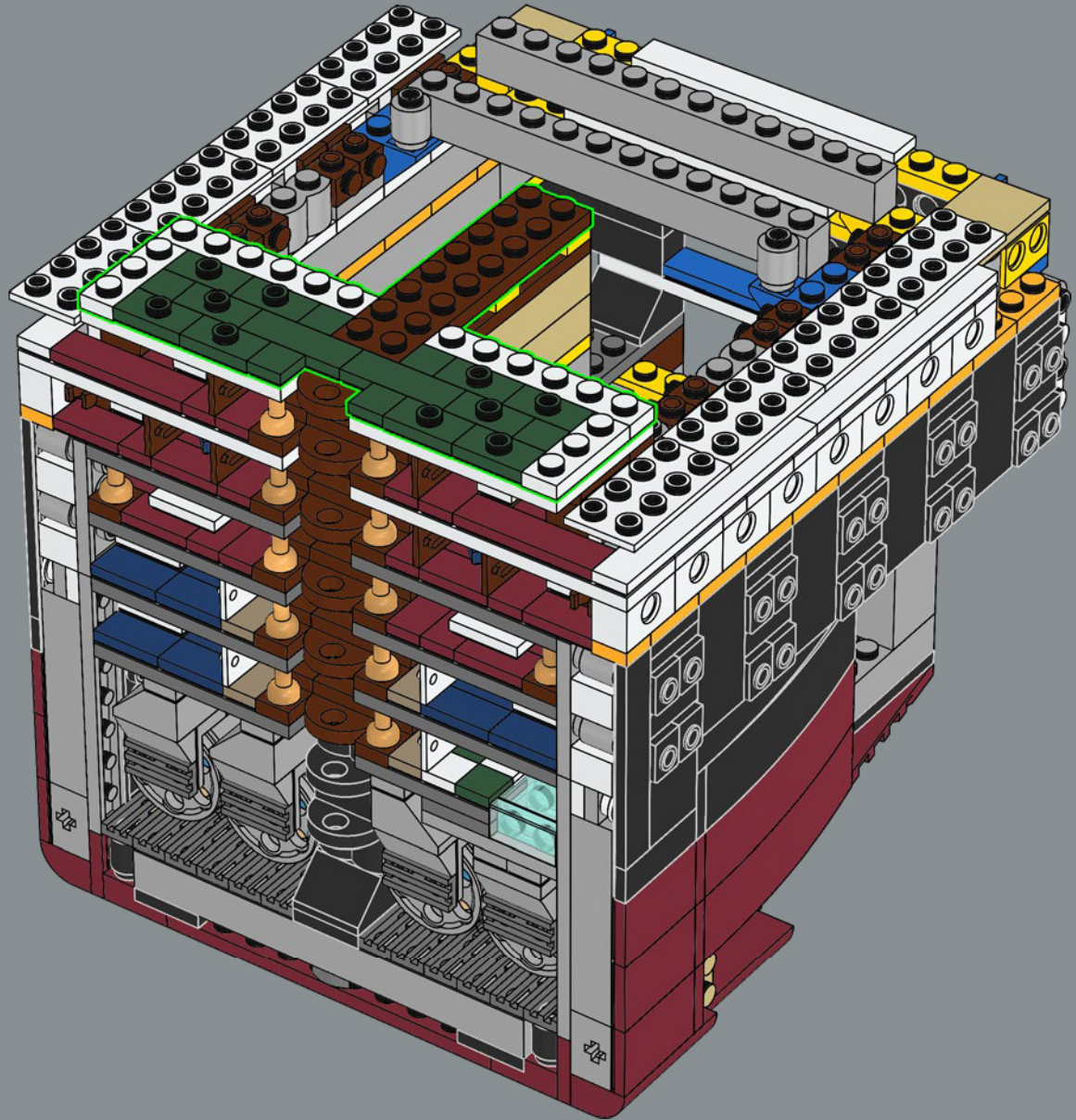

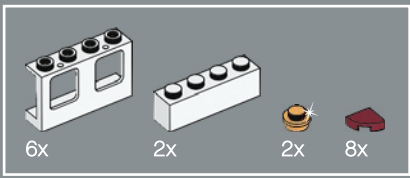

232

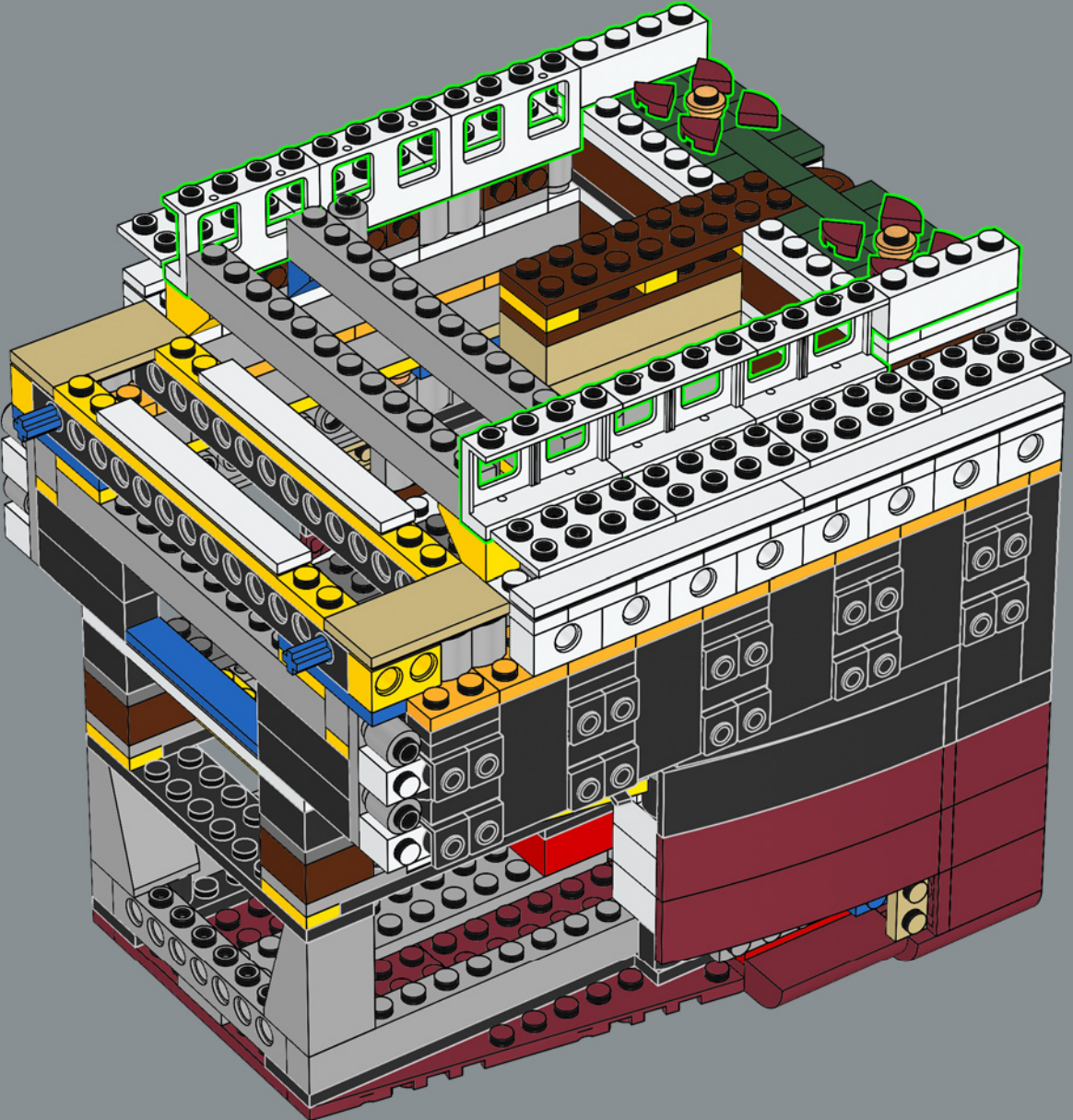

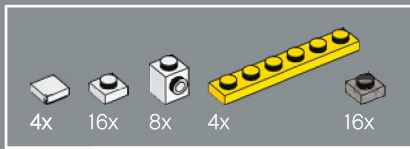

233

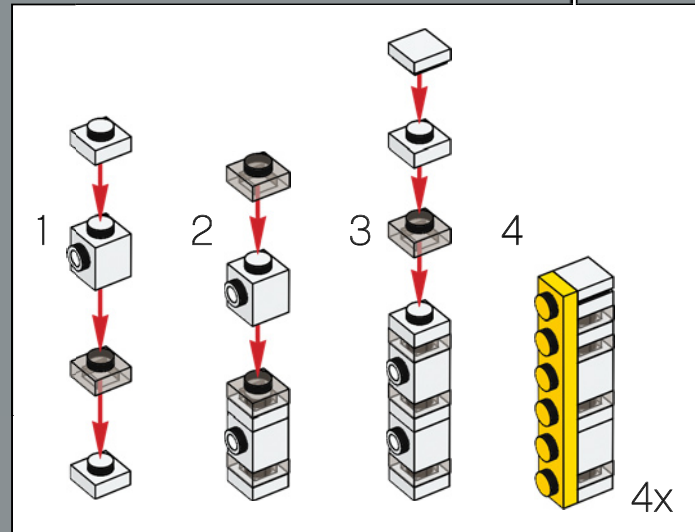
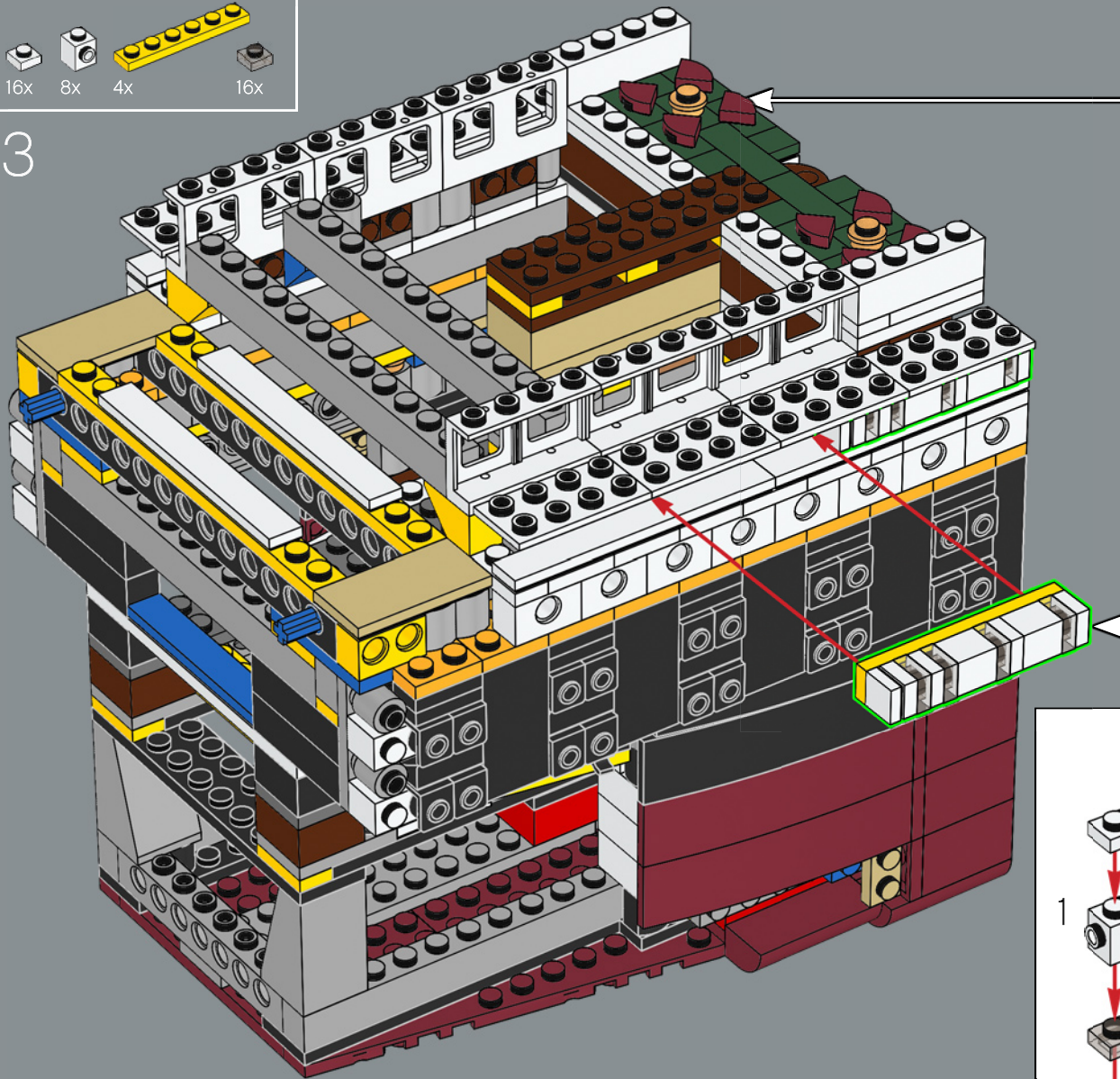

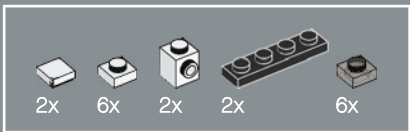

234

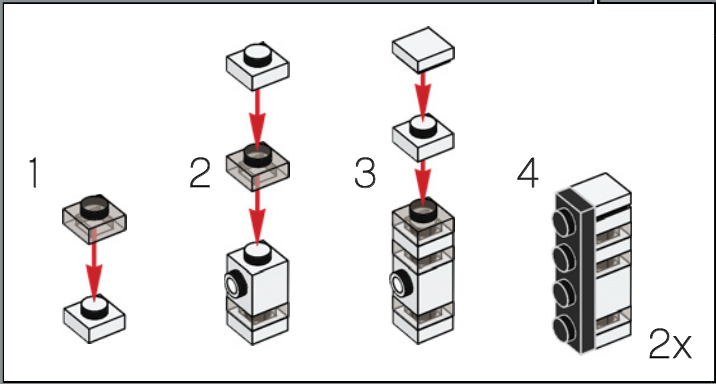
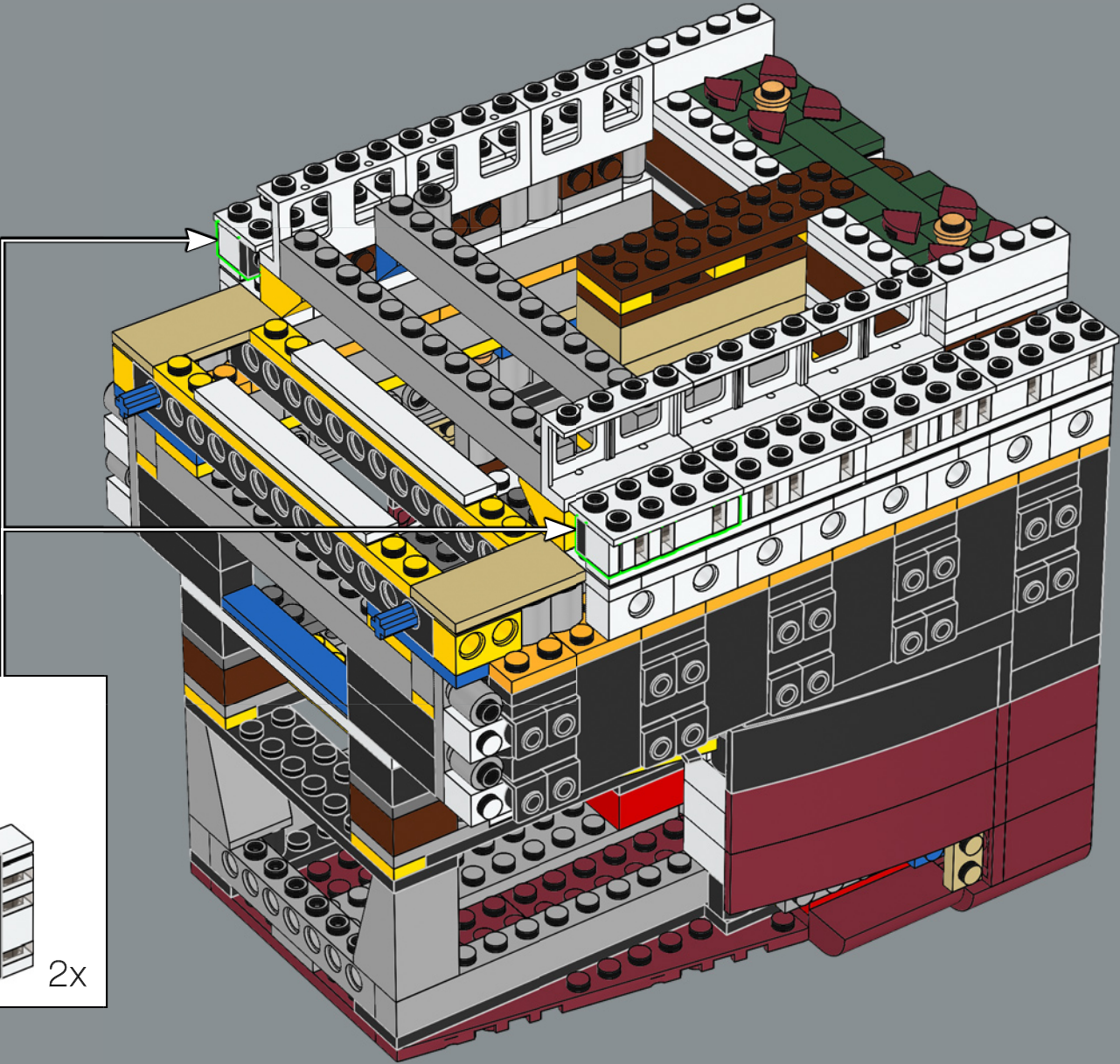

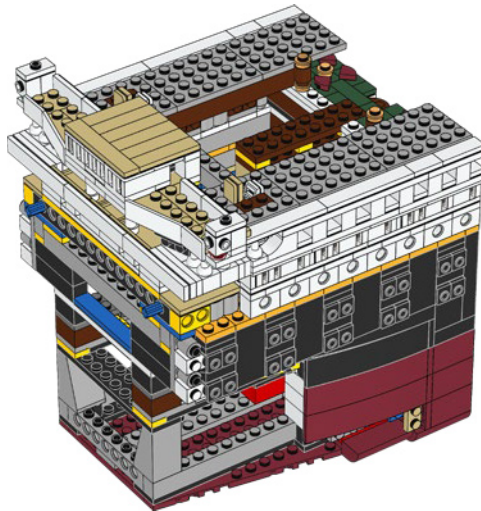
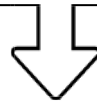

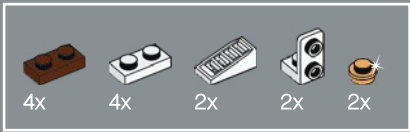

235

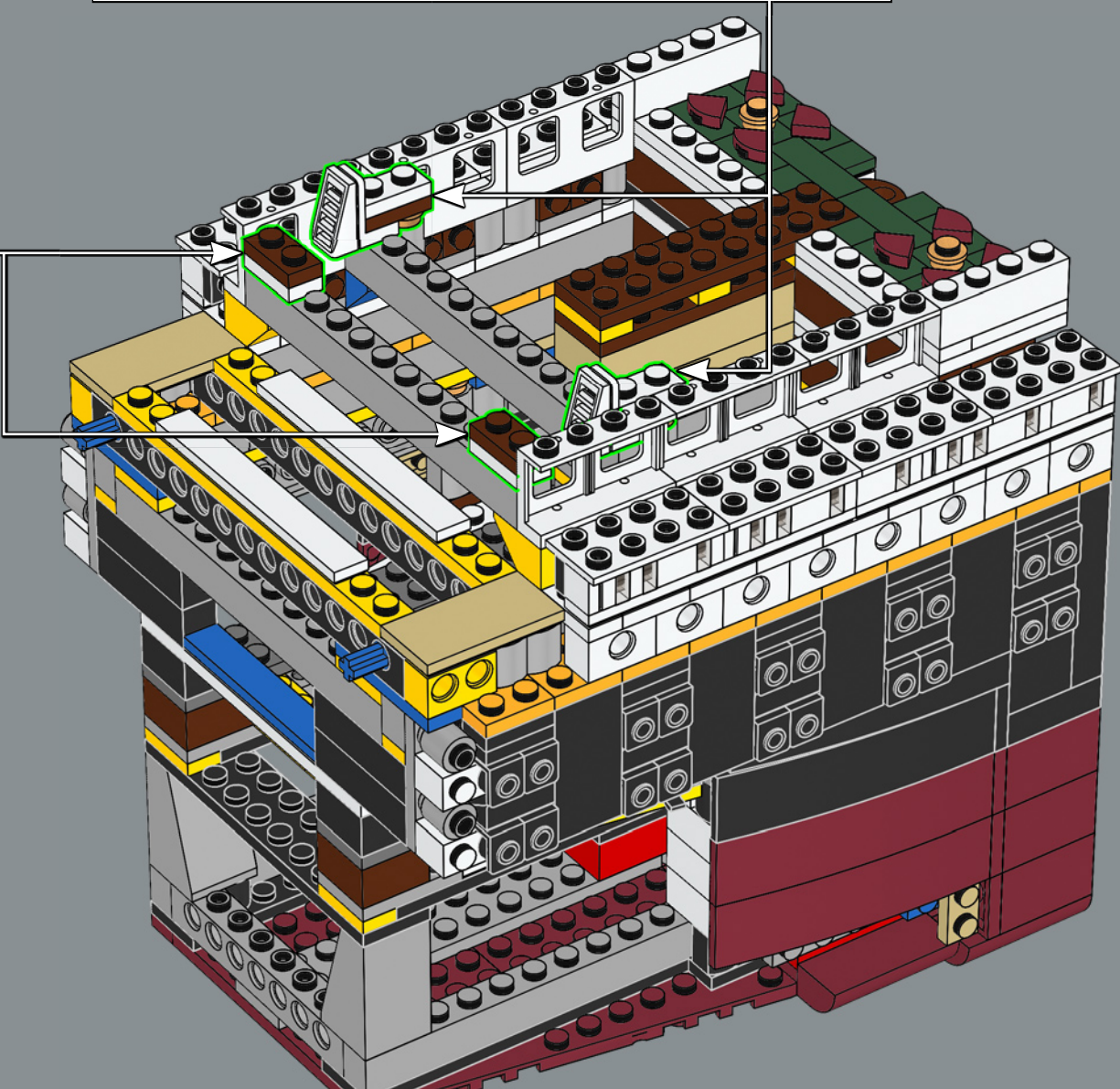
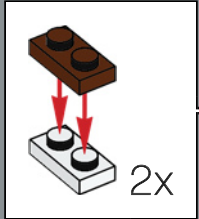
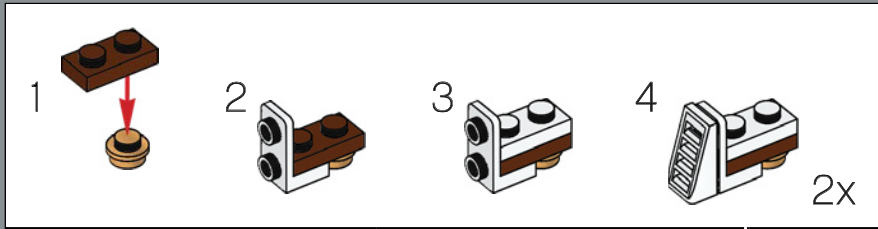

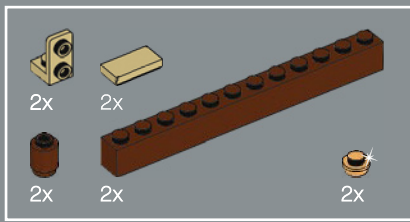

236

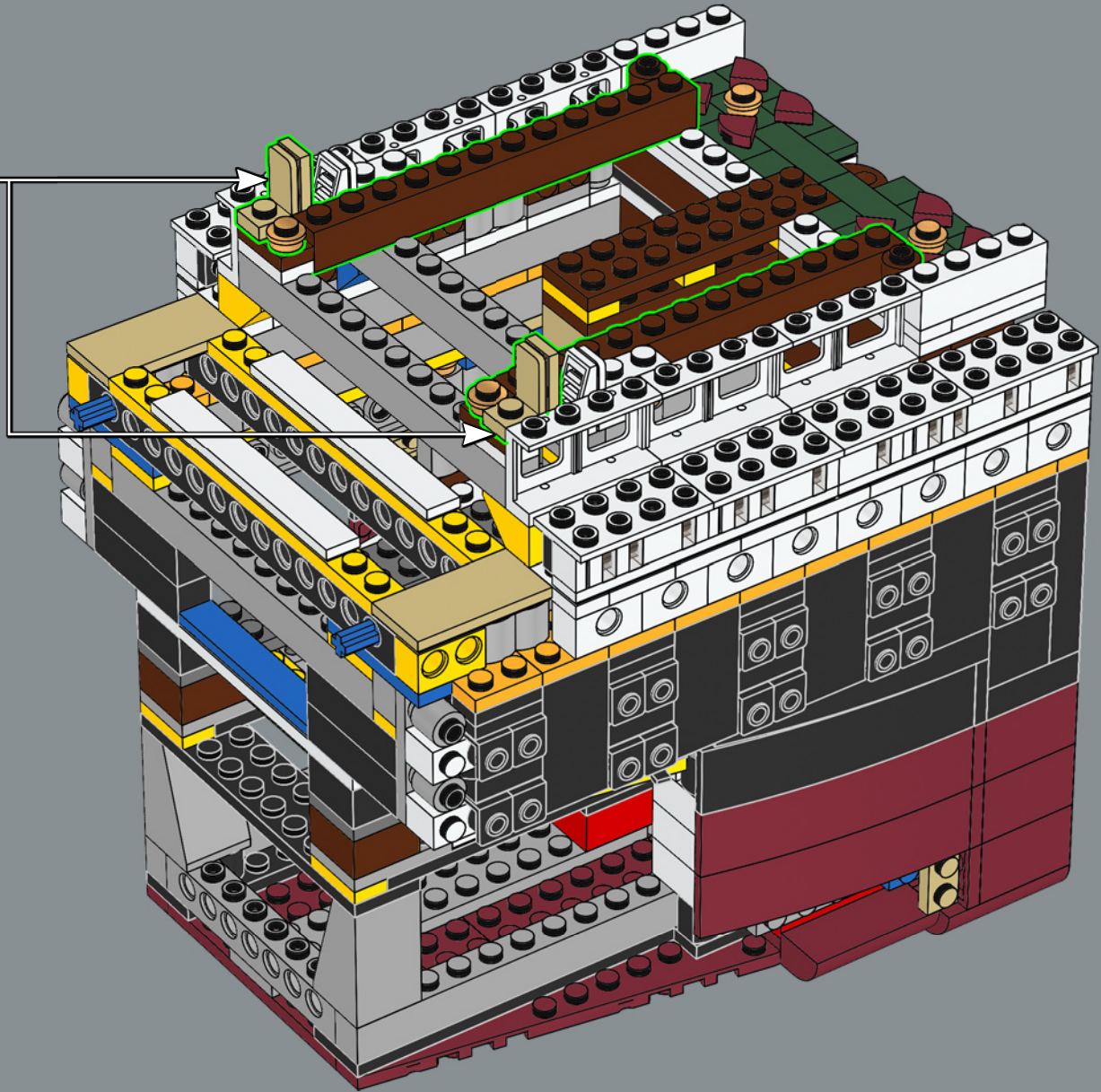
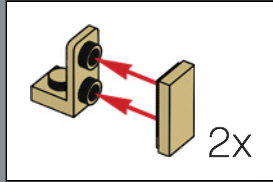

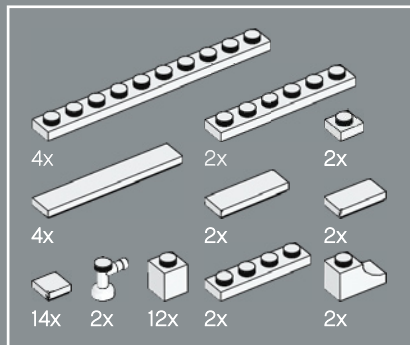
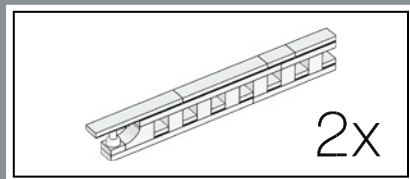

237

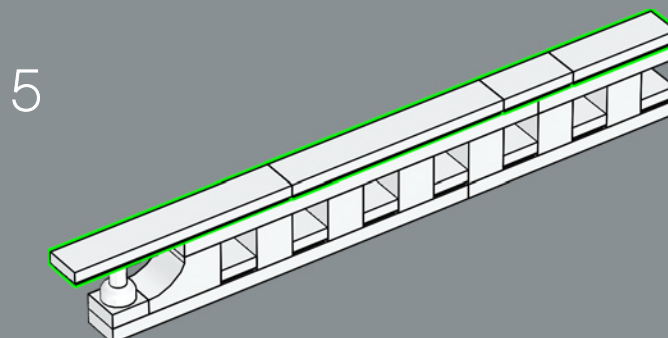
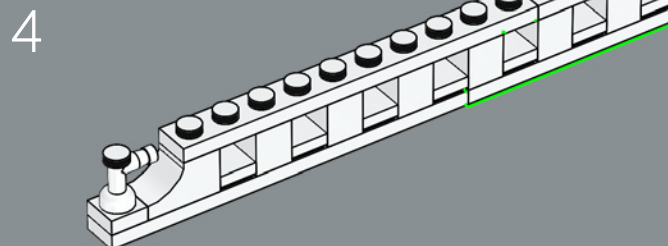
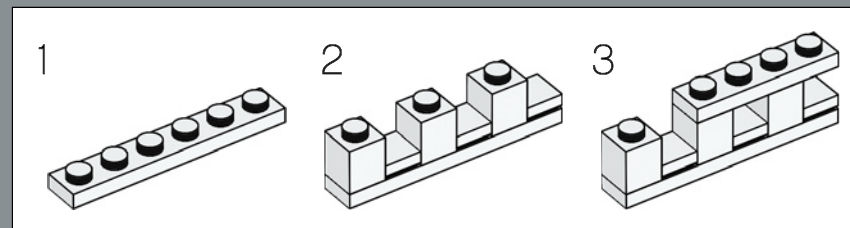
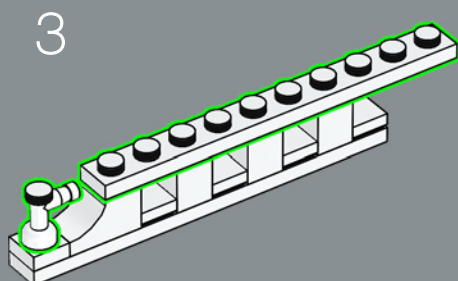
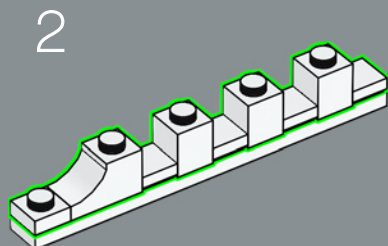
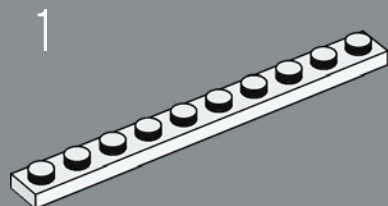

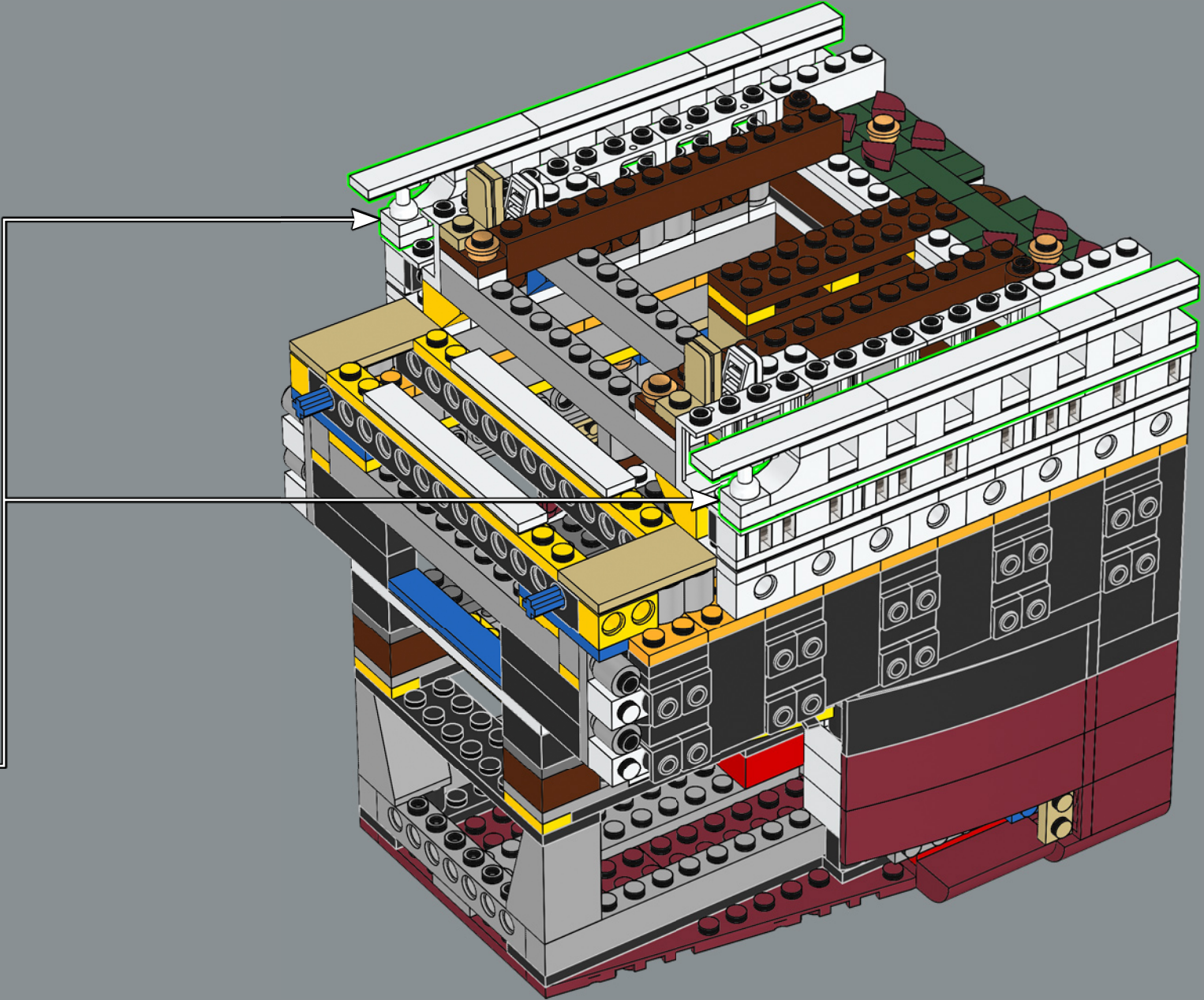

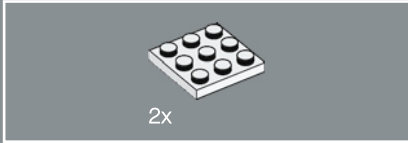
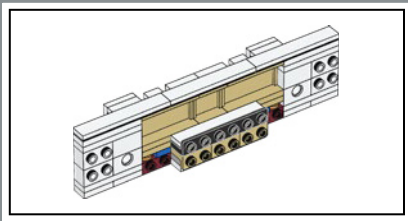

238

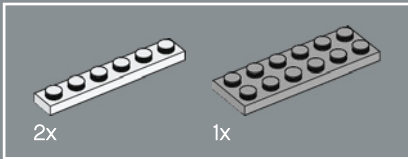
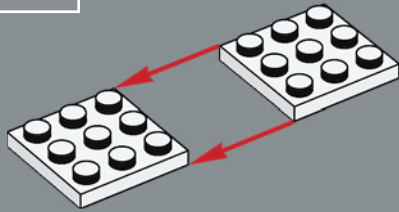

239

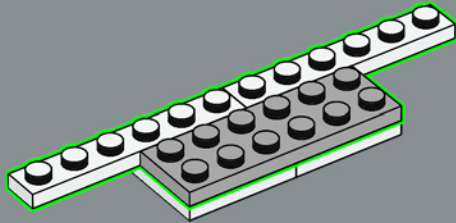

240

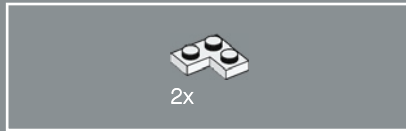
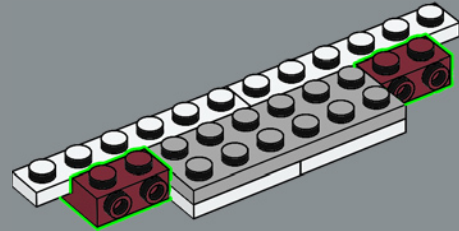

241

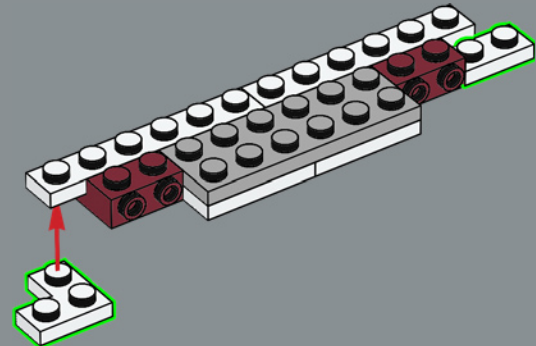

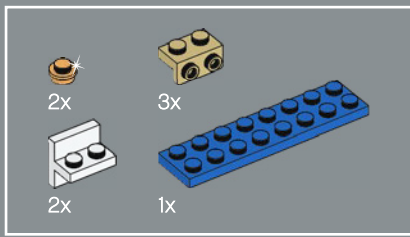

242

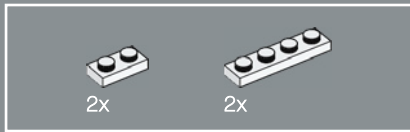
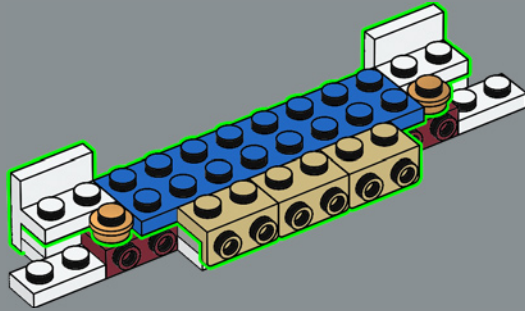

243

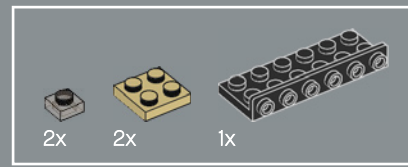
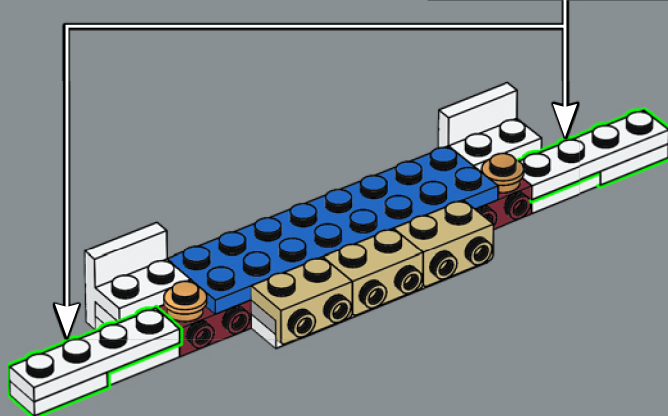
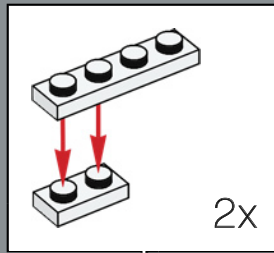

244

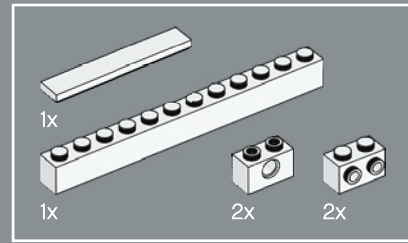
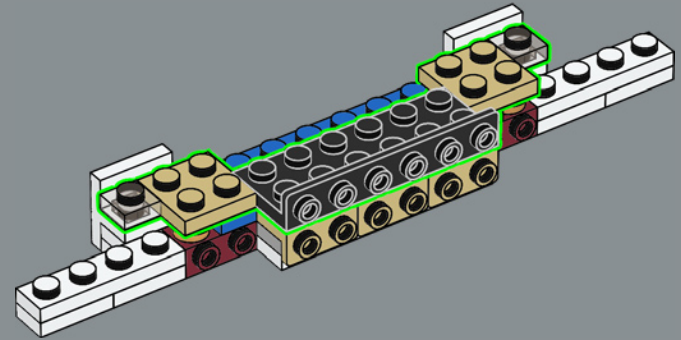

245

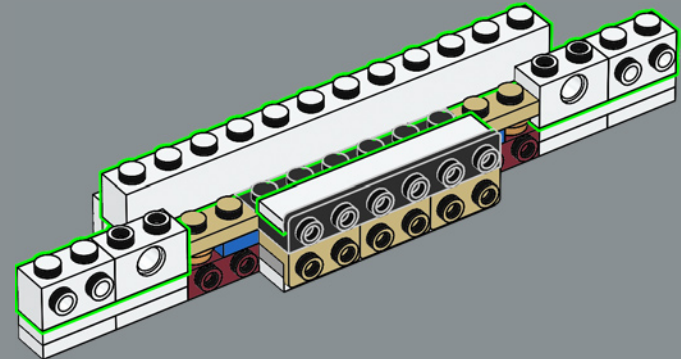

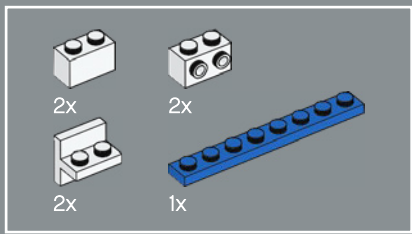

246

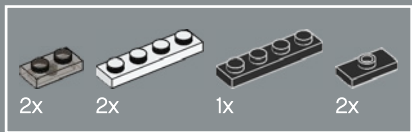
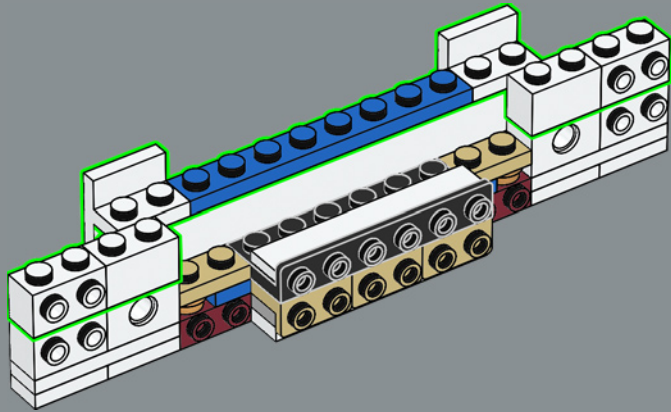

247

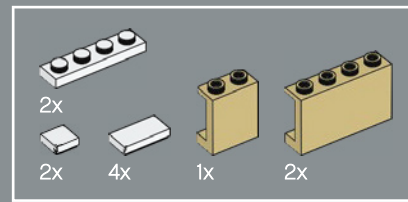
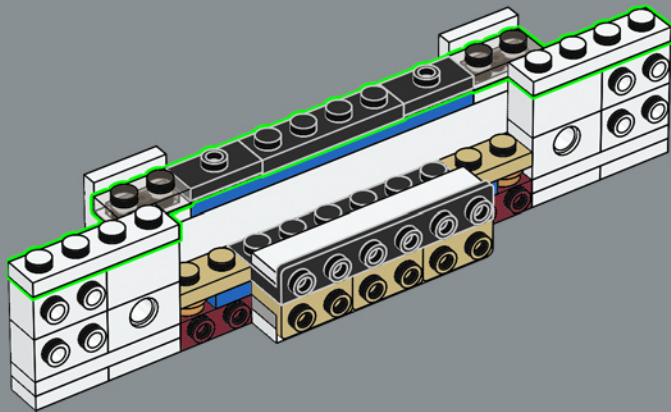

248

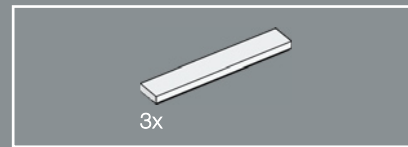
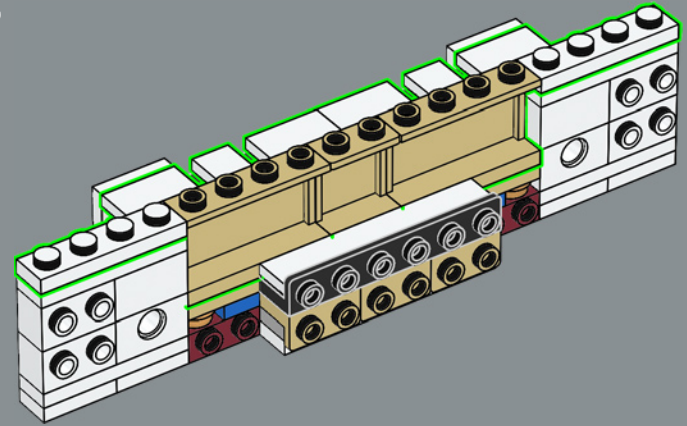

249

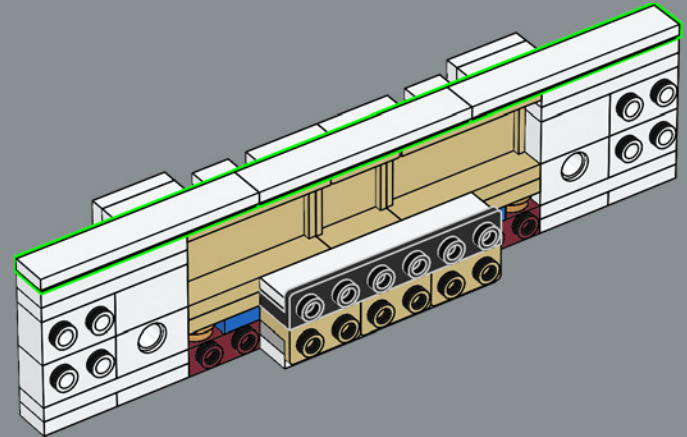

250

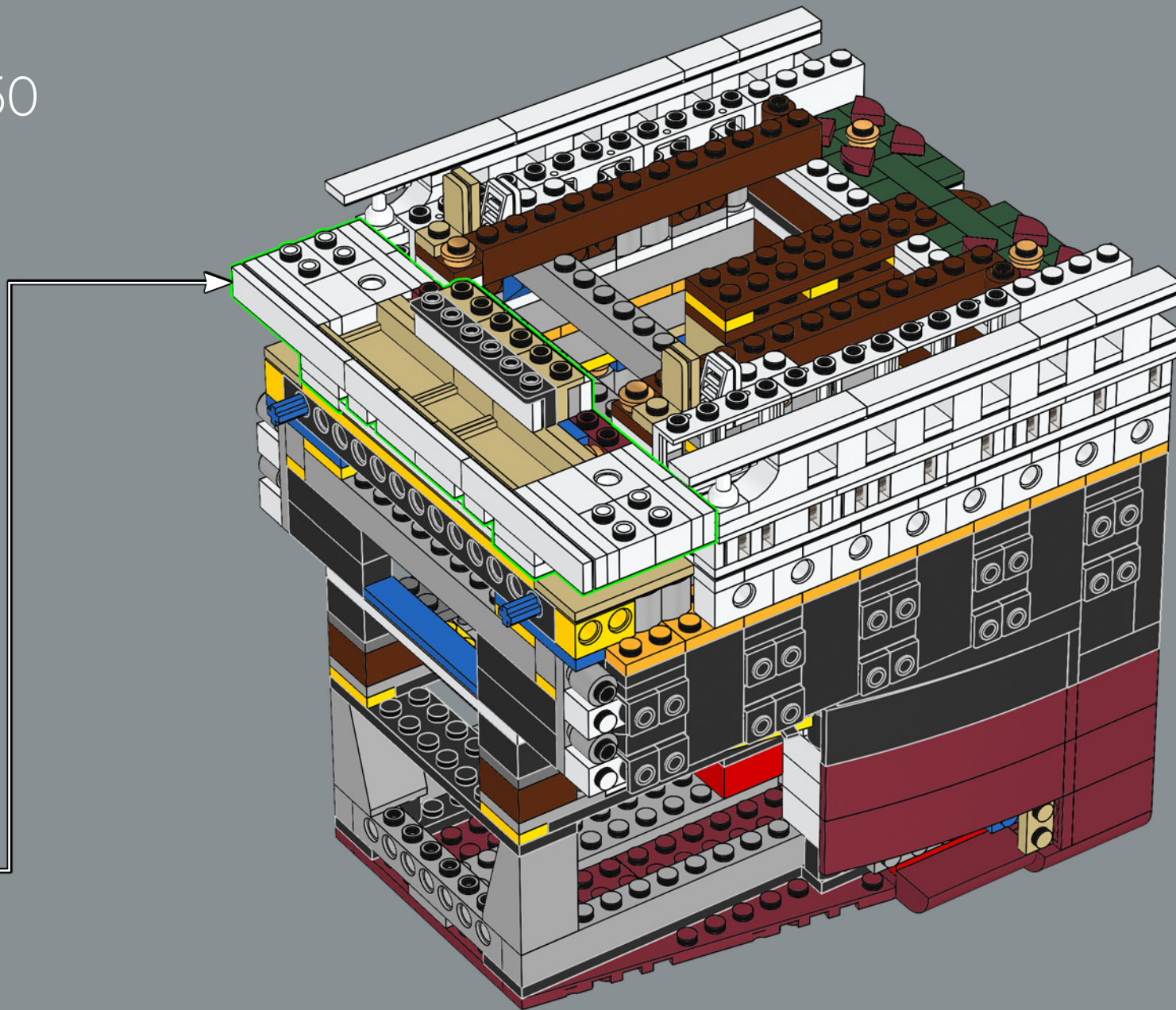

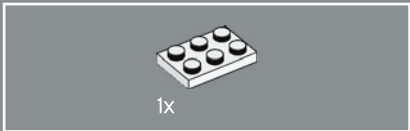
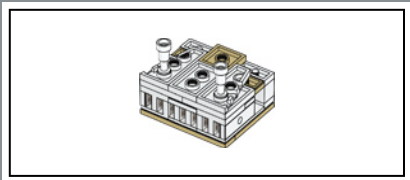

251

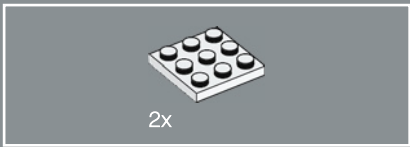

252

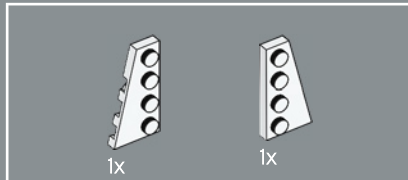
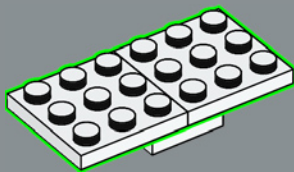

253

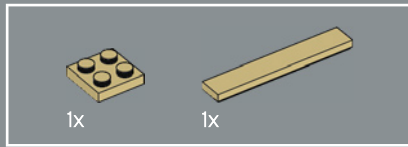
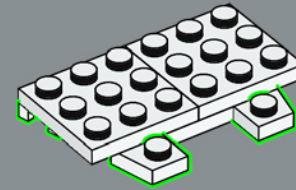

254

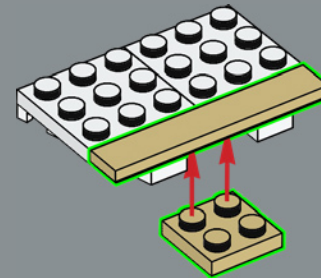

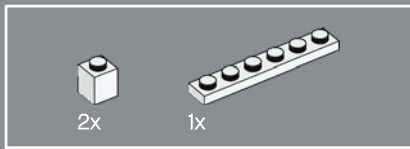

255

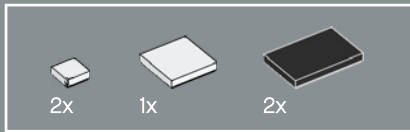
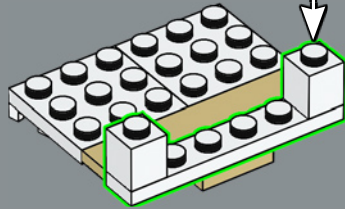
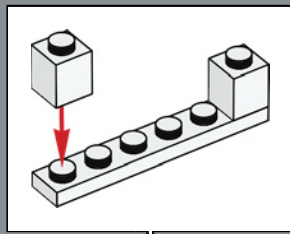

256

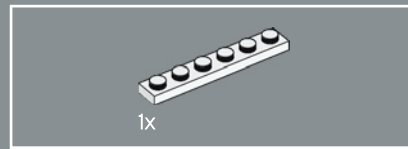
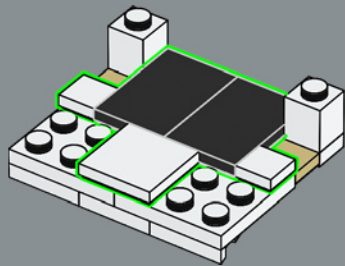

257

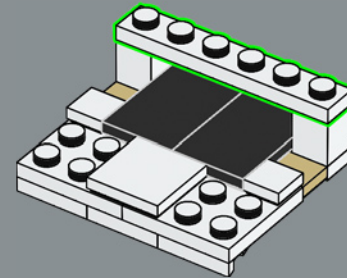

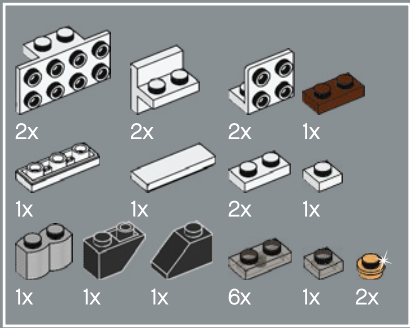

258

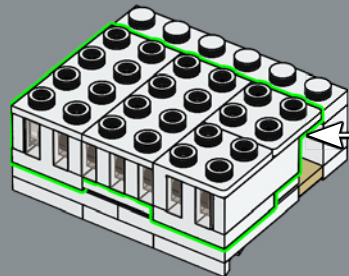
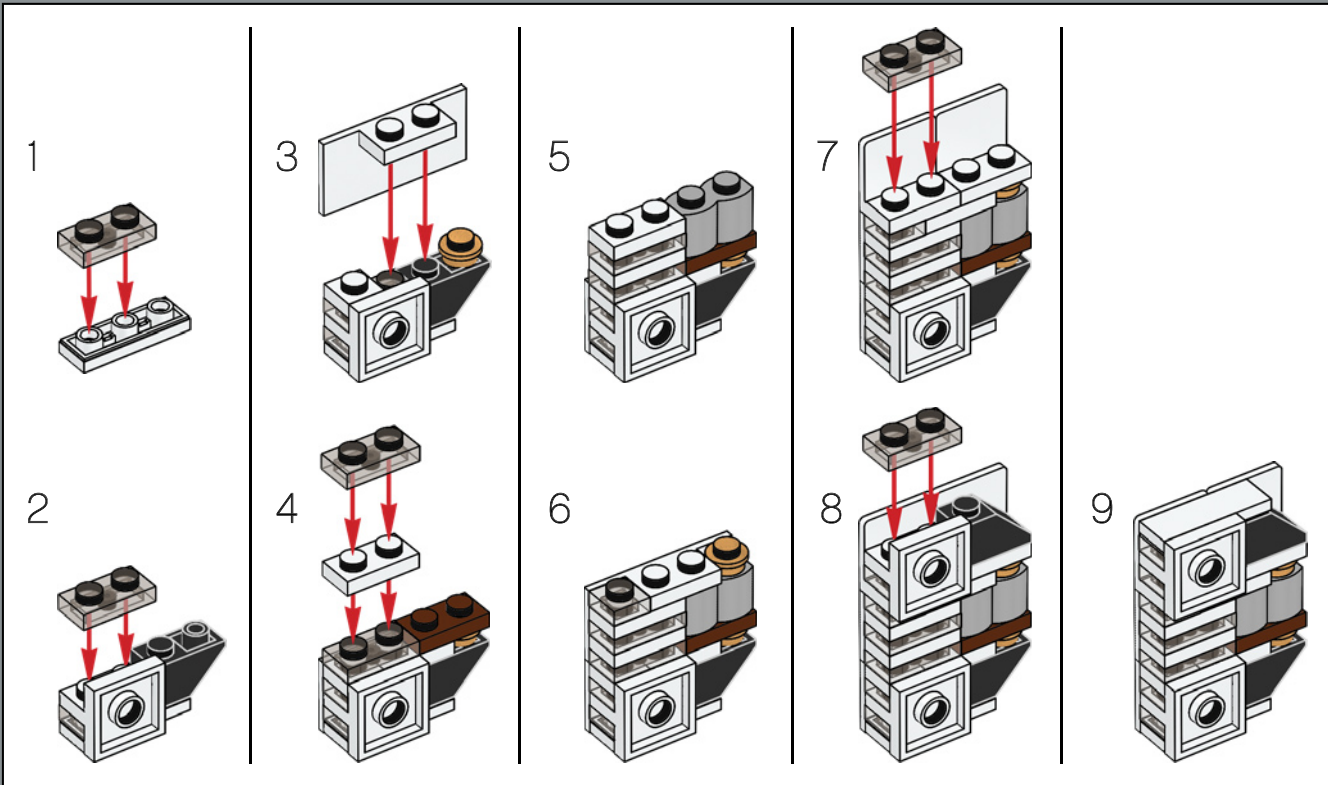

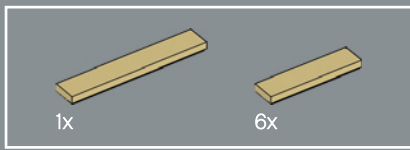

259

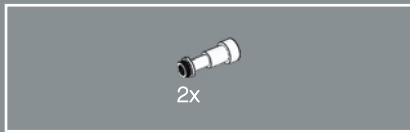
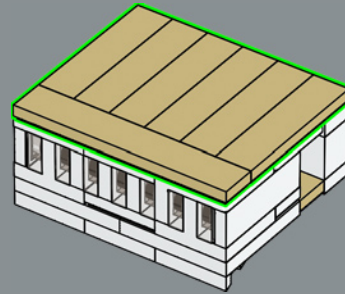

260

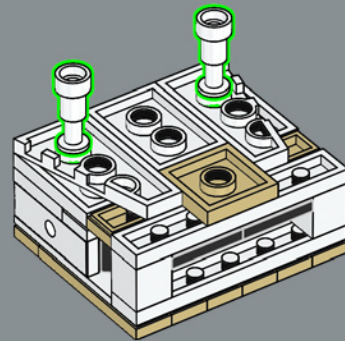

桥楼位于甲板之上 2.4 米 (8 英尺), 并向两侧延伸, 以便在停靠时控制船体。

261

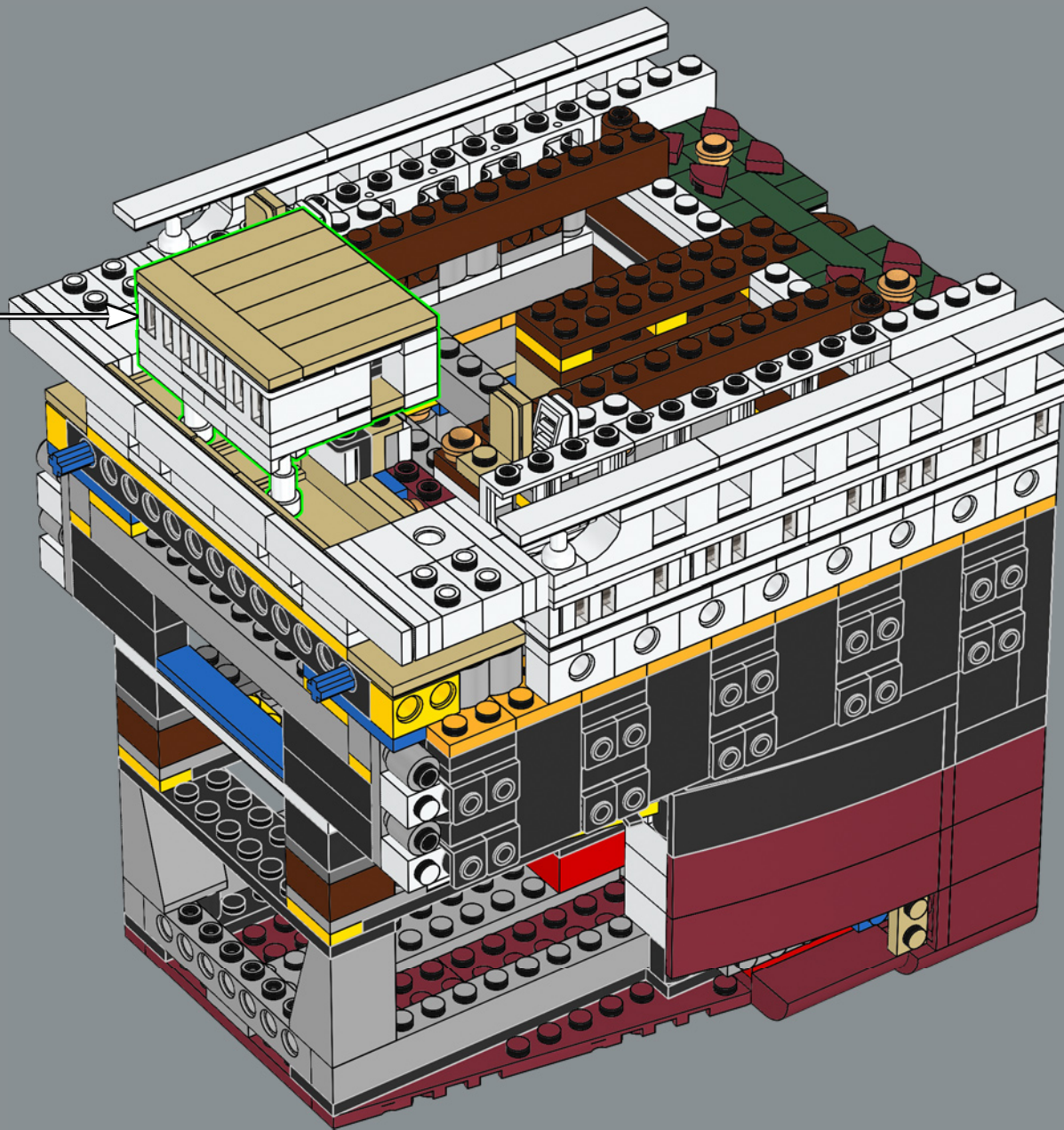



262

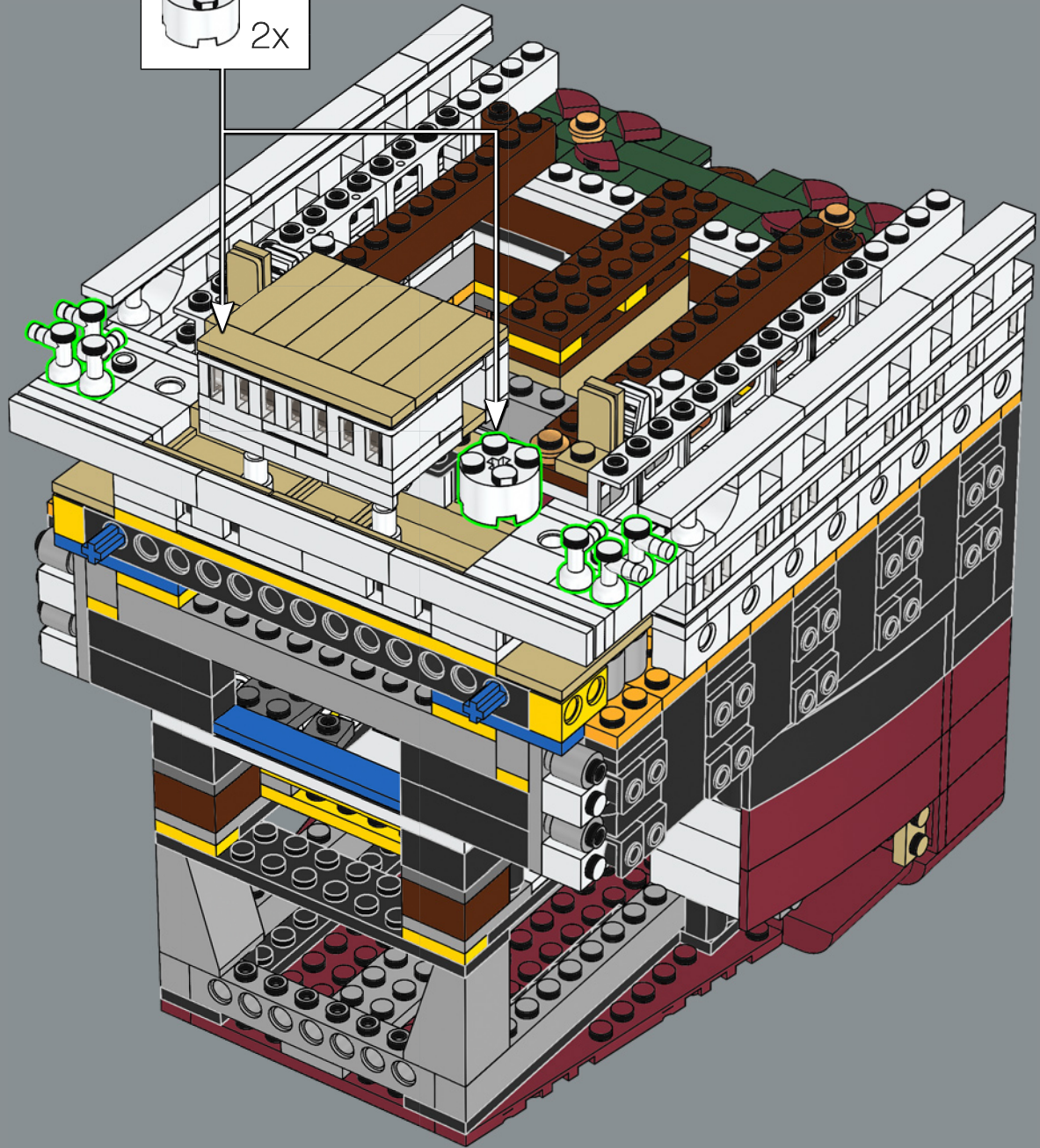
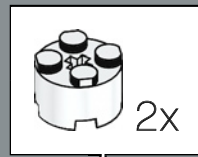

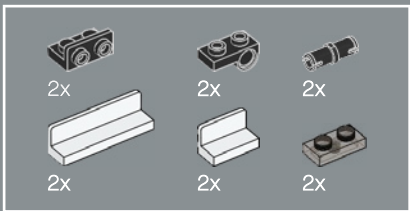

263

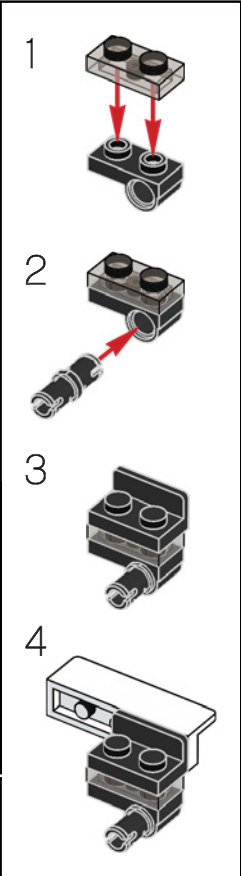
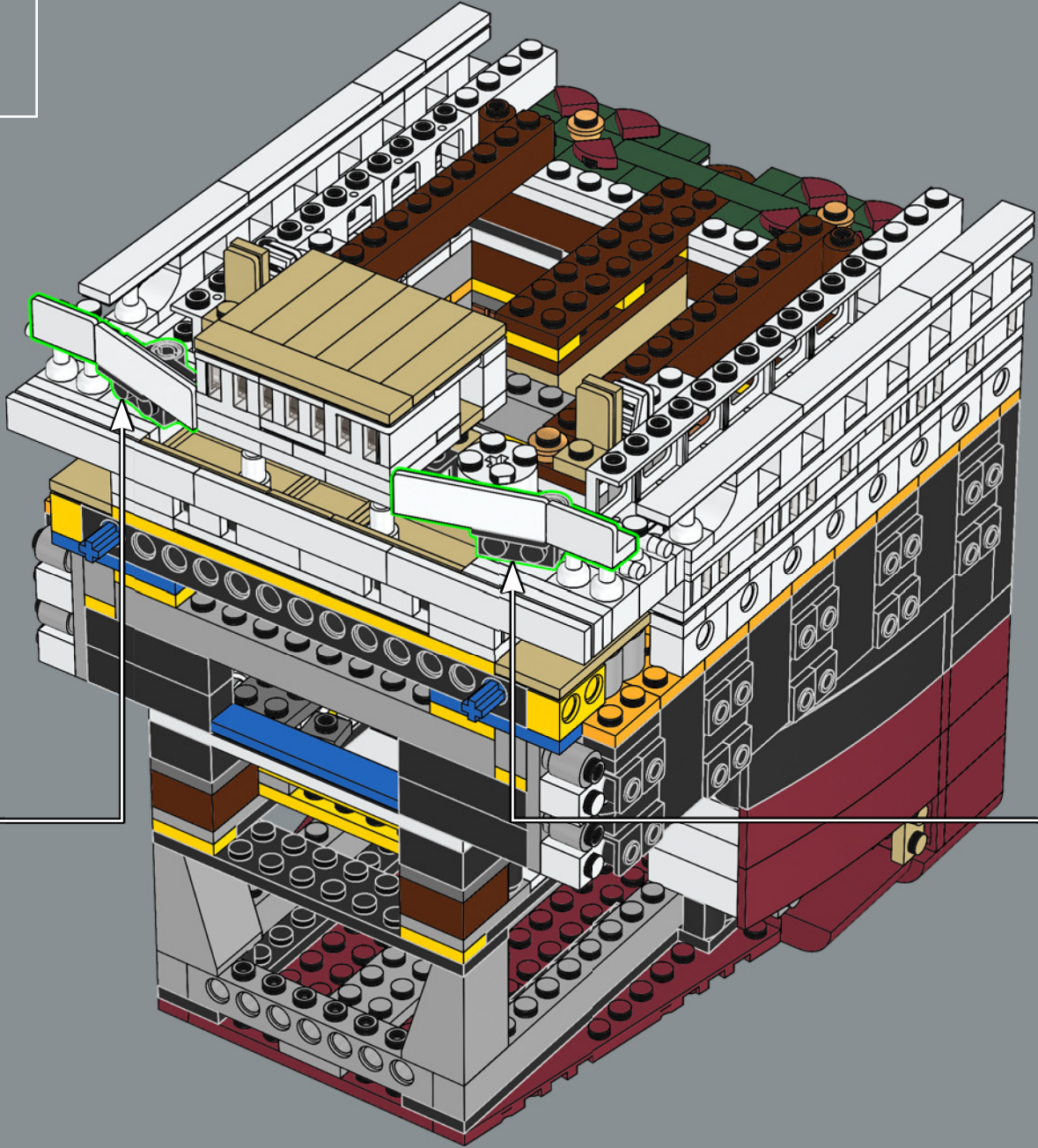
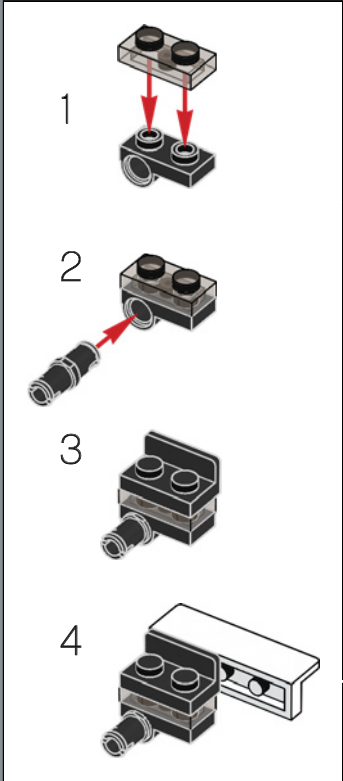

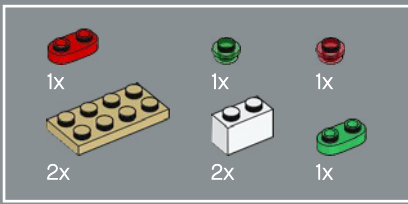

264

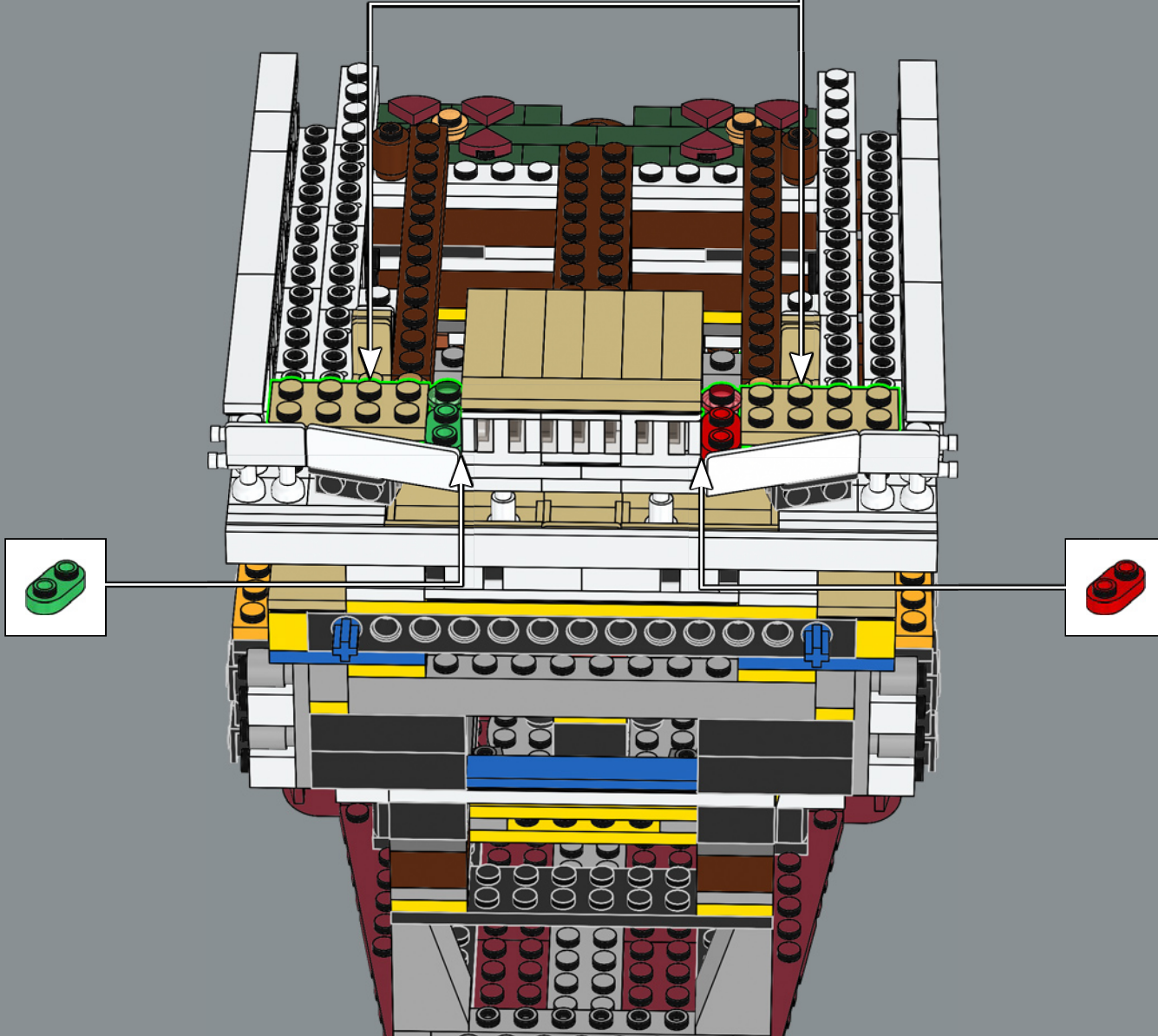
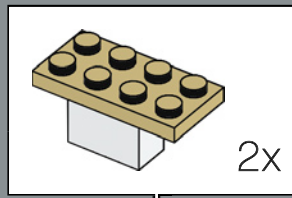

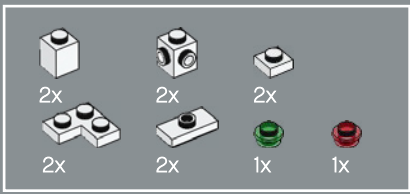

265

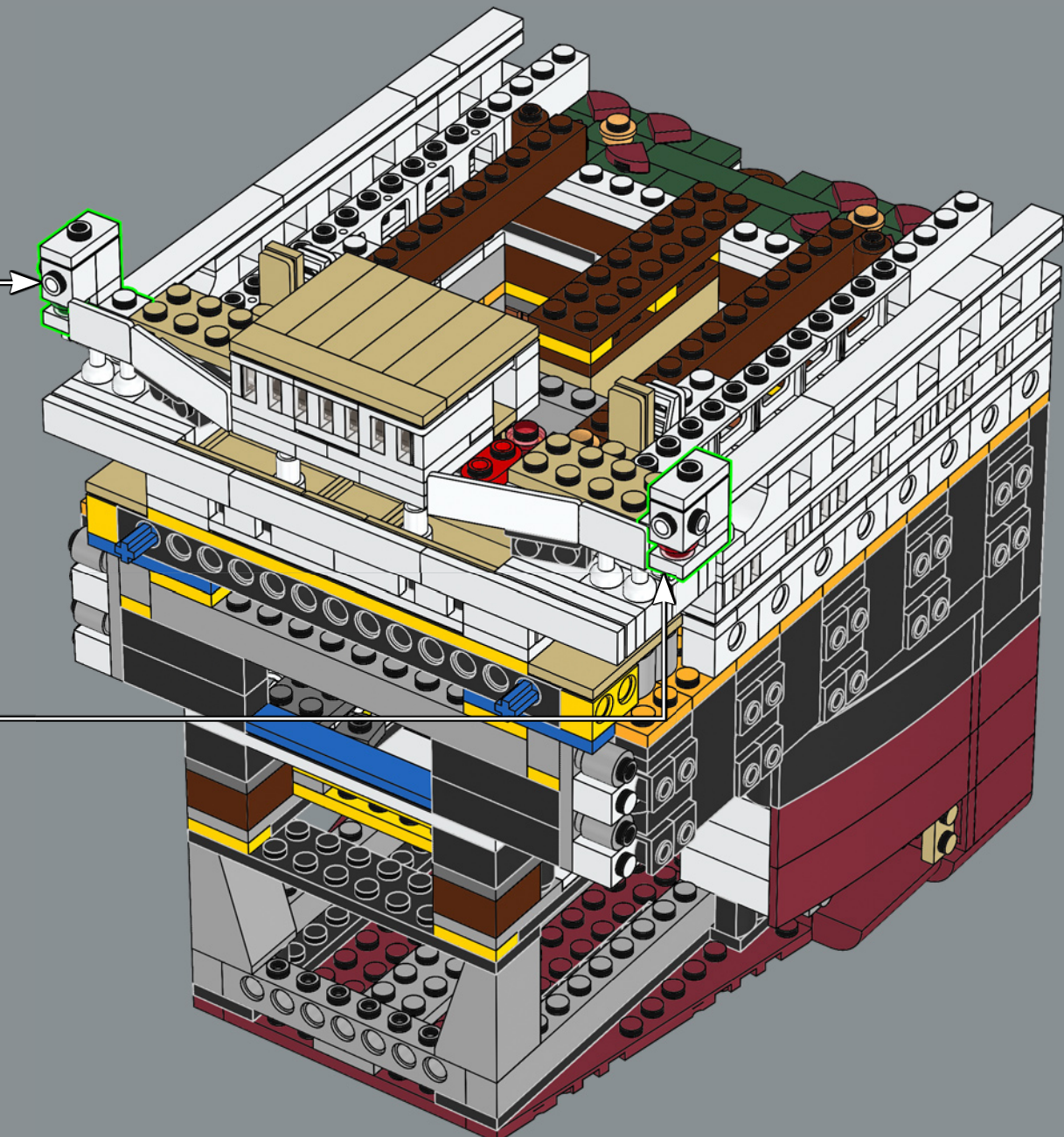
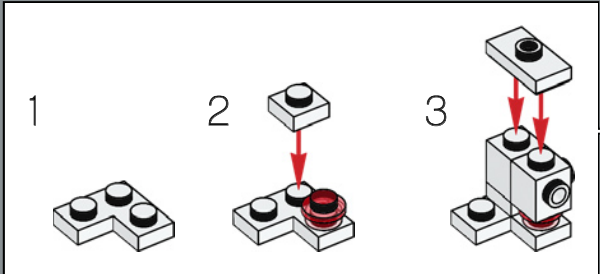
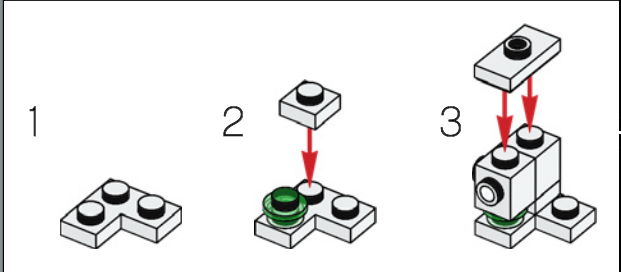

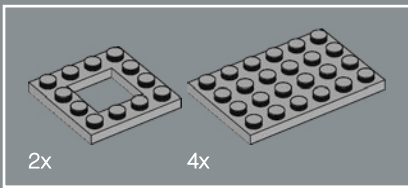

266

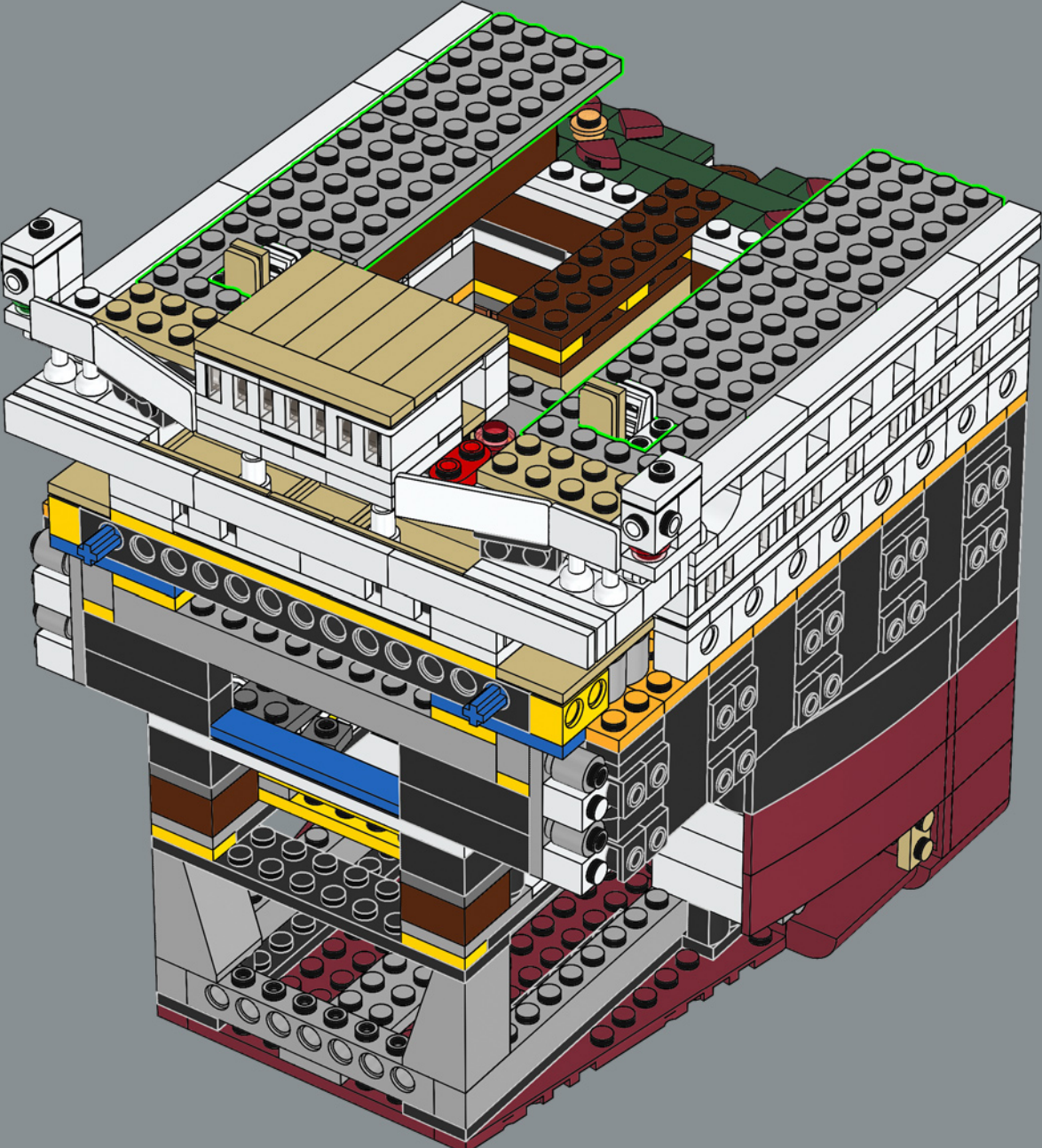

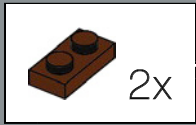
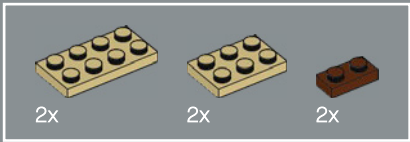

267

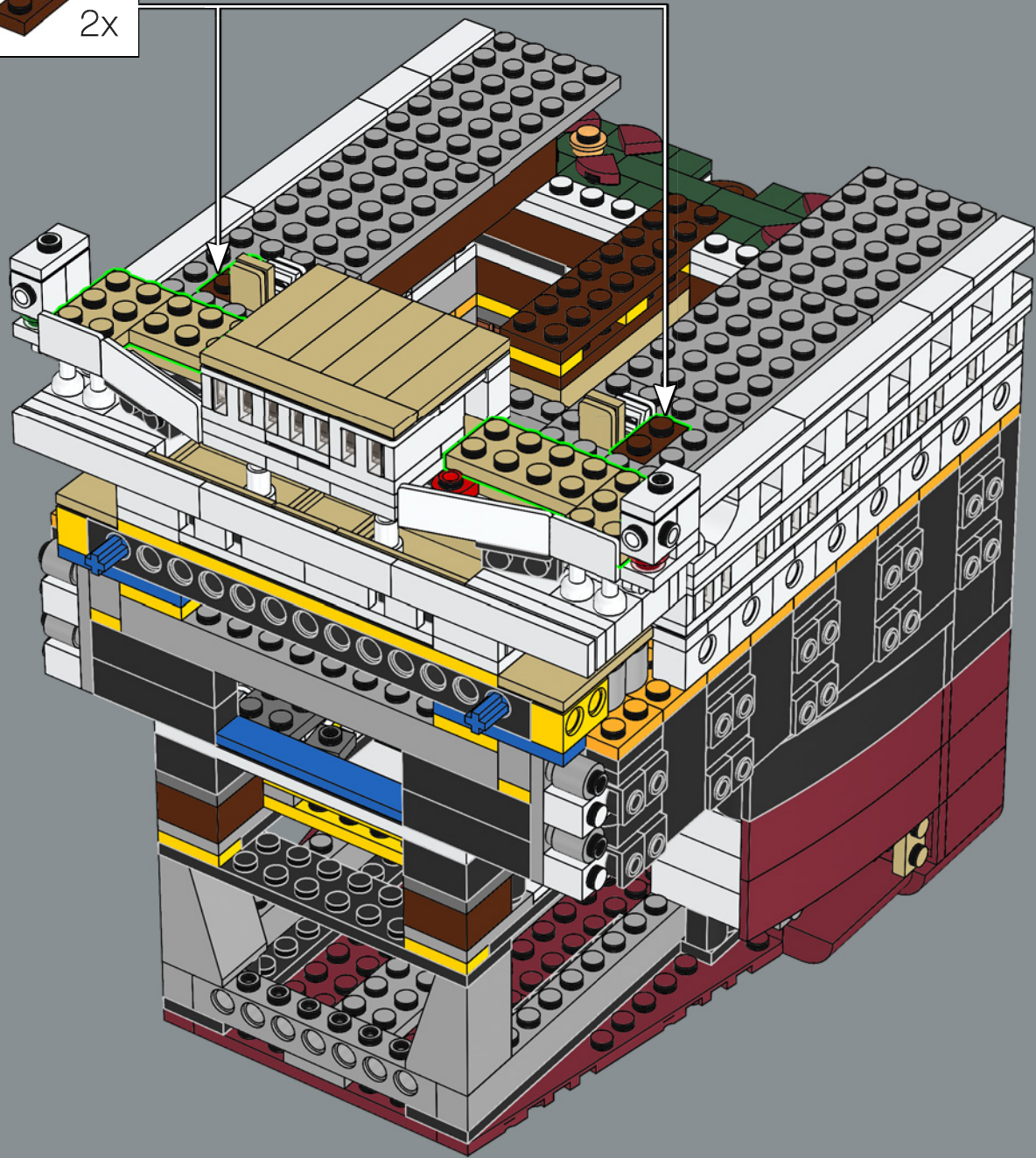

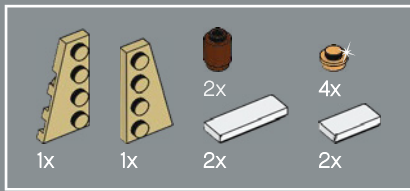

268

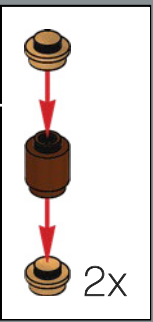
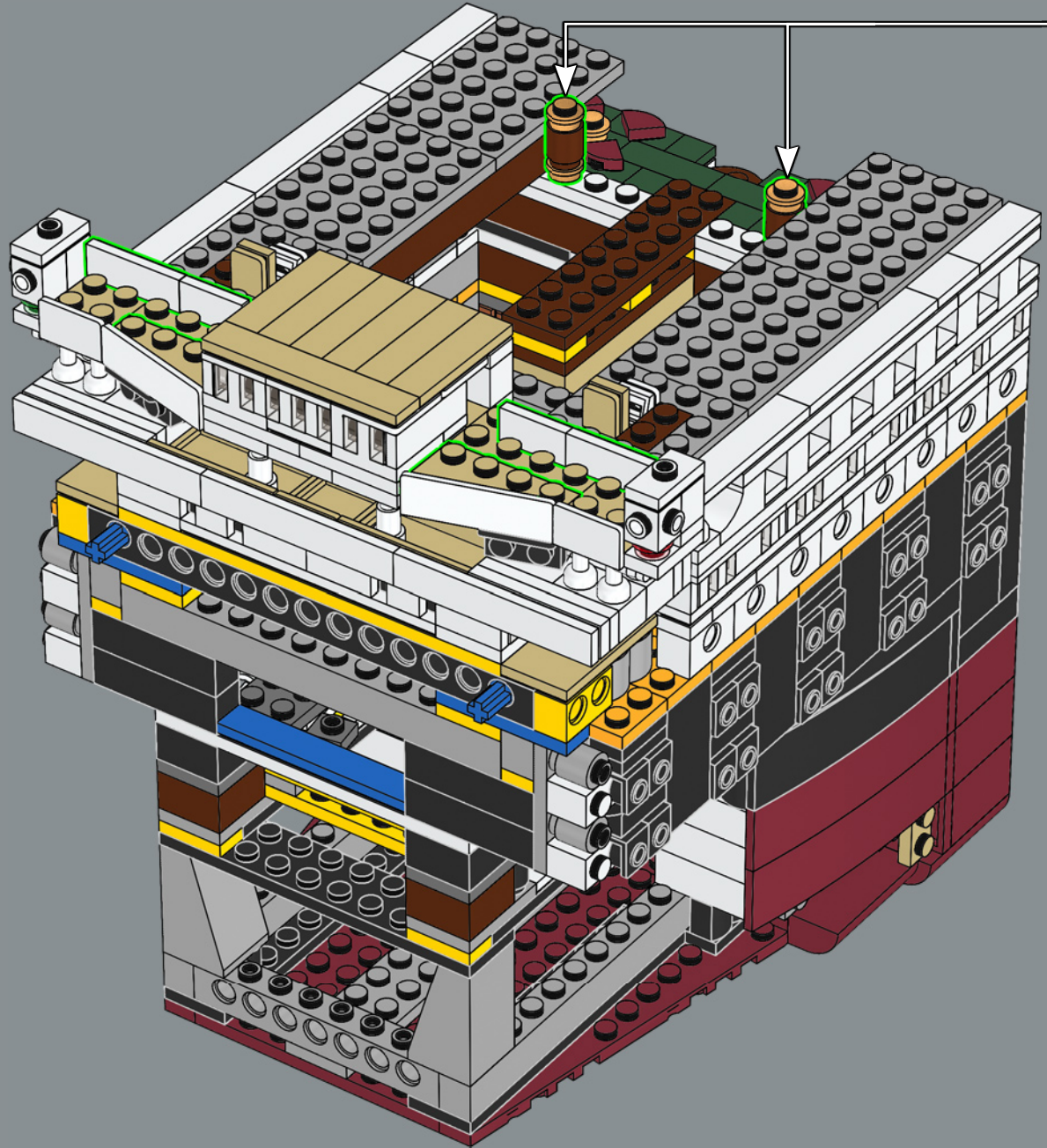
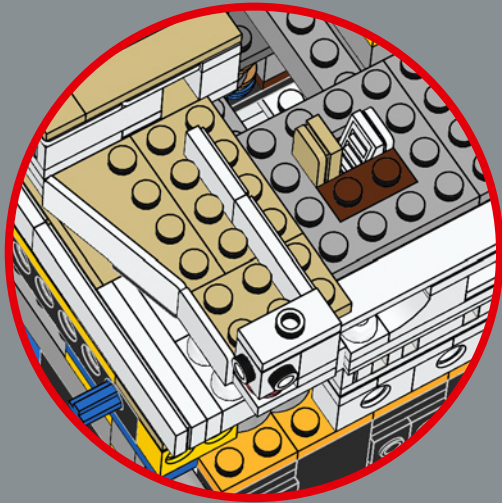
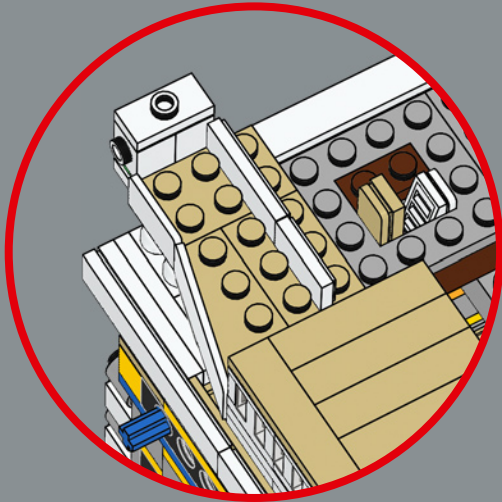

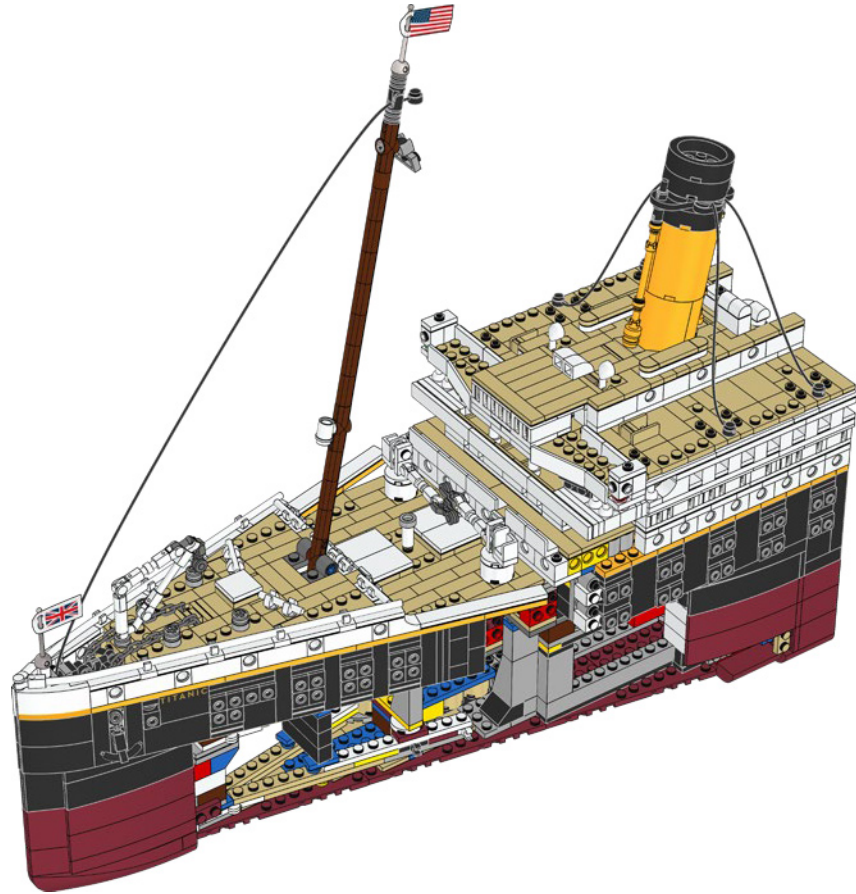
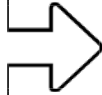

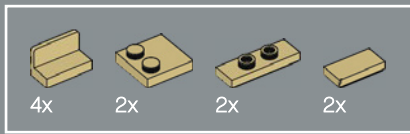

269

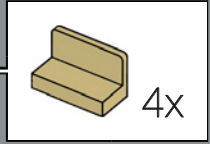
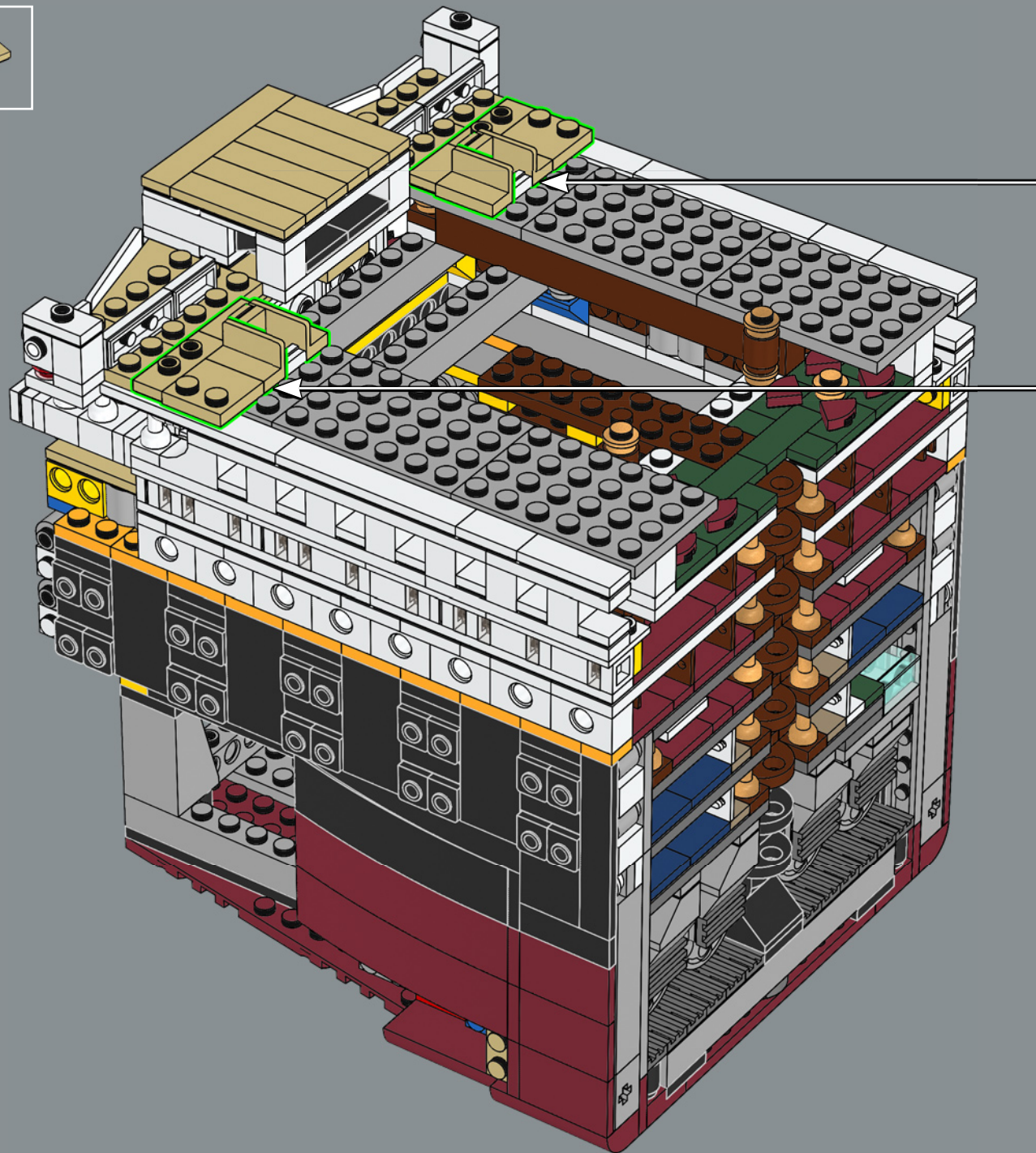

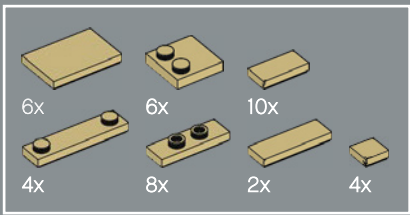

270

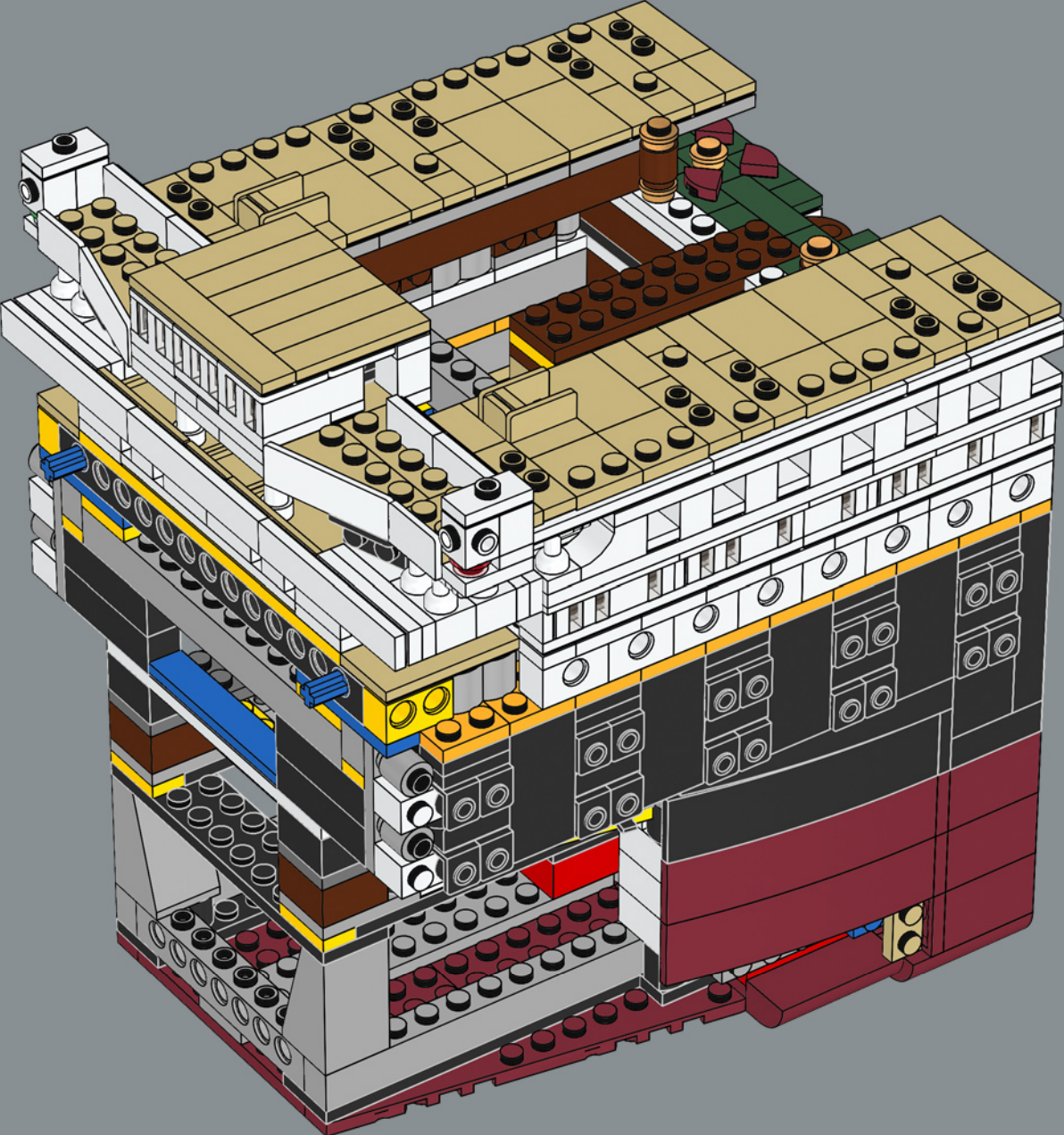

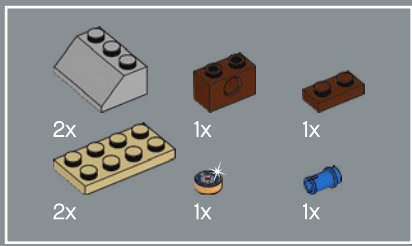

274

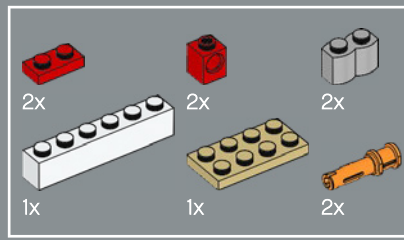
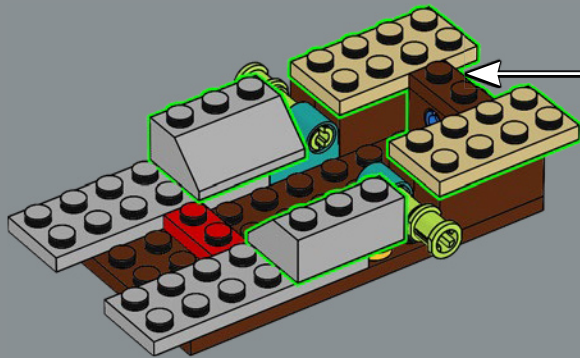
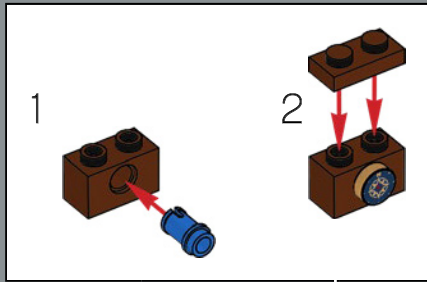

275

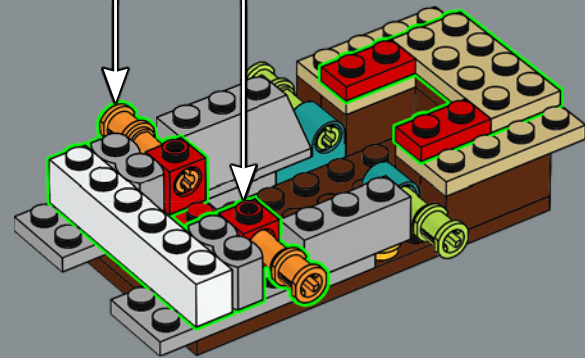
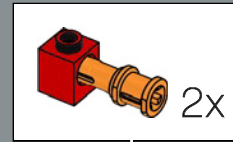

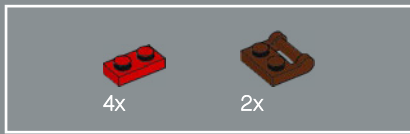

276

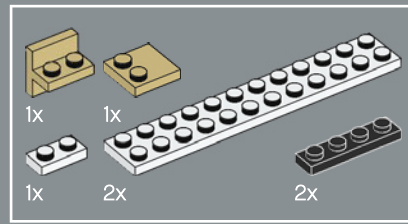
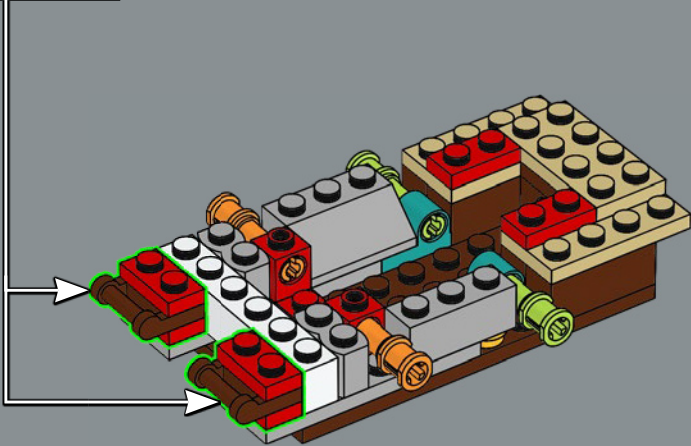
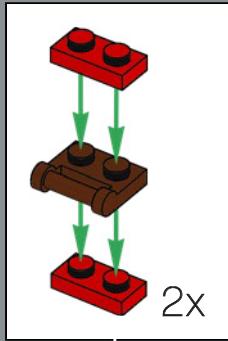

277

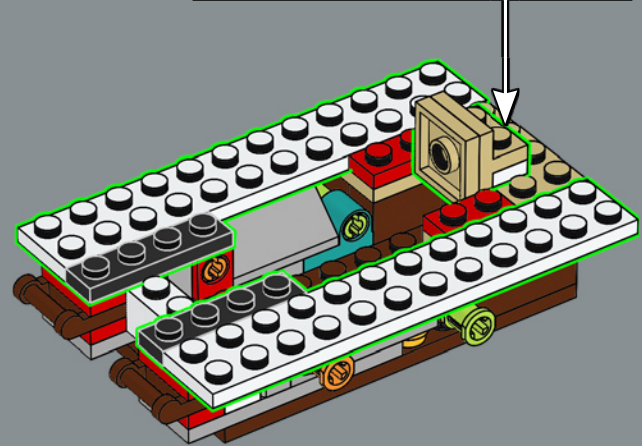
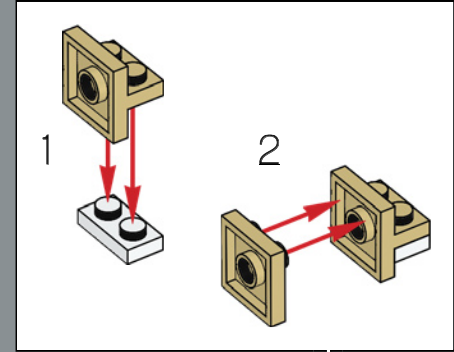

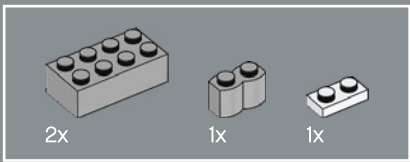

278

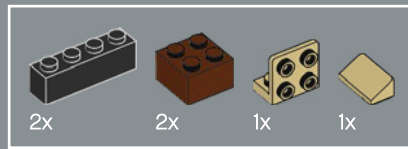
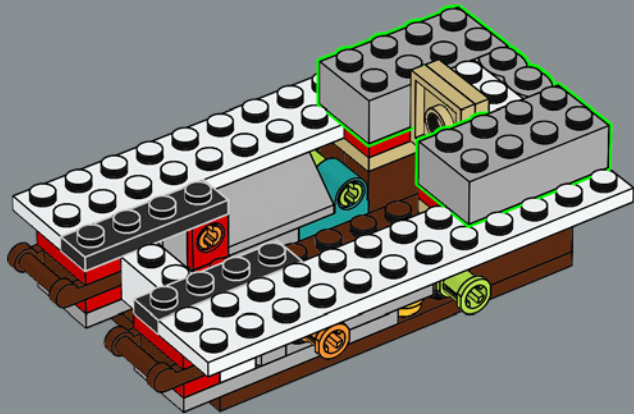

279

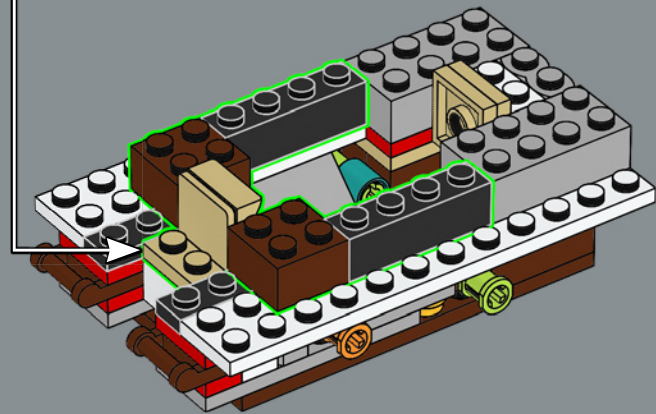
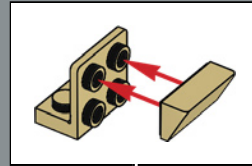

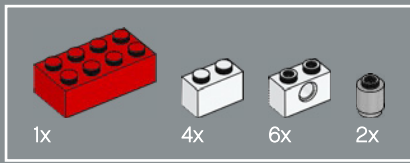

280

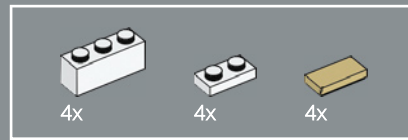
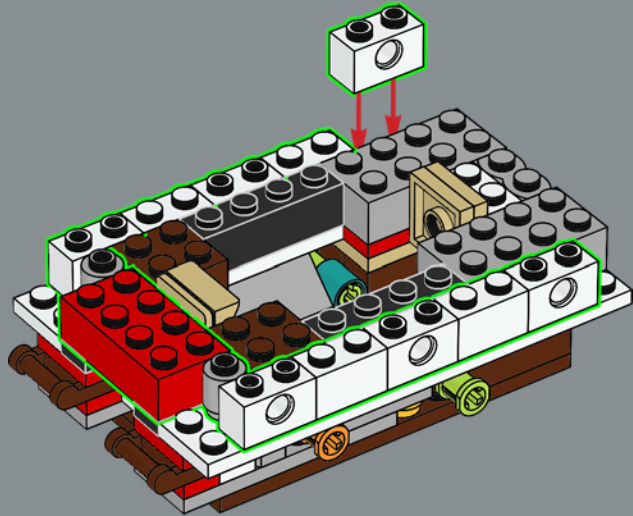

281

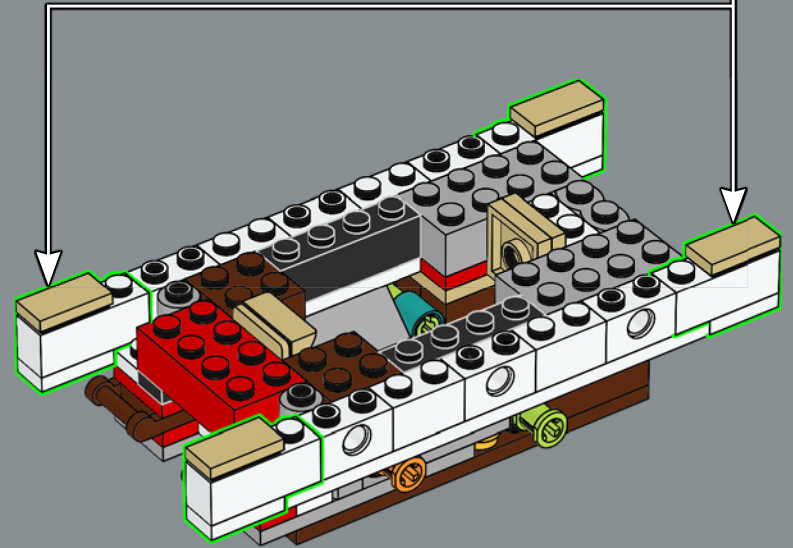
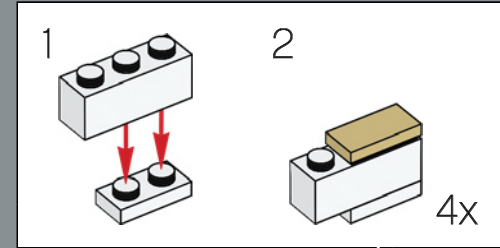

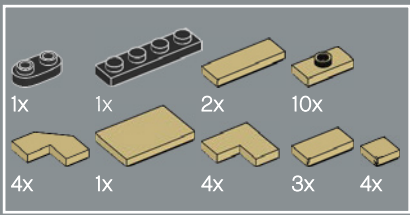

282

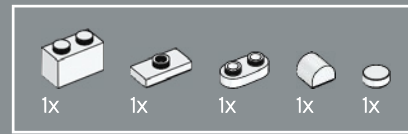
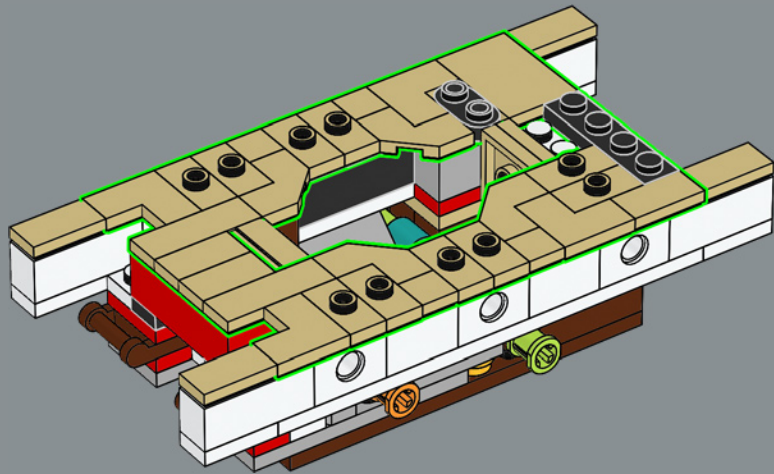

283

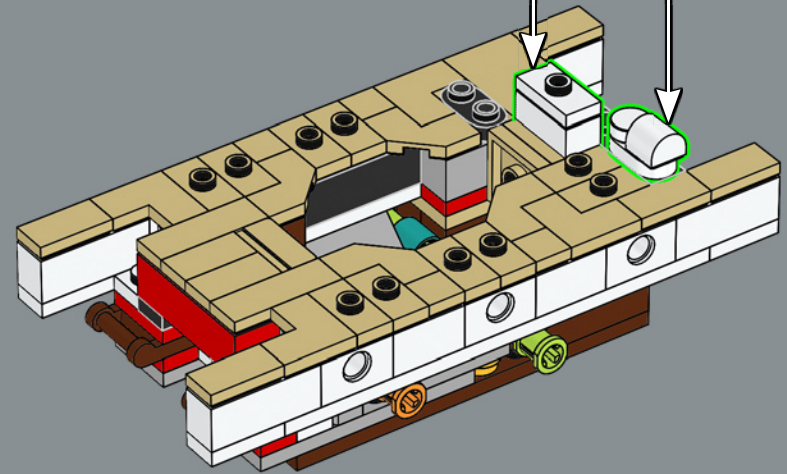
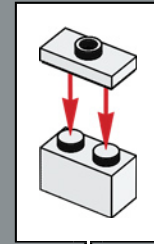
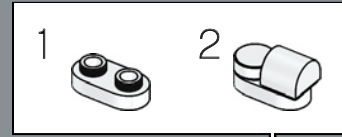

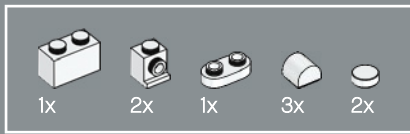

284

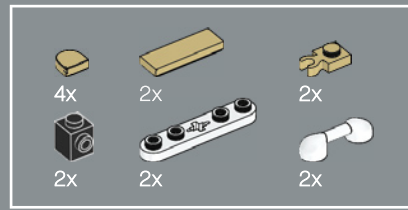
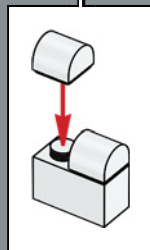
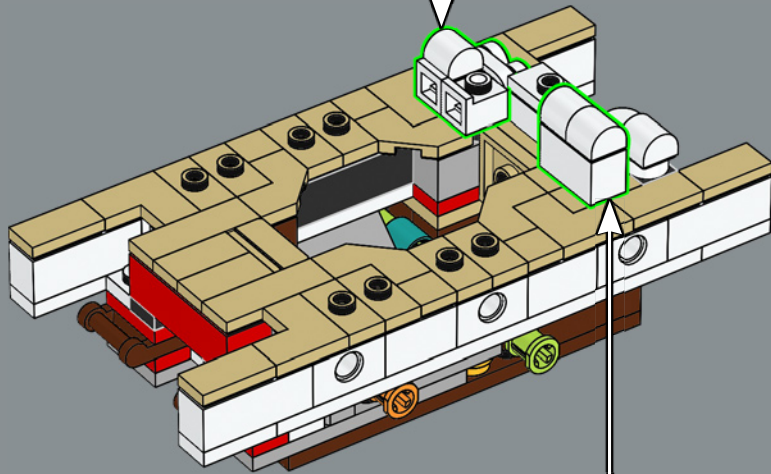
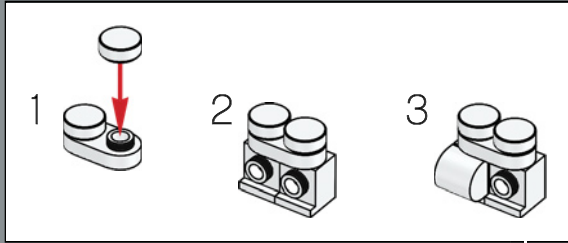

285

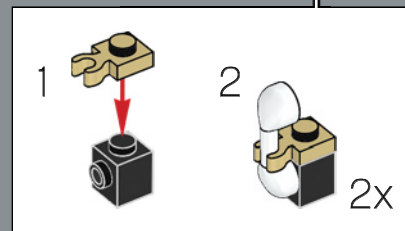
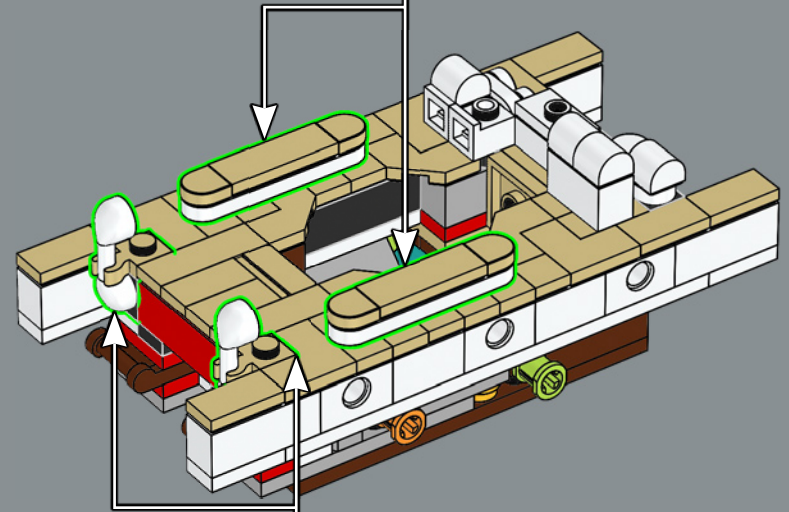
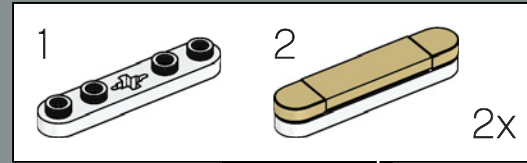

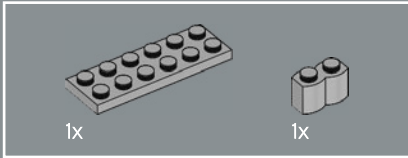
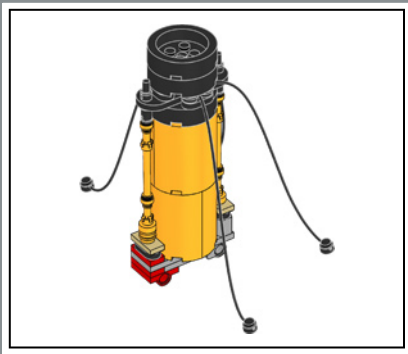

286

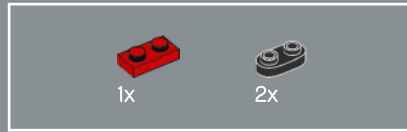
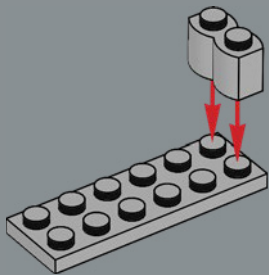

287

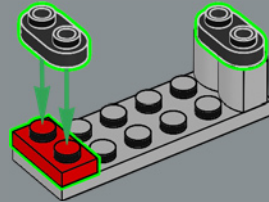

288

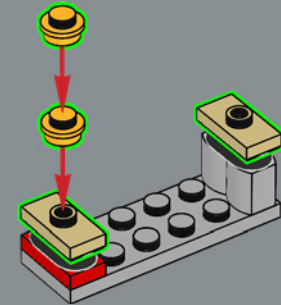

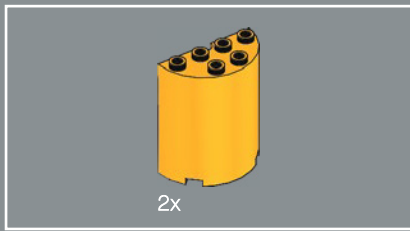

289

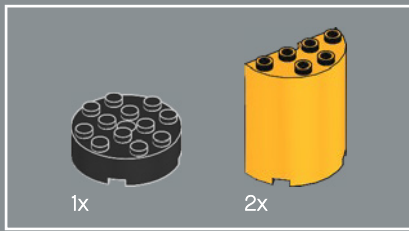
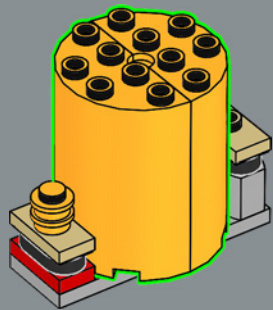

290

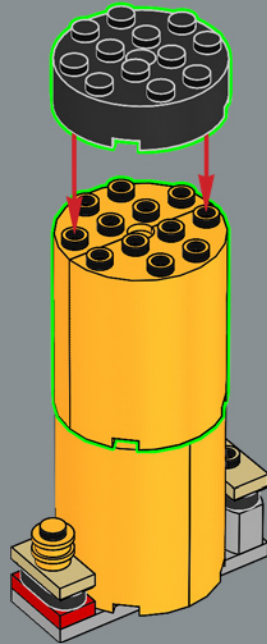

291

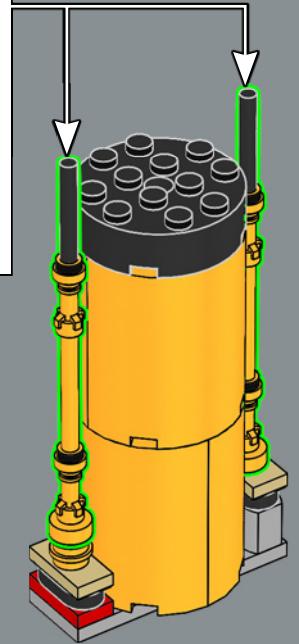
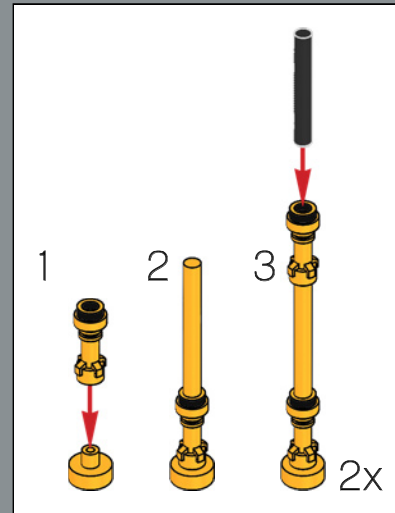

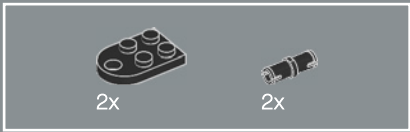

292

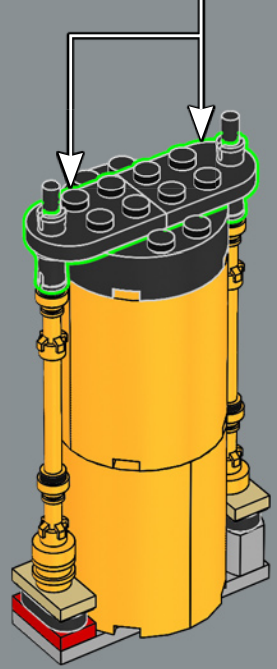
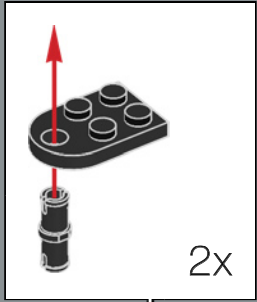

293

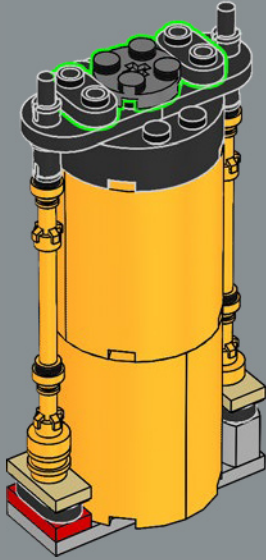

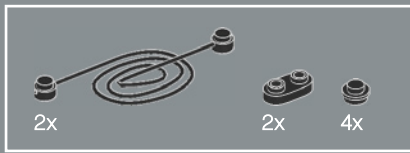

294

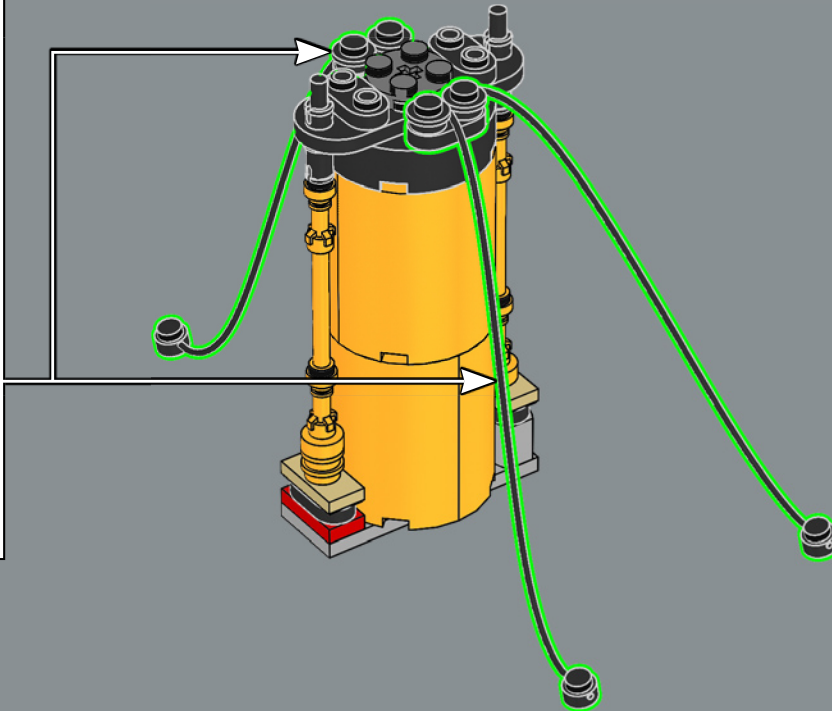
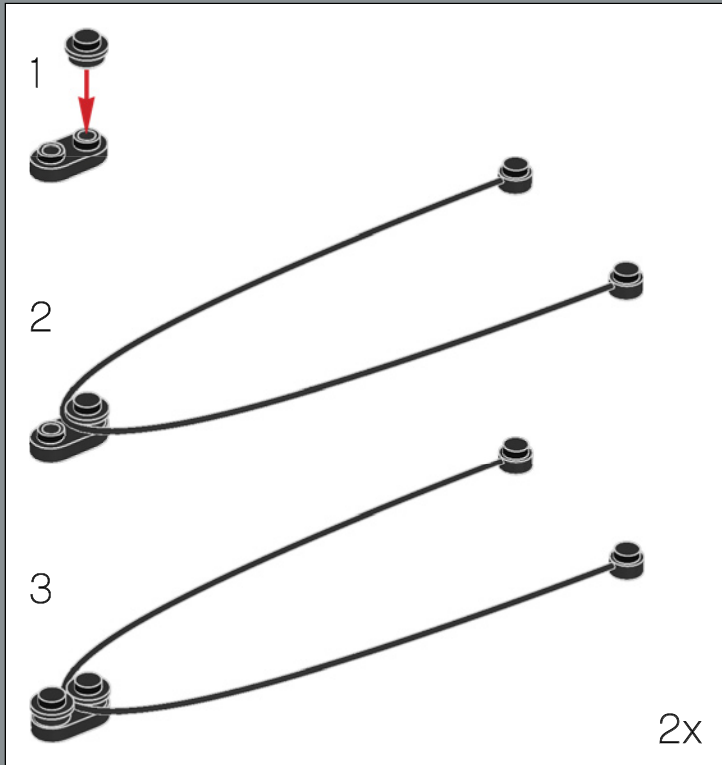

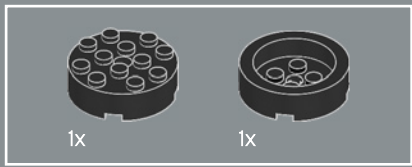

295

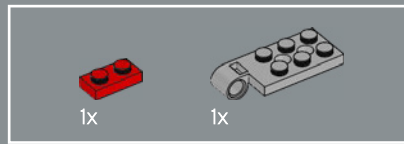
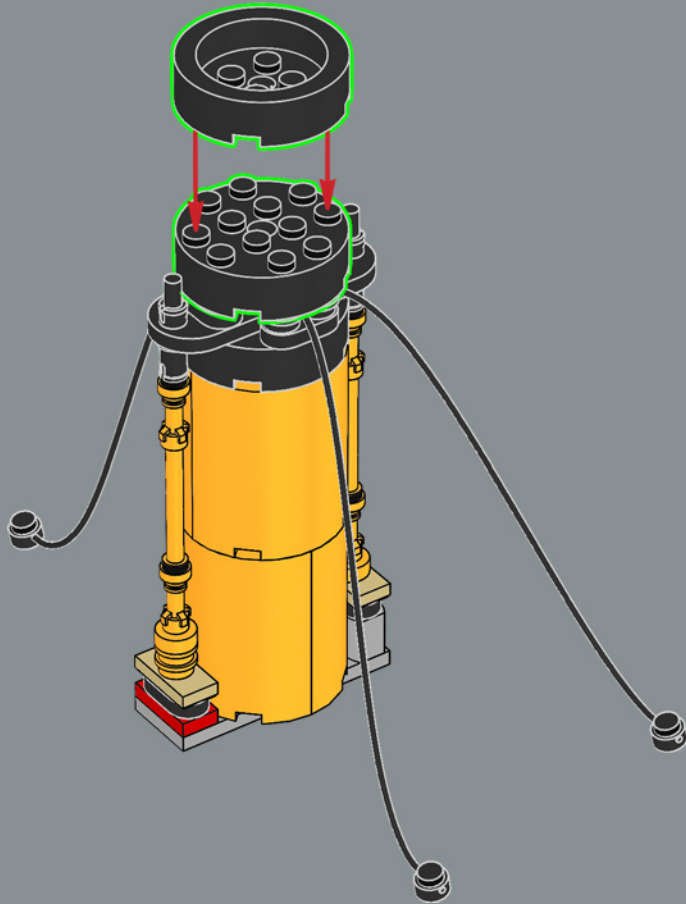

296

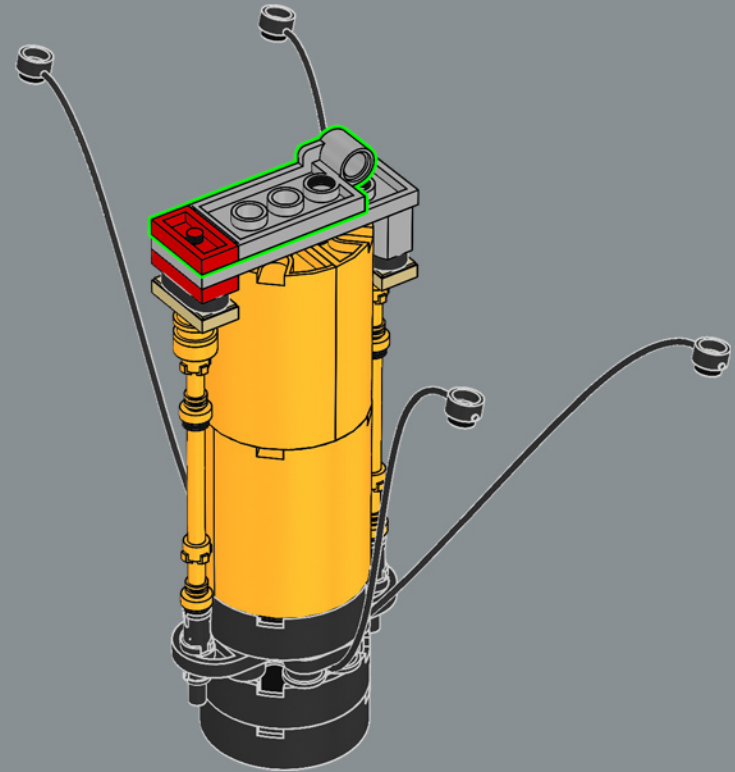

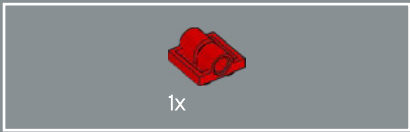

297

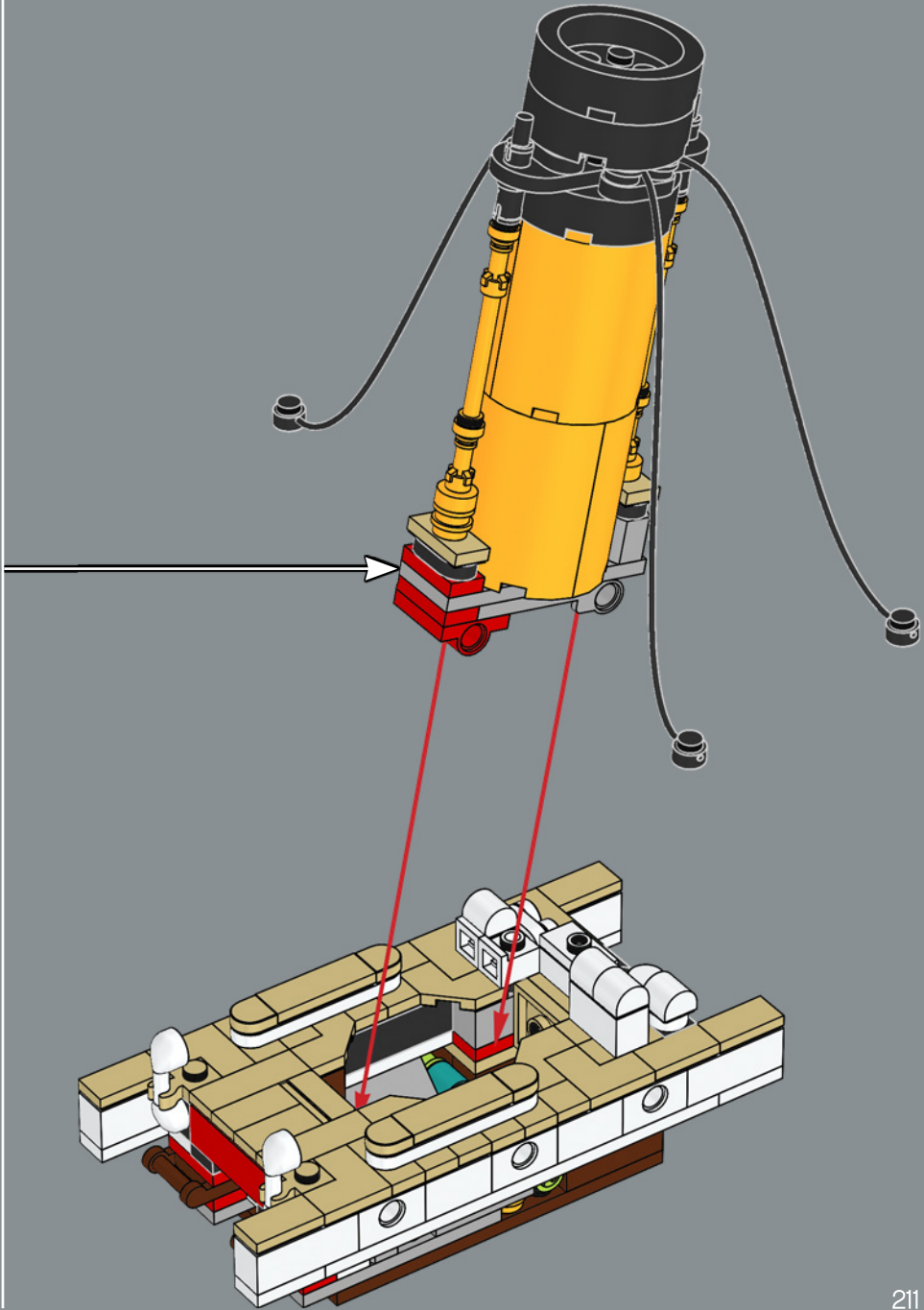
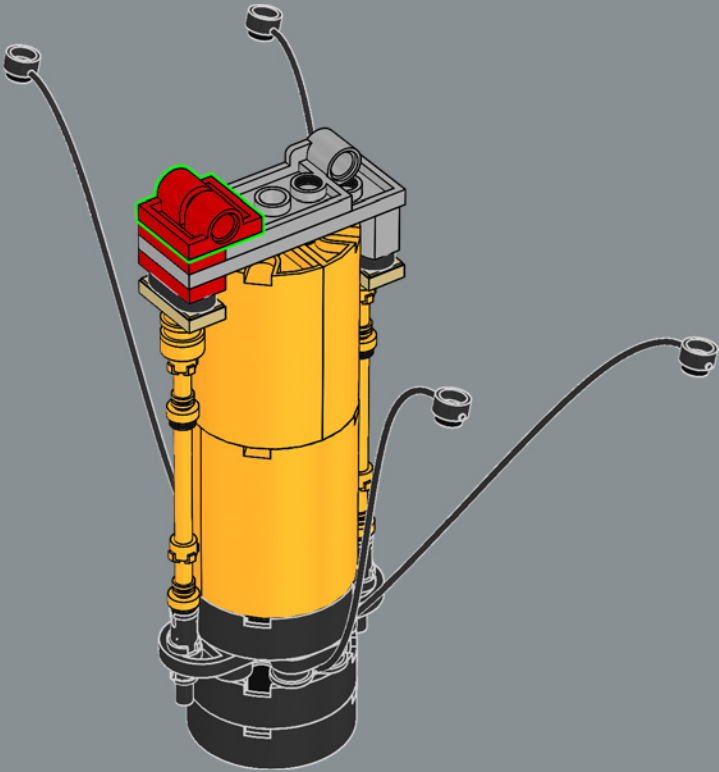

这艘船的通信室拥有世界上最强大的发报机之一，能够向 563 公里 (350 英里) 半径范围内的区域发报。

298

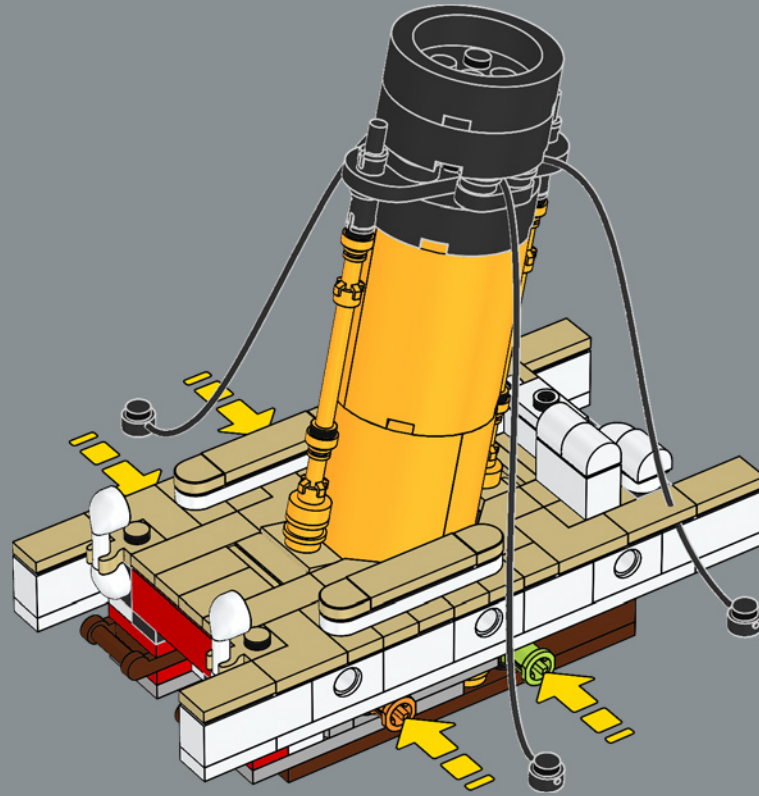

299

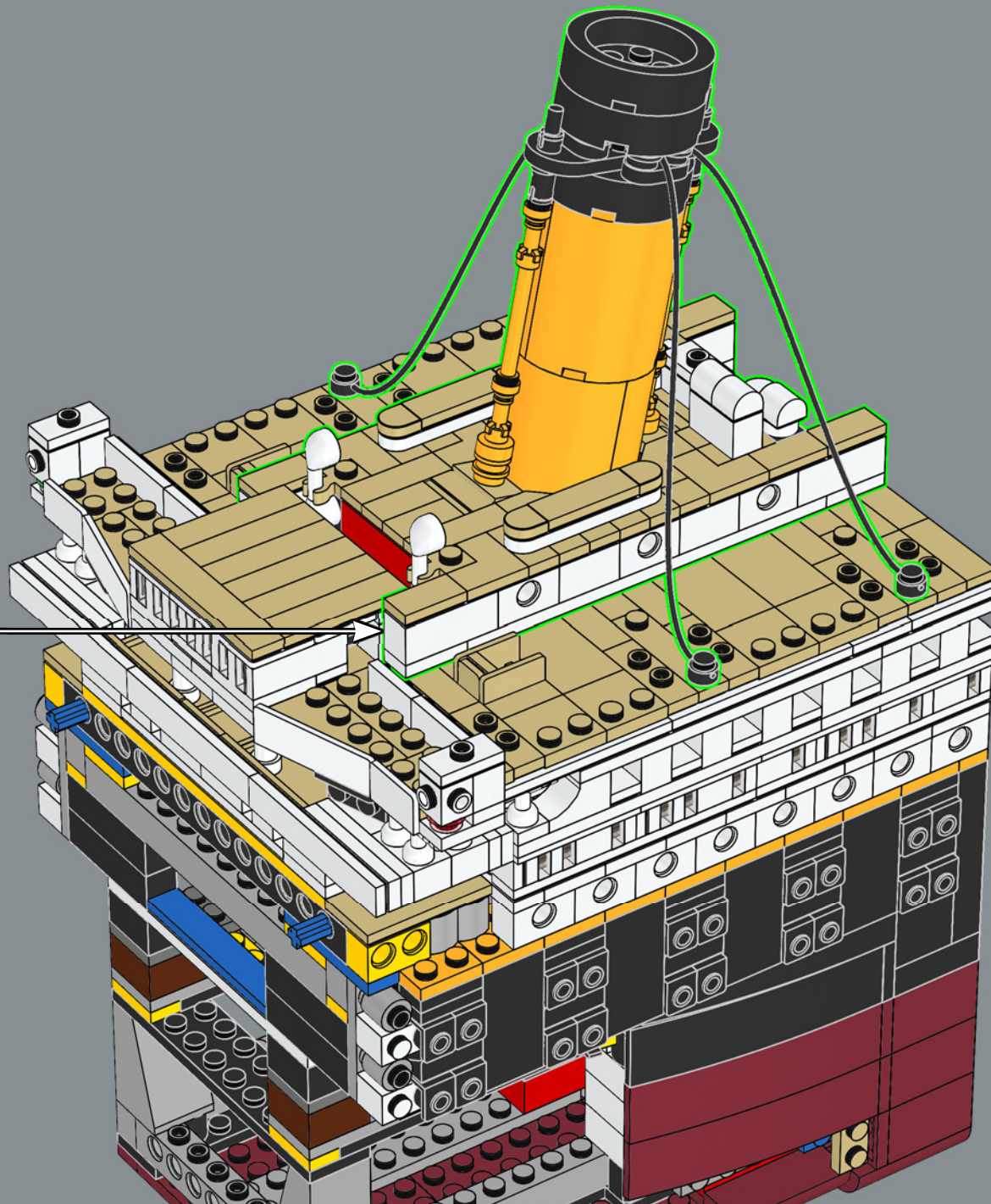

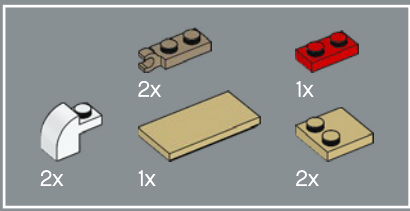

300

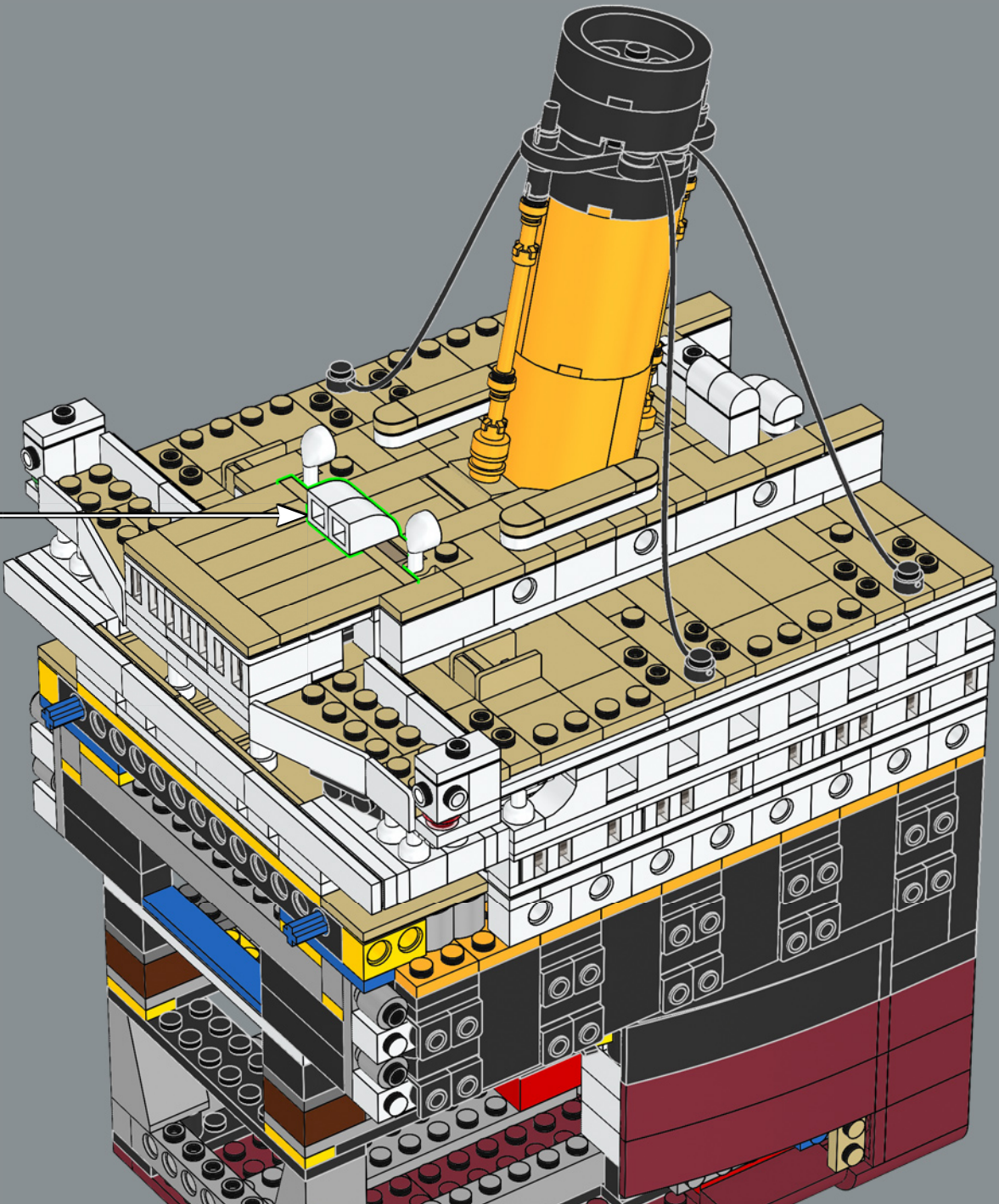
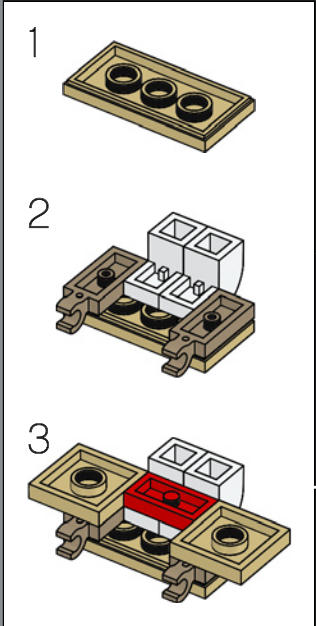

301

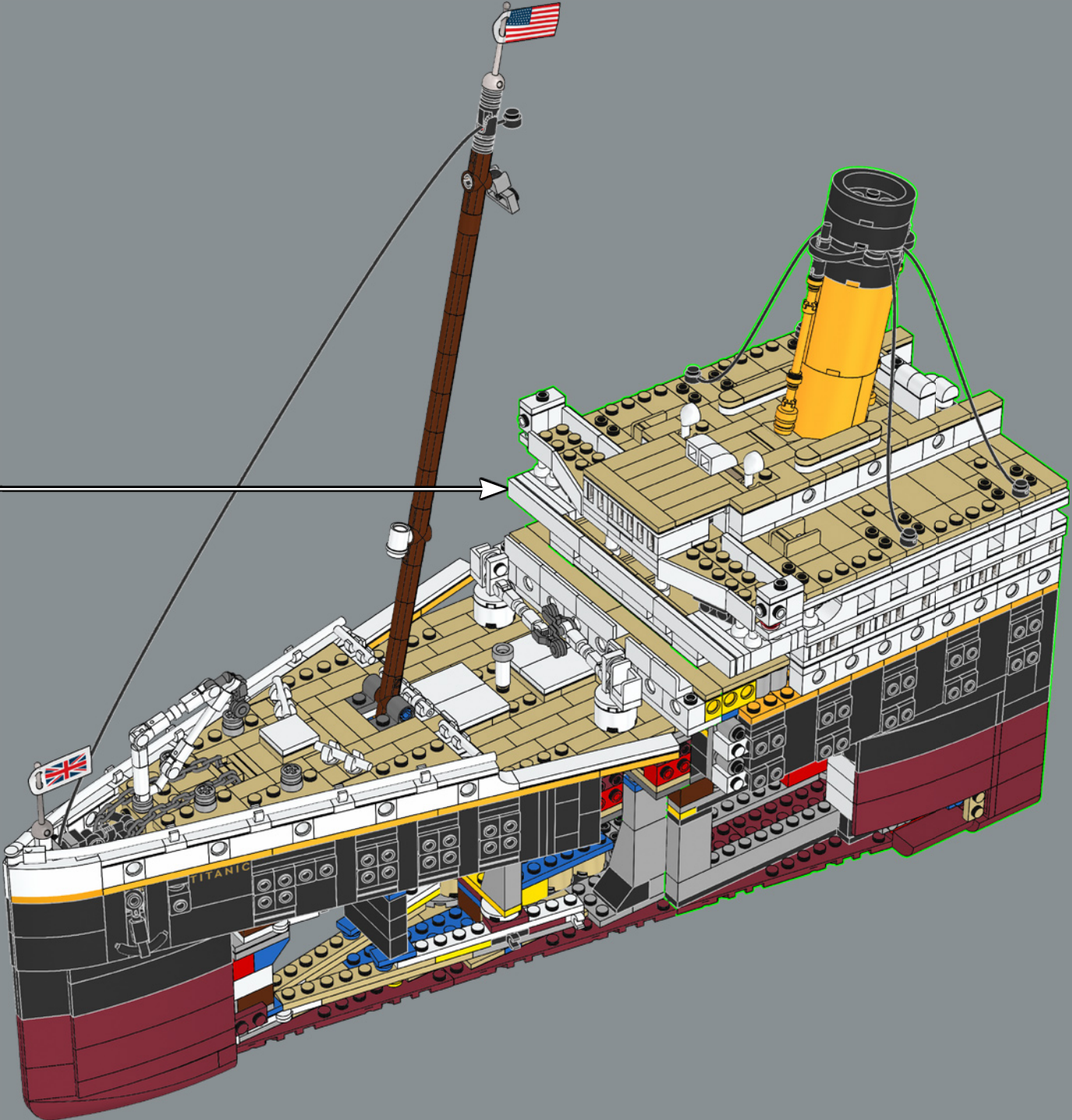

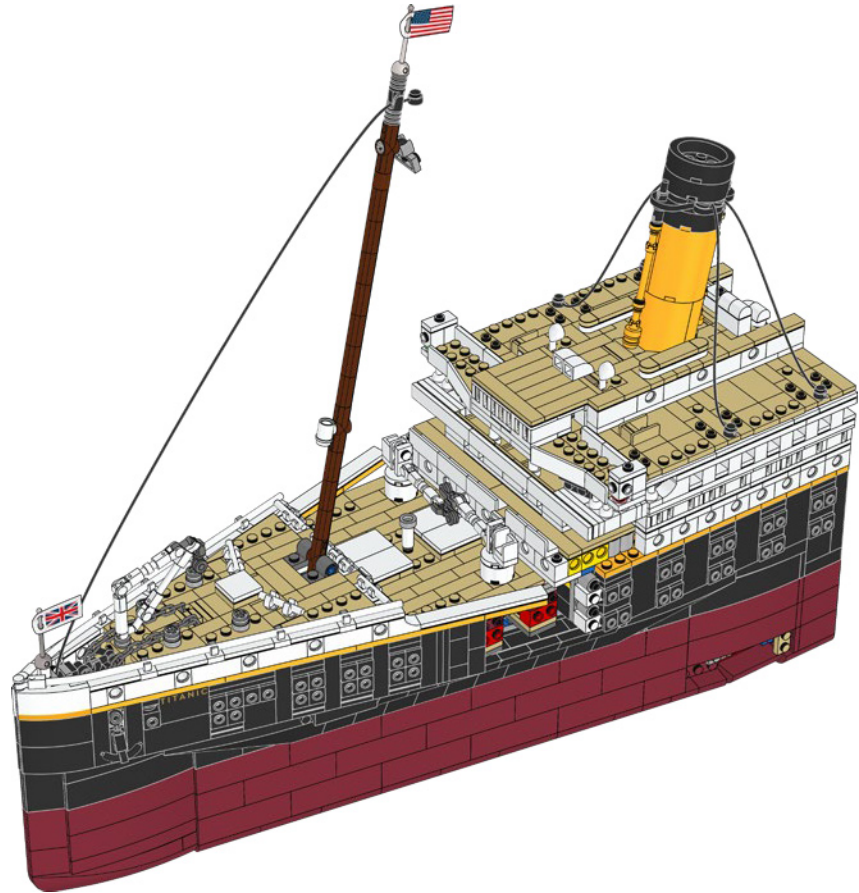
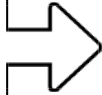

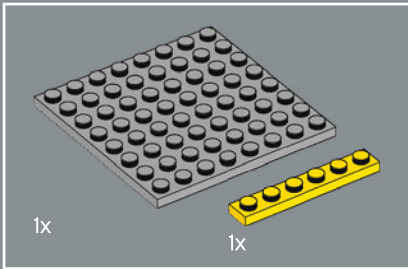
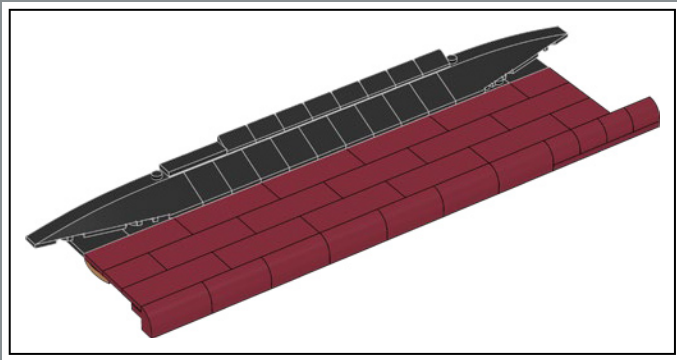

302

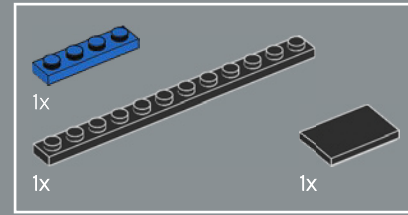
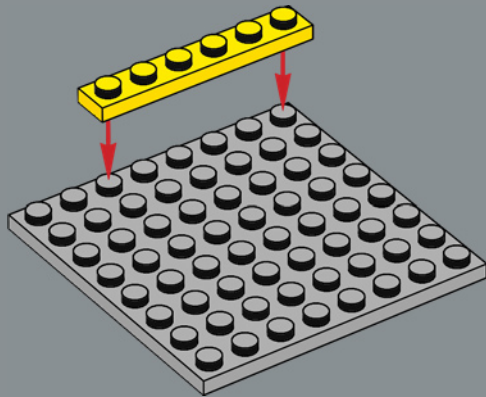

303

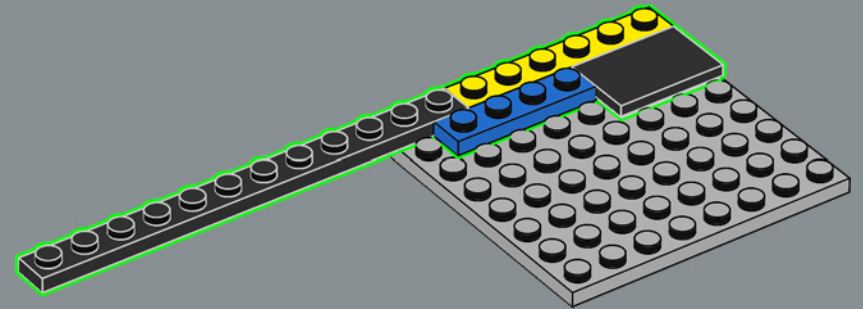

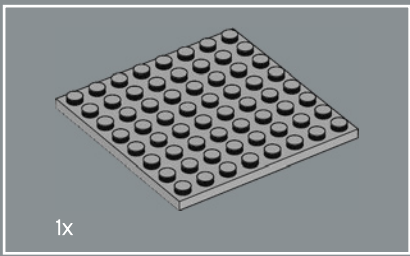

304

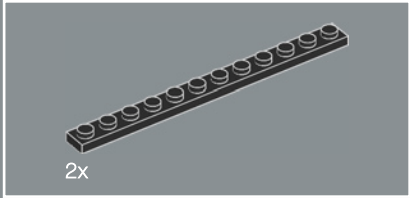
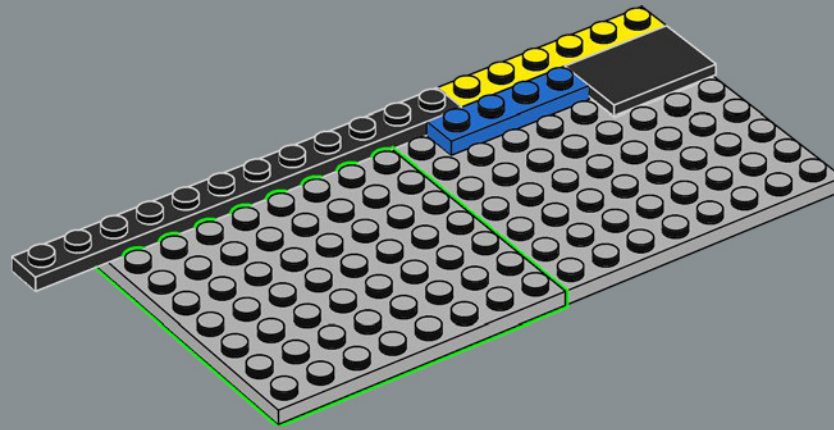

305

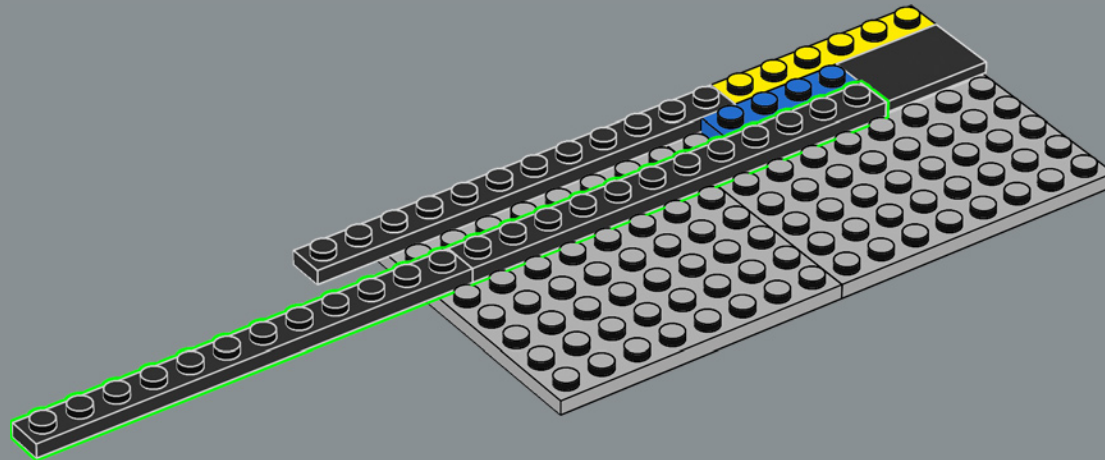

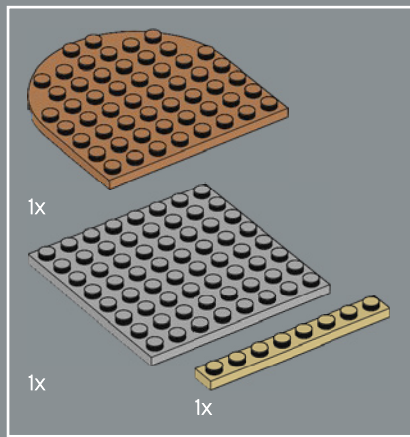

306

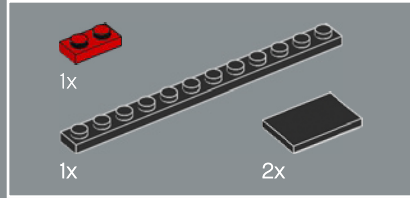
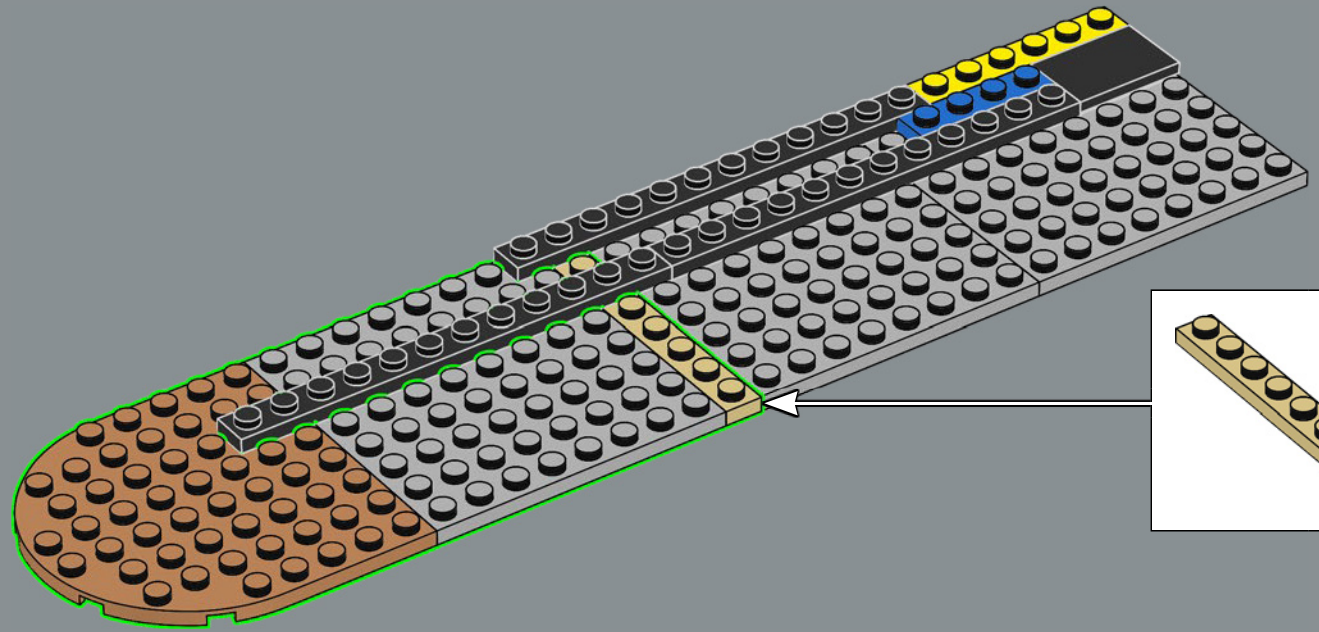

307

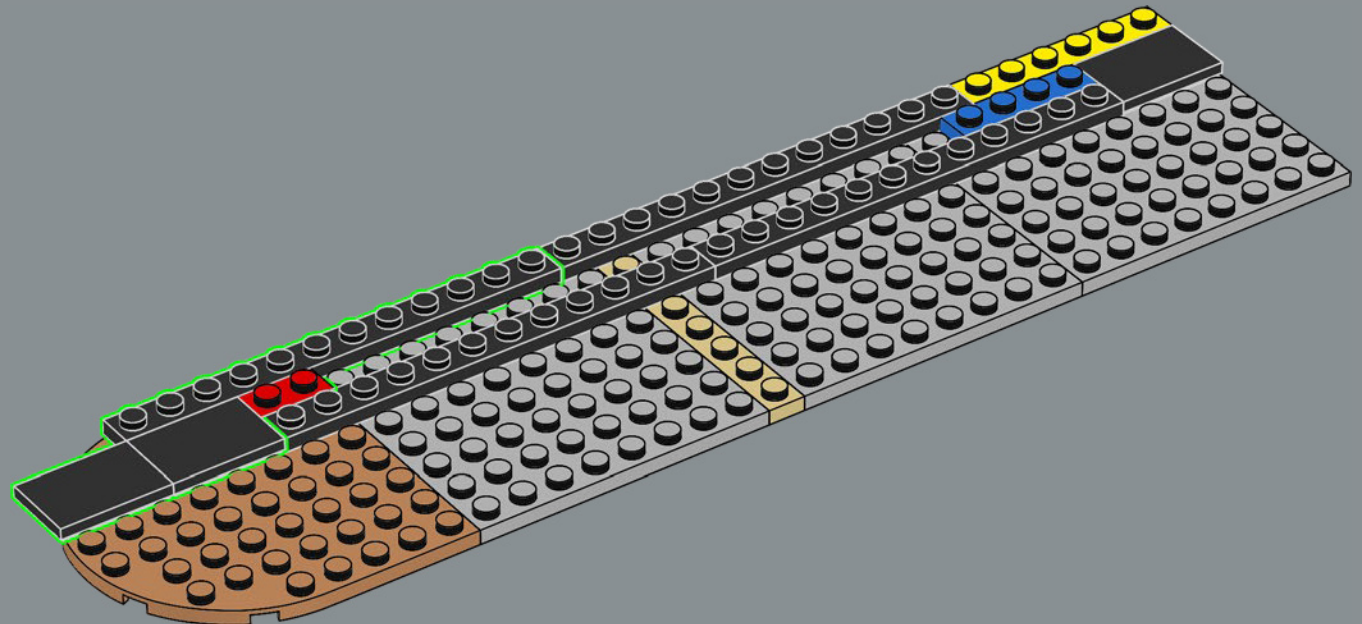

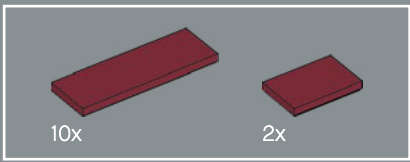

308

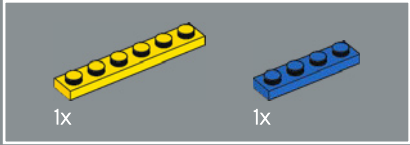
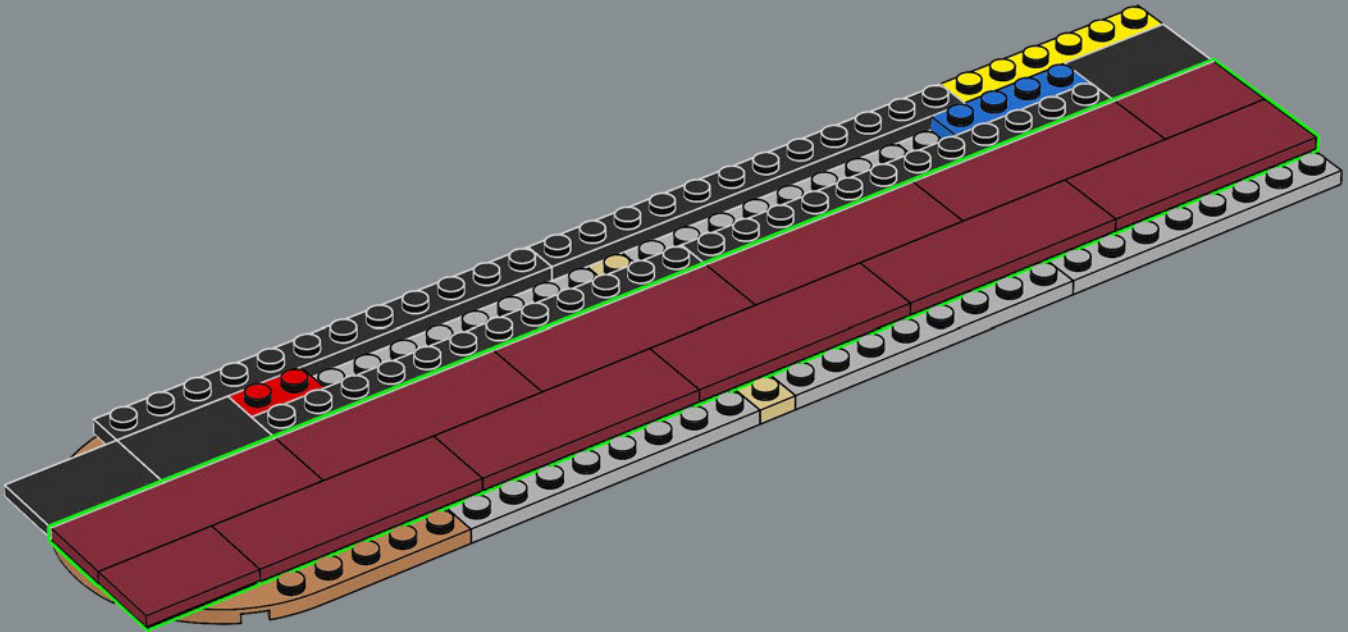

309

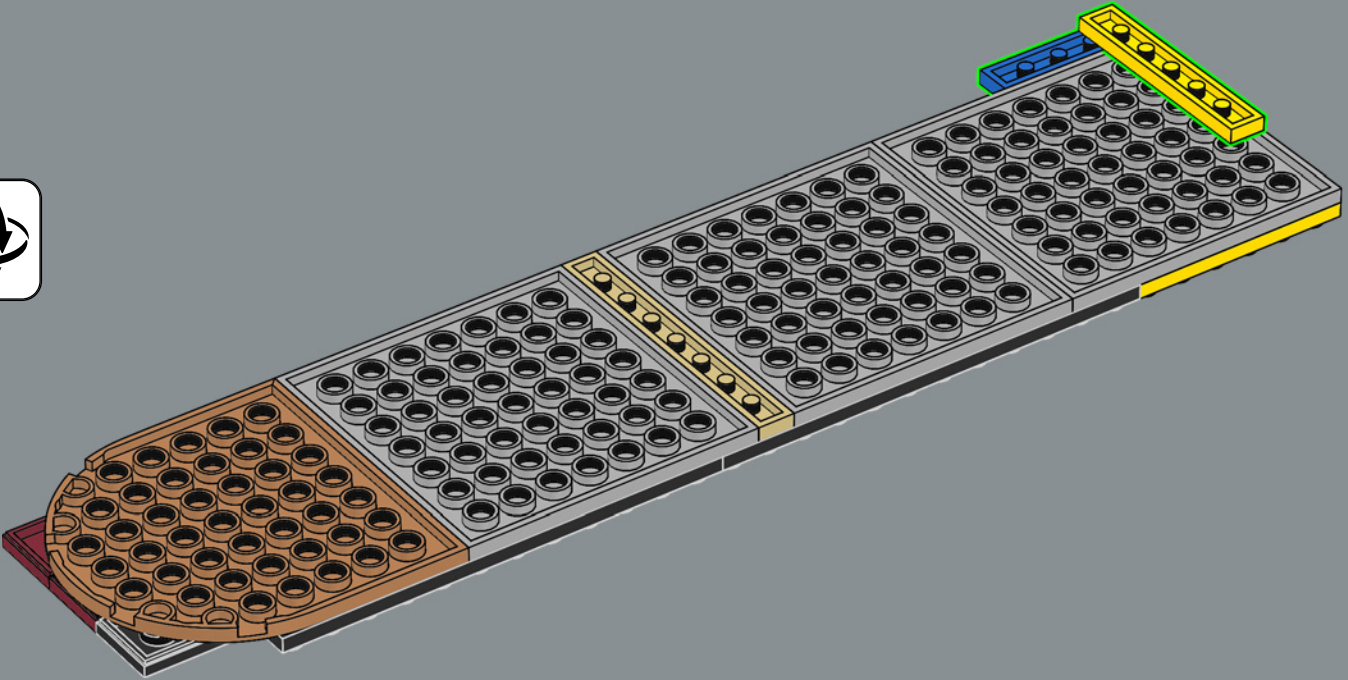

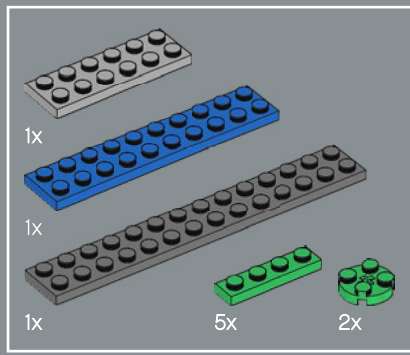

310

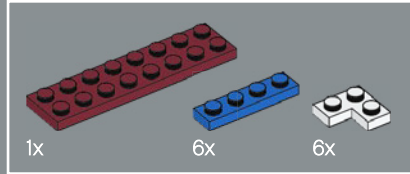
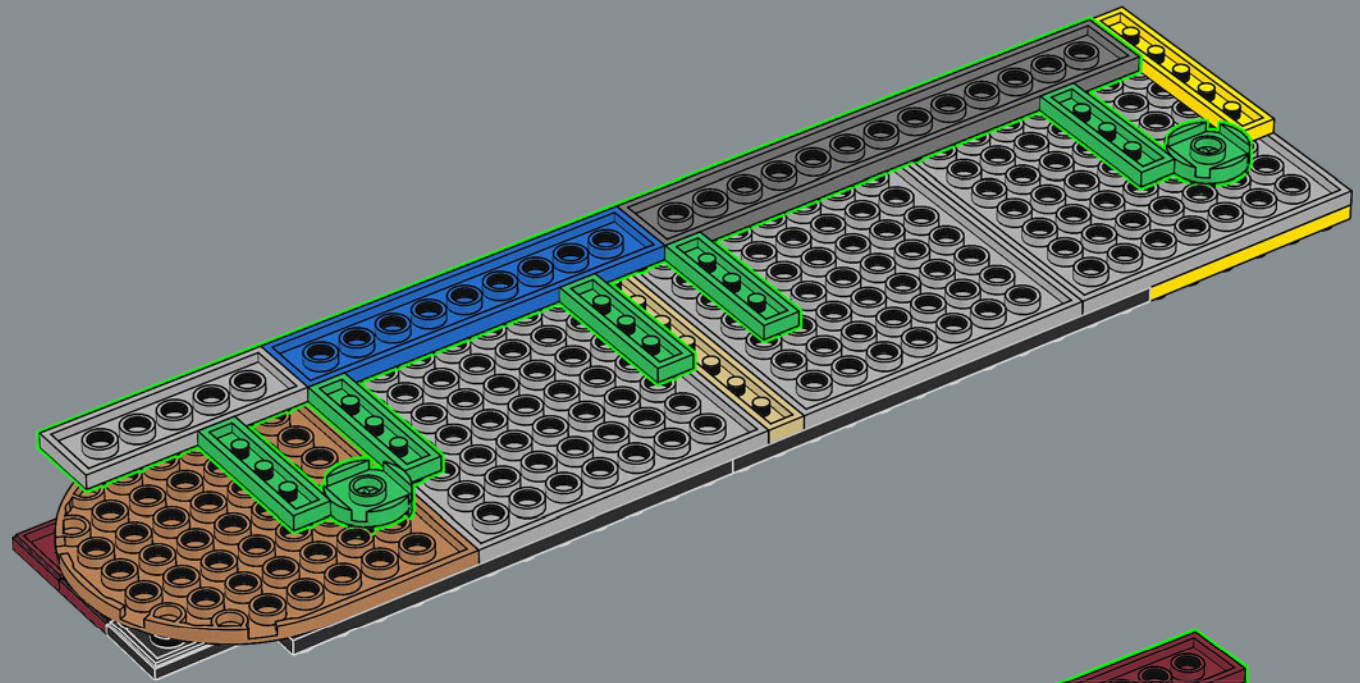

311

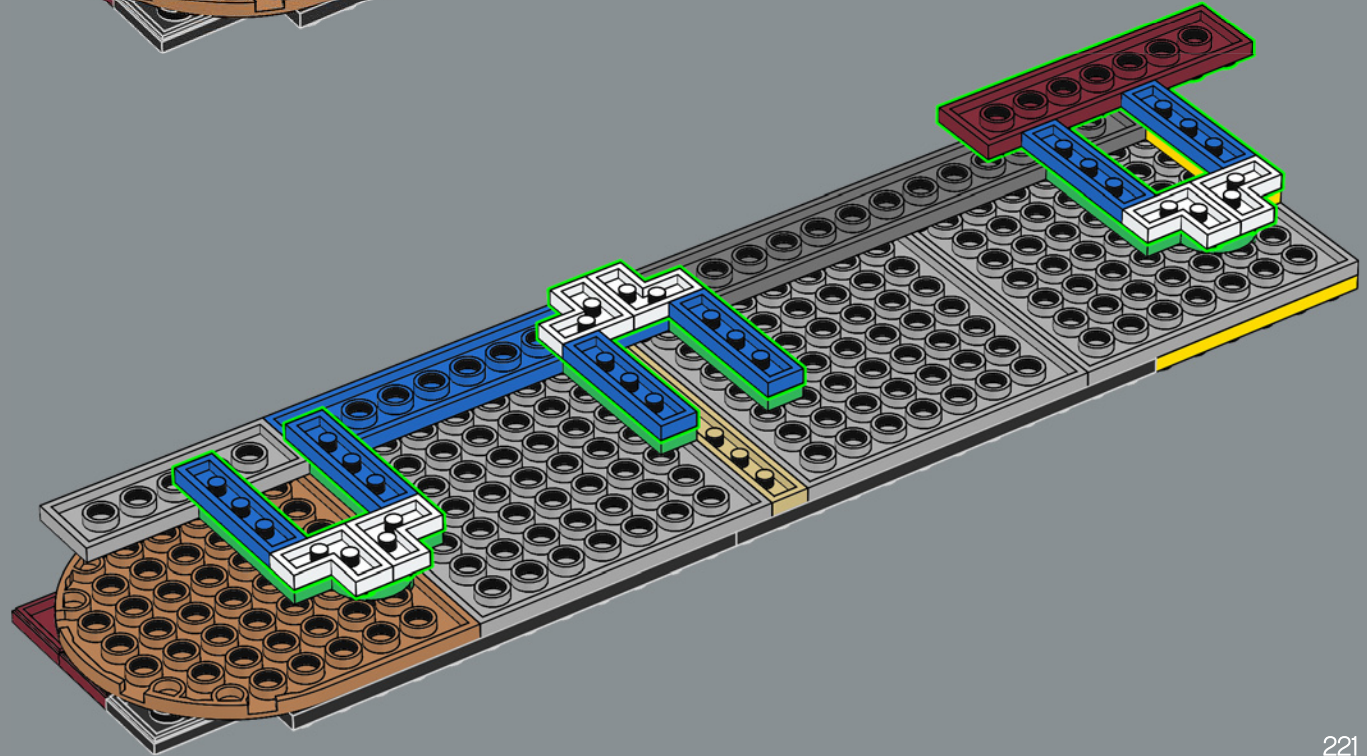

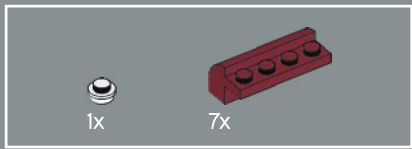

312

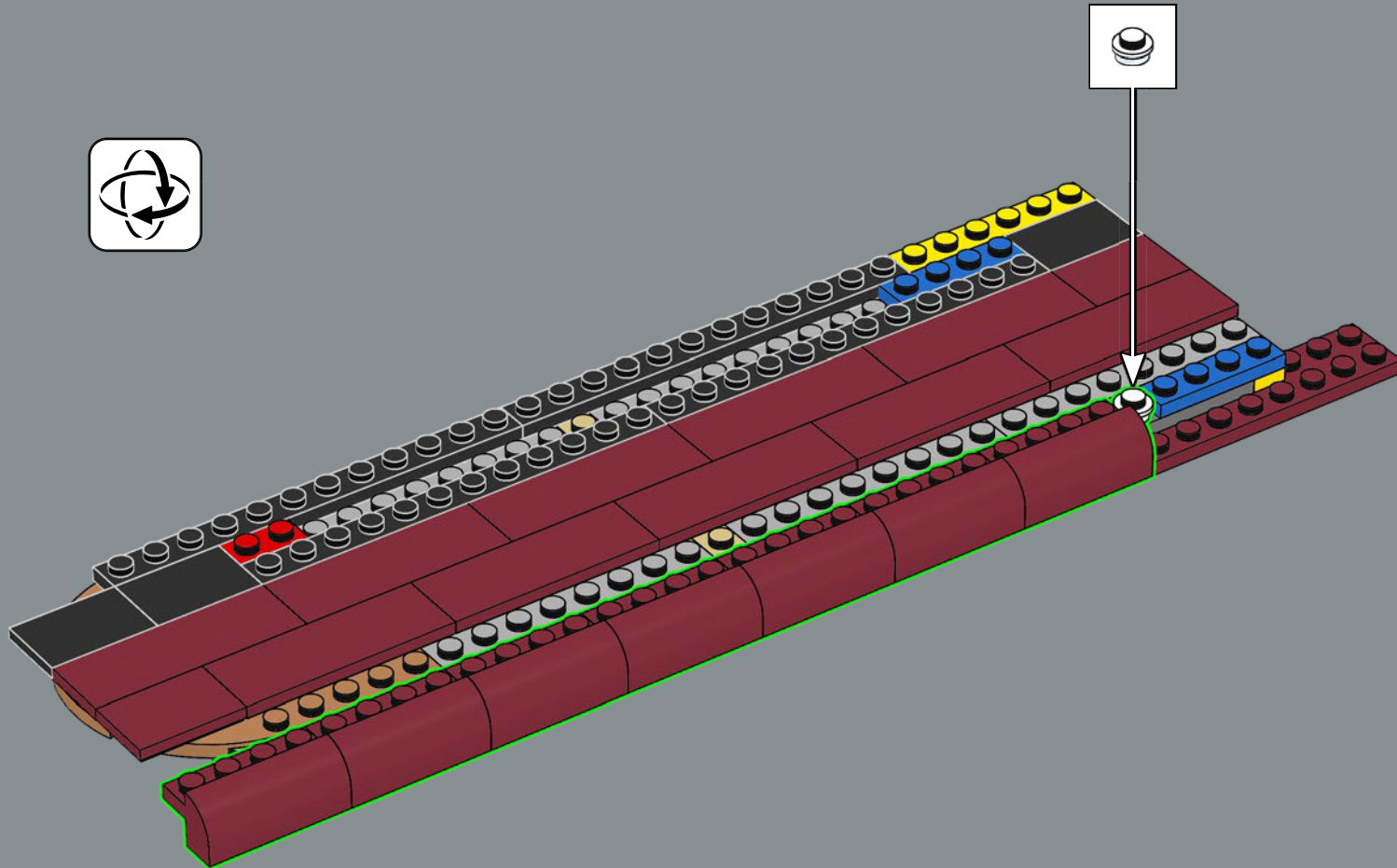

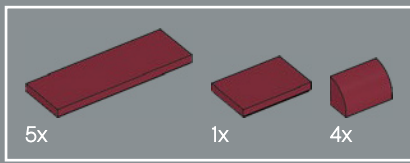

313

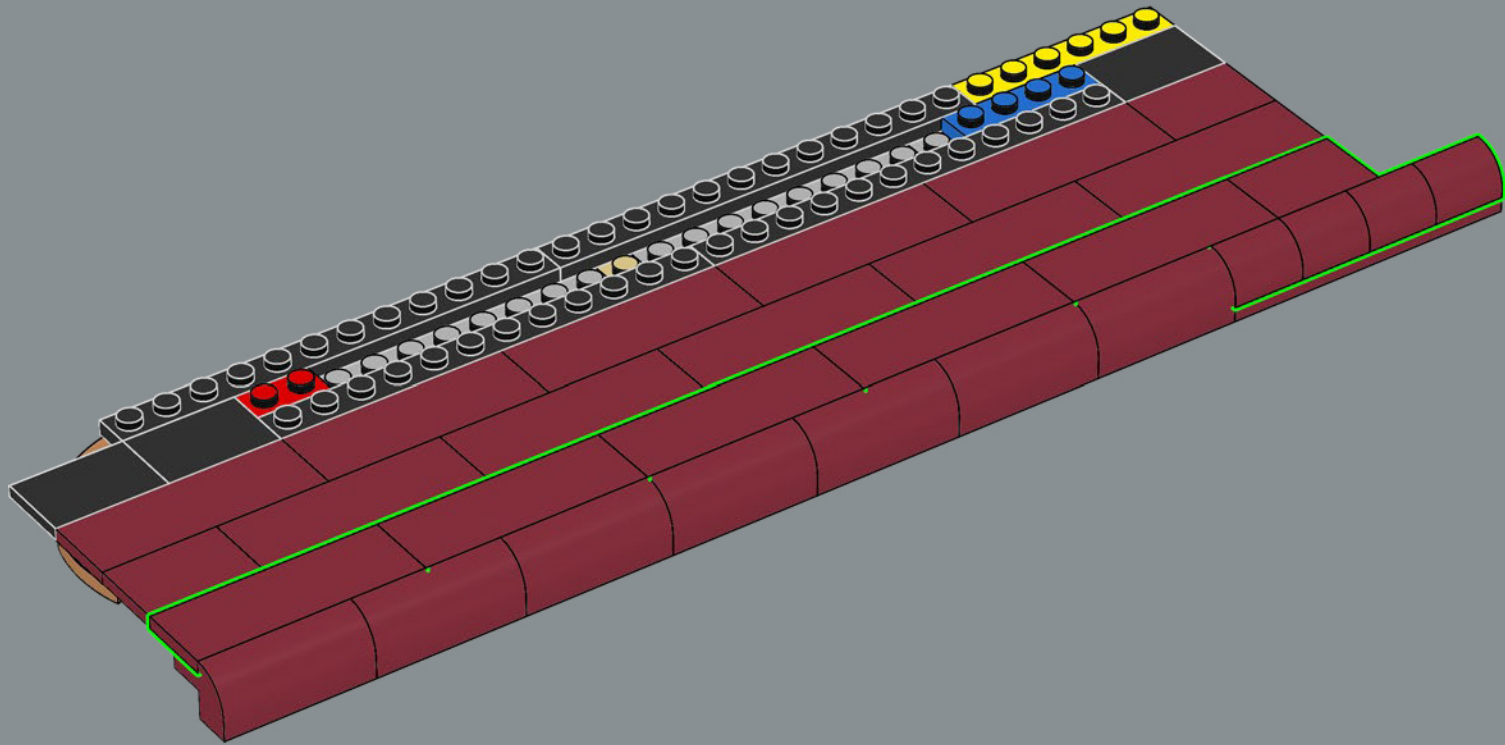

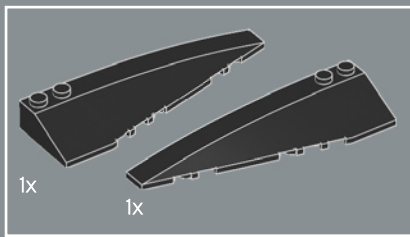

315

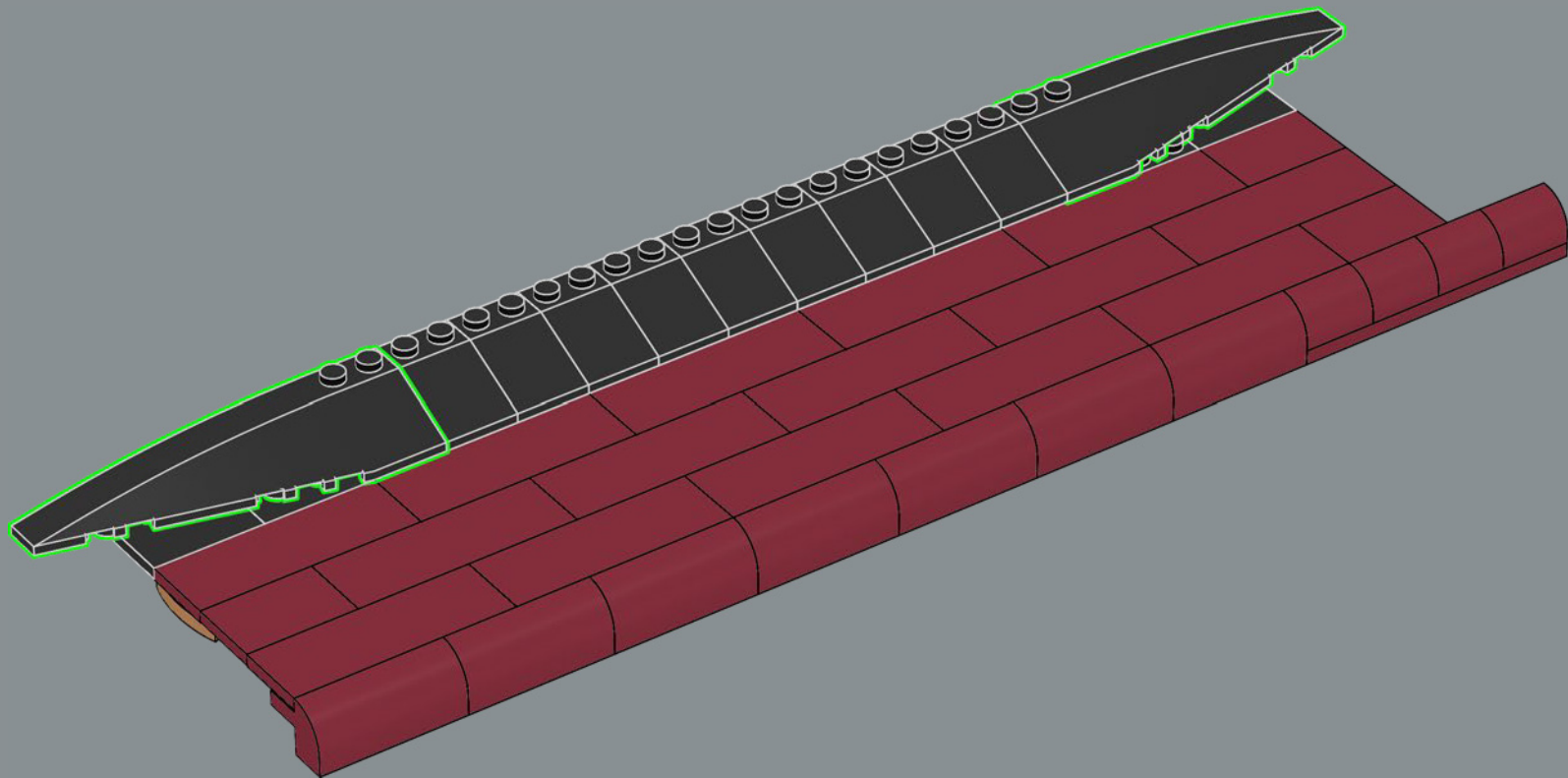

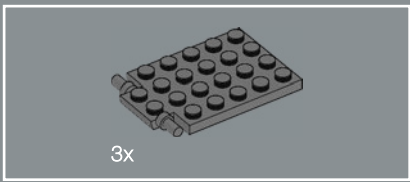

316

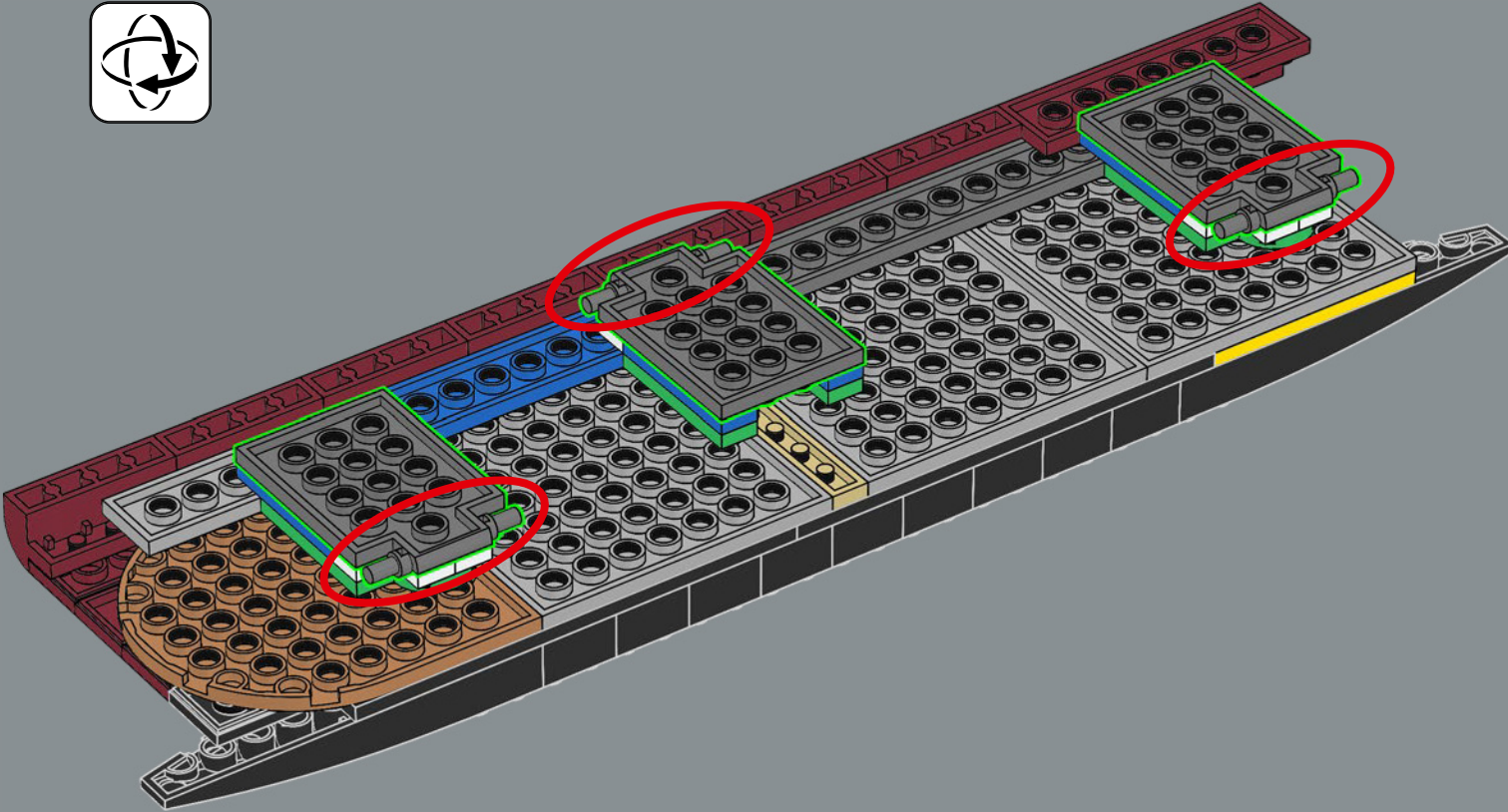



317

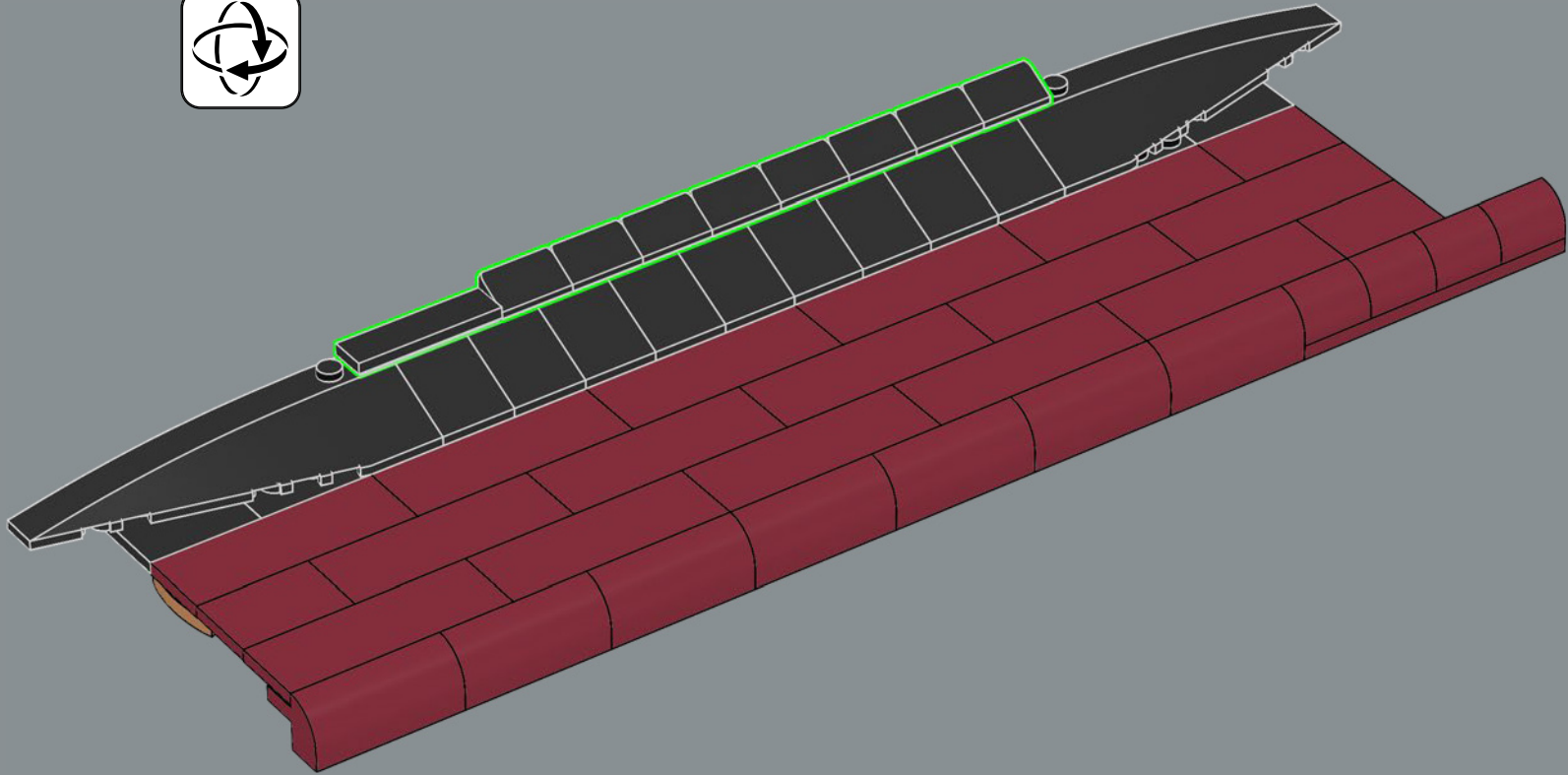

318

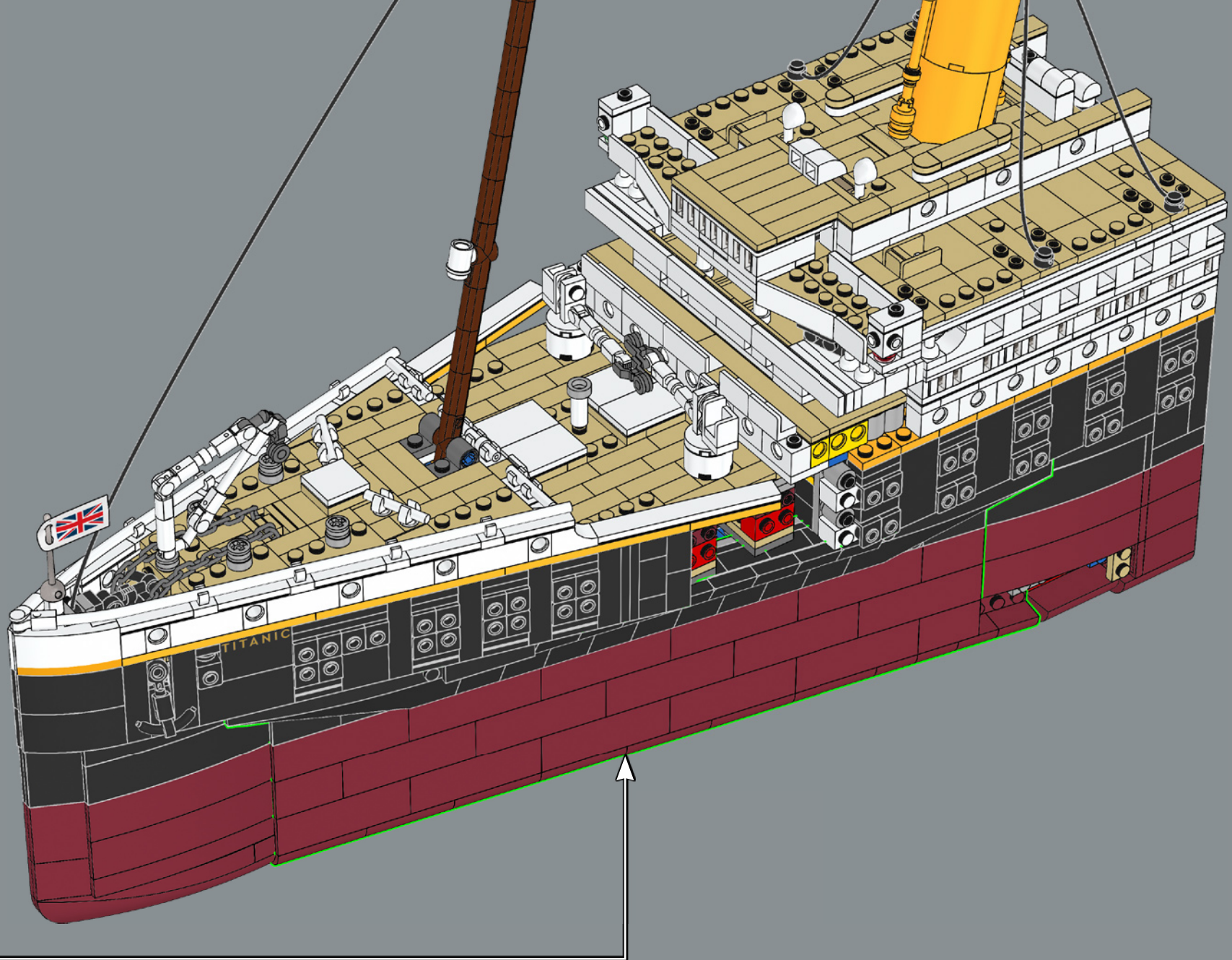

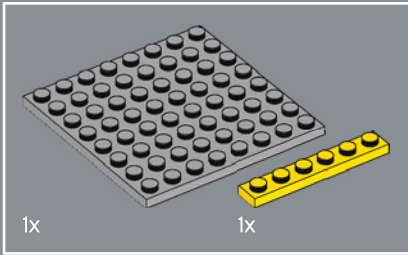
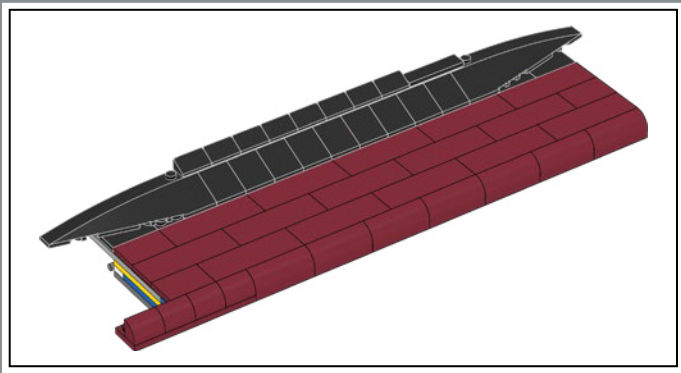

319

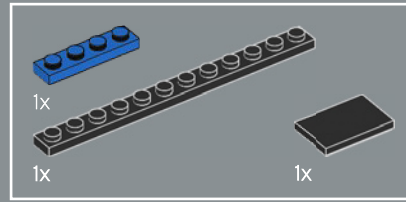
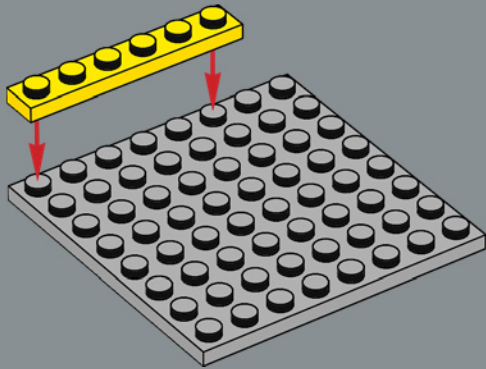

320

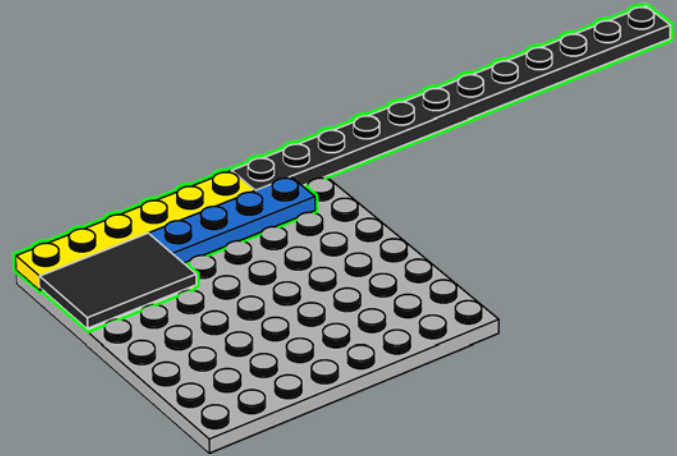

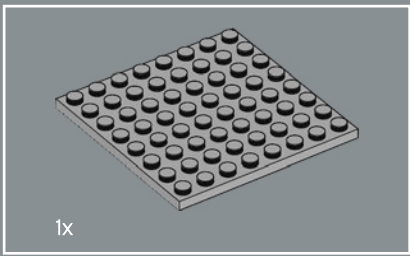

321

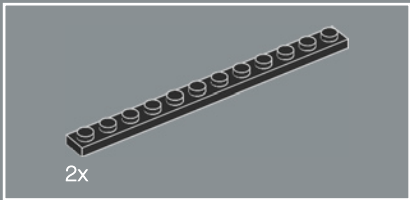
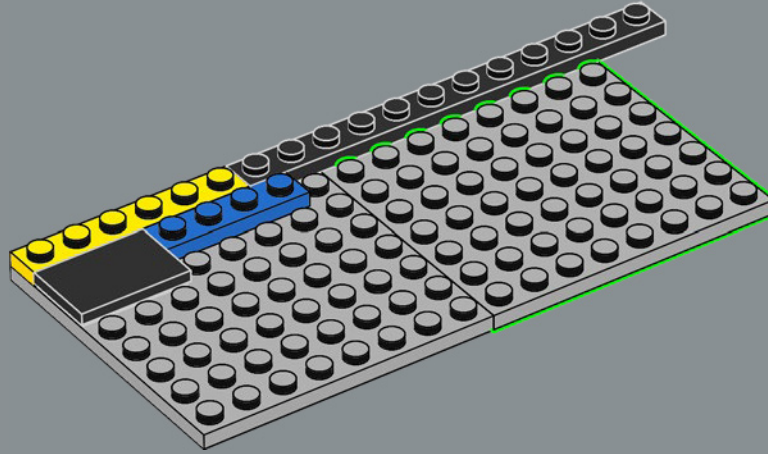

322

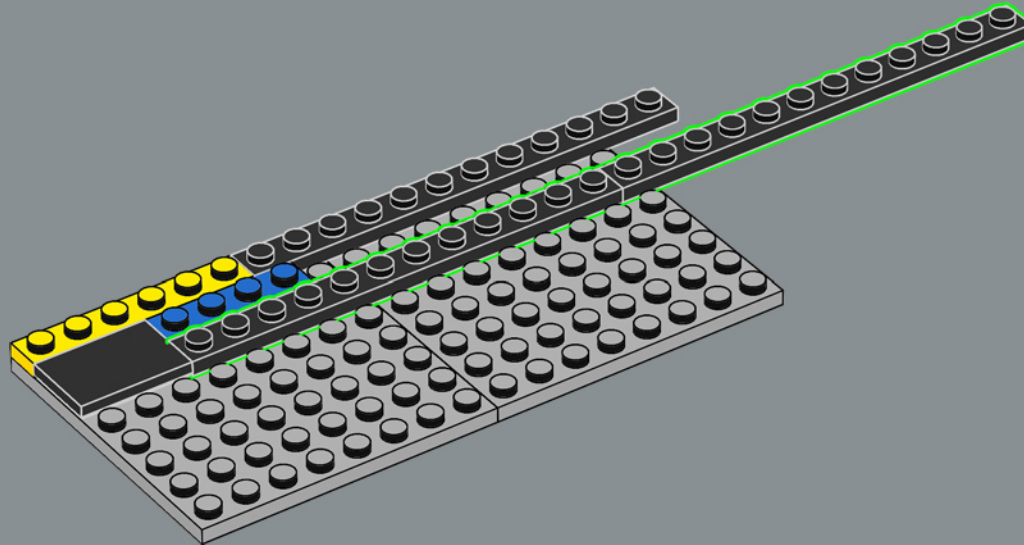

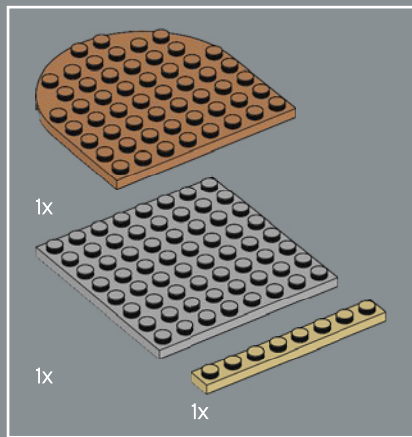

323

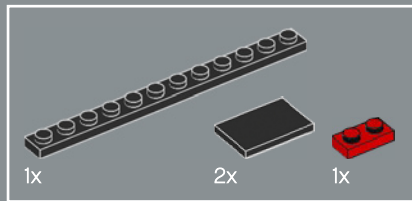
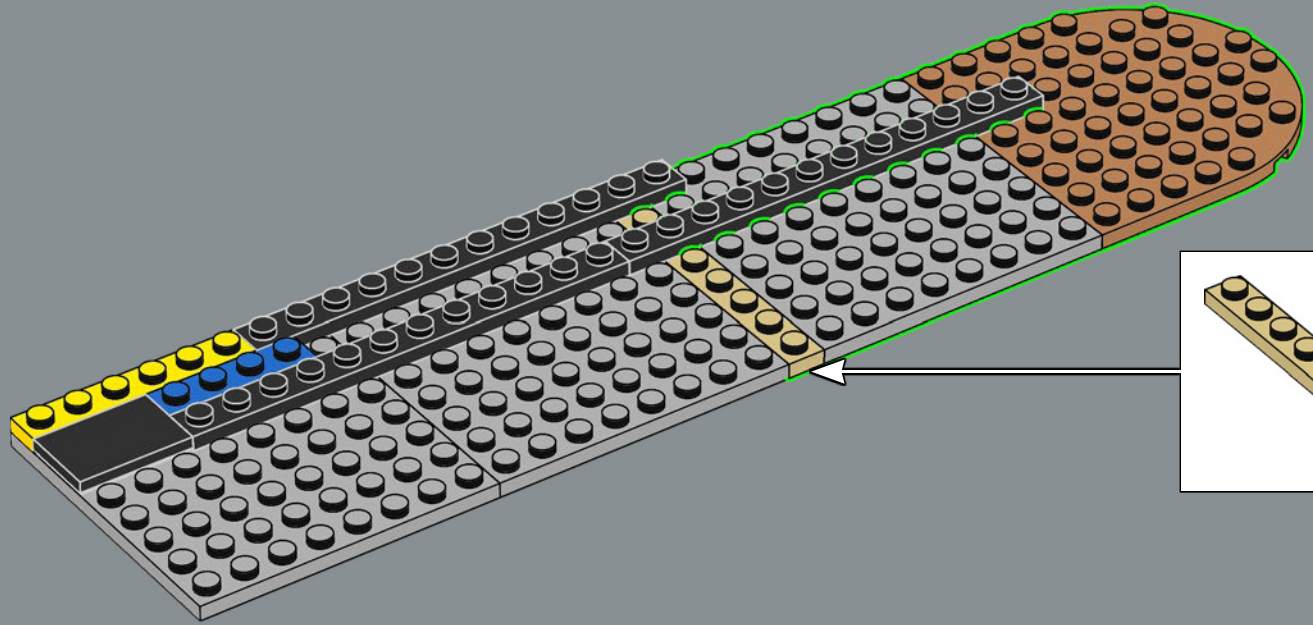

324

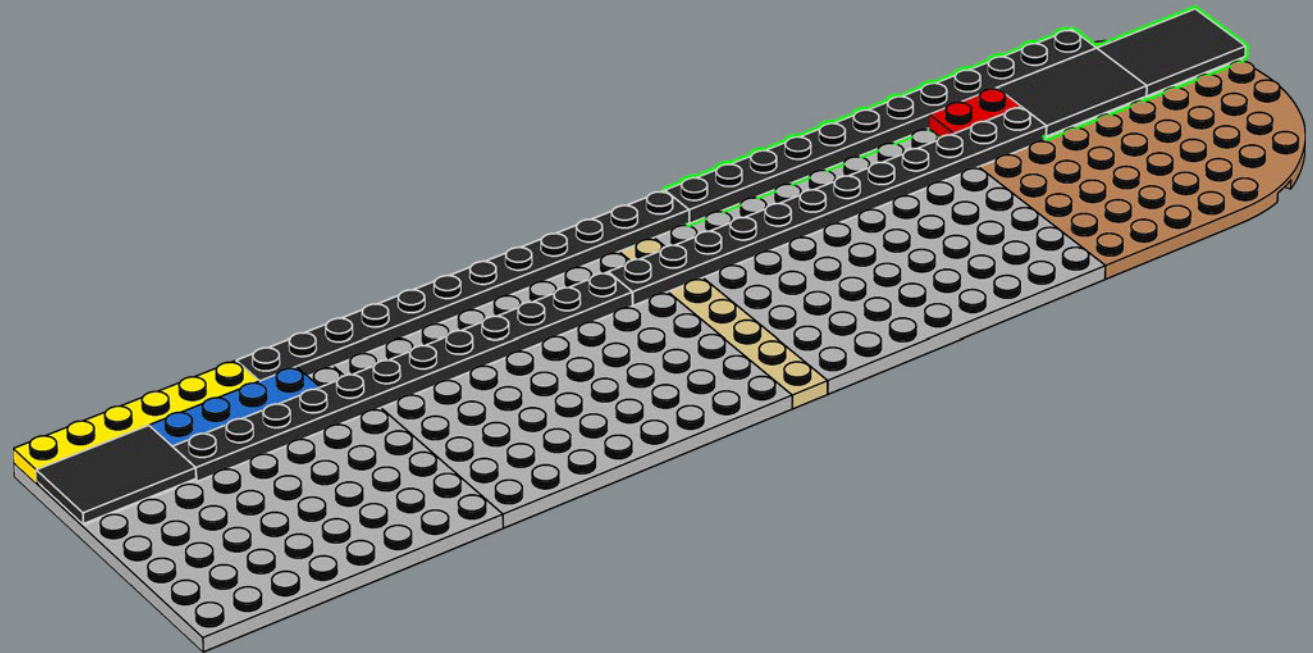

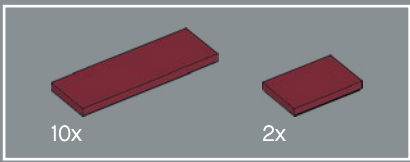

325

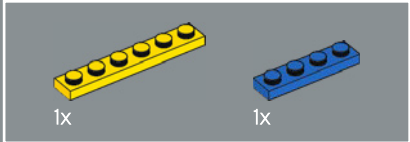
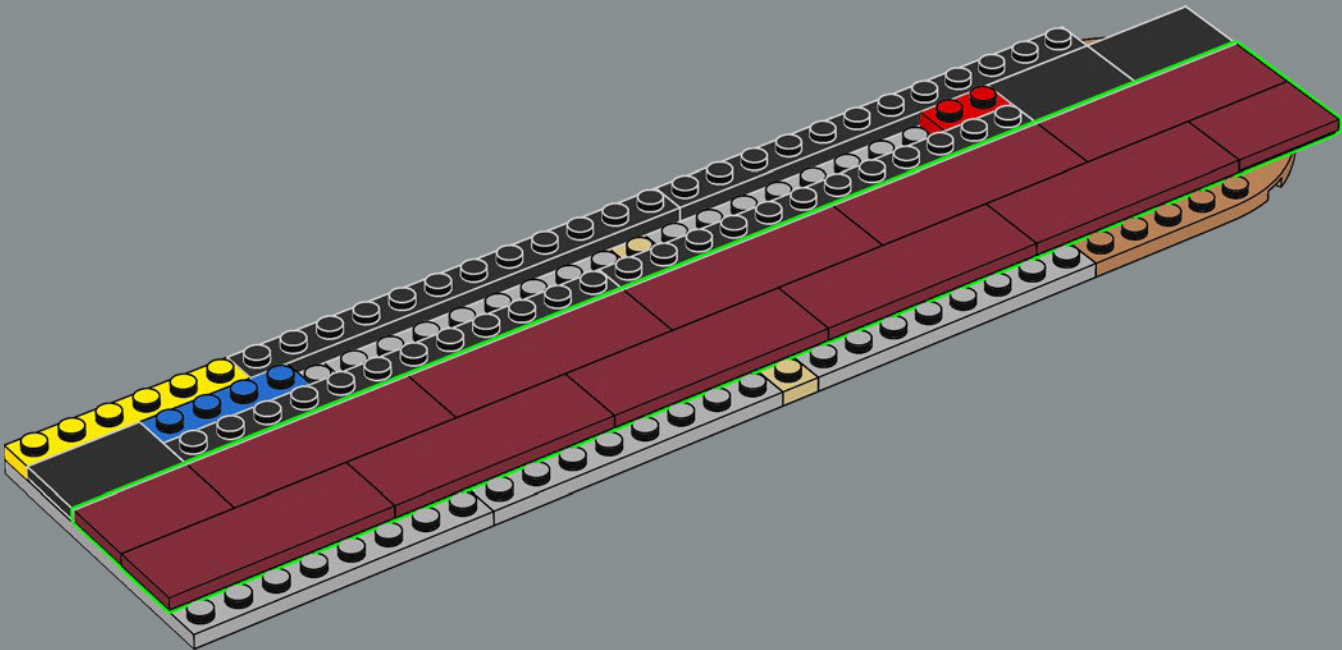

326

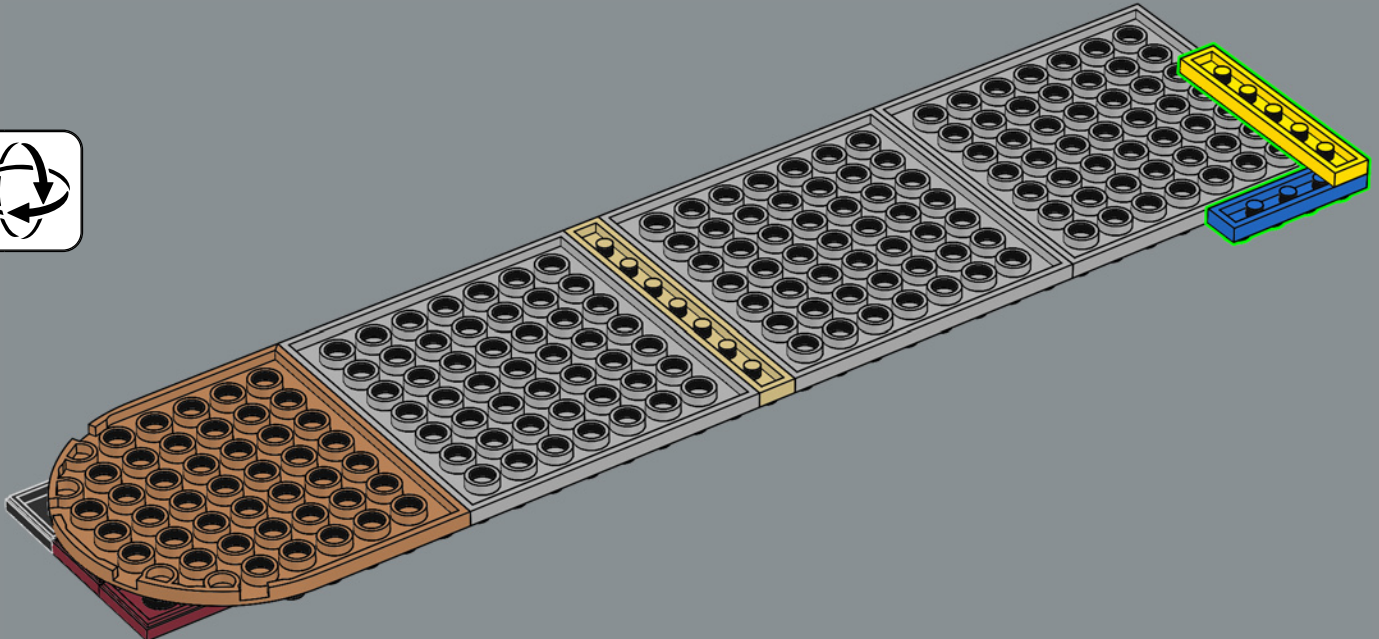

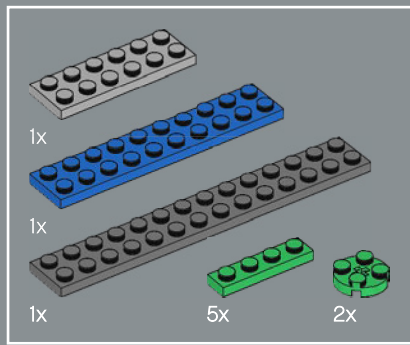

327

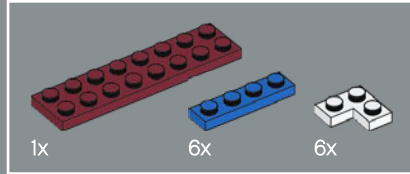
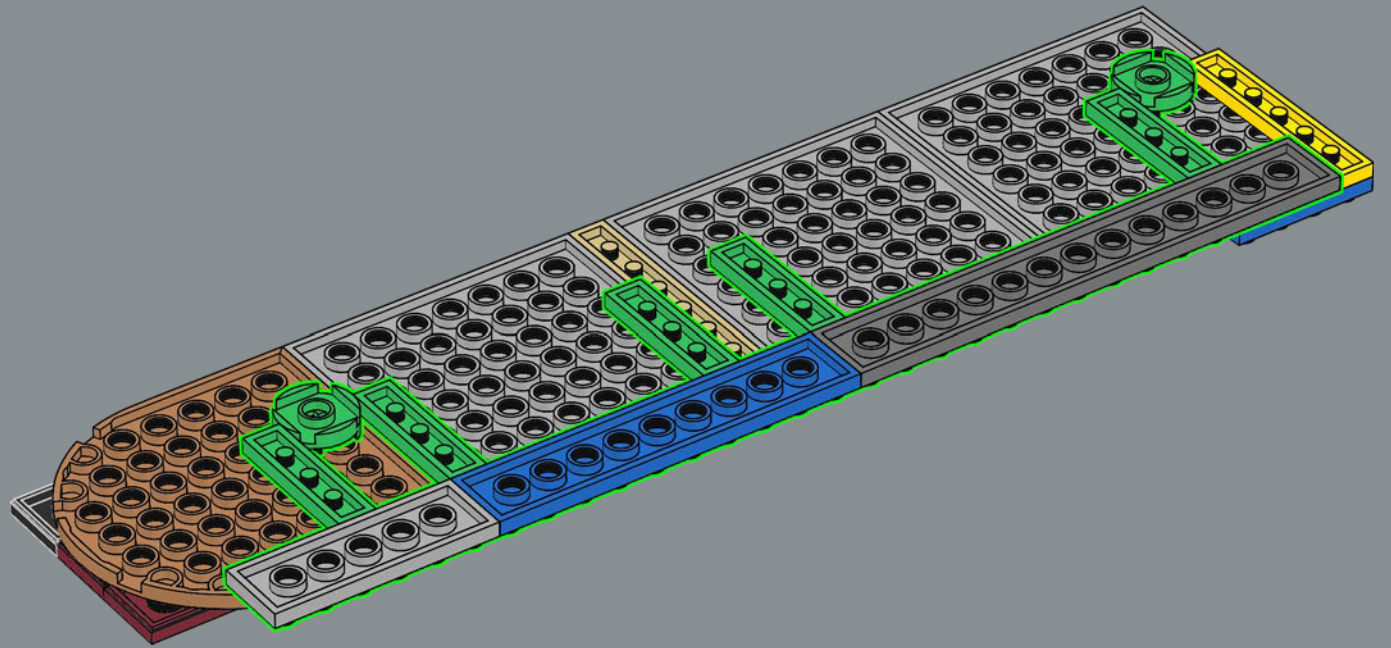

328

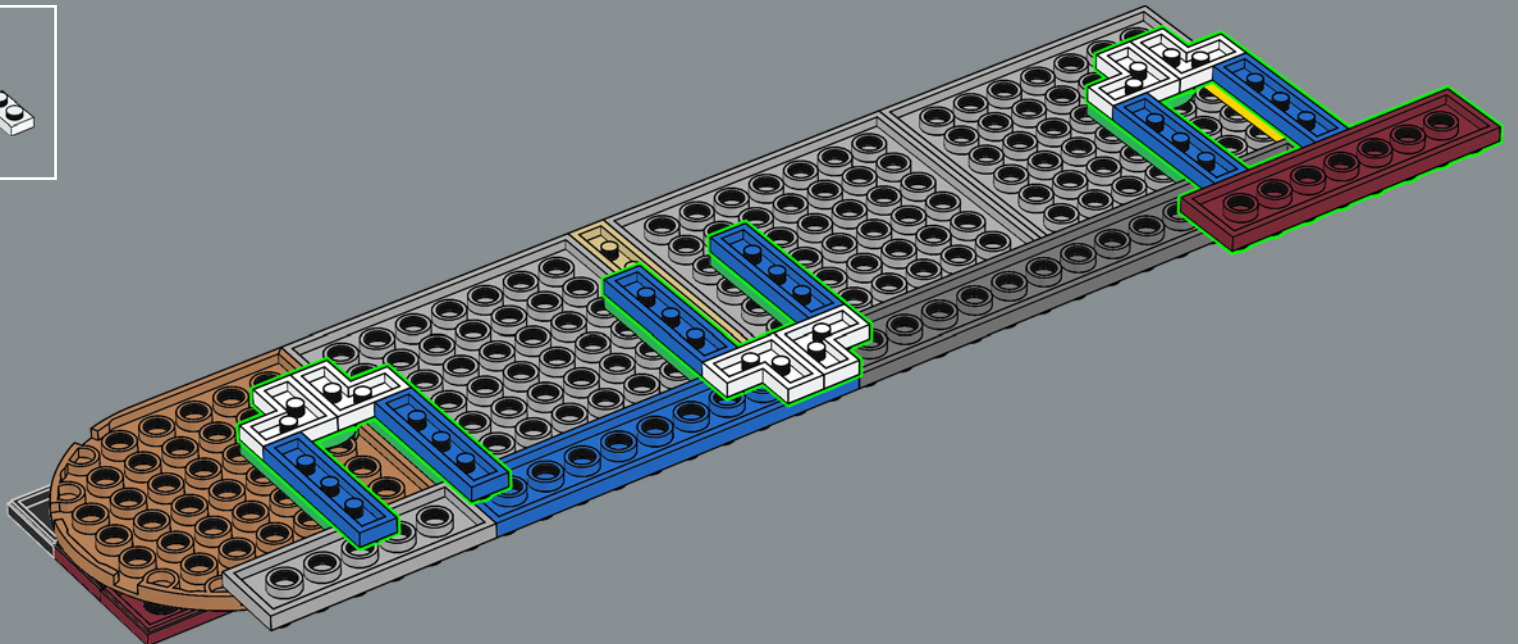

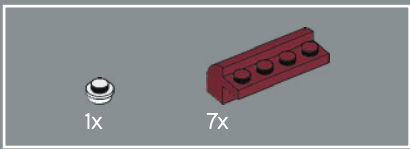

329

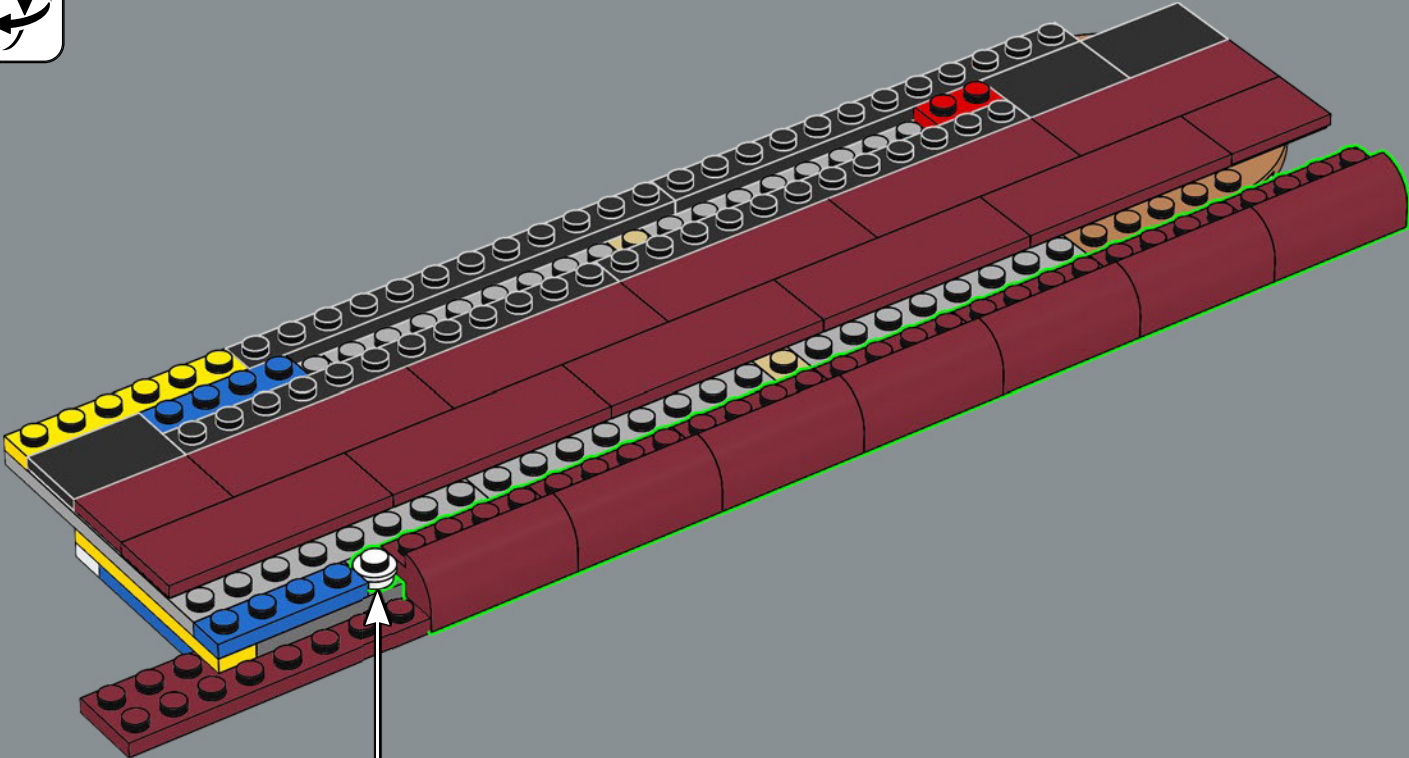

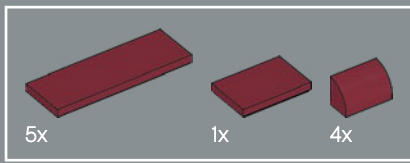

330

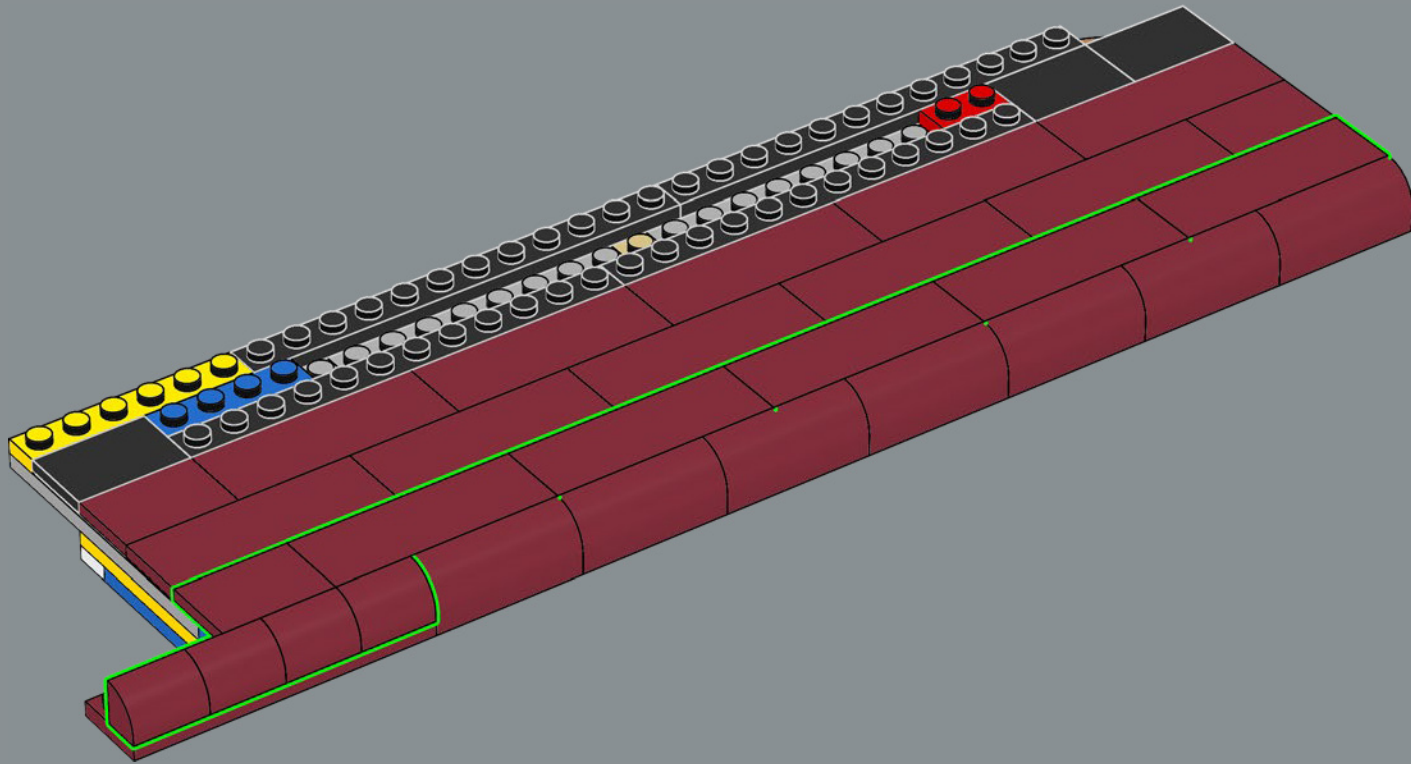



331

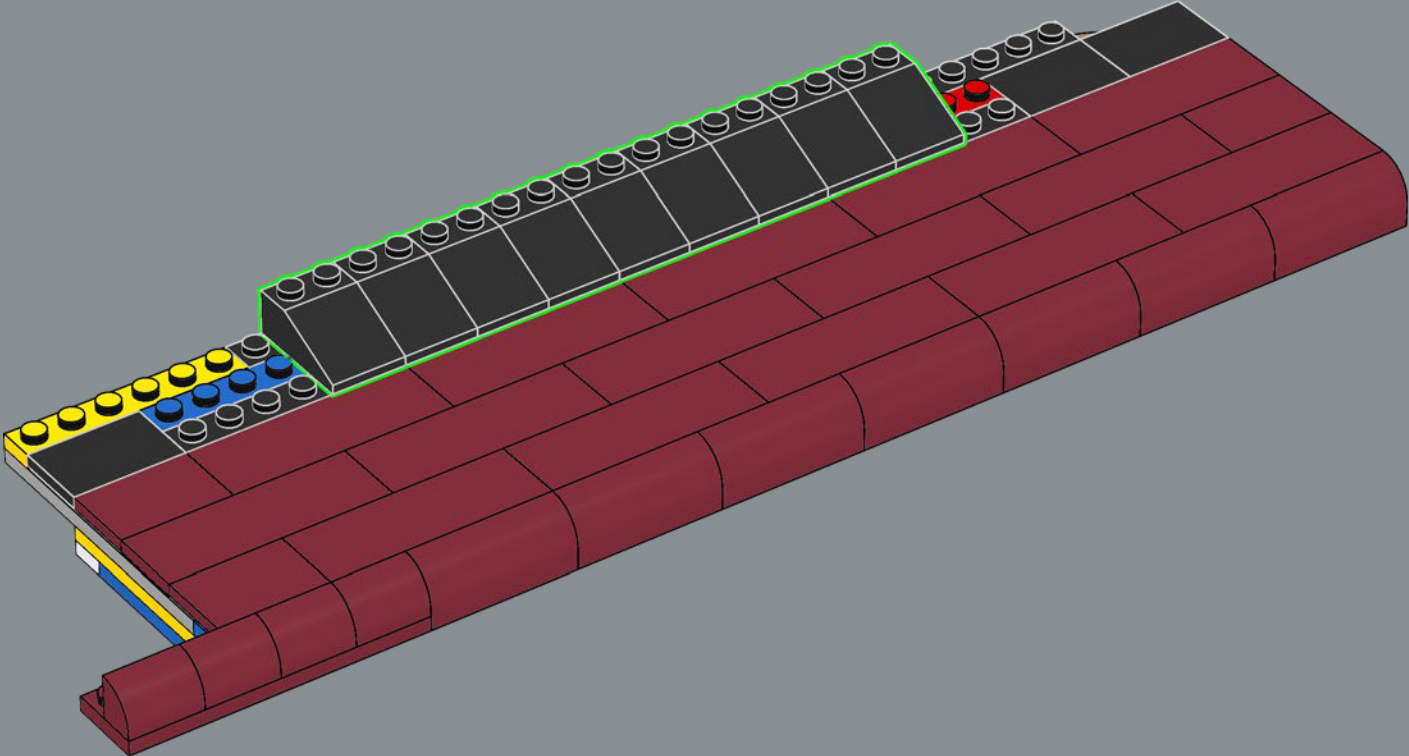

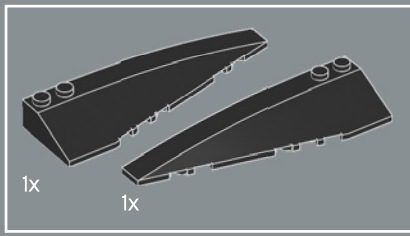

332

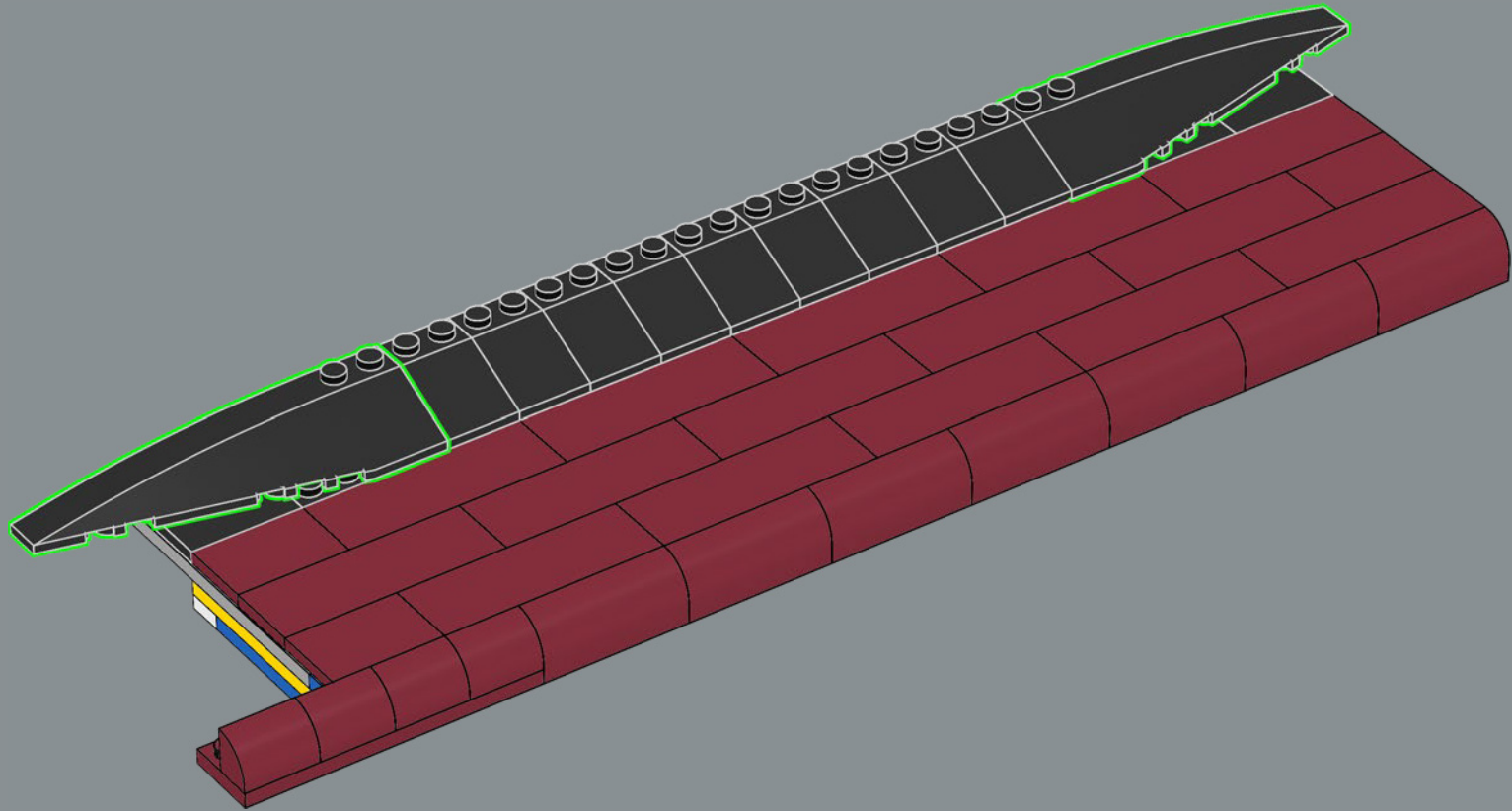

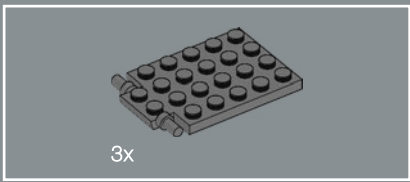

333

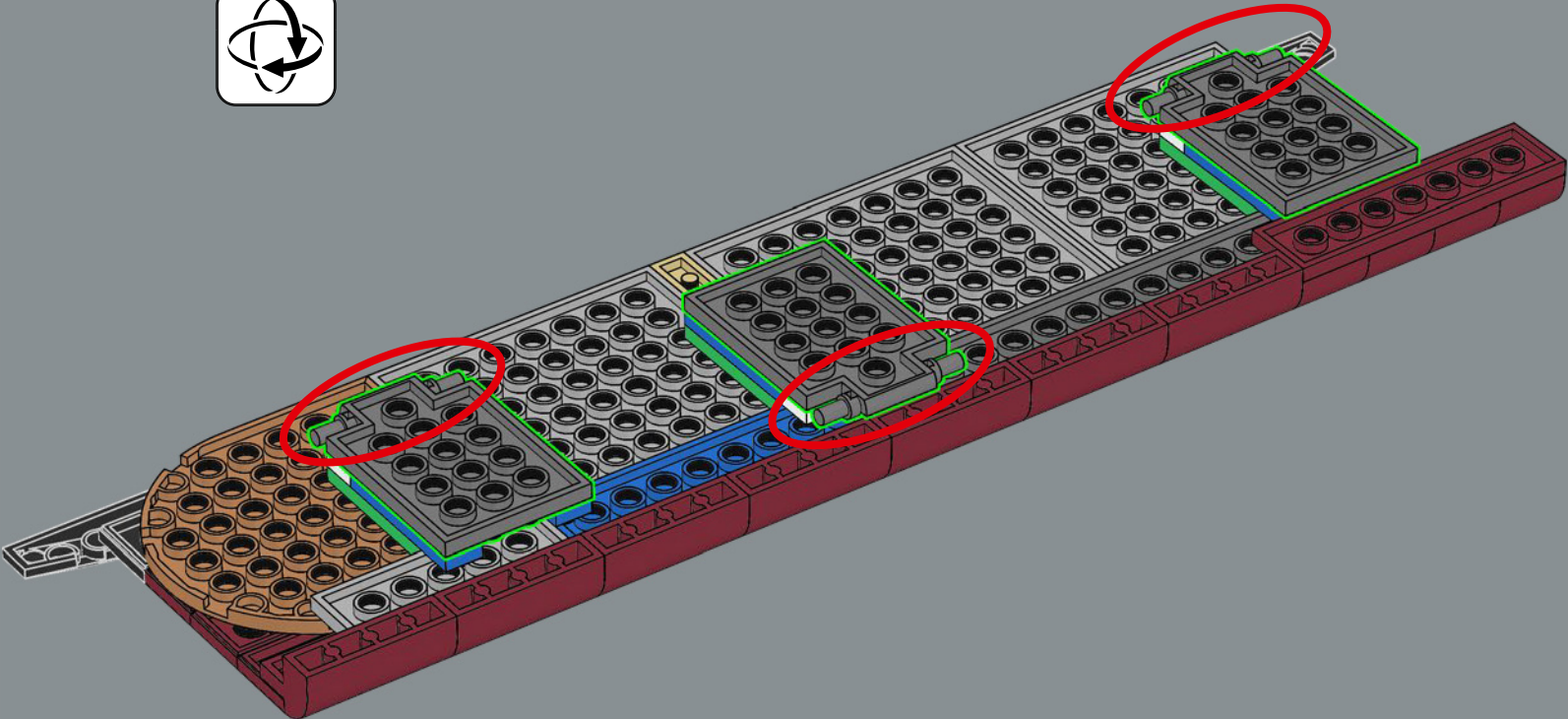



334

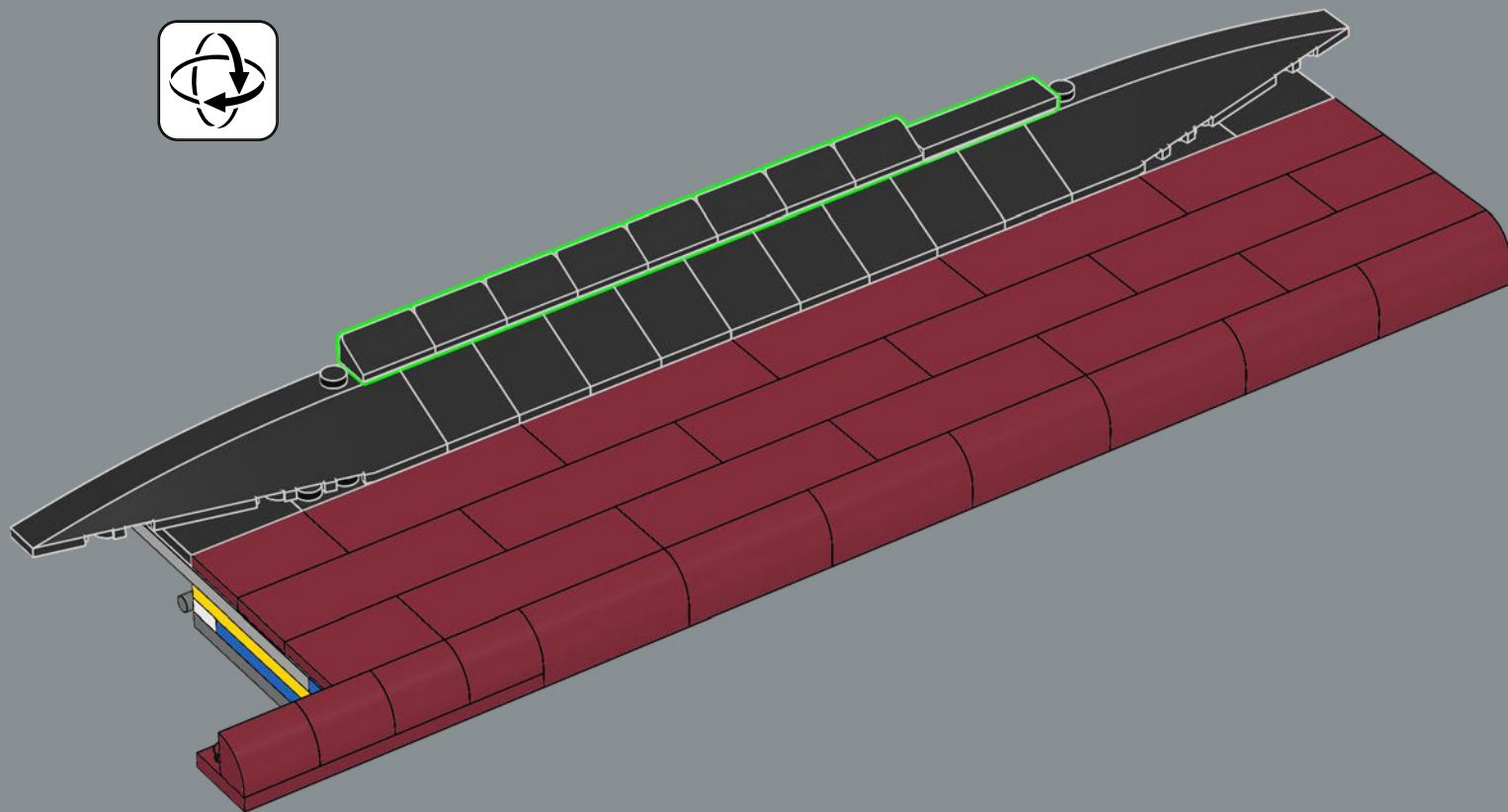

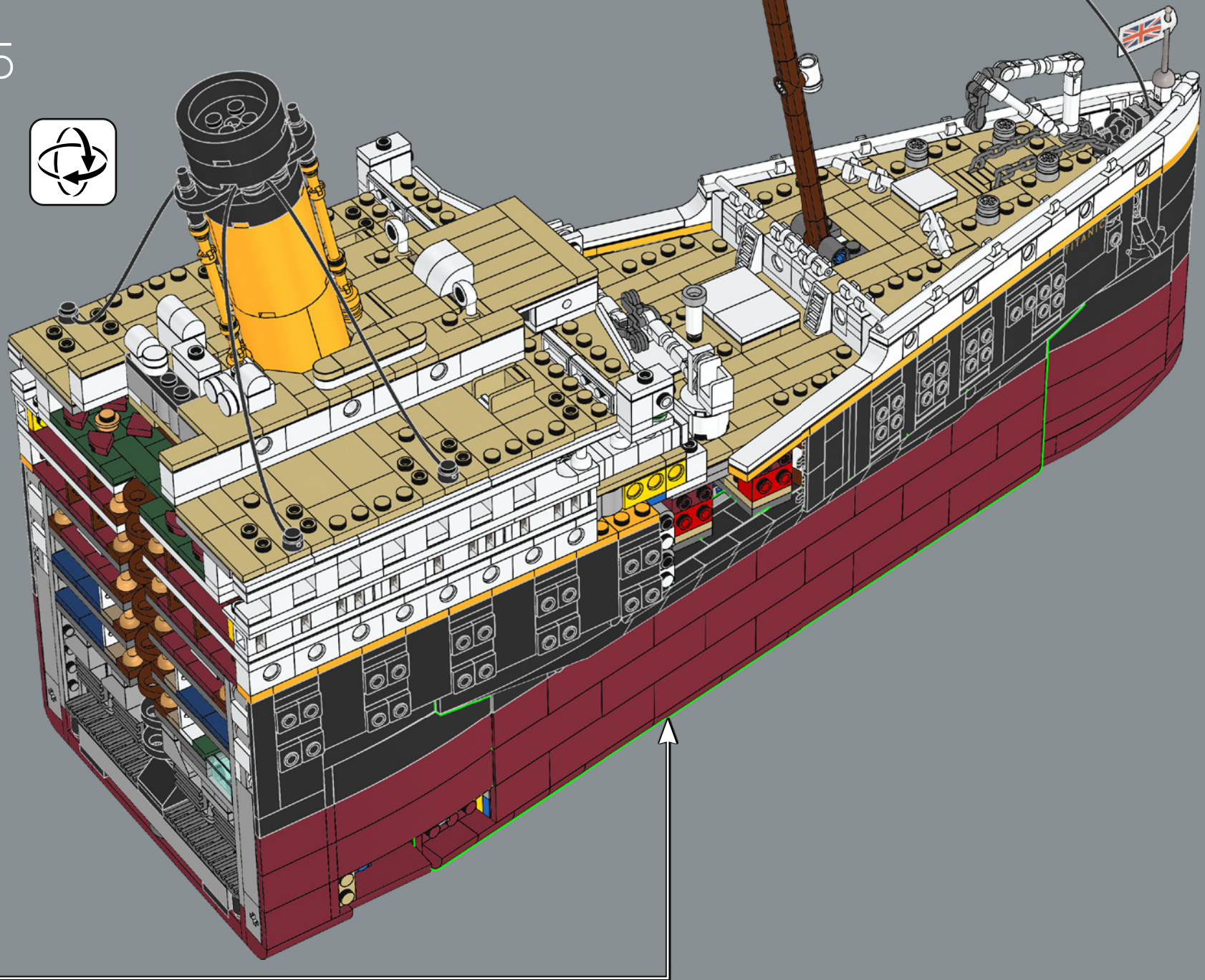

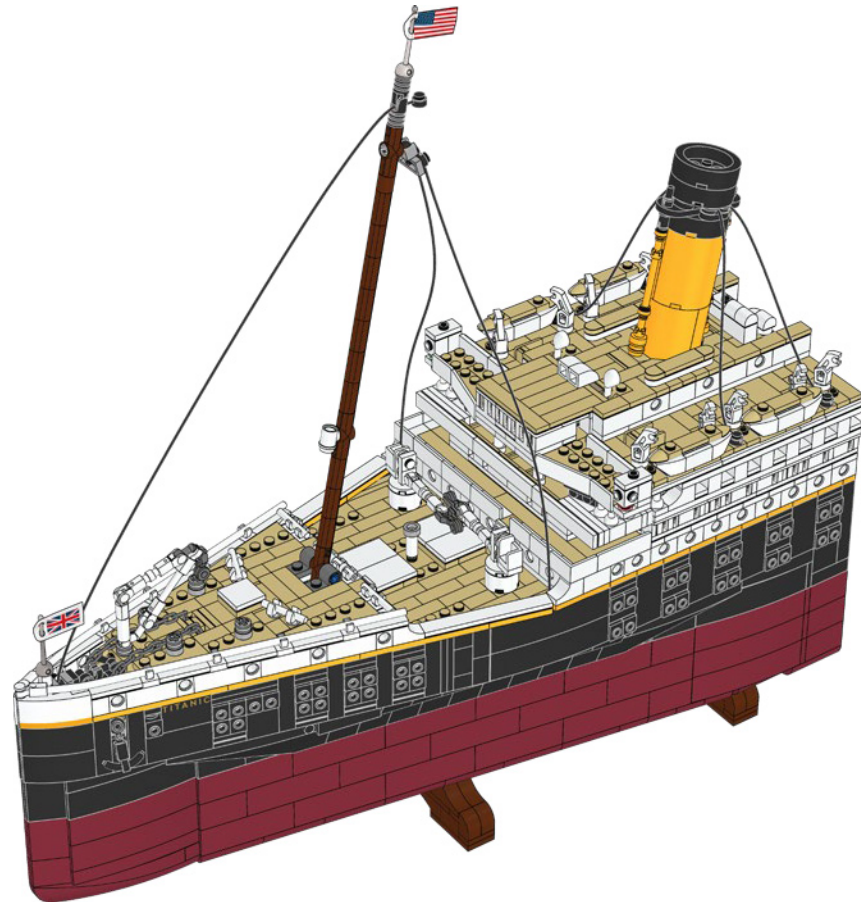
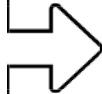

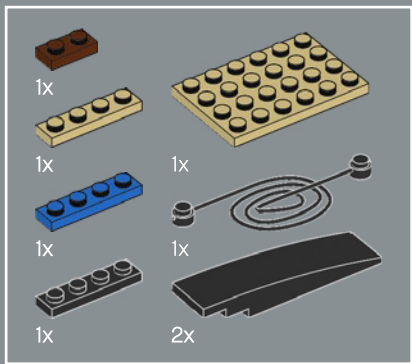

336

1

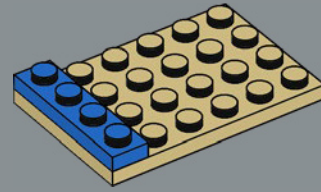

2

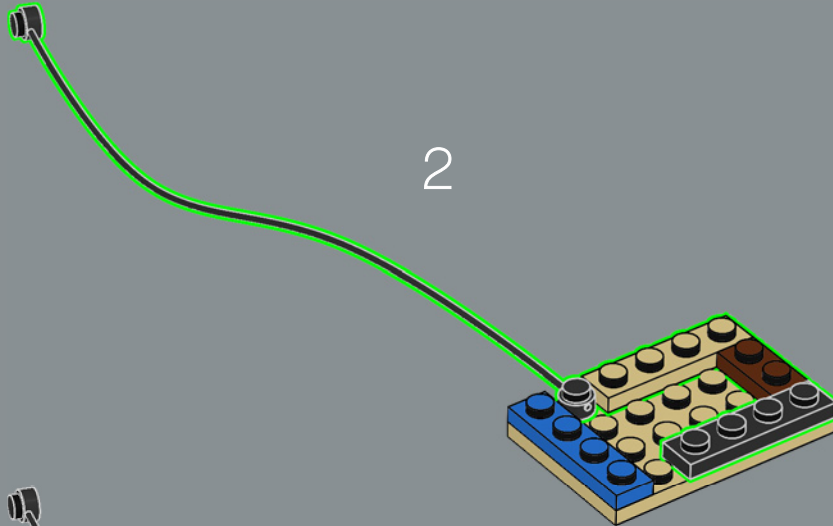

3

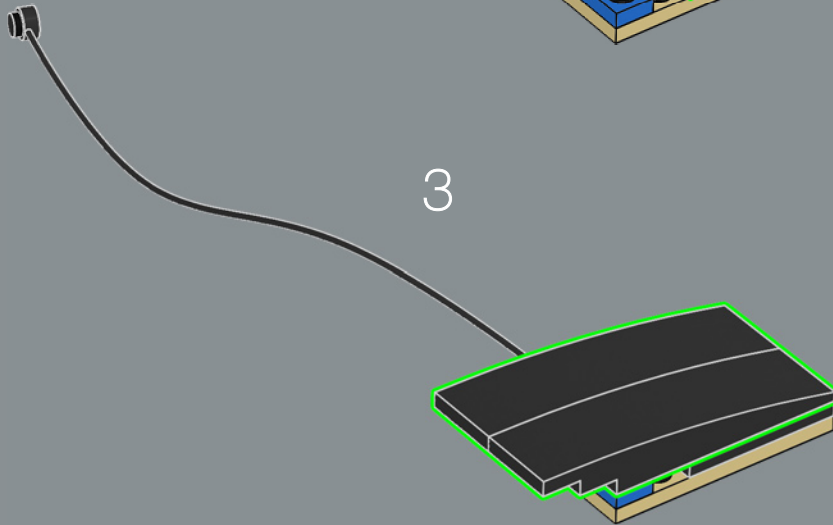

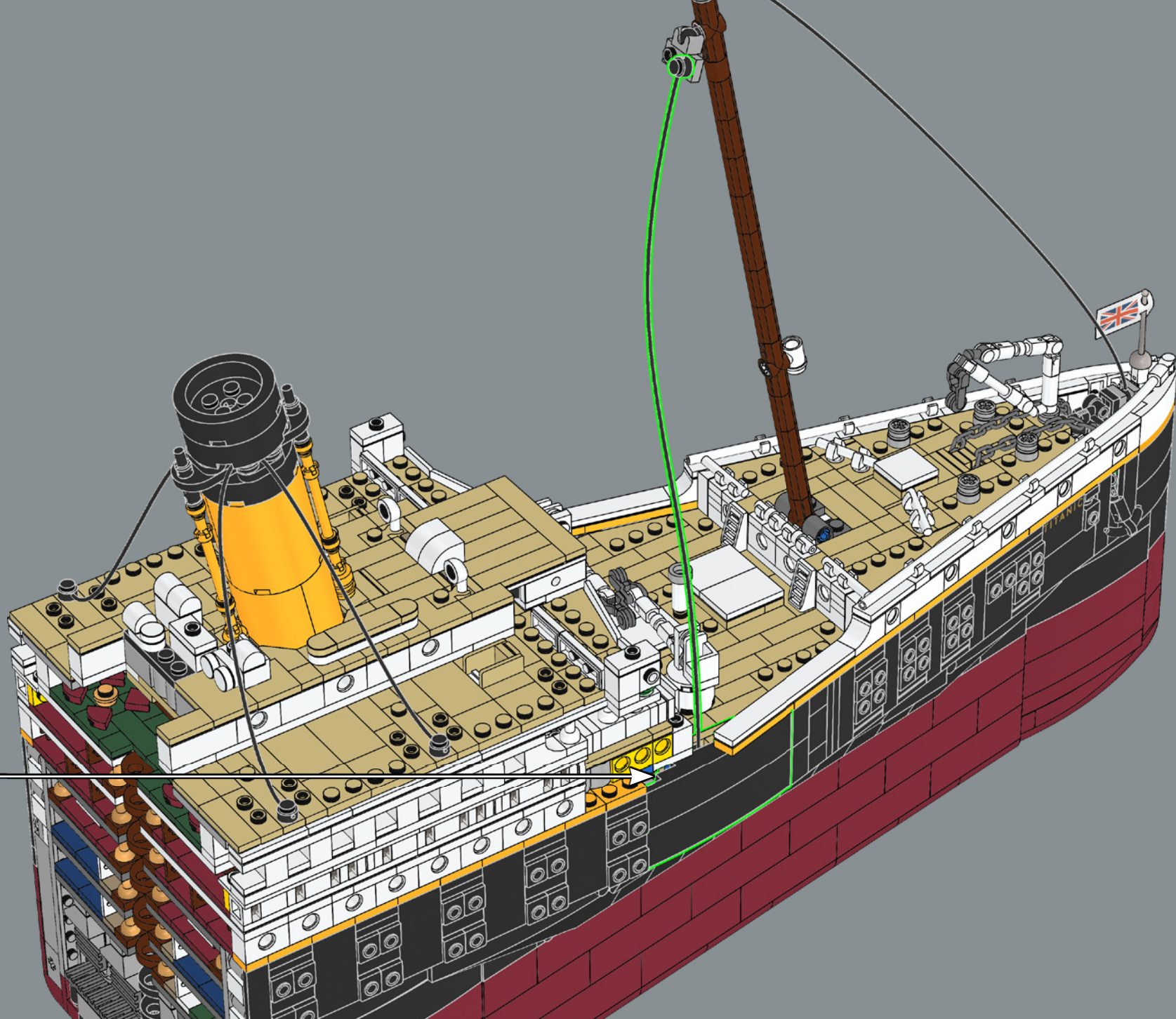

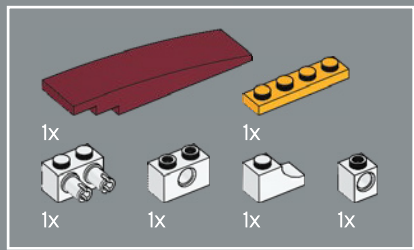

337

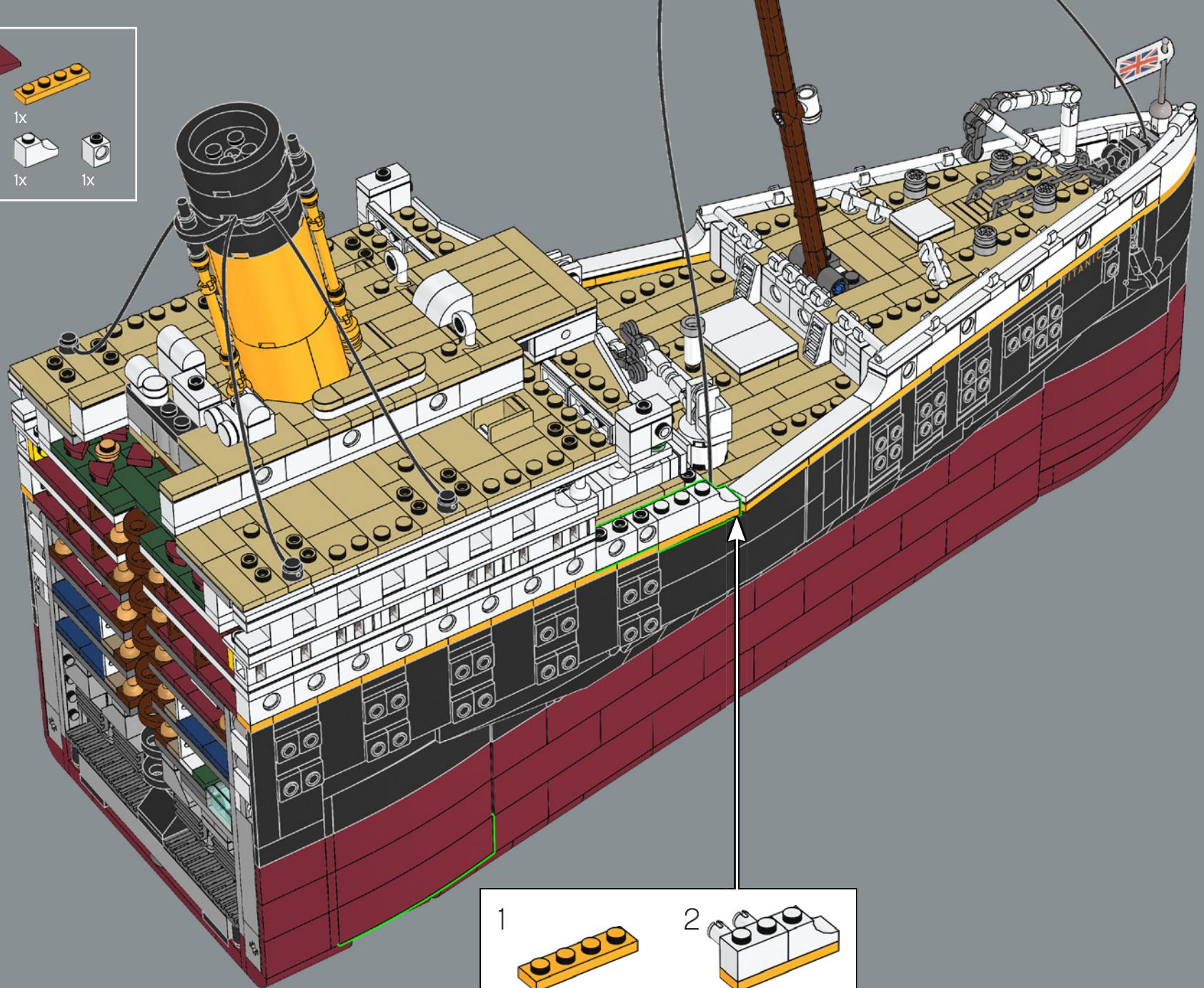

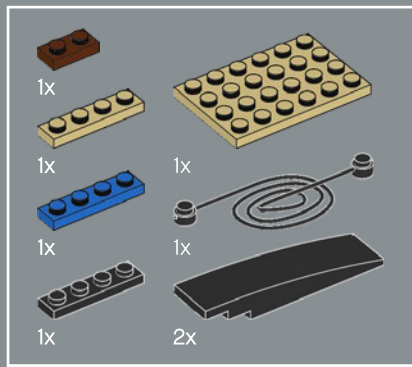

338

1

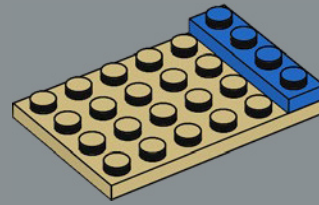

2

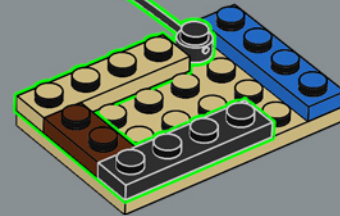

3

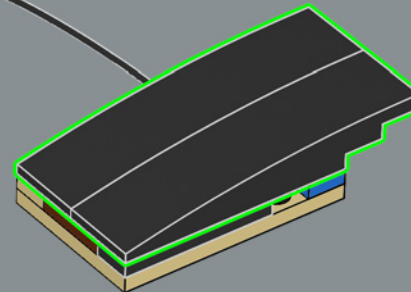

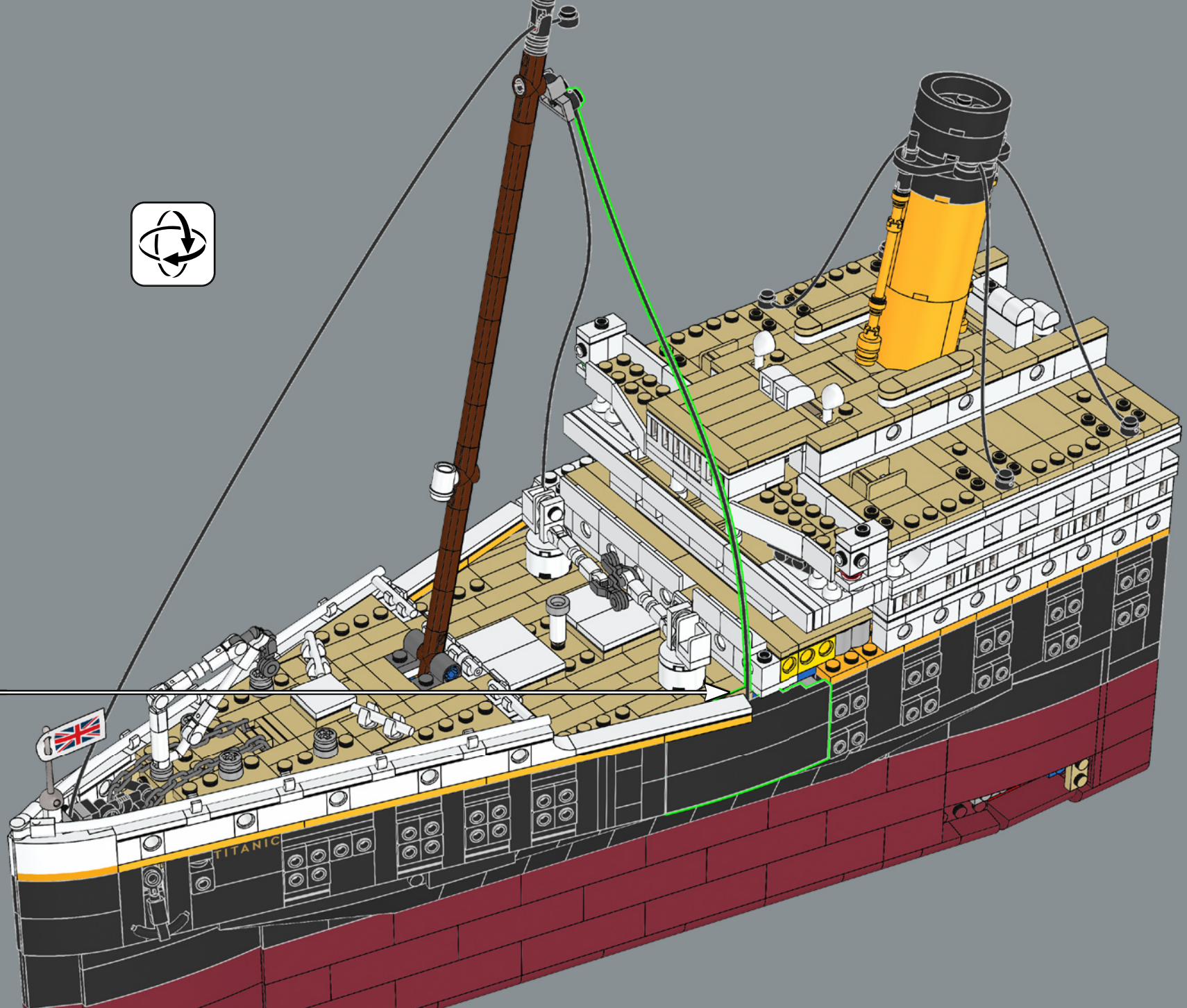

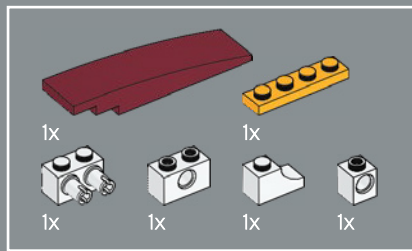

339

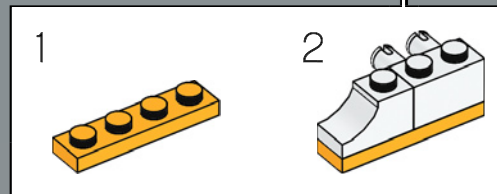
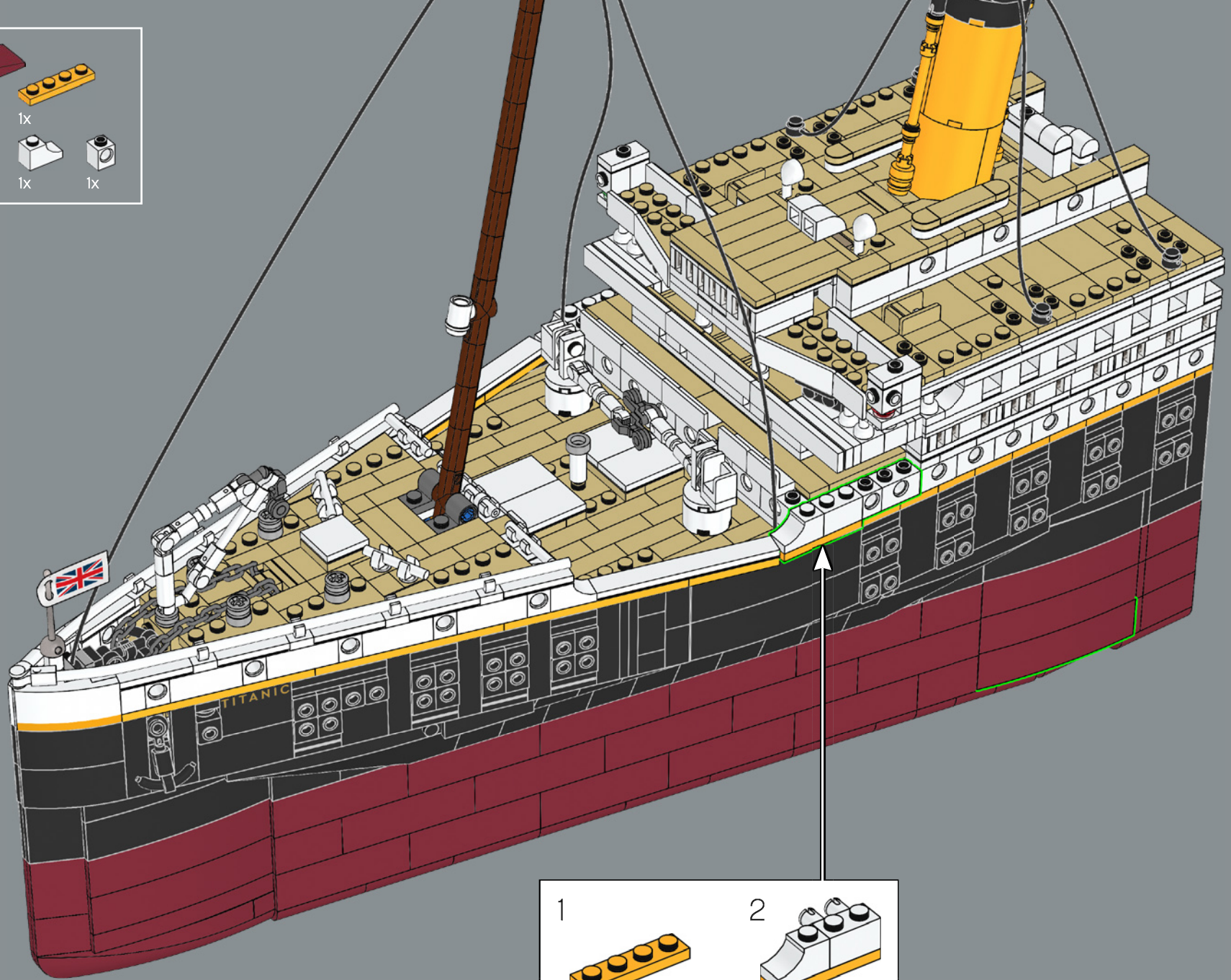

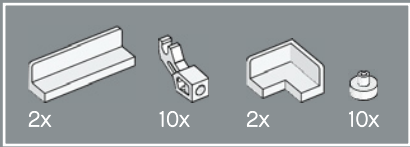

340

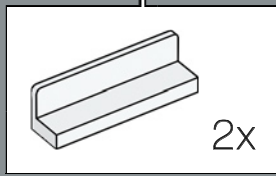
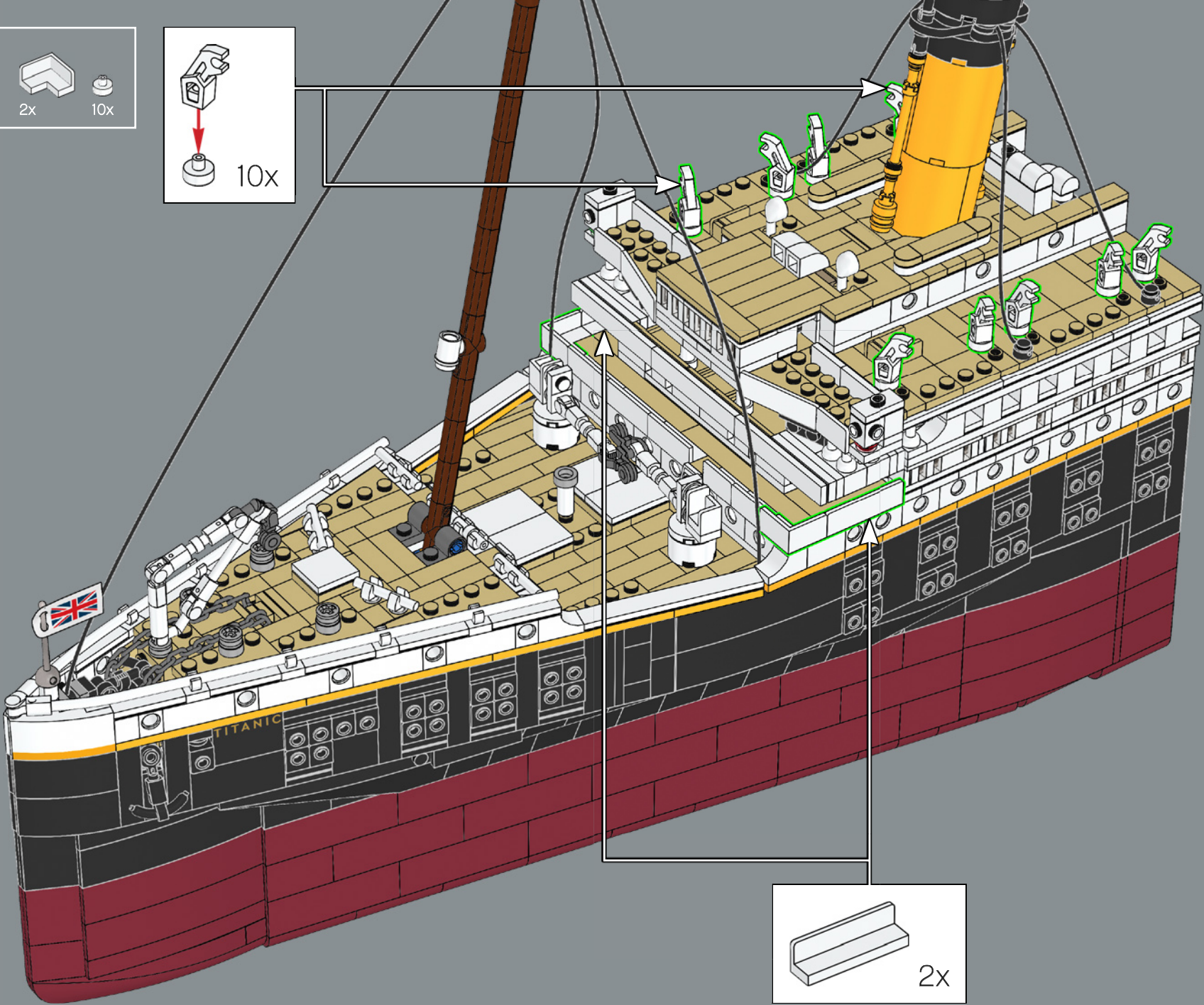
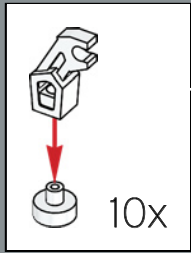



341

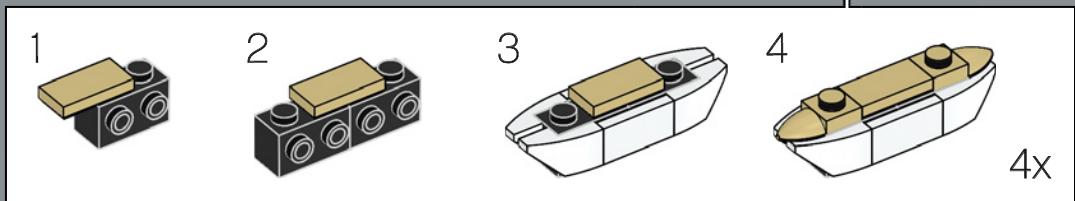
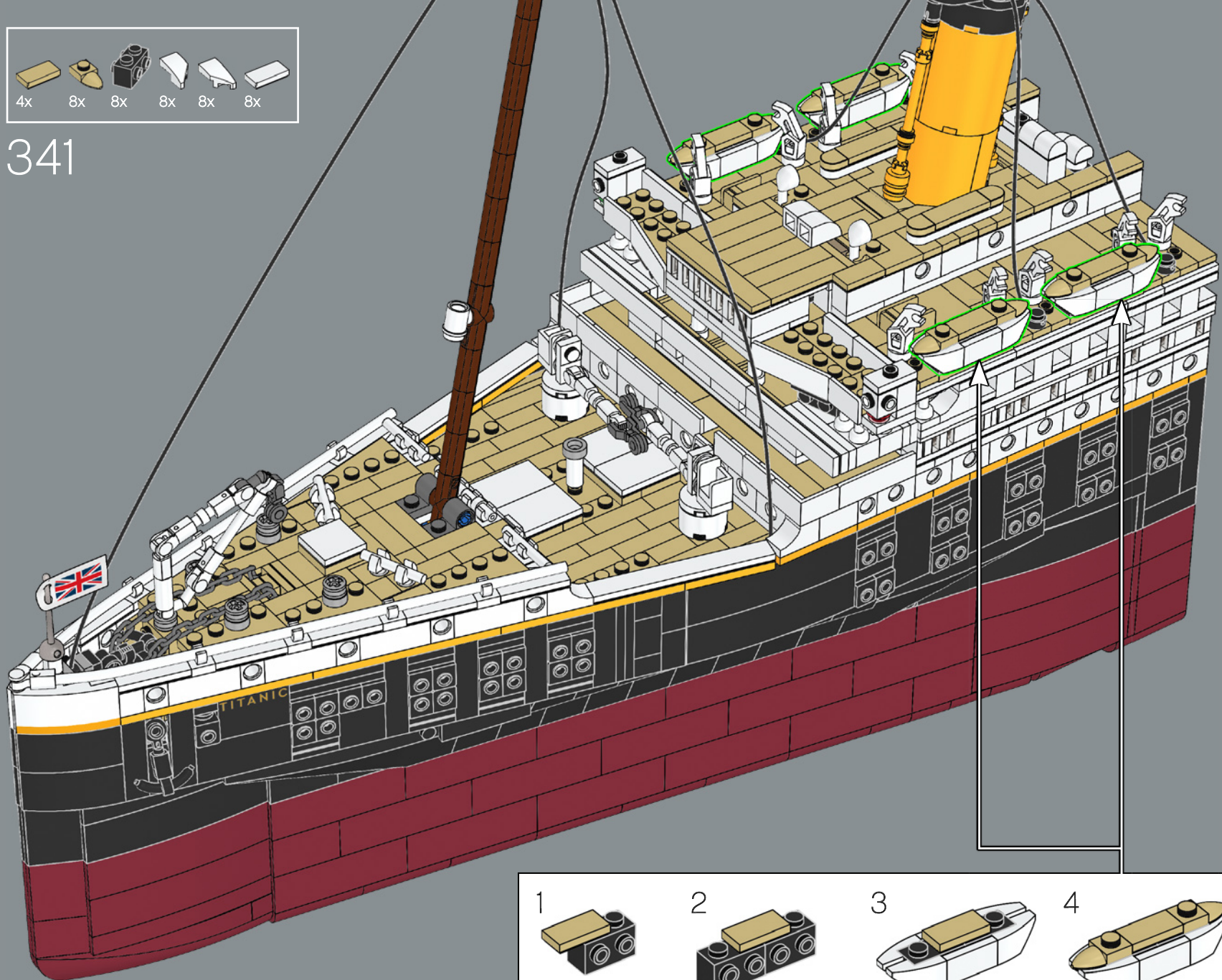

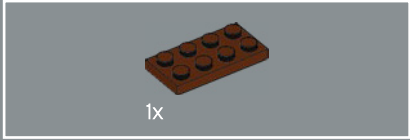
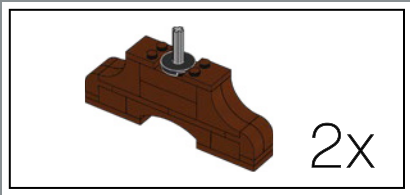

342

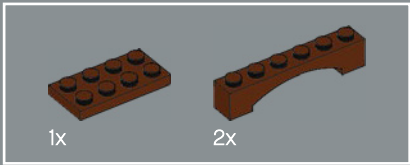
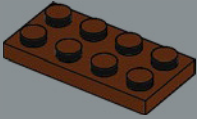

343

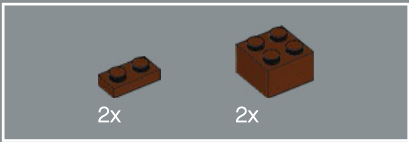
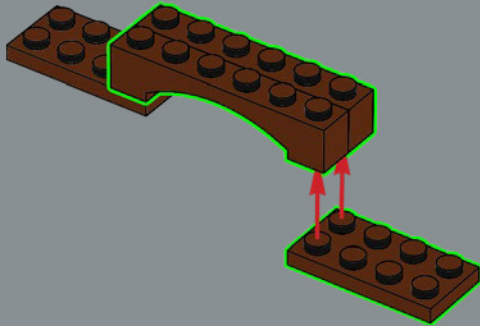

344

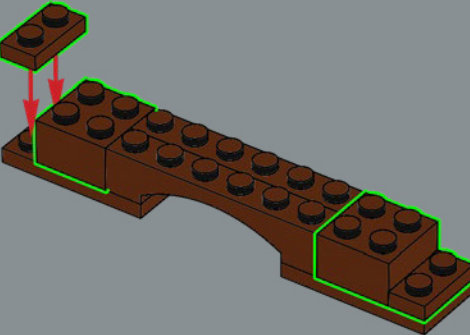

345

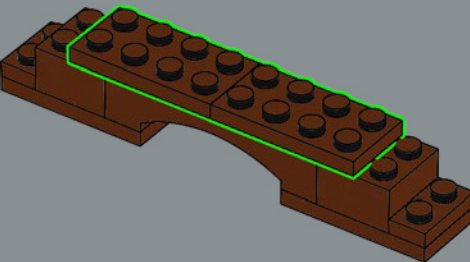

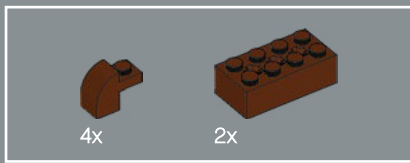

346

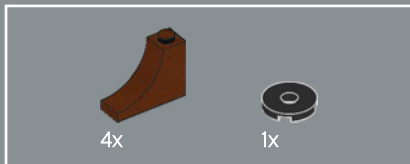
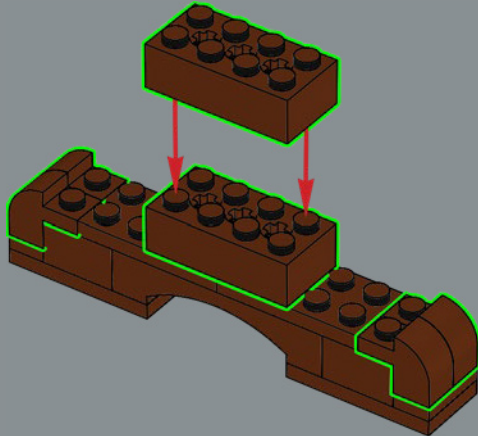

347

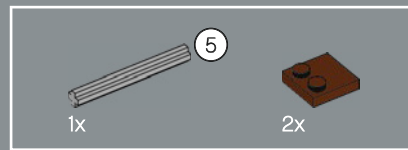
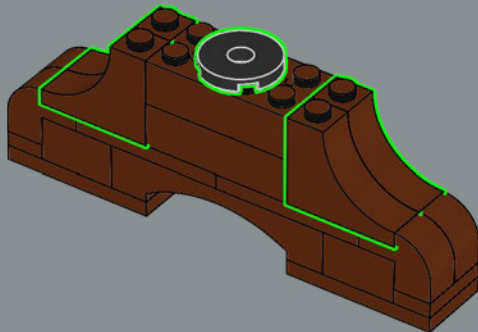

348

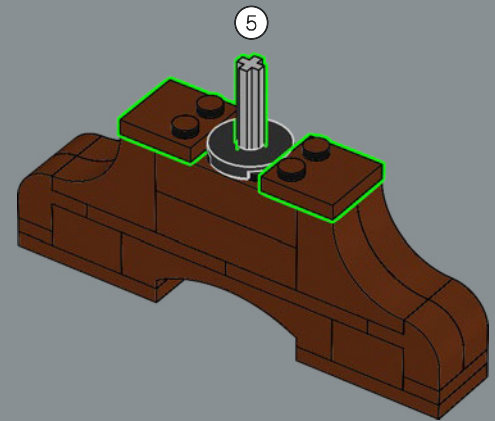
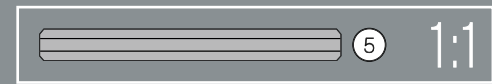

2x

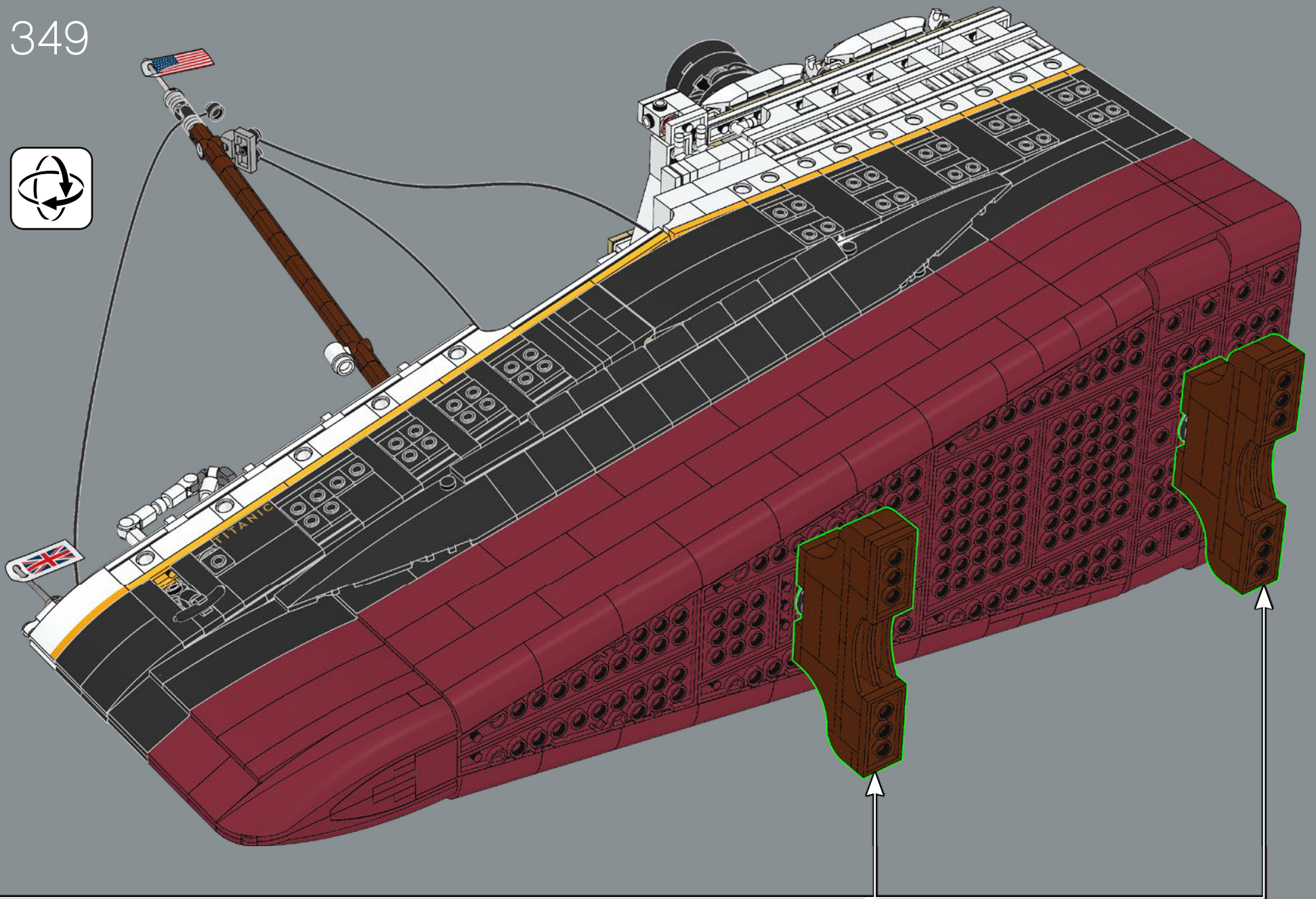

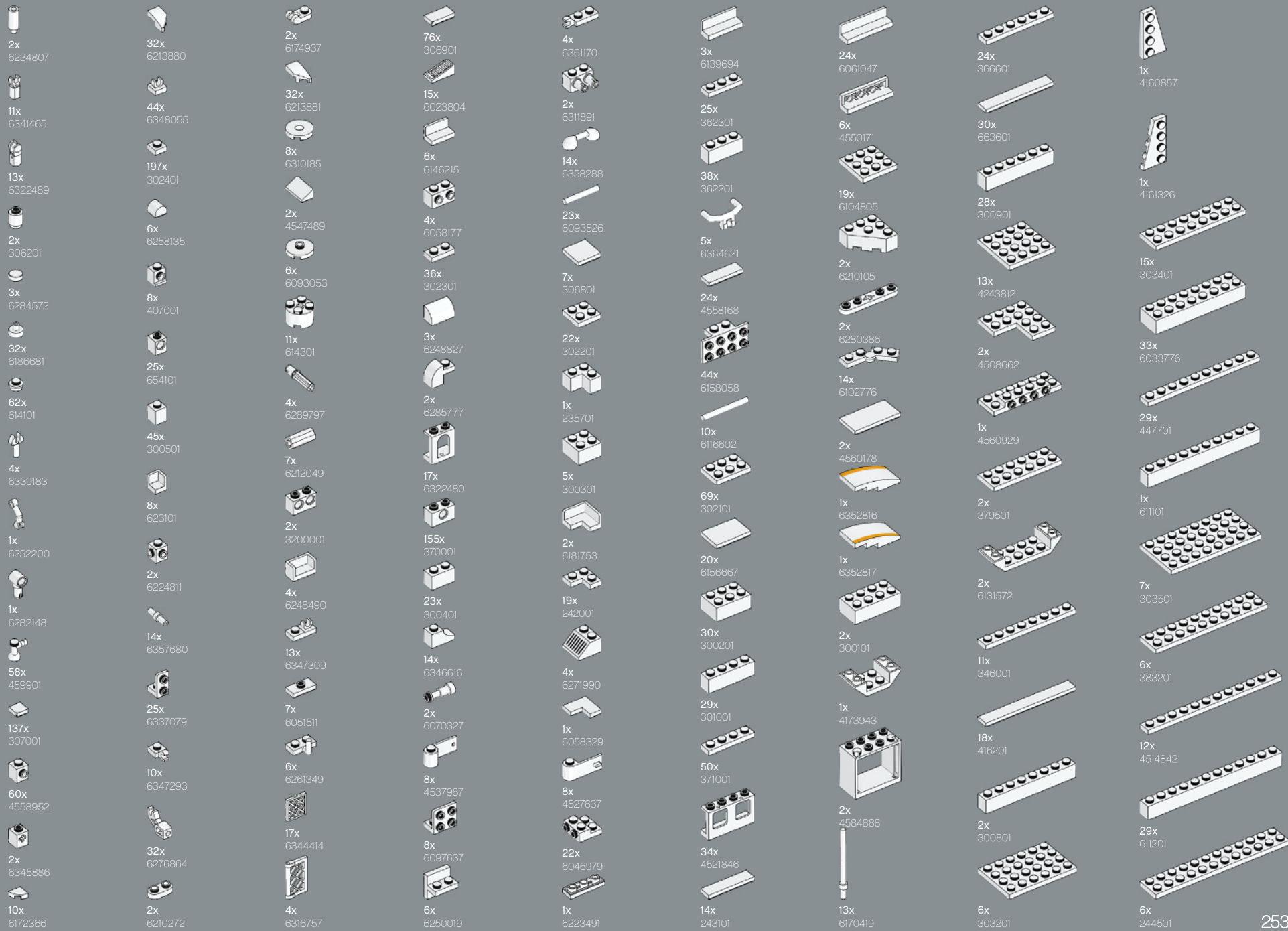

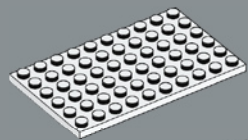

5x
4528341

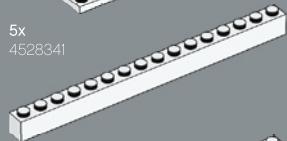

6x
246501



13x
4119227



2x
6365707

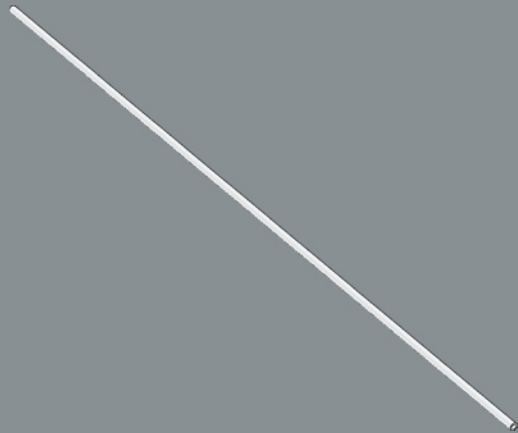

1x
6364683



1x
6370720

- 4x 6353196
- 44x 4118793
- 83x 6360078
- 2x 4113915
- 5x 4179771
- 54x 4125253
- 10x 4516055
- 20x 4159553
- 2x 4612603
- 2x 6357613
- 32x 4224793
- 4x 6355727
- 6x 6351413
- 14x 6352222
- 8x 6177890
- 8x 6177891

- 4x 4624086
- 4x 6232037
- 50x 4218749
- 41x 6092587
- 2x 6338180
- 4x 6148262
- 6x 4109995
- 6x 6146221
- 2x 6024495
- 13x 4205107
- 1x 6063943
- 2x 6294481
- 2x 6103001
- 153x 4114026
- 21x 4113917

- 20x 6034929
- 2x 4273526
- 2x 6214334
- 4x 6117975
- 4x 6249809
- 10x 6174925
- 5x 6253003
- 2x 6314477
- 2x 6358290
- 2x 6358289
- 2x 6358289

- 1x 4565387
- 39x 4185177
- 44x 6221467
- 44x 4114084
- 47x 6173057
- 18x 4114077
- 16x 6265572
- 4x 6211975
- 96x 6131896
- 14x 4121921
- 2x 4624088
- 34x 6211966
- 2x 6318084
- 8x 4118790
- 9x 6175367

- 2x 4500453
- 5x 4666999
- 2x 4113233
- 12x 4550324
- 26x 6257600
- 2x 6195544
- 2x 6115031
- 2x 4208072
- 33x 4114309
- 53x 6122047
- 8x 6351905
- 2x 4112982
- 10x 4157277

- 3x 6331158
- 4x 4113993
- 5x 4181134
- 49x 4114324
- 11x 4544139
- 12x 4159774
- 2x 4114001
- 2x 4125217
- 2x 4166138
- 3x 4509897

- 4x 6070501
- 6x 6093864
- 6x 6284574
- 2x 306221
- 8x 654121
- 10x 6345429
- 1x 6210269
- 46x 4142865
- 2x 6168634
- 4x 6019155
- 1x 6265697
- 22x 302321
- 2x 245821
- 2x 6313831

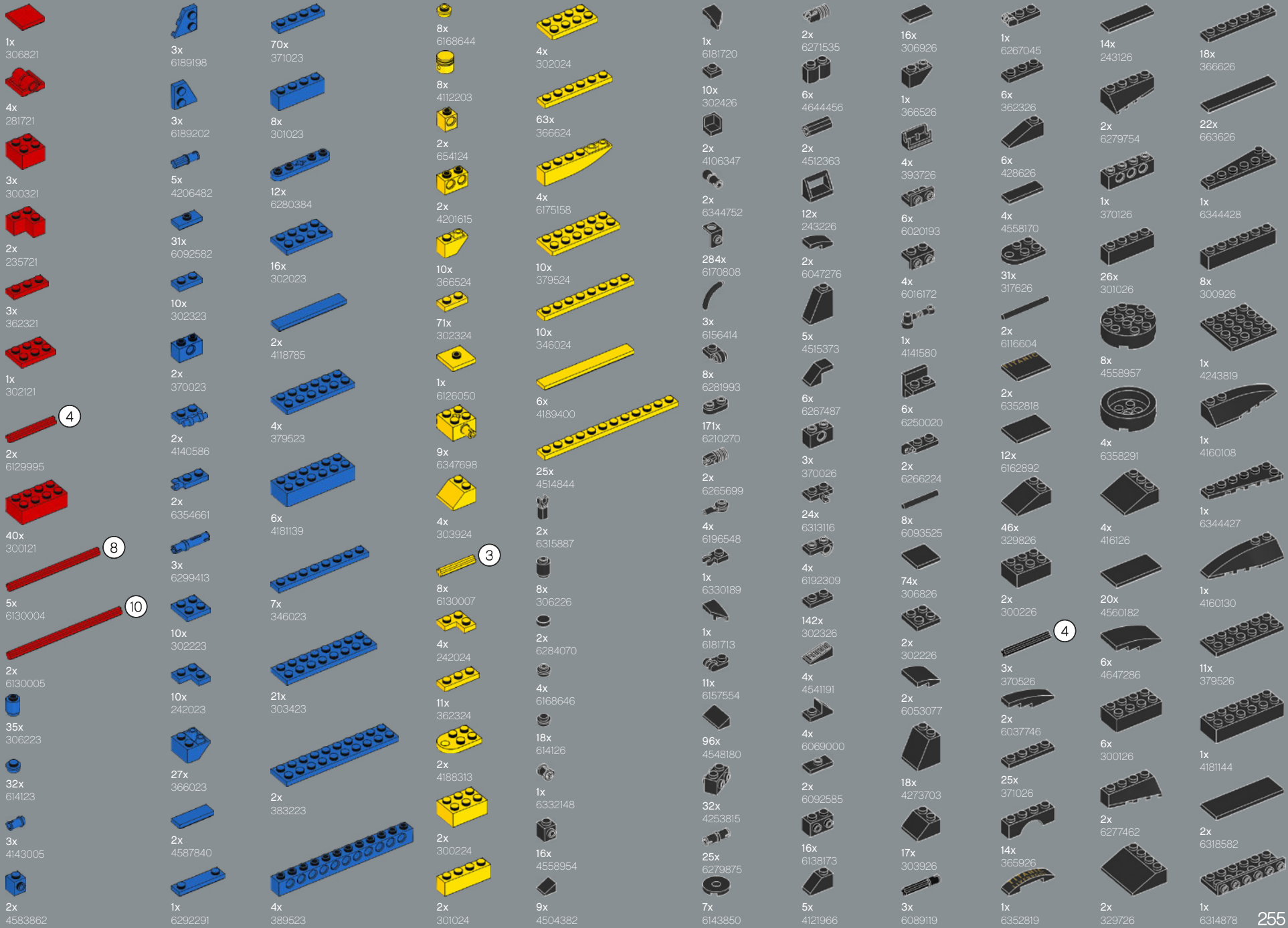

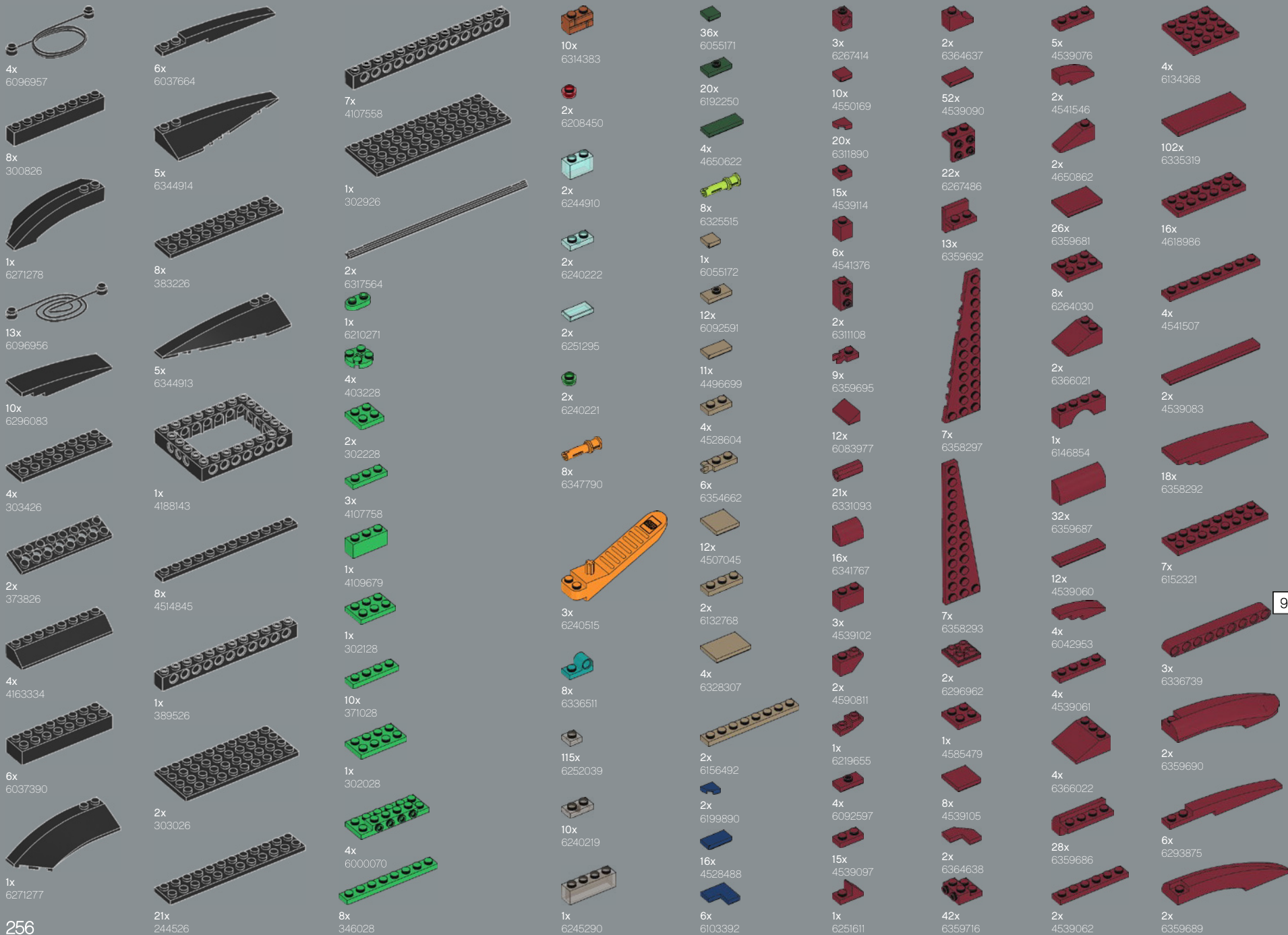

4x
6096957

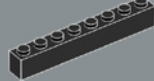

8x
300826



1x
6271278



13x
6096956



10x
6296083



4x
303426



2x
373826

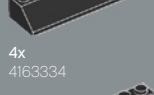

4x
4163334



6x
6037390



1x
6271277



6x
6037664

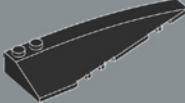

5x
6344914

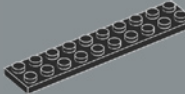

8x
383226



5x
6344913

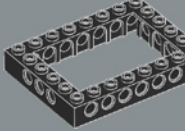

1x
4188143



8x
4514845



1x
389526

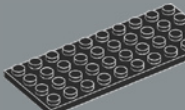

2x
303026

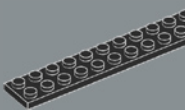

21x
244526



7x
4107558

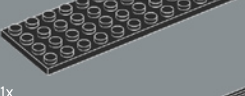

1x
302926



2x
6317564



1x
6210271



4x
403228



2x
302228



3x
4107758



1x
4109679



1x
302128



10x
371028



1x
302028



4x
6000070



8x
346028



10x
6314383



2x
6208450



2x
6244910



2x
6240222



2x
6251295



2x
6240221



8x
6347790



3x
6240515



8x
6336511



115x
6252039



10x
6240219



1x
6245290



6x
6103392



36x
6055171



20x
6192250



4x
4650622



8x
6325515



1x
6055172



12x
6092591



11x
4496699



4x
4528604



6x
6354662



12x
4507045



2x
6132768



4x
6328307



2x
6156492



2x
6199890



16x
4528488



3x
6267414



10x
4550169



20x
6311890



15x
4539114



6x
4541376



2x
6311108



9x
6359695



12x
6083977



21x
6331093



16x
6341767



3x
4539102



2x
4590811



1x
6219655



4x
6092597



15x
4539097



2x
6364637



52x
4539090



22x
6267486



13x
6359692



7x
6358297



7x
6358293



2x
6296962



1x
4585479



8x
4539105



2x
6366022



8x
4539105



2x
6364638



42x
6359716



5x
4539076



2x
4541546



2x
4650862



26x
6359681



8x
6264030



2x
6366021



1x
6146854



32x
6359687



12x
4539060



4x
6042953



4x
4539061



4x
6366022



28x
6359686



2x
4539062

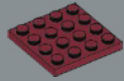

4x
6134368

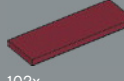

102x
6335319

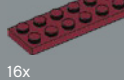

16x
4618986



4x
4541507



2x
4539083

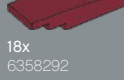

18x
6358292

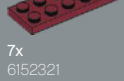

7x
6152321

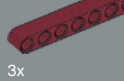

3x
6336739

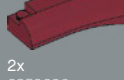

2x
6359690



6x
6293875

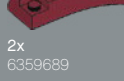

2x
6359689

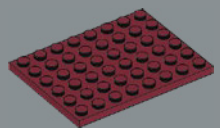

11x
6028115

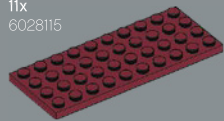

8x
6186106



8x
6245265



16x
6134252



8x
6223719



16x
6331261



6x
6073040



6x
6028736



91x
6097503



16x
6358295



16x
6020073



4x
6359223



12x
6020074



9x
6192205

6x
4211183



19x
4216581



1x
6170813



2x
6149677



12x
4221744



26x
4211288



46x
4225469



4x
6325717



29x
4531751



2x
4211222



1x
4211252



14x
6365885



105x
4211150



24x
6335567



1x
4211151



10x
6365884



24x
4645103



39x
6236915



20x
6196221



30x
4211210



10x
6365883



5x
6333110



6x
4211220



20x
4211152



24x
6133833



9x
6172636



30x
4211186



14x
6365882



1x
4221590



18x
4211193



12x
4655611



1x
4216615



6x
6313736



2x
4211211



2x
4222627



1x
6338230

88x
4211412

23x
6258831

7x
6172165

1x
4211483

3x
4558953



12x
4211399



2x
6225242



2x
6345639



8x
6335378



8x
4211375



8x
6227897



4x
4568637



2x
6352979



2x
6352983



1x
6352986



1x
6352997



1x
6353001



155x
4550325



2x
6372076



16x
6093859

4x
6327412



9x
6338165



2x
4211564



20x
4211398



8x
4211414



8x
4211440



10x
6206249



1x
6326078



8x
6146300



8x
4211363



4x
4211494



2x
4211614



4x
6117967

6x
4654580



8x
4211609



4x
6337268



4x
6078211



4x
6198932



4x
4667578



4x
4211461



4x
4211632



4x
6321743



1x
4208988



1x
4209006

8x
4211397



46x
6212077



6x
6007894



6x
4234535



4x
4211815



4x
6078212



8x
6195471



1x
6346487



4x
6326483



1x
6304930



15x
6211969



8x
4211419



11x
4211773



30x
4211396



1x
4211386



9x
4211394



1x
4211441



2x
4211445



26x
4211636



8x
6230229



2x
4211361



2x
4211395



8x
4211385



6x
4211639



4x
6256117



8x
6105964



6x
4211393



16x
4211438



2x
4612621



2x
4211837



2x
4527174



4x
6015349



35x
4211452



13x
4211795



4x
6225219



4x
4211425



2x
4211442



3

5

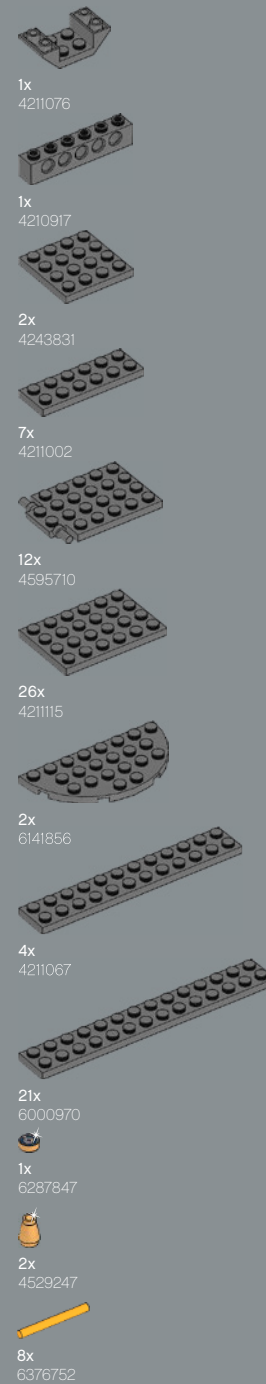
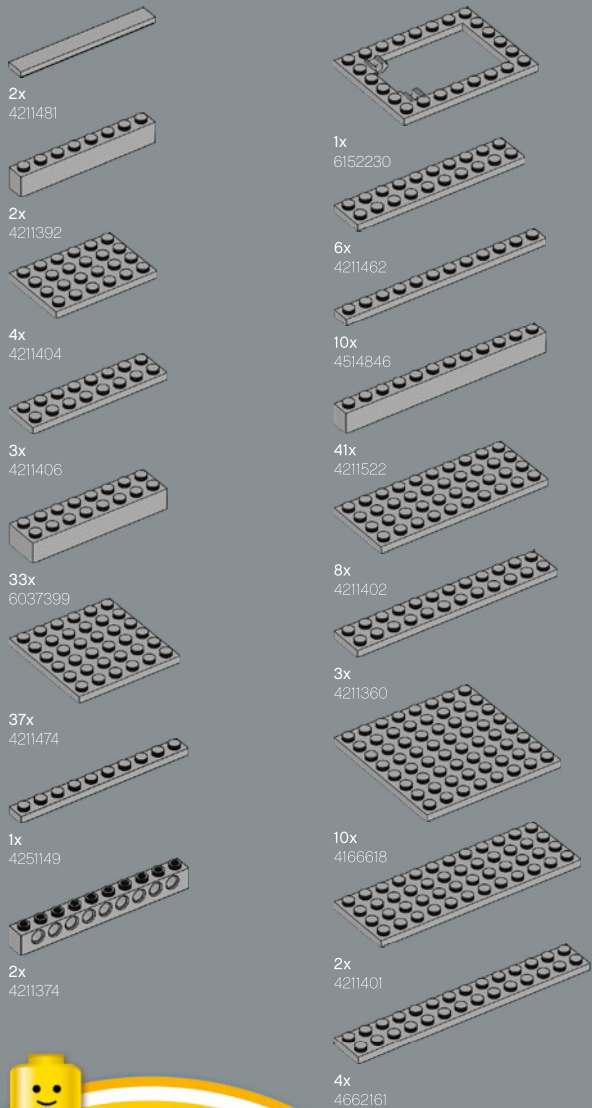

Customer Service
Kundenservice
Service Consommateurs
Servicio Al Consumidor

LEGO.com/service or dial





FEEDBACK AND WIN



FEEDBACK AND WIN

Your feedback will help shape the future development of this product series.

Please visit:

FEEDBACK UND GEWINNEN

Dein Feedback trägt zur Weiterentwicklung dieser Produktreihe bei.

Geh auf:

COMMENTEZ ET GAGNEZ

Vos commentaires nous aideront à concevoir les futurs produits de cette gamme.

Rendez-vous sur :

COMENTA Y GANA

Tu opinión nos ayudará a dar forma al desarrollo de esta serie de productos en el futuro.

Visita:

反馈有奖

您的反馈将有助于我们在今后改进本系列产品。

请访问：

[LEGO.com/productfeedback](https://www.lego.com/productfeedback)

By completing, you will automatically enter a drawing to win a LEGO® set.

Terms & Conditions apply.

Durch Ausfüllen nimmst du automatisch an der Verlosung eines LEGO® Preises teil.

Es gelten die Teilnahmebedingungen.

En envoyant vos commentaires, vous serez automatiquement inscrit(e) à un tirage au sort qui vous permettra de remporter un prix LEGO®.

Offre soumise à conditions.

Al contestar, participarás automáticamente en el sorteo y podrás ganar un set LEGO®.

Sujeto a Términos y Condiciones.

完成我们的反馈调查，即可自动进入抽奖环节，赢取乐高®套装。

适用《条款和条件》。

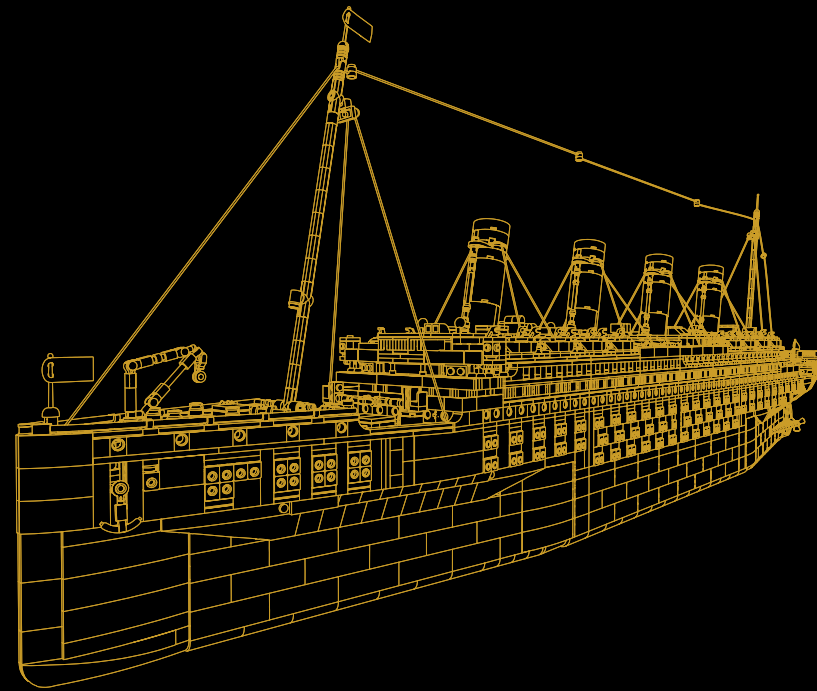

LEGO and the LEGO logo are trademarks of the LEGO Group. ©2021 The LEGO Group.