

---

# TITANIC

BOOK 3

---

# THE UNSINKABLE OCEAN LINER

Though the RMS *Titanic* boasted many advanced safety features, outdated maritime safety regulations dictated that the liner only needed to have 20 lifeboats onboard: enough for just one third of her crew and passengers. When she collided with an iceberg at high speed just before midnight on April 14<sup>th</sup>, 1912 and quickly began to sink, the lack of lifeboats ensured only 710 people survived while more than 1,500 perished. As a direct result of the tragedy, new wide-ranging international safety standards were introduced, many of which are still in force today.

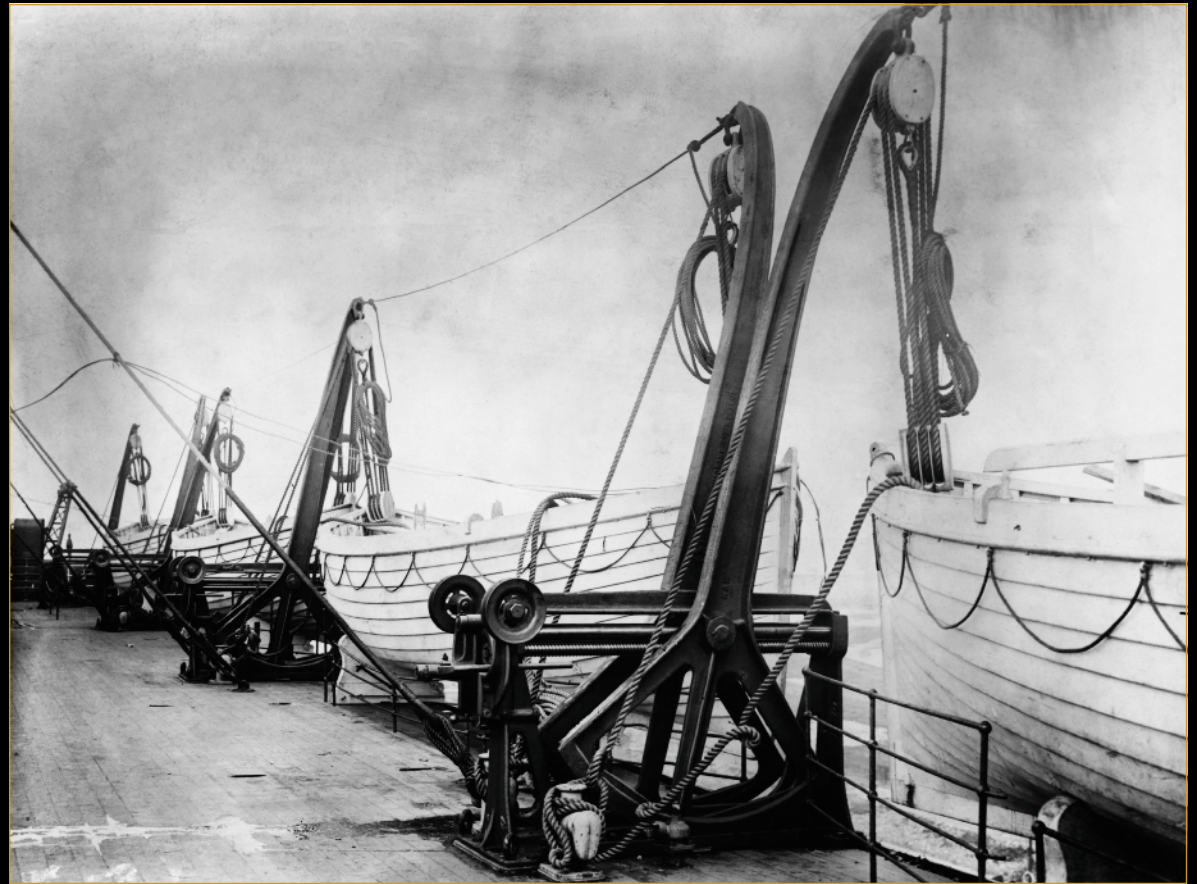

↑ Lifeboats in their davits on the *Titanic*.

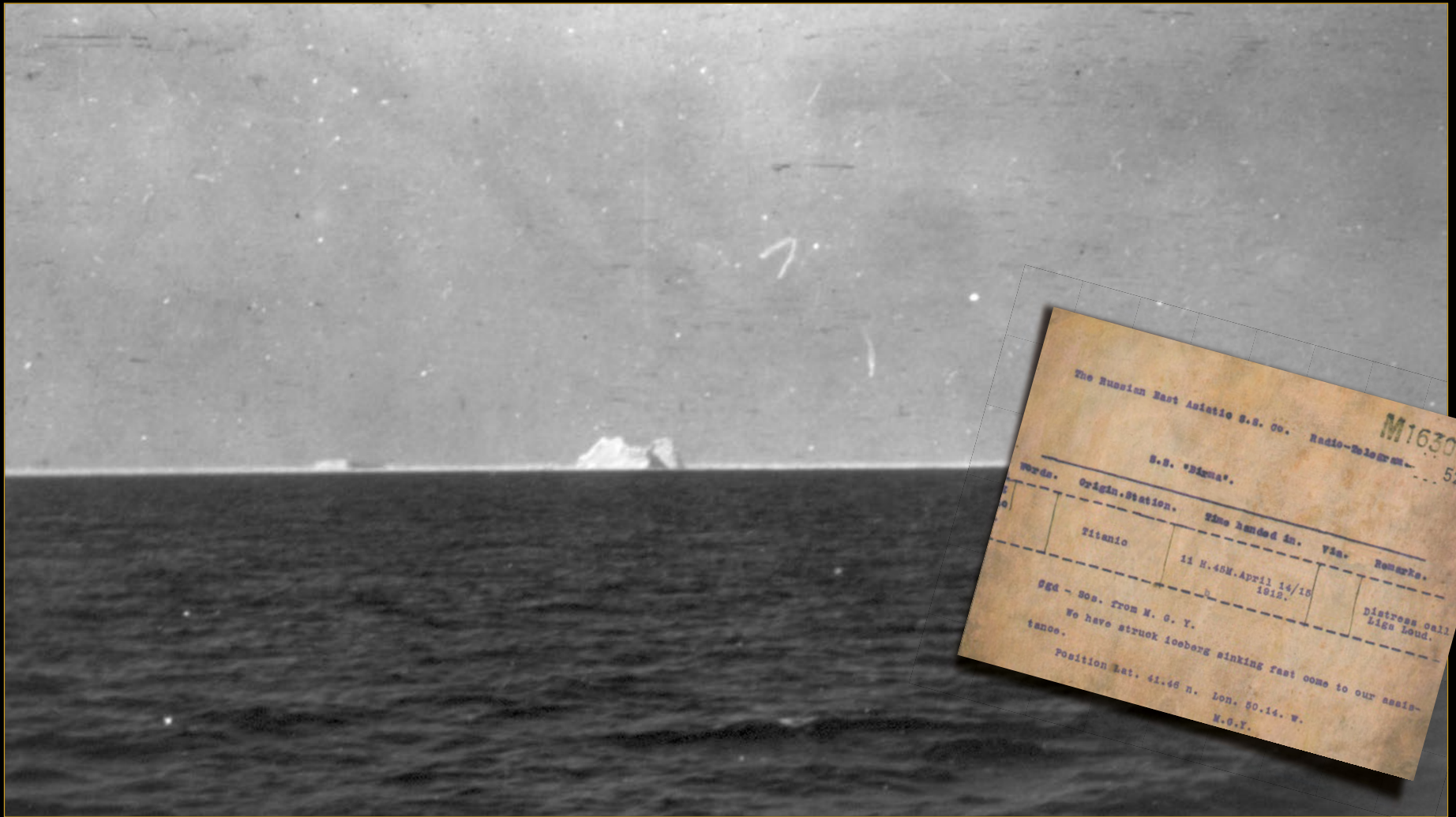

↑ The presumed location of the disaster taken from the SS Carpathia which picked up survivors from the Titanic.

↗ A telegram transmitted from RMS Titanic to the SS Birma requesting assistance.

---

# IMPRESSIVE SCALE

At its launch, the *Titanic* was the largest man-made vessel ever constructed. She was over 269 meters (882.9 ft.) long and measured 53.3 meters (175 ft.) from the bottom of the hull to the top of her smokestacks. Likewise, the LEGO® version of the RMS *Titanic* is the longest LEGO model created so far and one of the most intricate.

*The LEGO version of the Titanic is built at 1:200 scale, the same scale as the LEGO Architecture Statue of Liberty set.*

*The Titanic was 11 times as long as the blue whale, the largest animal ever known to have lived on Earth.*

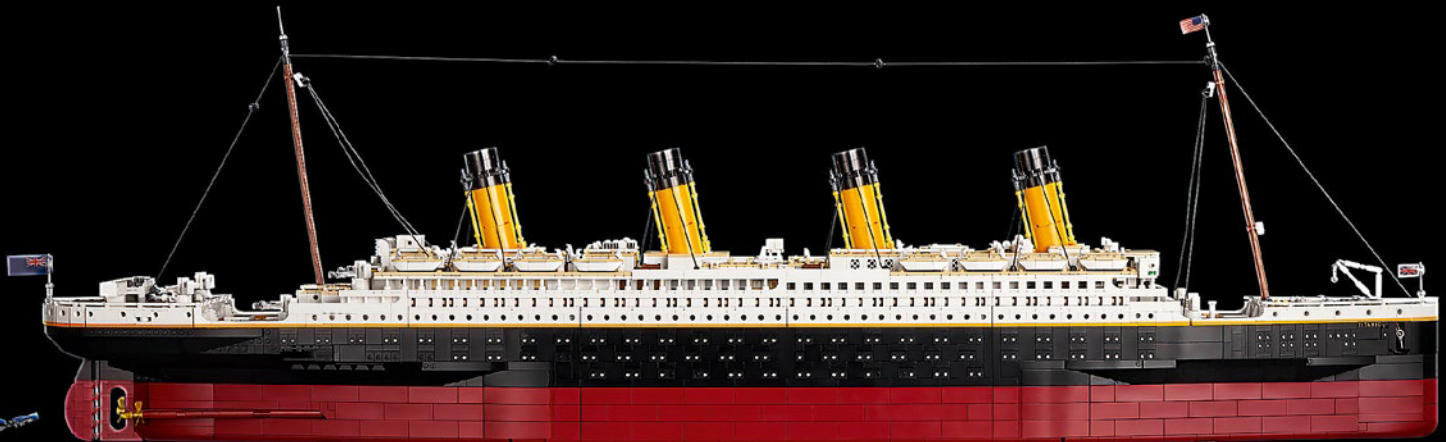

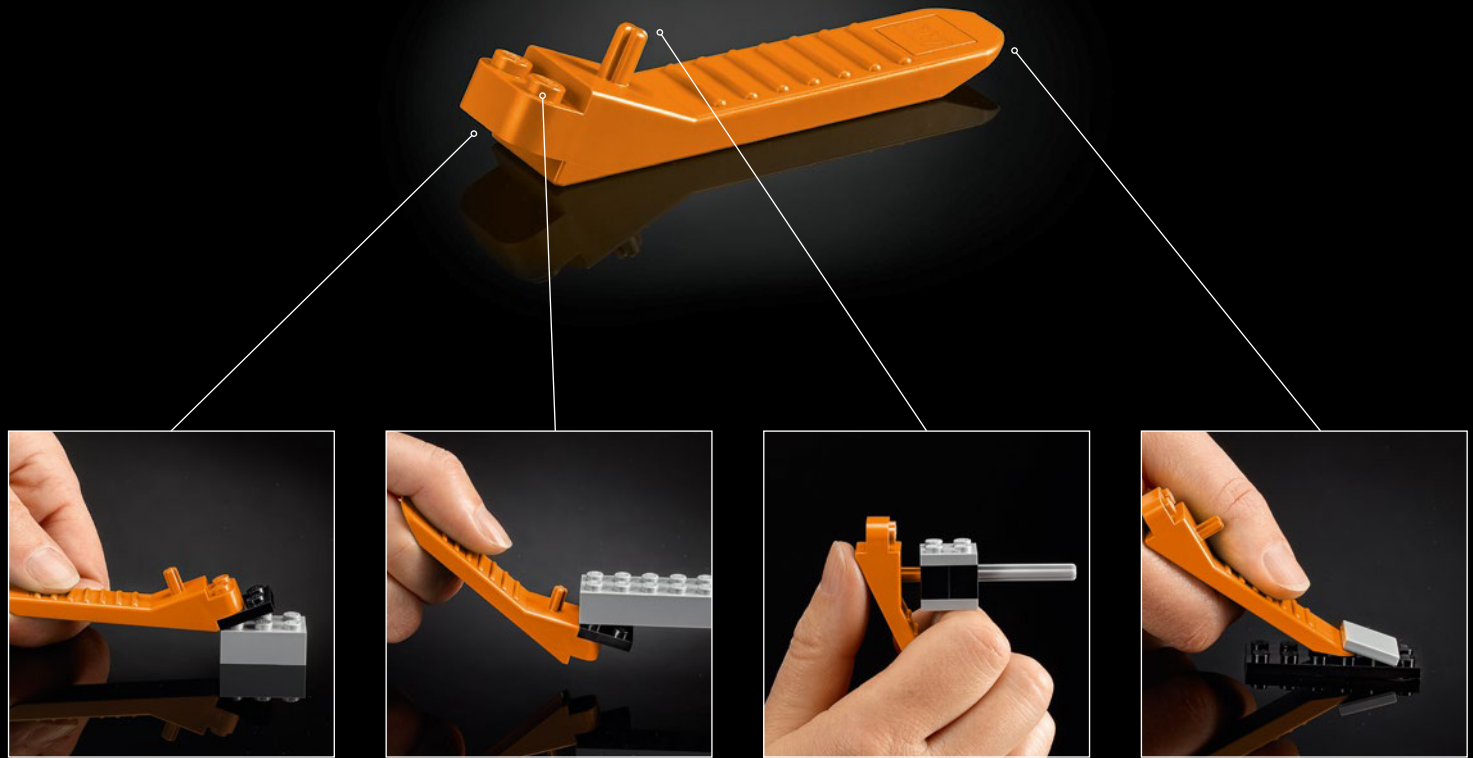

[LEGO.com/brickseparator](https://www.LEGO.com/brickseparator)

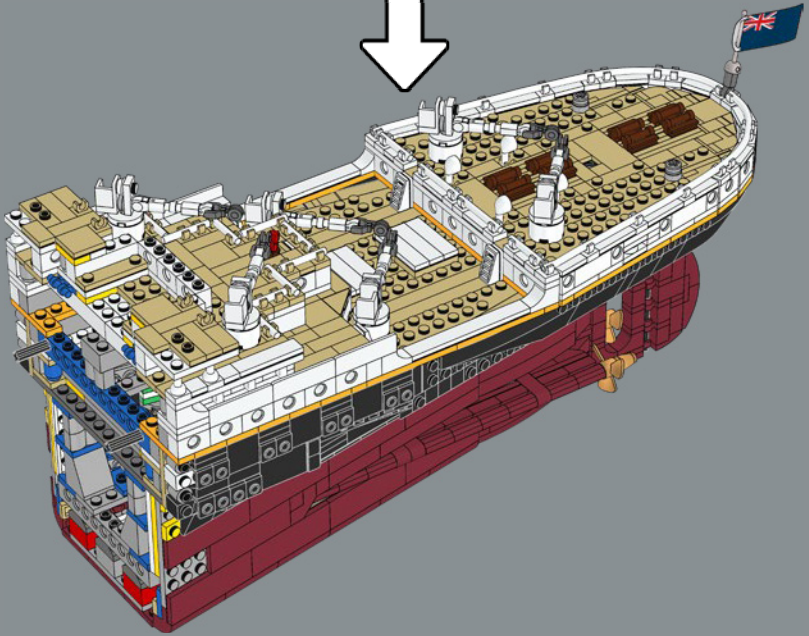
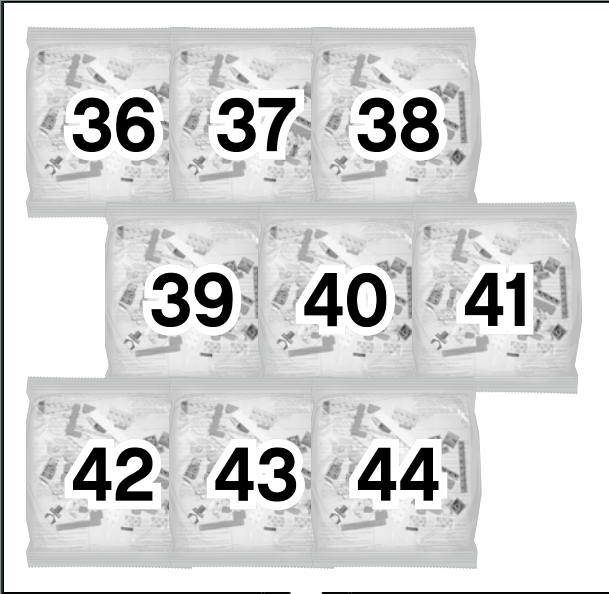
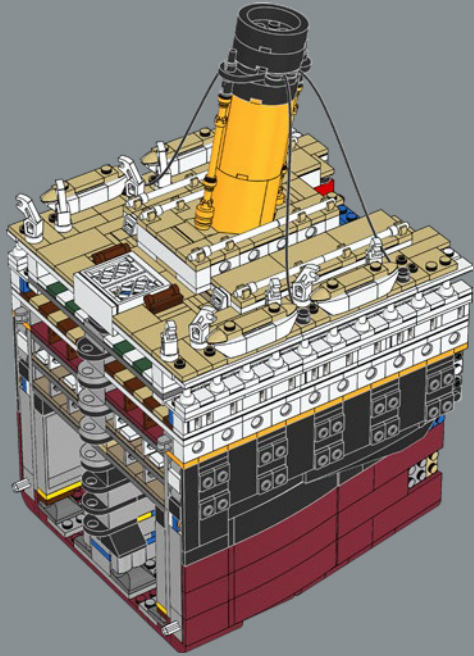
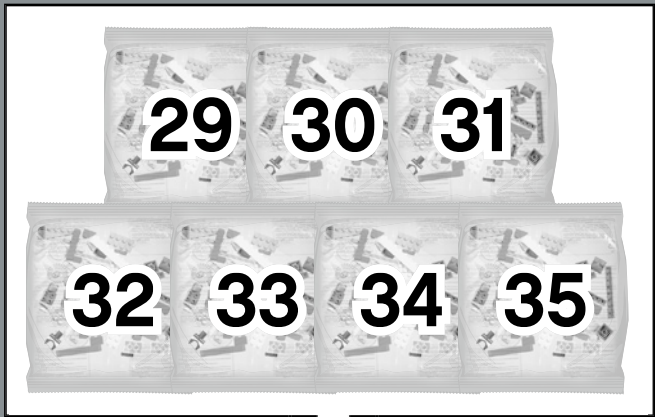

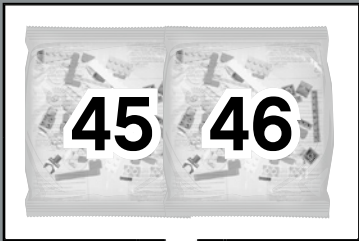

45

46

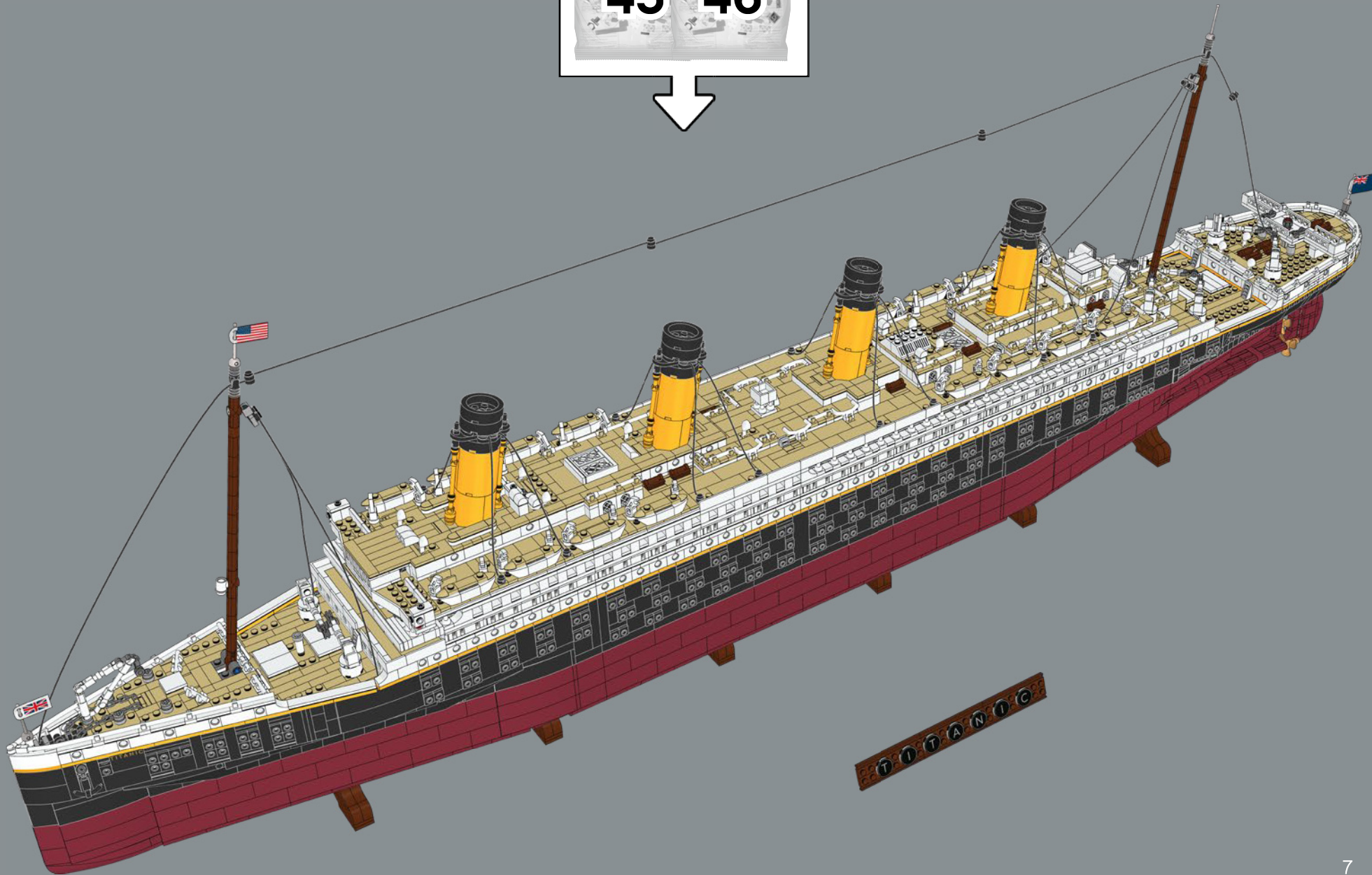

TITANIC

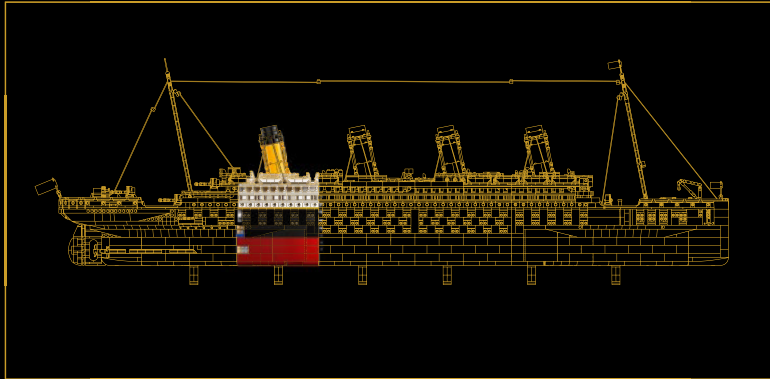

## SECTION 5:

# FUNNEL & ENGINE ROOM

In this section the model narrows as it tapers towards the propellers and rudder at the stern of the ship. You will also build the model's final funnel. On the real *Titanic*, this funnel was not connected to any boilers but was included in the design of the ship to make it feel more beautiful and complete.

↓ At the top of this section, you will add the ship's reading room and some of its 2nd class cabins.





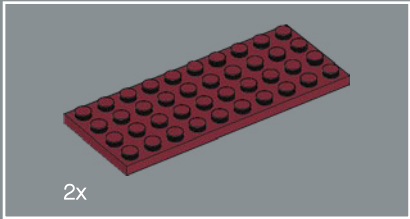
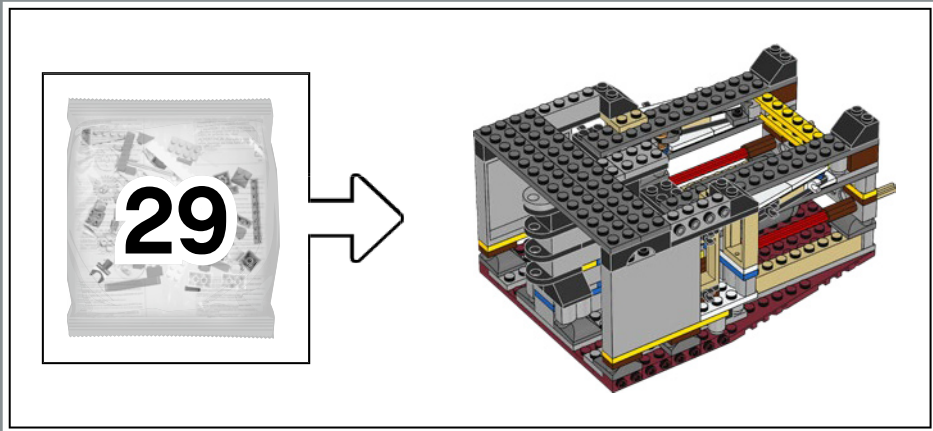

1

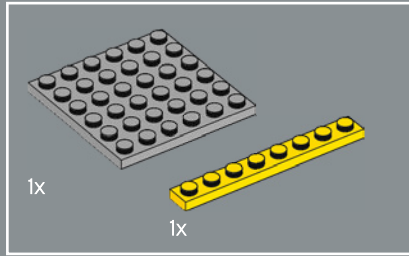
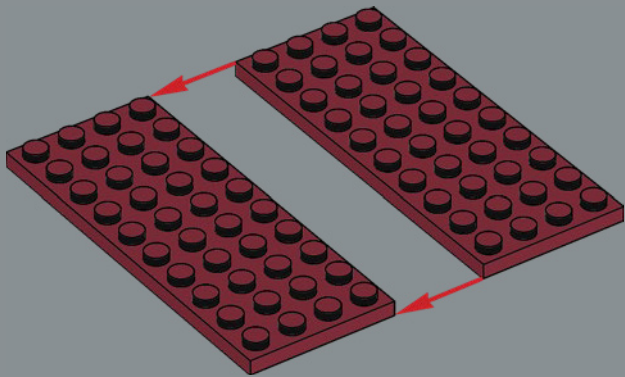

2

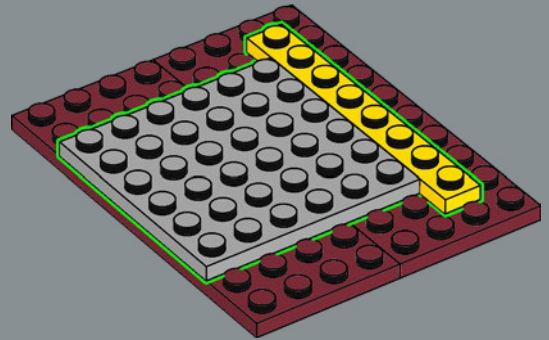

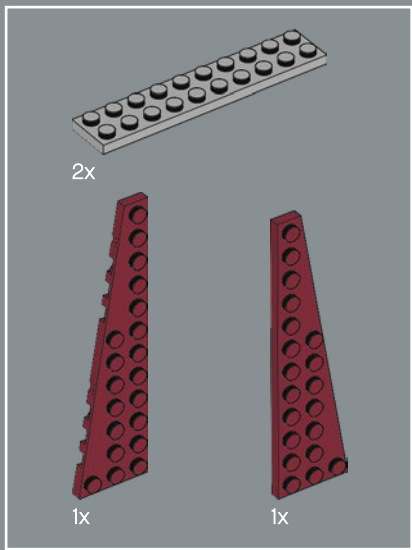

3

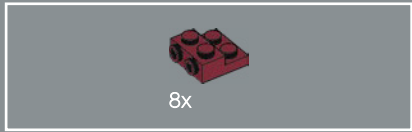
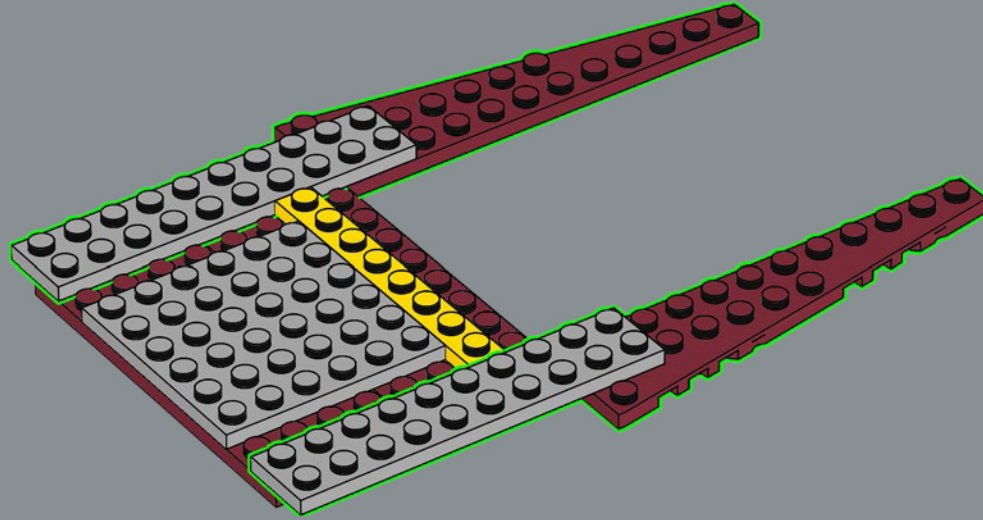

4

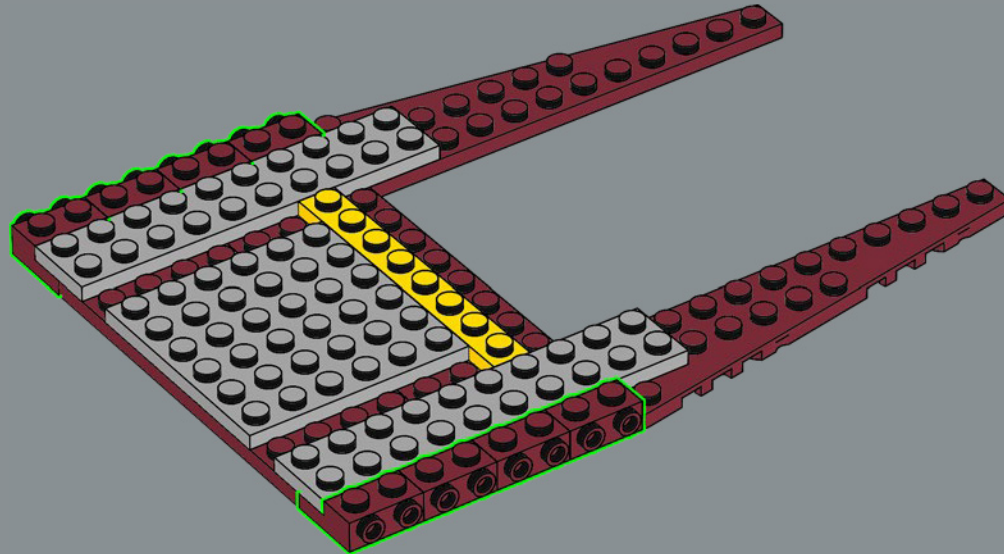

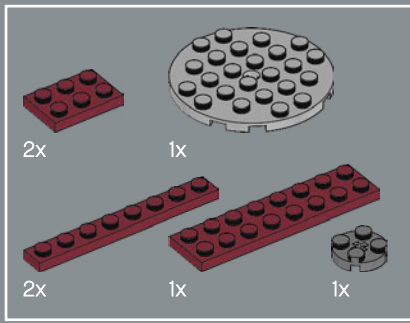

5

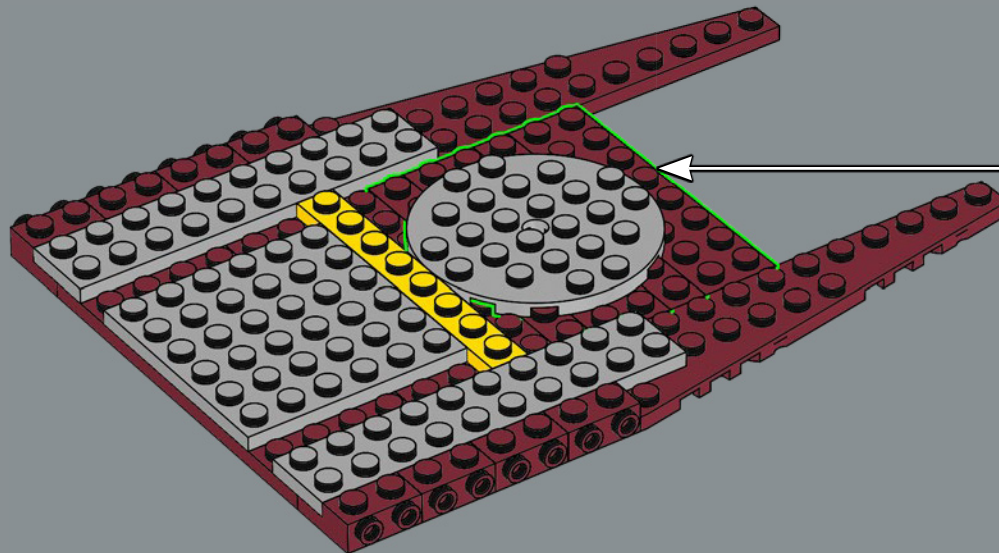
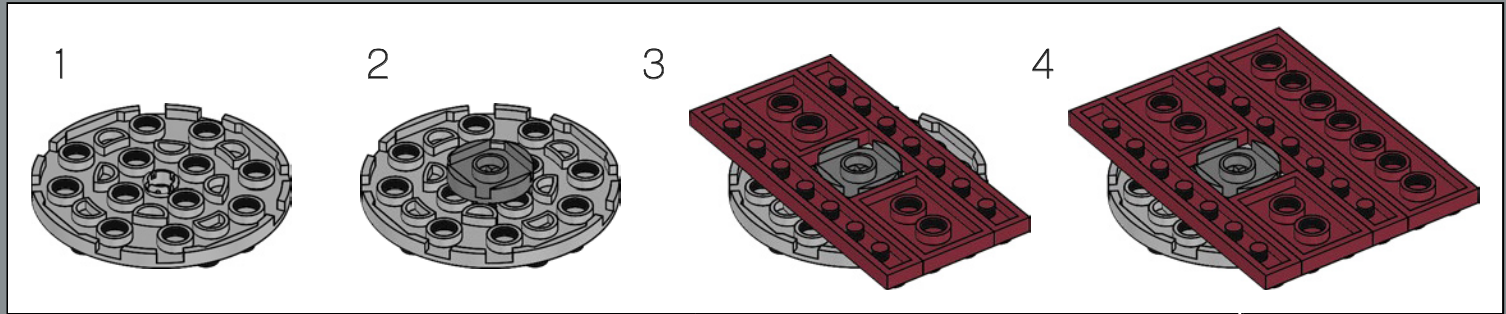

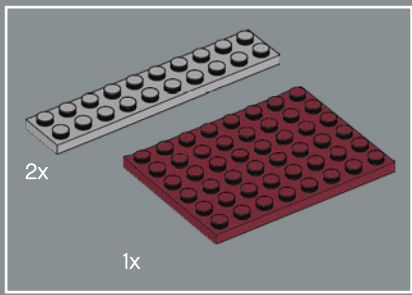

6

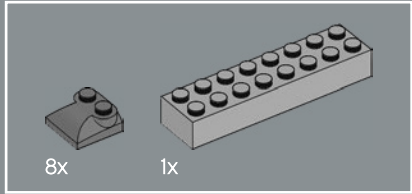
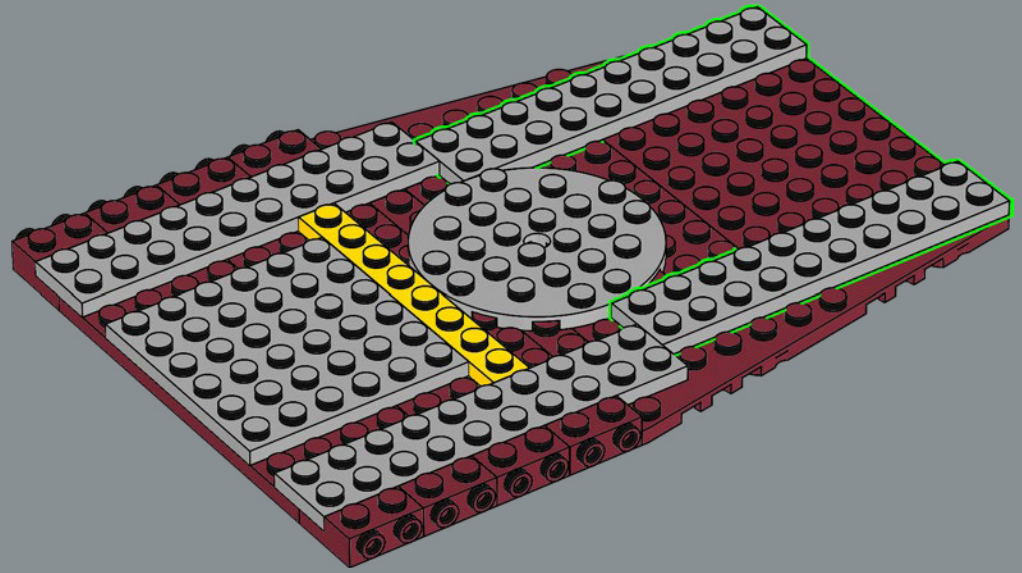

7

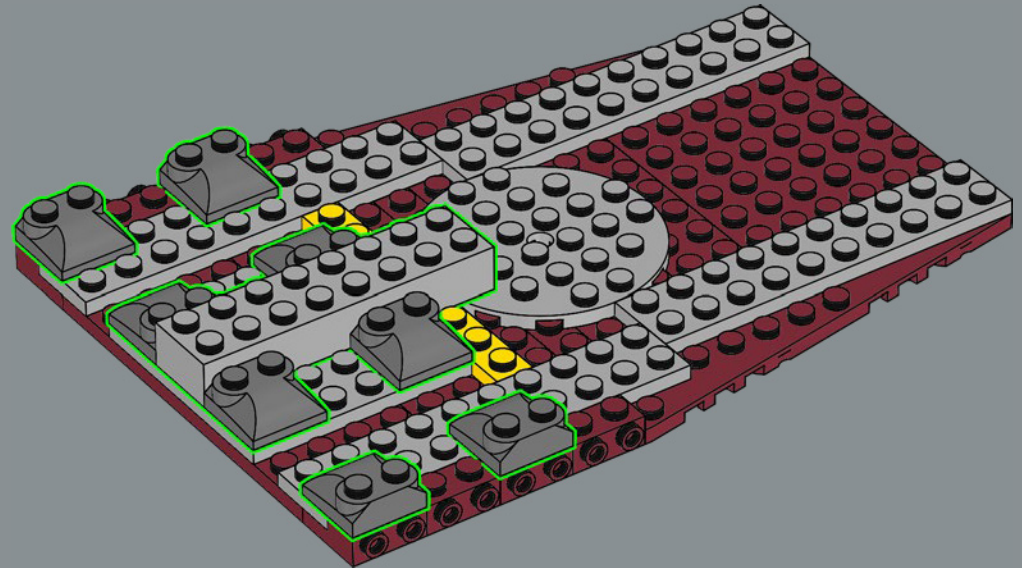



8

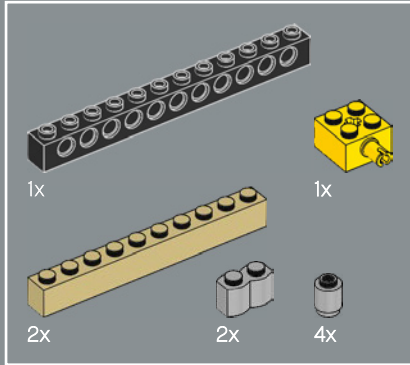
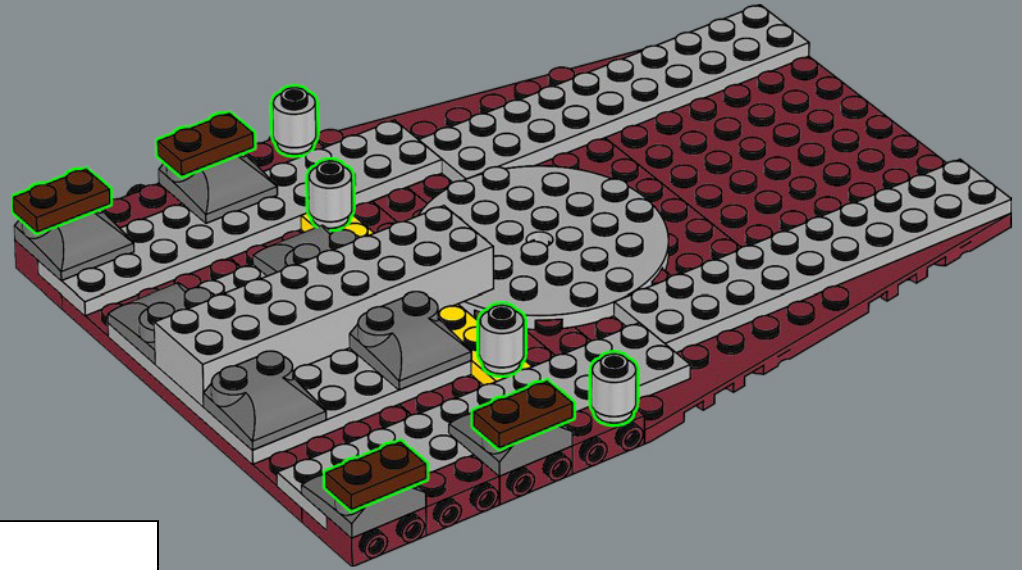

9

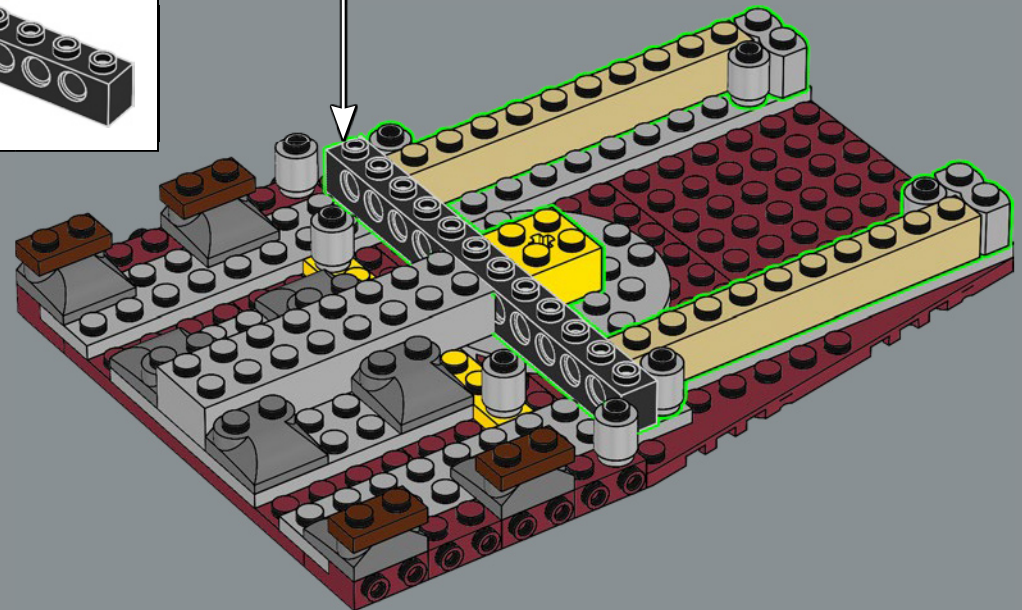
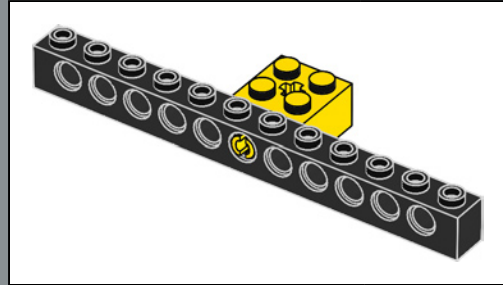

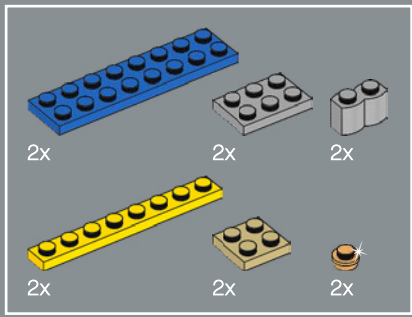

10

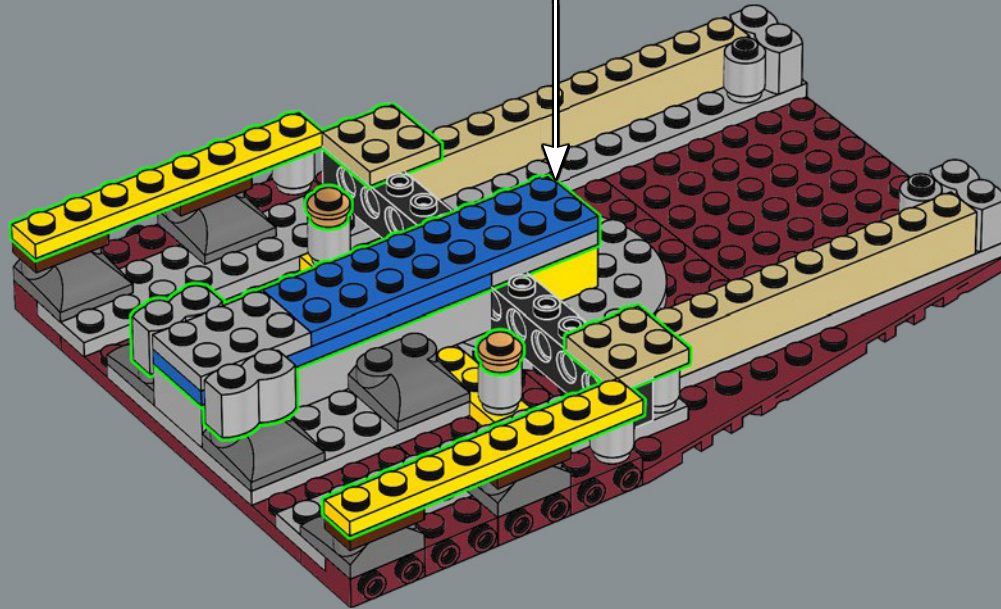
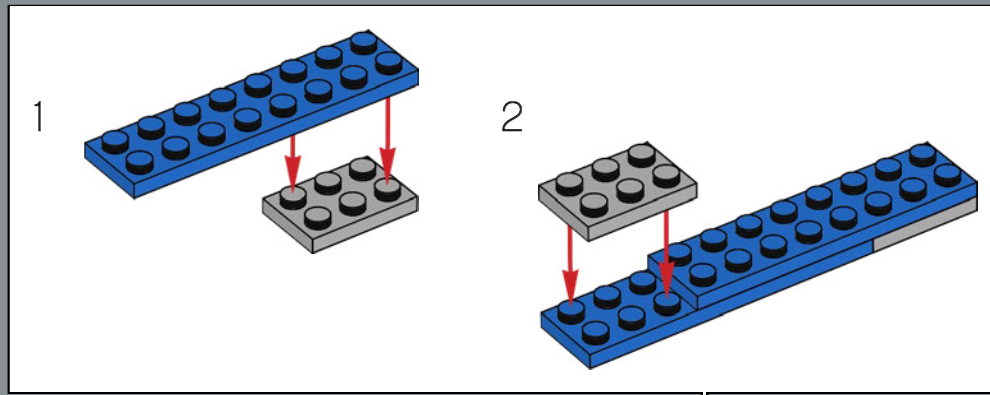



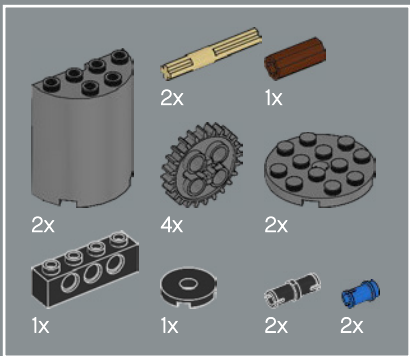

12

1

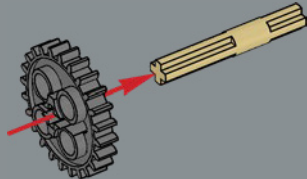

2

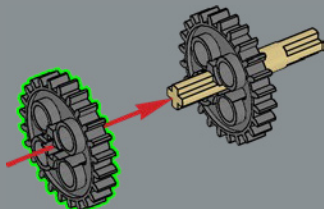

3

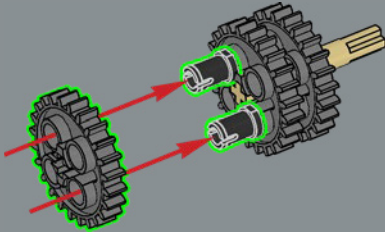

4

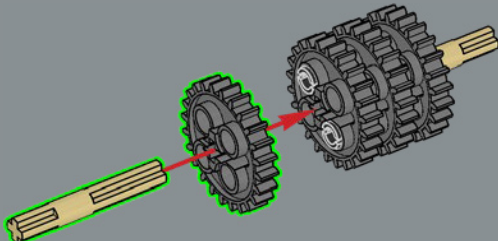

5

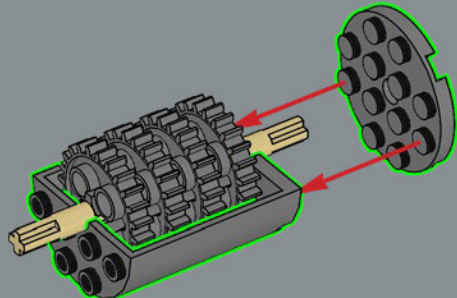

6

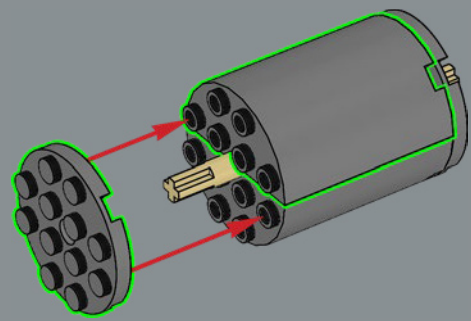

7

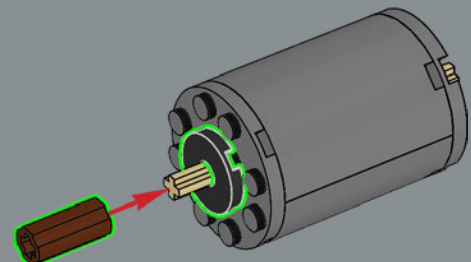

8

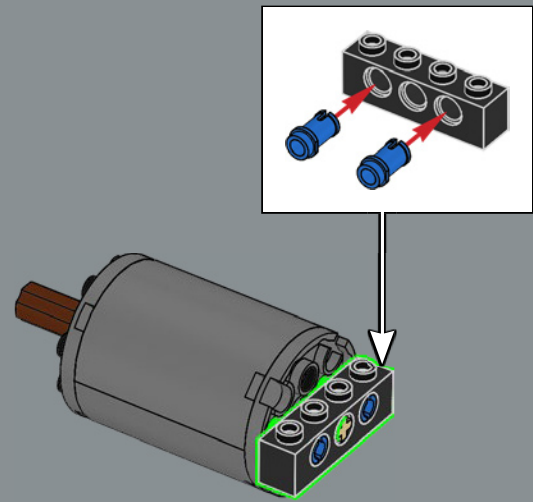



---

The *Titanic*'s electrical plant was capable of producing more power than an average city power station of the time.

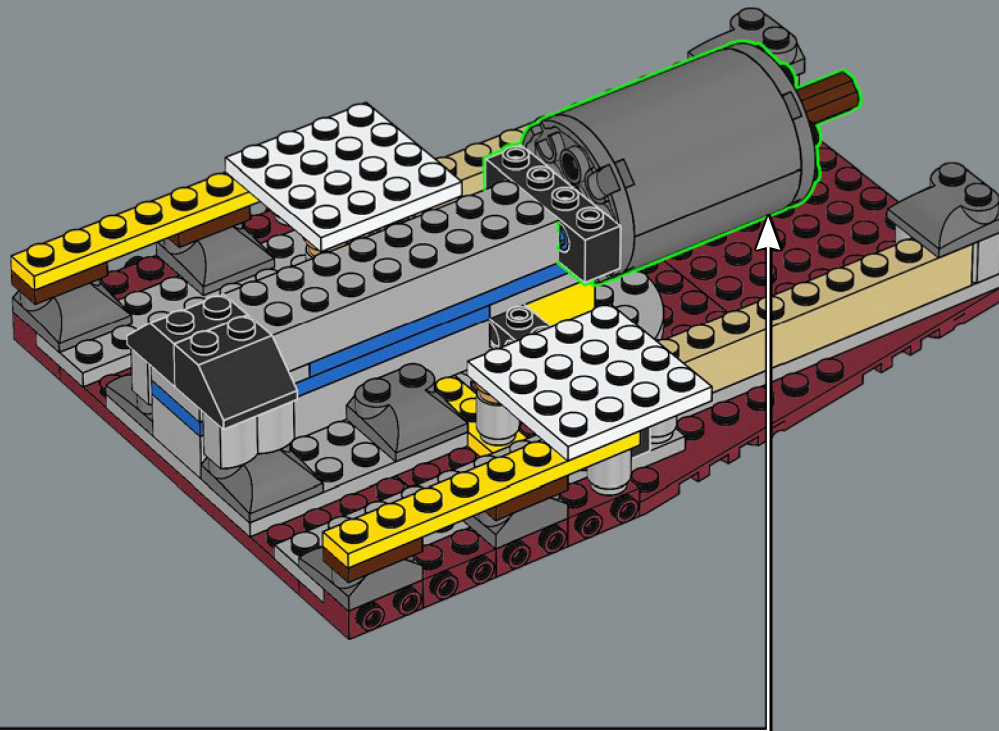

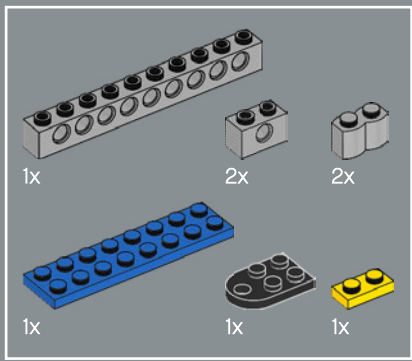

13

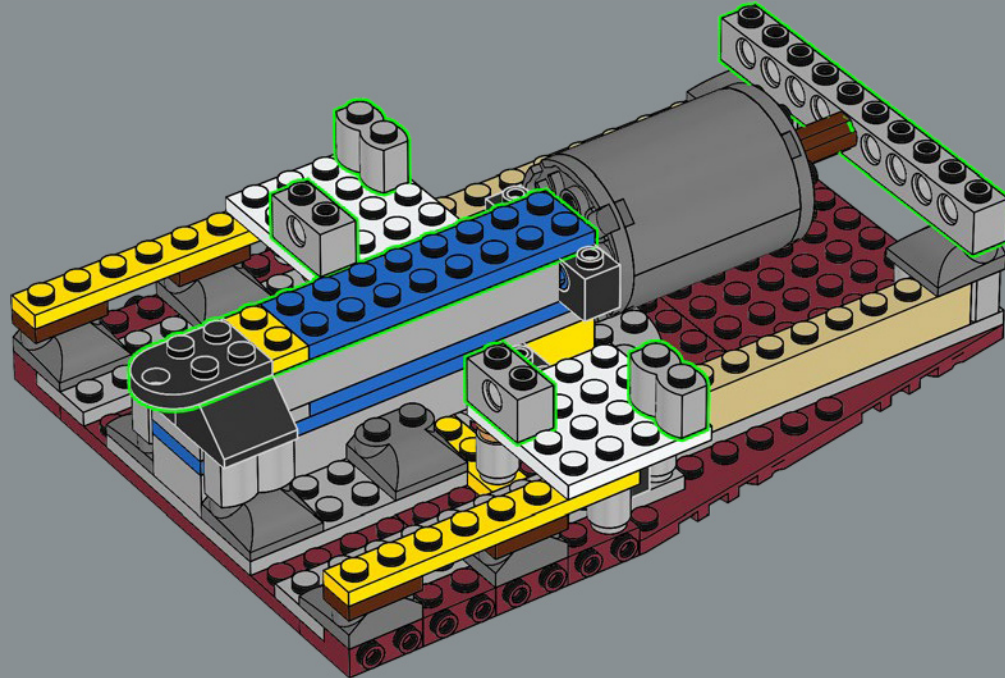

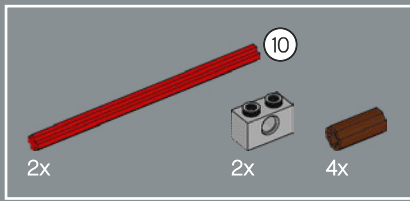

14

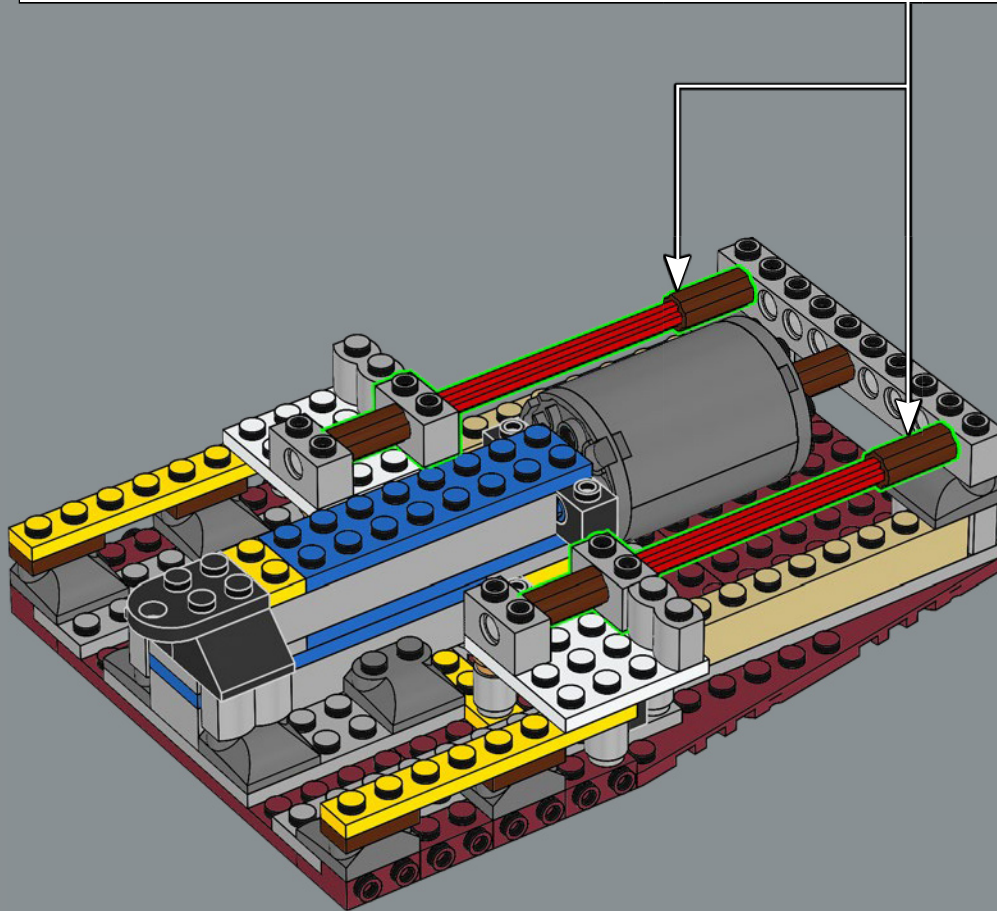
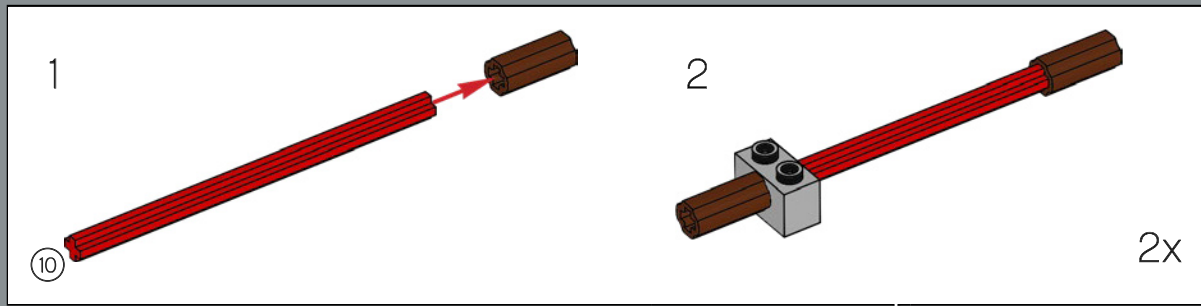



15

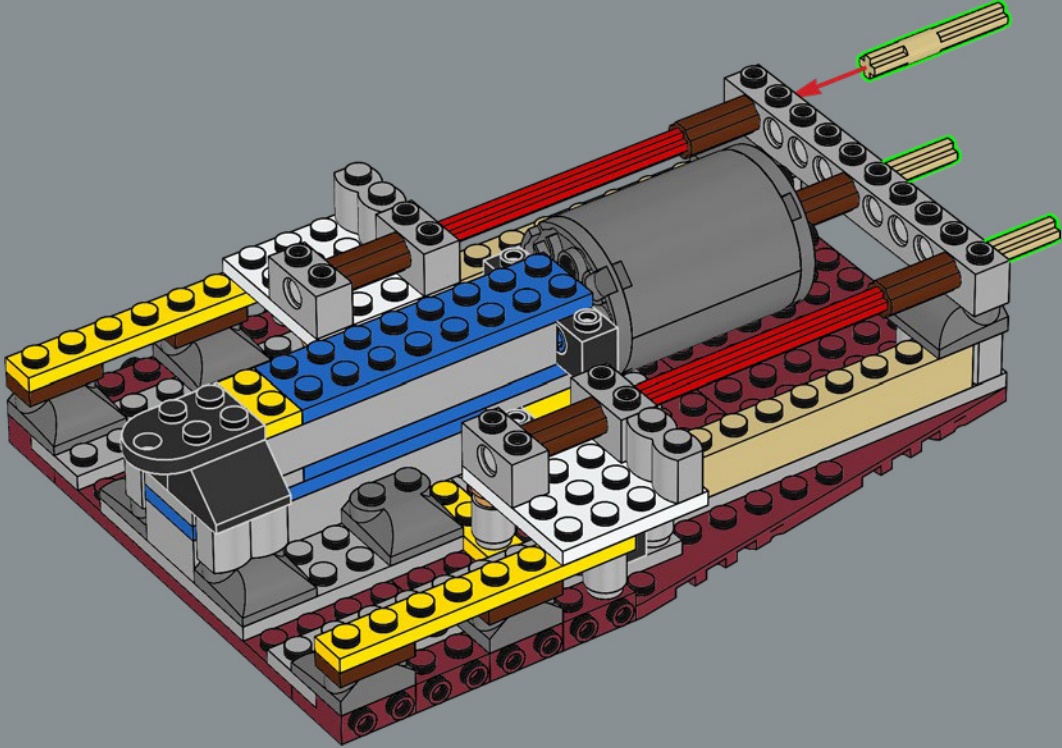

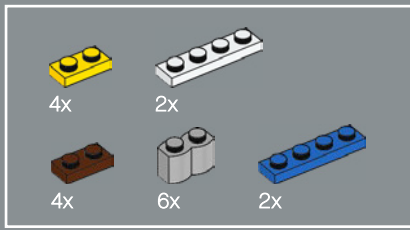

16

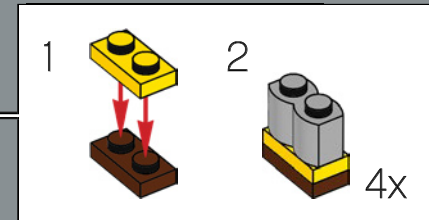
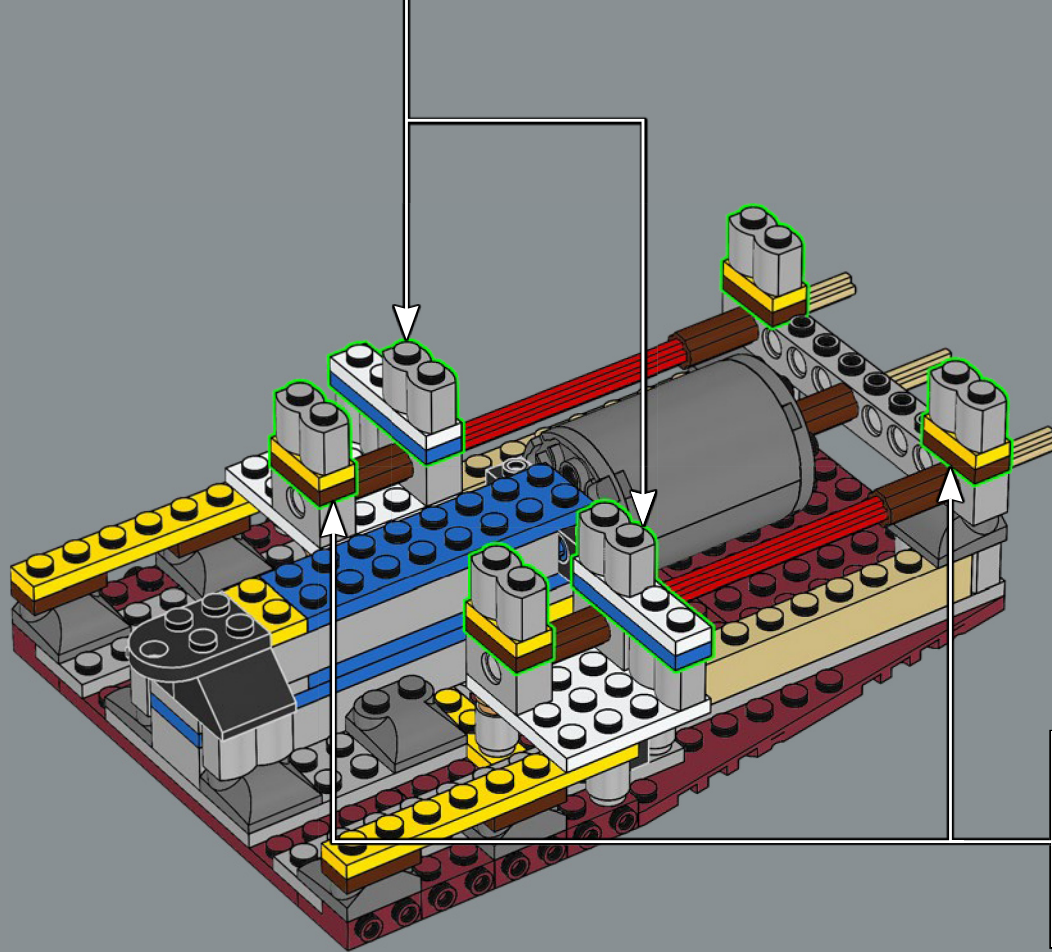
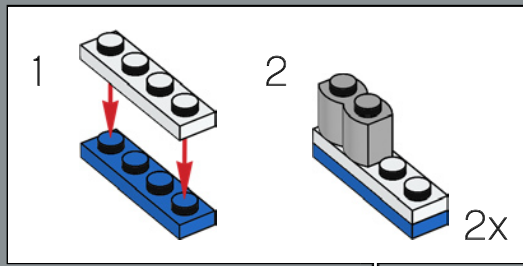

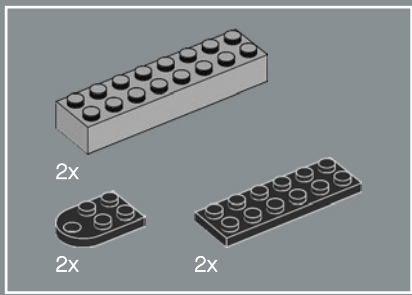

17

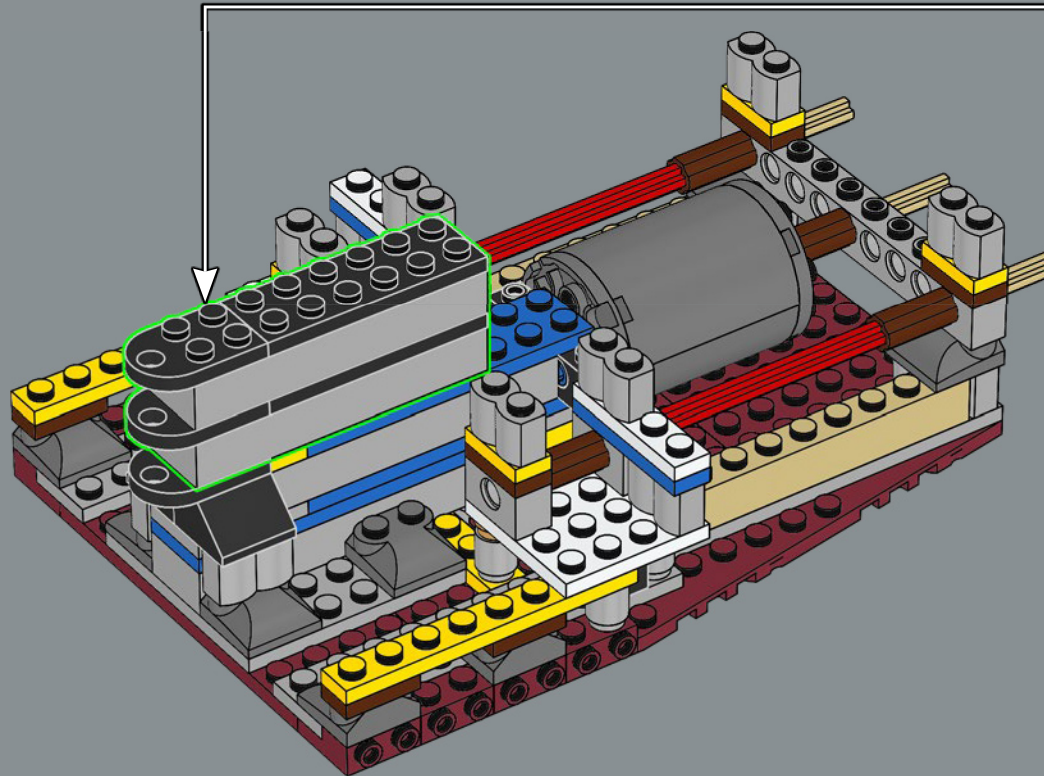
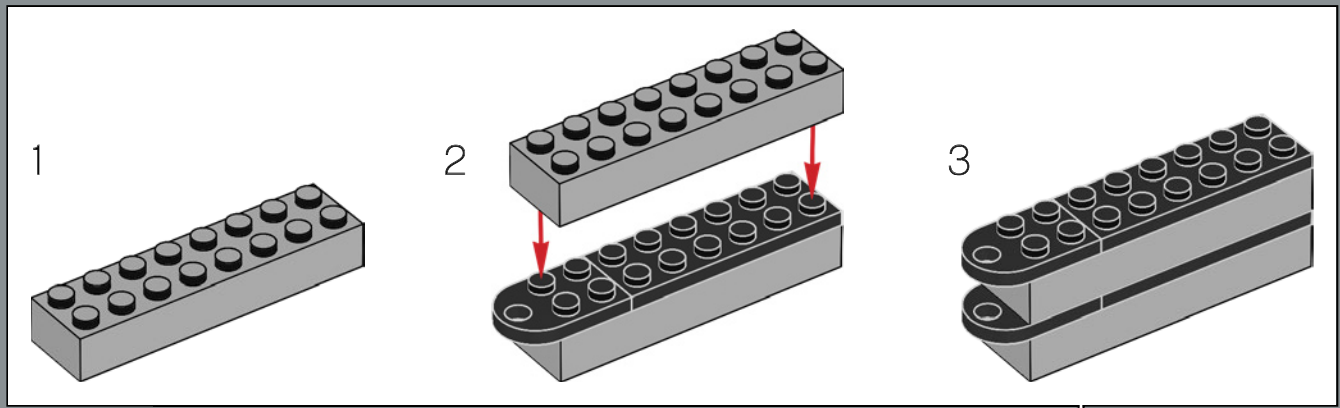

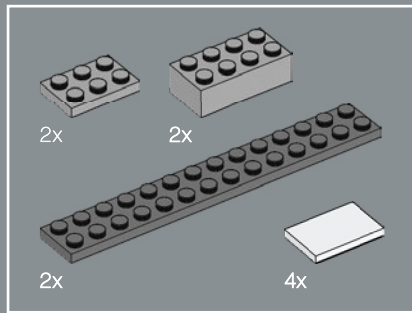

18

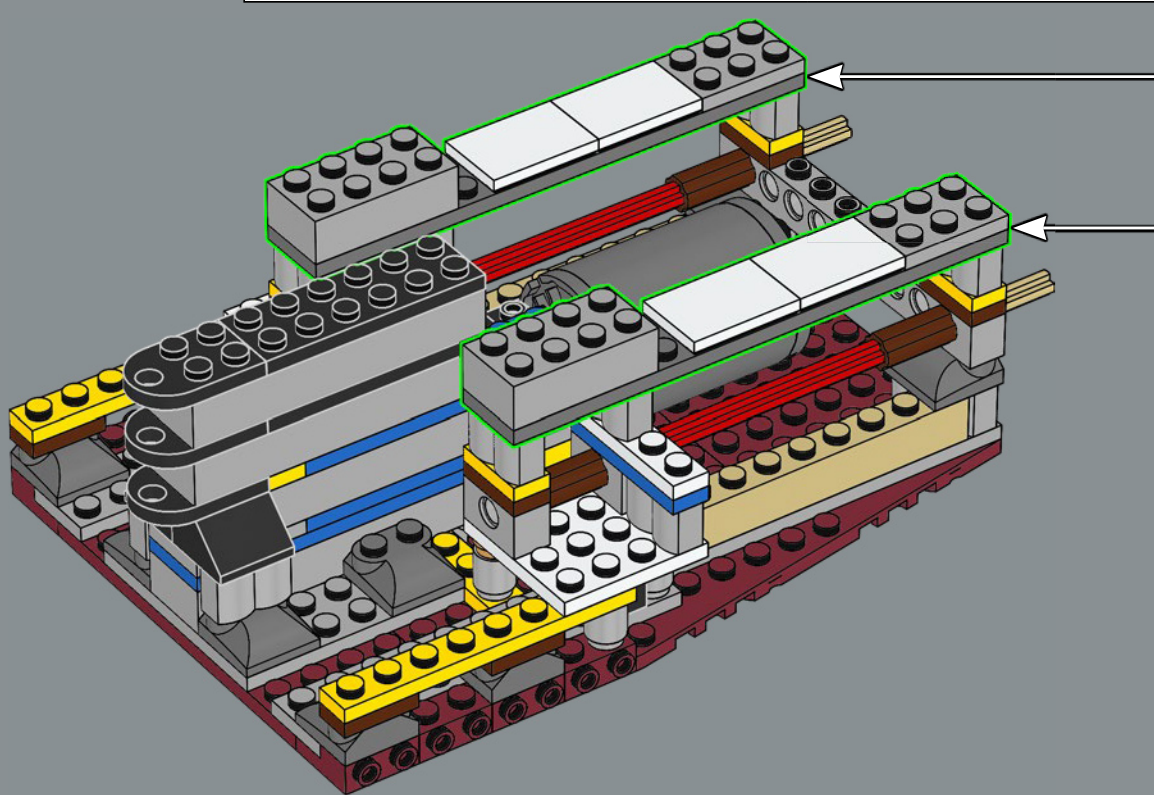
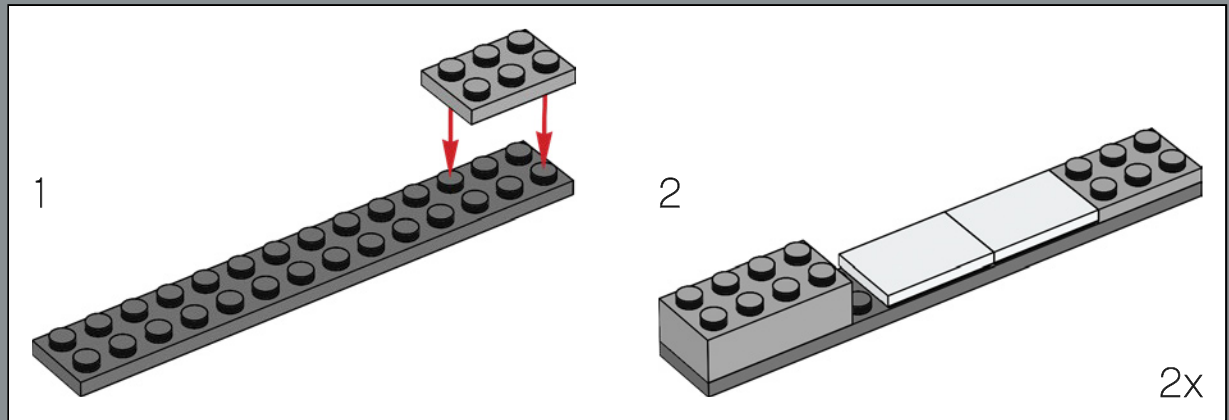

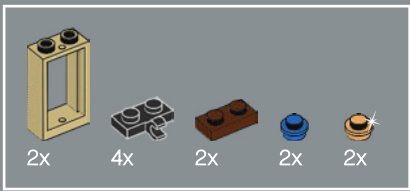

19

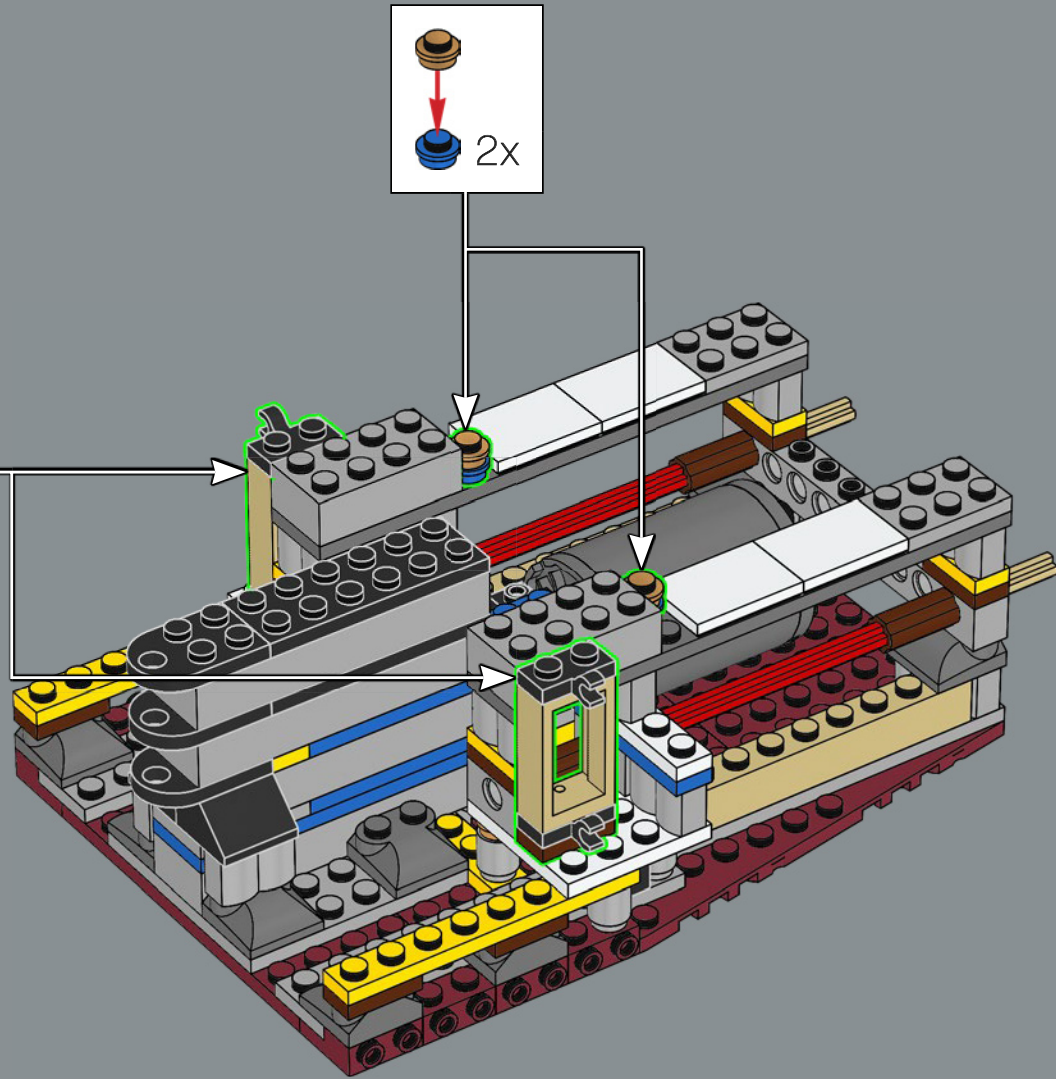
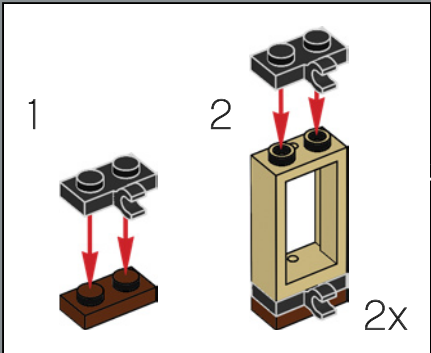
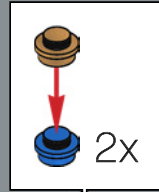



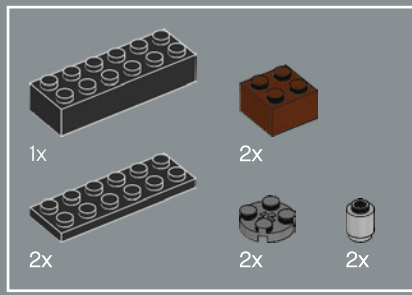

20

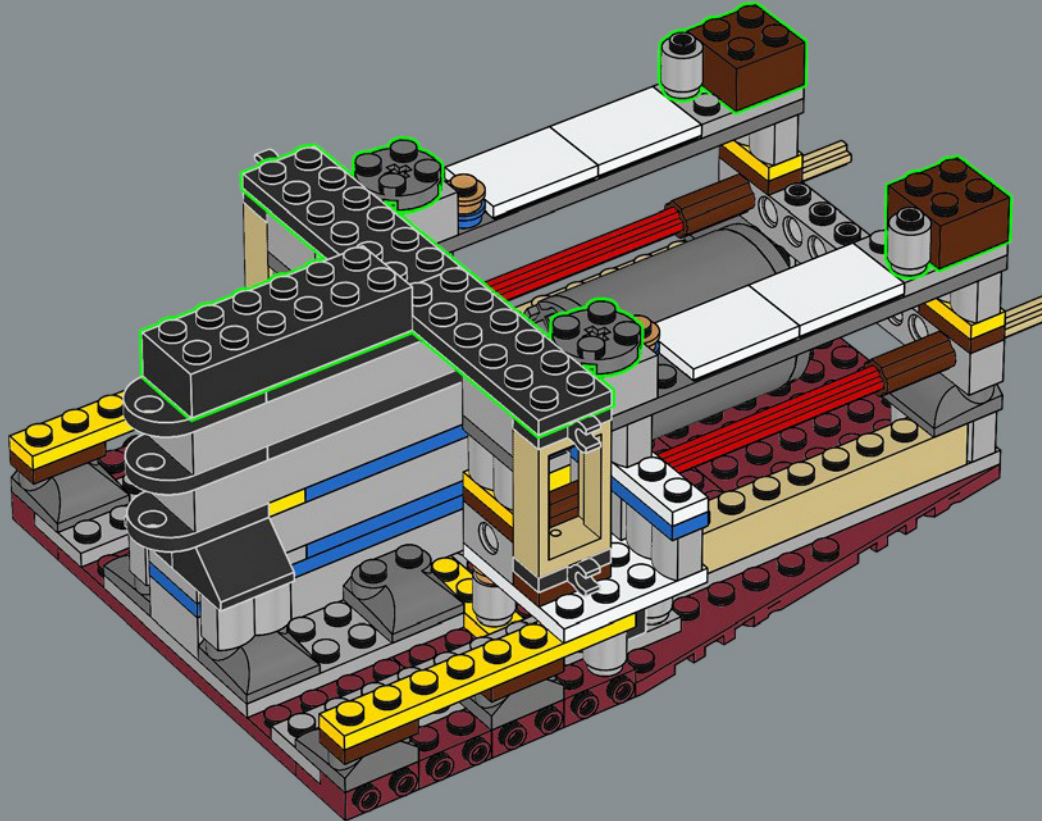



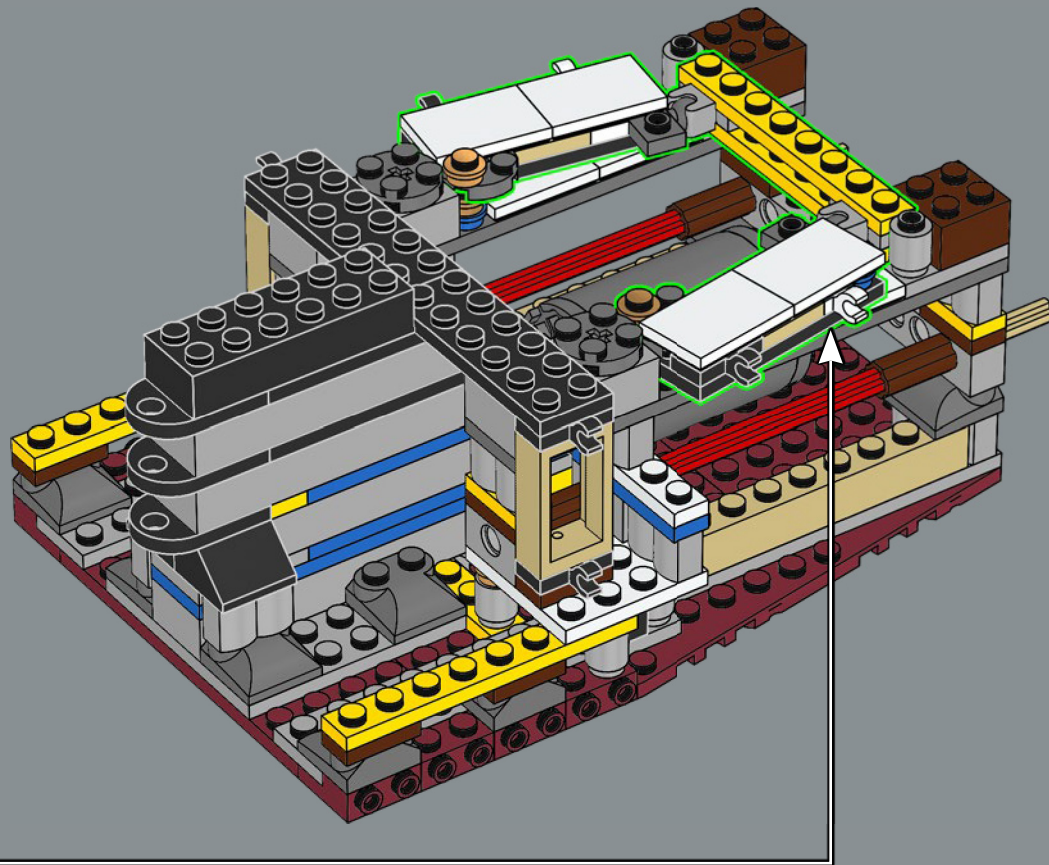

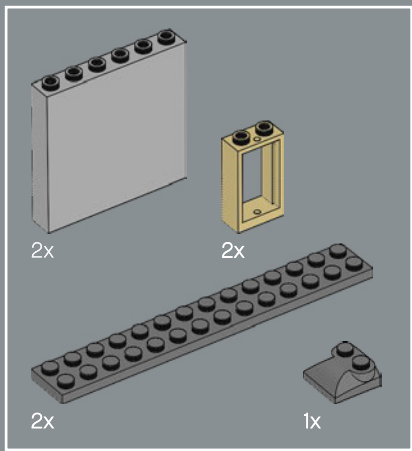

22

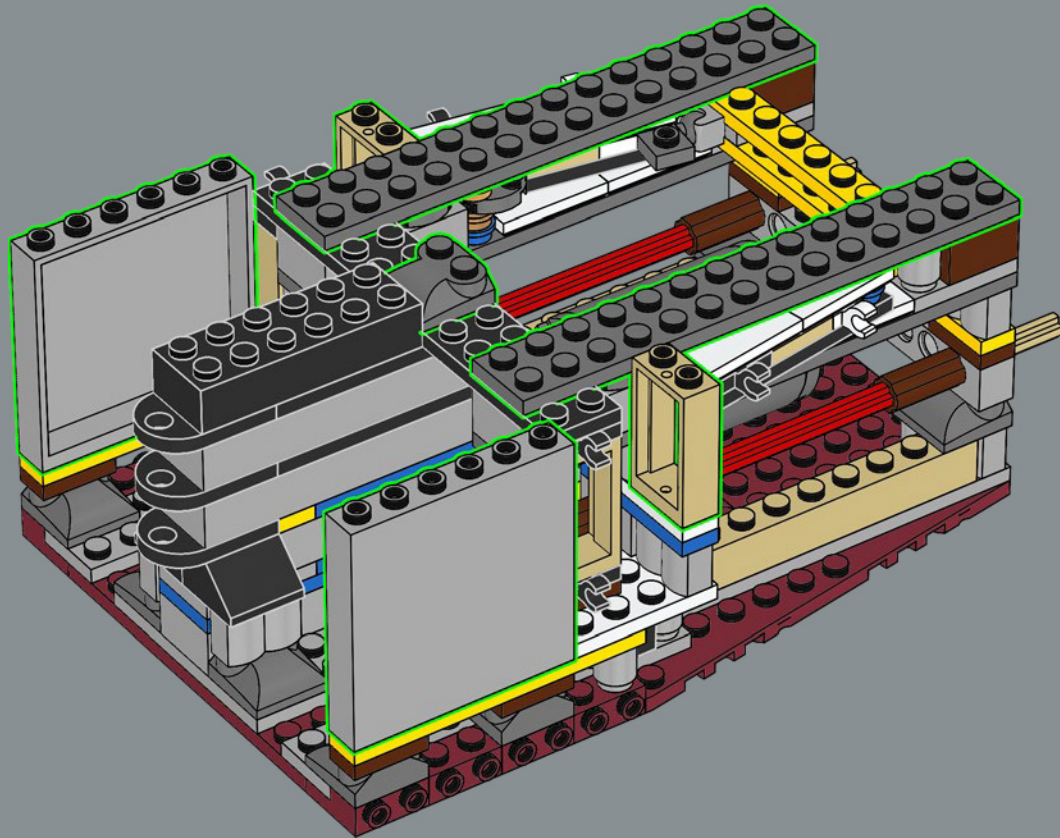

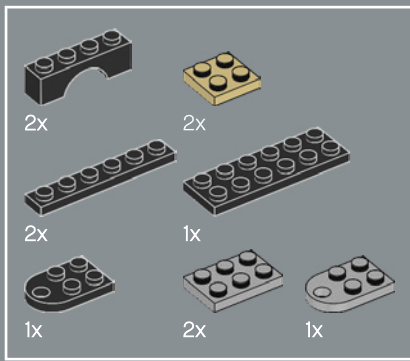

23

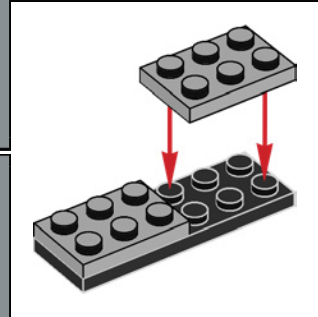
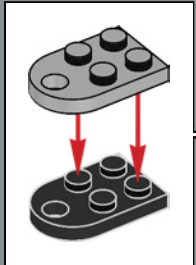
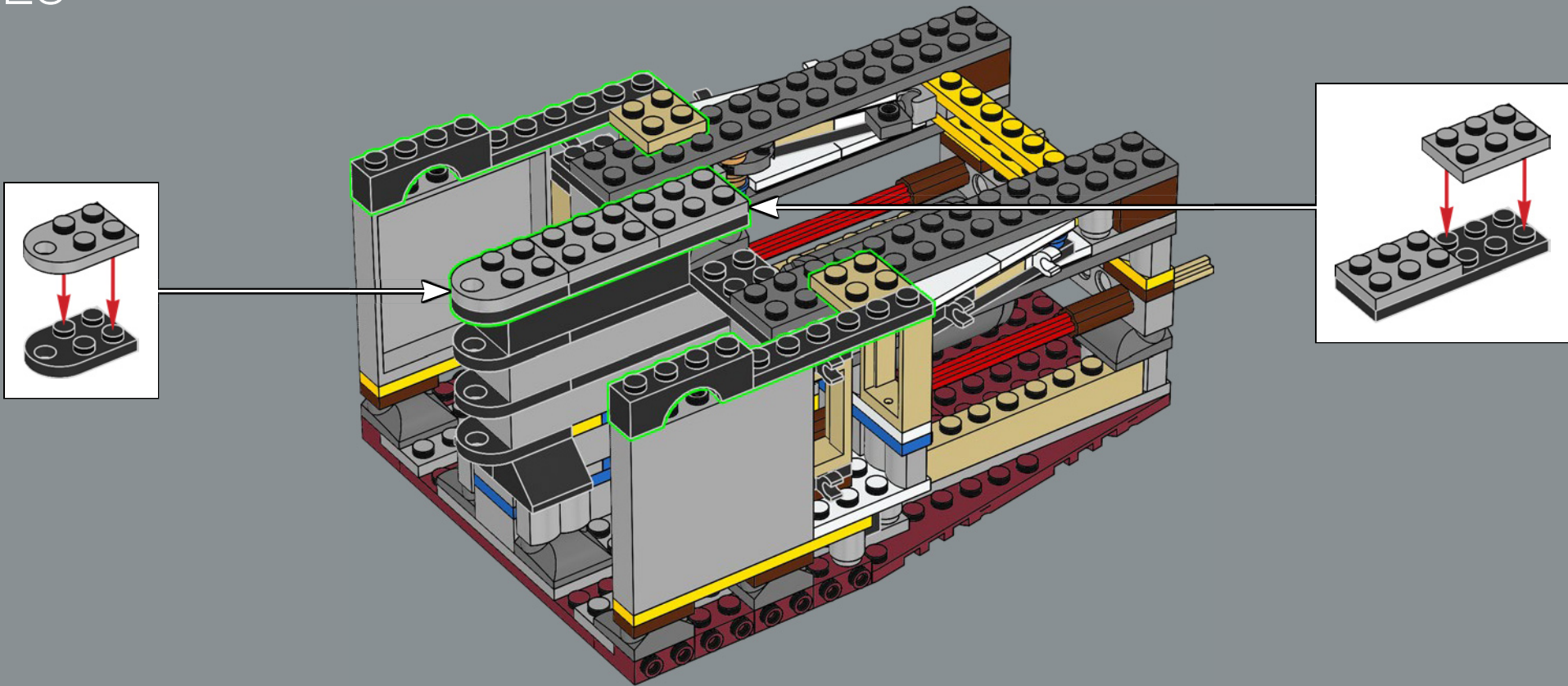

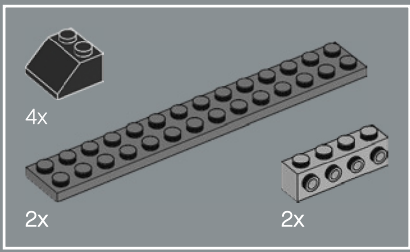

24

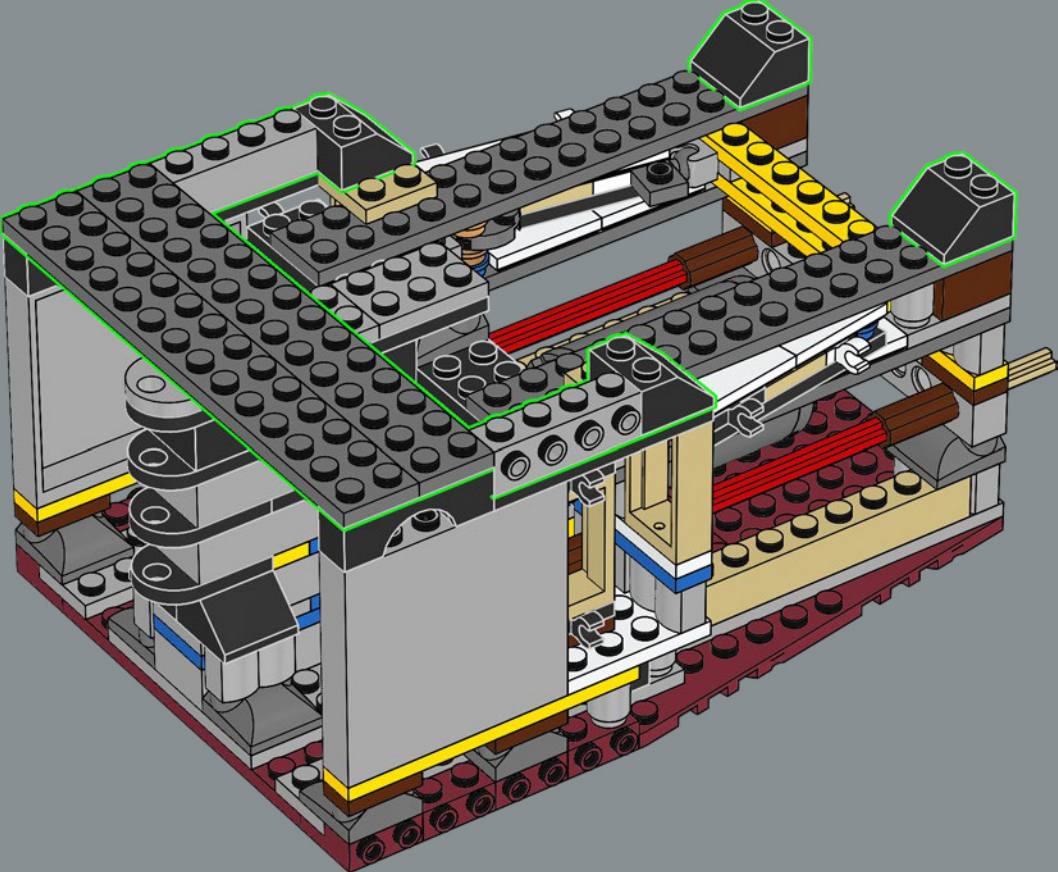

30

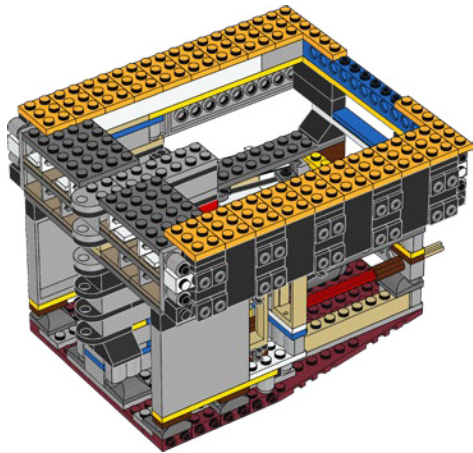
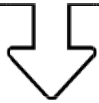

4x



1x

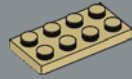

4x

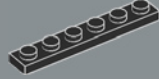

2x



2x

25

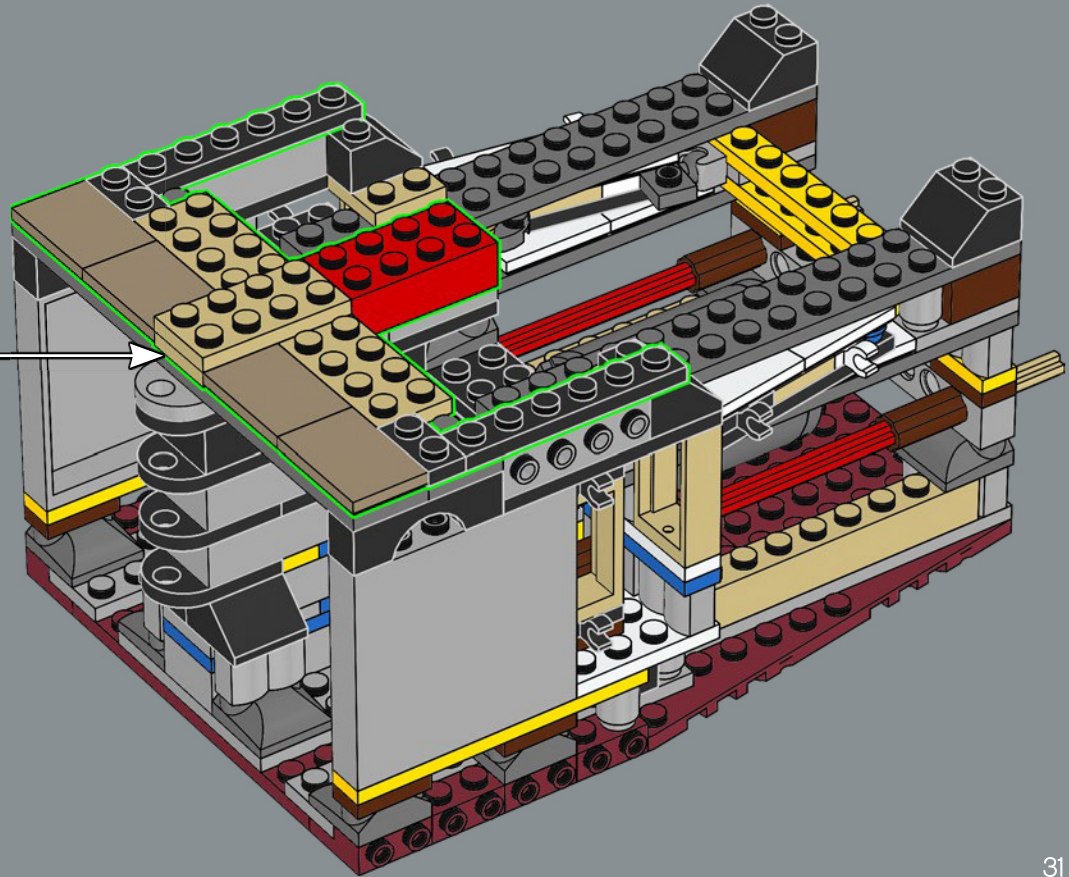
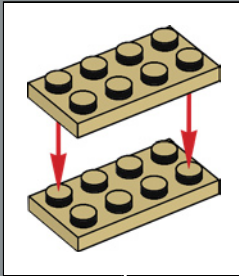

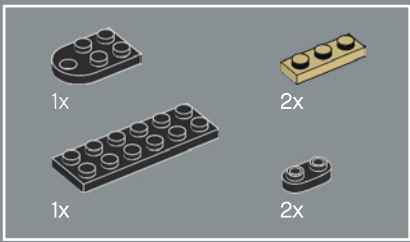

26

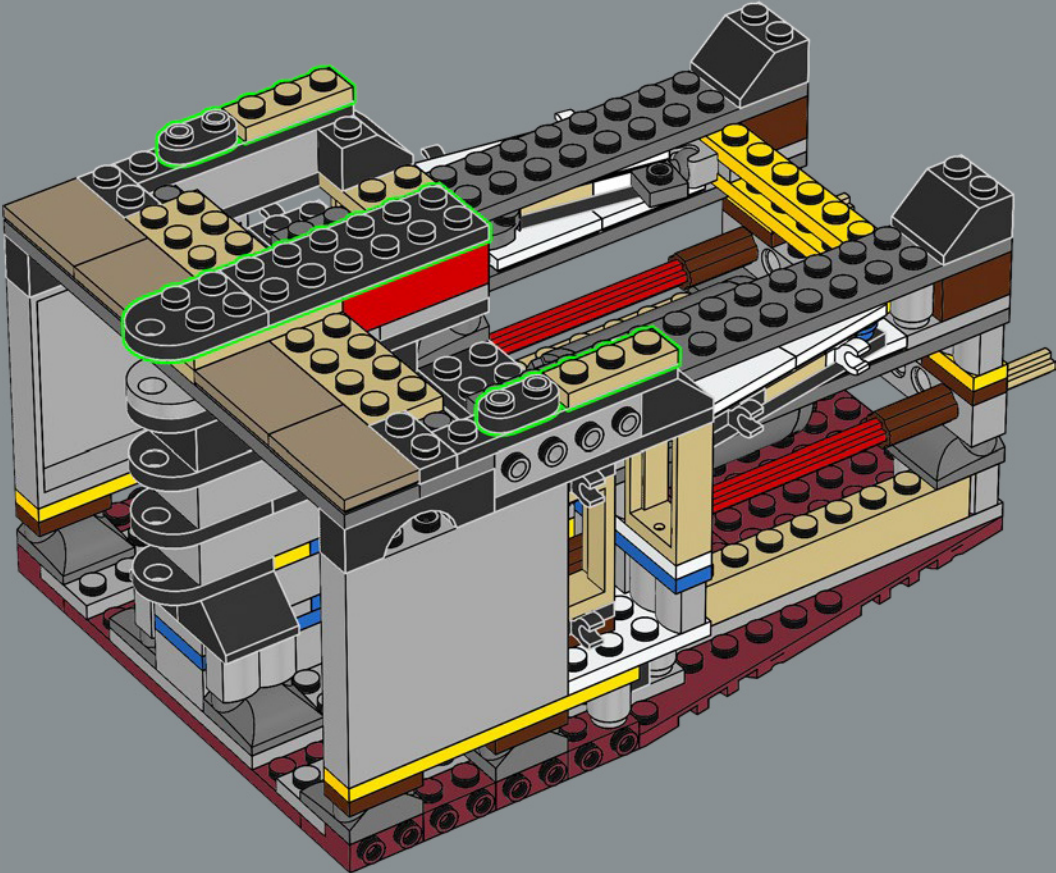



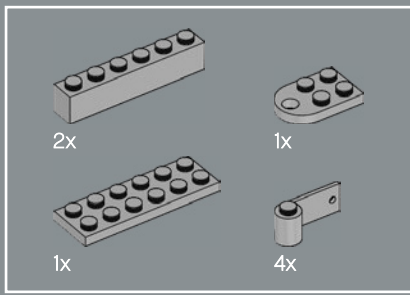

27

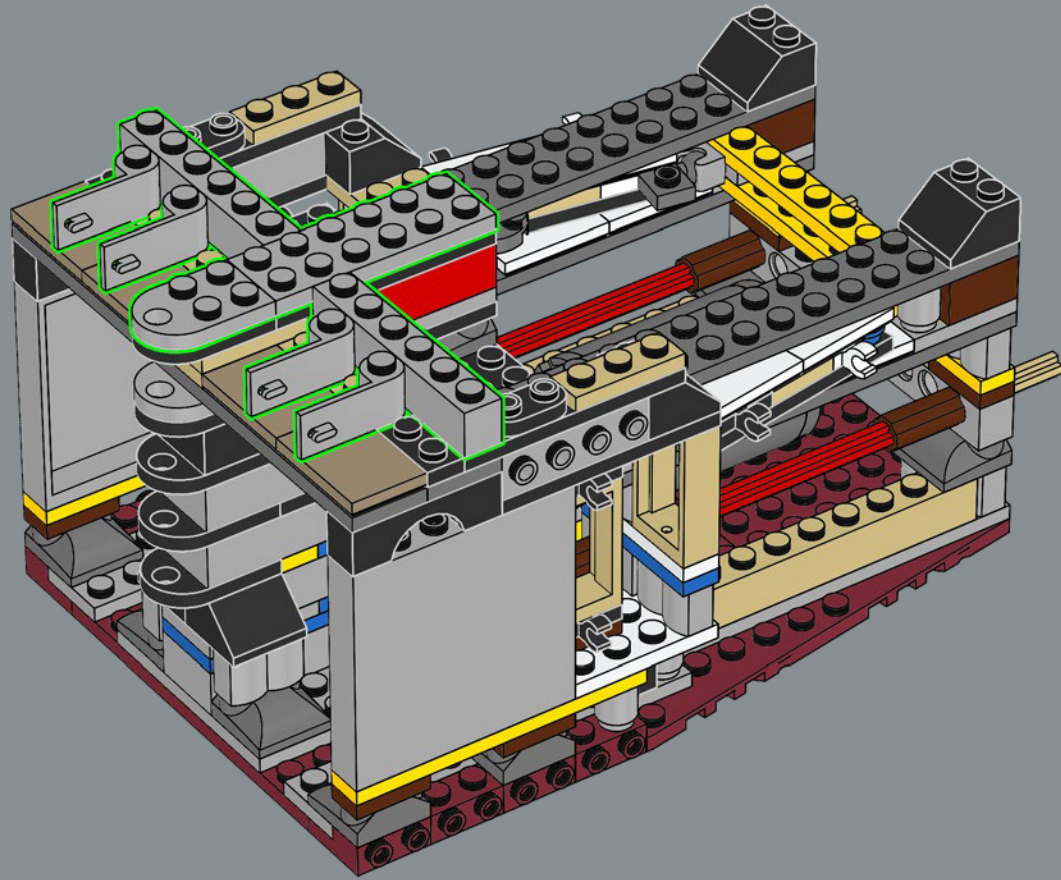

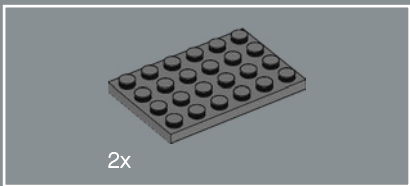

28

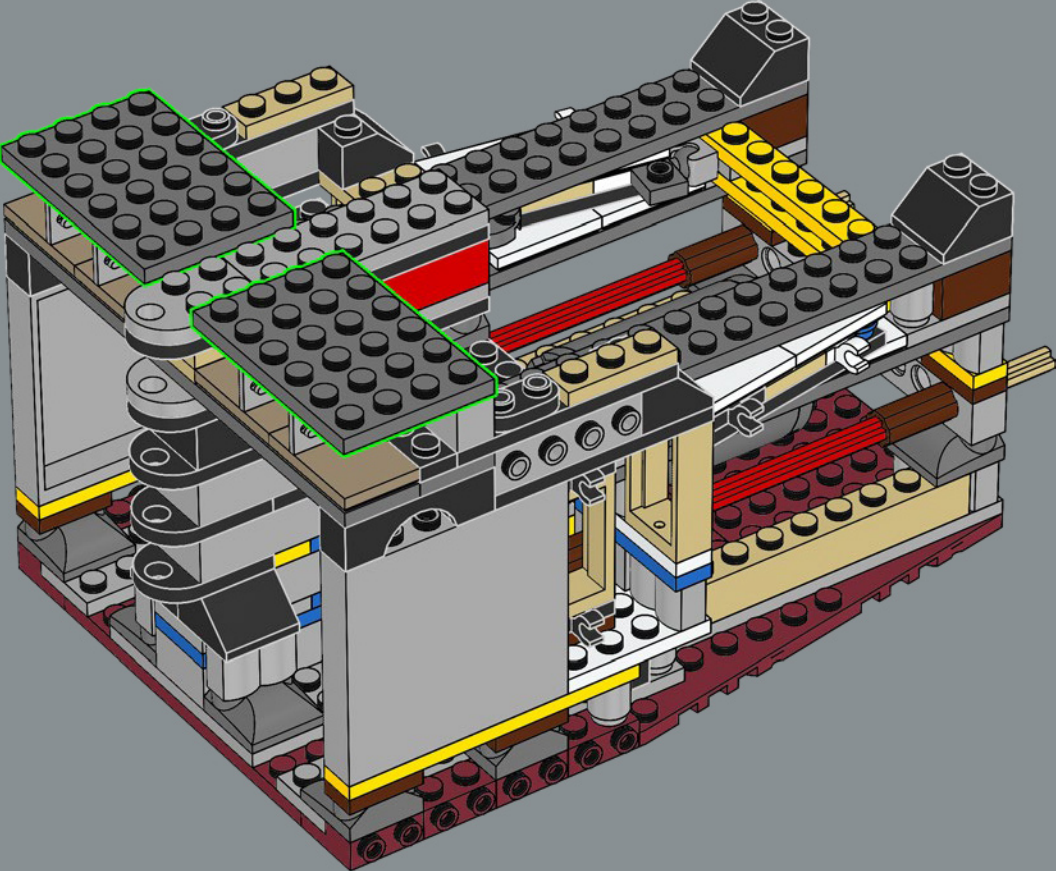

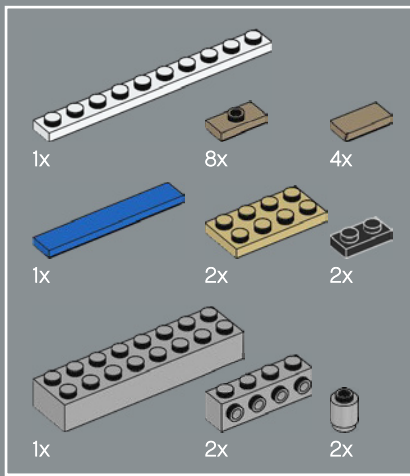

29

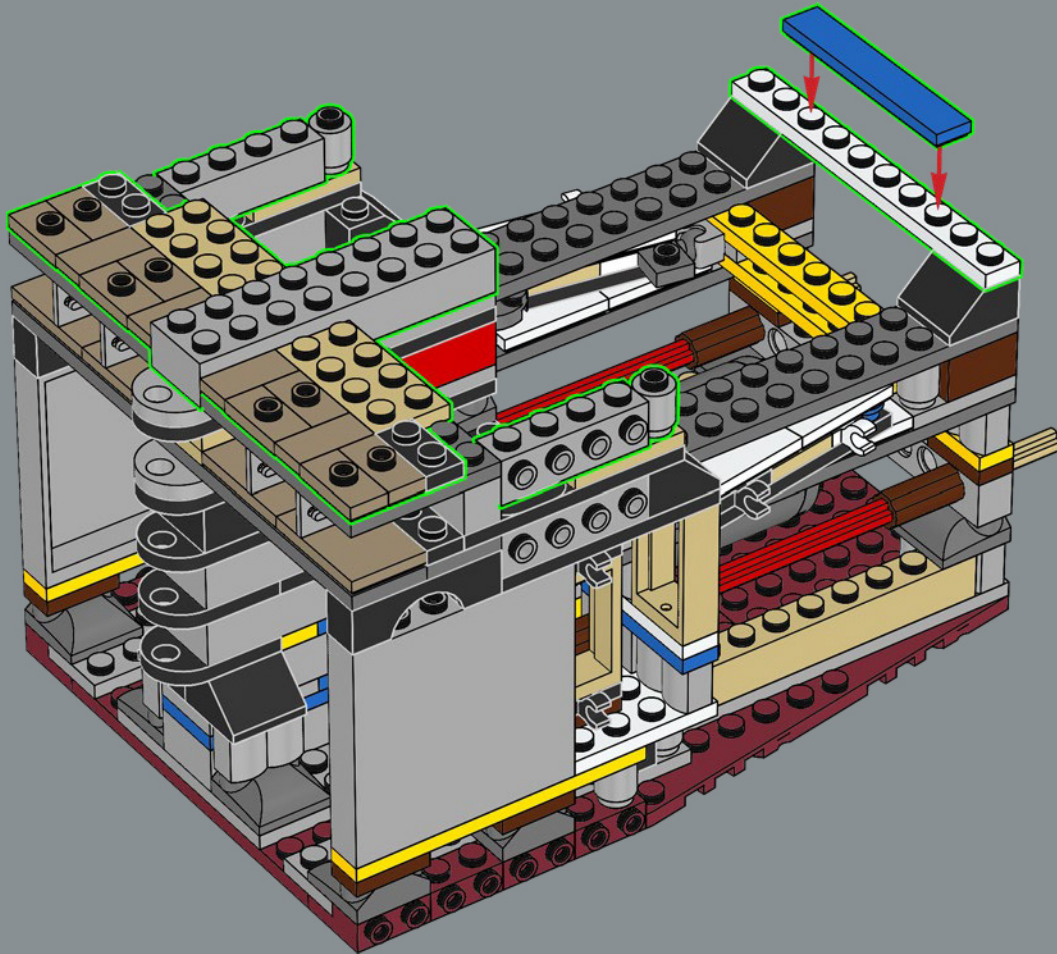

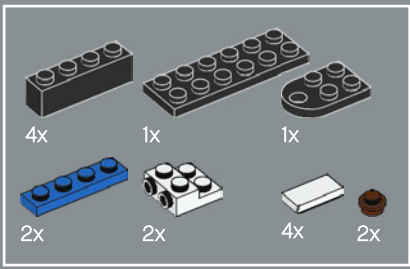

30

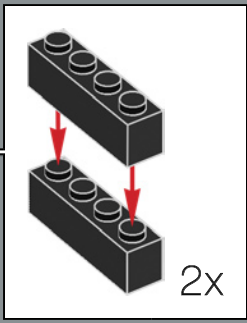
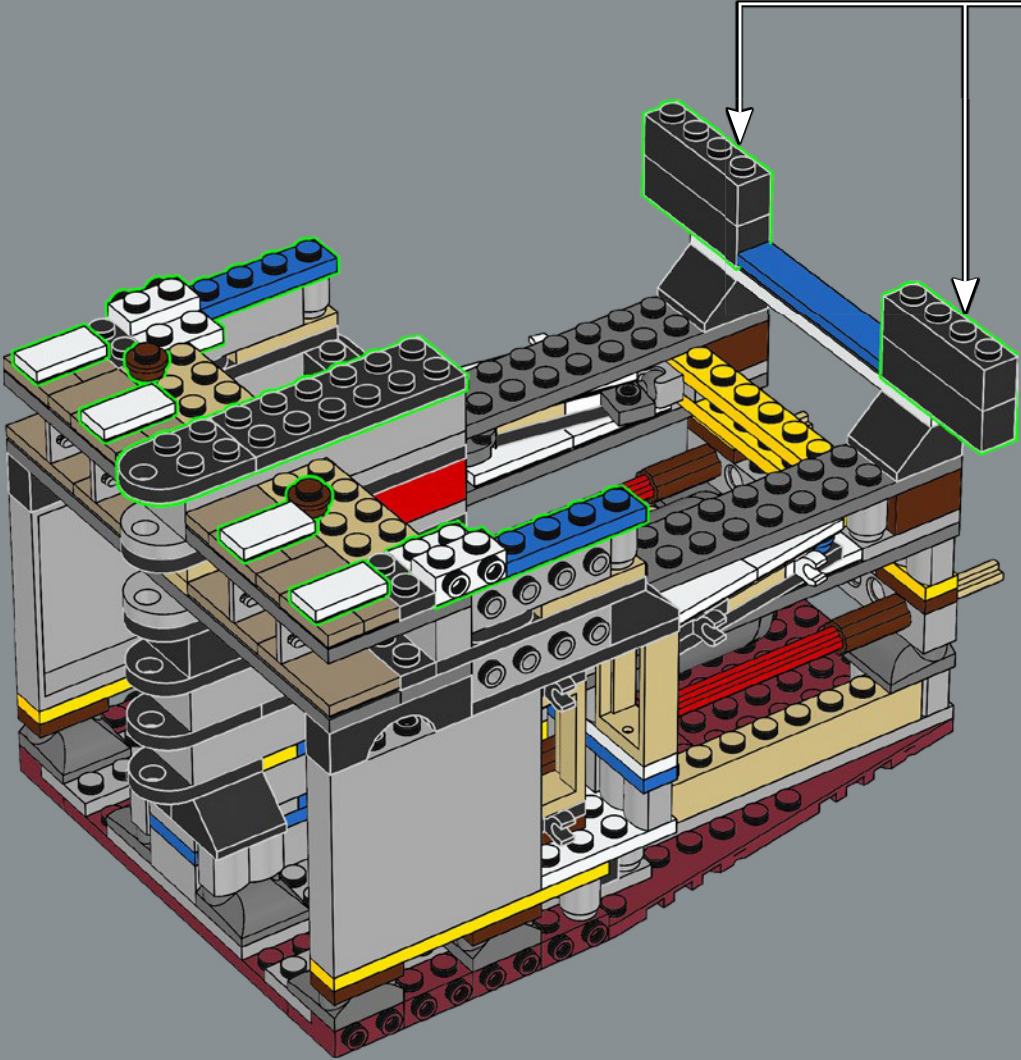

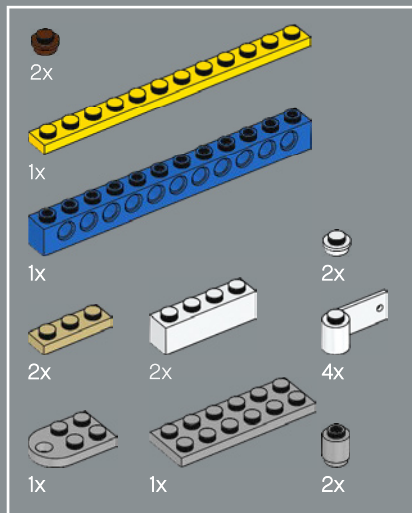

31

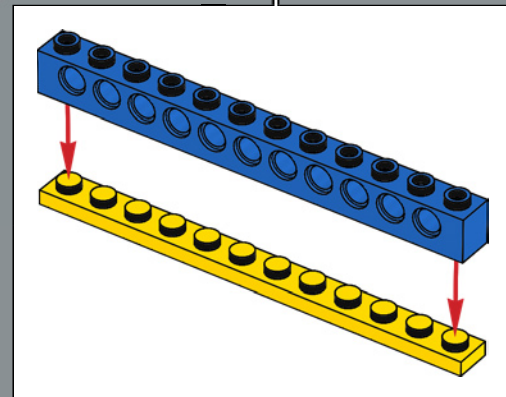
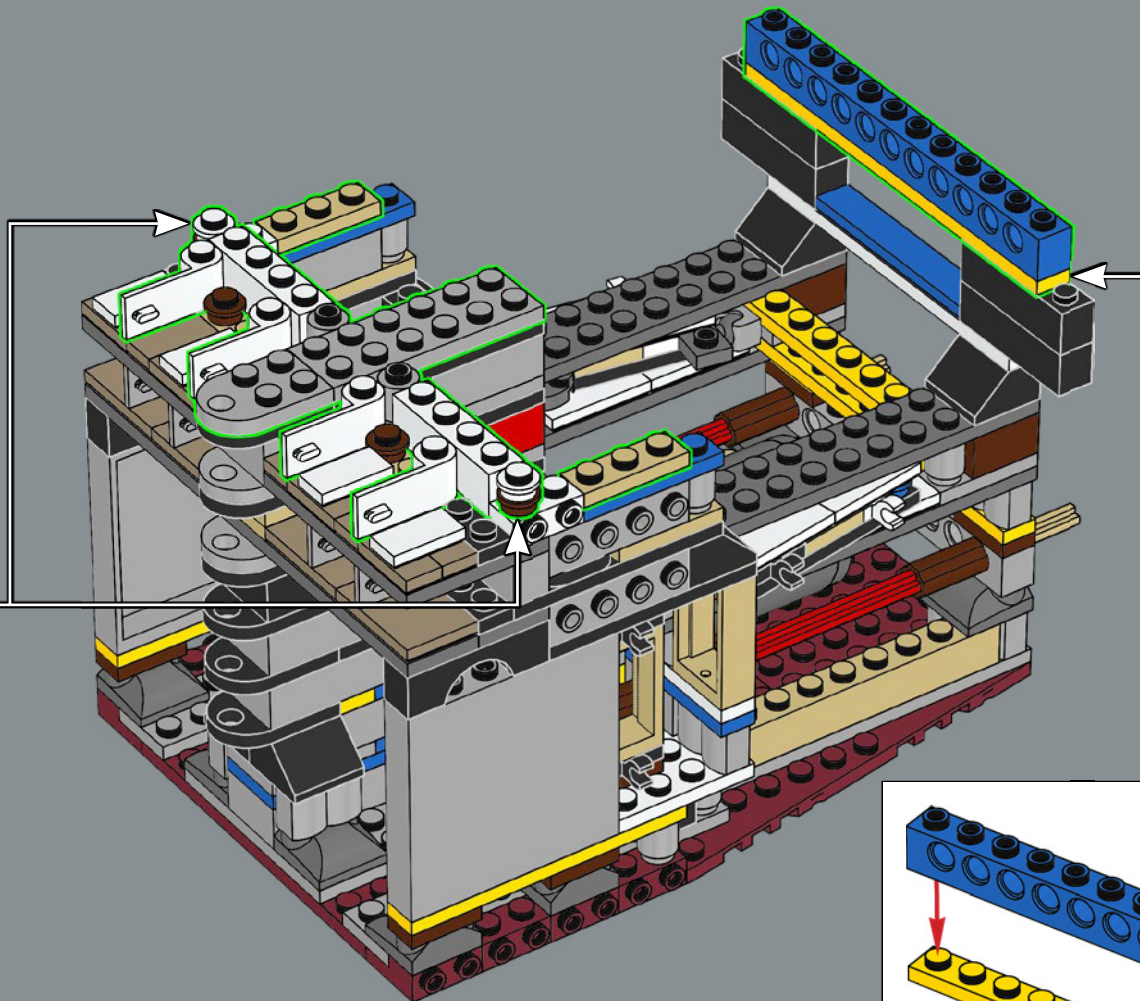
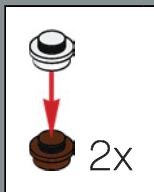



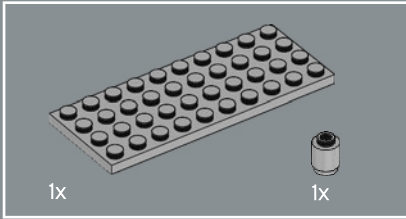
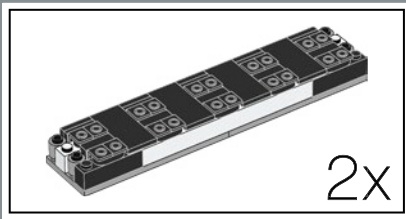

33

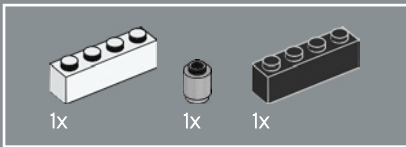
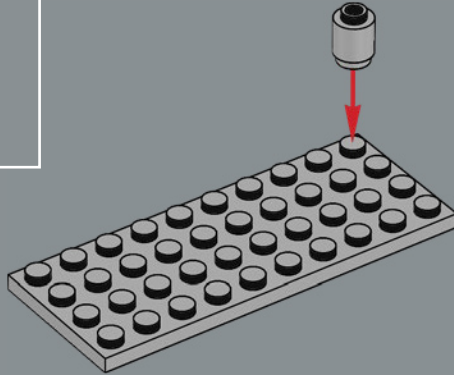

34

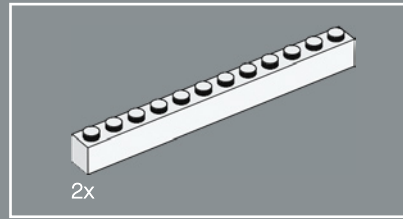
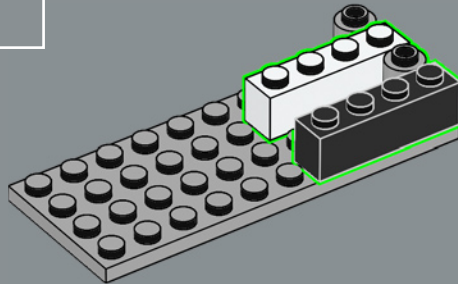

35

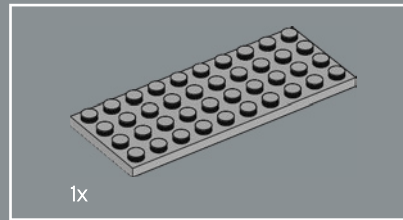
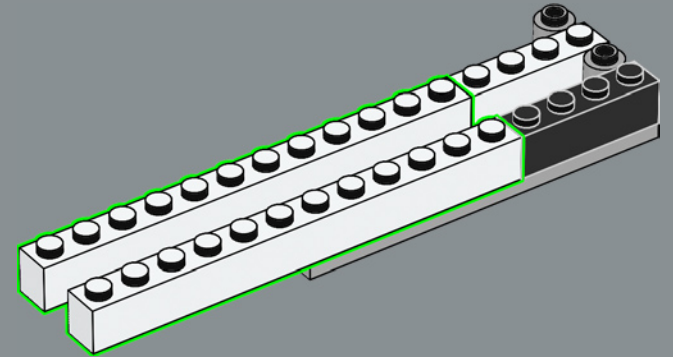

36

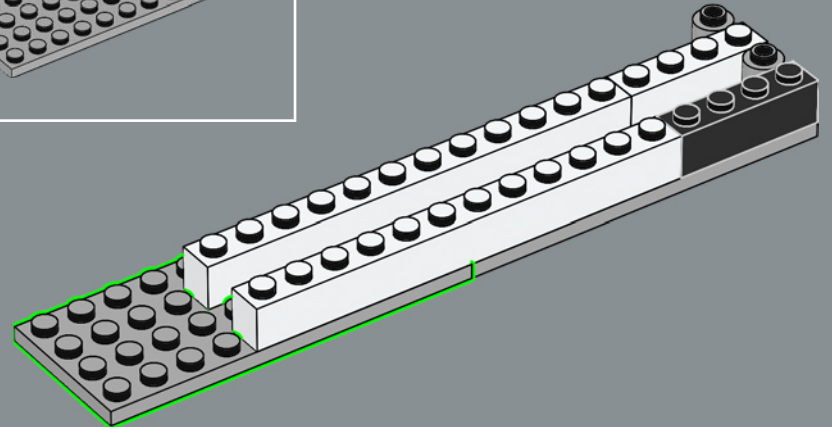

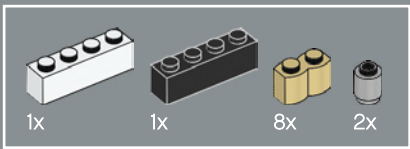

37

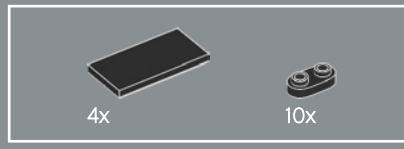
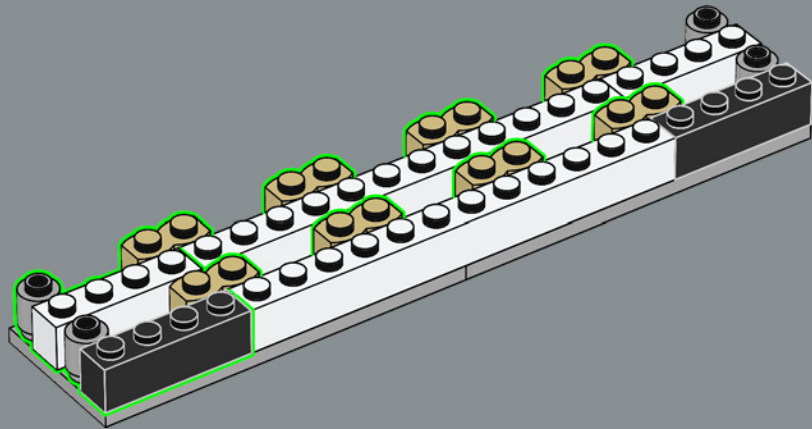

38

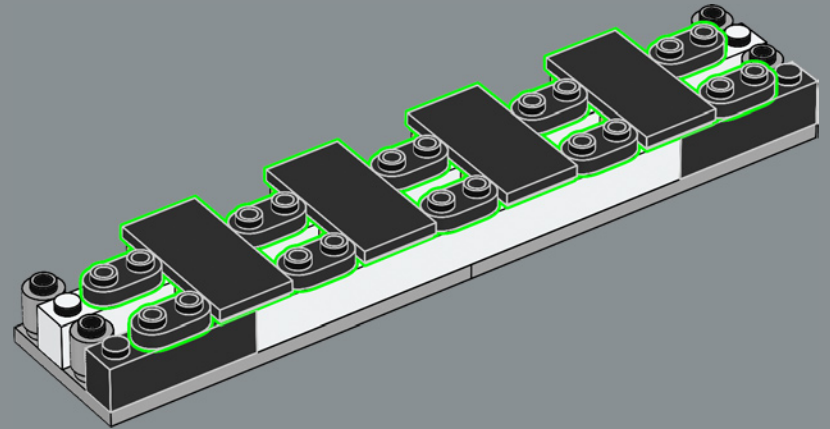





39

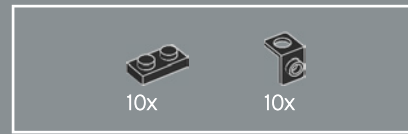
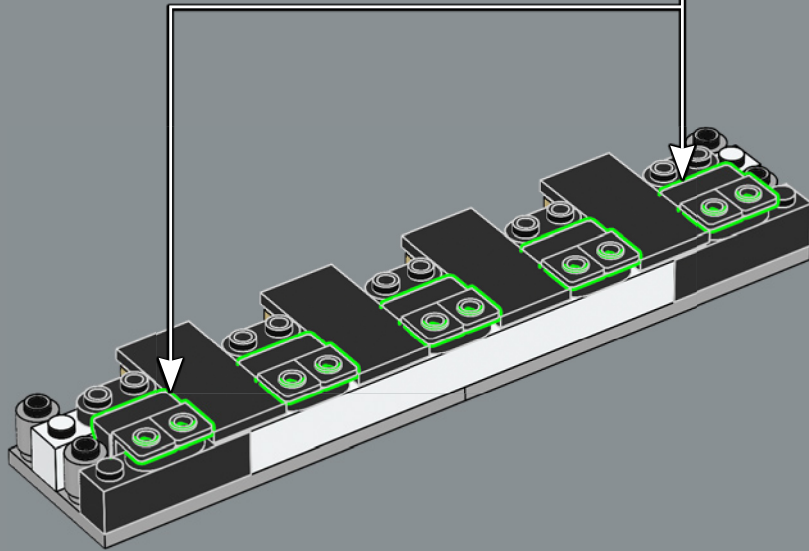
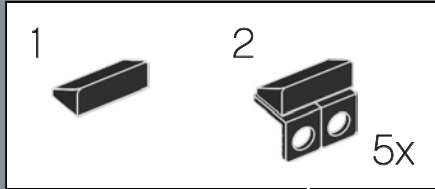

40

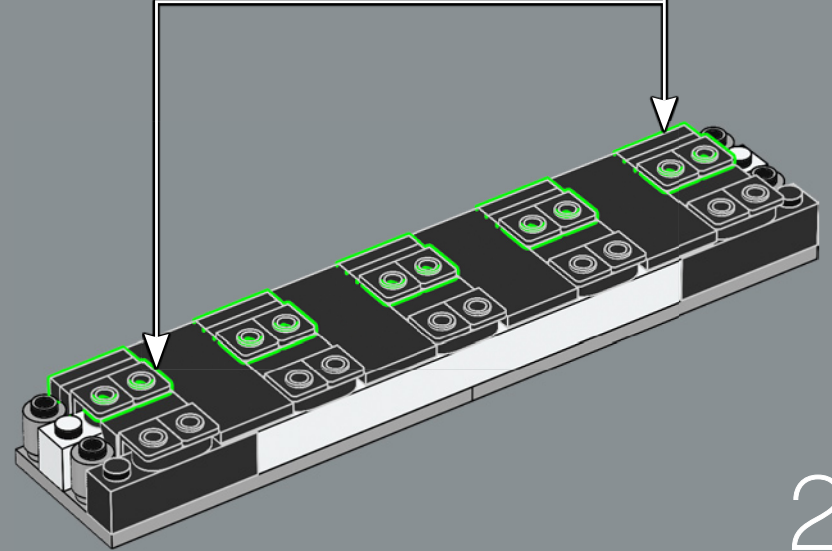
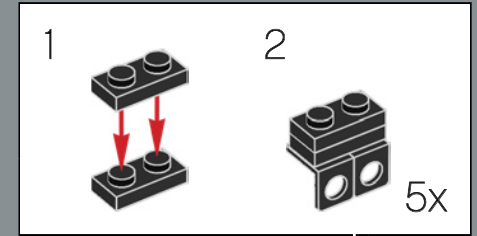

2x

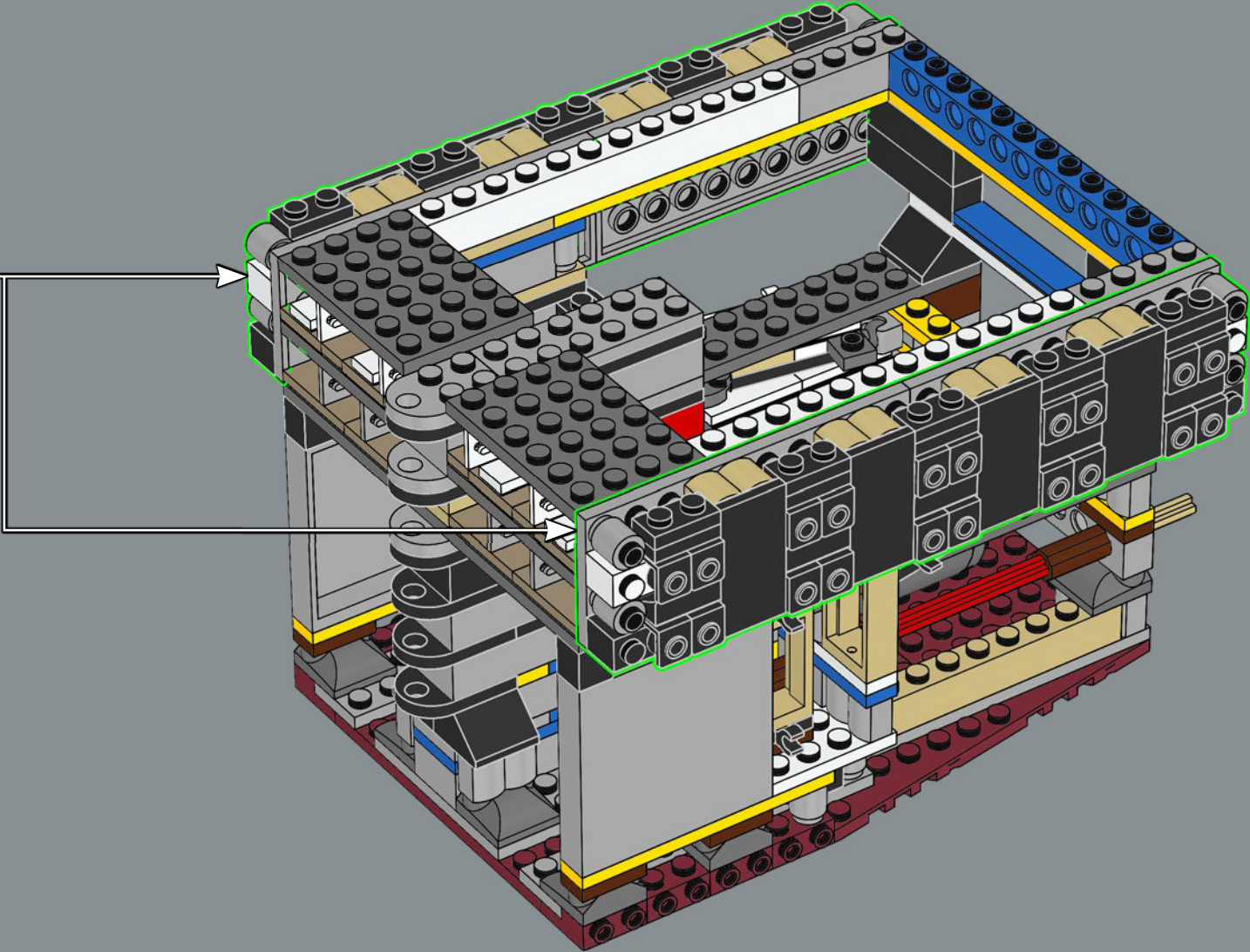

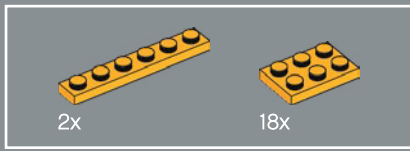

42

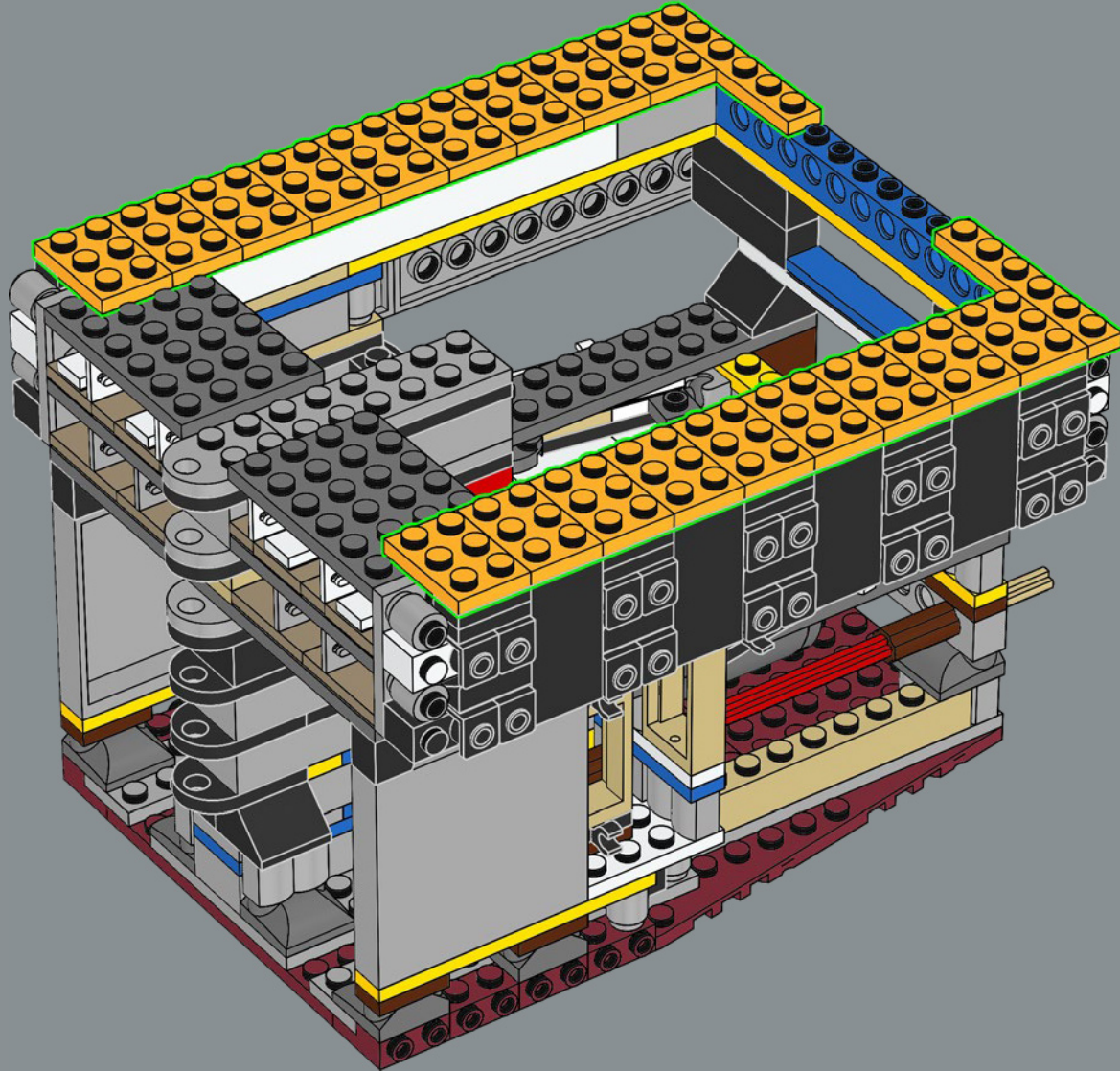

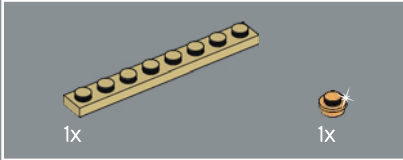
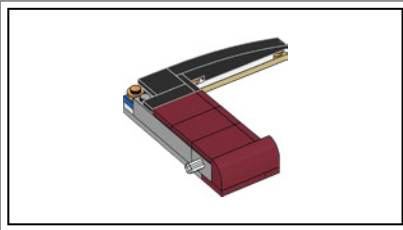
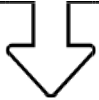

43

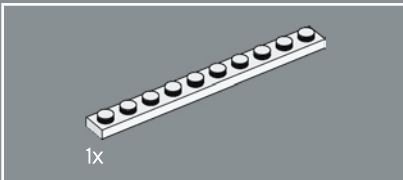
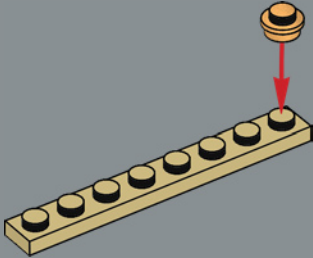

44

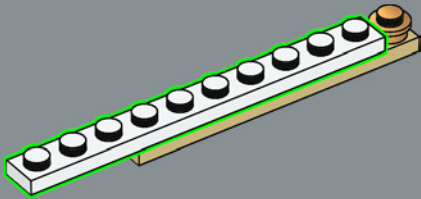

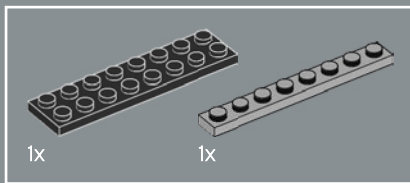

45

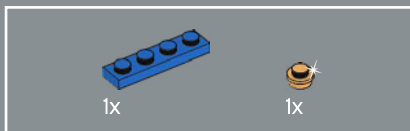
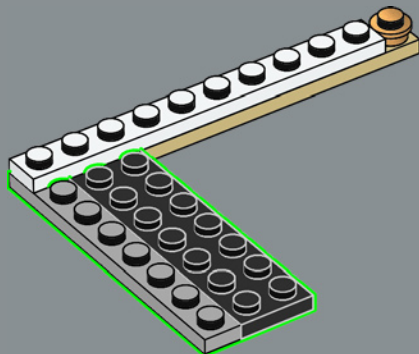

46

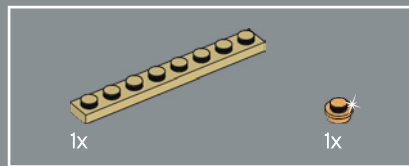
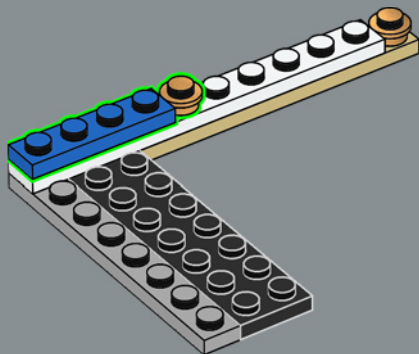

47

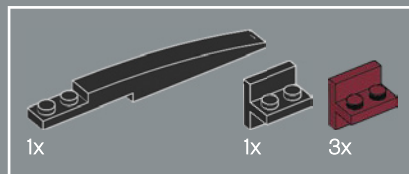
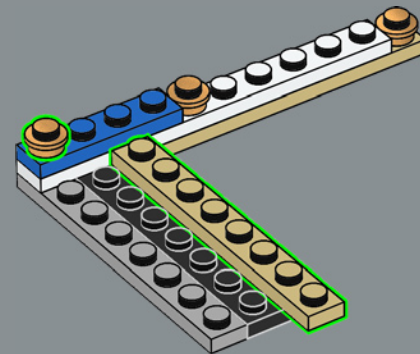

48

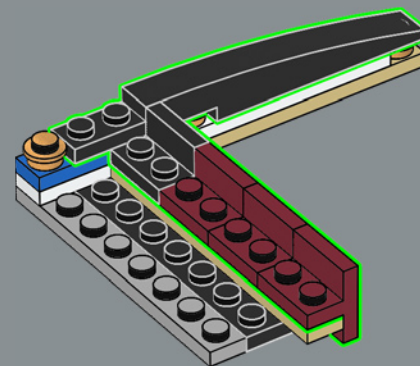

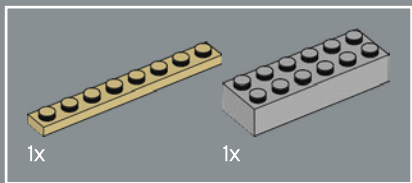

49

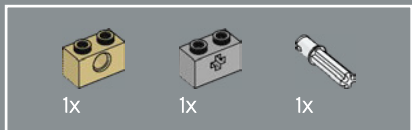
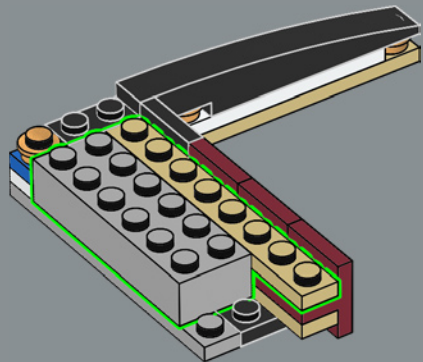

50

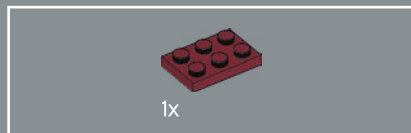
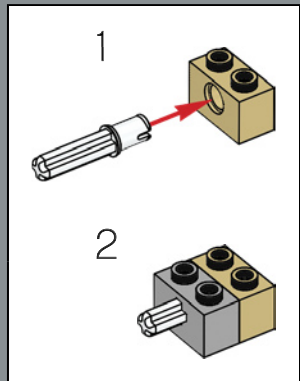
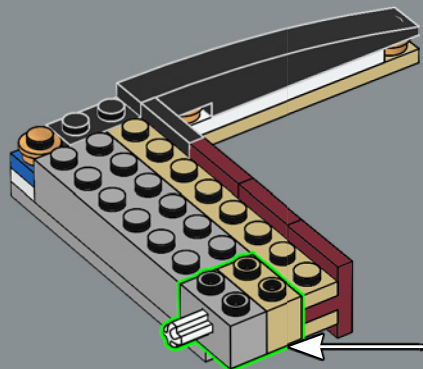

51

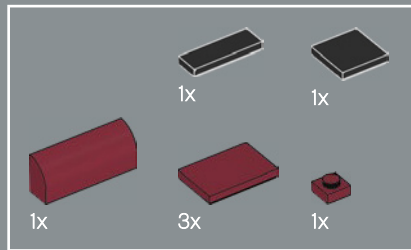
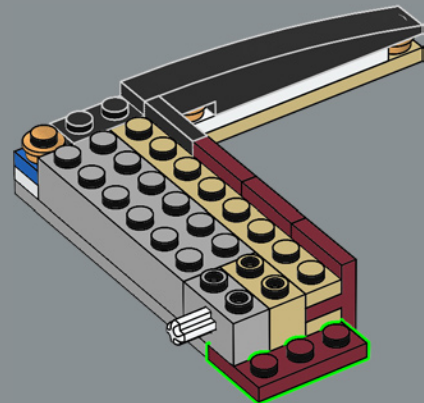

52

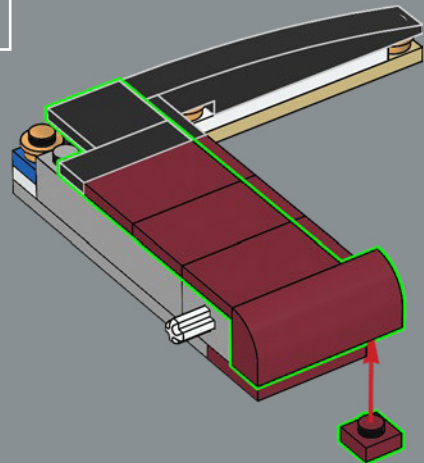

53

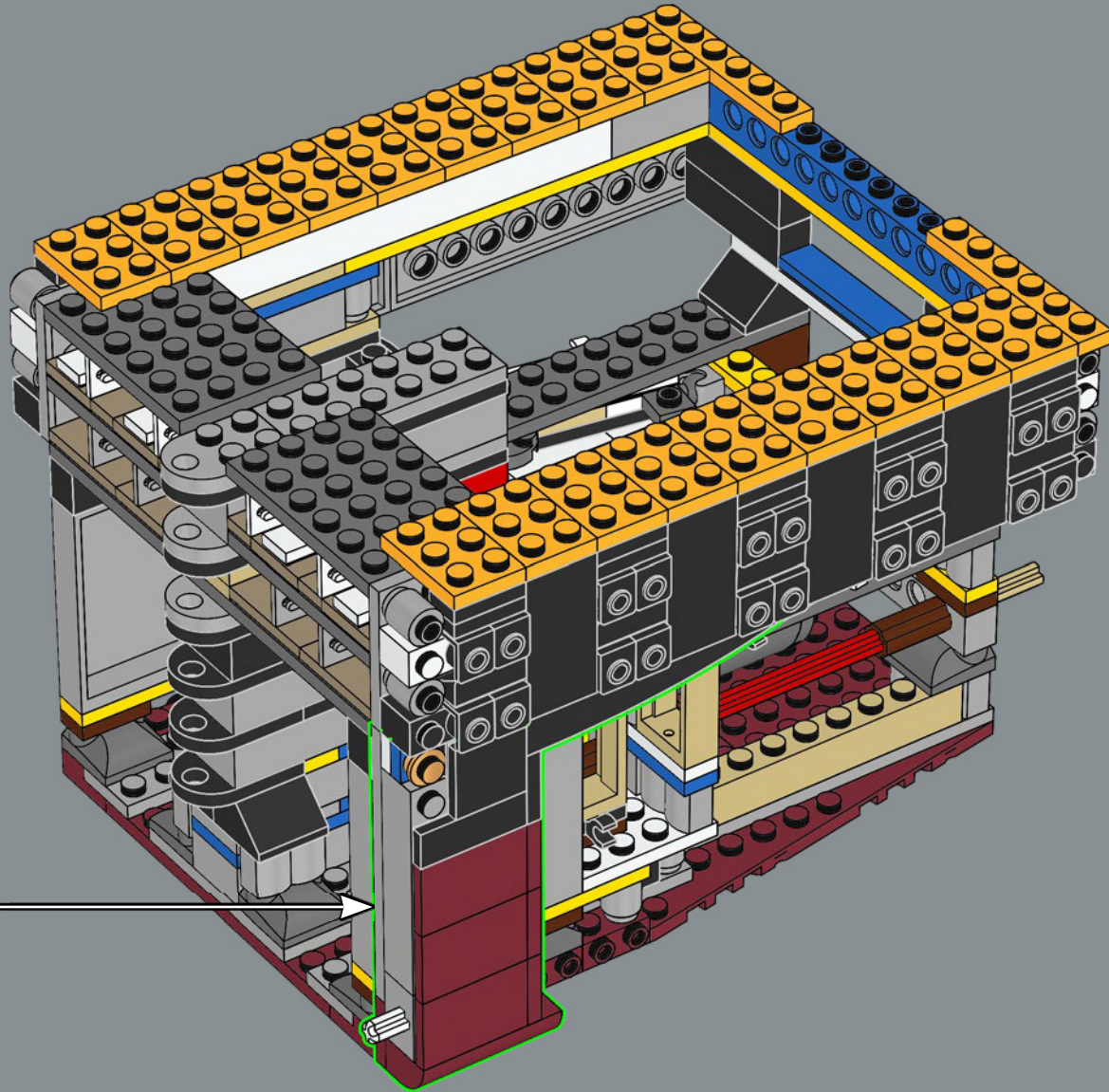

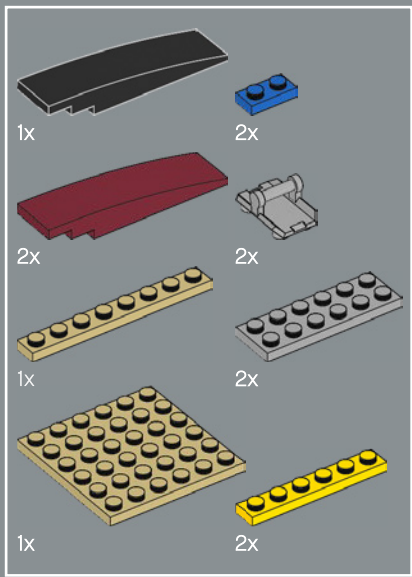

54

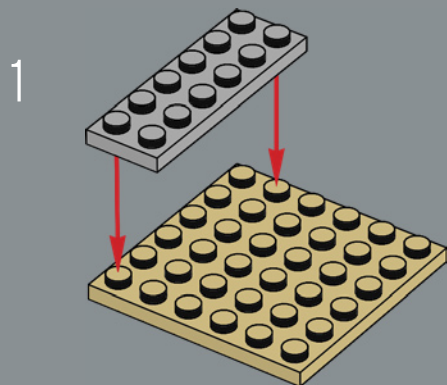

2

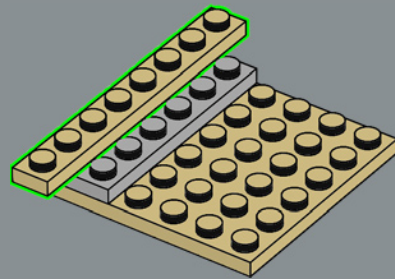

3

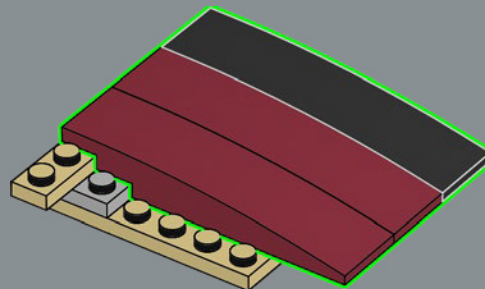

4

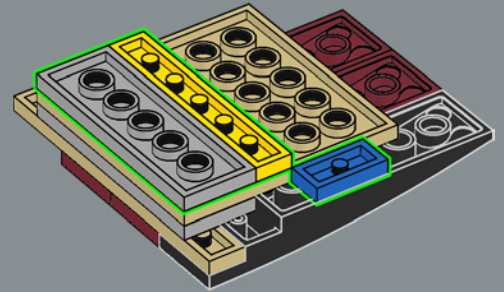

5

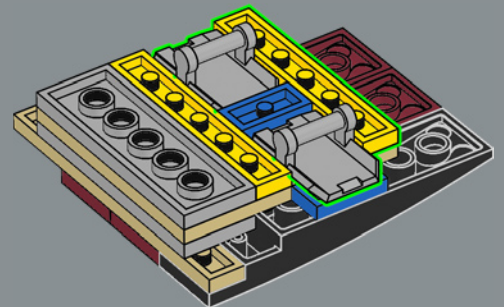



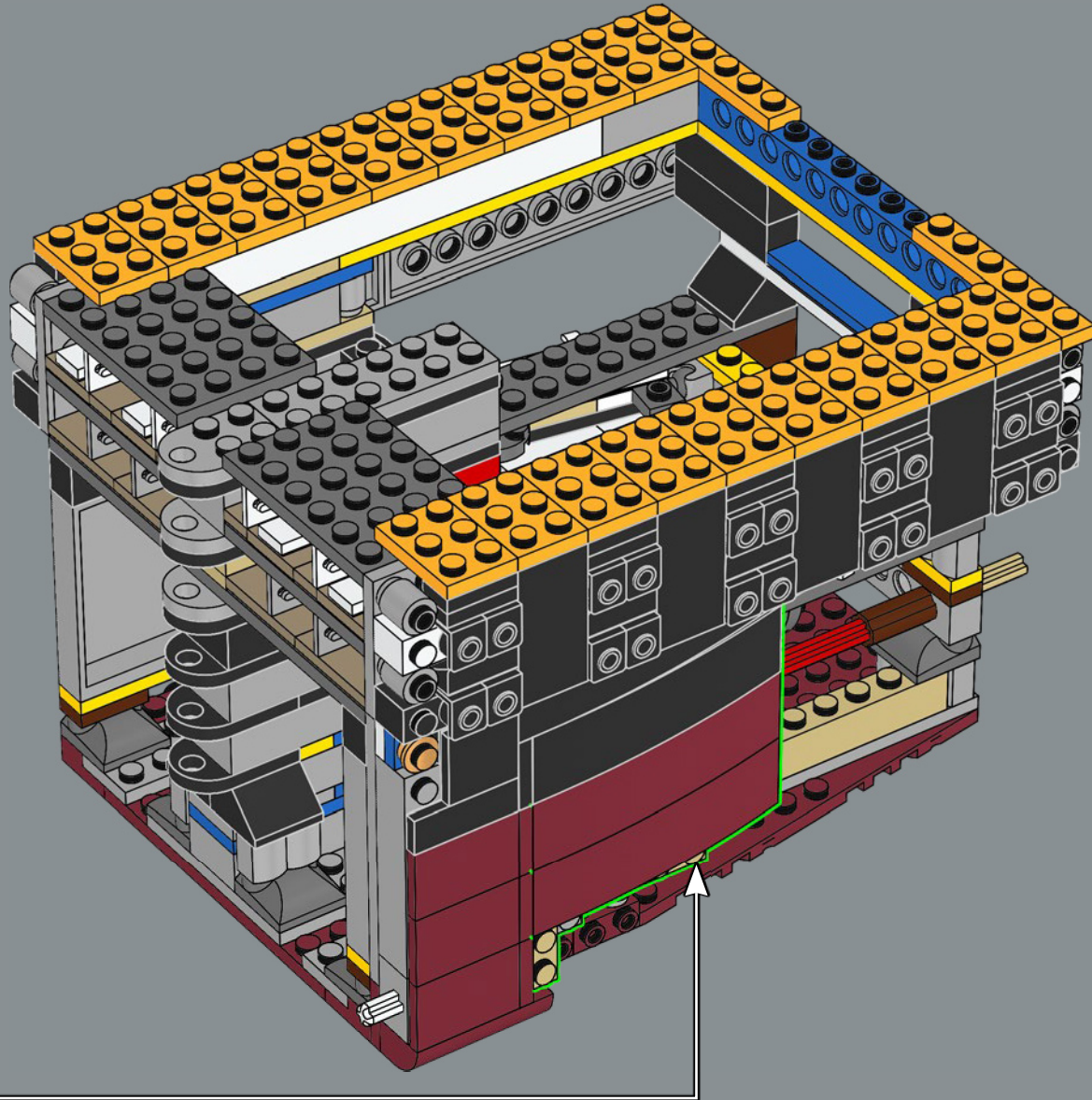

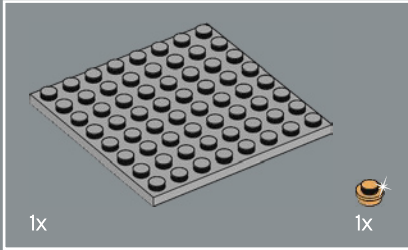
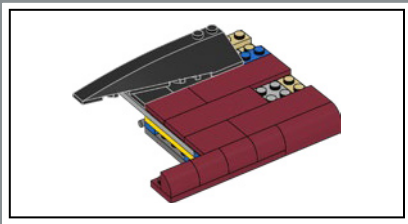

55

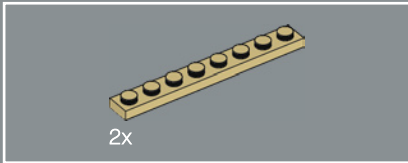
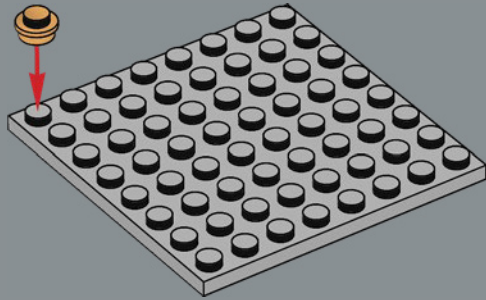

56

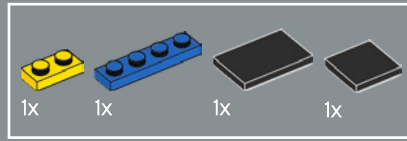
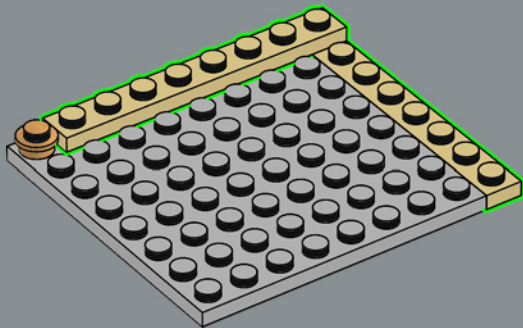

57

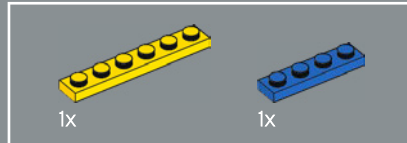
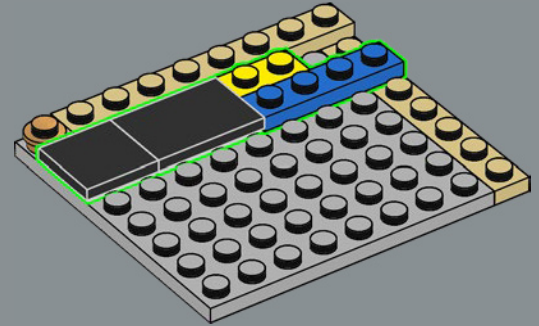

58

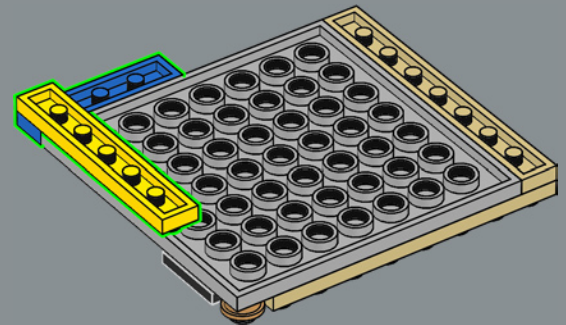
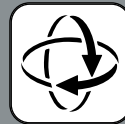

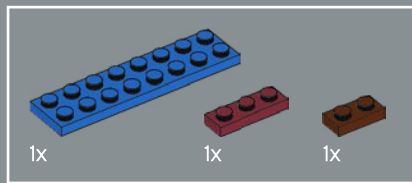

59

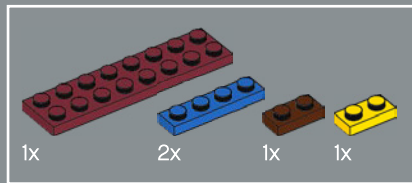
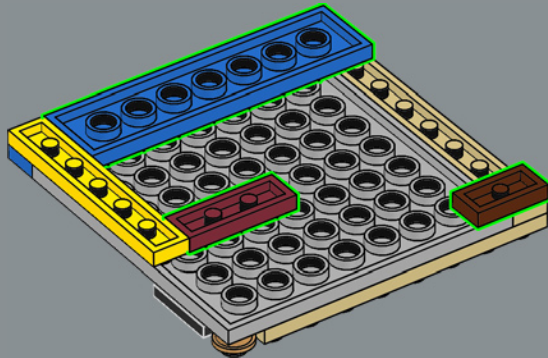

60

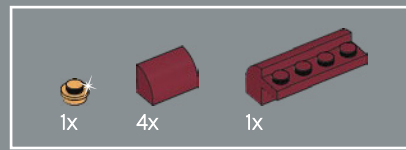
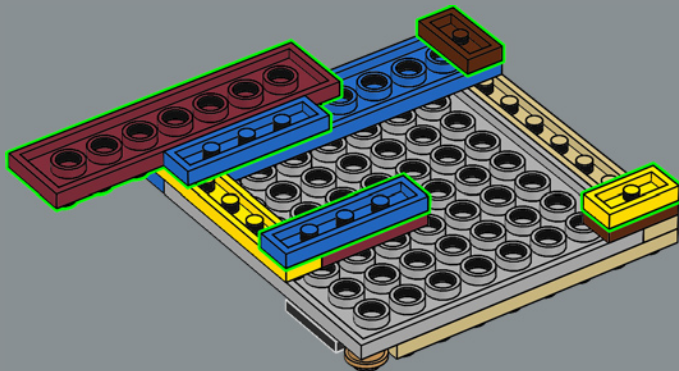

61

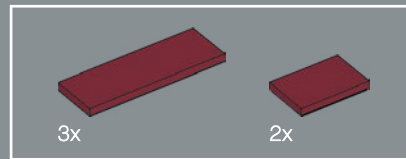
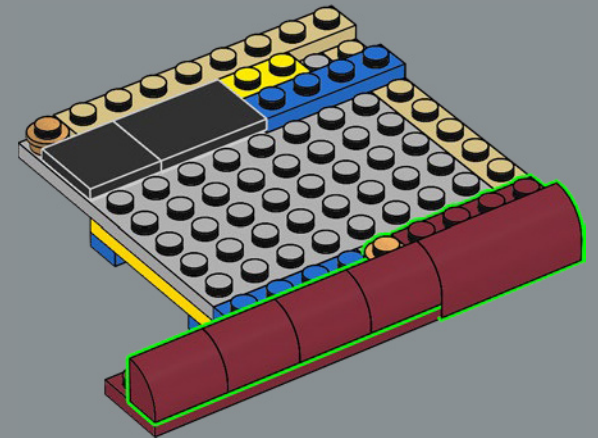

62

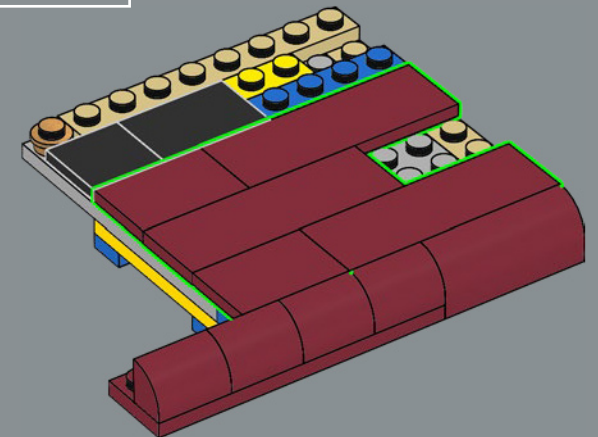

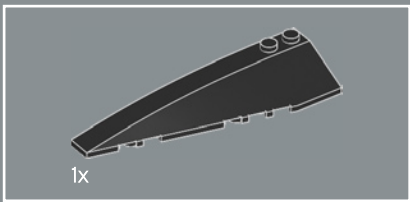

63

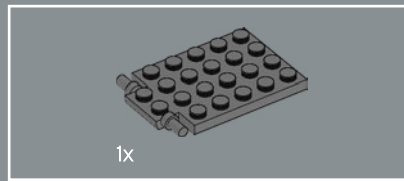
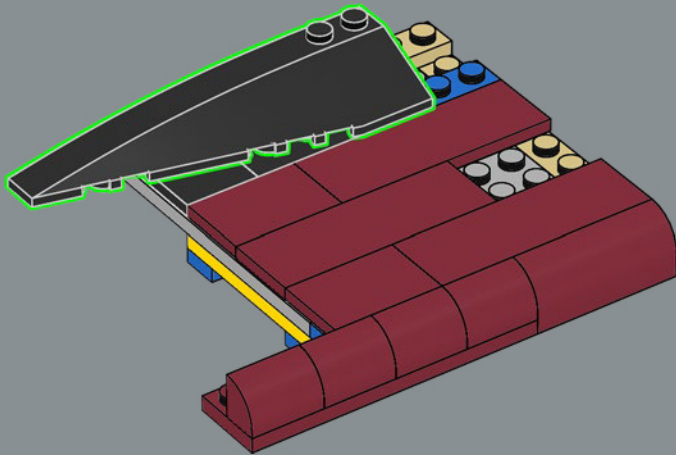

64

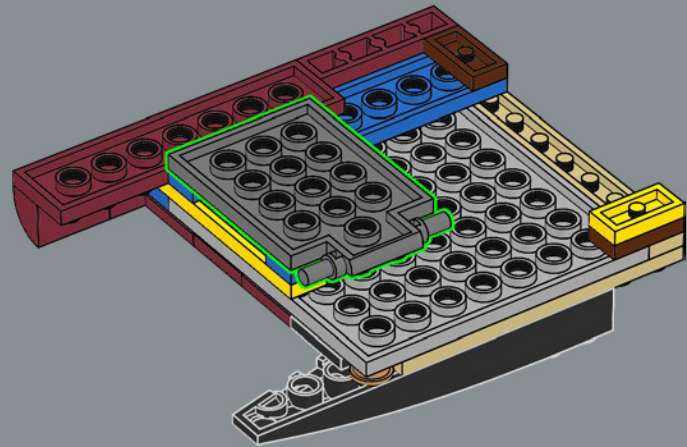

65

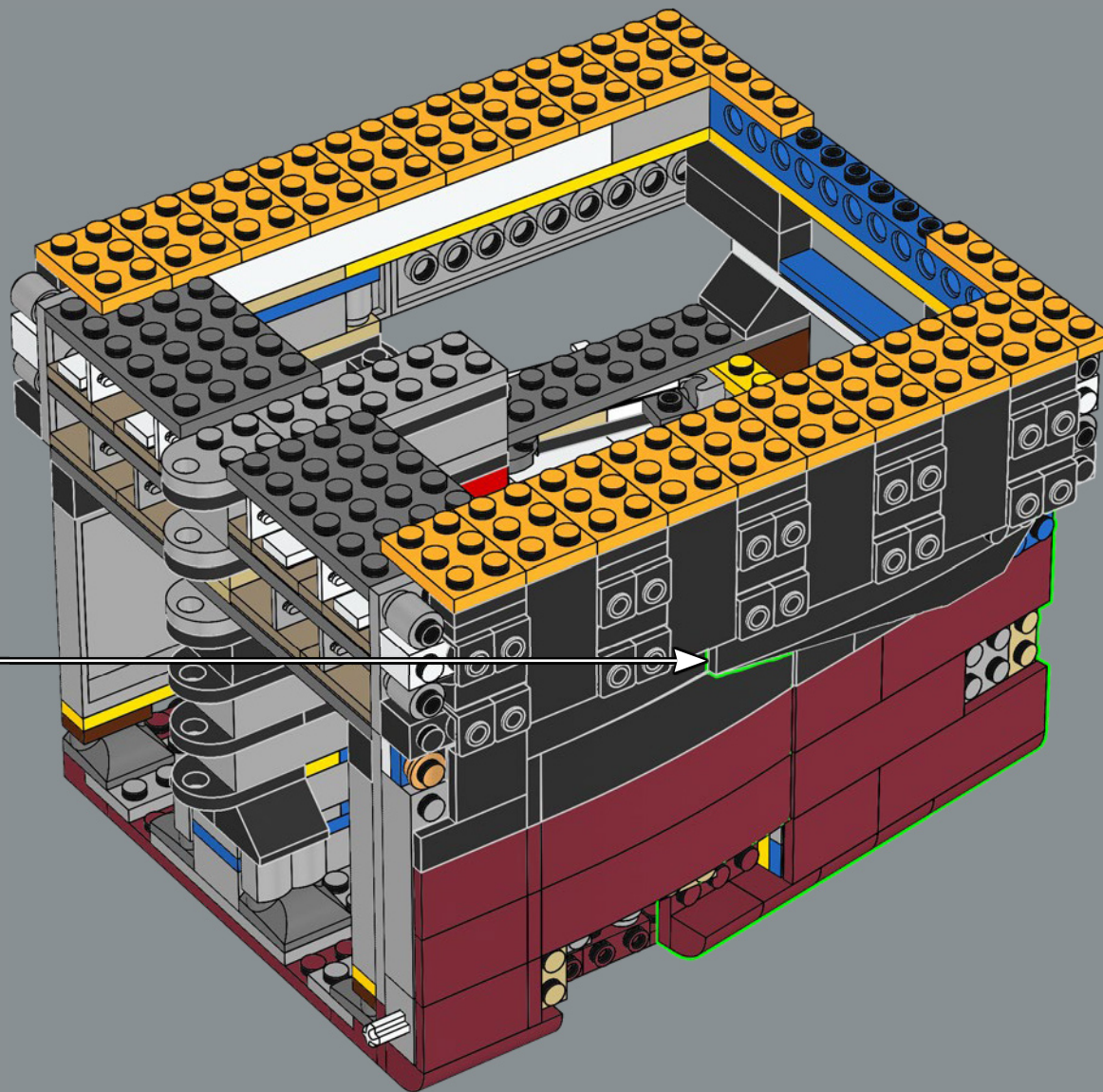

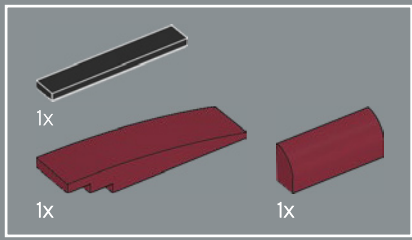

66

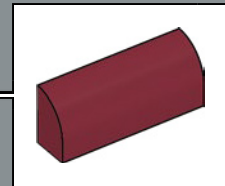
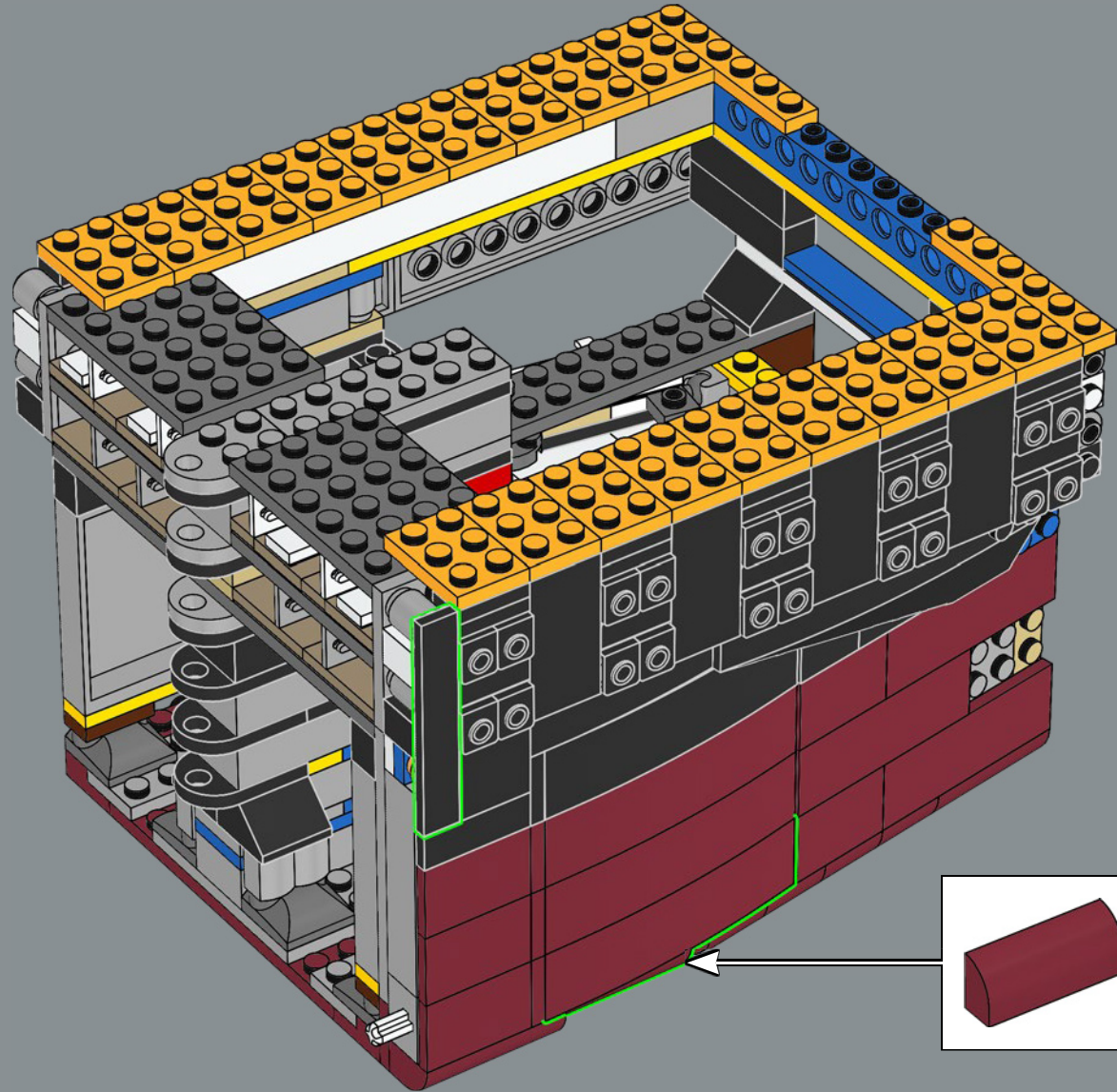

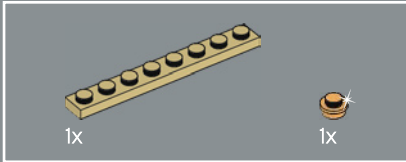
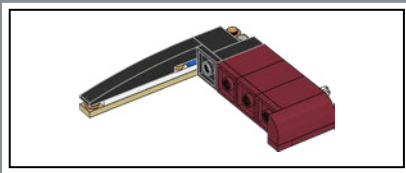

67

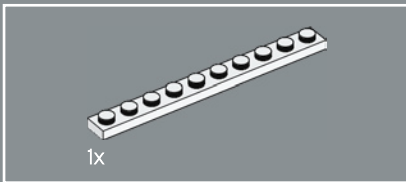
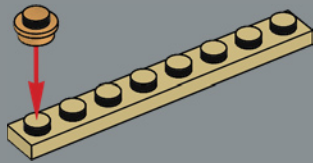

68

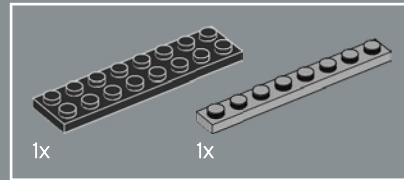
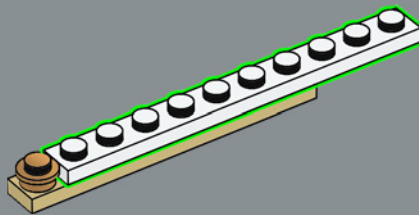

69

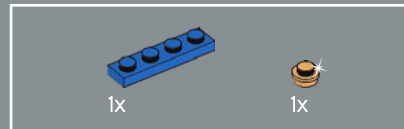
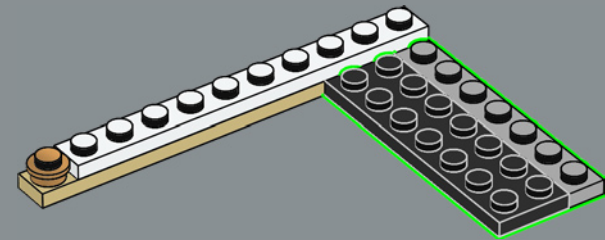

70

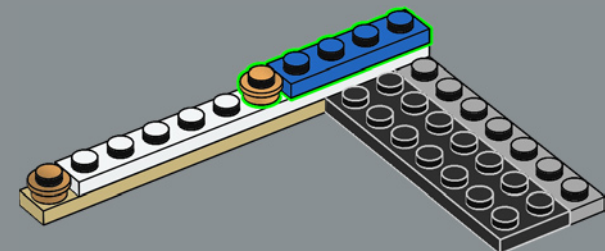

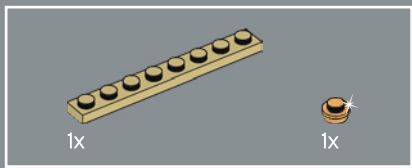

71

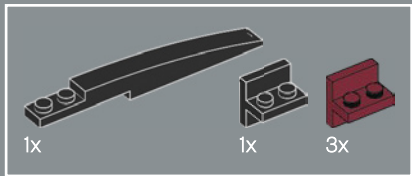
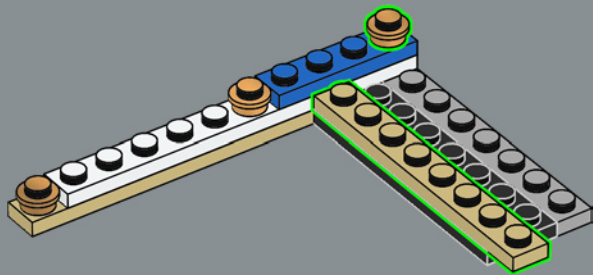

72

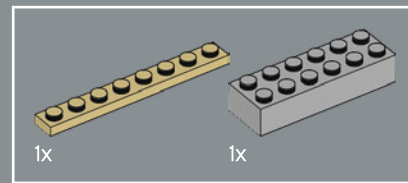
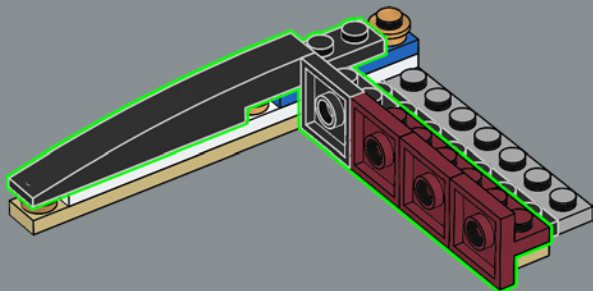

73

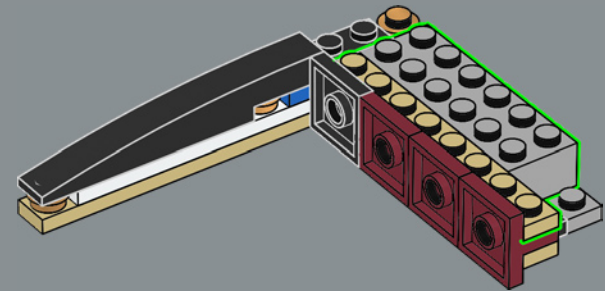



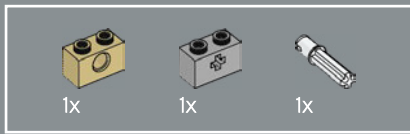

74

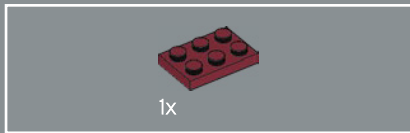
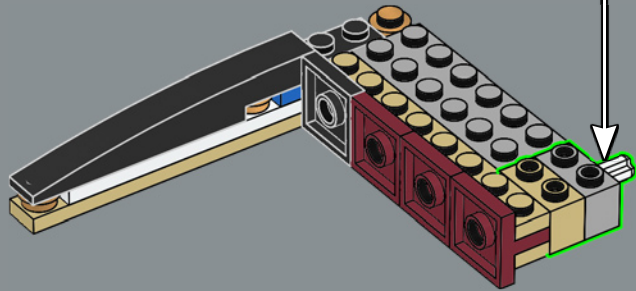
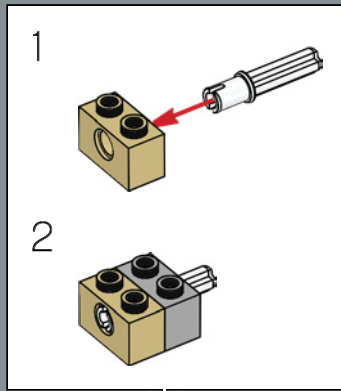

75

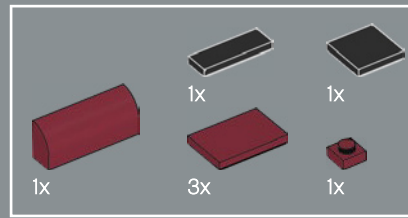
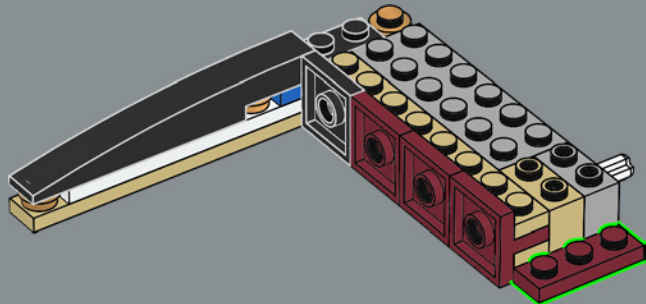

76

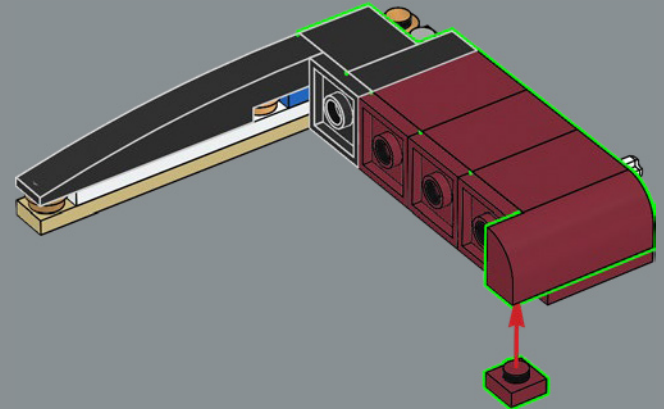

77

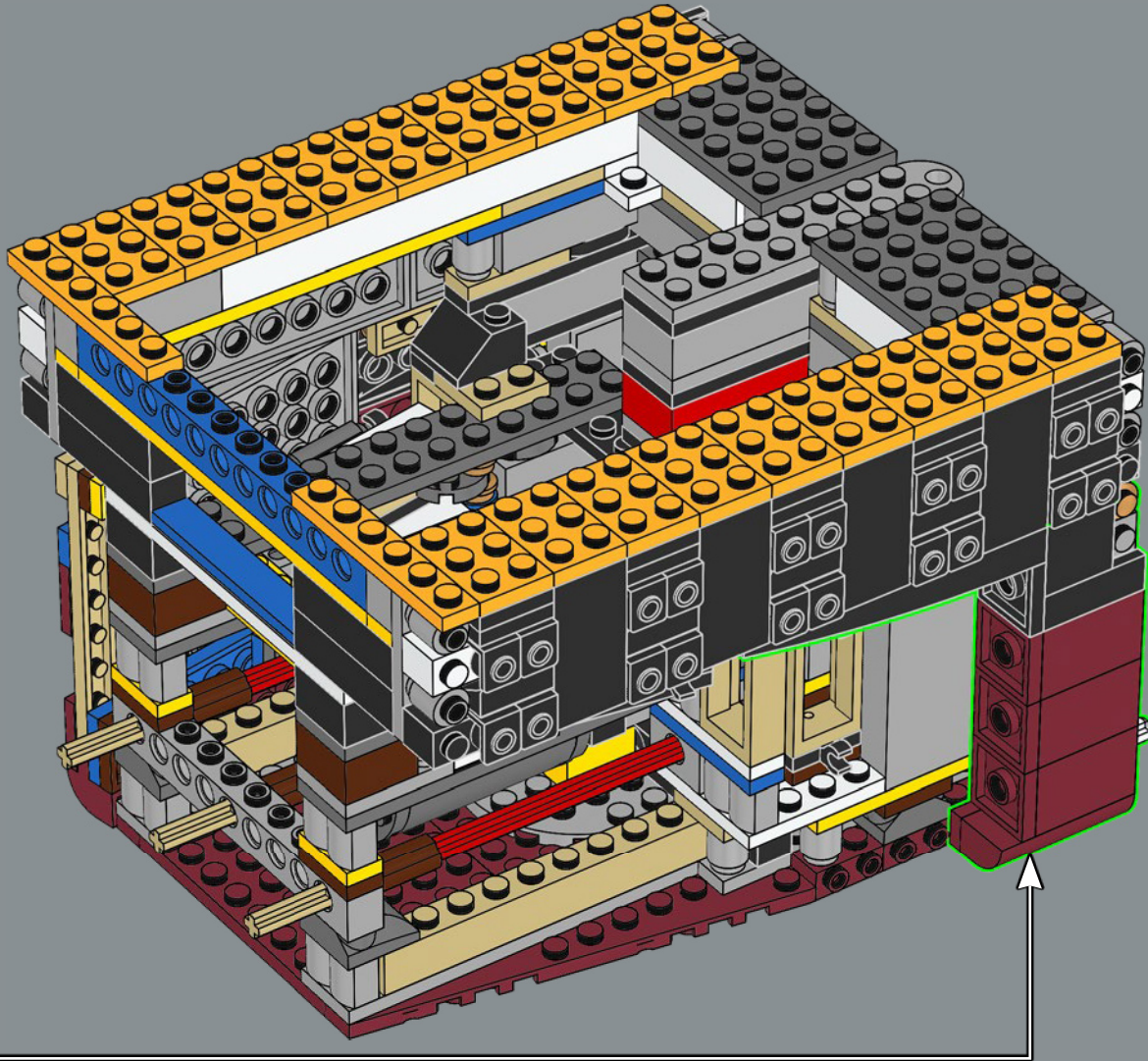

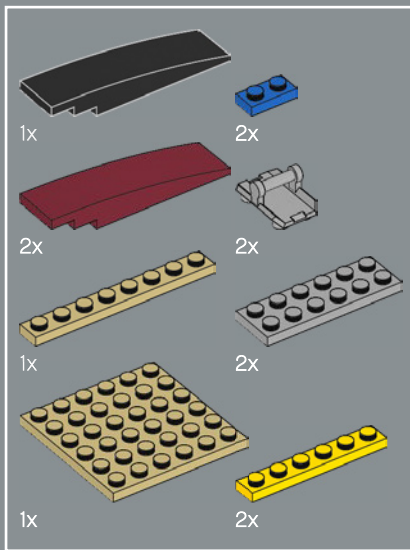

78

1

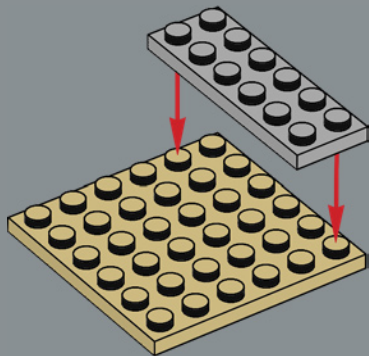

2

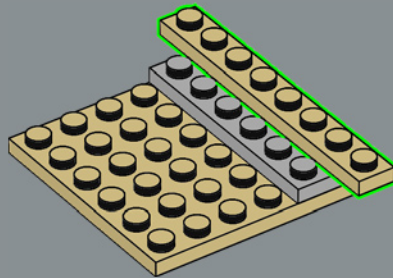

3

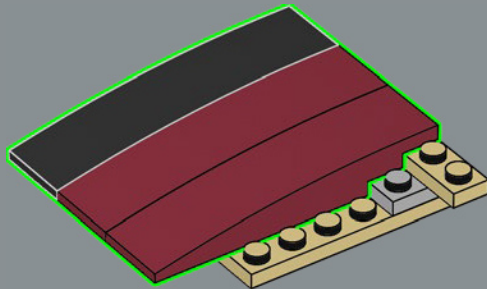

4

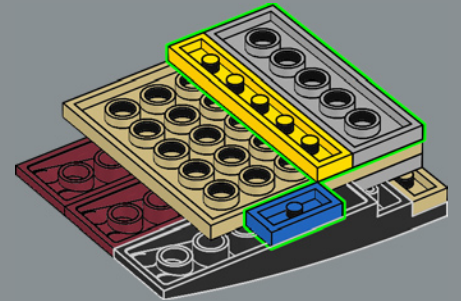

5

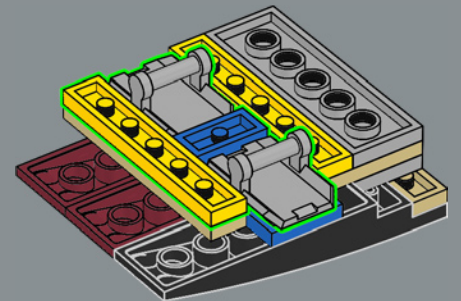

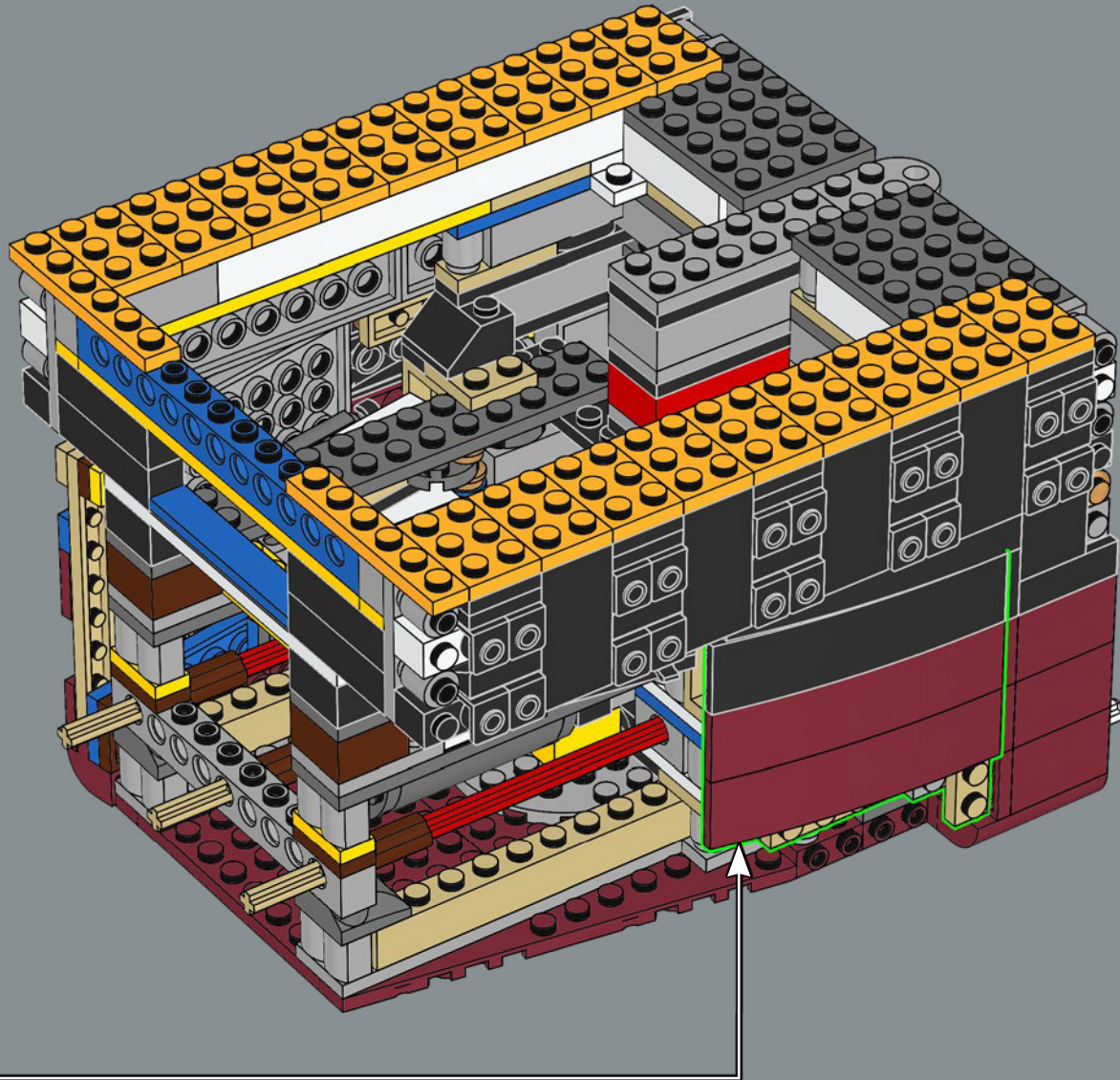

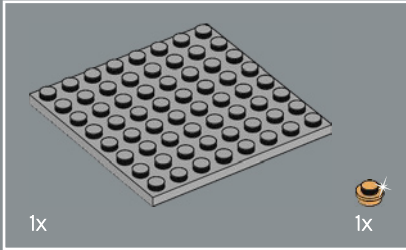
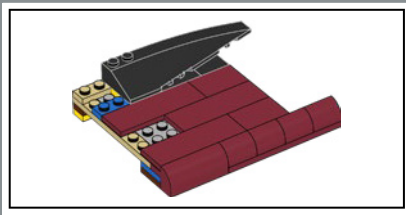

79

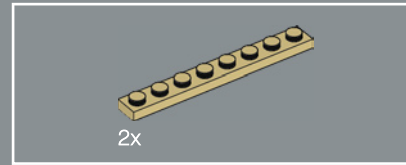
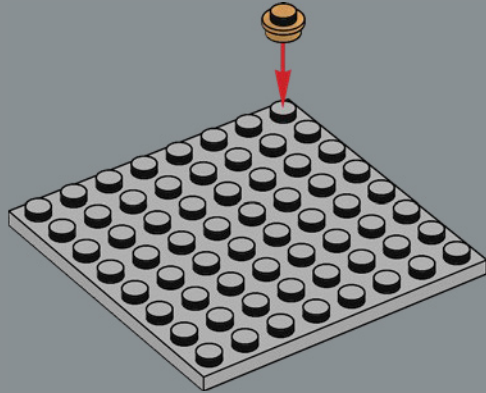

80

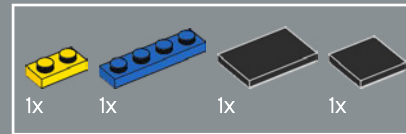
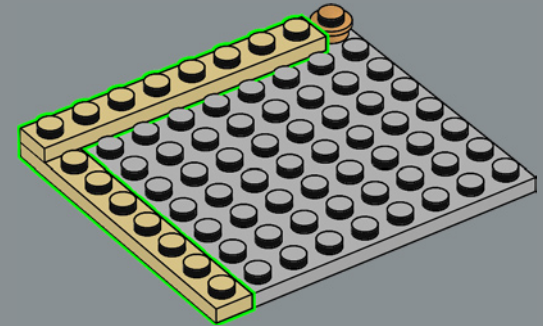

81

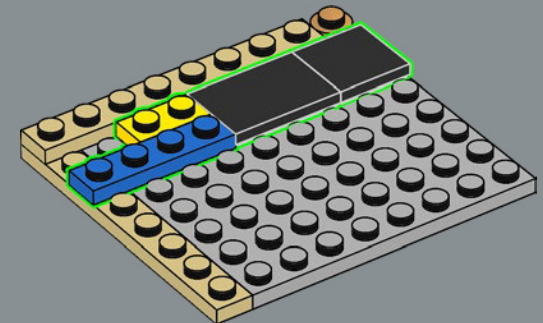

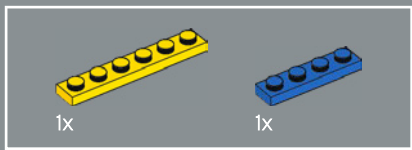

82

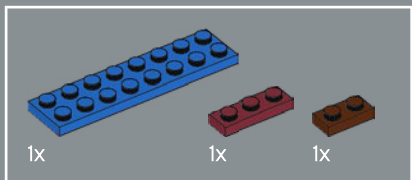
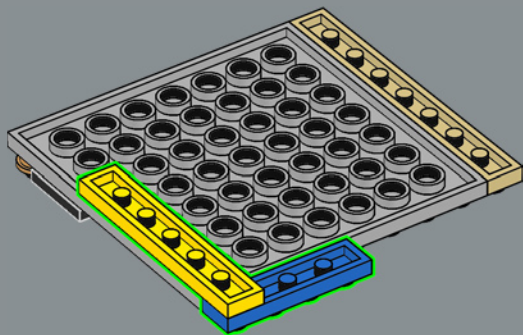

83

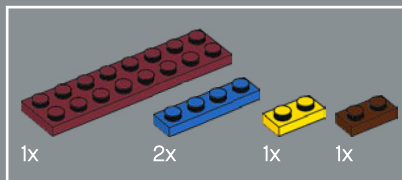
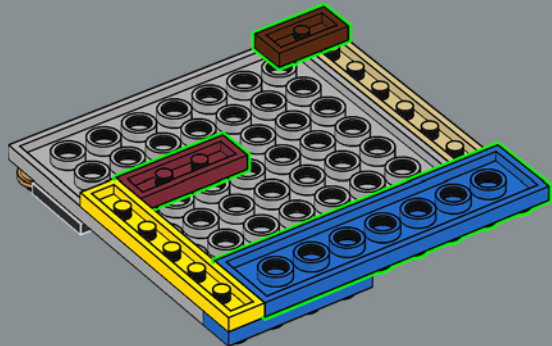

84

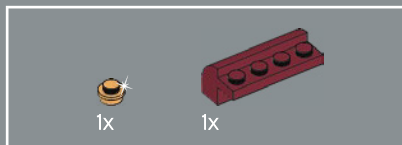
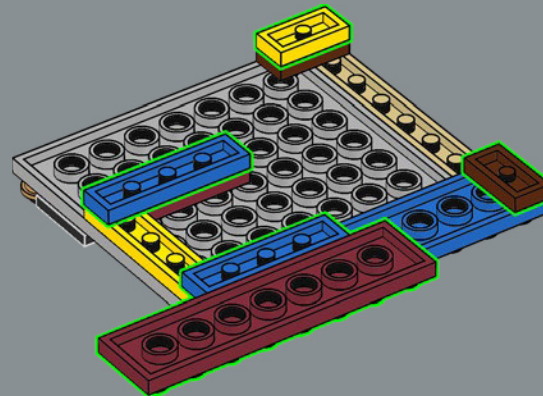

85

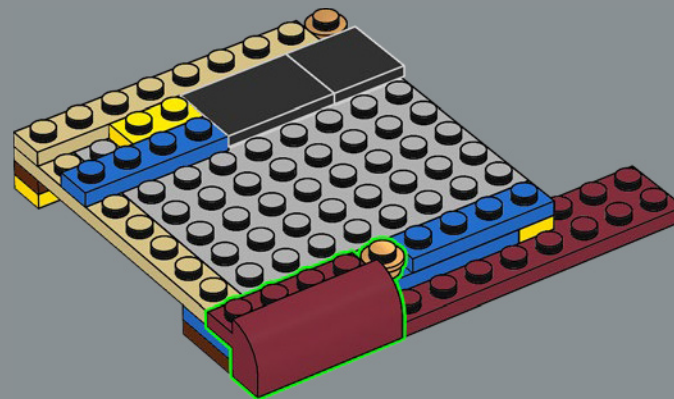

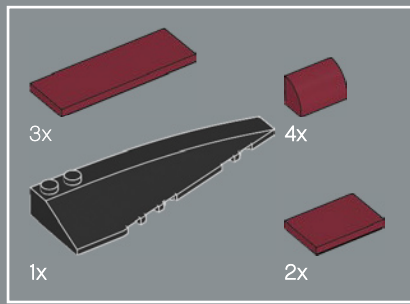

86

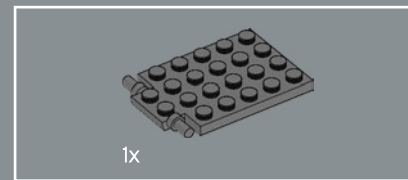
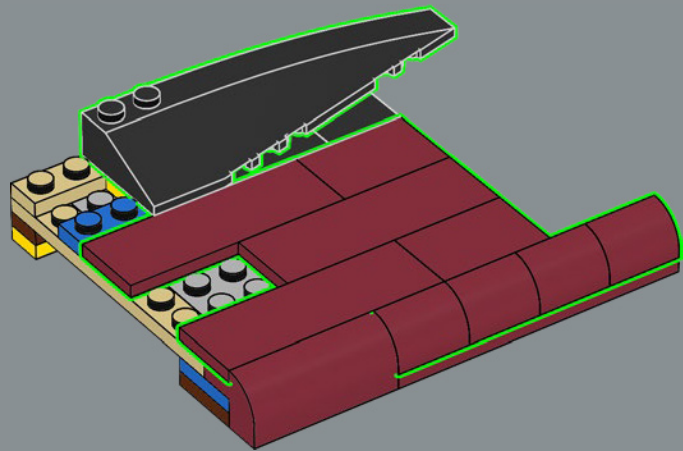

87

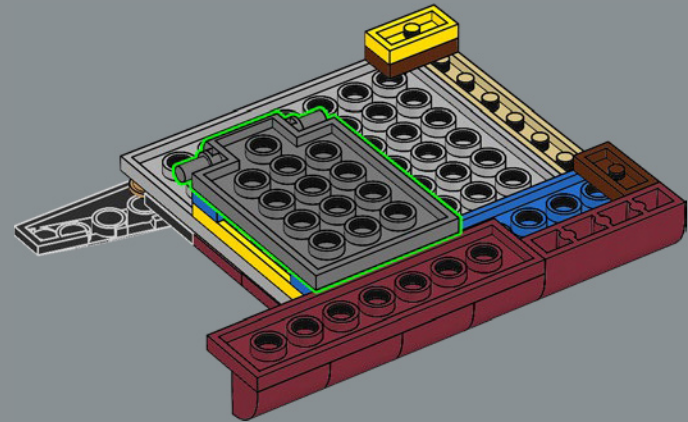
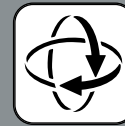

The *Titanic* was 640 km (400 miles) from land when she struck the iceberg.

88

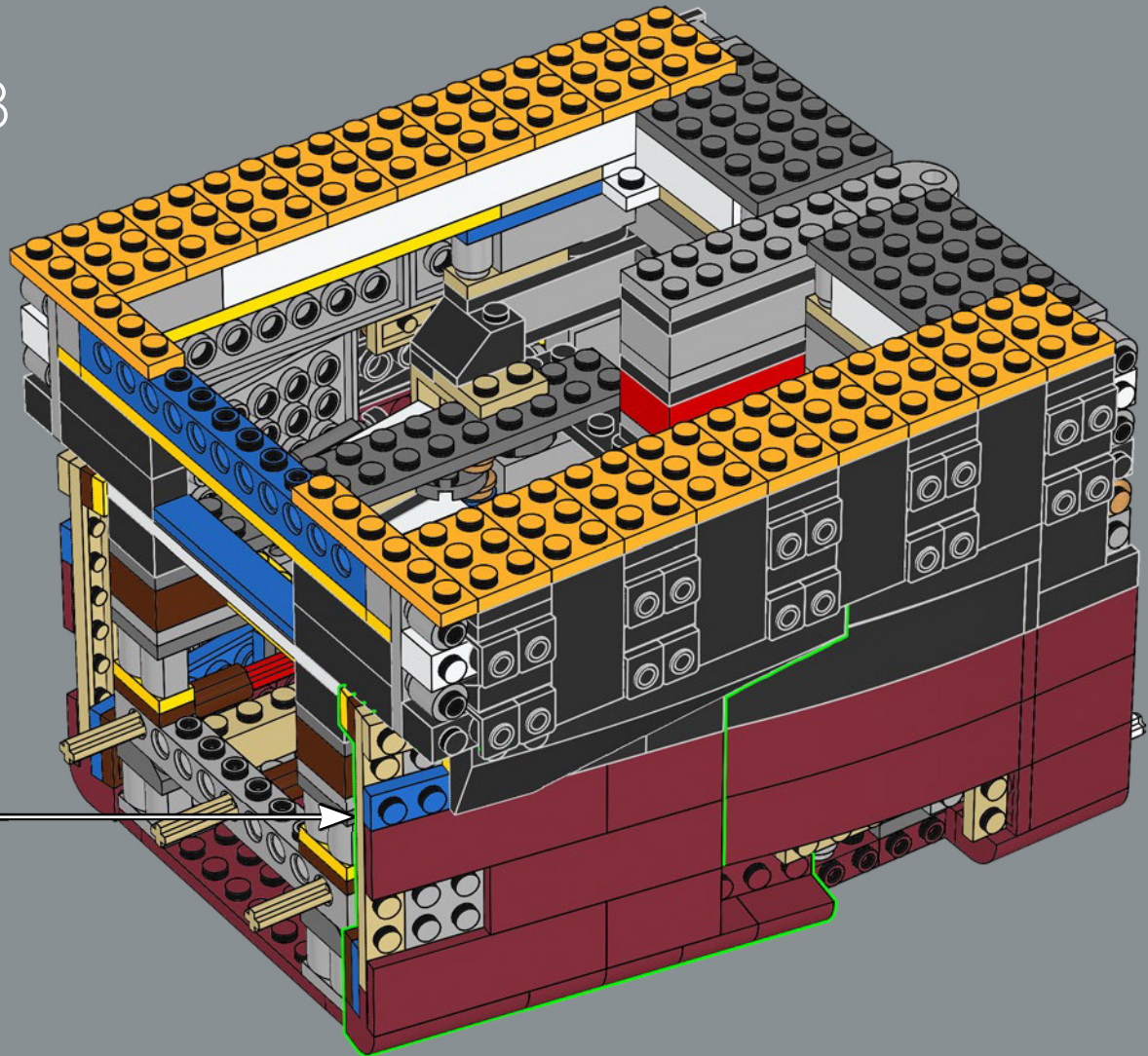



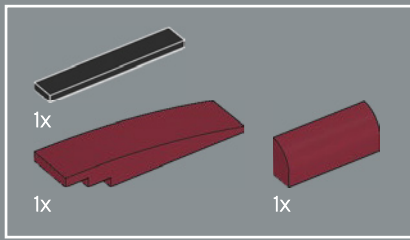

89

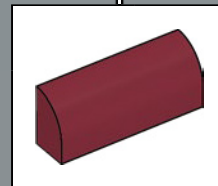
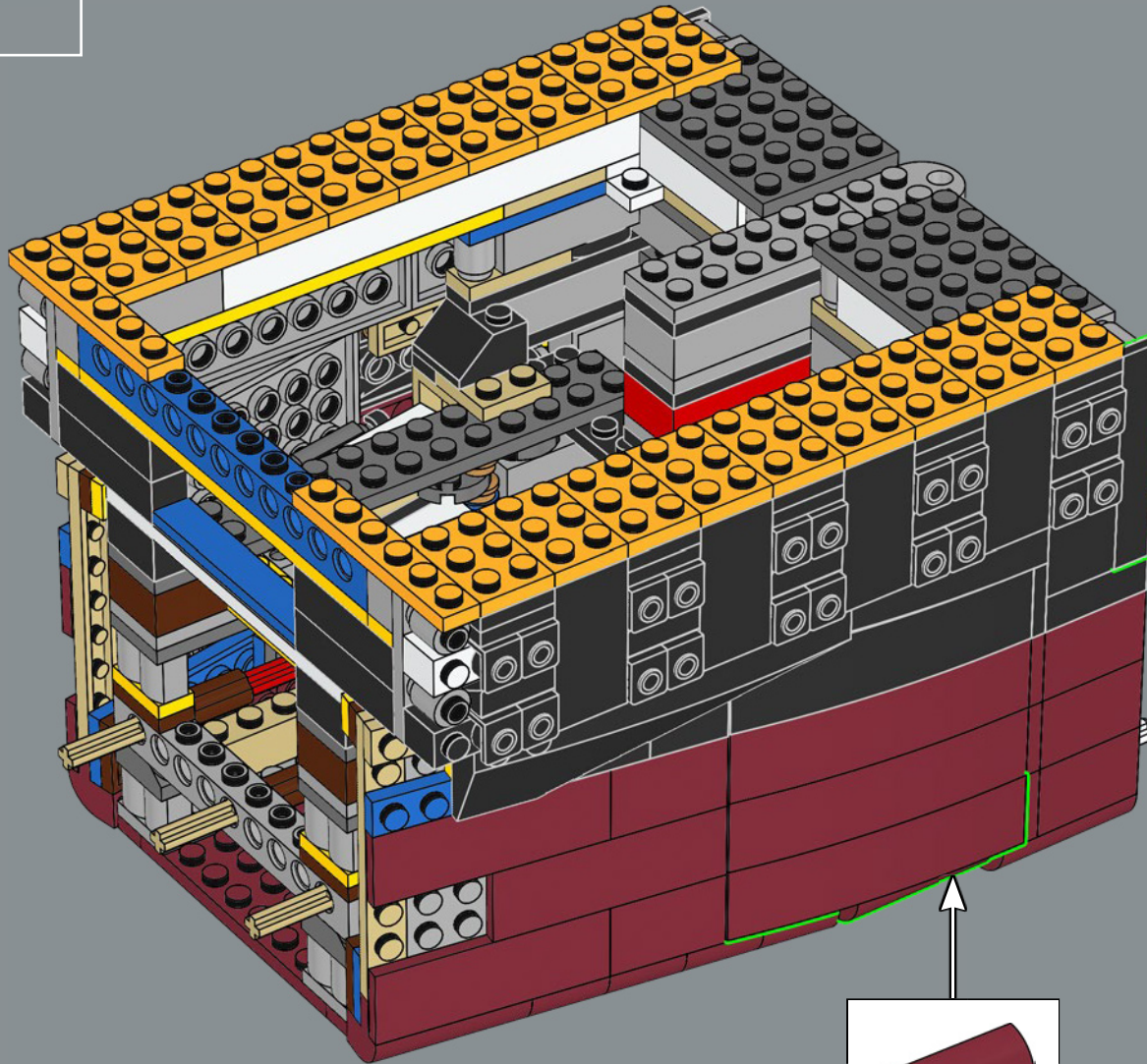

32

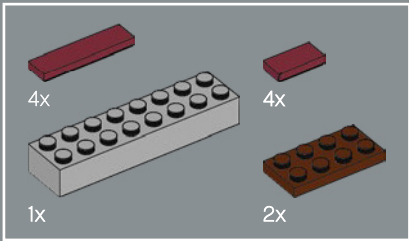

90

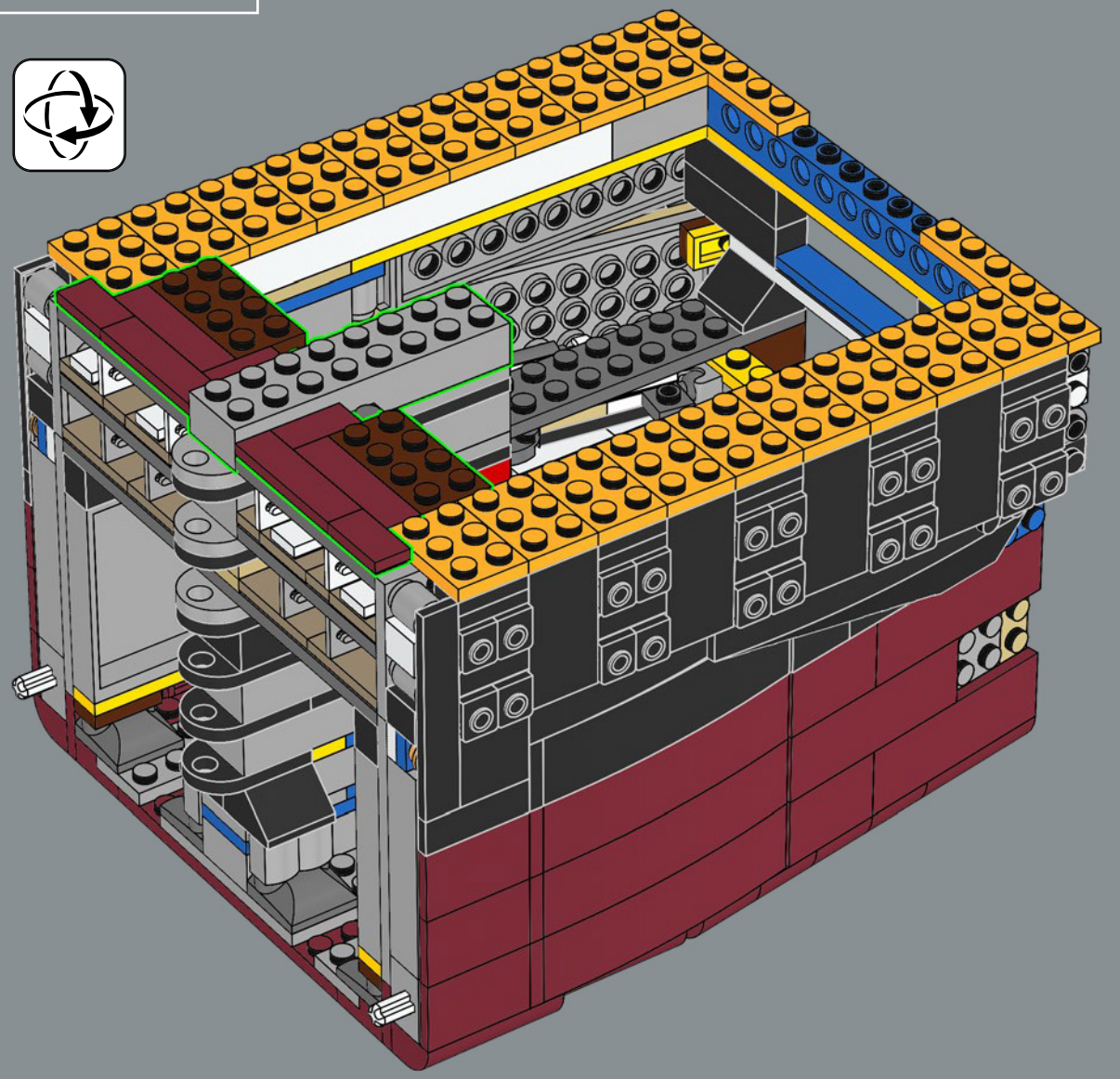
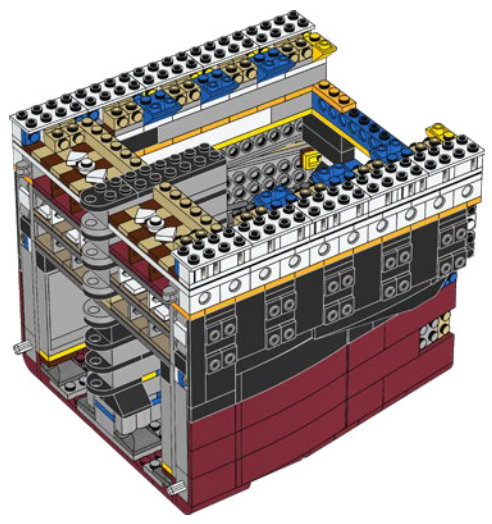

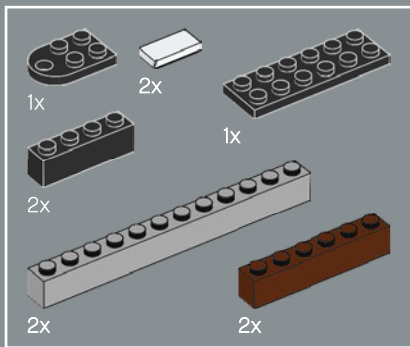

91

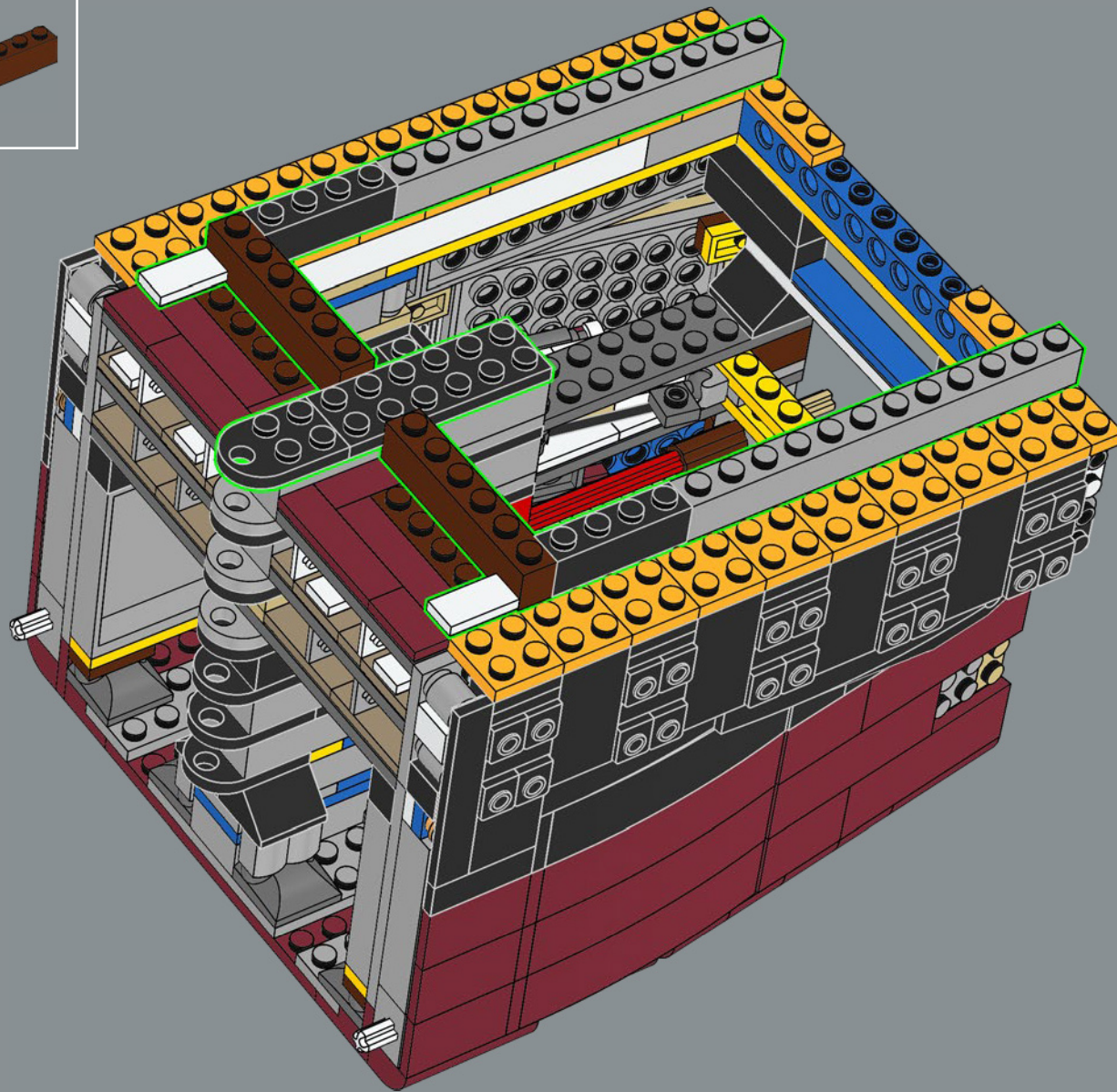

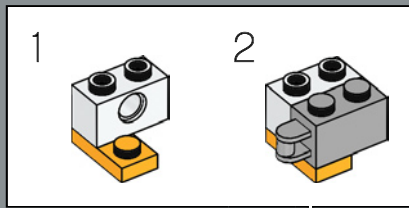
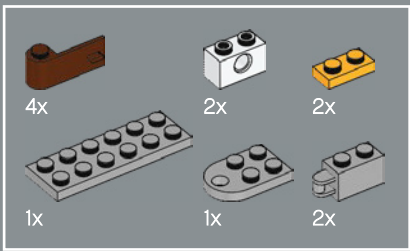

92

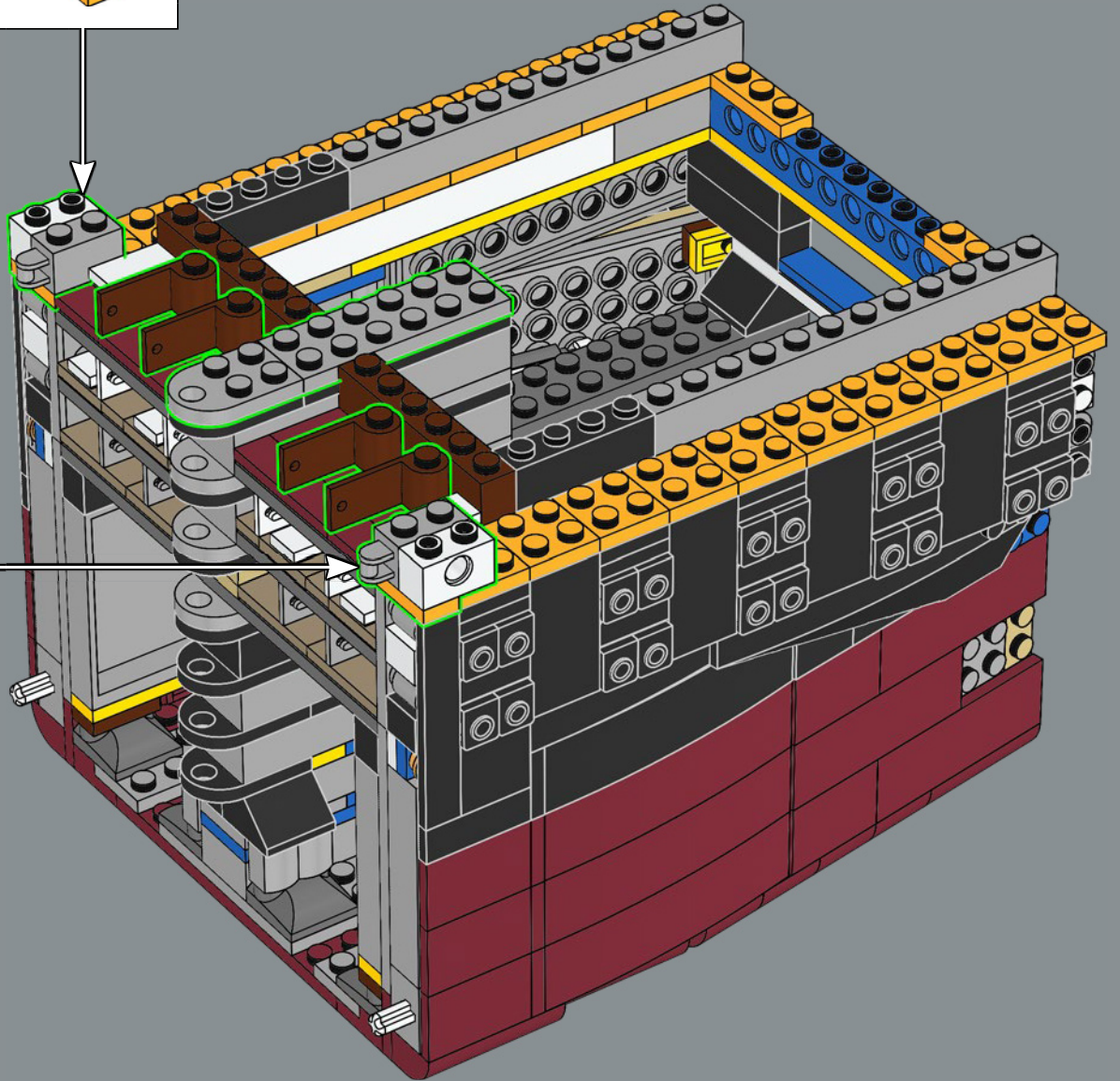
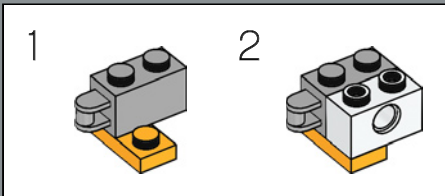



18x

93

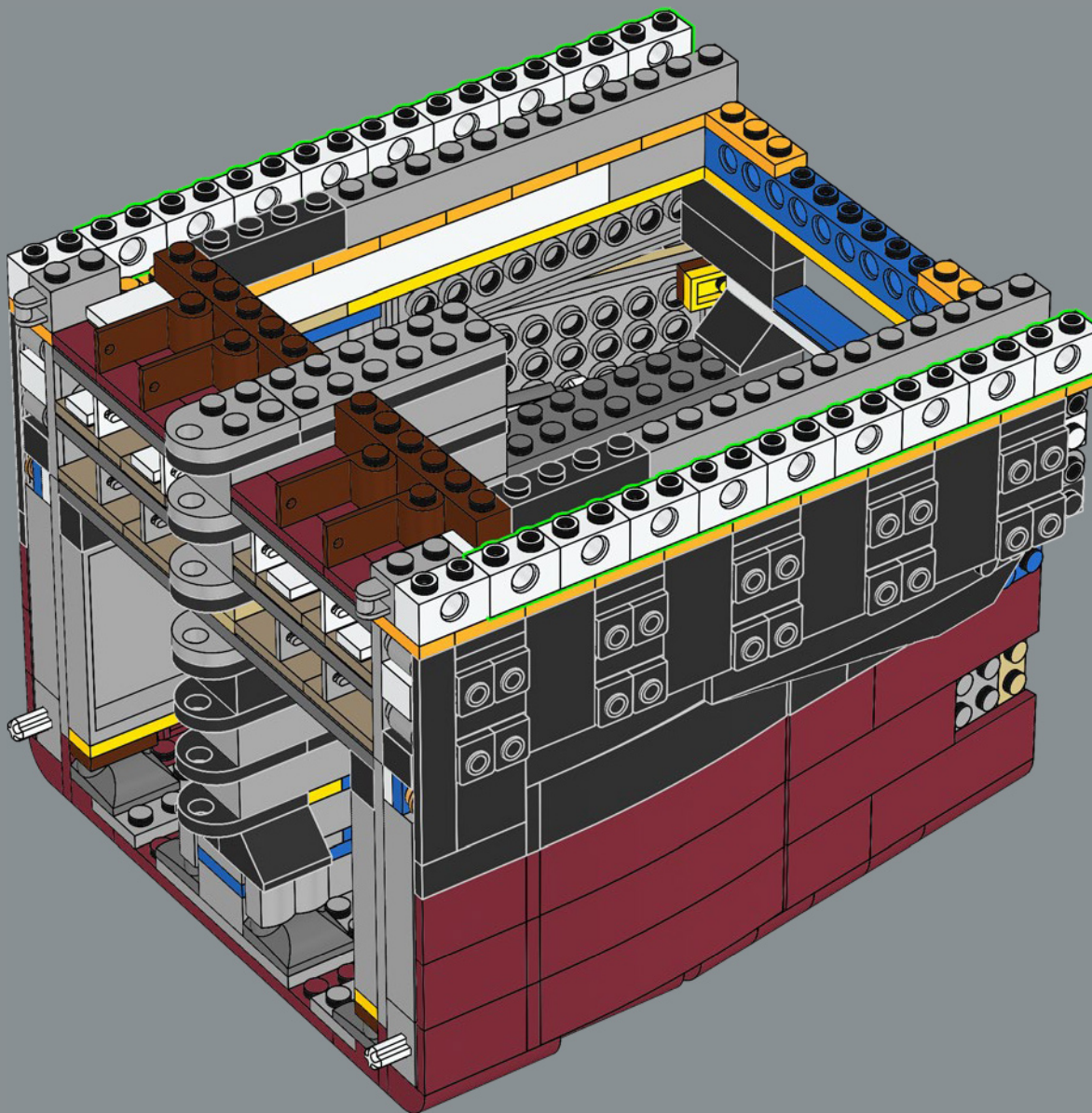

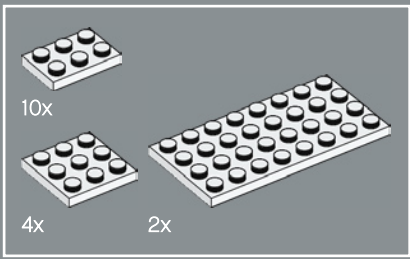

94

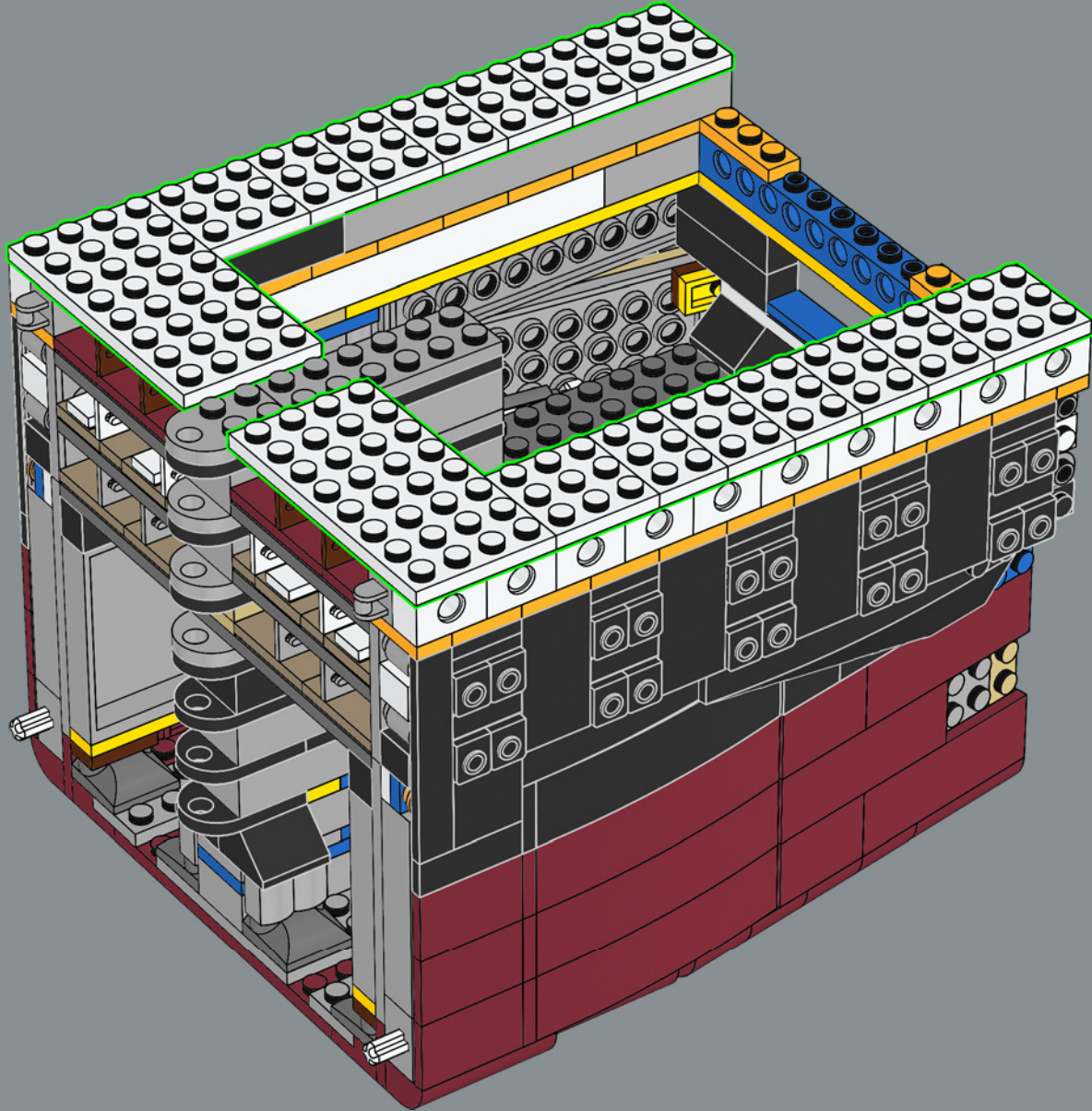

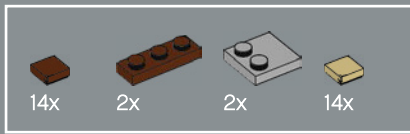

95

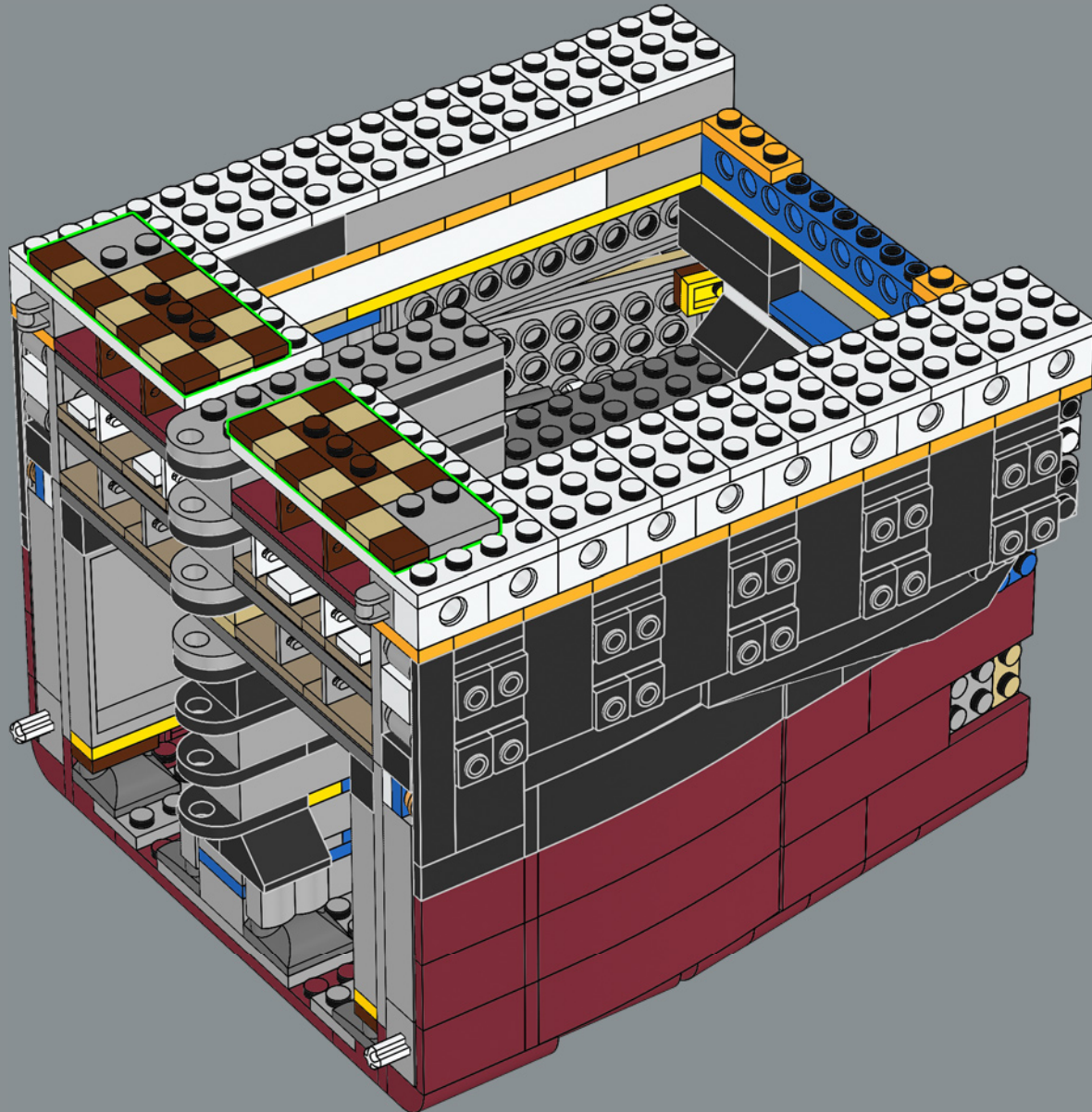

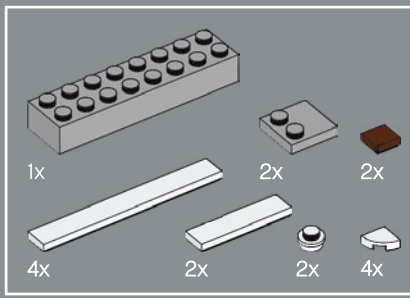

96

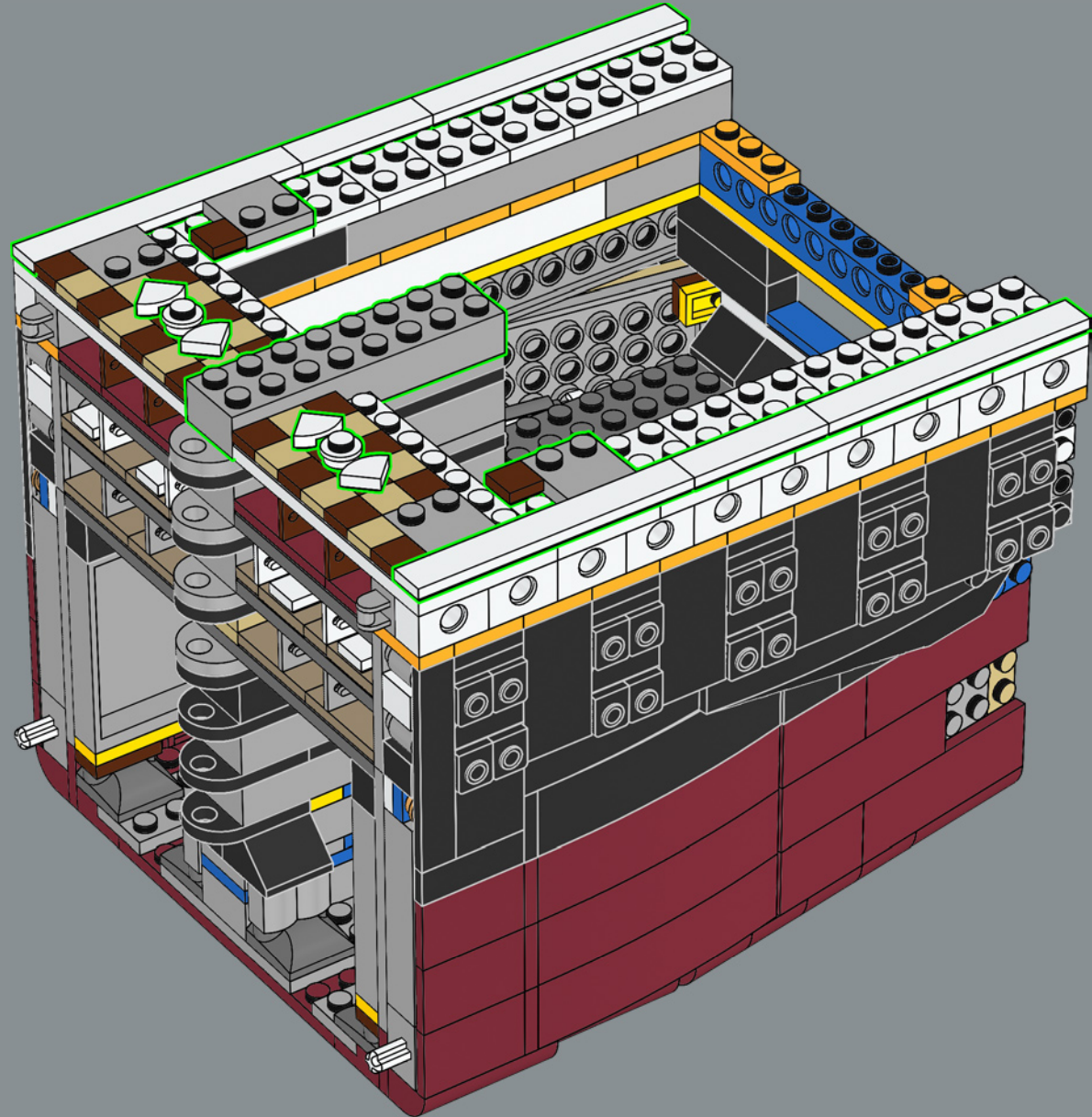



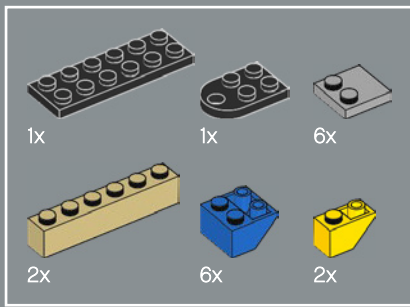

97

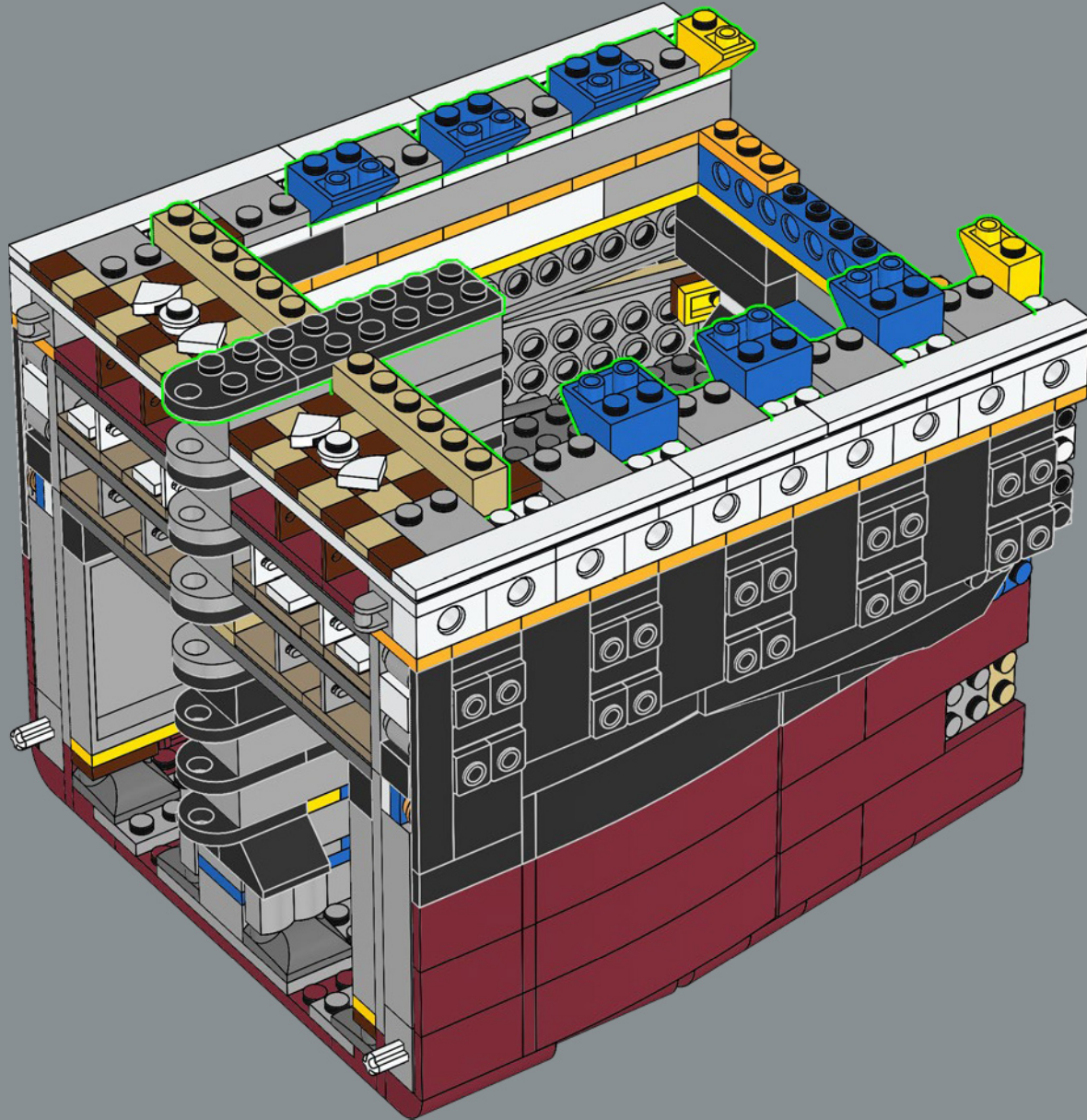

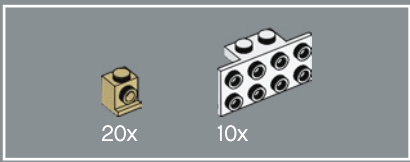

98

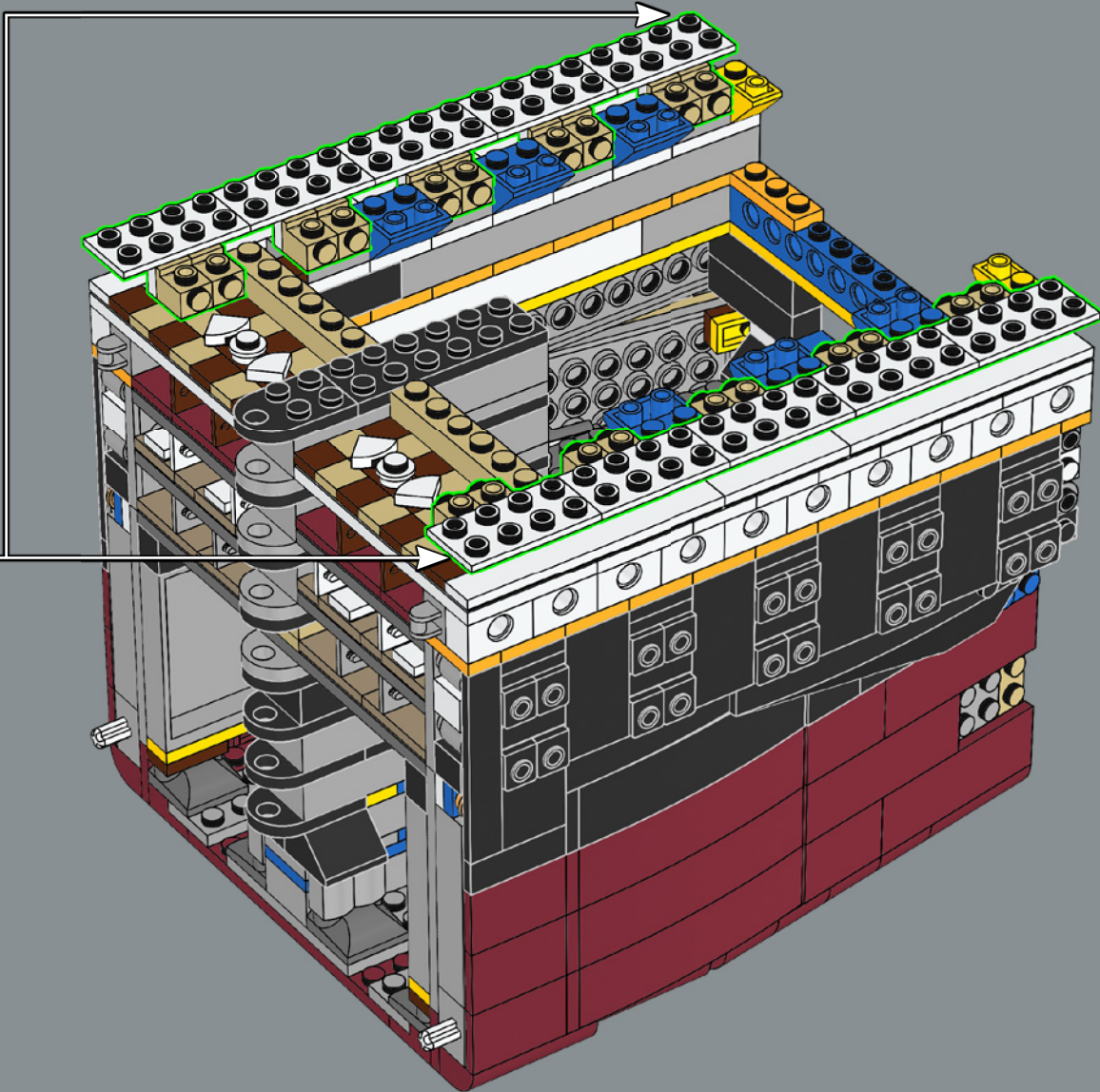
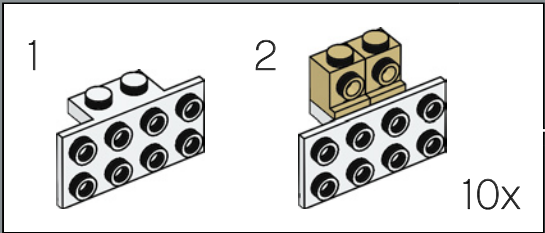

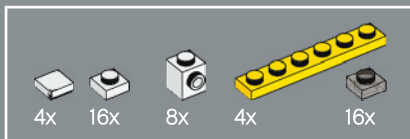

99

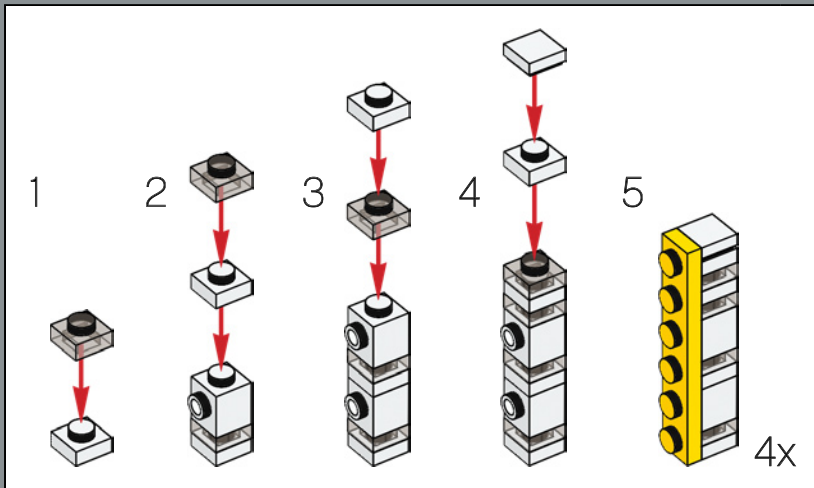
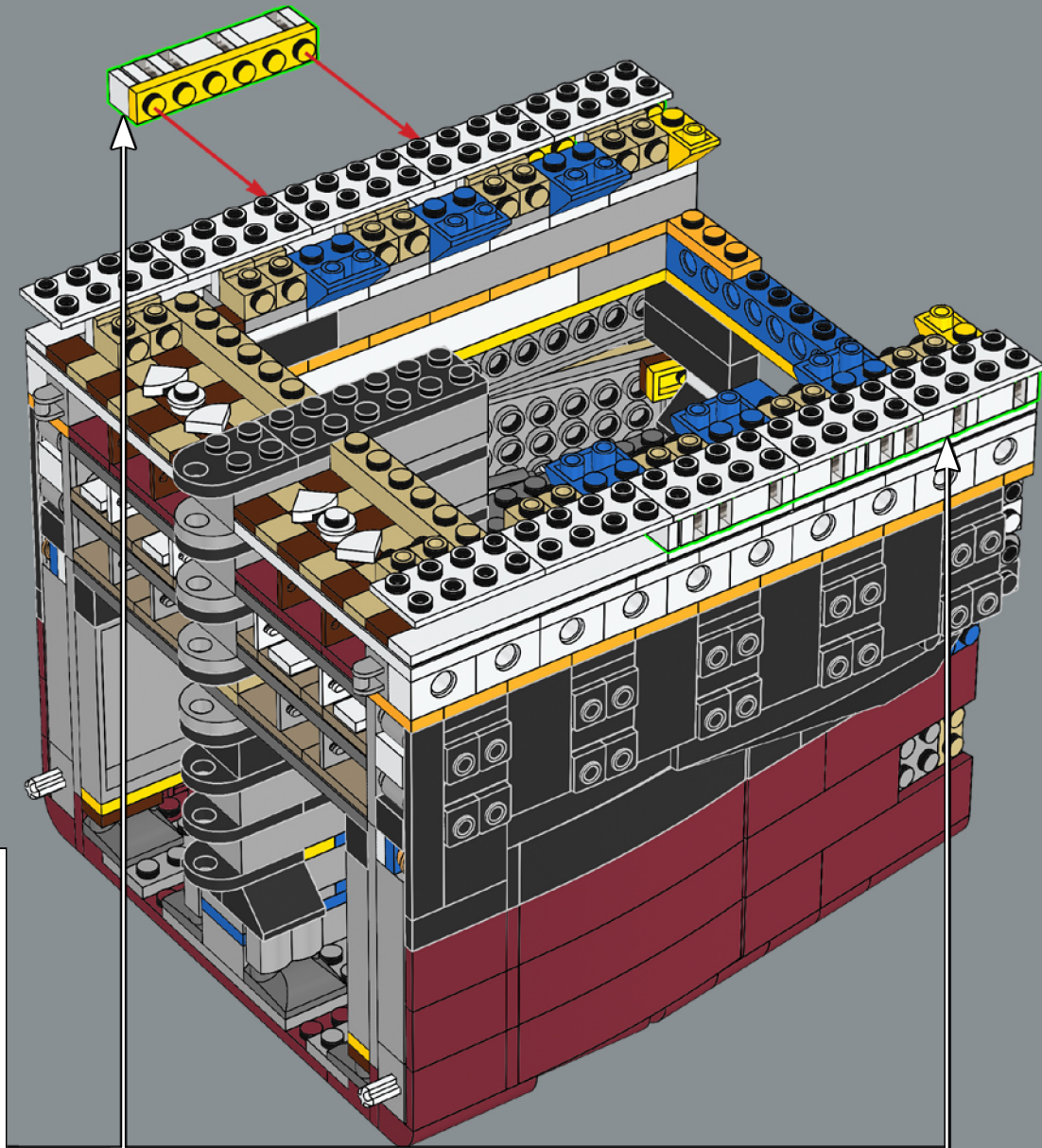

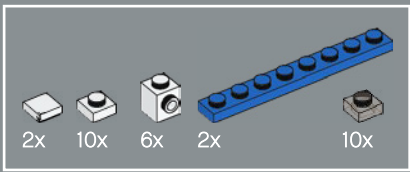

100

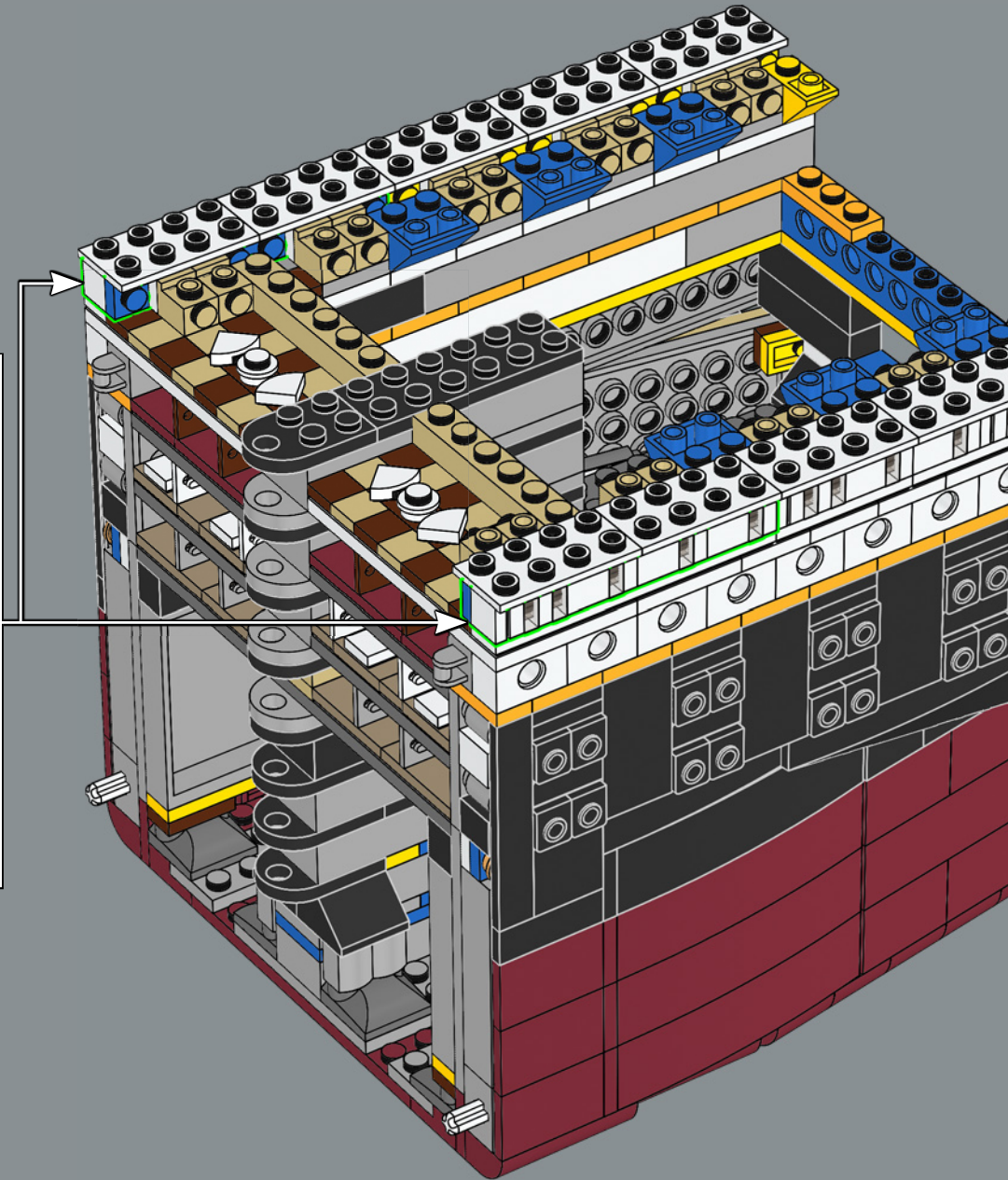
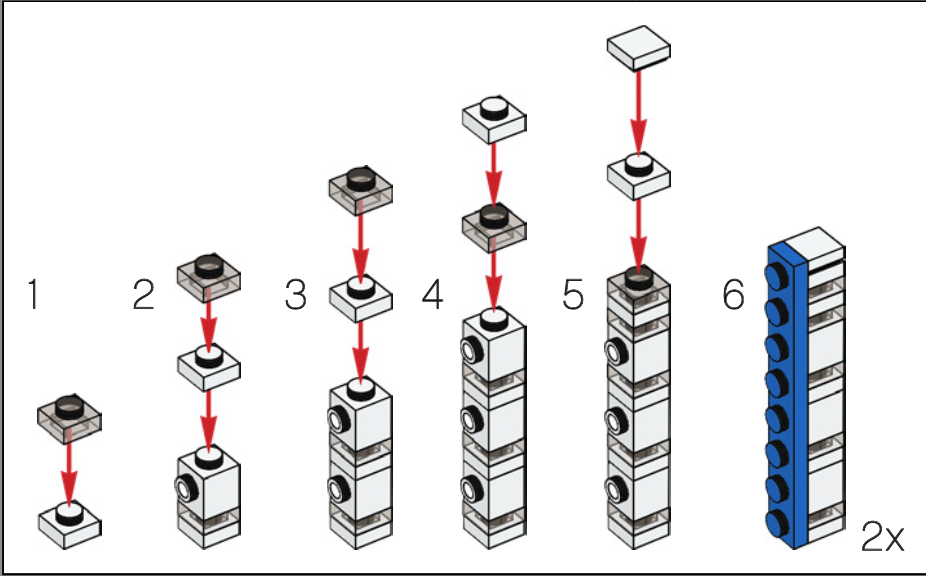

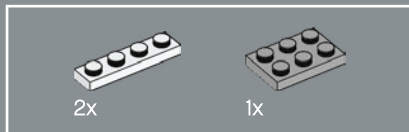
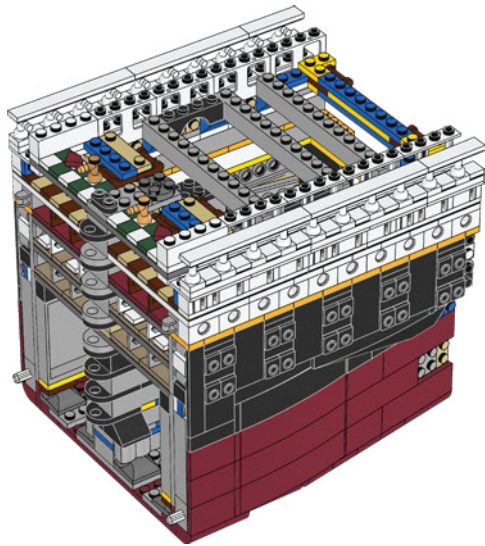
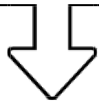

101

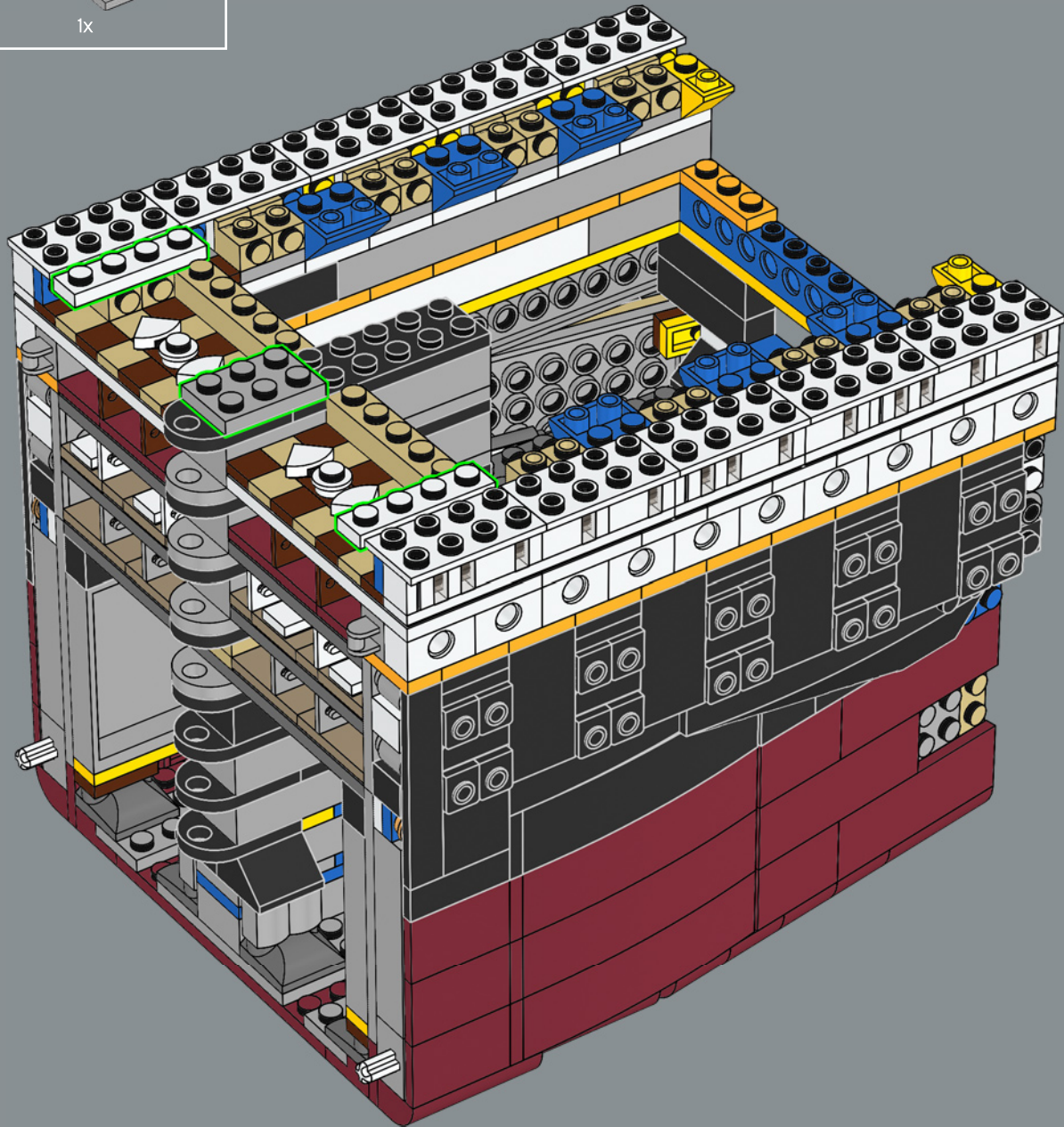

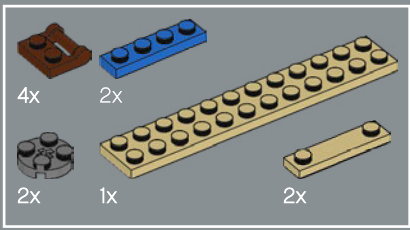

102

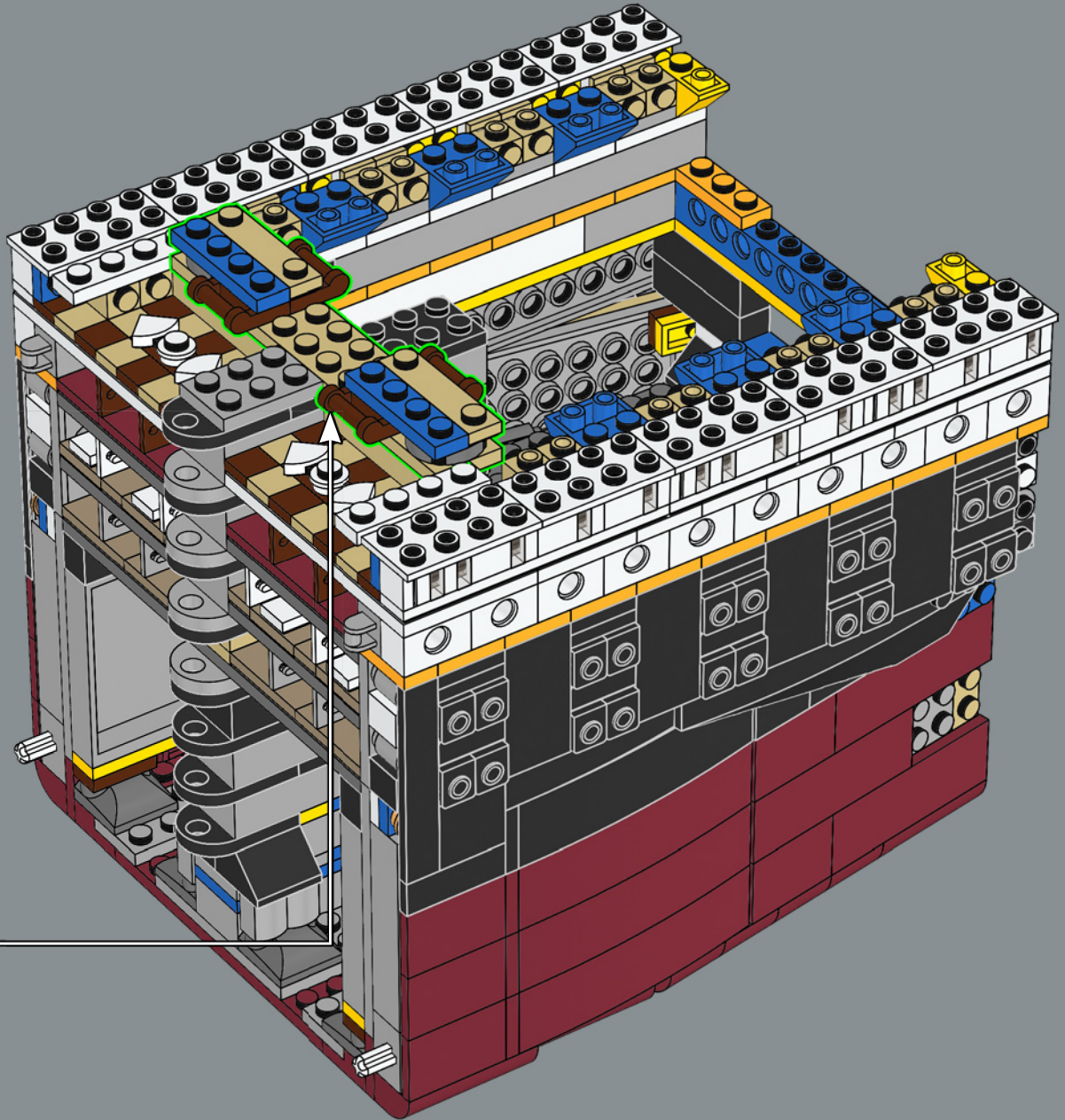
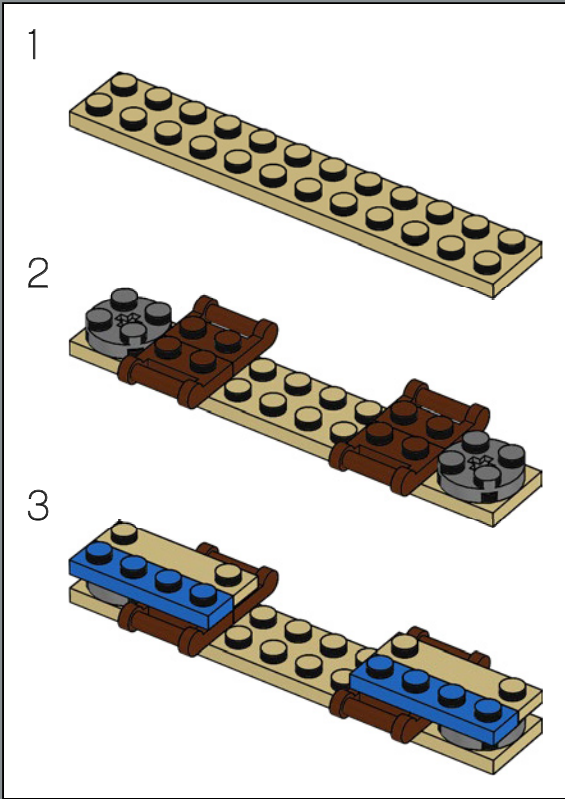

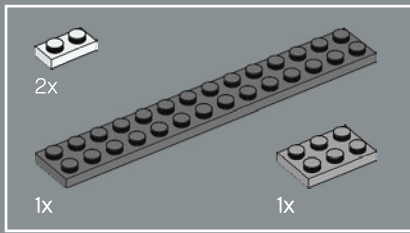

103

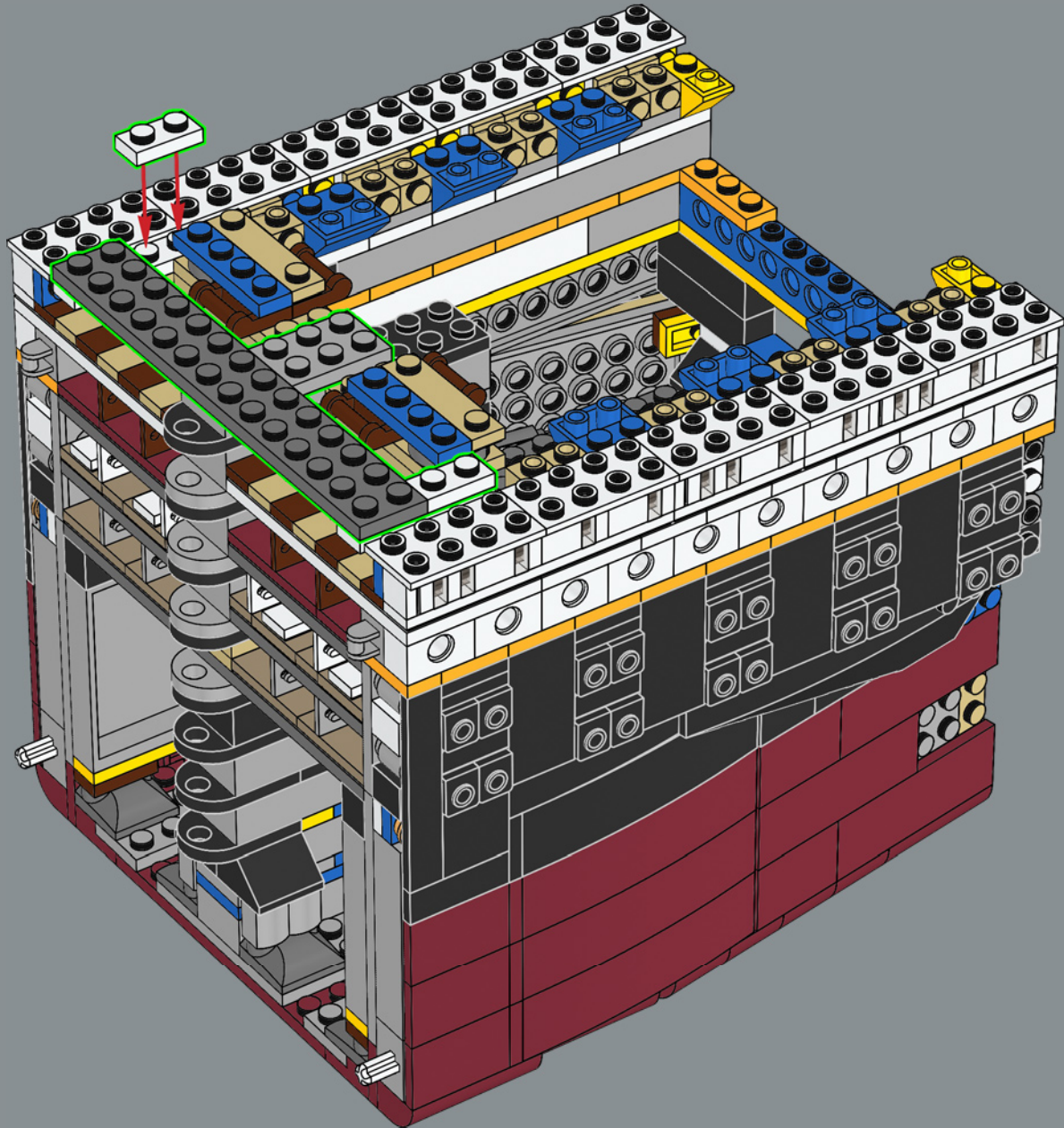

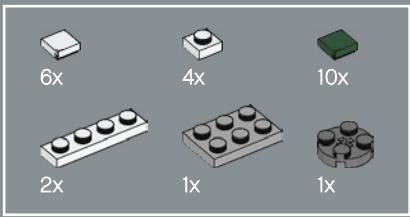

104

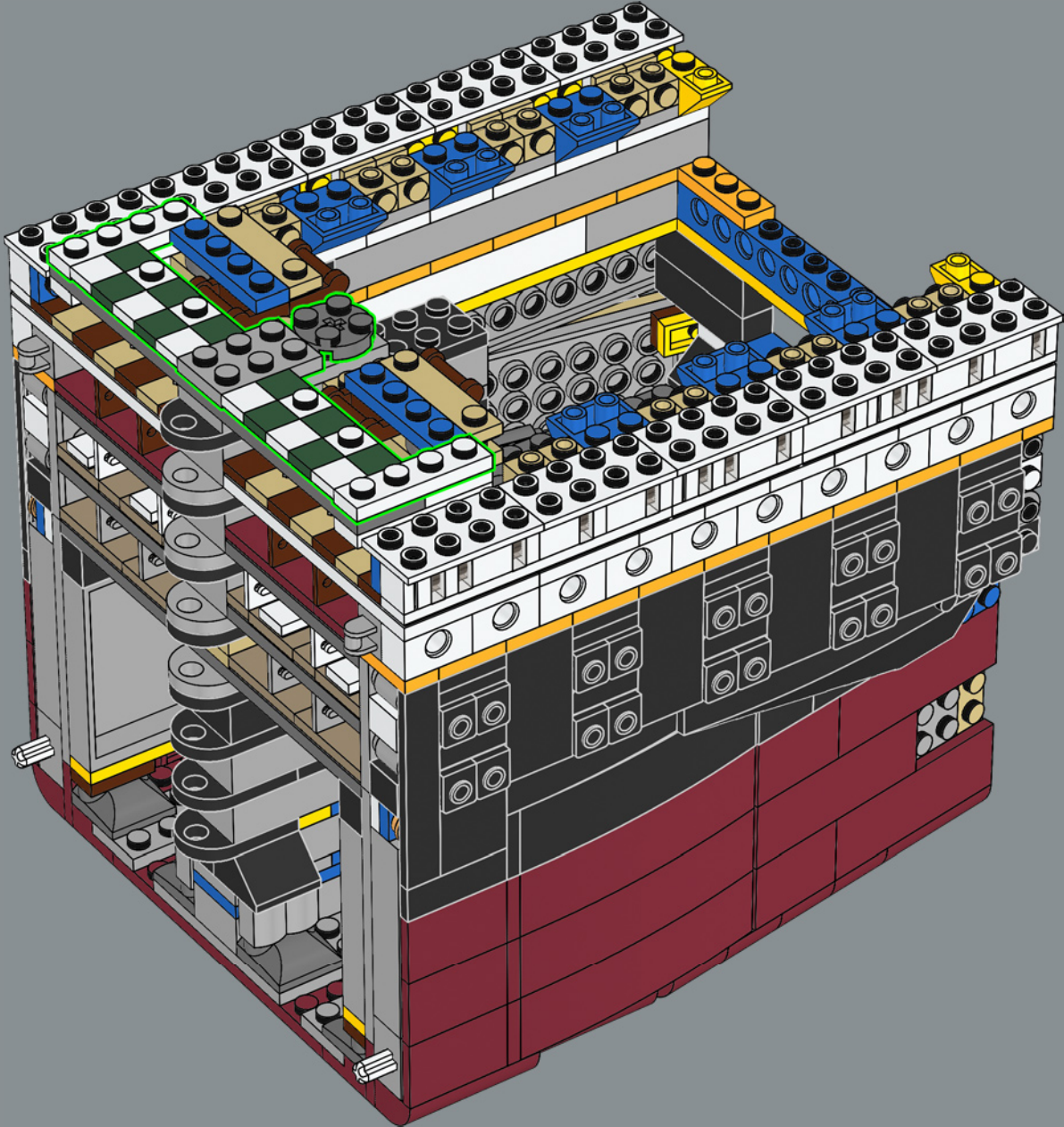



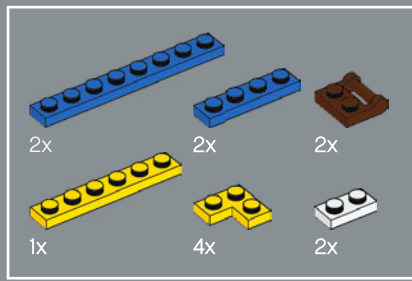

105

1

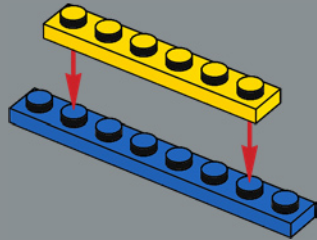

2

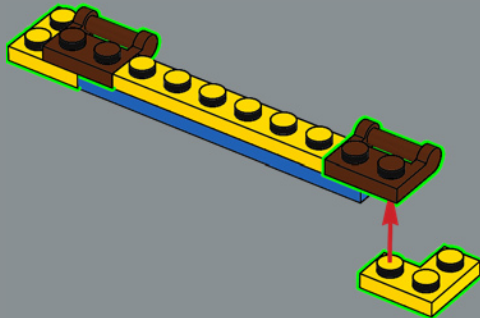

3

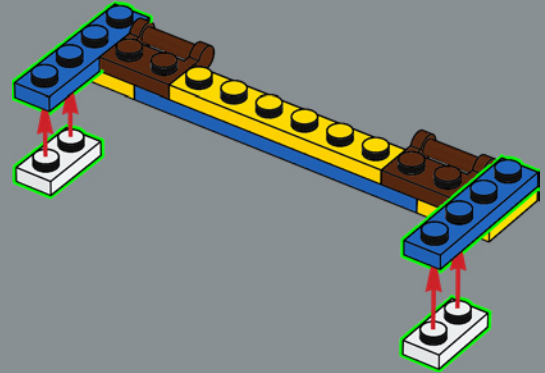

4

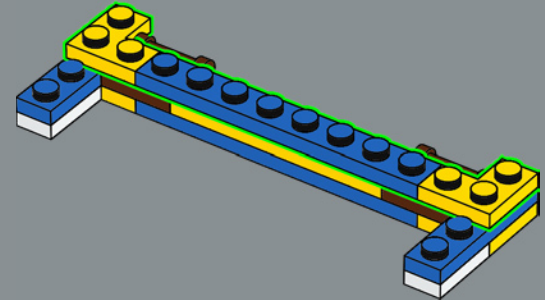

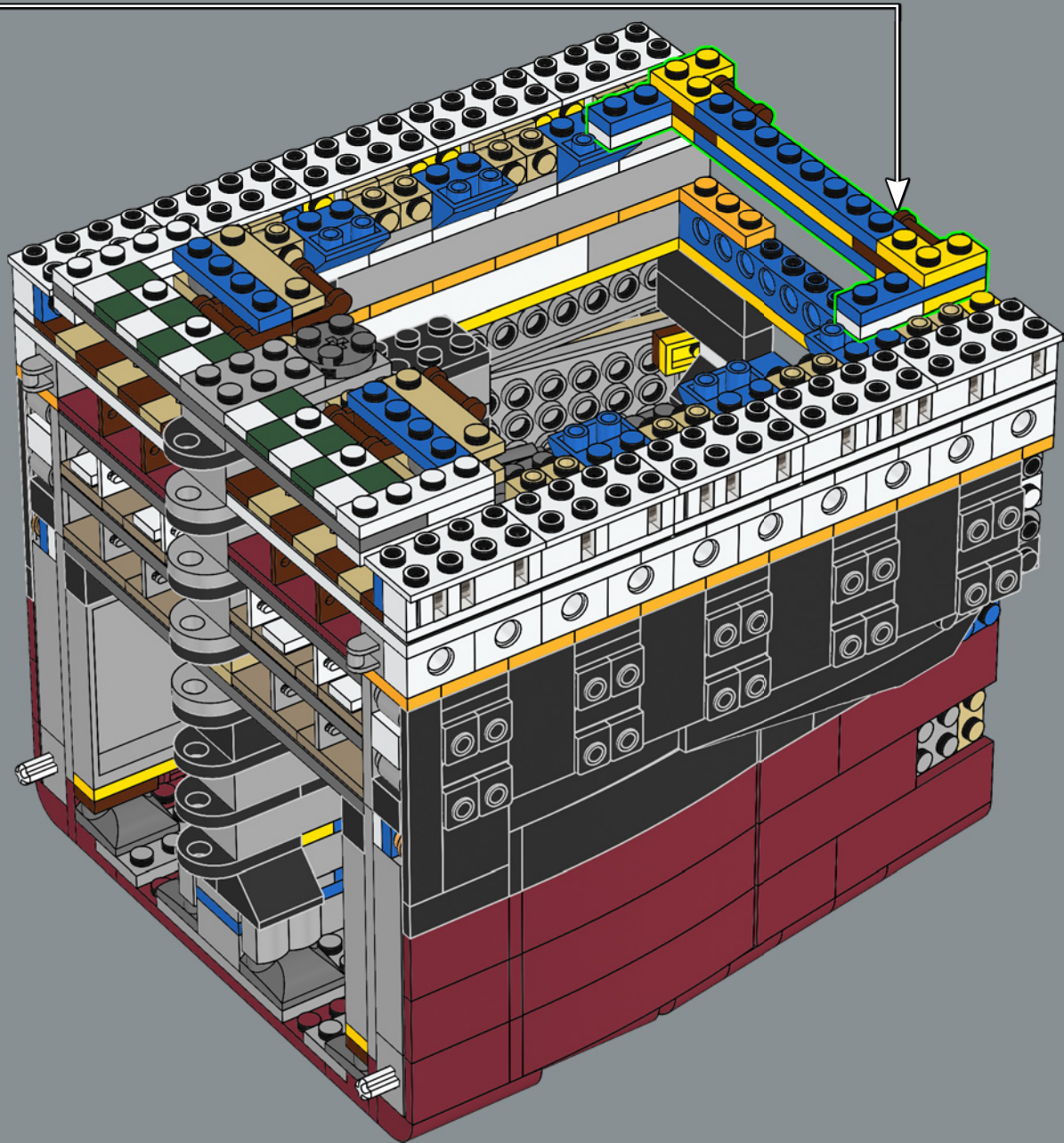

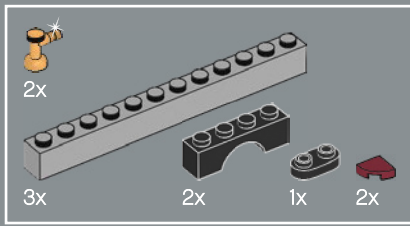

106

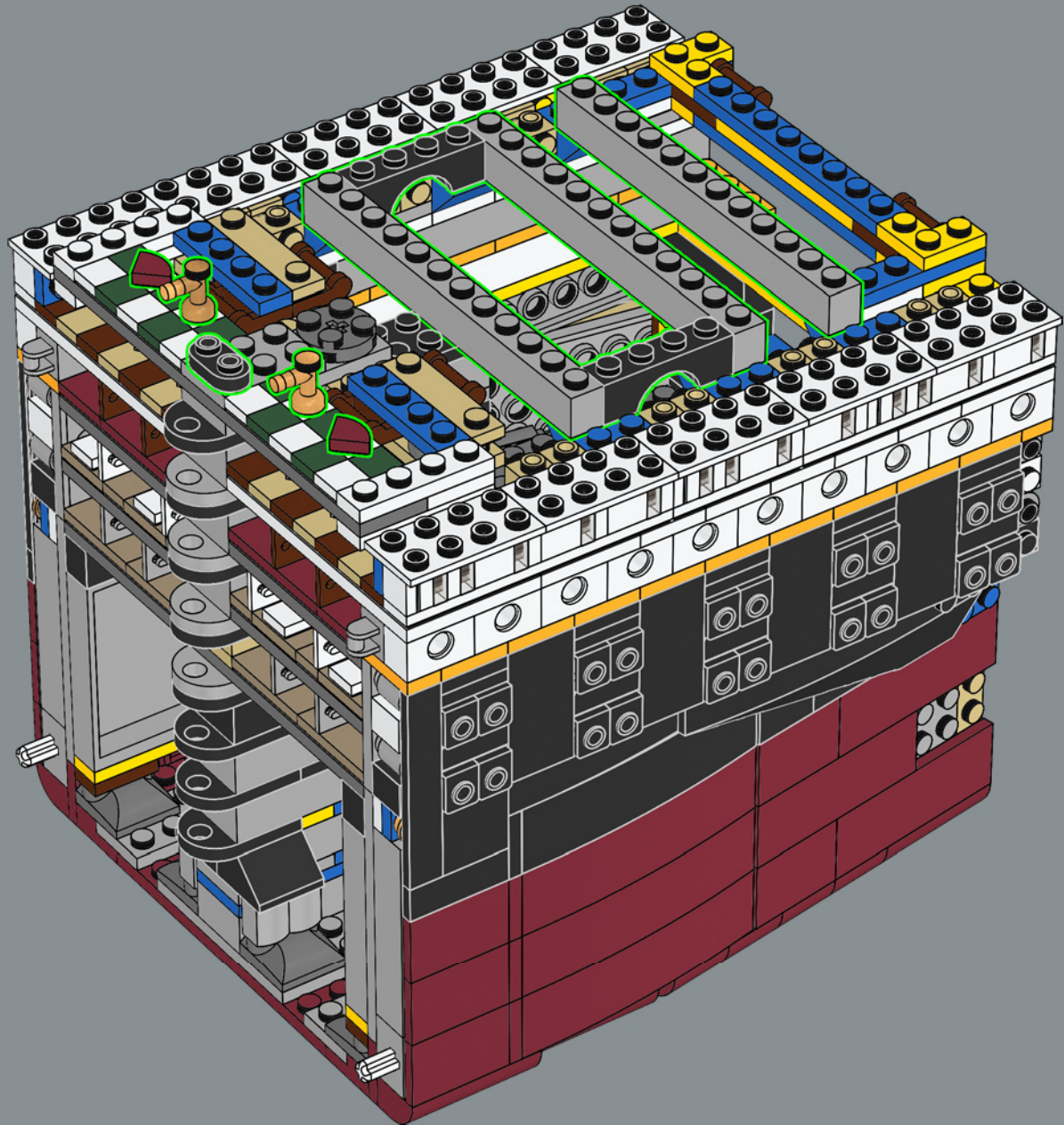

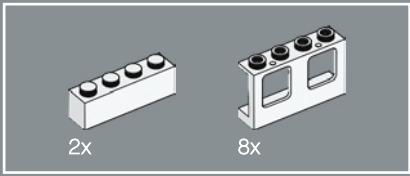

107

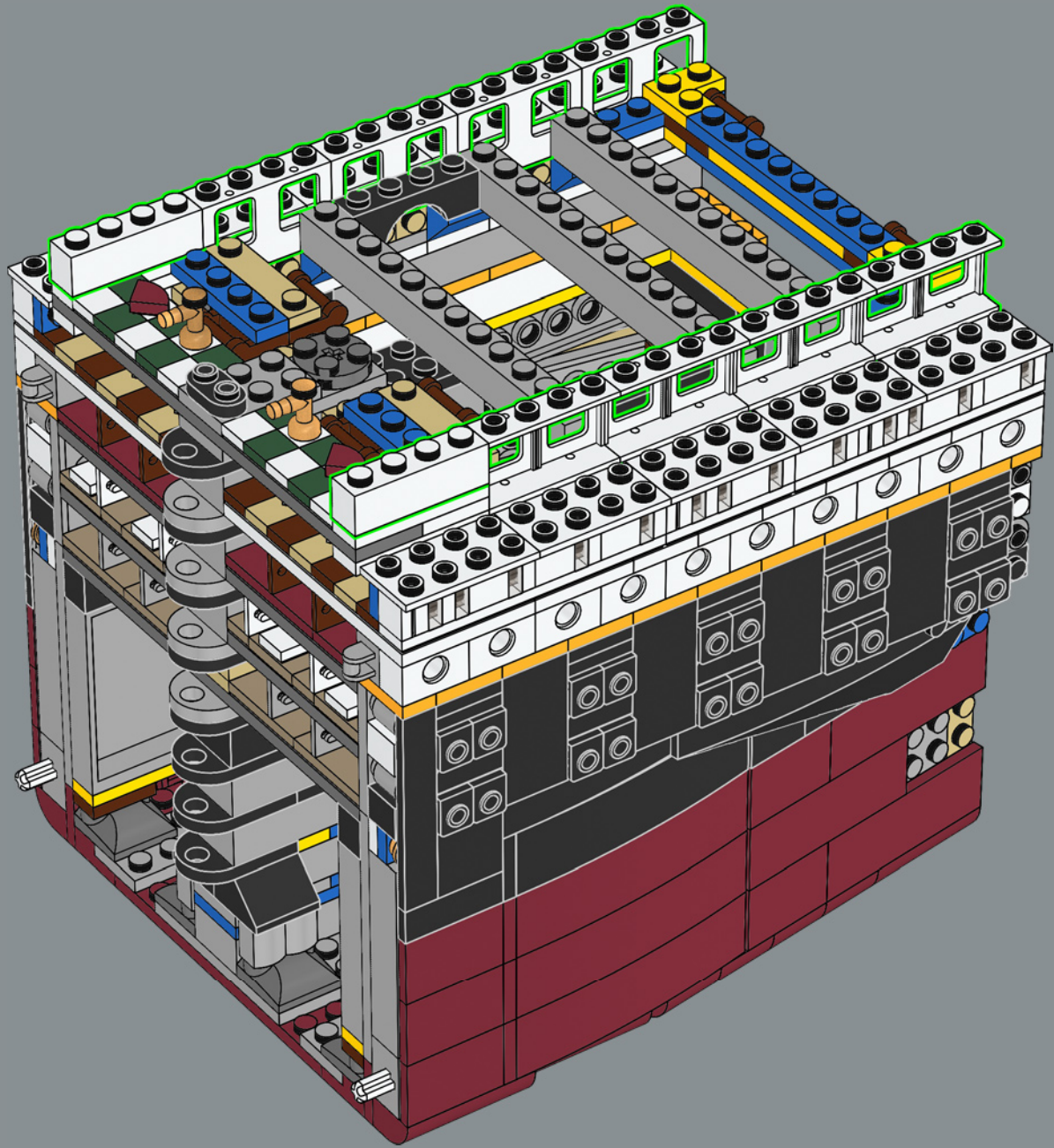

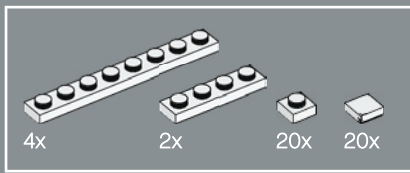

108

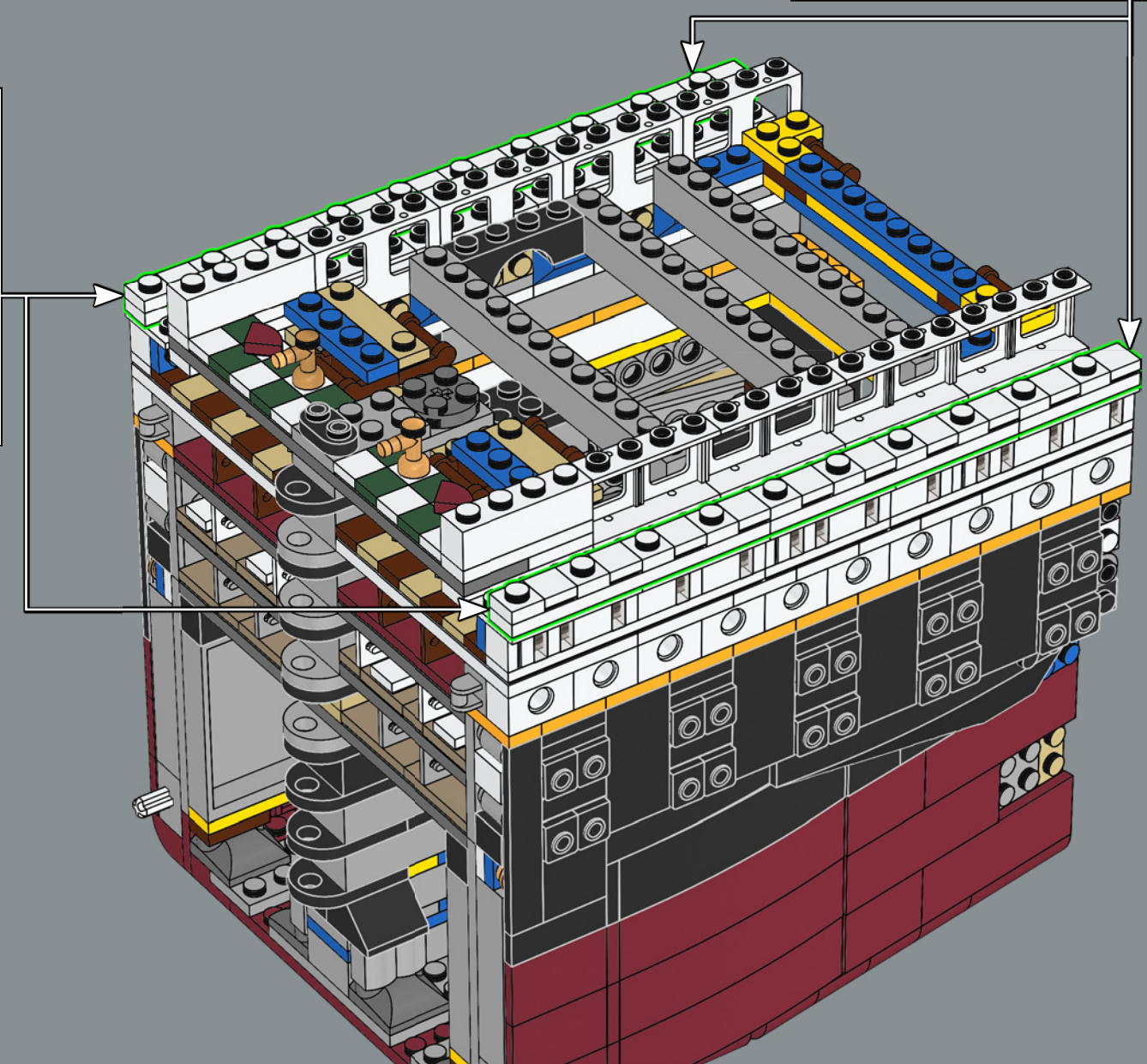
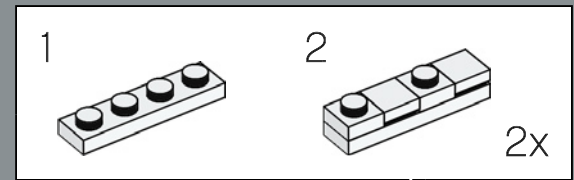
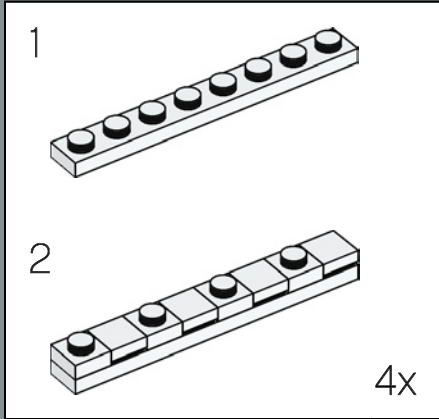



20x

109

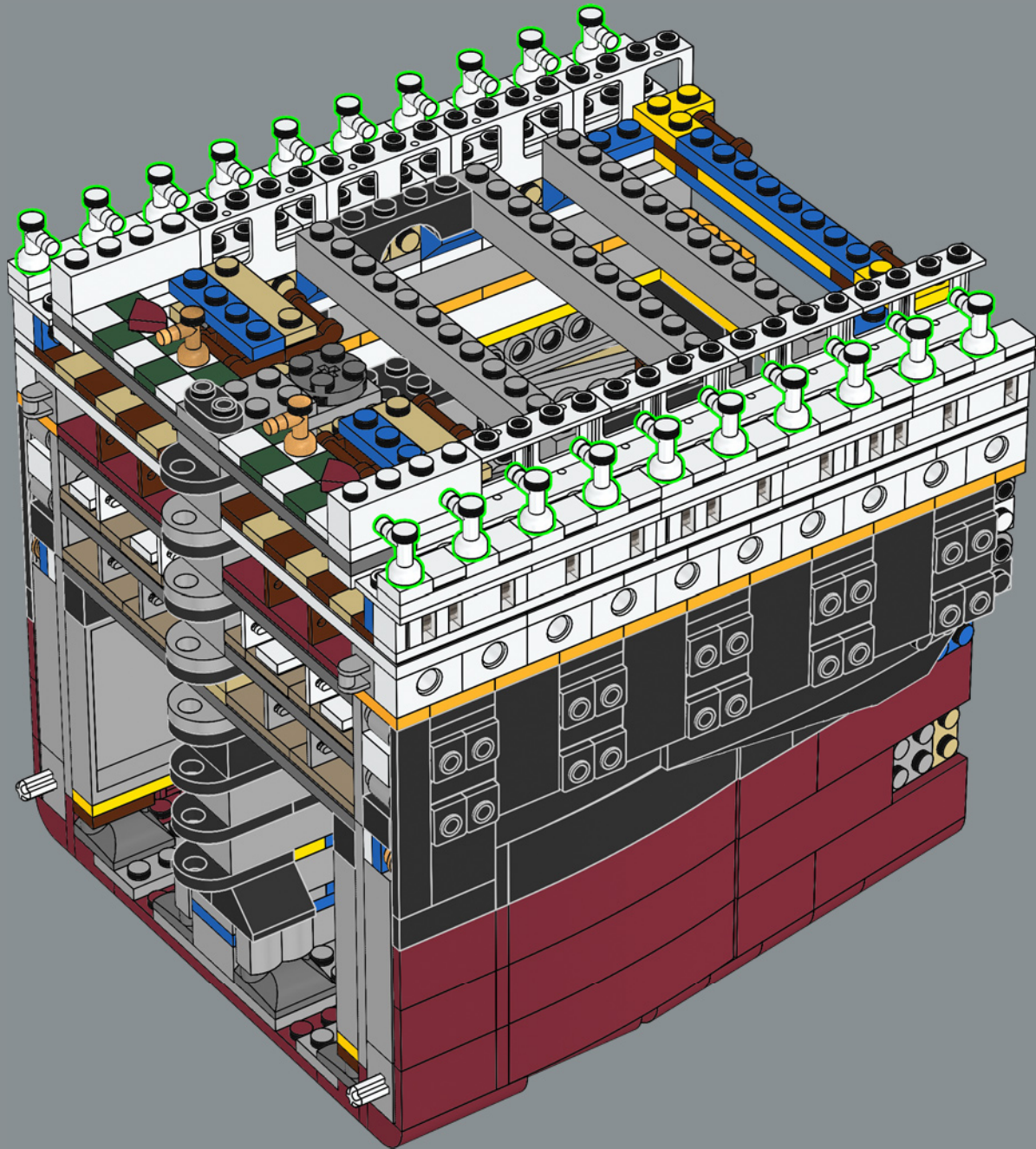

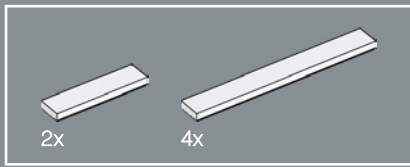

110

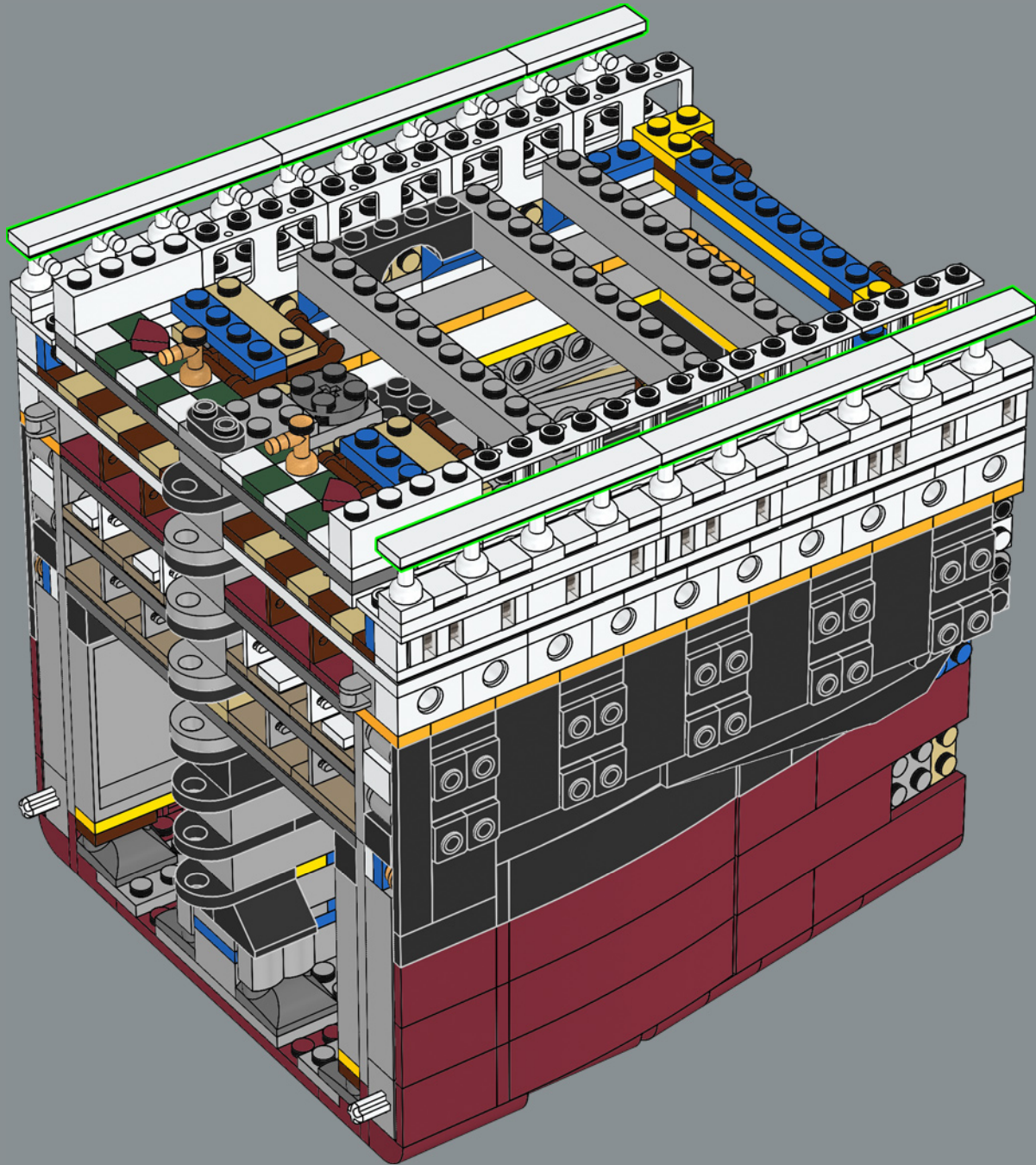

34

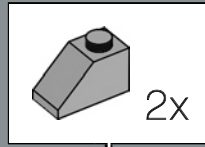
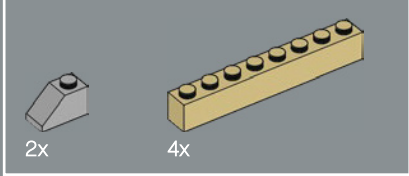

111

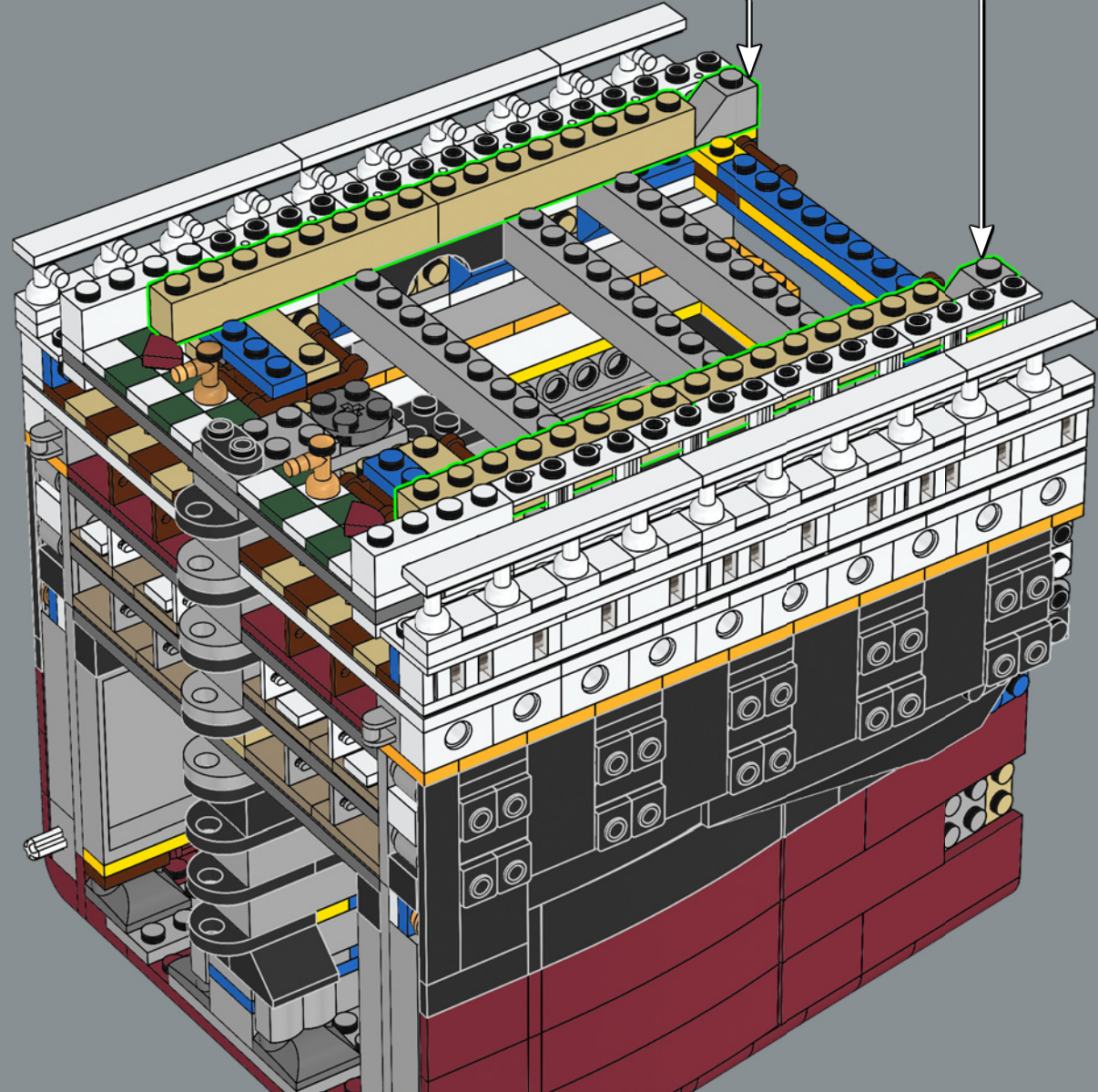



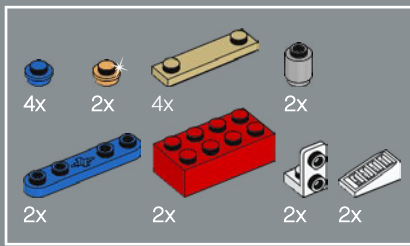

112

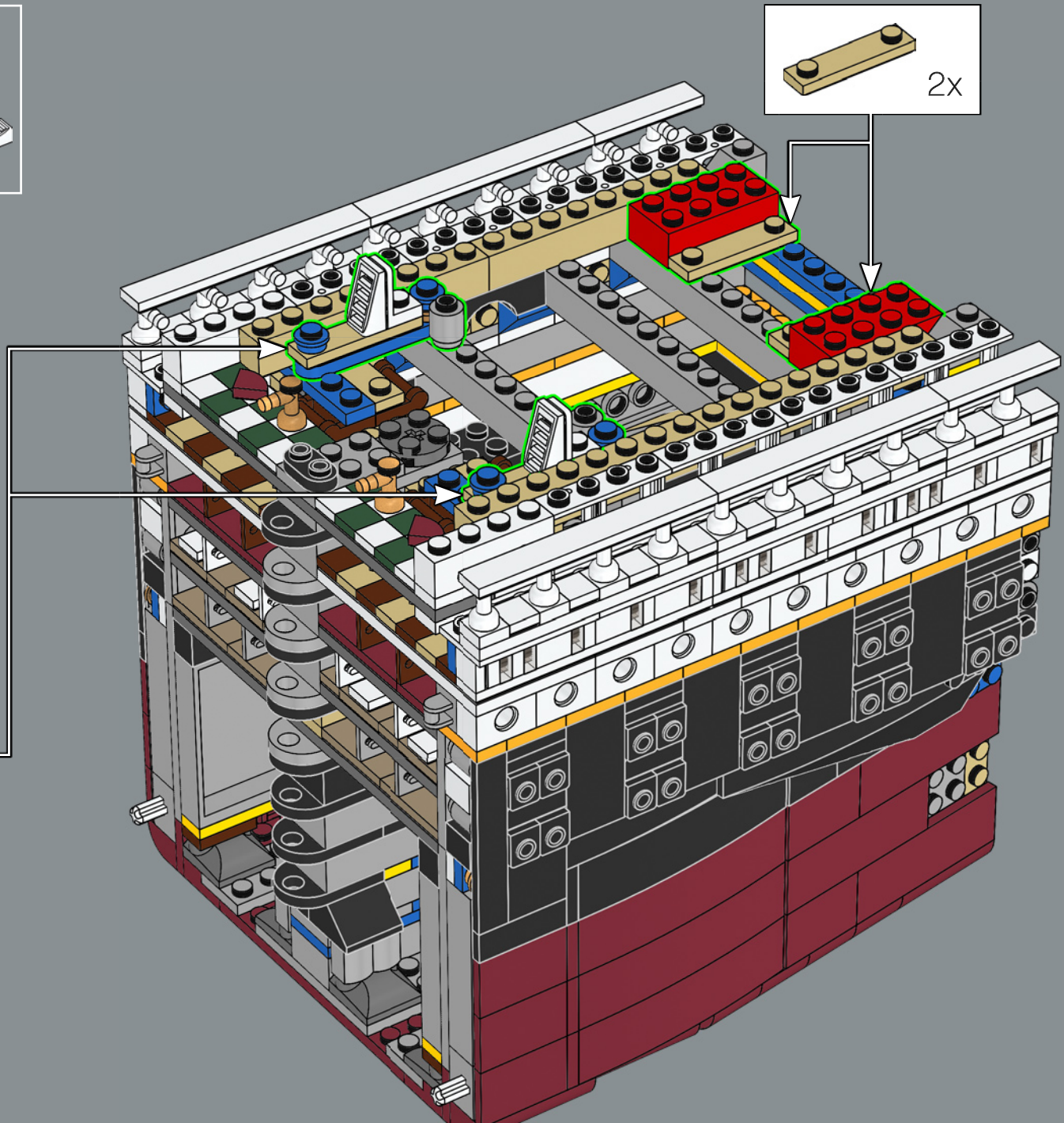
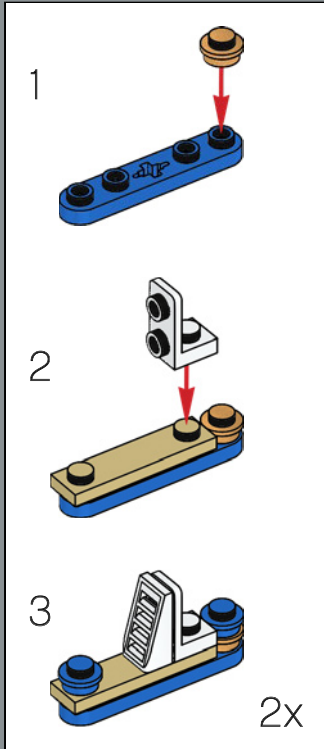

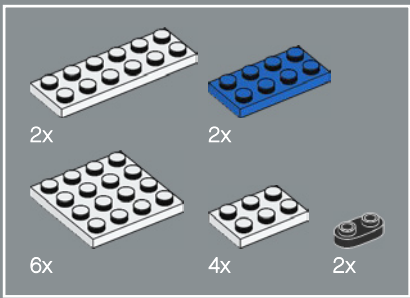

113

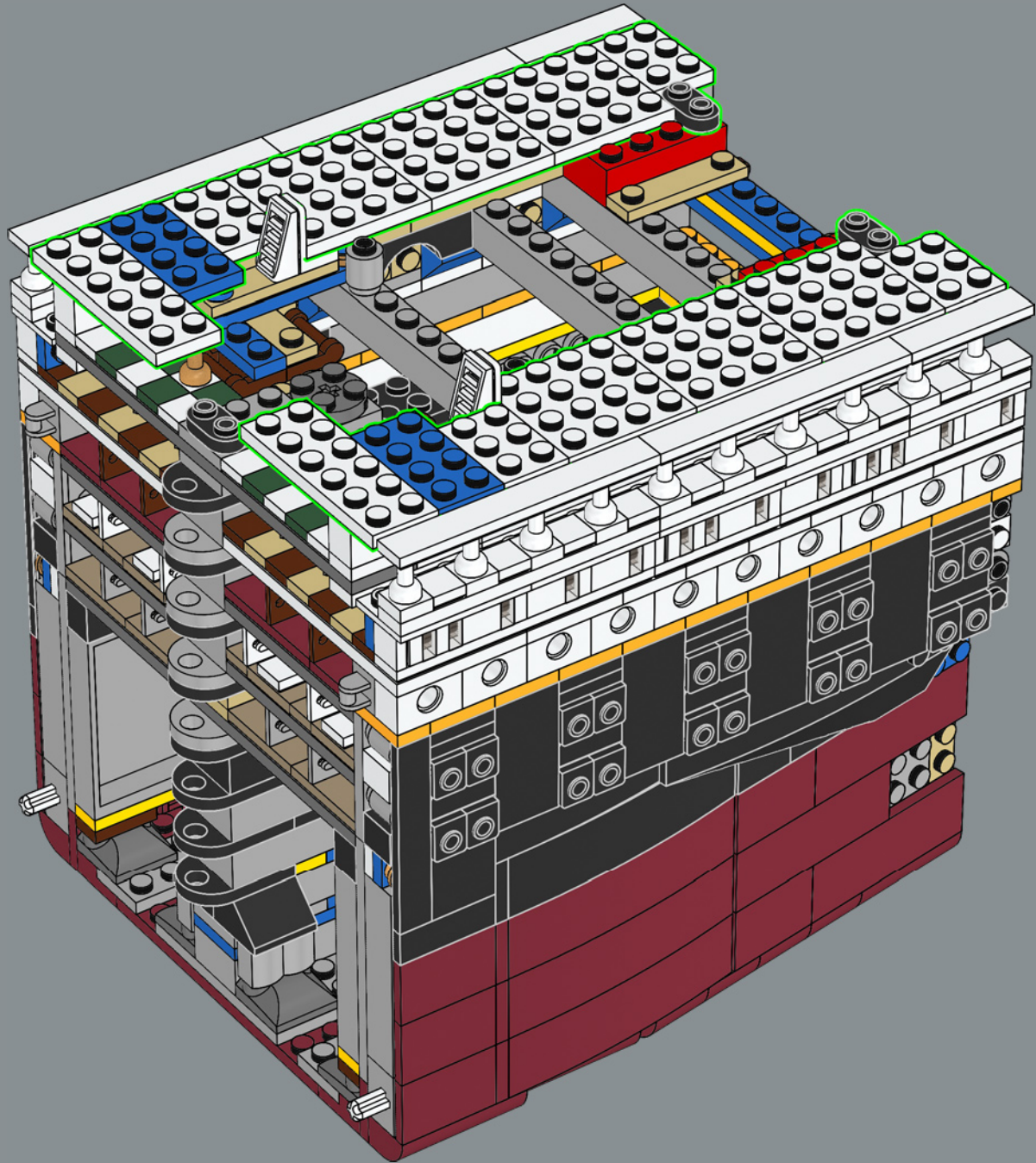

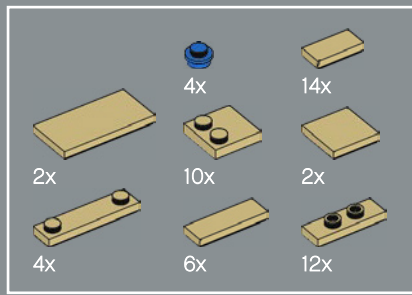

114

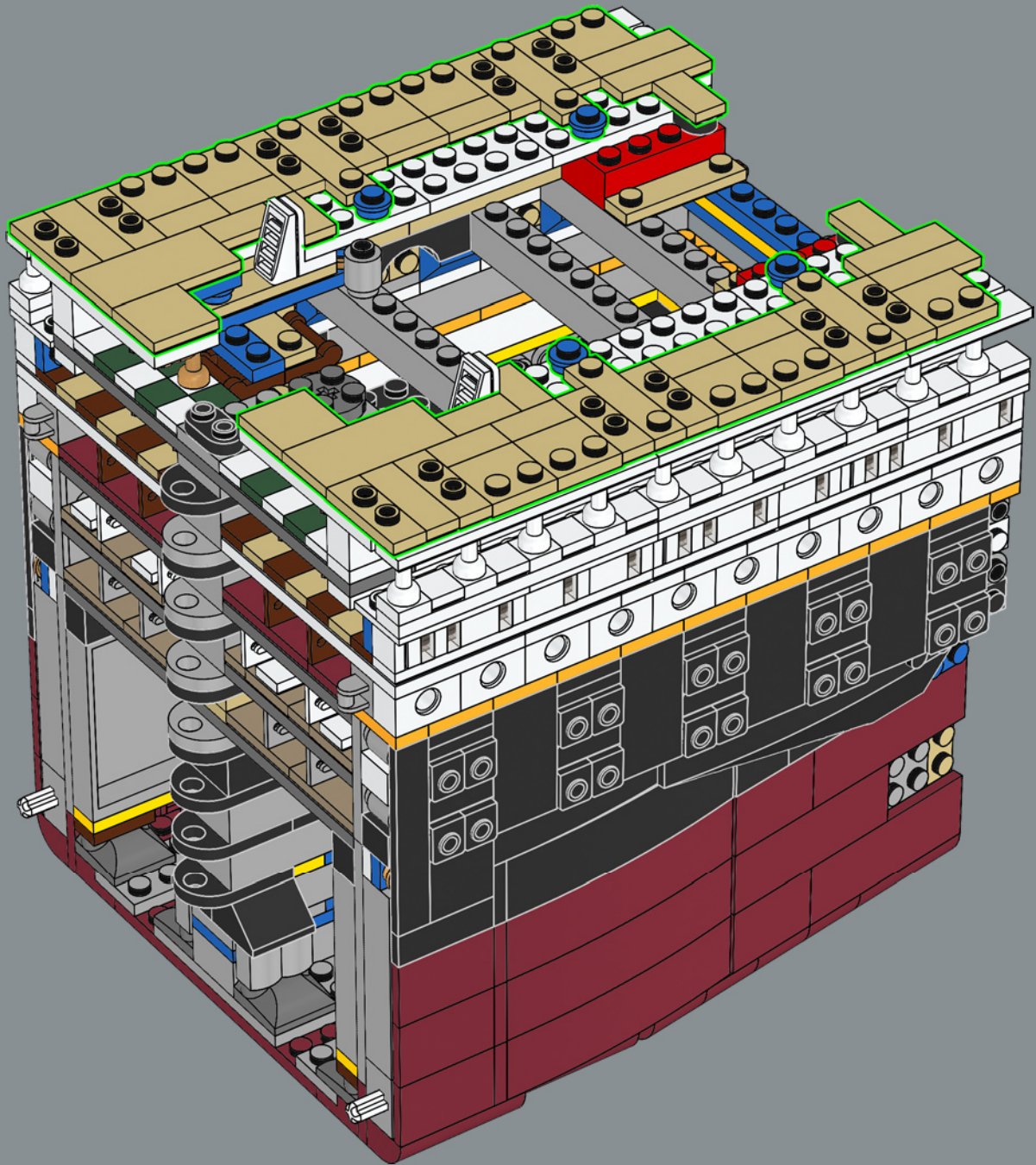

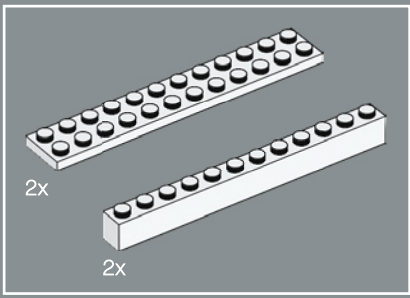

115

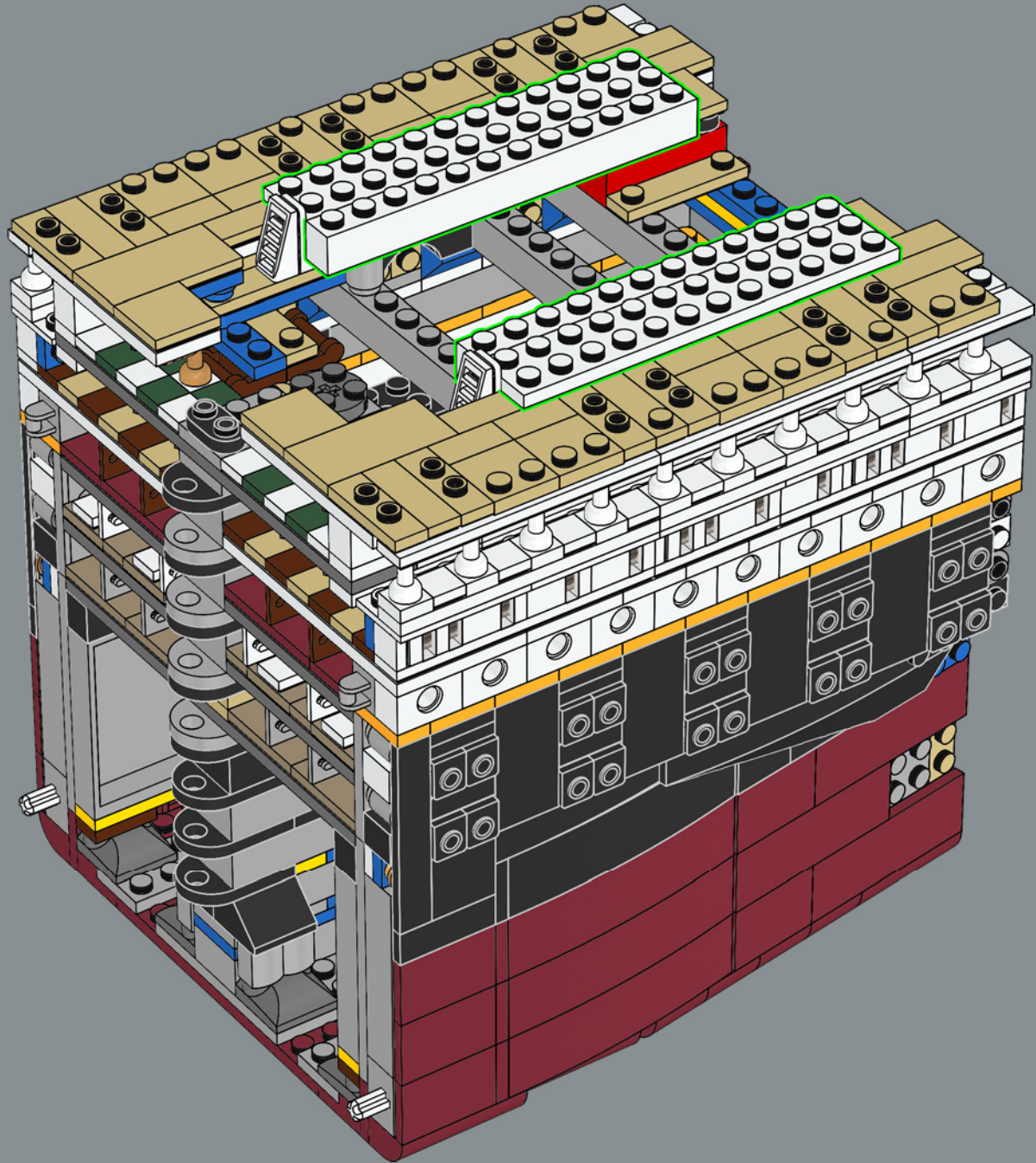

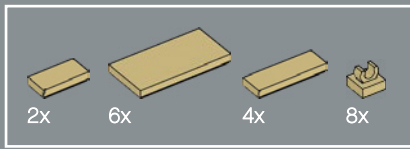

116

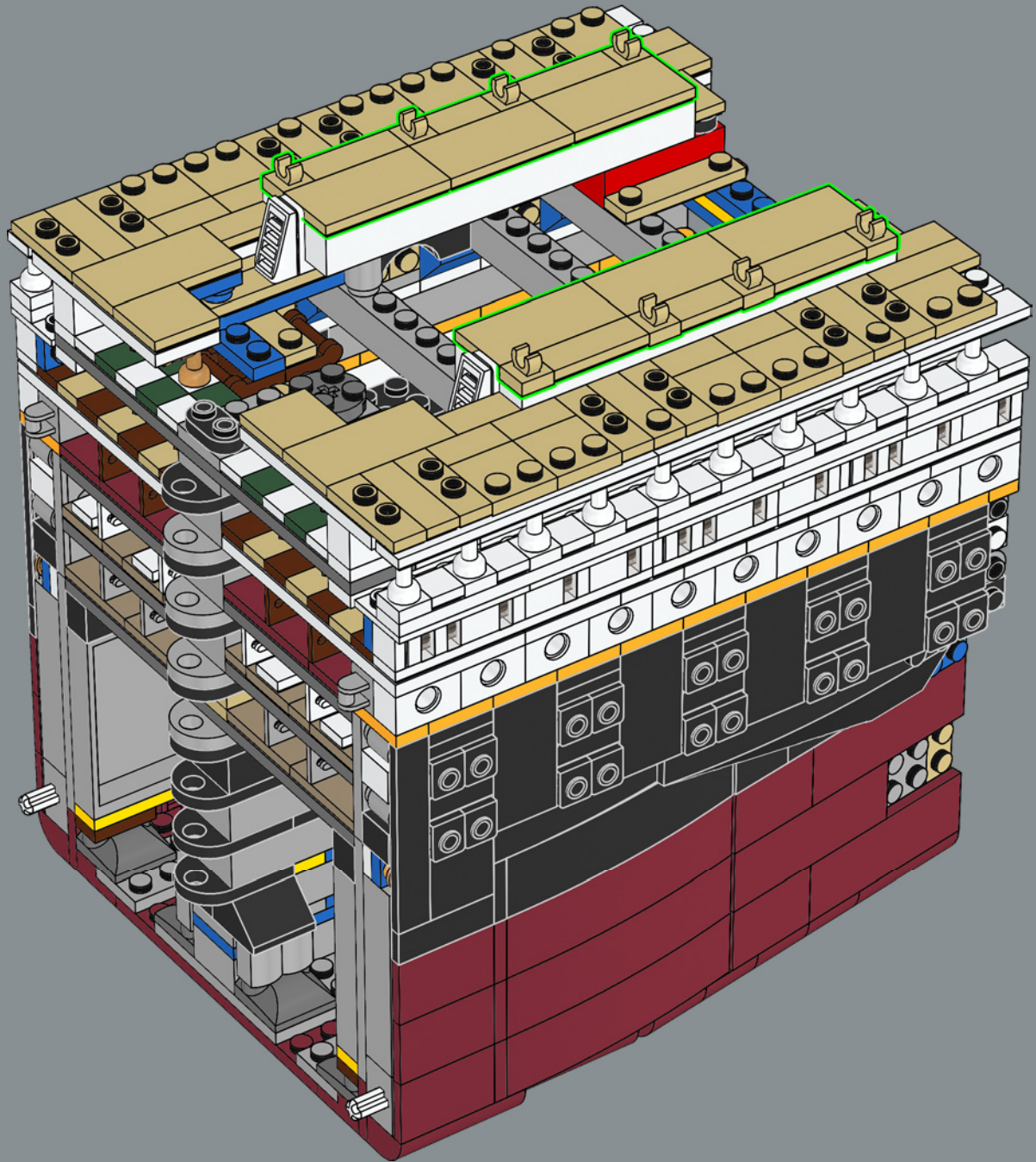

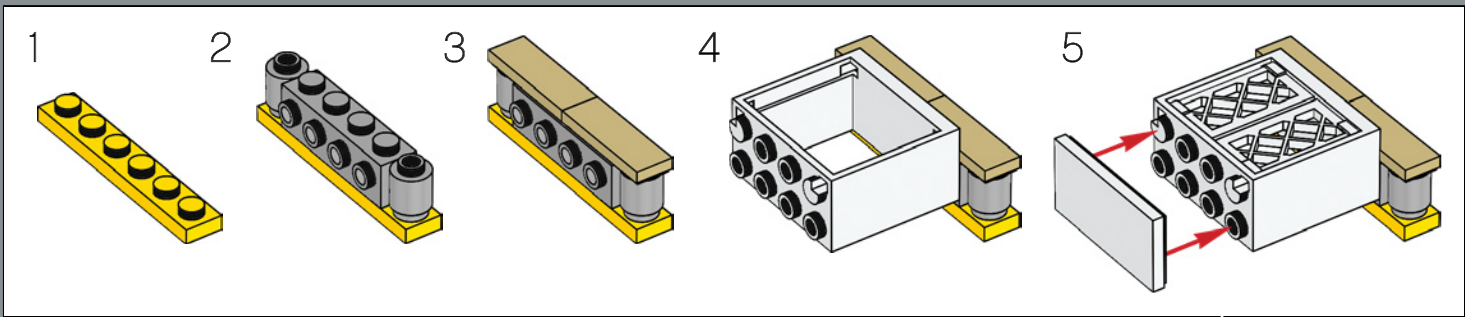
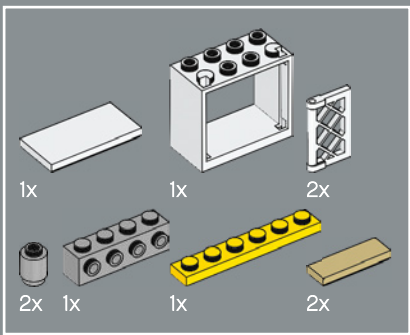

117

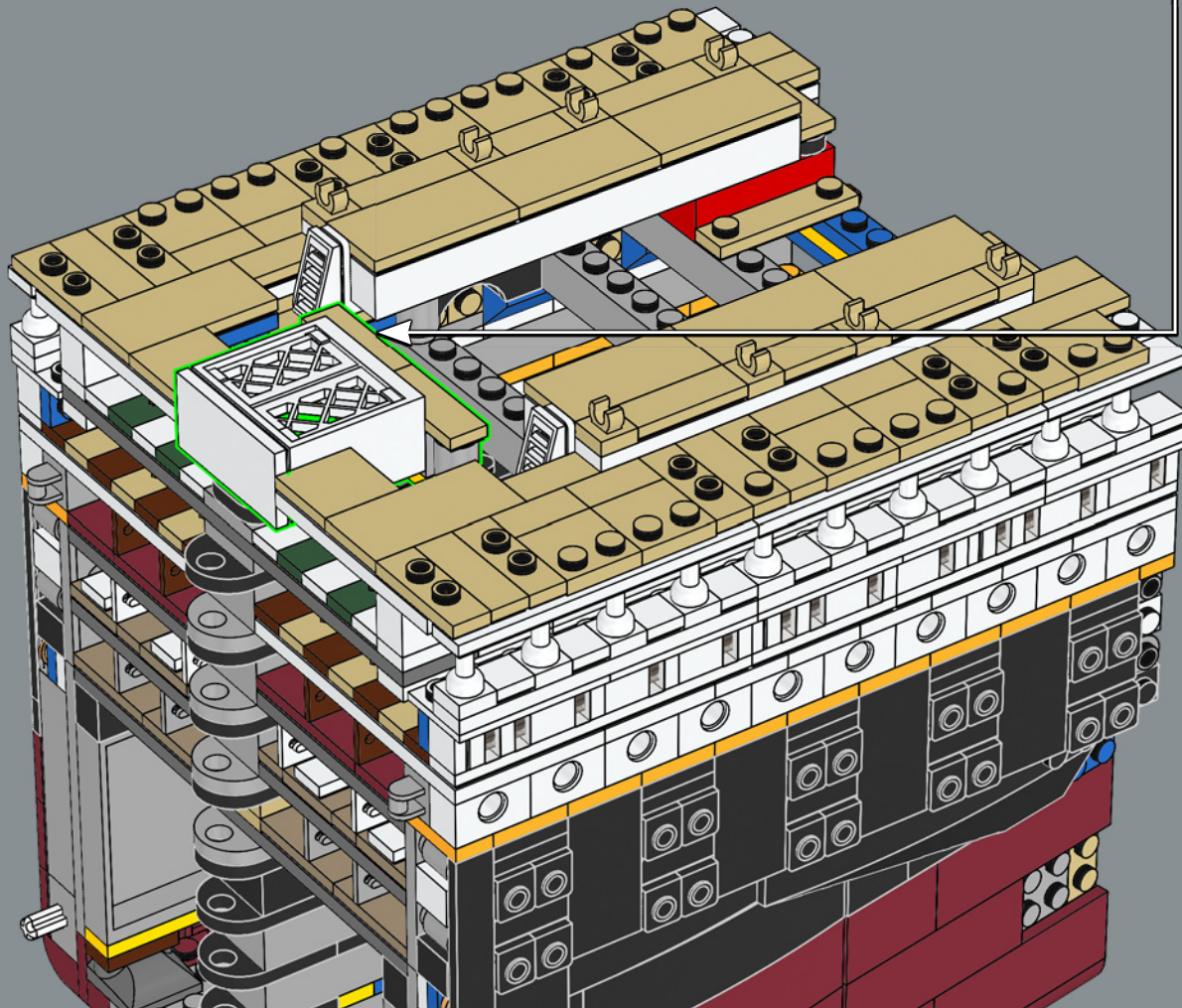

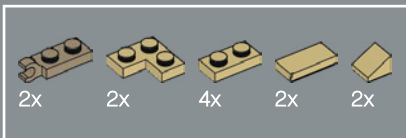

118

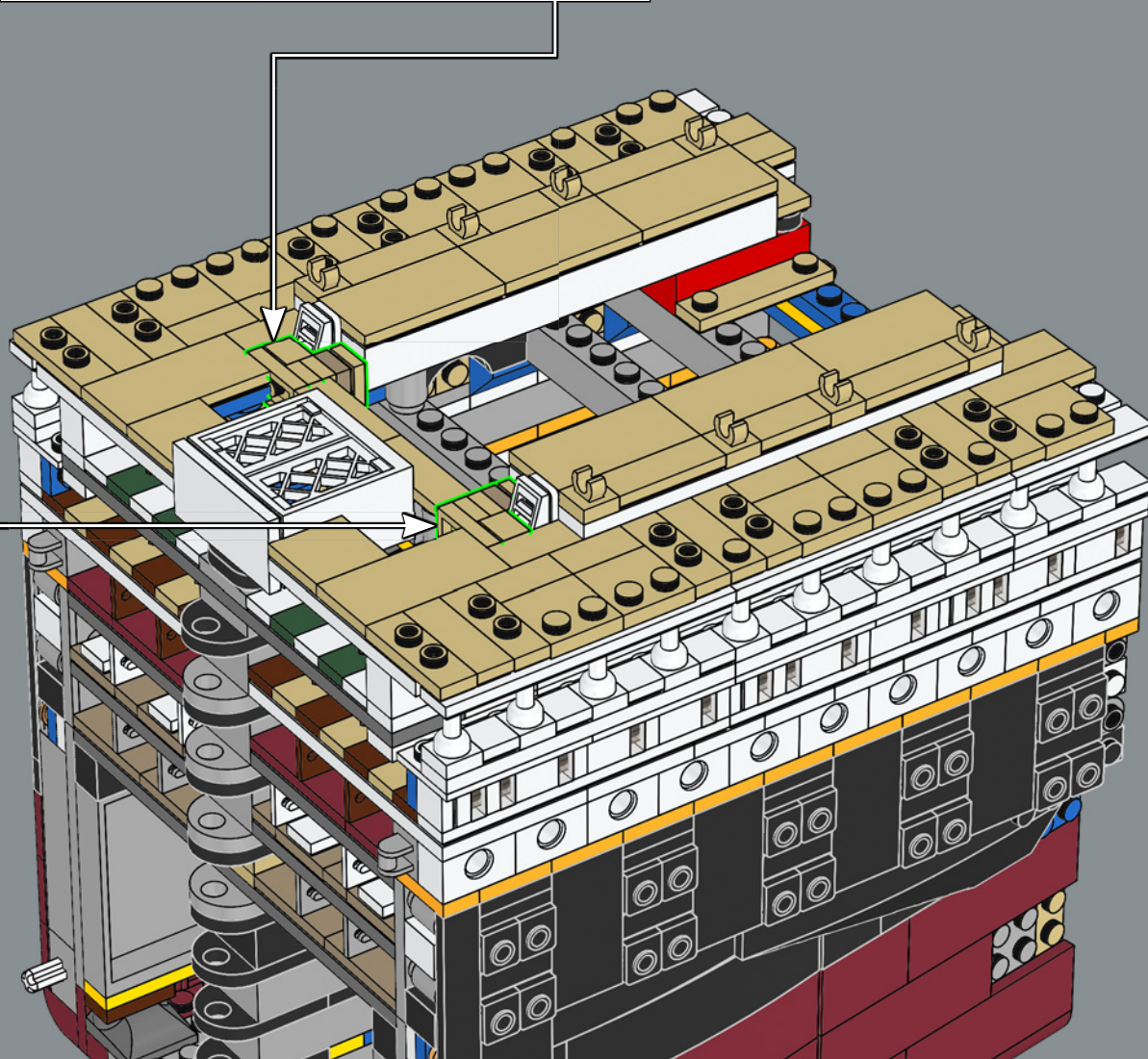
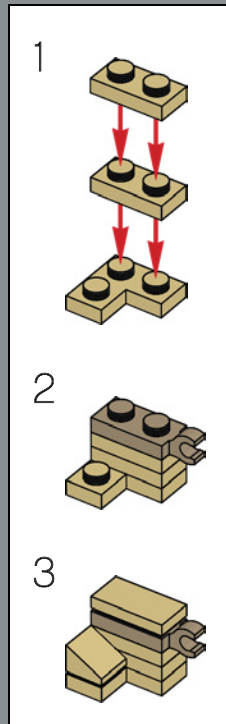
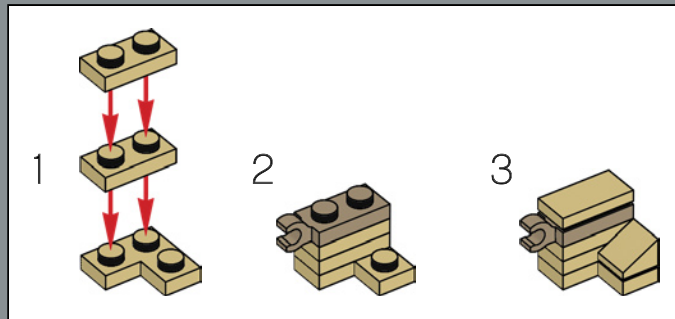

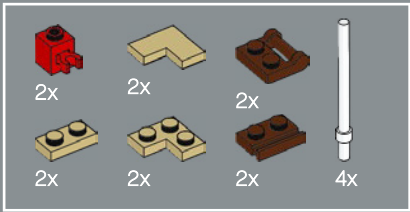

119

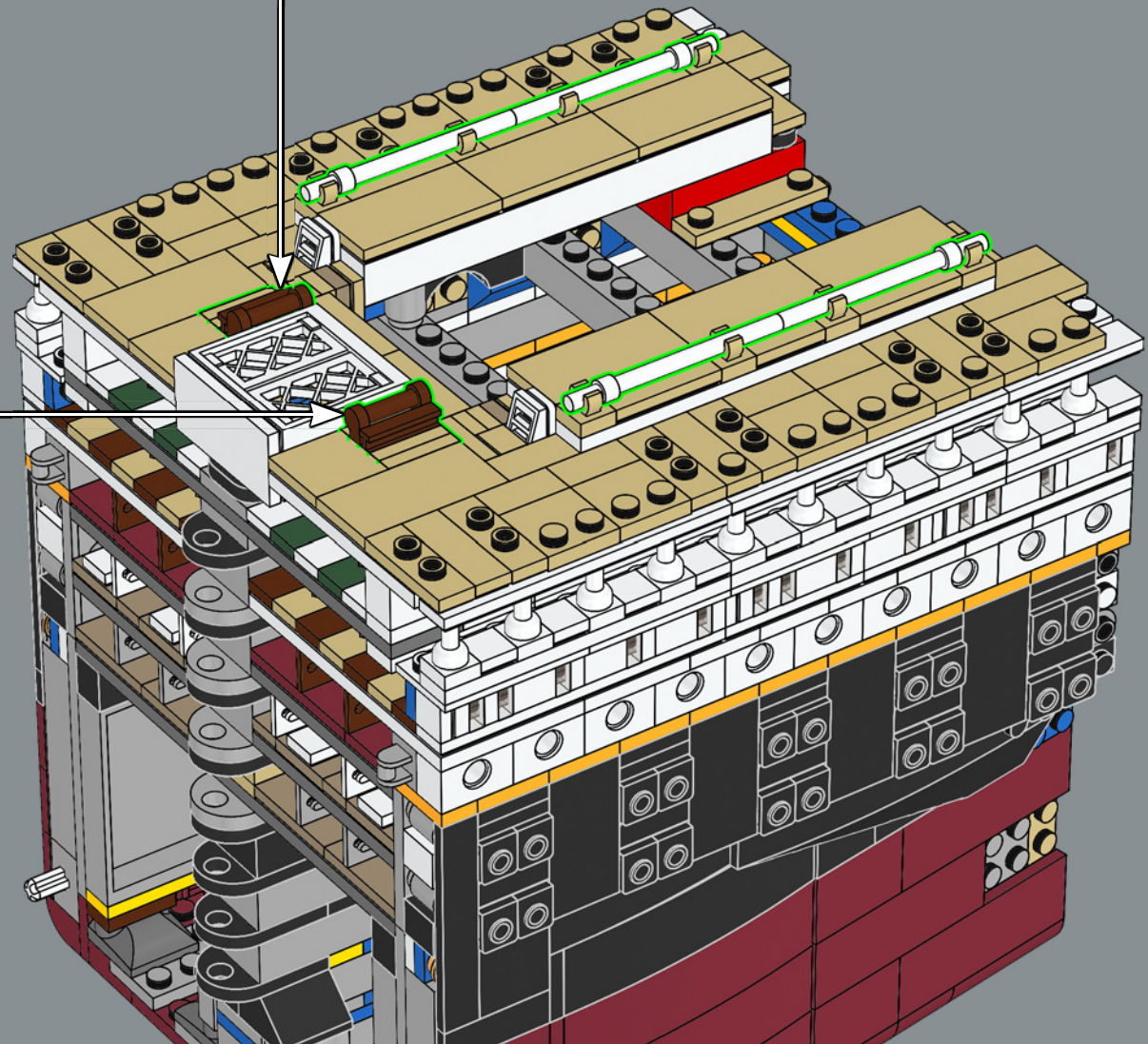
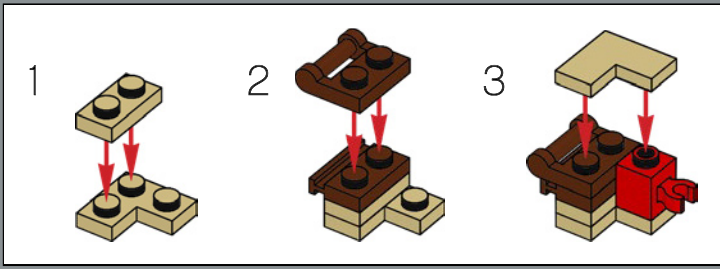
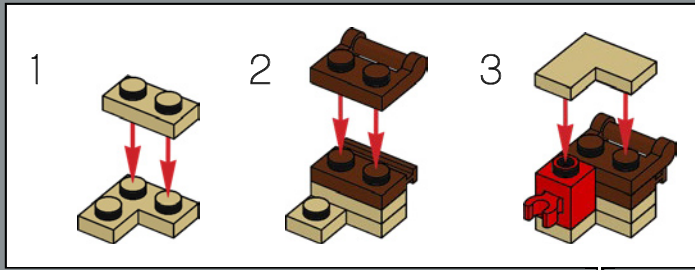



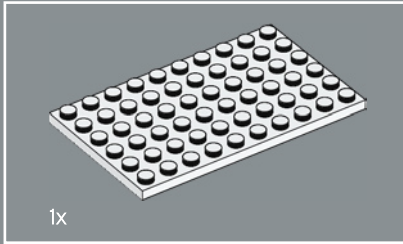
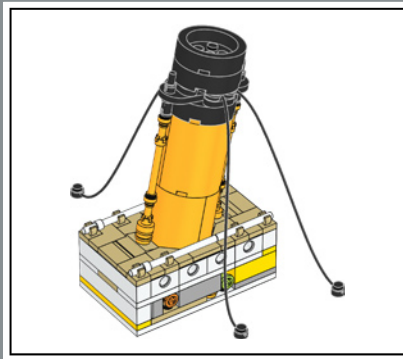
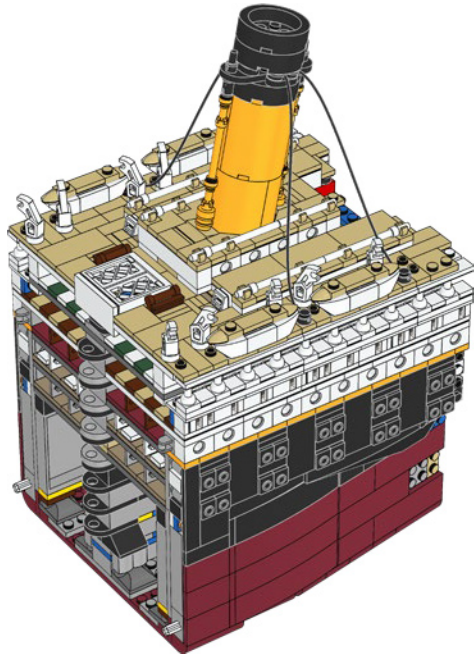

120

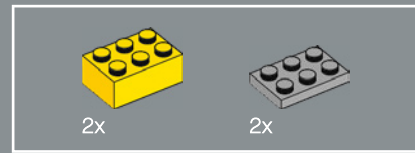
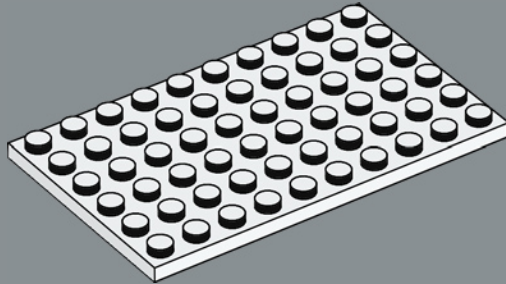

121

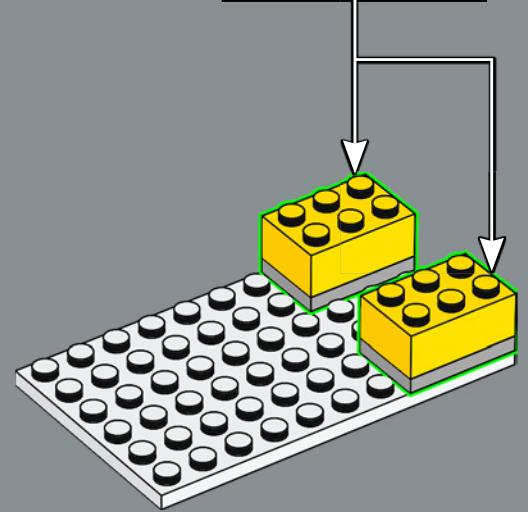
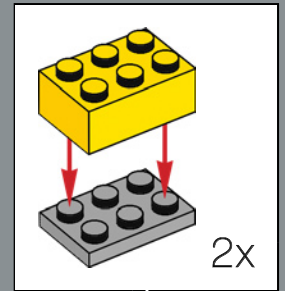

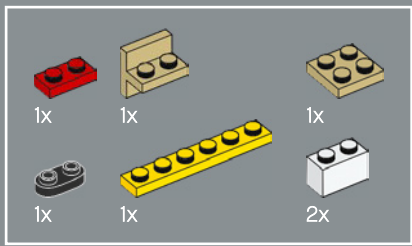

122

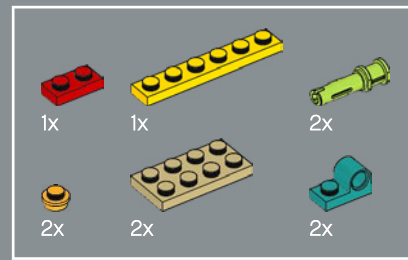
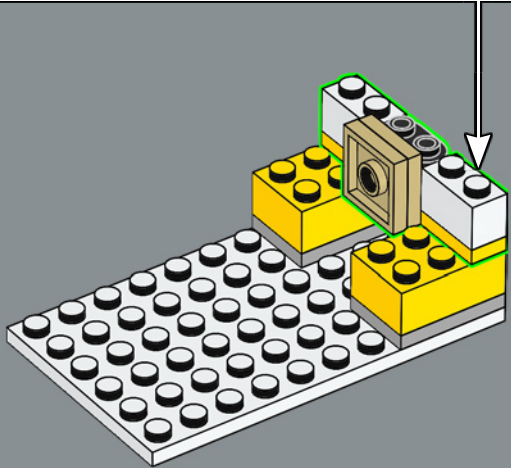
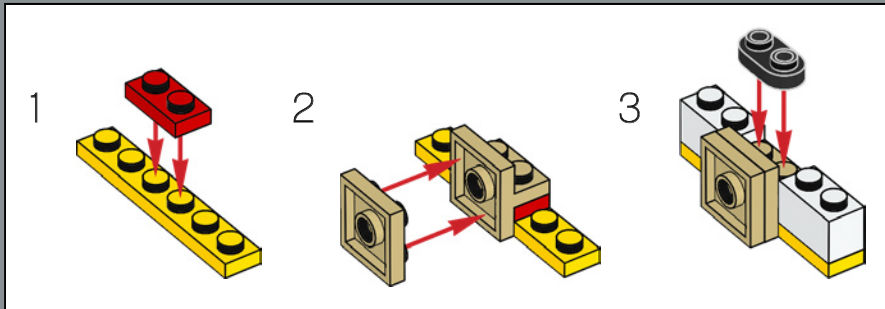

123

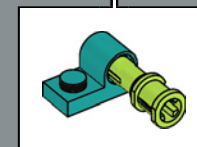
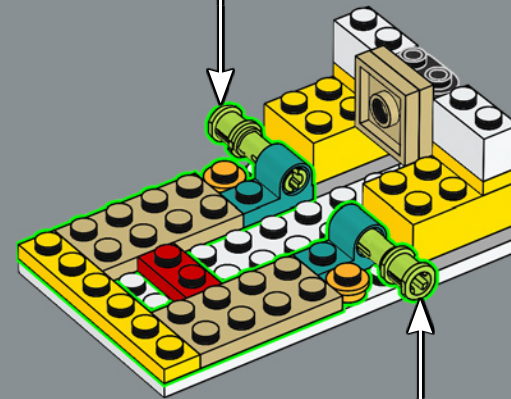
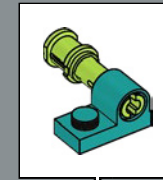

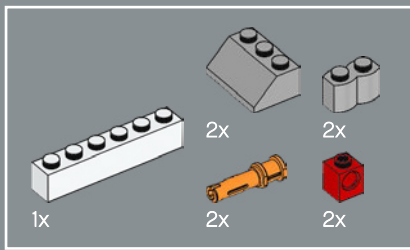

124

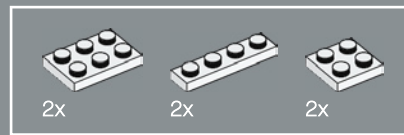
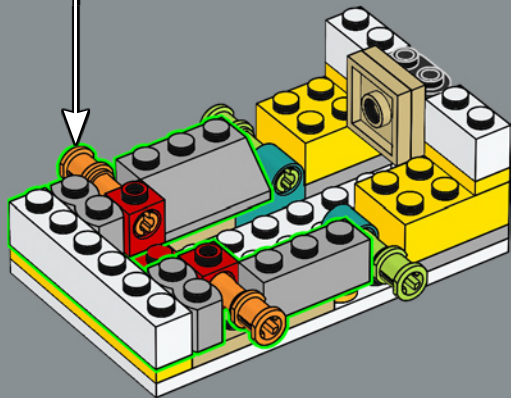
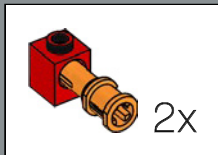

125

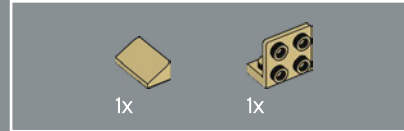
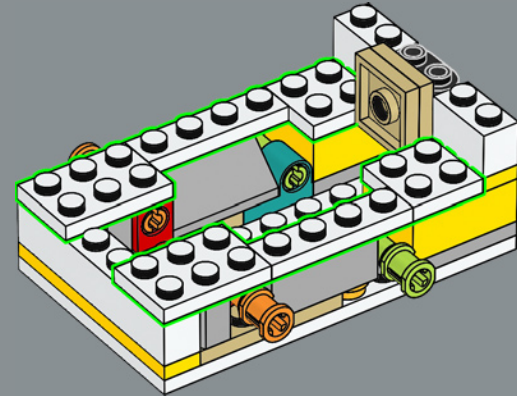

126

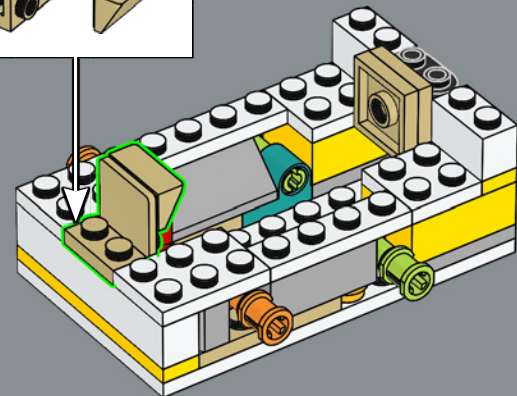
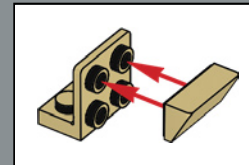



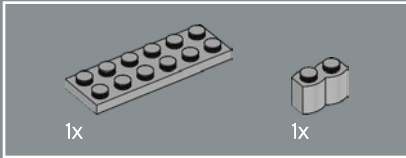
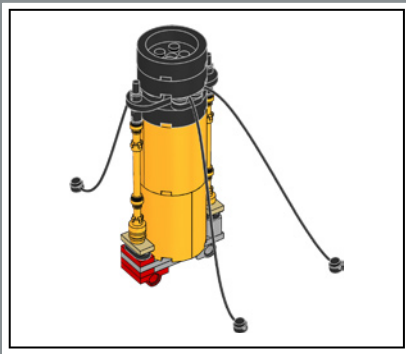

130

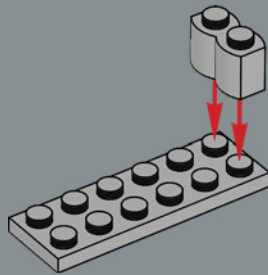

131

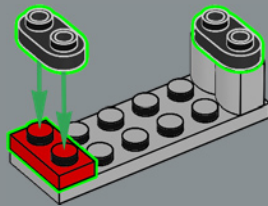

132

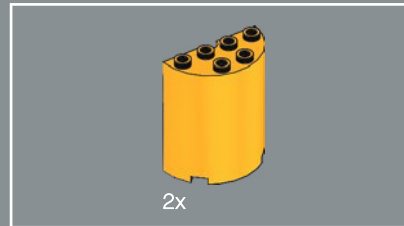
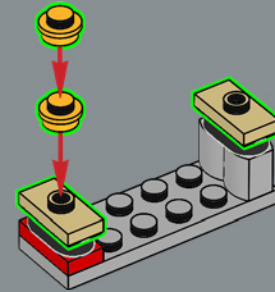

133

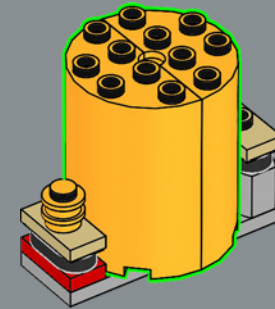

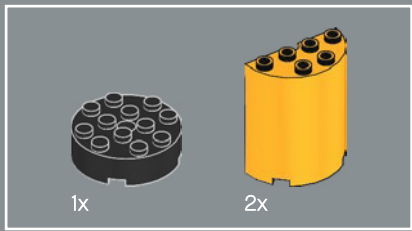

134

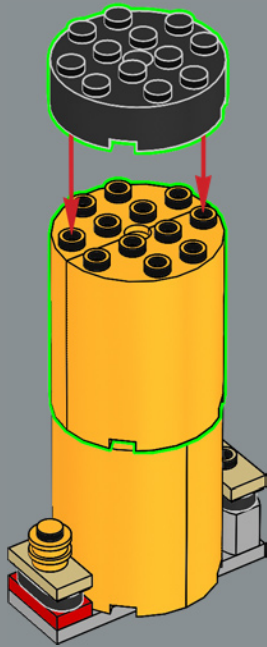

135

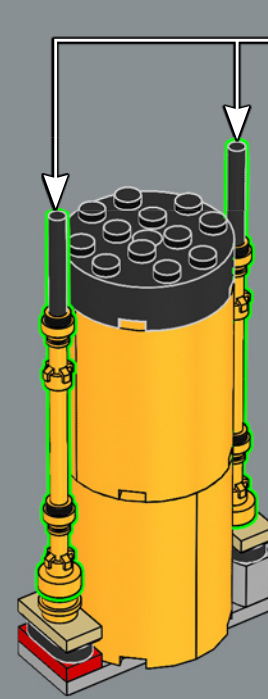
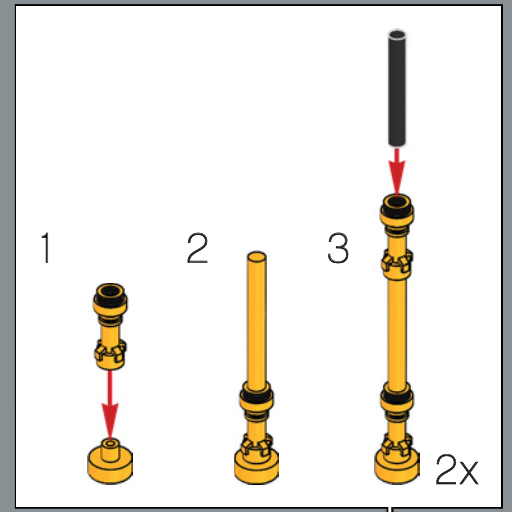

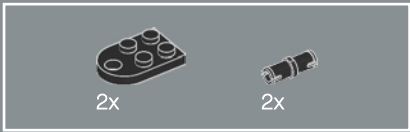

136

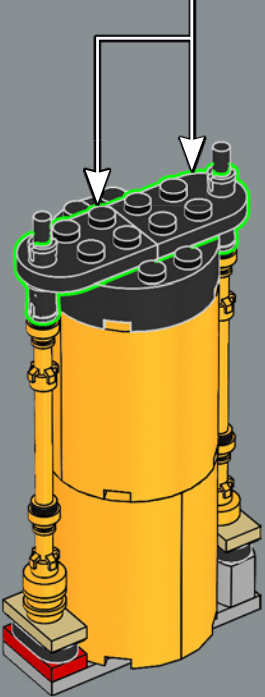
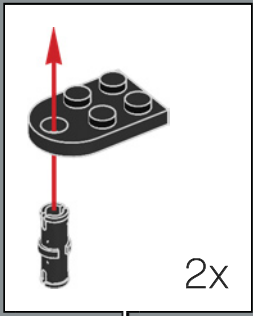

137

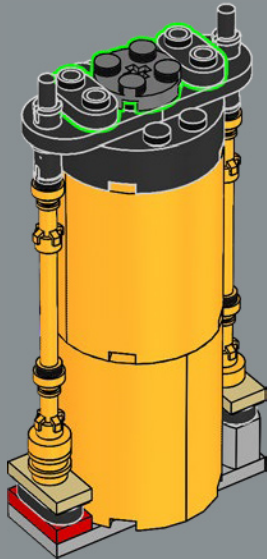

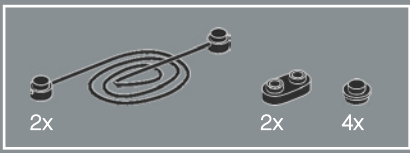

138

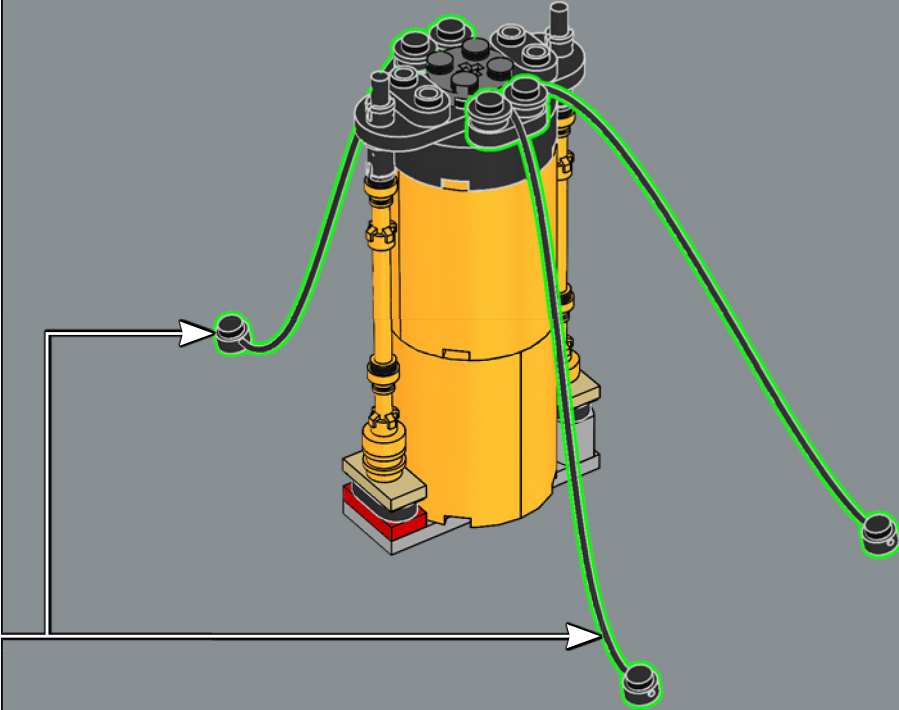
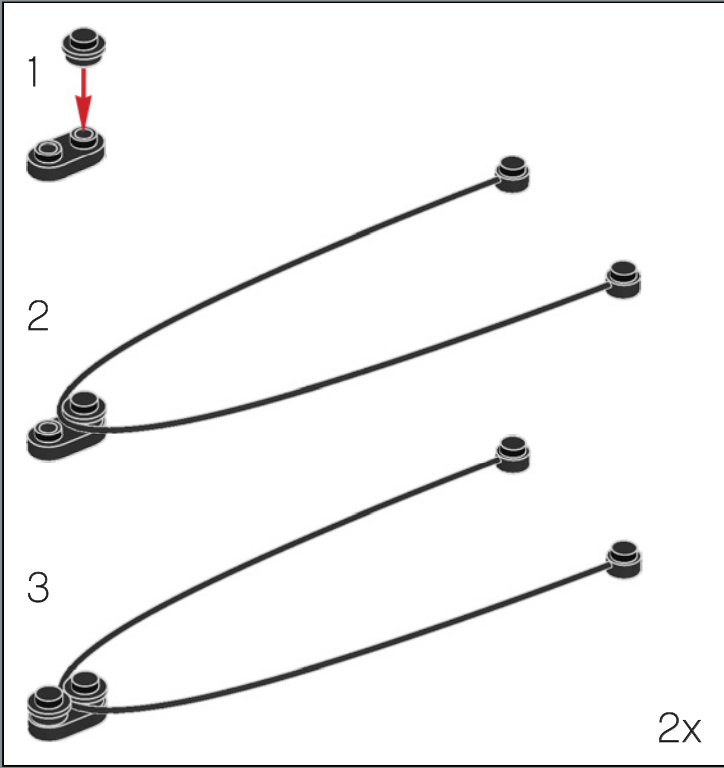



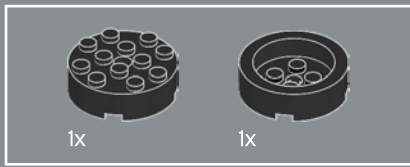

139

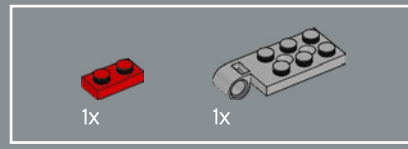
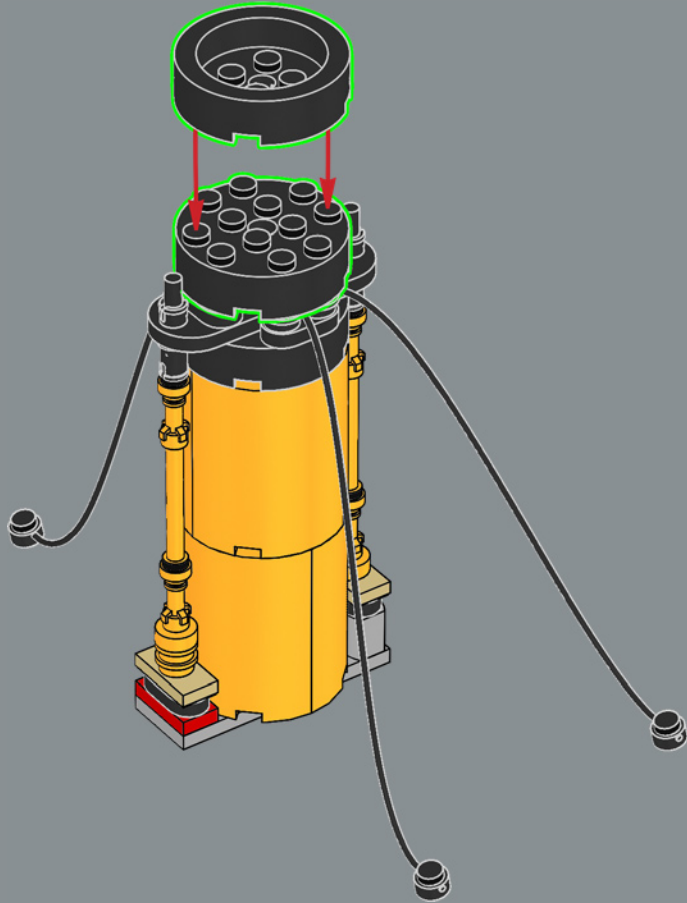

140

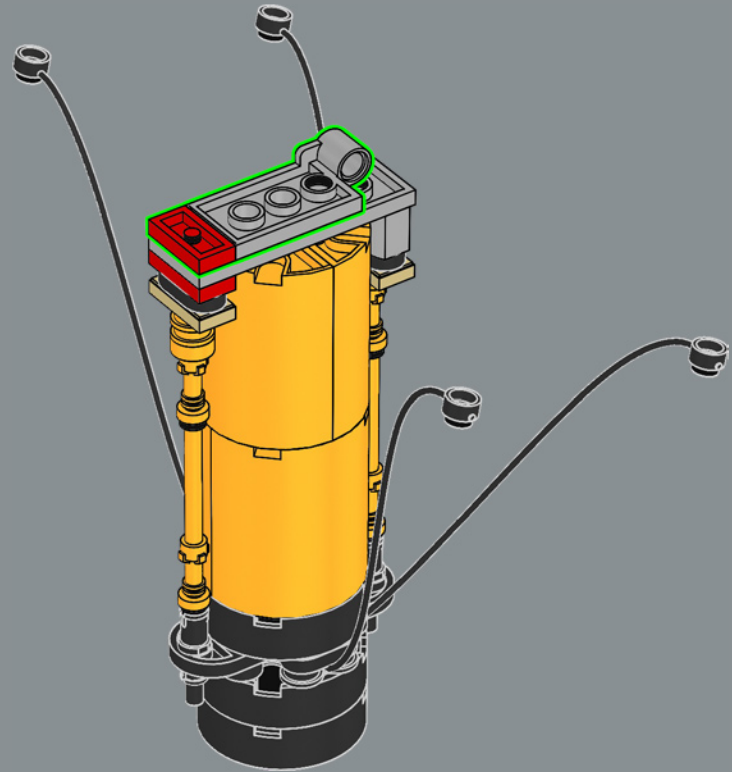

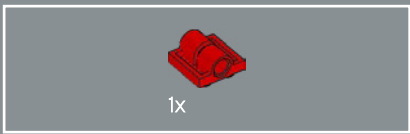

141

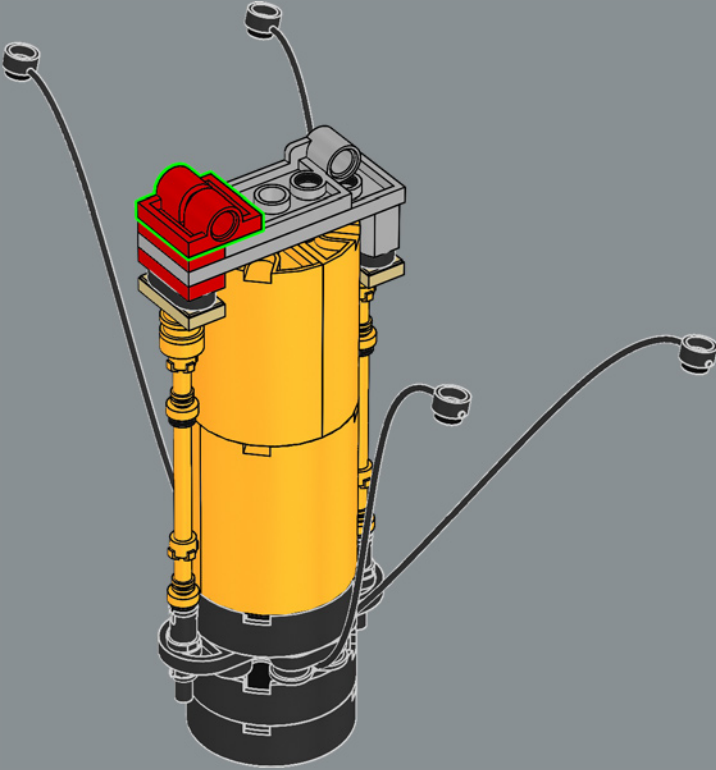

142

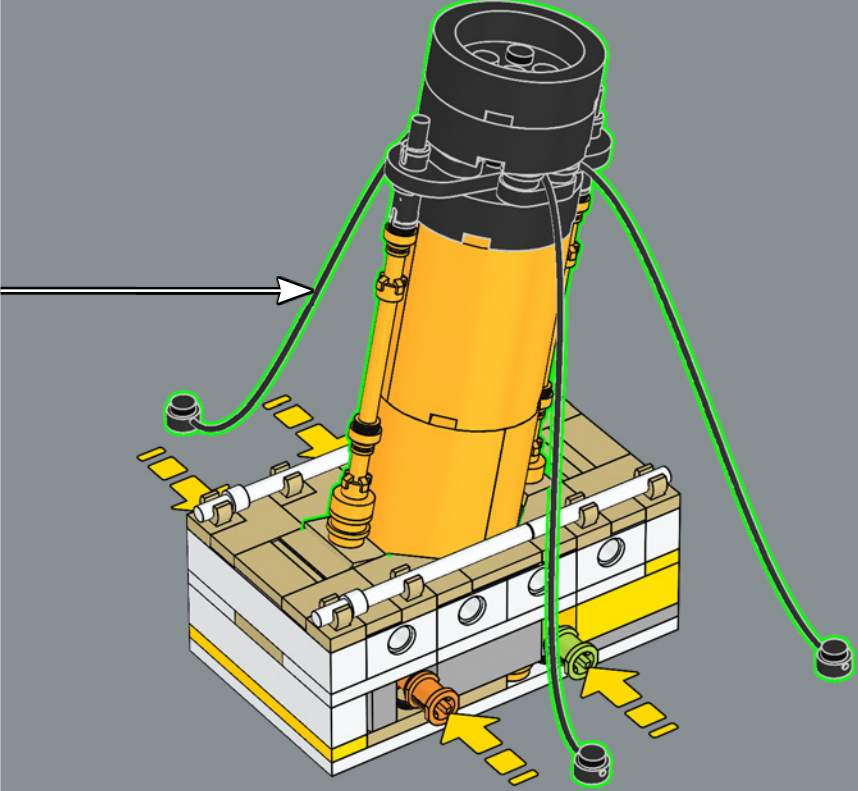

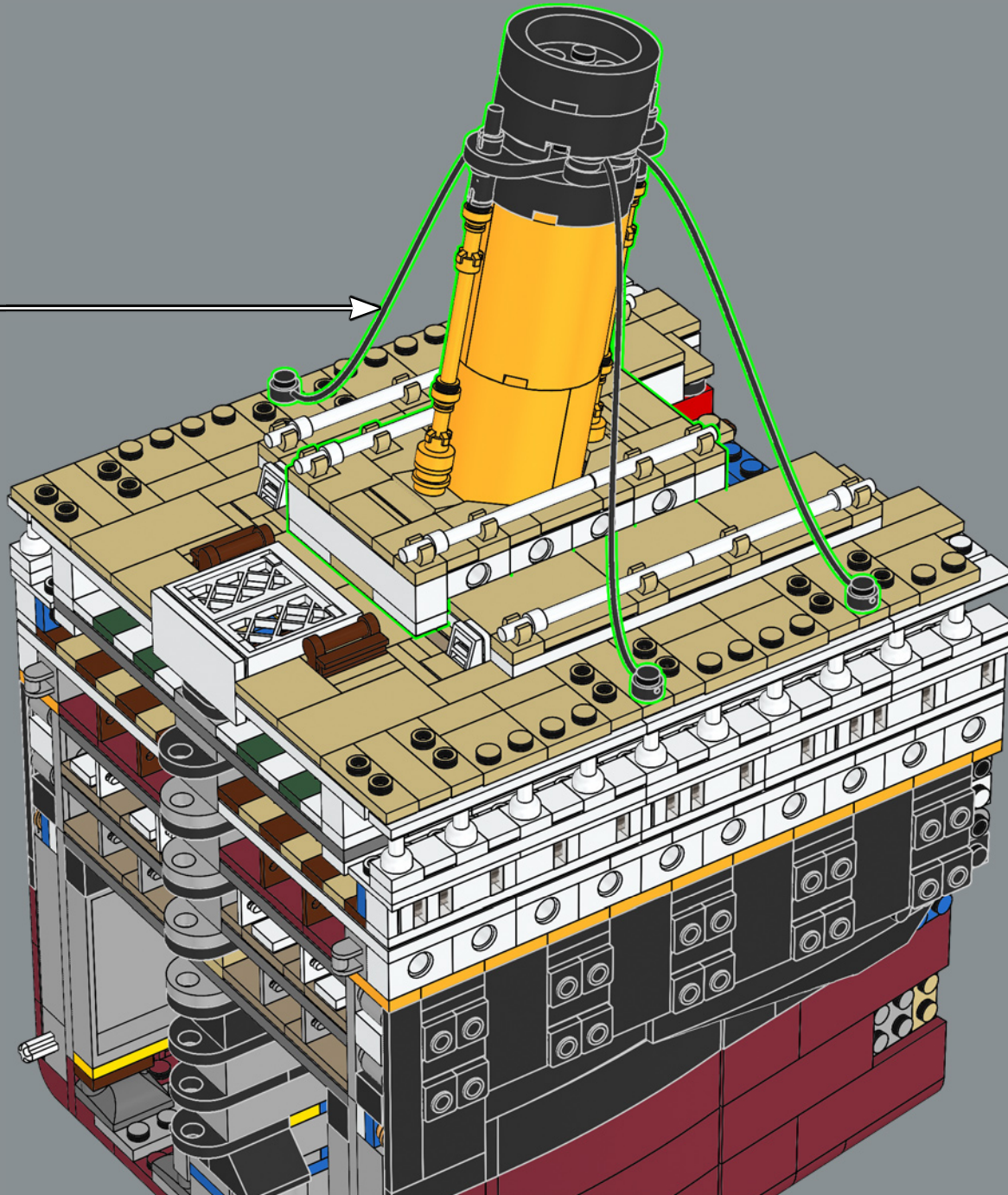

The *Titanic* had four funnels, though only three were functional—the last one was a dummy, installed for aesthetic purposes.

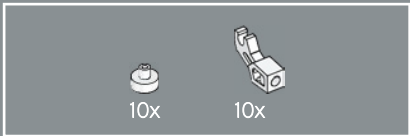

144

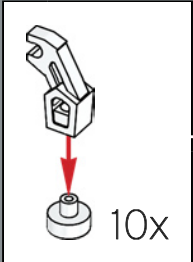
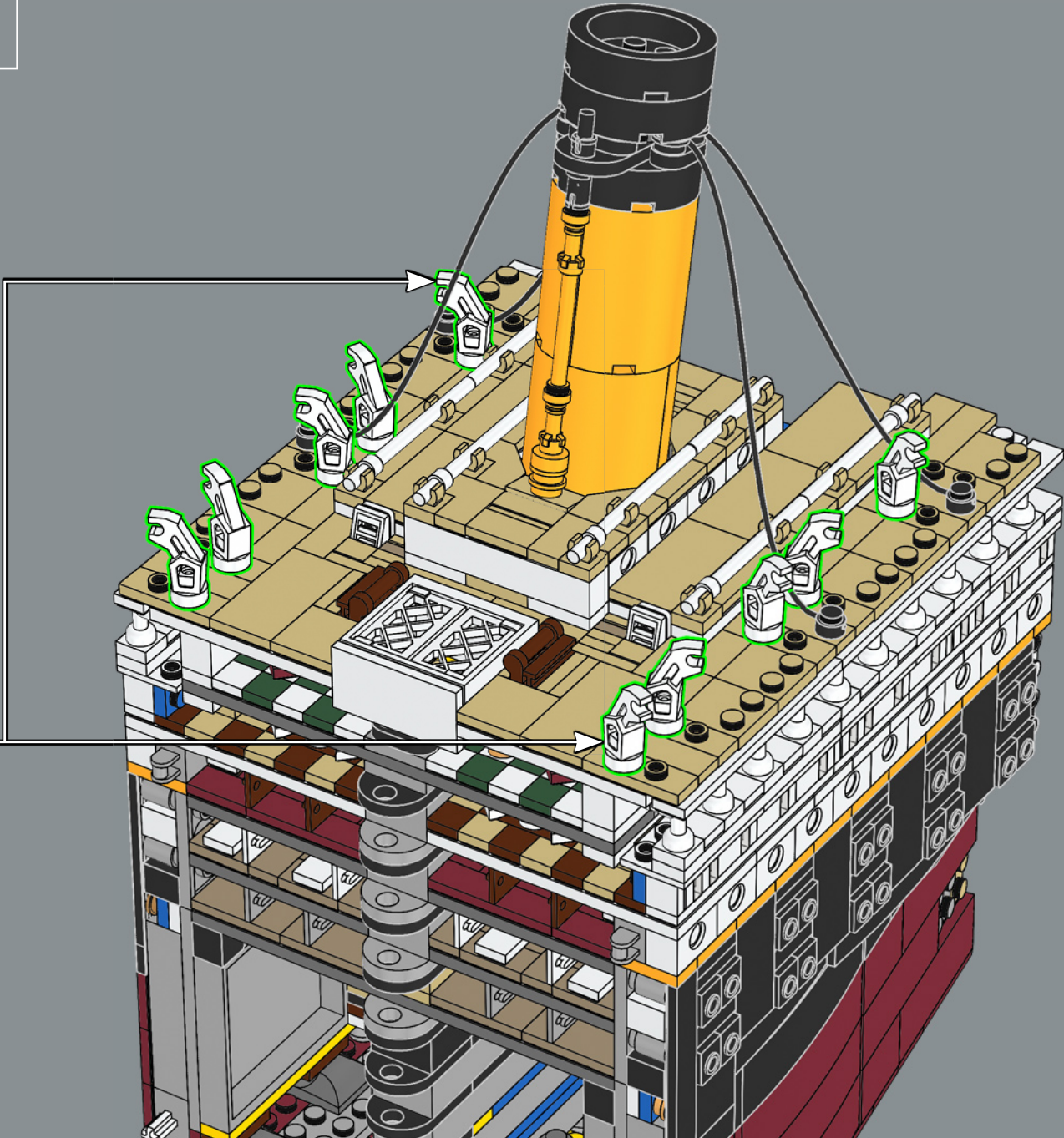

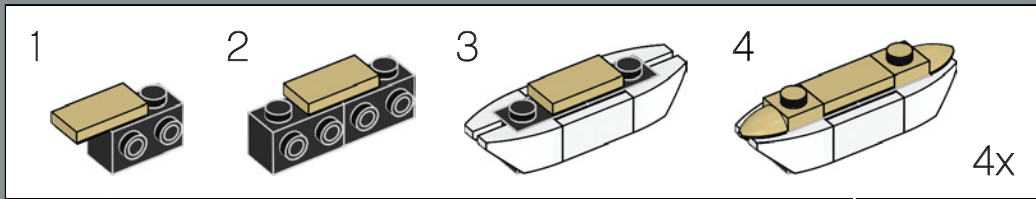
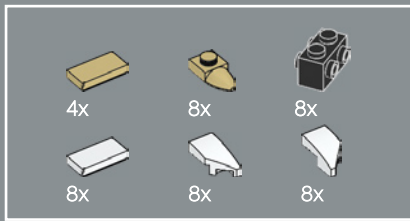

145

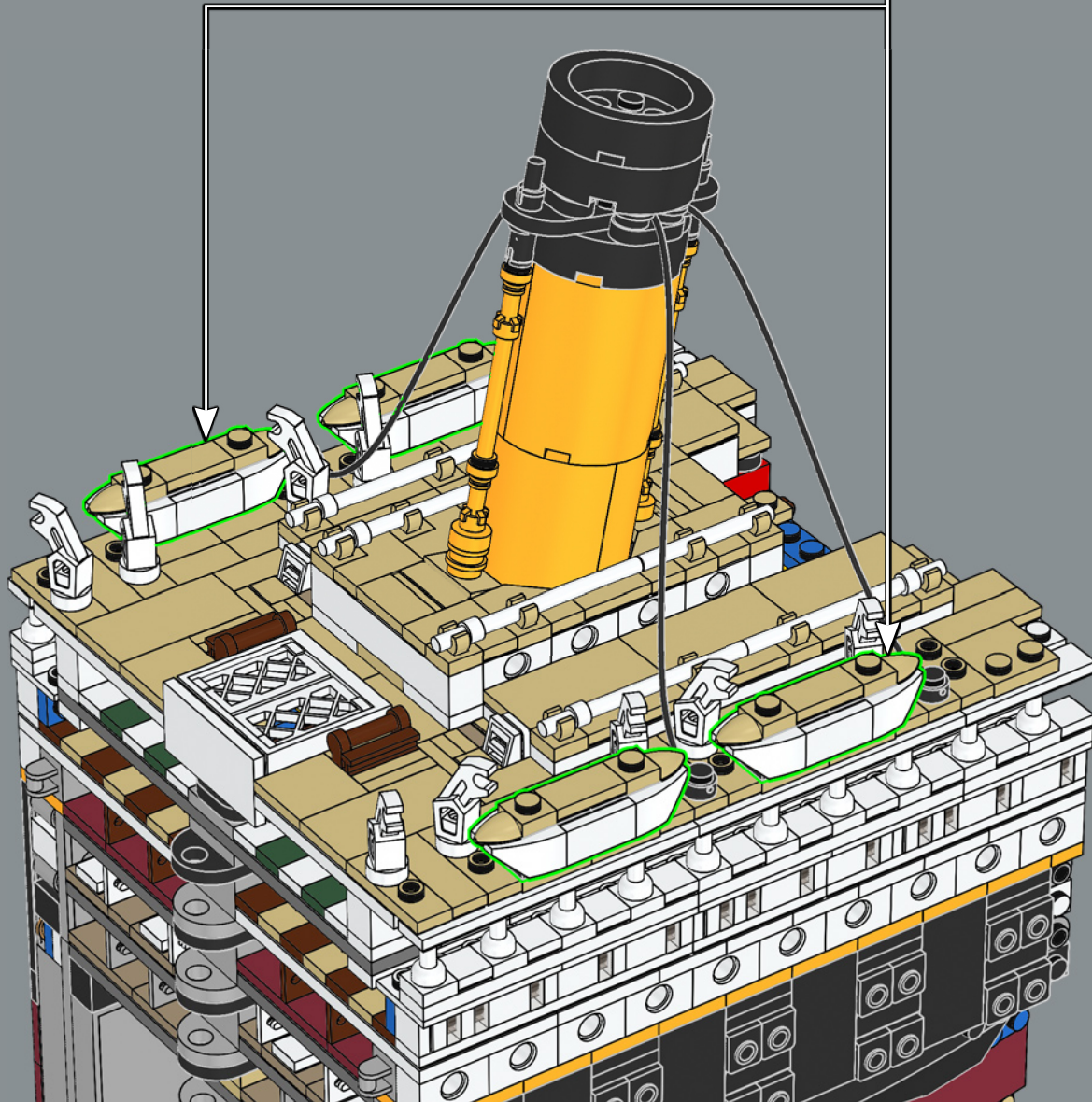

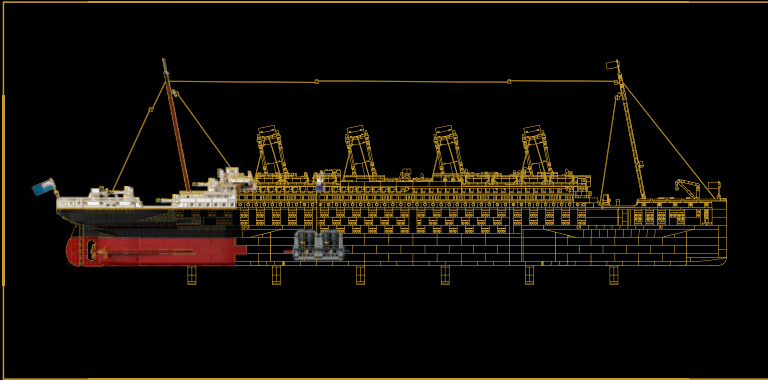

## SECTION 6:

# STERN & WELL DECK

This final section is the most complicated section of the hull and includes the rudder and three main driveshafts that connect the propellers to the engines. You will build the two main piston engines that are linked directly to the port and starboard screws. Turning the screws moves the engine crankshafts and pistons inside the model.

↓ The exterior details of this section include the stern bridge and benches for the 3rd class passengers.



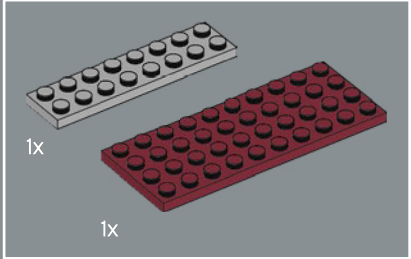
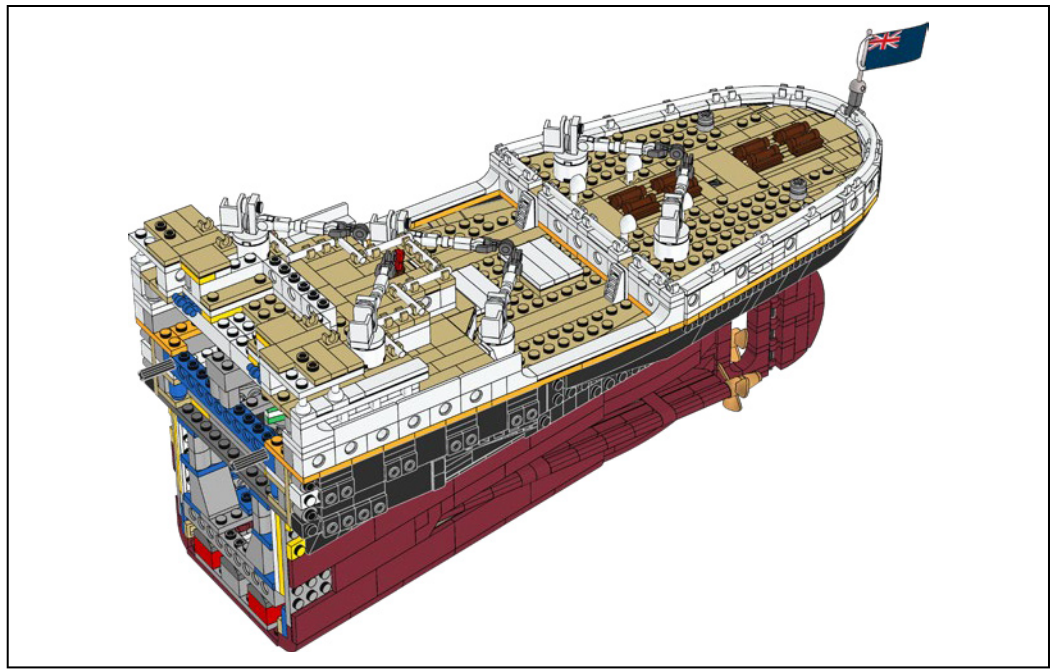
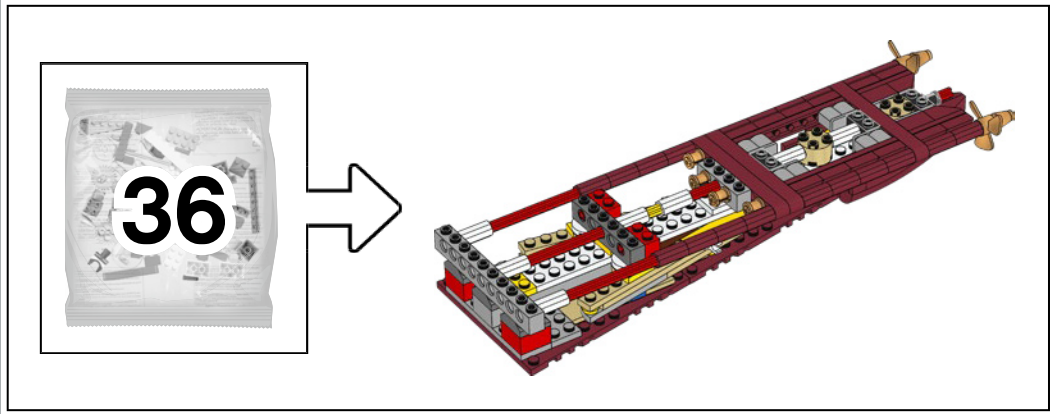

146

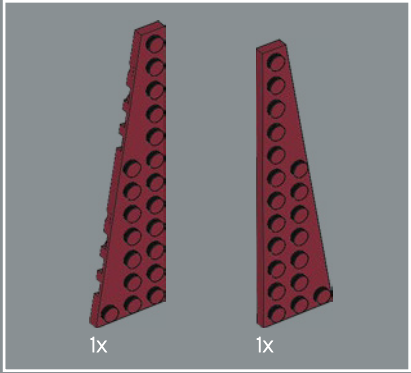
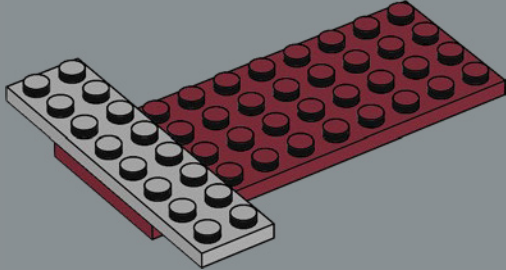

147

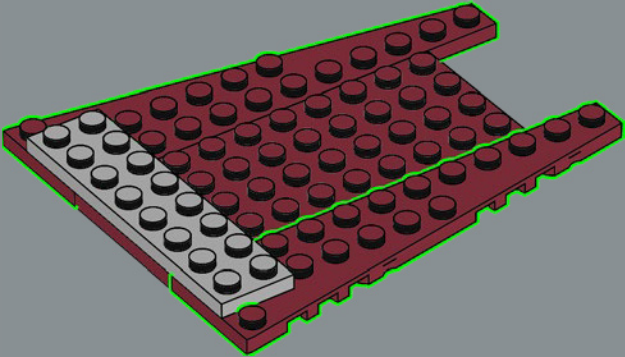

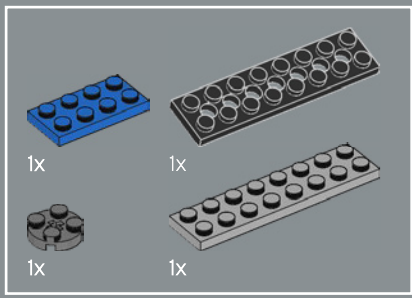

148

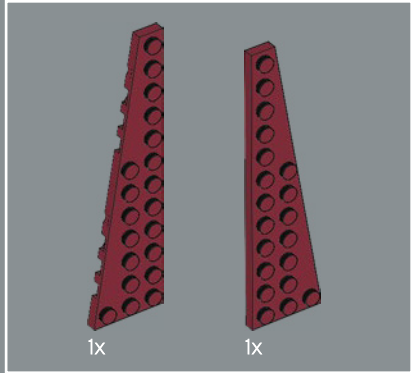
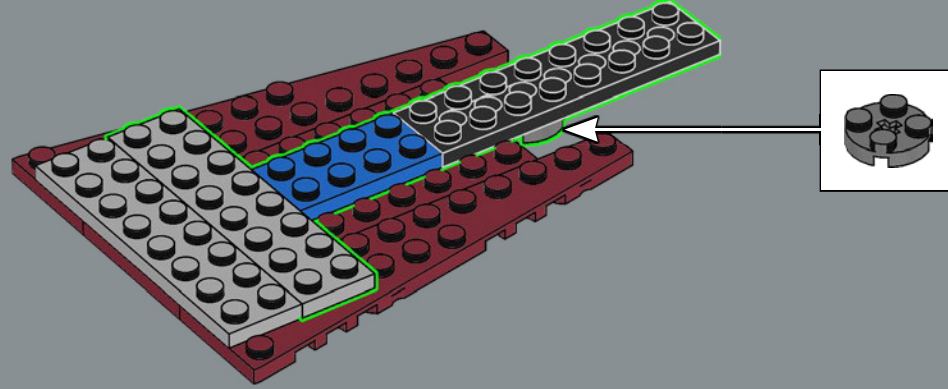

149

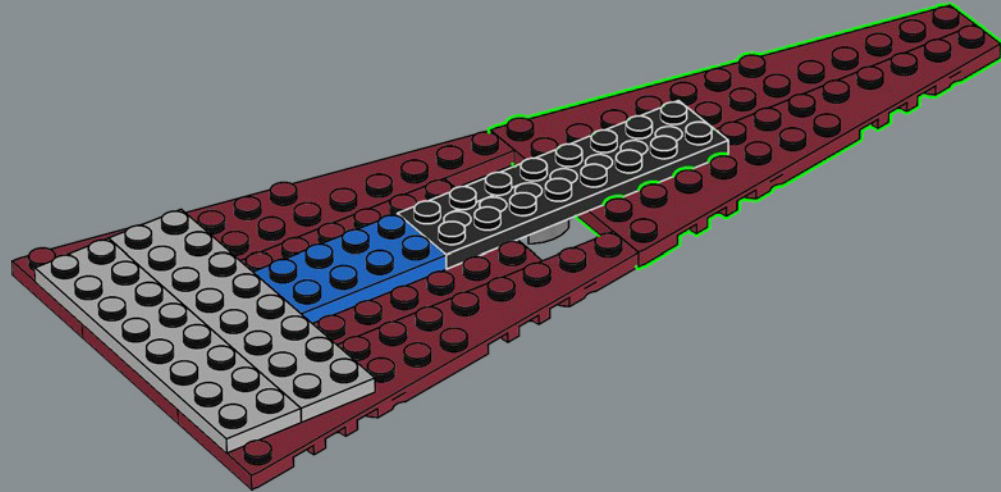



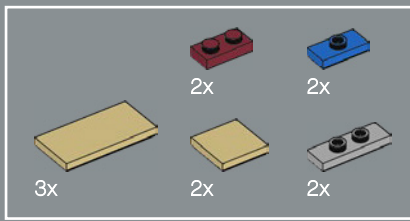

150

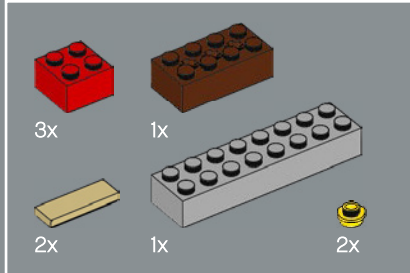
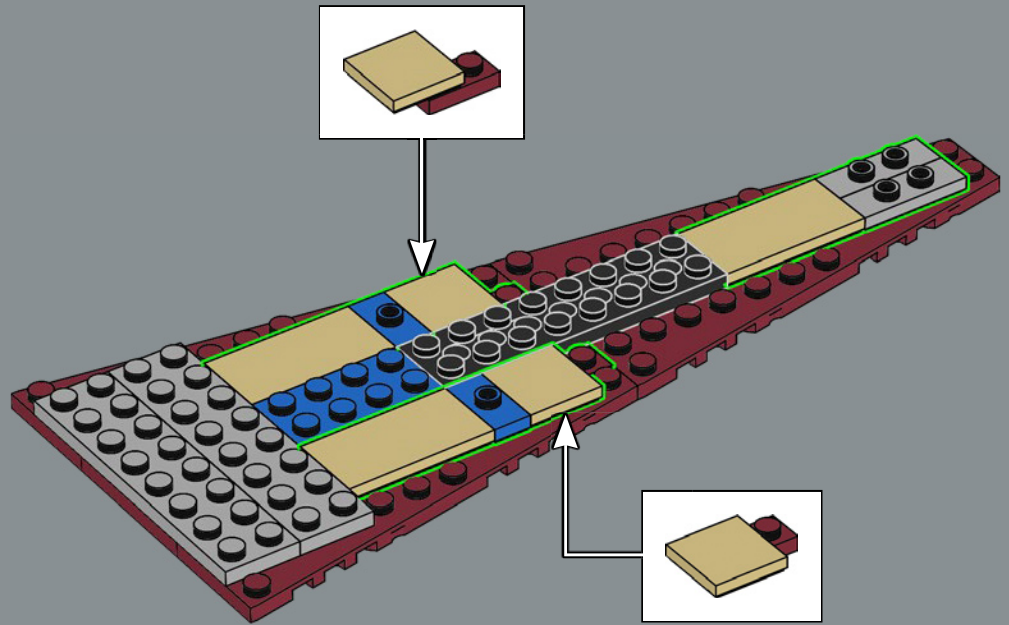

151

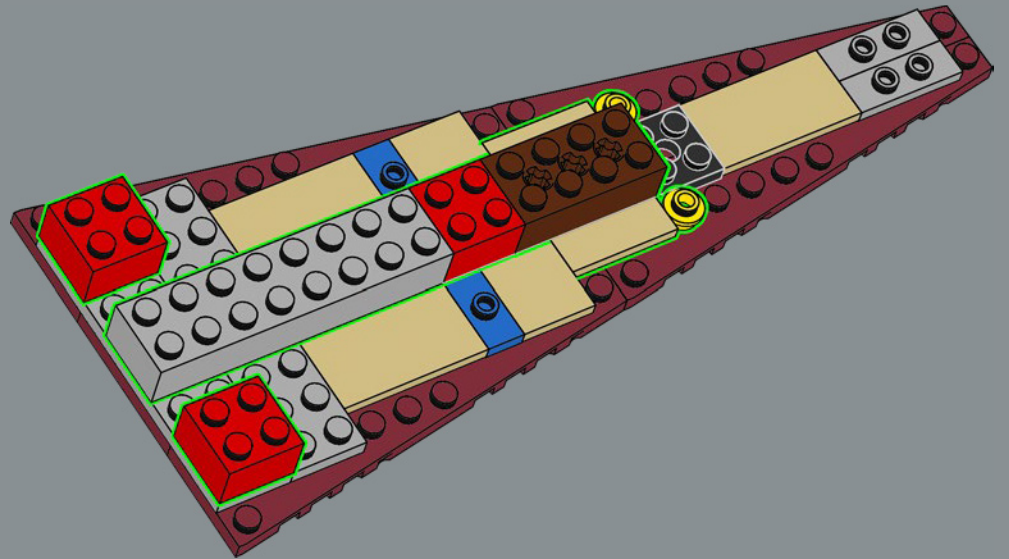

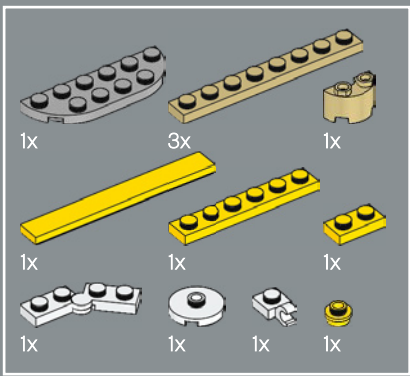

152

1

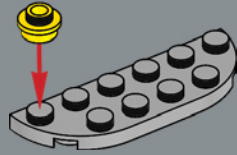

2

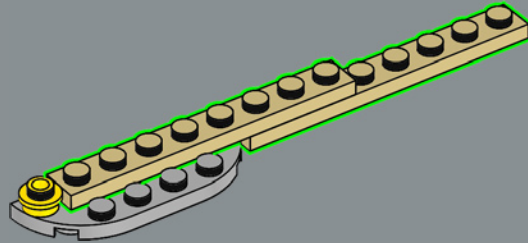

3

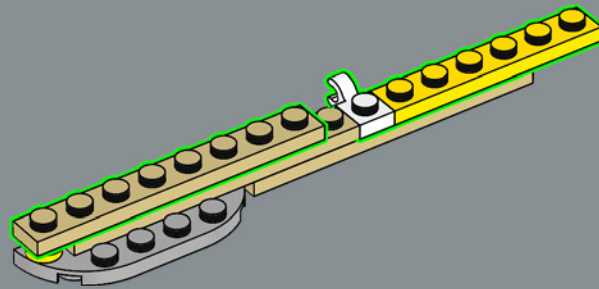

4

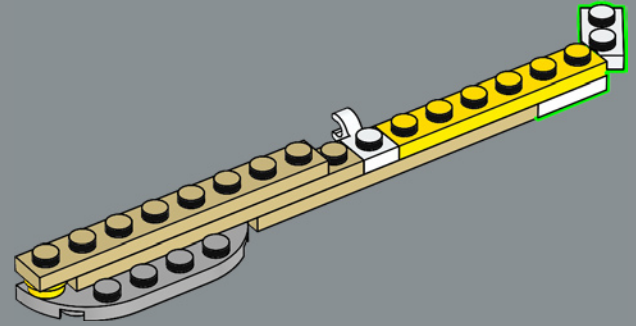

5

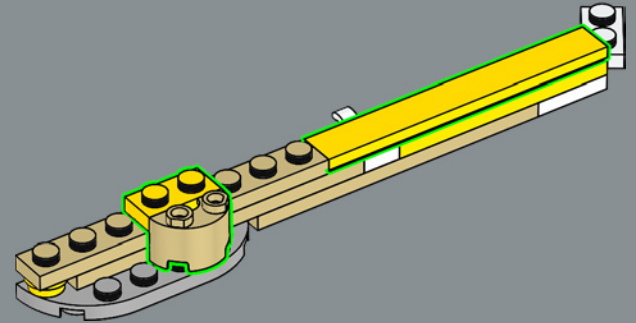

6

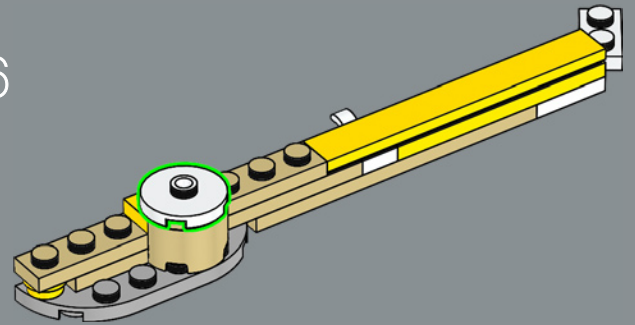

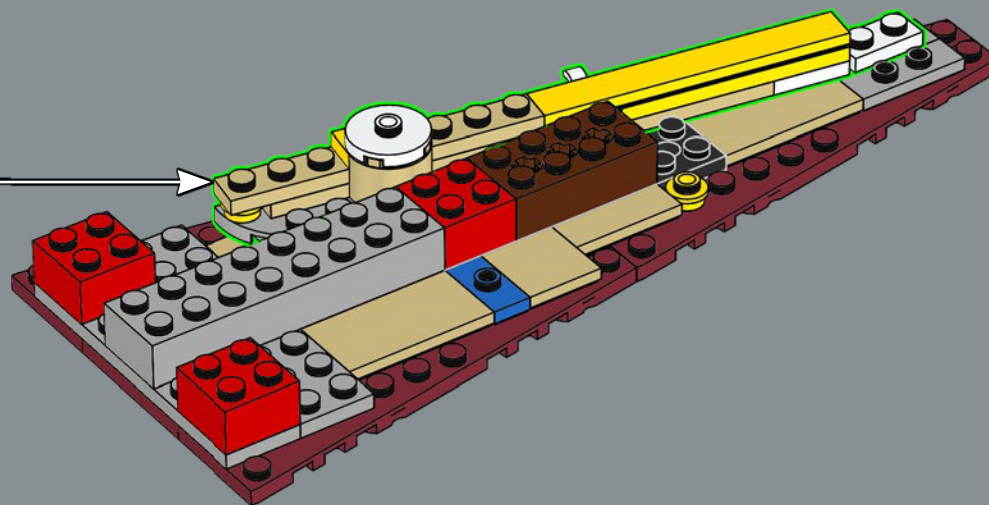



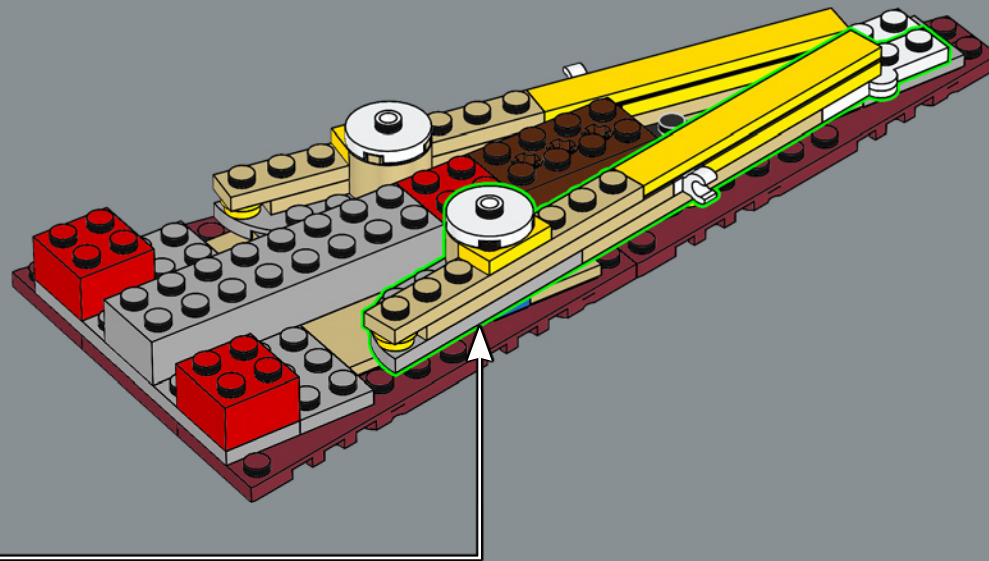

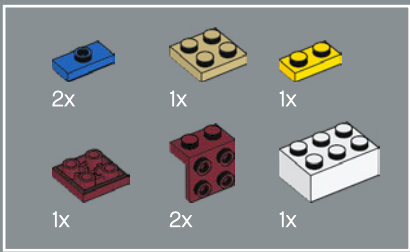

154

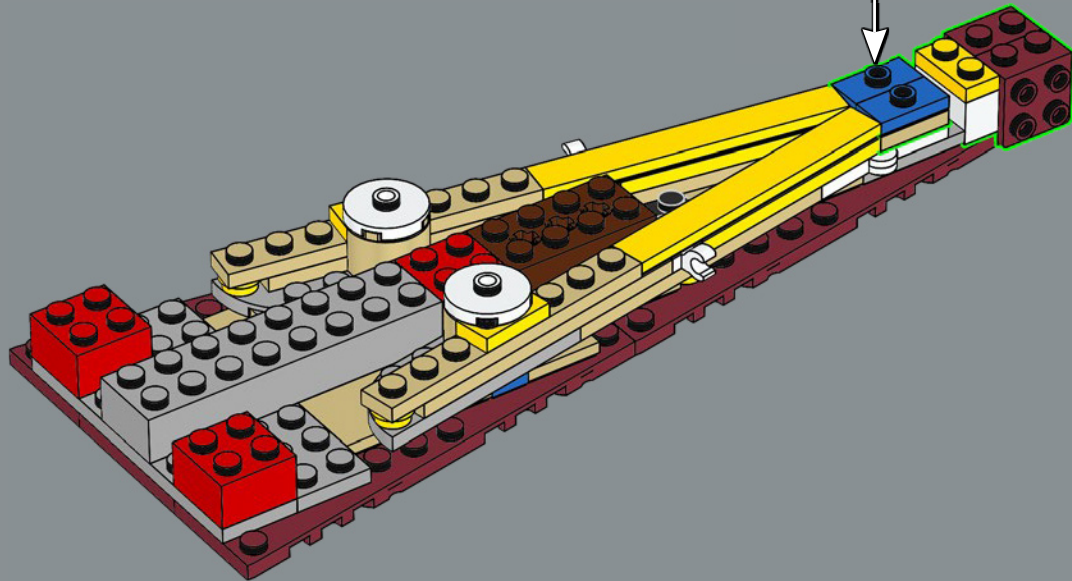
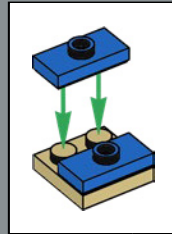
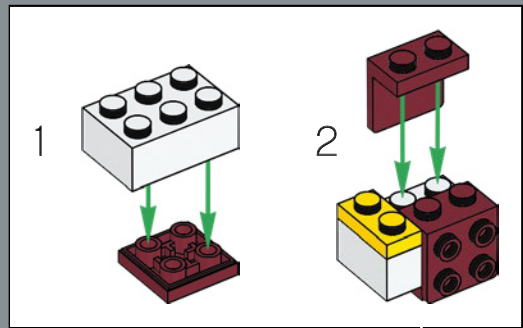

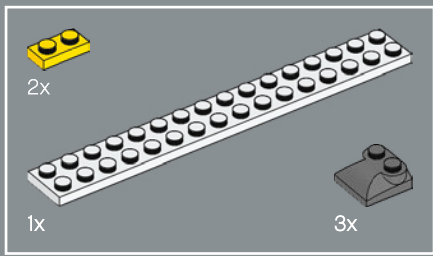

155

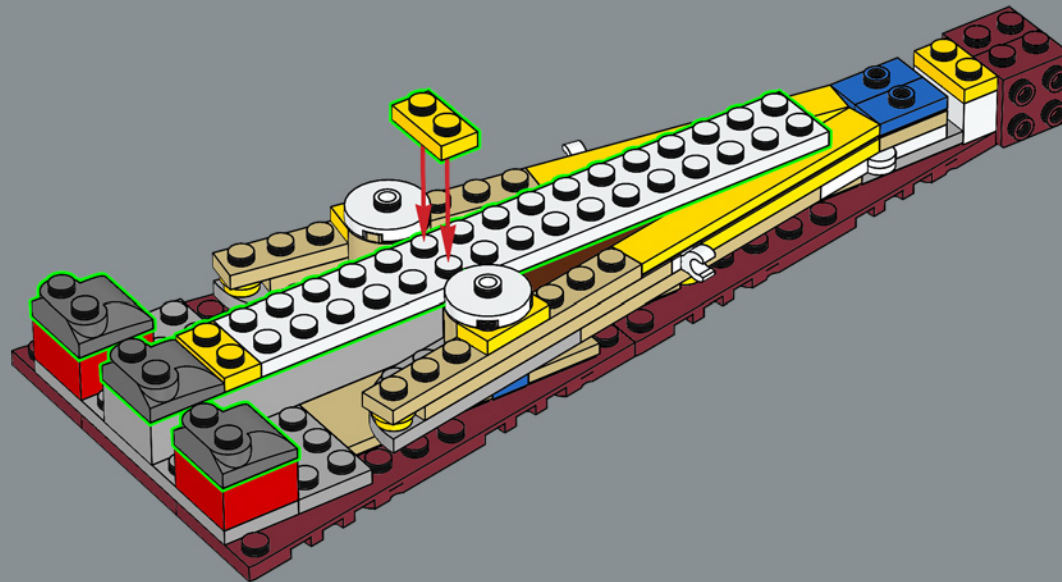

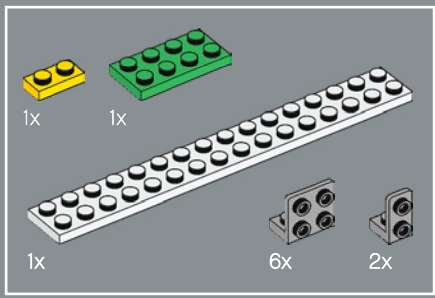

156

1

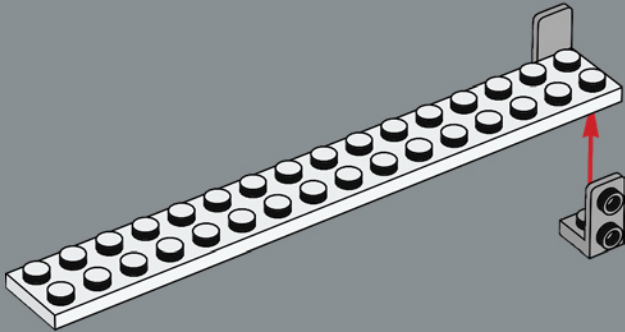

2

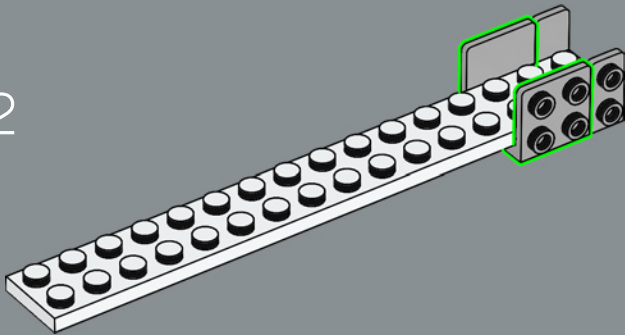

3

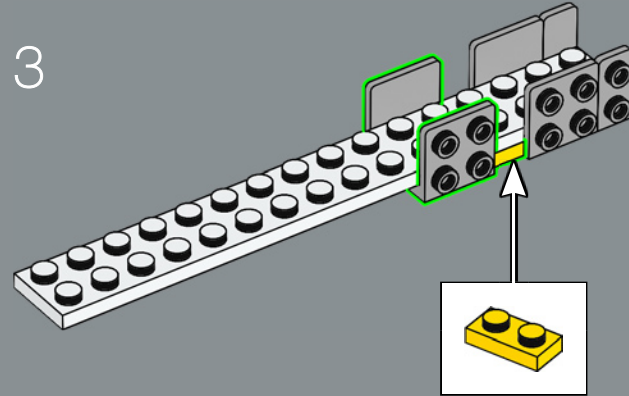

4

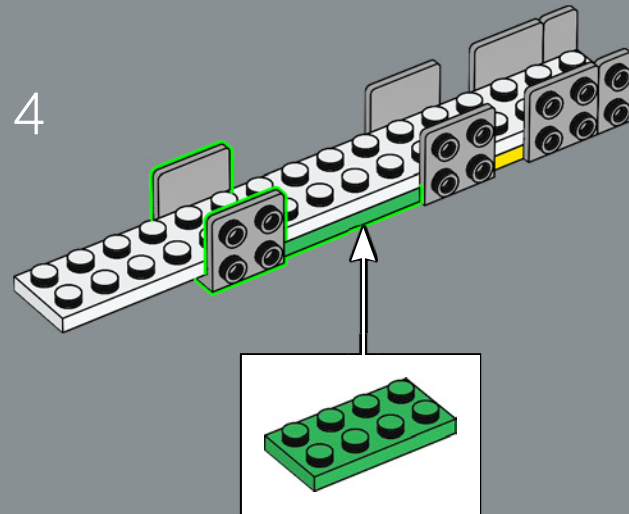



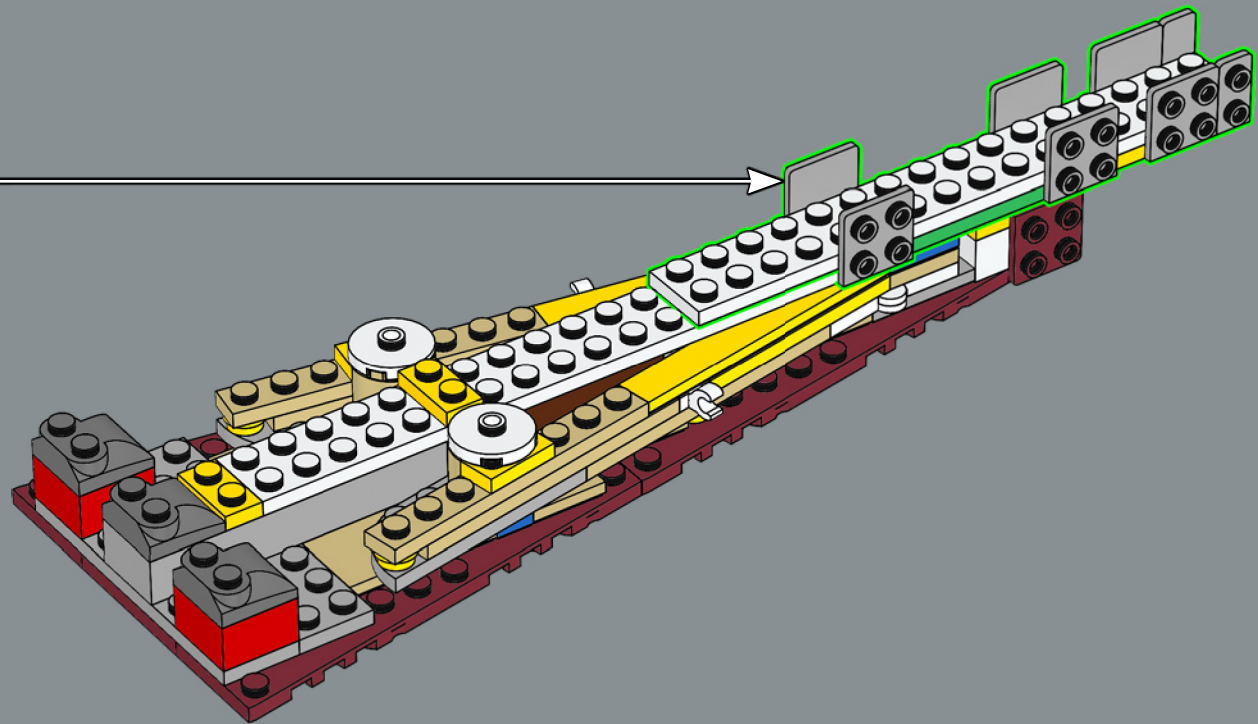

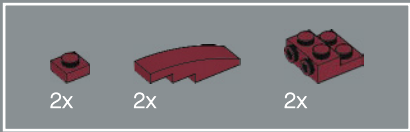

157

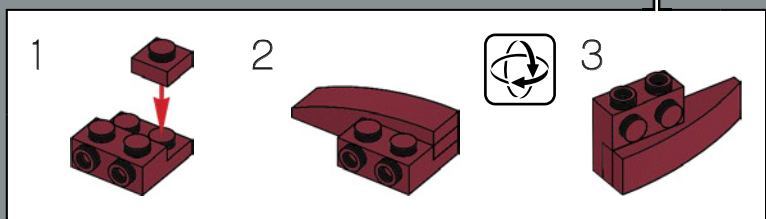
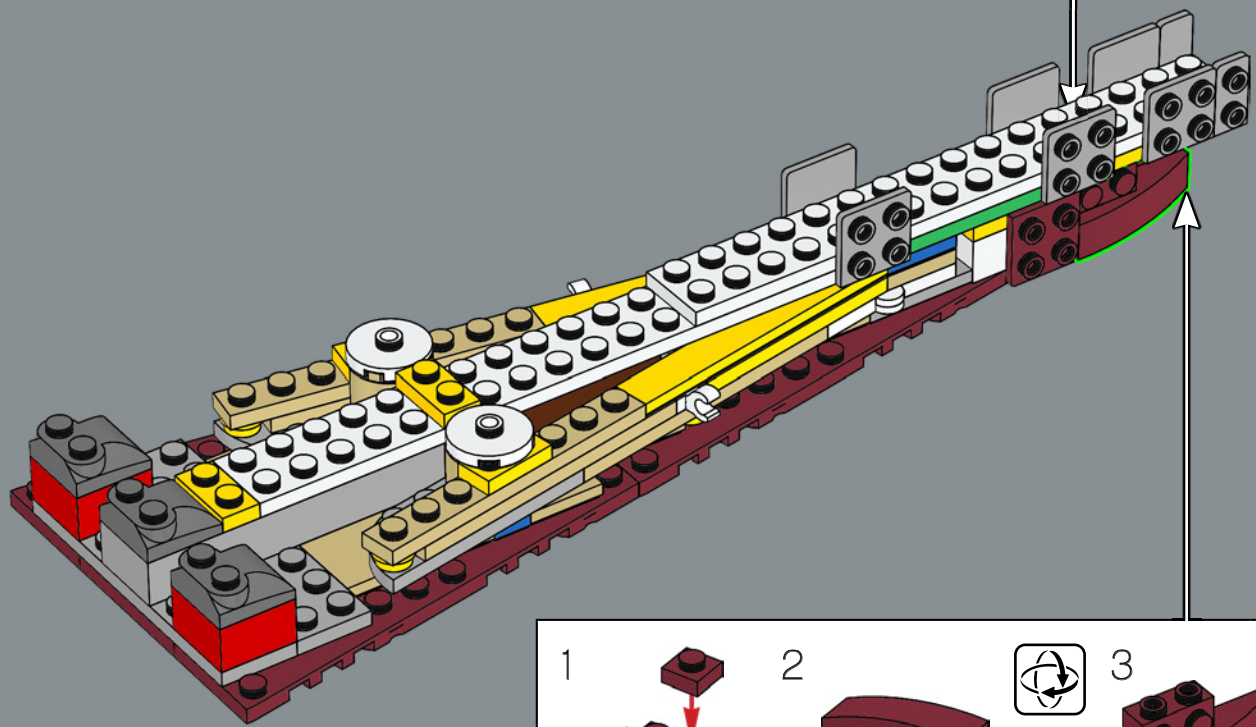
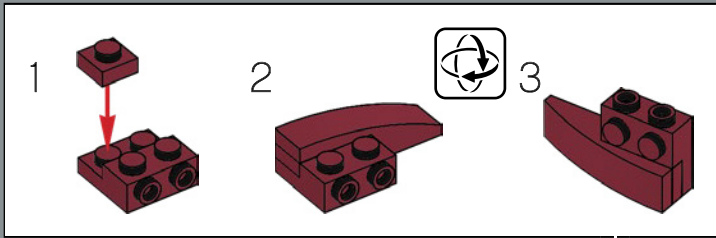

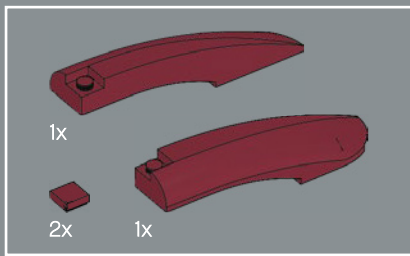

158

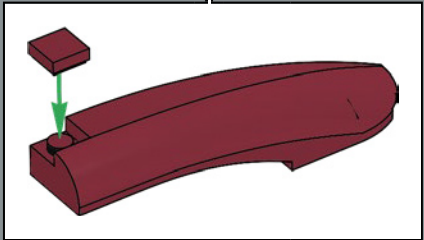
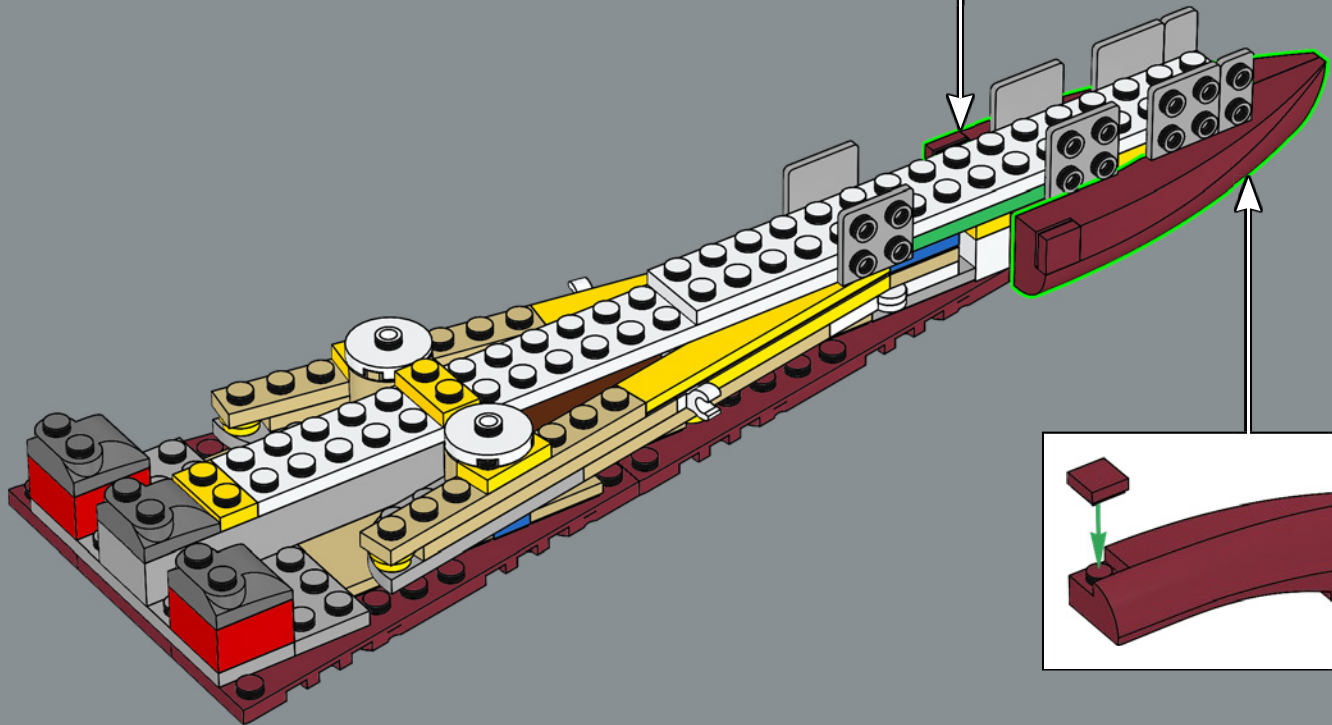
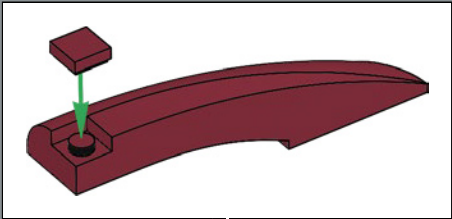

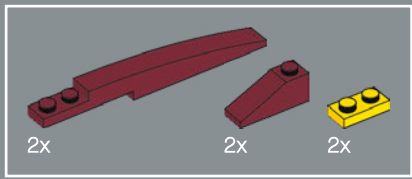

159

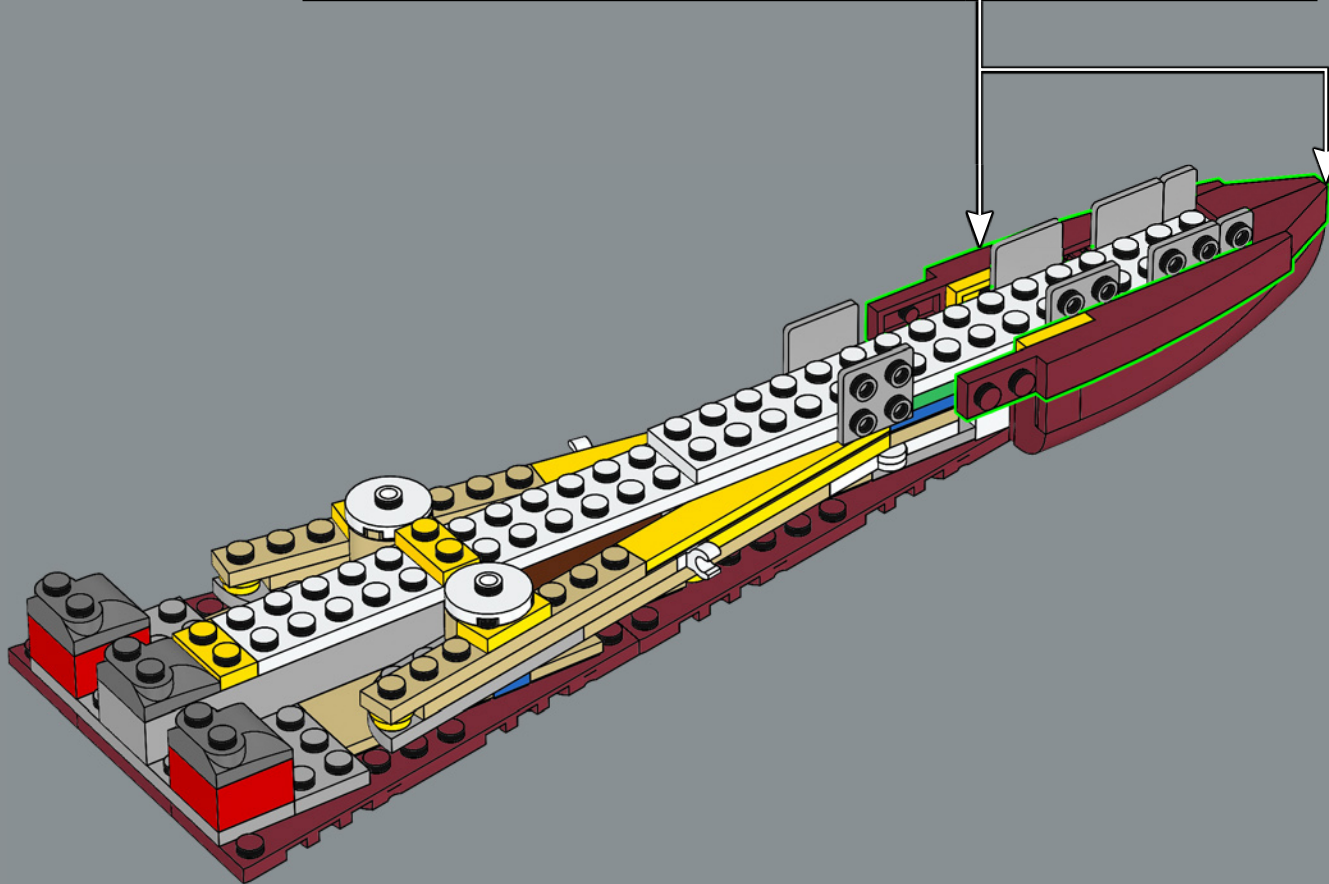
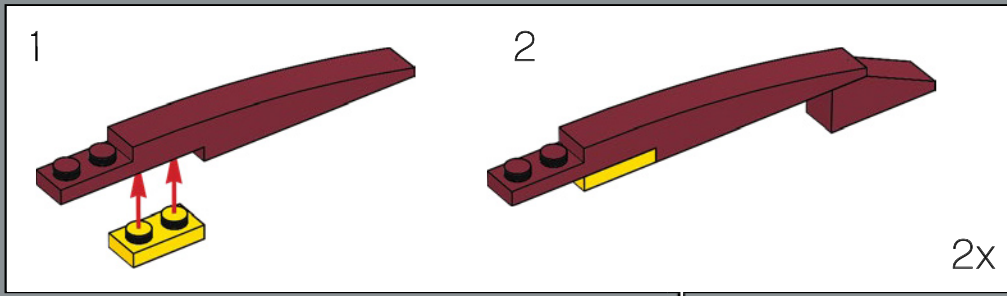

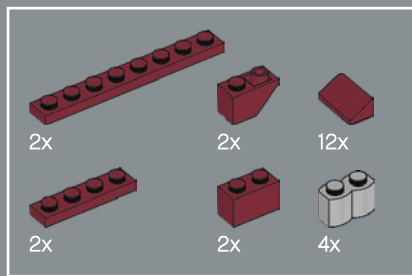

160

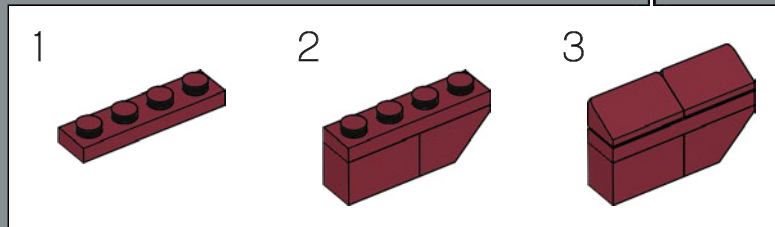
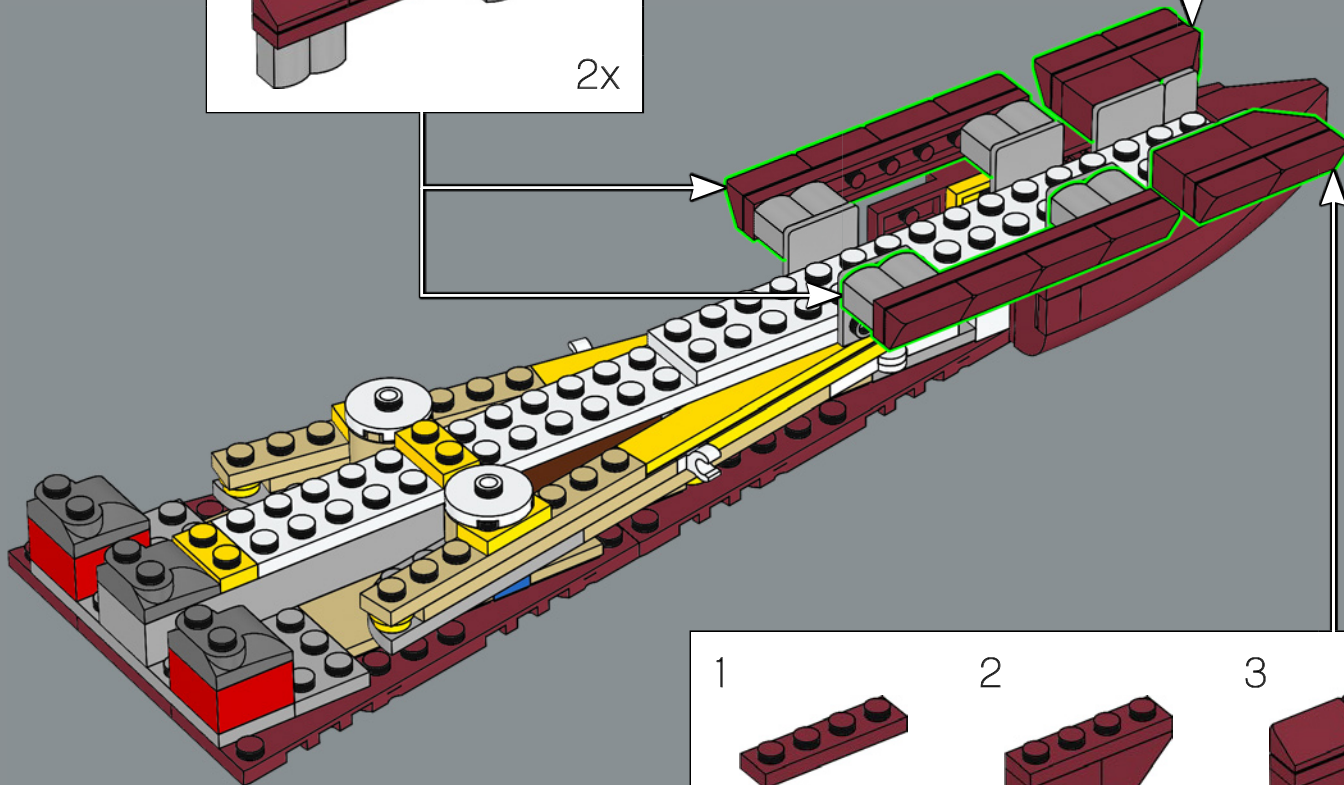
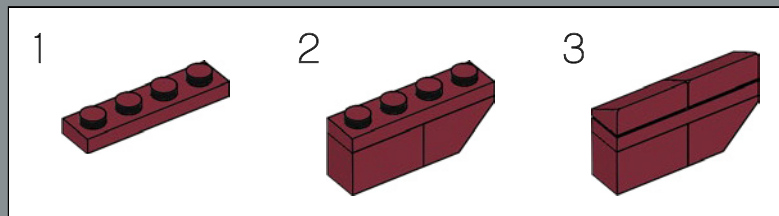
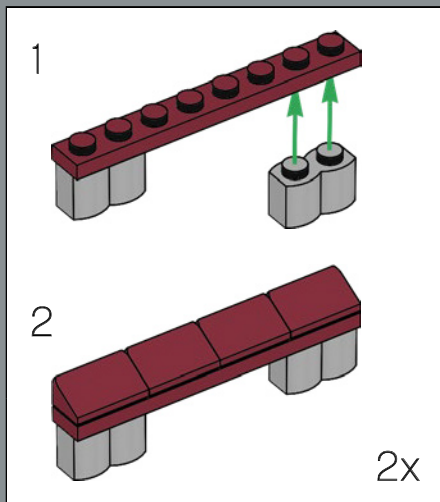

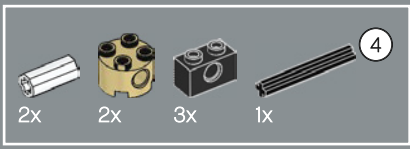

161

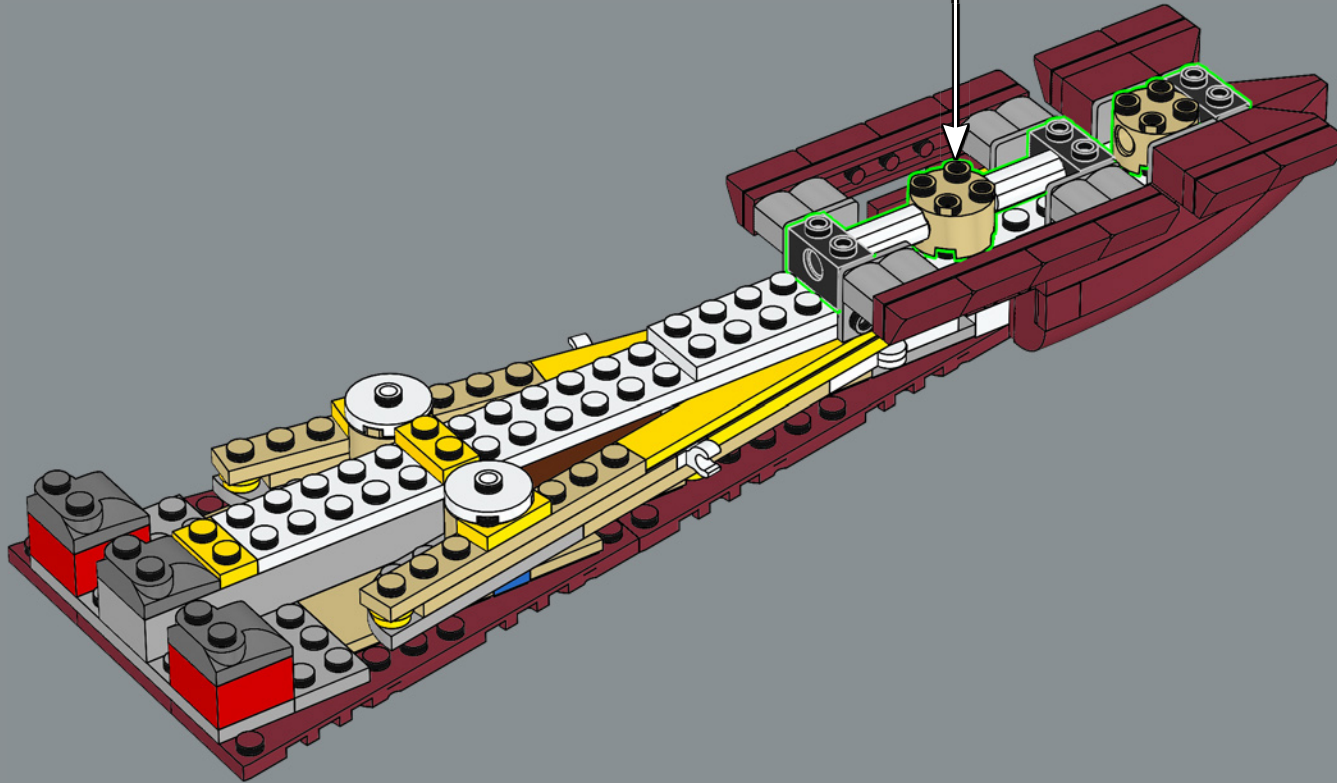
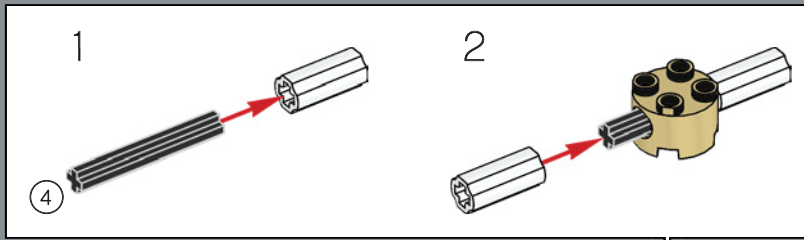

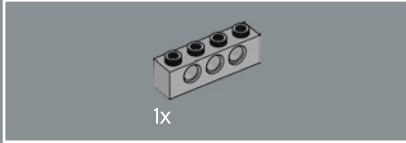
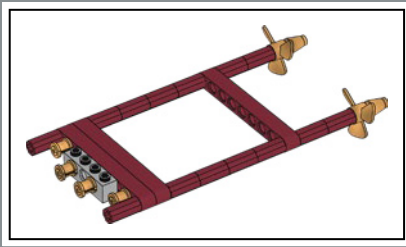

162

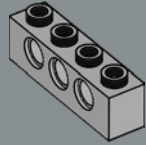

163

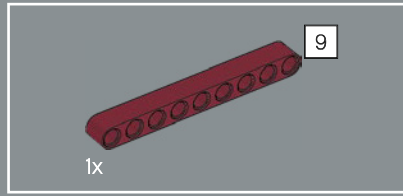
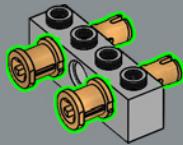

164

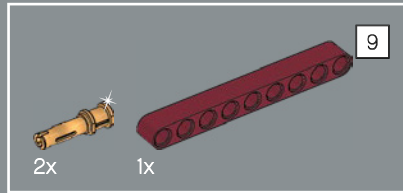
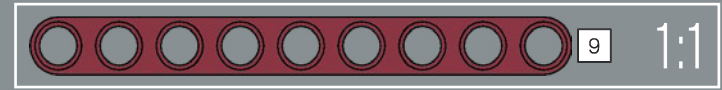

165

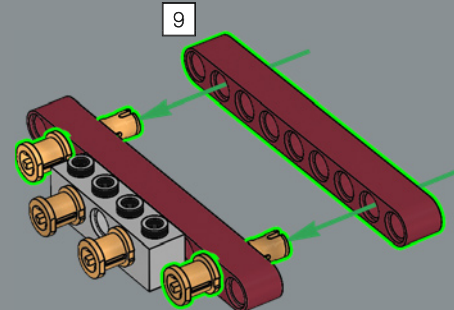
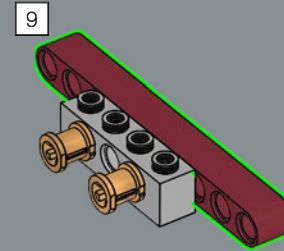

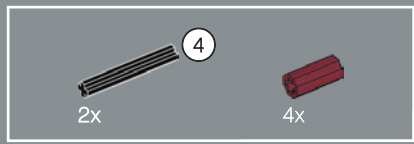

166

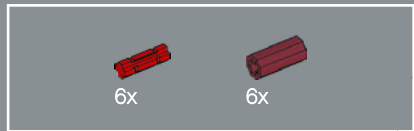
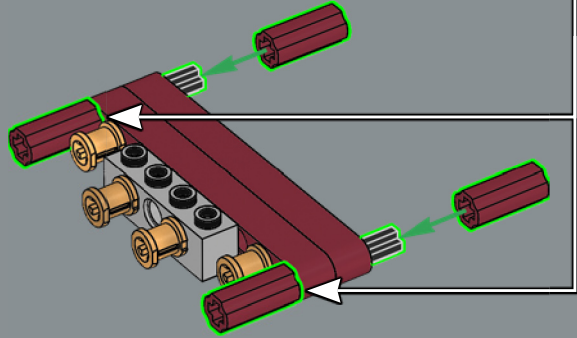
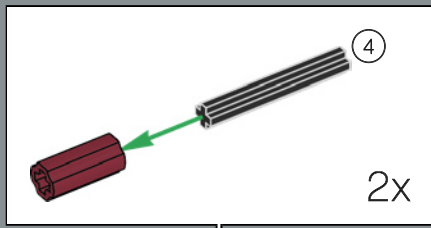

167

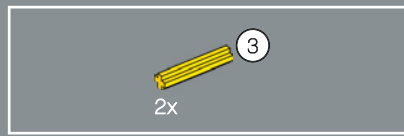
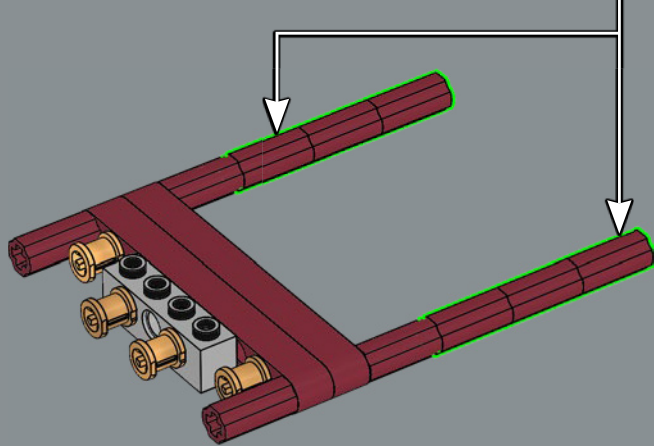
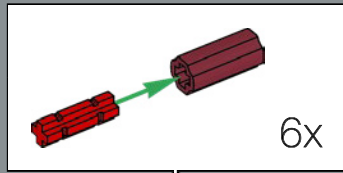

168

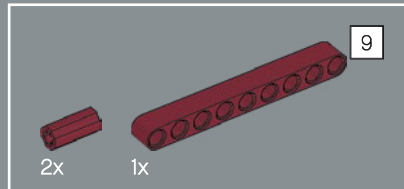
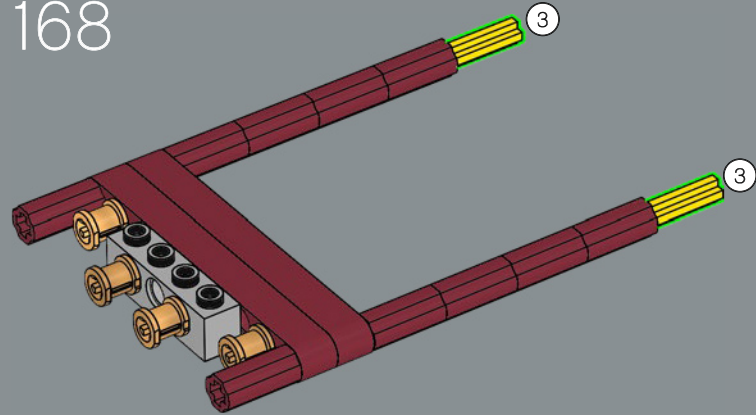

169

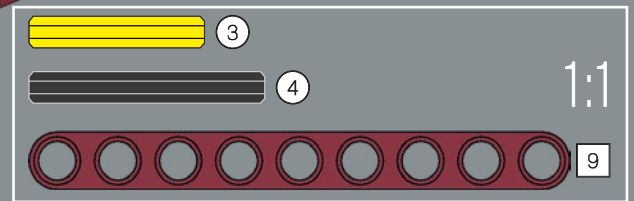
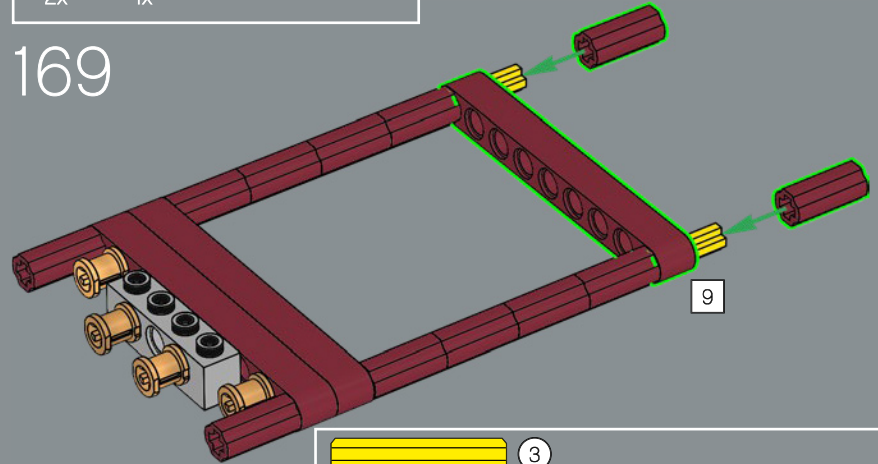



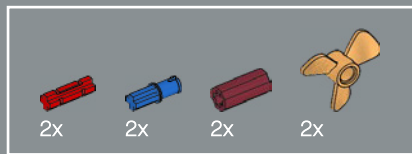

170

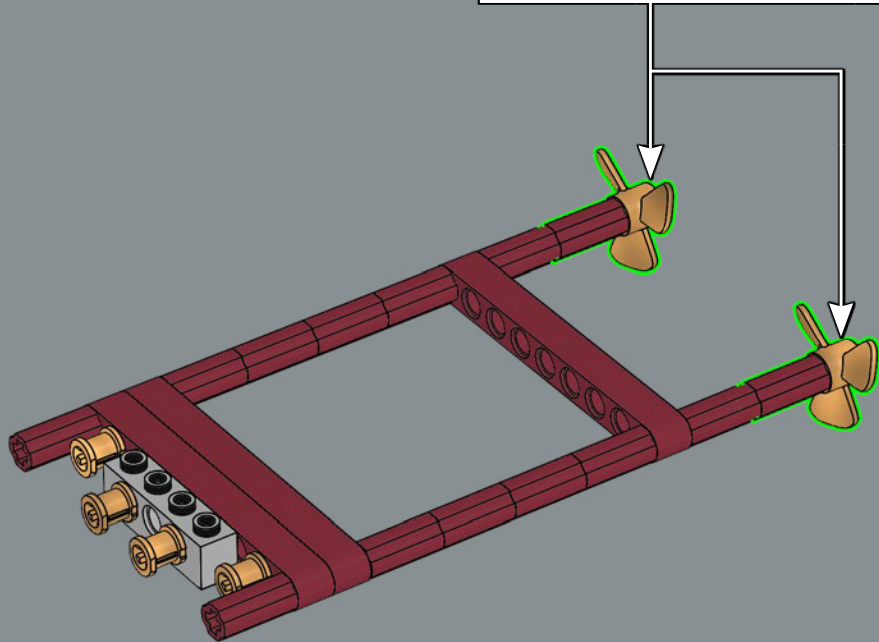
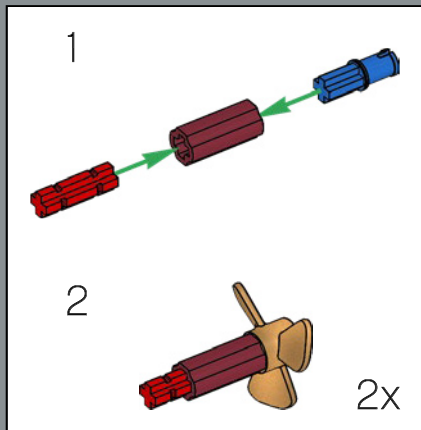

171

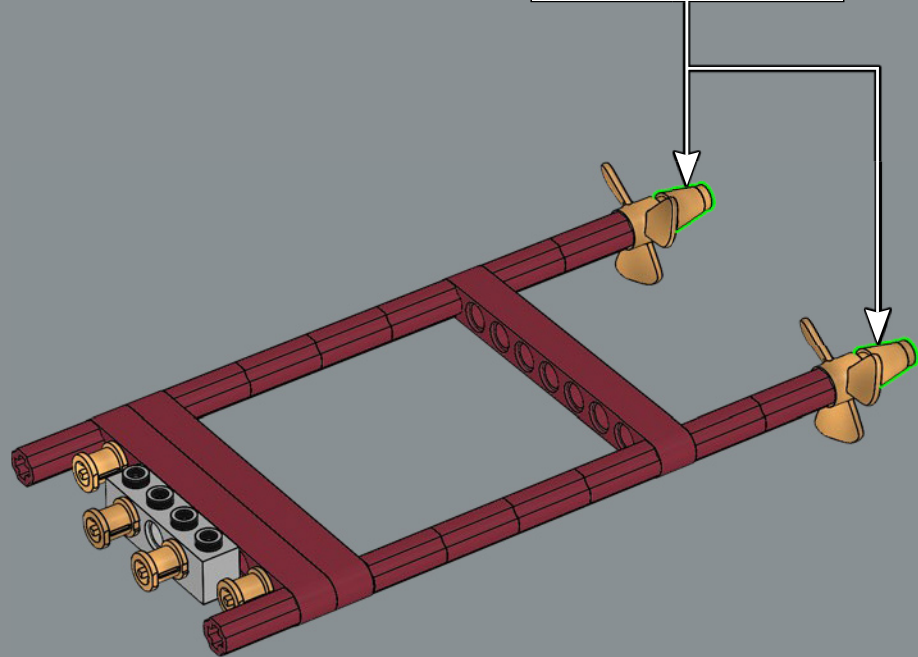
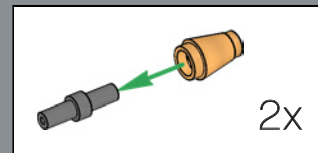

172

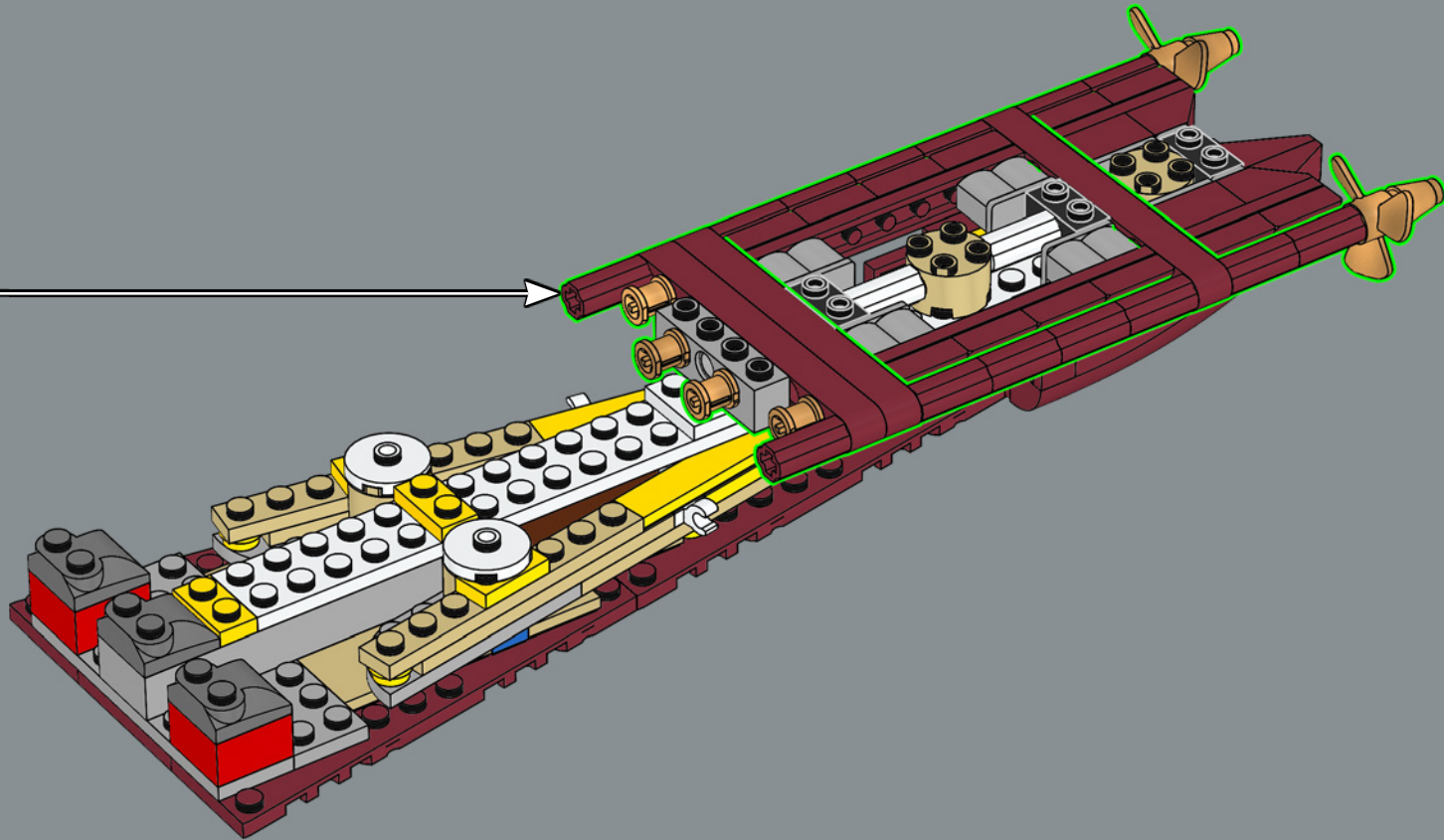

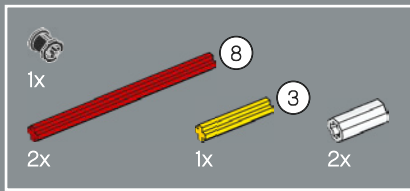

173

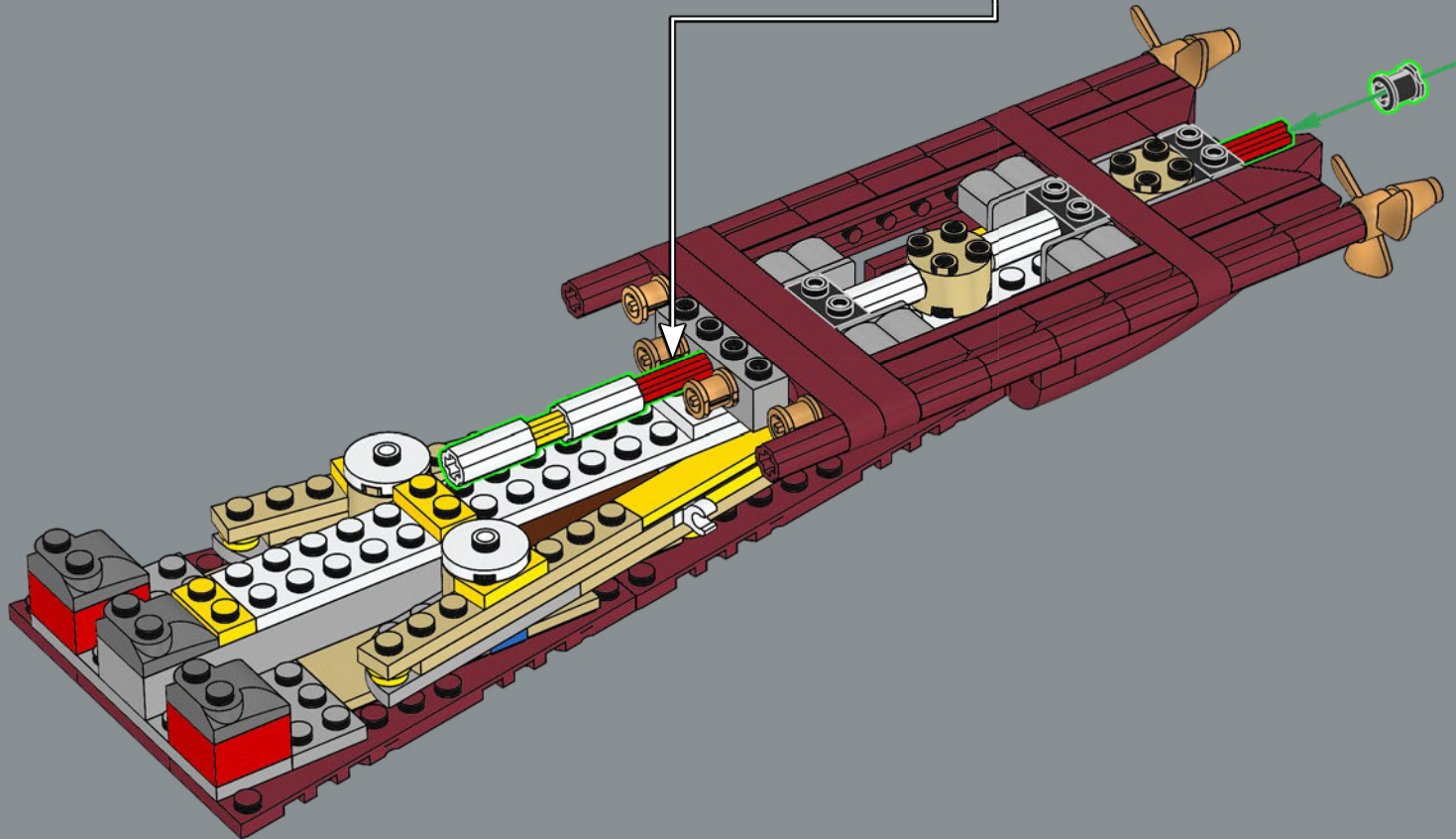
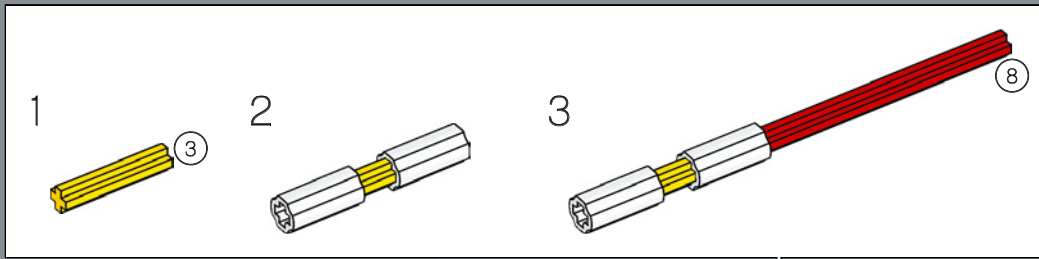

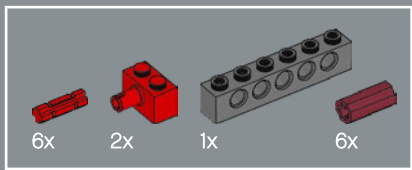

174

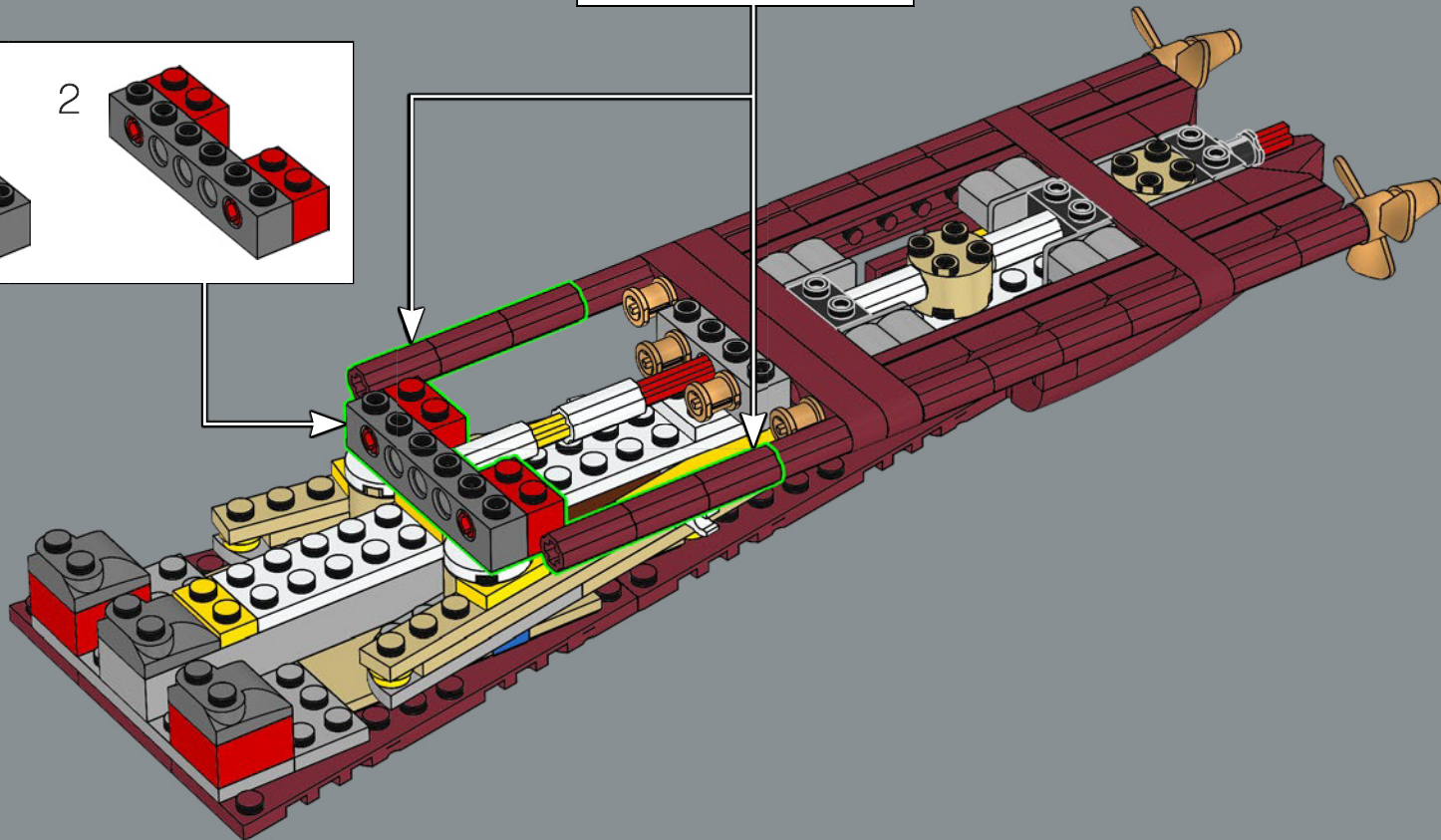
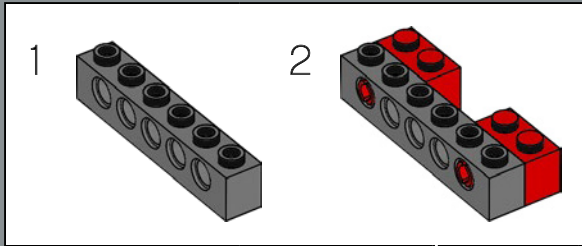
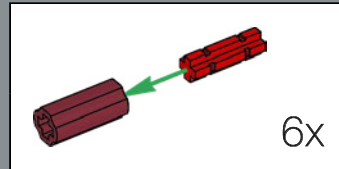

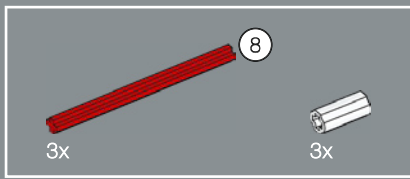

175

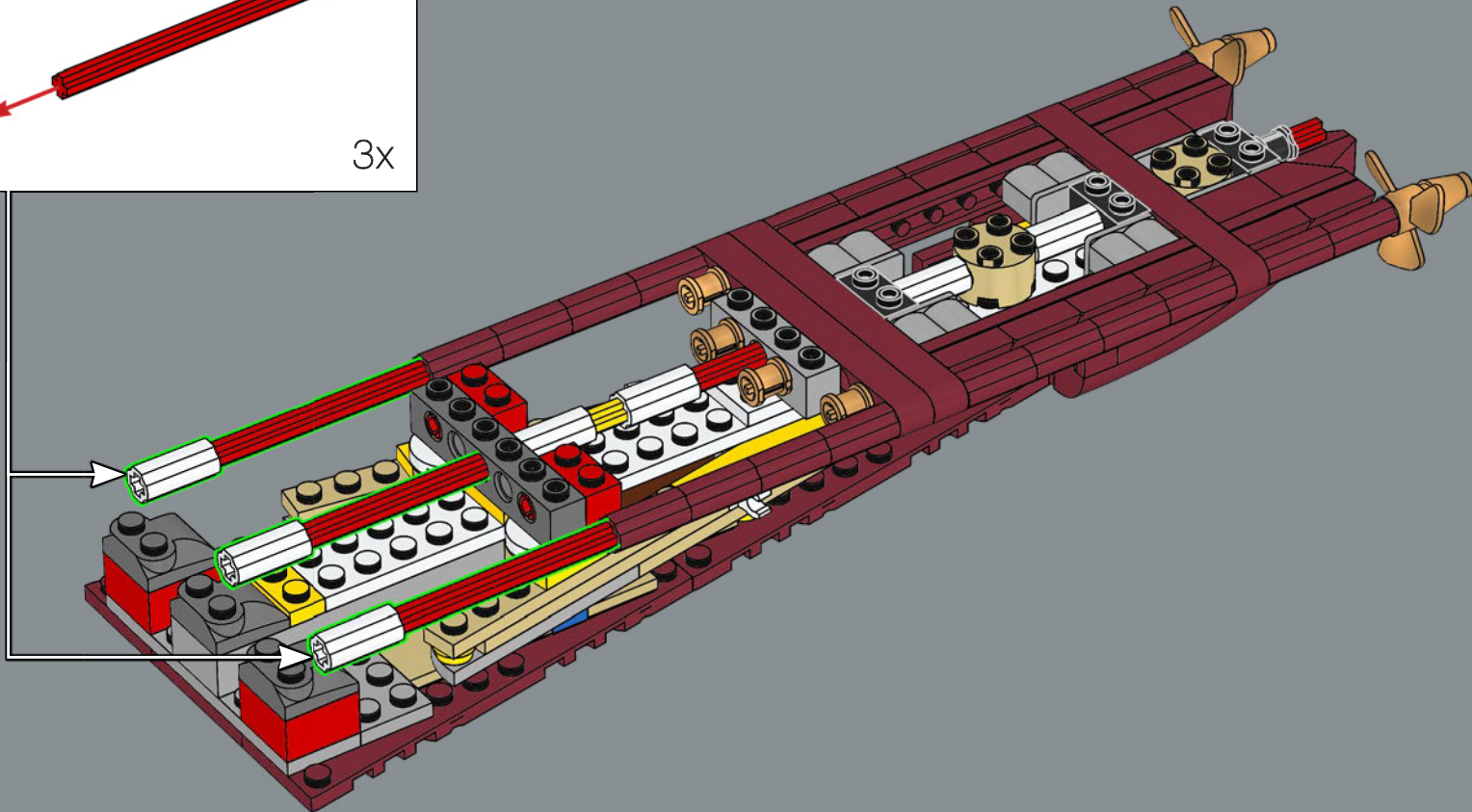
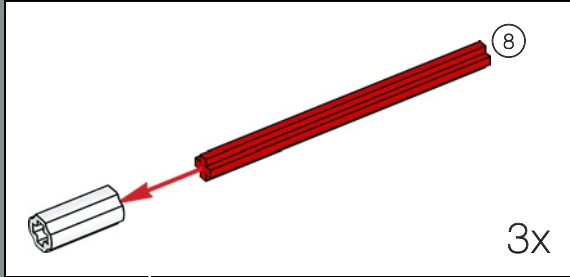

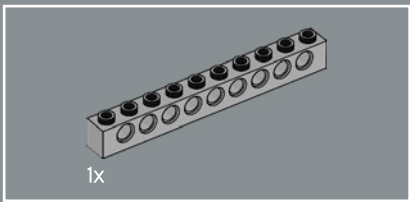

176

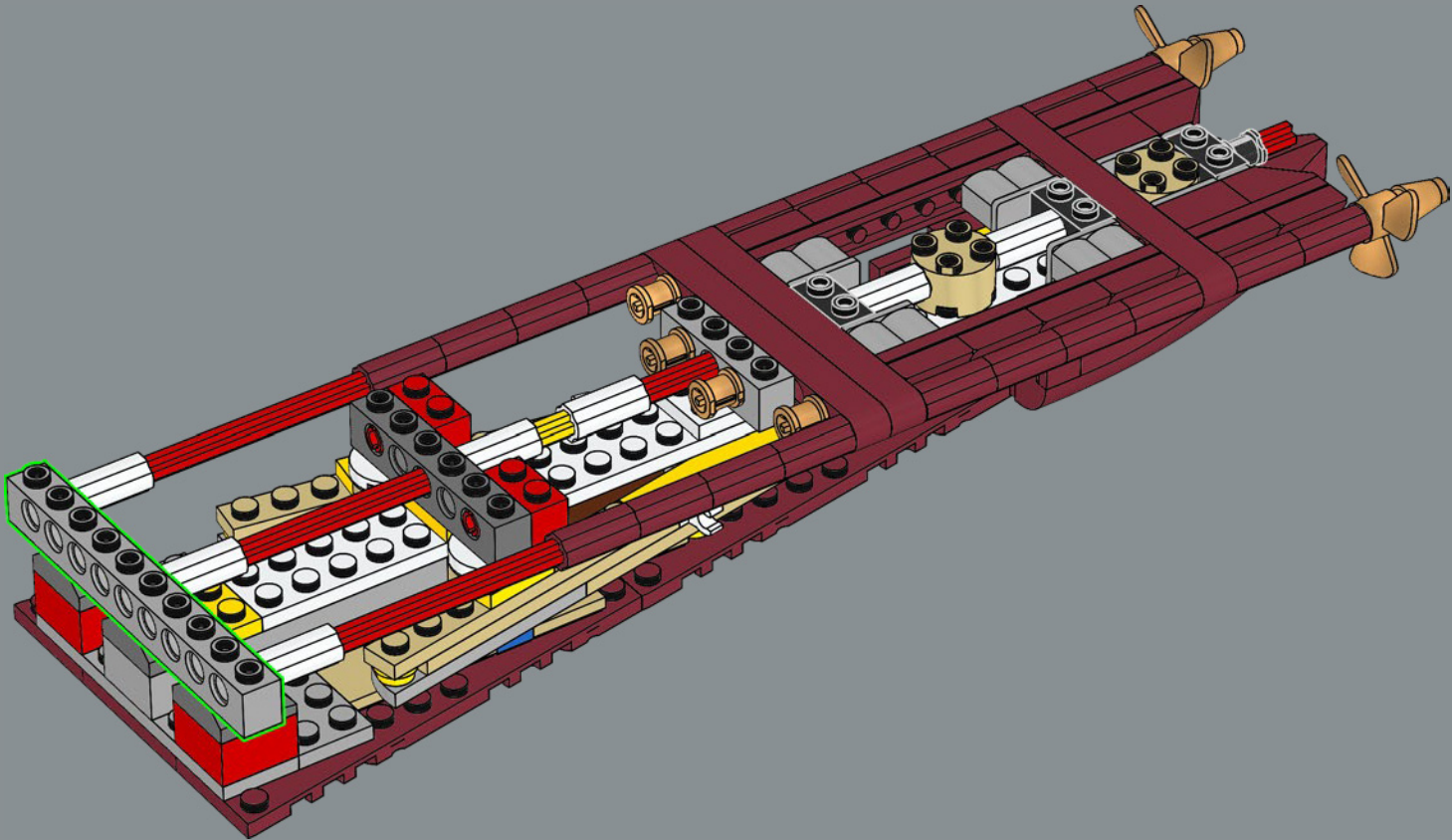

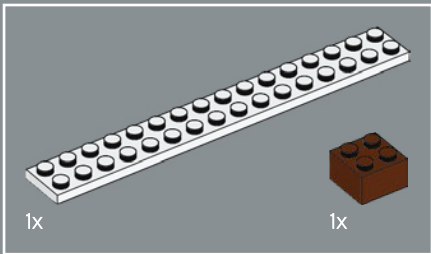
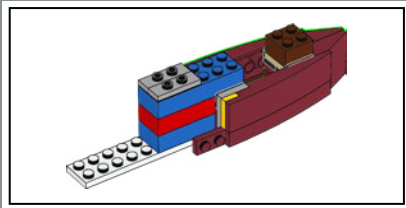
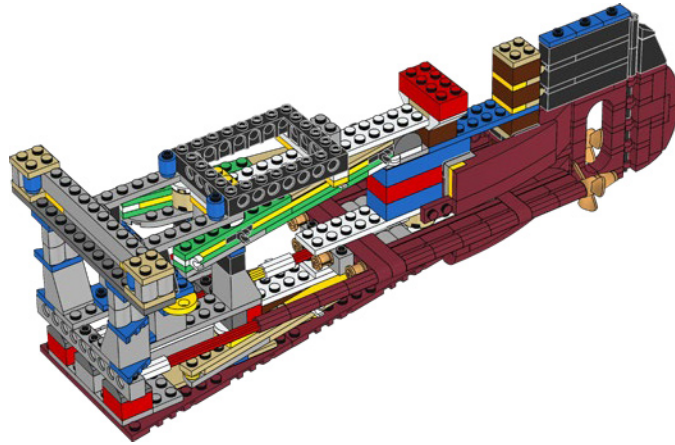
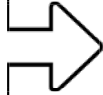

177

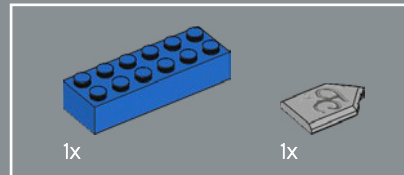
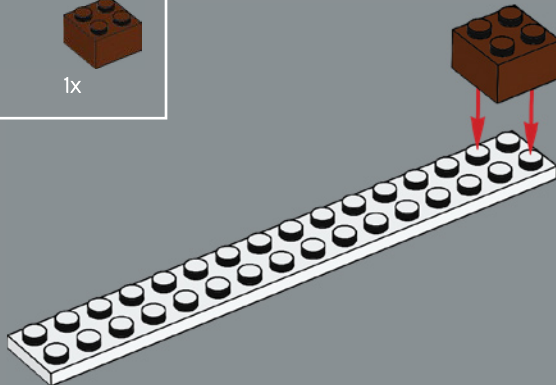

178

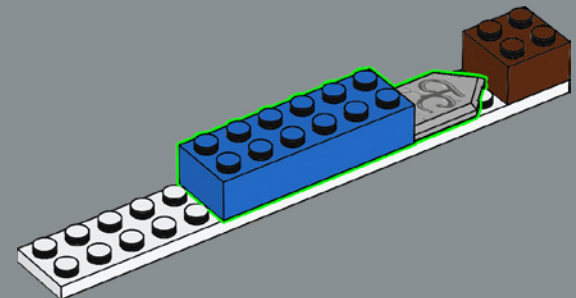



4x

179

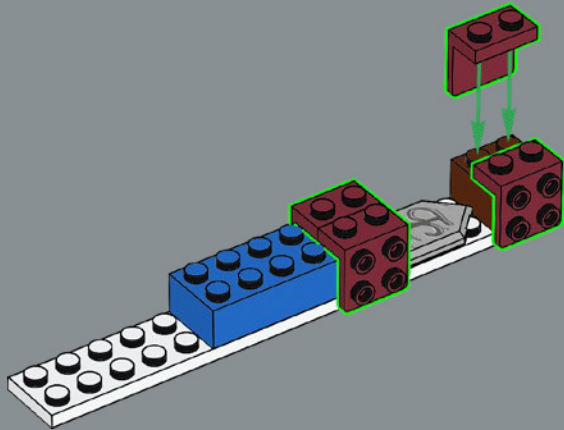

4x

180

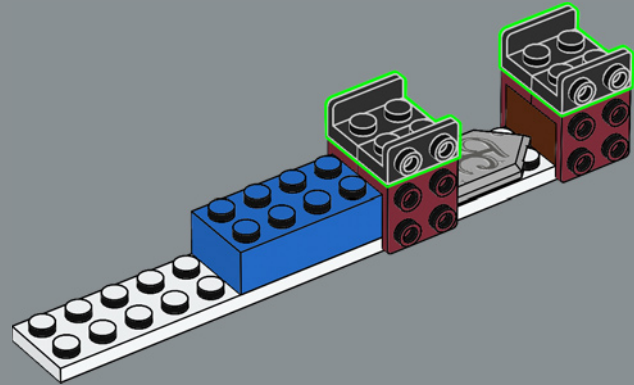



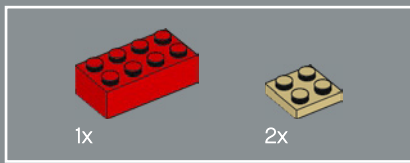

181

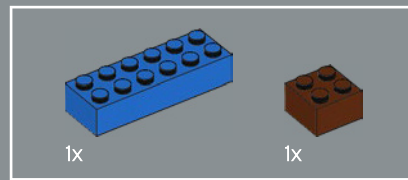
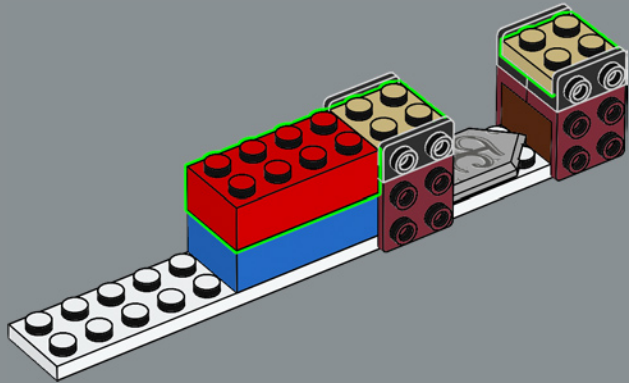

182

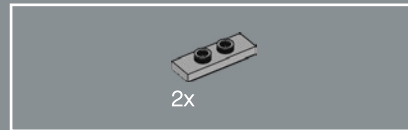
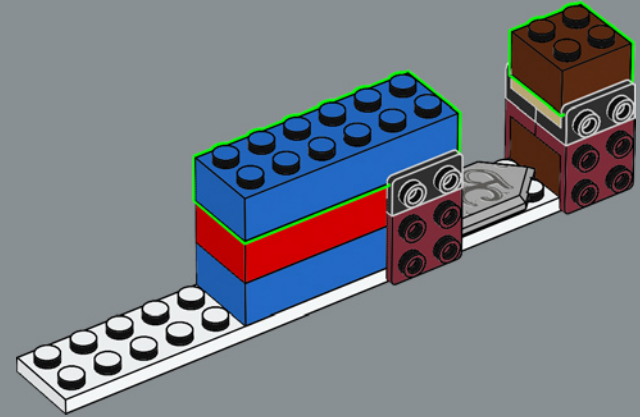

183

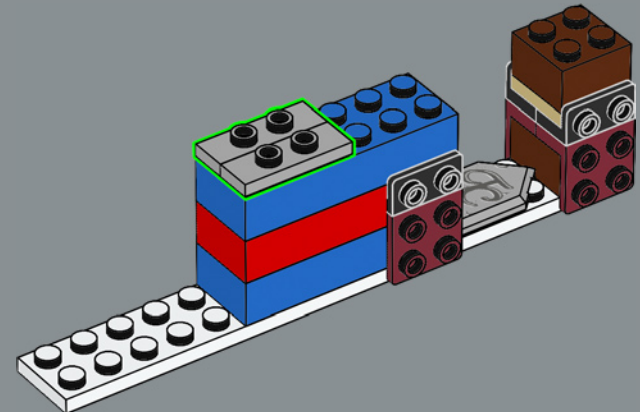

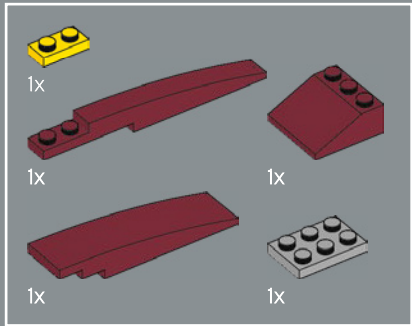

184

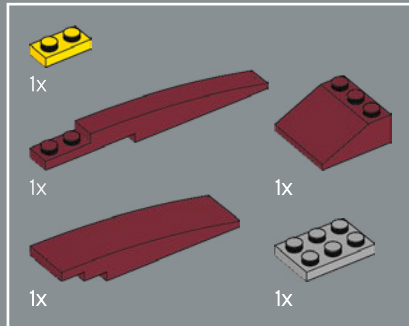
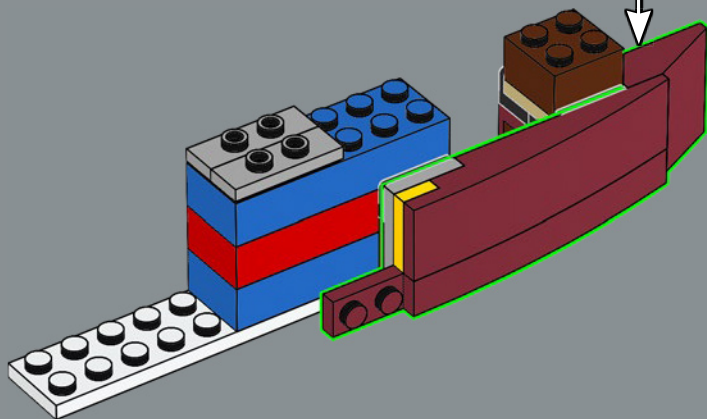
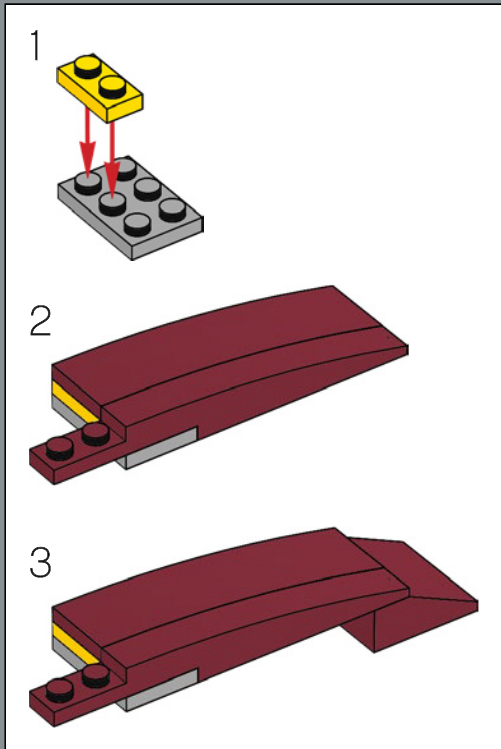

185

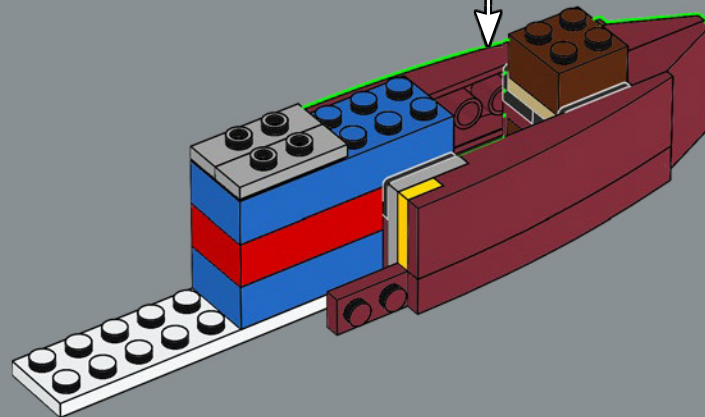
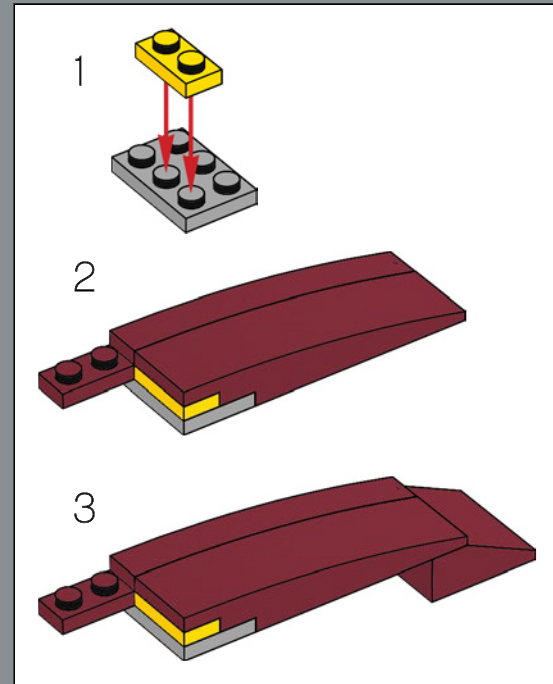



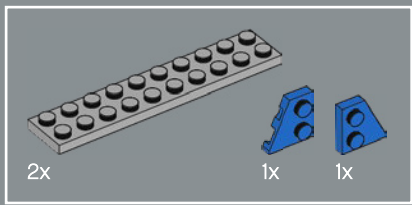

187

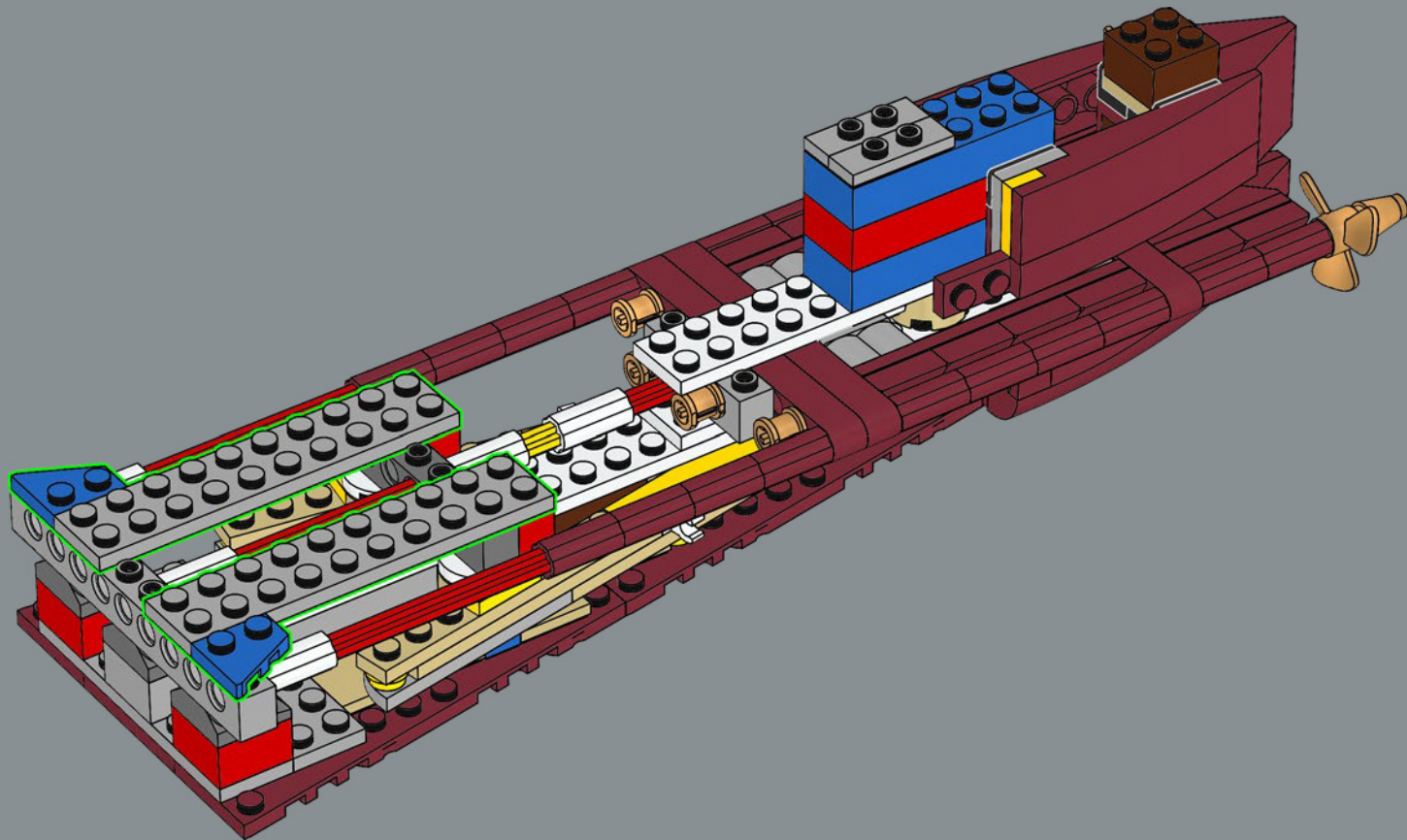

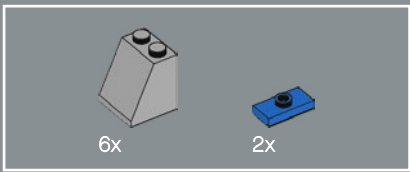

188

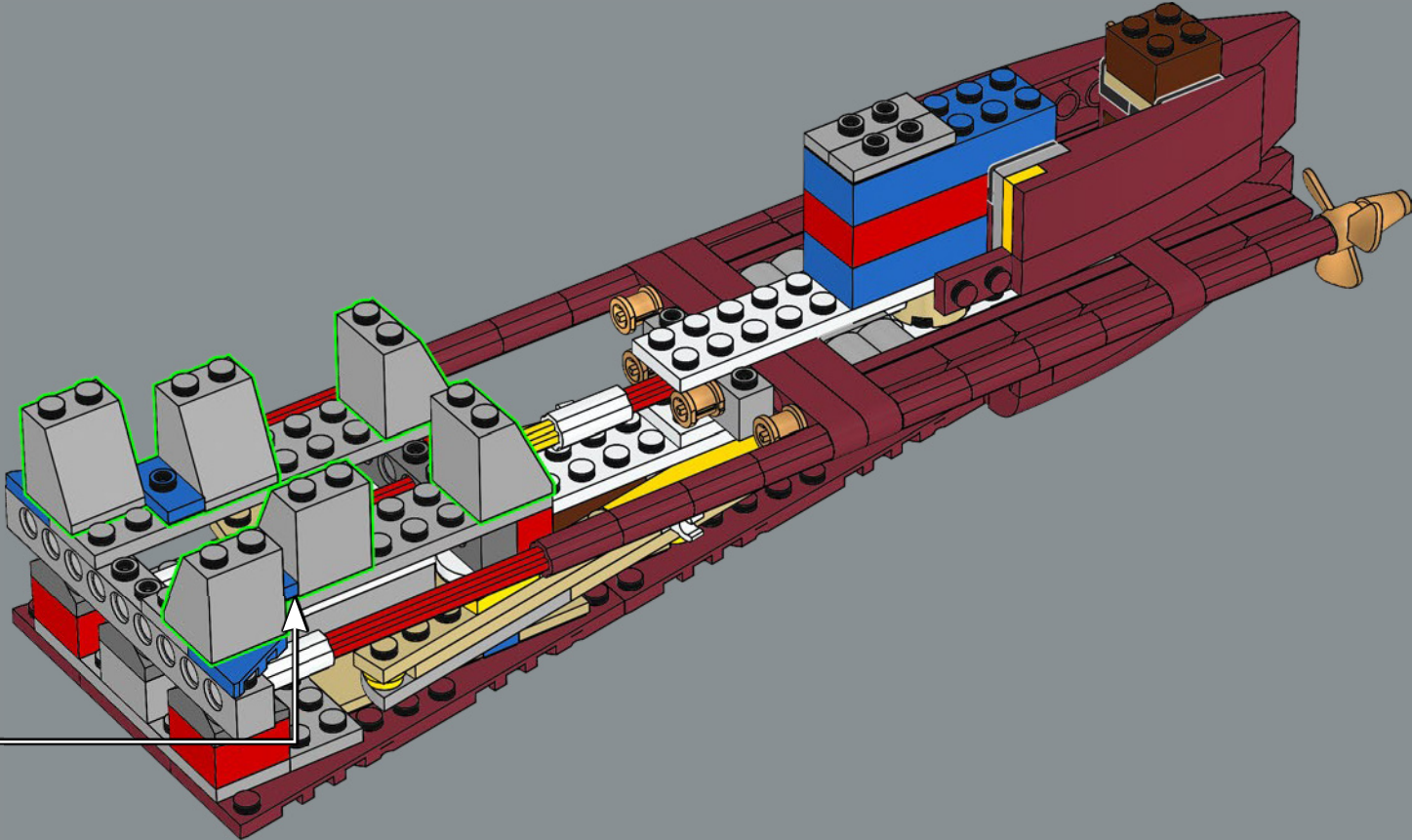

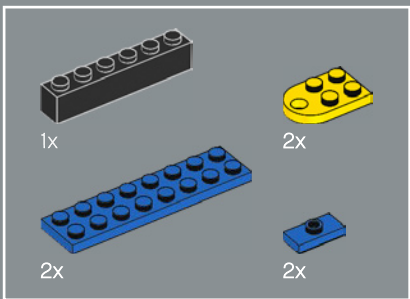

189

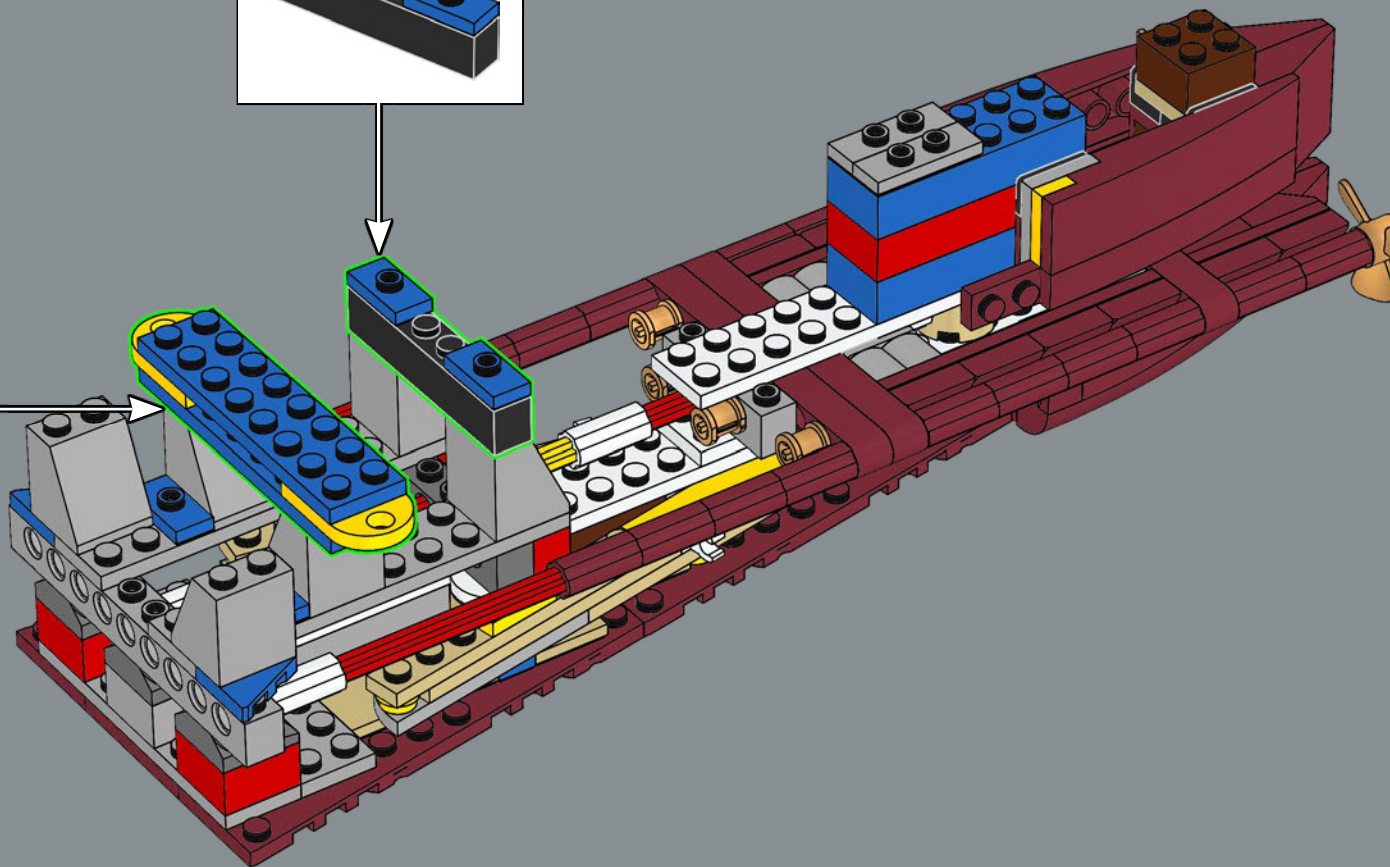
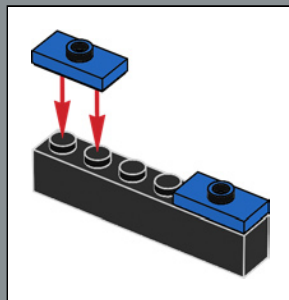
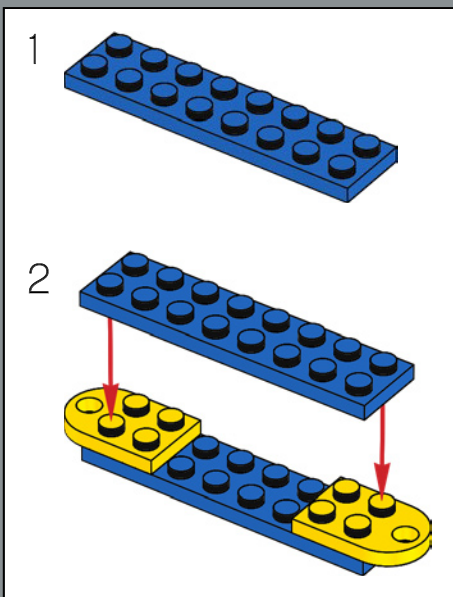

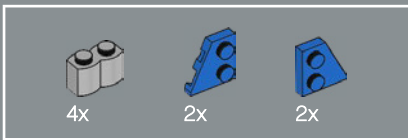

190

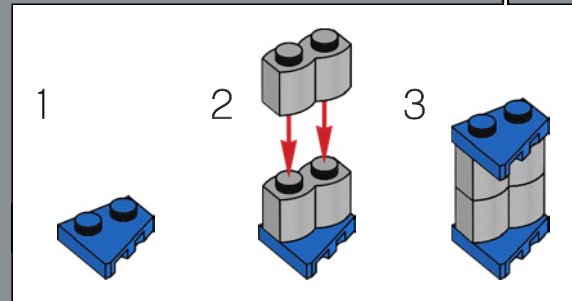
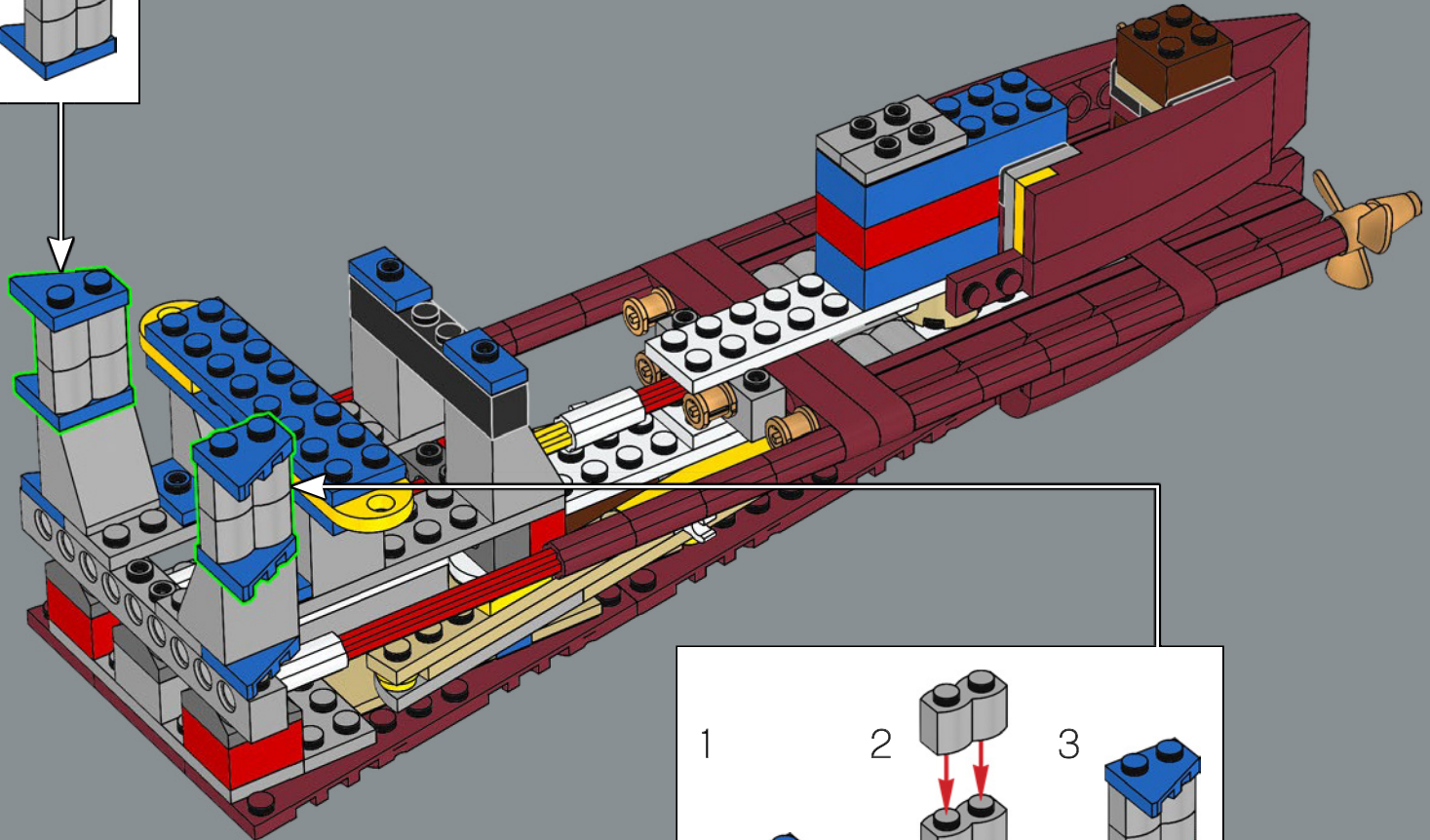
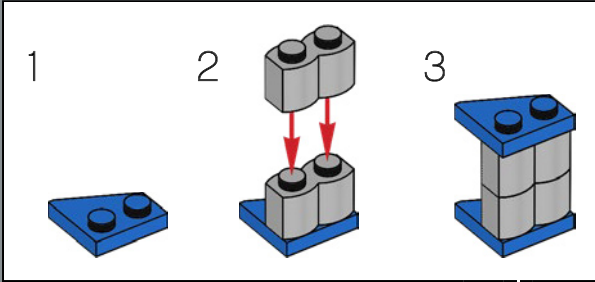

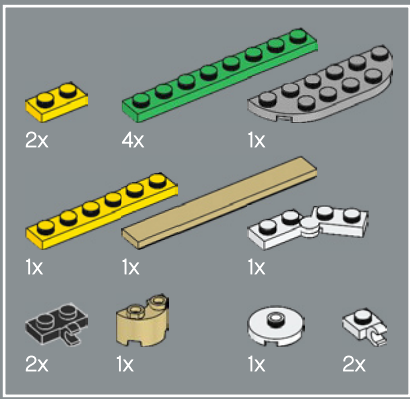

191

1



2

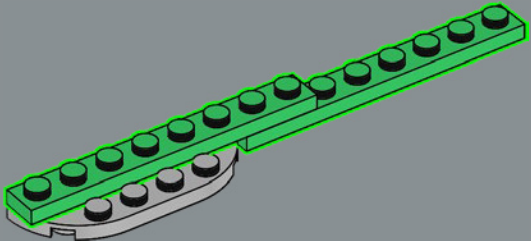

3

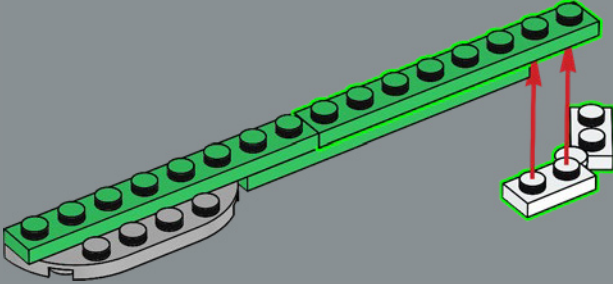

4

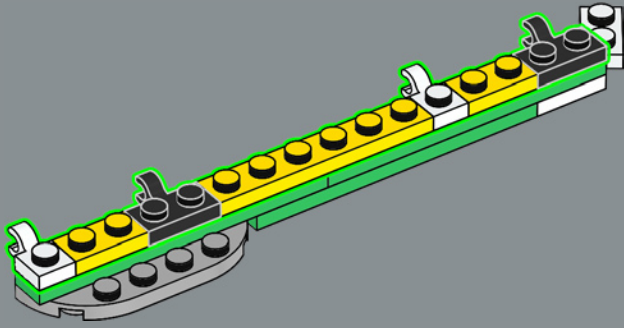

5

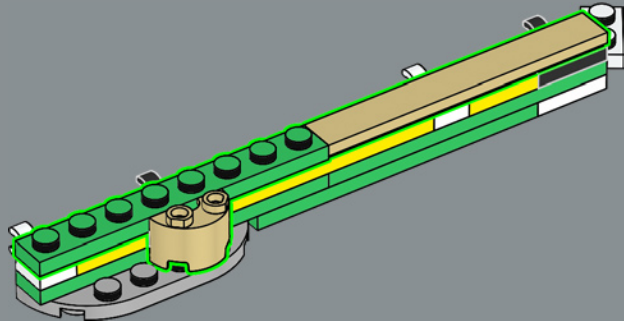

6

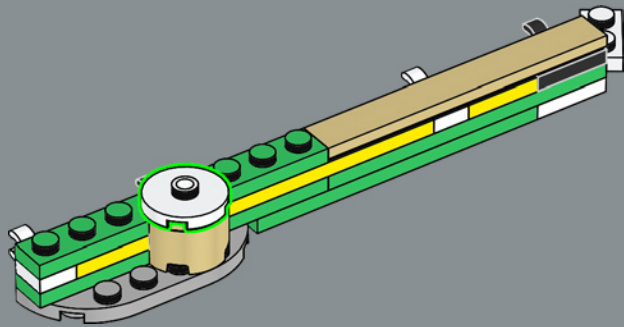



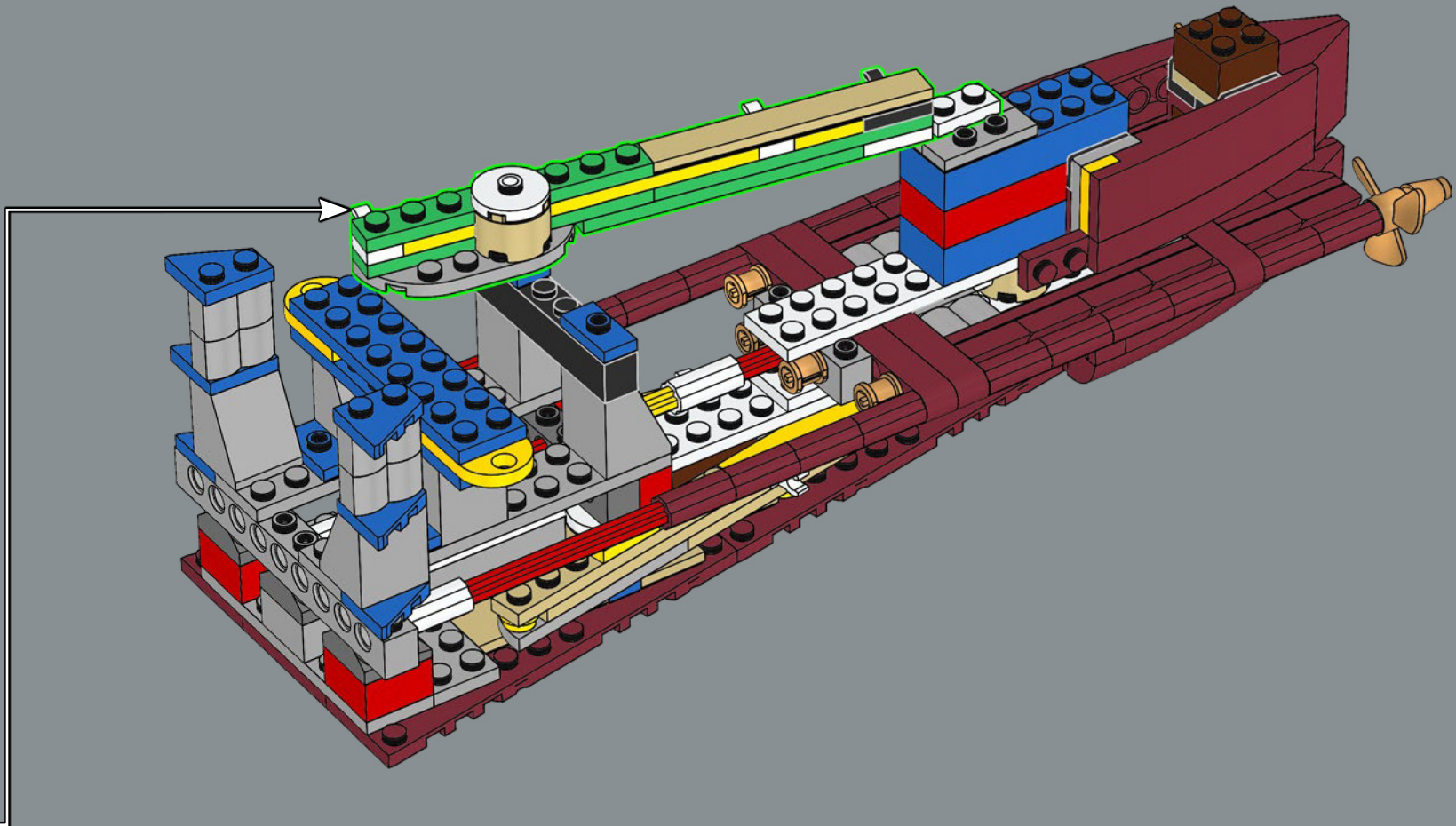

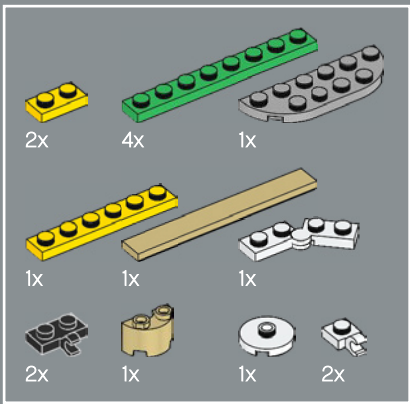

192

1

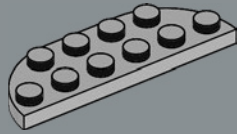

2

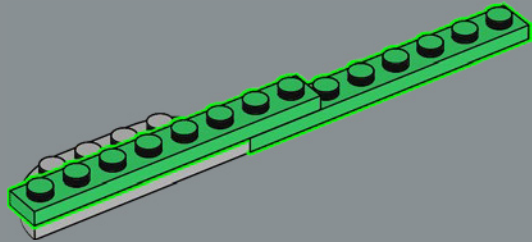

3

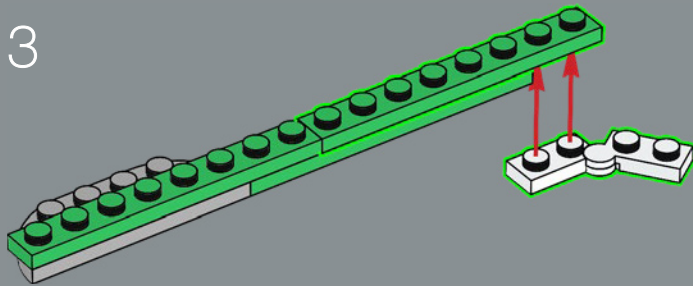

4

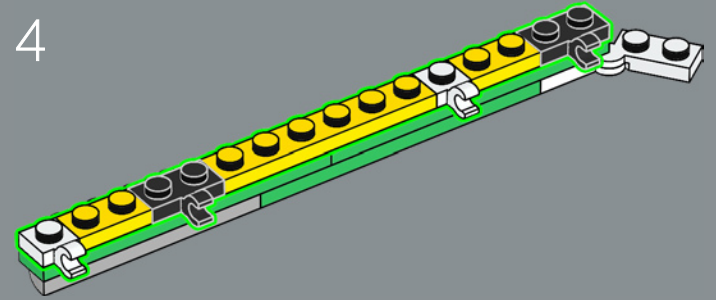

5

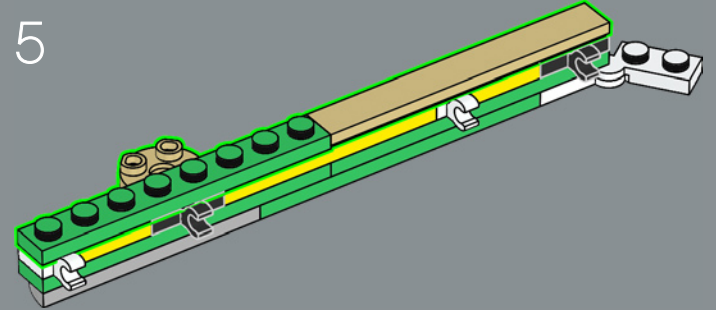

6

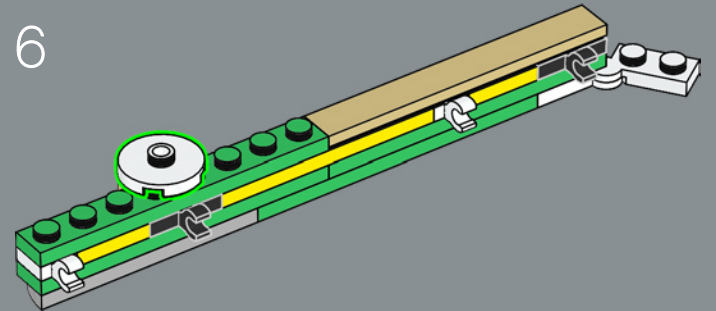

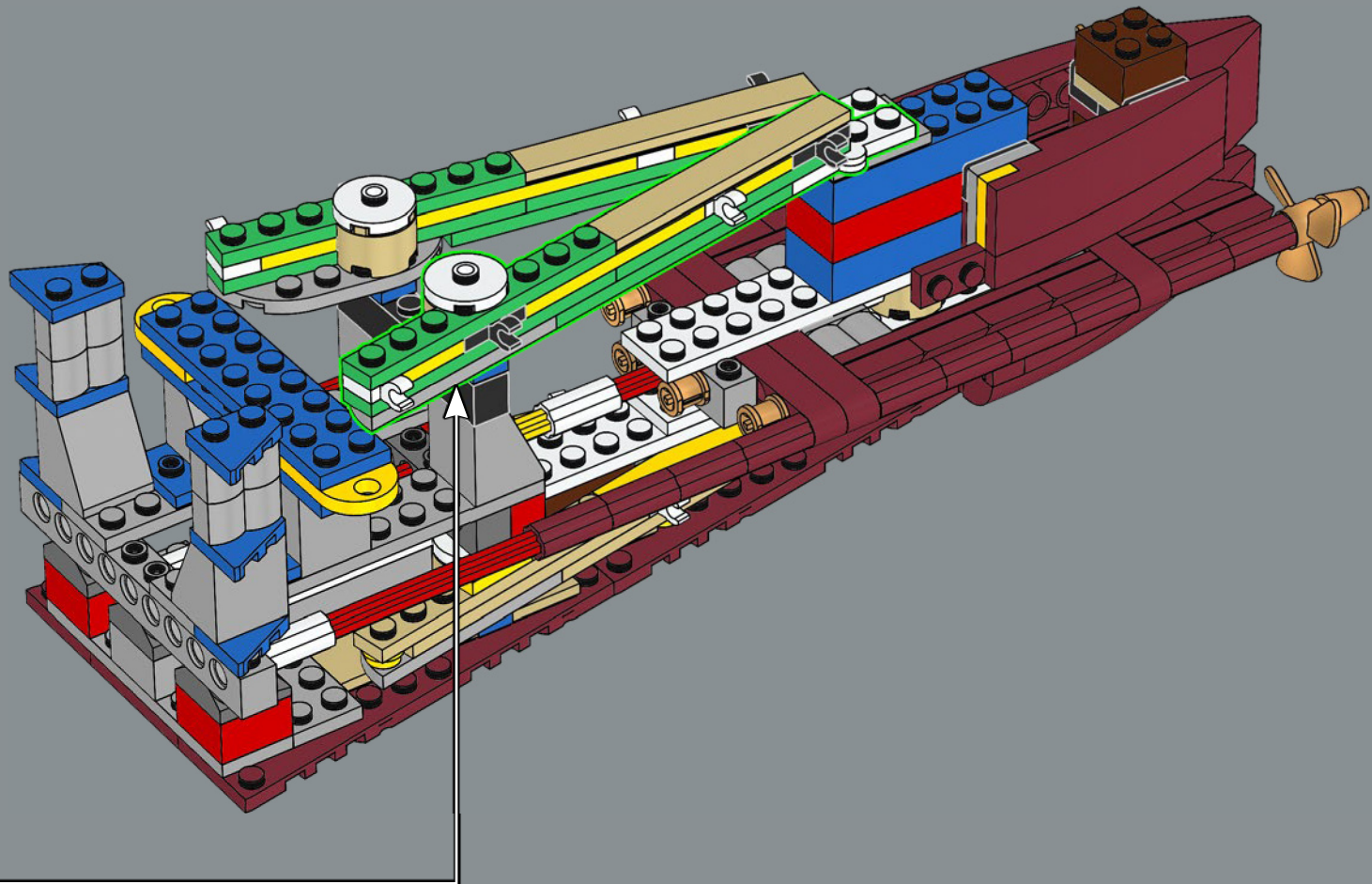

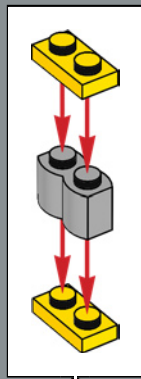
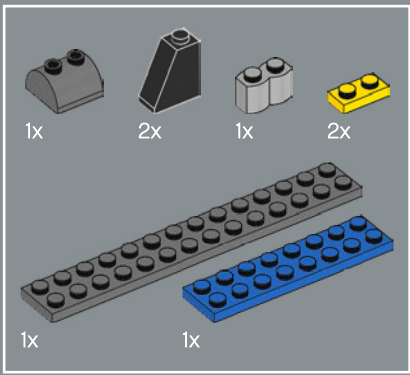

193

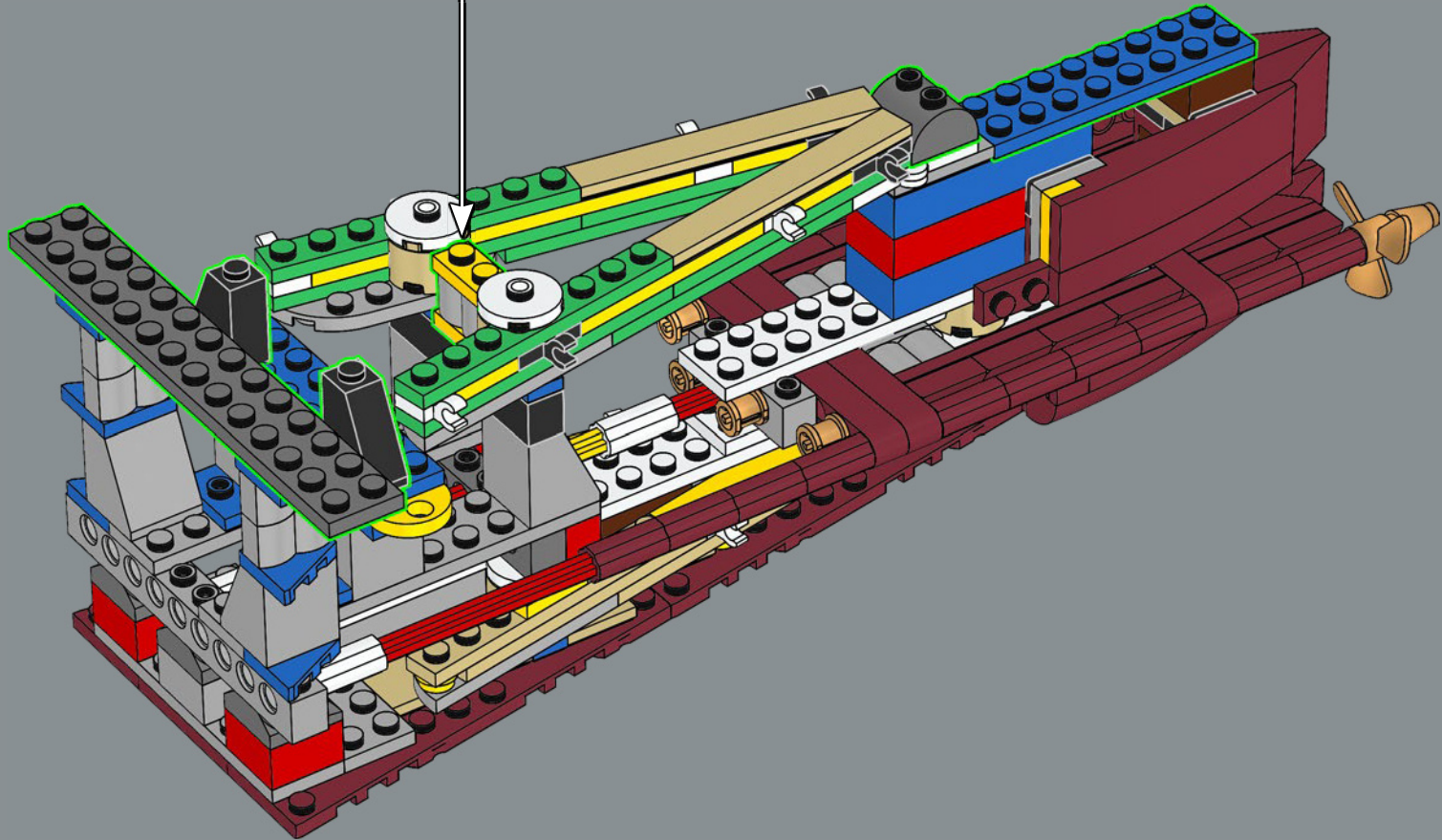

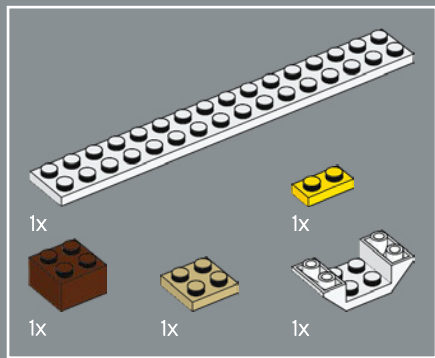

194

1

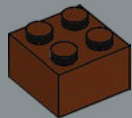

2

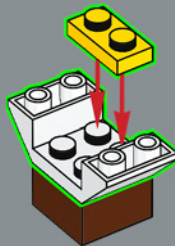

3

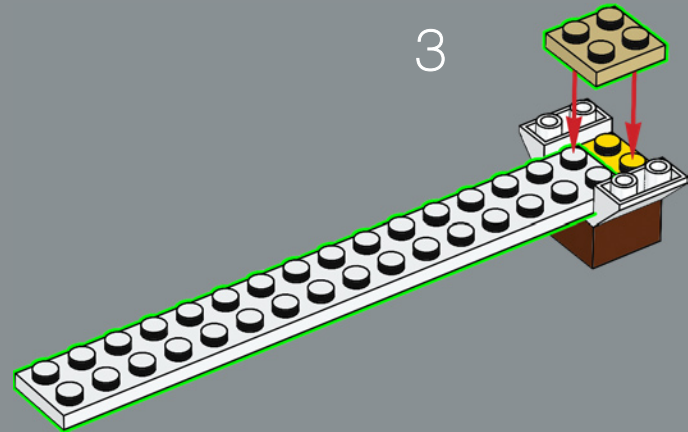

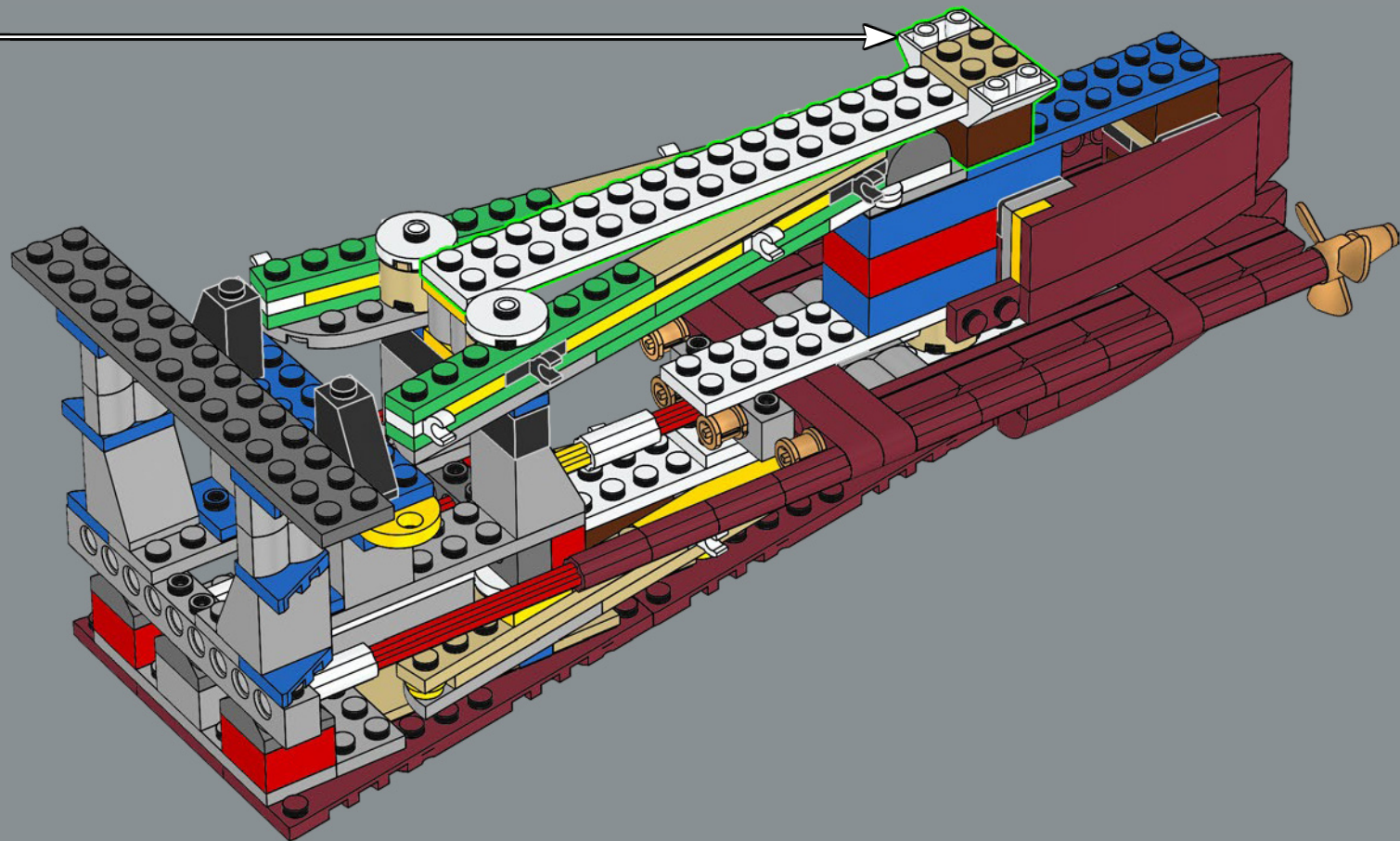

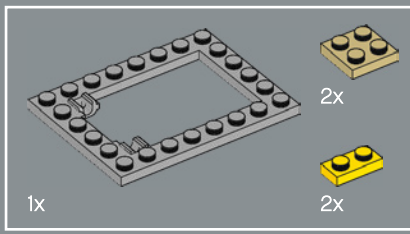

195

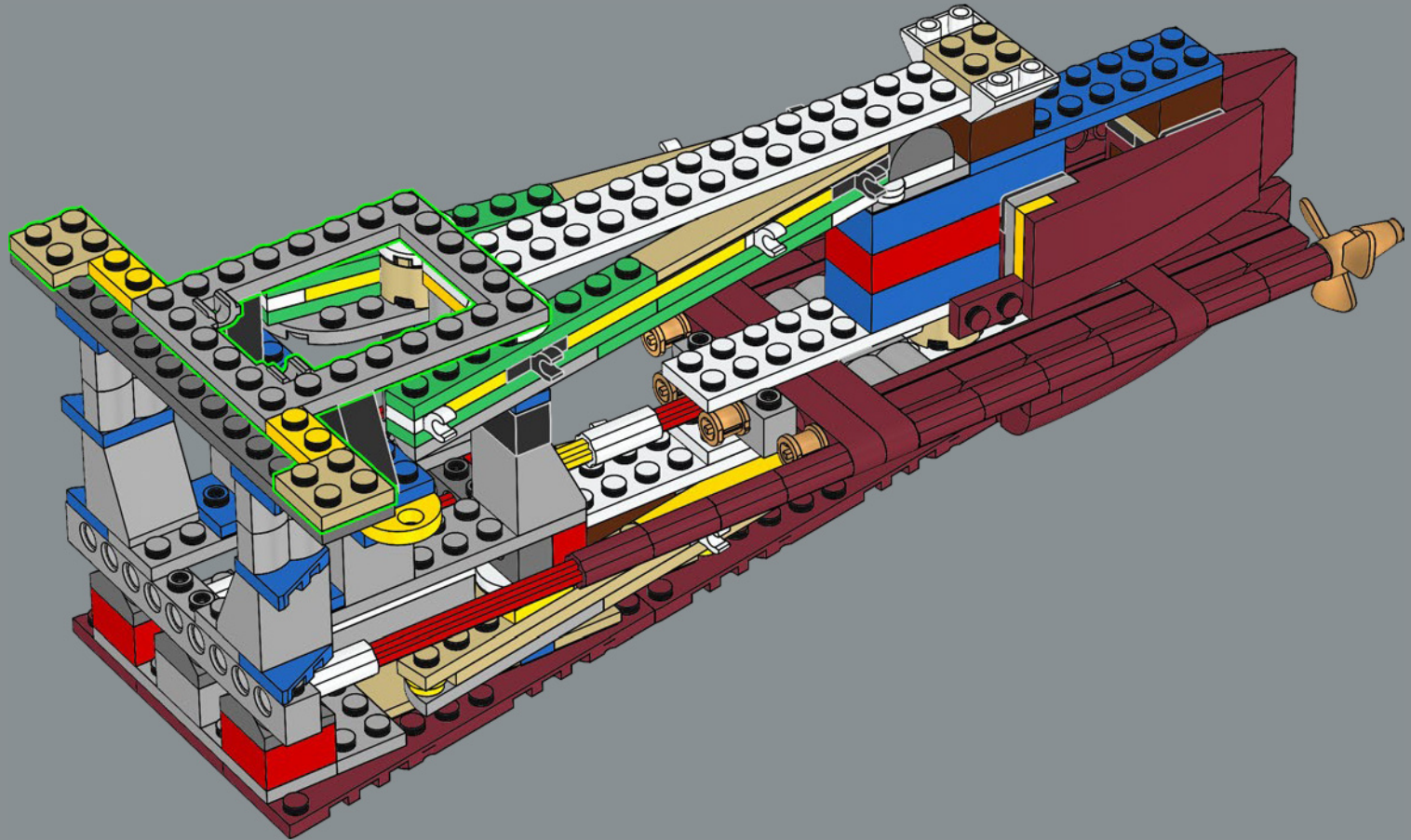

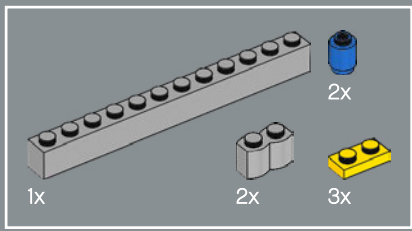

196

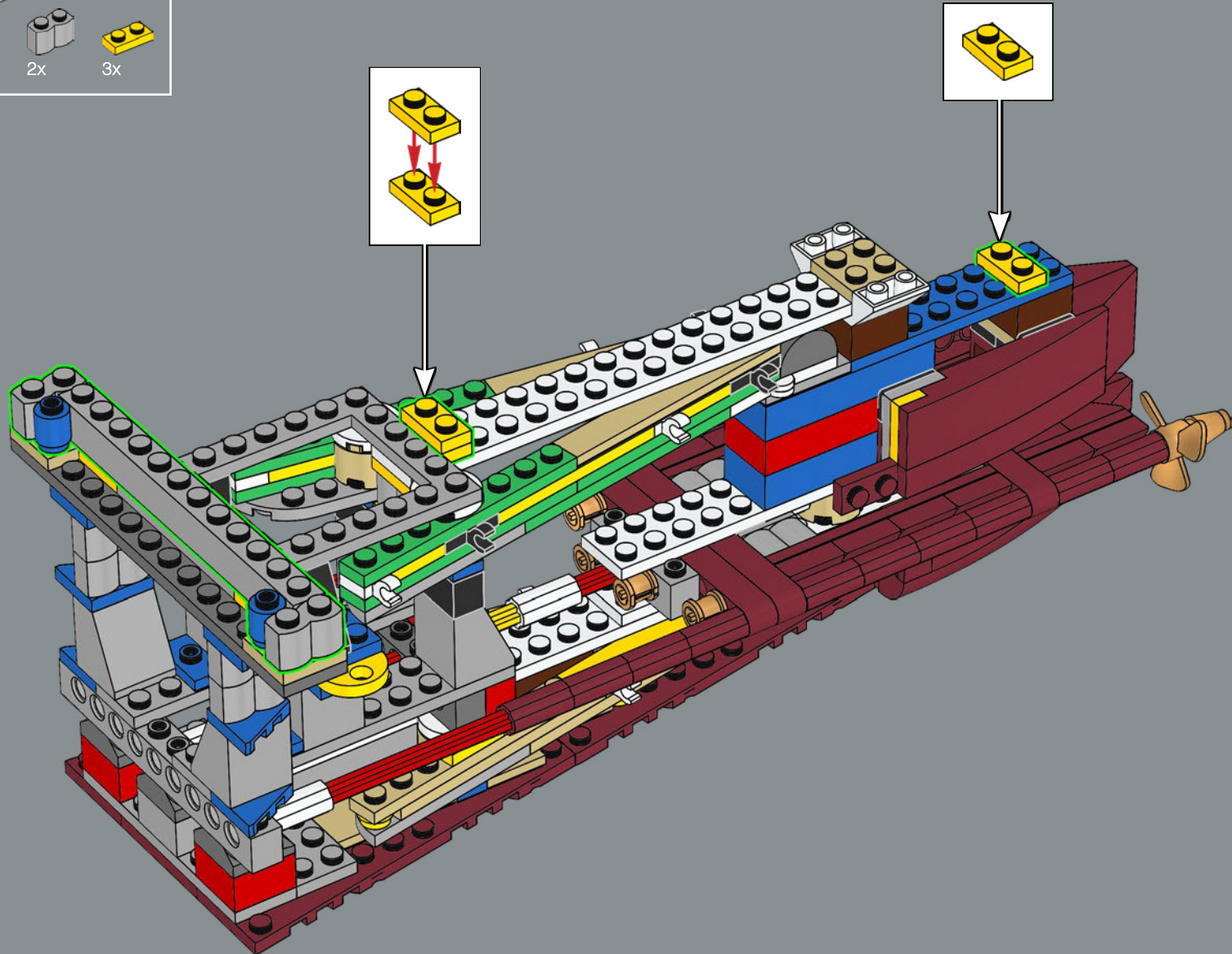



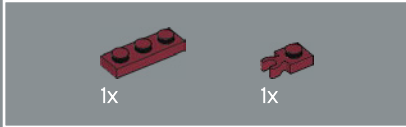
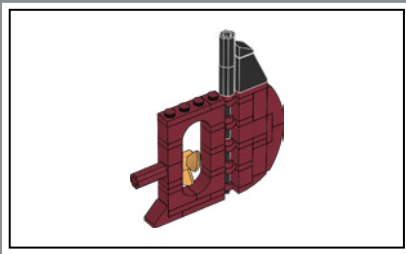

197

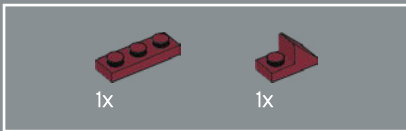
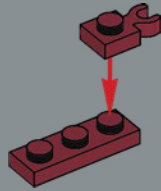

198

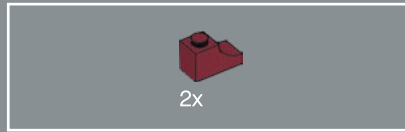
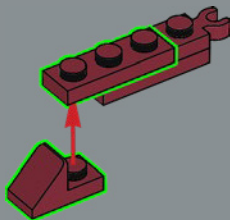

199

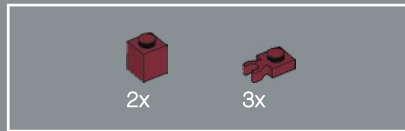
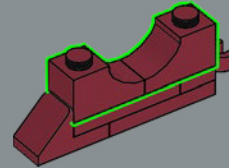

200

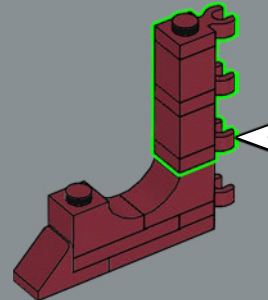
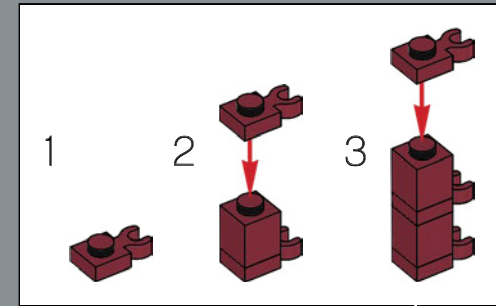

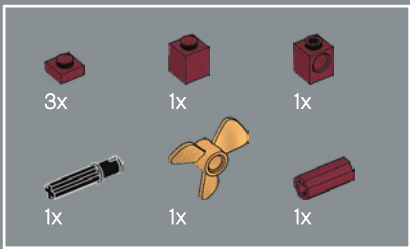

201

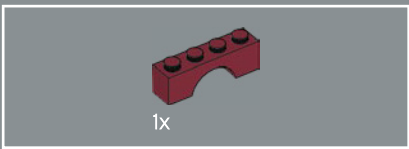
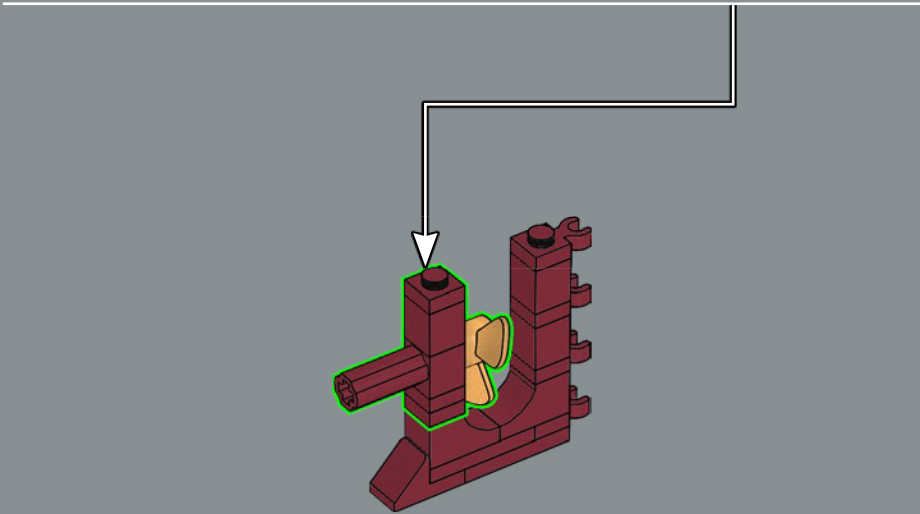
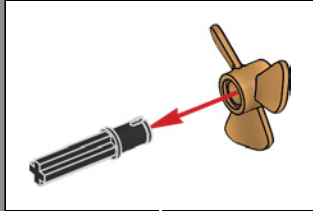
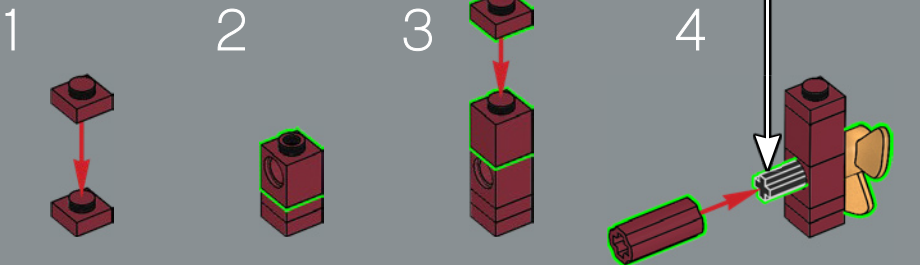

202

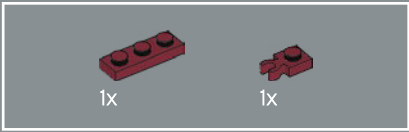
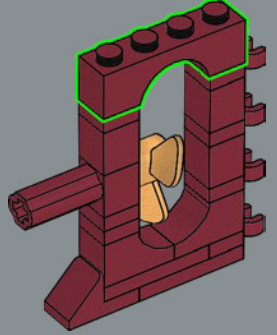

203

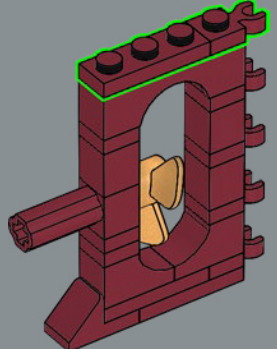

204

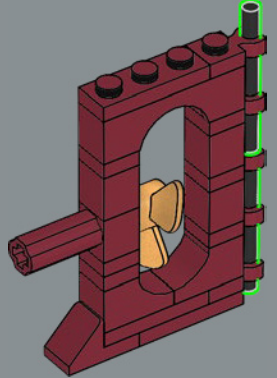

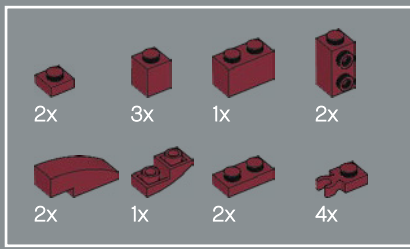

205

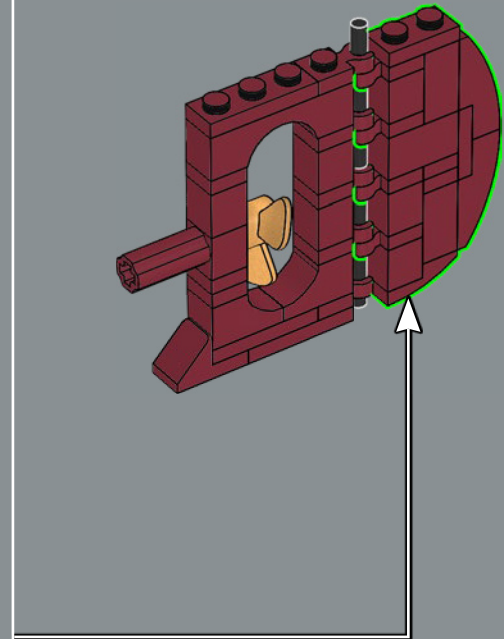
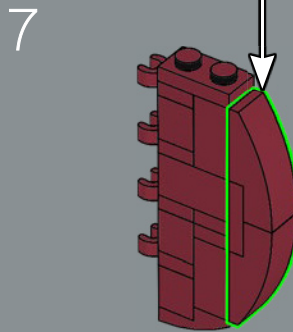
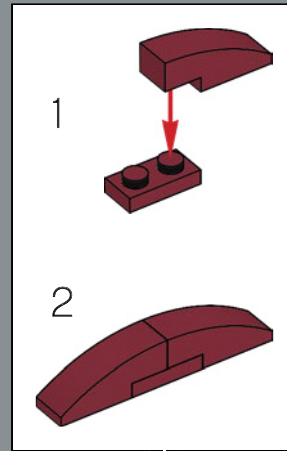
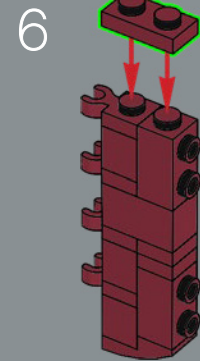
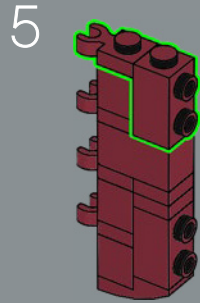
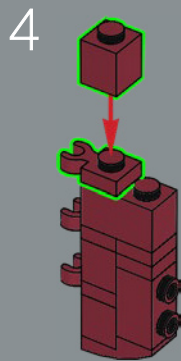
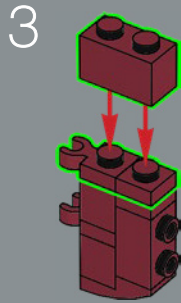
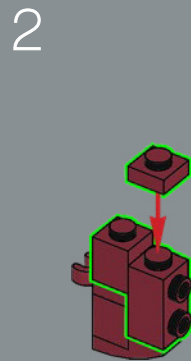
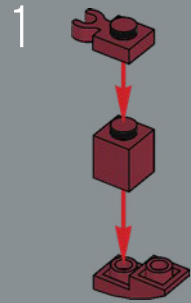

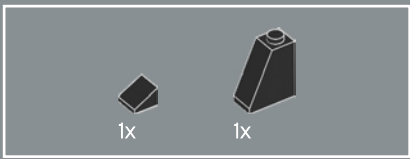

206

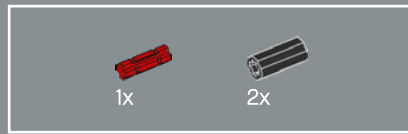
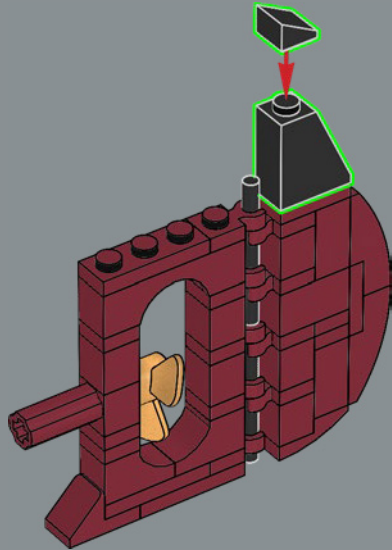

207

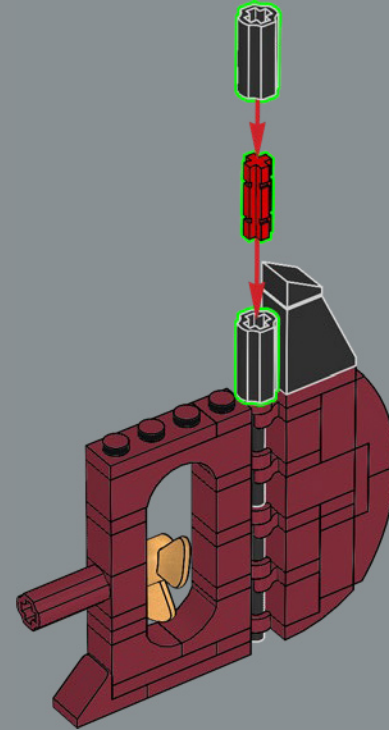

The ship's rudder was so large at 24 meters (78.8 ft.) high, 4.65 meters (15.3 ft.) long, and weighing over 100 tonnes (110.2 US tons), it required steering engines to move it.

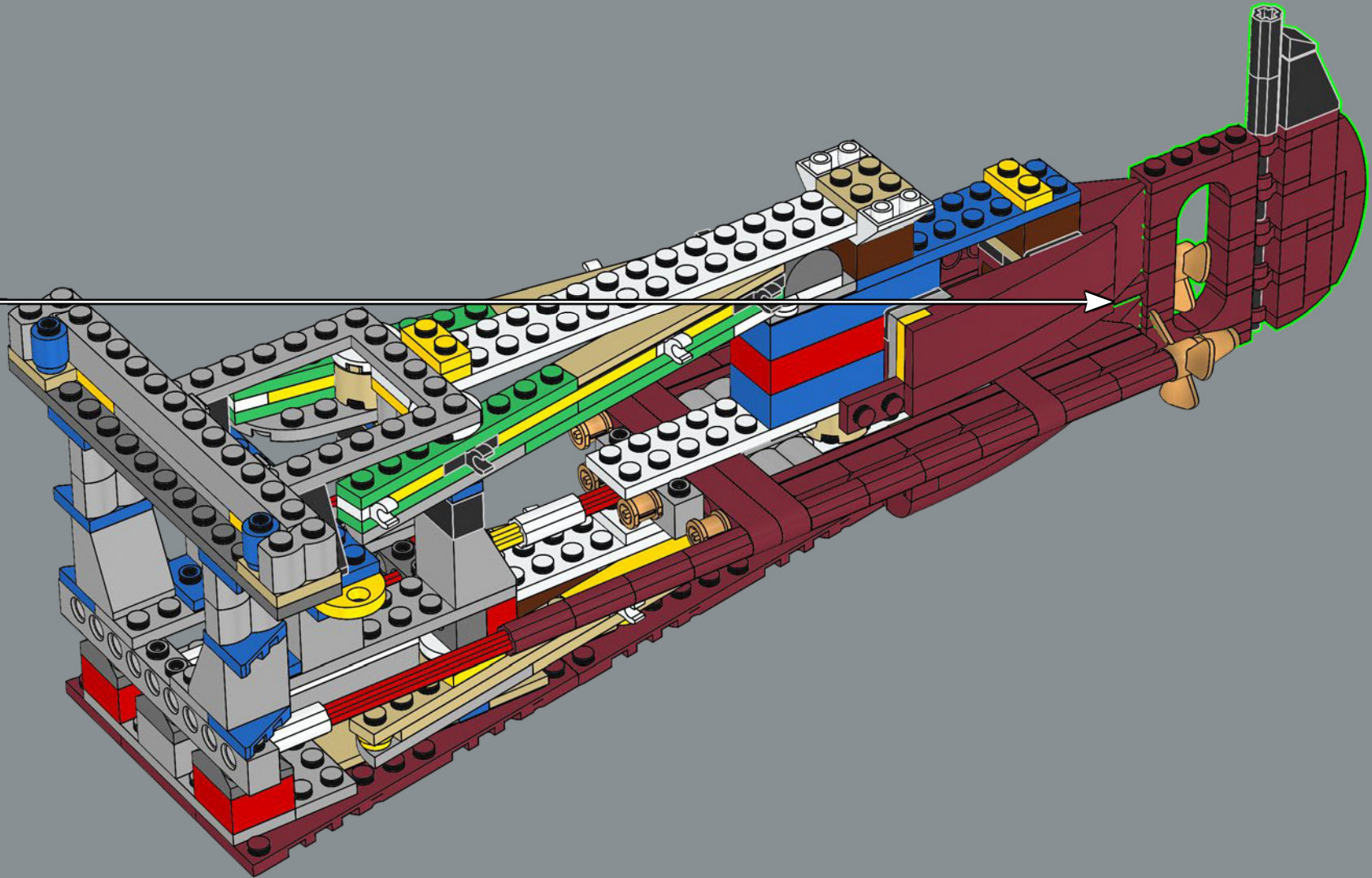

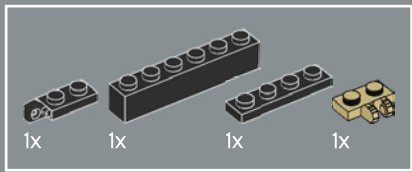

209

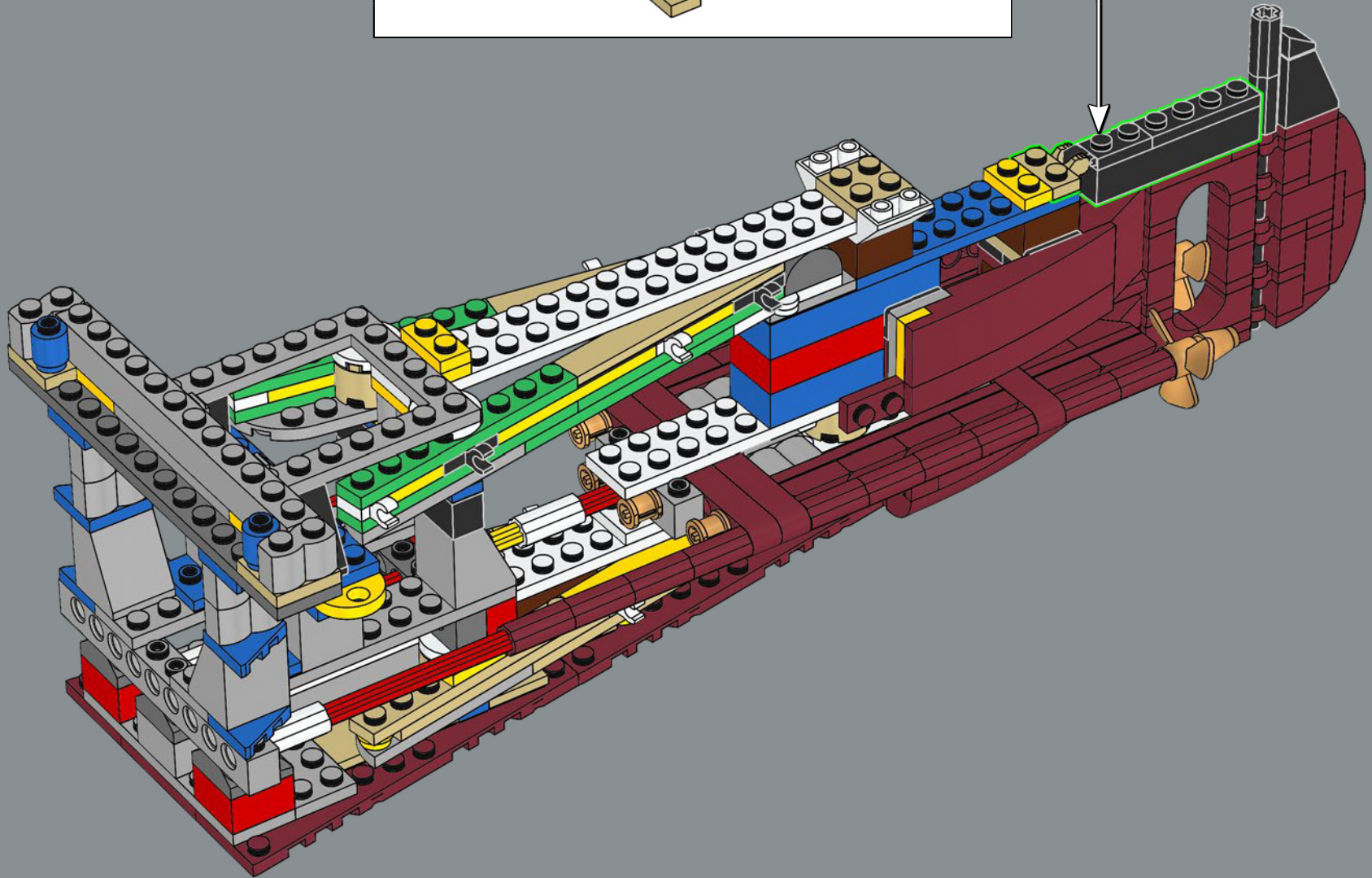
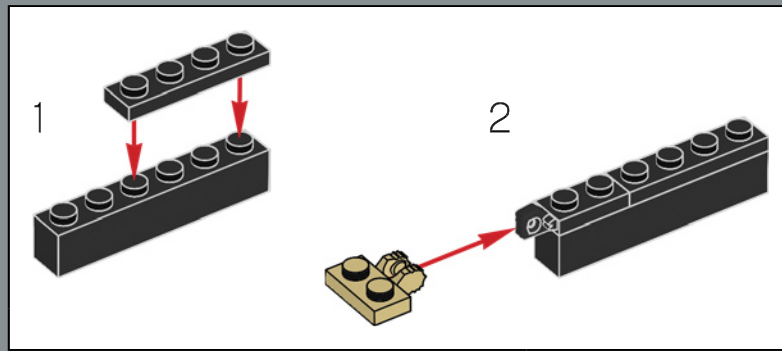

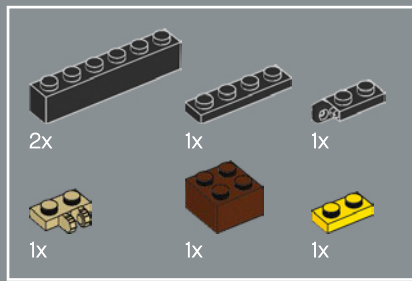

210

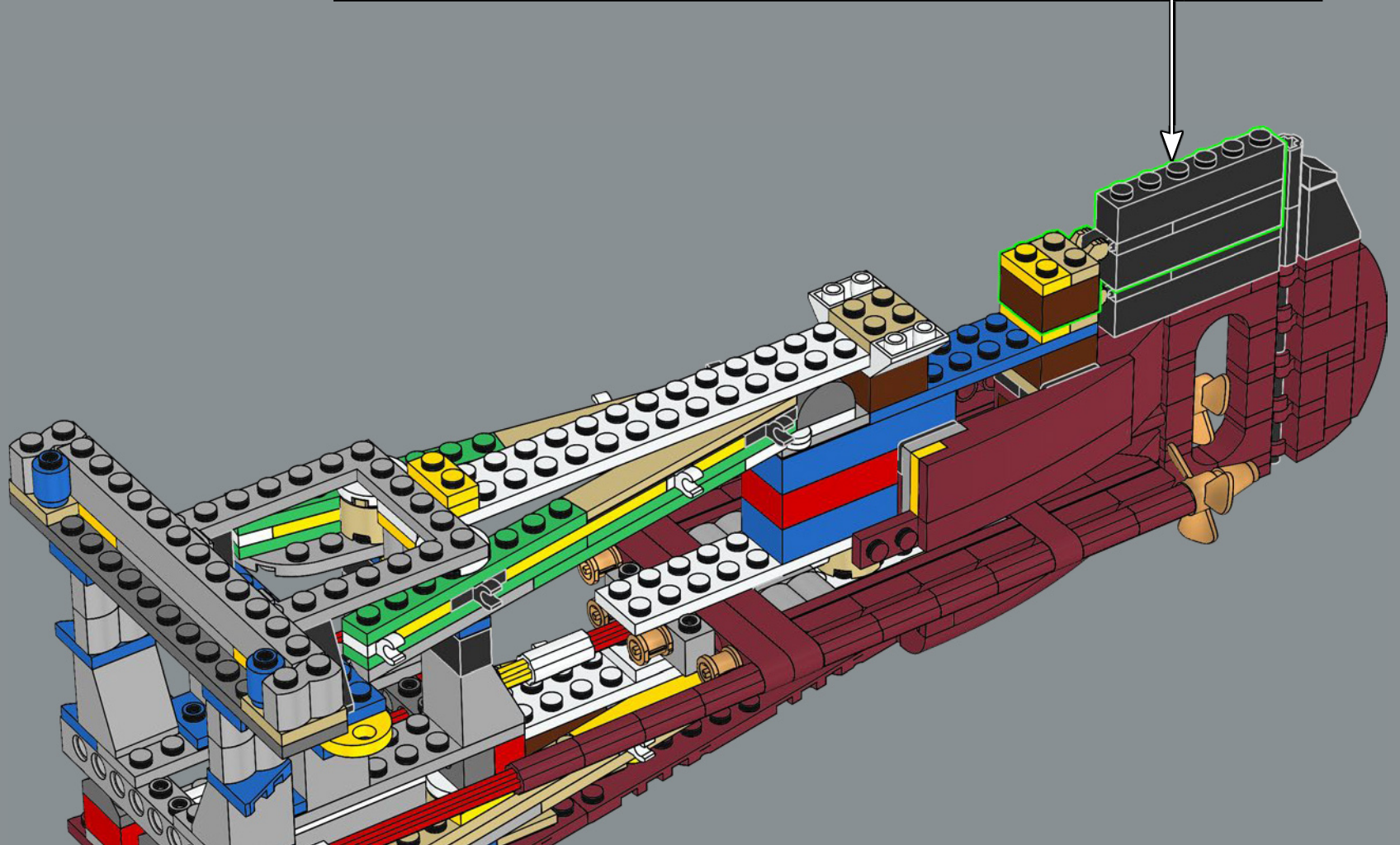
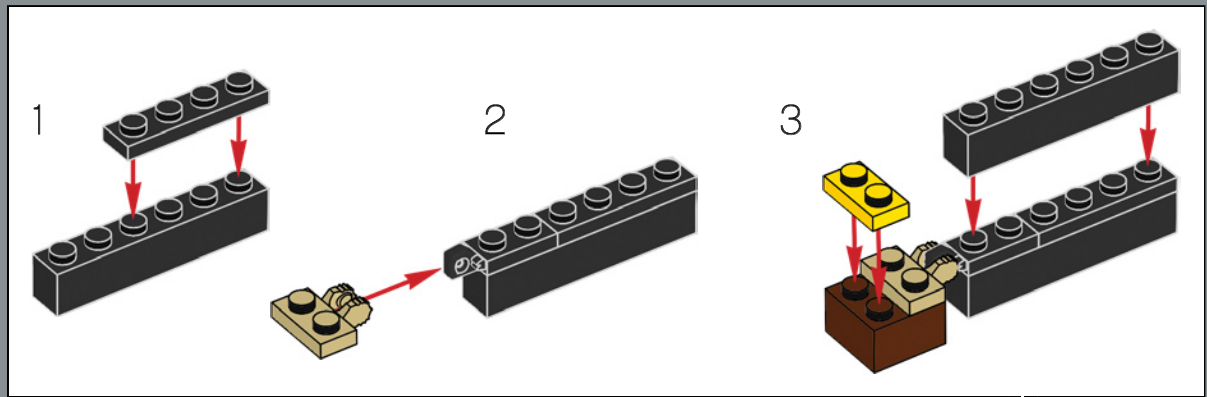

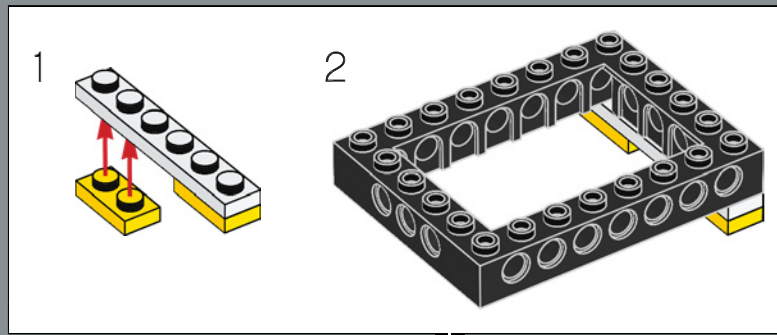
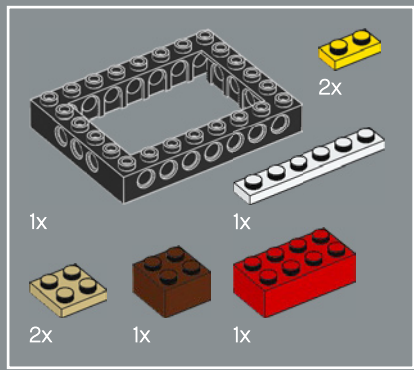

211

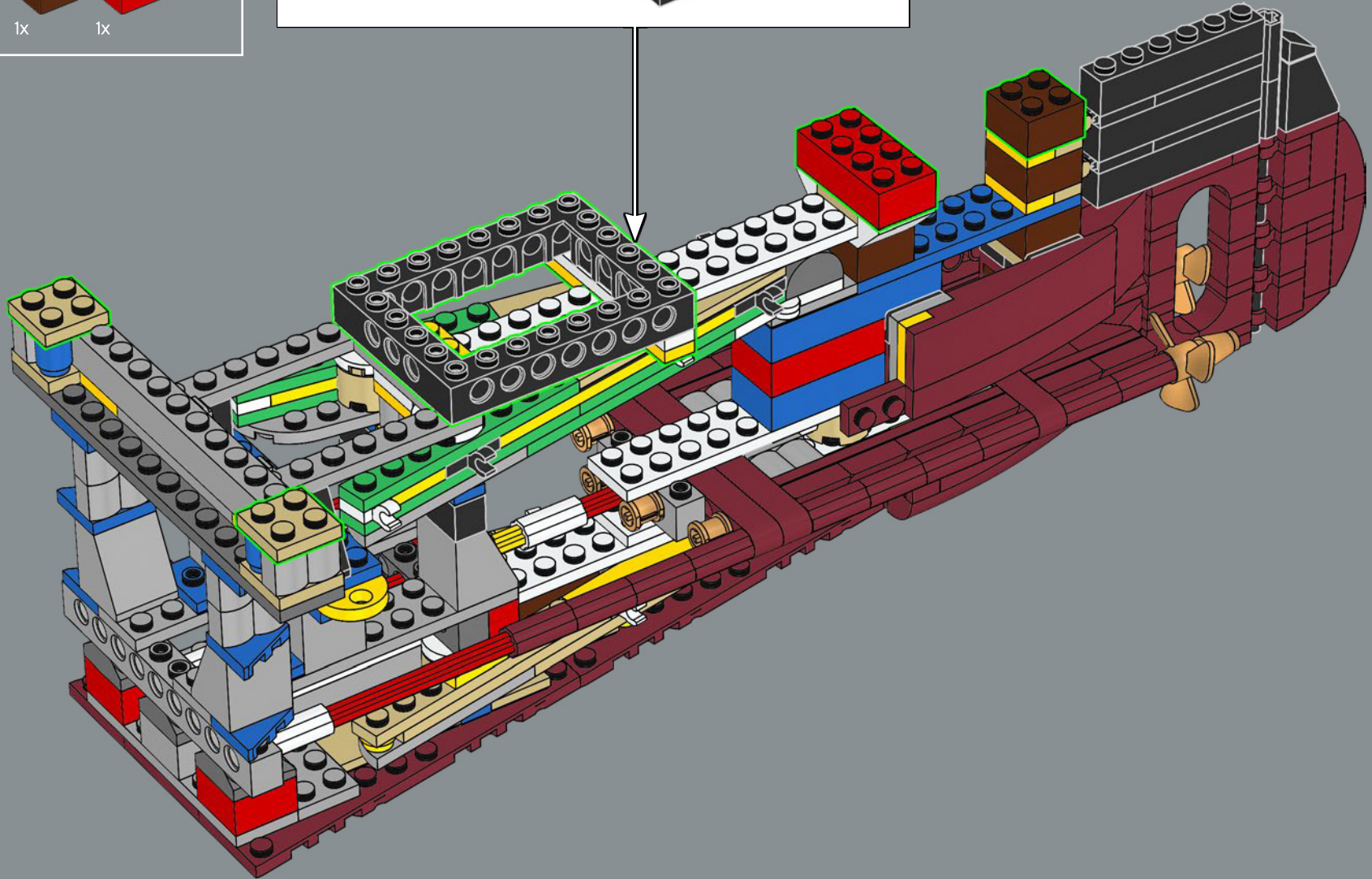



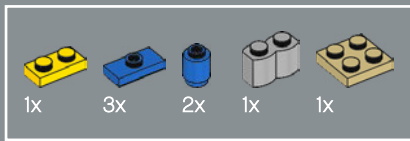

212

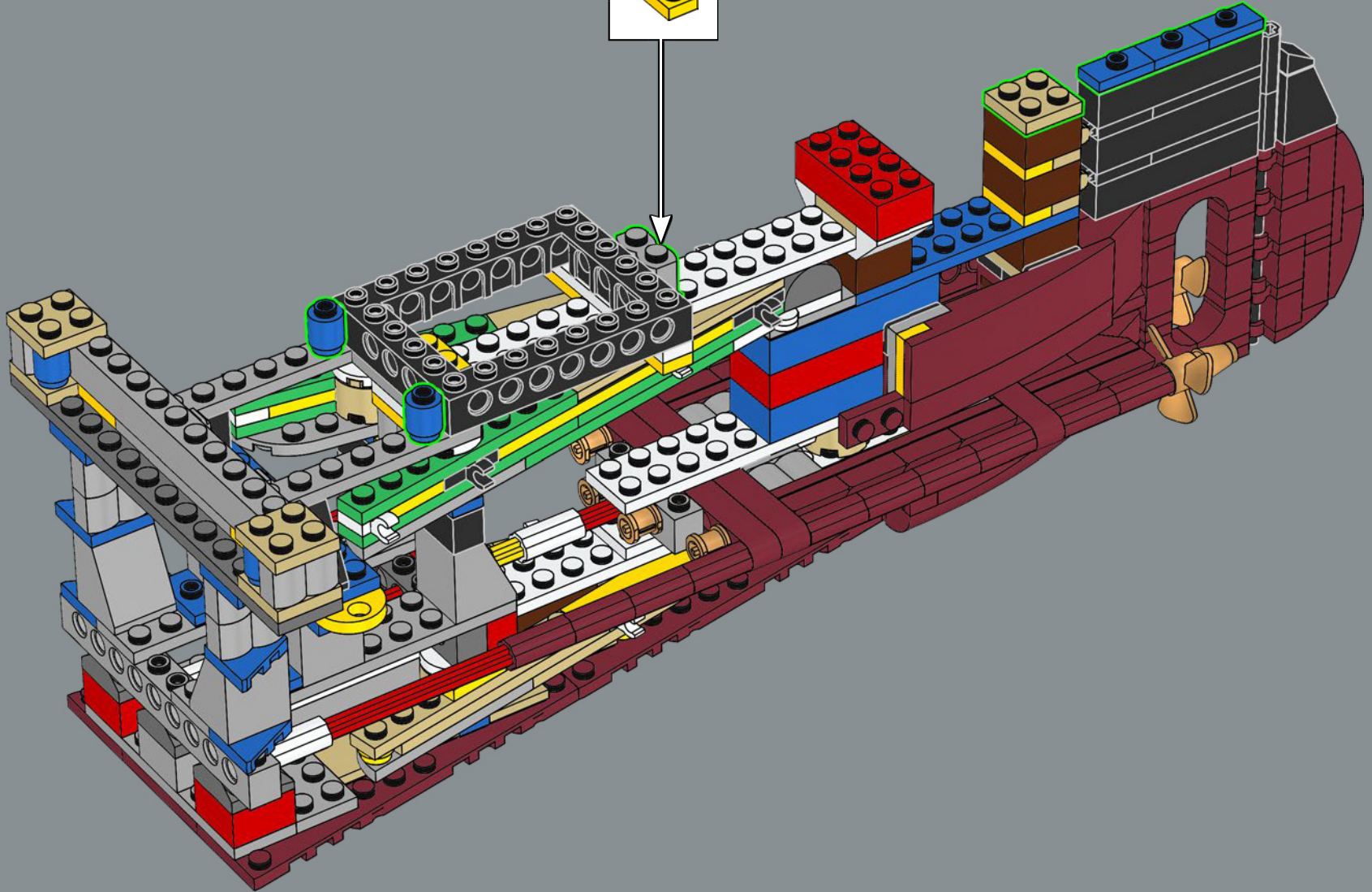
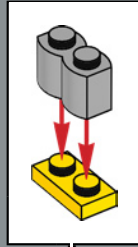

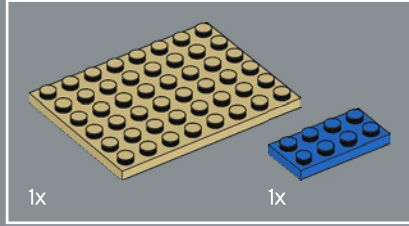
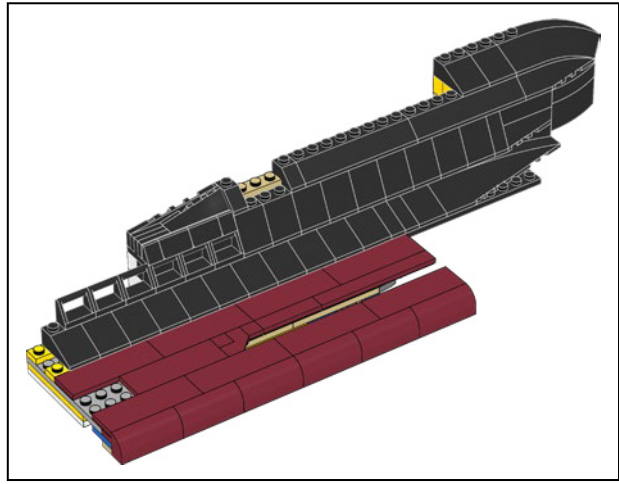
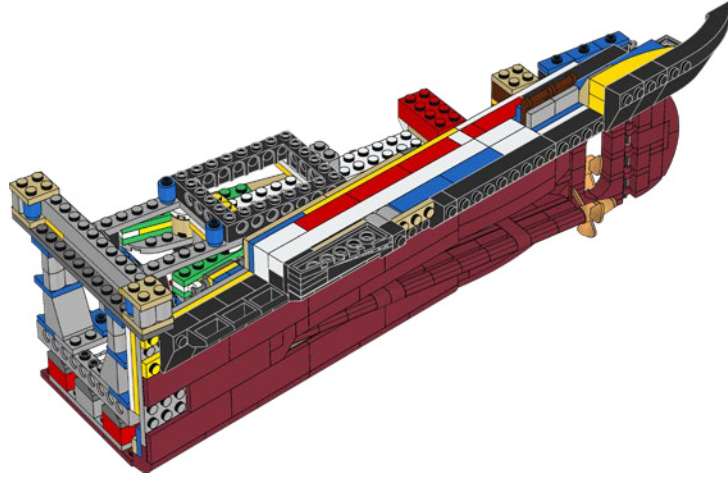
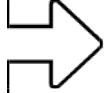

213

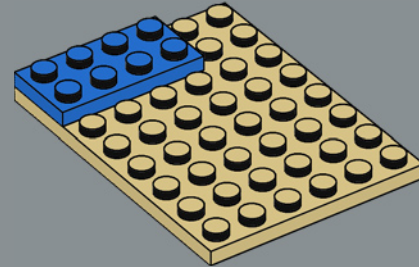

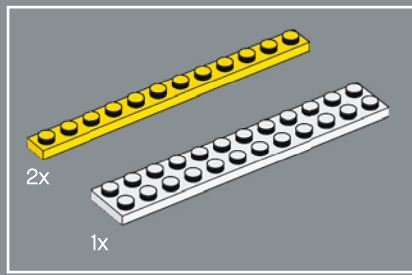

214

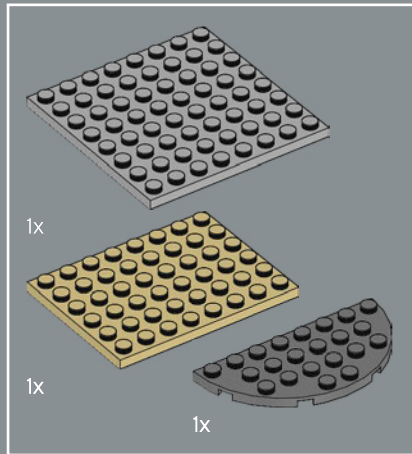
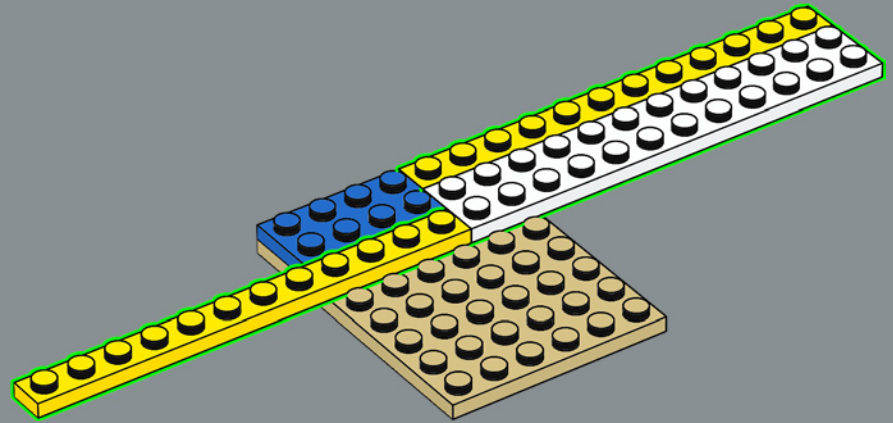

215

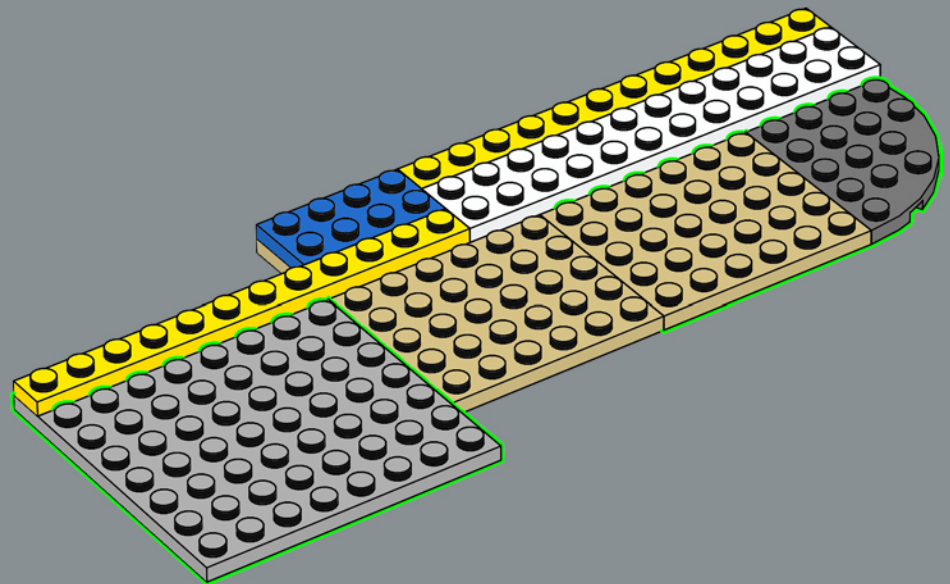

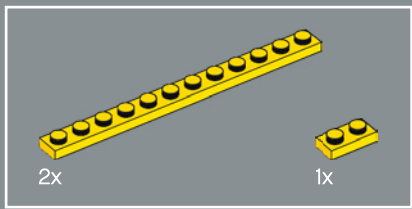

216

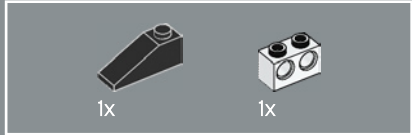
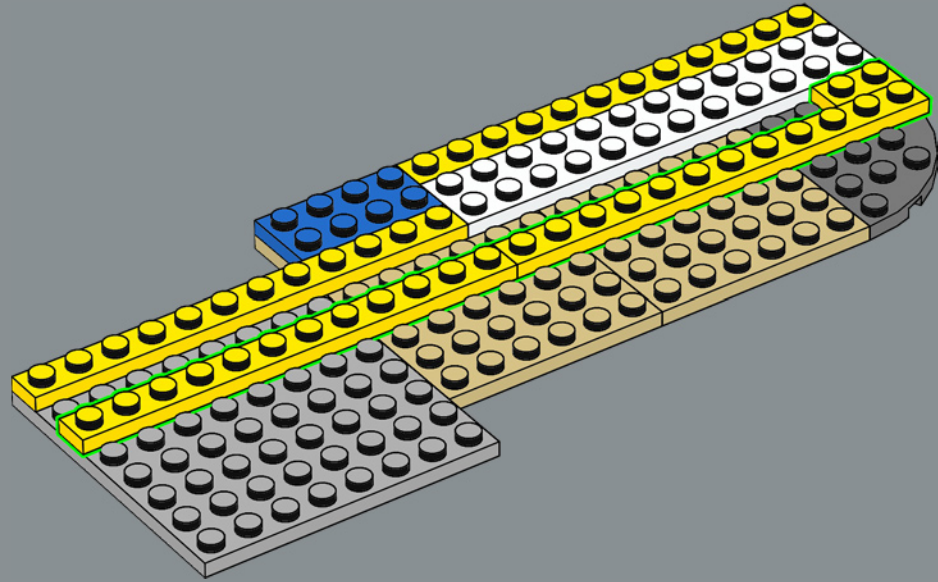

217

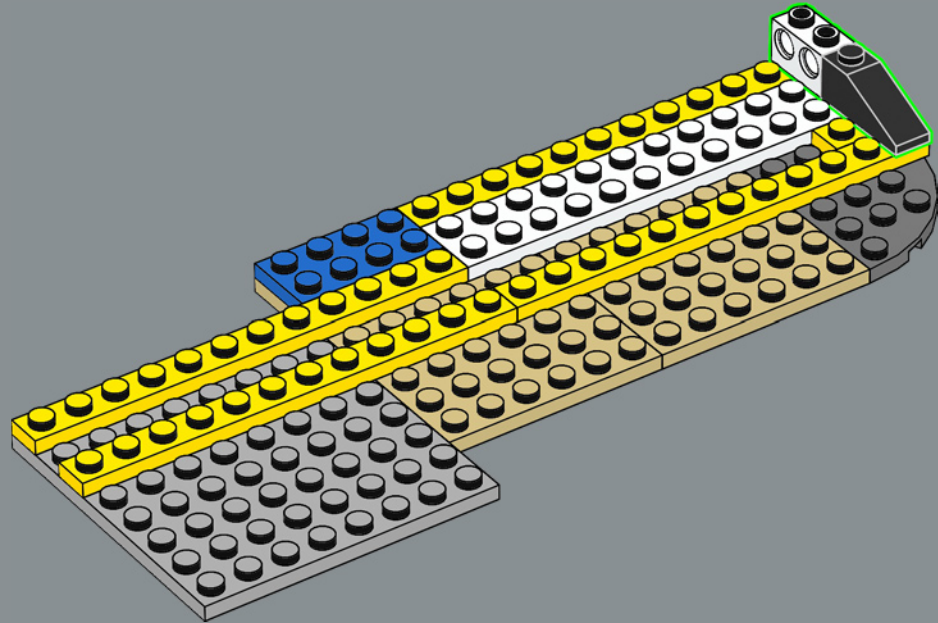

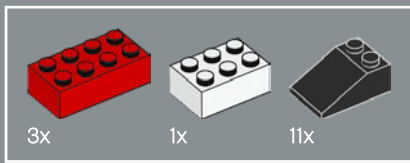

218

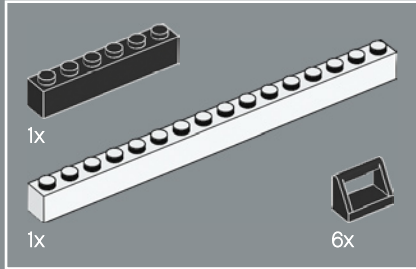
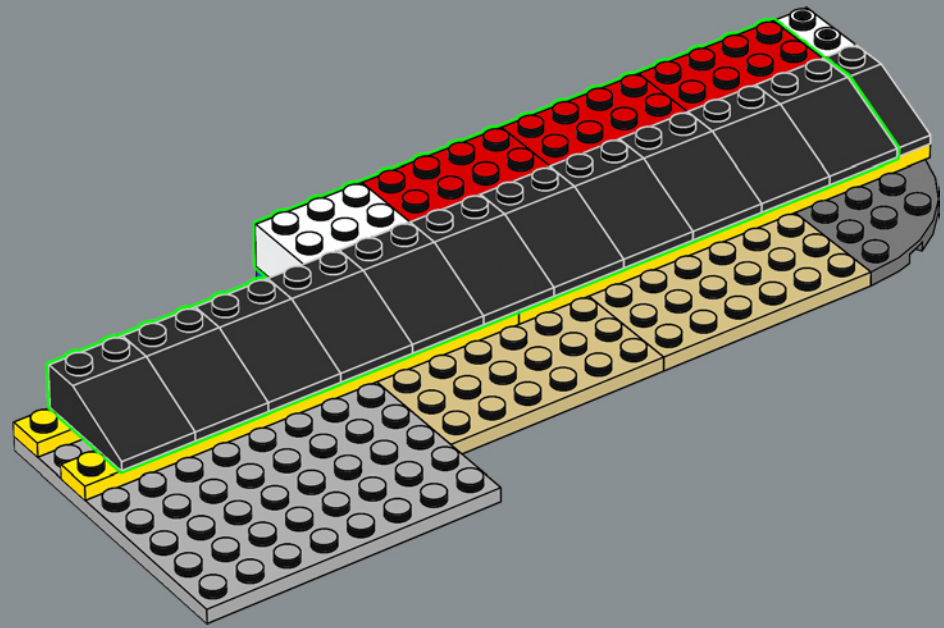

219

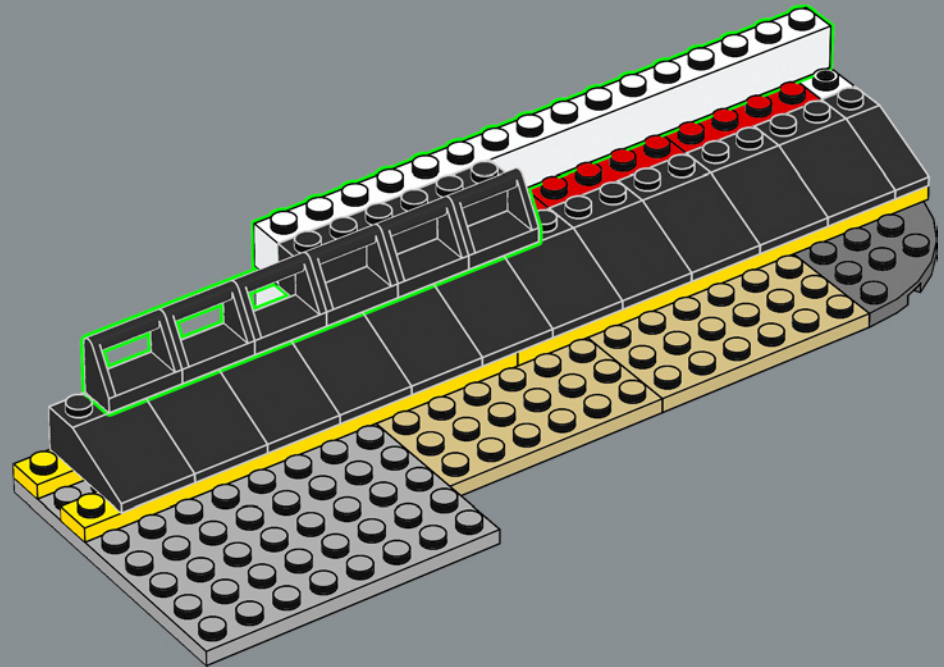

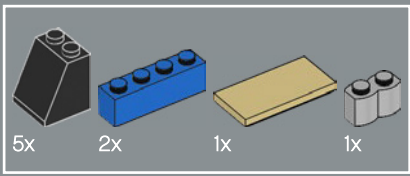

220

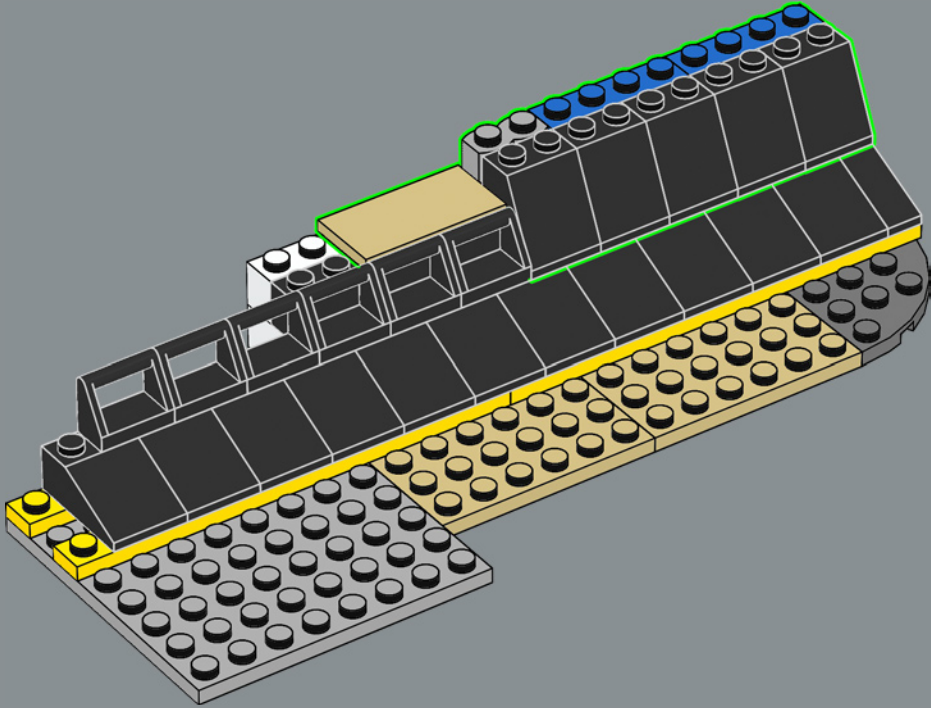

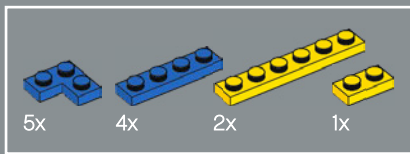

221

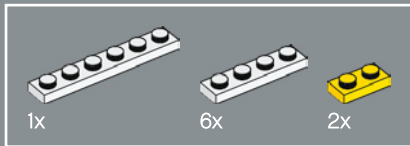
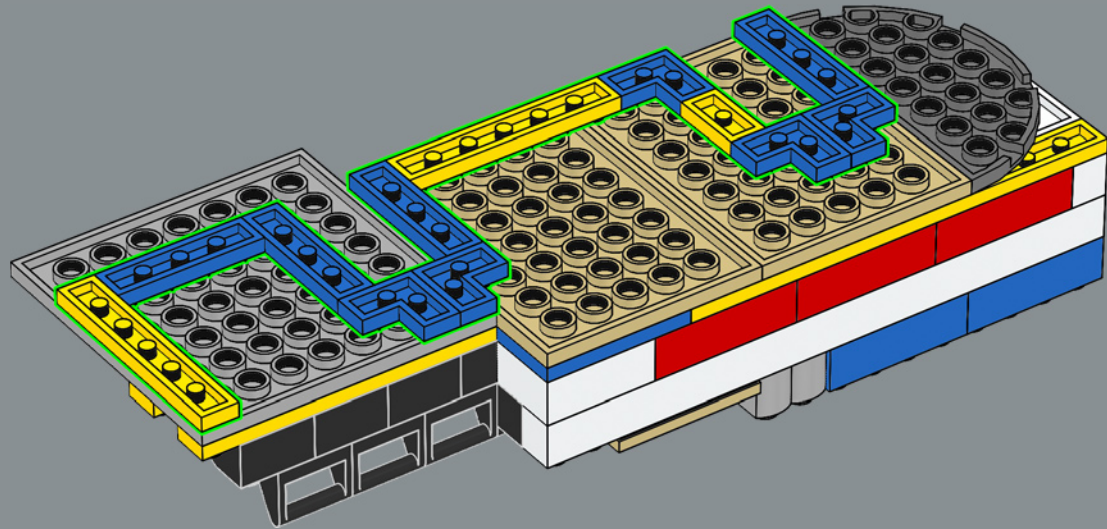

222

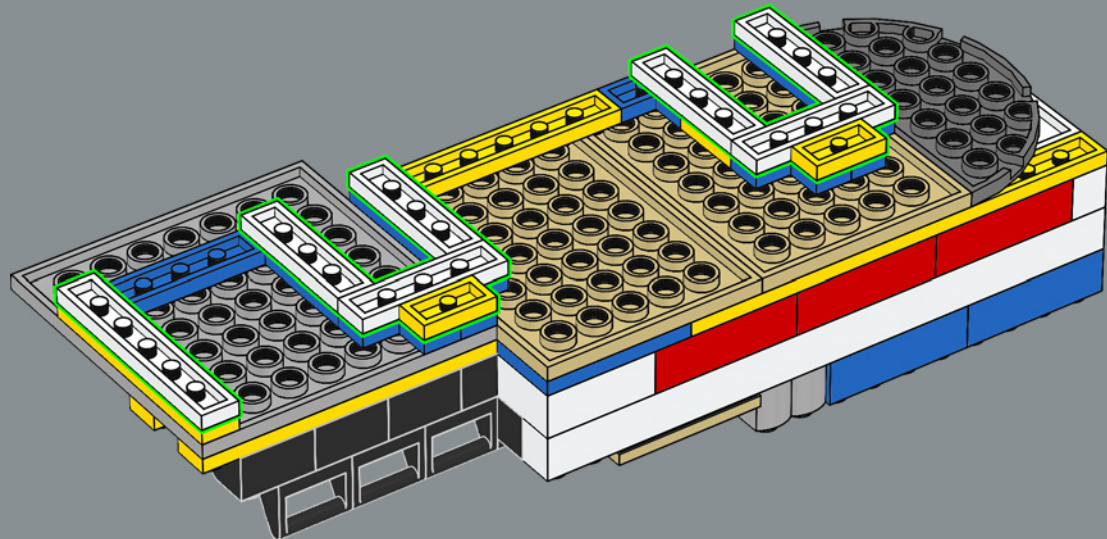

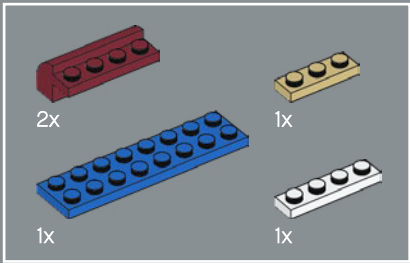

223

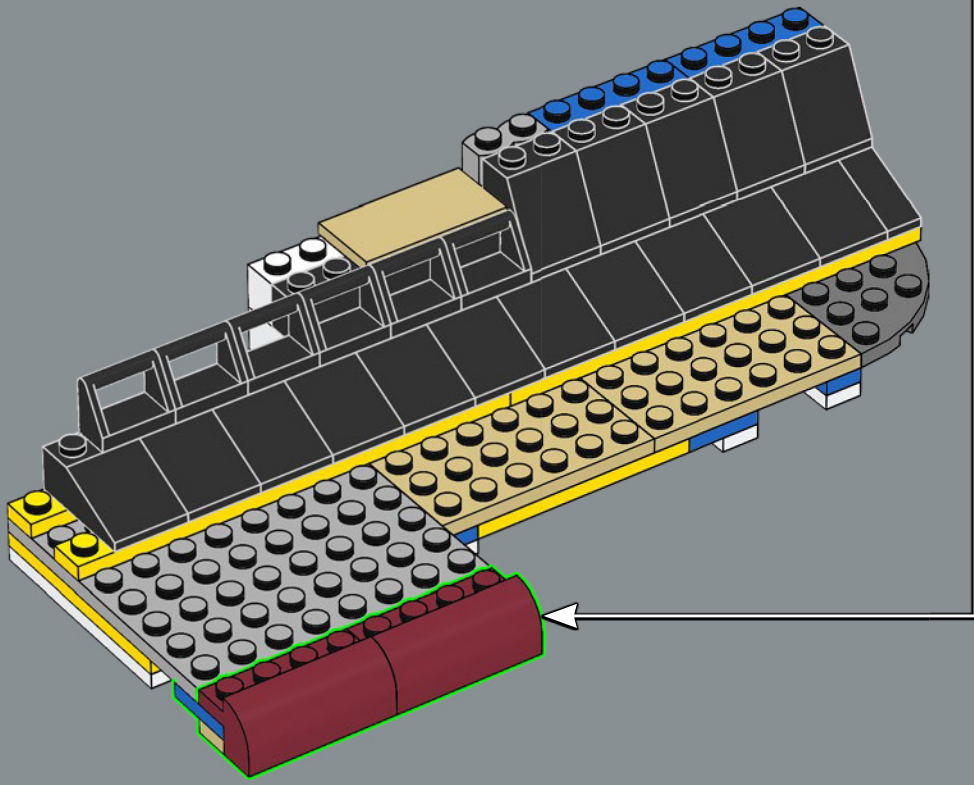
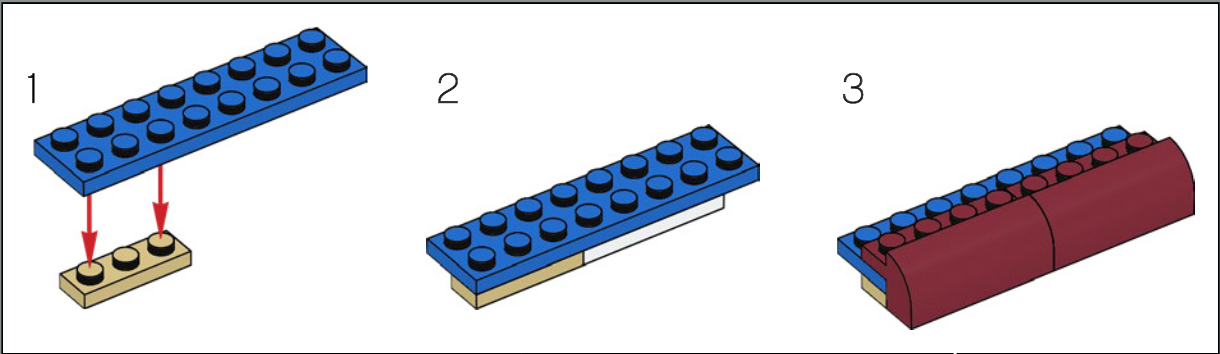



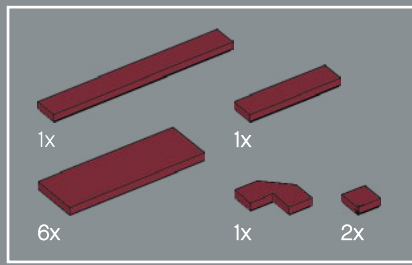

224

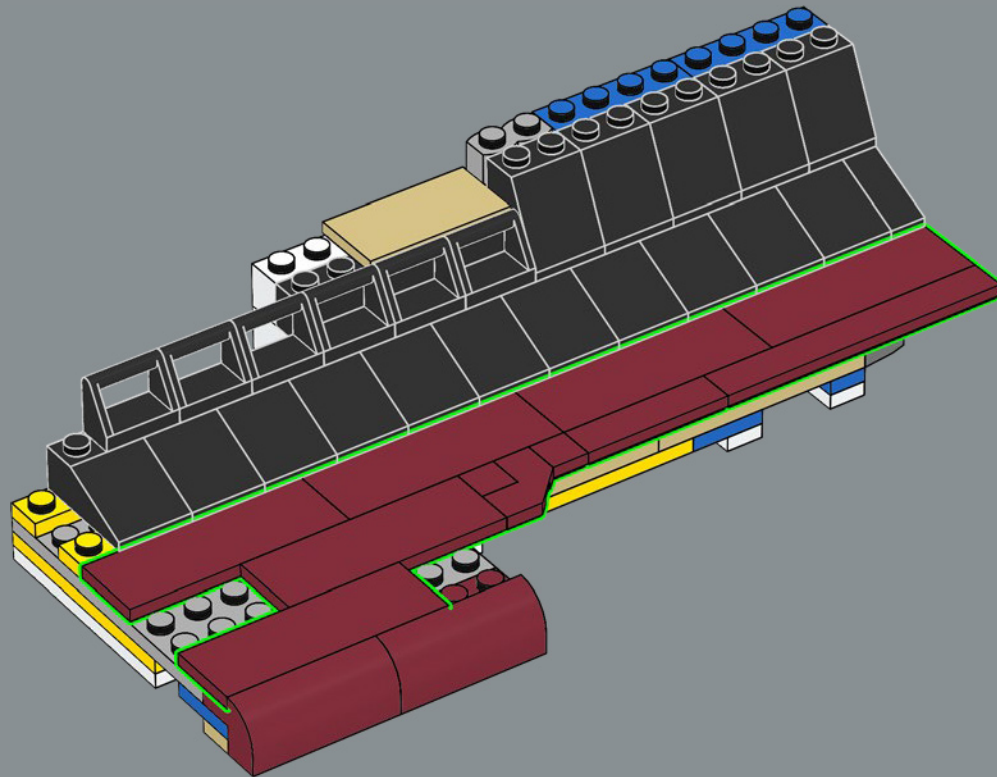

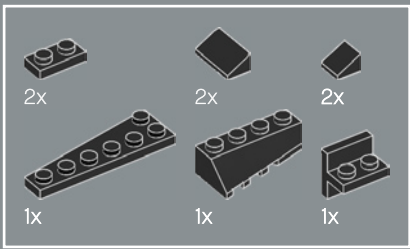

225

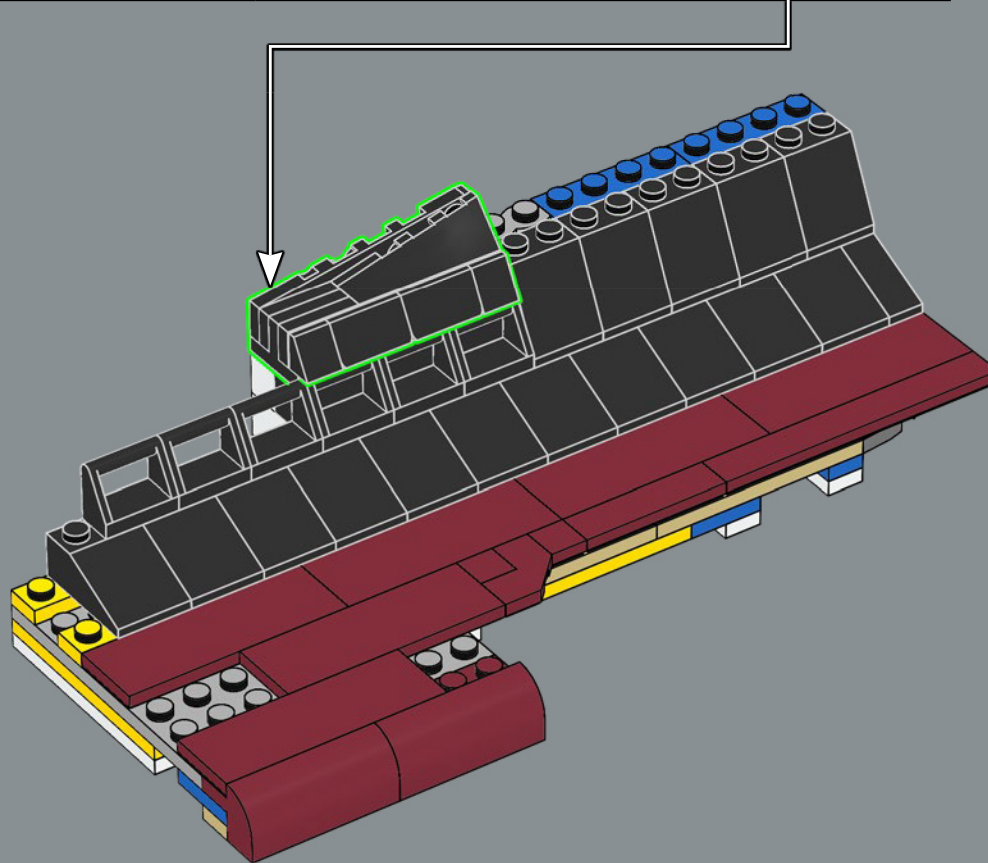
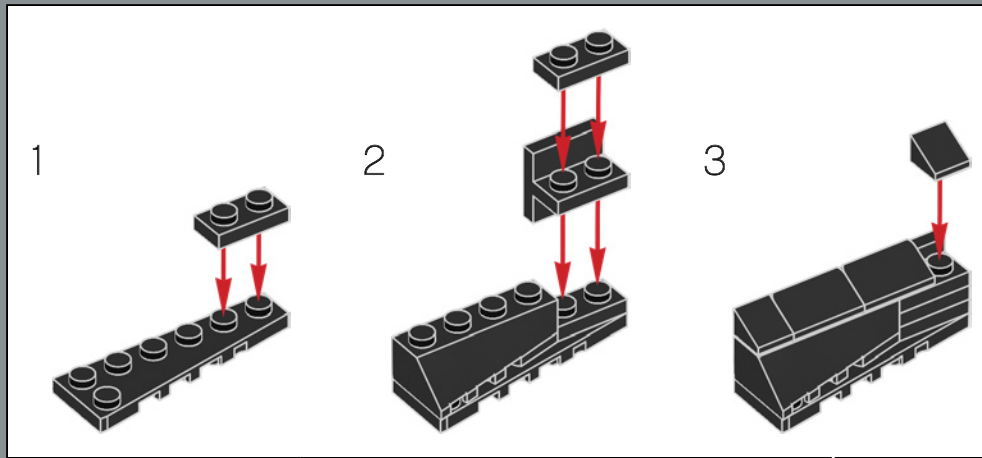

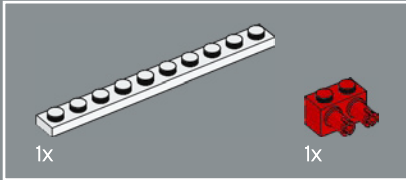
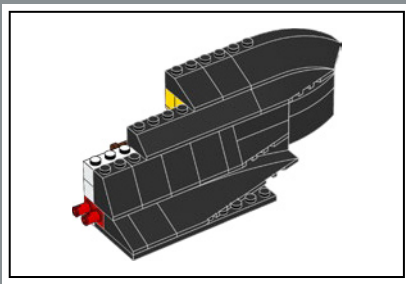

226

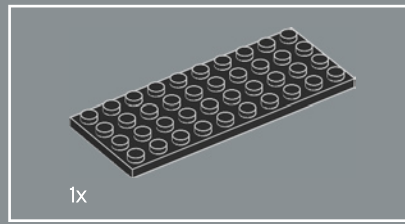
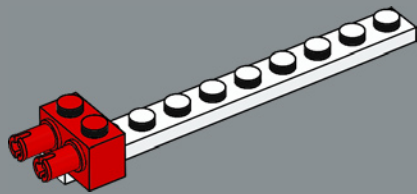

227

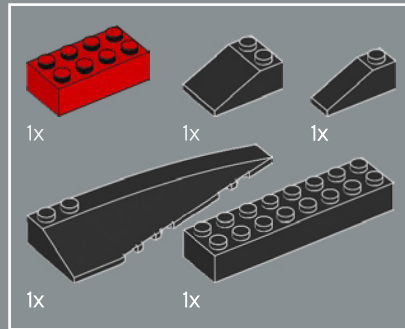
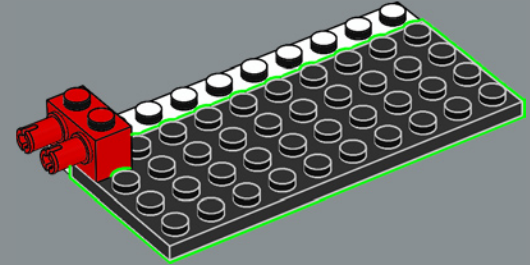

228

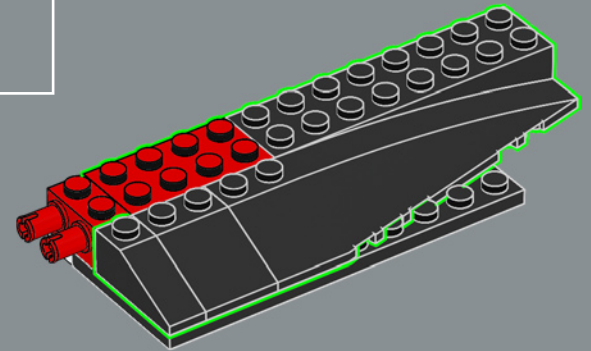

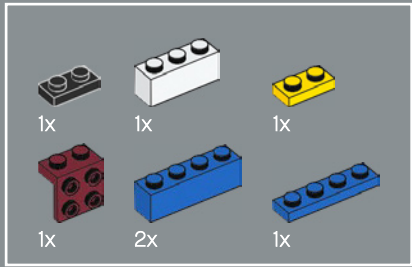

229

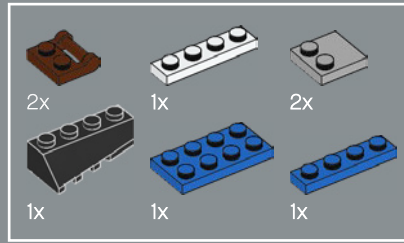
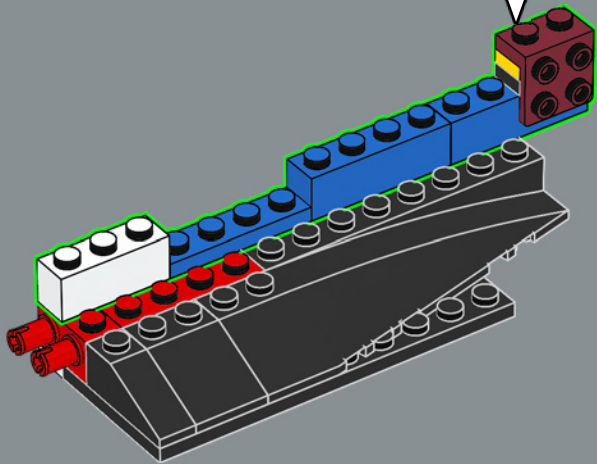
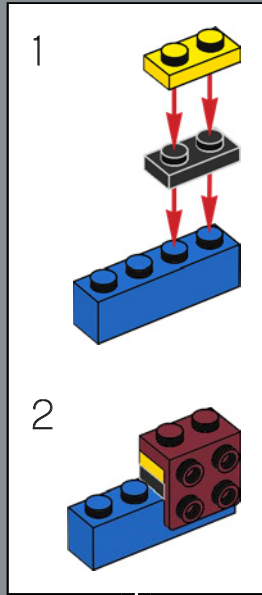

230

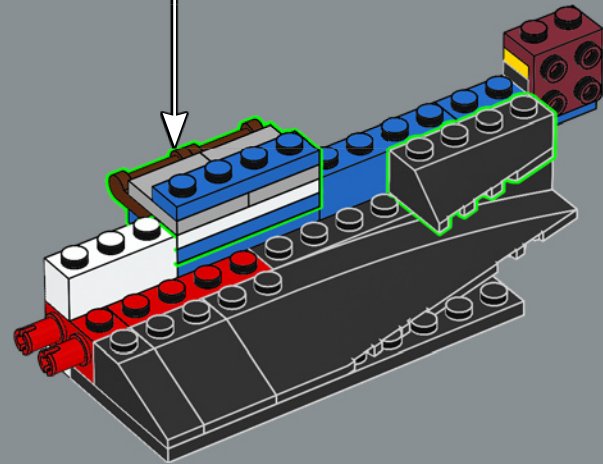
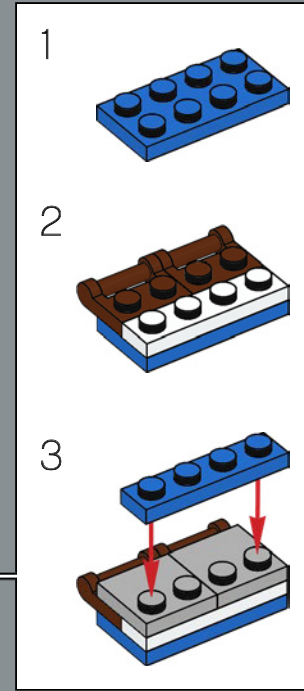

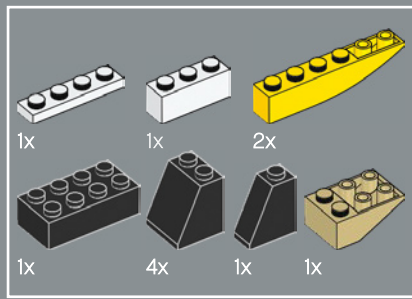

231

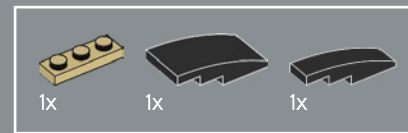
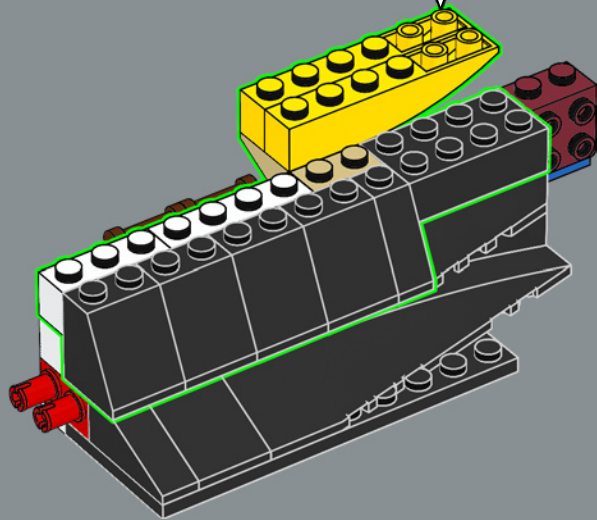
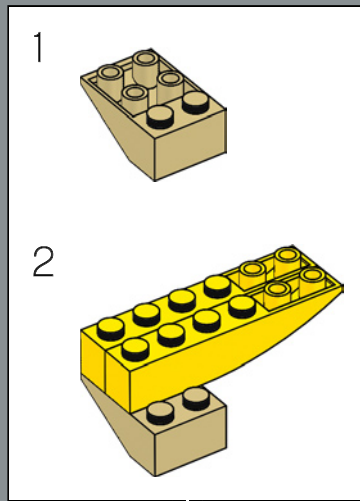

232

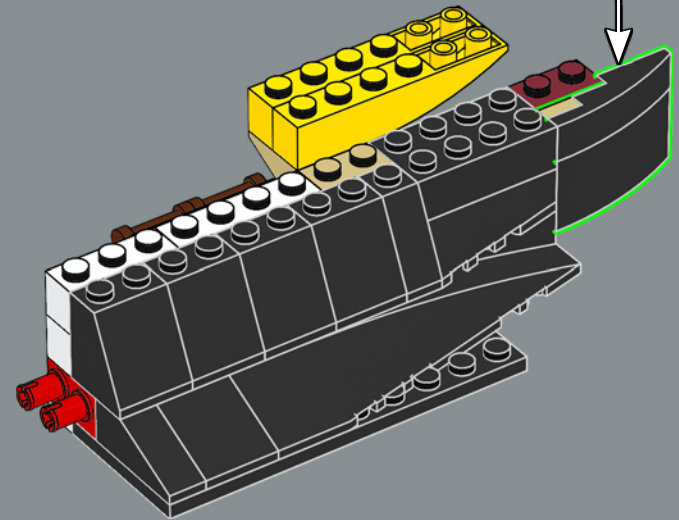
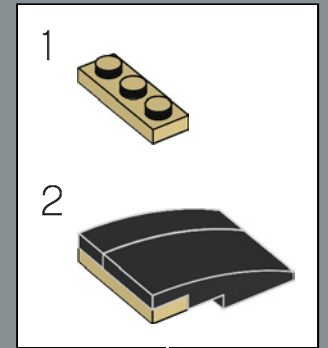

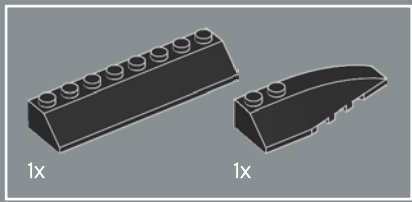

233

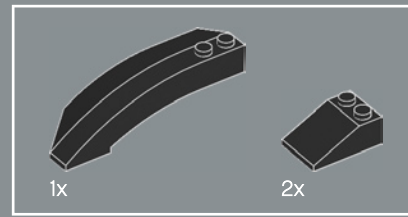
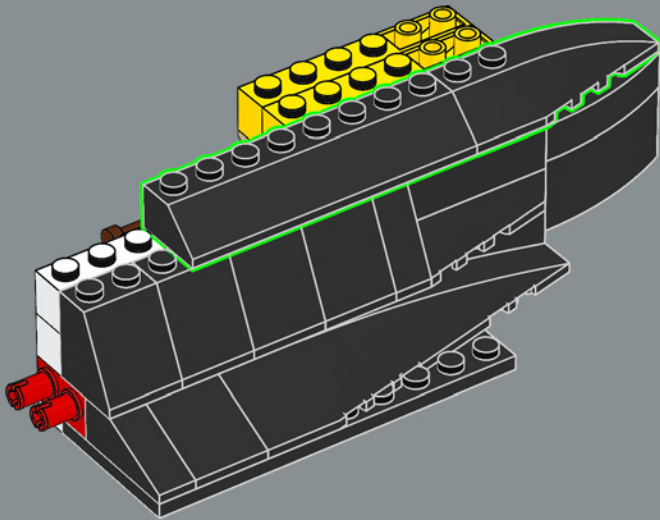

234

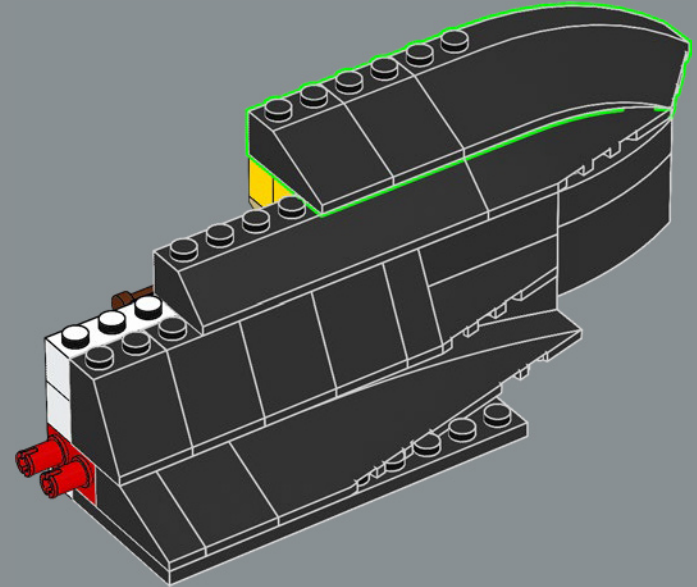

235

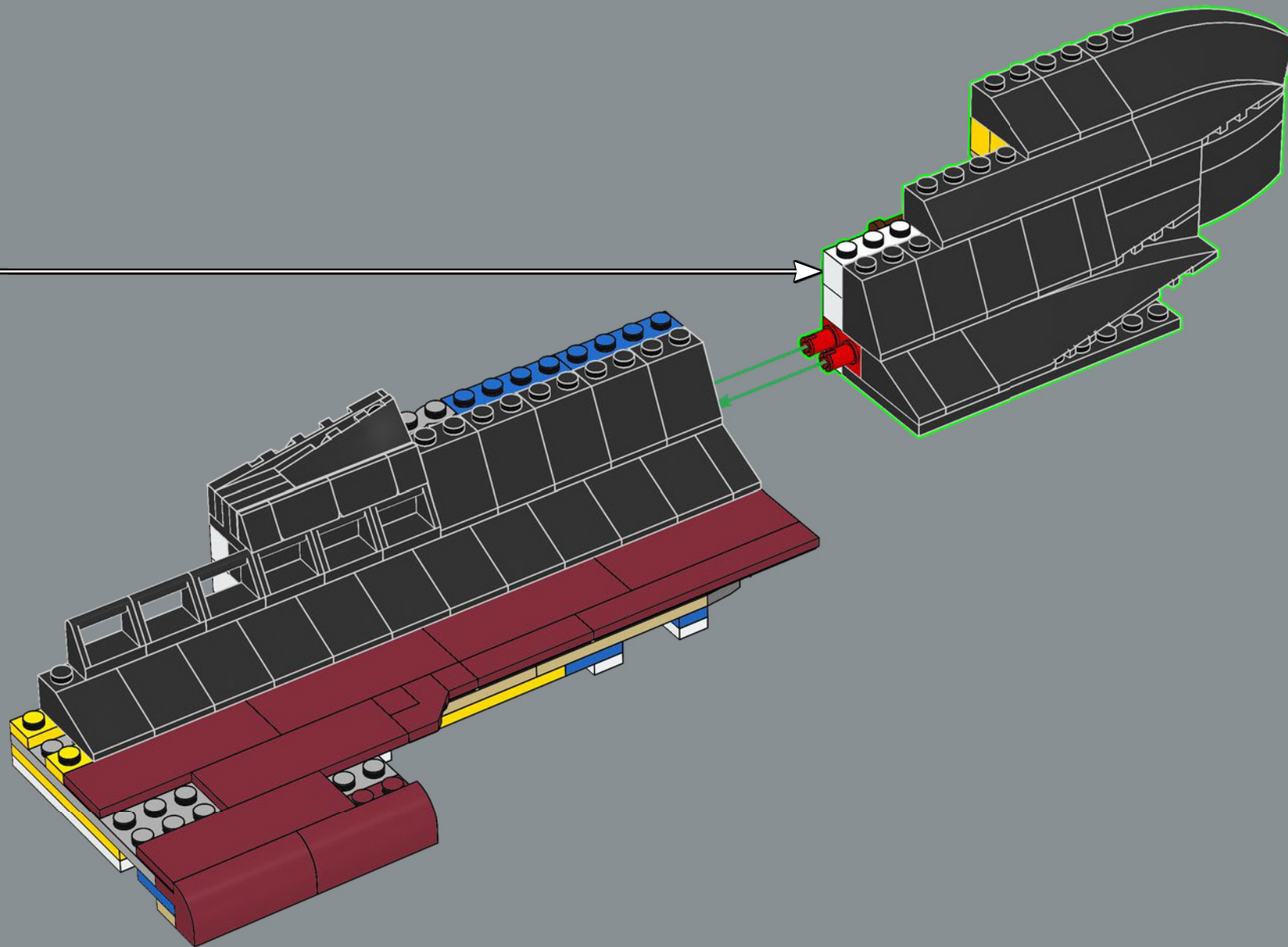

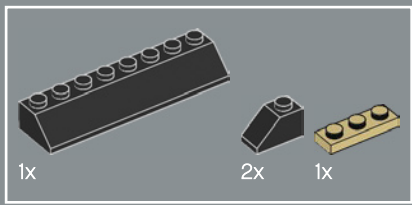

236

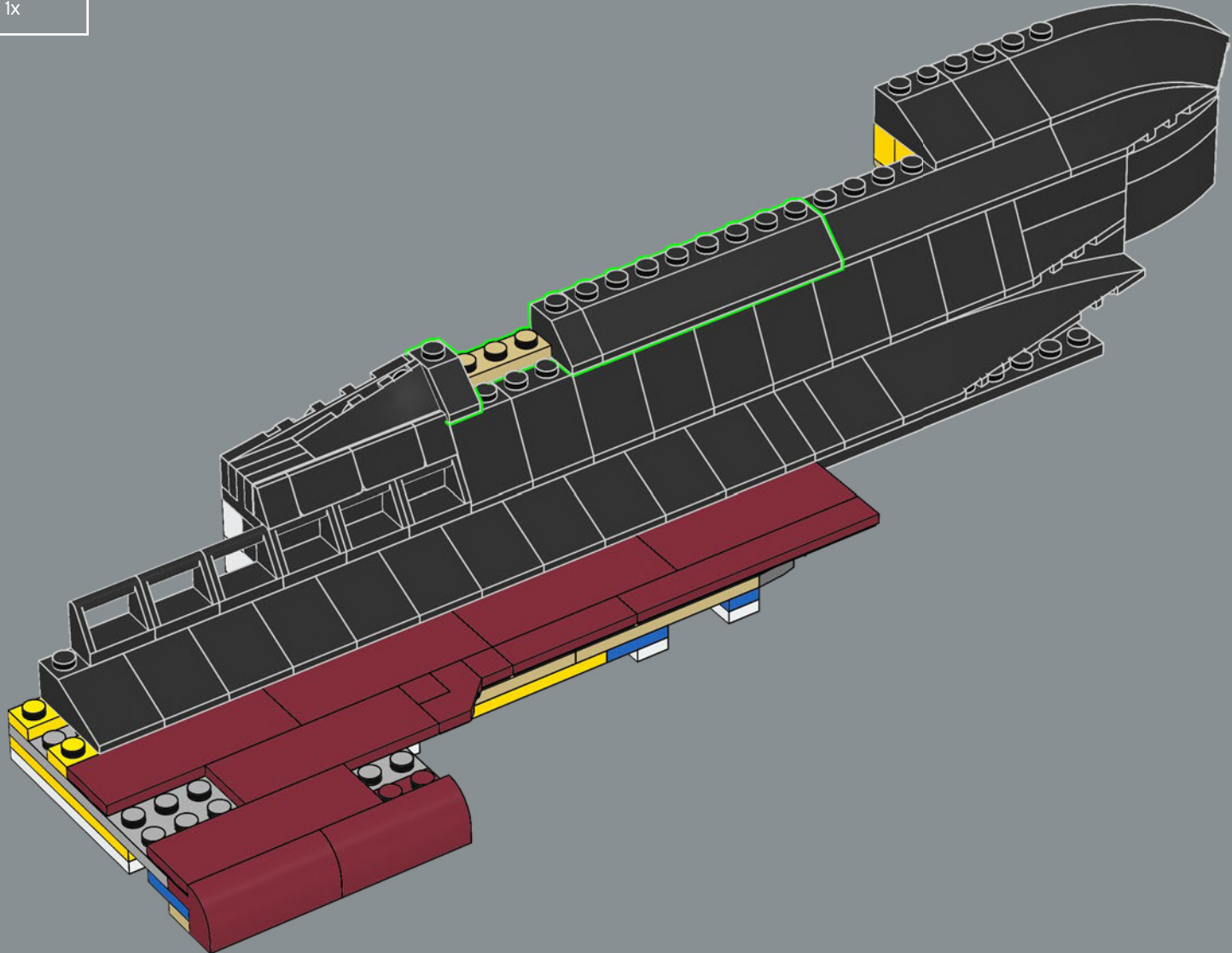



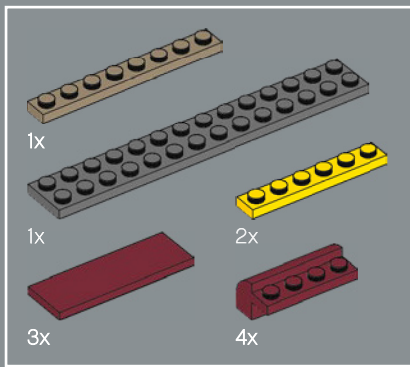

237

1

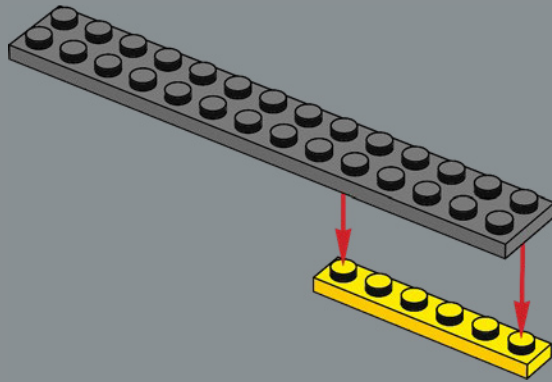

2

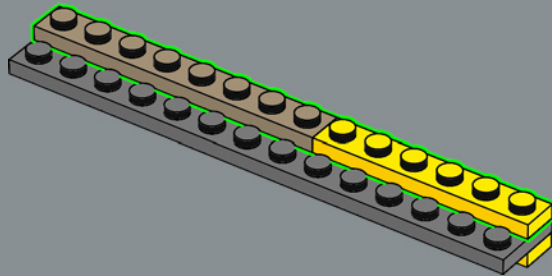

3

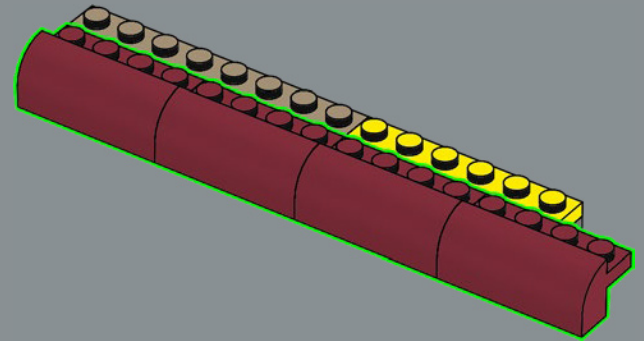

4

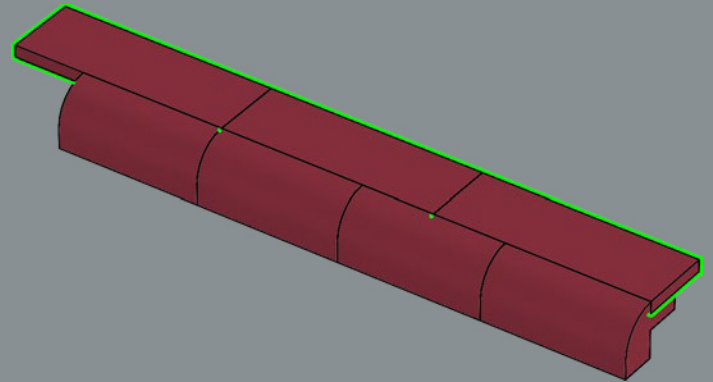

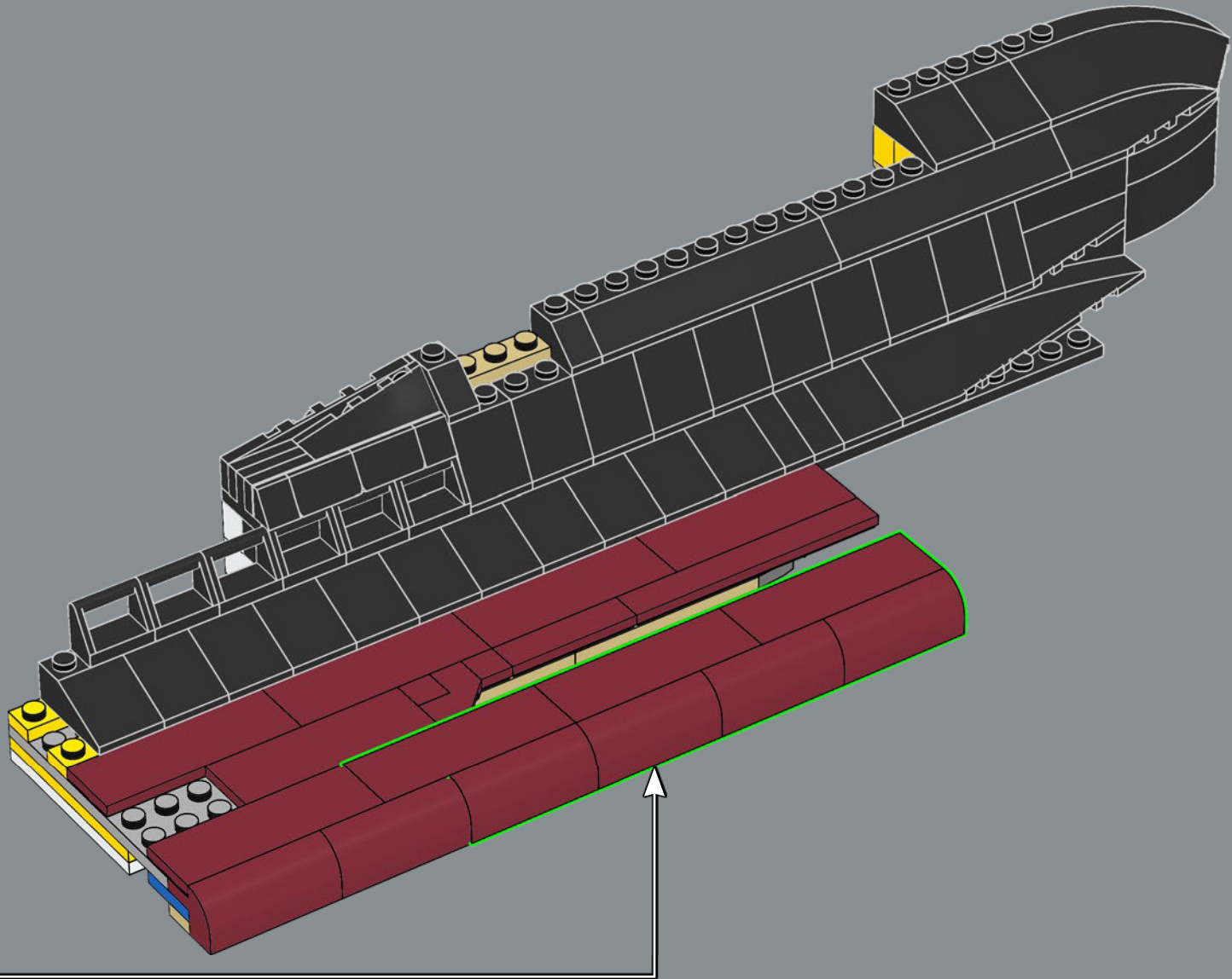

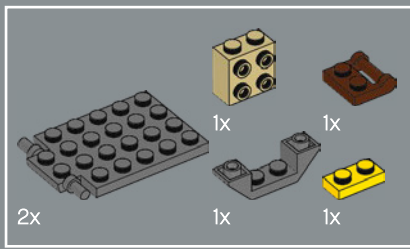

238

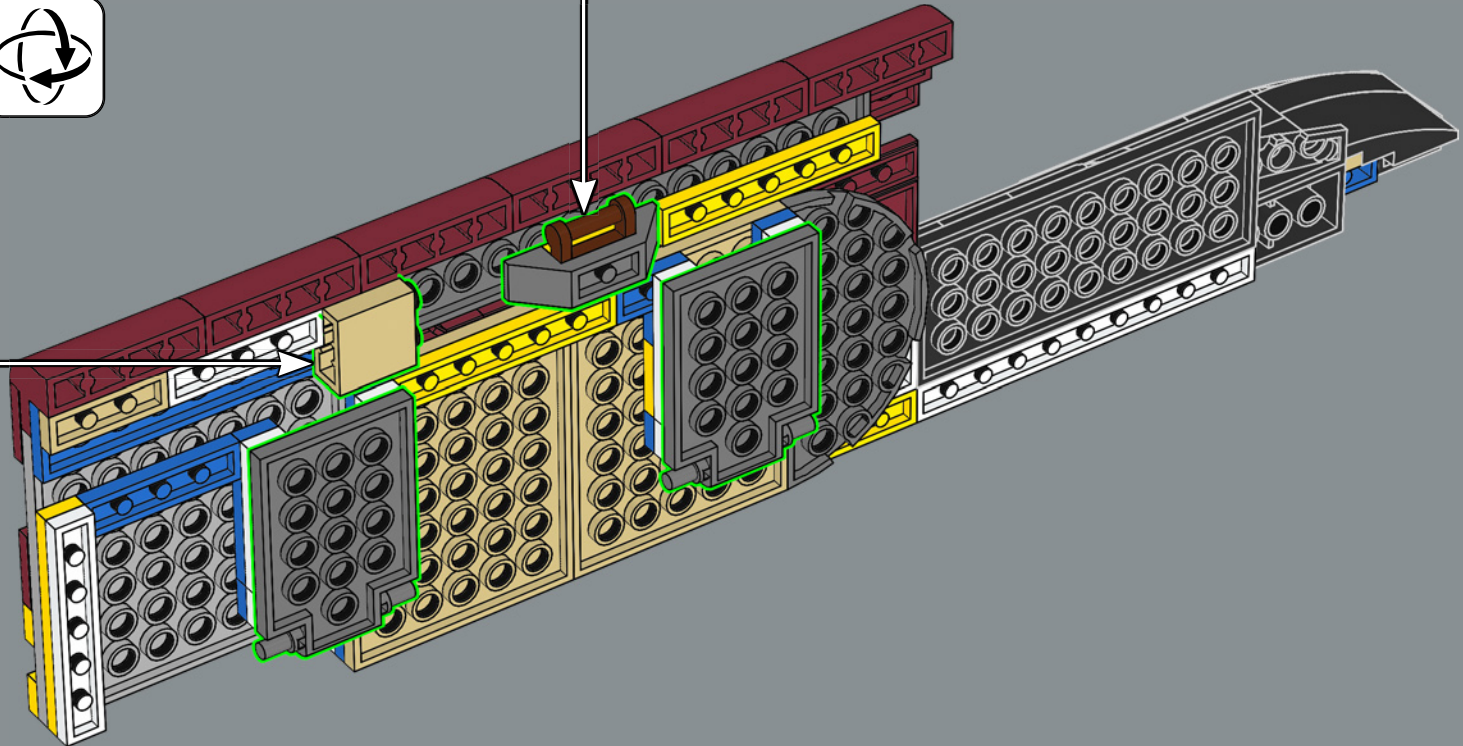
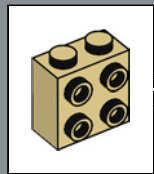
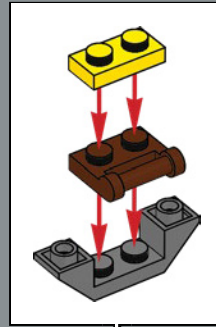

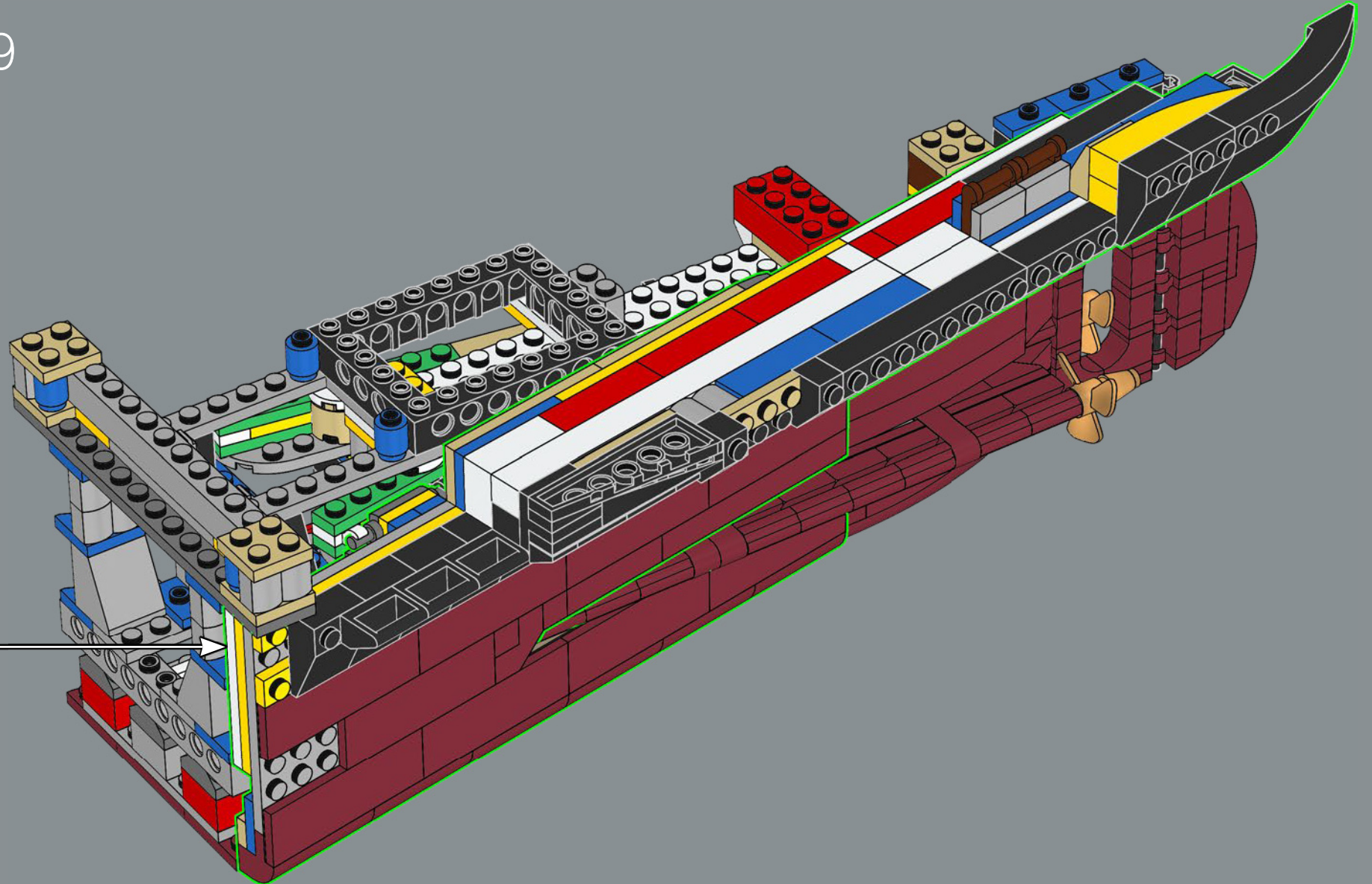

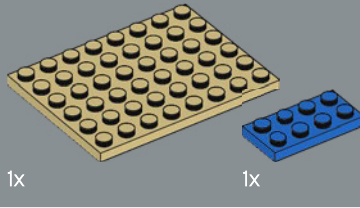
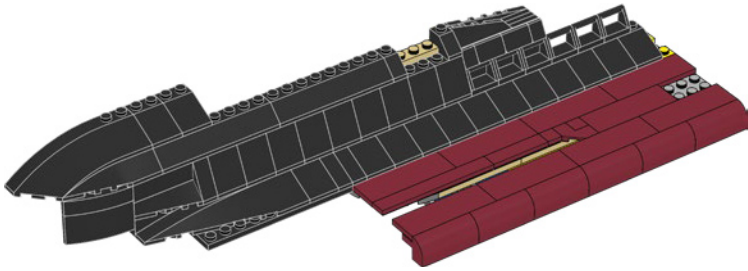
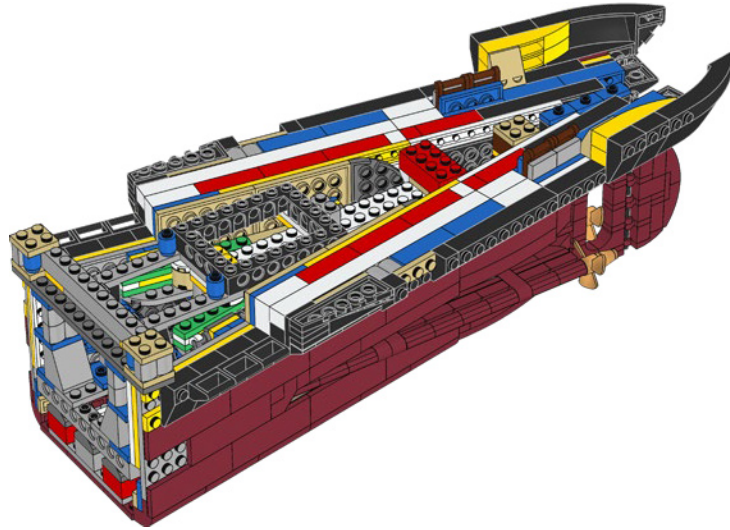
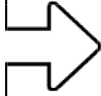

240

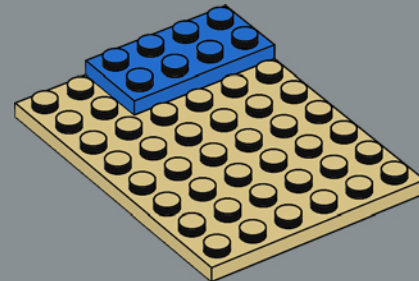

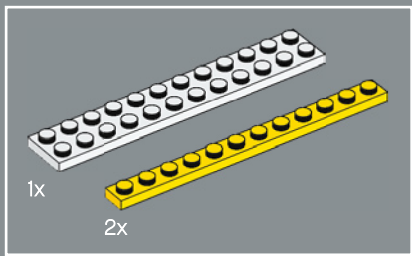

241

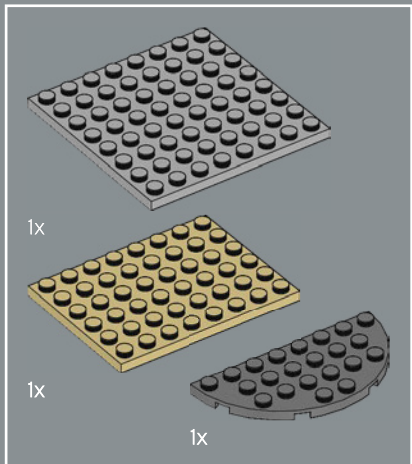
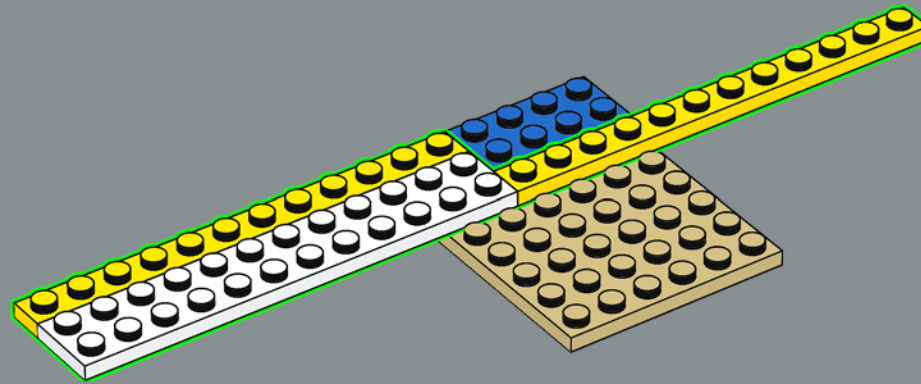

242

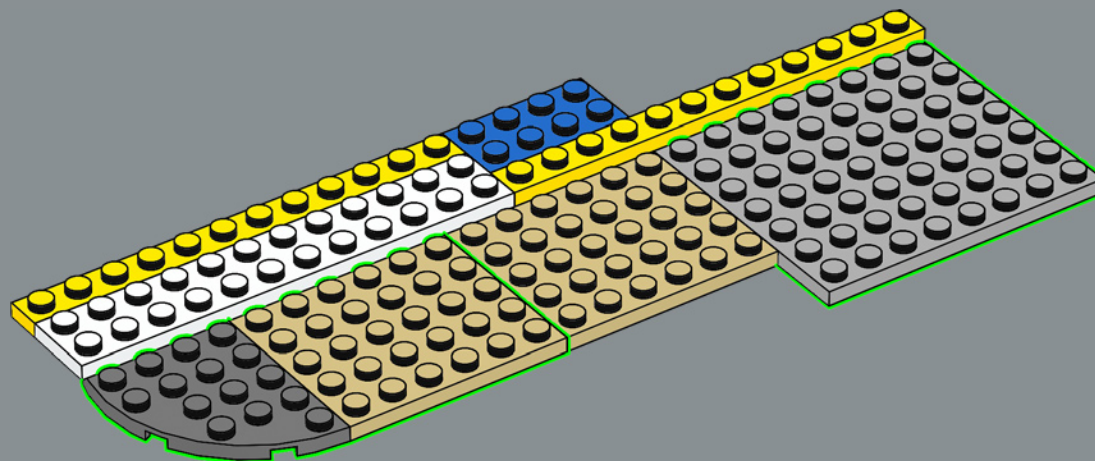

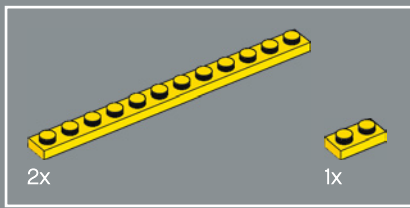

243

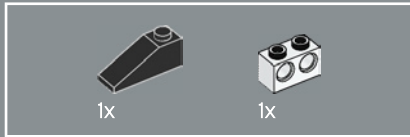
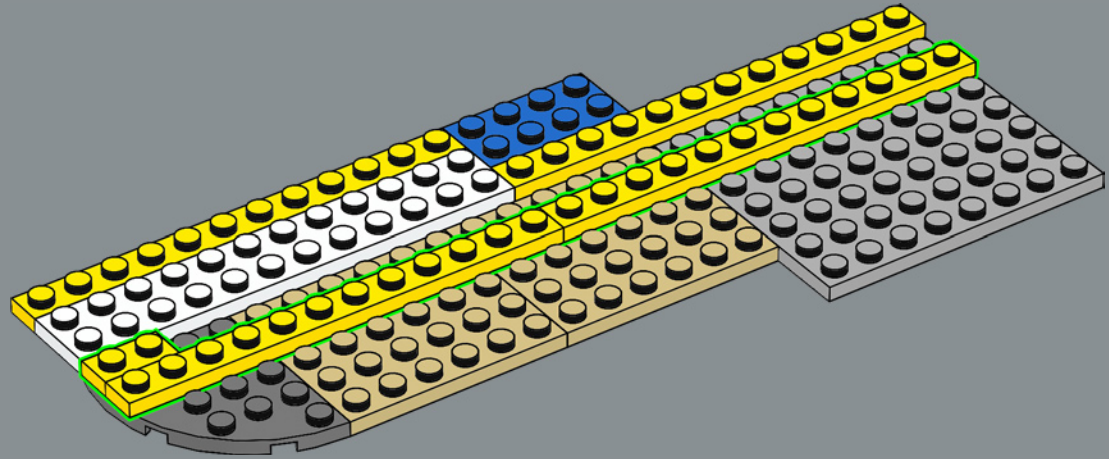

244

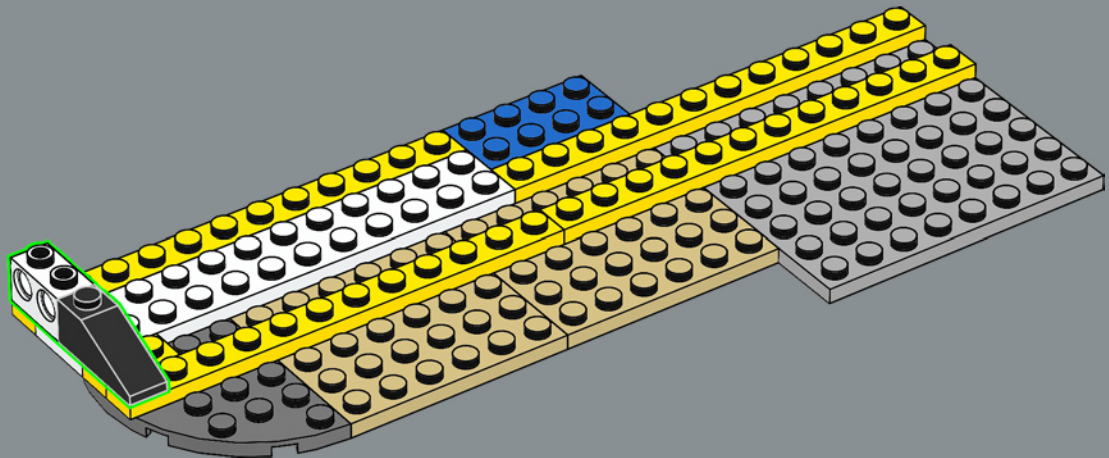

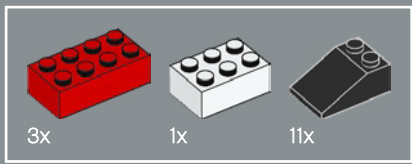

245

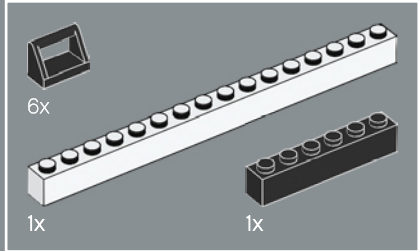
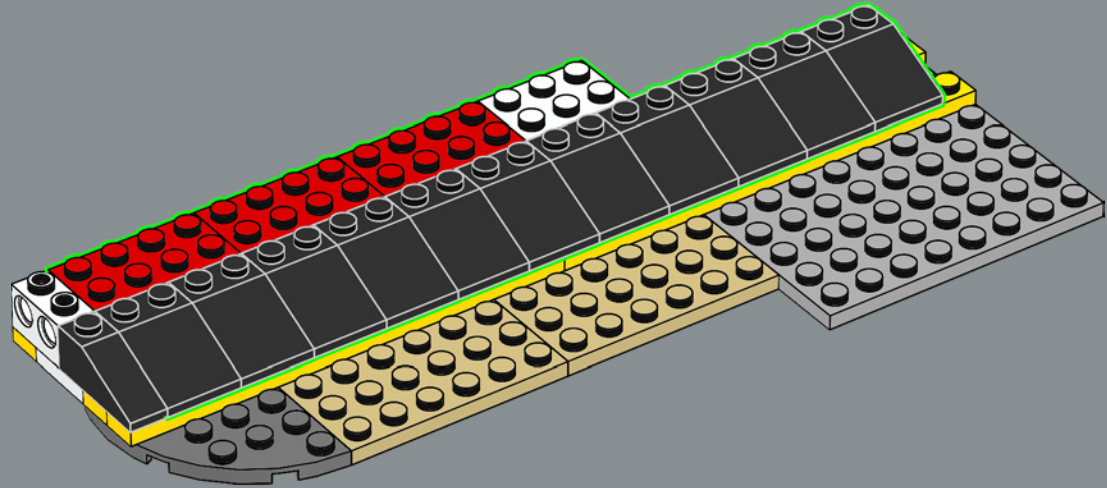

246

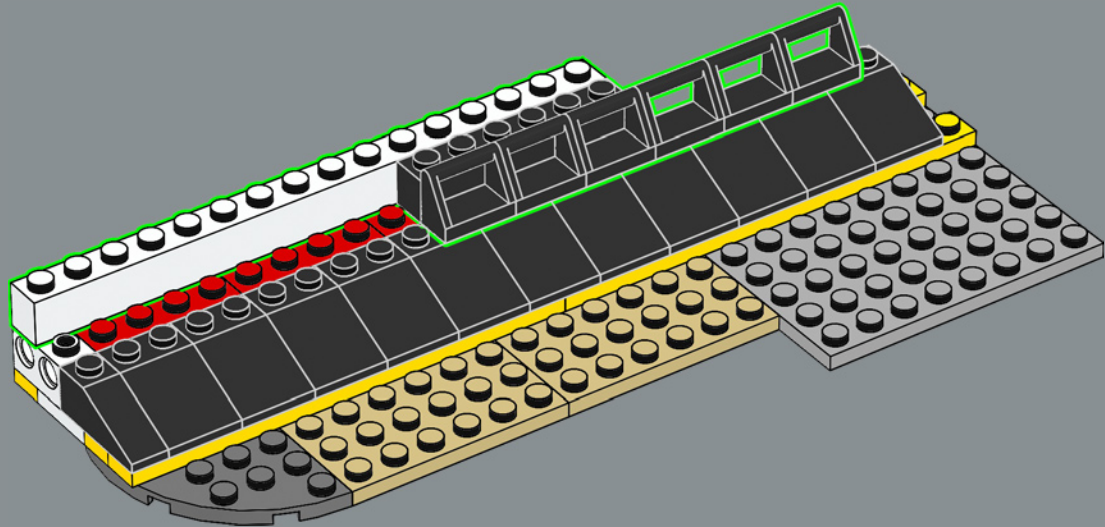



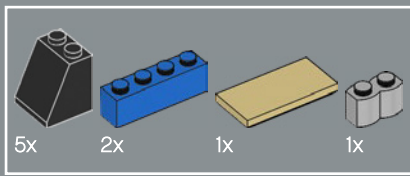

247

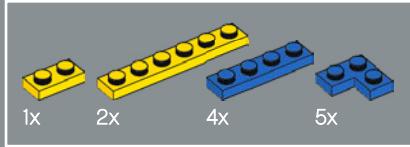
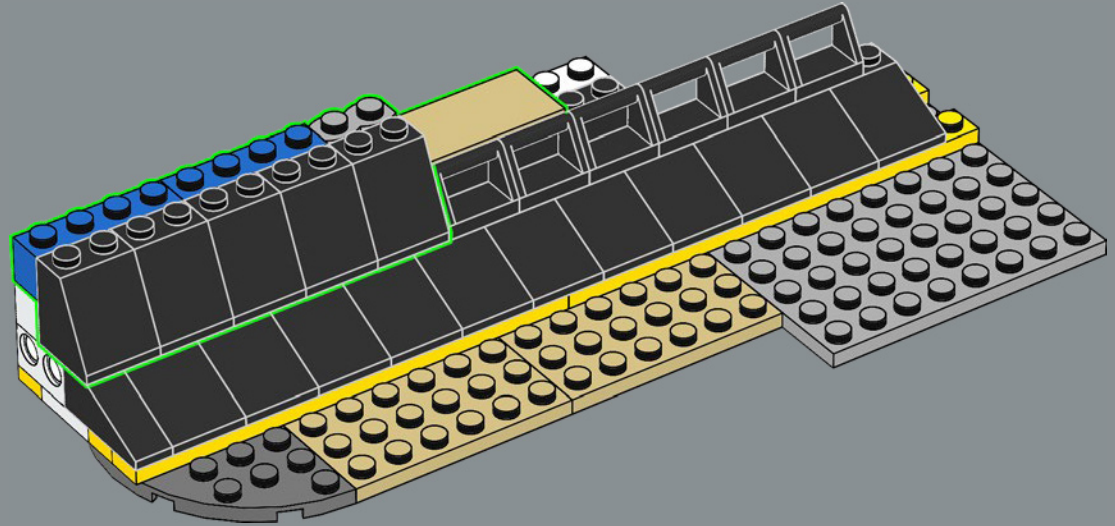

248

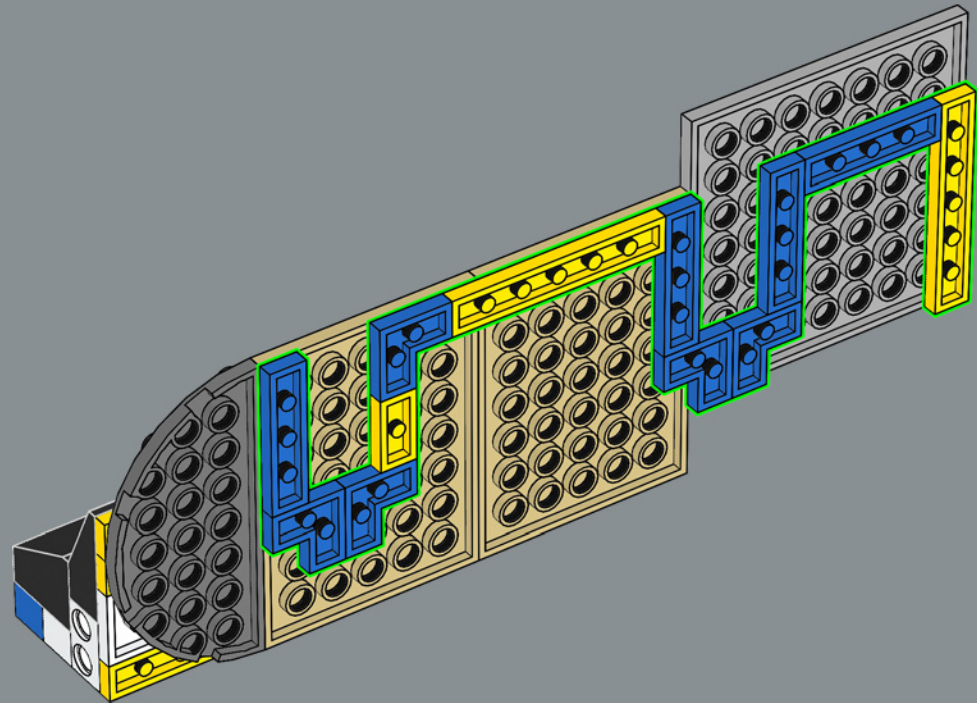

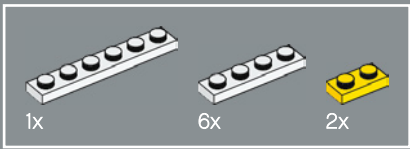

249

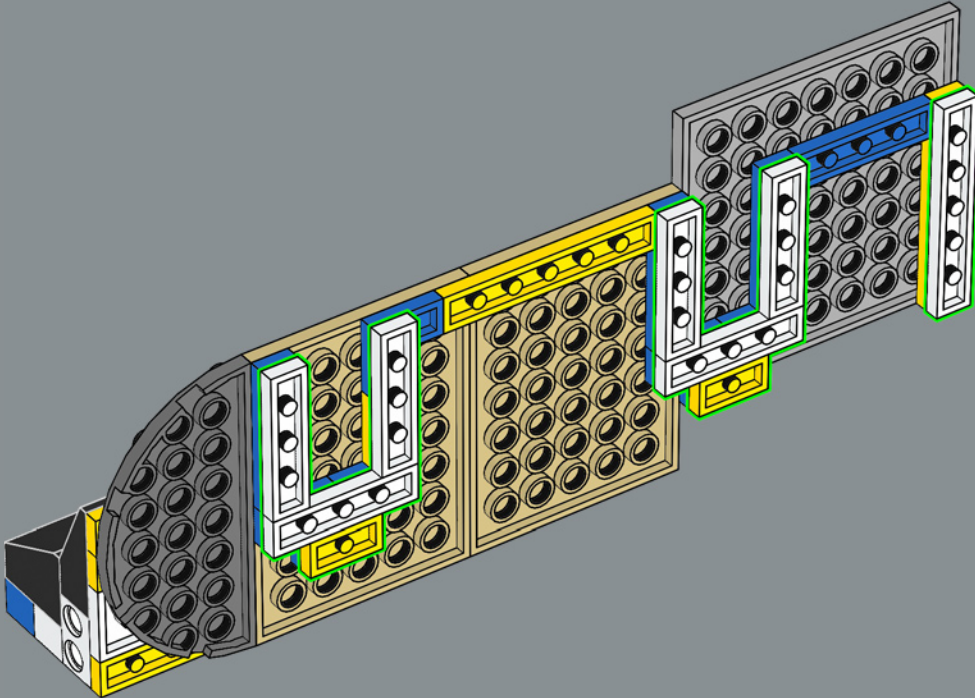

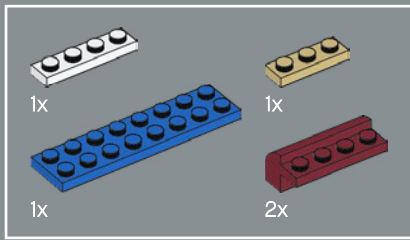

250

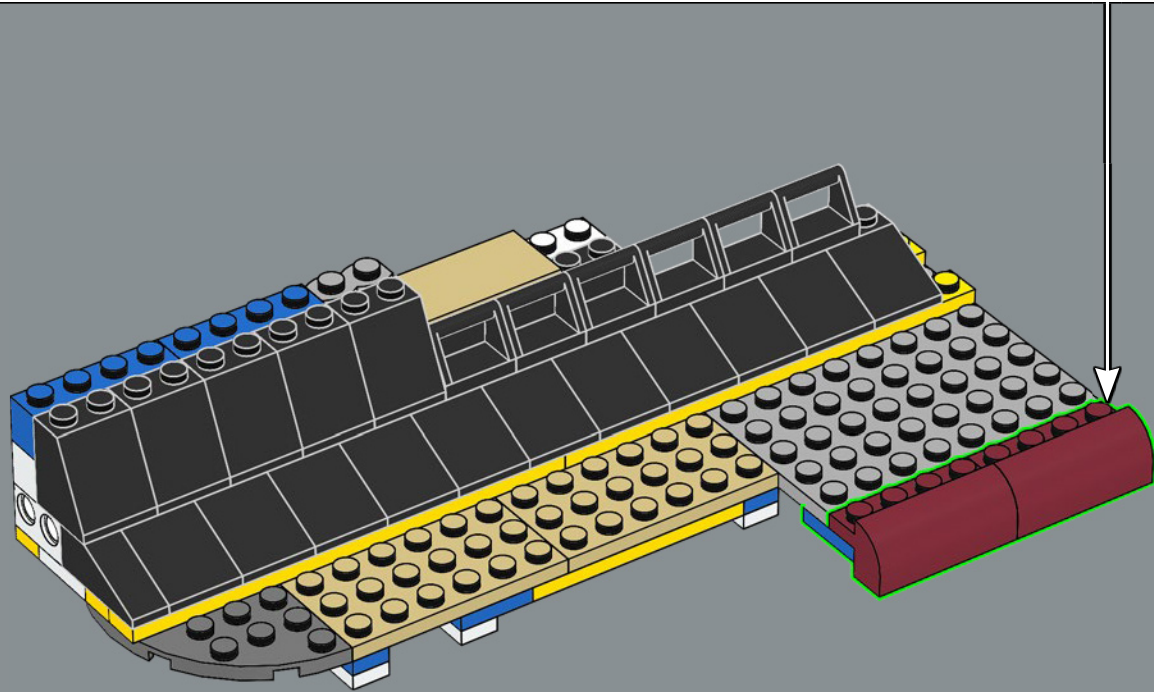
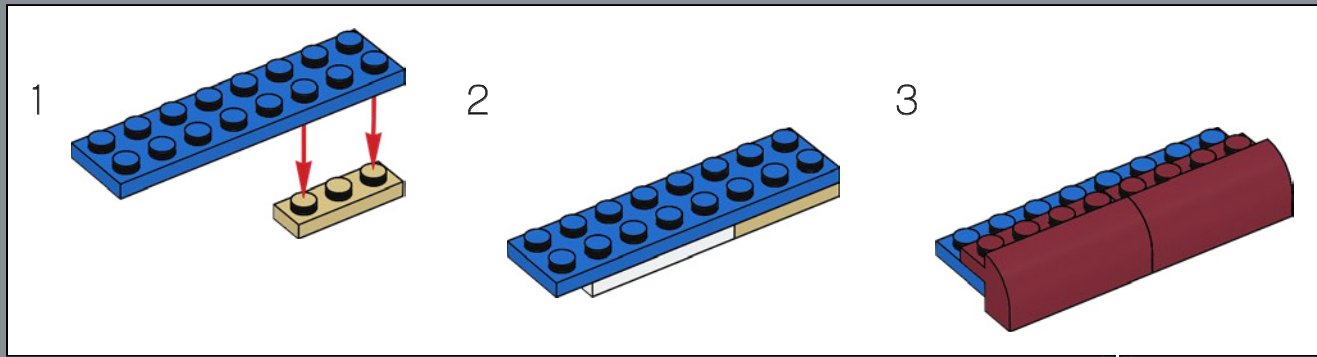

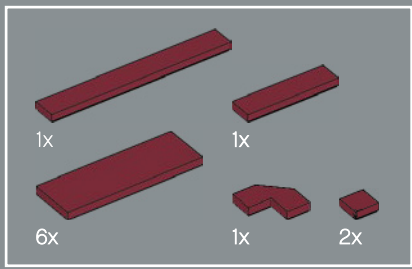

251

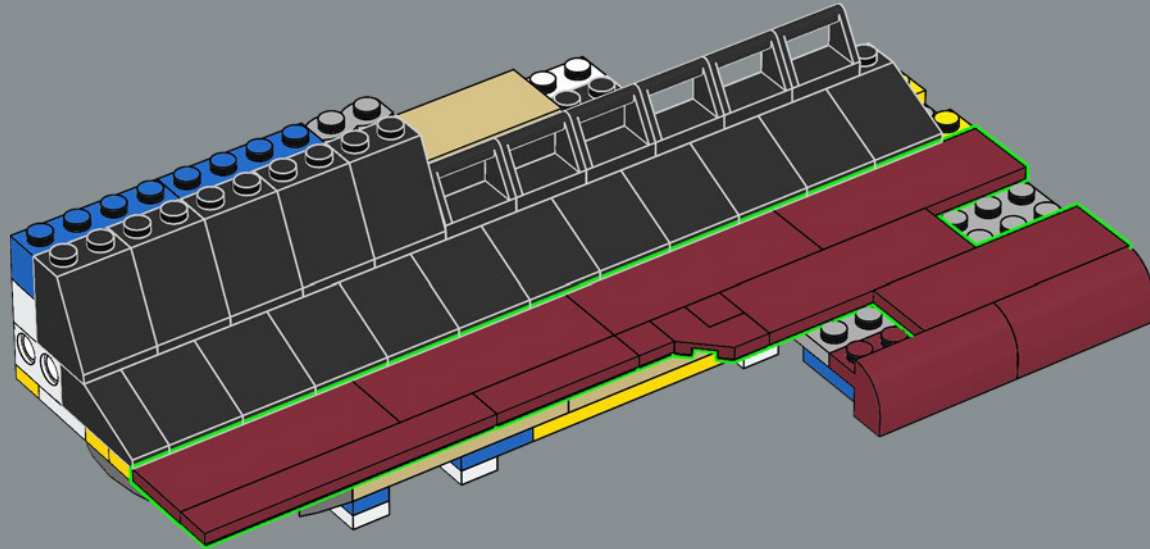

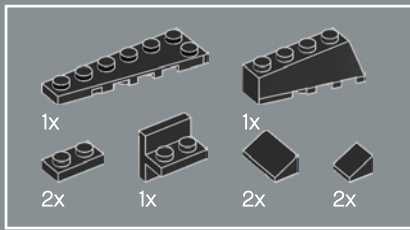

252

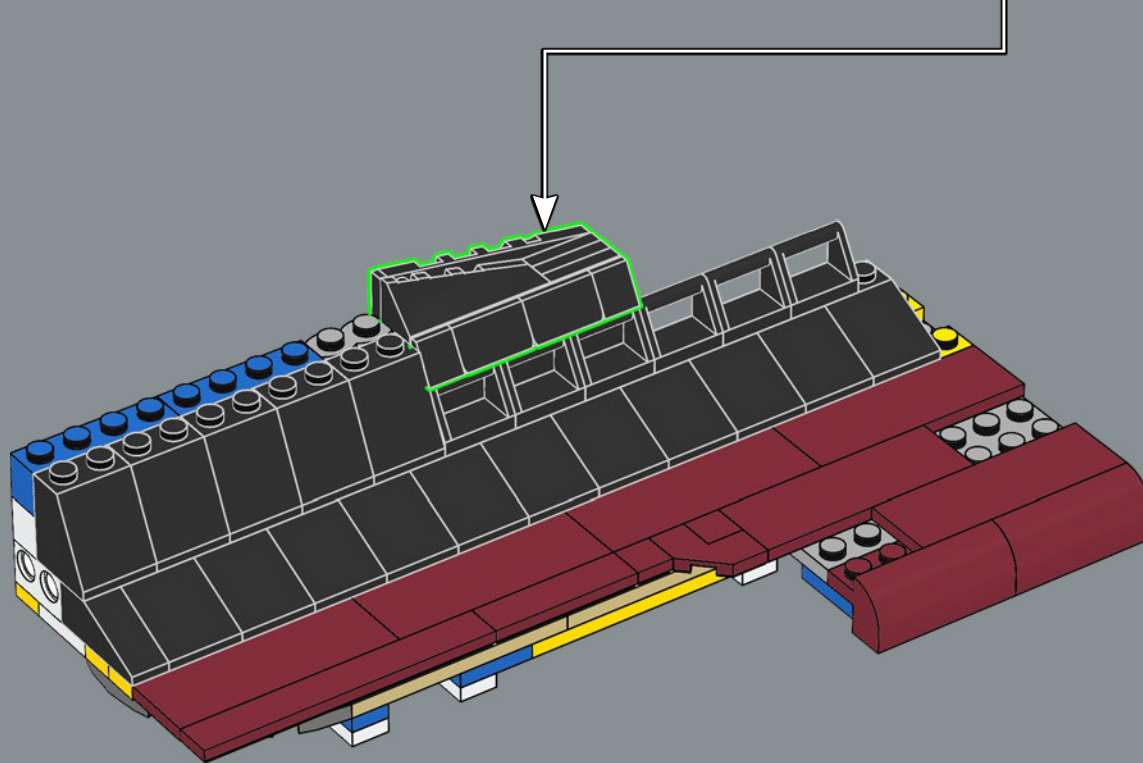
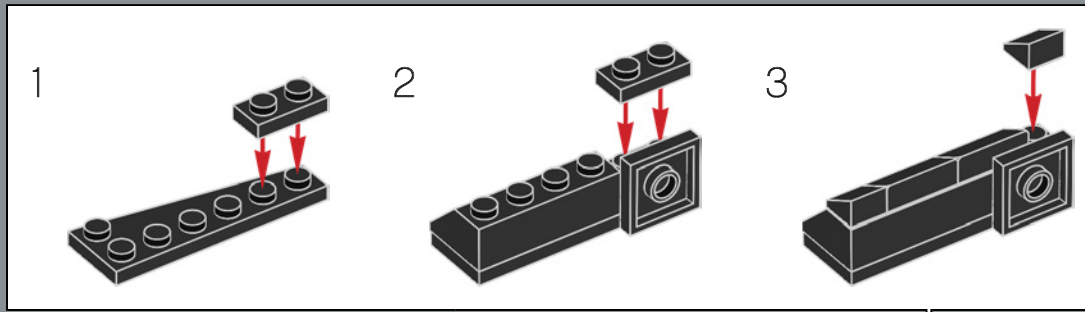

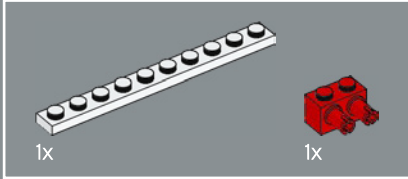
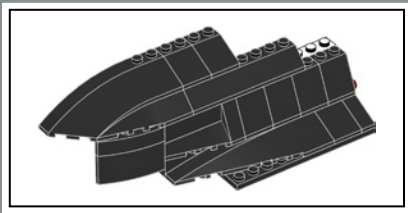

253

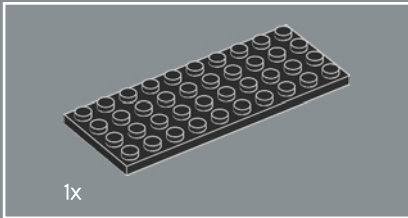
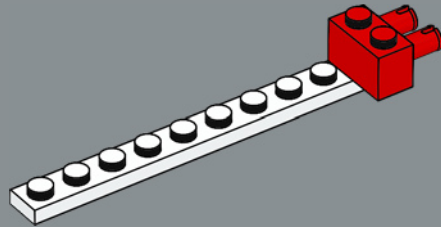

254

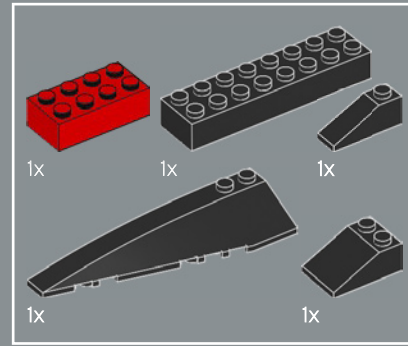
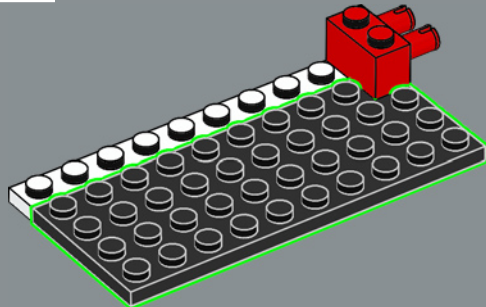

255

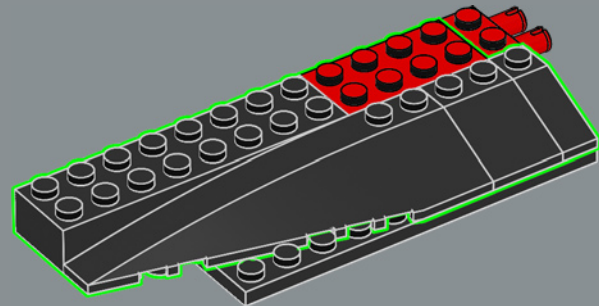

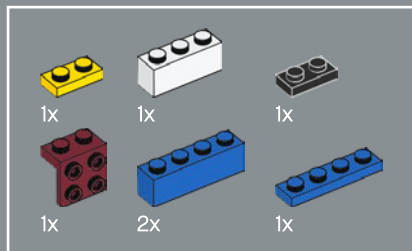

256

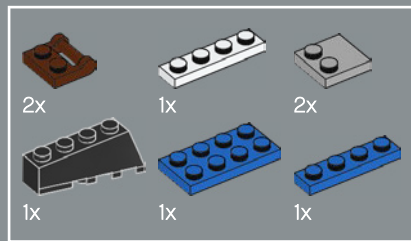
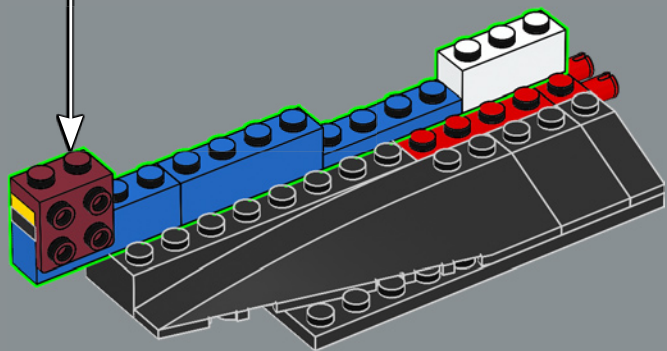
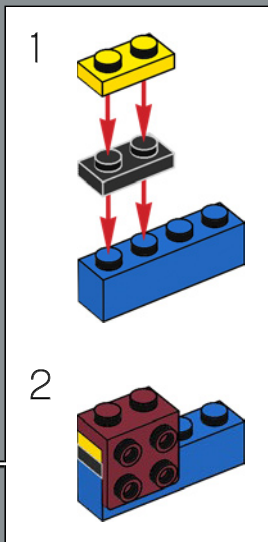

257

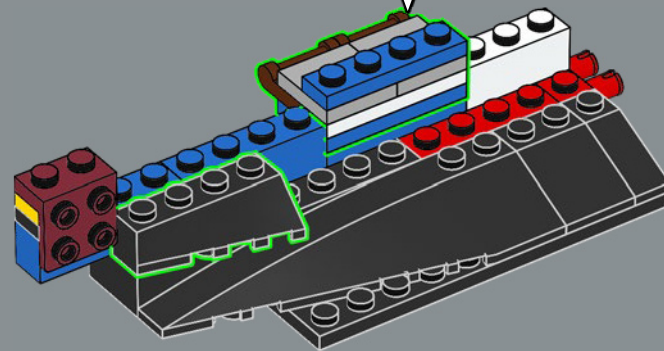
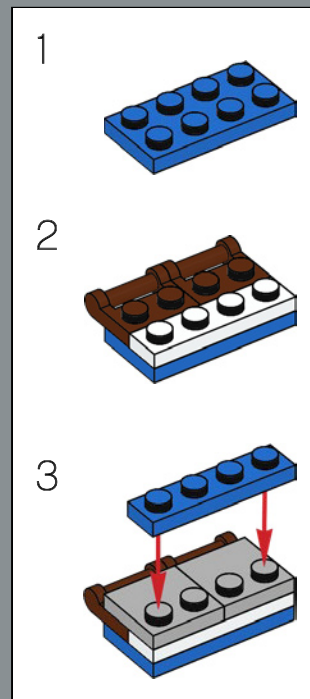

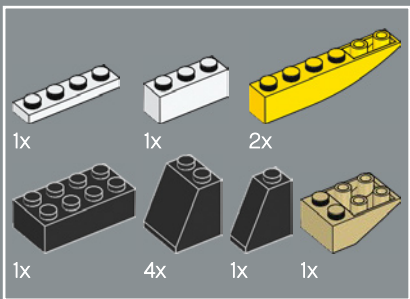

258

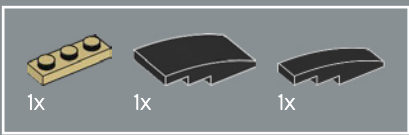
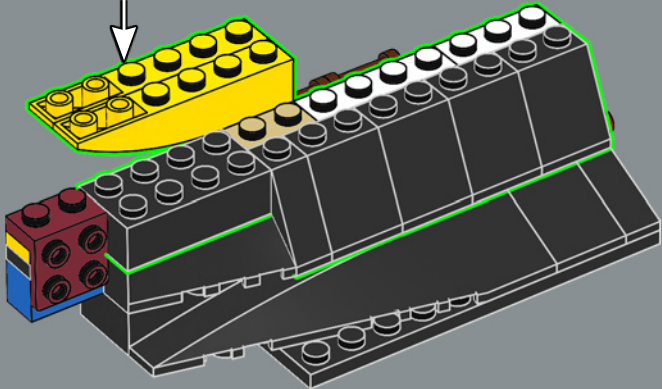
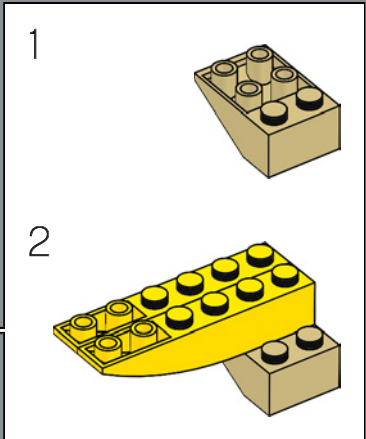

259

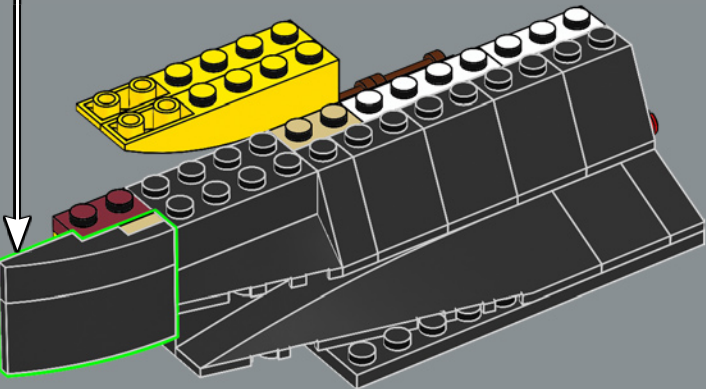
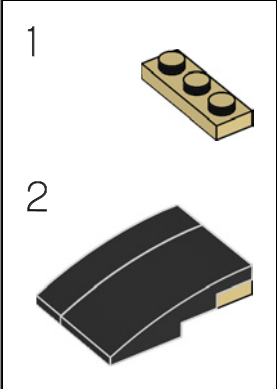



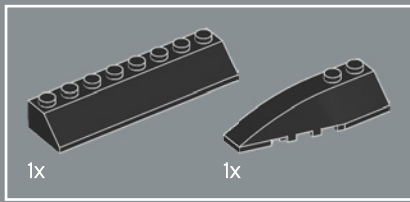

260

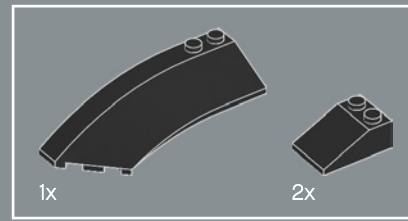
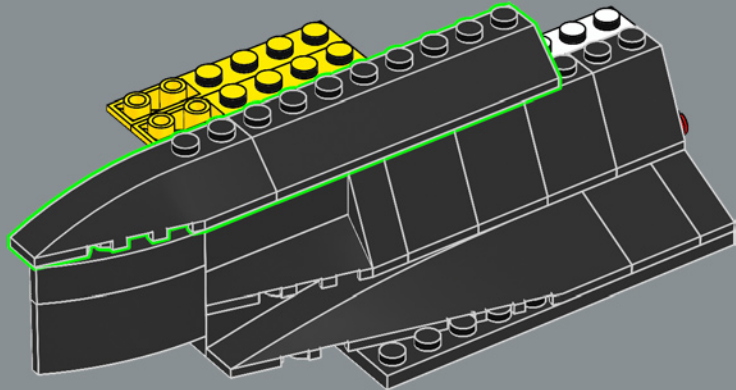

261

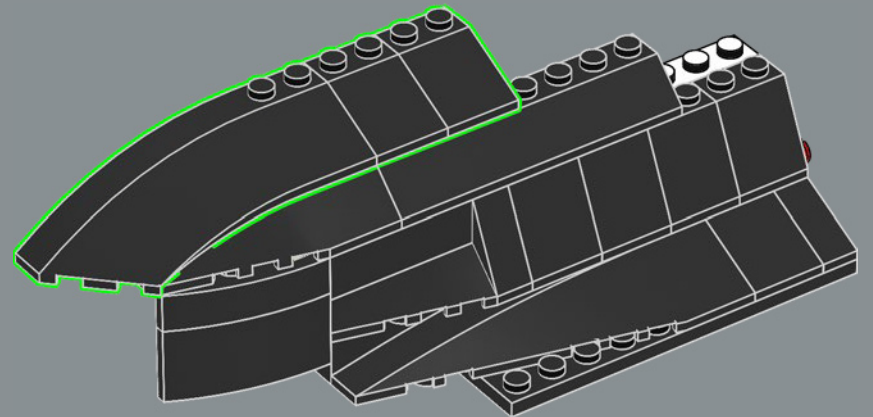

262

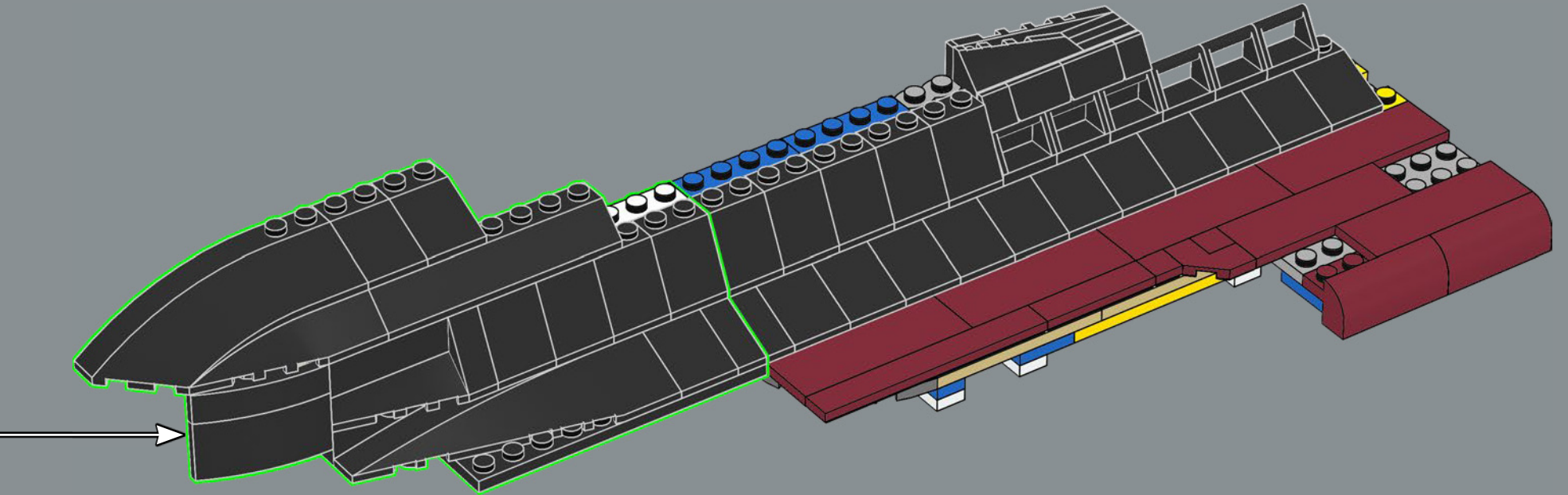

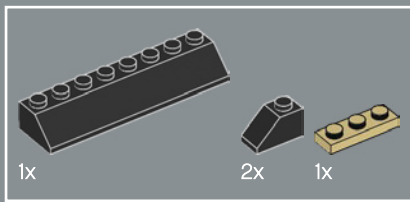

263

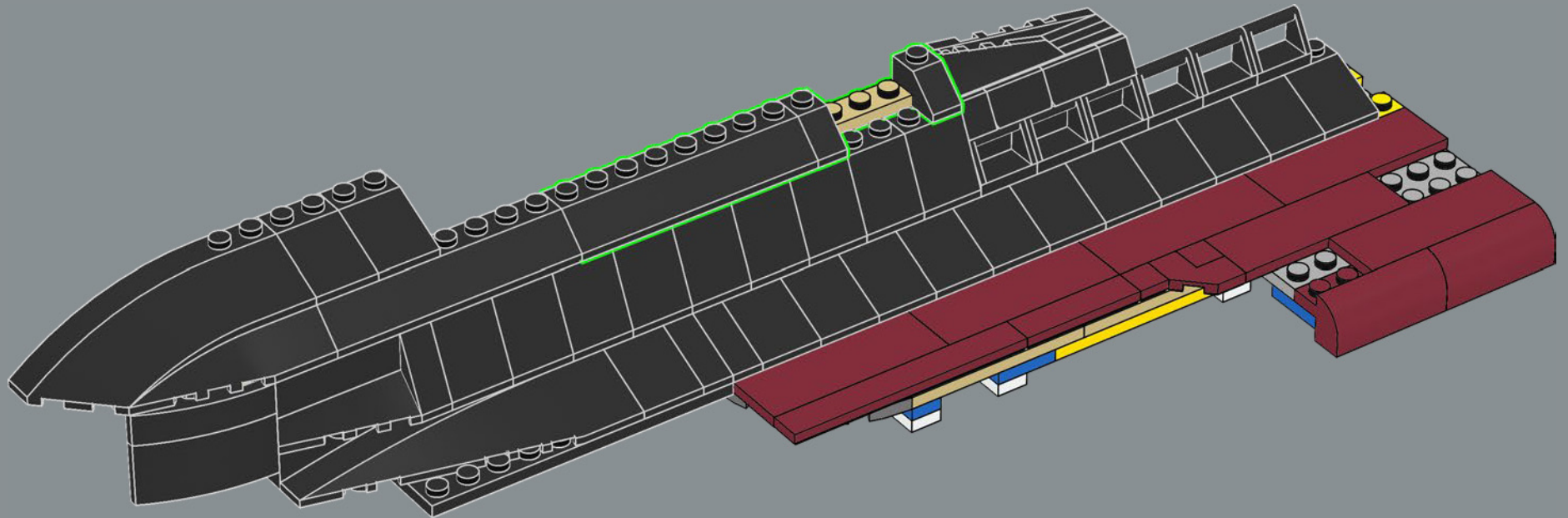

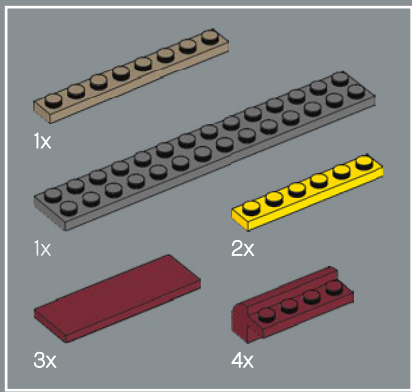

264

1

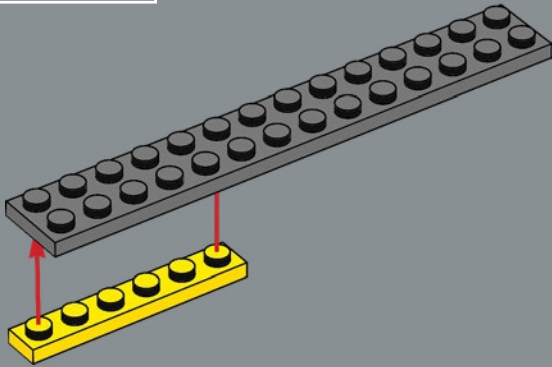

2

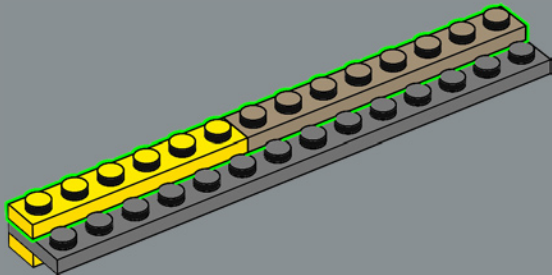

3

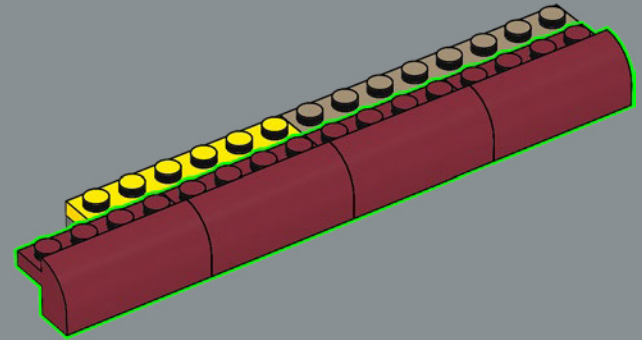

4

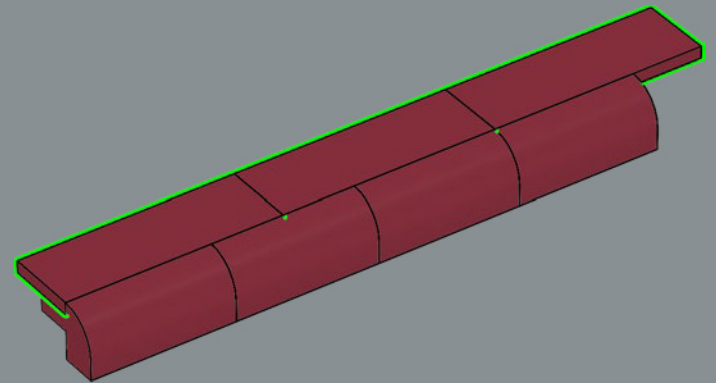

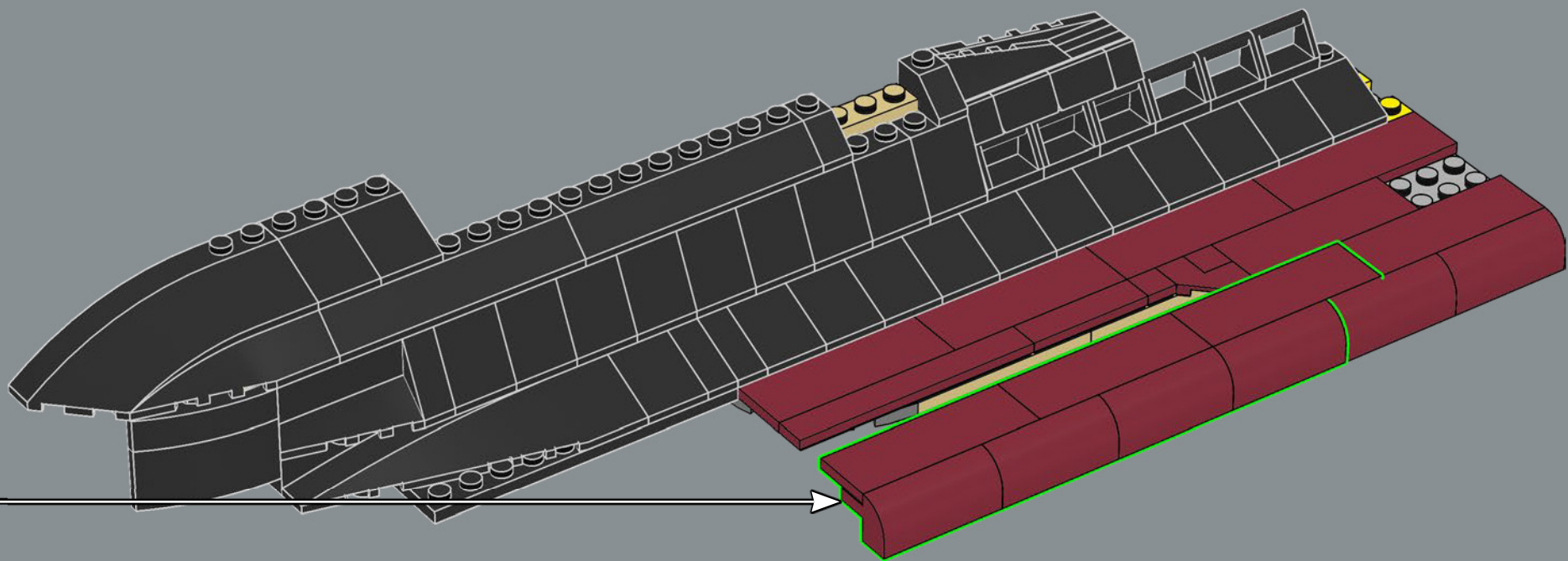

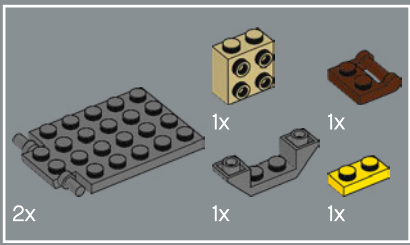

265

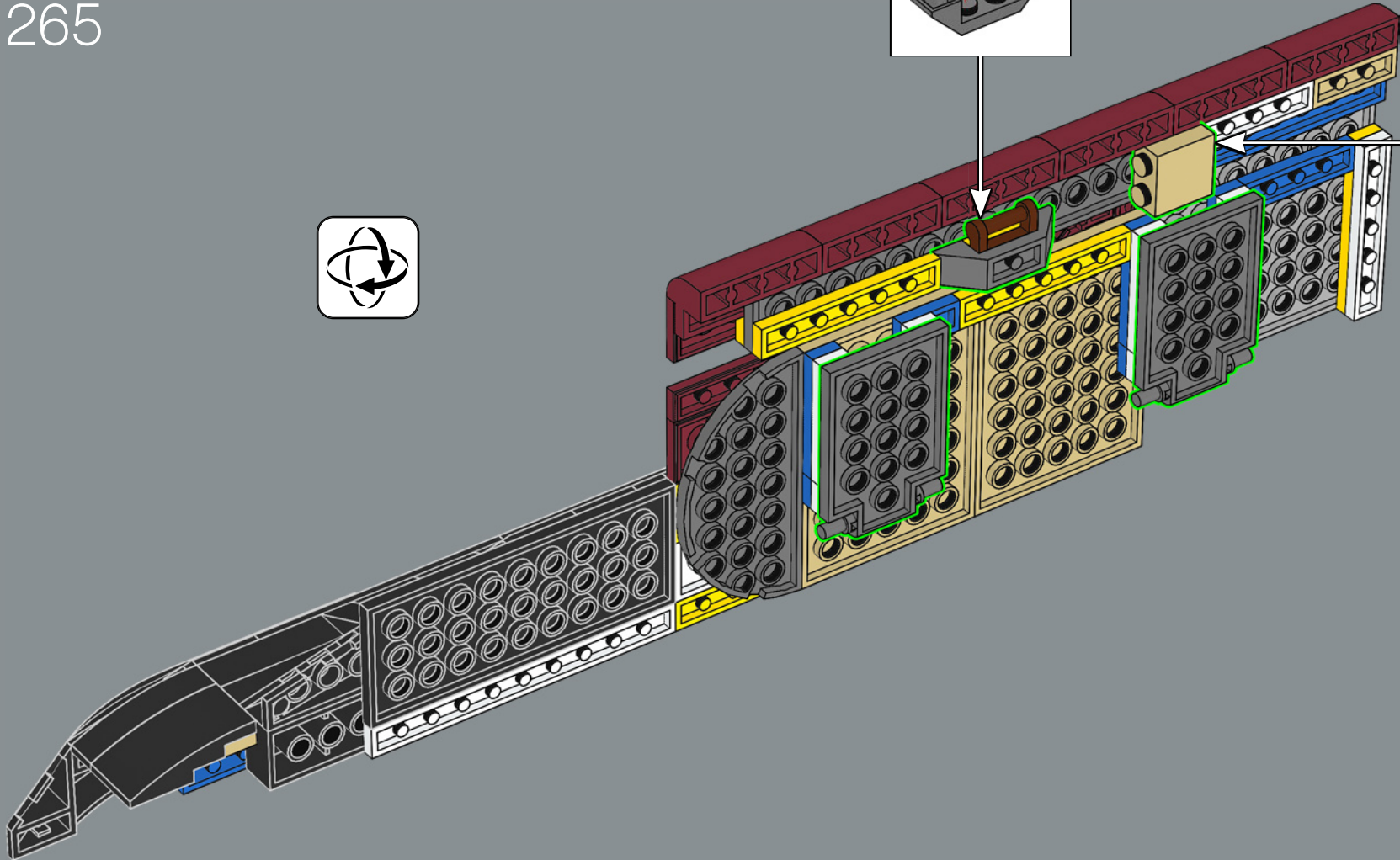
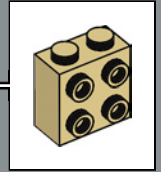
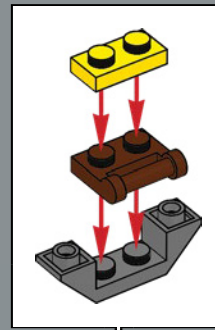

266

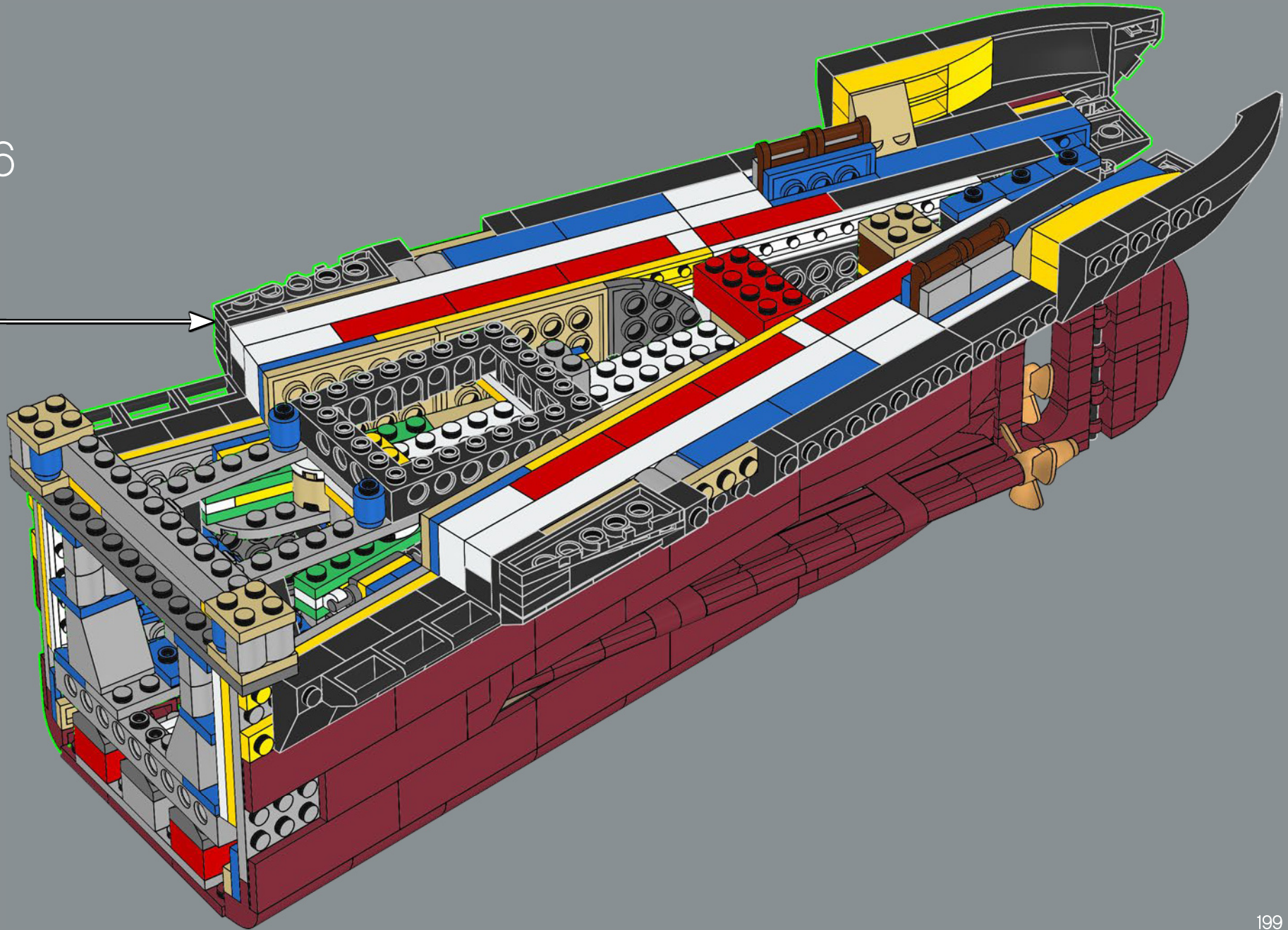

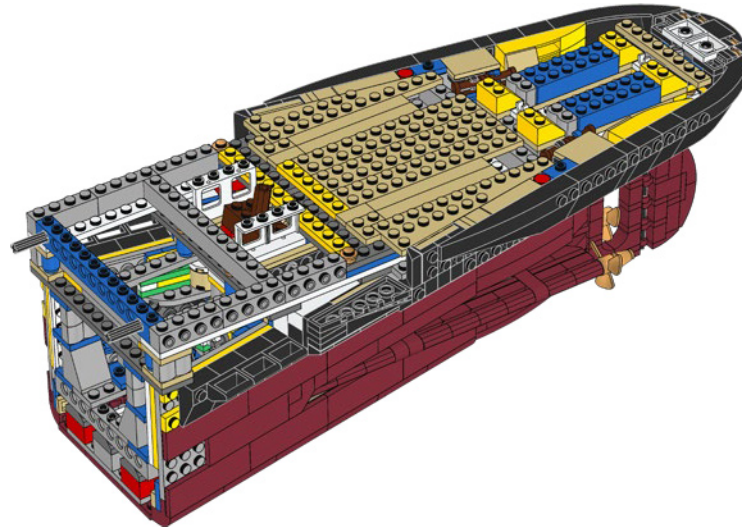
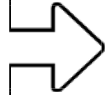



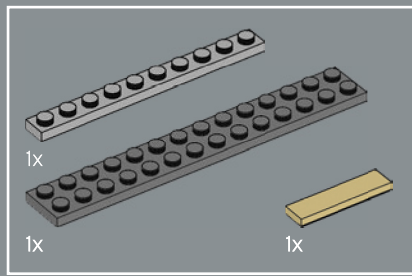

267

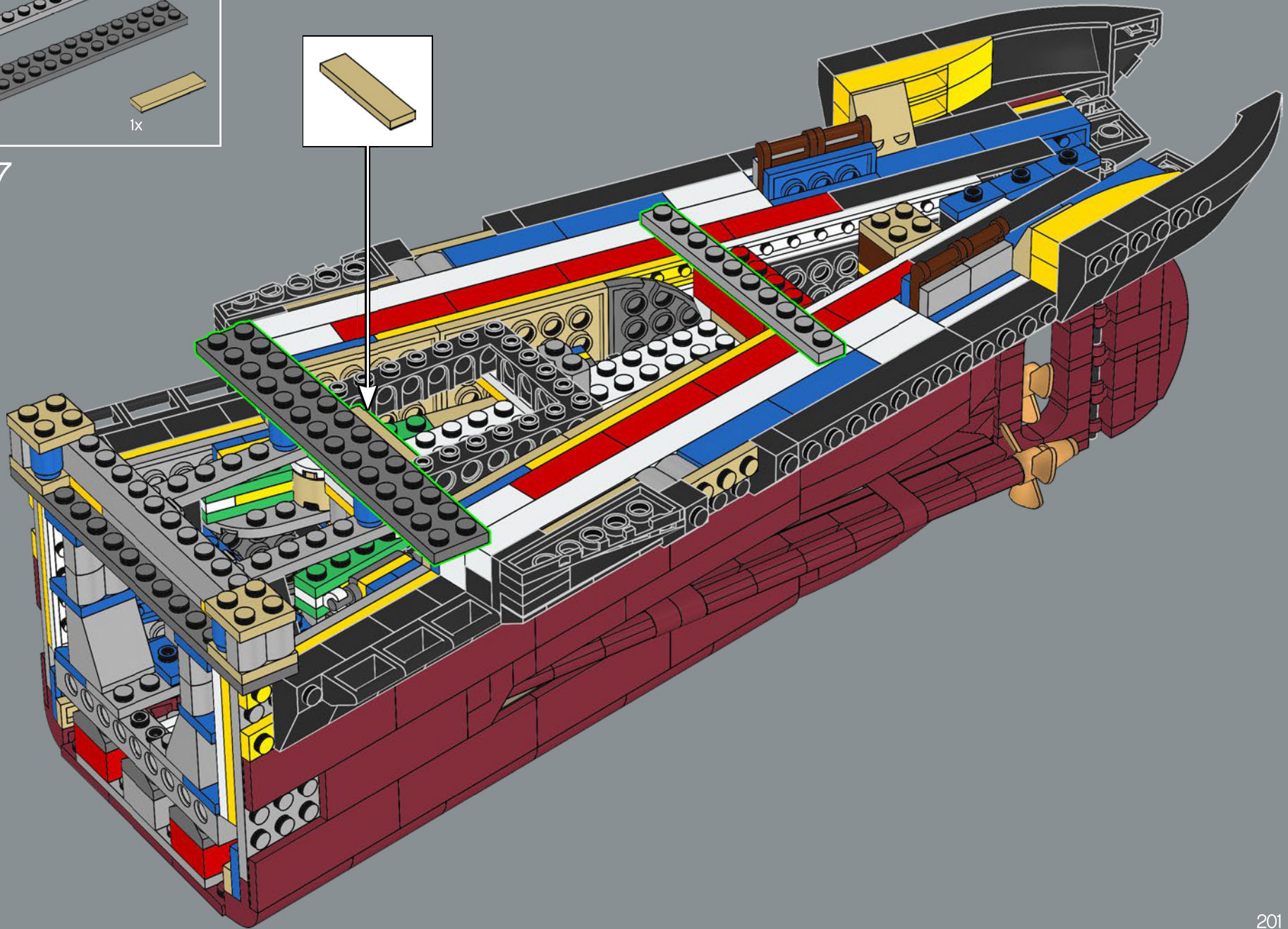
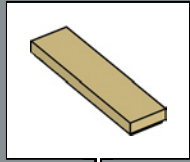

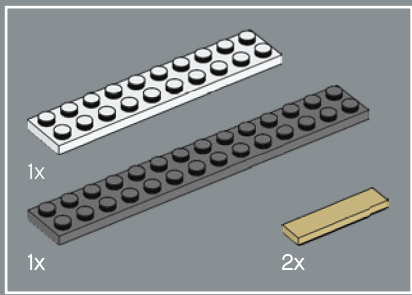

268

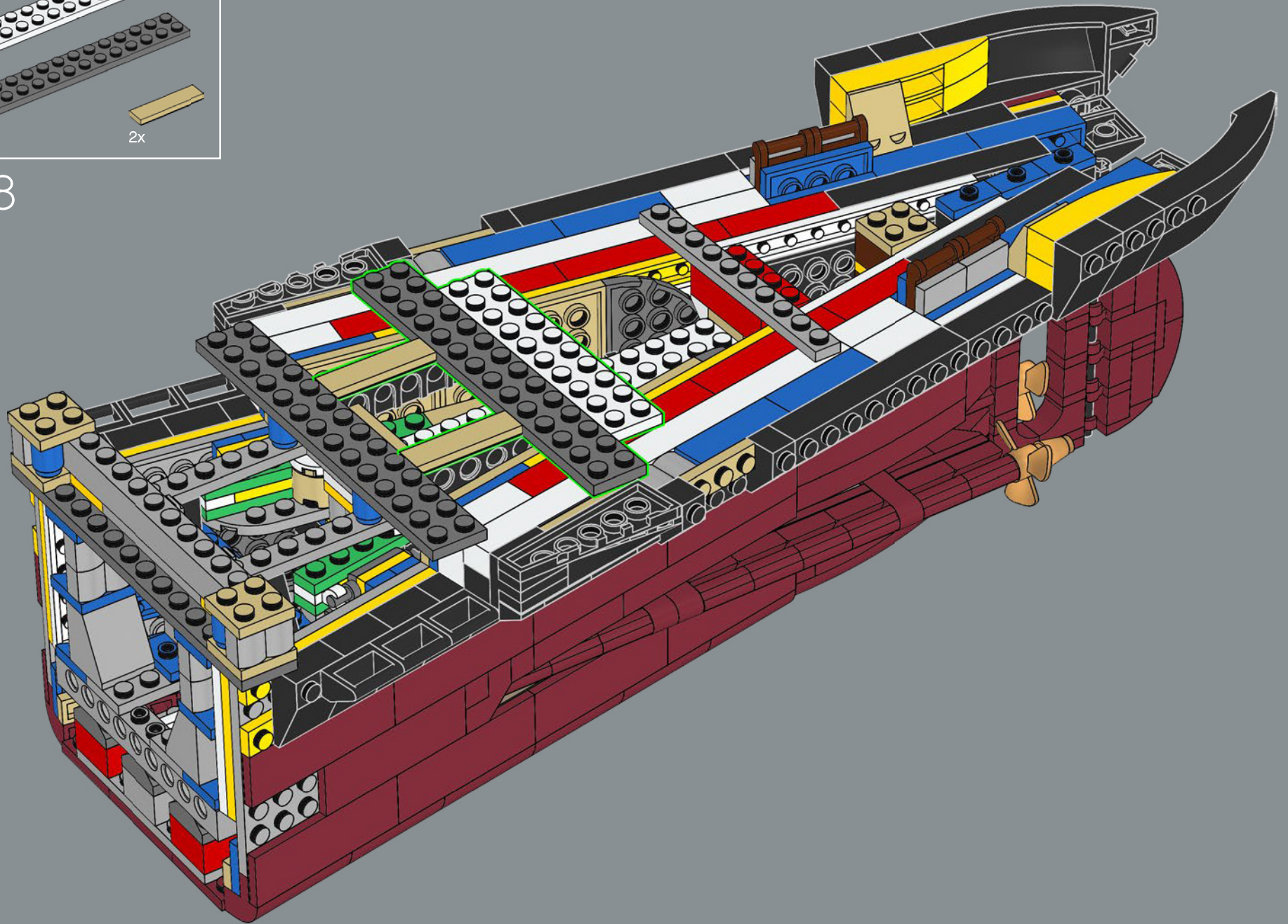

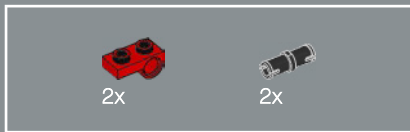

269

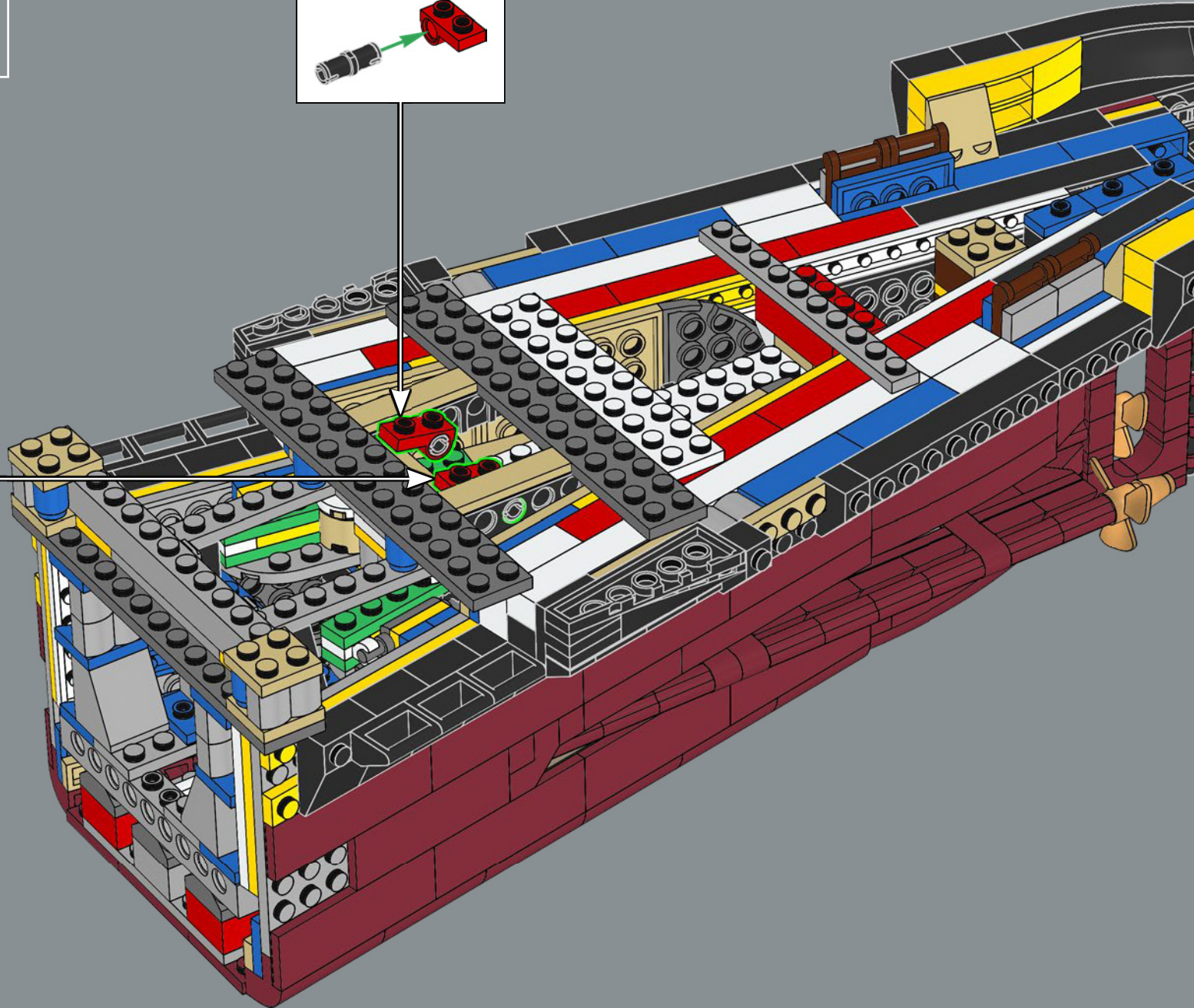
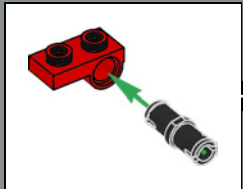
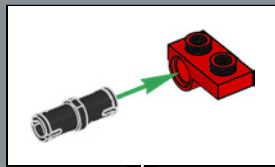

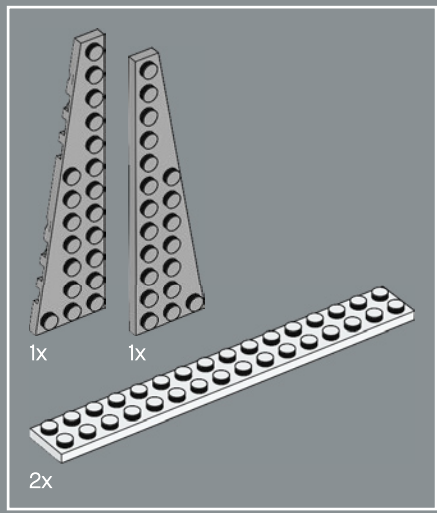

270

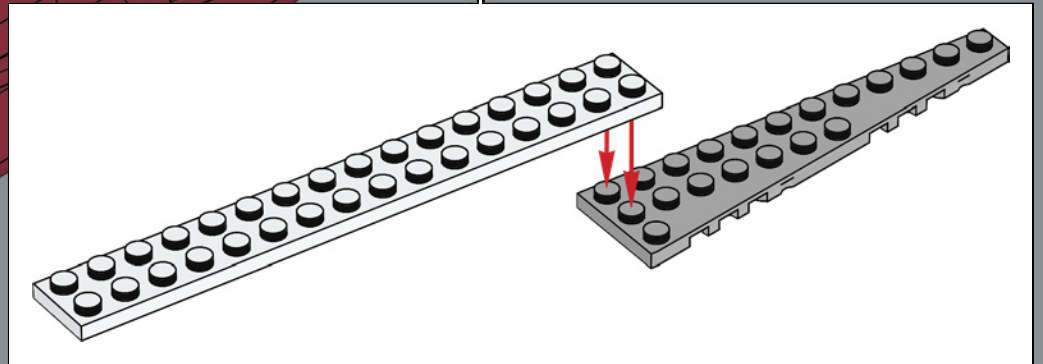
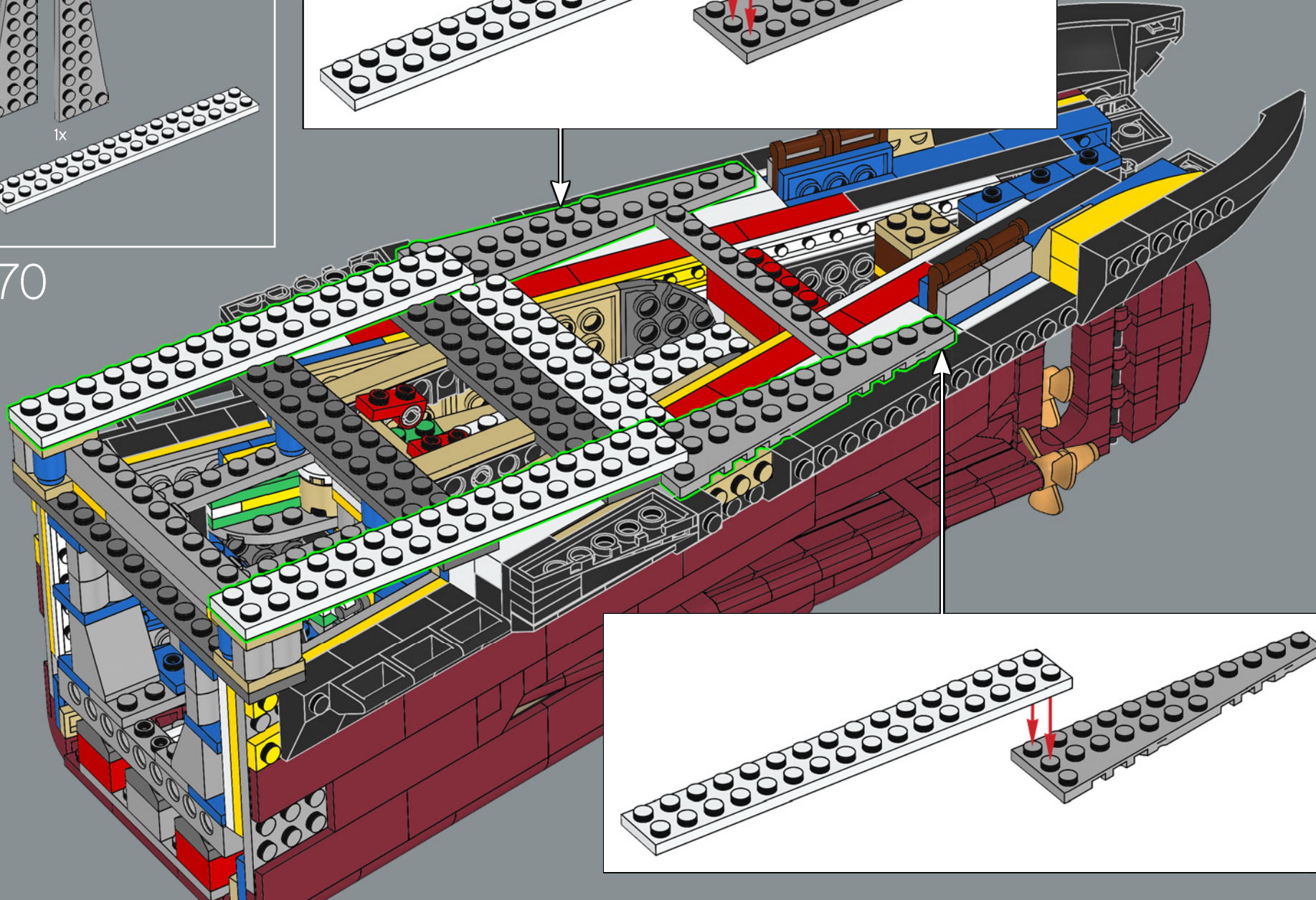
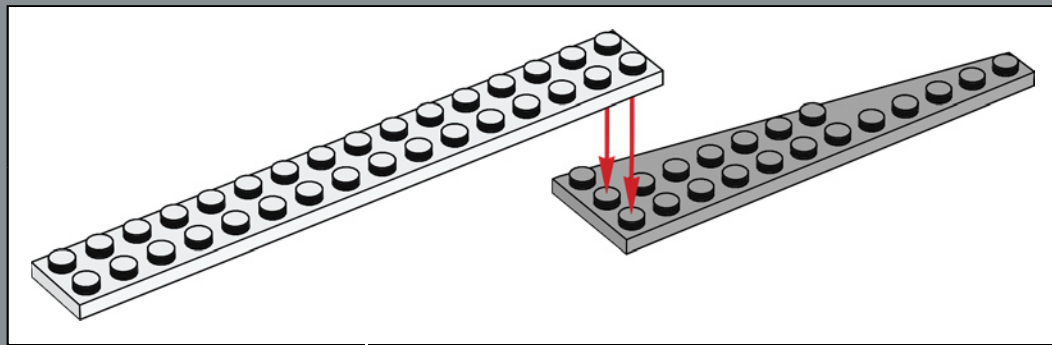

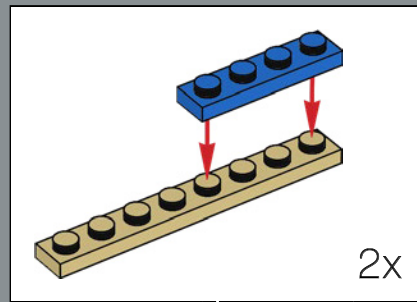
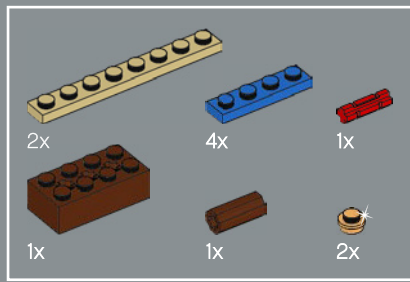

271

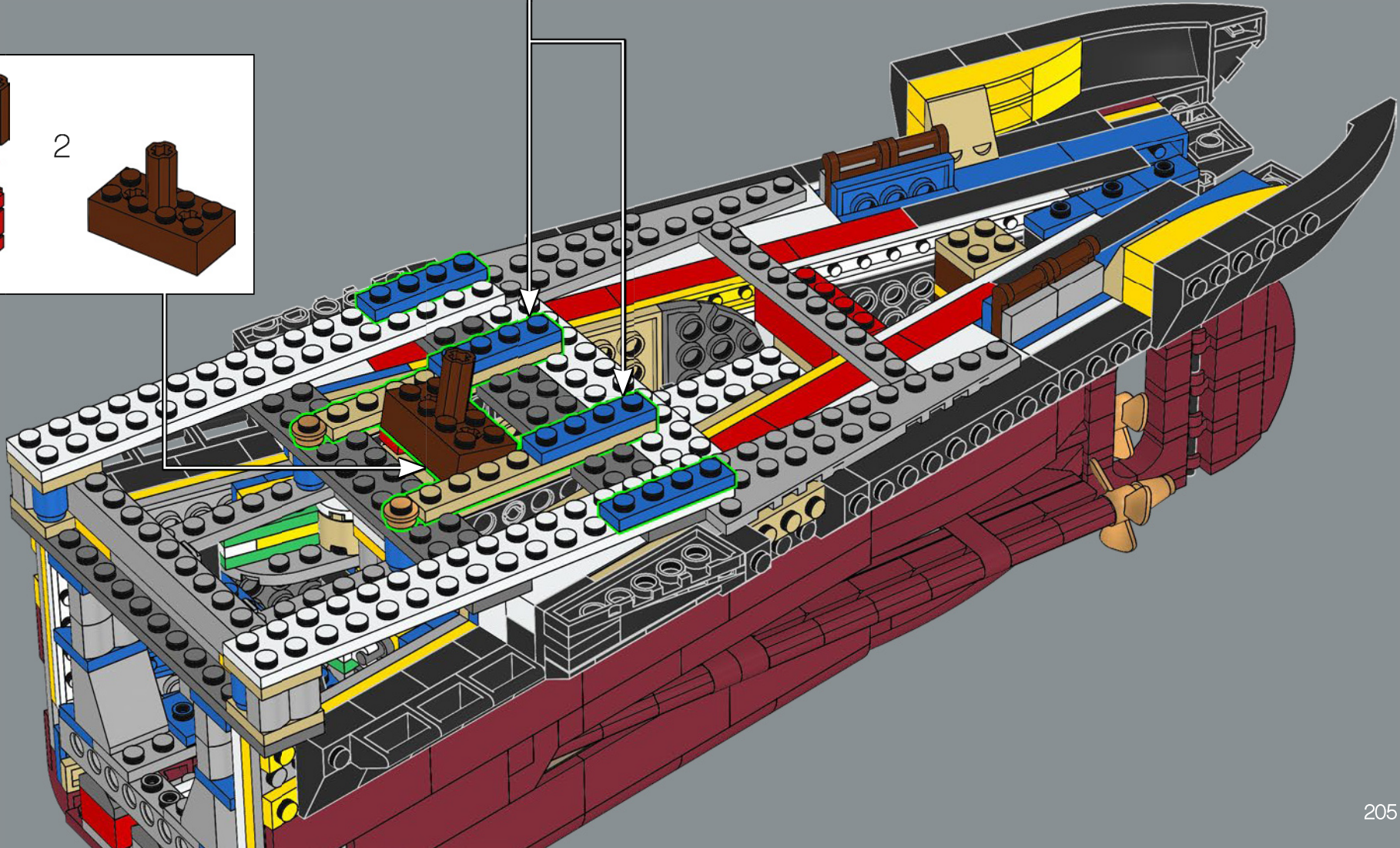
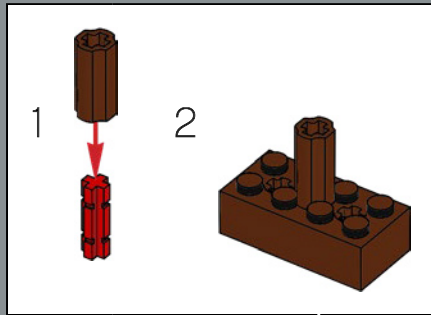

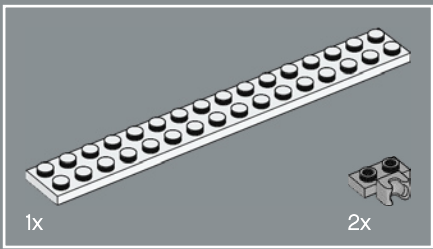

272

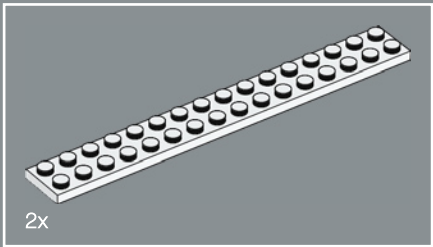
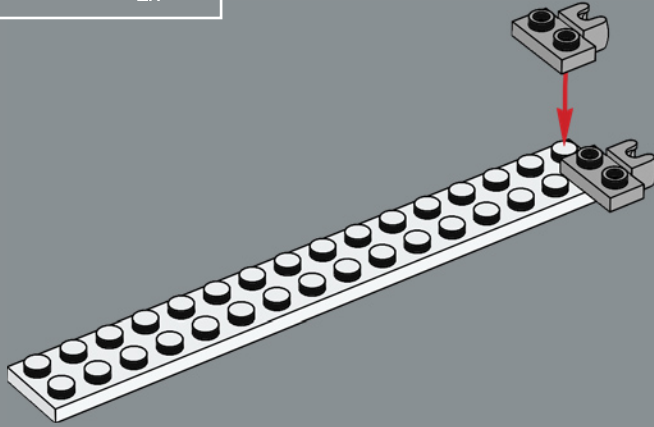

273

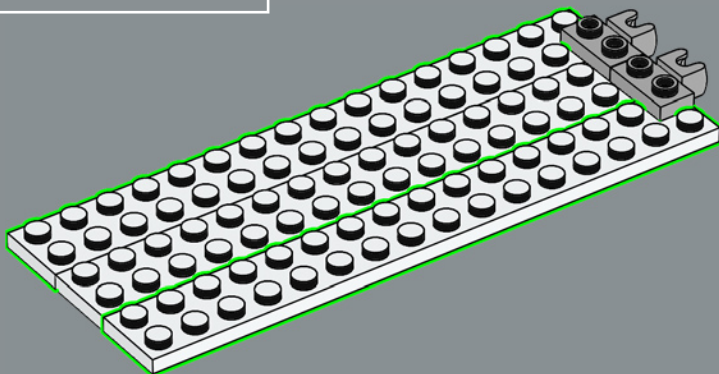

274

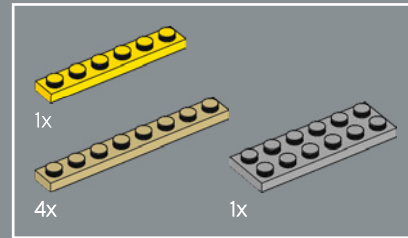
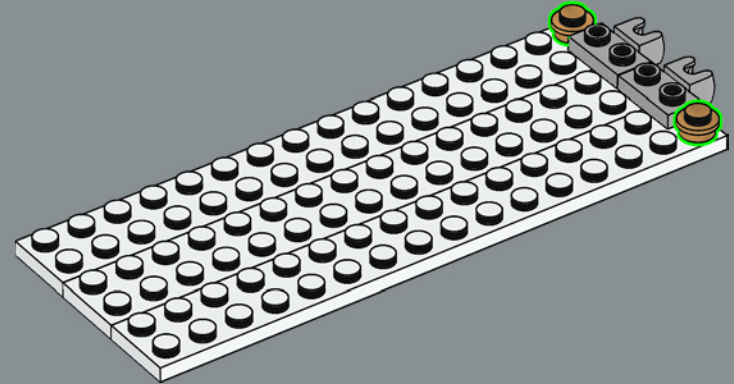

275

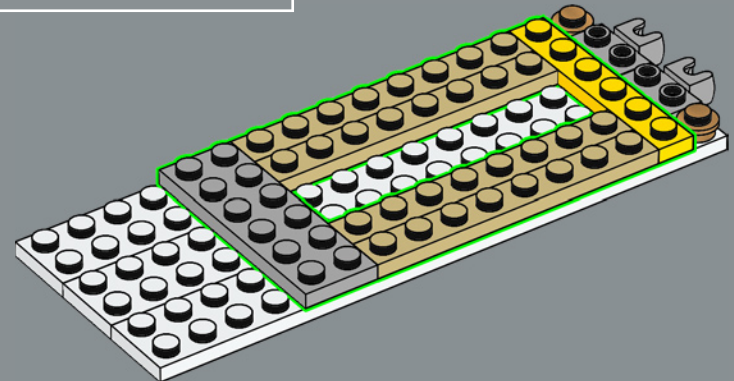

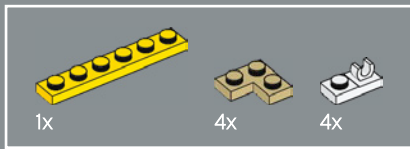

276

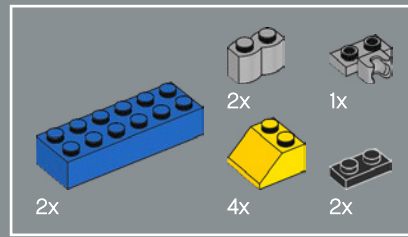
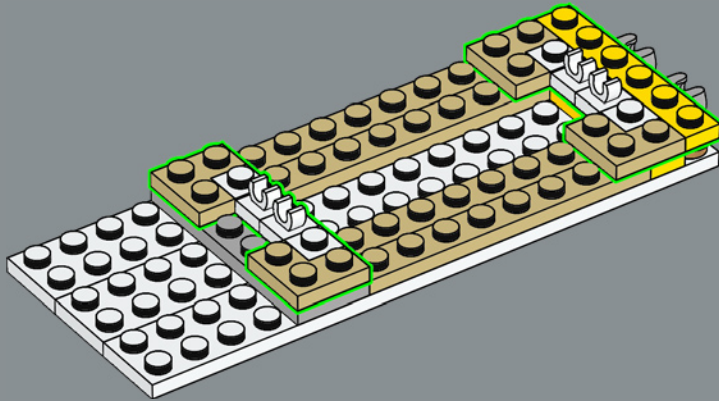

277

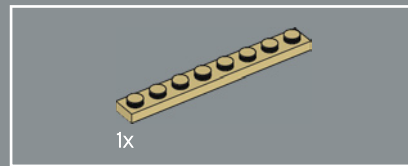
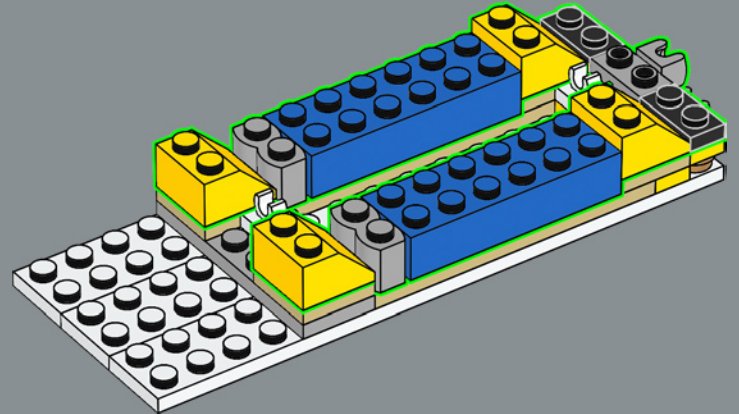

278

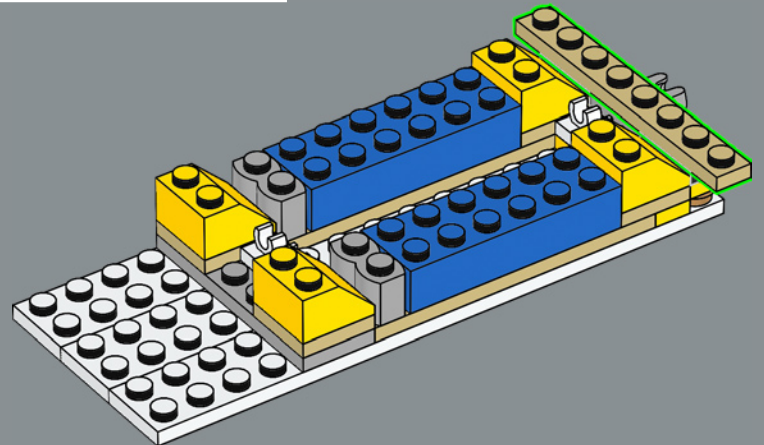

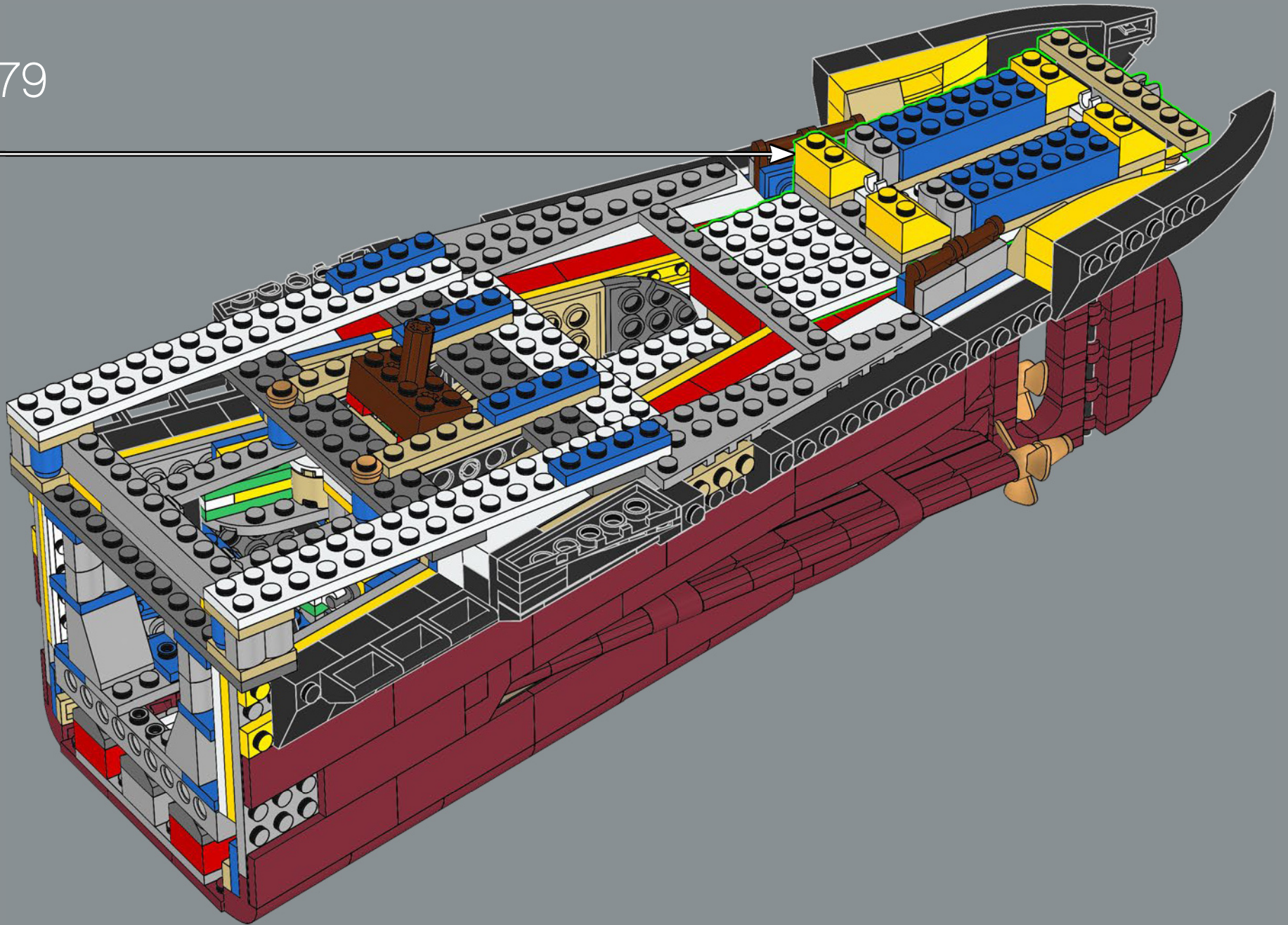



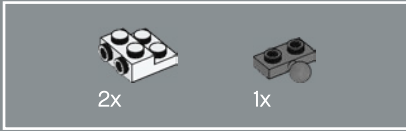
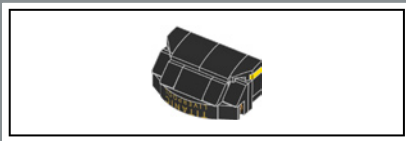

280

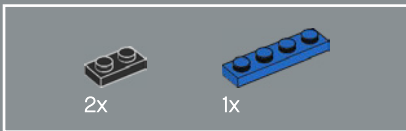
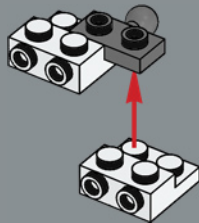

281

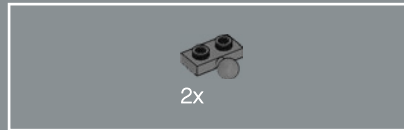
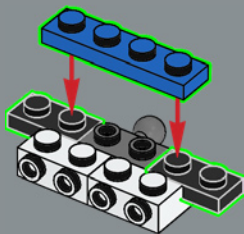

282

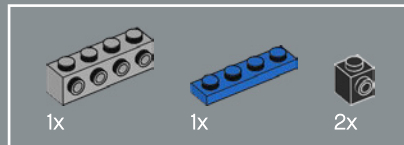
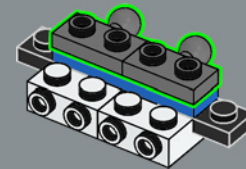

283

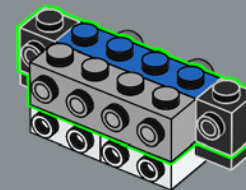

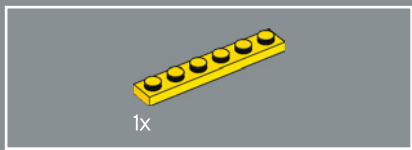

284

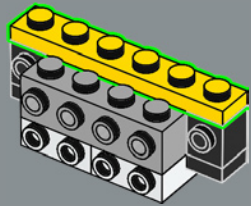

285

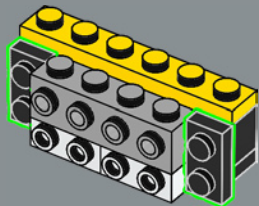

286

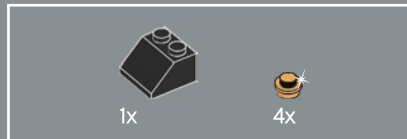
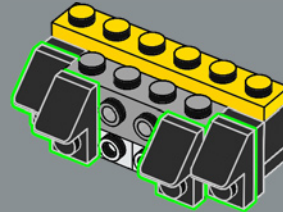

287

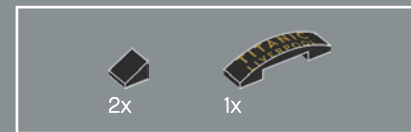
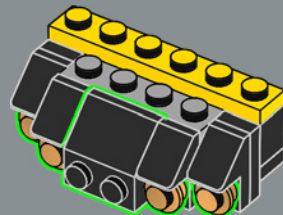

288

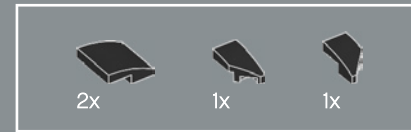
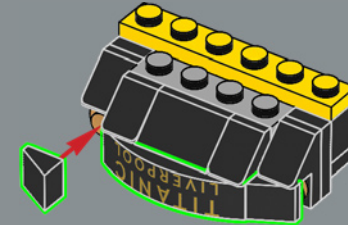

289

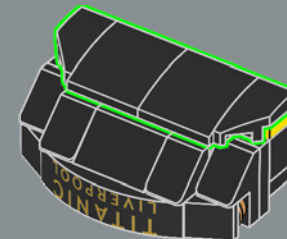

The *Titanic* lacked a searchlight and had no Public Address system.

290

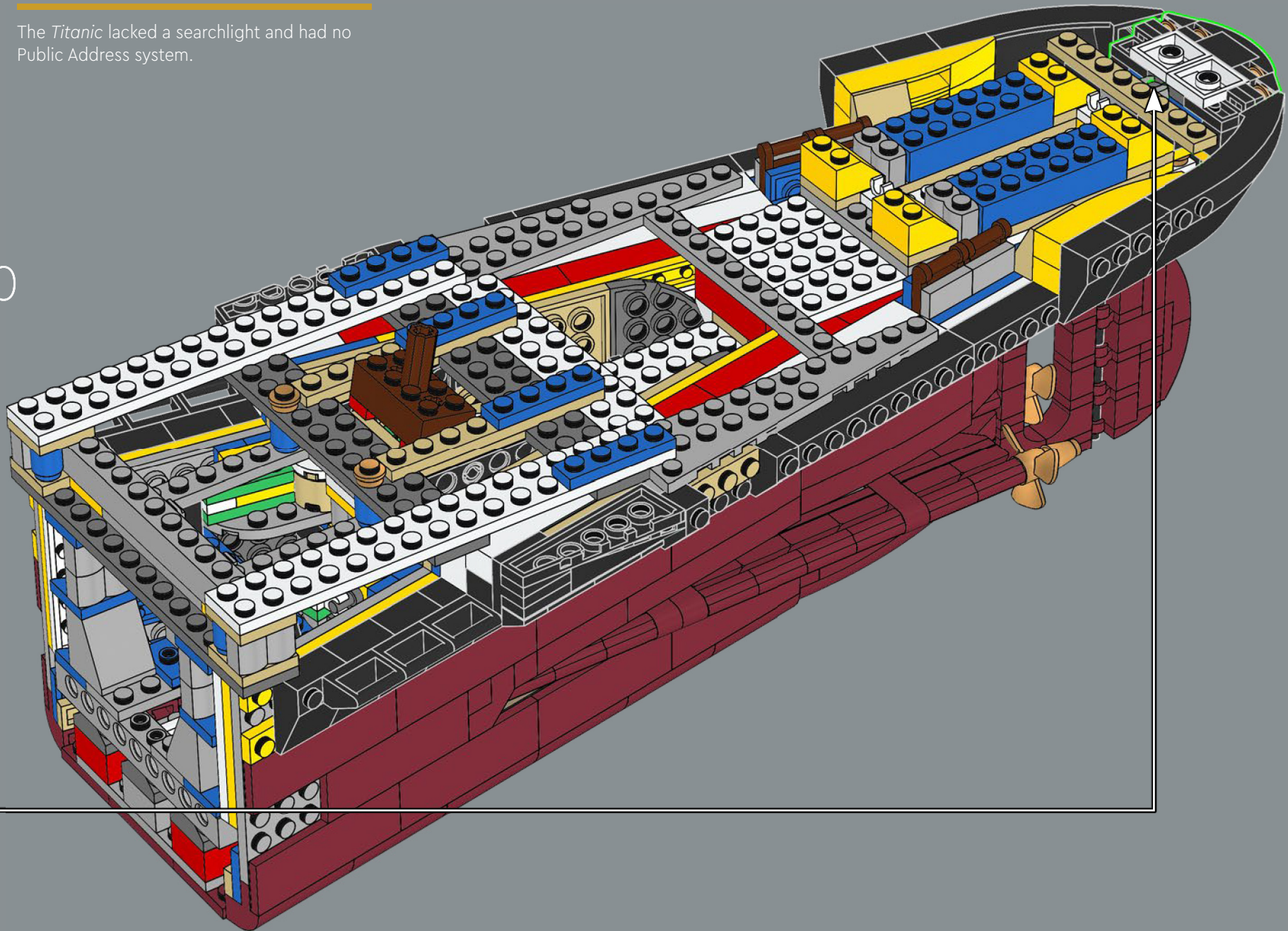

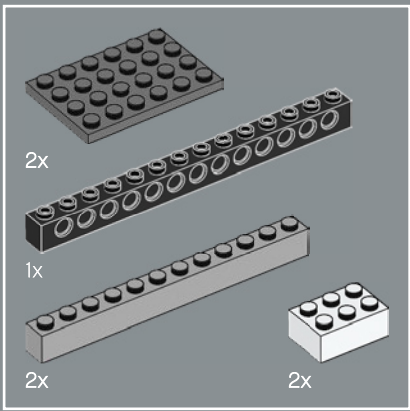

291

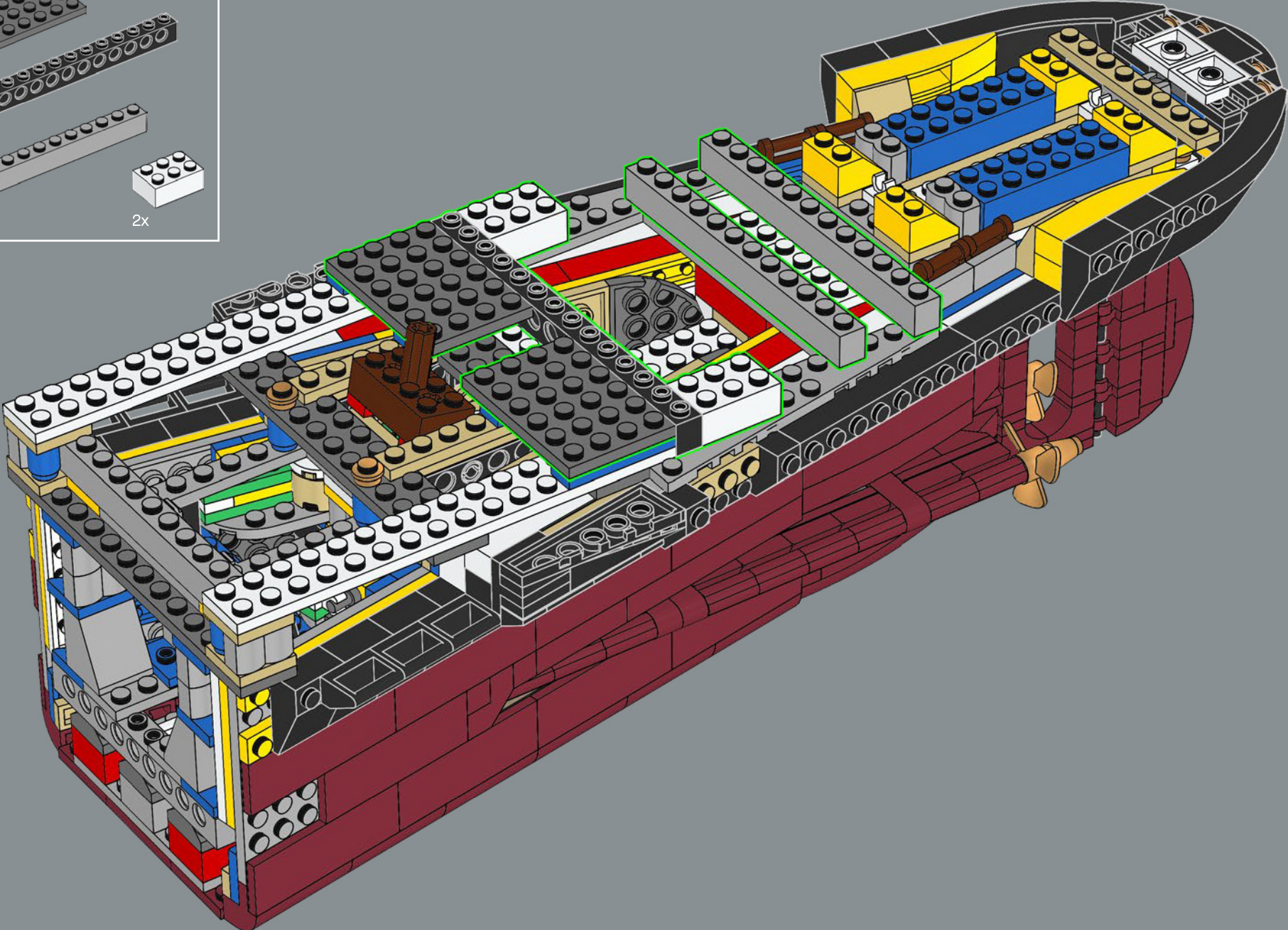

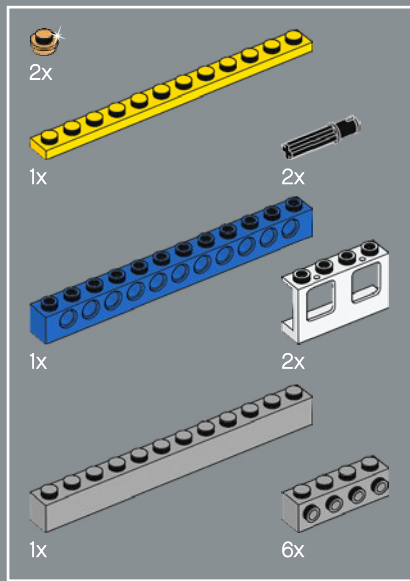

292

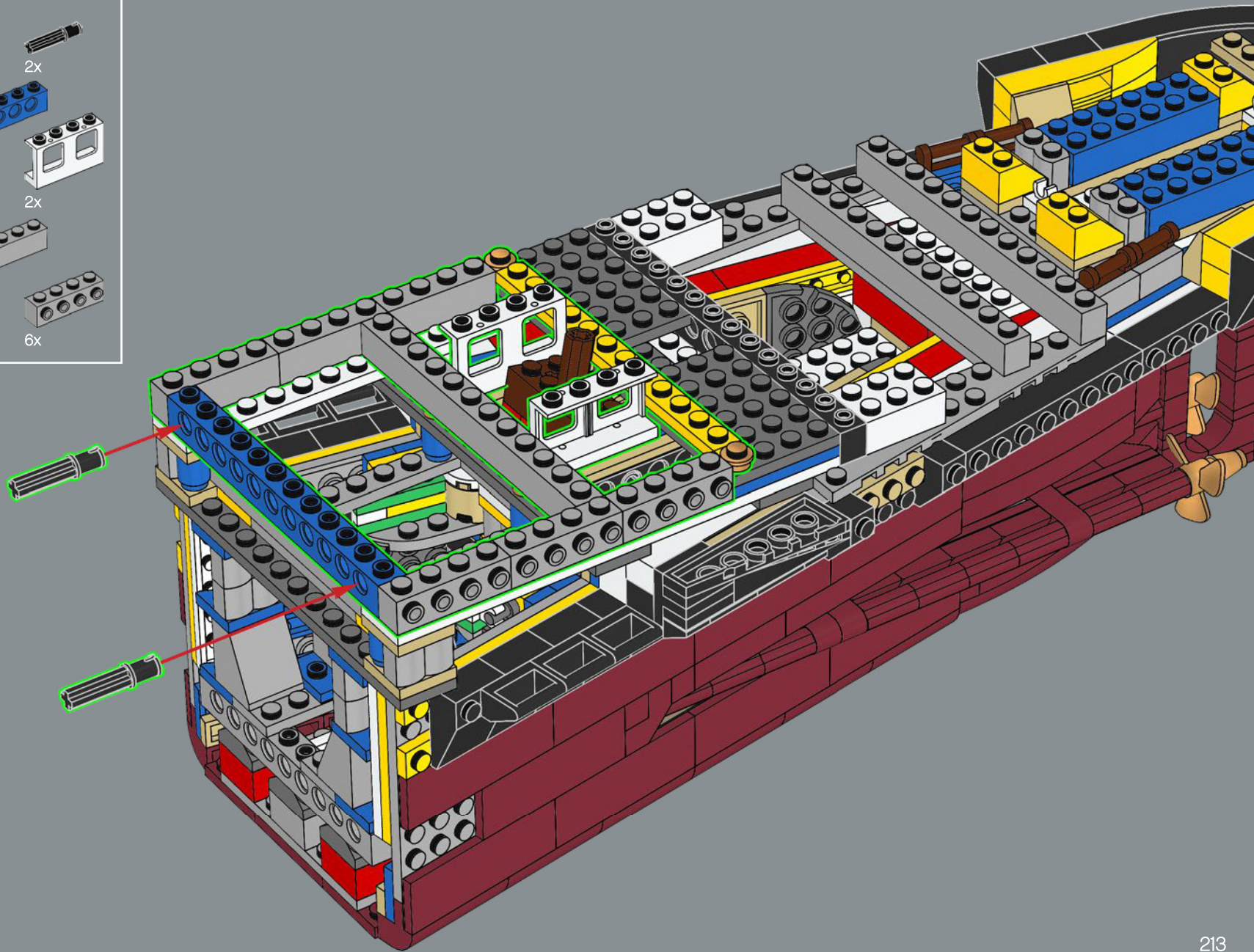

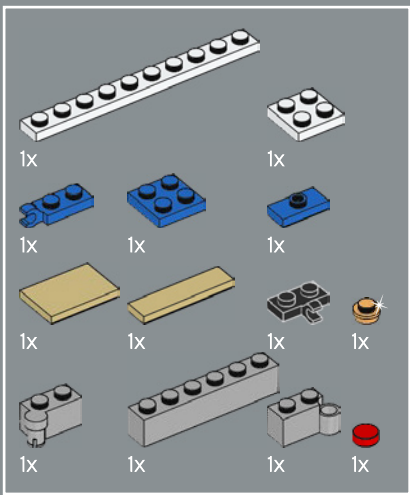

293

1

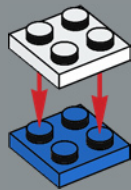

2

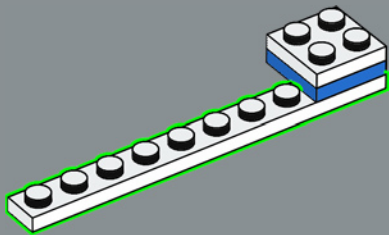

3

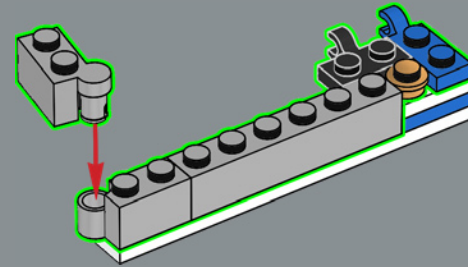

4

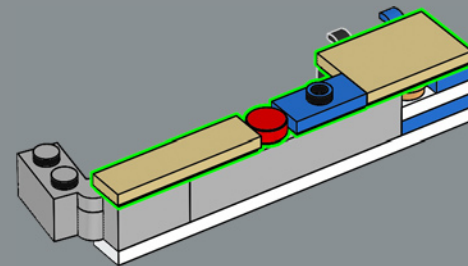

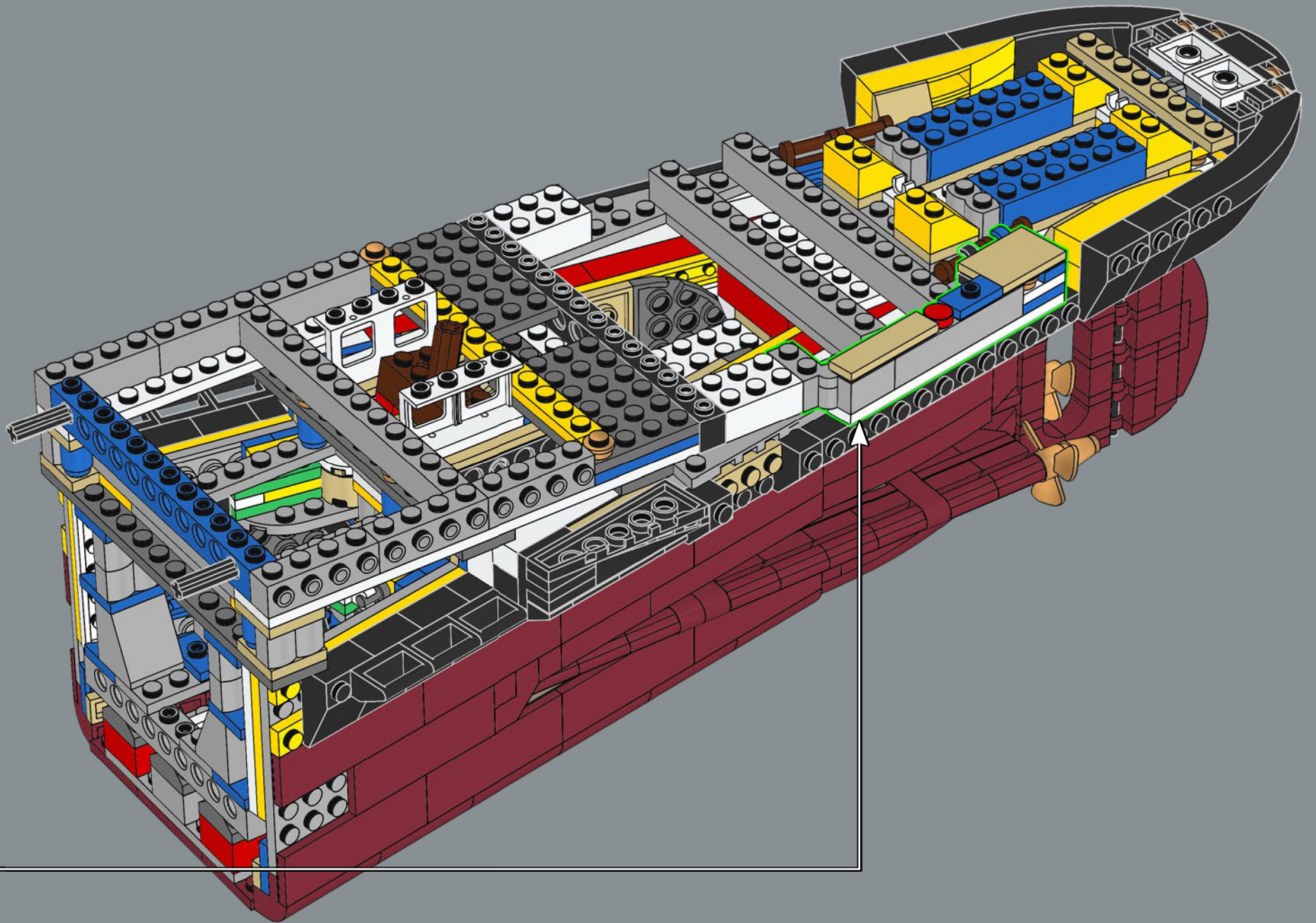

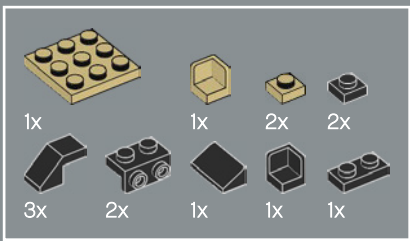

294

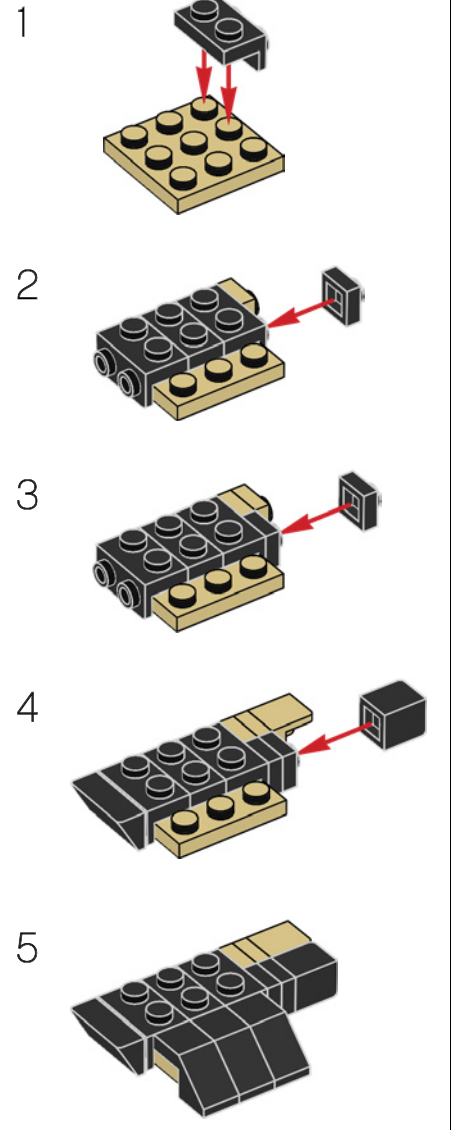
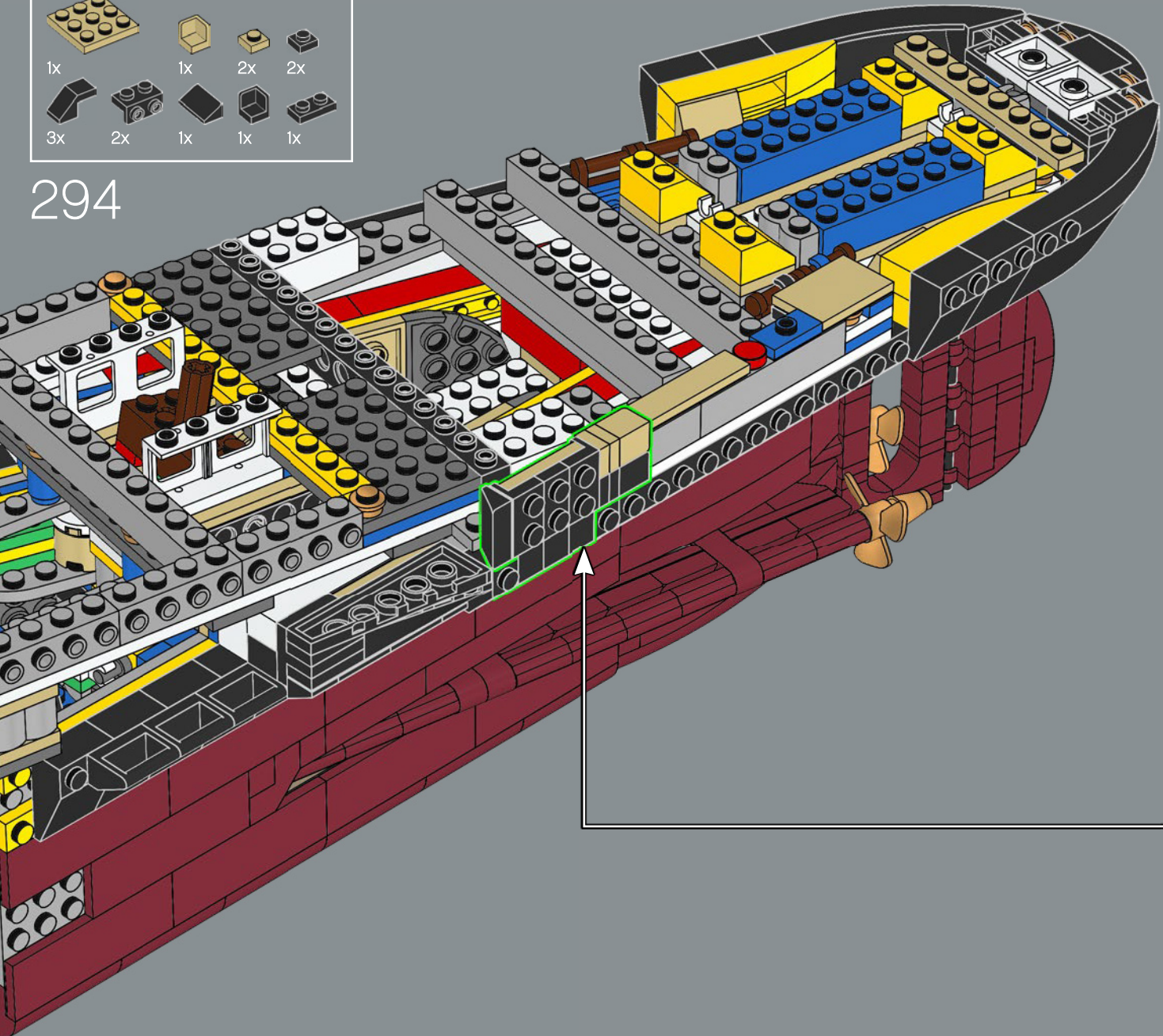



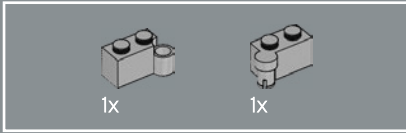
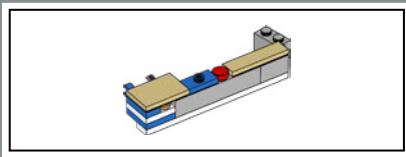

295

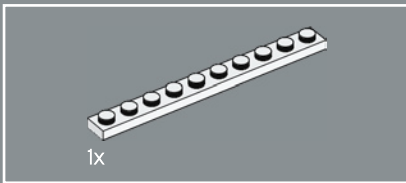
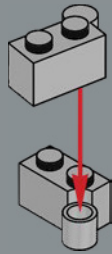

296

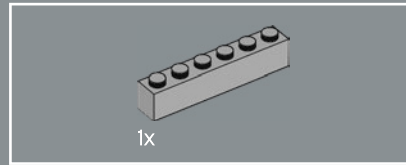
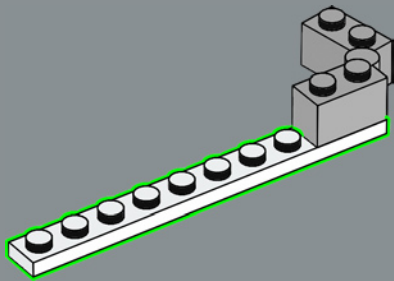

297

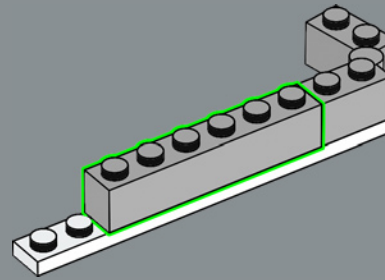

298

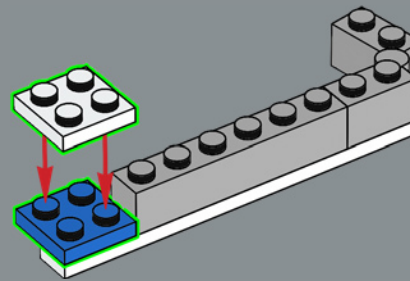

299

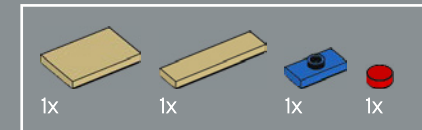
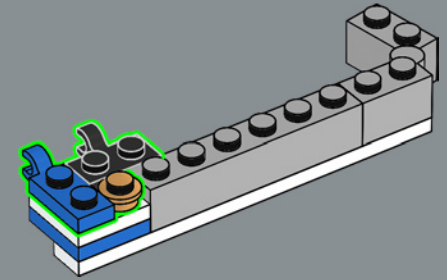

300

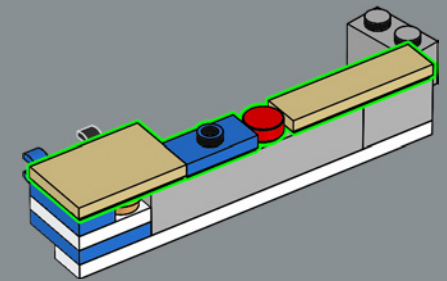

301

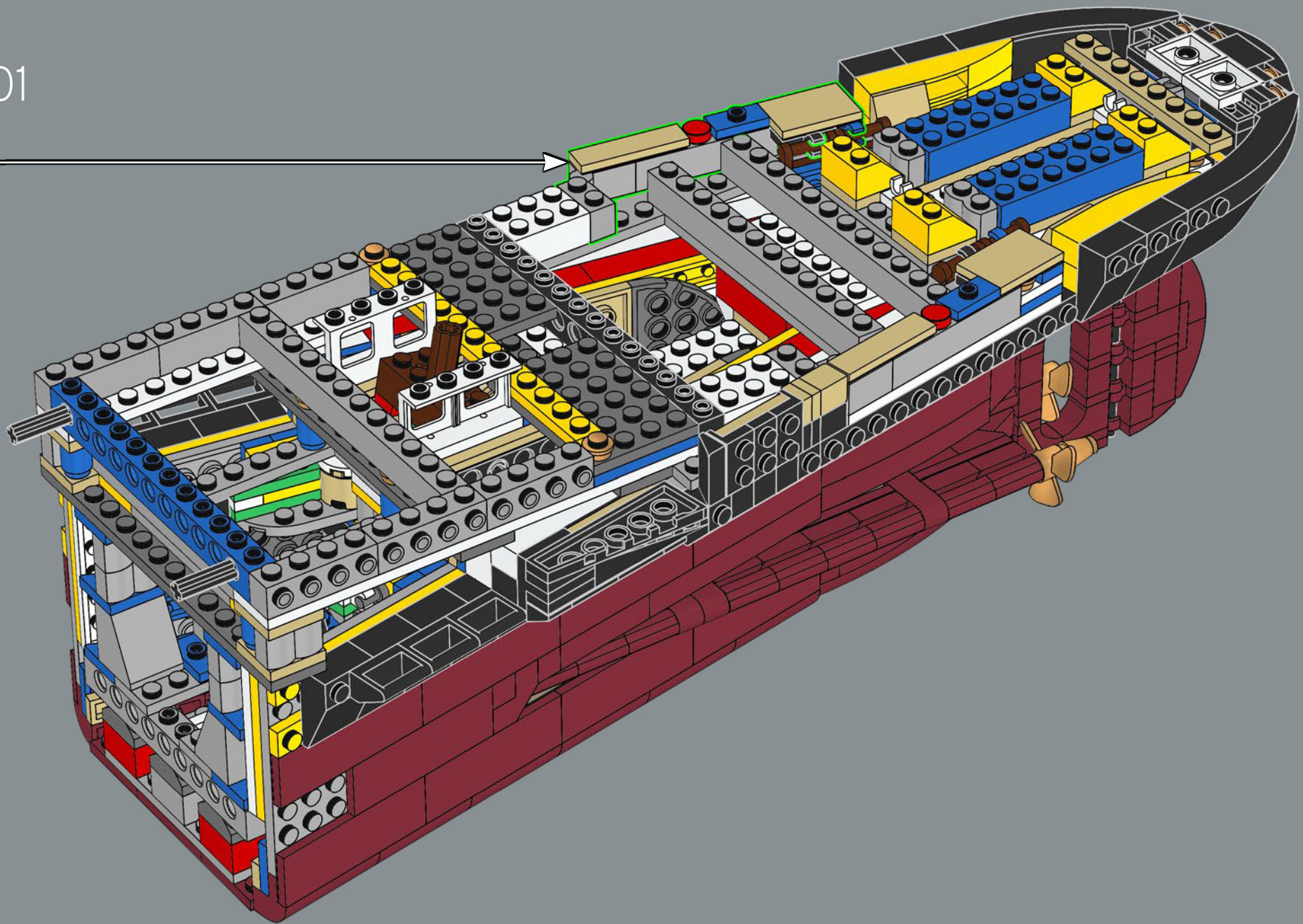

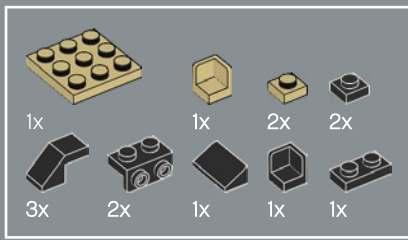

302

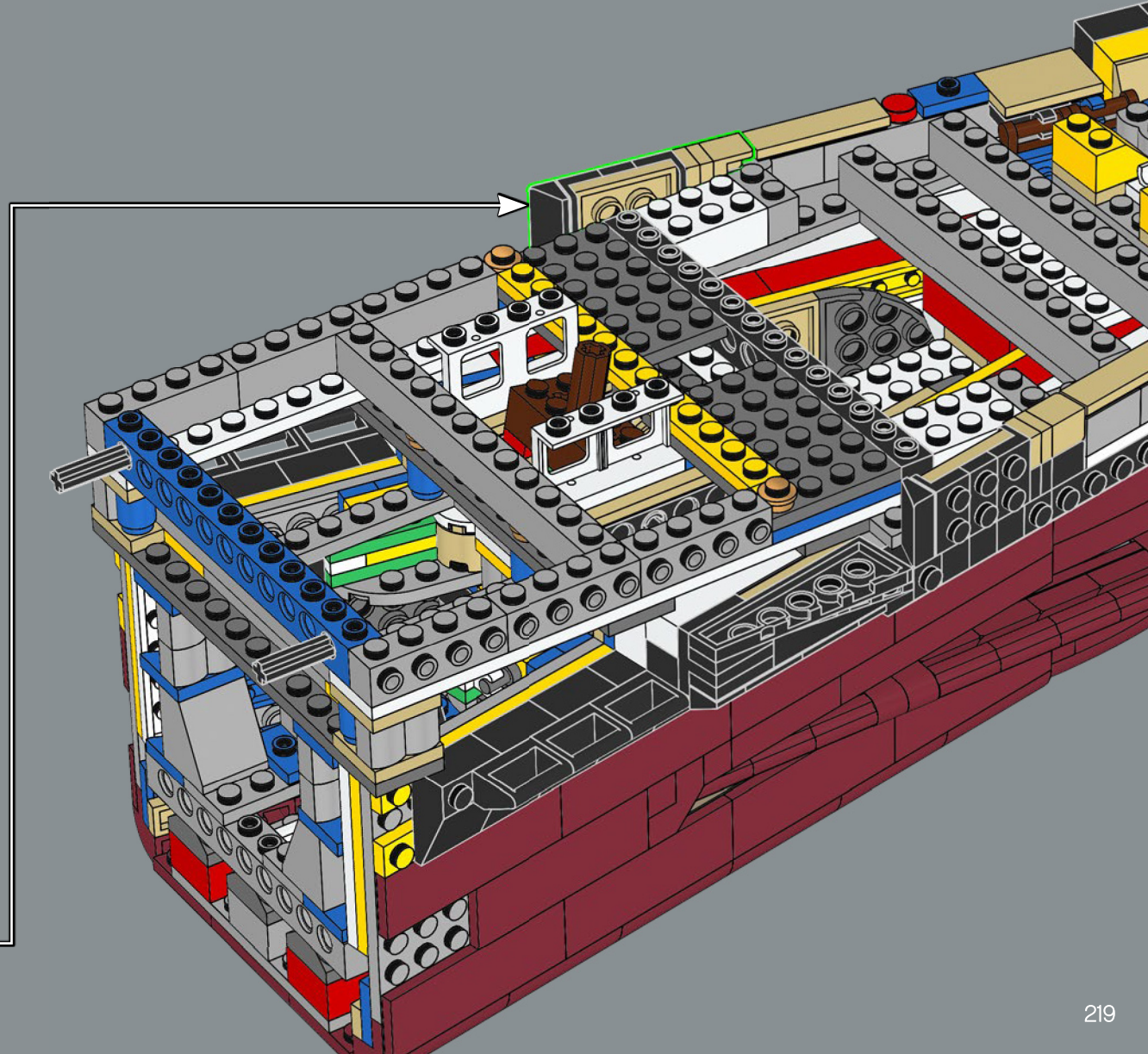
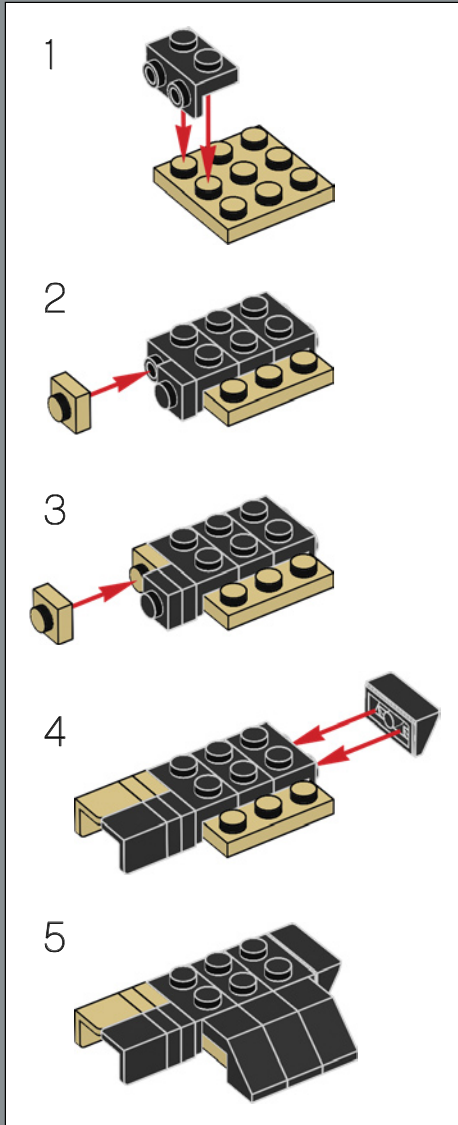

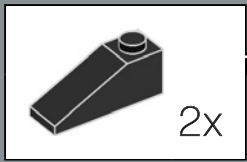
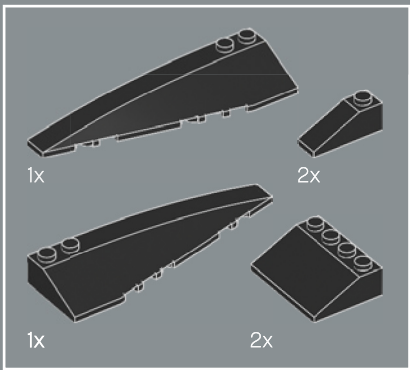

303

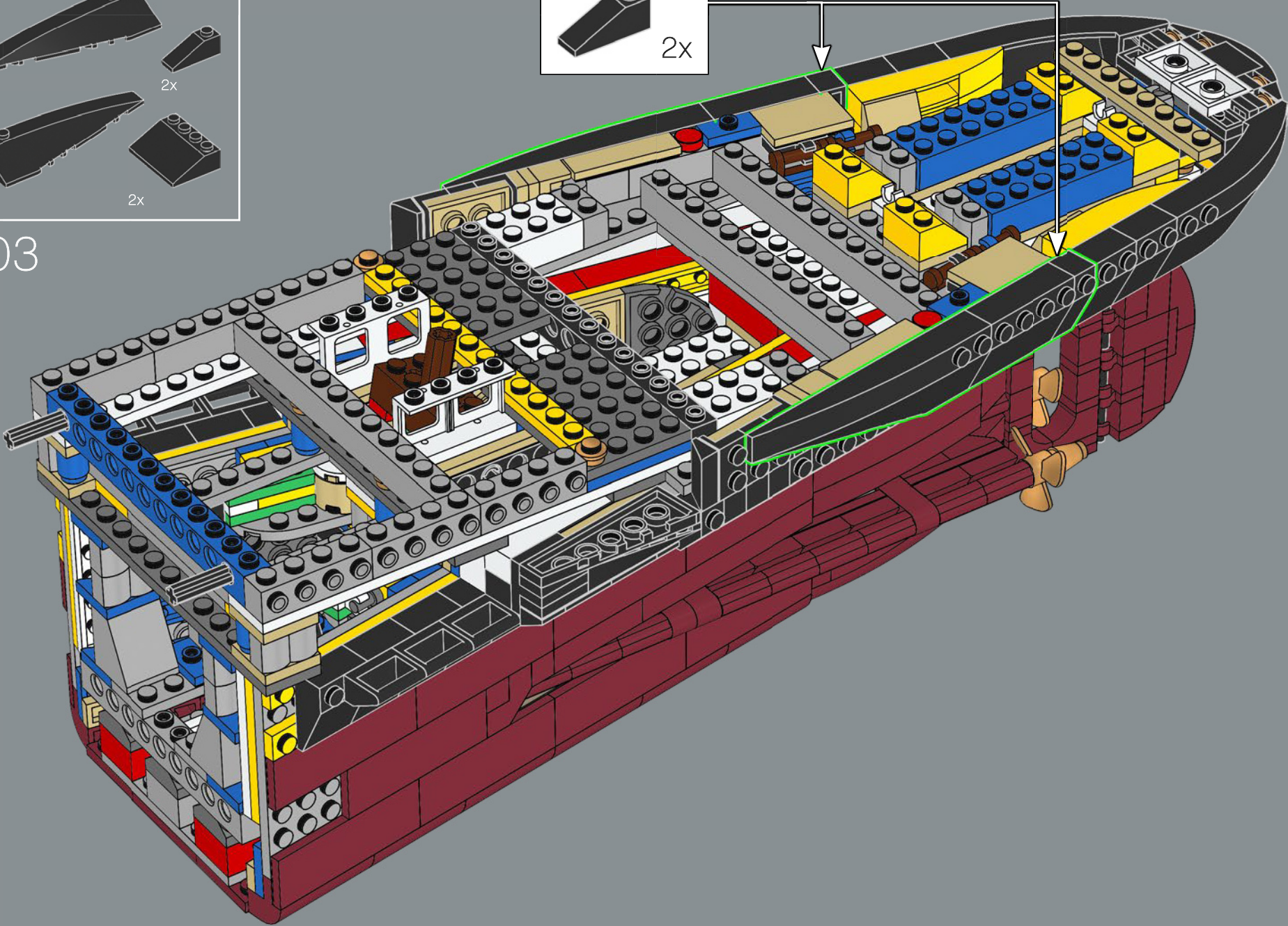

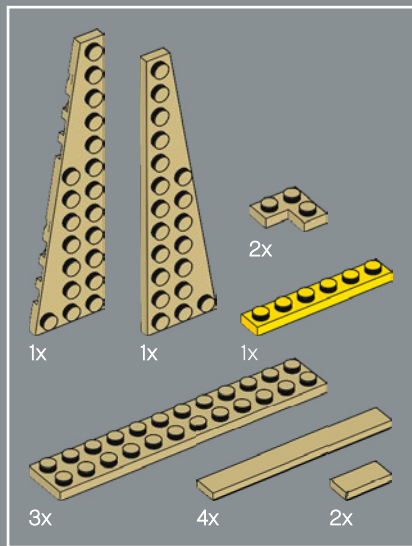

304

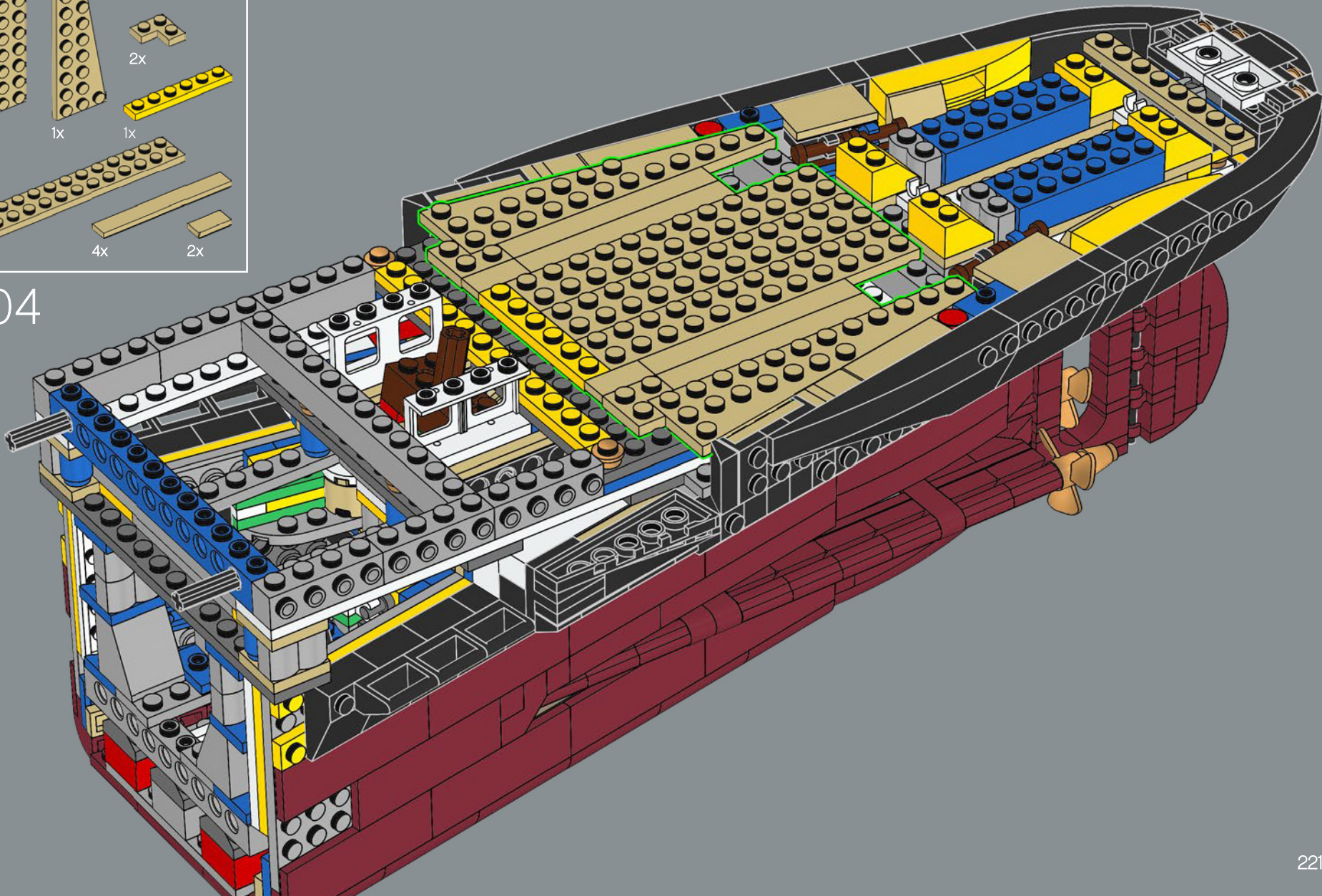

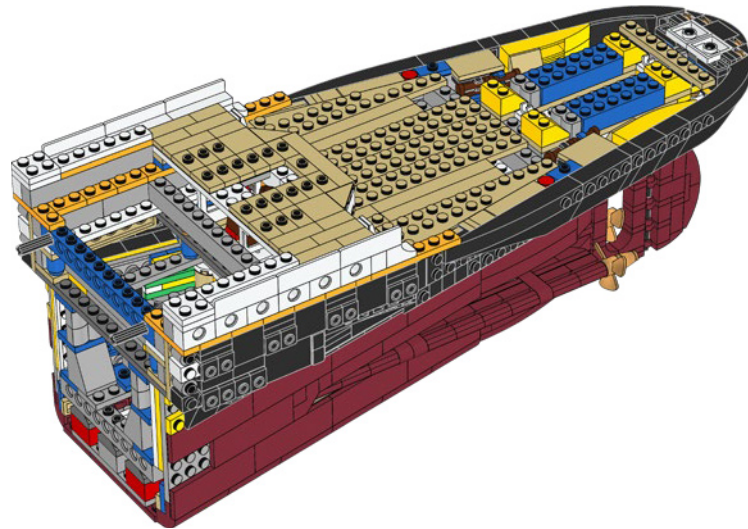

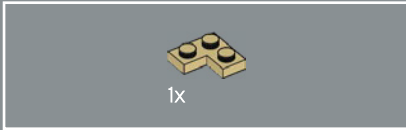
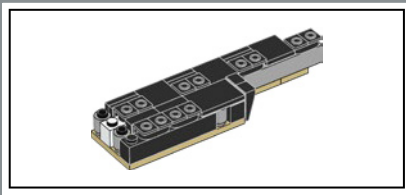

305

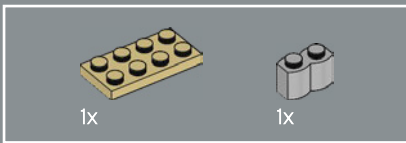
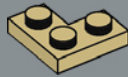

306

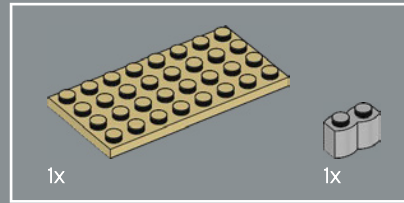
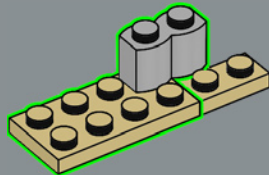

307

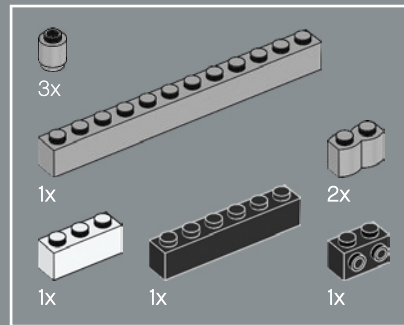
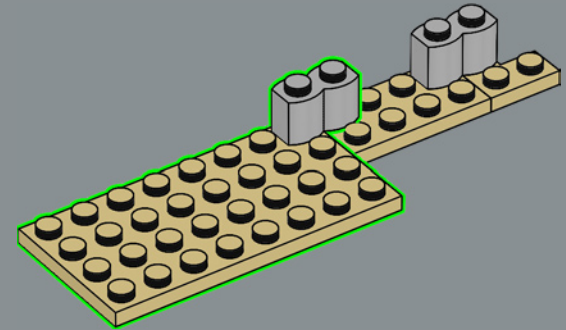

308

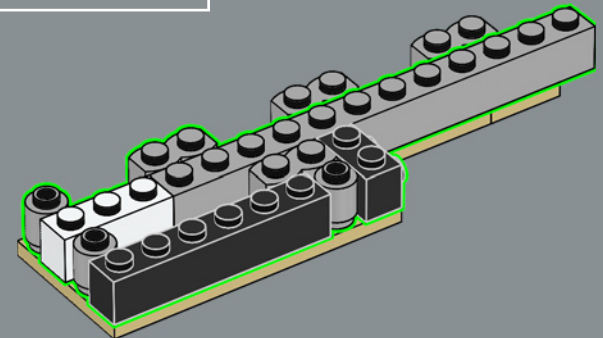

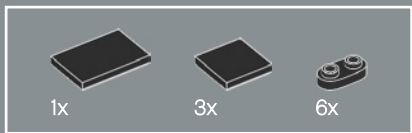

309

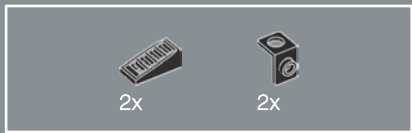
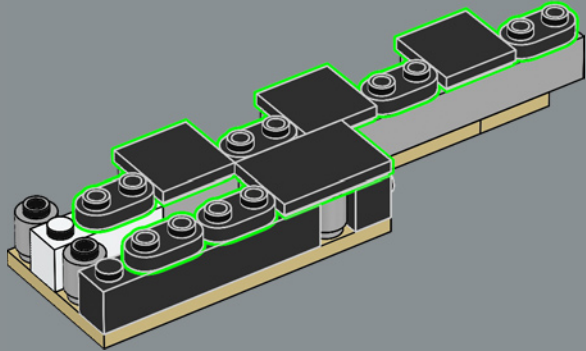

310

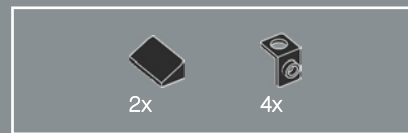
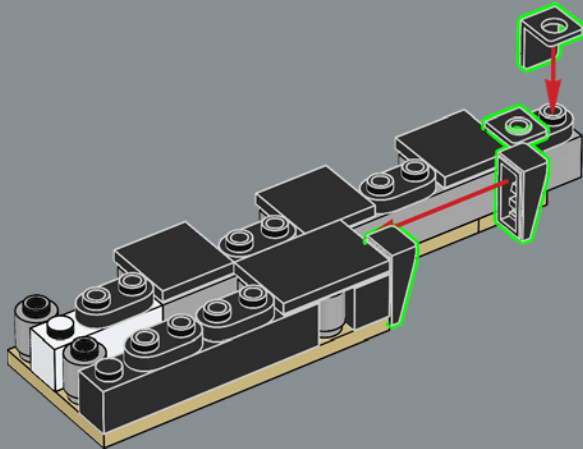

311

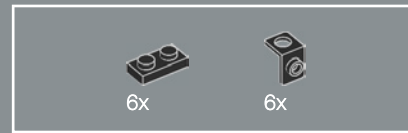
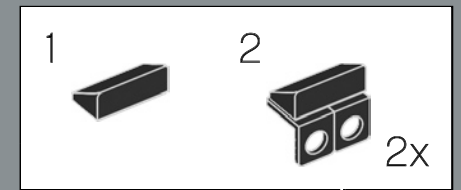
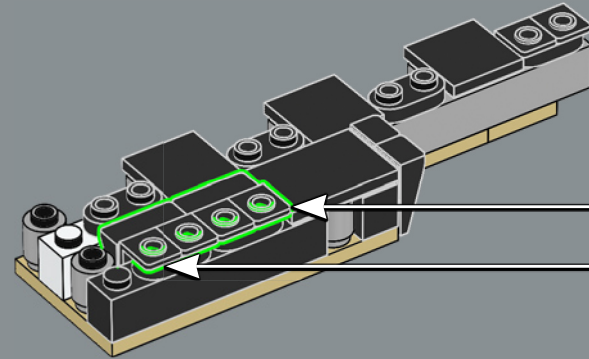

312

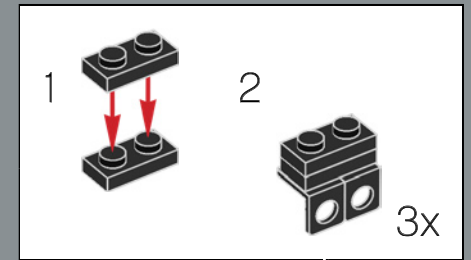
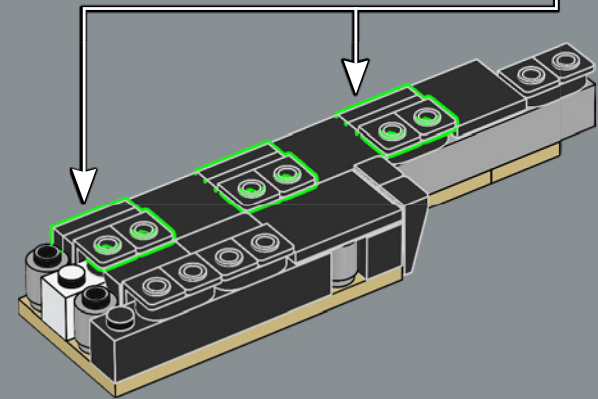



313

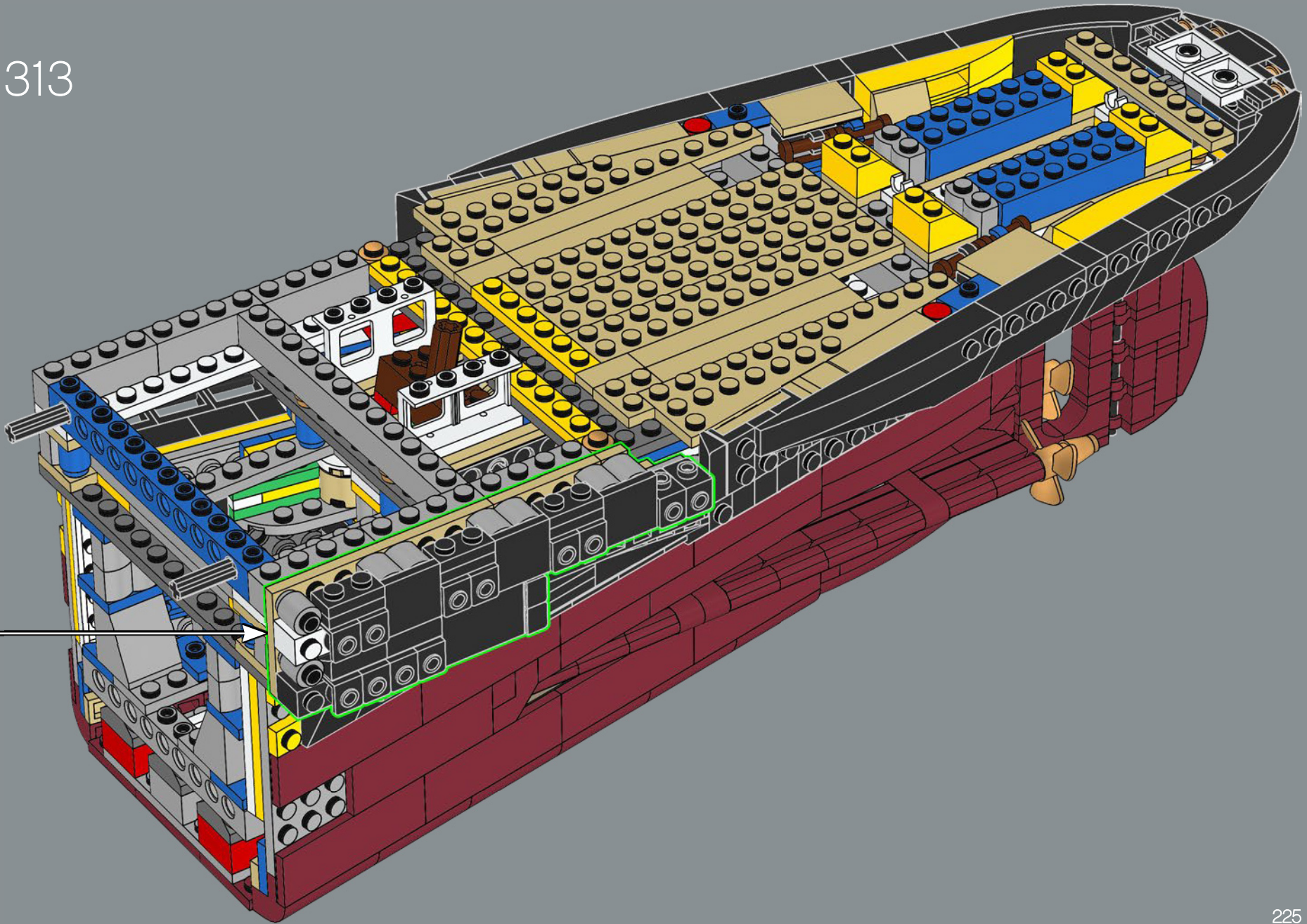

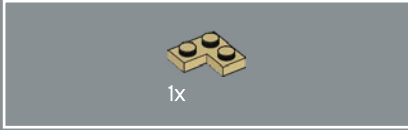
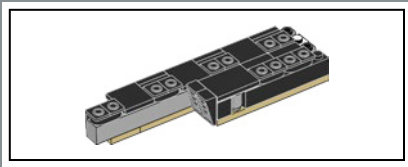

314

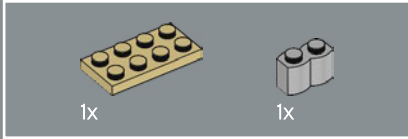
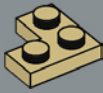

315

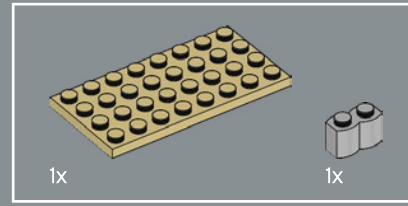
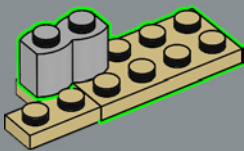

316

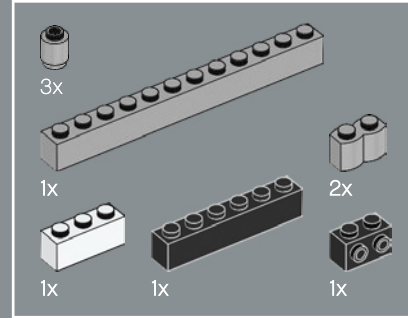
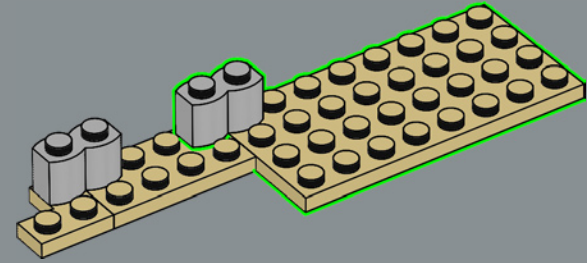

317

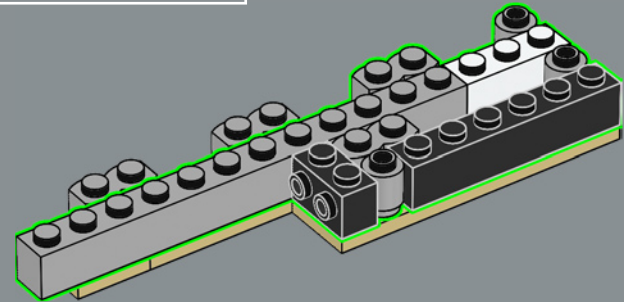

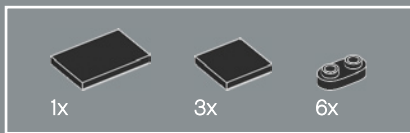

318

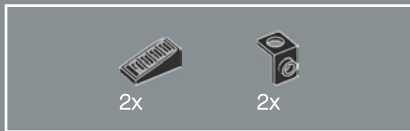
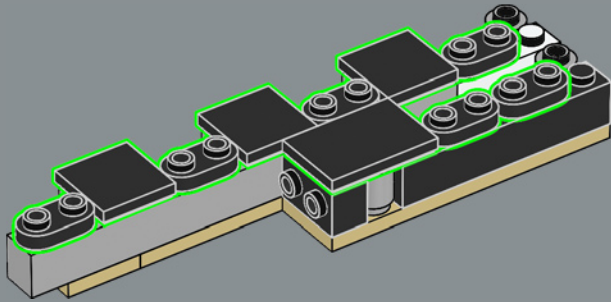

319

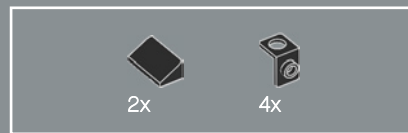
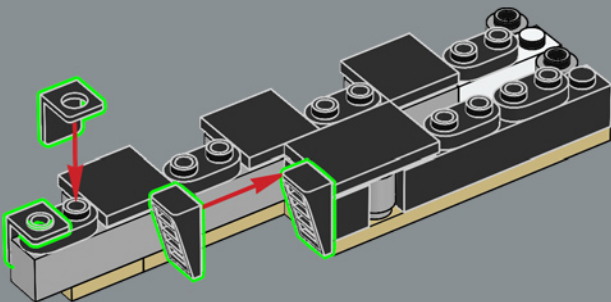

320

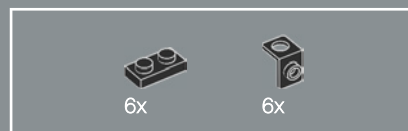
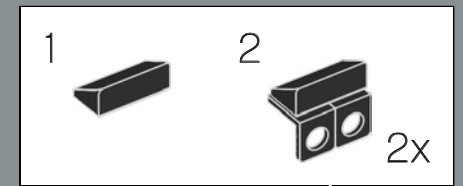
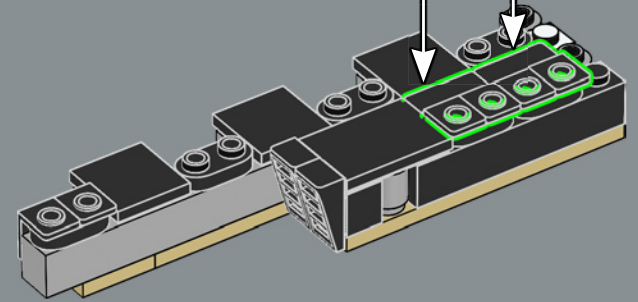

321

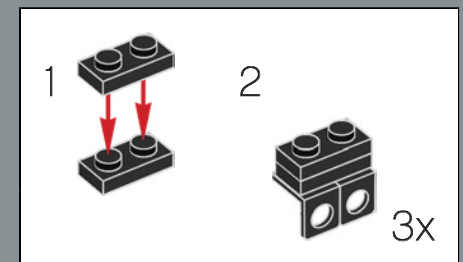
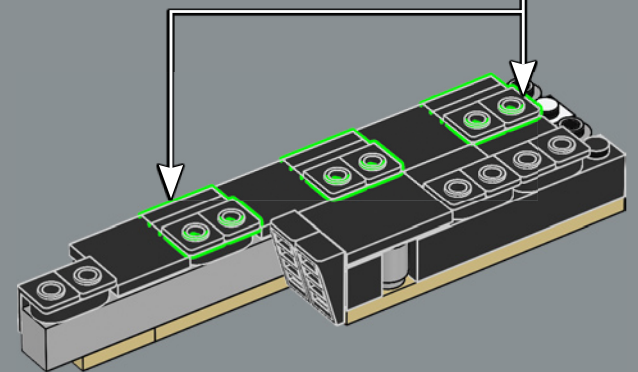

322

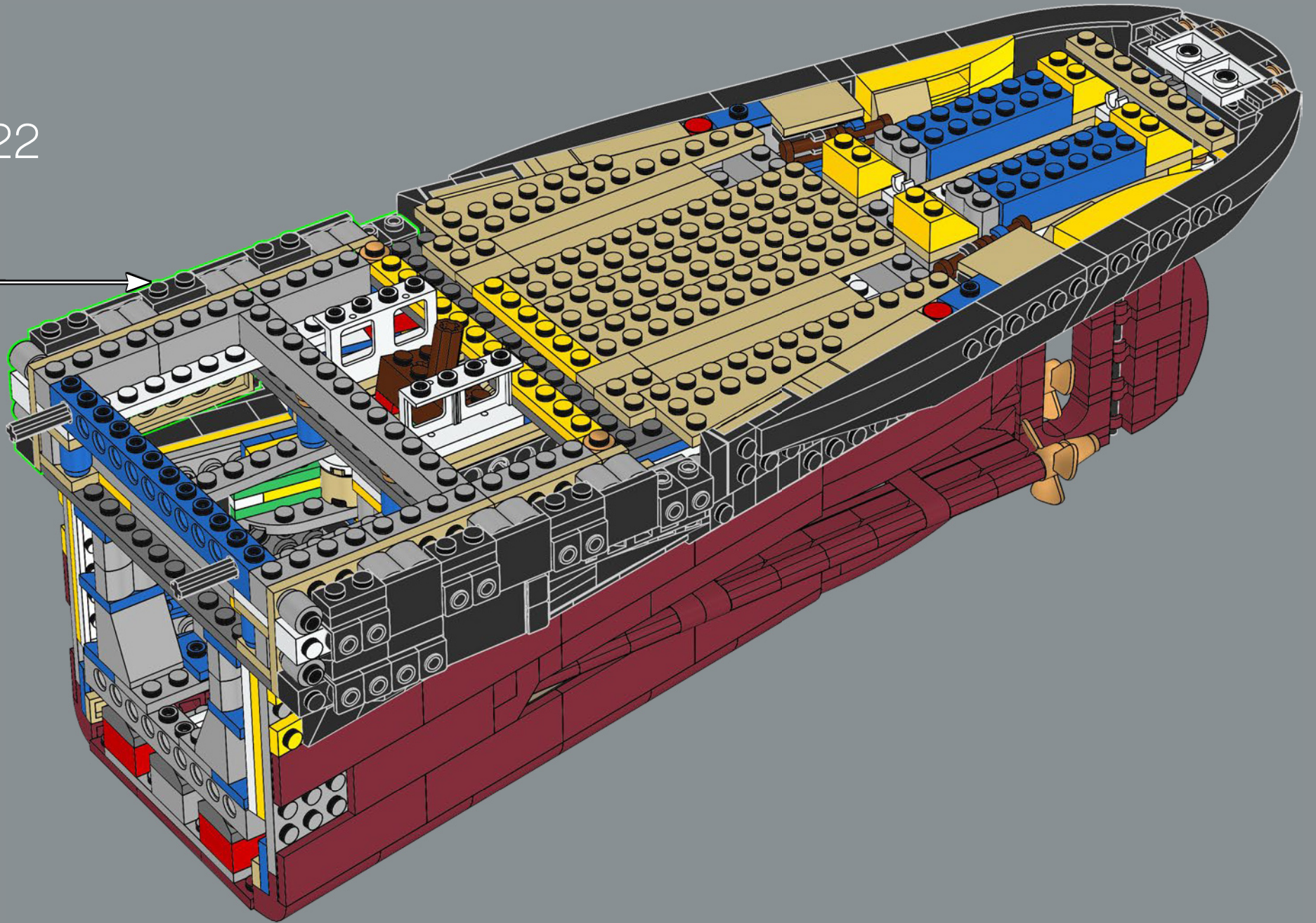

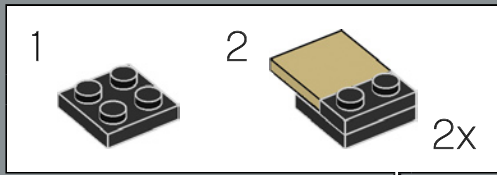
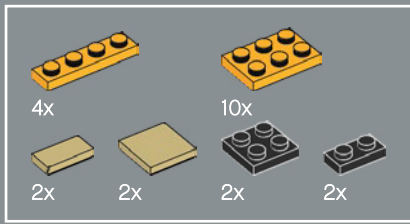

323

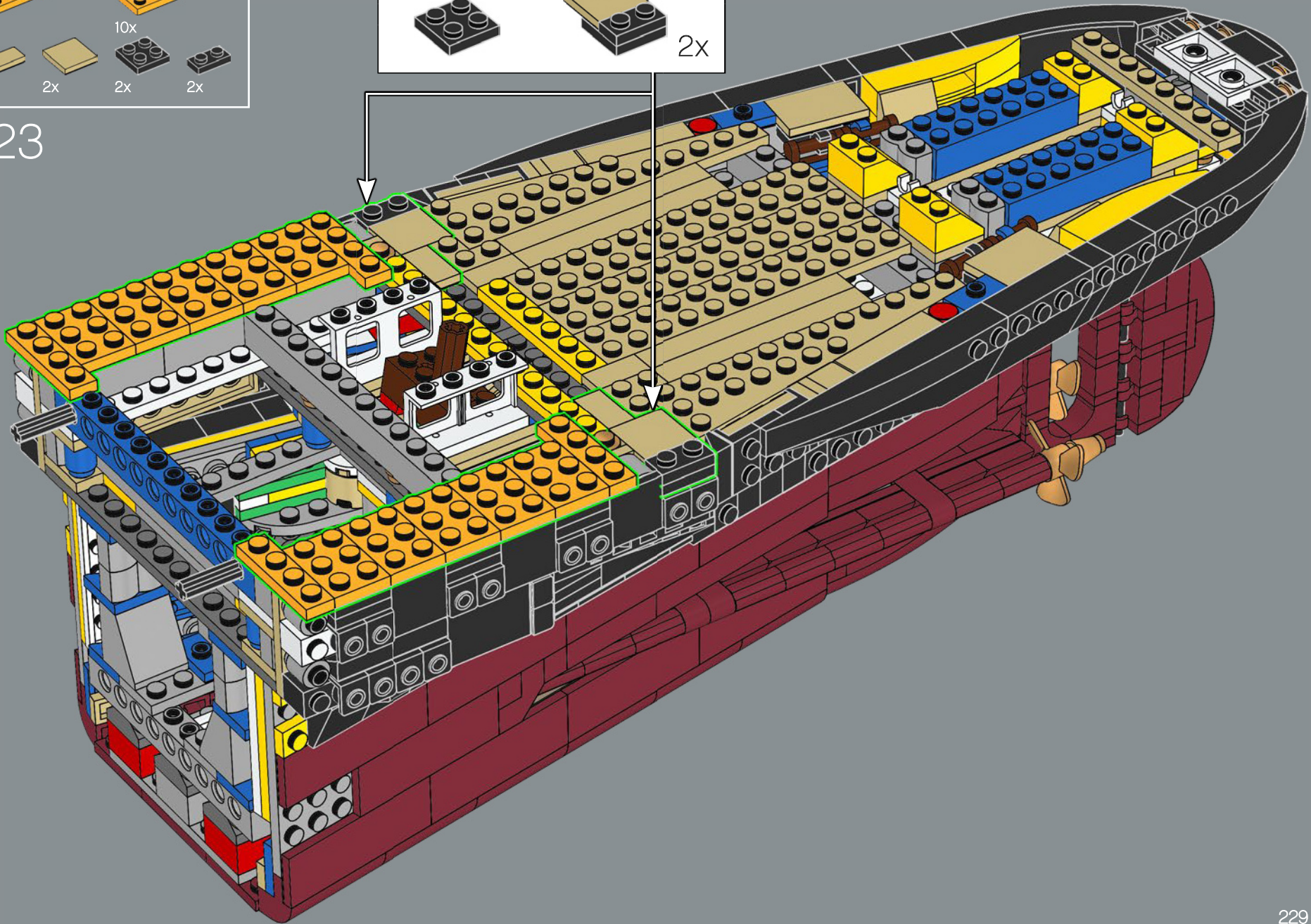

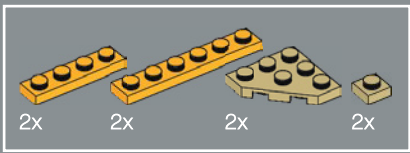

324

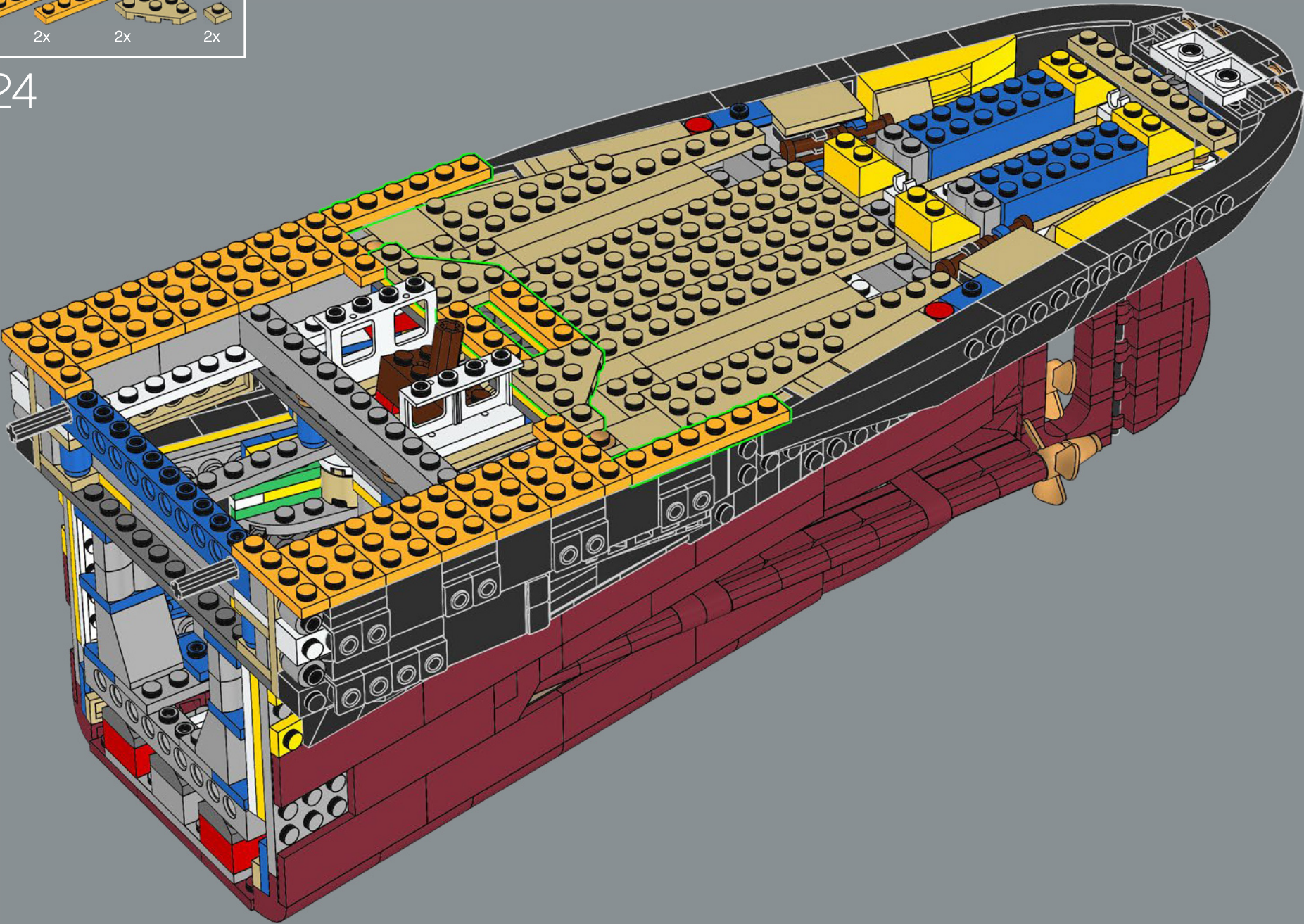

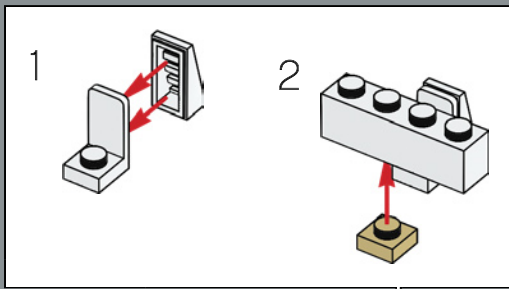
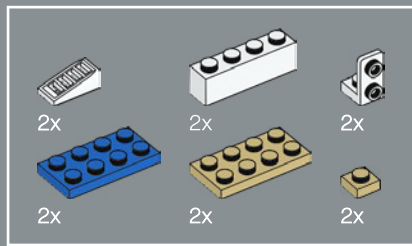

325

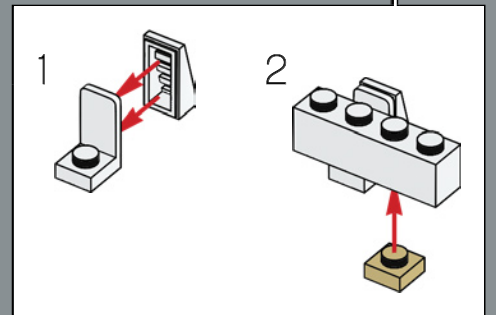
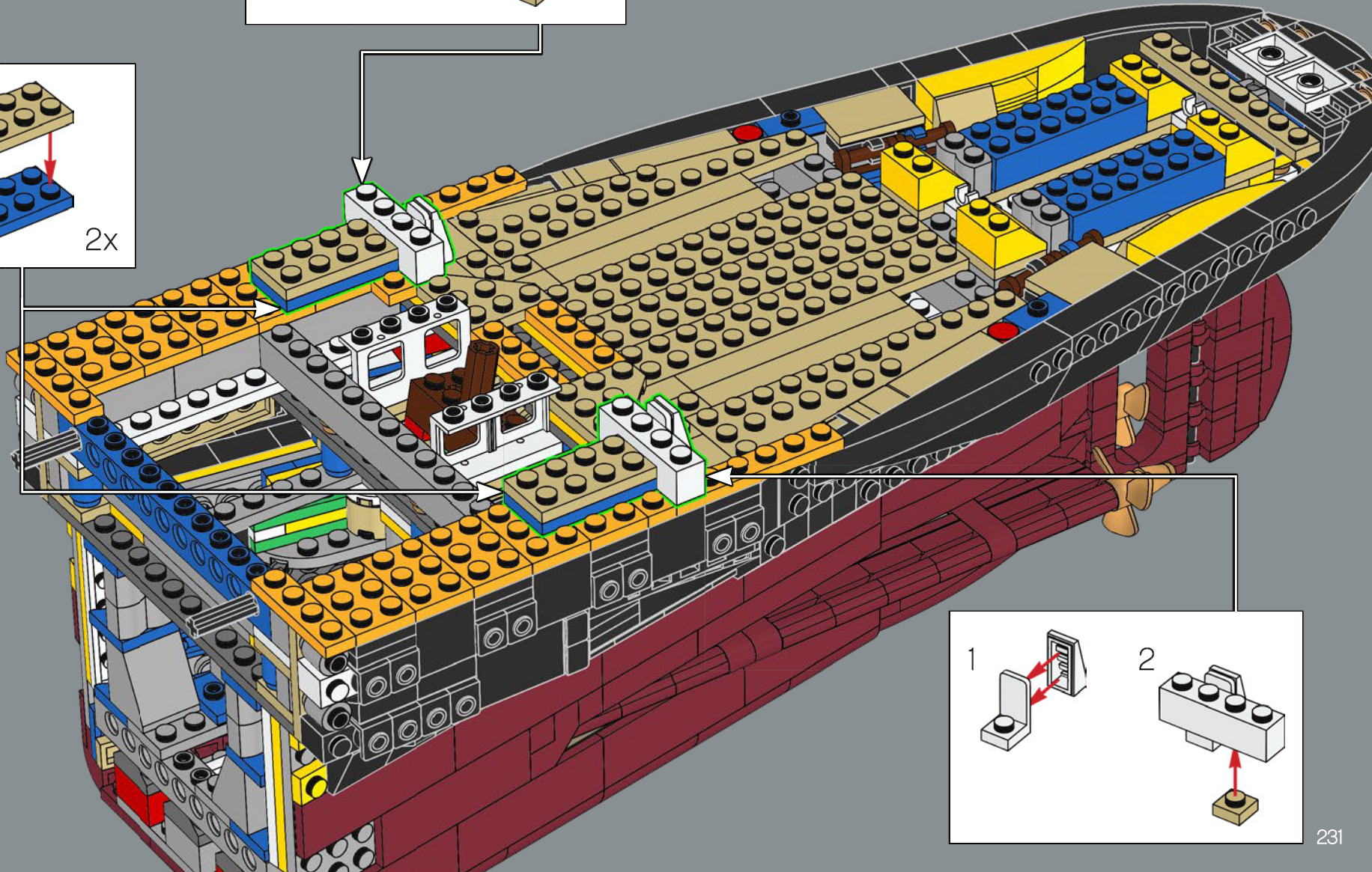
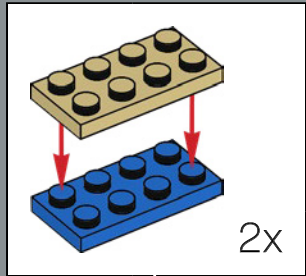

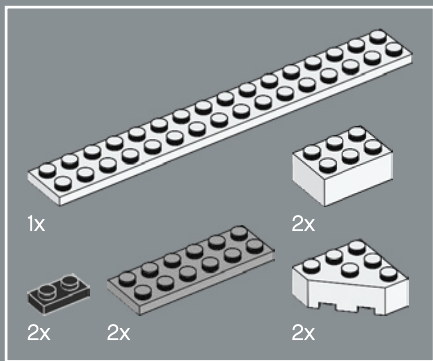

326

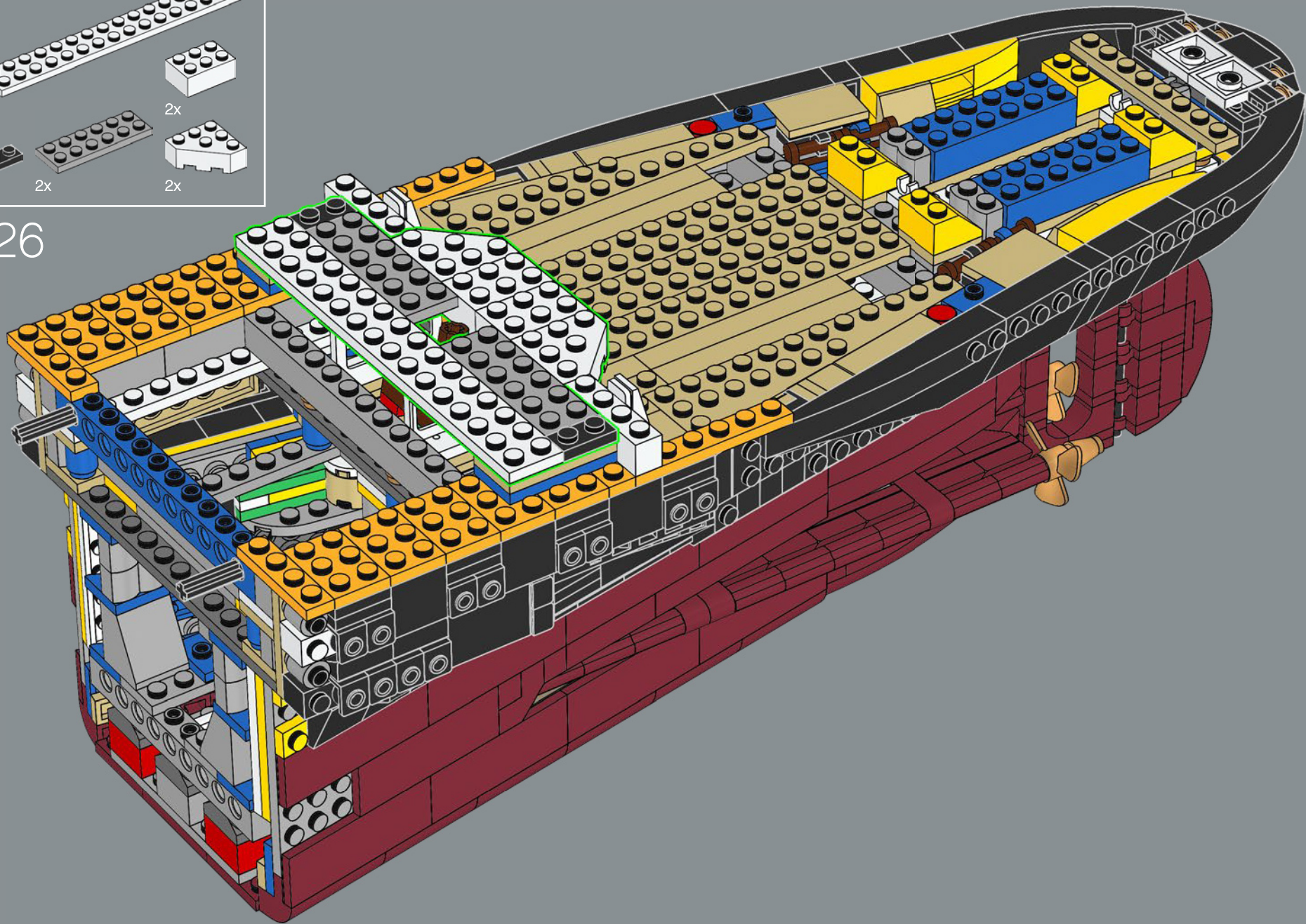



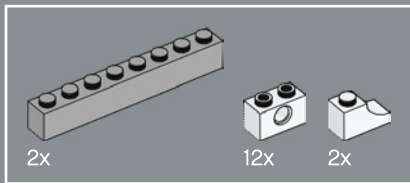

327

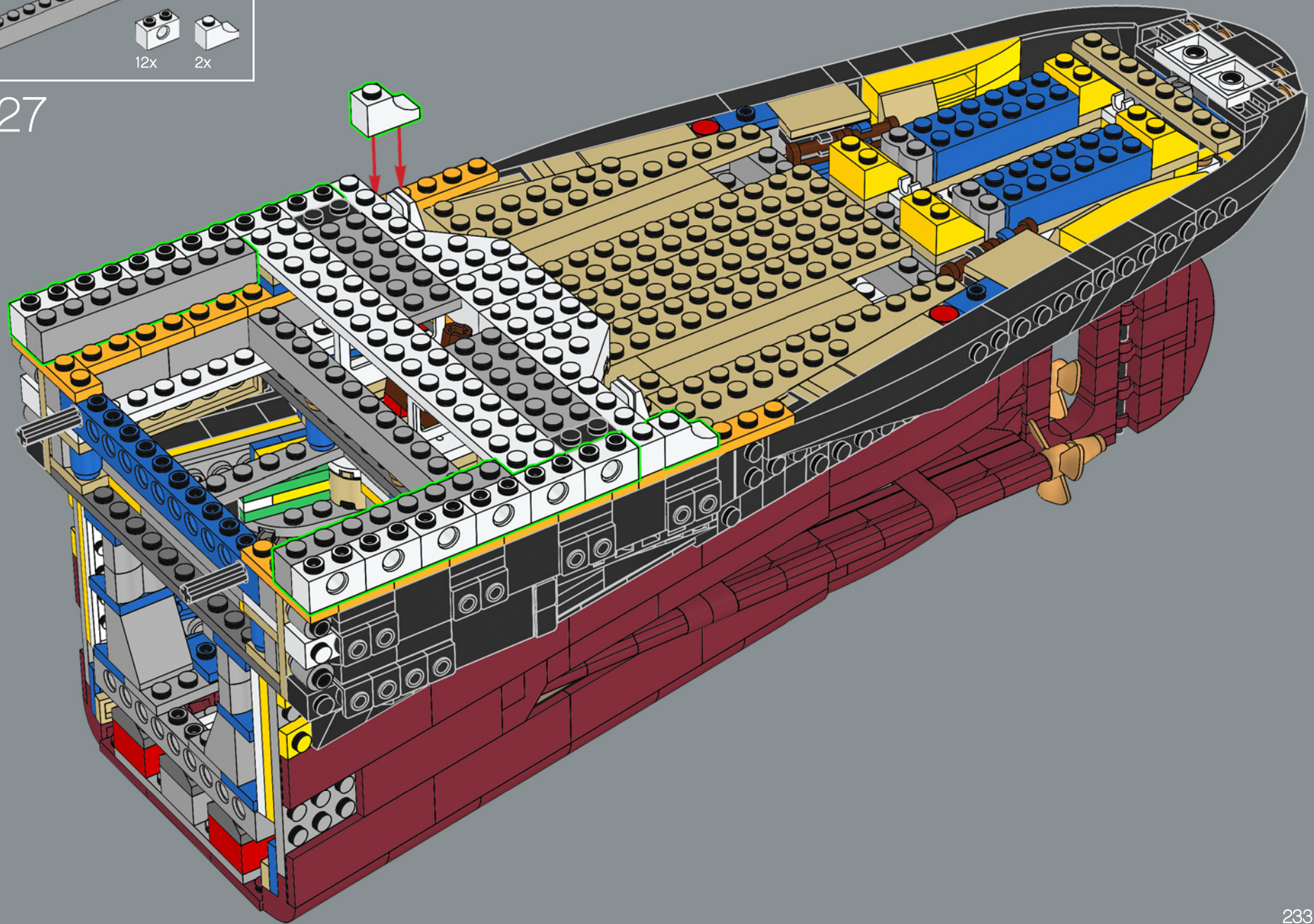

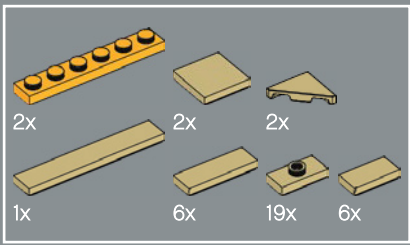

328

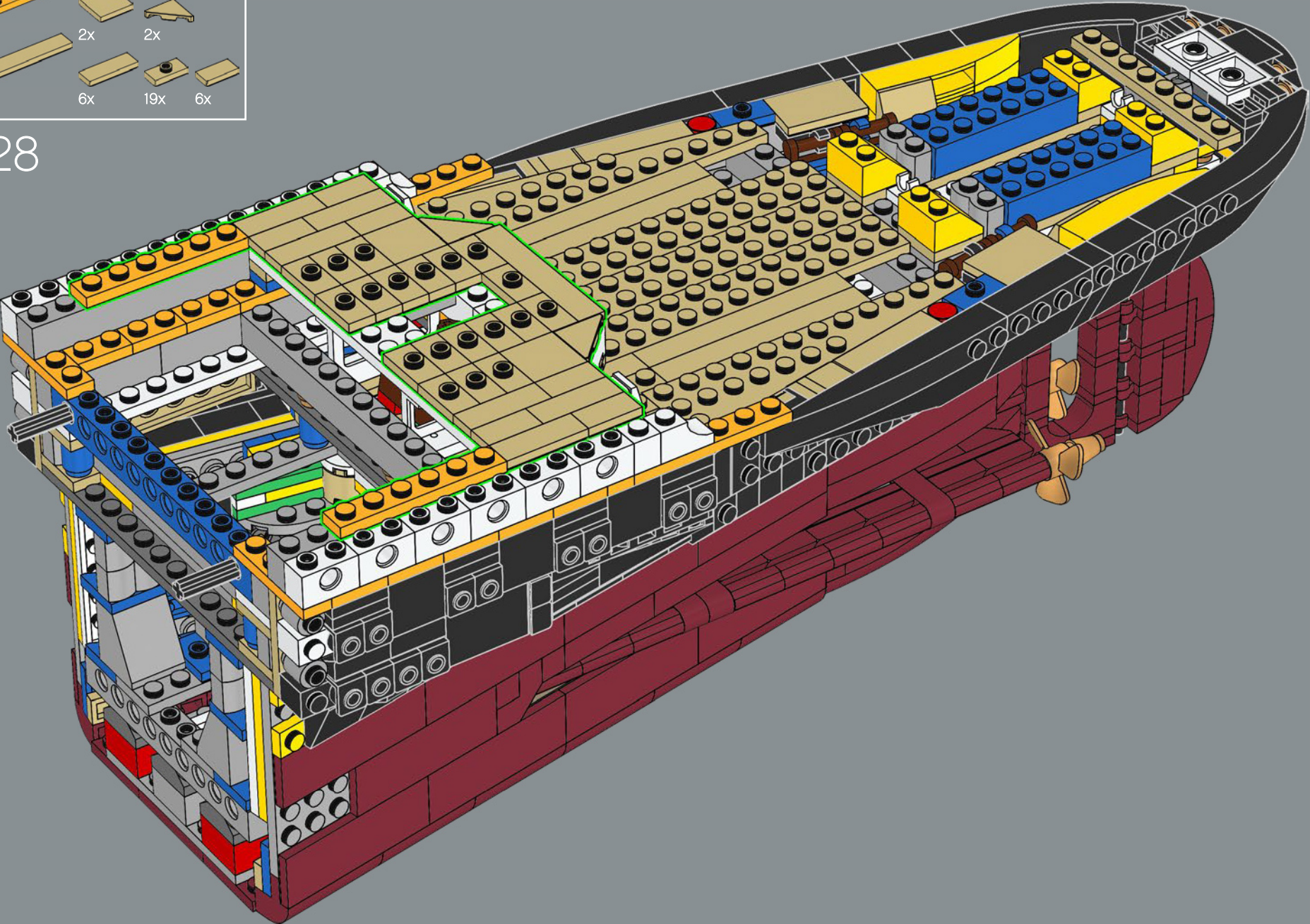

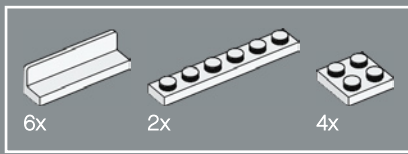

329

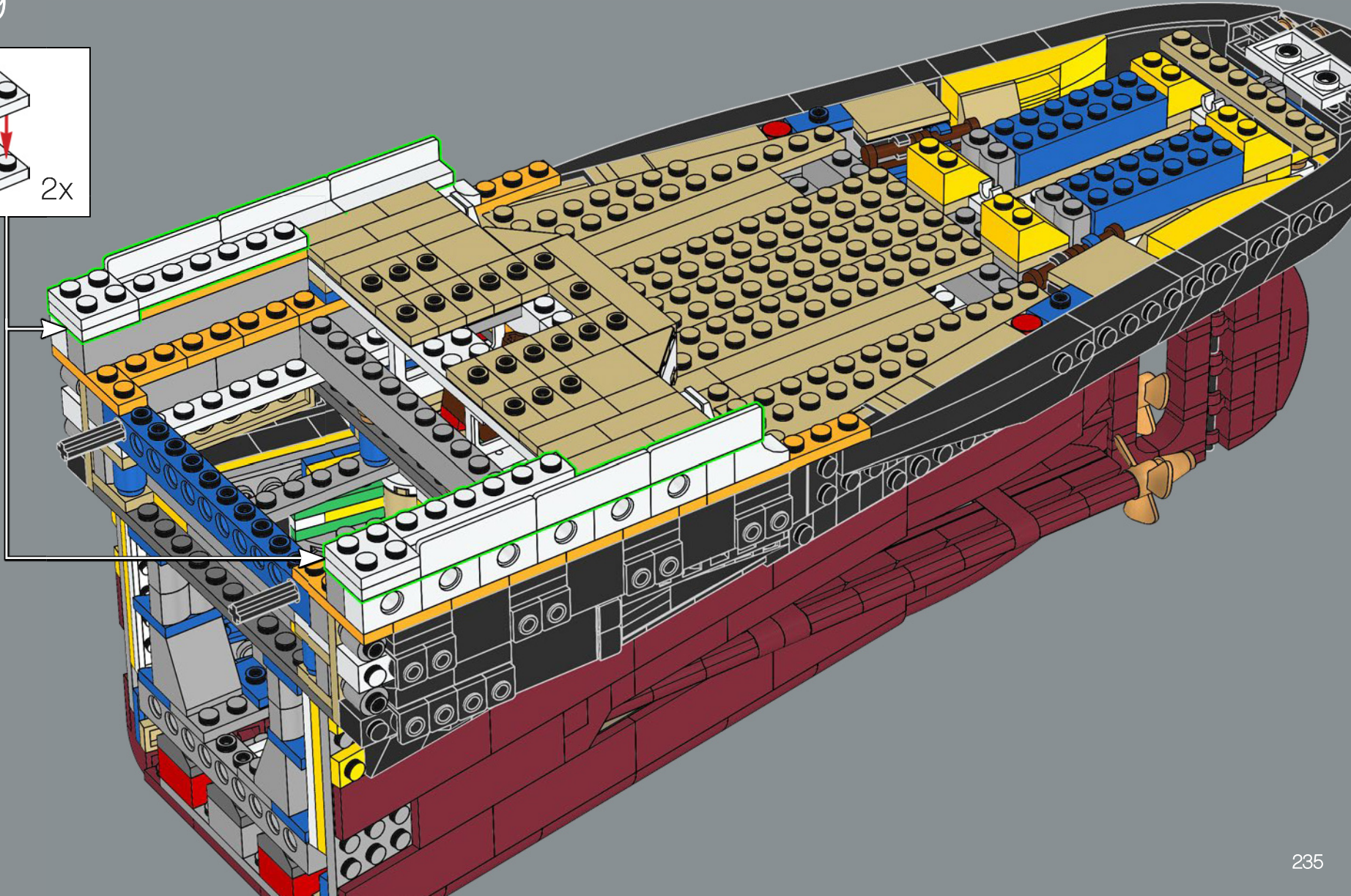
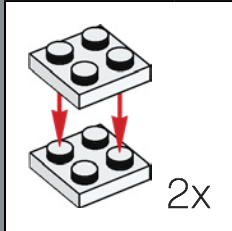

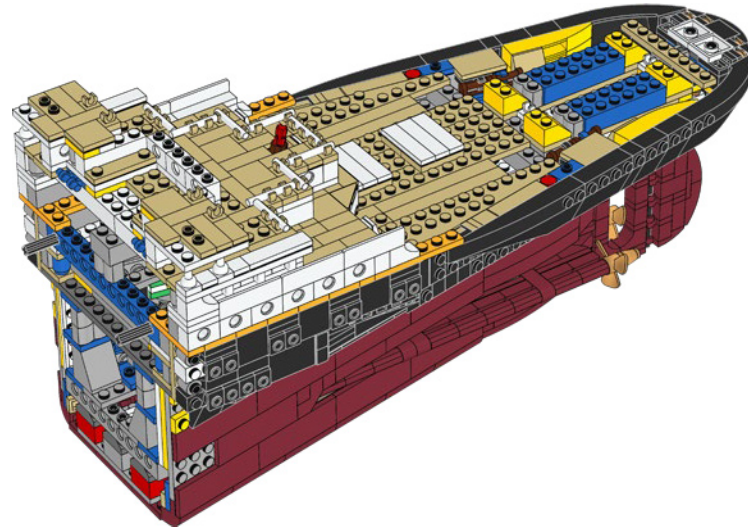
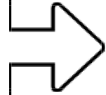

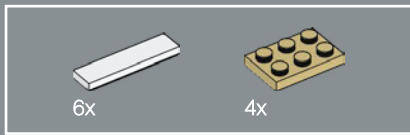

330

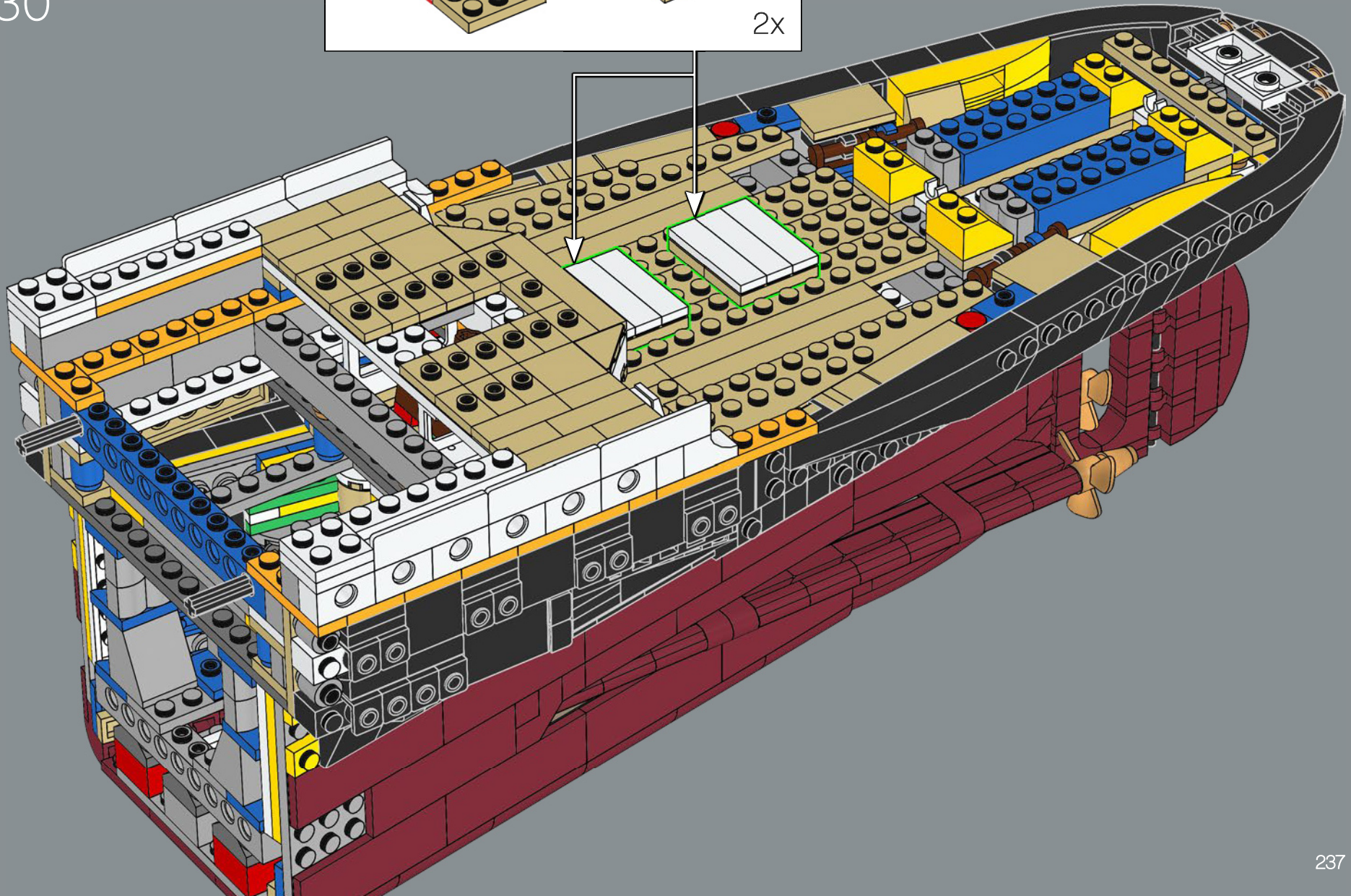
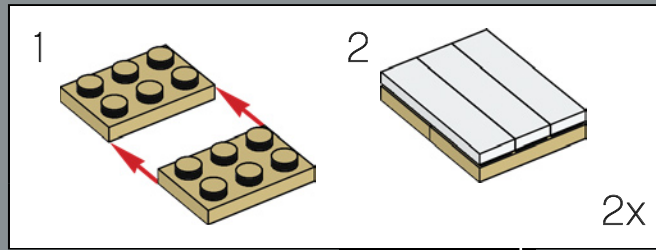

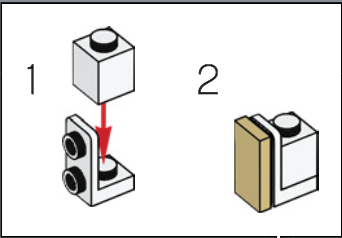
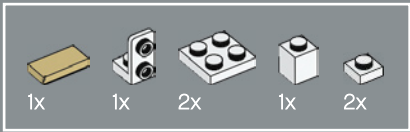

331

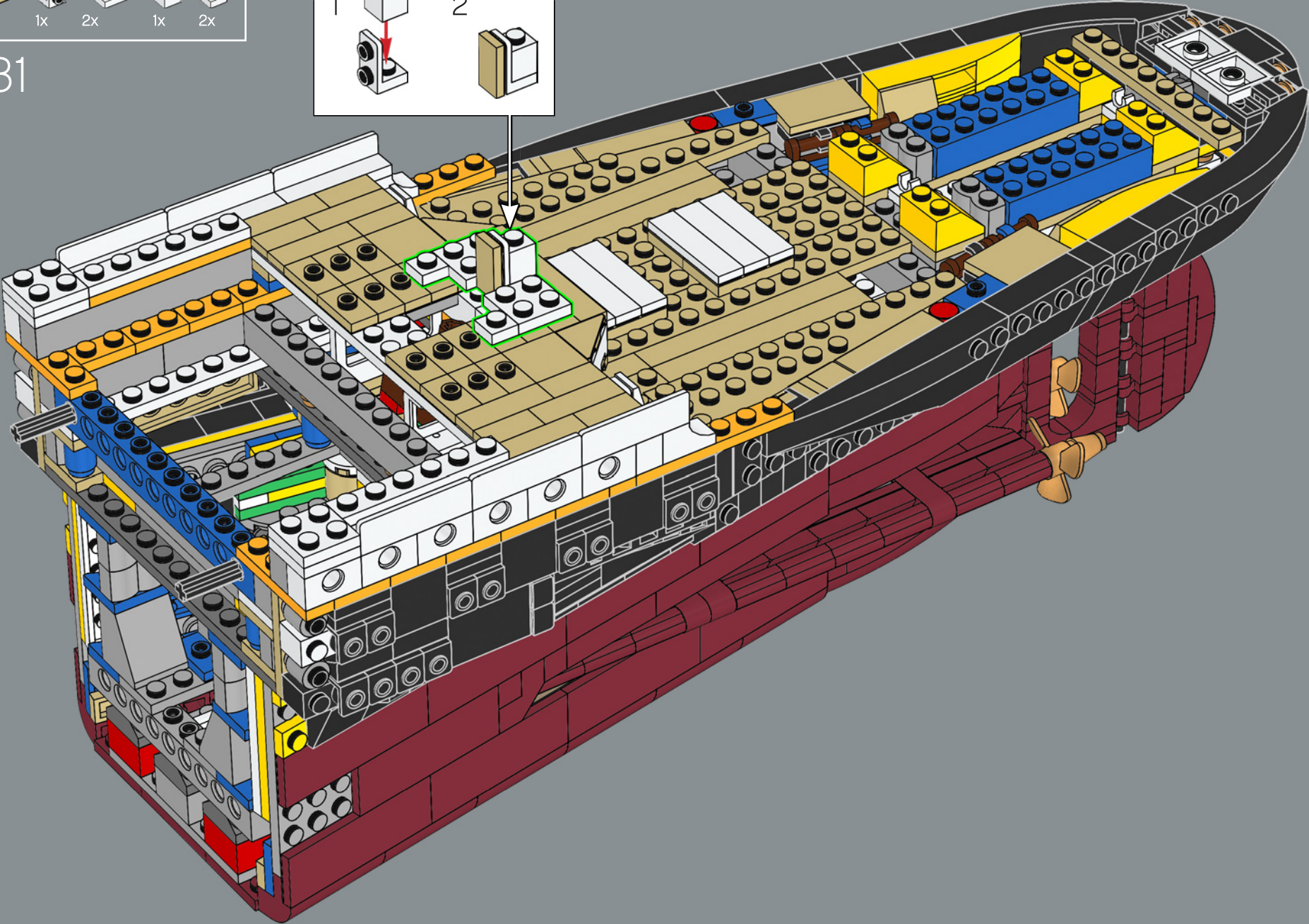

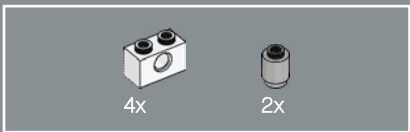

332

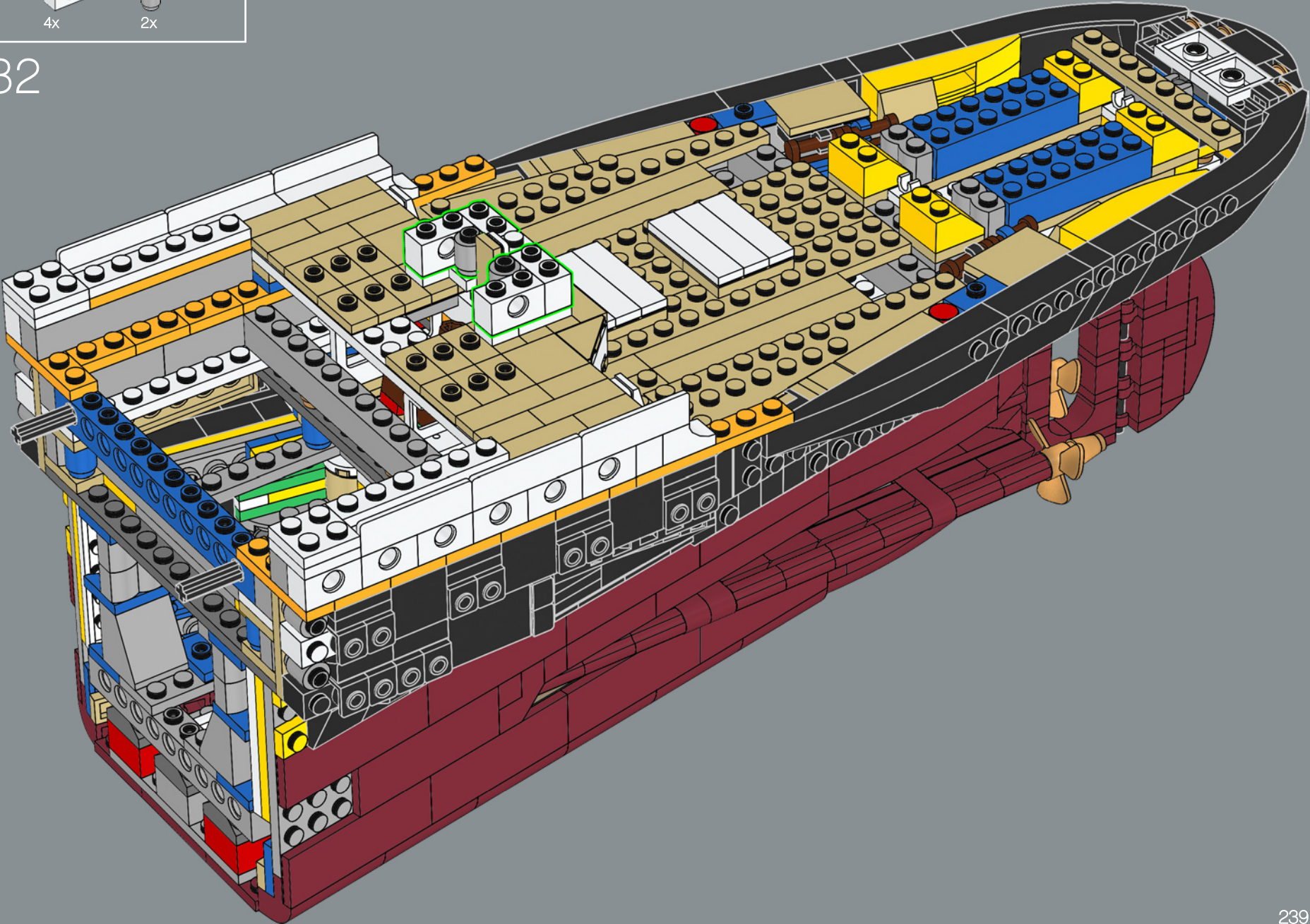

- 2x
- 1x
- 1x
- 2x
- 2x

333

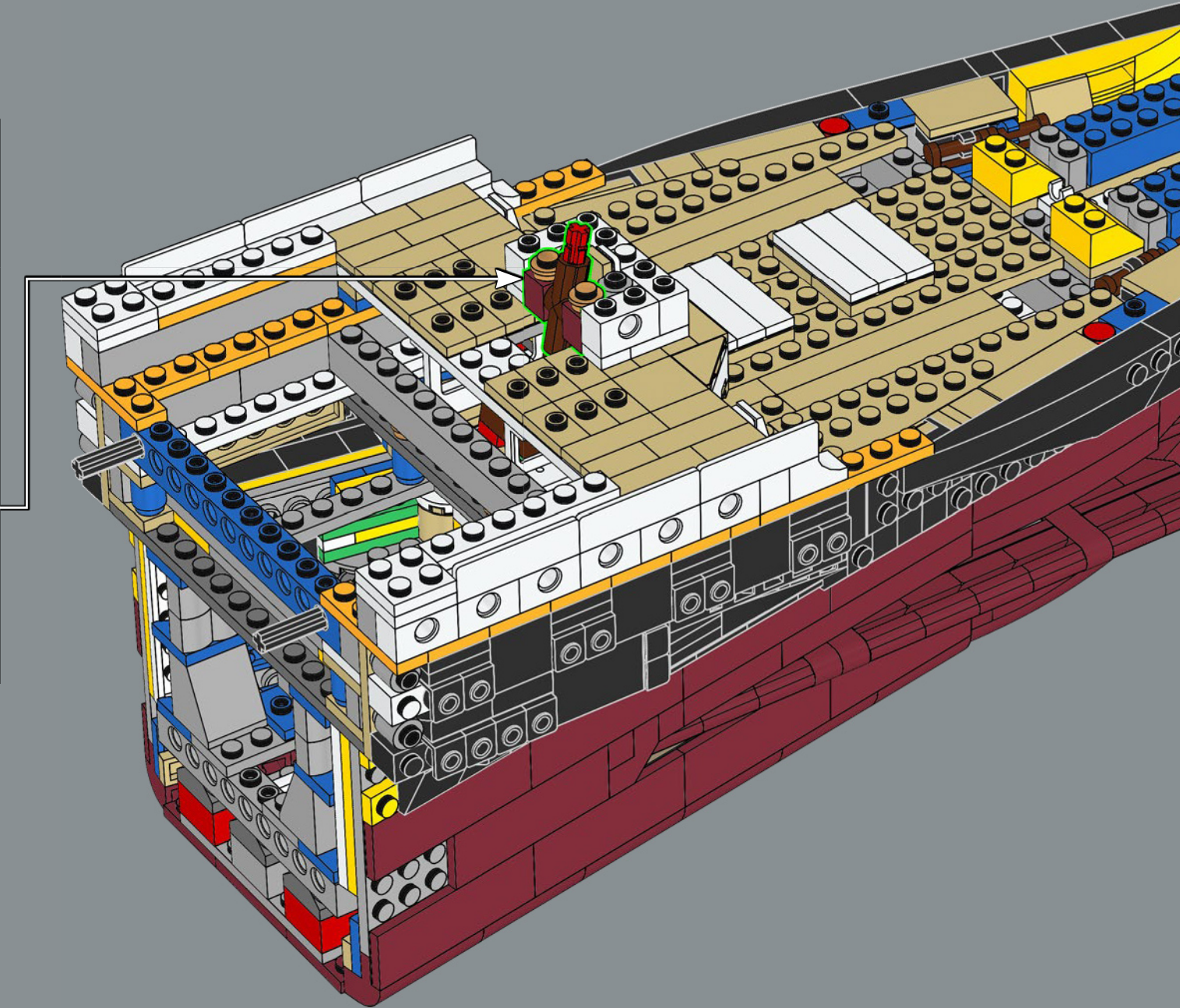
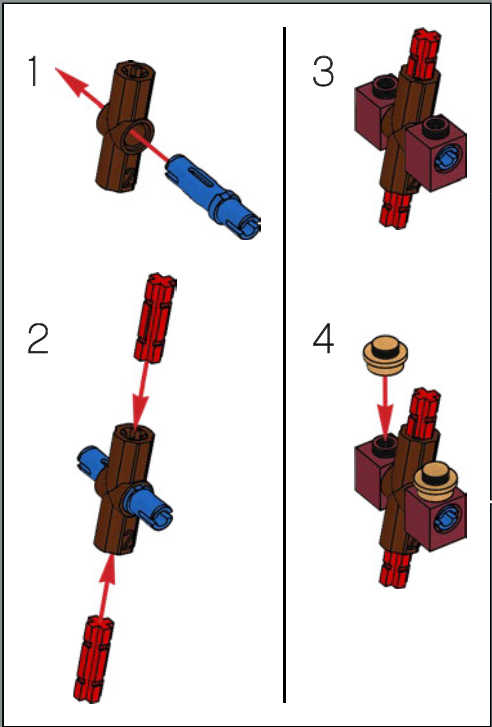



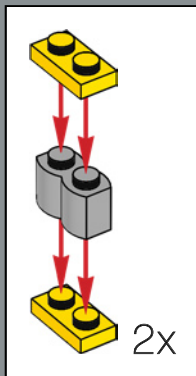
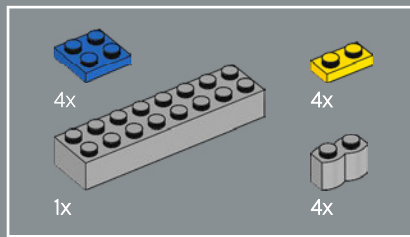

334

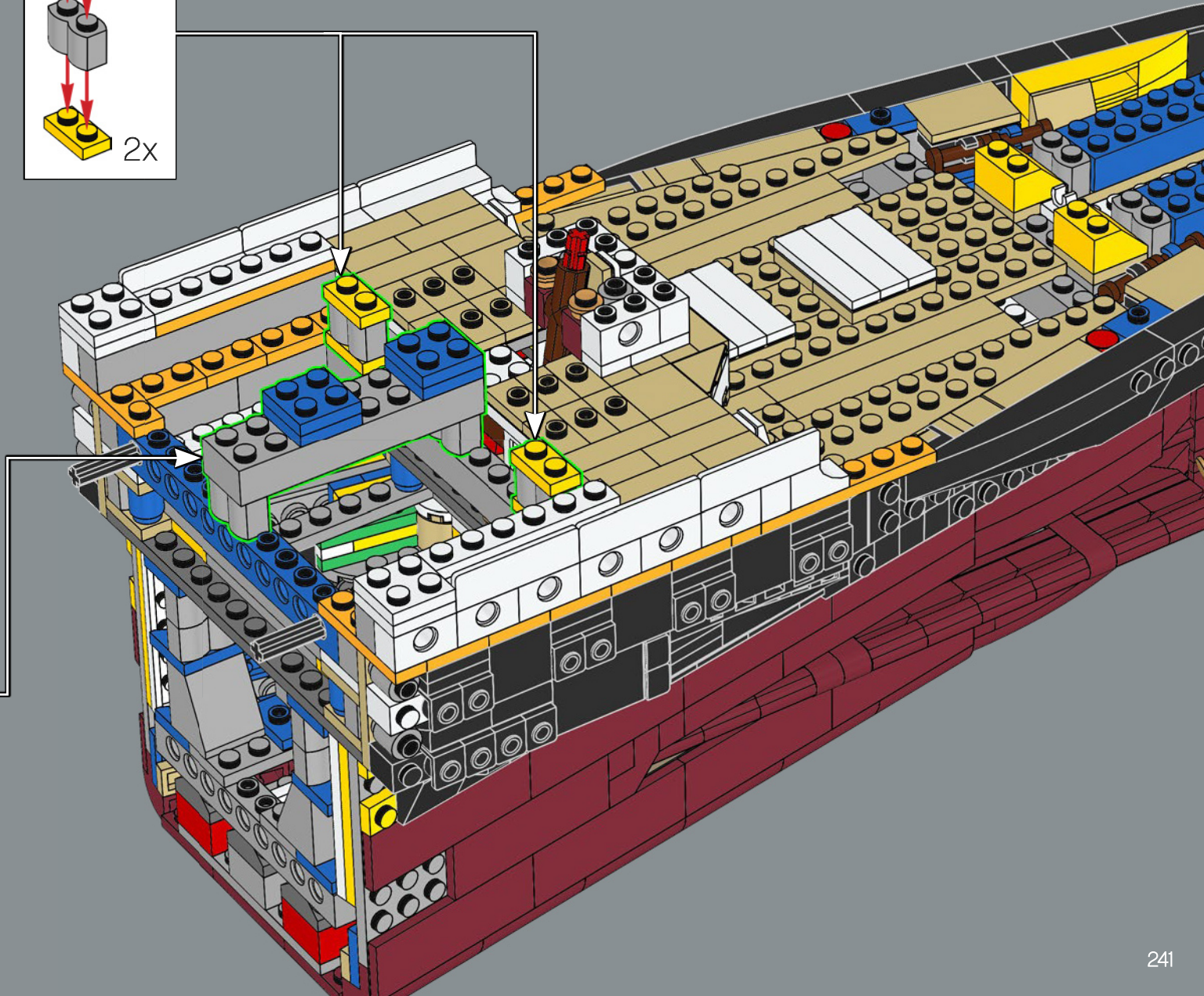
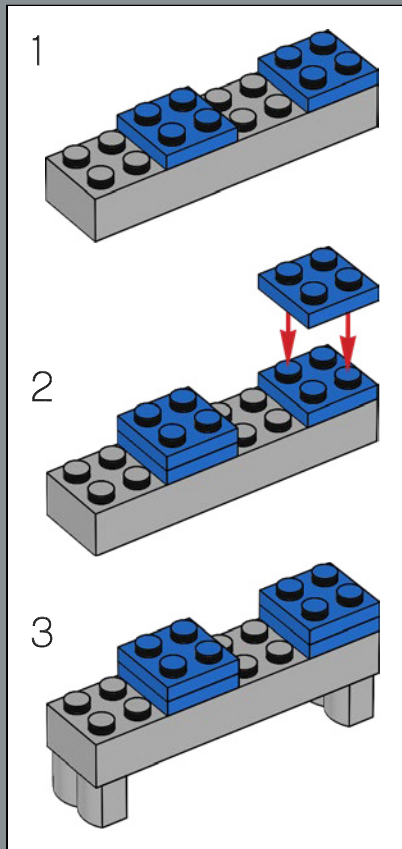

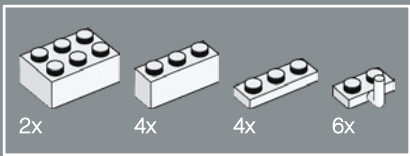

335

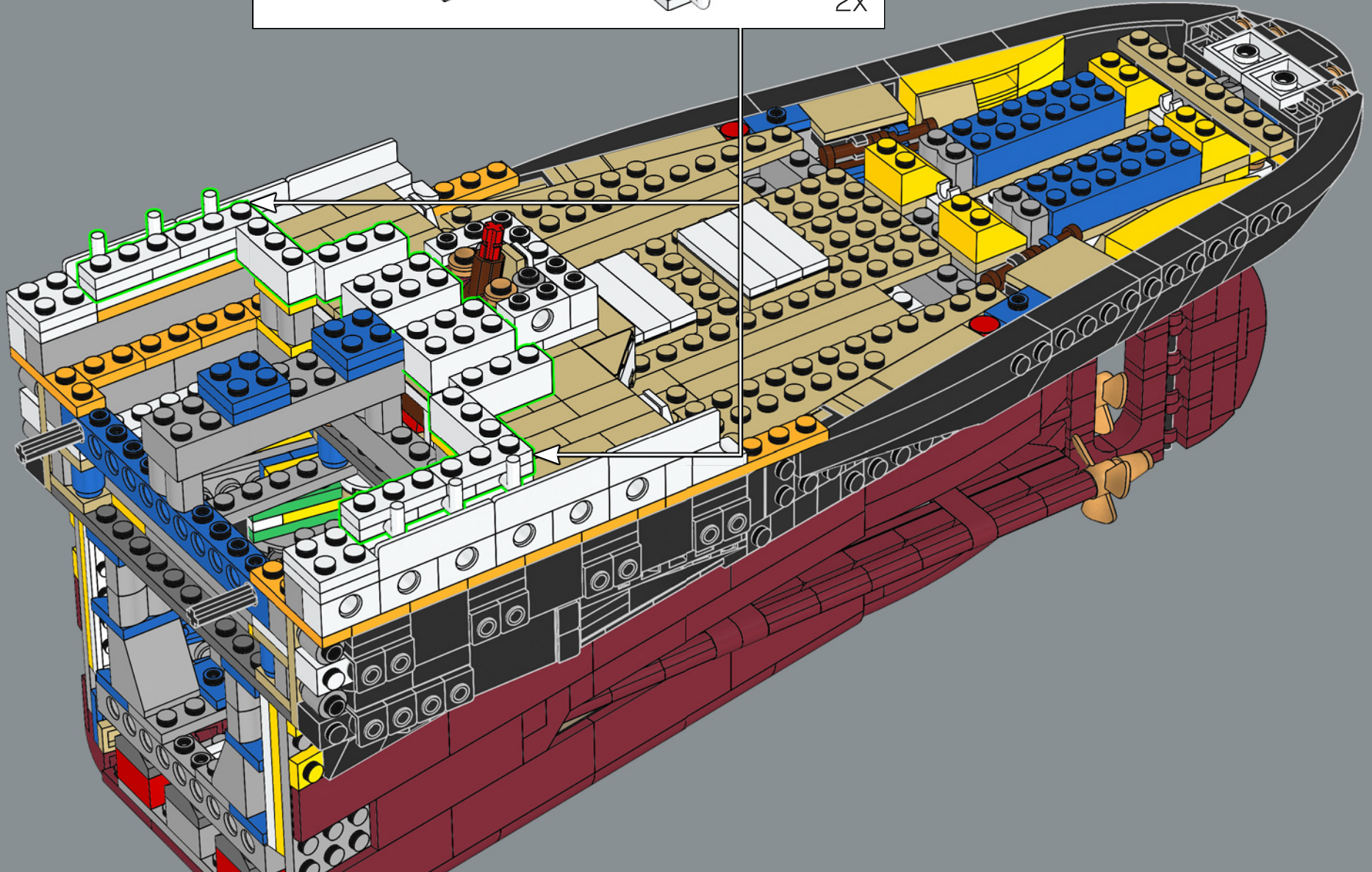
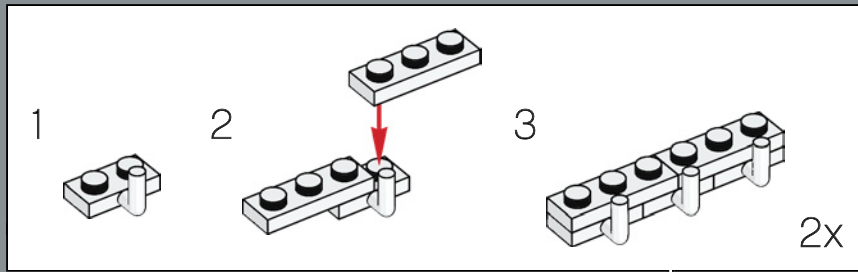

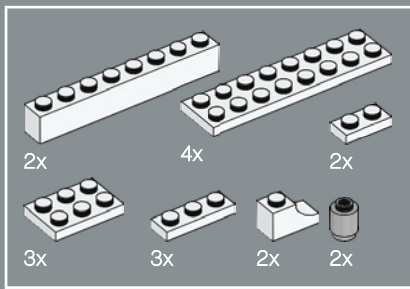

336

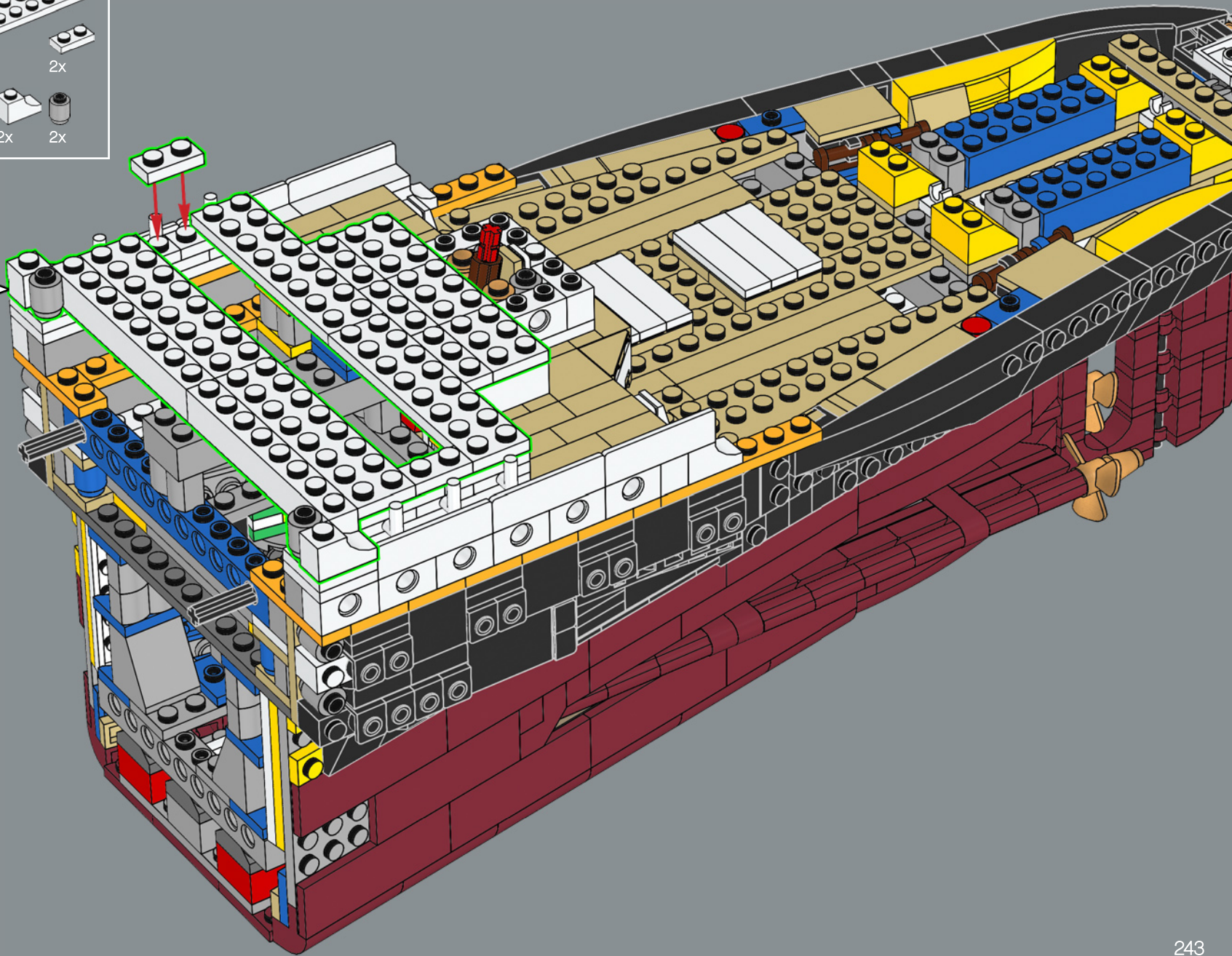
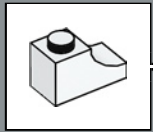

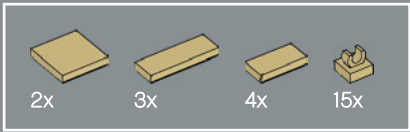

337

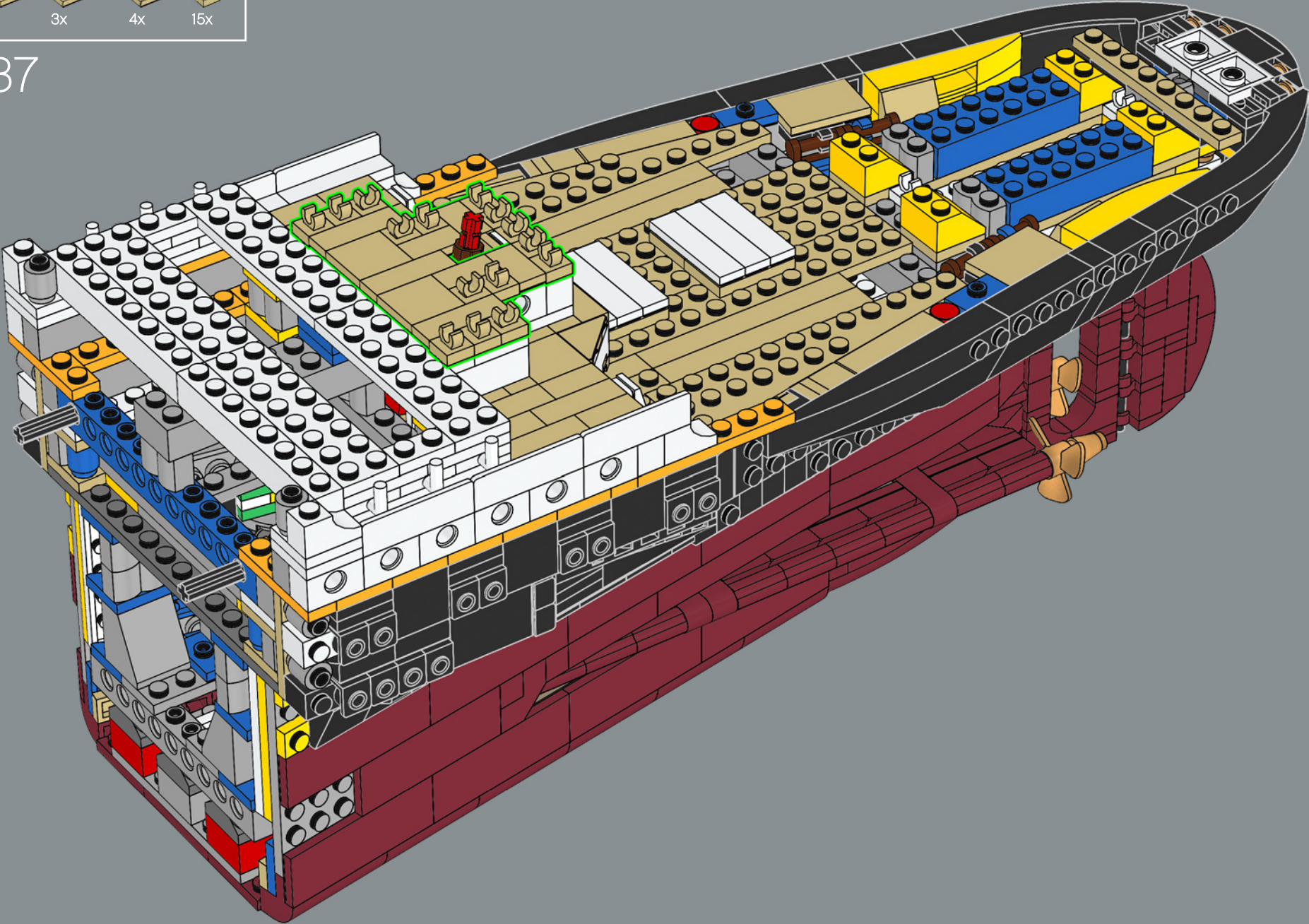



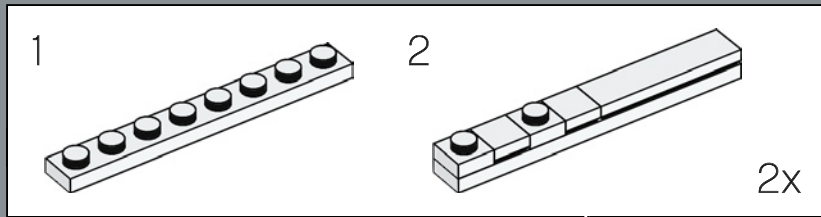
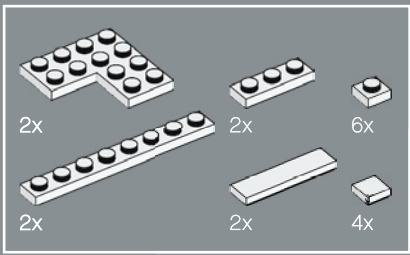

339

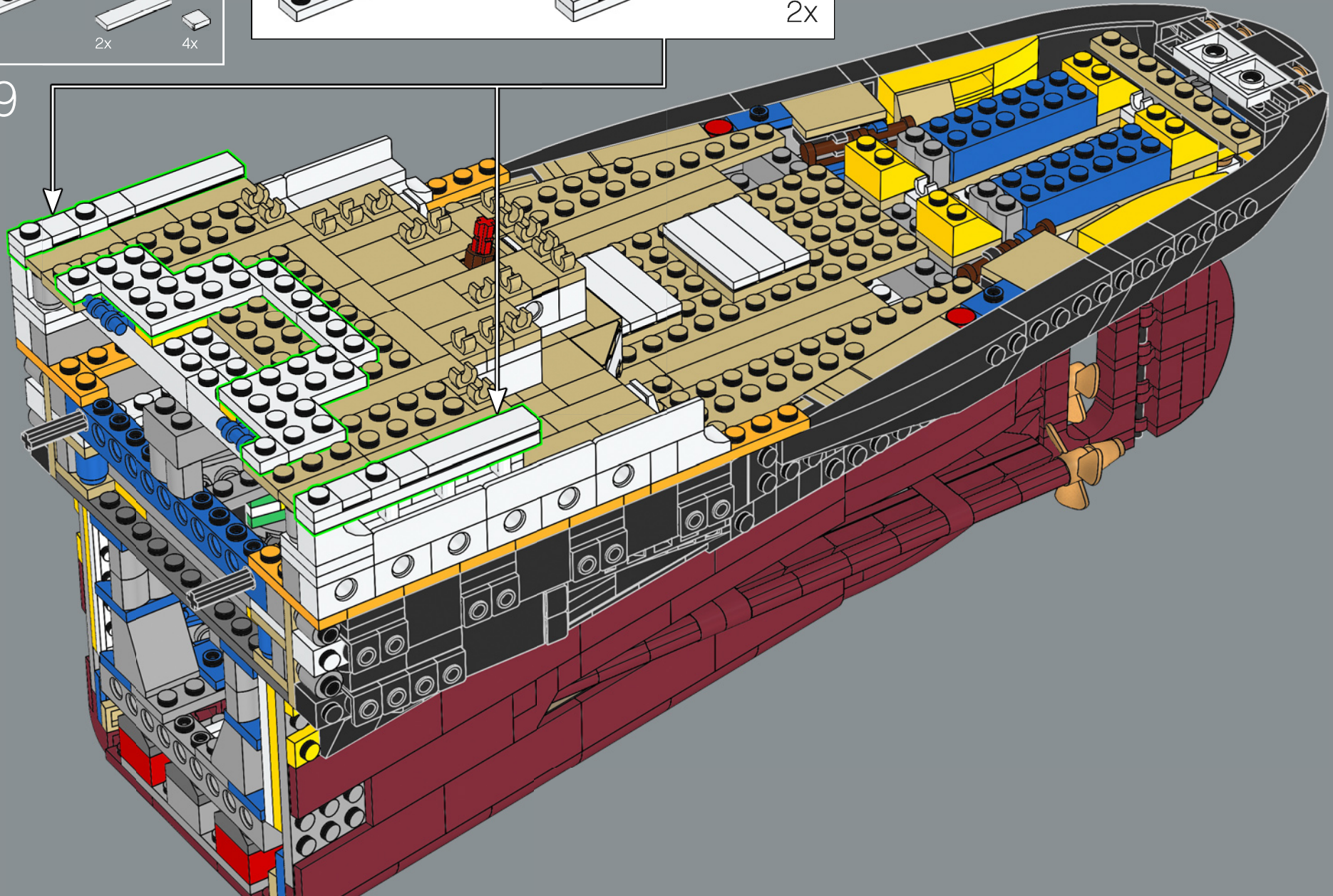

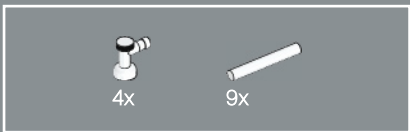

340

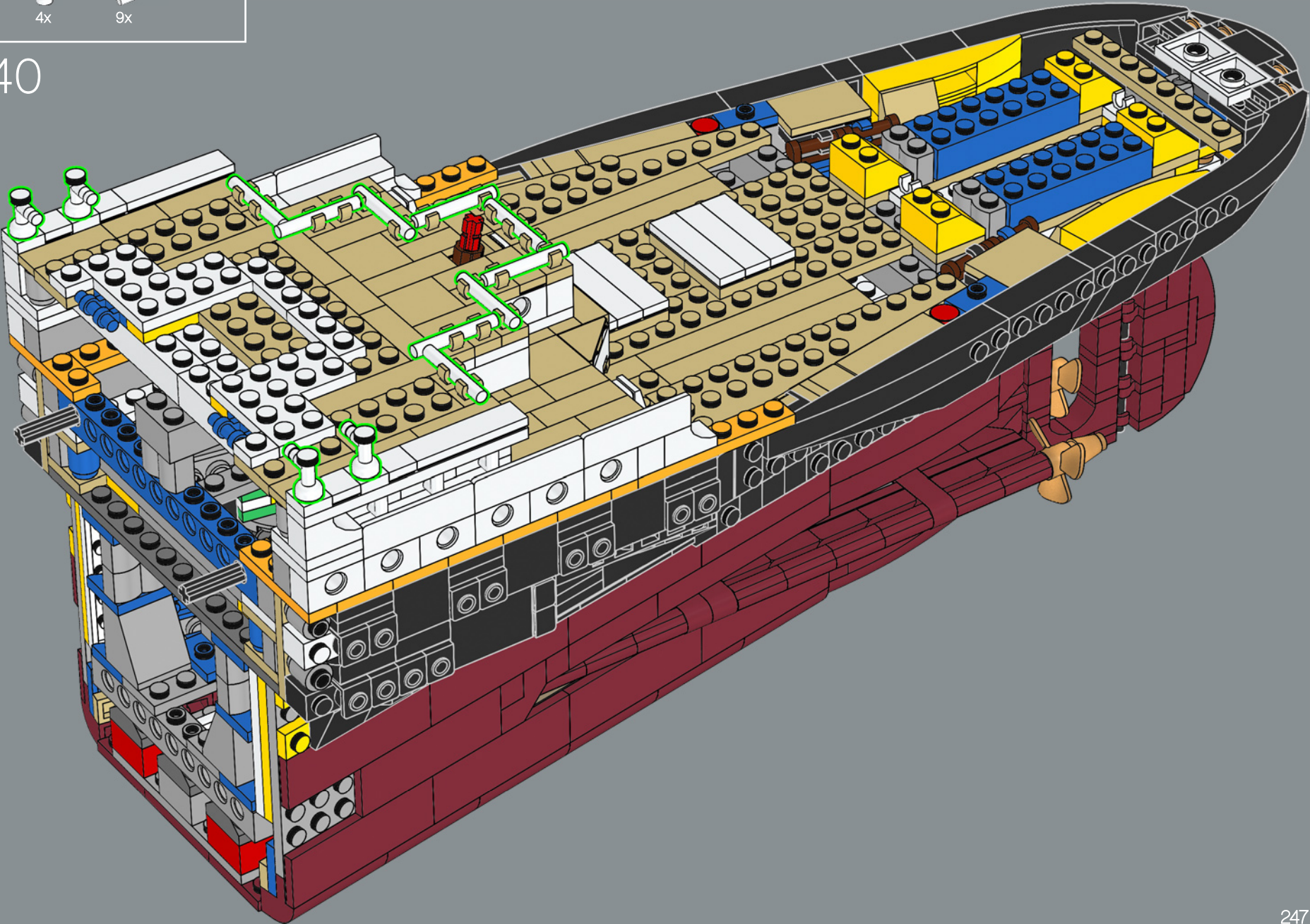

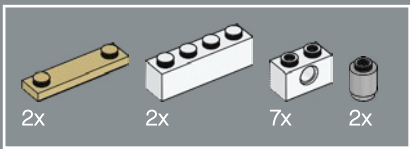

341

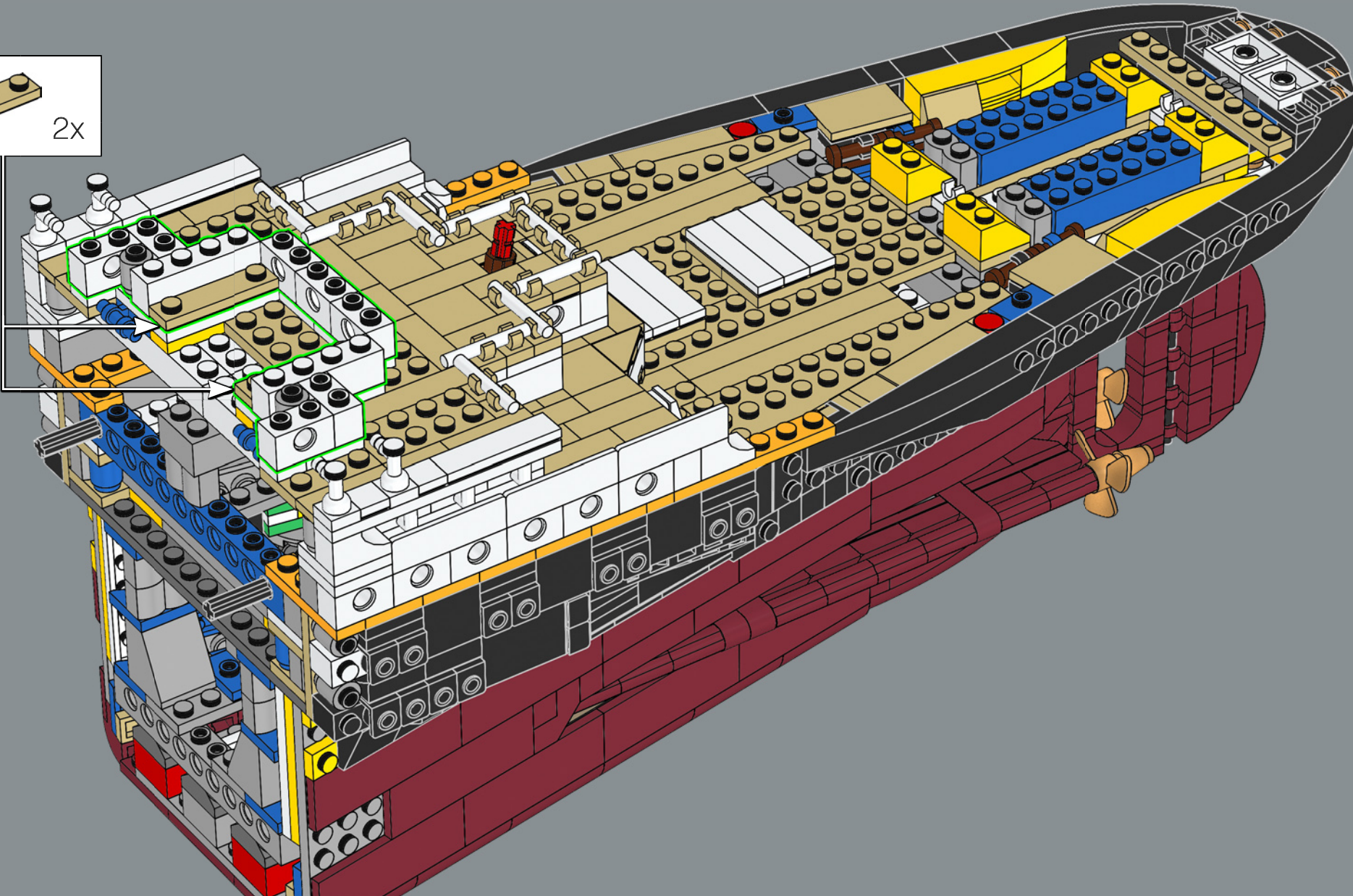
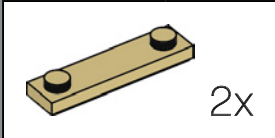



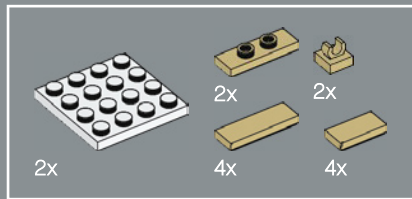

342

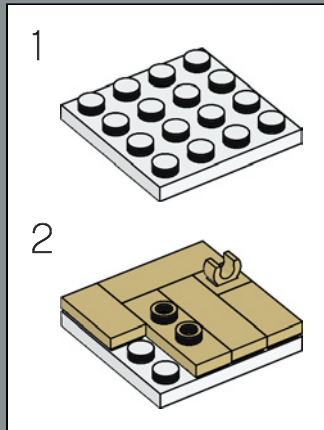
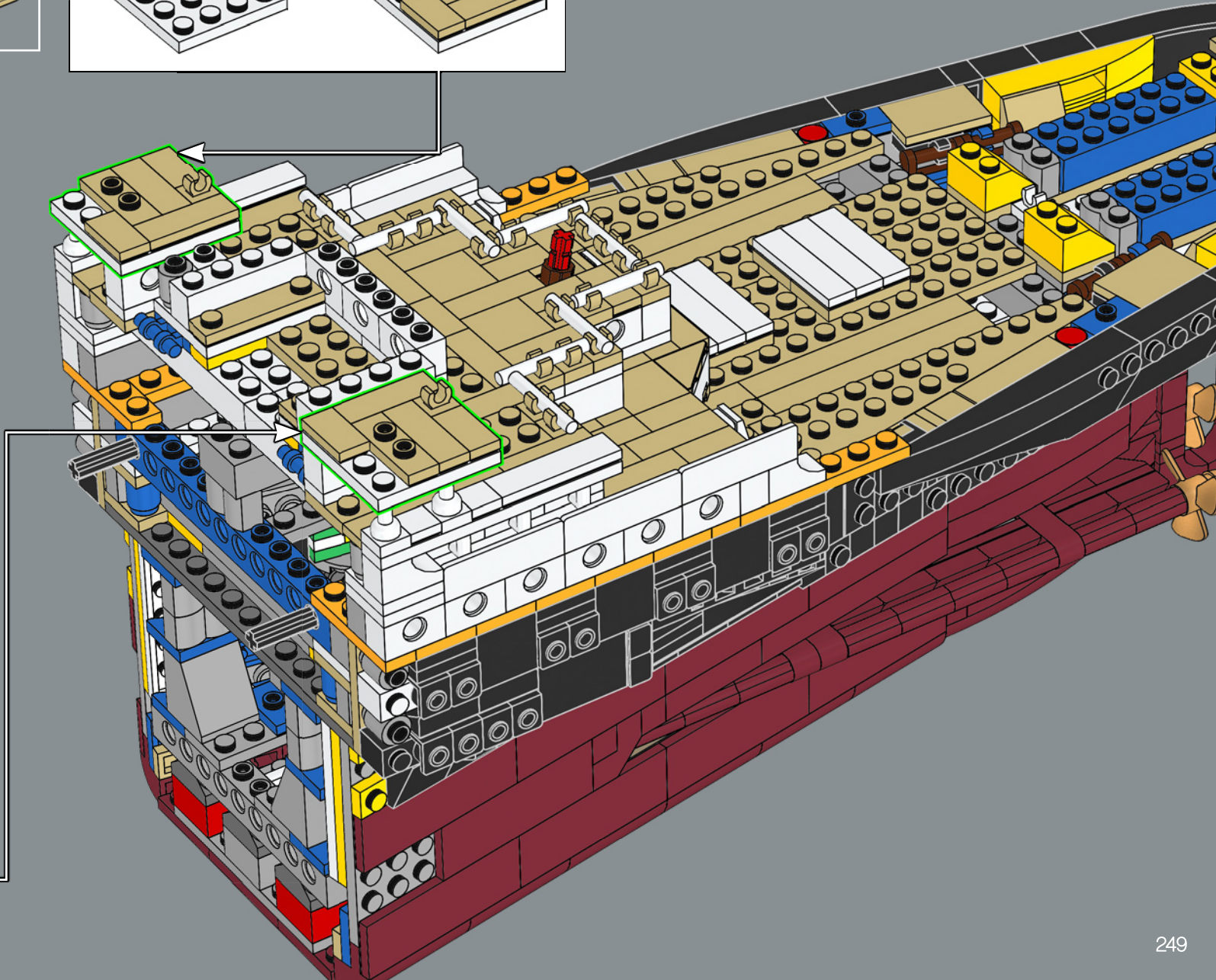
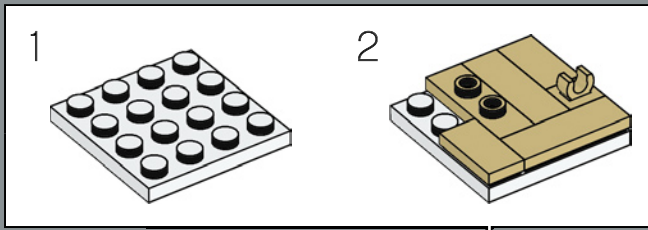

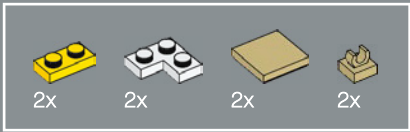

343

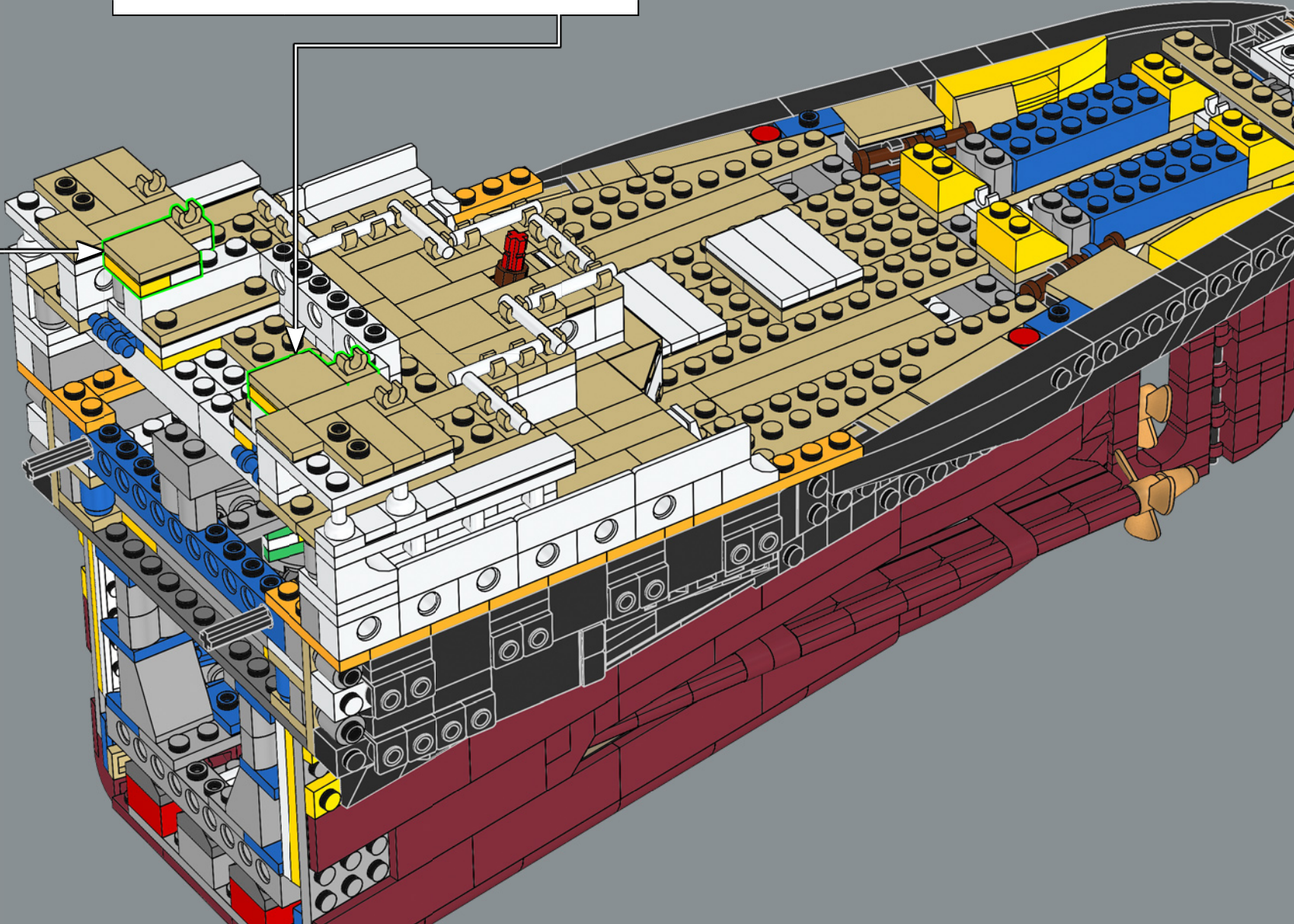
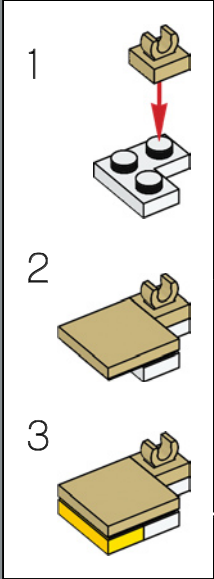
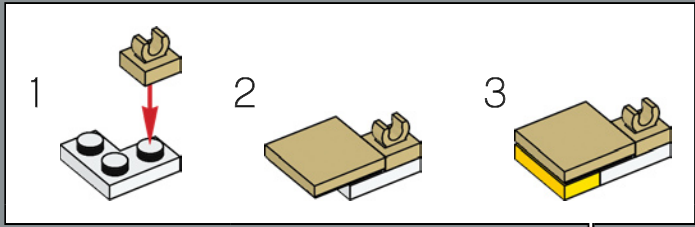

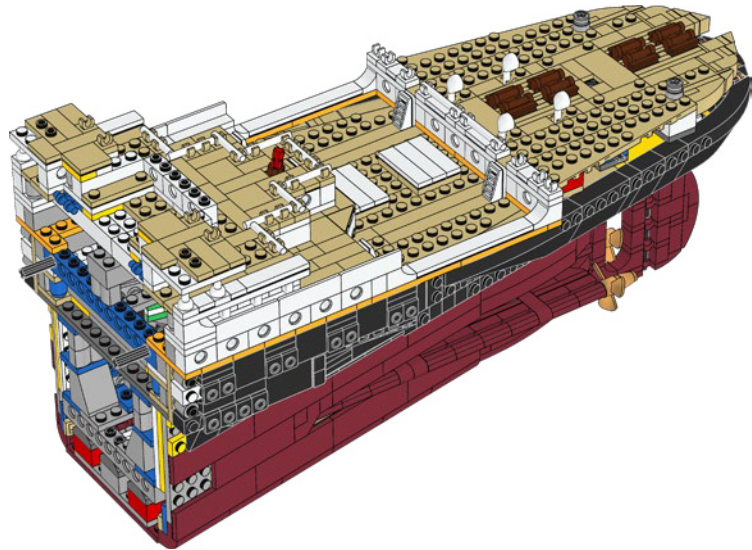

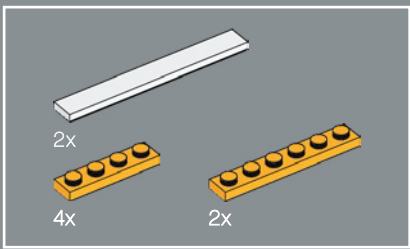

344

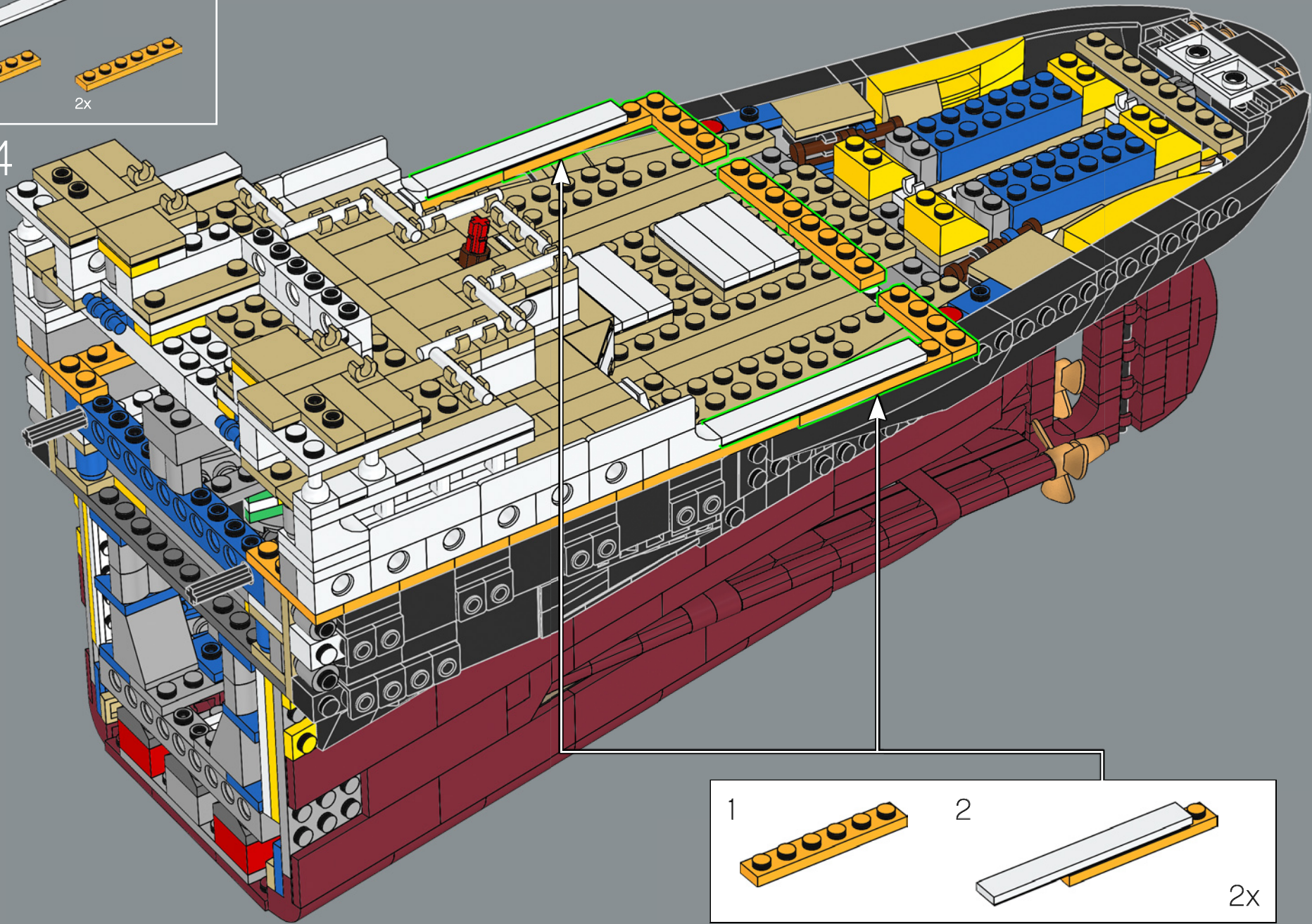

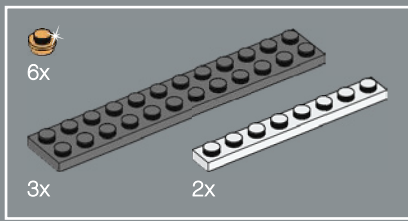

345

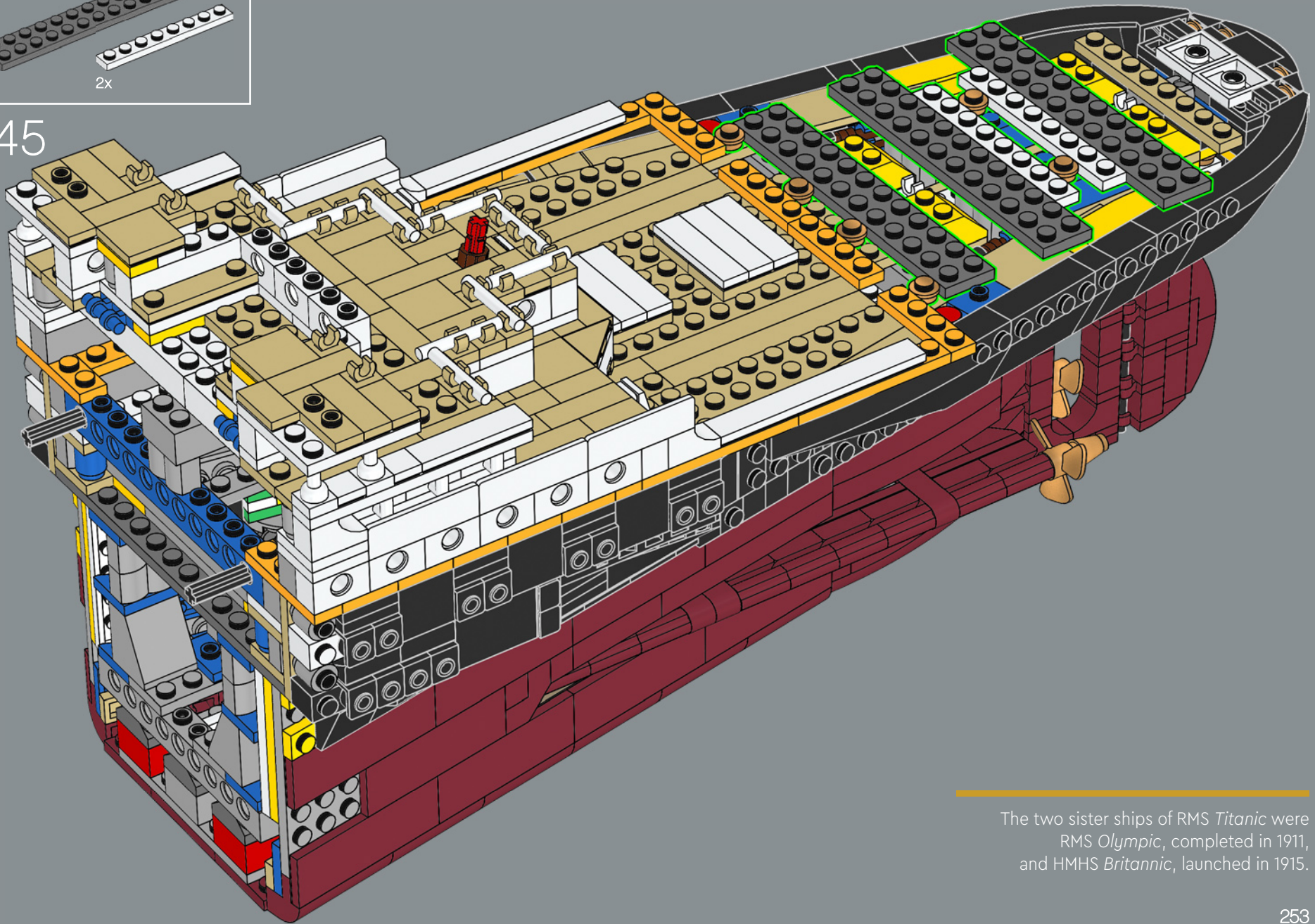

The two sister ships of RMS *Titanic* were RMS *Olympic*, completed in 1911, and HMHS *Britannic*, launched in 1915.

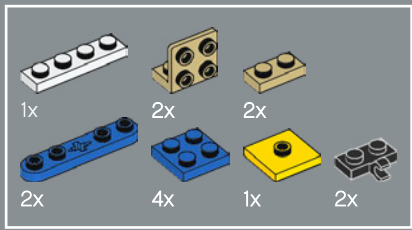

346

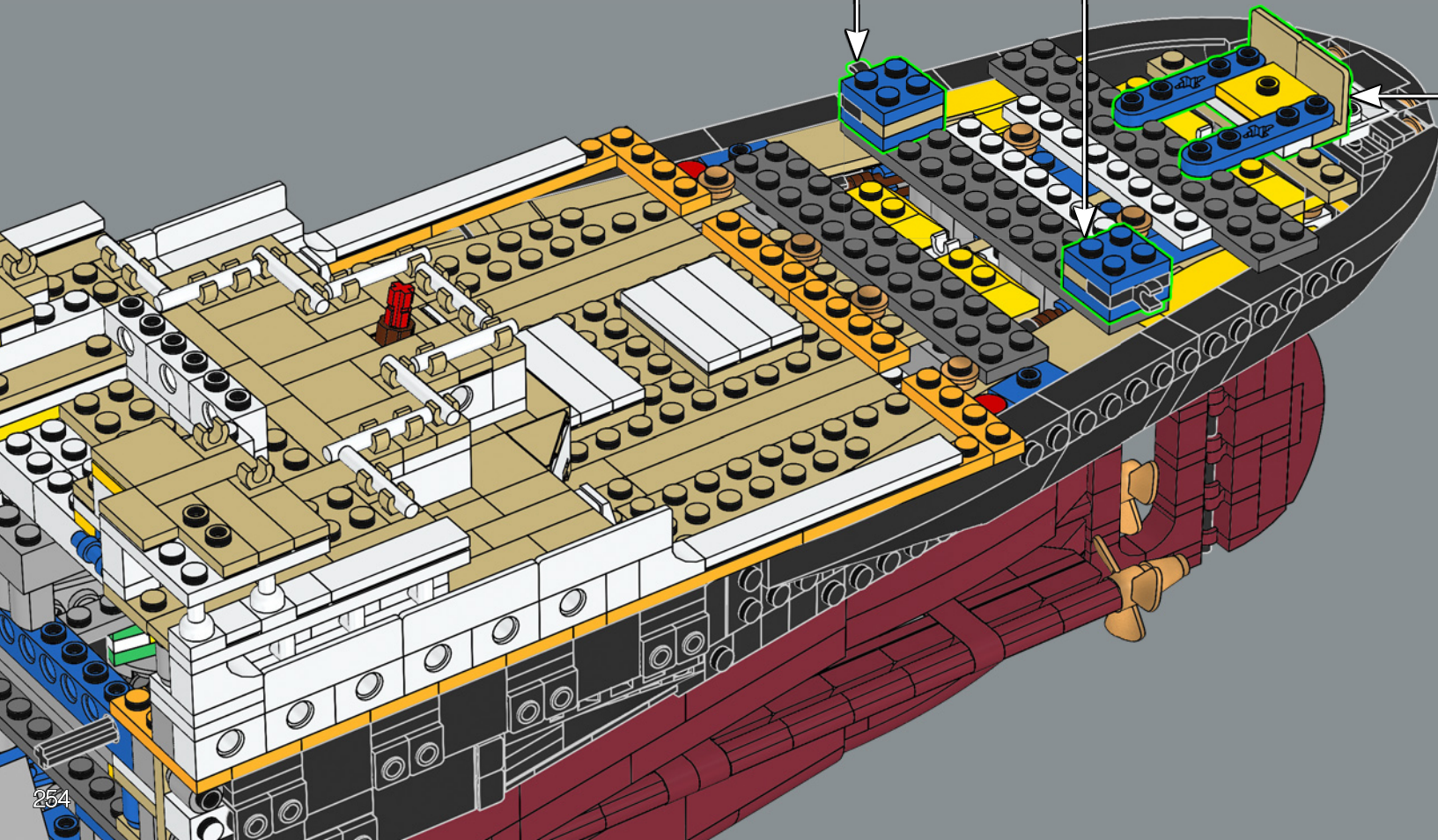
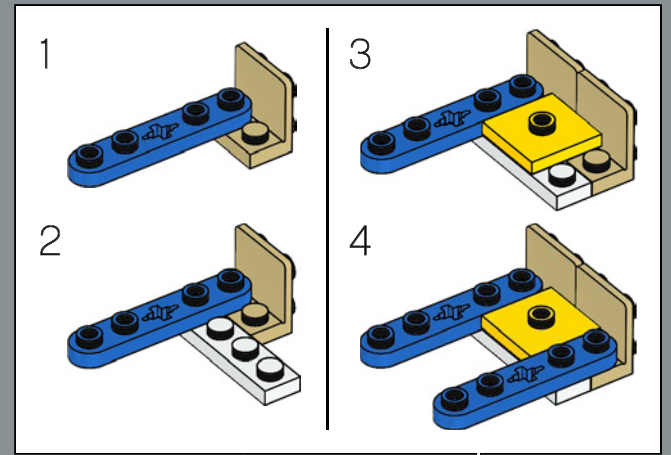
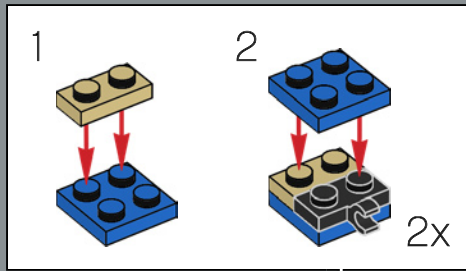

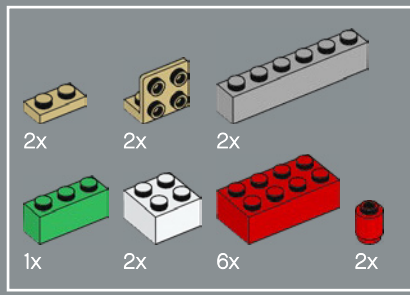

347

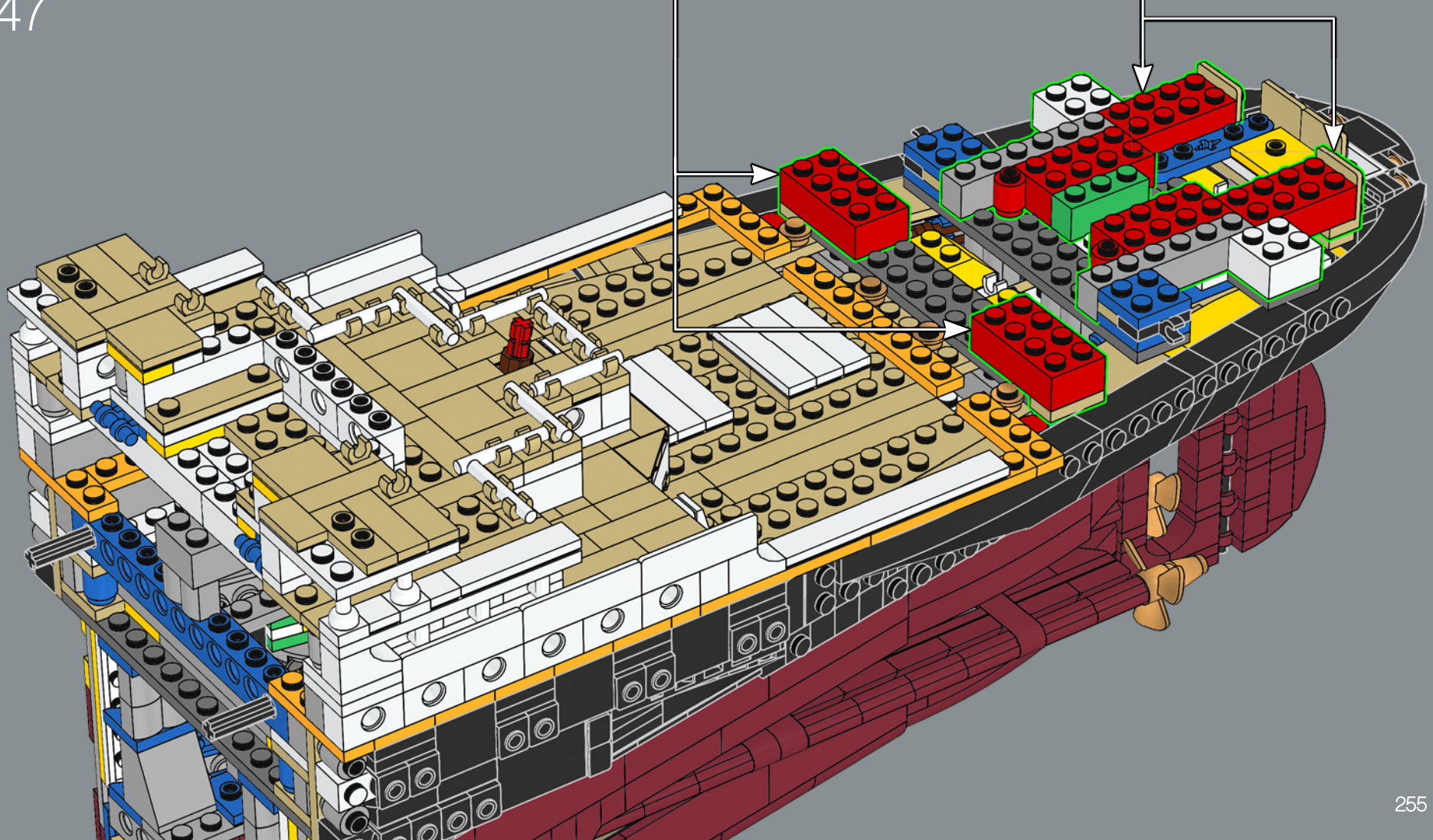
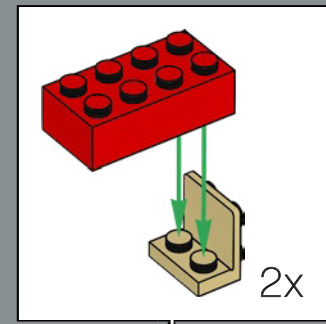
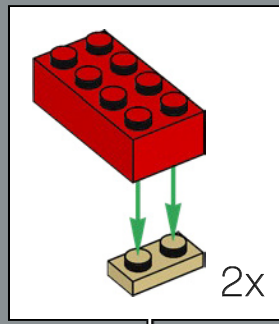

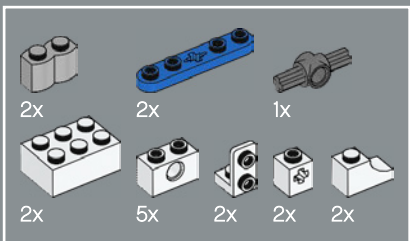

348

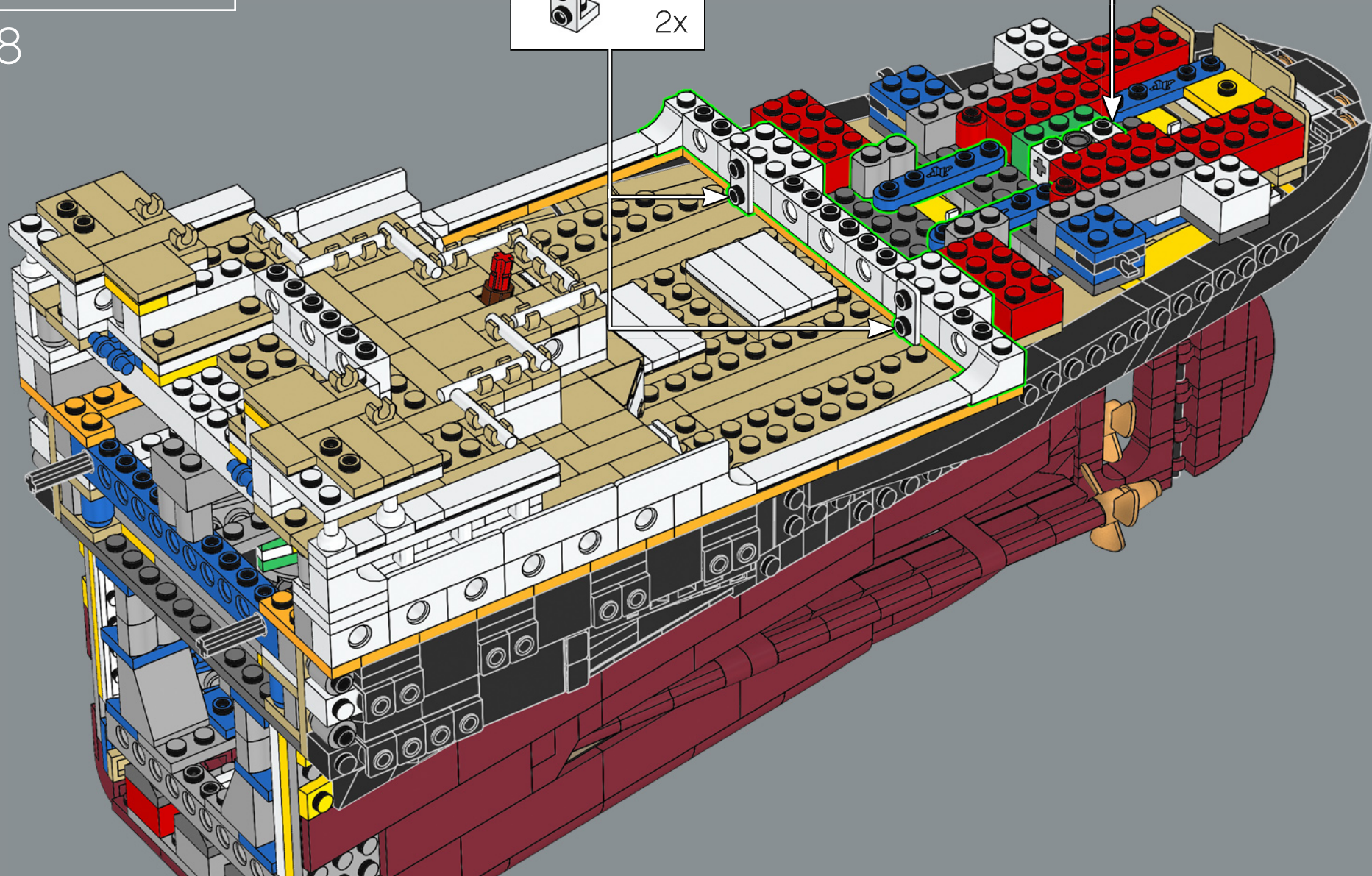
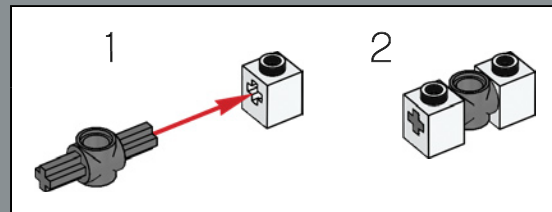
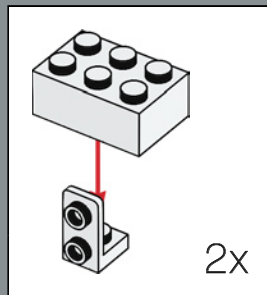



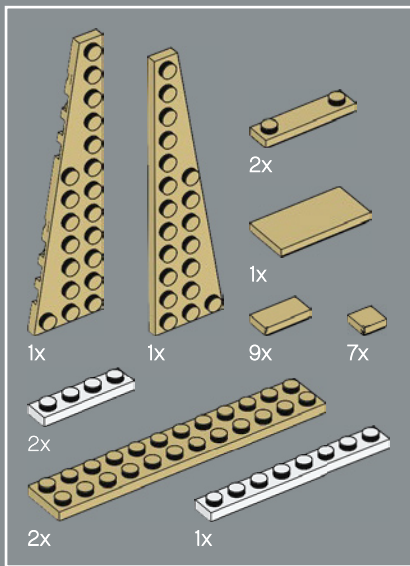

349

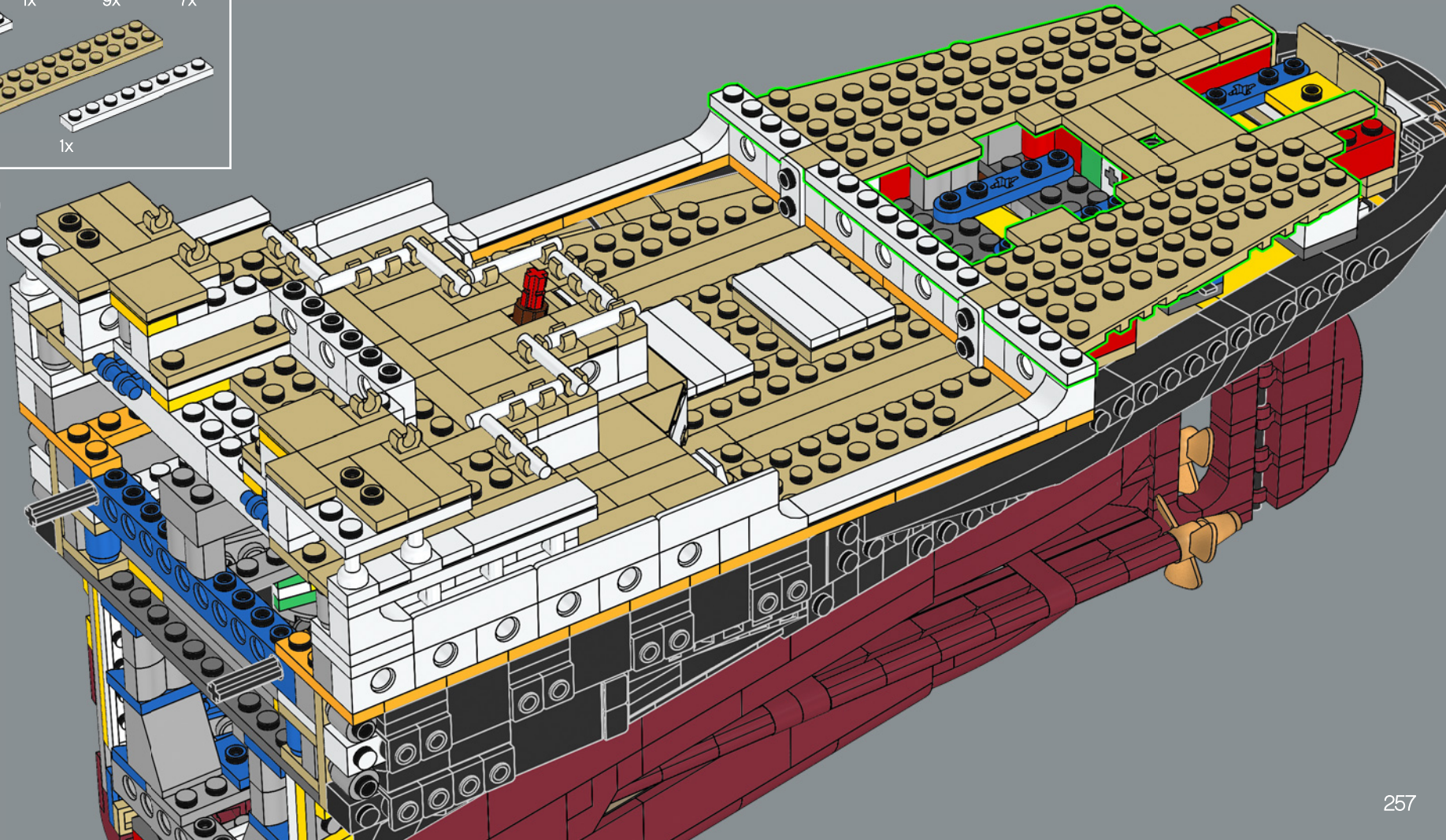

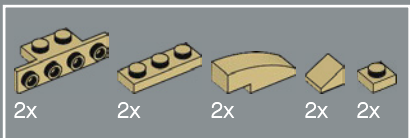

350

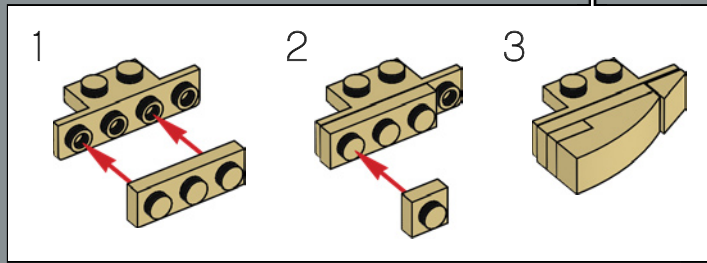
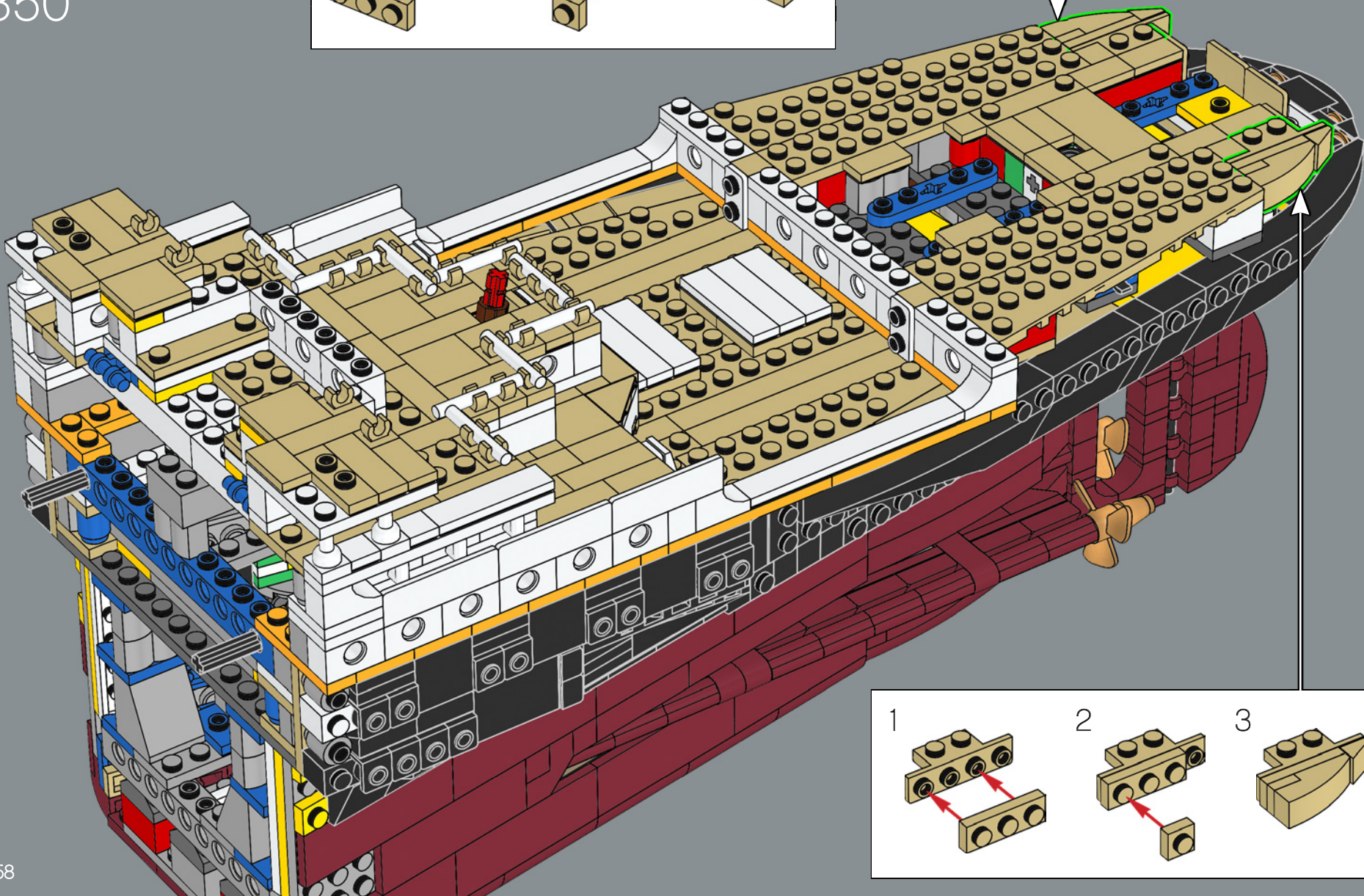
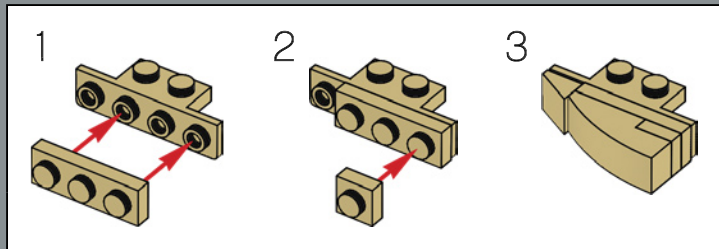

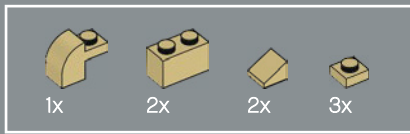

351

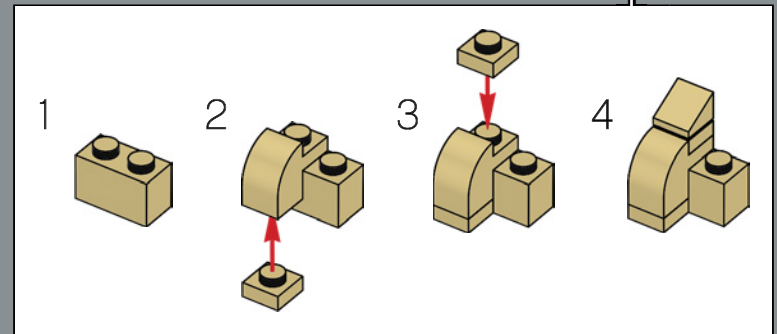
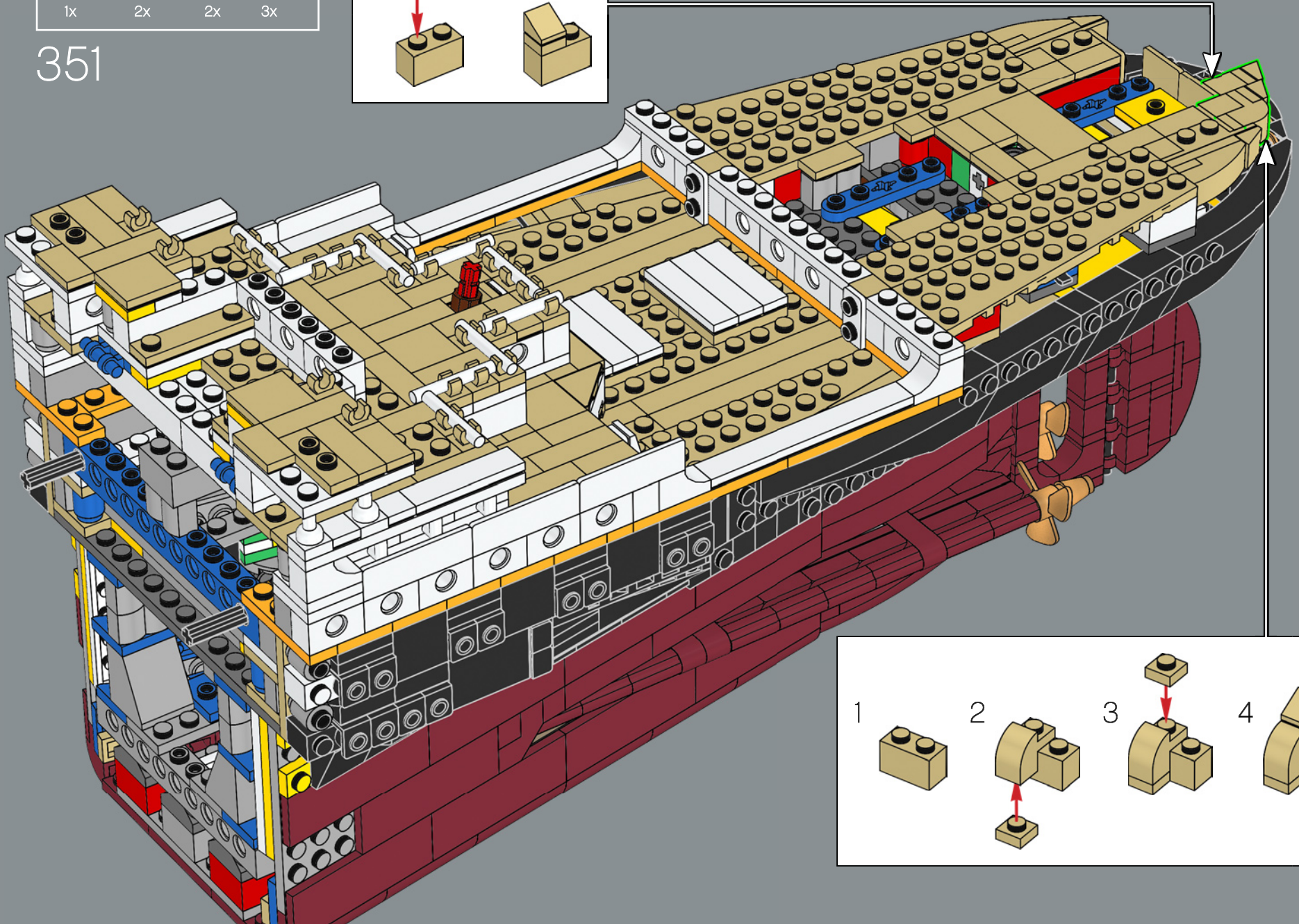
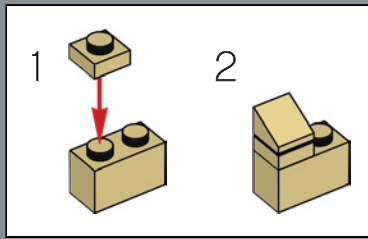

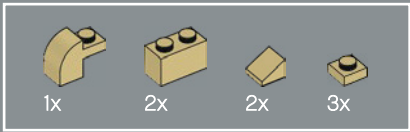

352

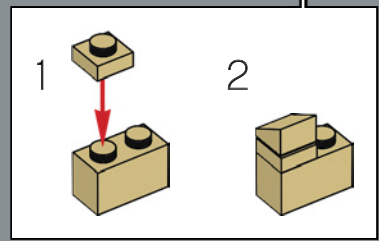
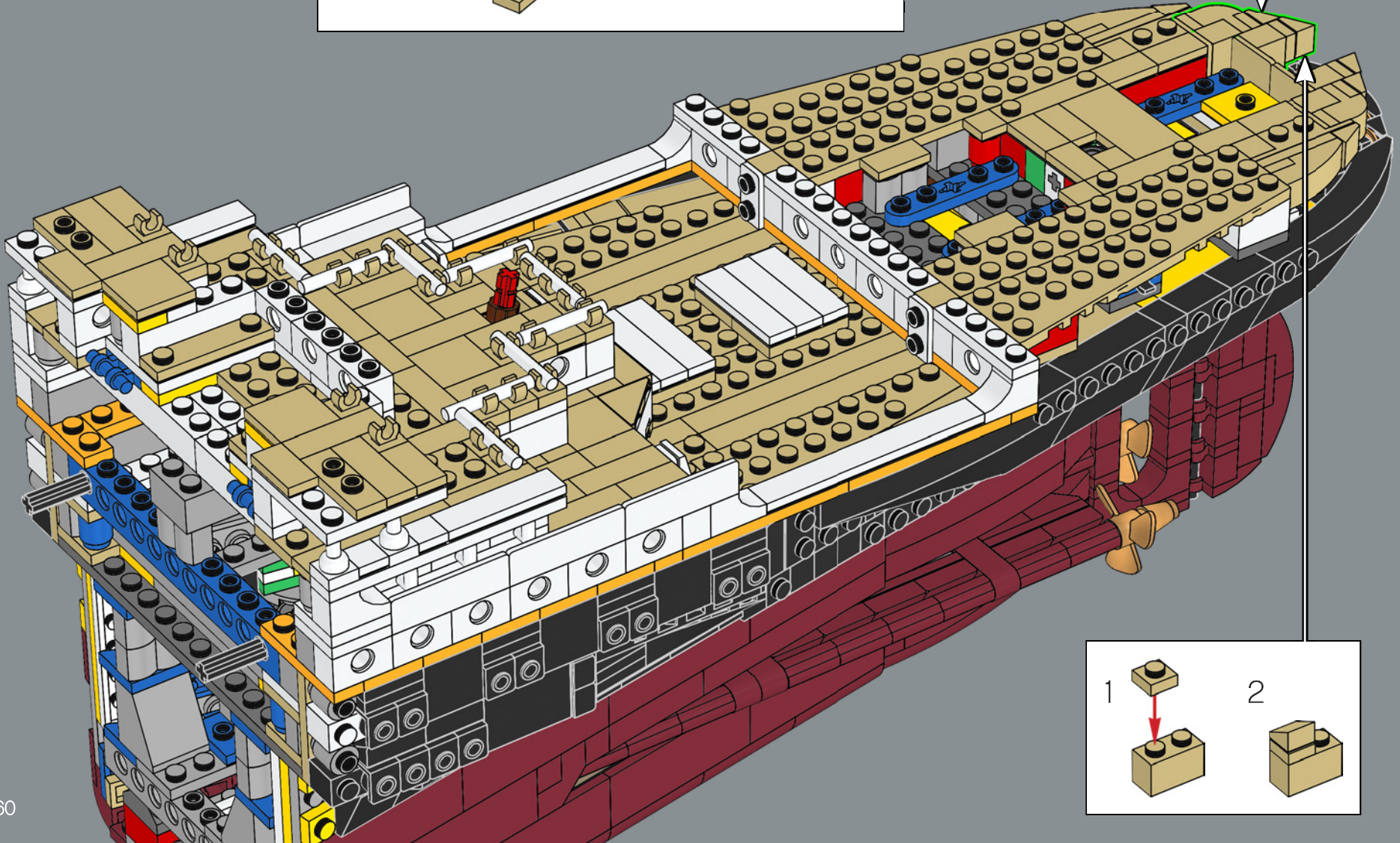
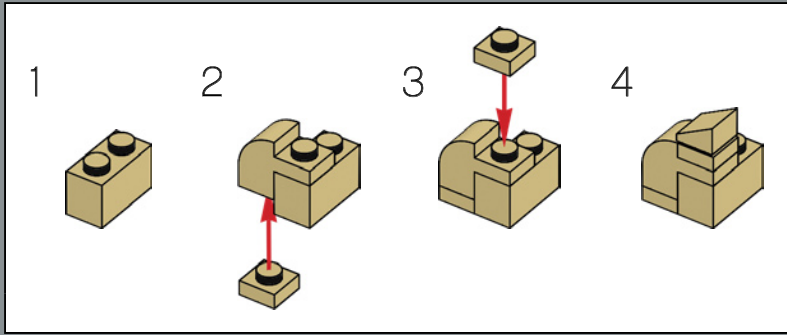

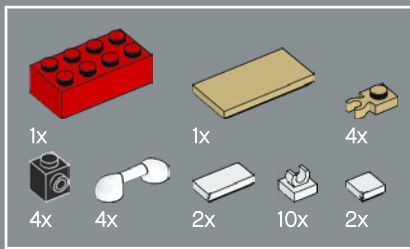

353

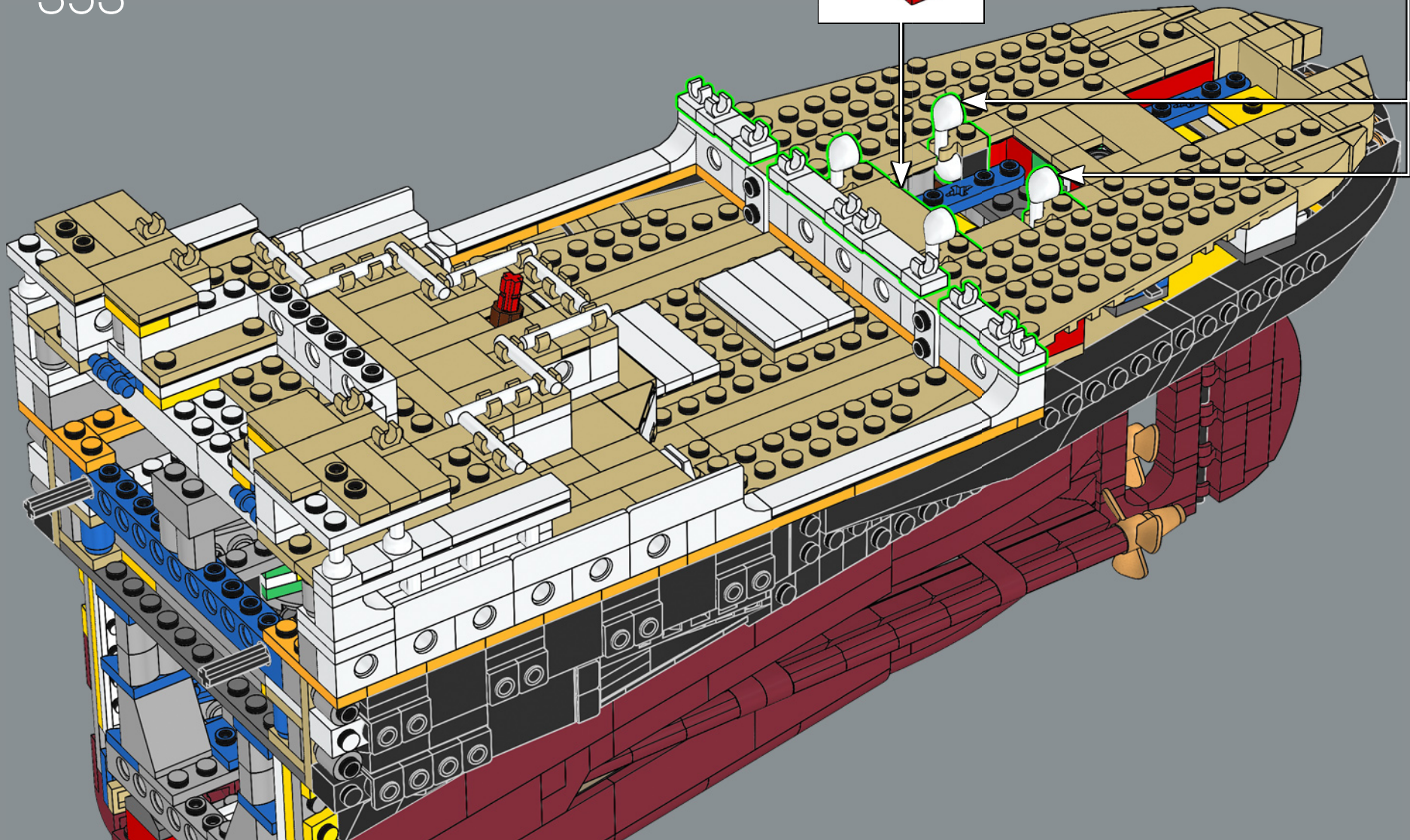
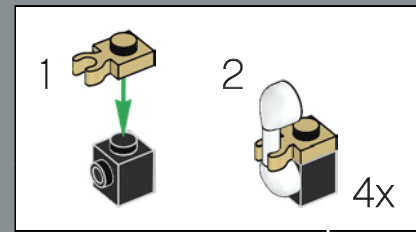
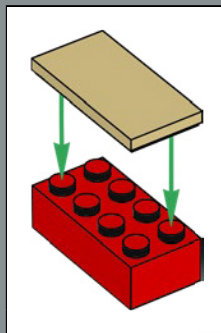



354

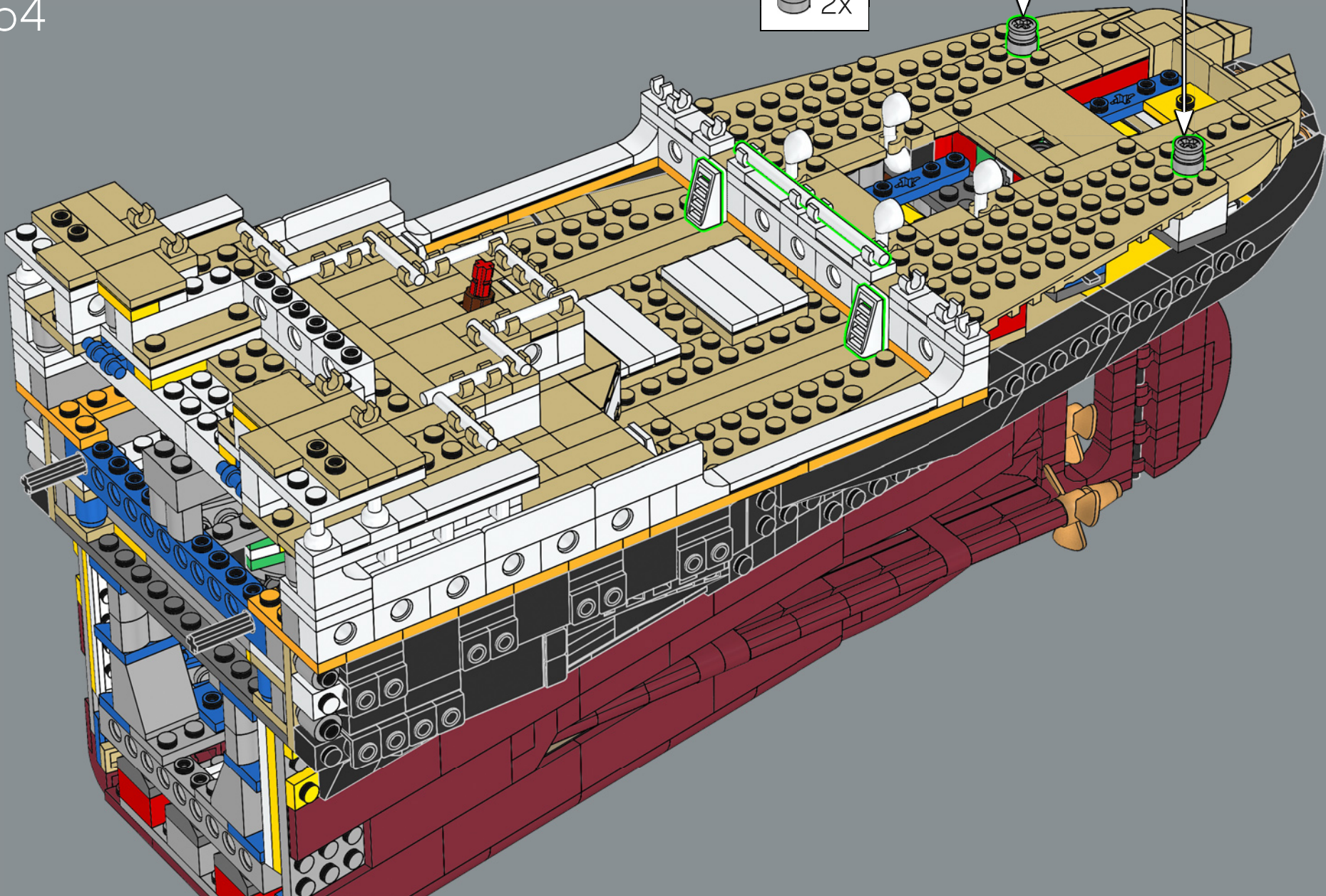
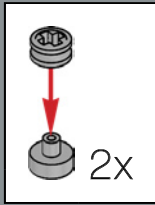

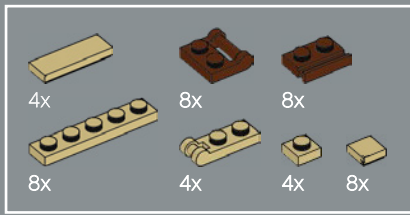

355

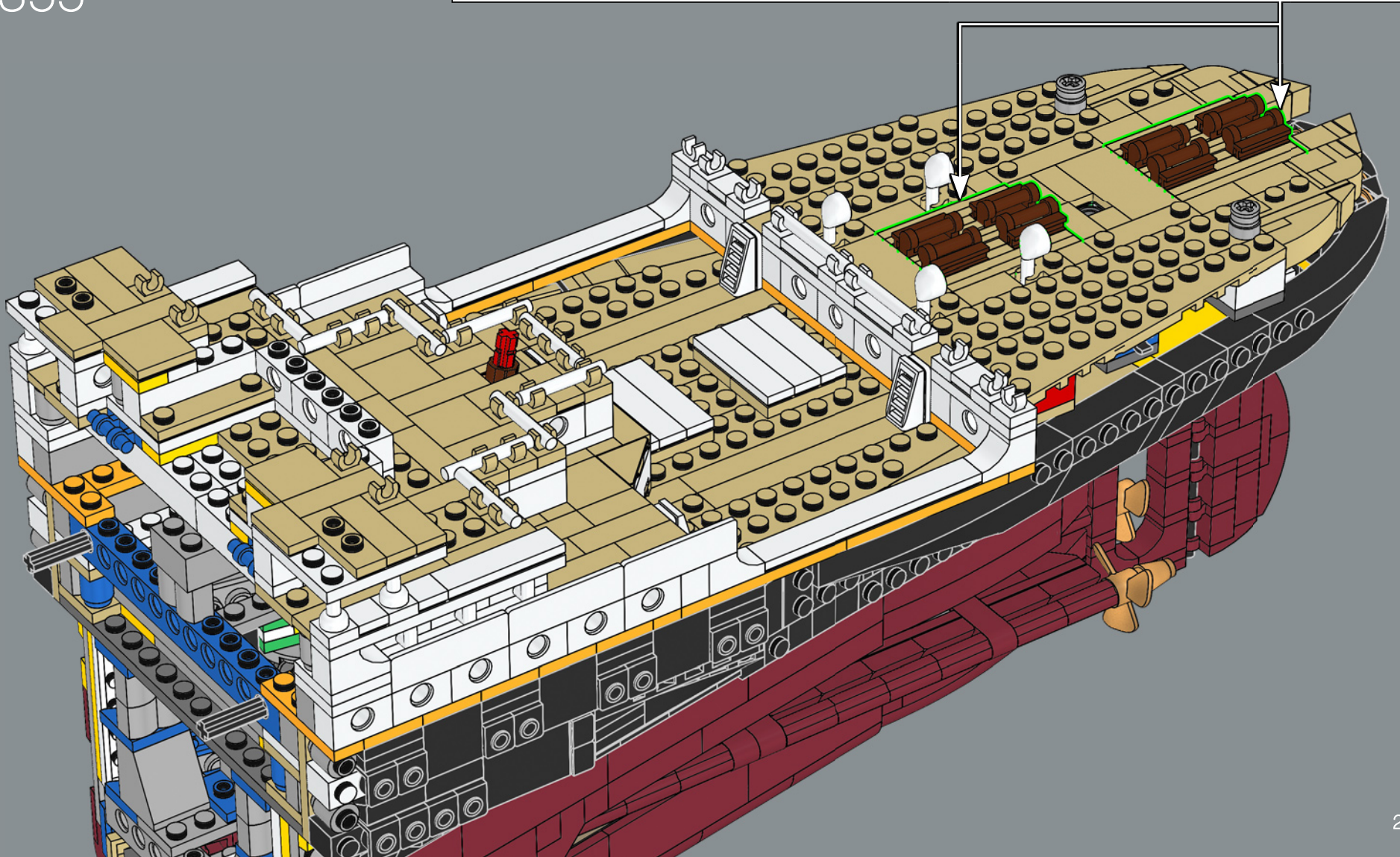
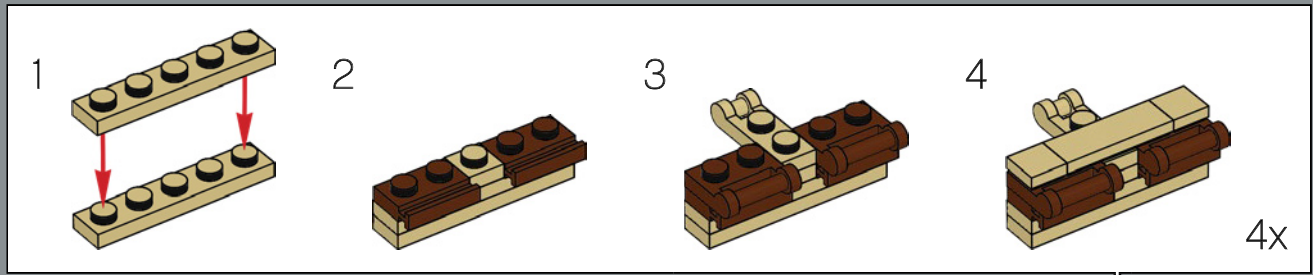

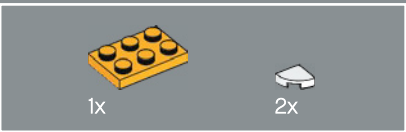
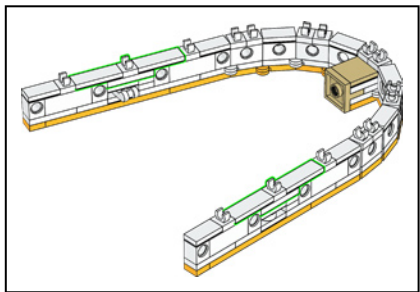
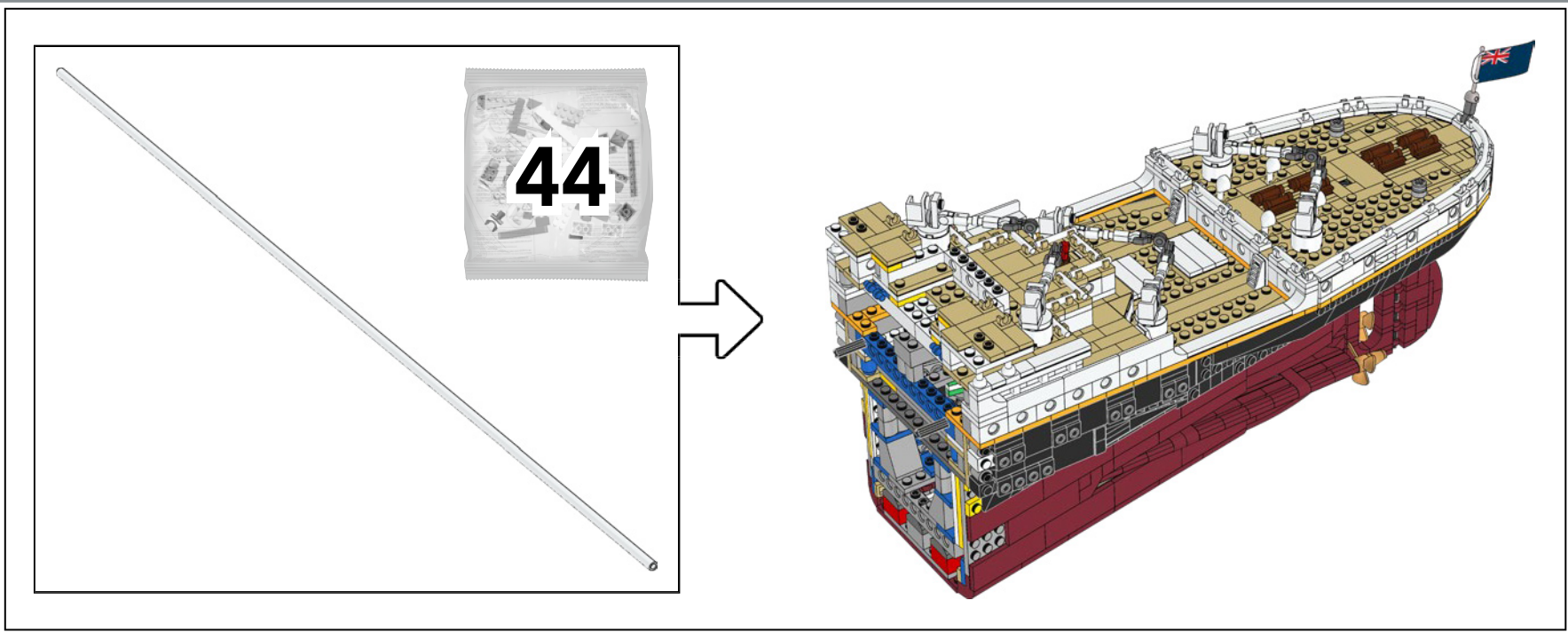

356

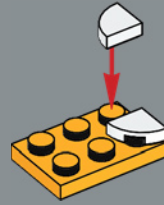

357

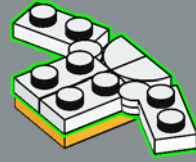



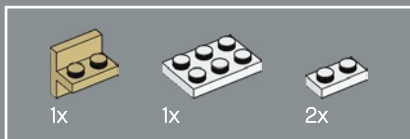

358

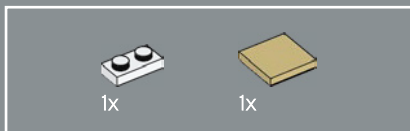
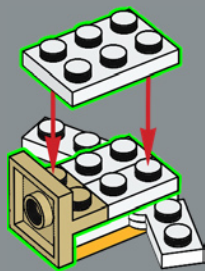

359

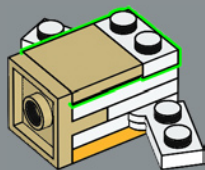

360

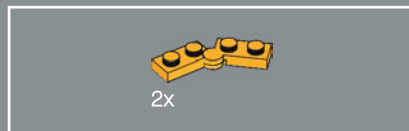
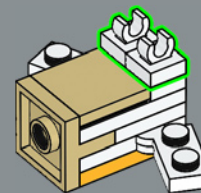

361

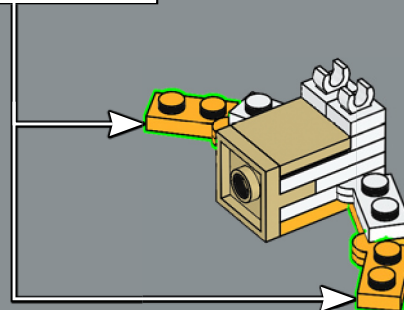
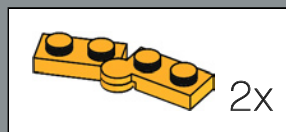



362

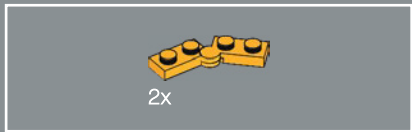
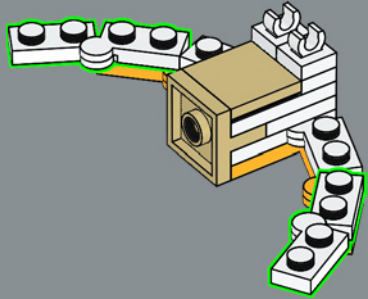

363

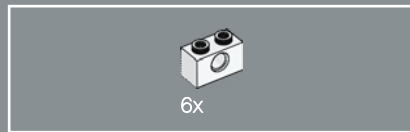
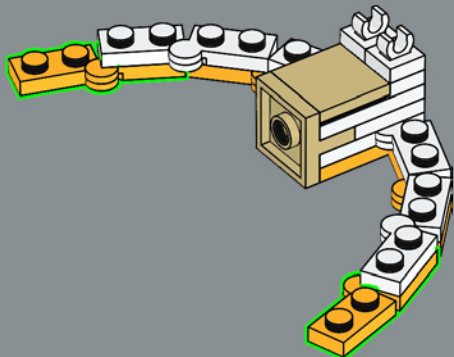

364

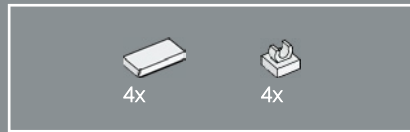
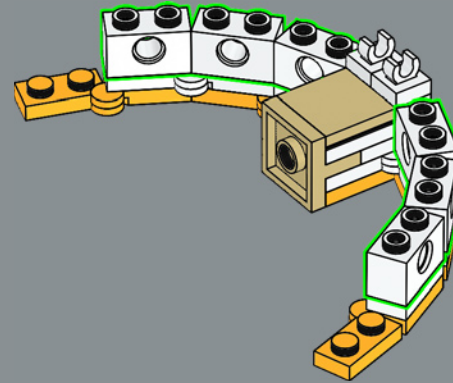

365

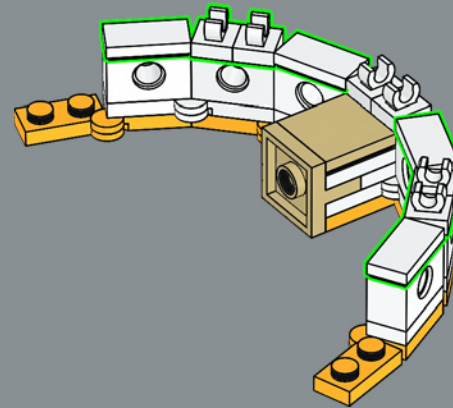



366

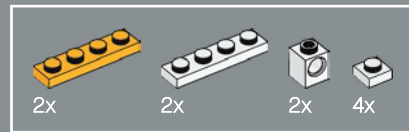
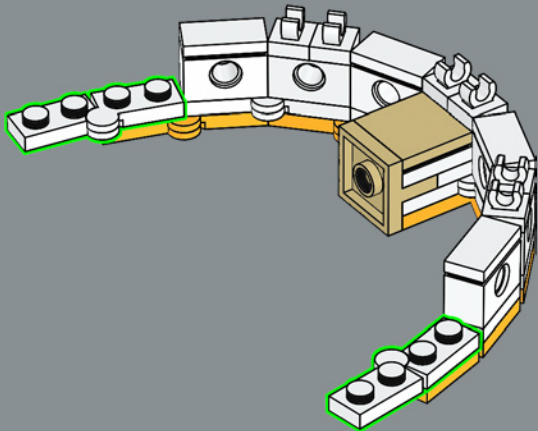

367

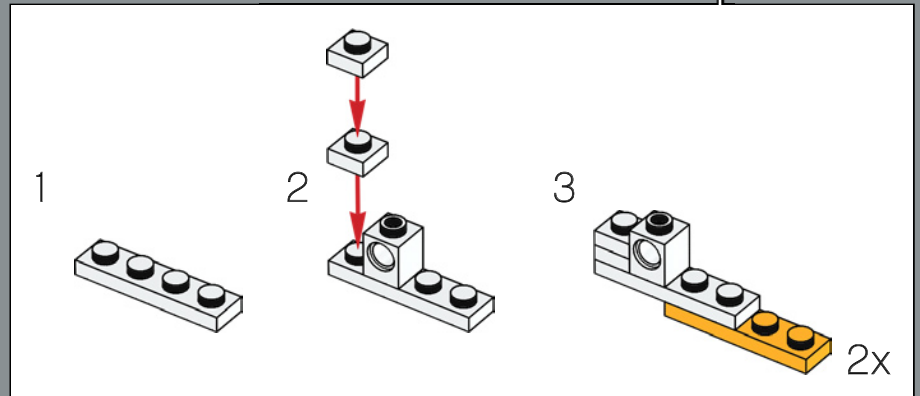
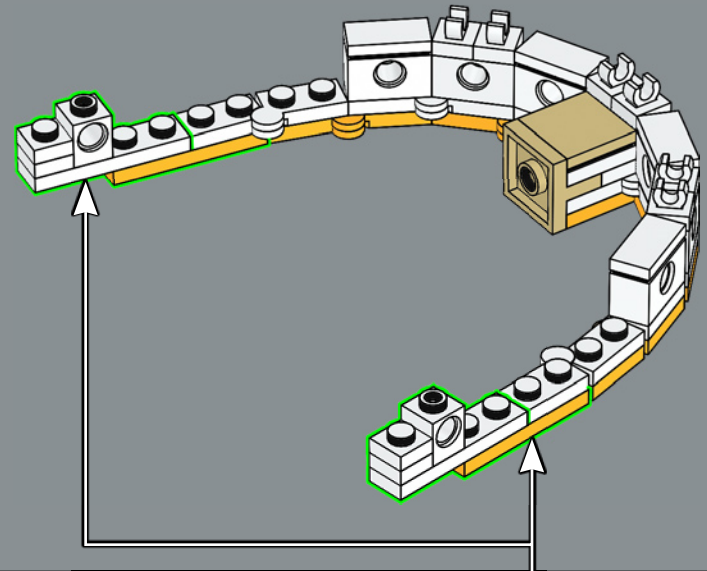

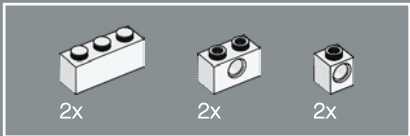

368

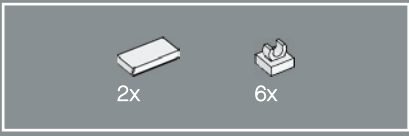
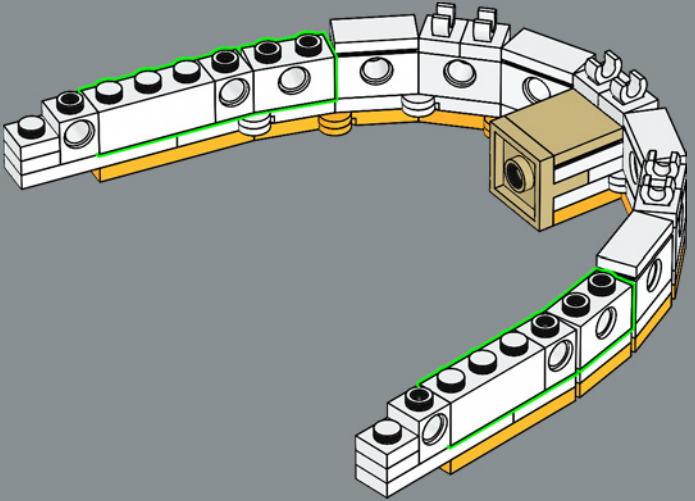

369

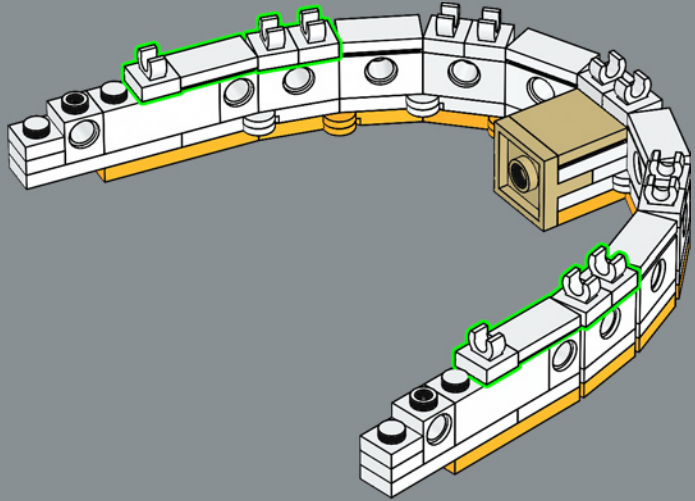

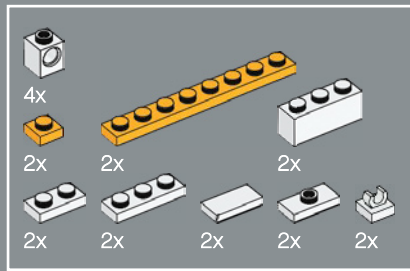

370

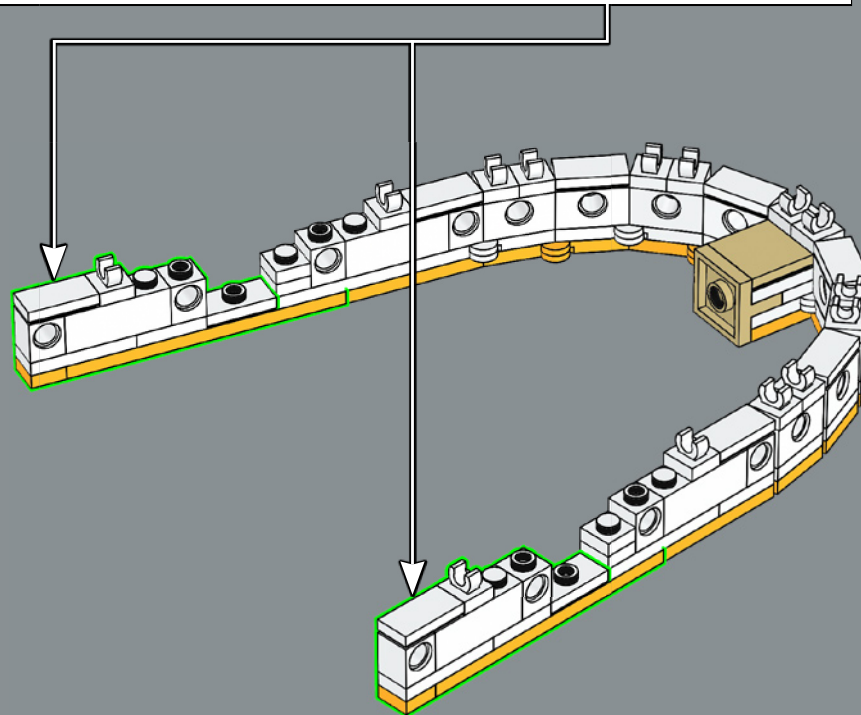
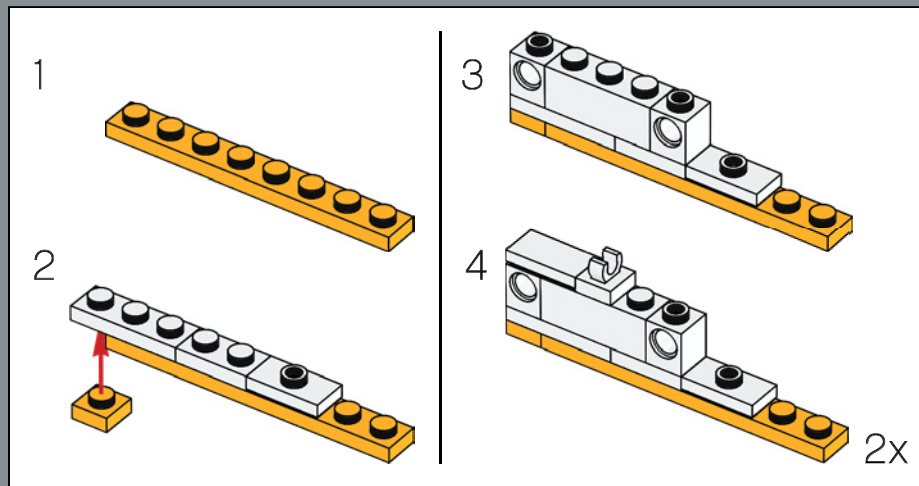



2x

371

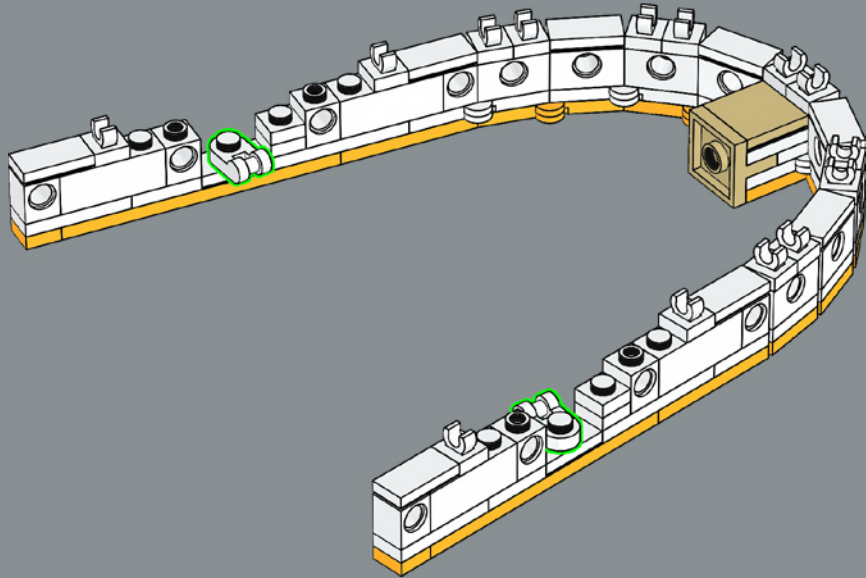

2x

372

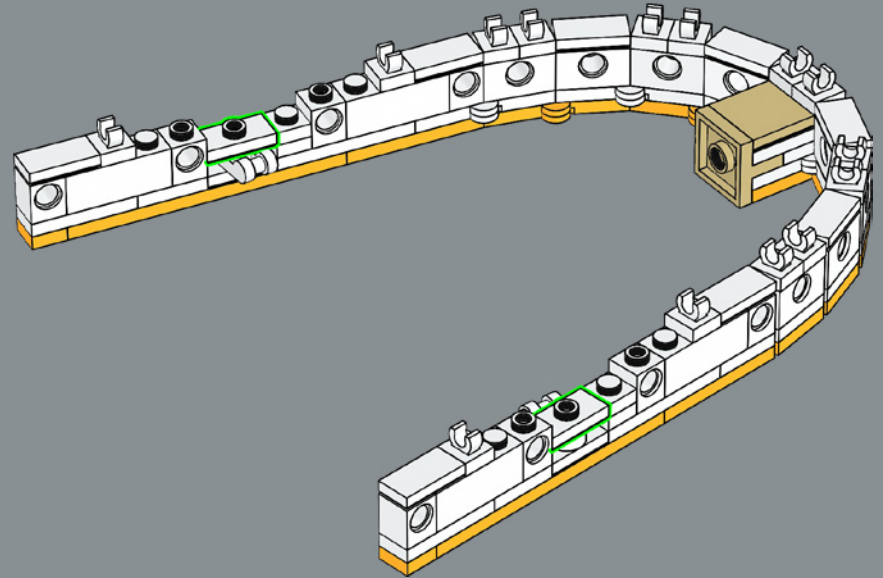

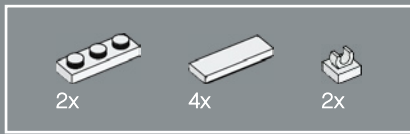

373

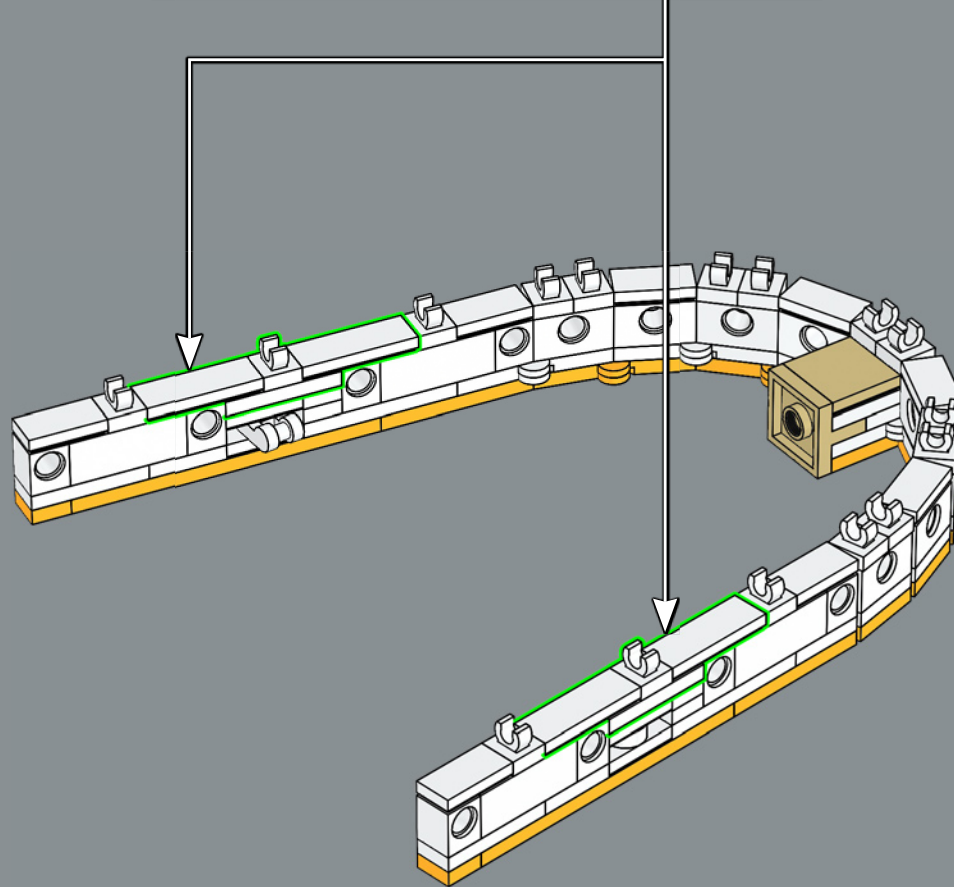
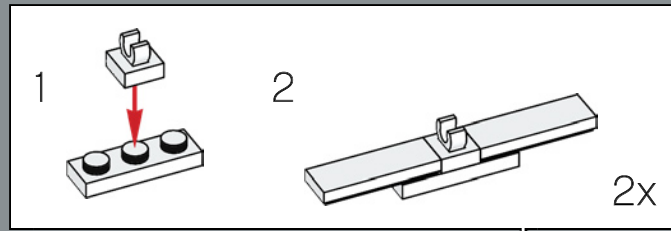

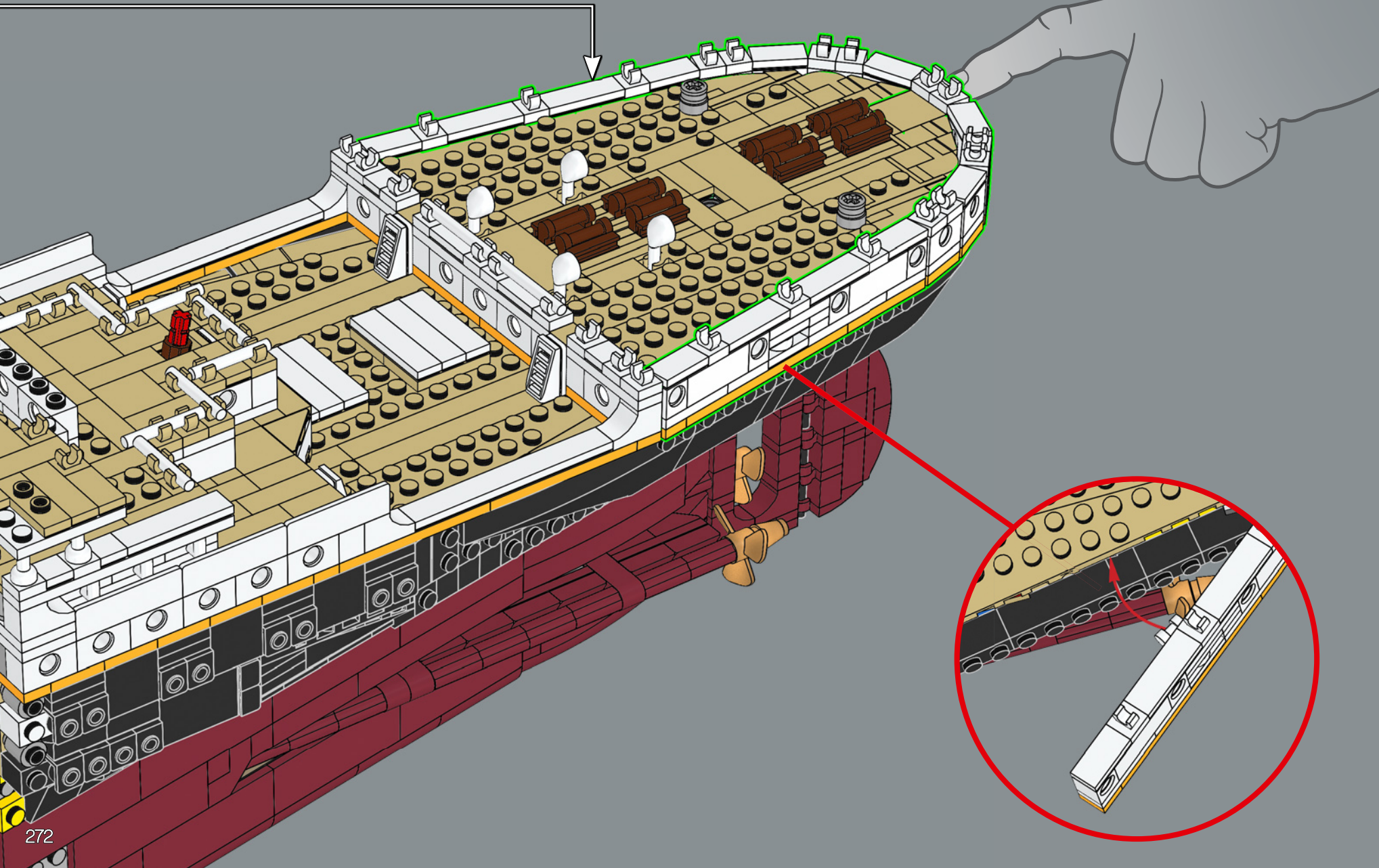



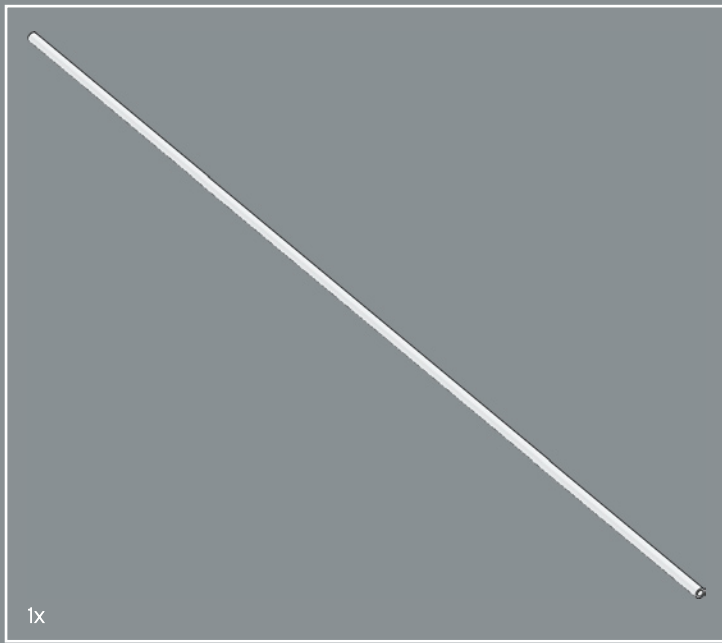

1x

375

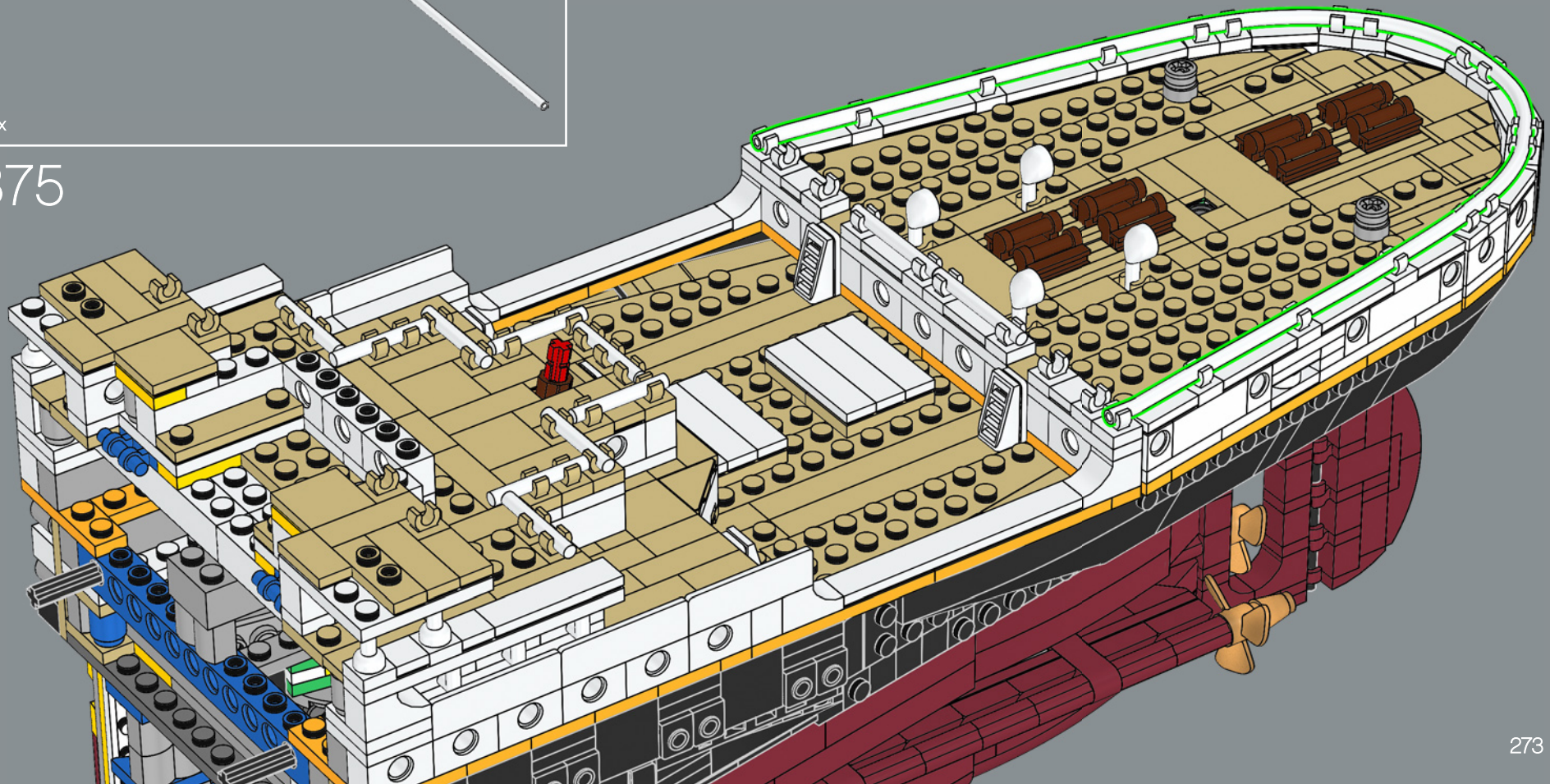



376

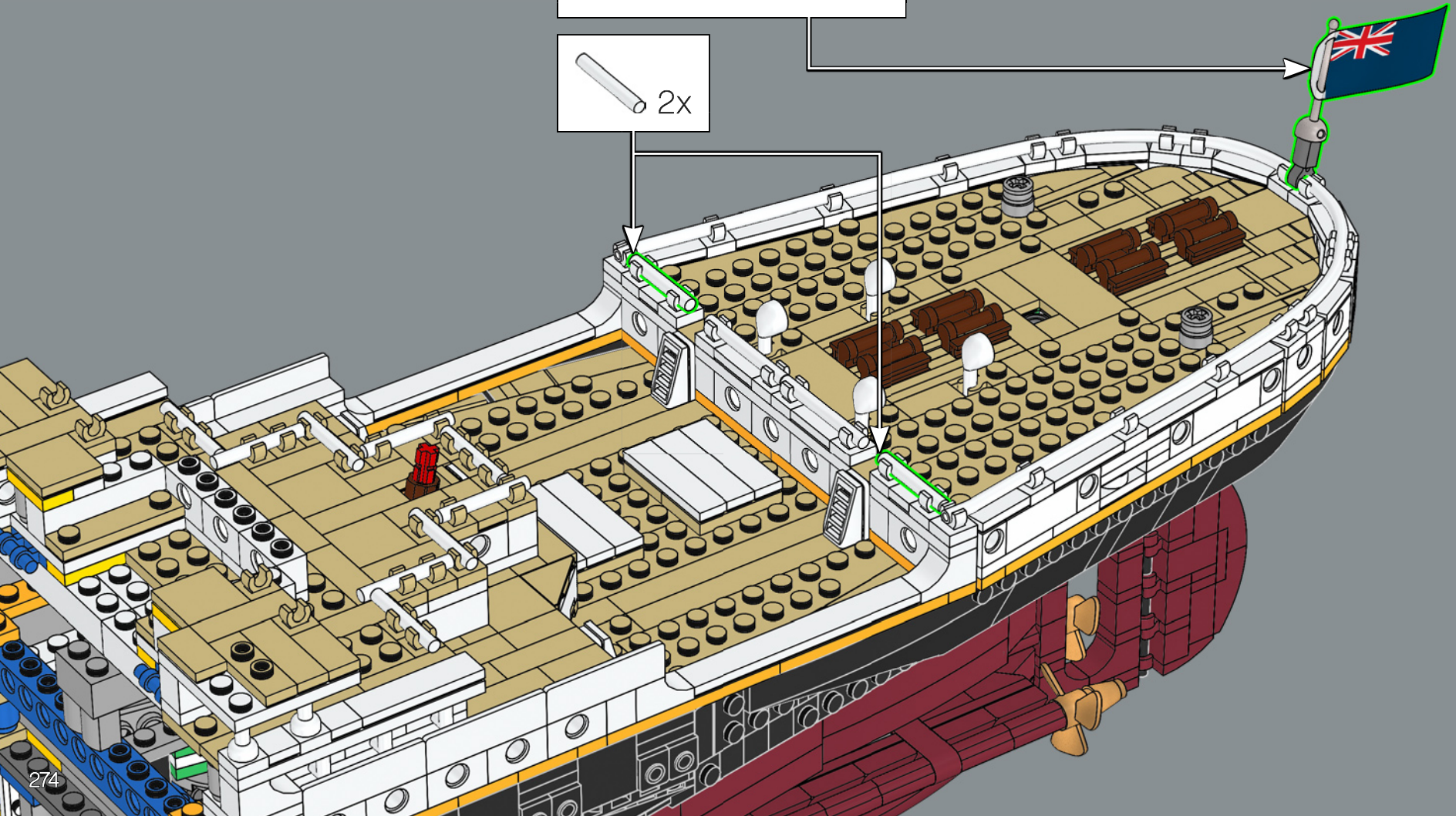
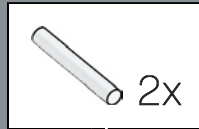
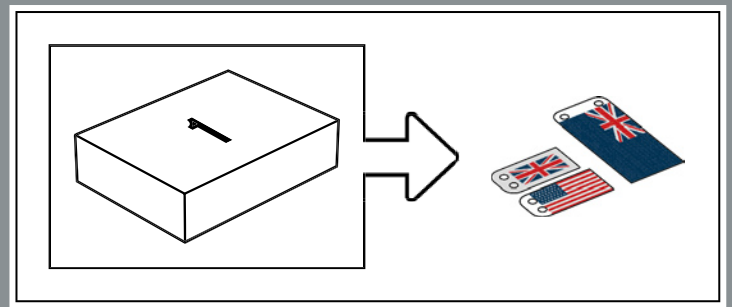
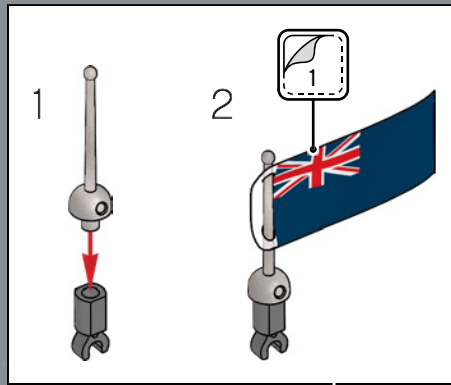

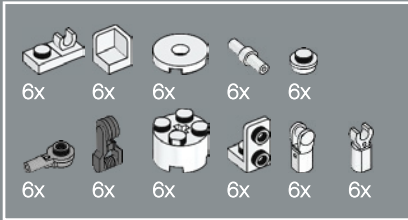
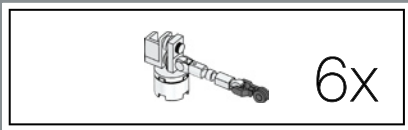

377

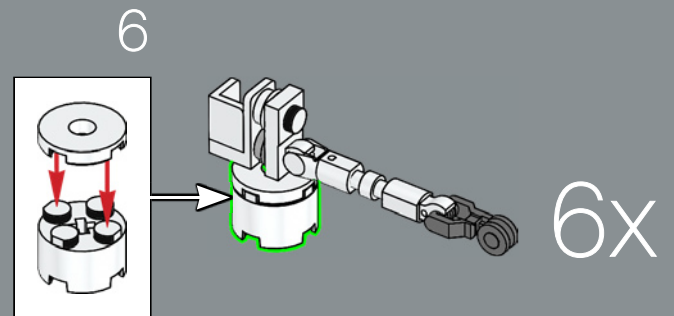
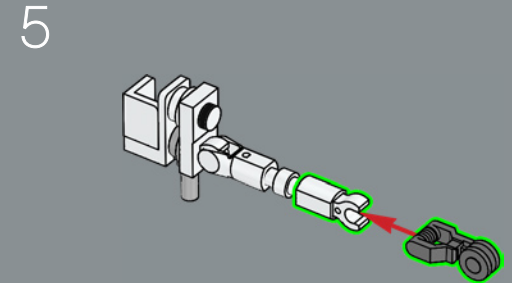
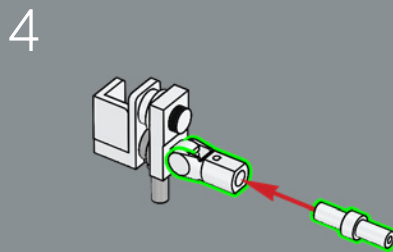
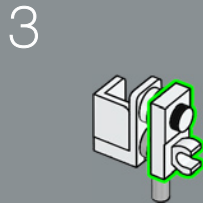
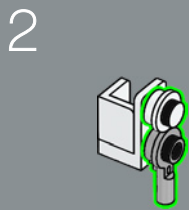
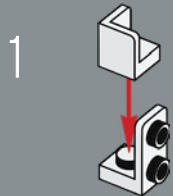

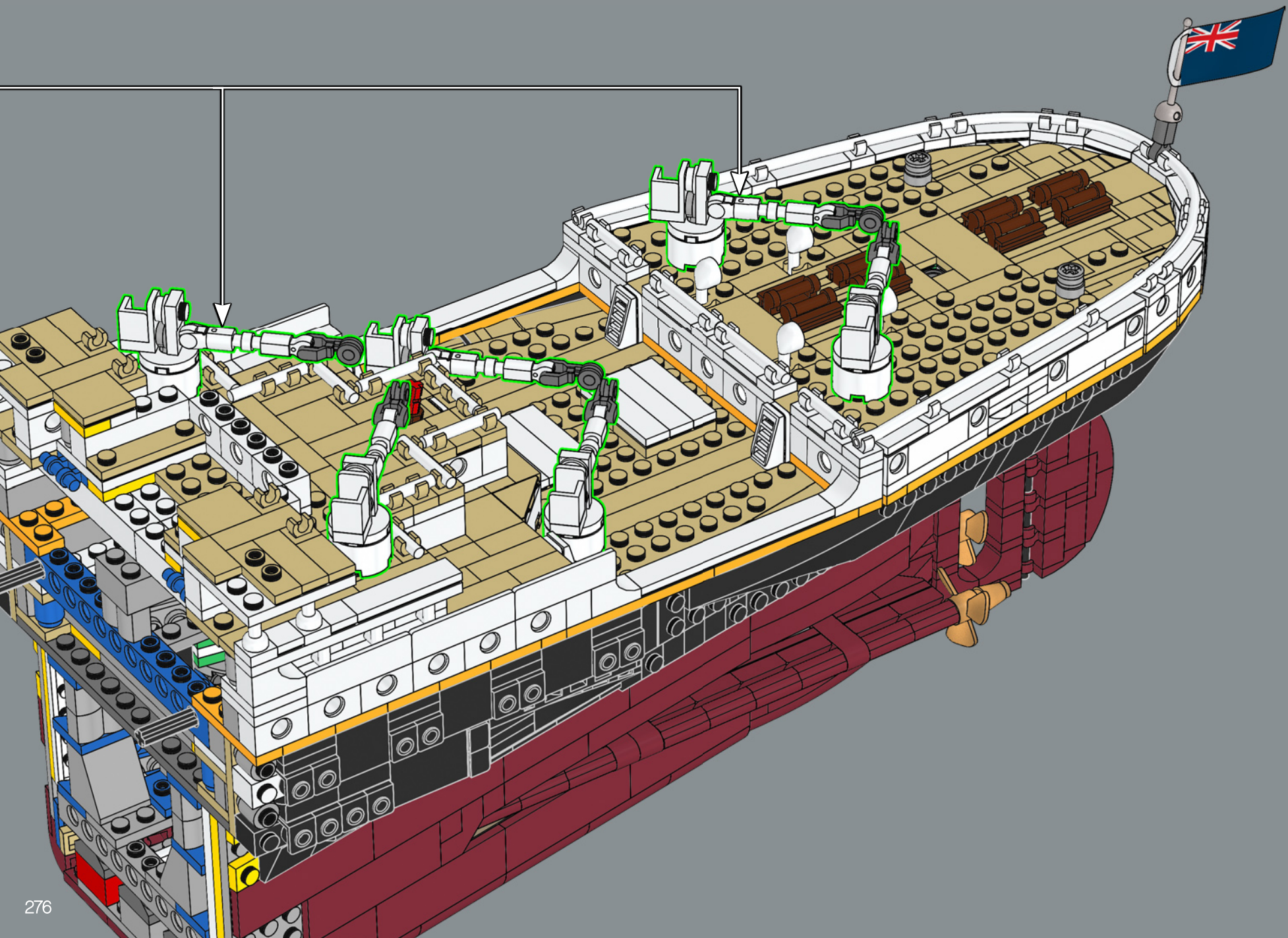

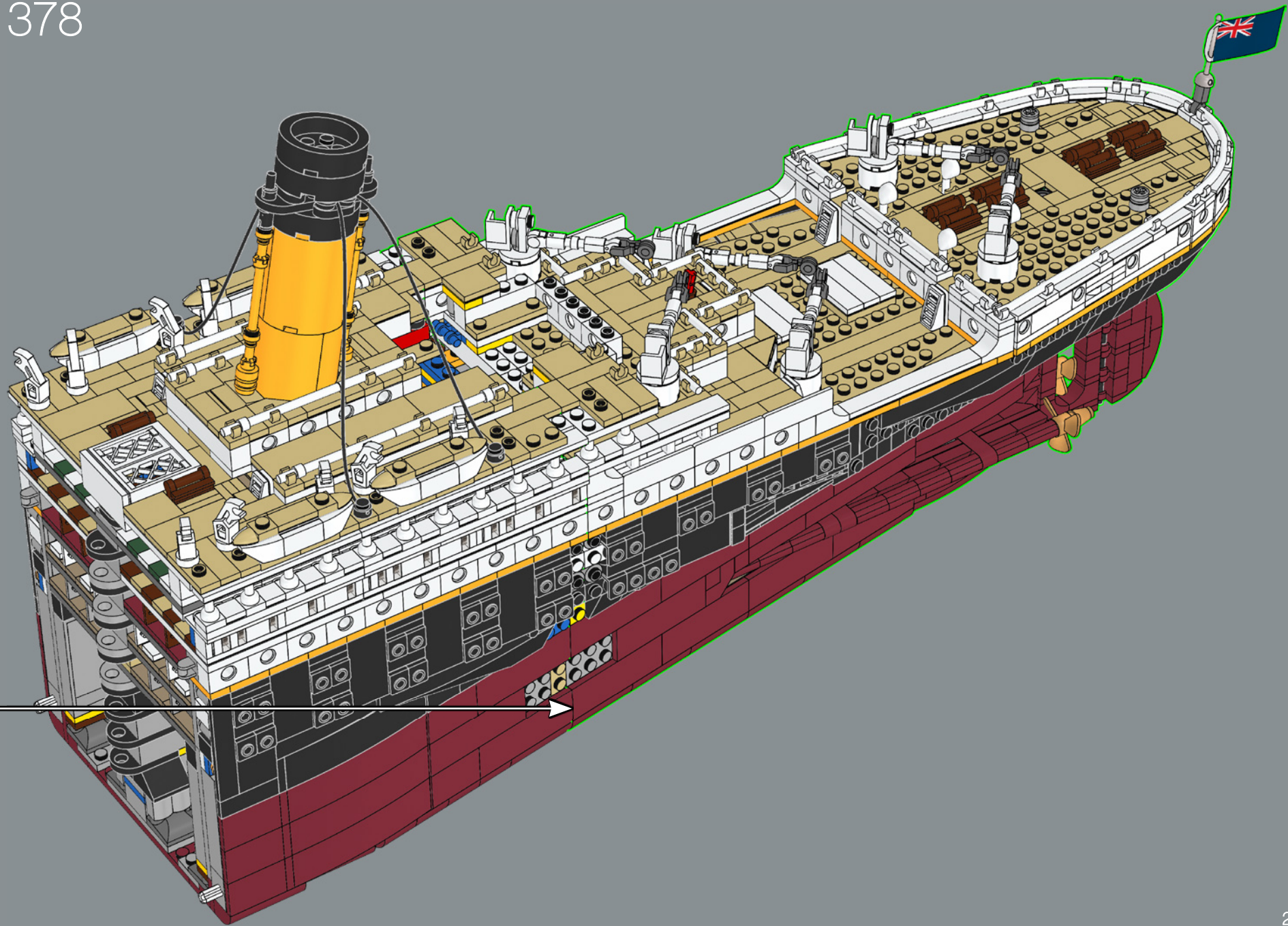

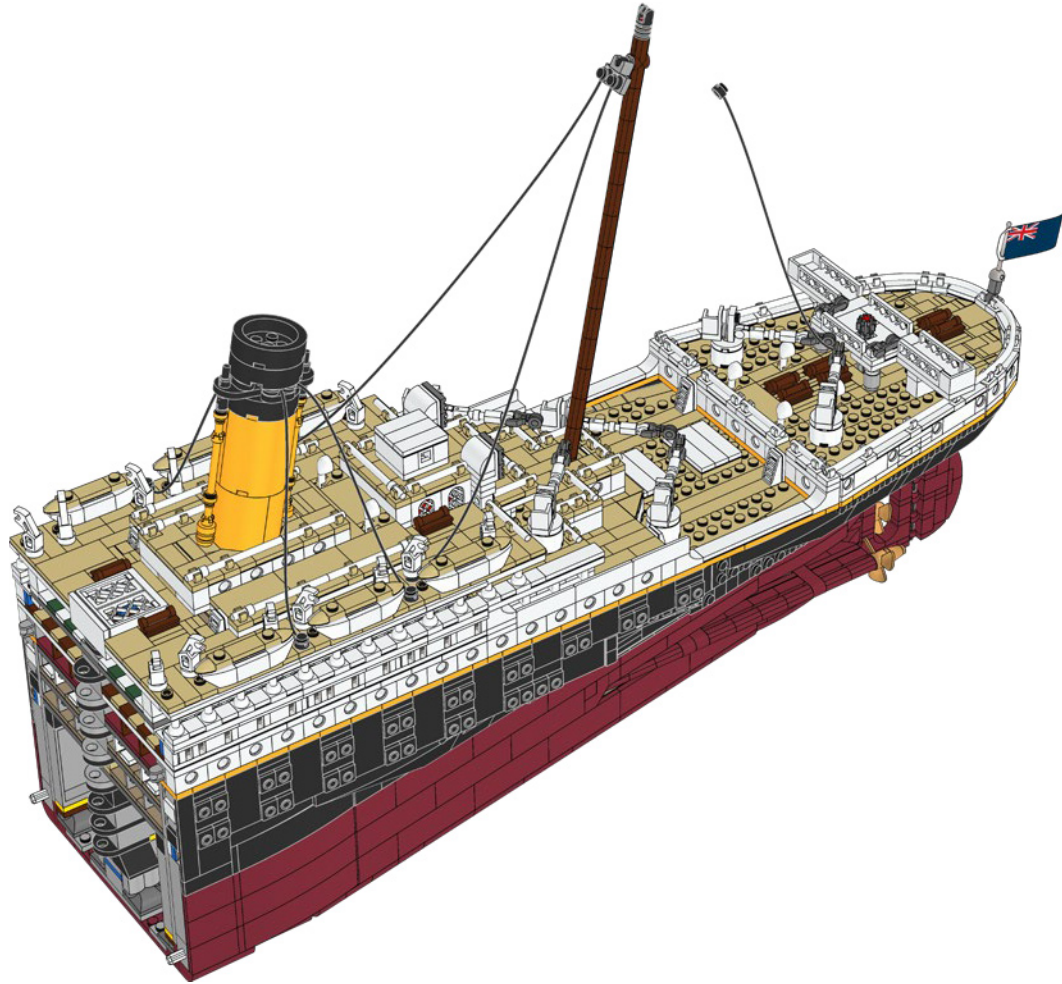
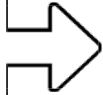

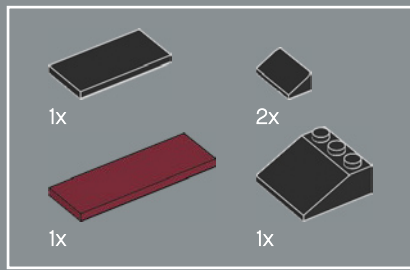

379

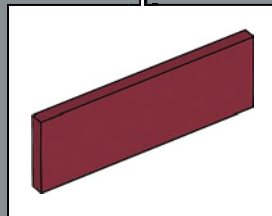
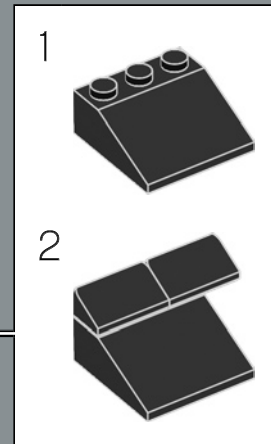
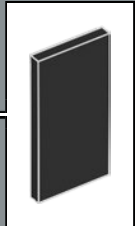
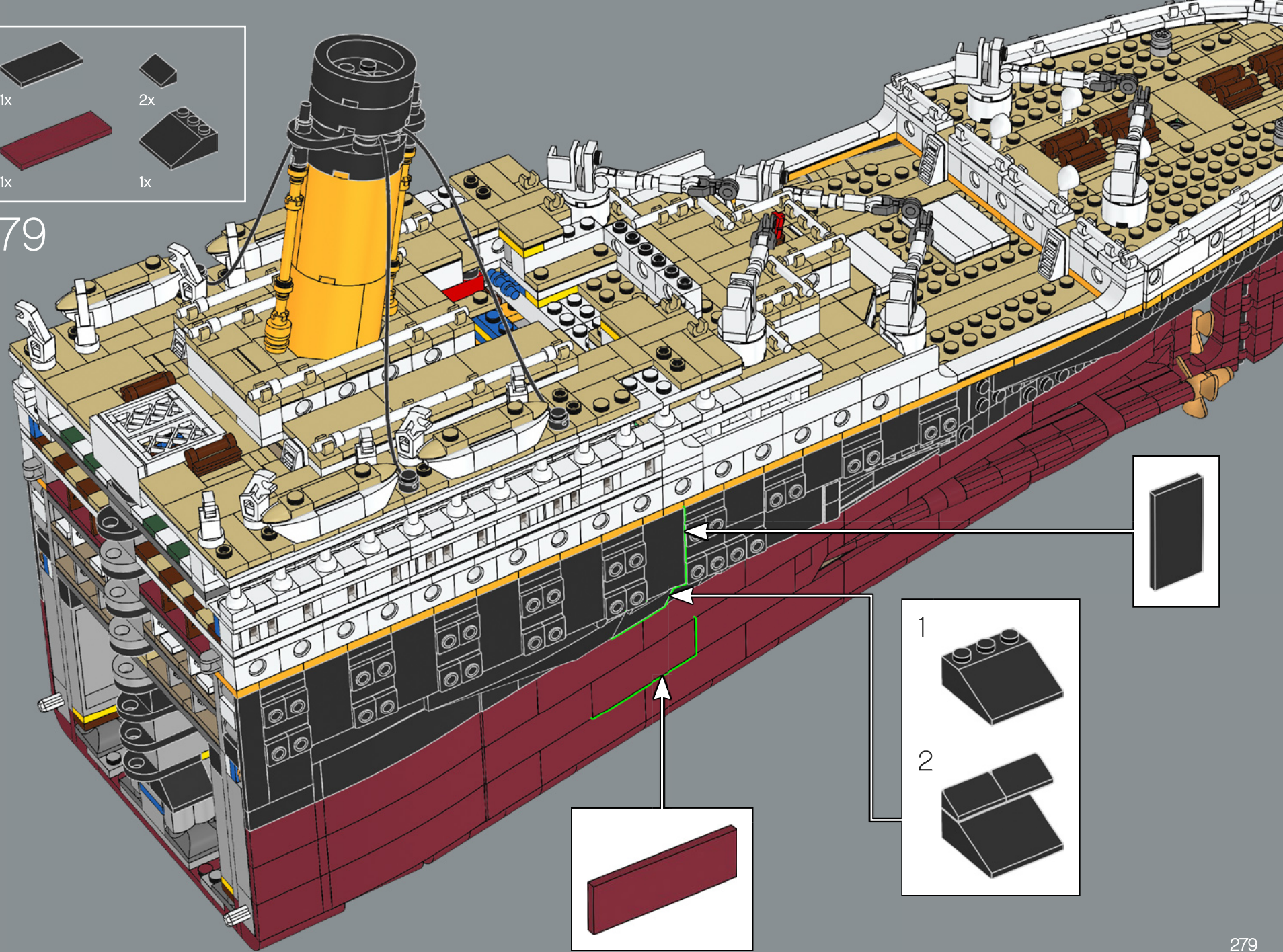

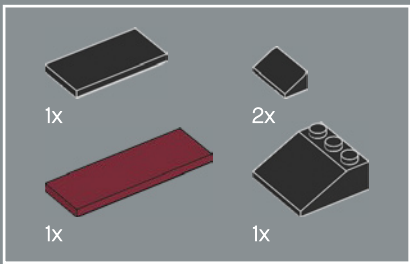

380

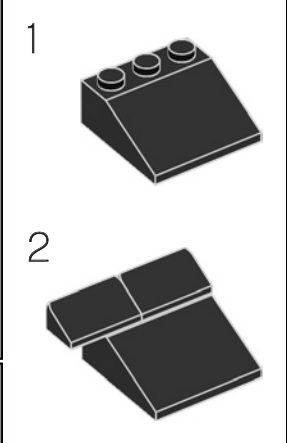
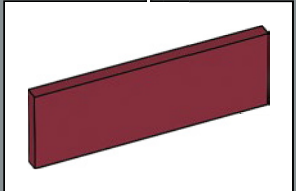
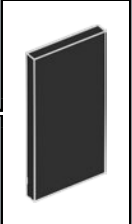
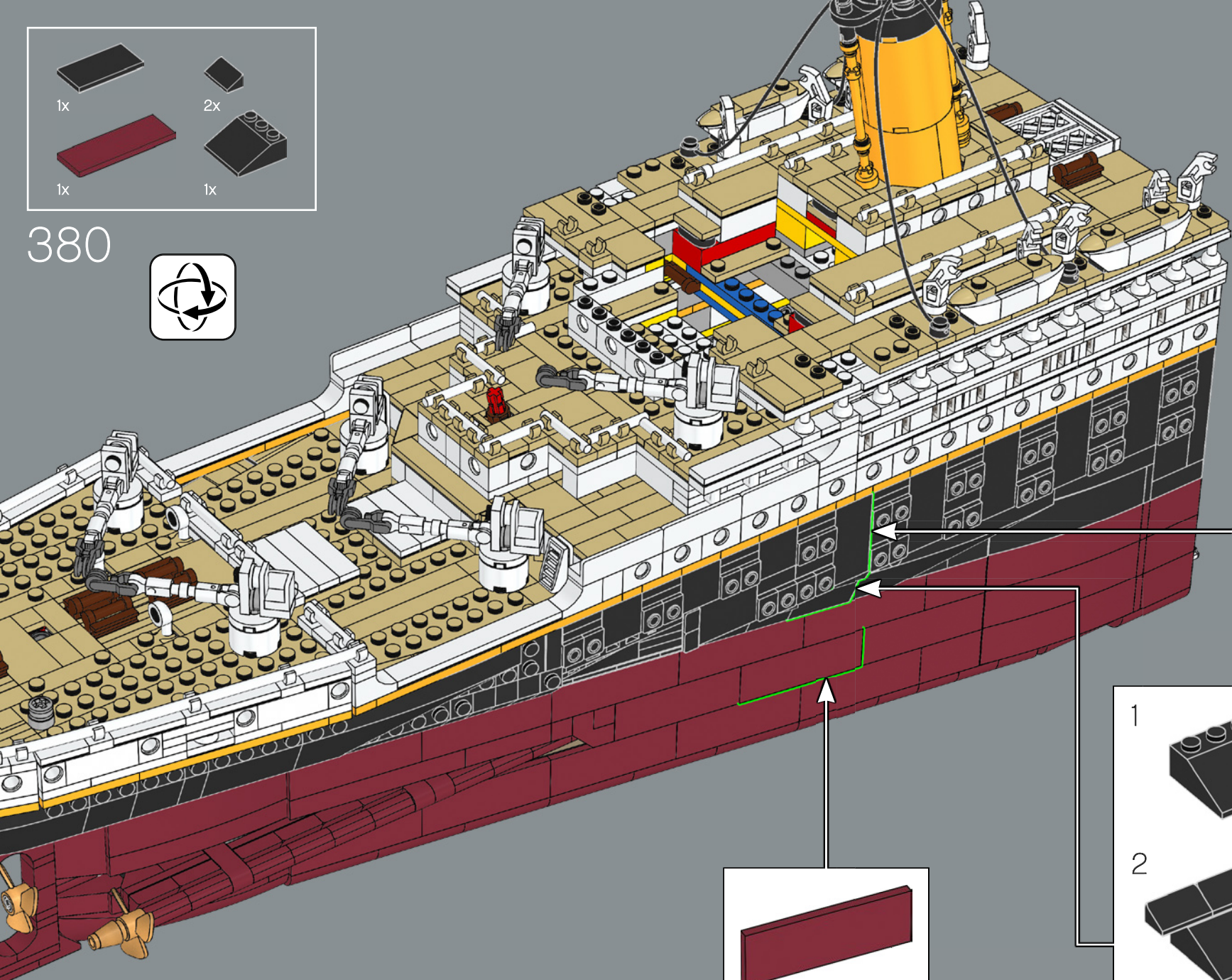



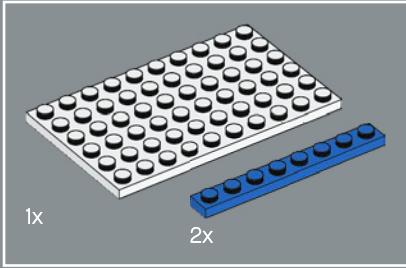
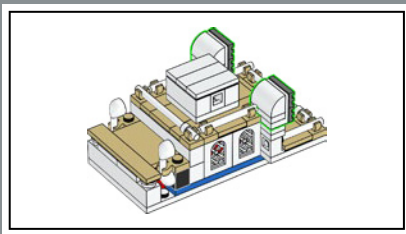

381

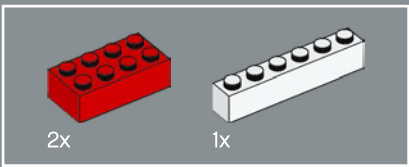
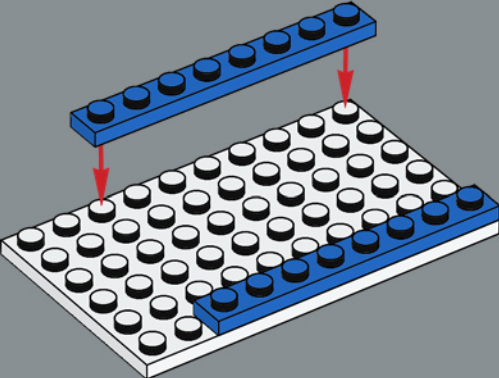

382

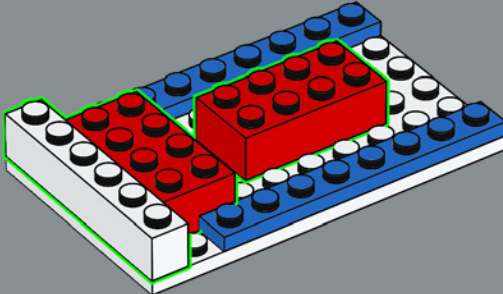

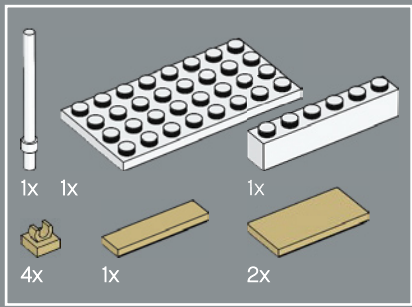

383

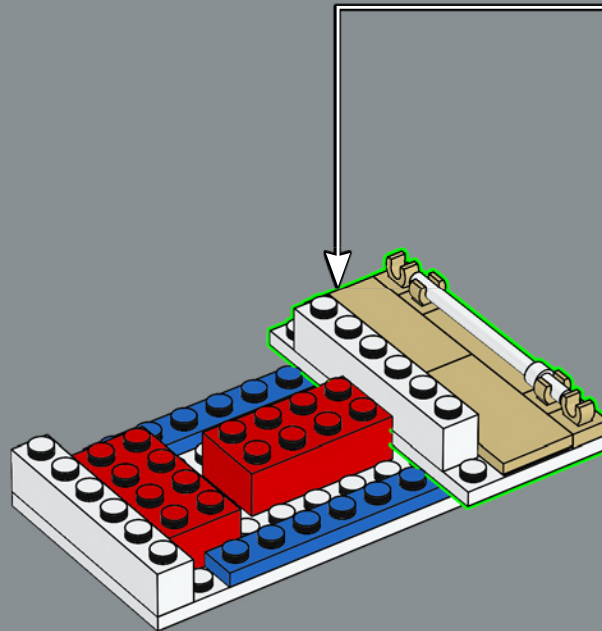
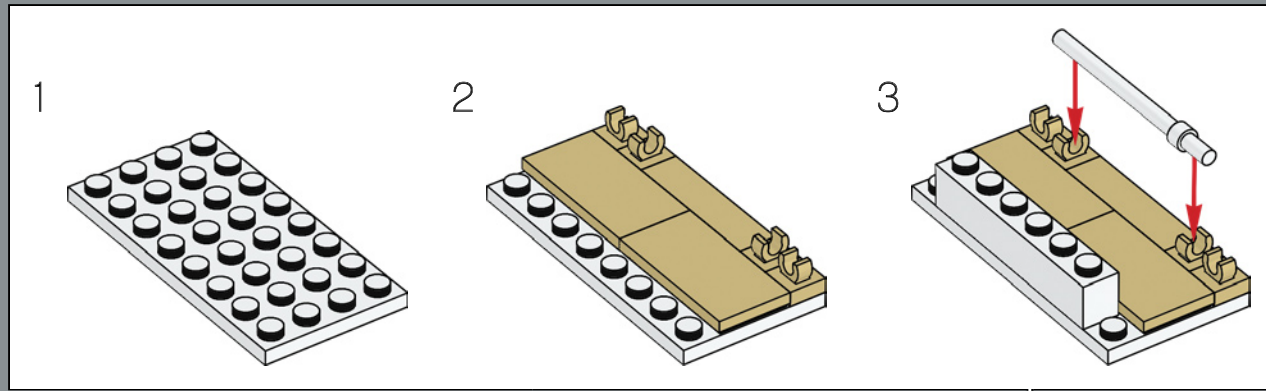

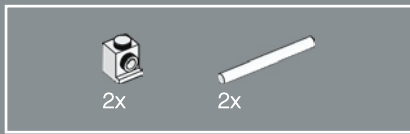

384

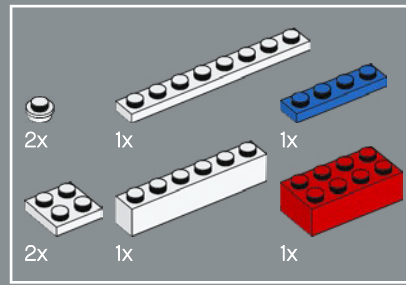
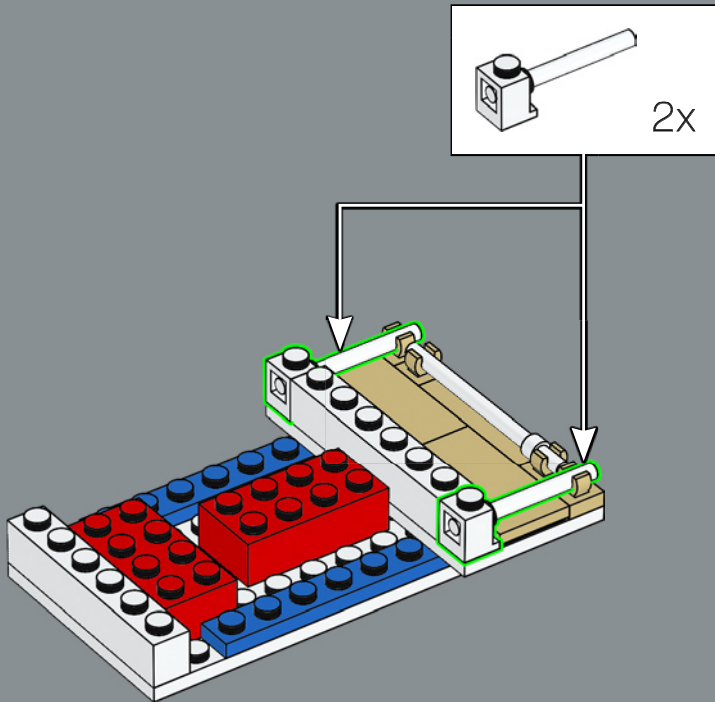

385

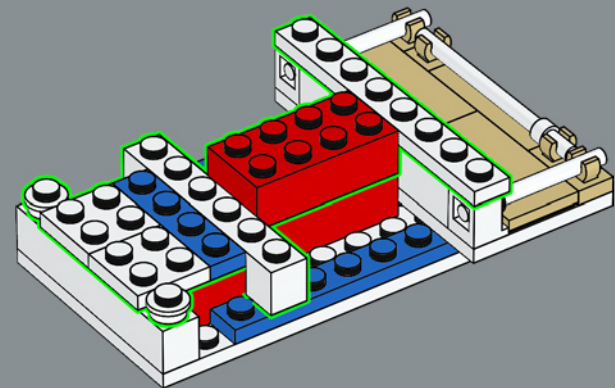

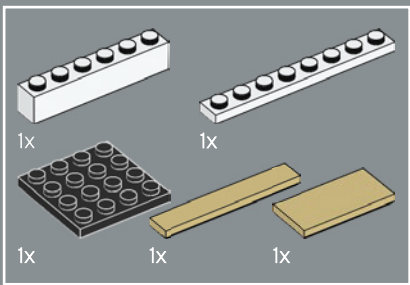

386

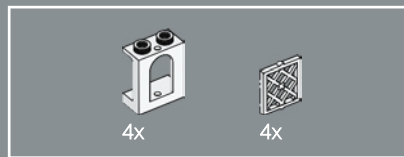
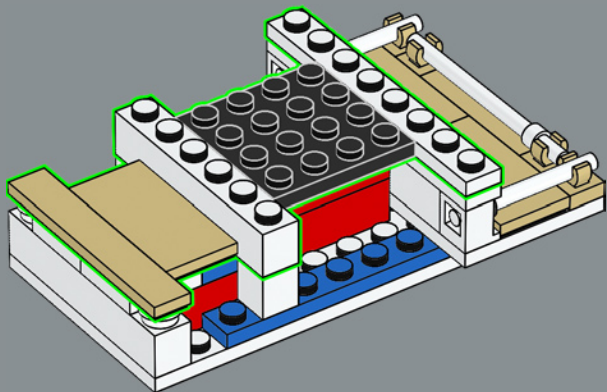

387

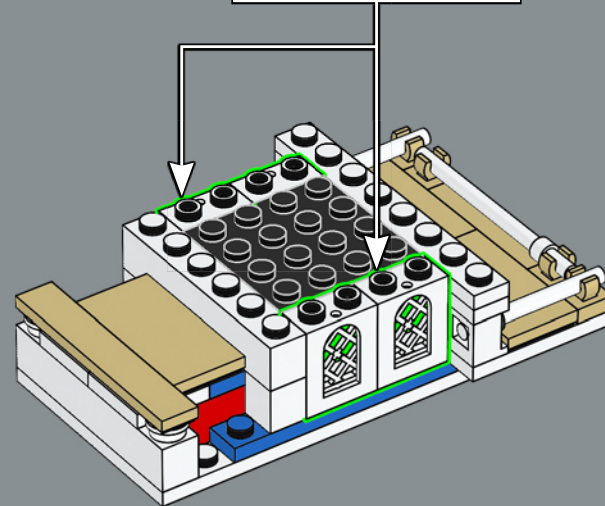
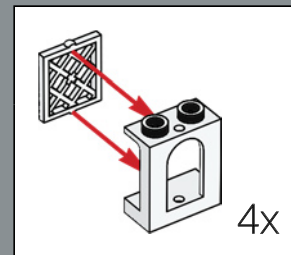

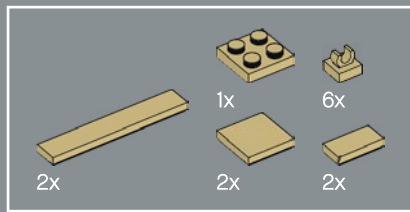

388

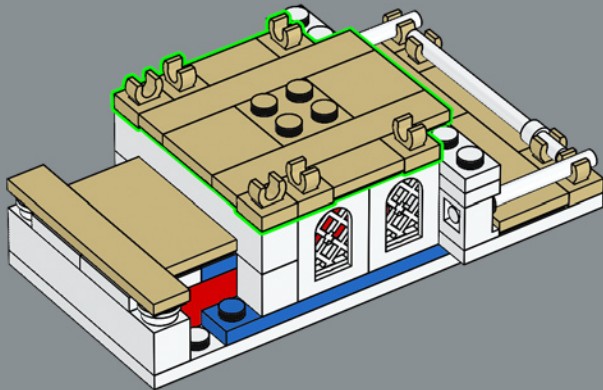

389

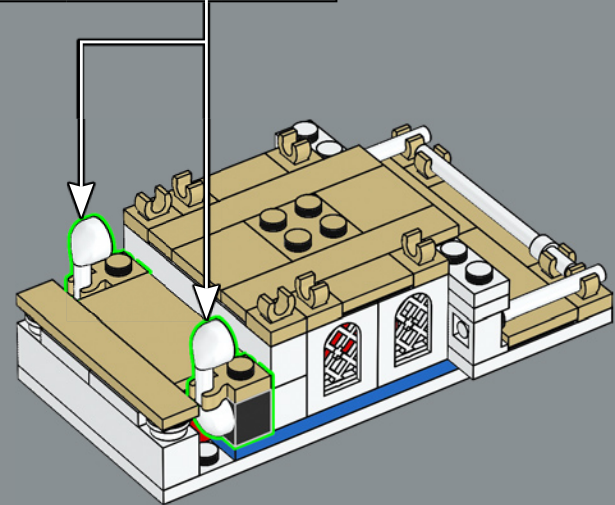
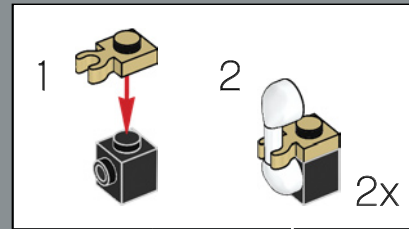

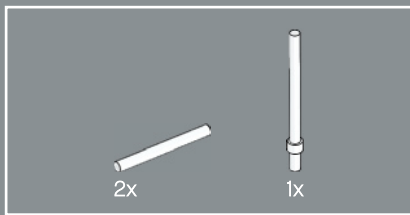

390

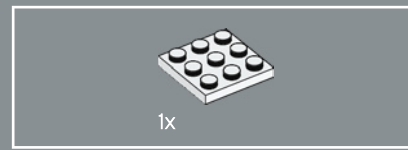
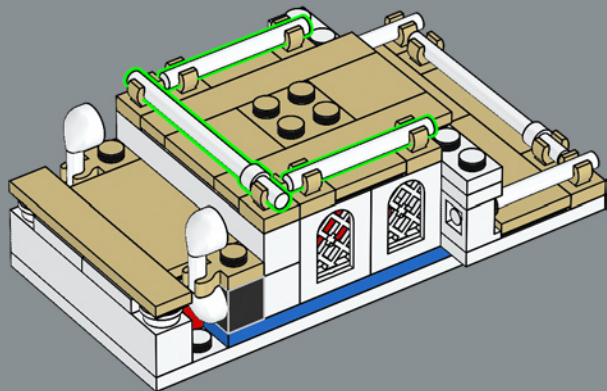

391

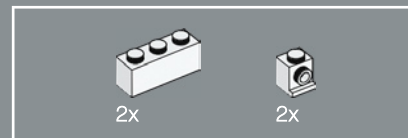
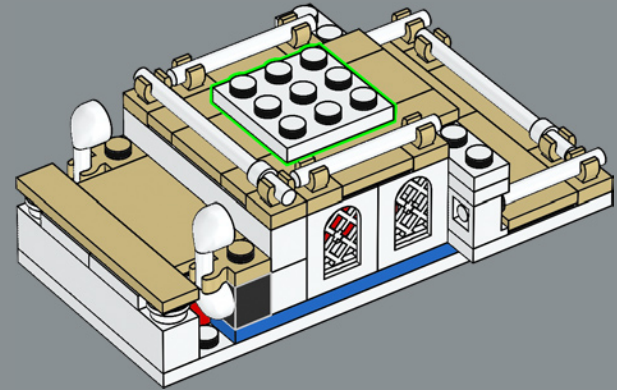

392

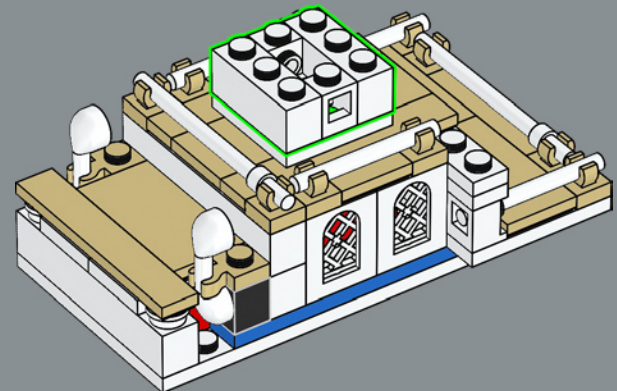

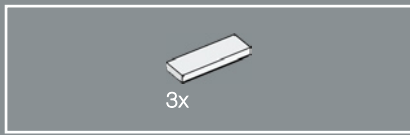

393

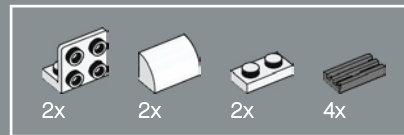
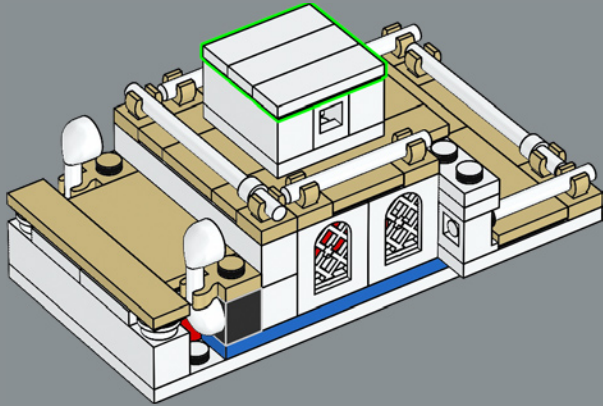

394

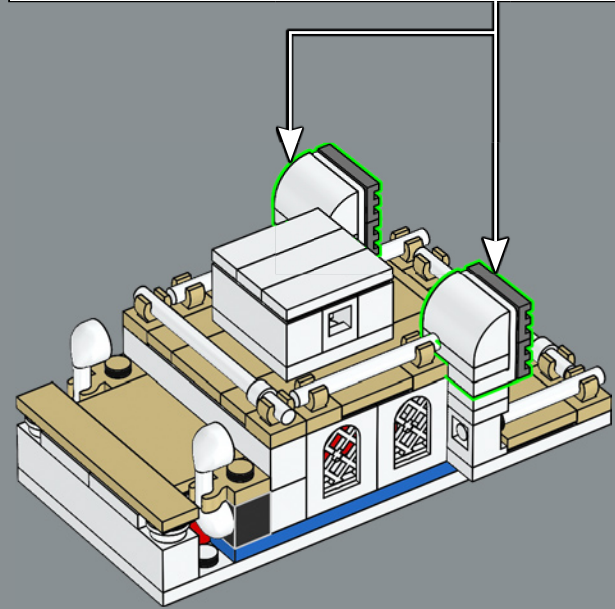
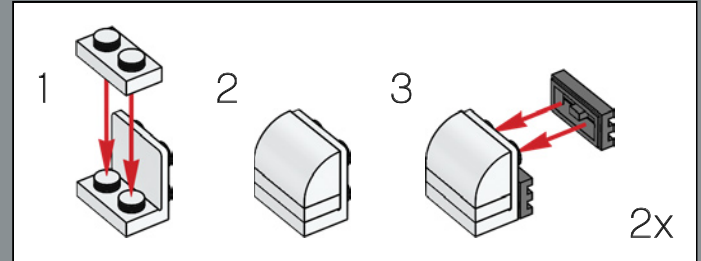

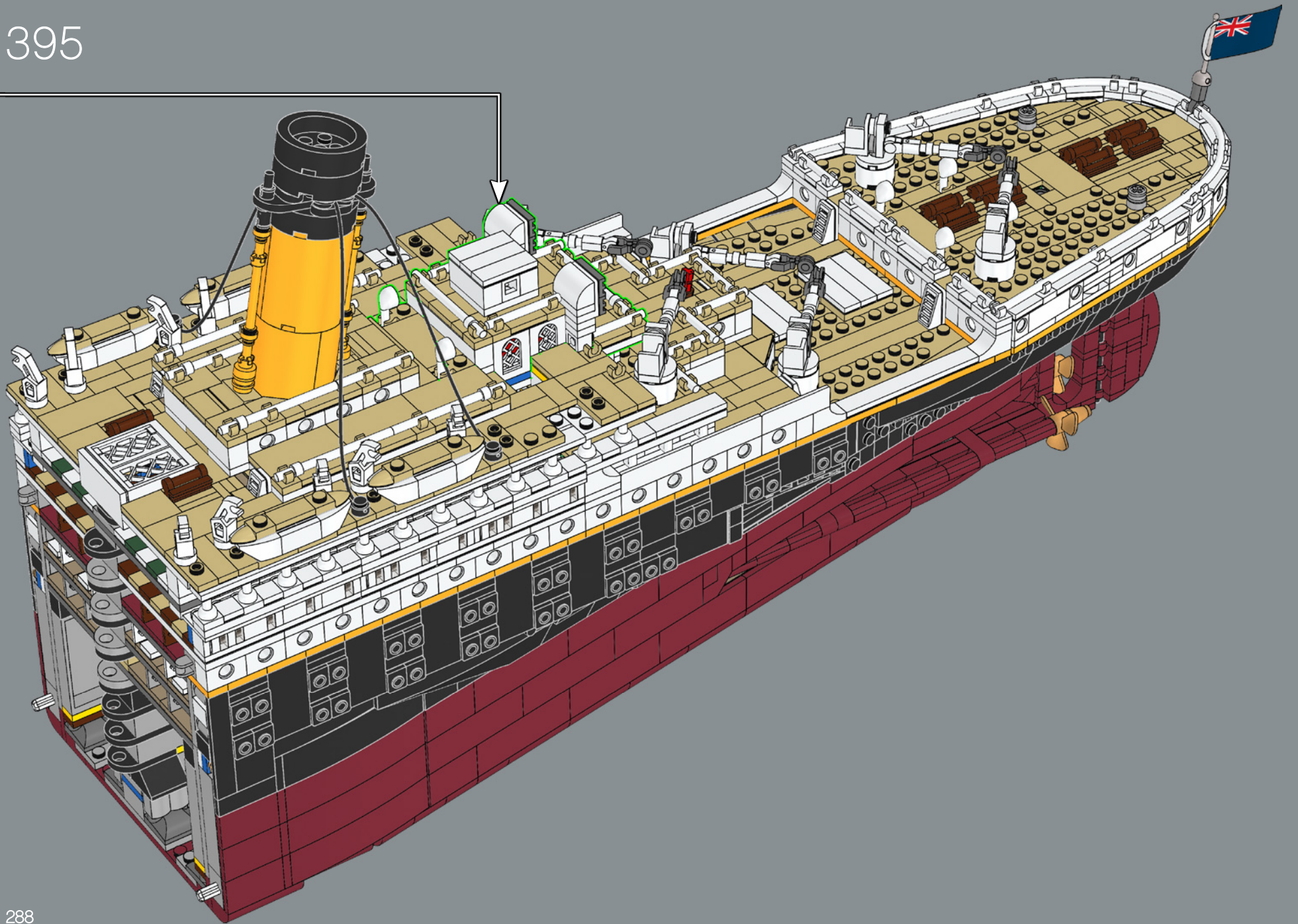



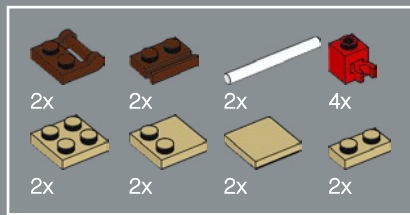

396

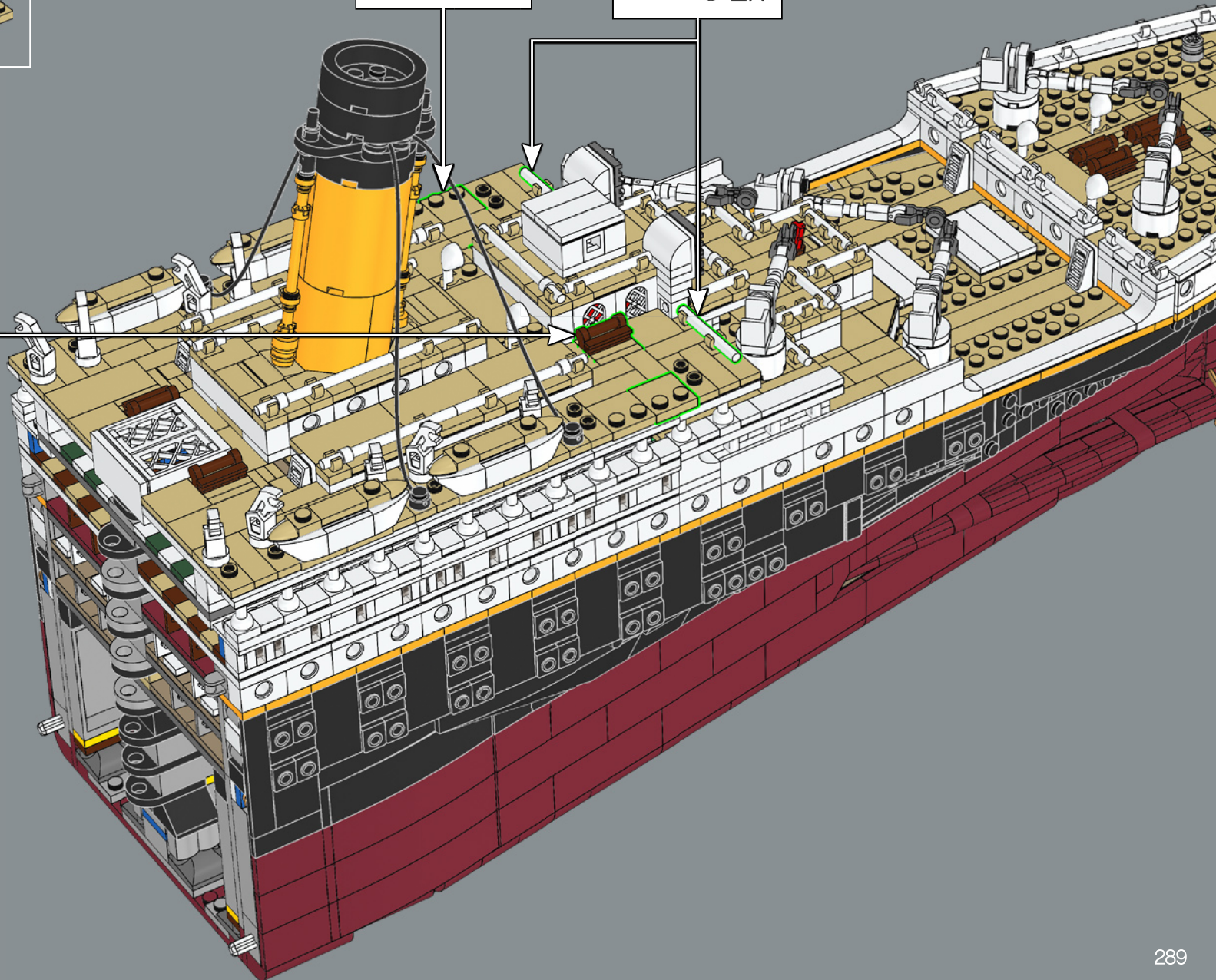
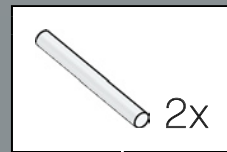
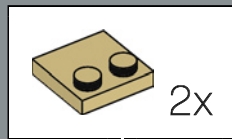
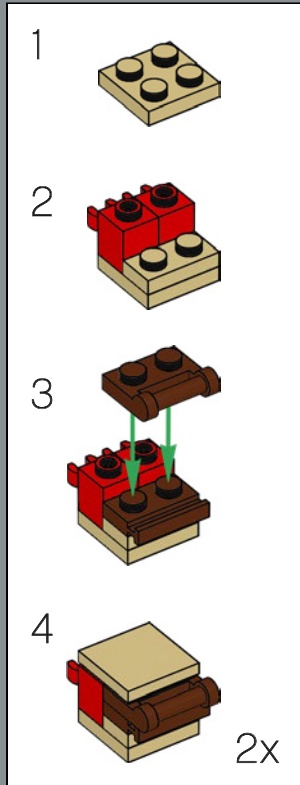

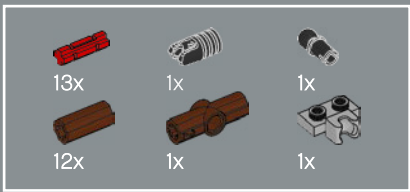

397

1

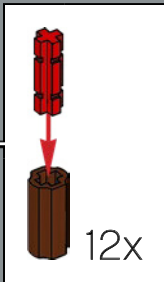
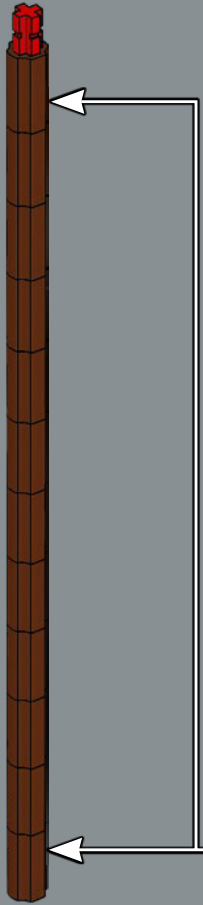

2



3

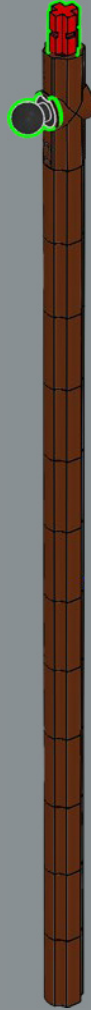

4

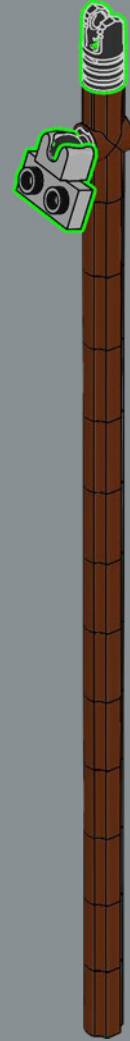

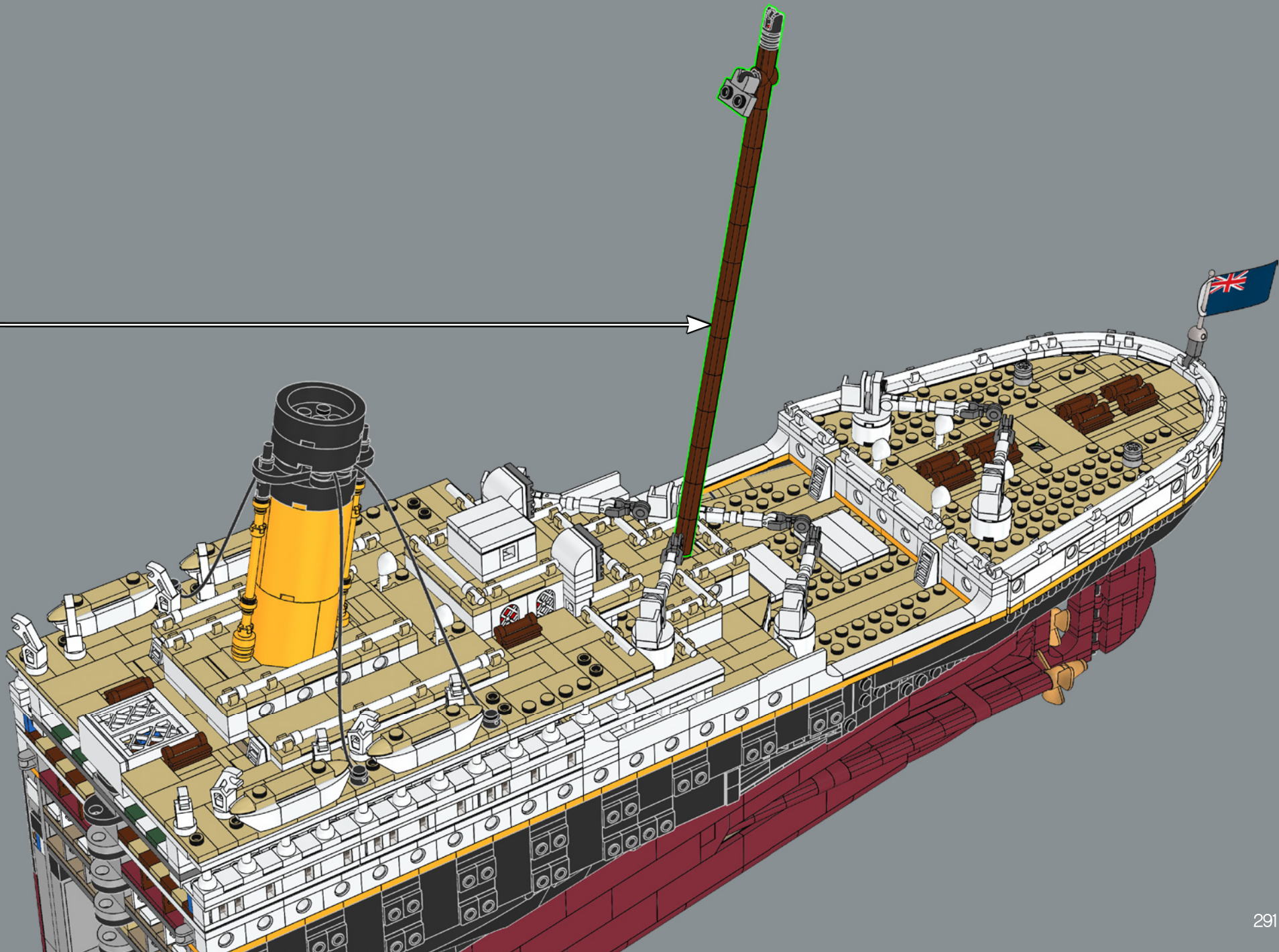

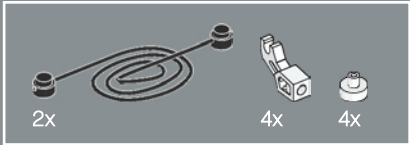
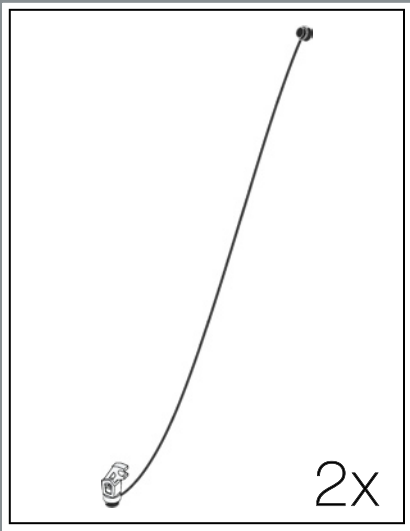

398

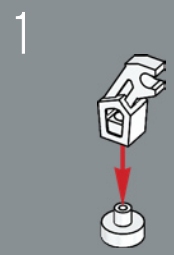

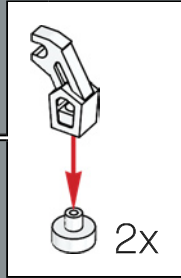
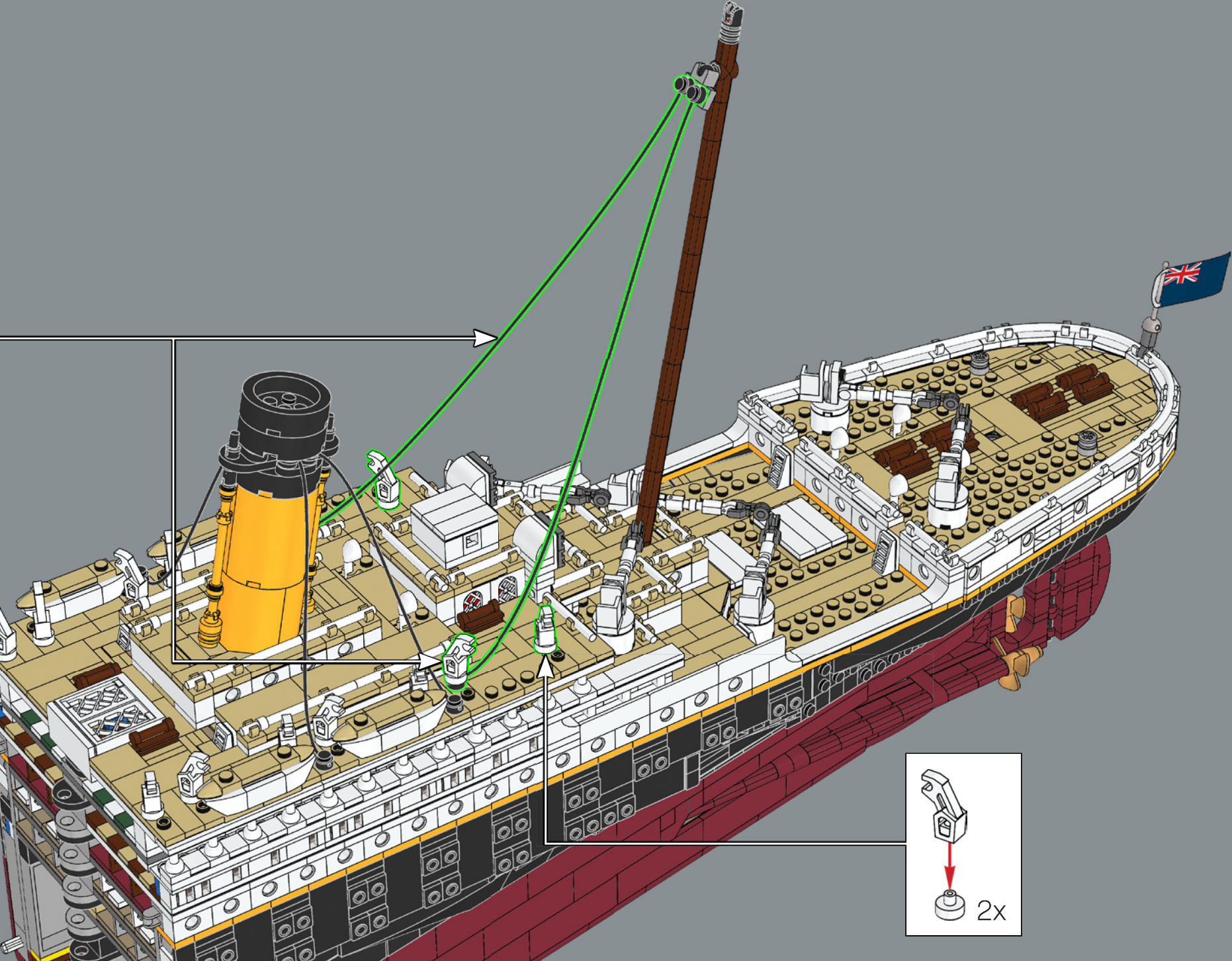



399

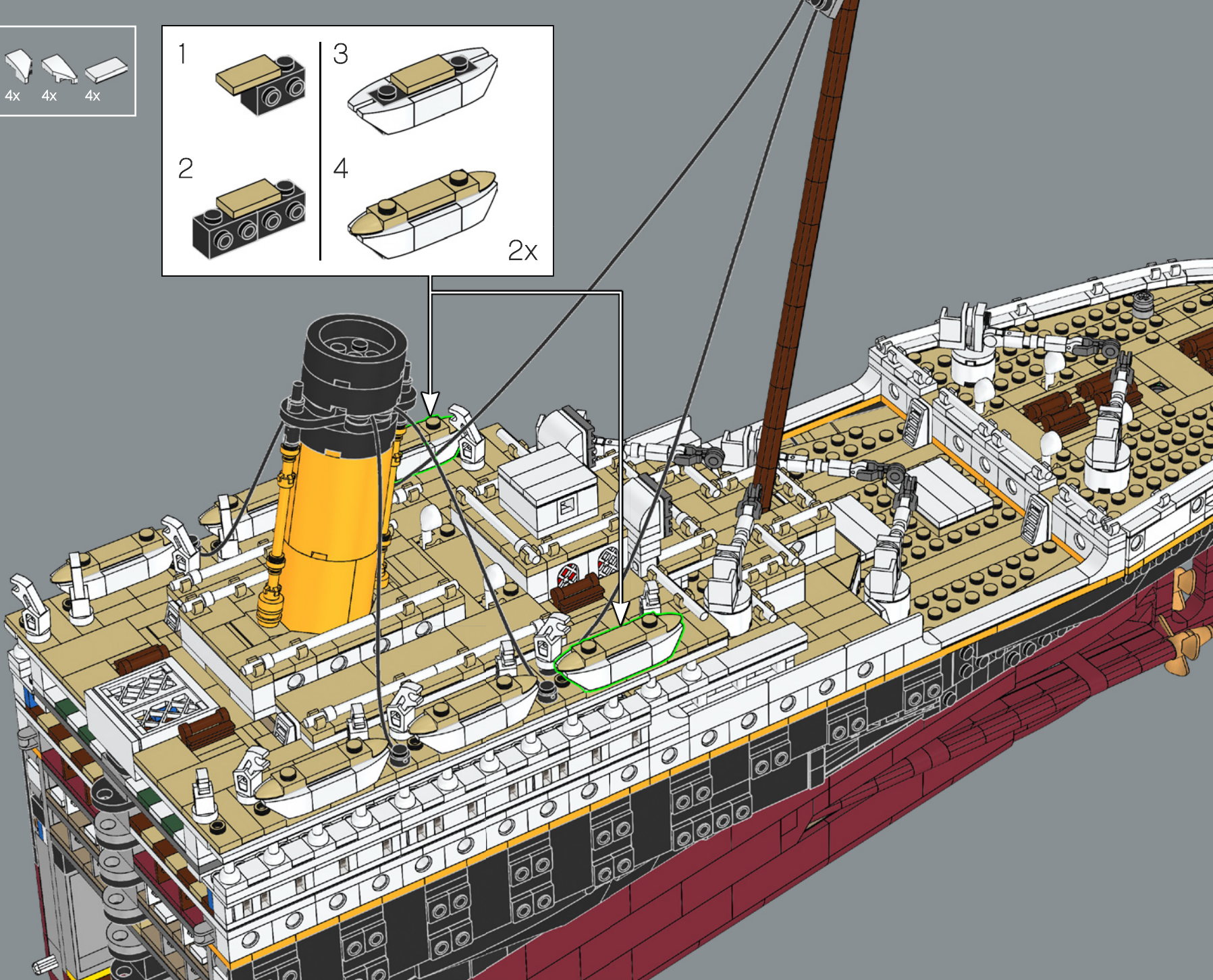
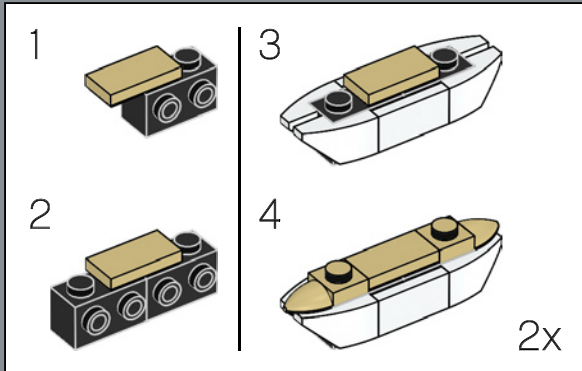

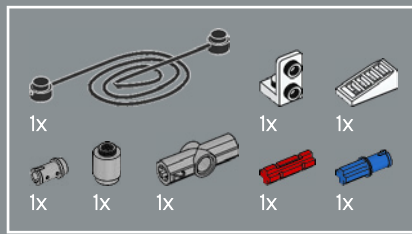

400

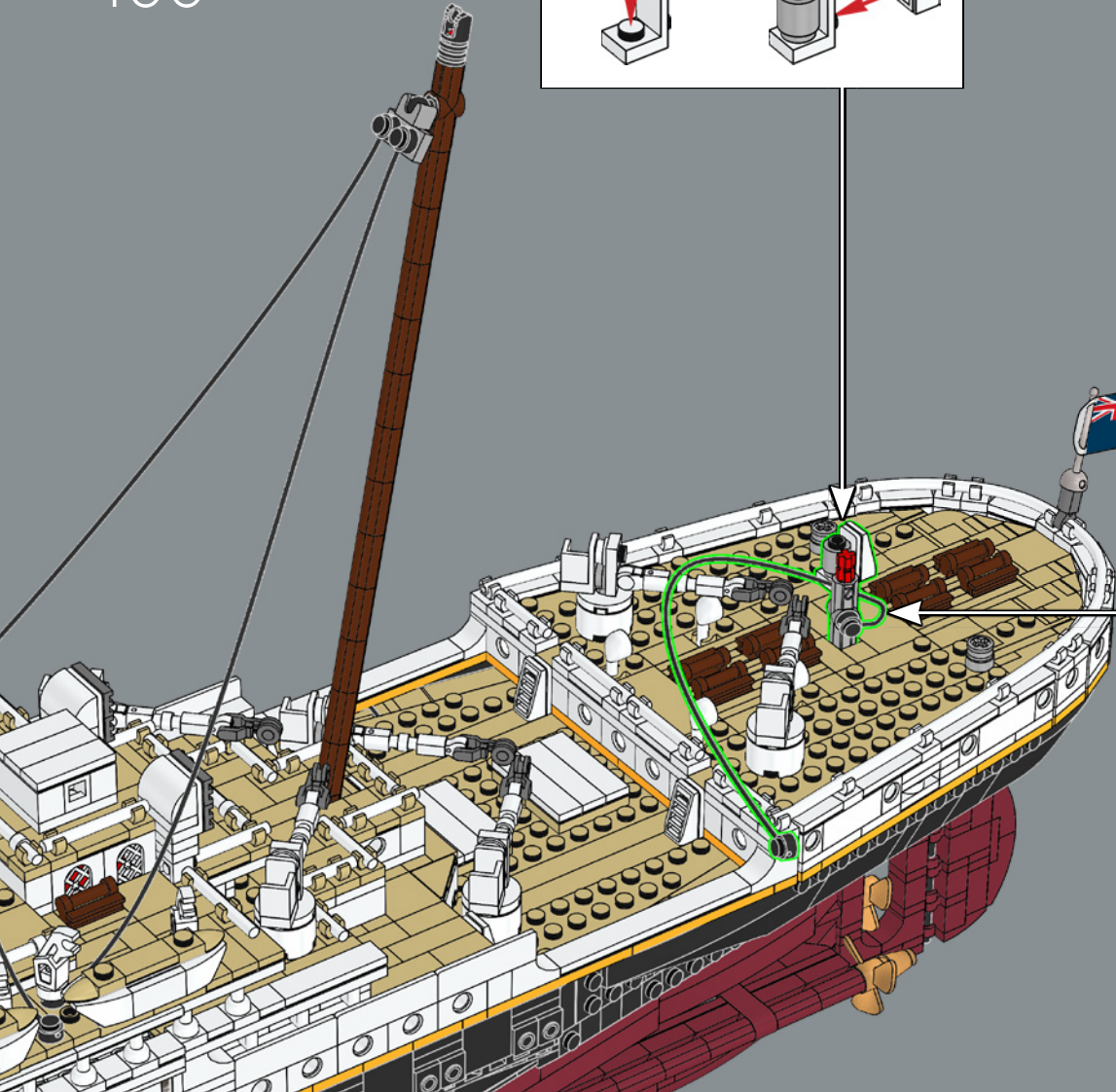
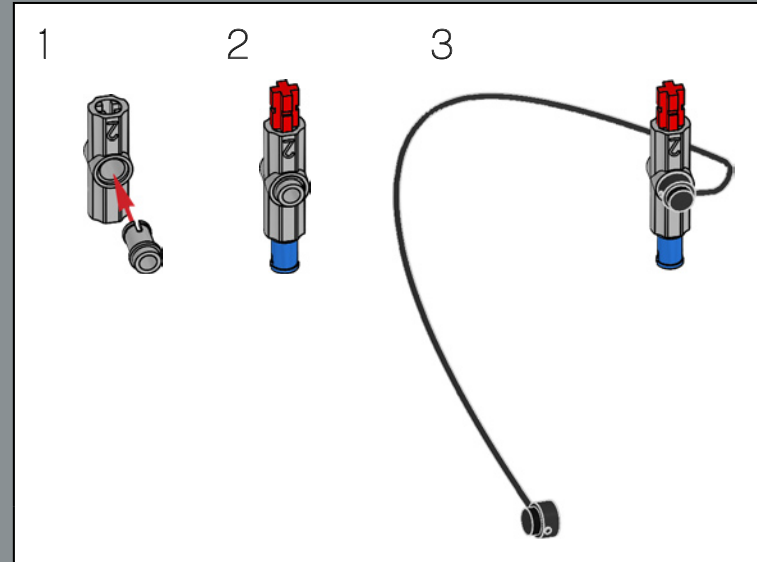
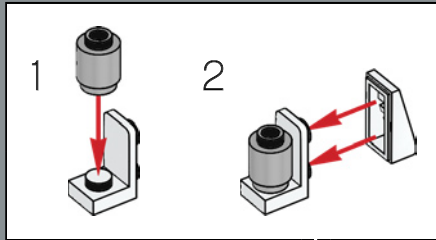

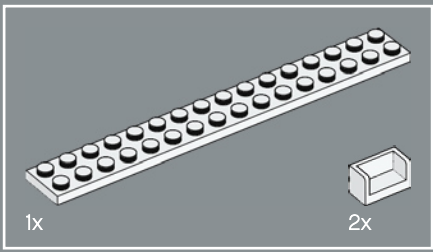

401

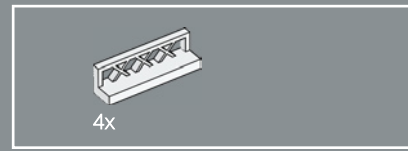
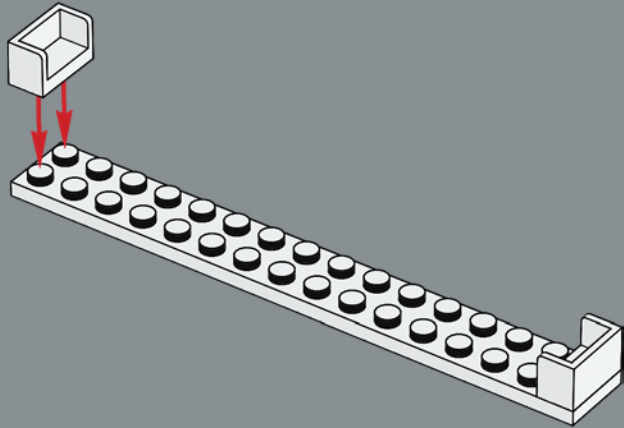

402

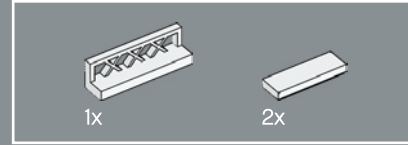
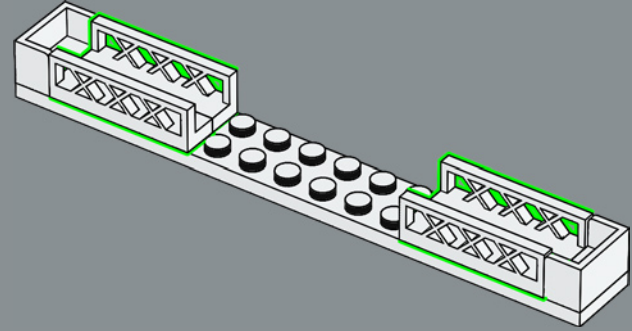

403

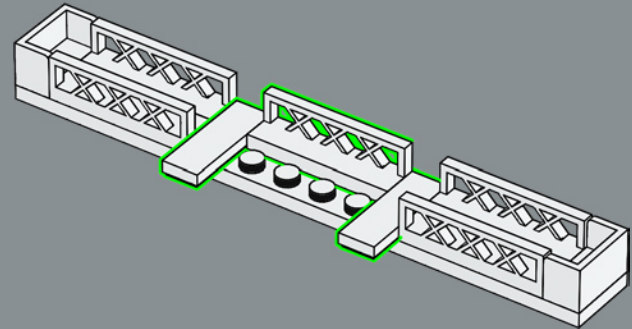



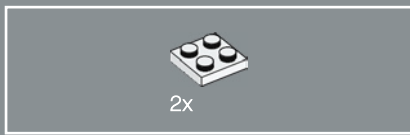

404

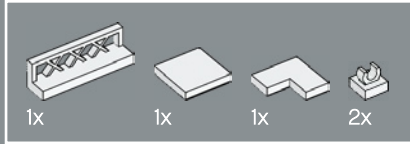
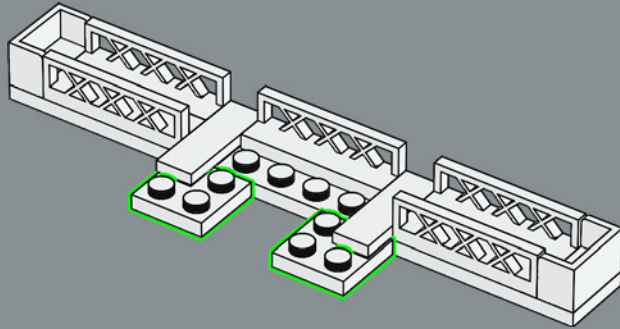

405

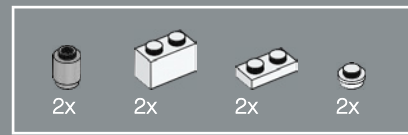
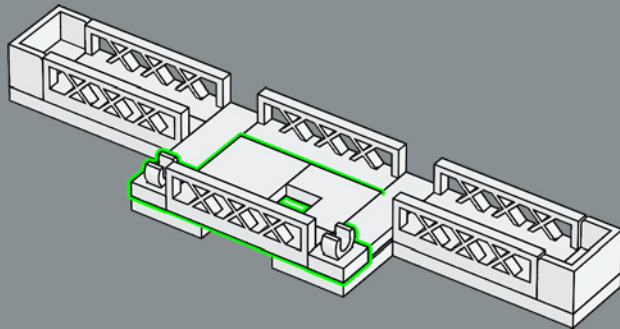

406

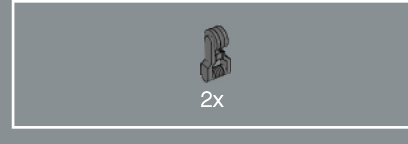
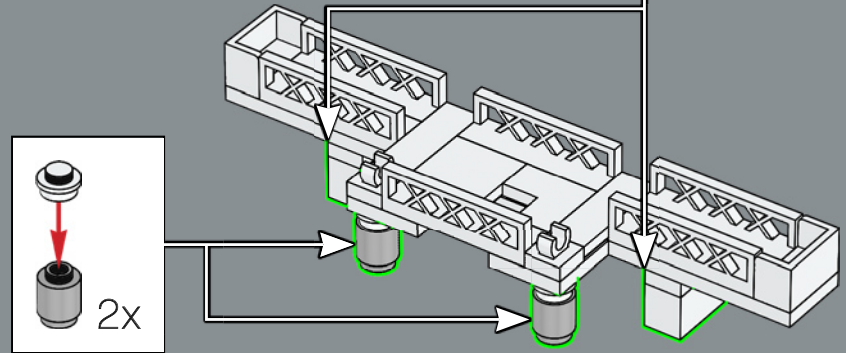

407

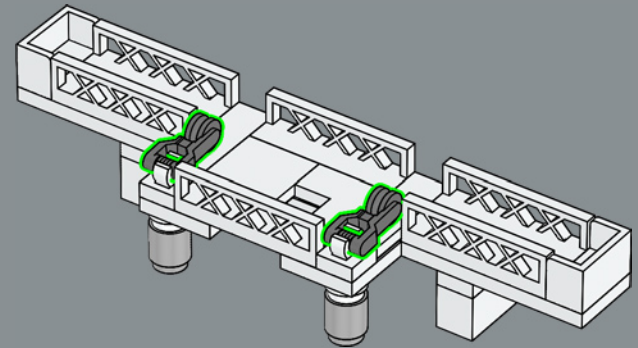



1x

408

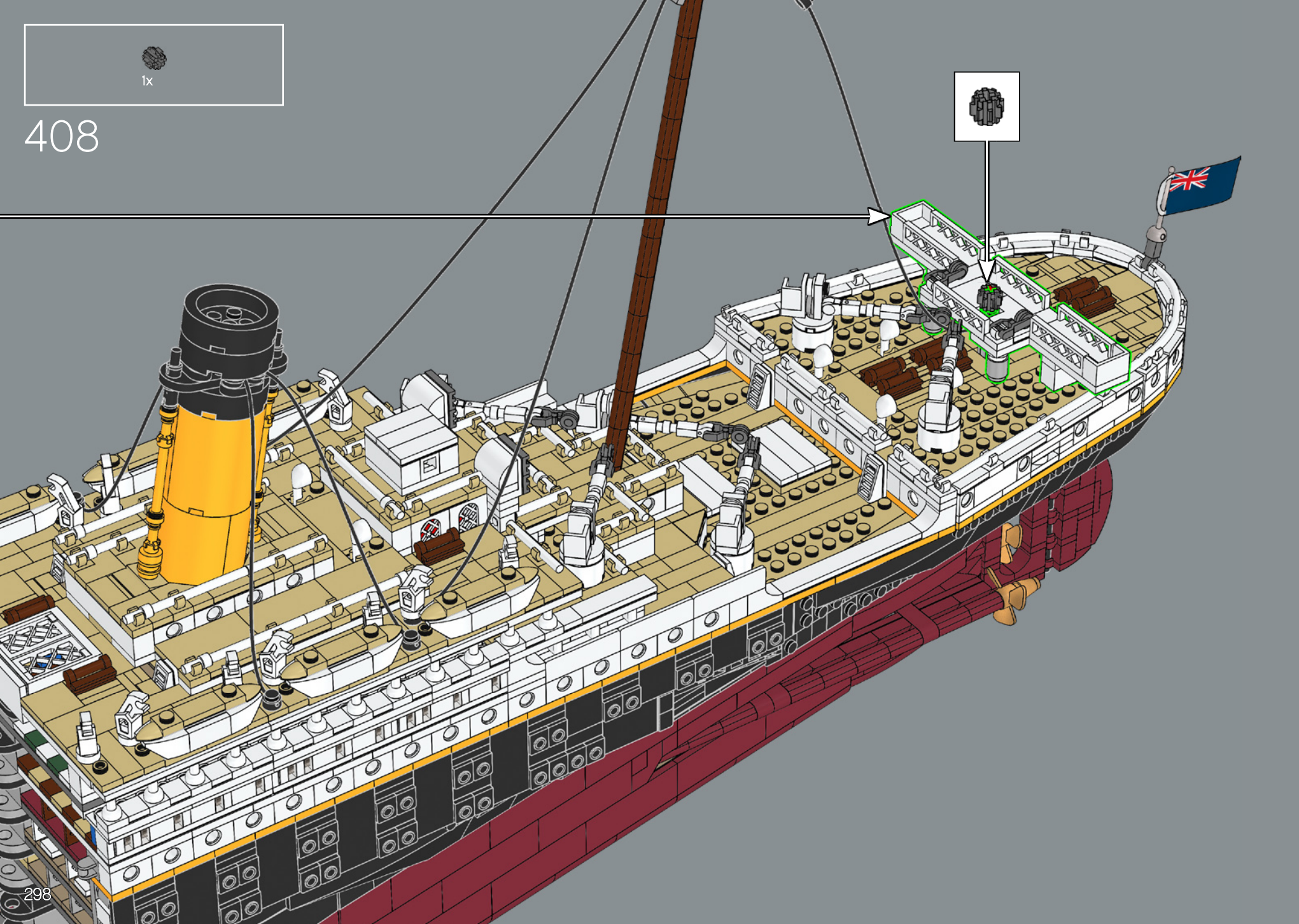

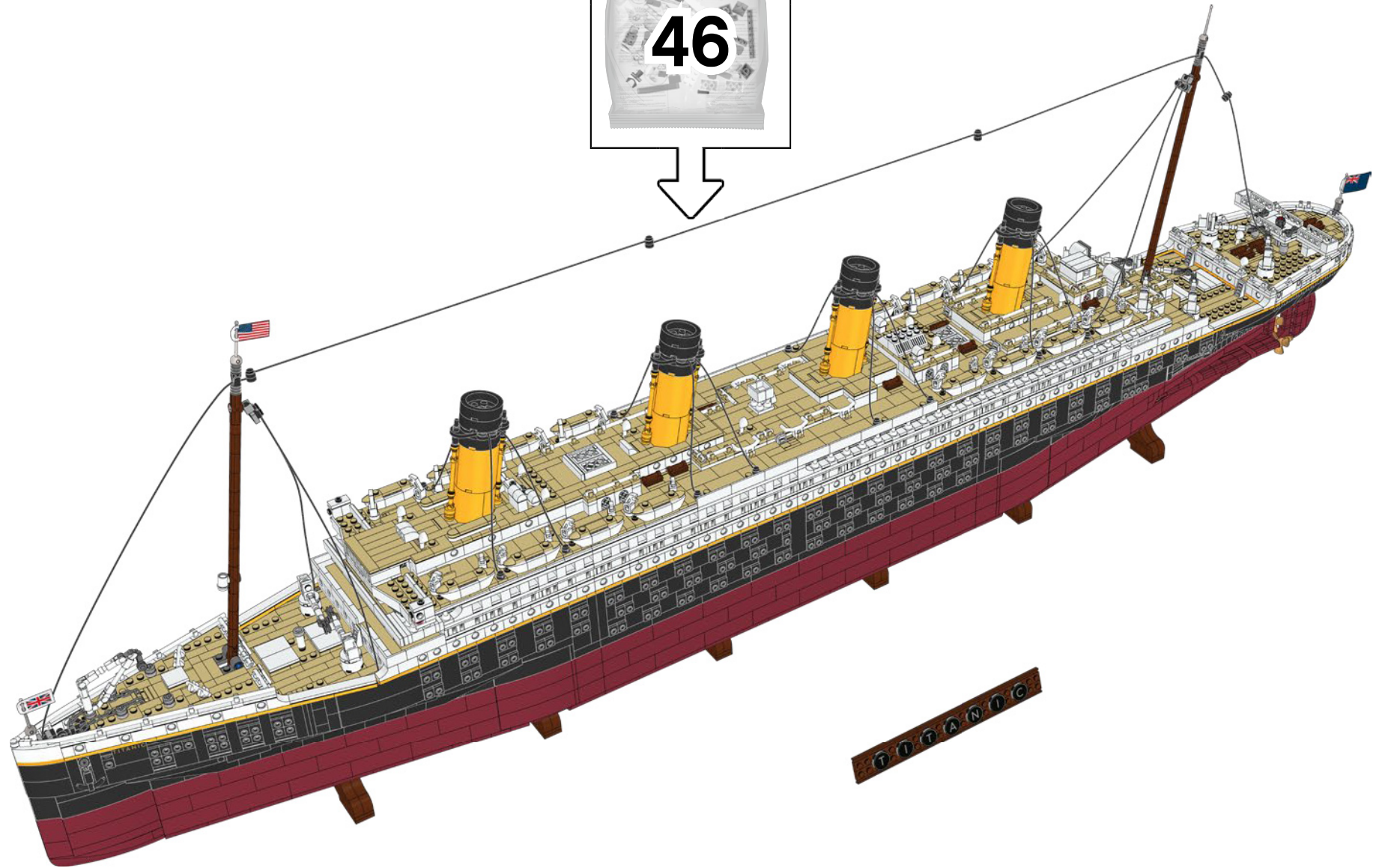

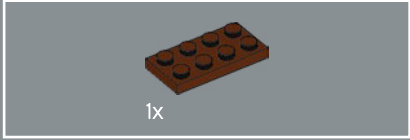
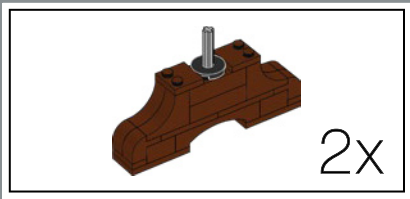

409

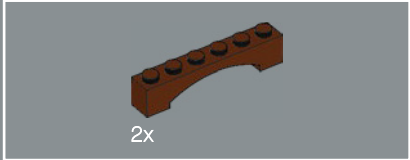
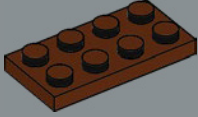

410

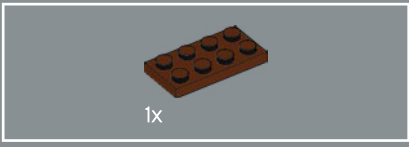
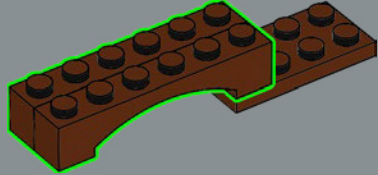

411

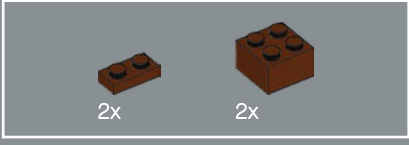
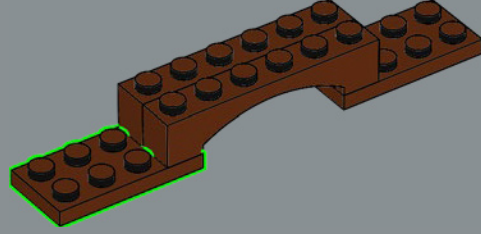

412

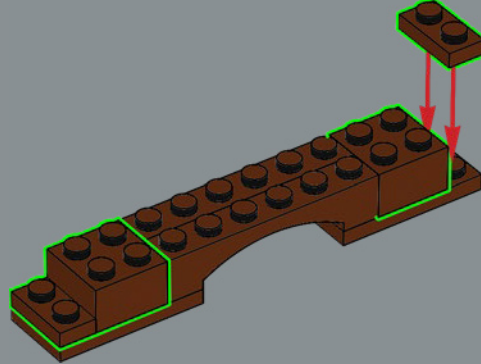

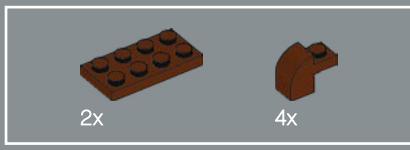

413

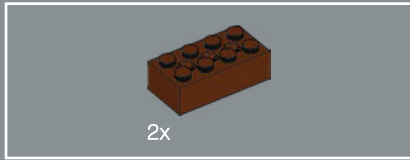
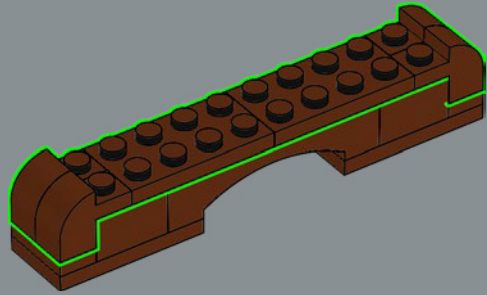

414

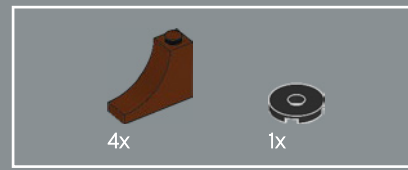
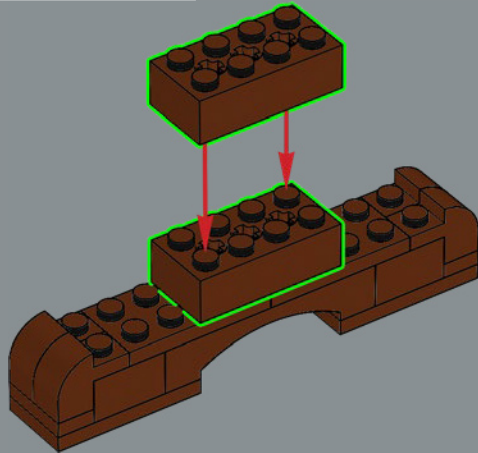

415

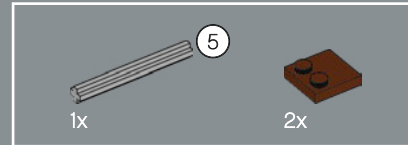
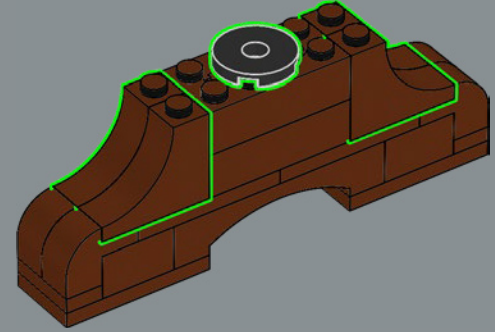

416

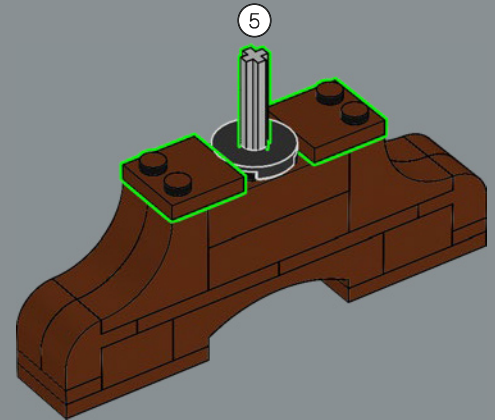

2x



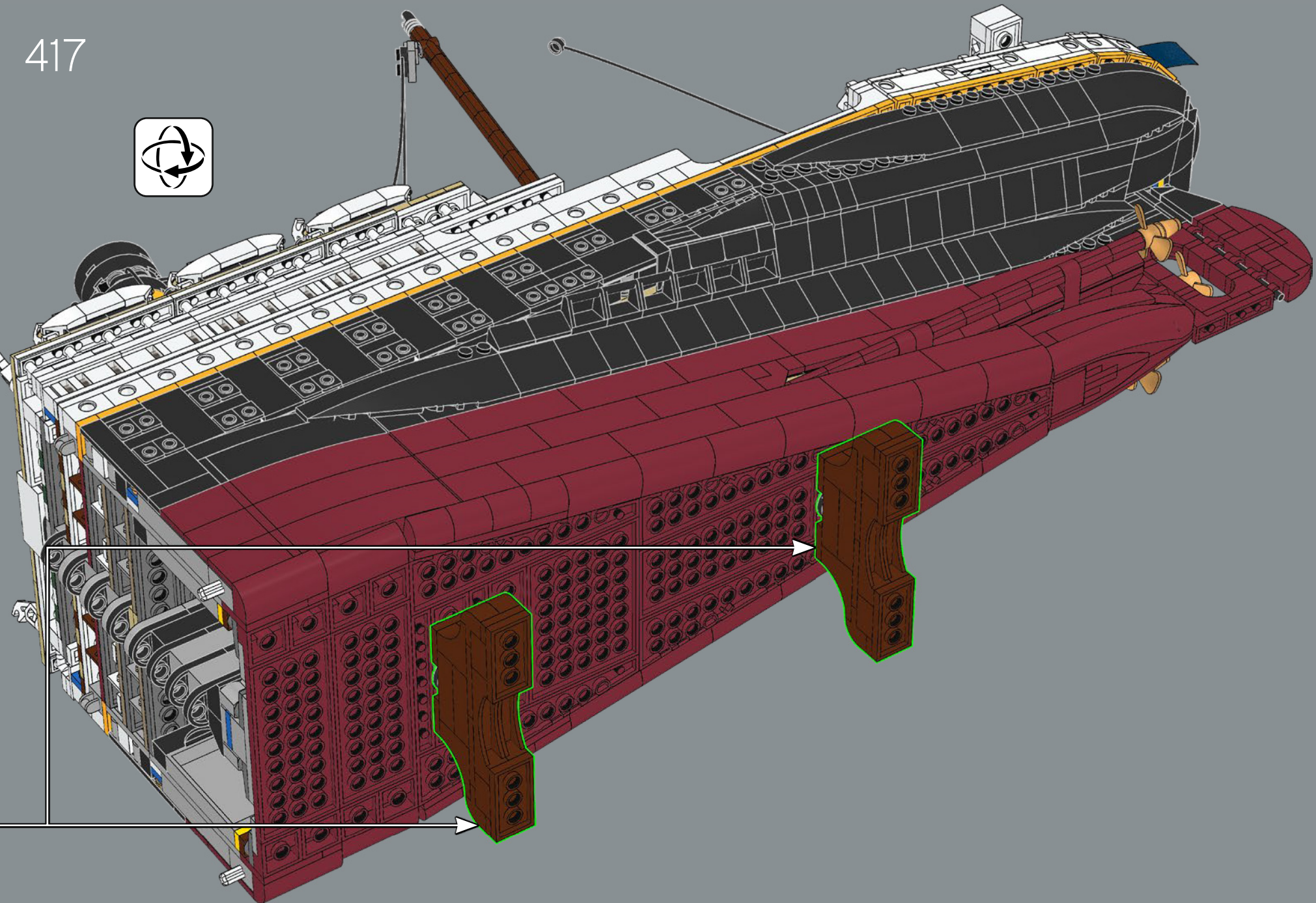

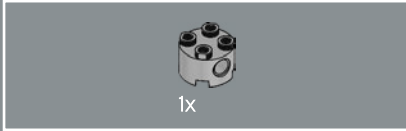
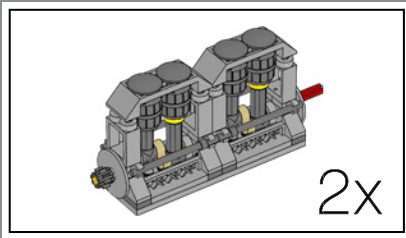

418

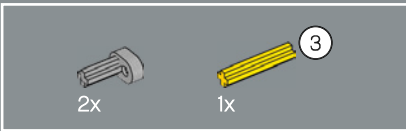

419

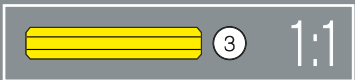
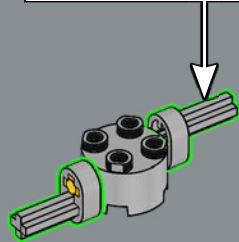
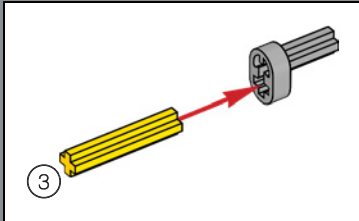

420

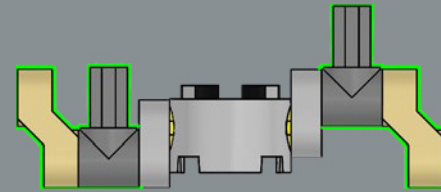

1:1

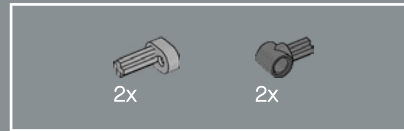

421

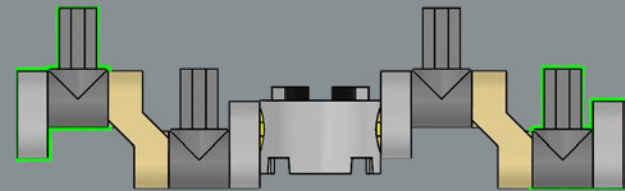

1:1

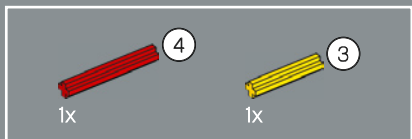

422

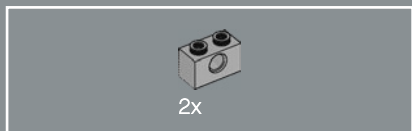
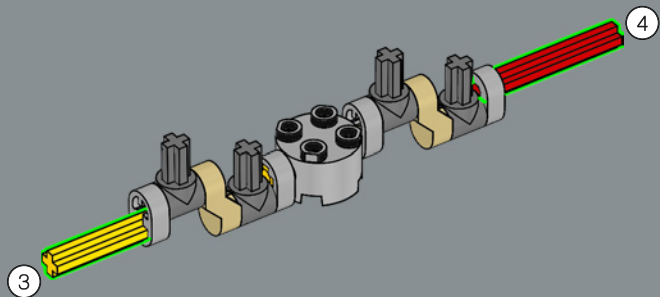

423

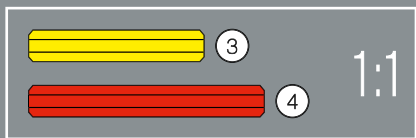
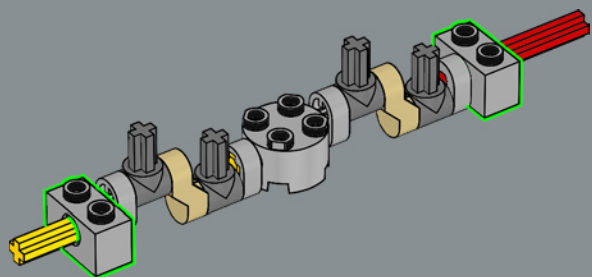

304

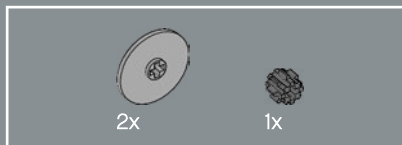

424

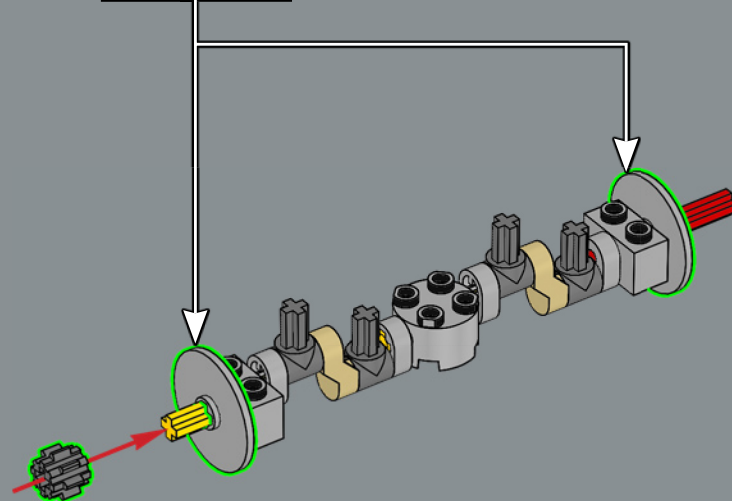
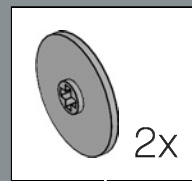



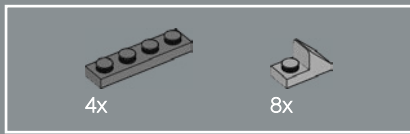

425

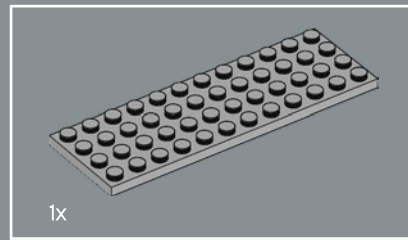
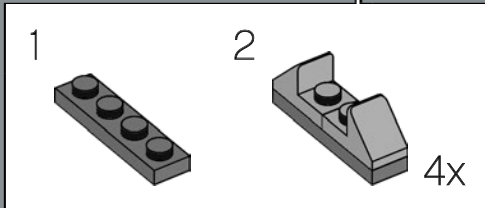
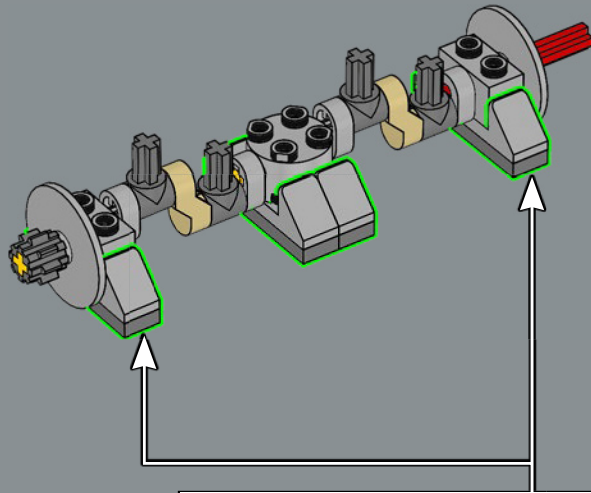

426

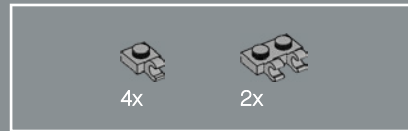
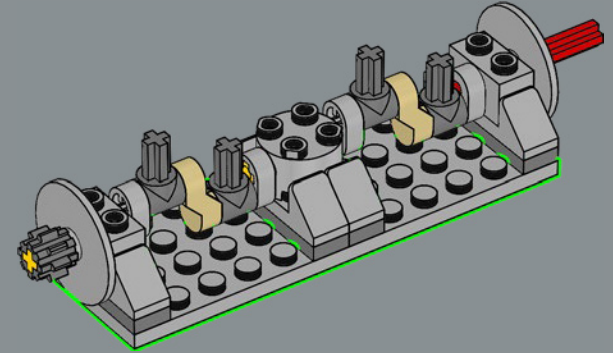

427

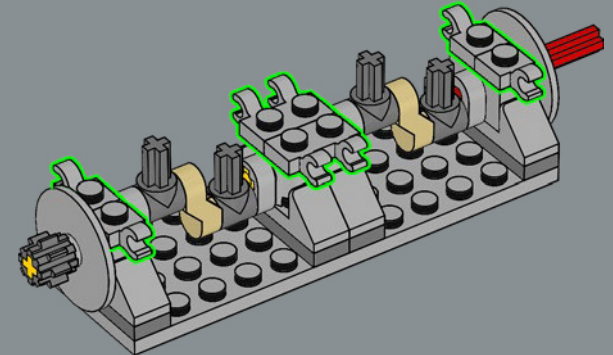



428

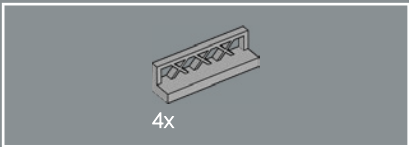
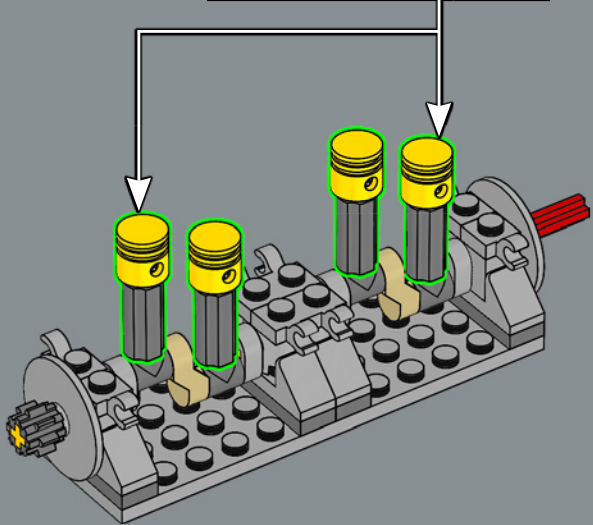
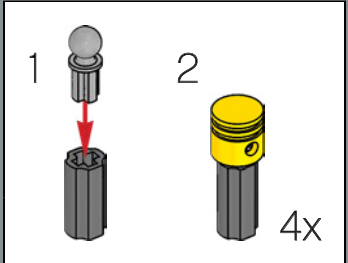

429

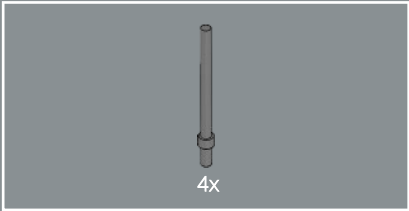
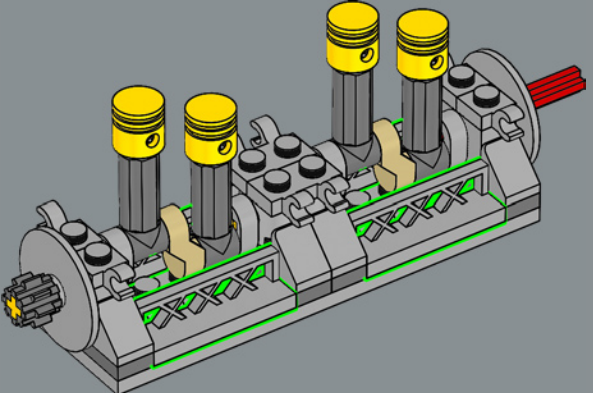

430

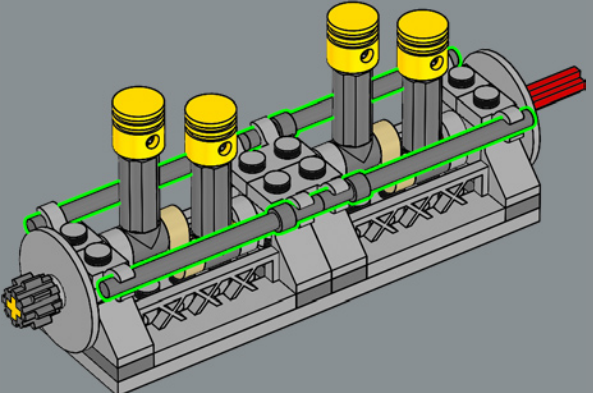

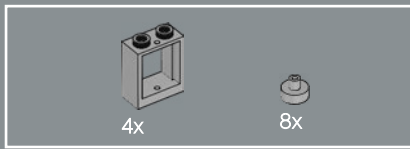

431

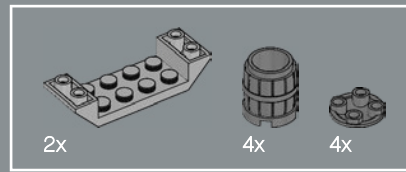
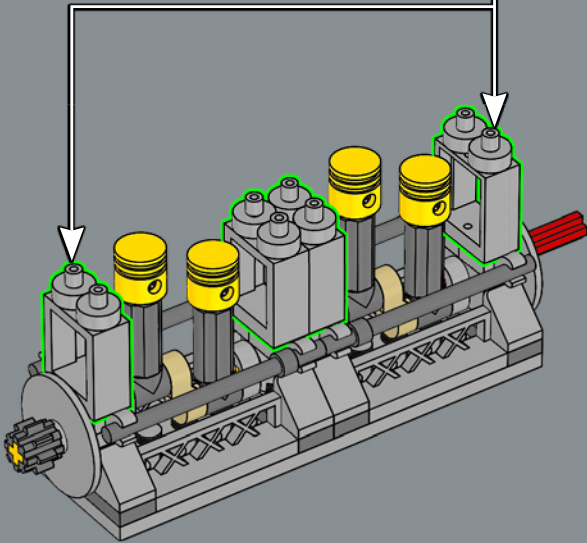
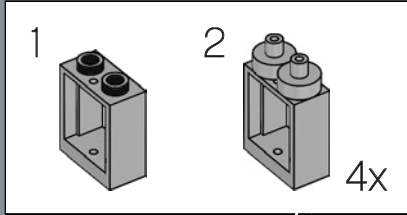

432

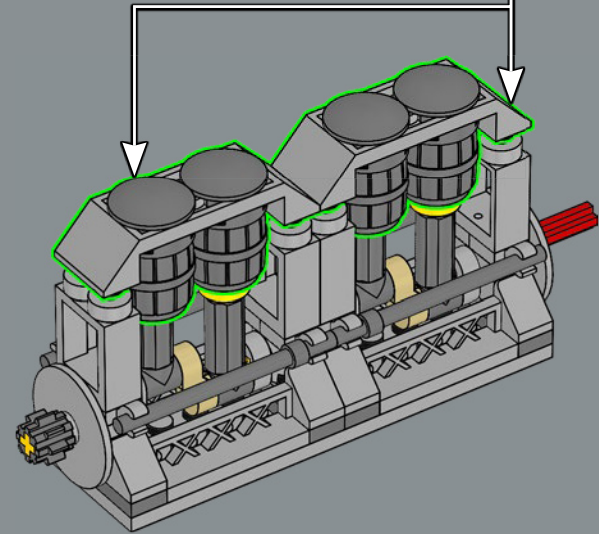
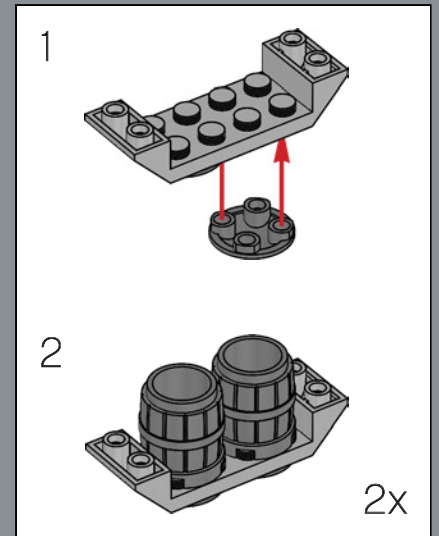

433

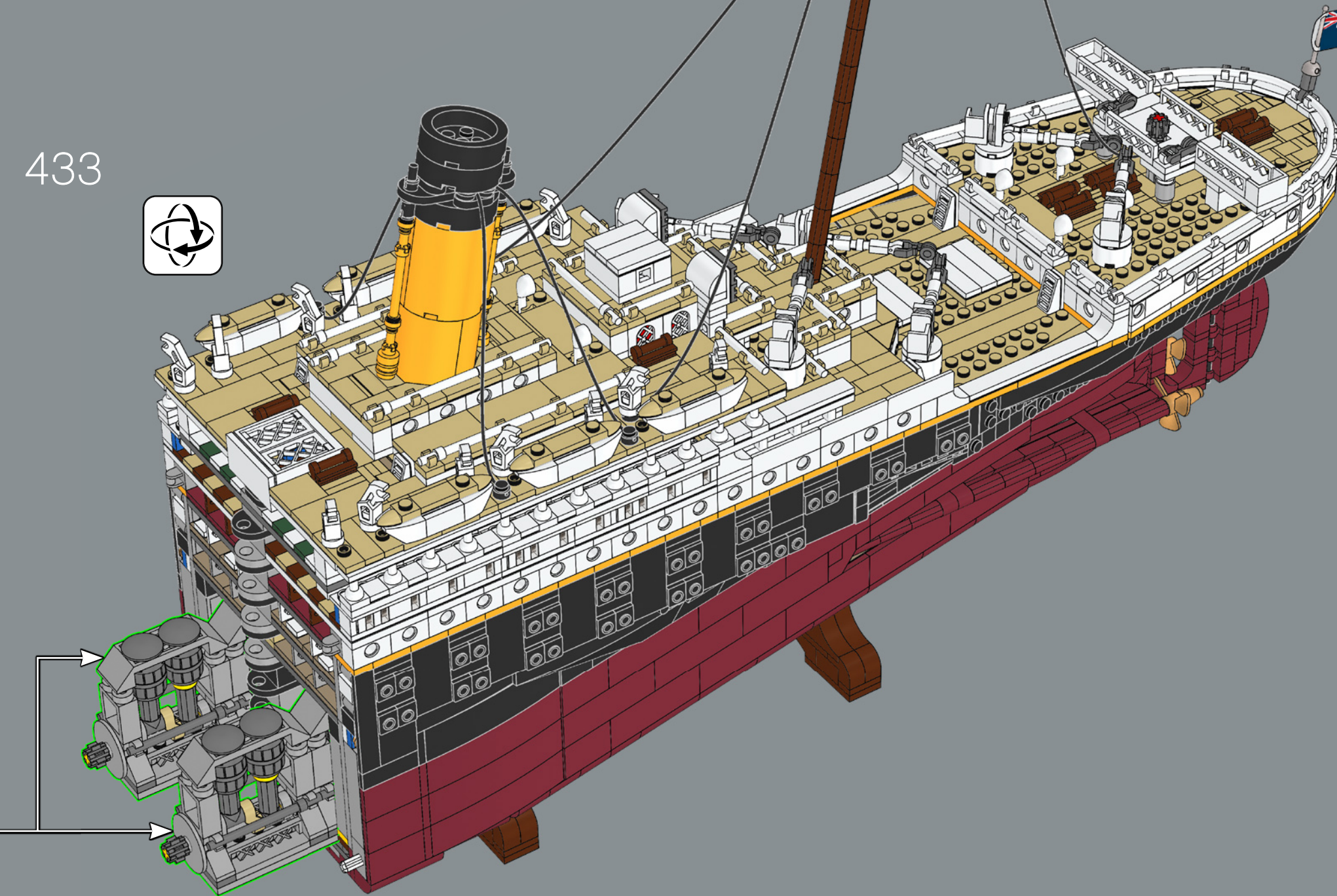

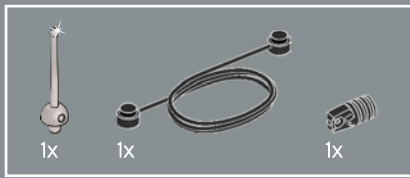

434

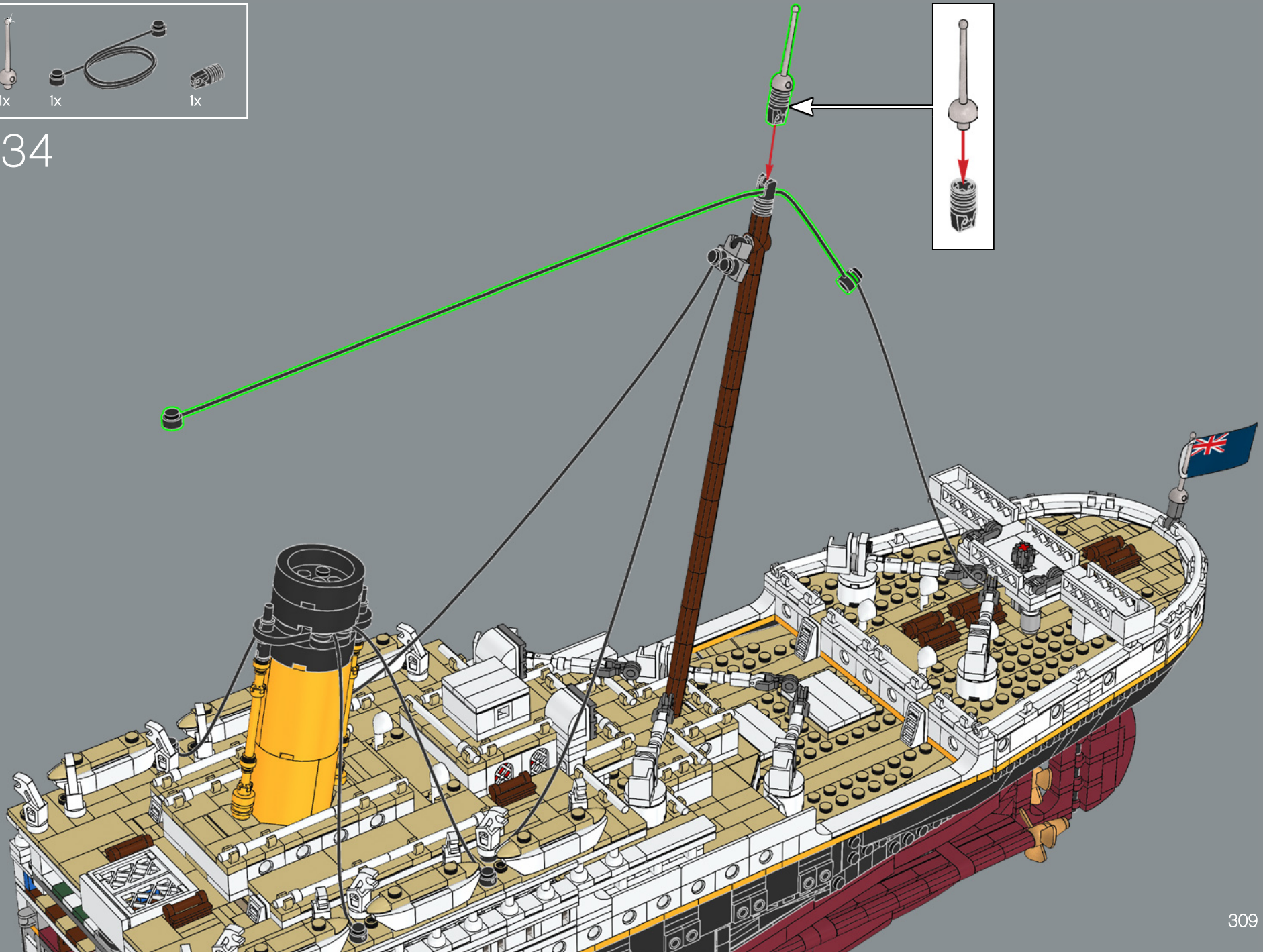

435

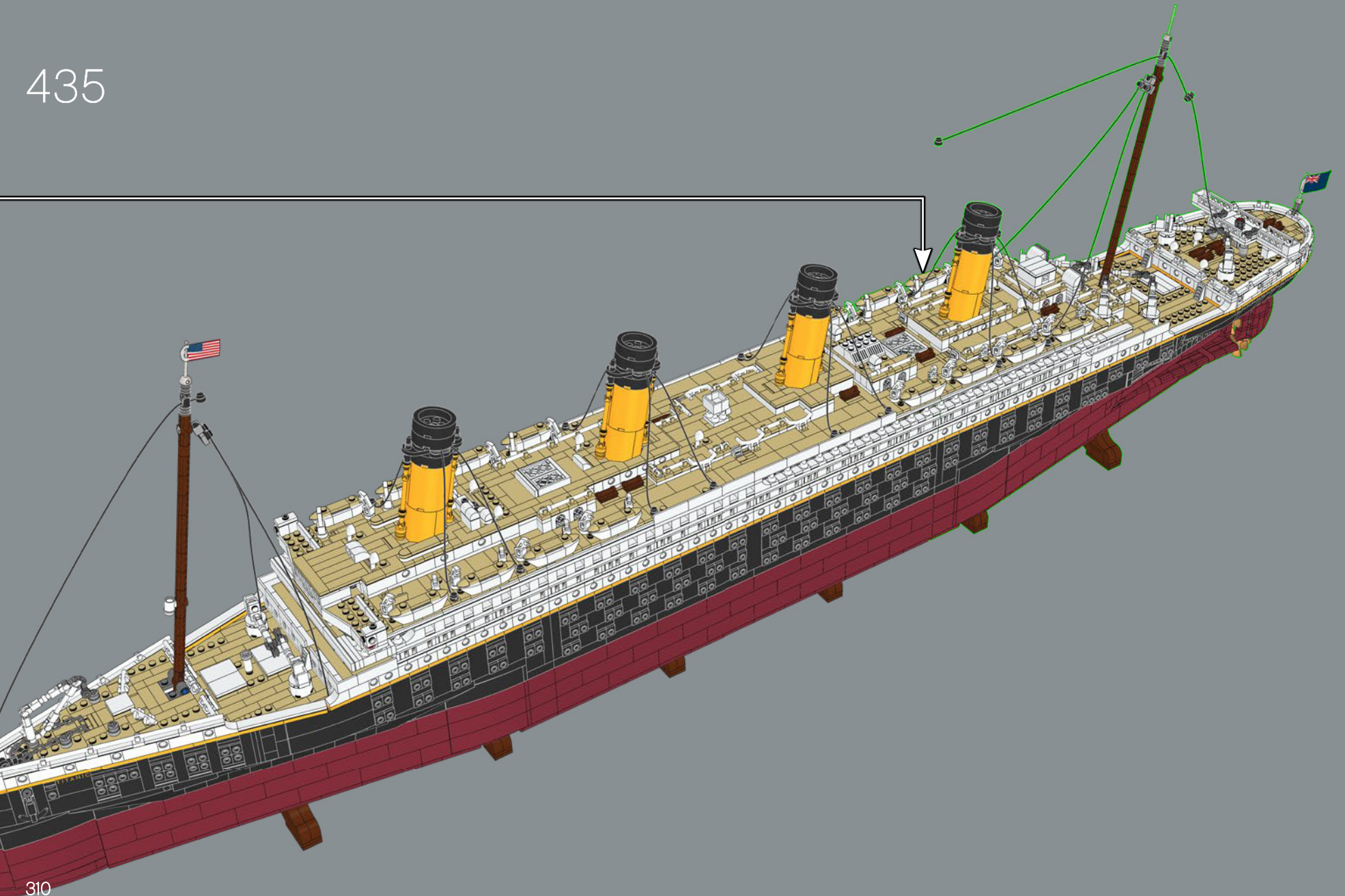

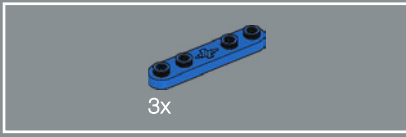
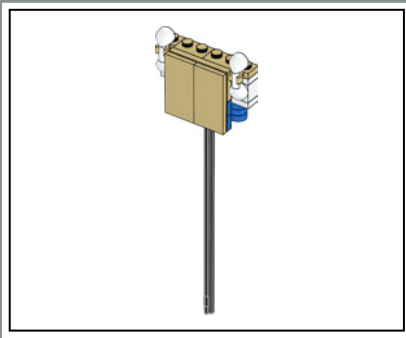

436

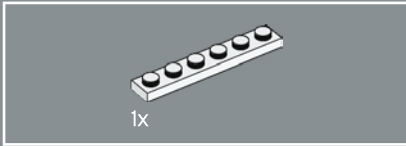
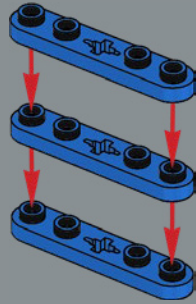

437

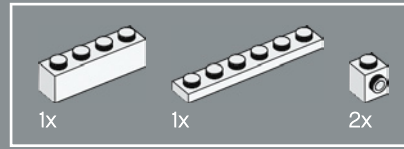
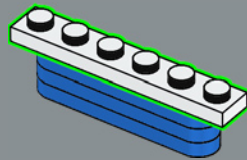

438

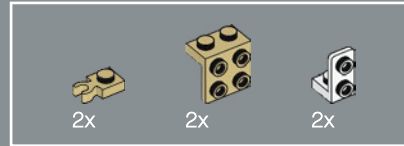
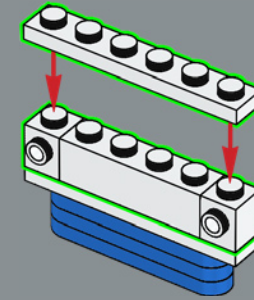

439

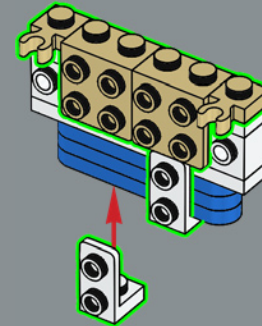

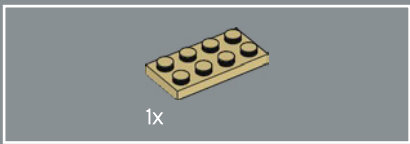

440

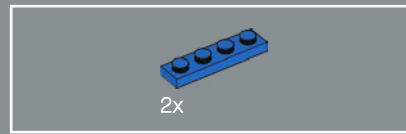
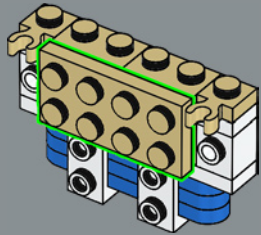

441

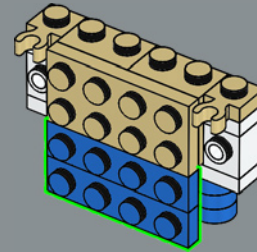



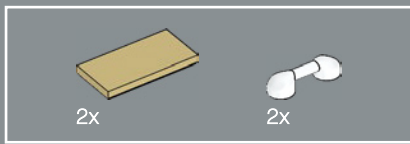

442

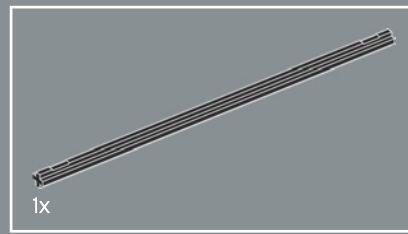
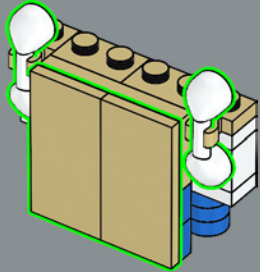

443

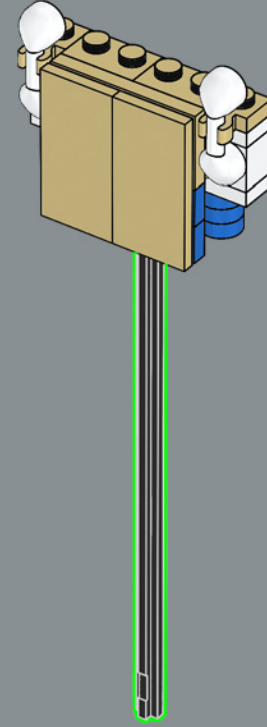

The *Titanic* was launched on the 31<sup>st</sup> of May  
1911 – 110 years ago in 2021.

444

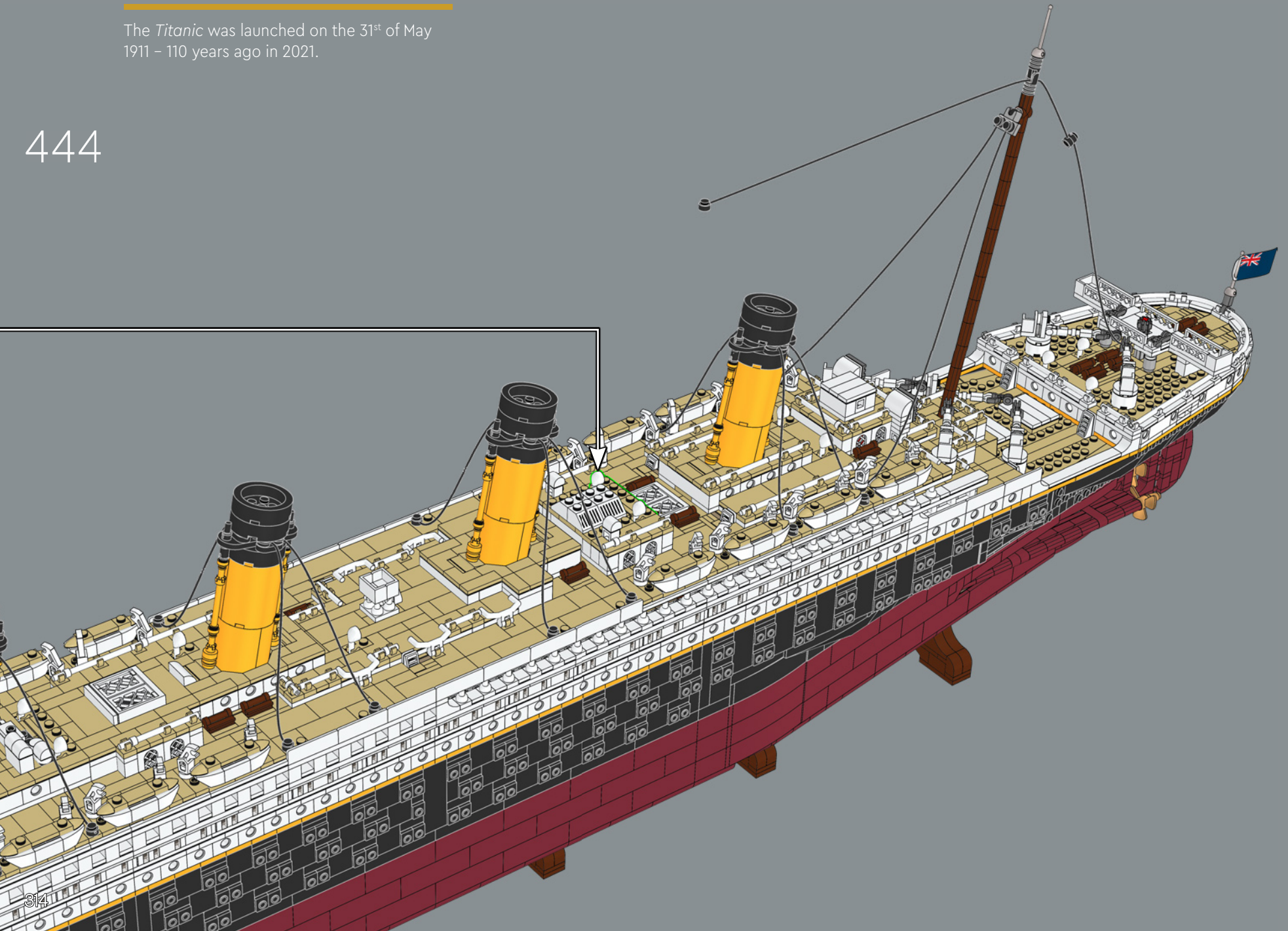

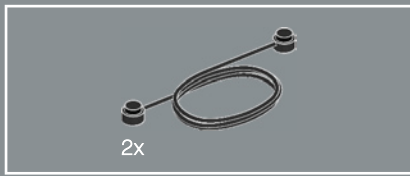

445

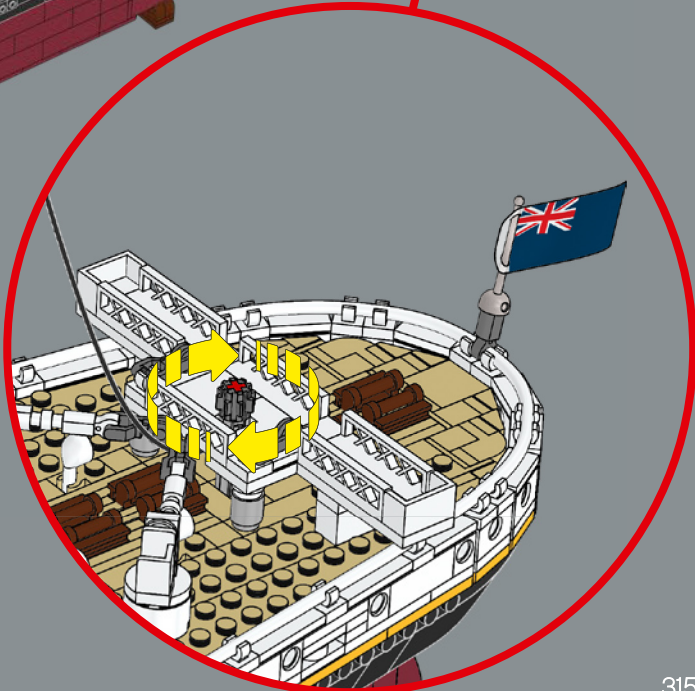
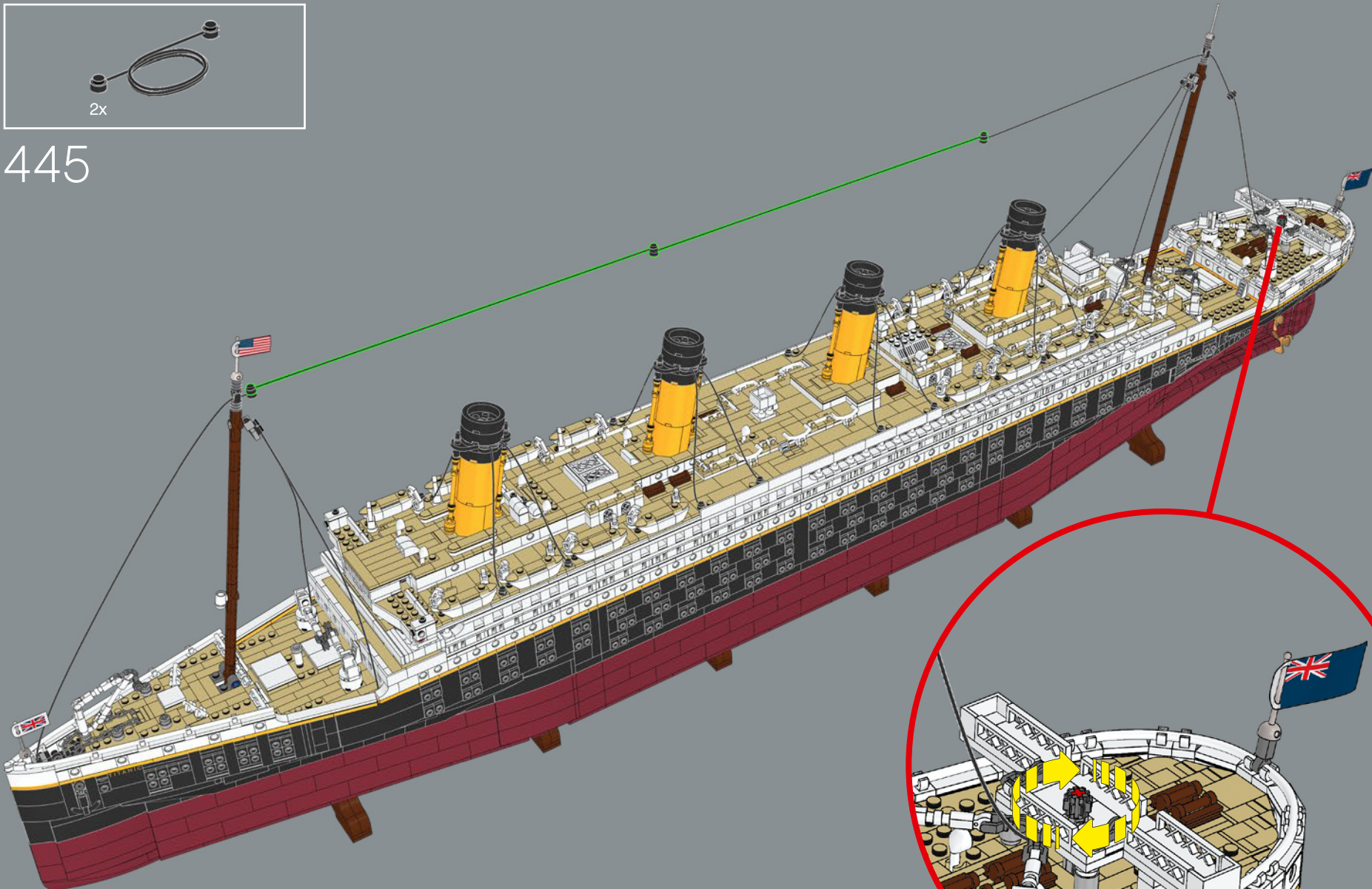

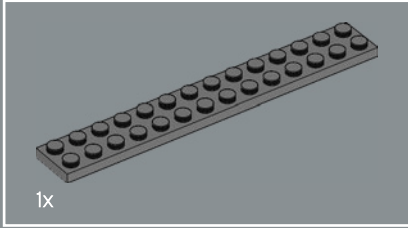
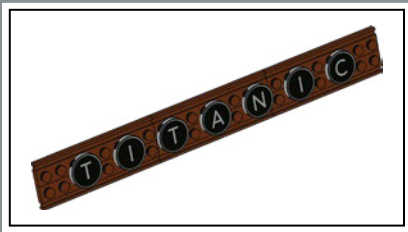

1x

446

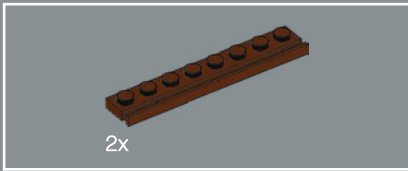
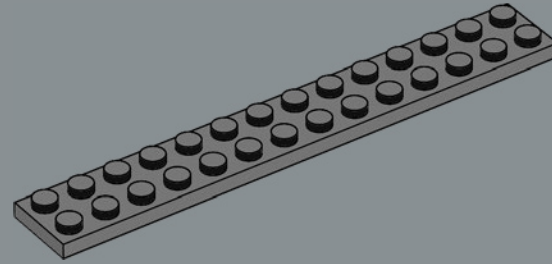

2x

447

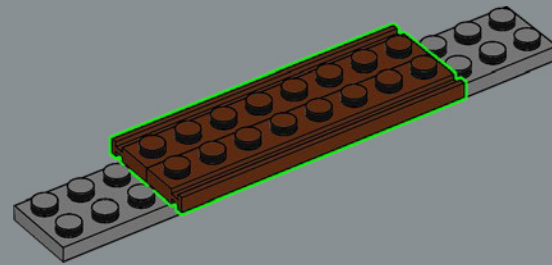

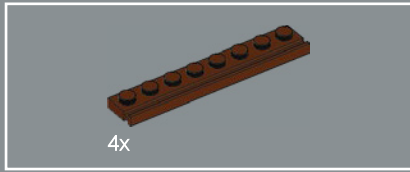

448

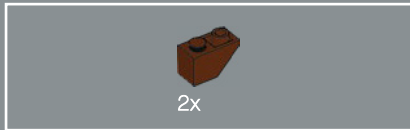
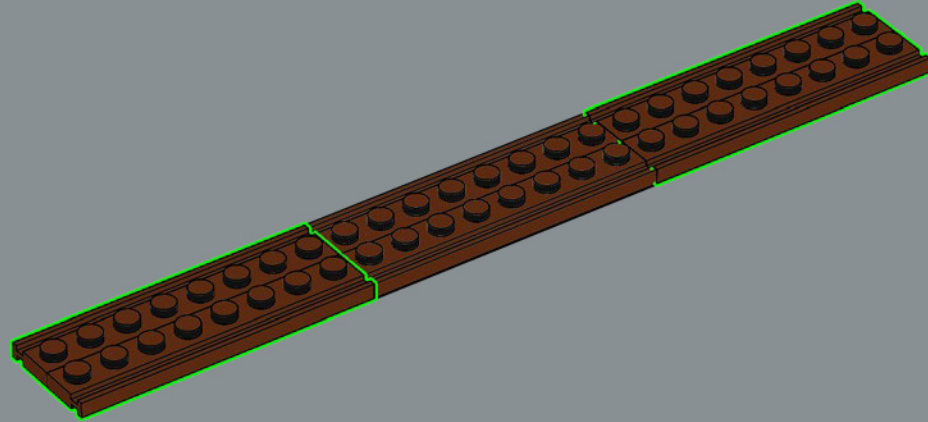

449

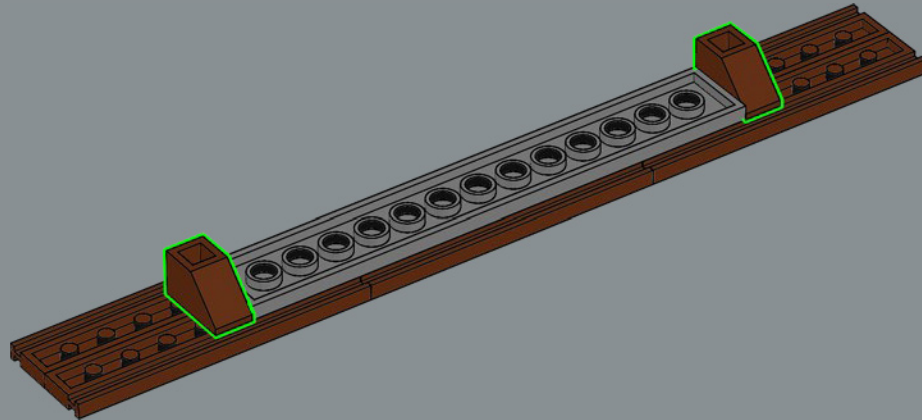



450

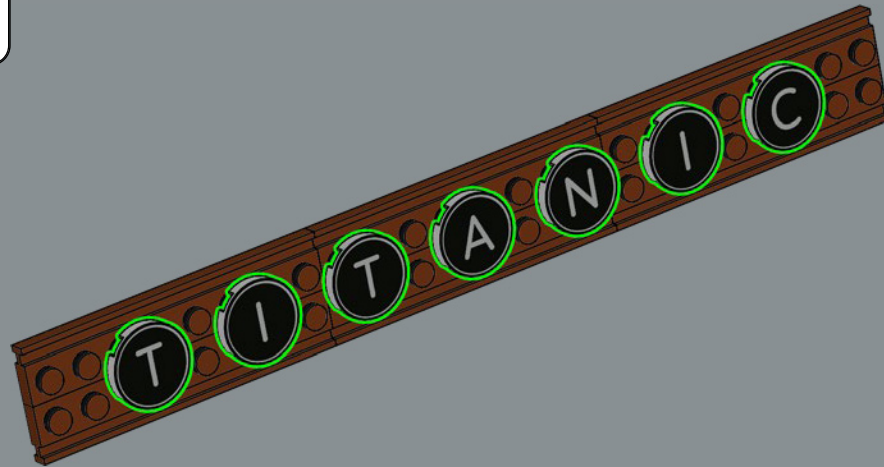

The name *Titanic* derives from the Titans of Greek mythology.

