



F.R.I.E.N.D.S
THE TELEVISION SERIES

公寓 19 号与 20 号 纽约州纽约市

● 还记得莫妮卡客厅的紫色墙壁、钱德勒和乔伊那可倾斜式电视躺椅吧！如果你是《老友记》的粉丝，那么你可以使用这款最新的乐高®套装向你喜爱的电视连续剧致敬，重温记忆，体验身临其境的感觉！除了捕捉两间公寓和连廊的标志性装饰，这款套装还充满了源自电视剧的细节和经典时刻的见证物。







钱德勒和乔伊的公寓

与大厅对面的女孩们的公寓相比，钱德勒和乔伊的公寓更小、更凌乱，是两个生活在纽约曼哈顿的年轻单身汉的完美生活空间。虽然节目的所有主角都生活在公寓中，但这里所有的固定装置和设备都源自典型的钱德勒和乔伊时期。

莫妮卡和瑞秋公寓

莫妮卡和瑞秋公寓位于纽约的格林威治村，最初是罗斯和莫妮卡祖母的公寓，公寓的客厅和开放式厨房将大胆的色彩与杂乱的家具不拘一格地混合在一起，这与莫妮卡本人非常喜欢整洁的天性形成鲜明对比！





大厅

● 此处是两间公寓之间的一个狭小空间，也是著名场景的发生处：钱德勒和瑞秋争夺一块掉落的奶酪蛋糕，并从地板上吃掉它，最后乔伊也加入了！



设计师寄语

开始着手这个模型时，我还不太熟悉这个节目。实际上，这款套装带给我的最大乐趣是与所有喜爱这个节目的同事交谈，了解节目中他们最喜爱的时刻……人们可以滔滔不绝地讲述，笑声不止，精彩回忆不断。我希望这款套装可以为其他拼搭它的人带去同样的快乐。

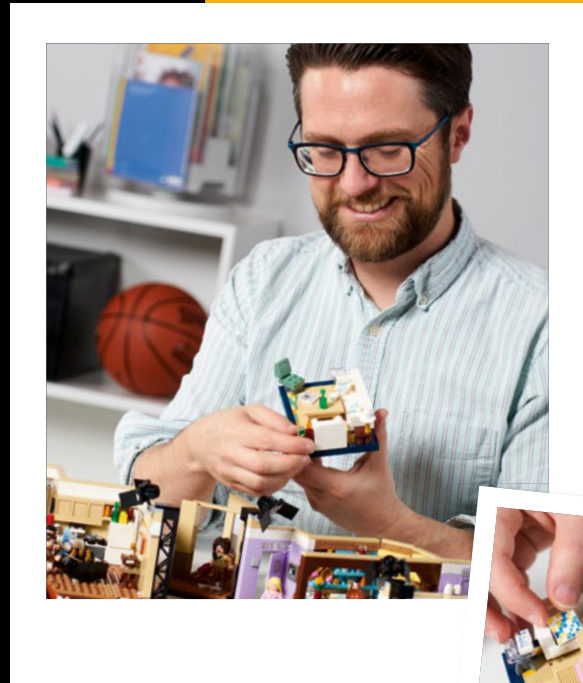

角色

● 本套装包含 7 个小人仔，包括所有主角，以及长期与钱德勒分分合合的女朋友珍妮丝，她的声音非常独特。



罗斯·盖勒
第 5 季-第 11 集：
“新年新气象”
罗斯炫耀皮裤。



莫妮卡·盖勒
第 7 季-第 9 集：
“糖果”
莫妮卡给邻居们做糖果。



瑞秋·格林
第 1 季-第 19 集：
“猴子被送走”
瑞秋把猴子丢了！



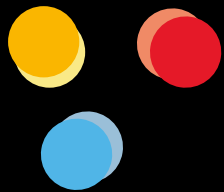

菲比·布菲

第 6 季-第 7 集:

“菲比跑步”

菲比跟瑞秋住在一起。



乔伊·崔比安尼

第 3 季-第 2 集:

“没人准备好”

乔伊把钱德勒的衣服都穿上了。



钱德勒·宾

第 4 季-第 2 集:

“转世灵猫”

钱德勒不会侧身滑步的地方!



珍妮丝

第 7 季-第 7 集:

“罗斯在图书馆”

珍妮丝不请自来，坚持要参加莫妮卡和钱德勒的婚礼。





[LEGO.com/brickseparator](https://www.lego.com/brickseparator)

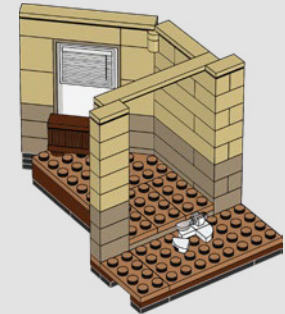
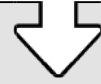
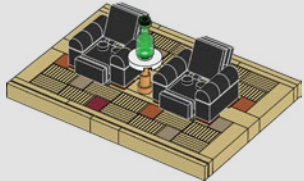
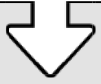

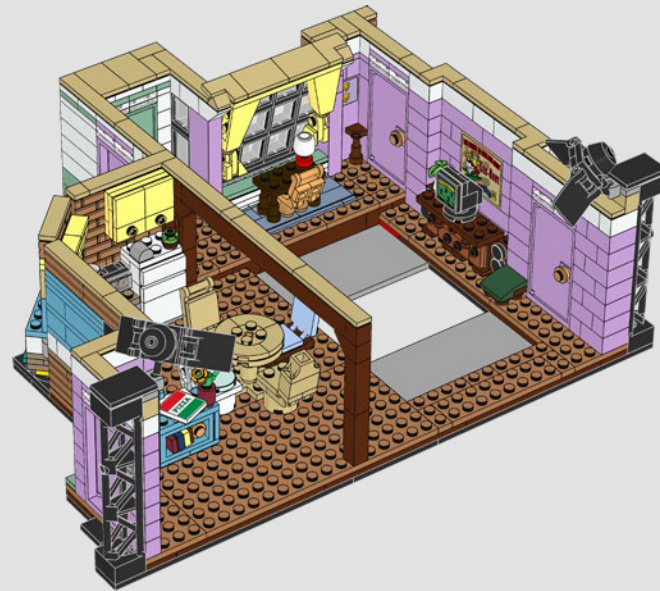
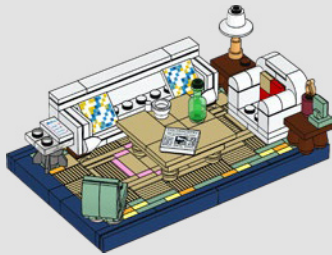

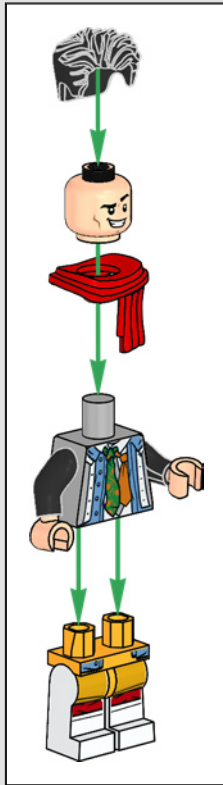
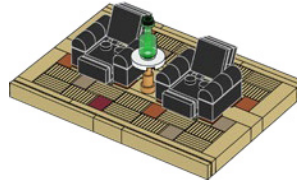

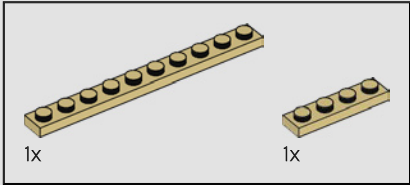
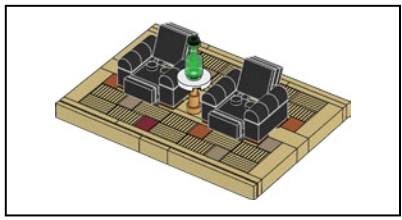

1

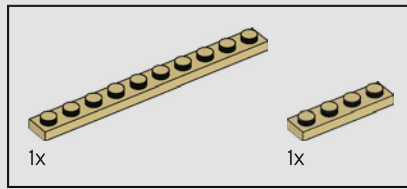
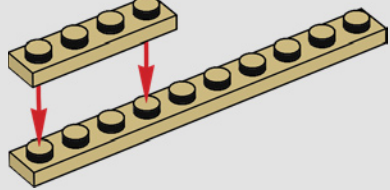

2

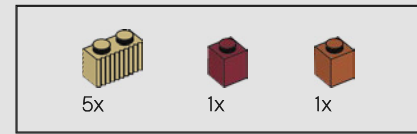
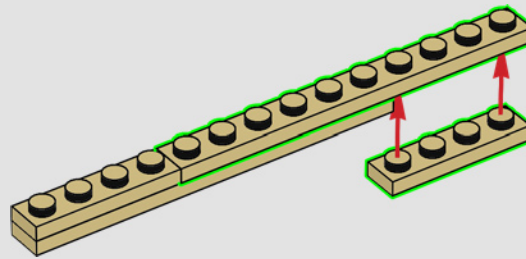

3

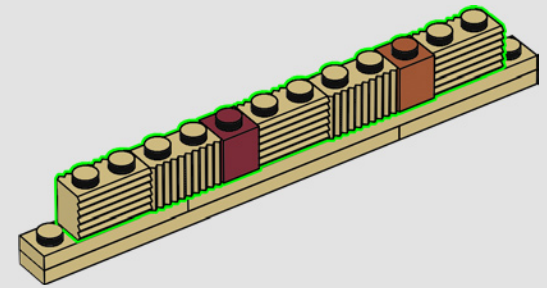

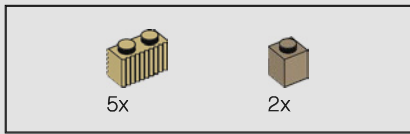

4

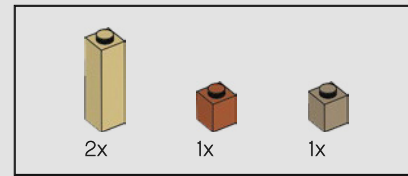
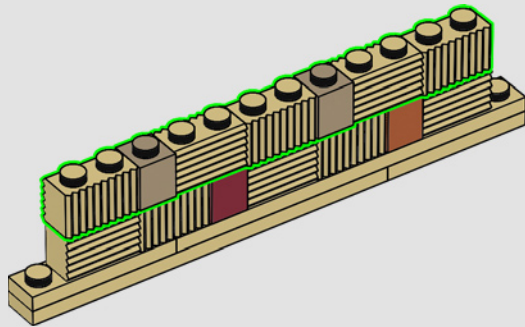

5

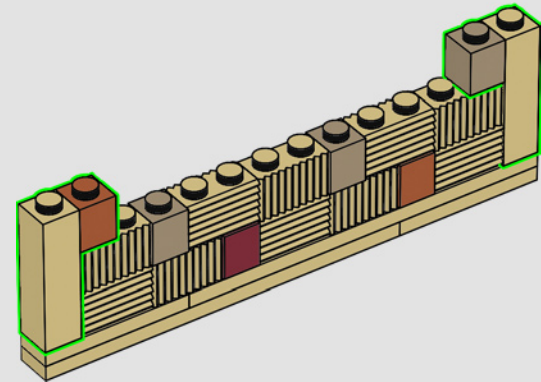

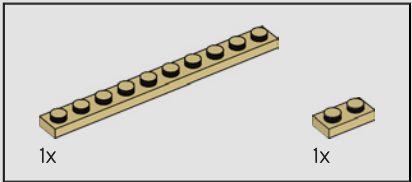
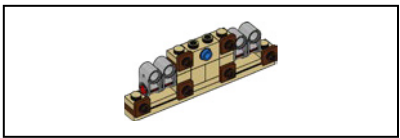

6

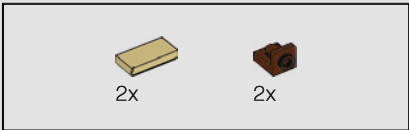
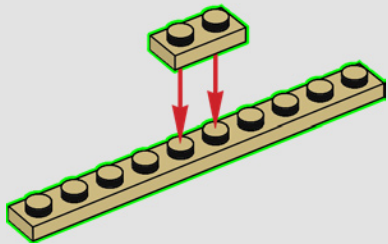

7

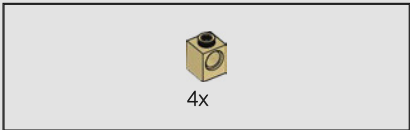
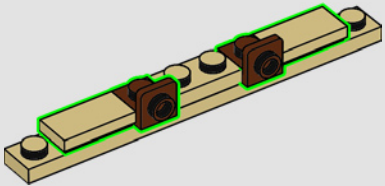

8

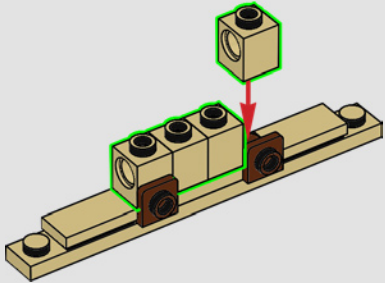

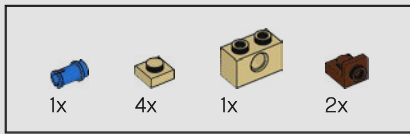

9

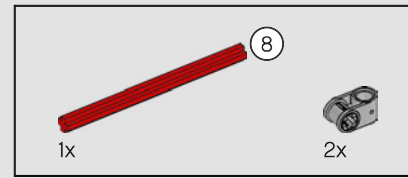
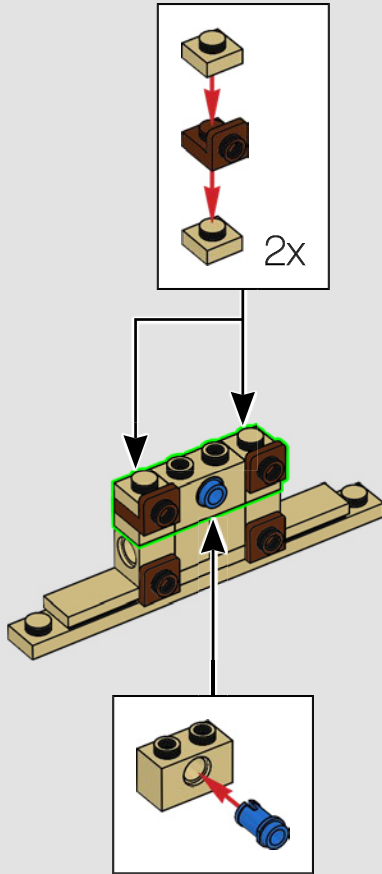

10

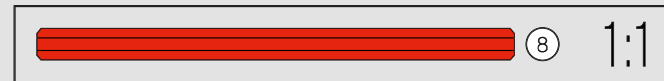
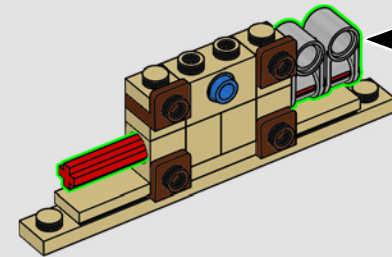
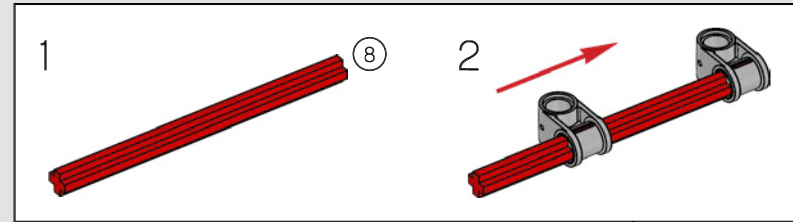



2x

11

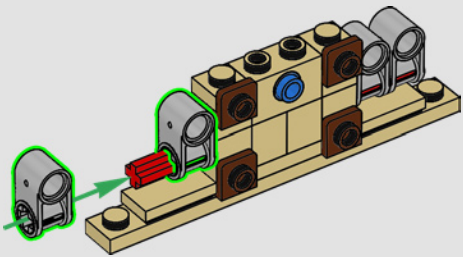

2x



2x

12

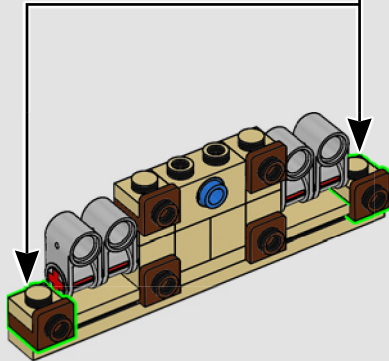
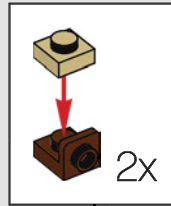

13

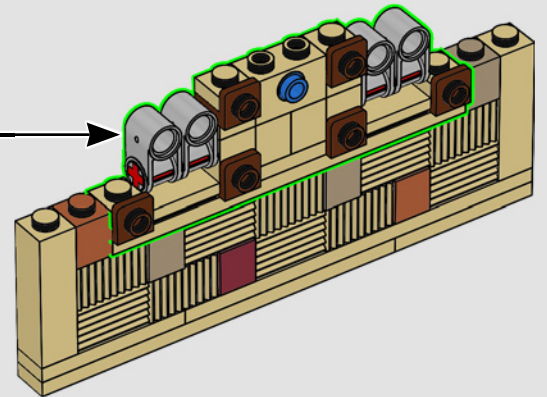

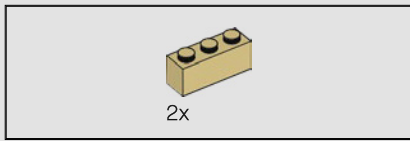

14

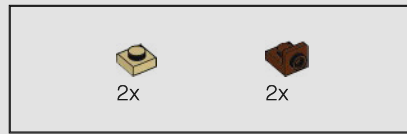
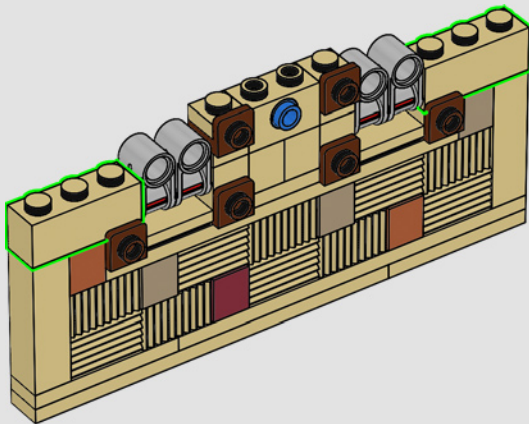

15

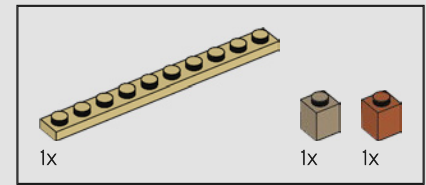
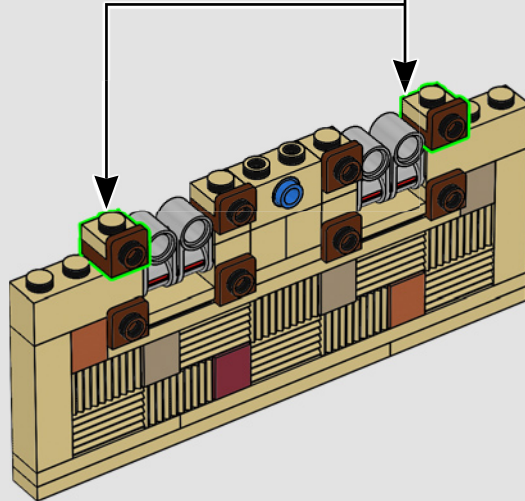
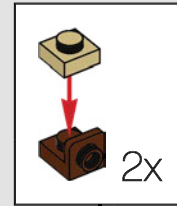

16

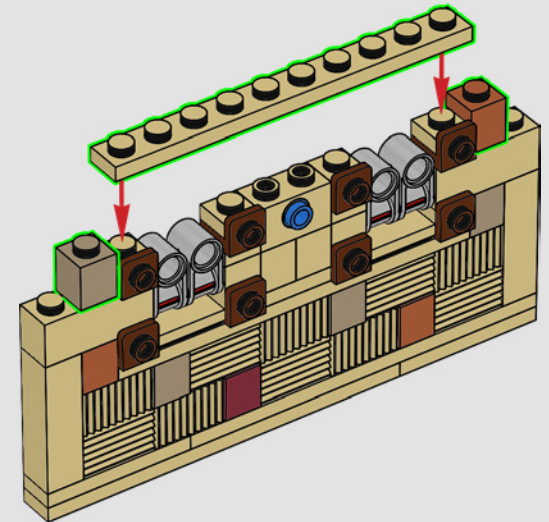

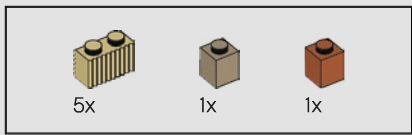

17

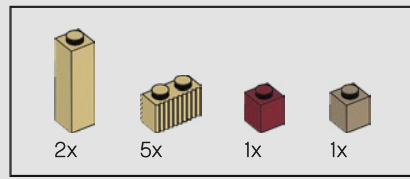
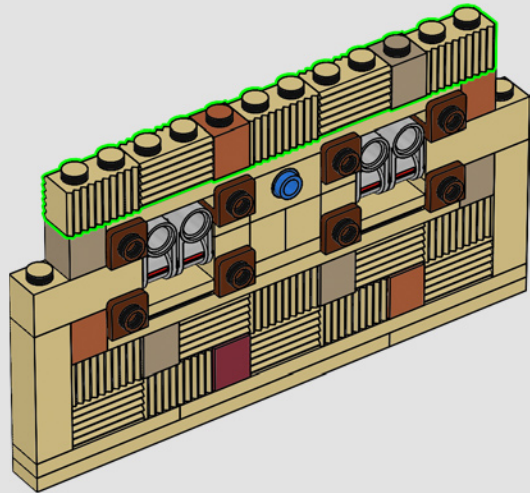

18

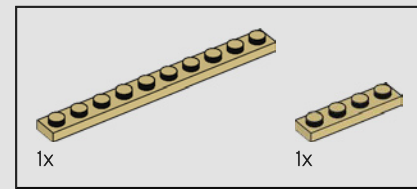
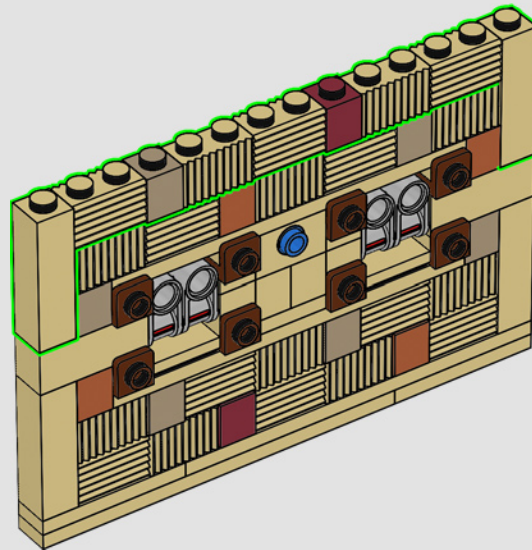

19

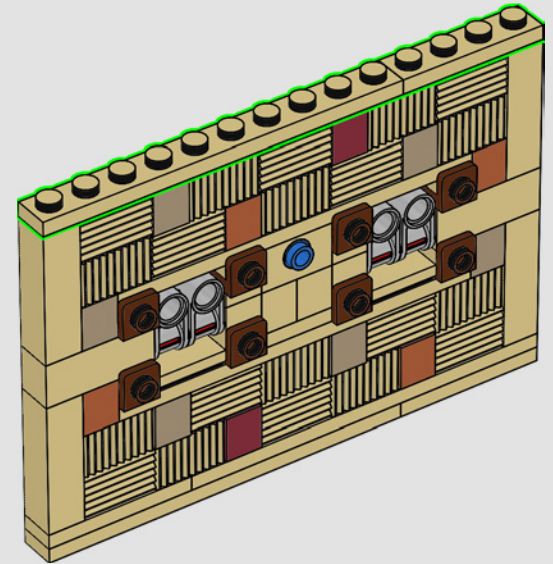

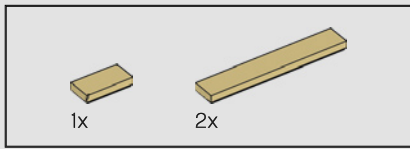

20

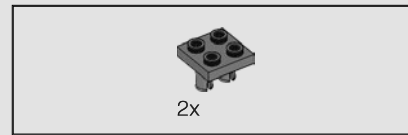
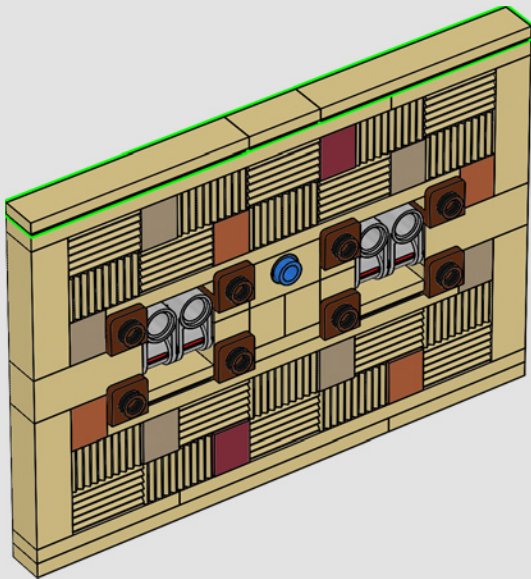

21

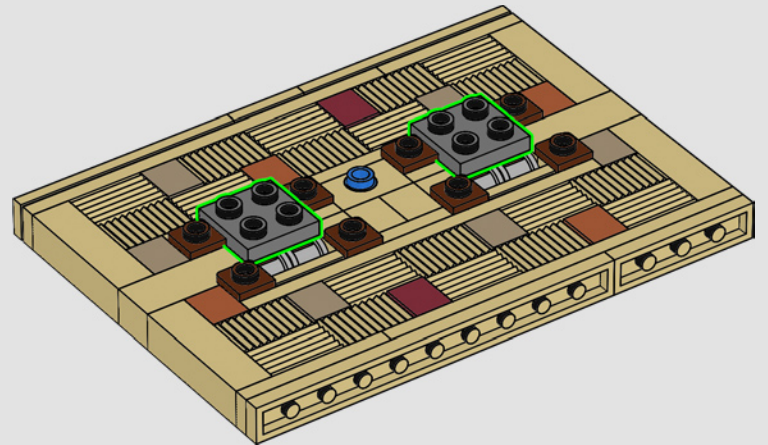
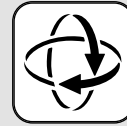

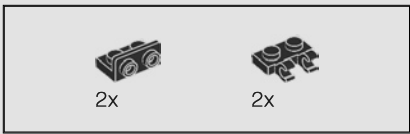

22

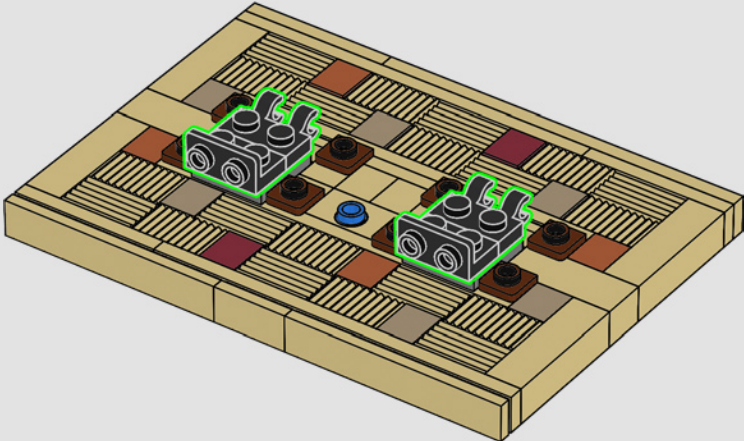

23

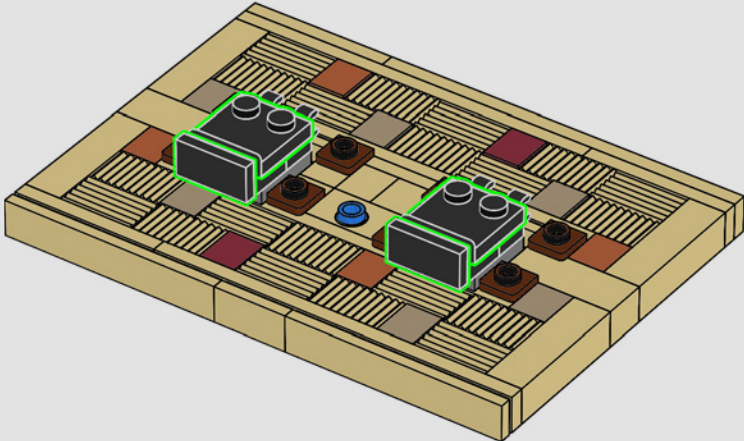

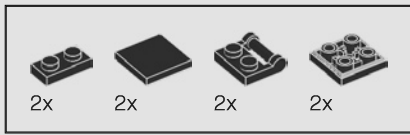

24

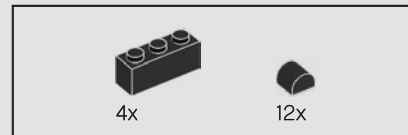
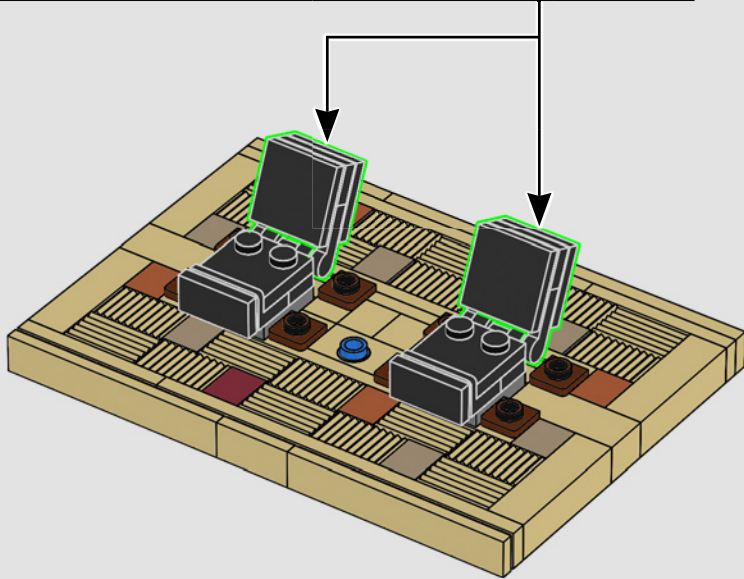
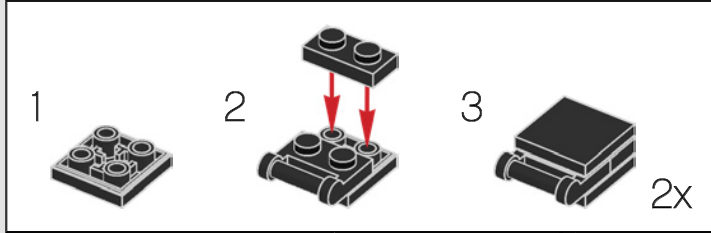

25

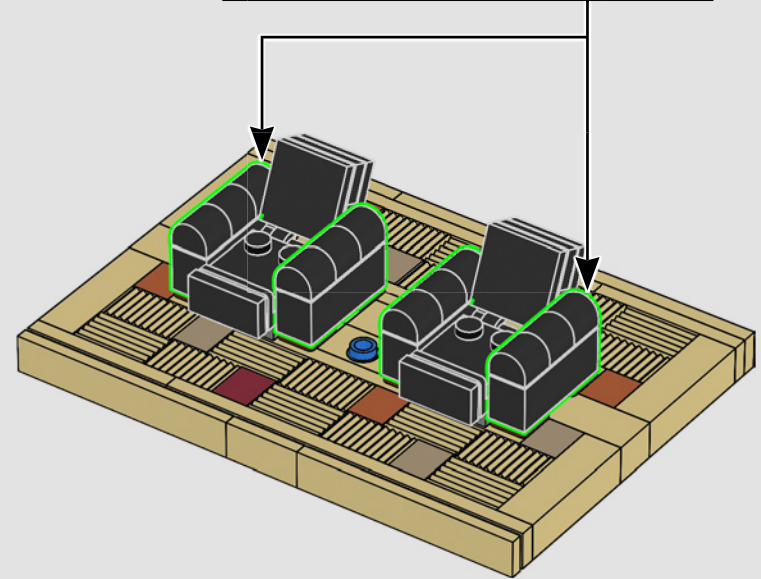
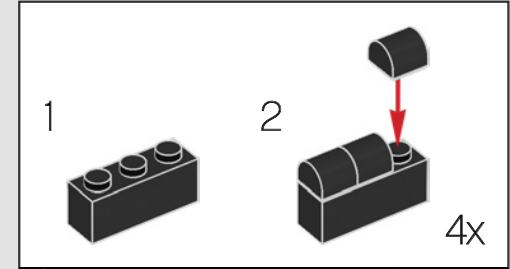

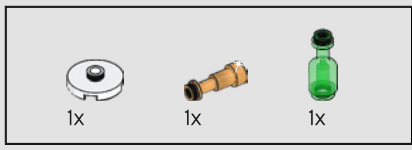

26

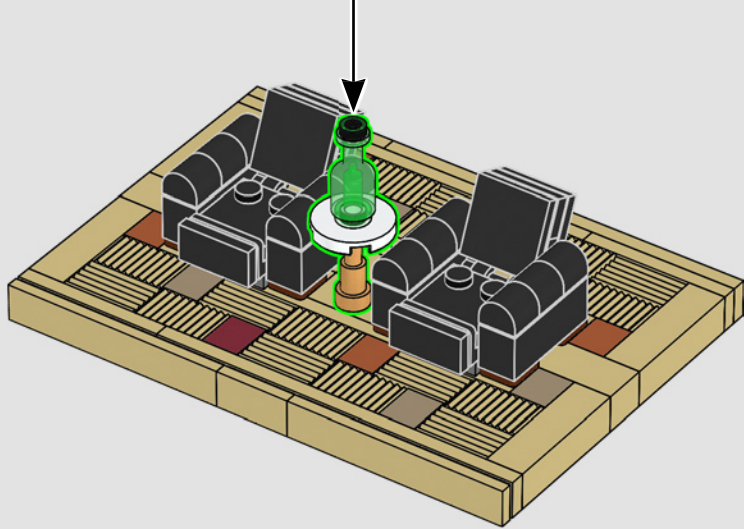
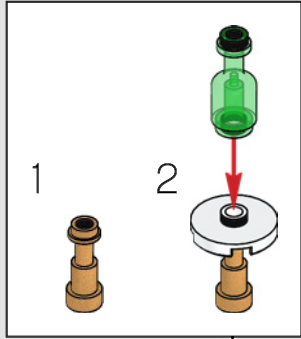

● 可倾斜式电视躺椅同时向后倾斜，源自标志性时刻：2 个大男孩第一次收到椅子，一起倾斜躺椅。



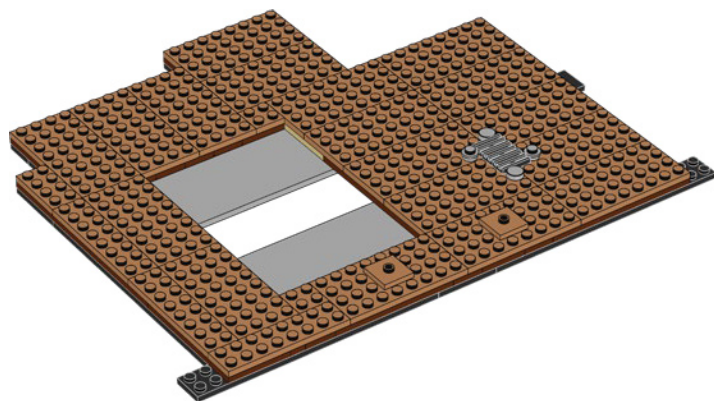

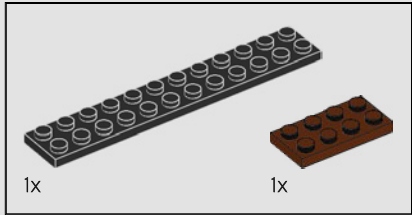
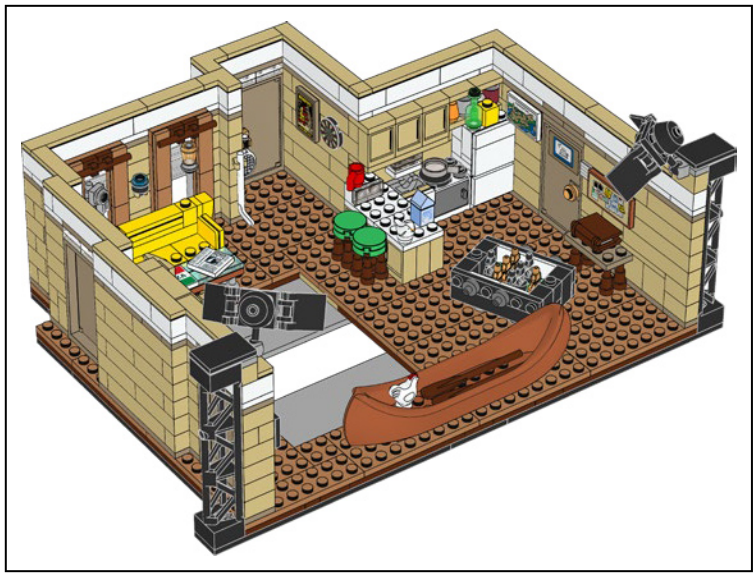

1

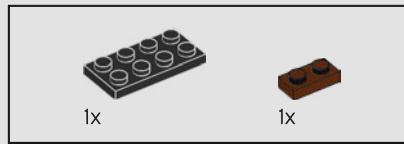
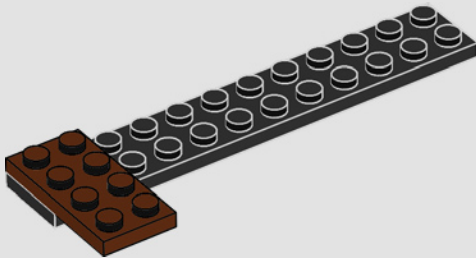

2

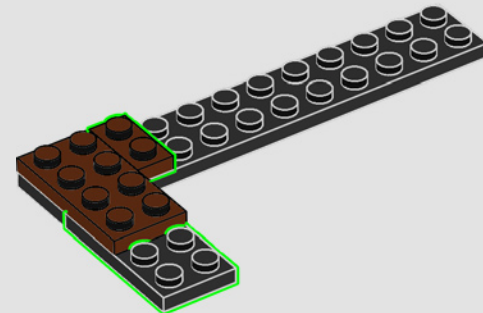

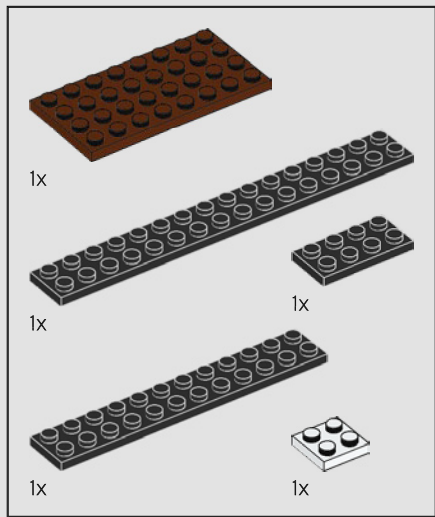

3

1

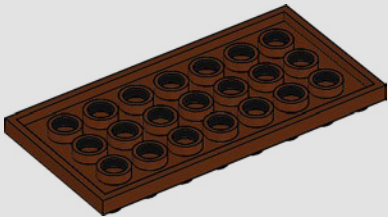

2

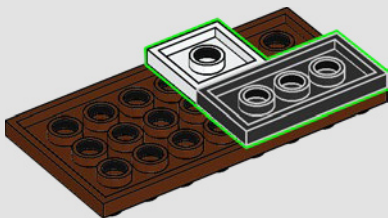

3

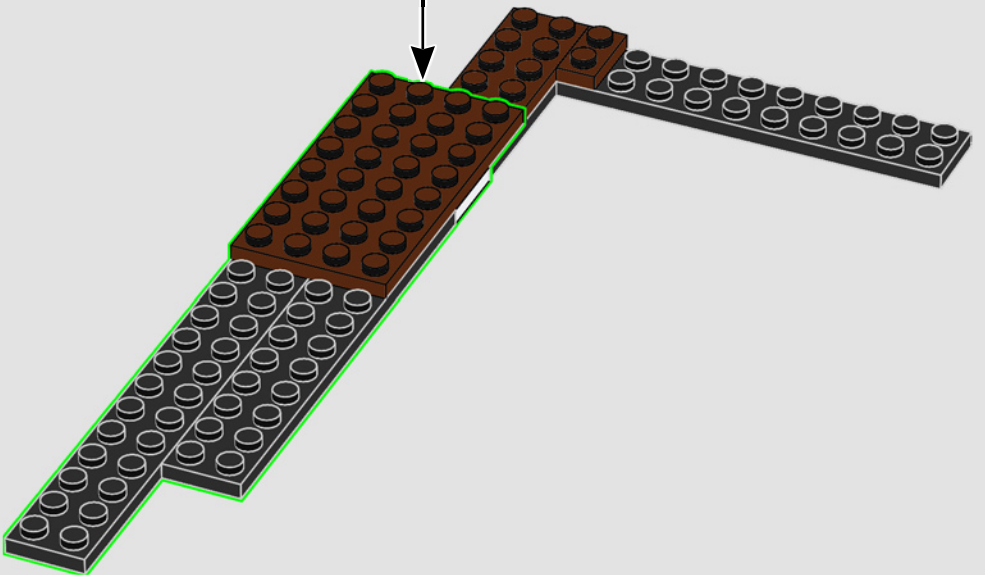
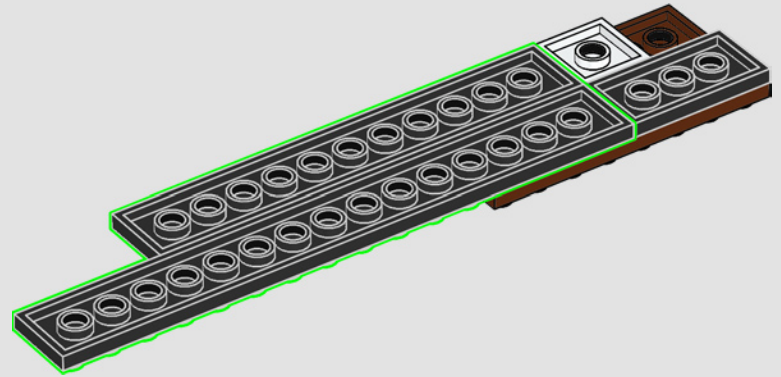

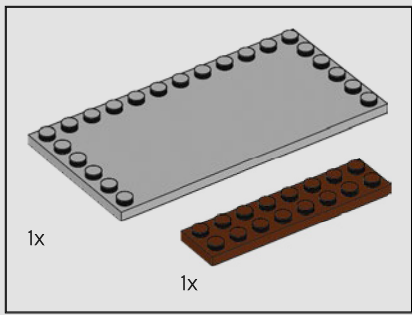

4

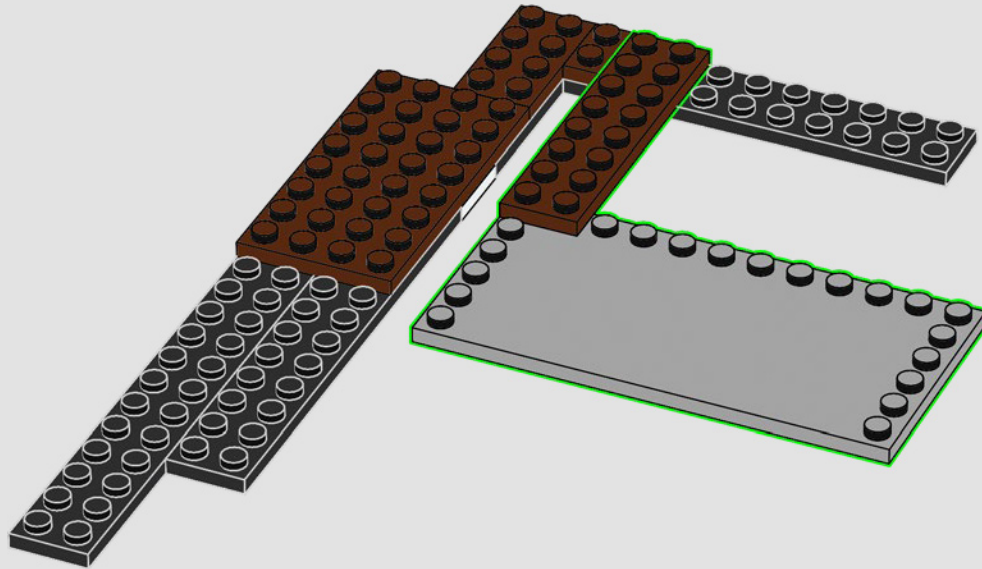

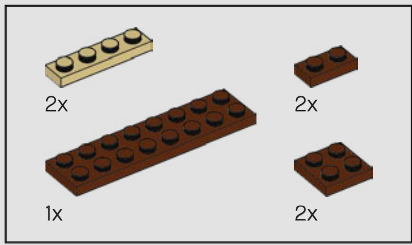

5

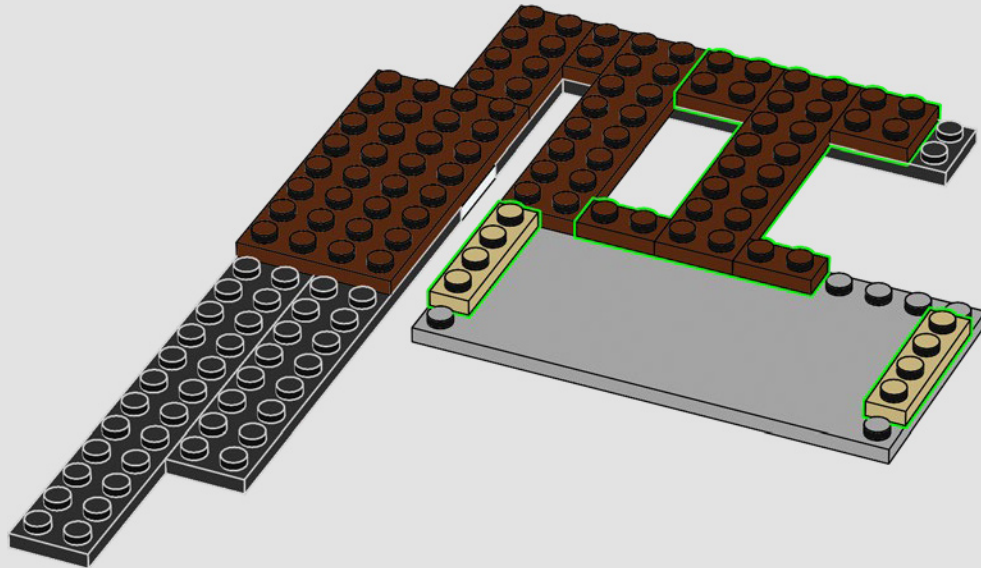

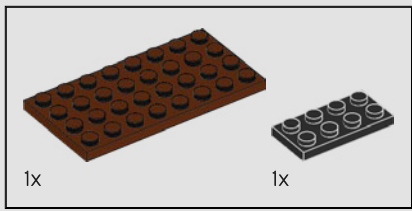

6

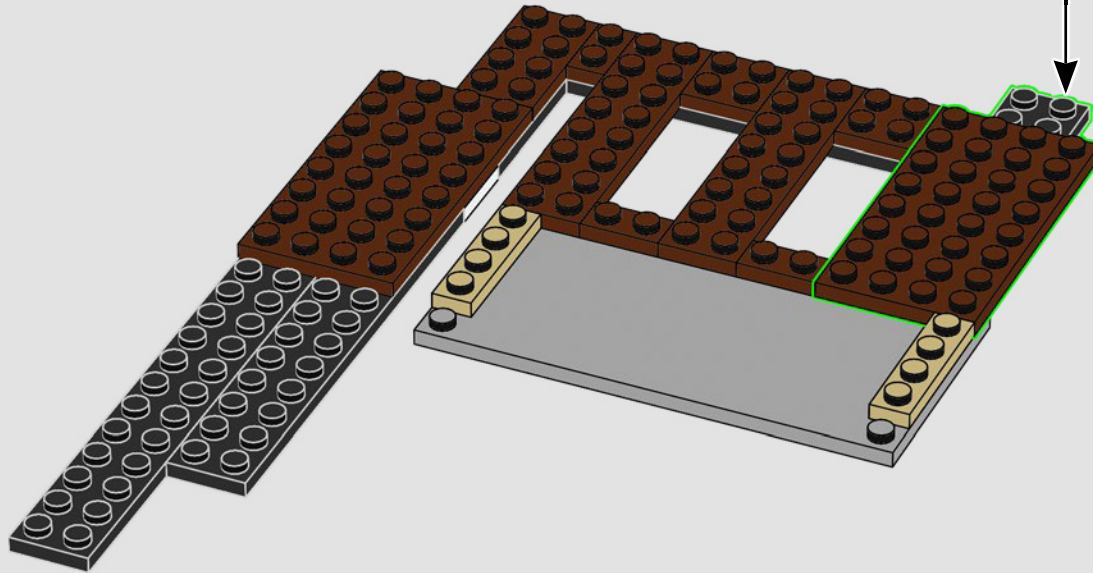
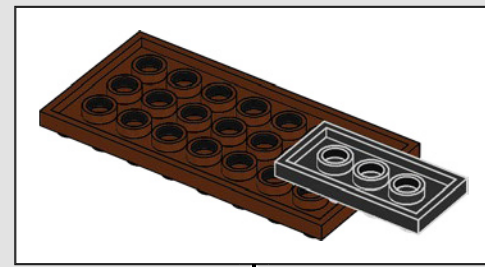

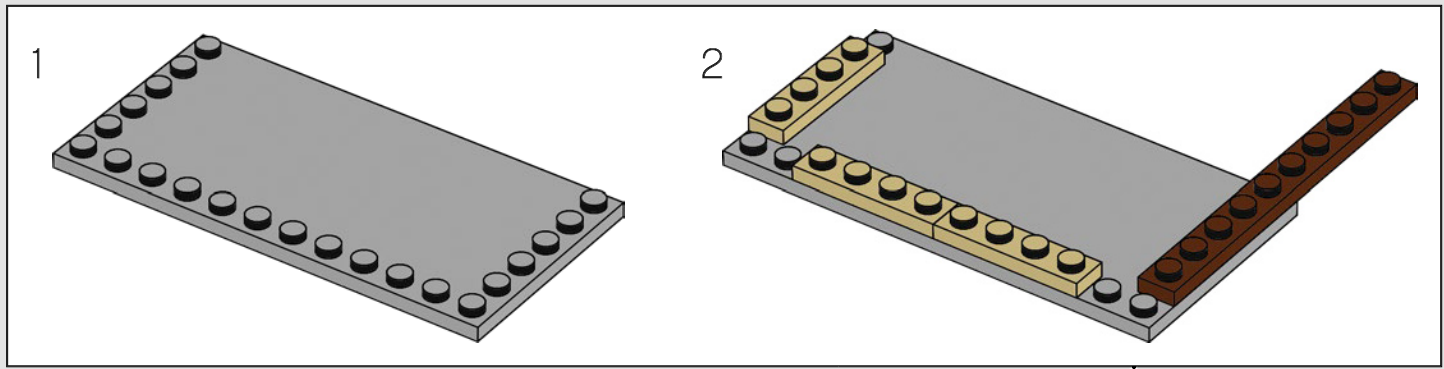
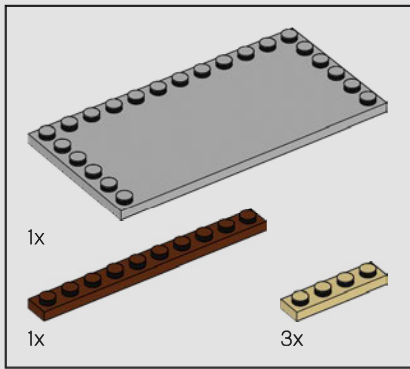

7

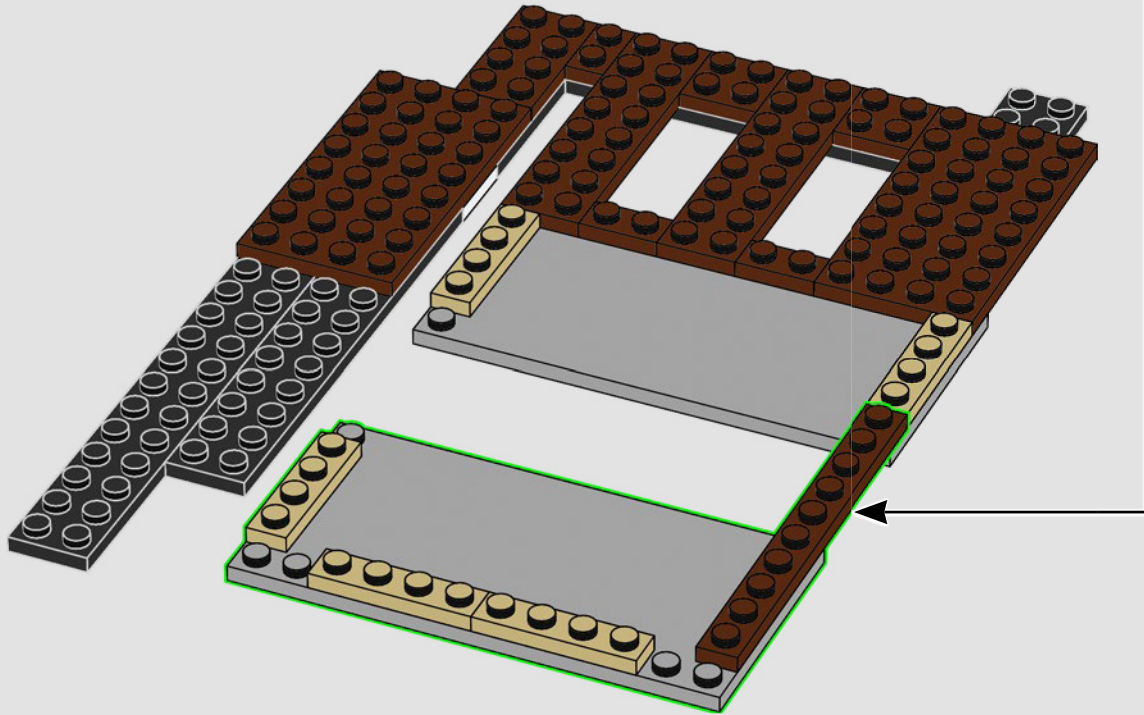

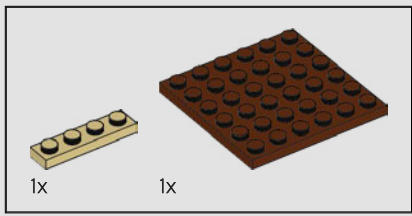

8

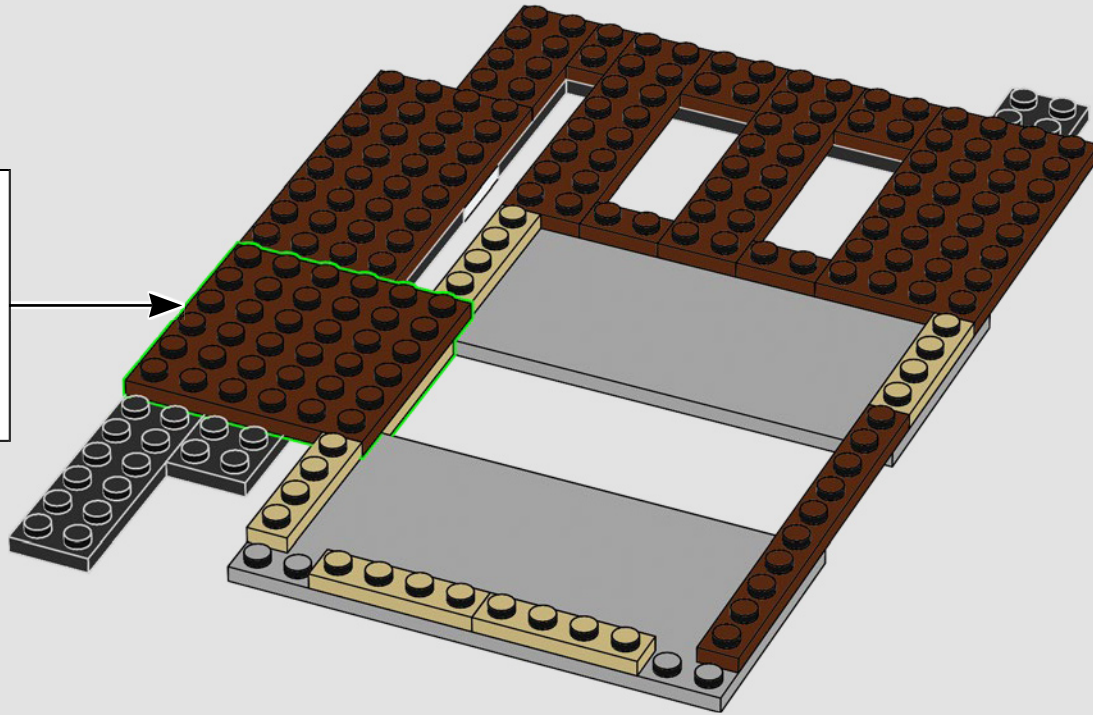

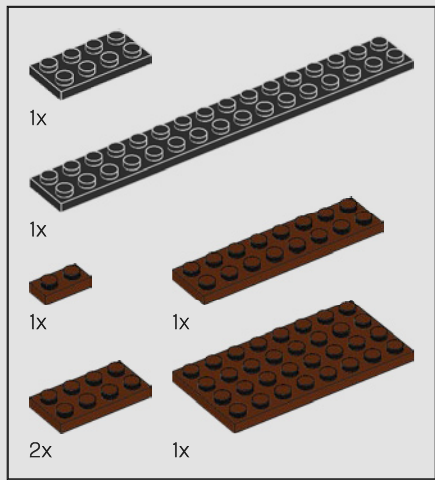

9

1

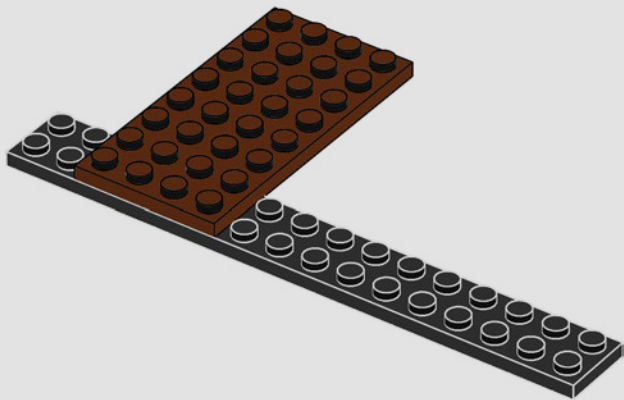

2

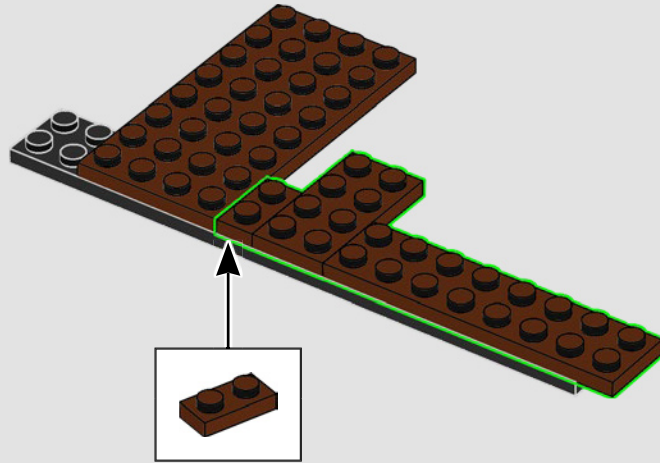

3

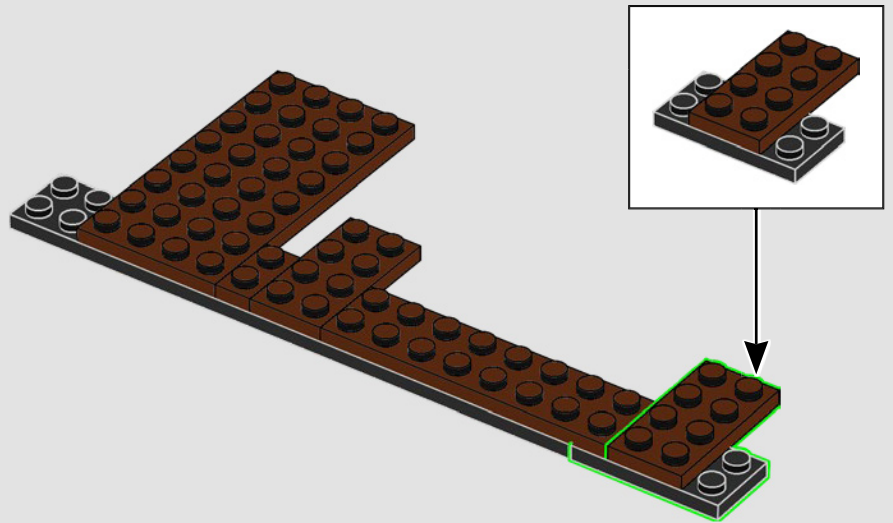

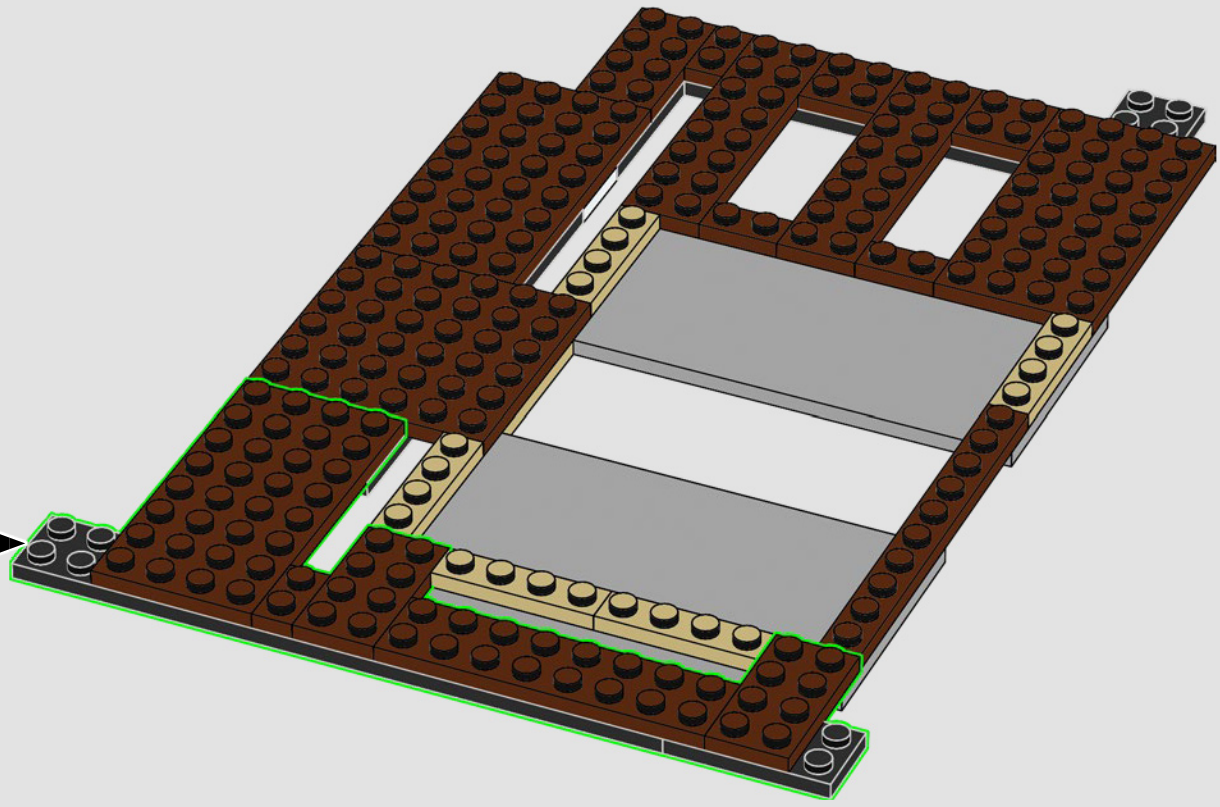

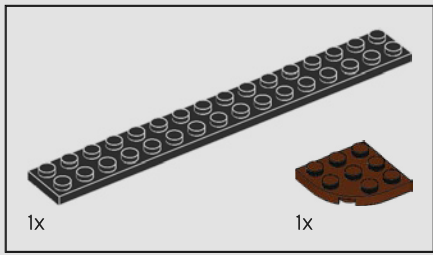

10

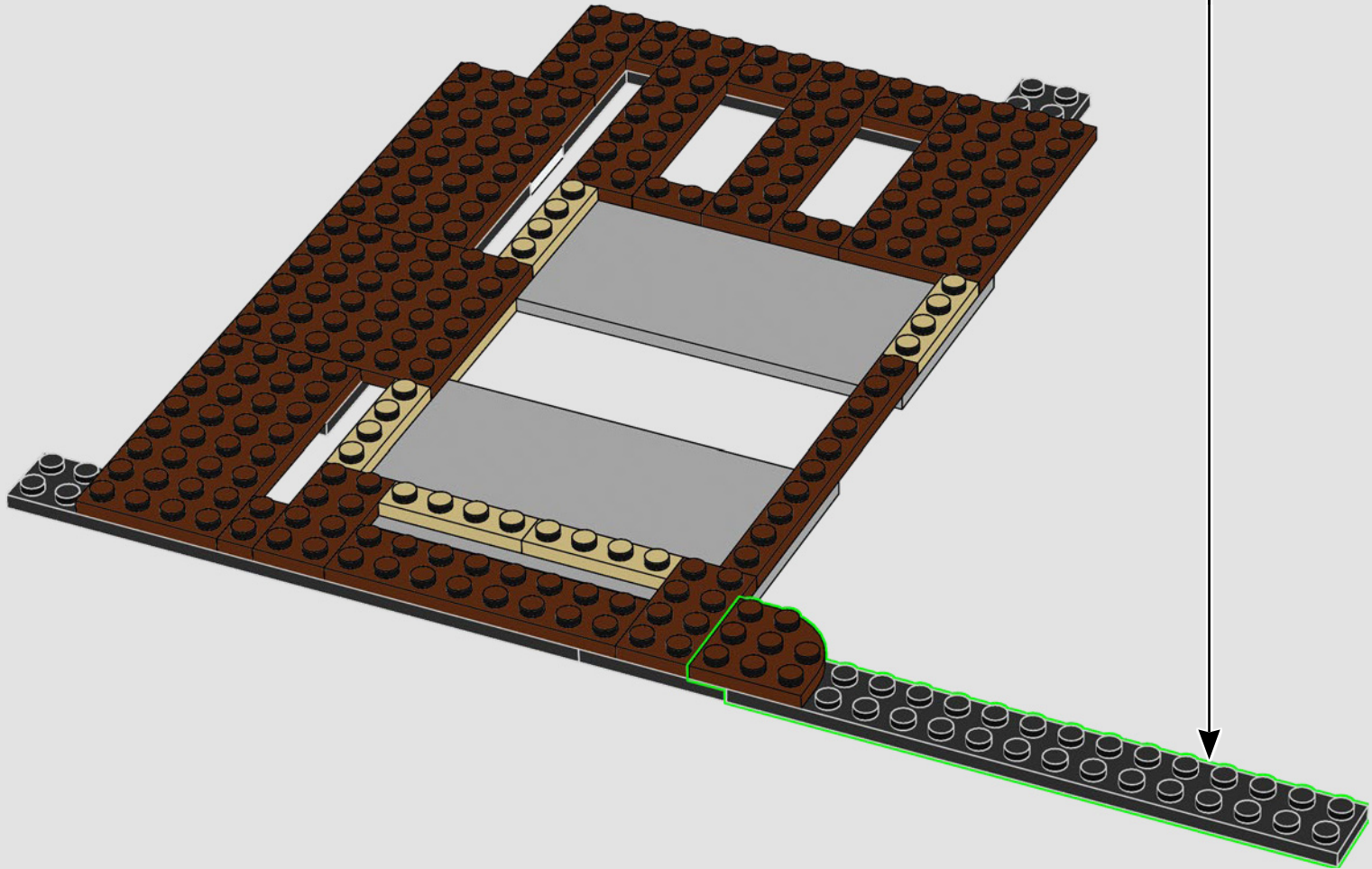
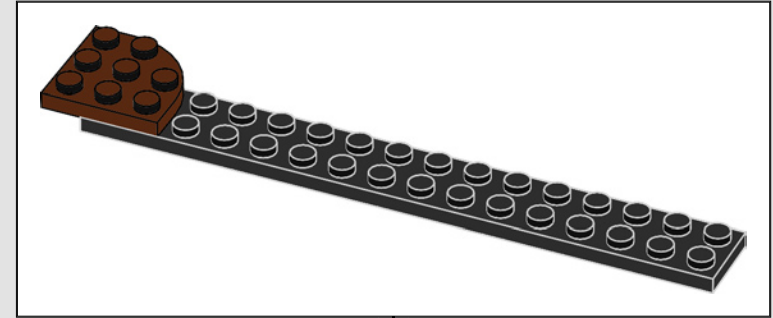

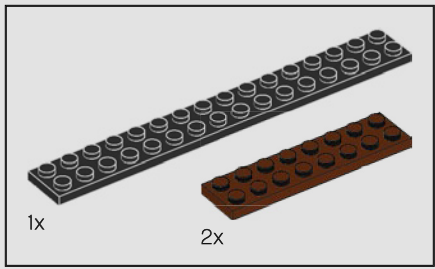

11

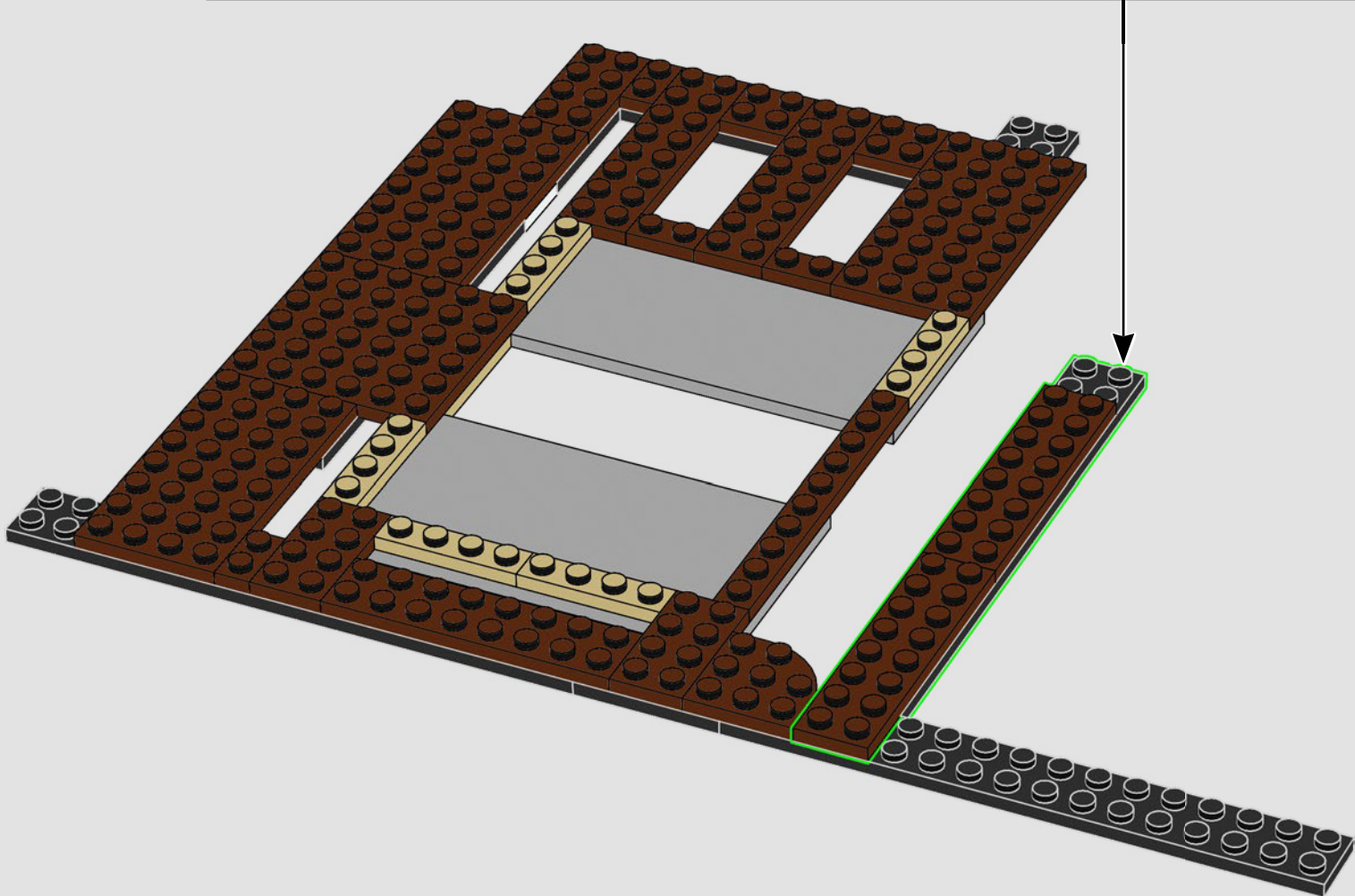
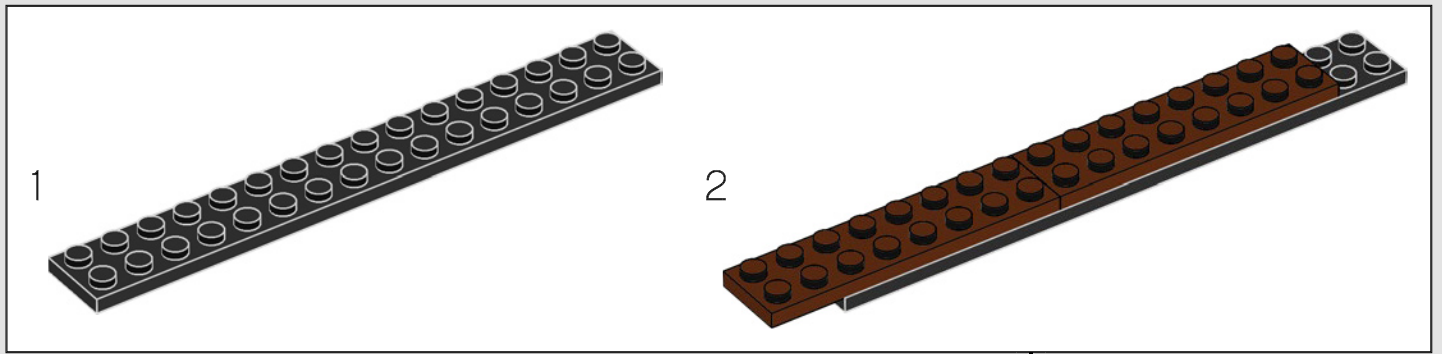

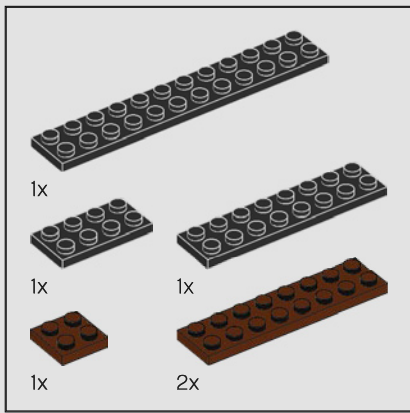

12

1

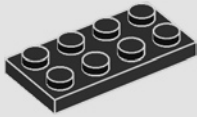

2

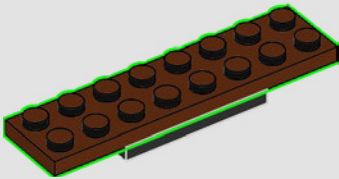

3

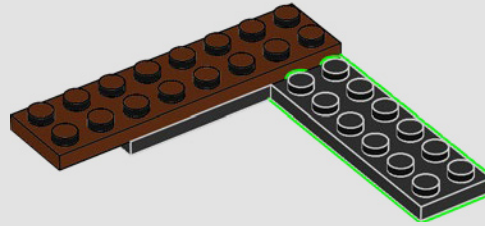

4

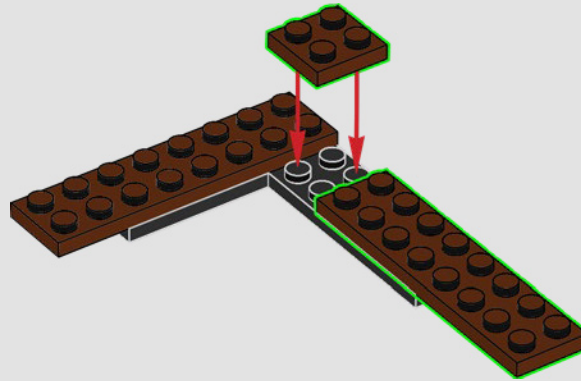

5

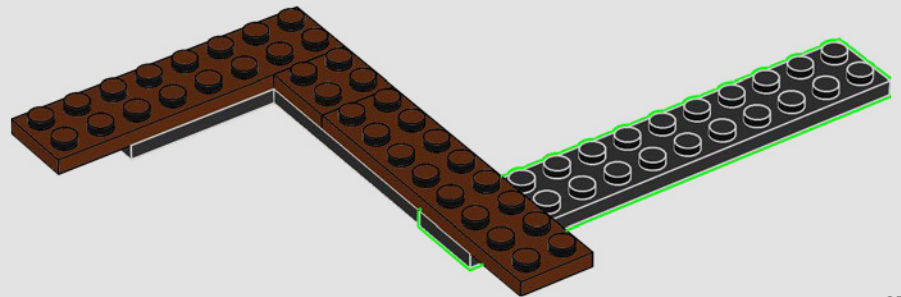

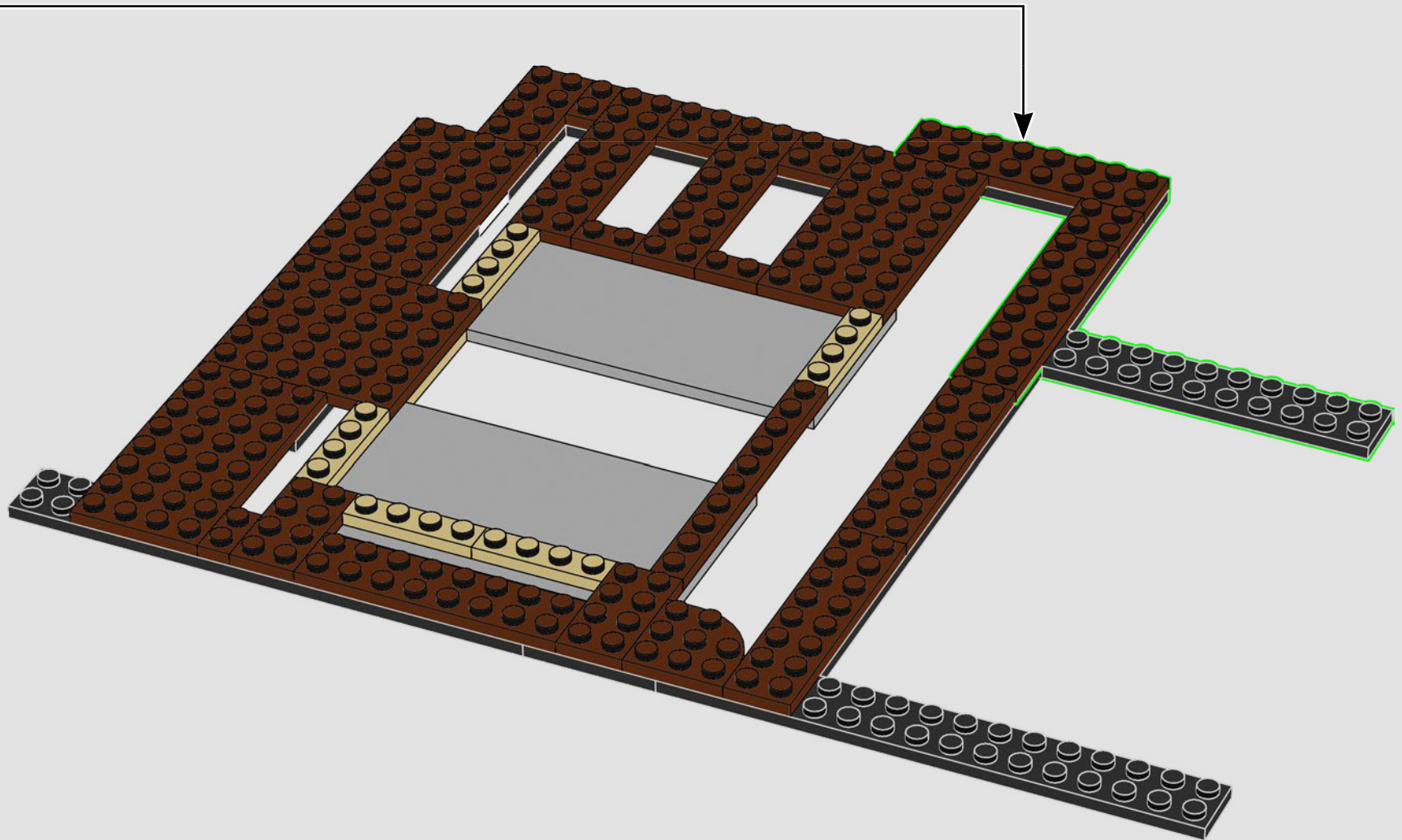

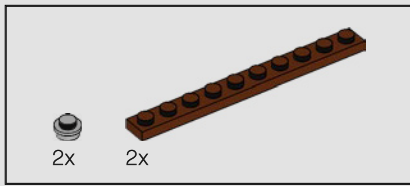

13

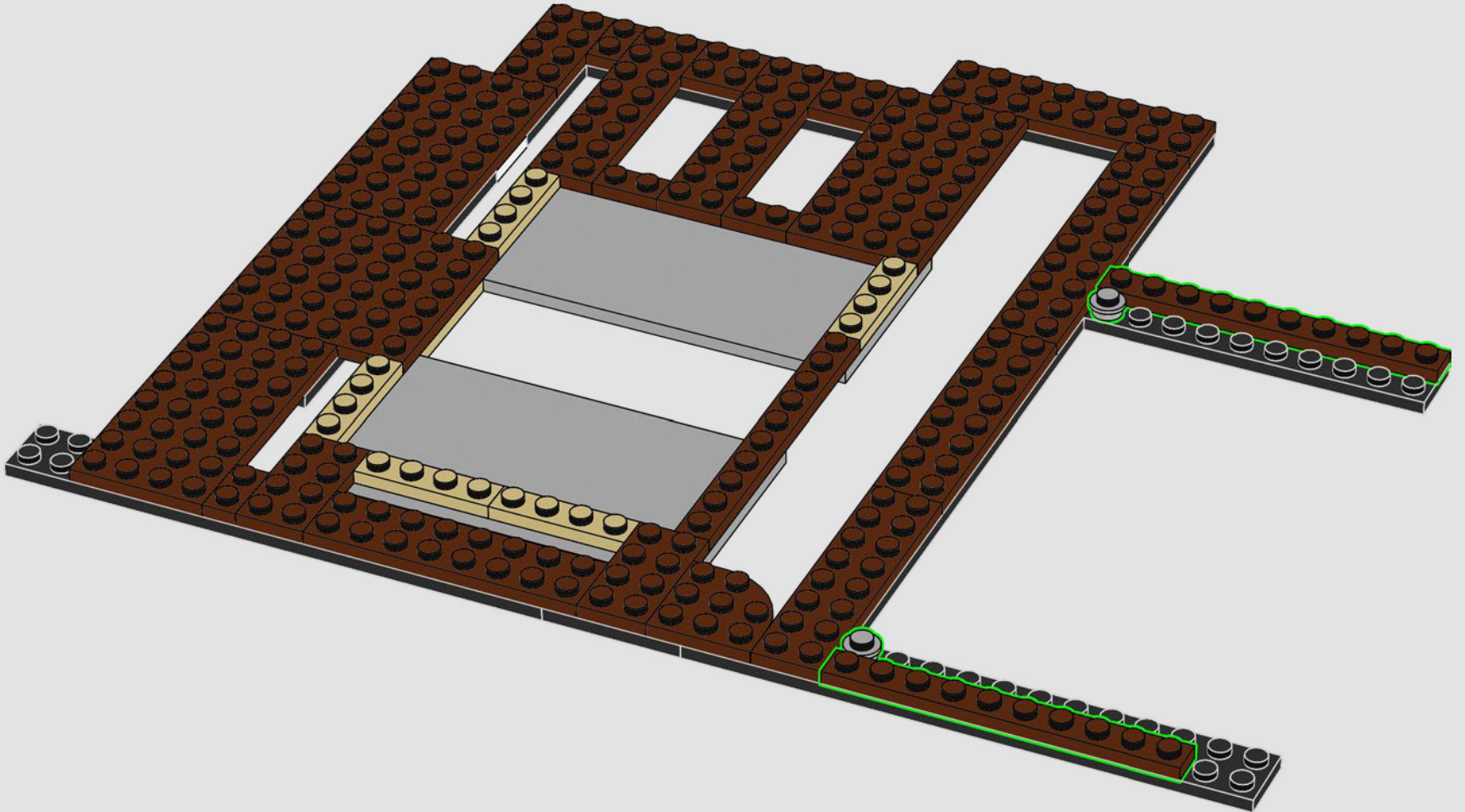

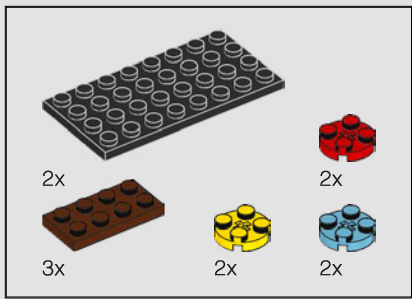

14

1

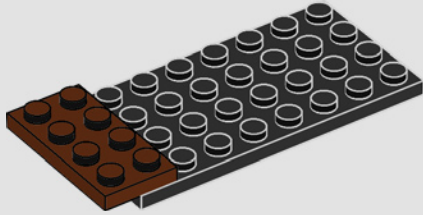

2

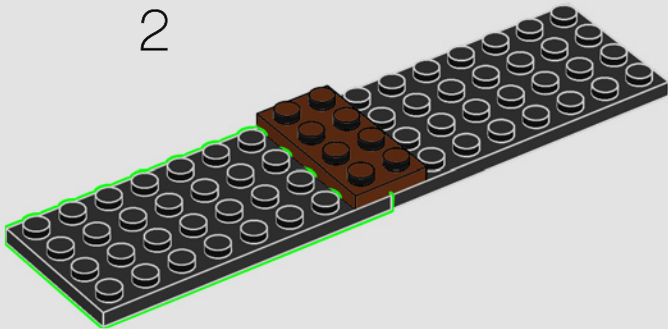

3

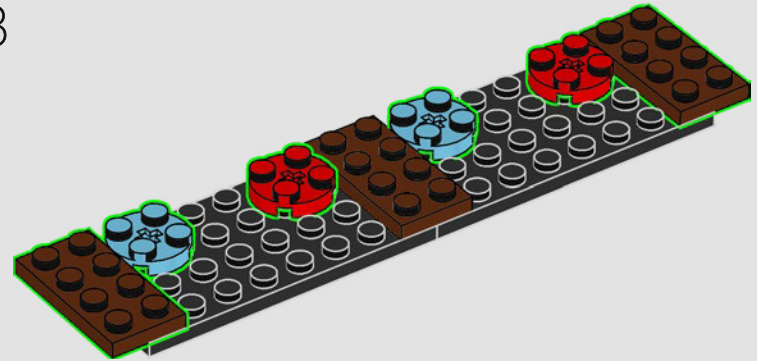

4

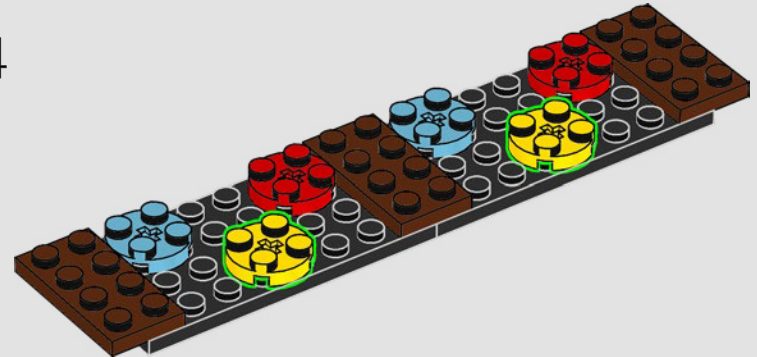

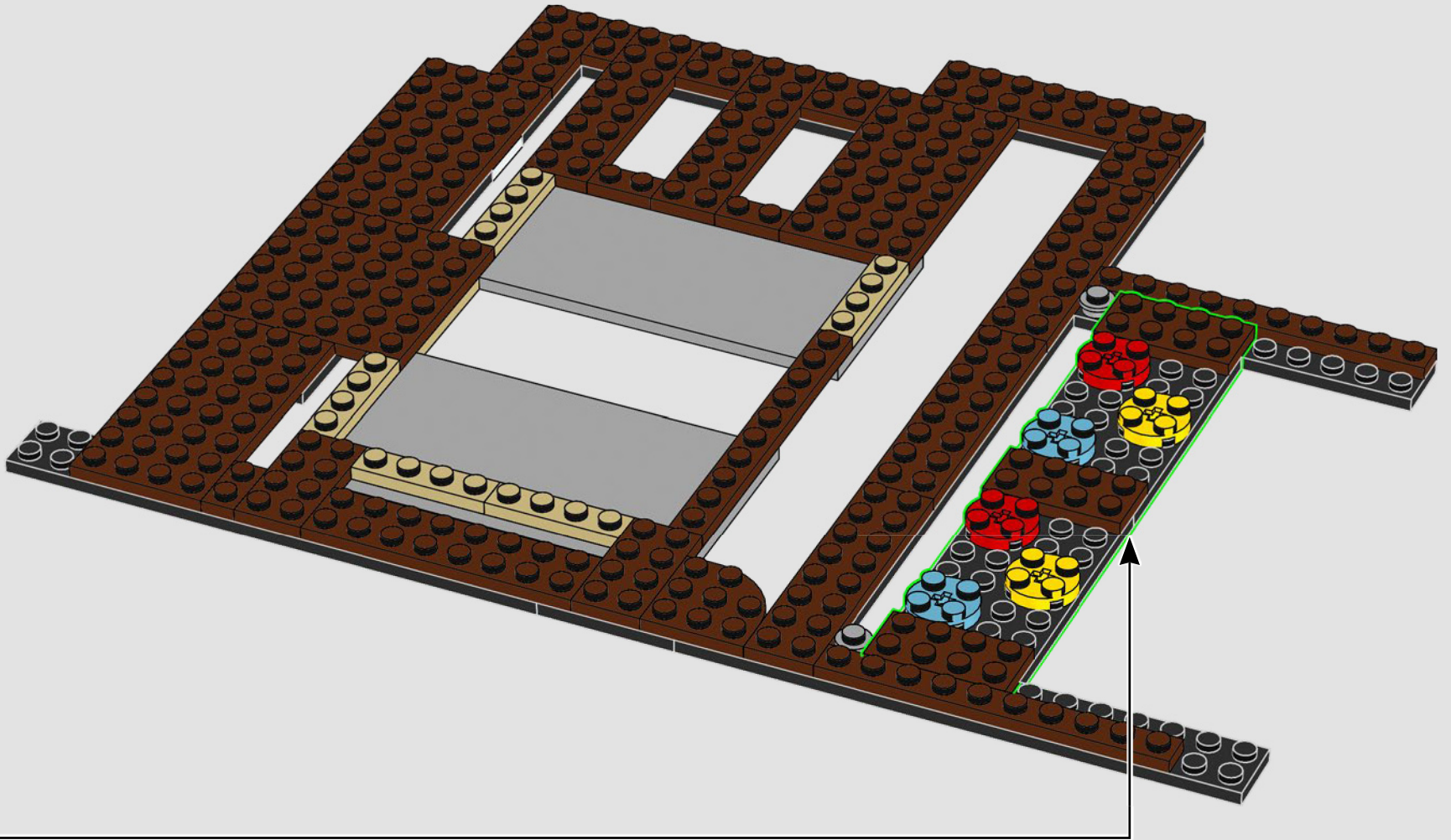

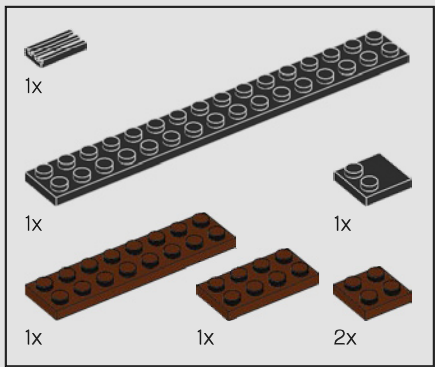

15

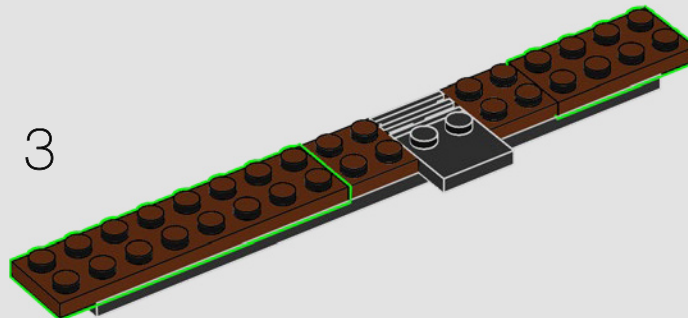
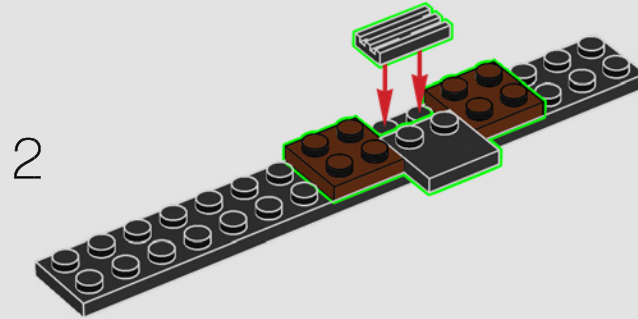
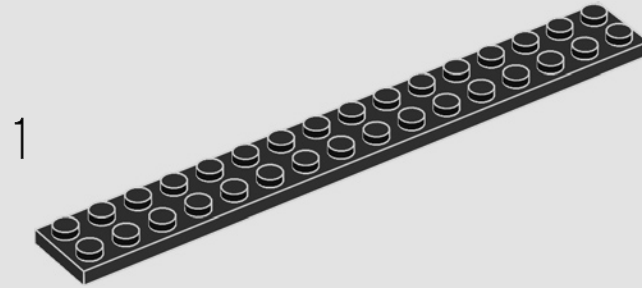

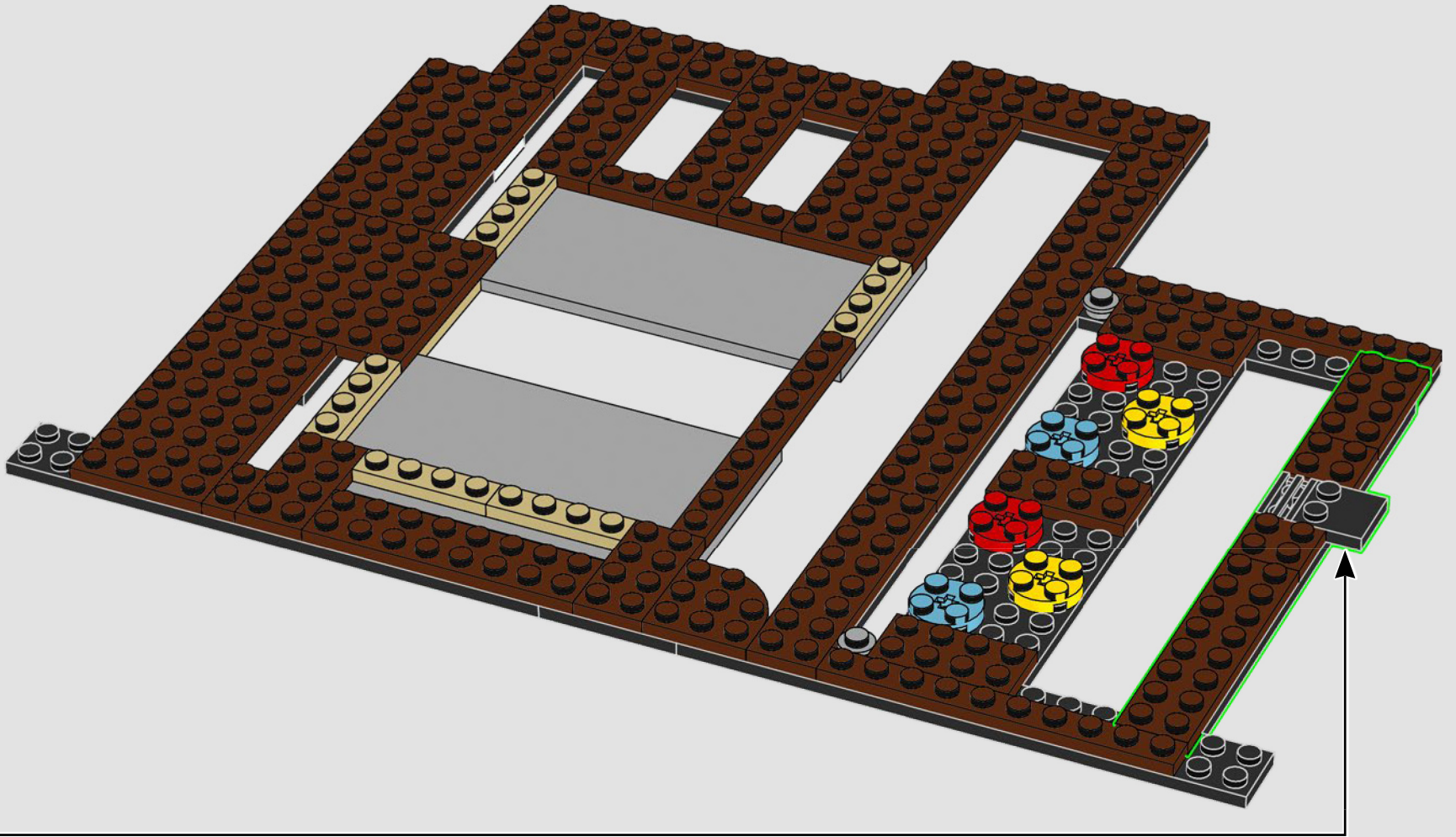

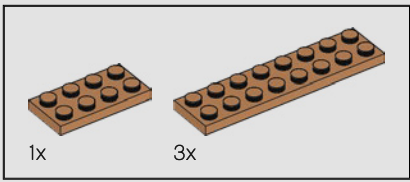

16

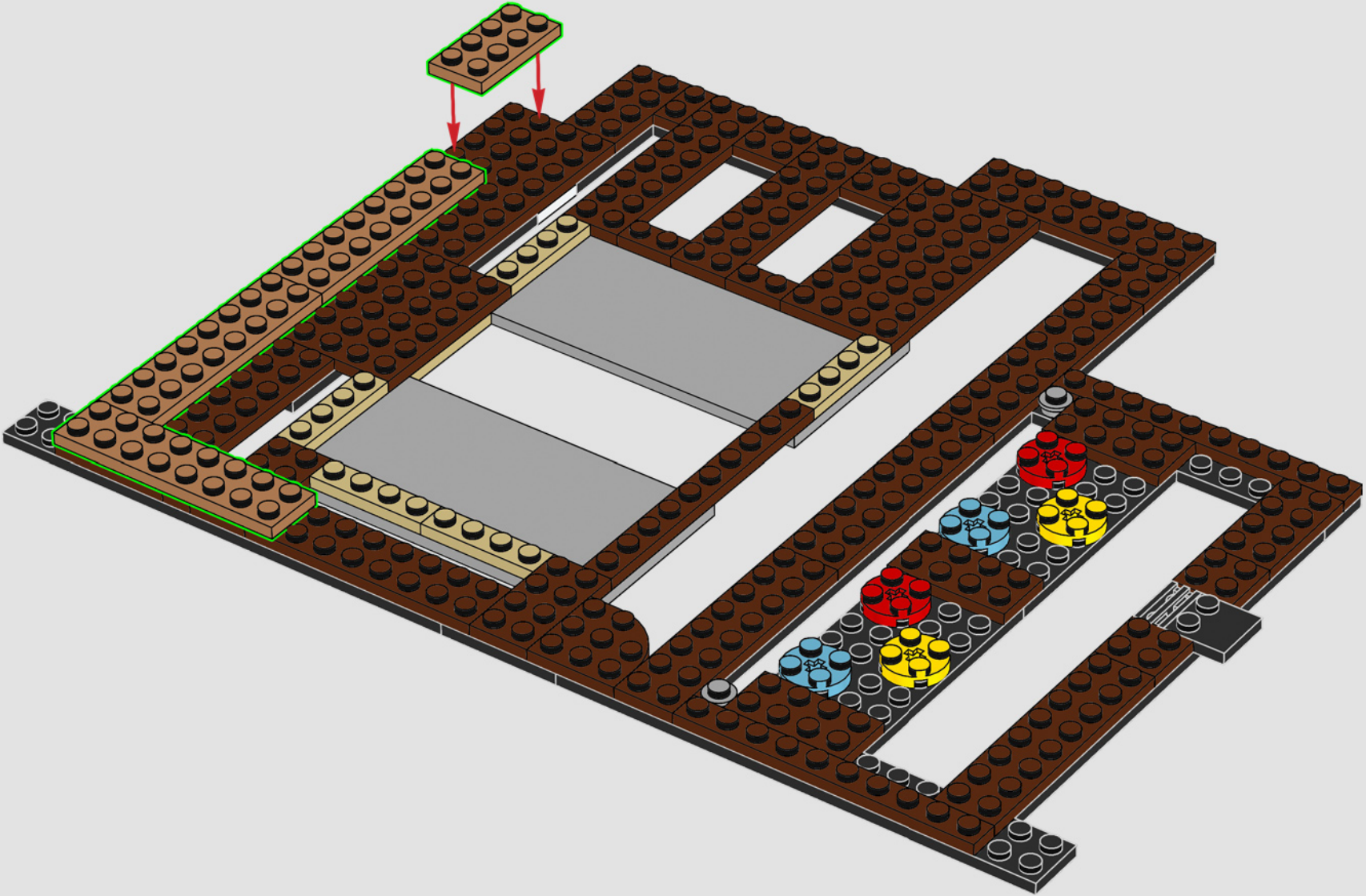

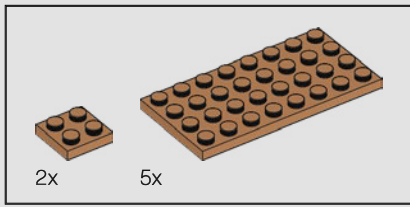

17

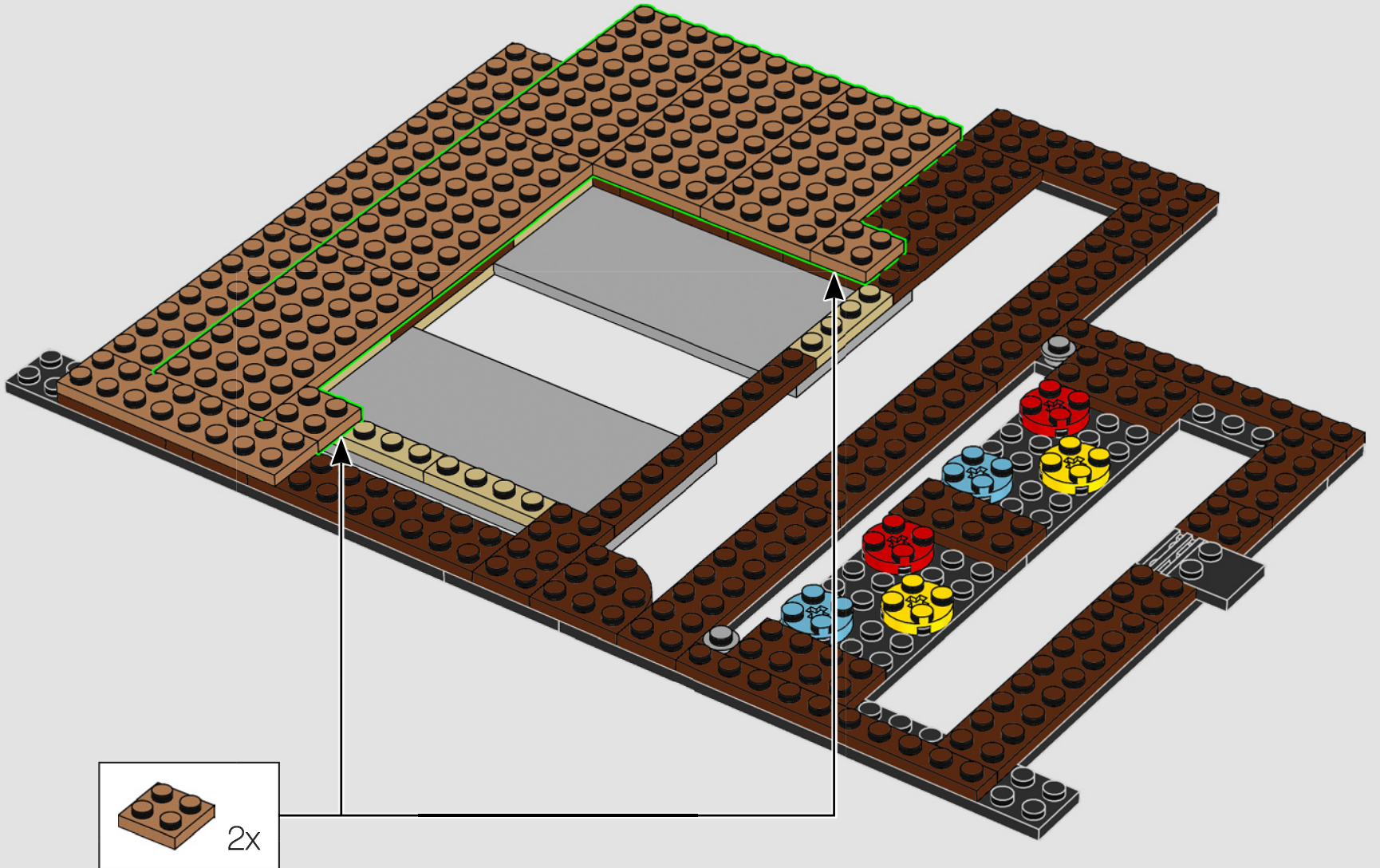

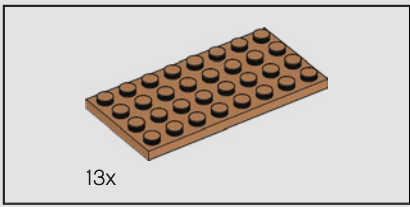

18

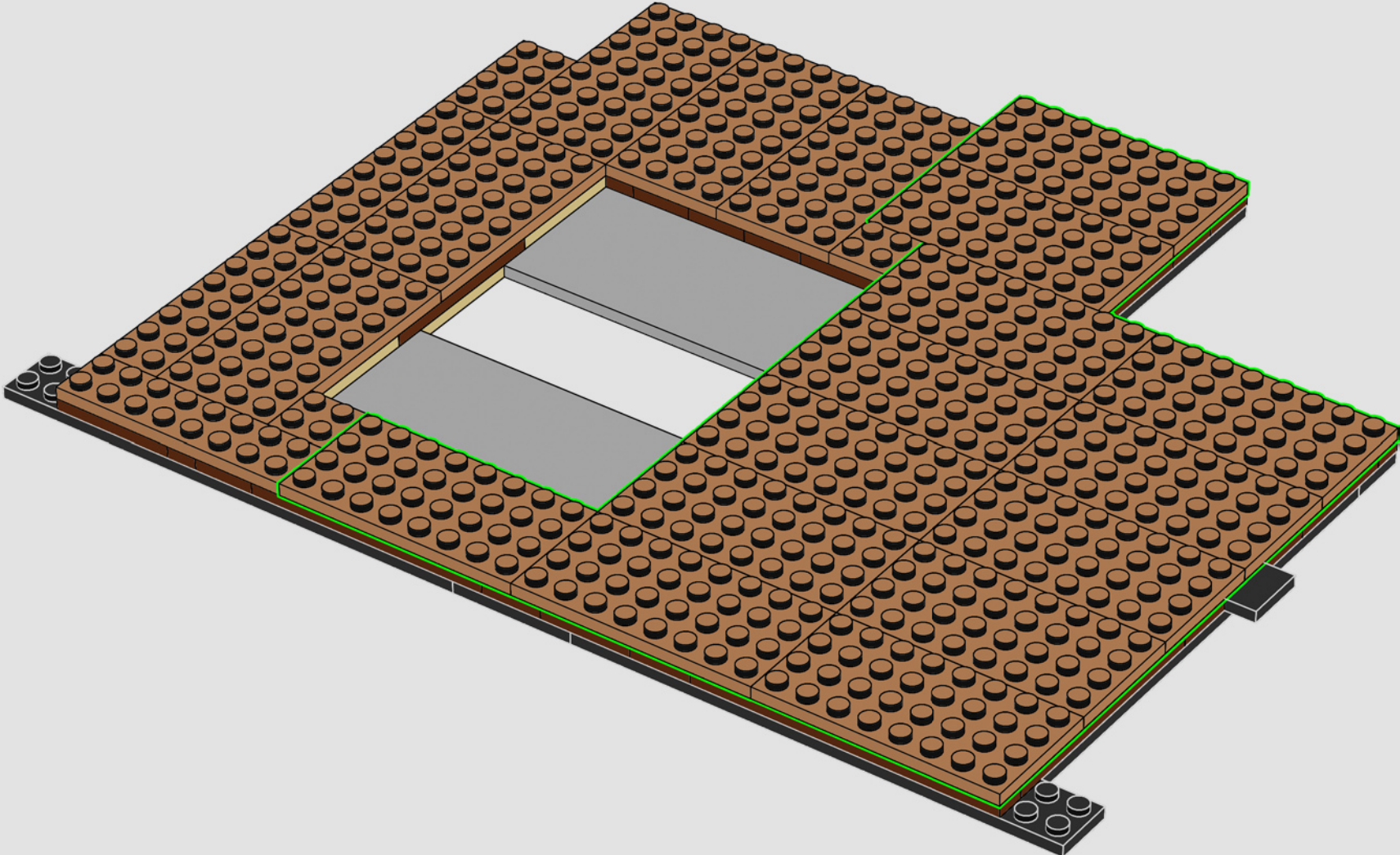

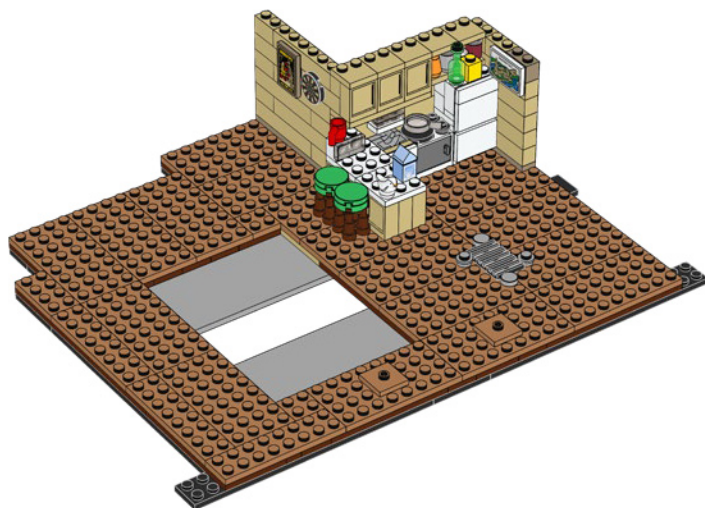

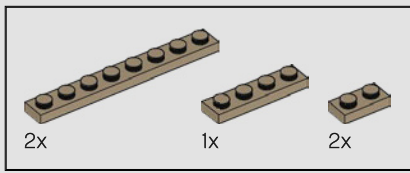

20

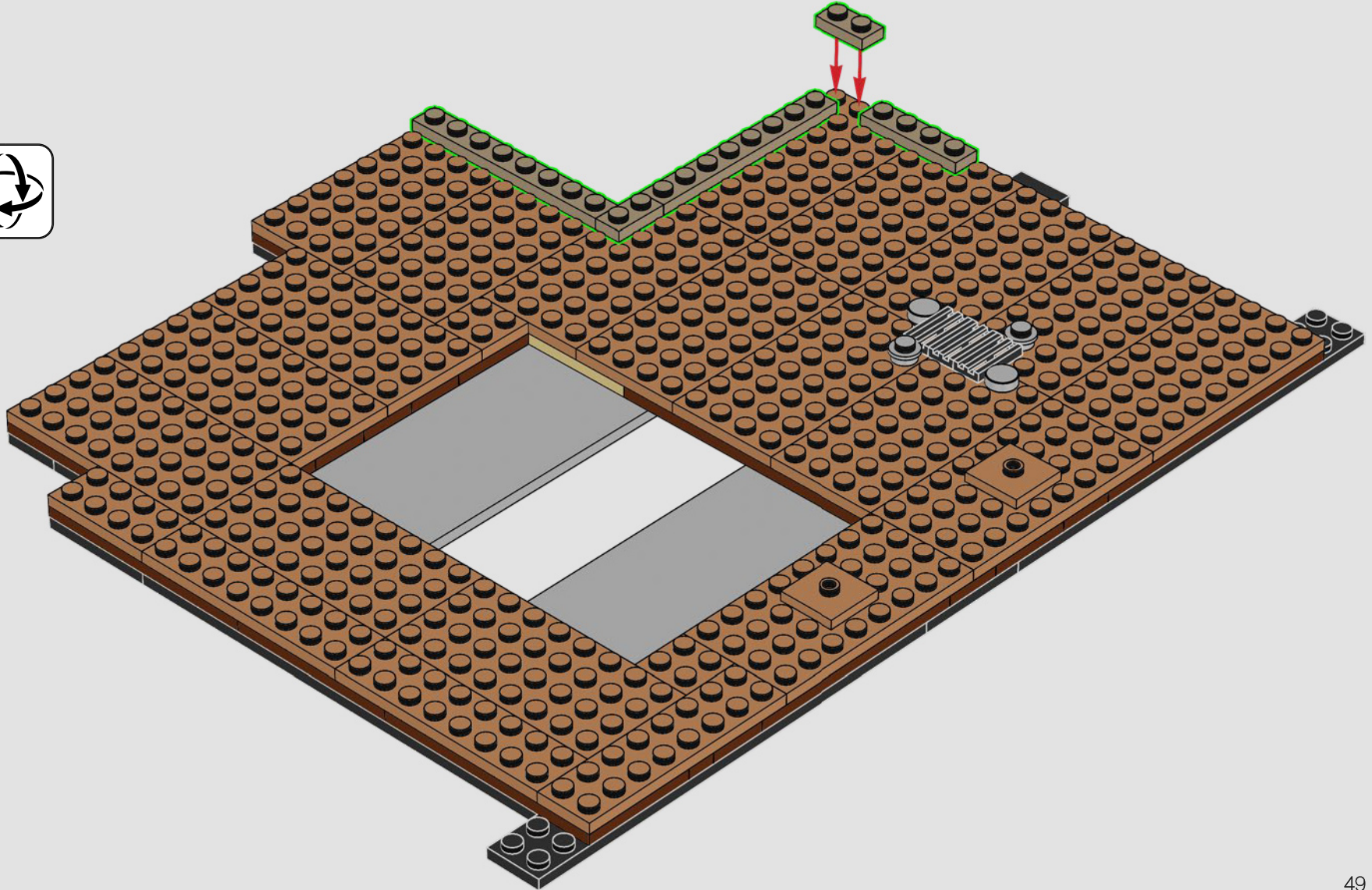

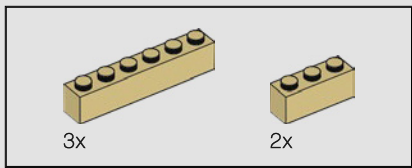

21

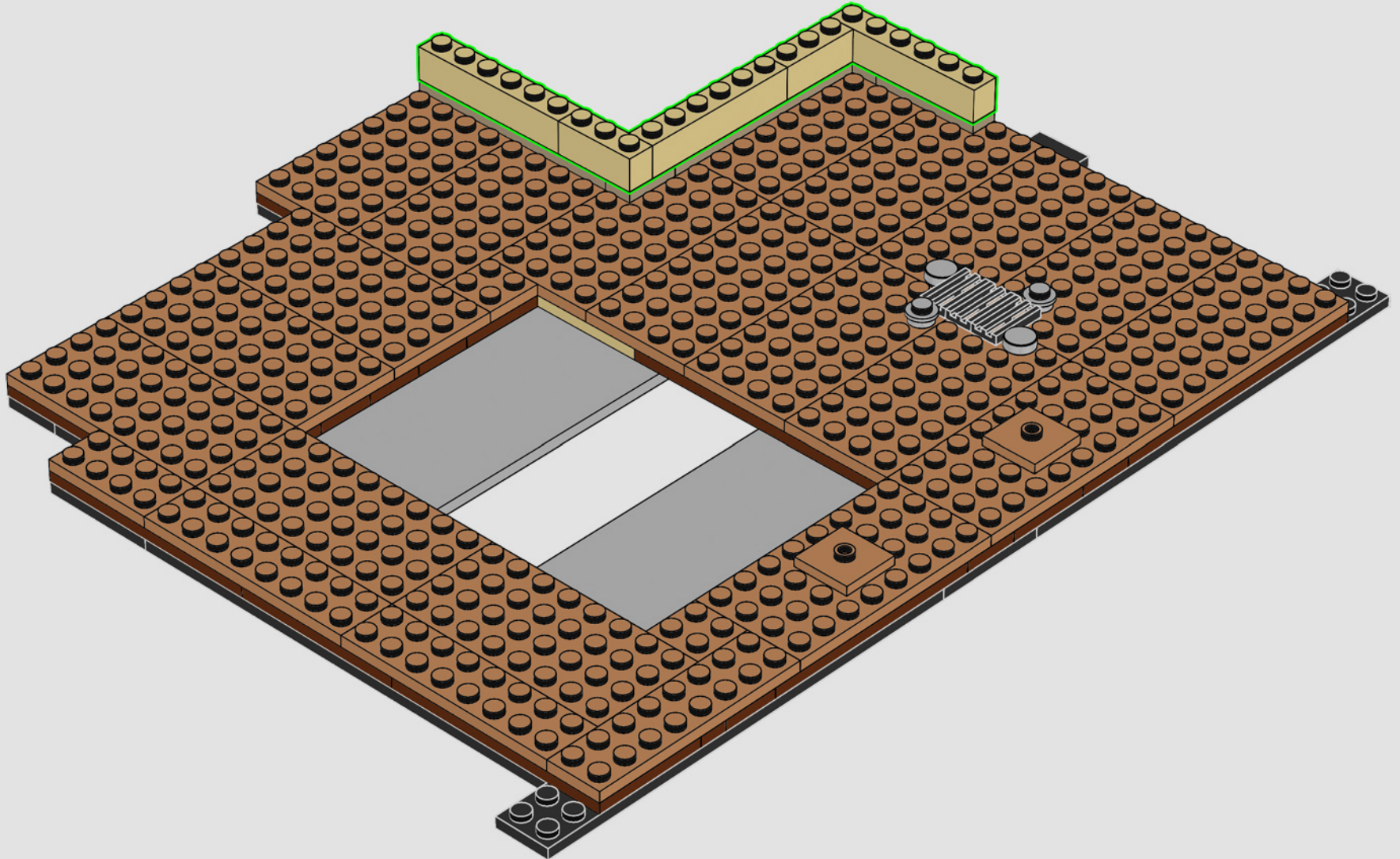

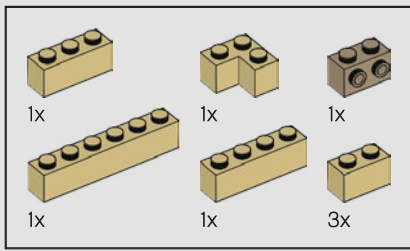

22

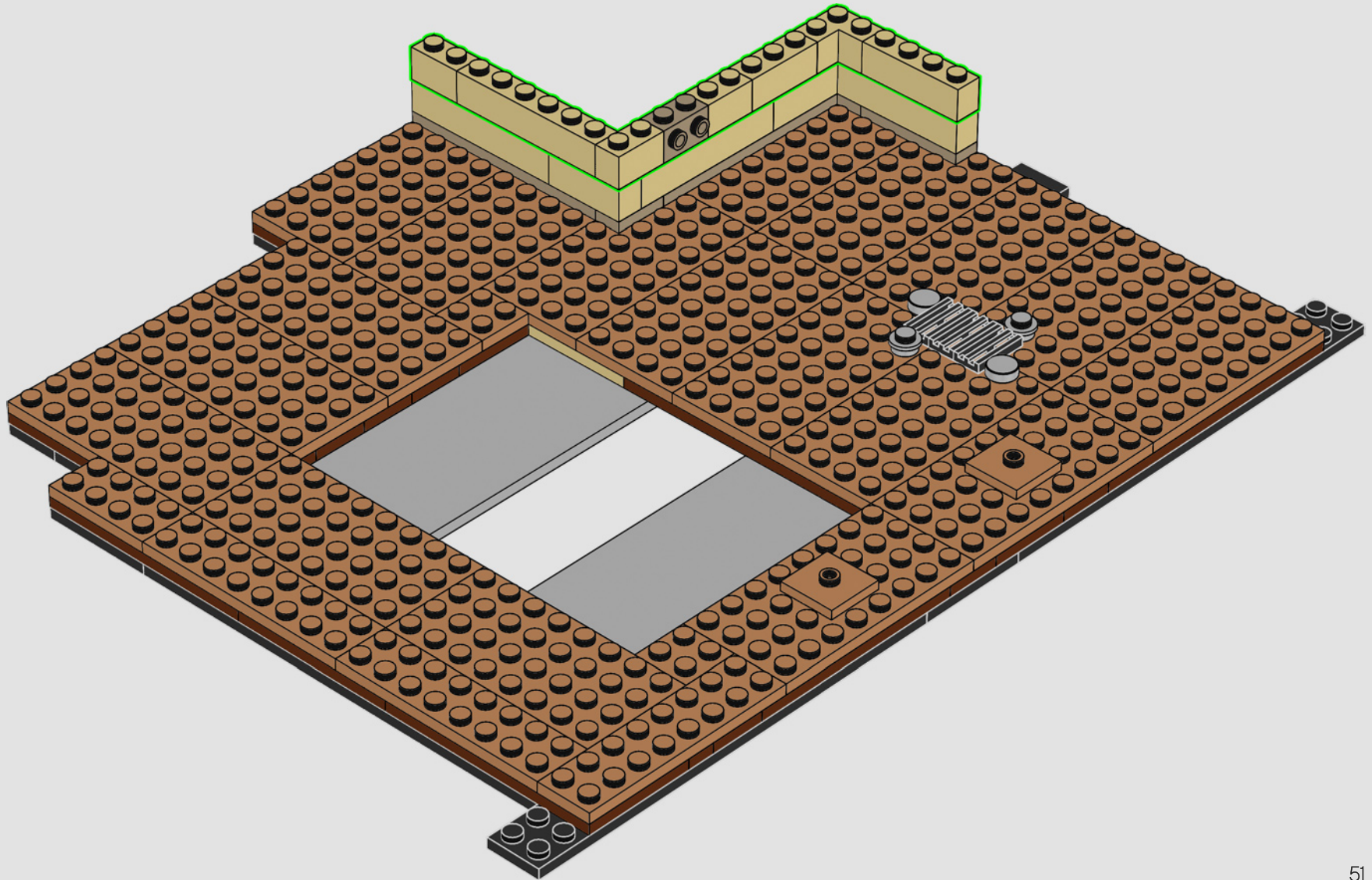

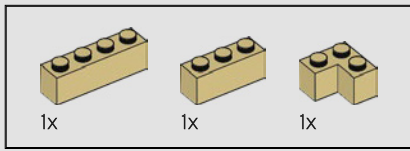

24

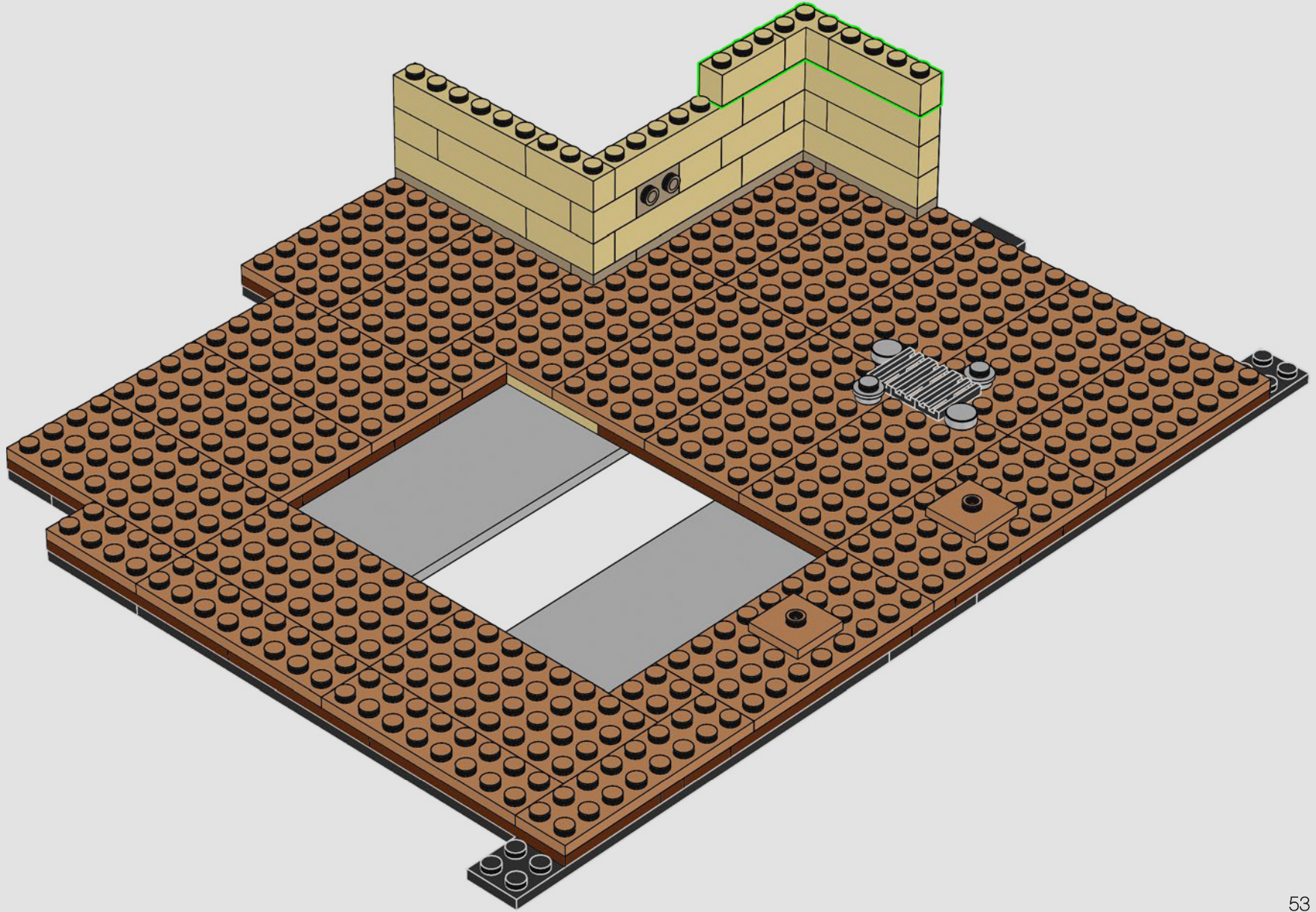

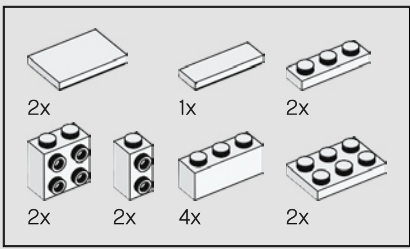

25

1

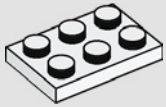

2

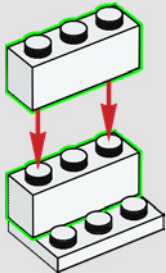

3

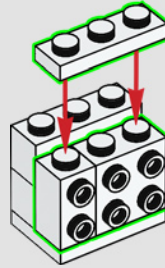

4

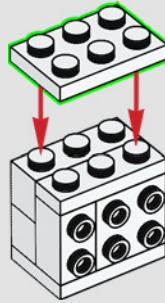

5

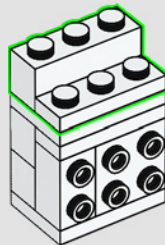

6

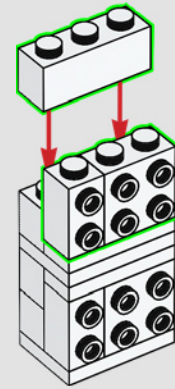

7

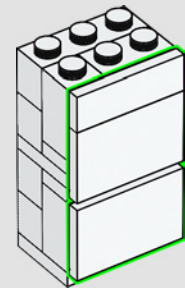

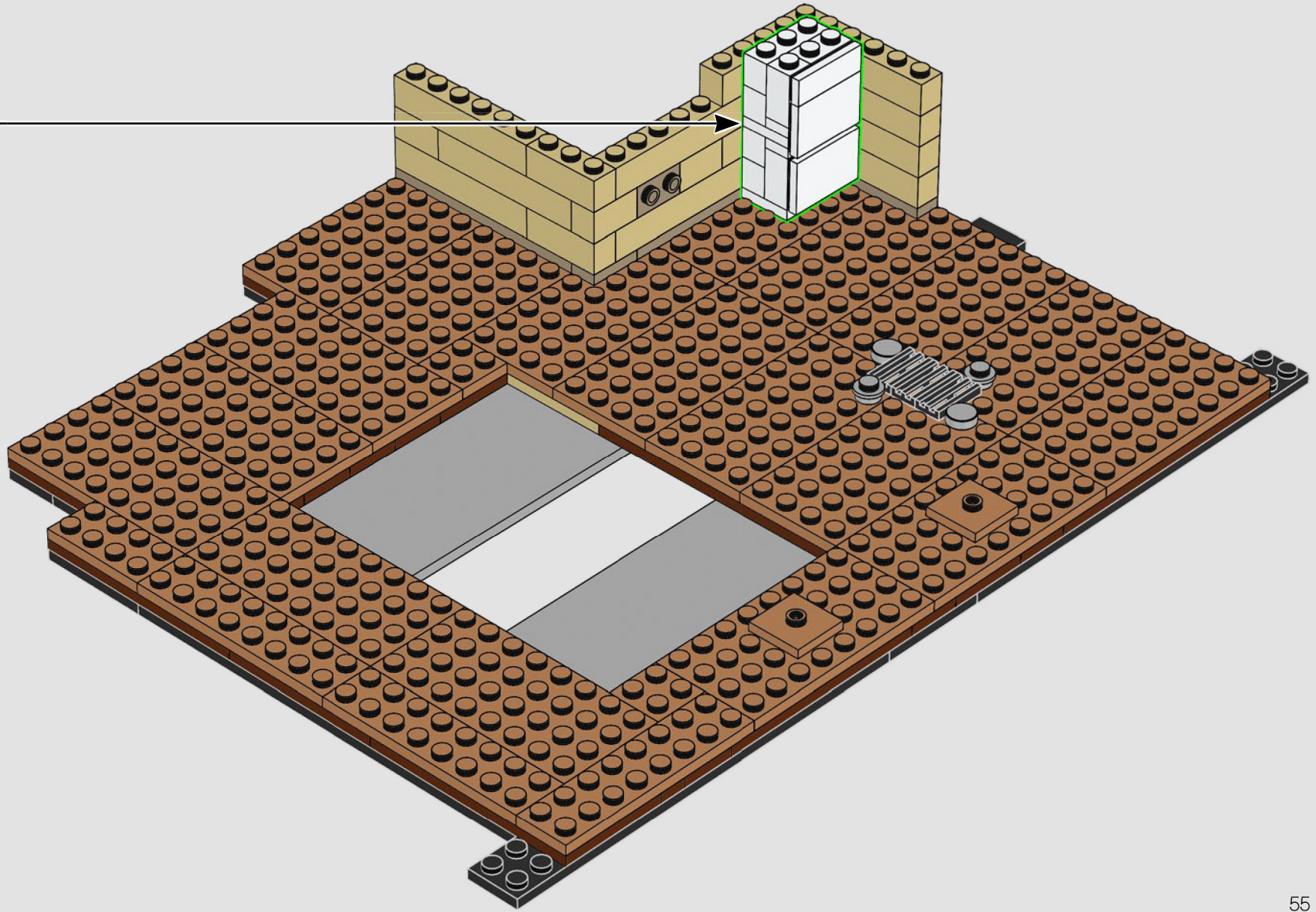

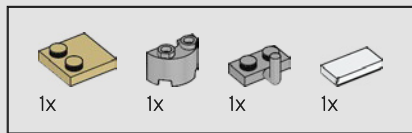

27

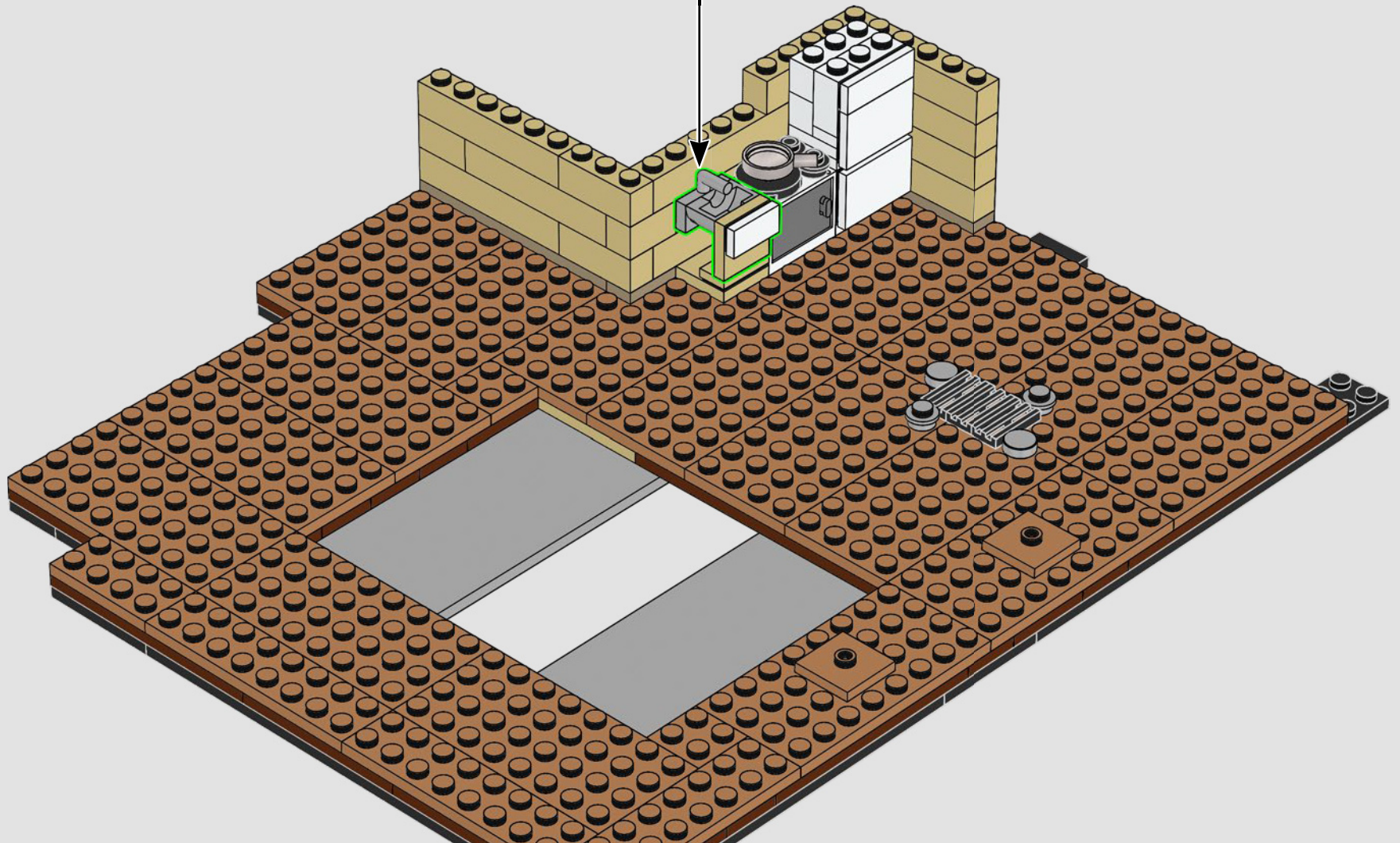
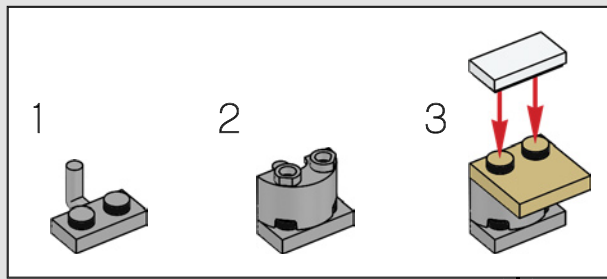

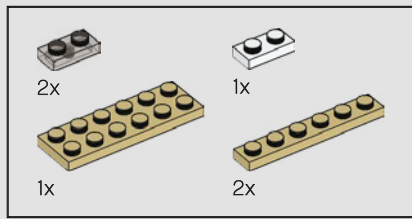

31

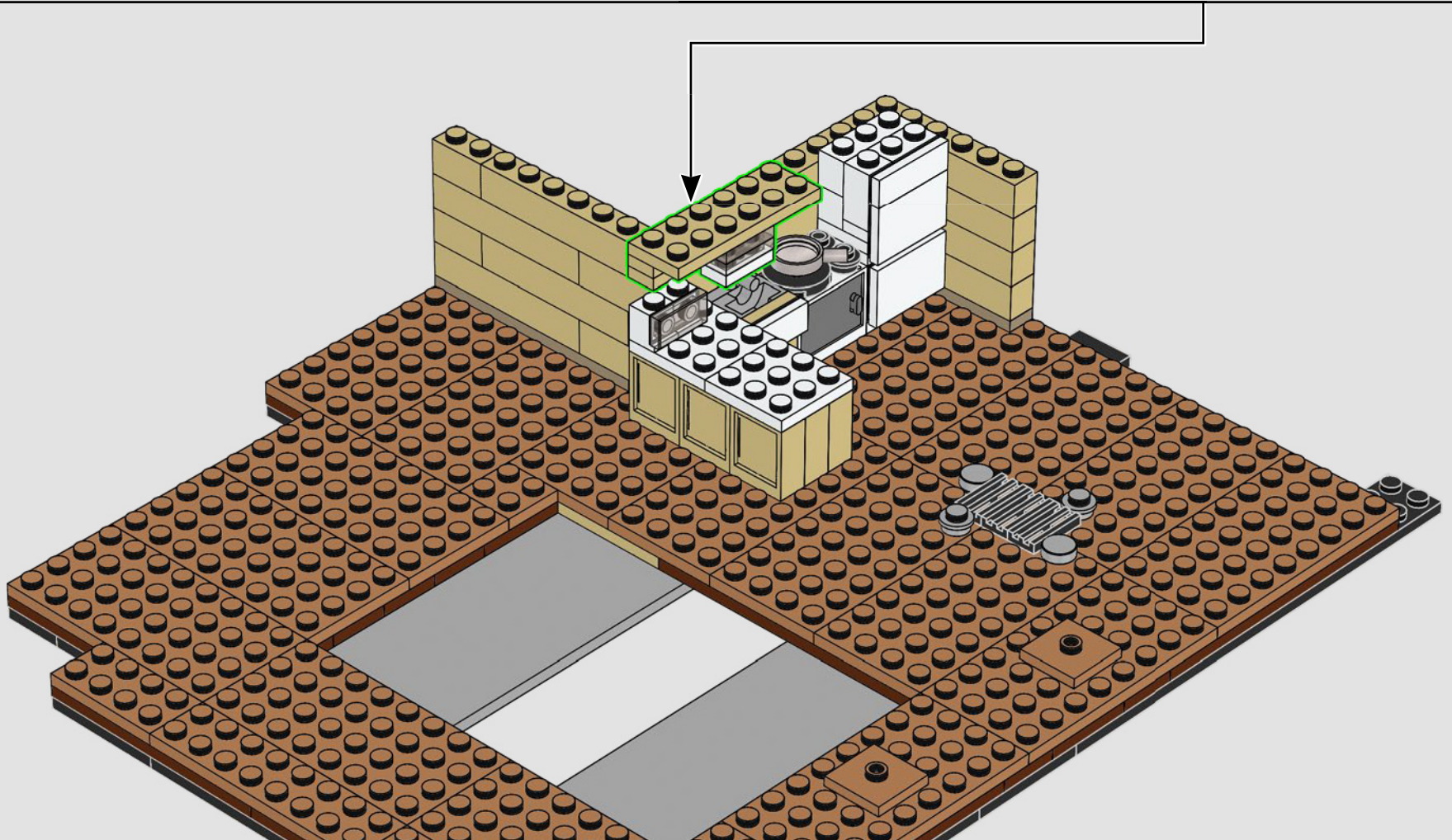
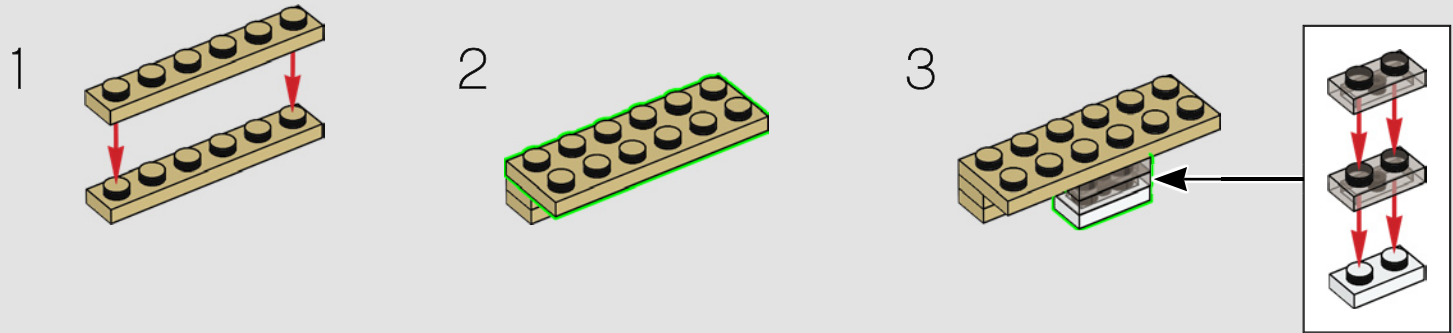

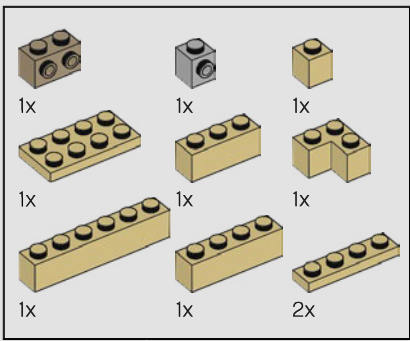

32

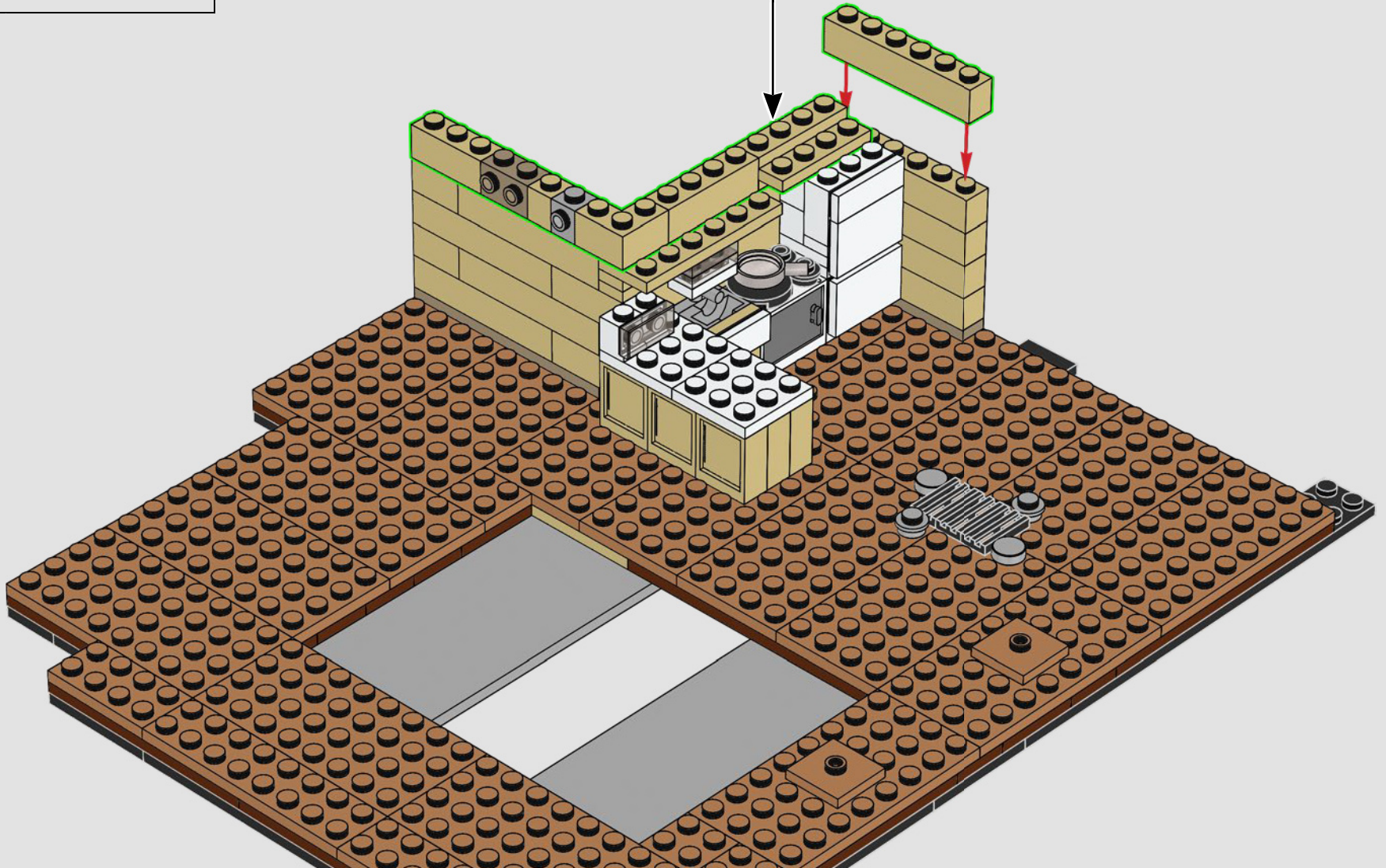
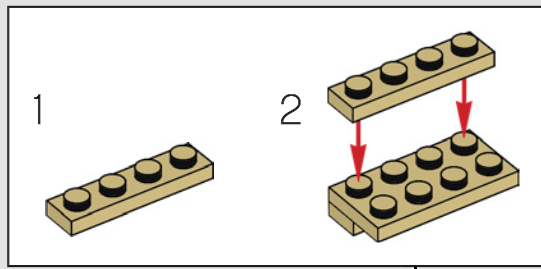



33

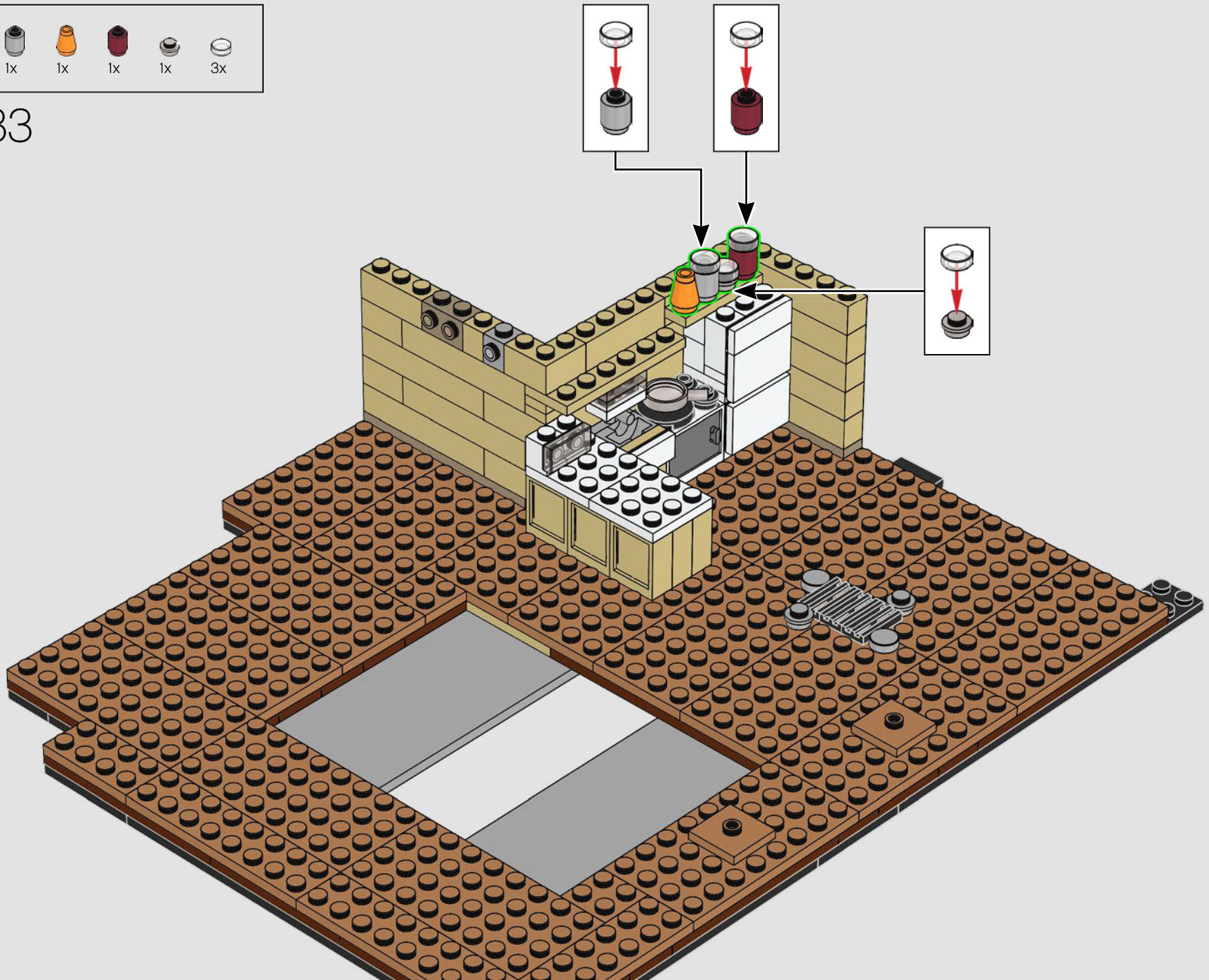

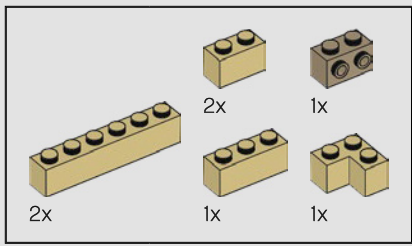

34

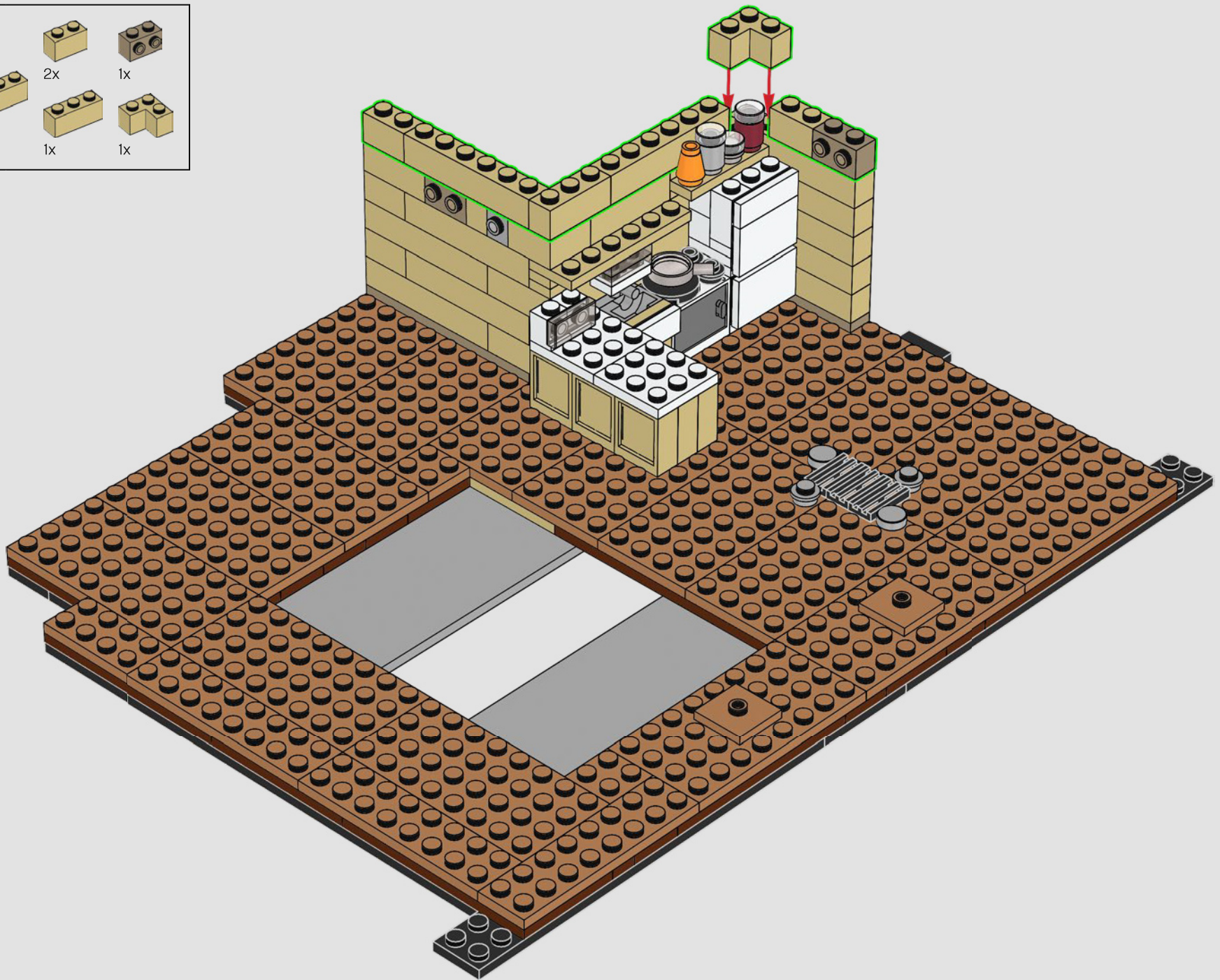

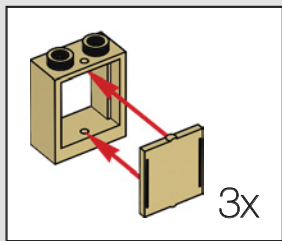
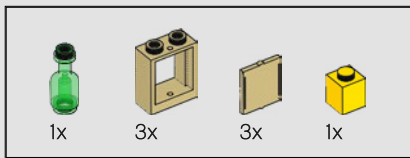

35

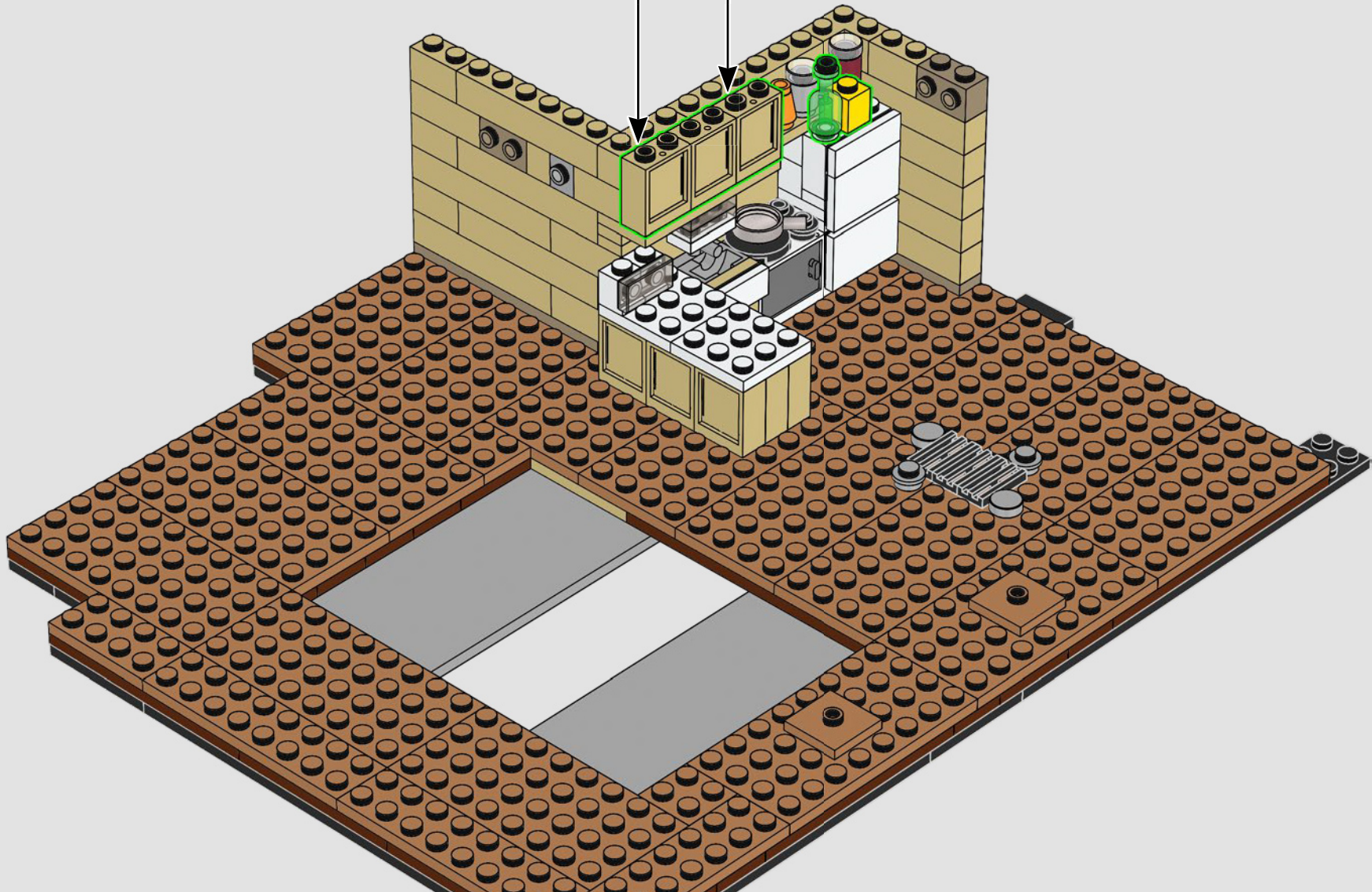

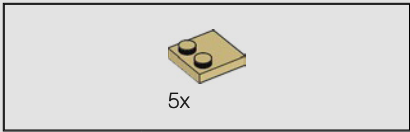

36

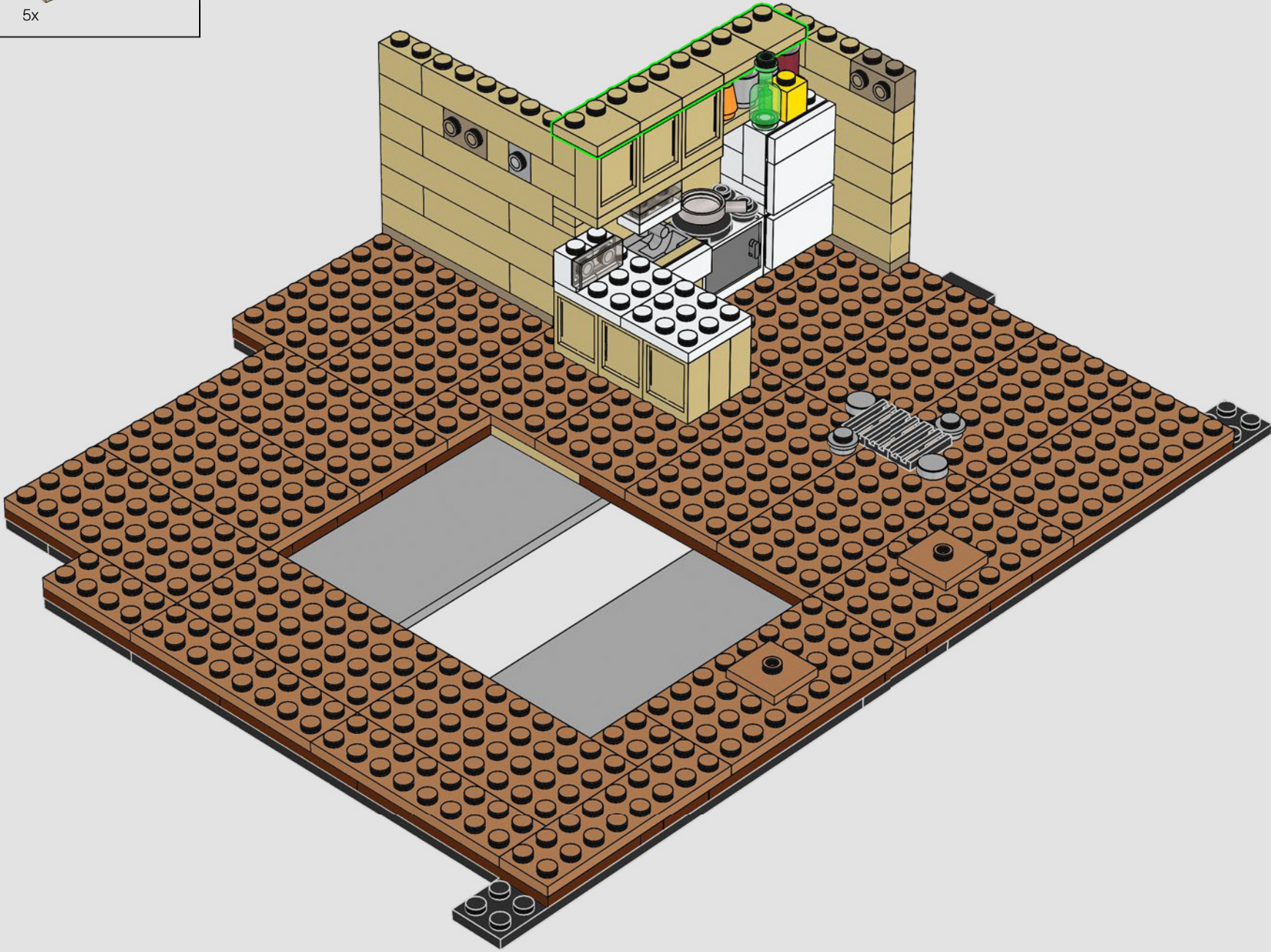

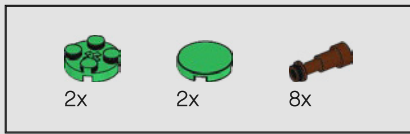

37

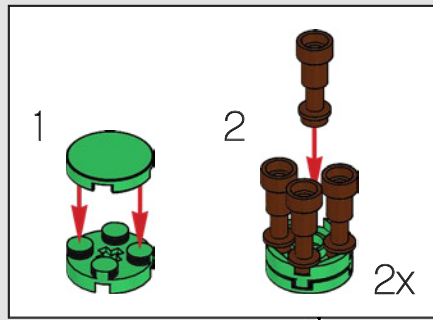

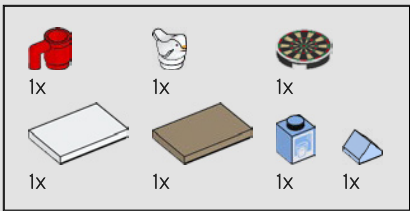

38

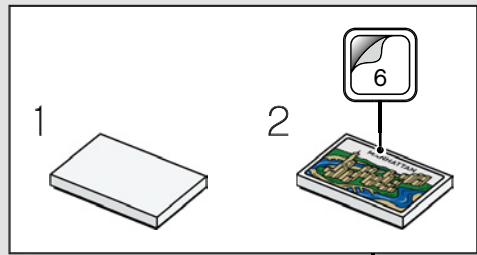
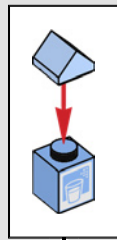
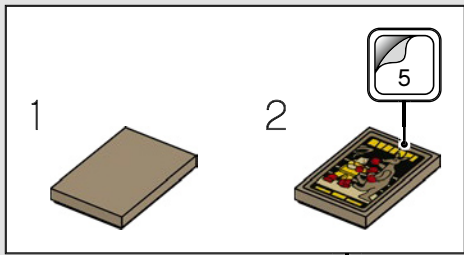

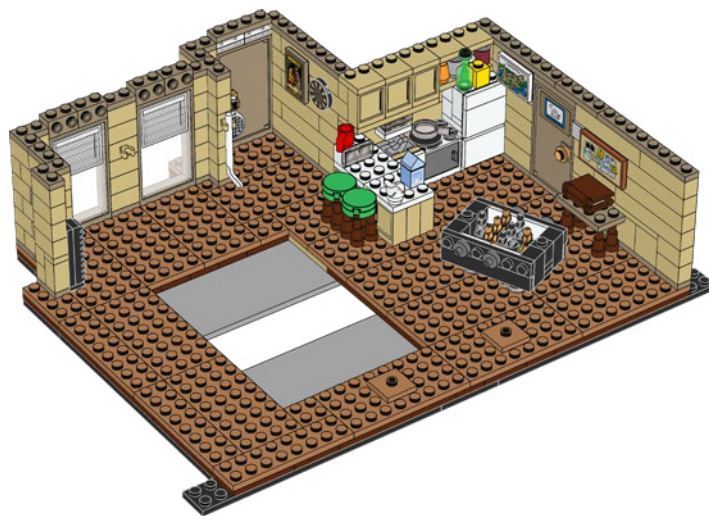

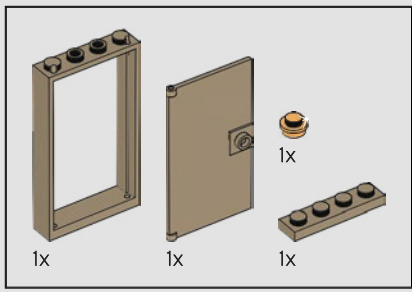

39

1

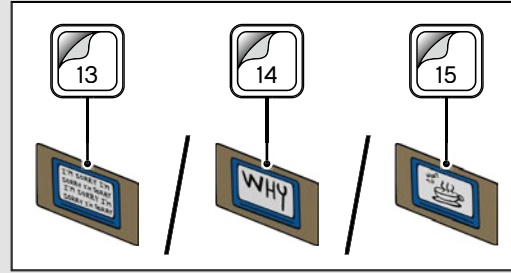
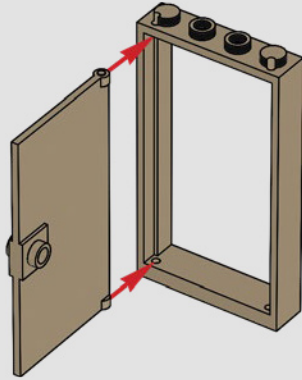

2

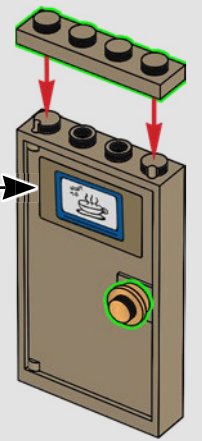

在大门背面的小白板上，可选贴 3 张贴纸之一。

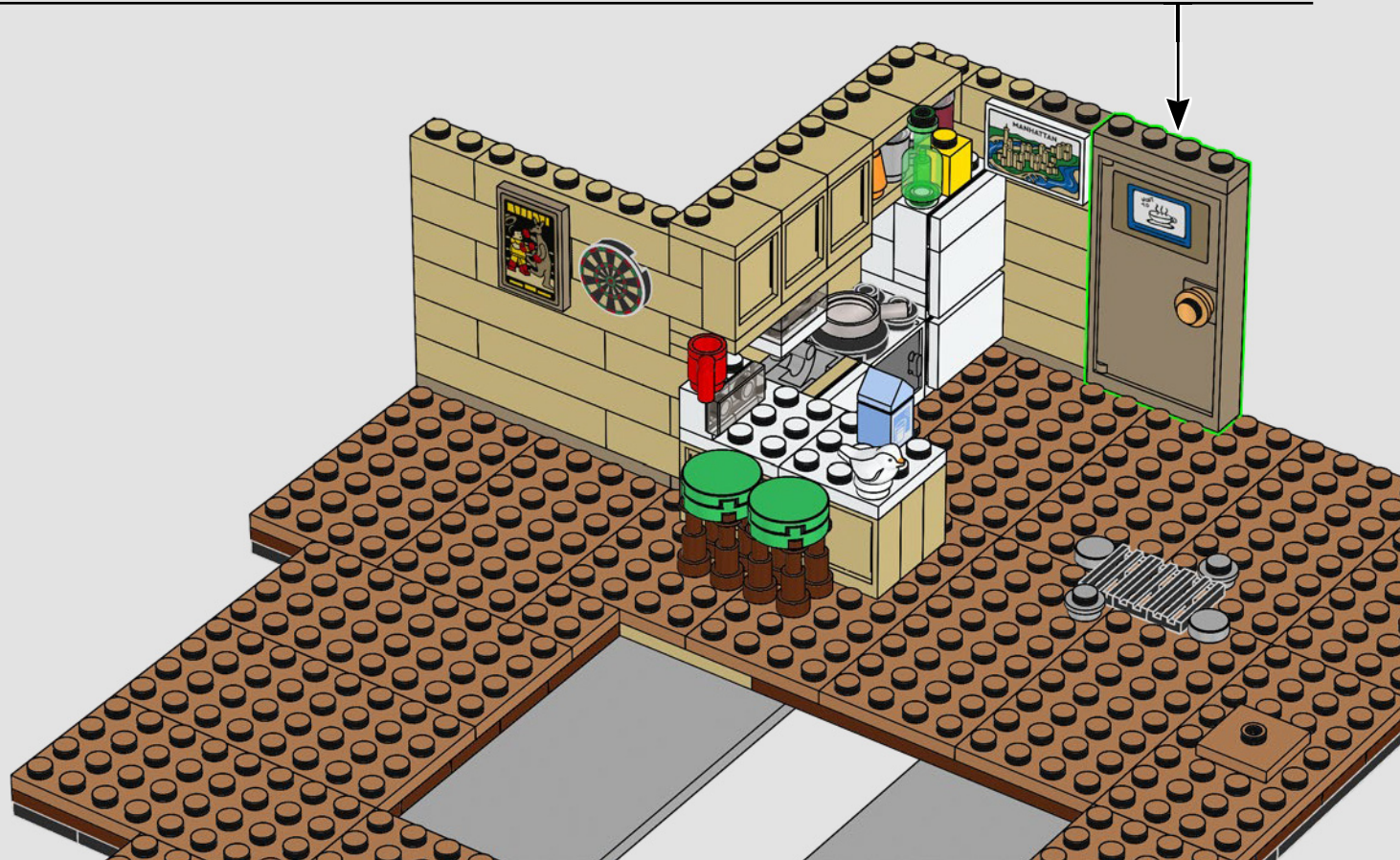

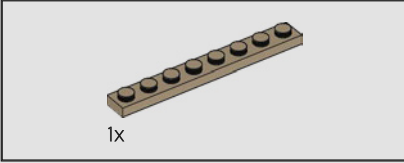
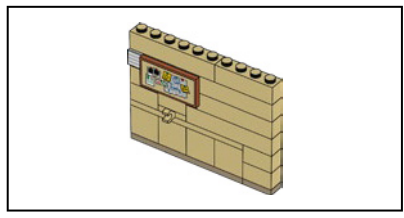

40

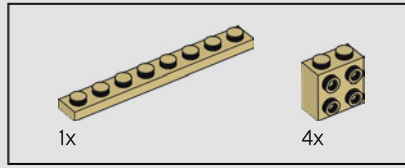
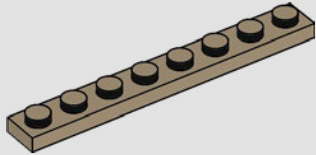

41

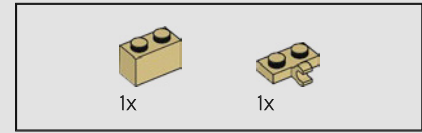
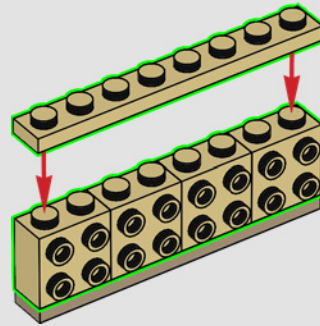

42

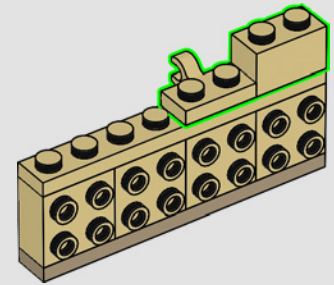

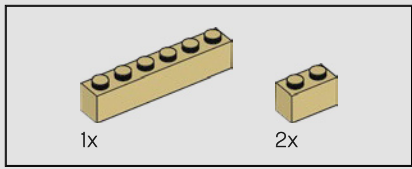

43

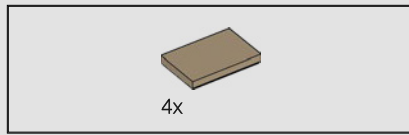
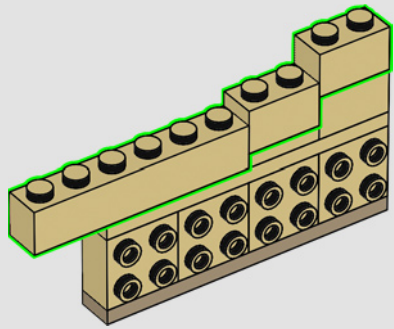

44

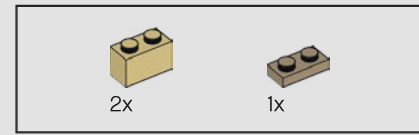
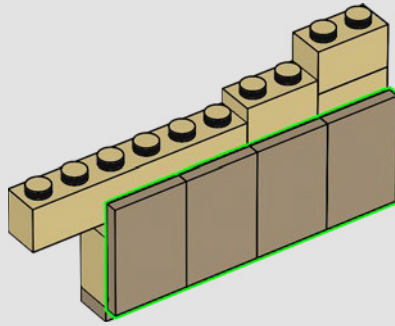

45

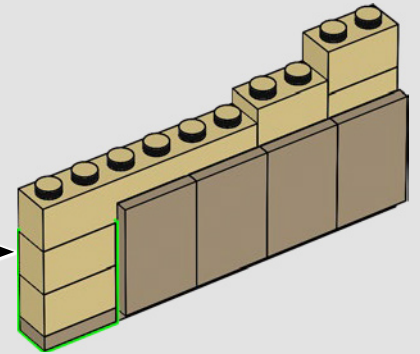
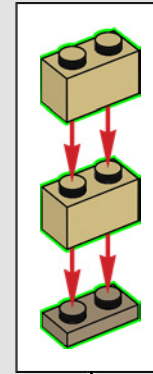

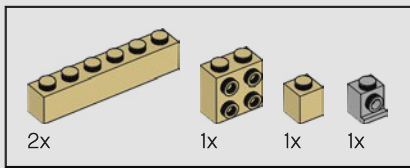

46

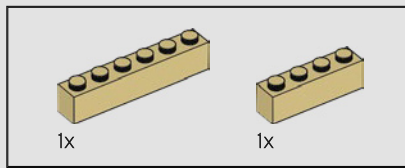
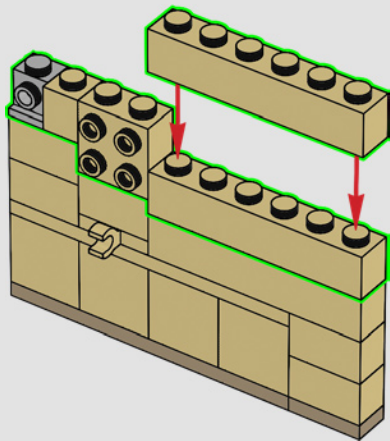

47

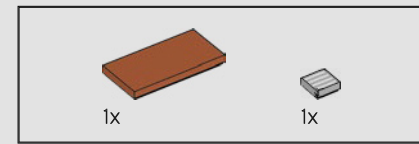
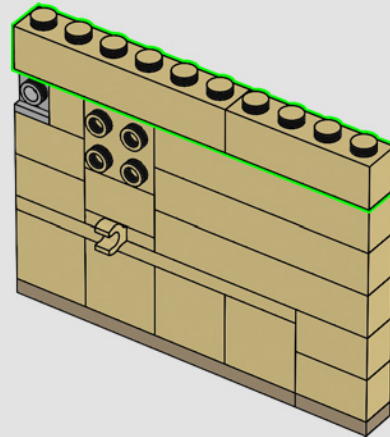

48

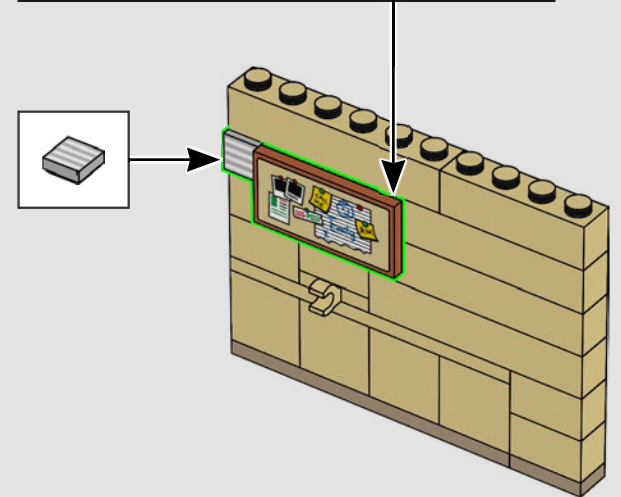
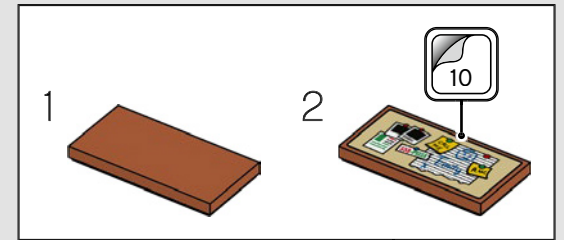

49

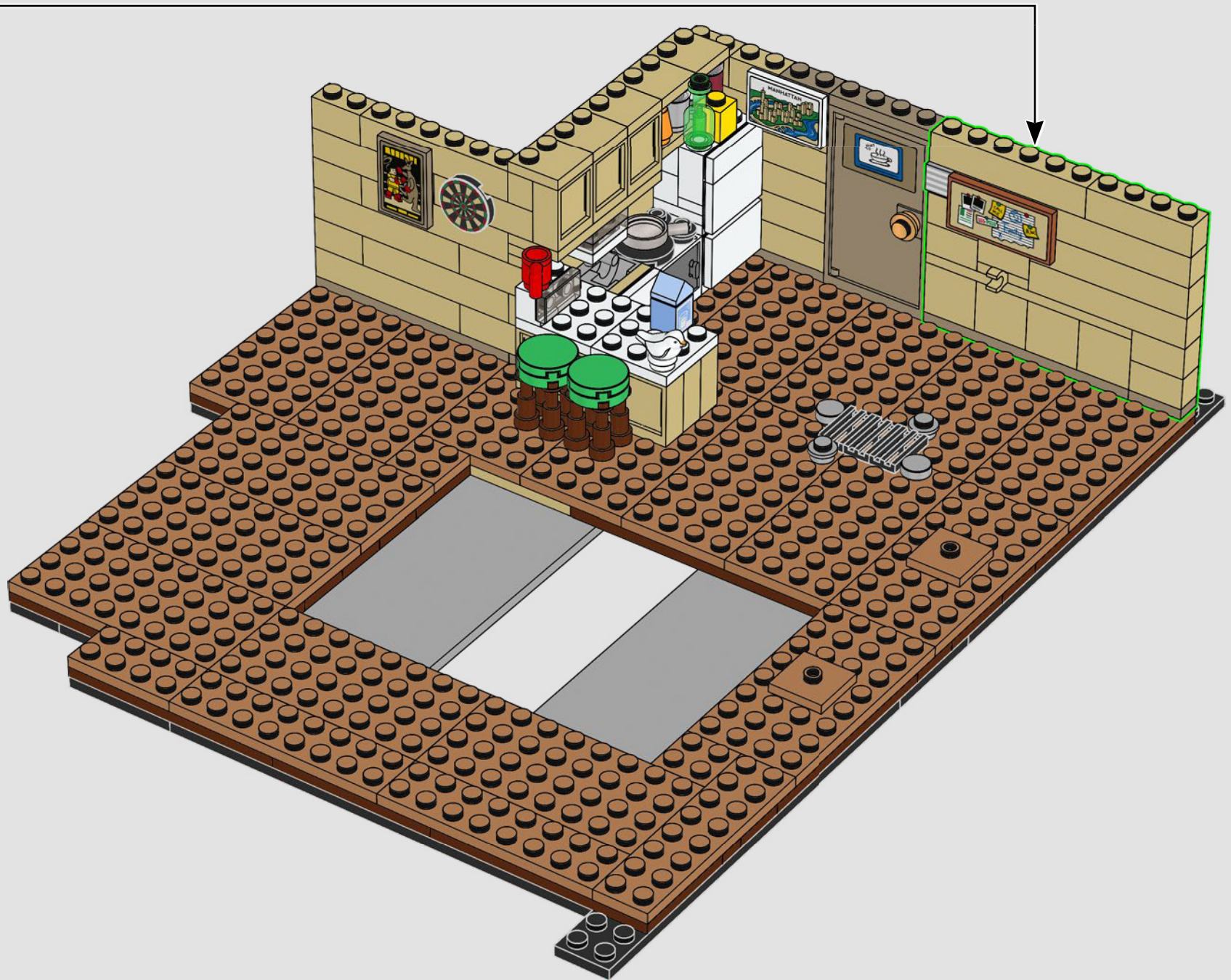

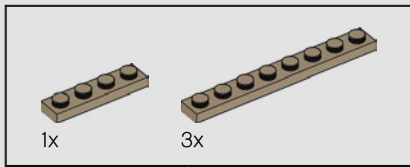

50



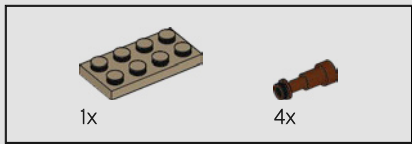

51

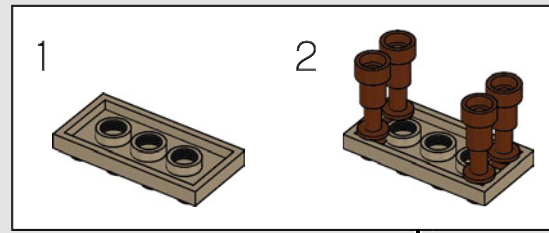

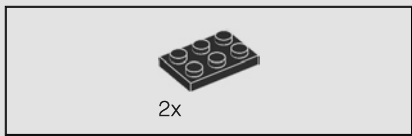

53

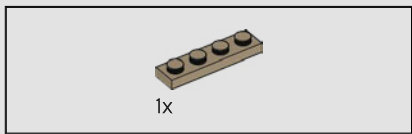
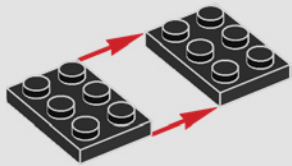

54

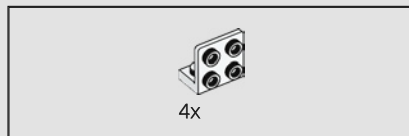
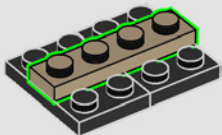

55

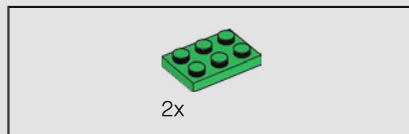
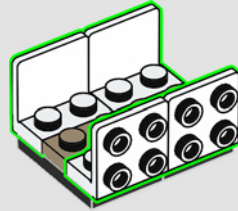

56

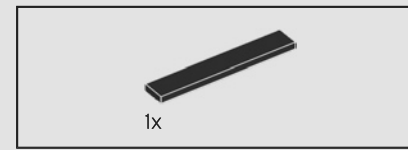
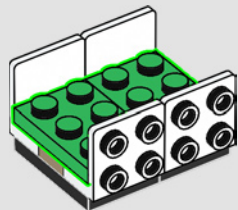

57

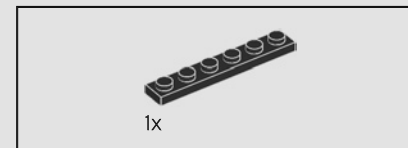
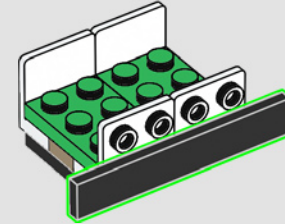

58

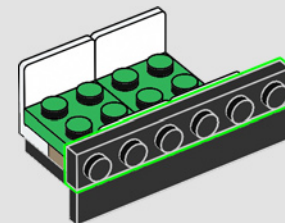

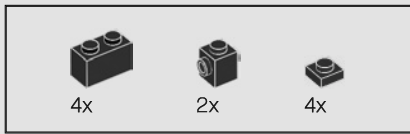

59

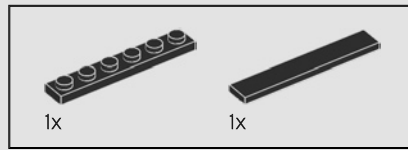
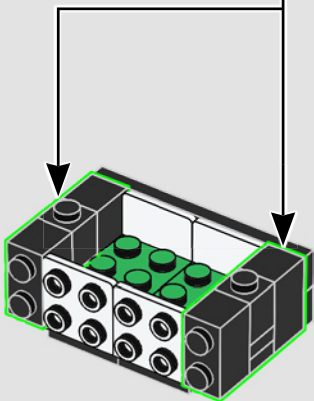
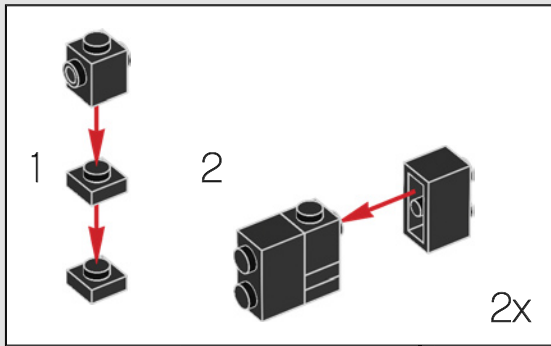

60

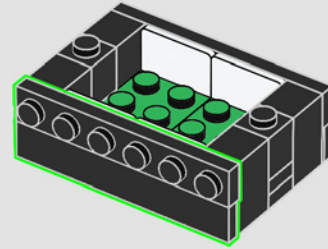

61

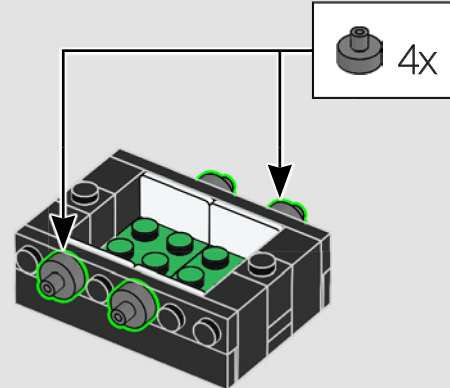

62

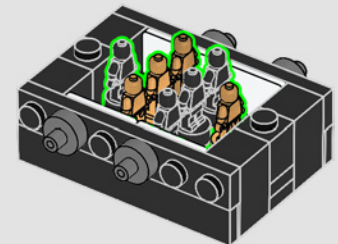

63



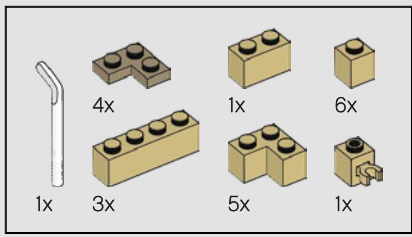

65

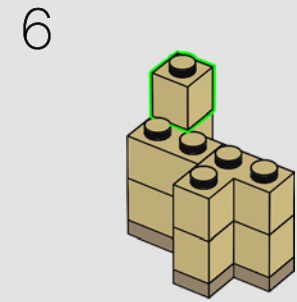
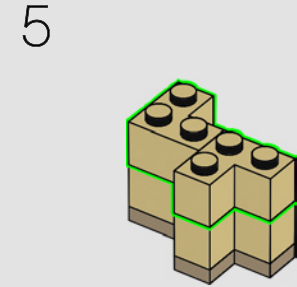
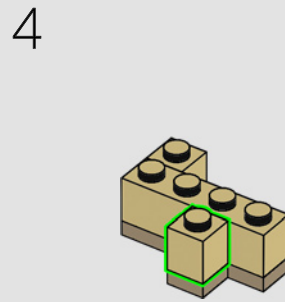
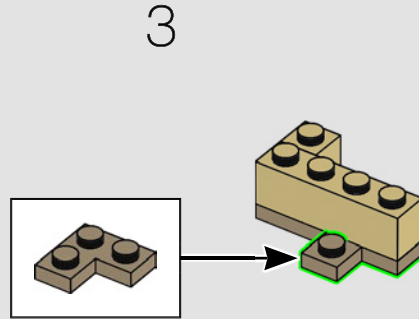
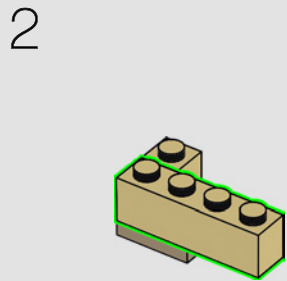
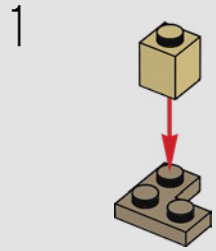

7

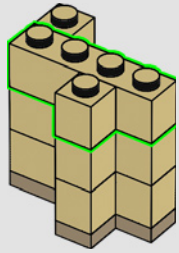

8

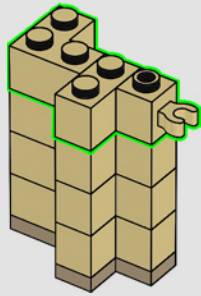

9

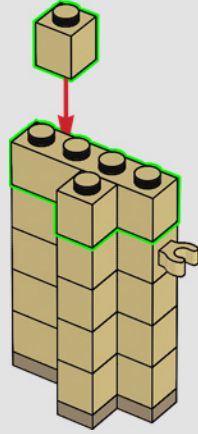

10

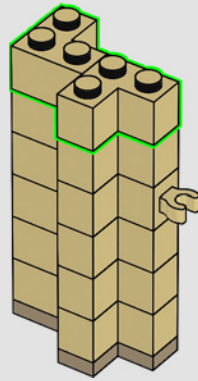

11

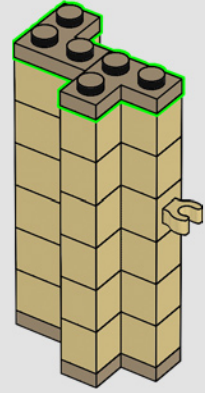

12

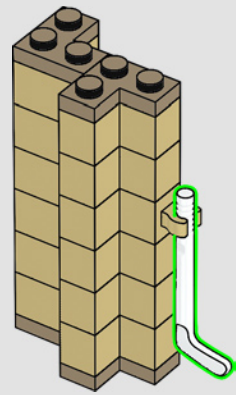

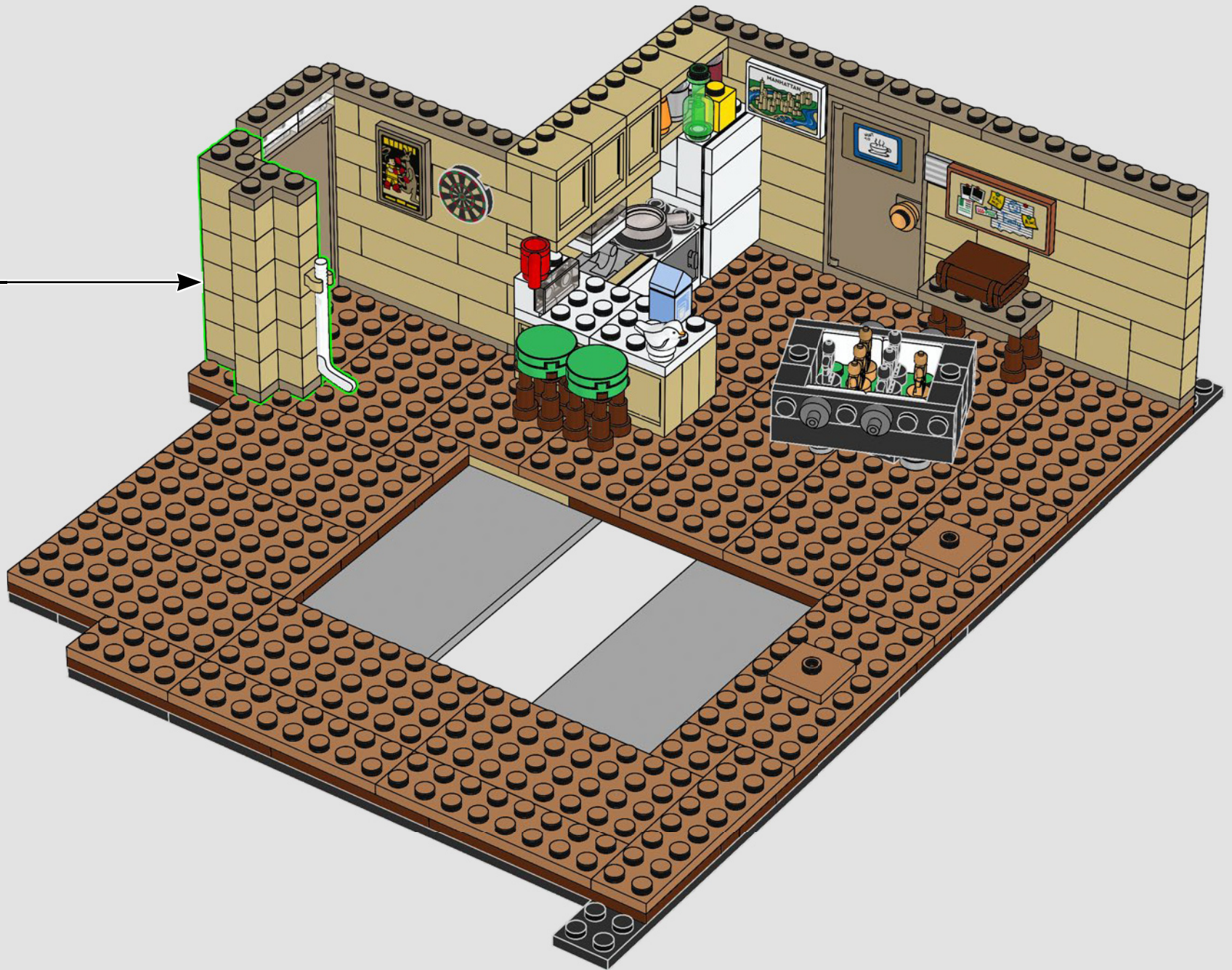

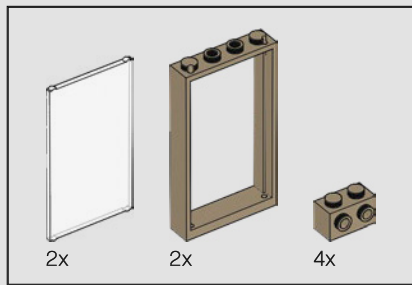

66

1

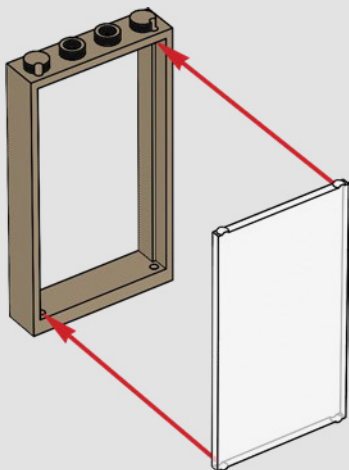

2

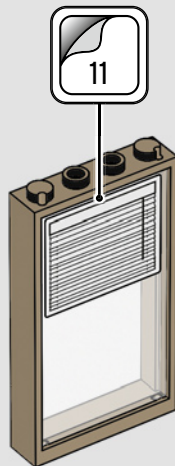

3

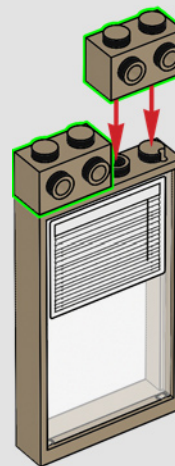

2x

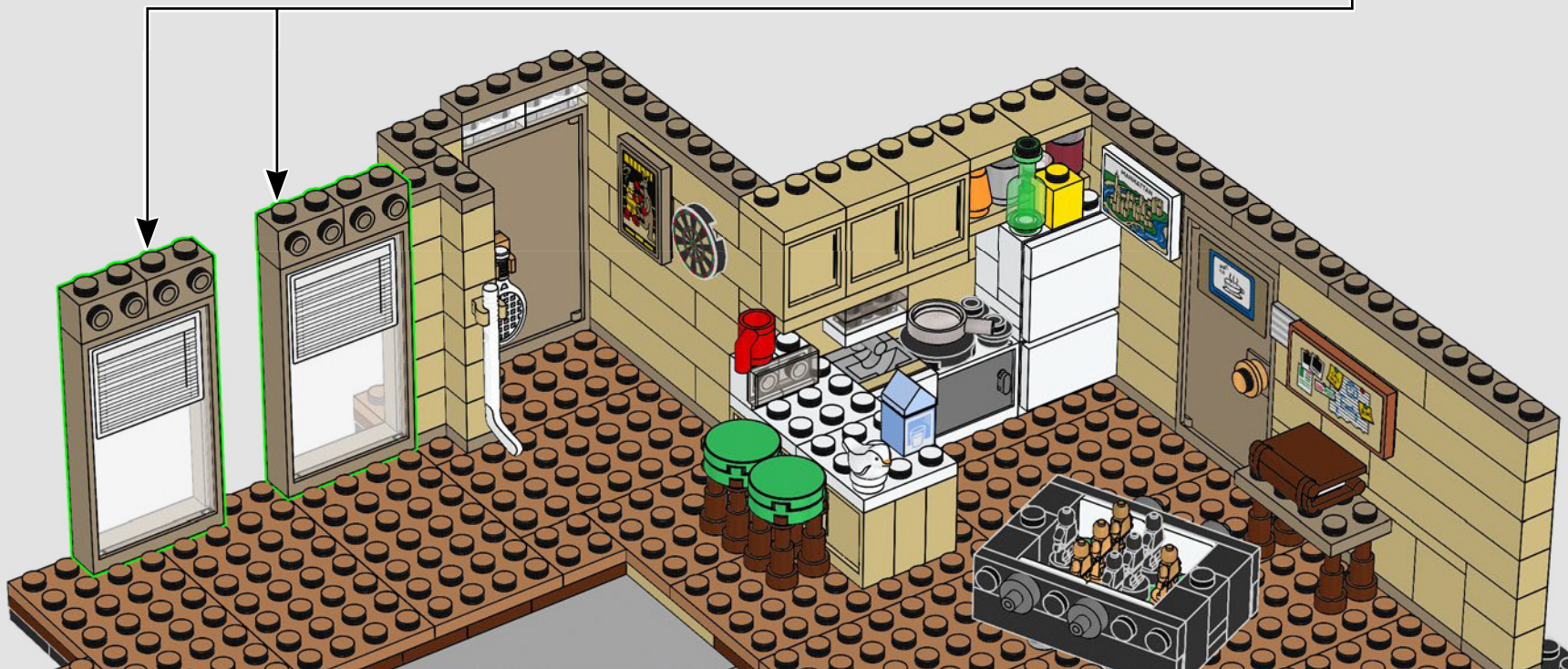

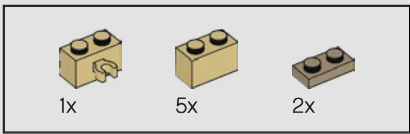

67

1

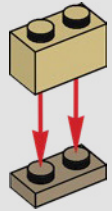

2

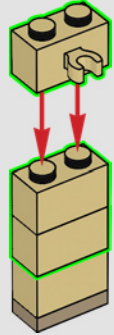

3

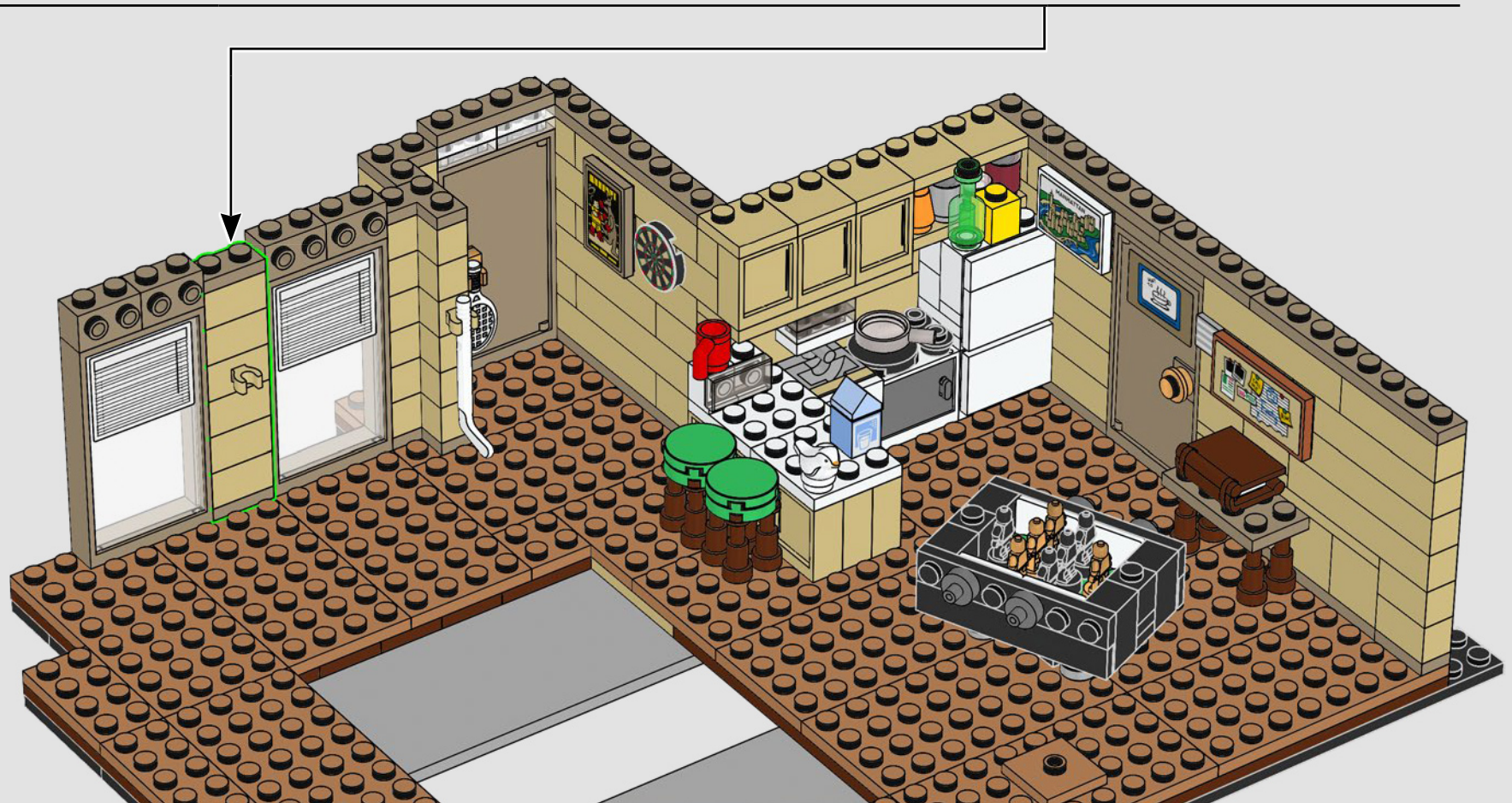
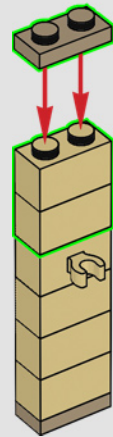

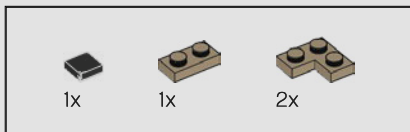

68



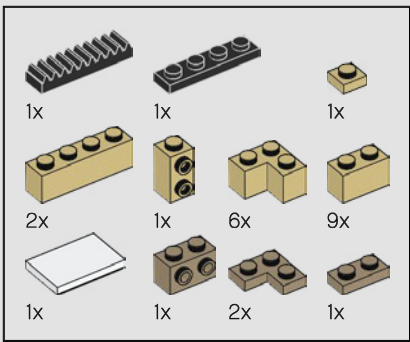

69

1

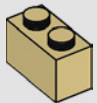

2

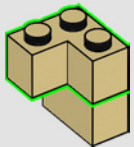

3

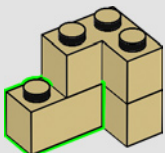

4

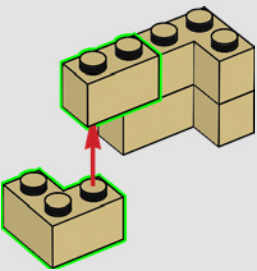

5

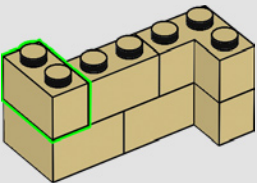

6

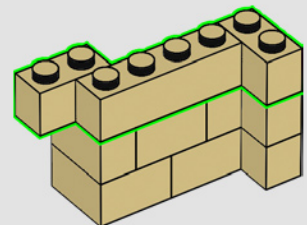

7

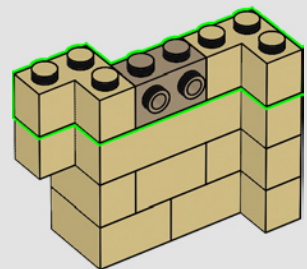

8

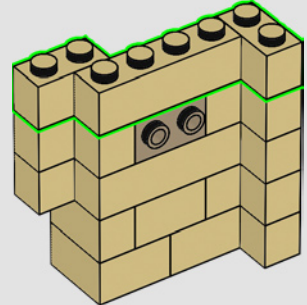

9

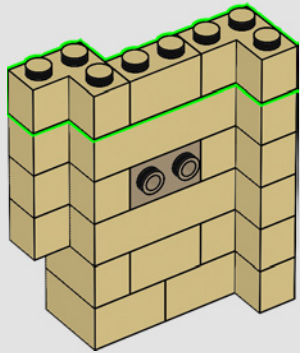

10

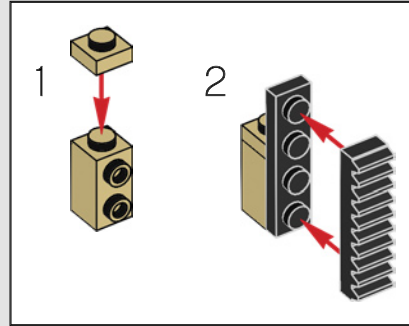
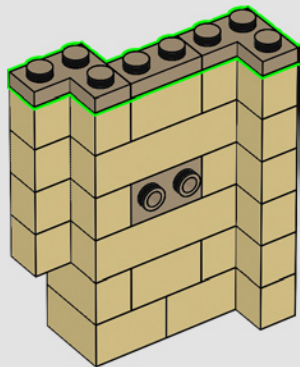

11

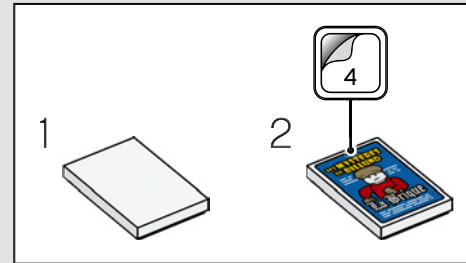
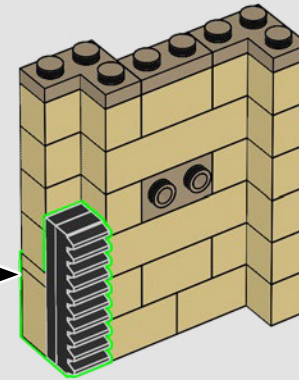

12

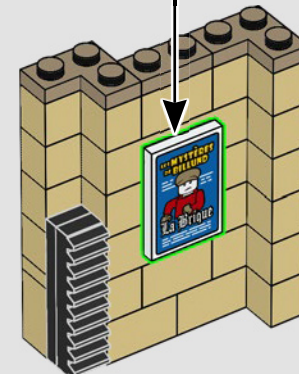

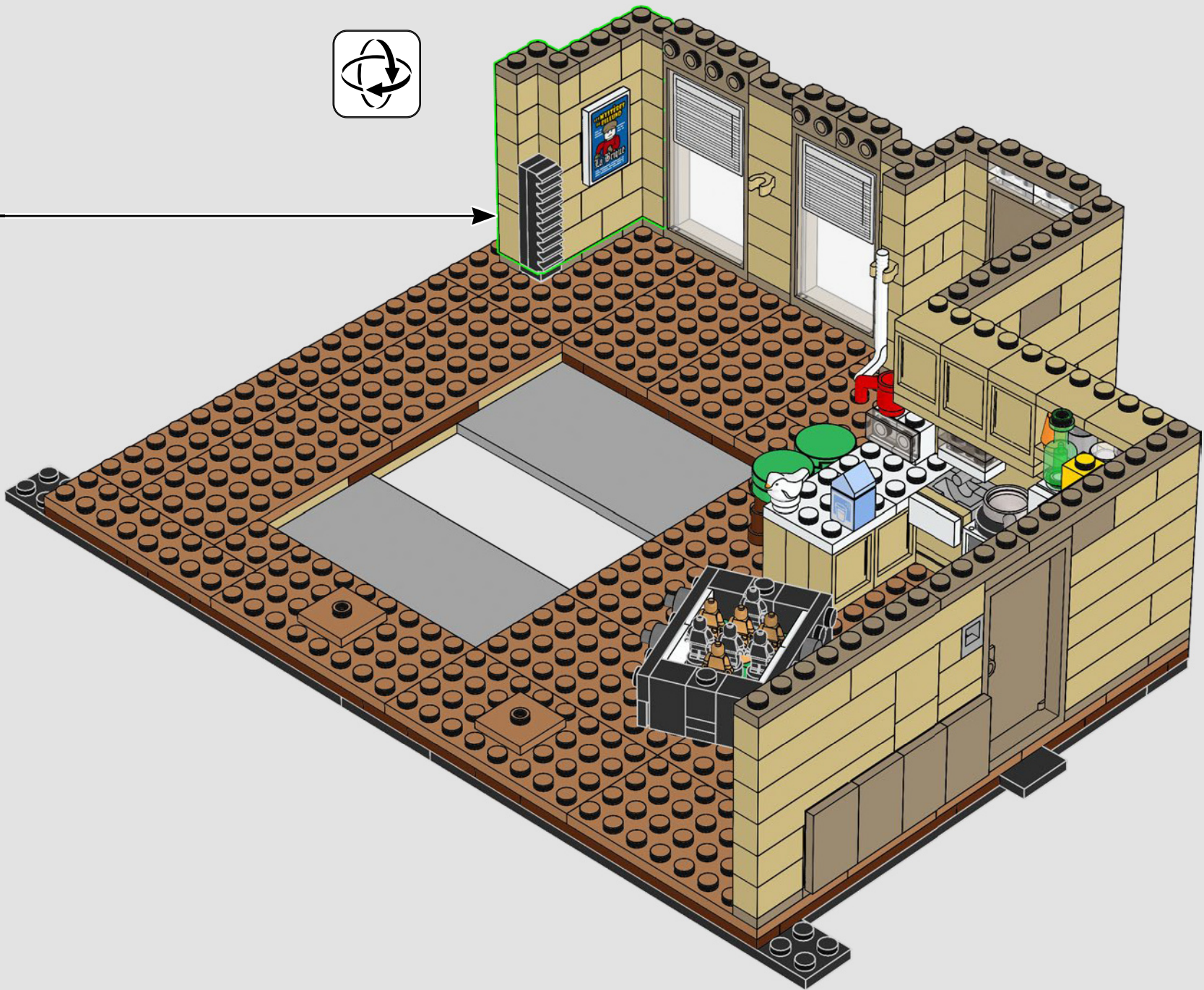

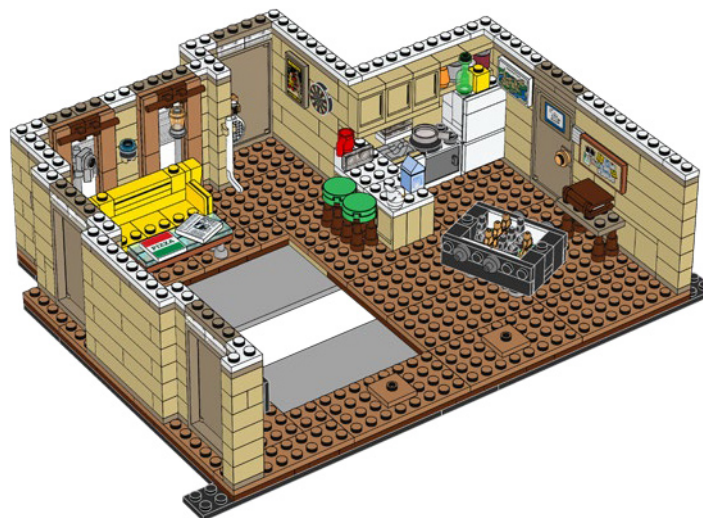

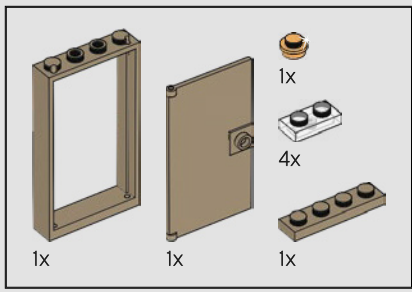

70

1

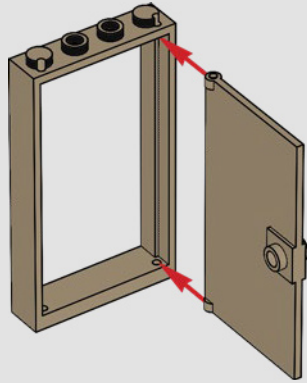

2

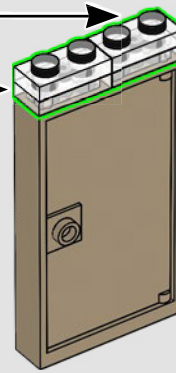
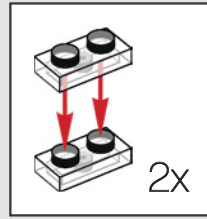

3

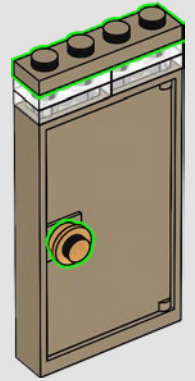

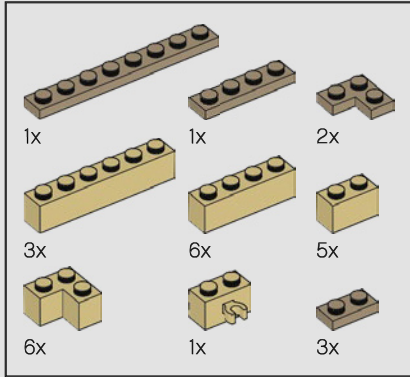
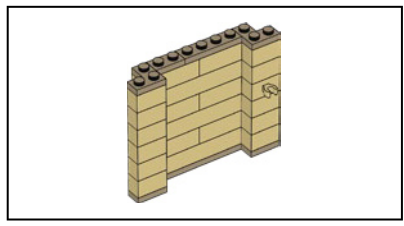

71

1

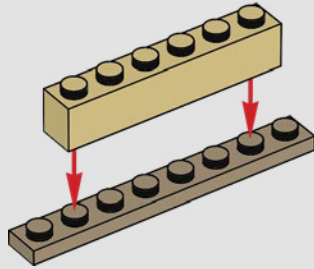

2

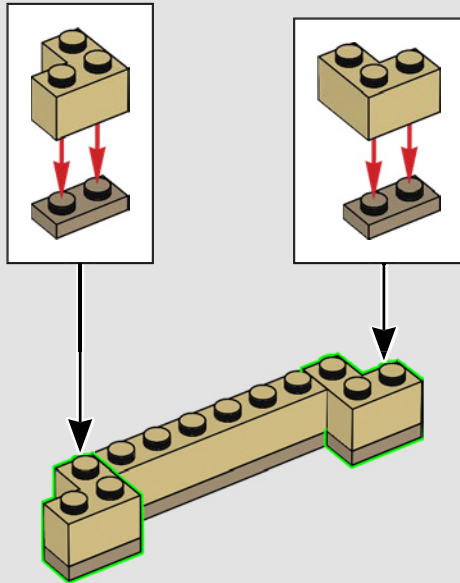

3

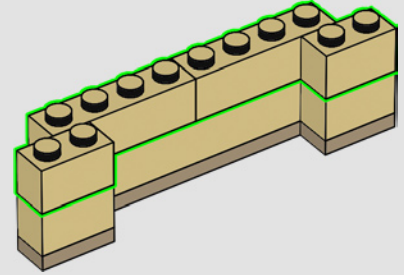

4

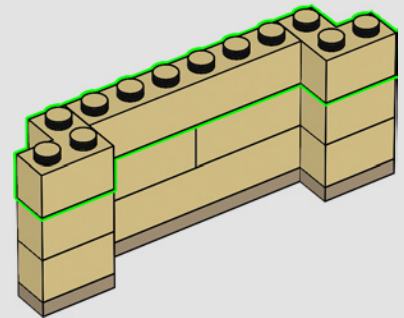

5

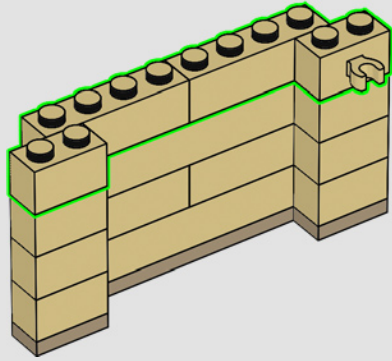

7

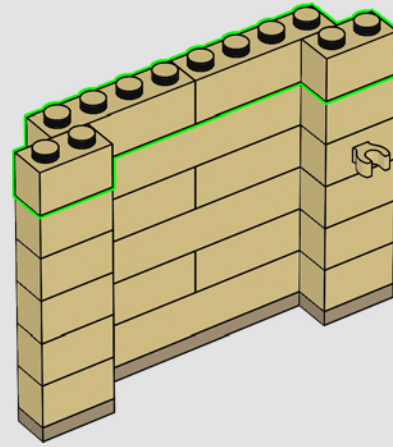

6

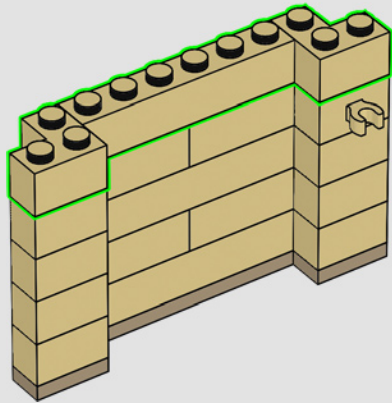

8

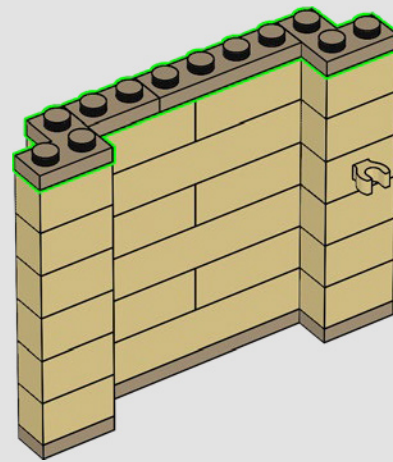

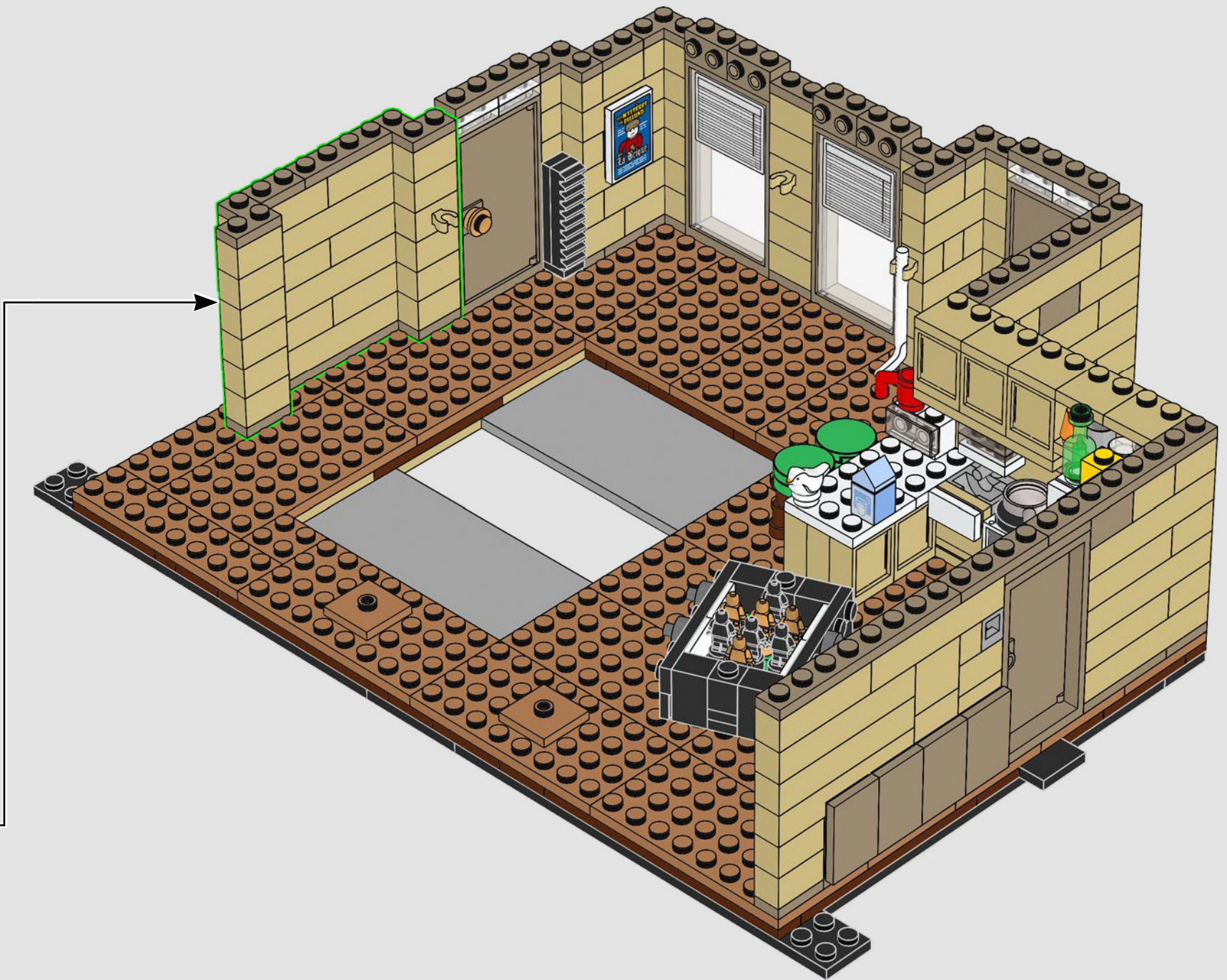

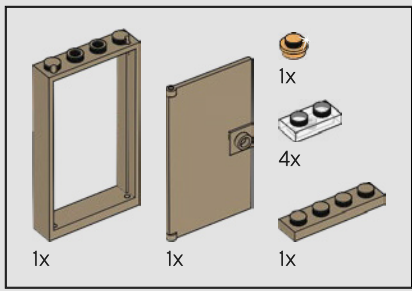

72

1

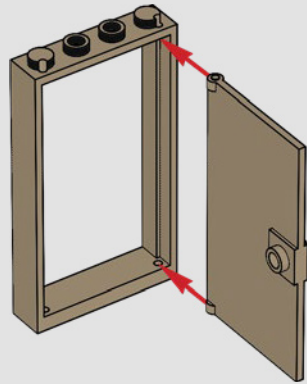

2

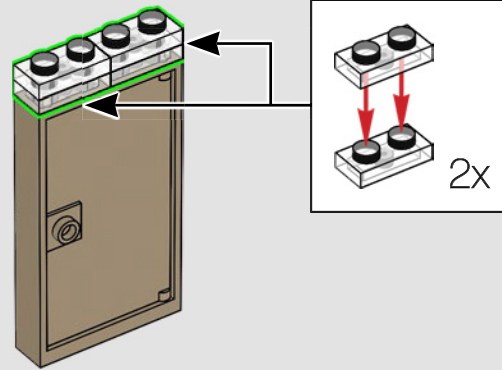

3

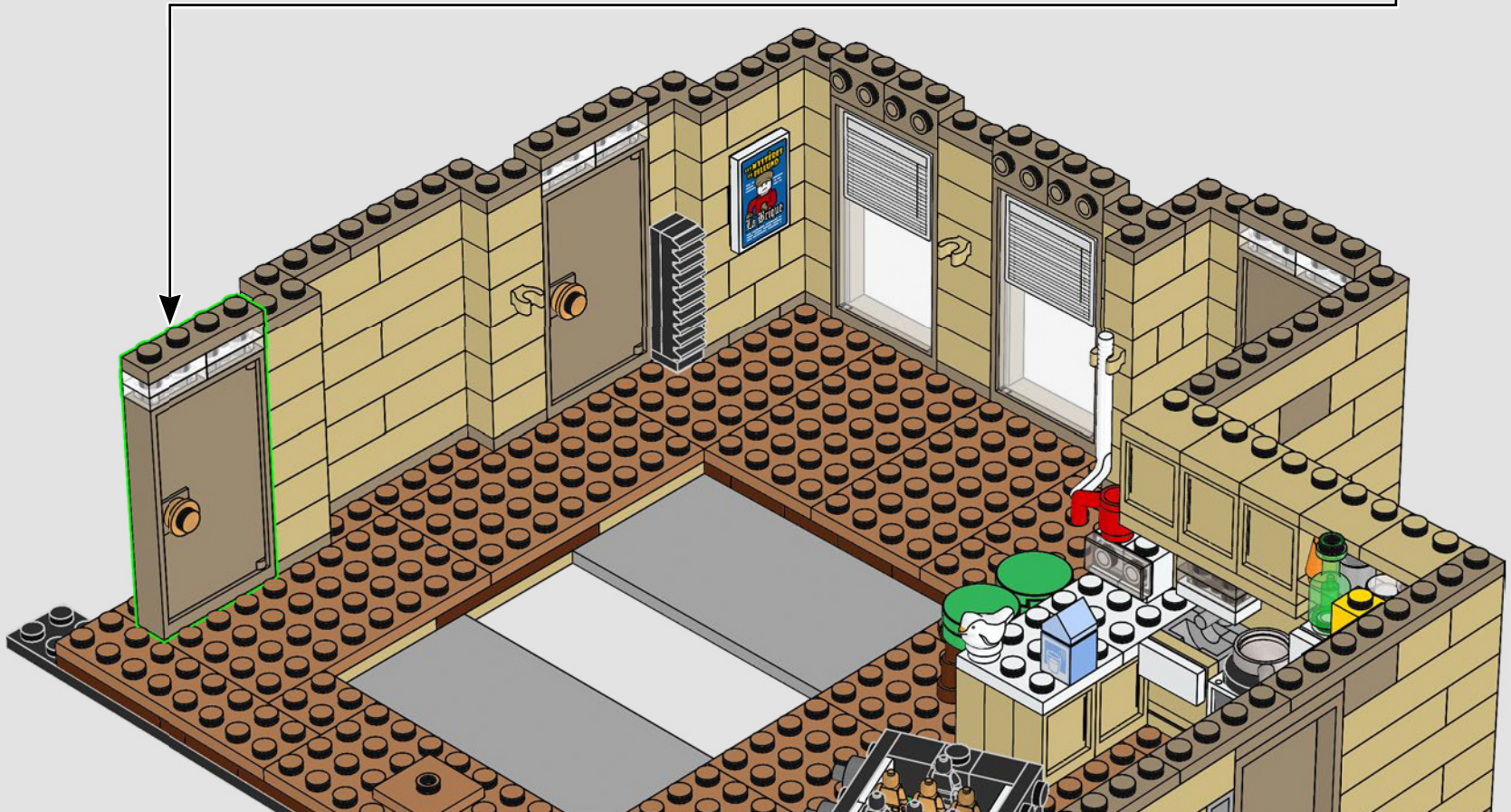
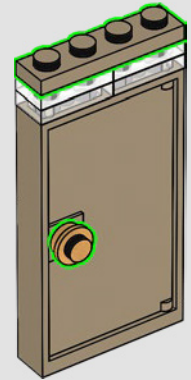

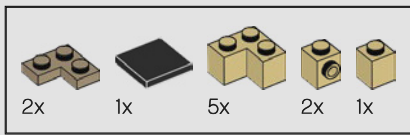

73

1

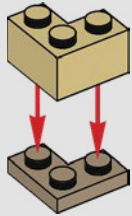

2

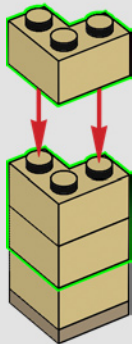

3

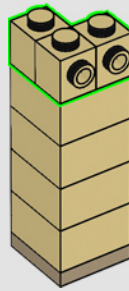

4

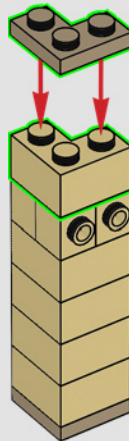

5

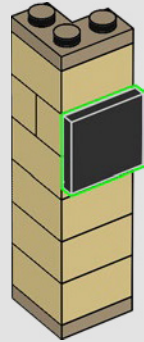

6

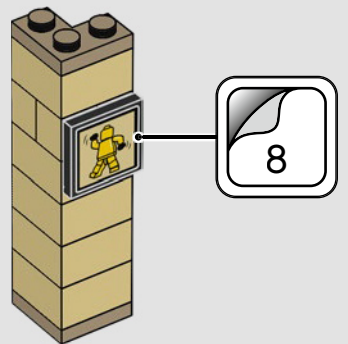

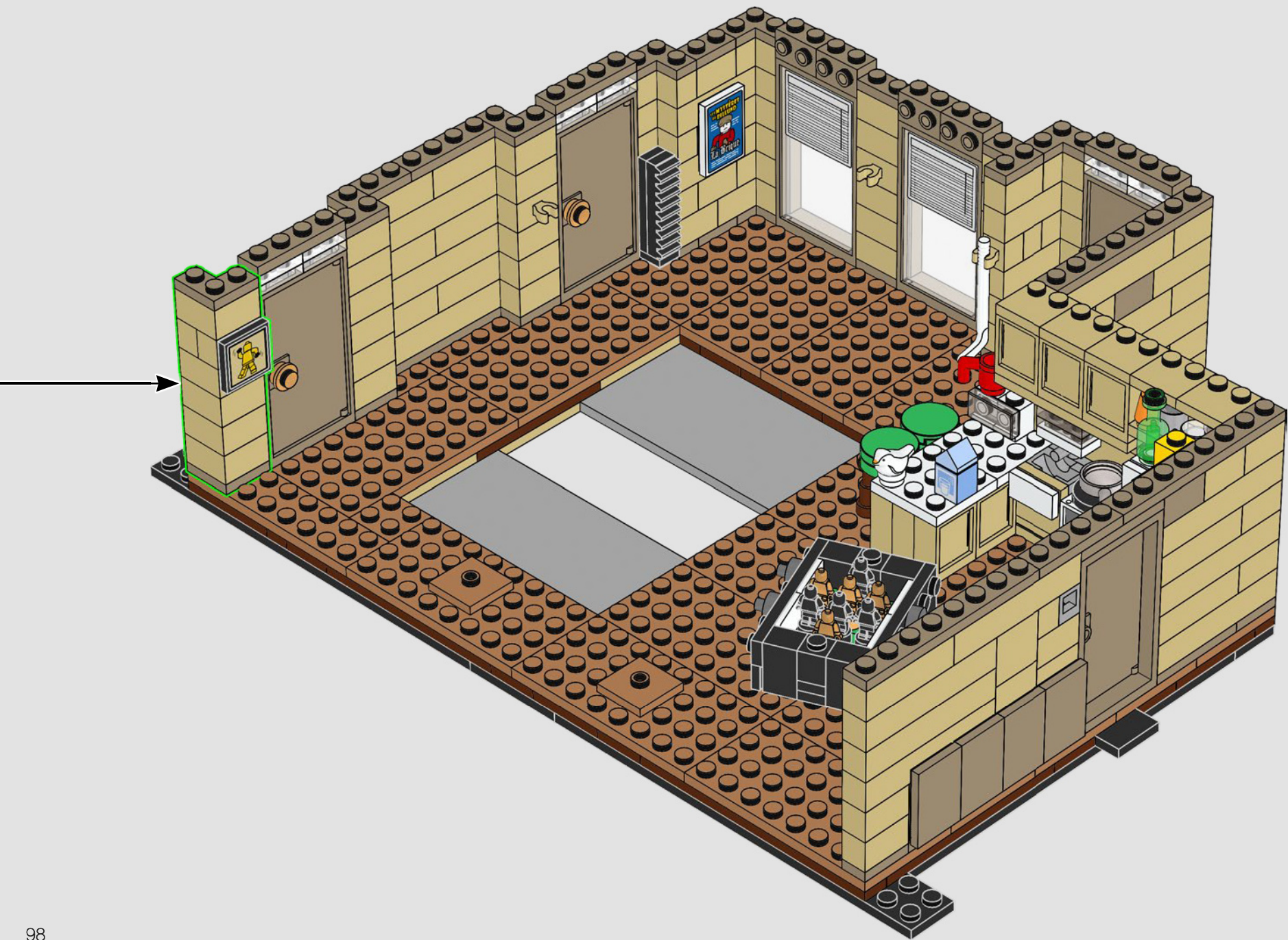

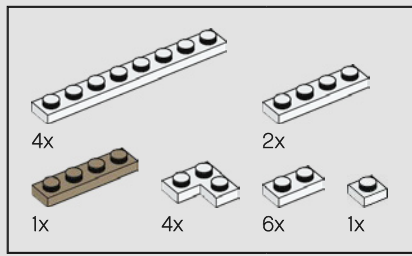

74



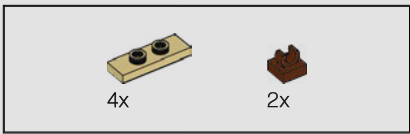

75



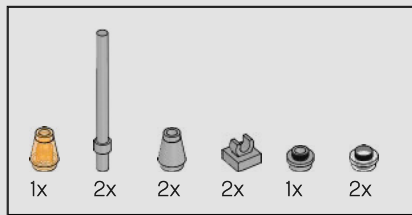

76

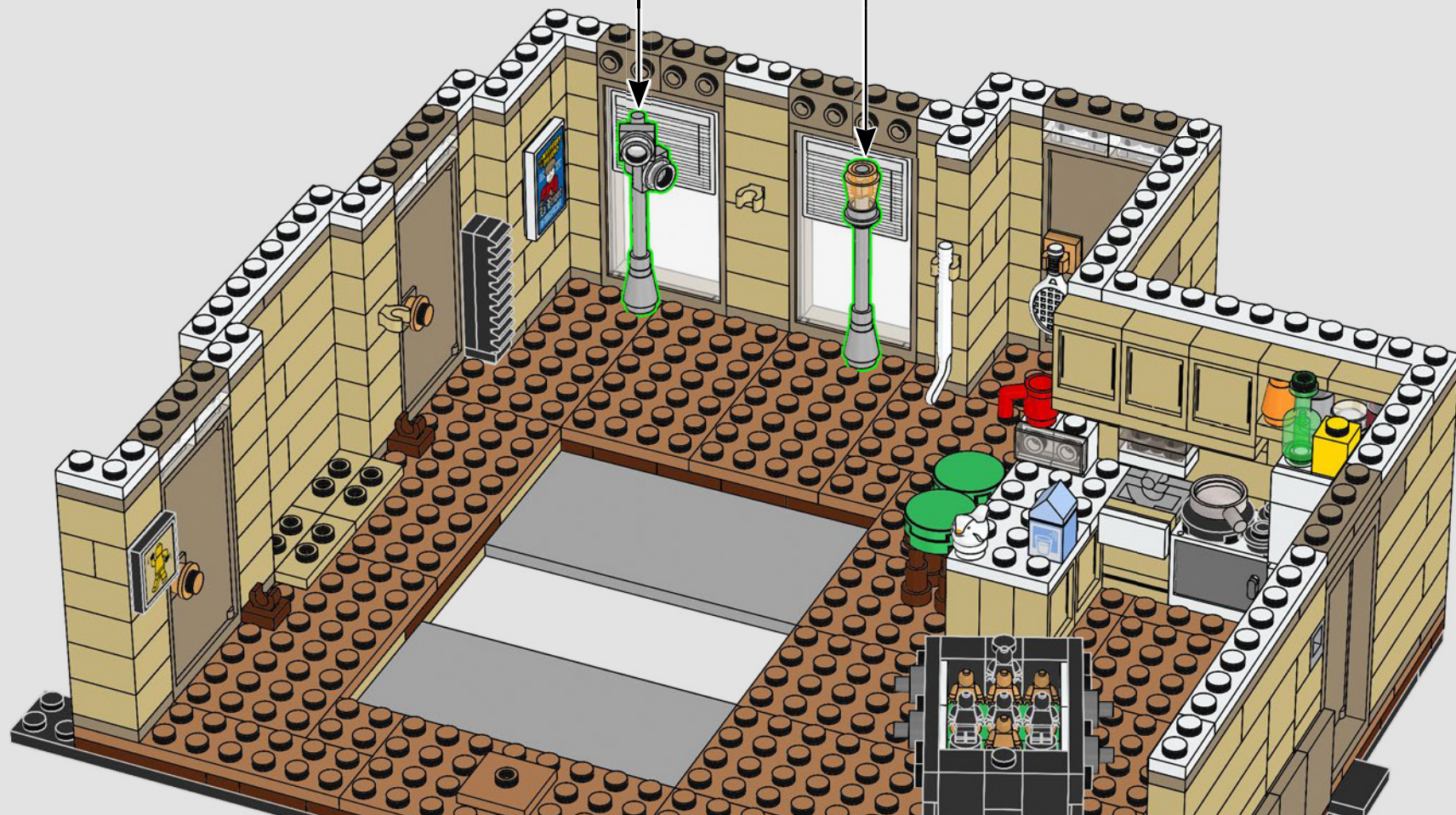
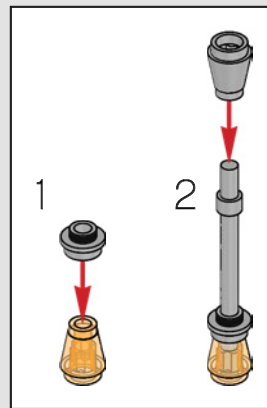
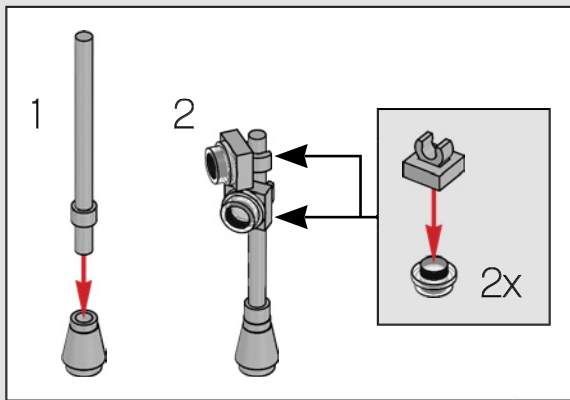

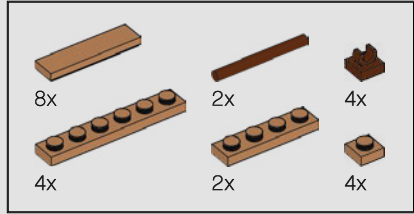
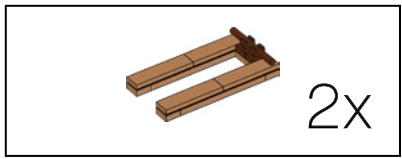

77

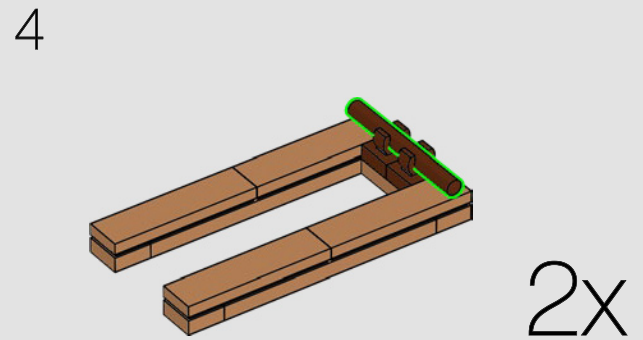
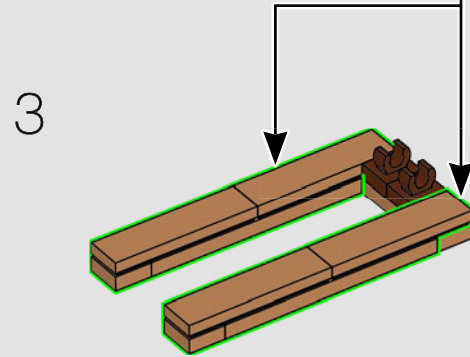
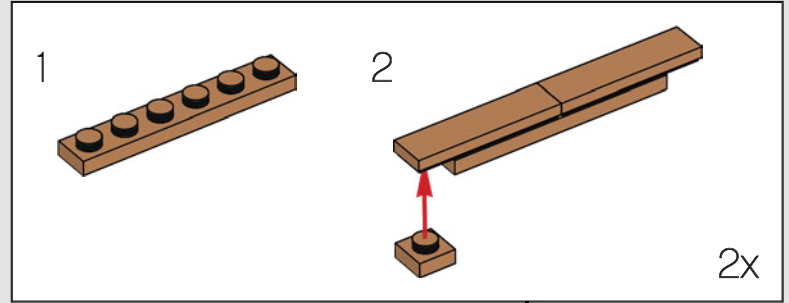
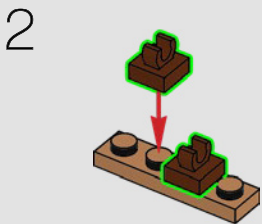
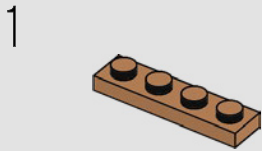

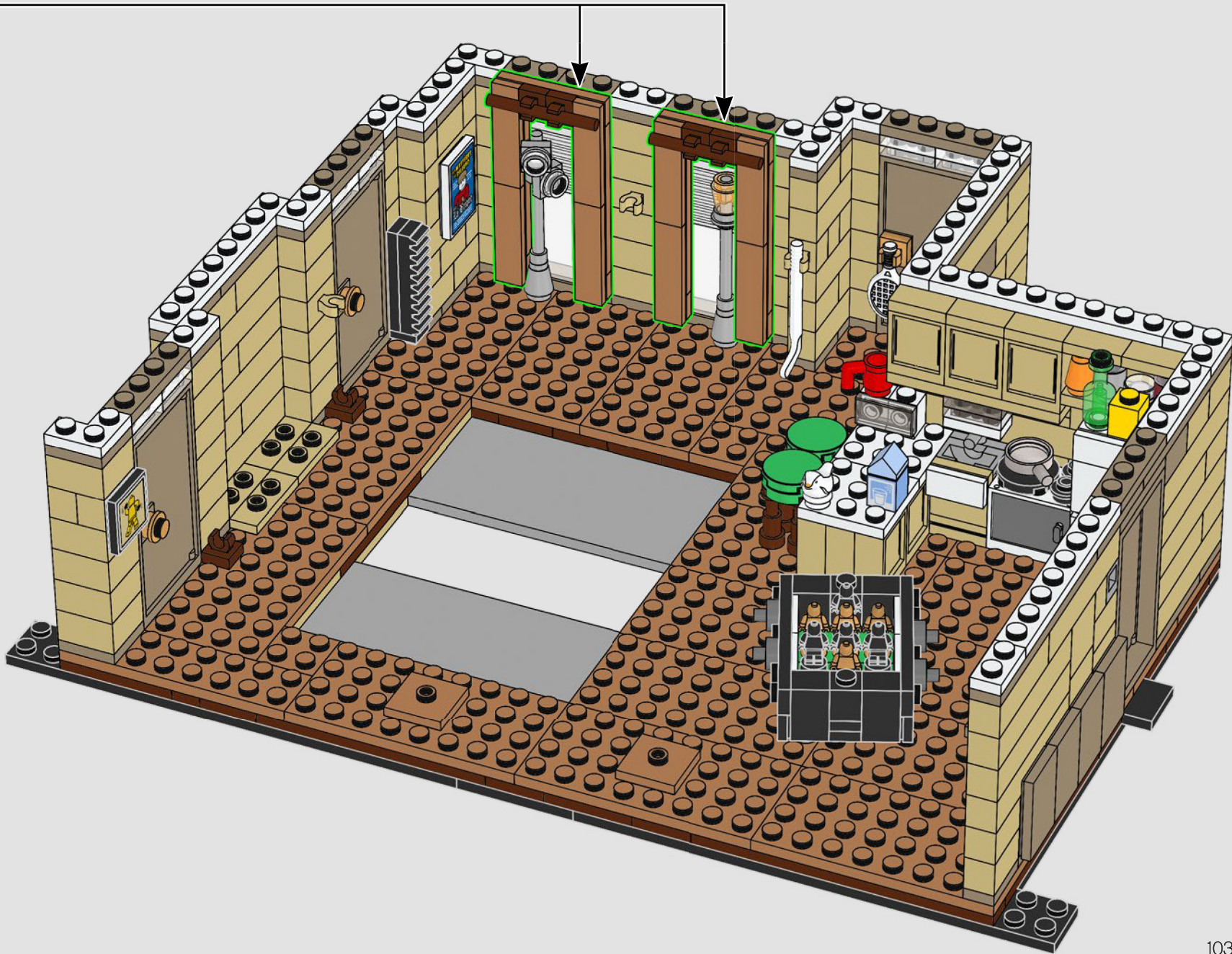

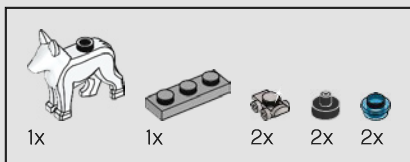

● 角落里的白色狗狗雕像
“拍拍狗”。



78

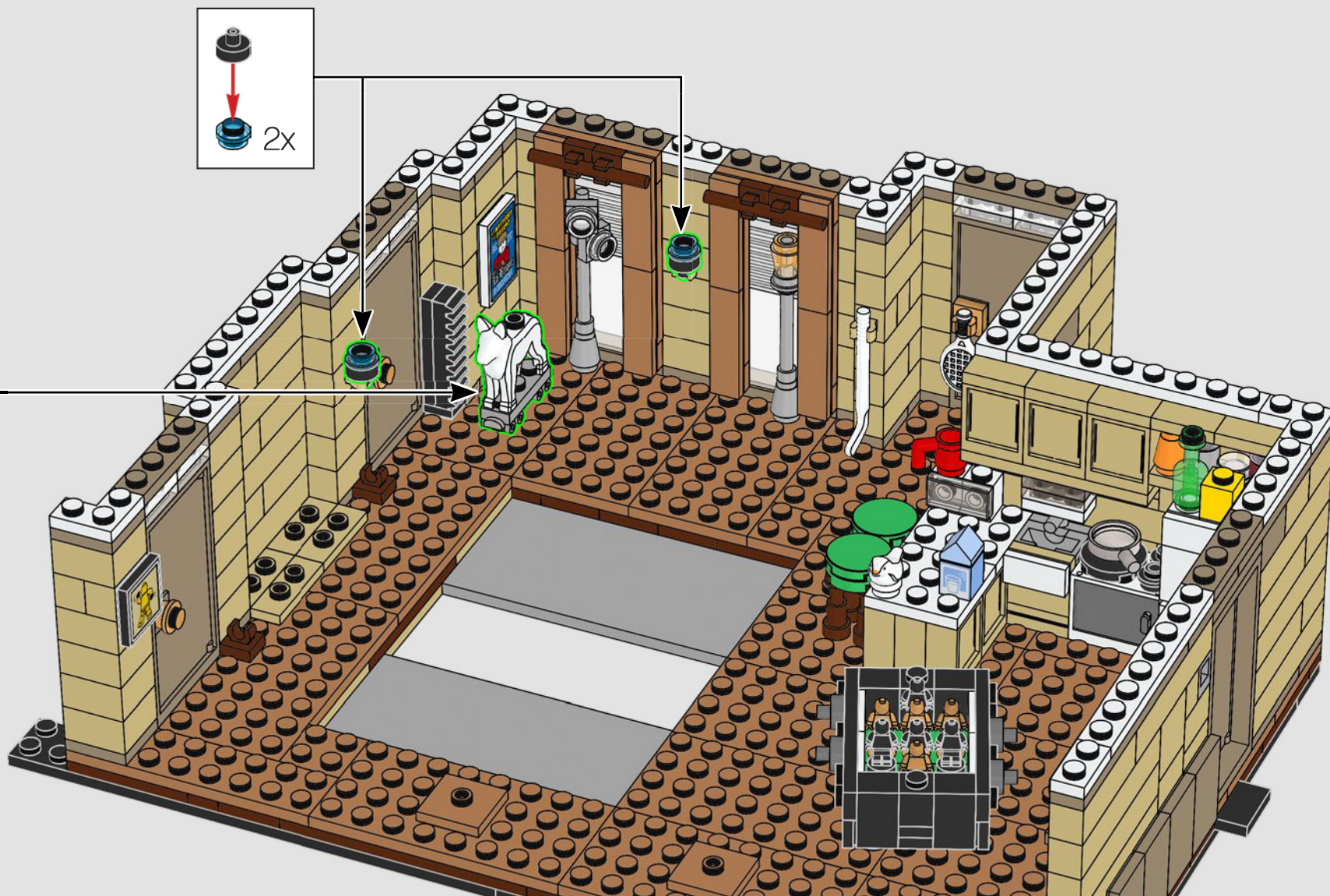
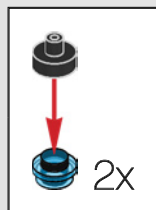
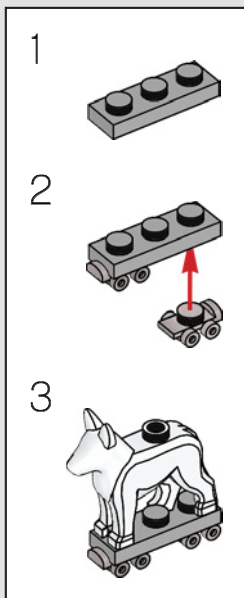

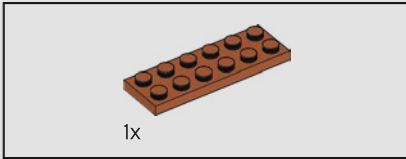
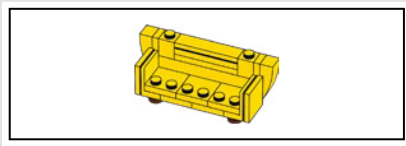

79

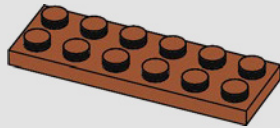

80

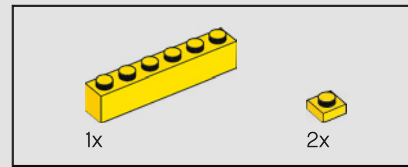
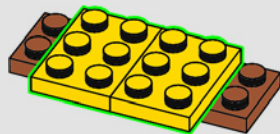

81

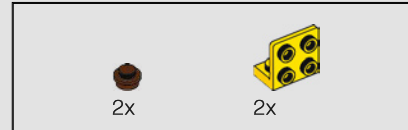
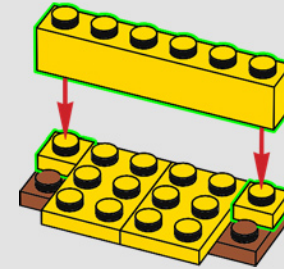

82

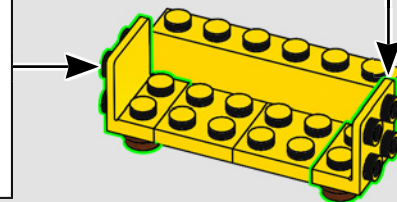
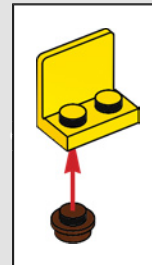
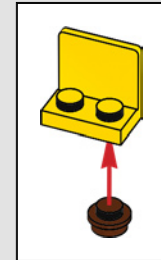

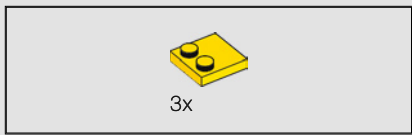

83

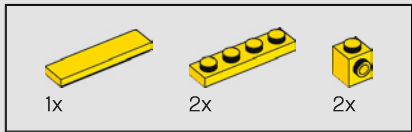
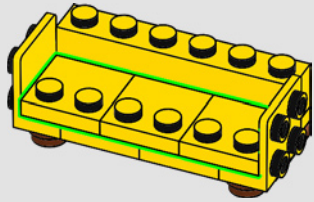

84

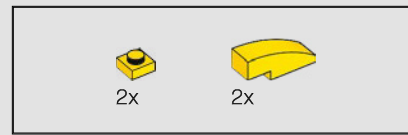
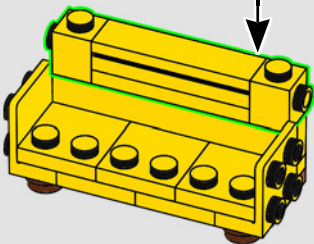
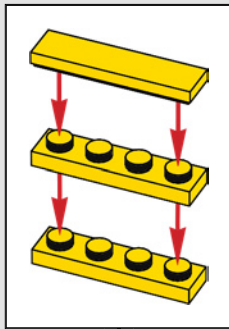

85

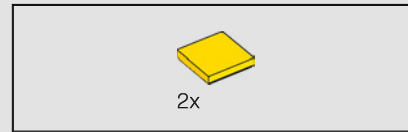
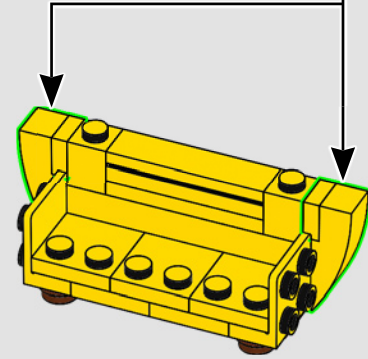
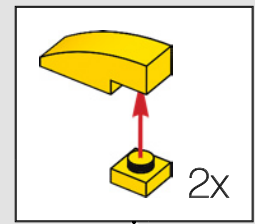

86

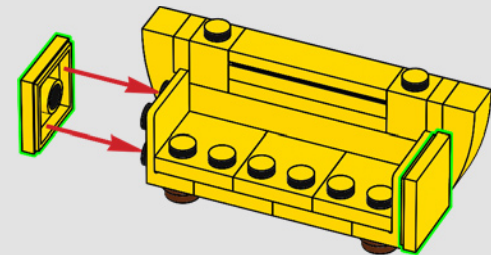

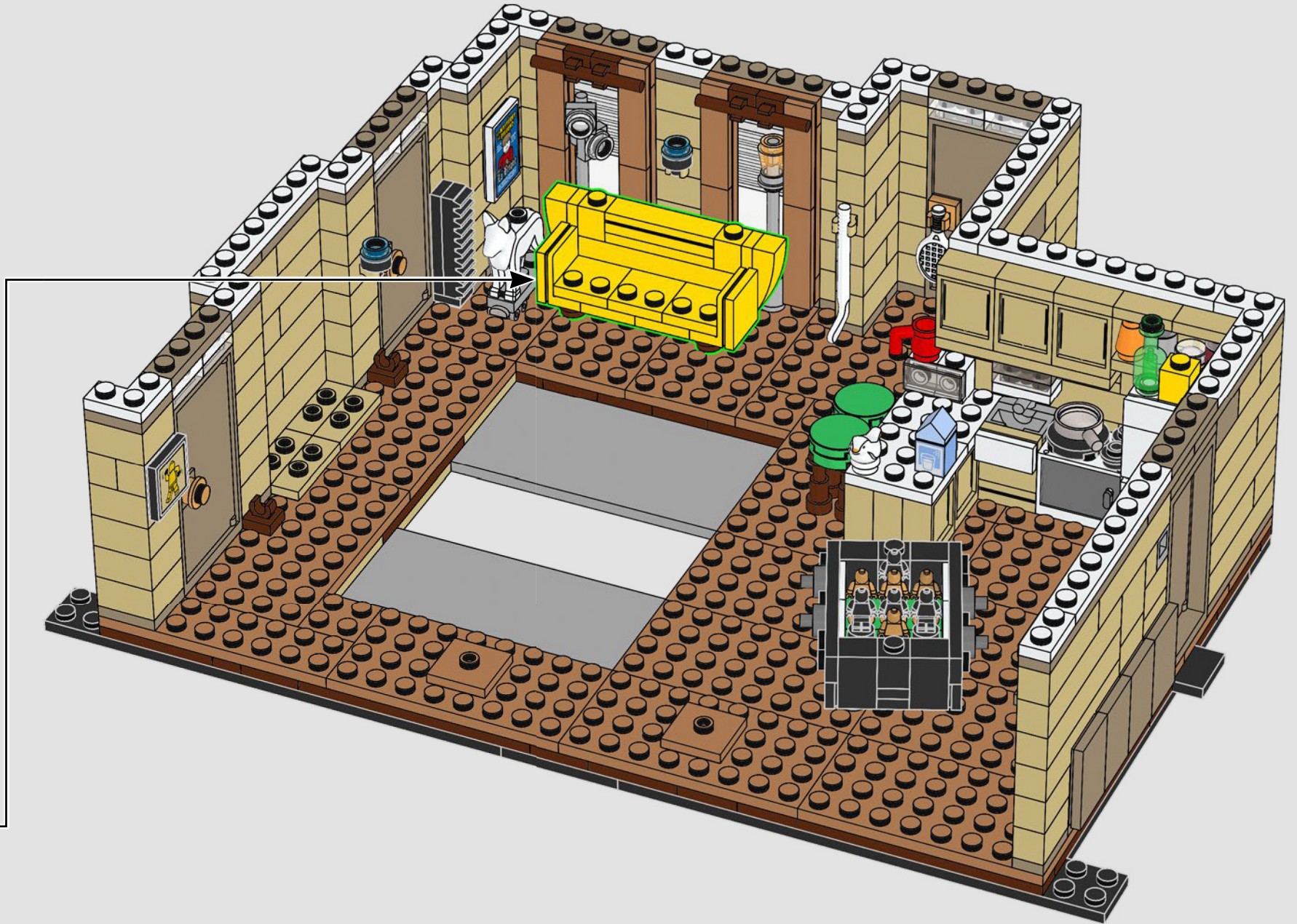

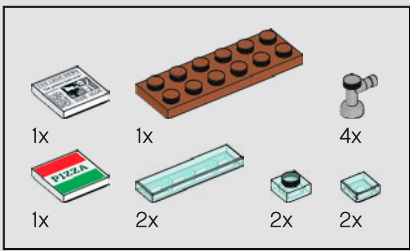

88

1

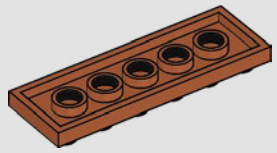

2

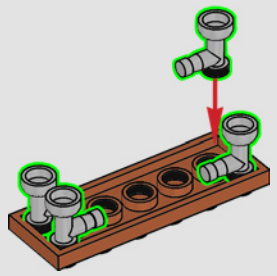

3

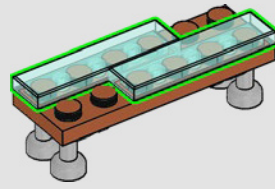
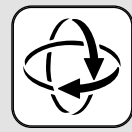

4

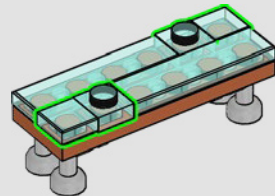

5

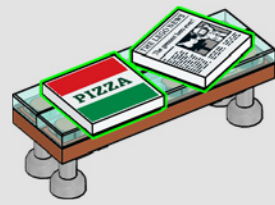

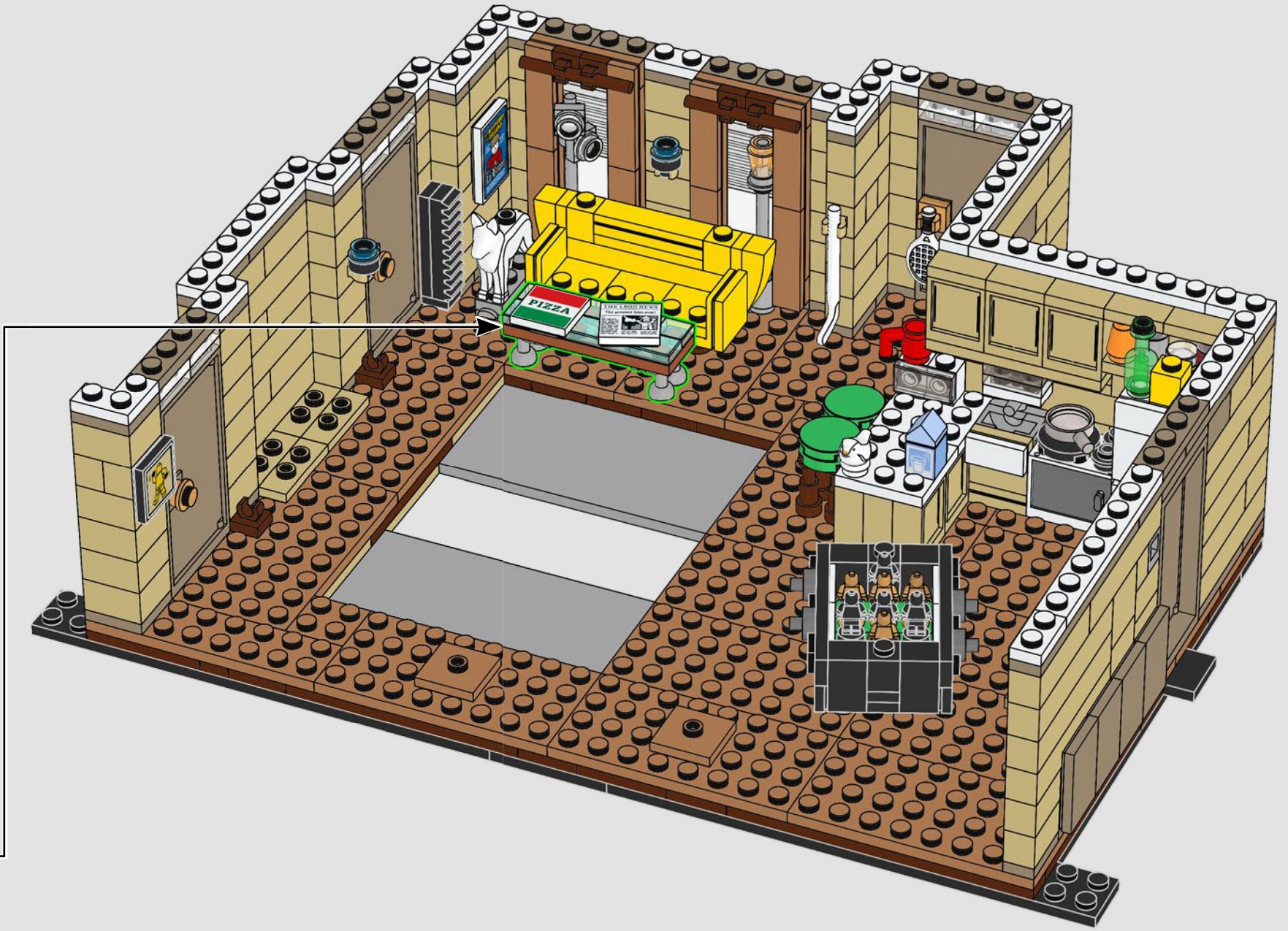

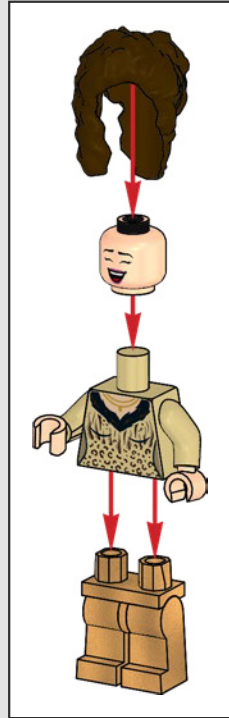
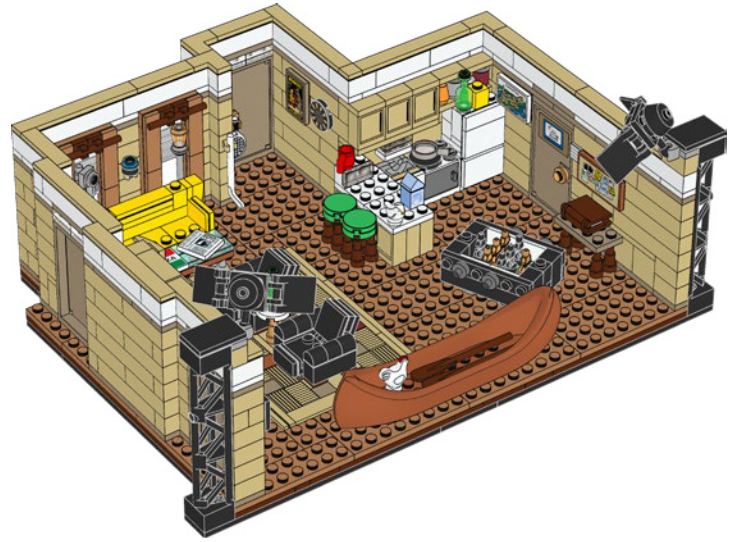
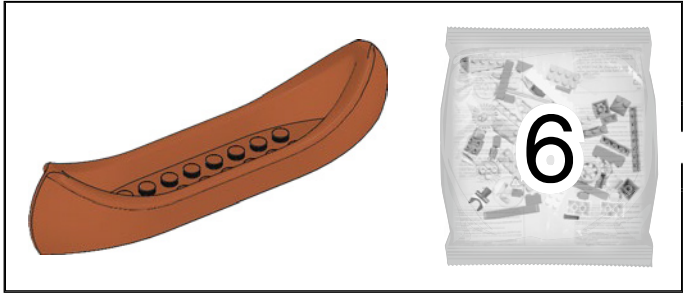

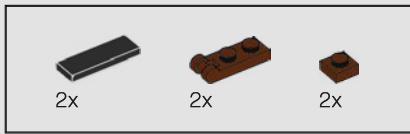

89

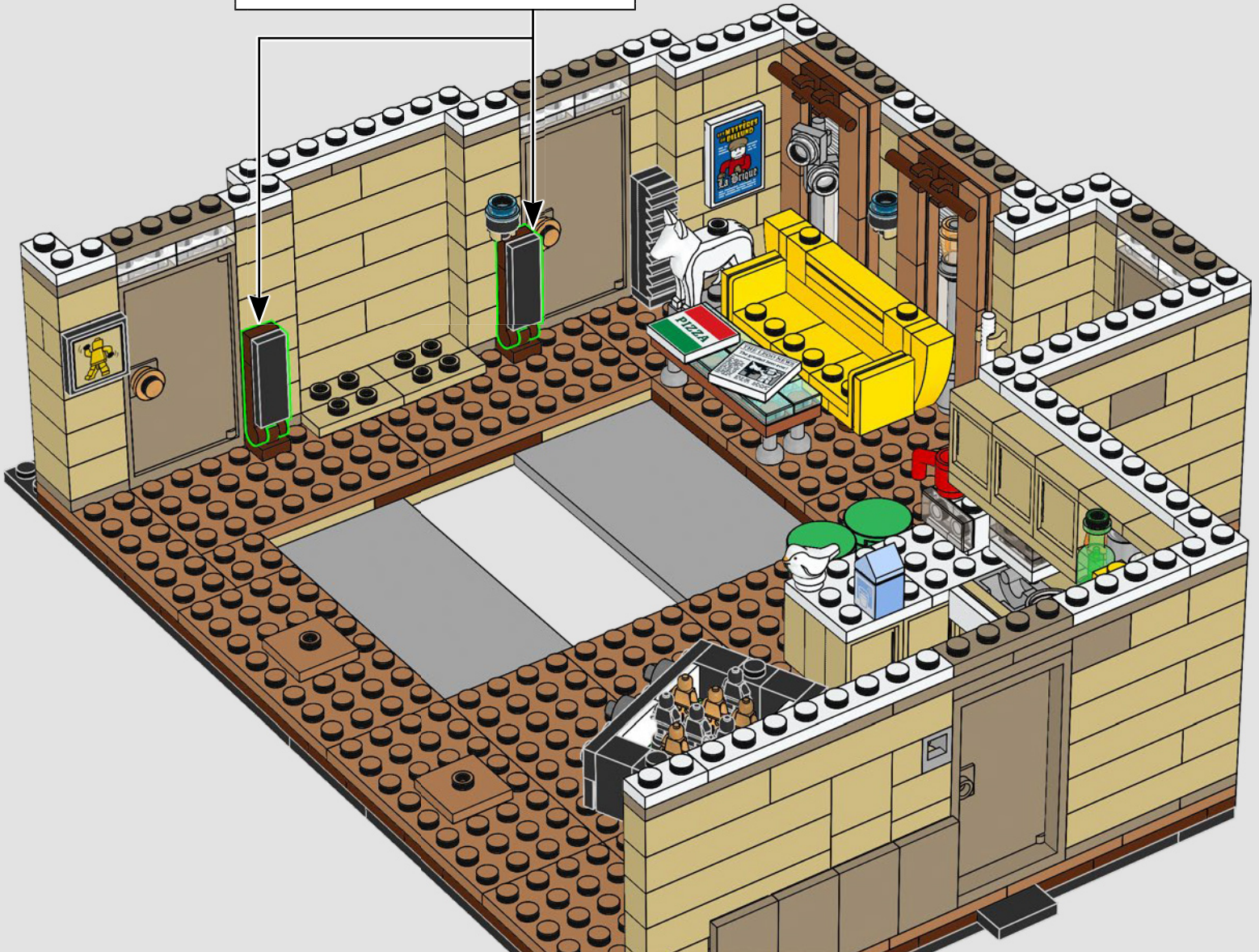
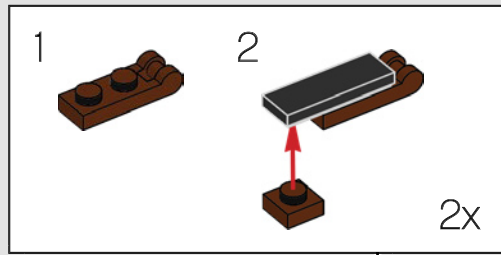

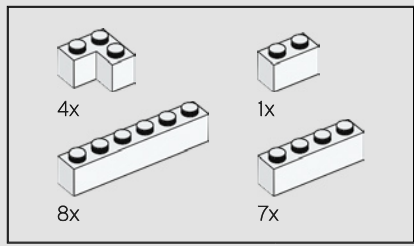

90

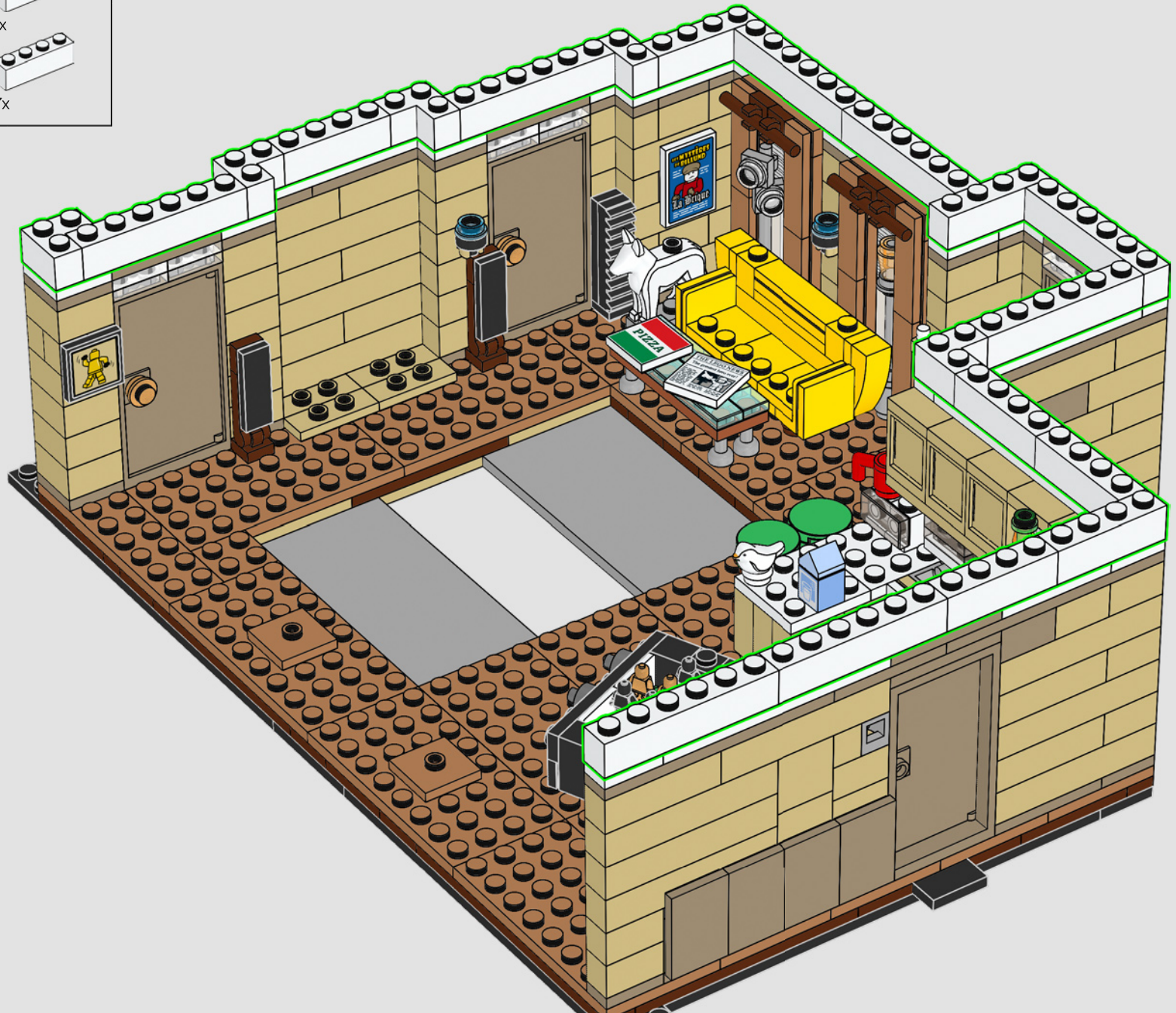

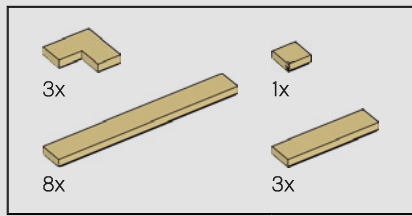

91



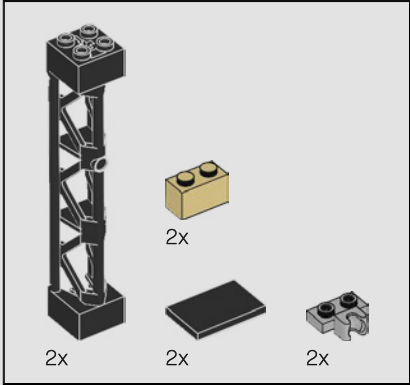
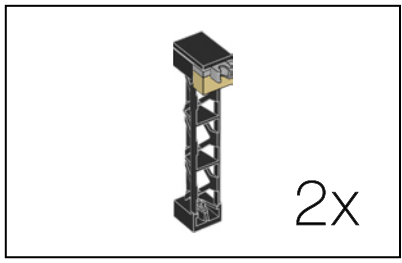

92

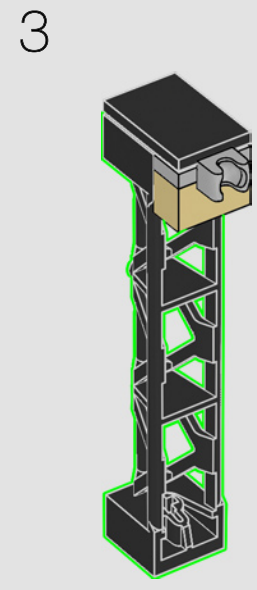
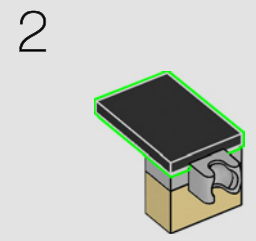
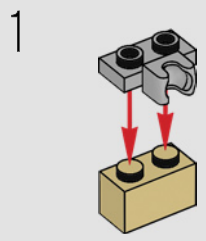



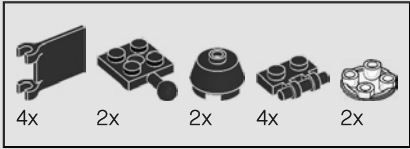
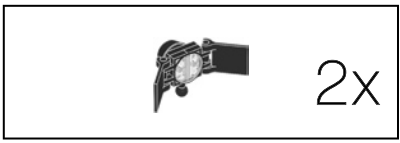

93

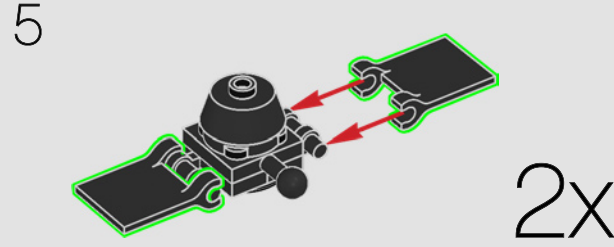
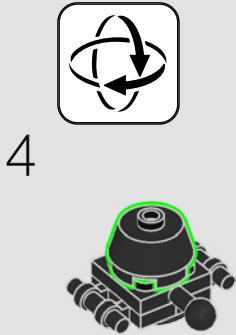
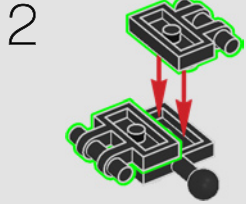

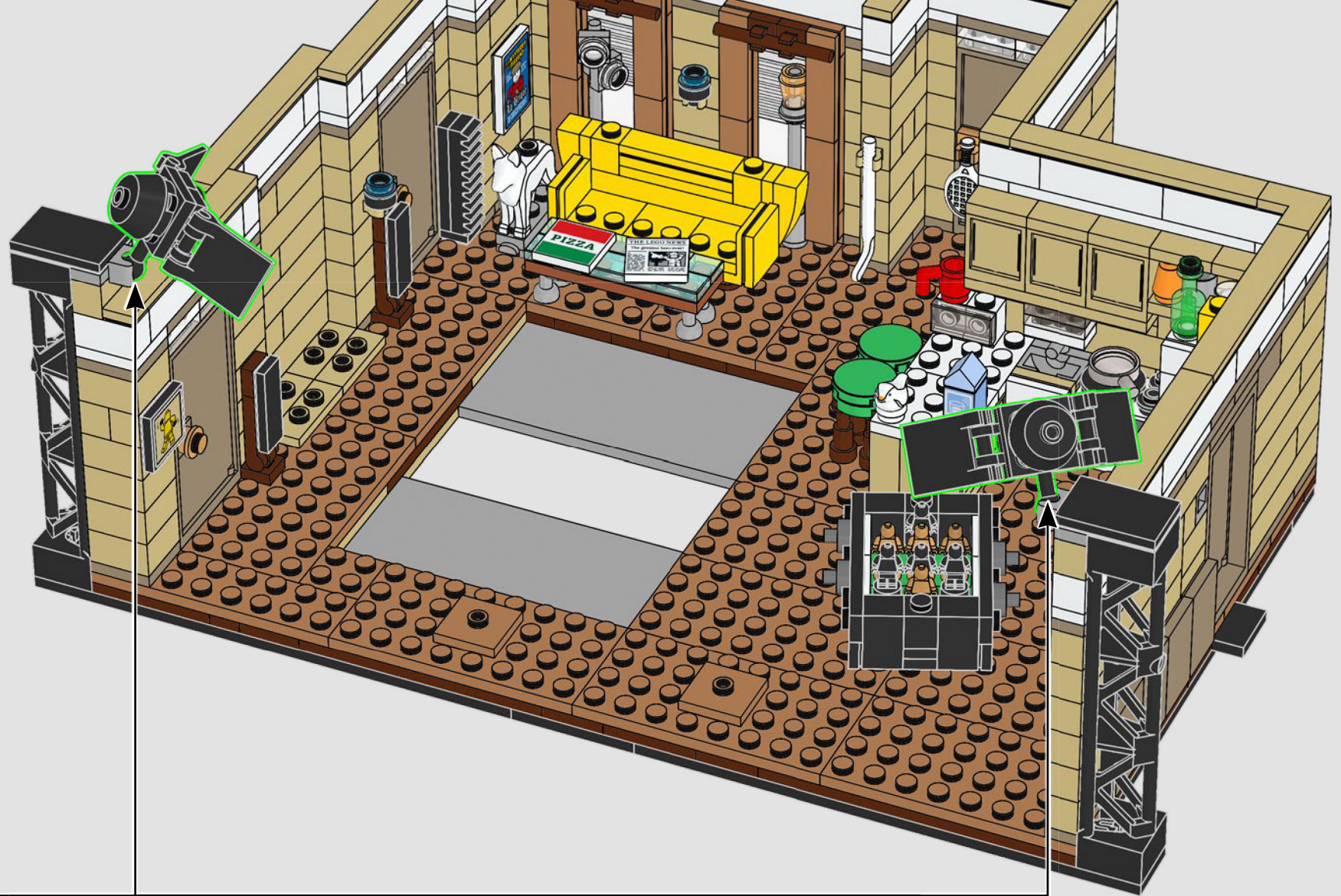

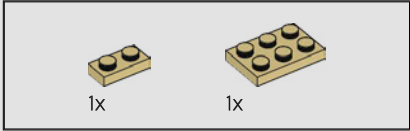
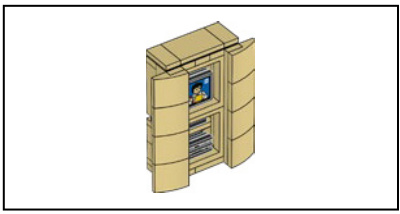

94

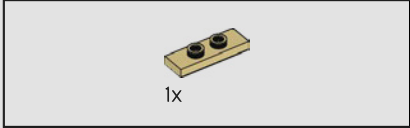
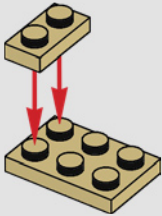

95

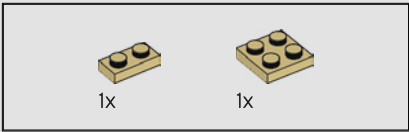
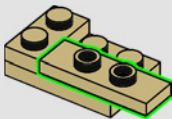

96

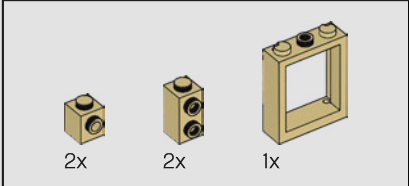
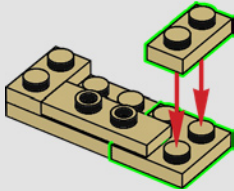

97

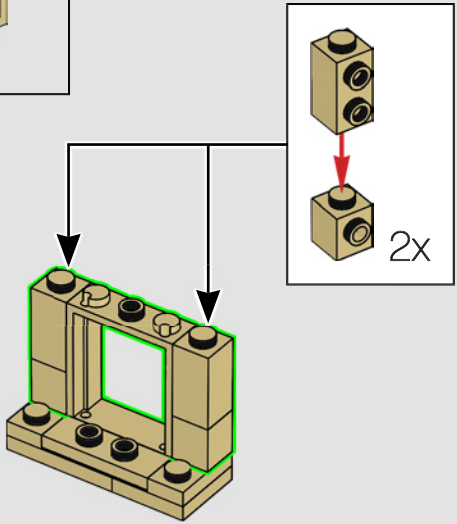

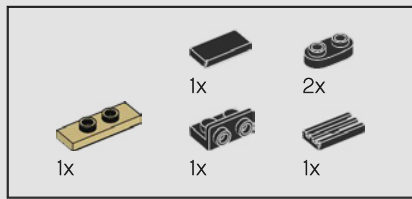

98

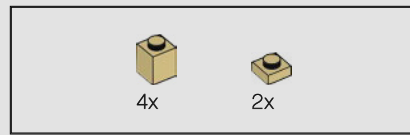
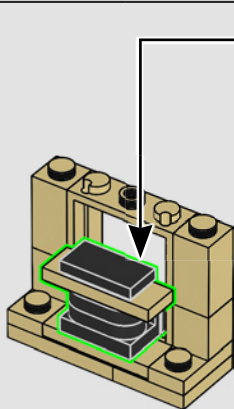
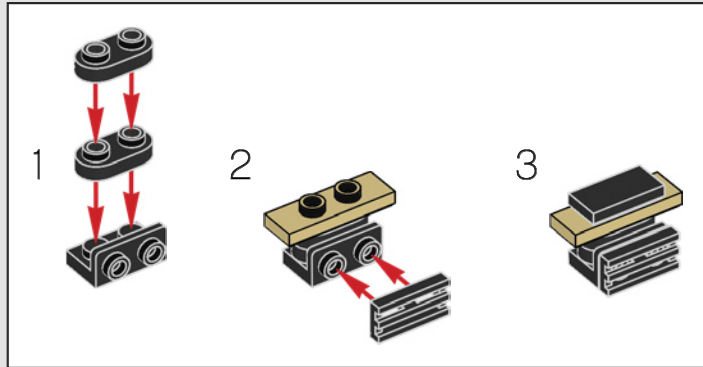

99

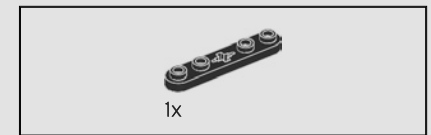
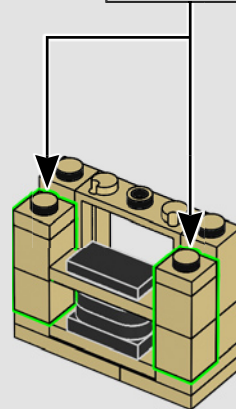
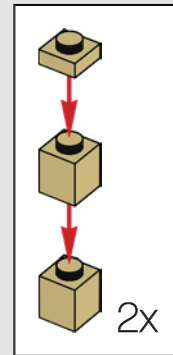

100

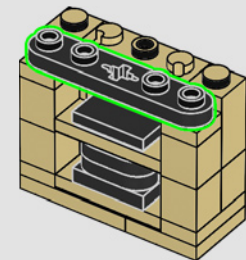

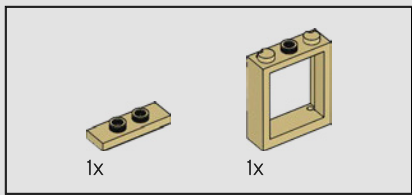

101

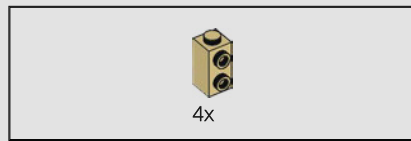
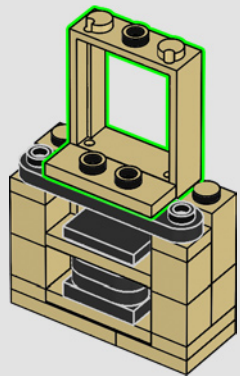

102

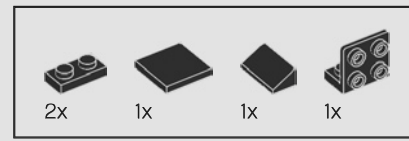
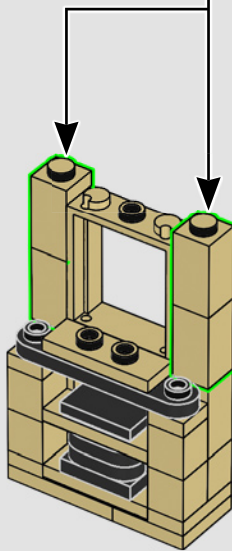
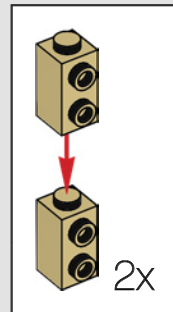

103

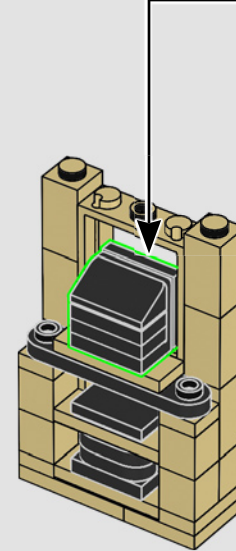
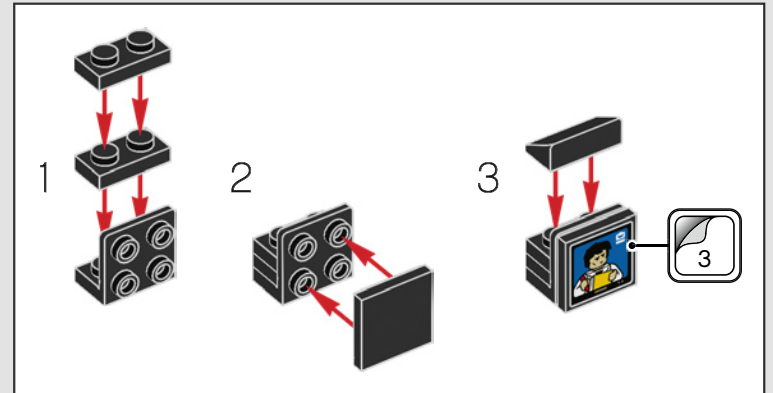

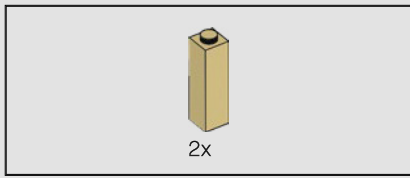

104

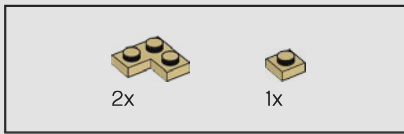
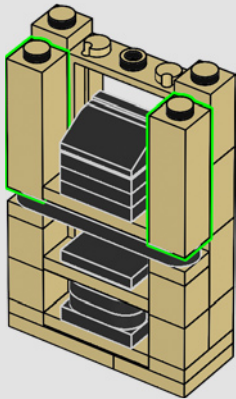

105

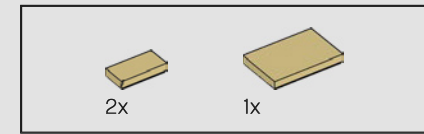
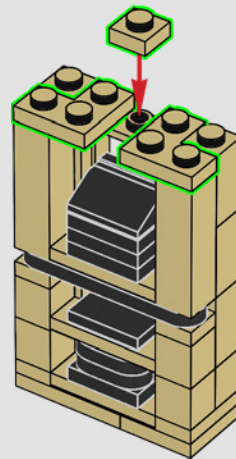

106

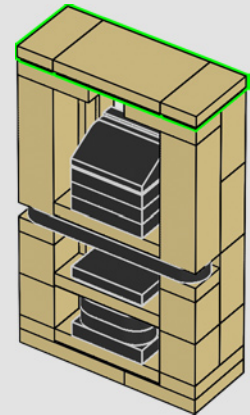

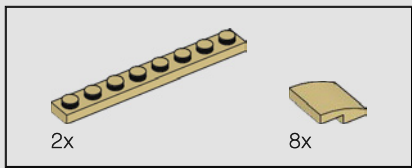

107

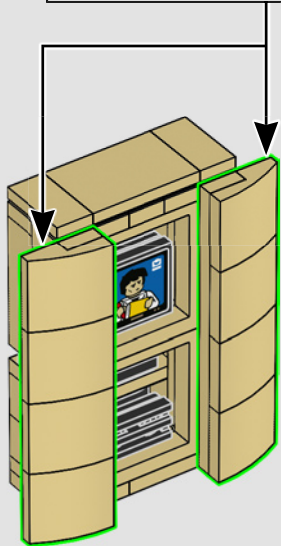
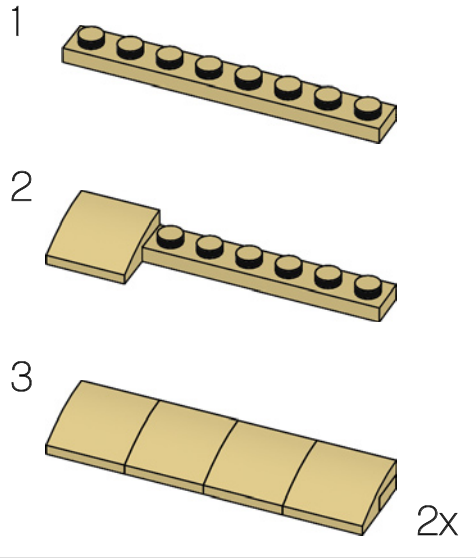

● 电视屏幕贴纸显示了乔伊的名字：Dr. Drake Ramoray，这是他在肥皂剧中的第一个主要和最出名的角色。



108



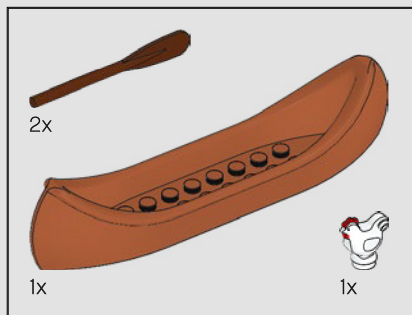

109

● 钱德勒和乔伊公寓中的家具被洗劫一空后，两人所乘坐的独木船。



1

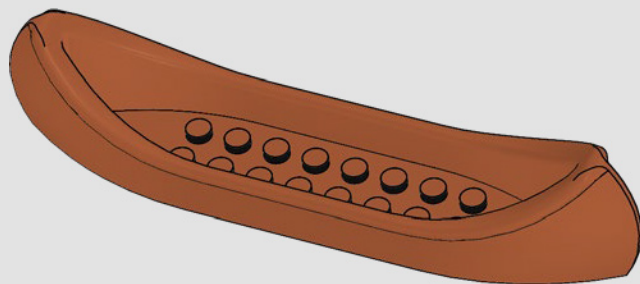

2

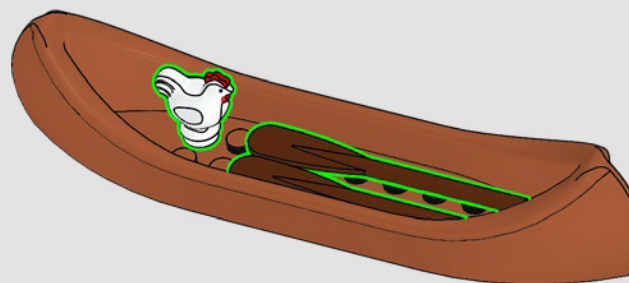

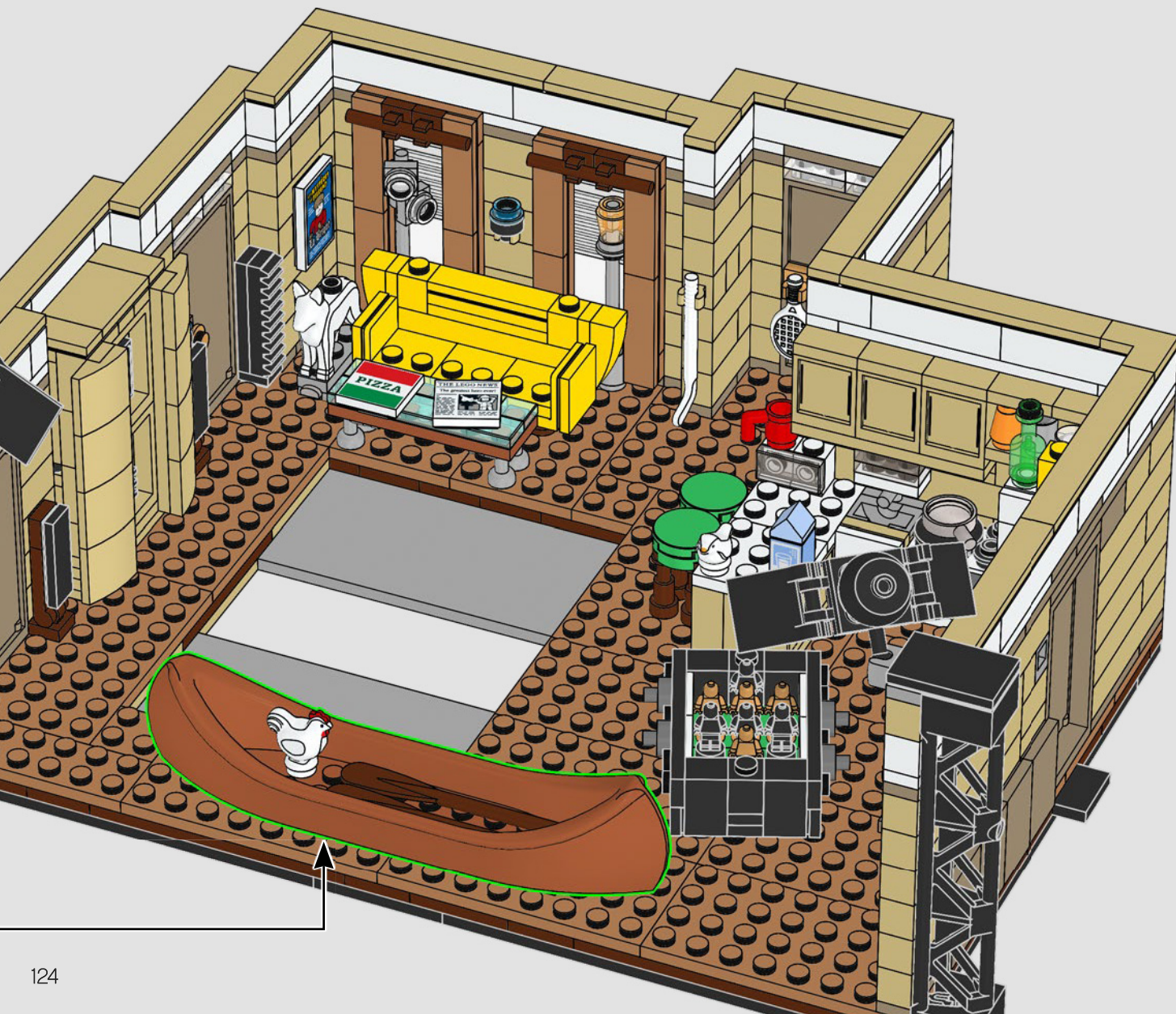

110

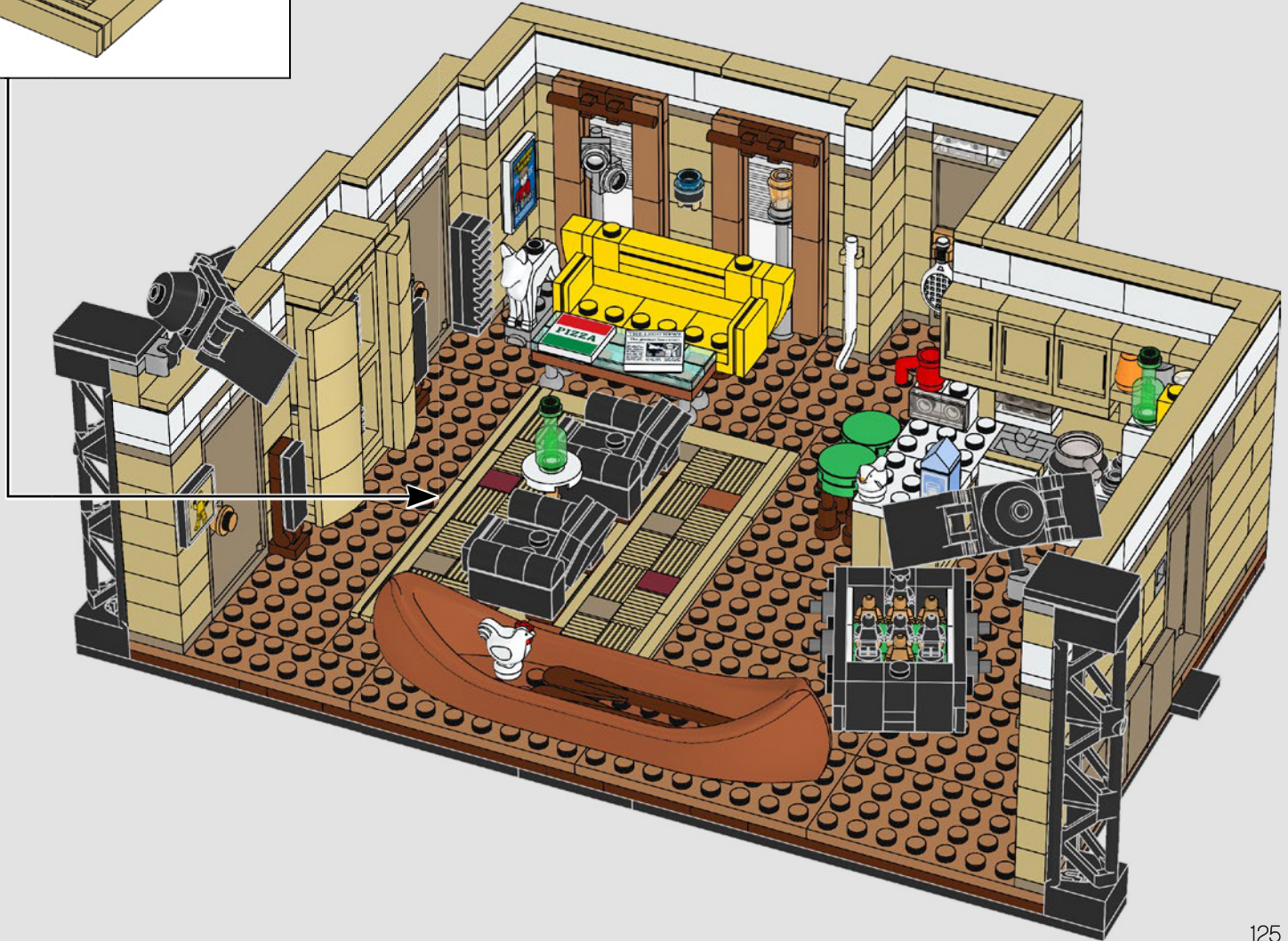
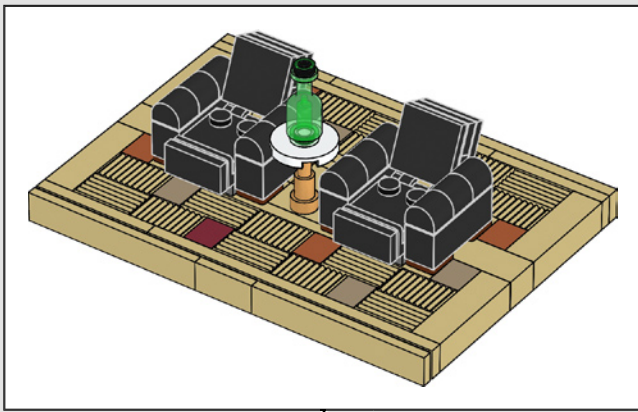

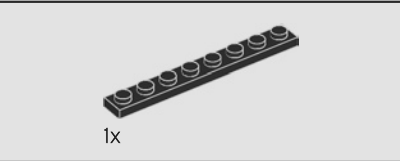
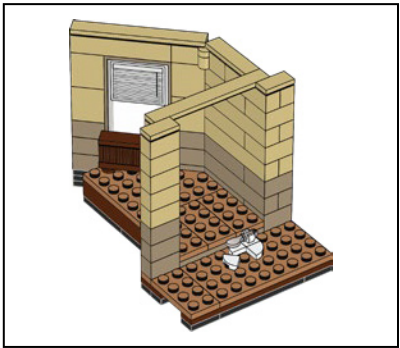
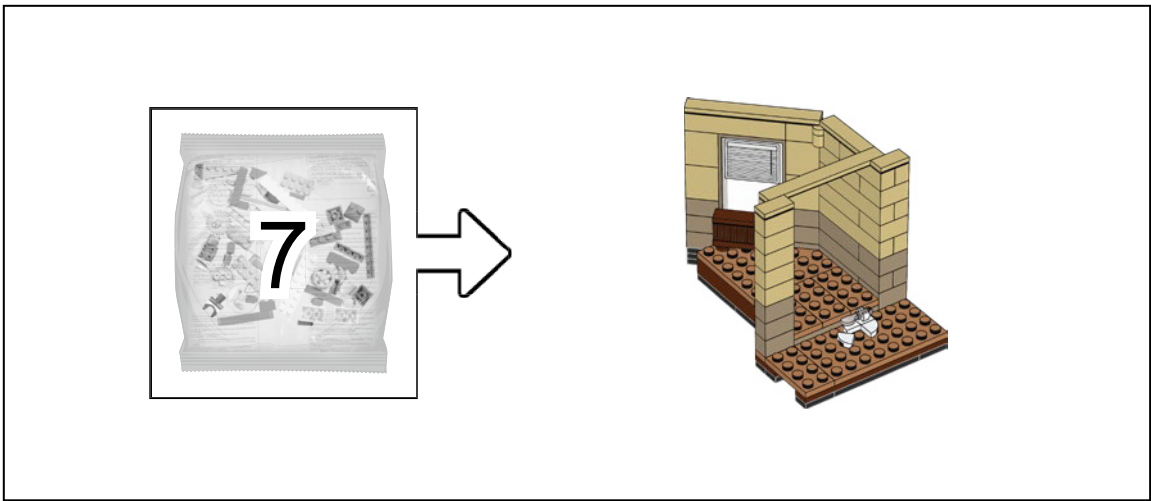

1

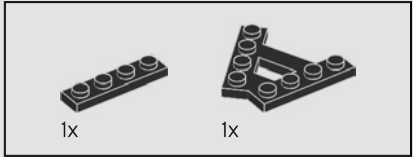
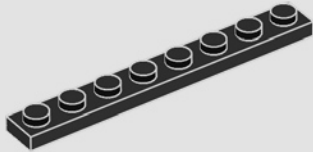

2

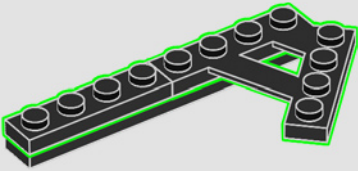

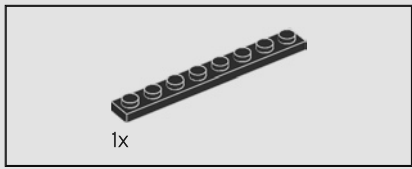

3

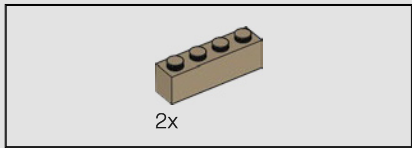
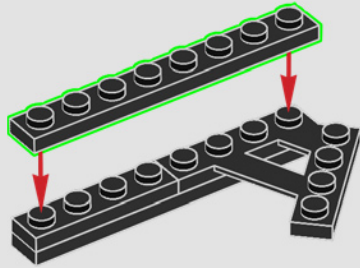

4

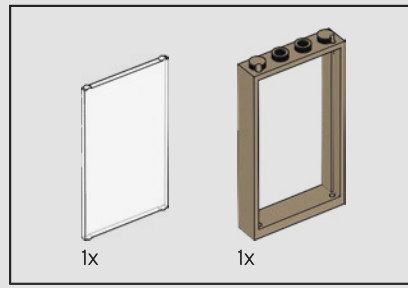
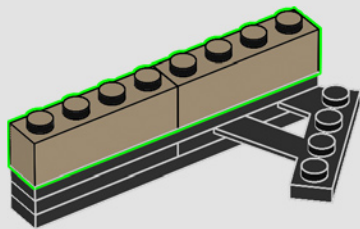

5

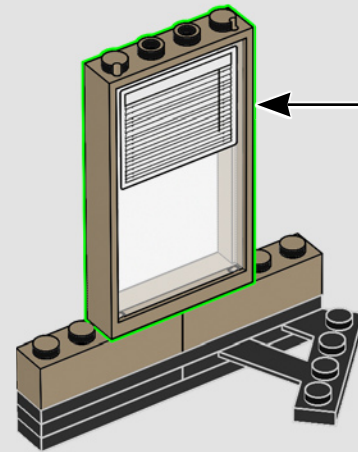
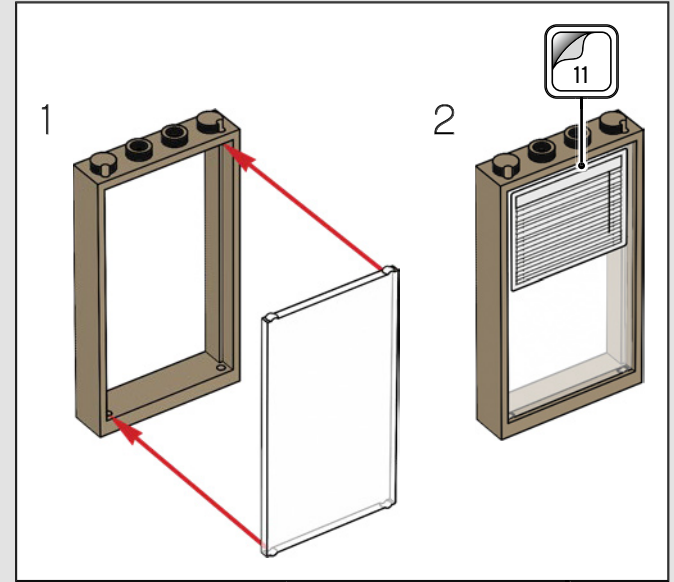

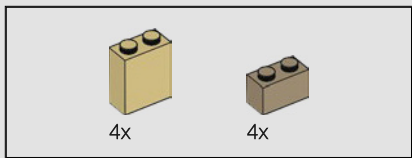

6

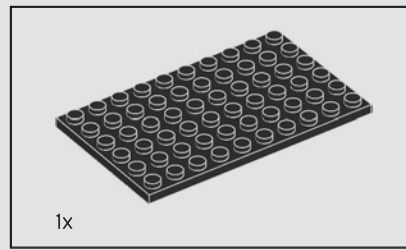
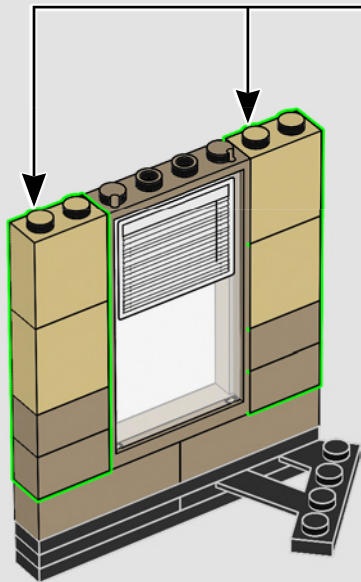
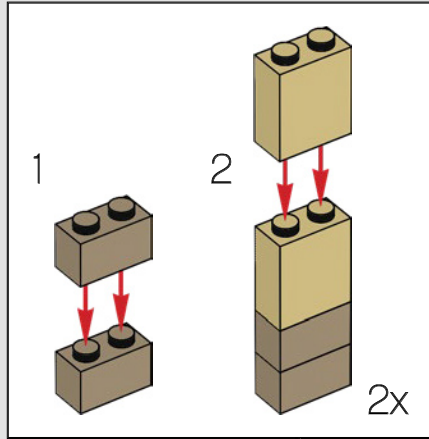

7

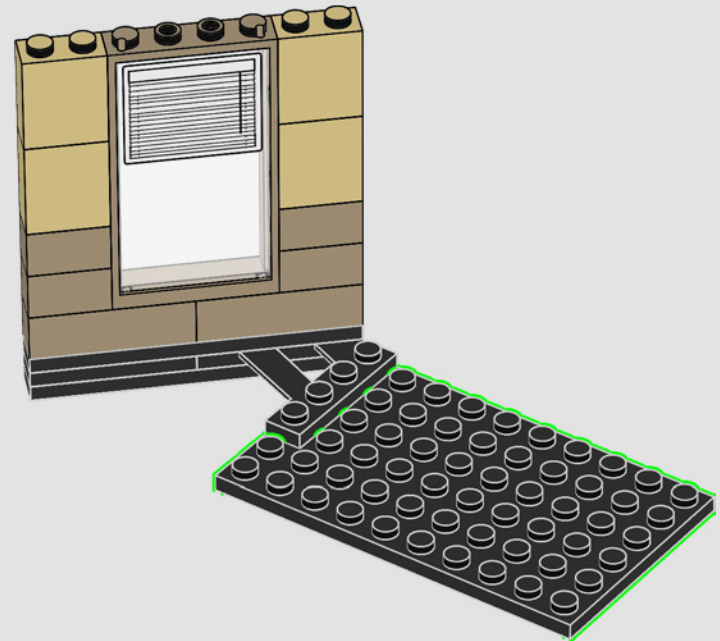

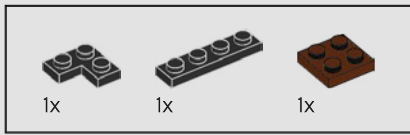

8

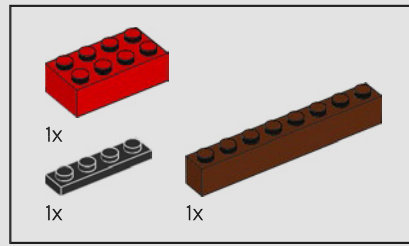
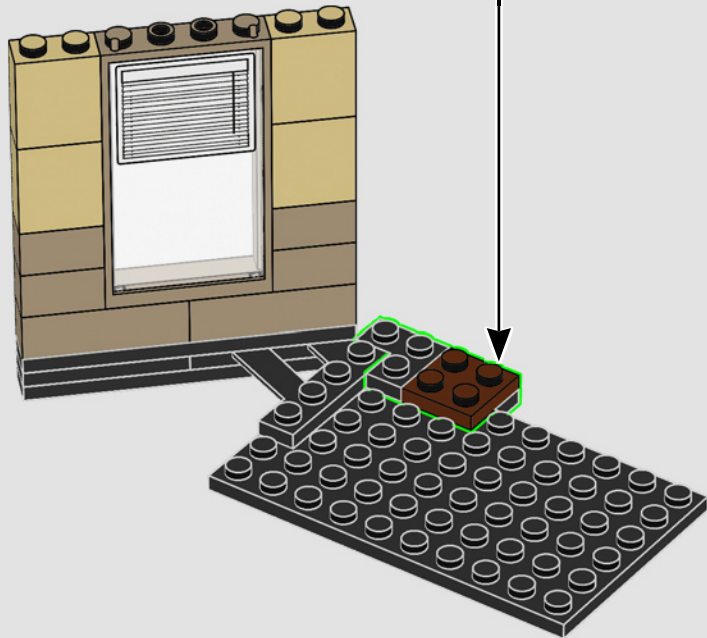
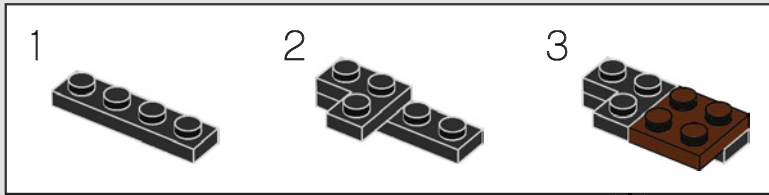

9

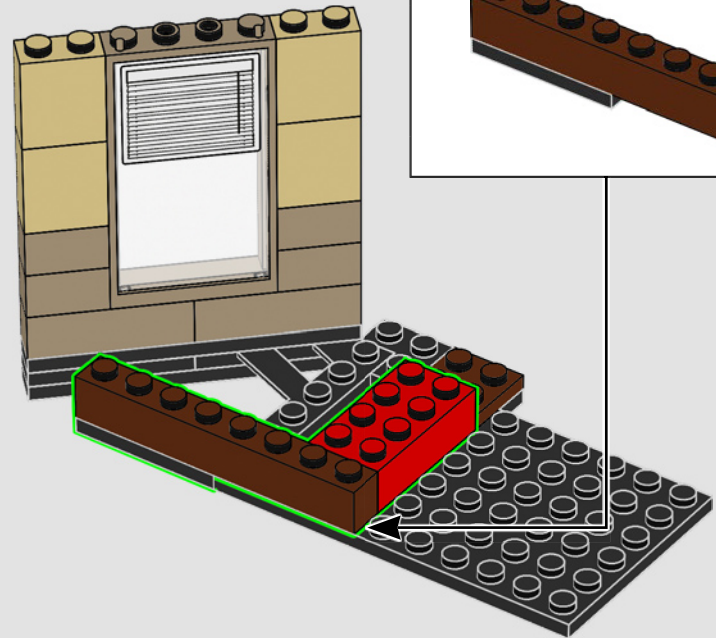
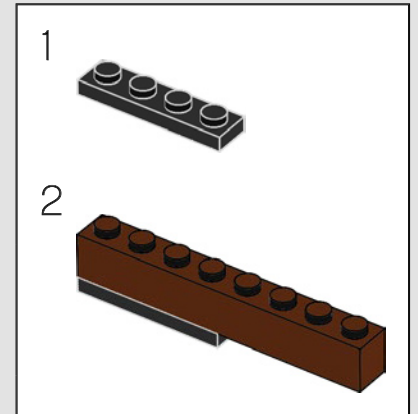

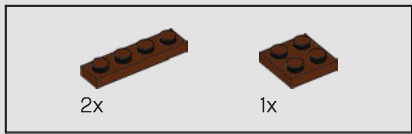

10

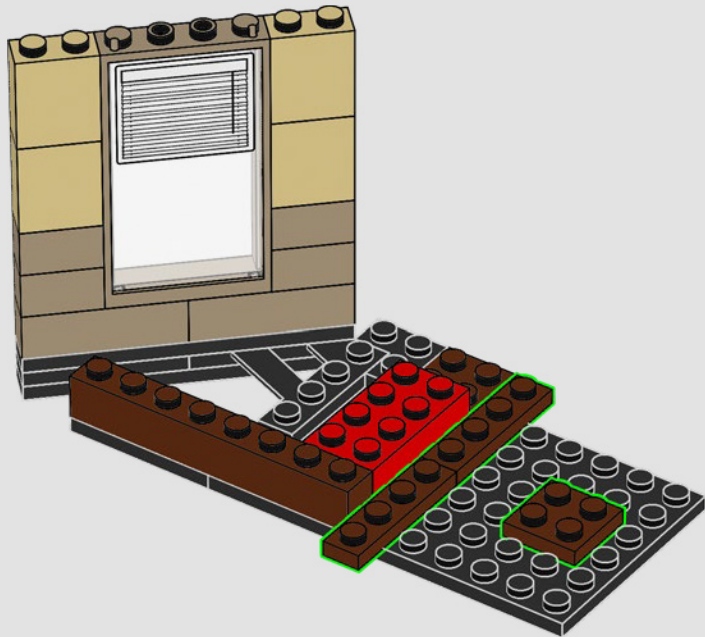

11

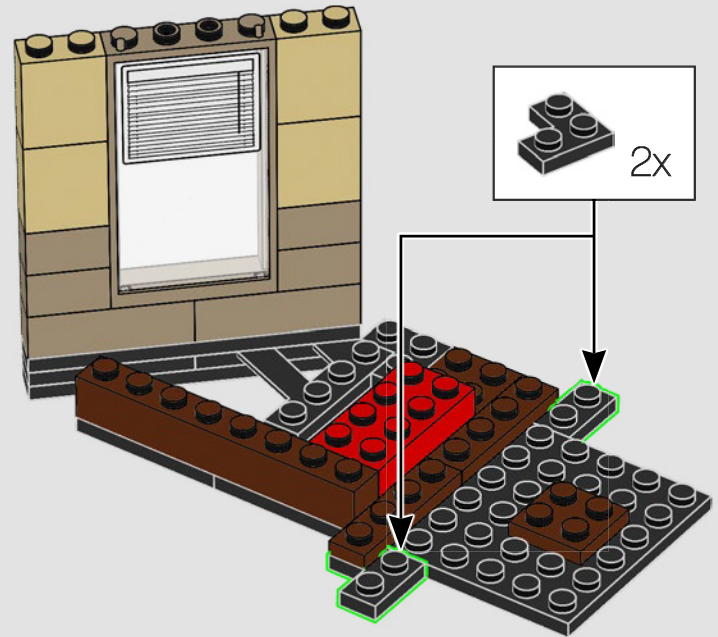

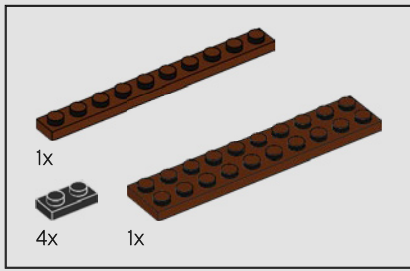

12

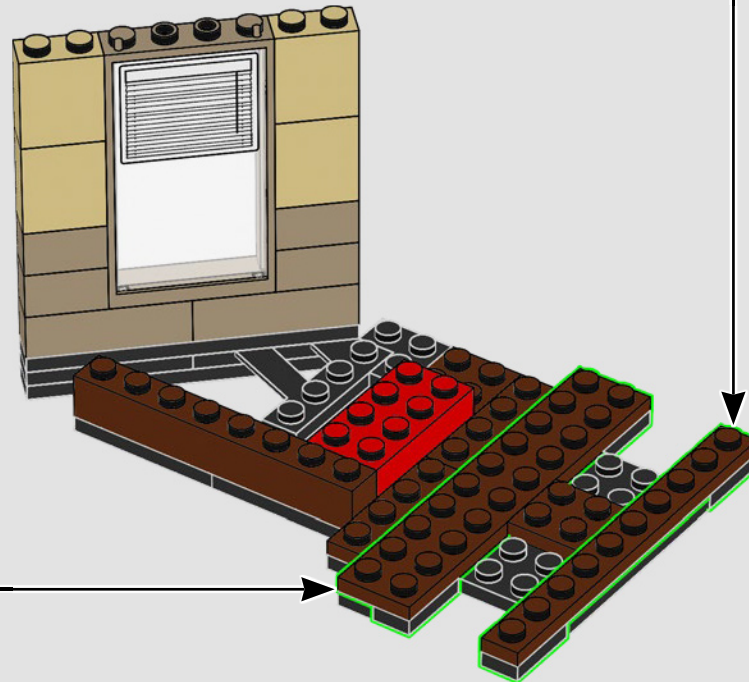
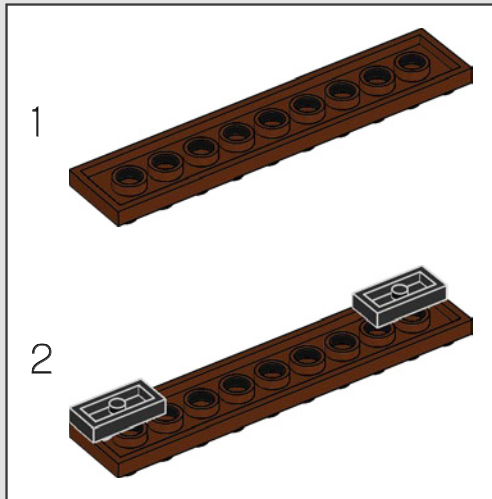
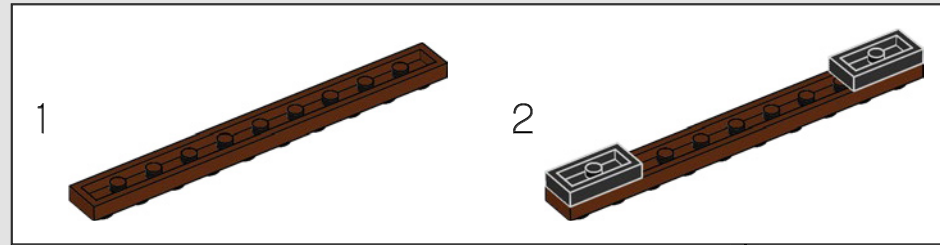

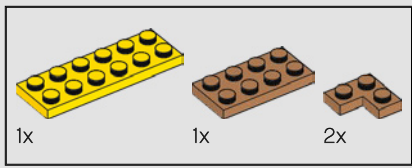

13

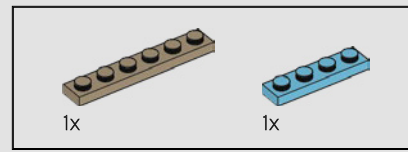

14

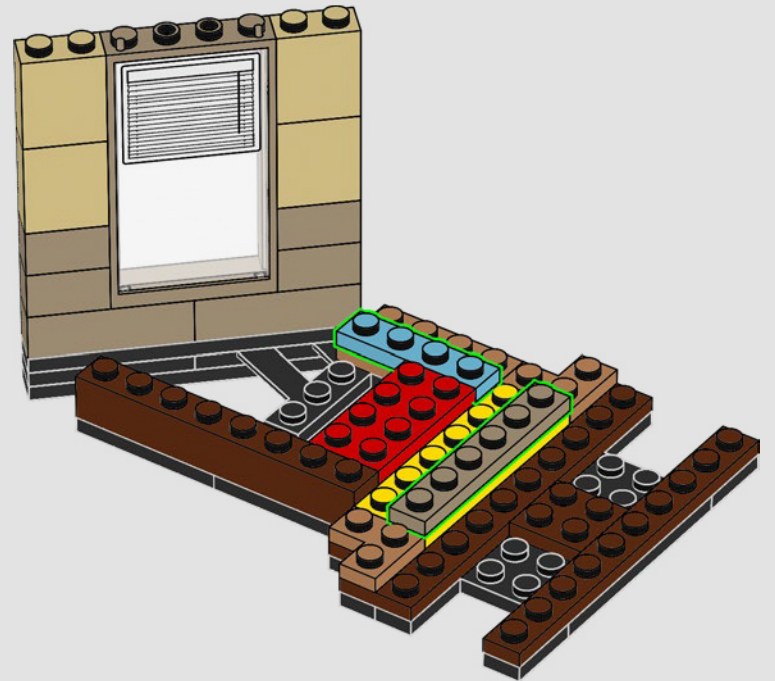

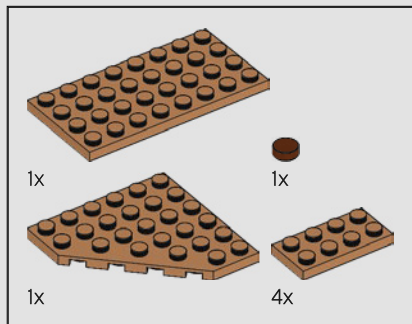

15

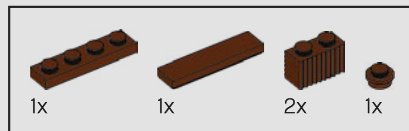
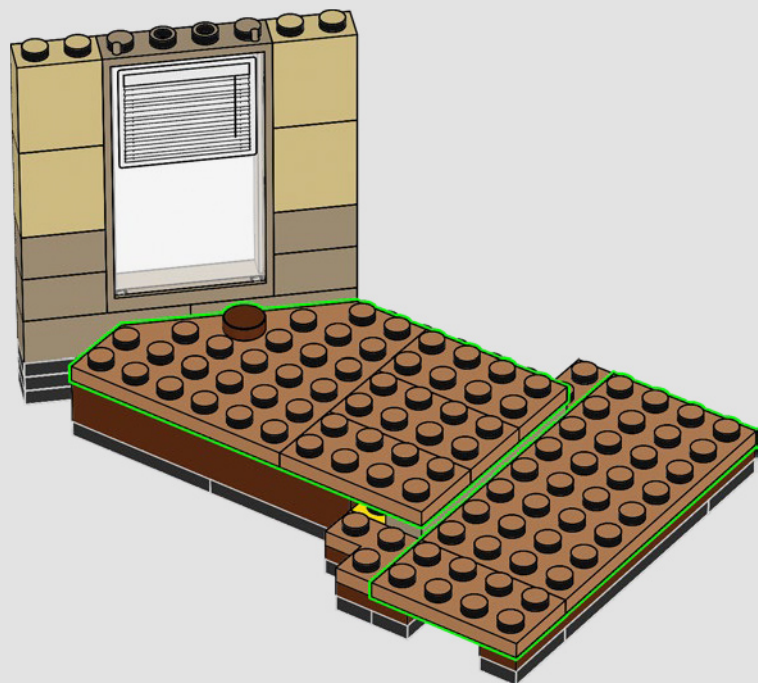

16

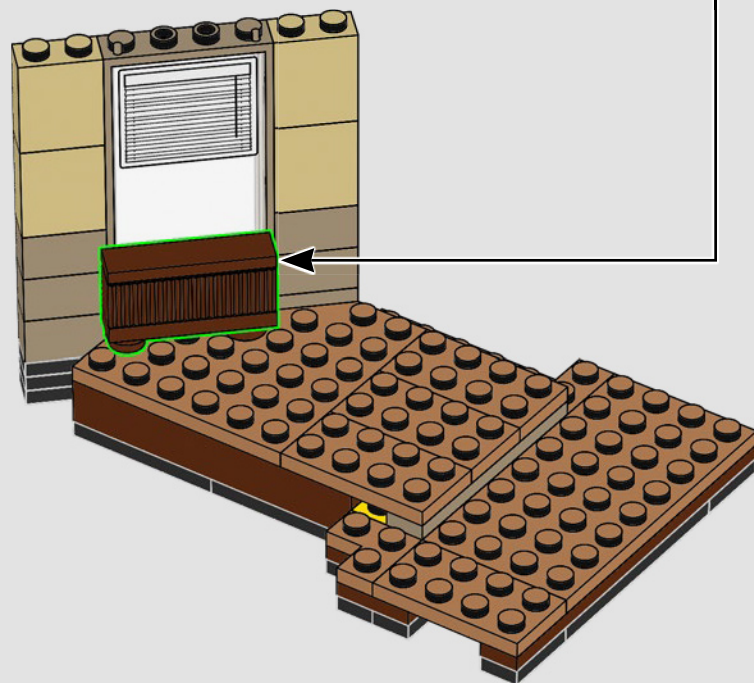
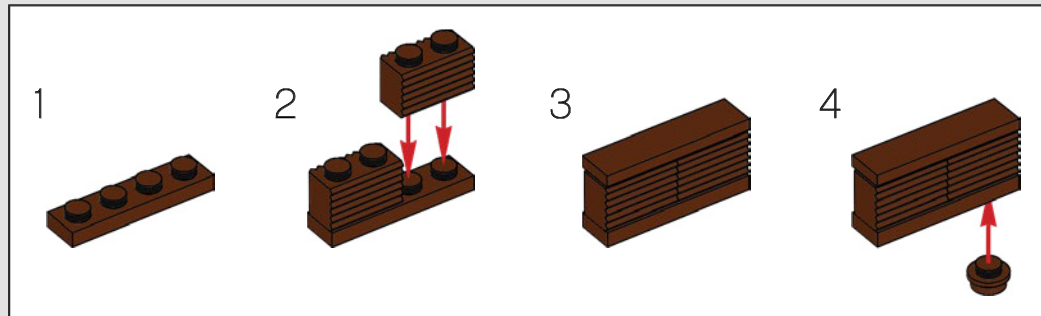

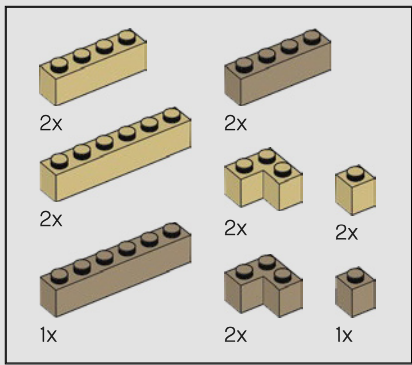

17

1

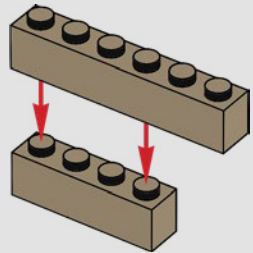

2

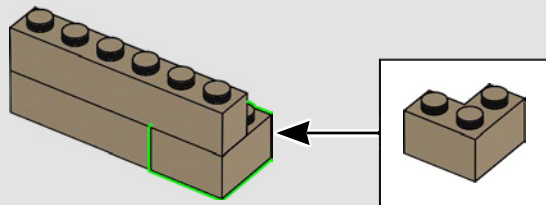

3

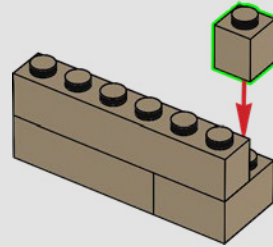

4

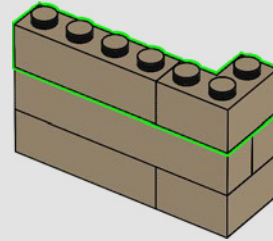

5

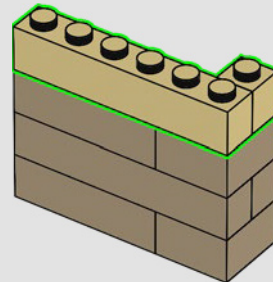

6

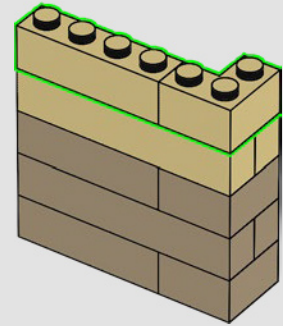

7

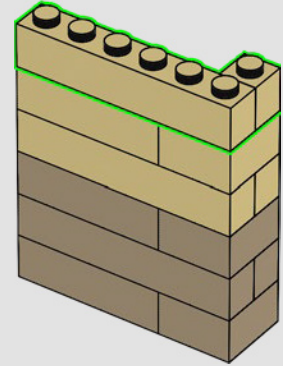

8

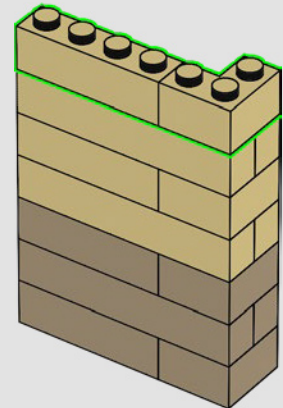

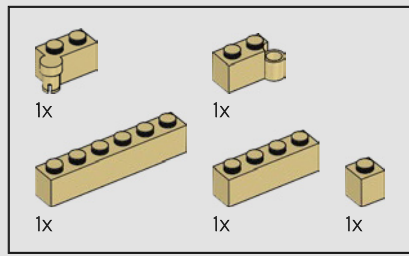

18

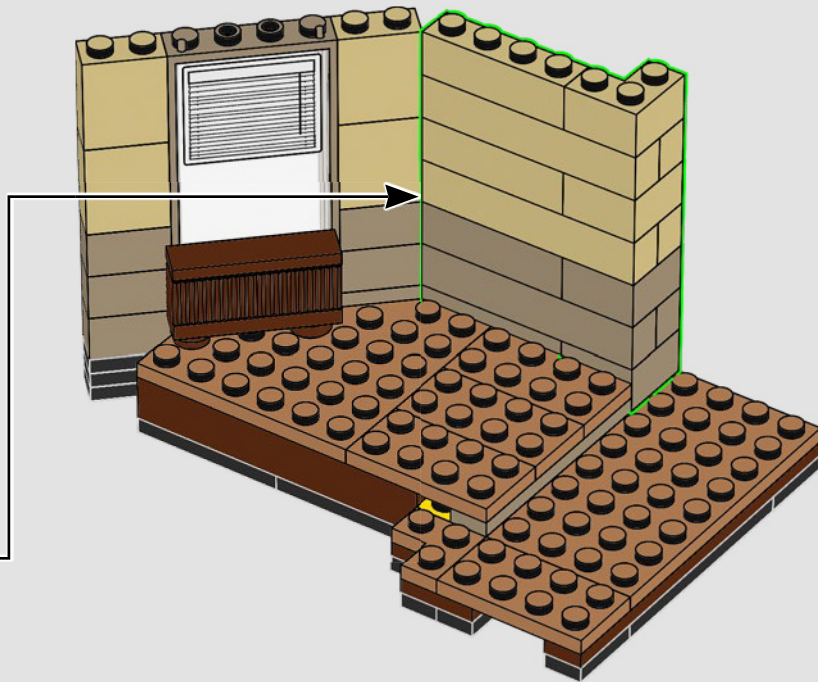
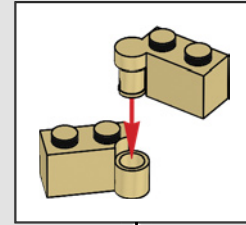

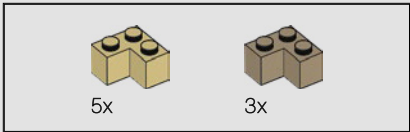

19

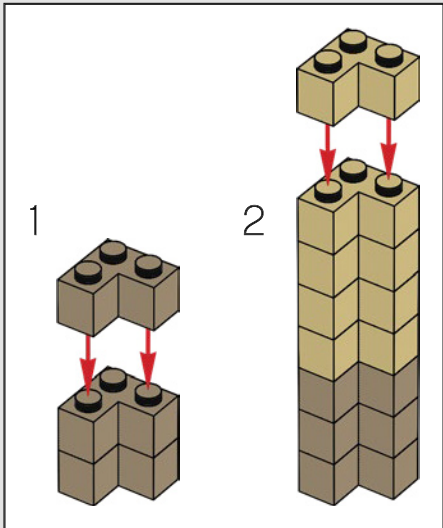

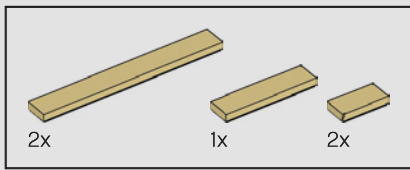

20

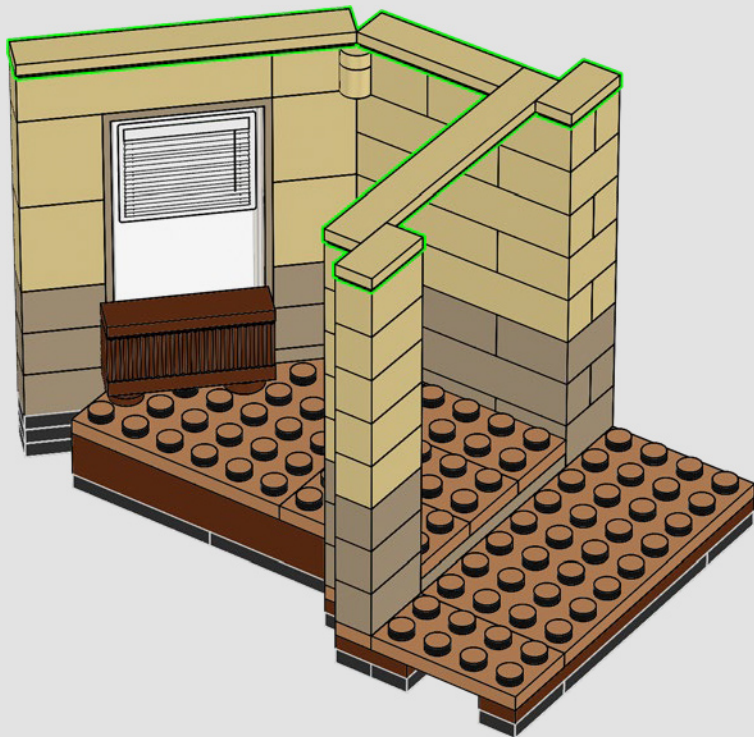

21

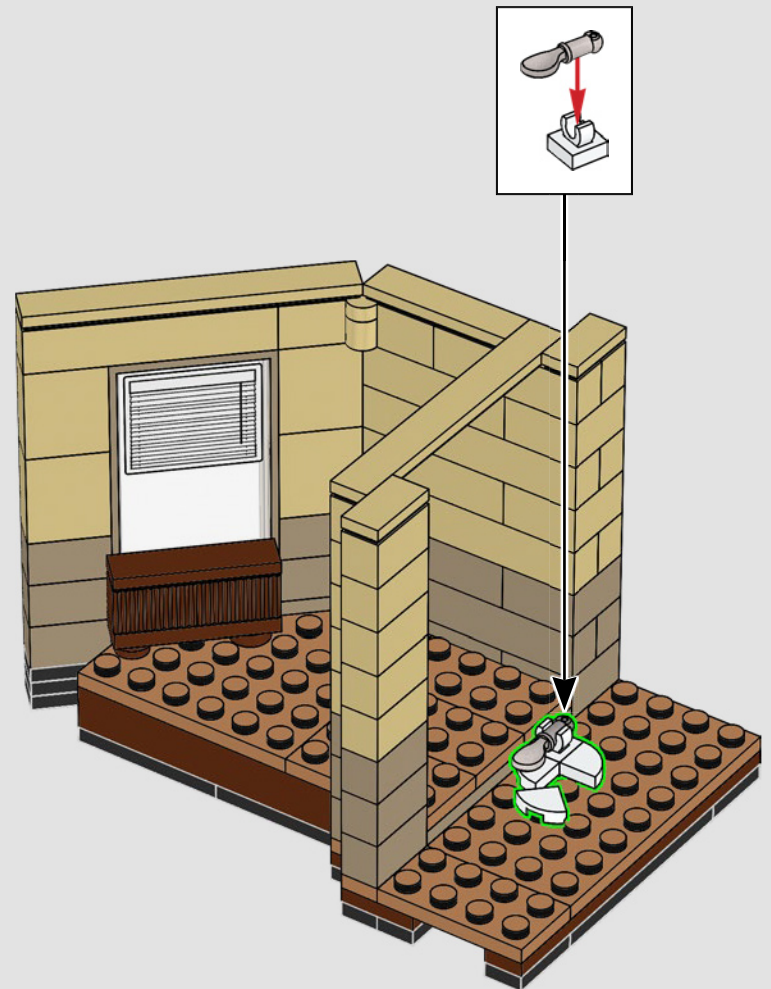



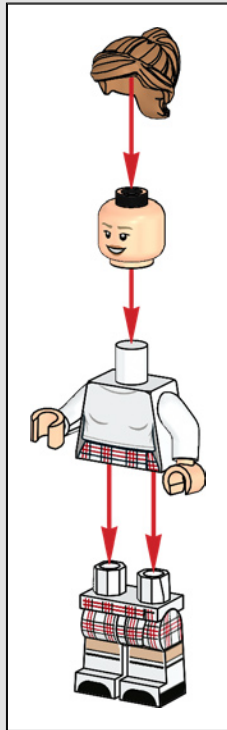
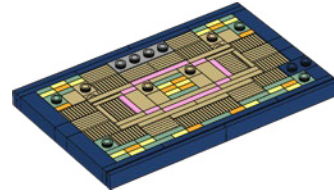

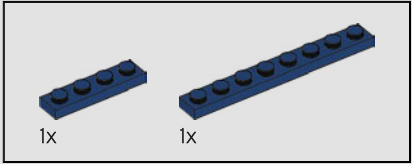
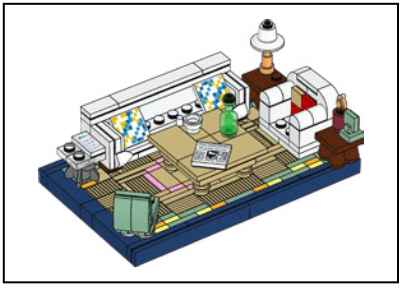

1

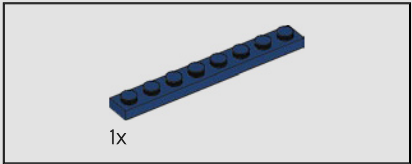
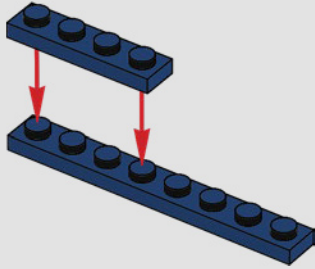

2

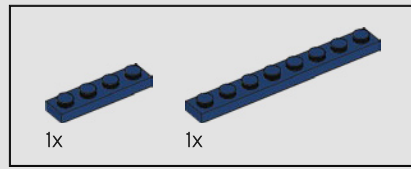
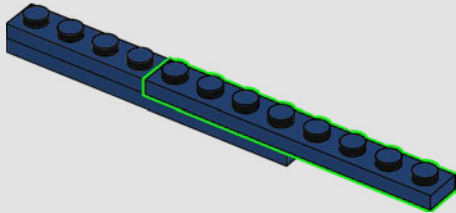

3

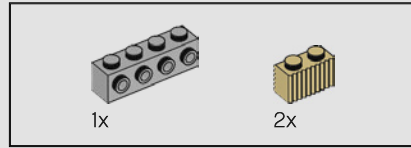
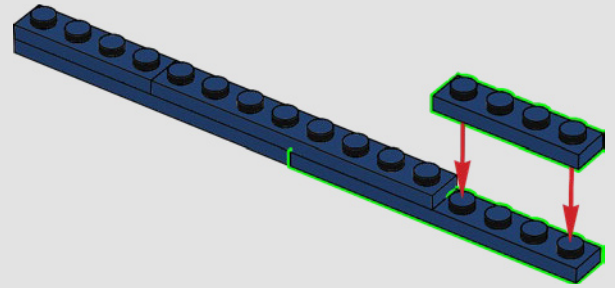

4

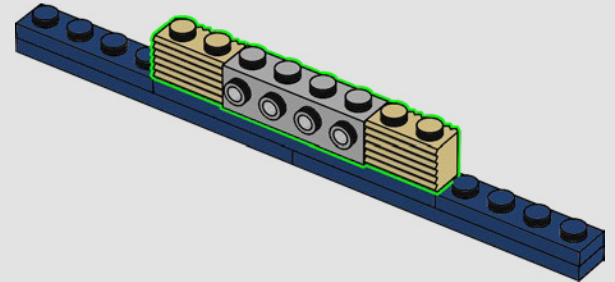

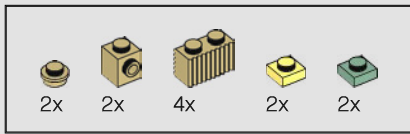

5

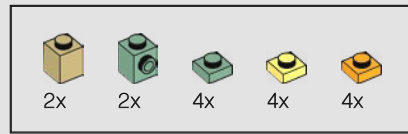
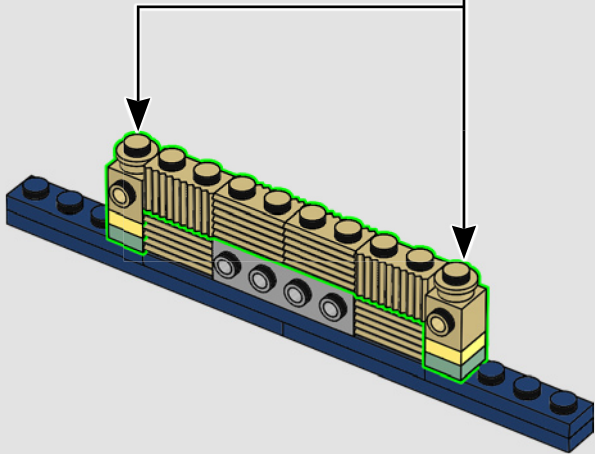
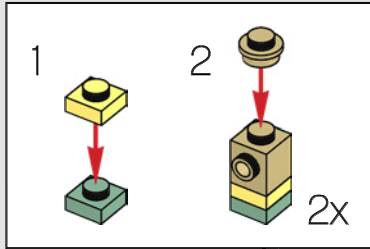

6

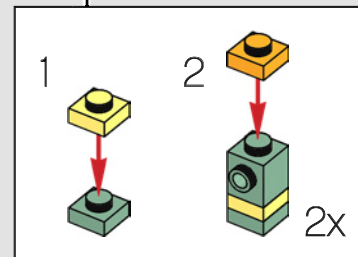
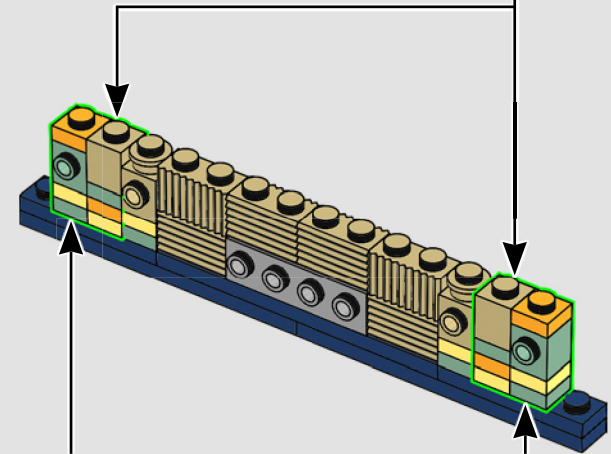
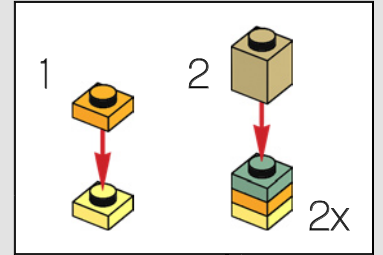

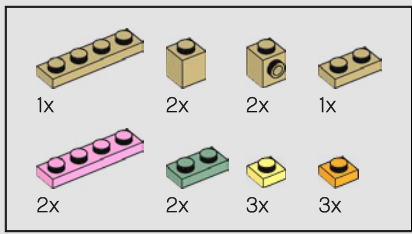

7

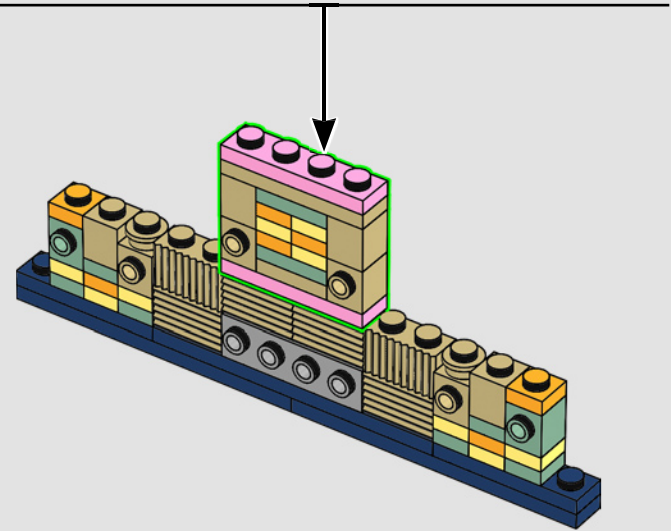
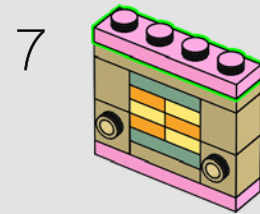
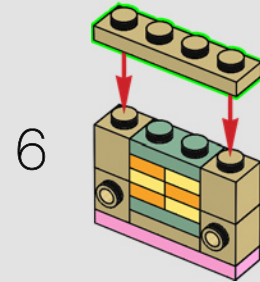
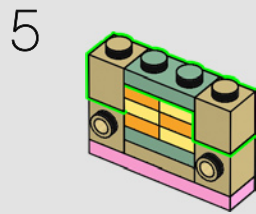
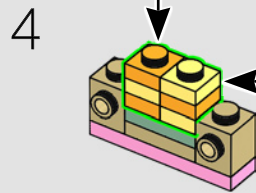
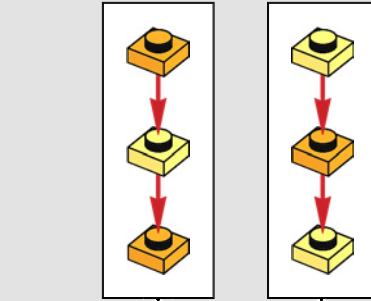
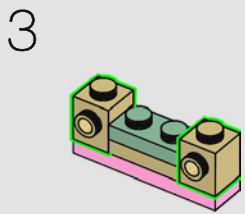
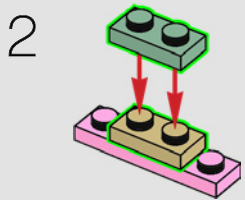
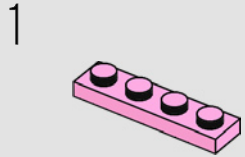

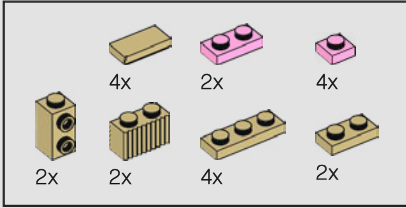
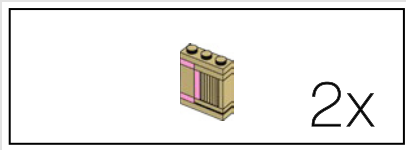

8

1

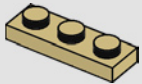

2

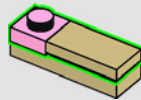

3

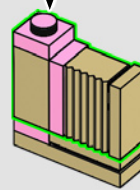

4

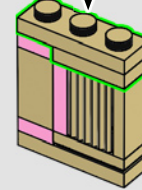

2x

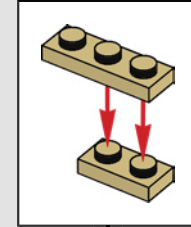
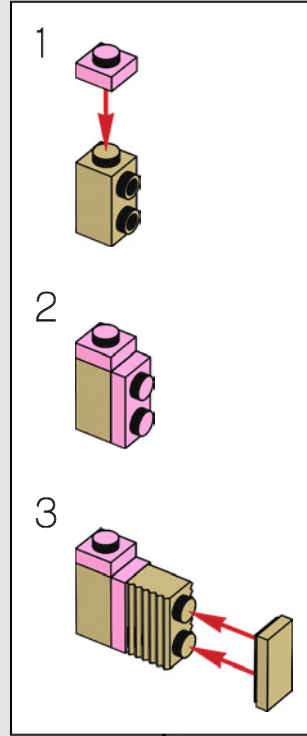

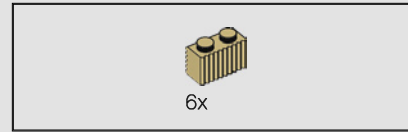
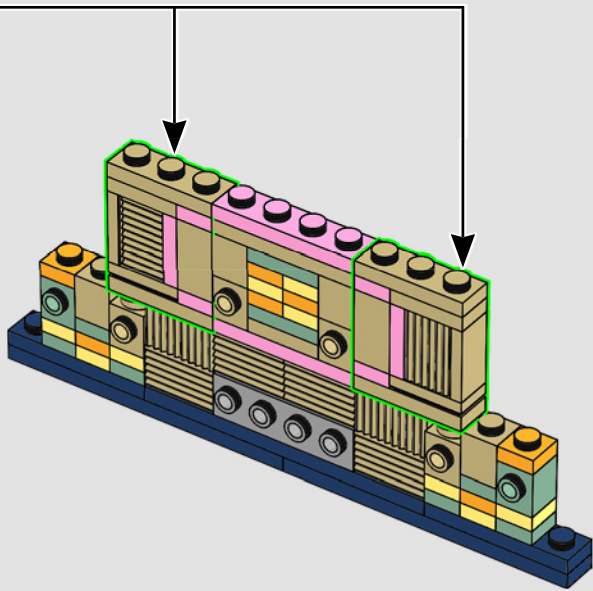

9

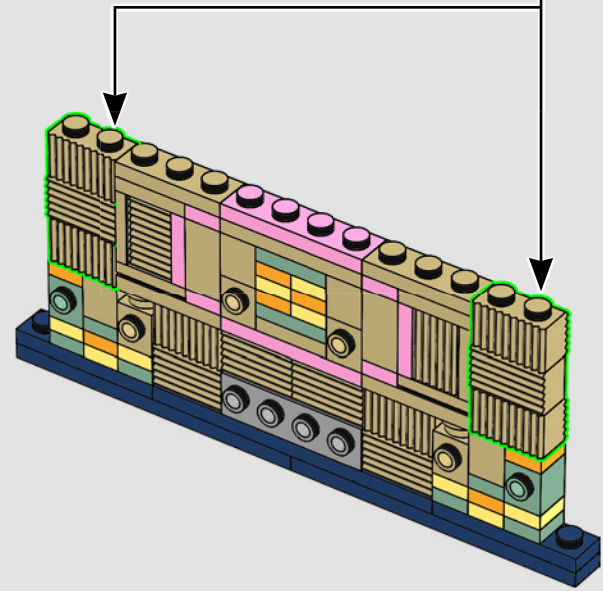
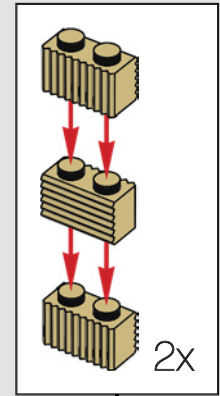

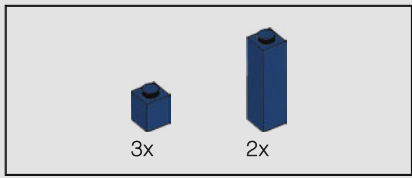

10

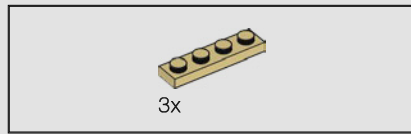
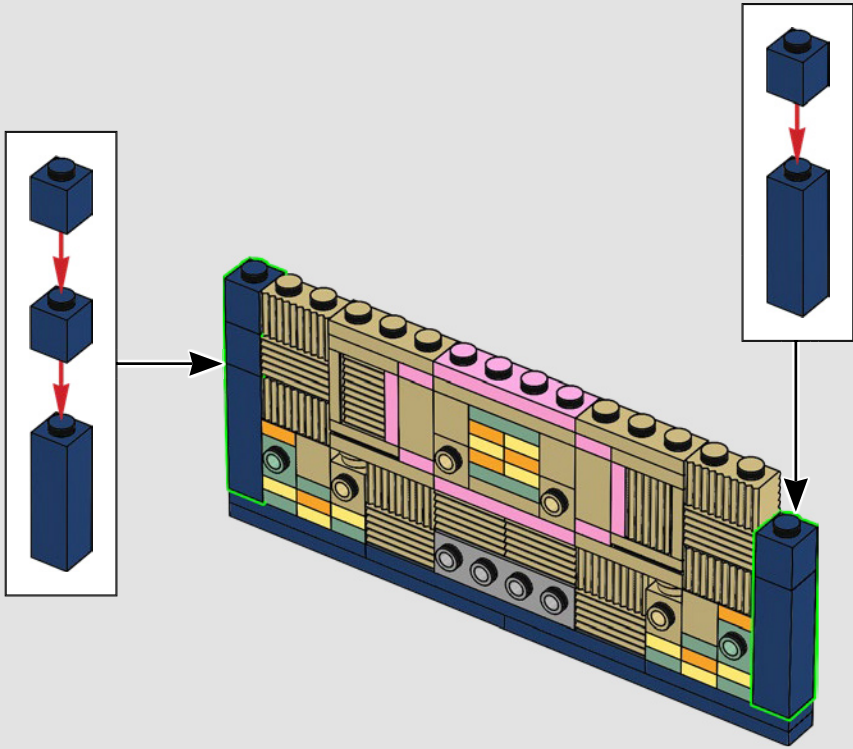

11

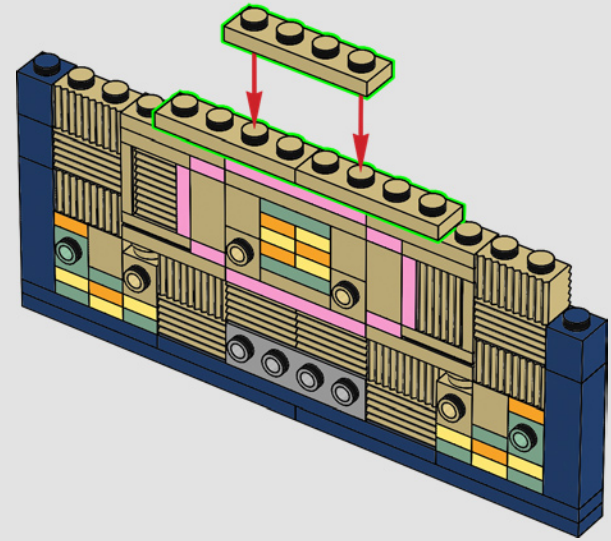

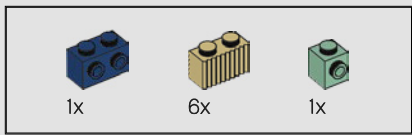

12

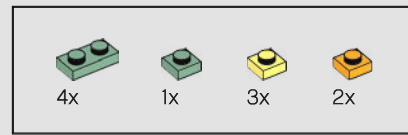
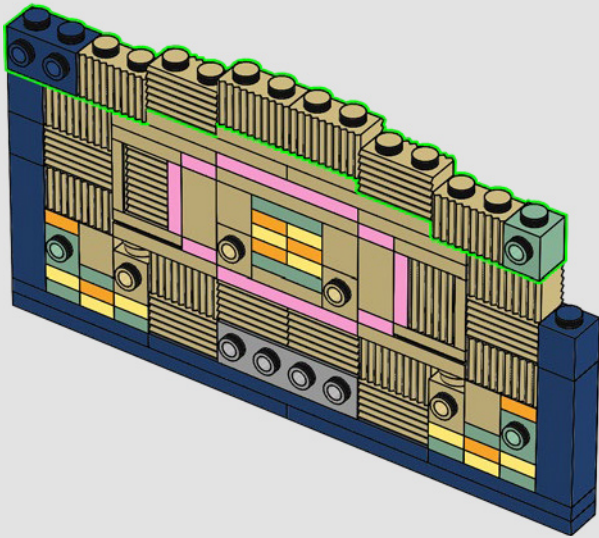

13

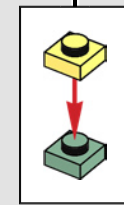
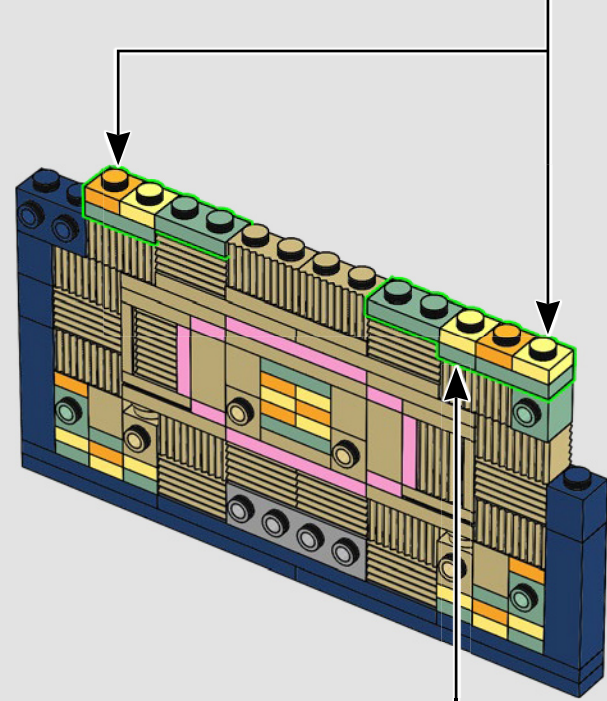
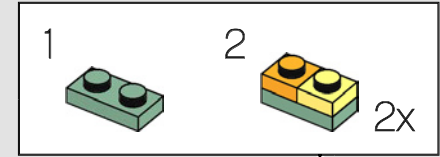

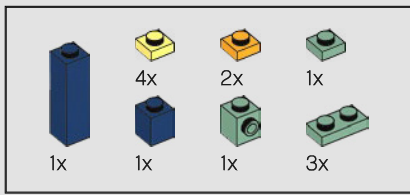

14

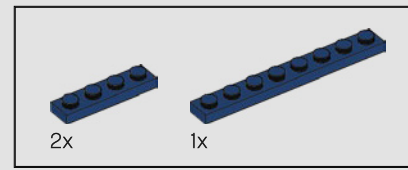
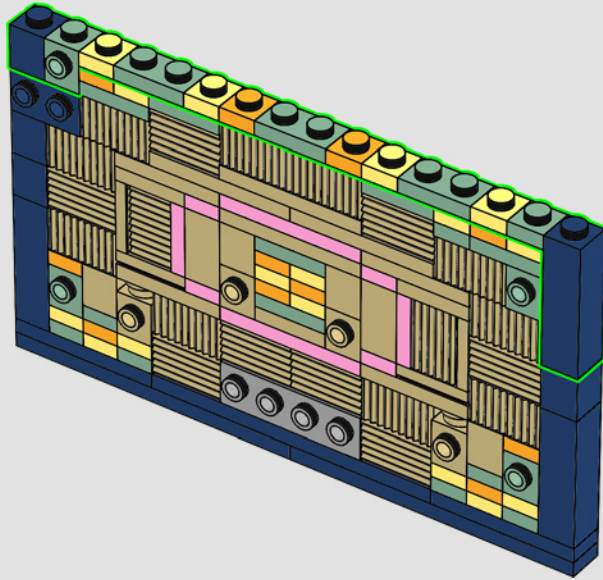

15

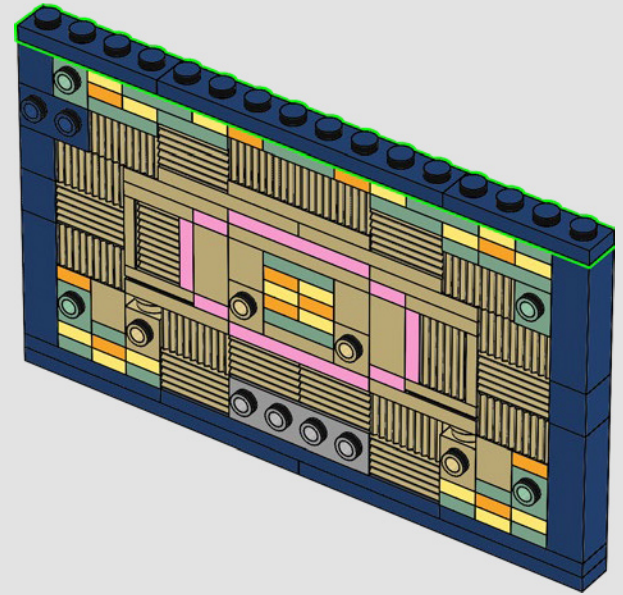

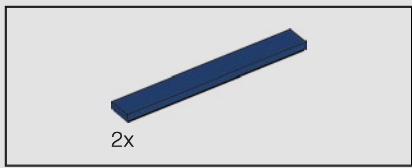

16

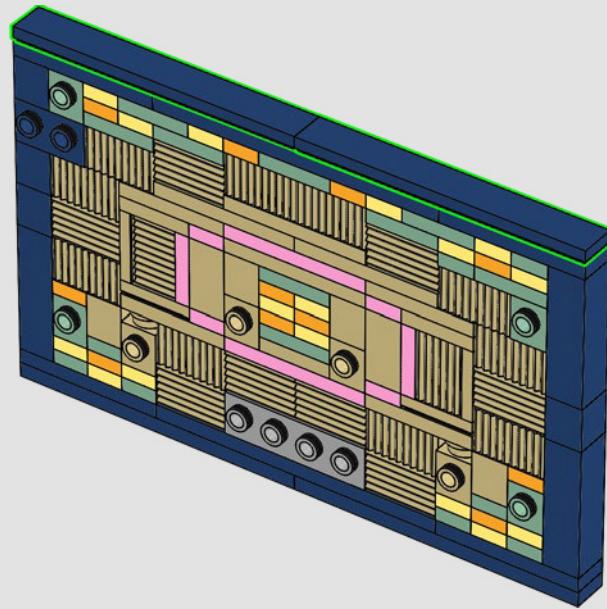

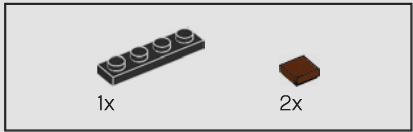
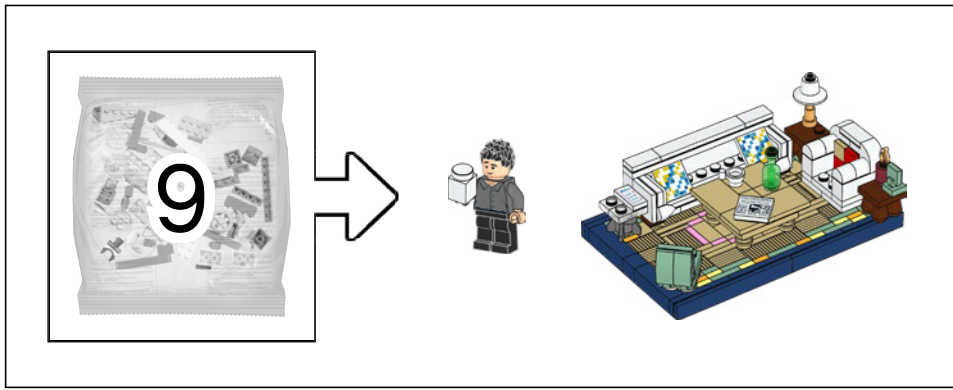

17

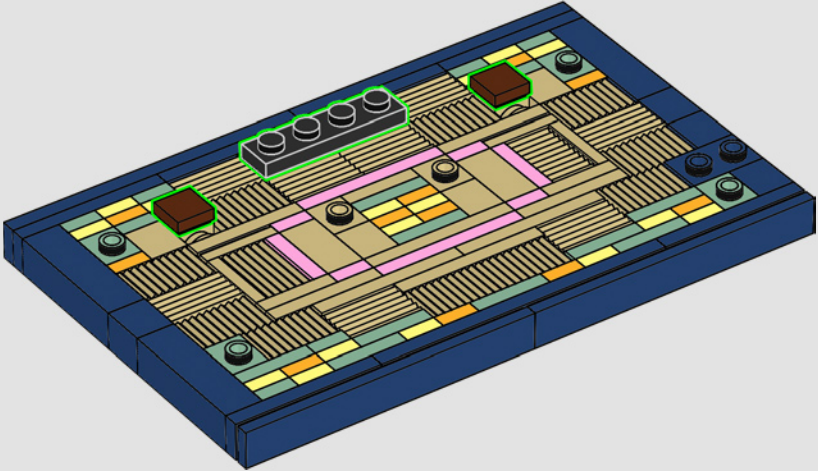
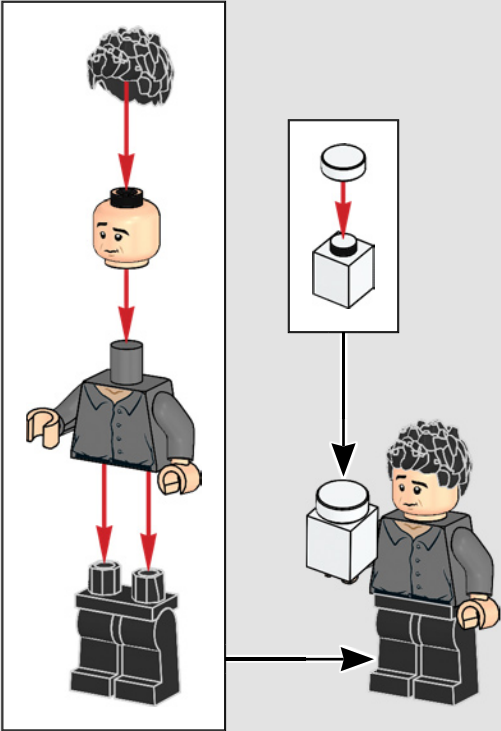

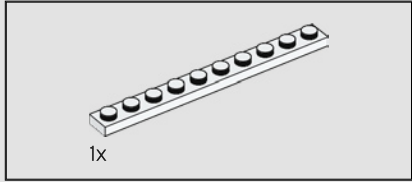
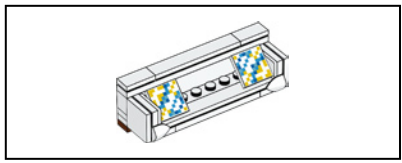

18

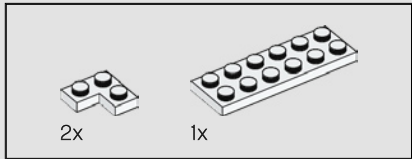
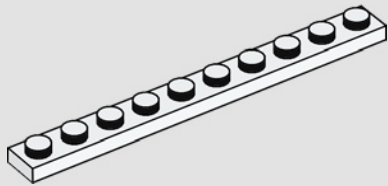

19

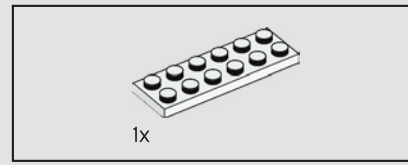
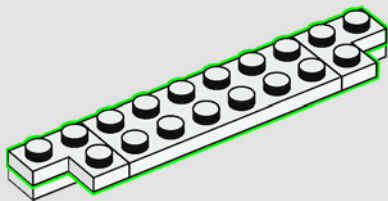

20

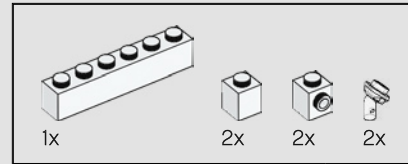
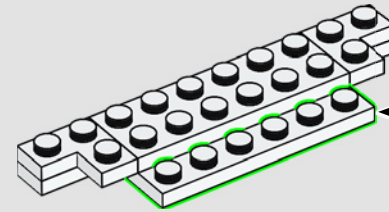
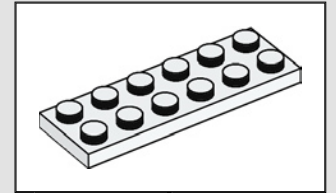

21

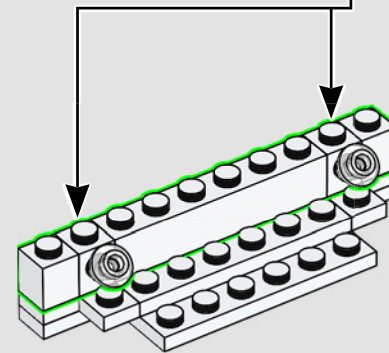
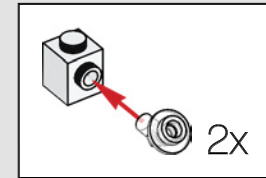

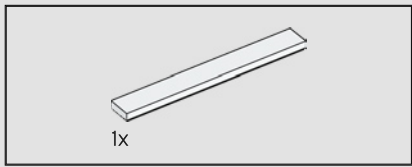

22

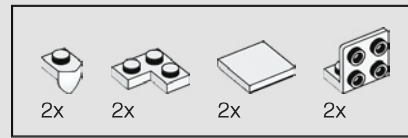
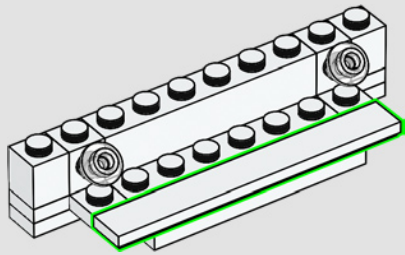

23

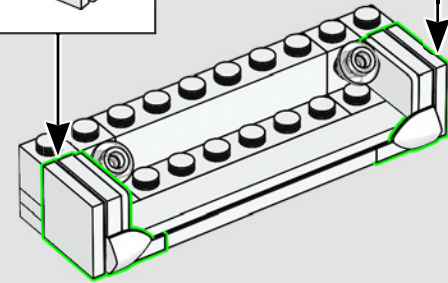
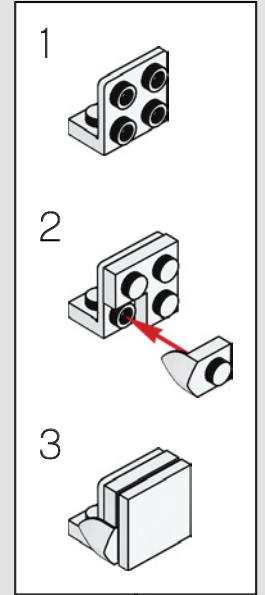
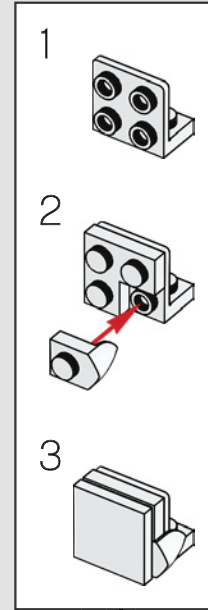

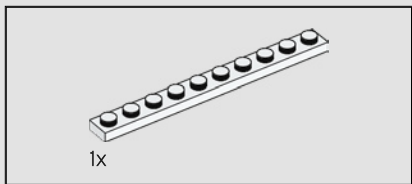

24

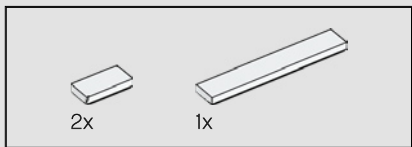
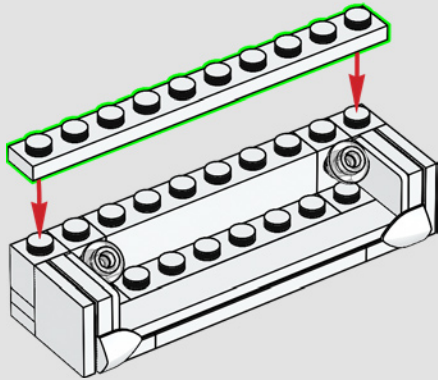

25

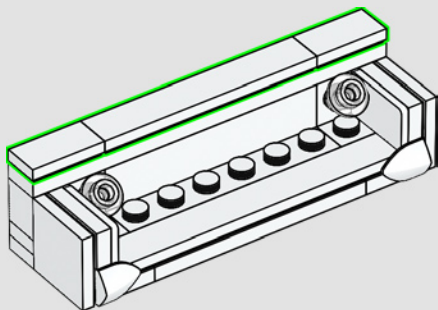

26

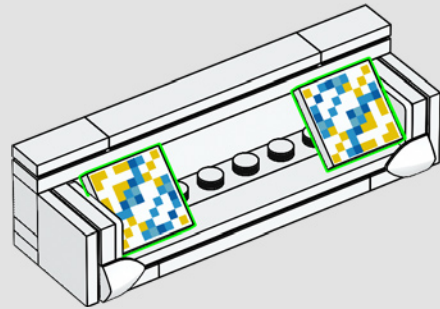

27

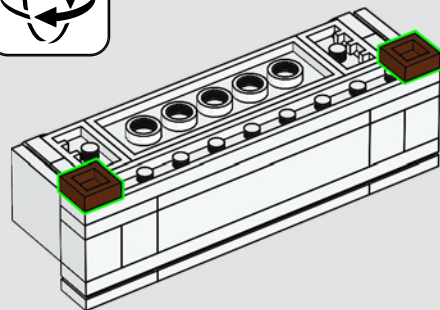

28

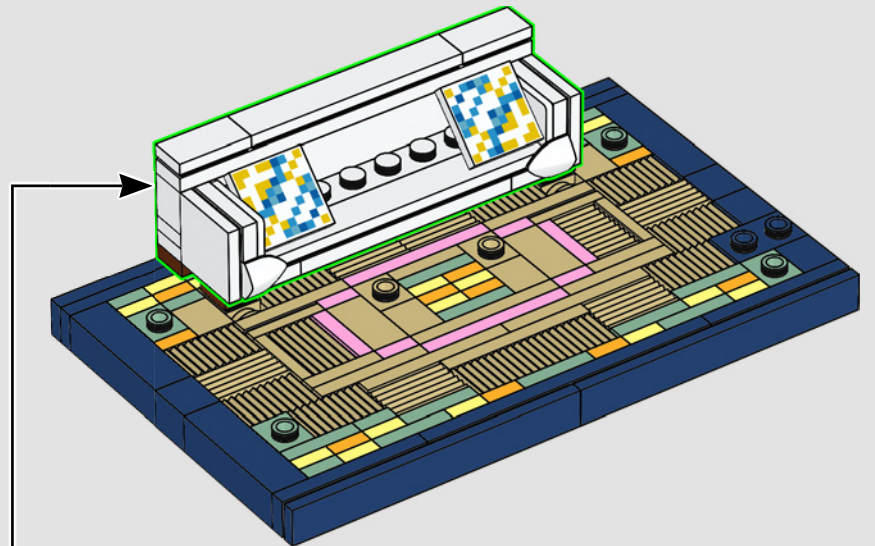

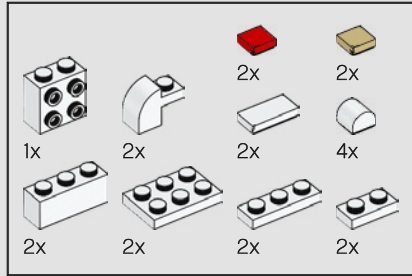
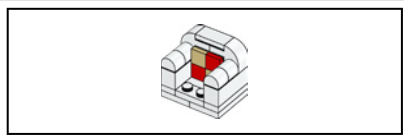

29

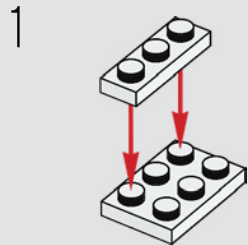

2

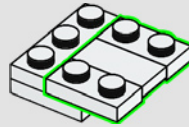

3

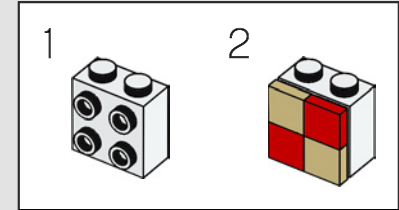
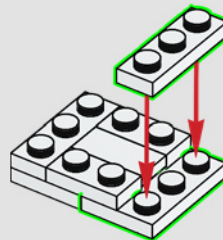

4

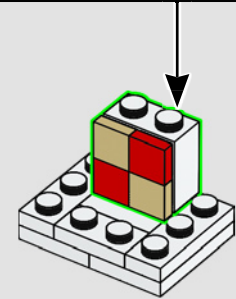

5

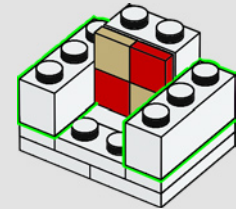

6

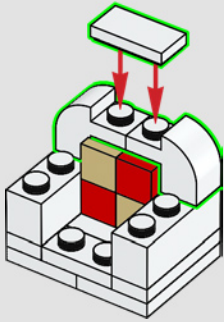

7

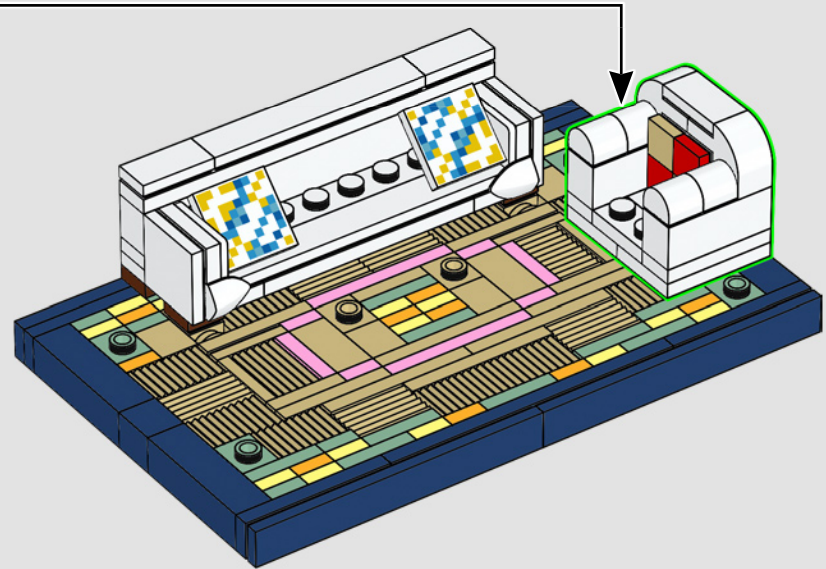
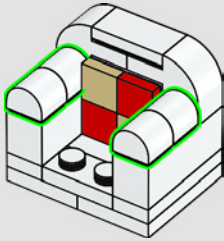

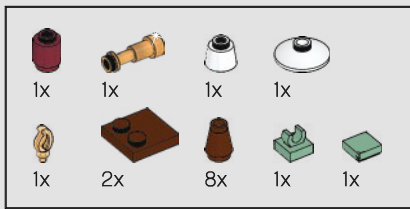

30

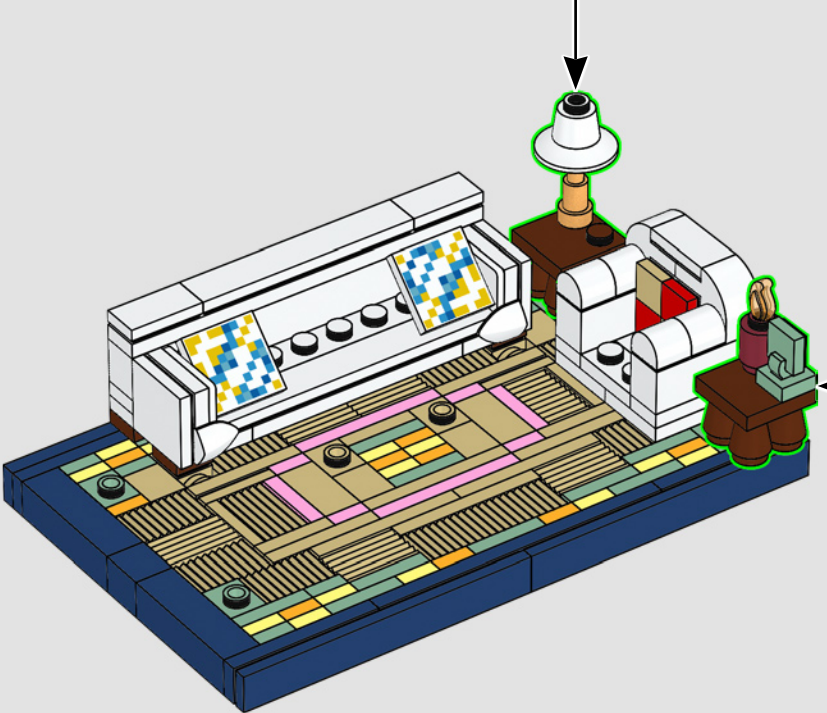
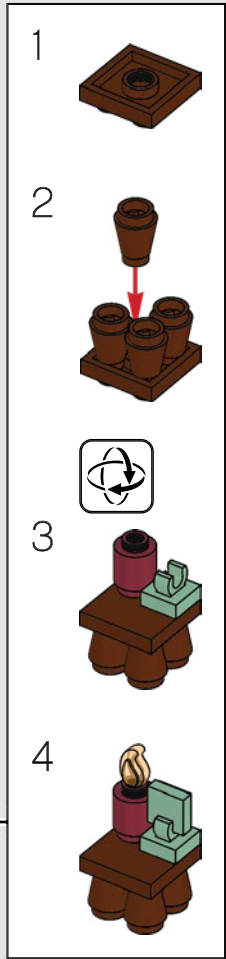
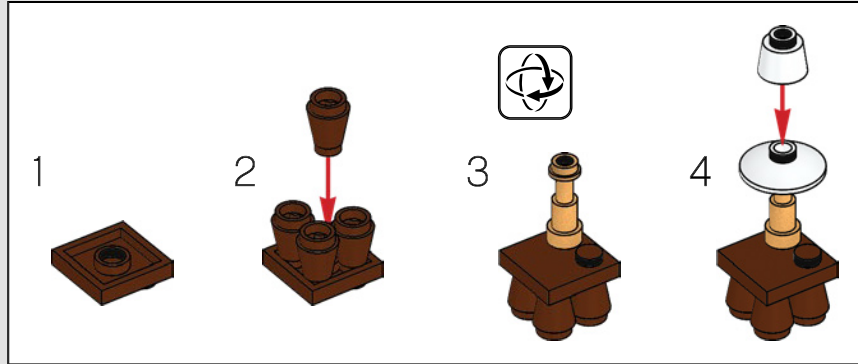

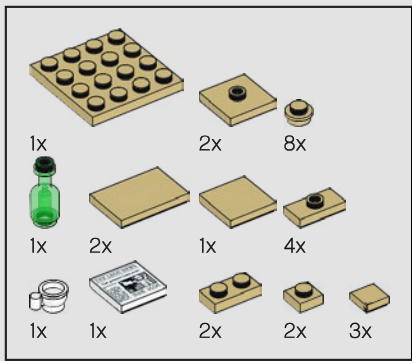

31

1

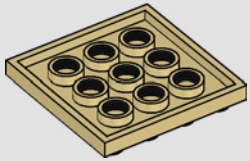

2

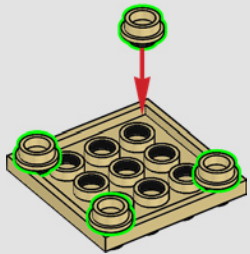

3

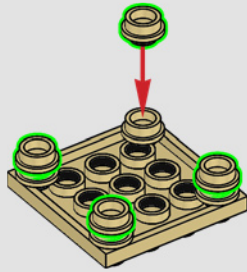

4

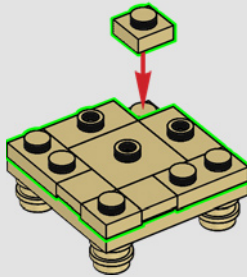

5

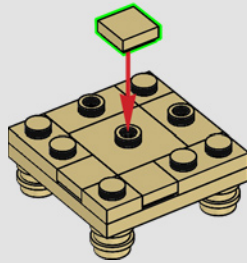

6

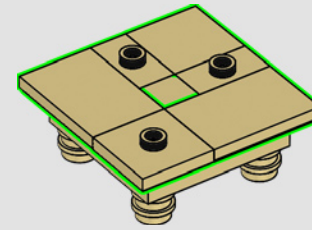

7

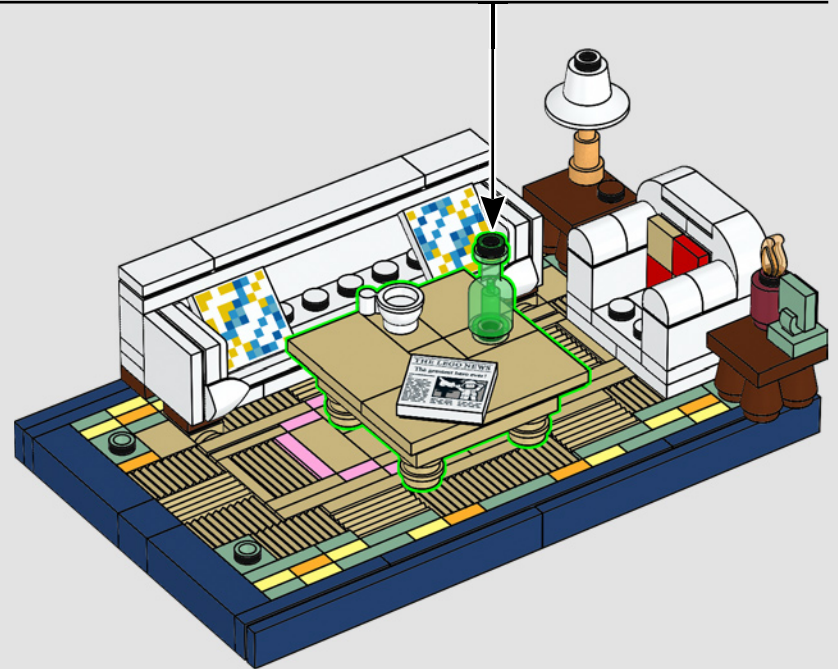

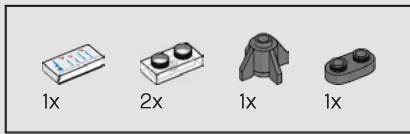

32

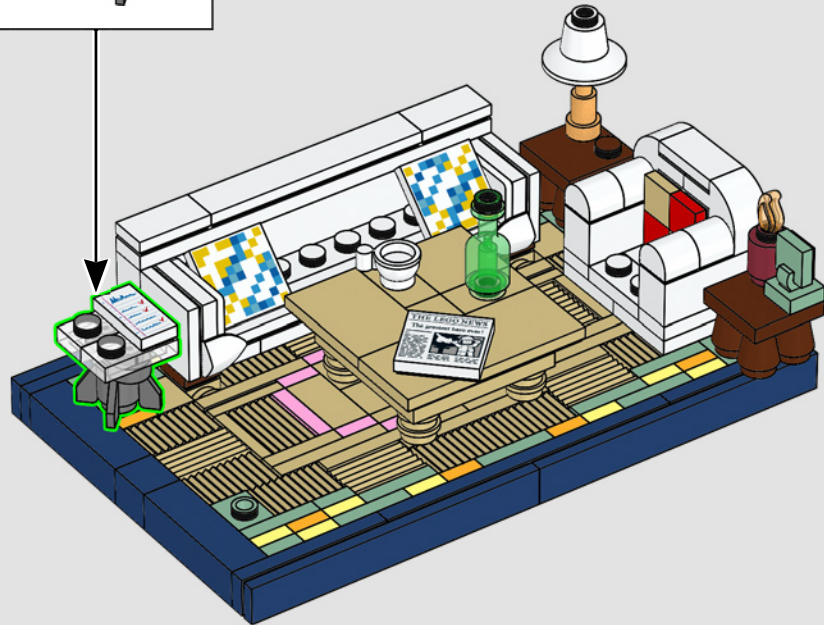
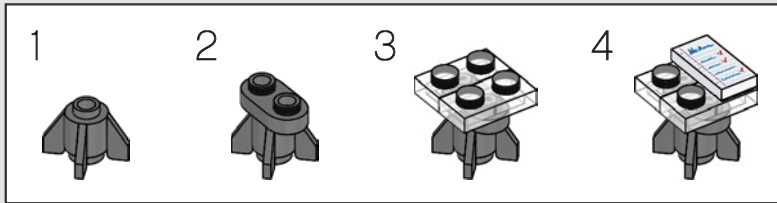

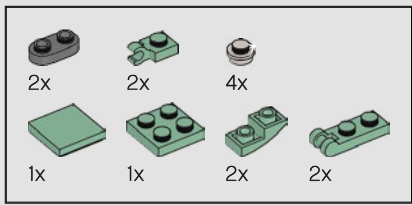

33

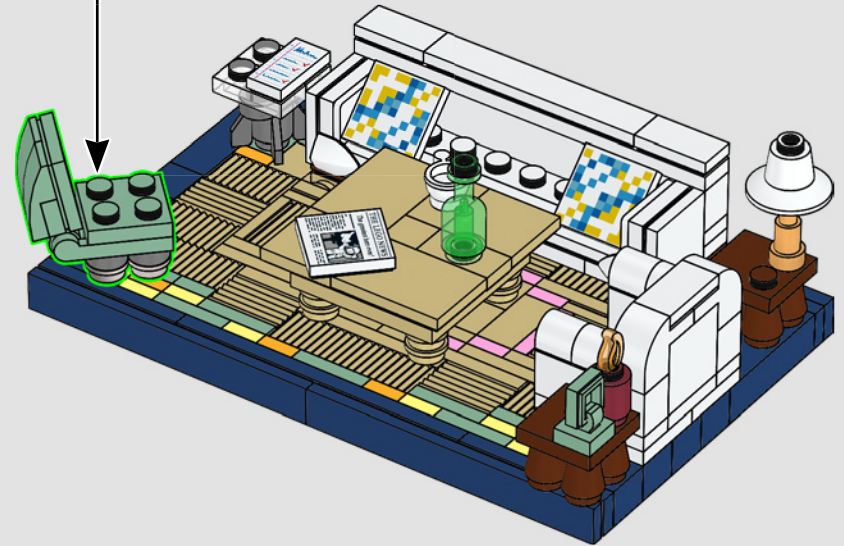
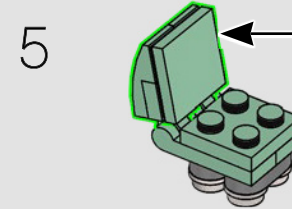
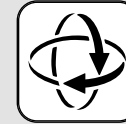
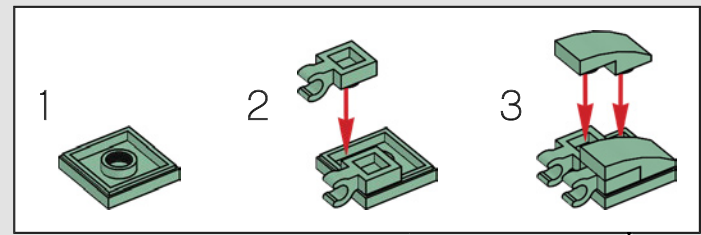
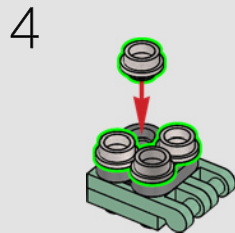
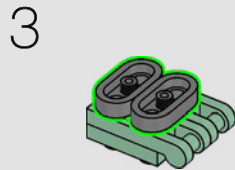
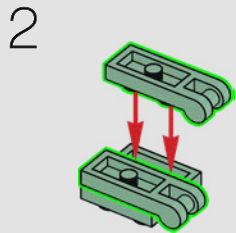
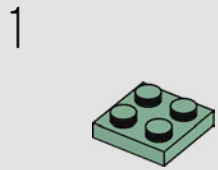

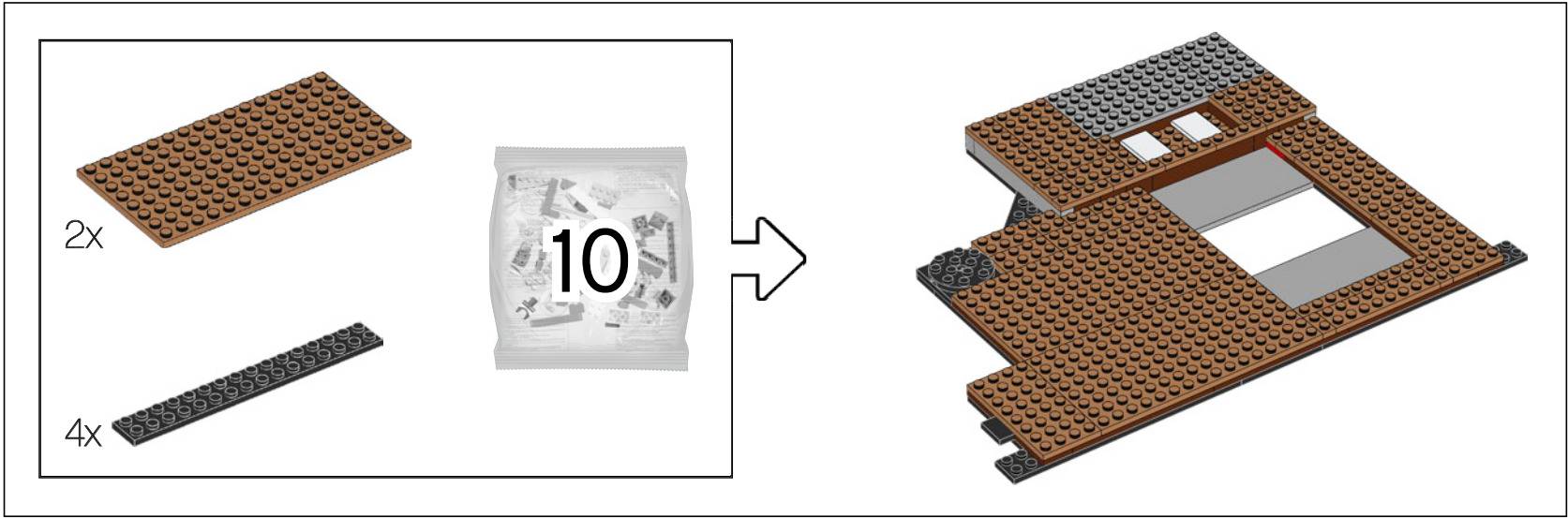

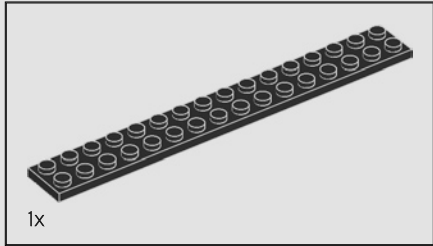
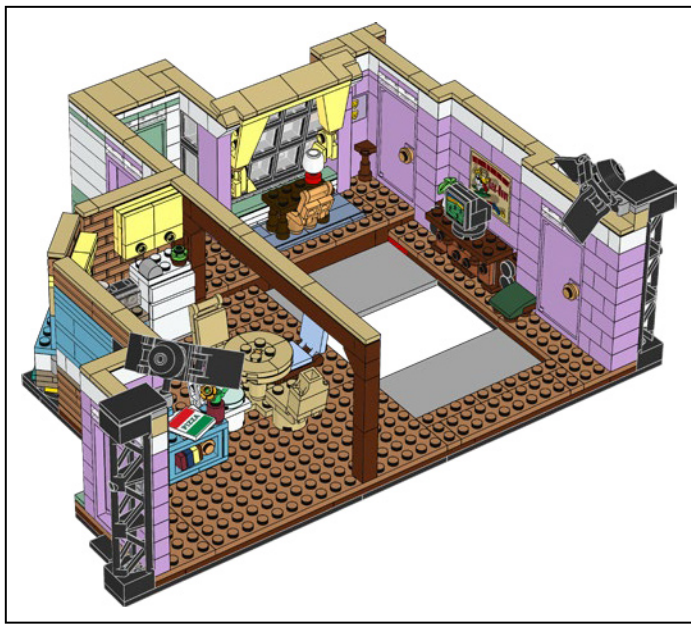

1

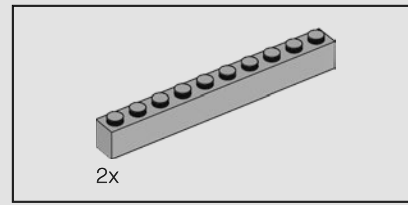
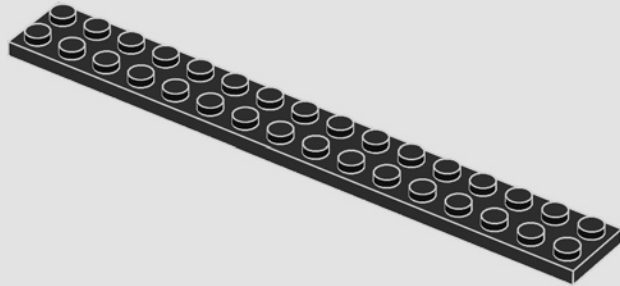

2

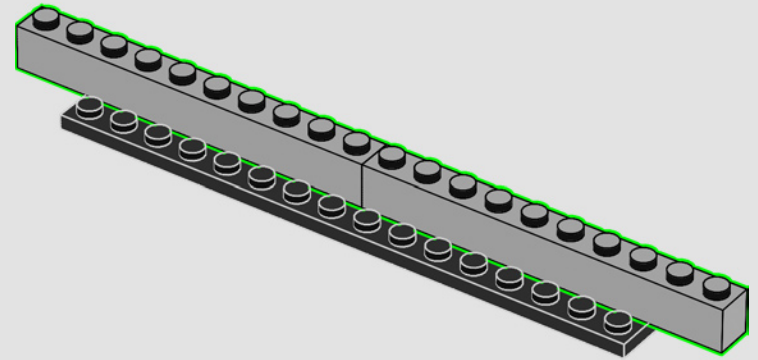

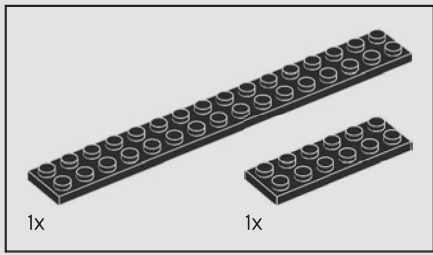

3

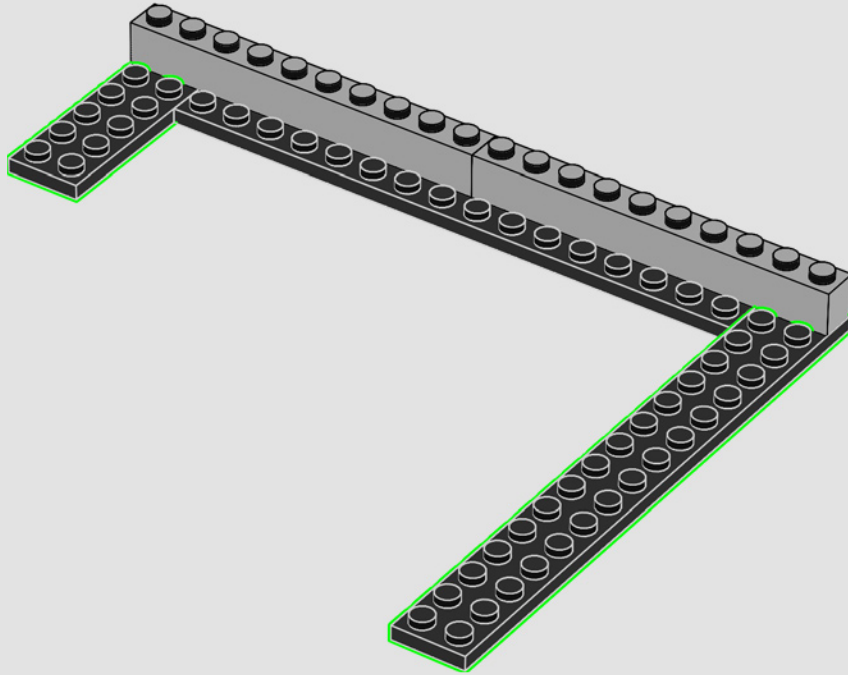

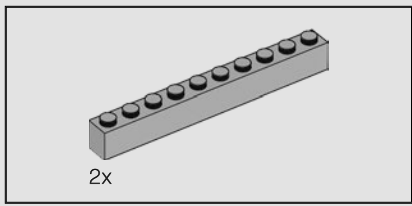

4

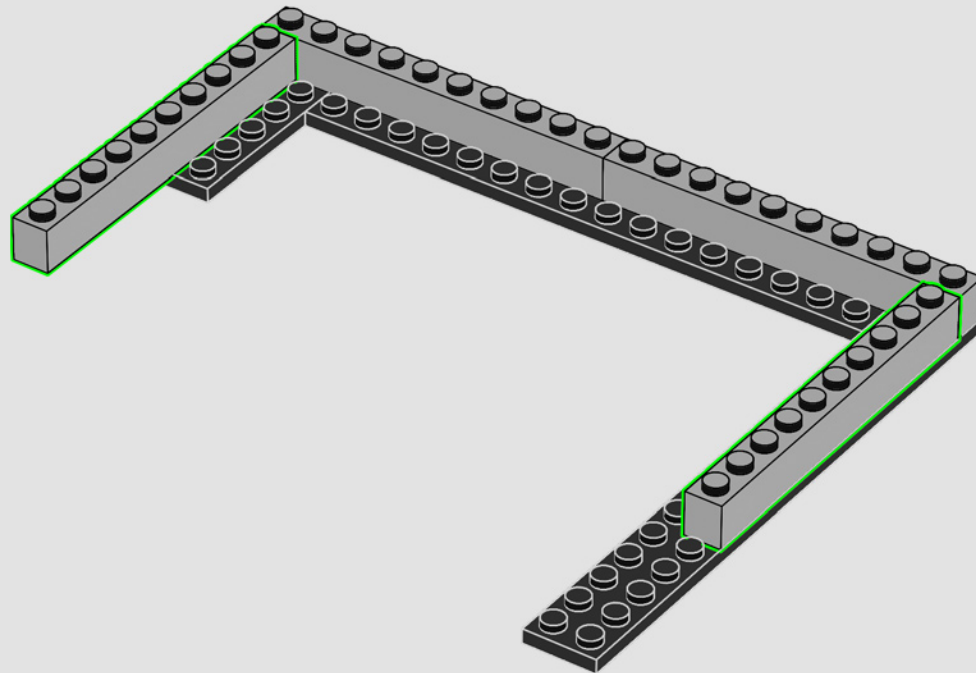

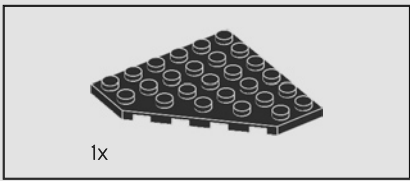

5

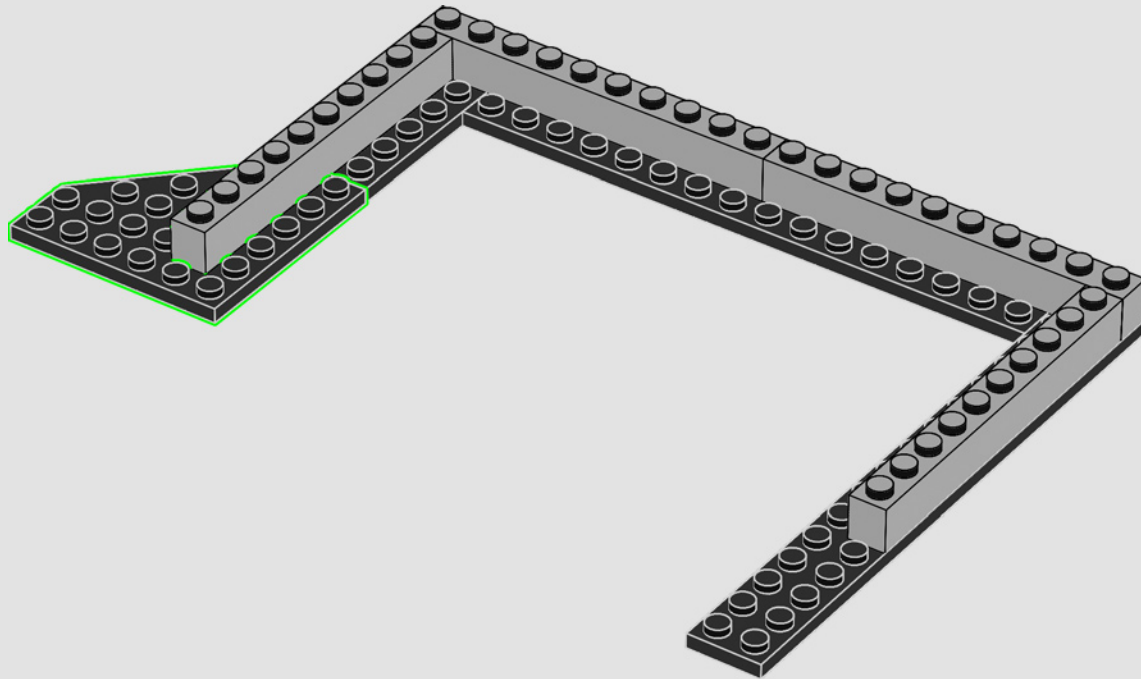

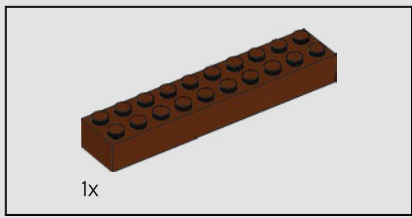

6

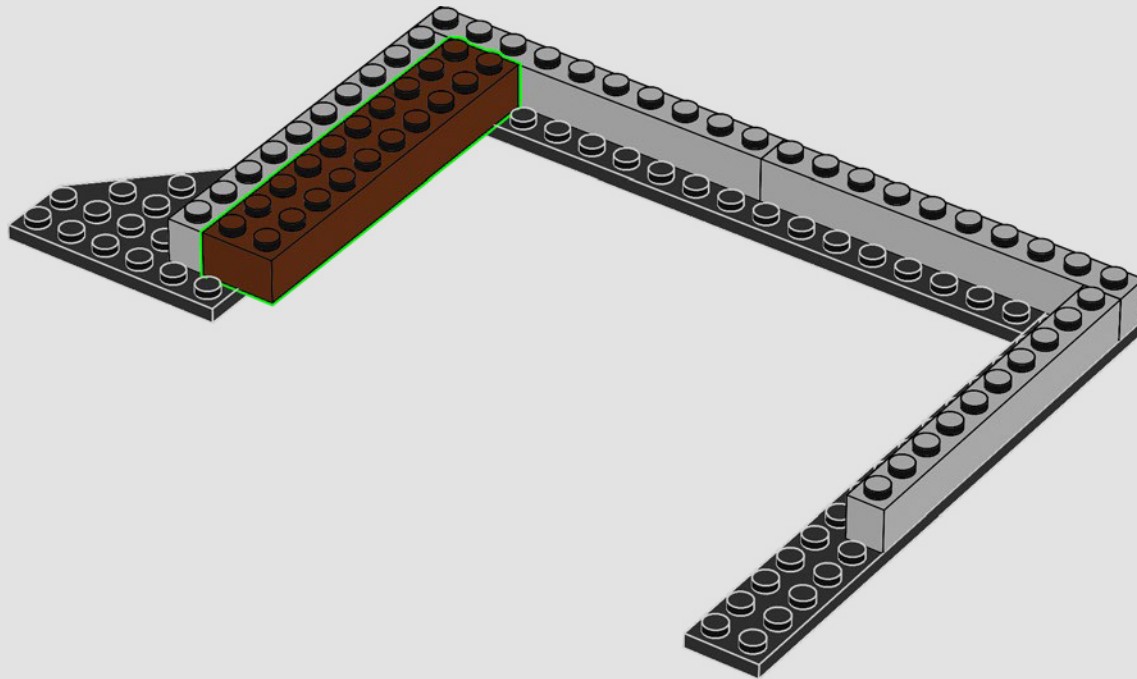

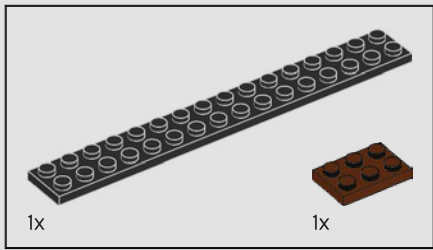

7

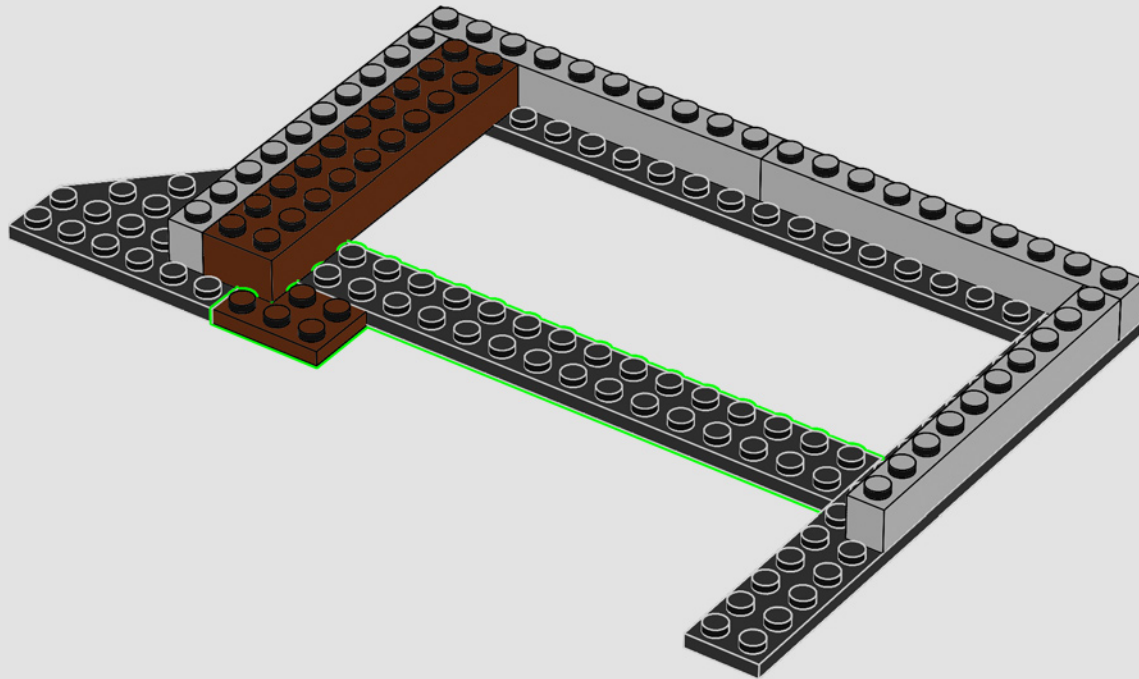

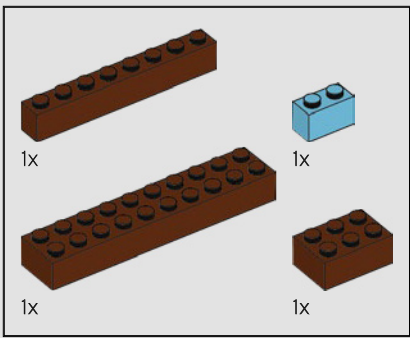

8

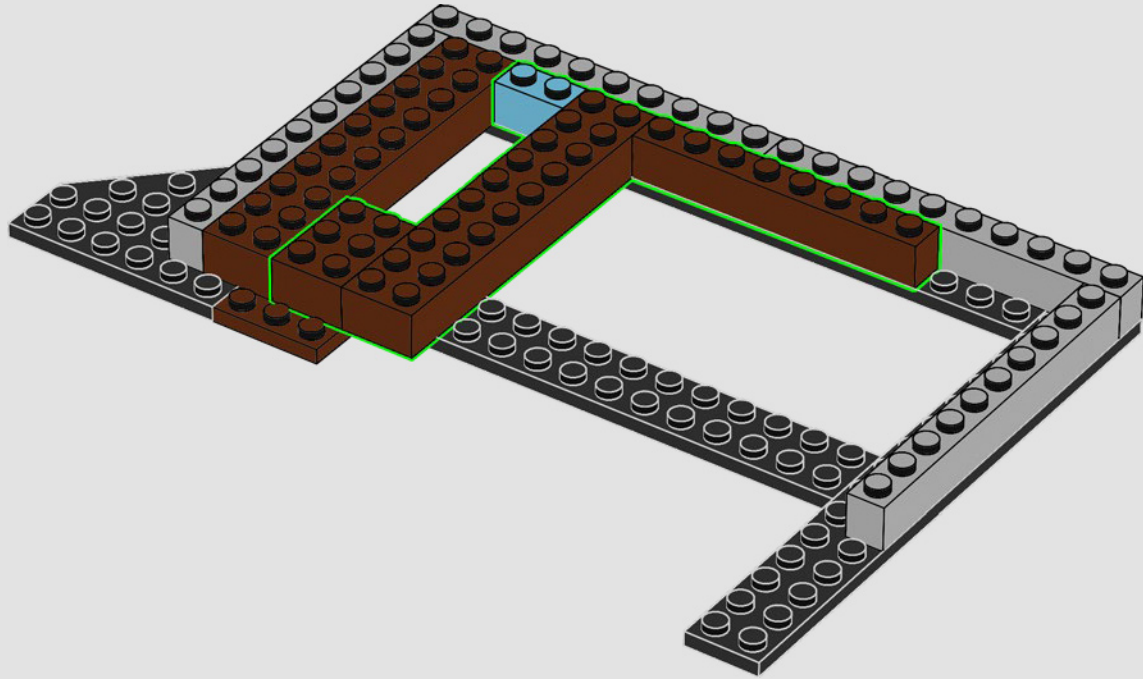

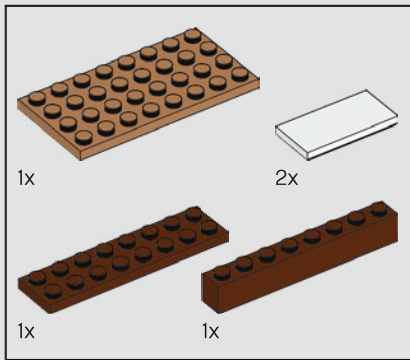

9

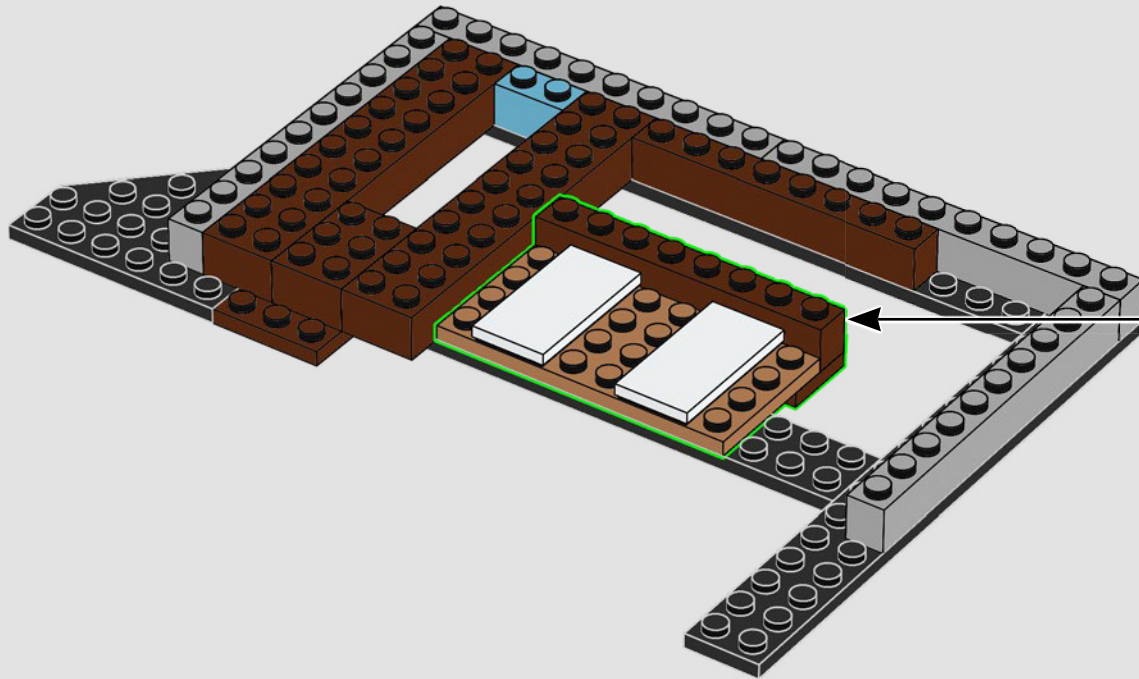
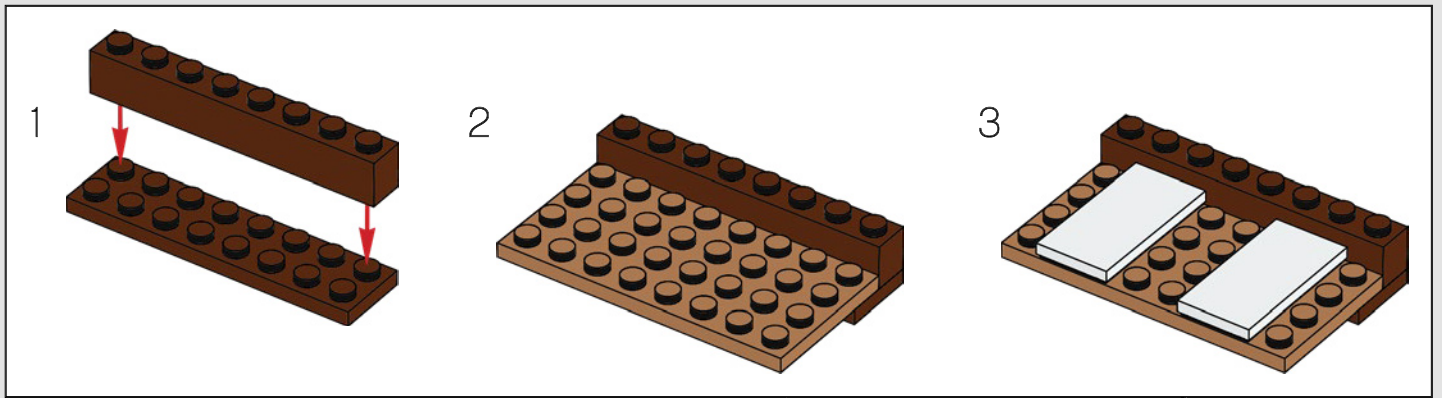

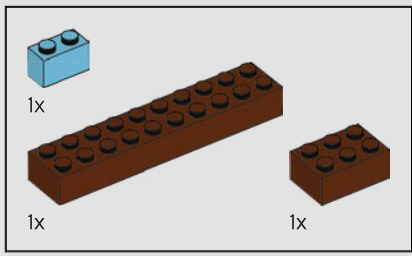

10

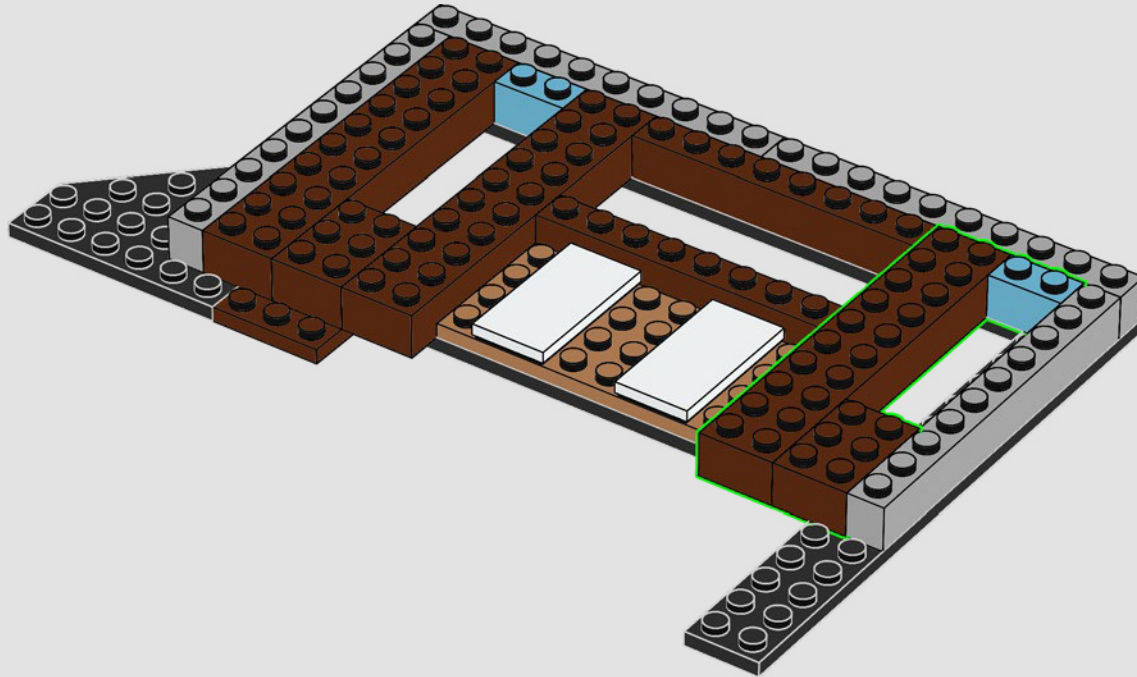

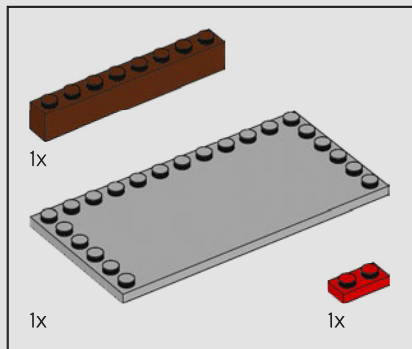

11

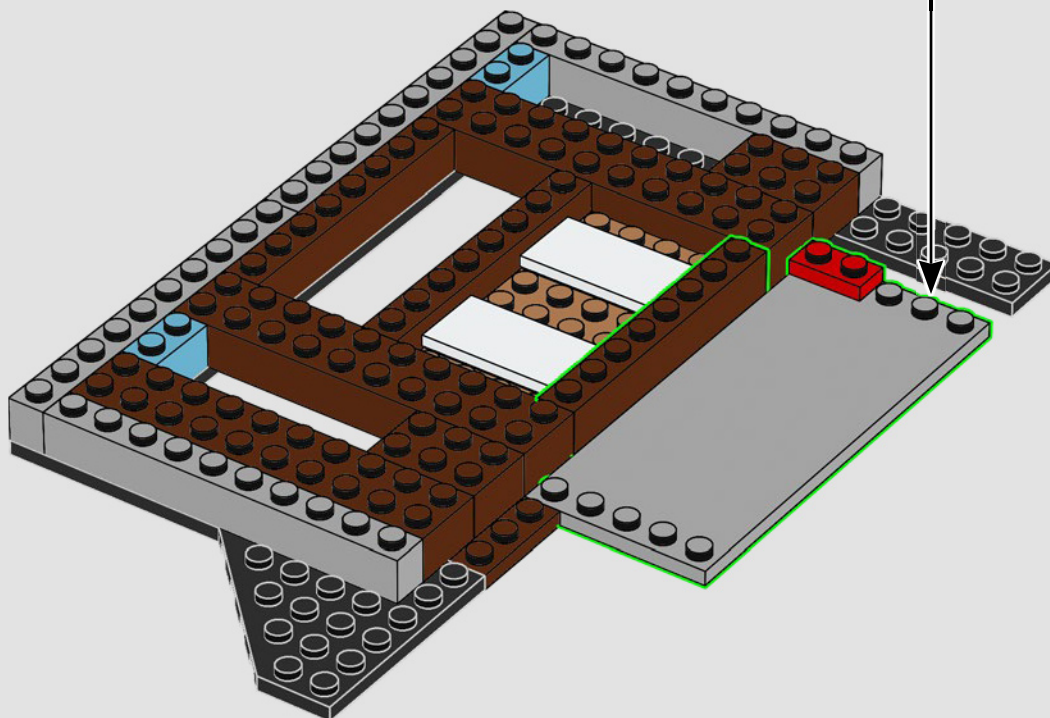
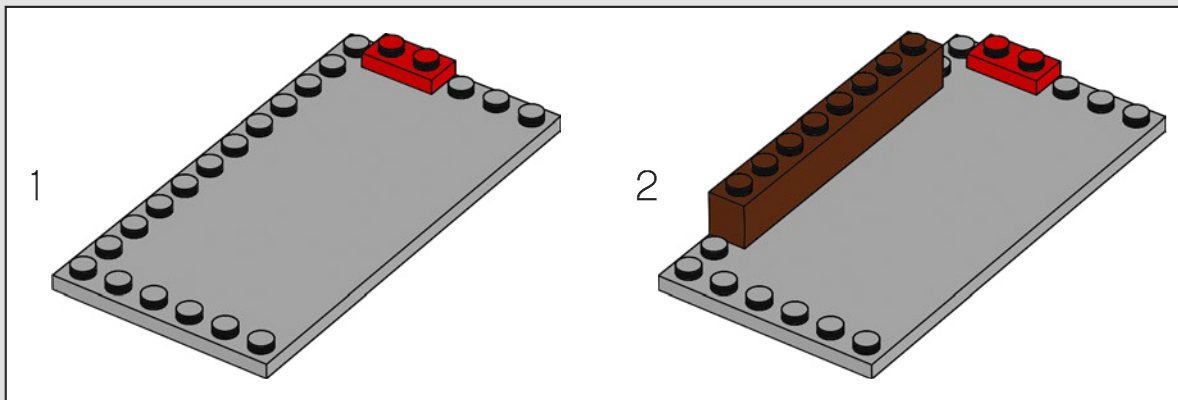

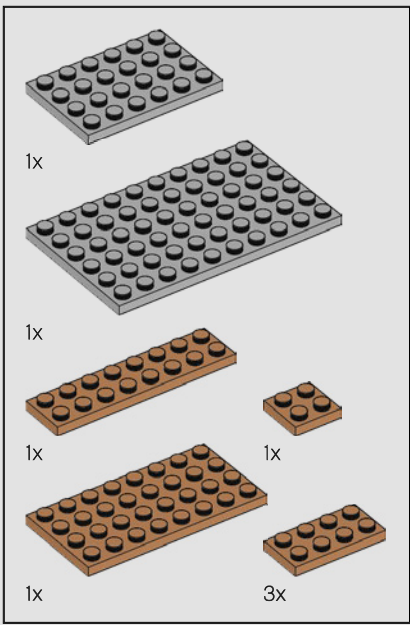

12

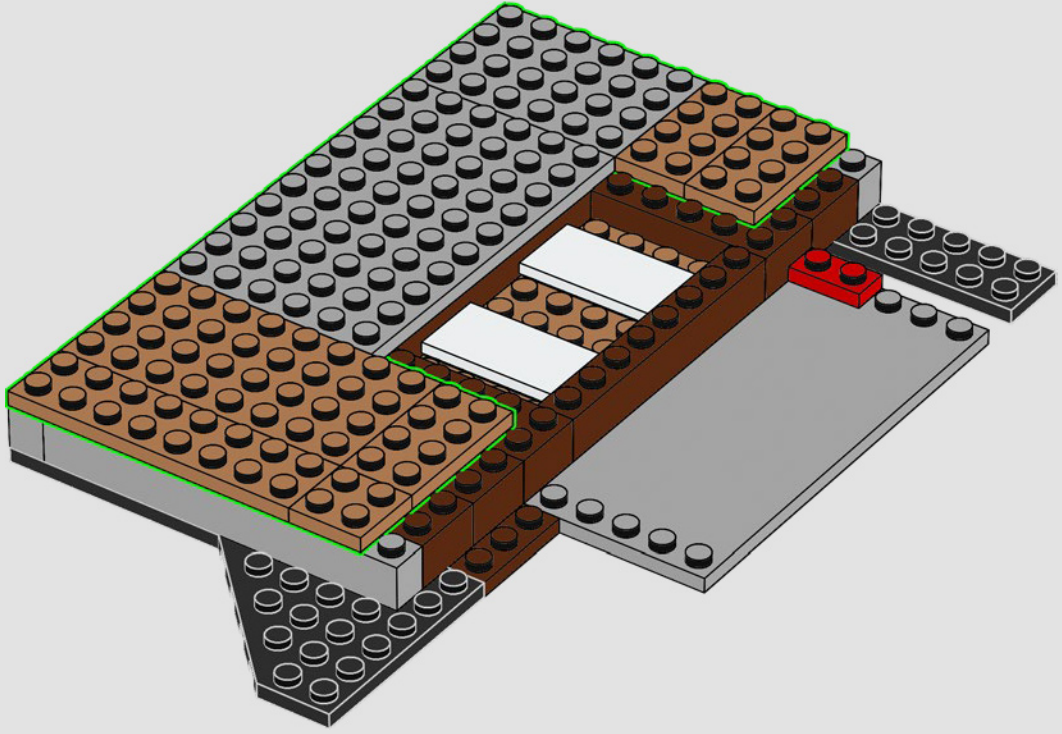

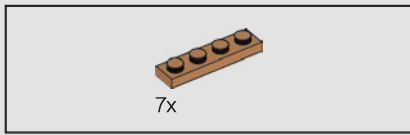

13

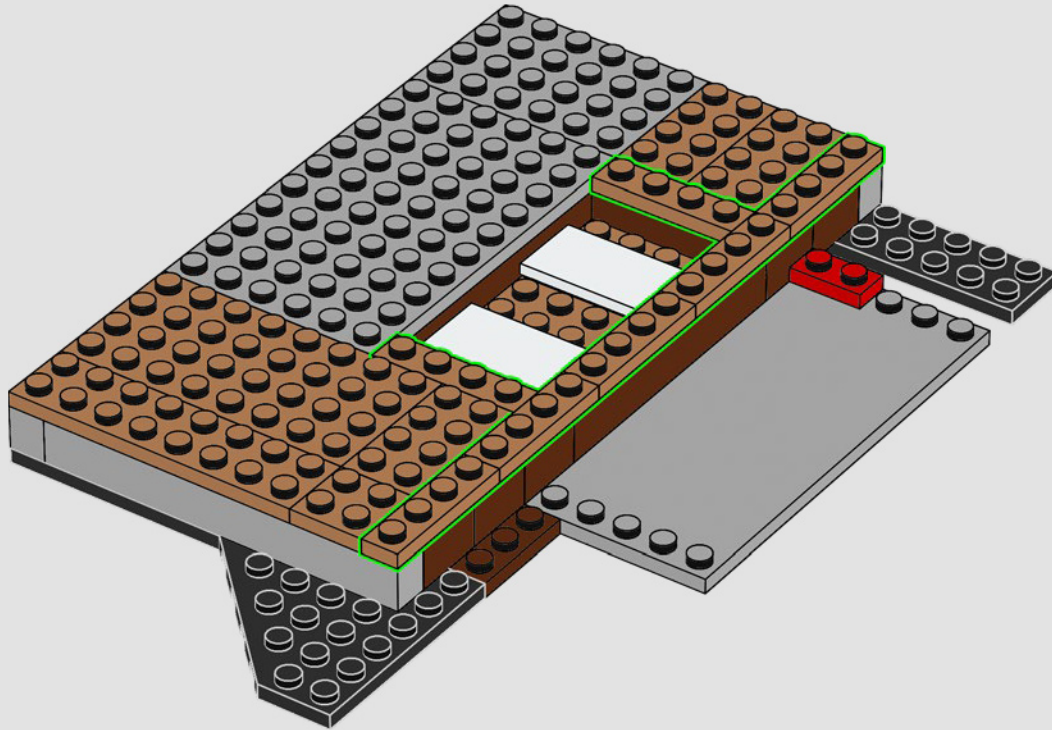

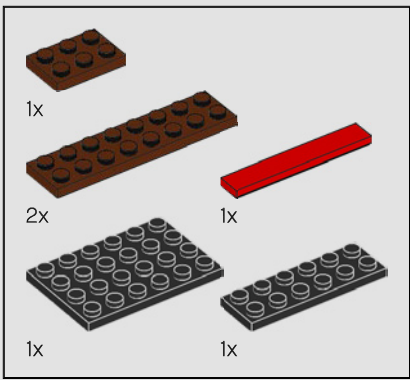

14

1

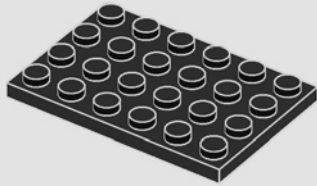

2

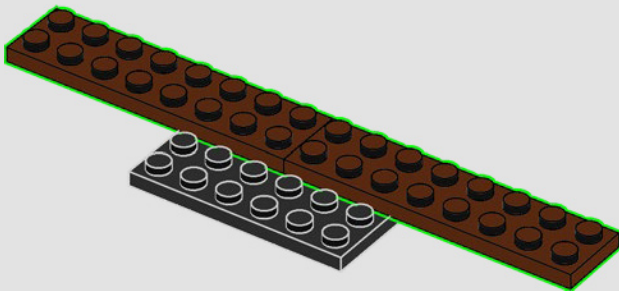

3

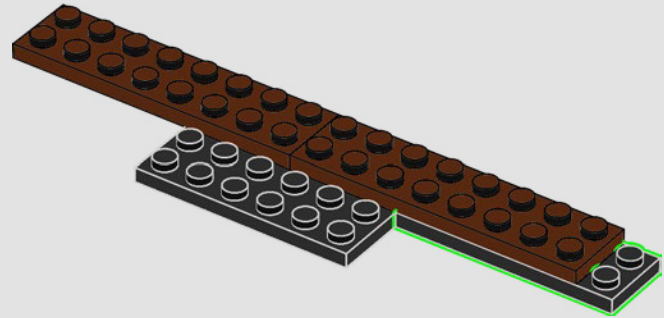

4

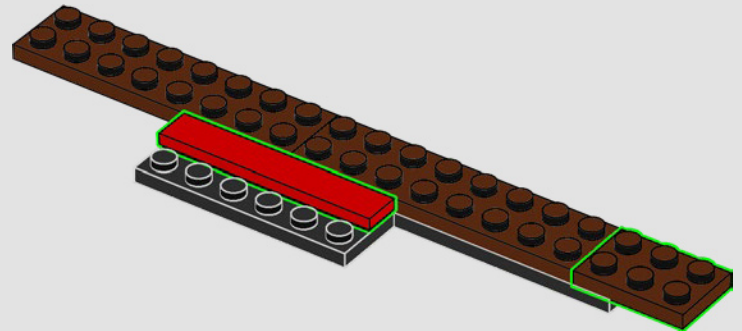

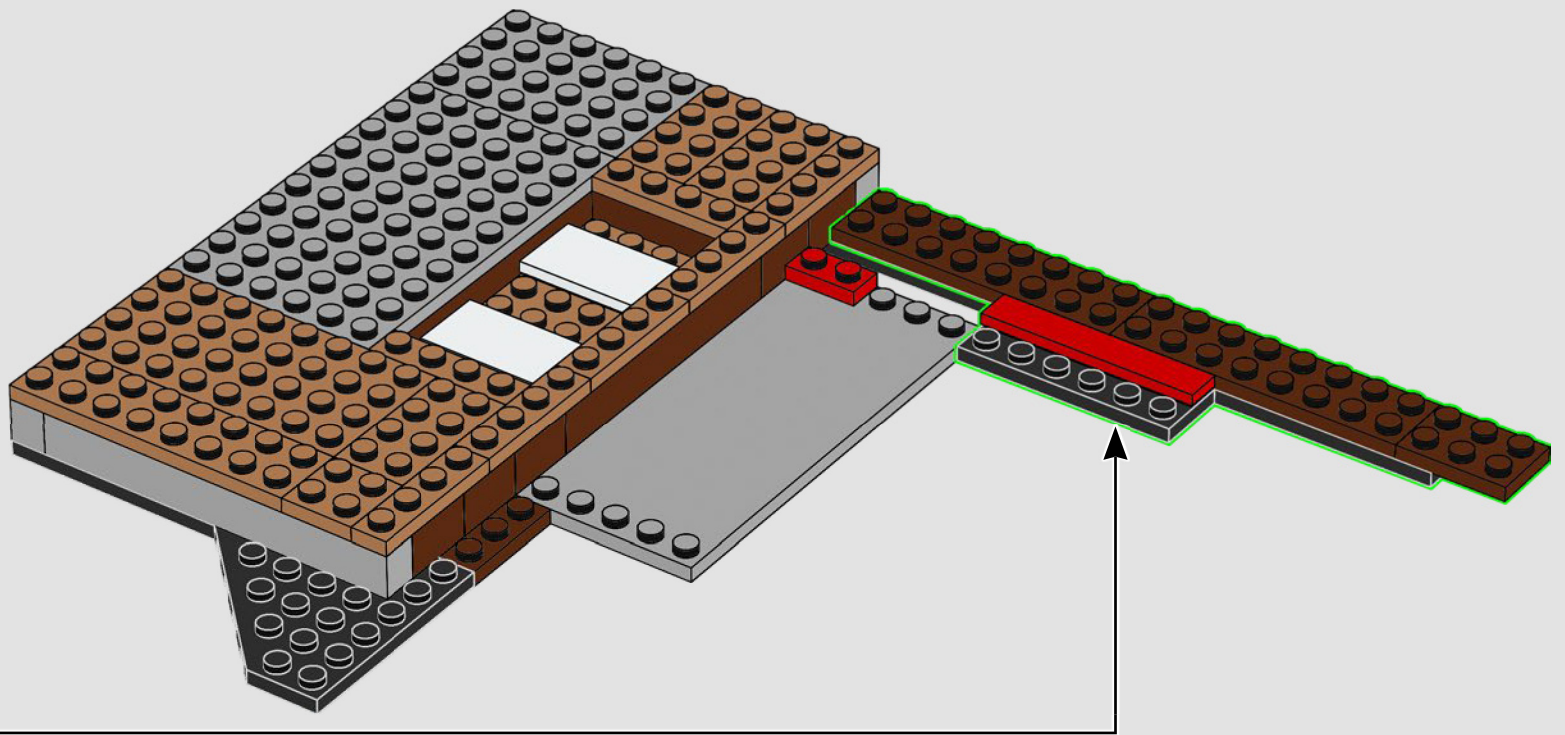

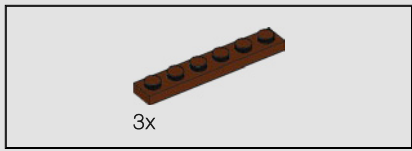

15

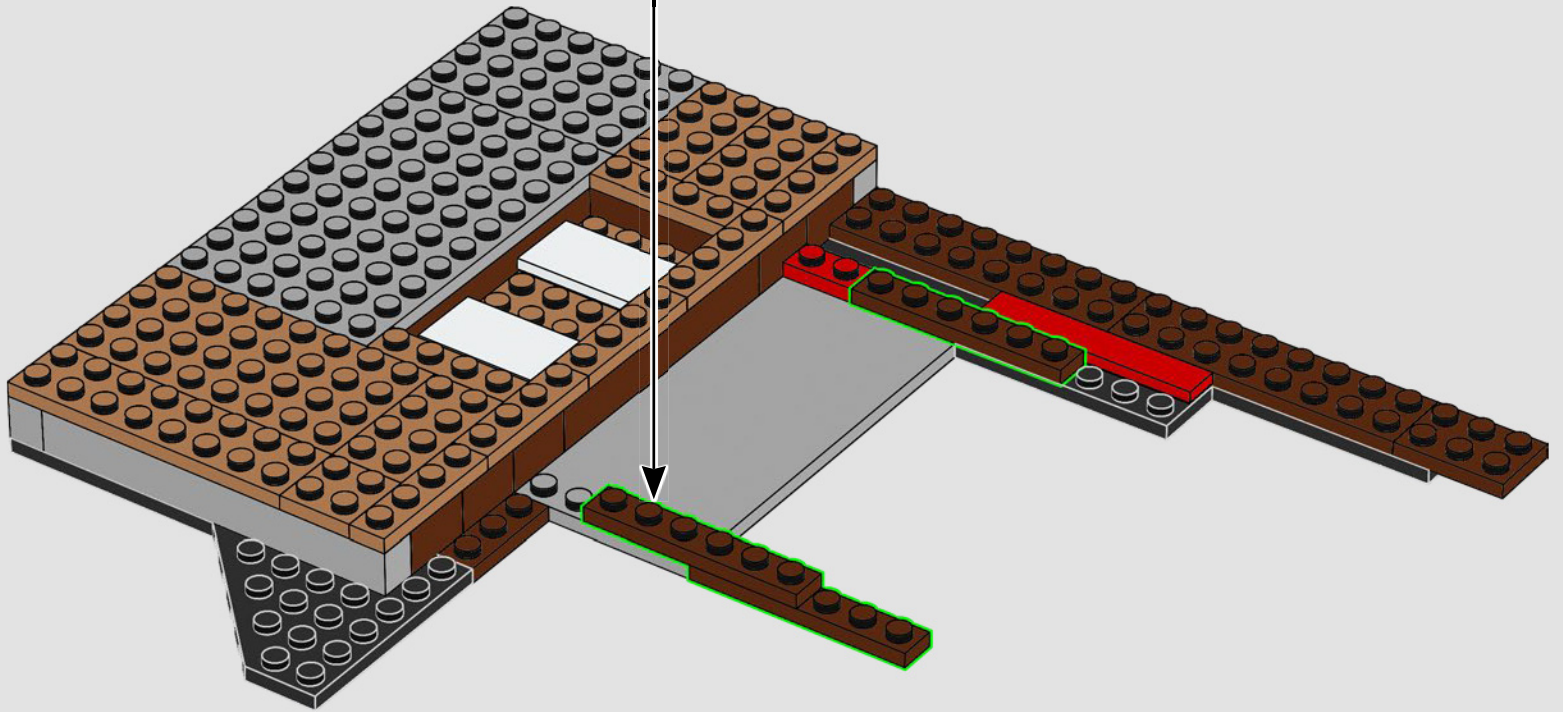
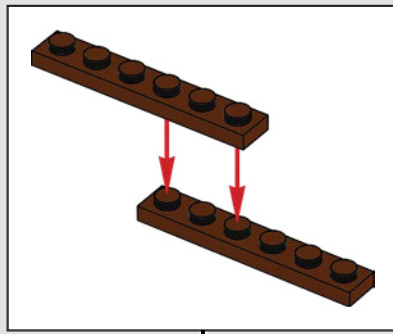

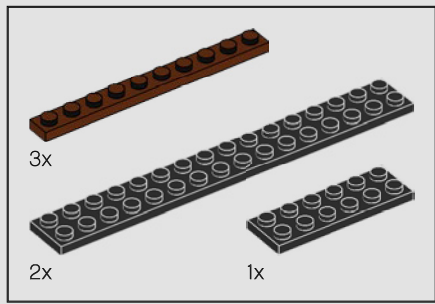

16

1

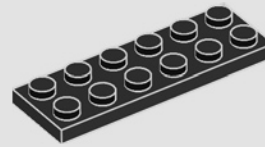

2

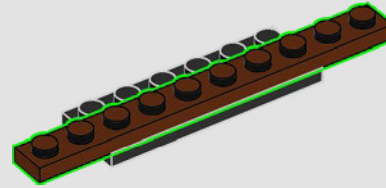

3

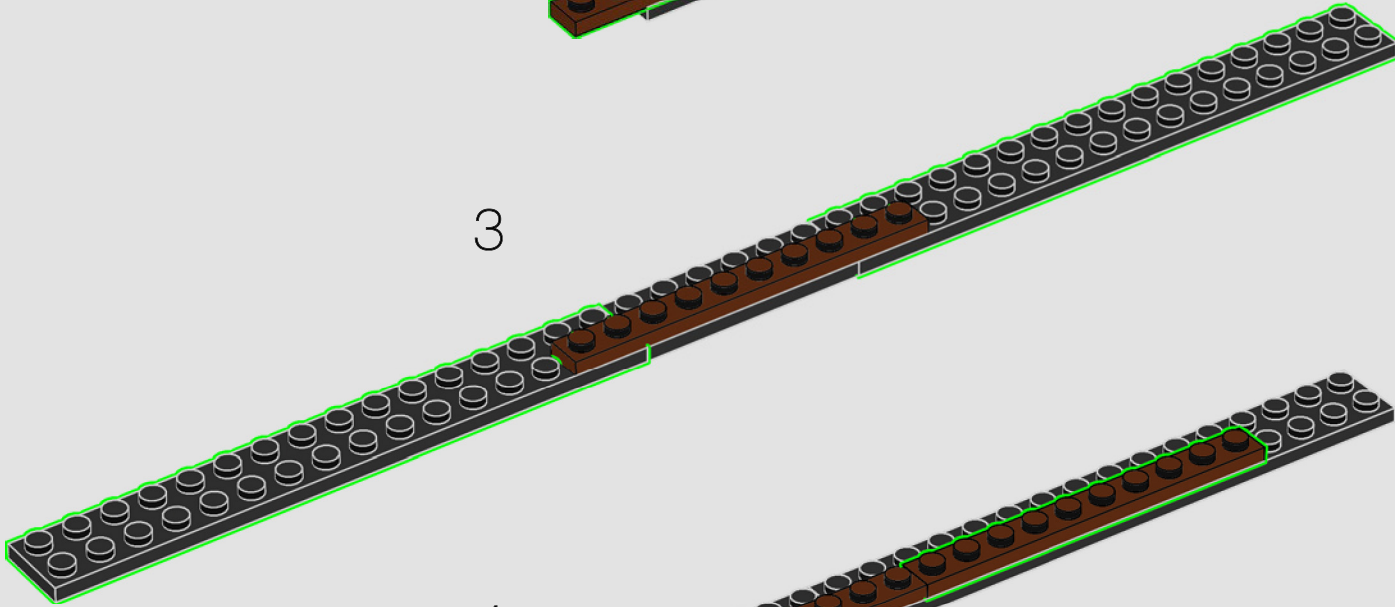

4

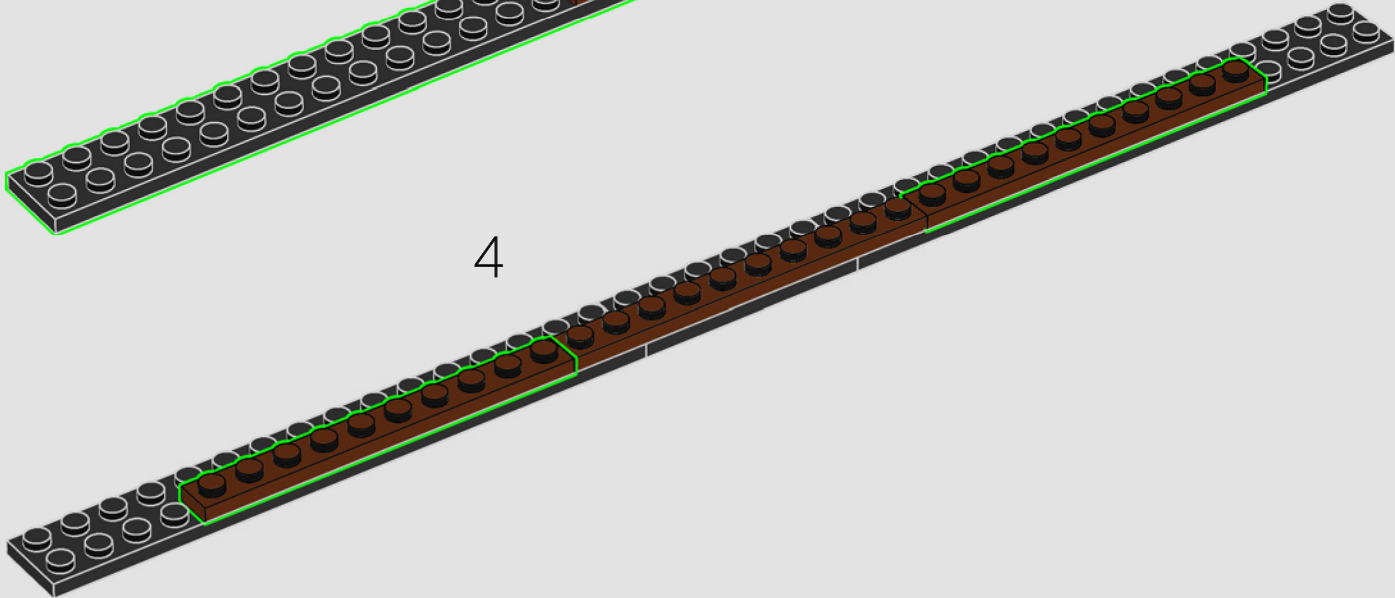

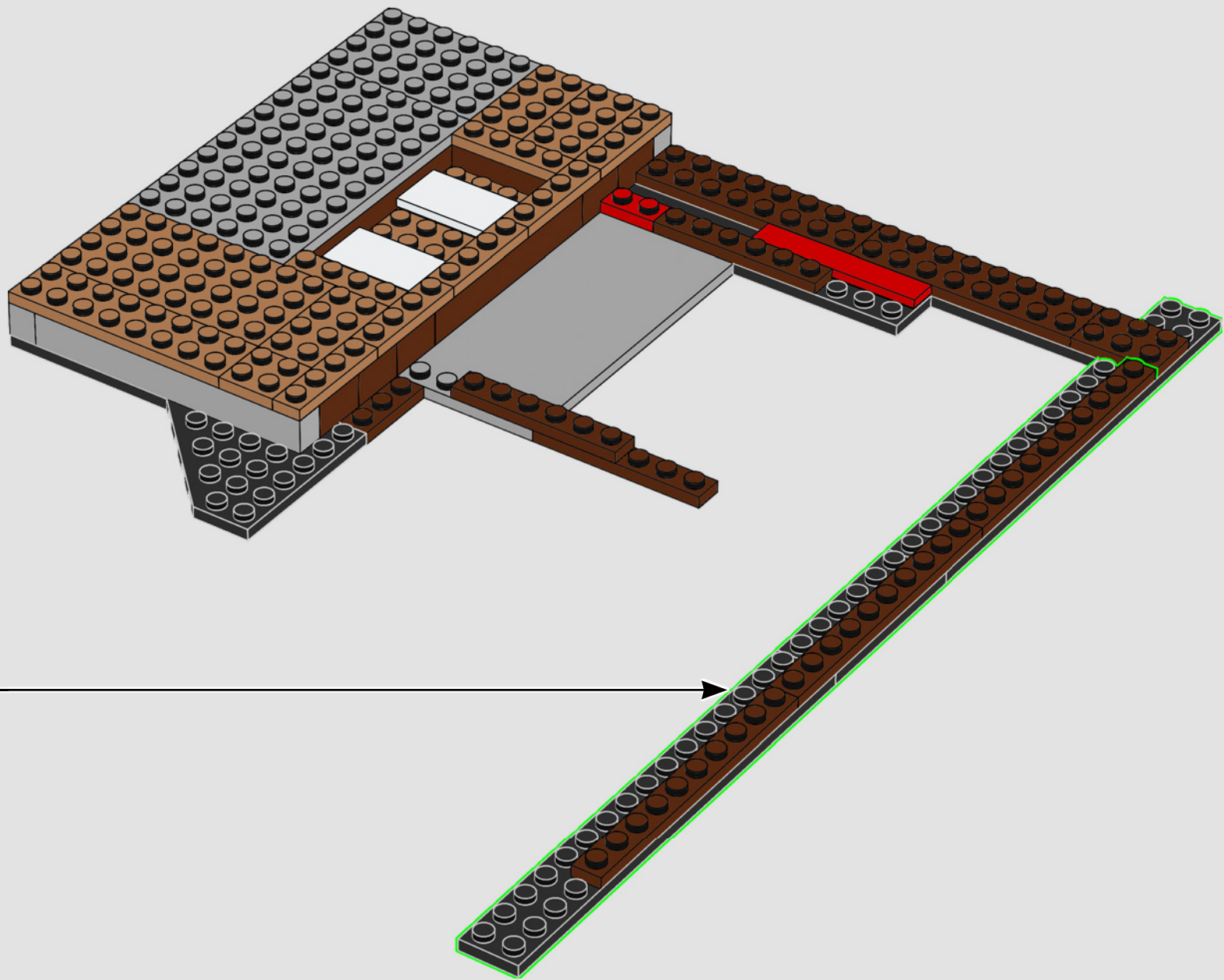

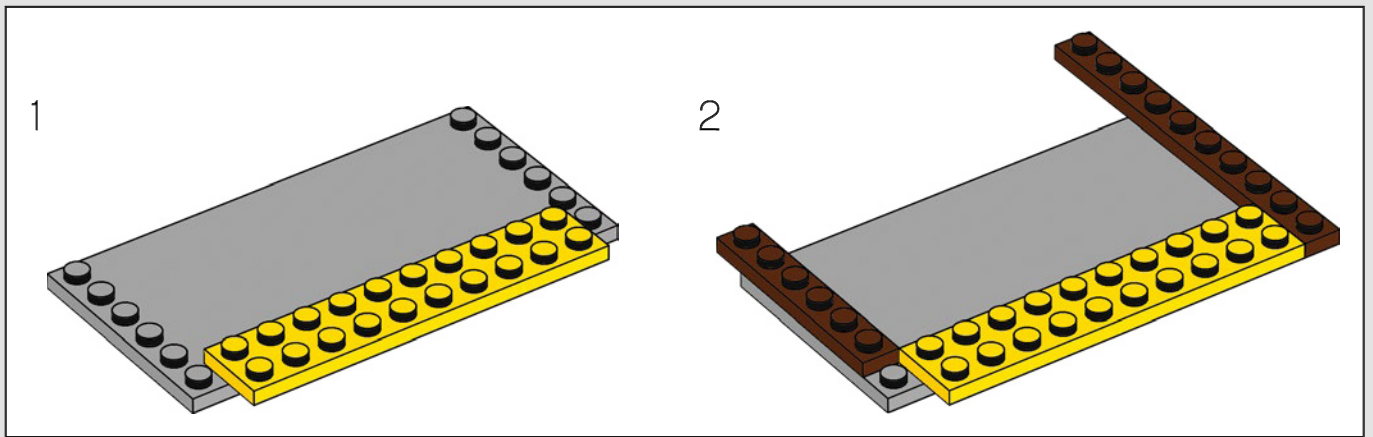
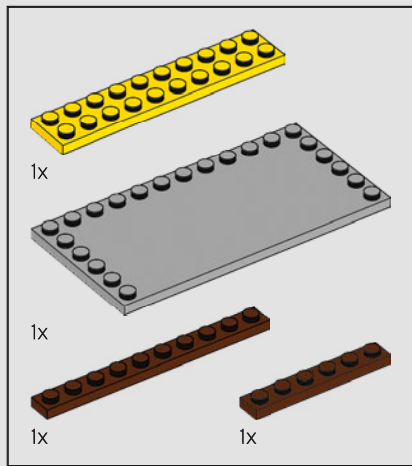

17

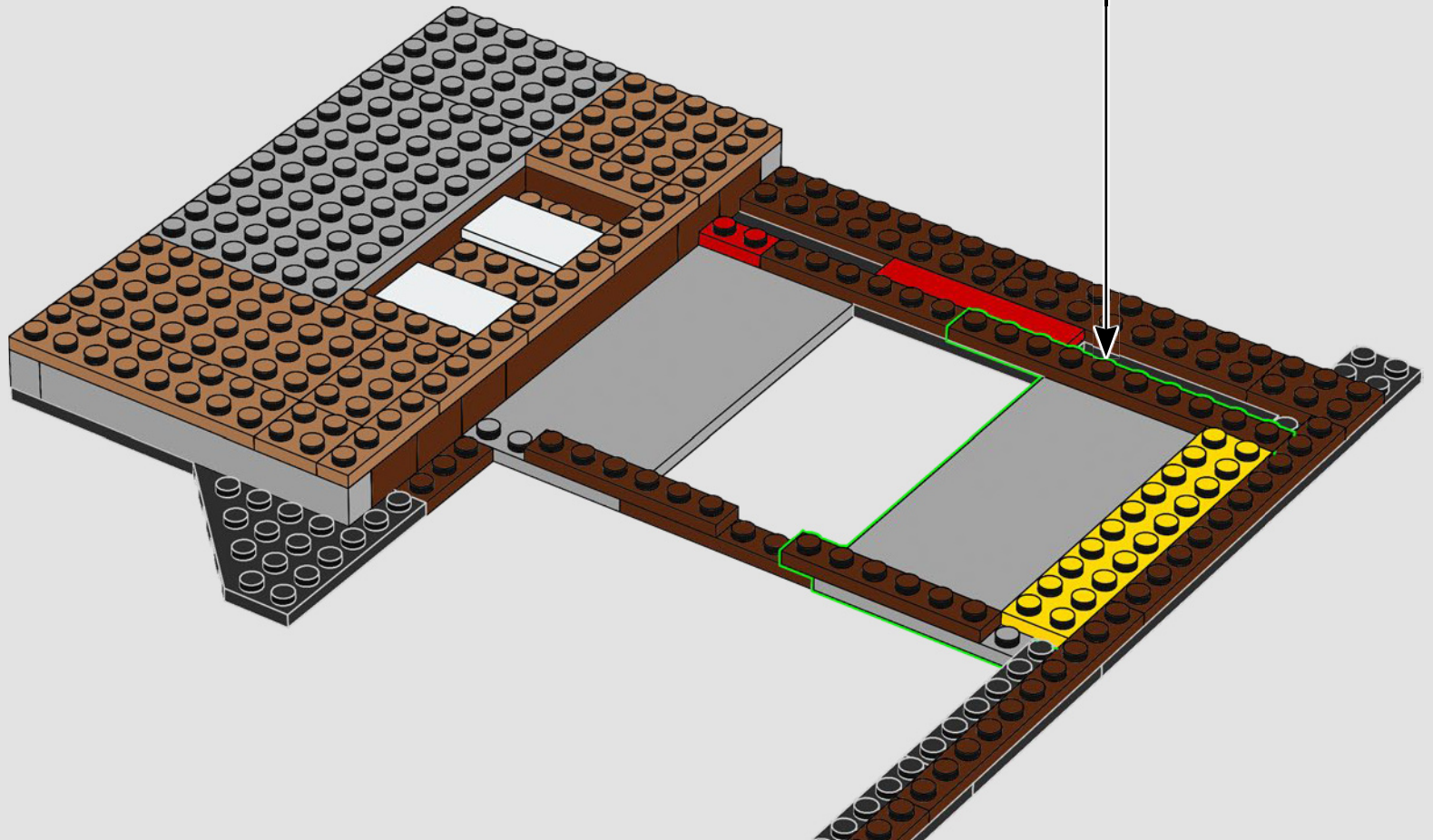

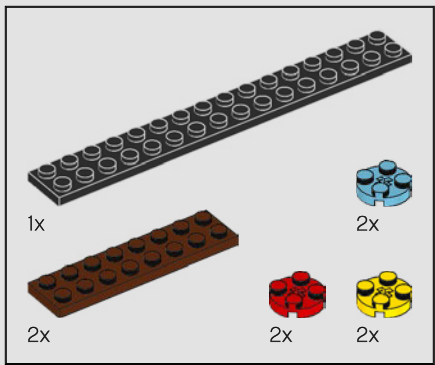

18

1

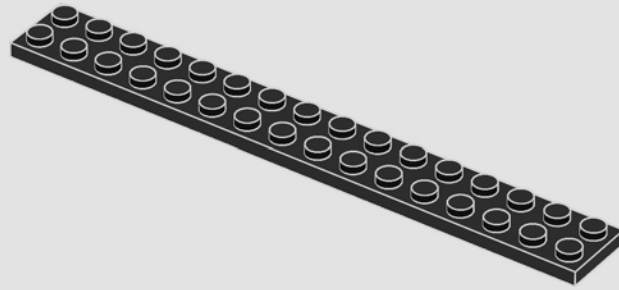

2

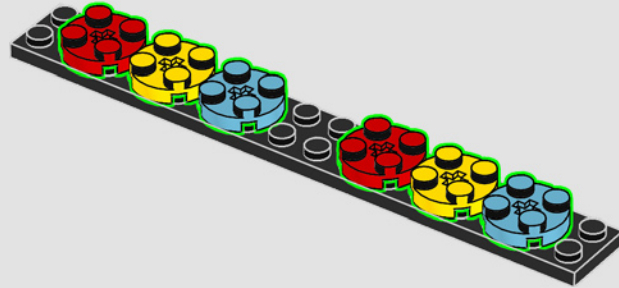

3

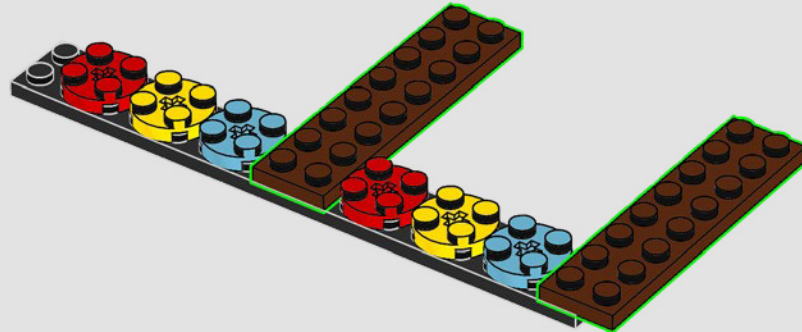

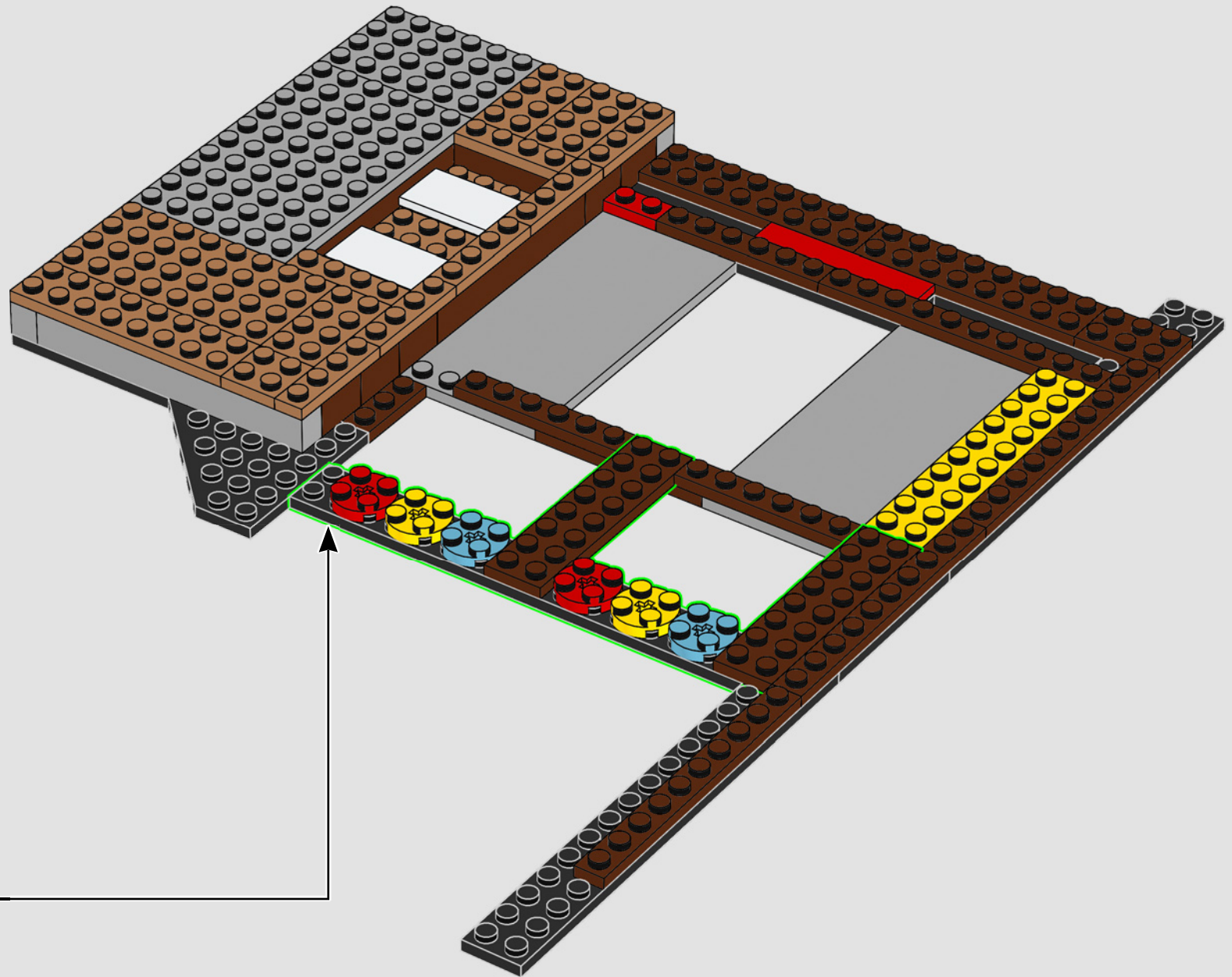

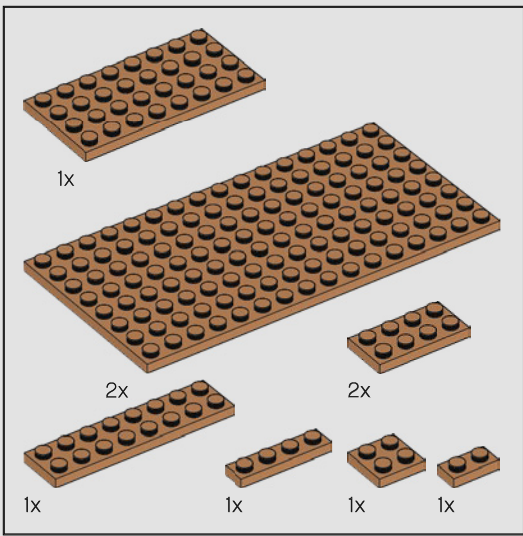

22

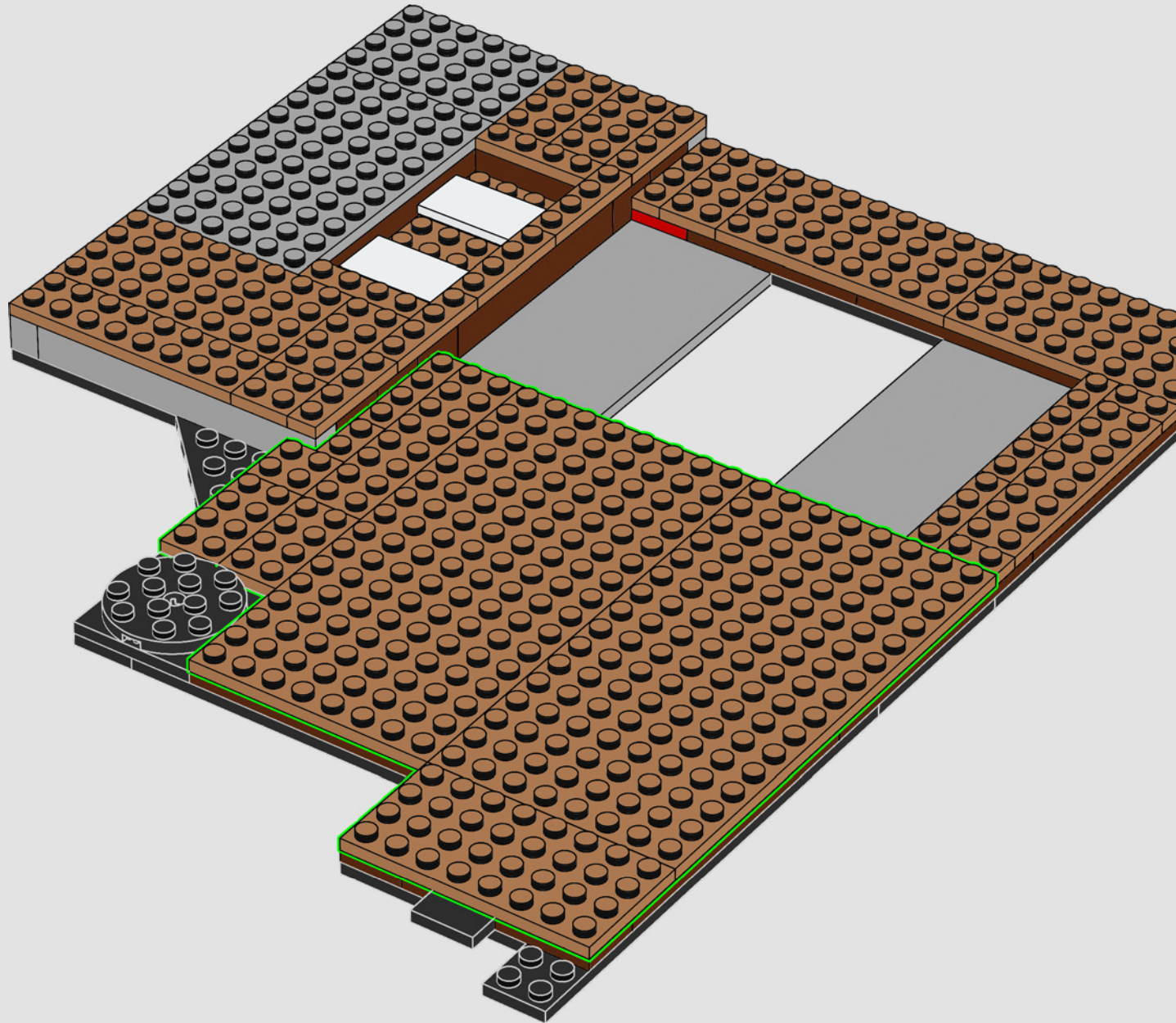

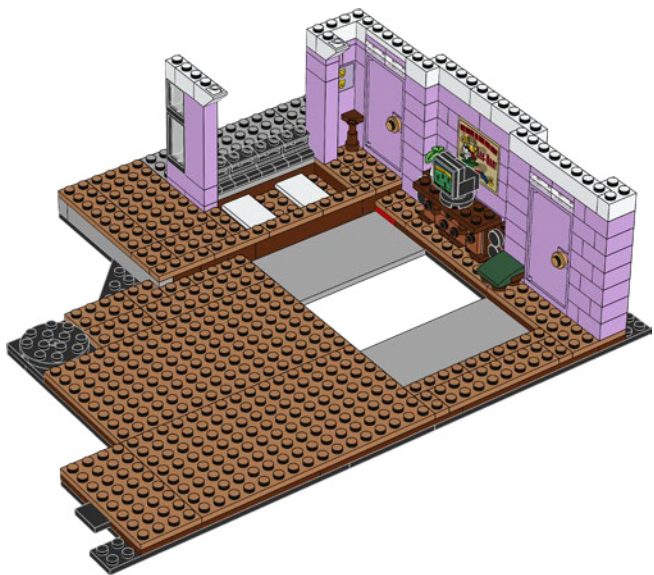



1x

23

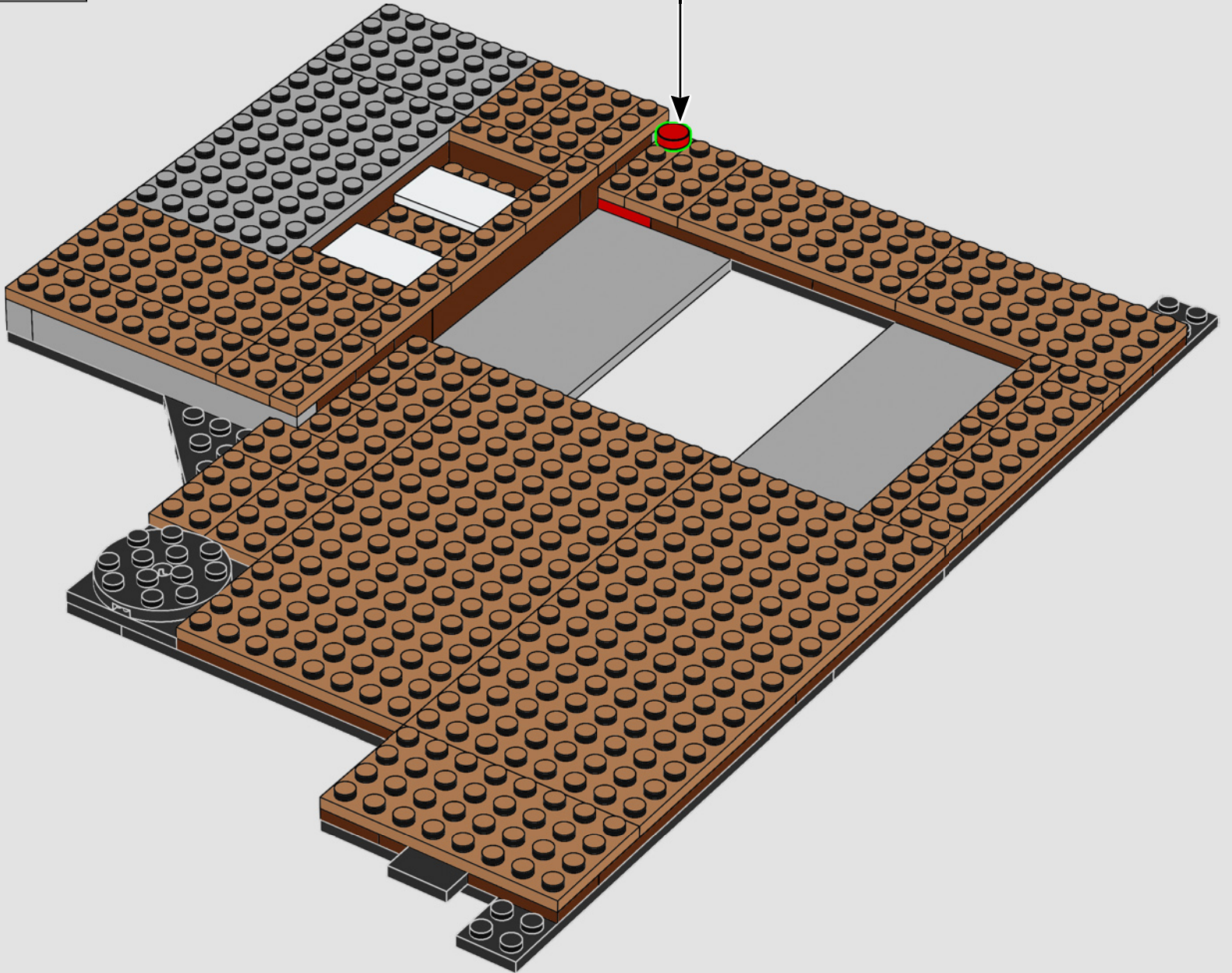

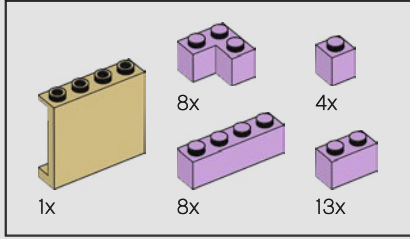
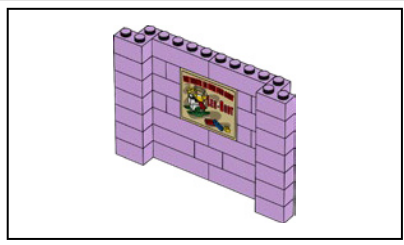

24

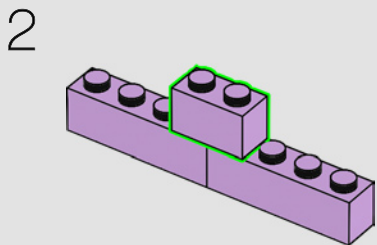
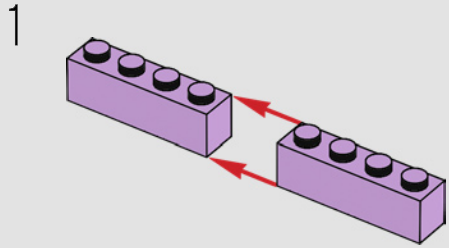

3

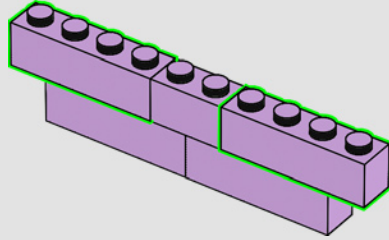

4

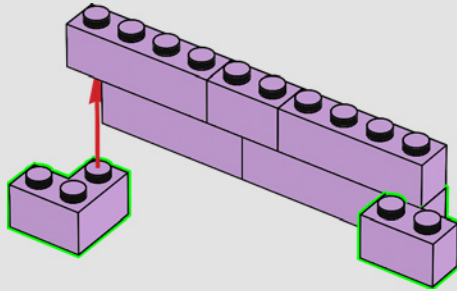

5

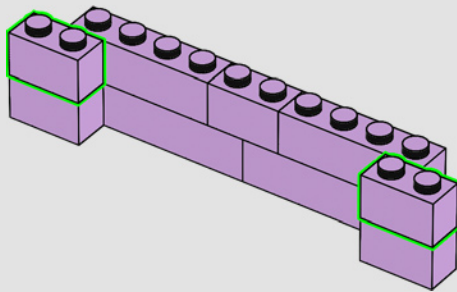

6

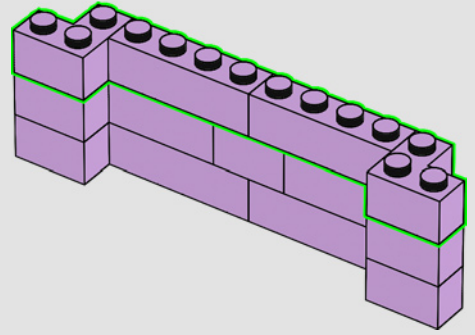

7

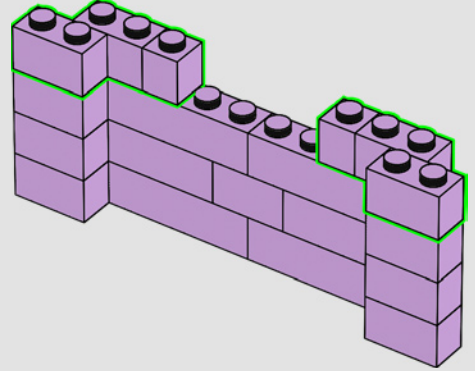

8

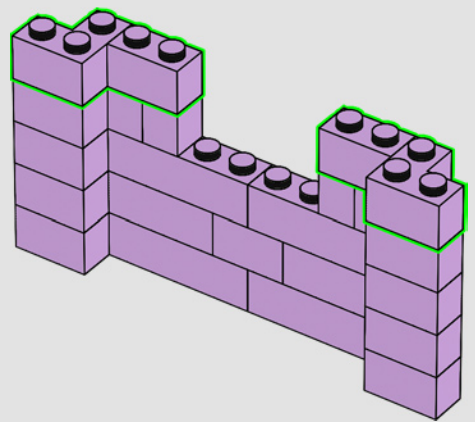

● 你还记得电视后面的大海报和门上著名的金色镜框吗？

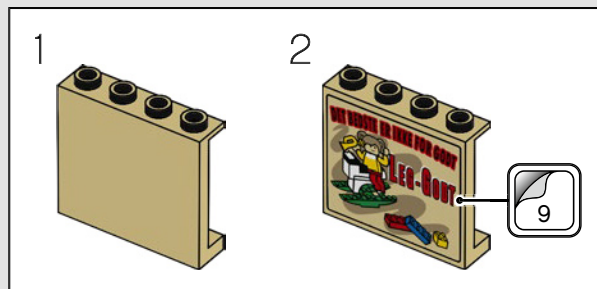

9

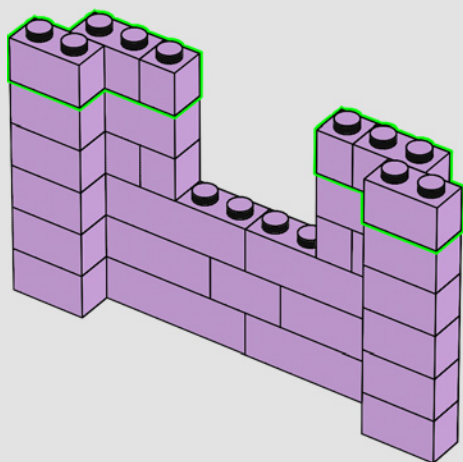

10

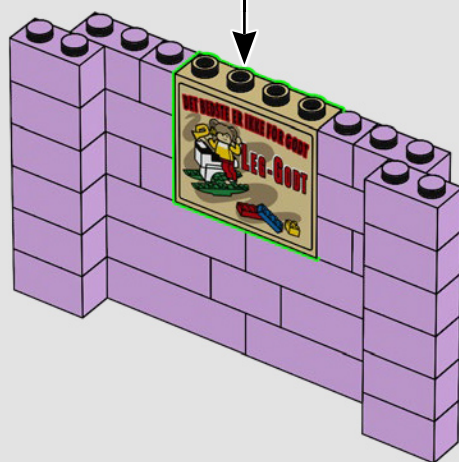

11

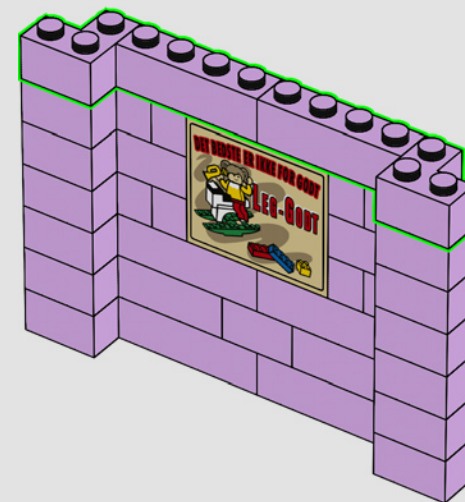

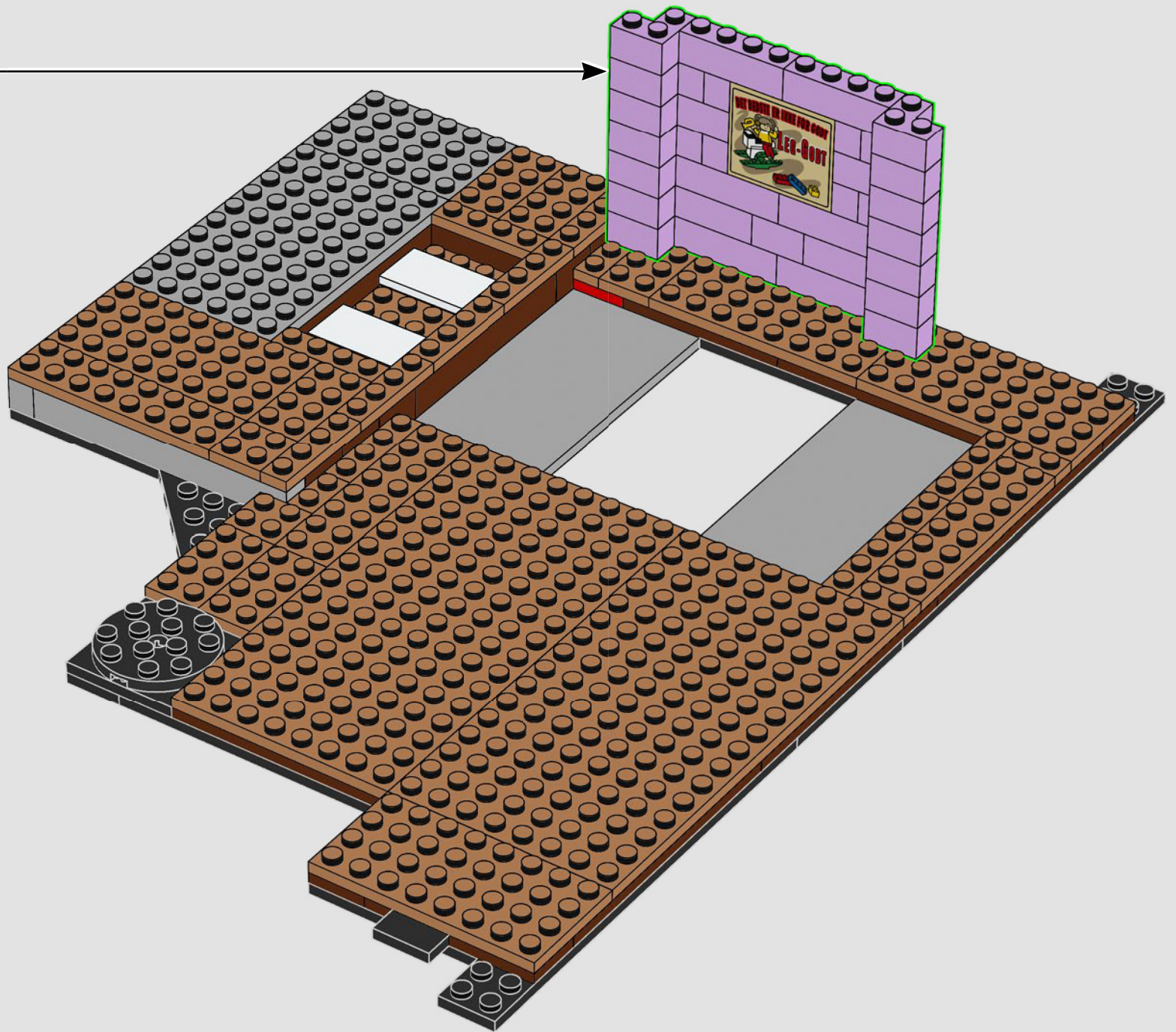

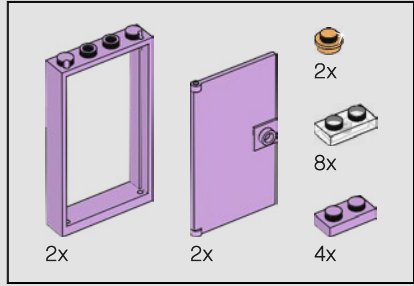

25

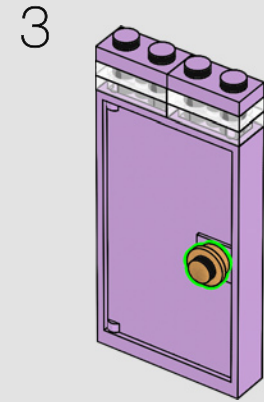
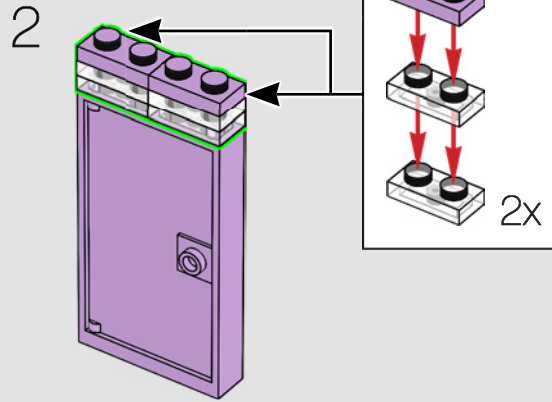
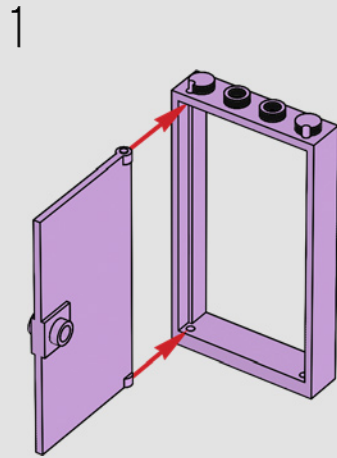

2x

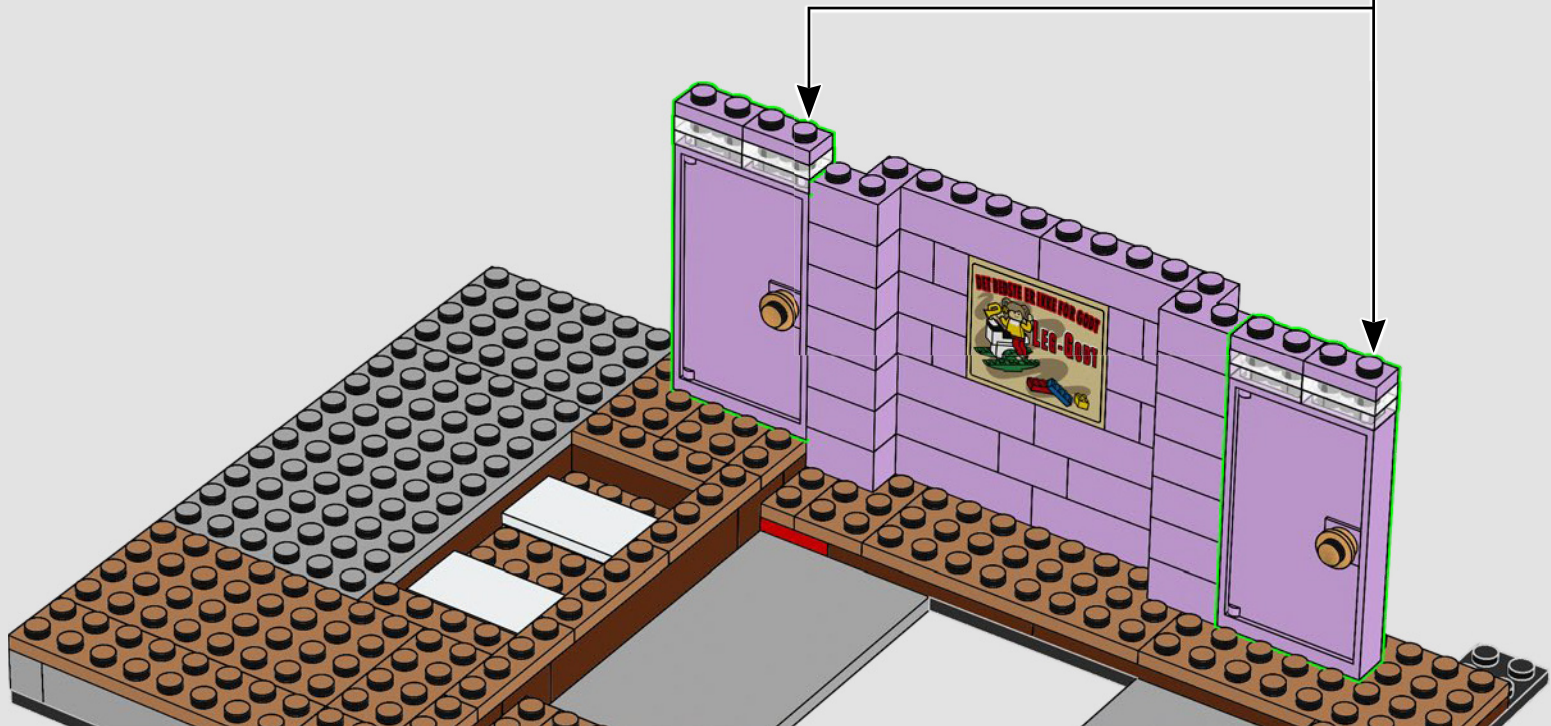

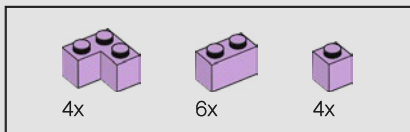

26

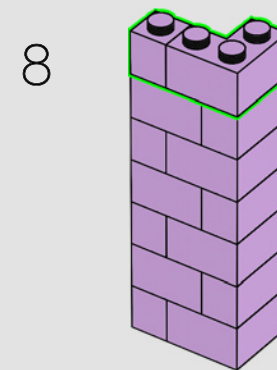
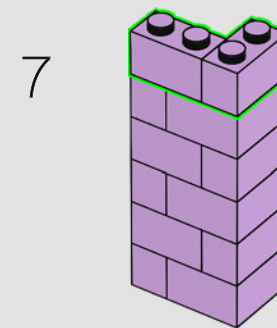
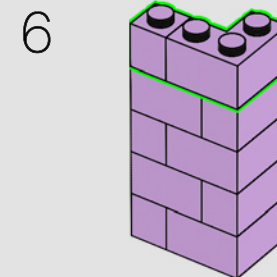
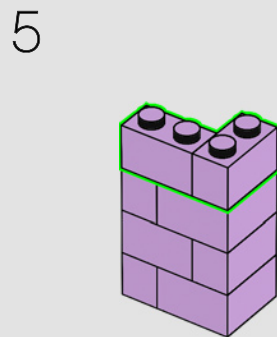
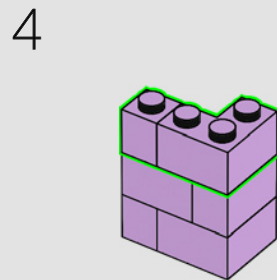
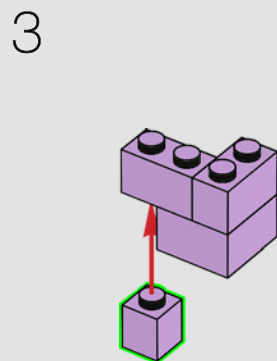
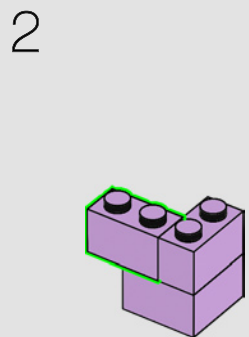
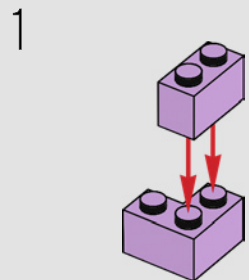

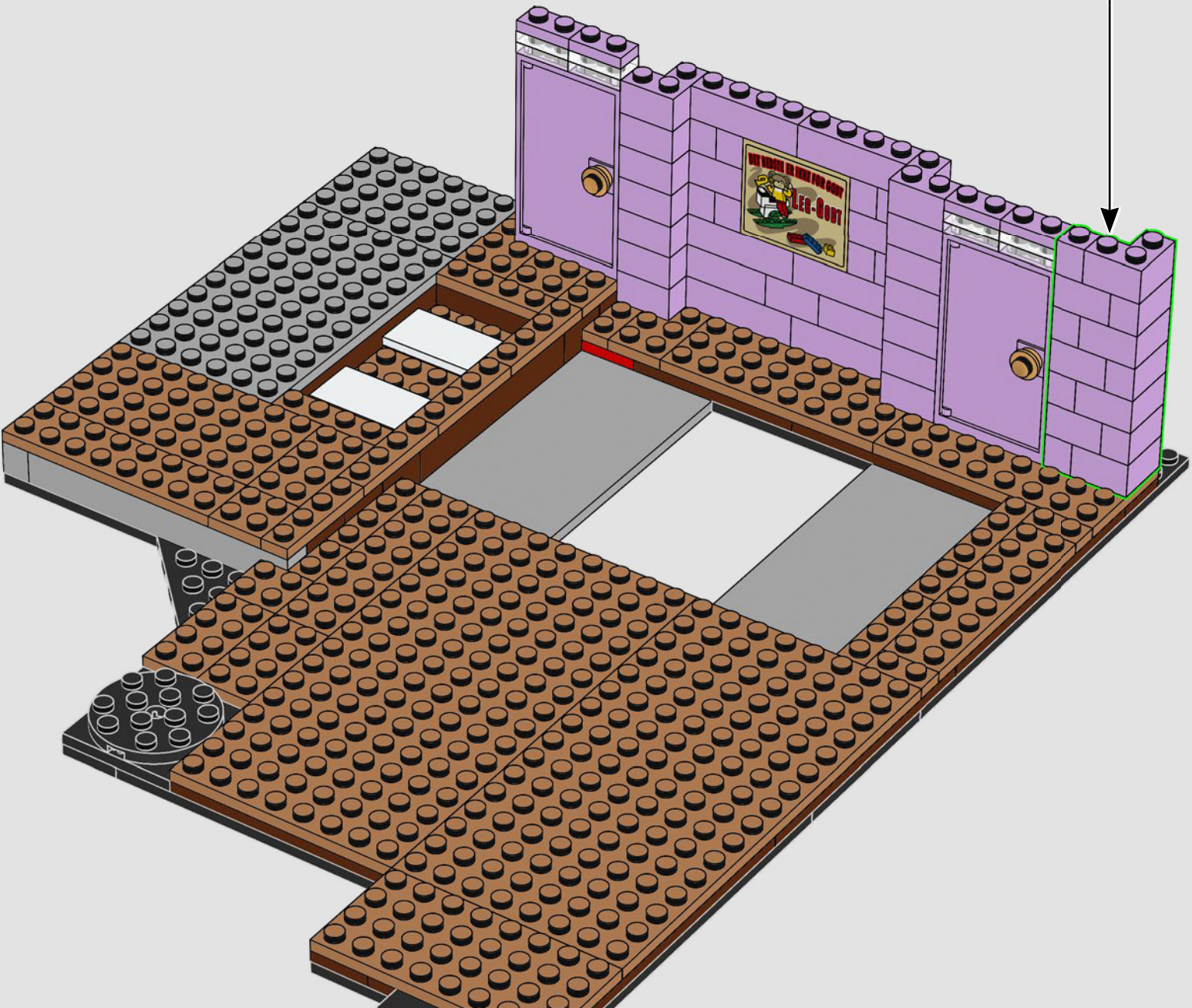

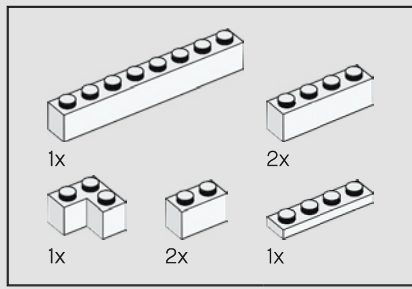

27

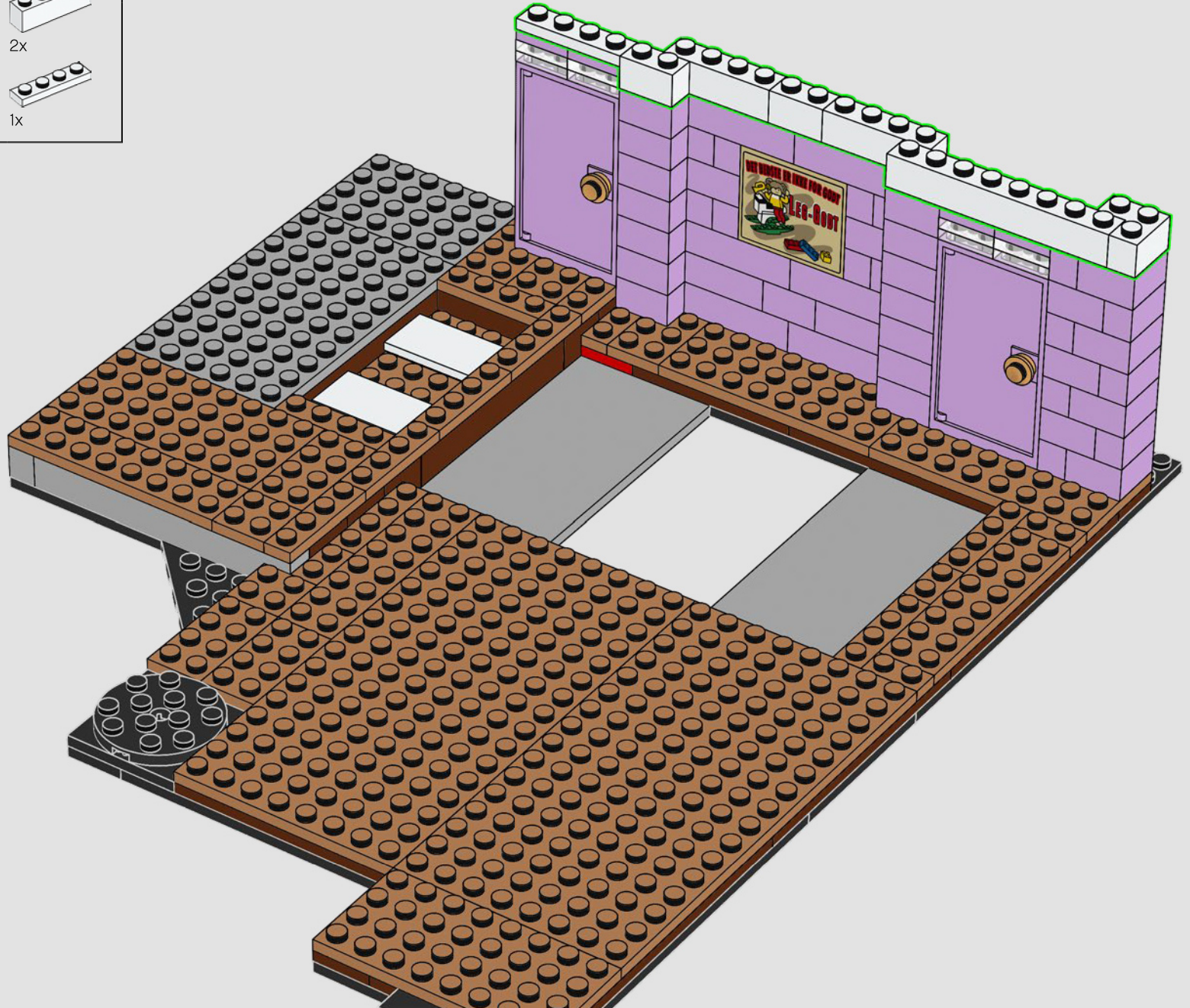

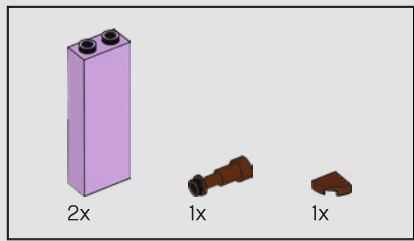

28

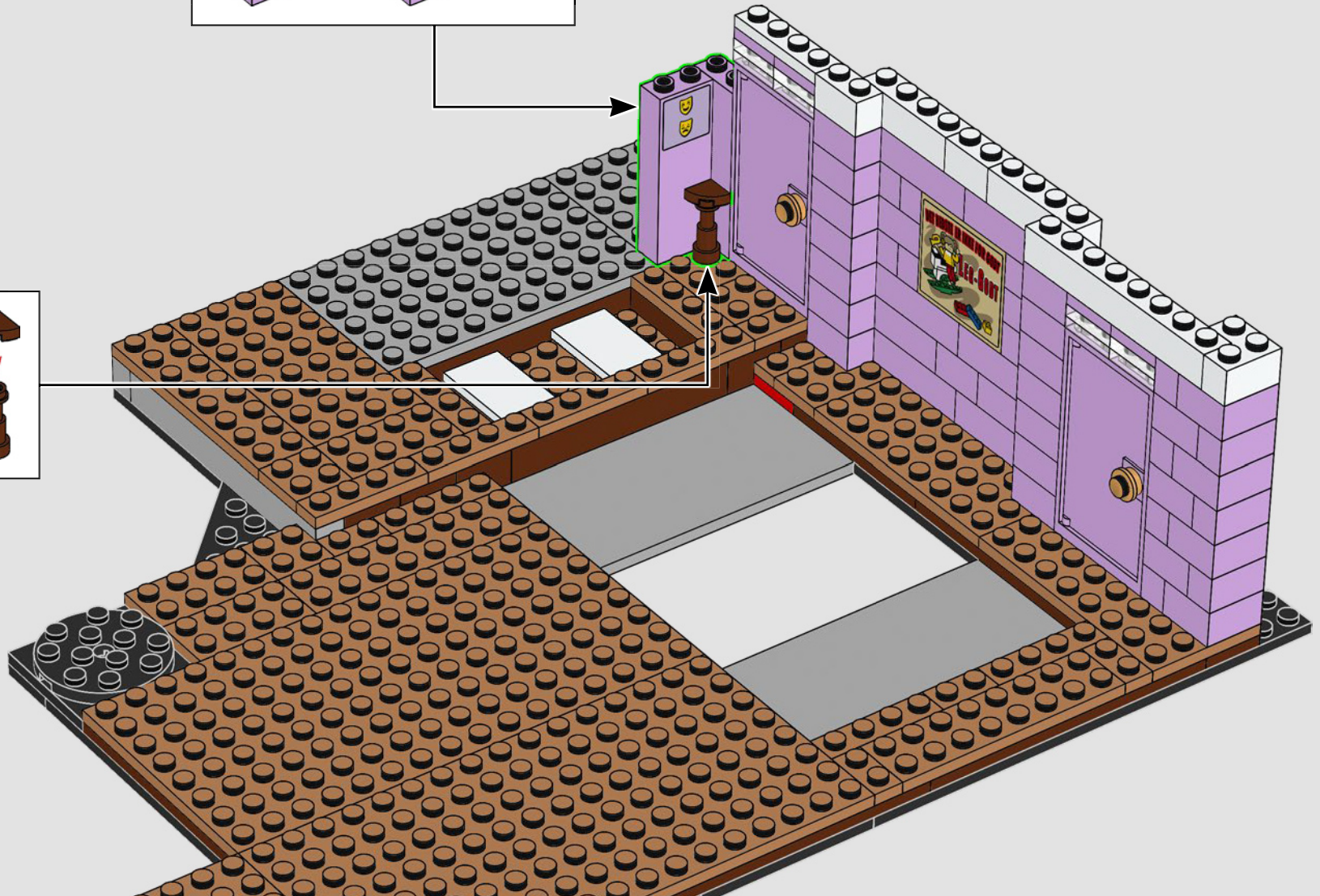
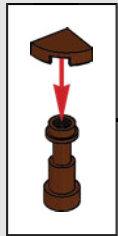
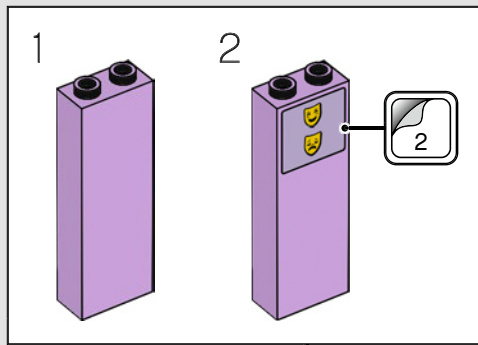

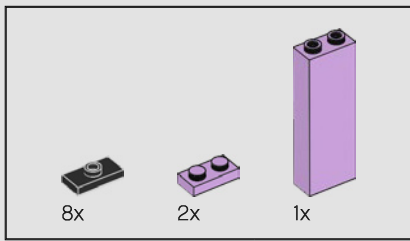

29

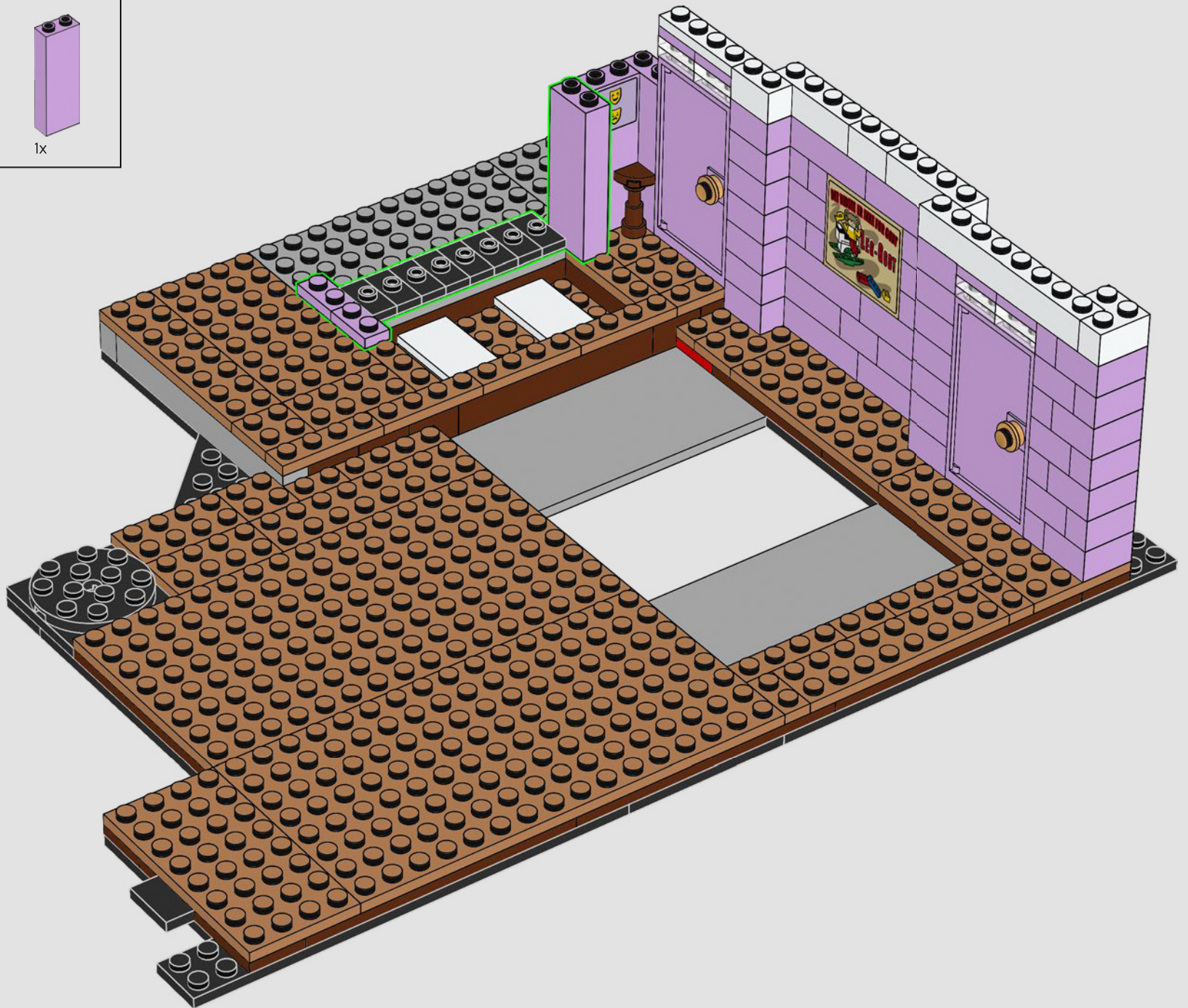

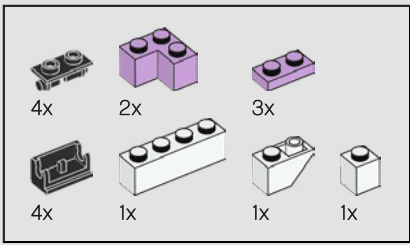

30

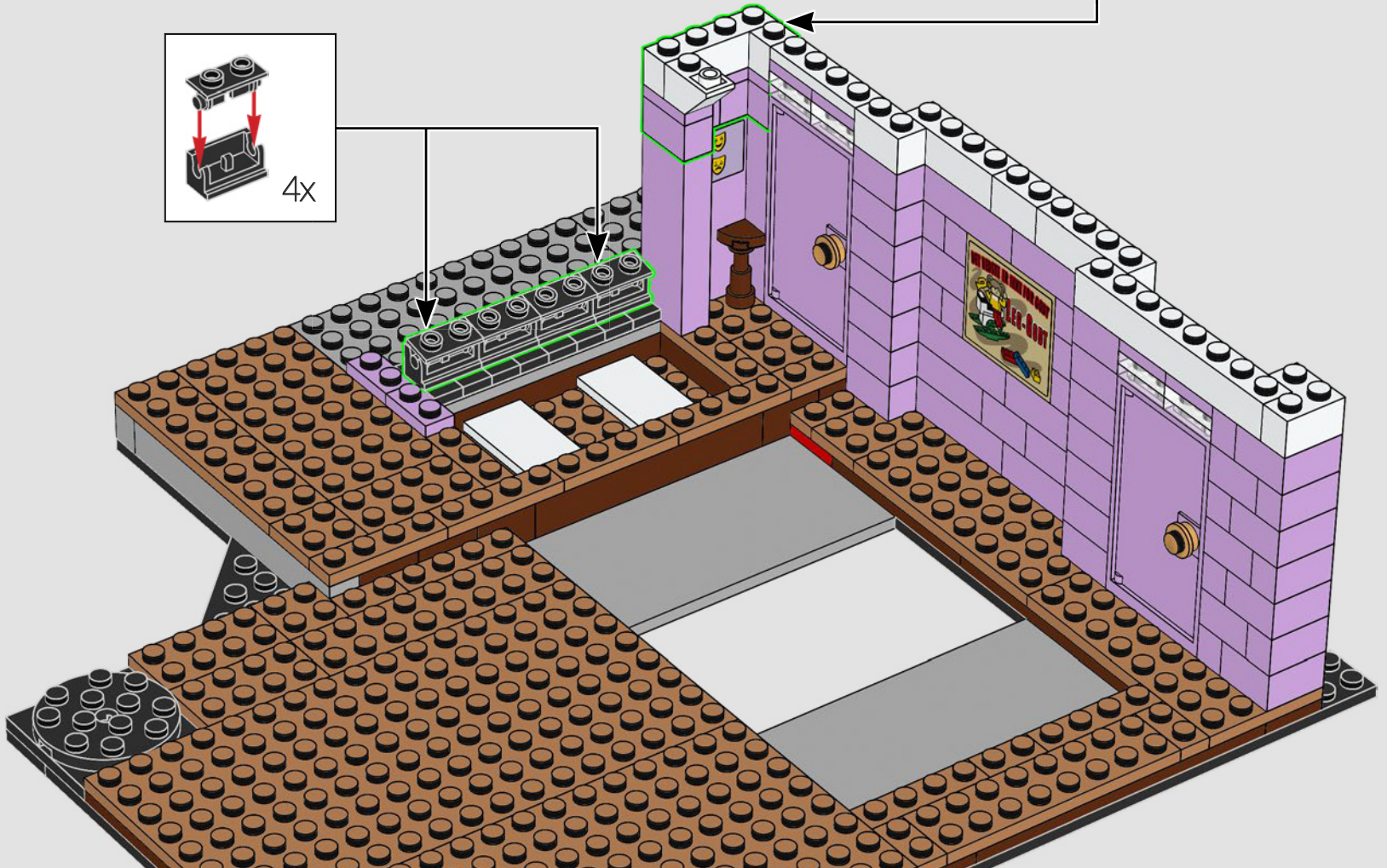
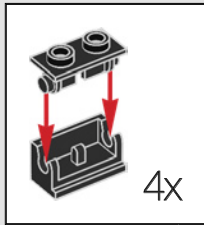
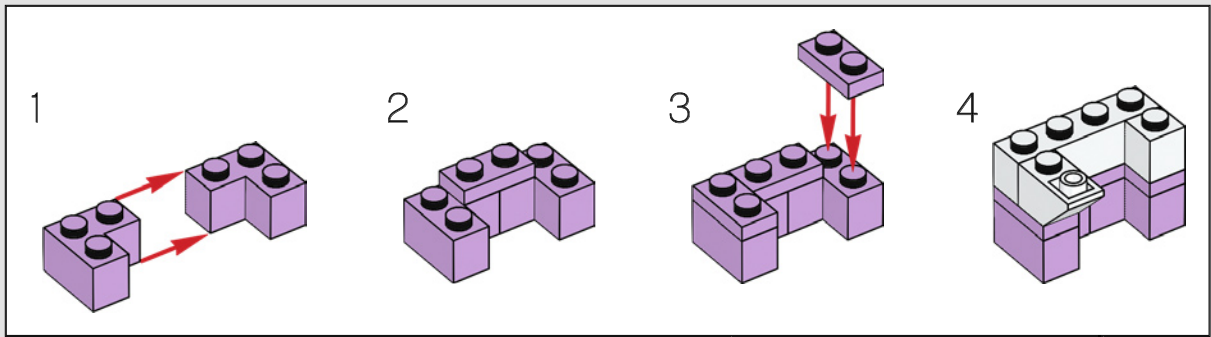

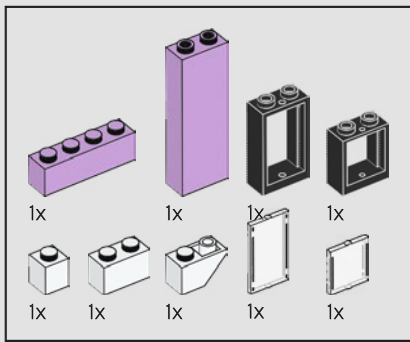

31

1

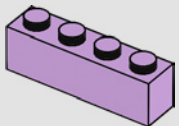

2

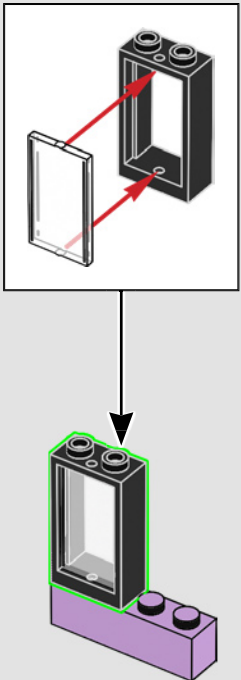

3

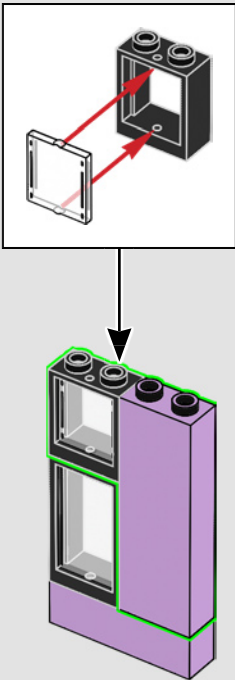

4

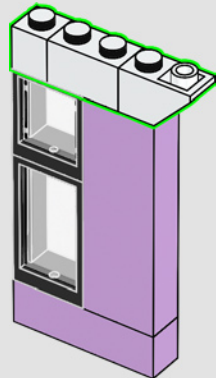

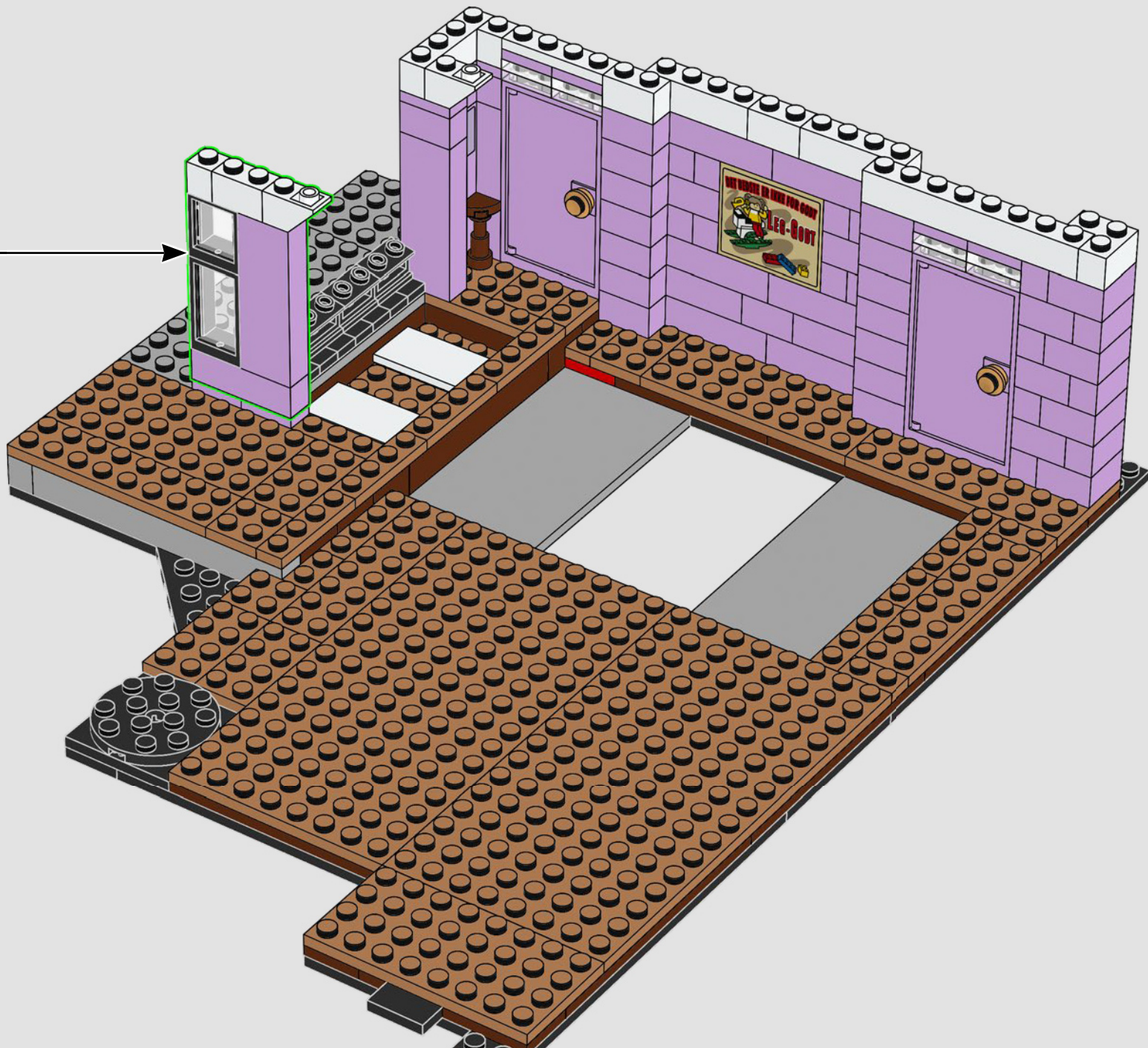

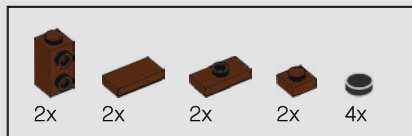

32

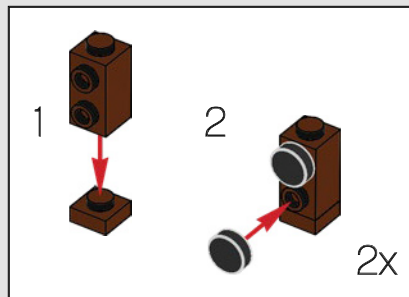

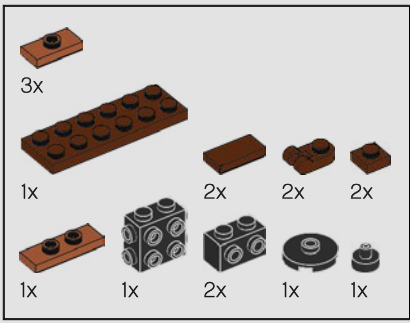

33

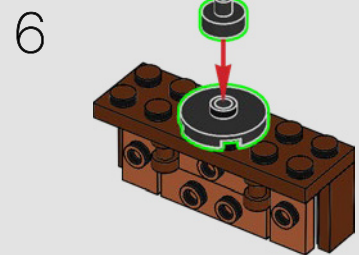
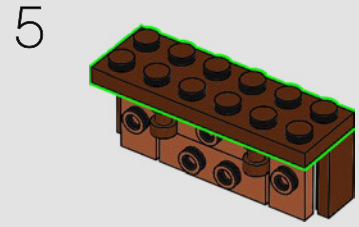
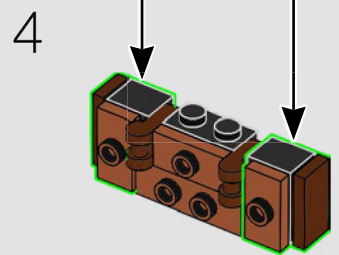
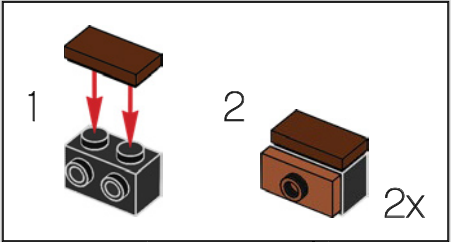
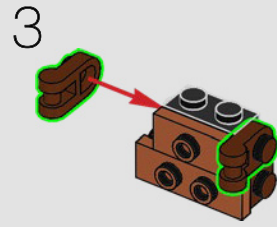
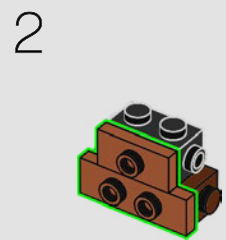
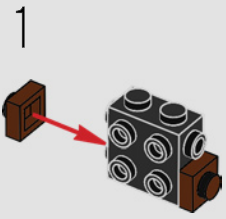





34

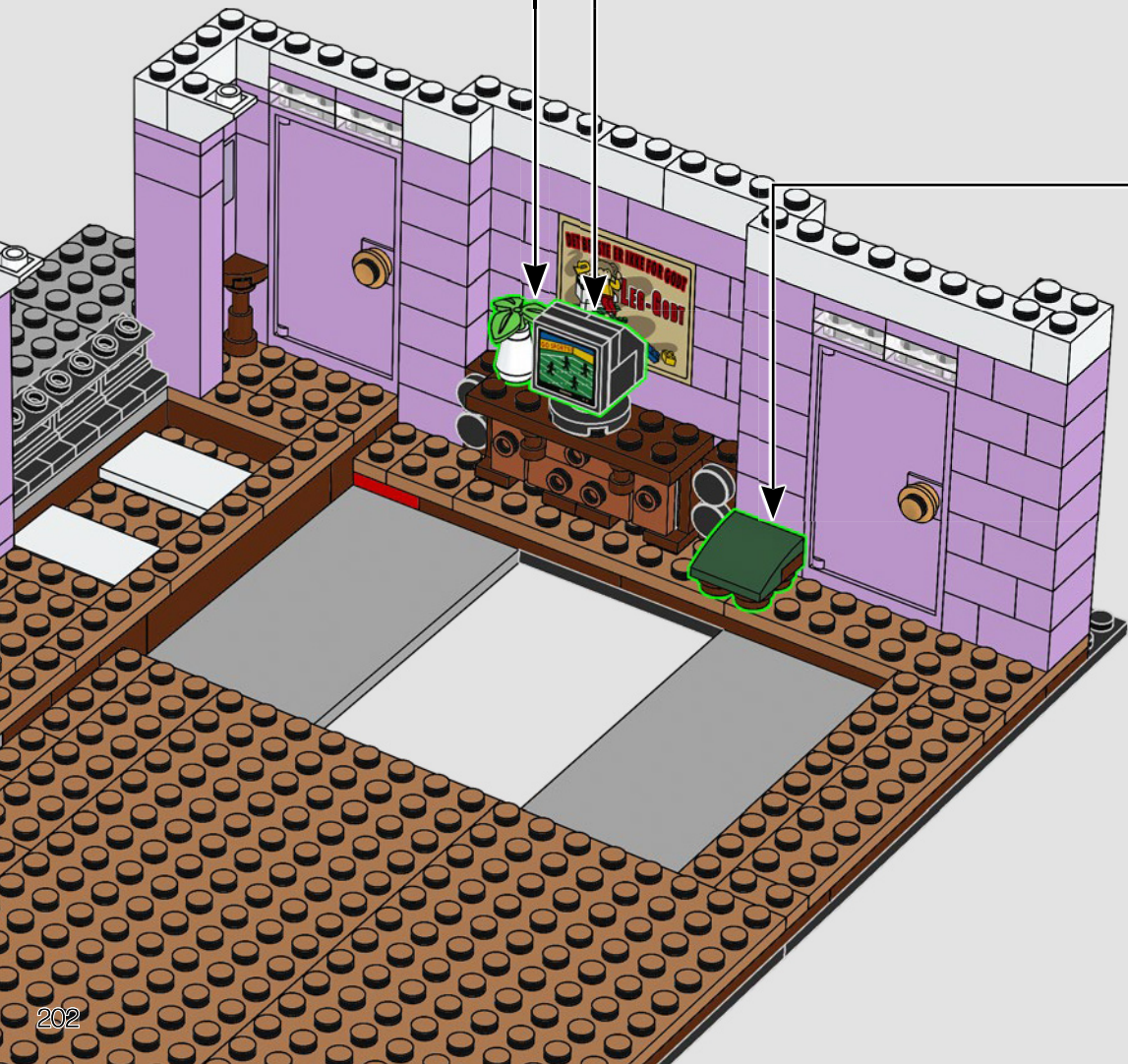
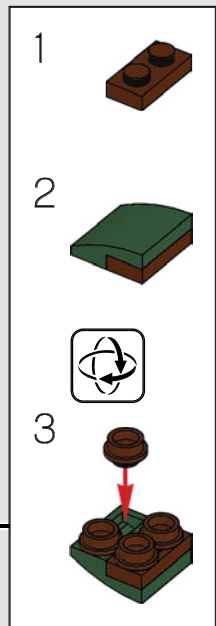
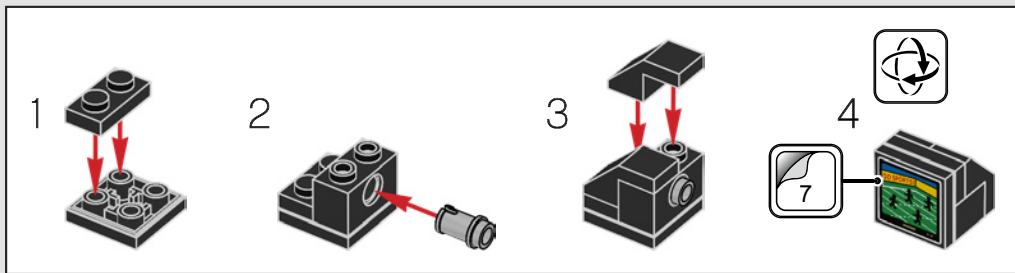
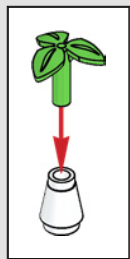

在感恩节期间，这些朋友们为了避免帮助莫妮卡做饭，在这个电视上观看了美式橄榄球比赛。

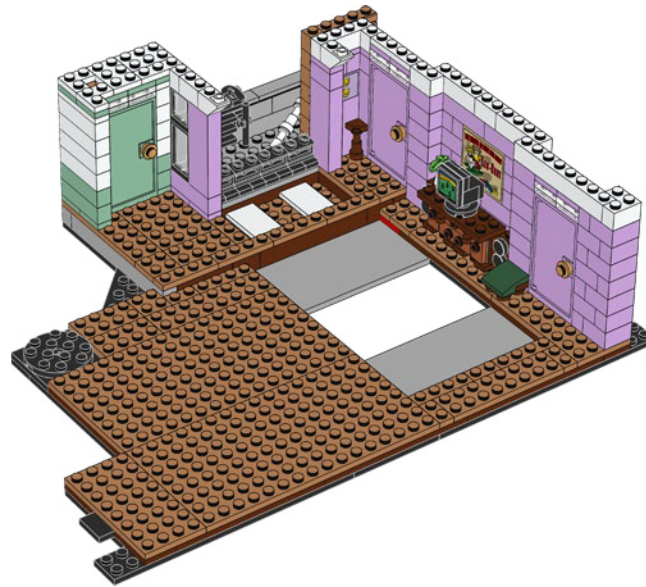
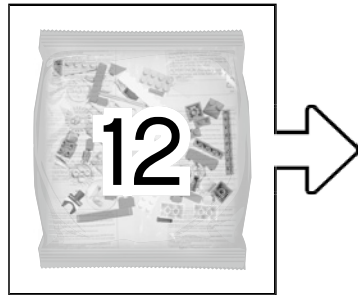

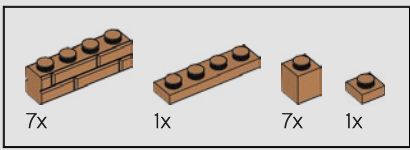

35

1

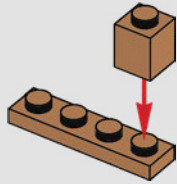

2

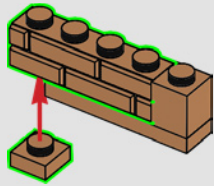

3

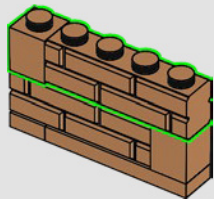

4

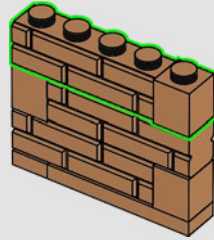

5

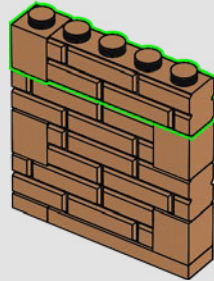

6

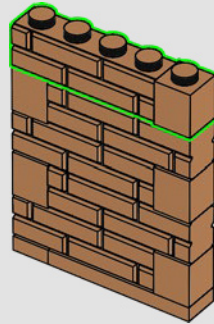

7

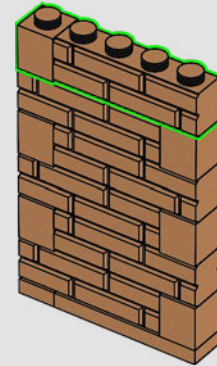

8

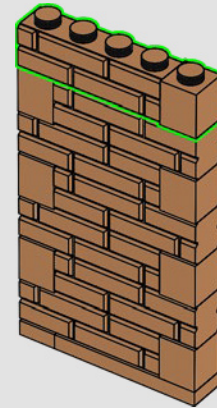

莫妮卡特别谈到了她的家具的位置，其中包括这个绿色垫椅。

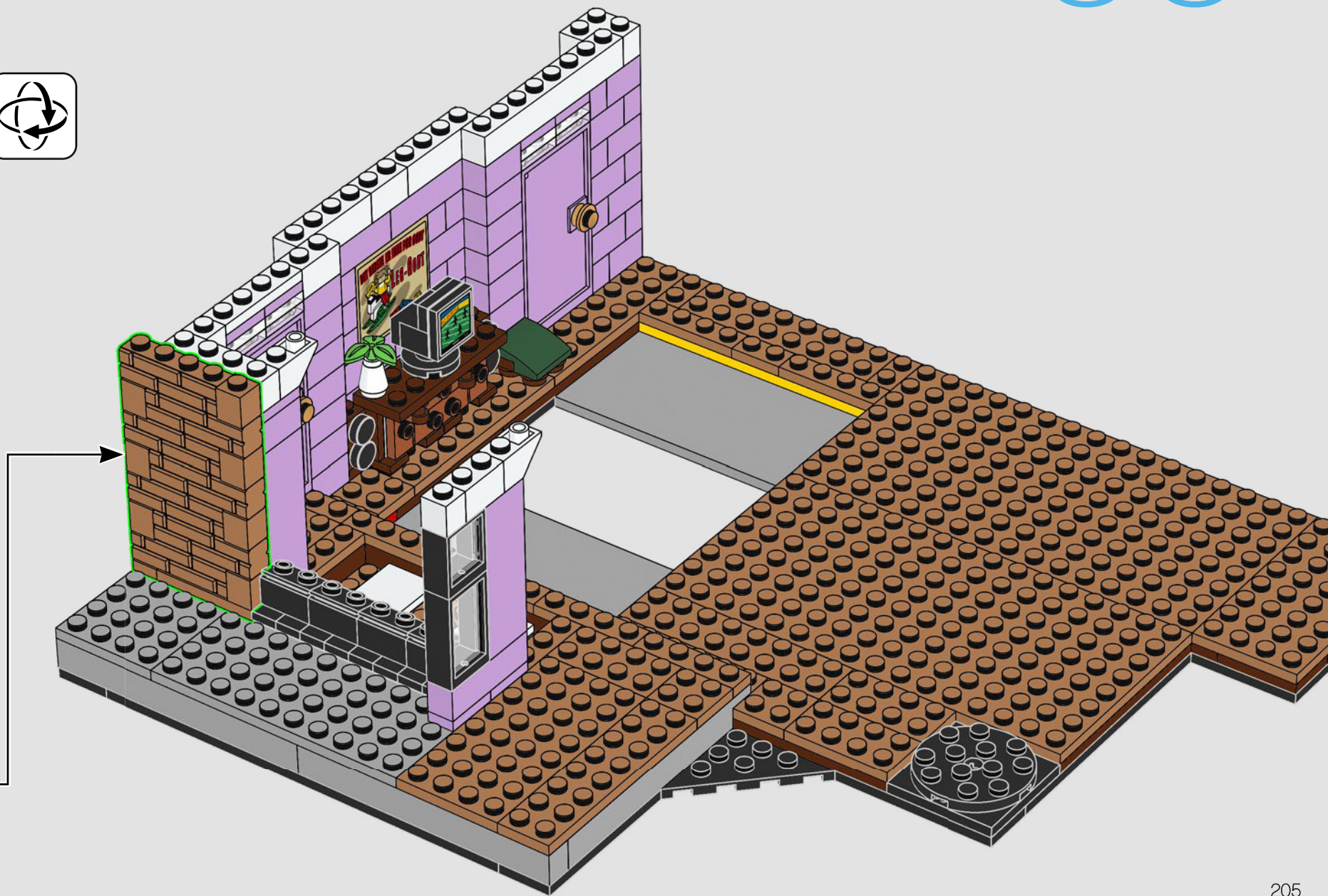

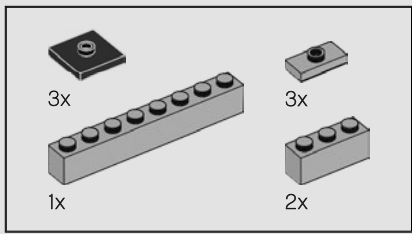

36

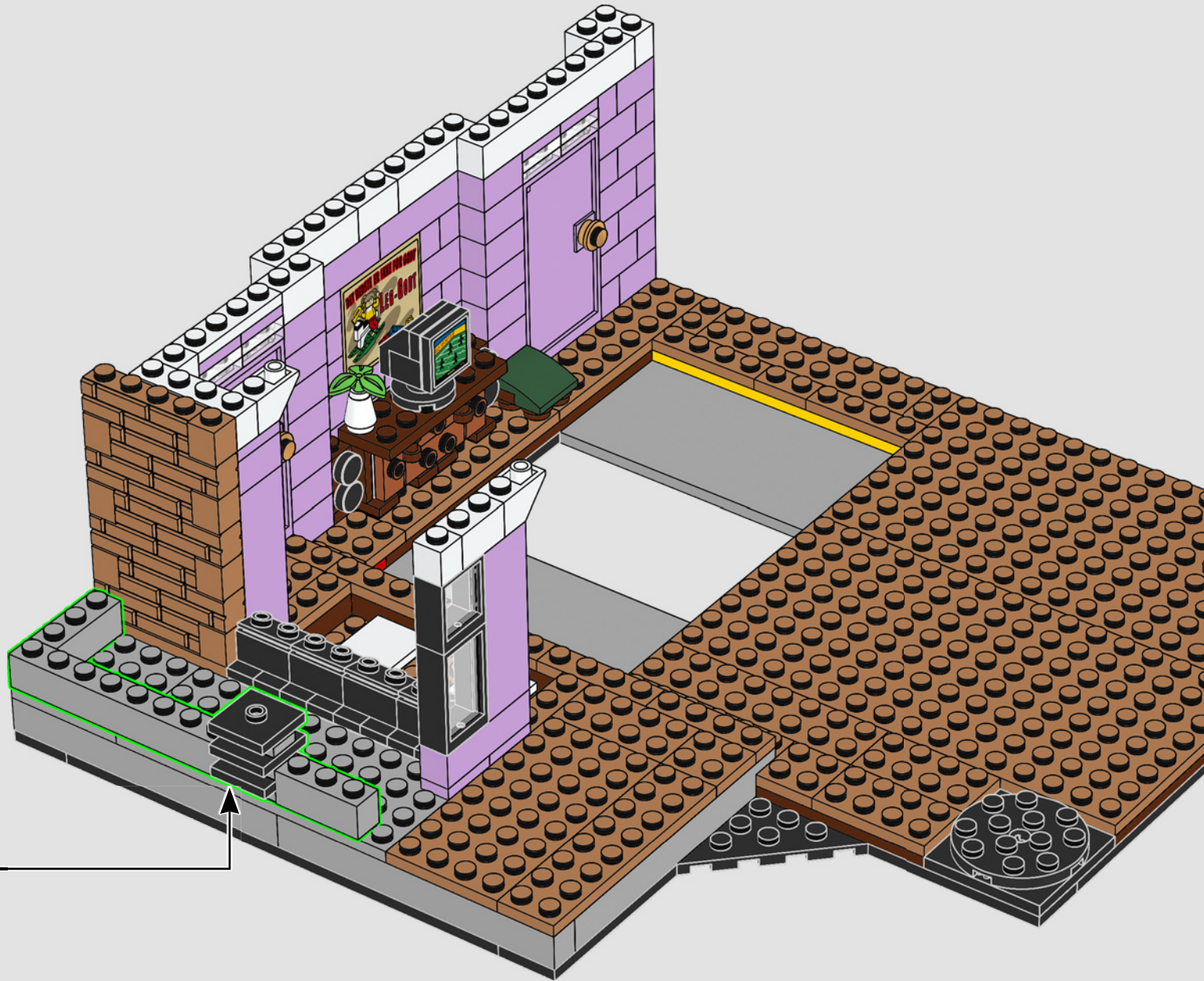
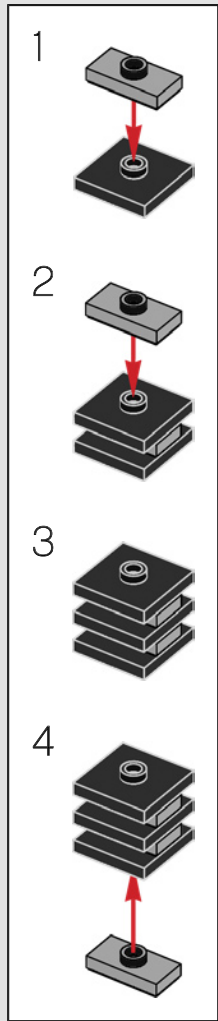

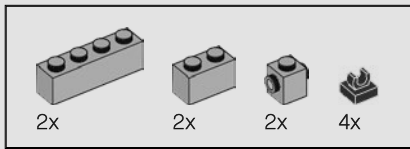

37

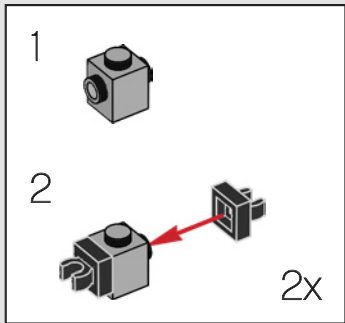
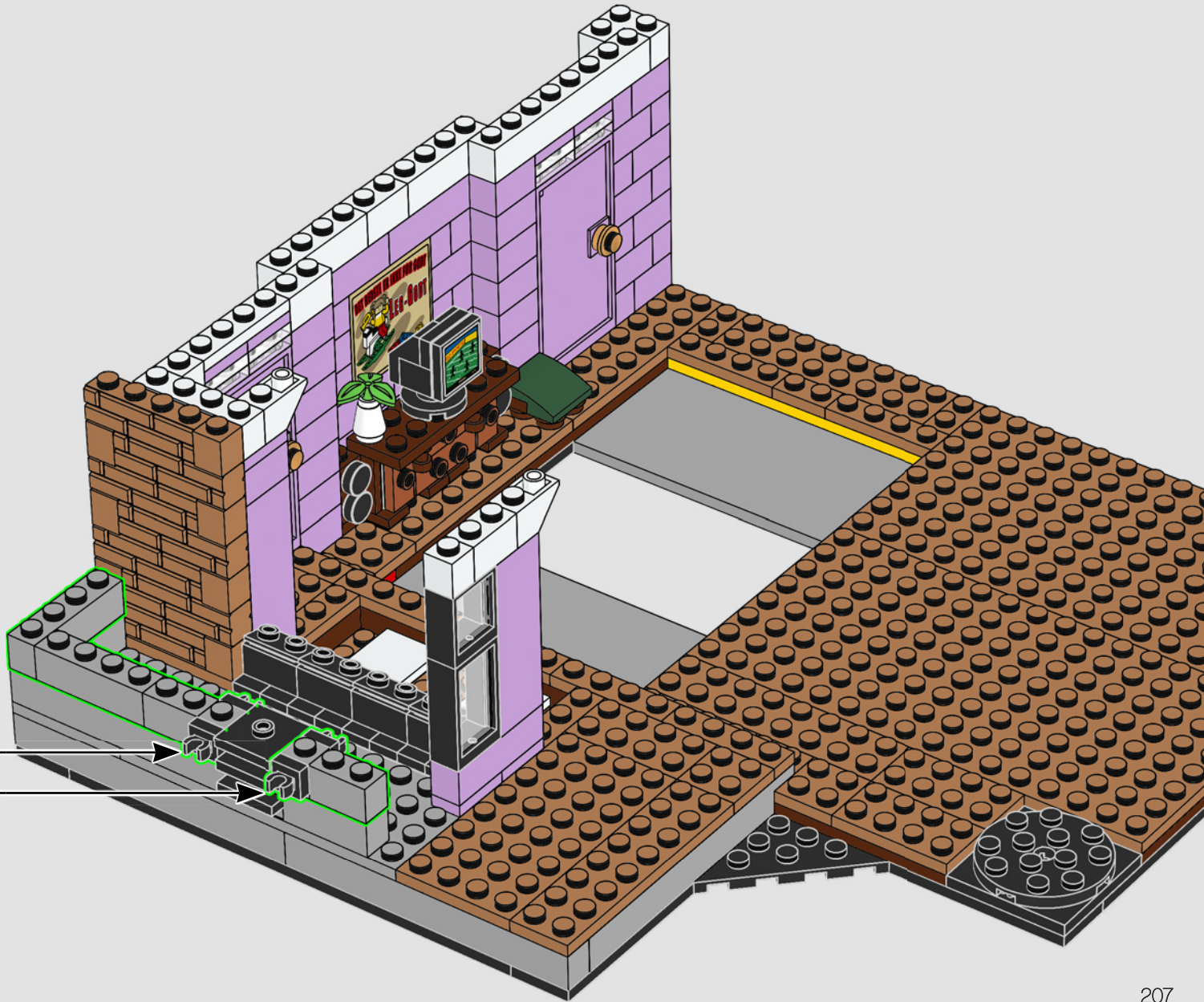

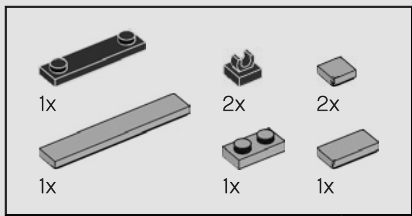

38

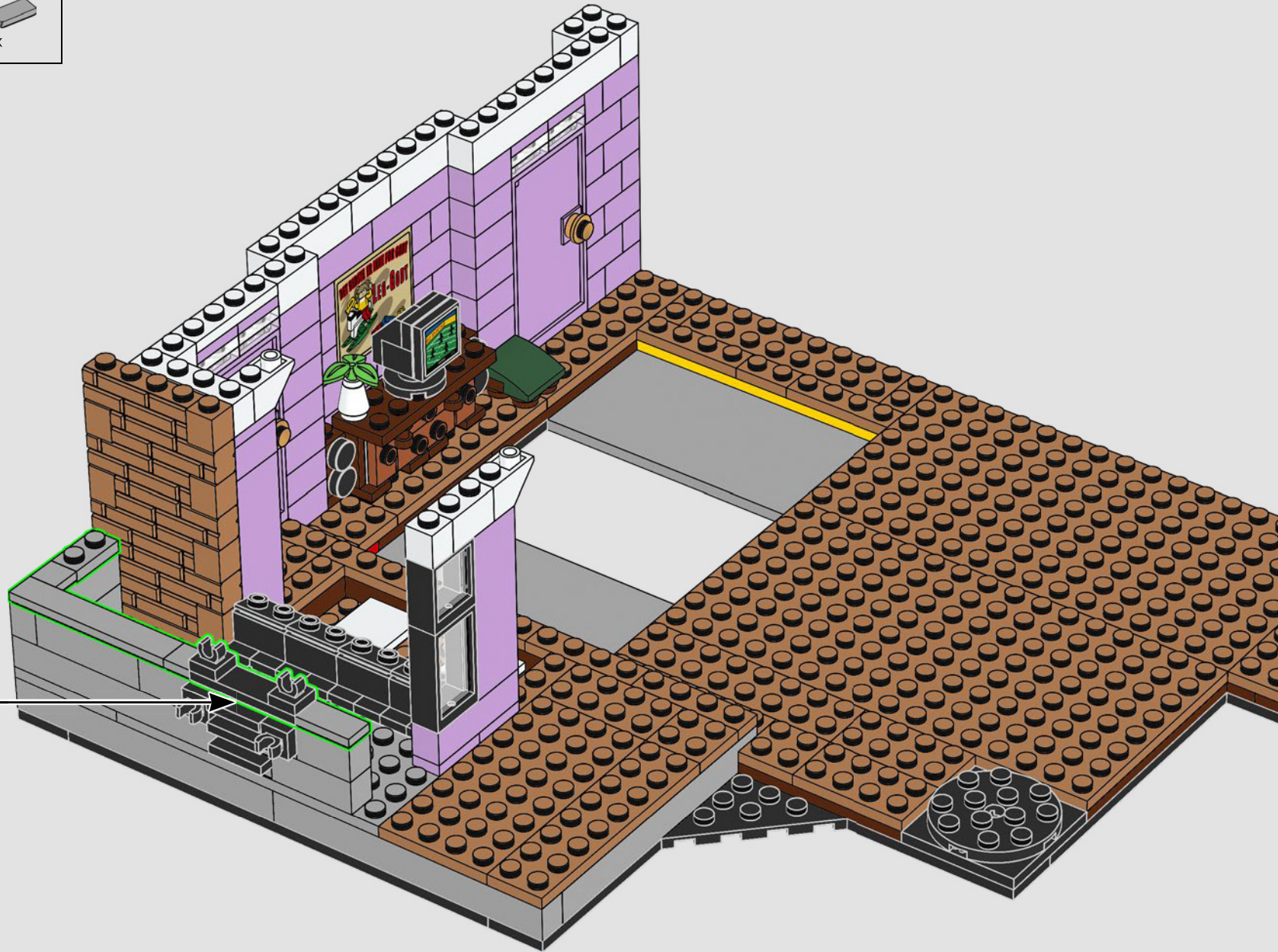
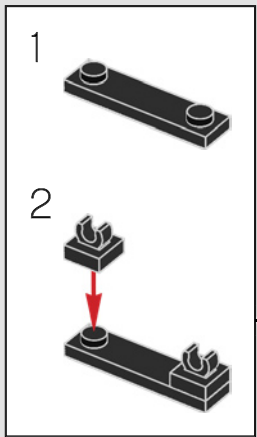



39

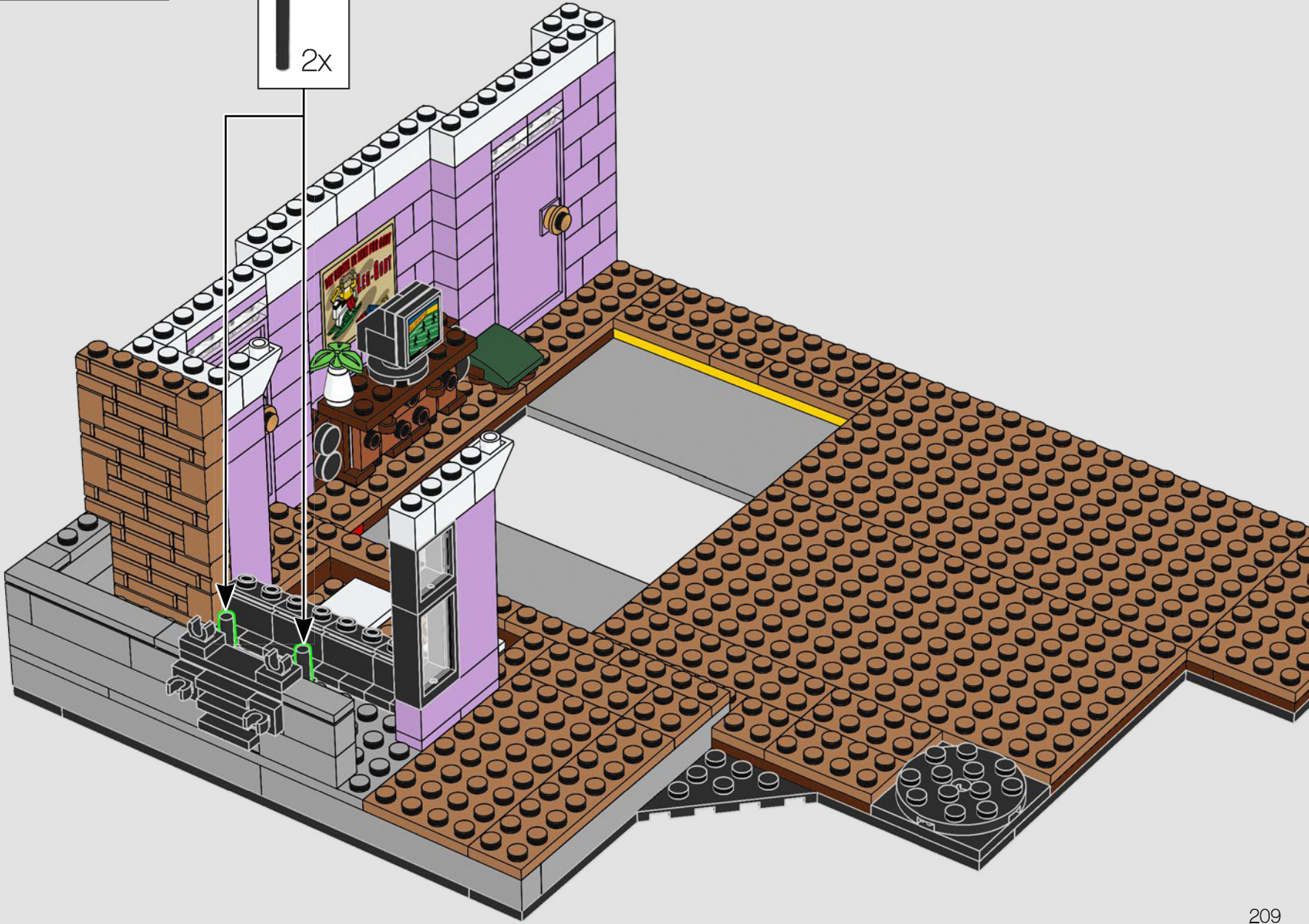
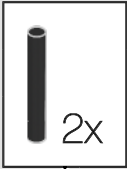



40

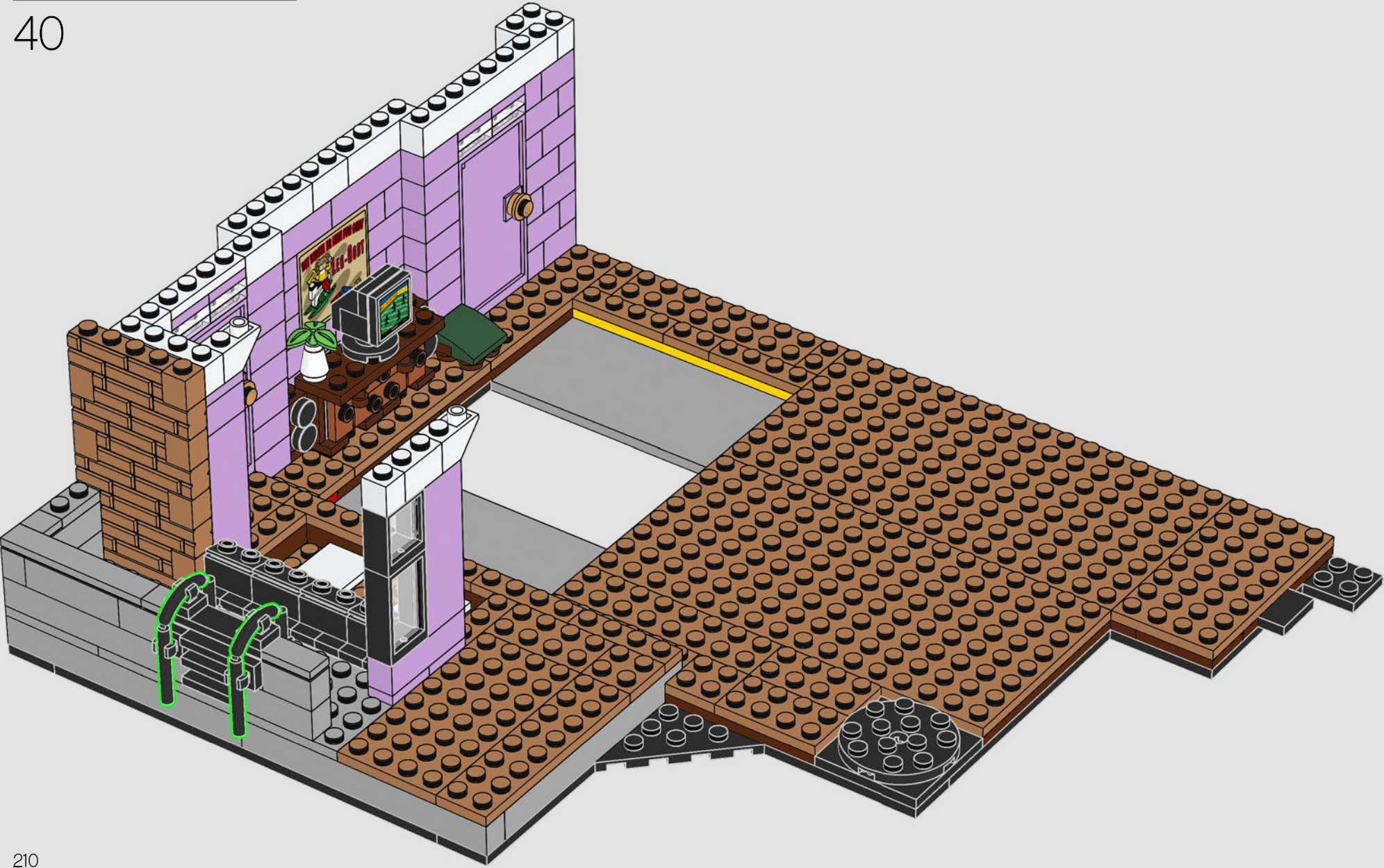

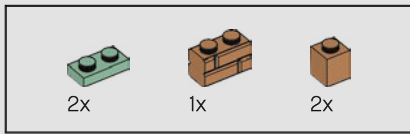

41

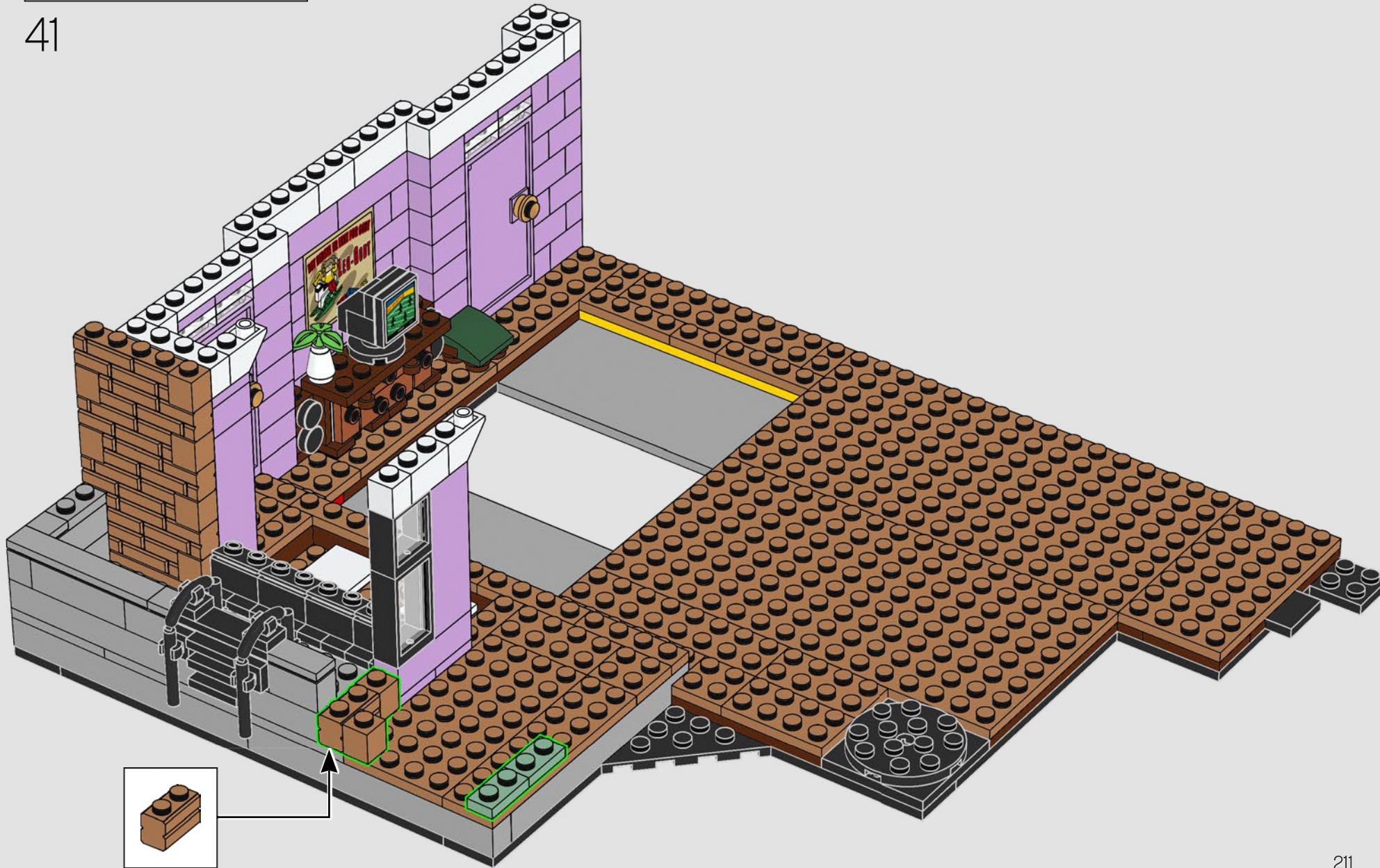

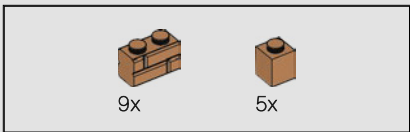

42

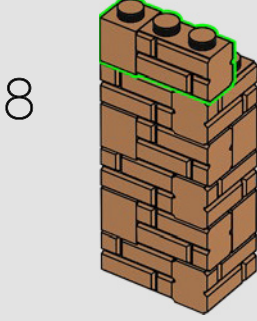
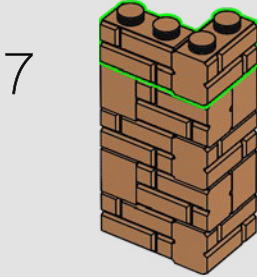
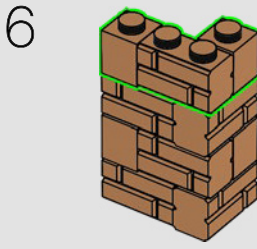
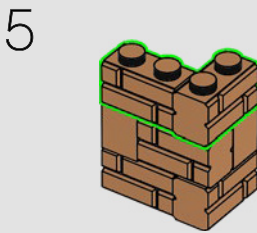
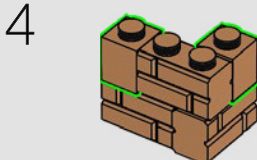
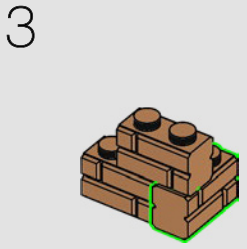
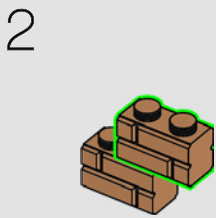

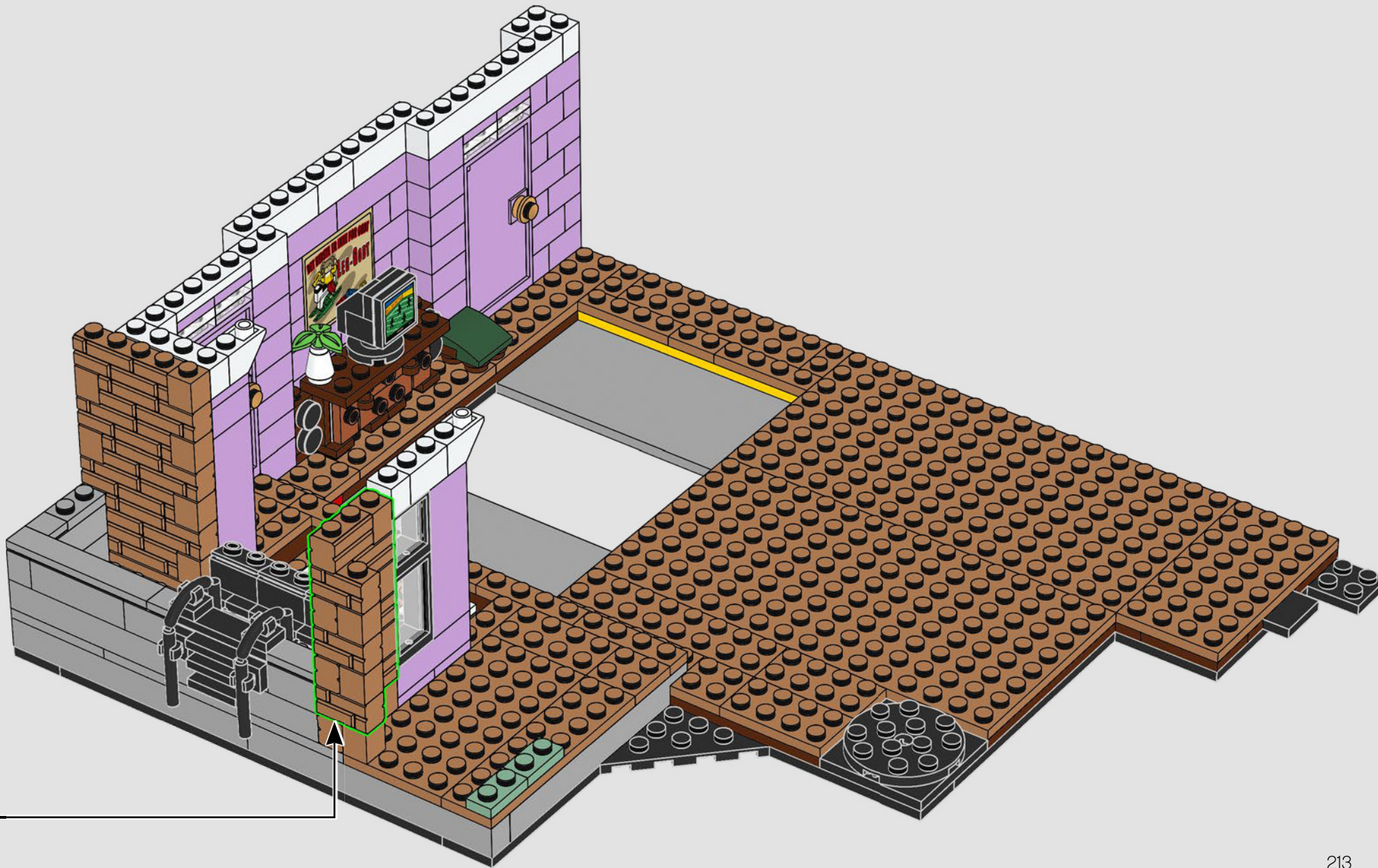

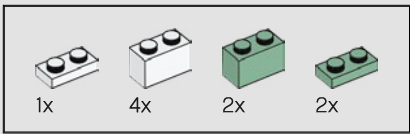

43

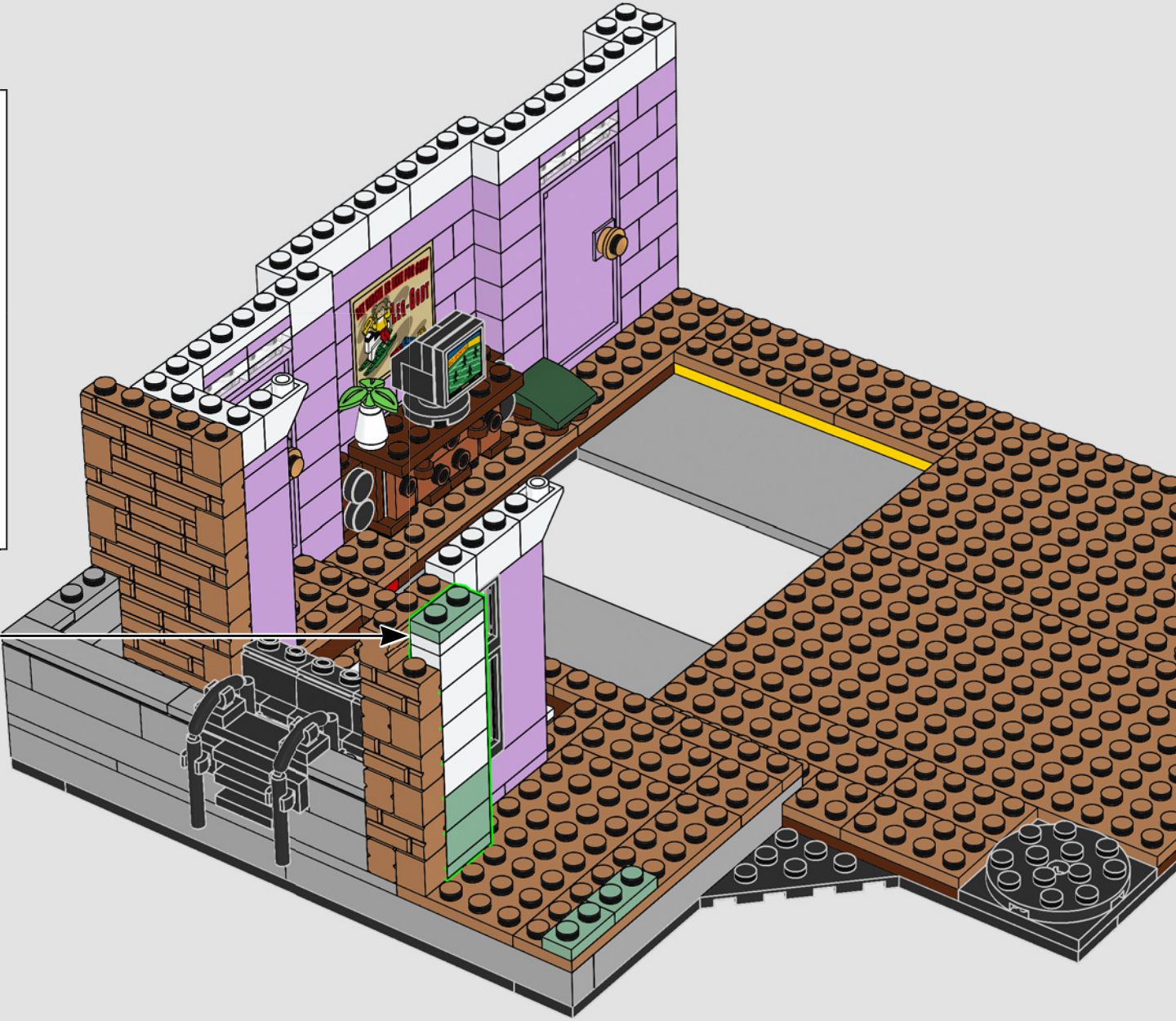
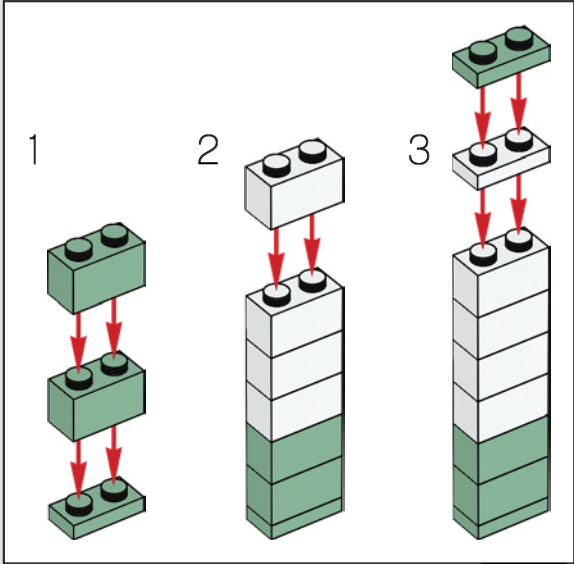

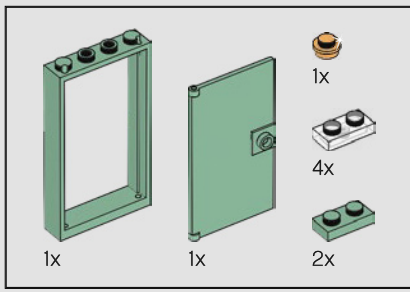

44

1

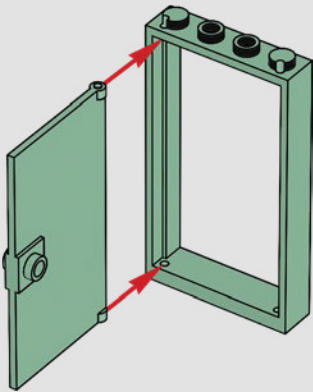

2

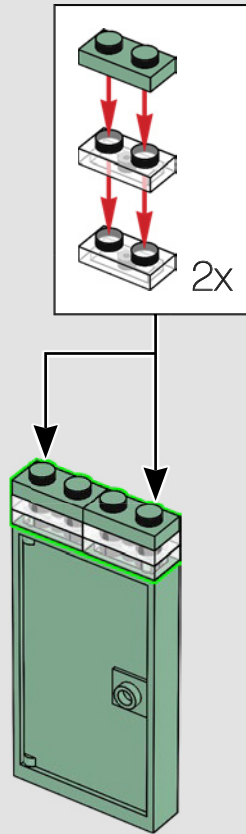

3



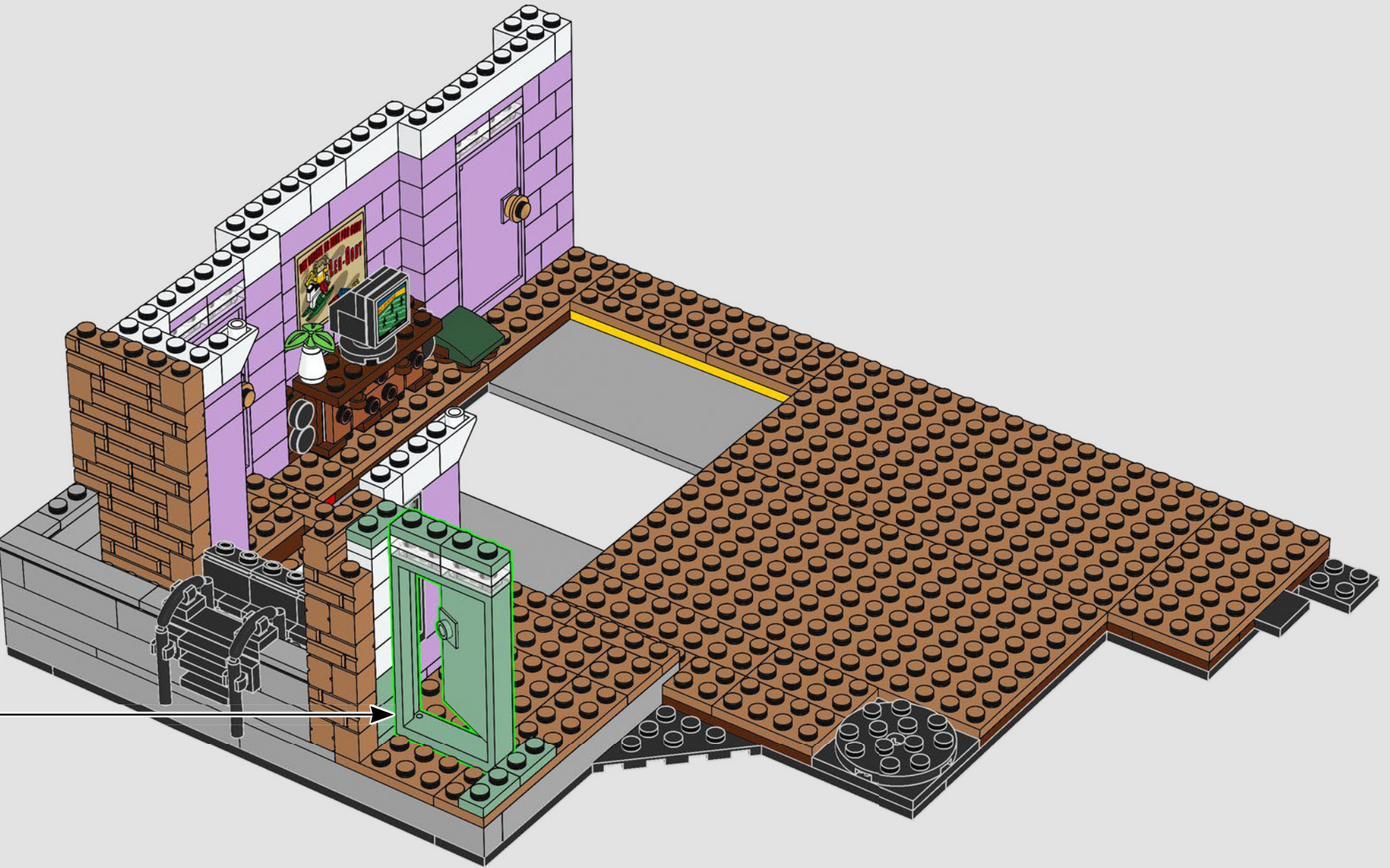

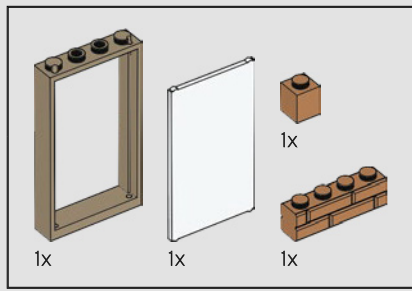

45

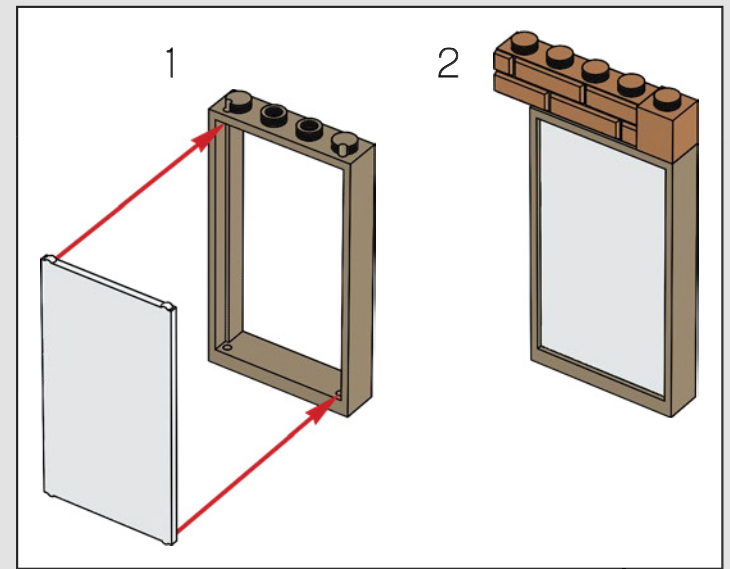
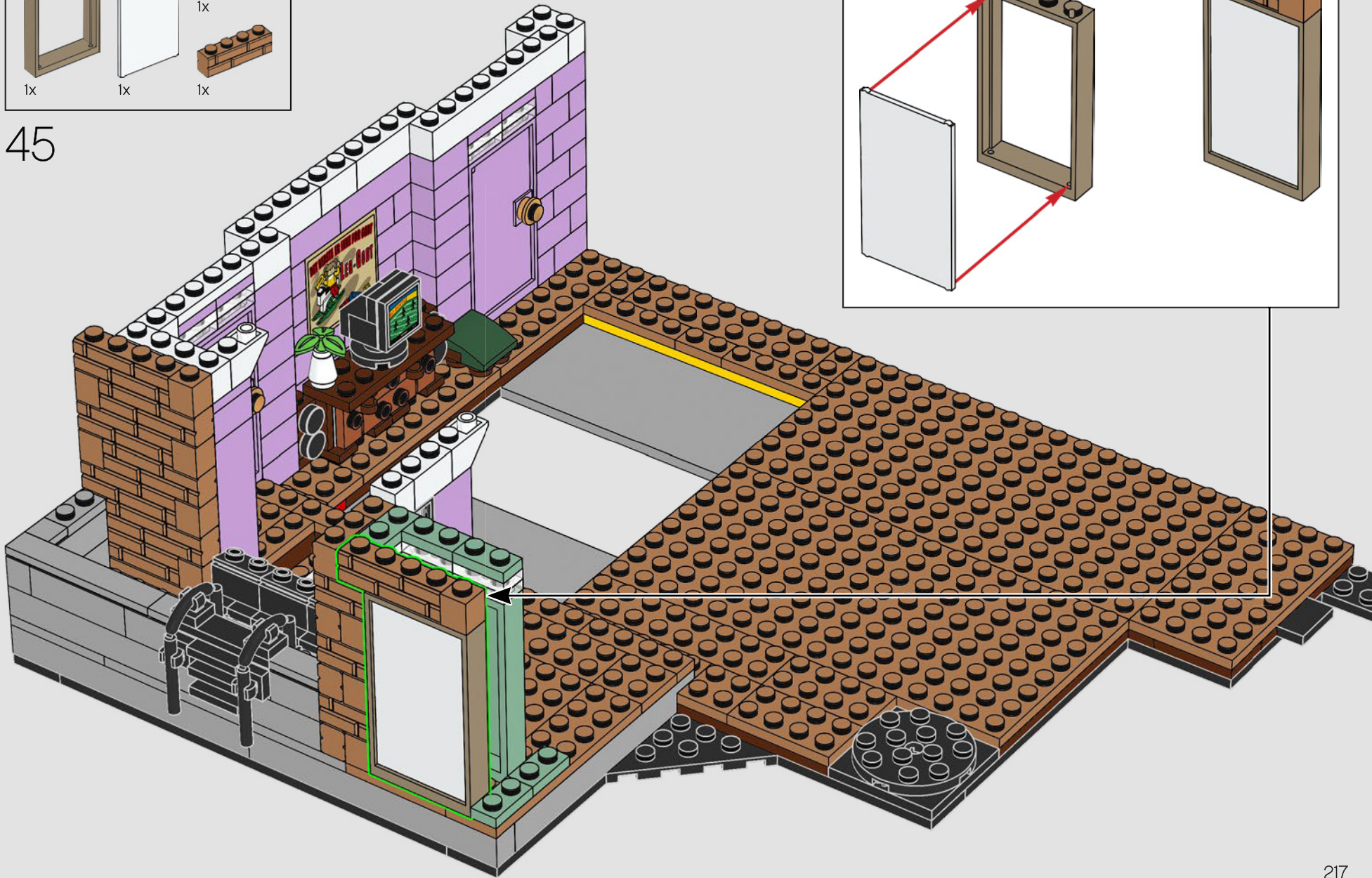

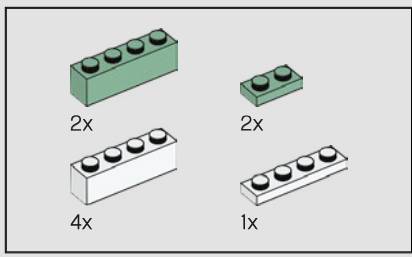

46

1

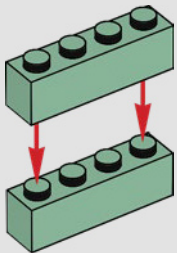

2

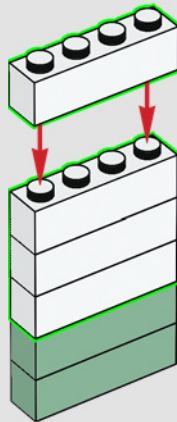

3

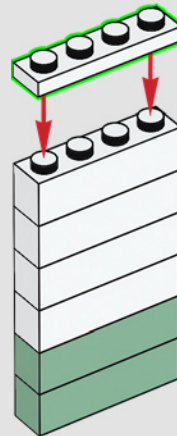

4

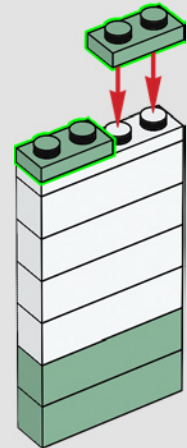

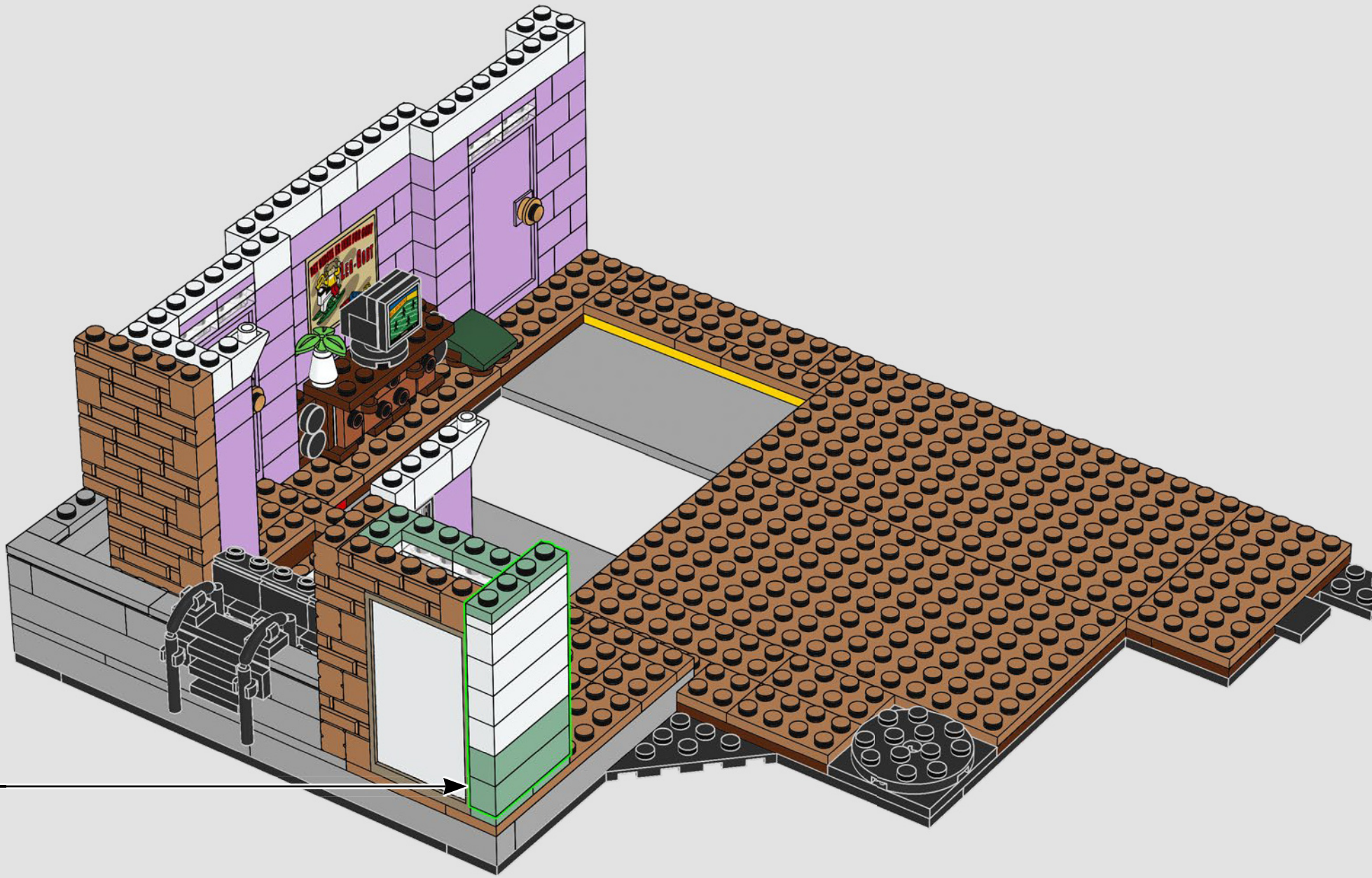

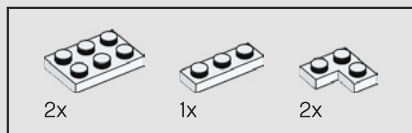

47

● 罗斯正要吻瑞秋时，阳台上的那只猫攻击了他。

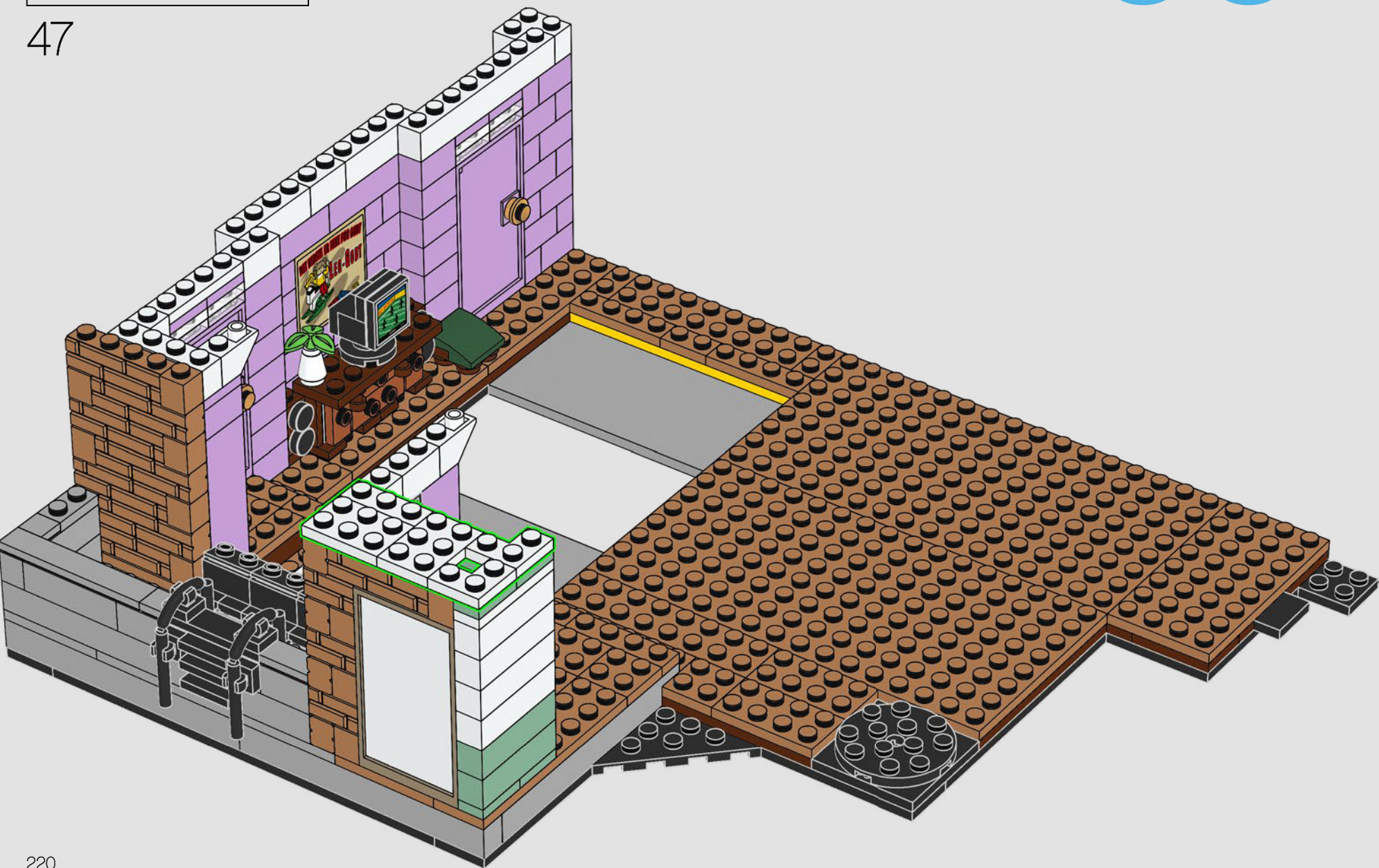

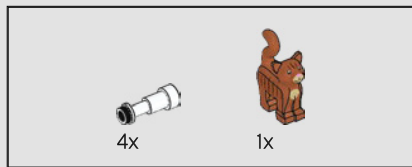

48

这帮朋友们以为对面大楼里的邻居已过世，他们用这根“戳棍”前去查看。



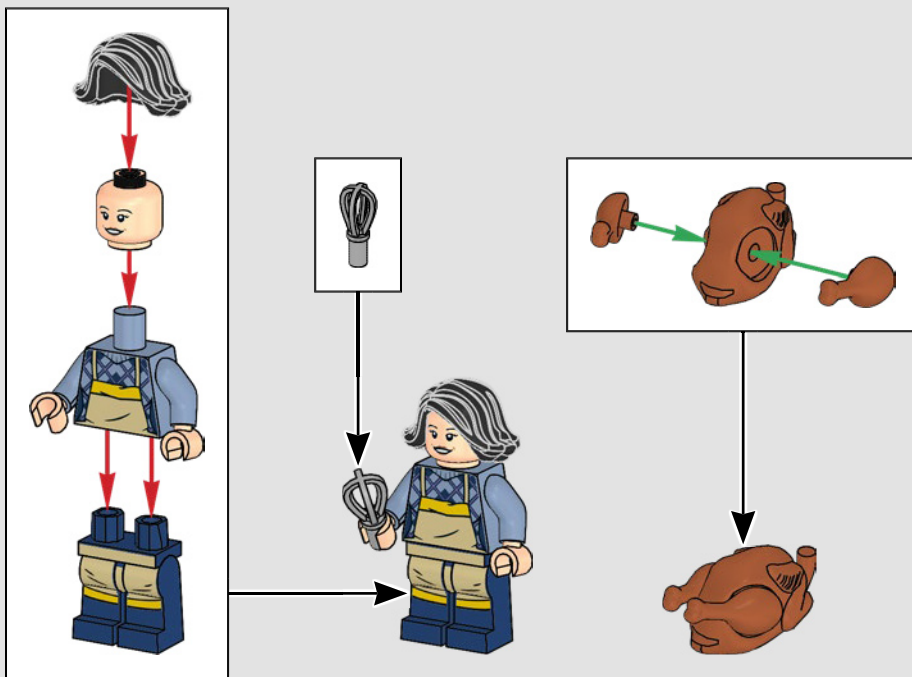
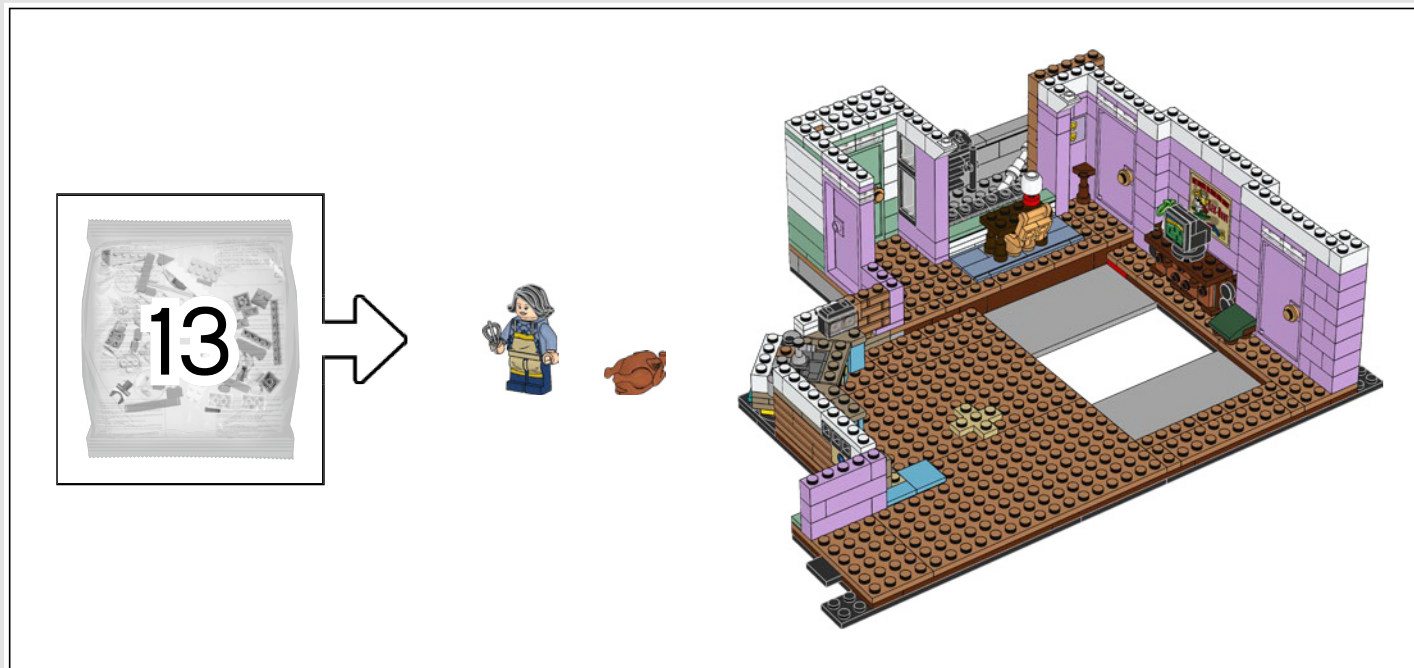

● 这只火鸡源自著名的感恩节插曲：莫妮卡头上戴着一只火鸡。

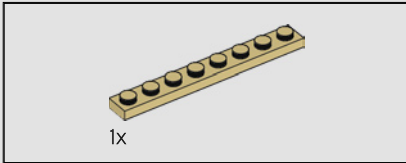
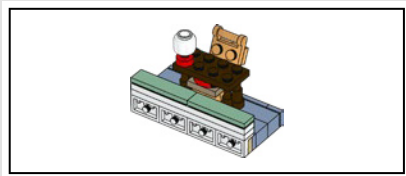

49

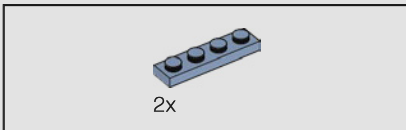
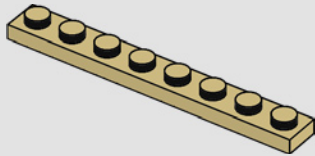

50

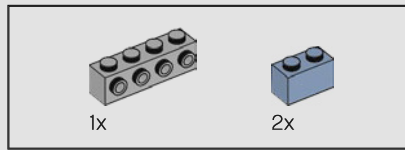
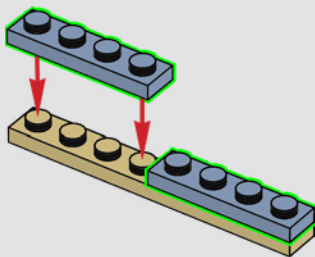

51

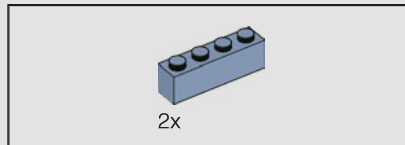
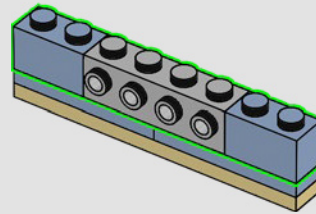

52

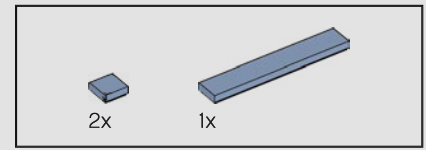
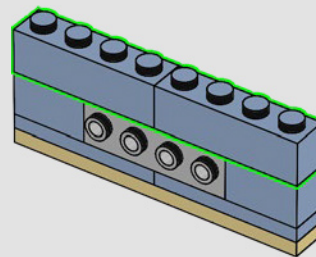

53

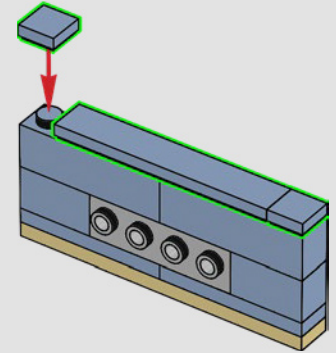

54

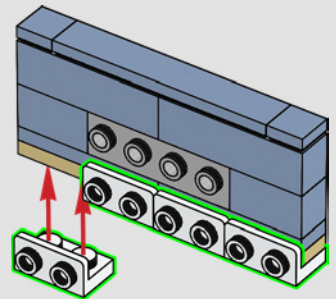

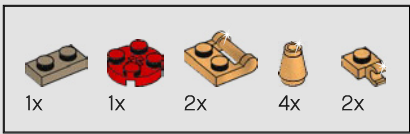

55

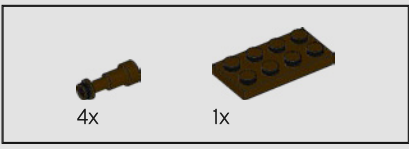
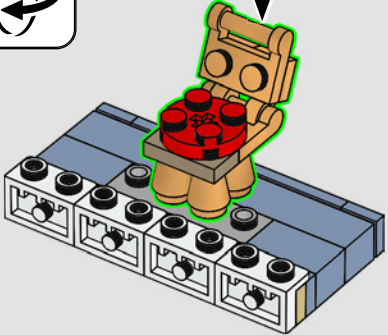
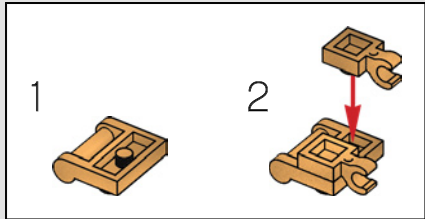
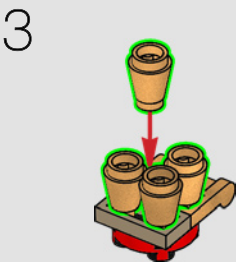

56

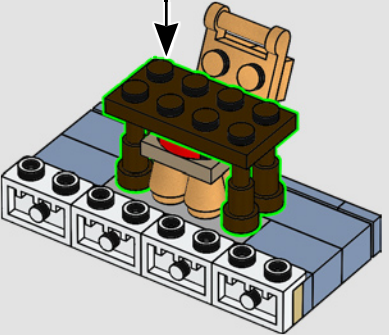
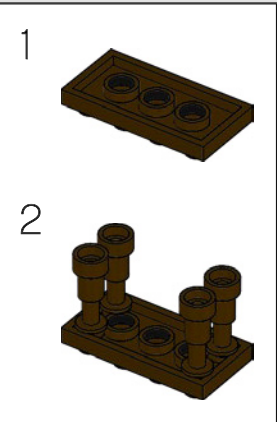

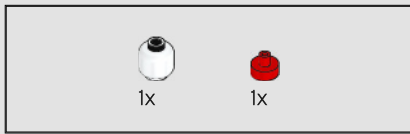

57

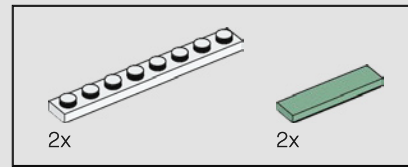
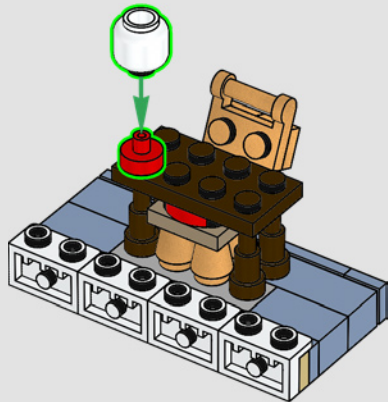

58

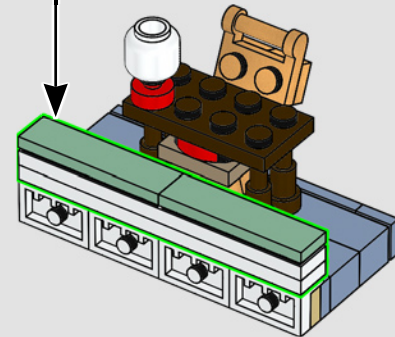
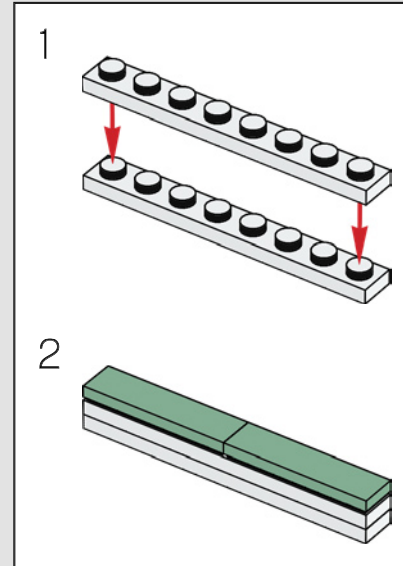



59

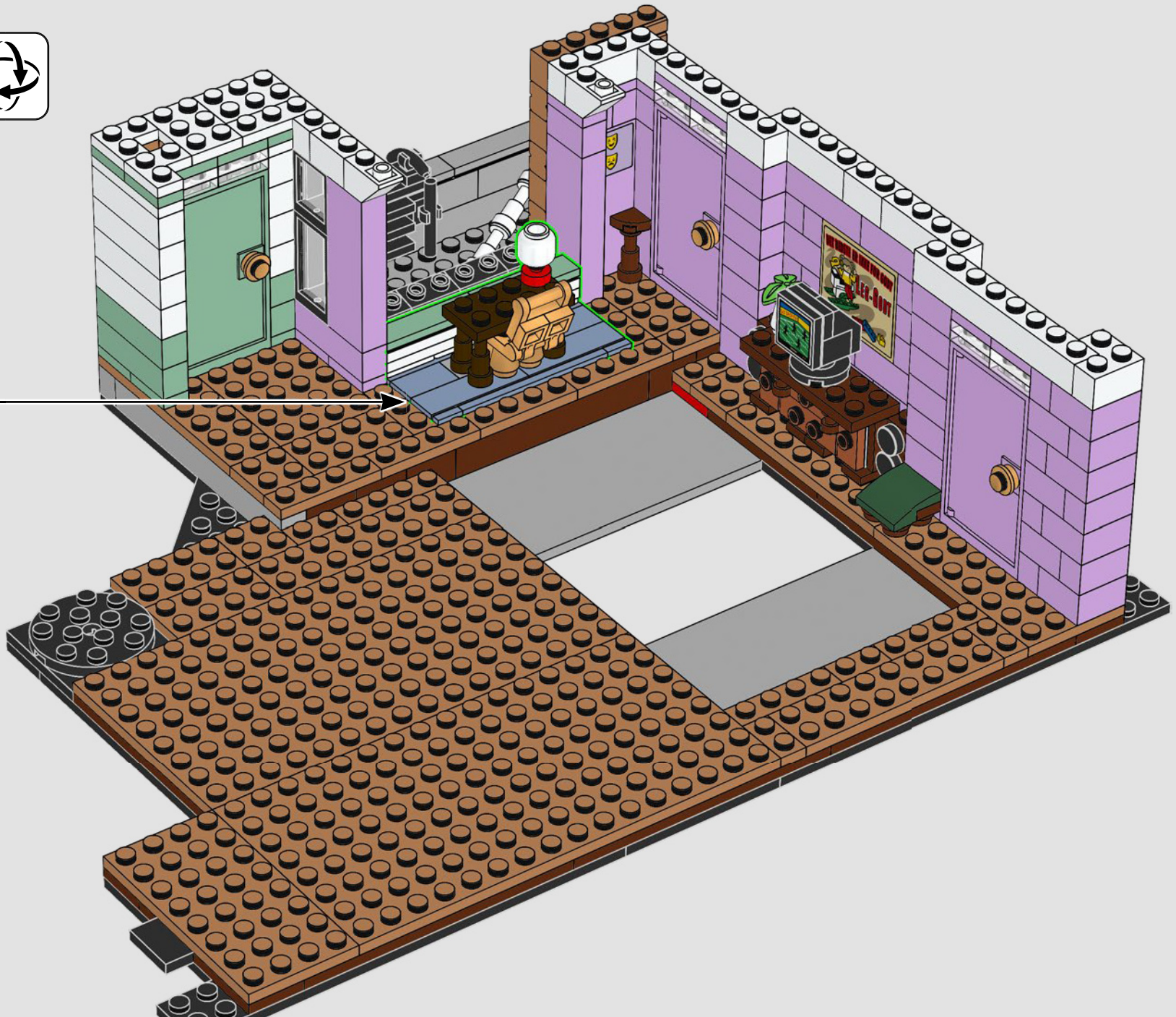

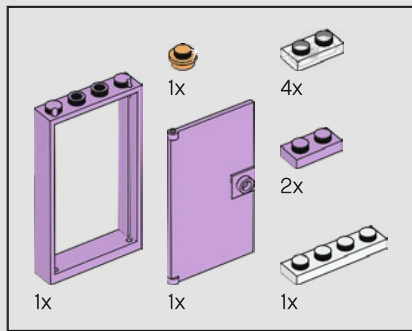

60

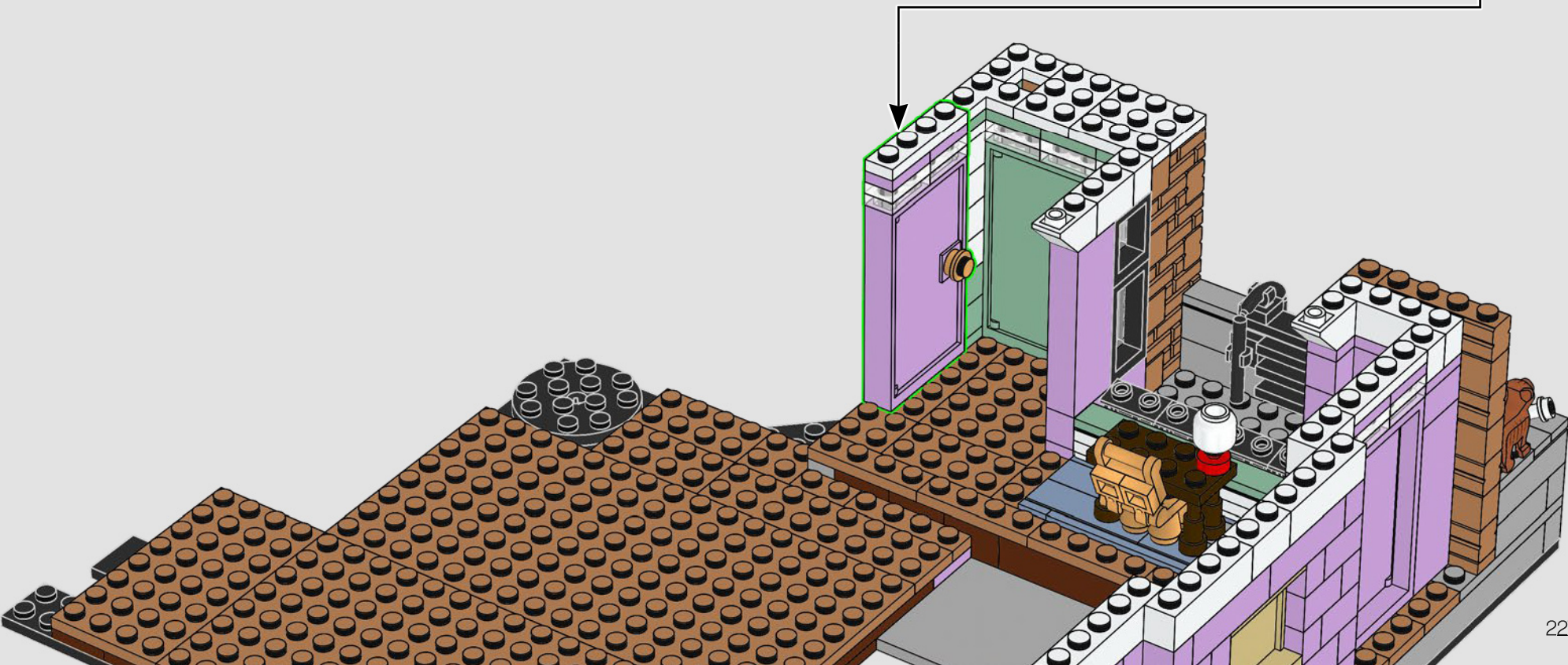
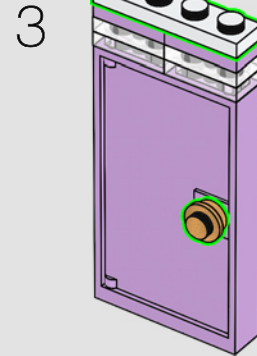
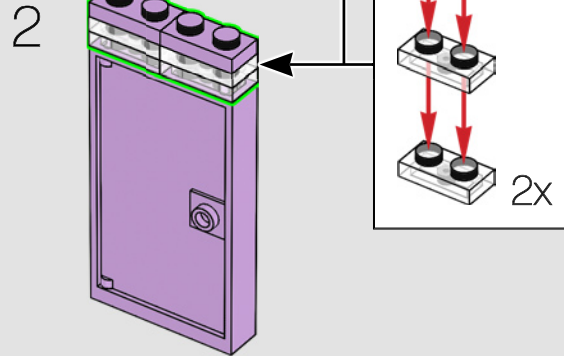
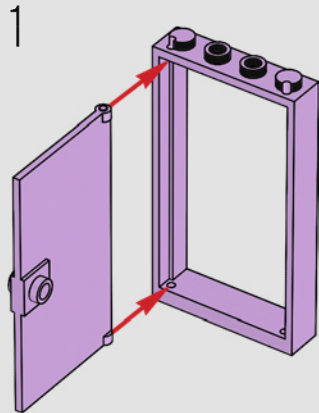

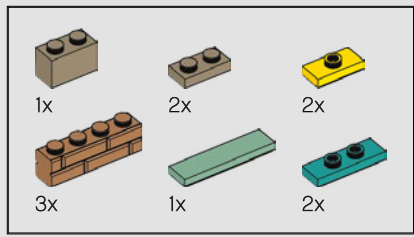

61

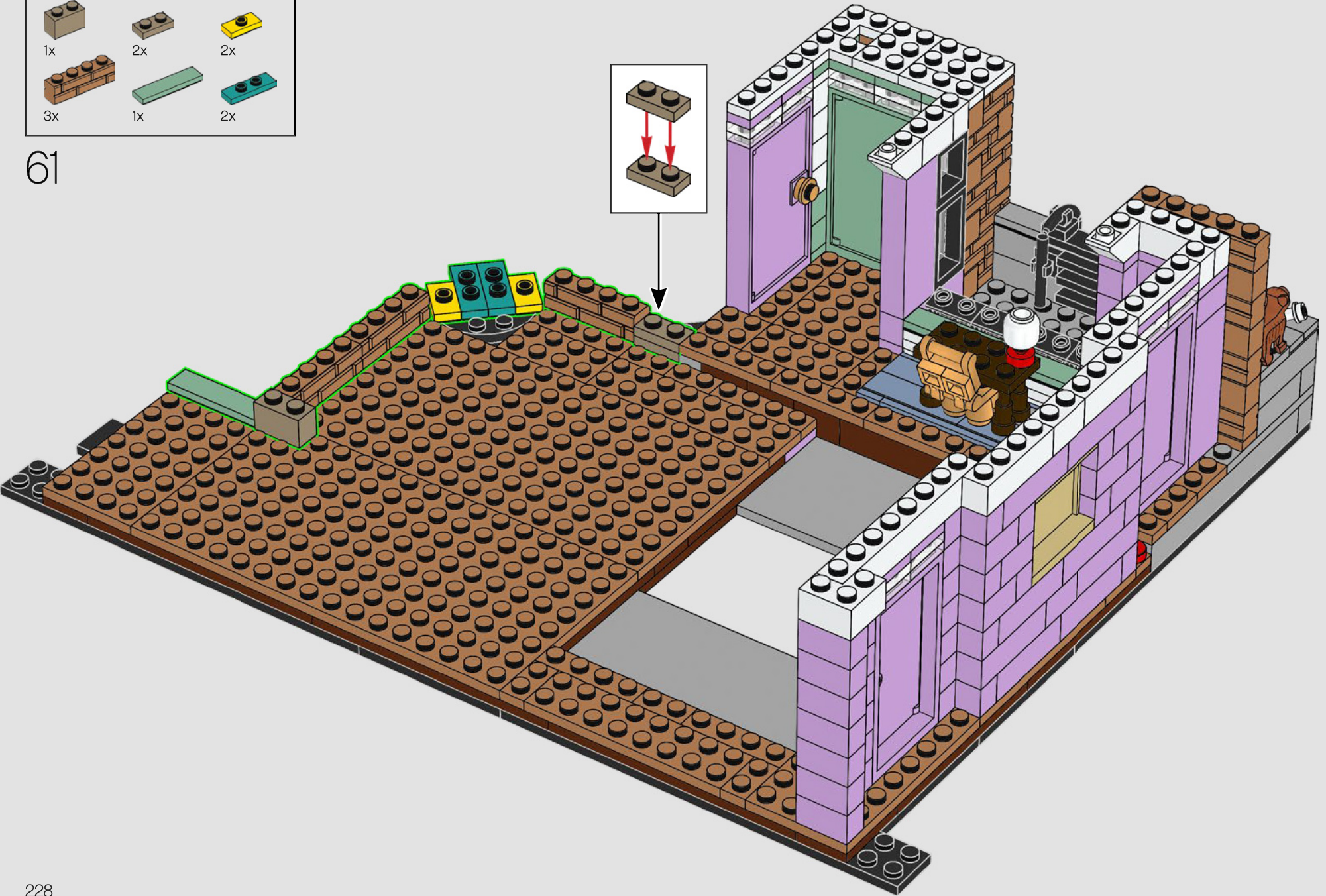
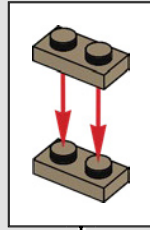

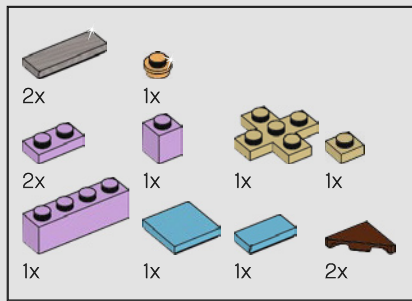

62



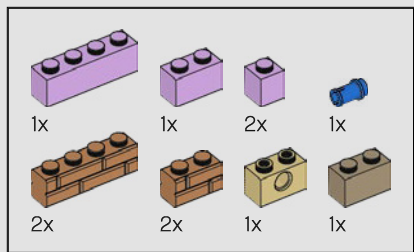

63

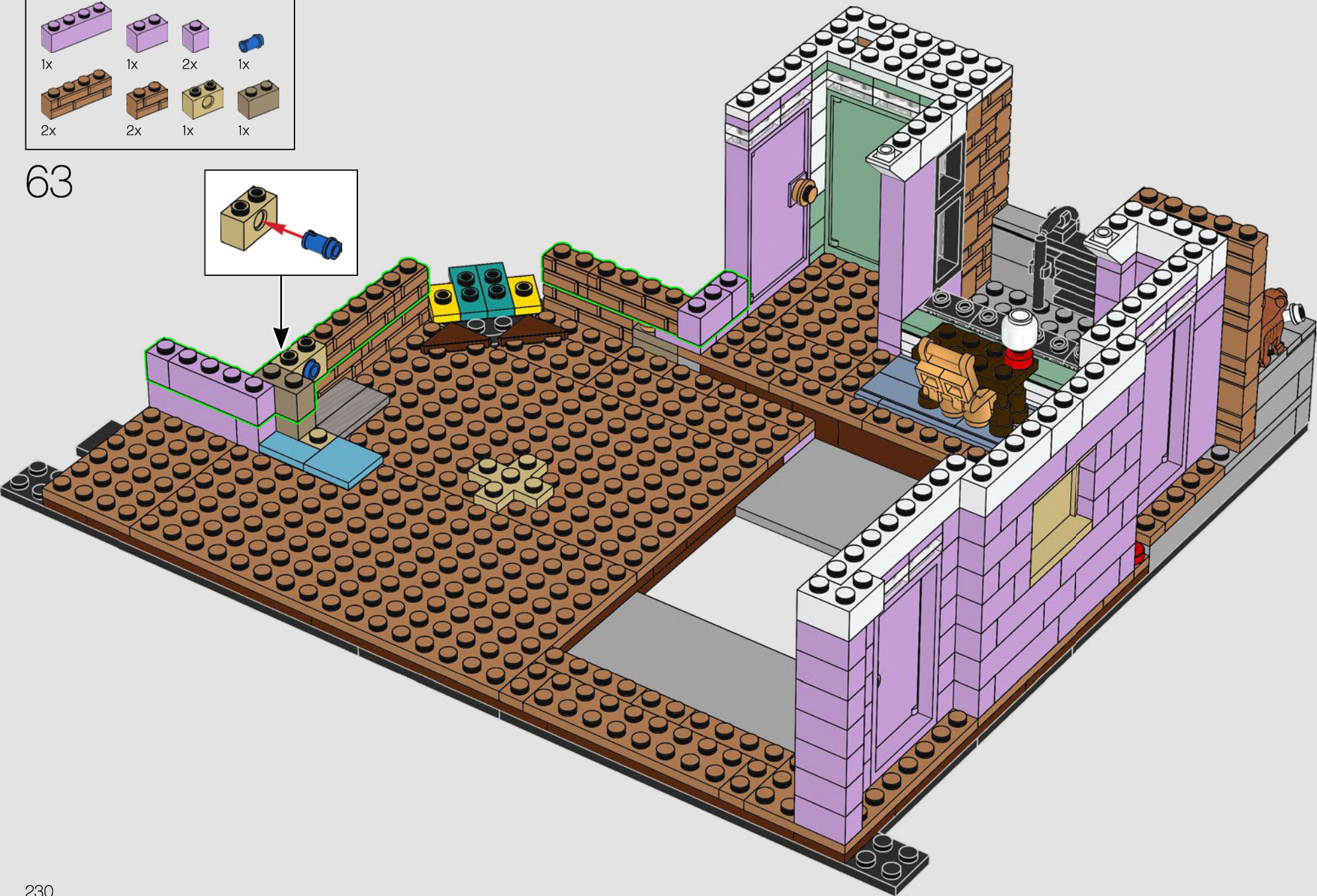
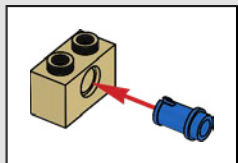

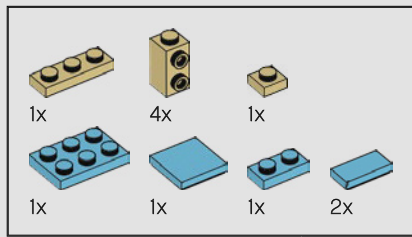

64

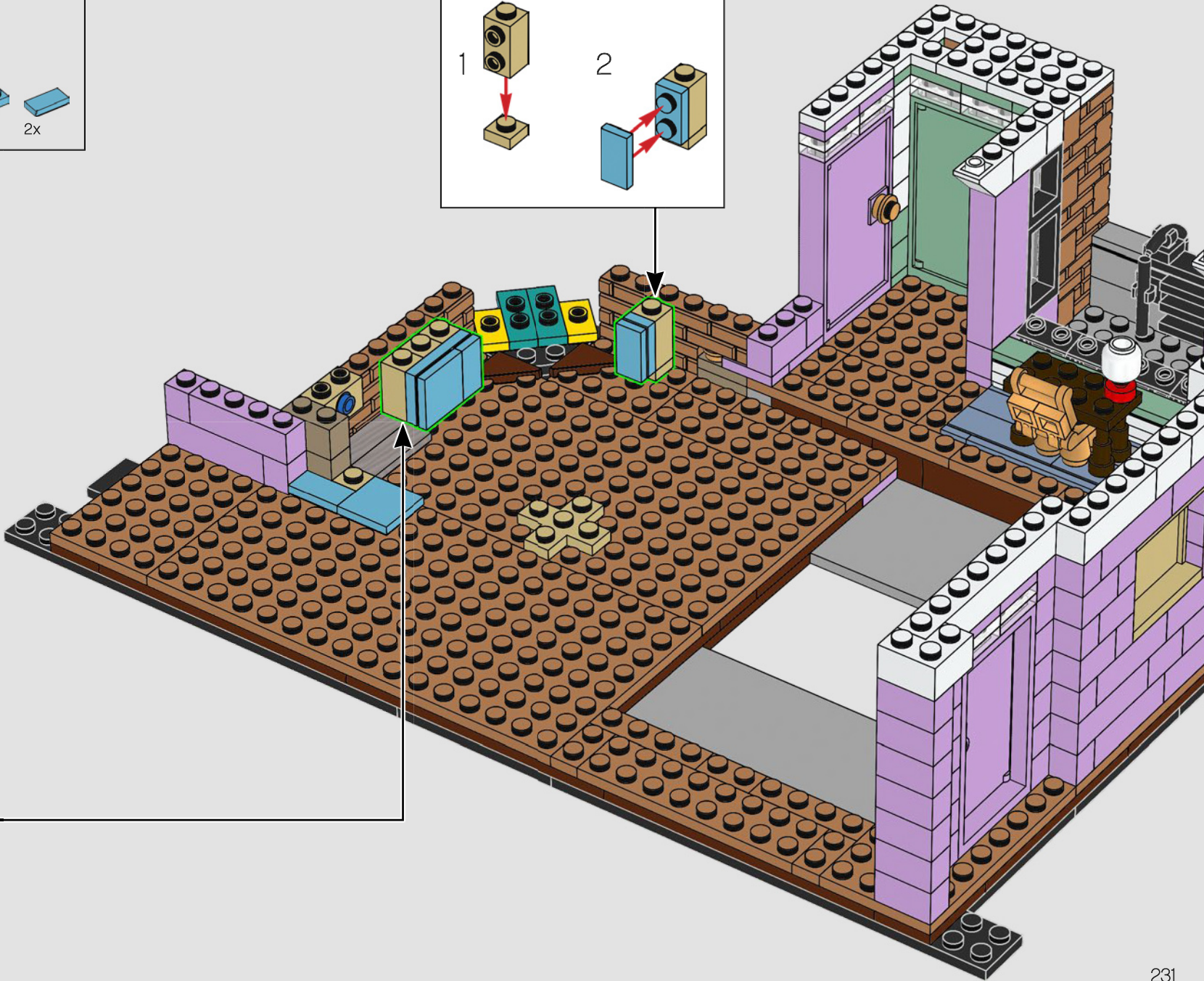
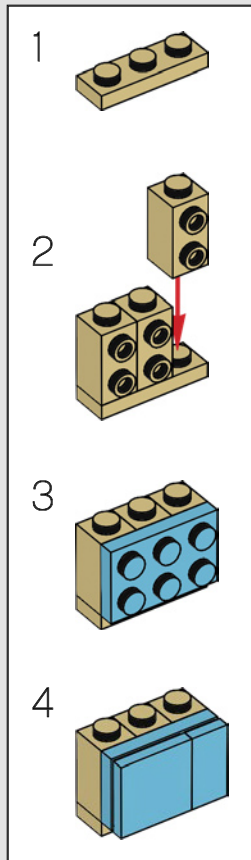
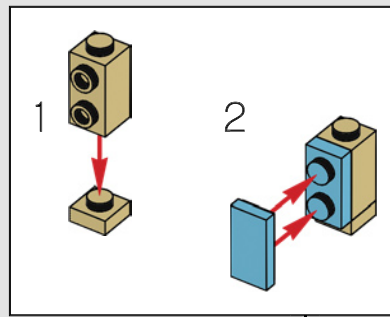

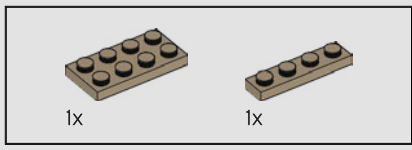

65

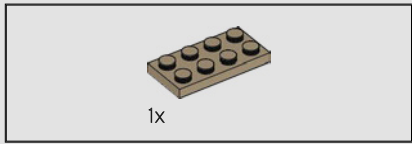
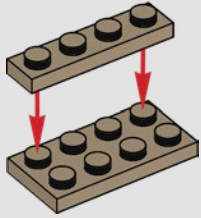

66

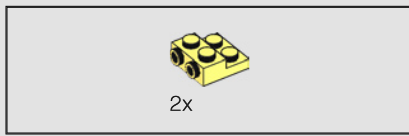
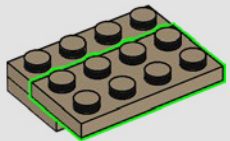

67

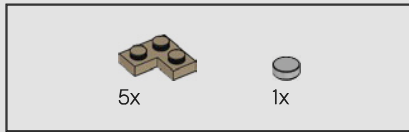
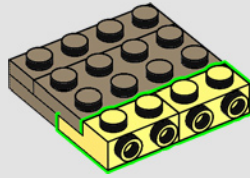

68

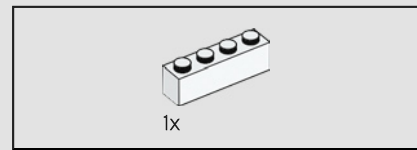
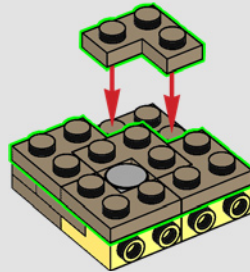

69

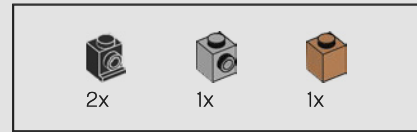
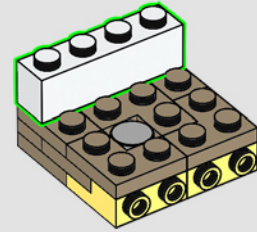

70

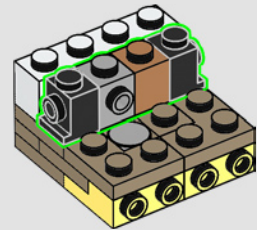



71

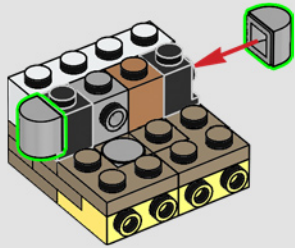

72

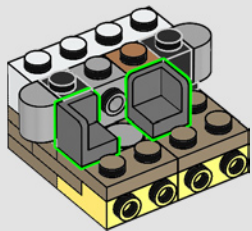

73

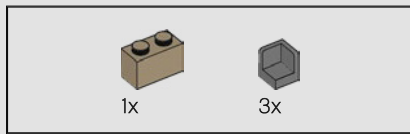
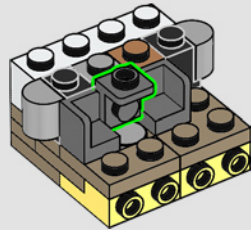

74

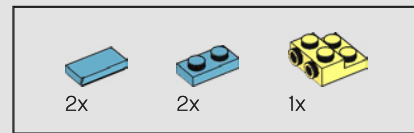
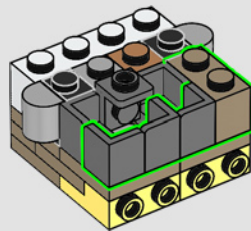

75

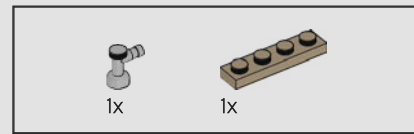
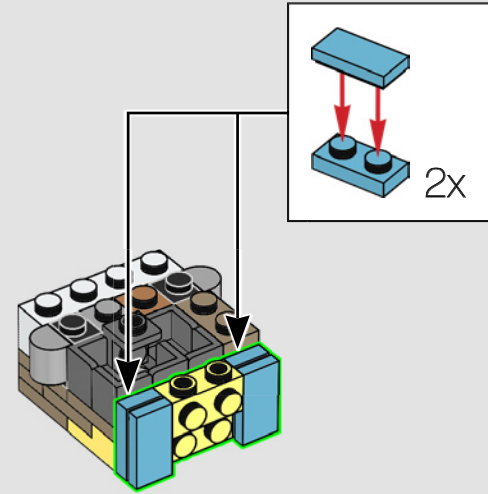

76

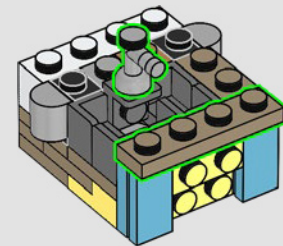

77

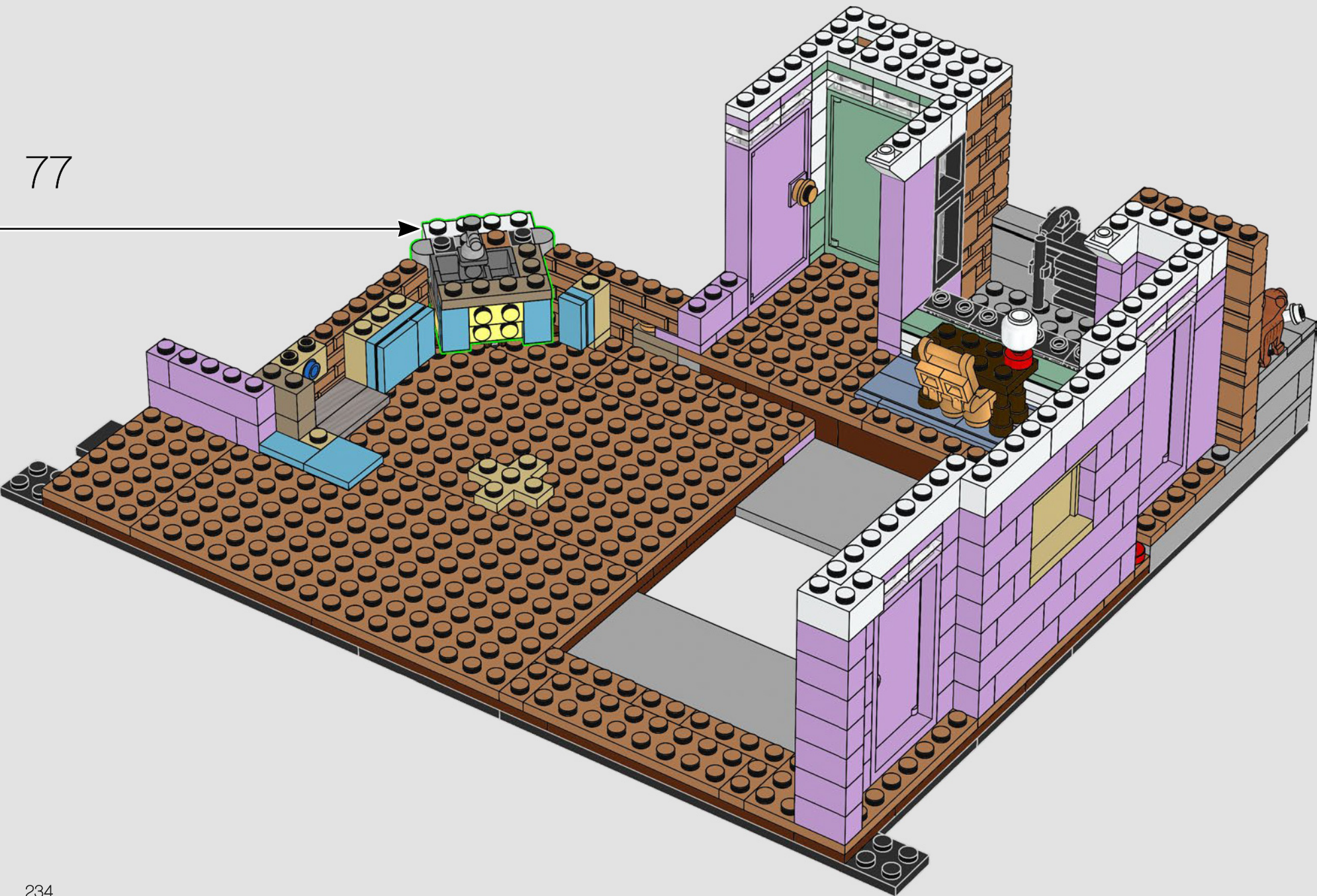

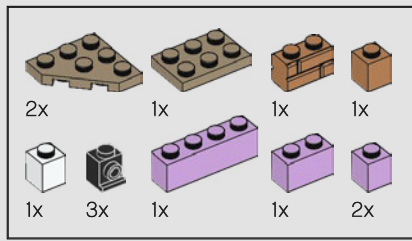

78

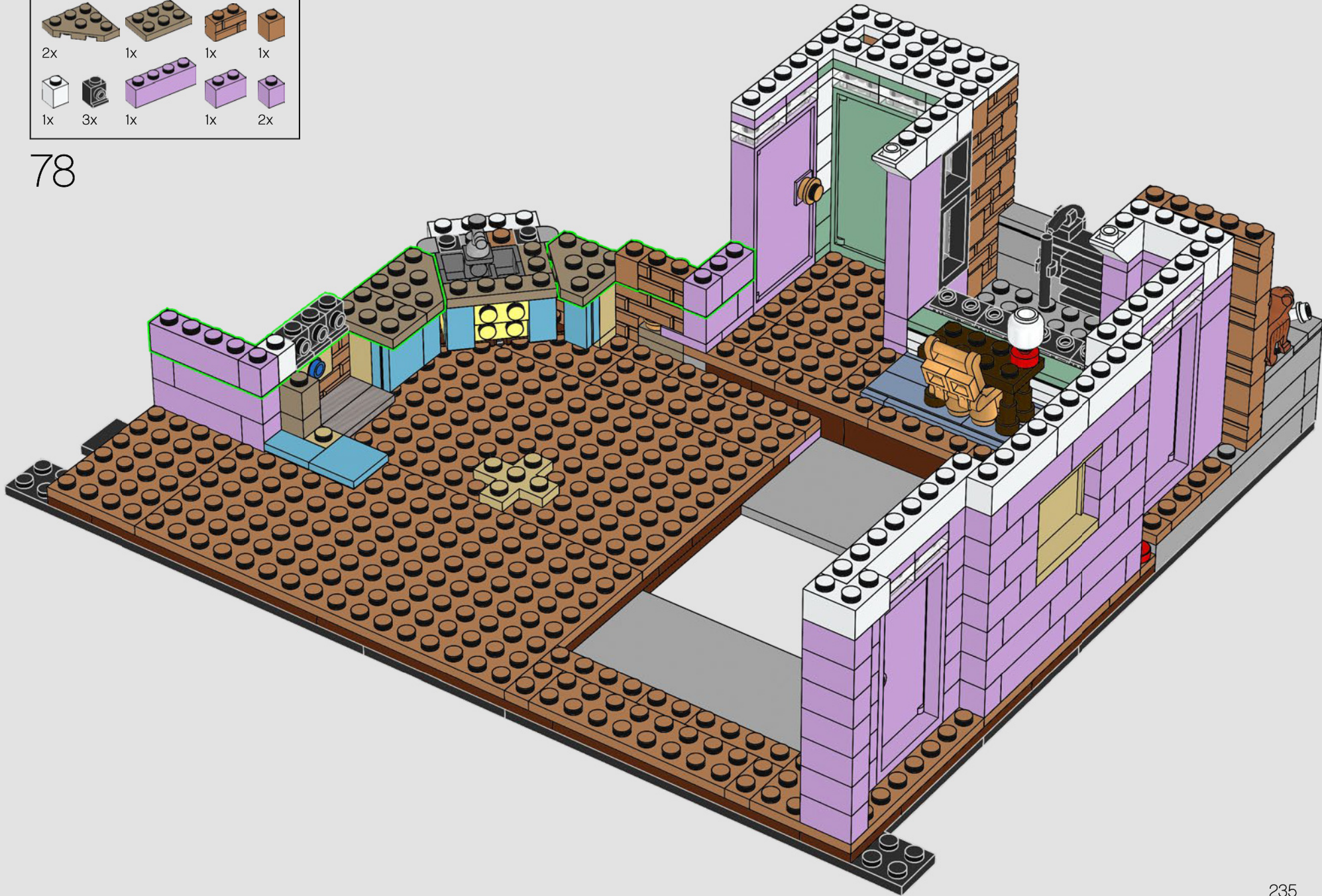

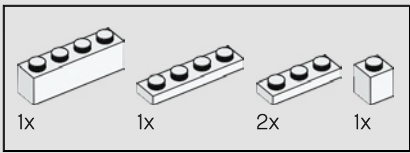

79

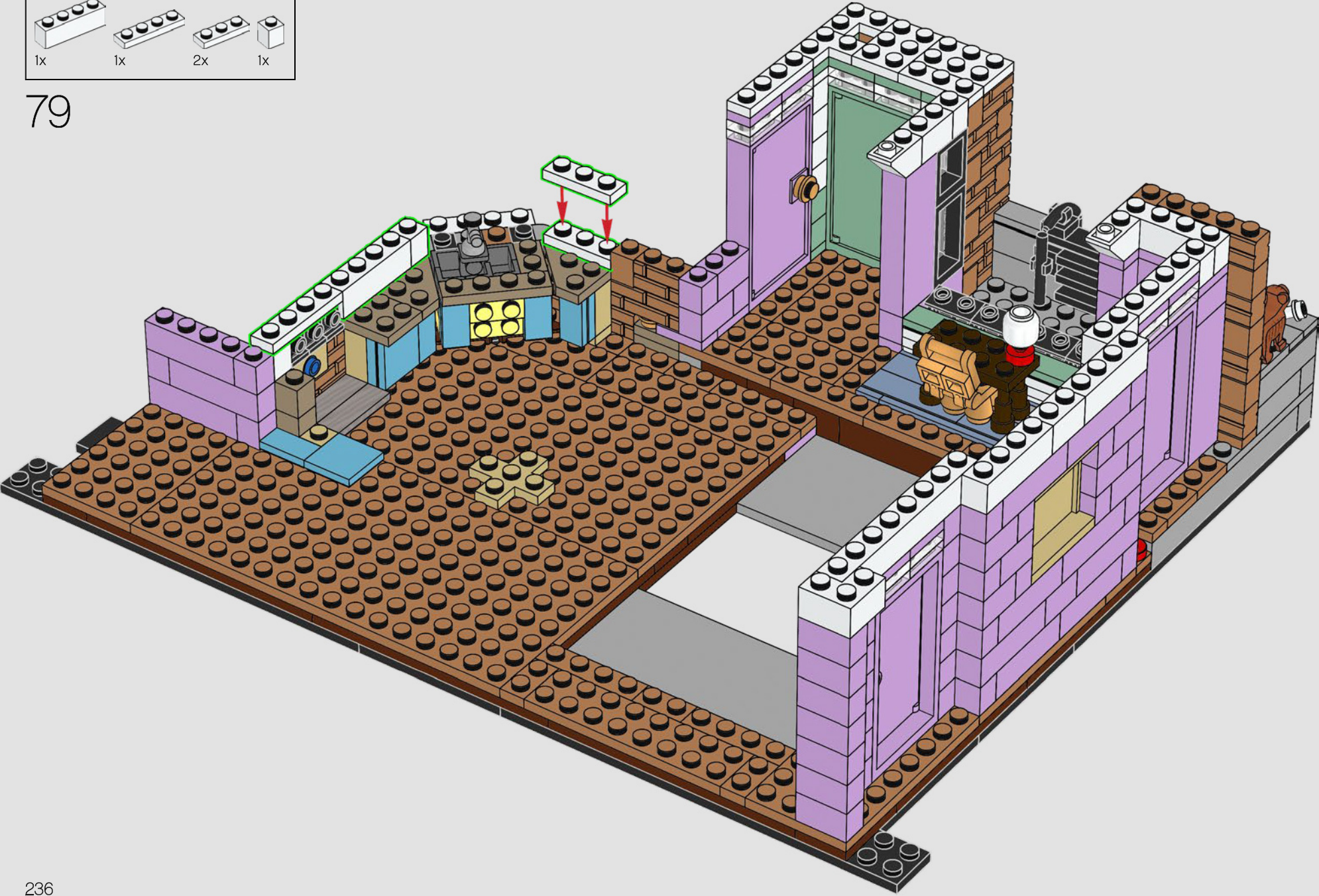

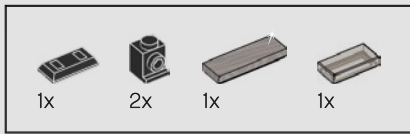

80

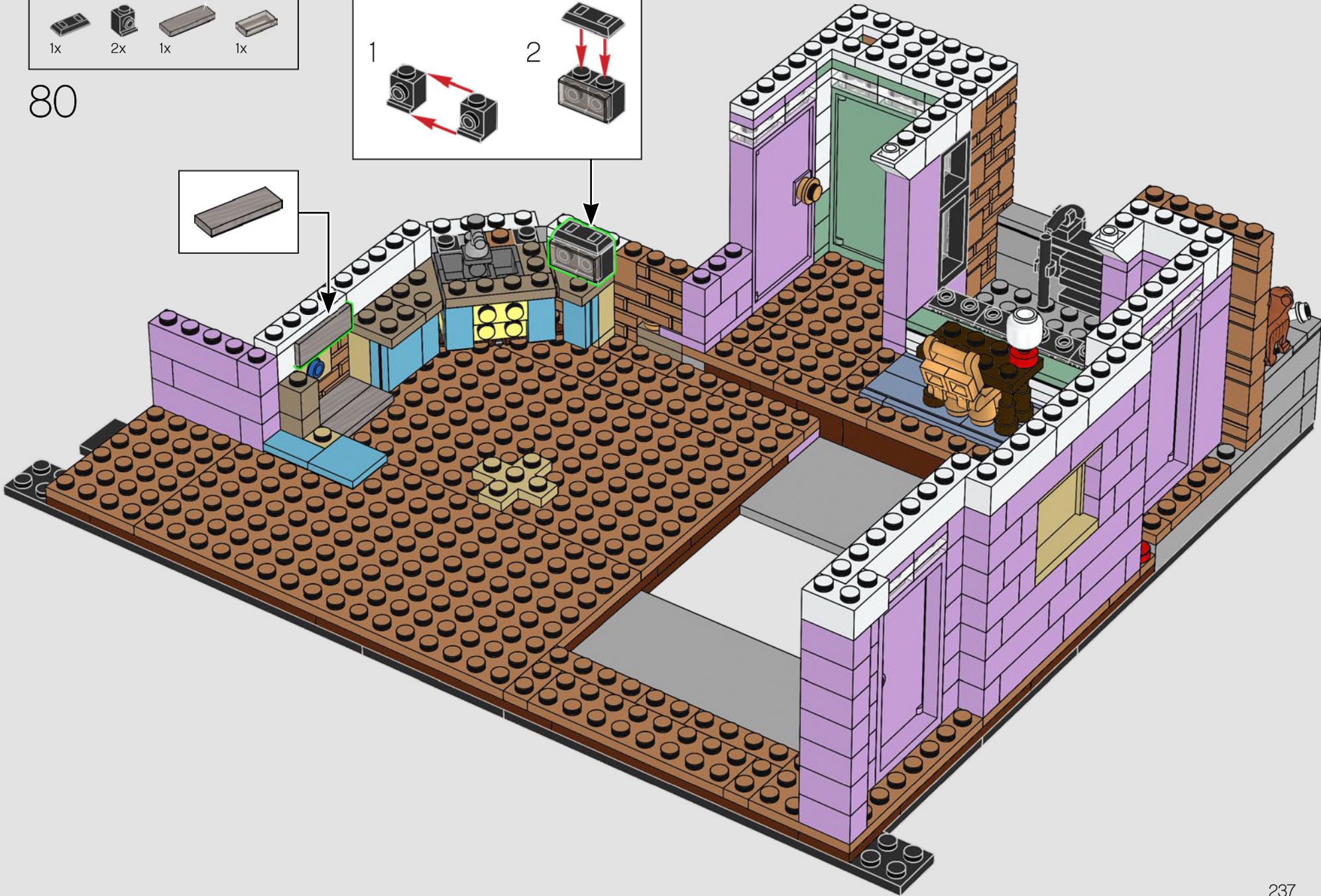
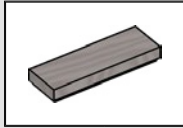
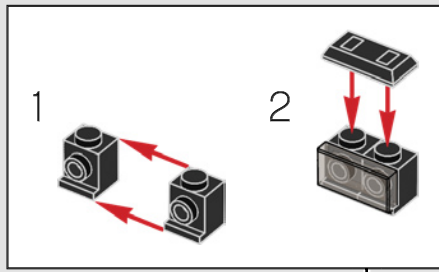

● 菲比色彩多样的手工娃娃屋.....不小心被烧毁了!

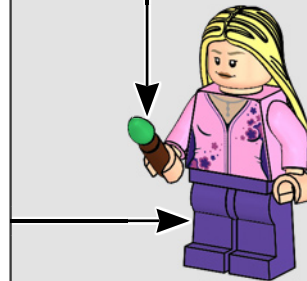
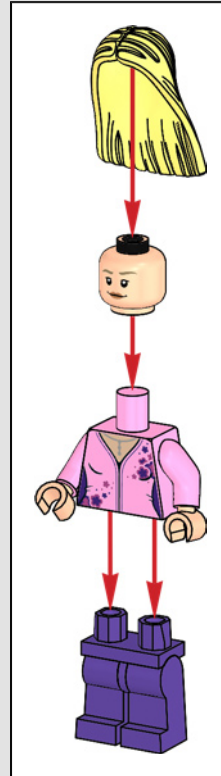
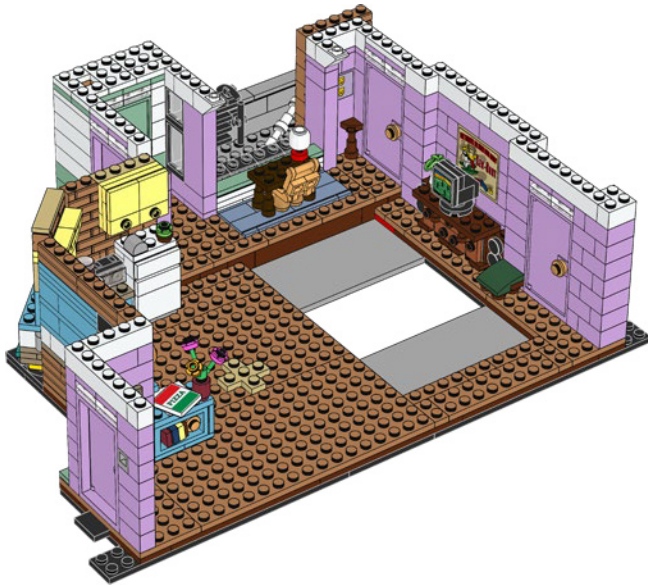
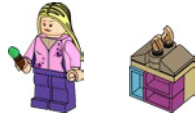
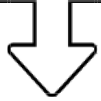

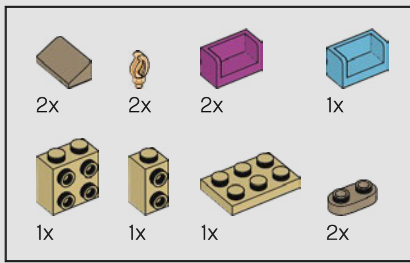

1

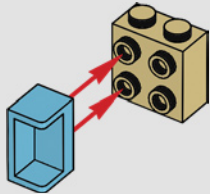

2

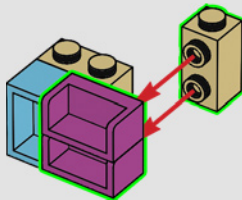

3

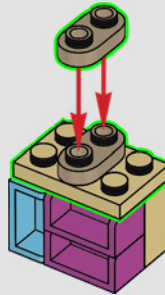

4

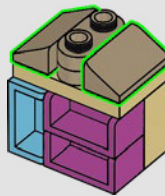

5

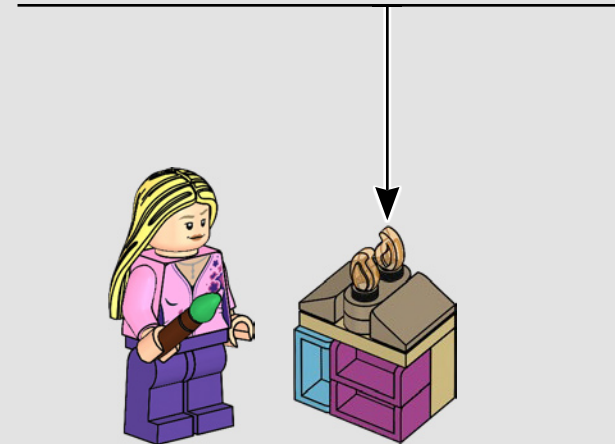
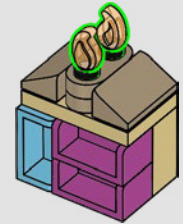

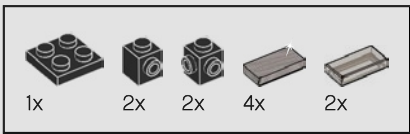

81

1

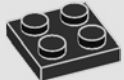

2

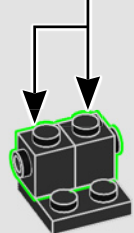

3

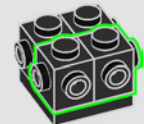

4

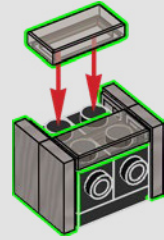

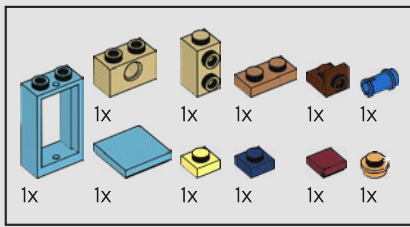

82

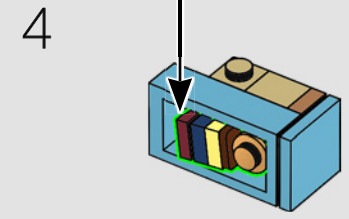
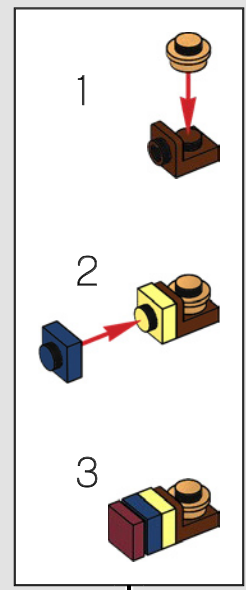
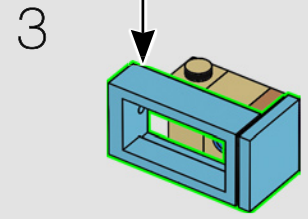
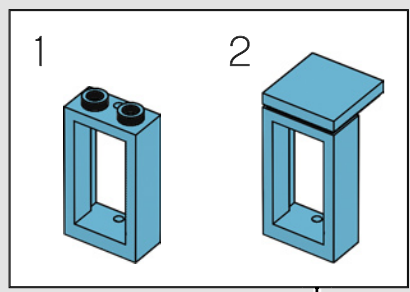
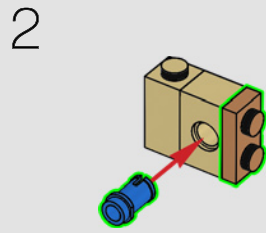
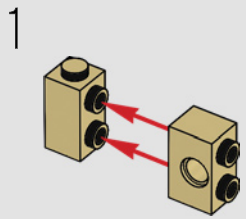

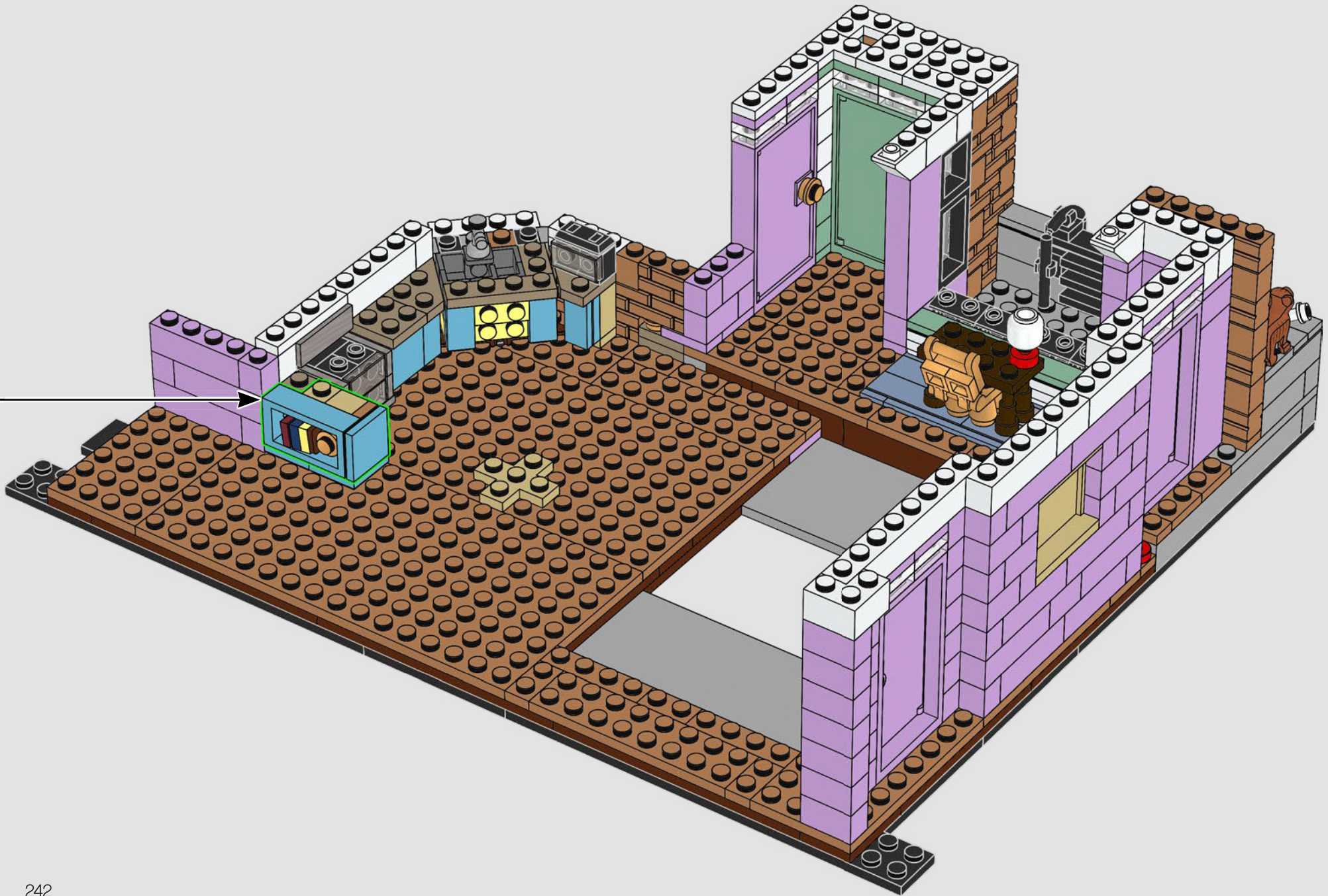

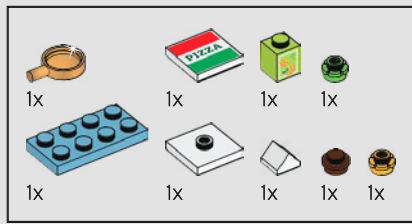

83

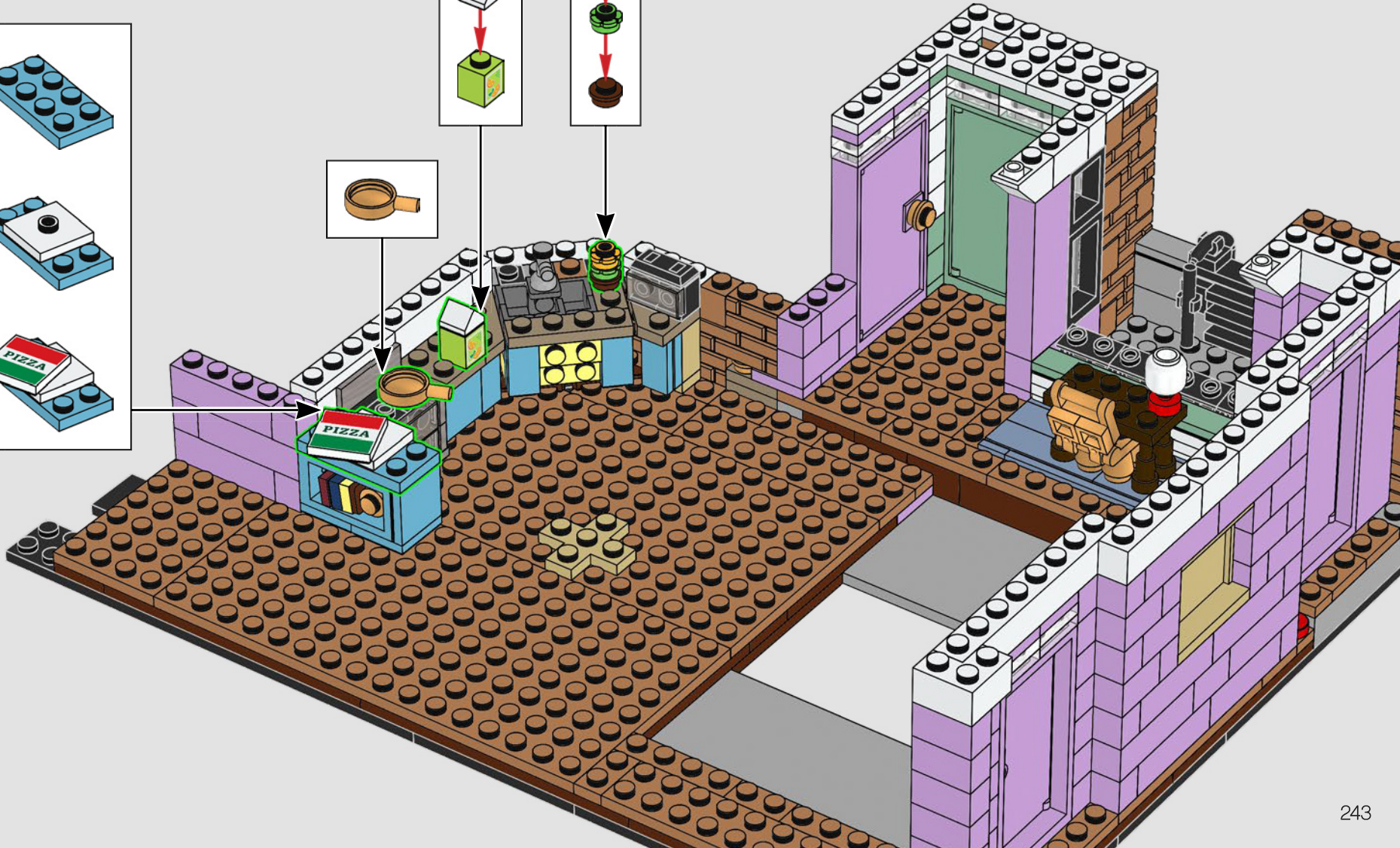
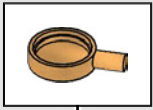
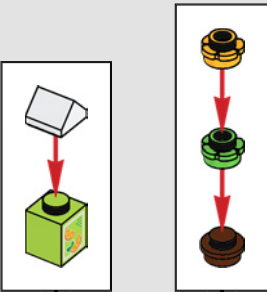
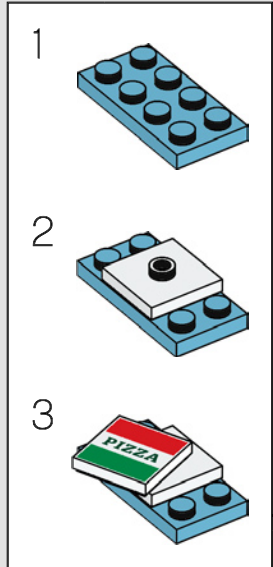

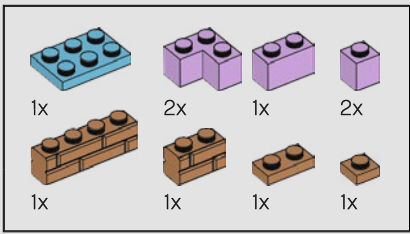

84

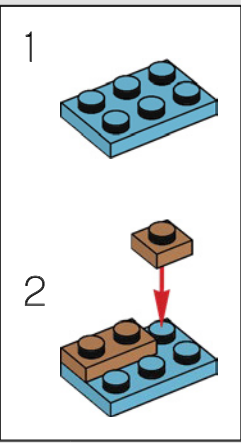

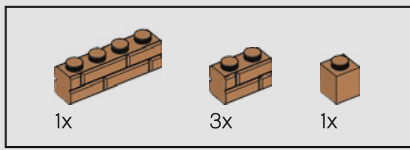

85

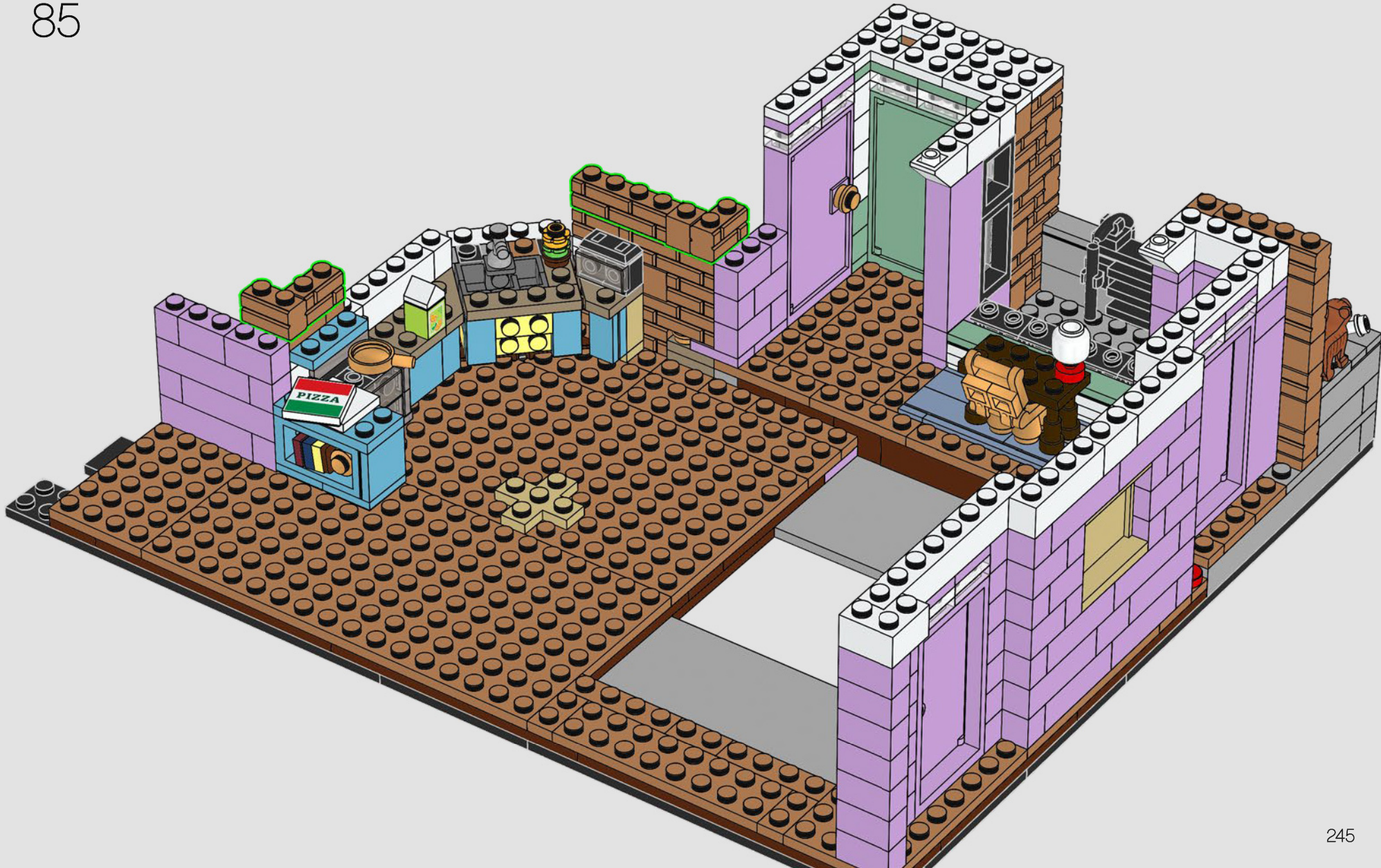

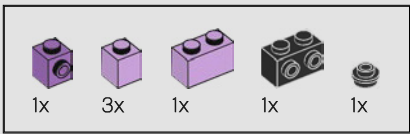

86

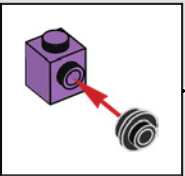

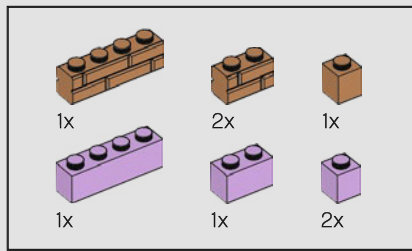

87



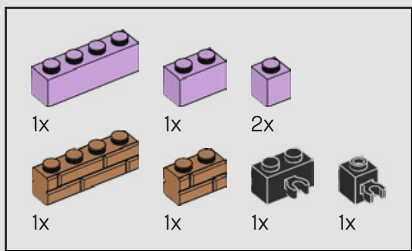

88



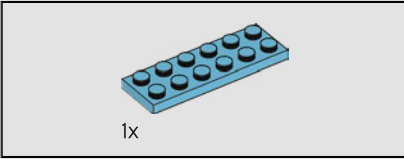
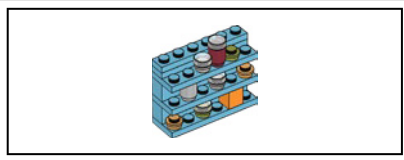

1x

89

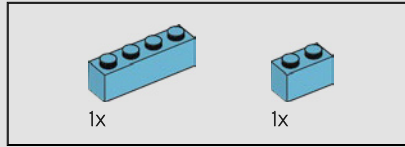
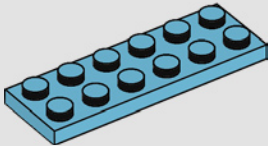

1x

1x

90

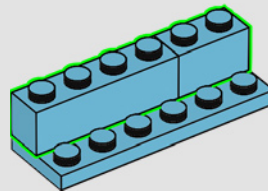

1x

1x

1x

1x

91

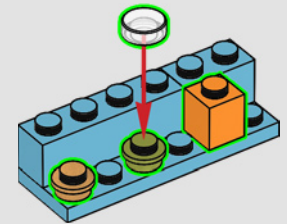

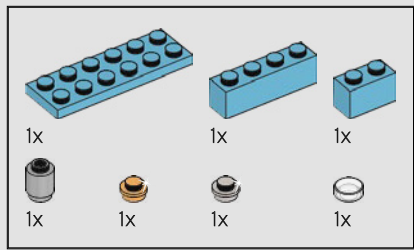

92

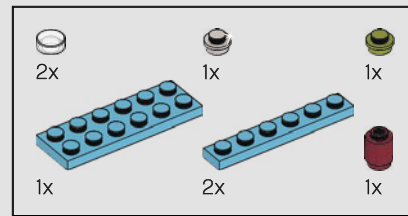
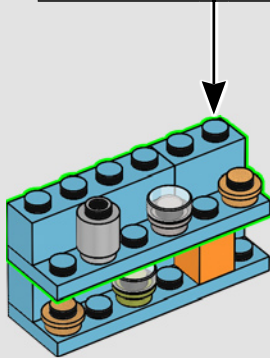
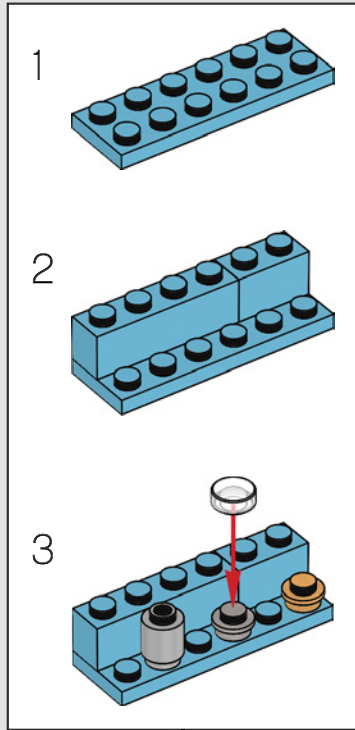

93

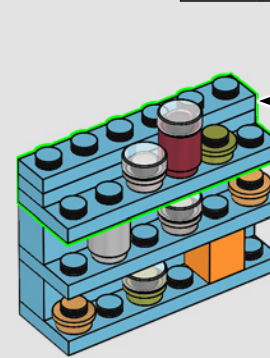
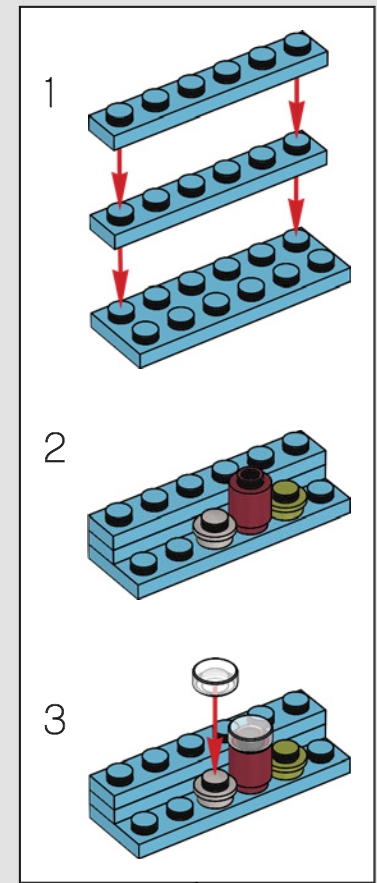

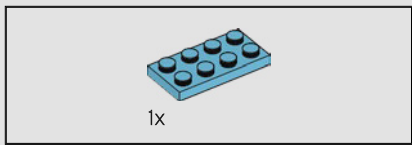

95

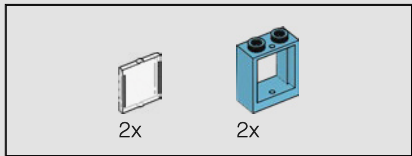
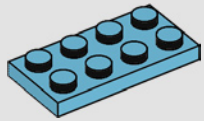

96

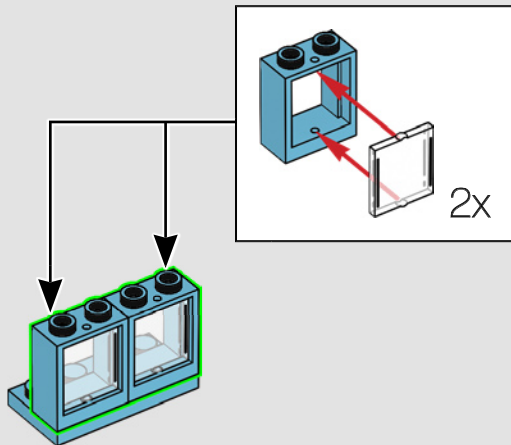

97

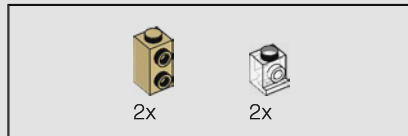
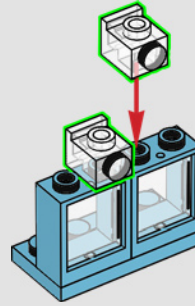

98

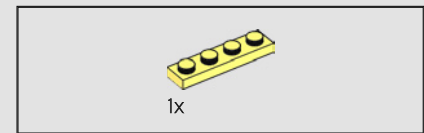
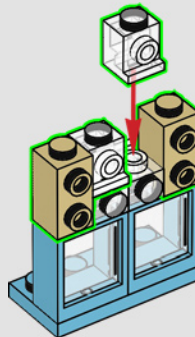

99

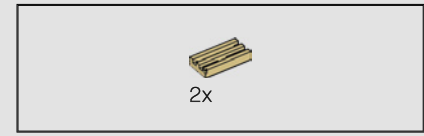
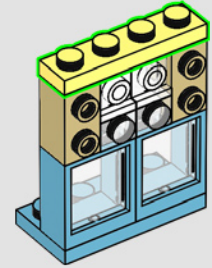

100

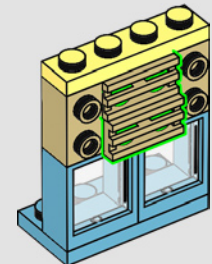

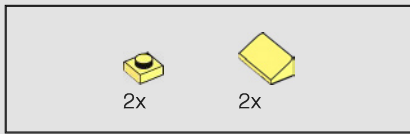

101

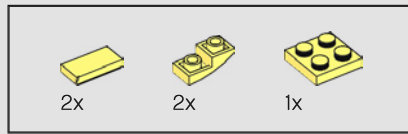
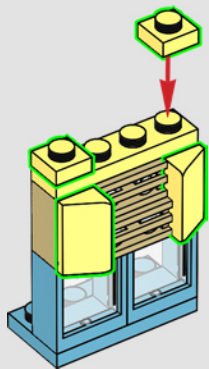

102

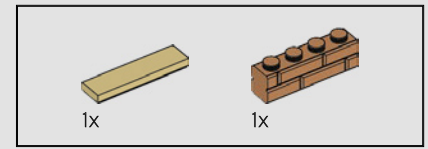
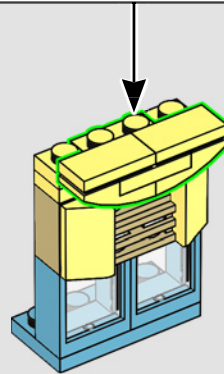
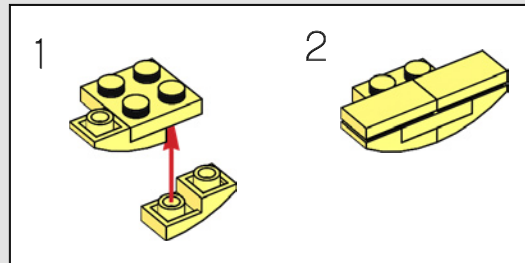

103

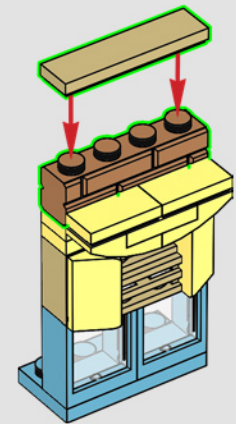

104

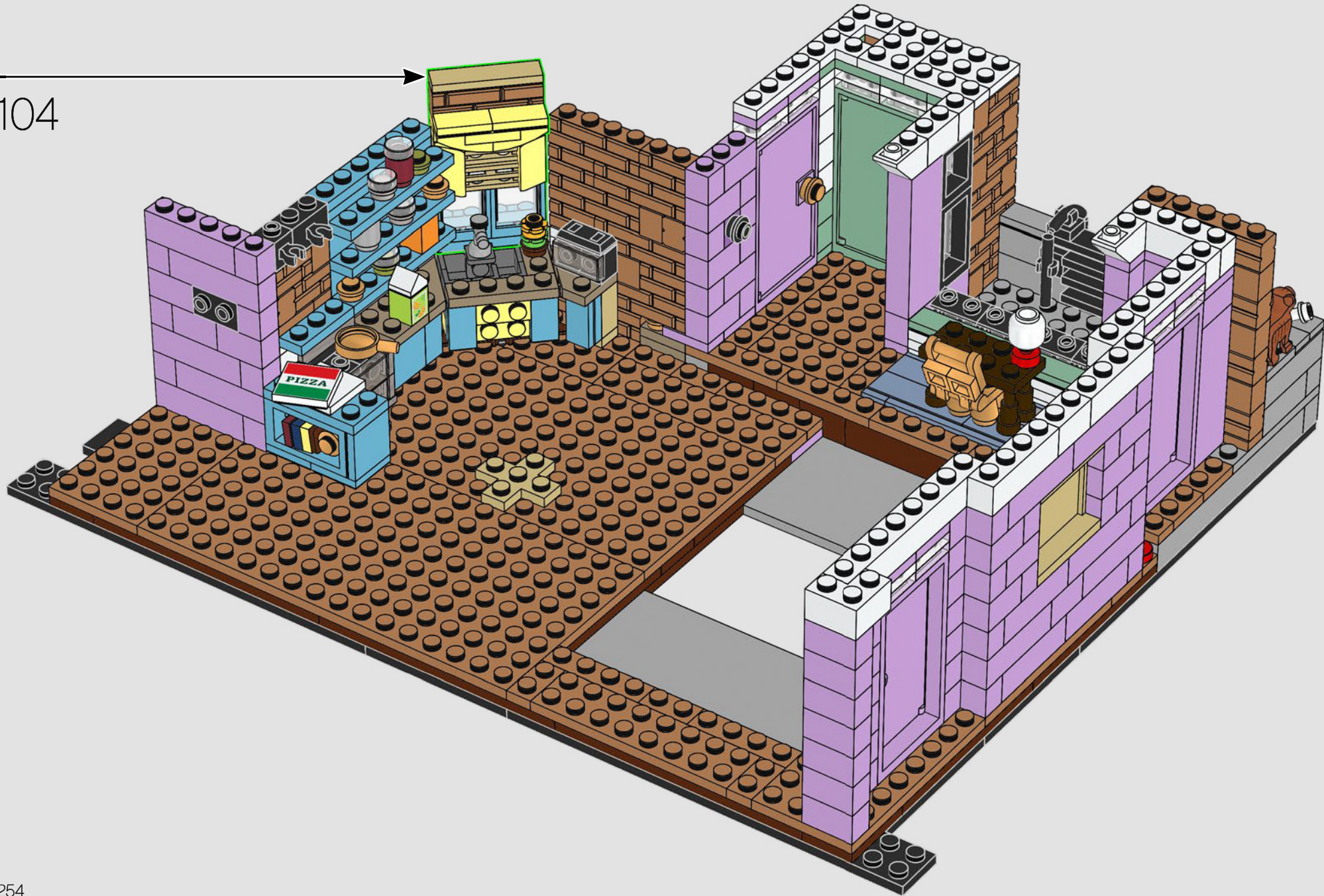

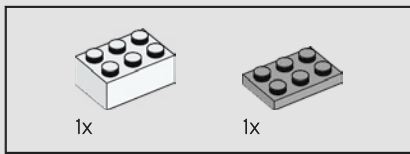

105

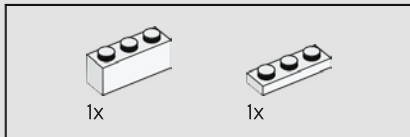
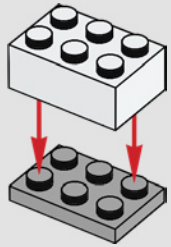

106

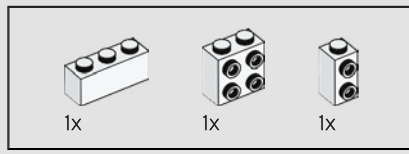
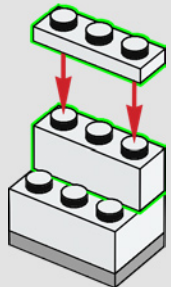

107

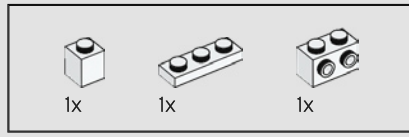
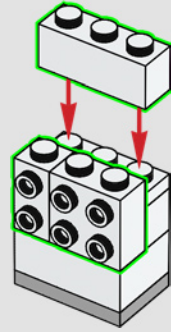

108

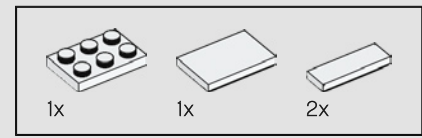
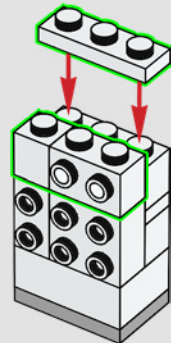

109

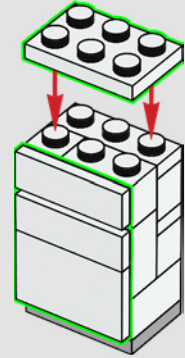

110

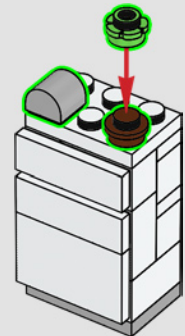

111

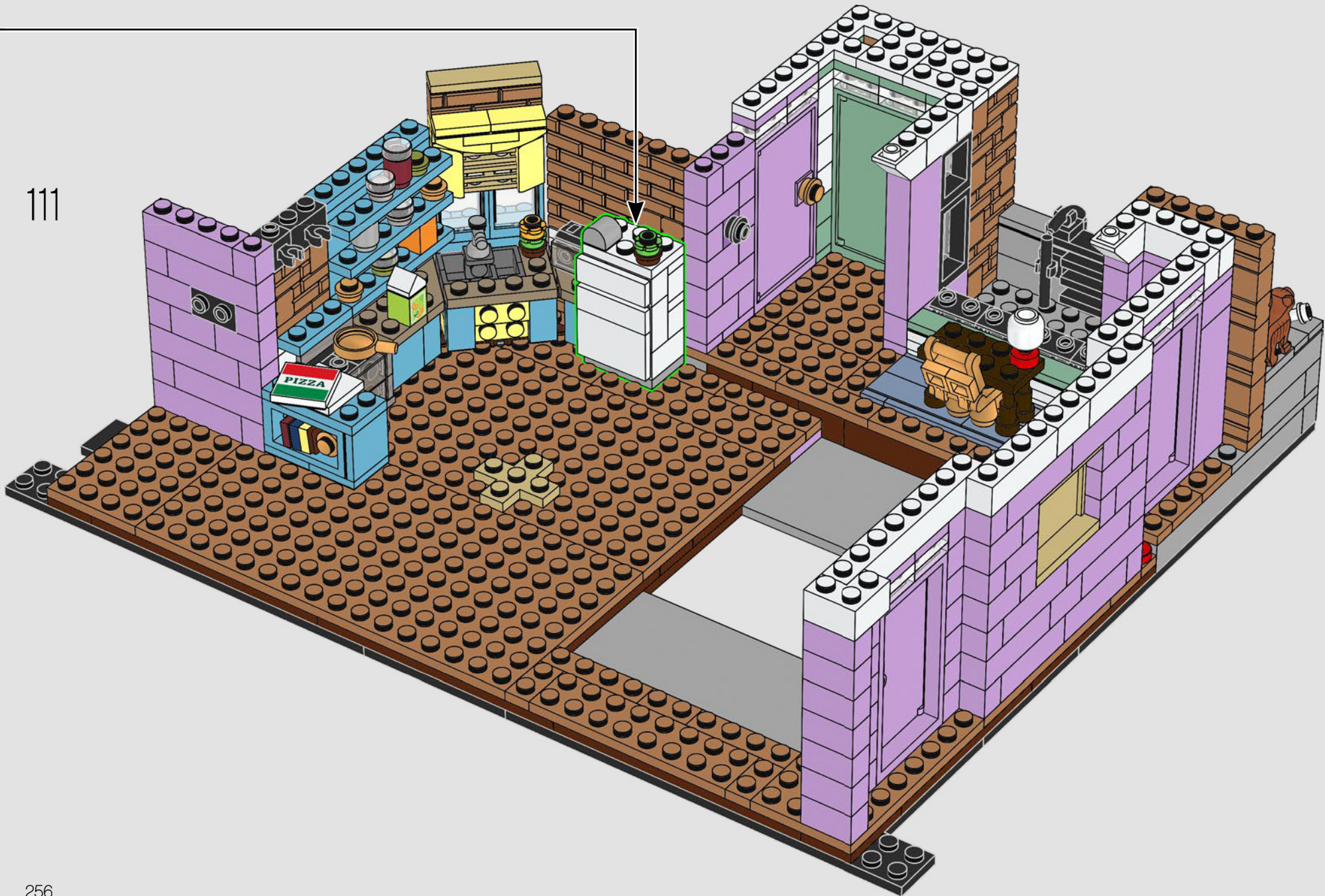

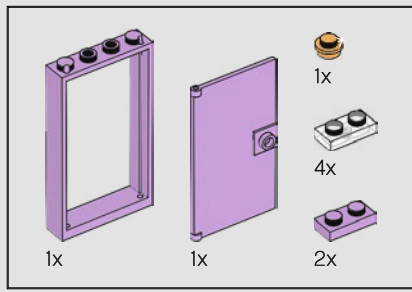

112

1

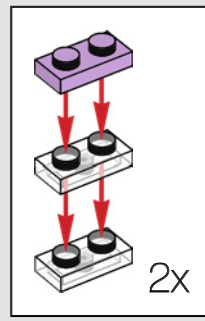
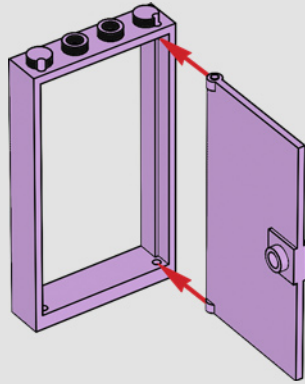

2

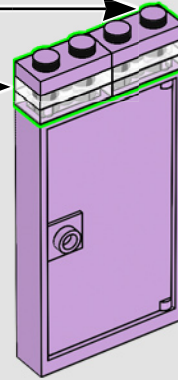

3

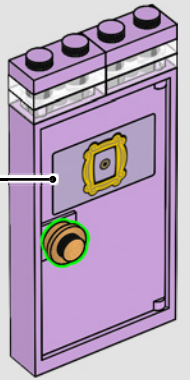

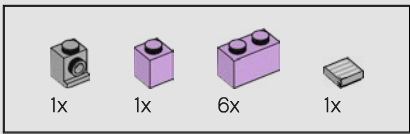

113

1

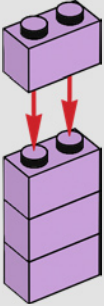

2

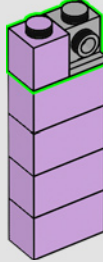

3

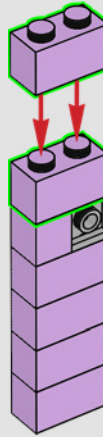

4

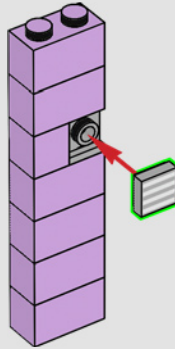

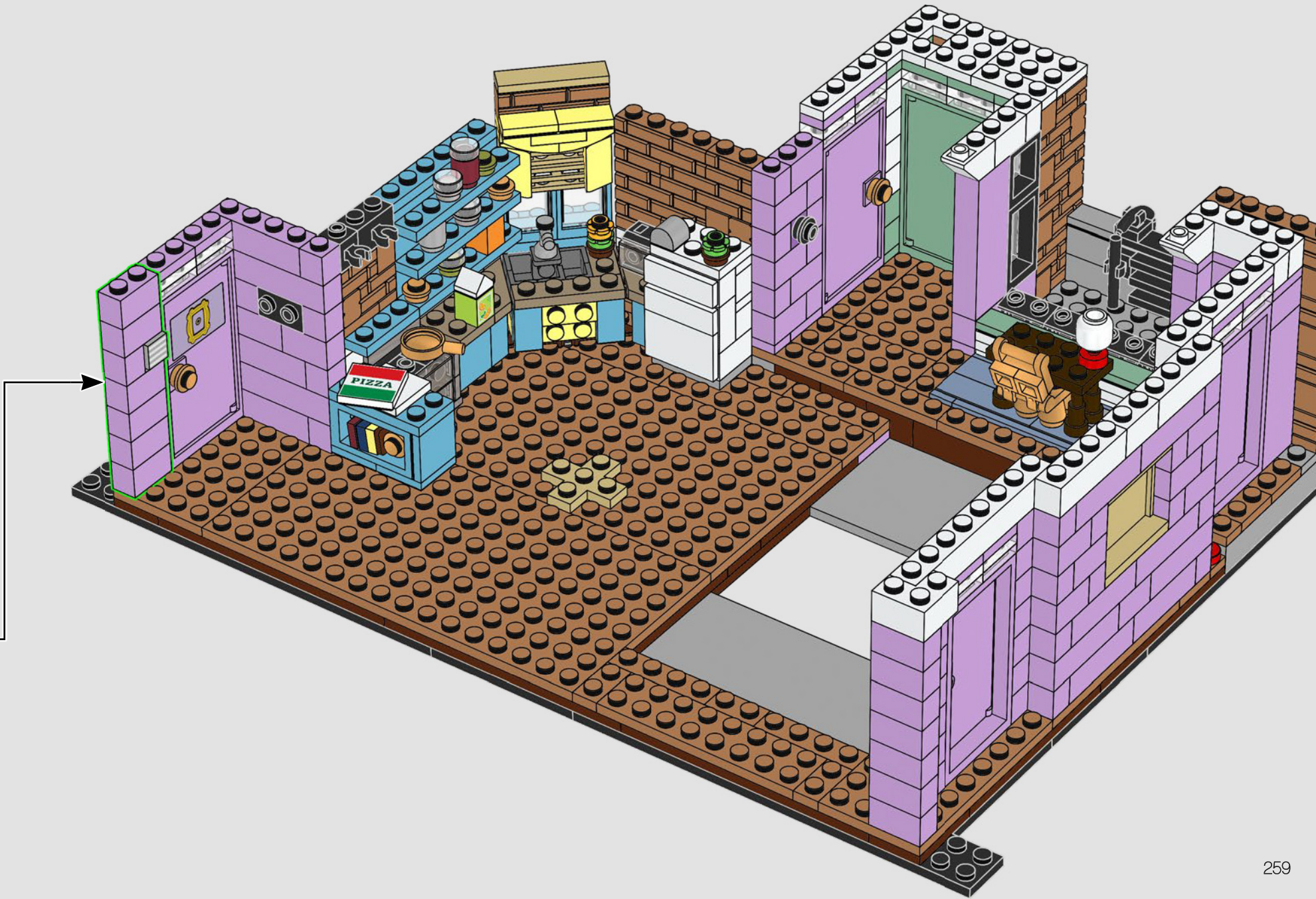

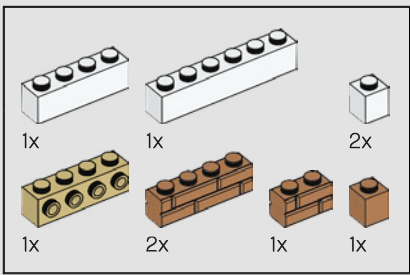

114



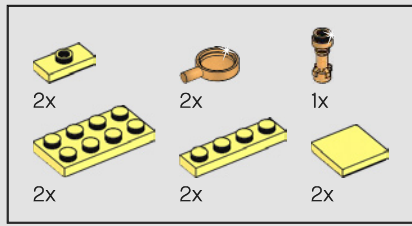

115

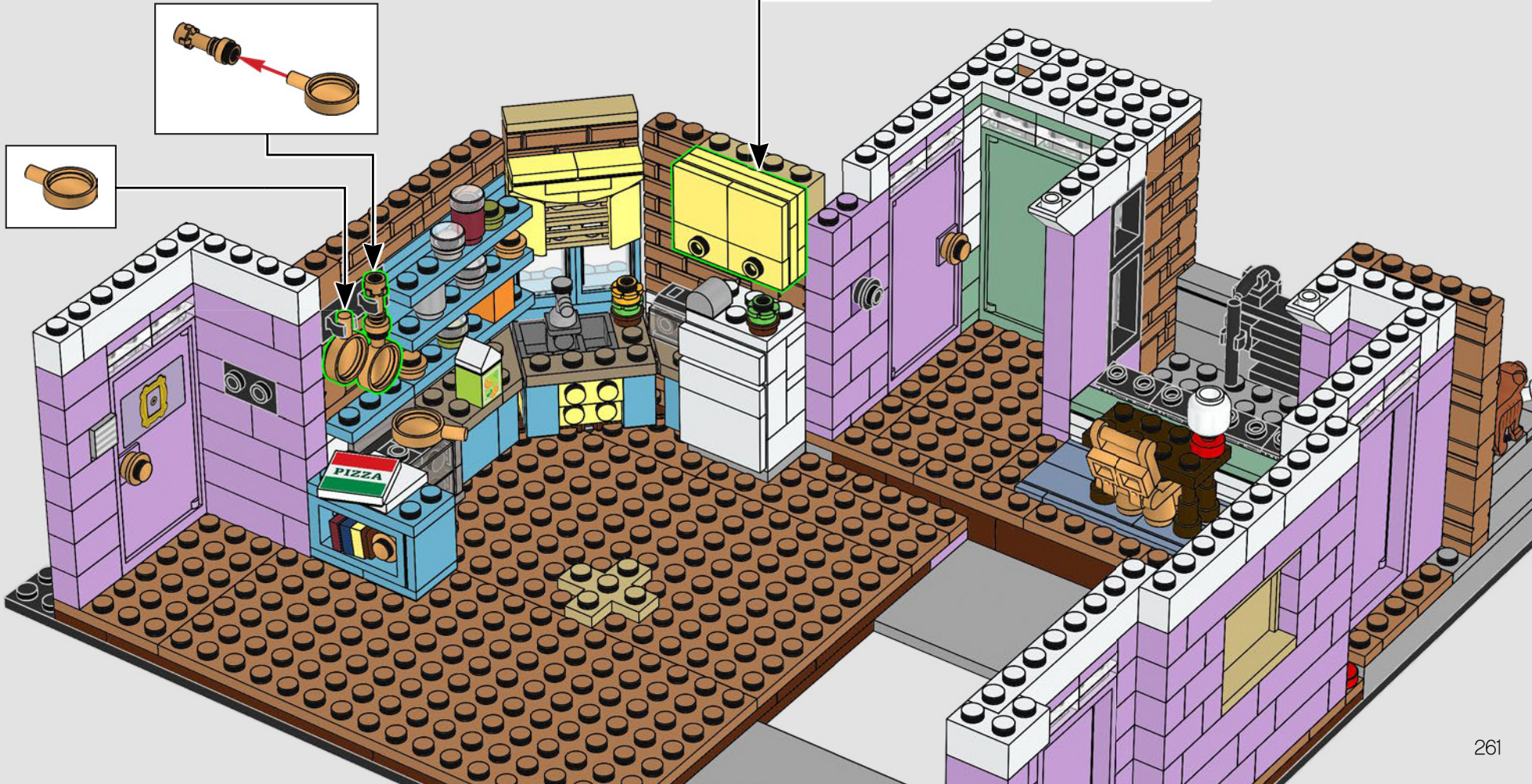
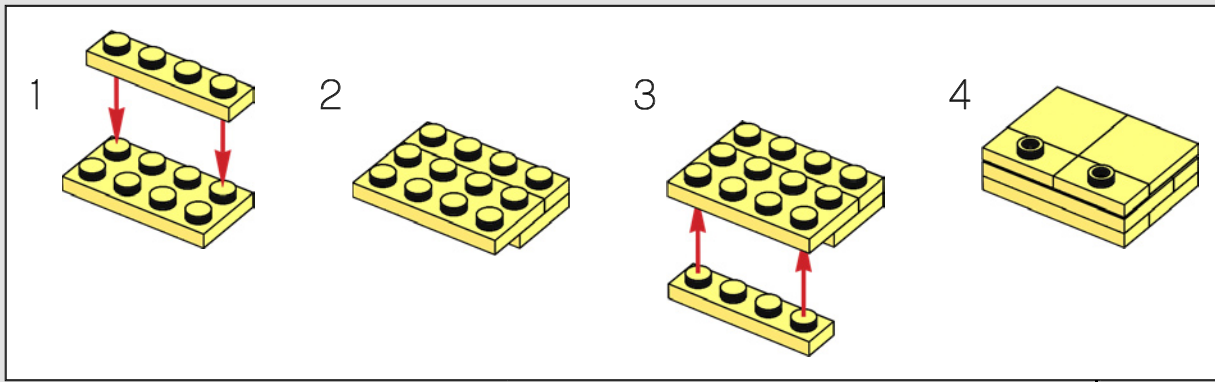



116

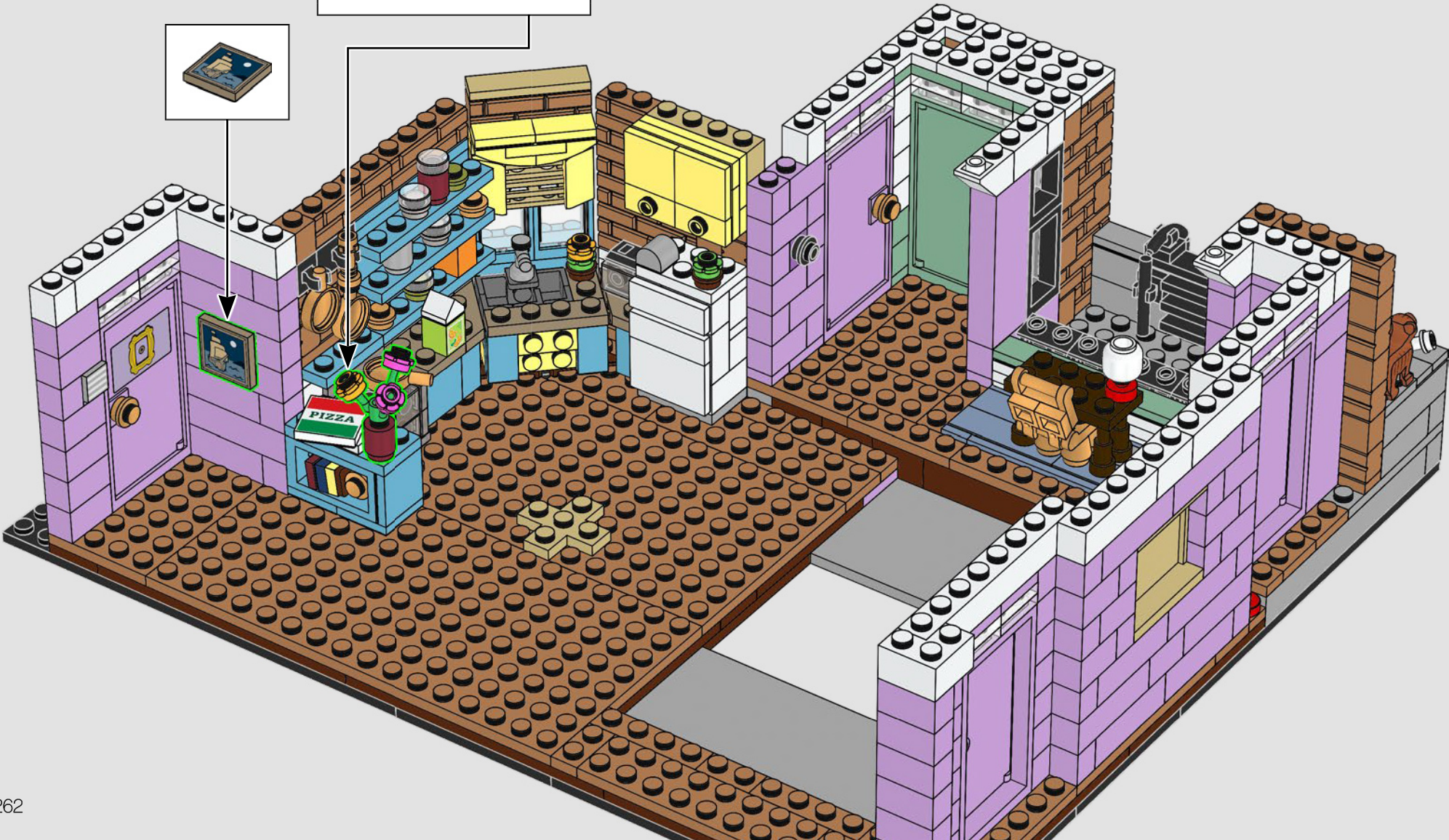
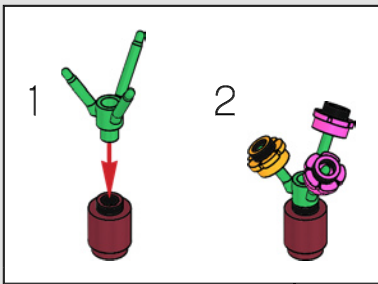

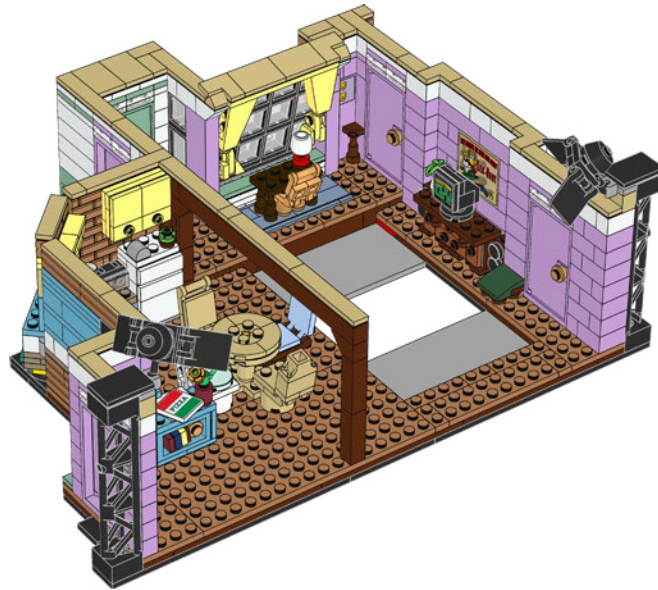

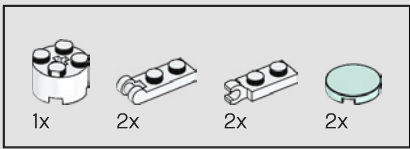

117

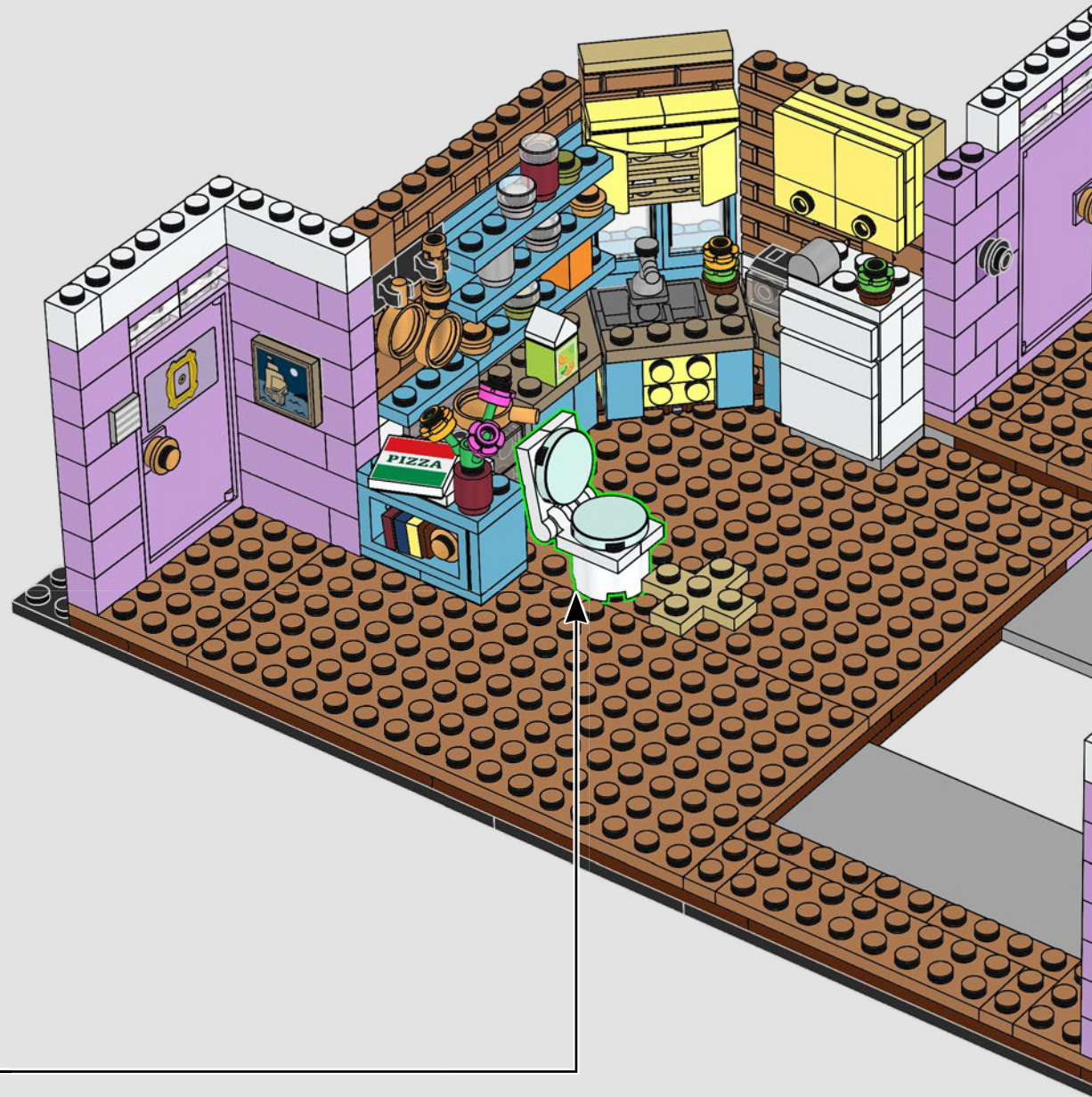
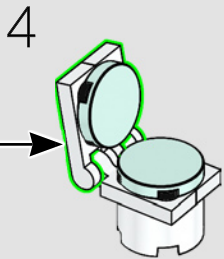
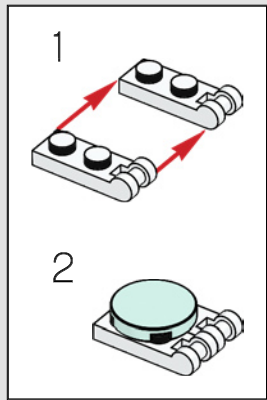
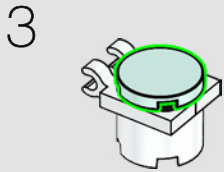
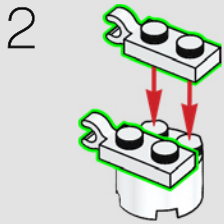
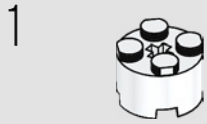

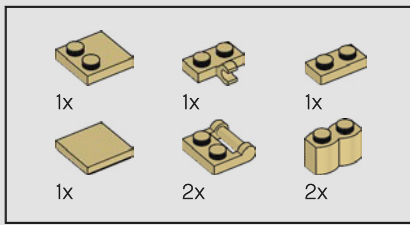

118

1



2

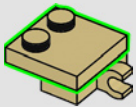

3

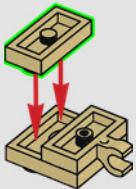

4

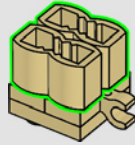

1

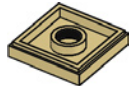

2

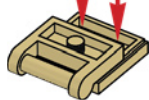
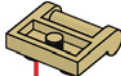

5

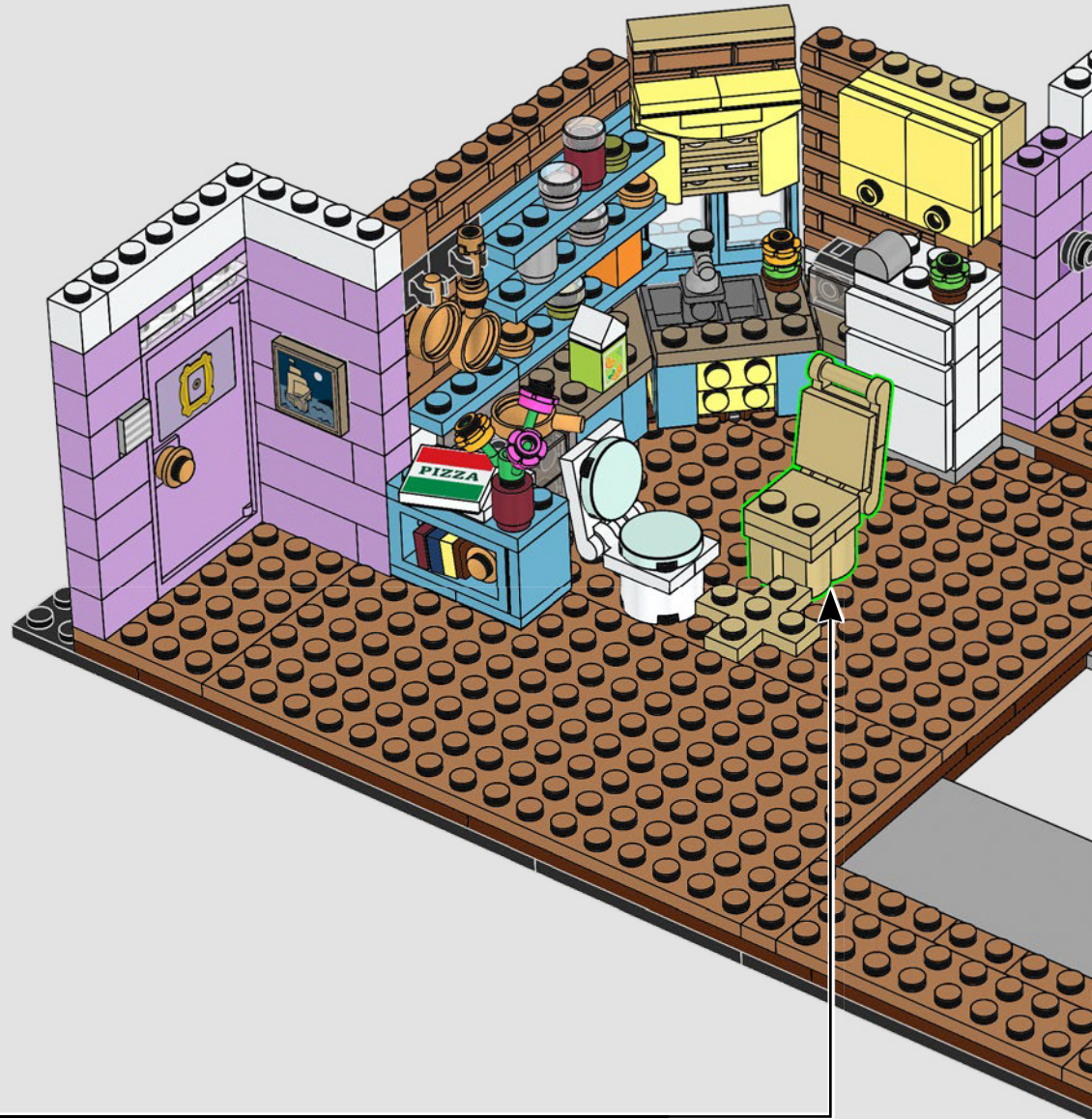
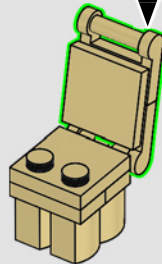

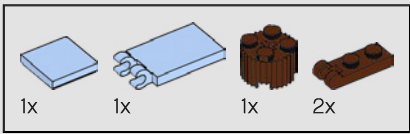

119

1



2



3

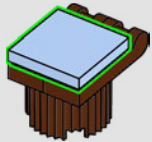

4

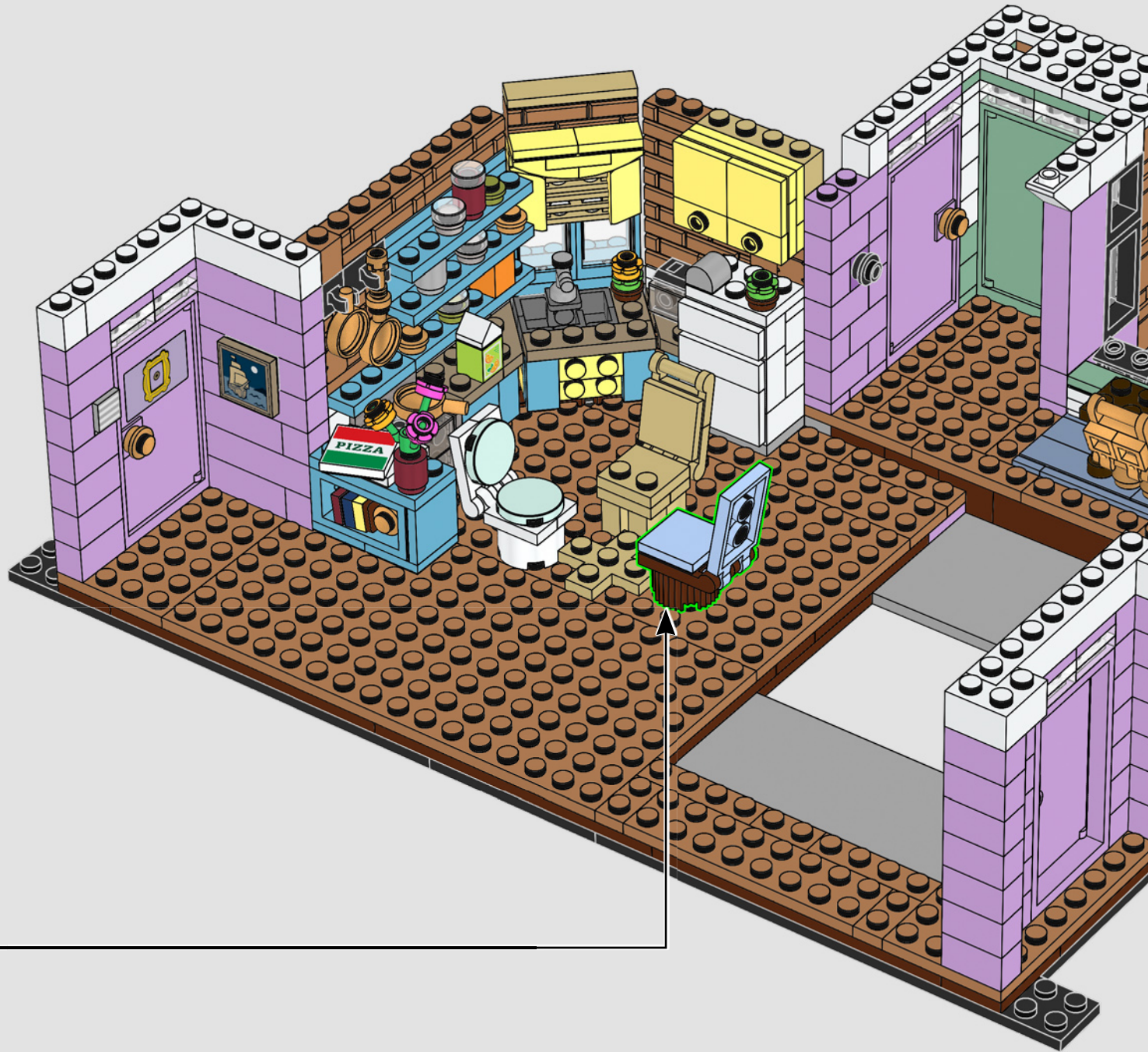
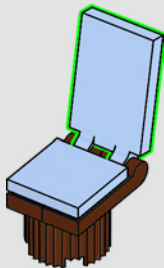

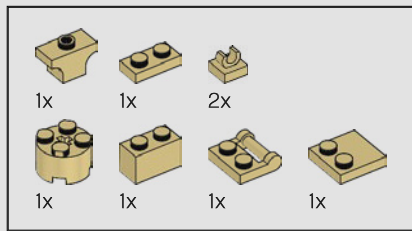

120

1

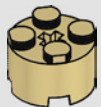

2

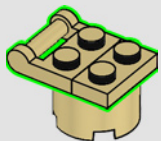

3

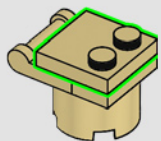

1



2



3

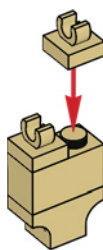

4

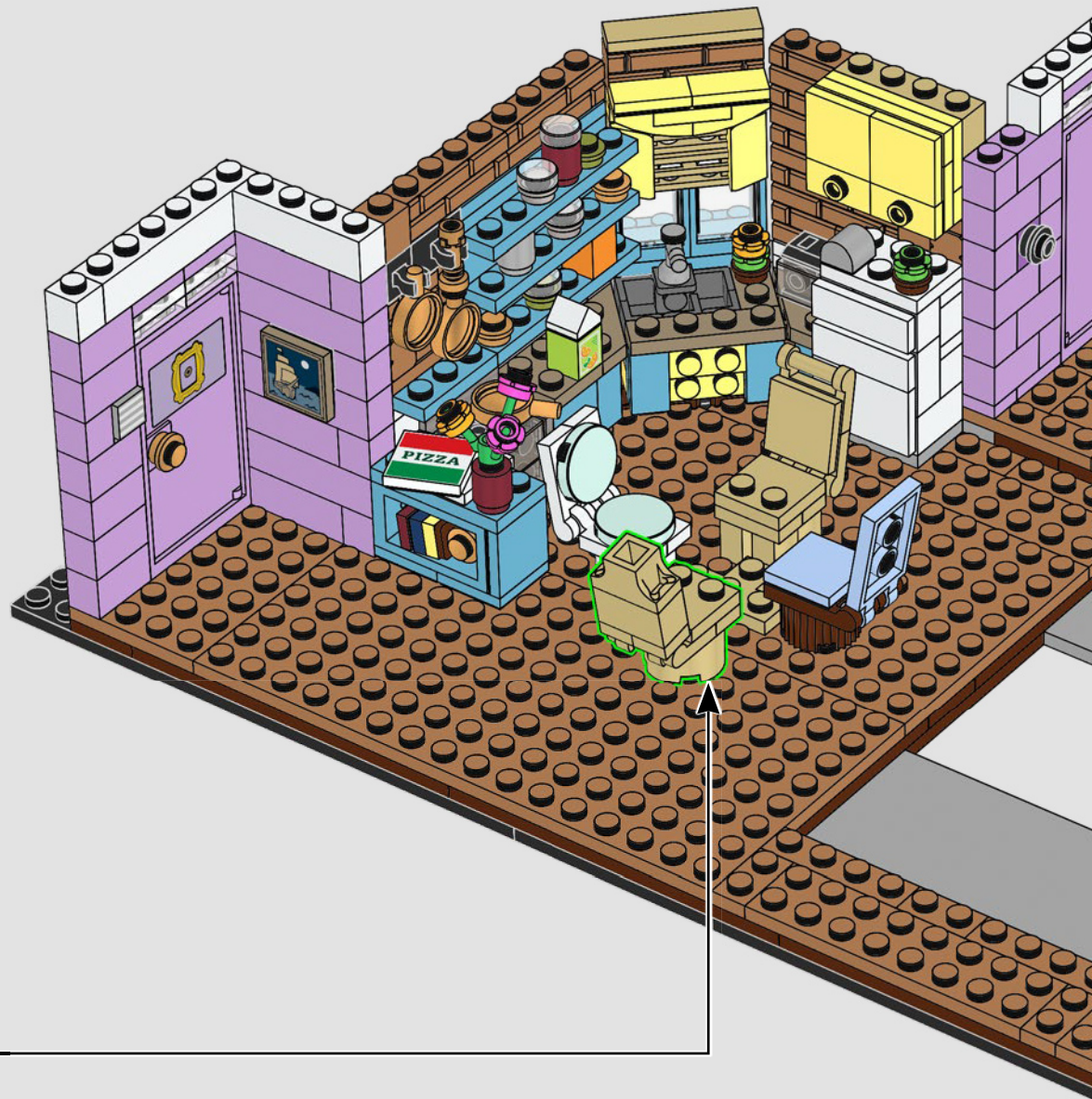
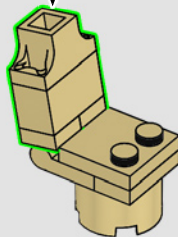

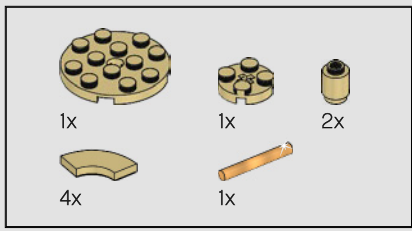

121

1



2

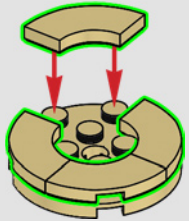

3

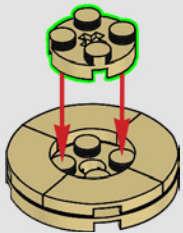

4

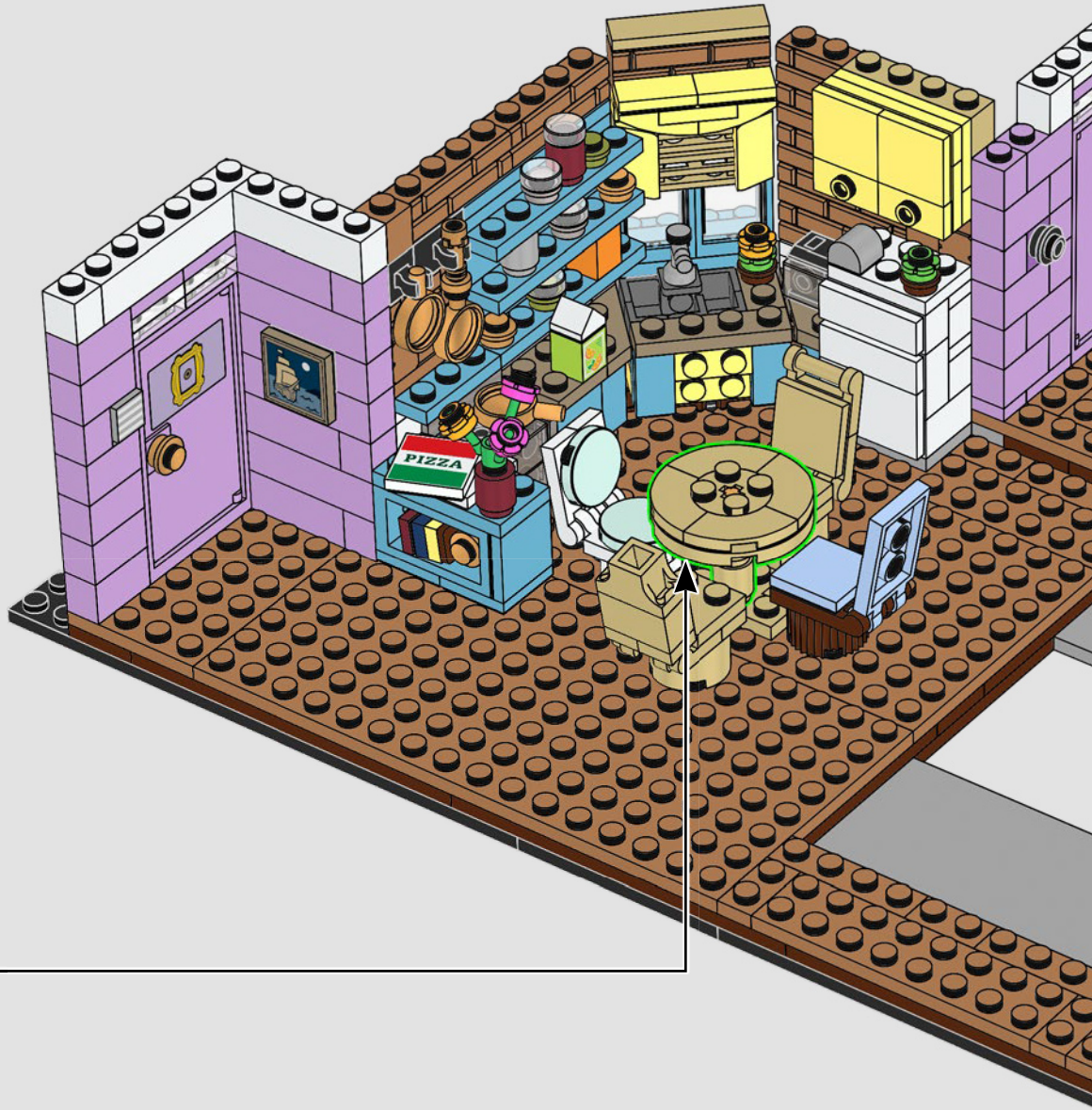
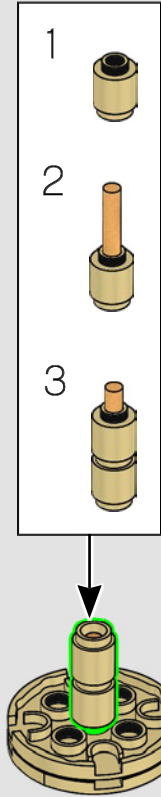

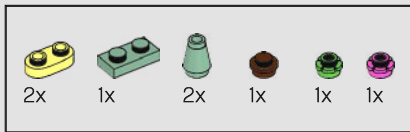

122

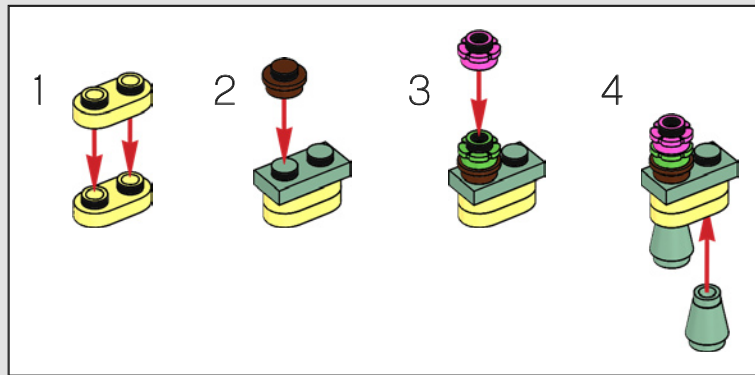

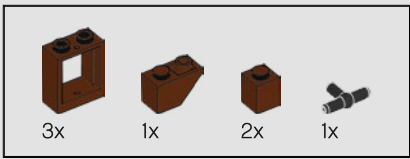

123

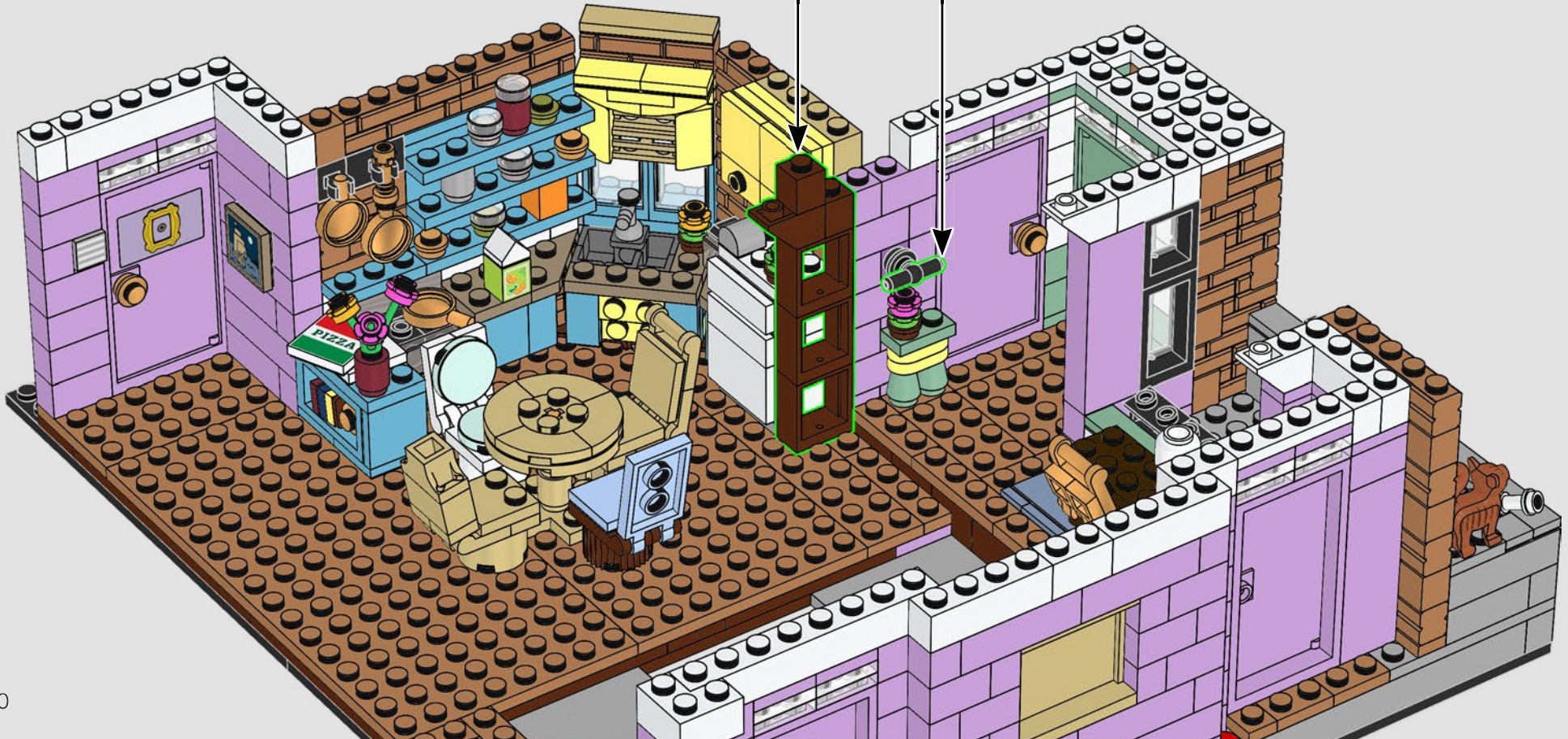
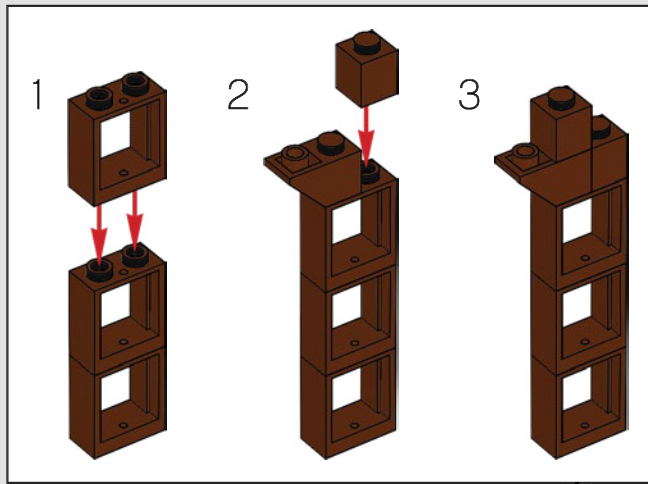

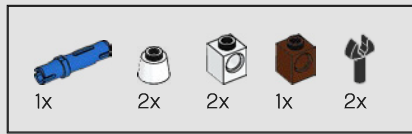

124

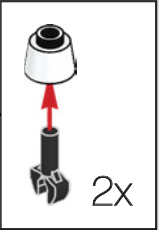
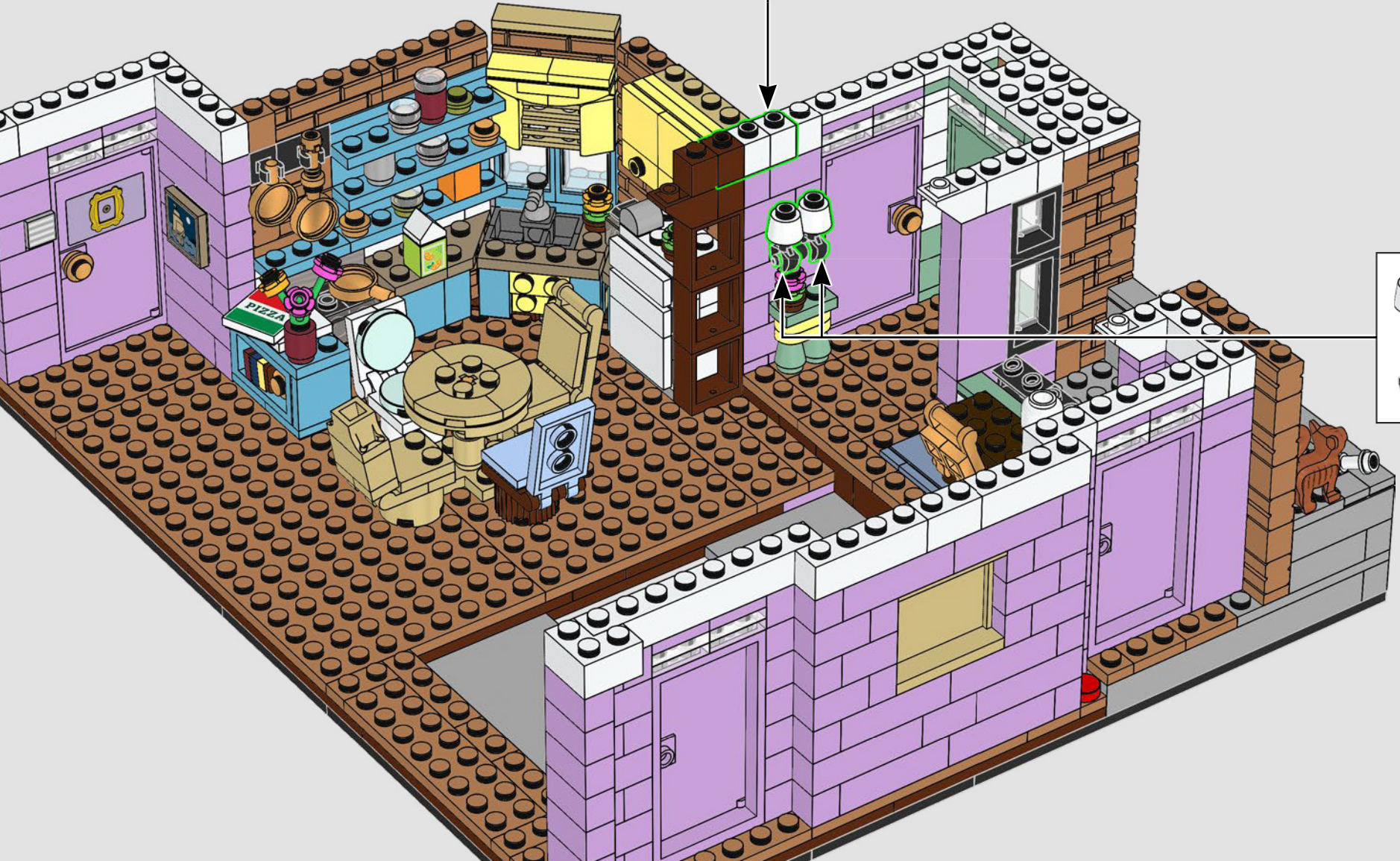
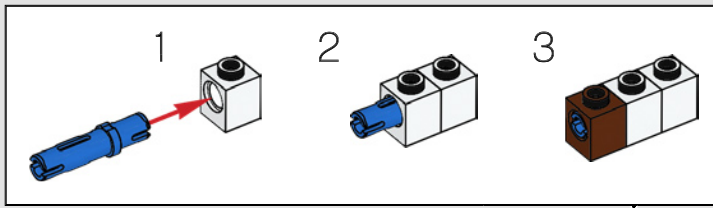

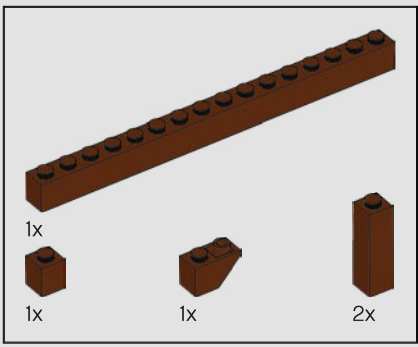

125

1



2

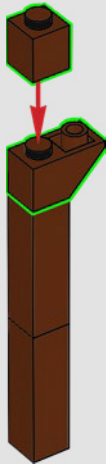

3

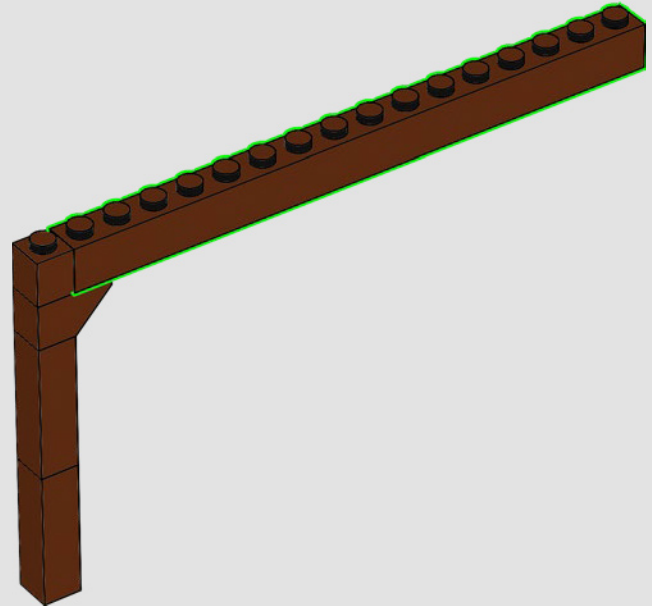

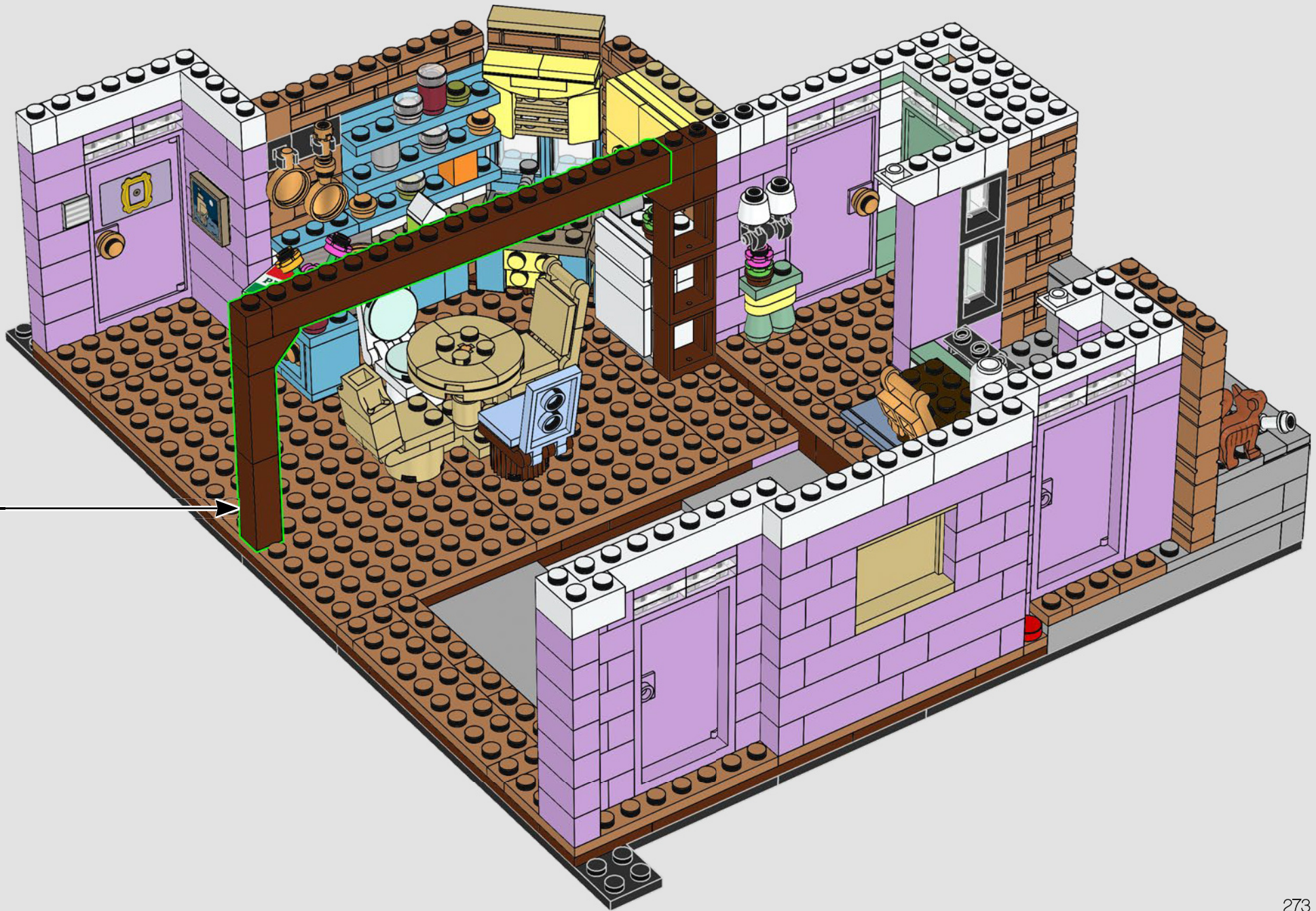

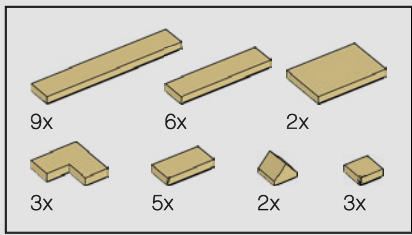

126



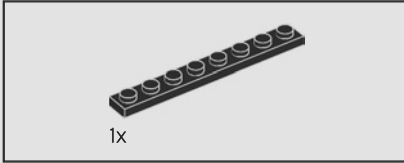
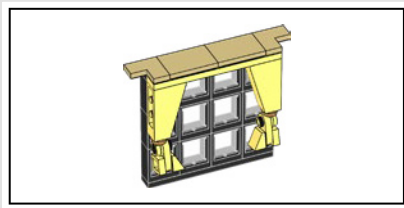

127

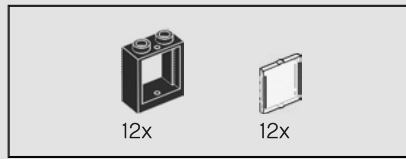
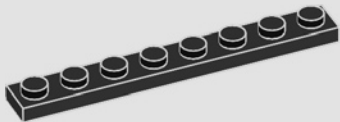

128

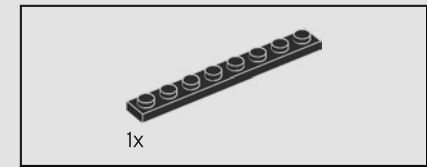
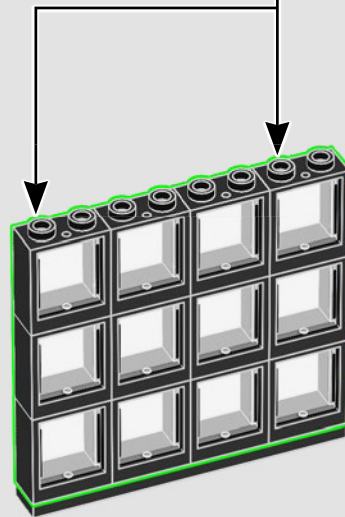
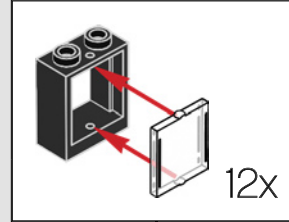

129

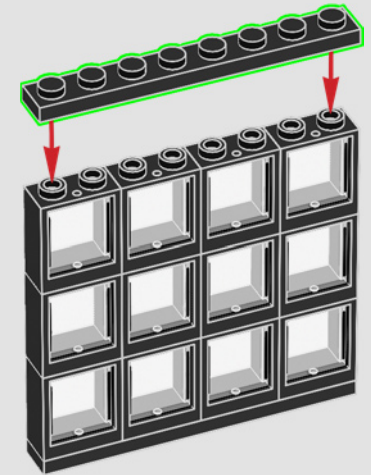

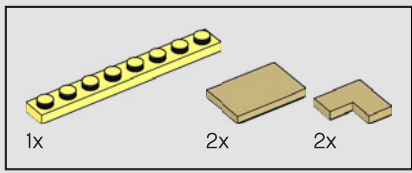

130

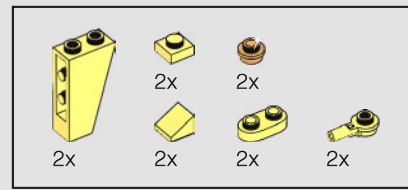
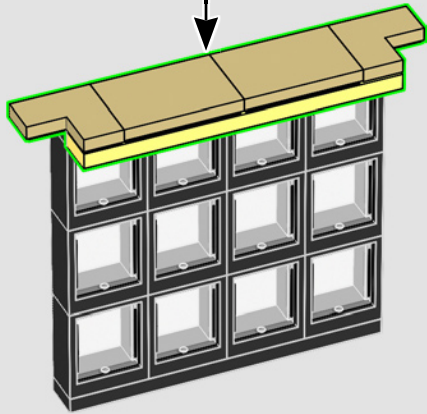
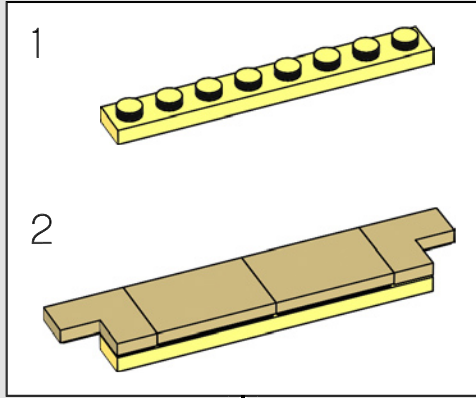

131

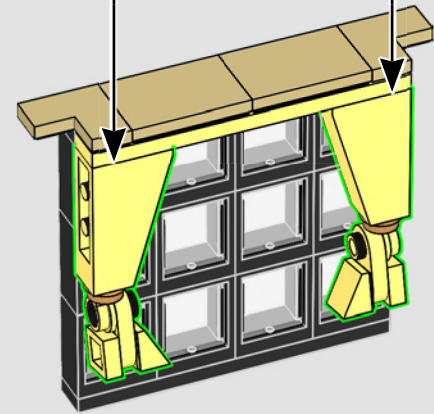
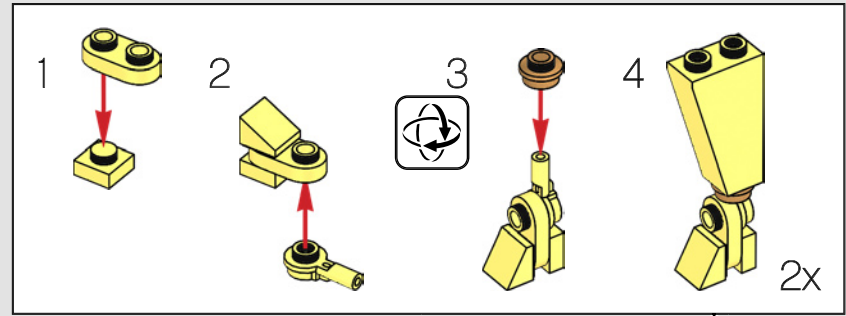

132

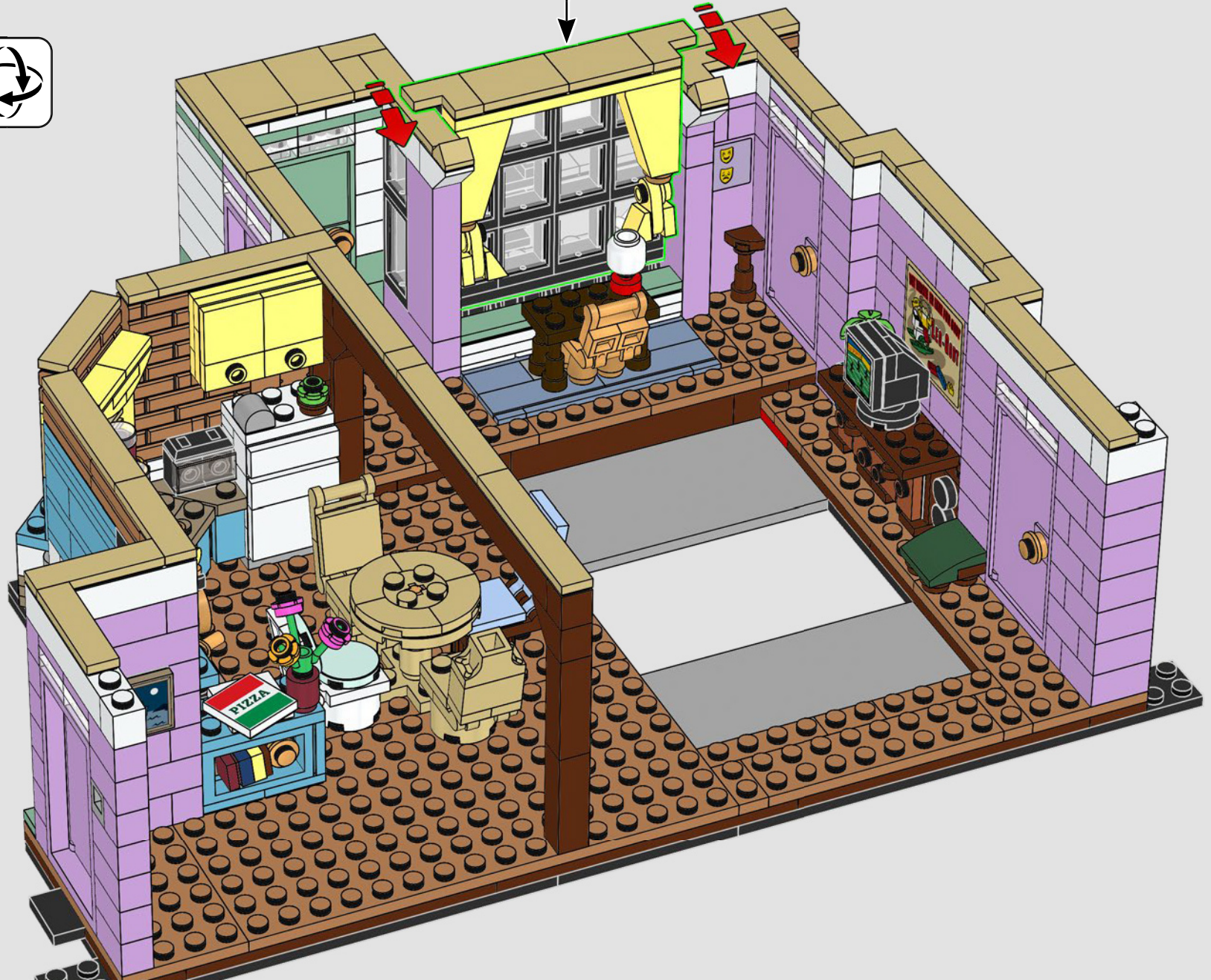

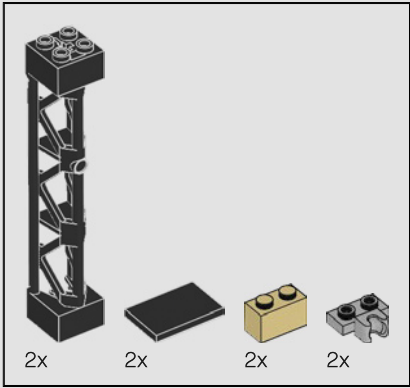
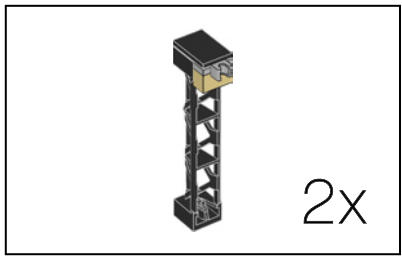

133

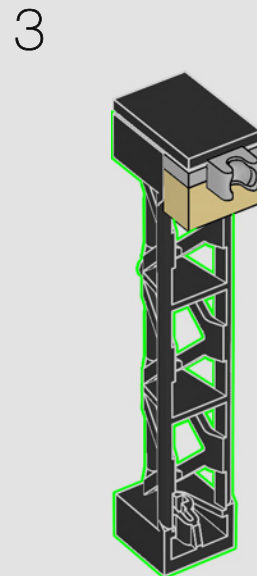
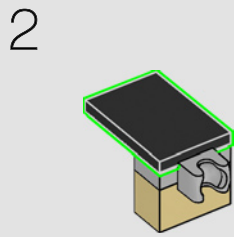
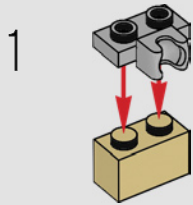



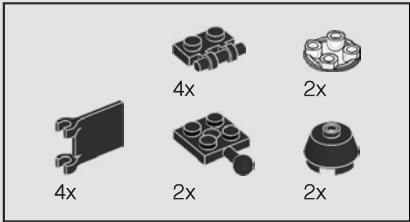
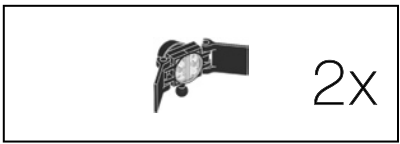

134

1

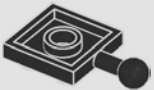

2

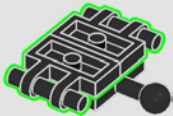

3



4

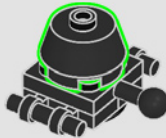
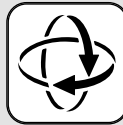

5

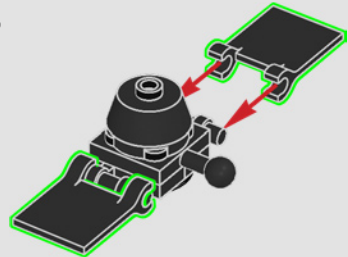

2x



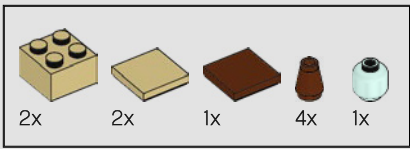

135

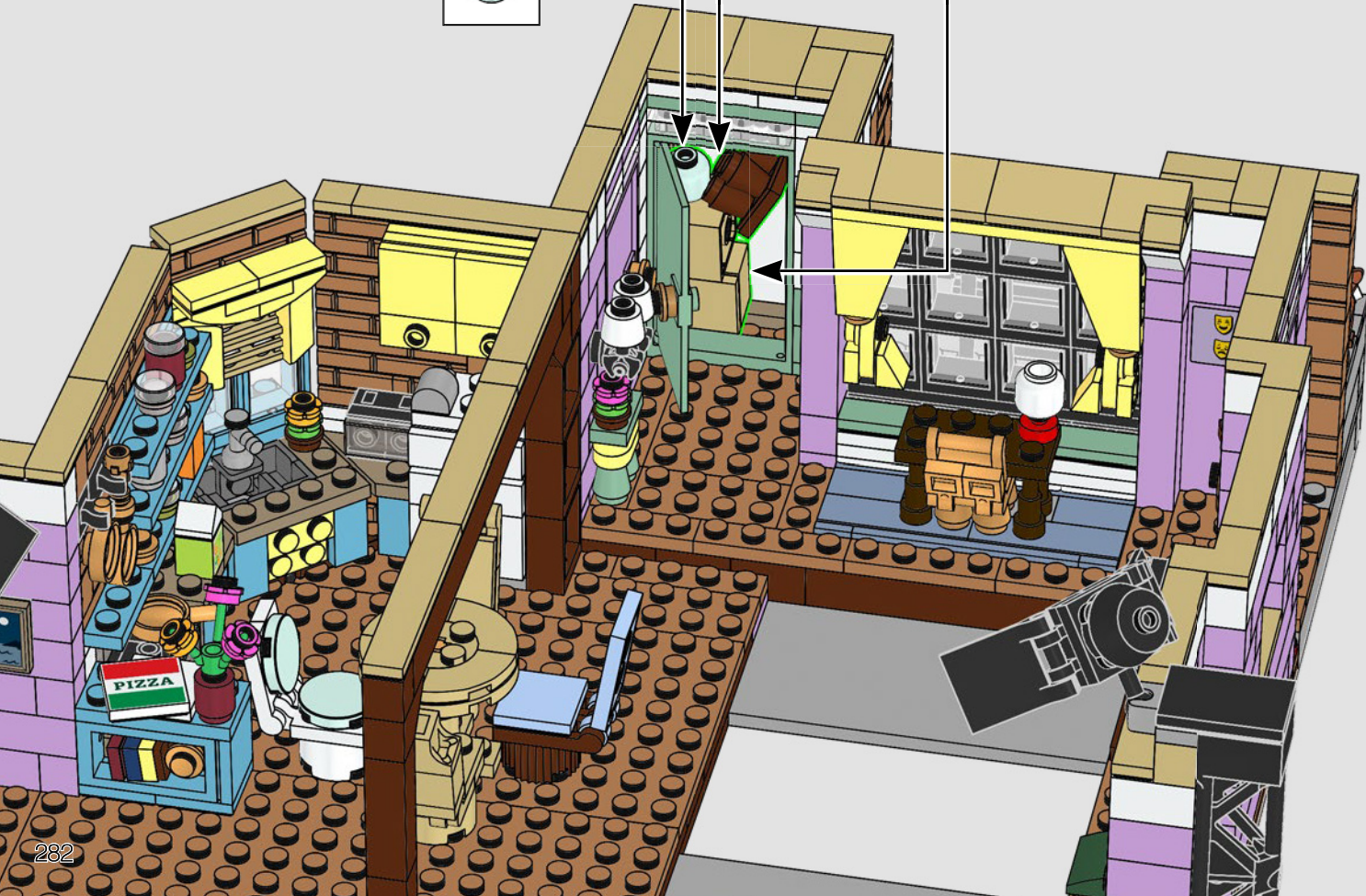
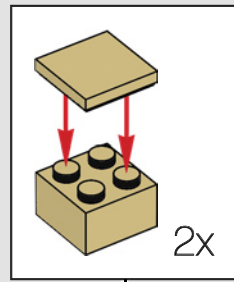
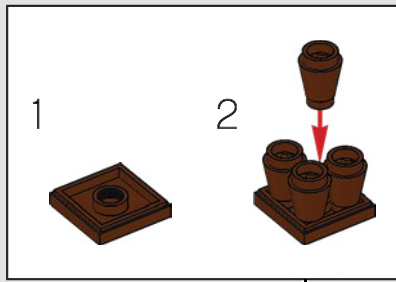

● 装满无用物品的衣橱是莫妮卡藏放杂物的地方。



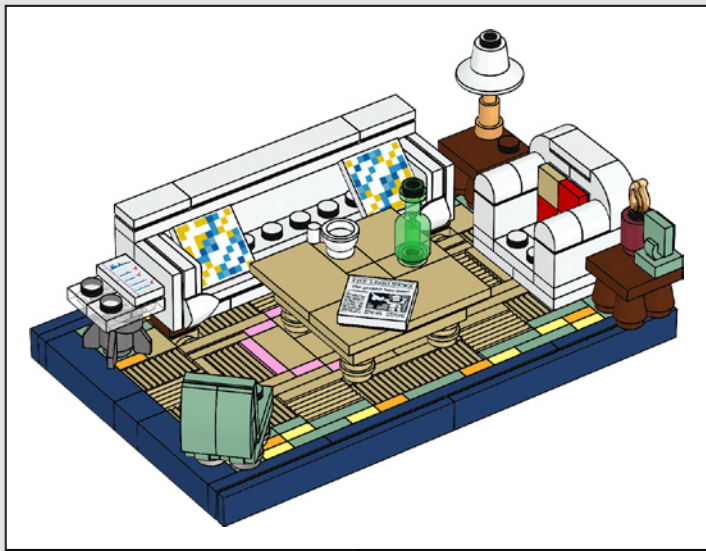

136



137

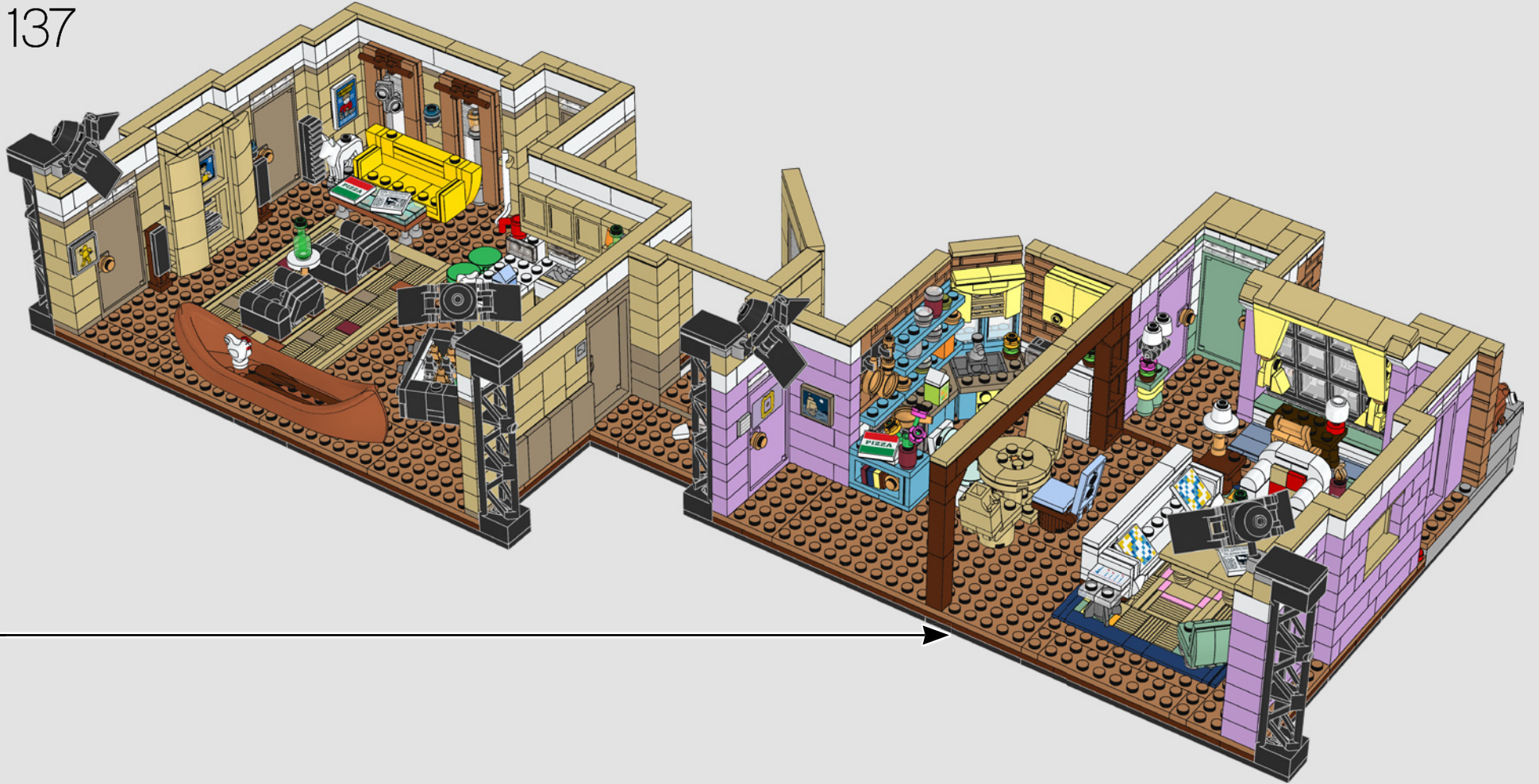





FEEDBACK AND WIN



FEEDBACK AND WIN

Your feedback will help shape the future development of this product series.

Please visit:

FEEDBACK UND GEWINNEN

Dein Feedback trägt zur Weiterentwicklung dieser Produktreihe bei.

Geh auf:

COMMENTEZ ET GAGNEZ

Vos commentaires nous aideront à concevoir les futurs produits de cette gamme.

Rendez-vous sur :

COMENTA Y GANA

Tu opinión nos ayudará a dar forma al desarrollo de esta serie de productos en el futuro.

Visita:

反馈有奖

您的反馈将有助于我们在今后改进本系列产品。

请访问：

[LEGO.com/productfeedback](https://www.lego.com/productfeedback)

By completing, you will automatically enter a drawing to win a LEGO® set.

Terms & Conditions apply.

Durch Ausfüllen nimmst du automatisch an der Verlosung eines LEGO® Preises teil.

Es gelten die Teilnahmebedingungen.

En envoyant vos commentaires, vous serez automatiquement inscrit(e) à un tirage au sort qui vous permettra de remporter un prix LEGO®.

Offre soumise à conditions.

Al contestar, participarás automáticamente en el sorteo y podrás ganar un set LEGO®.

Sujeto a Términos y Condiciones.

完成我们的反馈调查，即可自动进入抽奖环节，赢取乐高®套装。

适用《条款和条件》。

1x 6276148	2x 654101	2x 6285777	2x 6361170	2x 6104805	1x 6360037	1x 6236423	9x 6221467	7x 6175367	1x 4113993	3x 4143005
1x 4518400	3x 6218841	10x 302301	8x 362201	2x 4560178	2x 6252969	2x 6313119	8x 6046924	11x 4550324	1x 4113993	1x 6299413
1x 6284572	10x 300501	6x 306901	9x 362301	10x 300901	4x 4179771	1x 6364438	4x 4185177	15x 4113233	4x 4114324	4x 302424
1x 6052312	2x 6046905	4x 6218823	3x 4558168	1x 663601	8x 4579260	2x 4124456	1x 4114084	1x 4201062	10x 4544139	2x 4624985
3x 6173141	1x 6063275	4x 6070327	1x 6256050	2x 379501	20x 4113915	4x 6092587	8x 6173057	18x 4113916	5x 4143409	1x 300524
1x 6253309	1x 474001	4x 6070698	1x 6021730	6x 346001	6x 6057517	3x 4205107	4x 6226565	1x 6146877	1x 6284574	4x 403224
1x 362601	1x 614301	6x 6097637	1x 6021730	1x 416201	17x 6232135	8x 4578107	2x 4114306	1x 6302268	1x 6215539	2x 6092583
1x 6263451	1x 6093053	2x 6290444	7x 302101	1x 416201	8x 6256080	2x 6335307	2x 4114077	1x 6146877	2x 307021	2x 6208753
1x 6235083	1x 6338819	2x 6175184	5x 6156667	1x 300801	1x 4140562	17x 4114026	33x 4124455	1x 6302268	2x 307021	2x 306824
1x 302401	1x 6350040	1x 6126046	2x 6218212	2x 447701	1x 4125220	10x 4162465	10x 4124455	1x 4114309	1x 389921	2x 306824
1x 6348055	1x 6329599	2x 6126046	2x 6218212	2x 447701	1x 4125220	5x 4121921	10x 4124455	1x 4114309	1x 6298924	3x 6224666
2x 407001	1x 6192534	1x 302201	2x 306801	1x 4619665	2x 4218749	1x 6061575	5x 4121921	2x 4124067	5x 403221	2x 4247771
3x 6172366	1x 6192534	1x 302201	2x 306801	1x 4619665	2x 4218749	7x 6211966	1x 6061575	2x 4124067	2x 302321	2x 302124
4x 6258135	2x 366501	10x 242001	1x 300201	1x 300201	40x 4655900	1x 6214334	1x 6061575	21x 4112982	1x 300121	2x 371024
2x 4558952	8x 300401	5x 235701	17x 301001	1x 300201	1x 4107623	1x 6334219	7x 6211966	2x 4124067	1x 4113858	2x 302124
1x 6286834	1x 6058177	2x 4515364	6x 371001	2x 417070	10x 4161734	3x 4217562	1x 6211966	11x 4157277	1x 4113858	1x 243124
				2x 6230284	2x 6230284	2x 4565387	2x 6211966	1x 4243824	1x 6130004	1x 300924
				9x 4125253	9x 4125253		2x 4118790			



- 2x 6111685
- 1x 6262030
- 7x 6001824
- 2x 6231386
- 2x 6015449
- 13x 4528604
- 7x 4521914
- 8x 6310835
- 1x 4633881
- 5x 6310830
- 17x 4550168
- 4x 6344040
- 5x 6328307
- 1x 6035540
- 11x 4626904
- 4x 6001822
- 8x 6262970
- 2x 6038637
- 3x 4267874
- 1x 6015424
- 1x 4247151
- 7x 6156492
- 1x 6167894
- 4x 4184108
- 4x 4255413
- 3x 6345563
- 1x 6338823
- 1x 4528981
- 2x 6135606
- 4x 4502089
- 2x 4507080
- 4x 6250216
- 1x 6101285
- 2x 6134280
- 1x 6223913
- 8x 6099189
- 4x 6009656
- 1x 6348059
- 2x 6360112
- 18x 4655080
- 2x 6278553
- 2x 4616581
- 1x 6186823
- 1x 6133896
- 2x 6258387
- 1x 6346547
- 2x 4521947
- 3x 6192923
- 1x 6342692
- 4x 4539099
- 1x 4550169
- 2x 4541376
- 3x 6357747
- 1x 6172233
- 2x 6209681
- 11x 6073040
- 1x 6359662
- 1x 6284586
- 12x 4529242
- 10x 4216581
- 3x 4211242
- 6x 6348057
- 1x 6149677
- 8x 4221744
- 2x 4211288
- 2x 6177699
- 1x 4620075
- 2x 6201911
- 9x 6238874
- 1x 6174229
- 1x 6167879
- 2x 6153863
- 1x 6036503
- 2x 4223303
- 2x 6092590
- 5x 4211150
- 4x 4211151
- 3x 4595814
- 2x 4211222
- 13x 6310449
- 2x 6273865
- 1x 4271949
- 7x 4216695
- 2x 6196221
- 4x 6102975
- 2x 6116613
- 5x 4211189
- 2x 4216668
- 3x 4211190
- 1x 4211194
- 1x 4283660
- 7x 4211186
- 6x 4221590
- 2x 4609635
- 1x 4211247
- 4x 4263776
- 14x 4211211
- 1x 4217848
- 8x 4223683
- 3x 4211207
- 1x 4211214
- 3x 6096716
- 1x 6258989
- 2x 6170418
- 1x 6249246
- 2x 4211412
- 3x 6284071
- 2x 4529241
- 4x 4211525
- 1x 6168647
- 5x 4211503
- 1x 4211483
- 2x 6286223
- 2x 4211476
- 2x 6308012
- 3x 6262085
- 2x 4211415
- 2x 4558953
- 2x 4213567
- 1x 6311384
- 4x 6261375
- 4x 6043656
- 3x 6066097
- 2x 4211388
- 1x 4211398
- 1x 4211414
- 1x 6261353
- 2x 4211428
- 1x 4211429
- 1x 4211396
- 2x 4211636
- 2x 4211394
- 1x 4211549
- 1x 4211837
- 1x 4211392
- 1x 4211404
- 4x 4211521
- 1x 4211405

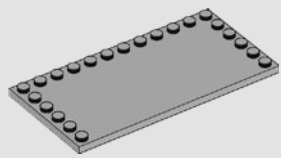

4x
4211836

4x
6271752

5x
6025235

1x
6225494

1x
6331222

3x
6221607

1x
4210811

2x
6284702

1x
6228085

1x
6162894

1x
6360050

3x
6209679

4x
6031883

2x
4654128

2x
6002148

21x
6058014

2x
6296498

4x
6296501

2x
6296963

2x
6296510

1x
6346546

2x
6195266

2x
6061201

2x
6296507

2x
6222971

2x
6286832

1x
6316265

3x
6296521

3x
6296521

3x
6248756

2x
6296524

1x
6248761

1x
4586410

1x
6338817

1x
6338820

1x
6343013

1x
6338824

1x
6338826

1x
6338828

1x
6338831

1x
6162427

1x
6347939

1x
6347975

1x
6347849

1x
6347981

1x
6348014

1x
6347824

1x
6347873

1x
6347869

1x
6003147

4x
6335932

4x
4529247

2x
6190252

12x
4523159

1x
6262138

2x
6284379

3x
6138068

1x
4512021

2x
4538126

2x
4585493

4x
6109752

2x
6287425

4x
6092674

1x
6248486

3x
6097419

5x
4649741

1x
6286836

3x
6060857

2x
4619513

1x
6070757

2x
6036238

2x
4655256

2x
4625036

3x
6146926

1x
6093529

8x
6194729

1x
6223146

6x
6127366

1x
6348012

4x
4538950

1x
6226792

20x
6057986

6x
6215606

1x
6093260

6x
6218360

21x
4656783

2x
6102994

4x
6056383

2x
6177535

8x
6102998

20x
6055309

15x
6167700

12x
6093494

4x
6295464

6x
6226644

1x
6346548

24x
6218145

2x
6272111

1x
6196796

7x
4633691

2x
6215447

1x
4624615

1x
6175870

2x
6096948

1x
6125776

23x
6097053

15x
6099190

31x
6099352

4x
6290505

4x
6344038

1x
6273909

2x
6258990

4x
6217492

3x
6217498

16x
6097870

14x
6097867

4x
6344416



Customer Service
Kundenservice
Service Consommateurs
Servicio Al Consumidor

LEGO.com/service or dial



: 00800 5346 5555

: 1-800-422-5346

LEGO and the LEGO logo are trademarks of the LEGO Group. ©2021 The LEGO Group.



FRIENDS and all related characters and elements © & ™ Warner Bros.
Entertainment Inc. WB SHIELD: © & ™ WBEI. (s21)