





STYLE MIS CLASSE

« Si vous n'êtes pas
prêt à vivre à plein
volume, visez la
moitié et allez-y. »

- Bobby Berk

QUEER EYE

PLUS QU'UN RELOOKING

Alors que beaucoup d'émissions de télé-réalité rabaissent les gens, le but de *Queer Eye* est, au contraire, de les faire grandir. Les Fab Five utilisent leurs expériences personnelles – les positives comme les négatives – pour exercer un impact constructif et durable sur les gens qu'ils rencontrent (ou bien les héros, comme ils préfèrent les appeler).

Découvrez la version LEGO® du loft original des Fab Five à Atlanta. Le styliste Tan France, l'expert culturel Karamo Brown, le spécialiste de la cuisine et du vin Antoni Porowski, le décorateur d'intérieur Bobby Berk et le coiffeur Jonathan Van Ness sont tous réunis et ont besoin de votre aide pour mener à bien leur toute dernière transformation. Amusez-vous bien !





« En tant que styliste, mon objectif est d'aider les gens à devenir la meilleure version d'eux-mêmes. »

- Tan France

TAN FRANCE

MODE



Né de parents pakistanais à Doncaster, dans le Yorkshire du Sud, Tan France a commencé à travailler aux États-Unis en 2008 et vit désormais à Salt Lake City, dans l'Utah. Créateur de vêtements et expert mode, Tan redonne confiance aux gens en veillant à ce qu'ils se sentent bien dans les vêtements qu'ils portent. La touche finale de la plupart de ses séances de relooking ? Le *french tuck* (ou « repli français »), qui consiste à rentrer son haut dans son pantalon à l'avant.





*« La nourriture offre un moment
de pur plaisir émotionnel dans
un monde parfois dur
et complexe. »*

- Antoni Porowski

ANTONI POROWSKI

CUISINE ET VIN



Fils d'immigrants polonais, Antoni a grandi à Montréal, au Canada, et parle le polonais, l'anglais et le français. Après s'être installé aux États-Unis, il a étudié la psychologie et le théâtre, puis s'est tourné vers la cuisine. Avant de rejoindre les Fab Five et d'encourager les gens à préparer eux-mêmes leurs repas, il a travaillé pour Ted Allen, l'expert culinaire de la série *Queer Eye* originale, diffusée au début des années 2000.



KARAMO BROWN

CULTURE

Karamo Brown est le coach et le thérapeute du groupe. Il aide les héros de l'émission à mieux se connaître et à surmonter les problèmes auxquels ils ont dû faire face dans leur vie. Né à Houston, au Texas, Karamo est d'origine jamaïcaine et cubaine et vit désormais à Los Angeles avec ses deux fils. Il milite activement pour la communauté LGBT noire.



« La vie ne nous tombe pas dessus. Elle nous répond. »

- Karamo Brown





« Lorsqu'on est heureux
chez soi, ce bonheur se
répand dans les autres
aspects de notre vie. »

- Bobby Berk



BOBBY BERK

DESIGN

Bobby a grandi dans une petite ville du Missouri. En 2003, il s'est installé à New York avec seulement 100 \$ en poche. Après avoir travaillé dur, il a décroché le poste de directeur créatif pour une entreprise d'ameublement, puis a lancé sa propre boutique en ligne. Dans l'émission *Queer Eye* de Netflix, Bobby réaménage les espaces de vie des héros pour les aider à transformer leur vie.

« Prenez soin de vous, car
c'est ce que les autres
voient de vous. »

- Jonathan Van Ness



JONATHAN VAN NESS

COIFFURE

Jonathan, le pom-pom boy enthousiaste des Fab Five, invite les héros à prendre du temps pour eux avec des séances de coiffure et de soins personnels. Lorsqu'il n'est pas en train de retravailler une coupe de cheveux dans *Queer Eye*, Jonathan est l'hôte dynamique d'une série de podcasts primés. C'est aussi un grand amateur de gymnastique et de patinage artistique. Selon la rumeur, il maîtriserait le boucle piqué et l'axel !





Bruley était l'adorable bouledogue français des saisons 3 et 4. Décédé en 2019, il a été immortalisé en version LEGO®.



CHAQUE INVITÉ EST UN HÉROS

Chaque héros de *Queer Eye* a une histoire unique à raconter. Certains ont perdu un être cher, surmonté une grave maladie ou subi le rejet de leur famille. D'autres ont tellement donné aux autres et à leurs communautés qu'ils n'ont pas eu assez de temps pour eux-mêmes. Pour les Fab Five, ce sont tous des héros qui méritent une transformation pour vivre une vie plus simple, plus saine et plus heureuse.



L'INVITÉ DE LA SEMAINE

Un set LEGO® *Queer Eye* ne peut être complet sans un relooking magique ! Voici Kathi Dooley, une enseignante dévouée qui a joué un rôle important dans les débuts

de Jonathan. Elle lui a apporté son soutien en faisant preuve de compréhension et de gentillesse. C'est maintenant au tour de Jonathan et ses amis de lui rendre la pareille...

Le relooking LEGO de Kathi Dooley



Avant

Après



Les talents de designer de Bobby ont été révélés pendant sa jeunesse... grâce à un set LEGO® !



PLUS QU'UN RELOOKING

UNE VRAIE COLLABORATION

Ce set LEGO® *Queer Eye* est le résultat d'une collaboration digne des Fab Five entre l'équipe de design LEGO et le gourou de la décoration de l'émission, Bobby Berk. Pour Bobby, le projet du set est très vite devenu une passion : « LEGO a joué un rôle si important dans mon enfance. L'assemblage de ces petites briques a stimulé mon imagination et ma créativité. » Pour Matthew Ashton, vice-président du design du Groupe LEGO, cette collaboration était le partenariat parfait : « Nous partageons tant de valeurs, comme la bienveillance, l'apprentissage, la créativité et le jeu. Les Fab Five transforment la vie des gens et notre mission est de stimuler la créativité des enfants et des adultes et de participer à la reconstruction d'un monde plus positif. »

En premier lieu, il fallait définir l'objet de ce set. L'équipe a rapidement opté pour le décor du loft de la première saison et a élaboré le plan du sol et la configuration du modèle. Pour Matthew, il était primordial que le set soit le plus détaillé possible : « Nous voulions reproduire les meubles du loft et inclure des détails emblématiques, tels que l'inscription « STYLE, TASTE, CLASS » (STYLE, GOÛT, CLASSE). Nous voulions également que chaque membre des Fab Five ait son propre espace, un lieu qui mette en valeur ses compétences uniques et ses contributions à l'équipe. »

« En collaborant avec l'équipe LEGO, mon rêve est devenu réalité ! C'est le rêve de tout enfant, et c'est maintenant ma réalité. »

- Bobby Berk



Bobby et Matthew lors des premières étapes du processus de conception.



TOUT S'IMBRIQUE PARFAITEMENT

Pour les Fab Five, le travail d'équipe est essentiel, et il en est de même pour élaborer un superbe set LEGO®. Outre Matthew, l'incroyable équipe LEGO était composée du graphiste senior, Diego Sancho, et de la designer d'éléments senior, Ruth Kelly.

Diego avait la lourde tâche de créer des figurines LEGO qui s'apparentent aux Fab 5 et concevoir l'ensemble des décorations et autocollants pour donner vie au loft : « J'ai pu apporter ma touche personnelle dans les illustrations du loft et offrir quelques surprises aux fans ! J'ai créé une affiche « Yaaas Queen » dans la cuisine, un clin d'œil à une expression chère aux LGBTQ+. En plus, si vous observez attentivement l'image, vous pouvez y voir l'inscription FAB 5 ! »

Pour Ruth, le défi était très différent : « Nous n'avions pas de perruques avec des cheveux aussi volumineux que ceux de Tan, j'ai donc dû en créer une nouvelle. Nous avons décidé de réaliser la perruque dans un plastique argenté brillant pour « rehausser » le look de Tan ! »

Matthew est fier du résultat, mais aussi de ce que le partenariat représente : « Les Fab Five ont eu un impact extrêmement positif sur la vie de tant de gens. C'est important de prendre le temps de rendre hommage à la gentillesse et c'est exactement ce qu'a permis cette collaboration. »



De gauche à droite :
Ruth Kelly, designer d'éléments senior
Matthew Ashton, vice-président du design
Diego Sancho, graphiste senior



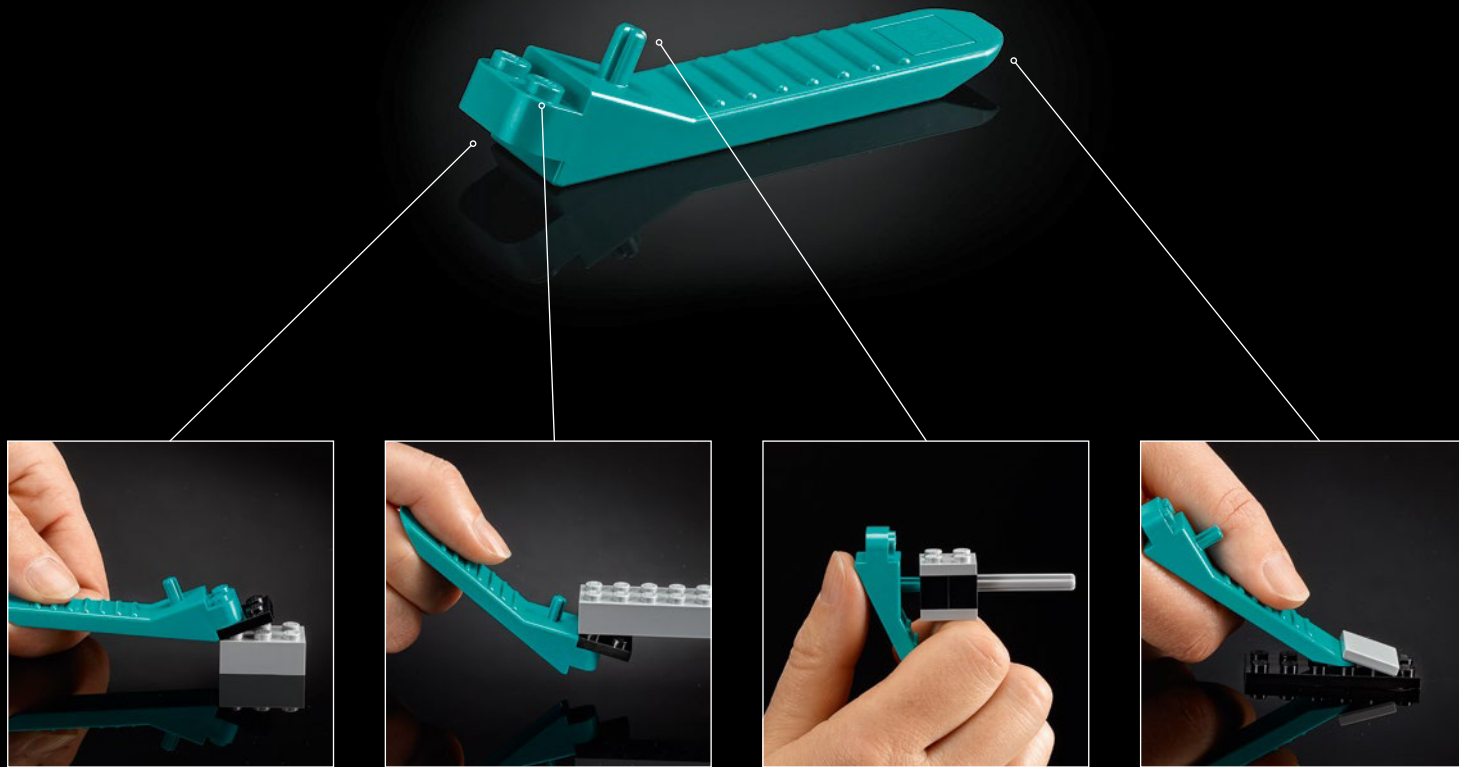

[LEGO.com/brickseparator](https://www.lego.com/brickseparator)

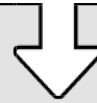
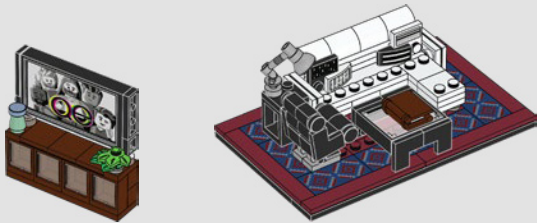
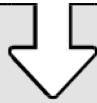

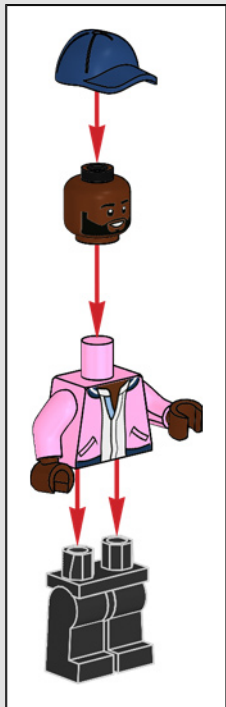
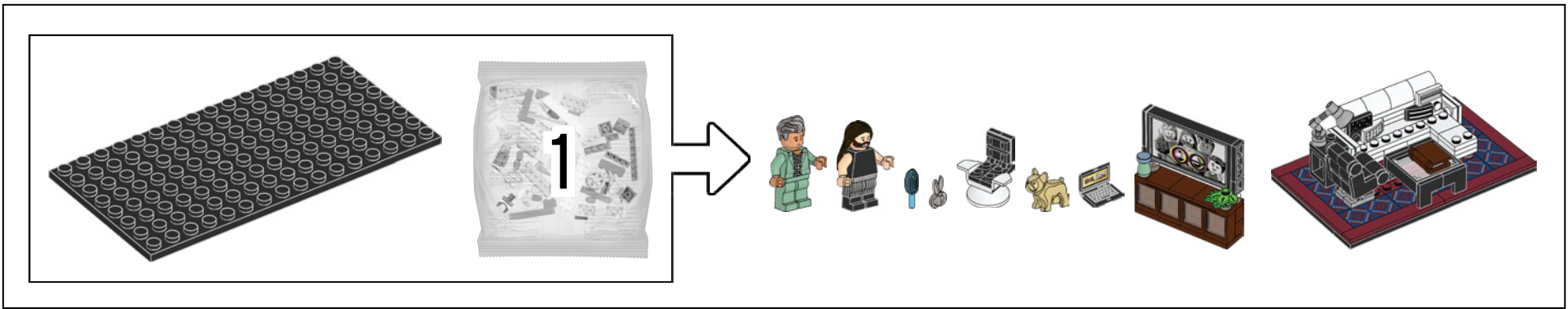

Karamo Brown

« Je suis heureux qu'ils n'aient pas oublié mon fameux blouson d'aviateur, et c'est un choix judicieux de m'avoir mis une casquette sur la tête pour couvrir cette bosse disgracieuse ! Ha ! »

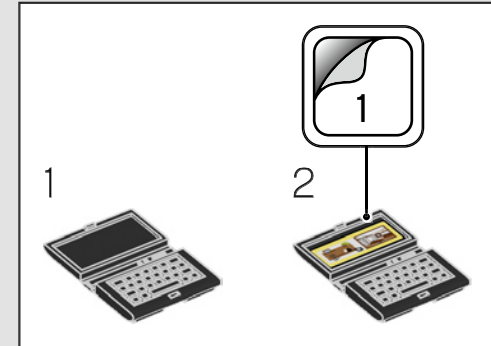

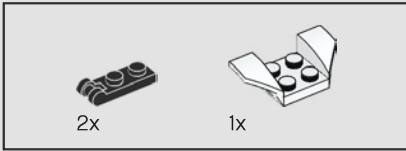
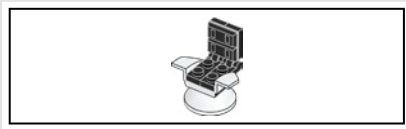

1

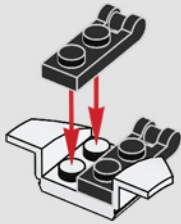

2

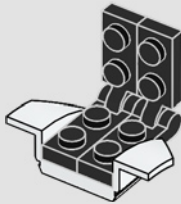

3

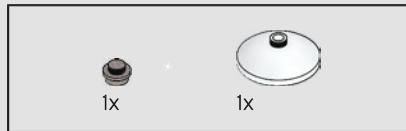
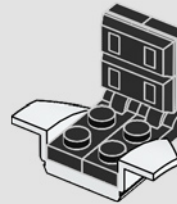

4

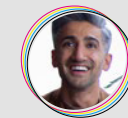
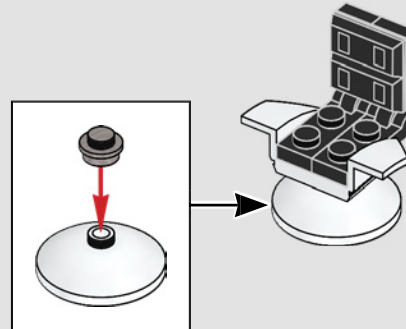

Tan France

« Ha ! Cette petite perruque LEGO® est la perfection même ! Et comme mes vrais cheveux, avec de la laque, ça ne bouge plus ! »



Jonathan Van Ness

« Nos figurines LEGO sont adorables ! »



Antoni Porowski

« C'est vraiment adorable d'avoir inclus Bruley ! Ce petit toutou me manque ! »

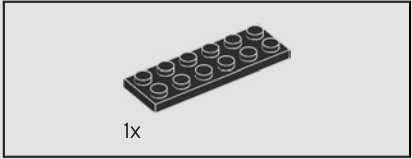
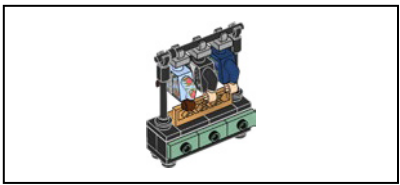

1

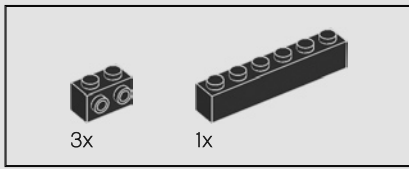
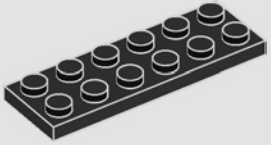

2

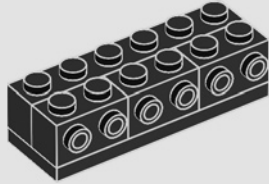

3

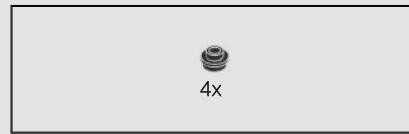
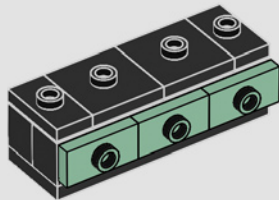

4

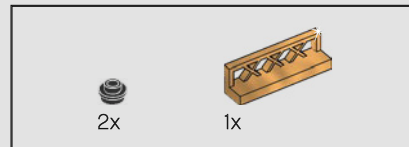
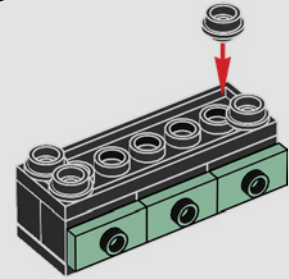
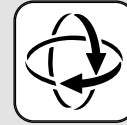

5

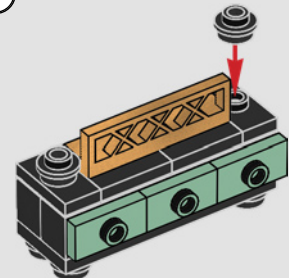
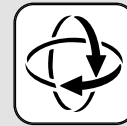



6

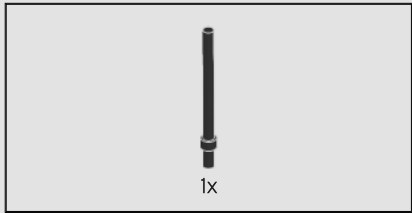
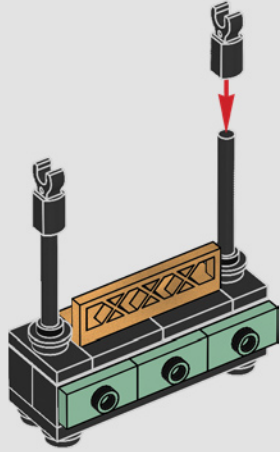

7

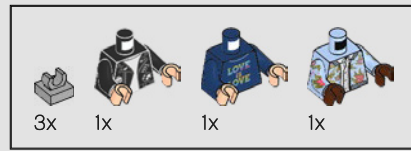
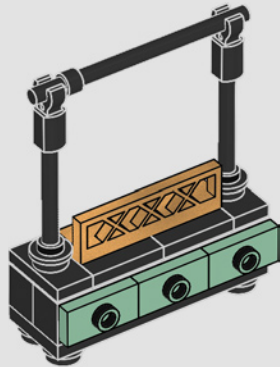

8

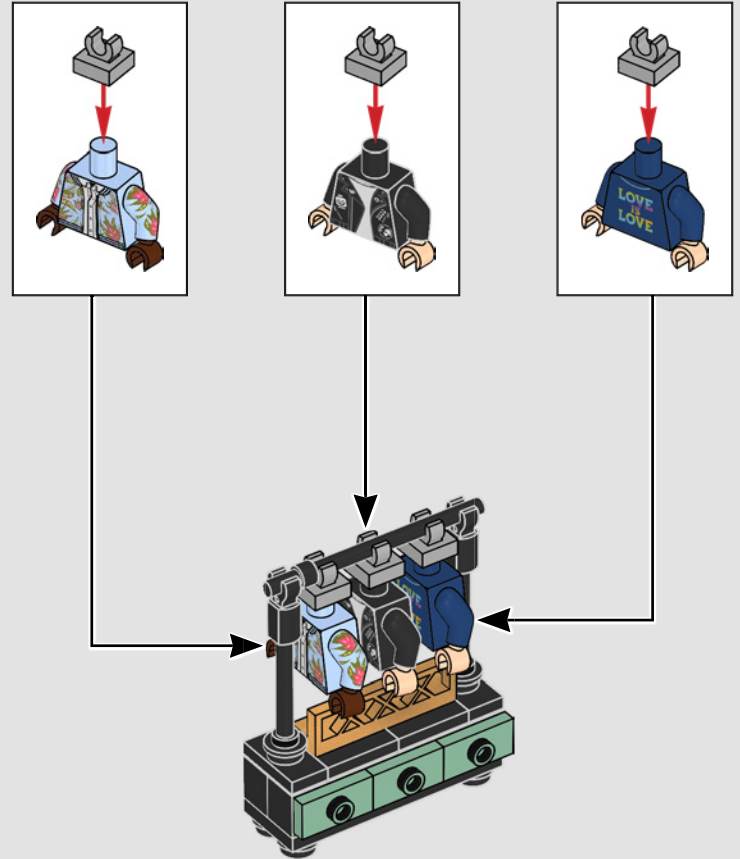

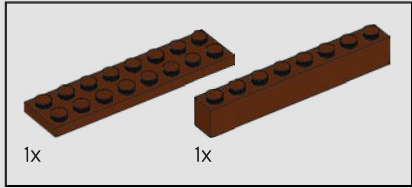

1

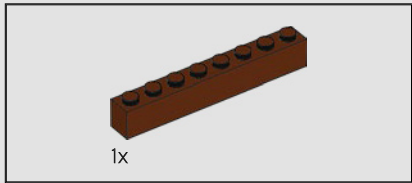
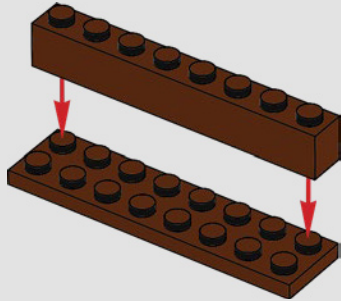

2

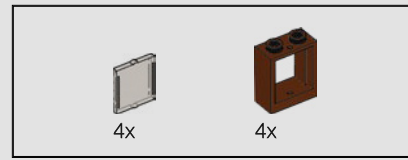
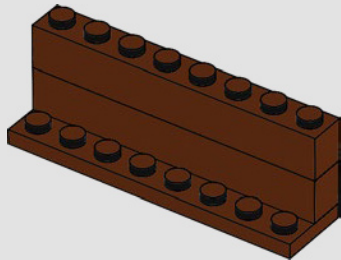

3

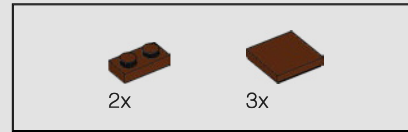
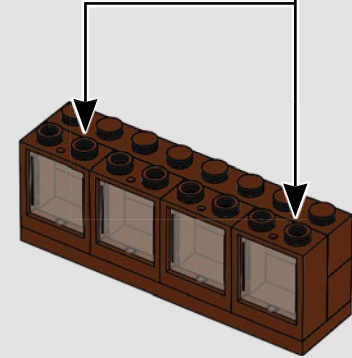
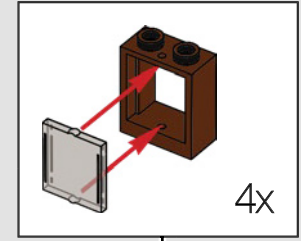

4

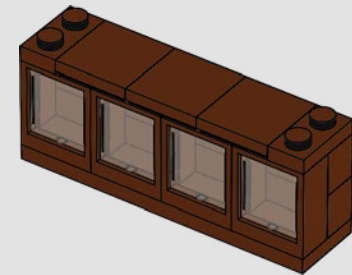



5

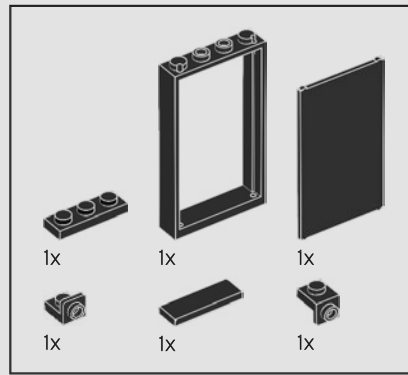
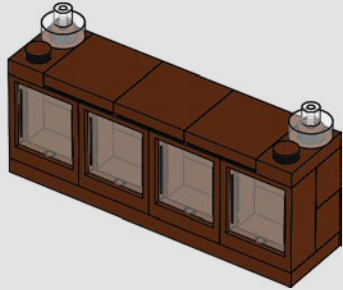

6

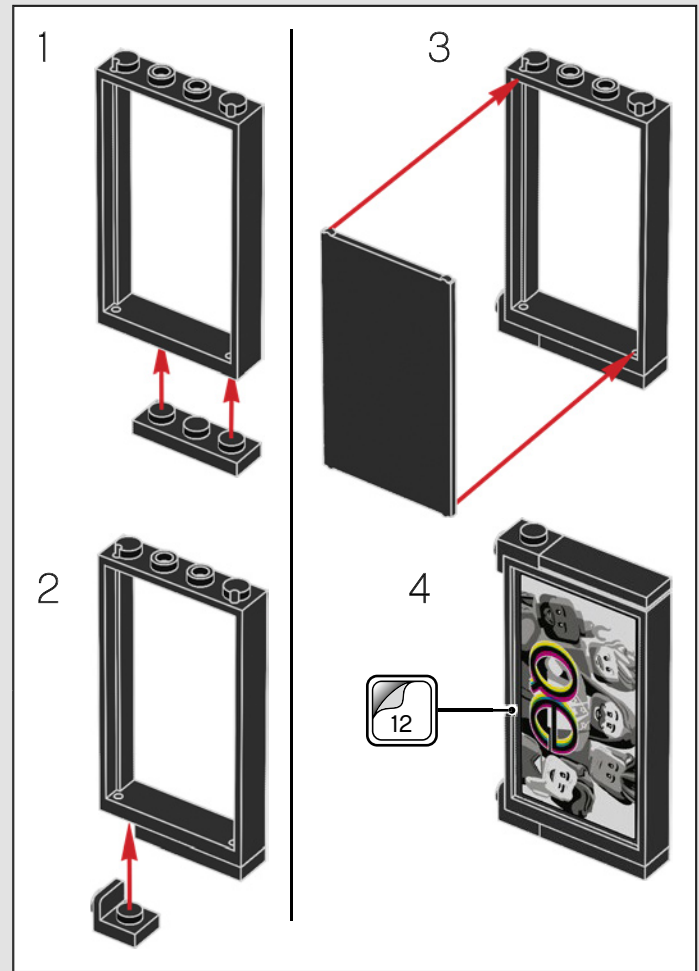
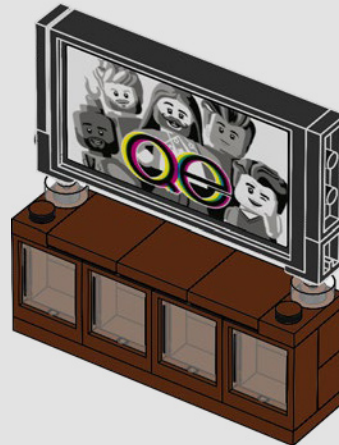



7



Jonathan Van Ness

« C'est très important d'intégrer la notion d'inclusion dans le processus créatif. C'est pourquoi je suis vraiment heureux que le Groupe LEGO soutienne l'inclusion de la communauté LGBTQ. »

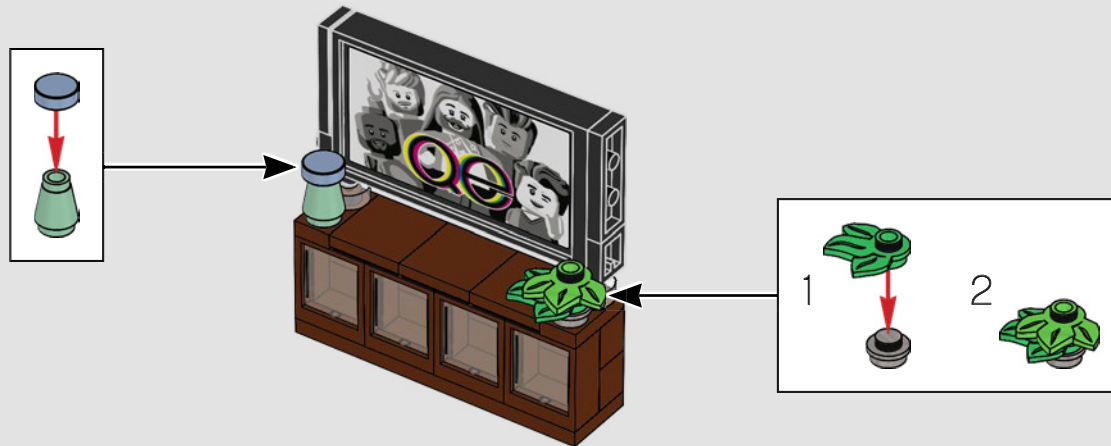

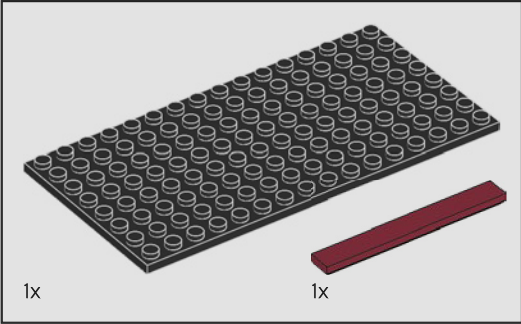
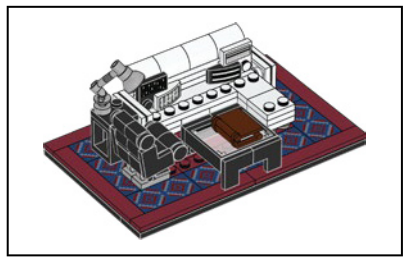

1

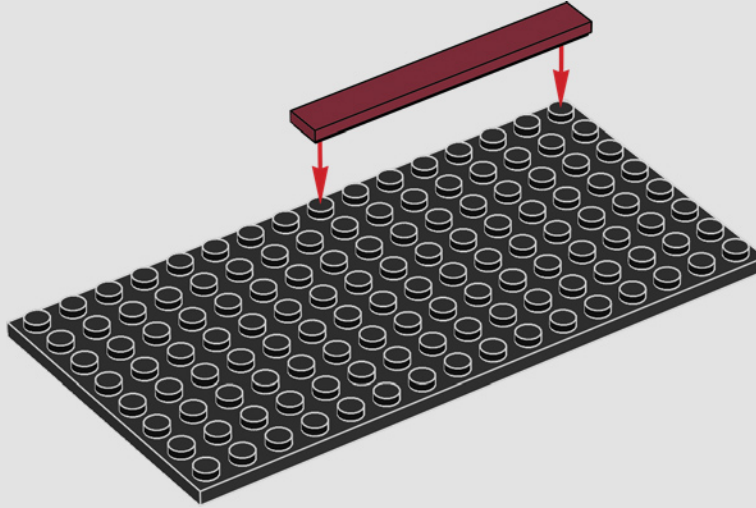

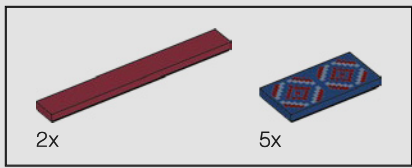

2

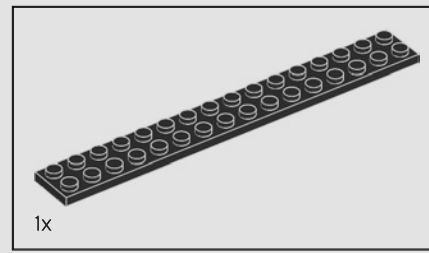
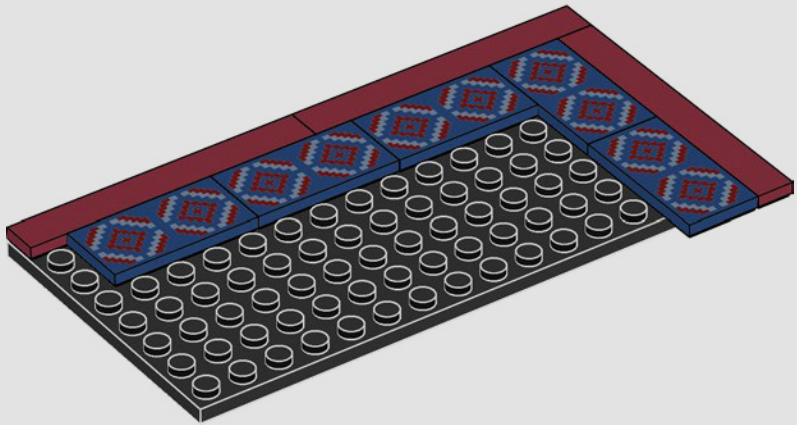

3

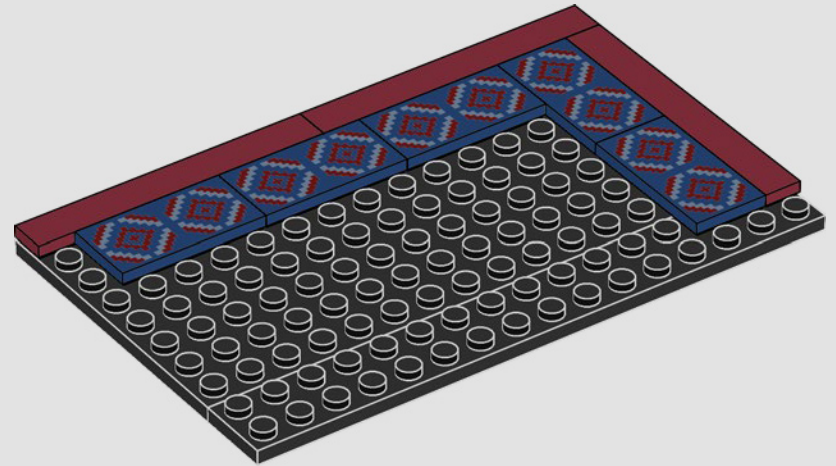

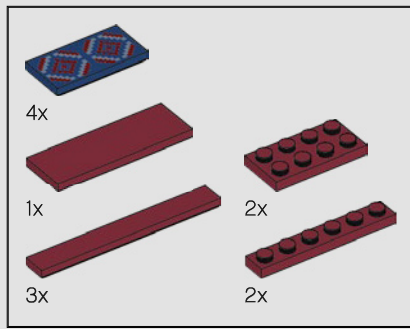

4

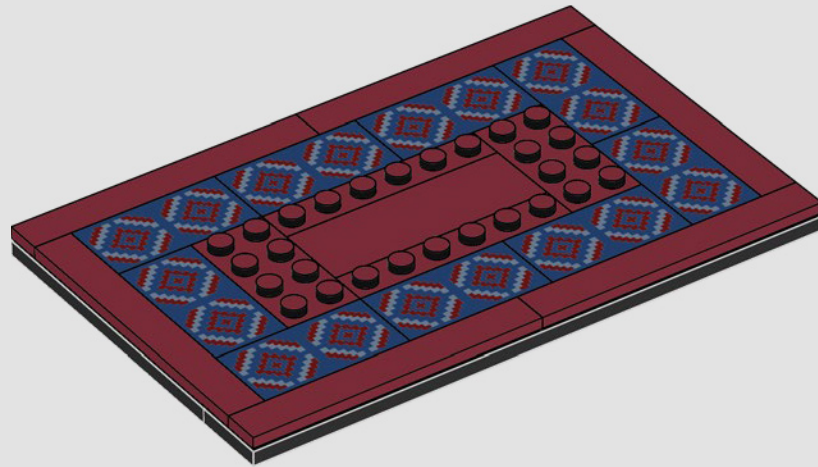

5

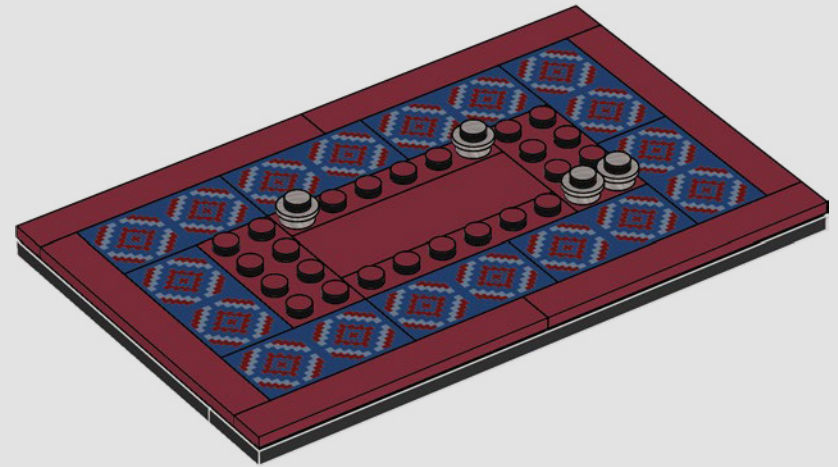

Jonathan Van Ness

« C'est incroyable de faire partie de l'imaginaire des personnes qui contribuent à bâtir un monde meilleur ! J'espère que cette collaboration saura éveiller l'imagination des gens. »

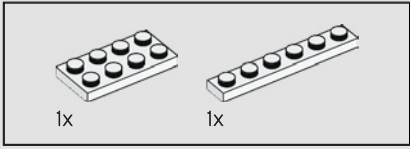
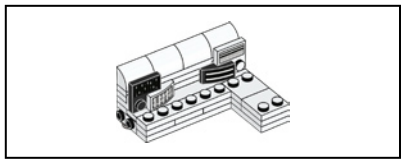

6

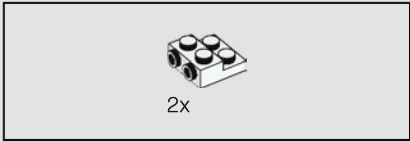
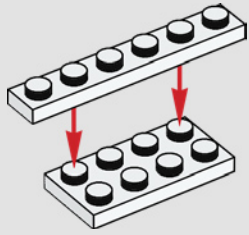

7

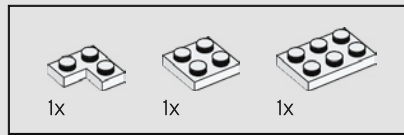
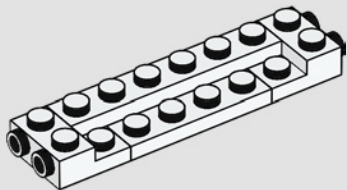

8

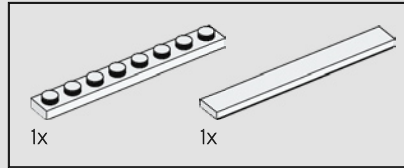
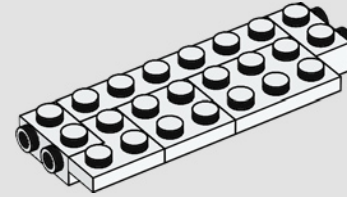

9

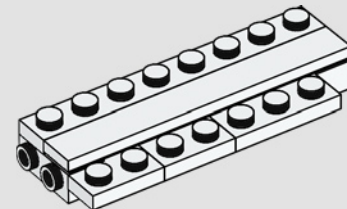

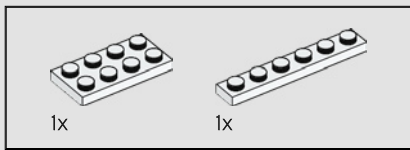

10

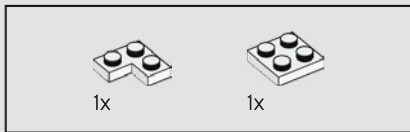
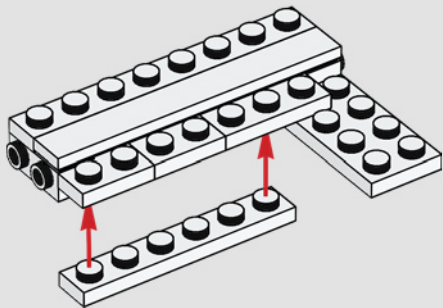

11

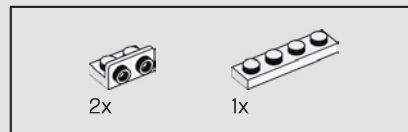
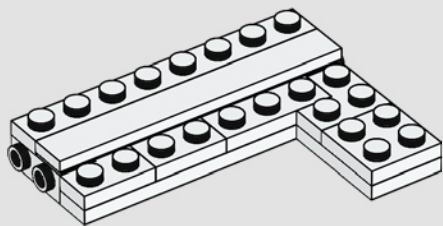

12

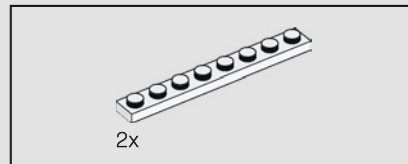
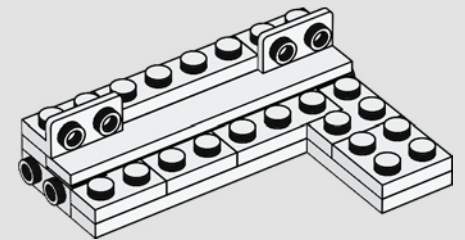

13

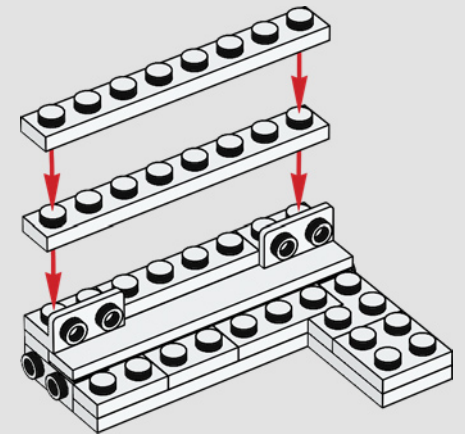

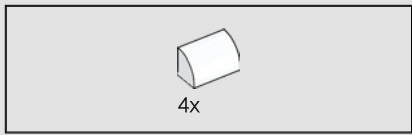

14

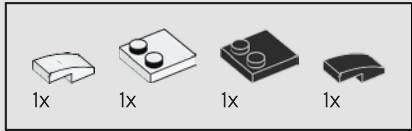
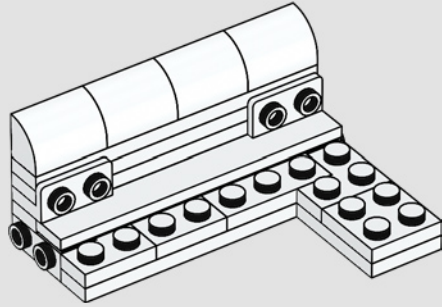

15

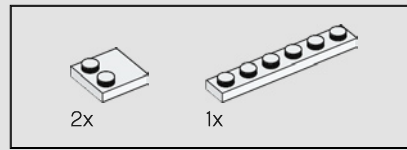
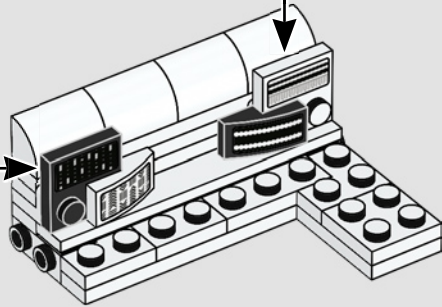
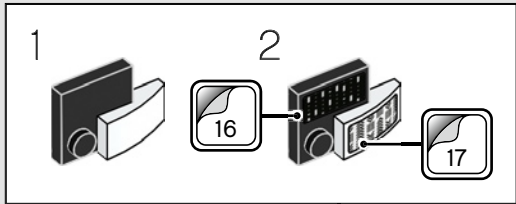
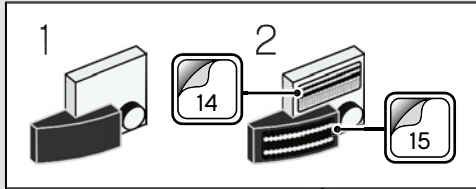

16

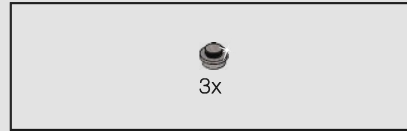
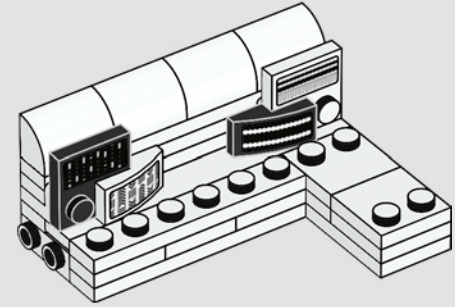

17

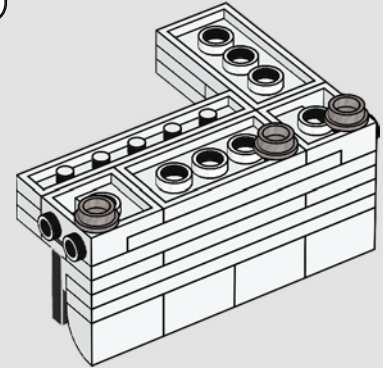
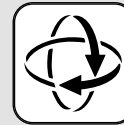

18

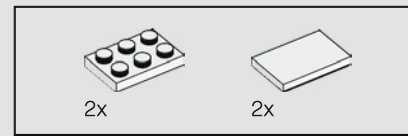
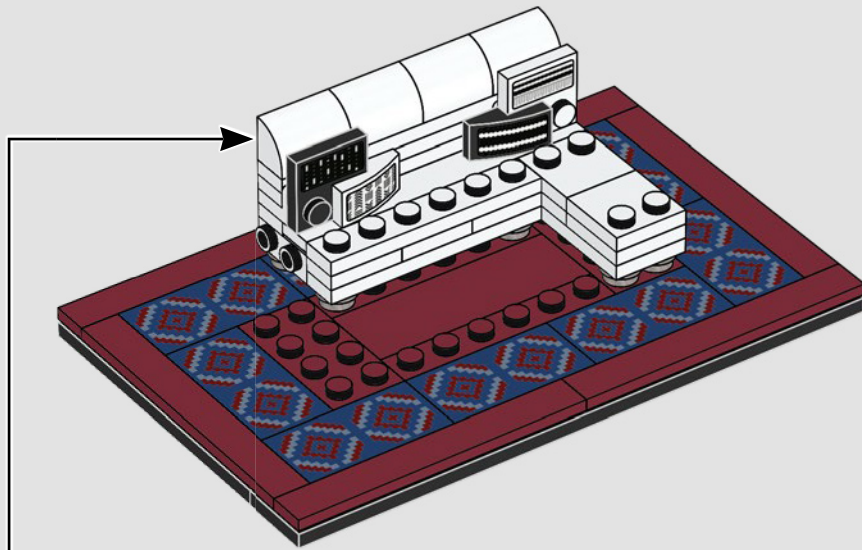

19

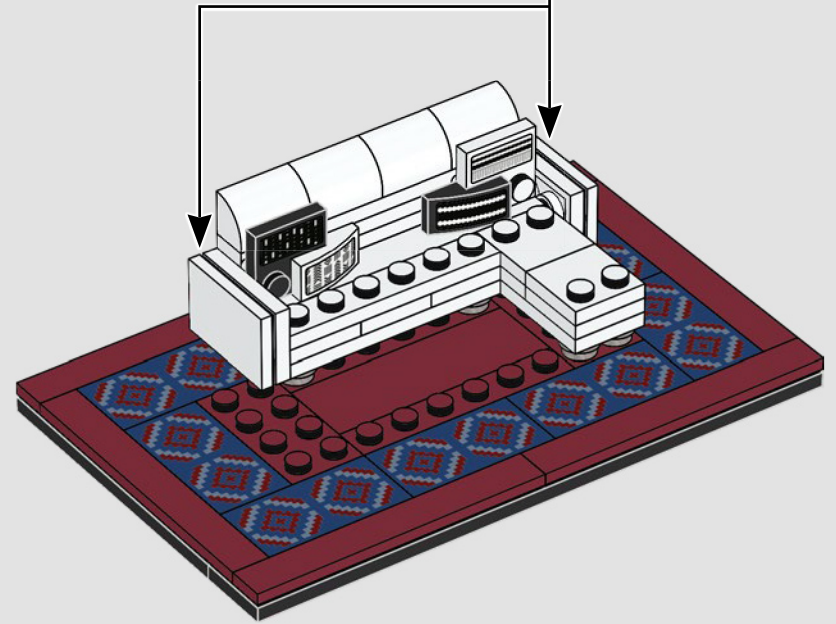
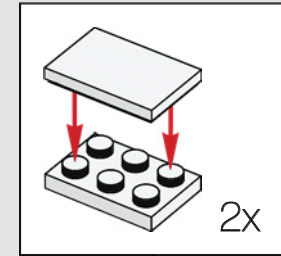

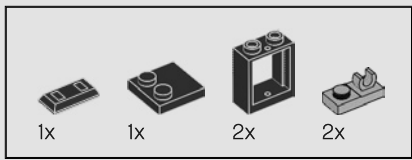

20

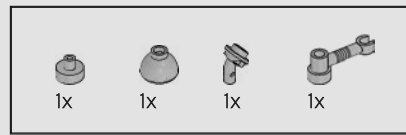
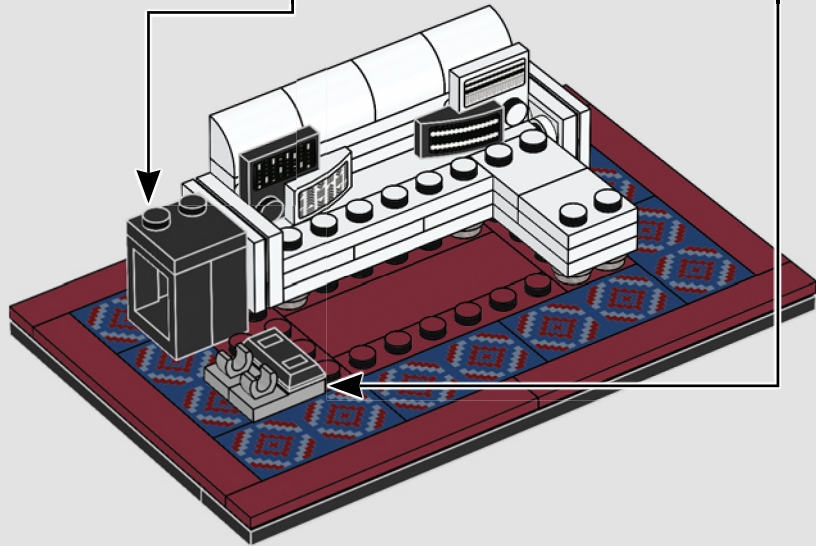
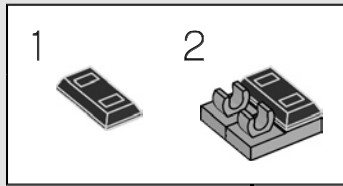
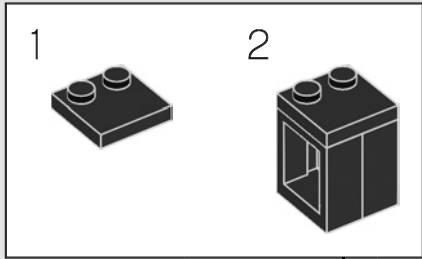

21

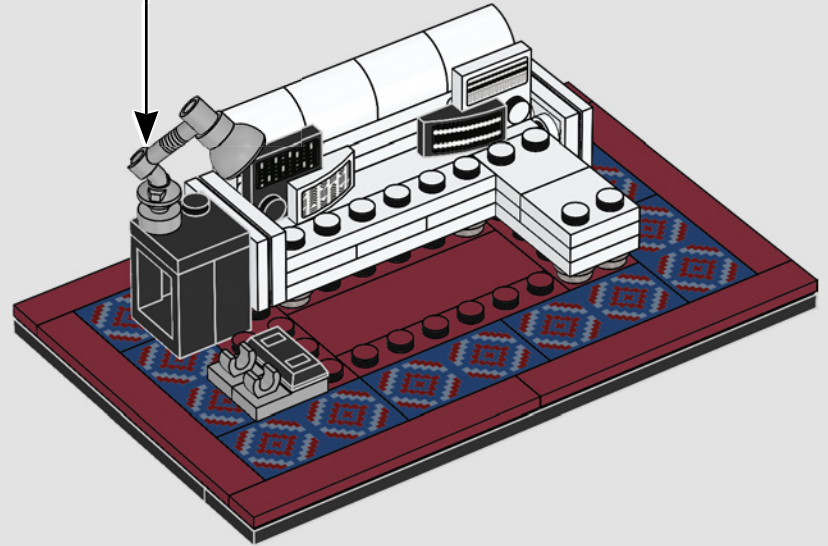
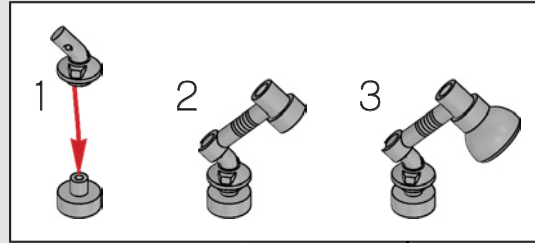

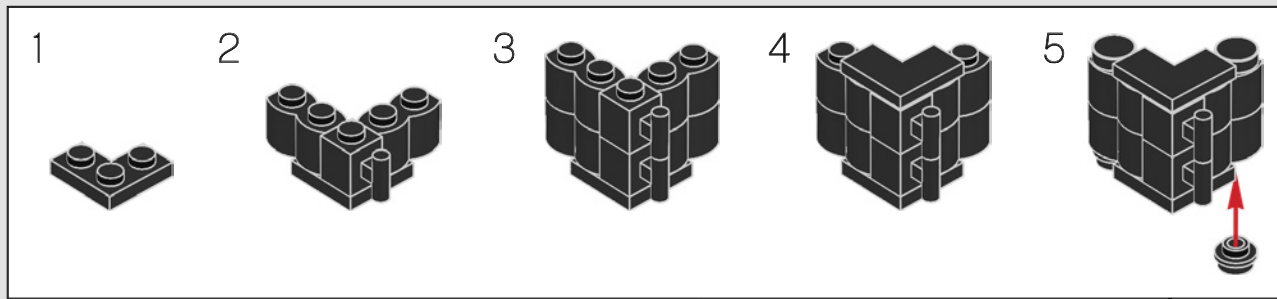
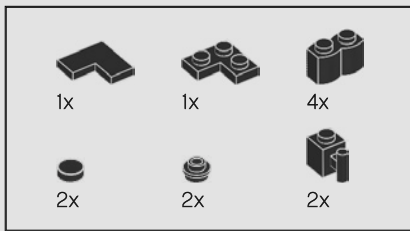

22

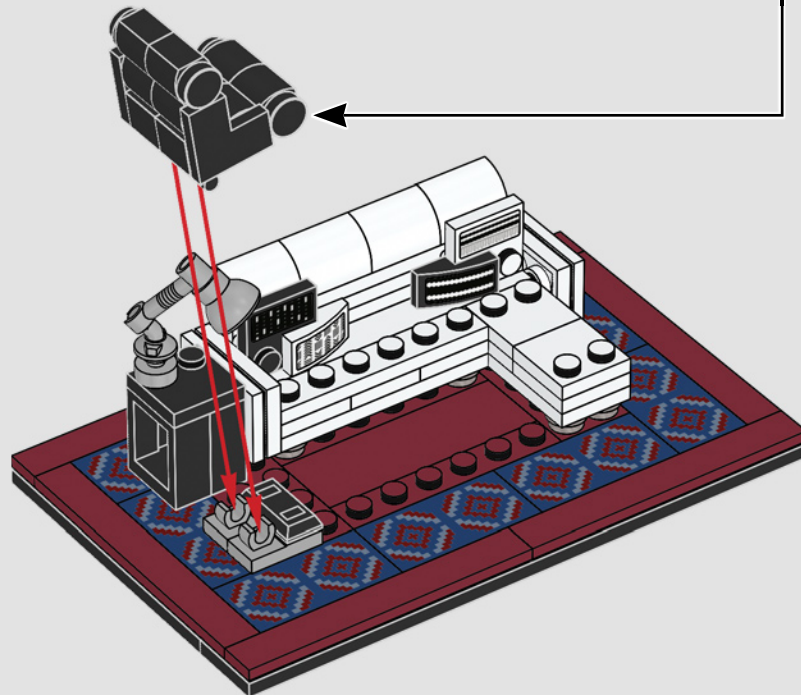

Tan France

« J'aime le processus créatif. Les briques LEGO® sont parfaites pour laisser libre cours à sa créativité, car elles permettent de créer ce que l'on veut avec son propre style. »

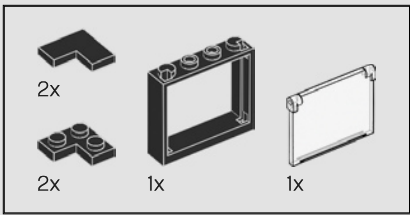

23

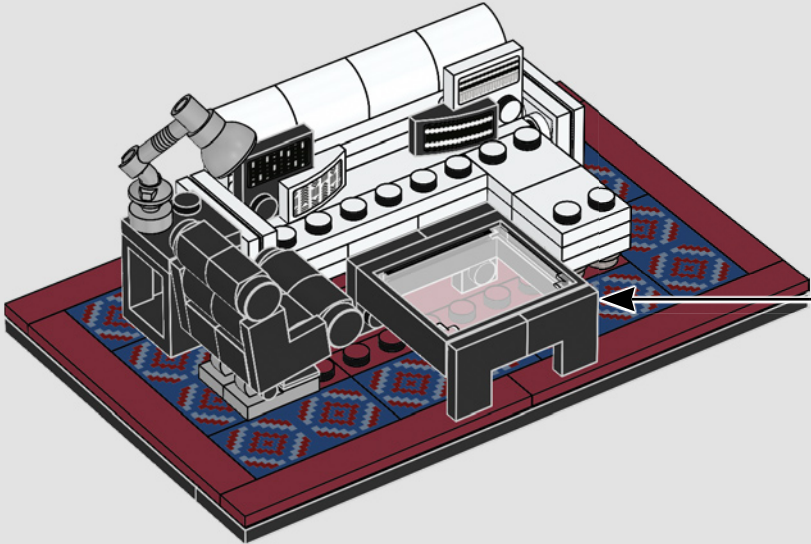
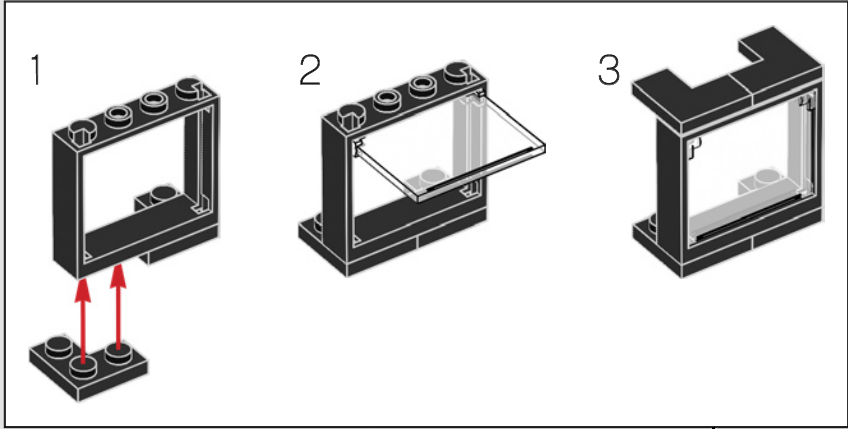

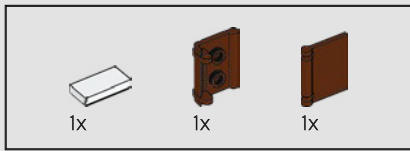

24



Karamo Brown

« Ce set me rappelle tant de bons souvenirs. C'est comme si je pouvais revivre l'émission une seconde fois dans ma version miniature ! »

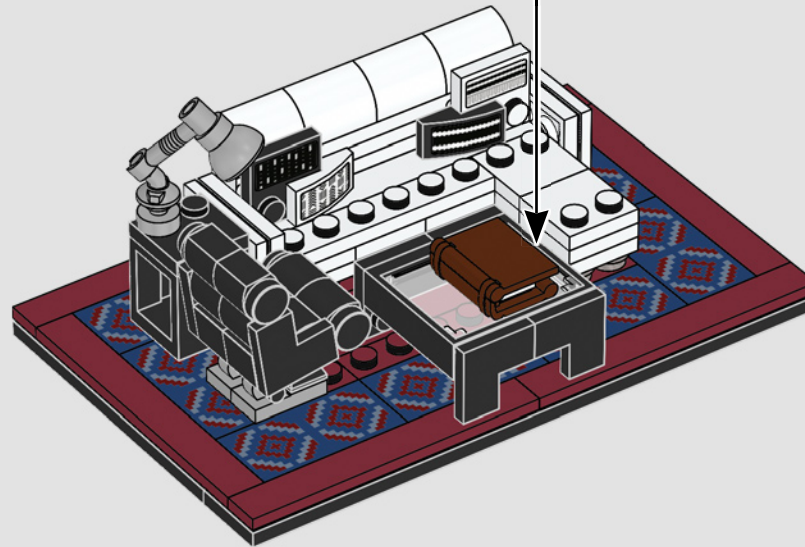
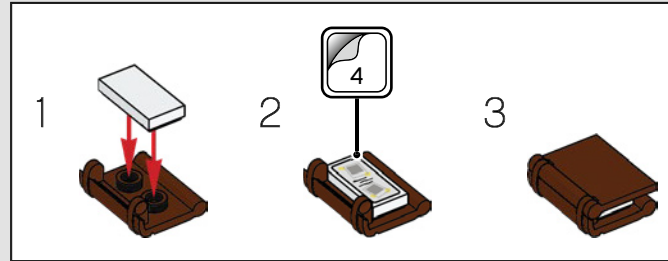

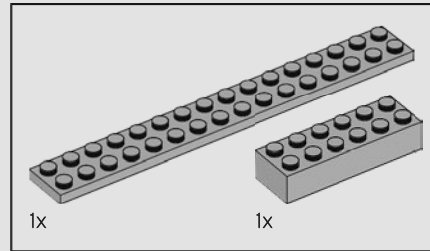
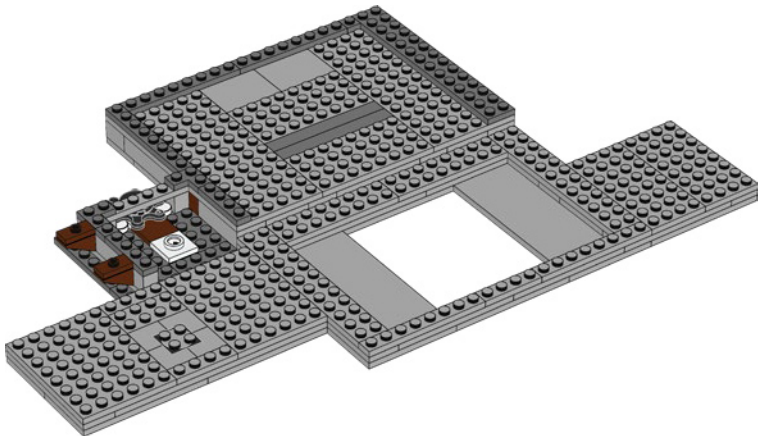
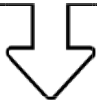

1

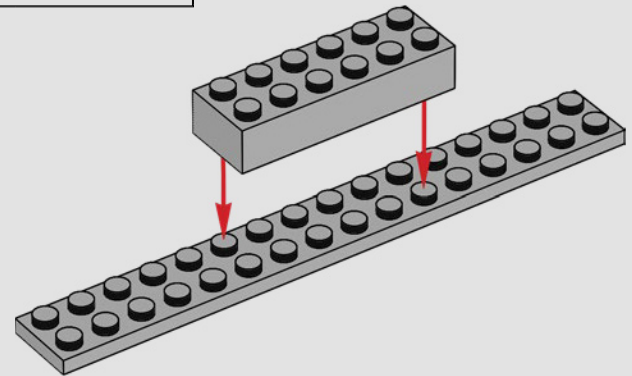

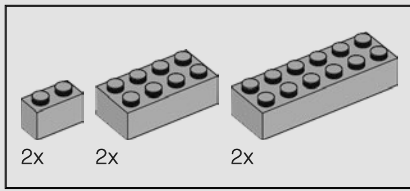

2

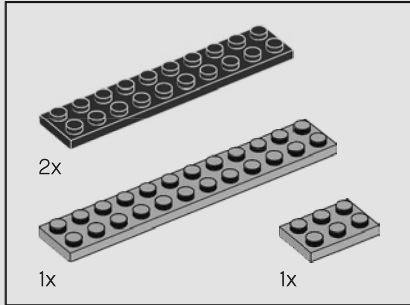
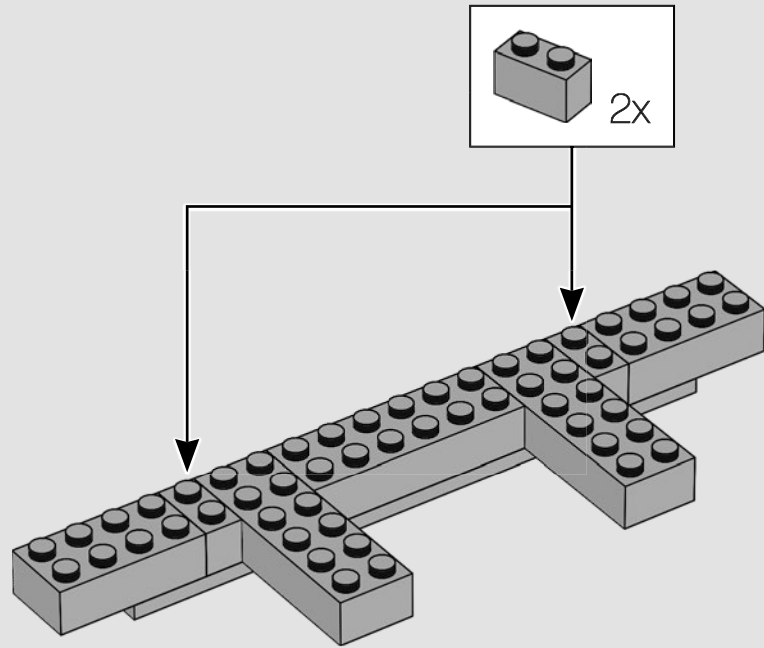

3

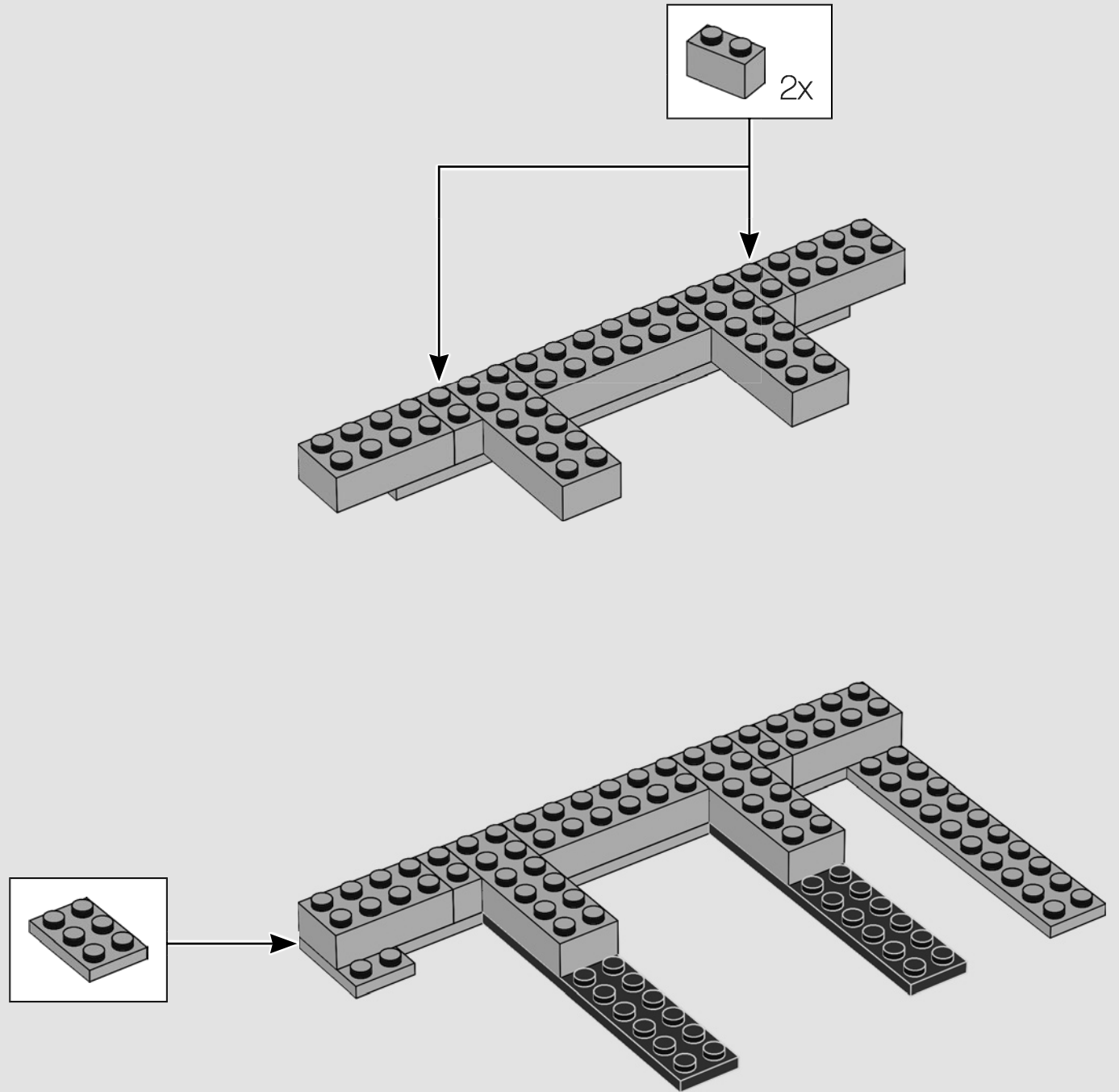

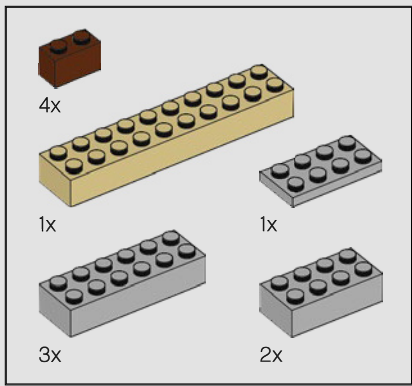

4

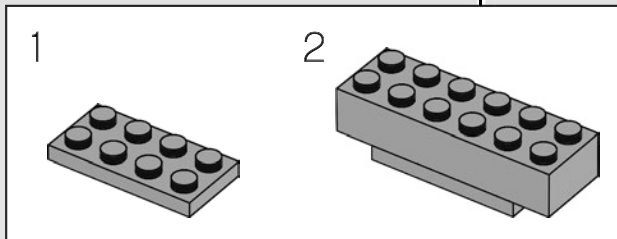
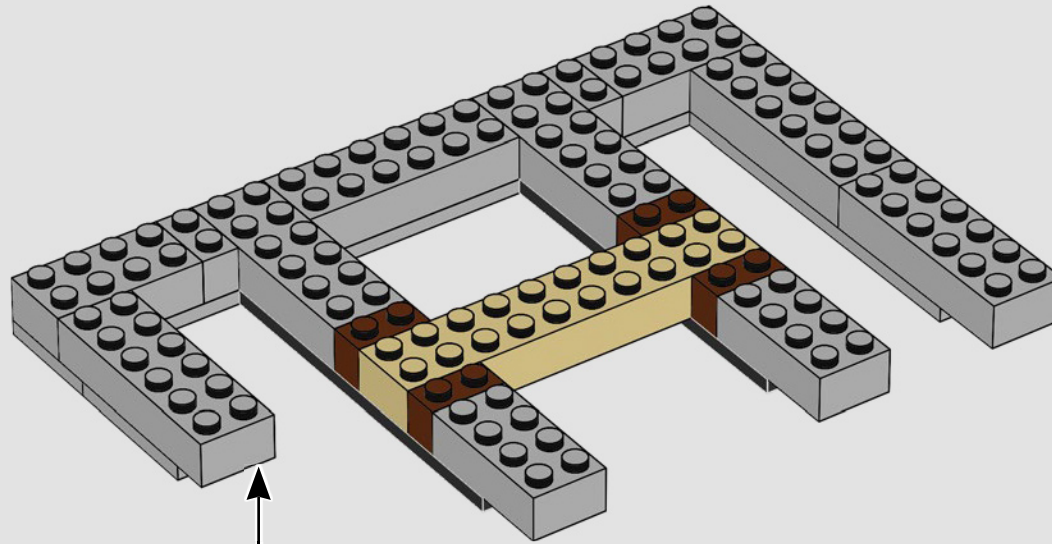

Karamo Brown

« C'est grâce aux gens que *Queer Eye* est unique. C'est grâce à l'équipe formidable avec laquelle je travaille chaque jour et aux rencontres incroyables que je fais dans l'émission et que je partage avec le monde entier. »

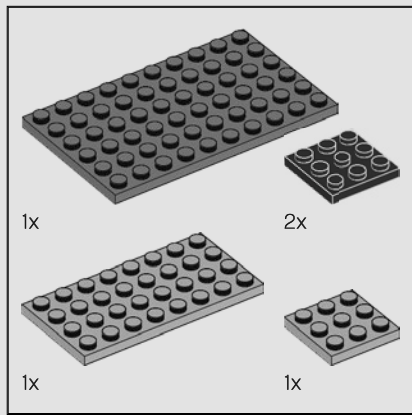

5

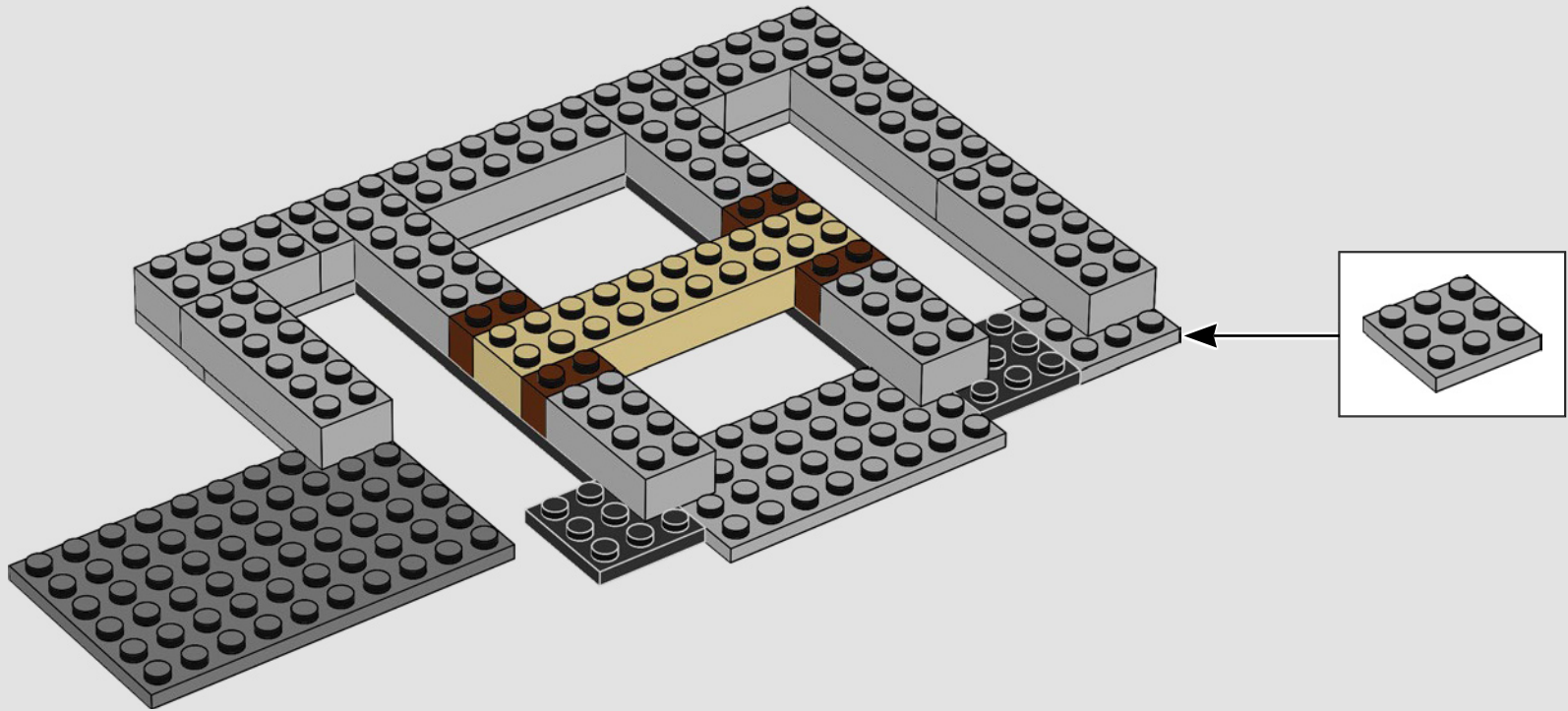

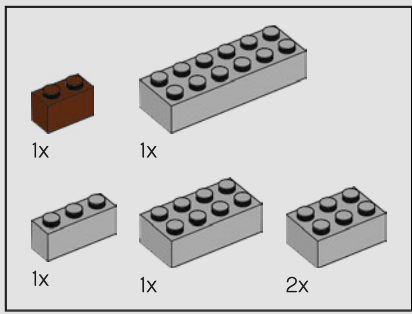

6

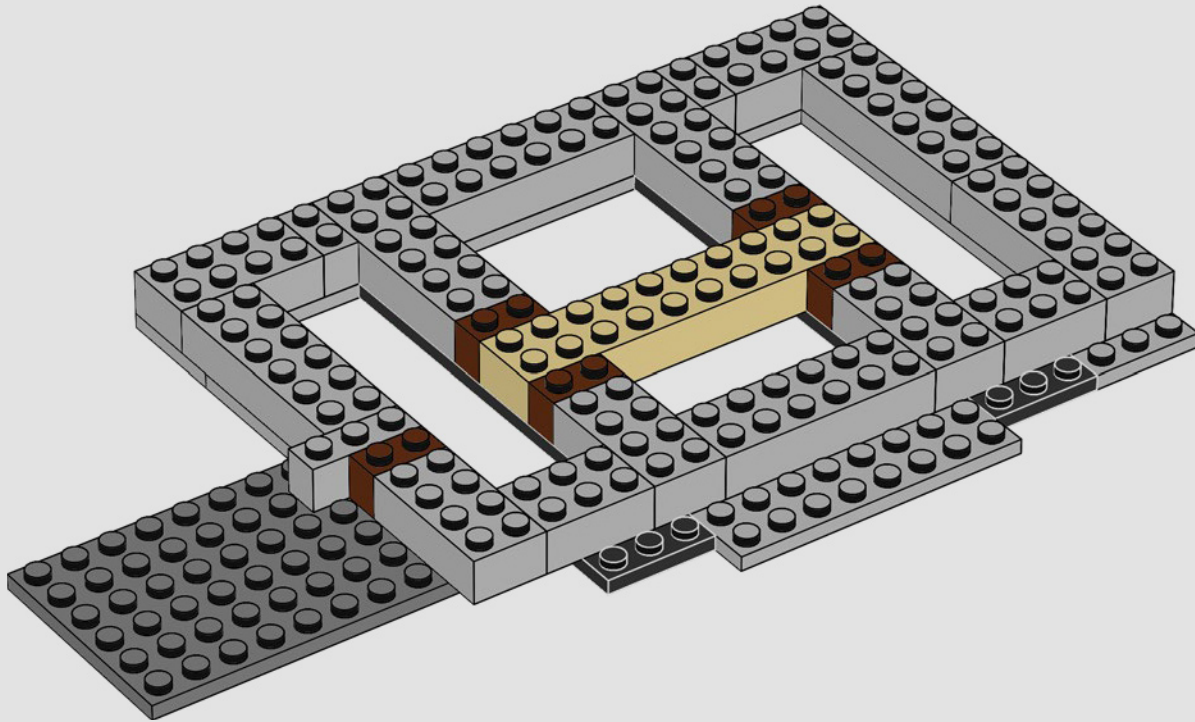

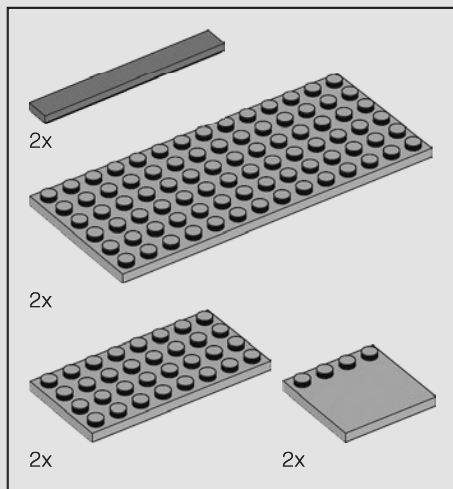

7

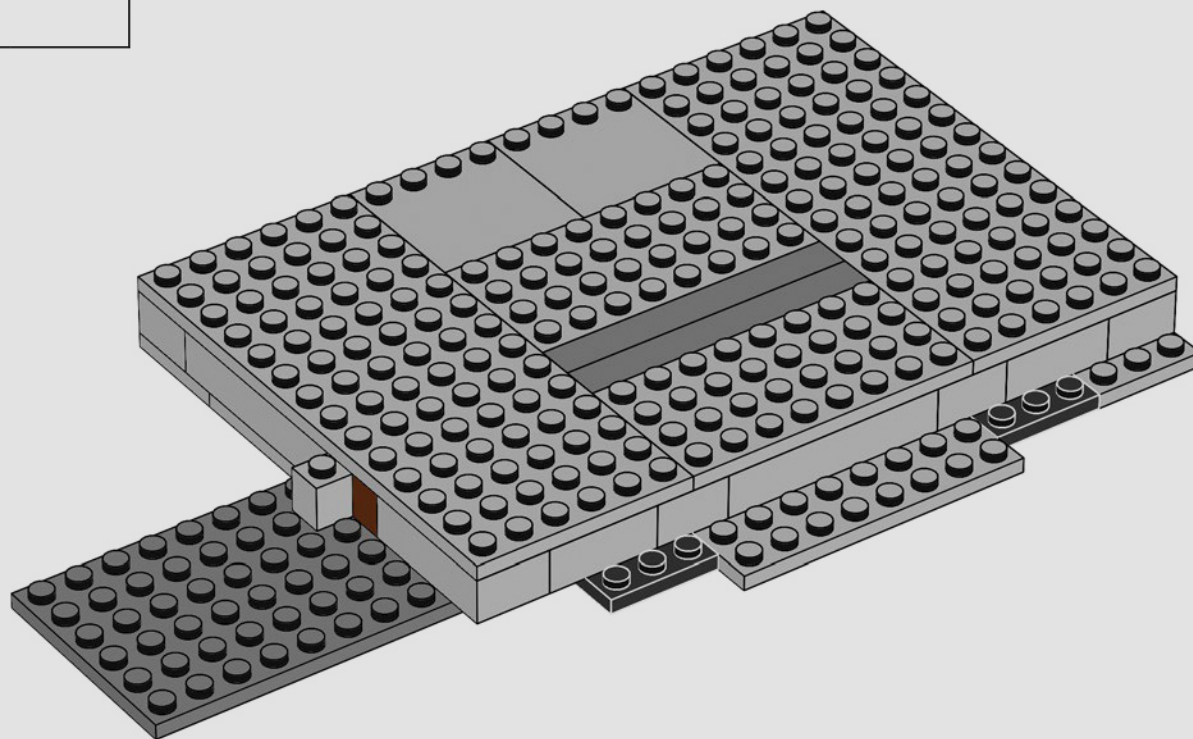

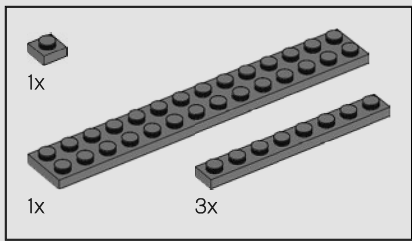

8

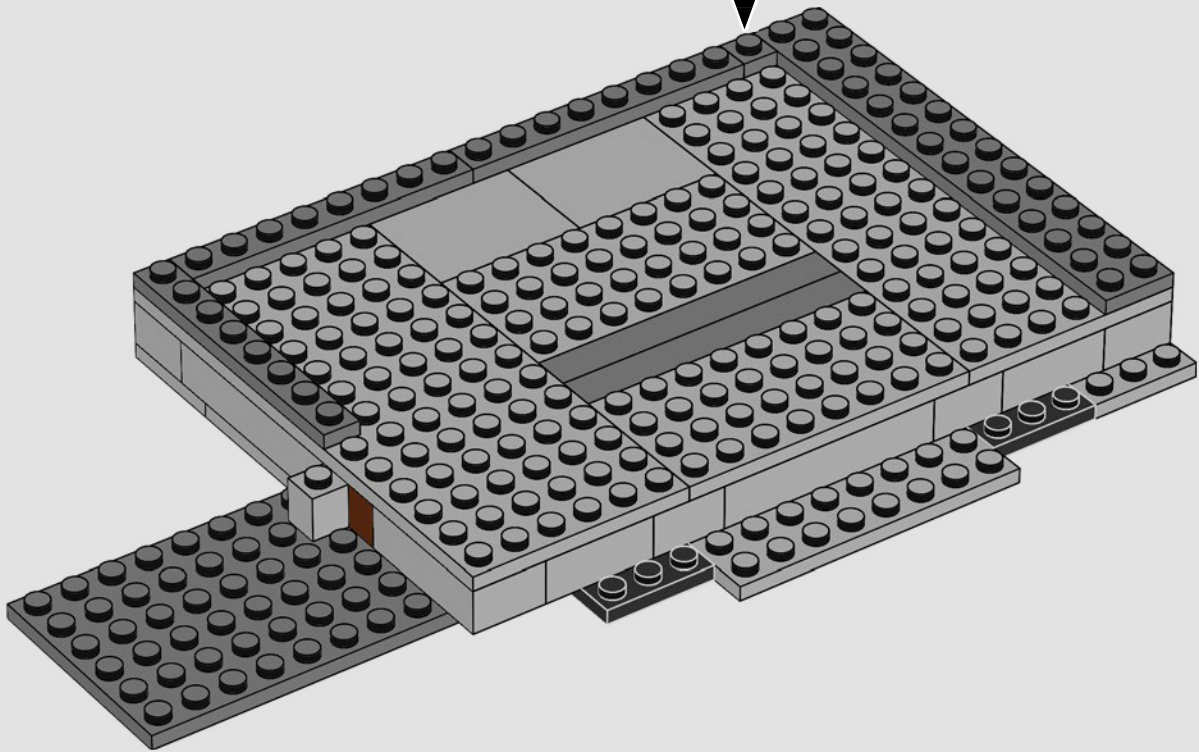
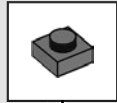

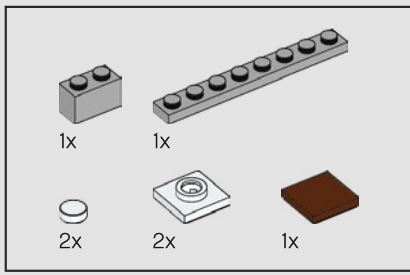

9

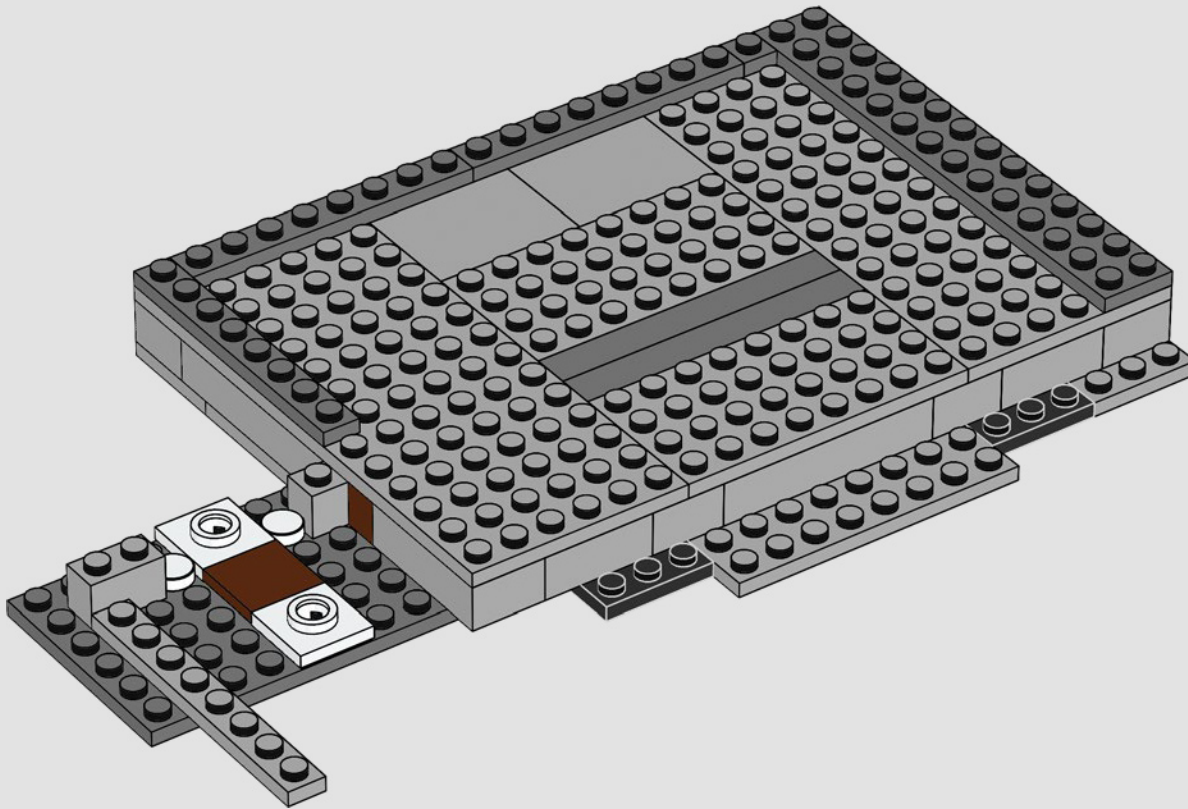

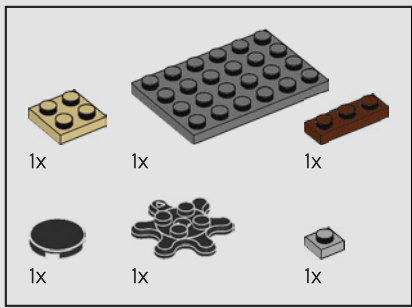

10

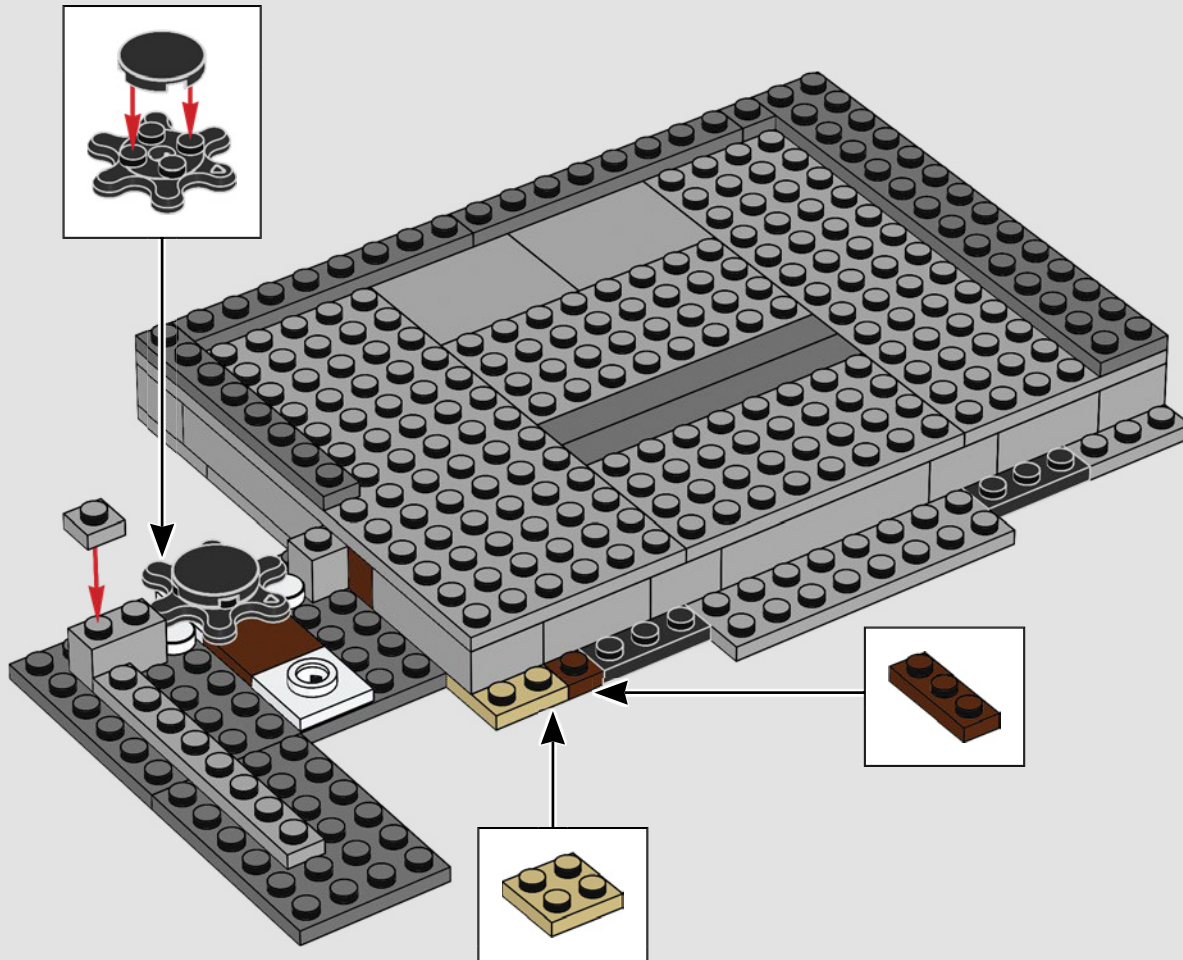

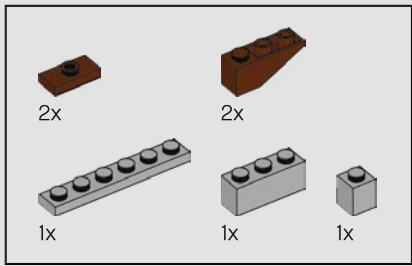

11

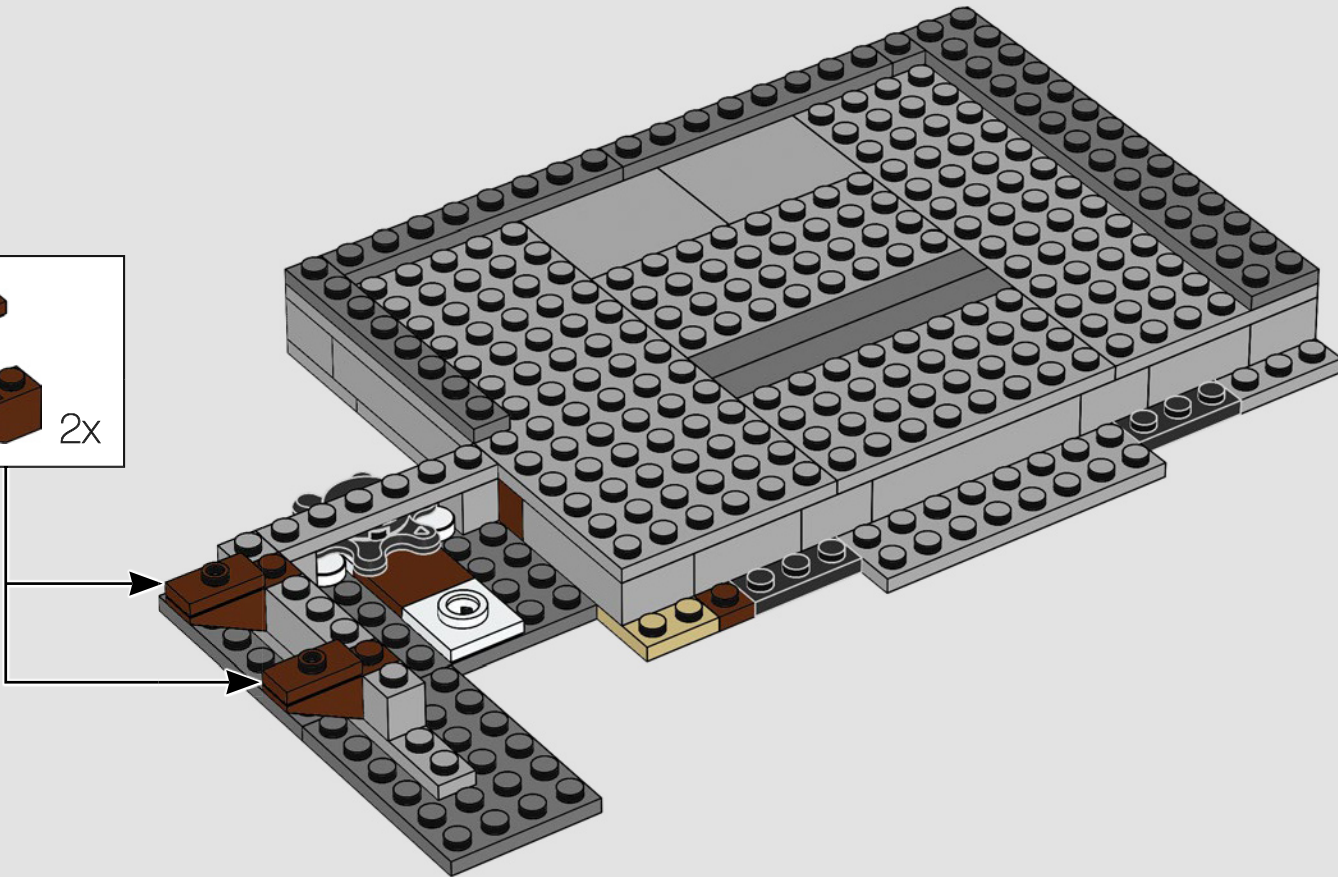
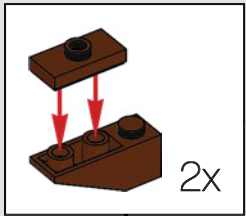

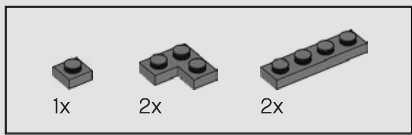

12

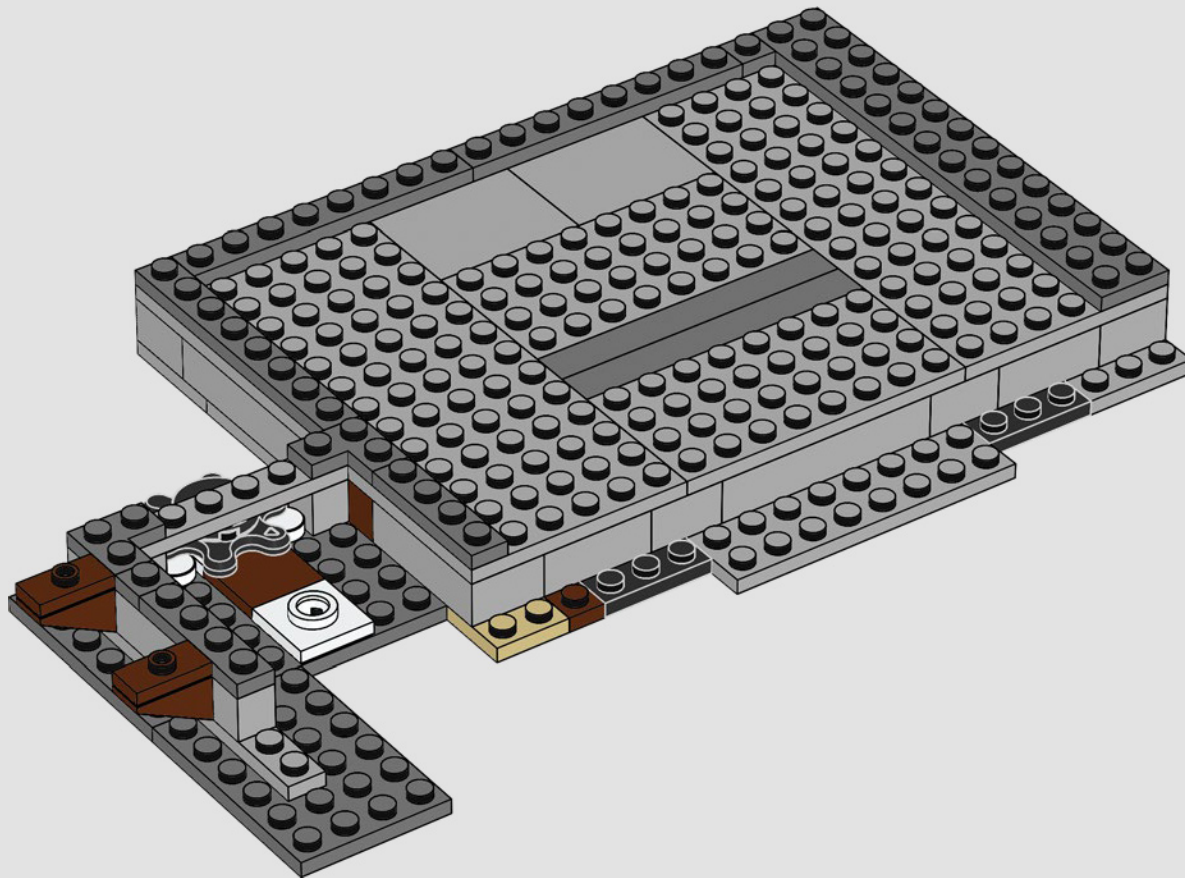

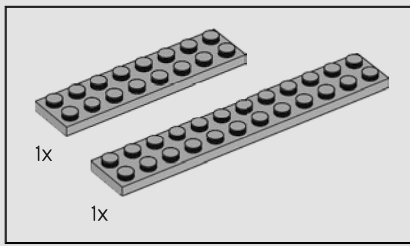

13

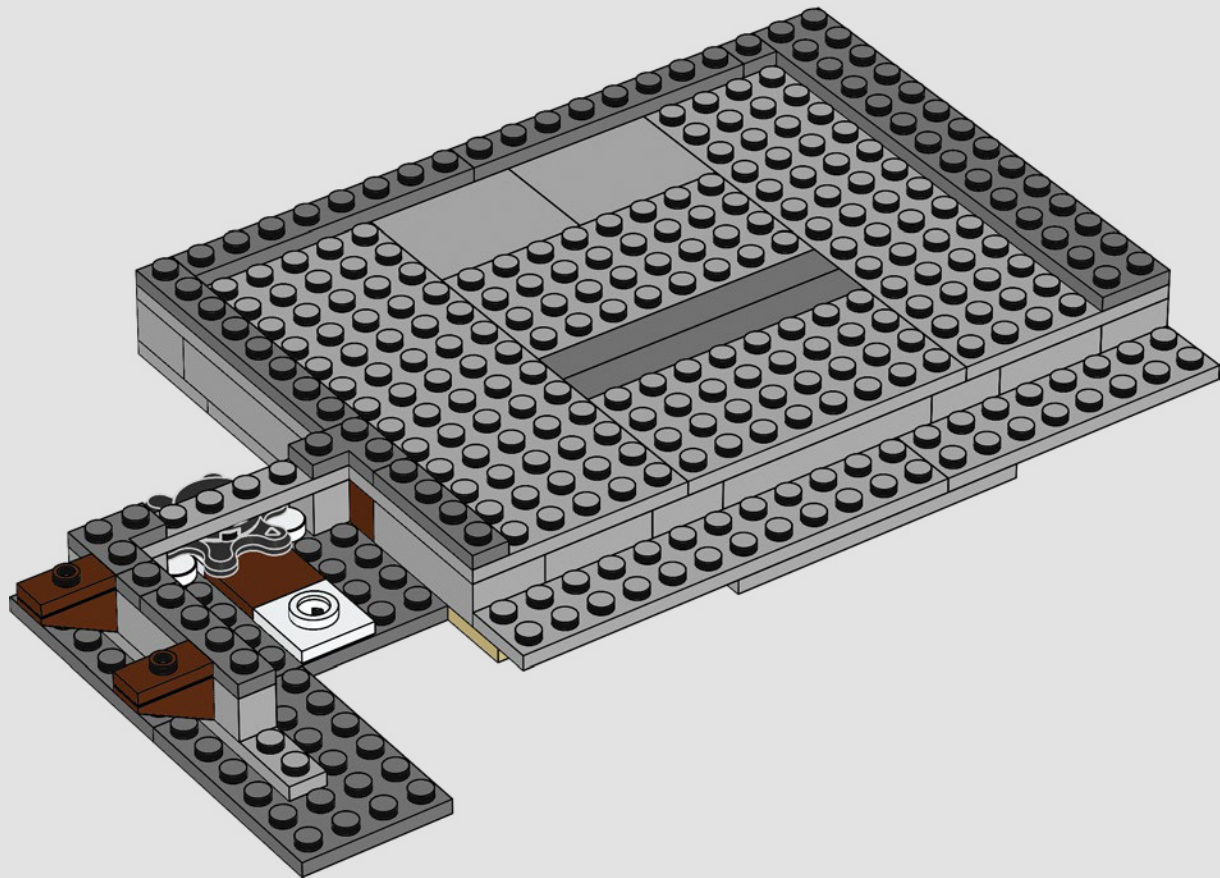

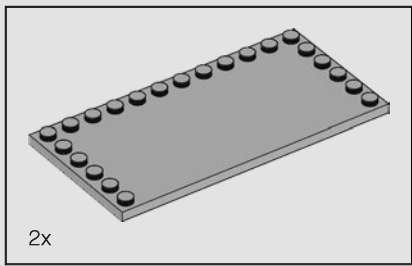

14

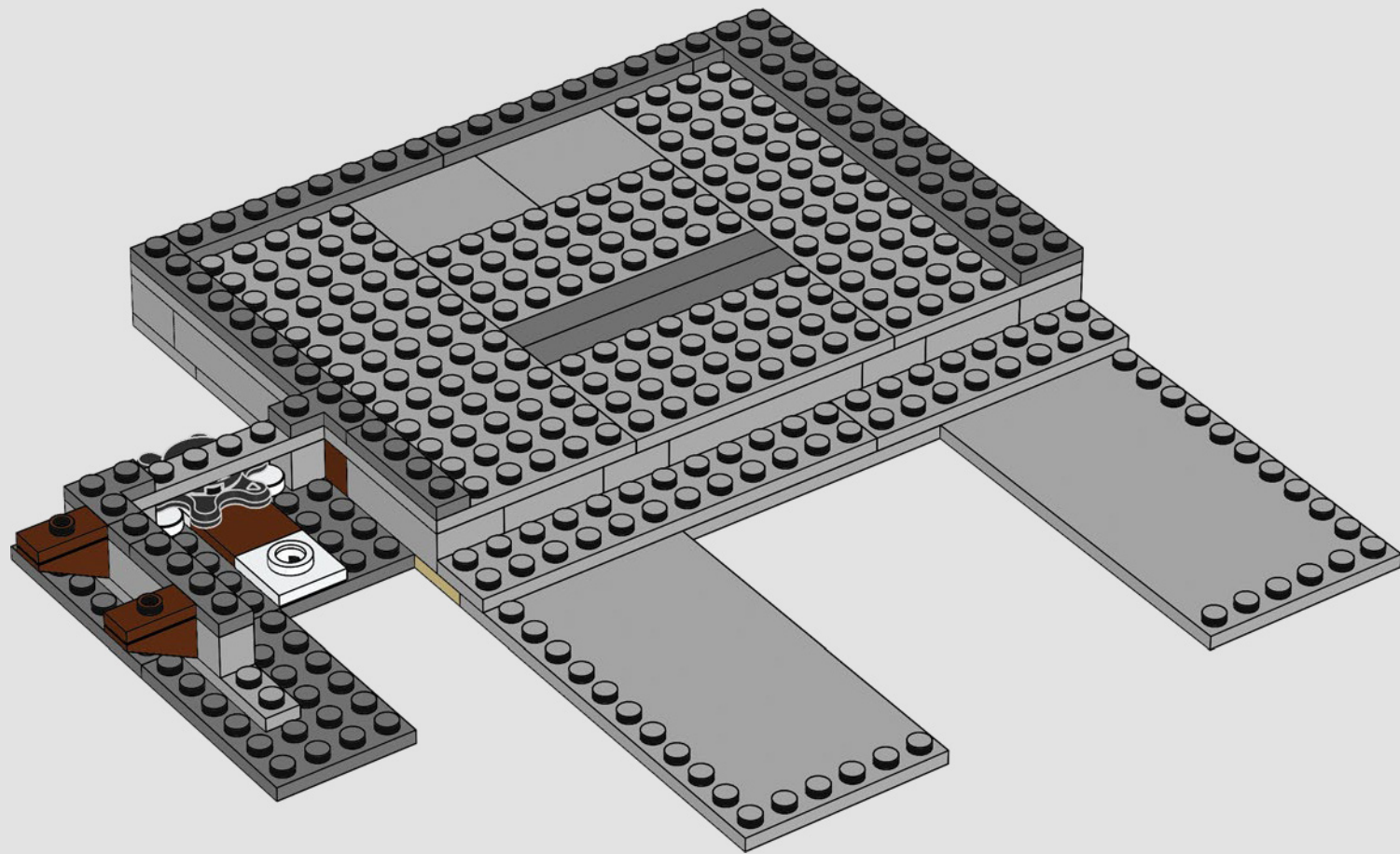

Jonathan Van Ness

« Mon but avec *Queer Eye* est de faire en sorte que les gens puissent nouer des liens et comprendre les autres, mais aussi se comprendre et s'accepter. »

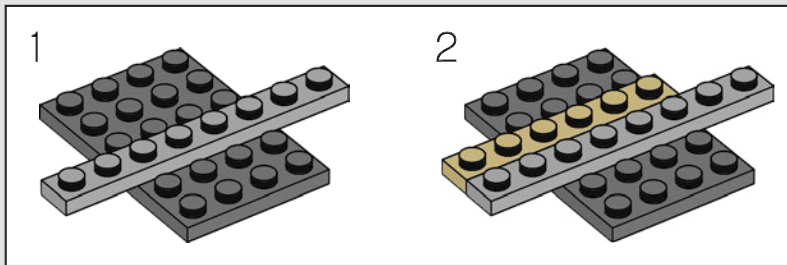
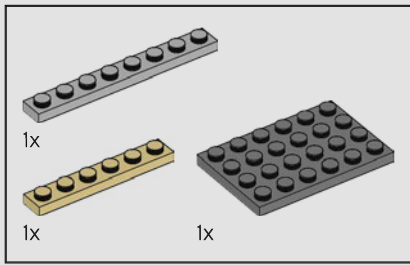

15

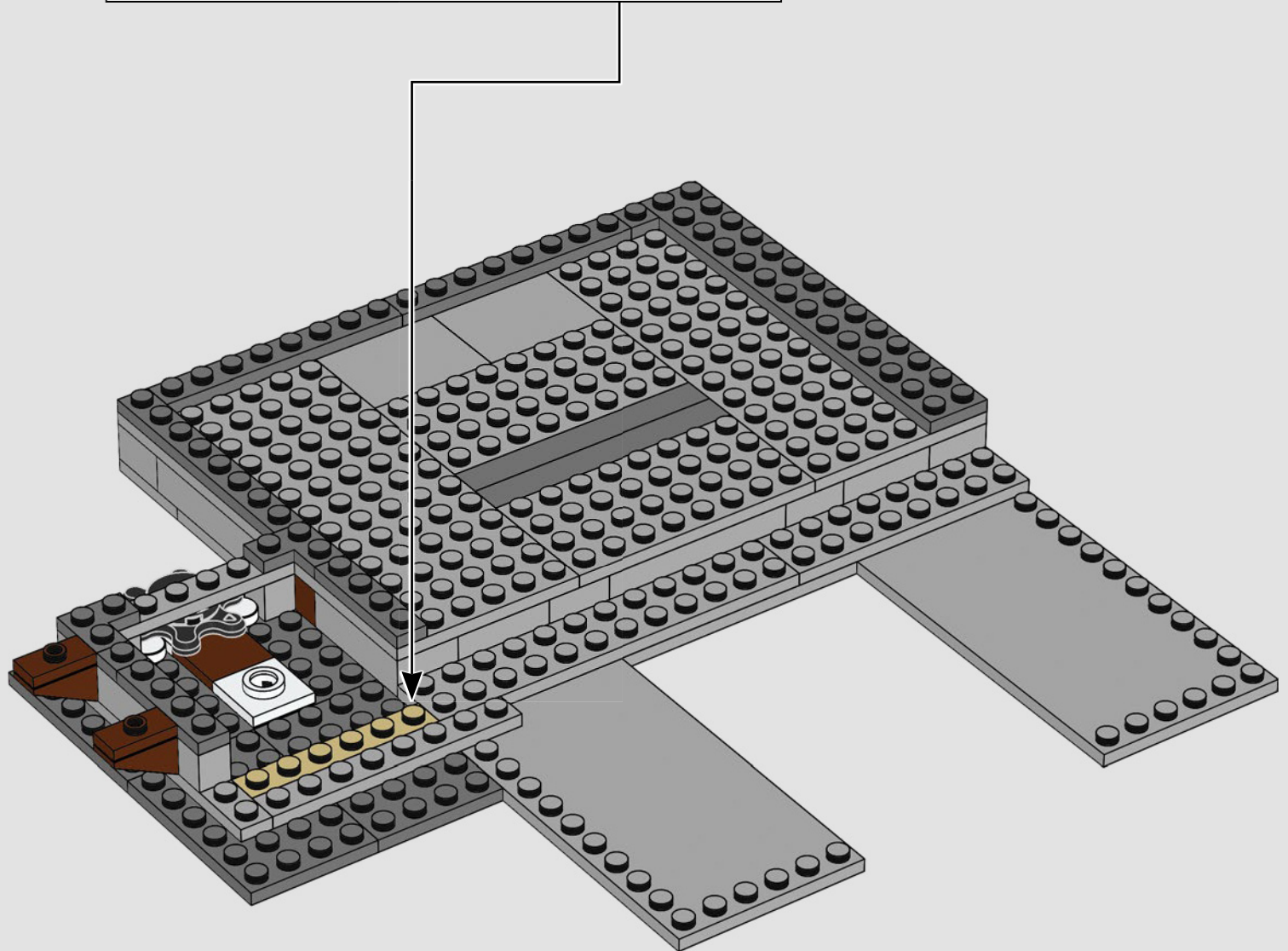

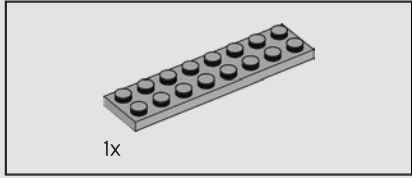
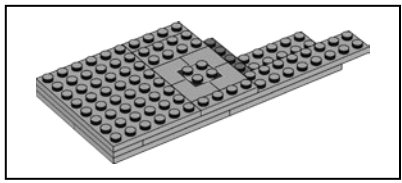

16

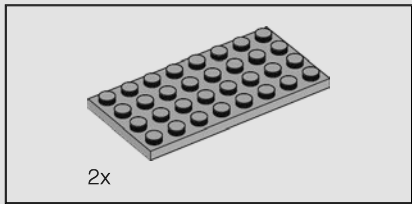
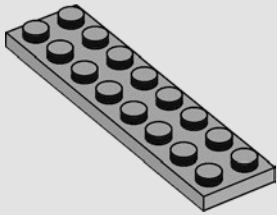

17

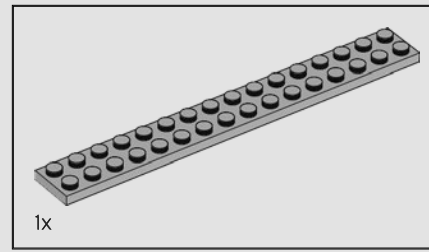
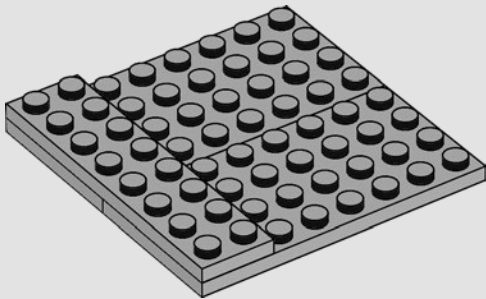

18

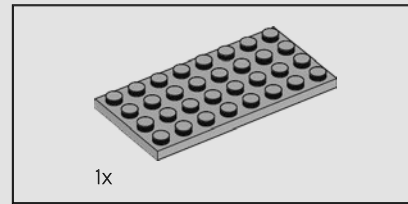
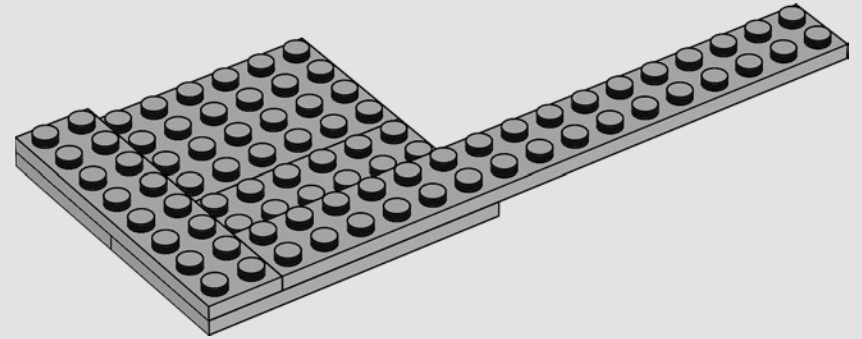

19

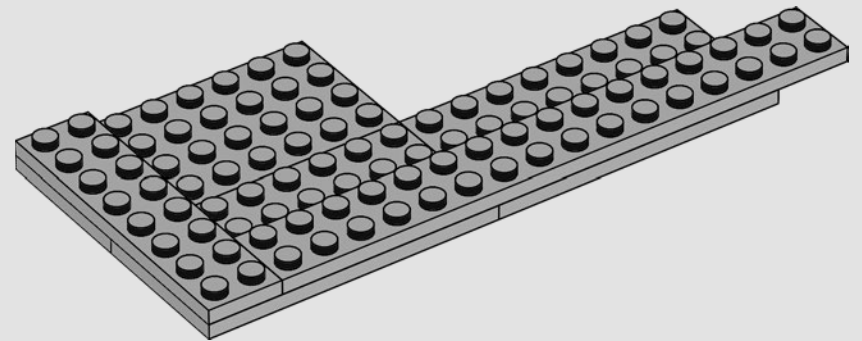

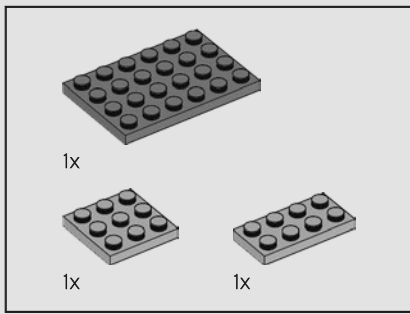

20

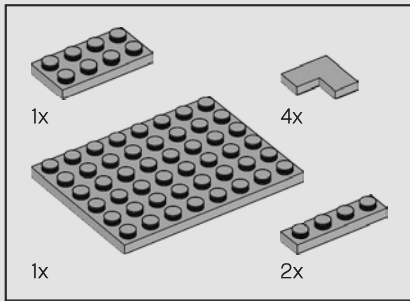
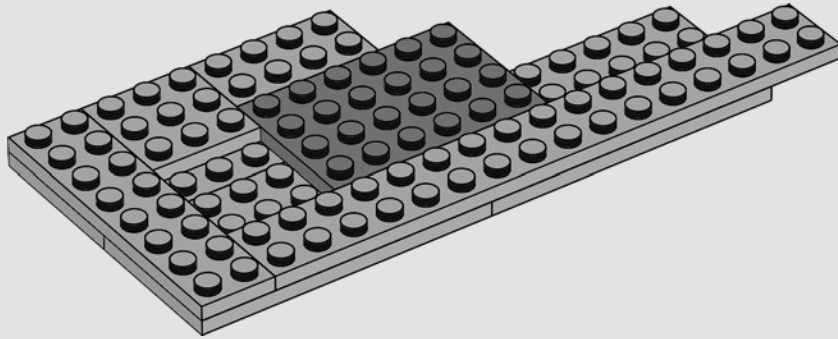

21

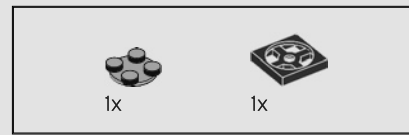
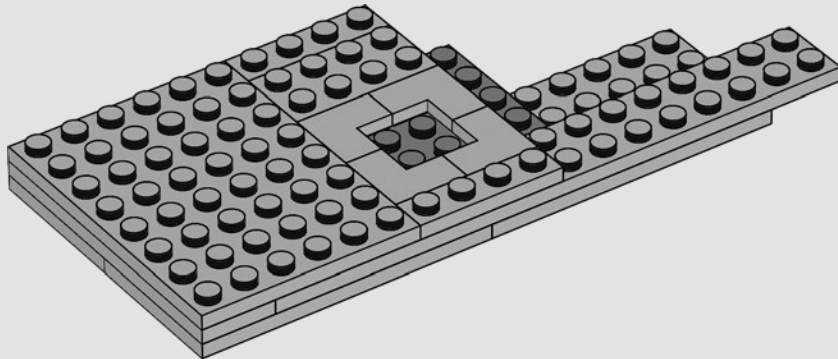

22

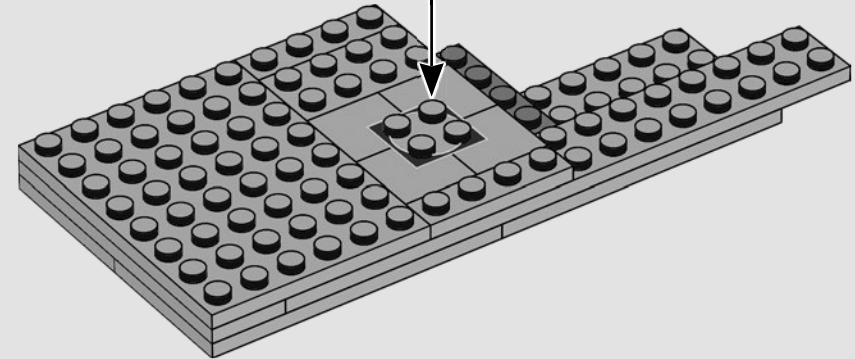
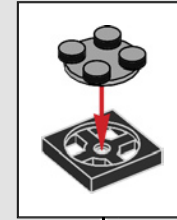



Karamo Brown

« LEGO® a été très important pour moi et ma famille. Grâce aux modèles LEGO, mes garçons se sont beaucoup amusés, et j'ai pu passer du temps avec eux et resserrer les liens qui nous unissent. »

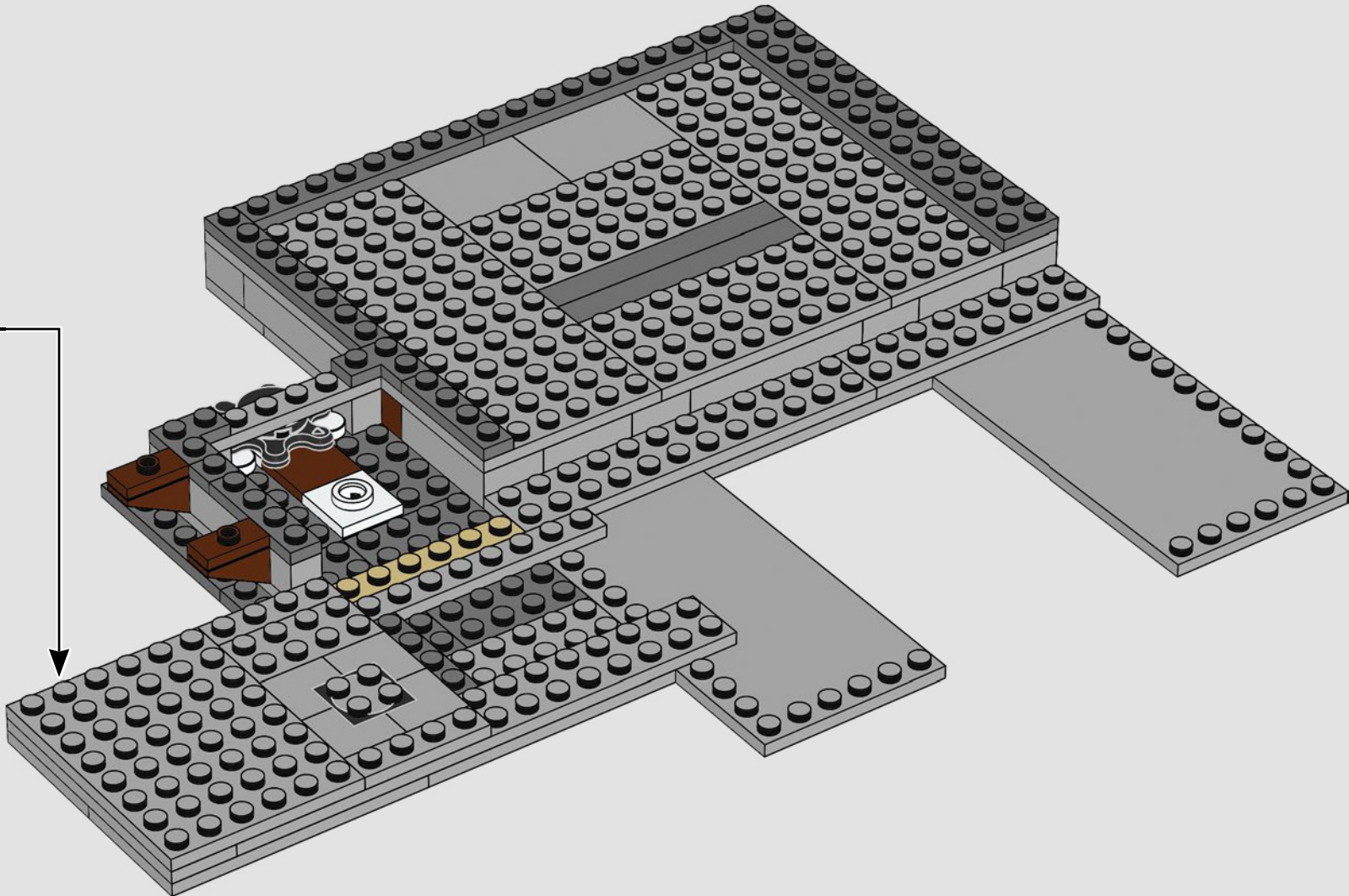

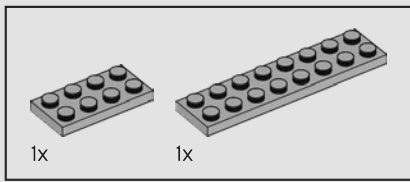

24

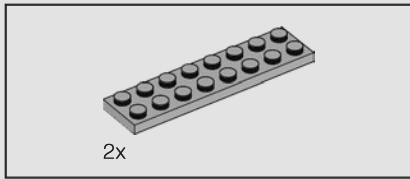
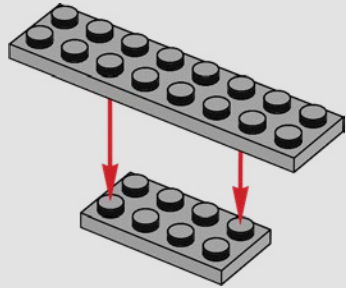

25

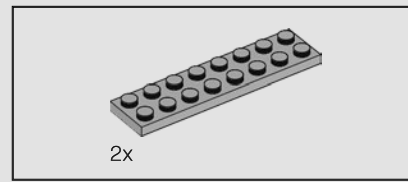
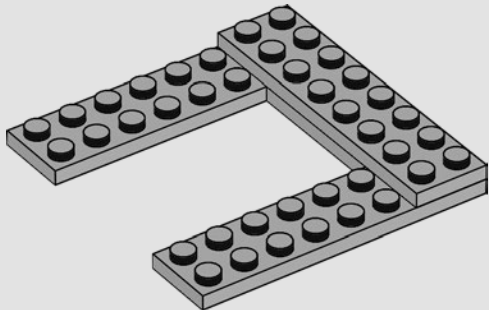

26

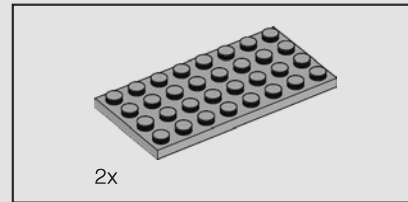
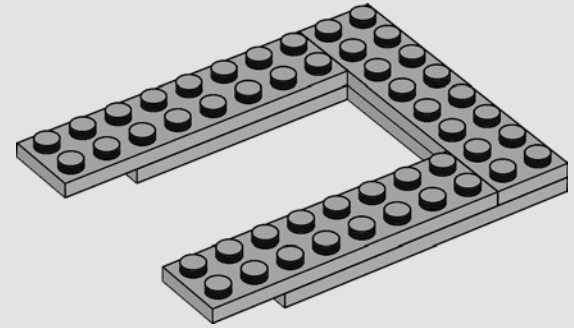

27

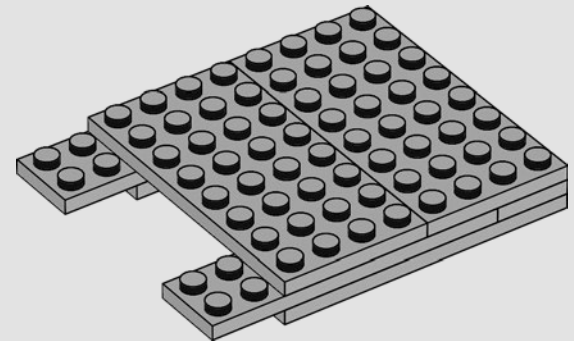

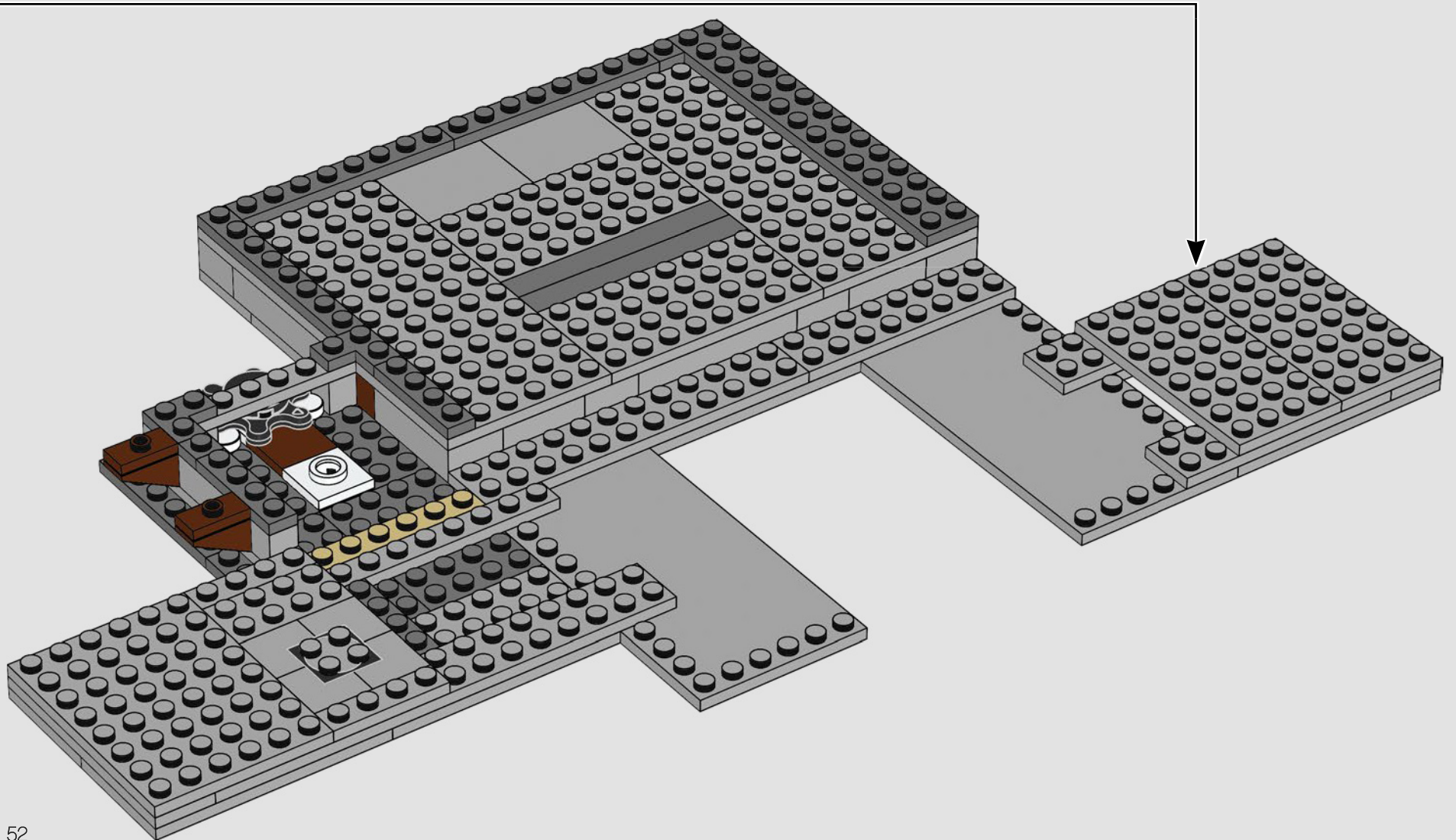

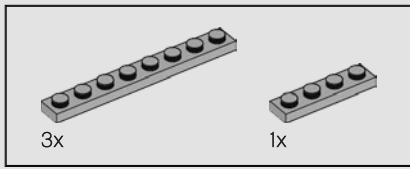

29

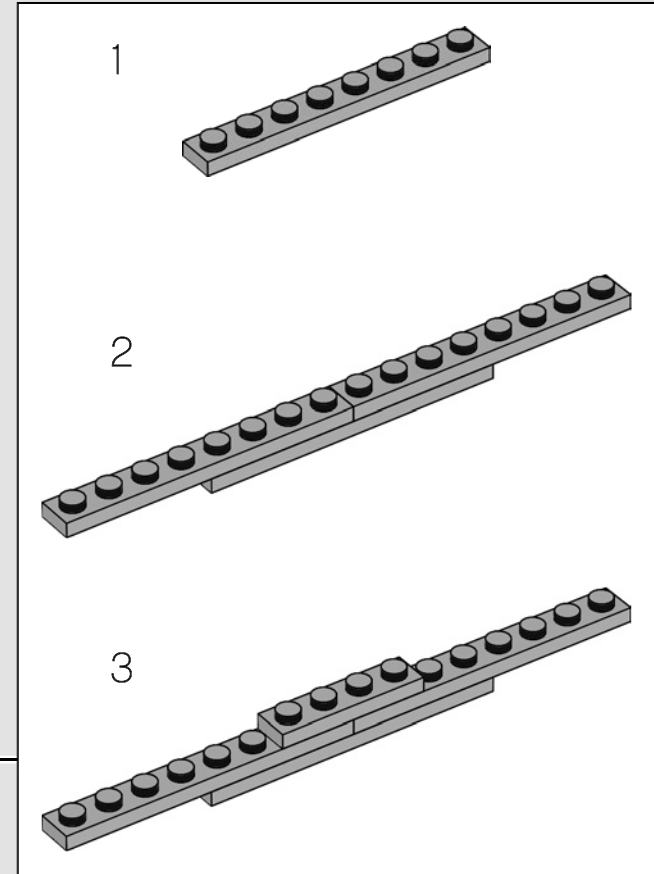
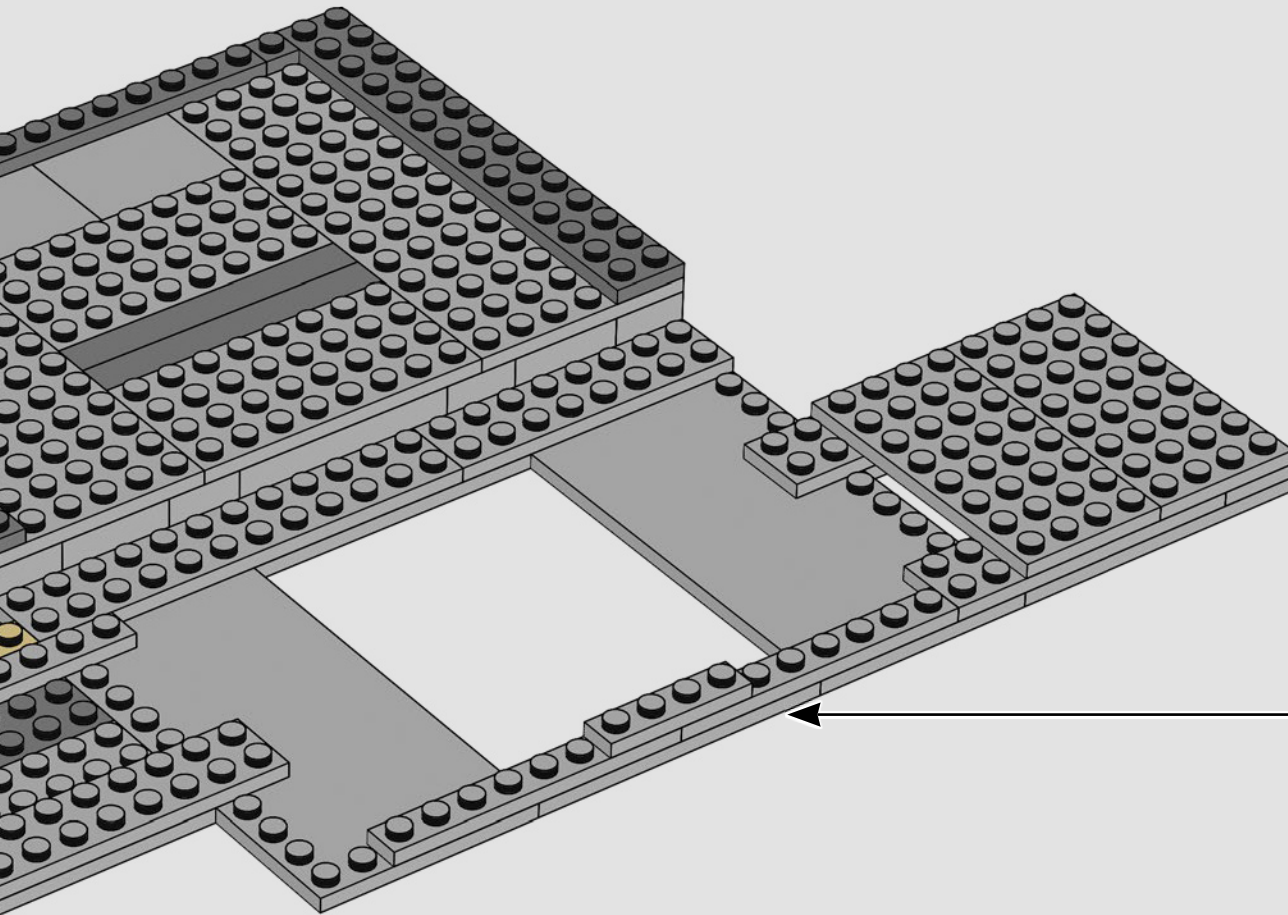

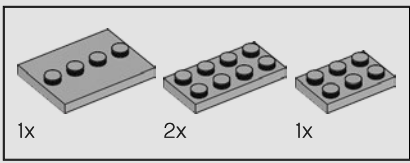

30

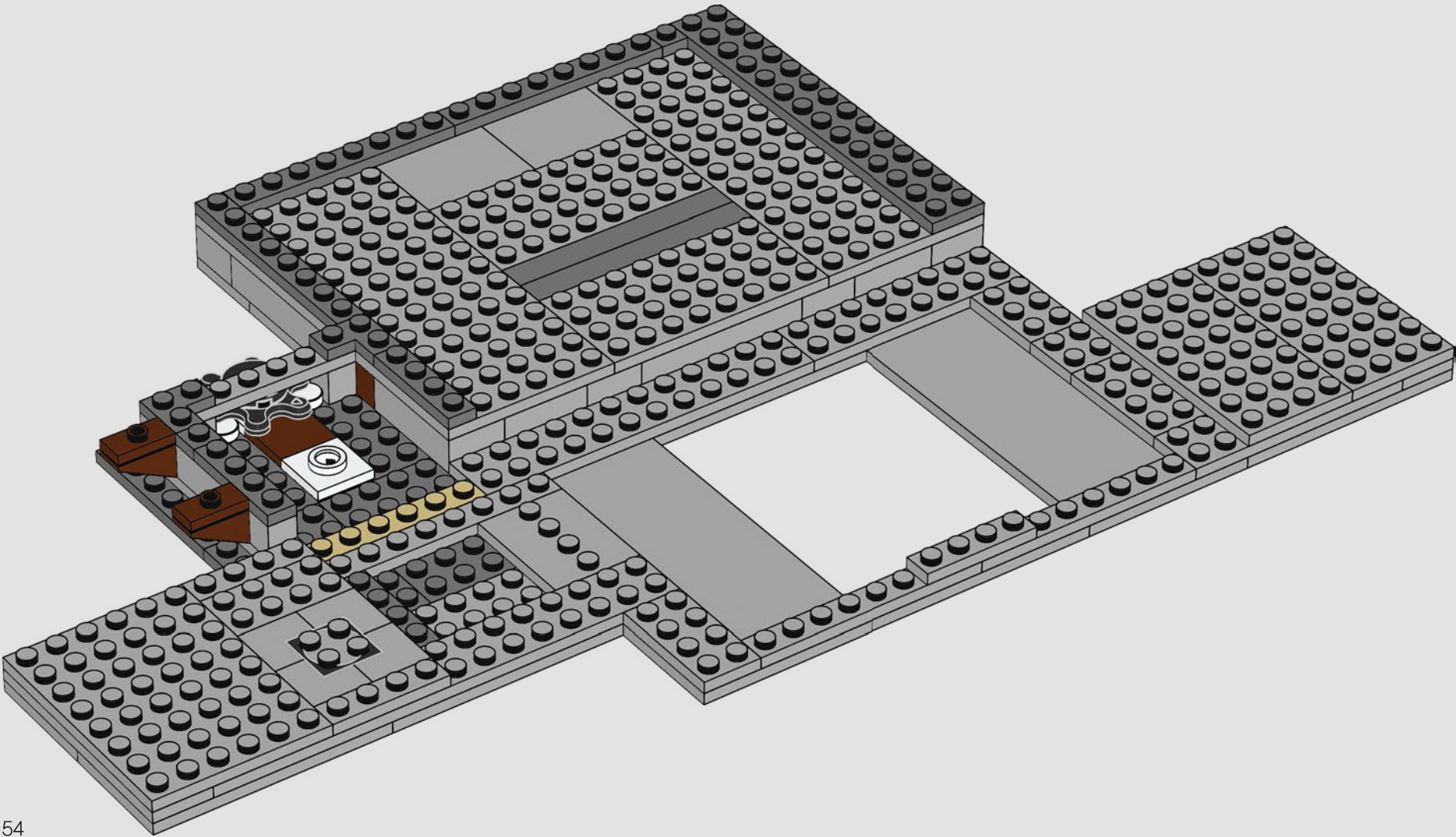

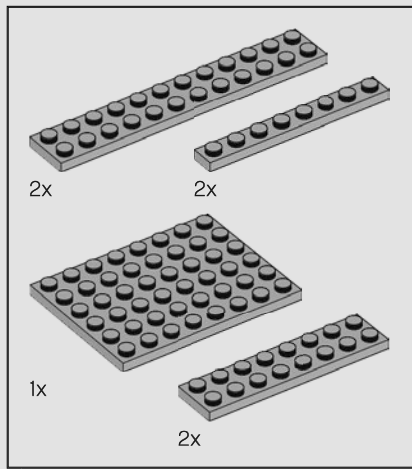

31

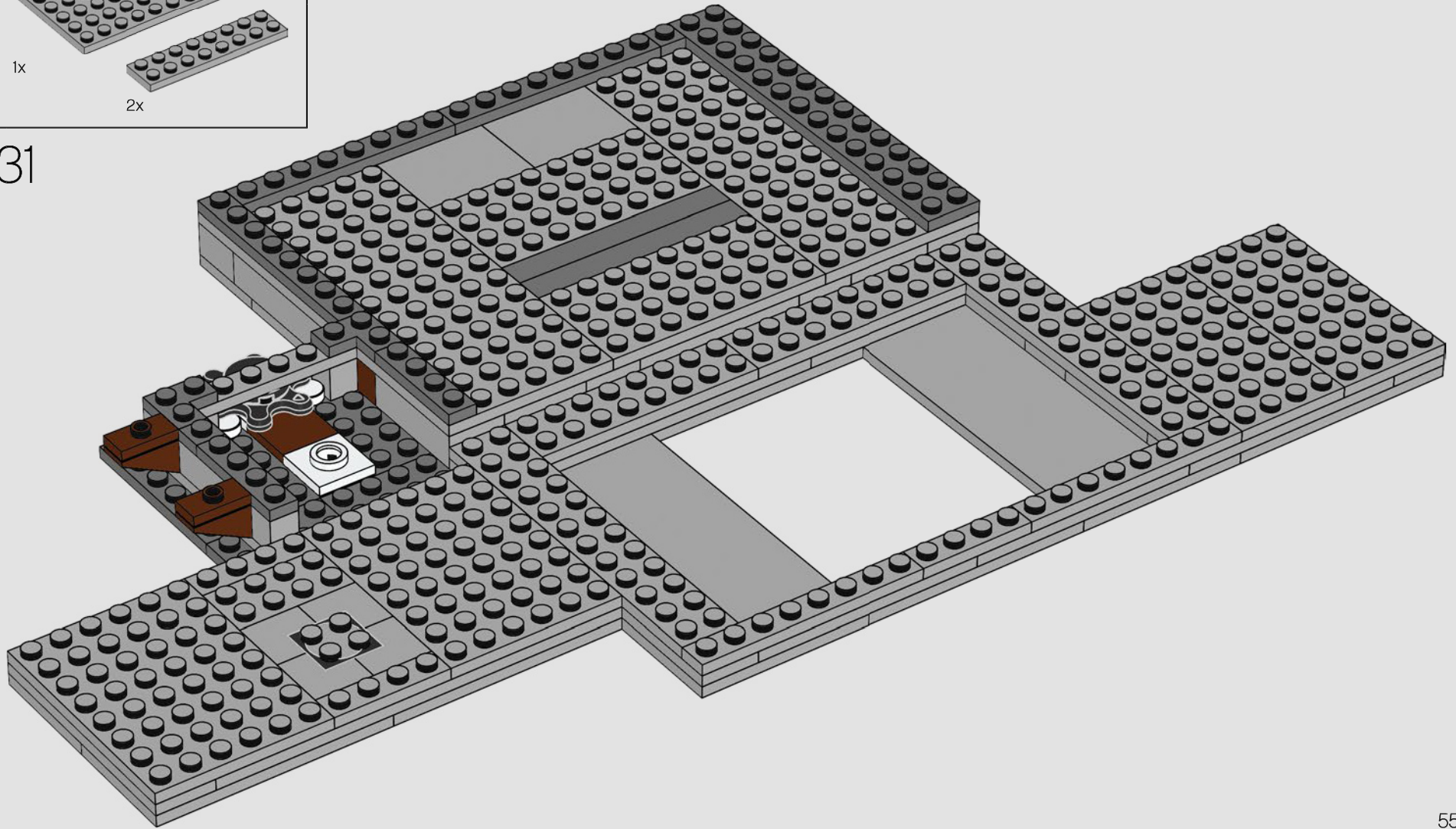

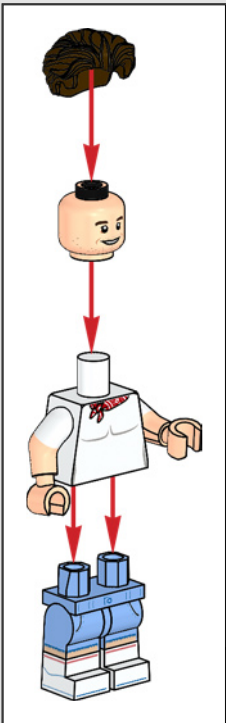
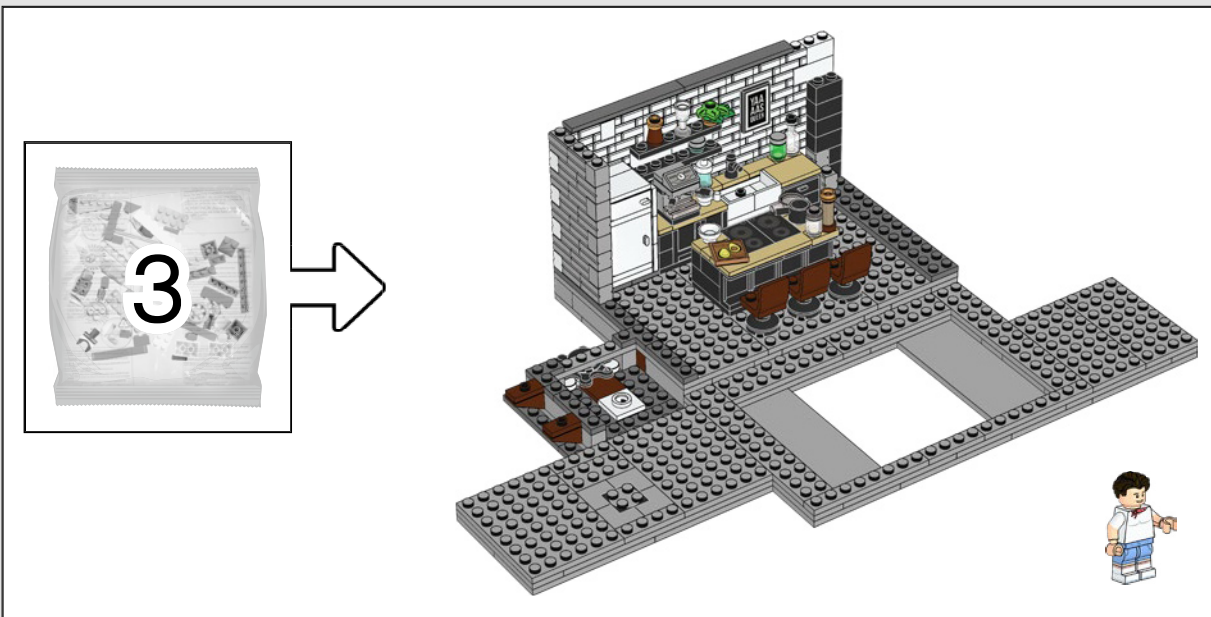

Antoni Porowski

« J'adore le petit foulard, et bien entendu, mon accessoire LEGO® se devait d'être une petite planche à découper avec des avocats. »

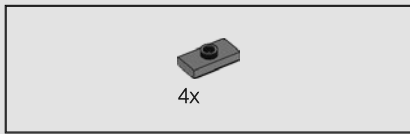

32

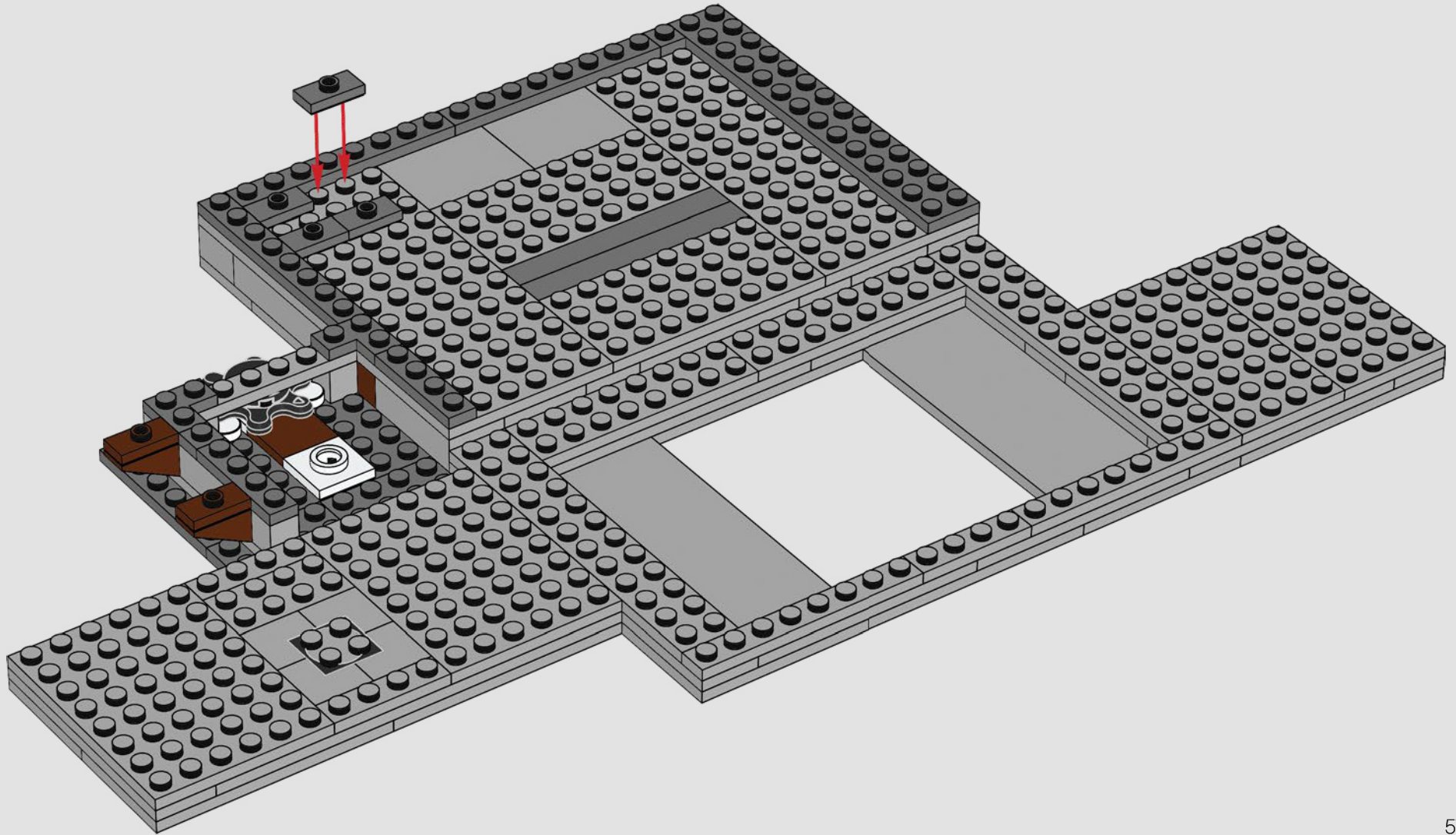

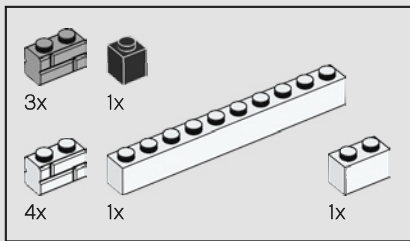

33



Bobby Berk

« Quand j'étais enfant, LEGO® a allumé la flamme créatrice en moi et m'a donné le sentiment que mes possibilités étaient tout aussi infinies que les choses que je pouvais construire. »

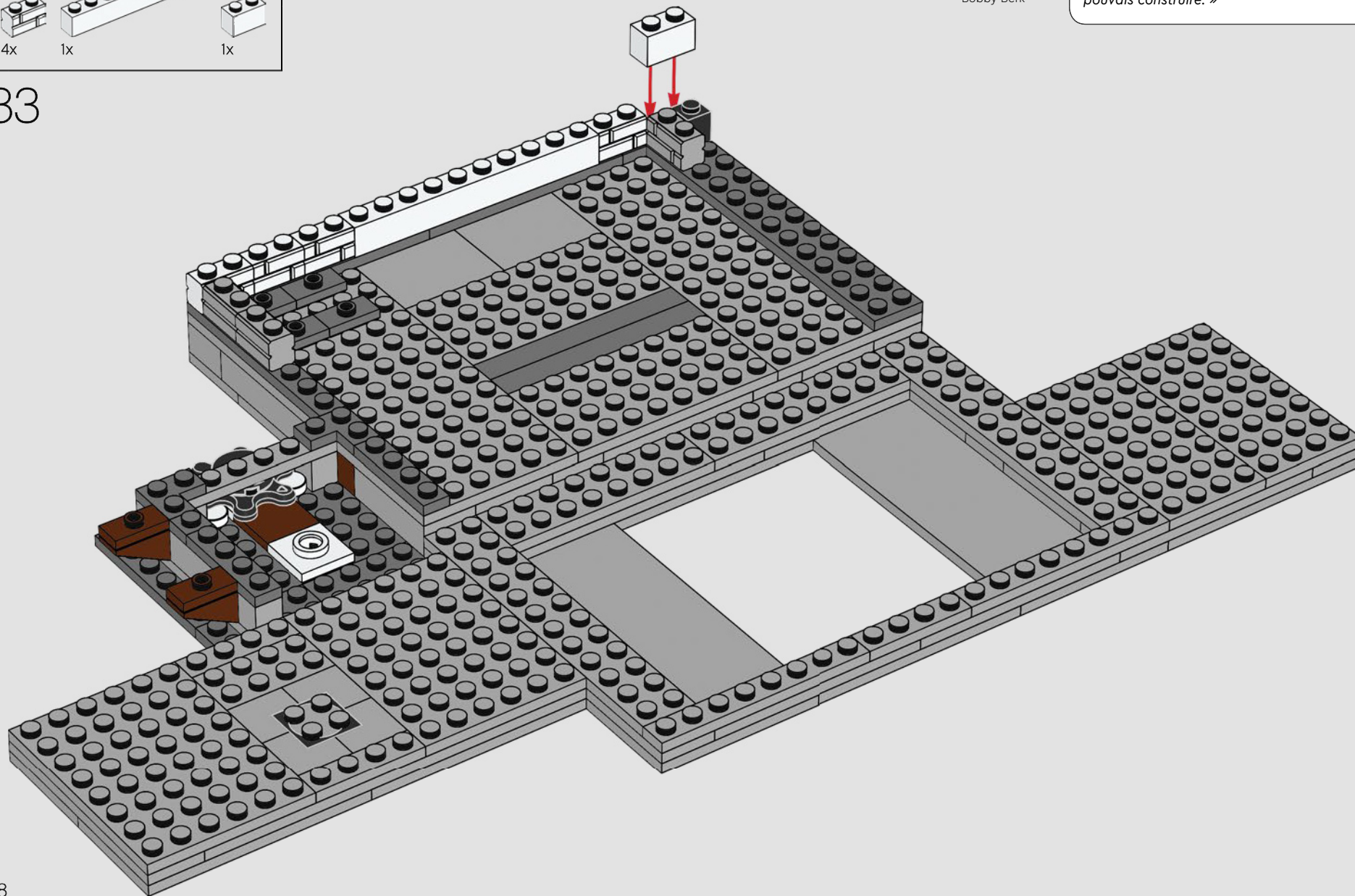

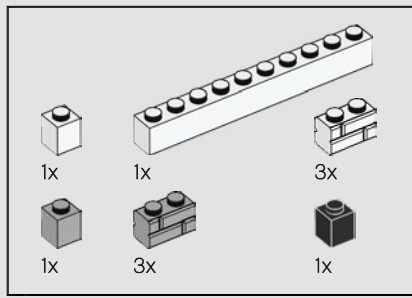

34

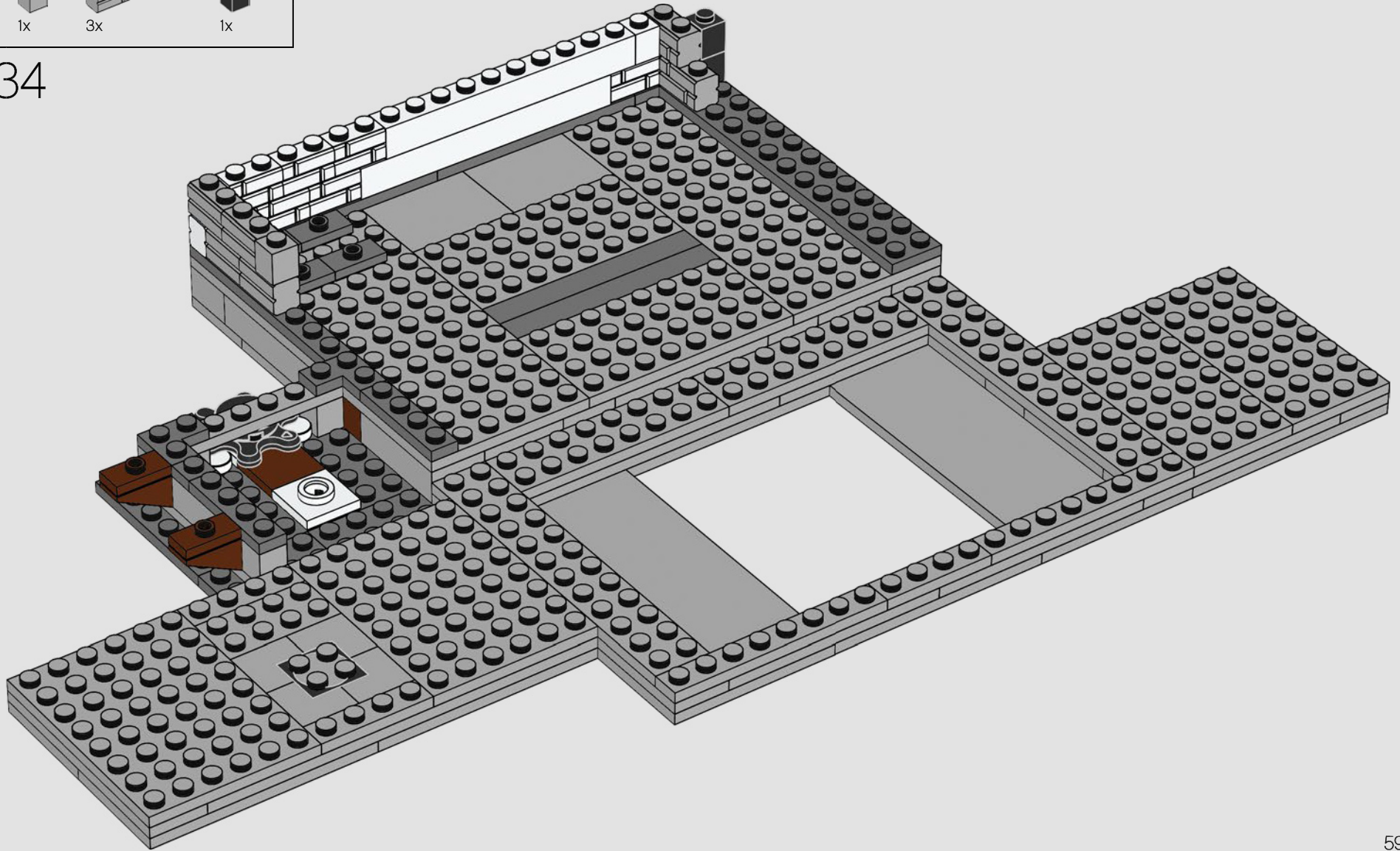

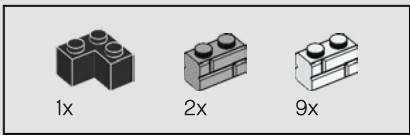

35

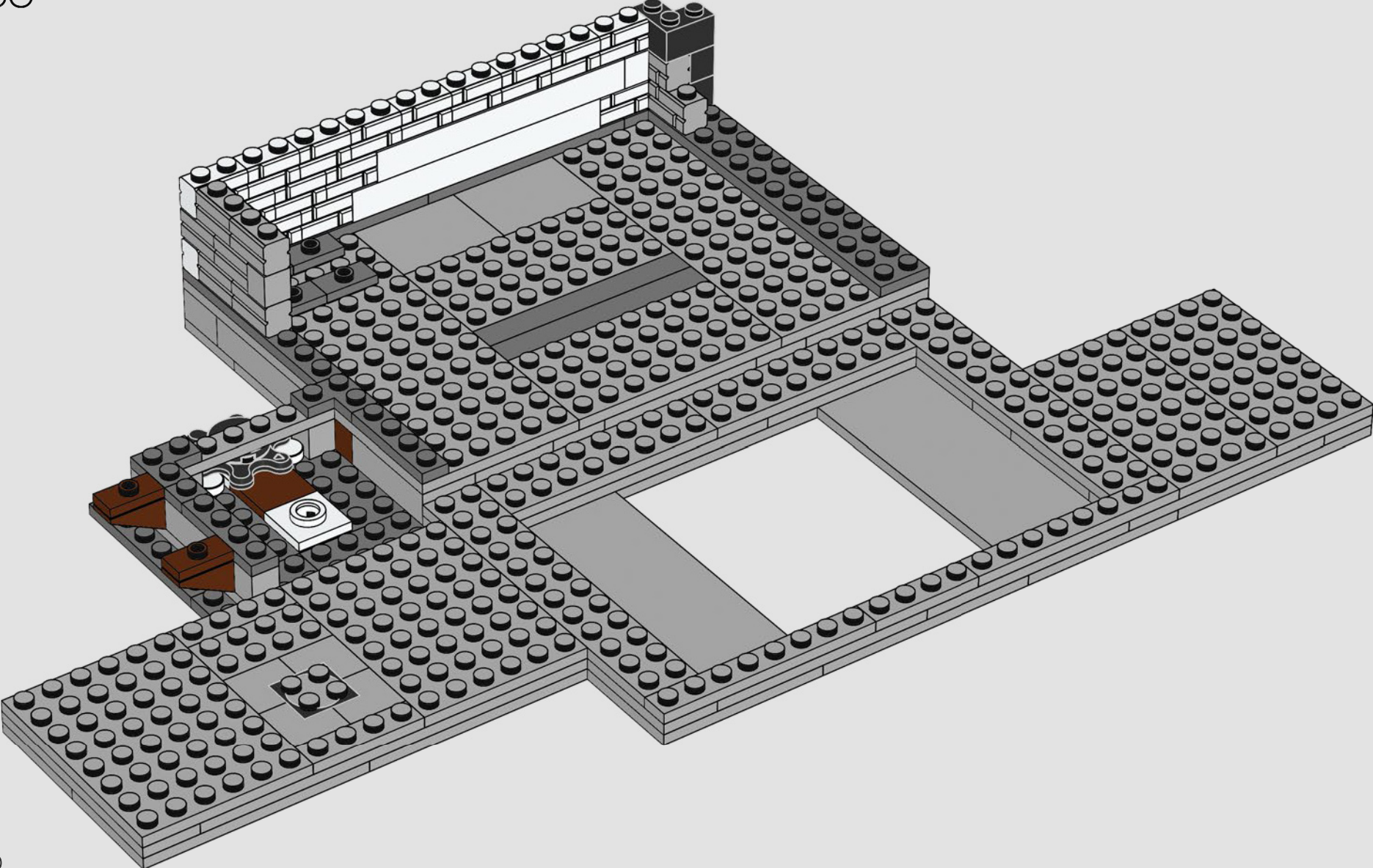

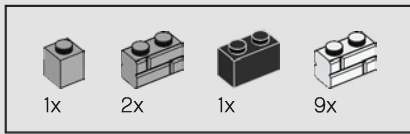

36

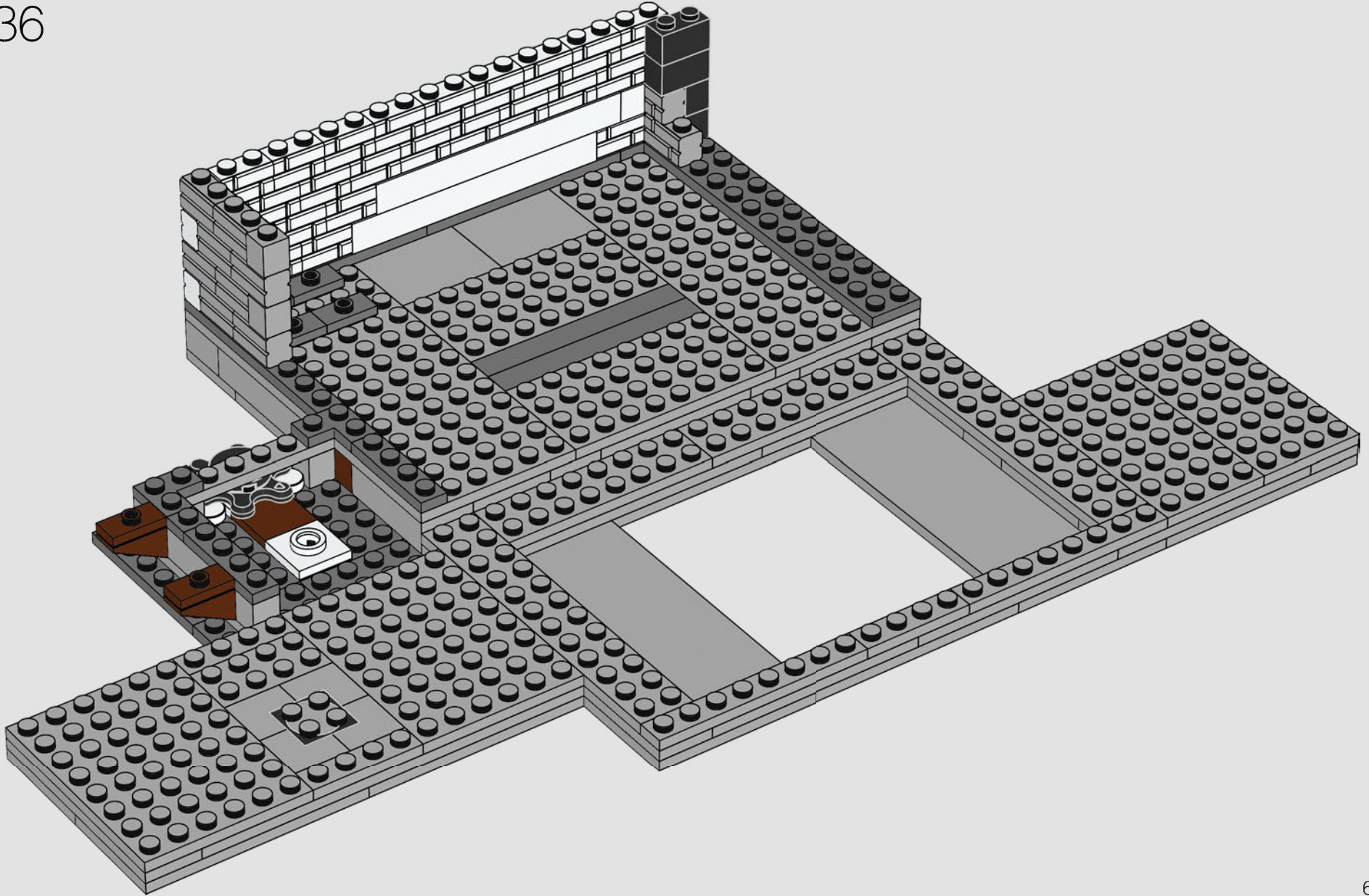

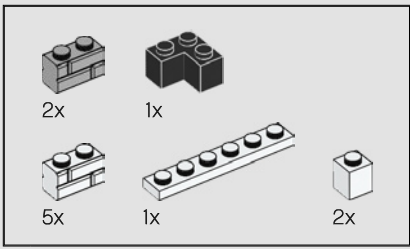

37

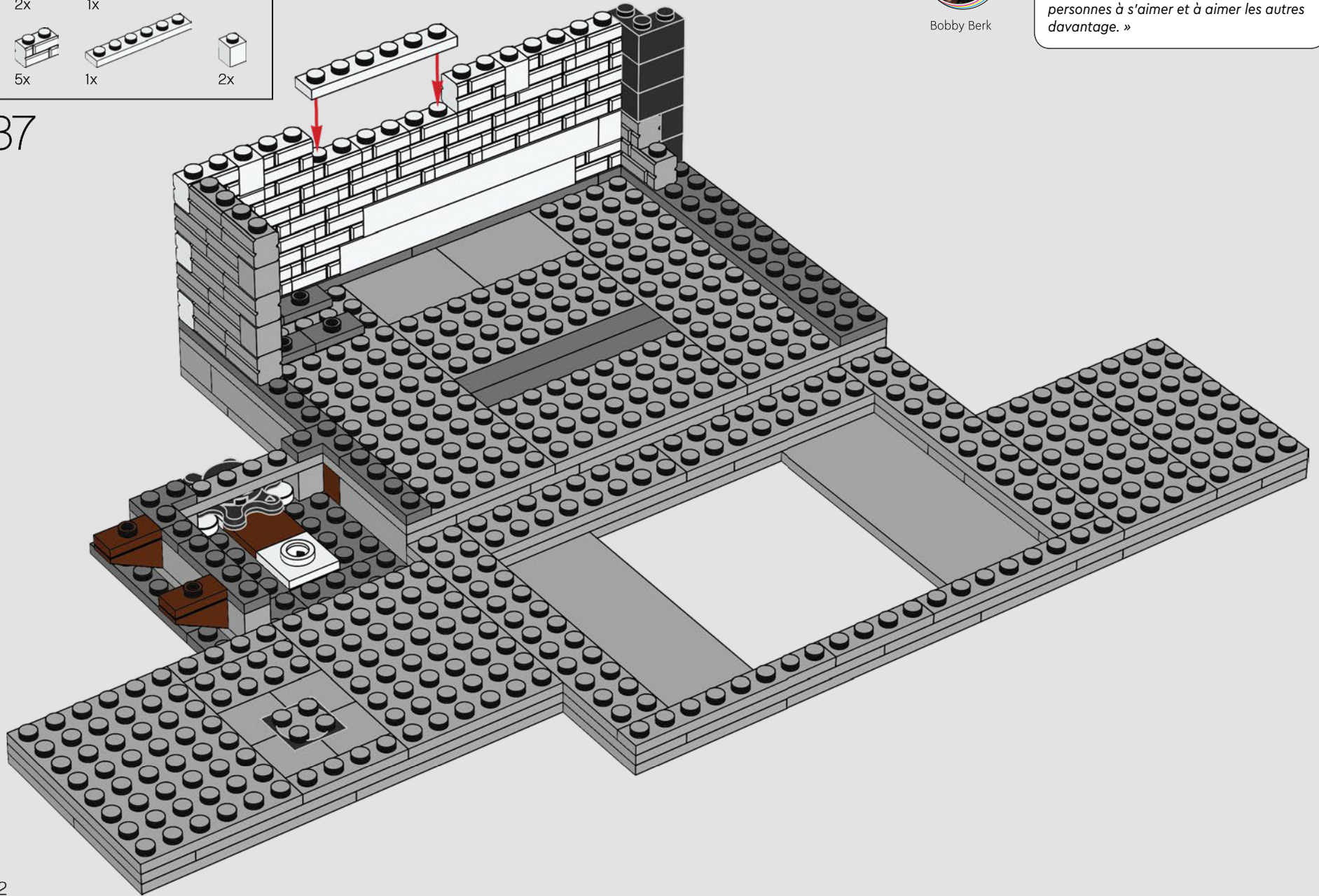

Bobby Berk

« Ma plus grande fierté est d'avoir réussi à créer une émission qui a du succès et qui a aidé des millions de personnes à s'aimer et à aimer les autres davantage. »

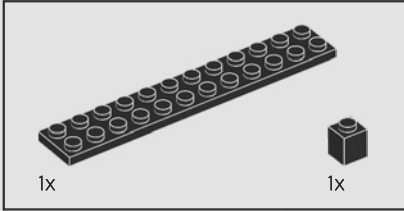
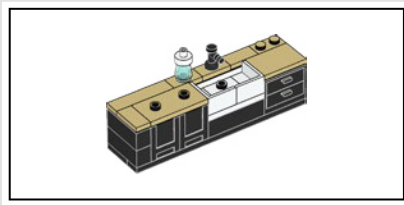

38

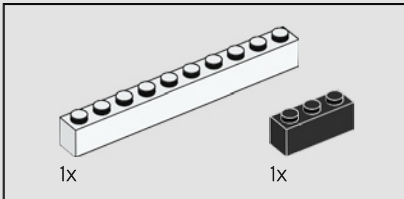
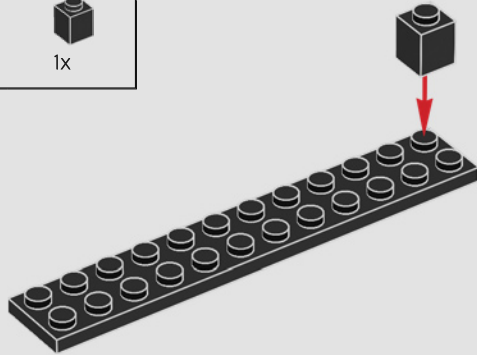

39

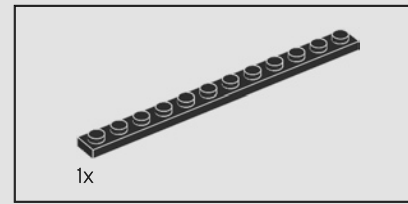
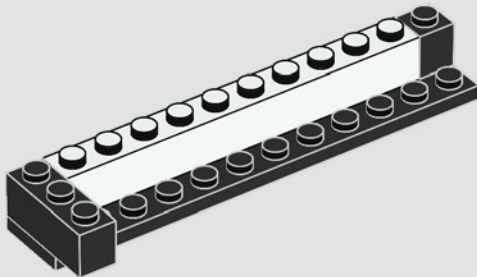

40

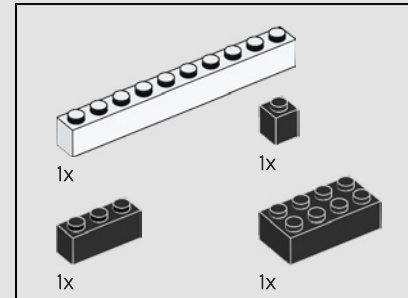
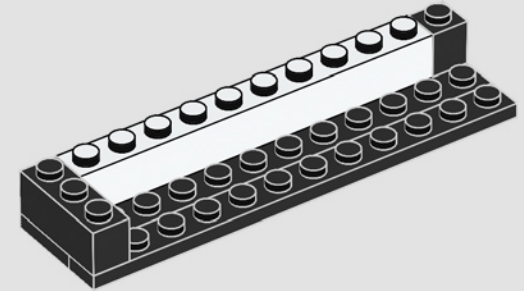

41

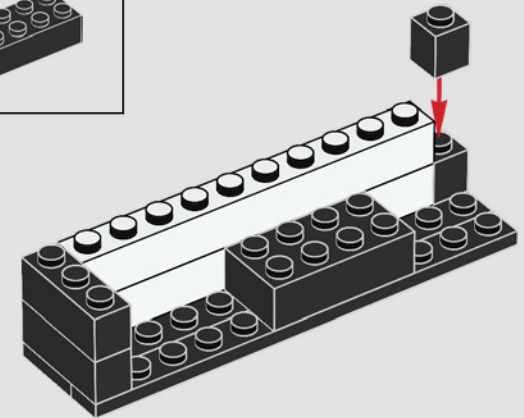

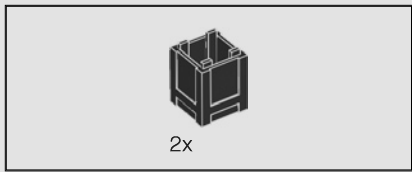

42

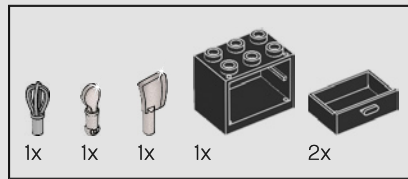
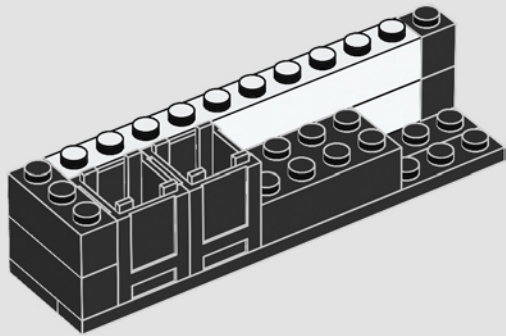

43

1

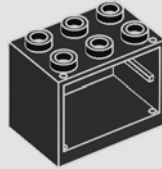

2

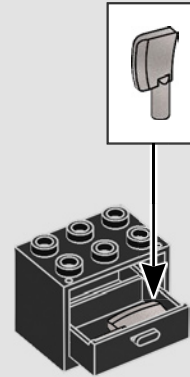

3

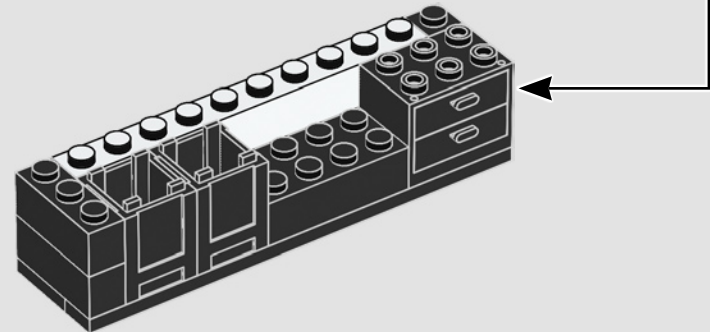
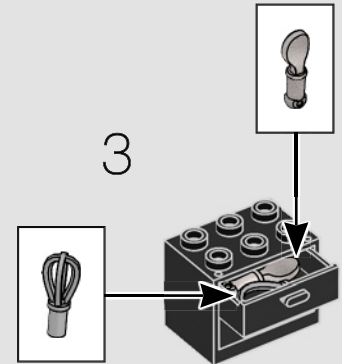

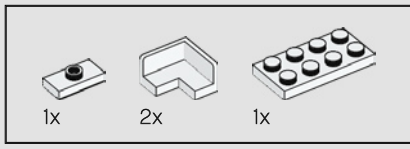

44

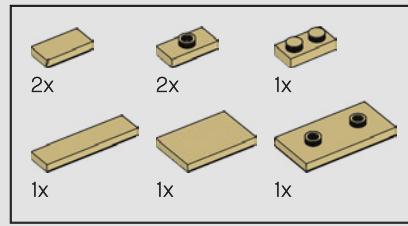
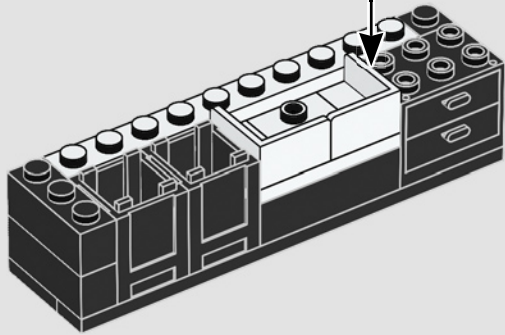
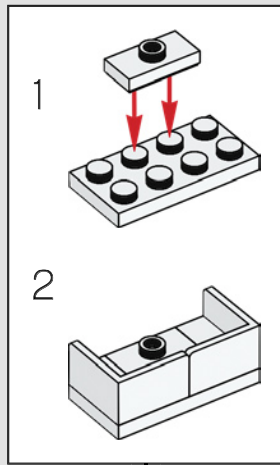

45

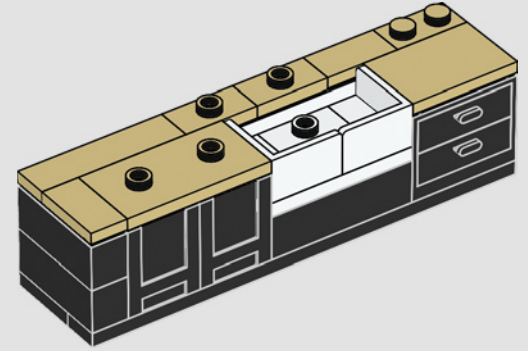

46

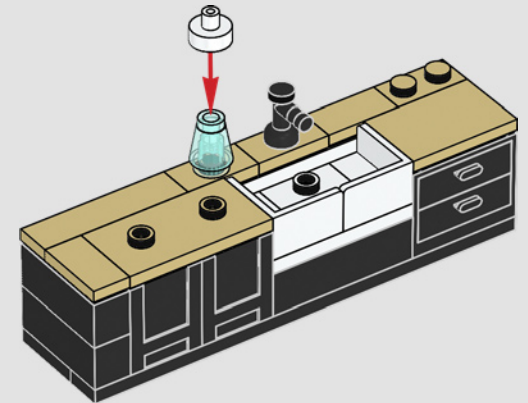

47



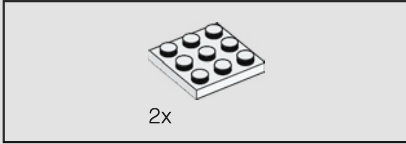
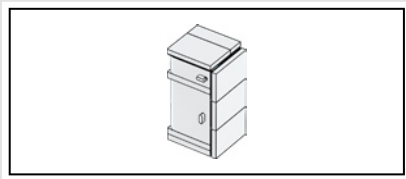

48

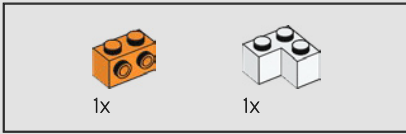
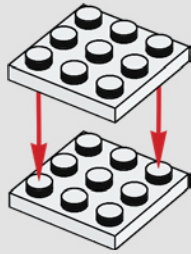

49

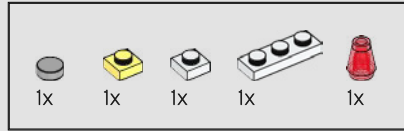
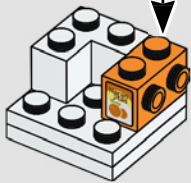
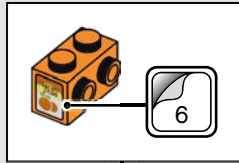

50

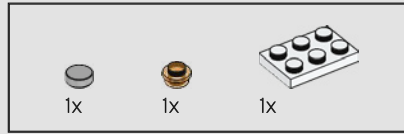
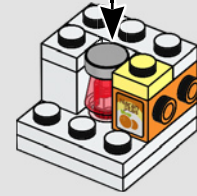
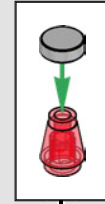

51

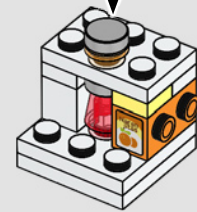
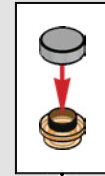

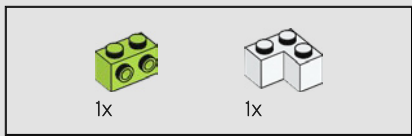

52

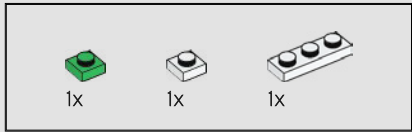
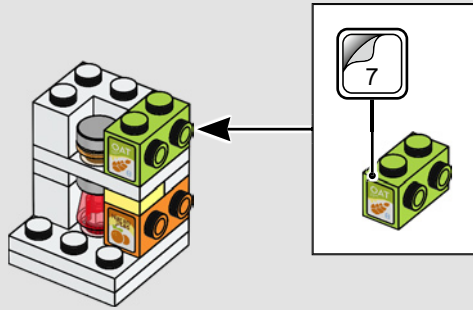

53

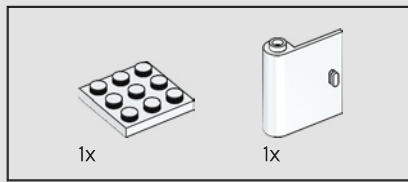

54

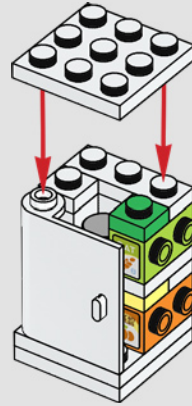

55

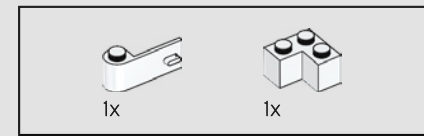
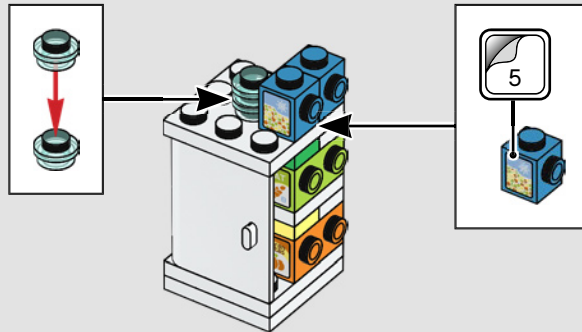

56

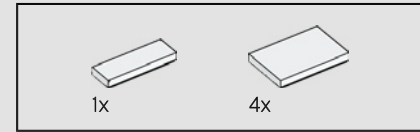

57

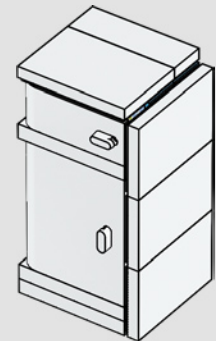

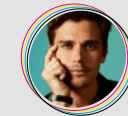

Antoni Porowski

« Construire avec LEGO®, c'est un peu comme préparer un repas. On peut bien sûr suivre la recette pour obtenir un résultat parfait ou bien faire des expériences pour créer quelque chose de personnel. »



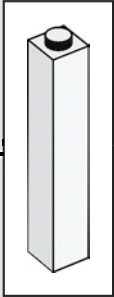
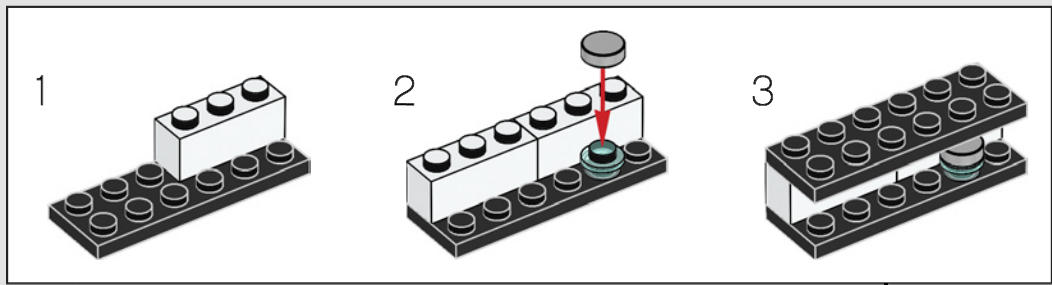
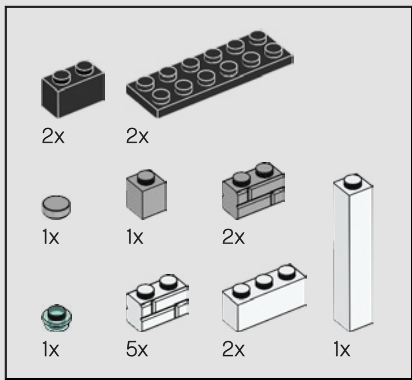

59

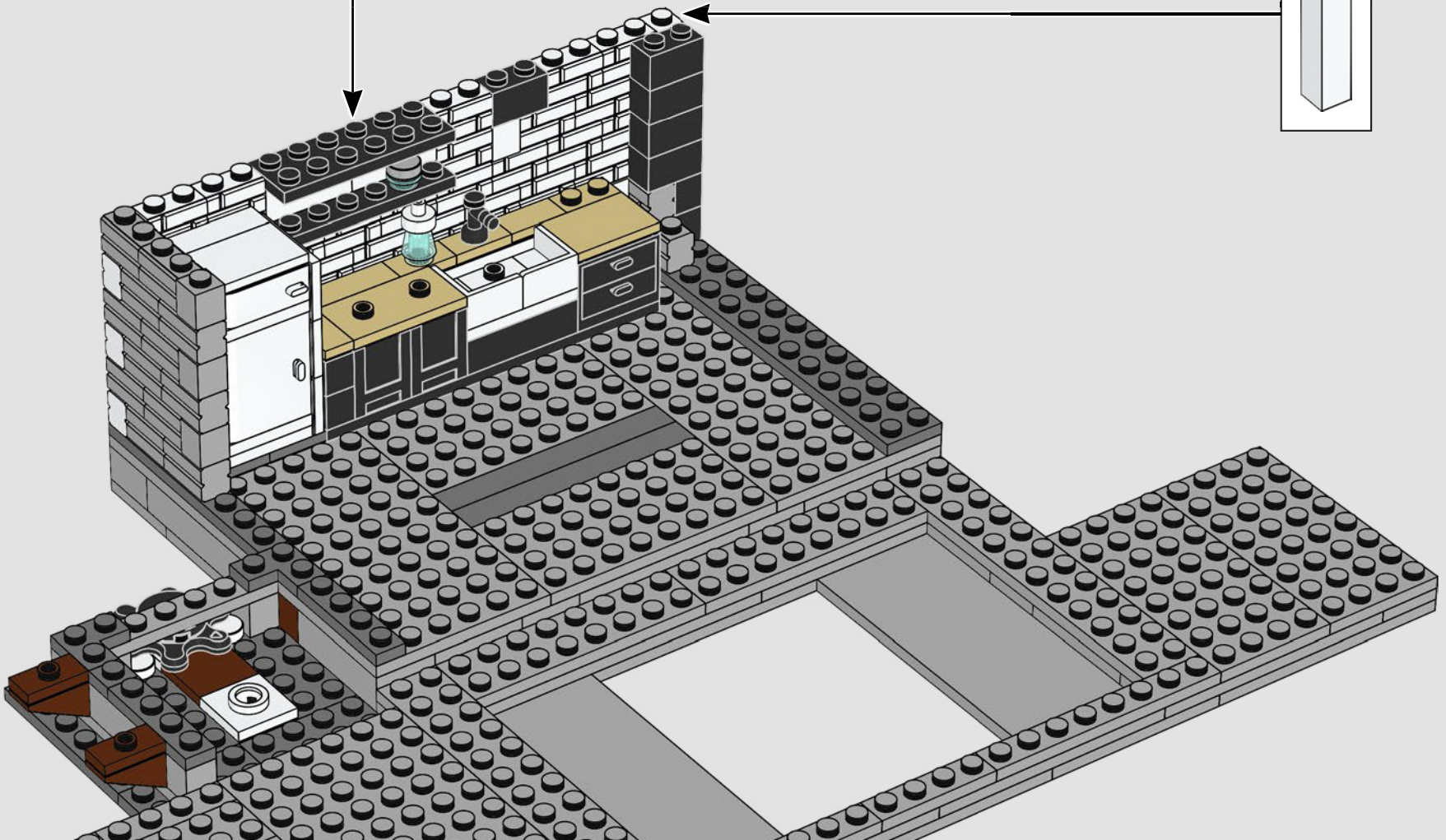

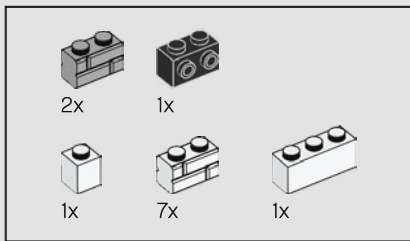

60

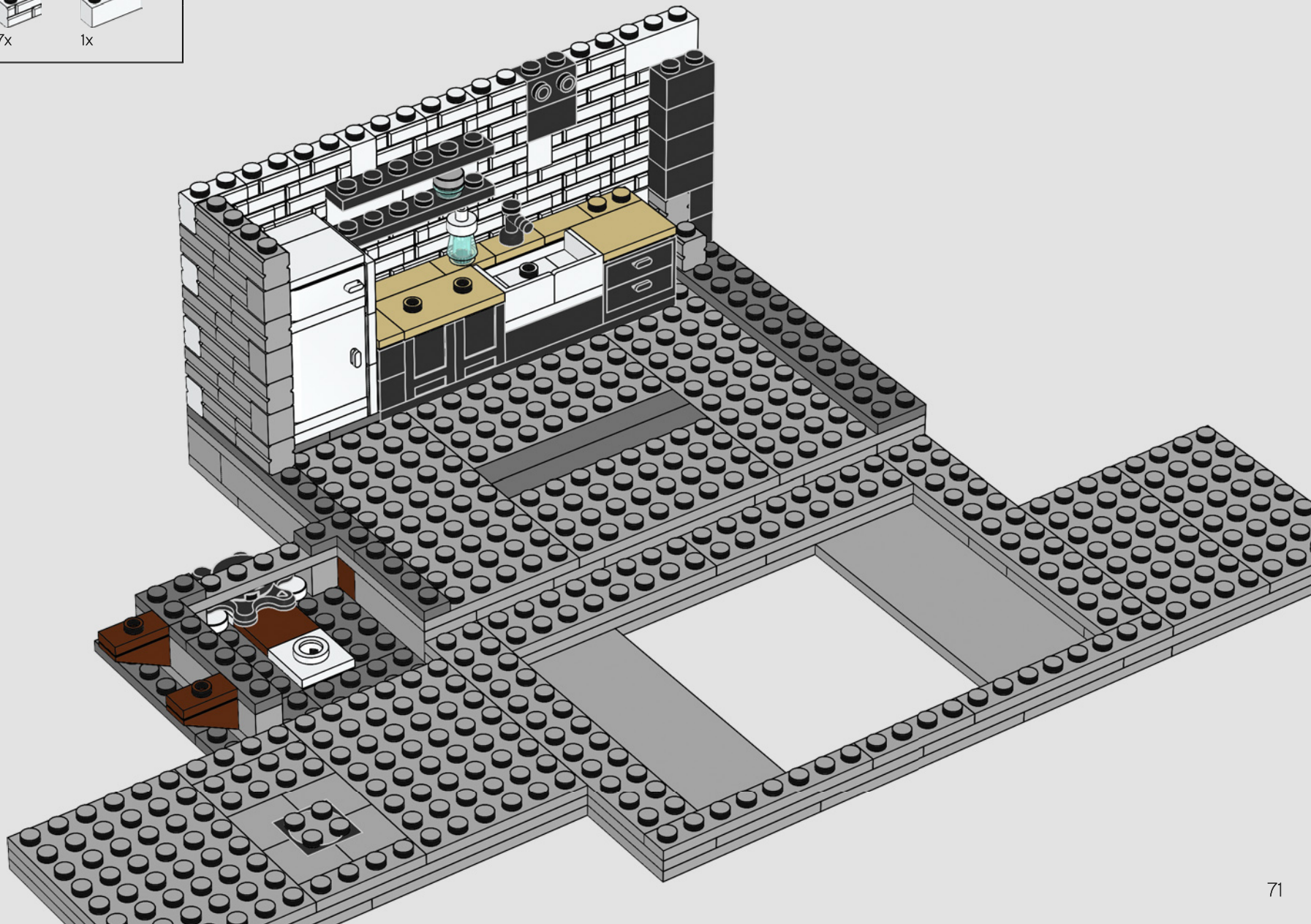

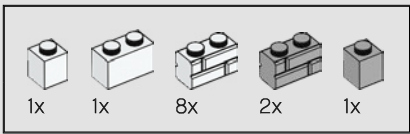

61



Bobby Berk

« La philosophie de *Queer Eye*, c'est de prendre un nouveau départ, se reconstruire et tirer le meilleur parti de soi-même. Et les modèles LEGO® ne sont-ils pas parfaits pour rendre hommage à cette idée ? »



62

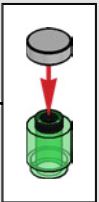
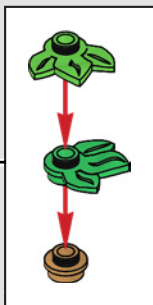
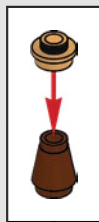
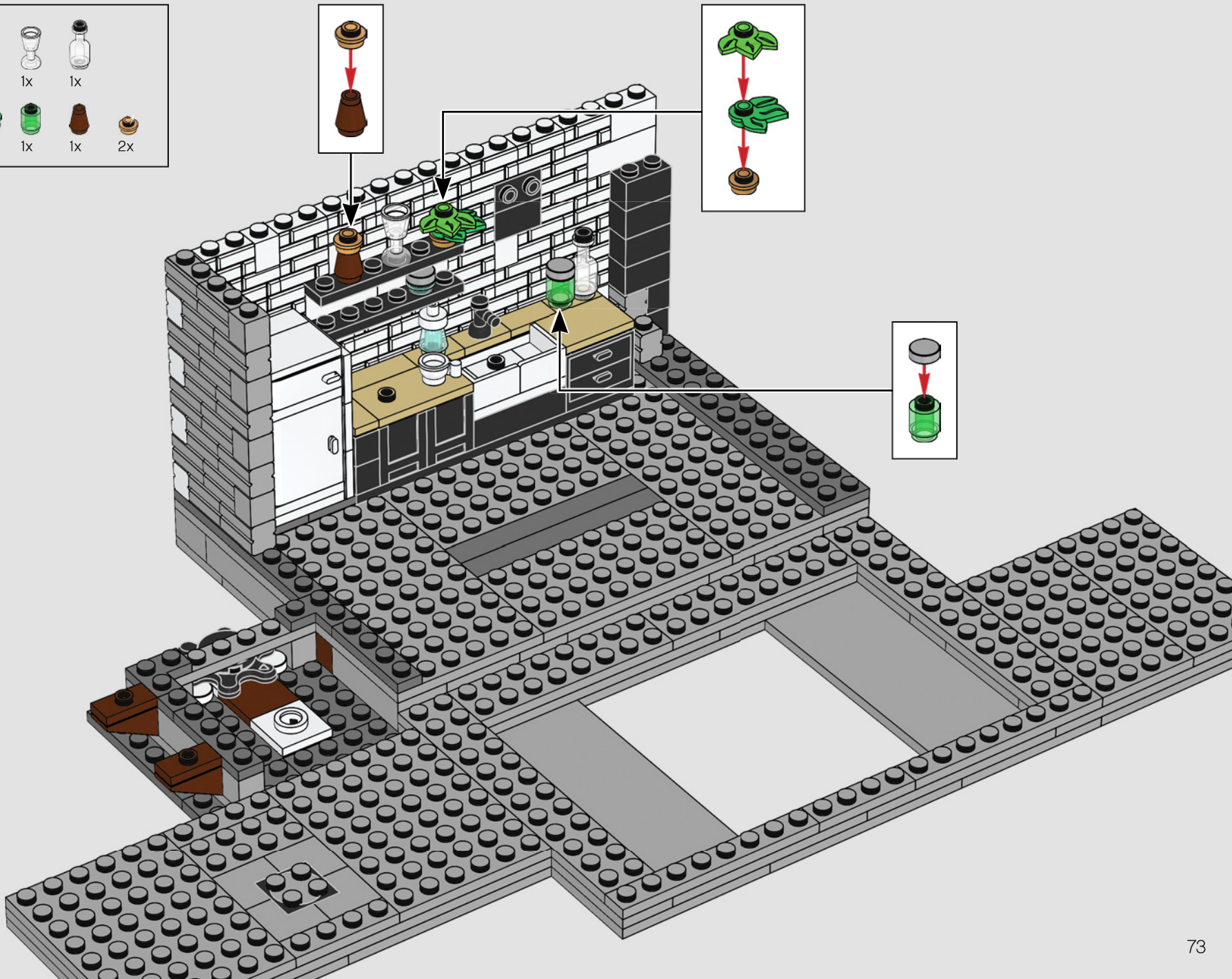

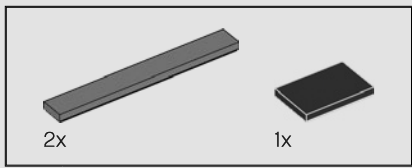

63

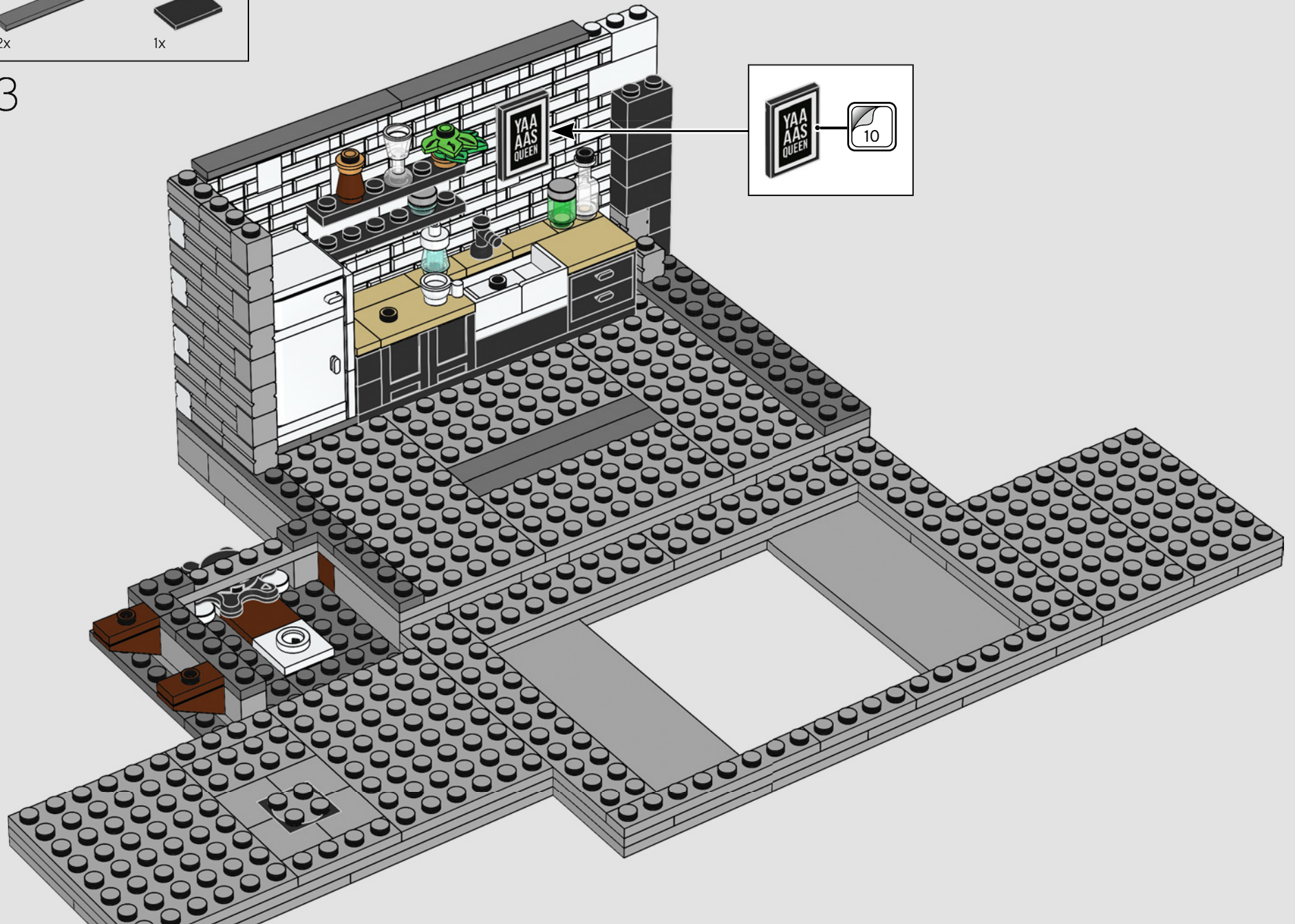

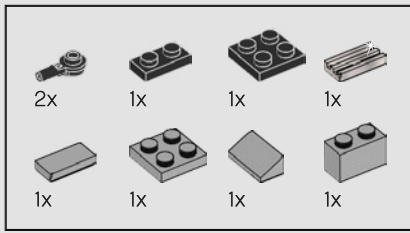

64

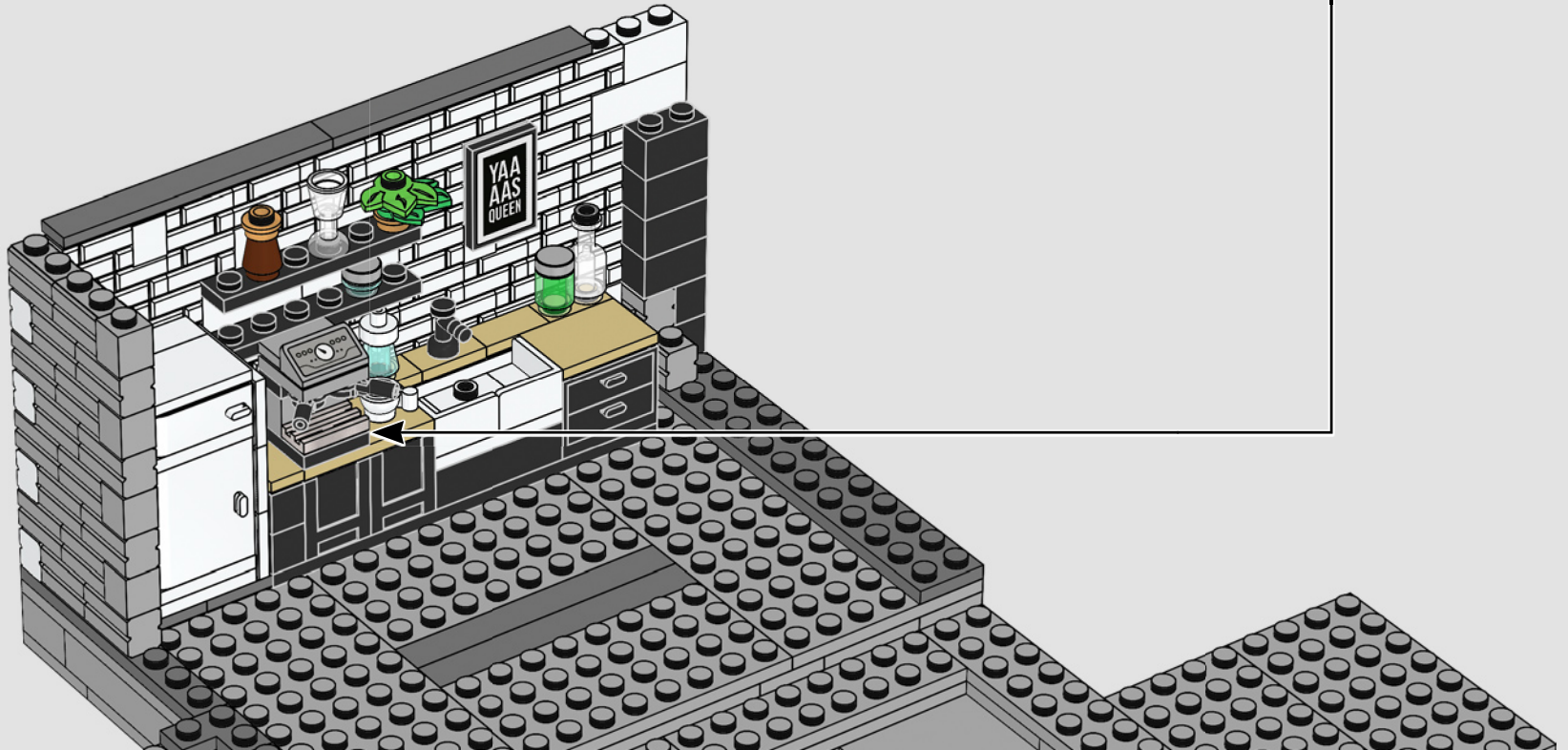
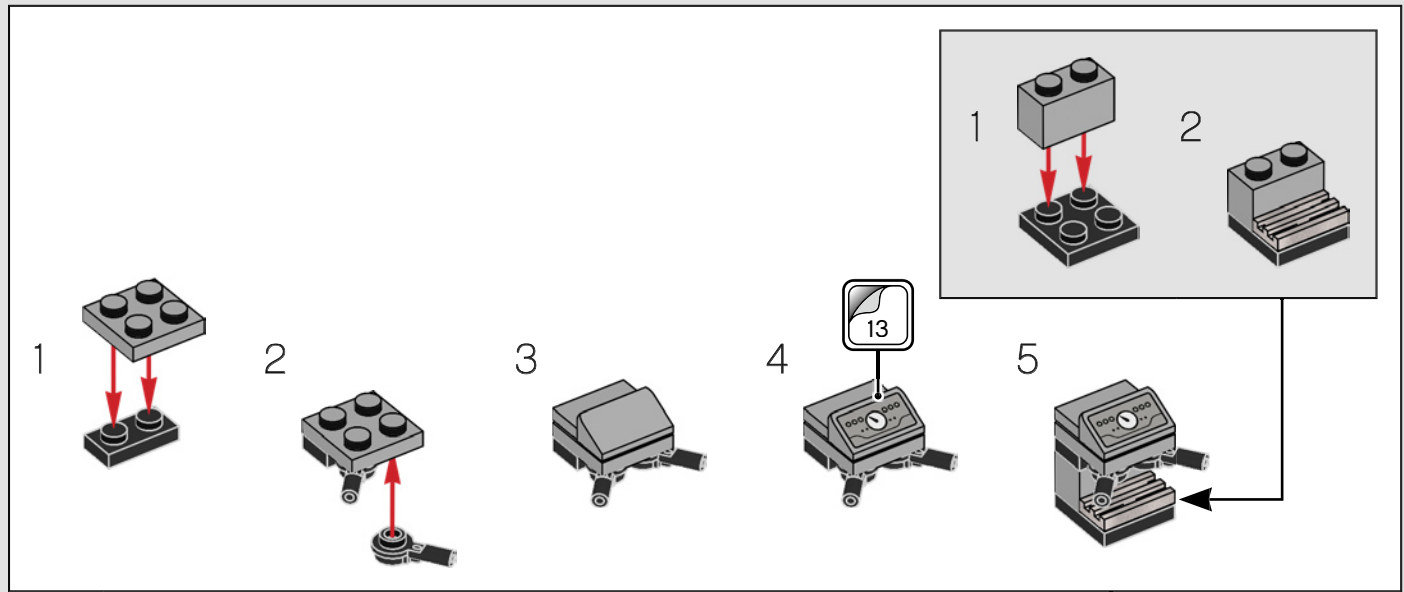

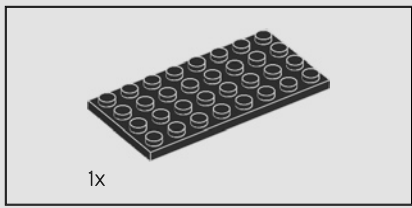

65

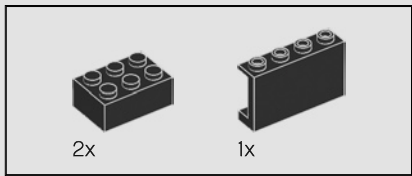
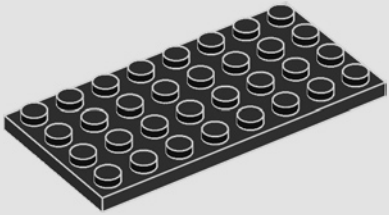

66

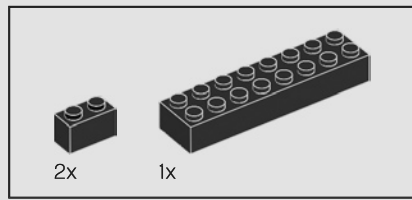
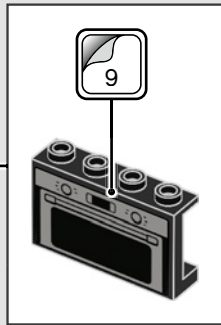
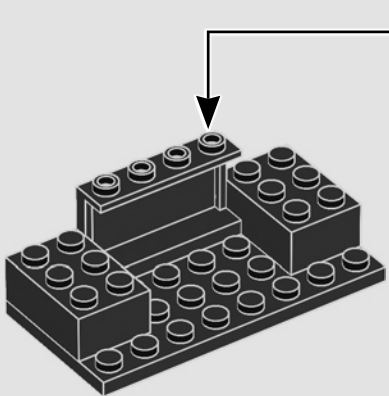

67

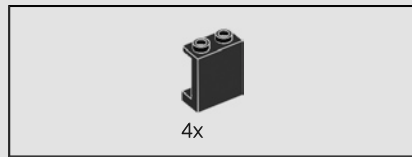
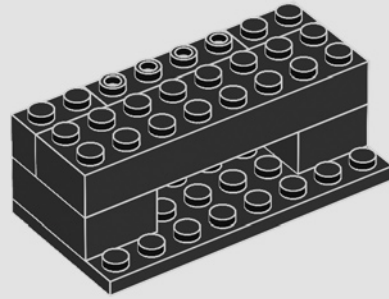

68

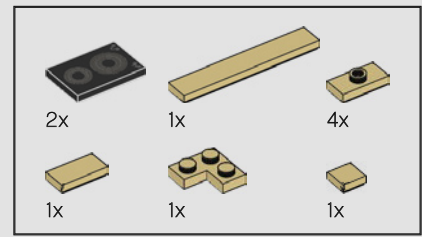
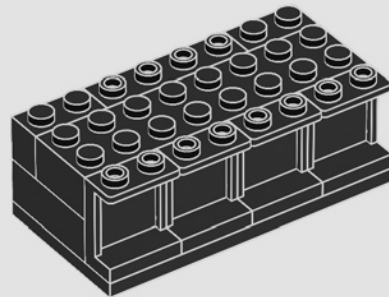

69

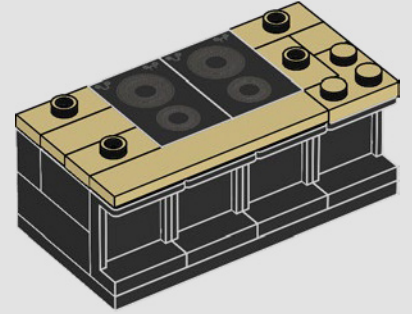

70

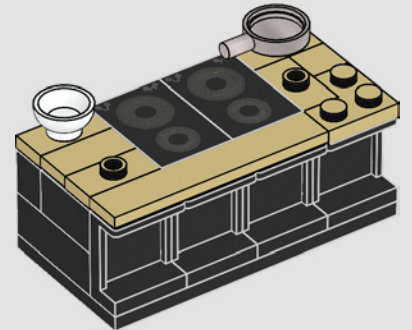

71

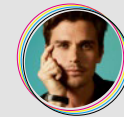
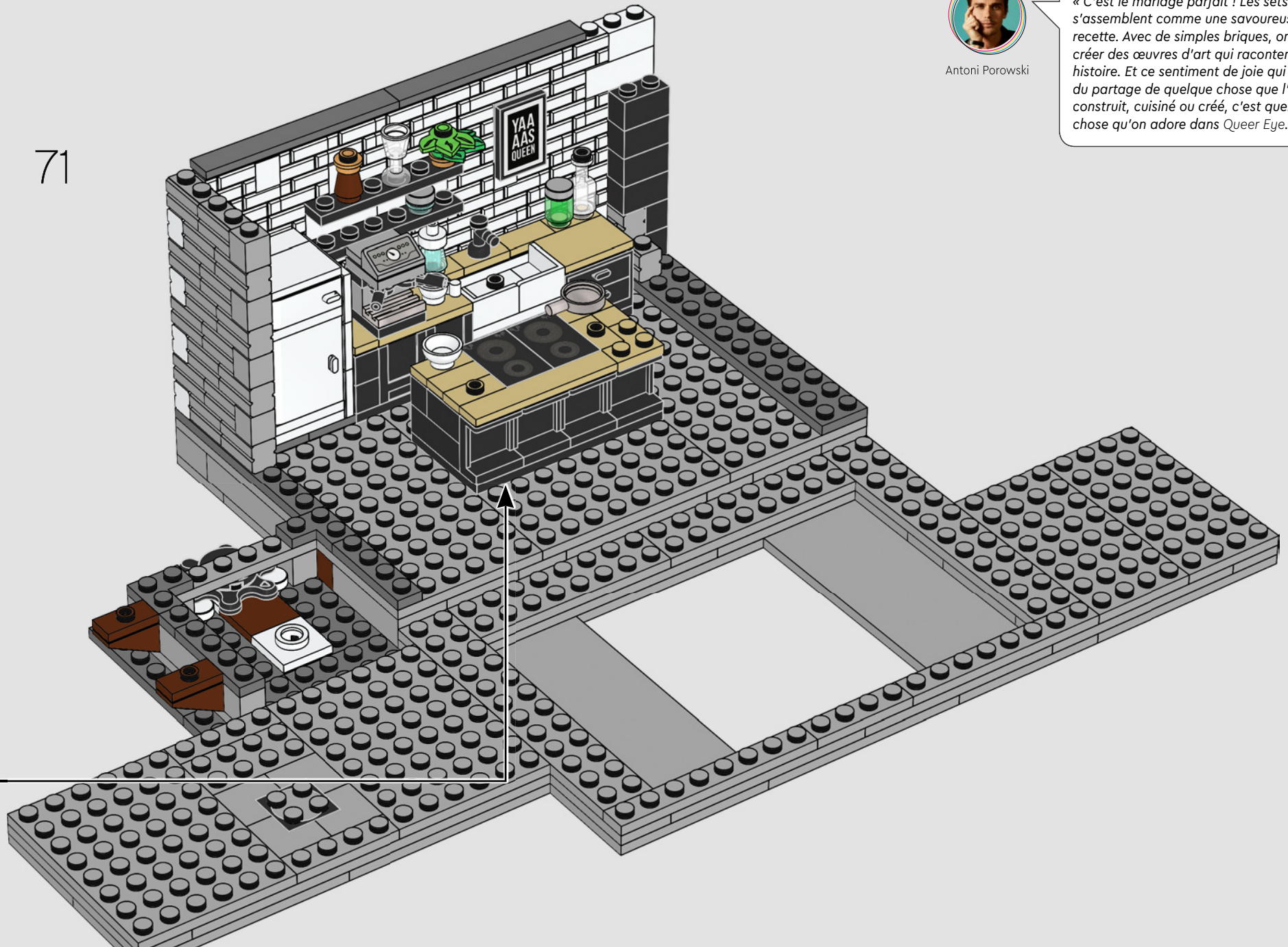

Antoni Porowski

« C'est le mariage parfait ! Les sets LEGO® s'assemblent comme une savoureuse recette. Avec de simples briques, on peut créer des œuvres d'art qui racontent une histoire. Et ce sentiment de joie qui naît du partage de quelque chose que l'on a construit, cuisiné ou créé, c'est quelque chose qu'on adore dans *Queer Eye*. »

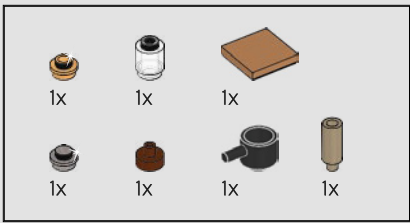

72

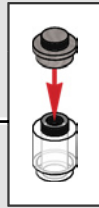
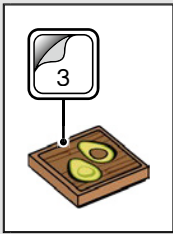
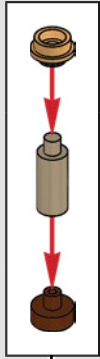
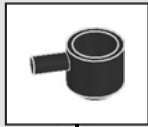

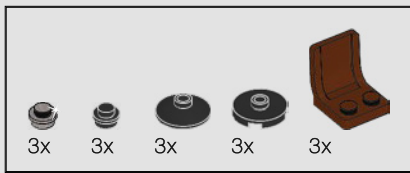

73

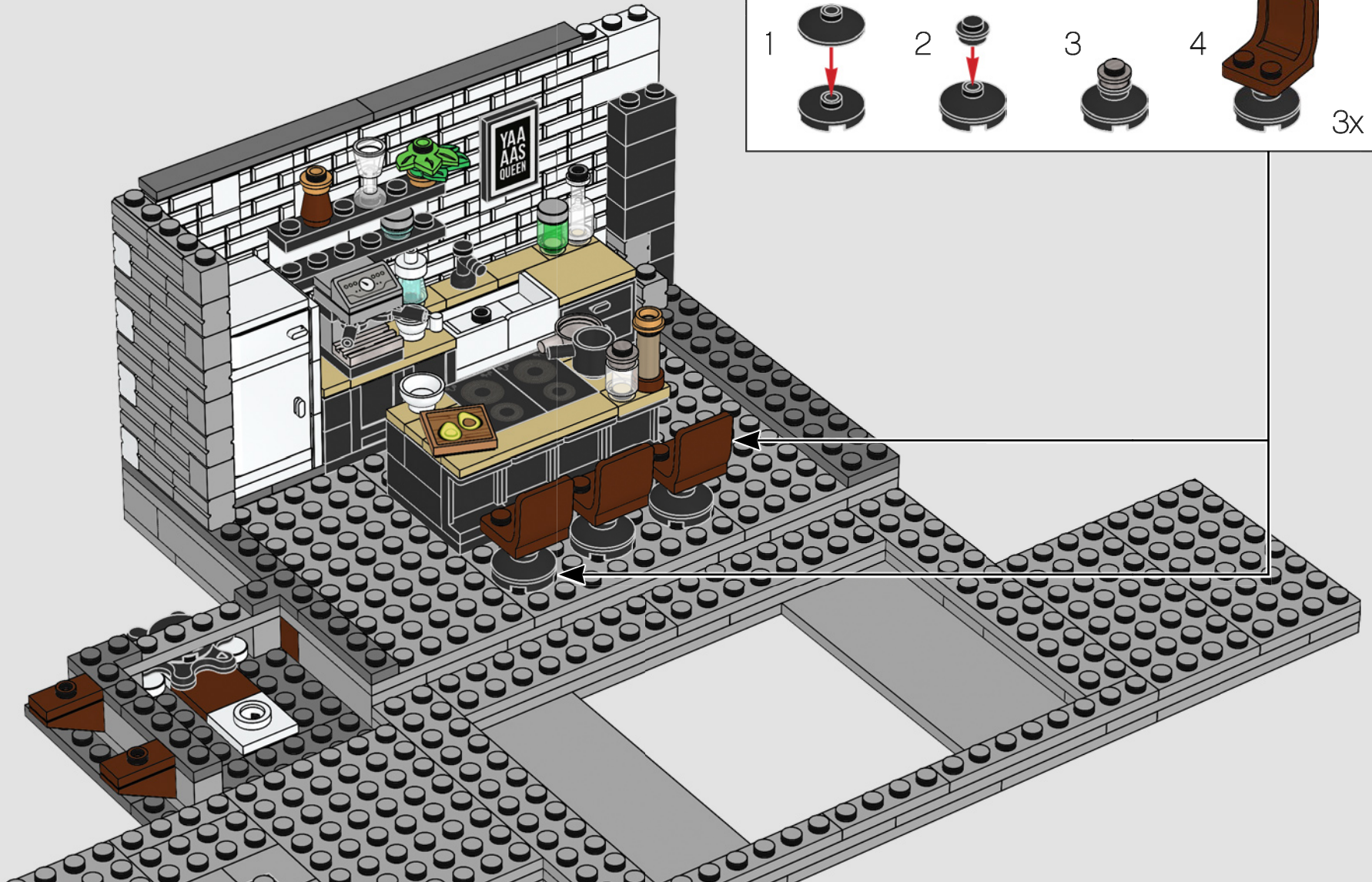
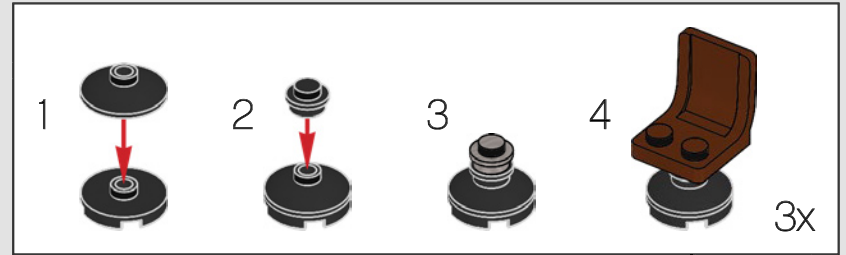

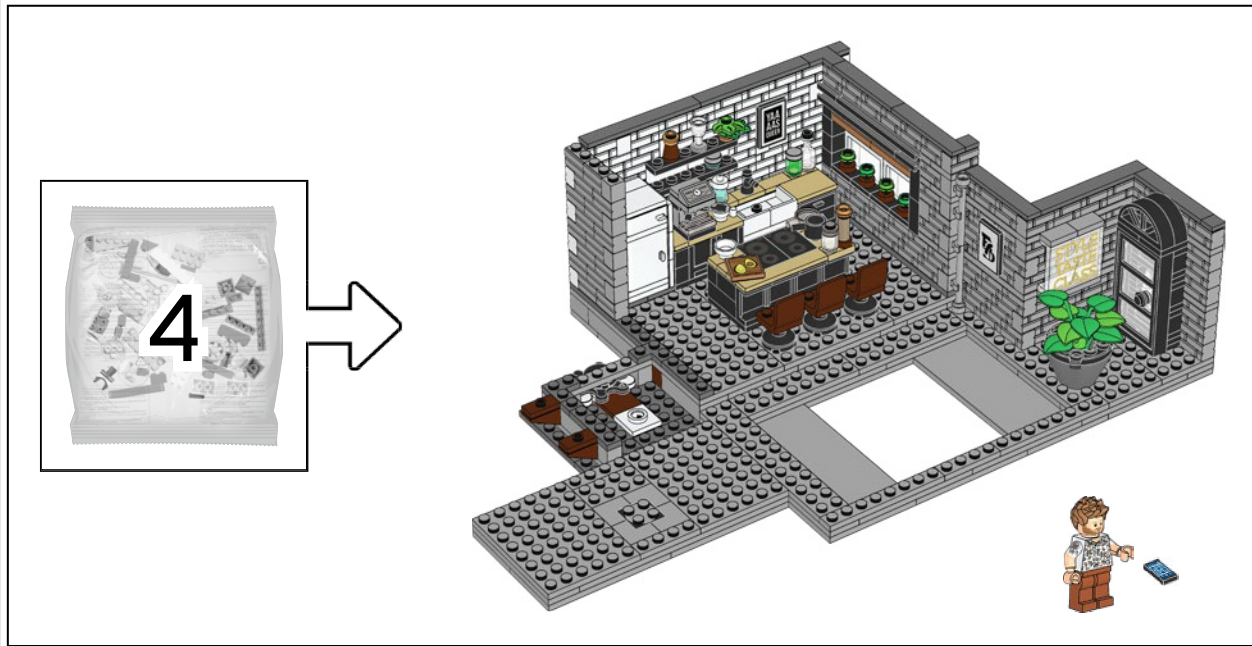

Bobby Berk

« C'est tellement surréaliste de me voir en figurine LEGO®. Mon moi de 7 ans aurait été stupéfait de savoir que ça arriverait ! »



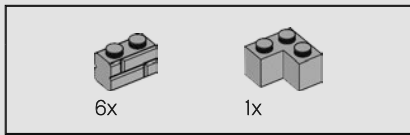

74

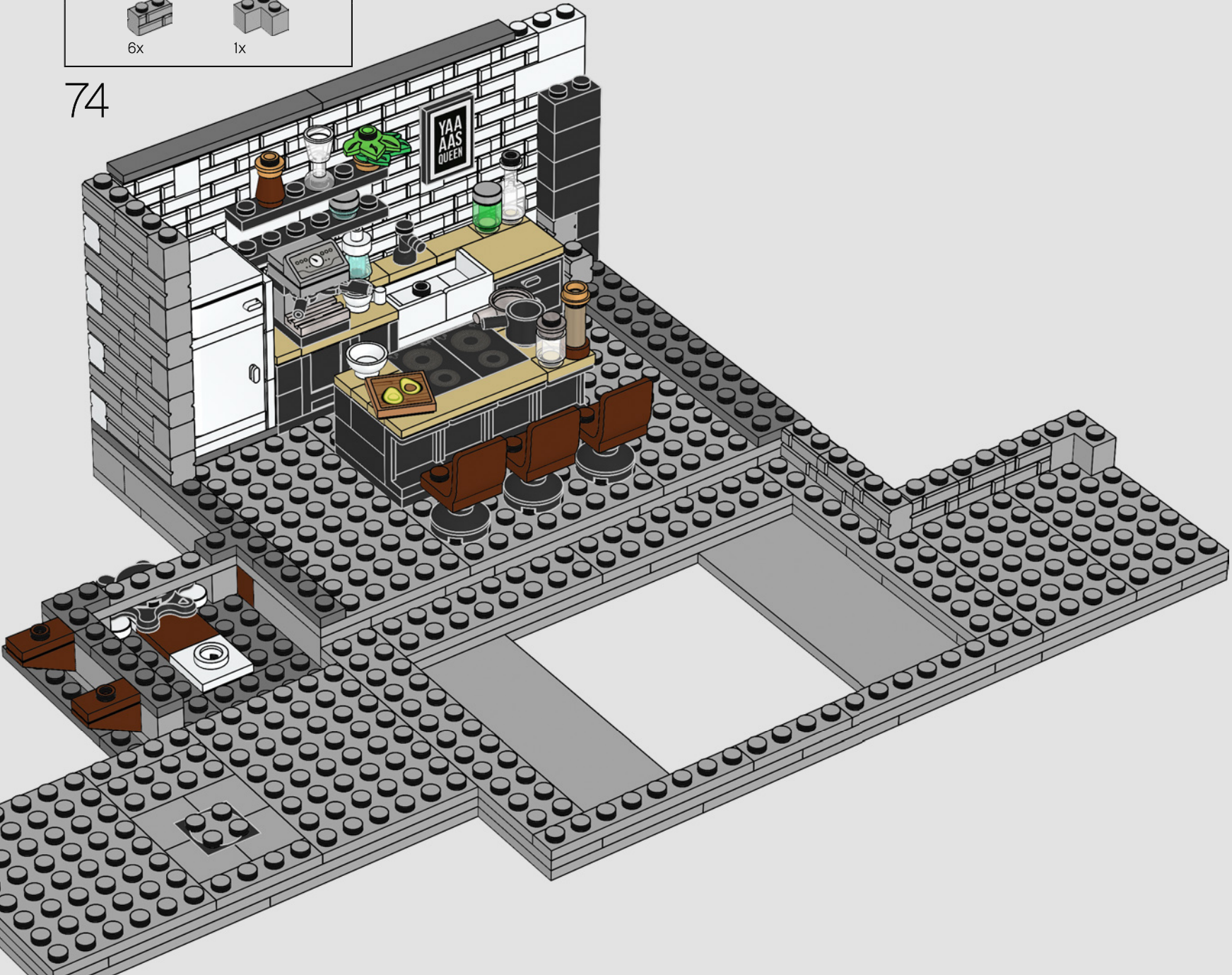

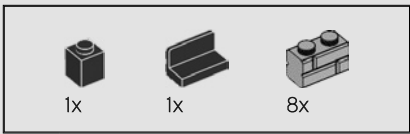

75

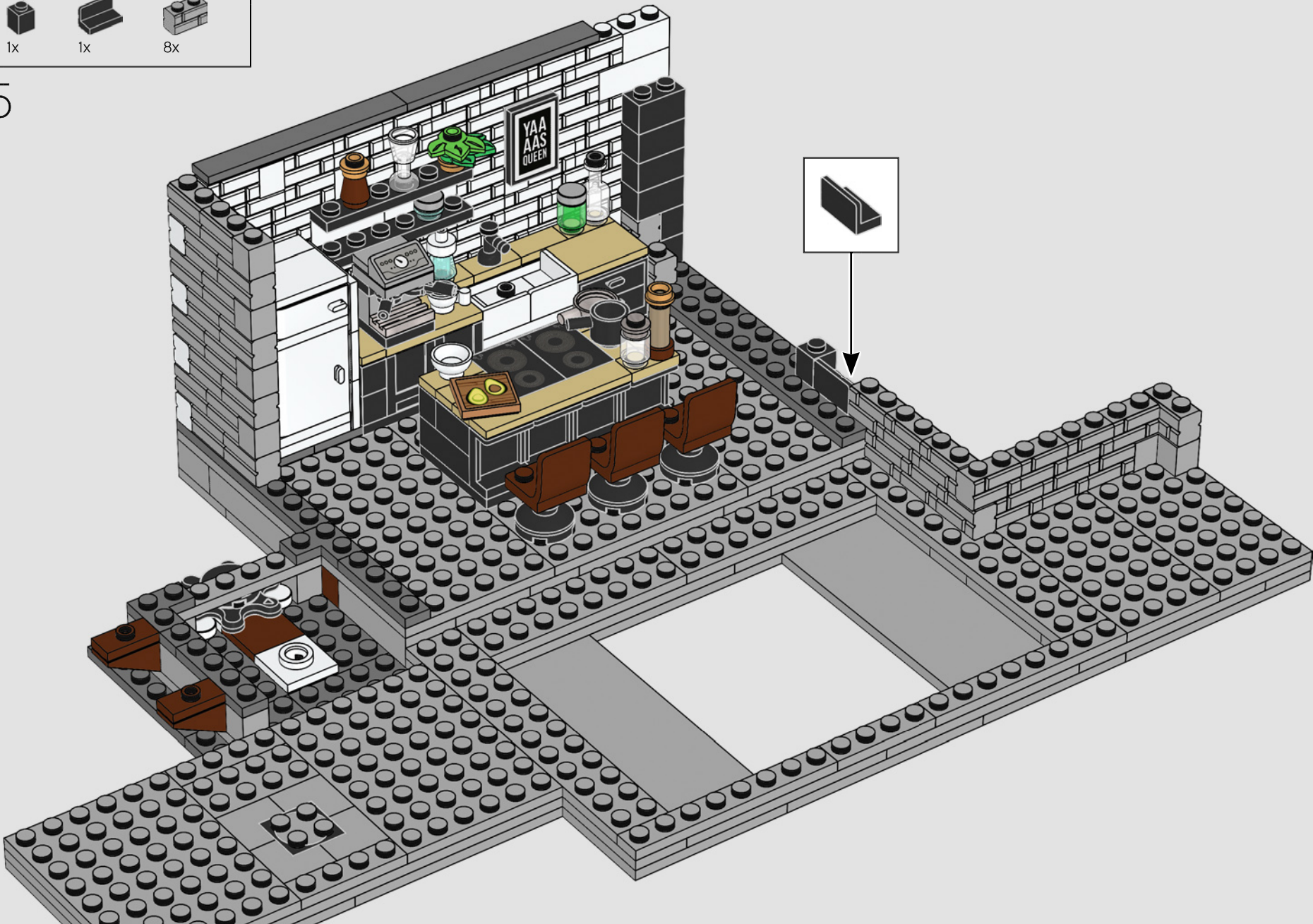

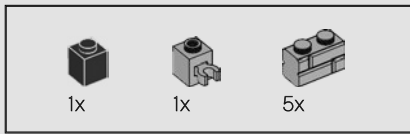

76

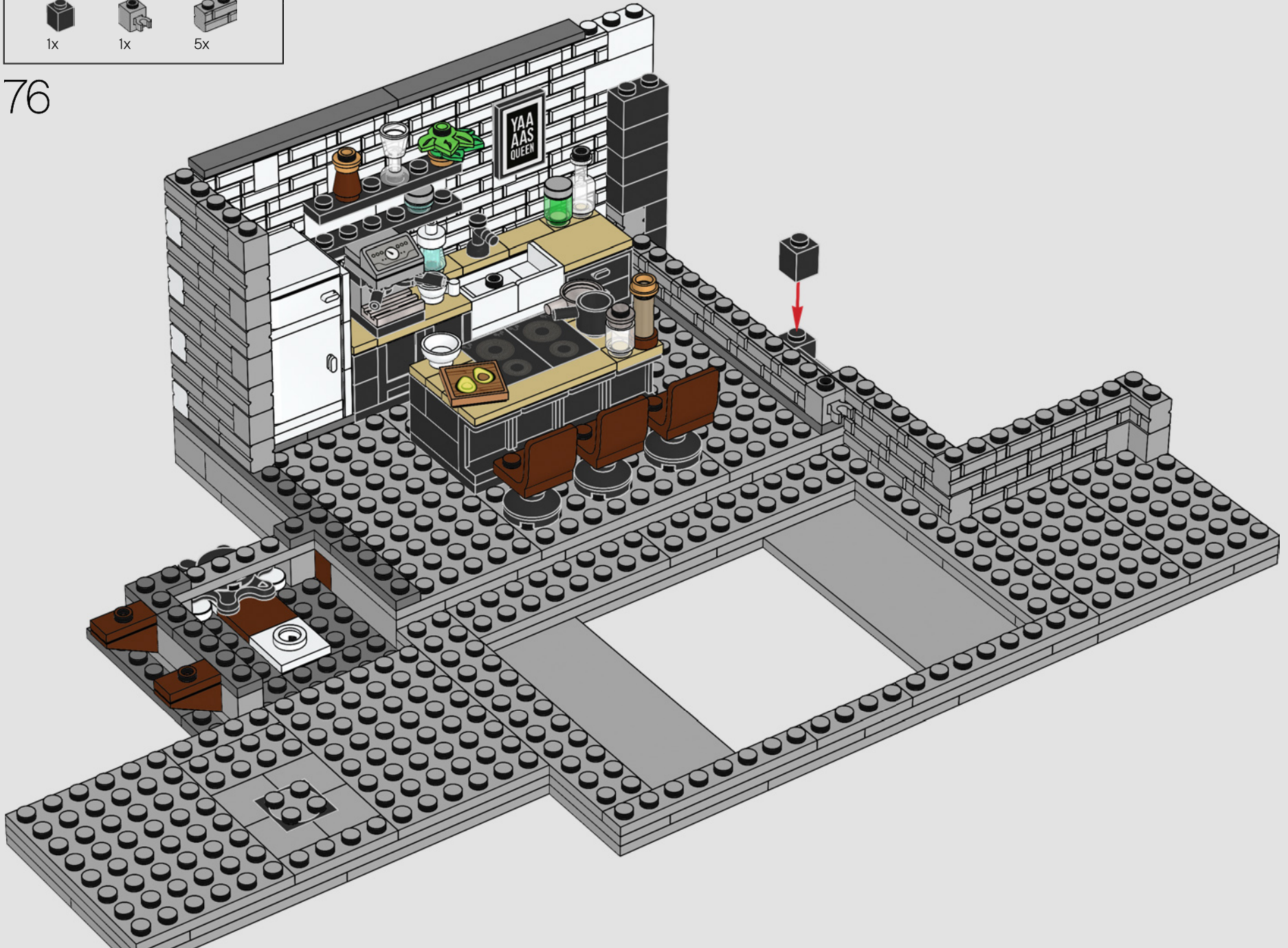

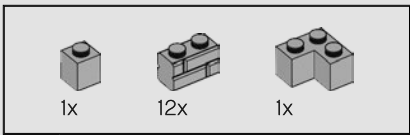

77

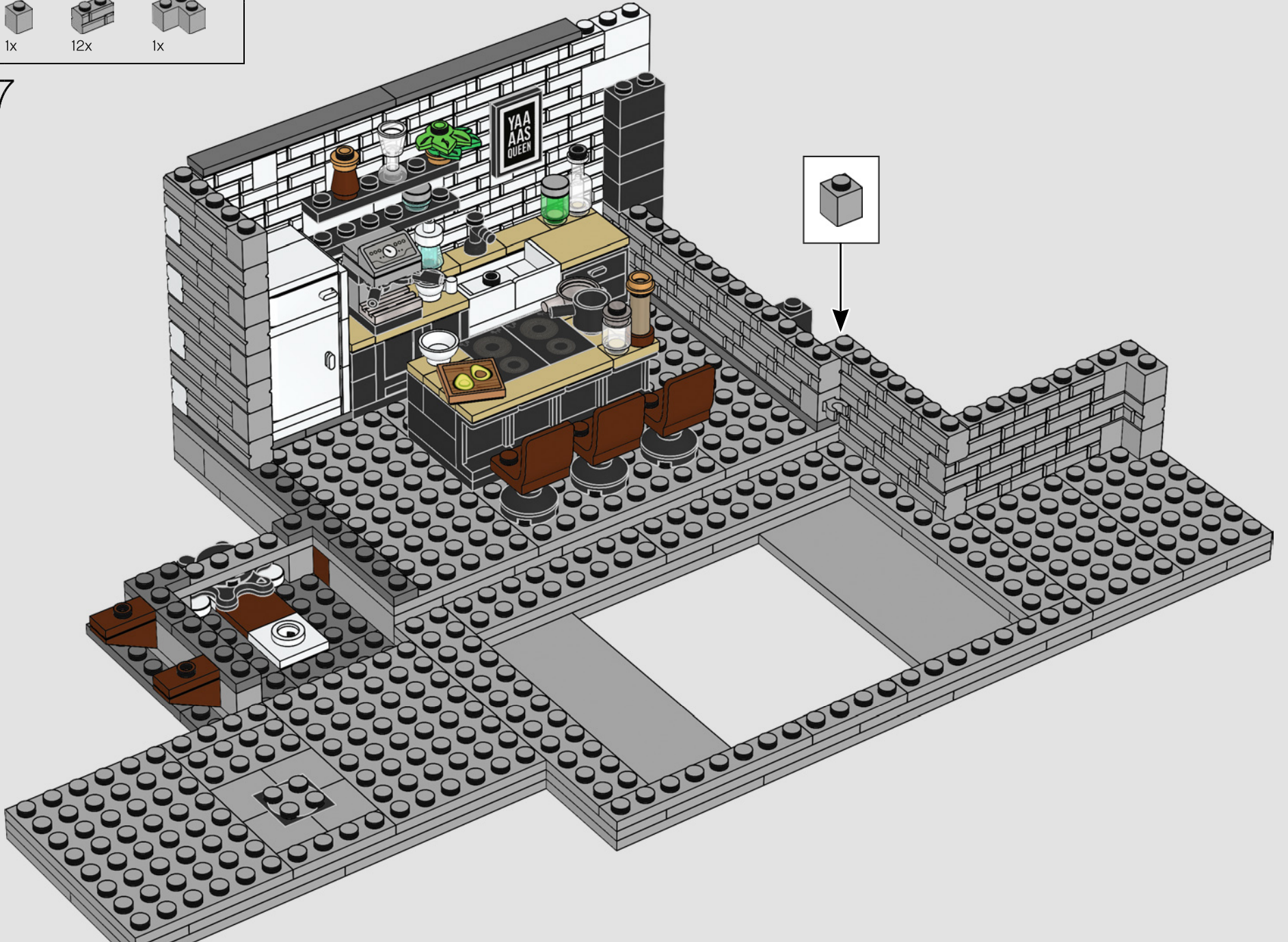



78

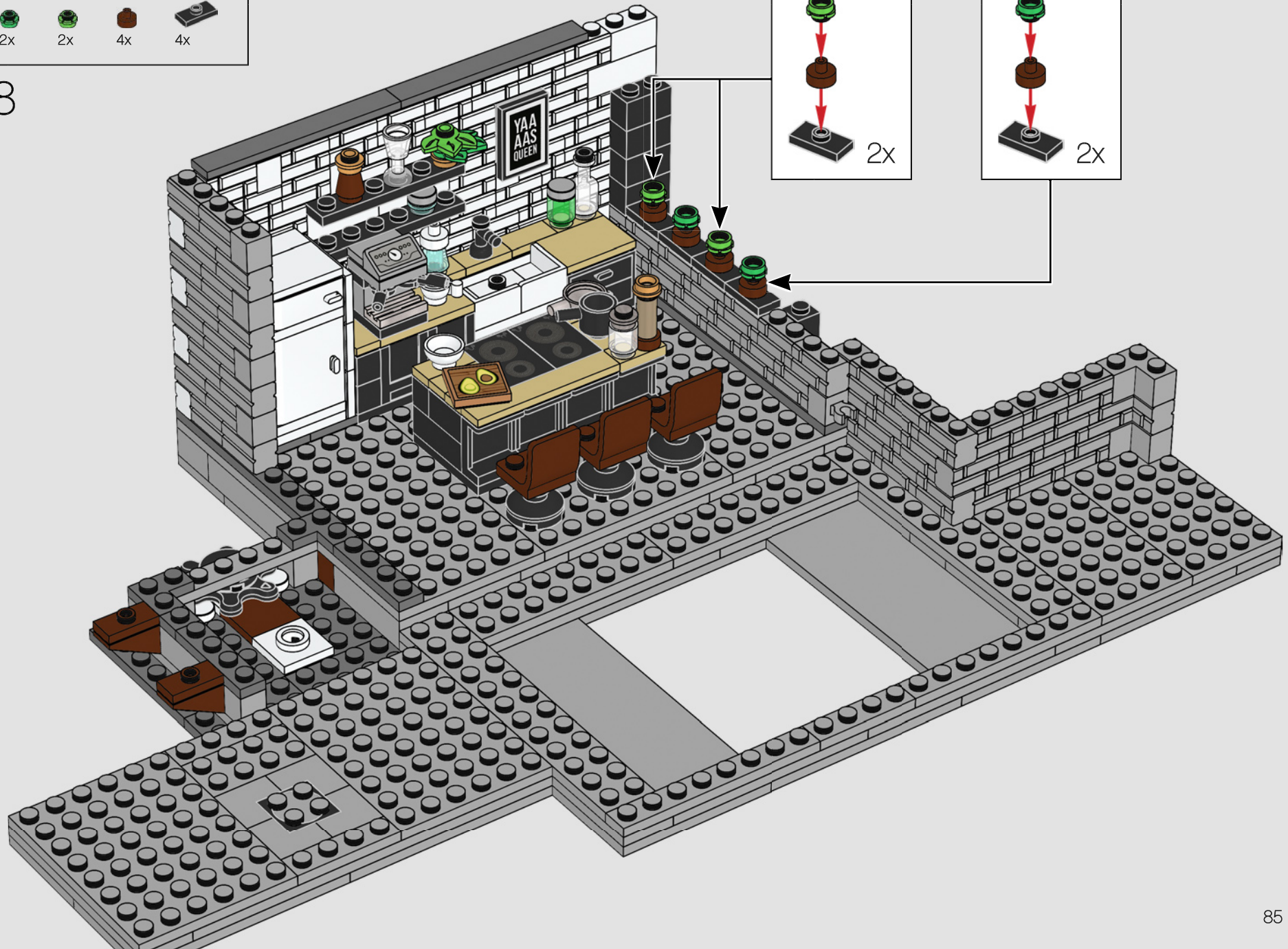
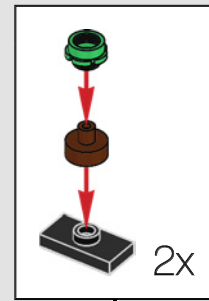
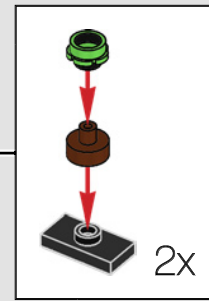

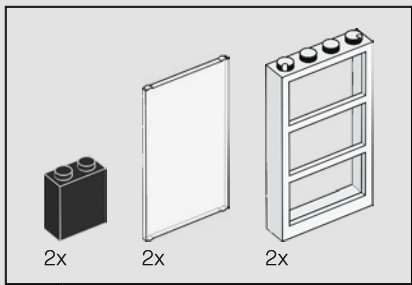

79

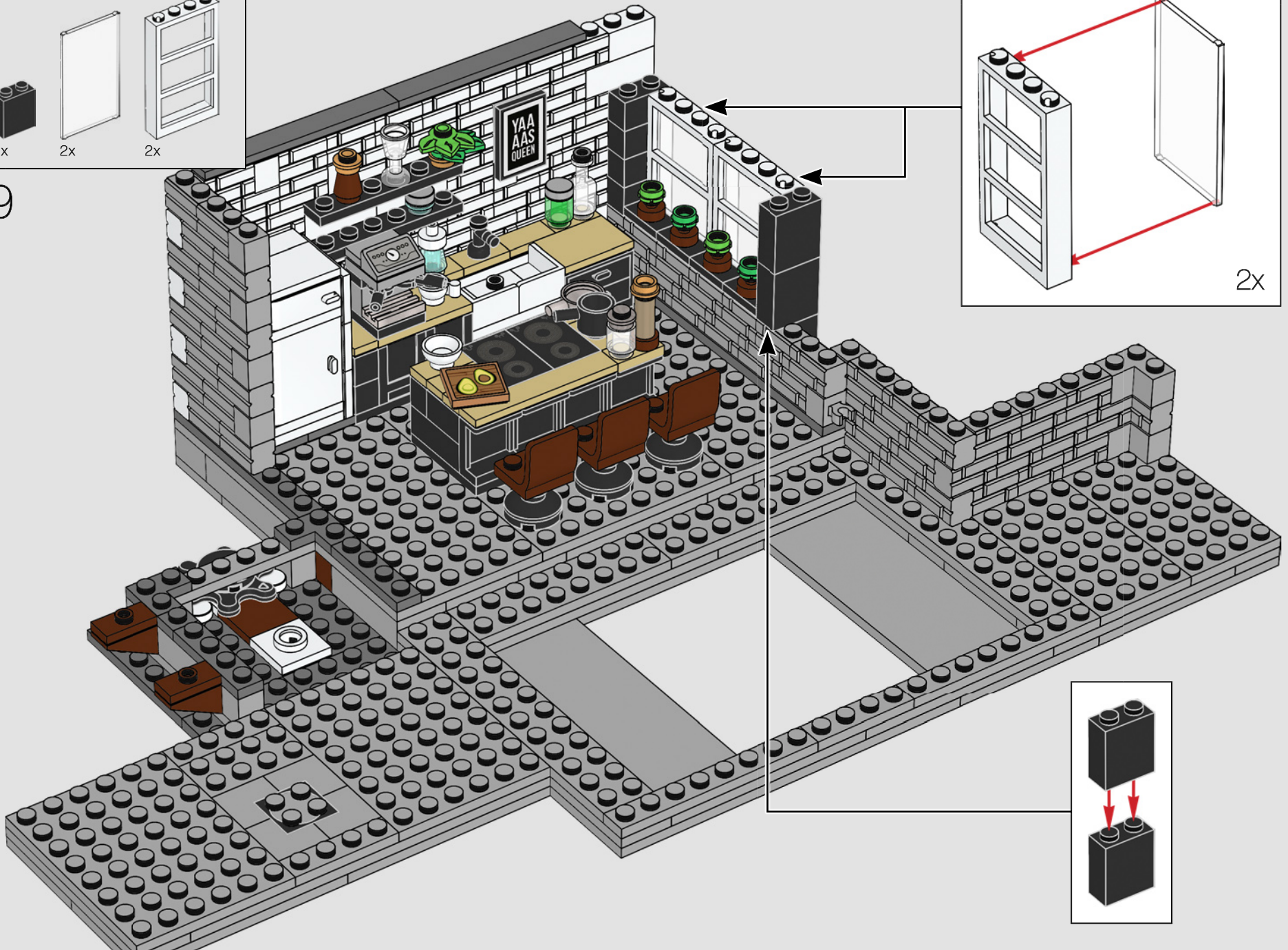

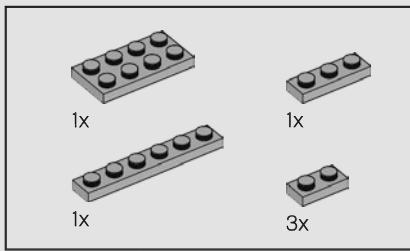

80

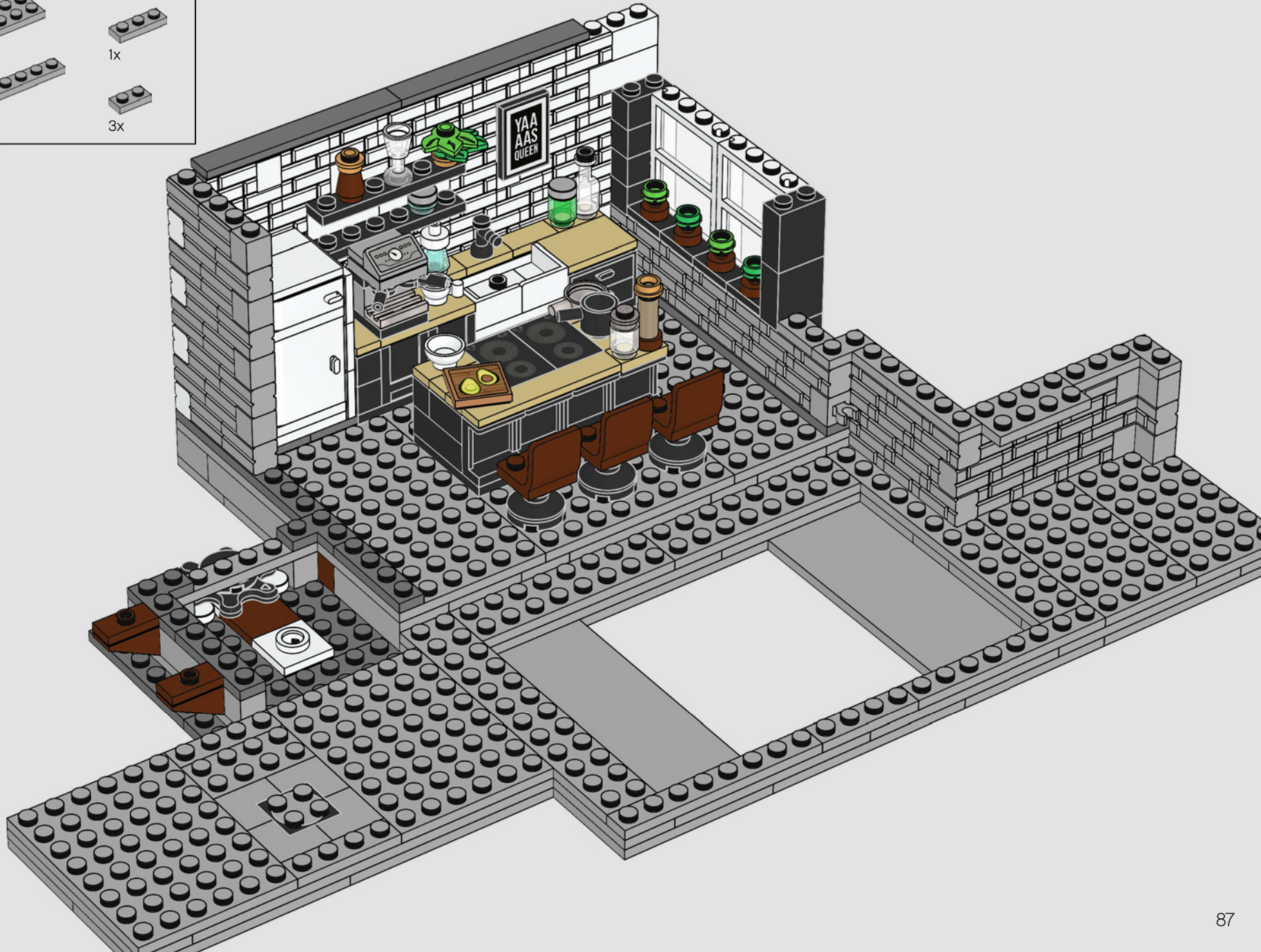

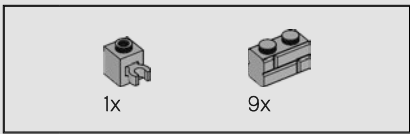

81



88

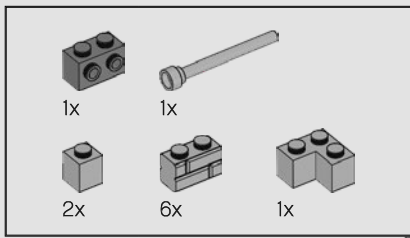

82

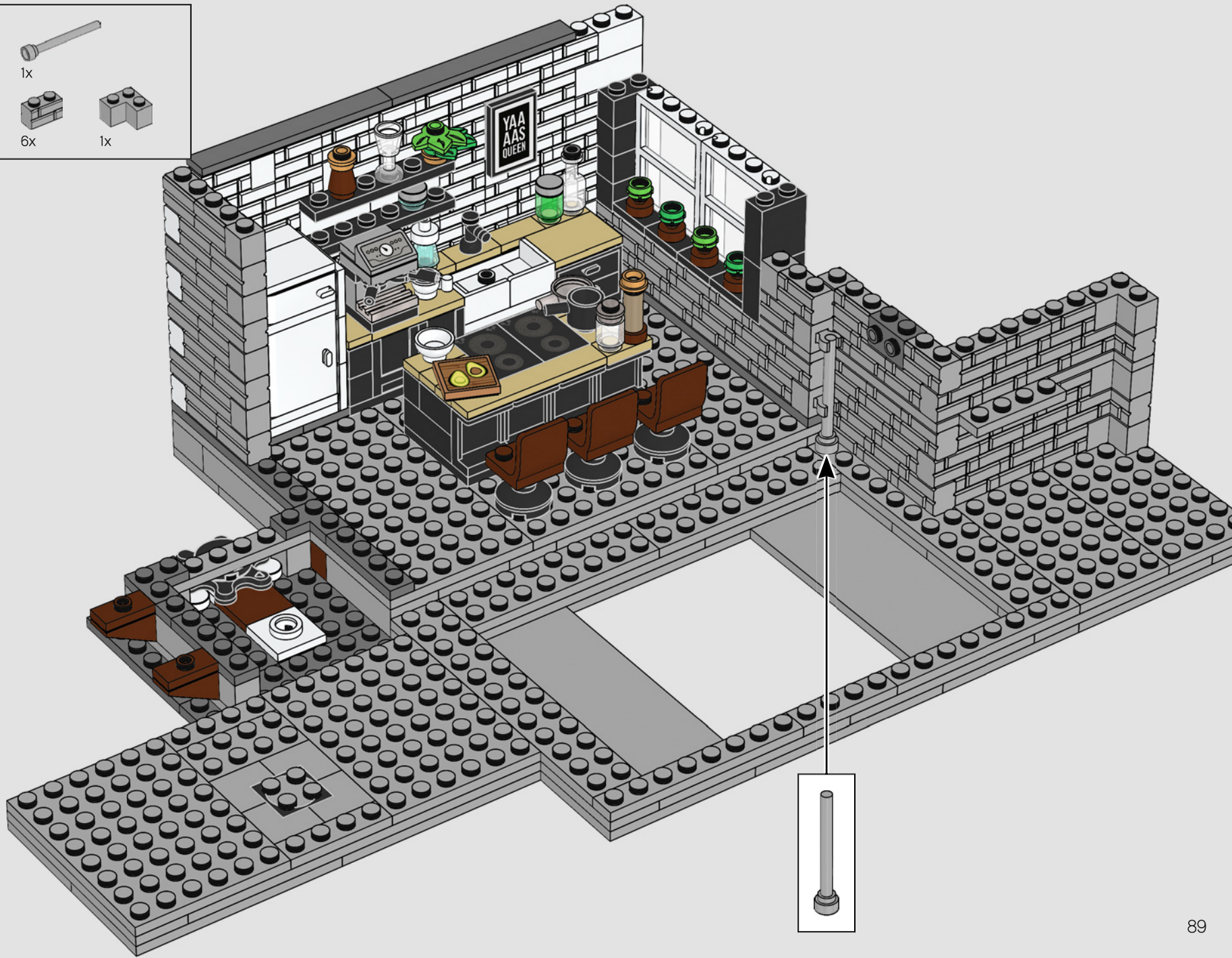

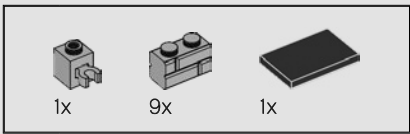

83

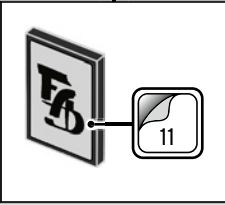
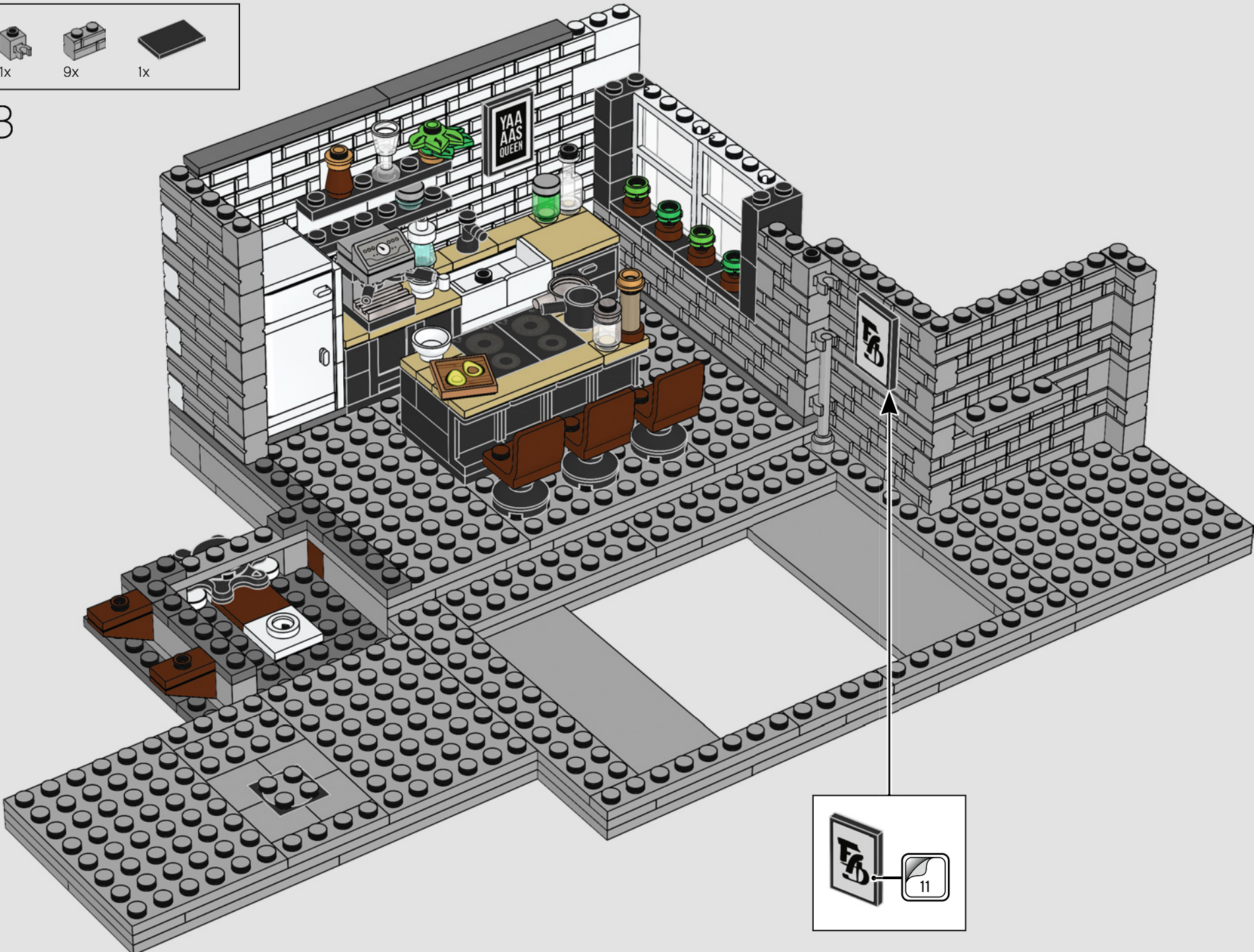

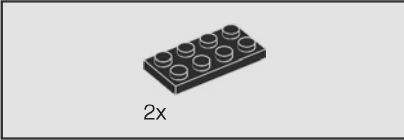
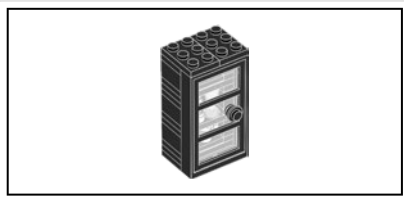

2x

84

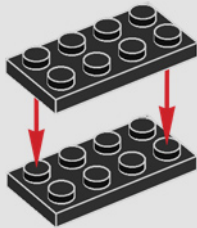

1x

2x

85

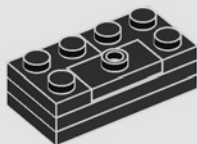

1x

1x

2x

86

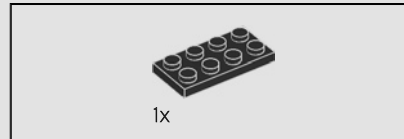
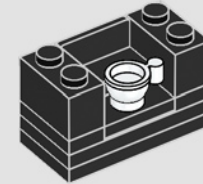

1x

87

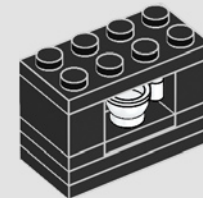

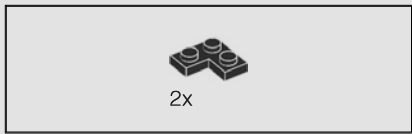

88

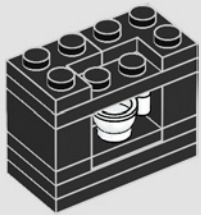

89



90

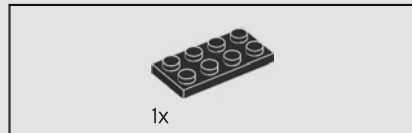

91

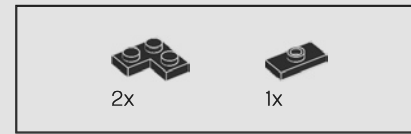

92

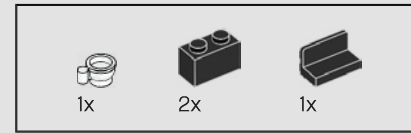

93



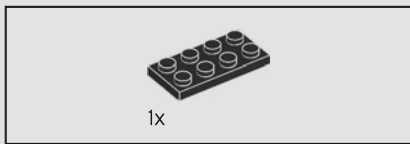

94

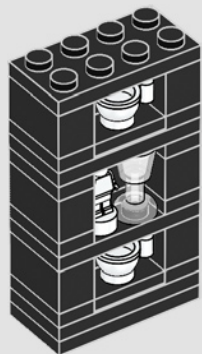

95

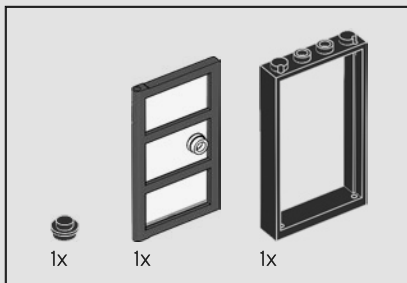
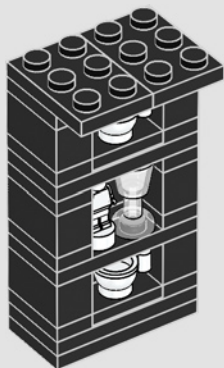

96

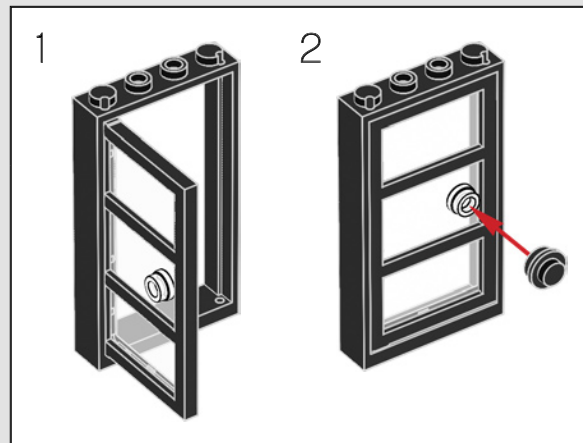
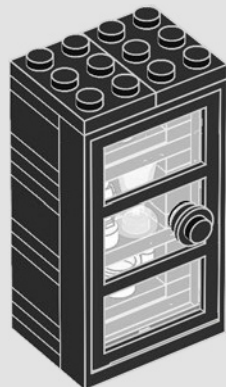

Antoni Porowski

« Quand j'étais petit, les jouets LEGO® étaient mes préférés. Je construisais des villes et des bateaux de pirates, je les détruisais, puis je recommençais. C'est assez incroyable de penser que les jeunes enfants pourront maintenant construire et jouer avec des modèles LGBTQ+. Je suis honoré de participer à ce partenariat unique. Dans son for intérieur, le petit Antoni de 10 ans crie de joie. »

97

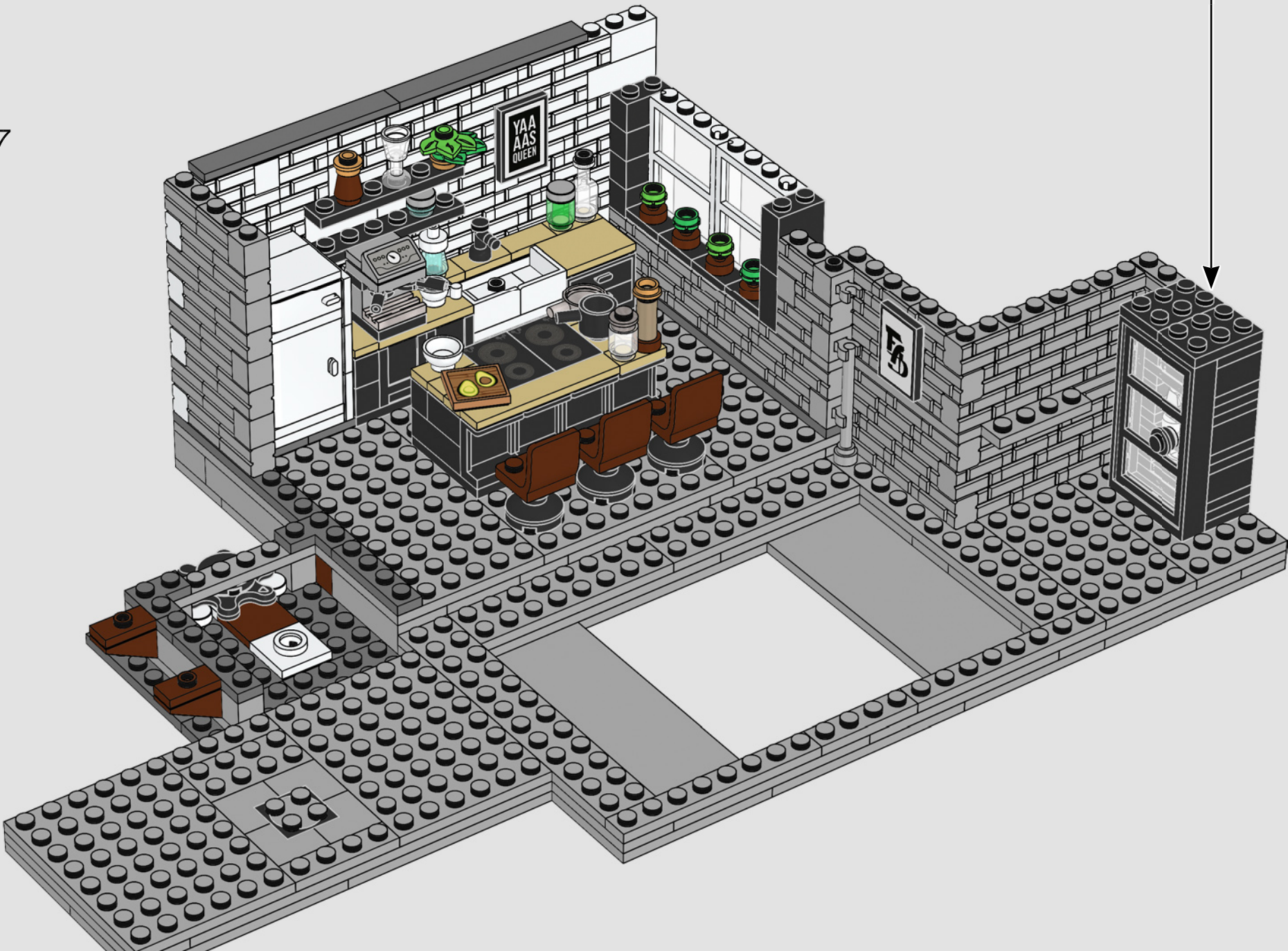

94

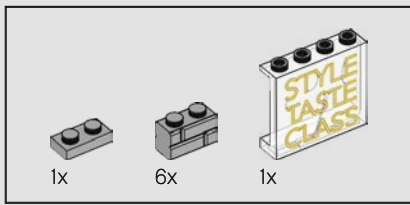

98

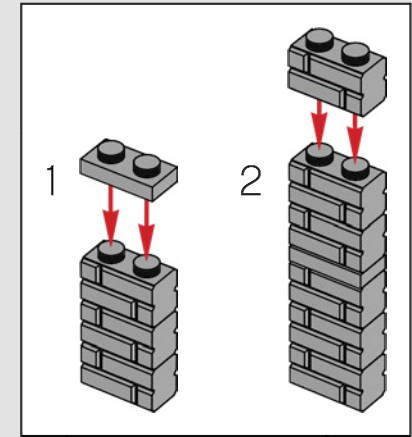
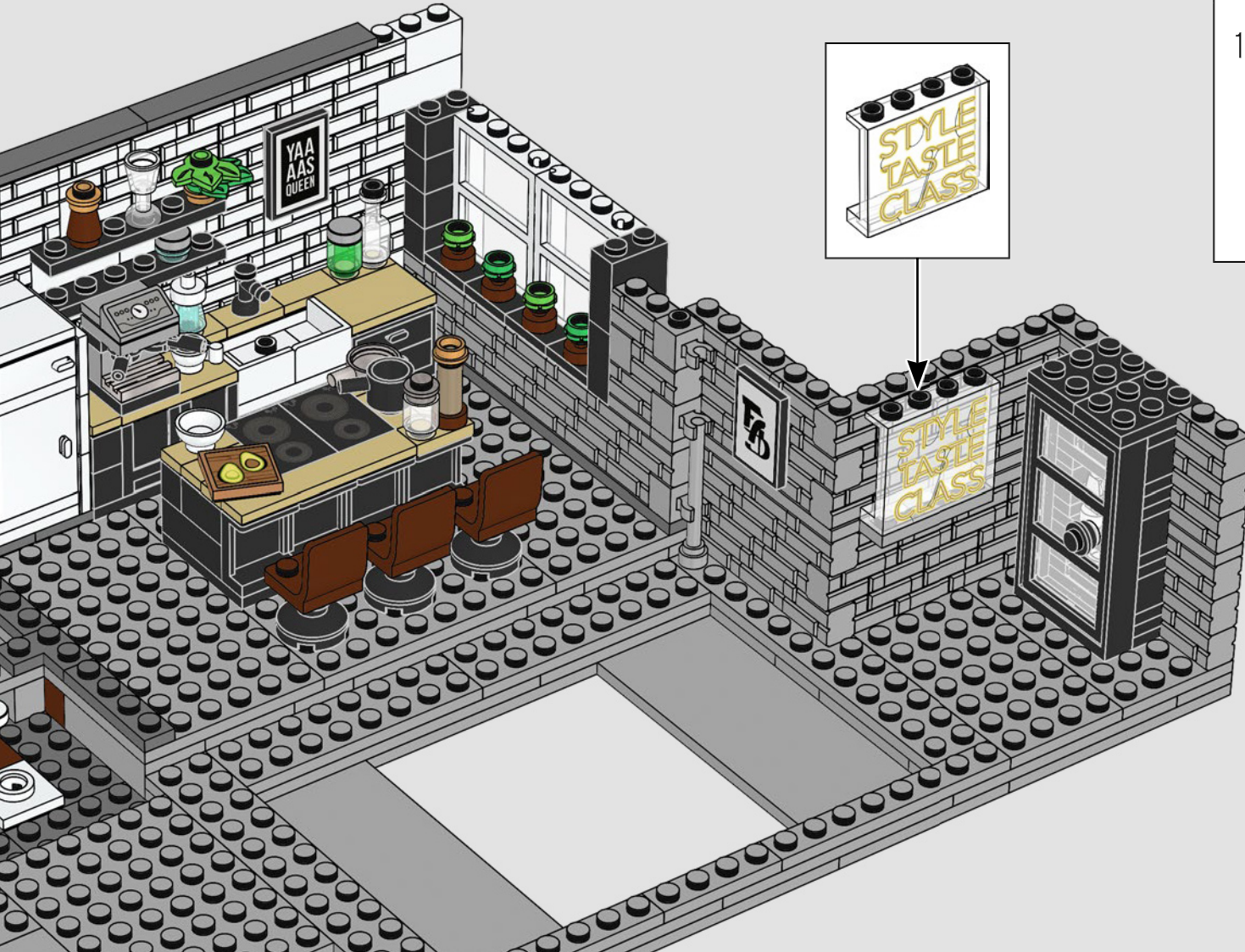

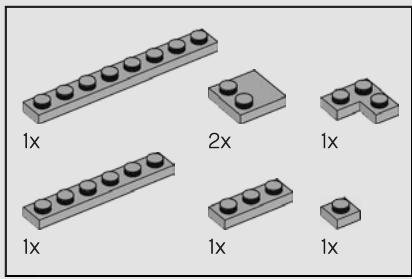

99



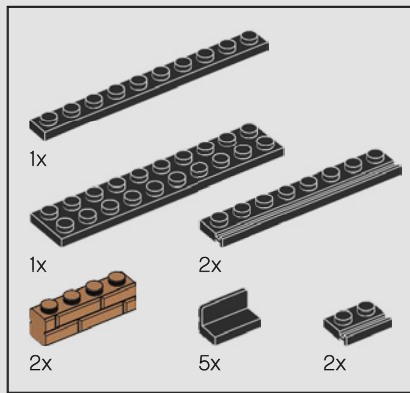

Tan France

« Nous, les Fab Five, sommes de grands enfants, et dans *Queer Eye*, nous avons parfois plus l'impression de jouer que de travailler. LEGO® étant une marque appréciée par les enfants de tous les âges, c'était tout à fait naturel pour nous de participer à la création de ce set ! »

100

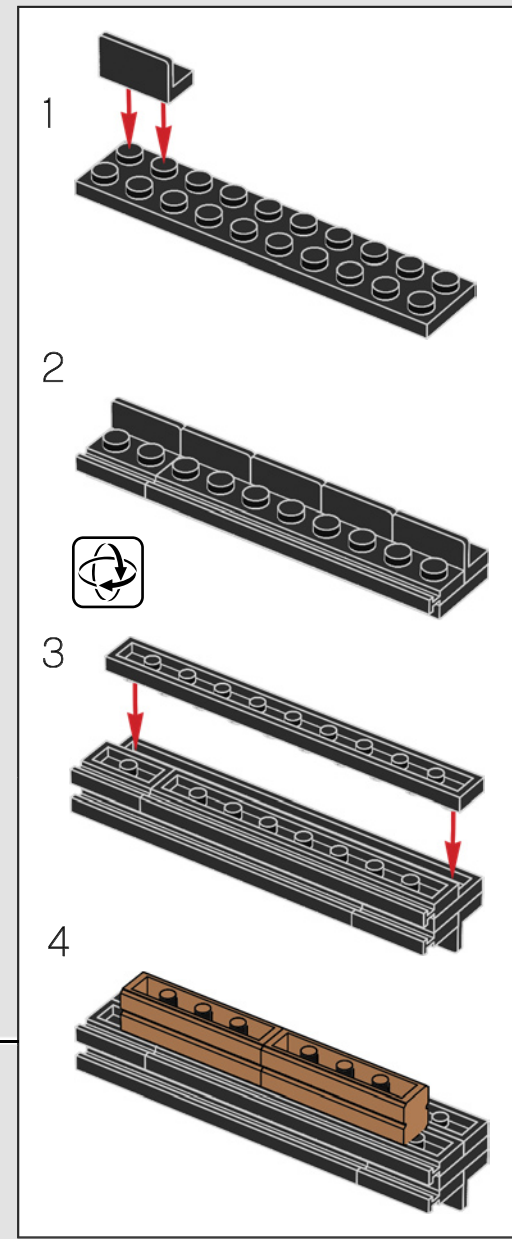

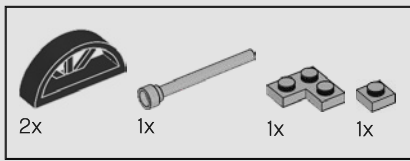

102

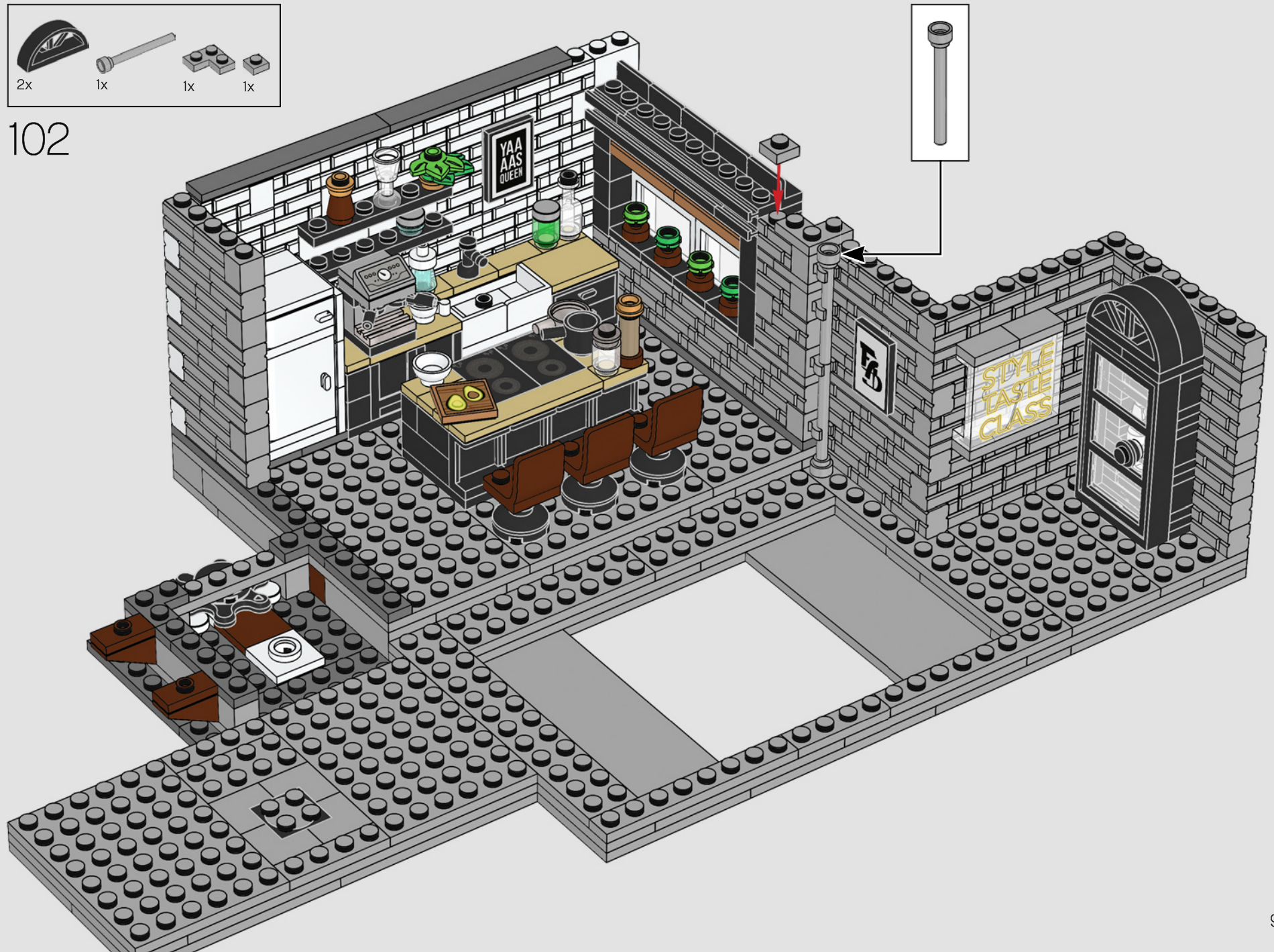



7x

103

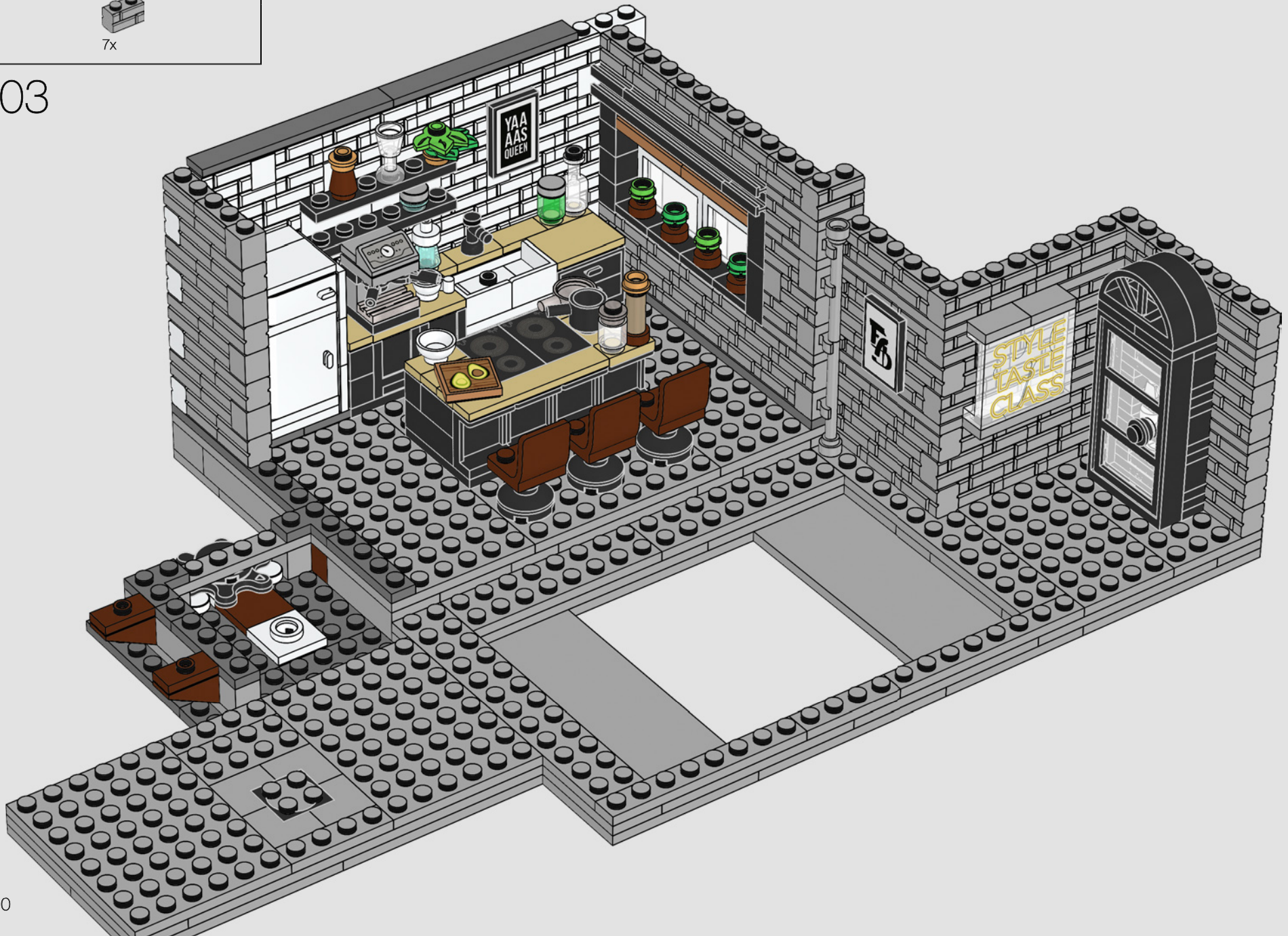

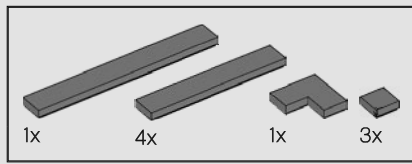

104



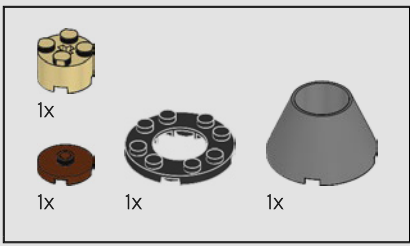

105

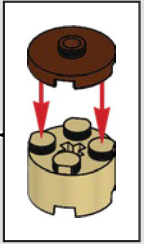
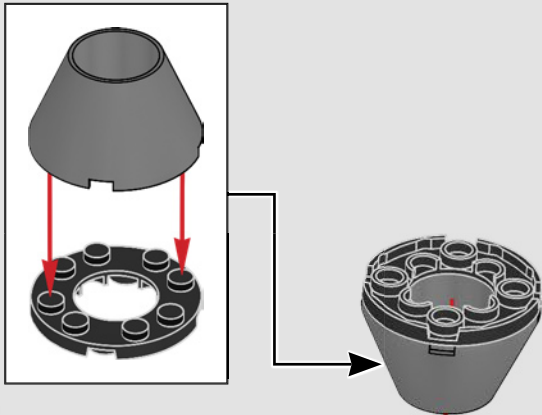

102

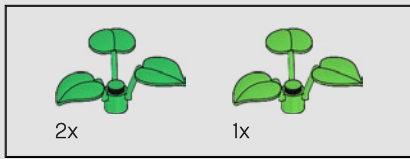

106

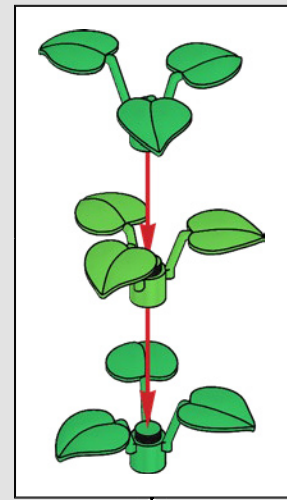

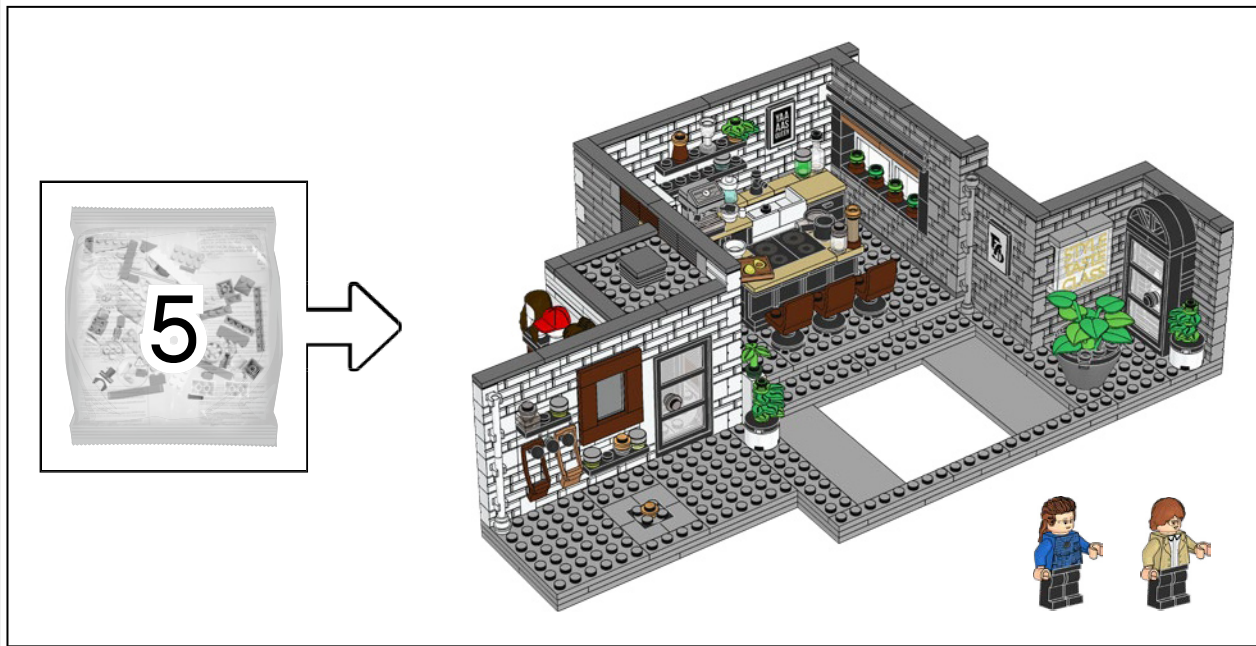

Jonathan Van Ness

« Je suis tellement heureux que Kathi Dooley soit incluse dans ce set ! C'est l'héroïne de mon enfance, et elle est si importante pour moi. En plus, c'est une chance puisque je peux désormais me débarrasser de sa coupe mulet autant que je le souhaite. »



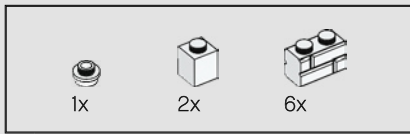

107



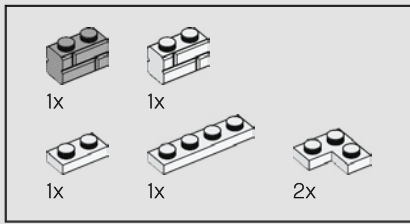

109



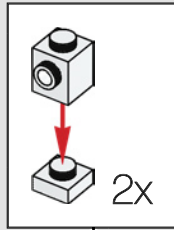
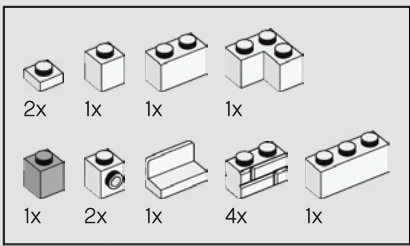

110



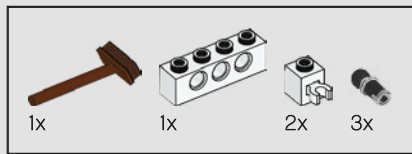

111

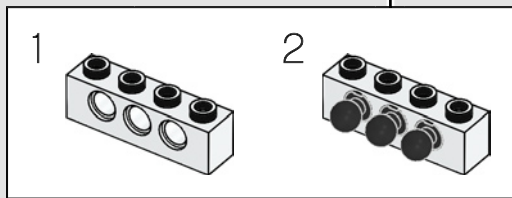
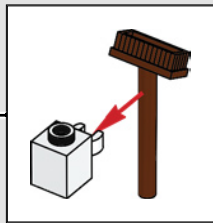

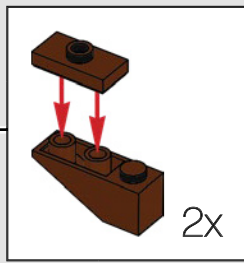
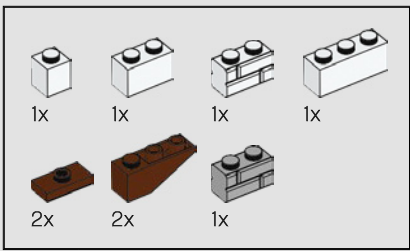

112



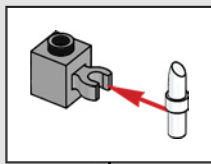
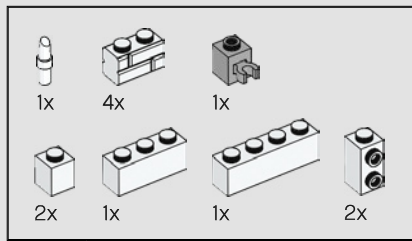

113



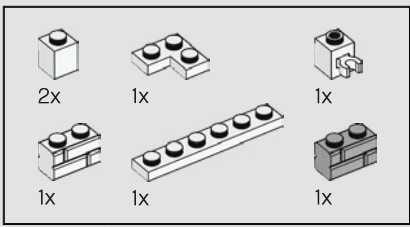

114



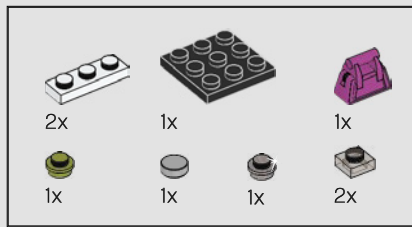

115

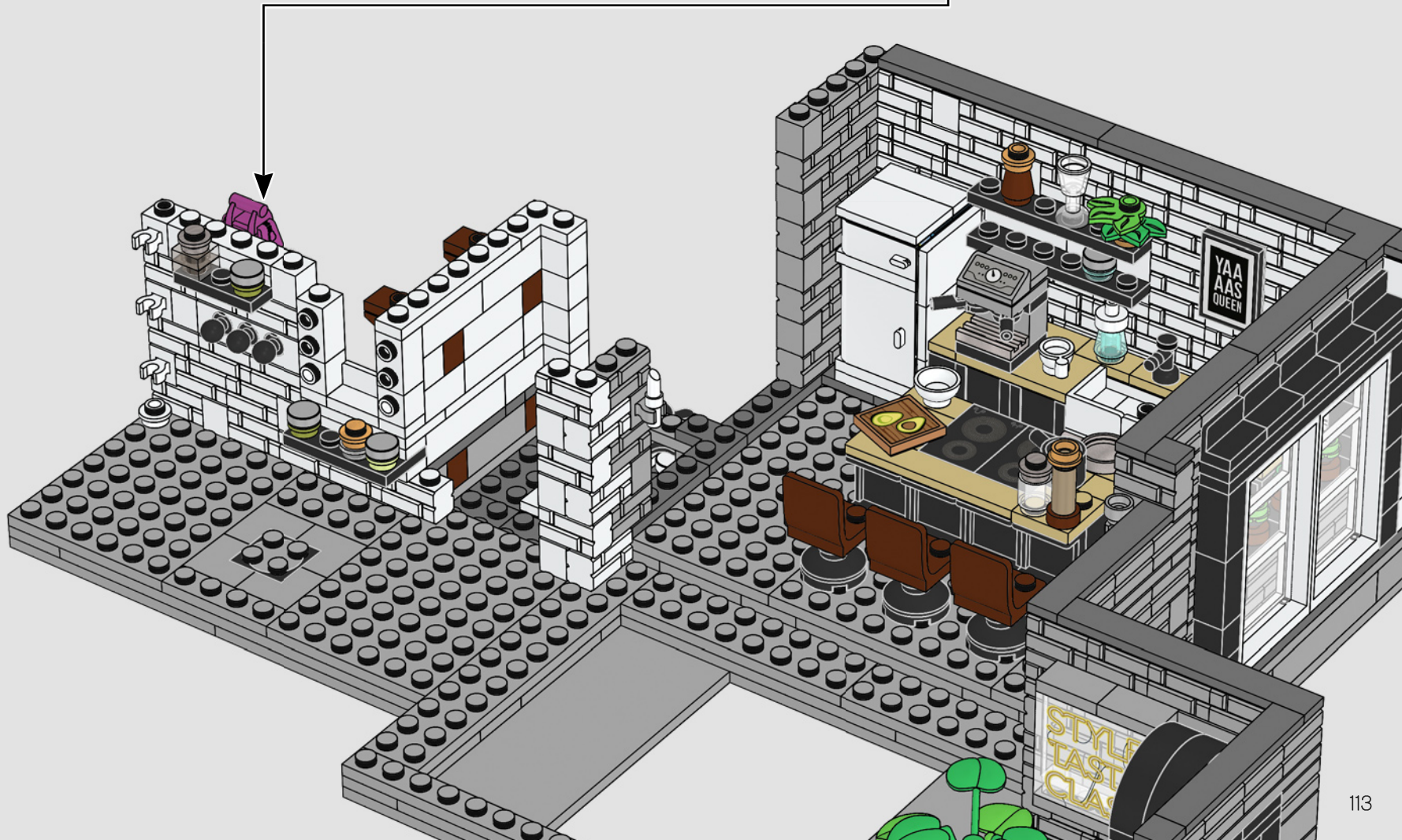
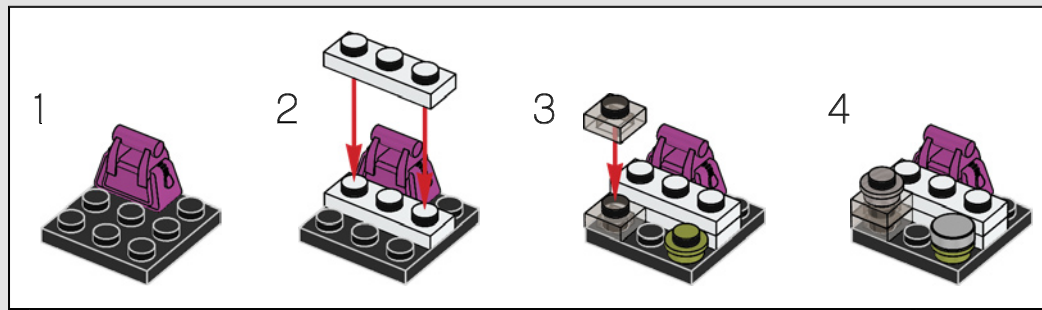

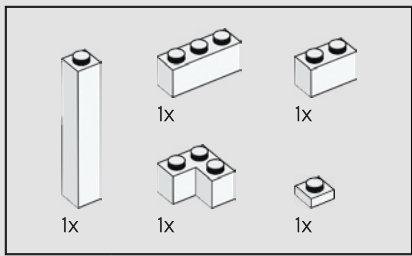

116



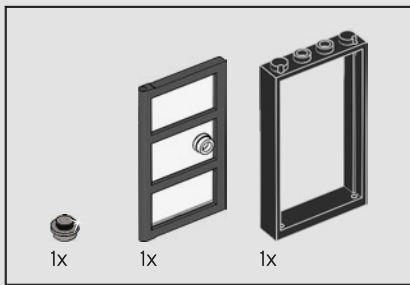

117

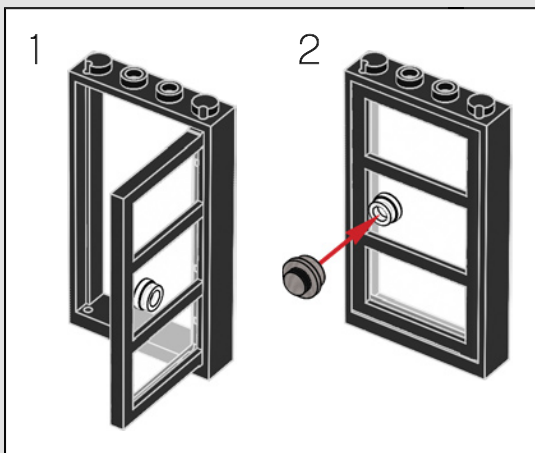

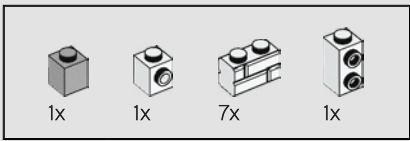

118



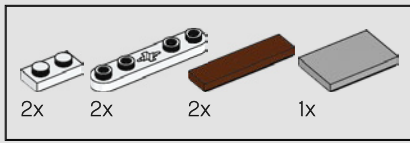

119

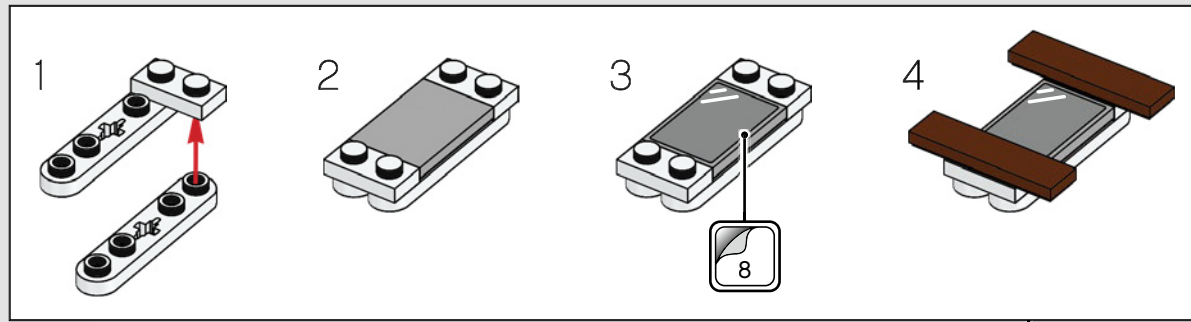

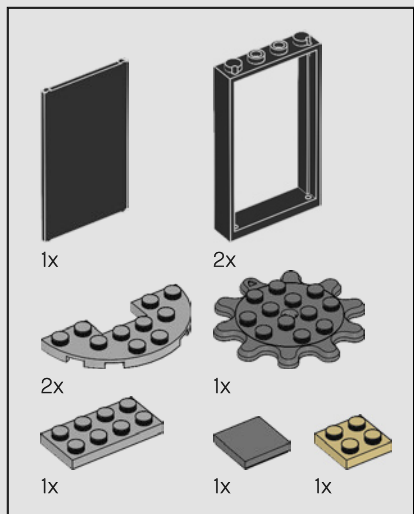

120

1

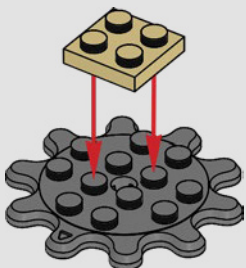

2

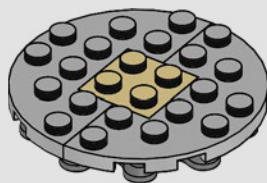

3

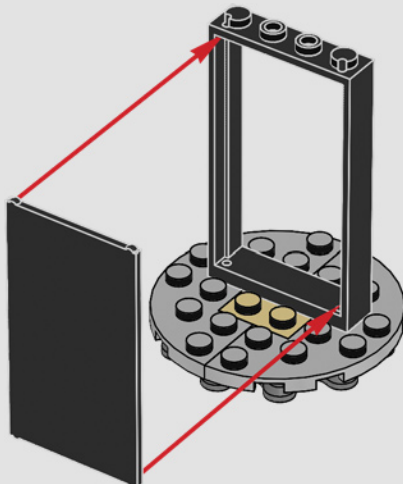

4

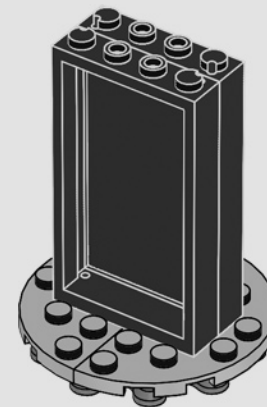

5

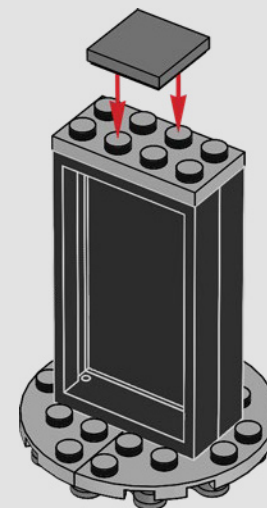

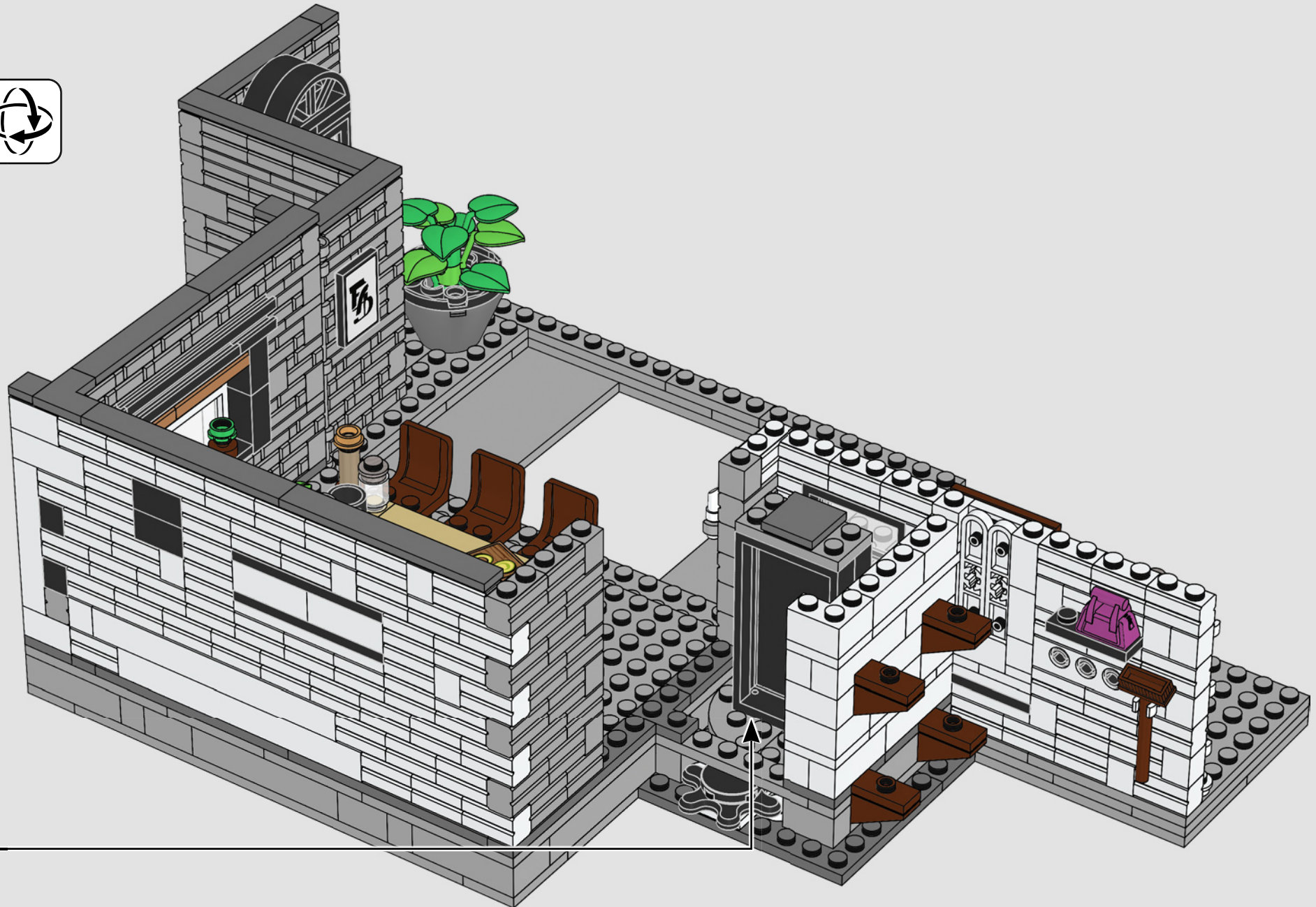

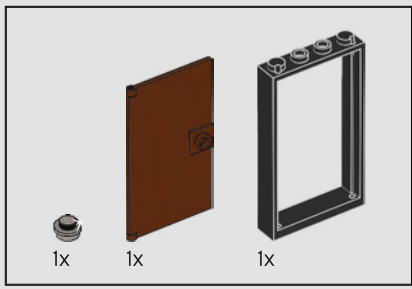

121

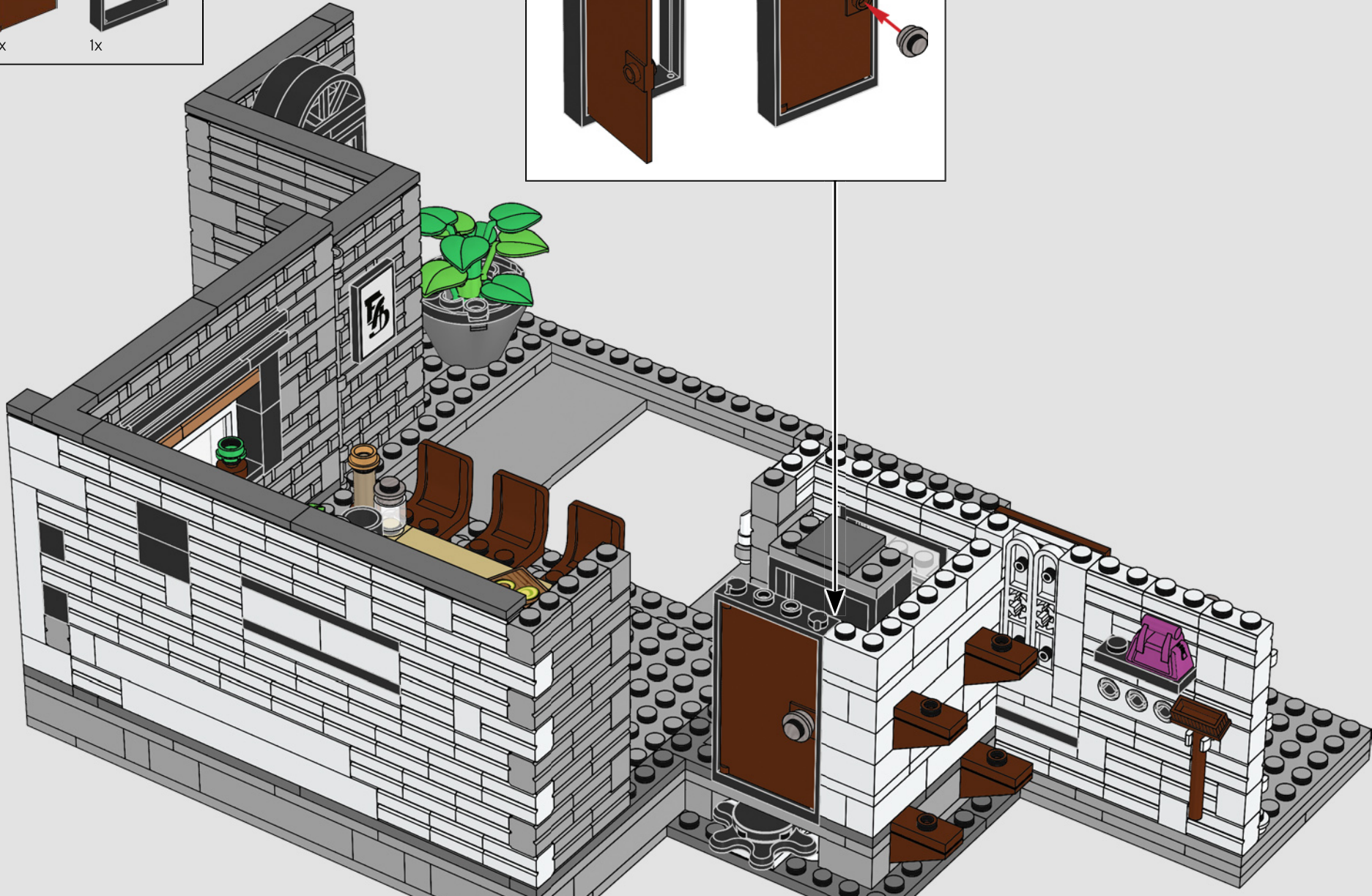
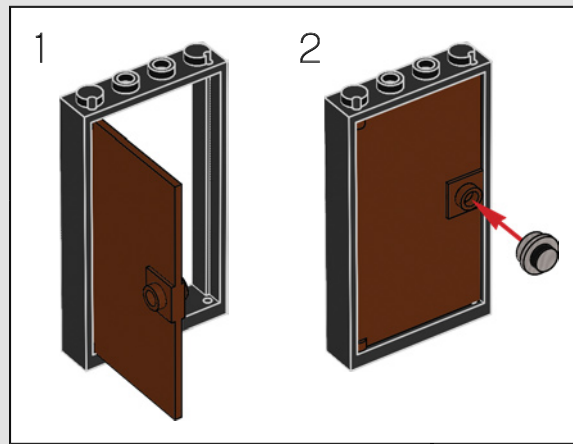

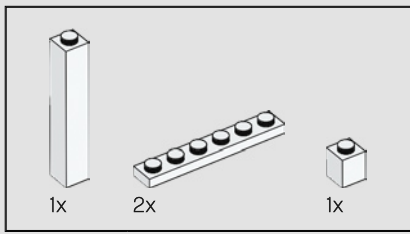

122

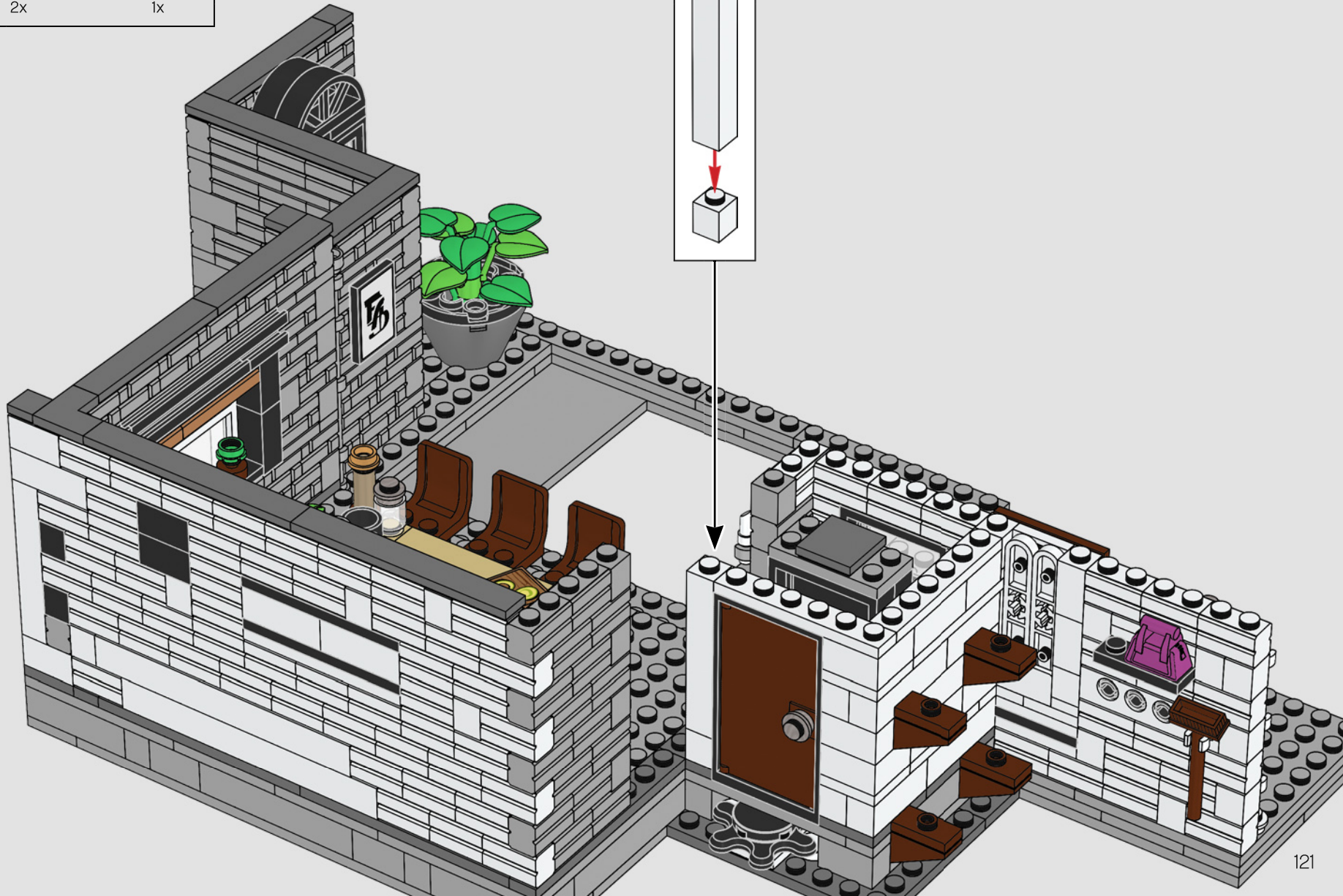

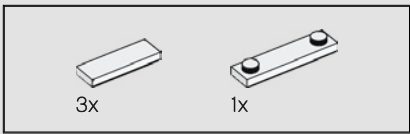

123



Tan France

« J'adore faire partie des Fab 5 et grâce à *Queer Eye*, j'ai le pouvoir de mettre en lumière la beauté de la diversité de notre communauté. C'était mon principal espoir quand j'ai auditionné pour l'émission, et je me considère très chanceux d'en être arrivé là. »

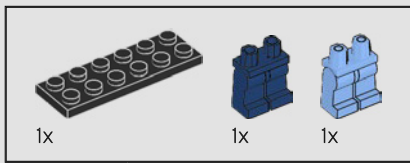

124

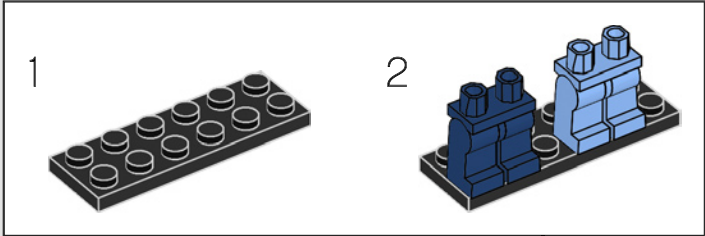
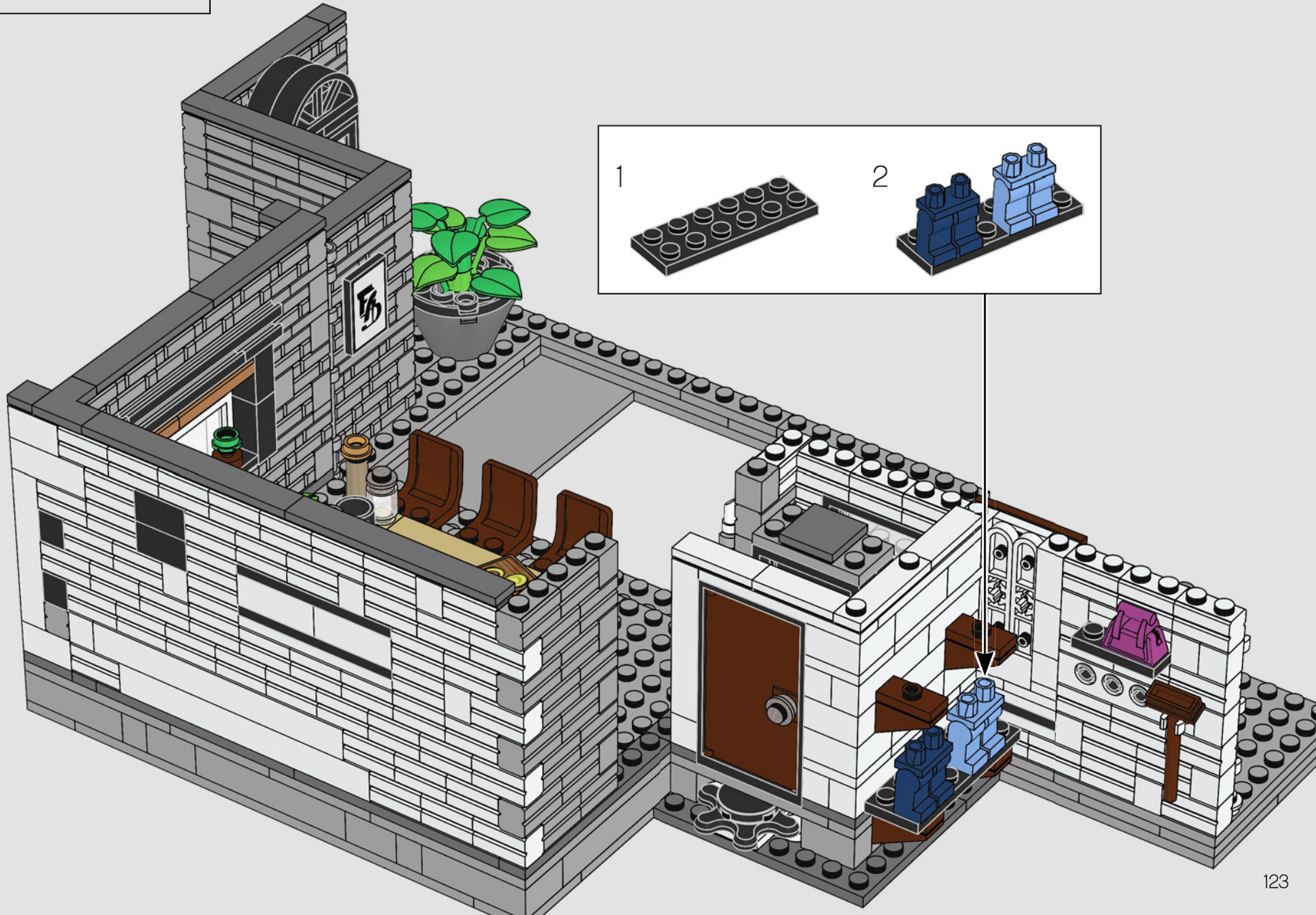

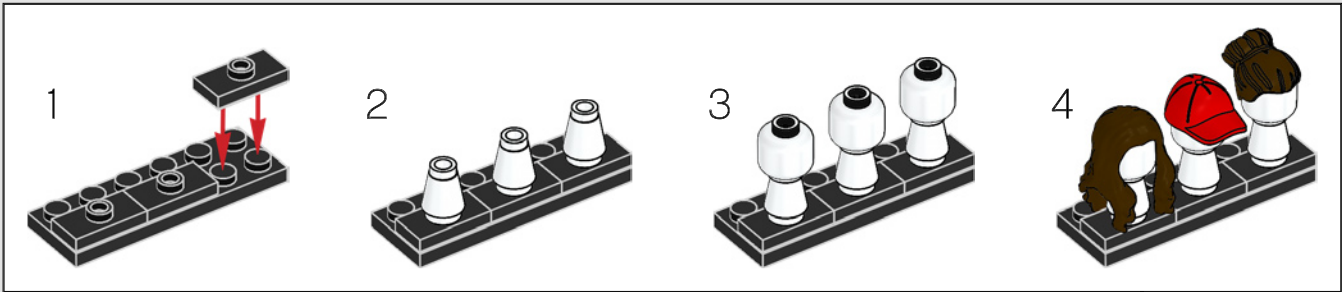
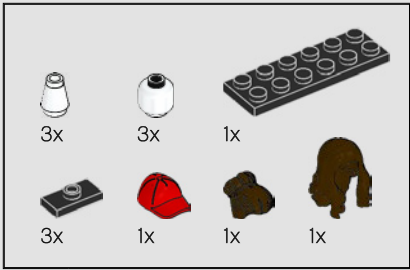

125



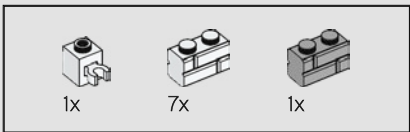

126



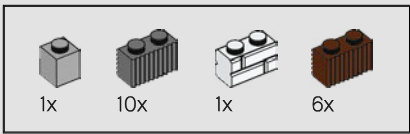

127

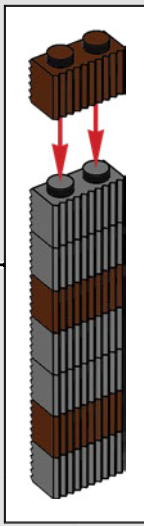
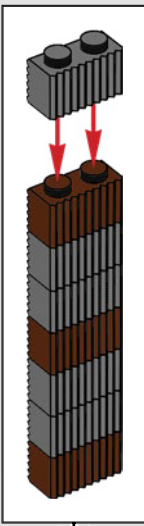

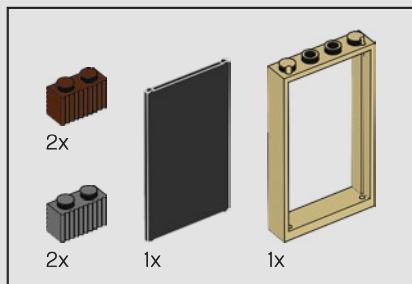

128

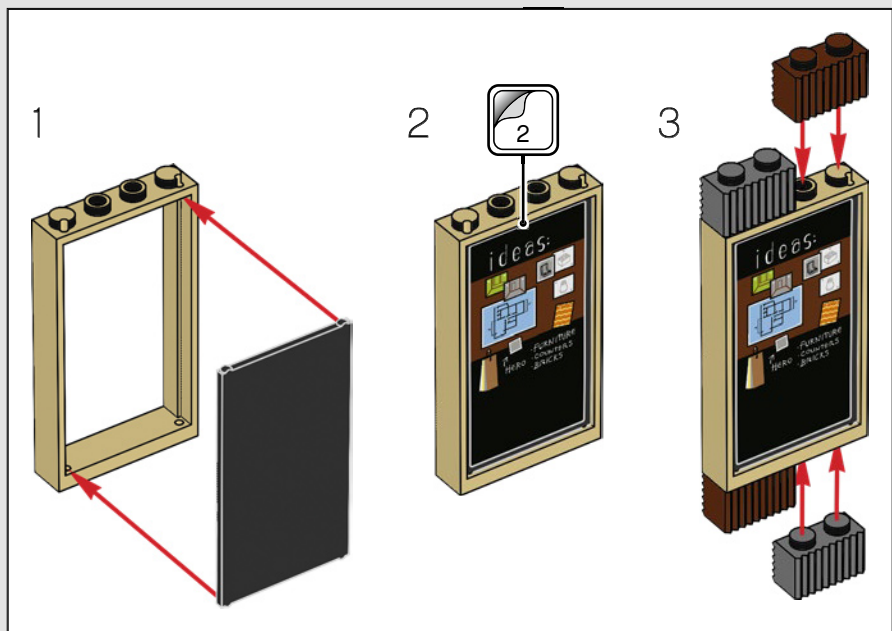

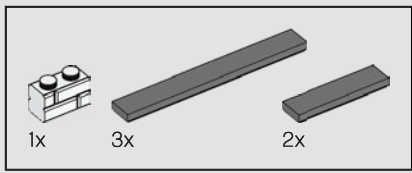

129

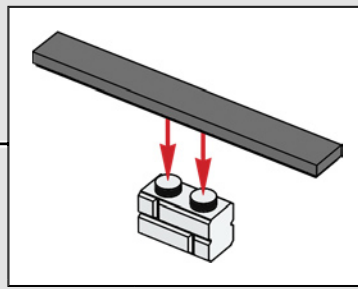

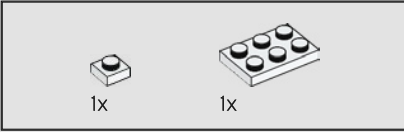
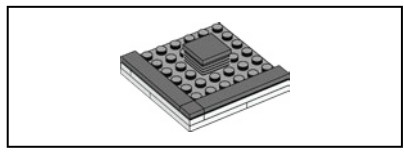

130

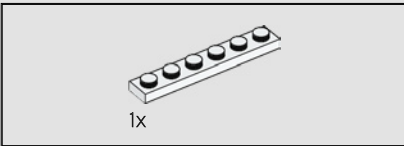
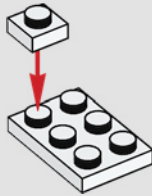

131

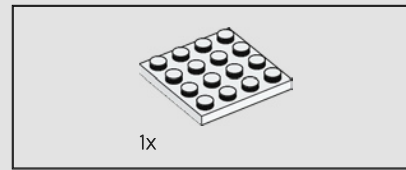
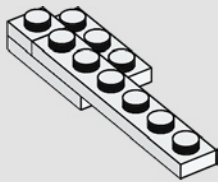

132

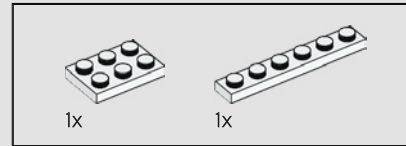
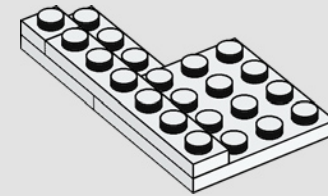

133

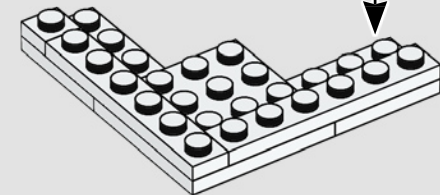
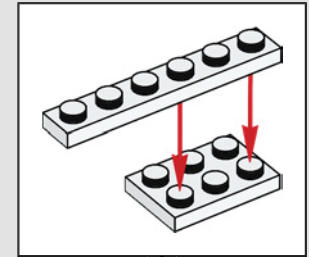

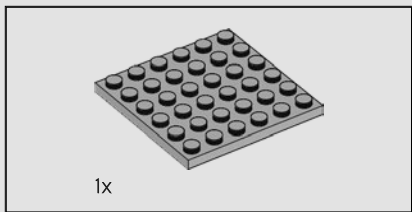

134

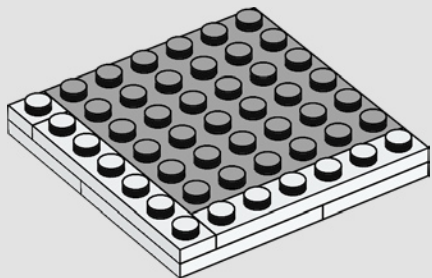

135

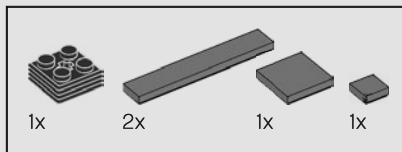
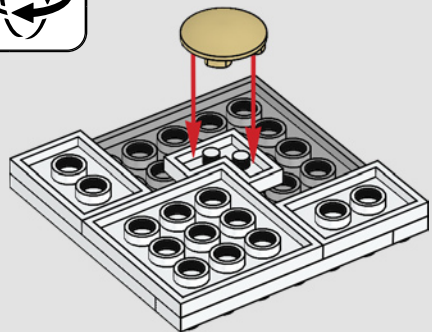

136

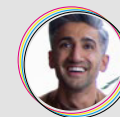
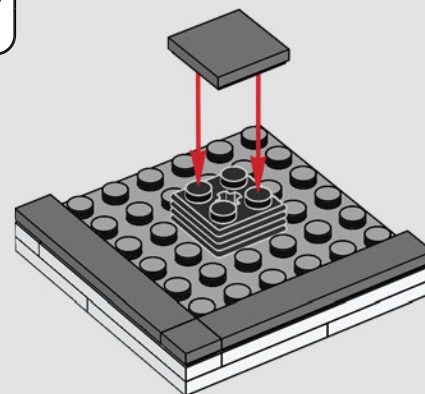

Tan France

« Cette salle de transformation est géniale ! Une rotation et « tadam », la voilà ! »

137



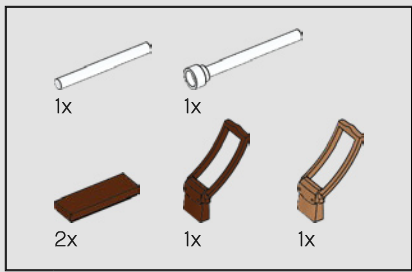

138



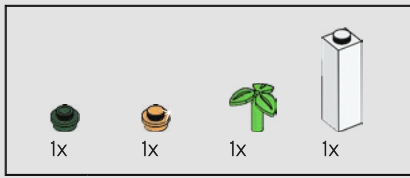

139

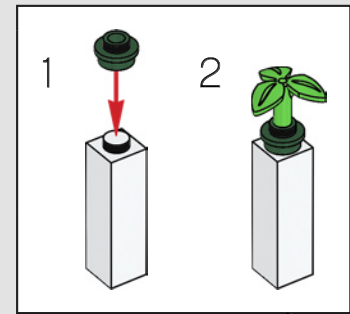

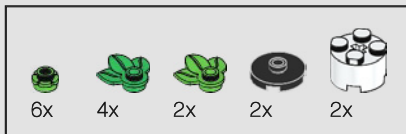

140

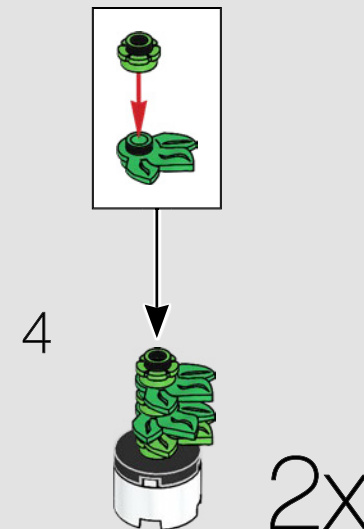
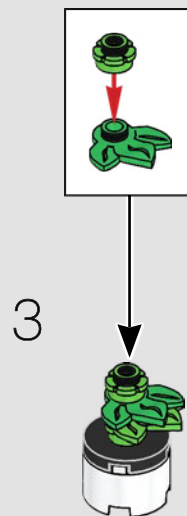
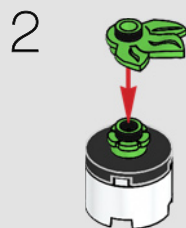
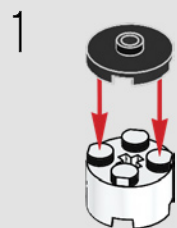

Karamo Brown

« Lorsqu'on est adulte, tout processus créatif est utile pour se recentrer et se changer les idées. La construction de modèles LEGO® est le moyen idéal de se détendre et décompresser, et toutes ces créations offrent un réel sentiment d'accomplissement. C'est ainsi que, tout comme notre émission, LEGO peut aider les gens à reconstruire leur vie. C'est le partenariat parfait. »





Bobby Berk

« Je suis très satisfait du résultat final. Je pense que nous avons vraiment réussi à reproduire l'essence de notre loft original ! »





FEEDBACK AND WIN



FEEDBACK AND WIN

Your feedback will help shape the future development of this product series.

Please visit:

FEEDBACK UND GEWINNEN

Dein Feedback trägt zur Weiterentwicklung dieser Produktreihe bei.

Geh auf:

COMMENTEZ ET GAGNEZ

Vos commentaires nous aideront à concevoir les futurs produits de cette gamme.

Rendez-vous sur :

COMENTA Y GANA

Tu opinión nos ayudará a dar forma al desarrollo de esta serie de productos en el futuro.

Visita:

反馈有奖

您的反馈将有助于我们在今后改进本系列产品。

请访问：

[LEGO.com/productfeedback](https://www.lego.com/productfeedback)

By completing, you will automatically enter a drawing to win a LEGO® set.

Terms & Conditions apply.

Durch Ausfüllen nimmst du automatisch an der Verlosung eines LEGO® Preises teil.

Es gelten die Teilnahmebedingungen.

En envoyant vos commentaires, vous serez automatiquement inscrit(e) à un tirage au sort qui vous permettra de remporter un prix LEGO®.

Offre soumise à conditions.

Al contestar, participarás automáticamente en el sorteo y podrás ganar un set LEGO®.

Sujeto a Términos y Condiciones.

完成我们的反馈调查，即可自动进入抽奖环节，赢取乐高®套装。

适用《条款和条件》。

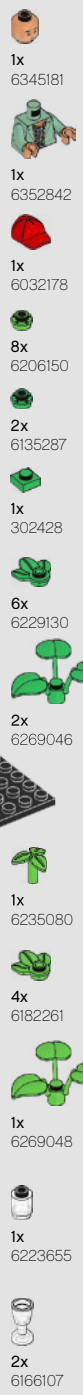



Customer Service
 Kundenservice
 Service Consommateurs
 Servicio Al Consumidor
 LEGO.com/service or dial





LEGO and the LEGO logo are trademarks of the LEGO Group. ©2021 The LEGO Group.

©2021, Scout Productions, Inc. and the Queer Eye logo are trademarks or registered trademarks of Scout Productions, in the United States of America and elsewhere. All rights reserved.