

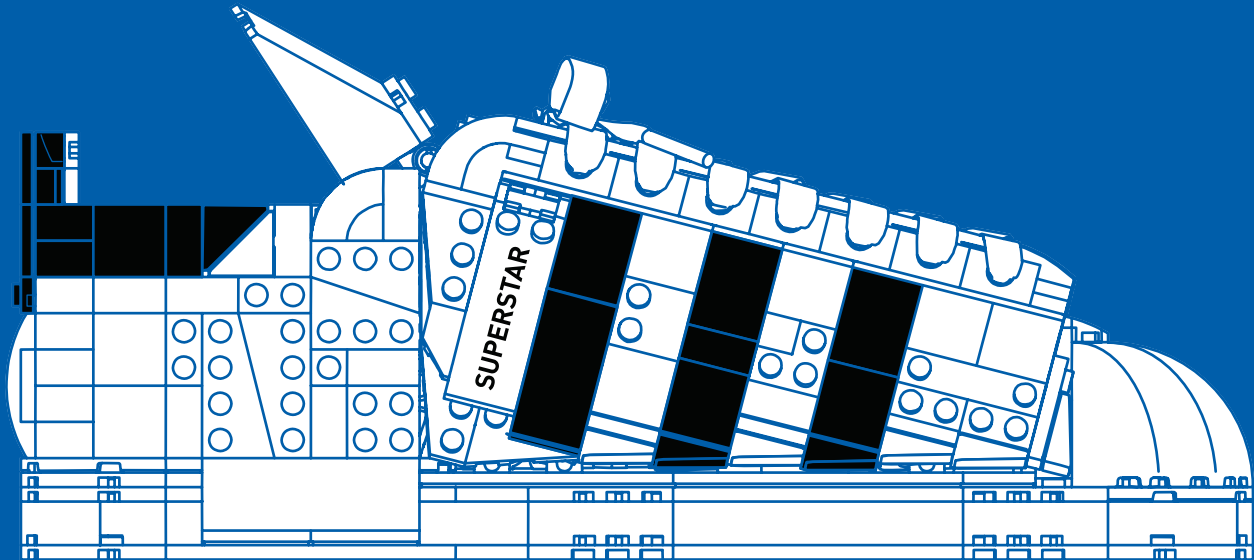

adidas
originals
superstar



Booklet available in English on
Livret disponible en français sur
Folleto disponible en español en

[LEGO.com/service/buildinginstructions](https://www.lego.com/service/buildinginstructions)

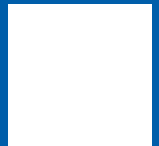



©The adidas Archive

*Credit Studio Waldeck / *Attribué à Studio Waldeck / * Crédito: Studio Waldeck

EN

ORIGINAL FROM THE START

In the early 1960s, adidas embarked on a mission to expand the brand into the American market. Their US distributor suggested that basketball offered the best opportunity. For several decades, the sport had been lacking in any significant innovation in both design and technology. But Horst Dassler, son of the company founder, had a vision and a love for the game, so he began development work on a shoe that was to become the Superstar.

FR

ORIGINALE DÈS LE DÉBUT

Au début des années 1960, adidas a entrepris de faire entrer la marque dans le marché américain. Son distributeur américain lui a présenté le basketball comme la meilleure option. Depuis plusieurs décennies, le sport avait connu peu d'innovations notables tant au niveau de la conception que de la technologie. Mais Horst Dassler, fils du fondateur de l'entreprise, avait une vision et un amour pour le jeu, et s'est alors lancé dans l'élaboration d'une chaussure qui allait devenir la Superstar.

ES

ORIGINAL DESDE EL PRINCIPIO

A inicios de los años 60, adidas emprendió la misión de ampliar su presencia como marca al mercado estadounidense. Su distribuidor en los EE. UU. sugirió que la mayor oportunidad de éxito se encontraba en el baloncesto. Habían pasado varias décadas sin que hubiera innovaciones significativas en el diseño y la tecnología asociados con ese deporte. Pero Horst Dassler, hijo del fundador de la compañía, motivado por una visión y la pasión que le inspiraba el juego, comenzó a trabajar en el desarrollo del zapato que conoceríamos como *Superstar*.



1970



1985



1993



2001



2015



2020

EN

WHERE SPORT AND ARTS MERGED

The story of the adidas Superstar started on the basketball court but rapidly moved onto the streets of New York. First adopted in NBA championships in the early 70s, the adidas Superstar quickly became a counter-culture classic and the must-have streetwear staple for up-and-coming musicians and skateboarders alike. The name Superstar felt fitting, and today athletes, artists and everyday stars continue to make this iconic shoe their own. With over 50 years on the street, the iconic silhouette has been re-imagined time and time again and continues to be at the forefront of modern sneaker culture.

FR

LÀ OÙ LE SPORT ET L'ART NE FONT QU'UN

L'adidas Superstar a fait ses débuts sur les terrains de basketball, mais s'est vite répandue dans les rues de New York. Adoptée pour la première fois dans les championnats de la NBA au début des années 1970, l'adidas Superstar est rapidement devenue un classique de la contre-culture et un incontournable pour les musiciens et planchistes de la jeune génération. Le nom Superstar semblait approprié, et aujourd'hui les athlètes, les artistes et les célébrités de tous les jours continuent de porter fièrement cette chaussure emblématique. Après plus de 50 ans de présence dans les rues, la chaussure a vu sa silhouette emblématique réinventée maintes fois, et continue d'être à l'avant-garde de la culture moderne des espadrilles.

ES

DONDE DEPORTE Y ARTE SE FUNDEN

La historia del modelo adidas Superstar comenzó en las canchas de baloncesto, pero rápidamente se trasladaría a las calles de Nueva York. Adoptado por primera vez en los campeonatos de la NBA de principios de los años 70, el adidas Superstar pronto se convertiría en un símbolo de la contracultura y un elemento infaltable en los atuendos informales tanto de promesas de la música como de patinadores talentosos. El nombre *Superstar* parecía apropiado desde el principio; incluso hoy en día, atletas, artistas y estrellas cotidianas siguen haciendo suyo este icónico zapato. Con más de 50 años en las calles, su inconfundible silueta ha sido reimaginada una y otra vez, y conserva su lugar como protagonista de la cultura moderna del calzado deportivo.

EN

GREAT PLAYERS INSIST ON GREAT SHOES

FR

LES BONS JOUEURS ONT BESOIN DE BONNES CHAUSSURES

ES

LOS MEJORES JUGADORES INSISTEN EN LOS MEJORES ZAPATOS

EN Foam-padded tongue. Relieves pressure of the laces.

FR Une languette rembourrée en mousse allège la pression des lacets.

ES Lengua con forro de espuma. Menos presión de las agujetas.

EN Shelltoe cap withstands heavy abuse.

FR Une coque avant encaisse les coups.

ES Cubierta de la punta que resiste el uso más intenso.

EN Special high SOFTPROTECT heel design.

FR La conception spéciale du talon protège tout en douceur.

ES Diseño especial de talón alto con forro SOFTPROTECT.

EN One-piece sole is bonded and stitched to uppers.

FR La semelle d'une seule pièce est collée et cousue aux empeignes.

ES La suela de una pieza está unida a la parte superior mediante pegamento y costuras.

EN World-famous 3 stripes mark now in real leather.

FR Les 3 rayures de renommée mondiale sont maintenant en cuir véritable.

ES Mundialmente famoso diseño de 3 franjas ahora confeccionado en piel de verdad.

EN Deep profile ribbing gives excellent traction.

FR Des rainures de profil profondes procurent une excellente adhérence.

ES Suelas con relieve profundo que proporcionan una excelente tracción.





It's official!

adidas "Americans" –
the official shoe of the
American Basketball Association



adidas basketball shoes – No.1 in lightness,
comfort and performance.

Superstar – an amazingly light leather
basketball shoe worn by the best pro and college players.
Promodel – a shoe for players who prefer high tops.
Tournament – extra comfortable, velour leather in
dazzling team colors – blue, red, gold and black.



EN

FROM THE DESIGN TEAM...

With a deep passion for both LEGO® building and adidas Superstar footwear, Senior LEGO Designer, Florian Müller, was the perfect person to create the LEGO version of this famous shoe.

“My task was to reproduce as many of the iconic details of the sneaker as possible, while ensuring the overall build experience was still fun and fulfilling.” Given the Superstar’s hoop-to-hip-hop cross-over, Florian also ensured you can display your finished shoe with or without its lace!

FR

MOT DE L'ÉQUIPE DE CONCEPTION...

Passionné tant par la construction LEGO® que par les chaussures adidas Superstar, Florian Müller, concepteur LEGO principal, était la personne idéale pour créer la version LEGO de la célèbre chaussure.

« Ma tâche était de reproduire autant de détails emblématiques de l'espadrille que possible, tout en assurant que l'expérience globale de construction soit toujours amusante et satisfaisante. » Compte tenu de la popularité de la Superstar tant auprès des adeptes de basketball que de hip-hop, Florian s'est également assuré que vous pouvez exposer votre chaussure finie avec ou sans lacet !

ES

IMPRESIONES DEL EQUIPO DE DISEÑO...

Con una profunda pasión tanto por construir con LEGO® como por el modelo adidas Superstar, Florian Müller, diseñador sénior de LEGO, era la persona ideal para crear la versión LEGO de este ícono del calzado.

“Mi tarea consistió en reproducir tantos de los inconfundibles detalles del zapato deportivo como fuera posible asegurando una experiencia de construcción divertida y satisfactoria”. Considerando la cercana relación del Superstar con la cultura del hip-hop, ¡Florian también se aseguró de que pudieras exponer el zapato terminado con o sin agujeta!



[LEGO.com/brickseparator](https://www.LEGO.com/brickseparator)

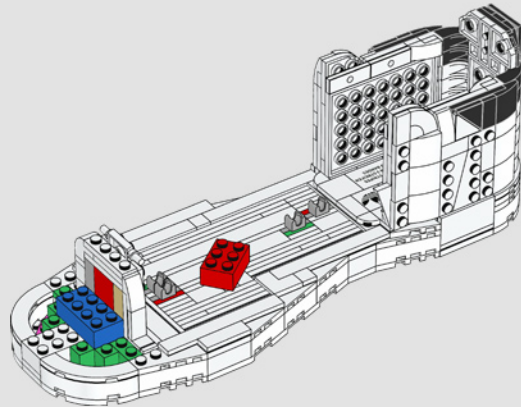
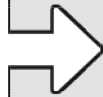
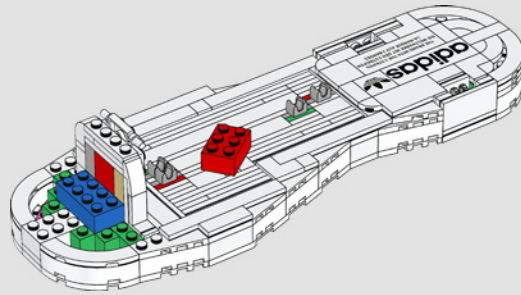
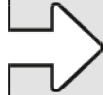
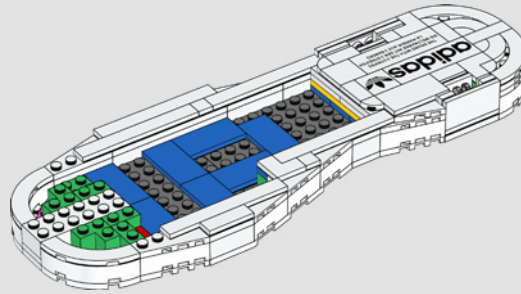
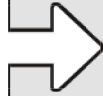

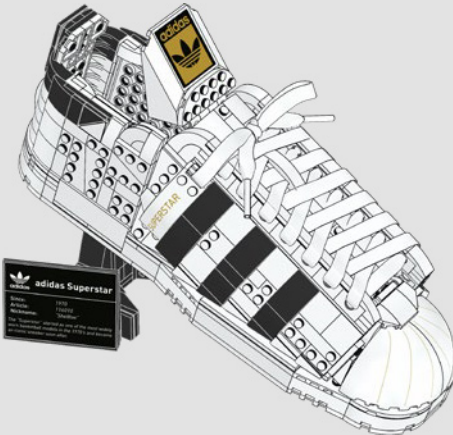
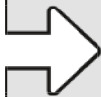
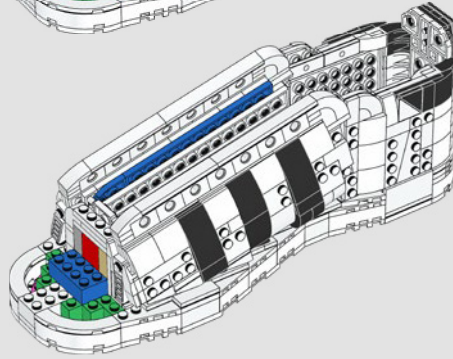
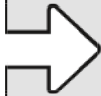
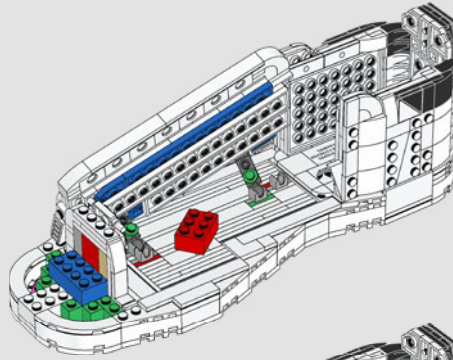
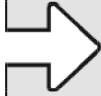

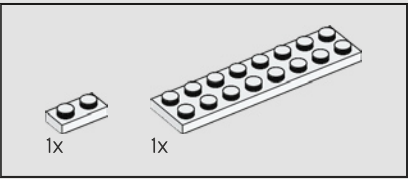
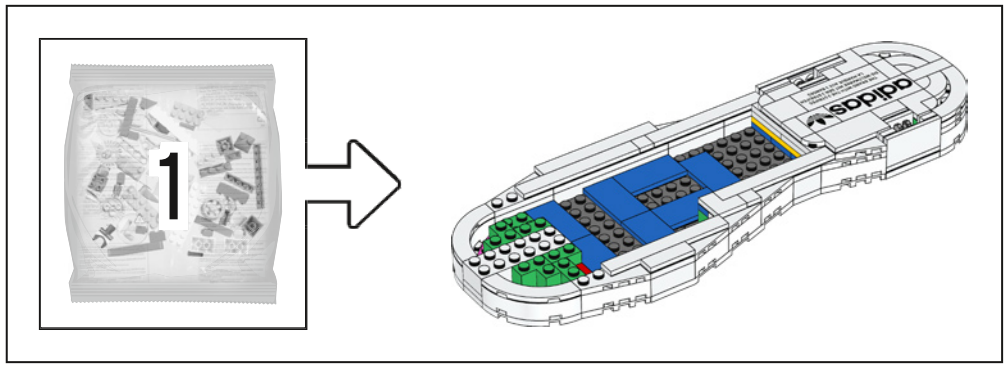

1

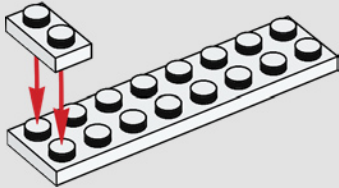

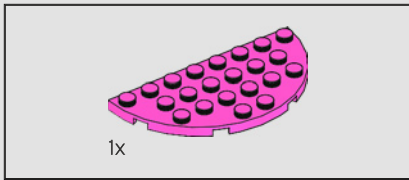

2

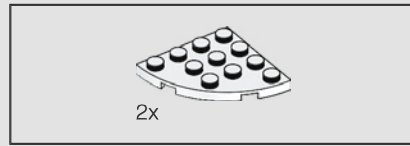
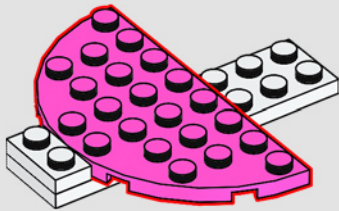

3

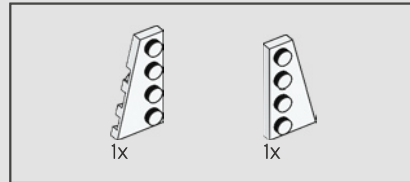
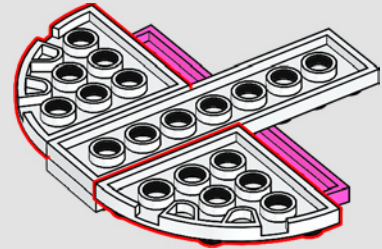

4

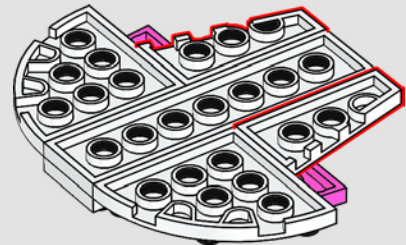

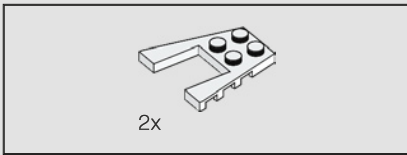

5

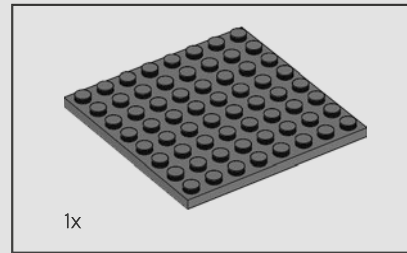
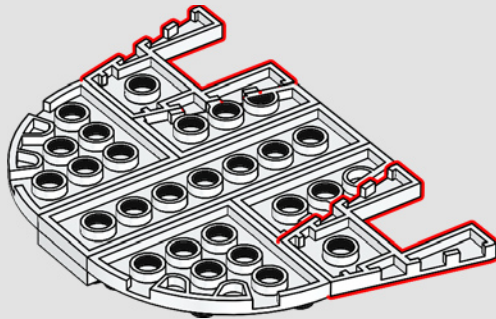

6

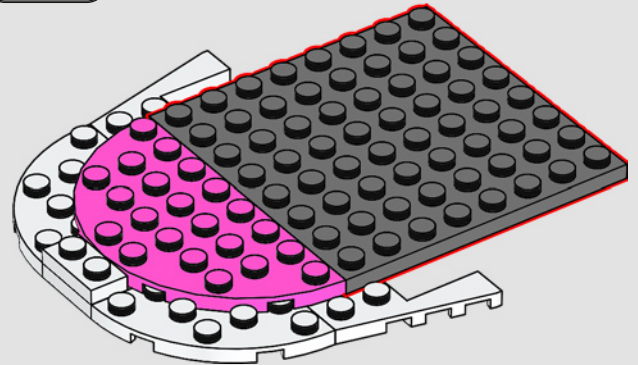

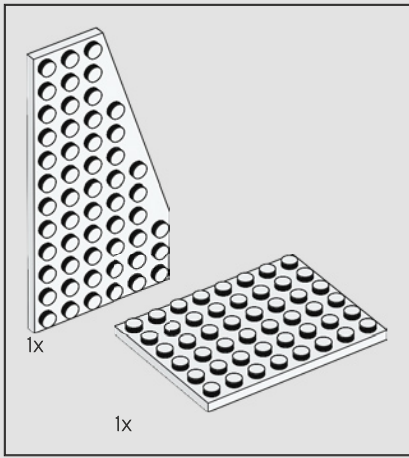

7

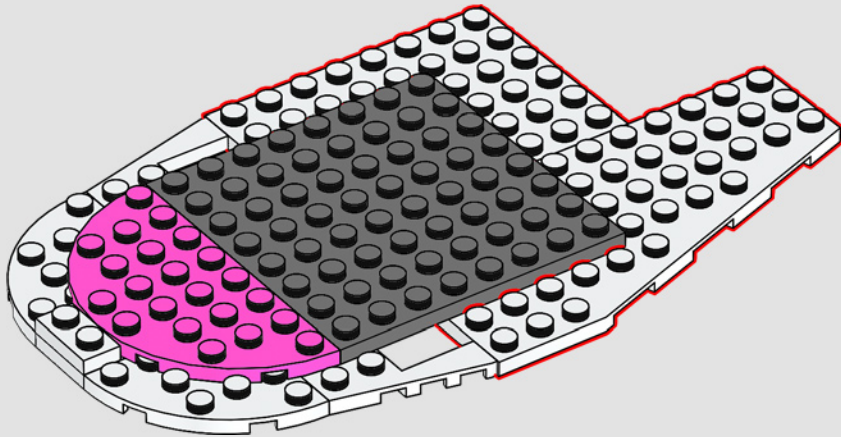

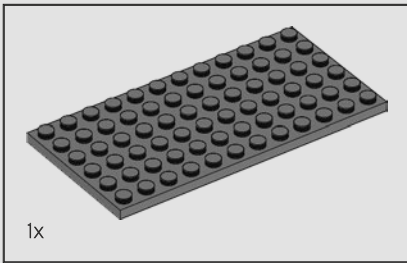

8

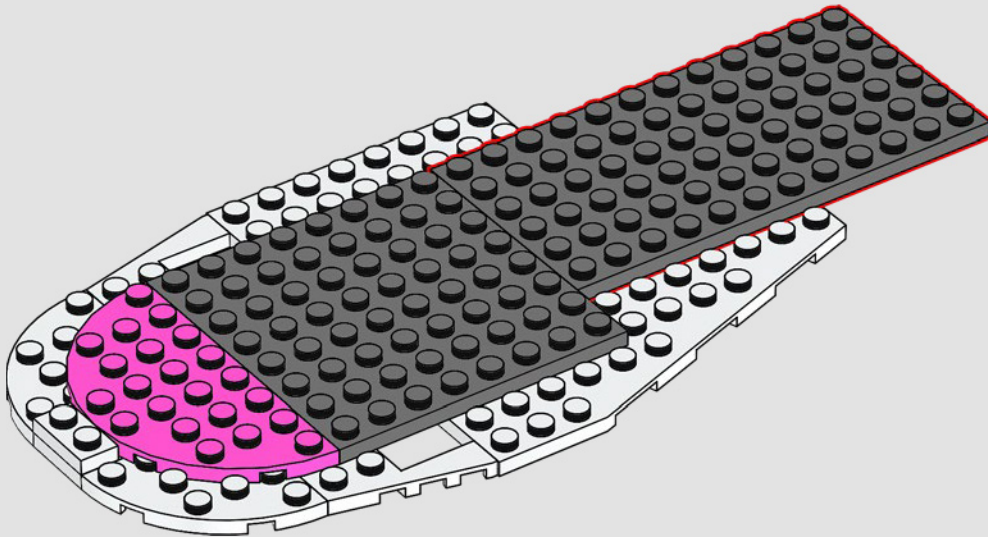

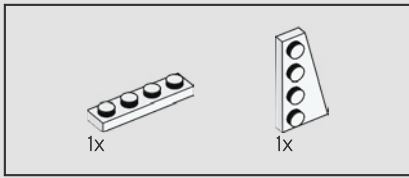

9

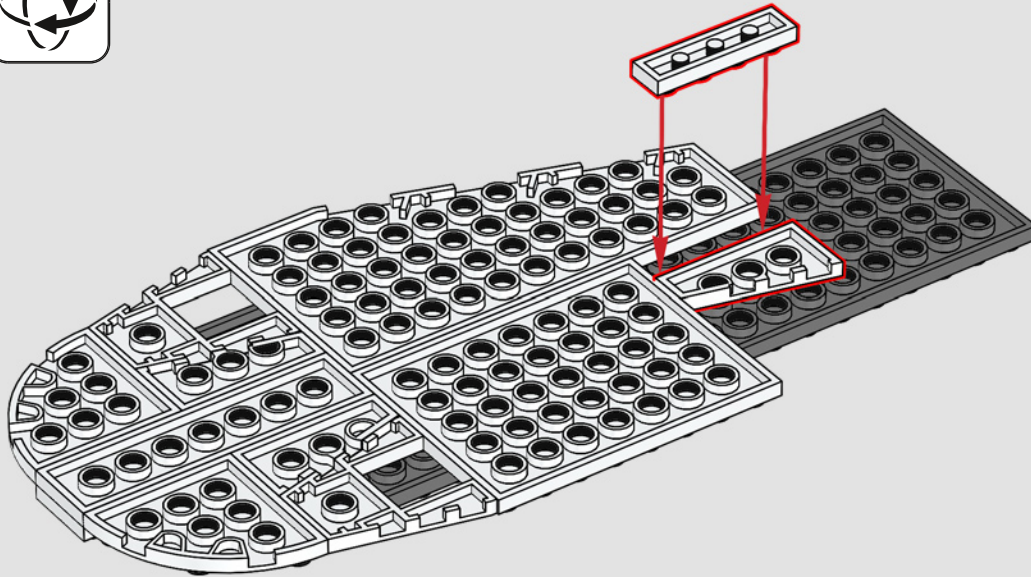

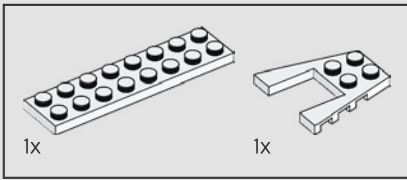

10

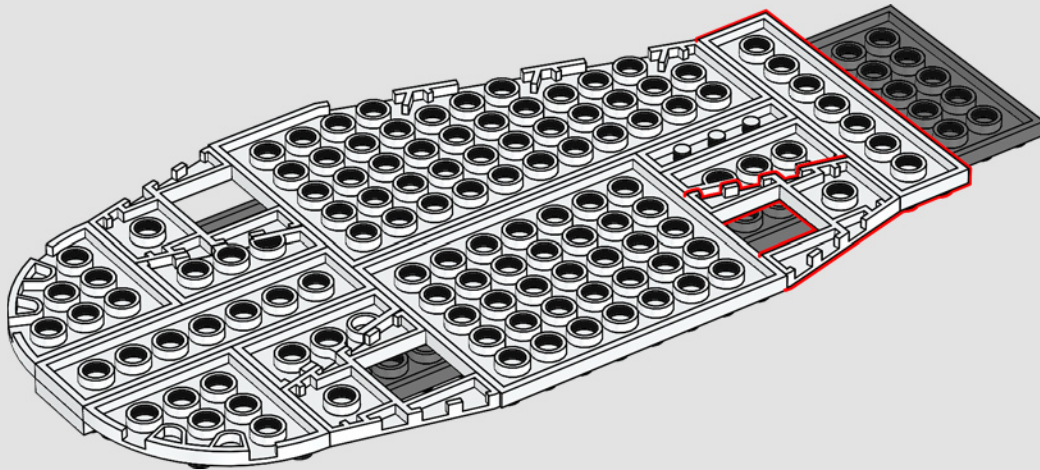

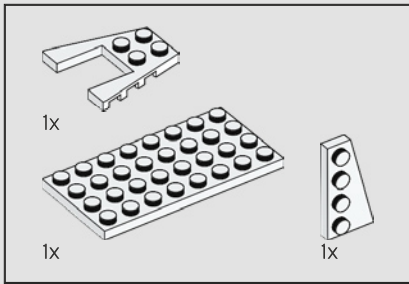

11

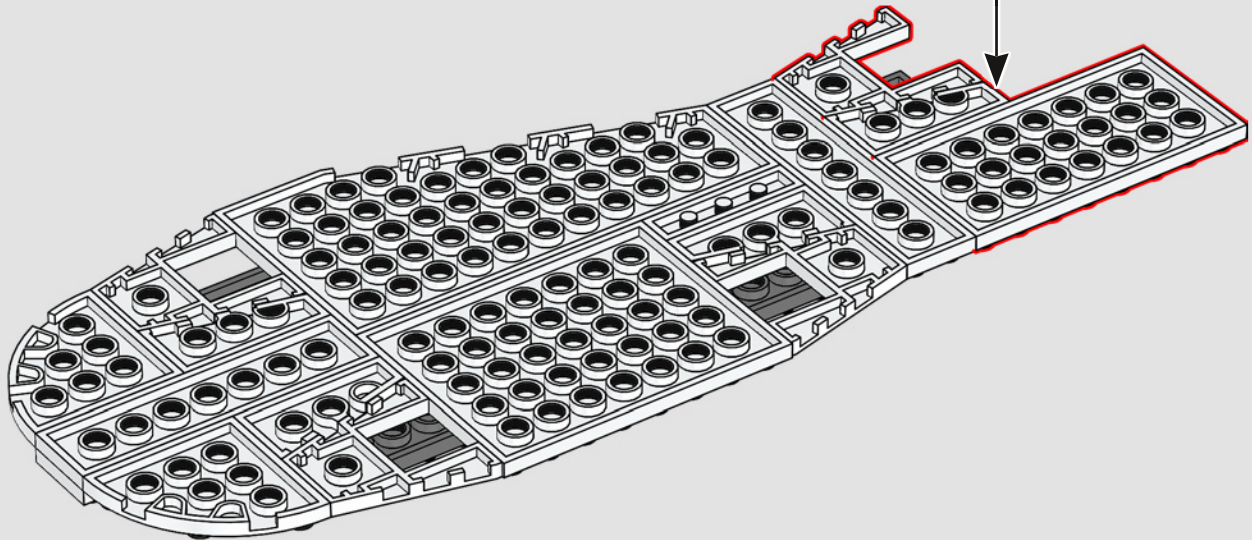
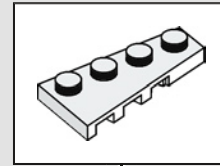

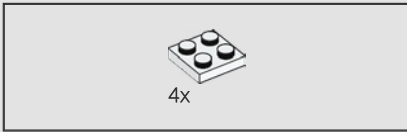

12

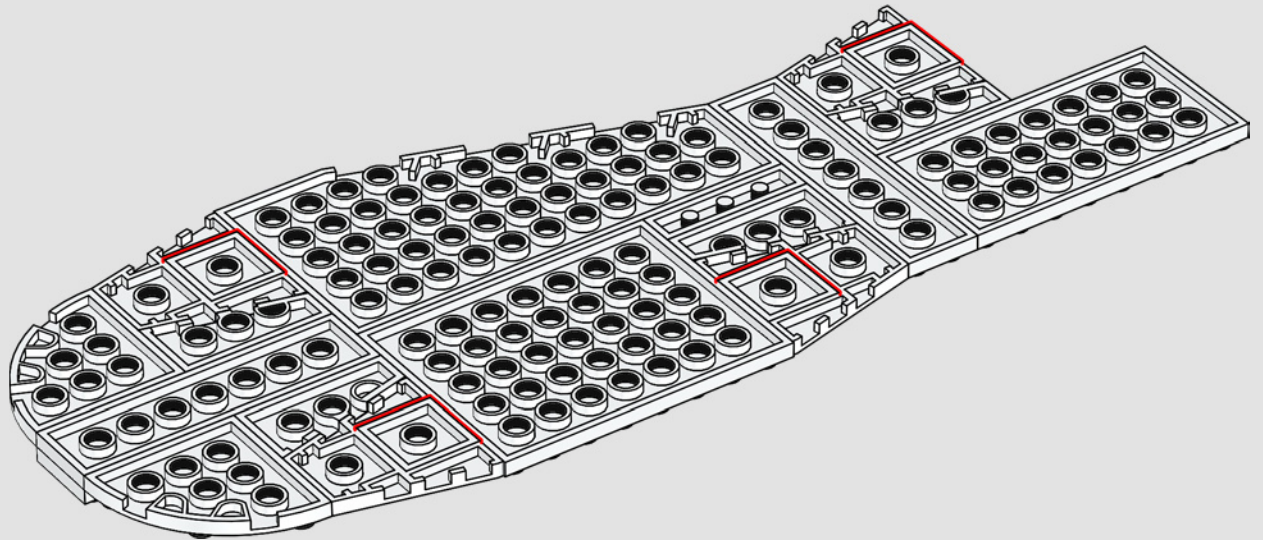

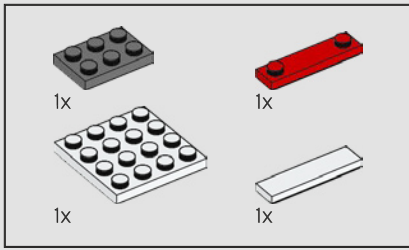

13

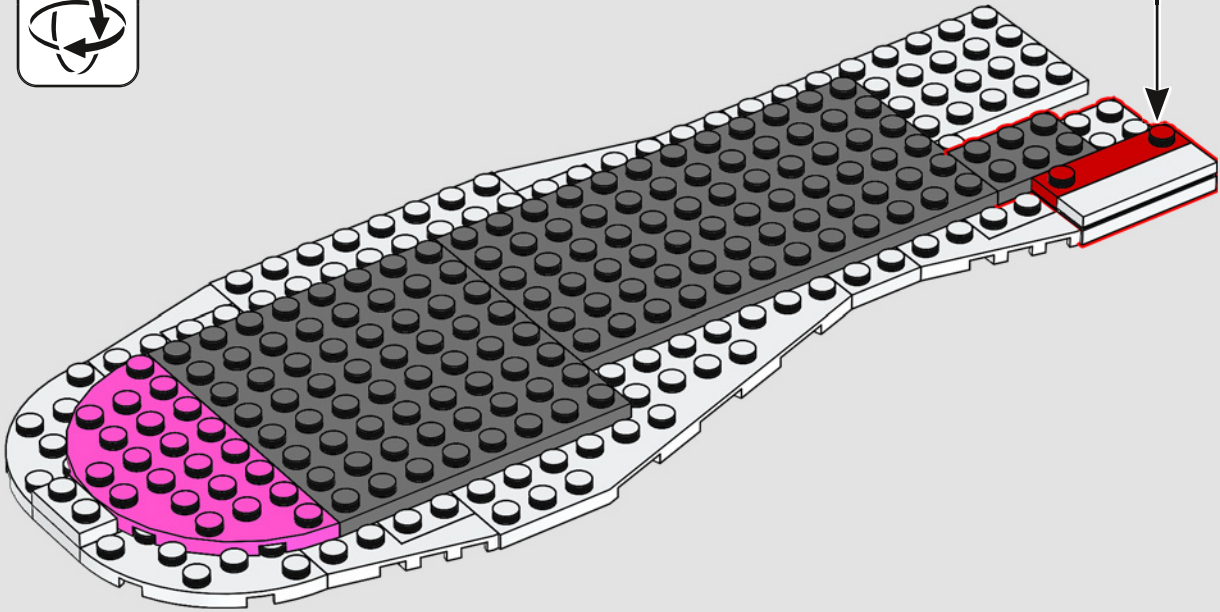
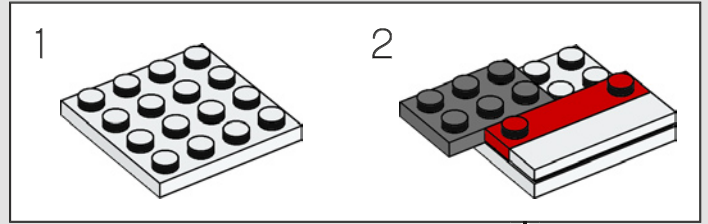

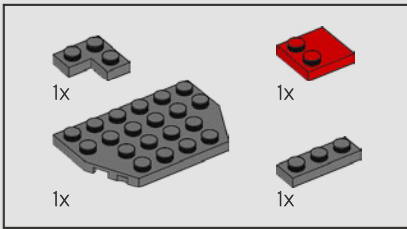

14

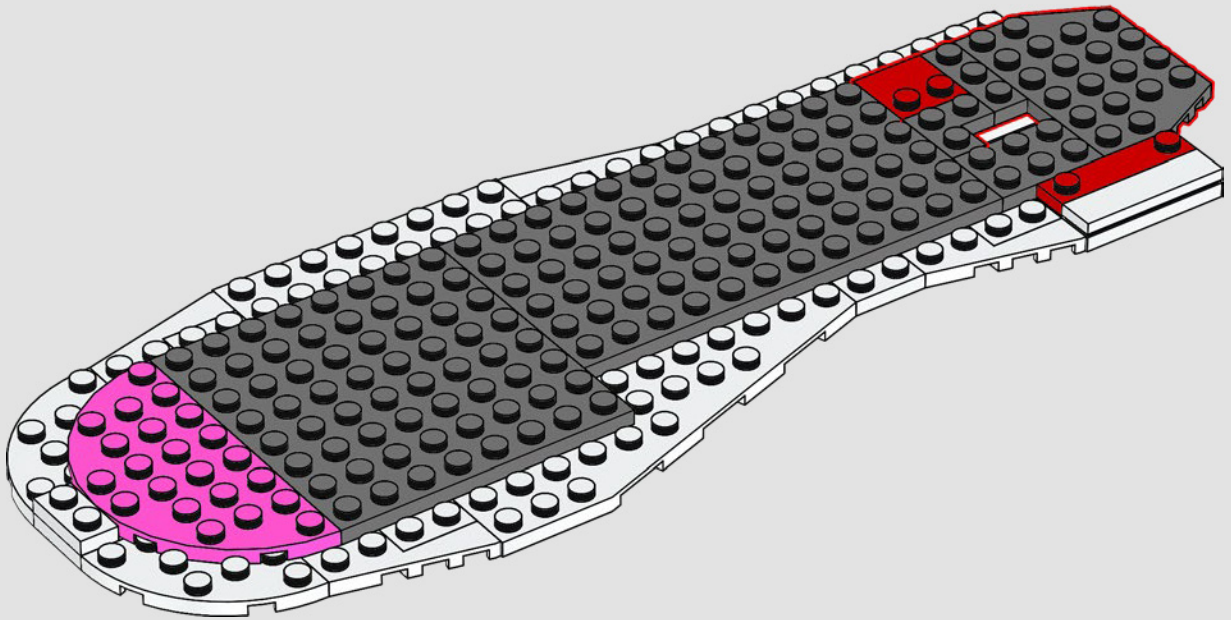

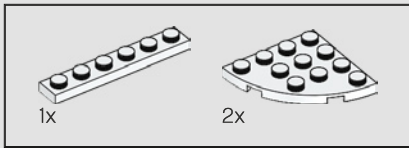

15

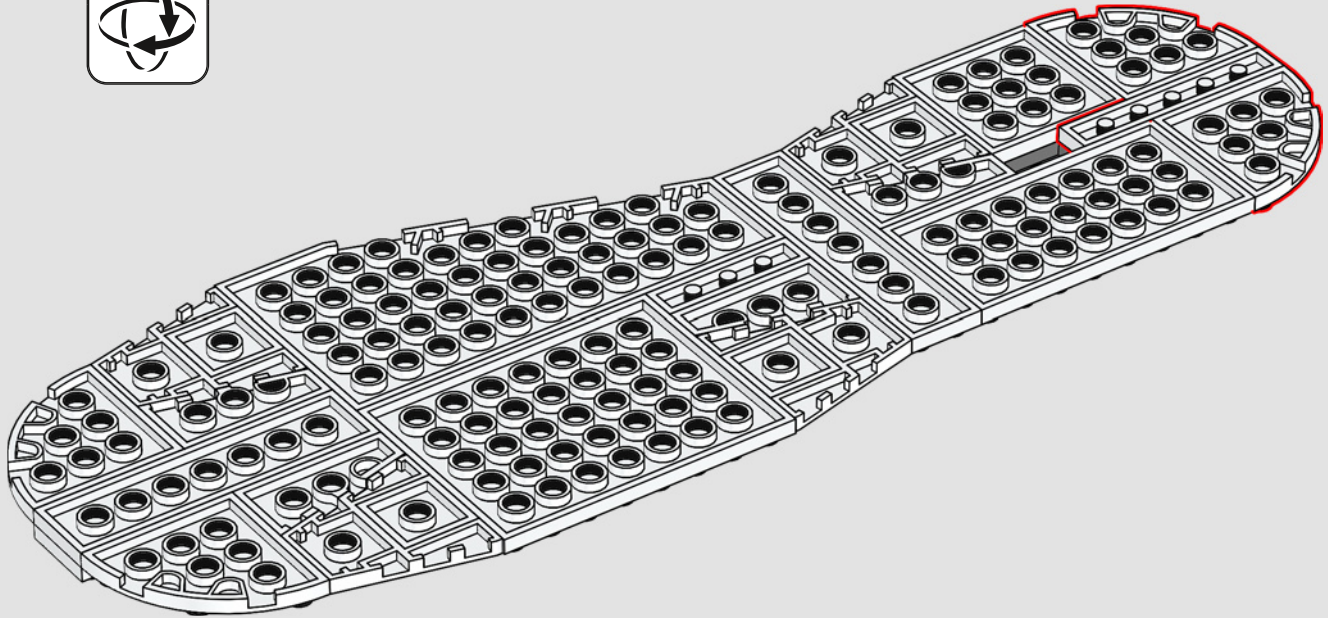

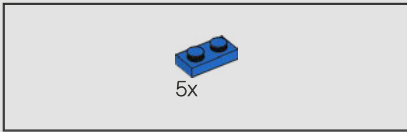

16

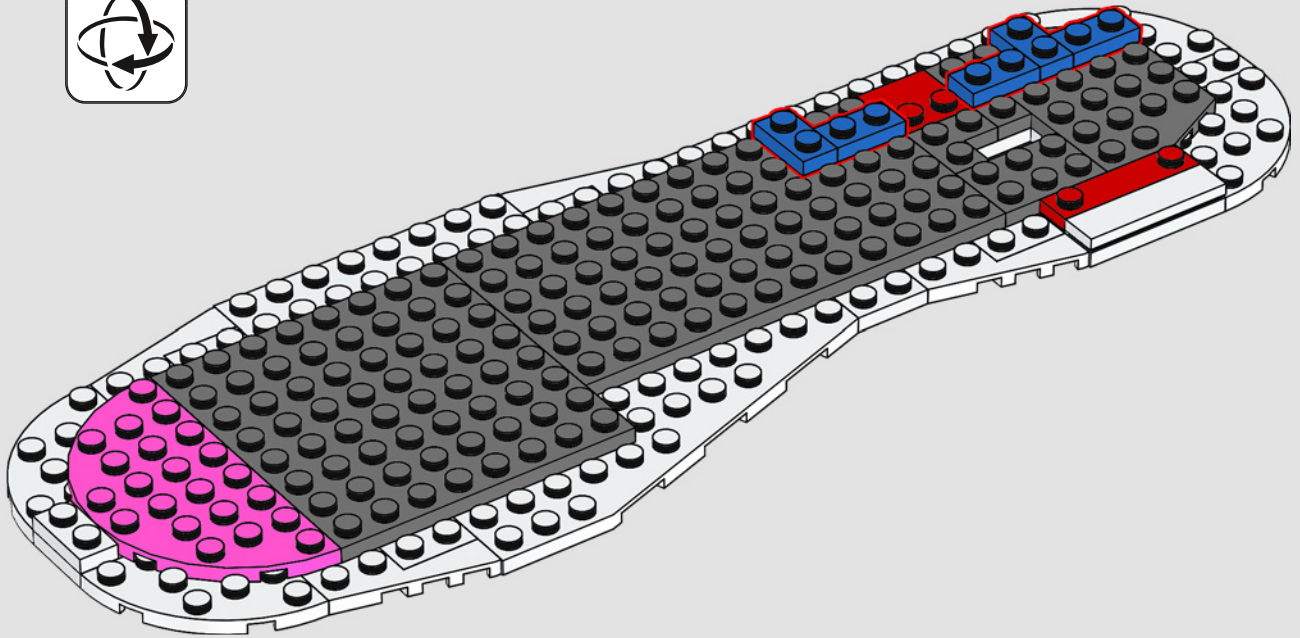

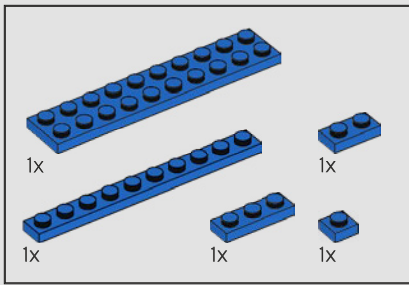

17

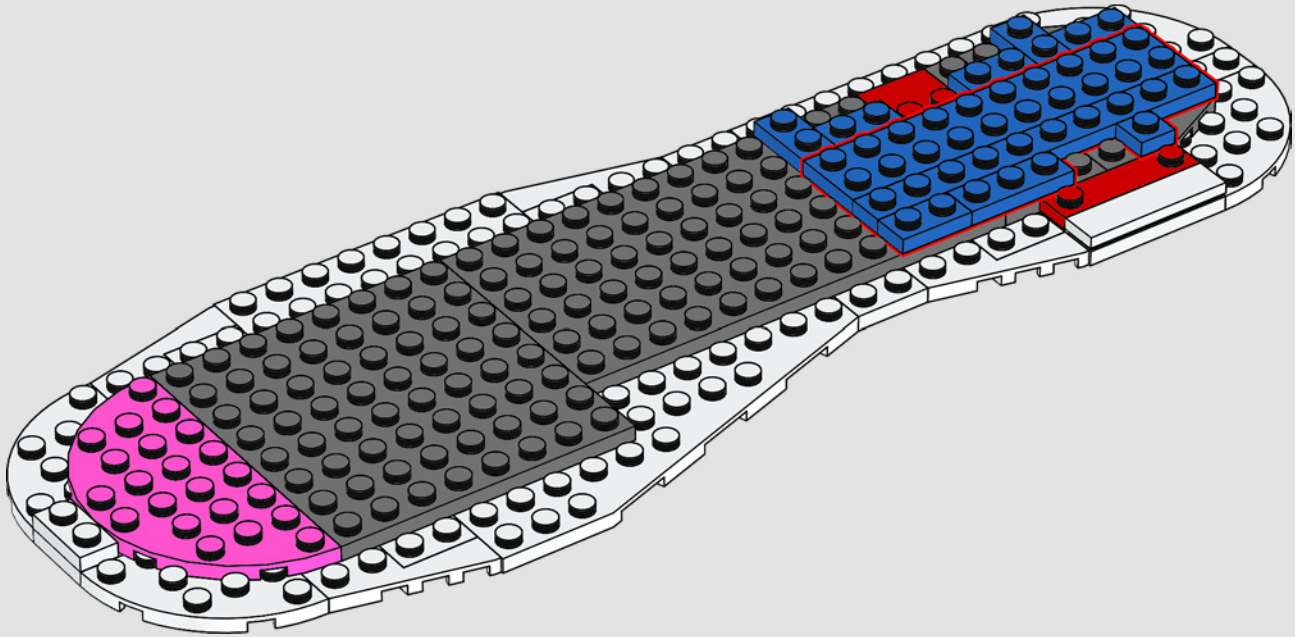

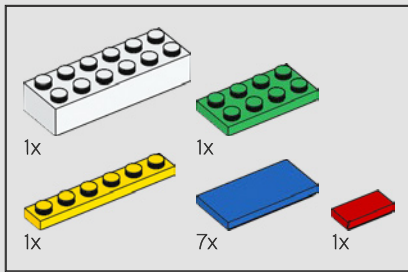

18

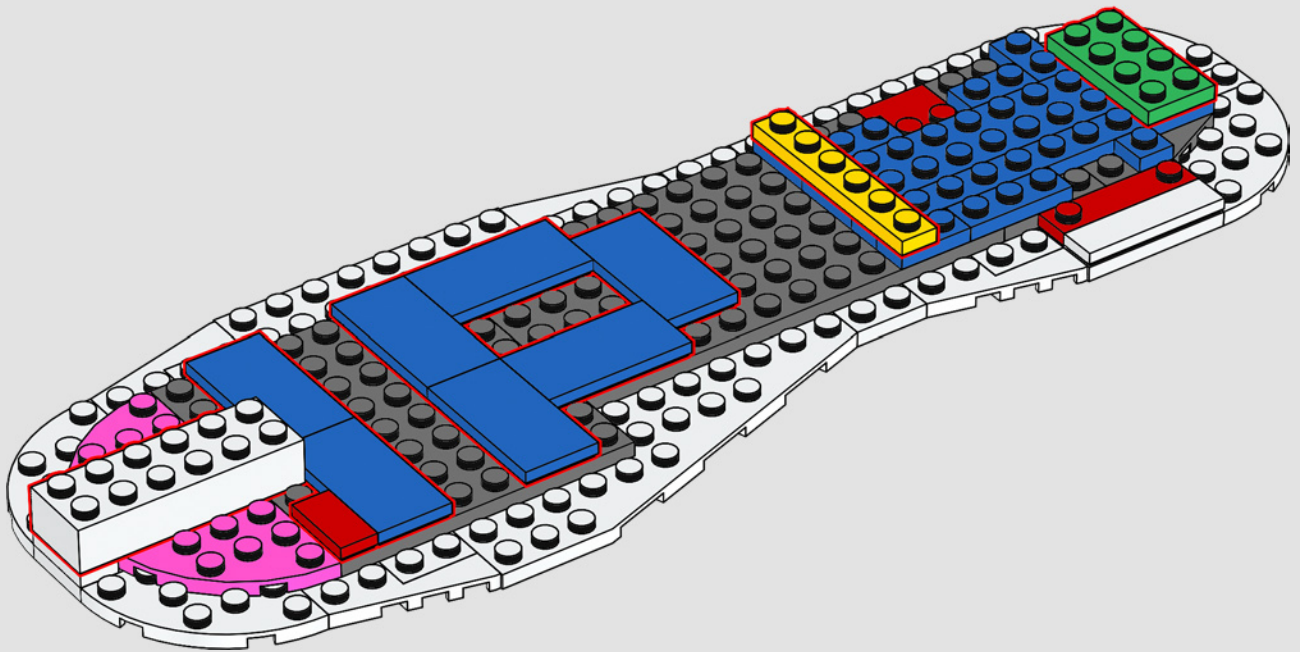

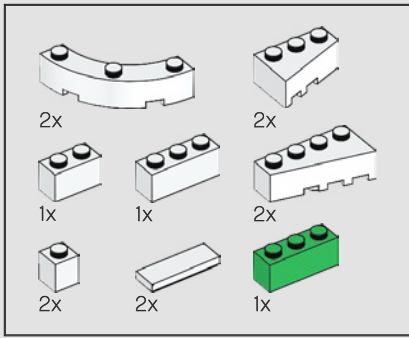

19

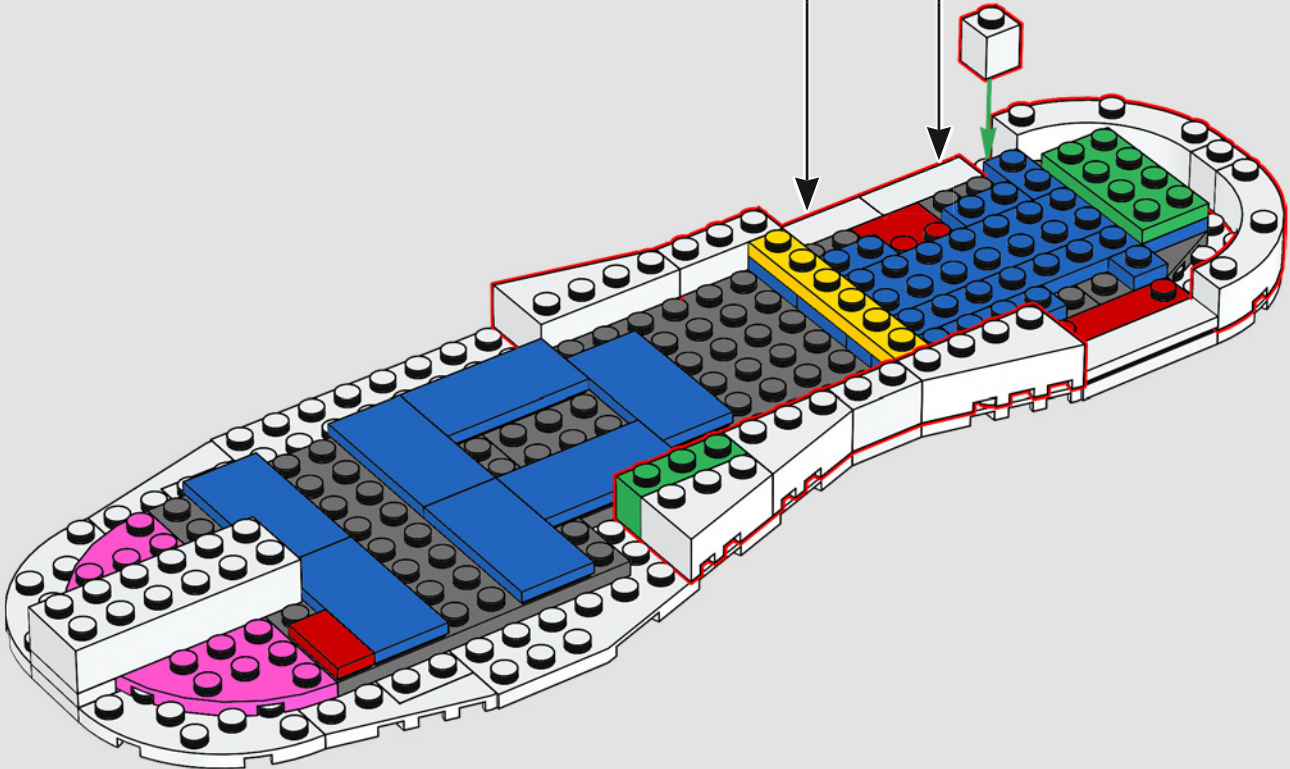
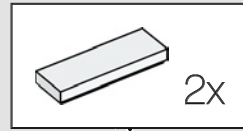

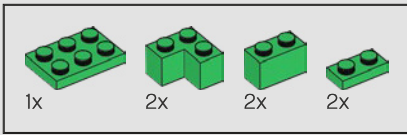

20

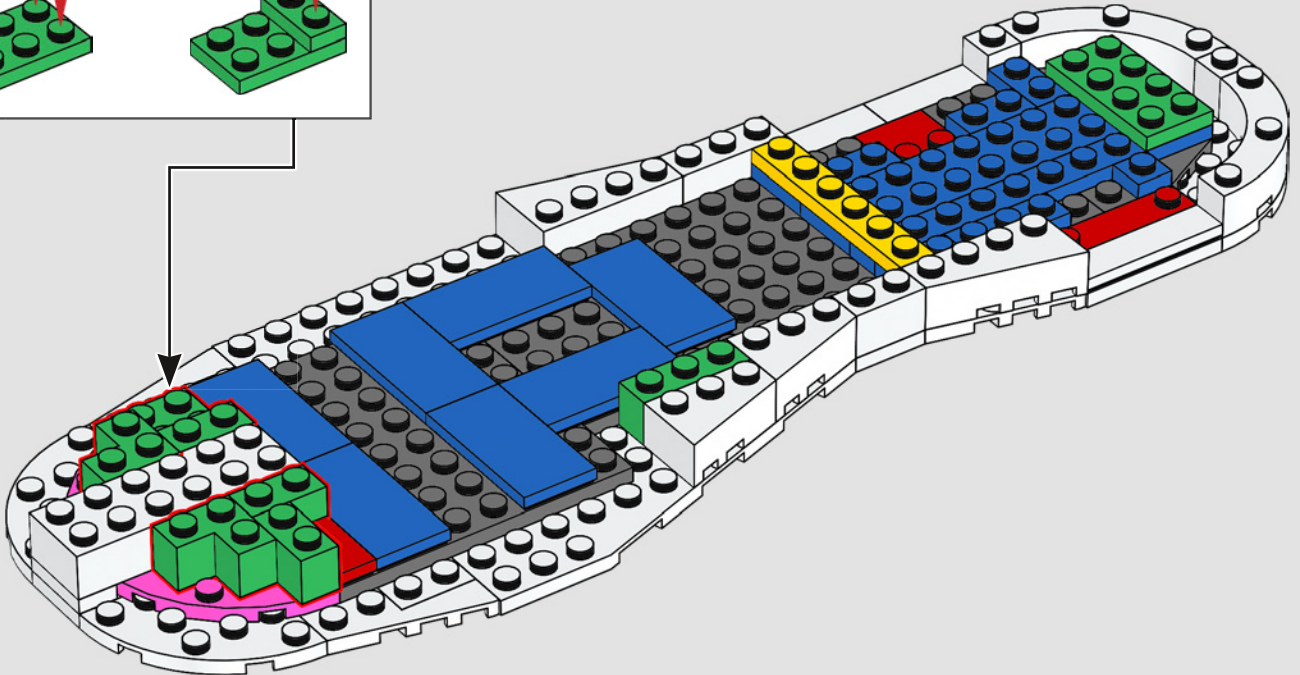
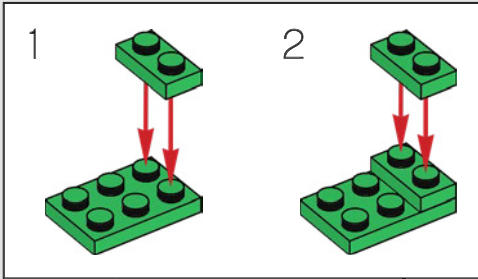

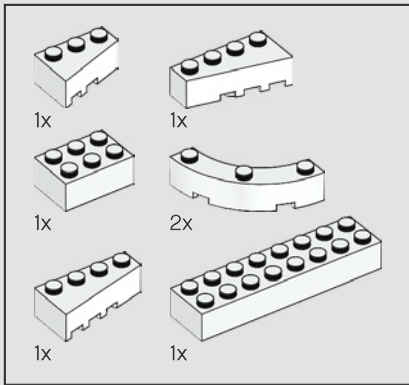

21

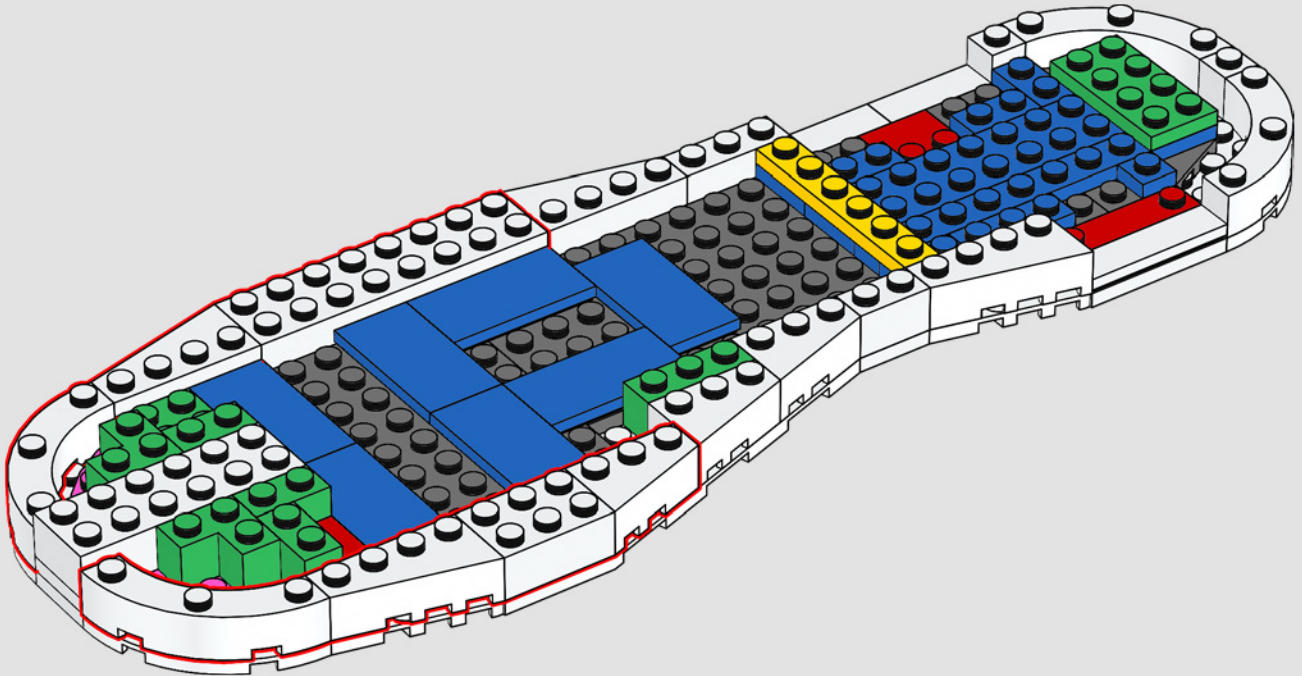

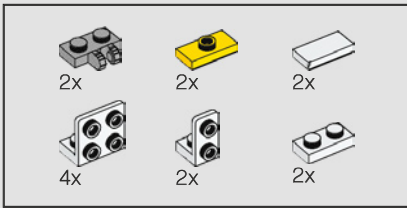

22

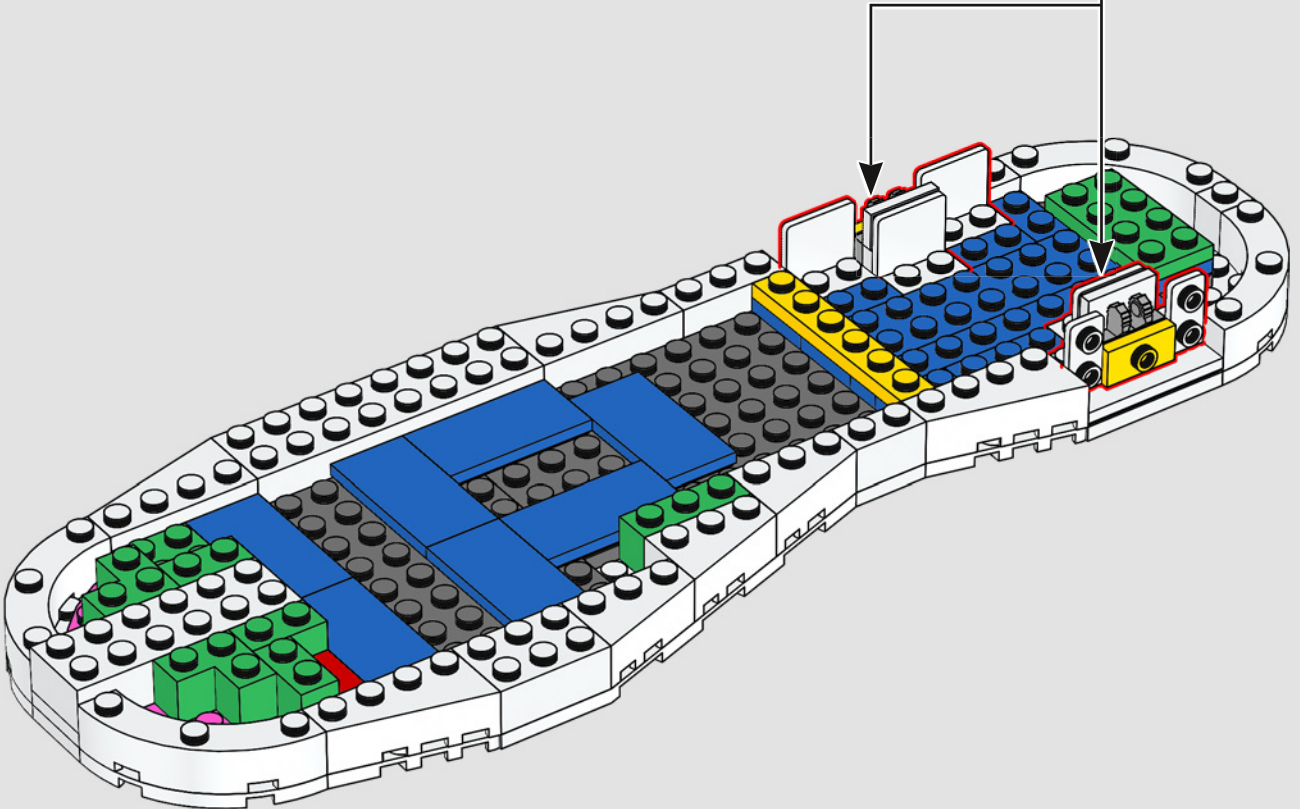
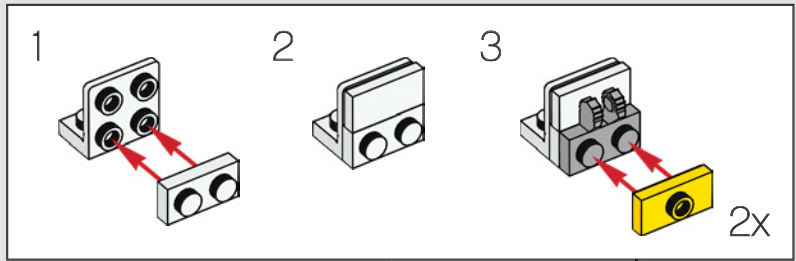

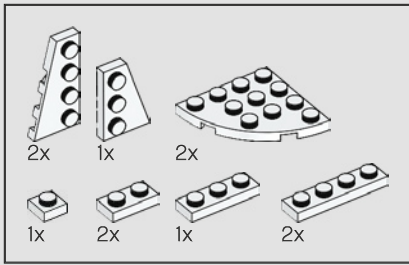

23

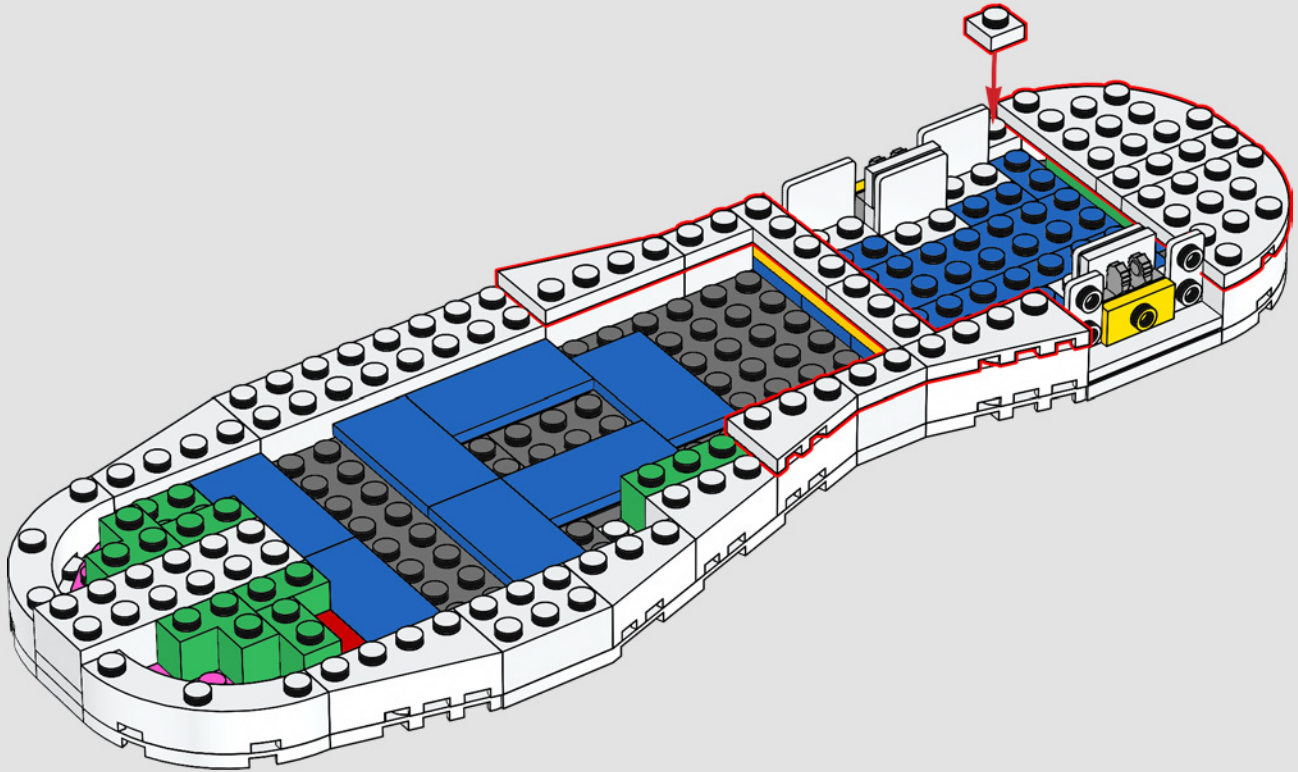

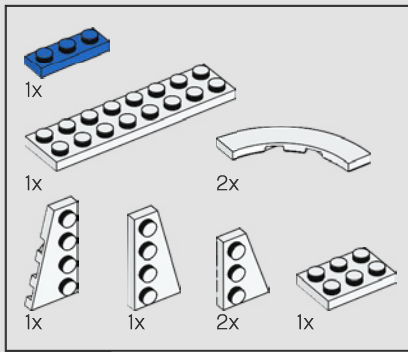

24

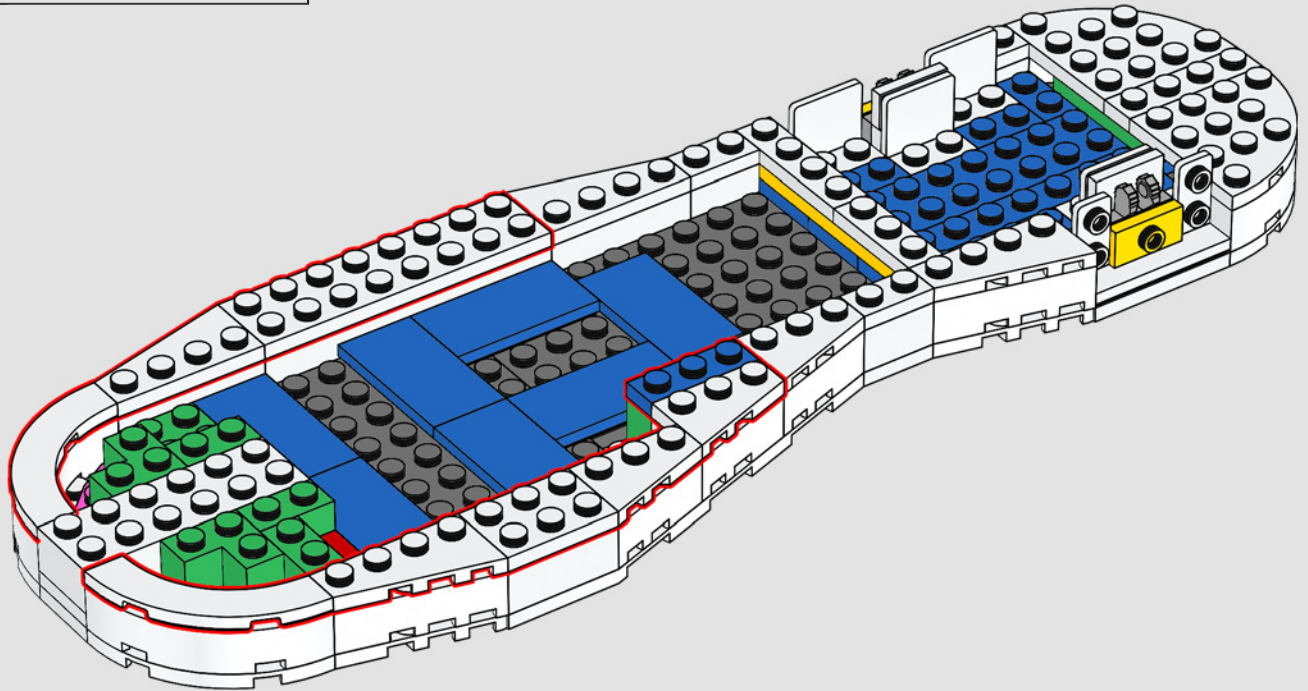

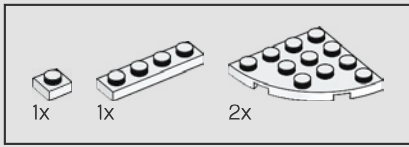

25

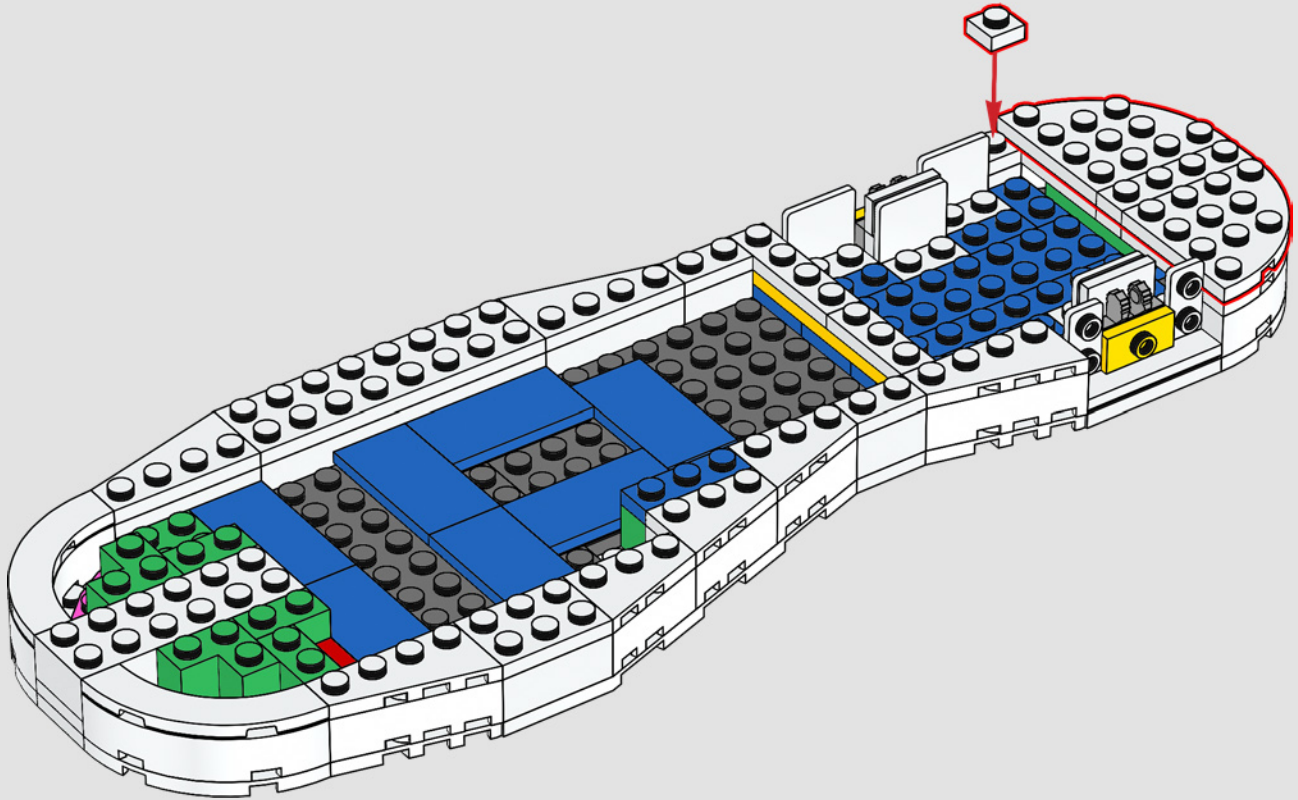

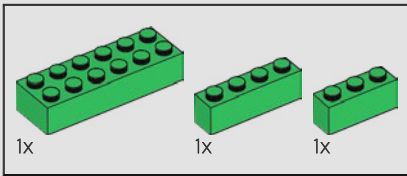

26

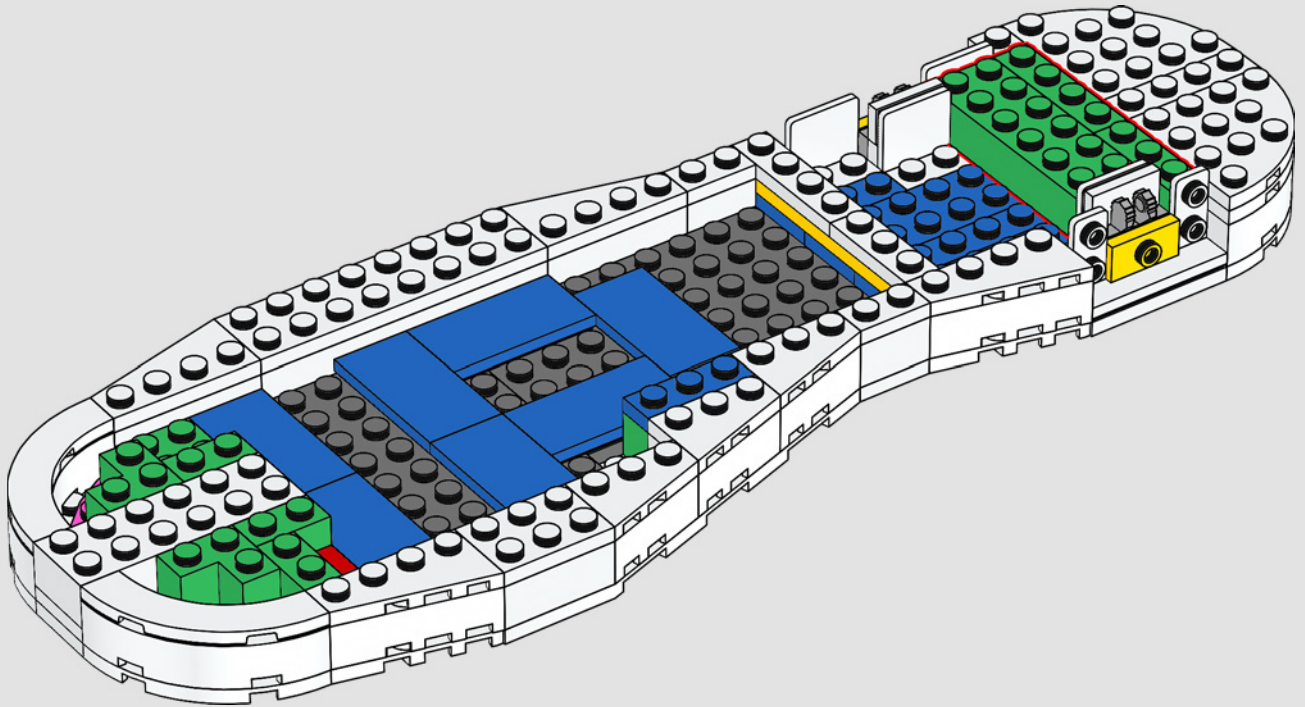

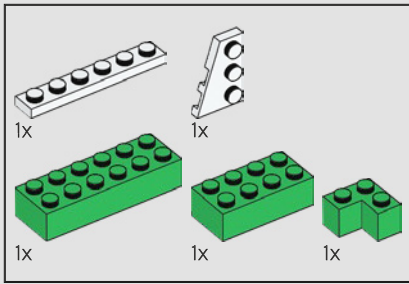

27

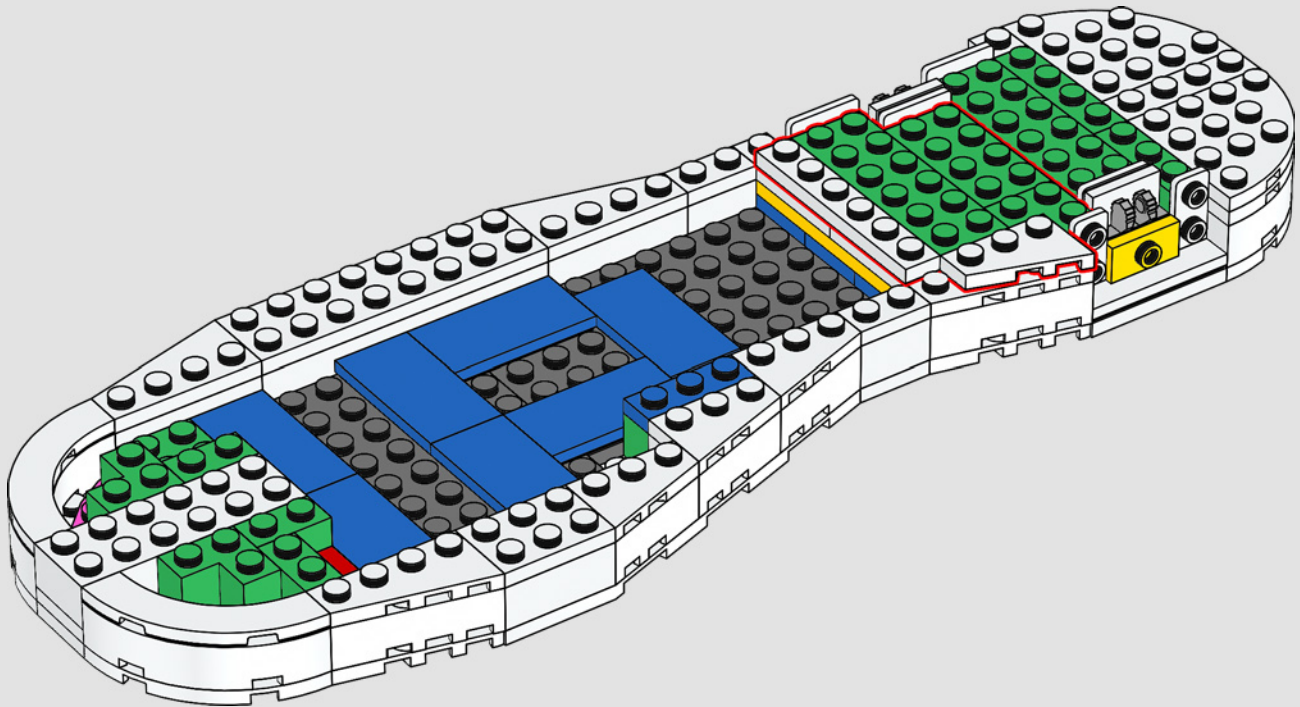

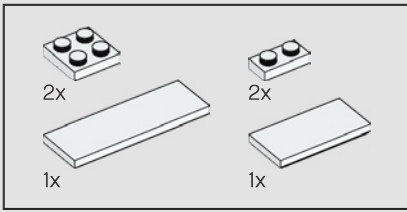

28

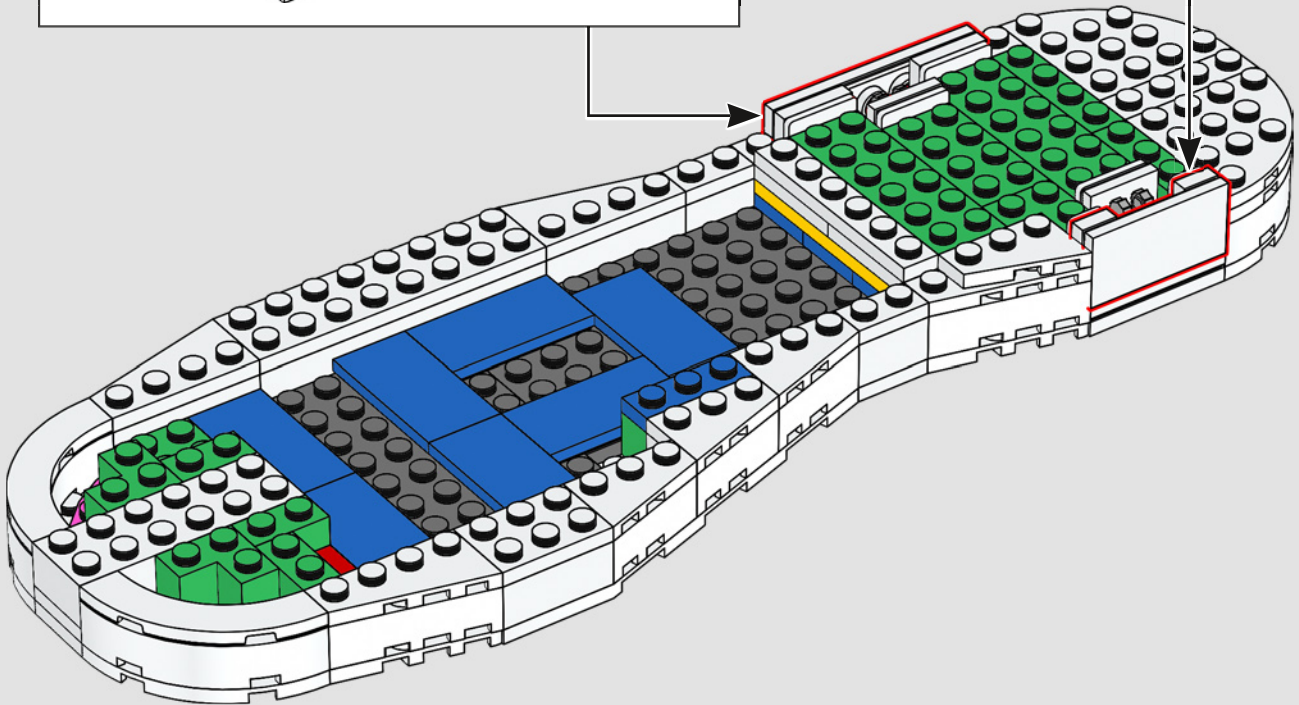
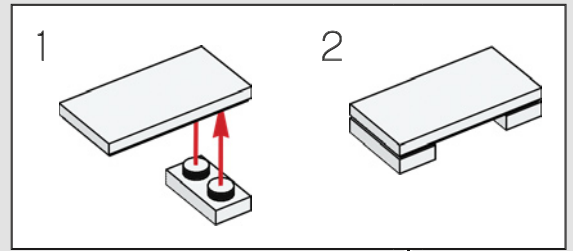
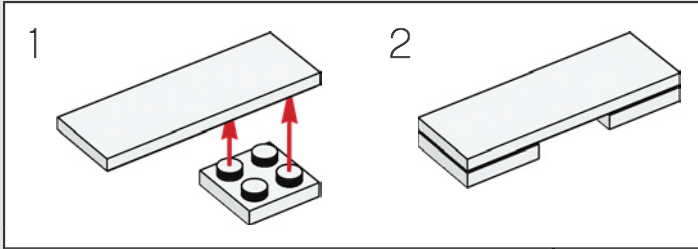

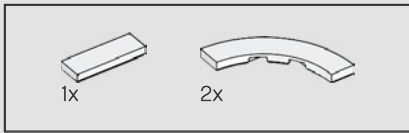

29

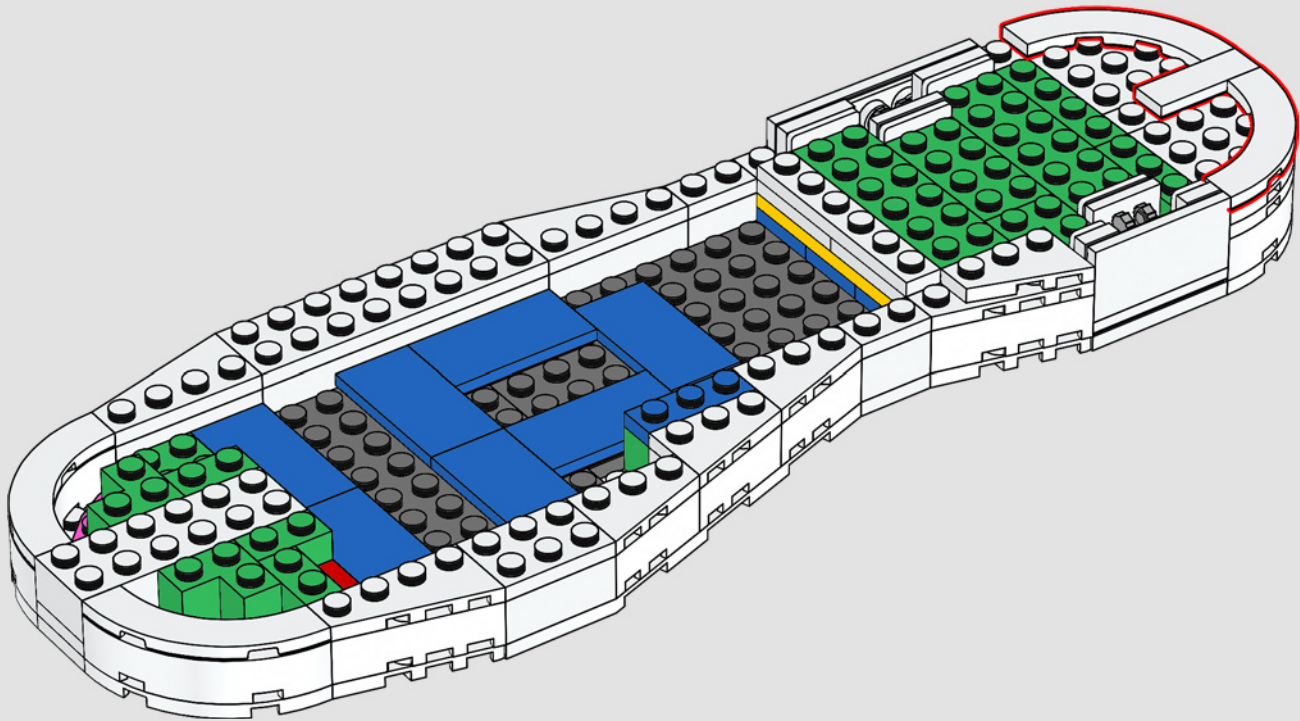

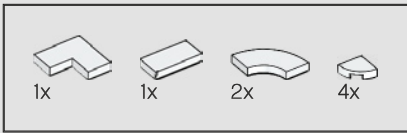

30

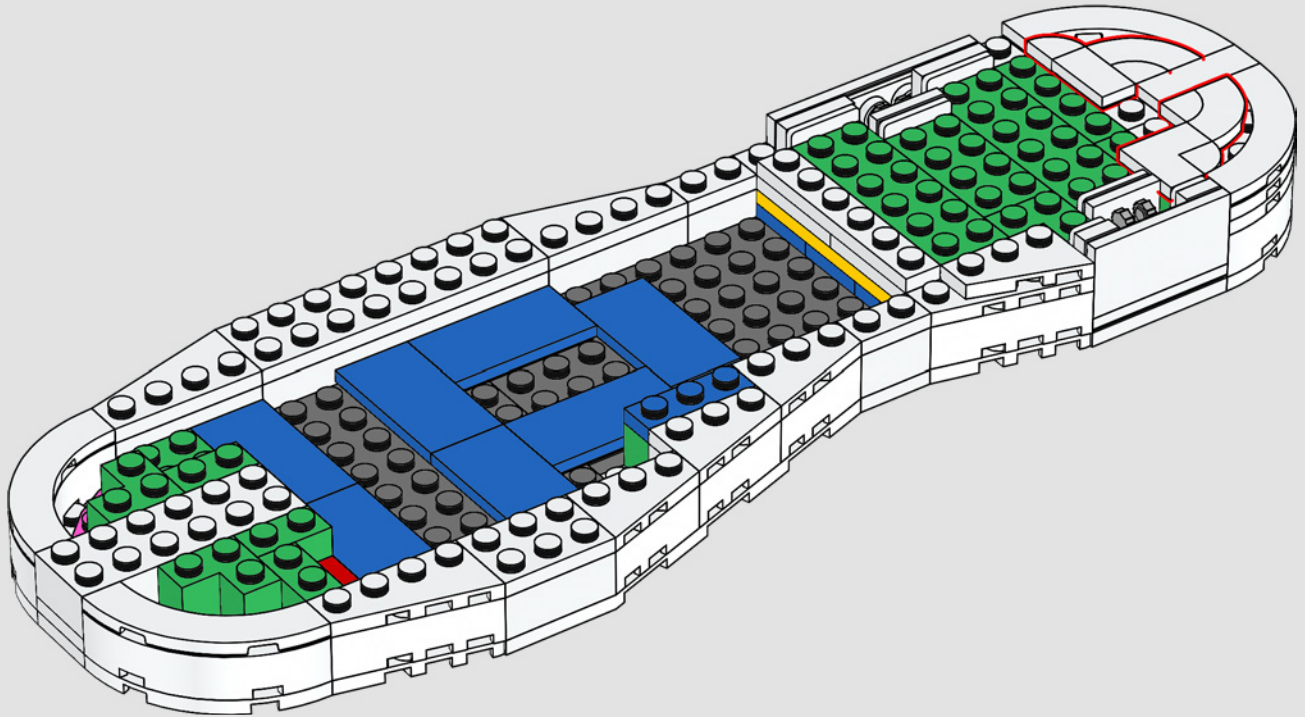

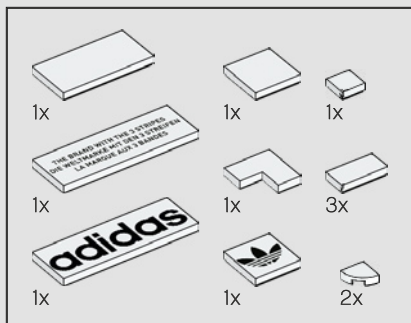

31

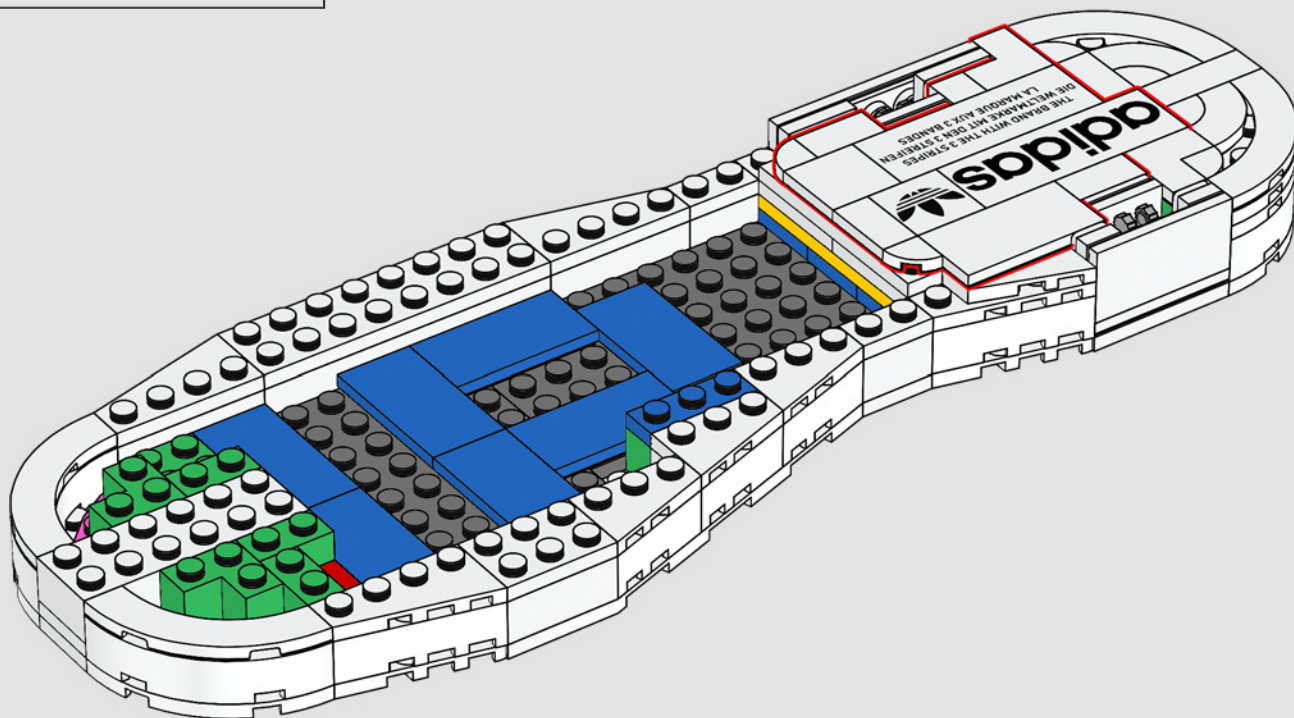

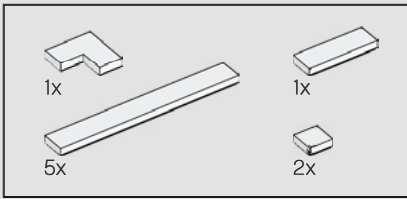

32

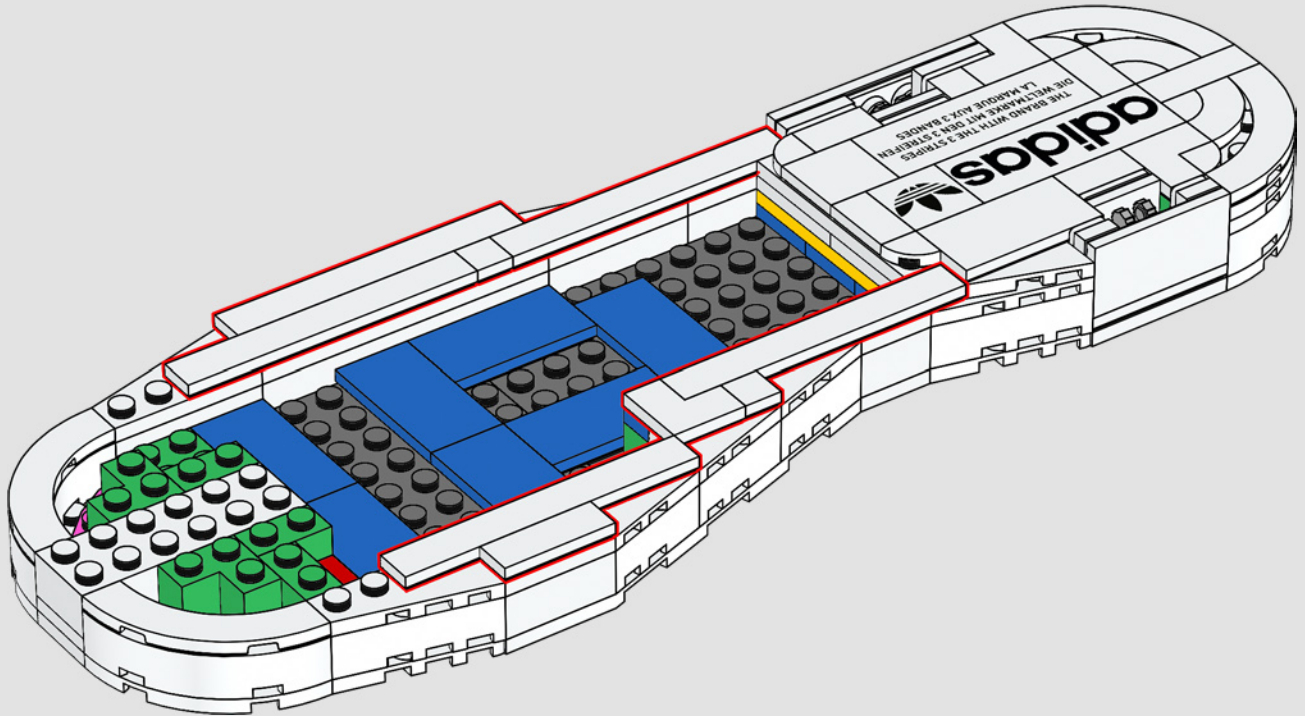

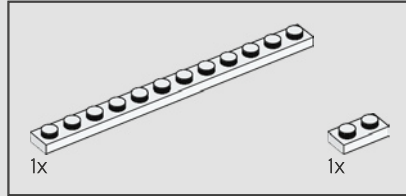
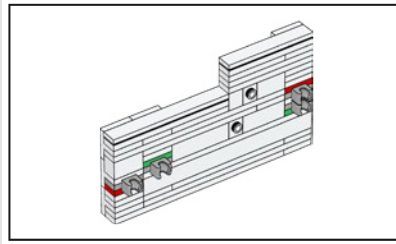
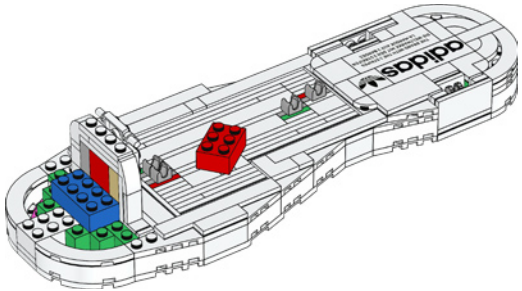
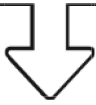

33

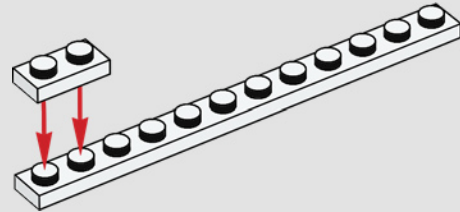

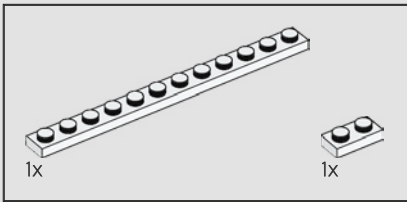

34

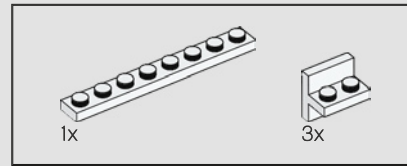
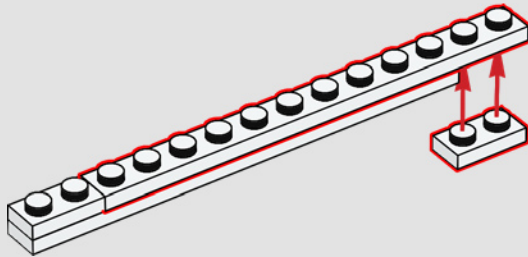

35

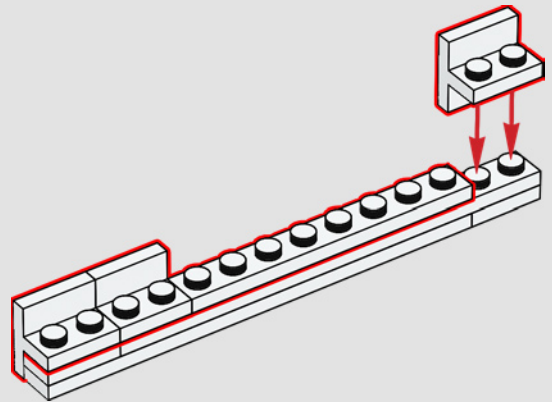

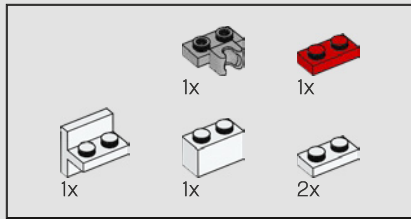

36

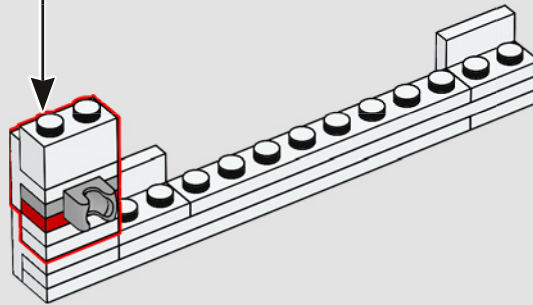
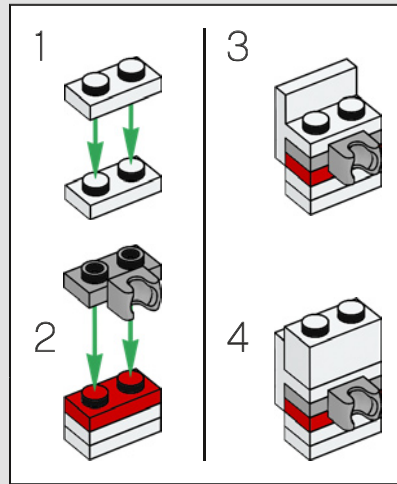

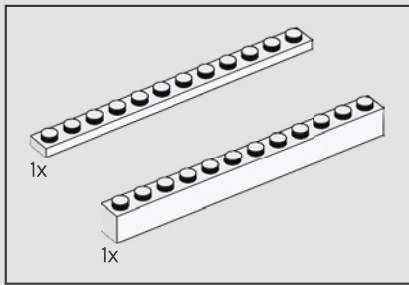

37

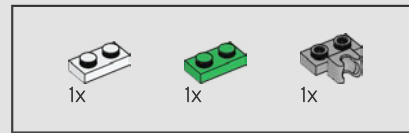
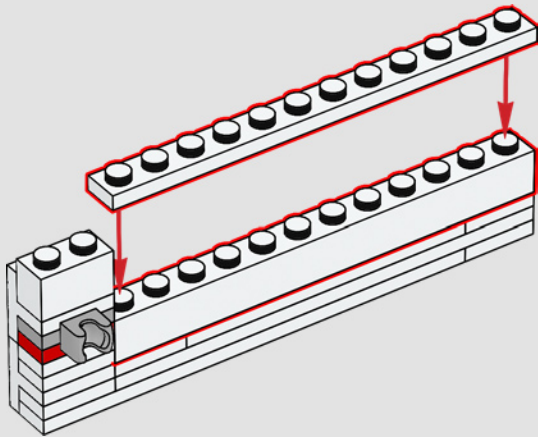

38

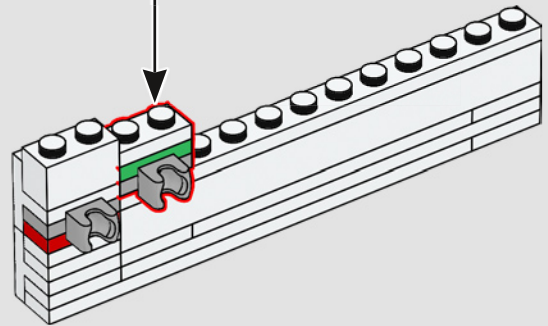
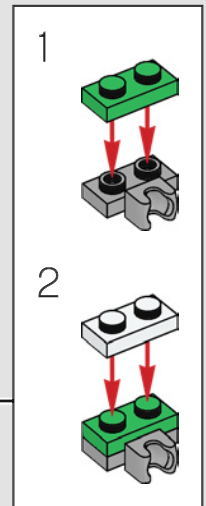

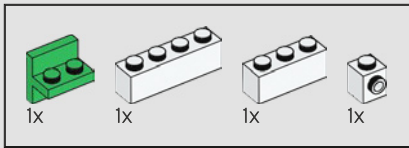

39

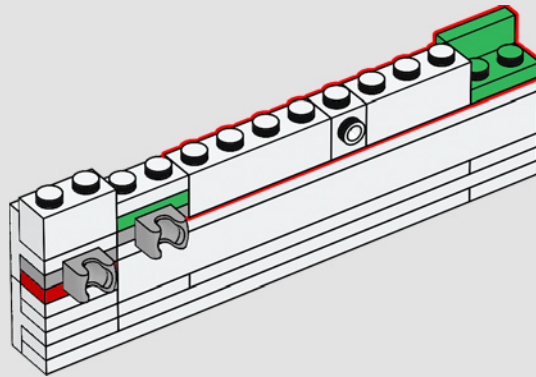

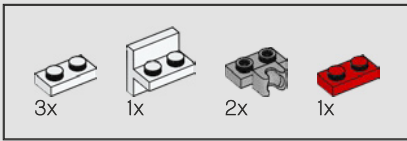

40

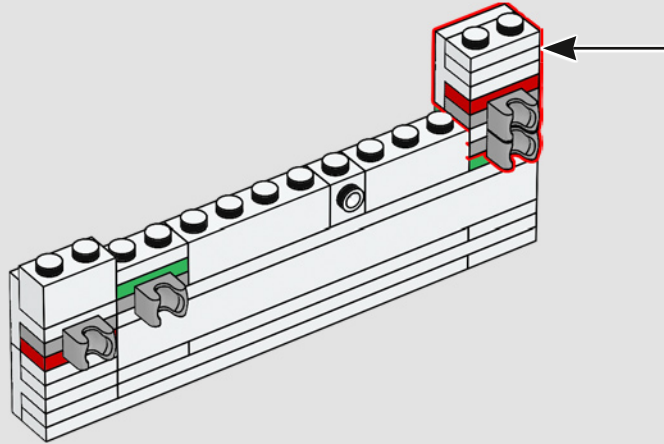
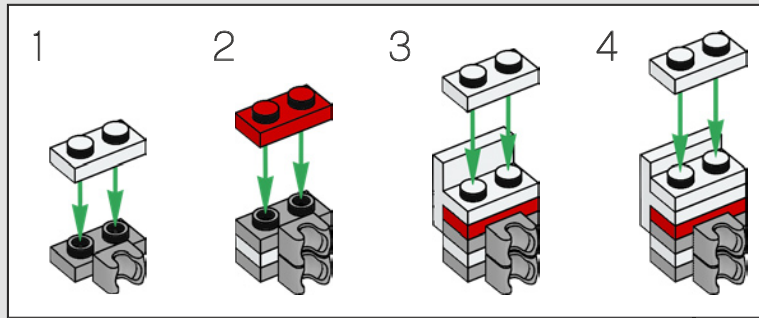

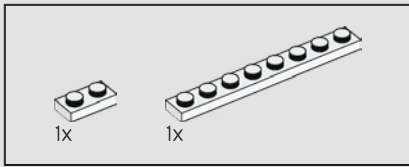

41

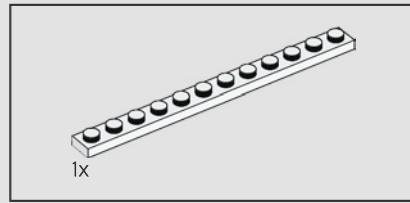
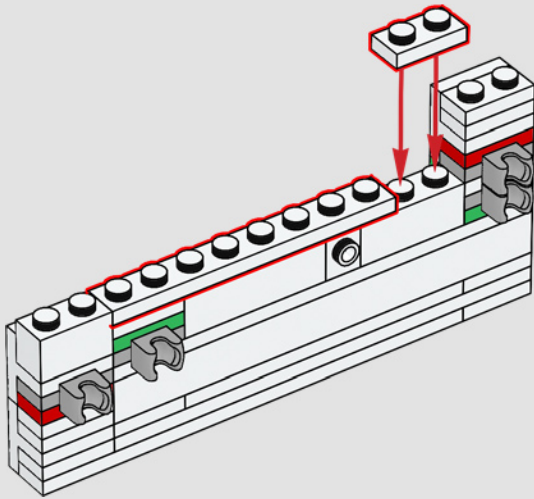

42

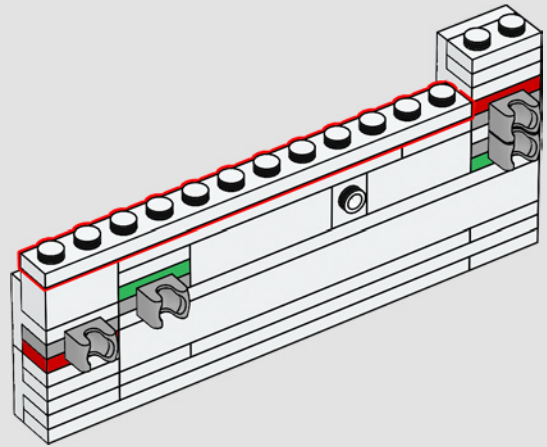

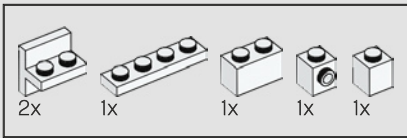

43

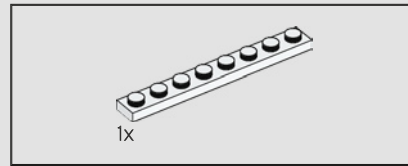
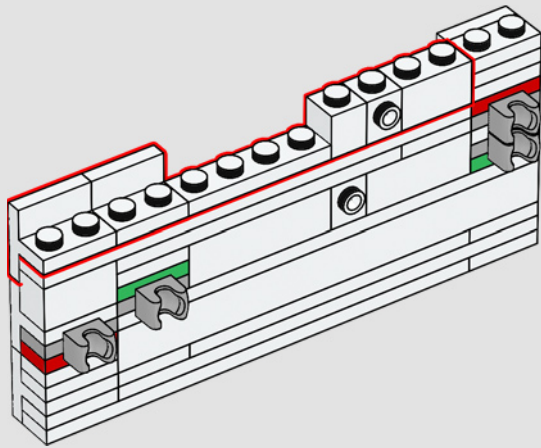

44

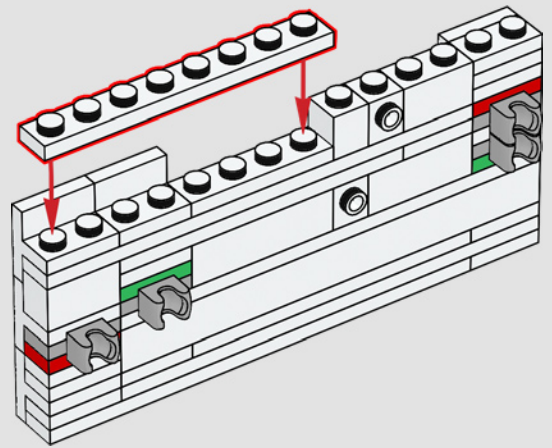

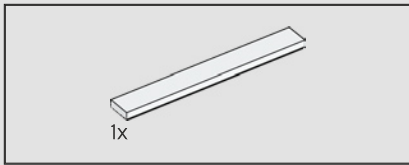

45

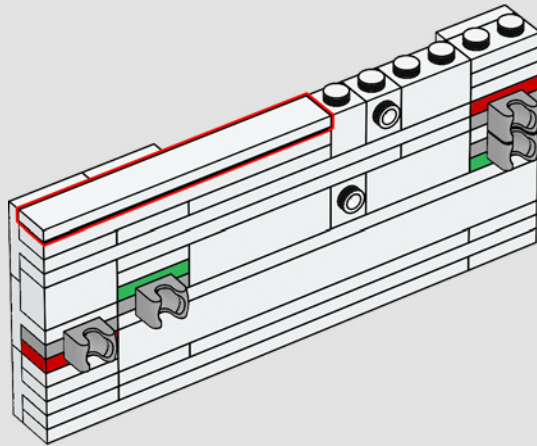

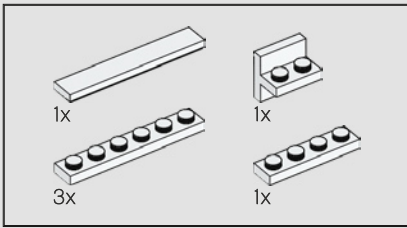

46

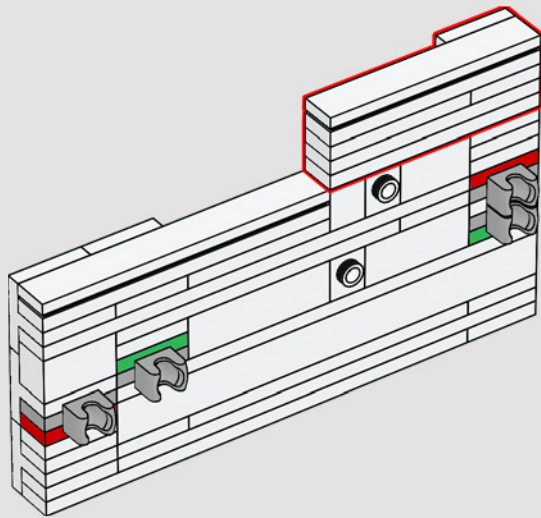
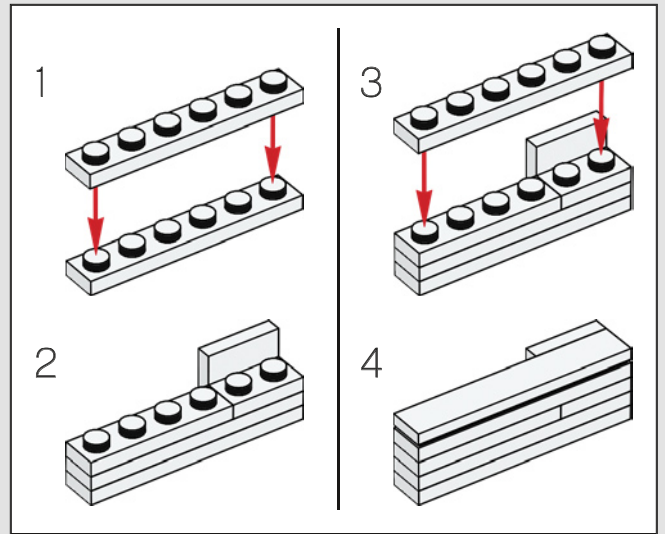

47

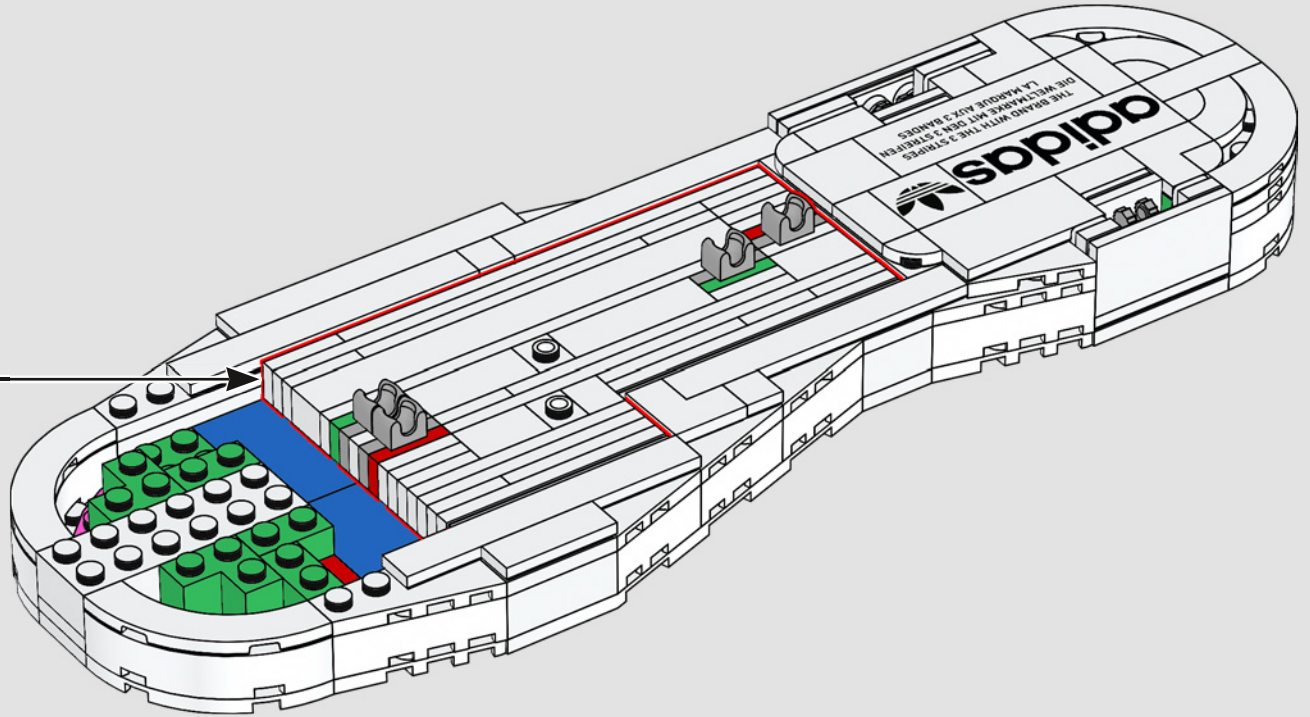

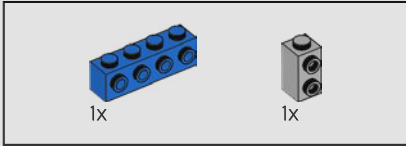
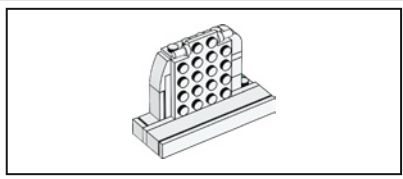

48

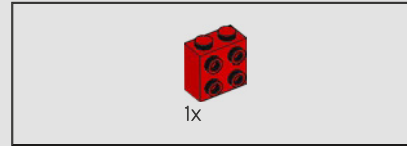
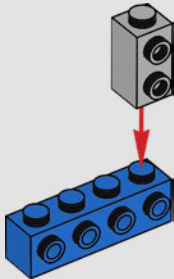

49

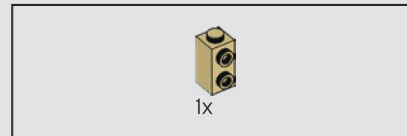
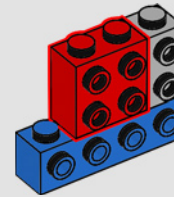

50

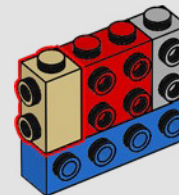

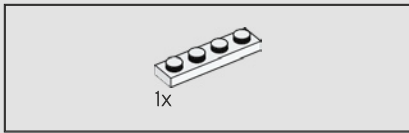

51

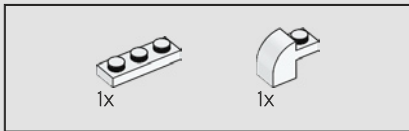
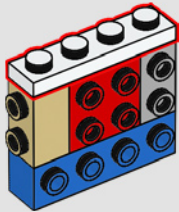

52

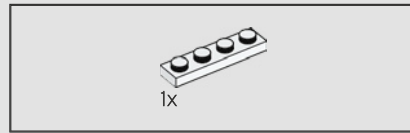
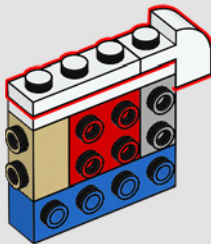

53

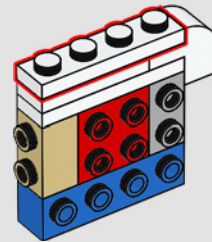

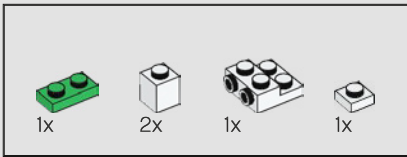

54

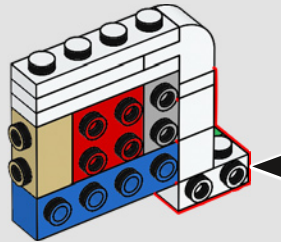
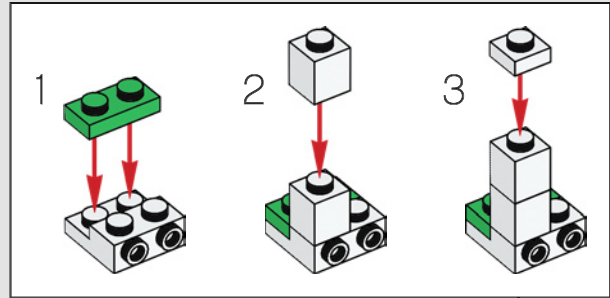

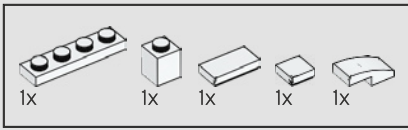

55

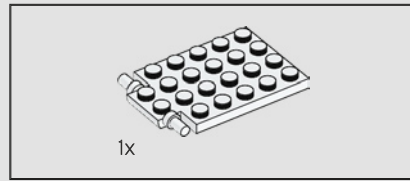
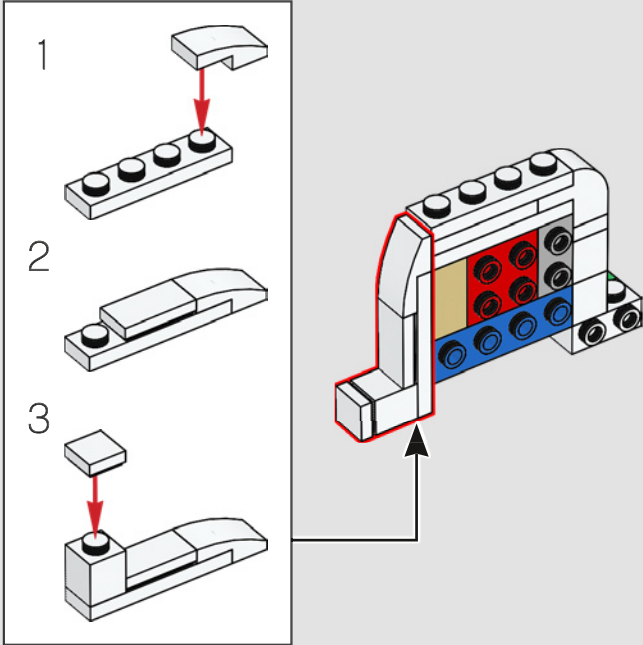

56

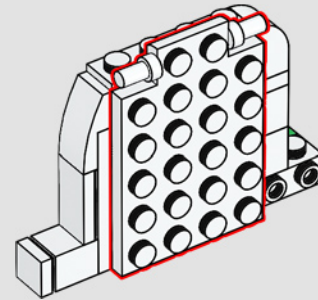

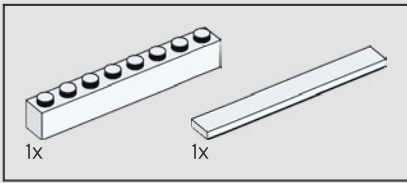

57

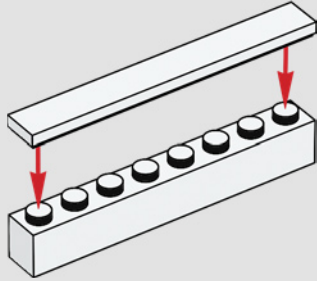

58

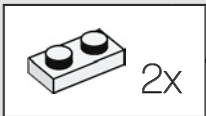
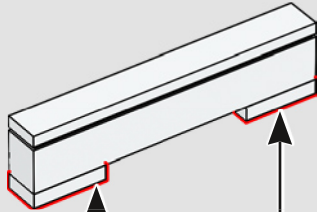

59

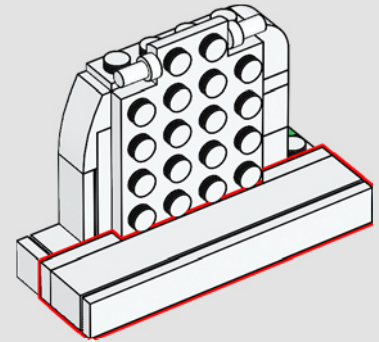

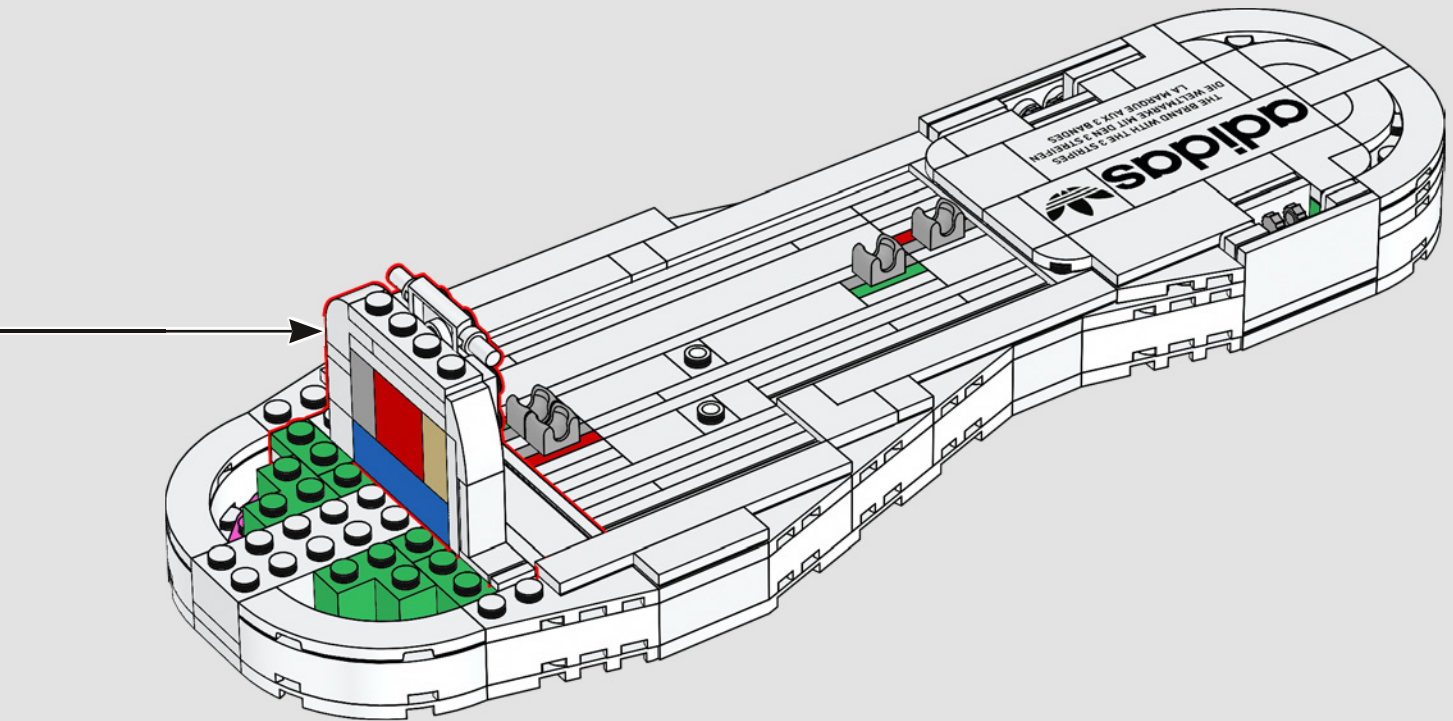

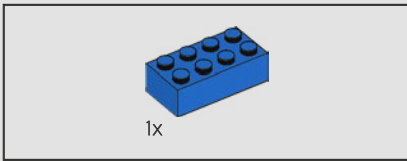

61

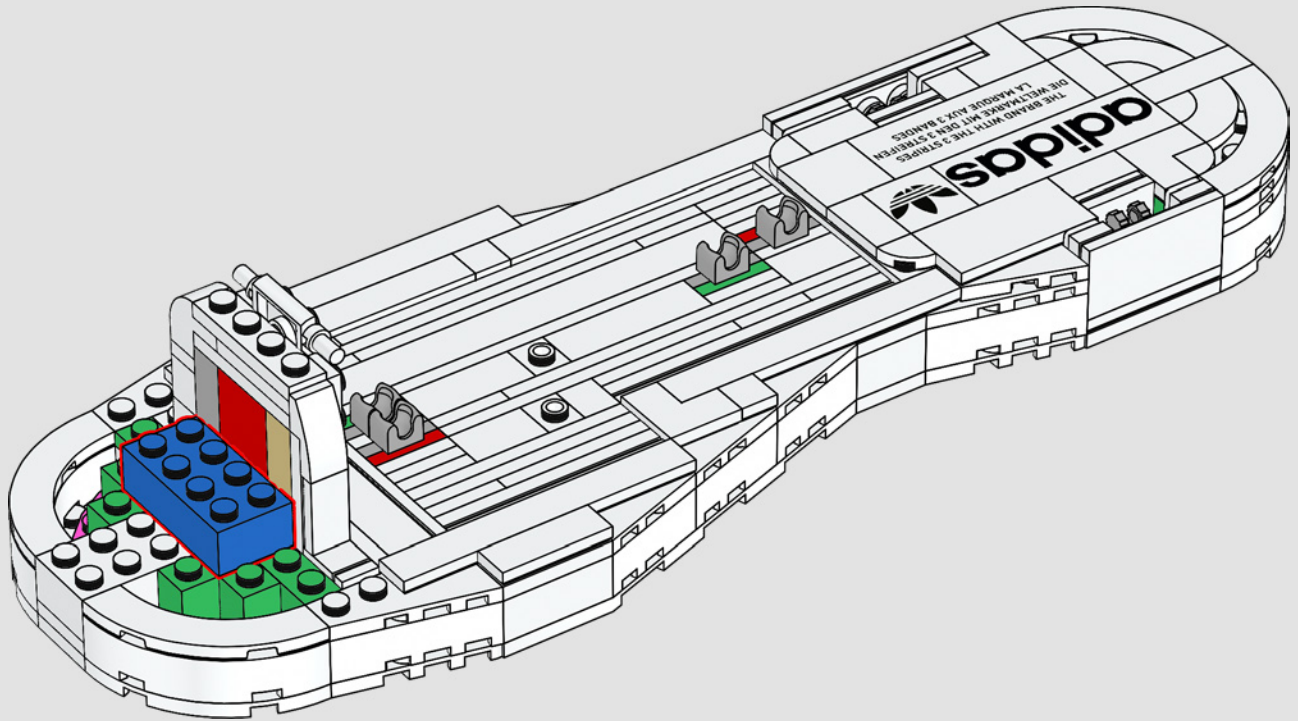

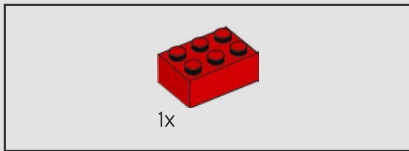

62

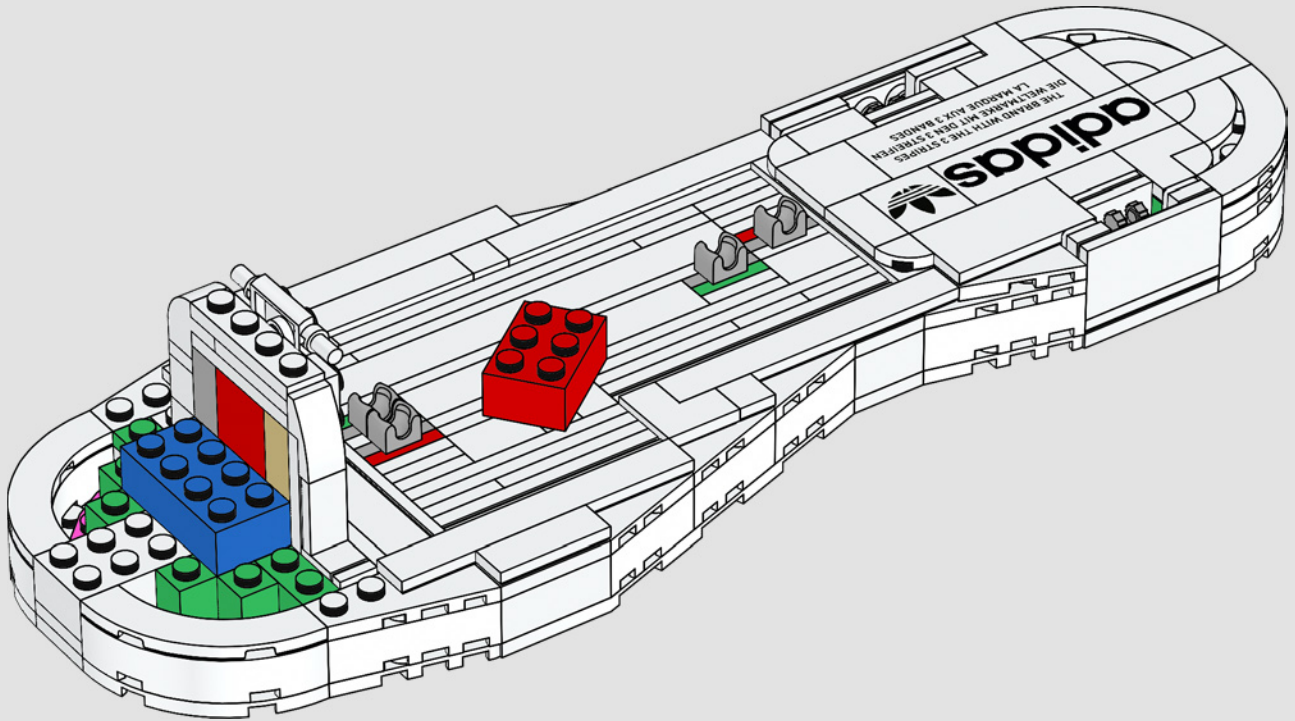

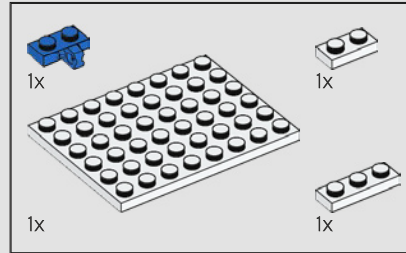
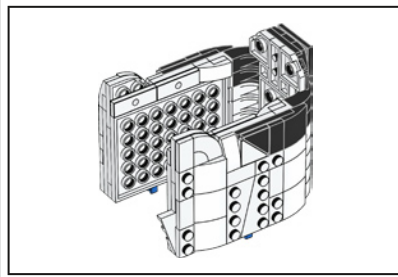

63

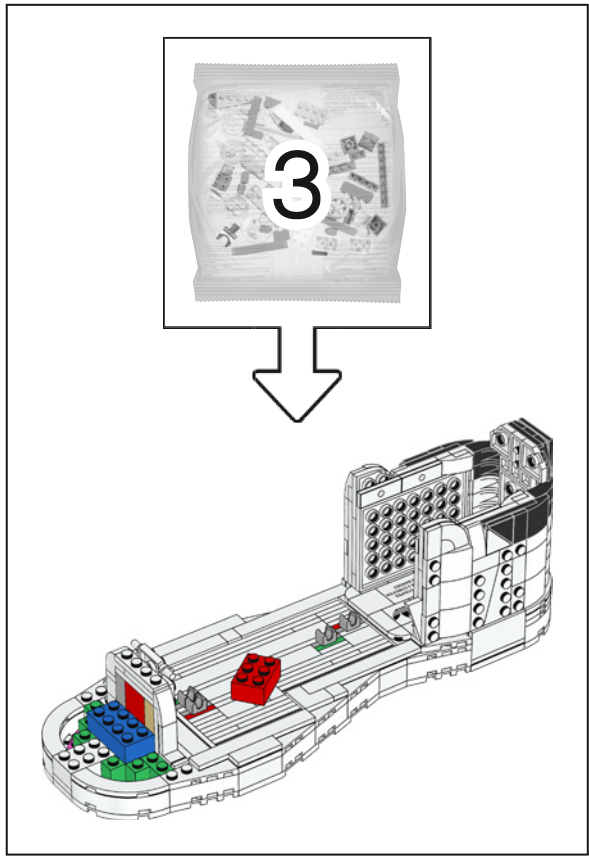
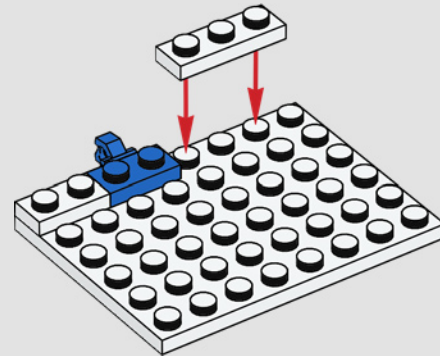

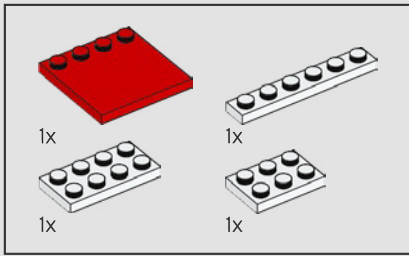

64

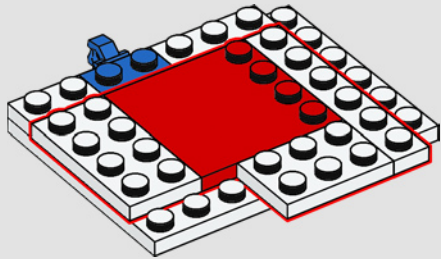

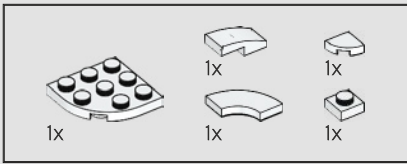

65

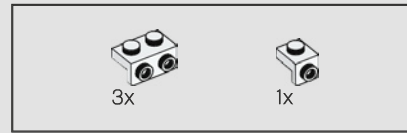
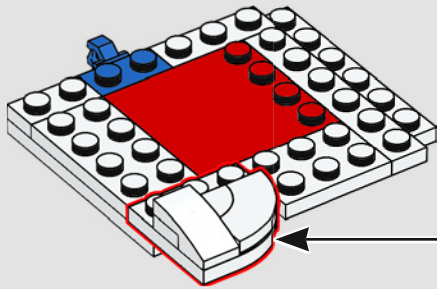
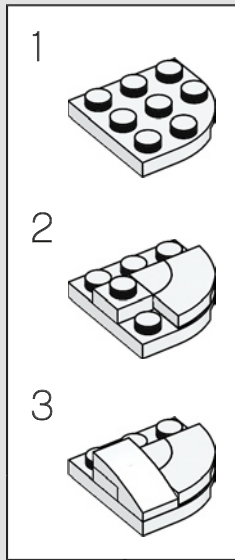

66

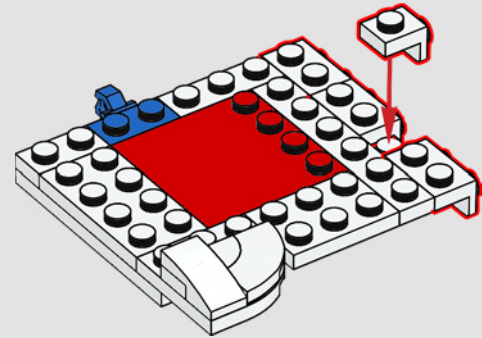

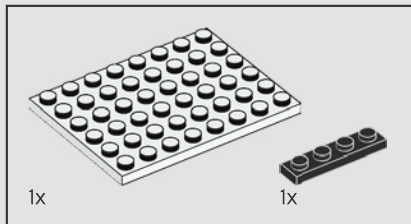

67

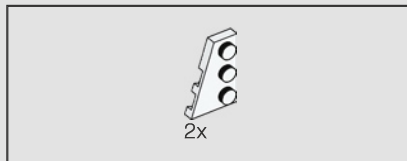
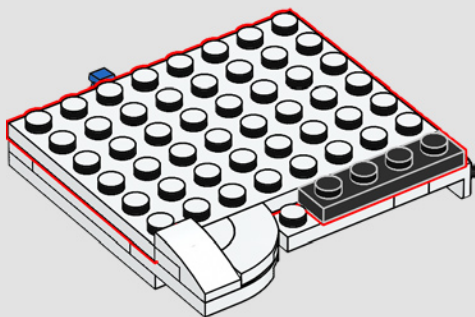

68

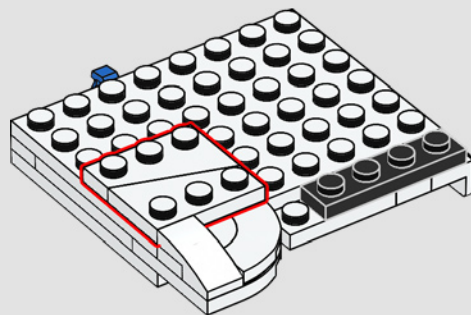

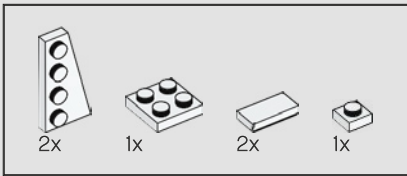

69

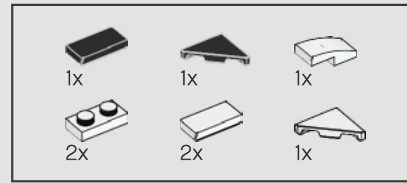
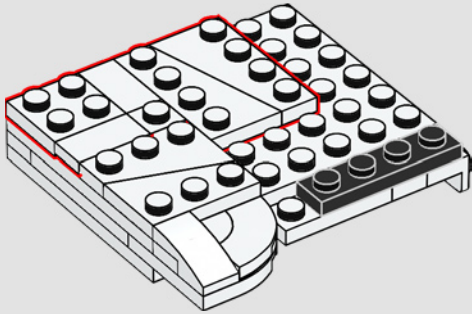

70

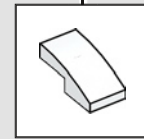
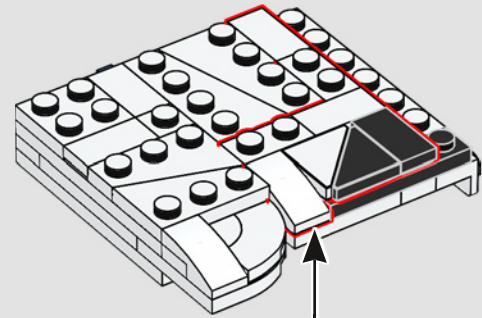

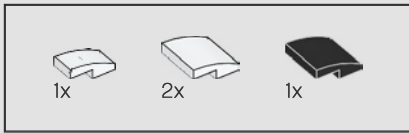

71

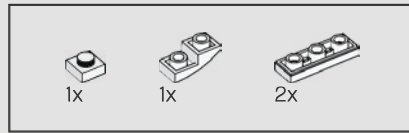
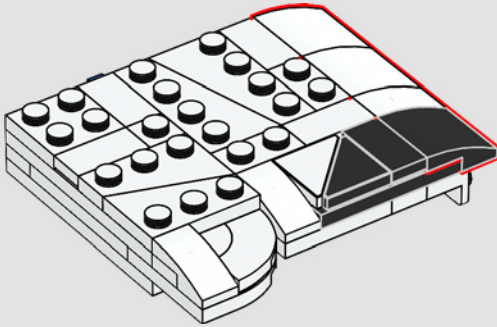

72

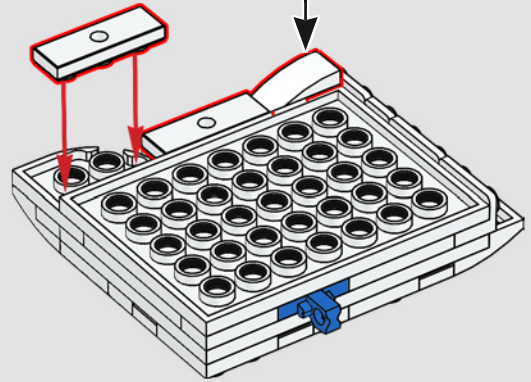
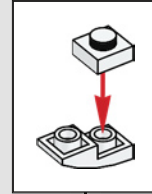

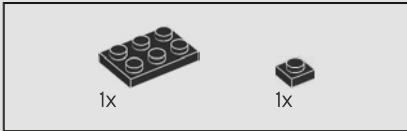
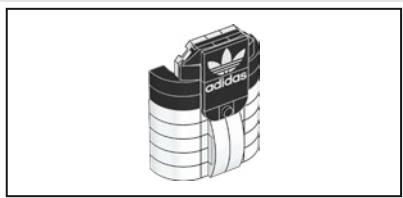

73

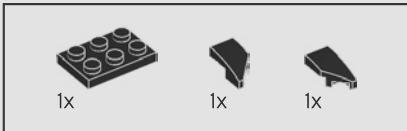

74

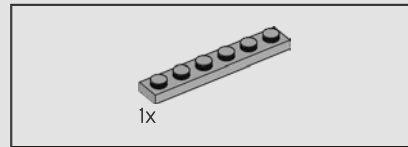
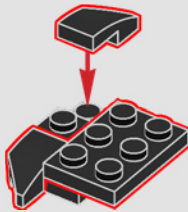

75

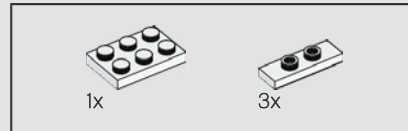
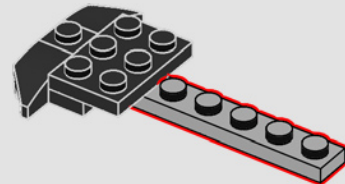

76

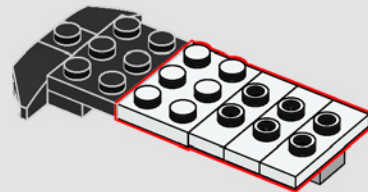



77

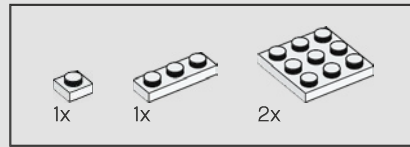
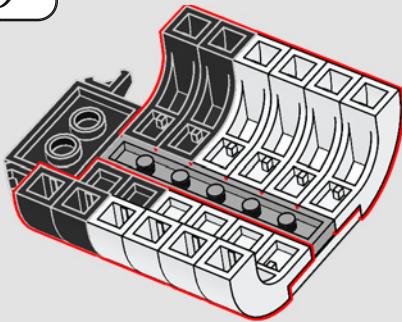

78

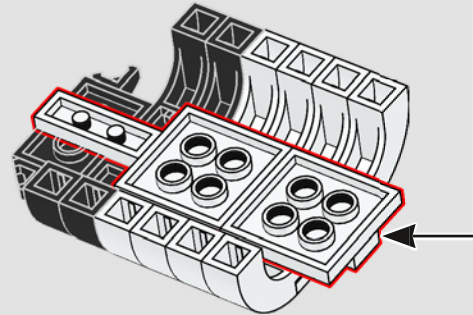
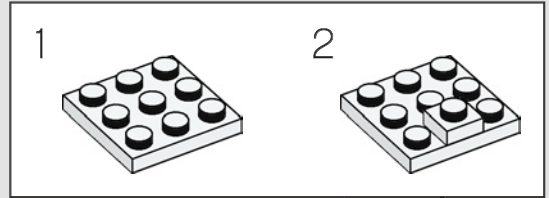

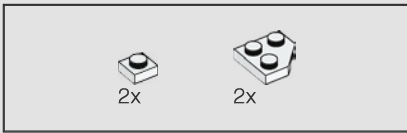

79

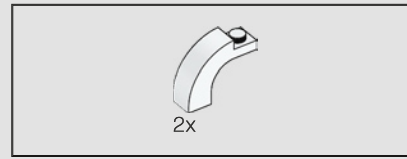
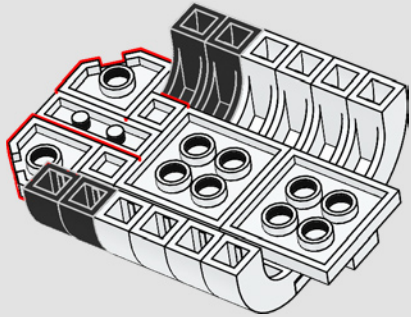

80

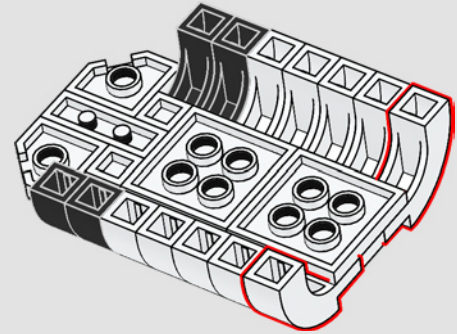

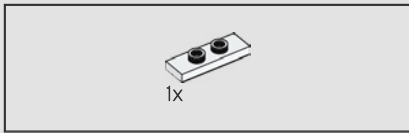

81

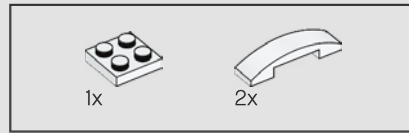
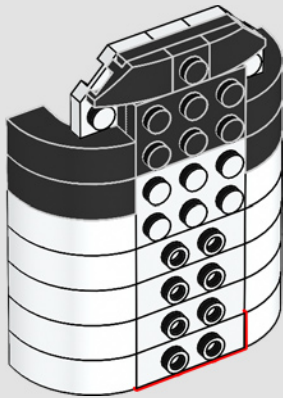

82

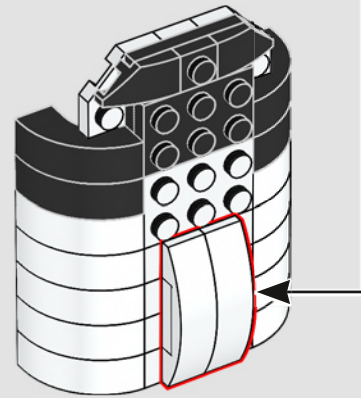
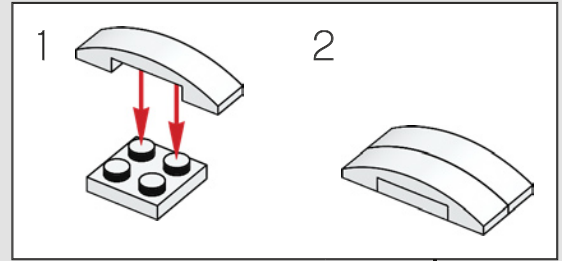

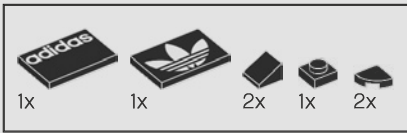

83

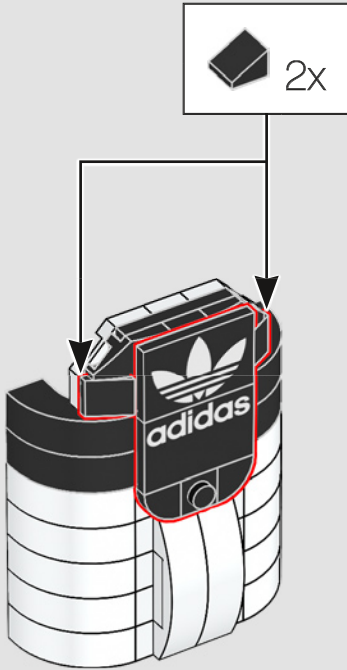

84

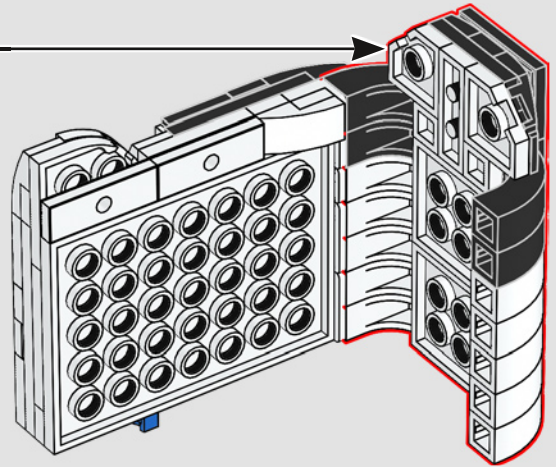

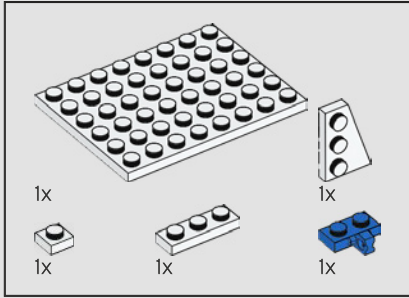
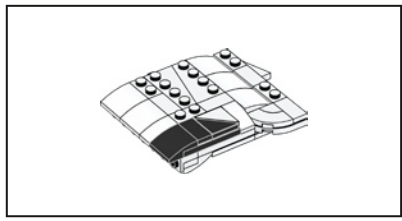

85

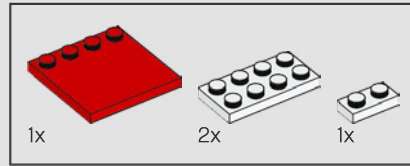
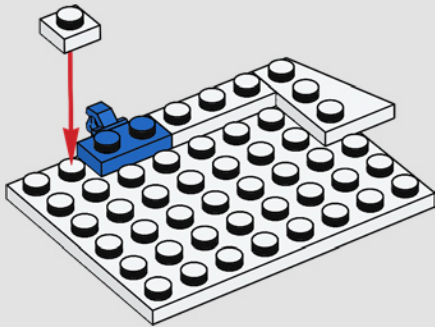

86

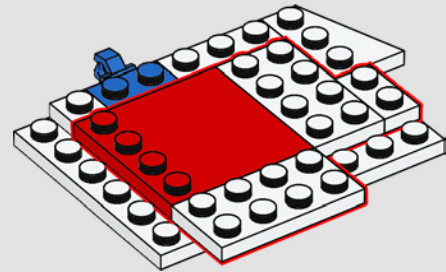

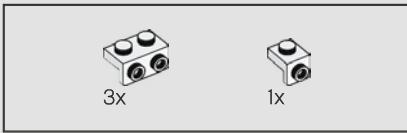

87

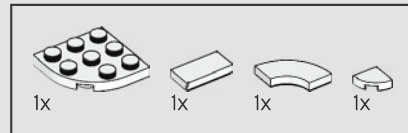
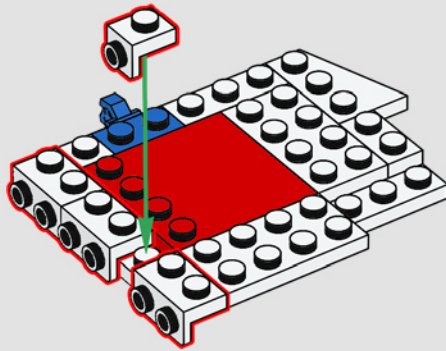

88

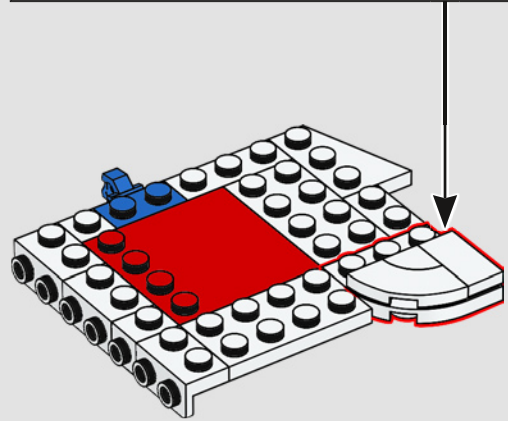
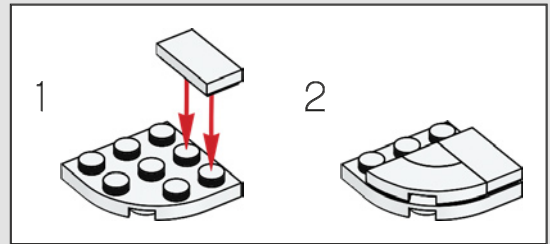

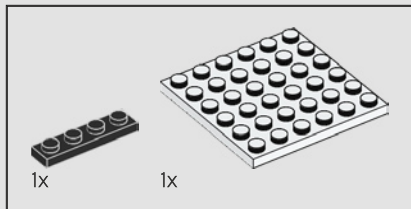

89

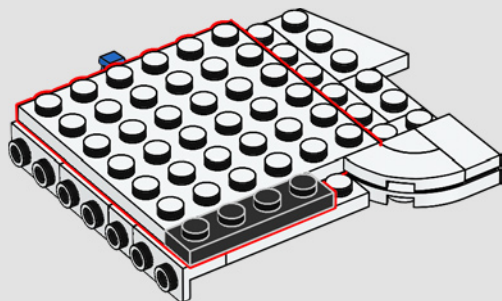

90

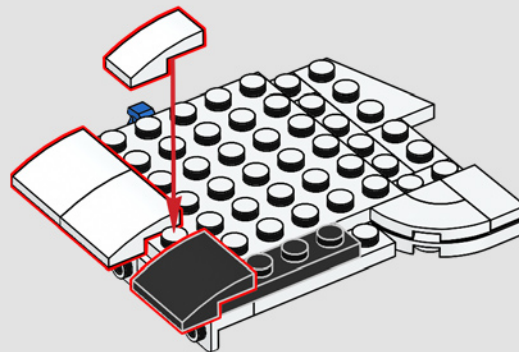

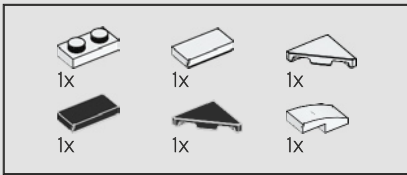

91

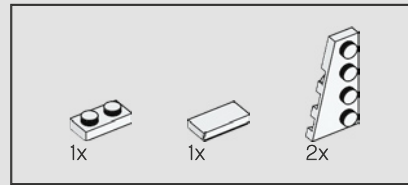
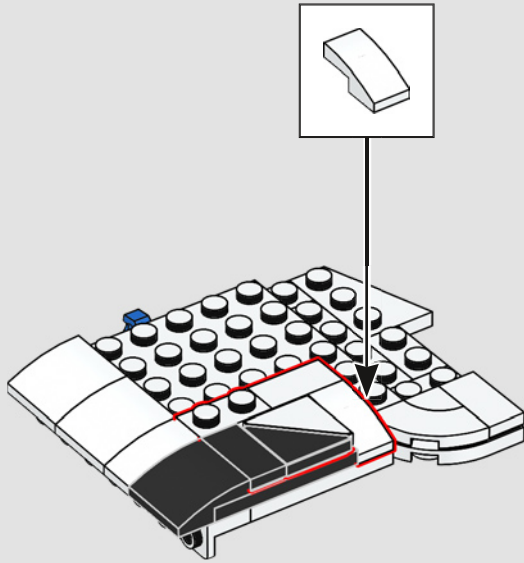

92

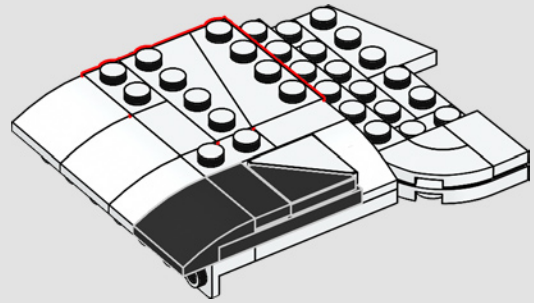

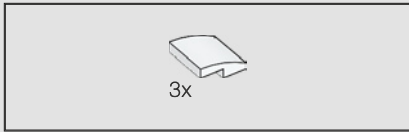

93

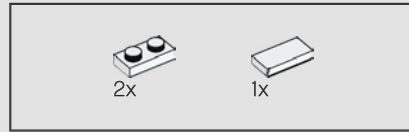
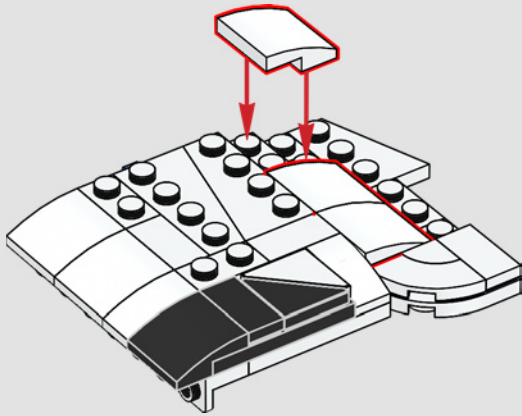

94

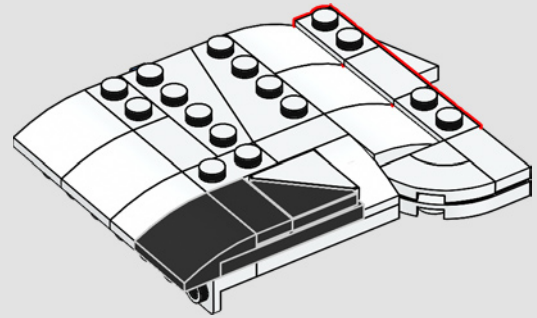

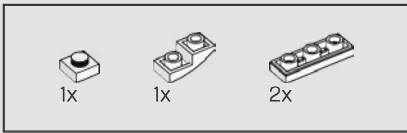

95

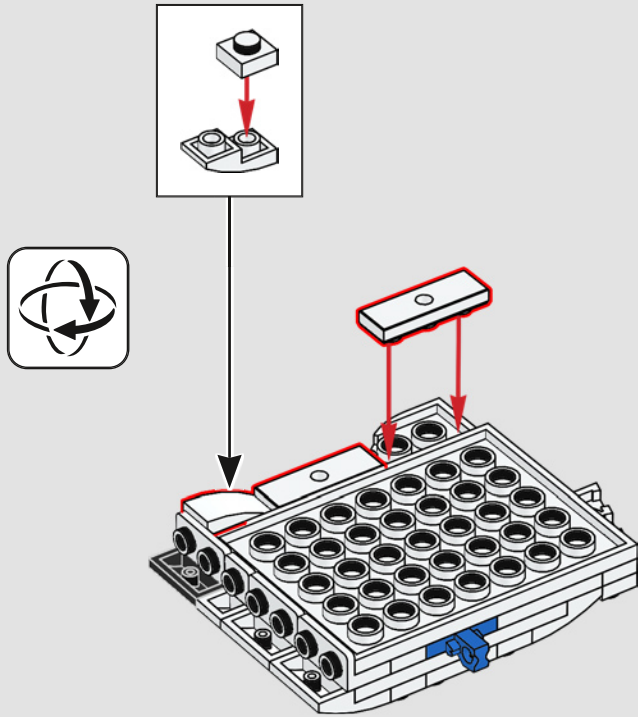

96

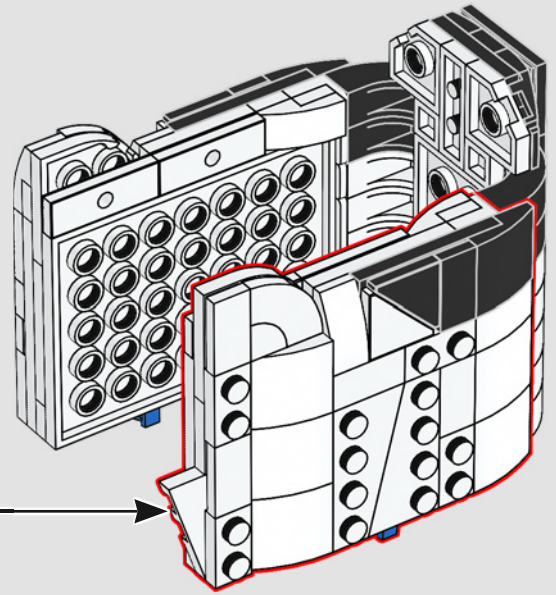

97

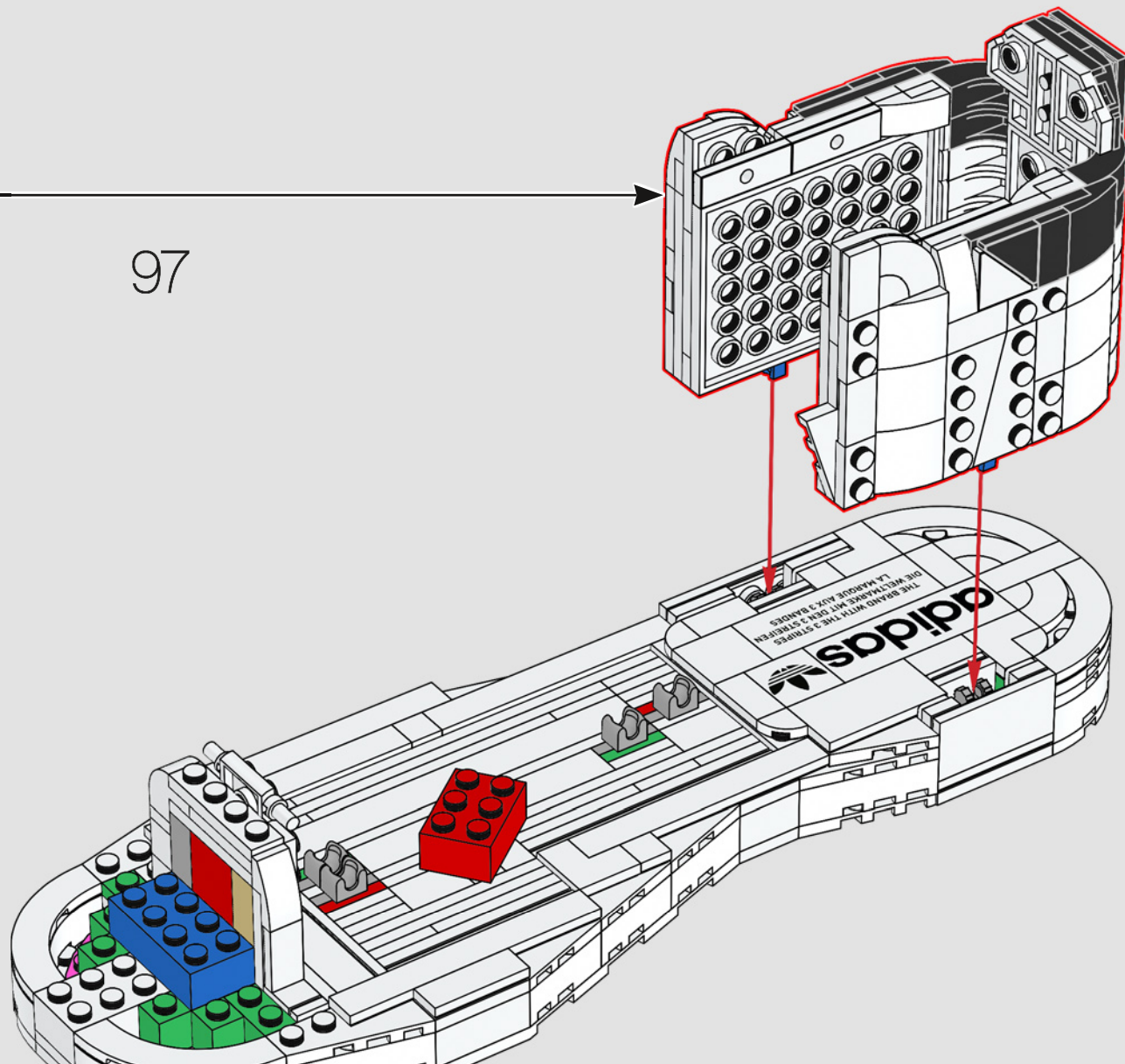

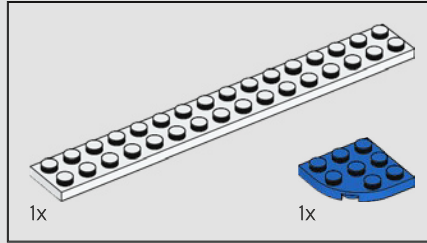
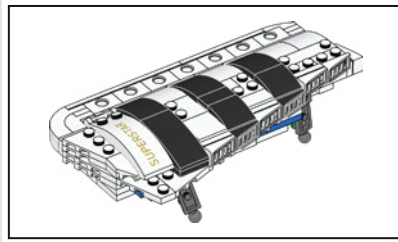

98

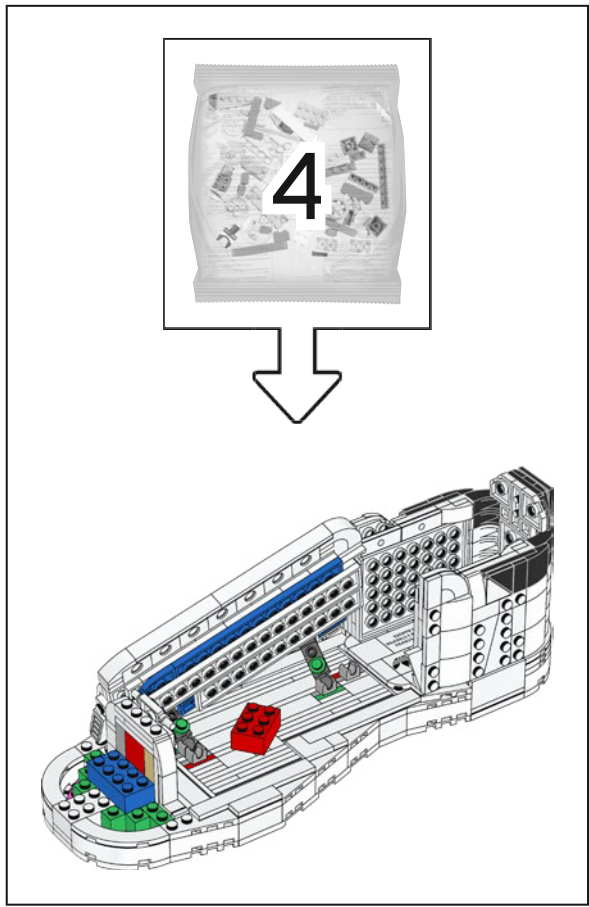
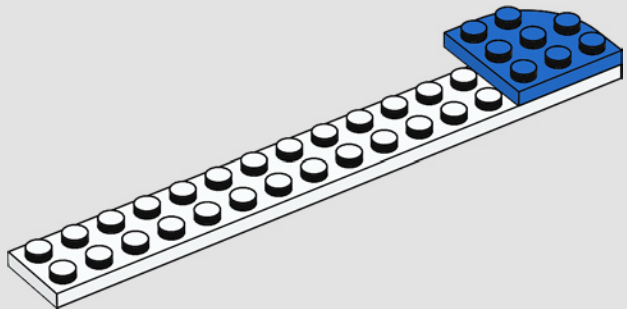

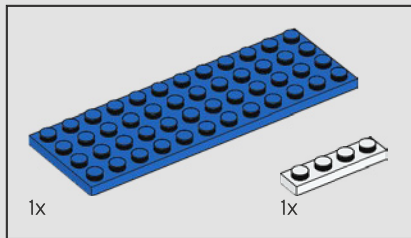

99

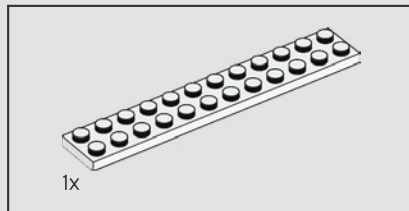
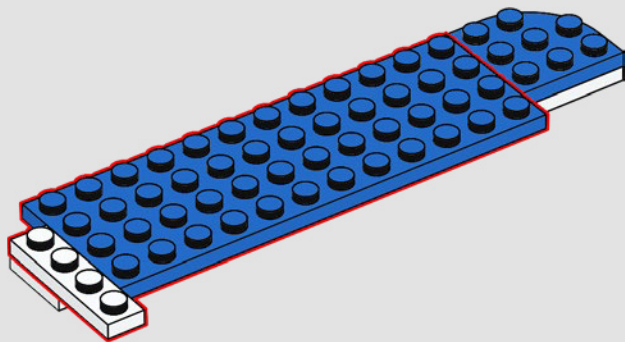

100

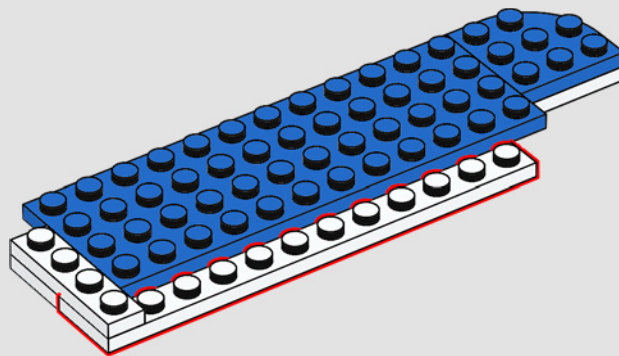

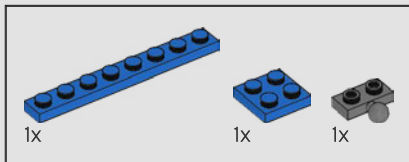

101

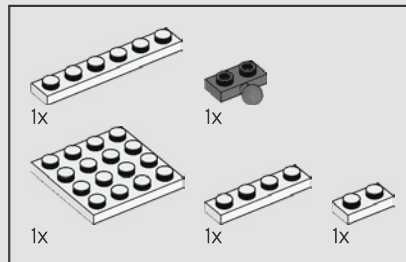
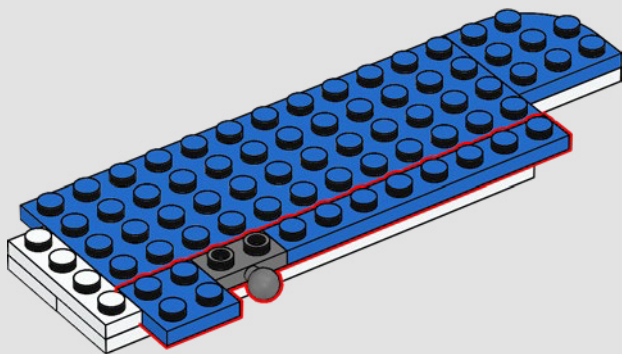

102

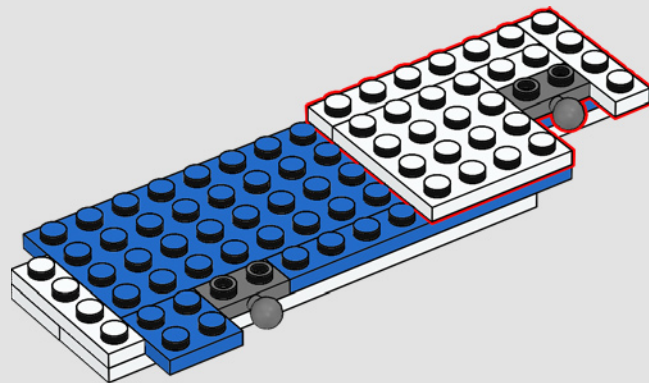

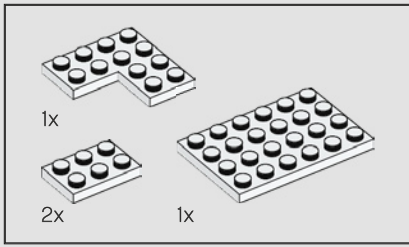

103

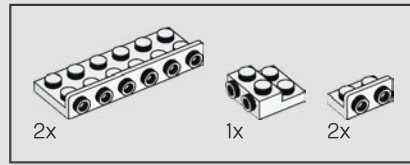
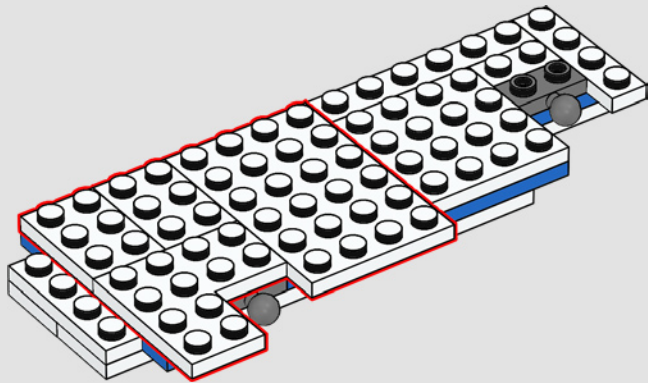

104

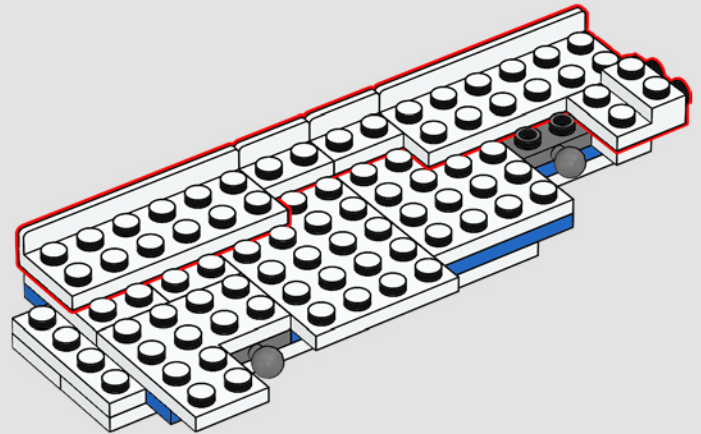

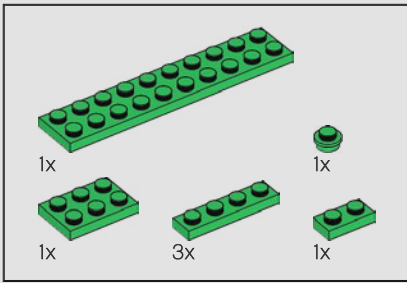

105

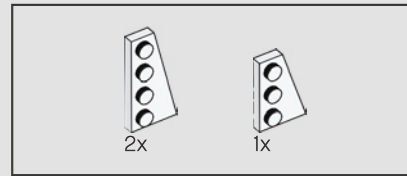
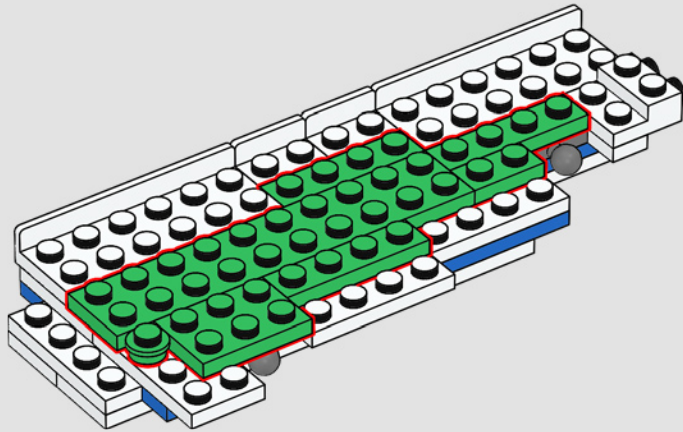

106

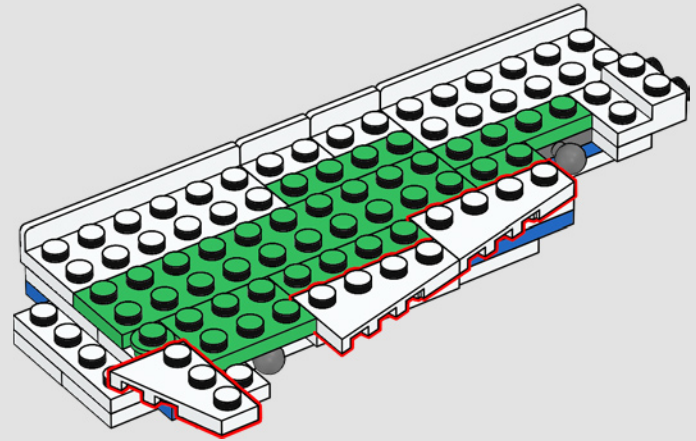

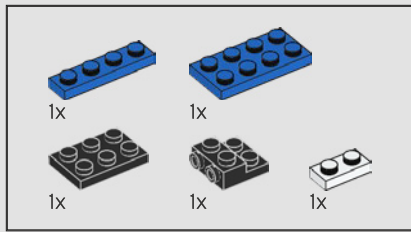

107

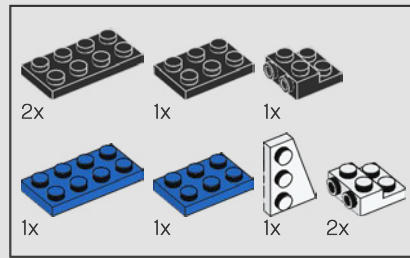
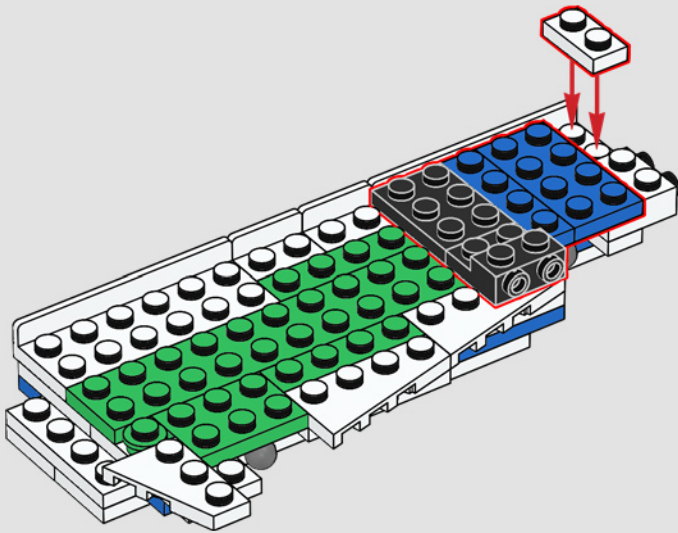

108

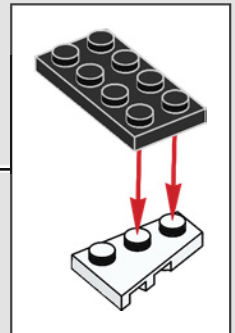
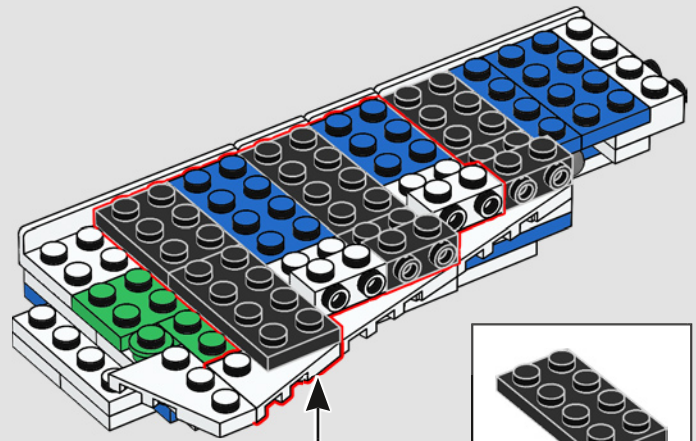

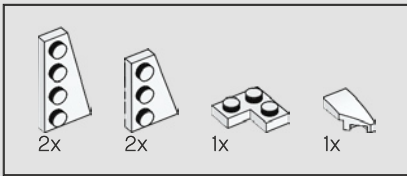

109

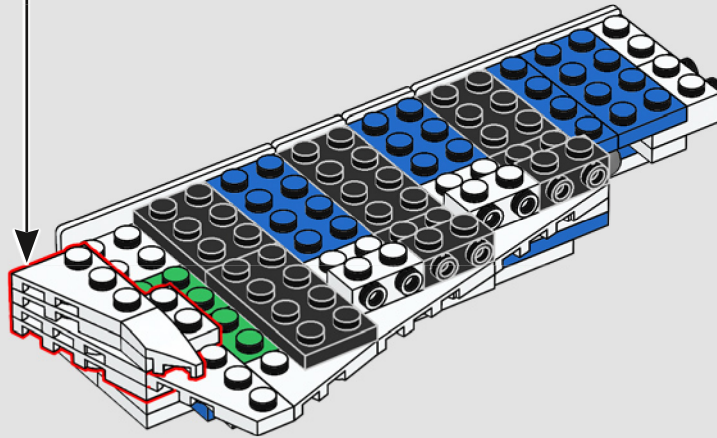
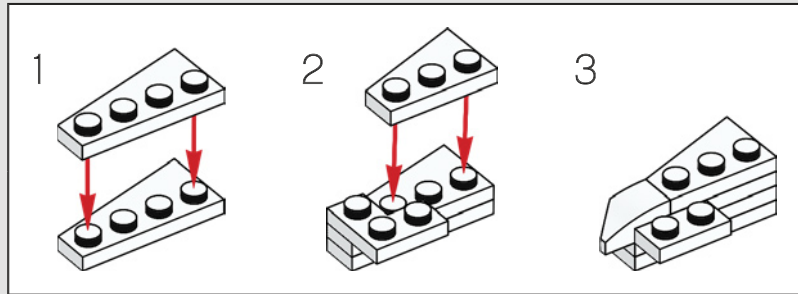

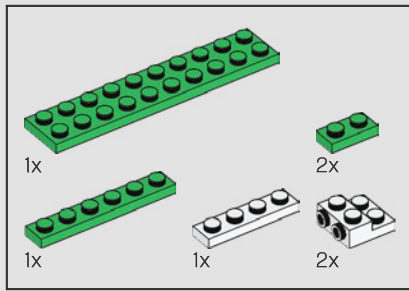

110

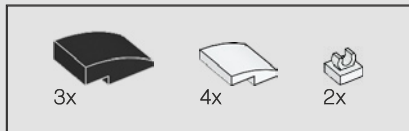
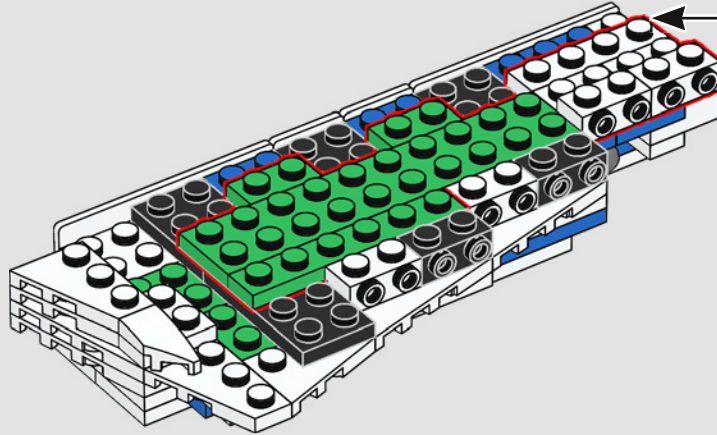

111

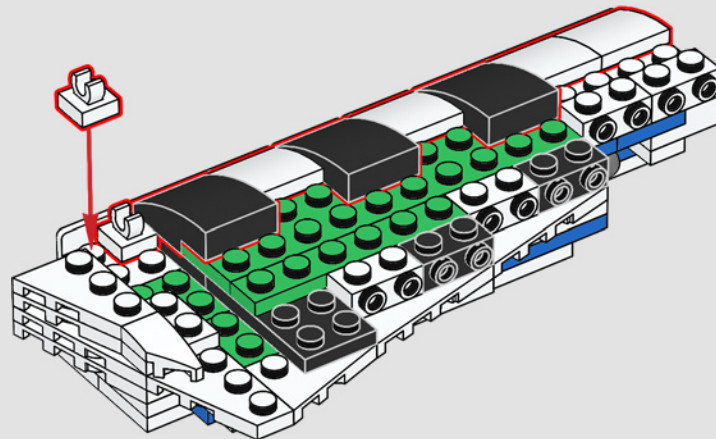

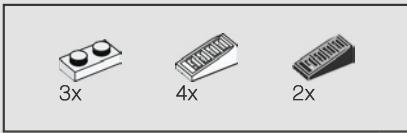

112

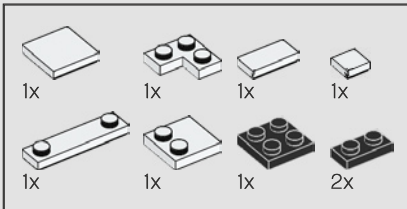
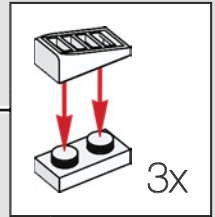
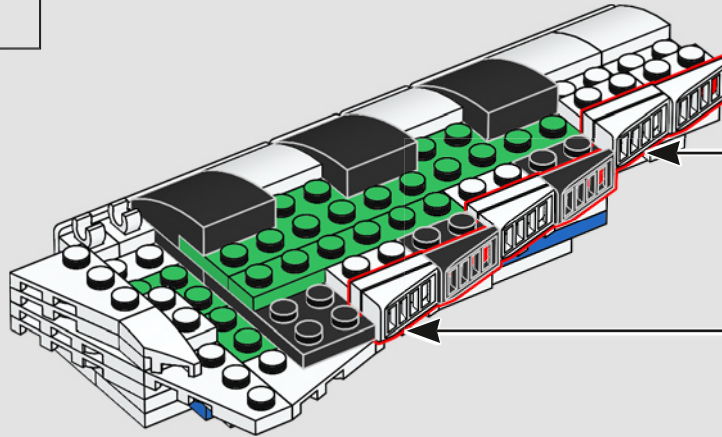

113

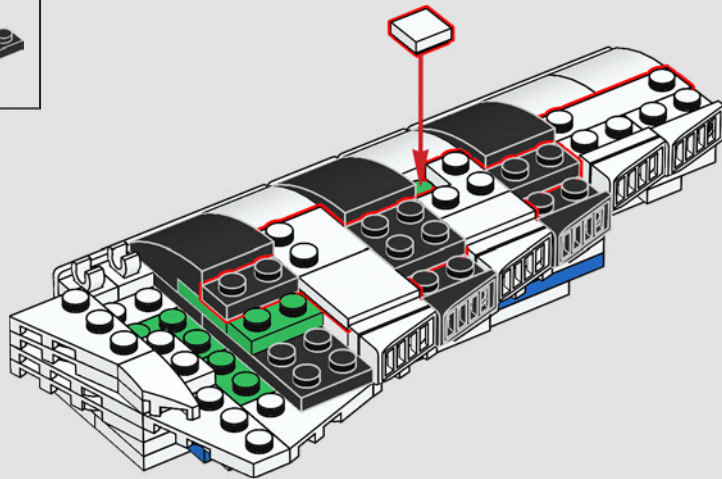

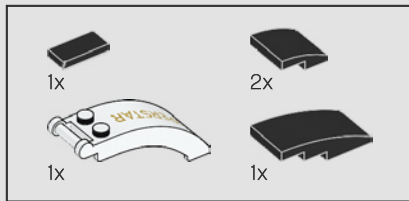

114

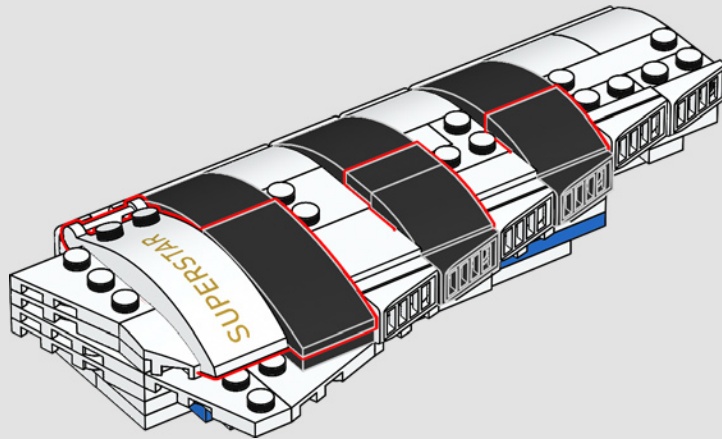

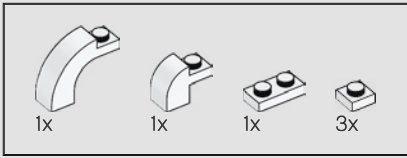

115

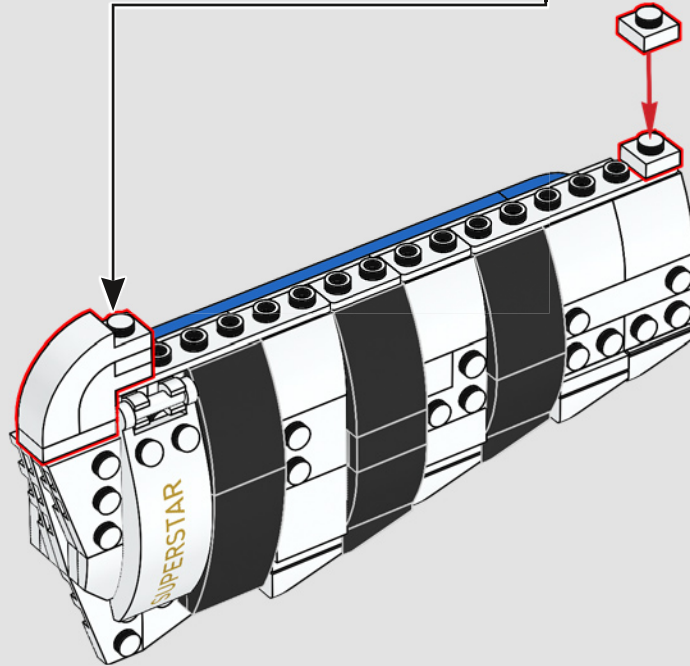
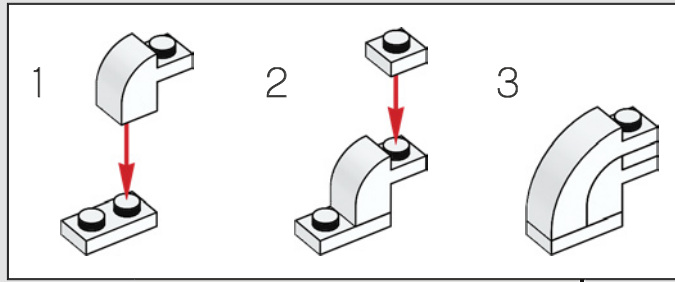

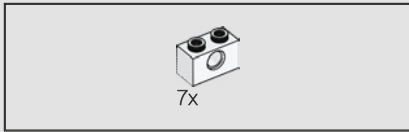

116

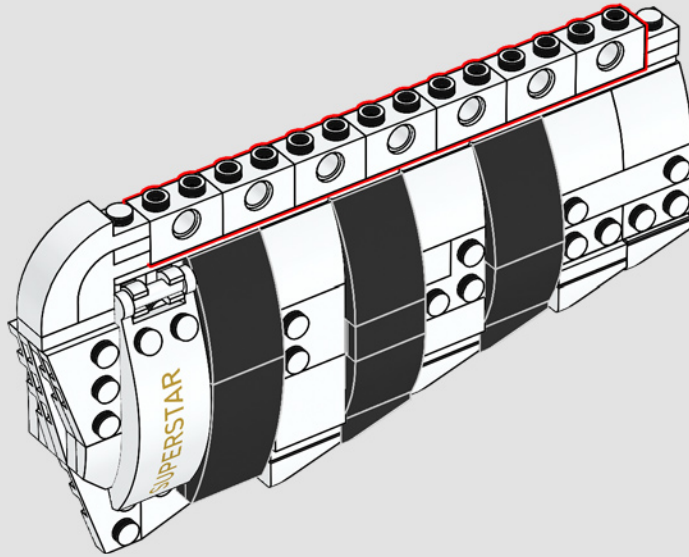

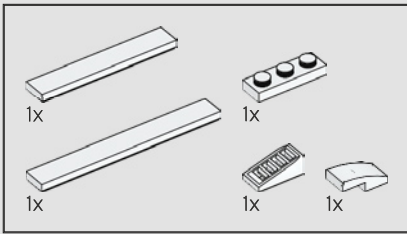

117

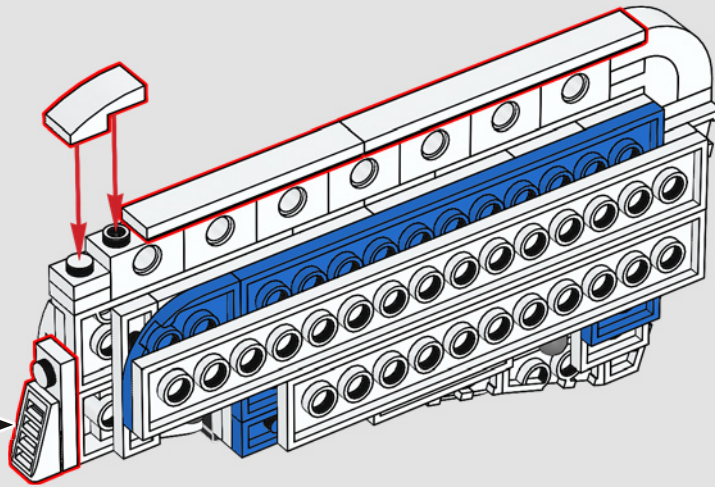
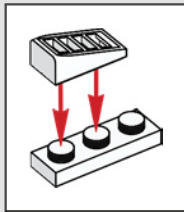



118

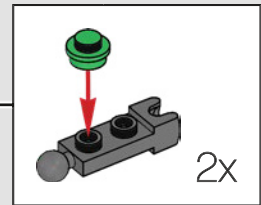
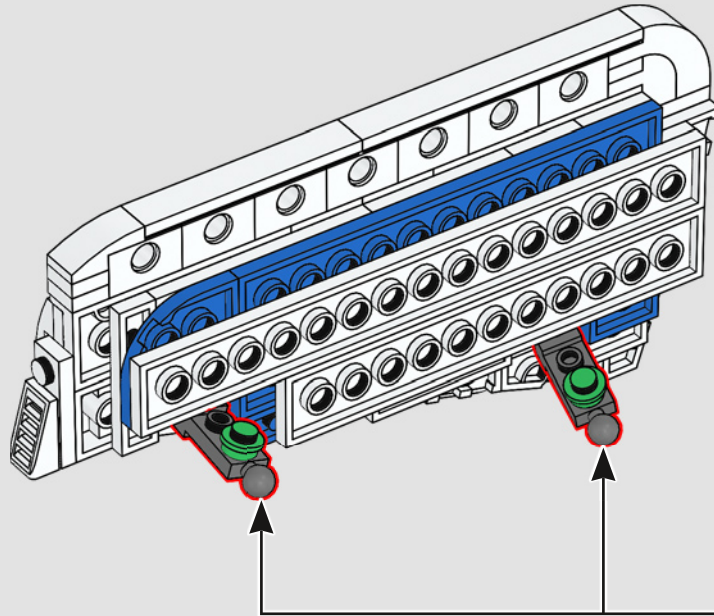

119

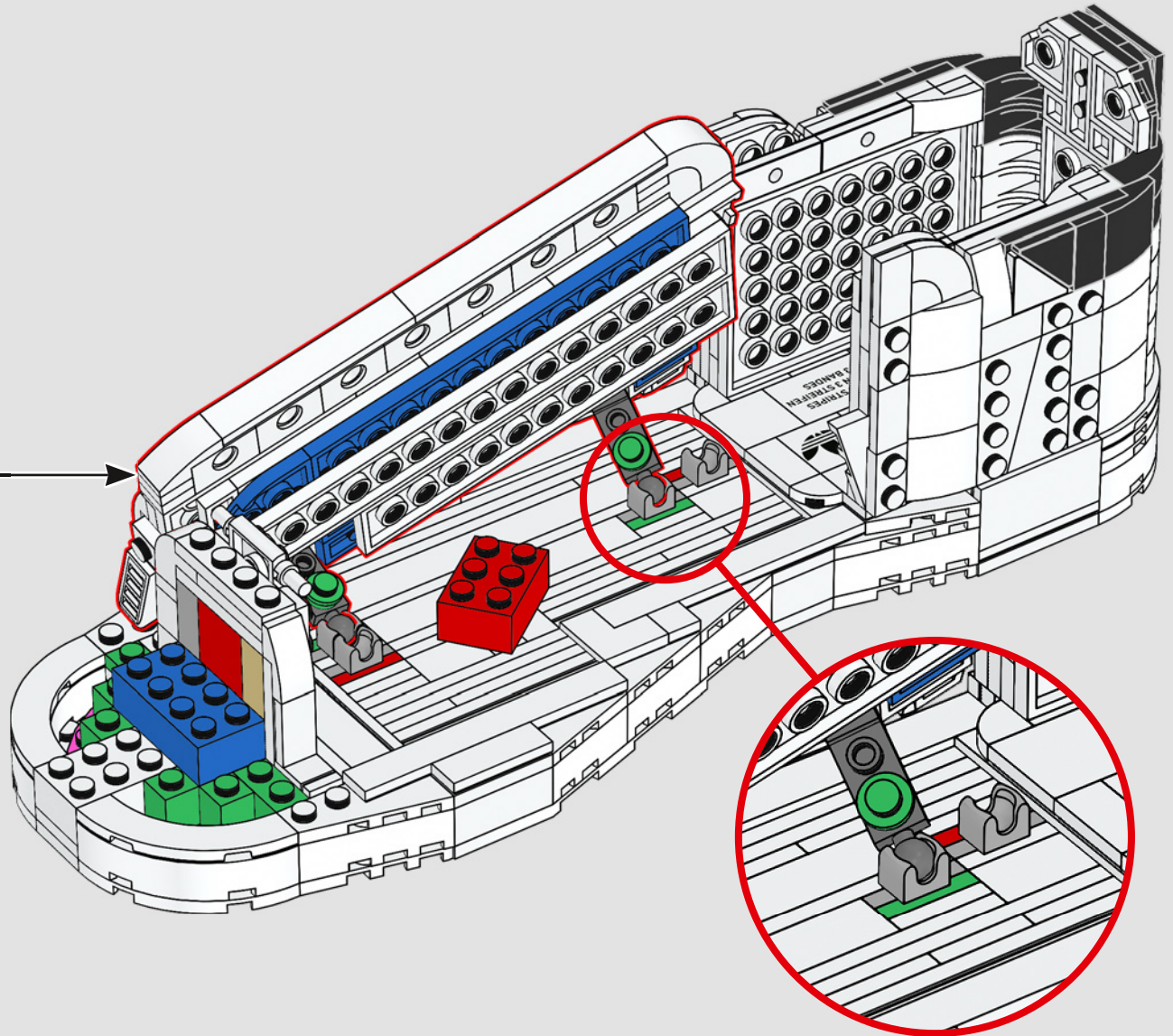

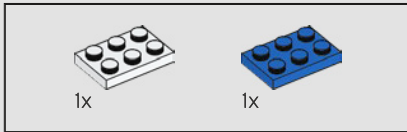
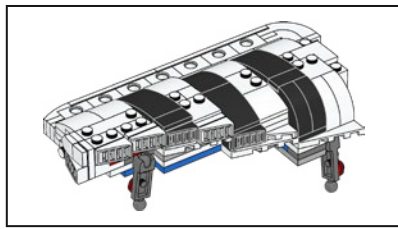
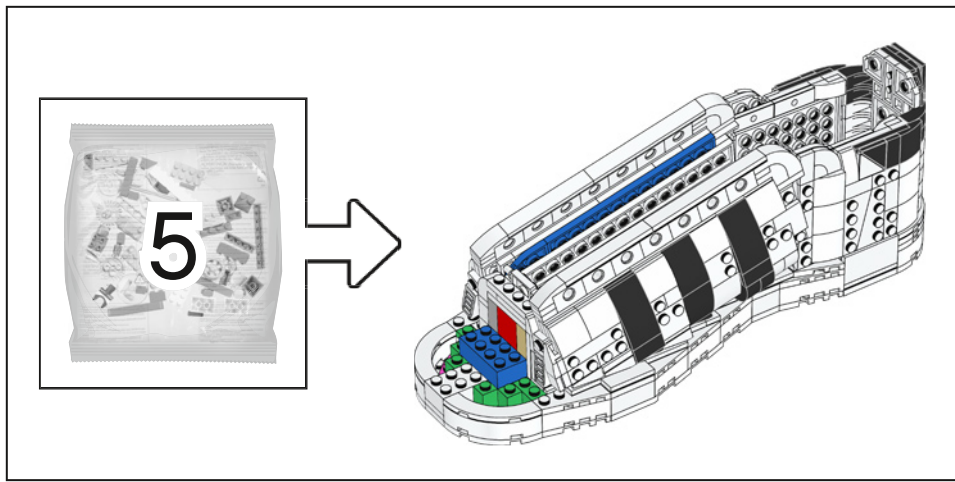

120

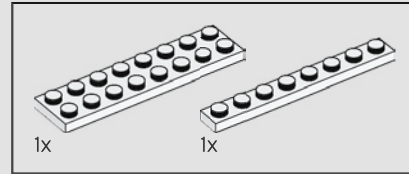

121

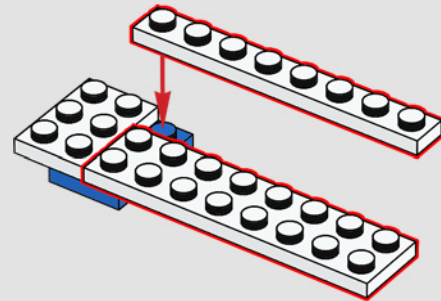

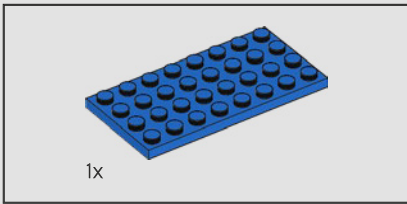

122

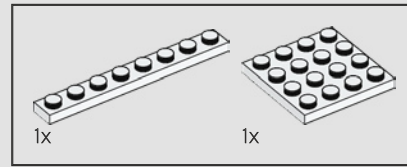
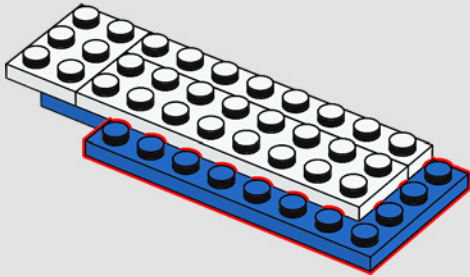

123

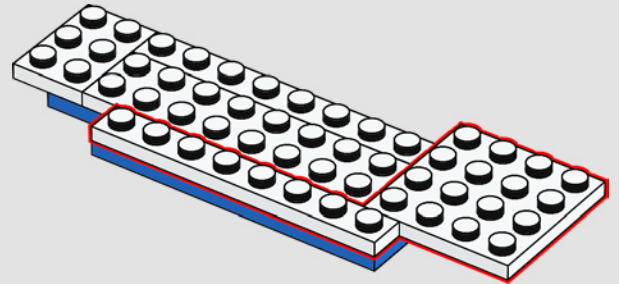

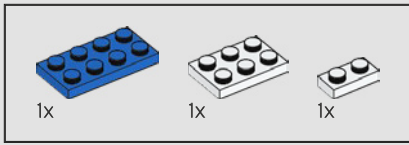

124

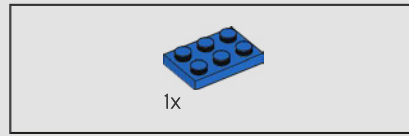
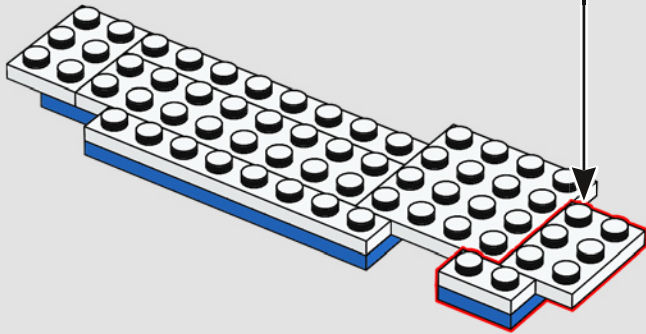
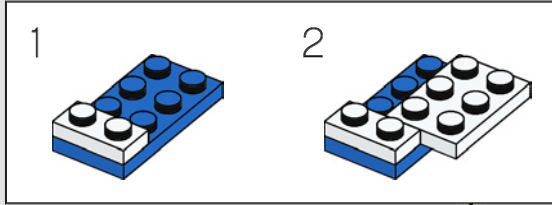

125

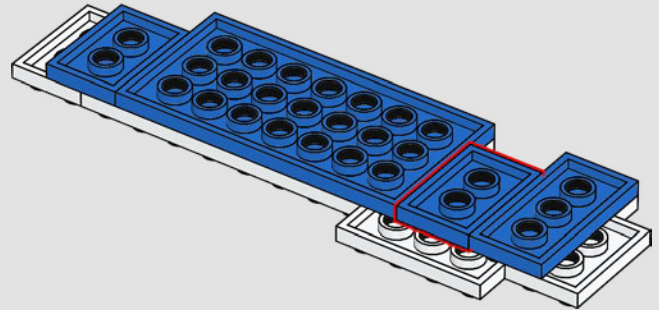
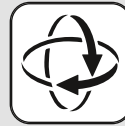

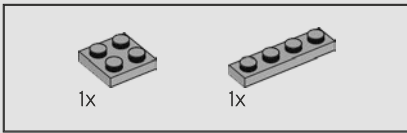

126

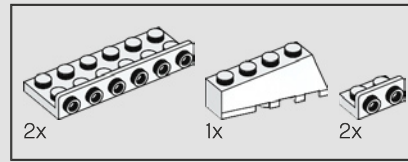
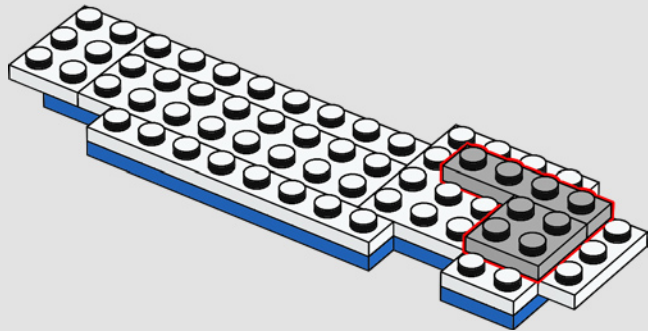

127

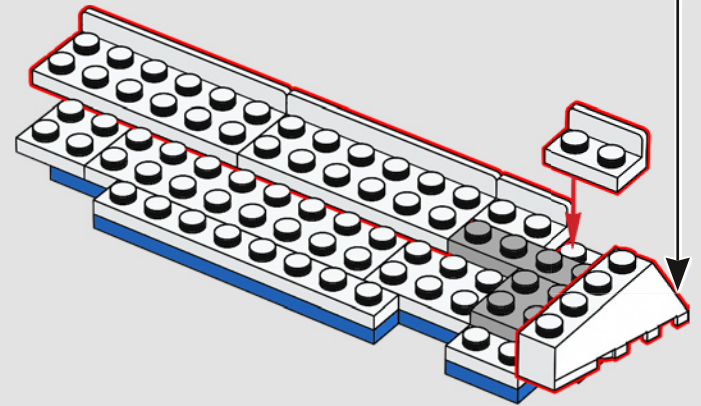
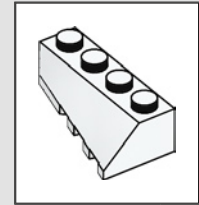

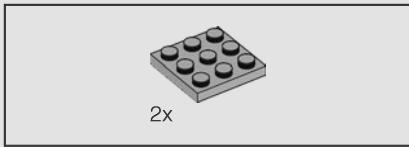

128

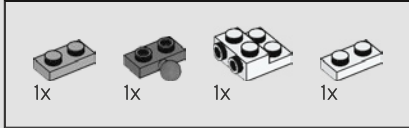
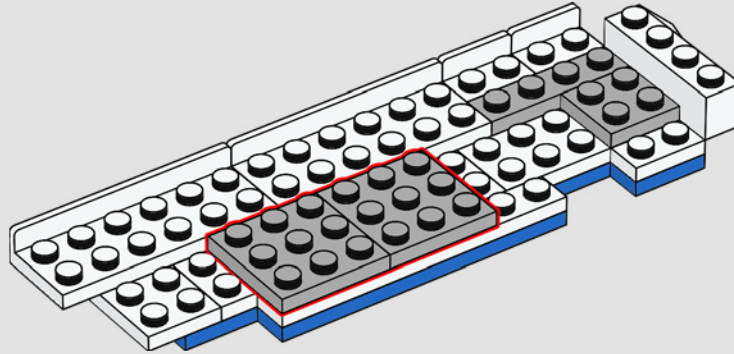

129

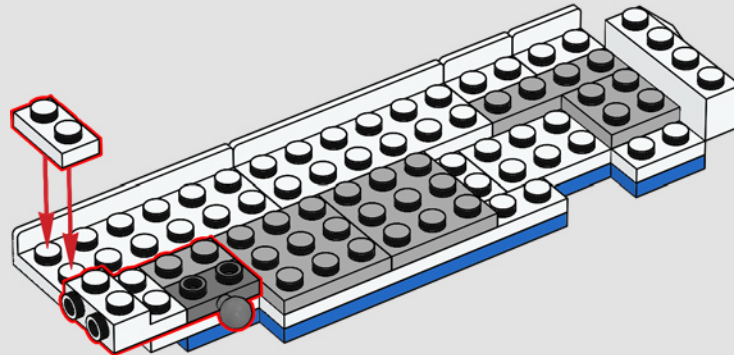

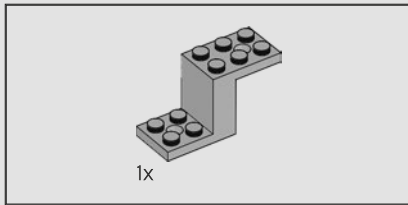
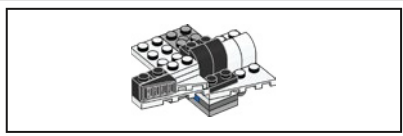

130

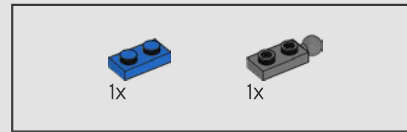
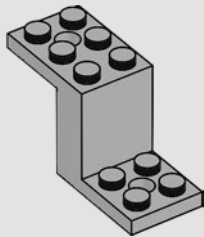

131

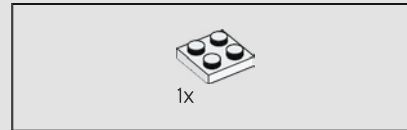
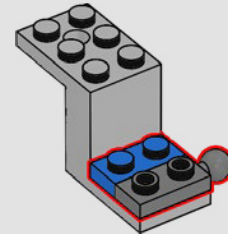

132

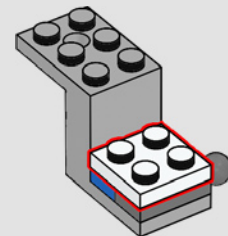

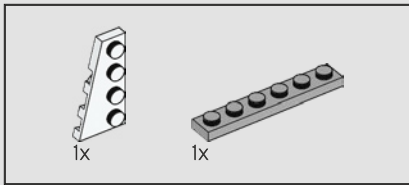

133

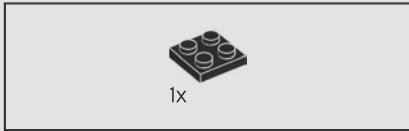
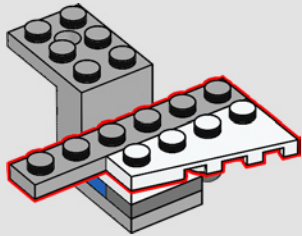

134

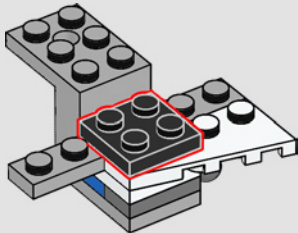

135

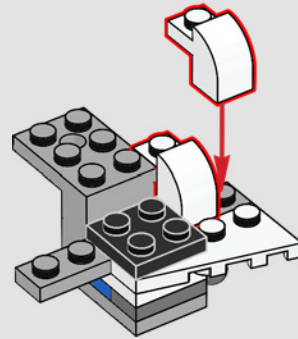

136

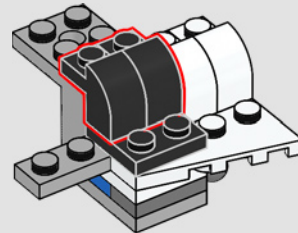

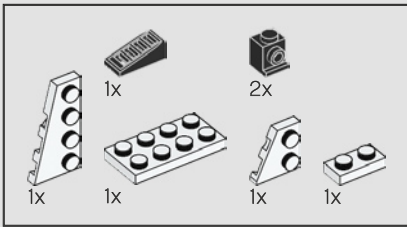

137

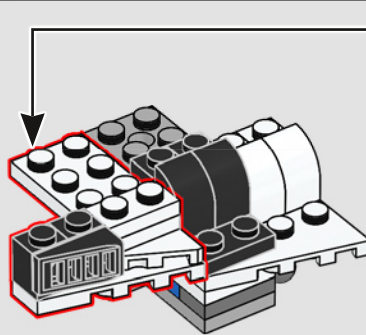
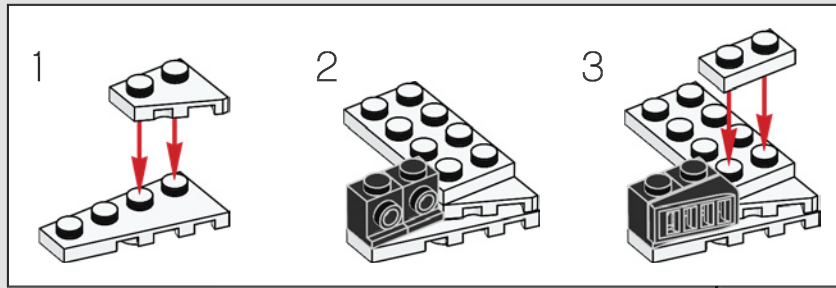

138

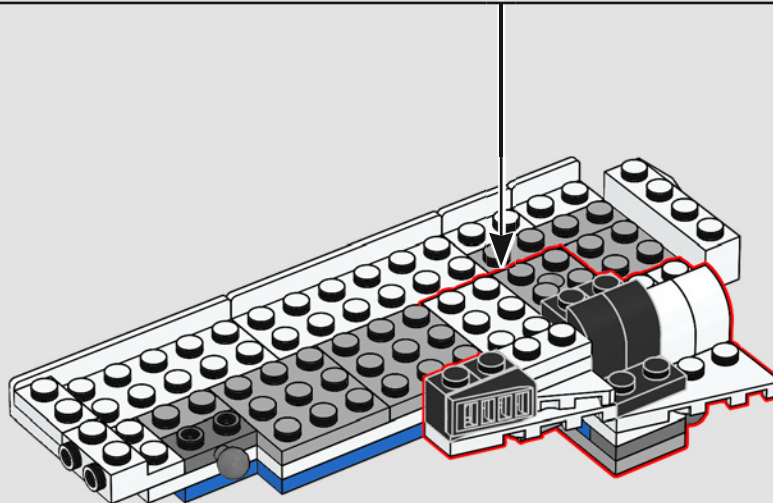

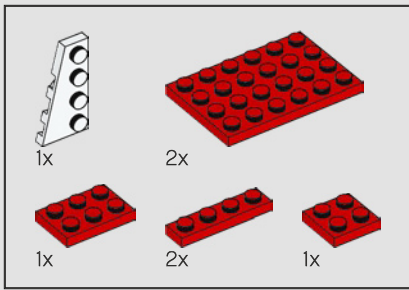

139

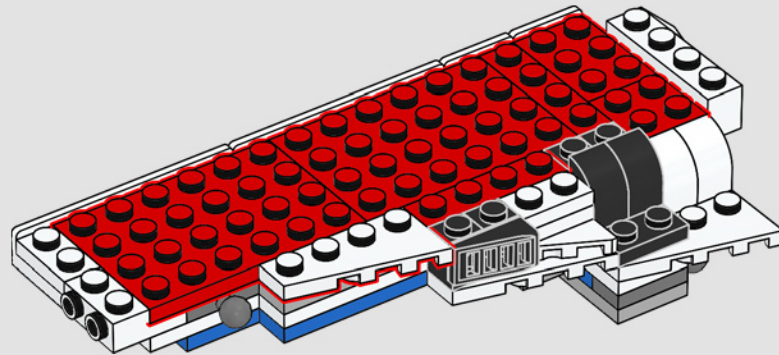

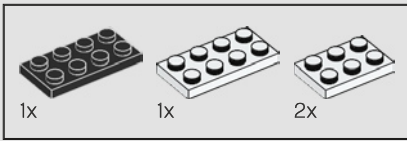

140

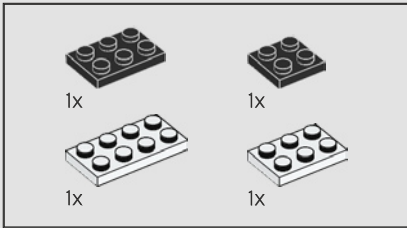
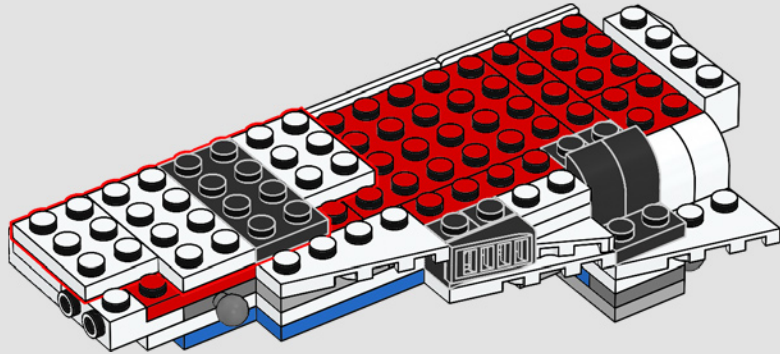

141

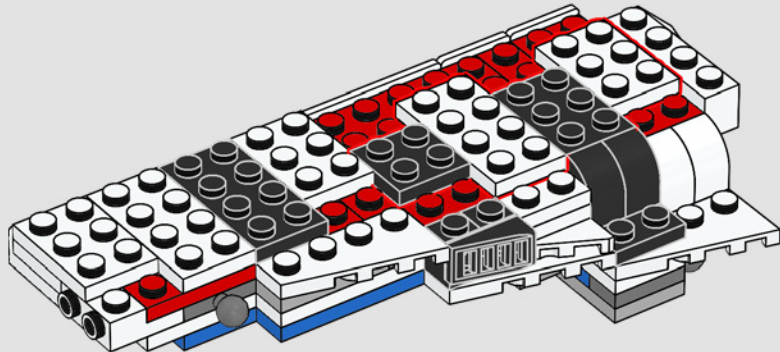



142

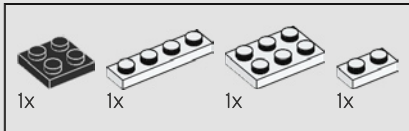
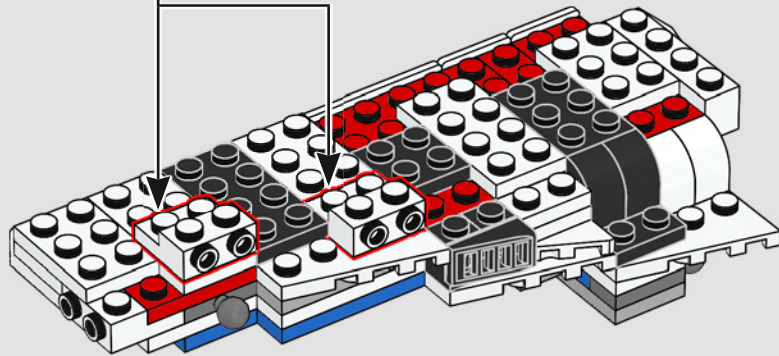
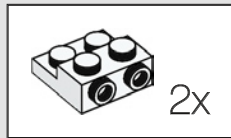

143

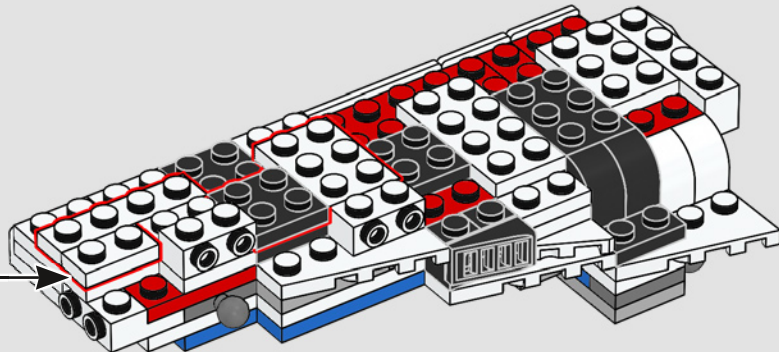
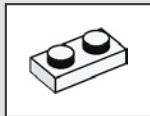



144

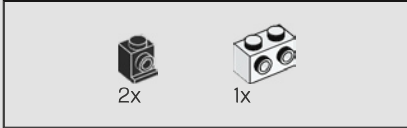
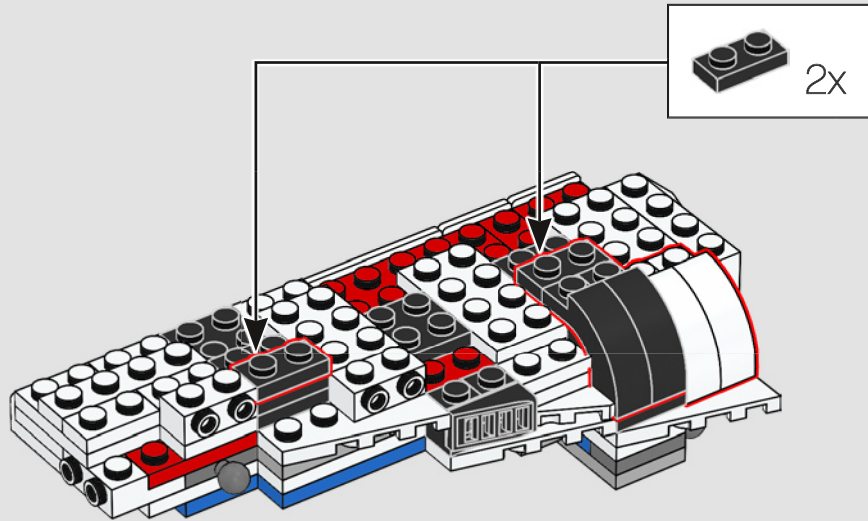

145

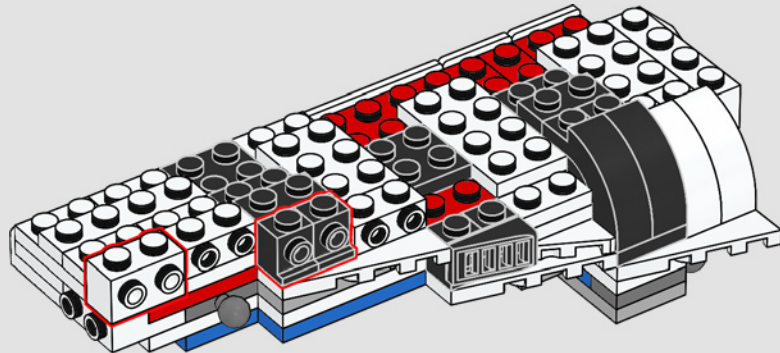

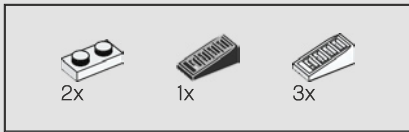

146

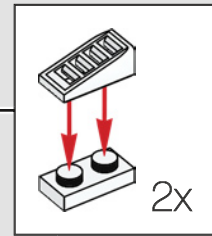
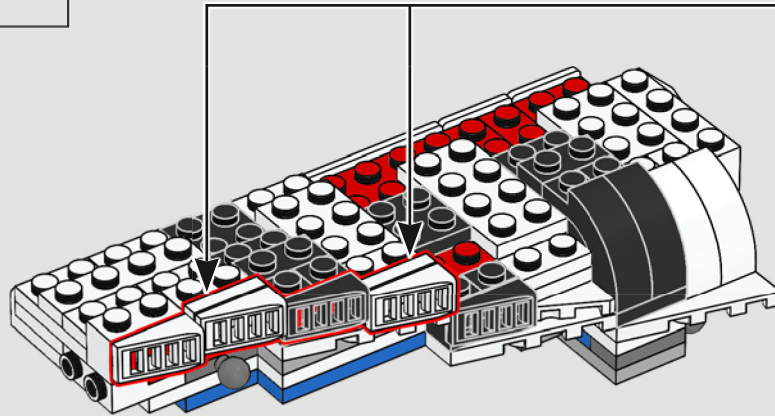

147

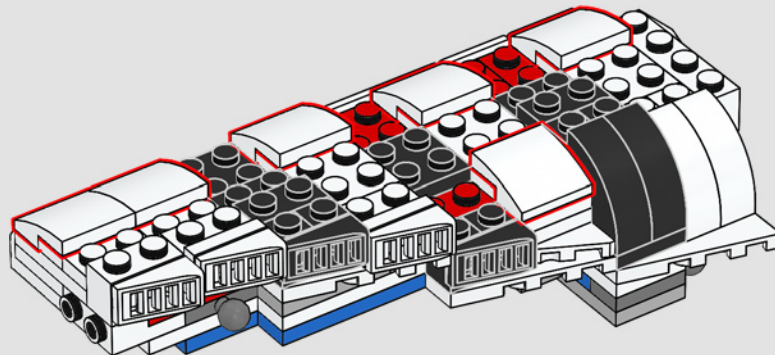

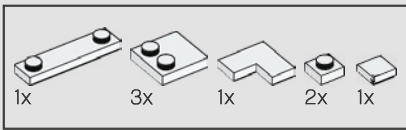

148

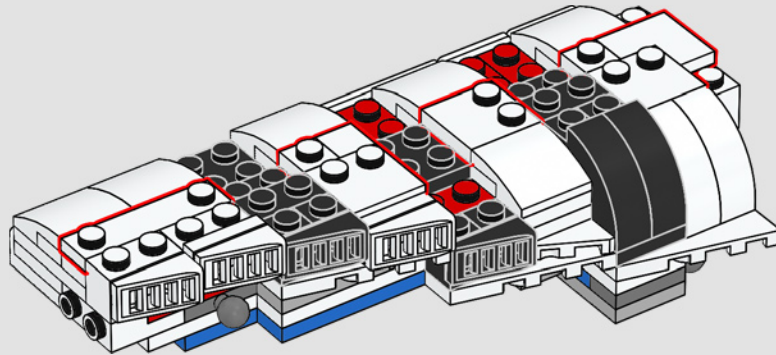

149

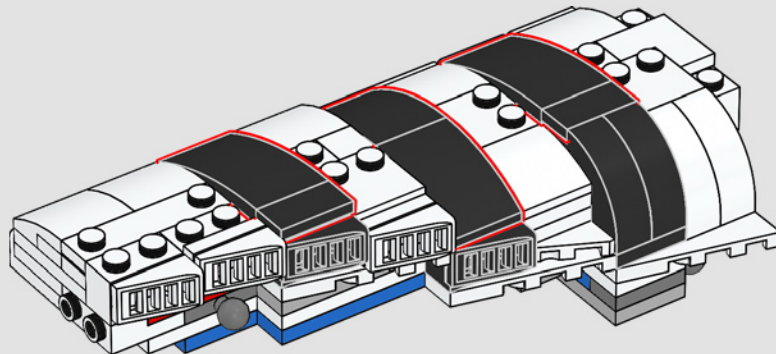

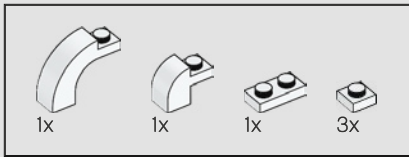

150

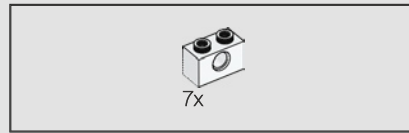
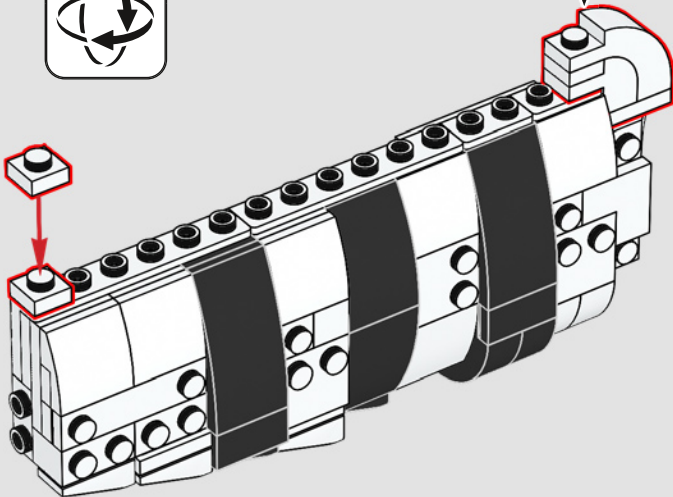
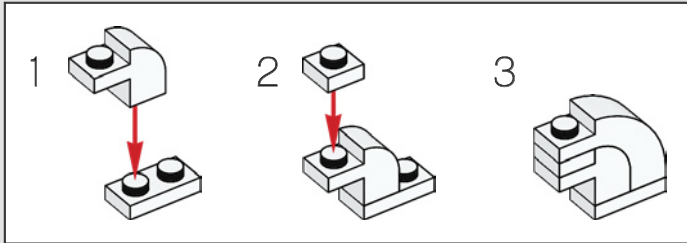

151

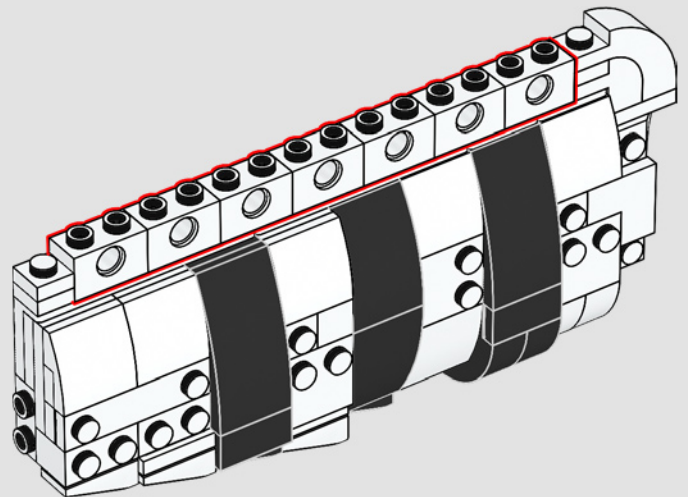

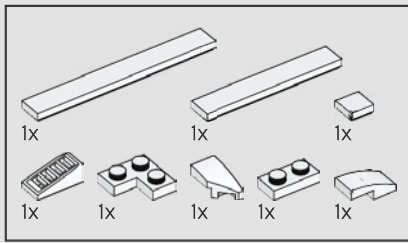

152

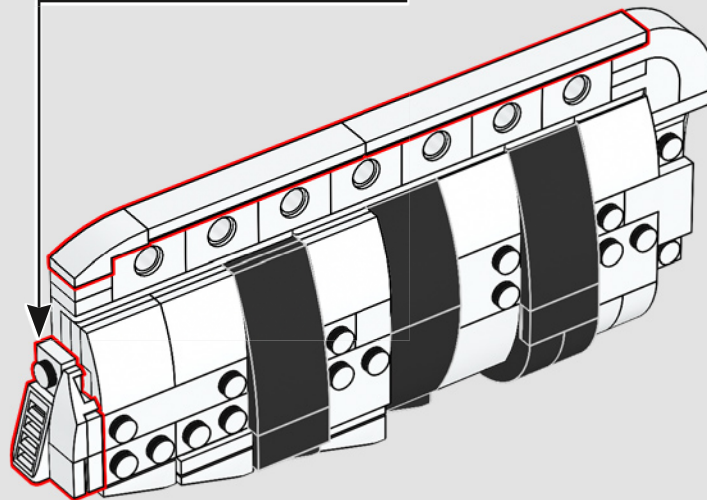
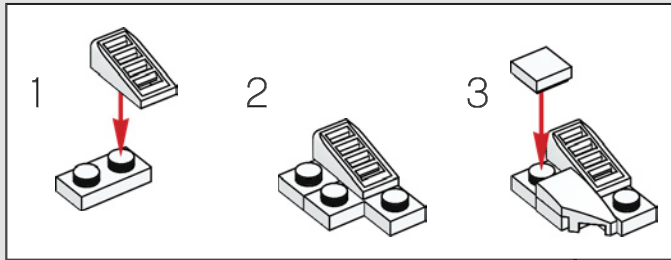



153

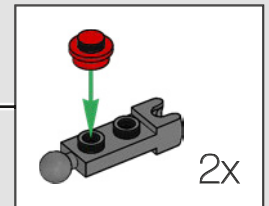
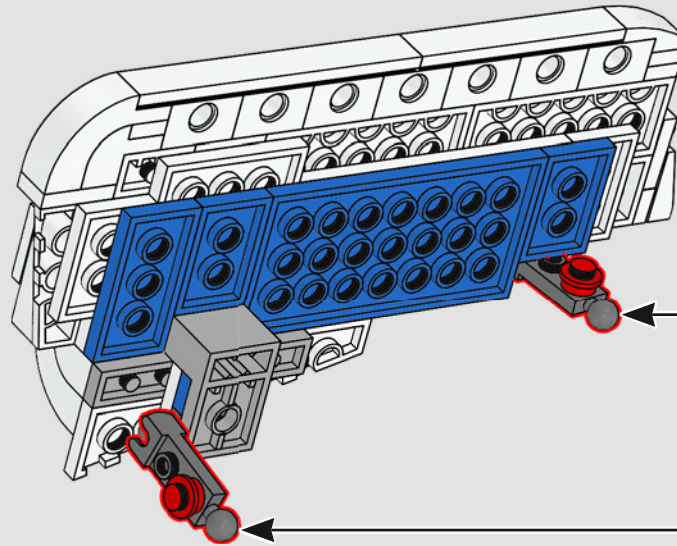

154

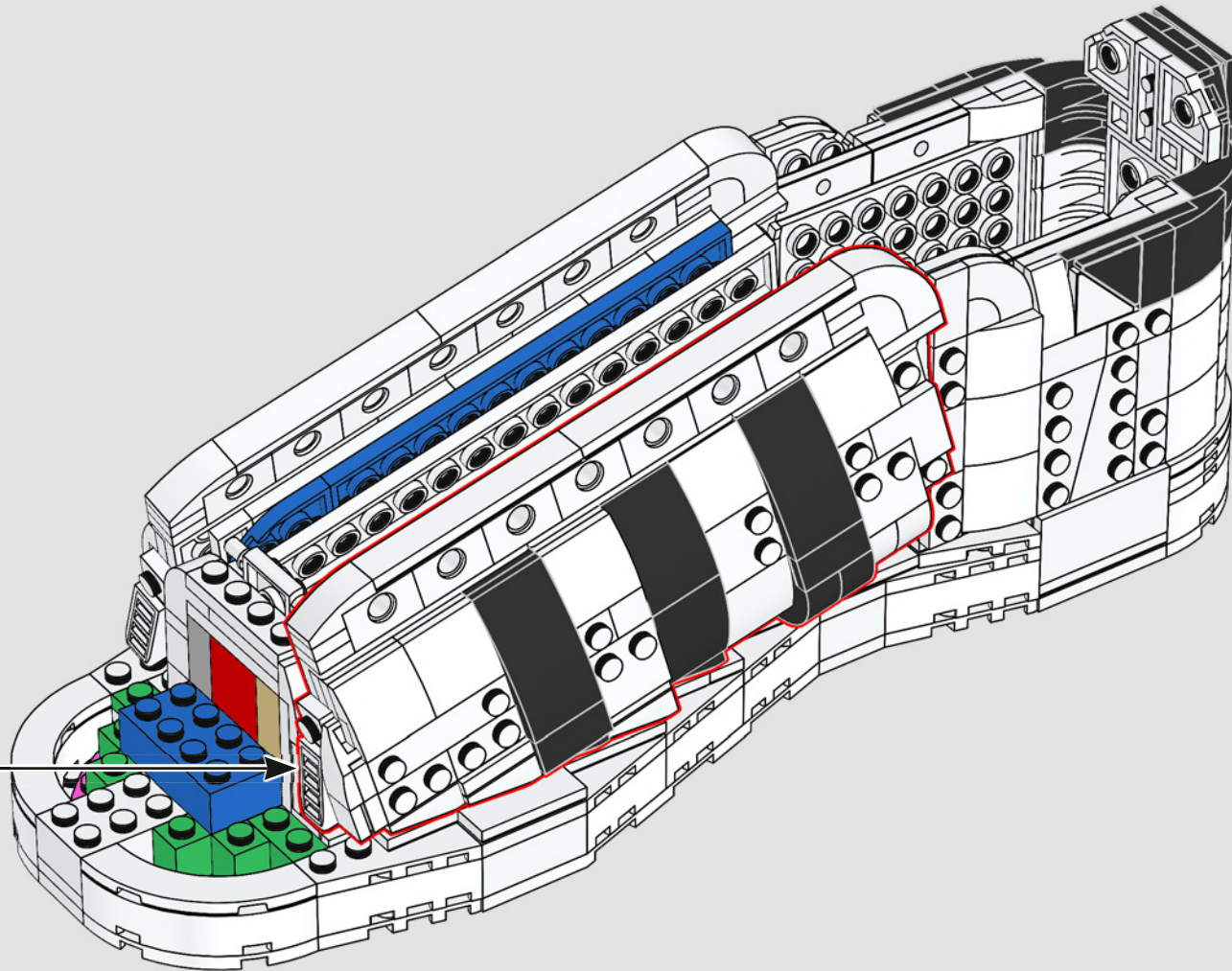

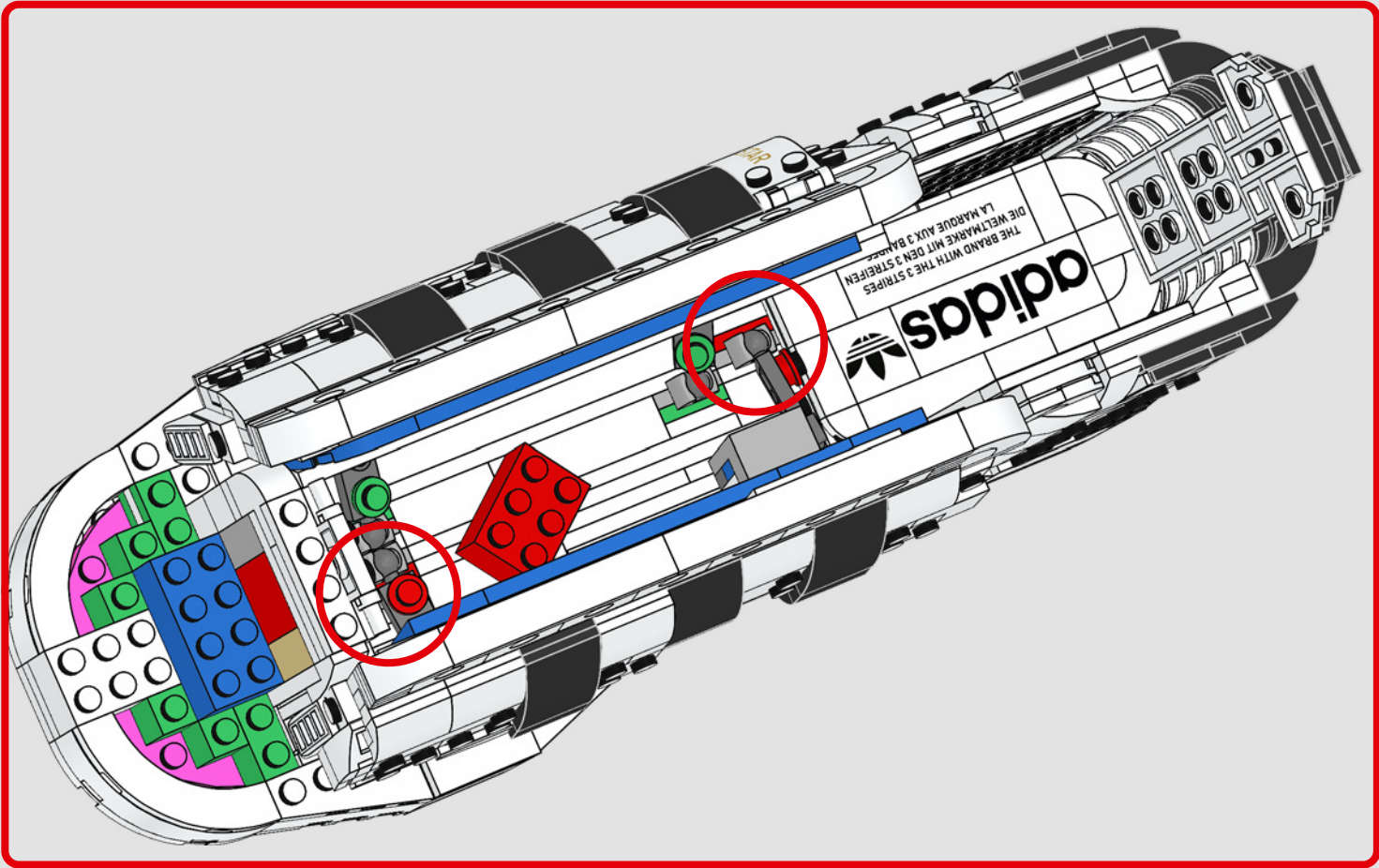

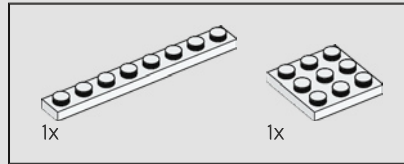
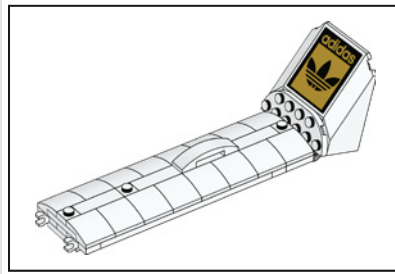
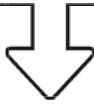

155

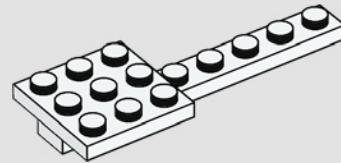

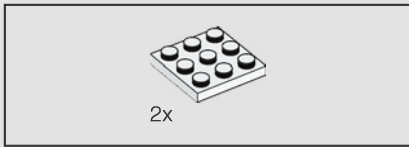

156

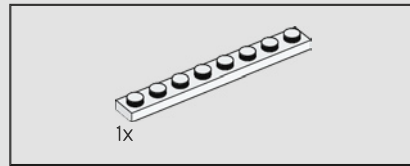
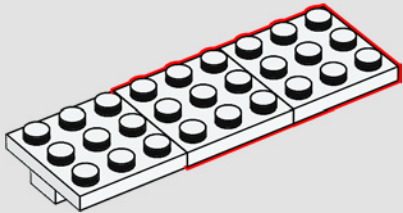

157

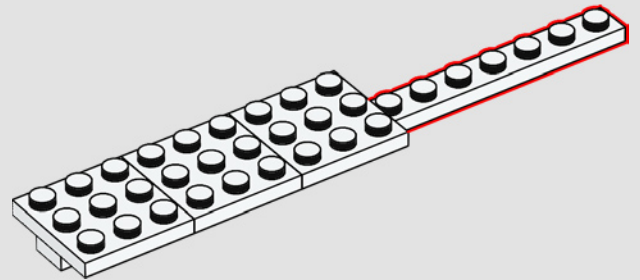

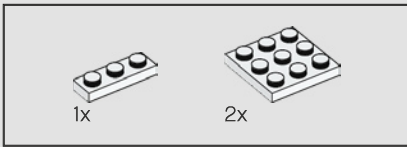

158

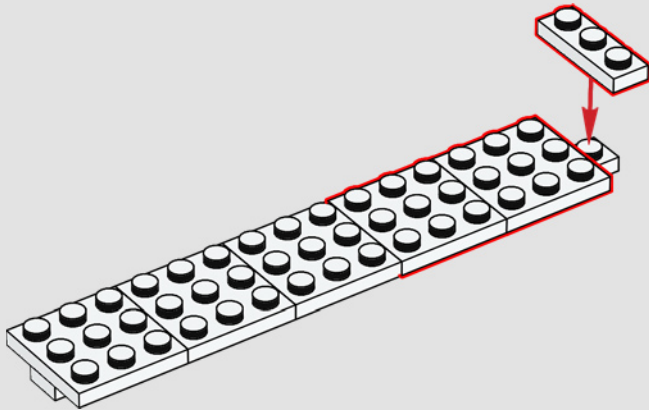

159

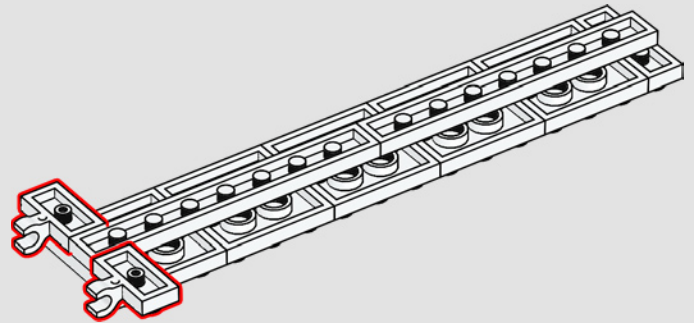

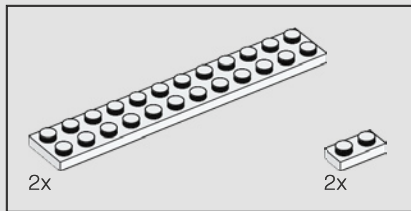

160

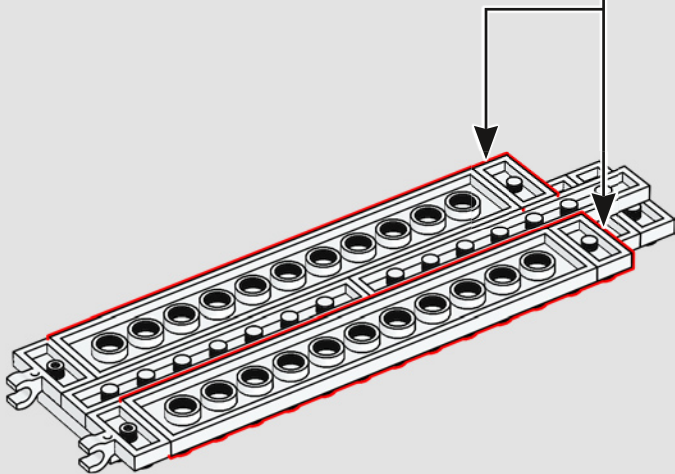
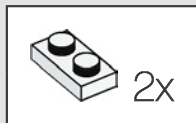

161

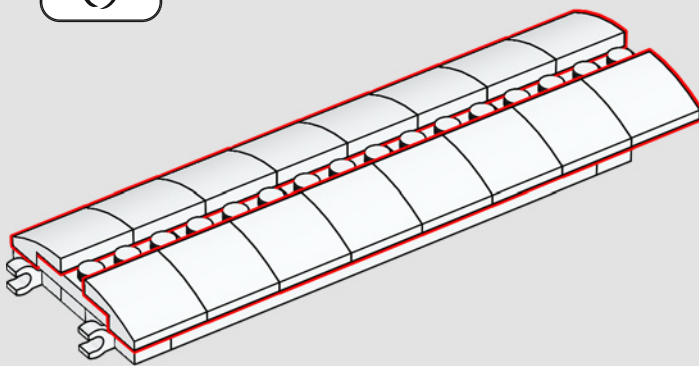

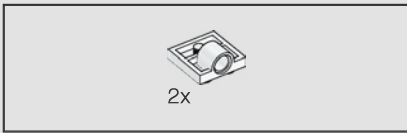

162

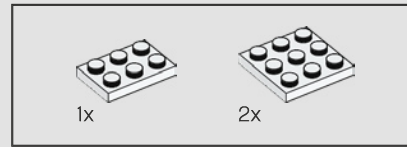
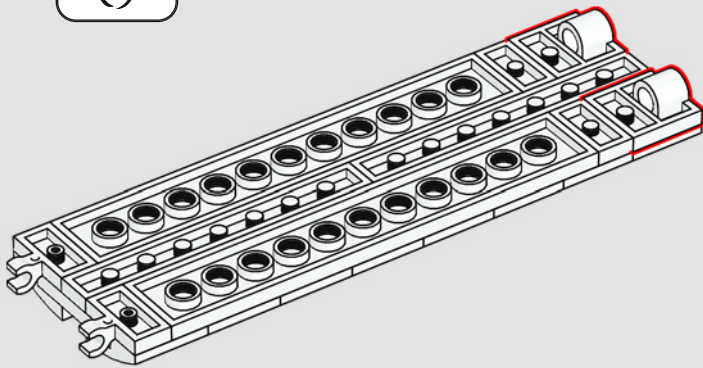

163

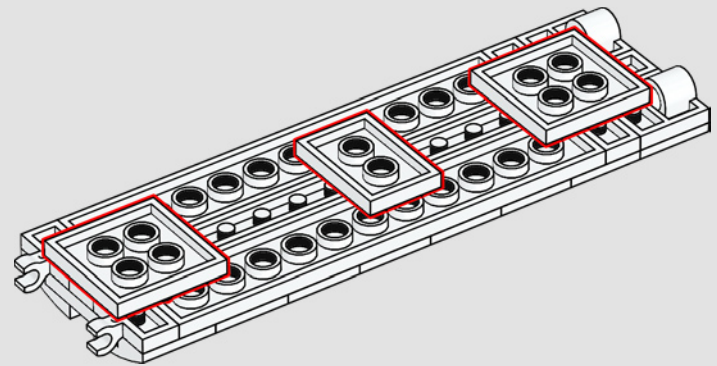

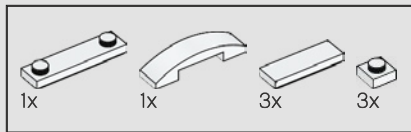

164

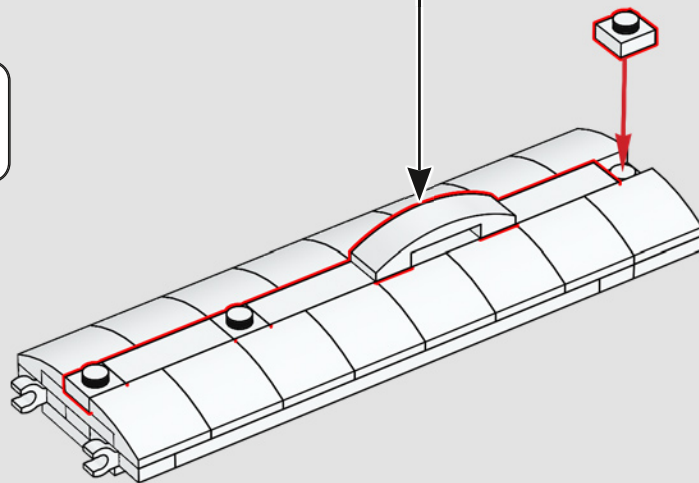
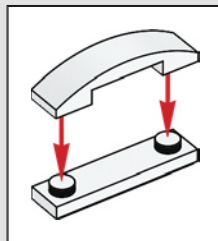

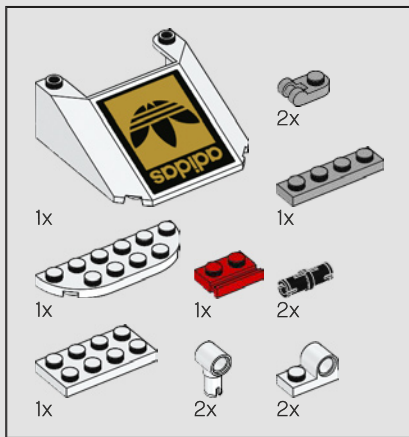

165

1

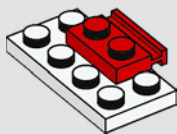

2

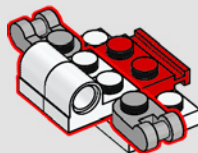

3

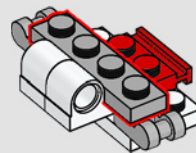

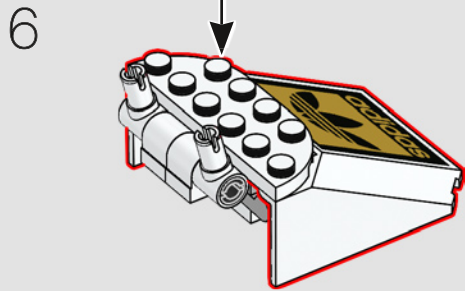
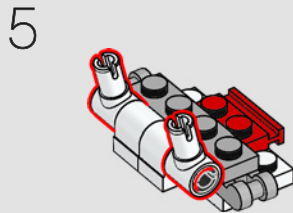
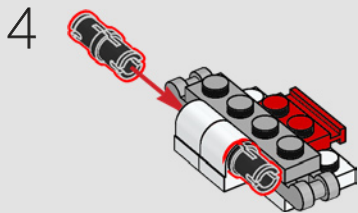

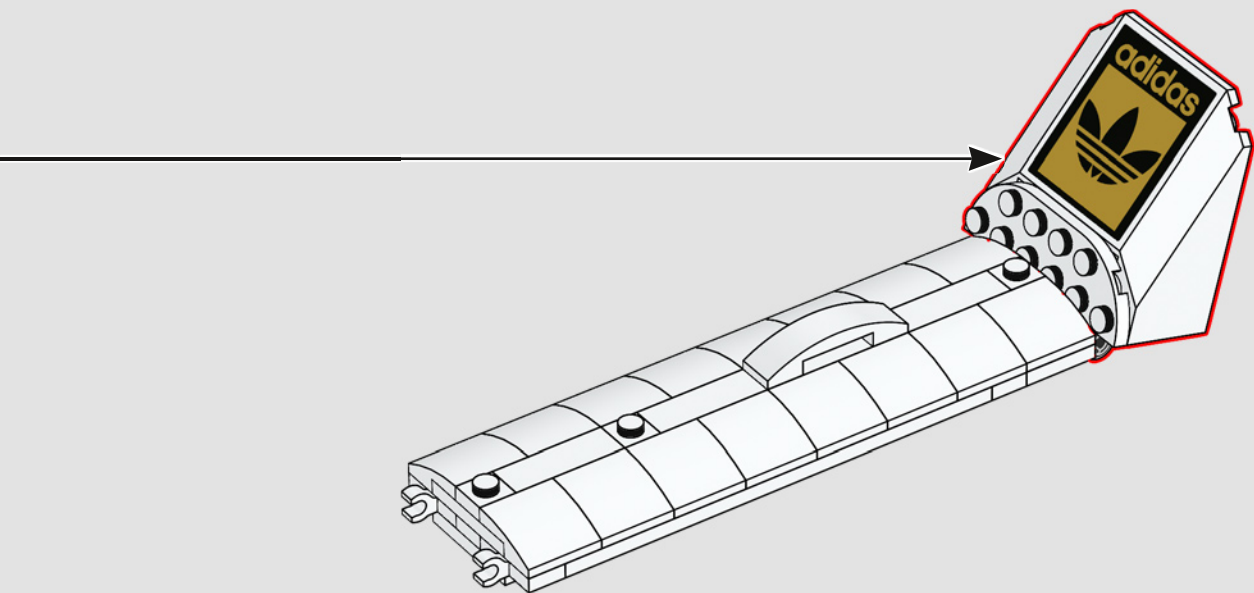

166

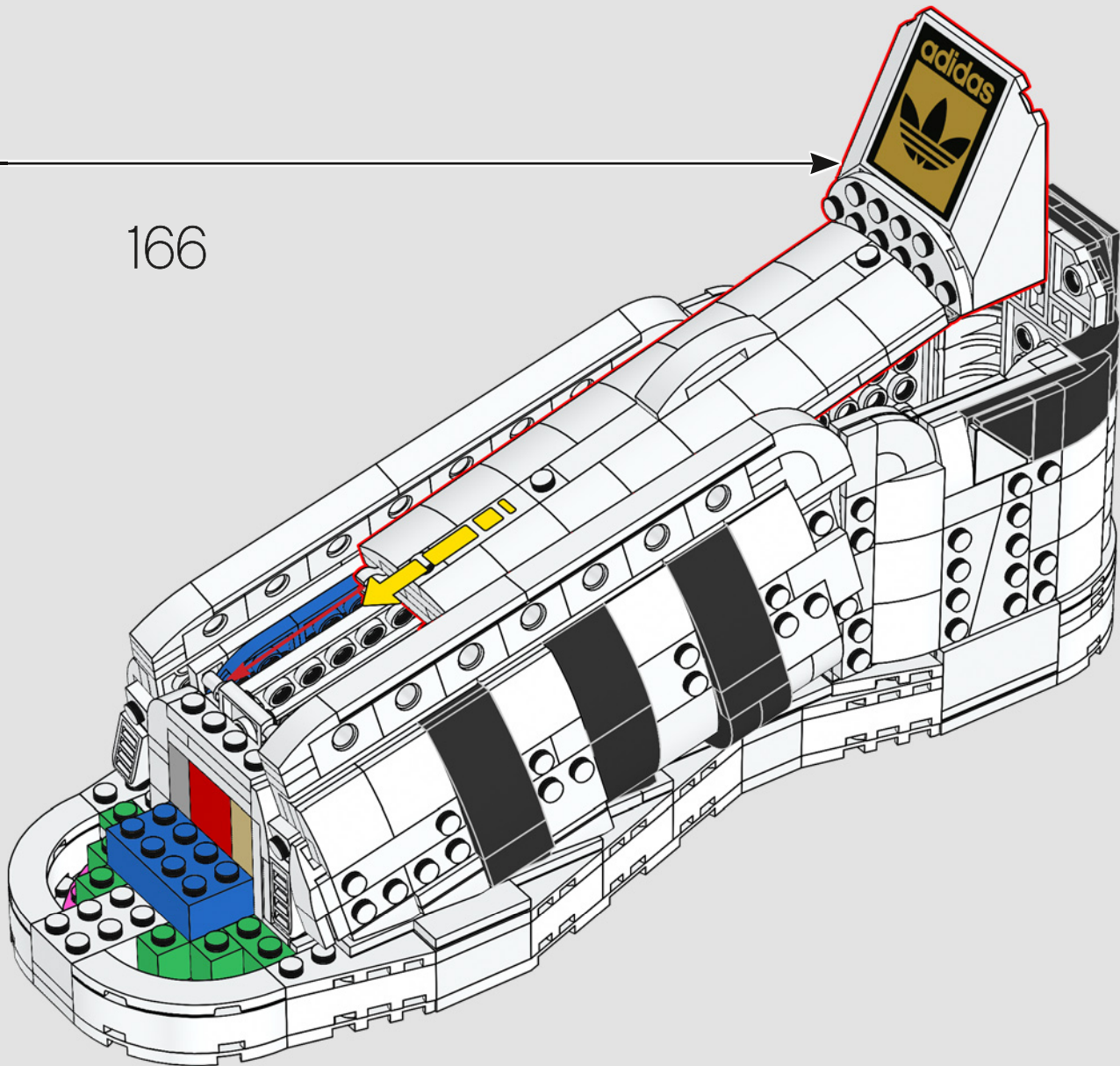

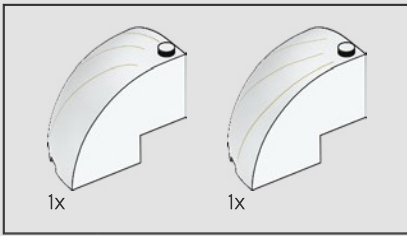

167

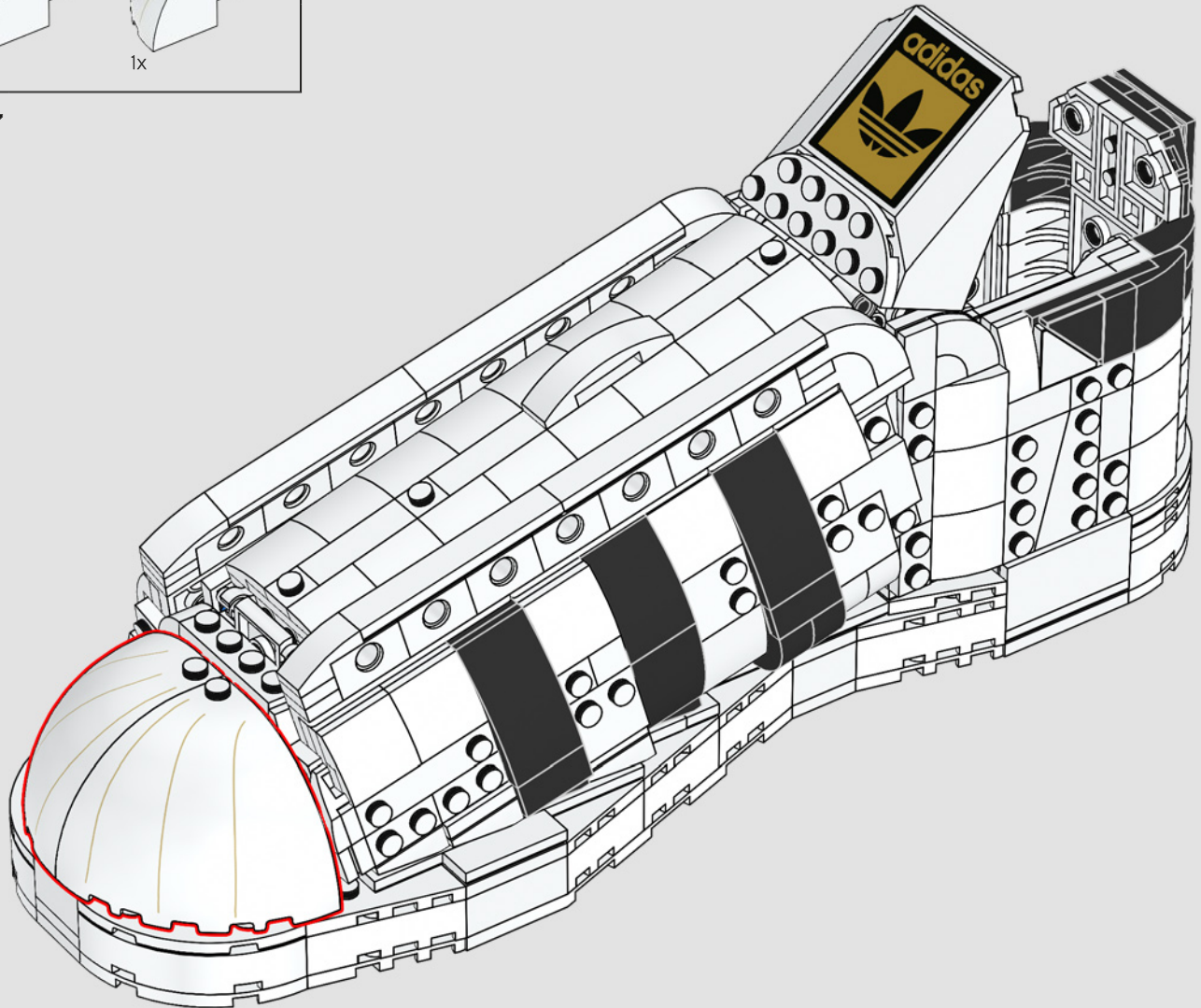



168

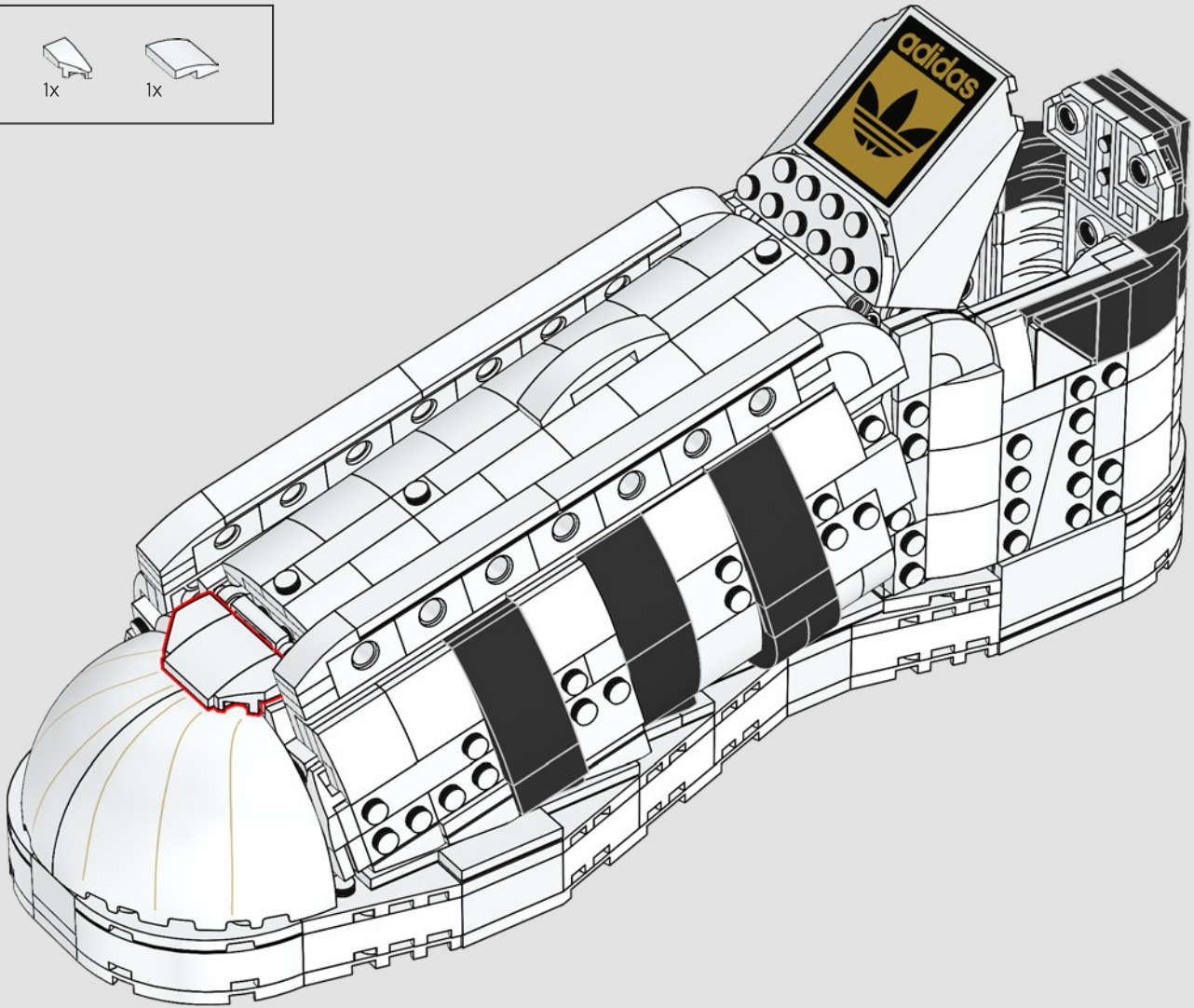

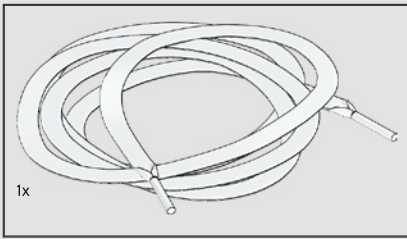

169

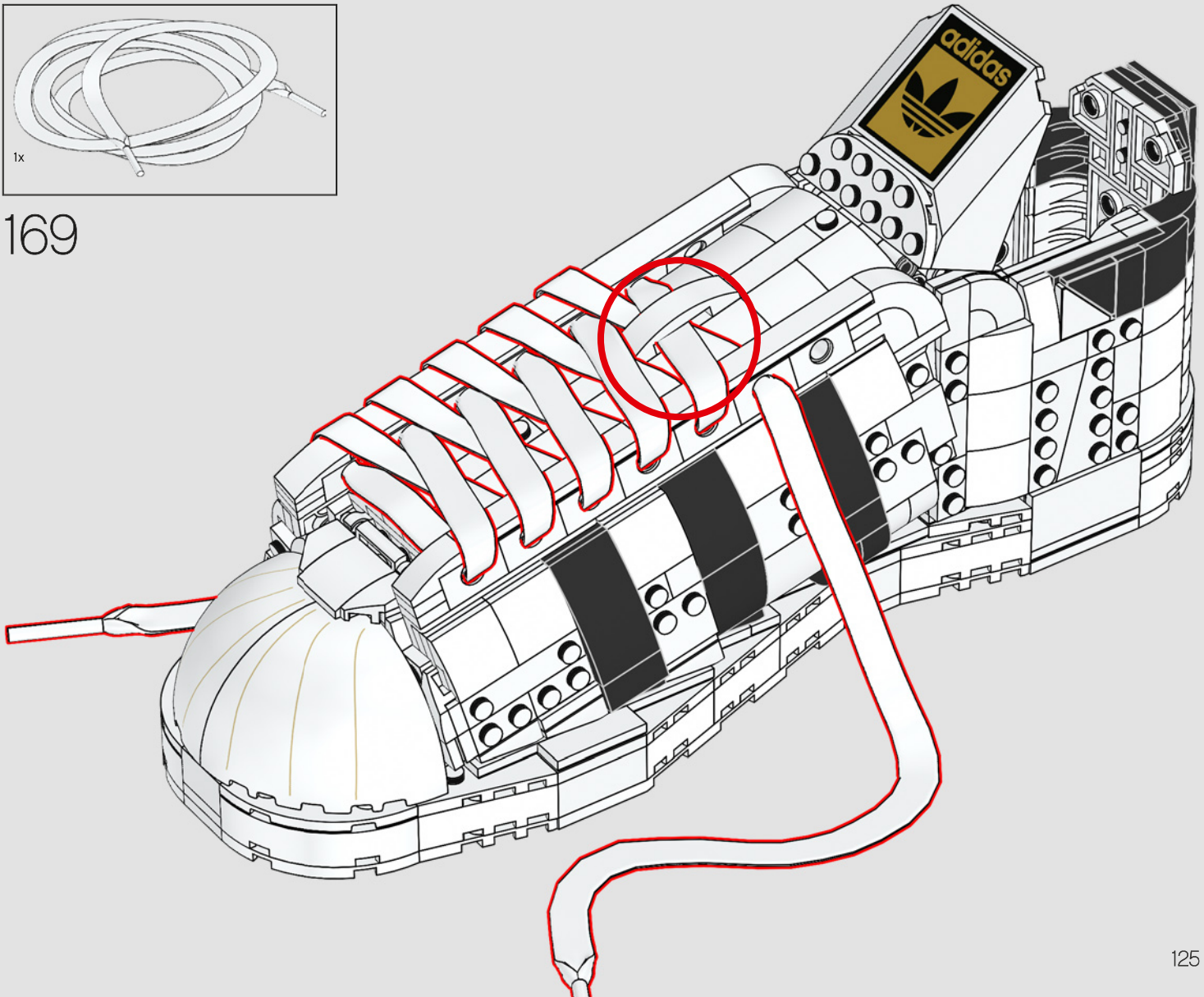

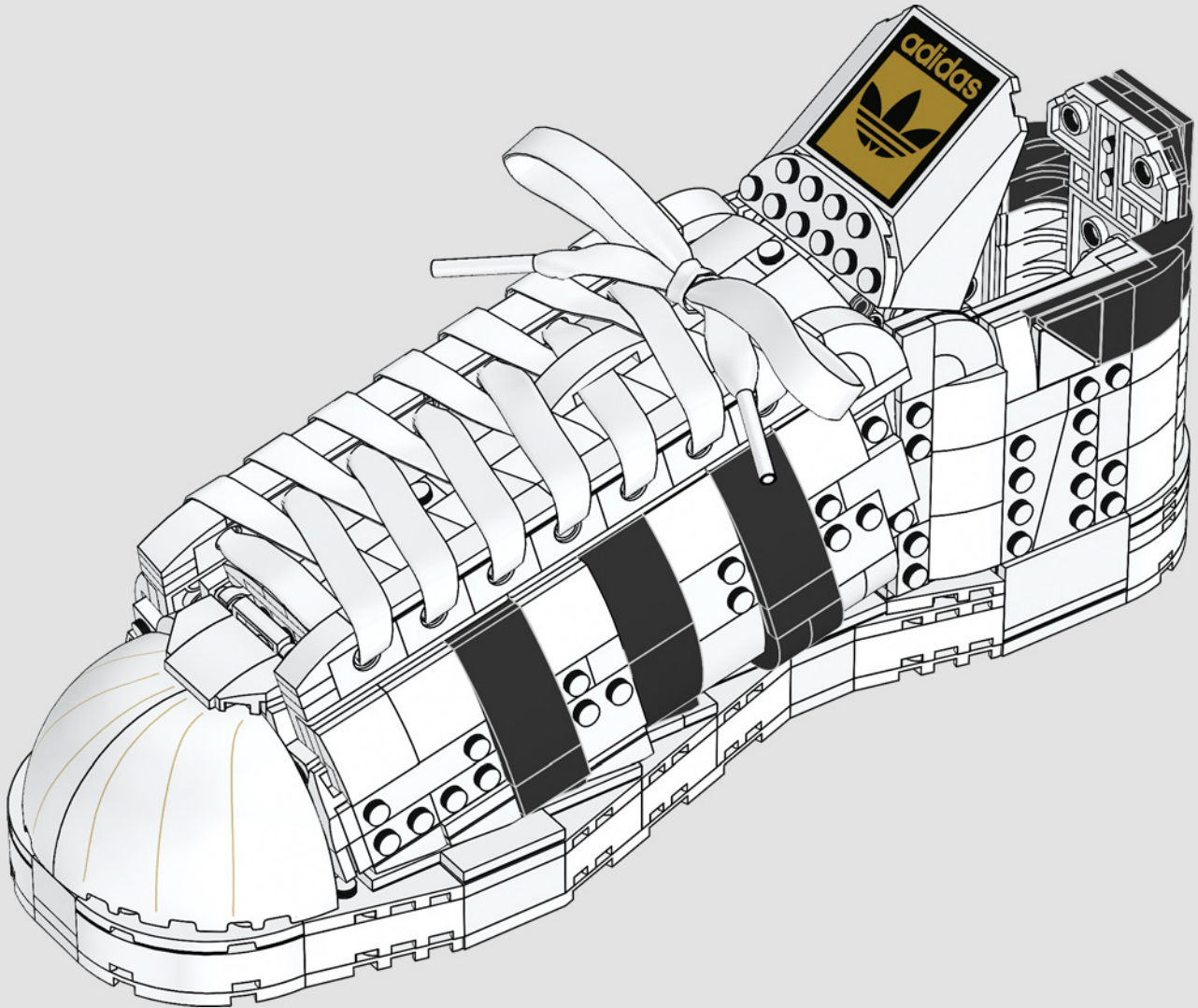

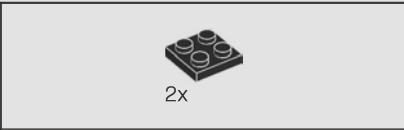

1

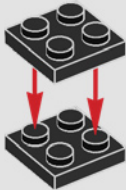

2

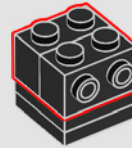

3

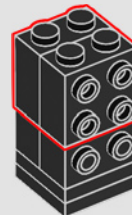



4

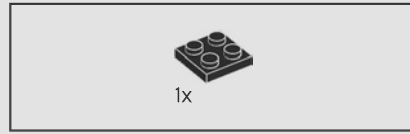
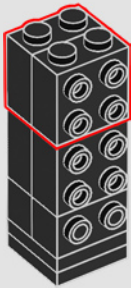

5

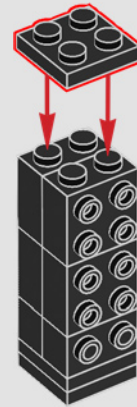



6

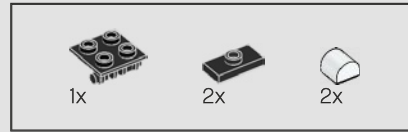
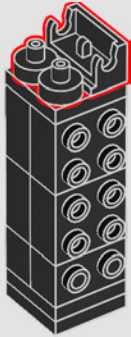

7

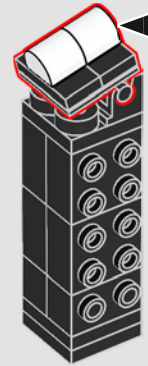
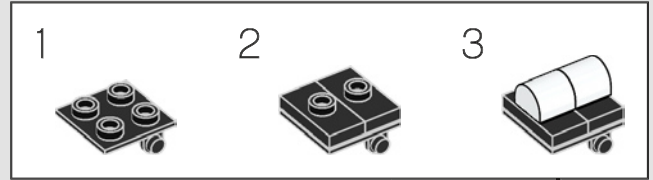

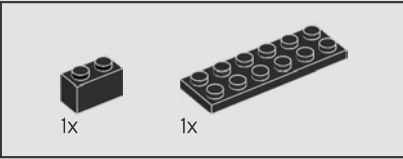
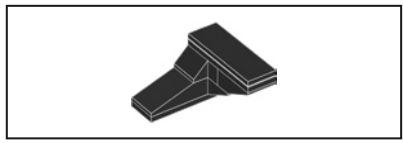

8

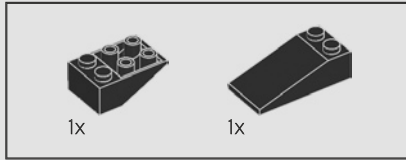
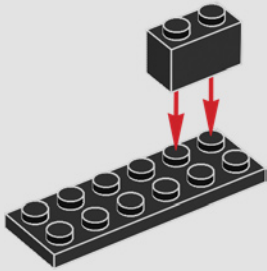

9

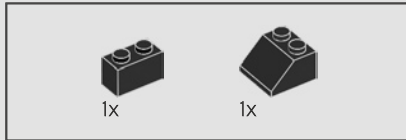
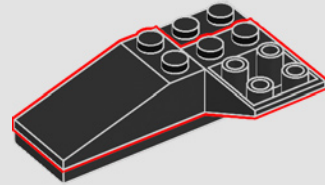

10

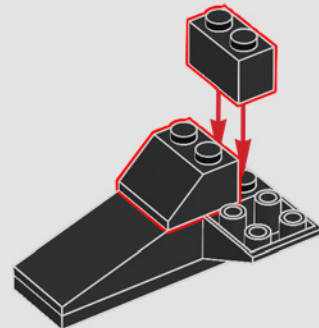

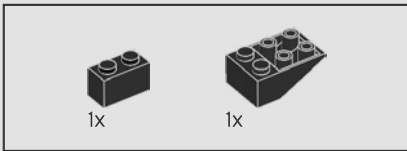

11

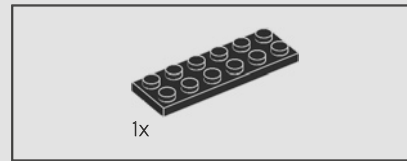
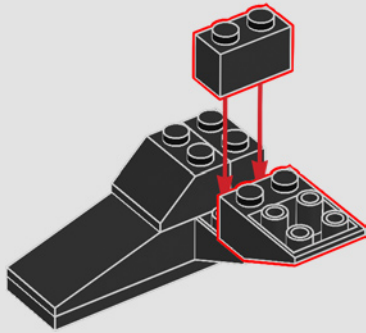

12

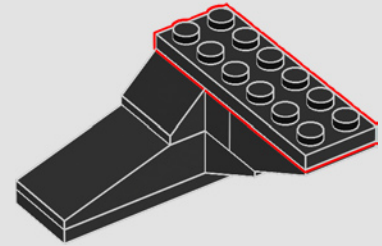

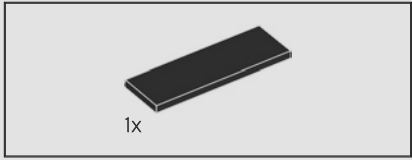

13

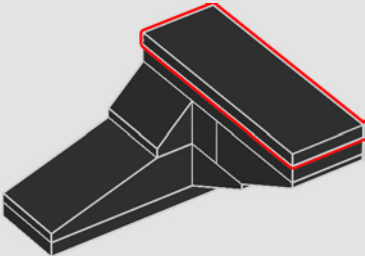

14

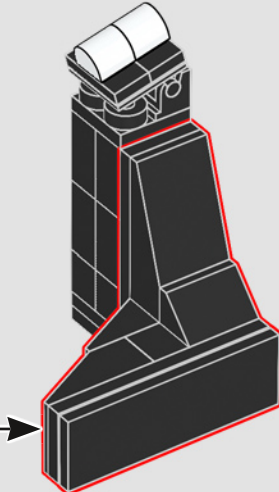

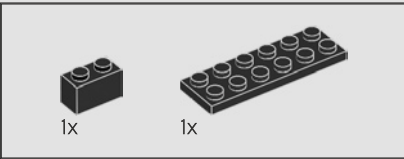
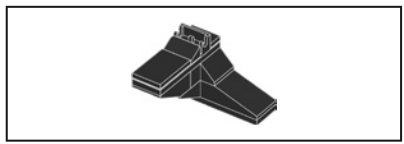

15

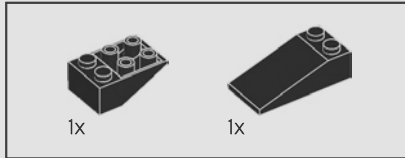
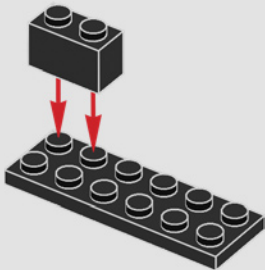

16

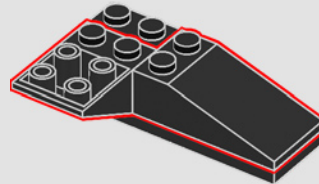

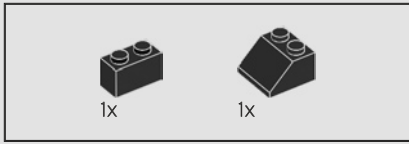

17

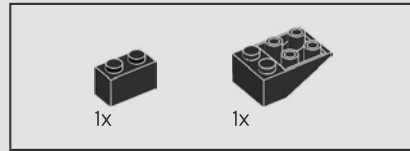
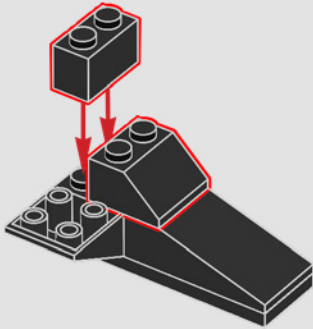

18

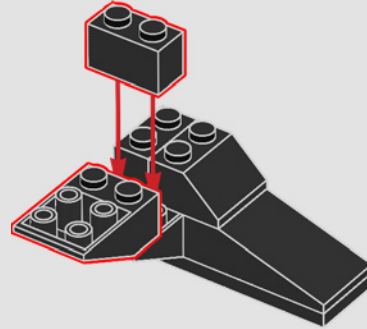

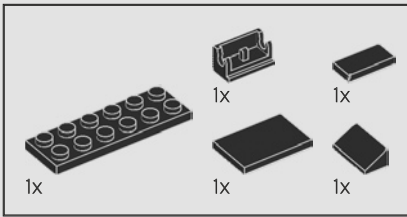

19

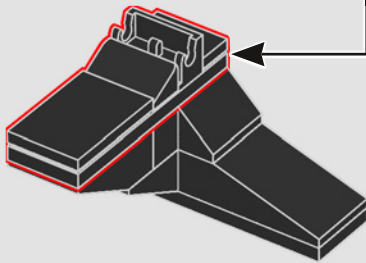
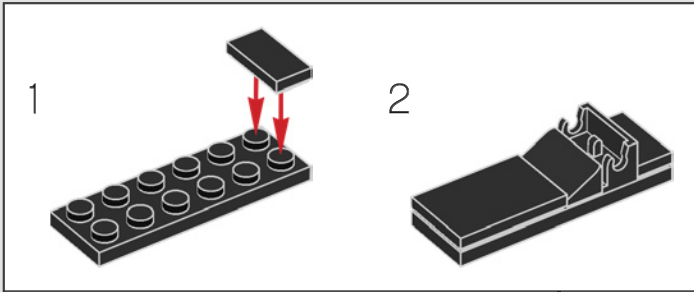

20

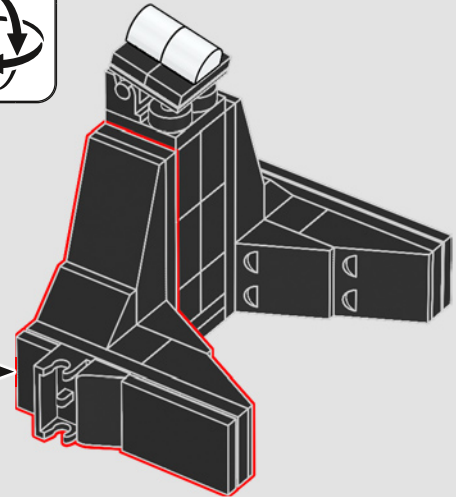

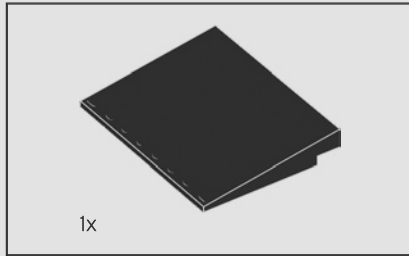

21

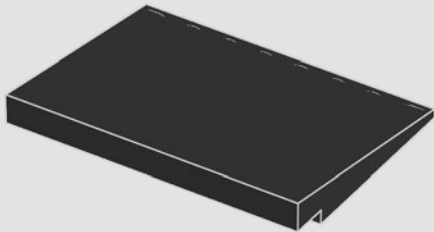

22

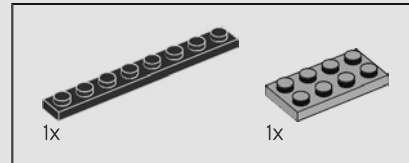

23

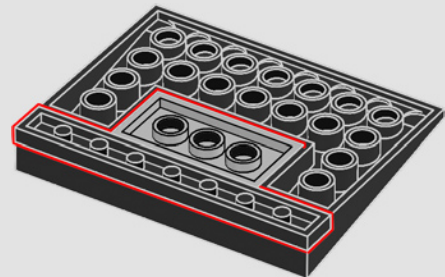

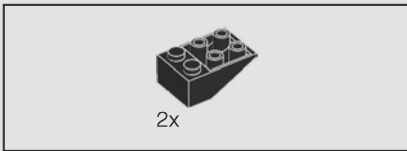

24

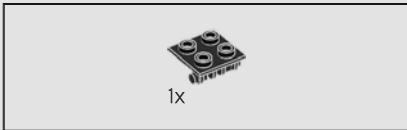
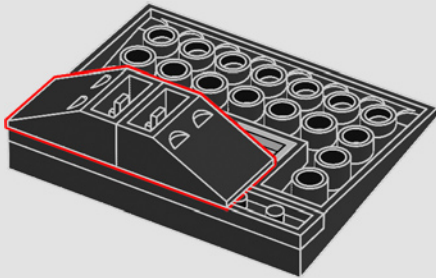

25

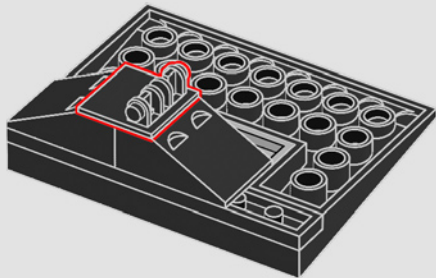

26



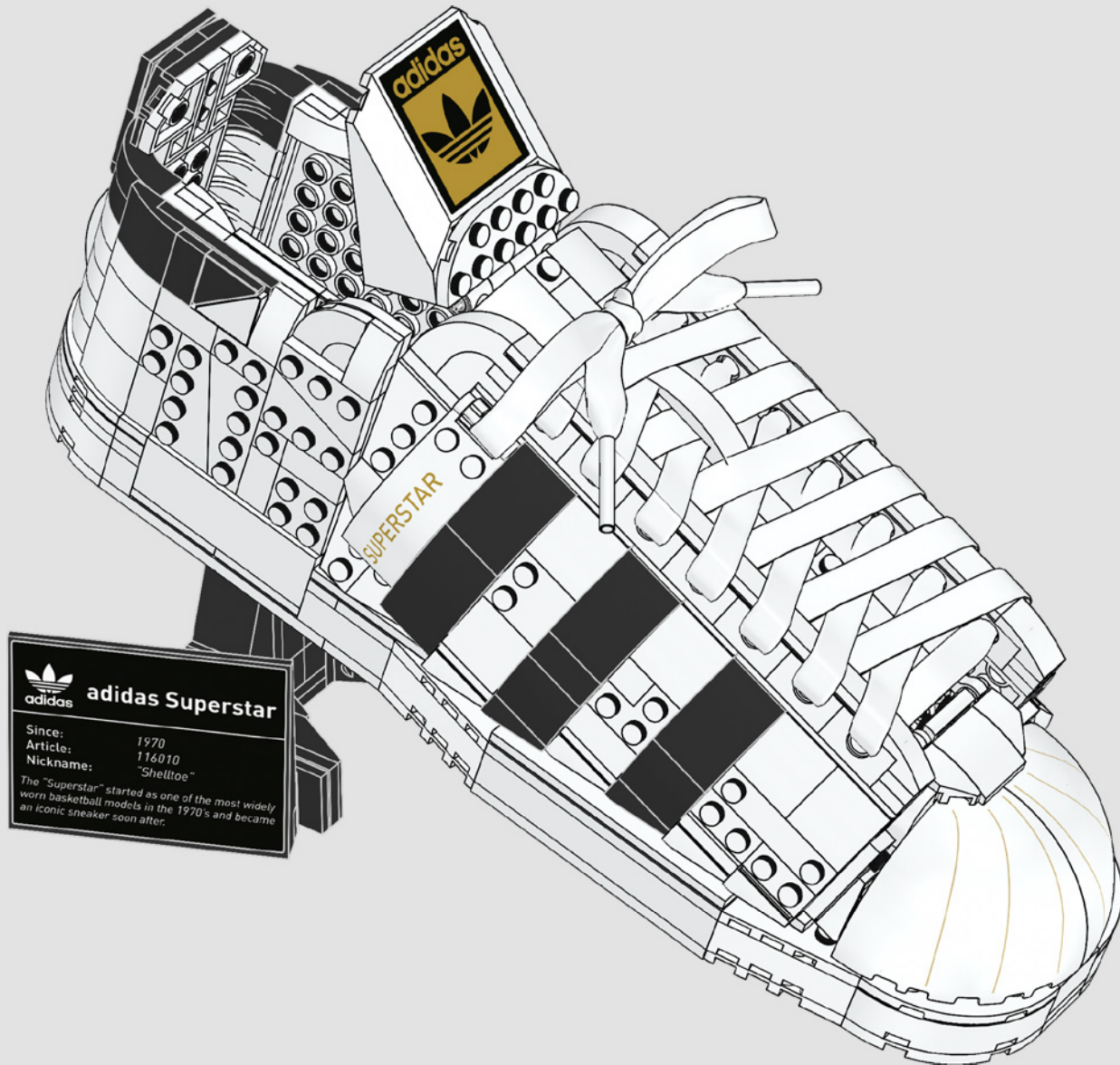

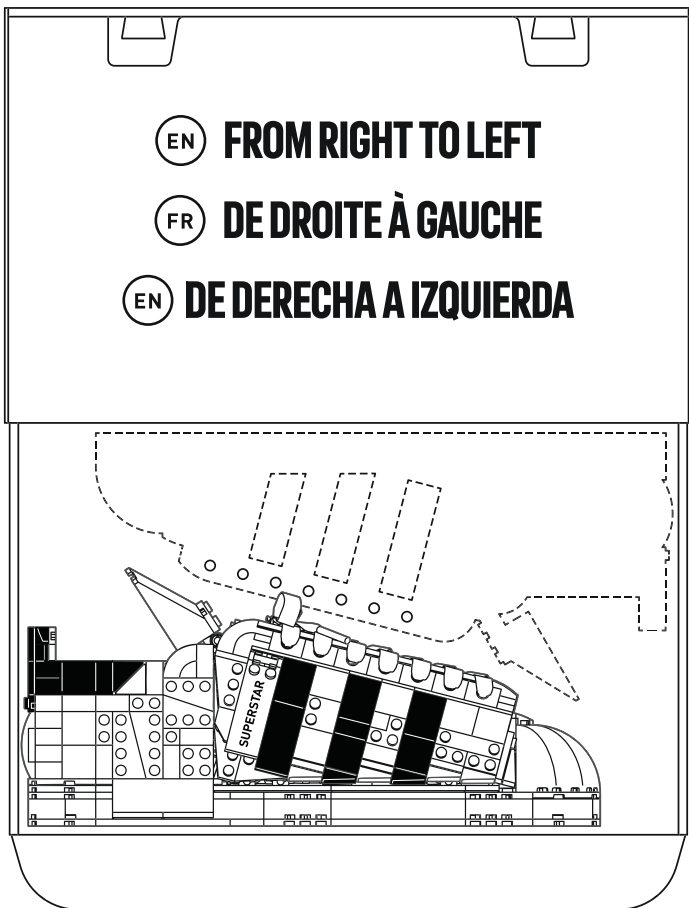

EN

HOW TO BUILD A LEFT SHOE

The model is based on a right, size US 7 1/2, UK 7, EU 40 2/3 shoe. If you'd like to build a left shoe instead, simply download the building instructions at www.LEGO.com/service/buildinginstructions/10282 and use the extra elements already included in this set.

FR

COMMENT CONSTRUIRE UNE CHAUSSURE GAUCHE

Le modèle est basé sur une chaussure droite de pointure US 7 1/2, GB 7, UE 40 2/3. Si vous souhaitez plutôt construire une chaussure gauche, téléchargez les instructions de montage au www.LEGO.com/service/buildinginstructions/10282 et utilisez les éléments supplémentaires déjà inclus dans cet ensemble.

ES

CÓMO CONSTRUIR UN ZAPATO IZQUIERDO

El modelo se basa en un zapato derecho de talla 7 1/2 (EE. UU.), 7 (Reino Unido) o 40 2/3 (Europa). Si prefieres construir el zapato izquierdo, simplemente descarga las instrucciones de construcción desde www.LEGO.com/service/buildinginstructions/10282 y usa las piezas adicionales incluidas en el set.

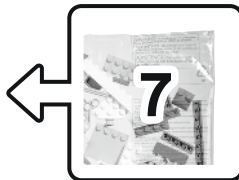

Download the PDF instructions for the adidas Originals Superstar left shoe build here:

Téléchargez les instructions de montage pour la chaussure gauche adidas Originals Superstar en format PDF ici :

Descarga aquí las instrucciones en para construir el zapato izquierdo adidas Originals Superstar en formato PDF:
LEGO.com/service/buildinginstructions/10282



FEEDBACK AND WIN



FEEDBACK AND WIN

Your feedback will help shape the future development of this product series.

Please visit:

FEEDBACK UND GEWINNEN

Dein Feedback trägt zur Weiterentwicklung dieser Produktreihe bei.

Geh auf:

COMMENTEZ ET GAGNEZ

Vos commentaires nous aideront à concevoir les futurs produits de cette gamme.

Rendez-vous sur :

COMENTA Y GANA

Tu opinión nos ayudará a dar forma al desarrollo de esta serie de productos en el futuro.

Visita:

反馈有奖

您的反馈将有助于我们在今后改进本系列产品。

请访问：

[LEGO.com/productfeedback](https://www.lego.com/productfeedback)

By completing, you will automatically enter a drawing to win a LEGO® set.

Terms & Conditions apply.

Durch Ausfüllen nimmst du automatisch an der Verlosung eines LEGO® Preises teil.

Es gelten die Teilnahmebedingungen.

En envoyant vos commentaires, vous serez automatiquement inscrit(e) à un tirage au sort qui vous permettra de remporter un prix LEGO®.

Offre soumise à conditions.

Al contestar, participarás automáticamente en el sorteo y podrás ganar un set LEGO®.

Sujeto a Términos y Condiciones.

完成我们的反馈调查，即可自动进入抽奖环节，赢取乐高®套装。

适用《条款和条件》。

LEGO and the LEGO logo are trademarks of the/son des marques de commerce du/son marcas registradas de LEGO Group.
©2021 The LEGO Group.

© adidas, the Trefoil logo and the 3-Stripes mark are registered trademarks of adidas AG used under licence by LEGO System A/S

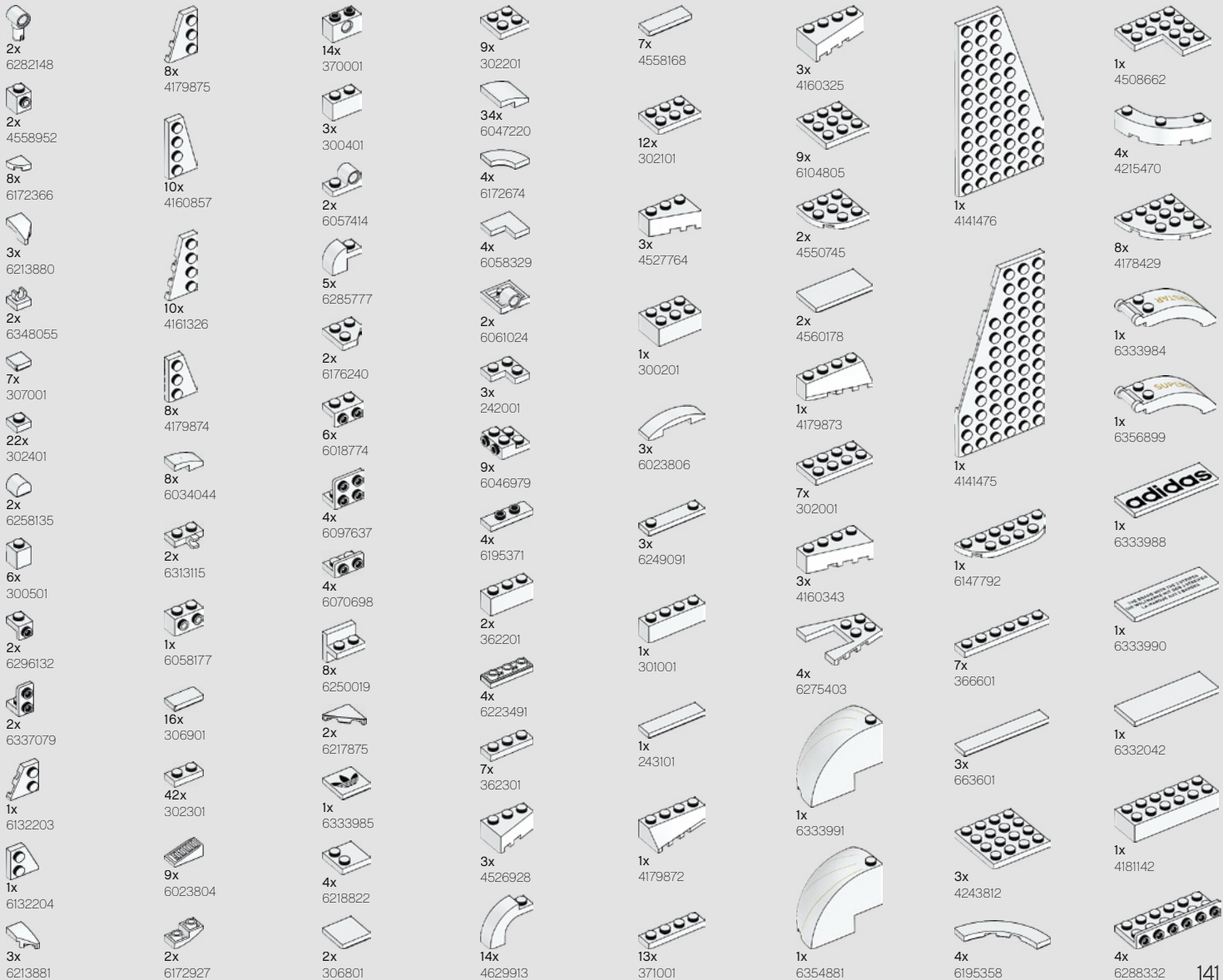

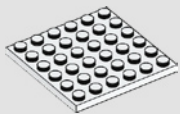

1x
4144012

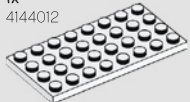

1x
303501

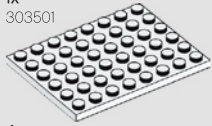

4x
303601



4x
4514842

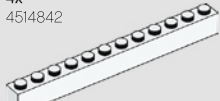

1x
611201

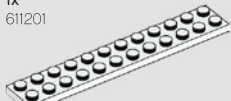

3x
244501

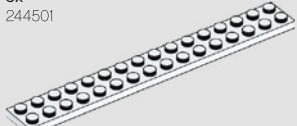

1x
4119227

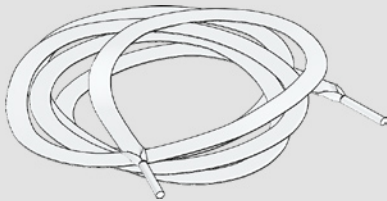

1x
6342961



1x
4599044



7x
346001



9x
416201



1x
300801

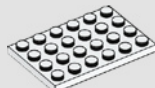

1x
303201



4x
303401



1x
6033776



1x
6354882

2x
614121

2x
302321

1x
306921

1x
6135130

1x
4612575

1x
6219819

1x
302221

1x
302121

1x
300221

2x
371021

2x
303221

2x
300426

1x
6256923

2x
4616342

2x
6186675

2x
4504382

1x
6181720

2x
302426

2x
6172383

4x
407026

1x
6181713

1x
4548180

2x
6279875

4x
4541191

6x
300426

2x
6092585

2x
6138173

4x
302326

2x
6184784

6x
306926

2x
393726

4x
6275806

2x
6214807

7x
302226

4x
6053077

2x
303926

2x
4124096

2x
6052126

6x
4618880

1x
6333986

1x
6333987

1x
6162892

5x
6147790

5x
302126

6x
374726

2x
371026

3x
302026

3x
4647286

2x
4185583

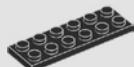

4x
379526



1x
6318582



1x
346026

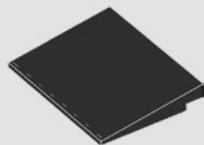

1x
4161067

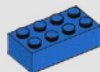

1x
300123



1x
346023



1x
447723

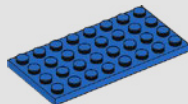

1x
303523



1x
4528850



1x
302423



7x
302323



2x
6266252



1x
302223



2x
362323



3x
302123



1x
371023



1x
4212411



1x
6288176



7x
4560180



3x
302023



1x
383223



1x
383223



1x
383223



1x
6225242



2x
6225246



2x
6266209



1x
4211398



4x
6043656



1x
4211397



2x
4211445



2x
6015347



1x
4211395



1x
6171067



2x
4211438



1x
6232135



1x
6232135



1x
6232135



1x
6232135



3x
4569058



2x
4107736



7x
302328



1x
6352550



3x
4125281



2x
4109679



2x
302128



1x
4112838



3x
371028



1x
302028



2x
383228



1x
4106356



1x
4106356



1x
4106356



1x
4106356

1x
4106356



1x
366628



2x
4181135

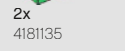

2x
6092583

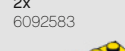

1x
366624

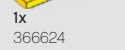

3x
6039479

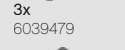

1x
6123814

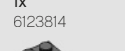

1x
4210635

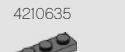

1x
4211133



4x
6039482



1x
4211043



1x
4521572



1x
4210802



1x
4256149



1x
6134869



1x
6240515

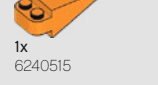

1x
6240515

Customer Service

Kundenservice

Service Consommateurs

Servicio Al Consumidor

LEGO.com/service or dial



: 00800 5346 5555

: 1-800-422-5346

