

FAIRGROUND COLLECTION
HAUNTED
HOUSE



LEGO®



Die Designer (von links nach rechts):

Niek „Elbow“ van Slagmaat
Milan „The Spice“ Madge
Carl „Mad Dog“ Merriam
Michael „Mike“ Psiaki
Austin „Pretty Pictures“ Carlson

Wir haben es geschafft.

204. Tag

Diese Expedition hatte es in sich. Am 20. Tag hätte mich das Fieber fast dahingerafft. Zwei Wochen später wäre mir fast der Fluch der Mumie zum Verhängnis geworden. Jedes Mal, wenn ich einen Stein platzierte ... schien eine weitere Woche vergangen zu sein! Glücklicherweise haben mich treue Gefährten auf dieses Abenteuer begleitet. Ohne ihre Hilfe wäre ich verloren gewesen. Nach vielen Sackgassen und plötzlichen Baustopps ... ist das Haus endlich fertig!

- Carl Merriam, Expeditionsleiter

PS: Hört niemals auf, Modelle zu bauen!

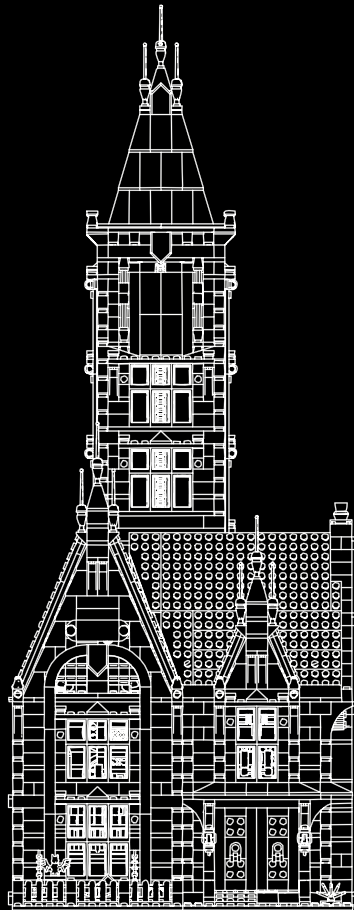

GEISTERHAUS

Das Geisterhaus ist eine gruselige Jahrmarktattraktion.

Dort wohnte einst Samuel von Barron, einer der größten Schurken der Welt. Auf der Suche nach alten Artefakten für seine zusammengeklautete Sammlung bereiste er die ganze Welt.

Aber vielleicht hat er sich zu viel unter den Nagel gerissen! Nachdem sich Barron den Rubin „Re-Gou“ geschnappt hatte, belegte der Pharao Hotep Samuels Haus für die nächsten 1000 Generationen mit einem Fluch. Tritt ein, falls du dich traust!

Lies die ganze Geschichte auf:

LEGO.COM/HAUNTEDHOUSE

Bereit für Powered Up Funktionen



10273



88009



88008 x2



LEGO® Powered Up
LEGO.com/apps



LADE DIR DIE KOSTENLOSE APP HERUNTER

ELEKTROMOTOREN

SMARTPHONE ODER TABLET ERFORDERLICH,
ABER NICHT ENTHALTEN

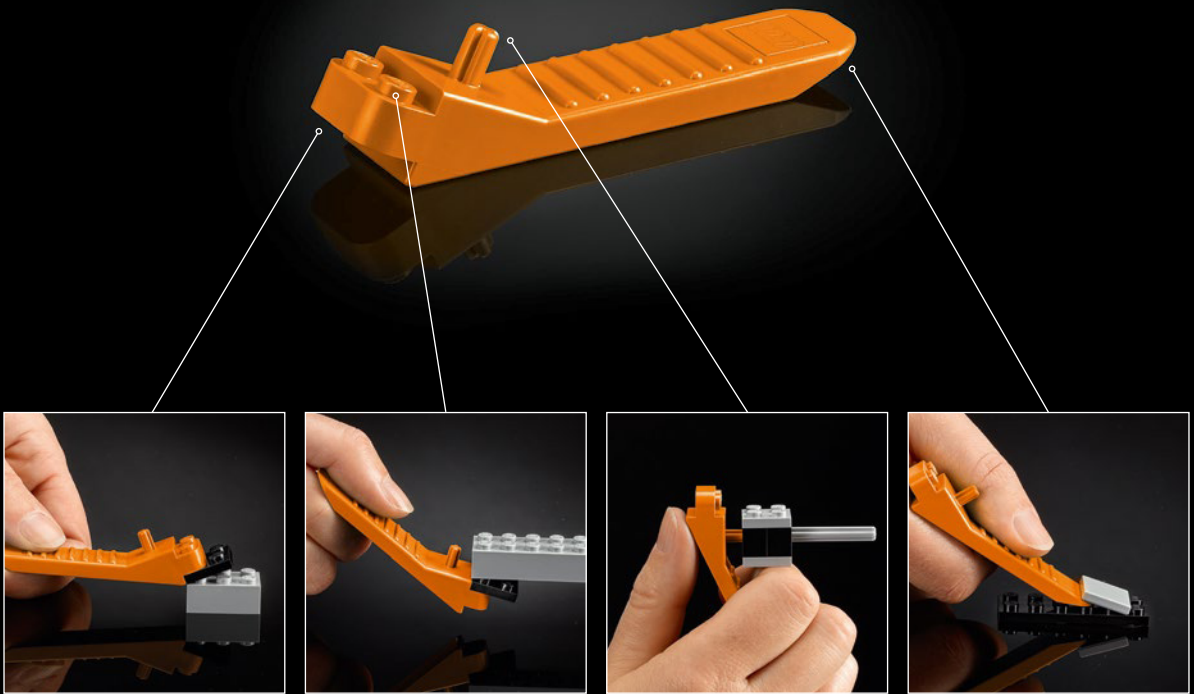

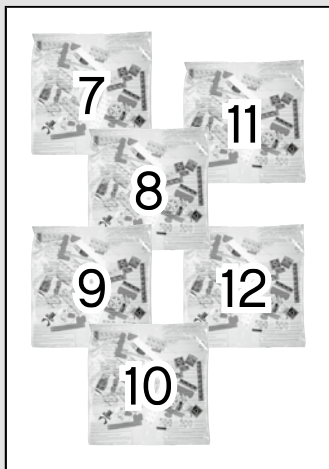
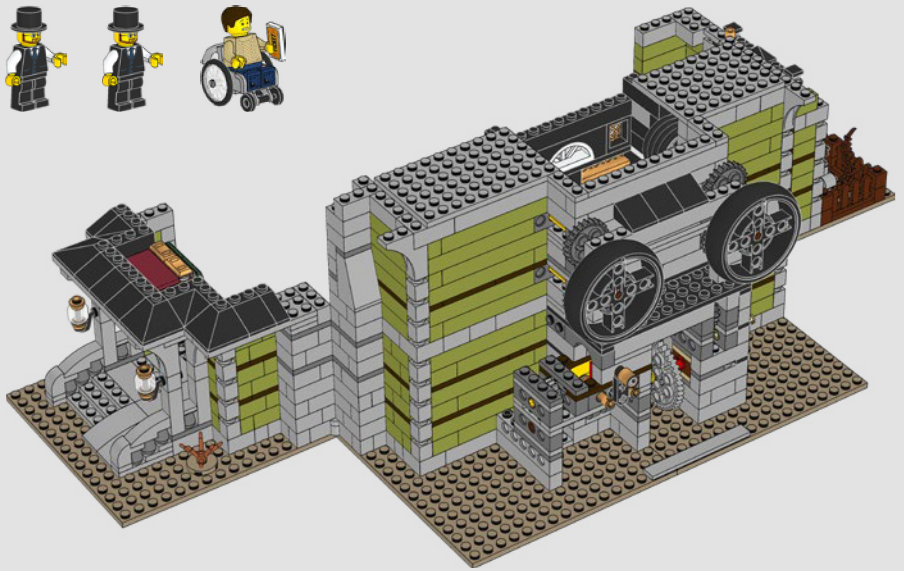
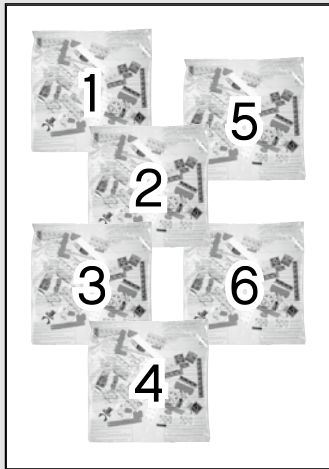

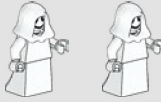
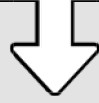
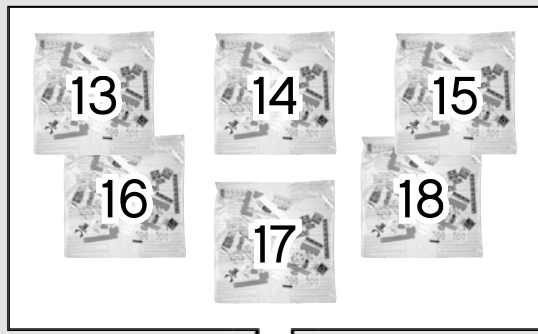

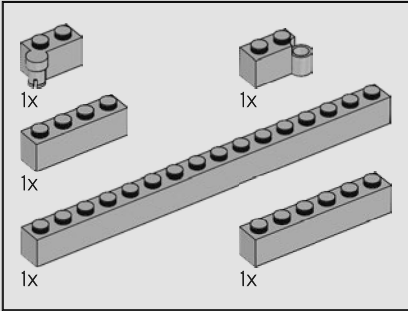
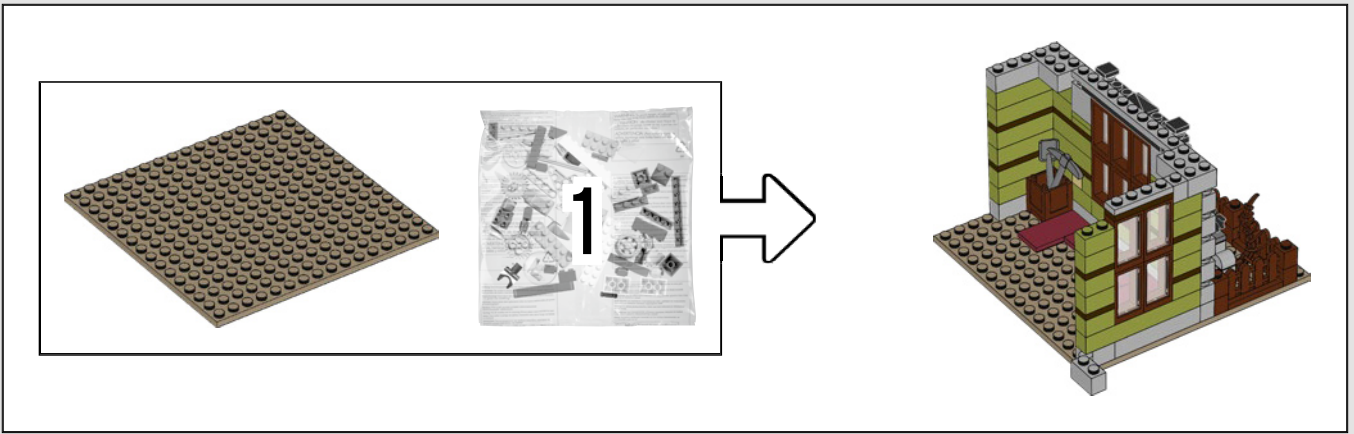

1

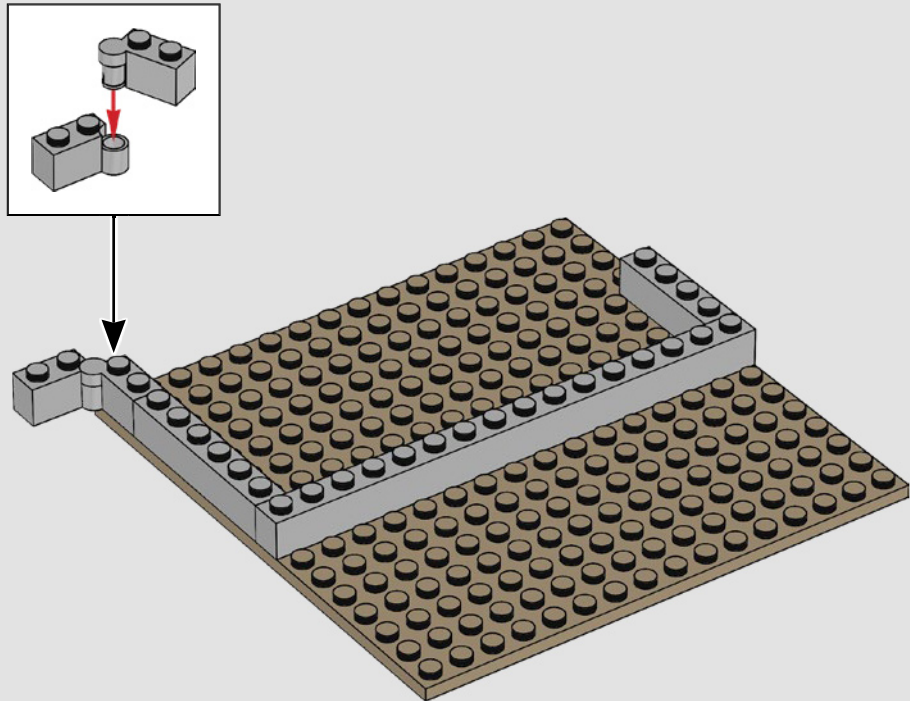

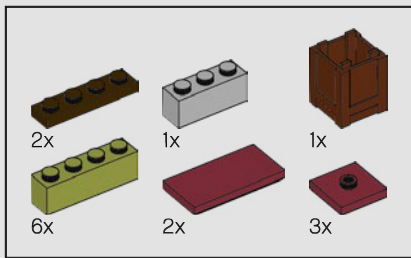

2

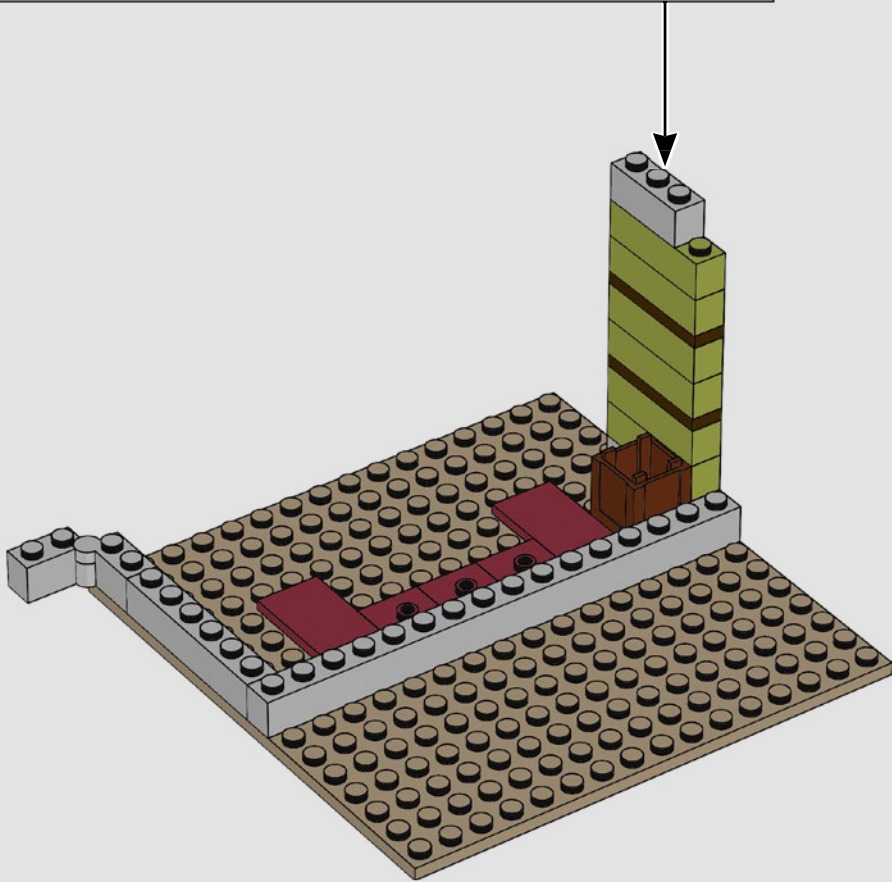
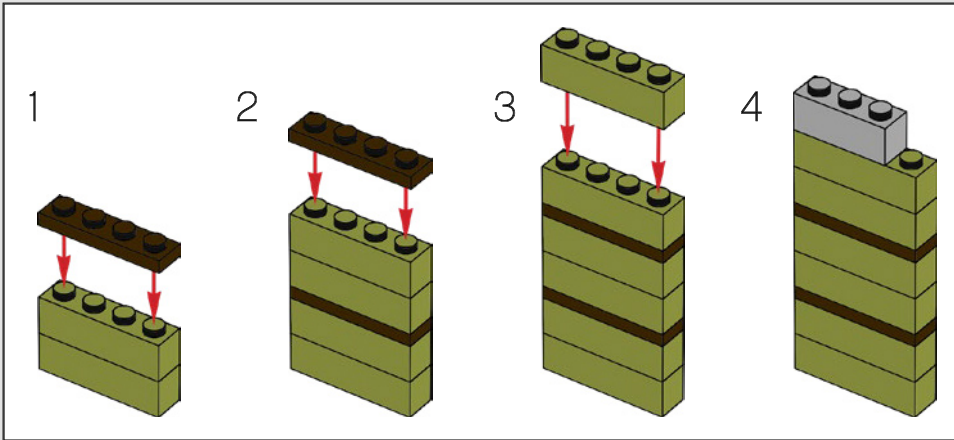

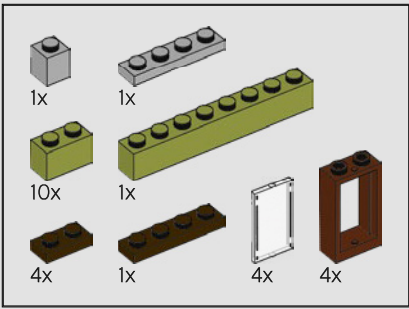

3

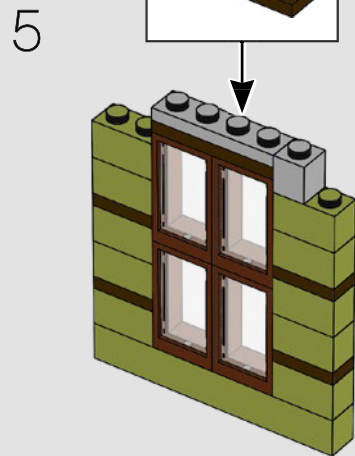
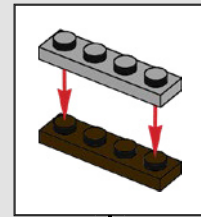
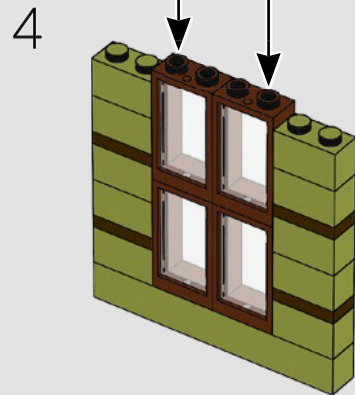
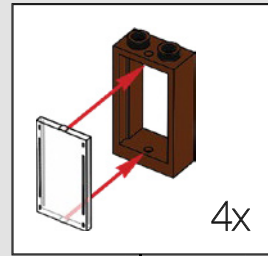
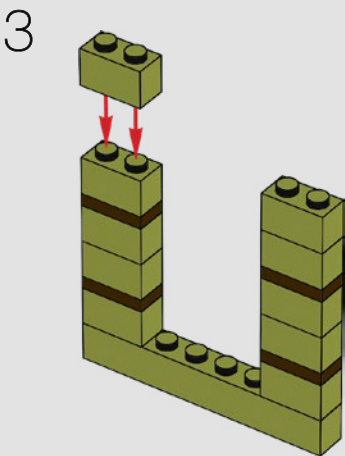
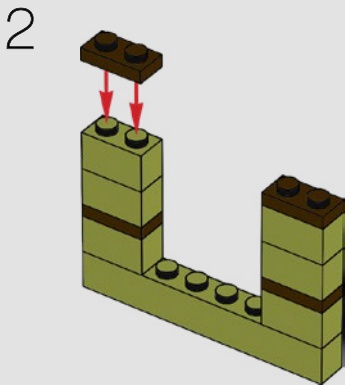
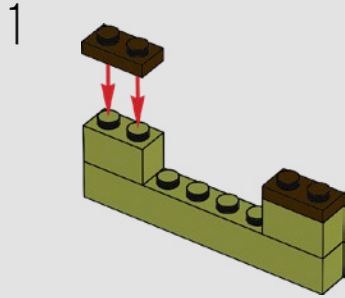

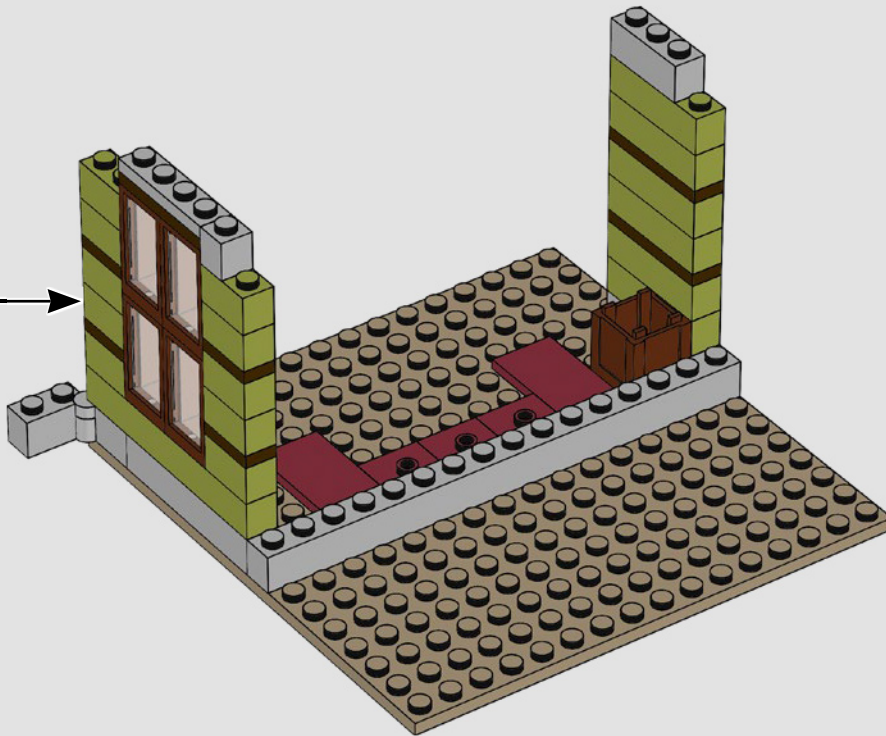

4

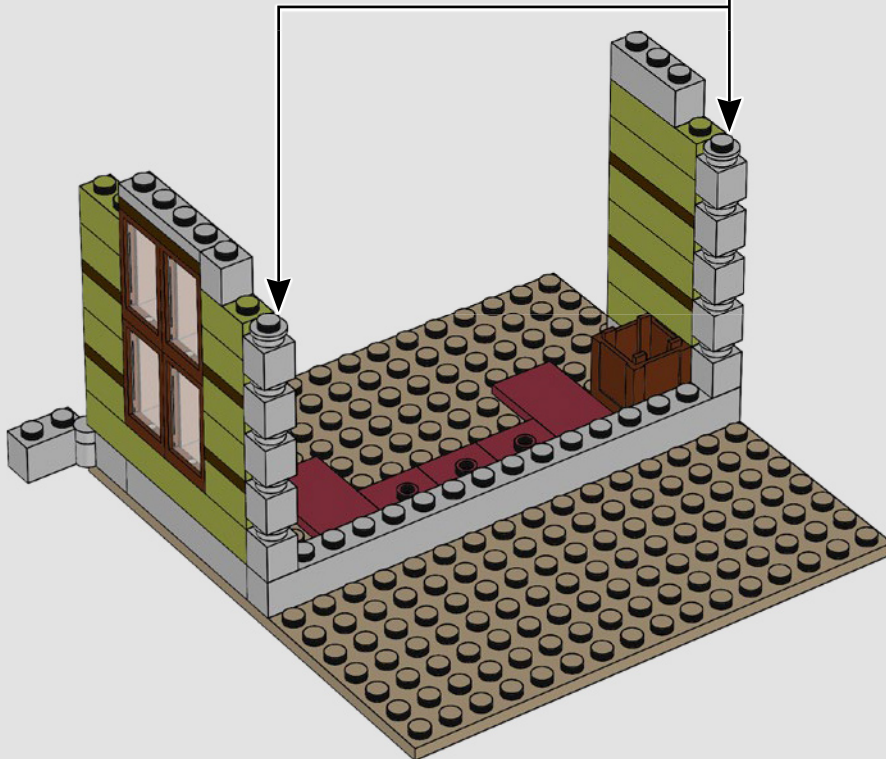
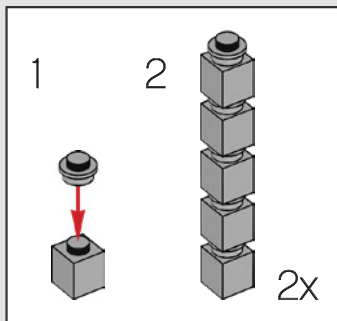

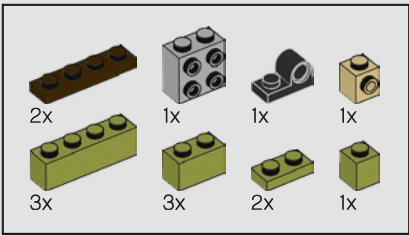

5

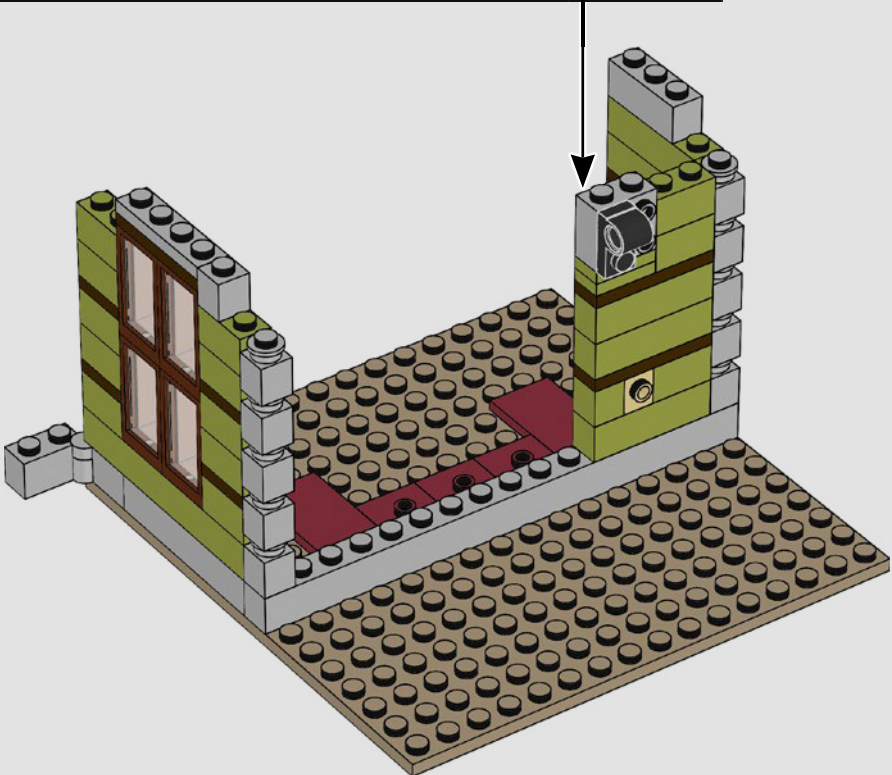
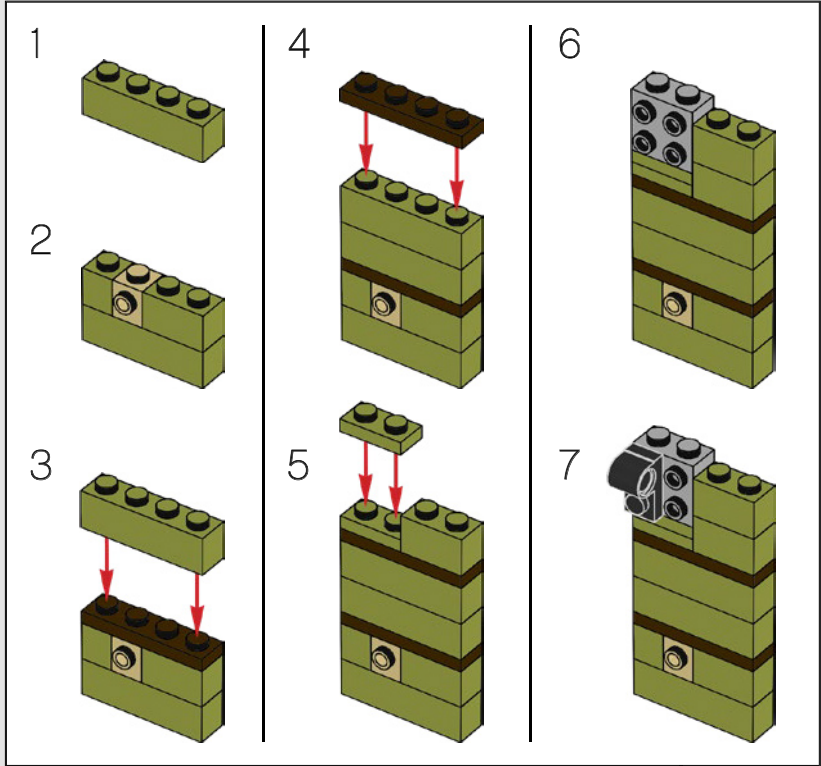

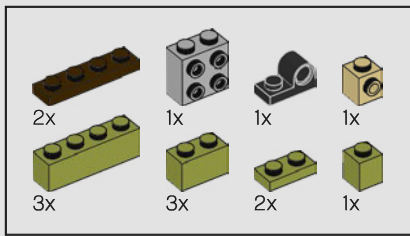

6

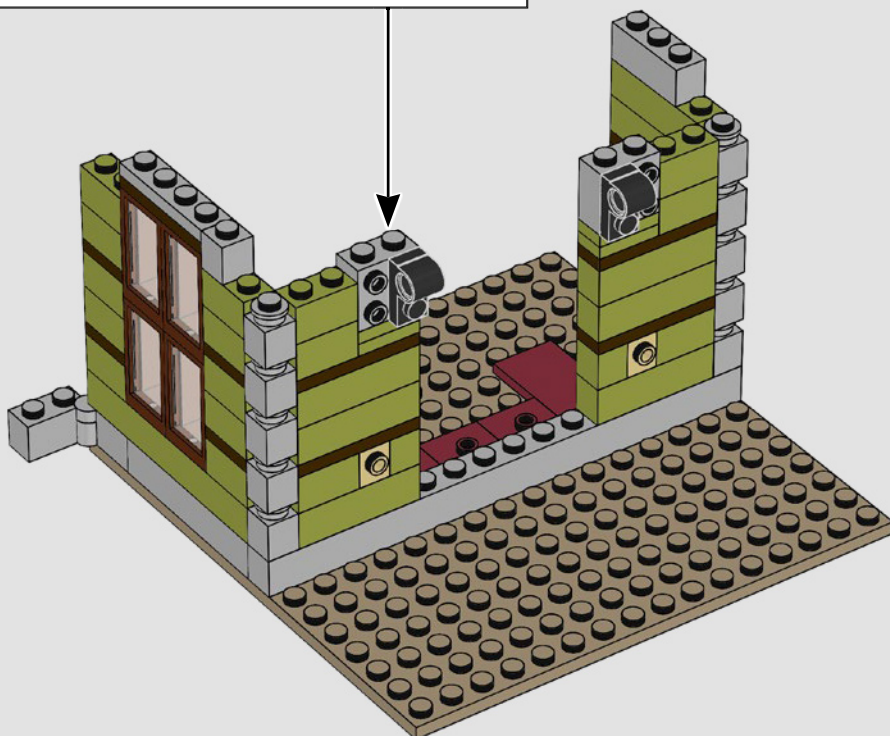
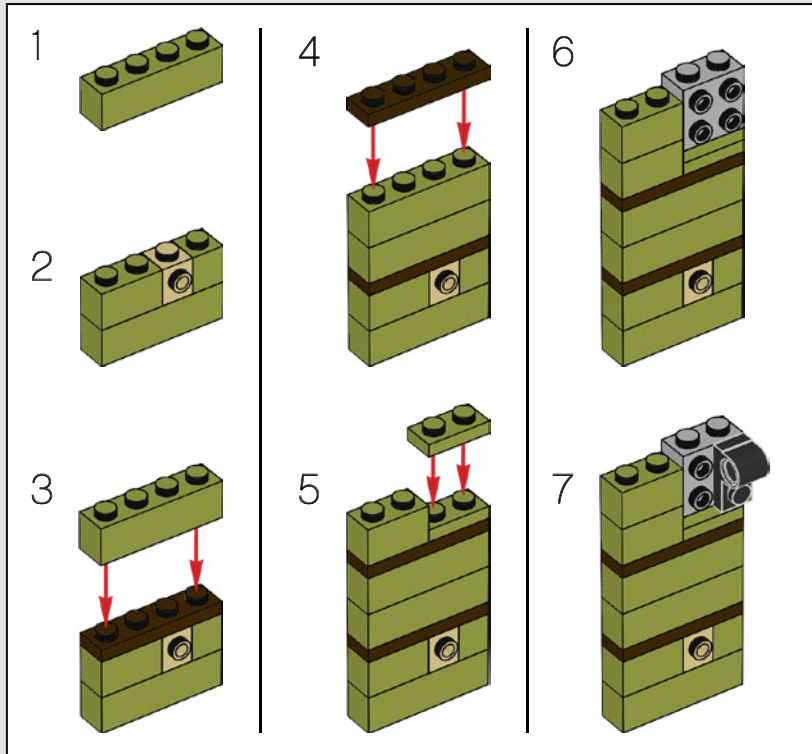

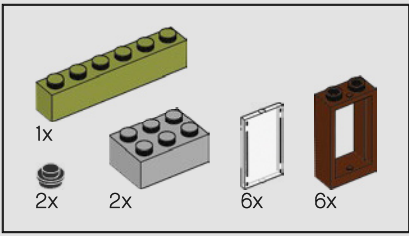

7

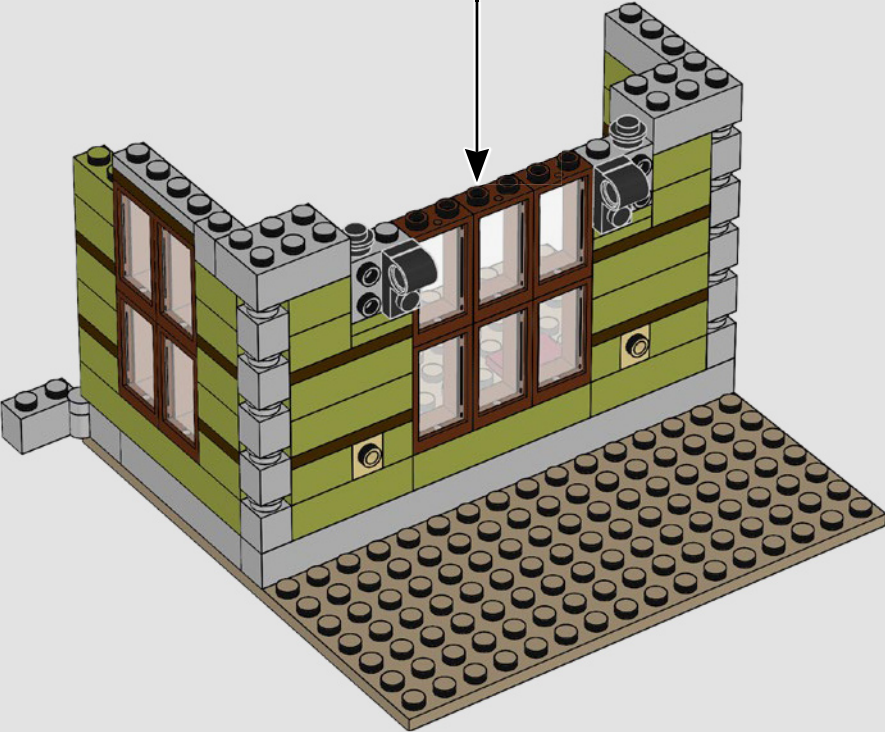
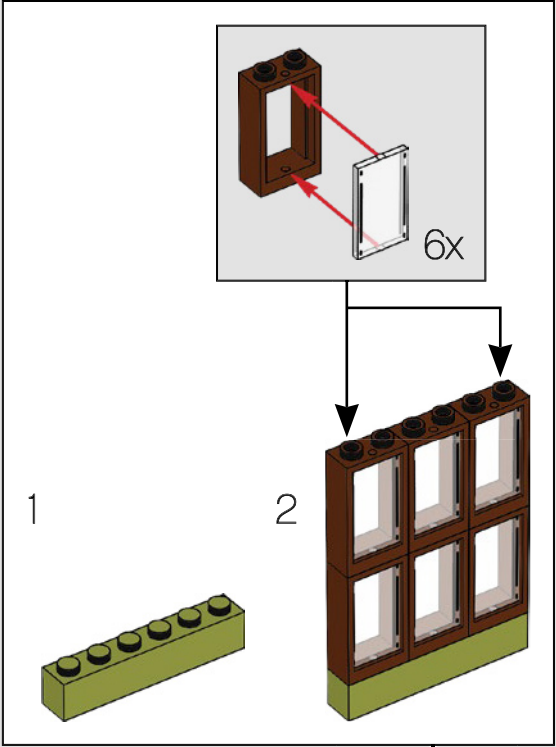

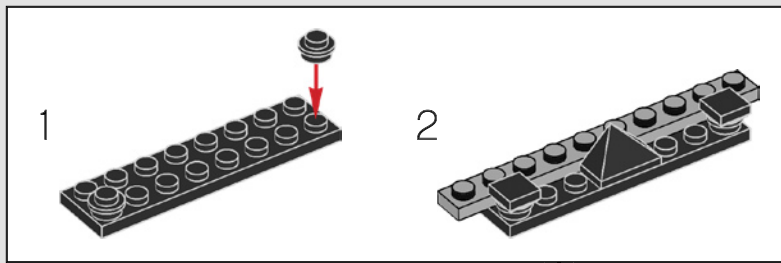
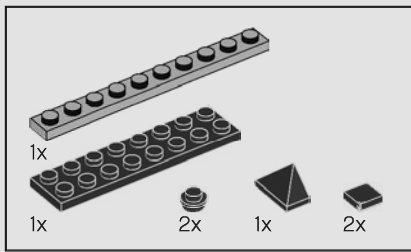

8

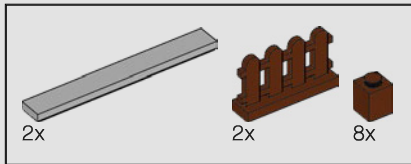
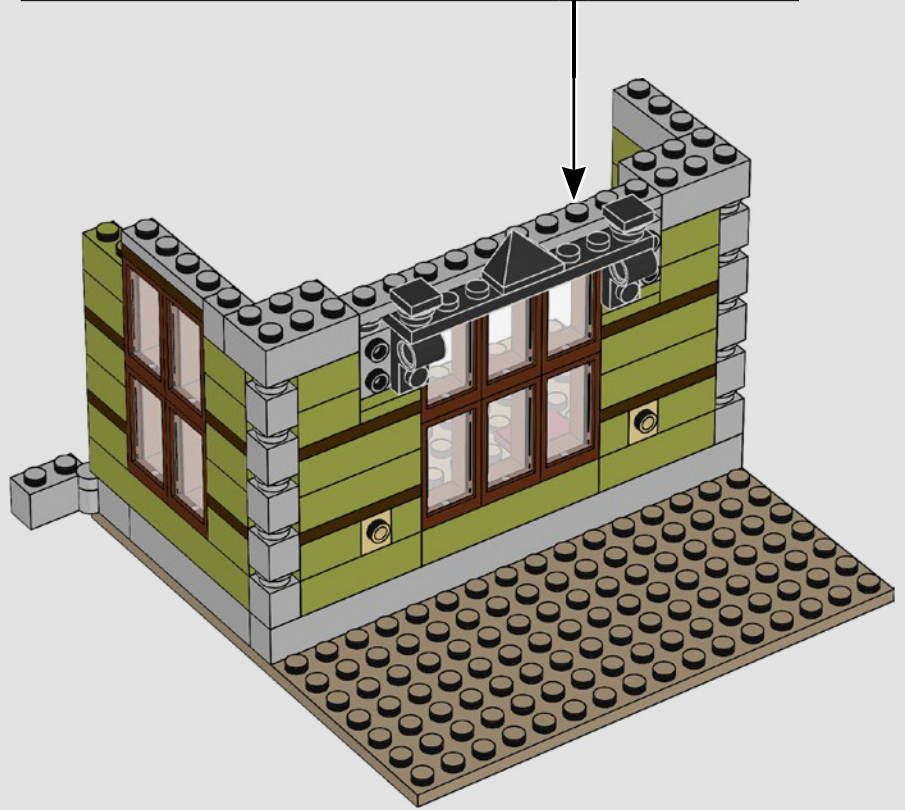

9

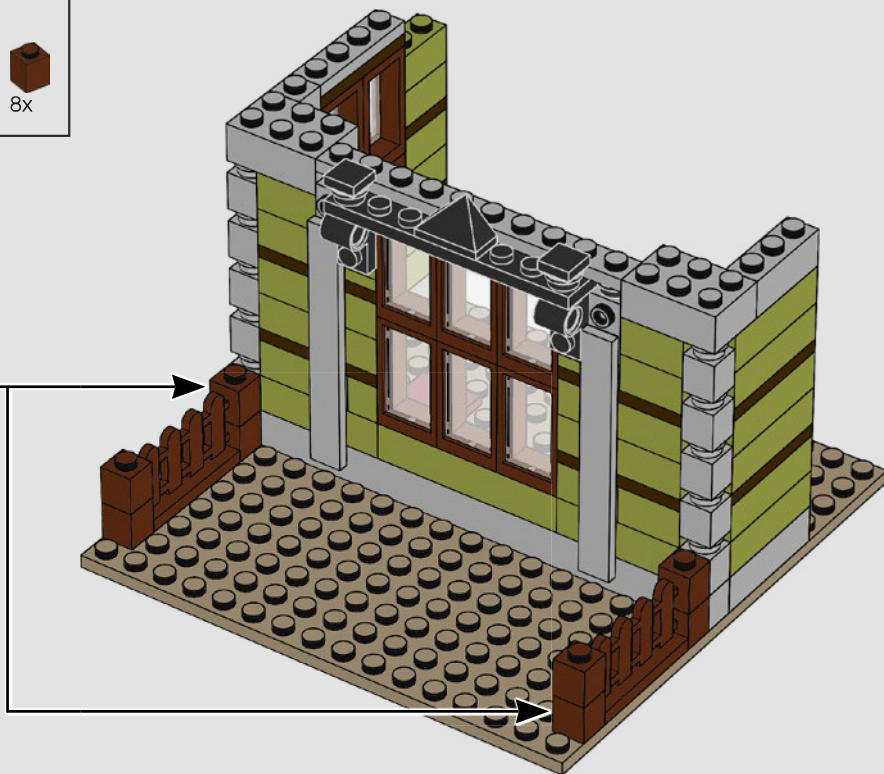
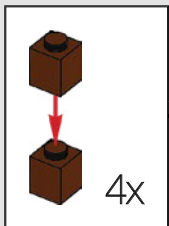

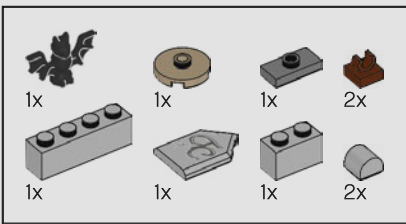

10

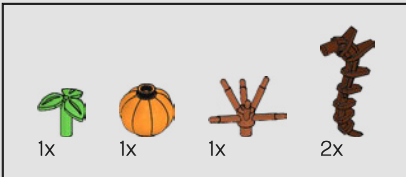
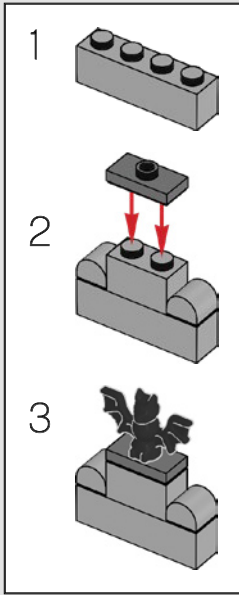

11

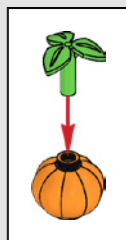

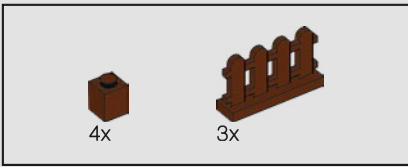

12

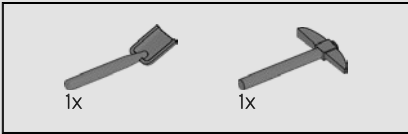
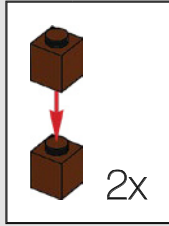

13

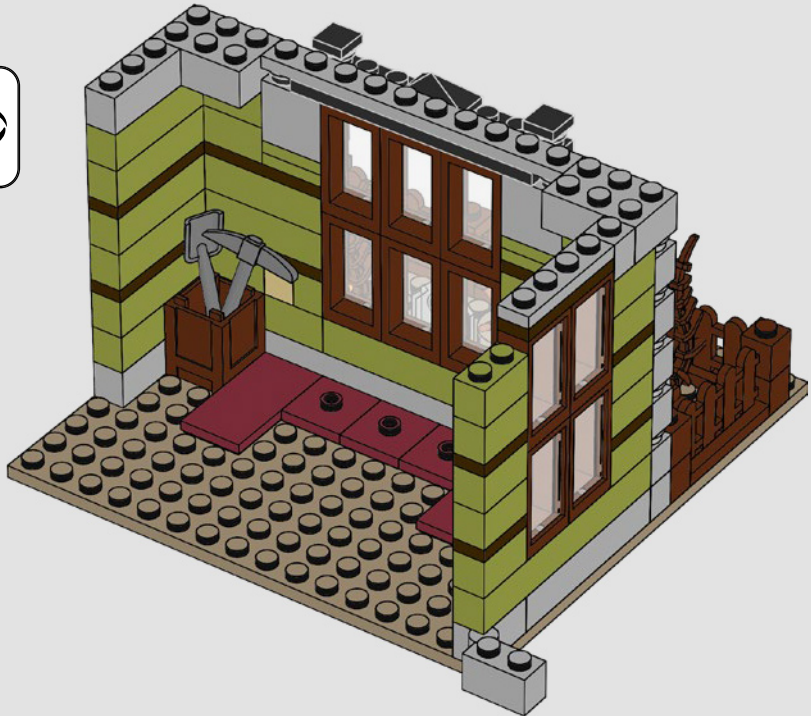

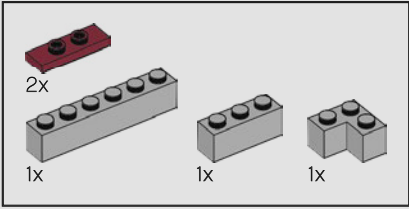
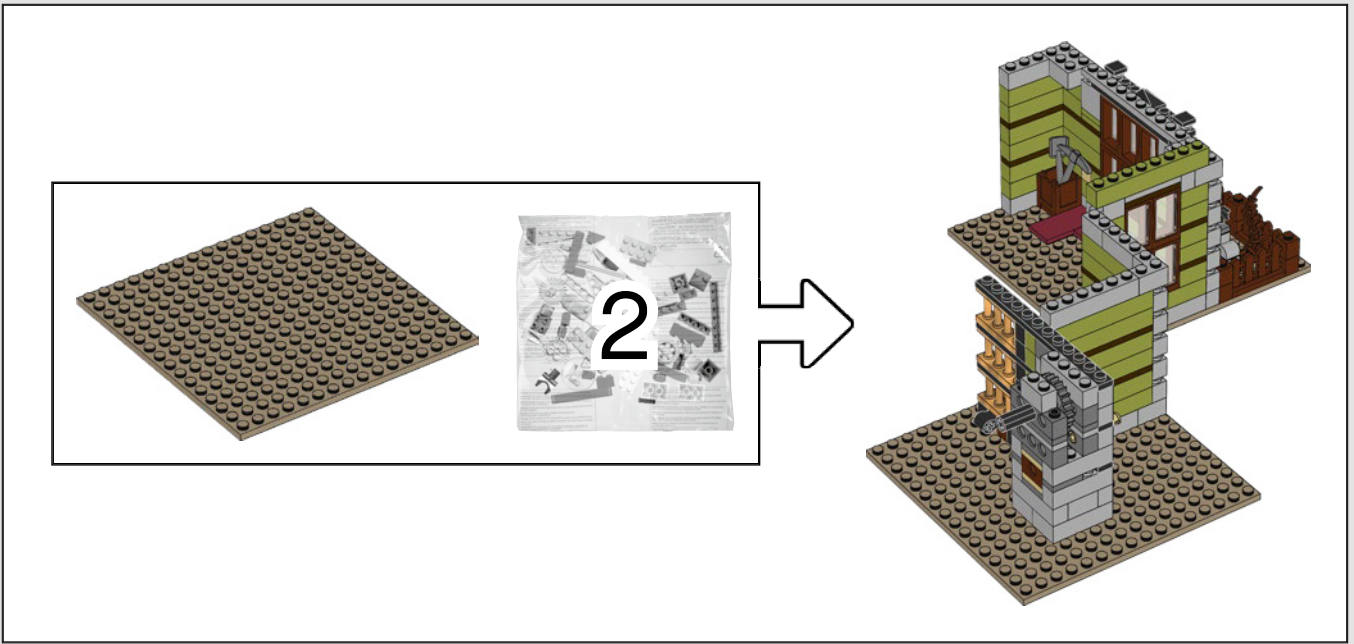

14

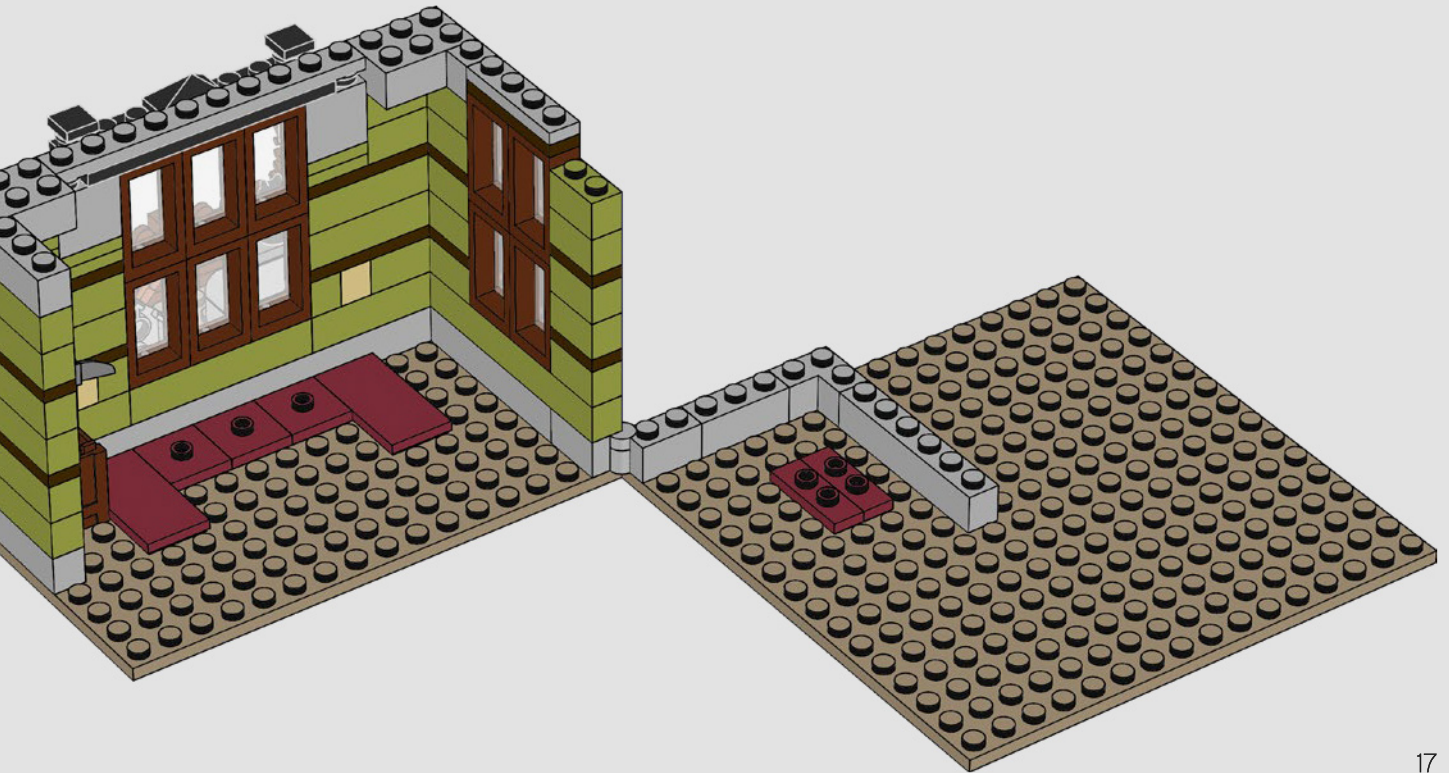

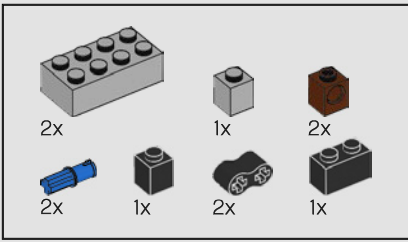

15

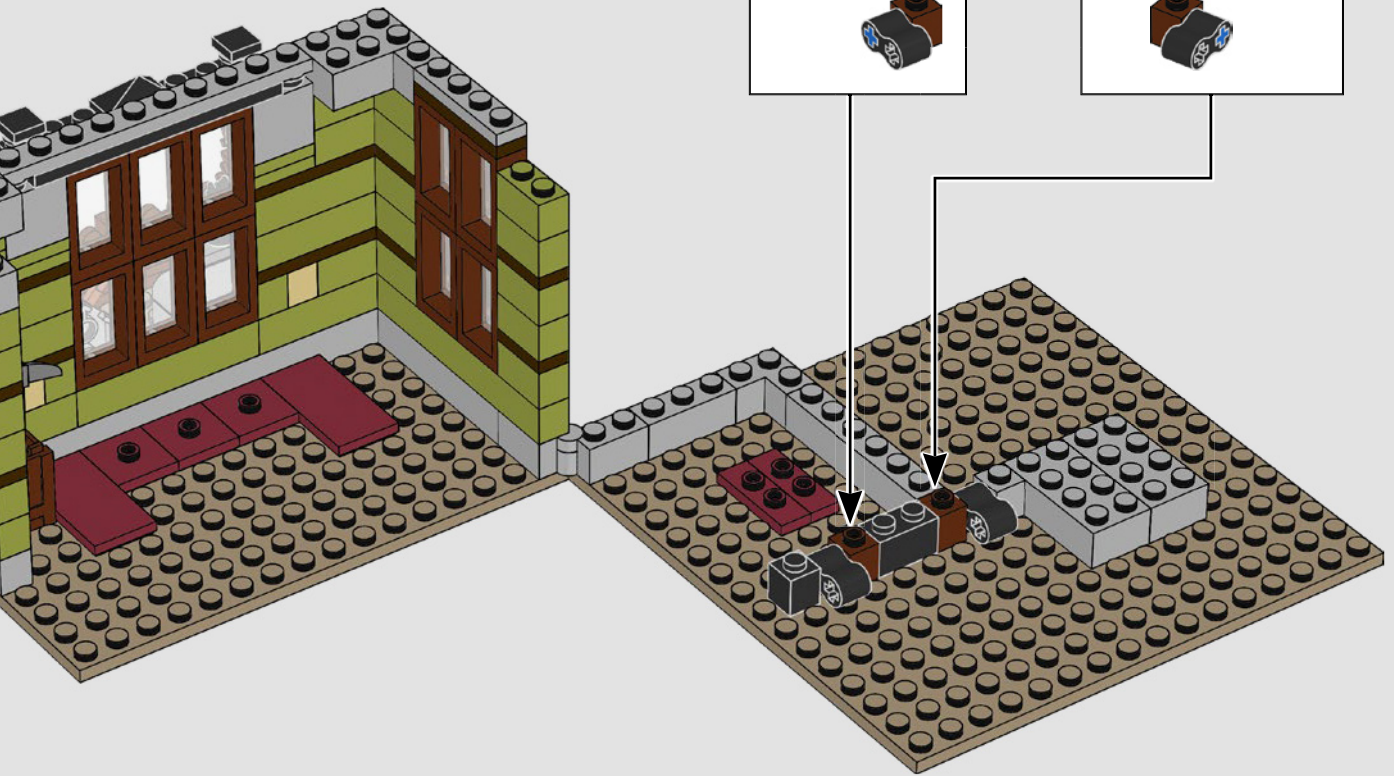

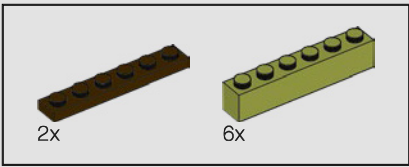

16

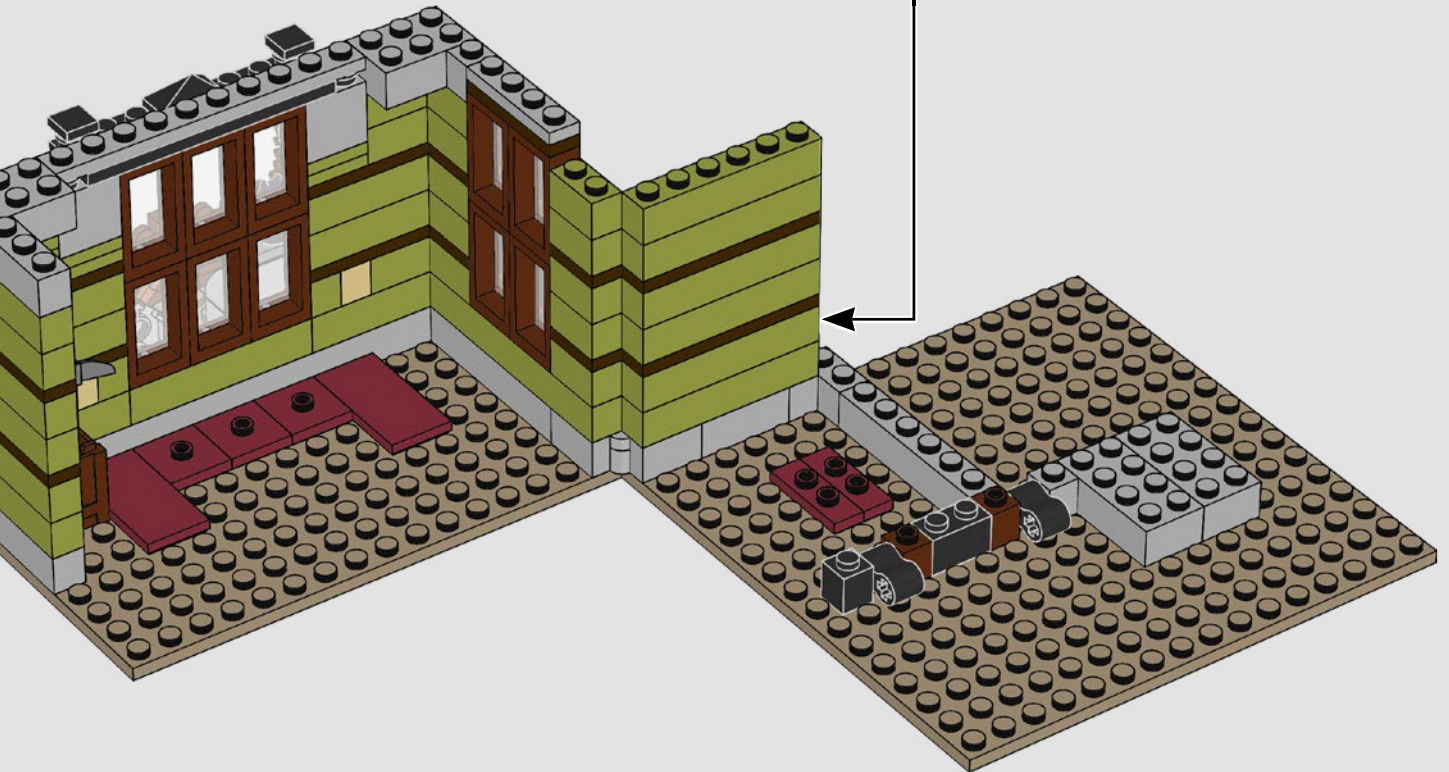
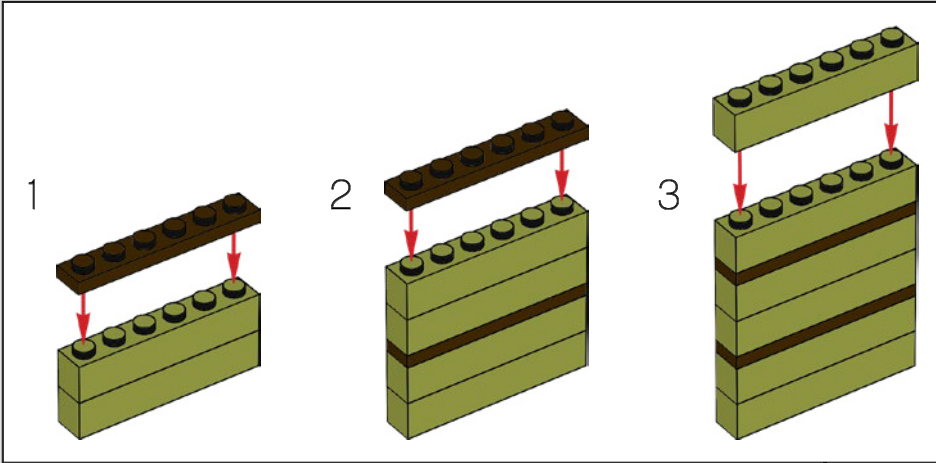

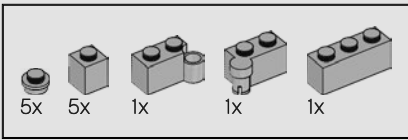

17

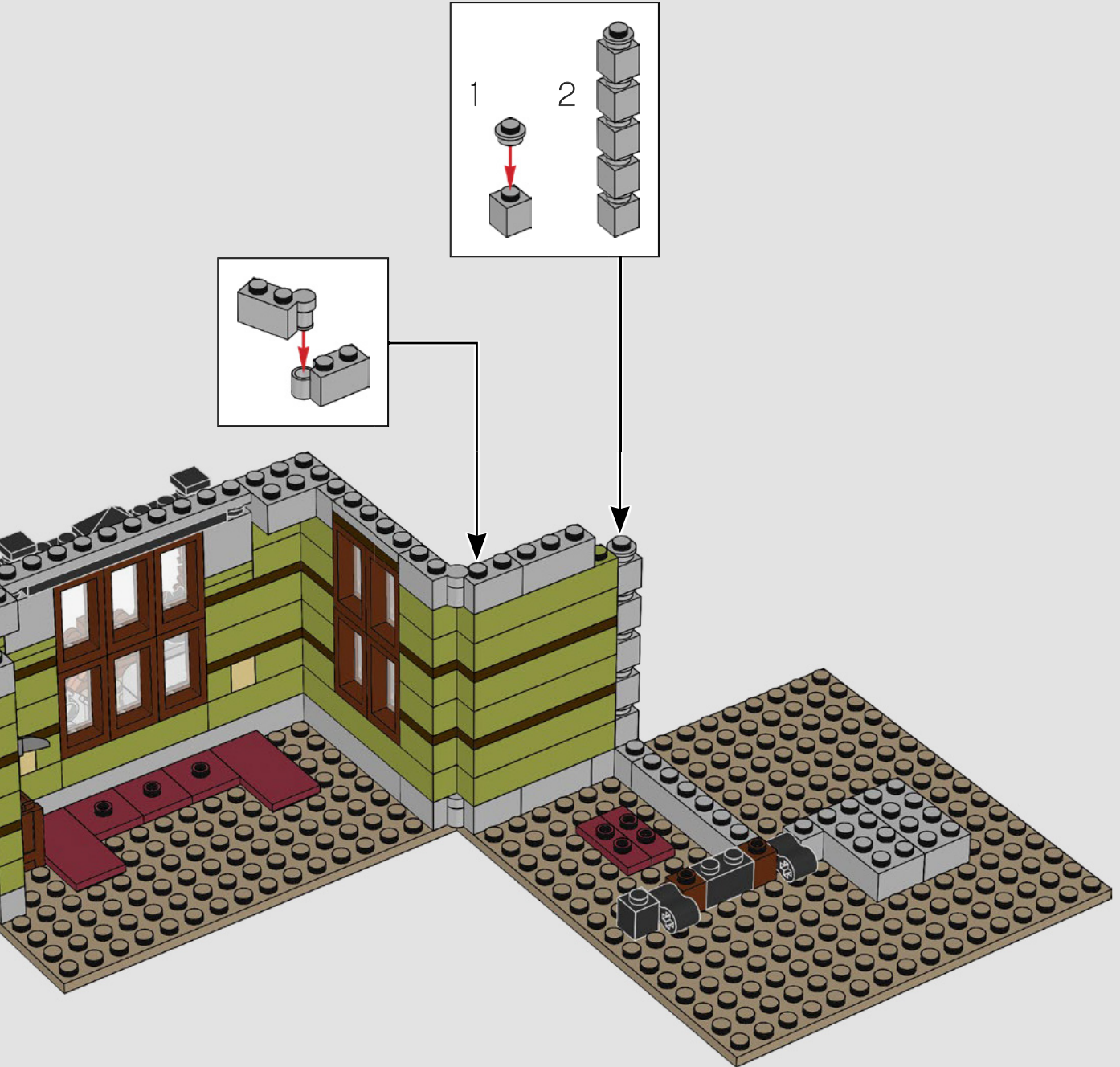

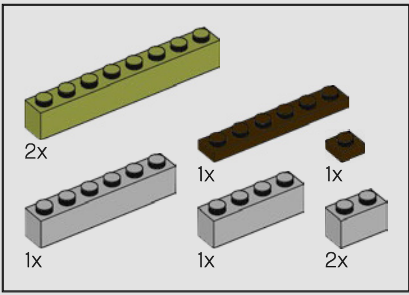

18

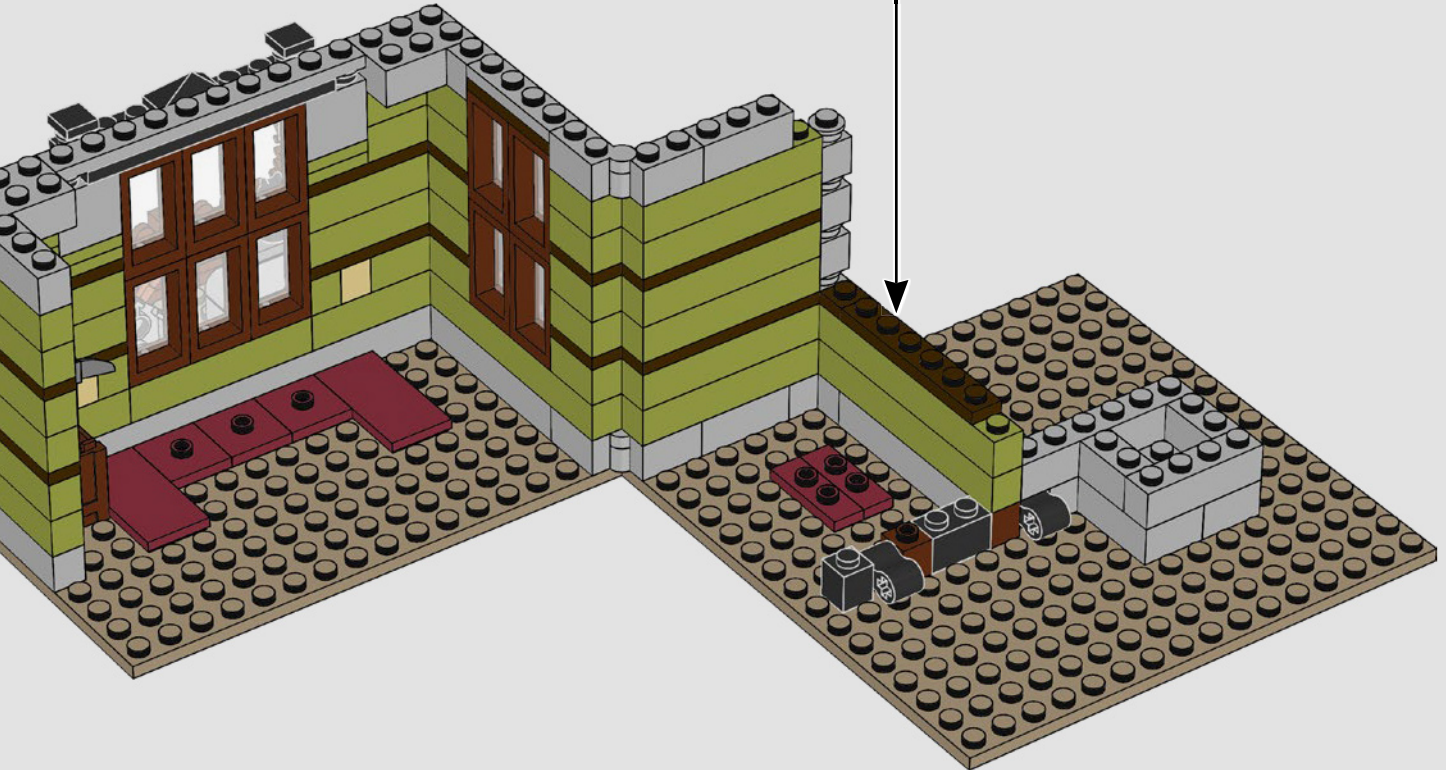
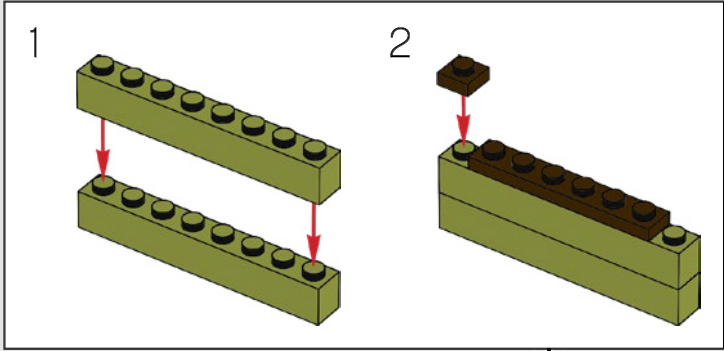

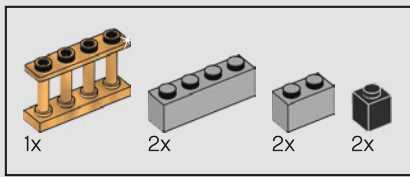

19

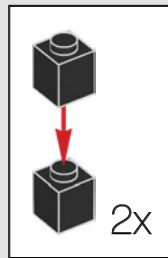

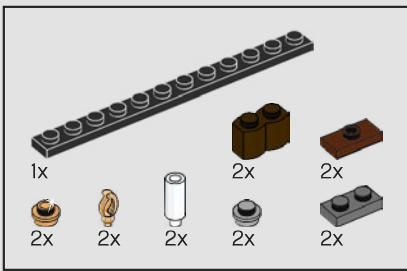

20

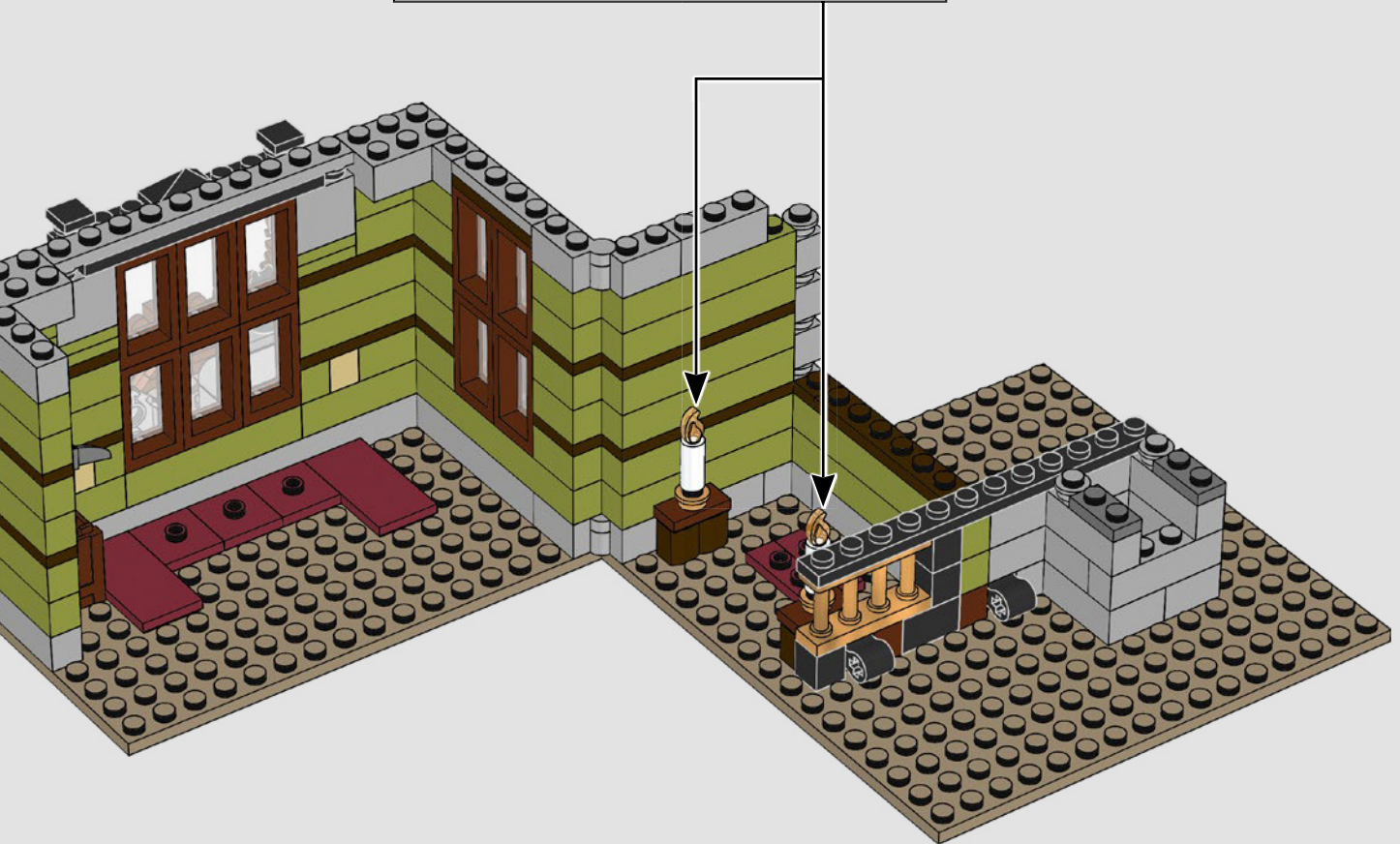
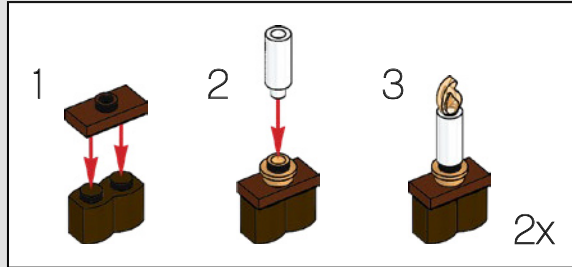

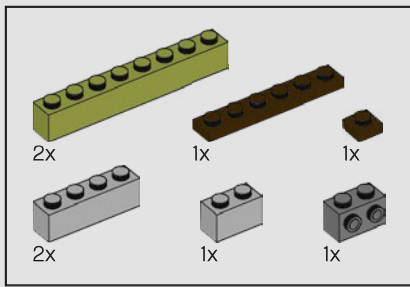

21

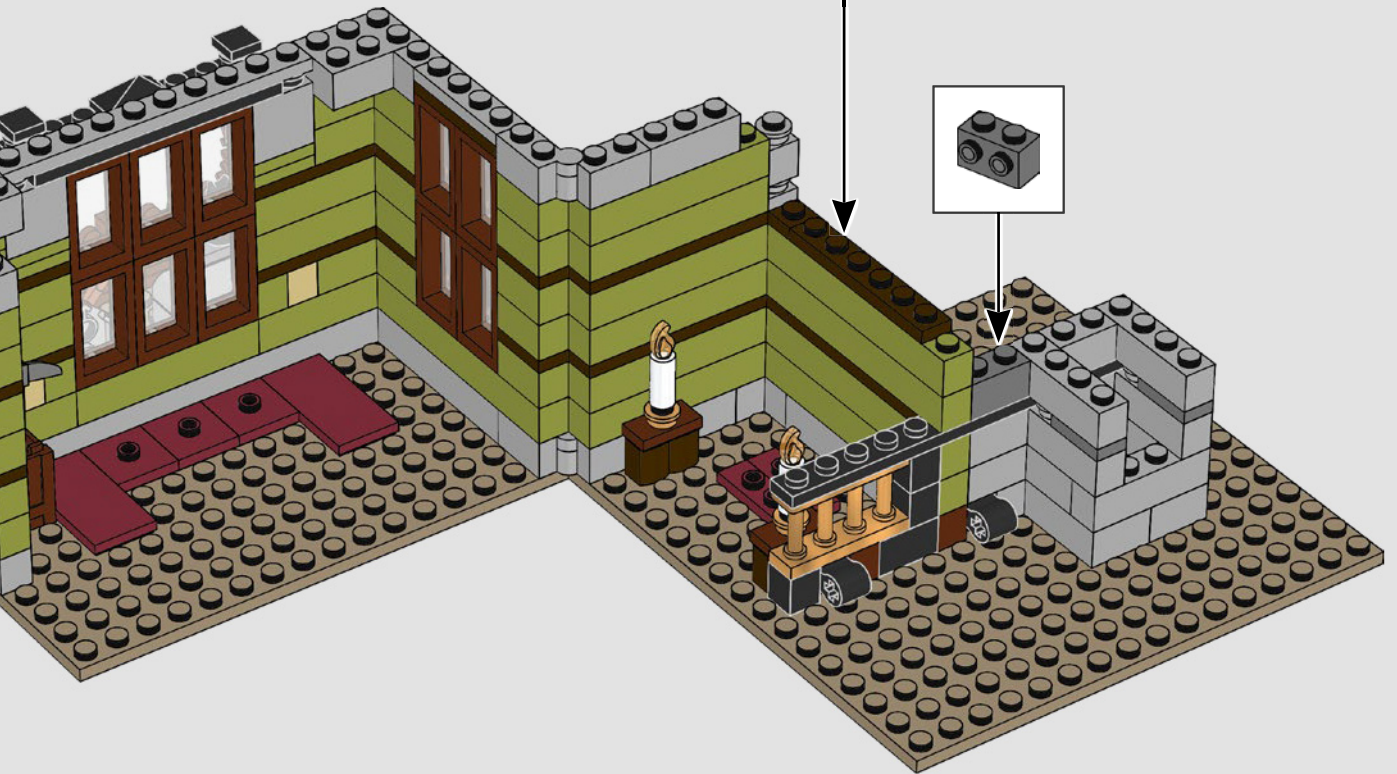
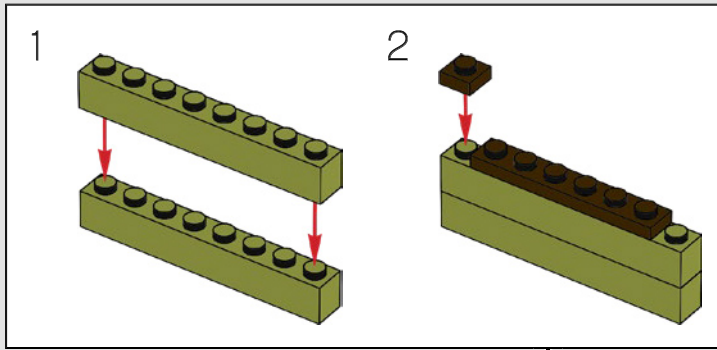

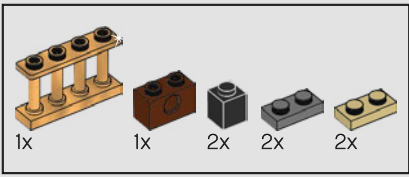

22

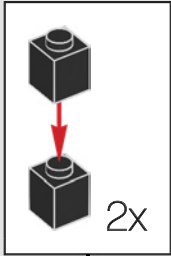
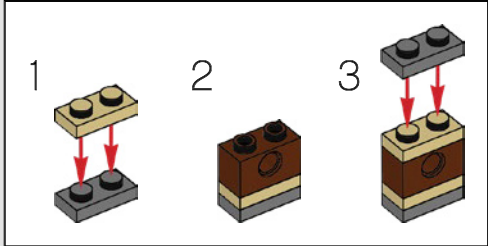

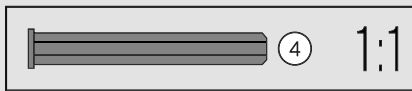
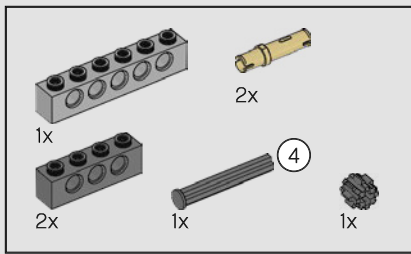

23

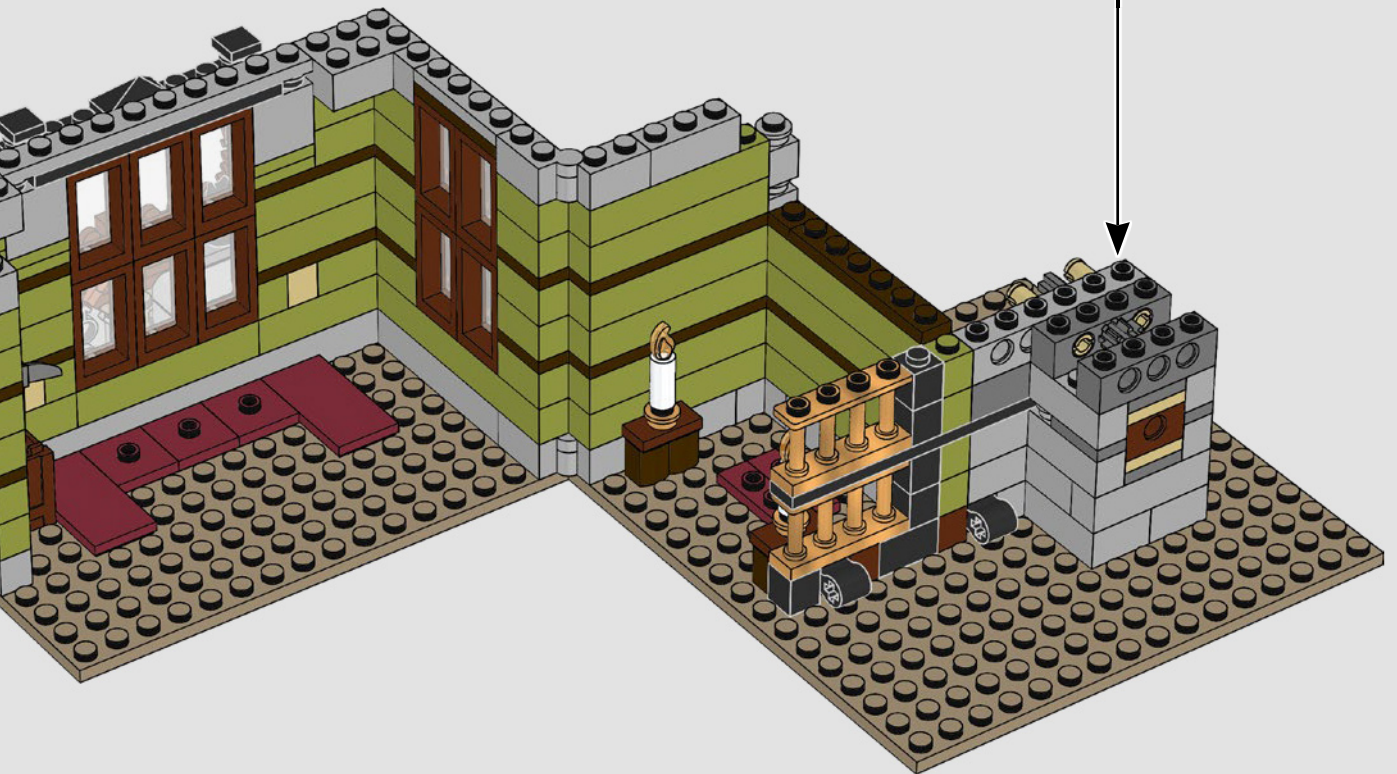
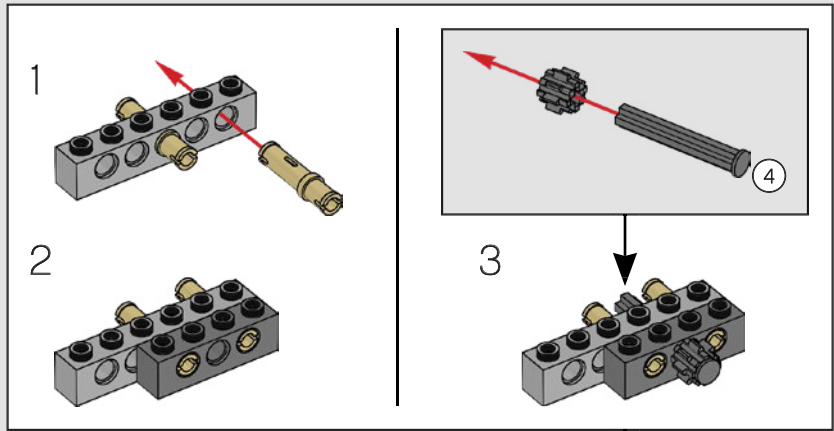

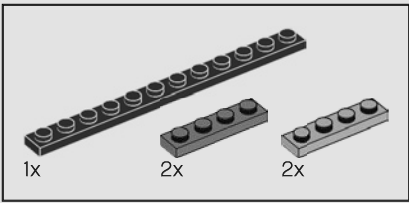

24



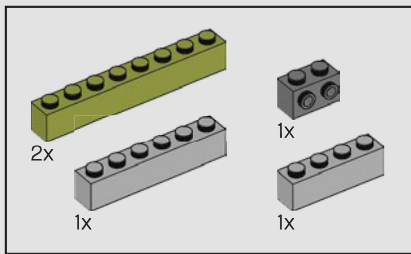

25

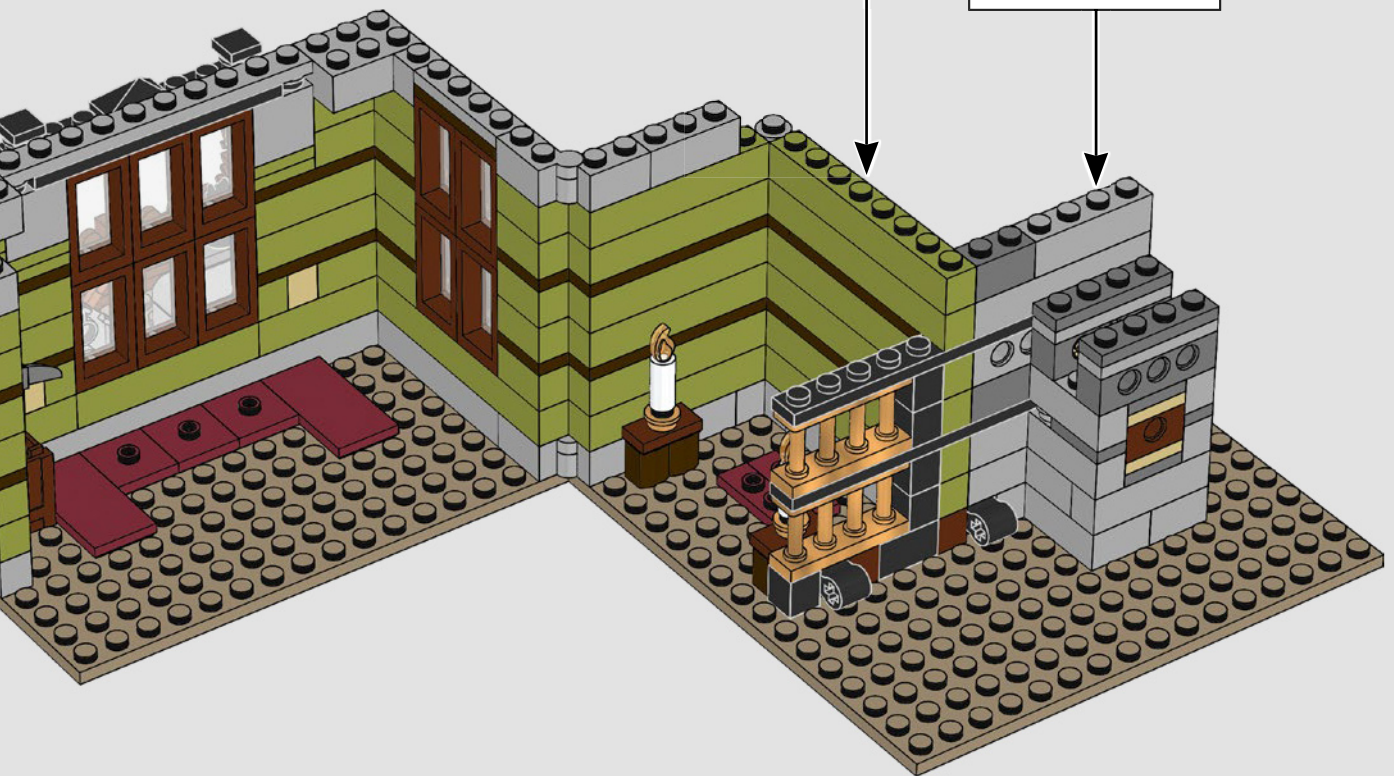
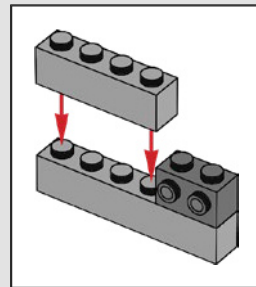
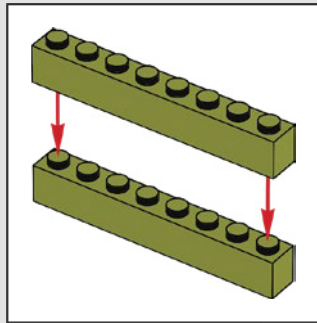

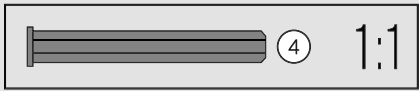
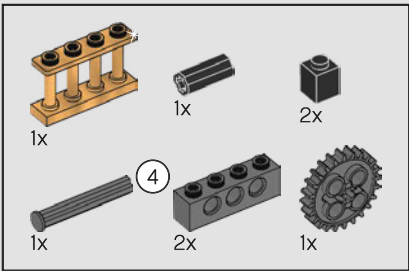

26

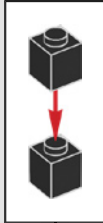
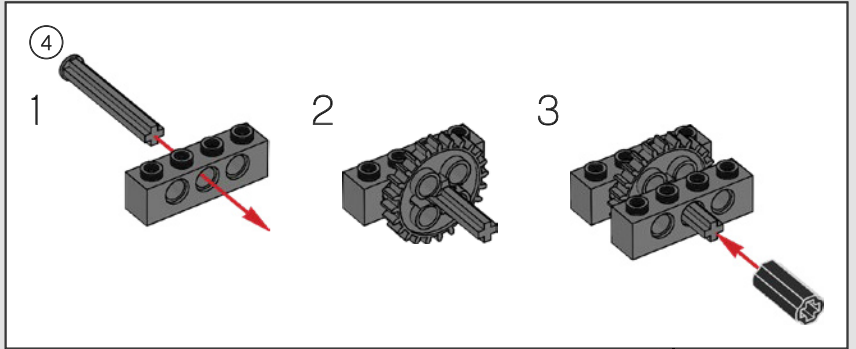

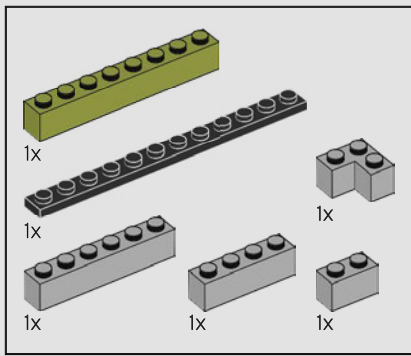

27

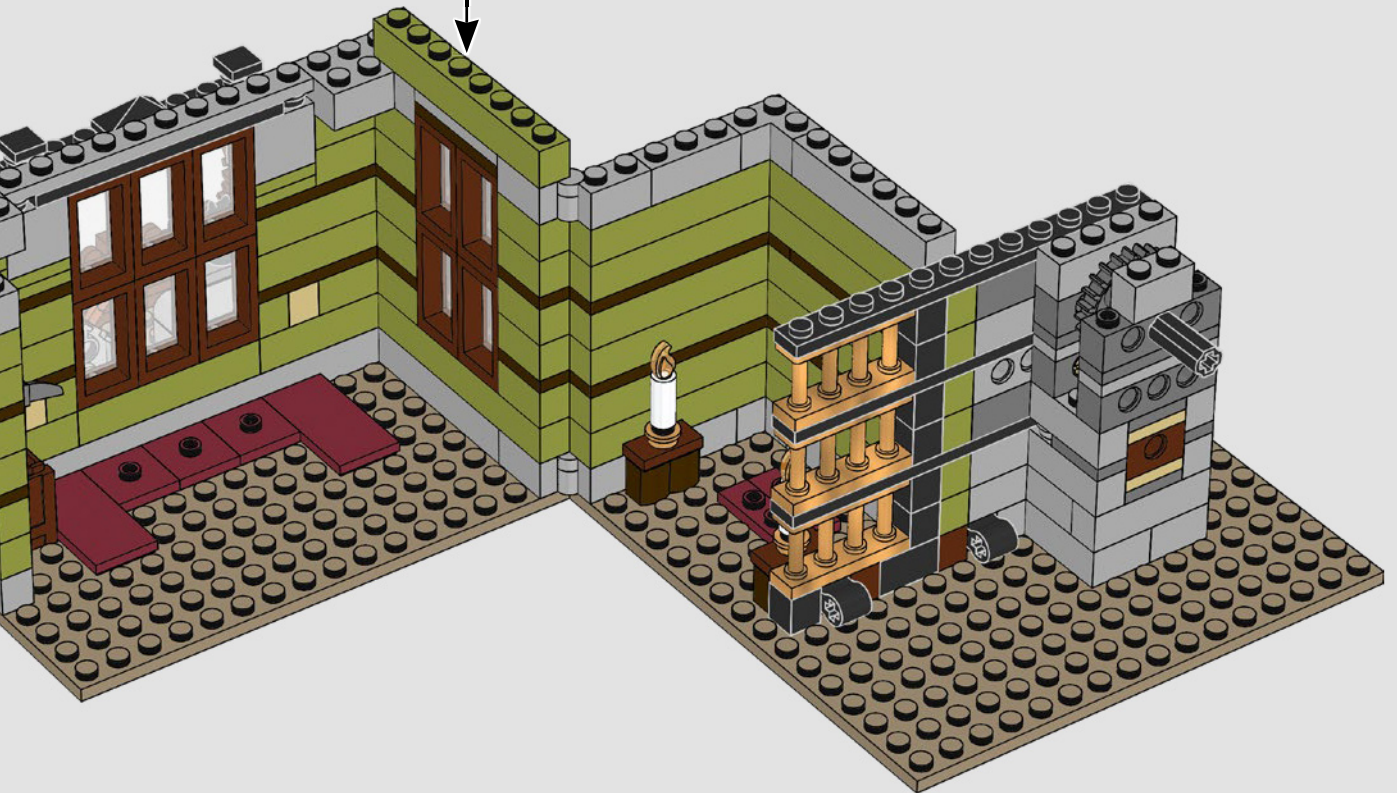
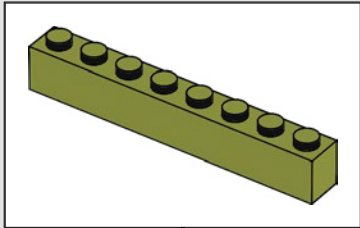

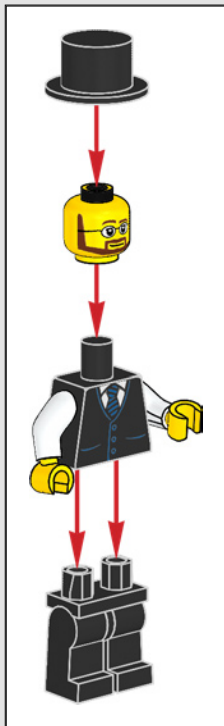
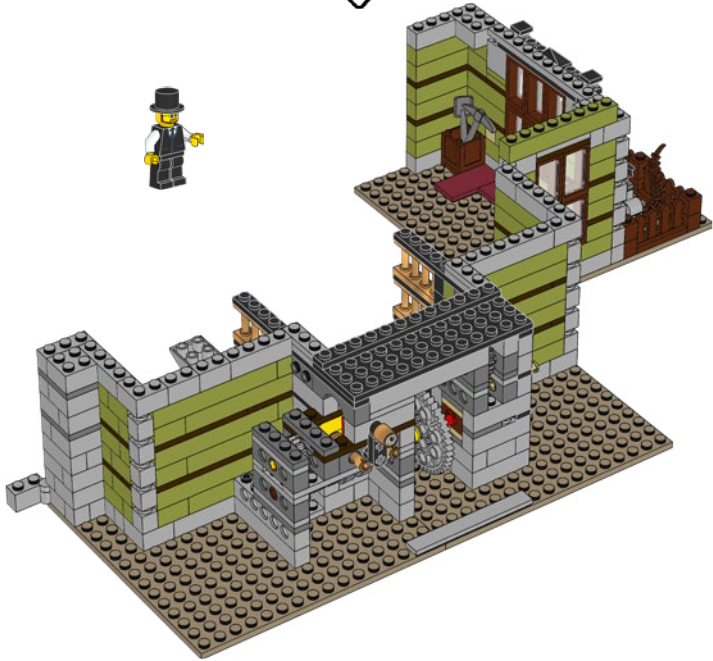
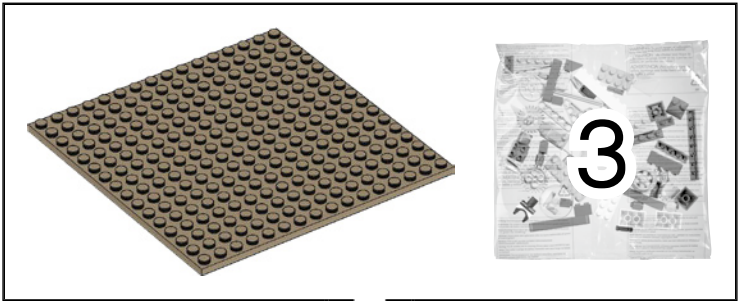

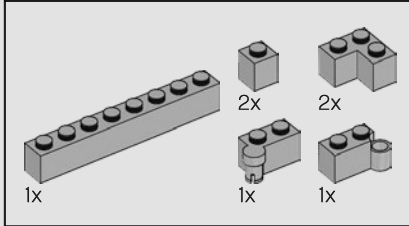
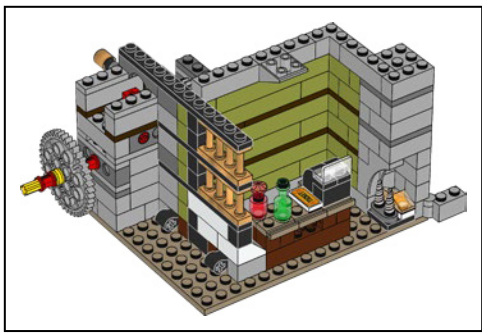

28

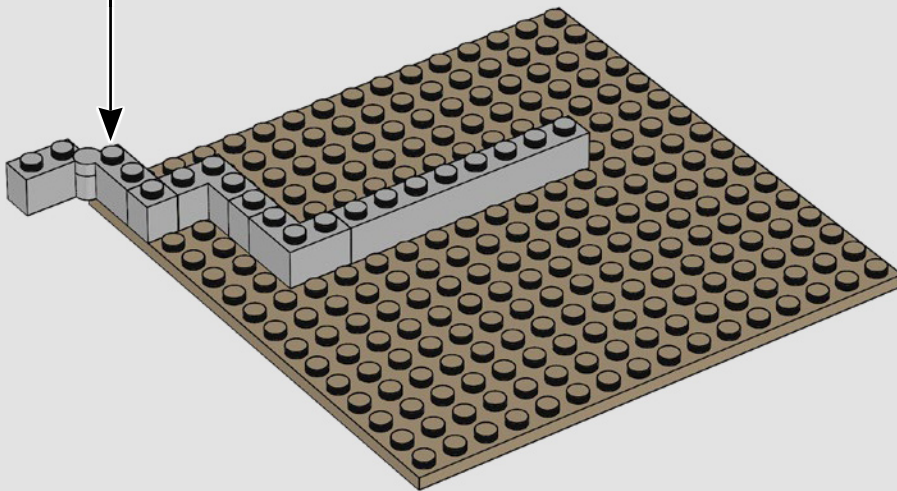
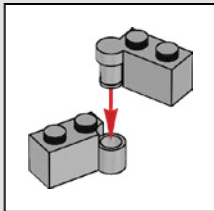

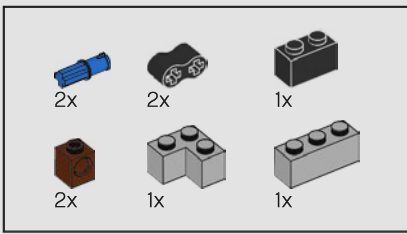

29

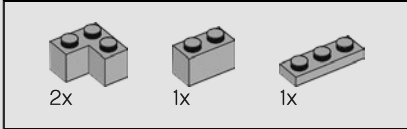
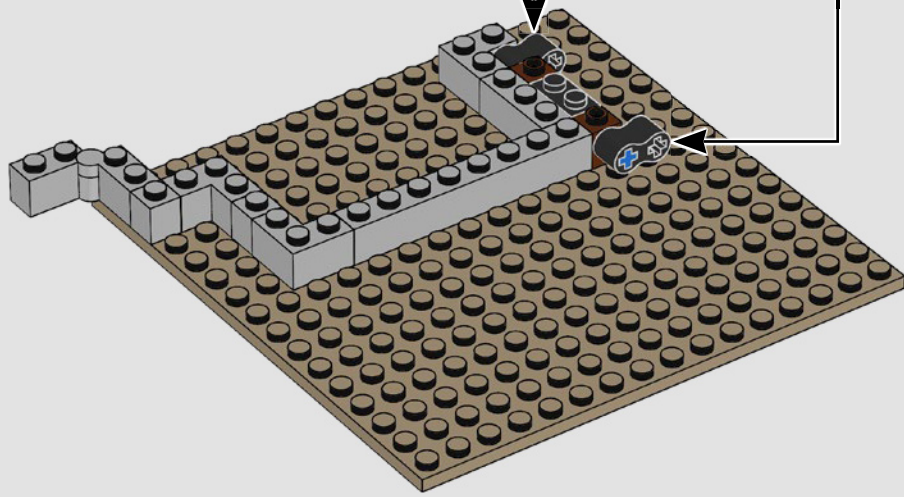
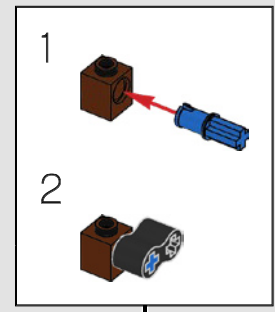
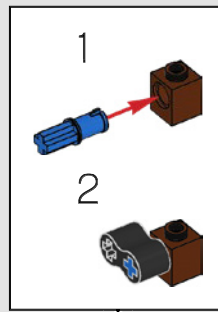

30

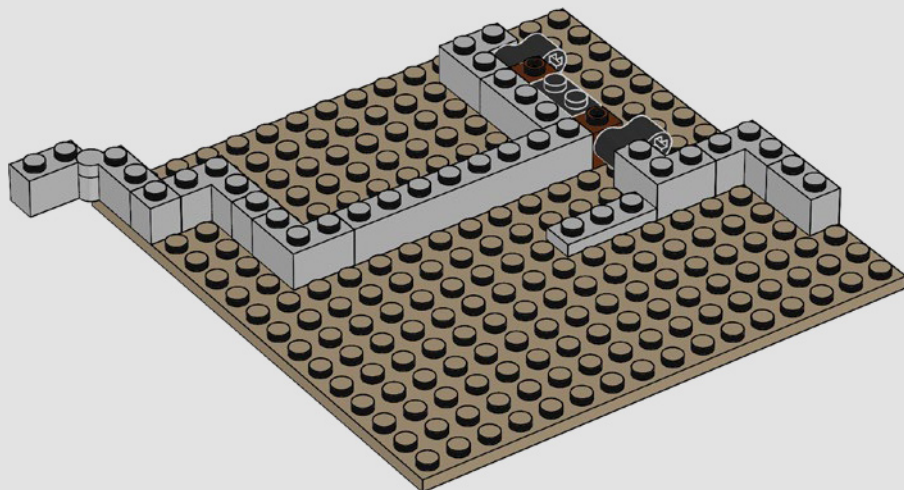

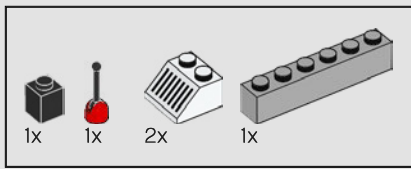

31

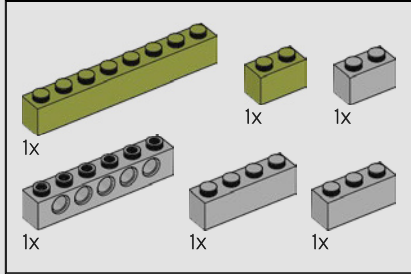
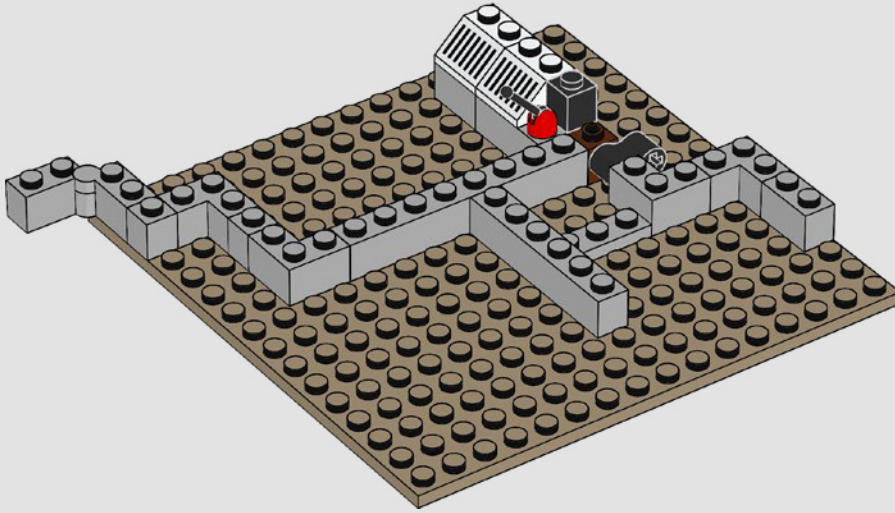

32

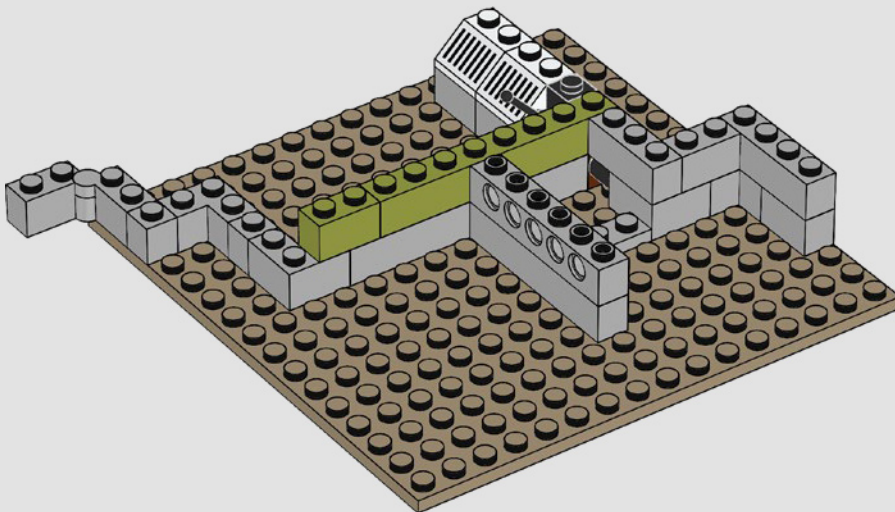

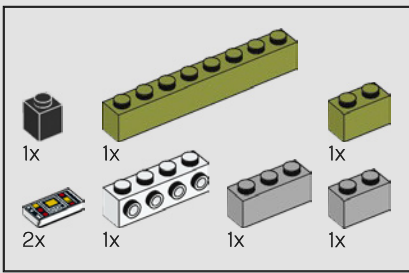

33

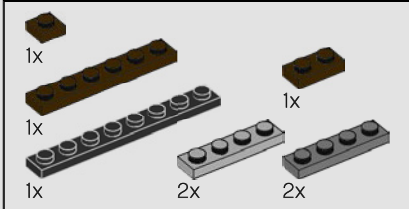
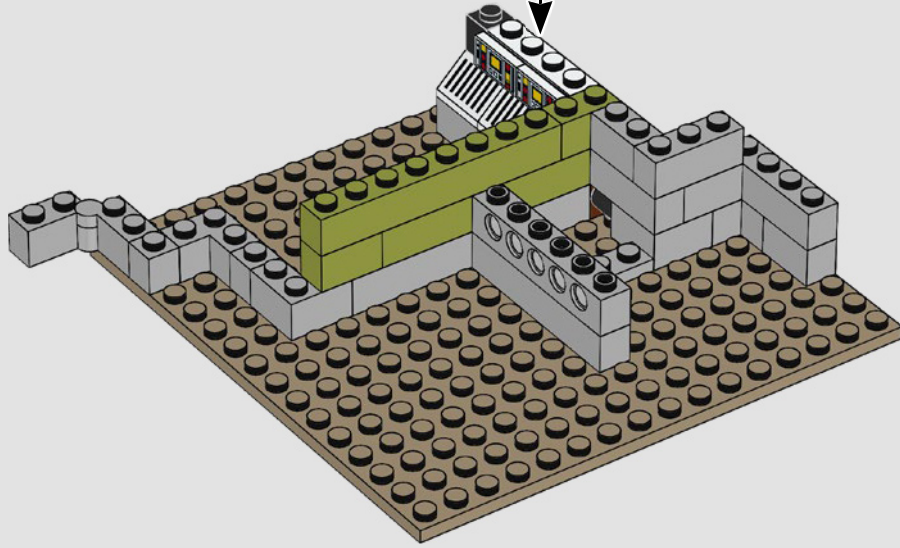
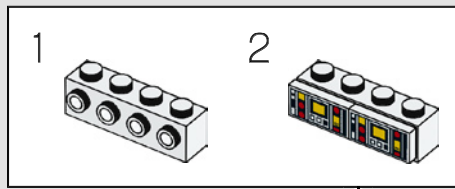

34

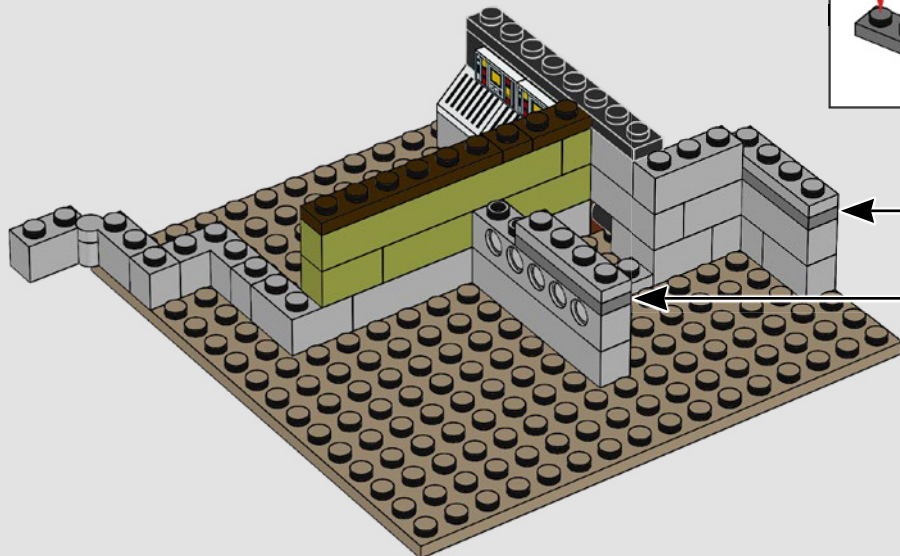
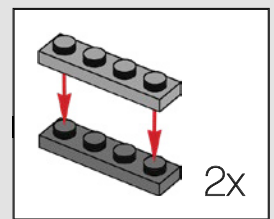

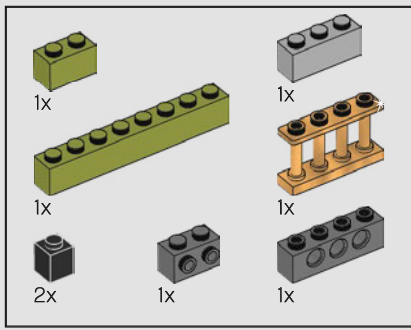

35

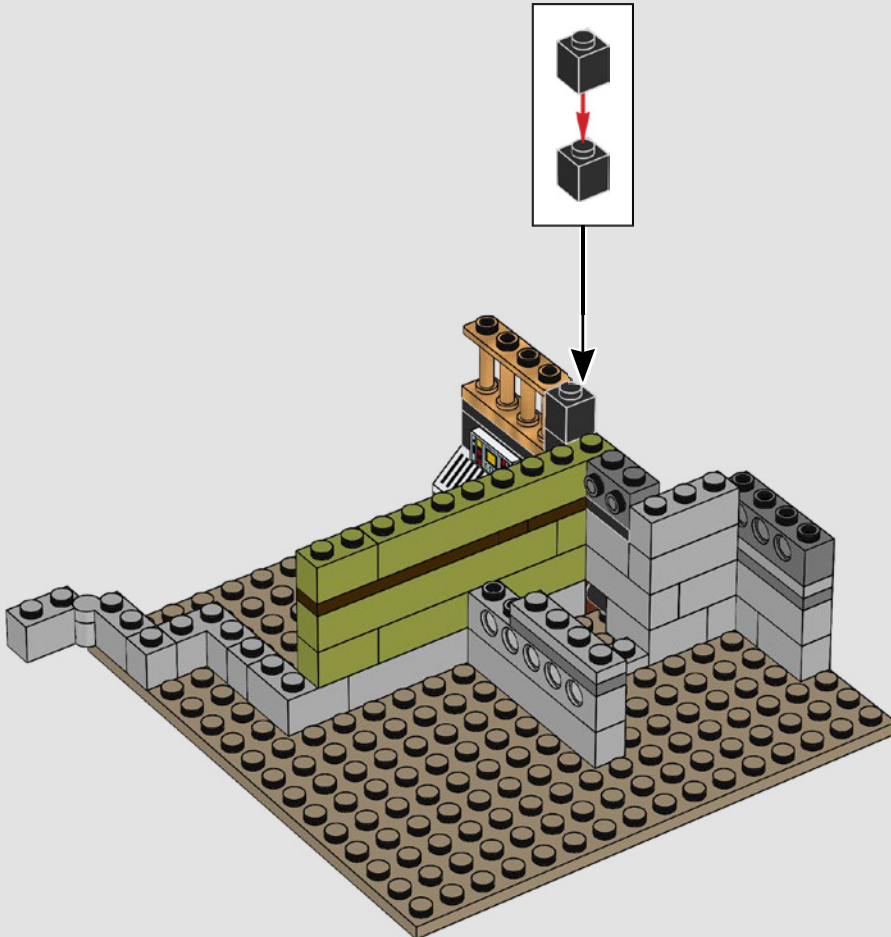

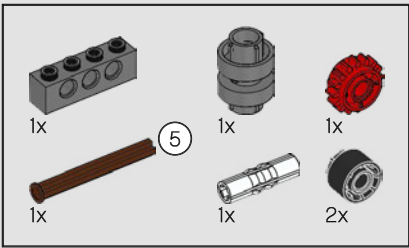

36

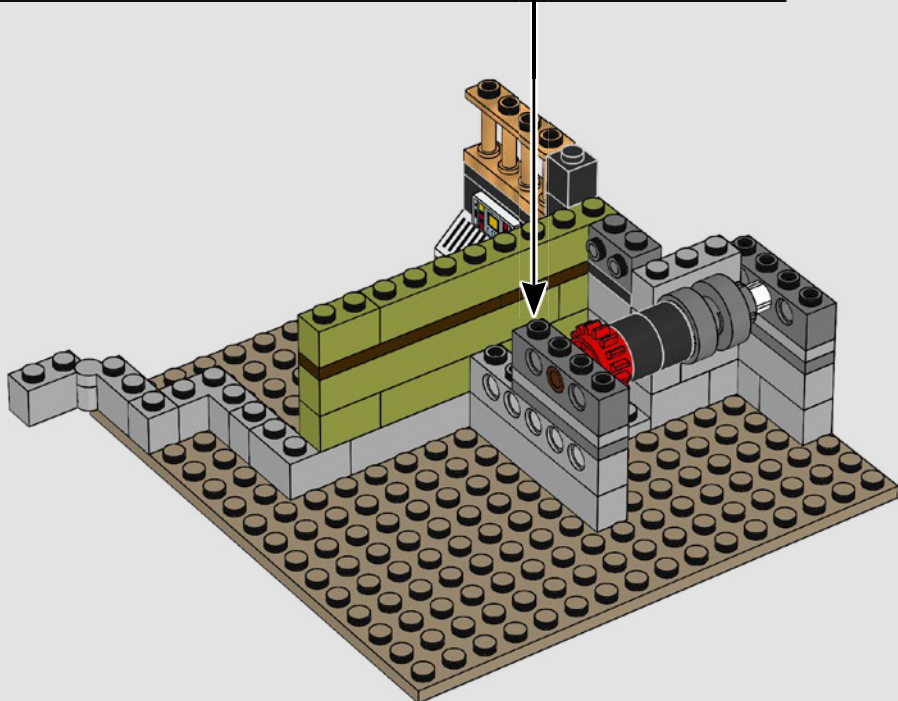
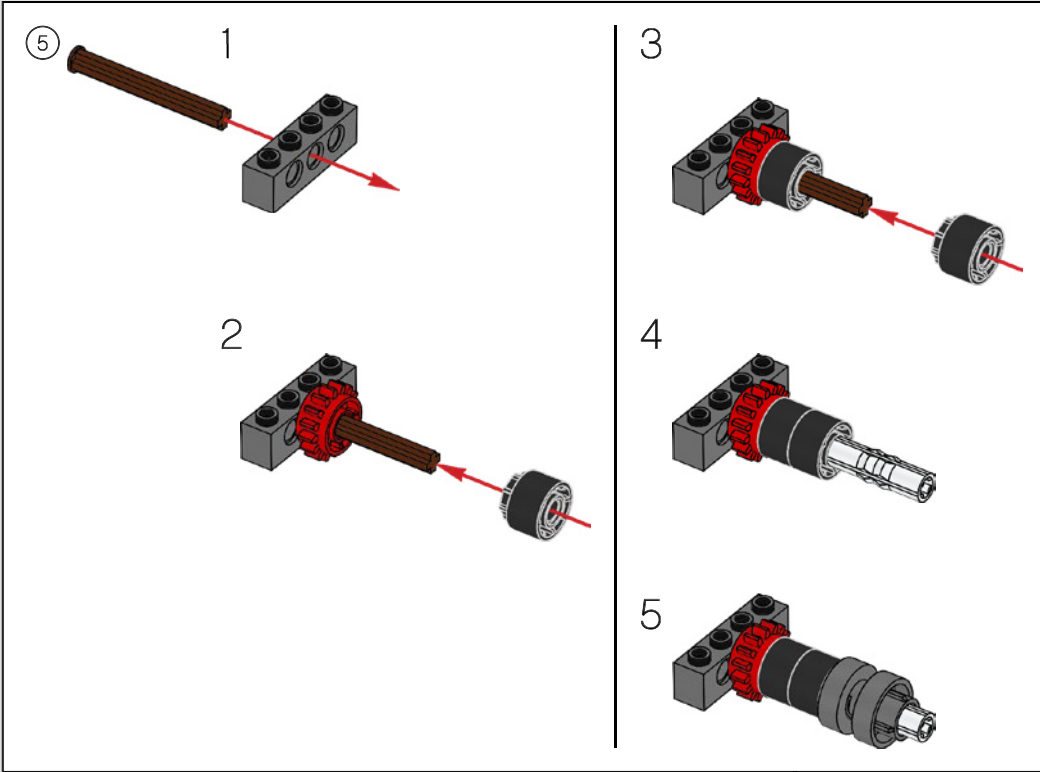

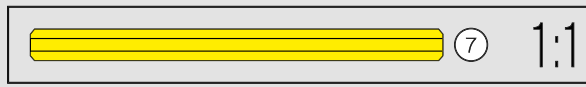
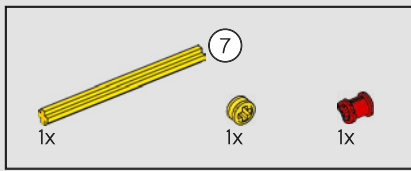

37

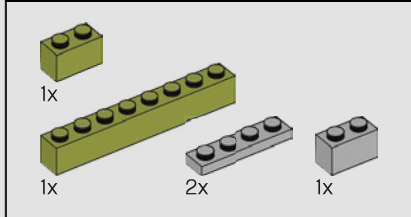
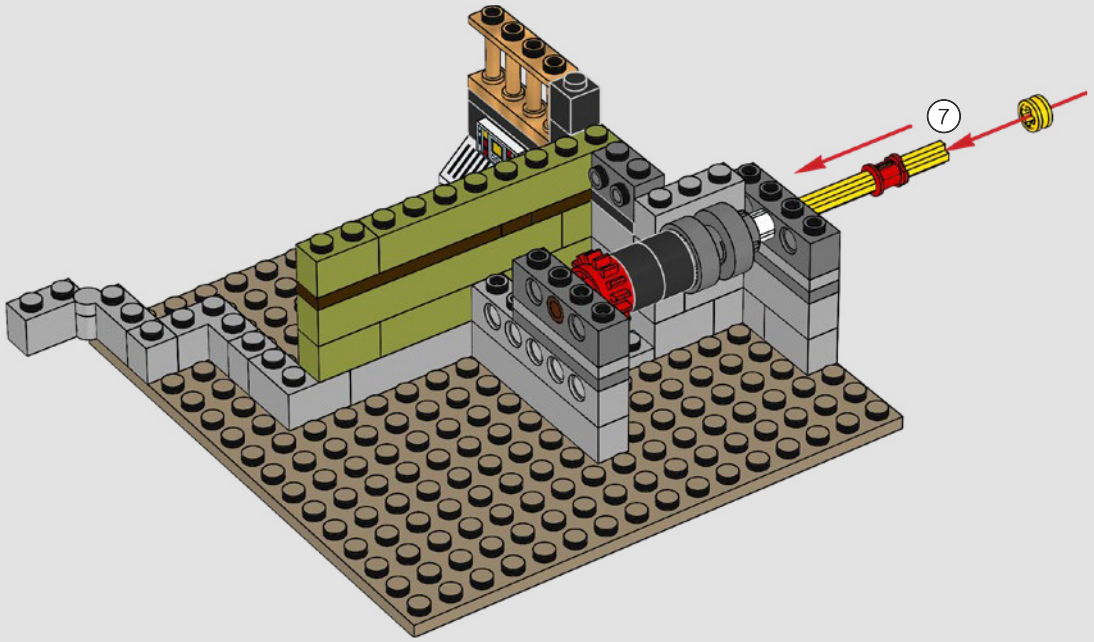

38

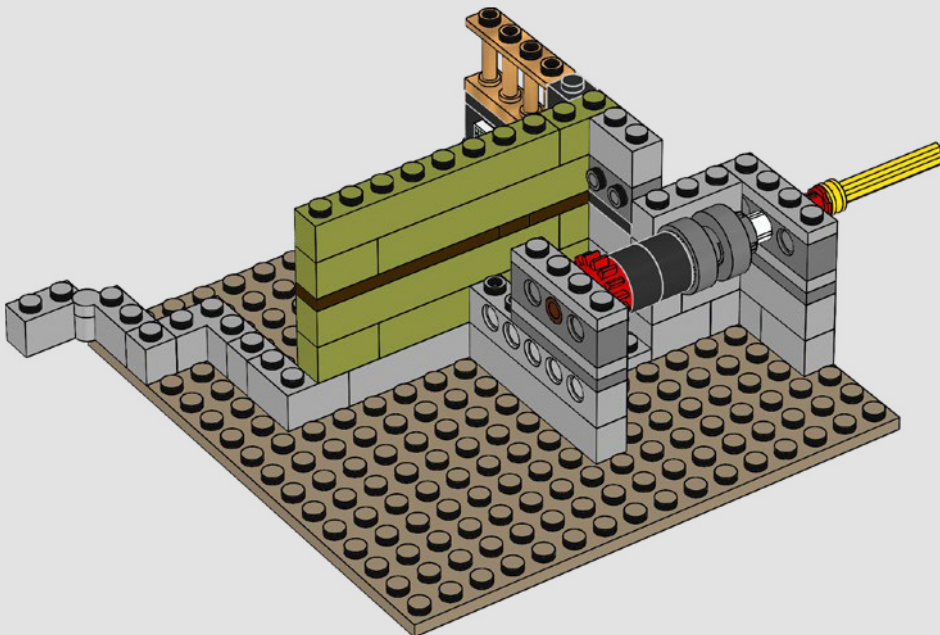

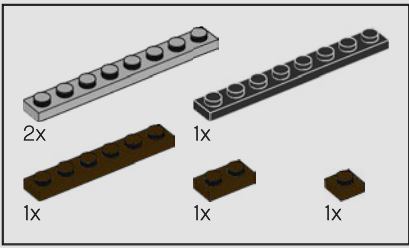

39

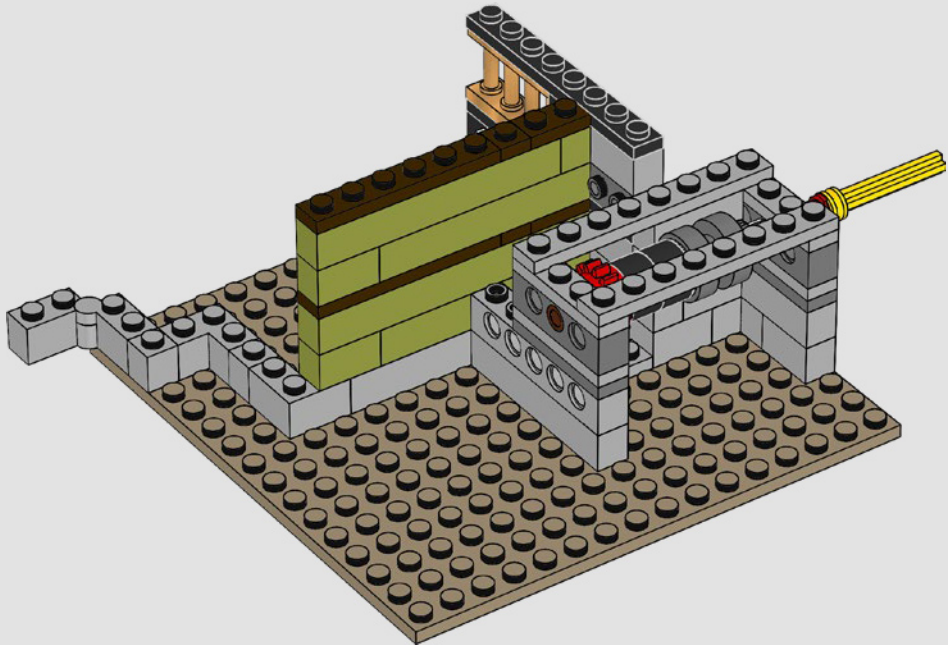

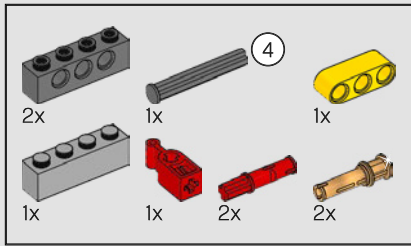

40

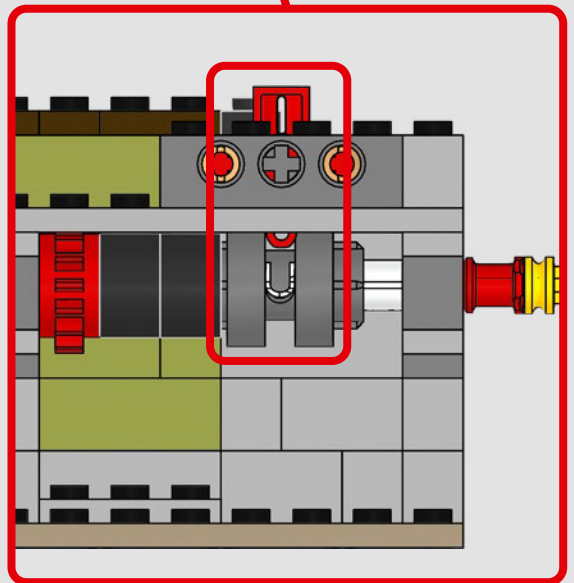
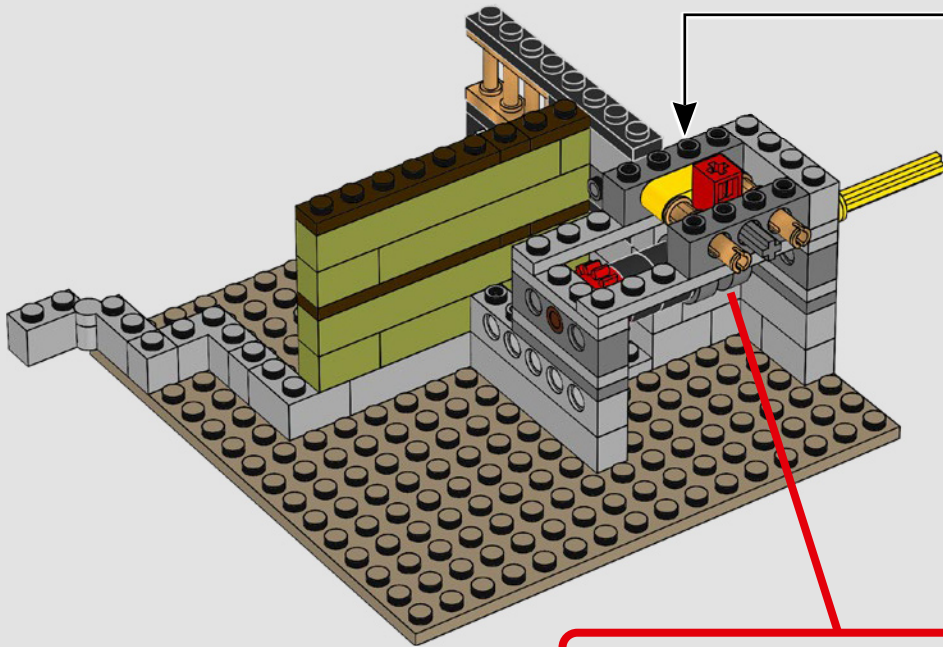
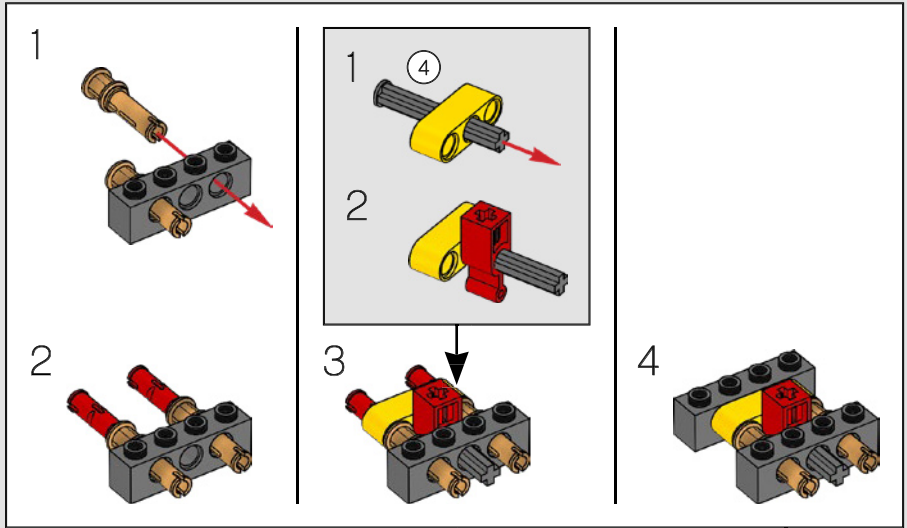
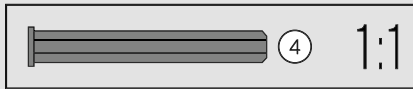

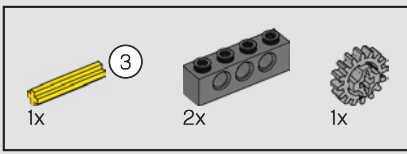

41

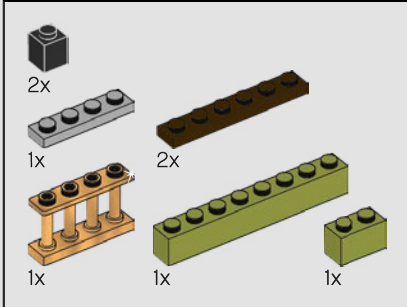
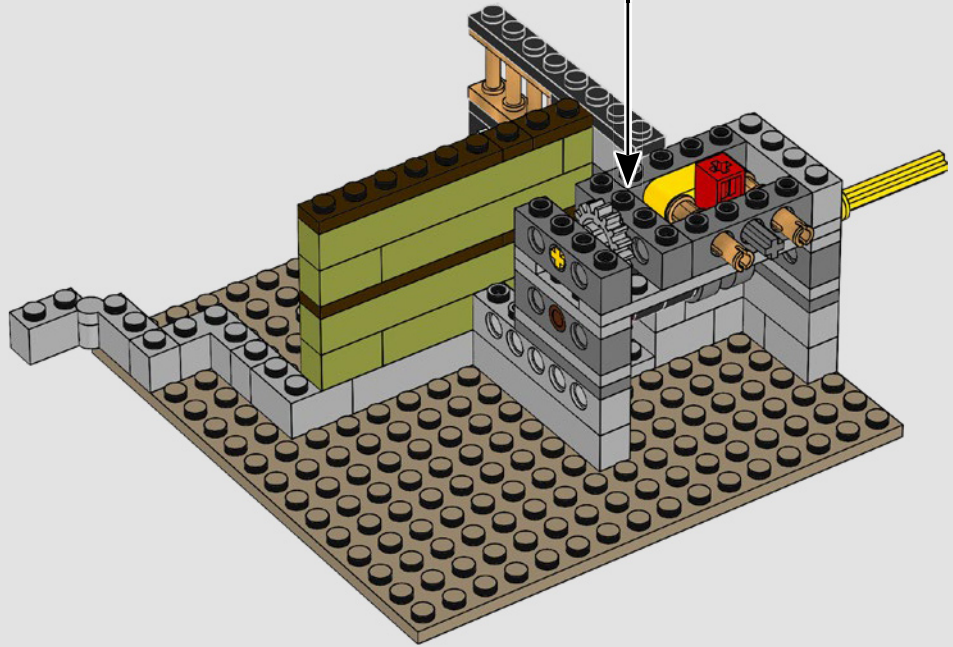
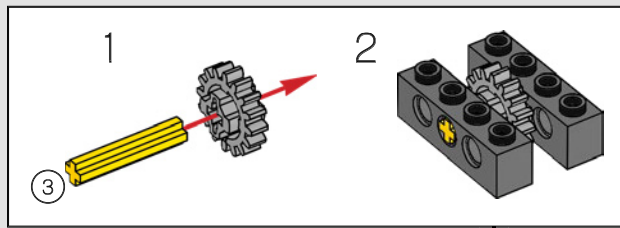

42

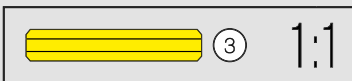
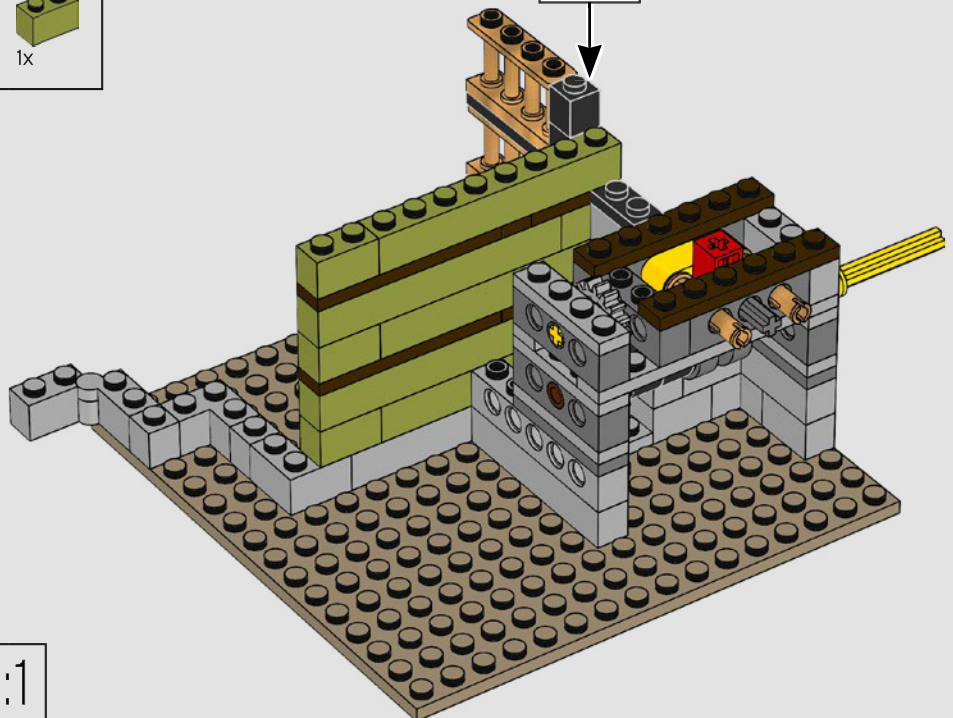
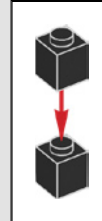

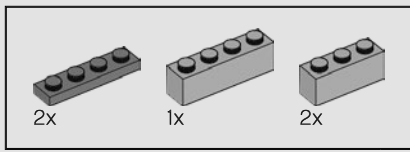

43

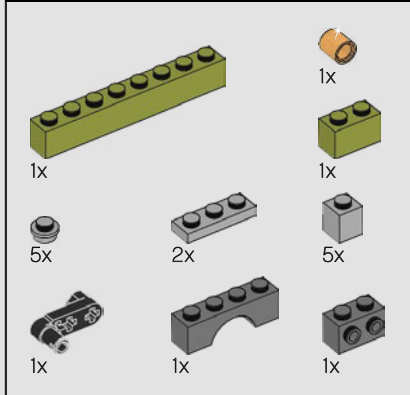
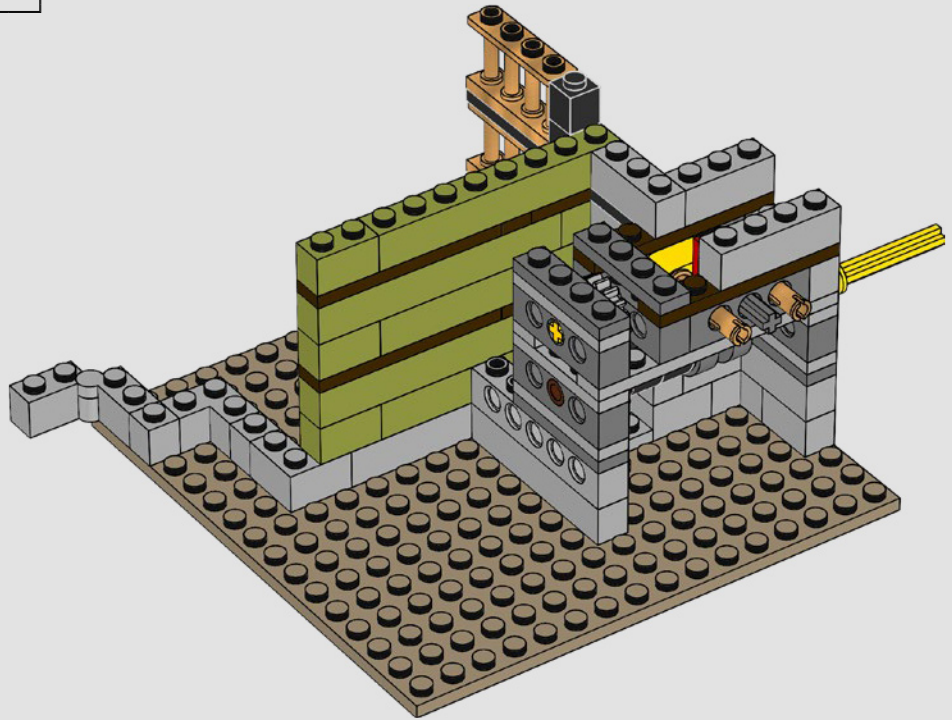

44

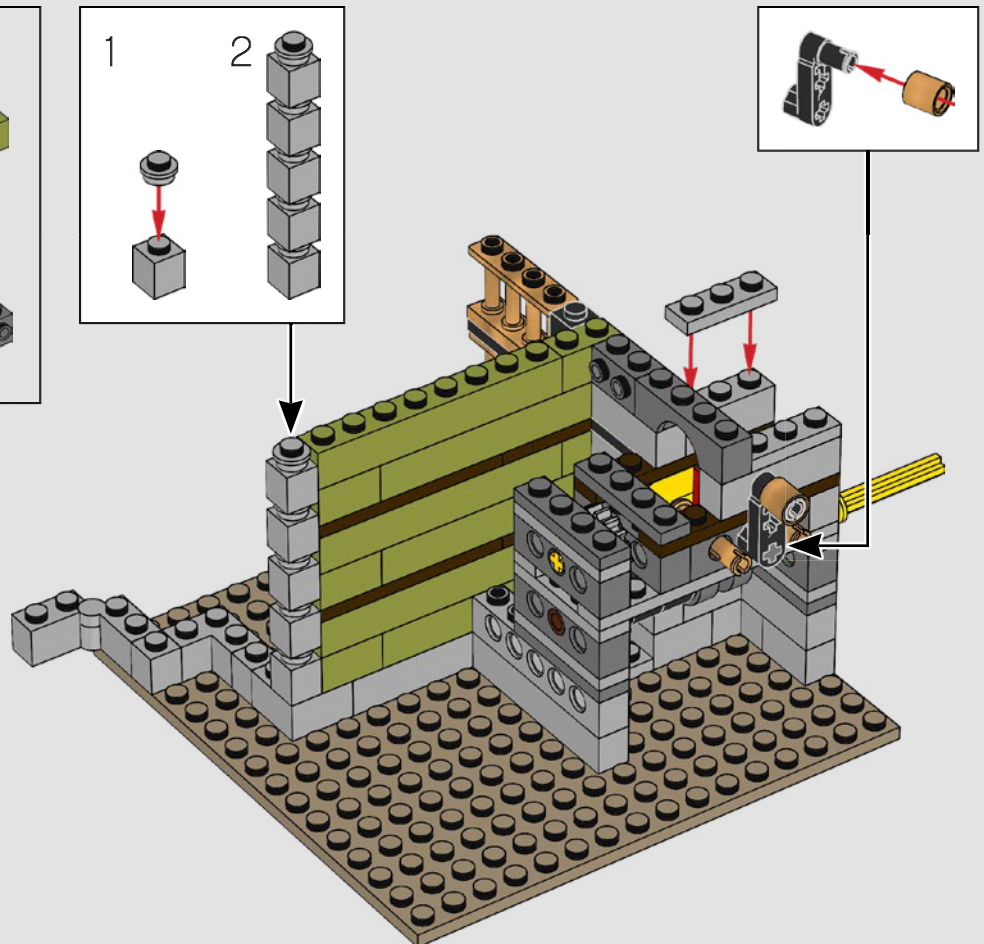

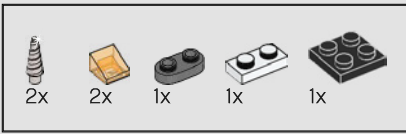

45

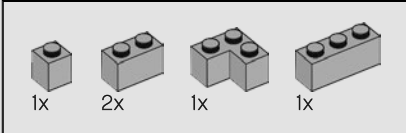
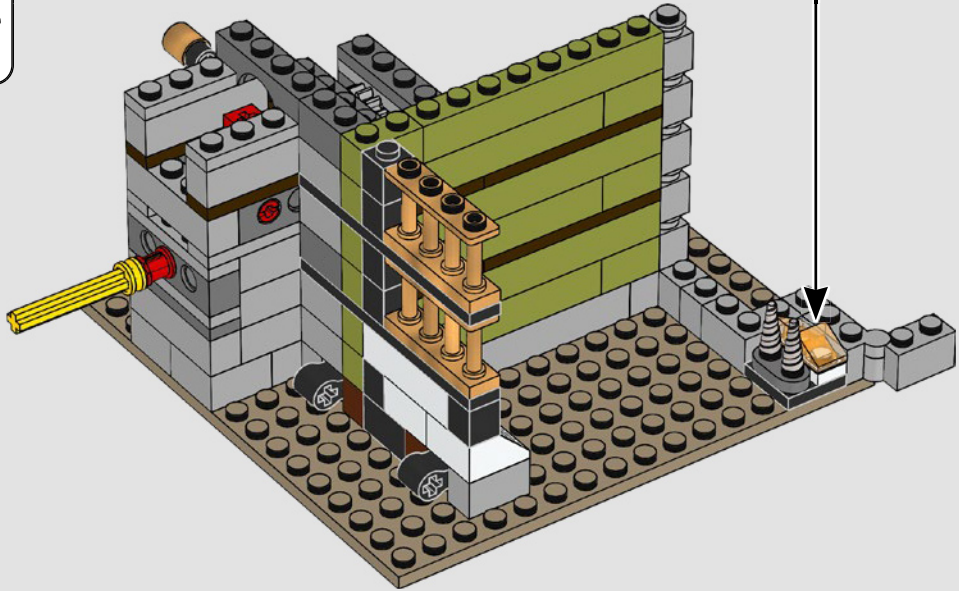
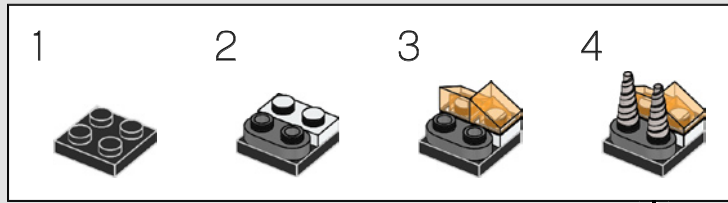

46

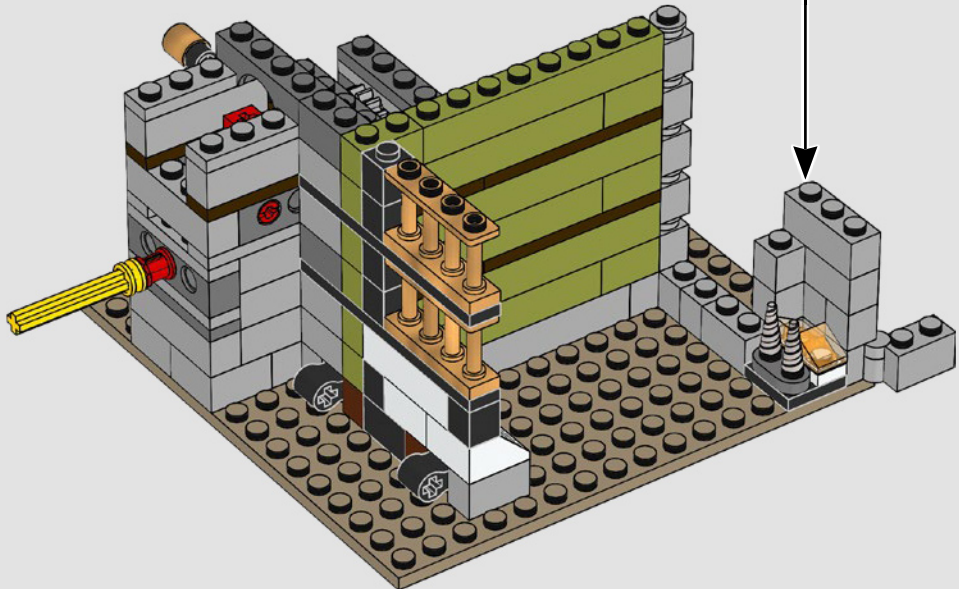
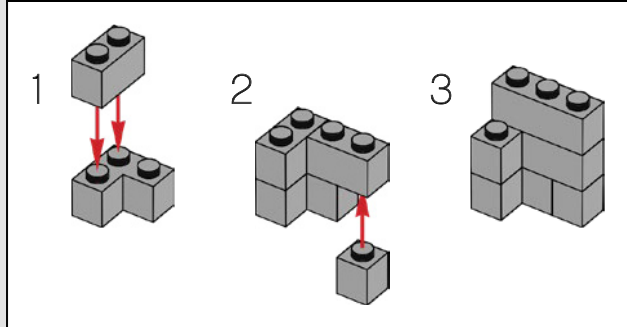

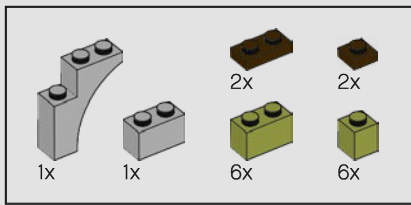

47

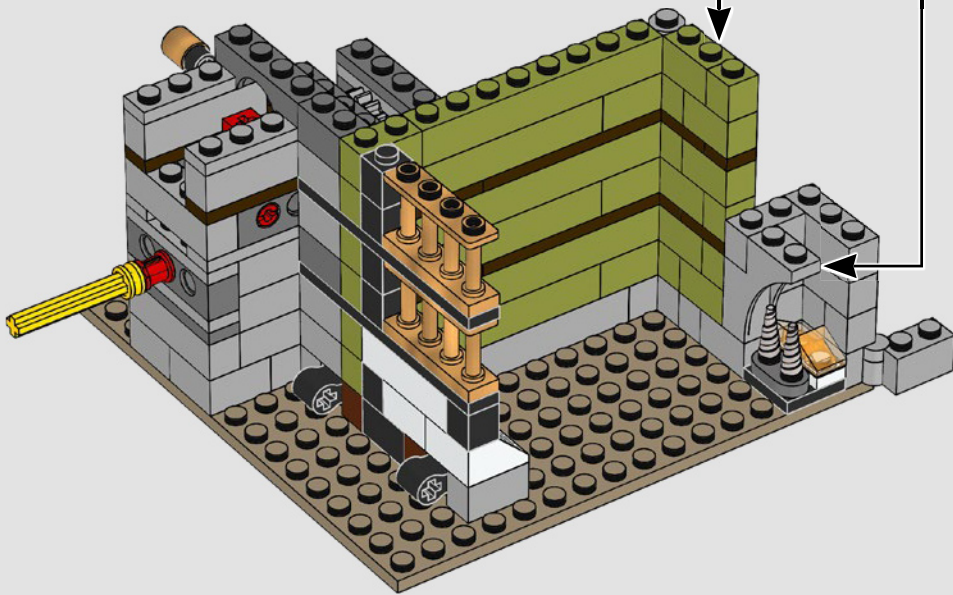
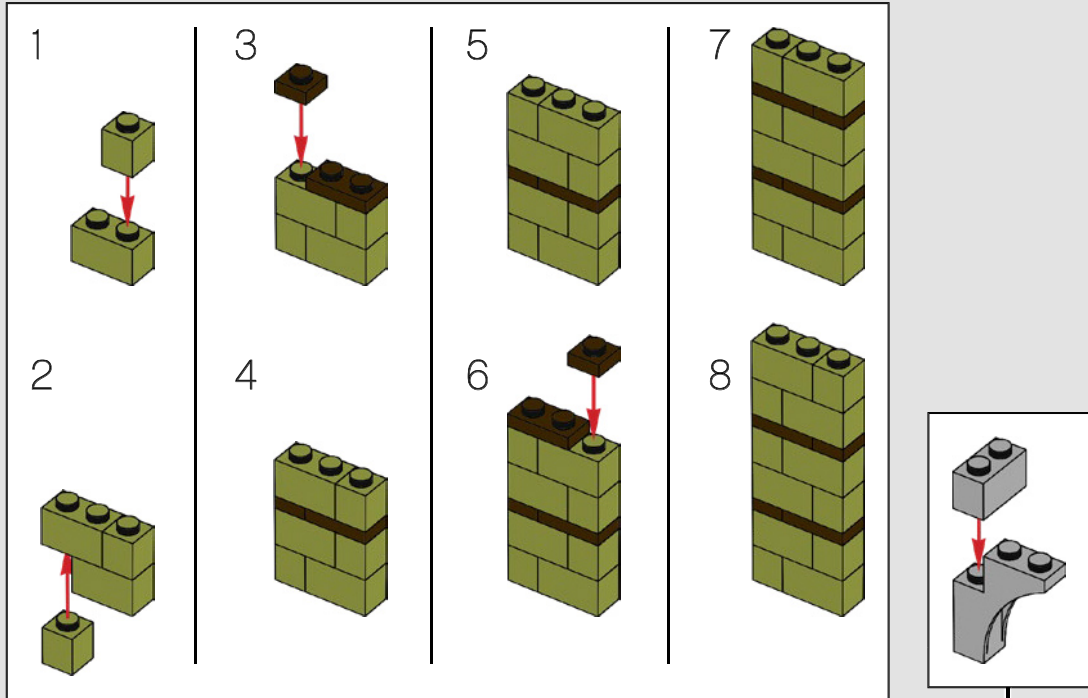

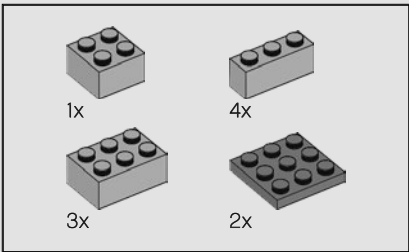

48

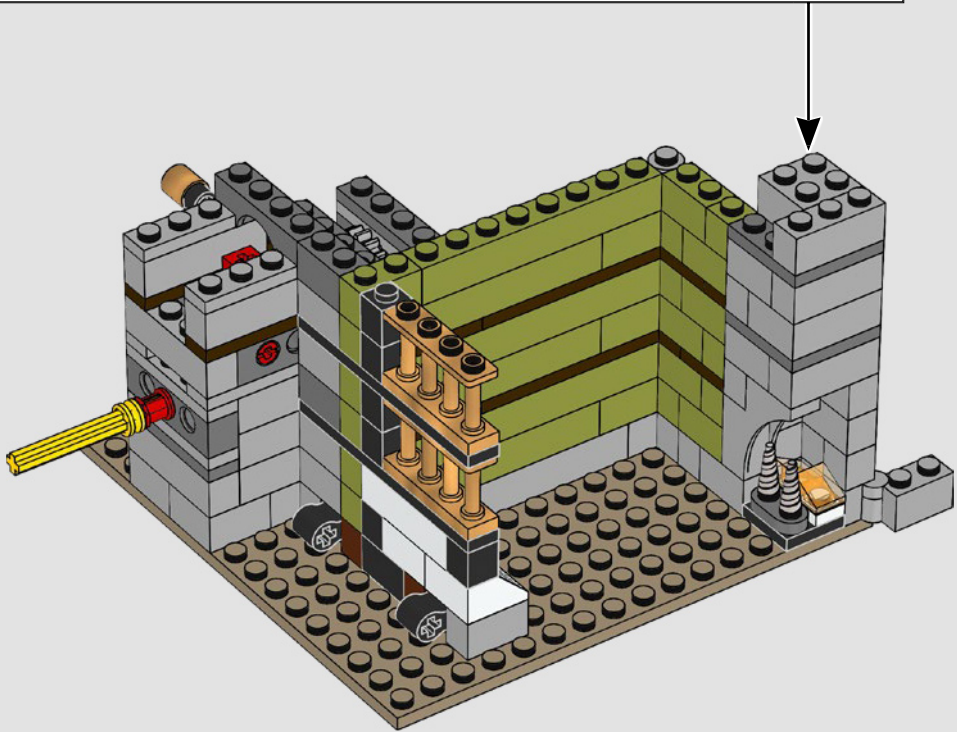
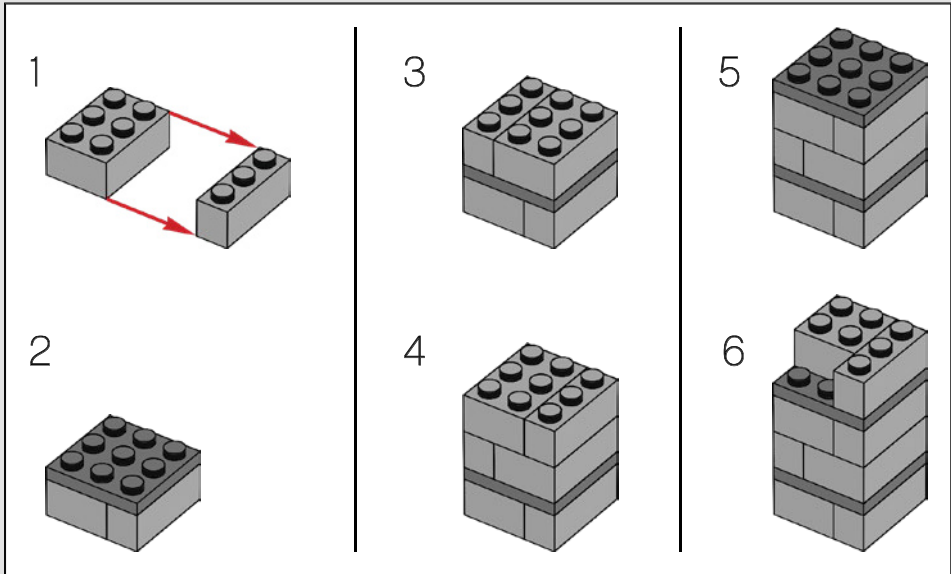

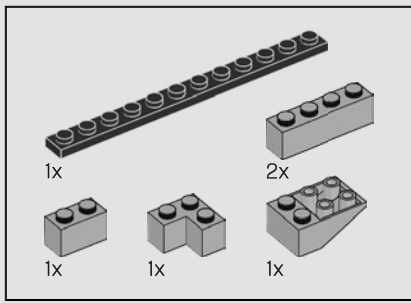

49

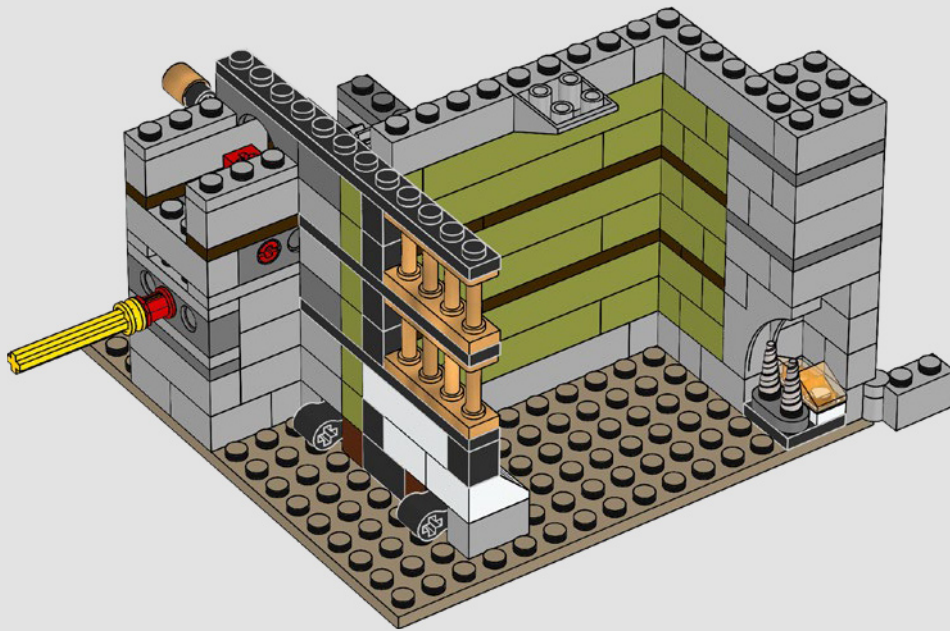

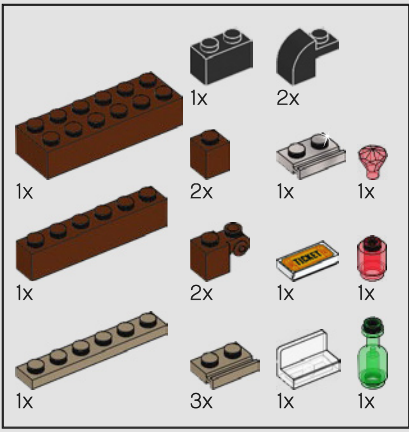

50

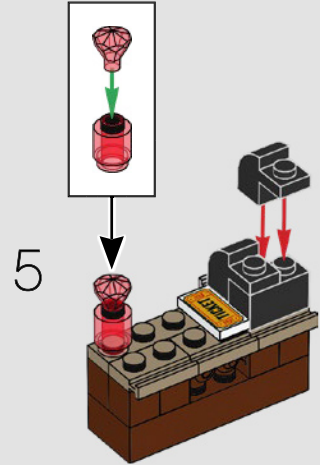
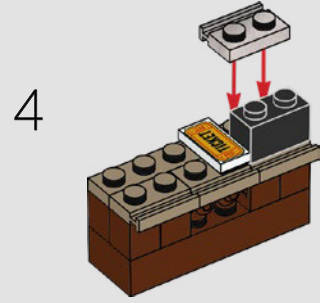
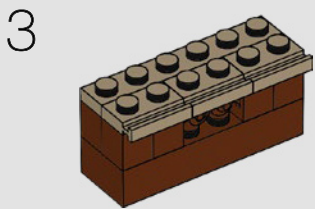
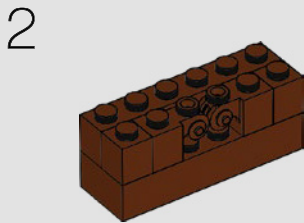
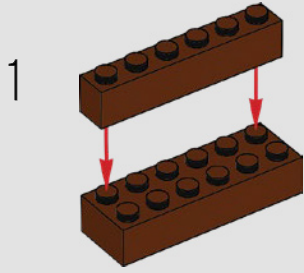

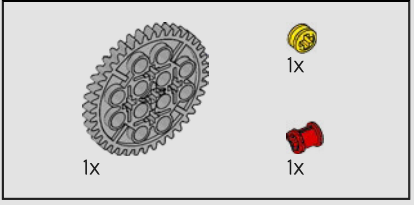
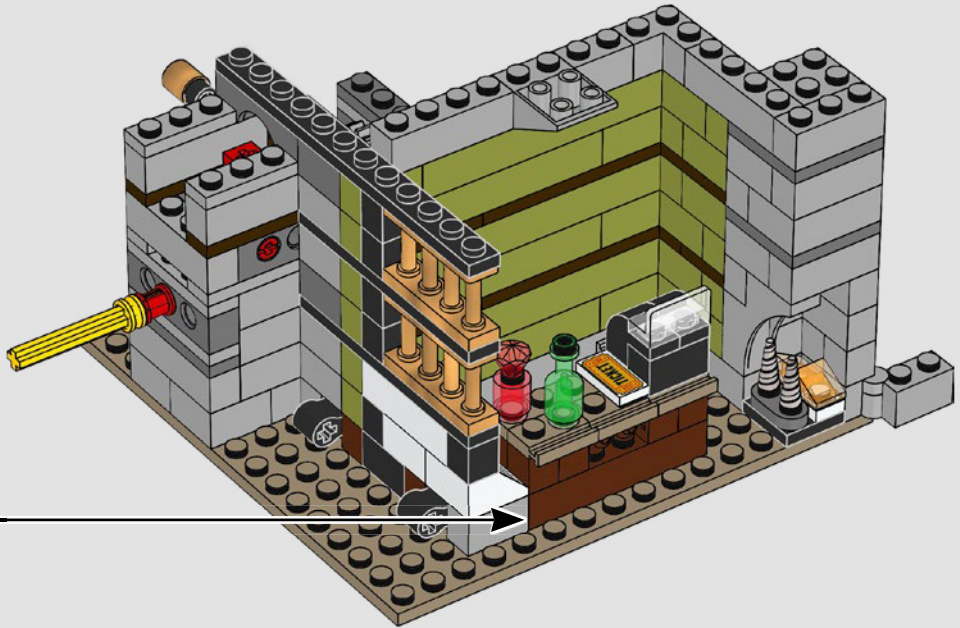

51

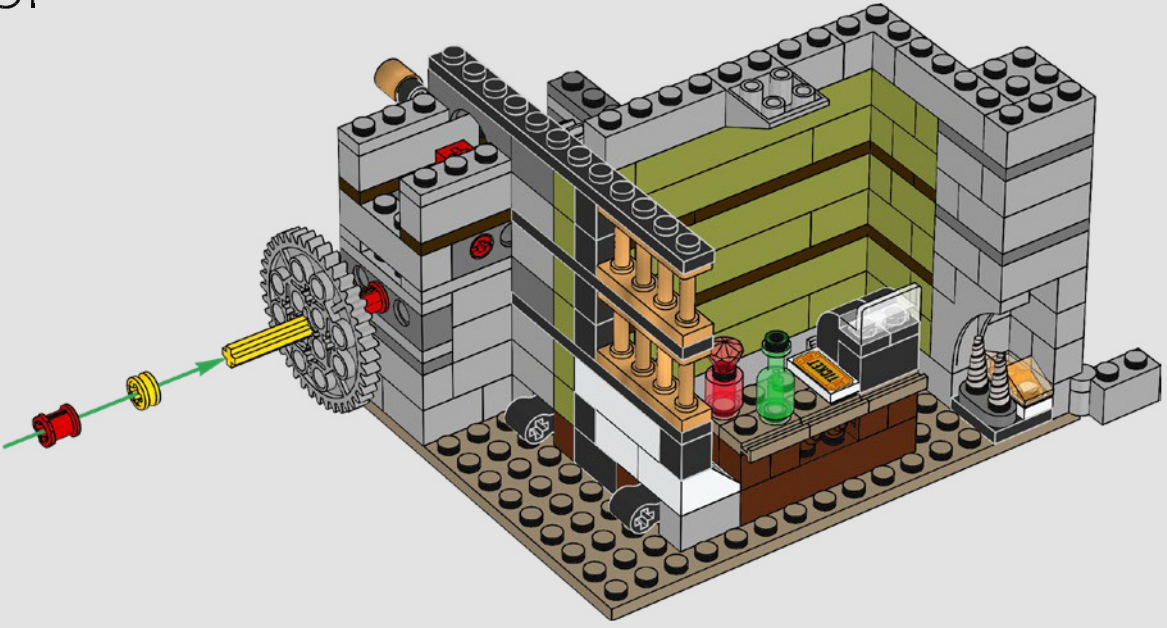

52

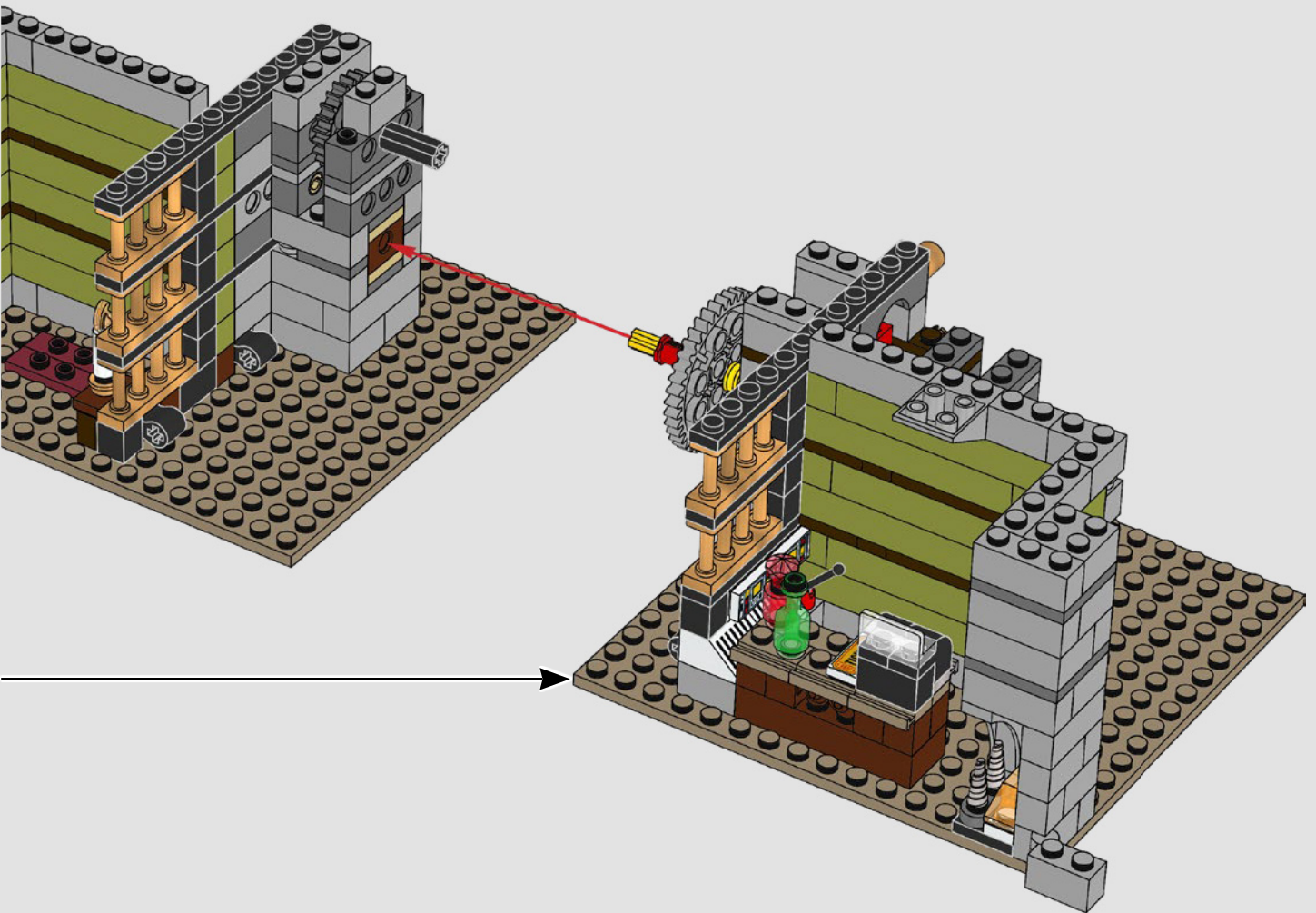

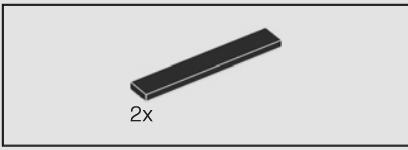

53



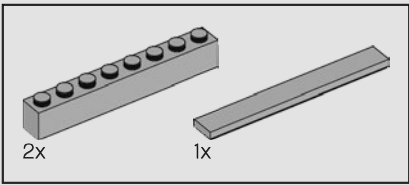

54

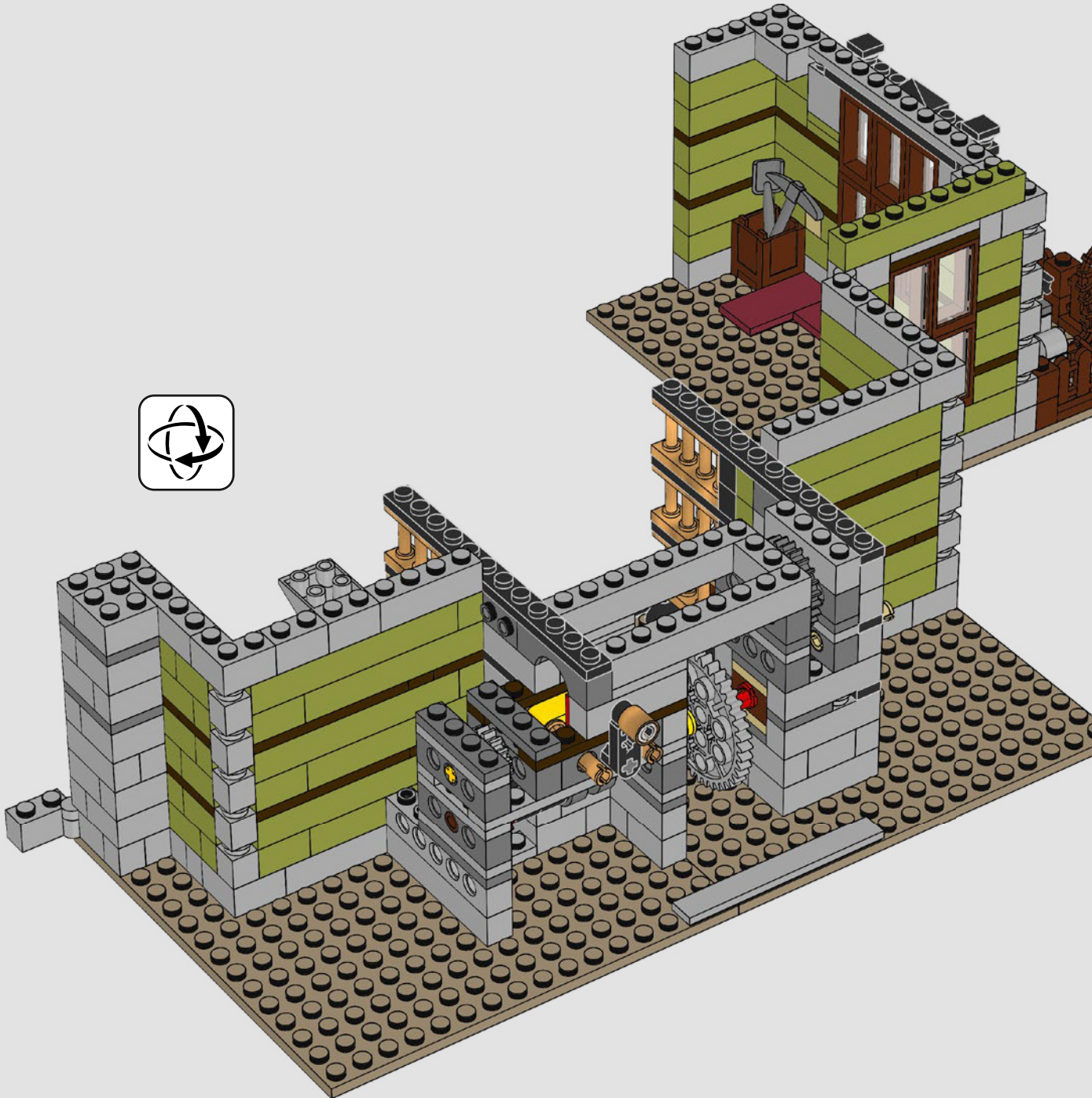

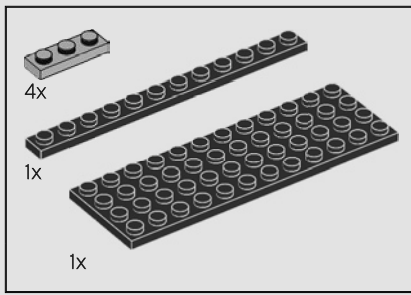

55

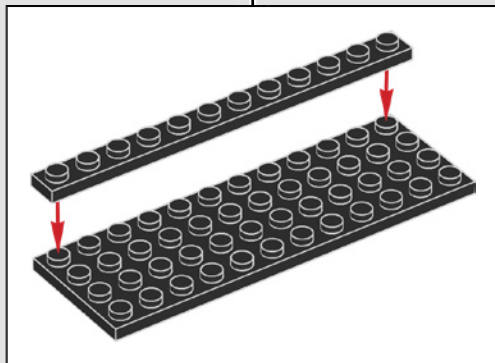
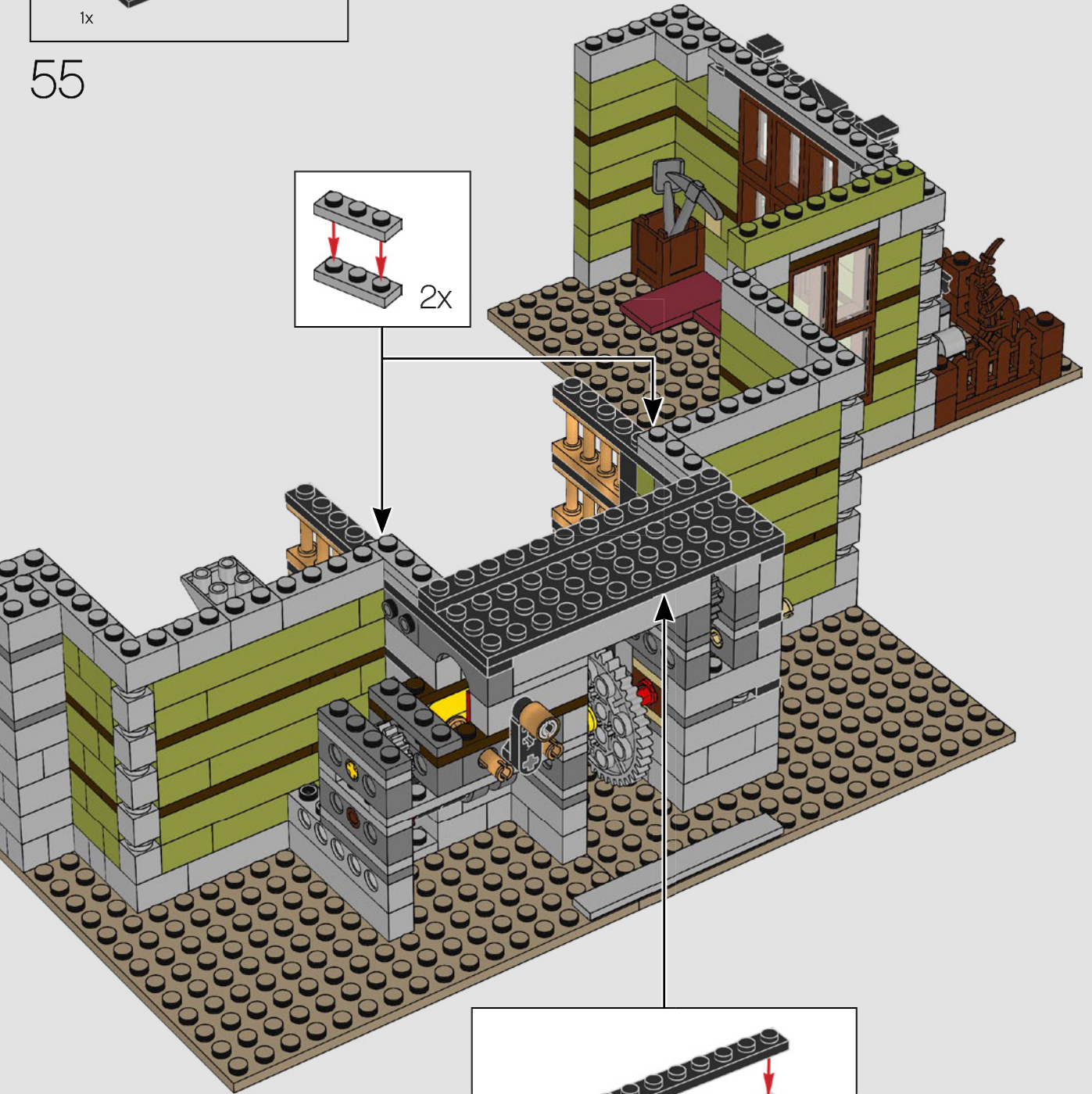
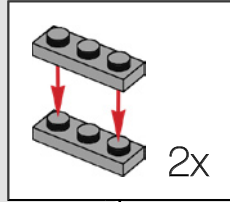

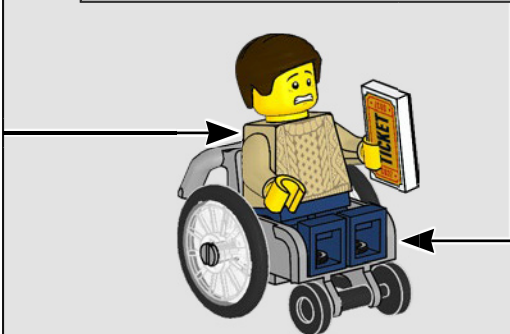
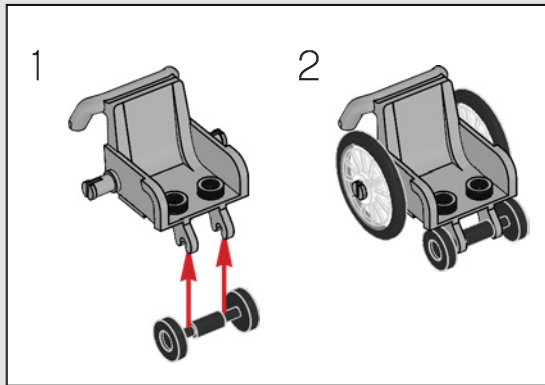
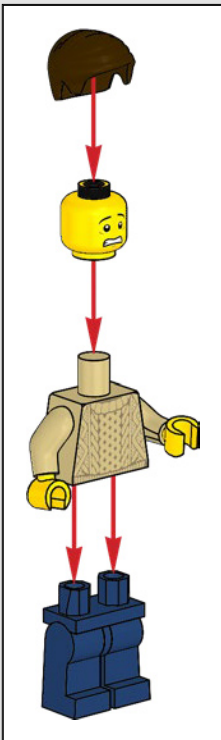
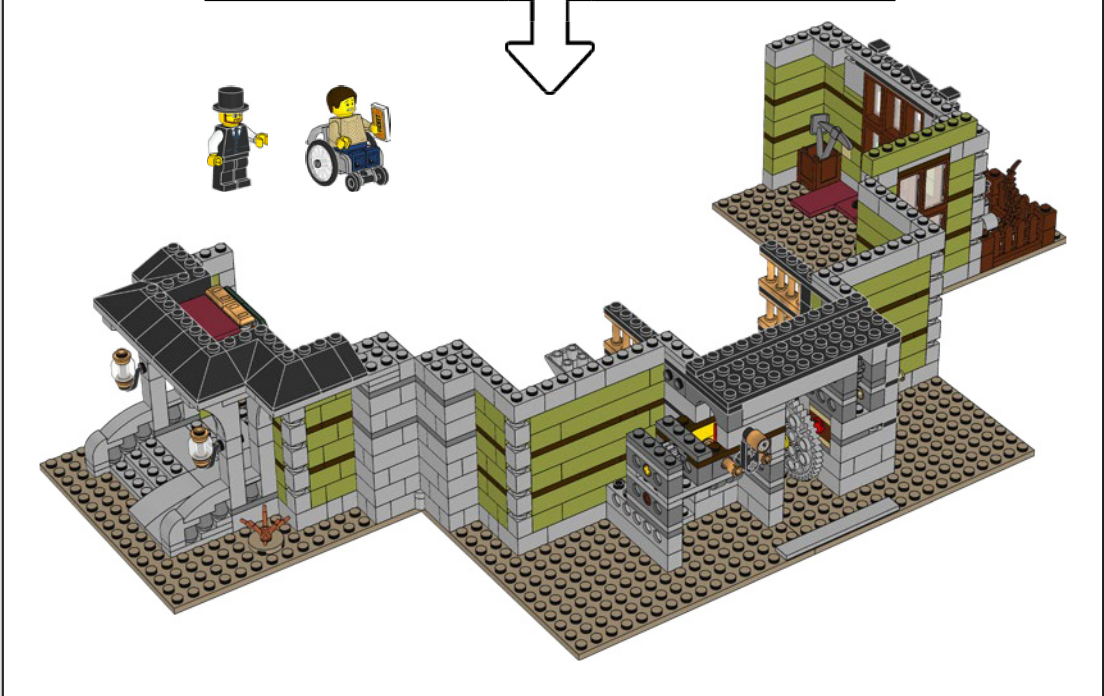
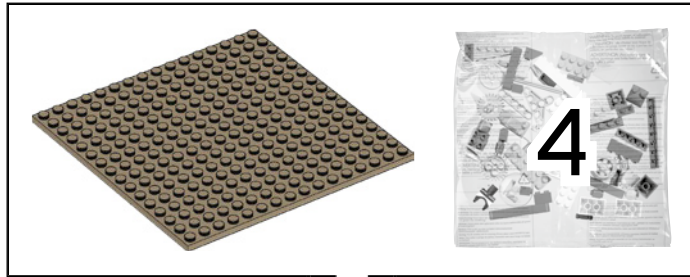

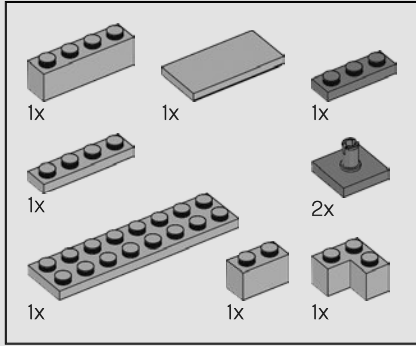
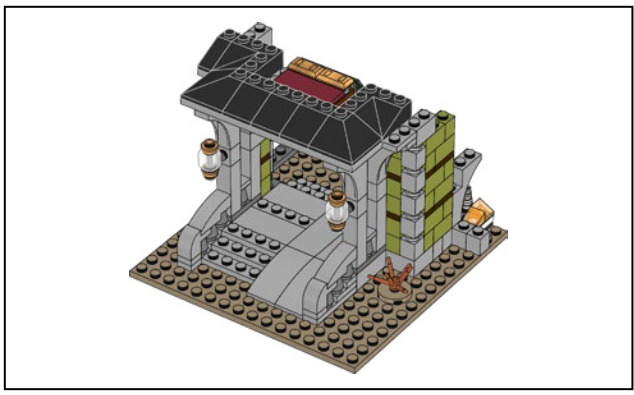

56

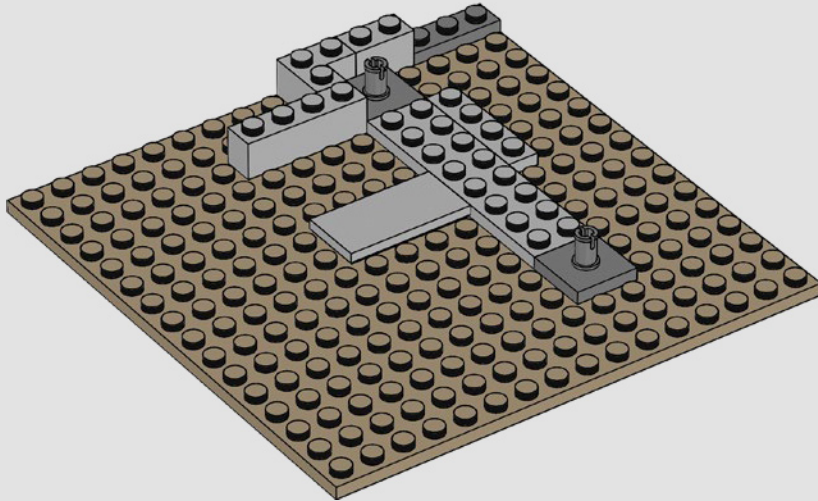

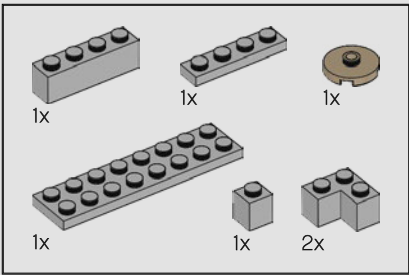

57

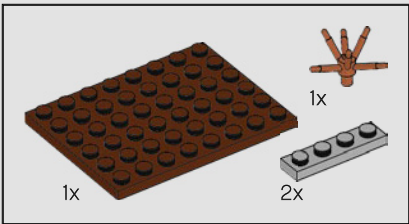
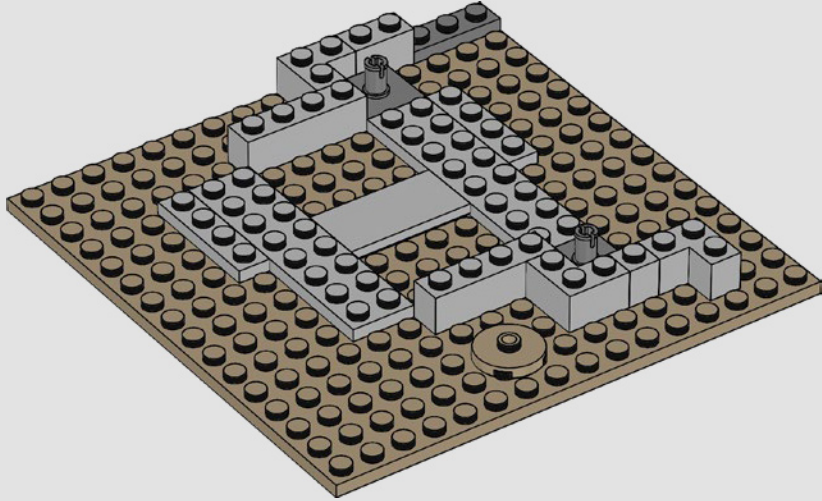

58

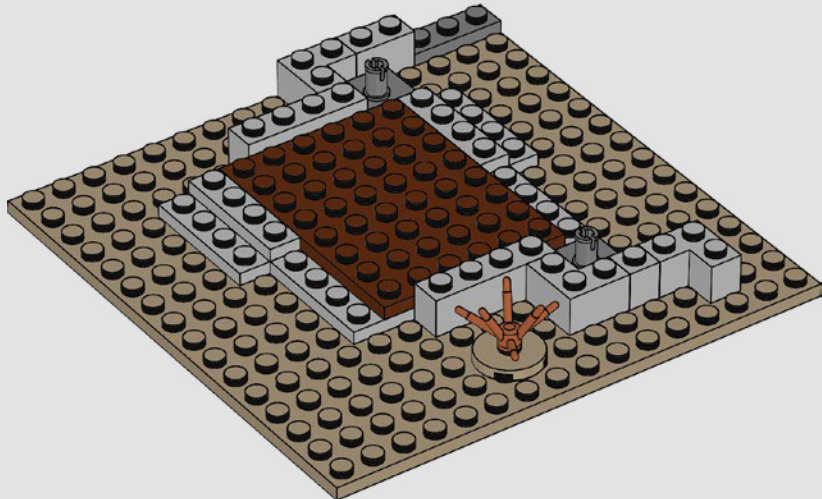

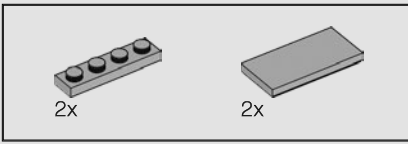

59

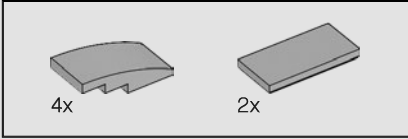
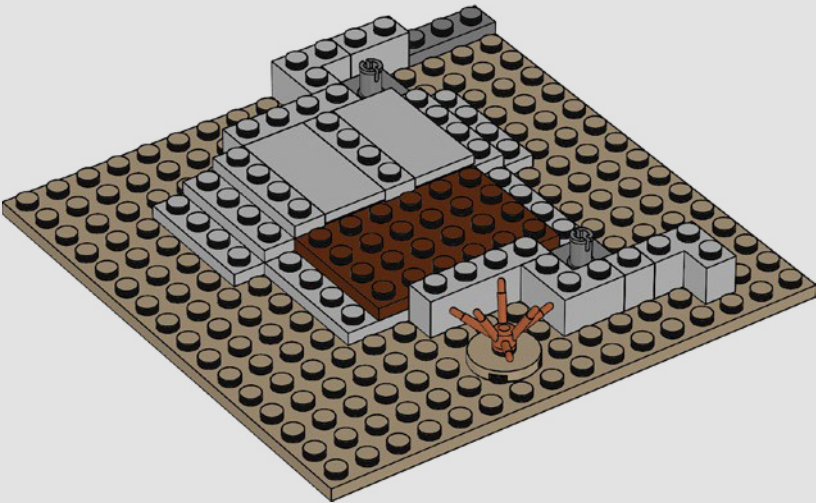

60

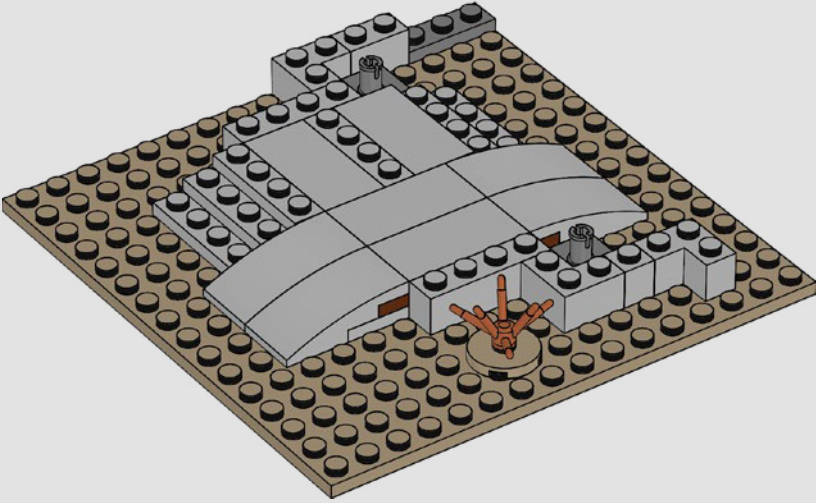

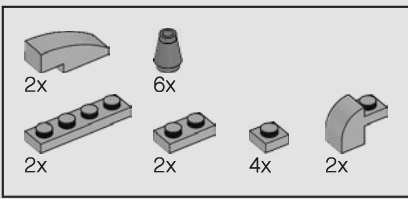

61

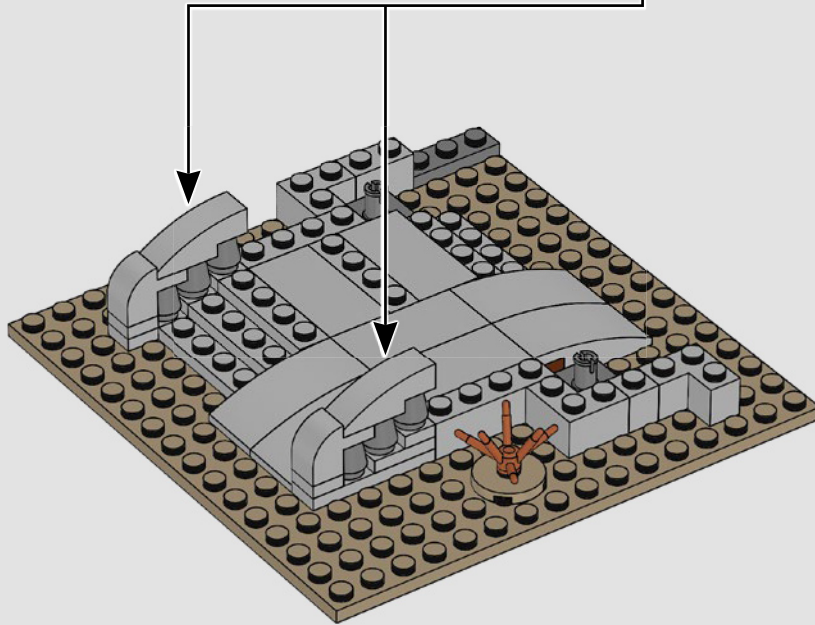
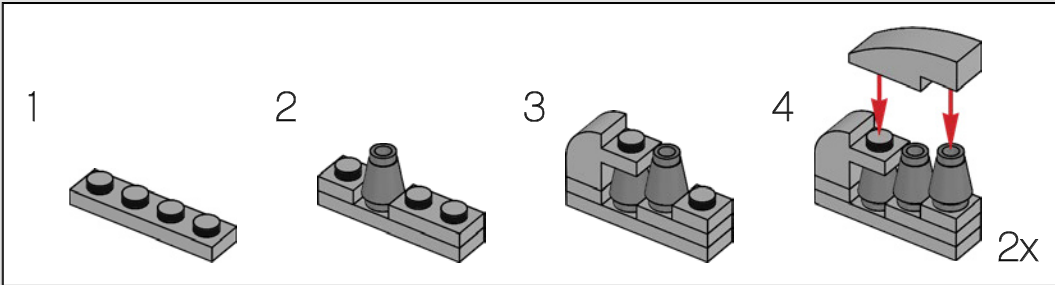

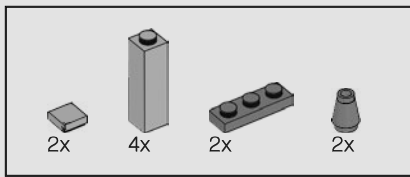

62

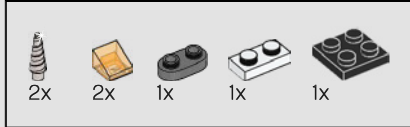
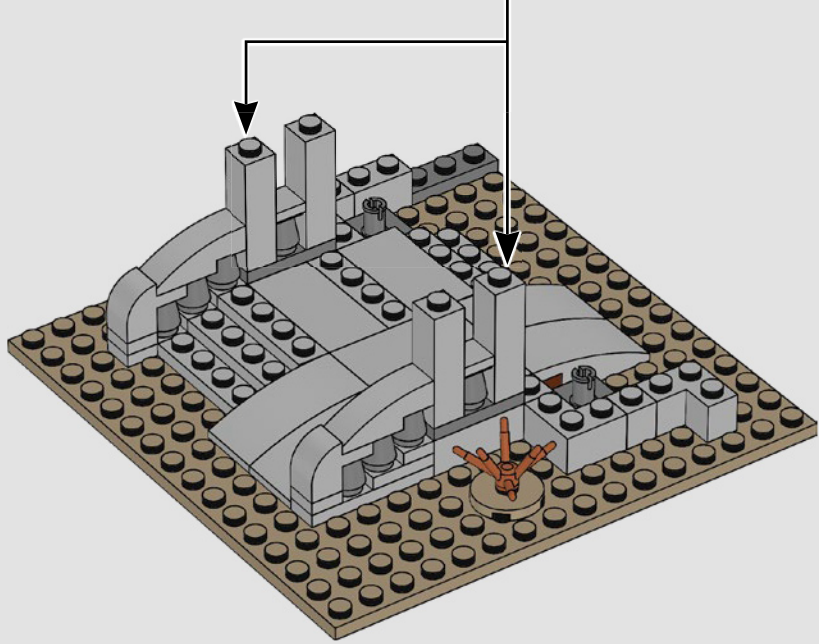
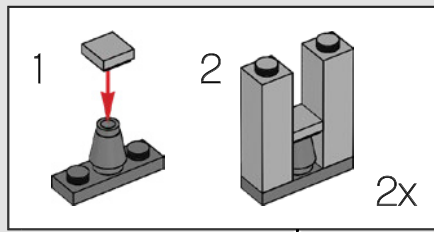

63

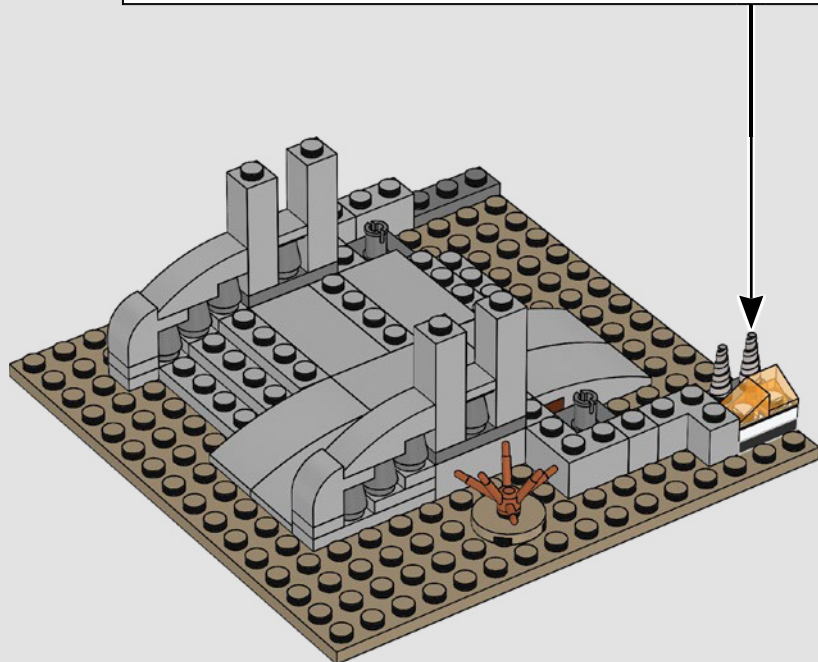
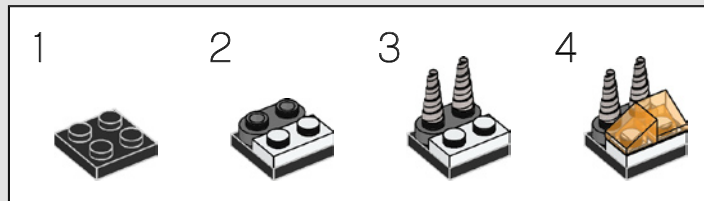

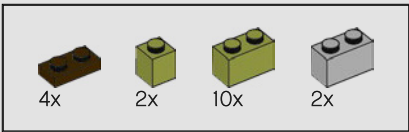

64

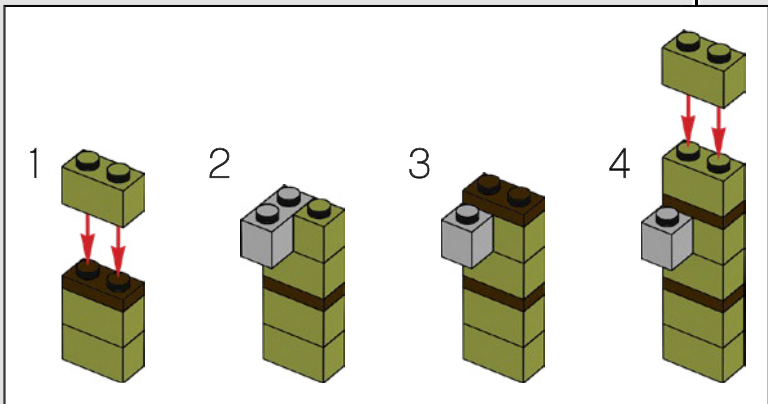
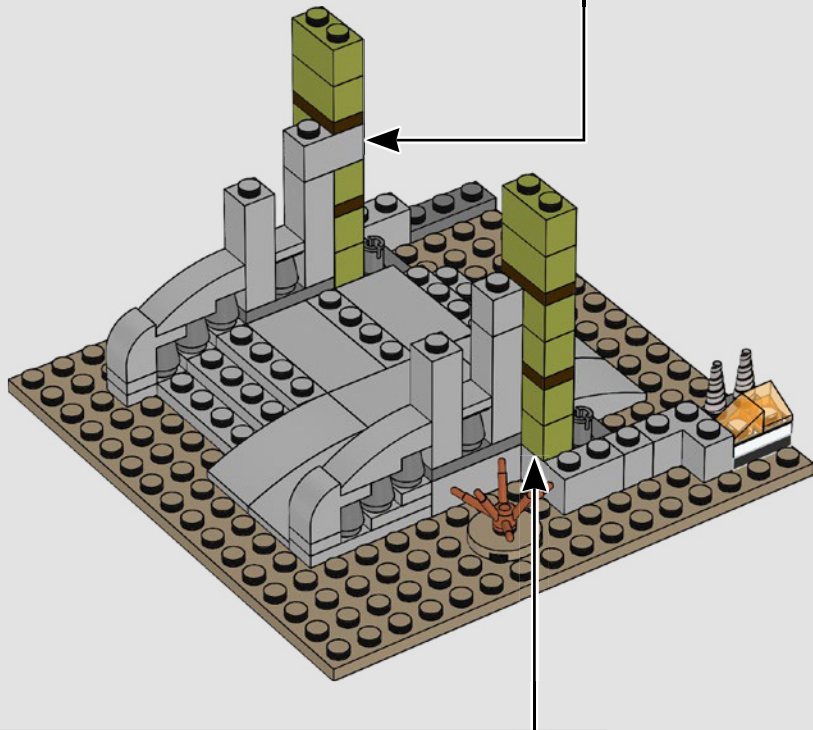
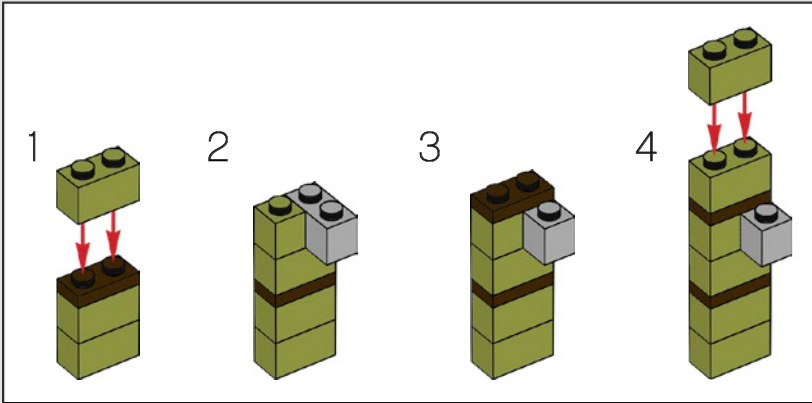

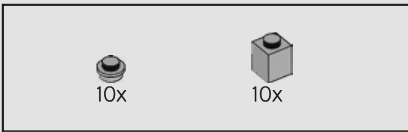

65

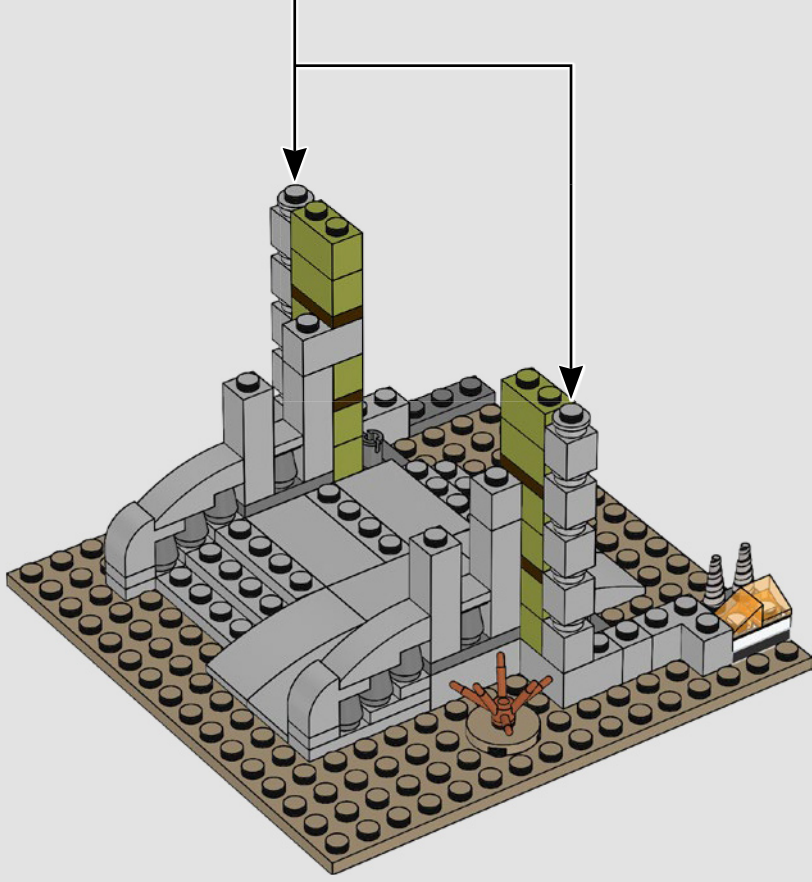
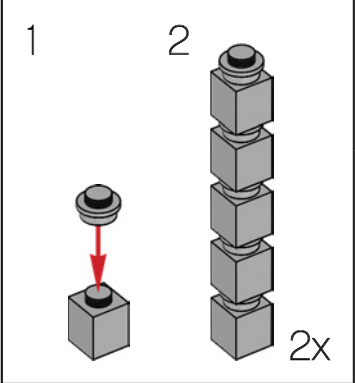

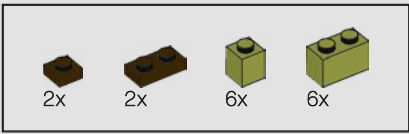

66

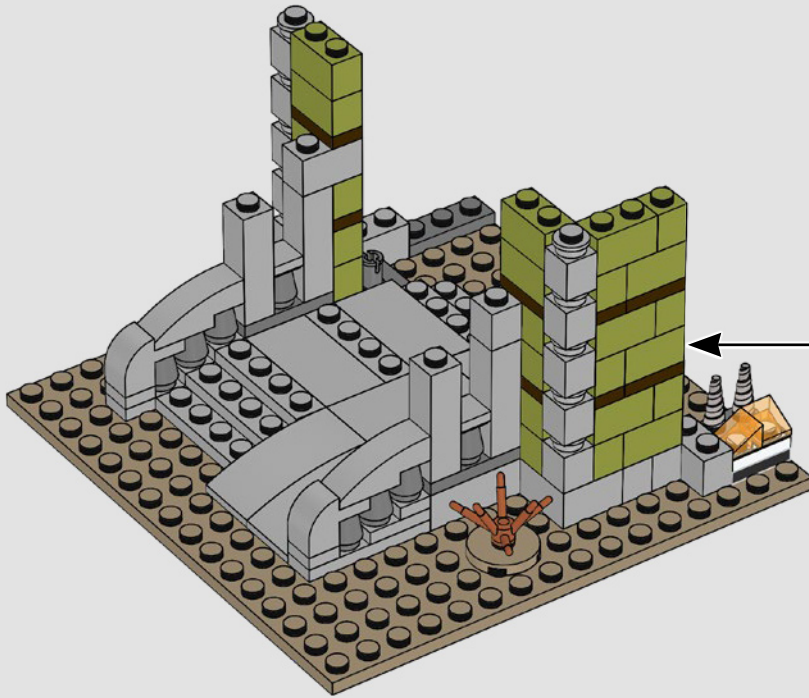
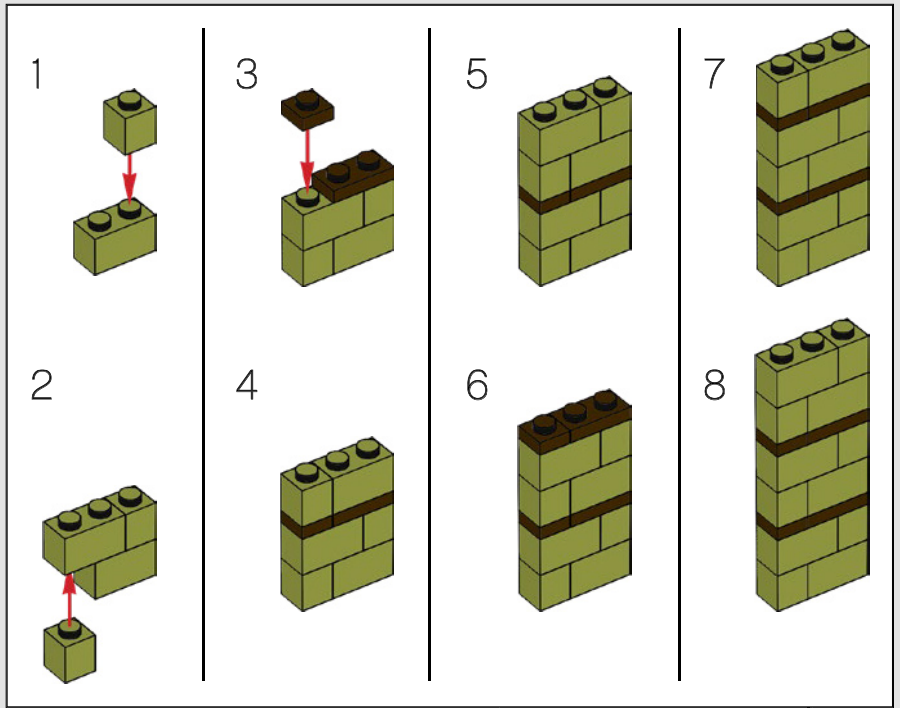

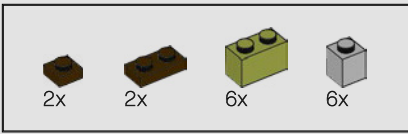

67

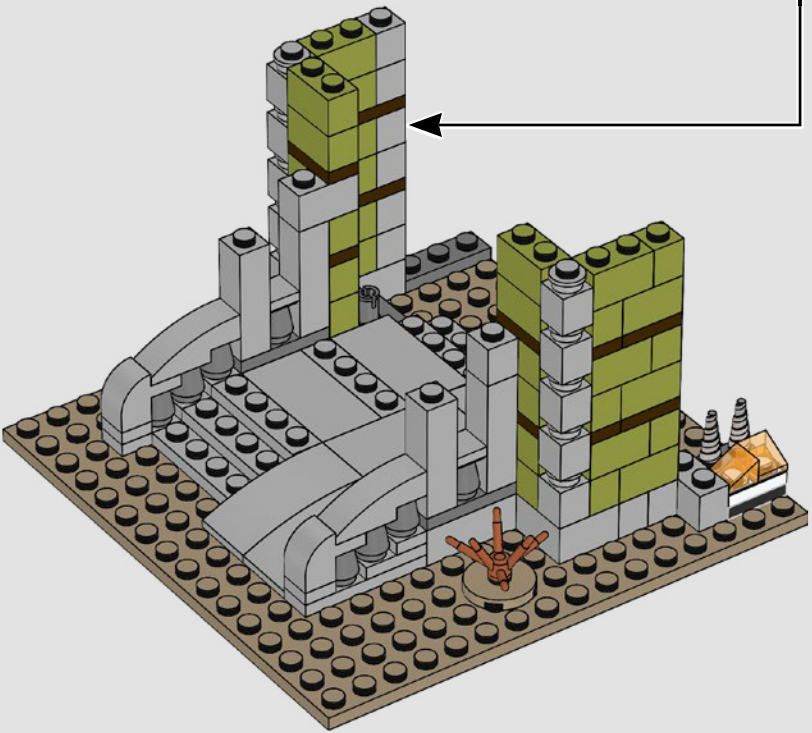
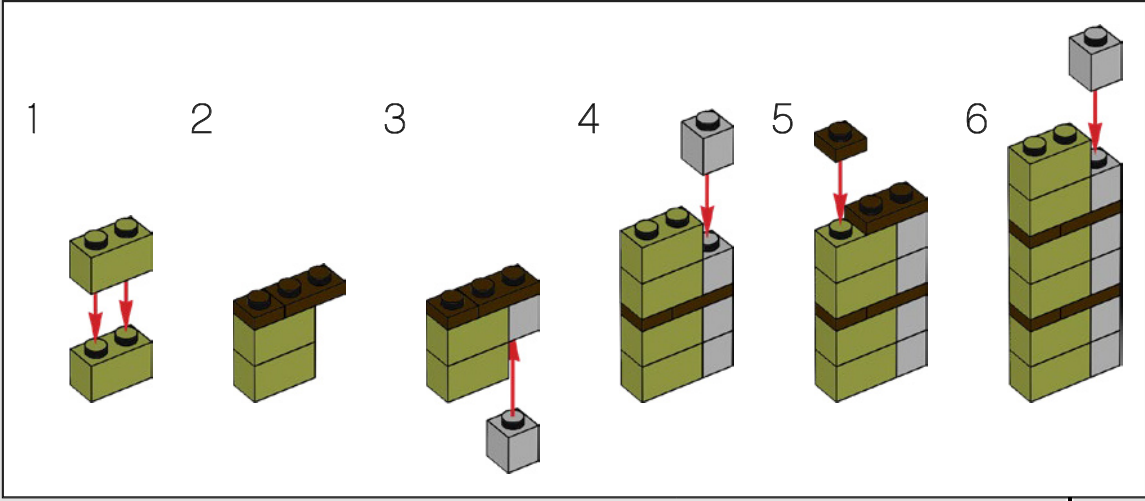

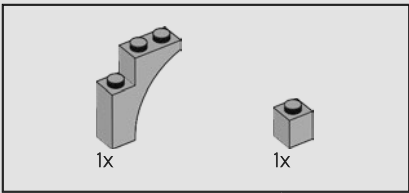

68

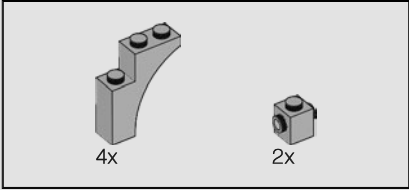
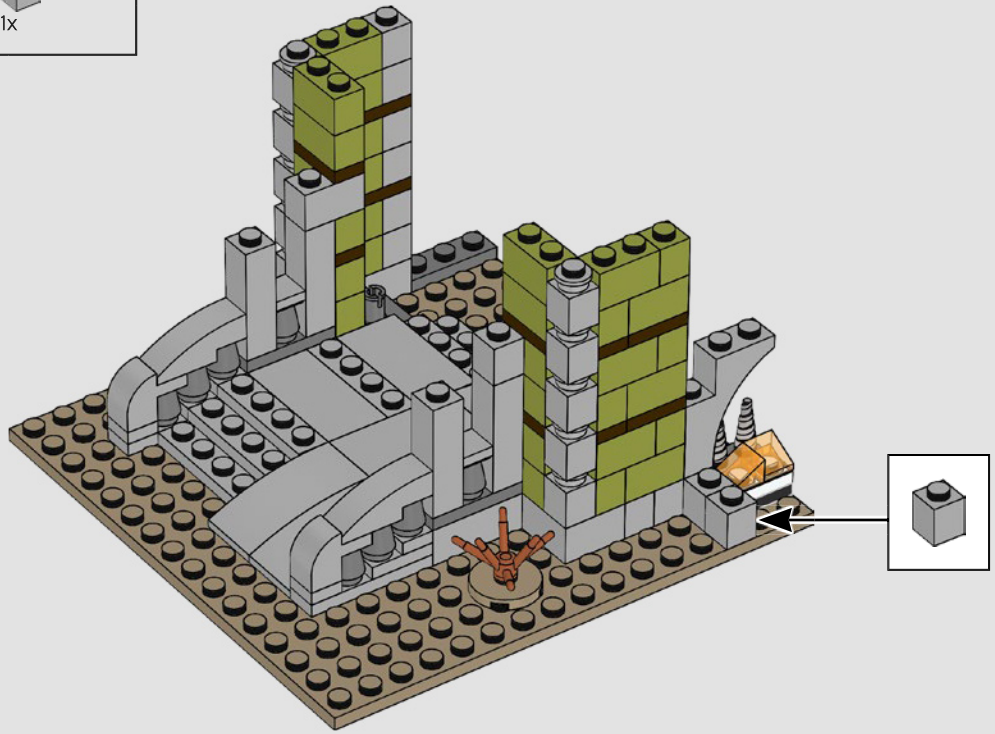

69

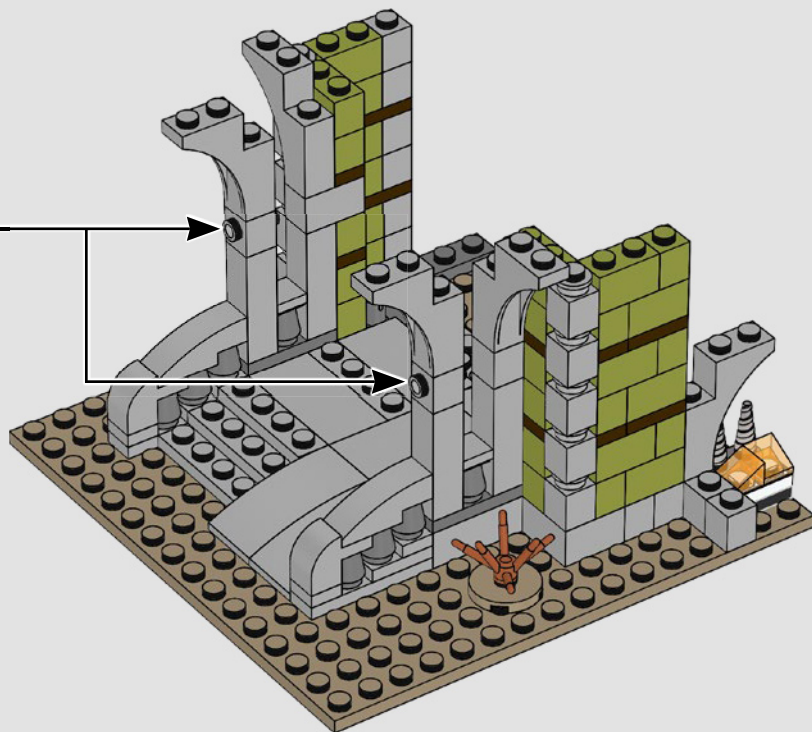
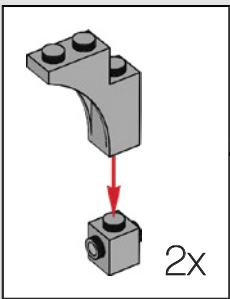

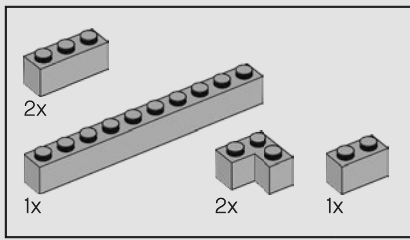

70

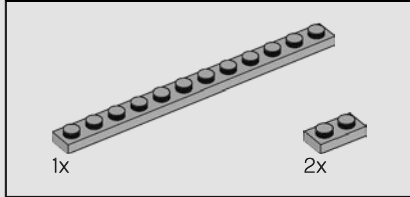
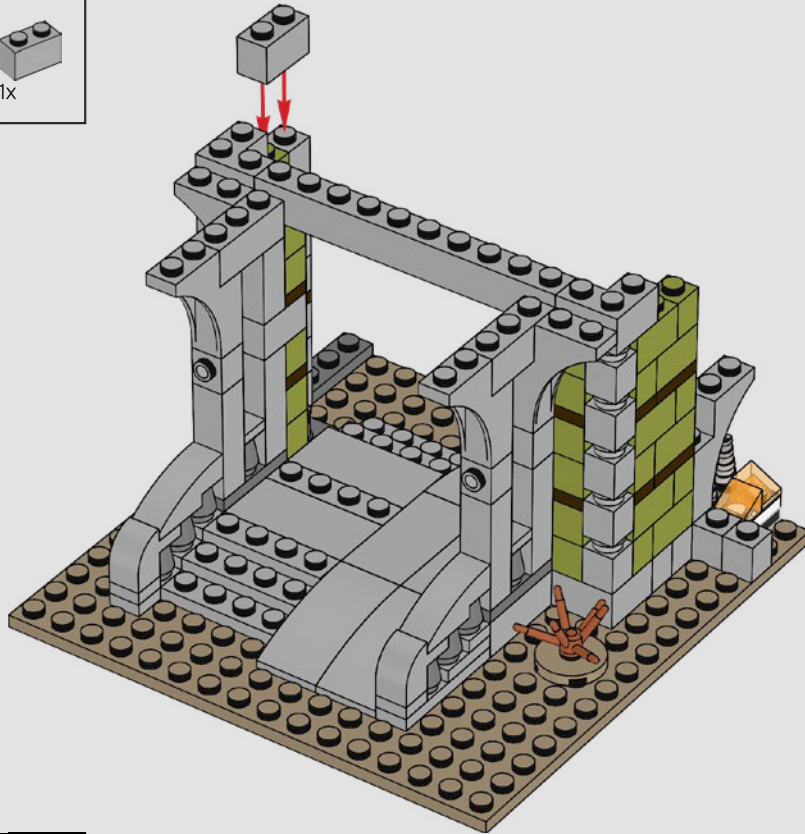

71

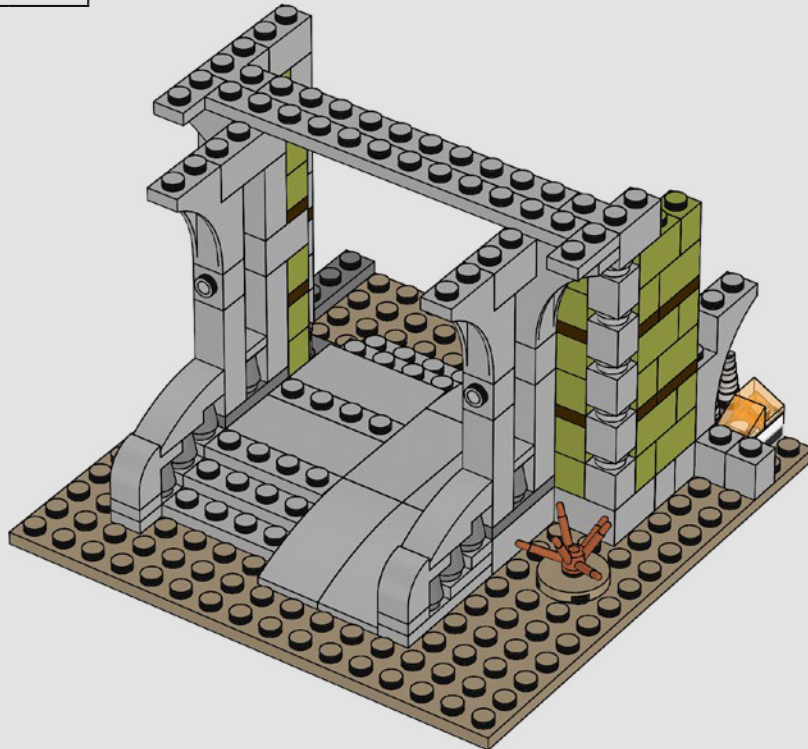

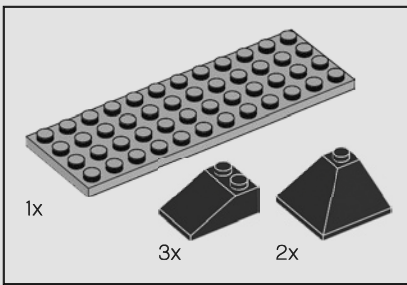

72

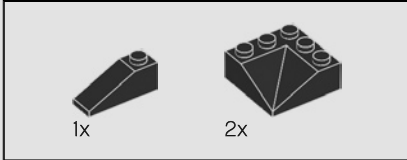
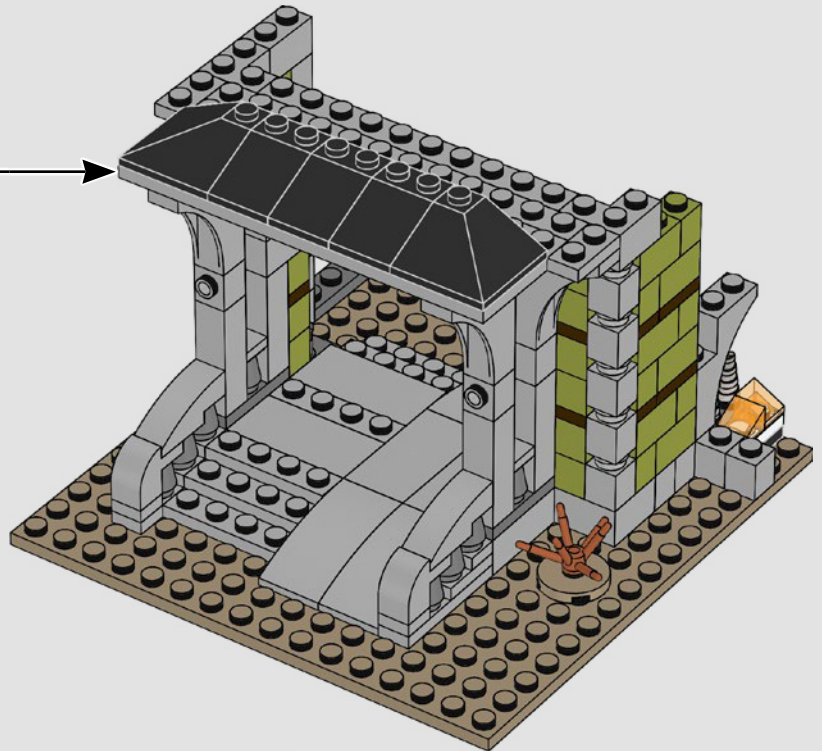
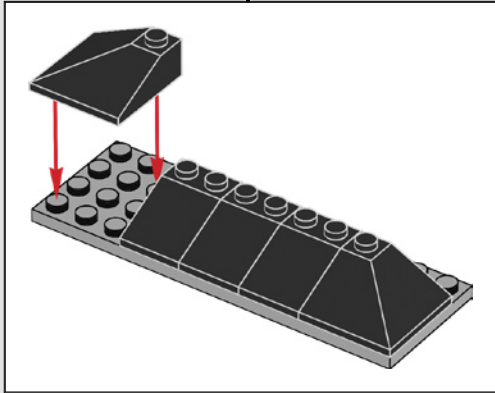

73

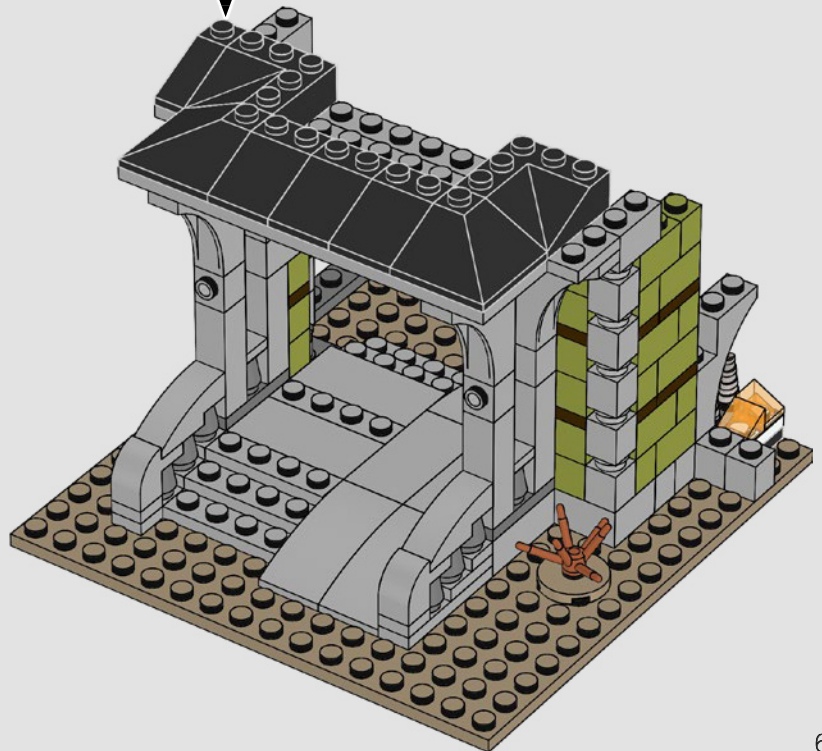
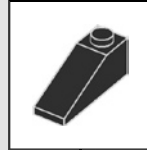

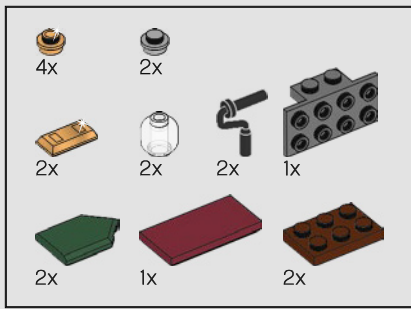

74

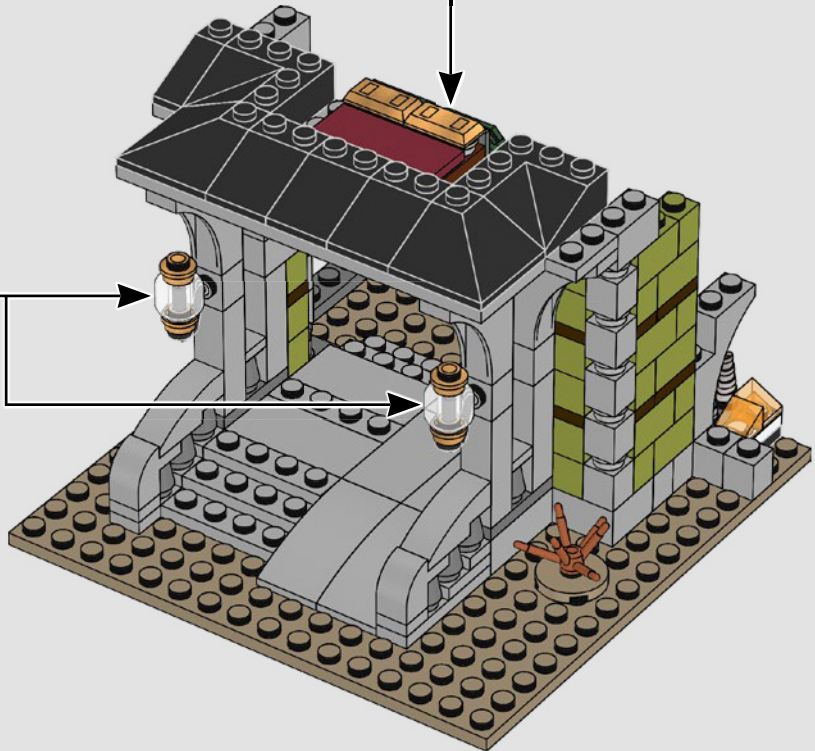
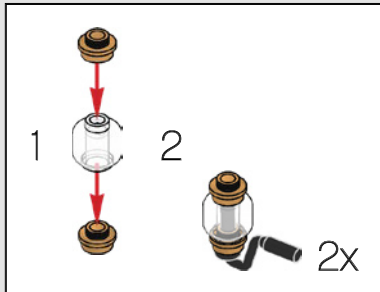
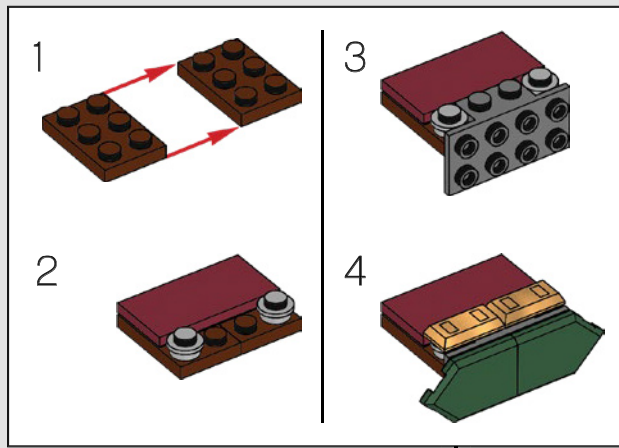

75

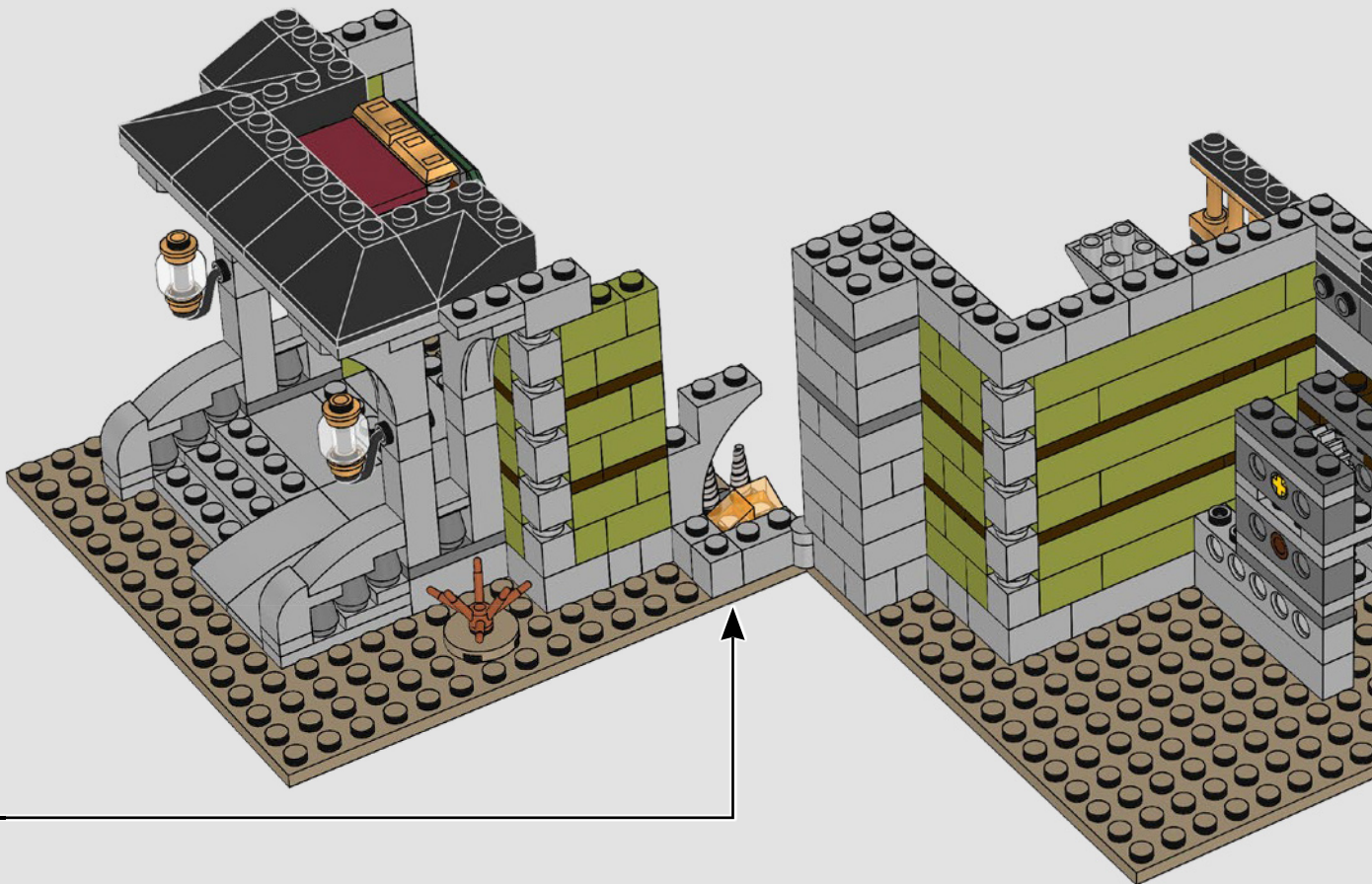

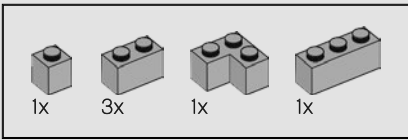

76

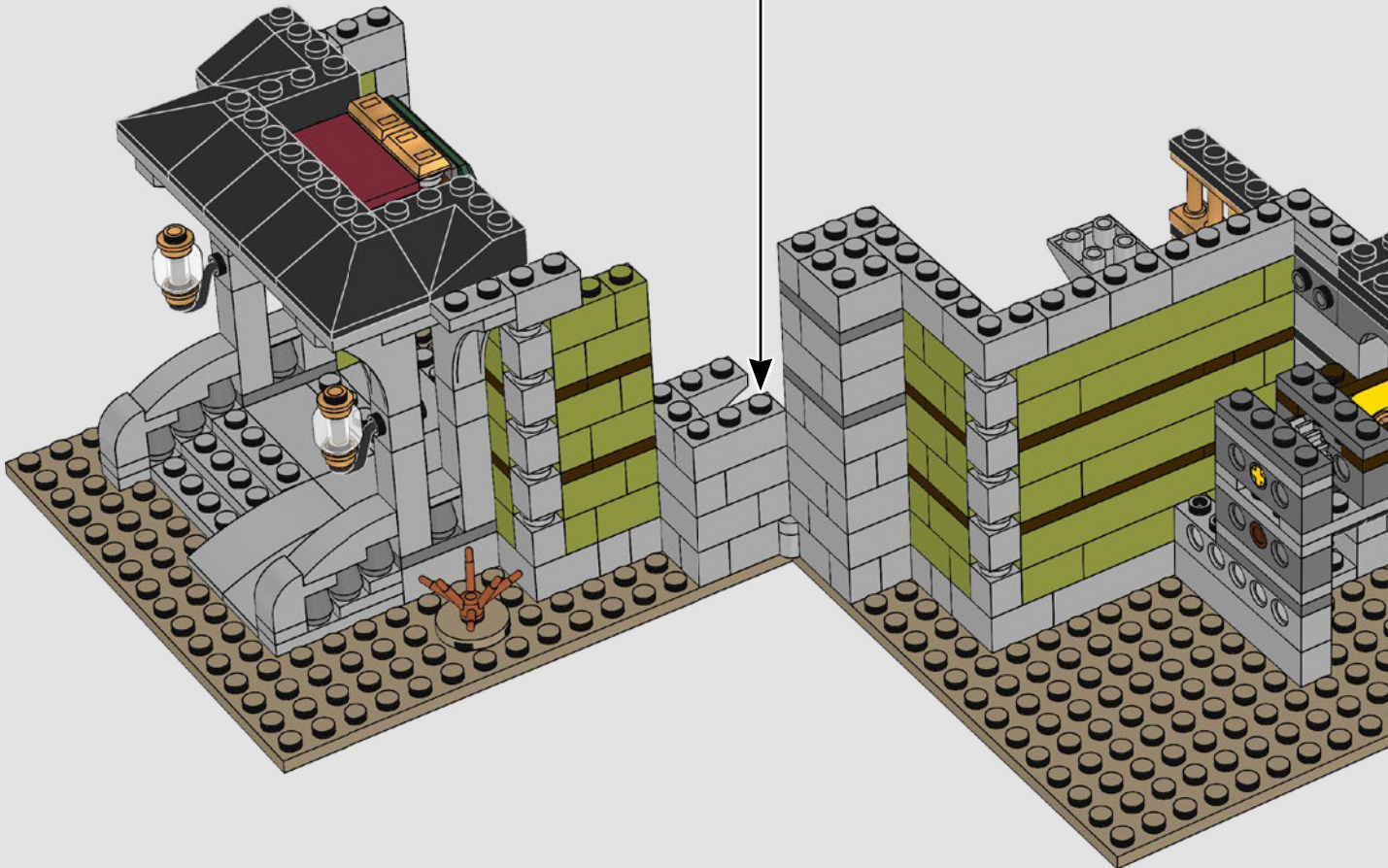
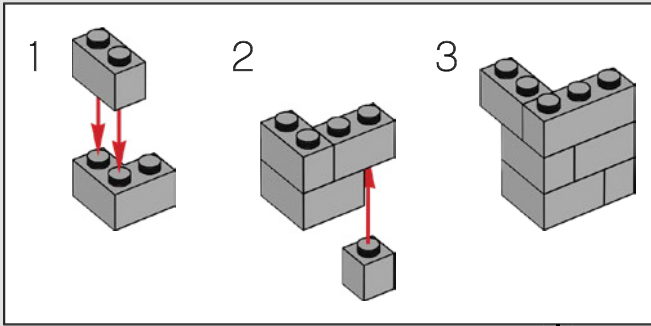

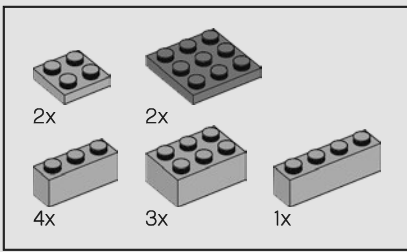

77

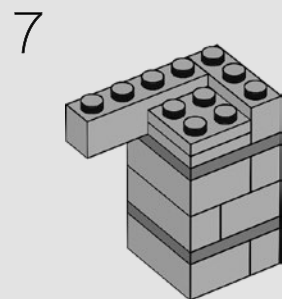
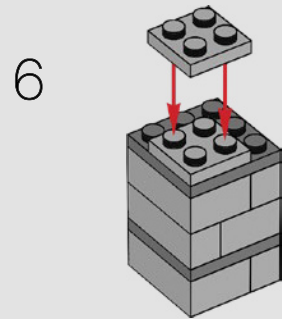
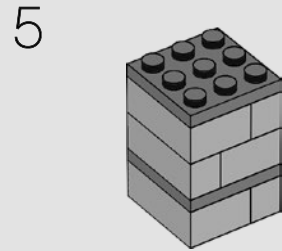
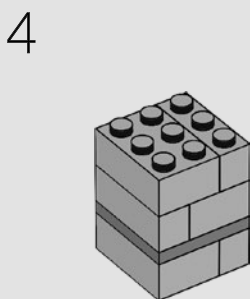
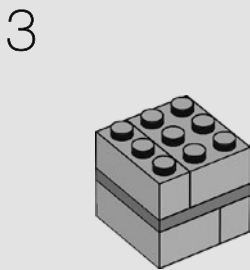
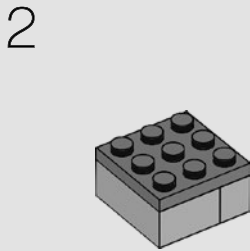
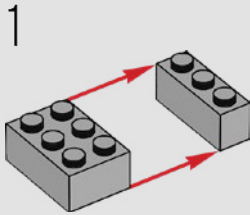

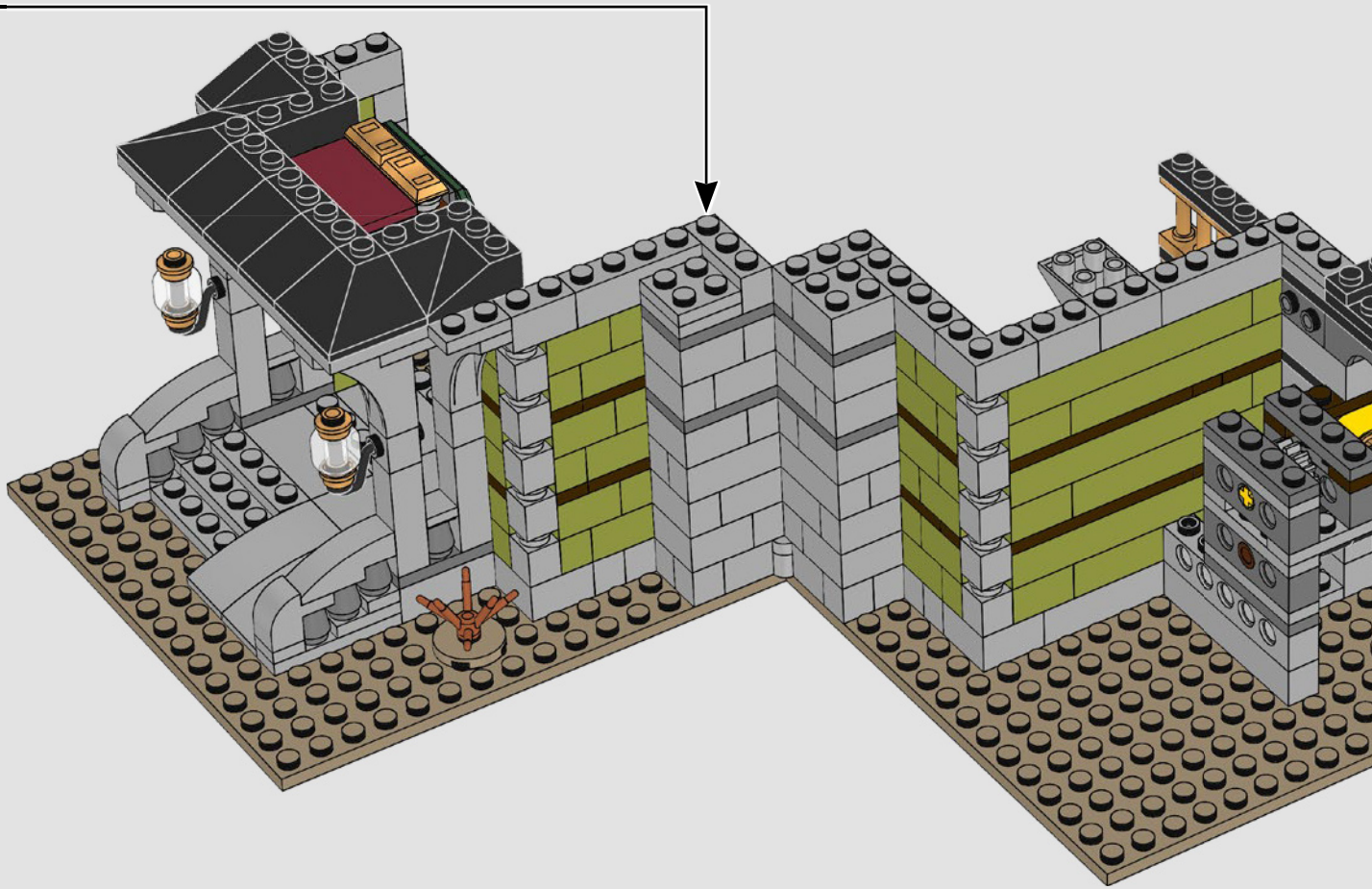

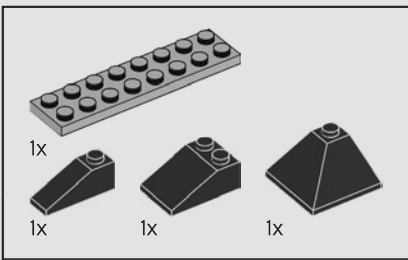

78

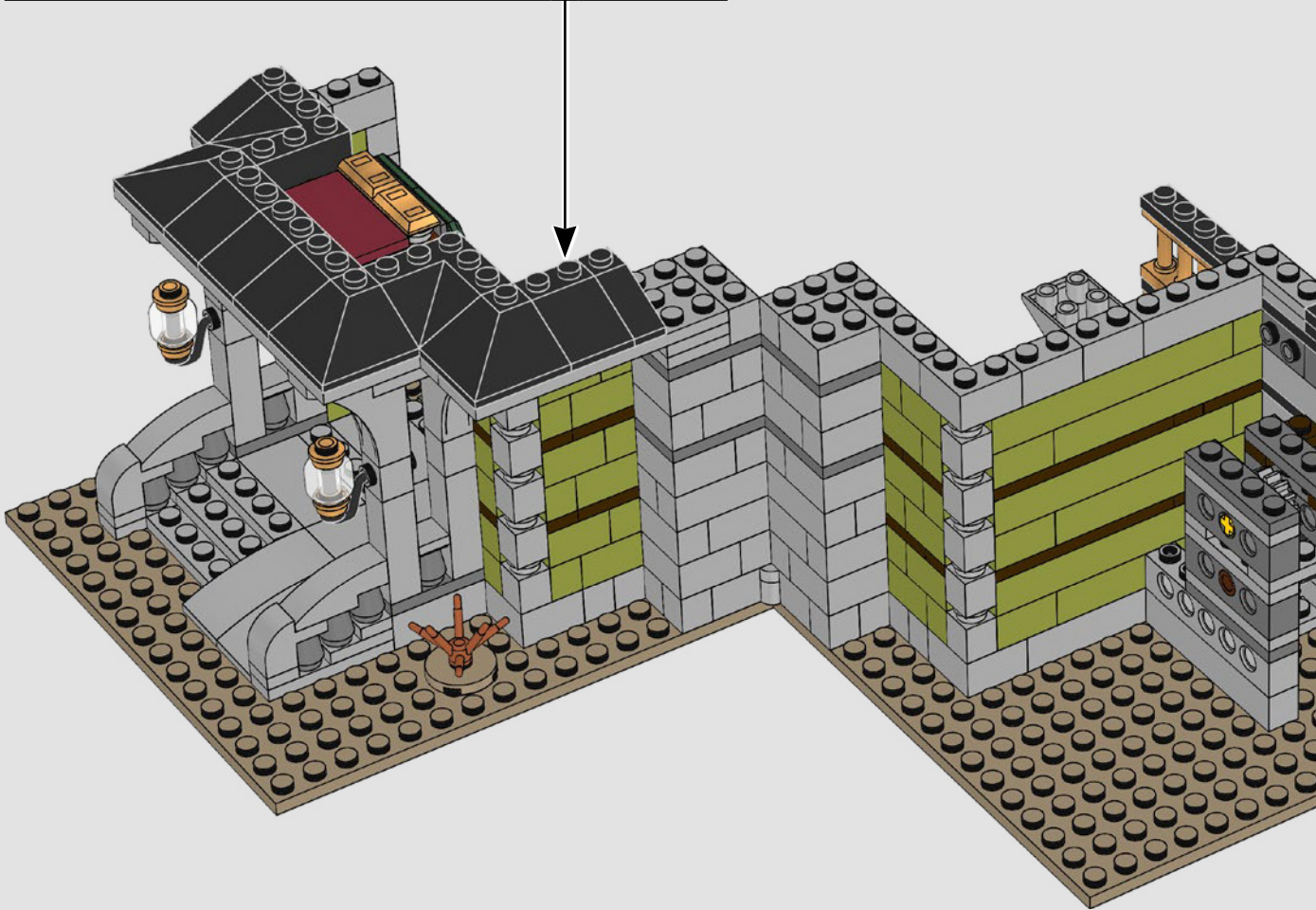
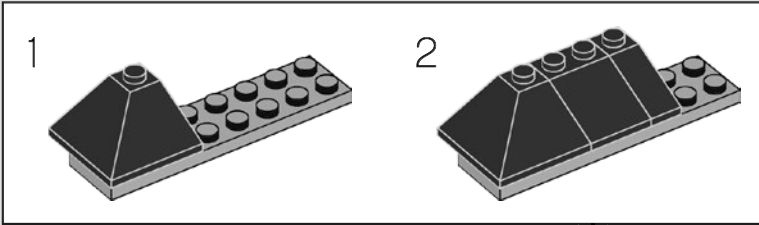

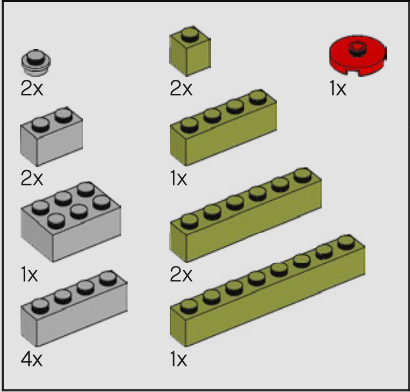

79

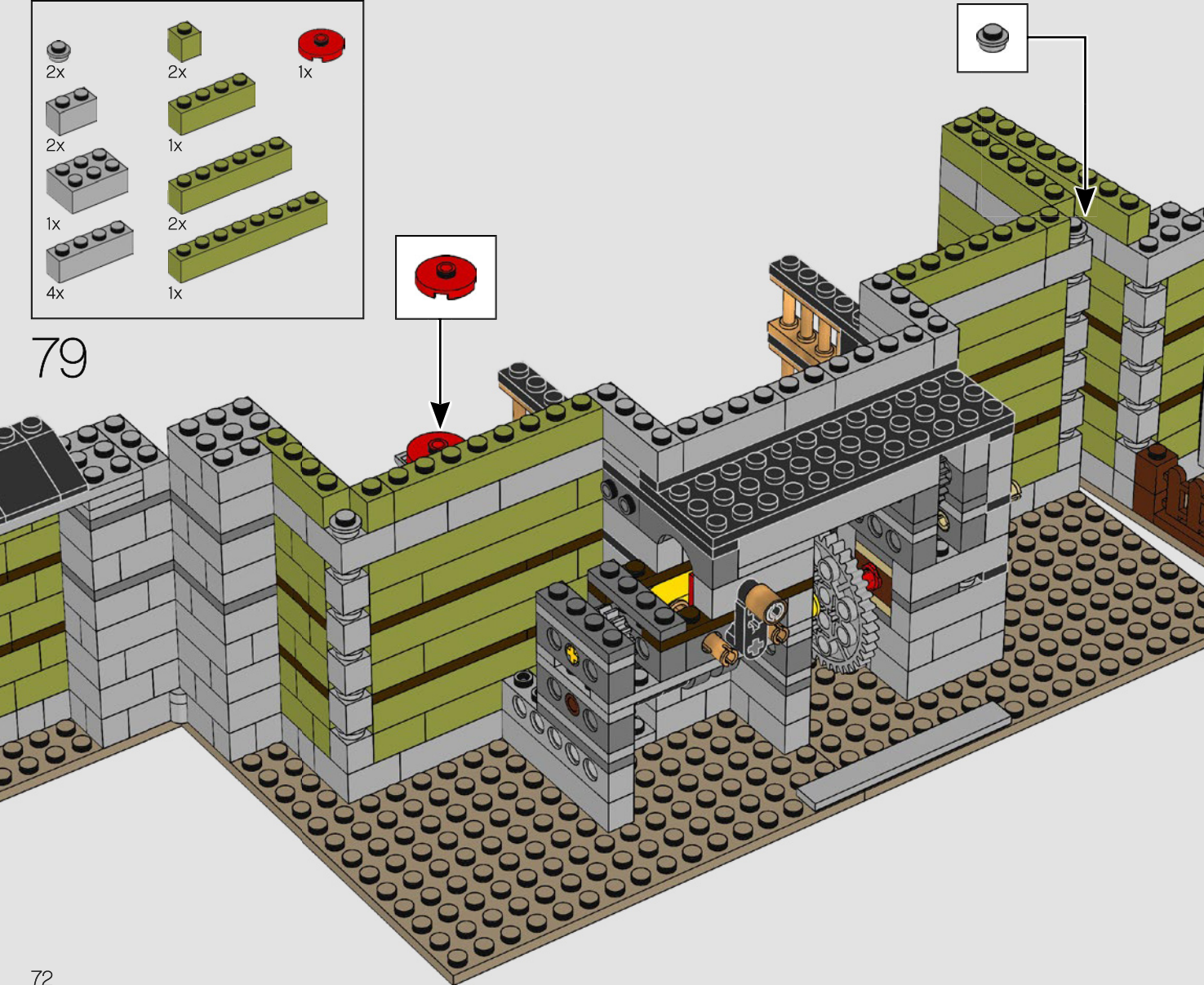

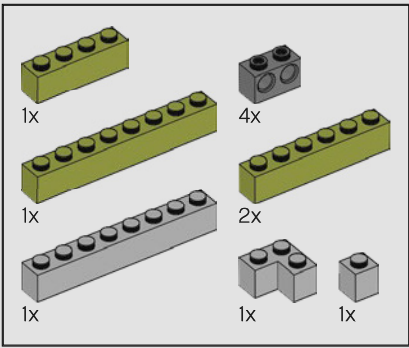

80

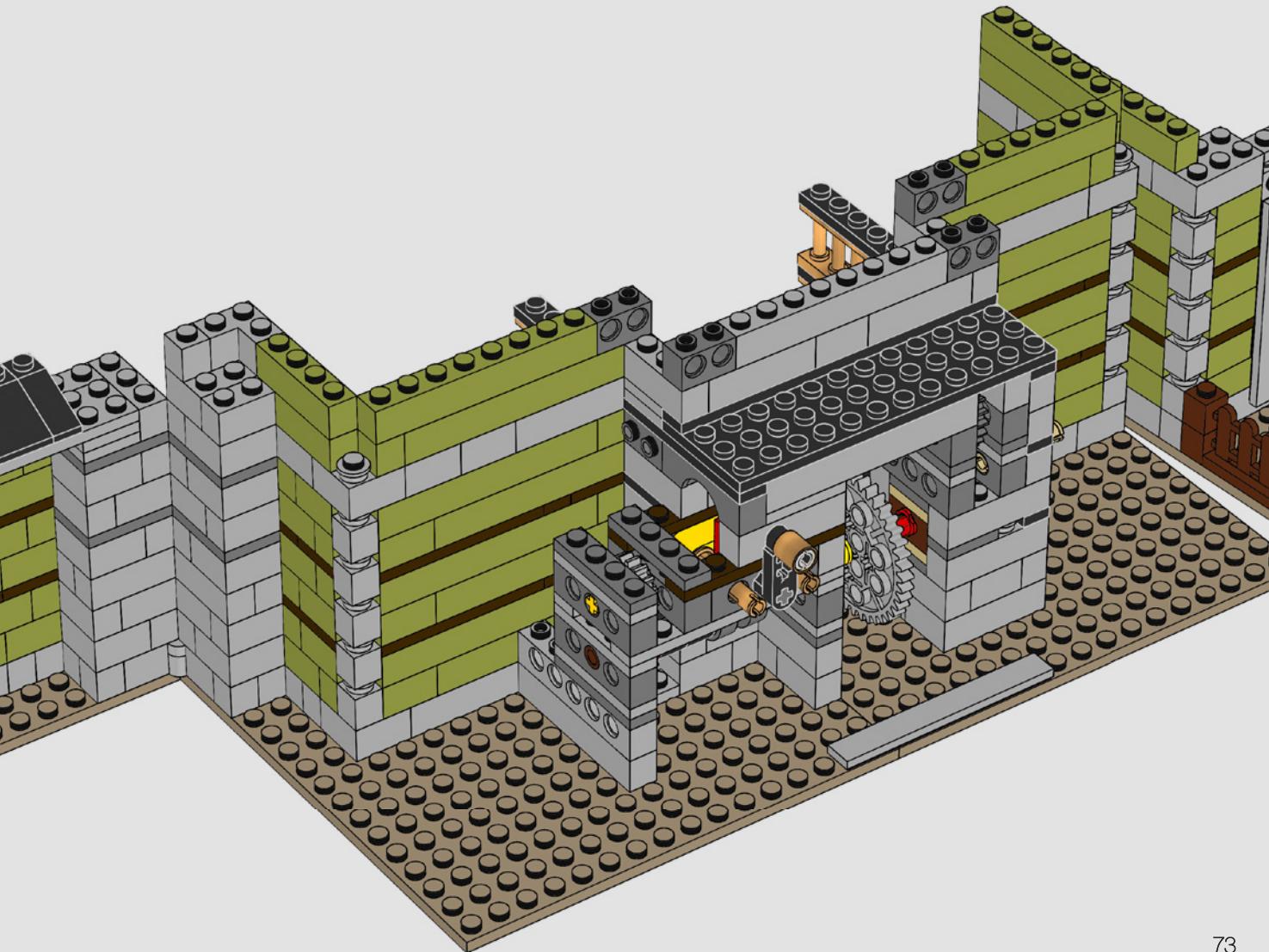

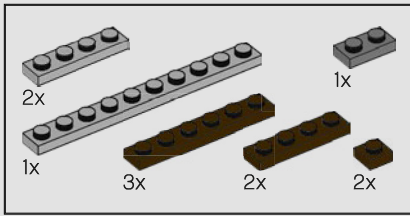

81

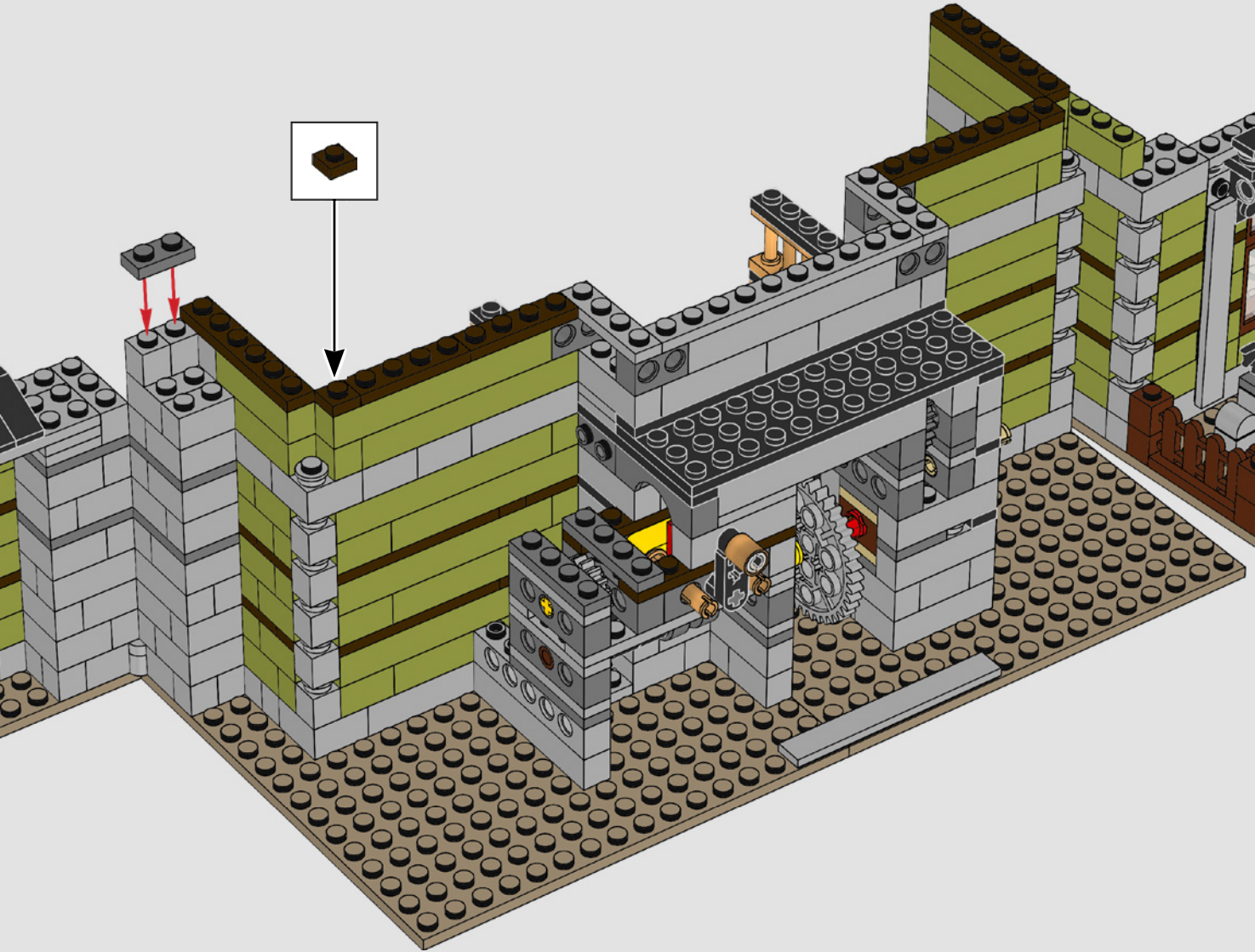

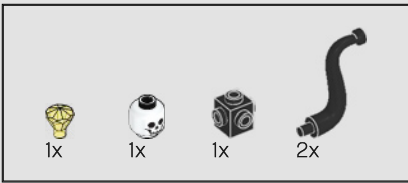

Der Götze vom Everest
 Dem aus einem Tempel am Everest geraubten Götzen wird nachgesagt, mit seinen Ranken in unbekannte Dimensionen vorzudringen. Er ist aber auch vorzüglich als Garderobe geeignet.

82

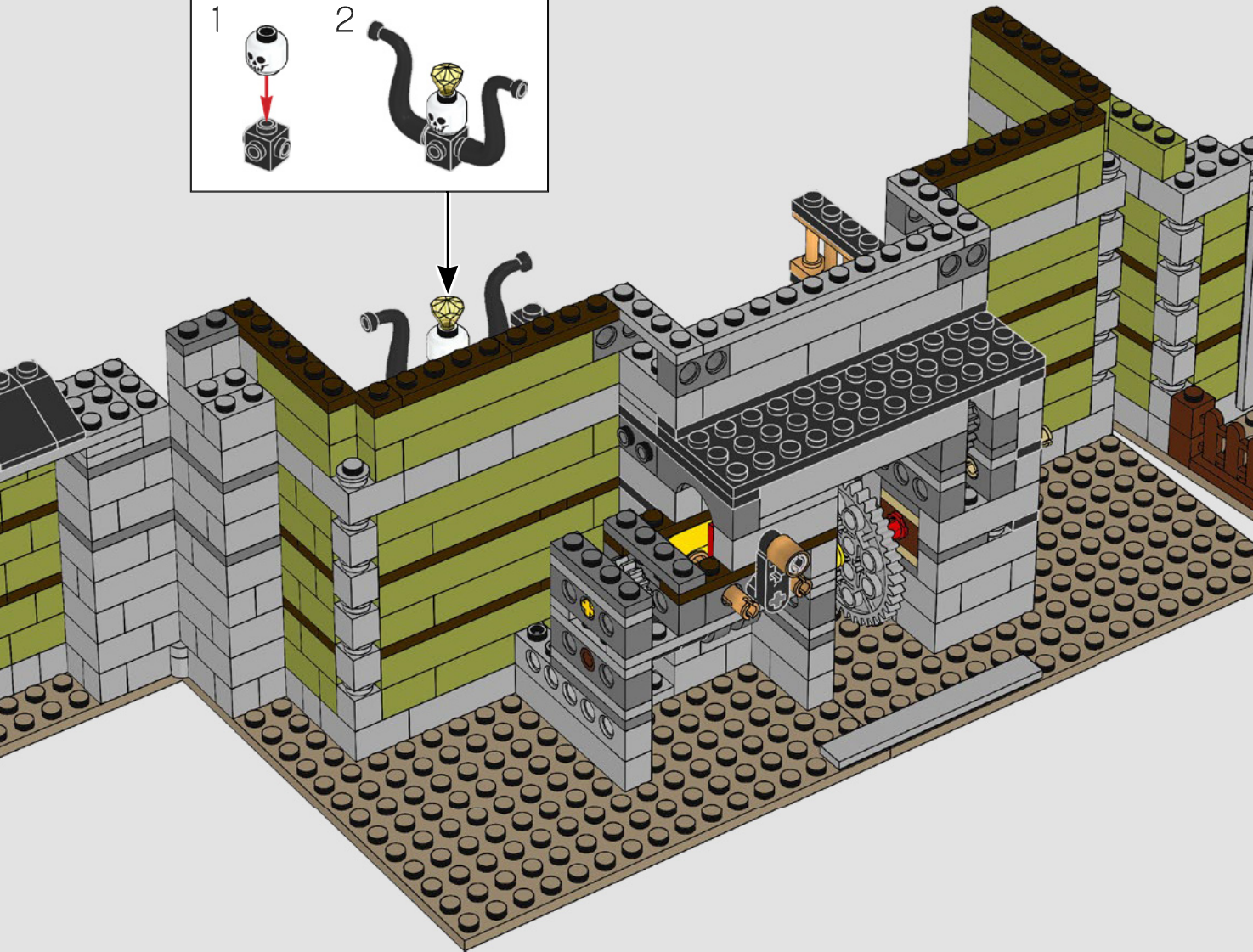
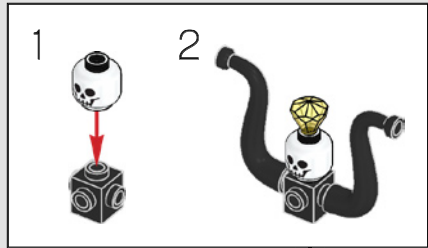

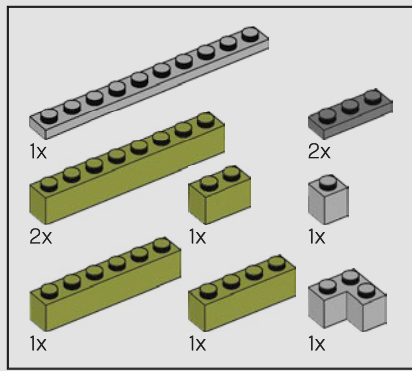

83

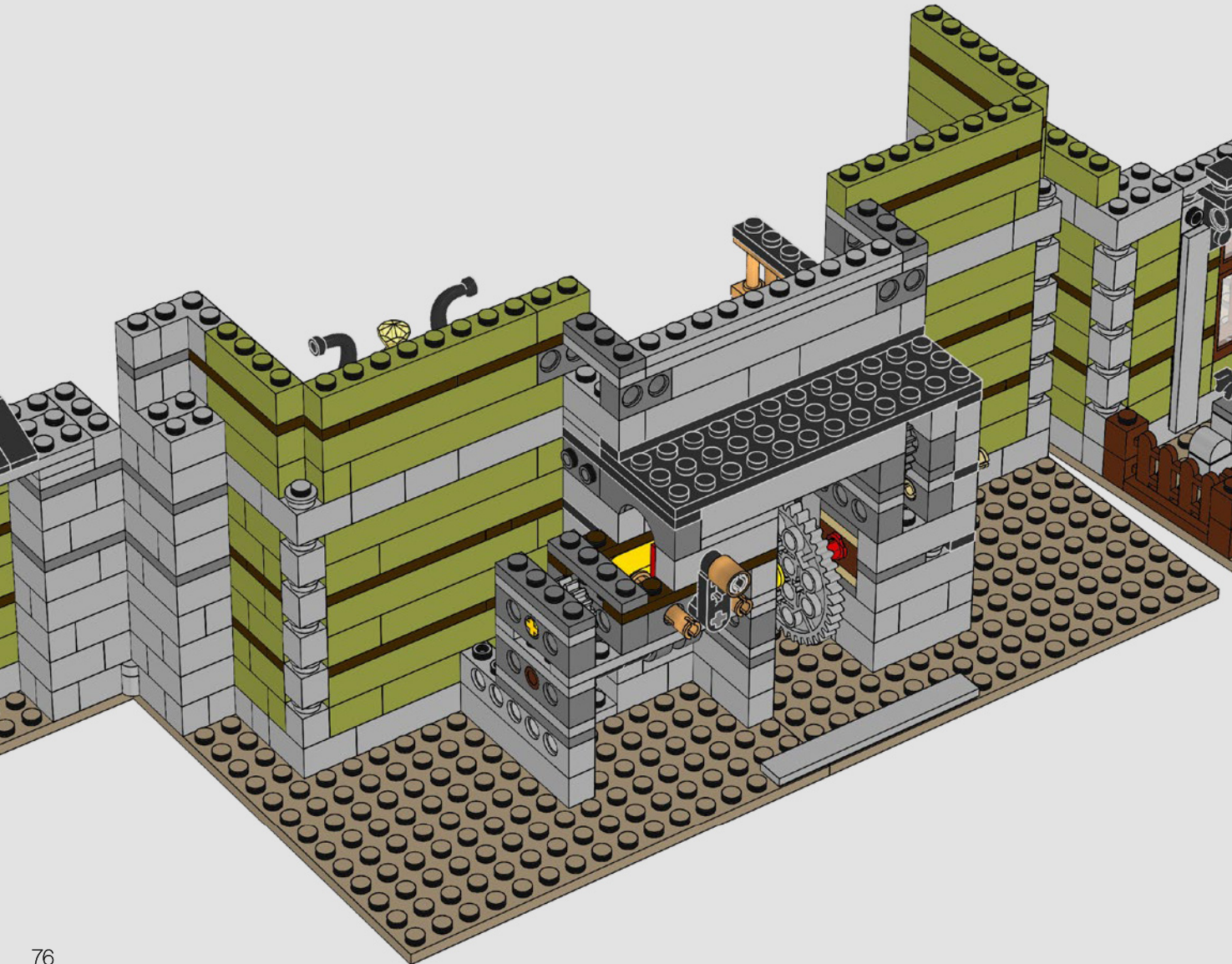

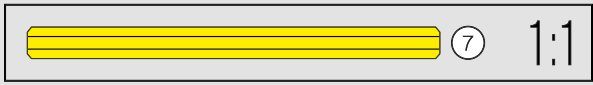
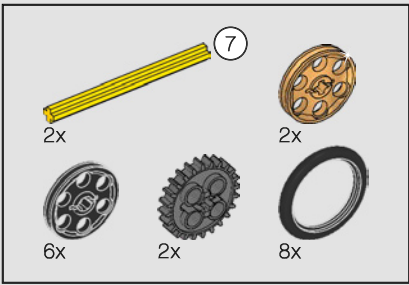

84

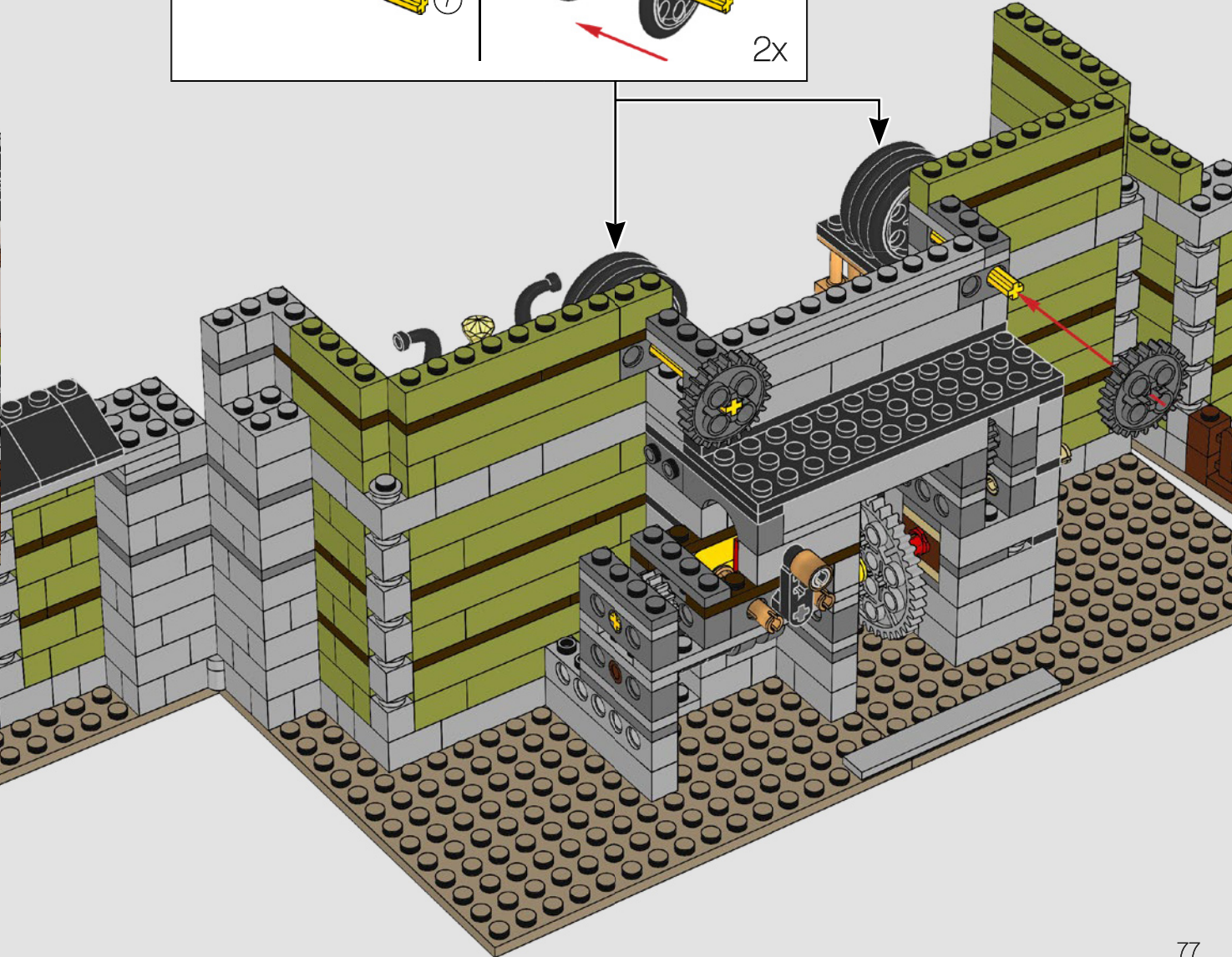
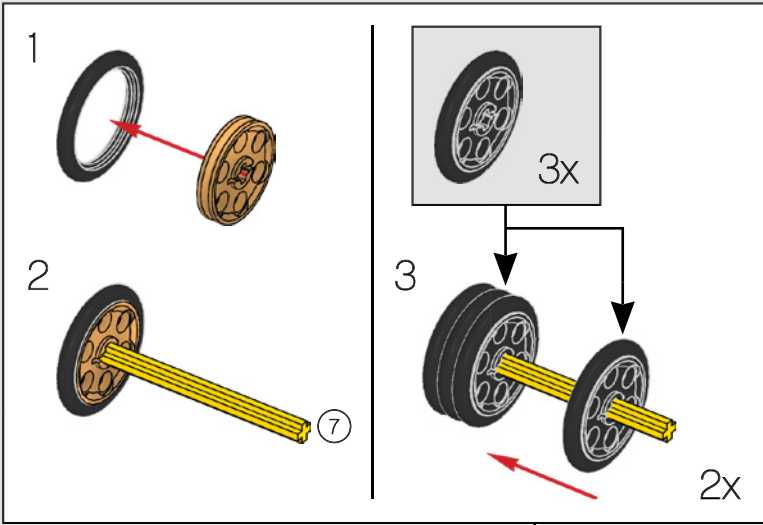

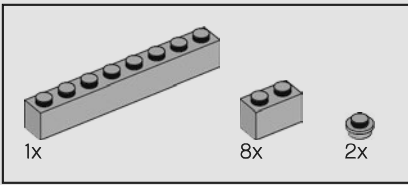

85

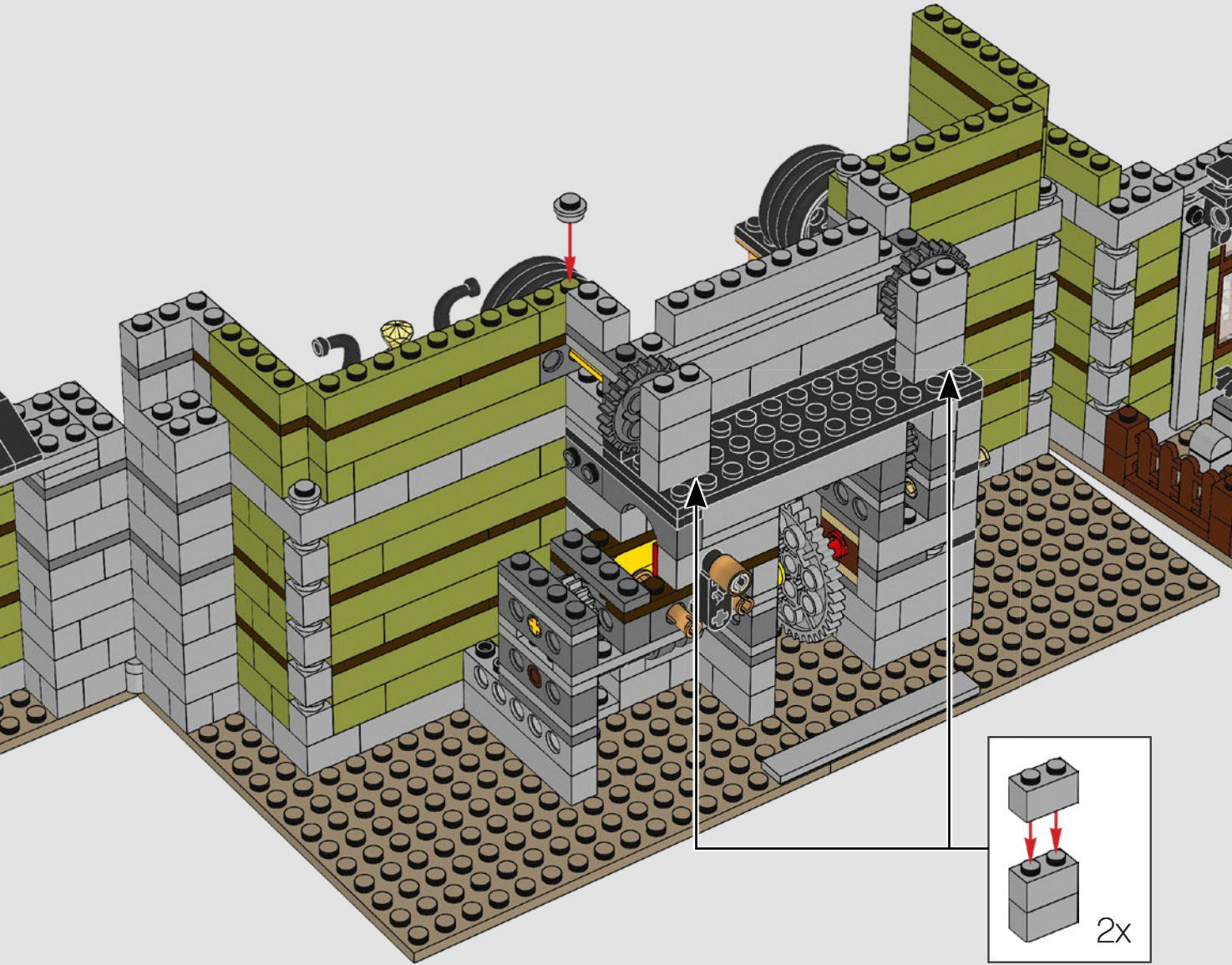

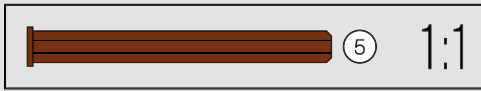
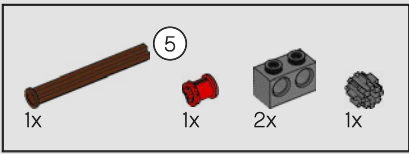

86

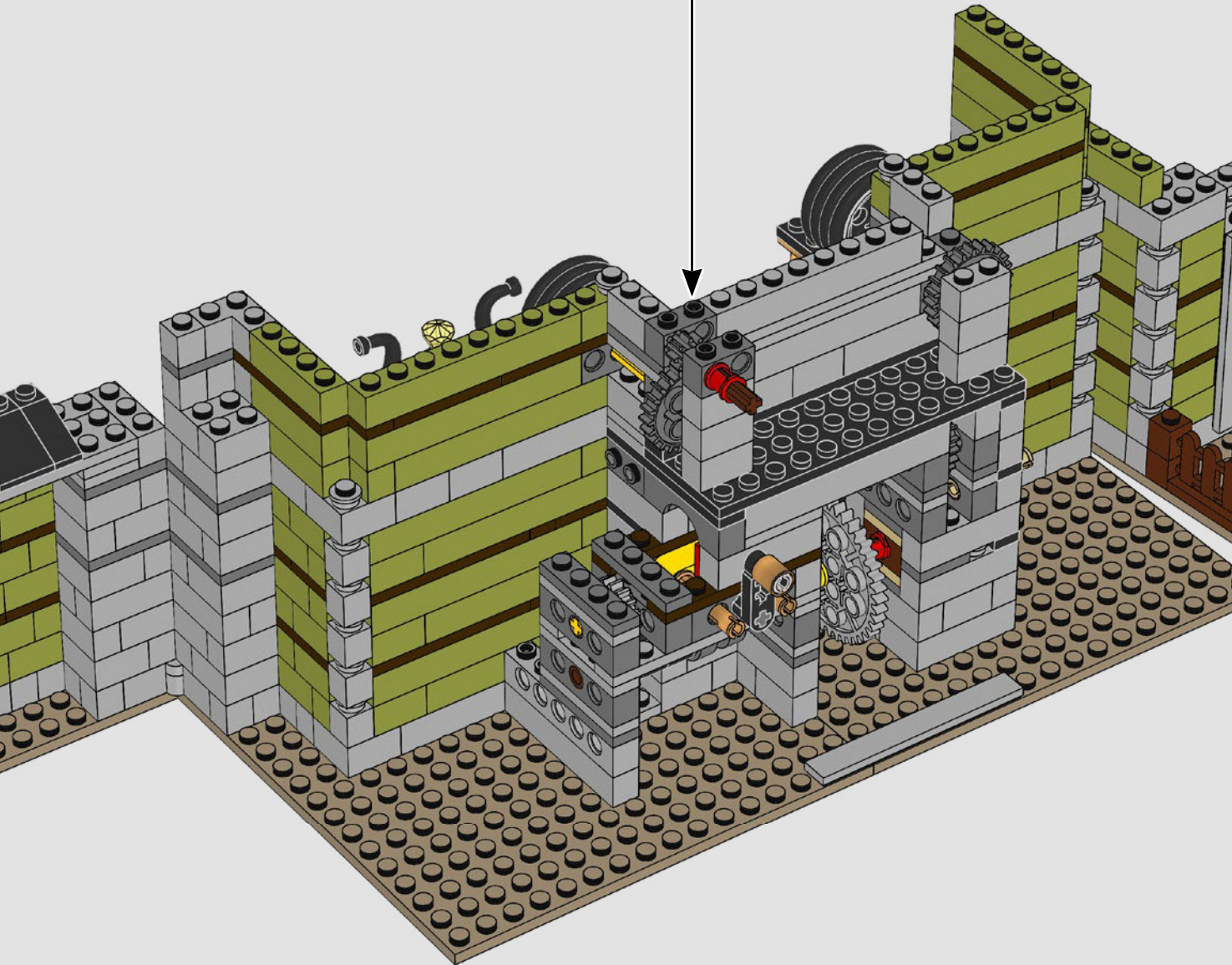
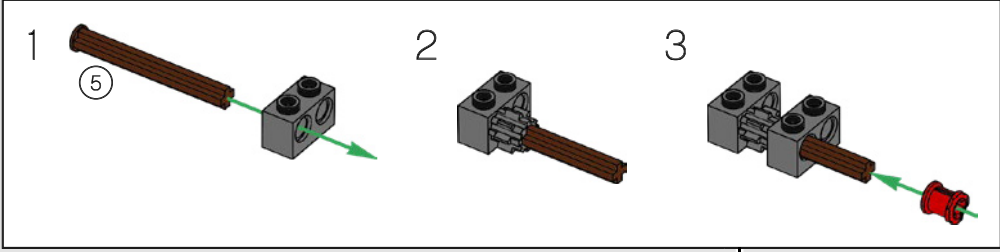

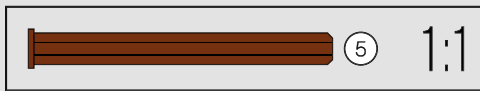
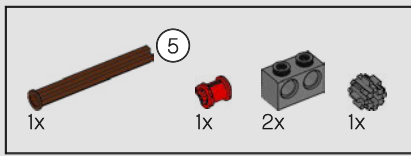

87

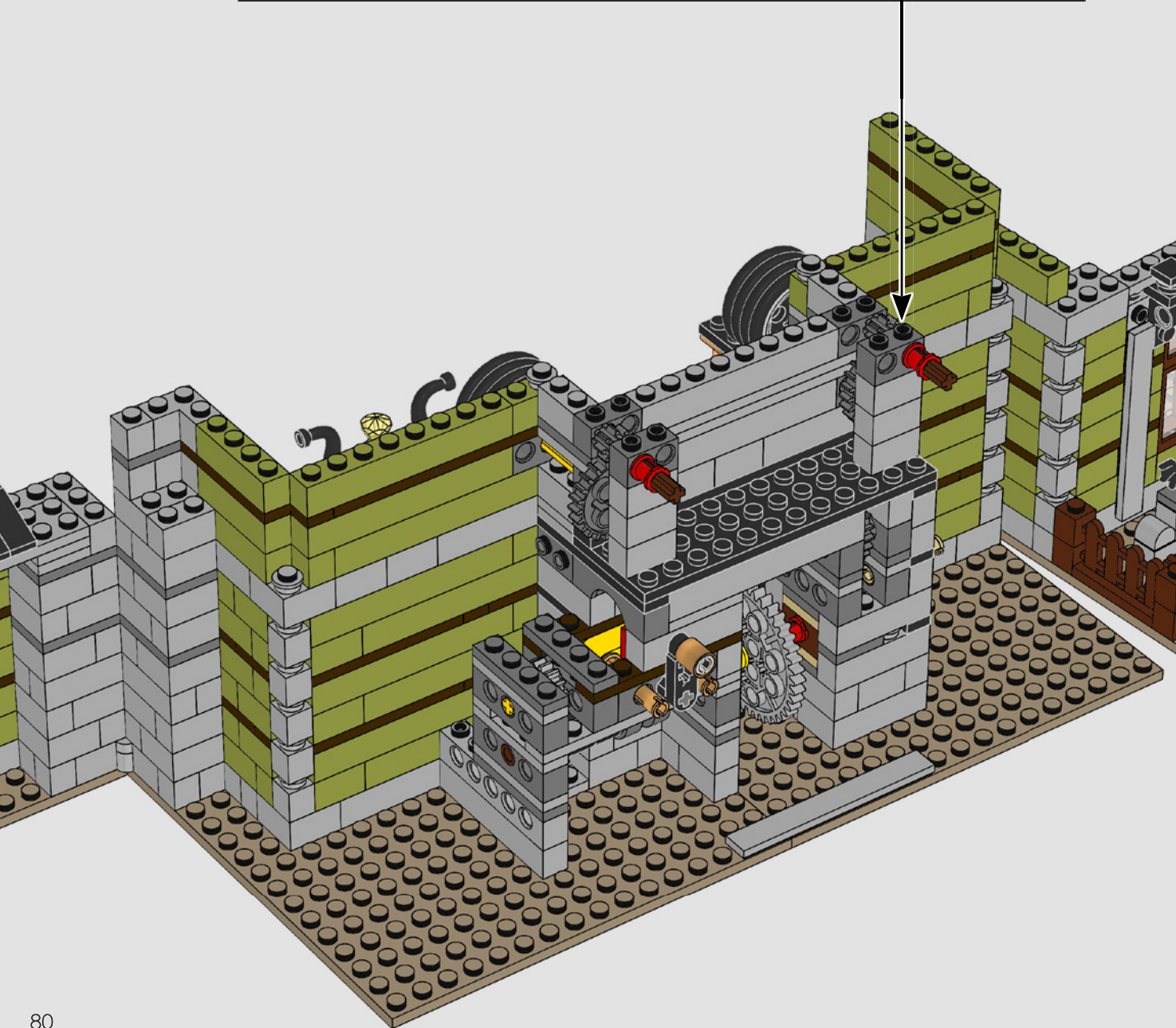
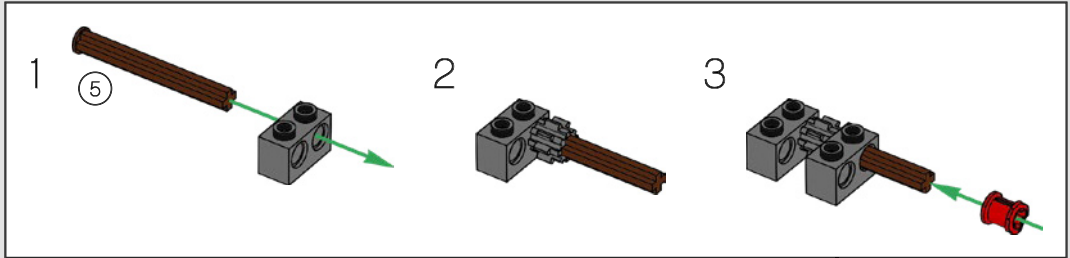

80

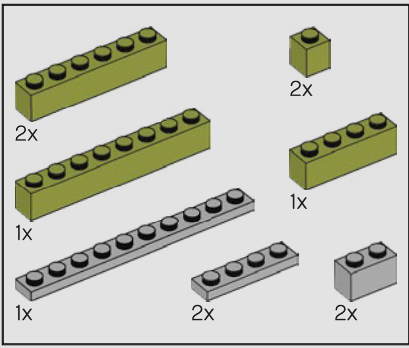

88

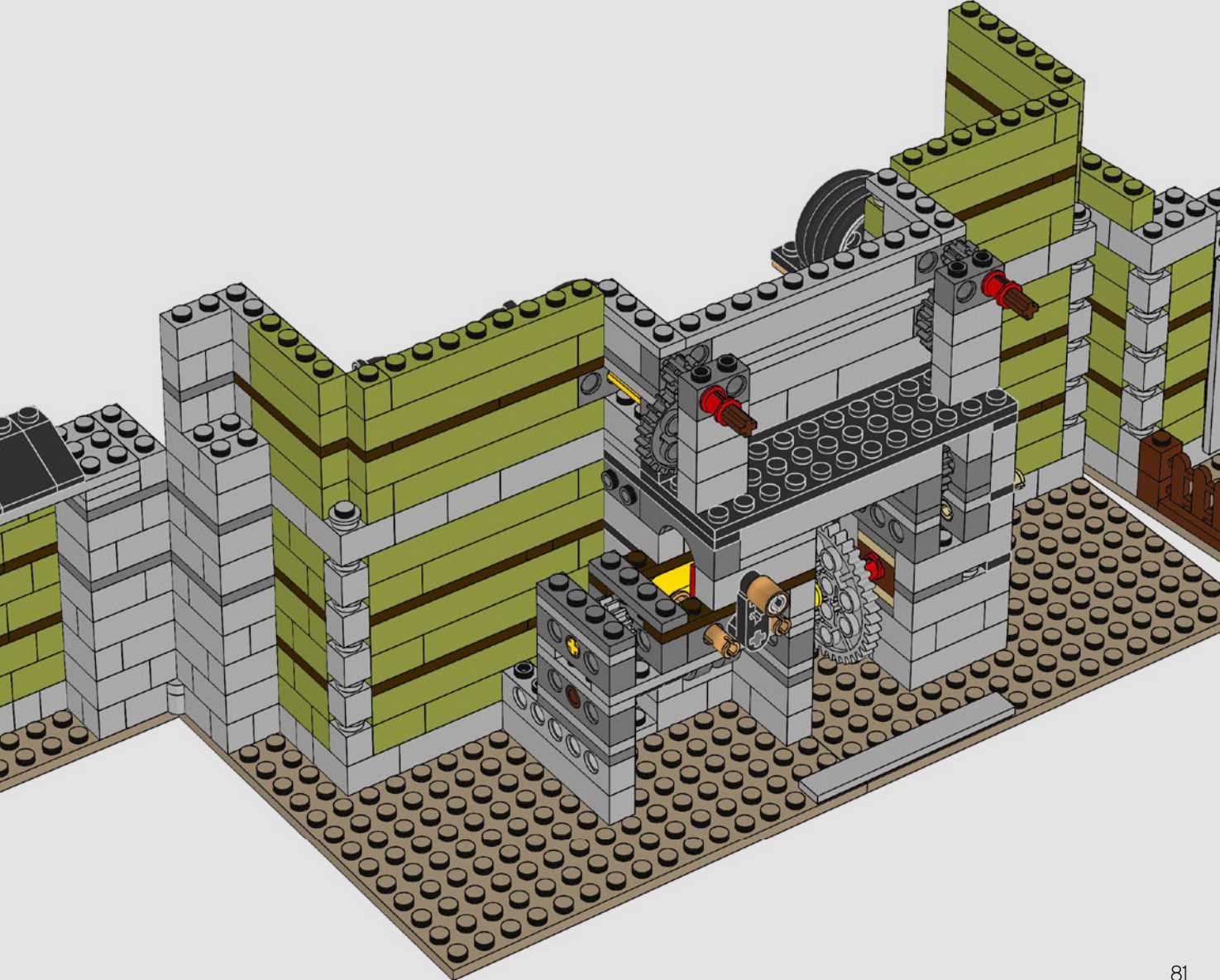

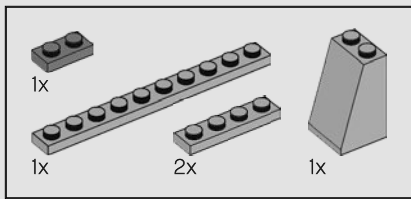

89

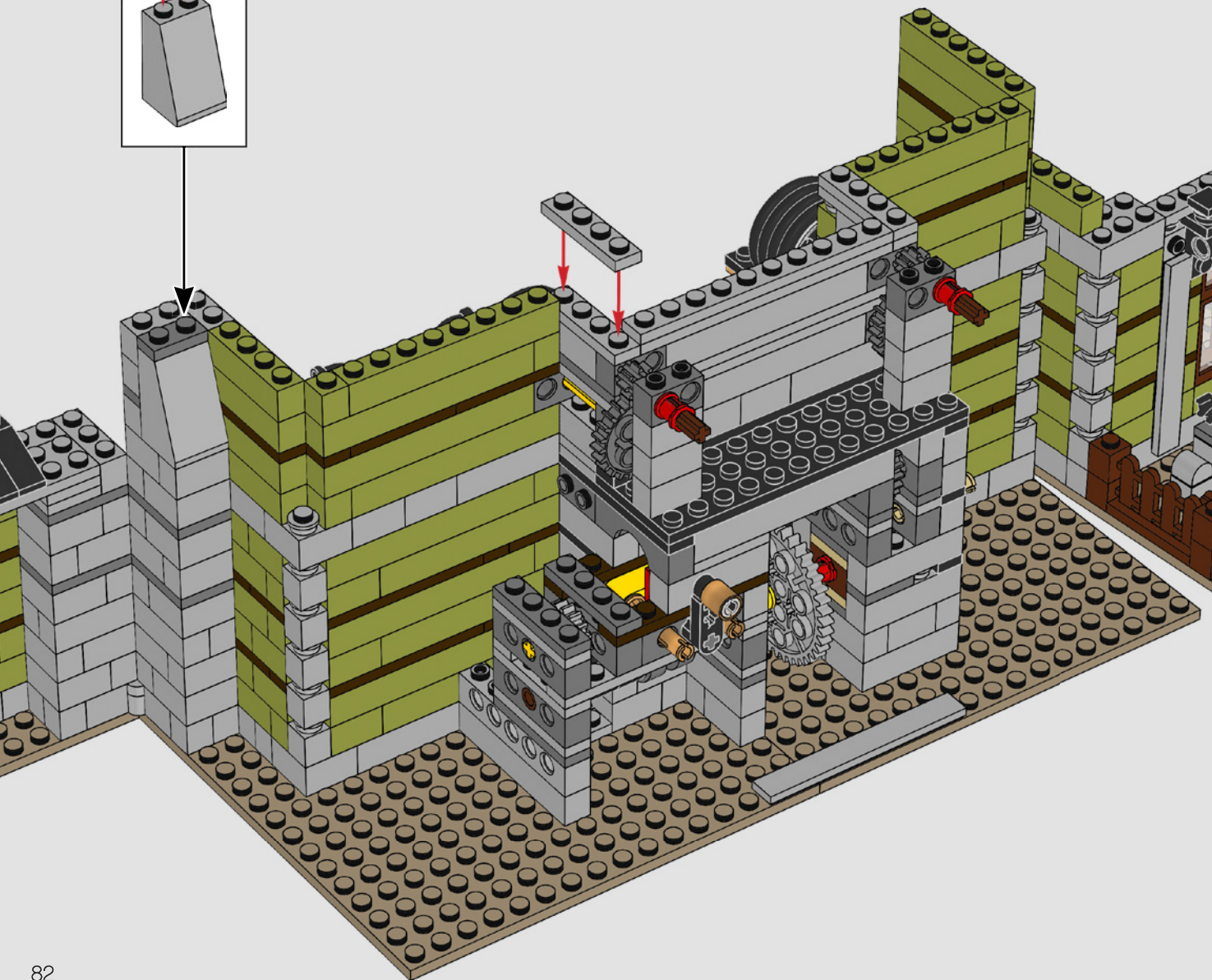
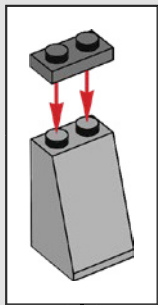

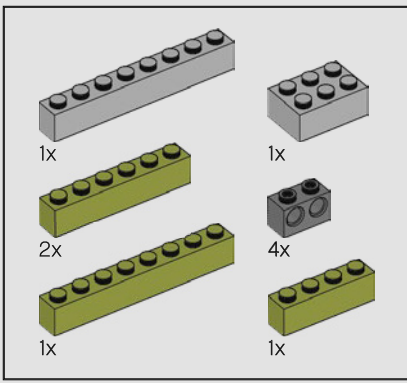

90

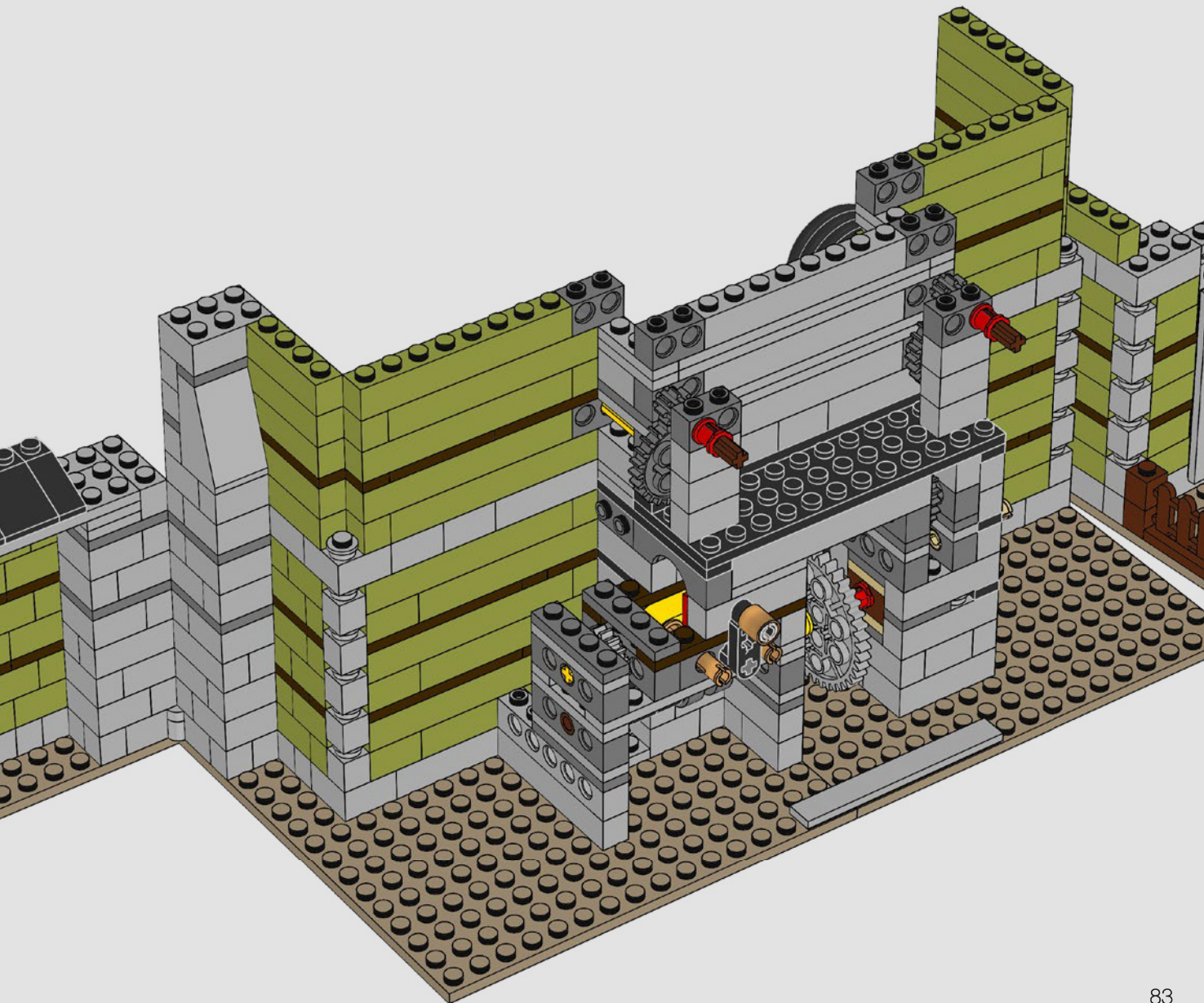

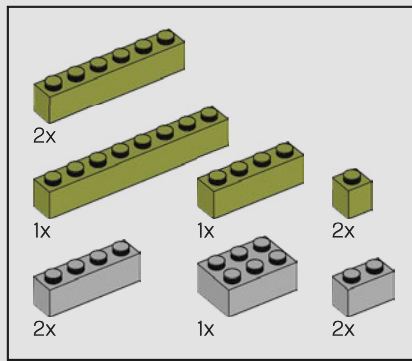

91

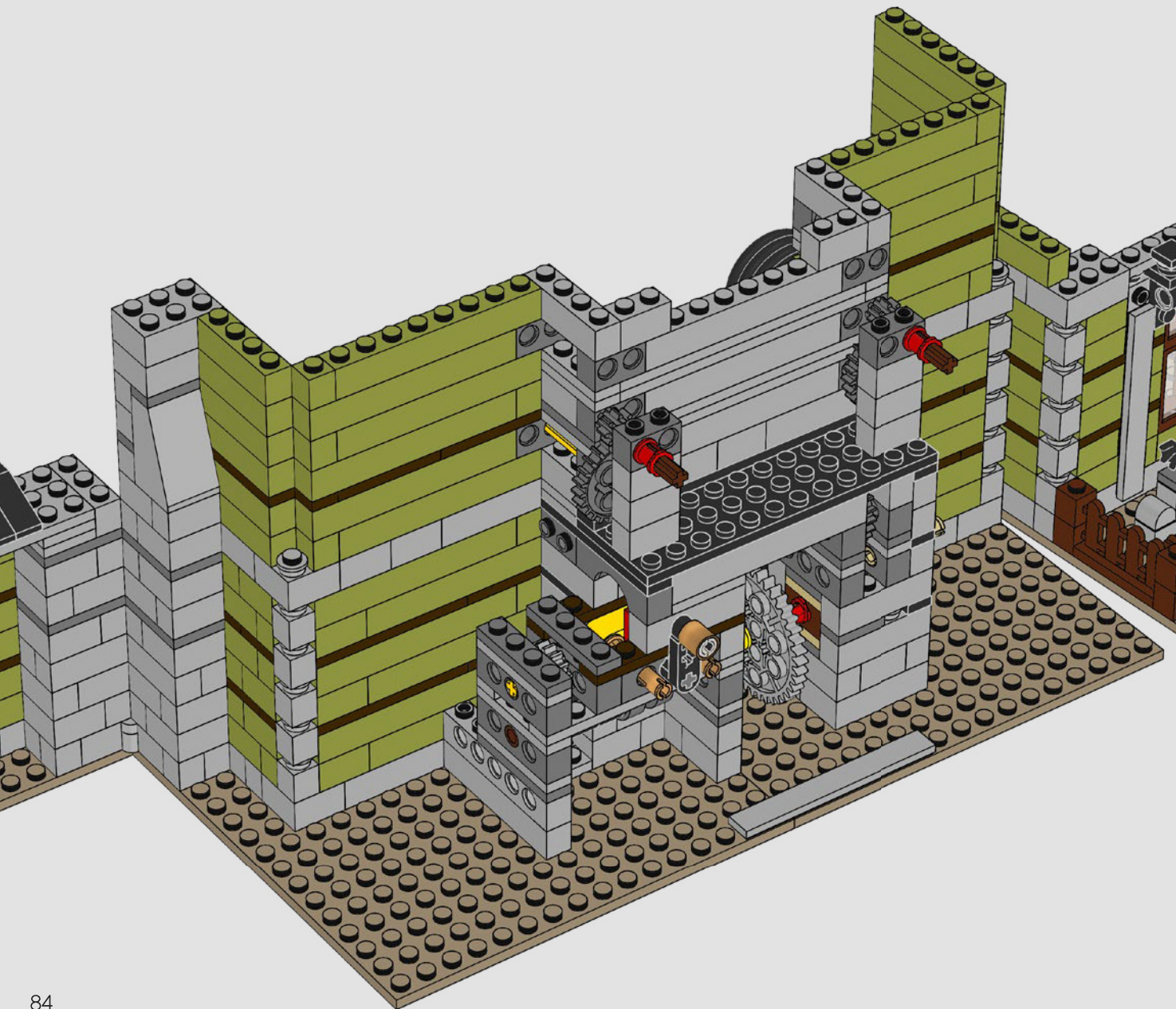

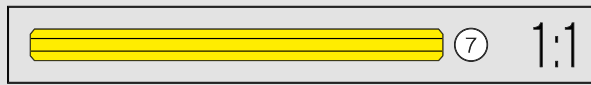
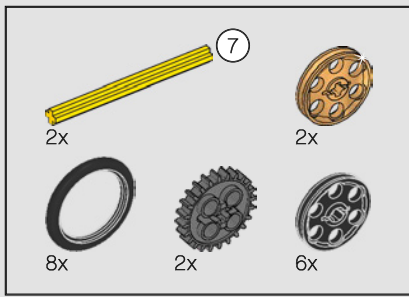

92

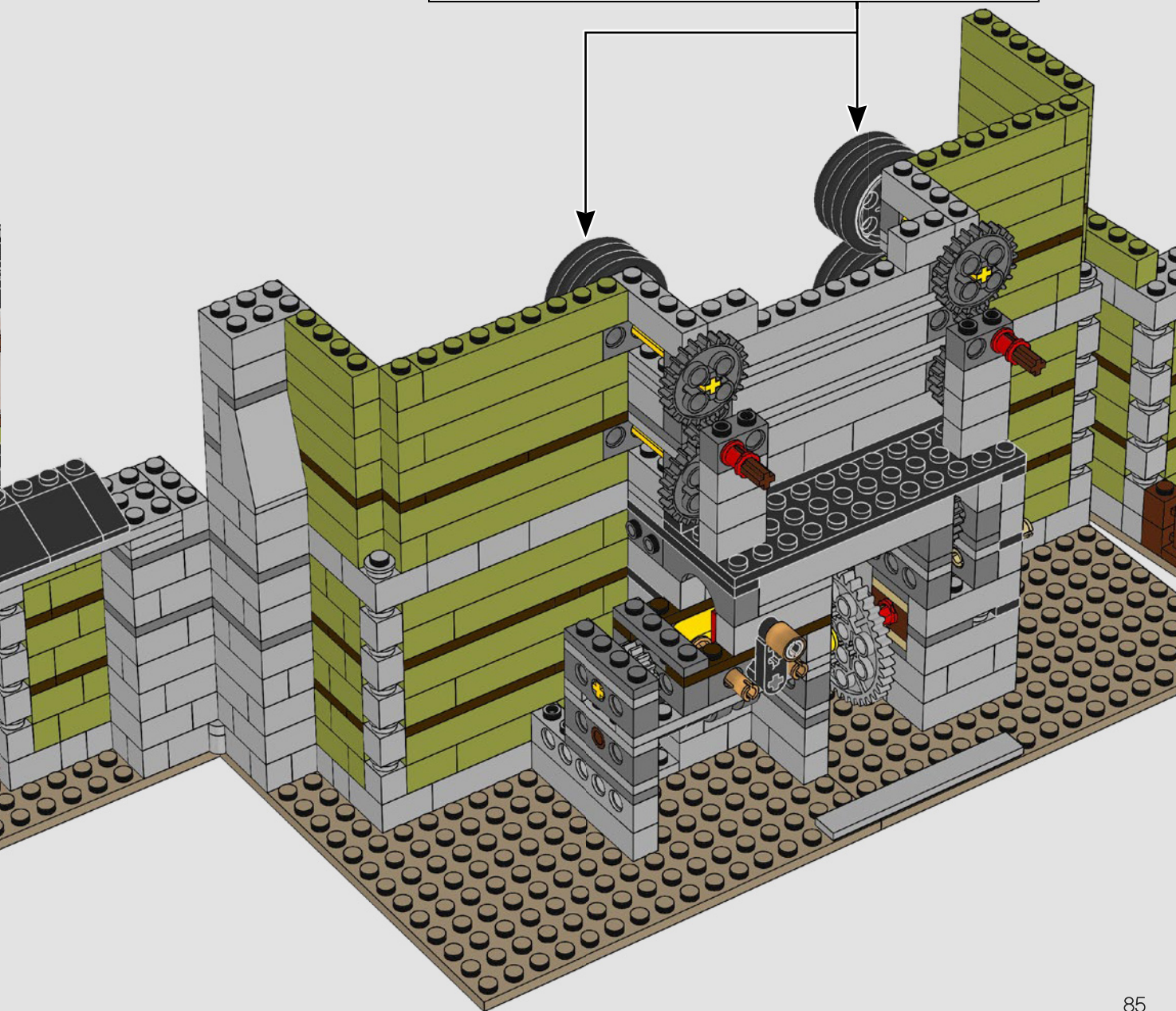
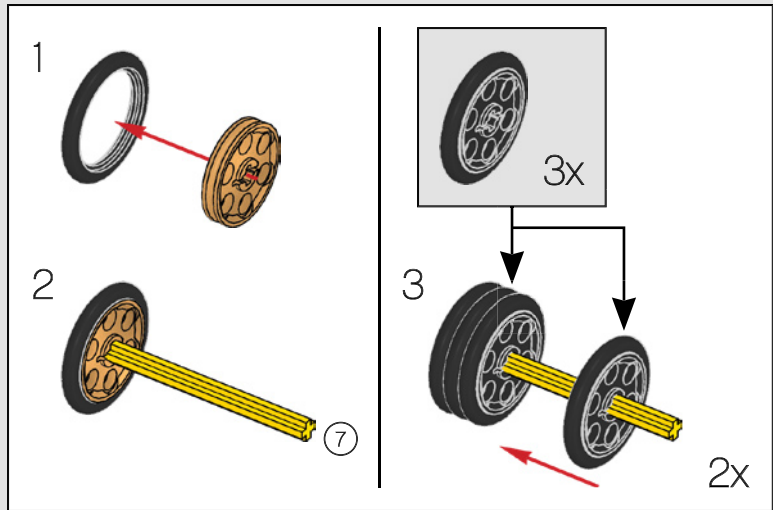

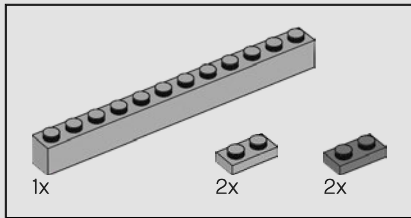

93

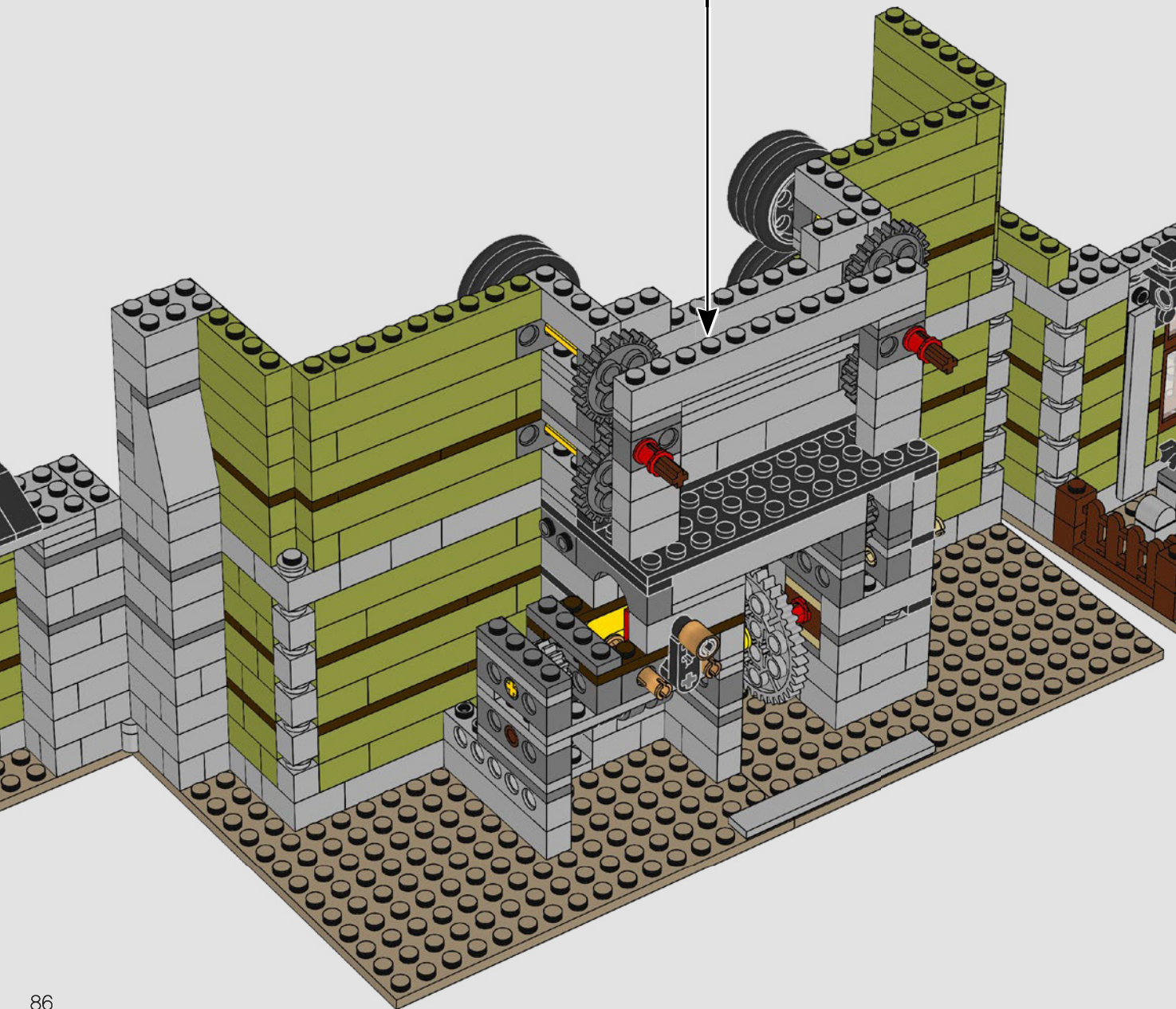
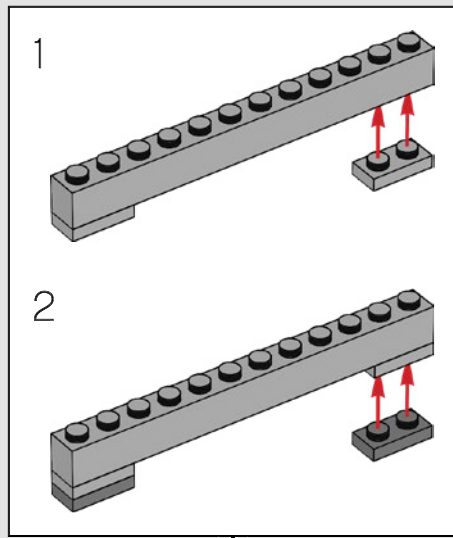

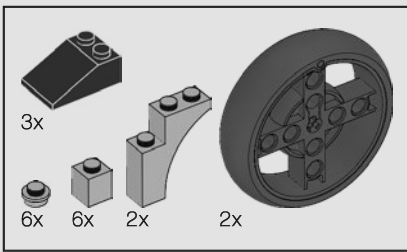

94

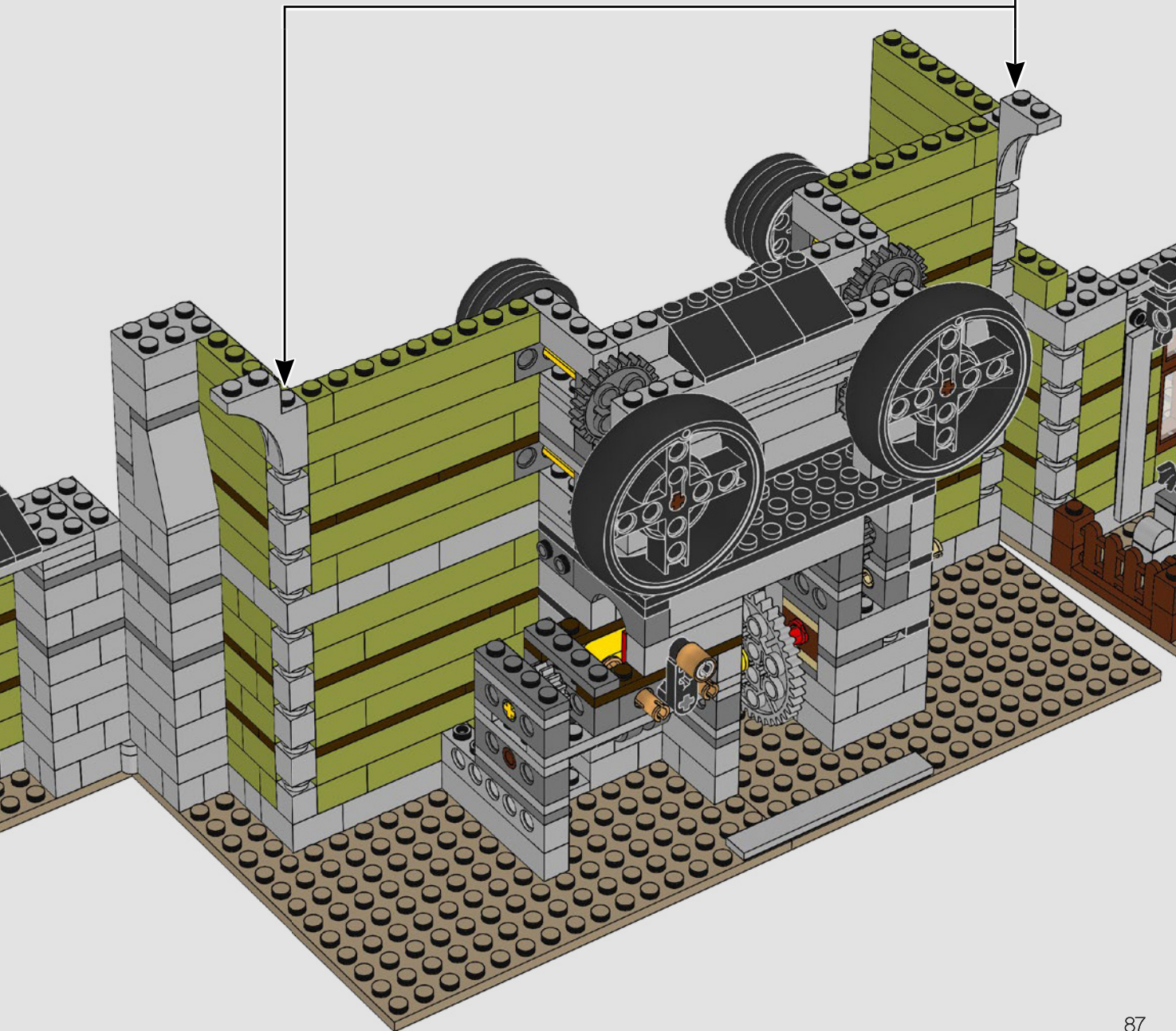
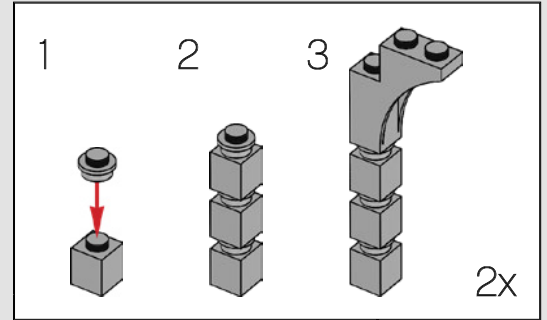

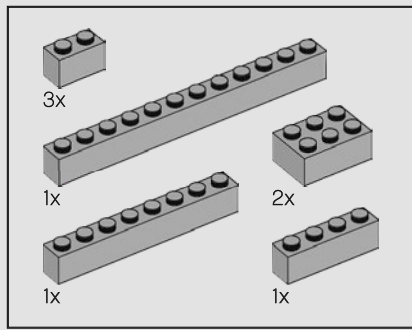

95

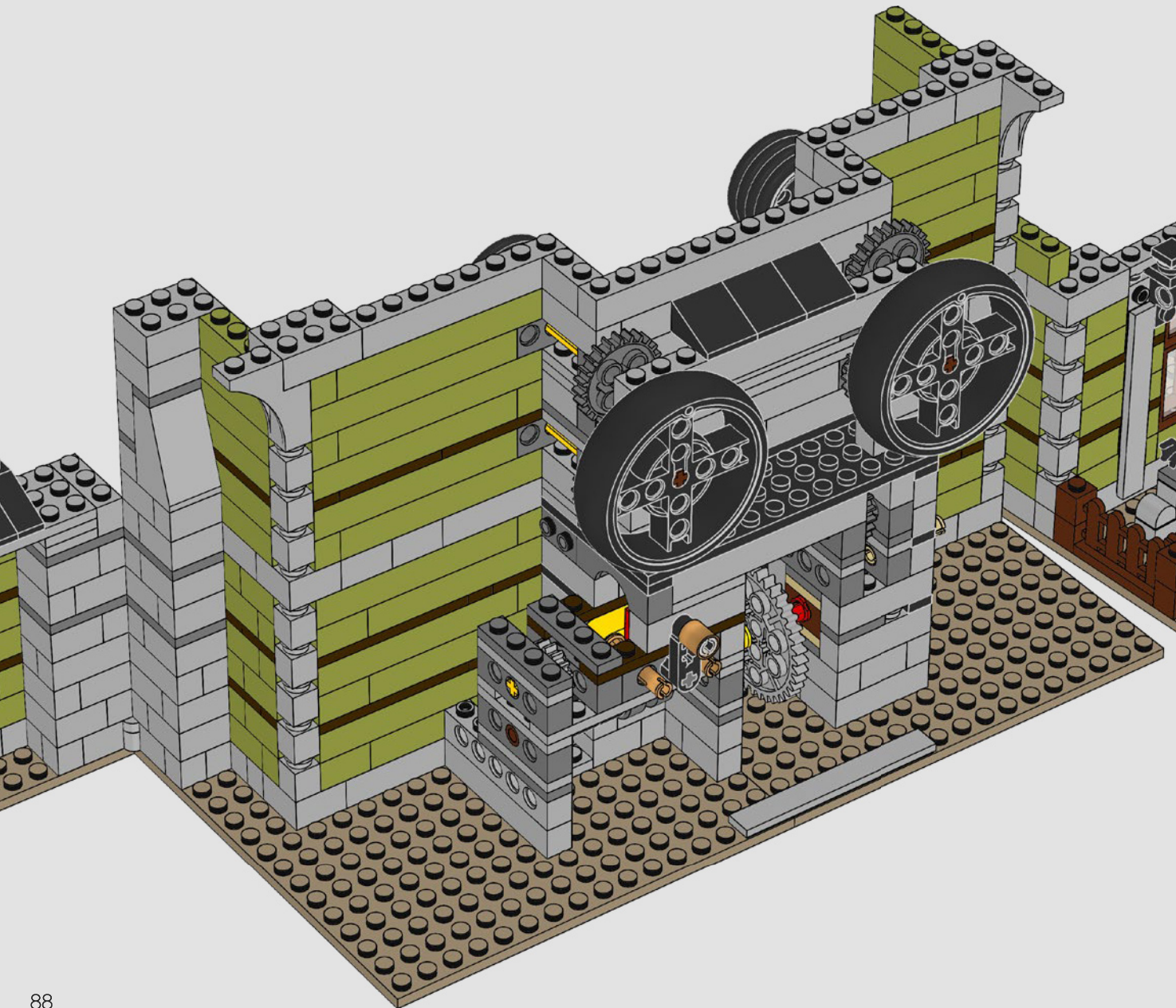

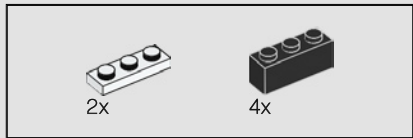
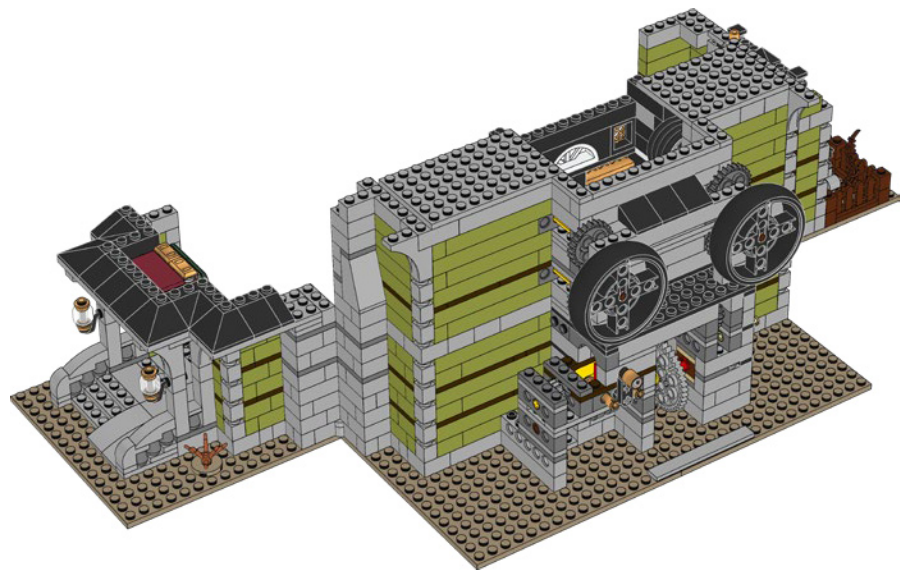

96

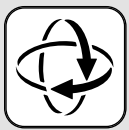
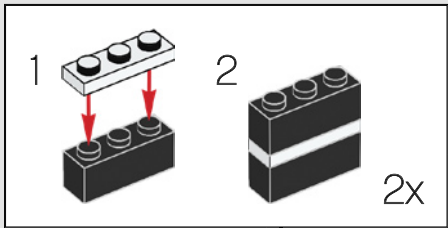

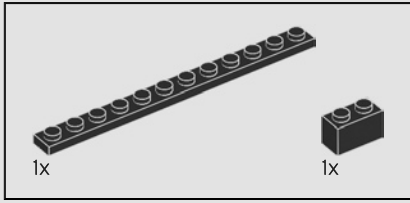
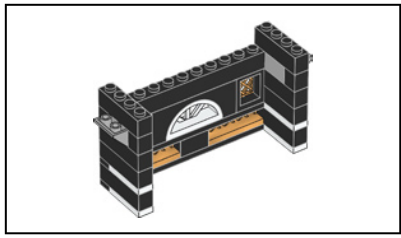

97

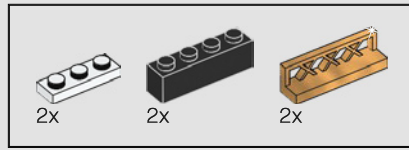
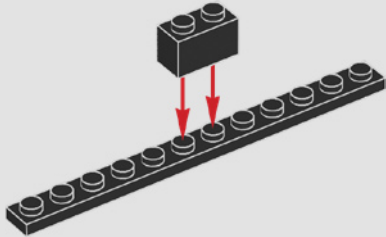

98

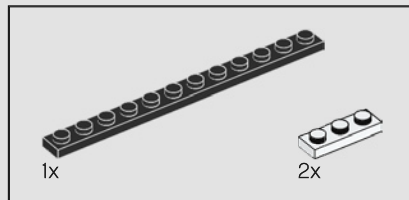
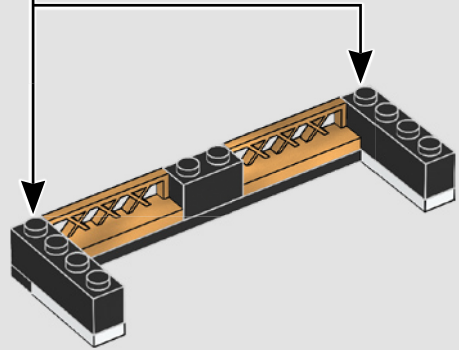
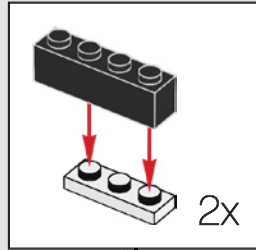

99

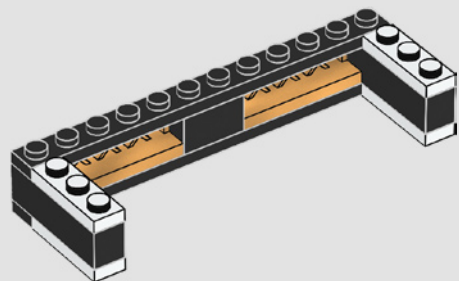

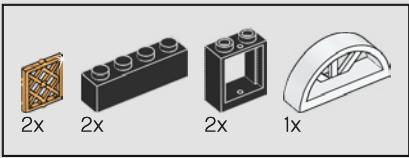

100

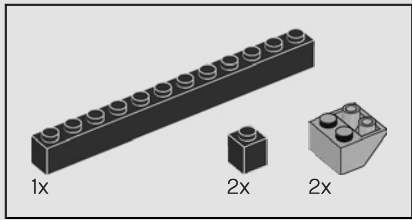
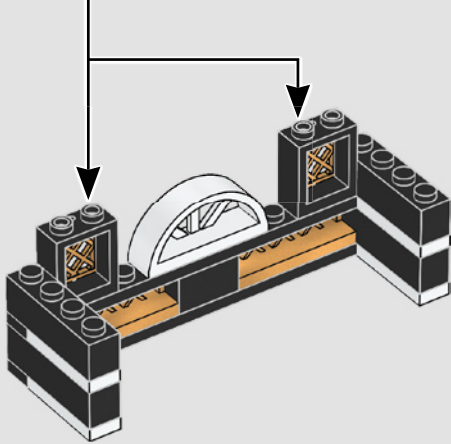
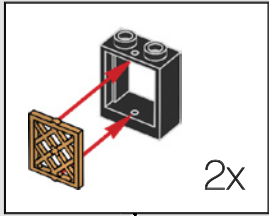

102

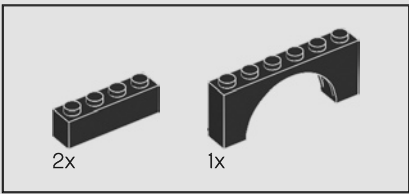
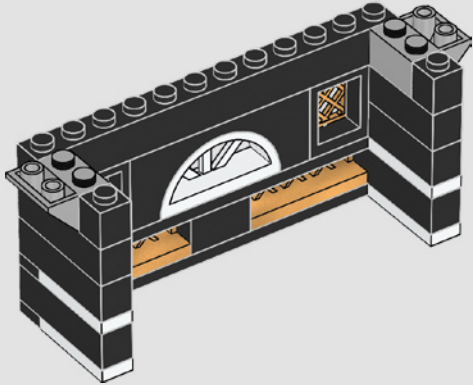

101

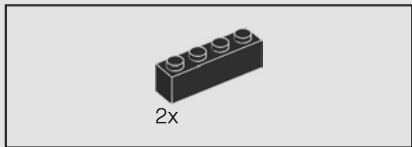
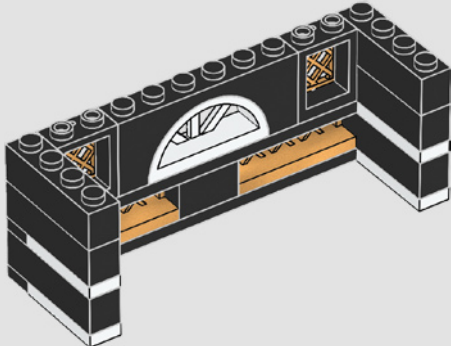

103

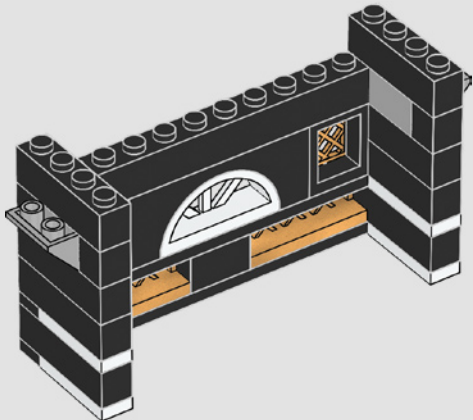



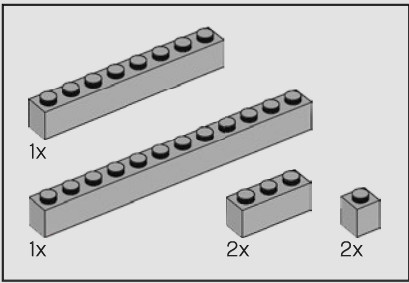

105



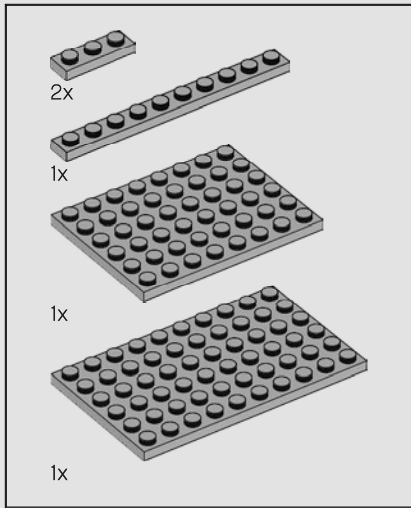

Der Obelisk des Bösen
 Von Barron stahl diesen Obelisken, weil seine Inschrift viel böser war als alles, was ihm je zu Gesicht gekommen war.

106

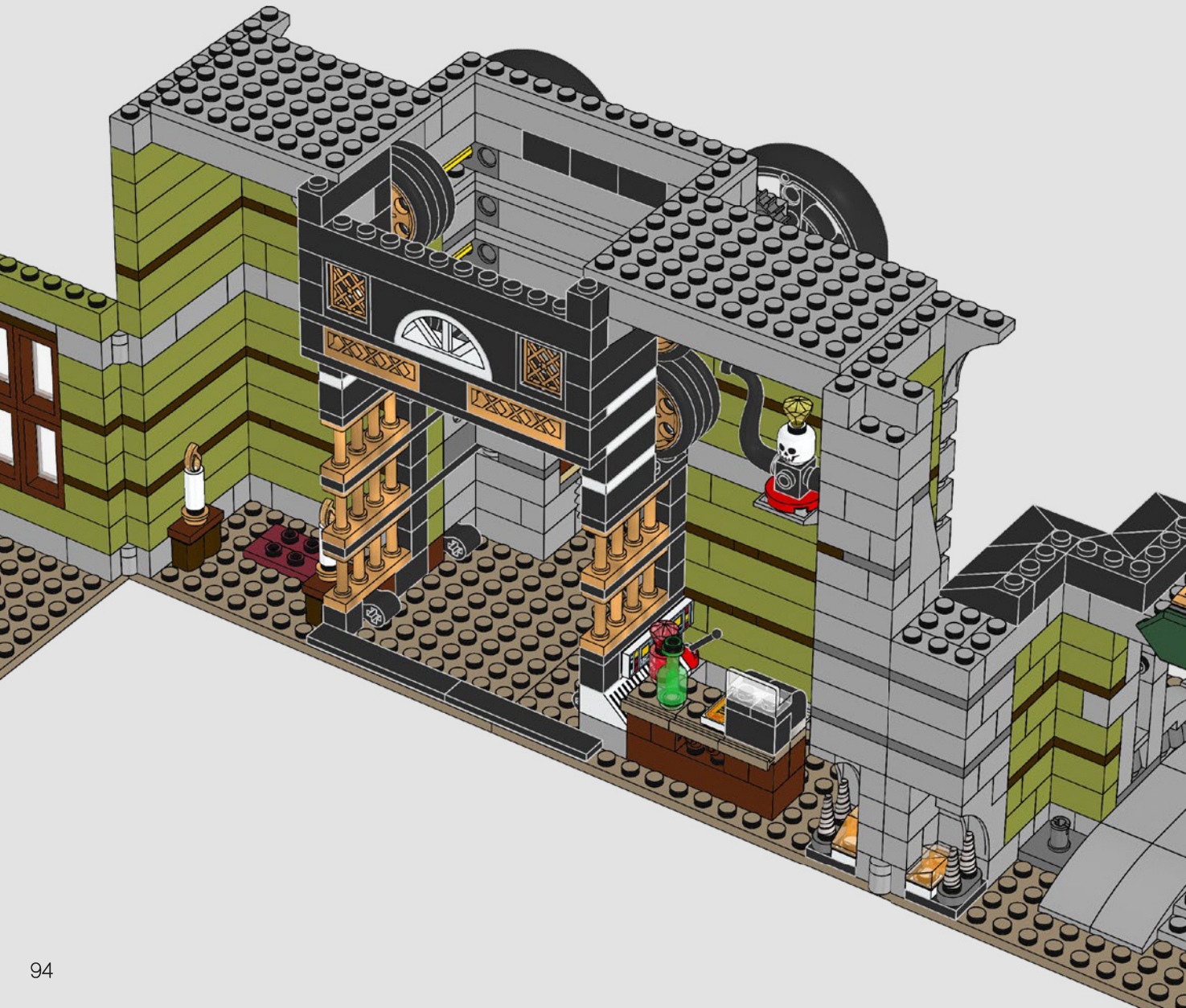

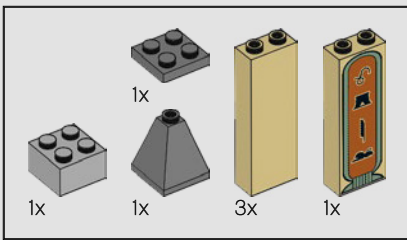

107

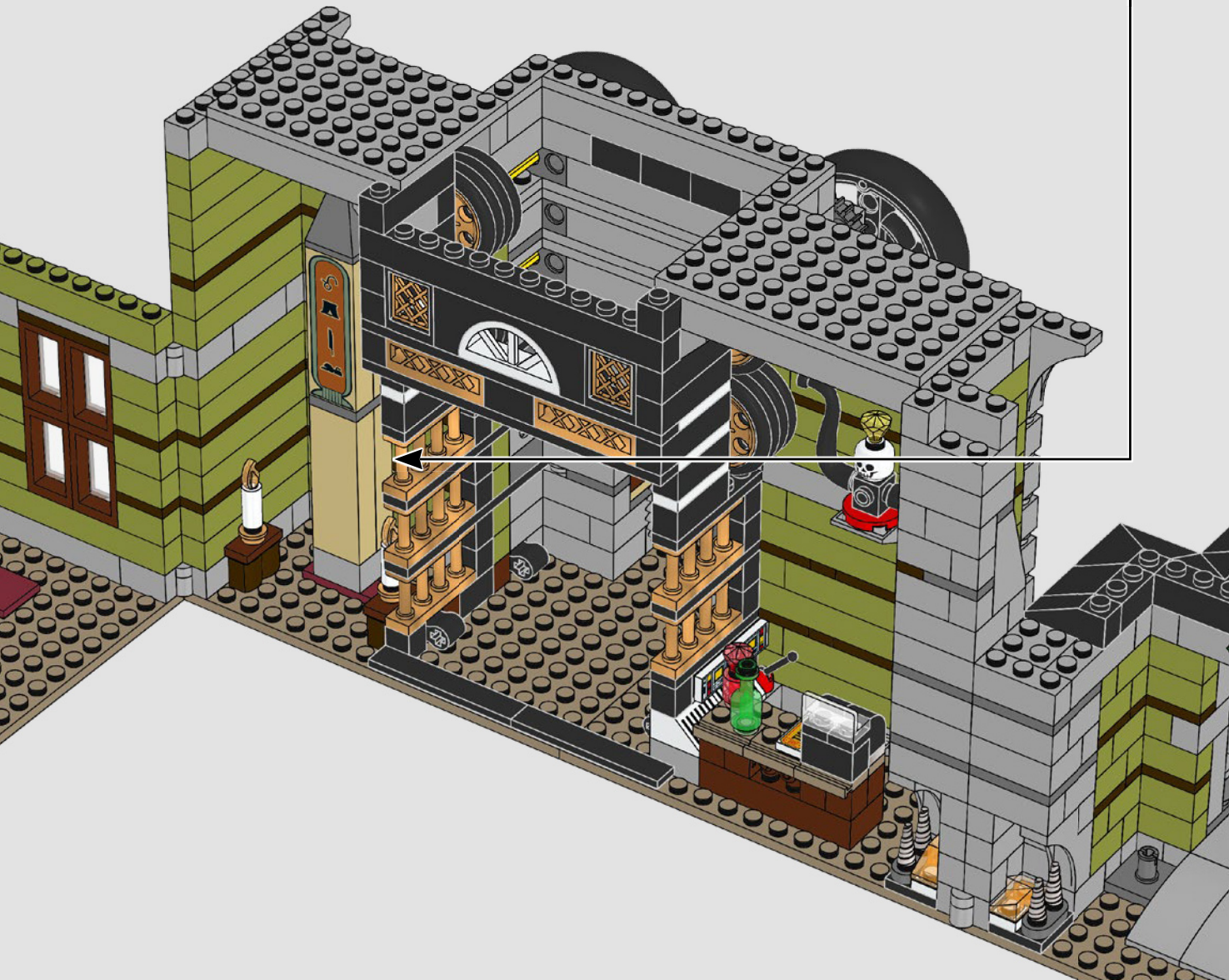
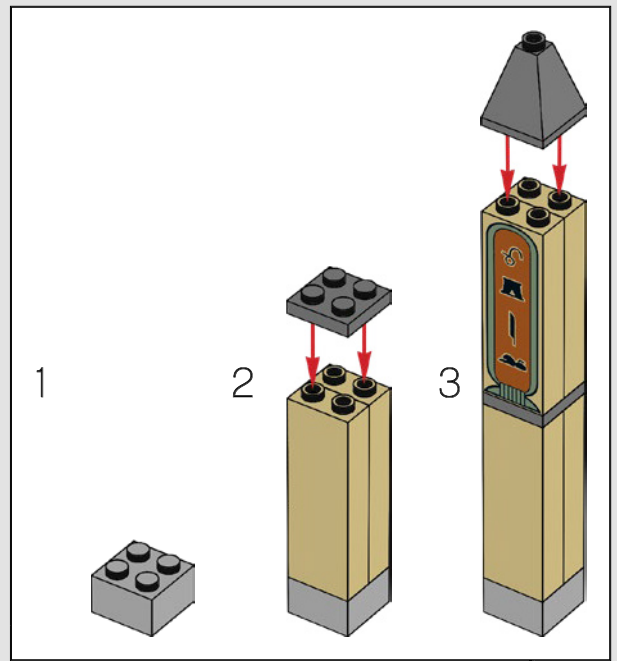

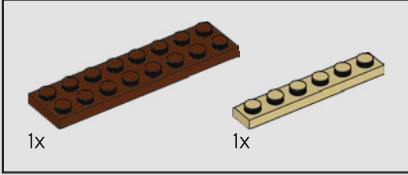
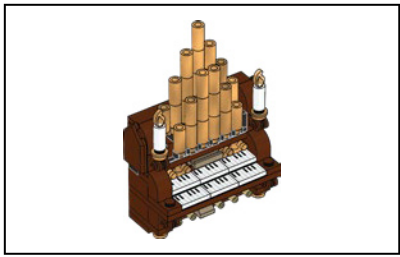

108

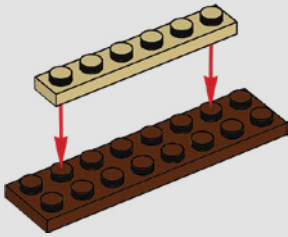

109

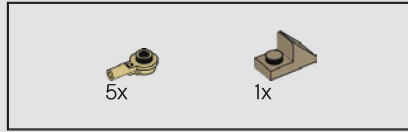
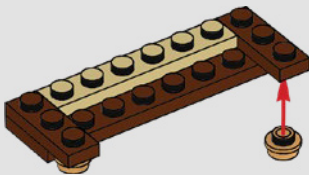

110

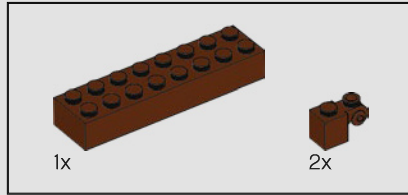
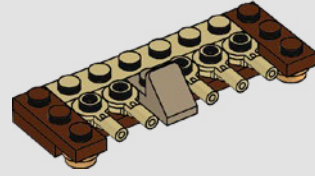

111

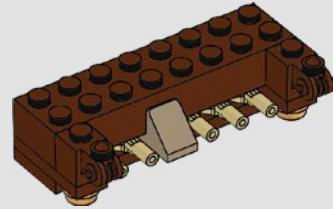

112

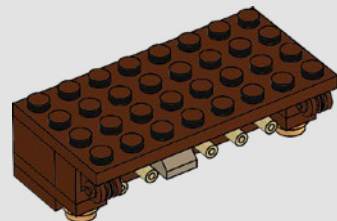

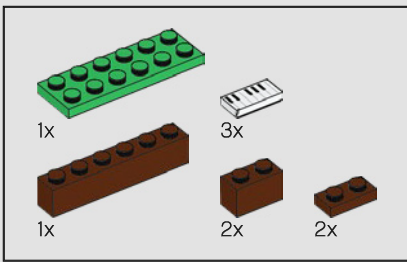

113

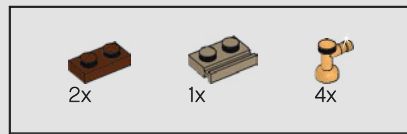
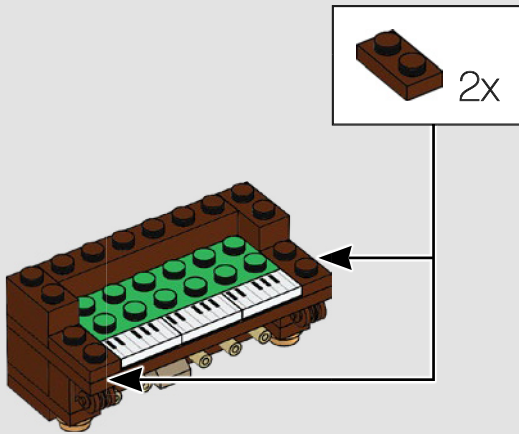

115

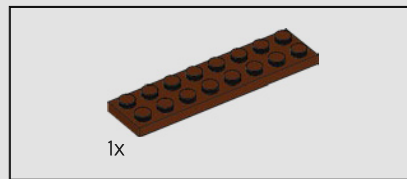
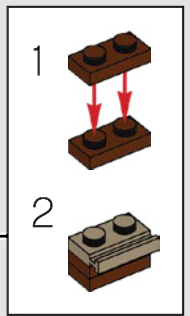
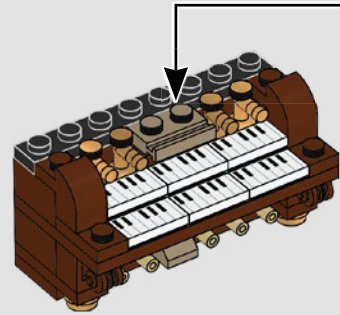

116

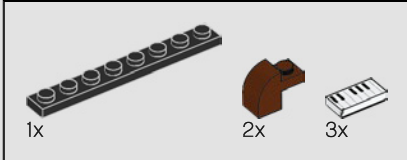
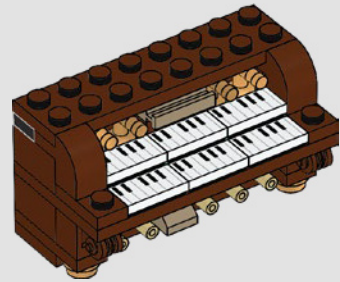

114

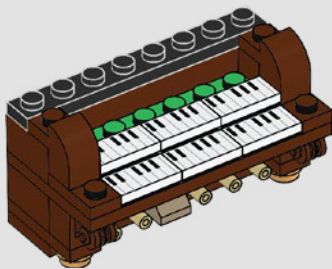

117

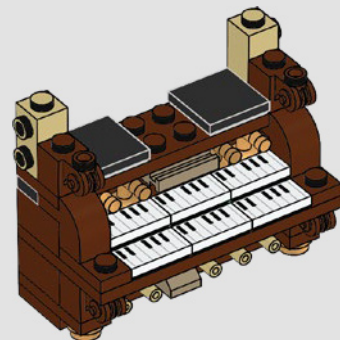

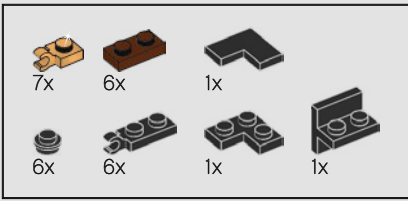

118

1



2

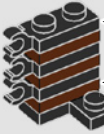
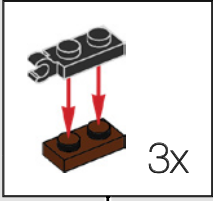

3

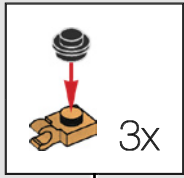

4

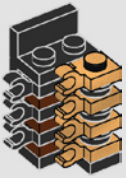

5

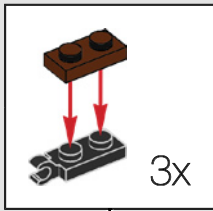

6

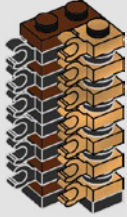
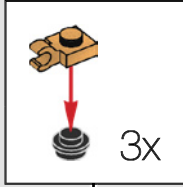

7

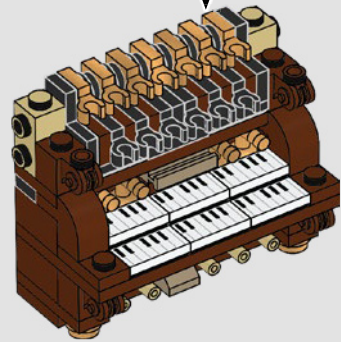
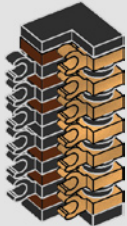

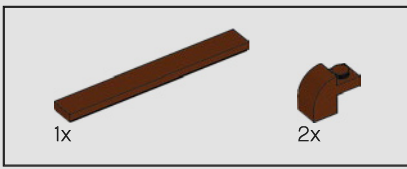

119

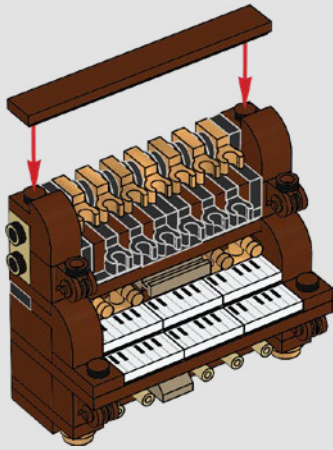

120

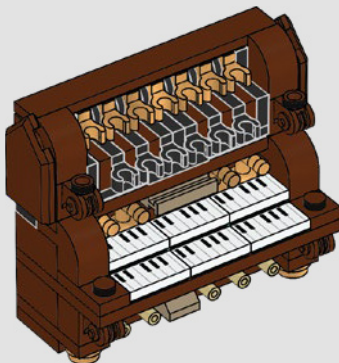

121

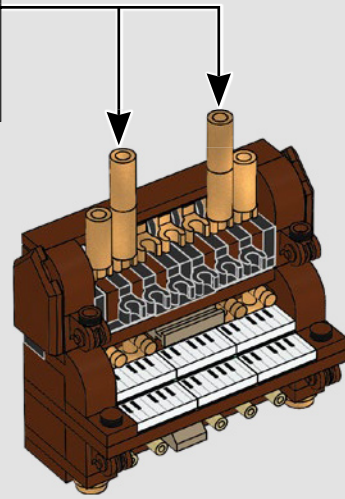
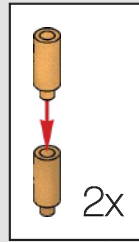

122

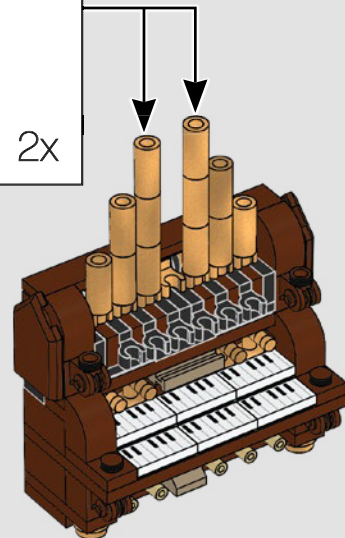
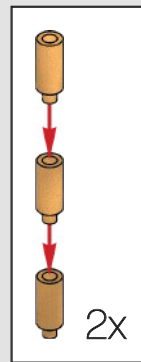

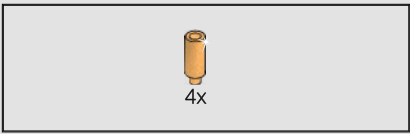

123

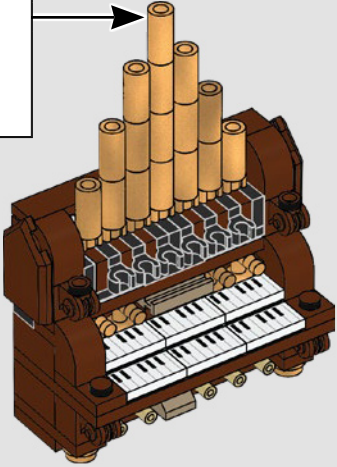
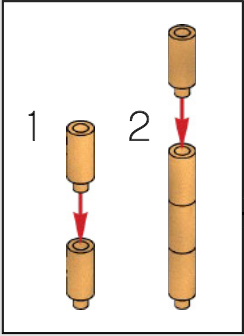

125

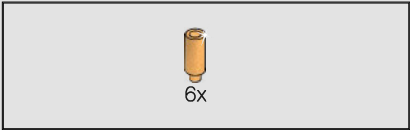
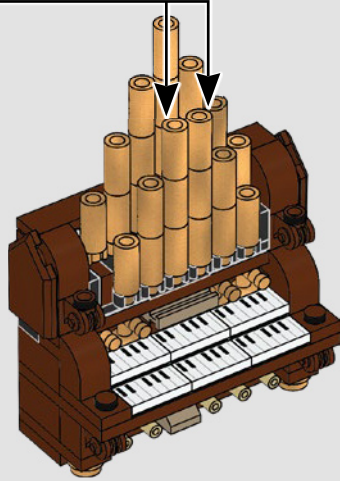
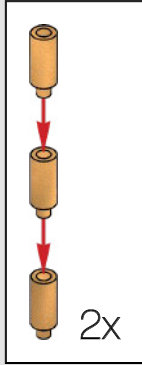

124

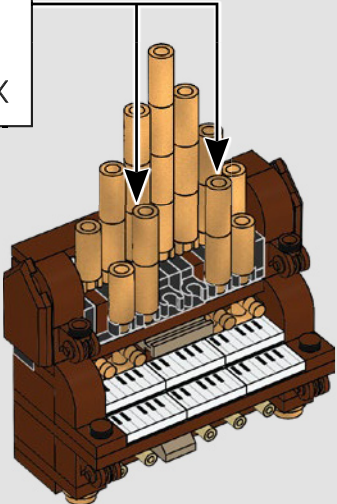
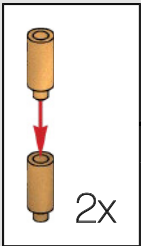

126

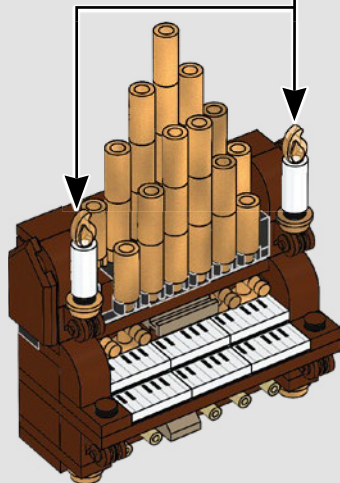
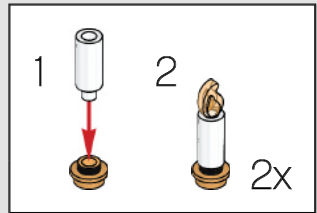

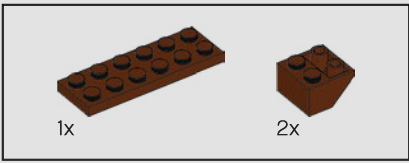

Die Orgel von Catarino
Von Barron ließ diese Orgel nach seinen Wünschen in Portugal bauen. Am liebsten spielte er die Erkennungssongs von TV-Serien auf dieser Orgel.

127

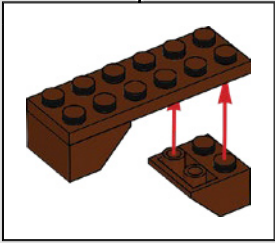
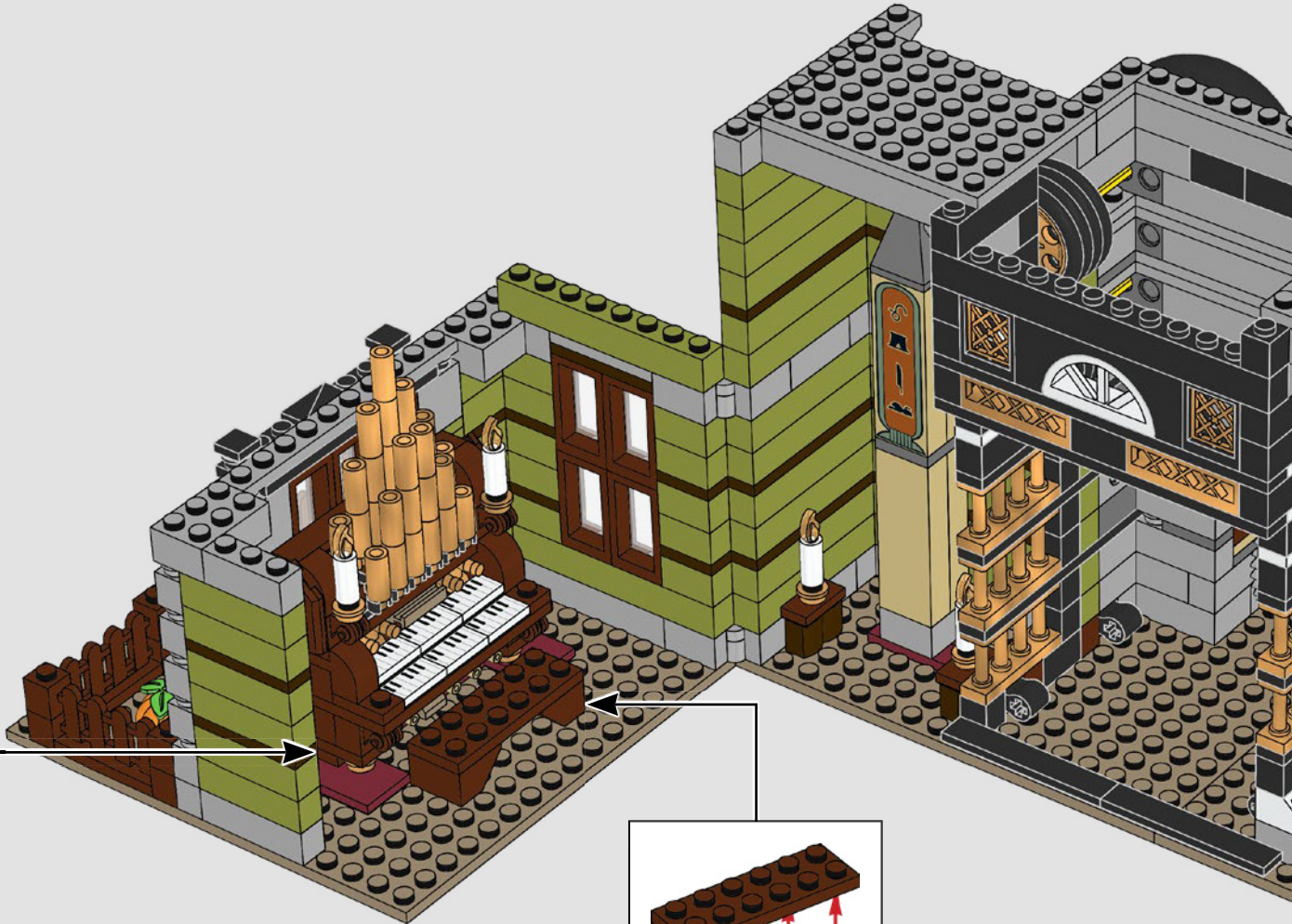

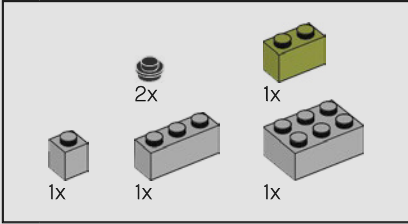
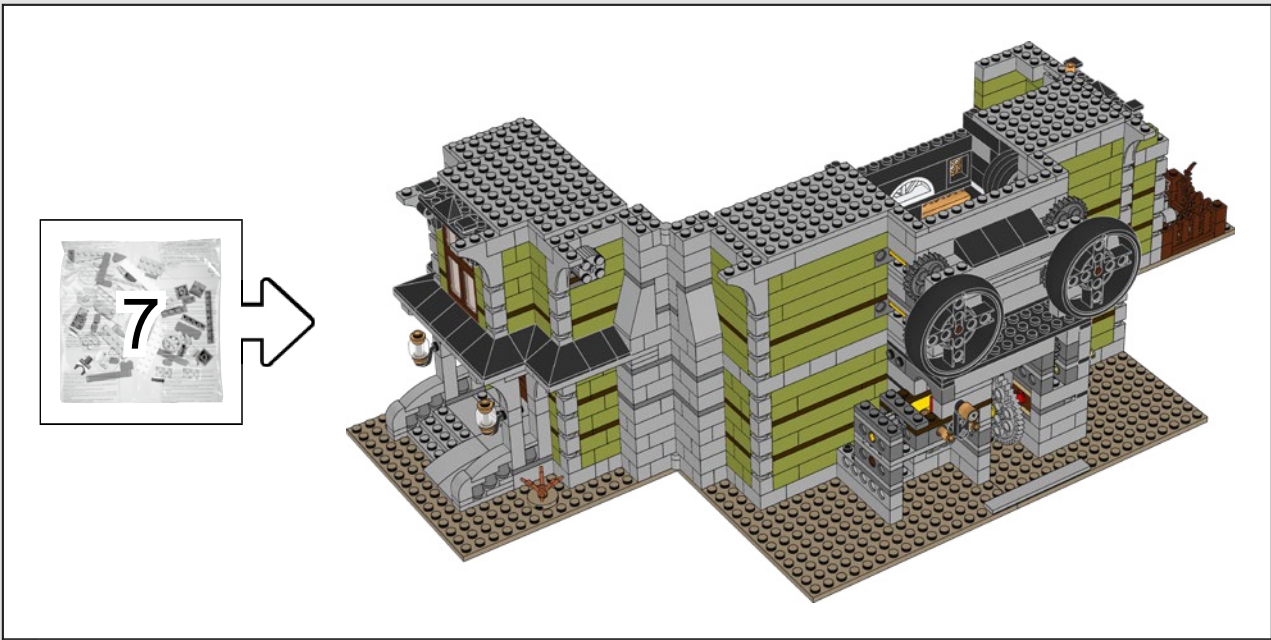

128

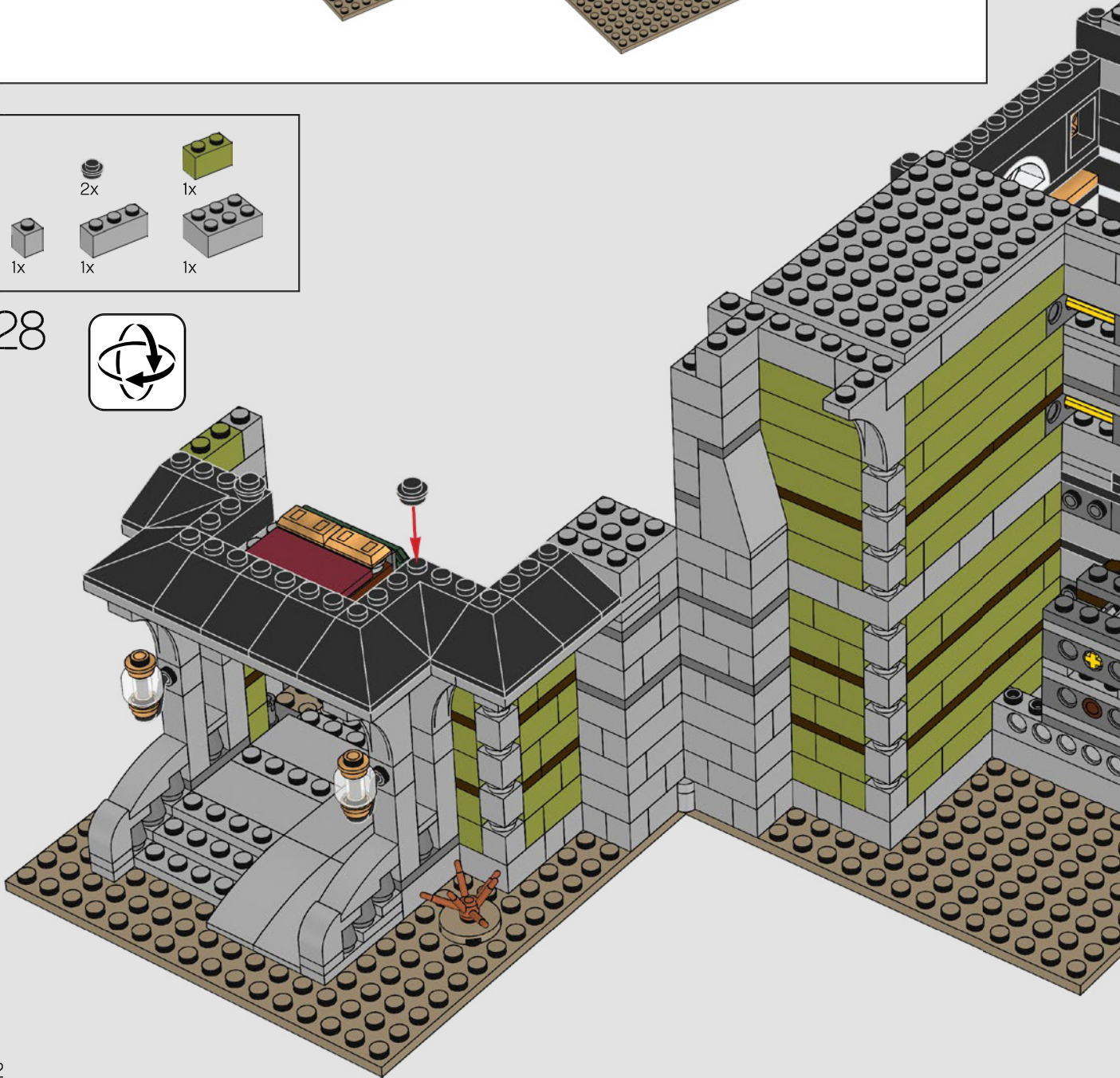

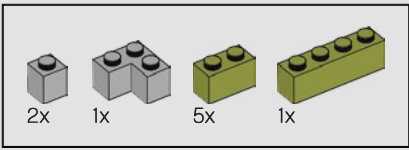

129

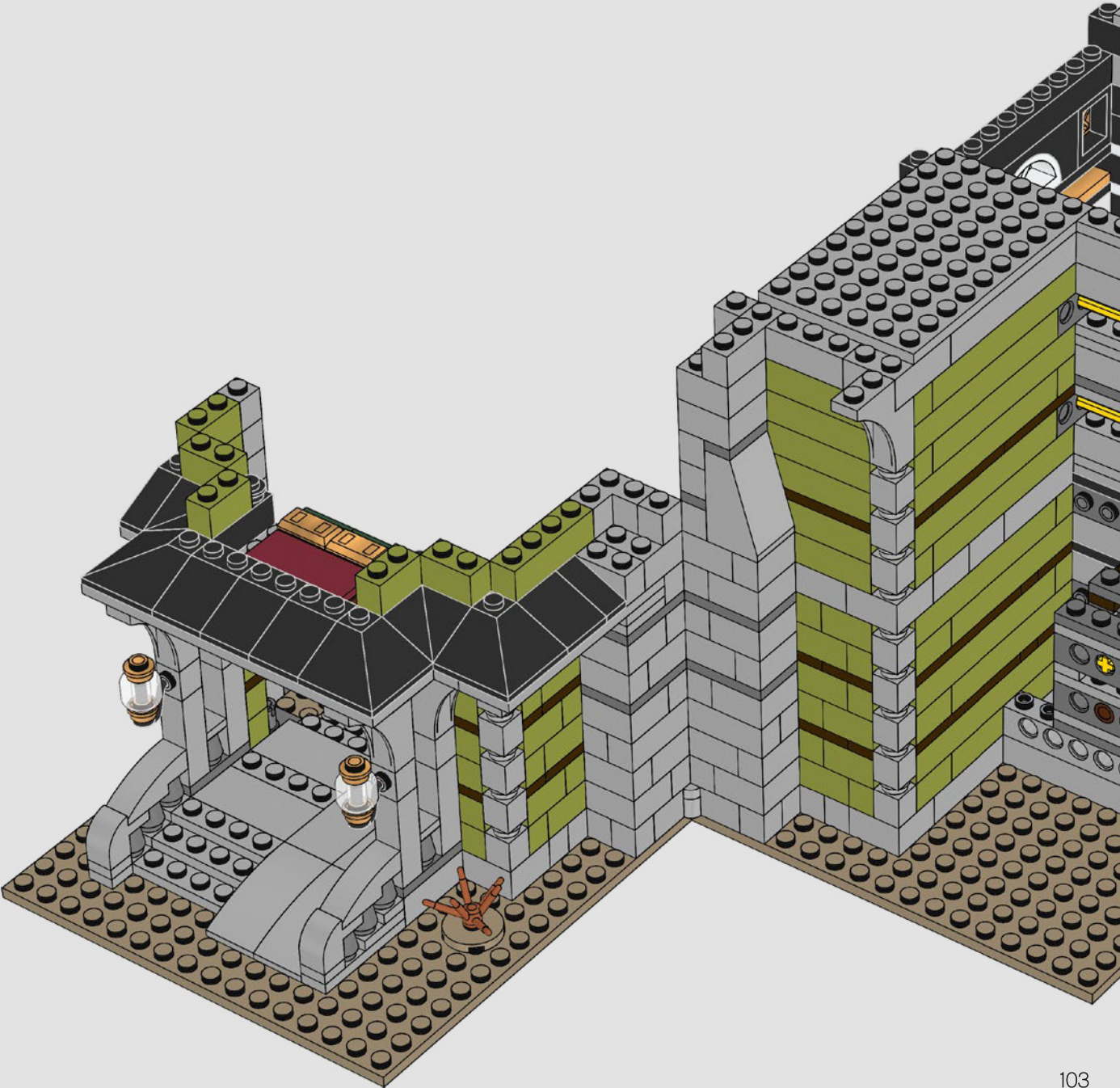

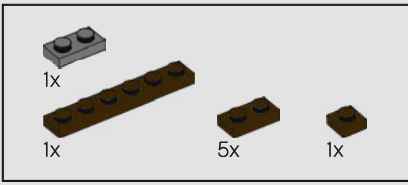

130



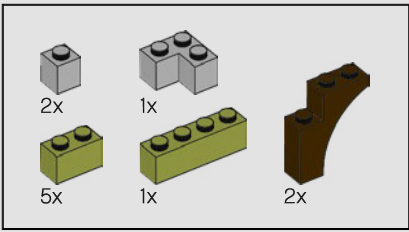

131

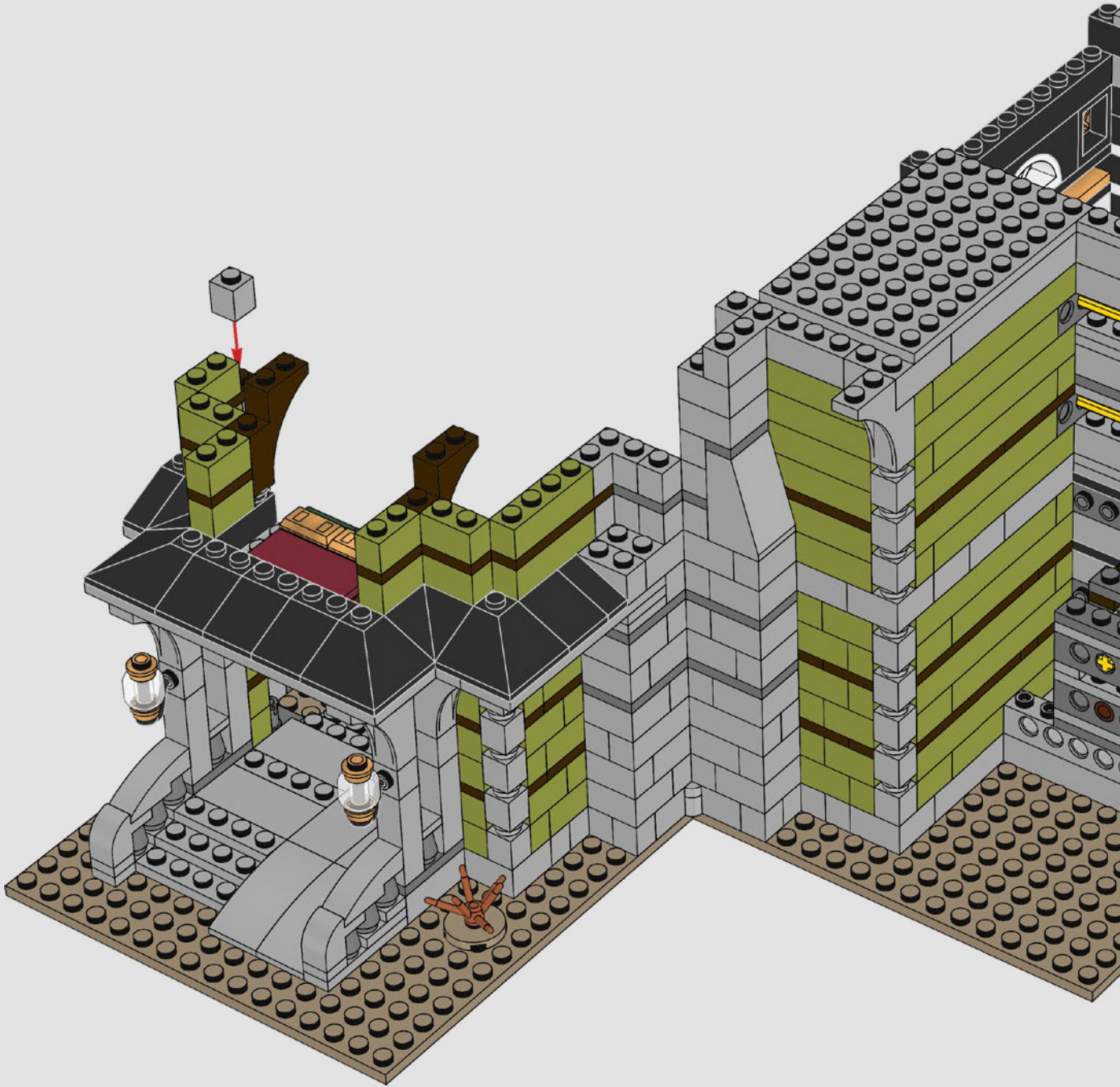

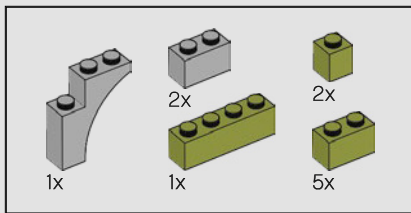

132



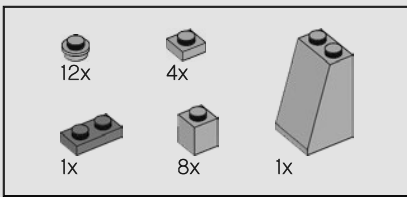

133

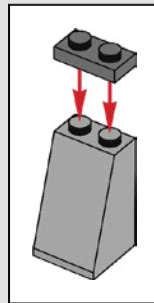
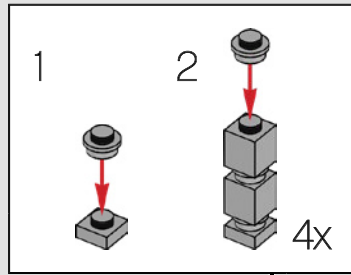

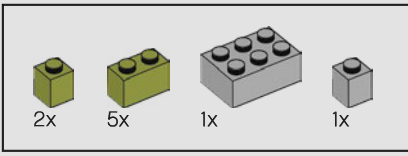

134



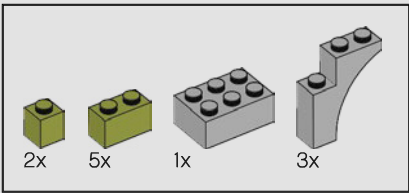

135

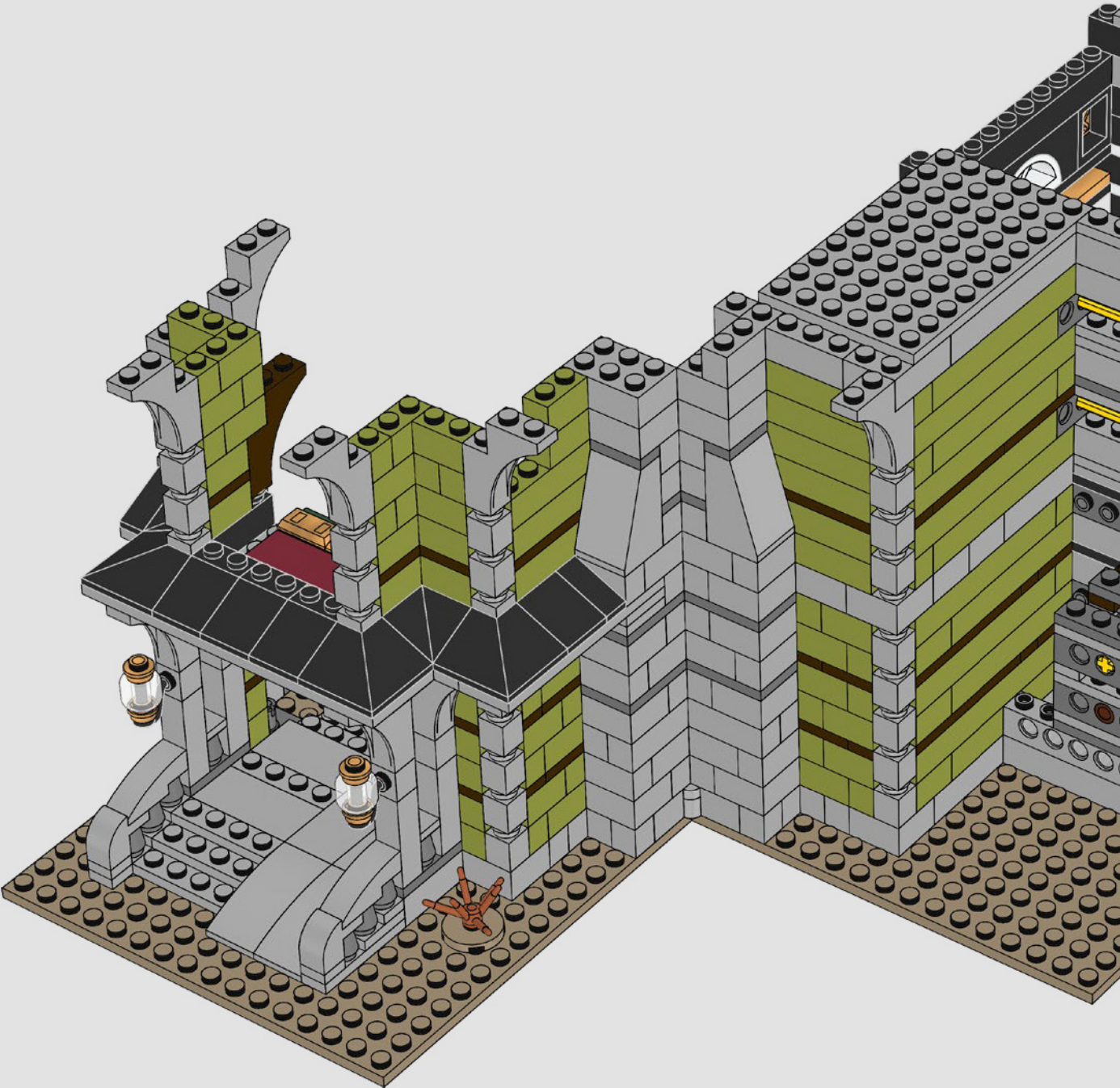

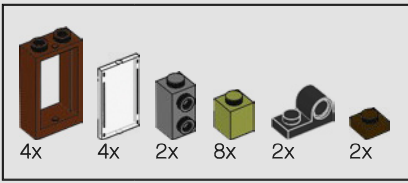

136

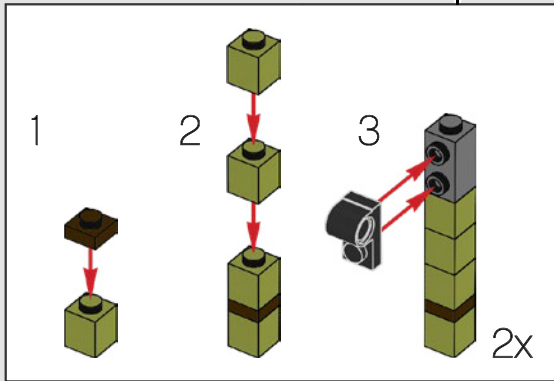
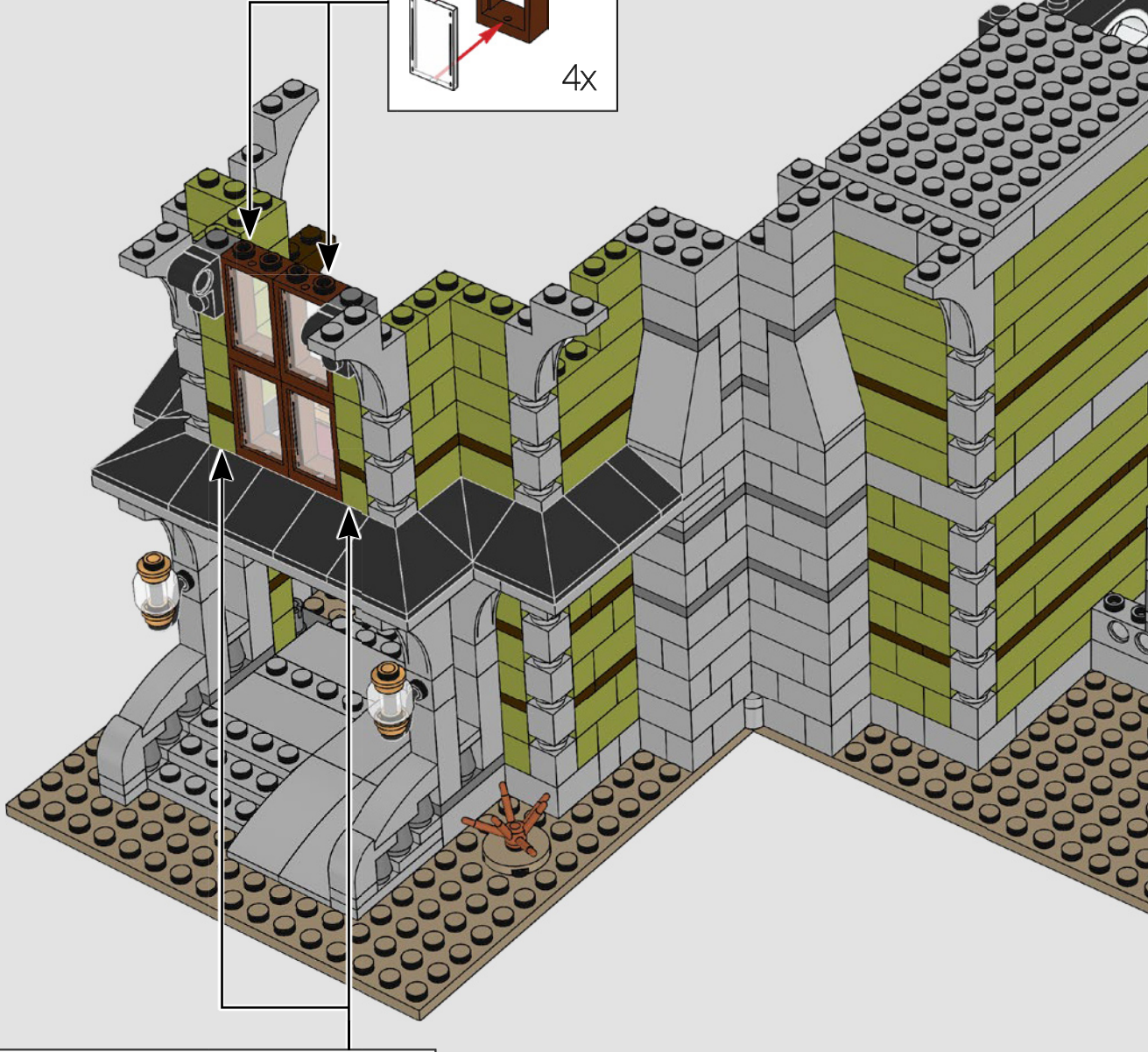
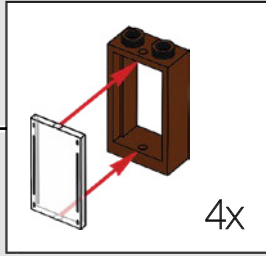

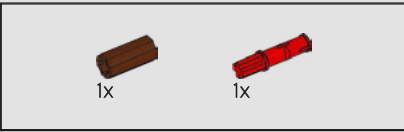
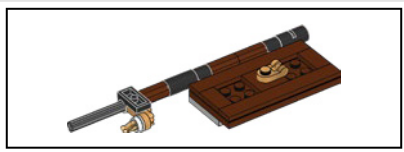

137

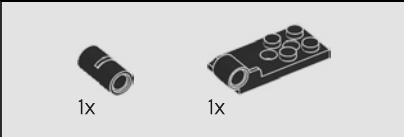
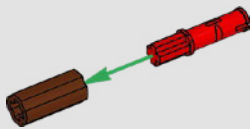

138

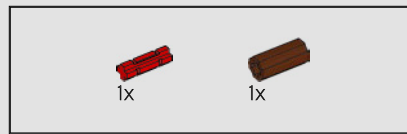
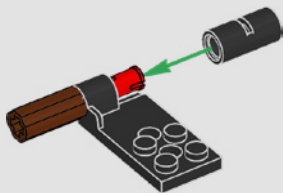

139

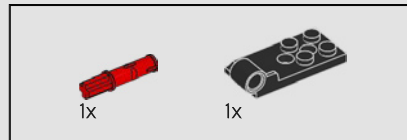
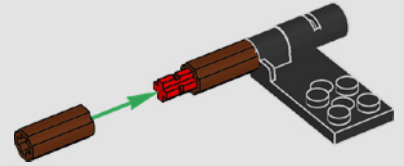

140

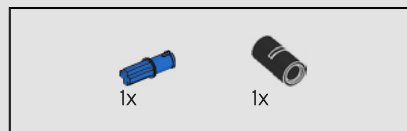
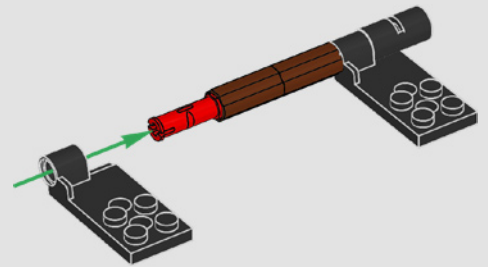

141

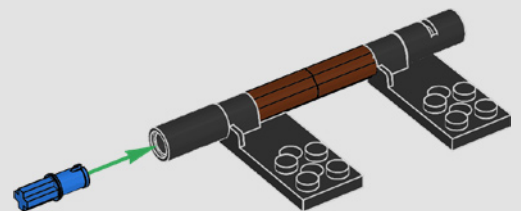

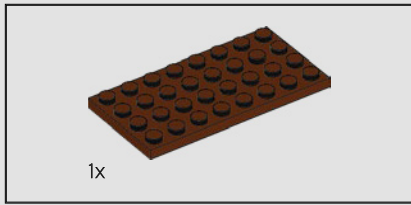

142

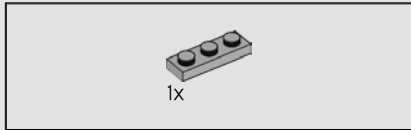
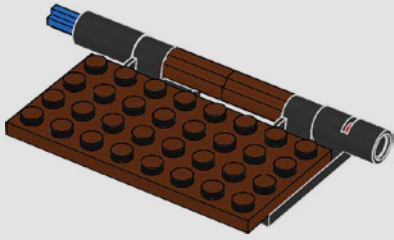

143

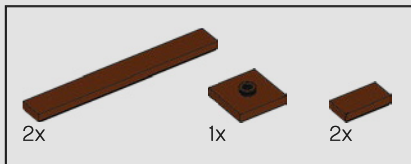
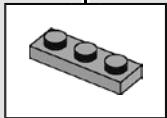
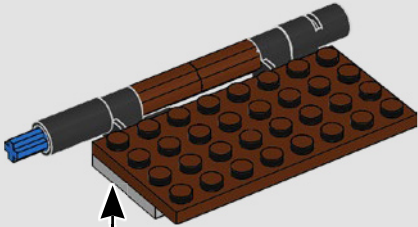

144

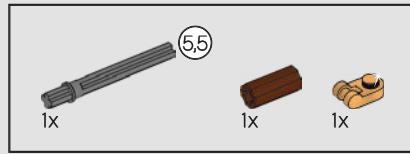
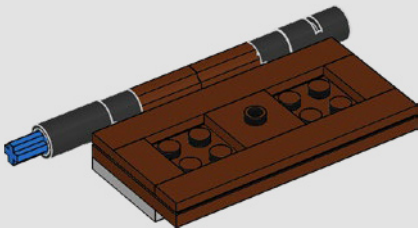

145

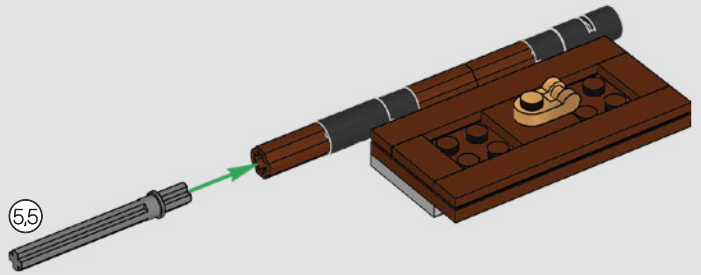

146

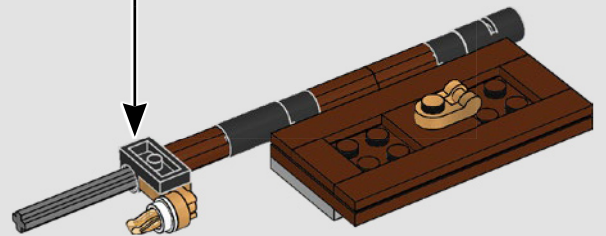
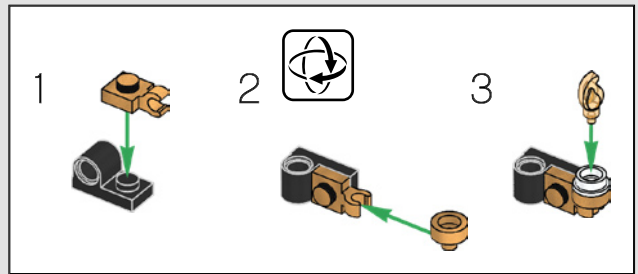

147



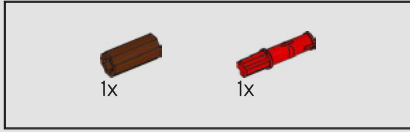
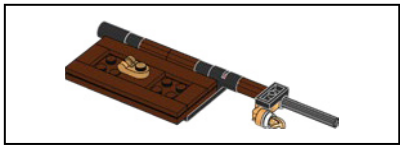

148

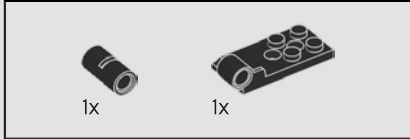
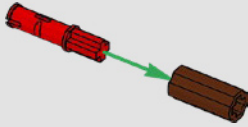

149

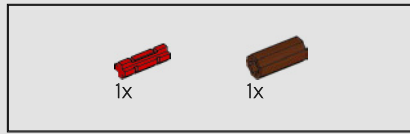
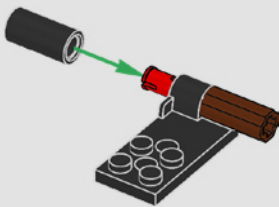

150

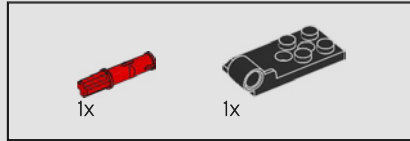
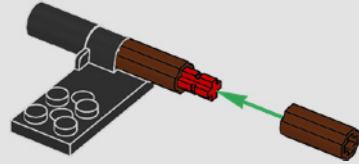

151

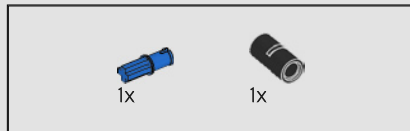
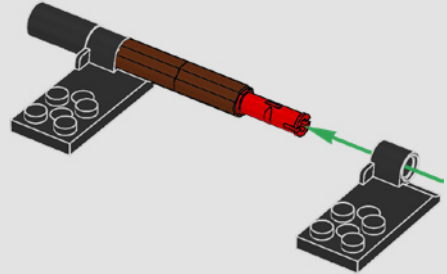

152

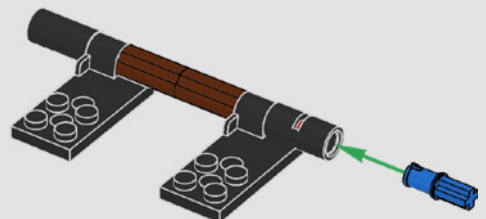

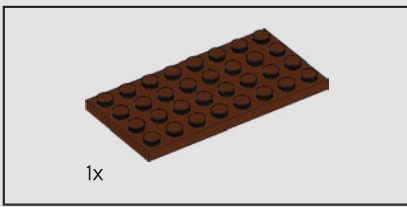

153

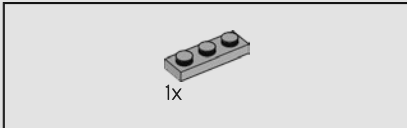
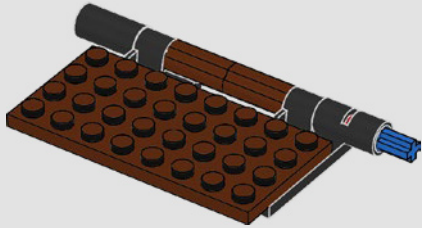

154

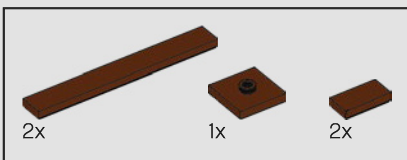
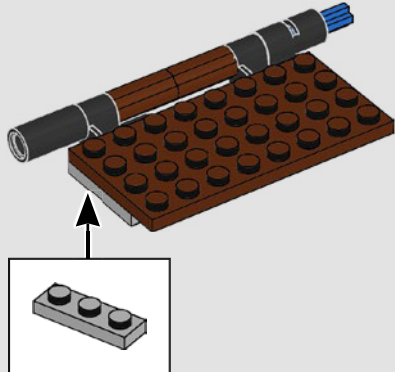

155

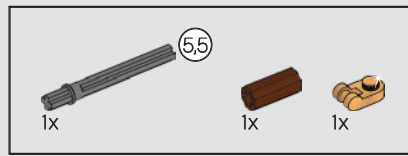
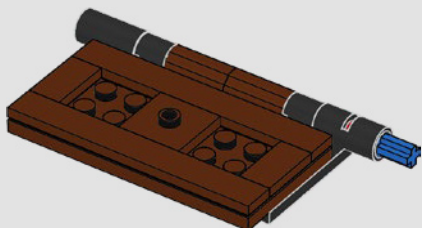

156

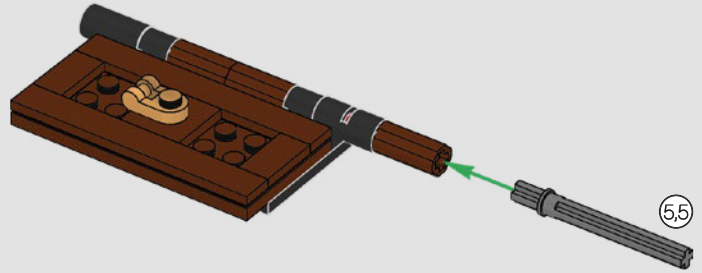

157

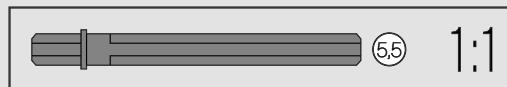
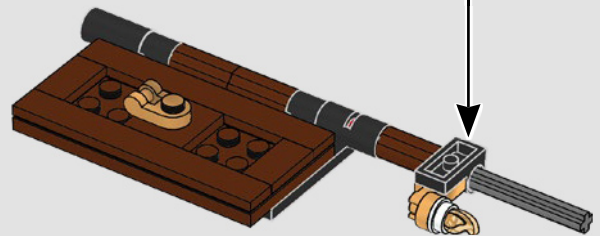
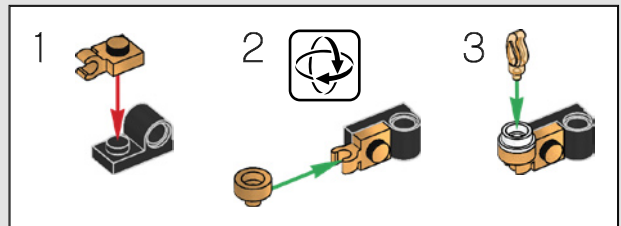

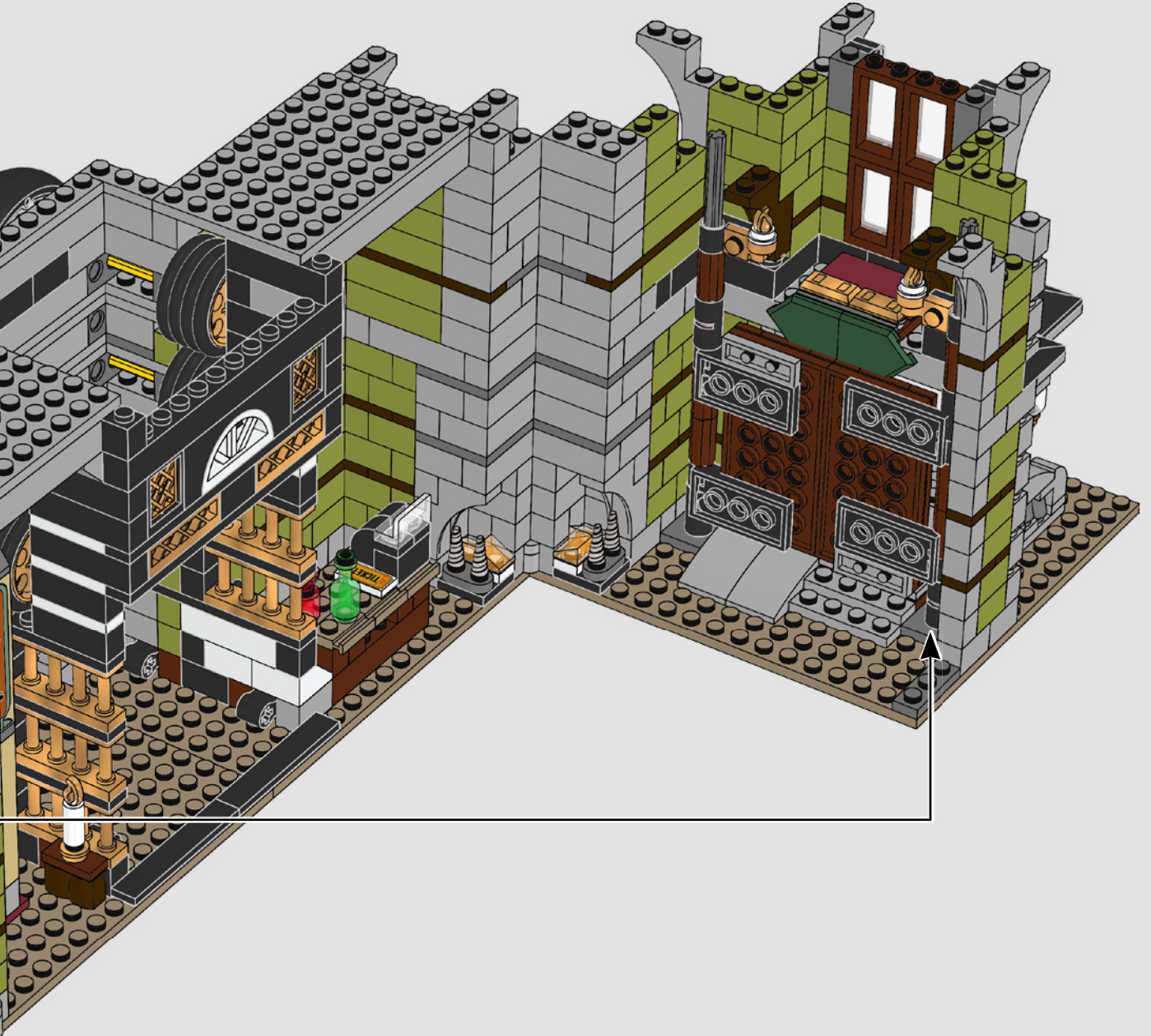

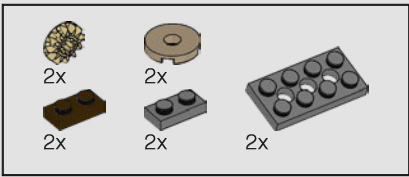

159

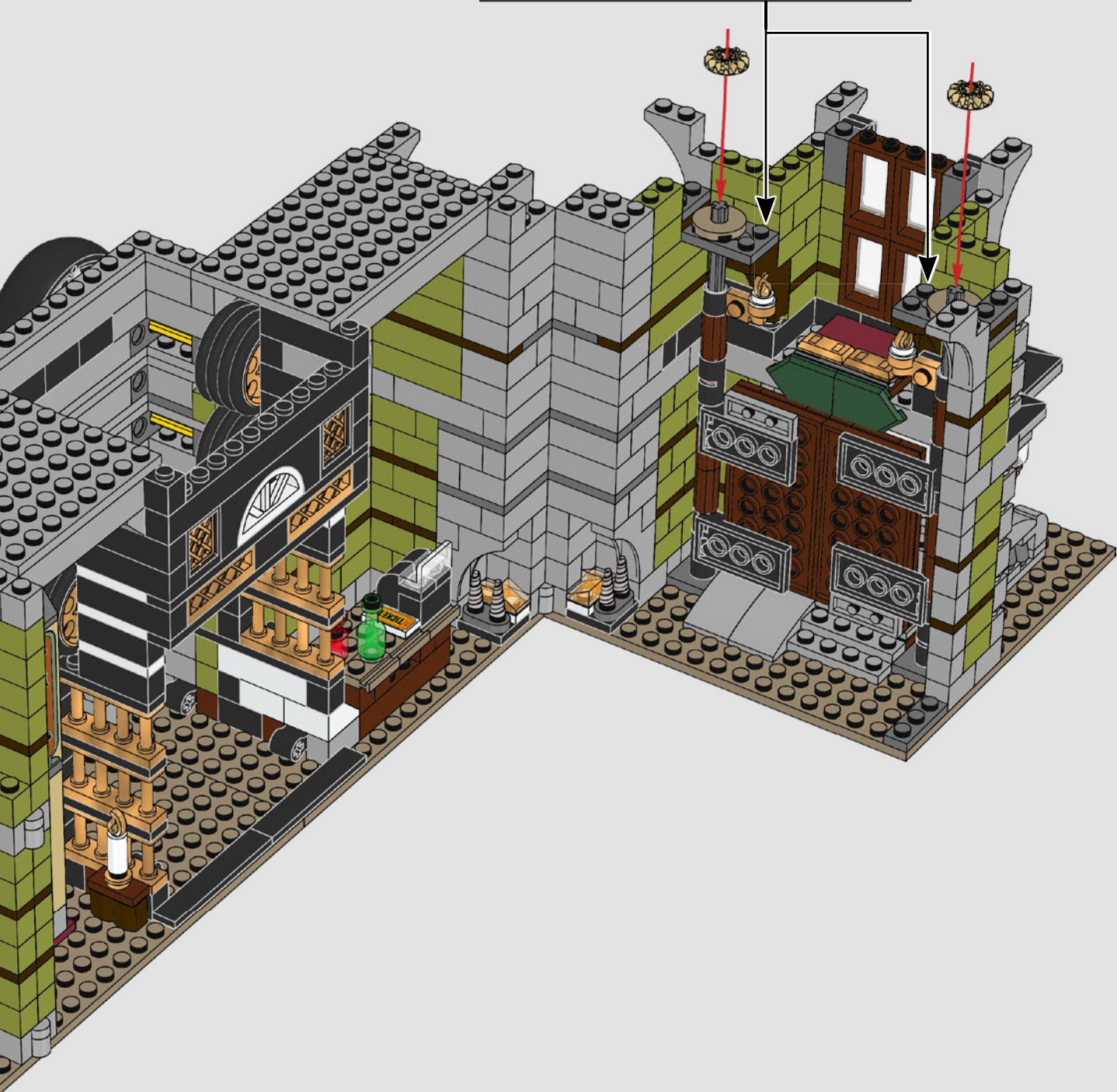
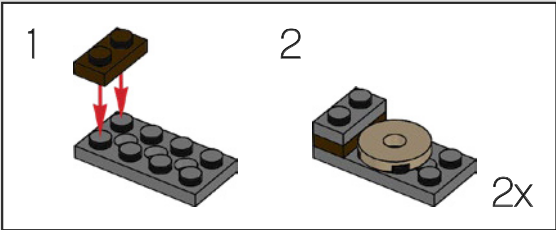

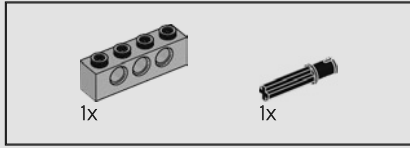
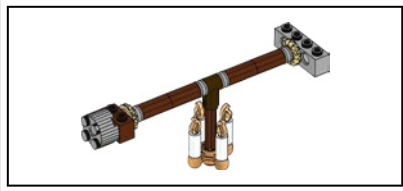

160

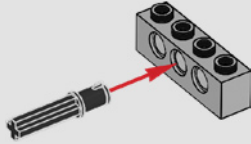

161

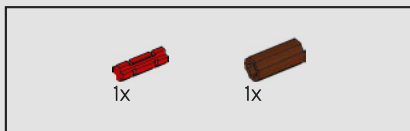
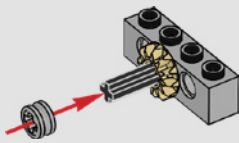

162

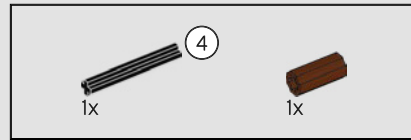
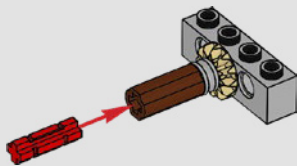

163

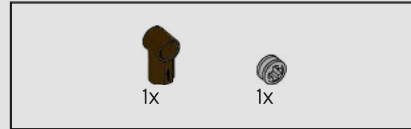
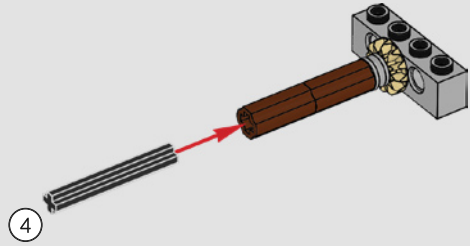

164

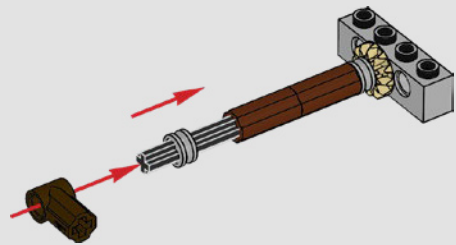

165

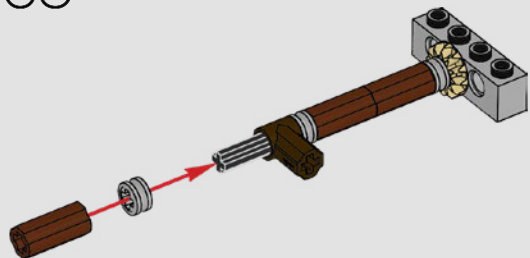

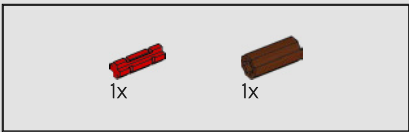

166

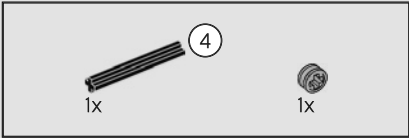
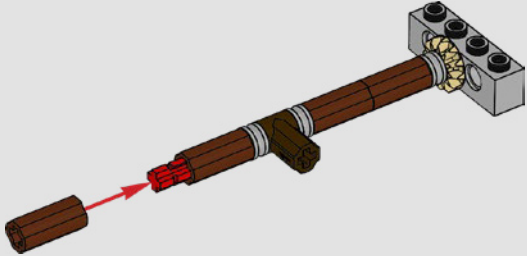

167

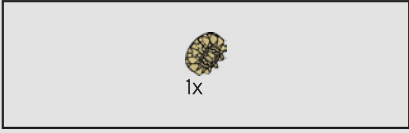
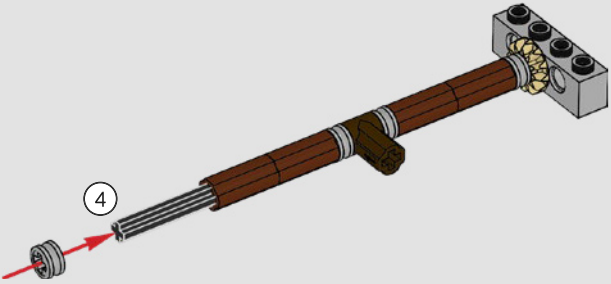

168

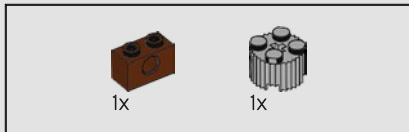
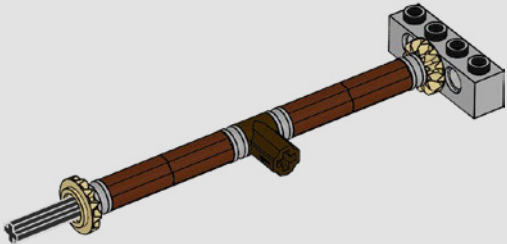

169

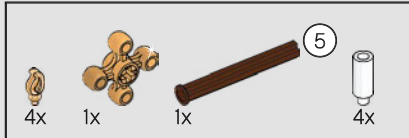
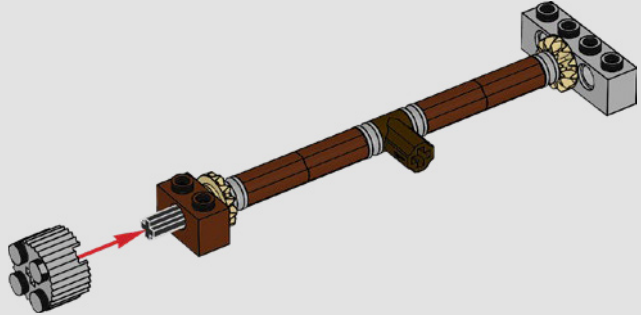

170

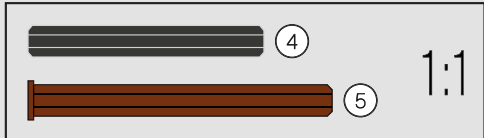
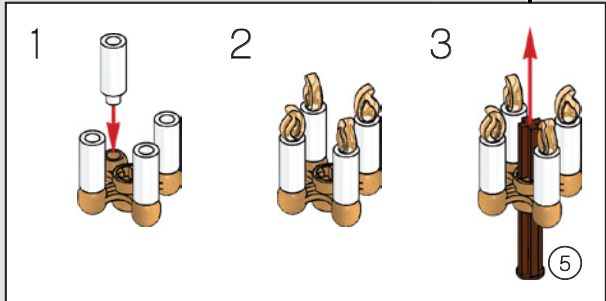
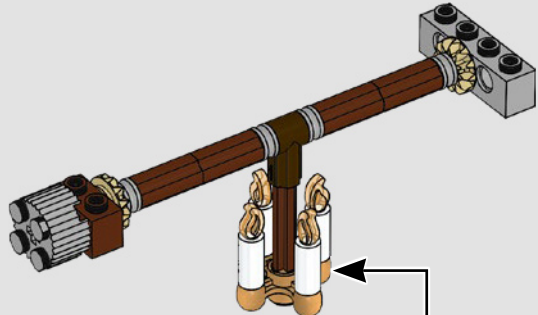

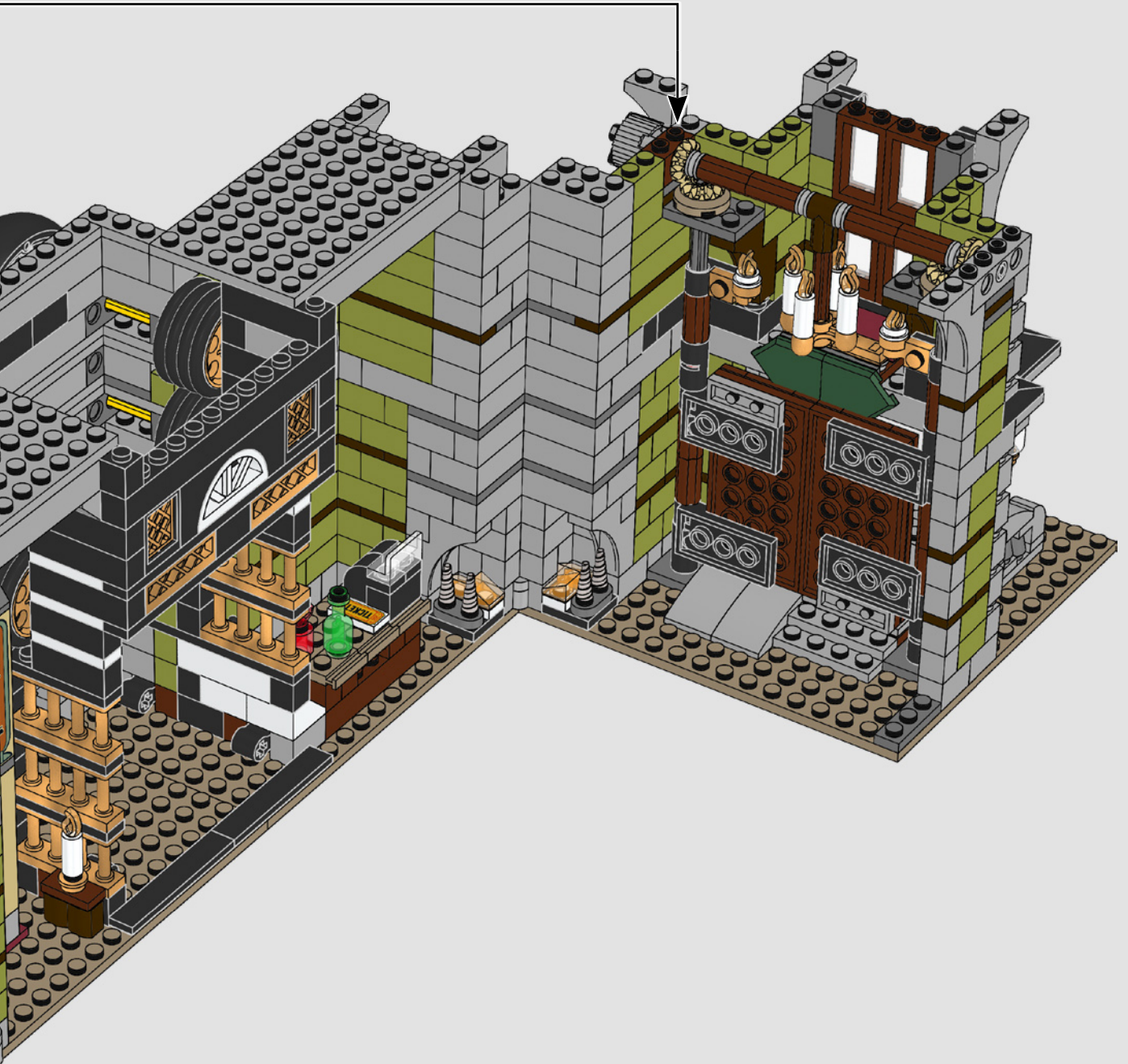

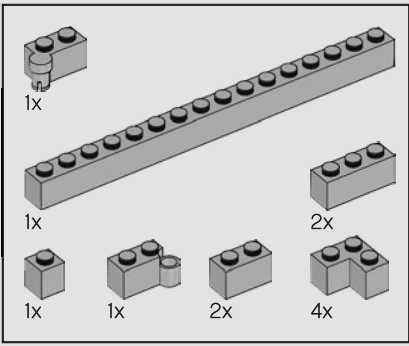

172

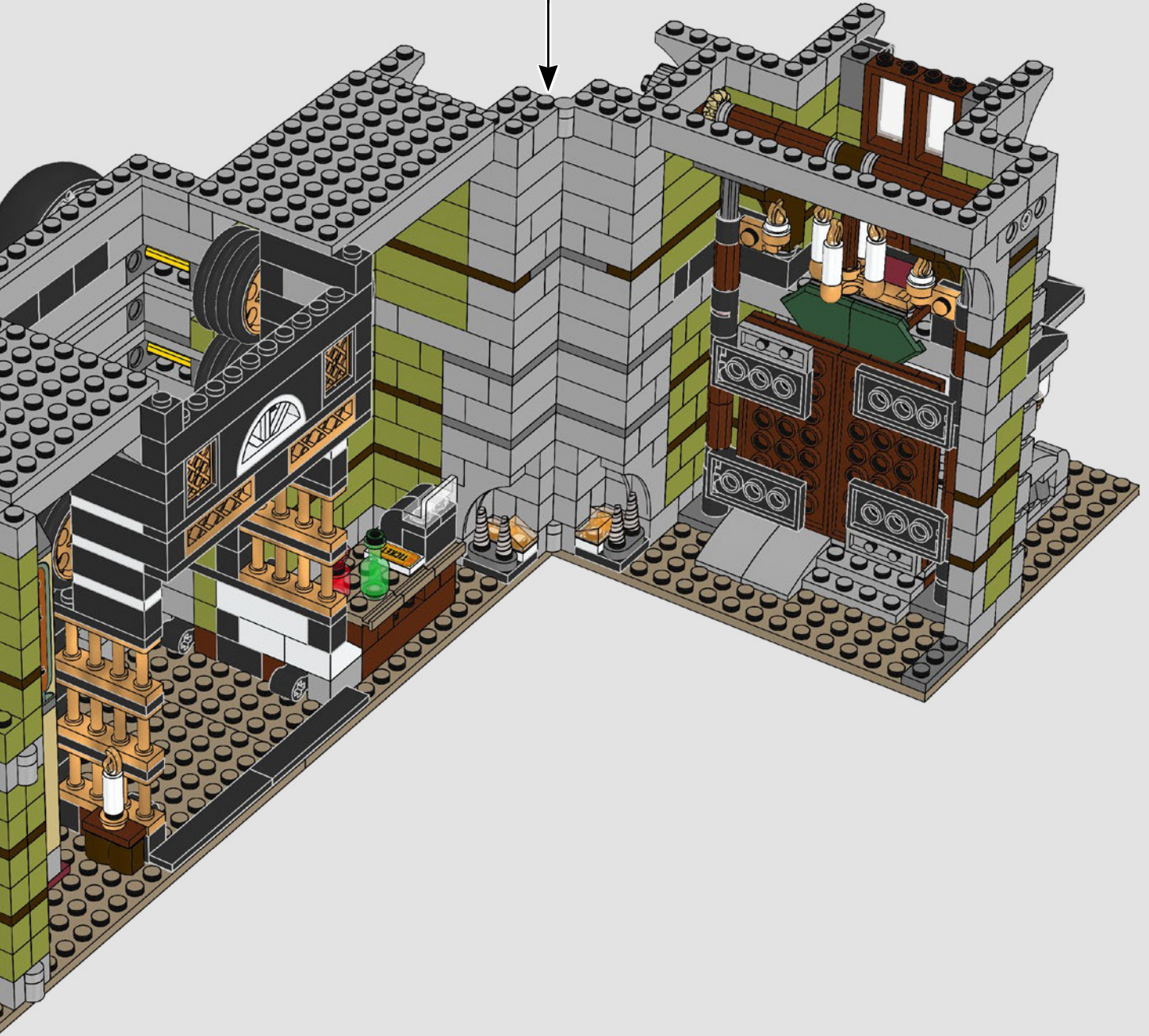
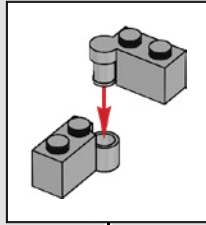

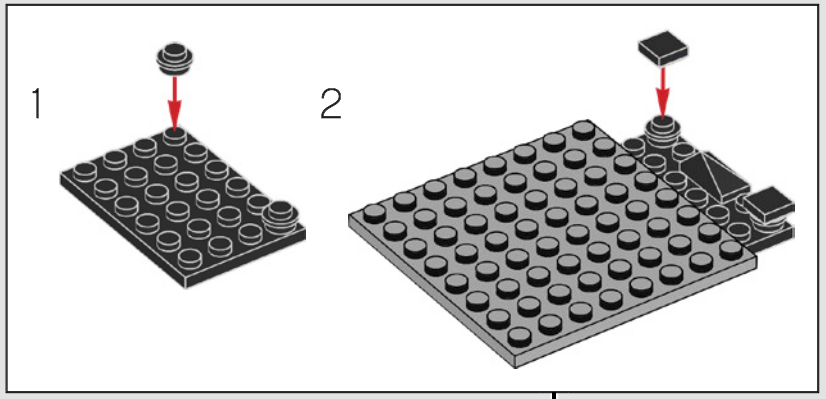
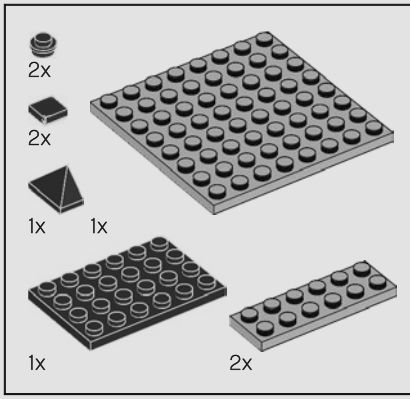

173



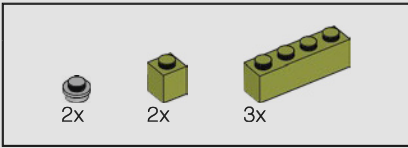
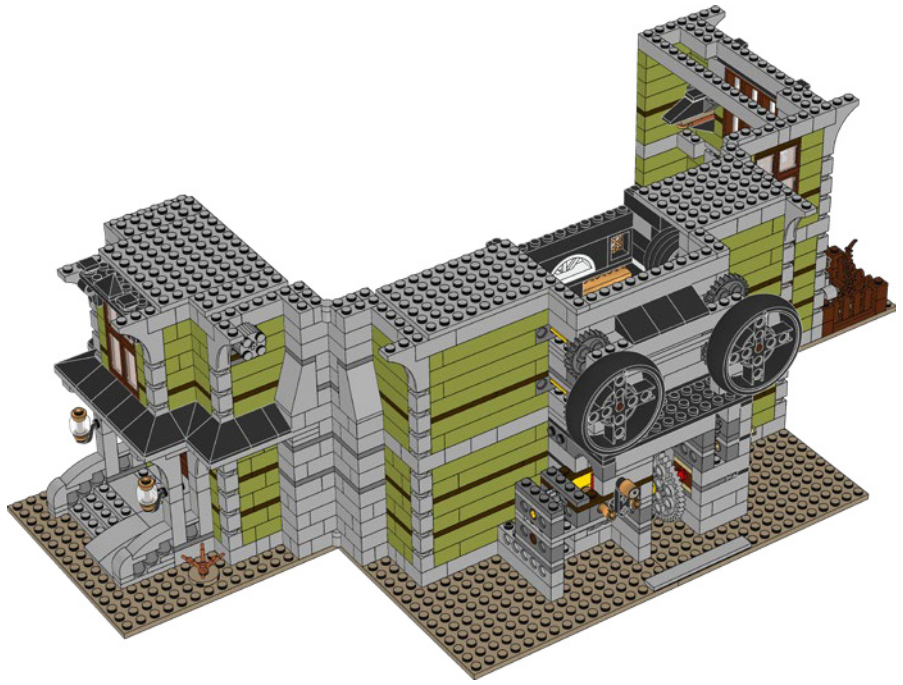

174

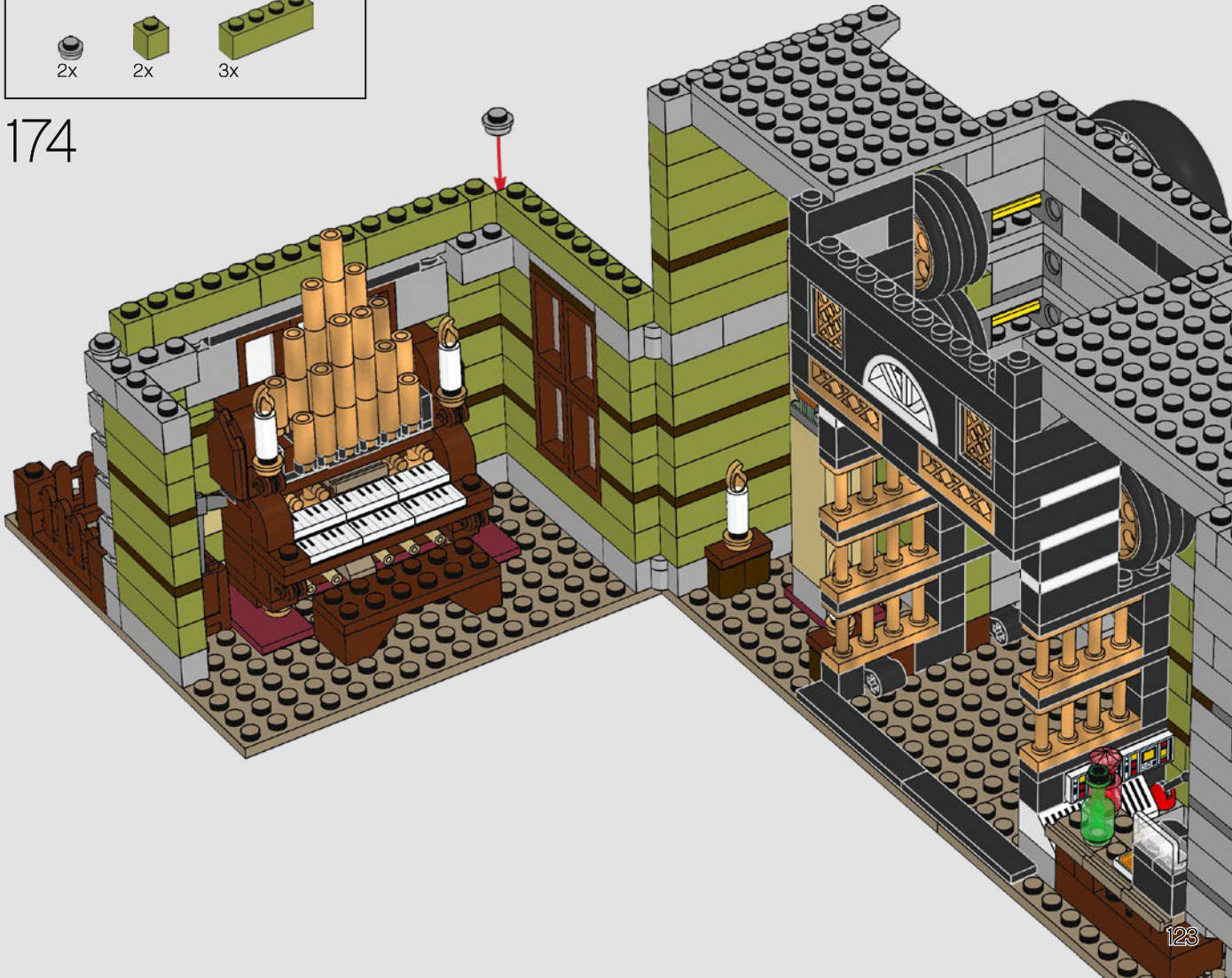

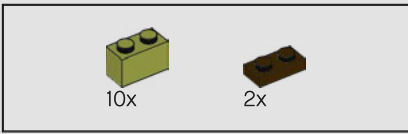

175

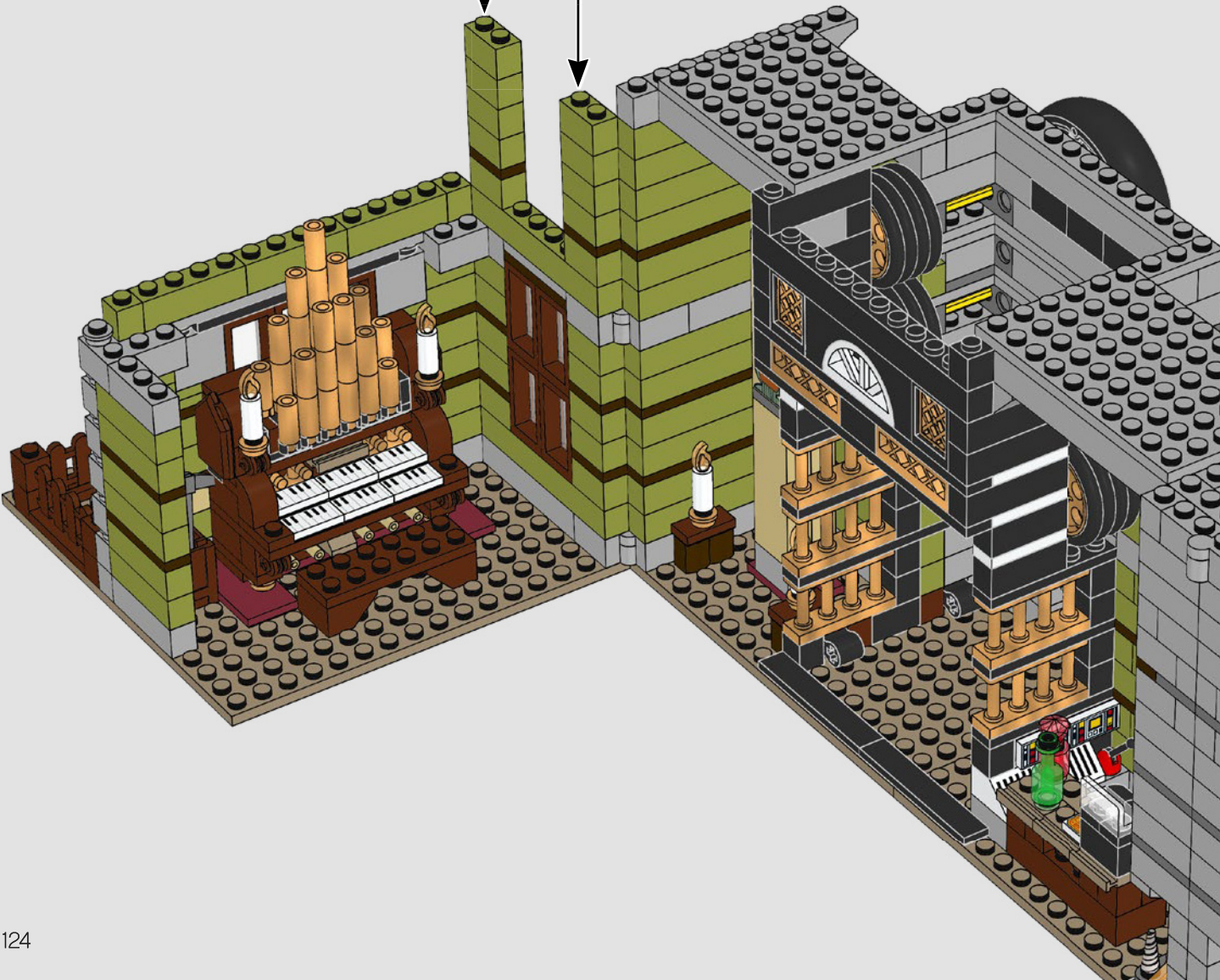
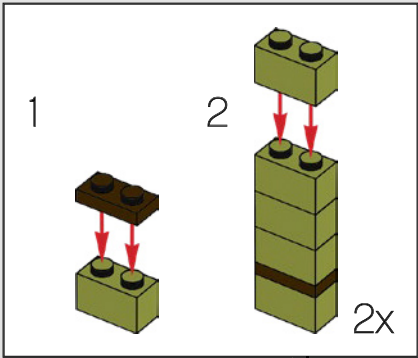

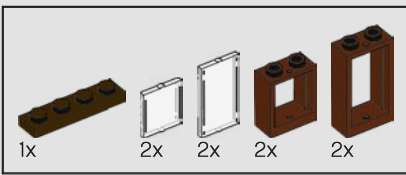

176

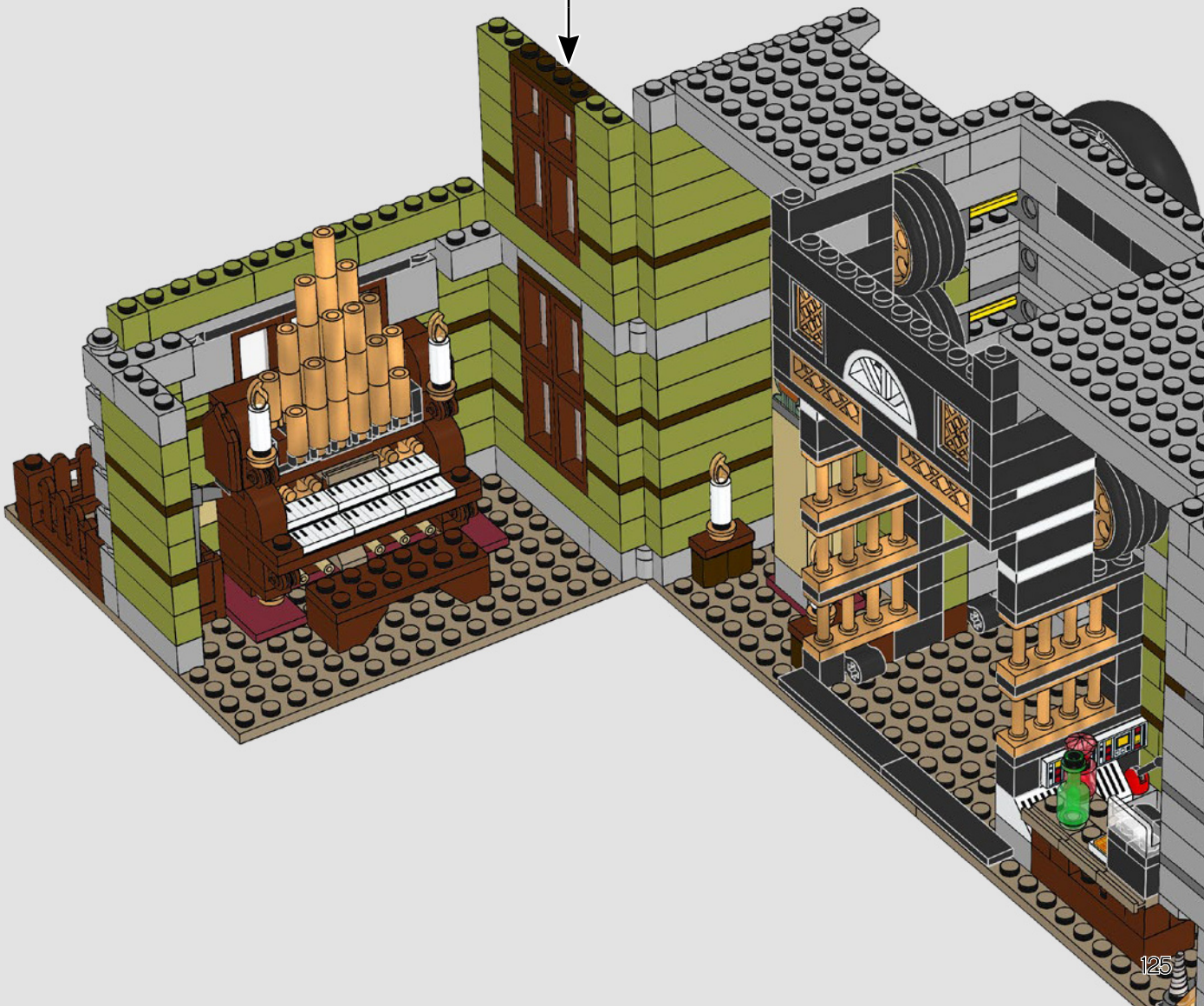
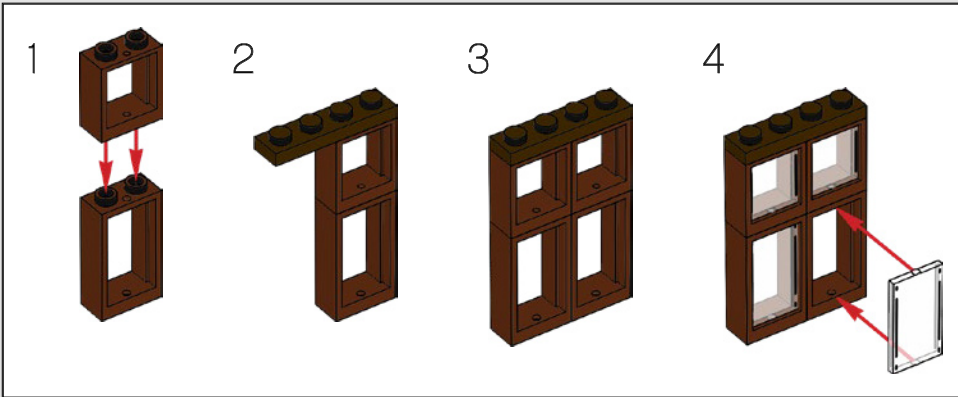

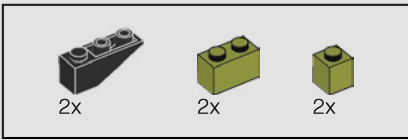

177

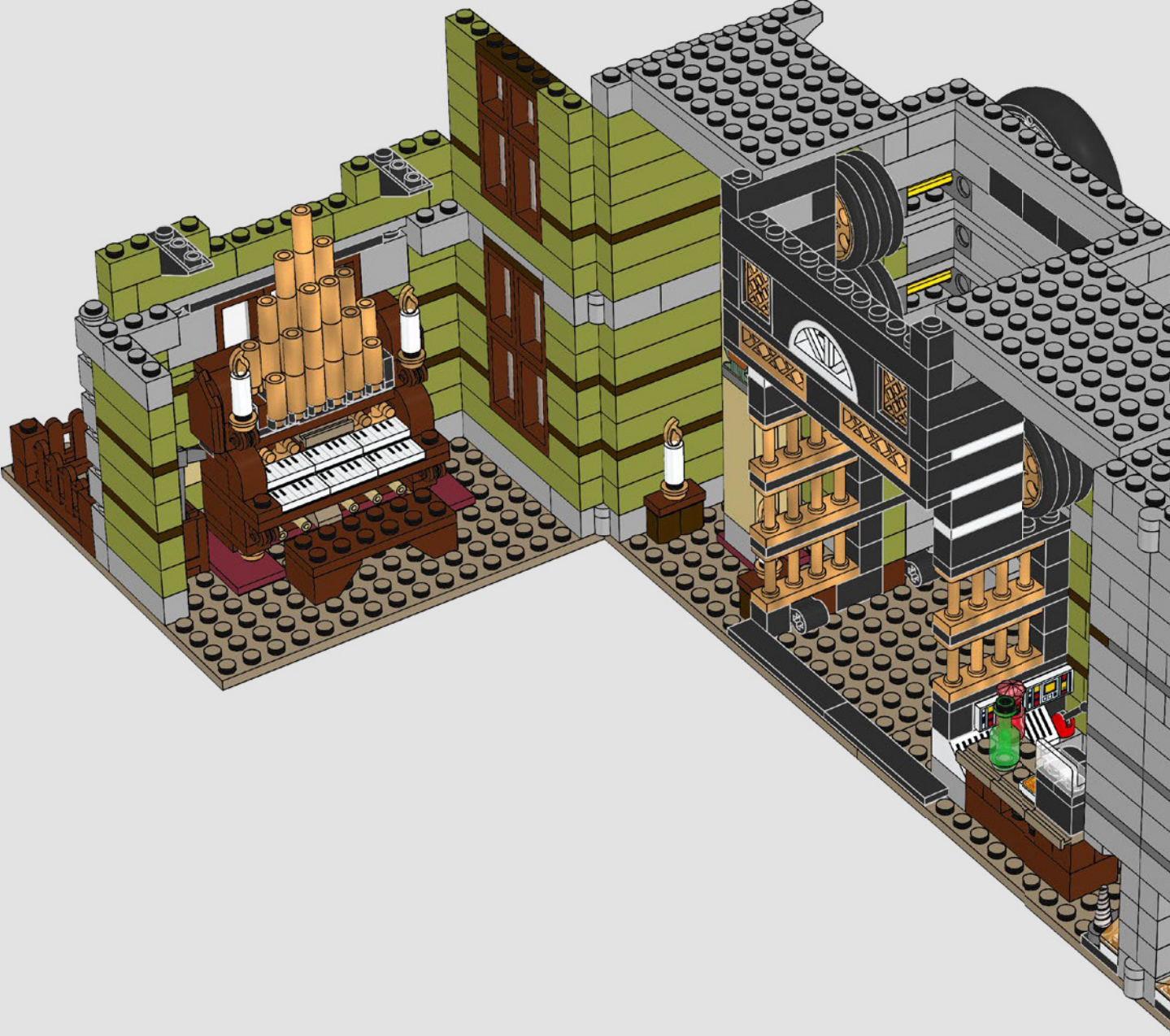

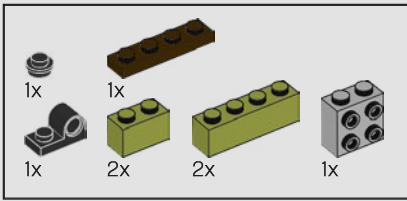

178

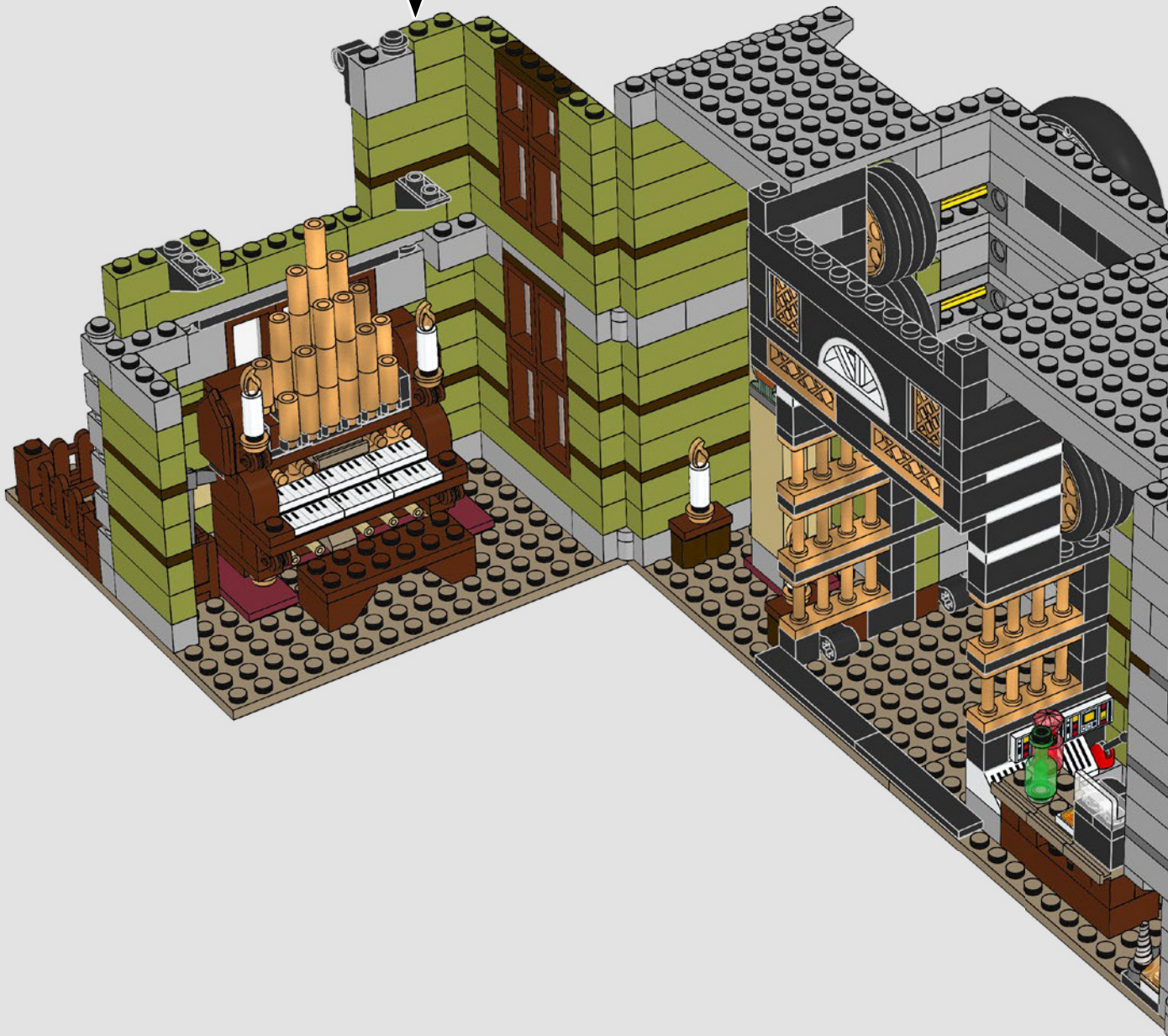
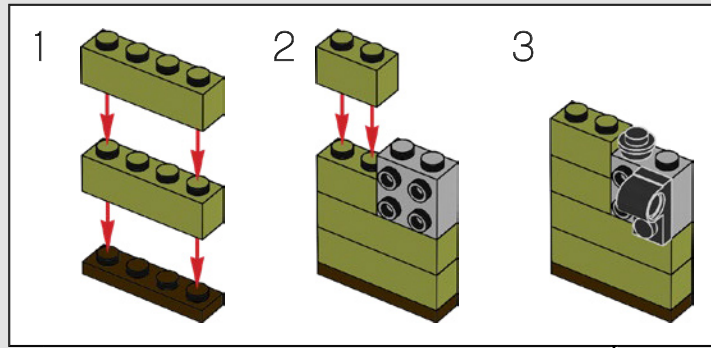

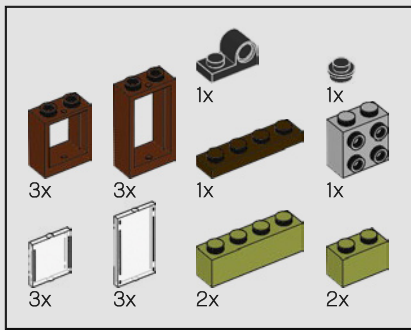

179

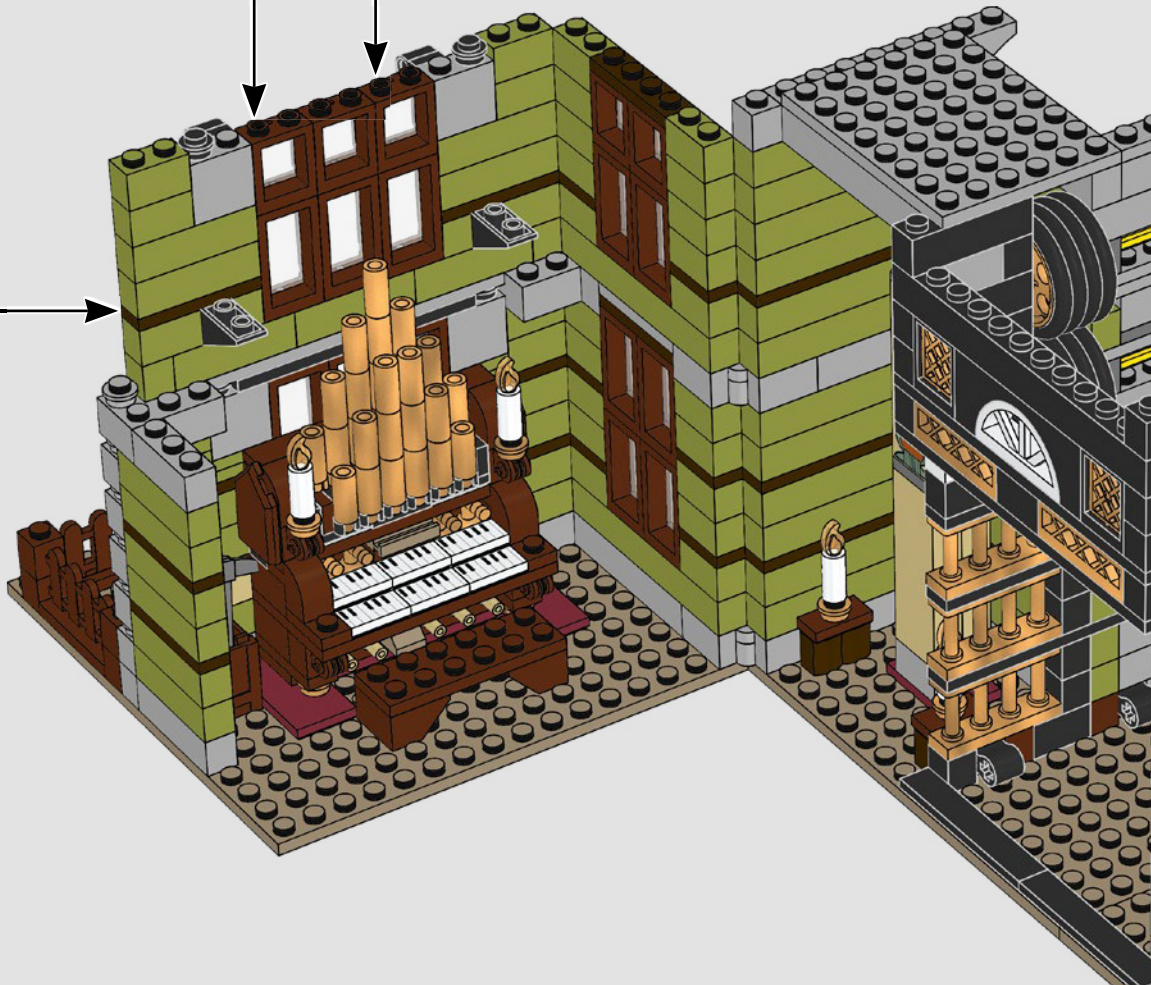
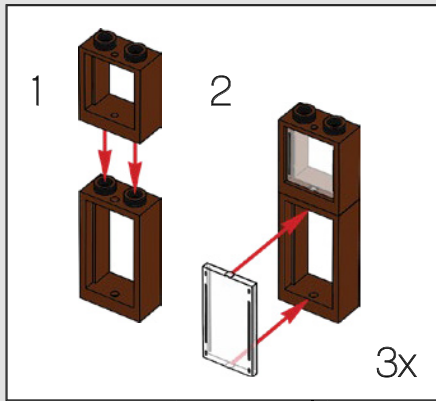
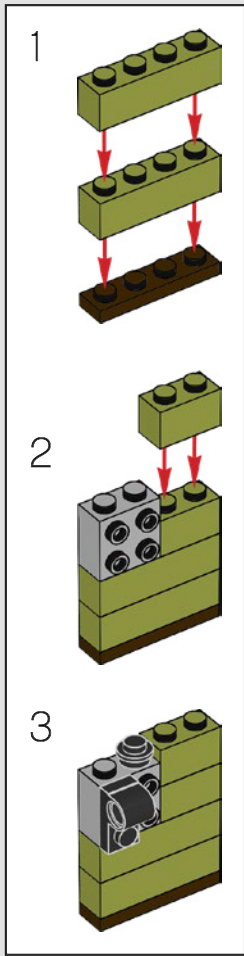

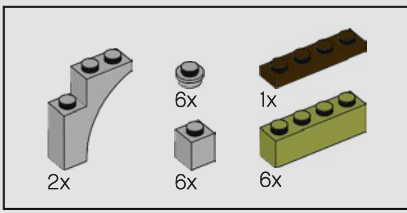

180

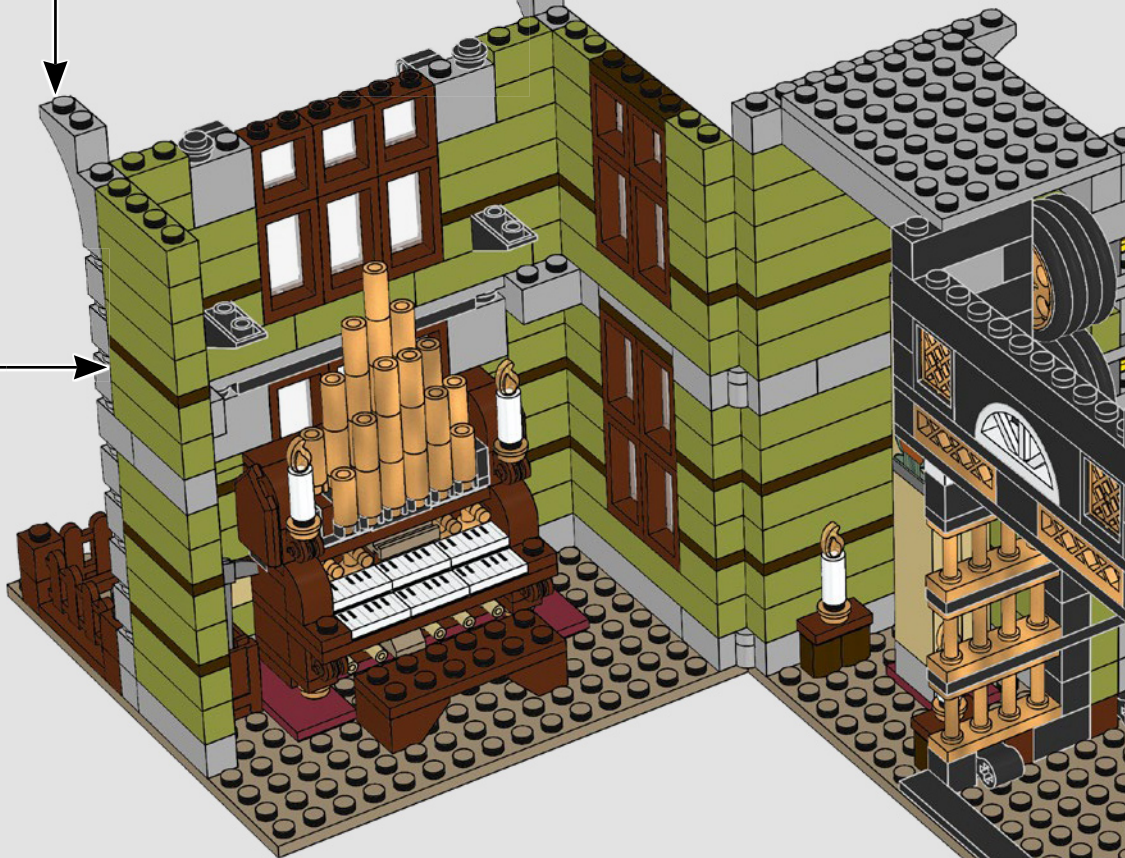
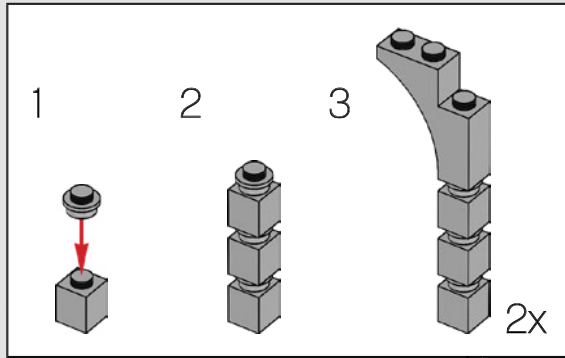
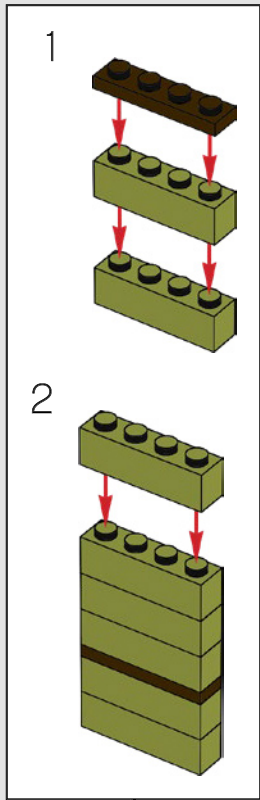

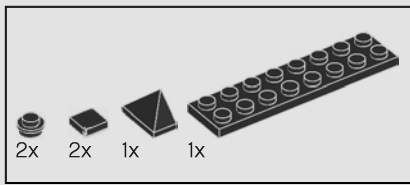

181

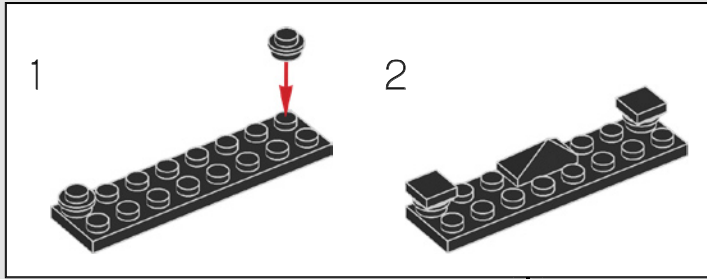

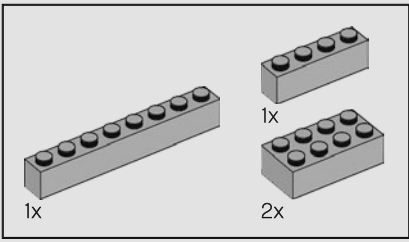

182

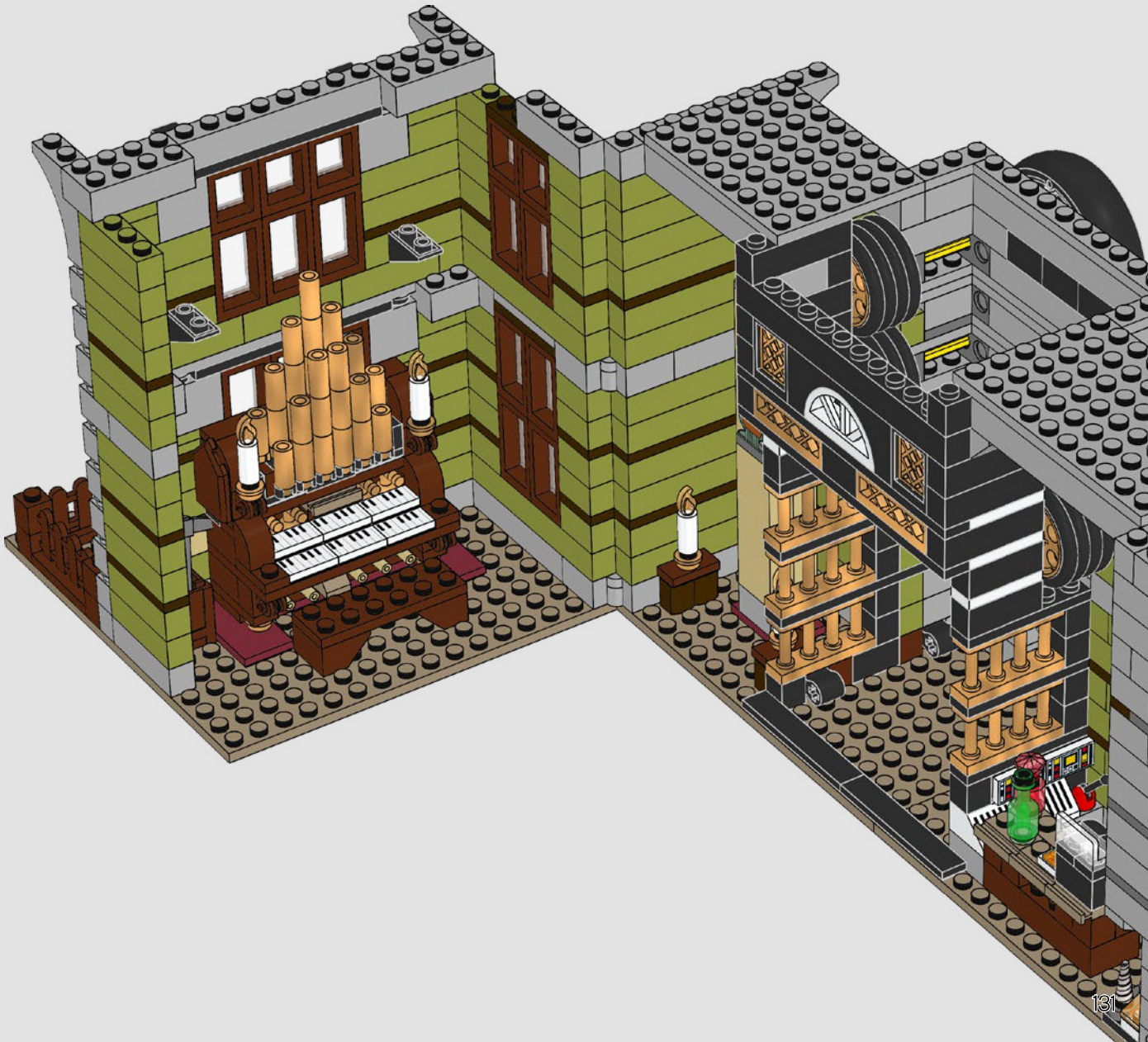

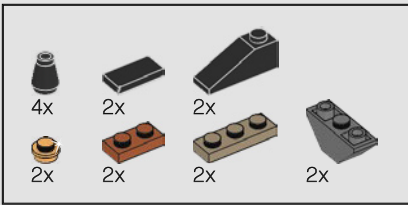

Die Häupter von Anubis
 Die aus dem Tempel von Anubis ausgeflogenen Häupter dienen angeblich „nur zur Dekoration und zu nichts anderem“.

183

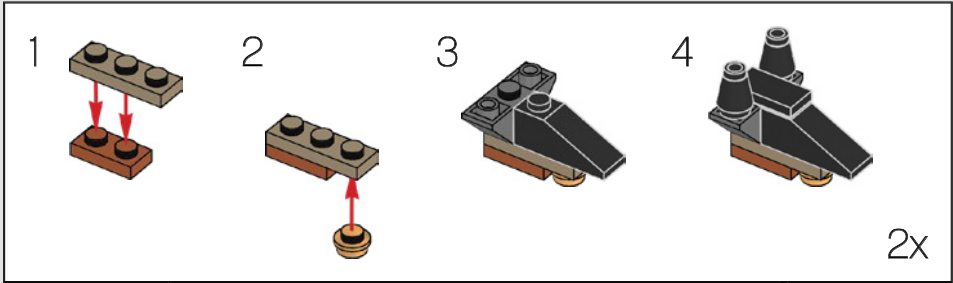

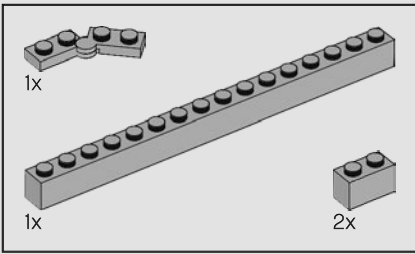

184

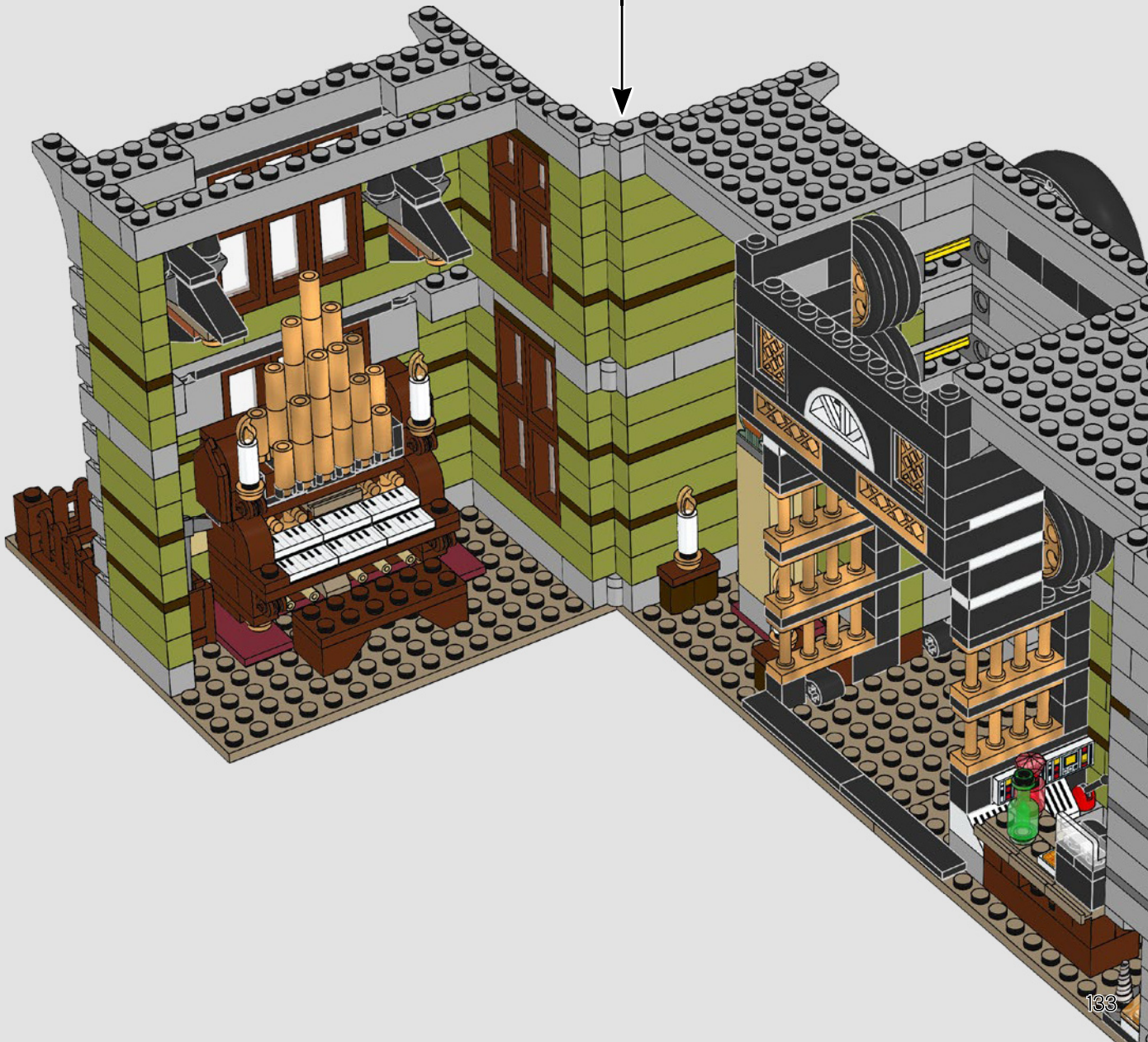
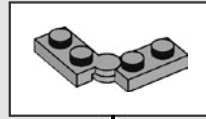

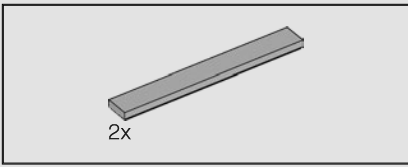

185



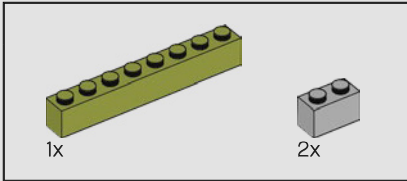
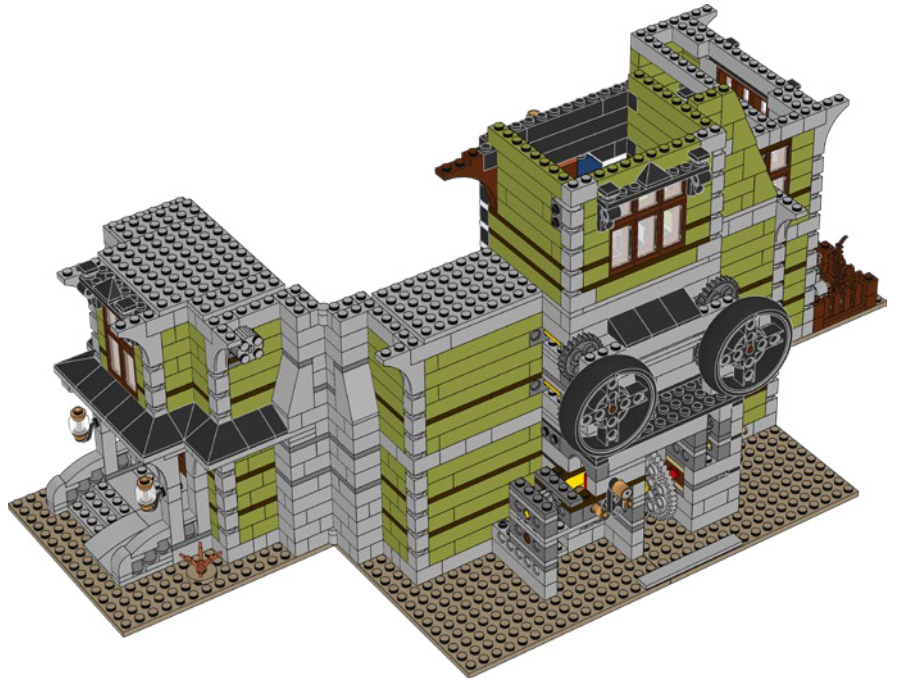

186



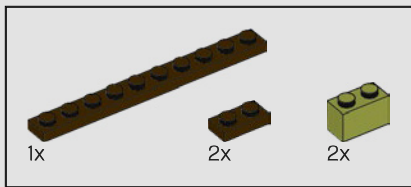

187

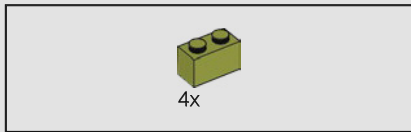
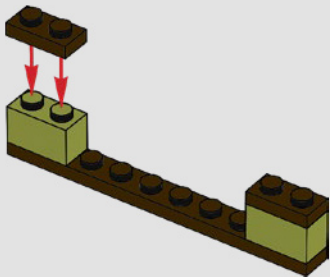

188

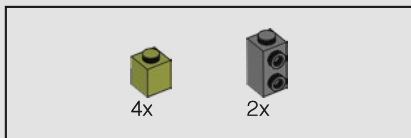
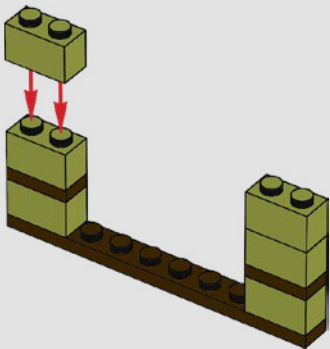

189

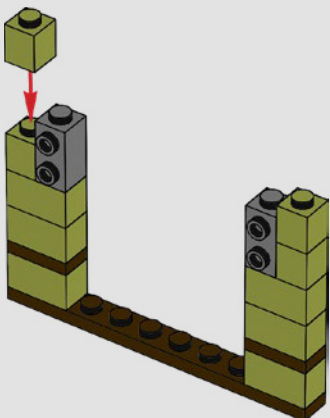

190

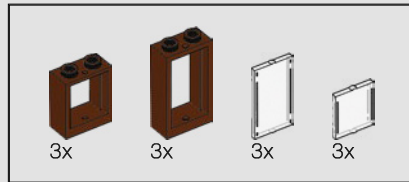
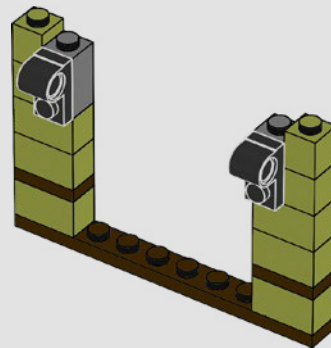

191

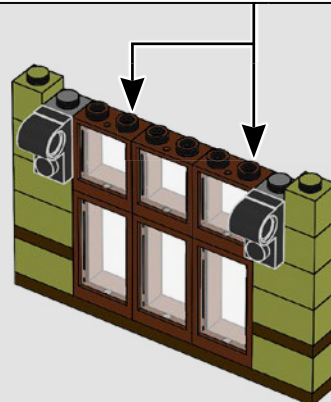
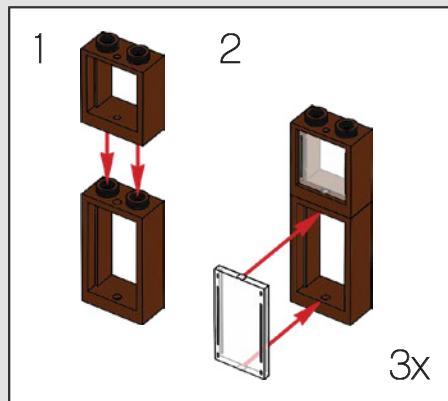

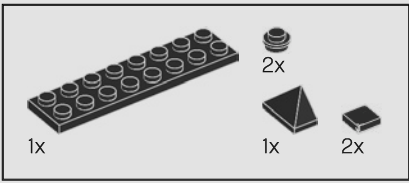

192

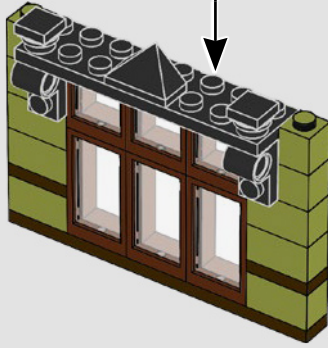
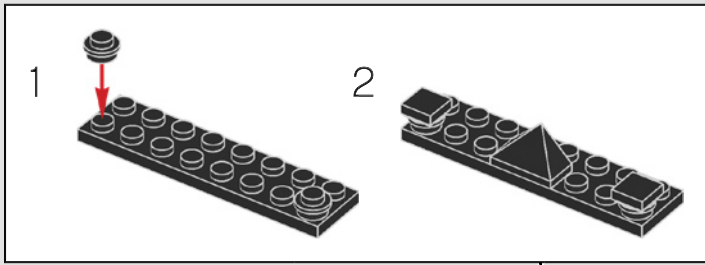

193





8x



8x

194

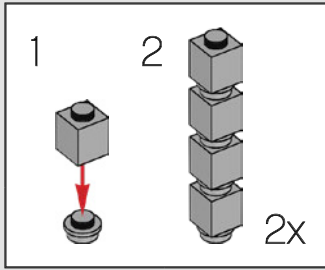

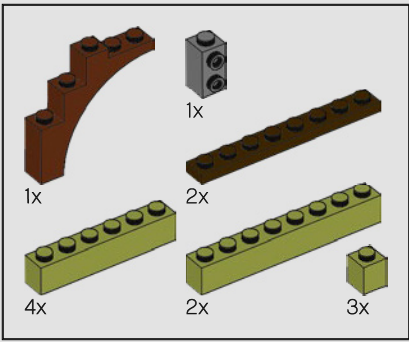

195

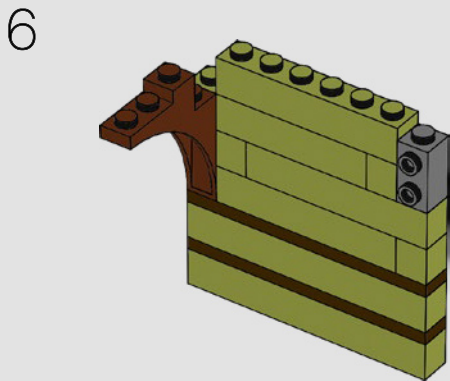
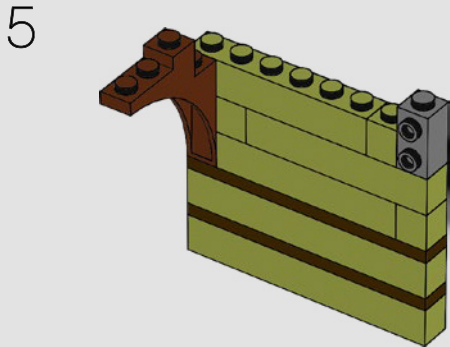
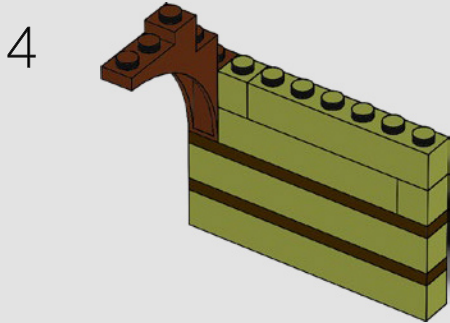
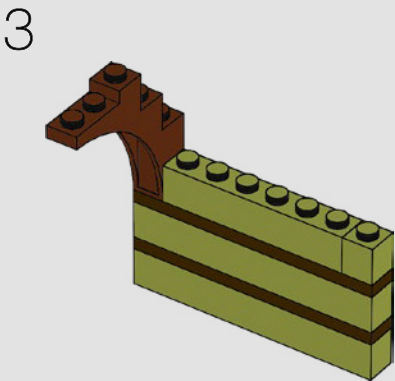
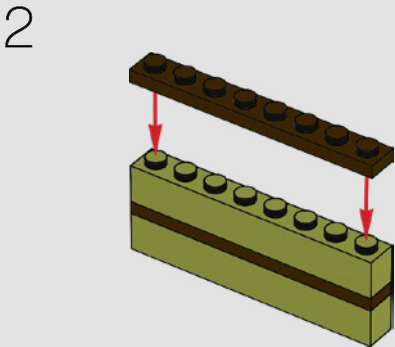
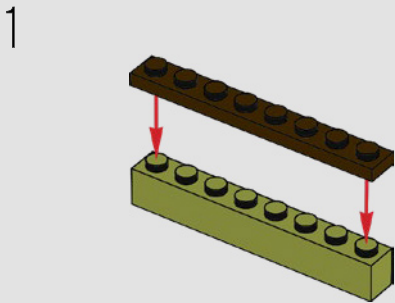



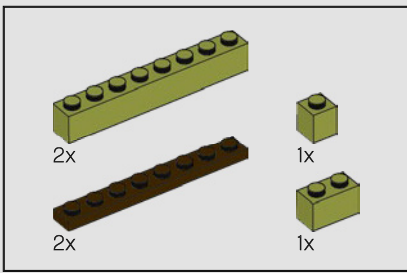

196

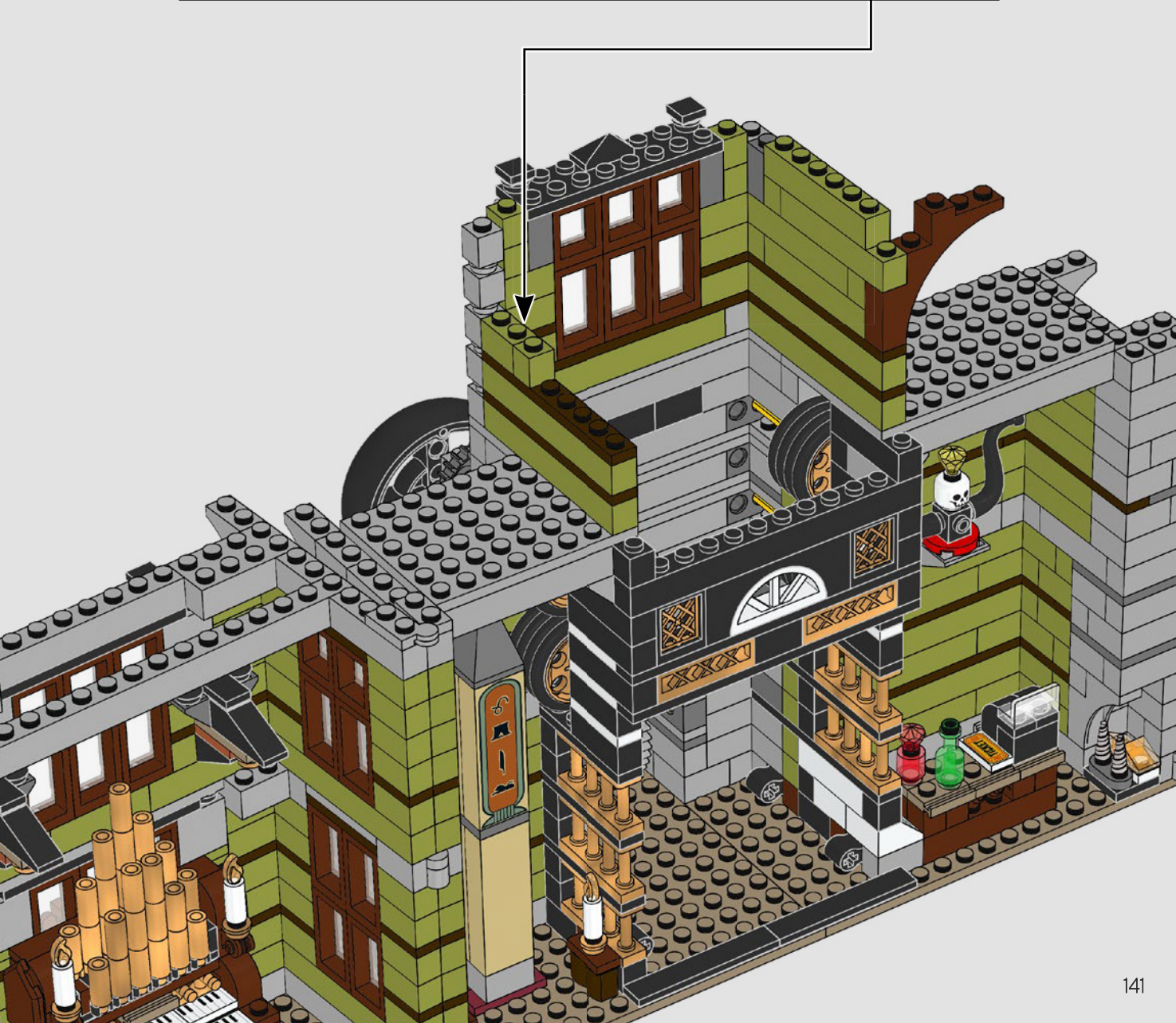
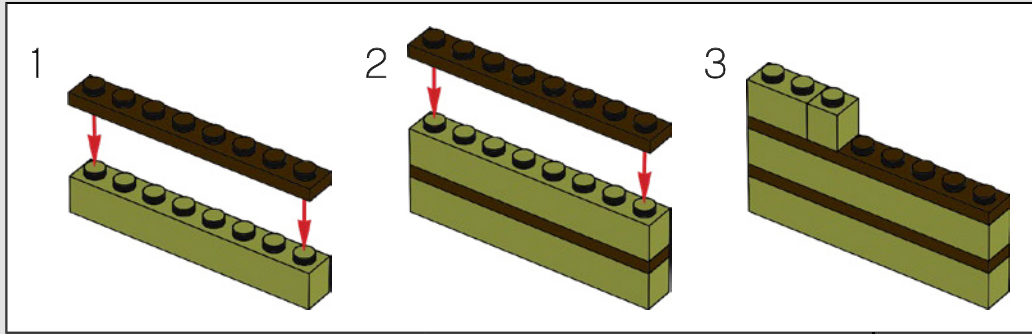

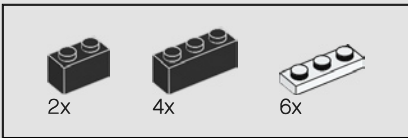

197

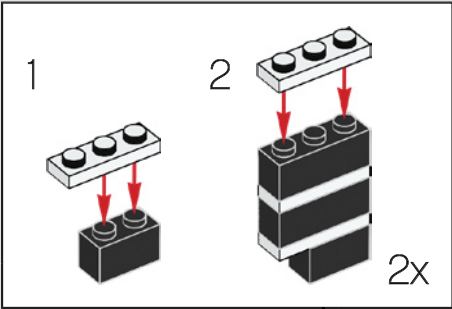

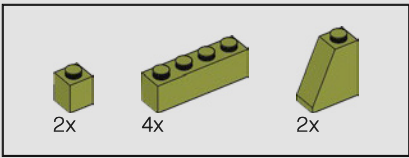

198

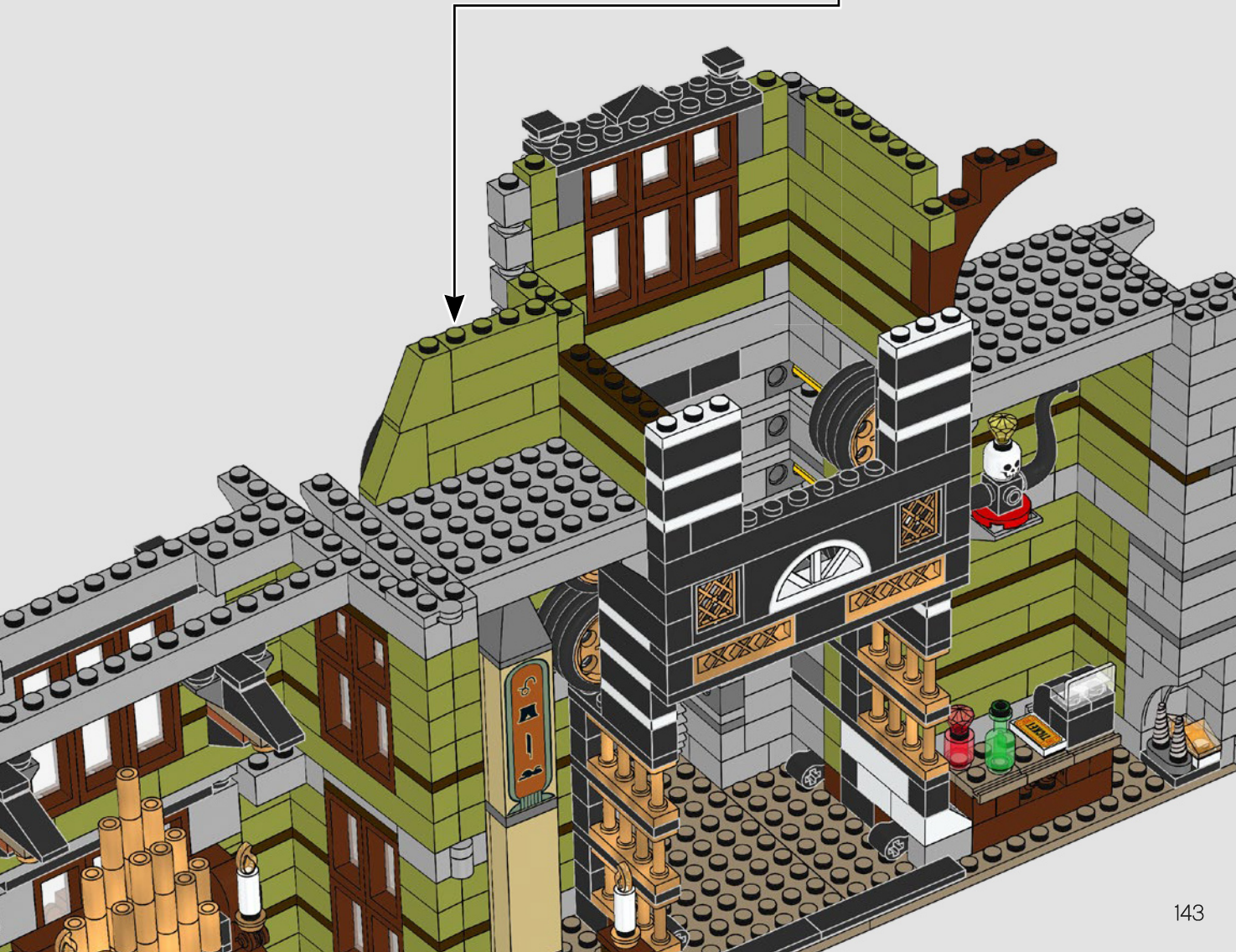
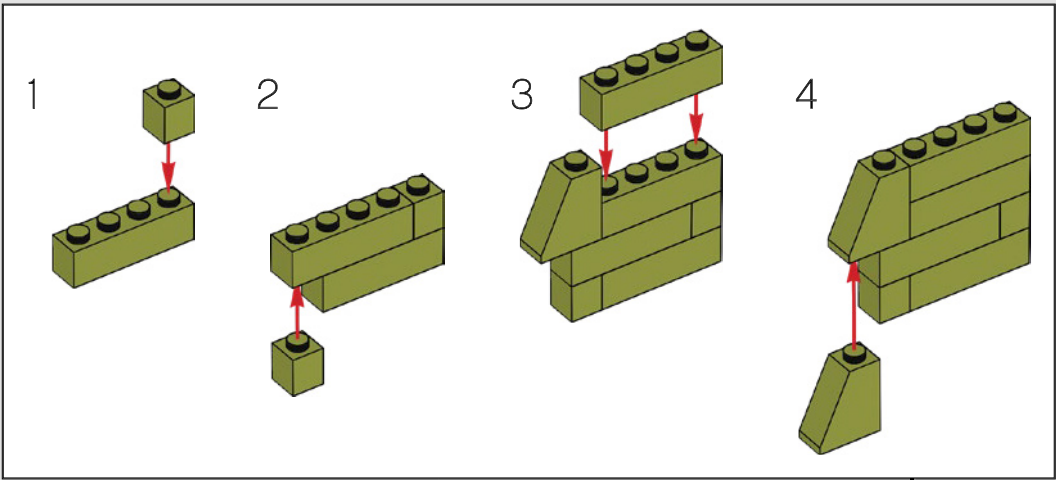

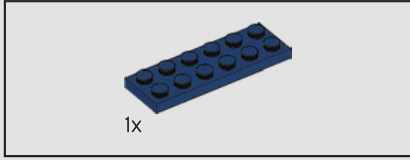
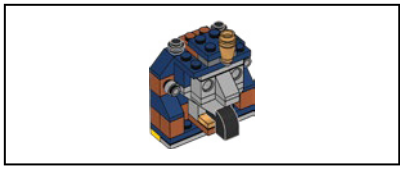

199

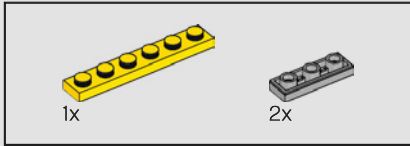
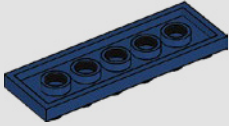

200

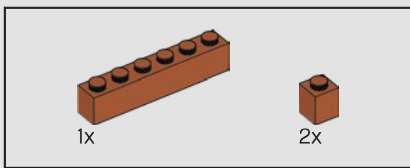
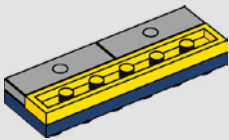

201

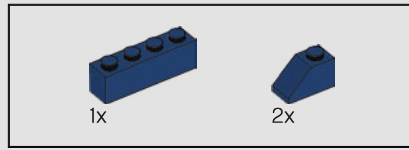
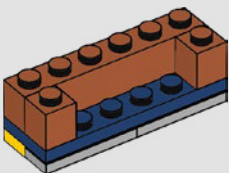

202

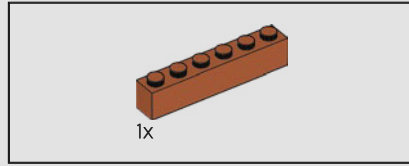
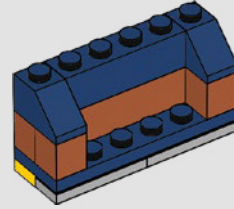

203

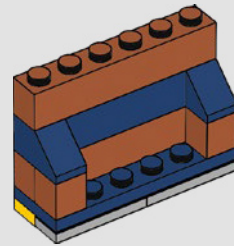

204

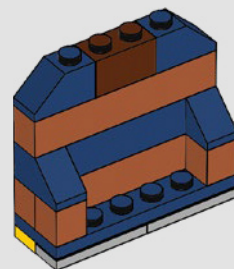

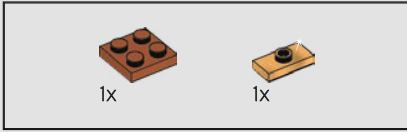
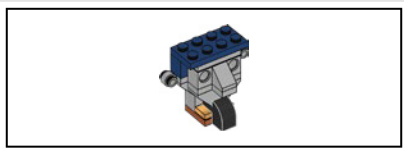

205

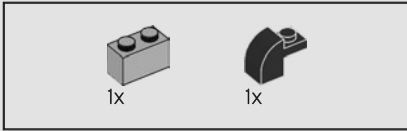
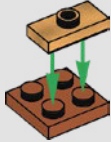

206

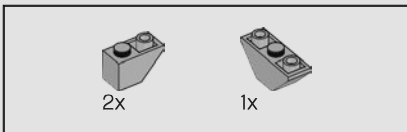

207

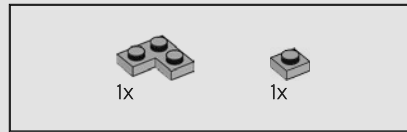
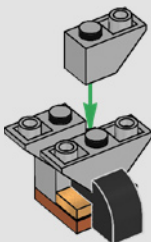

208

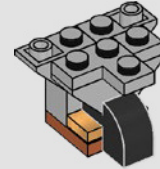

209

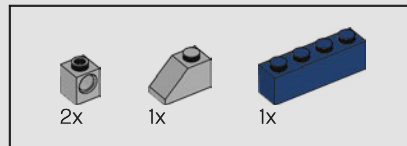
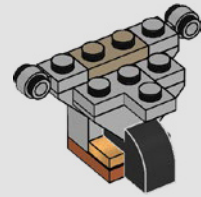

210

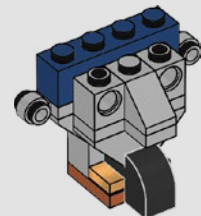

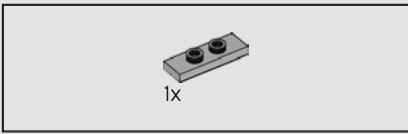

211

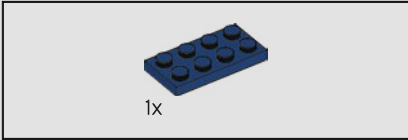
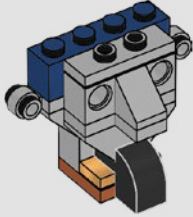

212

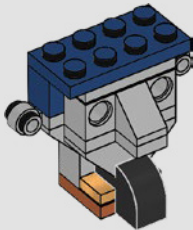

213

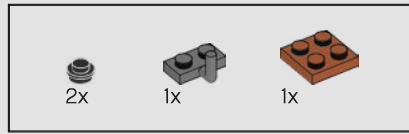
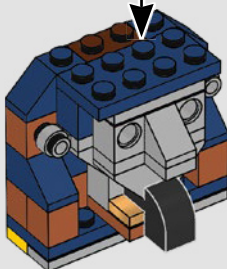

214

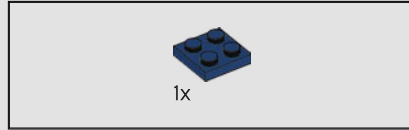
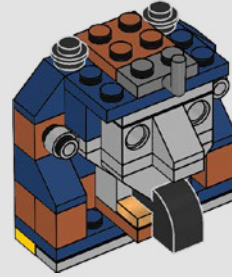

215

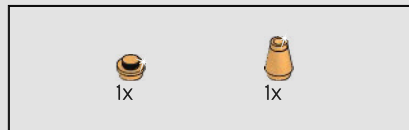
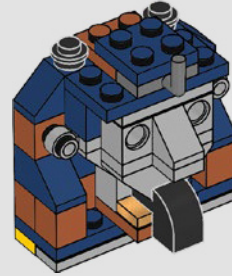

216

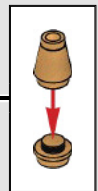
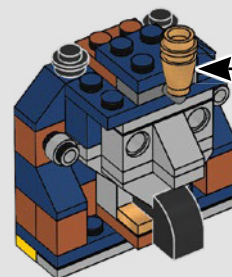

Das Gesicht der Sphinx
Das allererste ägyptische Stück, das sich der Baron unter den Nagel riss. Die gesamte Residenz wurde um diesen Kopf herum errichtet.

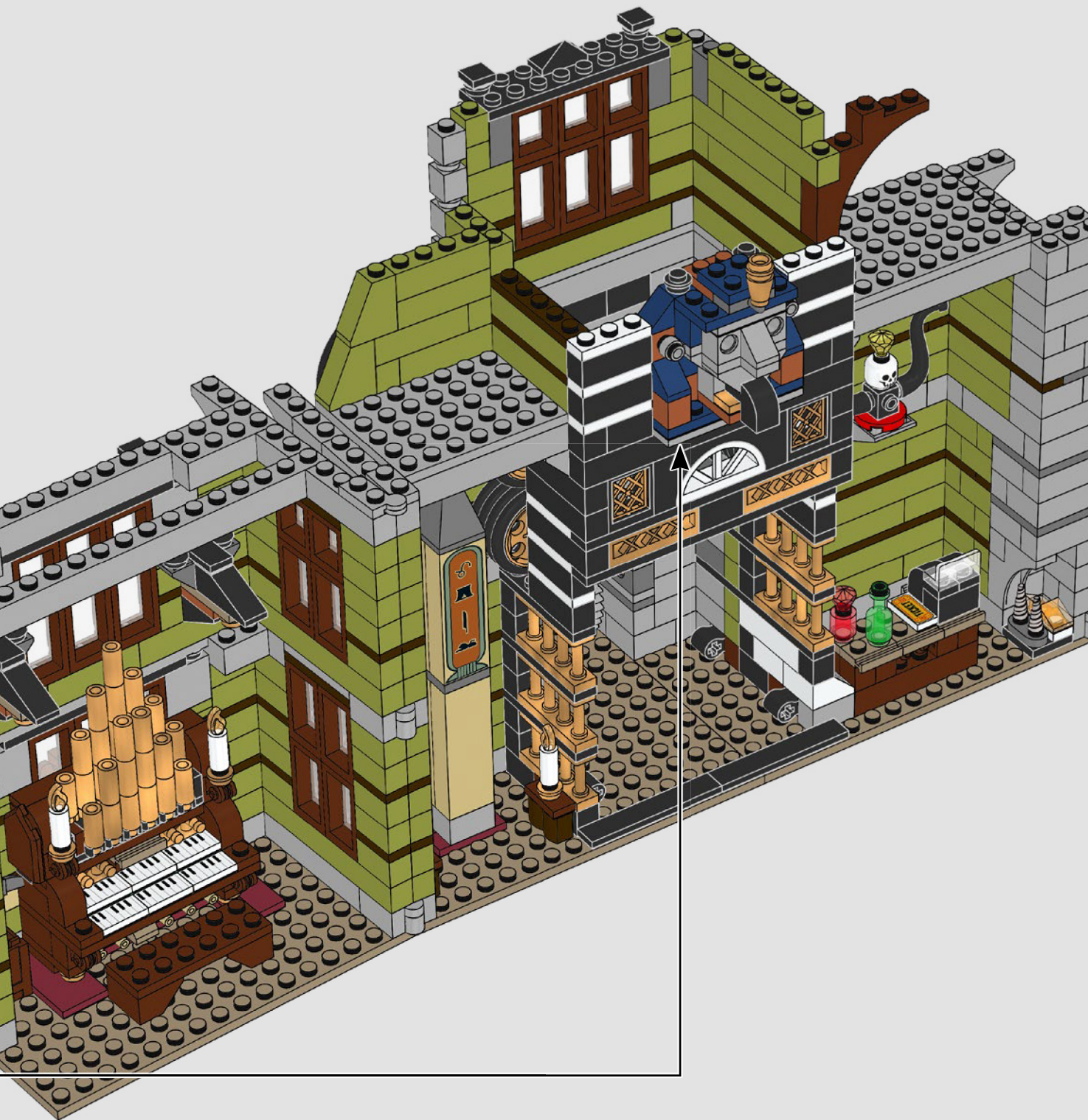

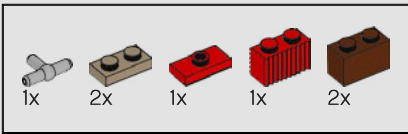

Der Notausgang
 Von Barron umrahmt das Gesicht der Sphinx mit
 Dynamit, nur für den Fall, dass ein Fluch auf ihr lastete.

218

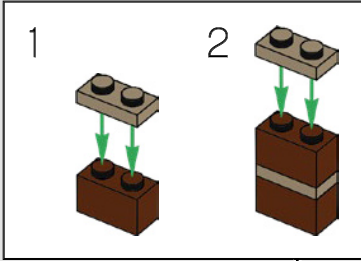
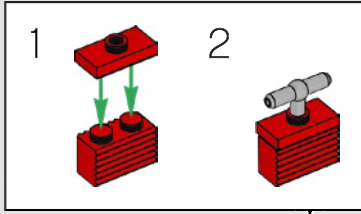

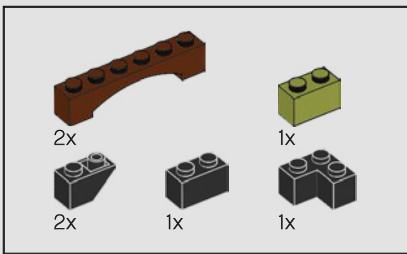

219

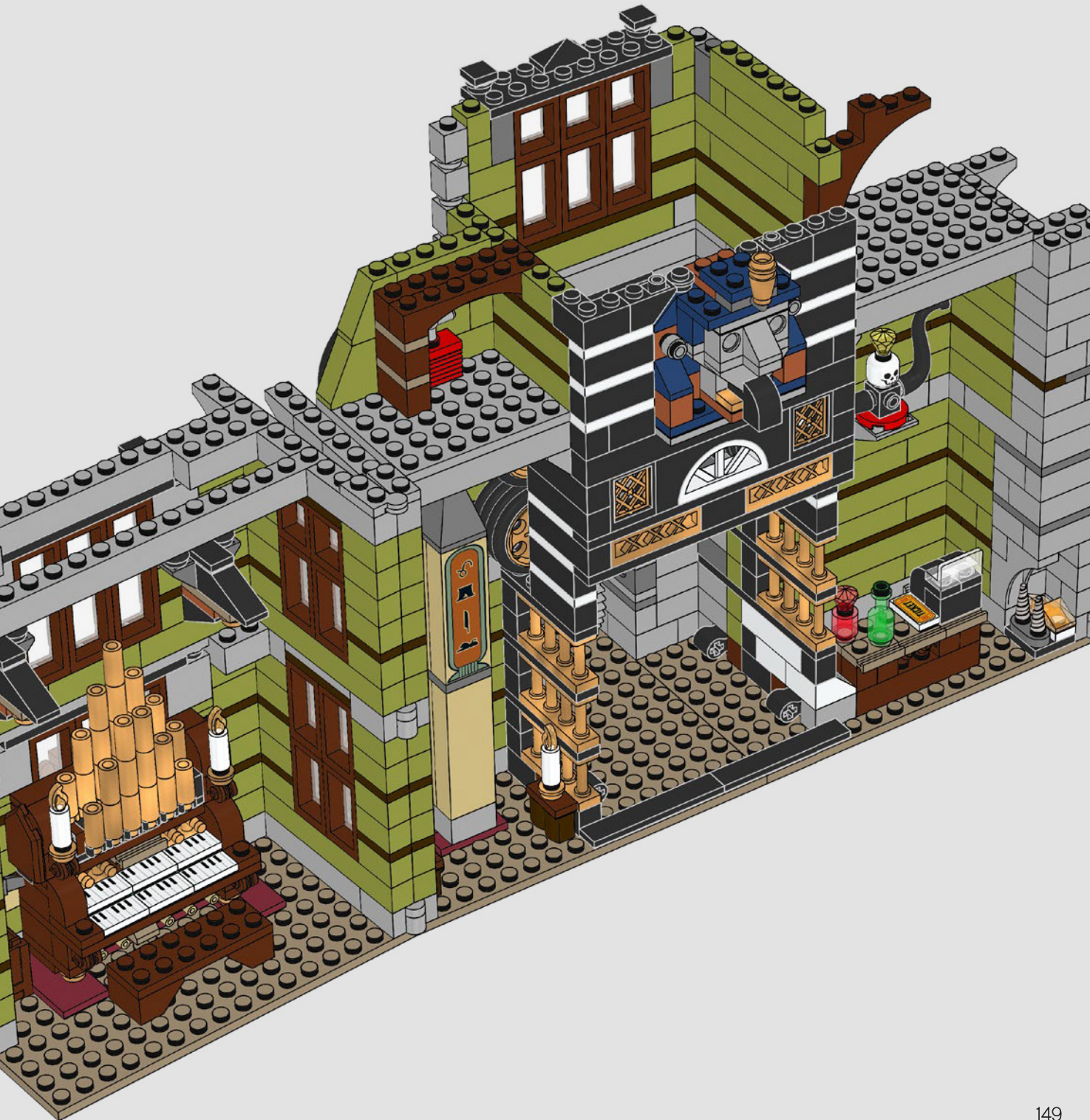

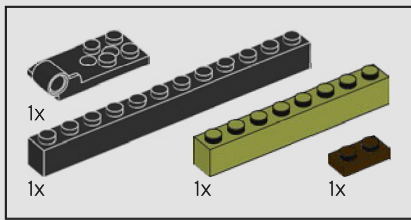

220



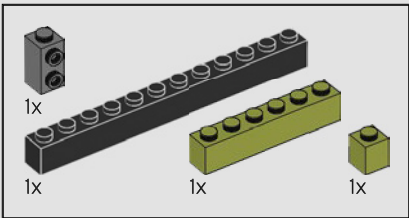

221

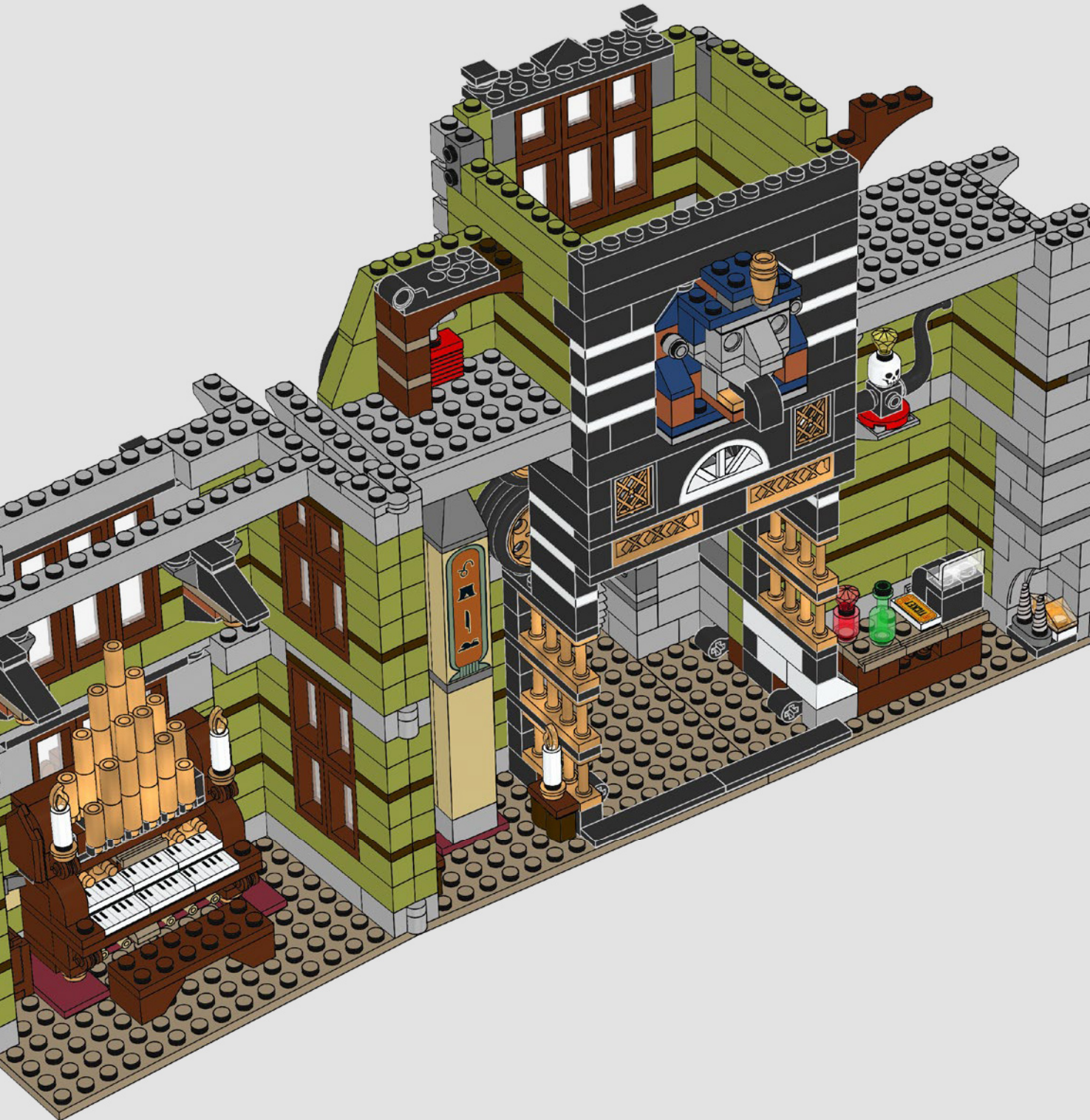

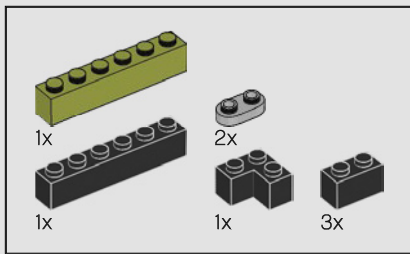

222



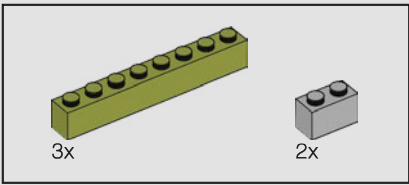

223

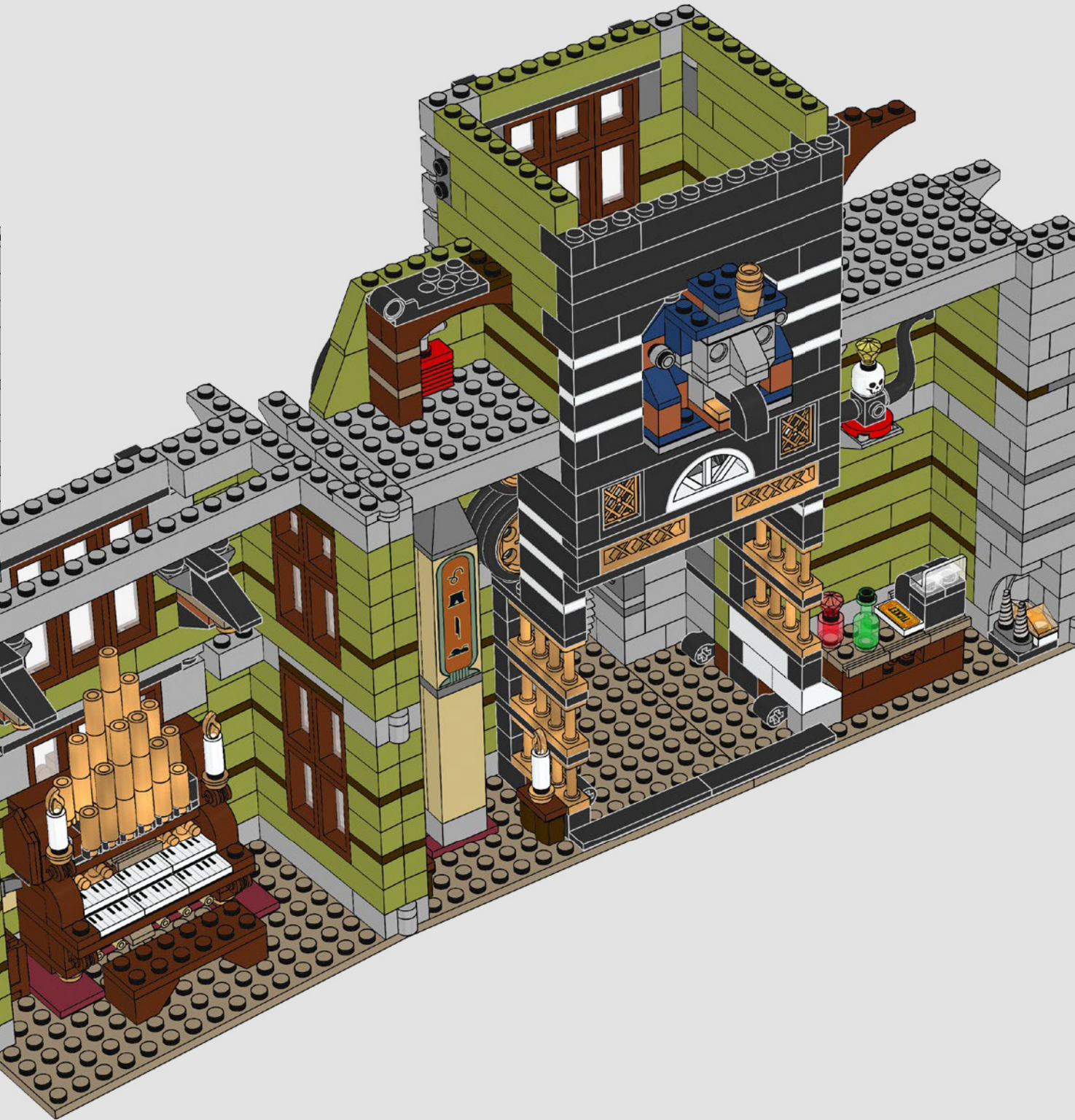

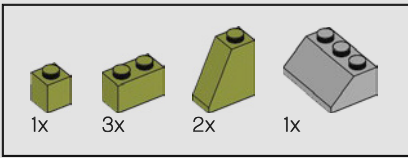

224

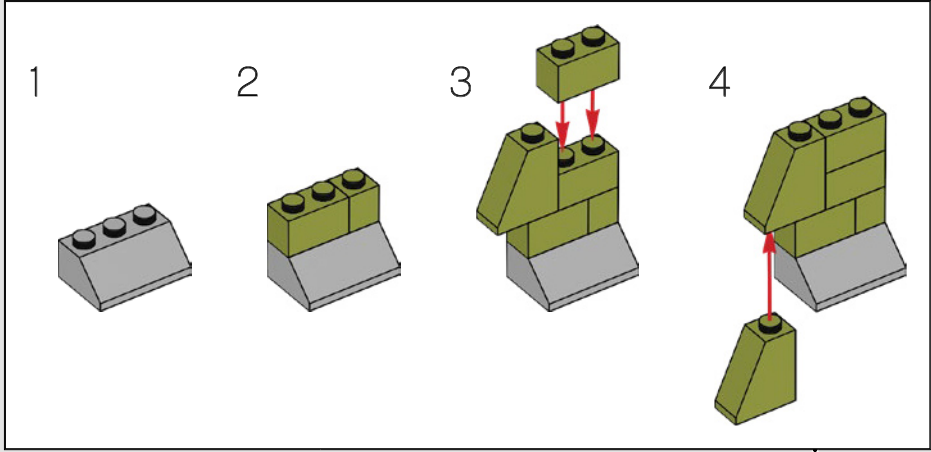

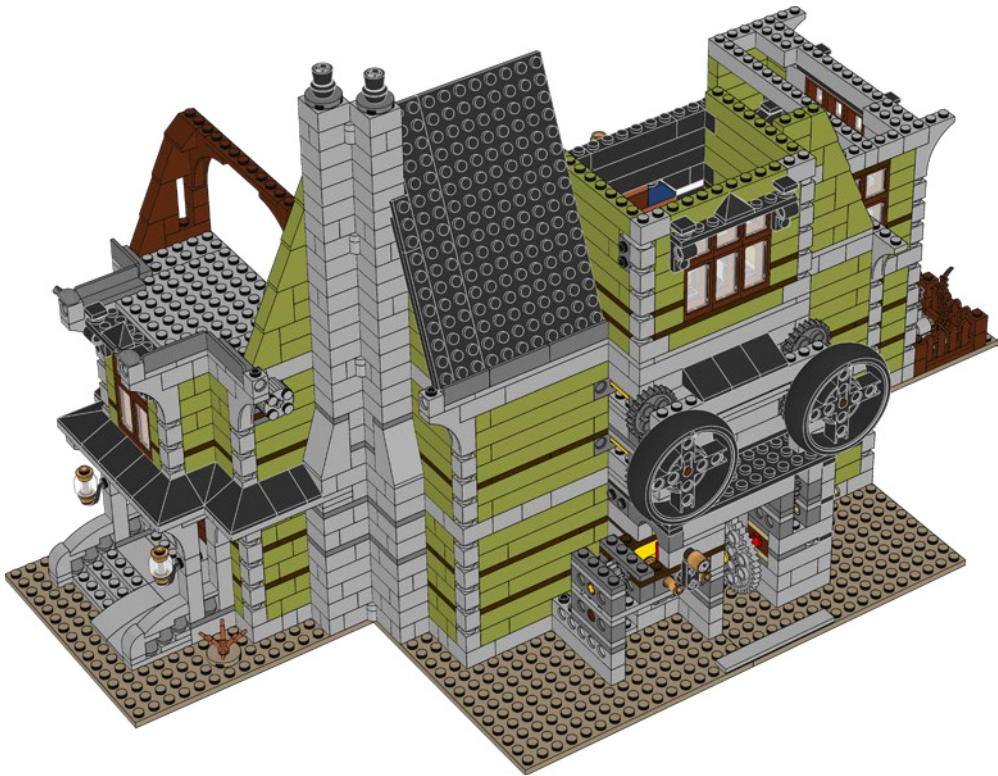
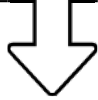
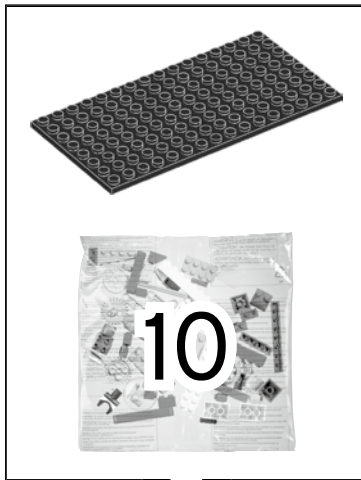

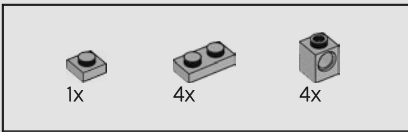

225



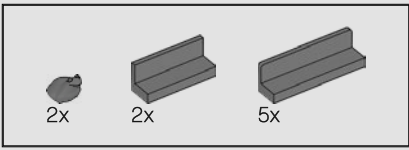

226

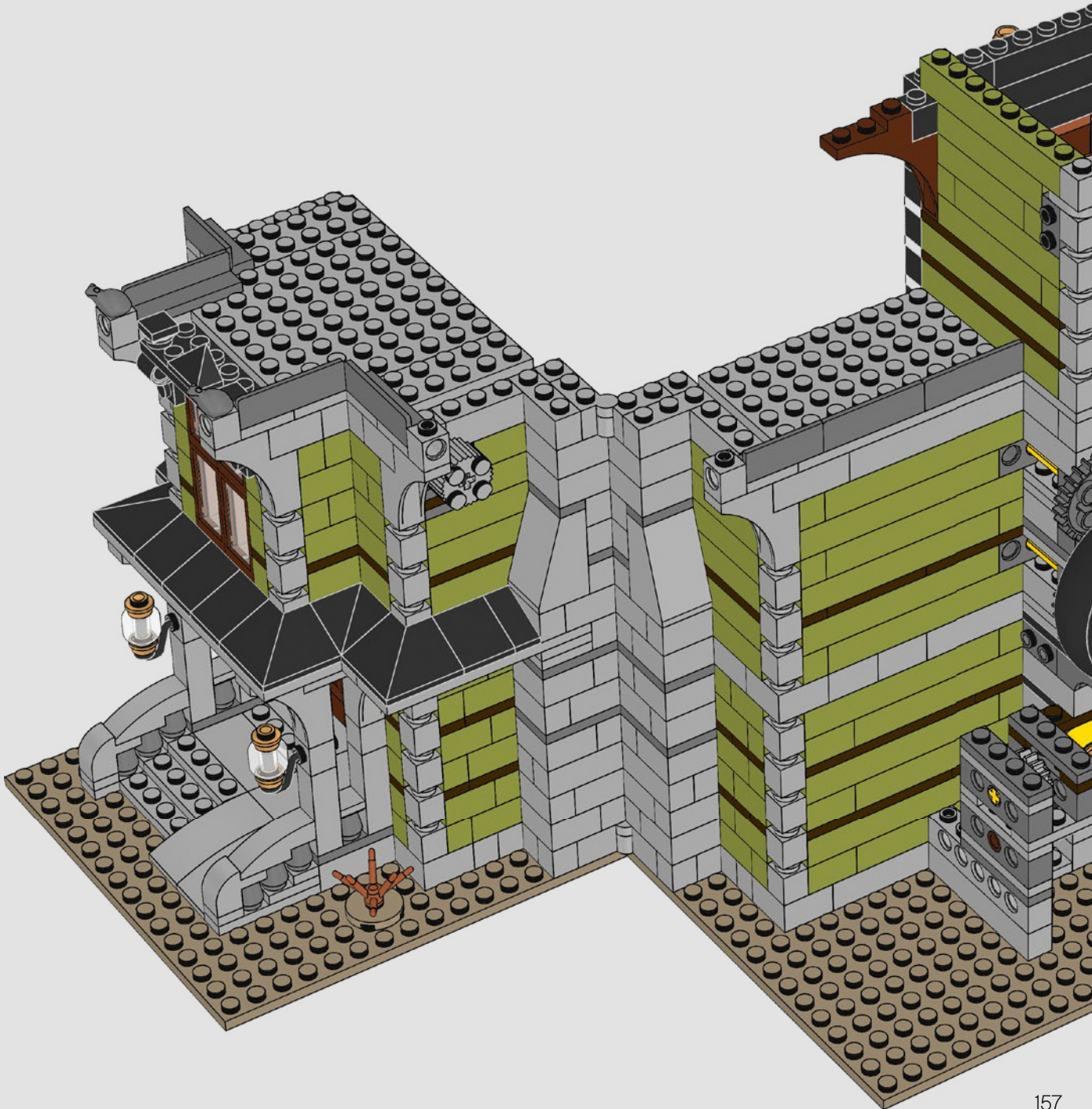

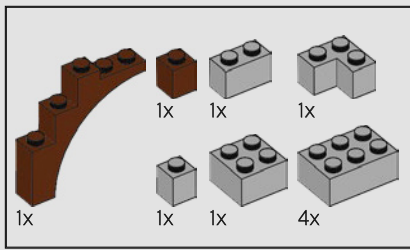

227

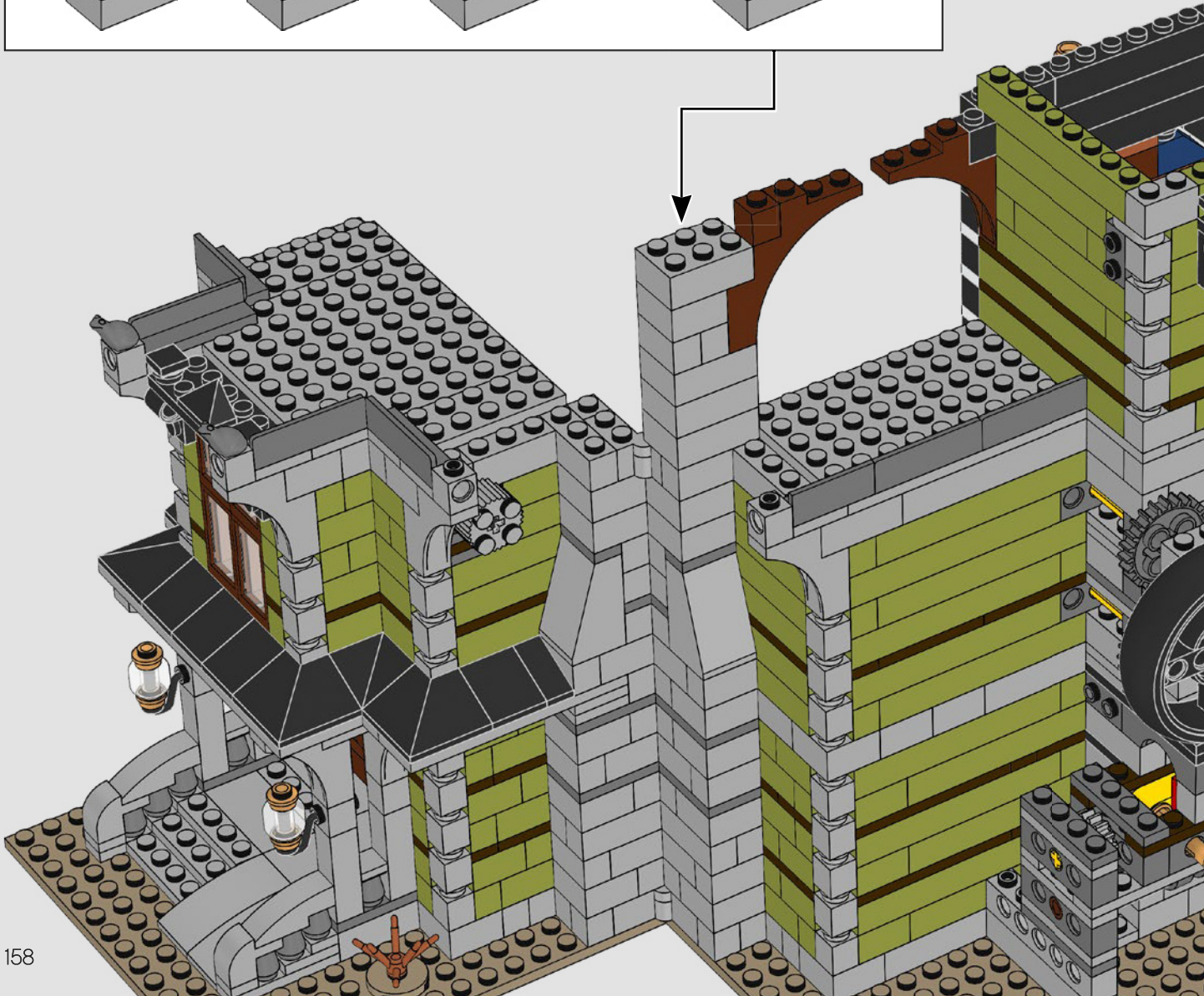
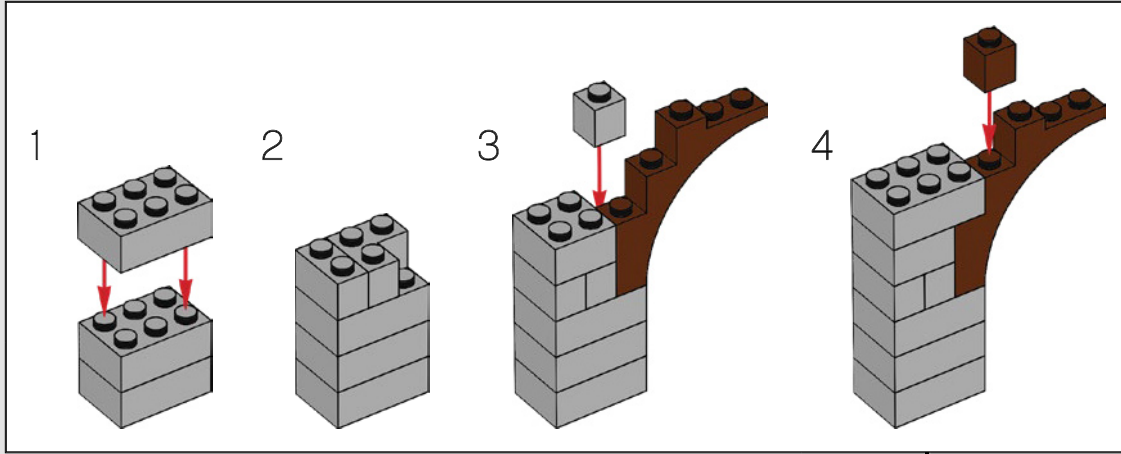

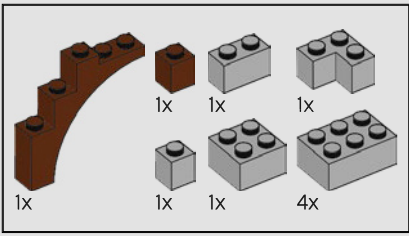

228

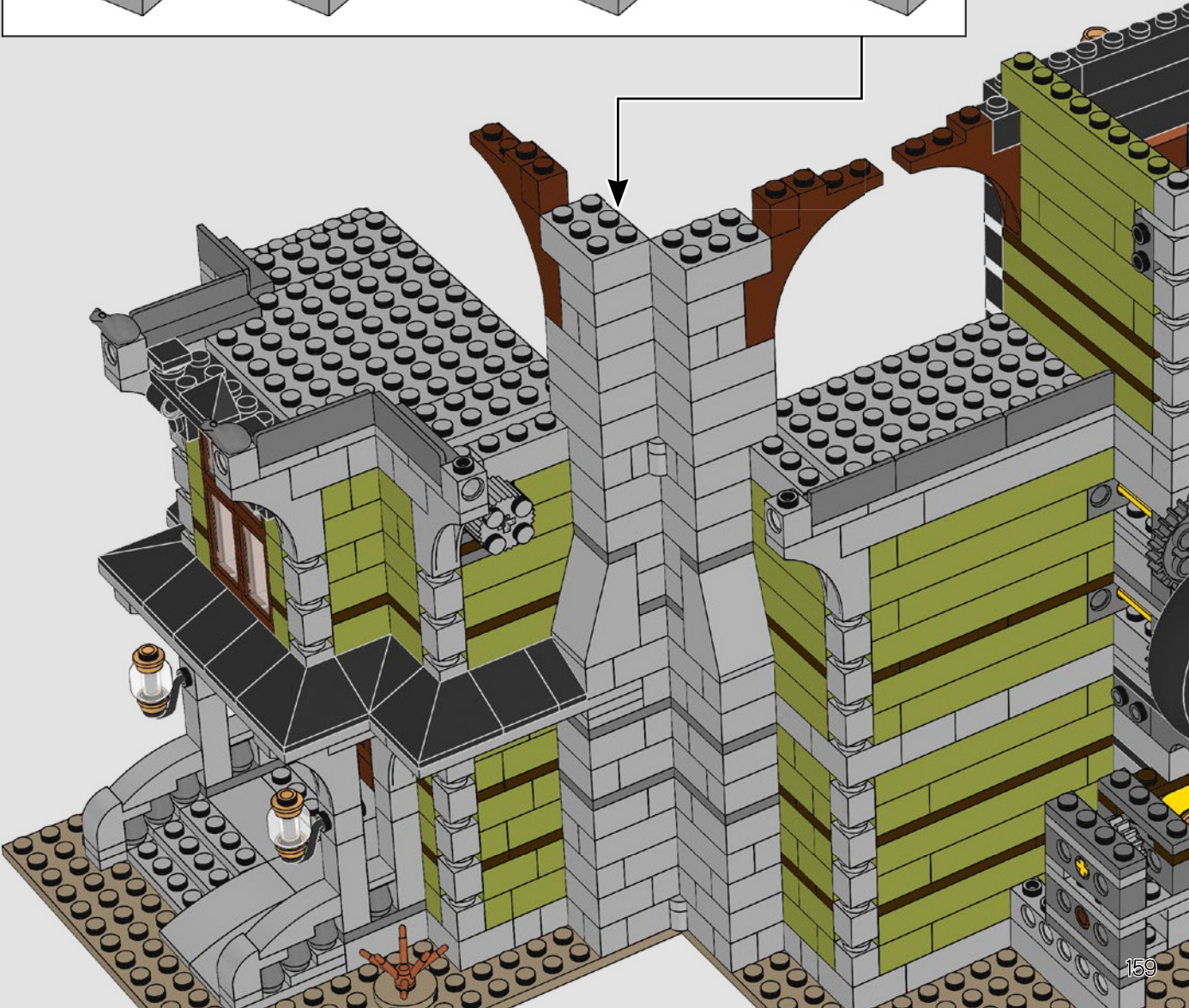
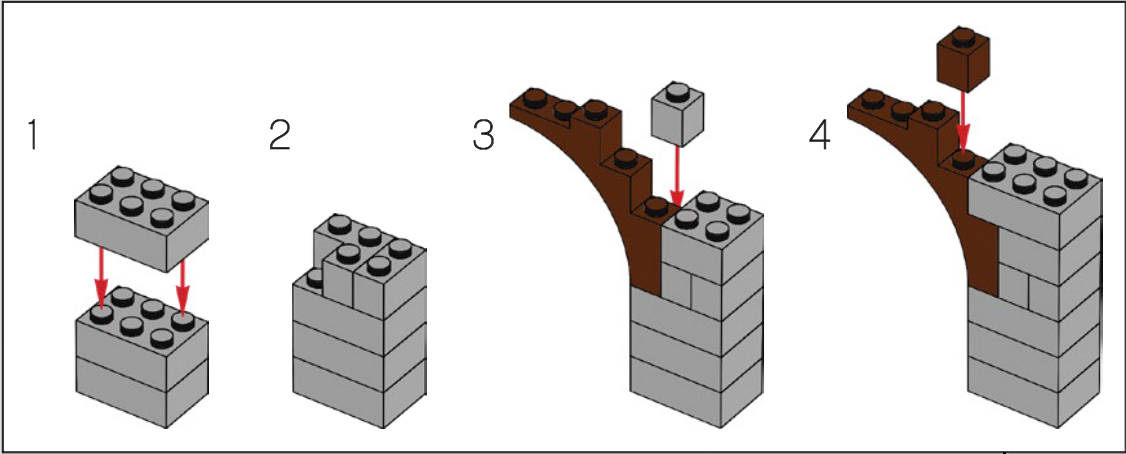

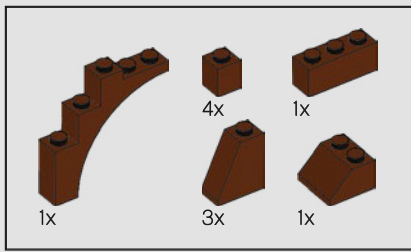

229

1

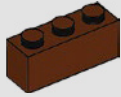

2

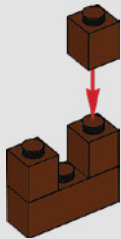

3

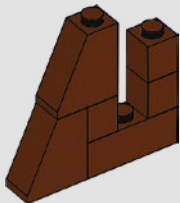

4

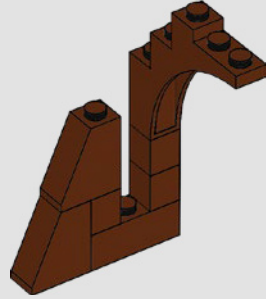

5

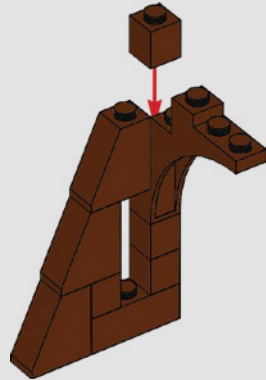

6

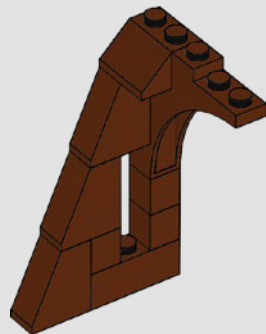

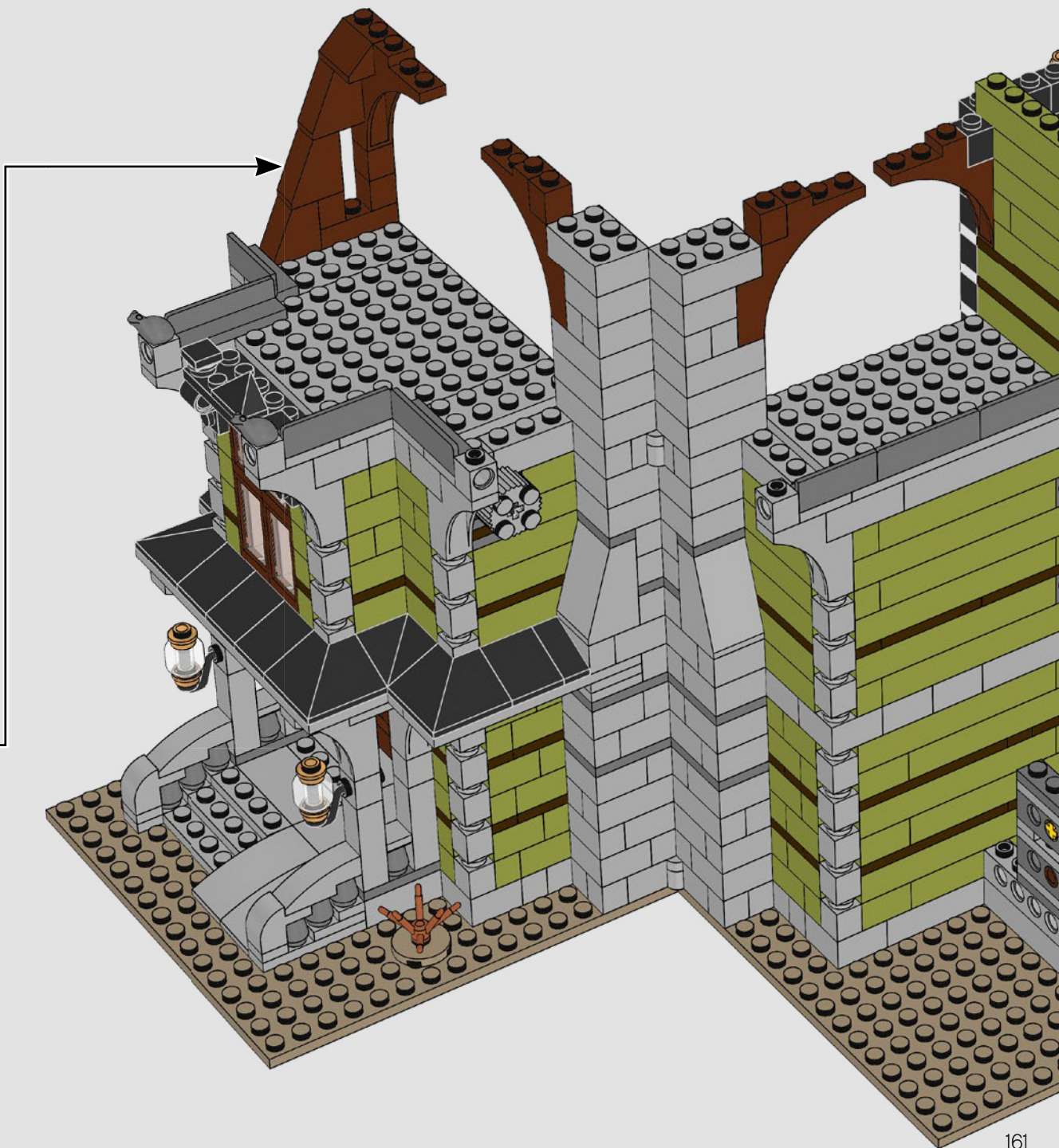

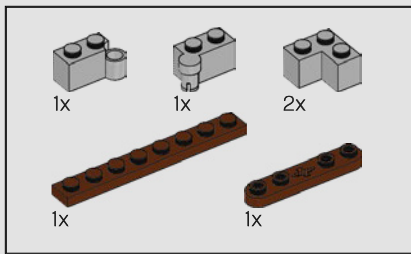

230

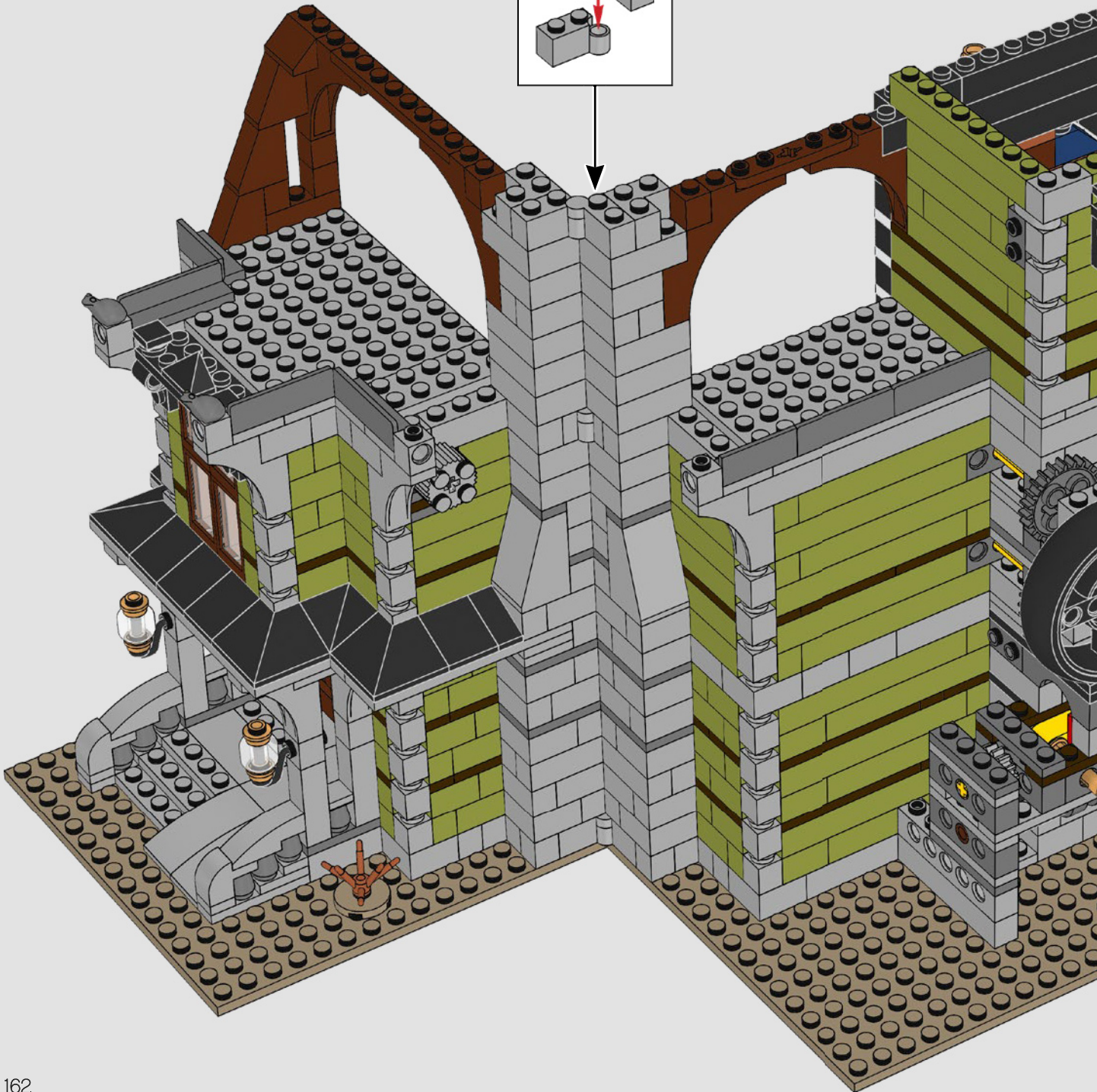
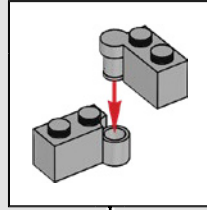

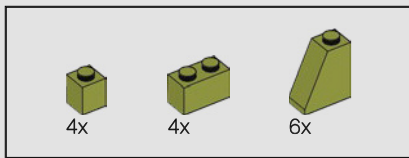

231

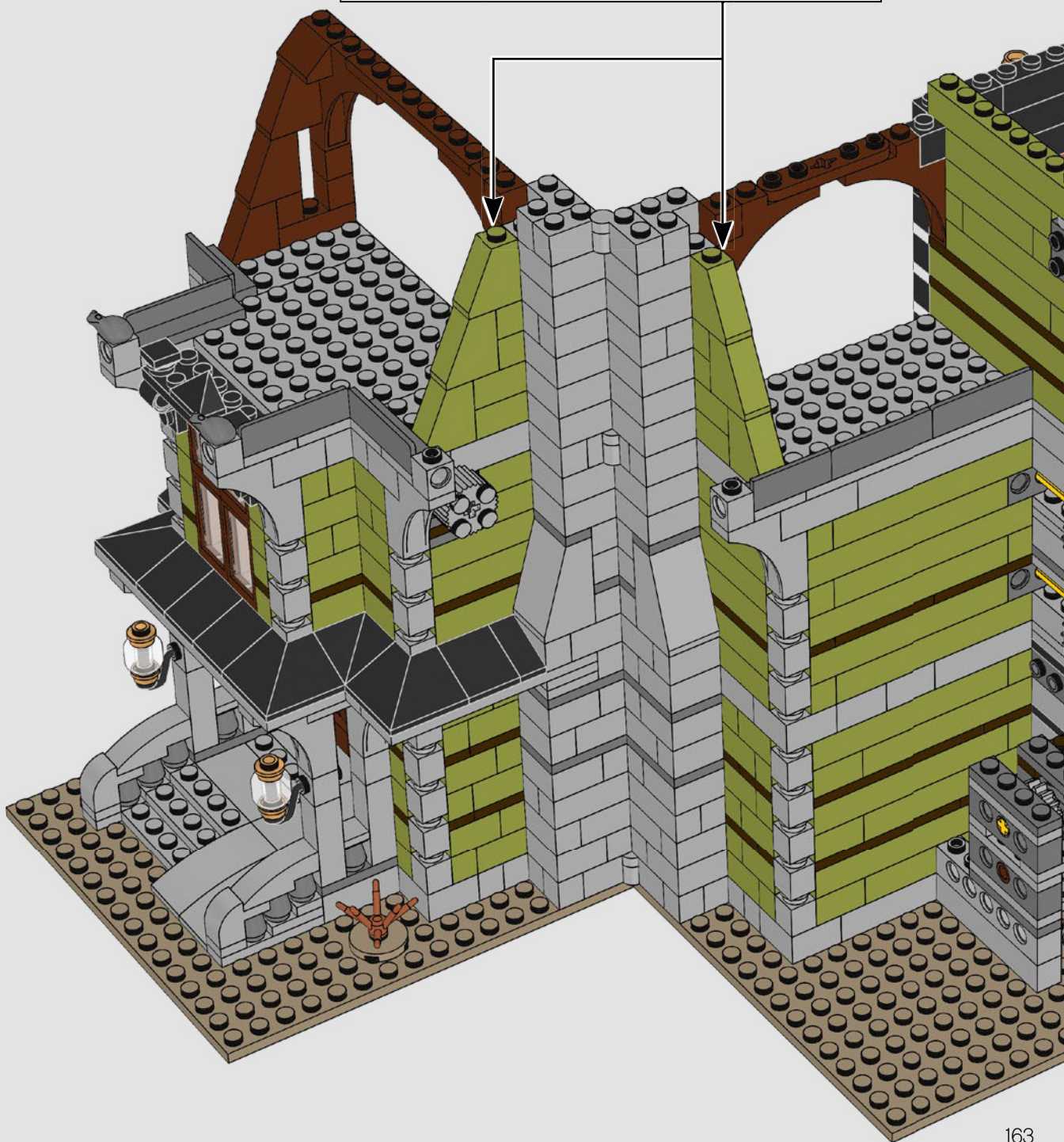
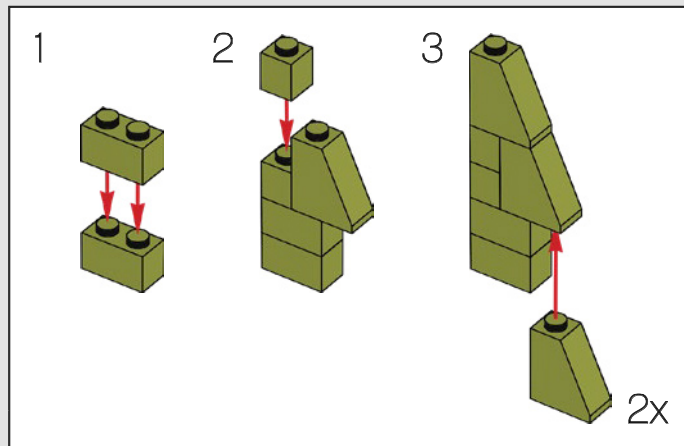

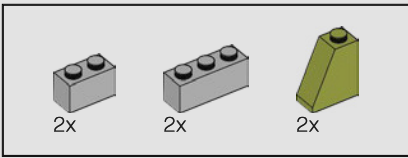

232

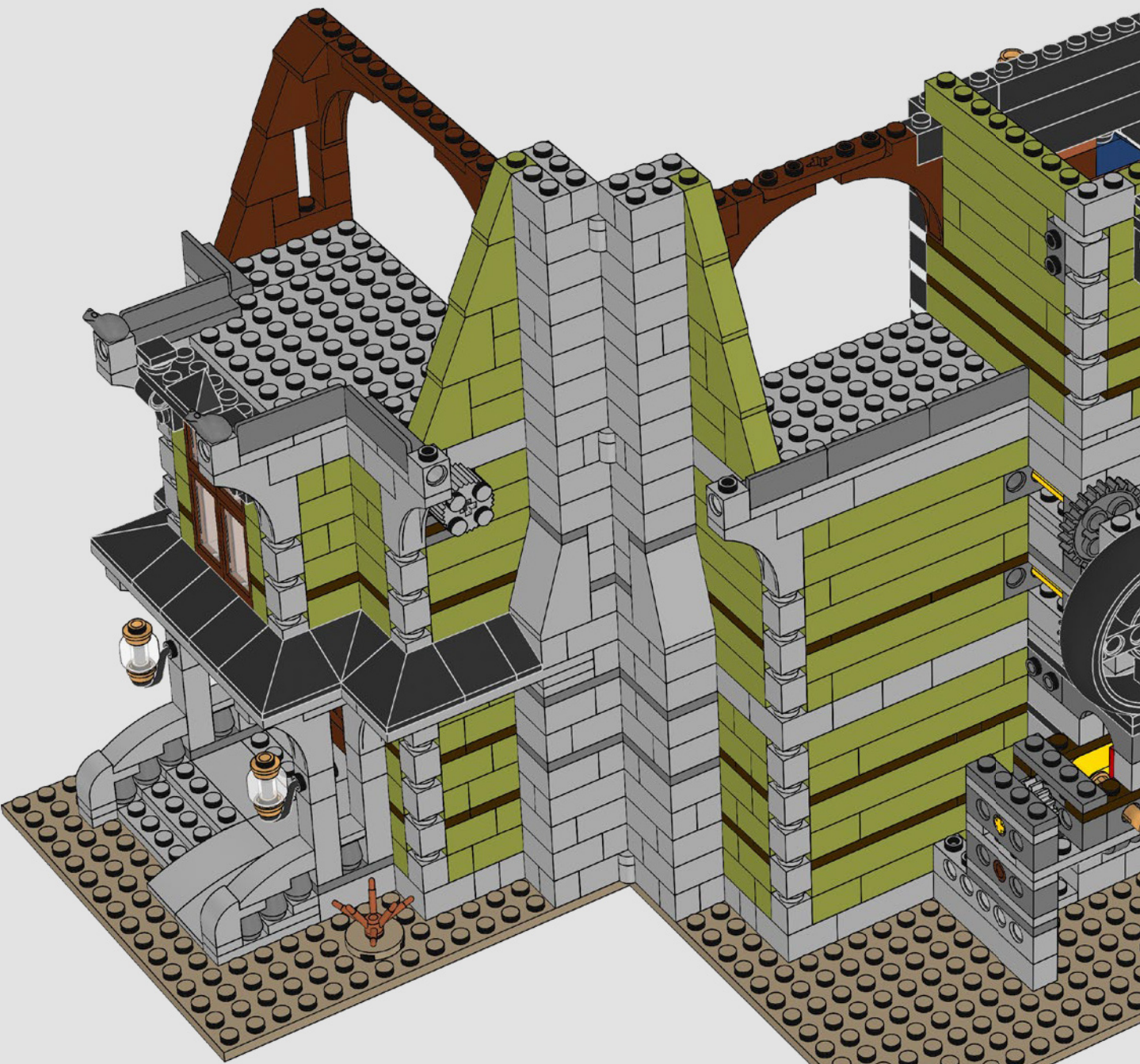

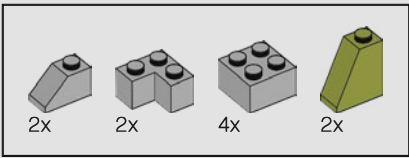

233

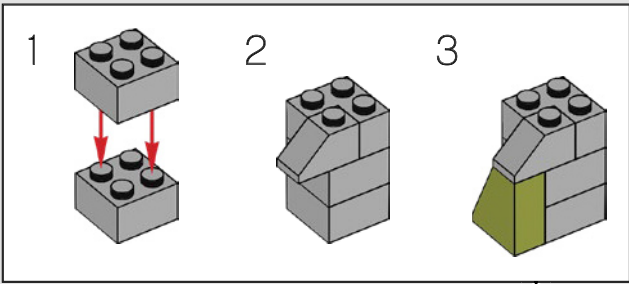

2

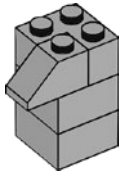

3

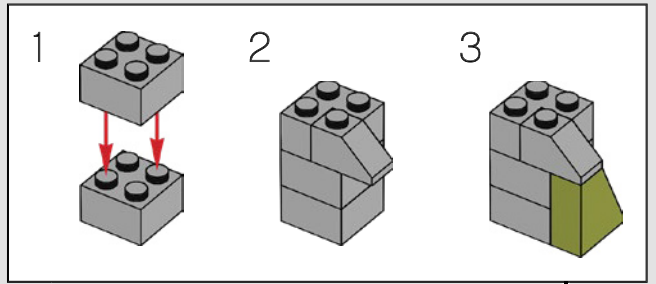
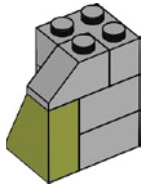

2

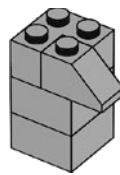

3

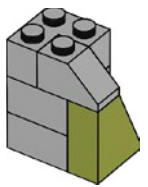

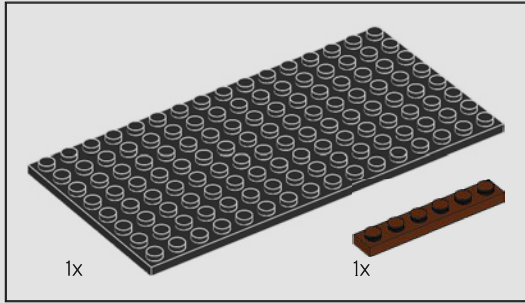
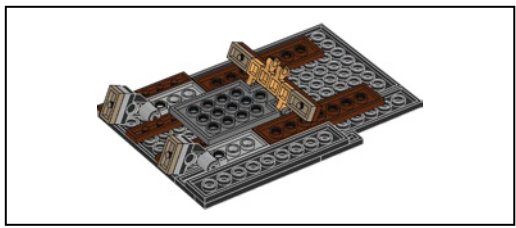

234

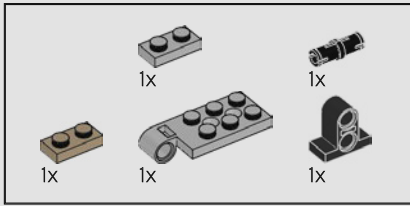
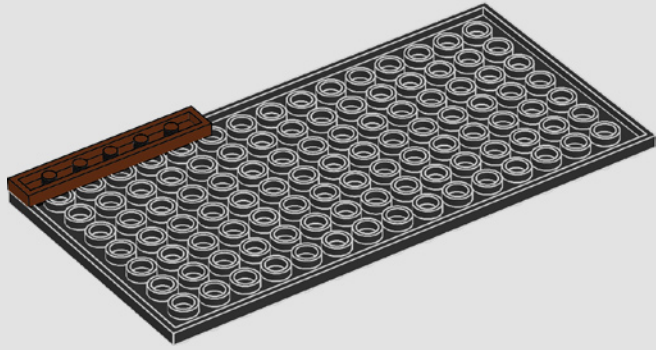

235

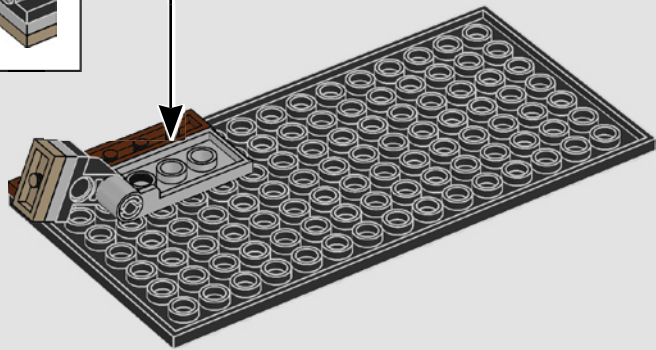
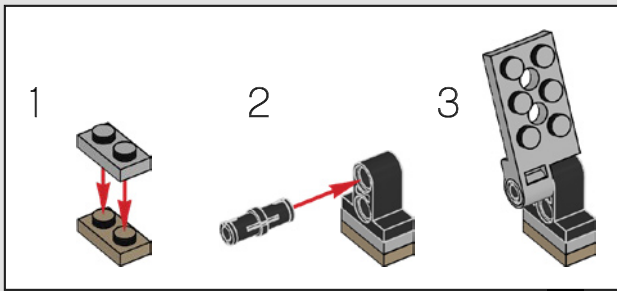

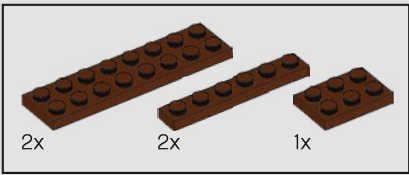

236

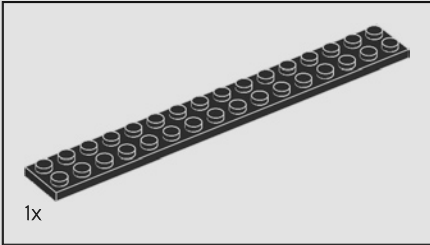
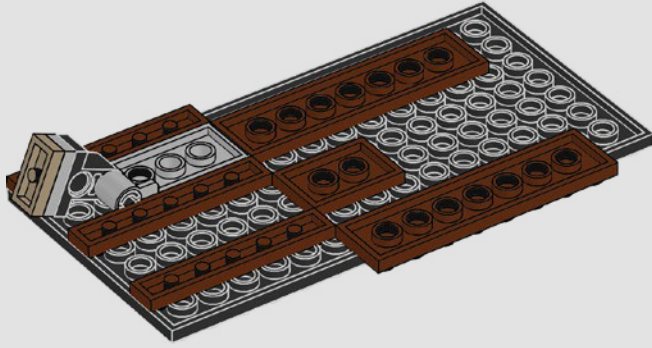

237

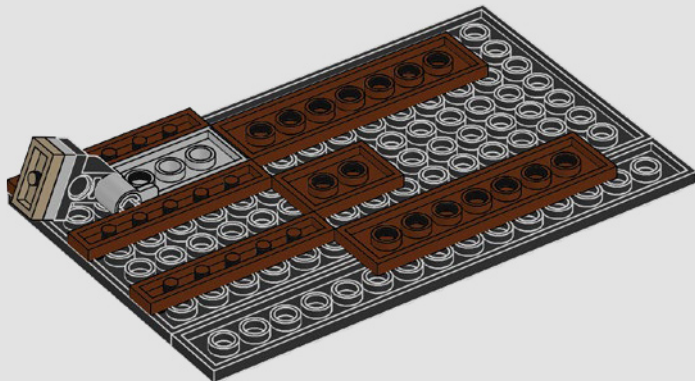

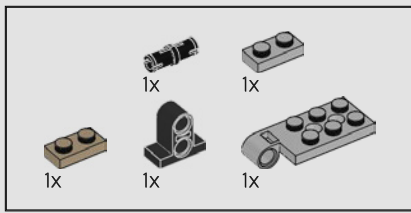

238

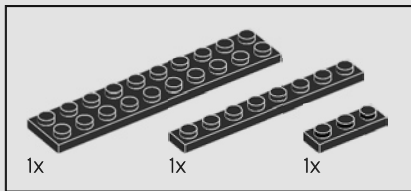
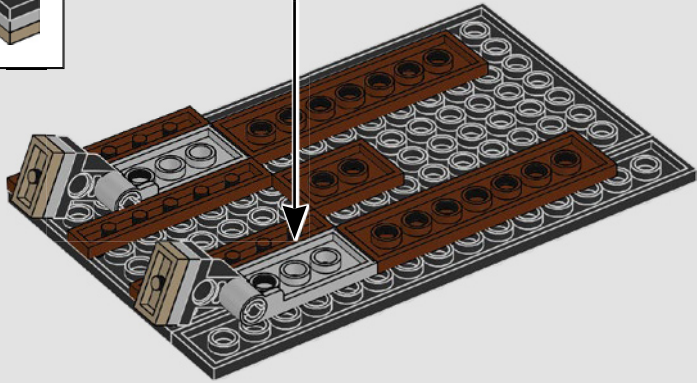
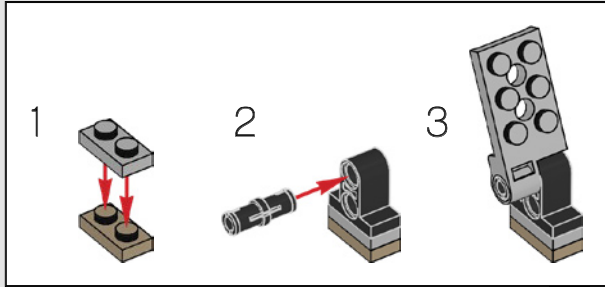

239

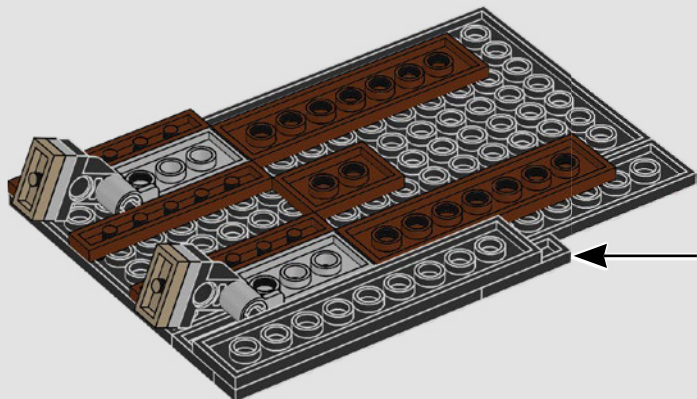
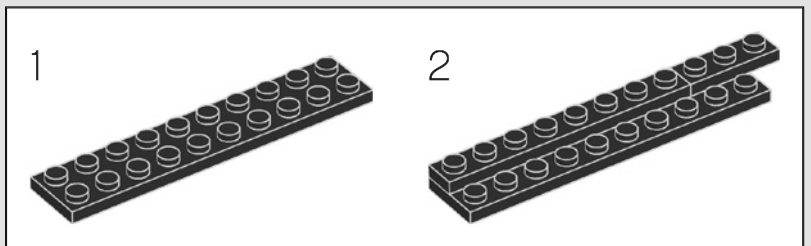

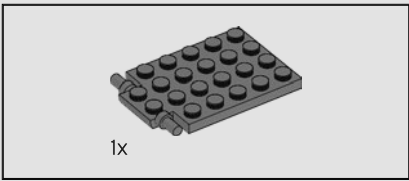

240

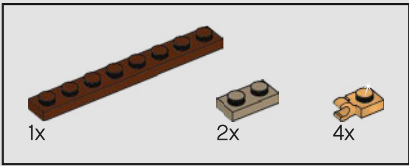
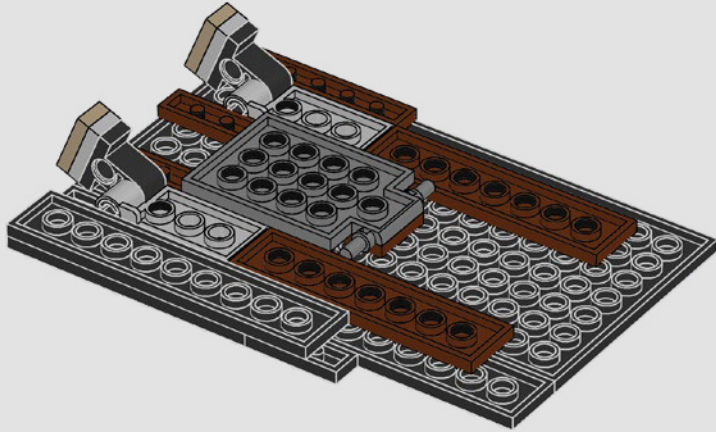

241

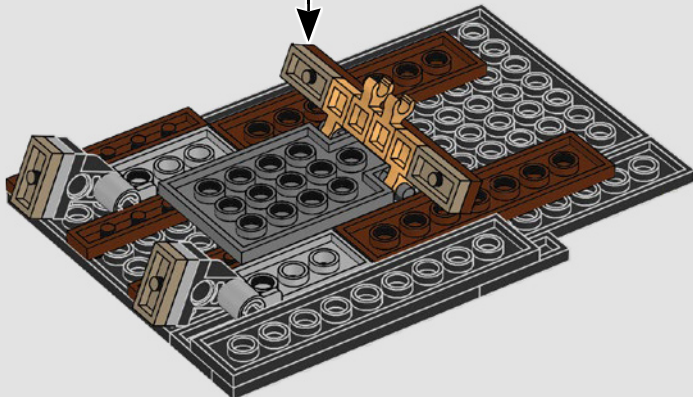
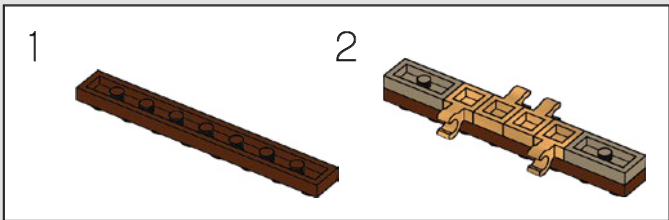

242

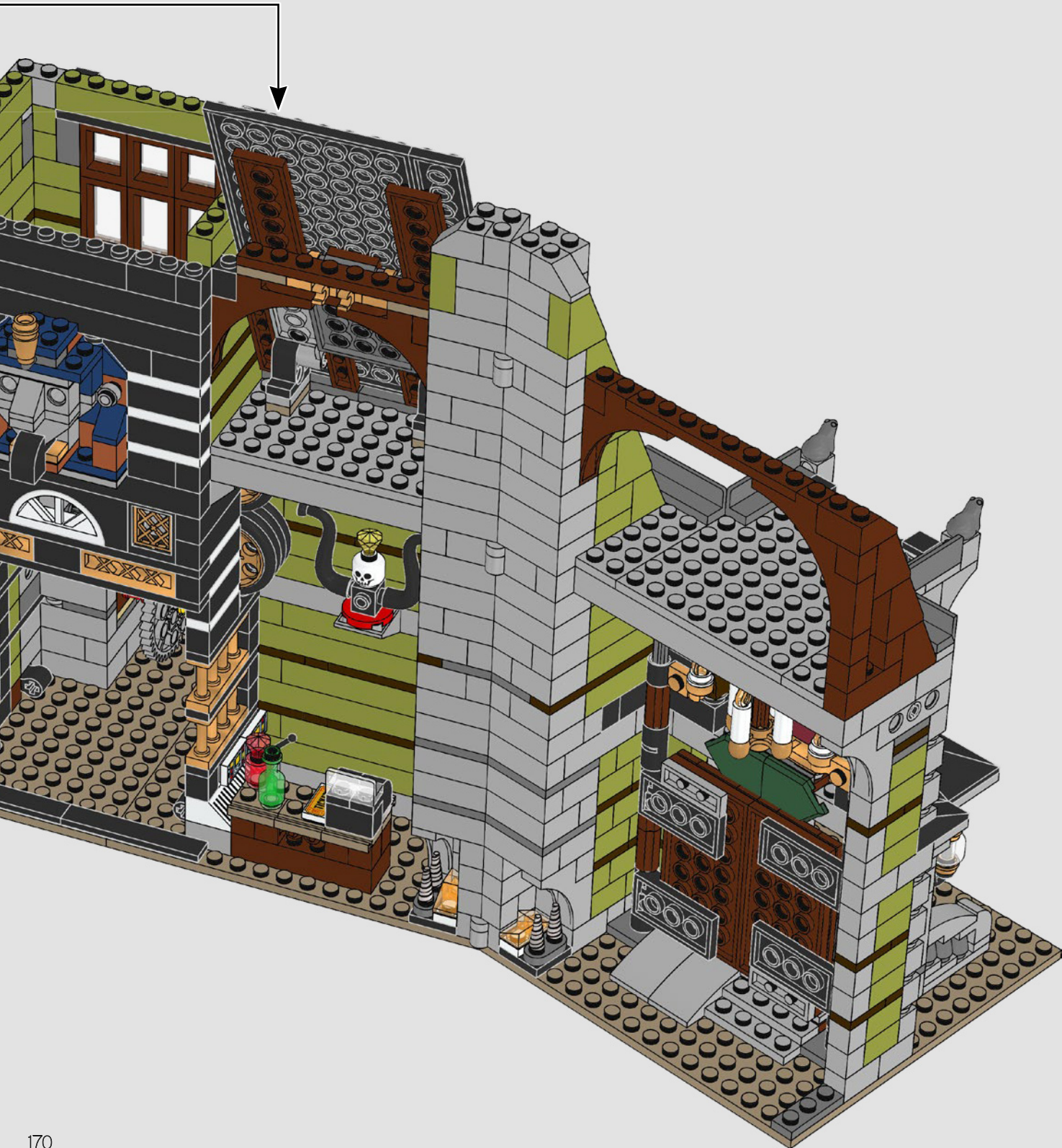

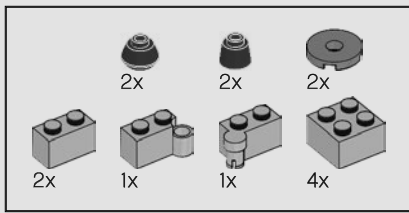

243

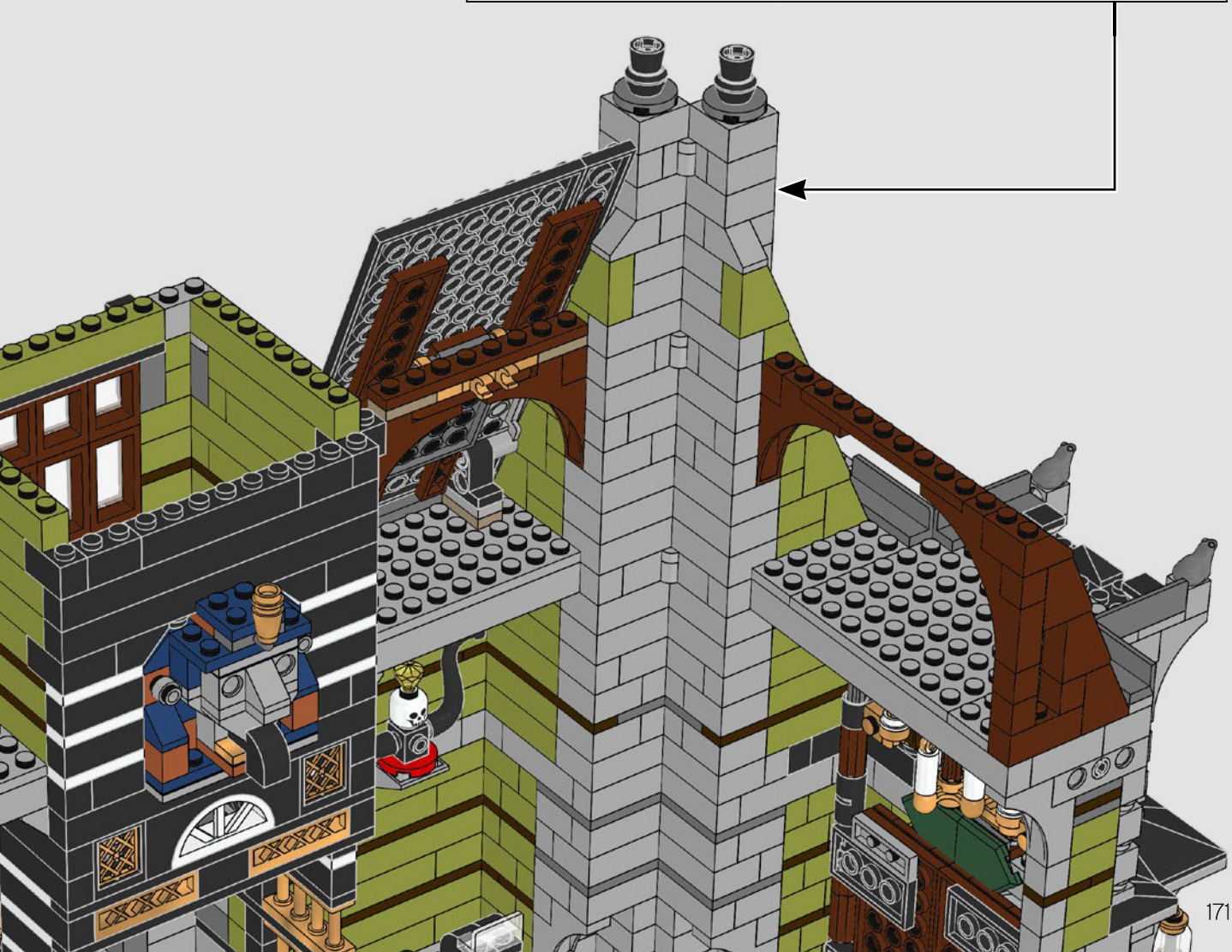
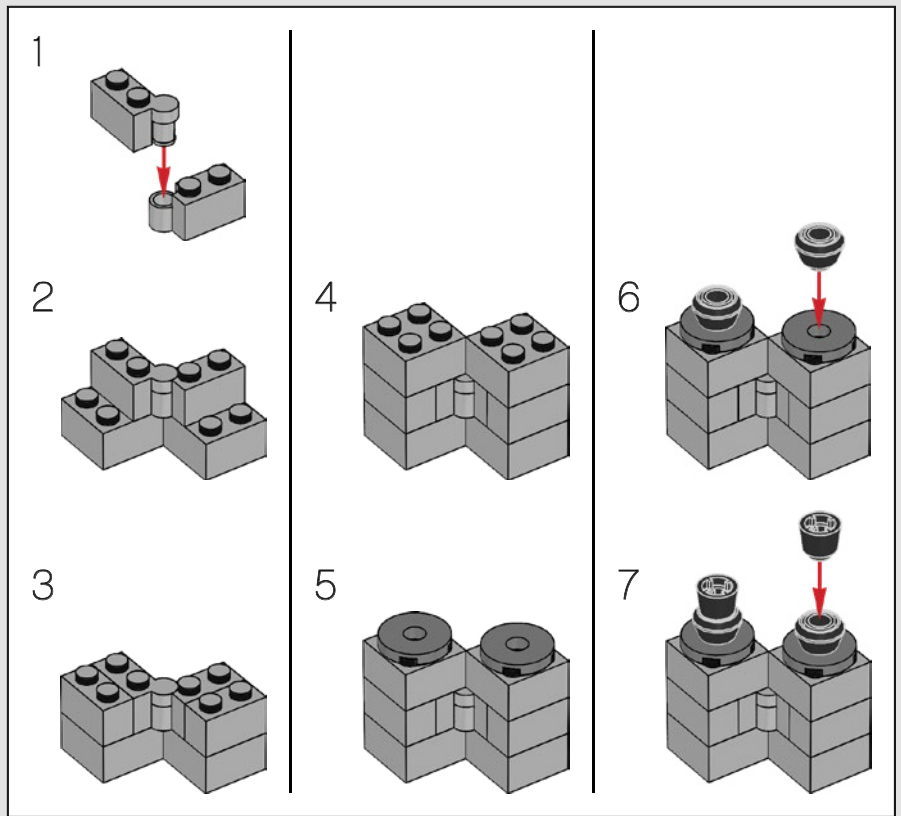

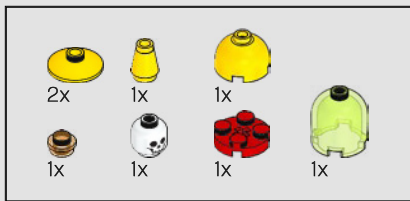

244

Der Reichsapfel von OGEL

Ein Prototyp der Superwaffe, mit der das böse OGEL-Imperium die Gedanken steuerte. Von Barron hatte immer einen davon griffbereit – „für schlechte Zeiten“.

Das goldenen Dings

Als von Barron nach dem goldenen Dings griff, tauchte plötzlich der Yeti auf und verspeiste seine linke Hand! Zum Glück hatte er damals bereits einen Haken als linke Hand, den er einfach ersetzen konnte.

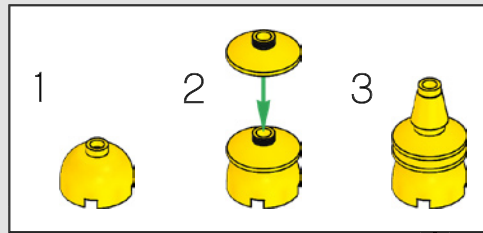
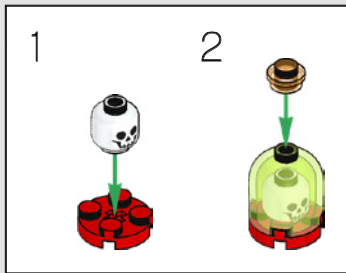

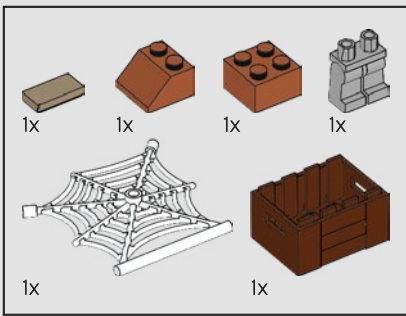

245

Die Kiste voll Krepel

Eine schwere, staubige Kiste voll Krepel. Auf einem ausgebleichten Aufkleber steht „I Love Trash“.

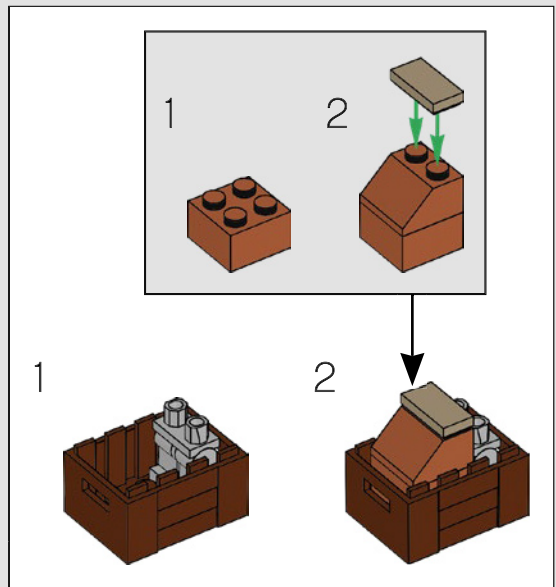

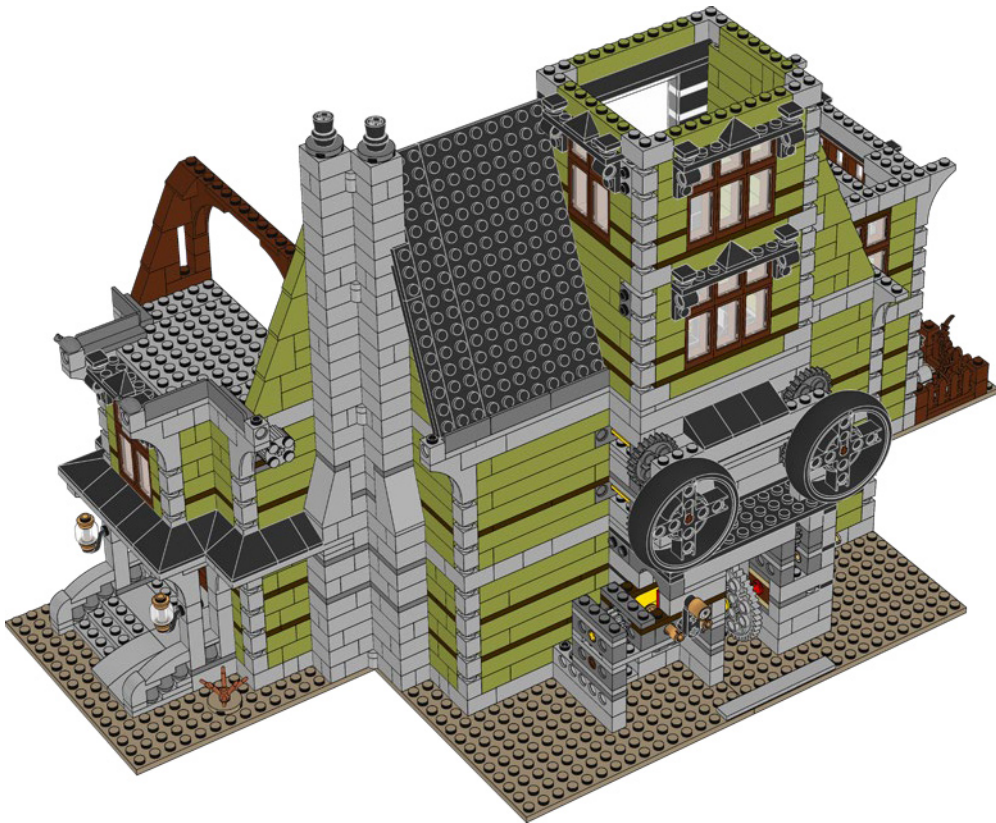
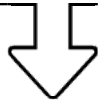

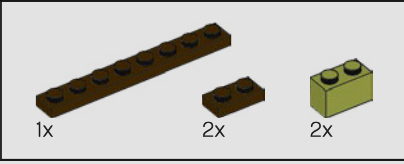
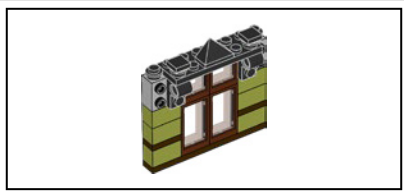

246

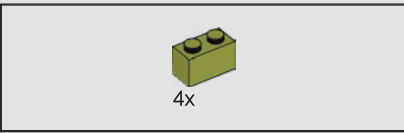
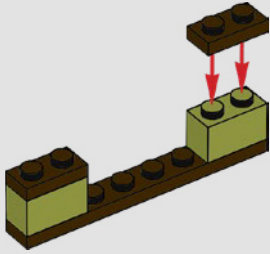

247

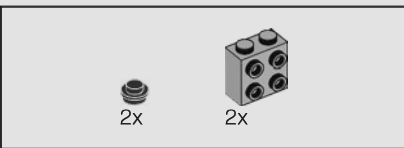
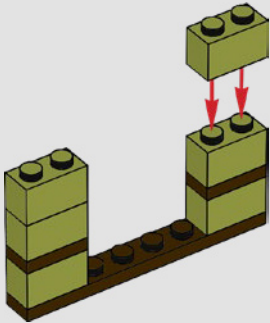

248

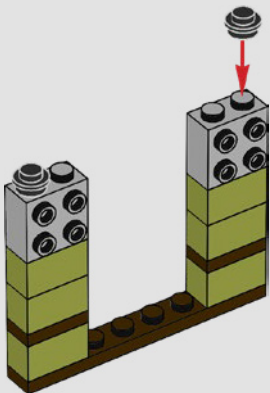

249

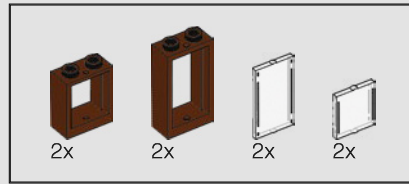
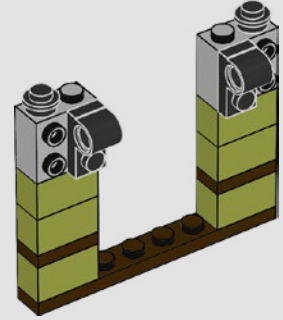

250

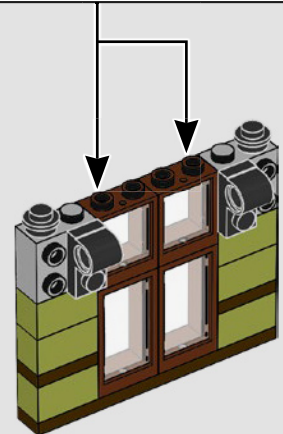
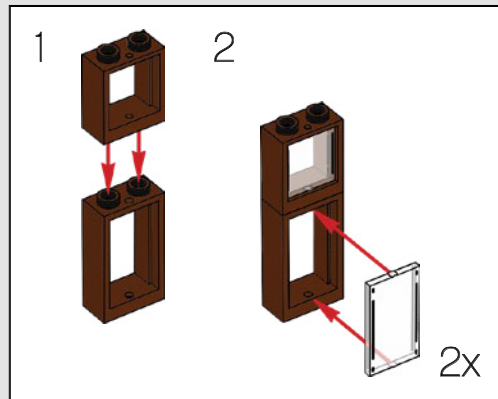

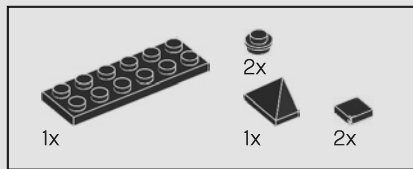

251

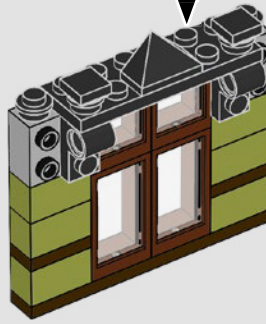
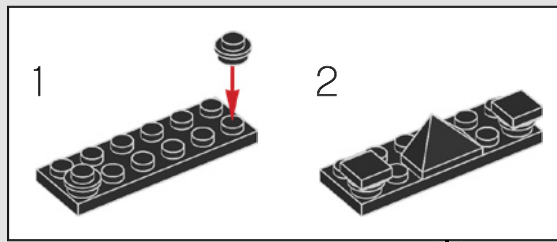

252



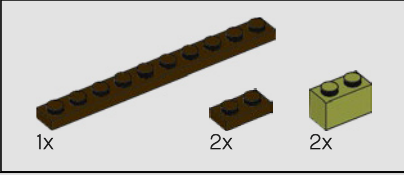
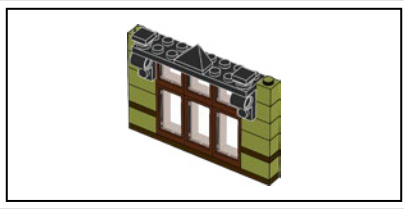

253

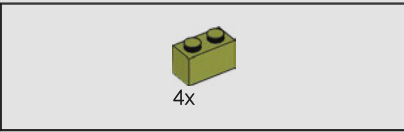
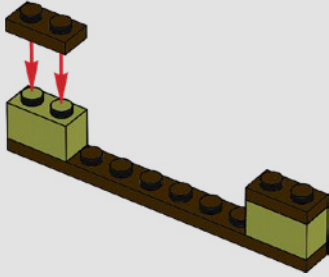

254

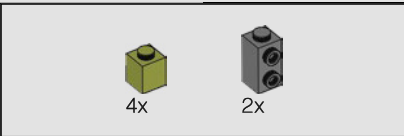
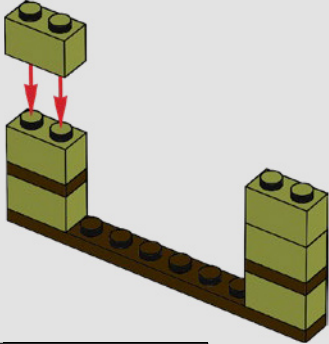

255

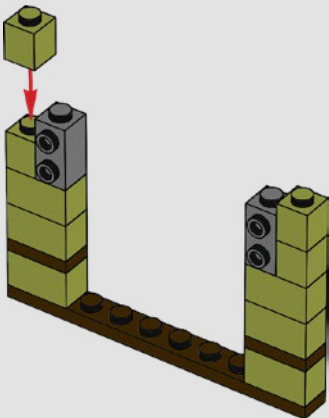

256

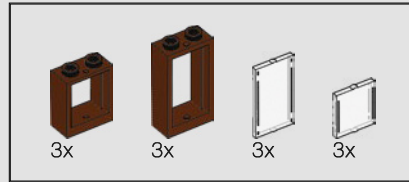
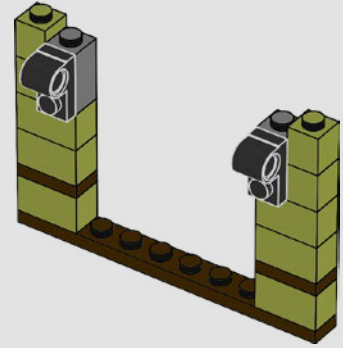

257

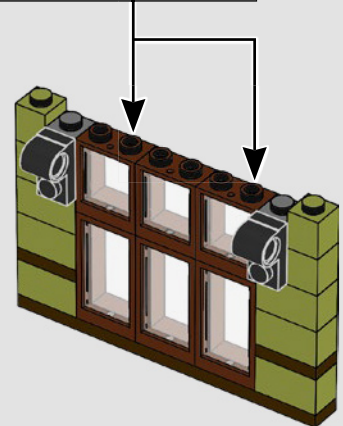
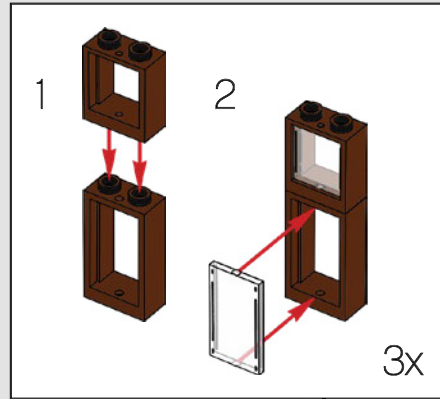

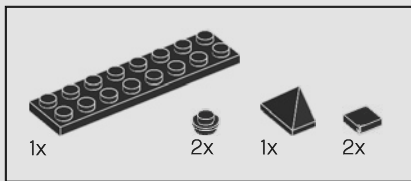

258

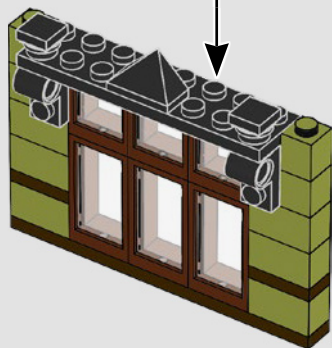
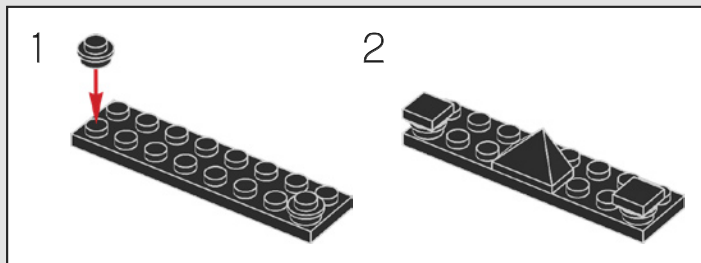

259





8x



10x

260

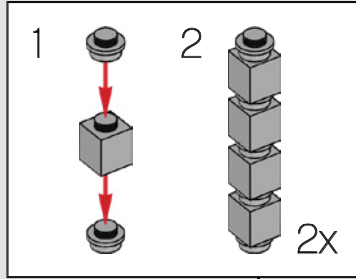

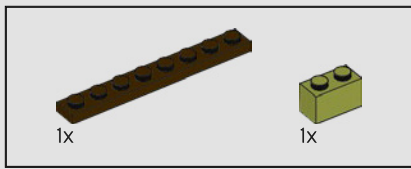

261

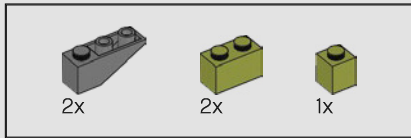
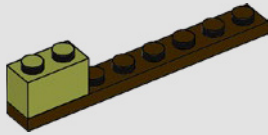

262

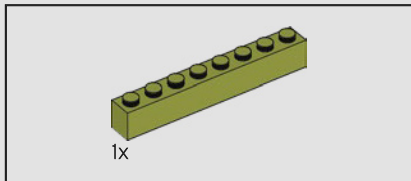
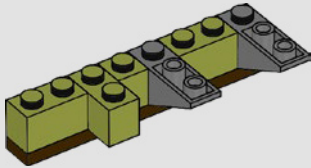

263

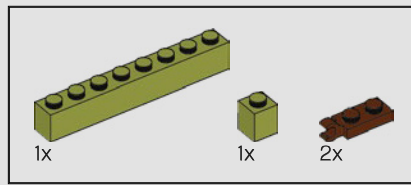
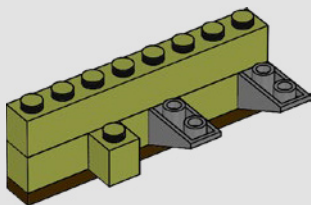

264

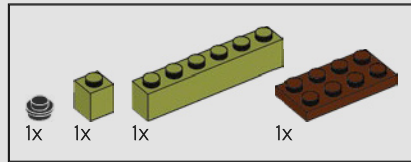
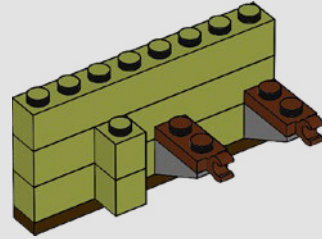

265

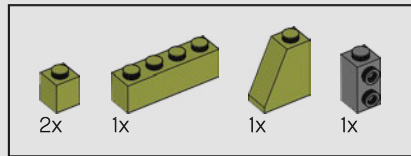
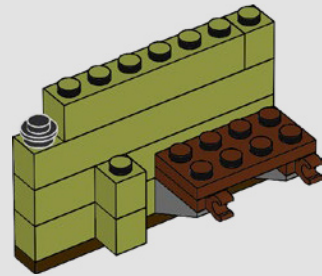

266

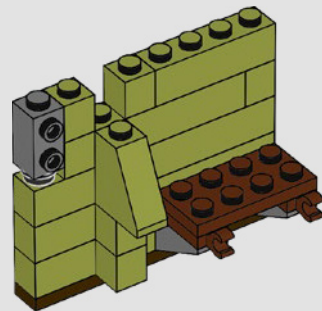

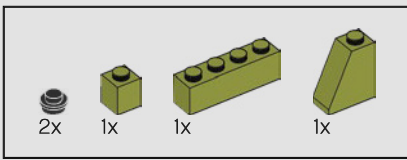

267

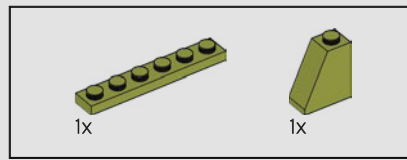
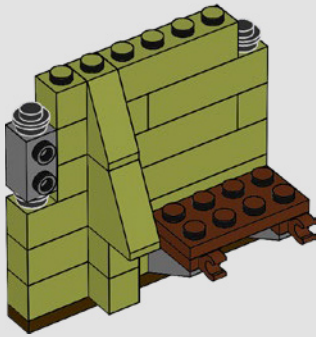

268

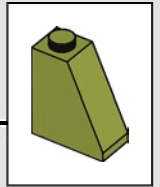
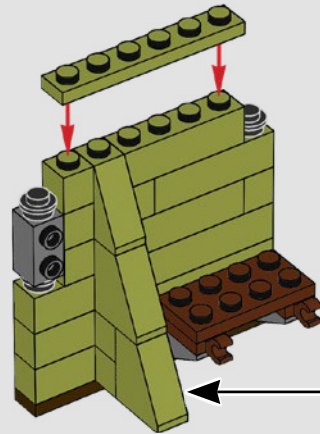

269



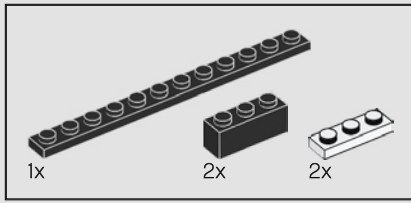

270

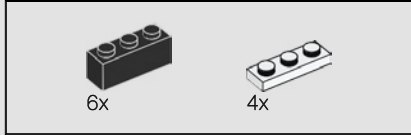
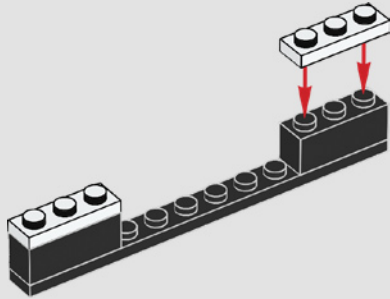

271

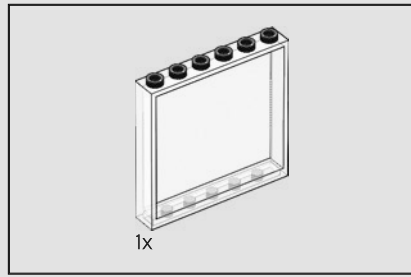
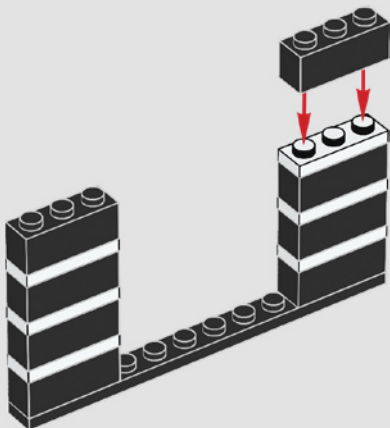

272

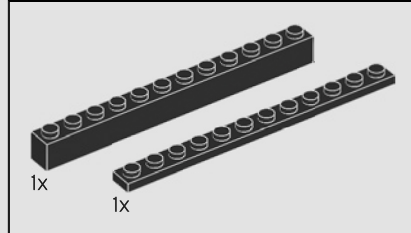
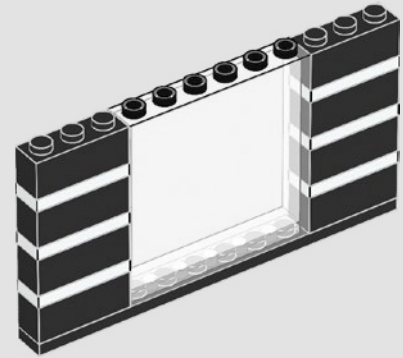

273

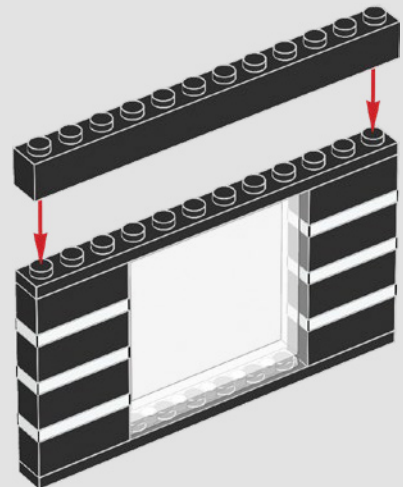

274



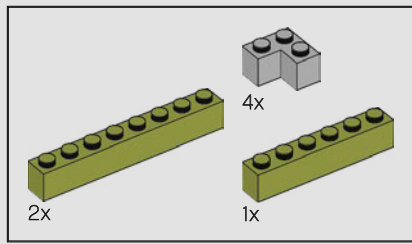

275

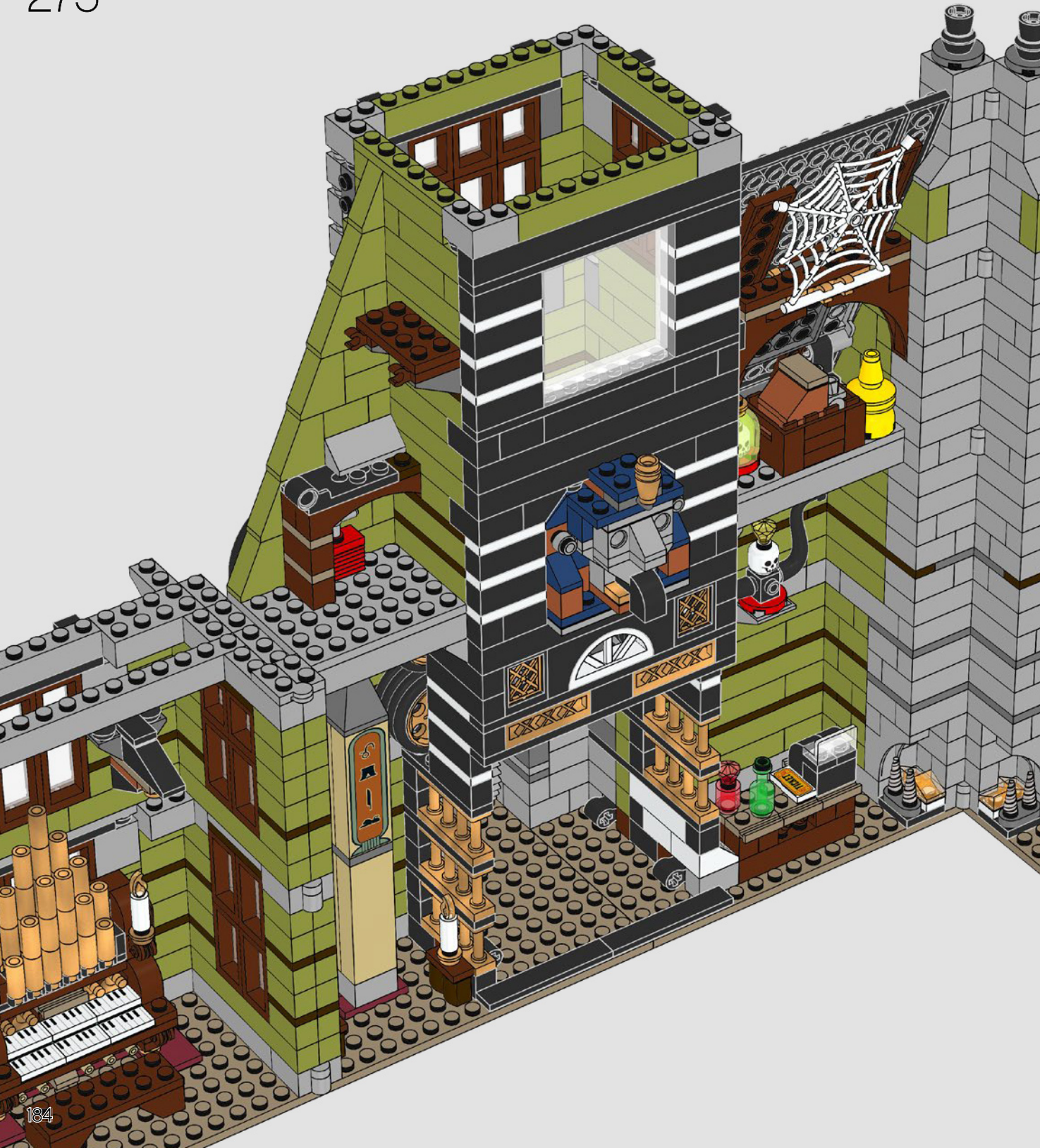

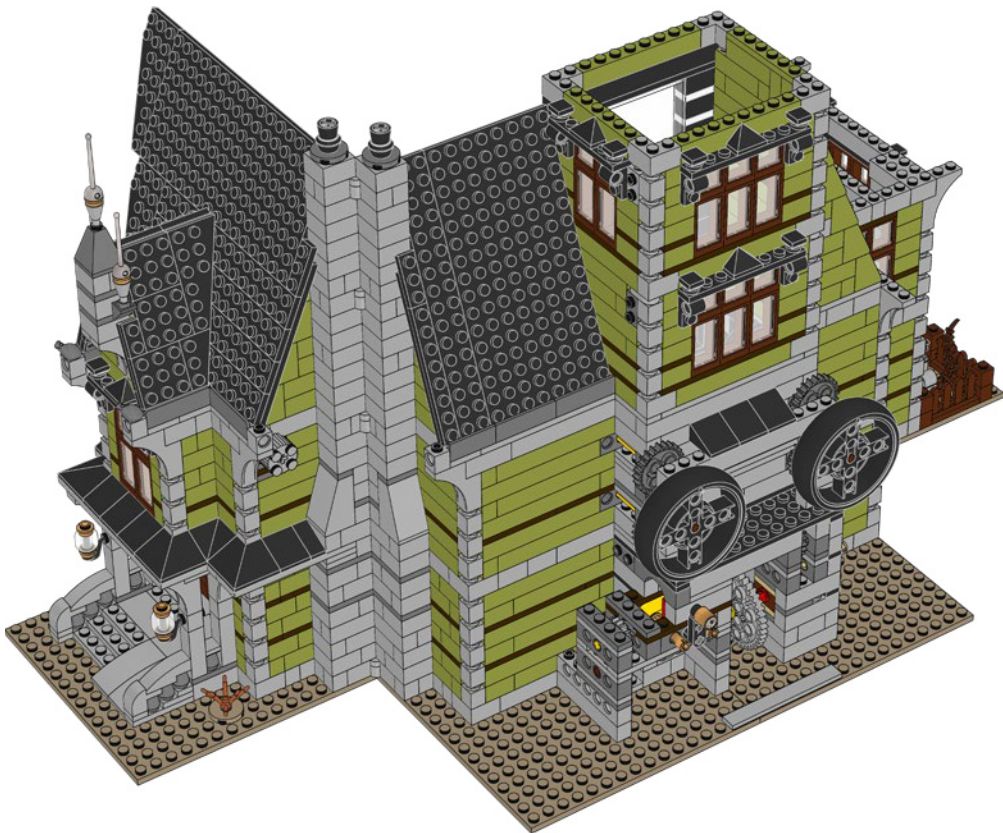
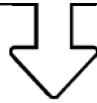
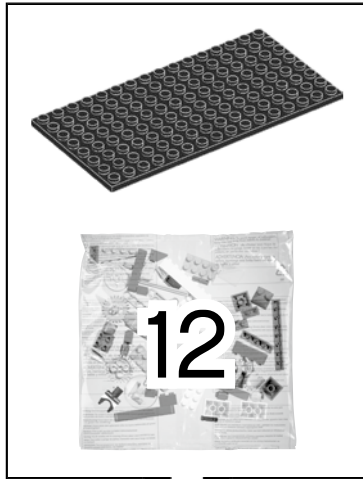

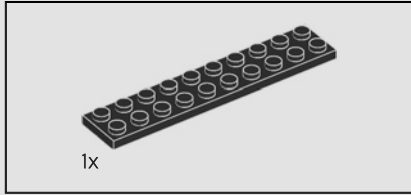
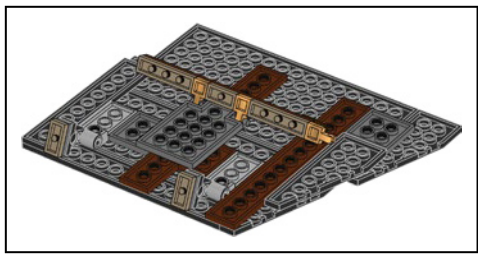

276

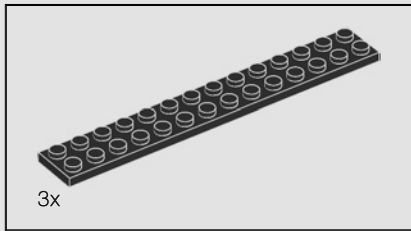
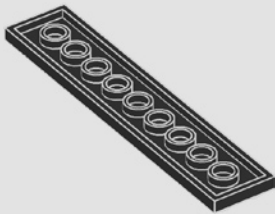

277

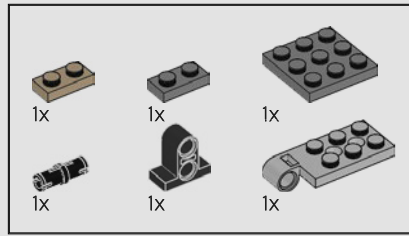
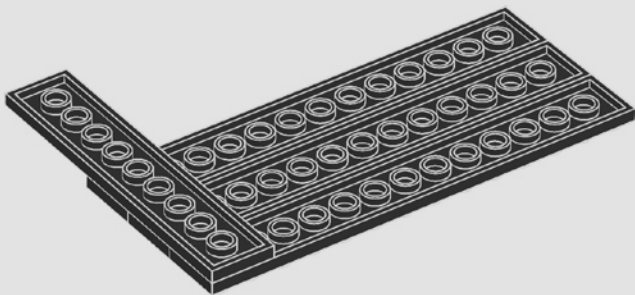

278

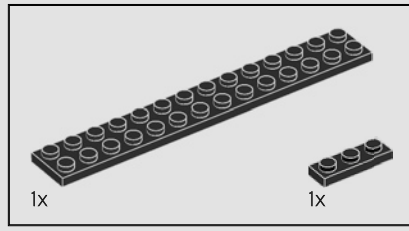
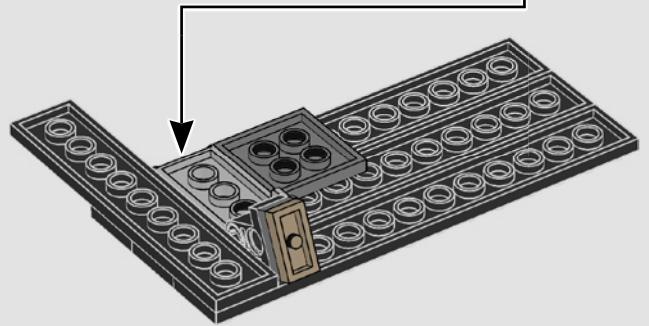
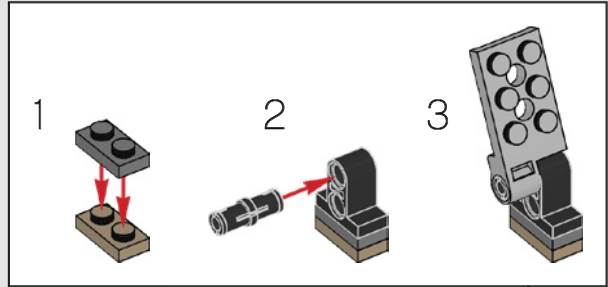

279

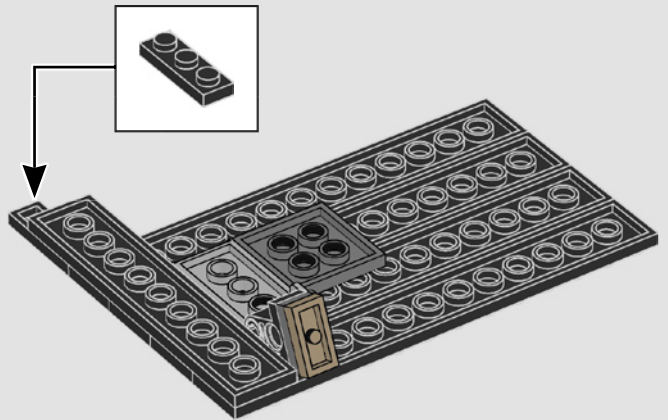

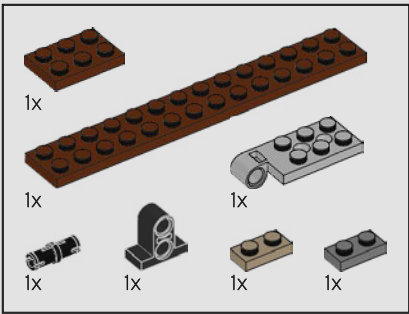

280

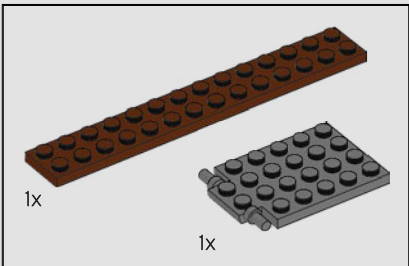
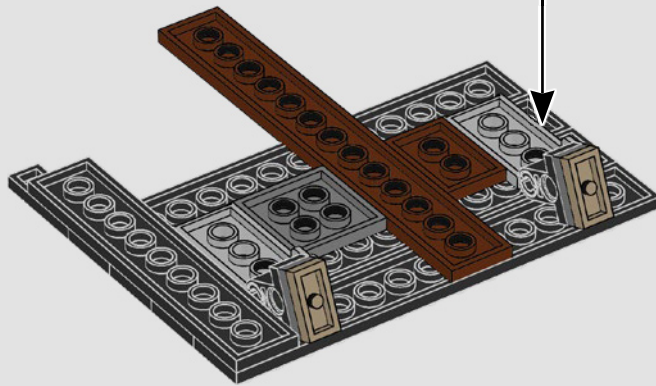
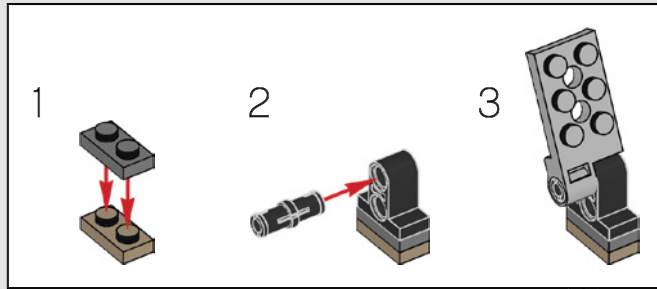

281

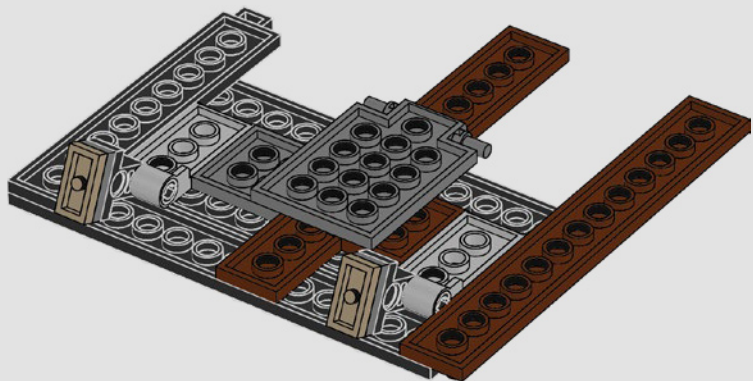

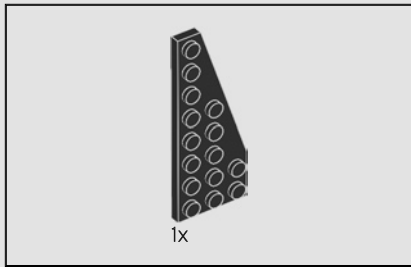

282

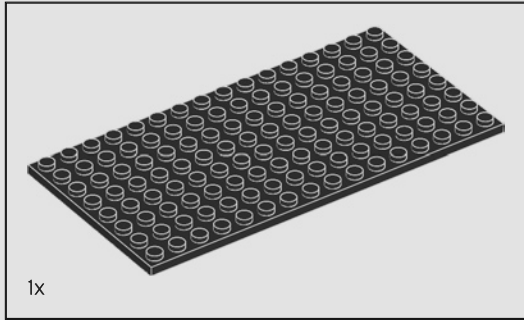
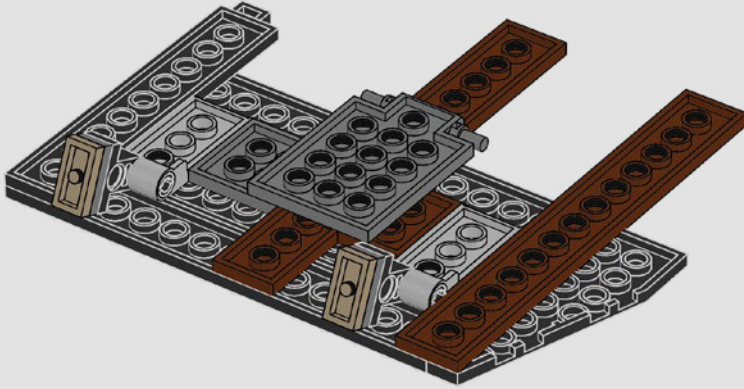

283

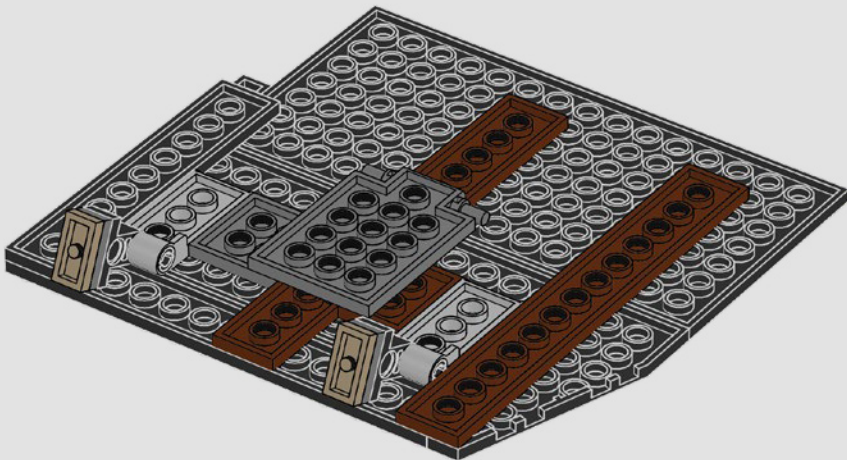

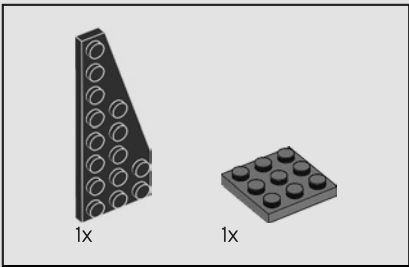

284

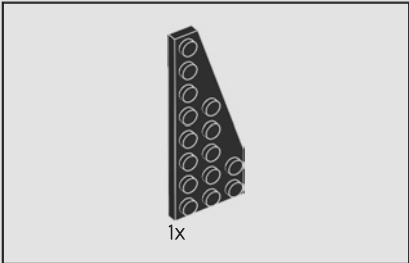
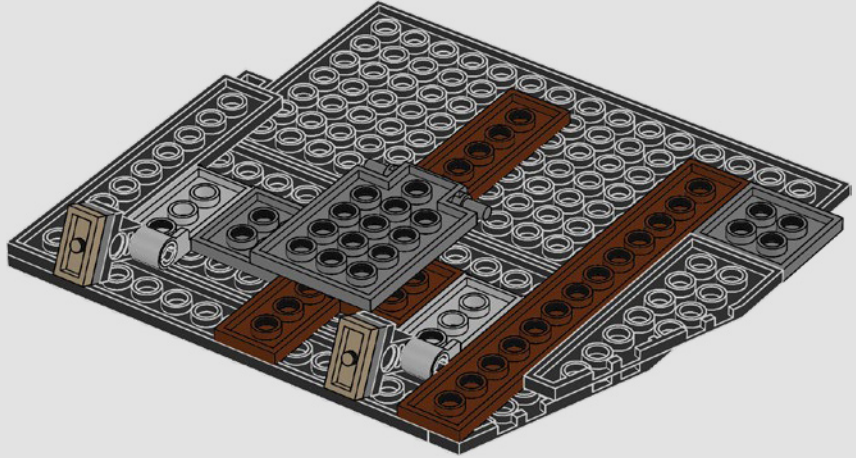

285

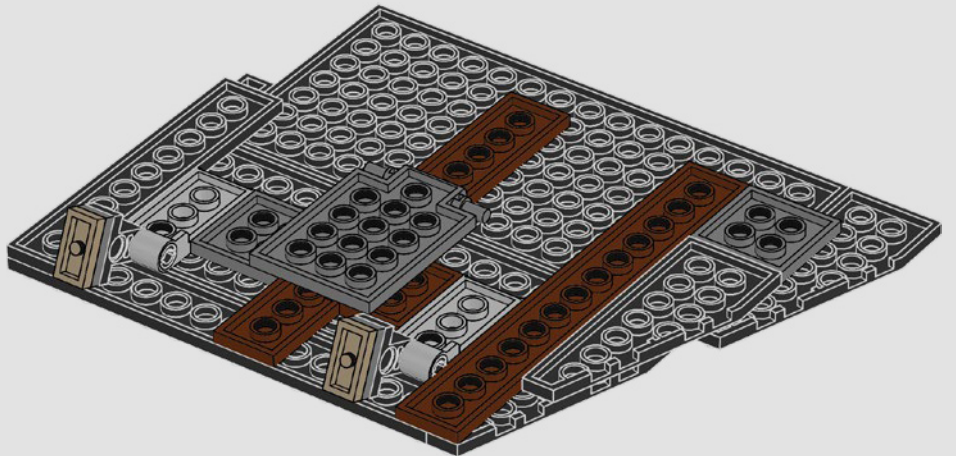

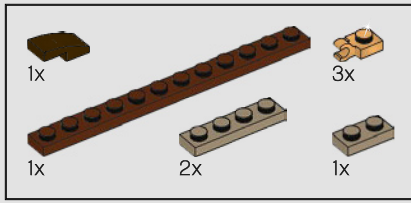

286

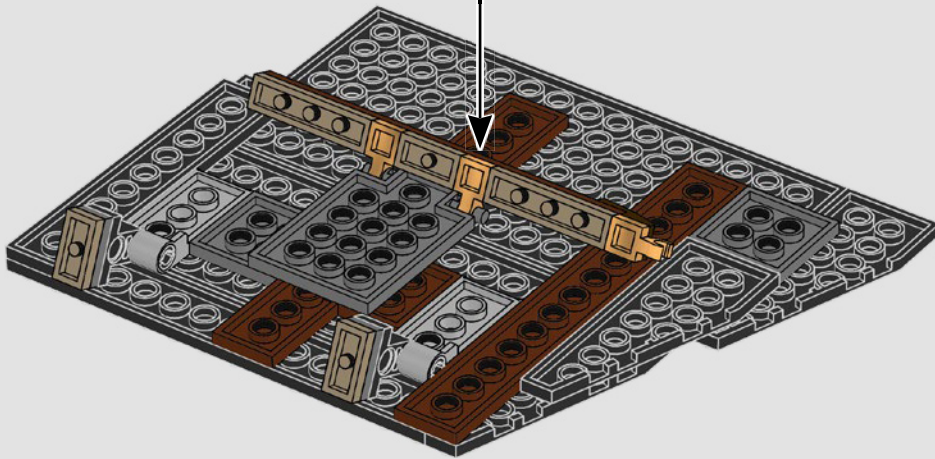
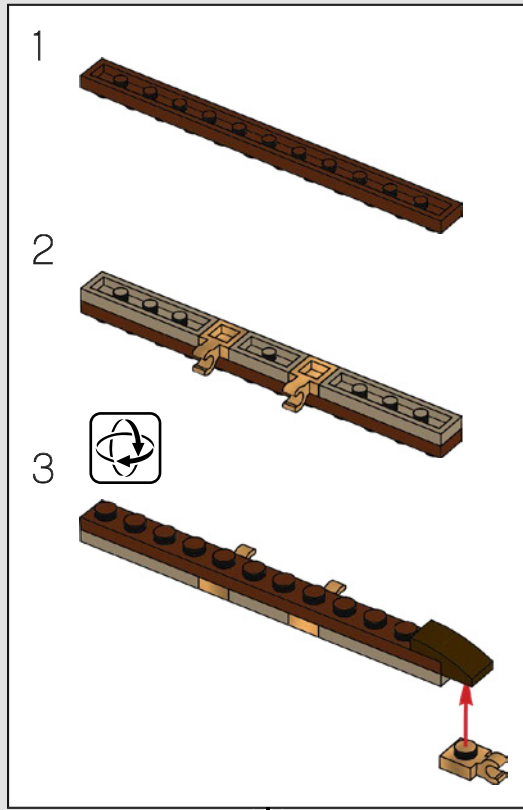

287

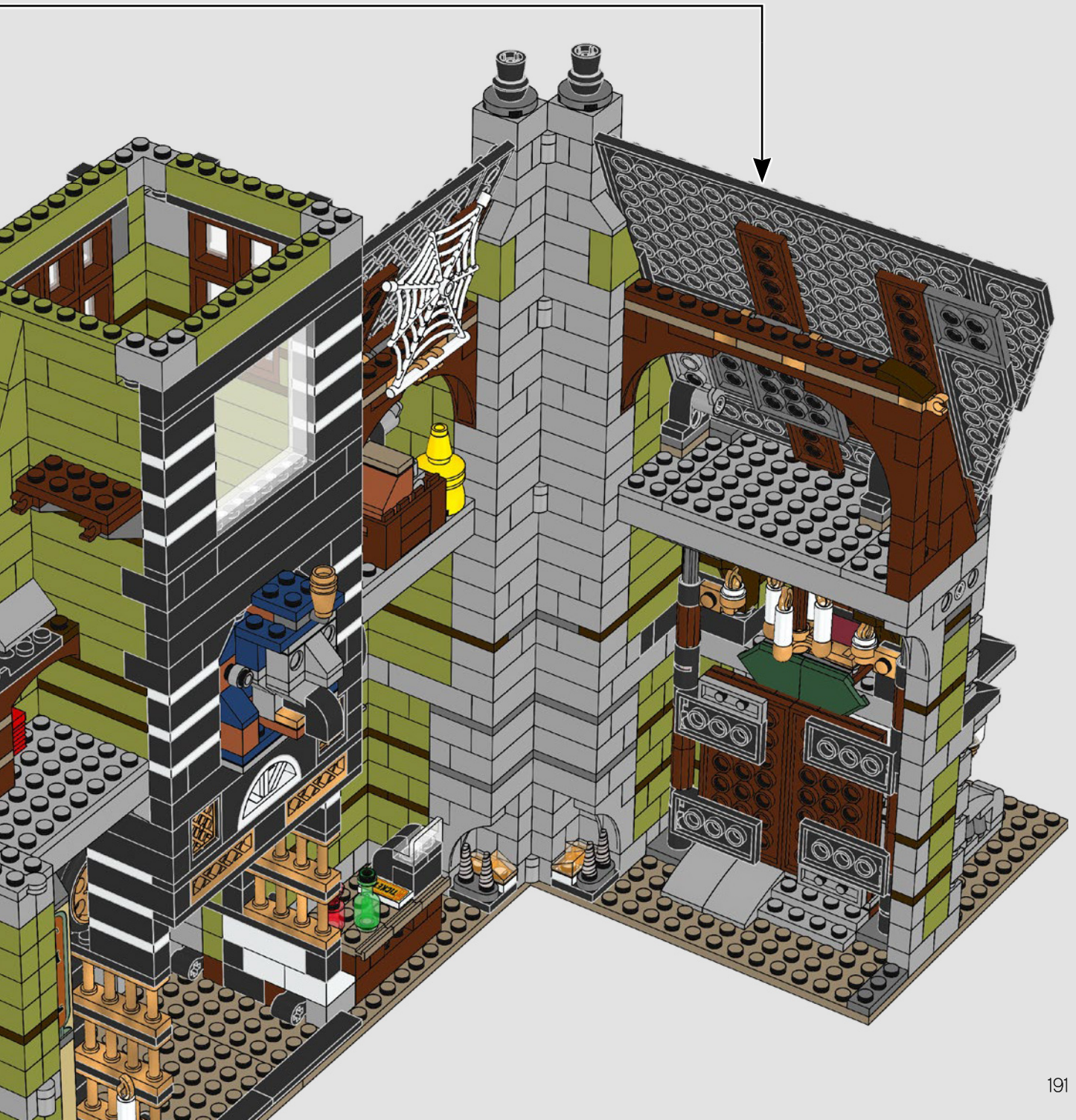



288

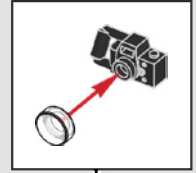
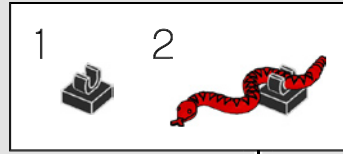

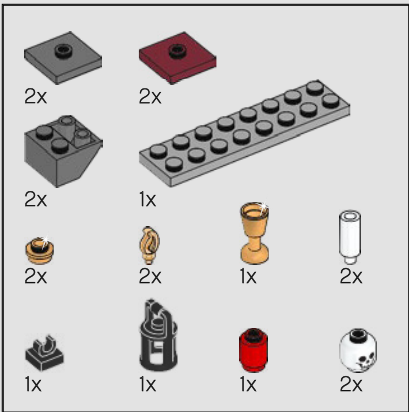

289

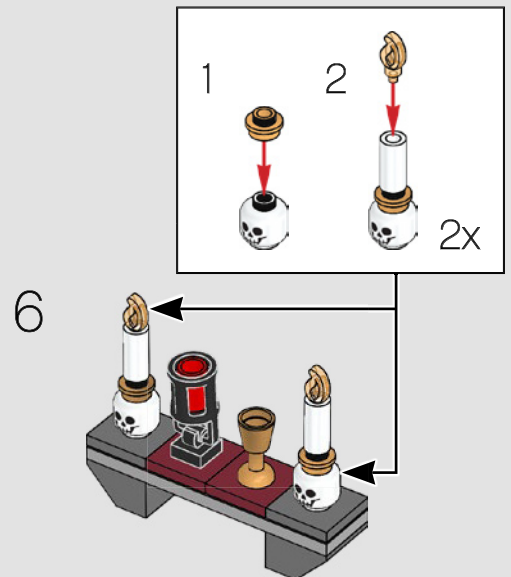
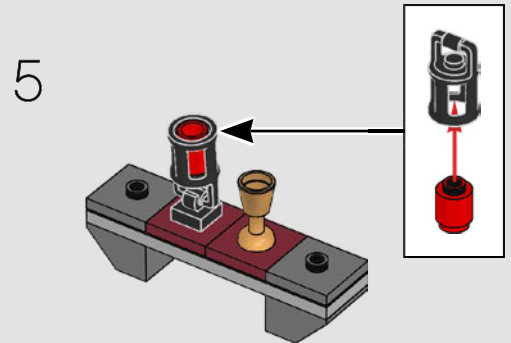
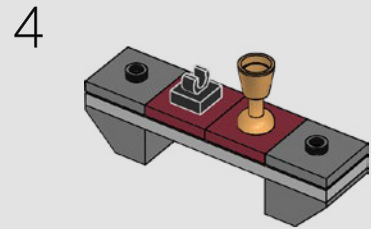
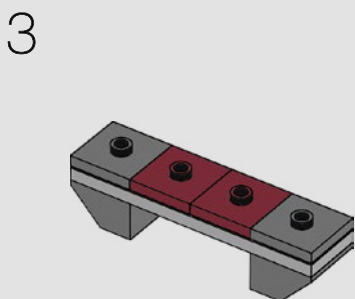
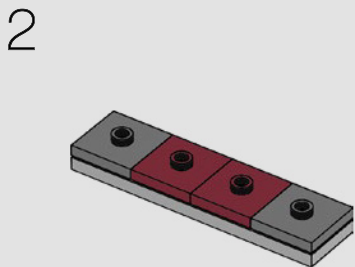
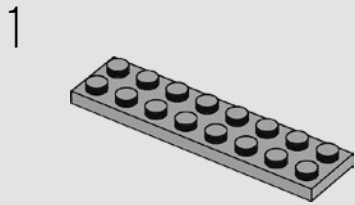

Der Altar von Alhazred

Es ist nicht bekannt, für welche finsternen Riten dieser wuchtige Steintisch ursprünglich vorgesehen war. Wenn es regnete, las der Baron. Dafür stand auf dem Altar die Leselampe.



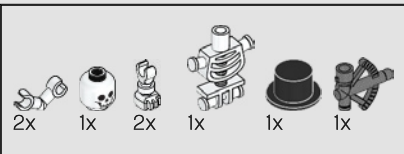

290

Das verbotene Skelett

Es heißt, Sam Sinisters Auto sei auf der Flucht vor dem Gesetz in die Luft geflogen und nur sein Skelett und der Zylinder wären übrig geblieben. Angeblich gab es einst auch einen dritten Zwillingbutler. Aber das sind nur Gerüchte.

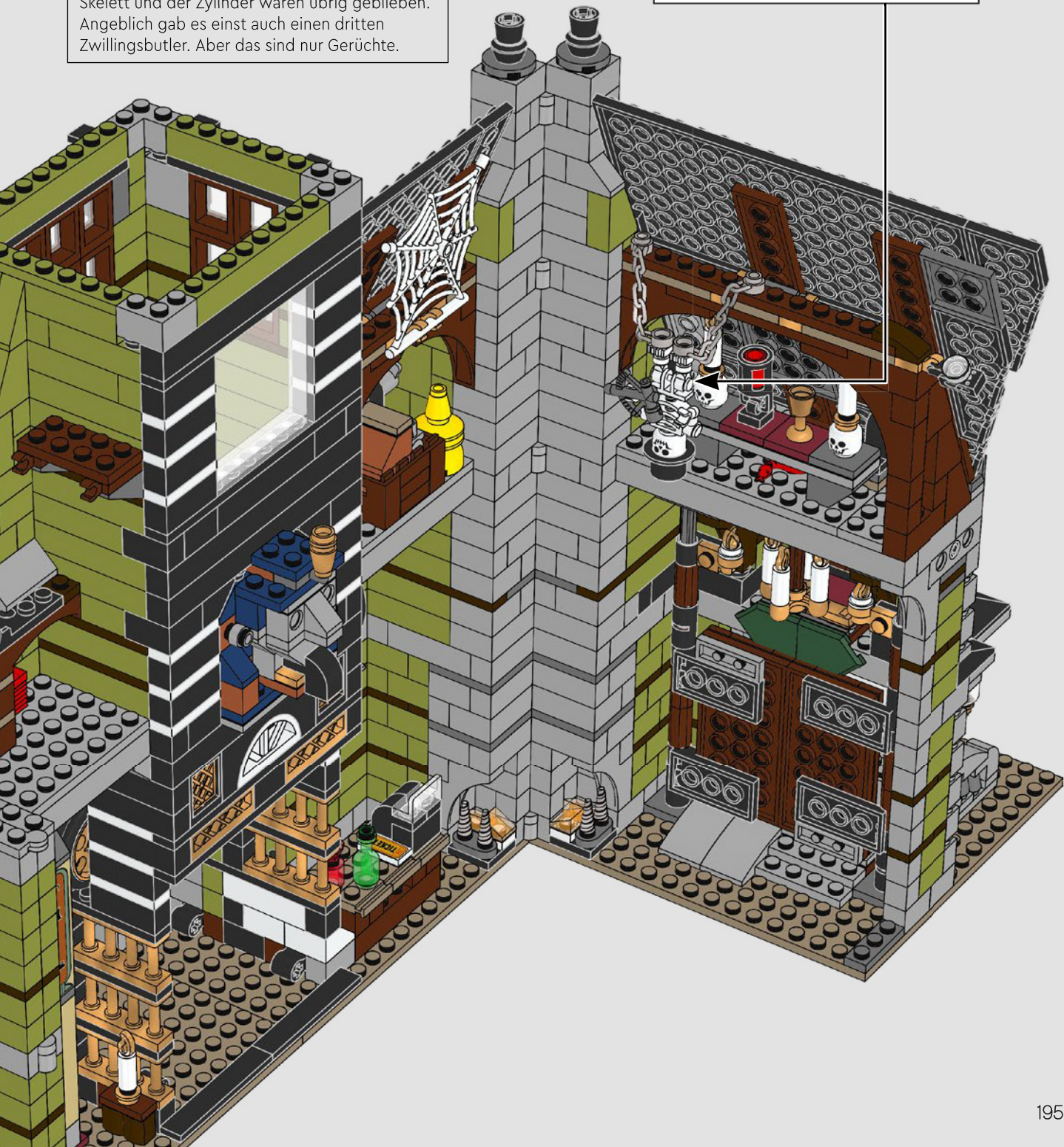
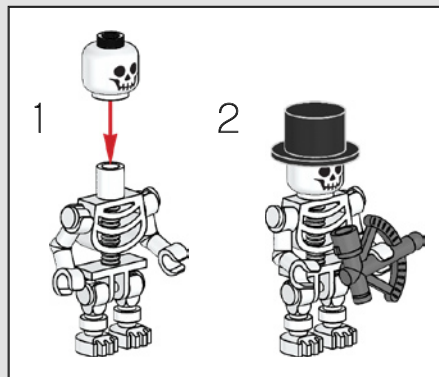

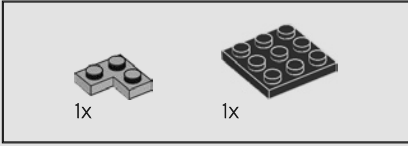
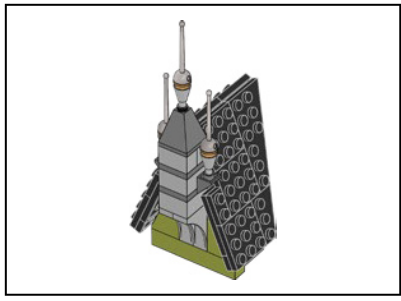

291

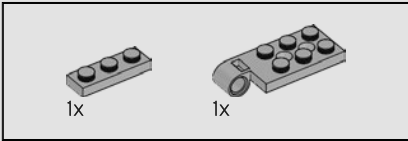
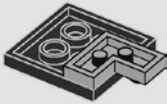

292

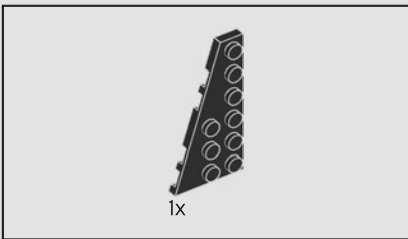
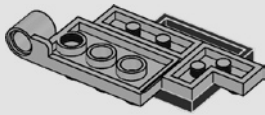

293

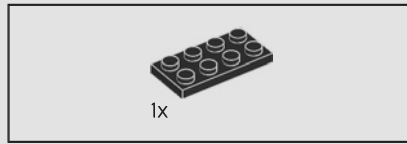
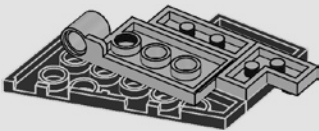

294

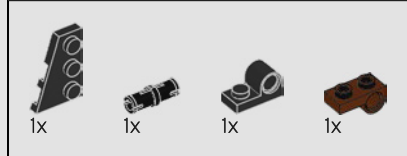
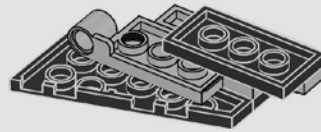

295

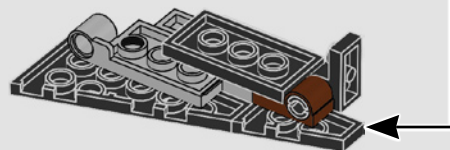
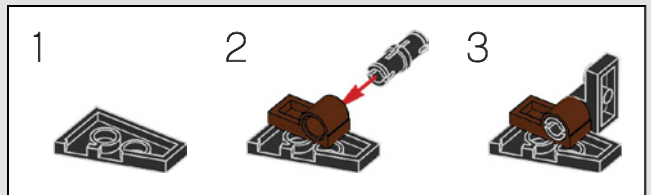



296

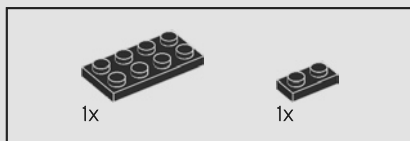
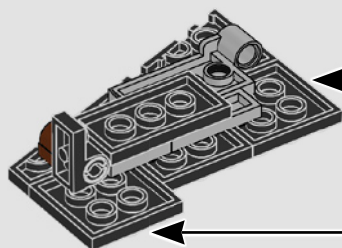
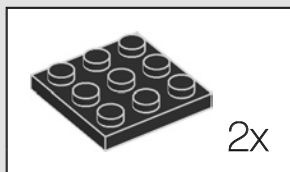

297

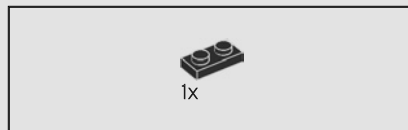
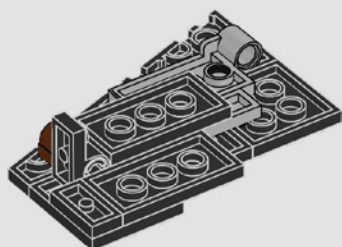

298

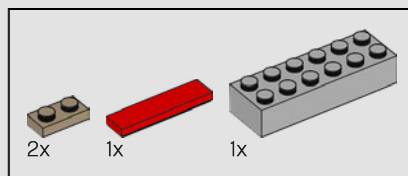
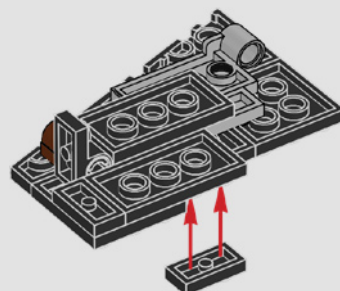

299

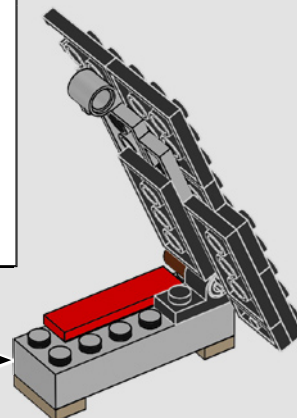
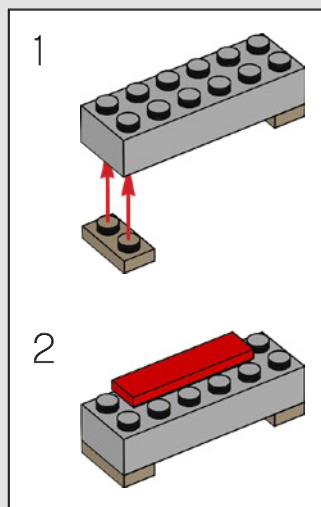

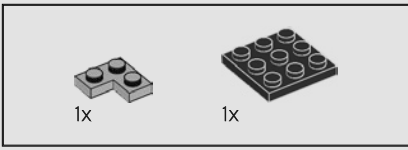

300

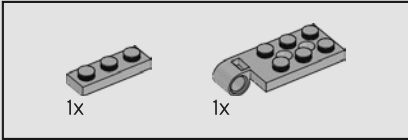
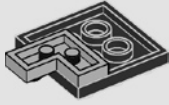

301

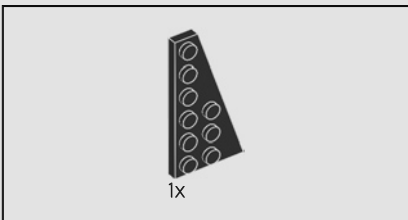
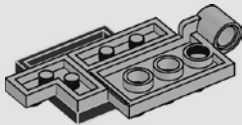

302

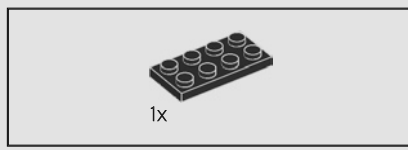
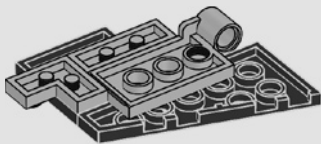

303

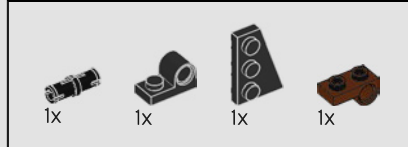
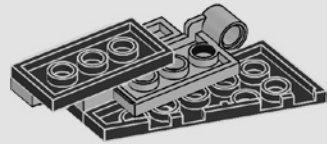

304

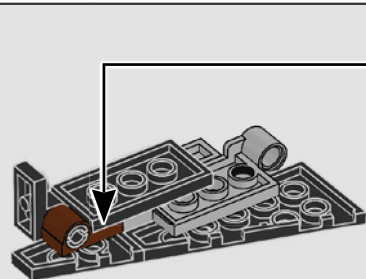
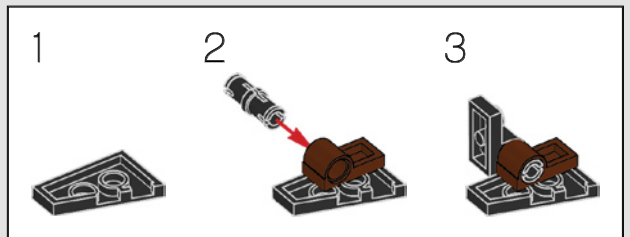

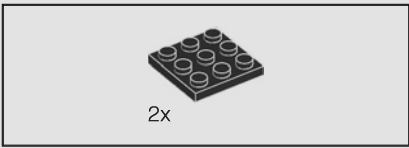

305

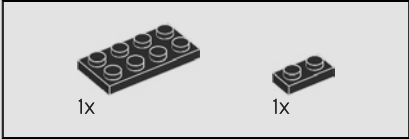
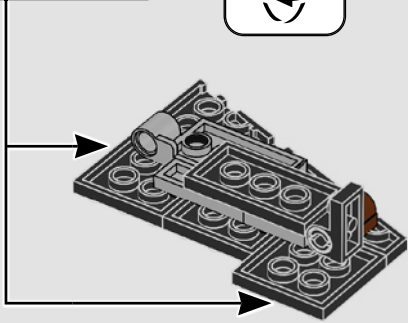
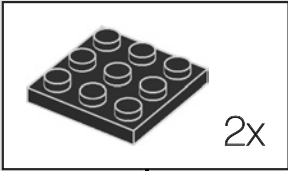

306

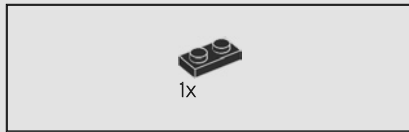
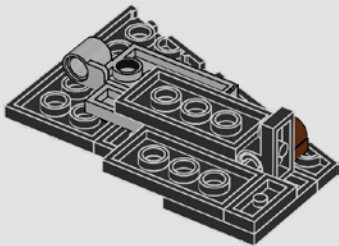

307

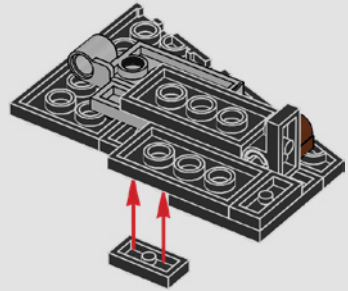

308

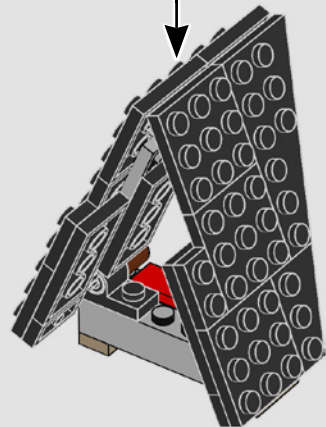

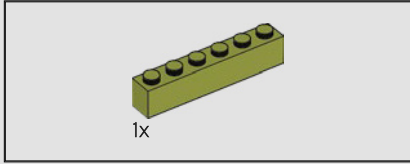
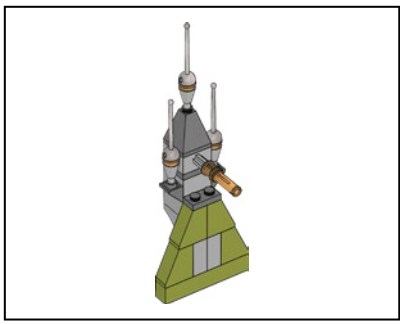

309

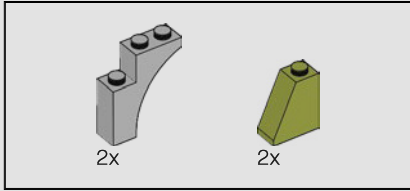
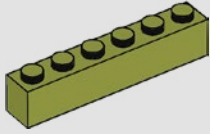

310

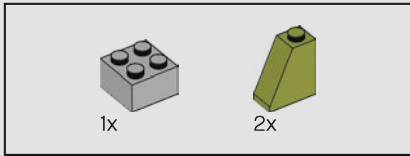
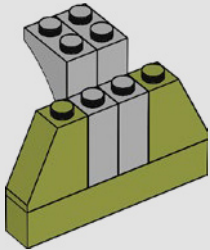

311

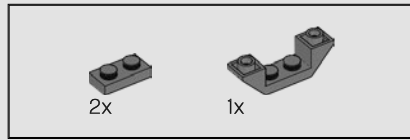
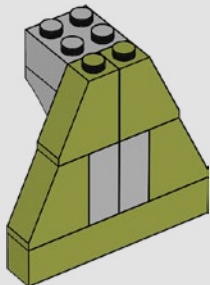

312

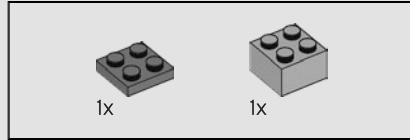
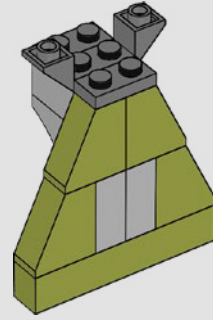

313

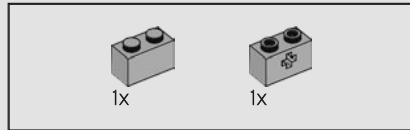
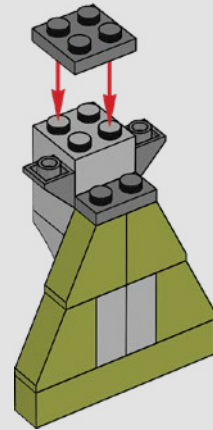

314

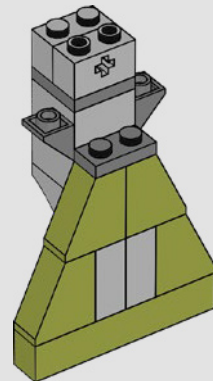

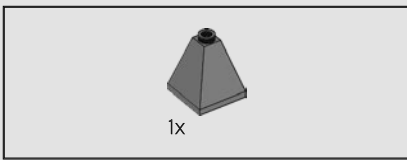

315

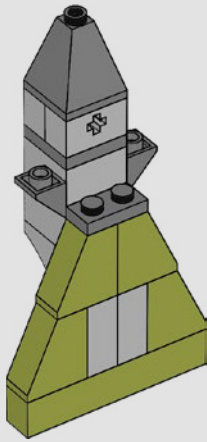

316

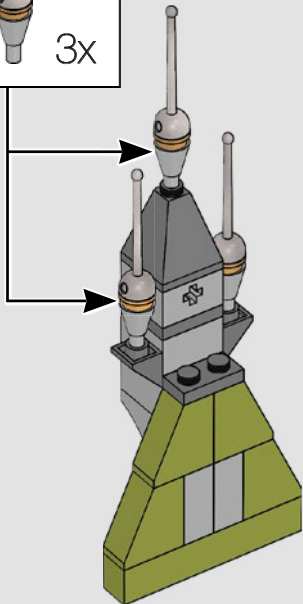
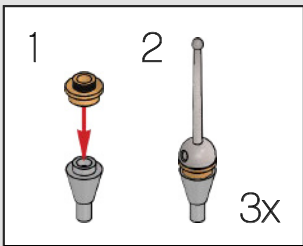

317

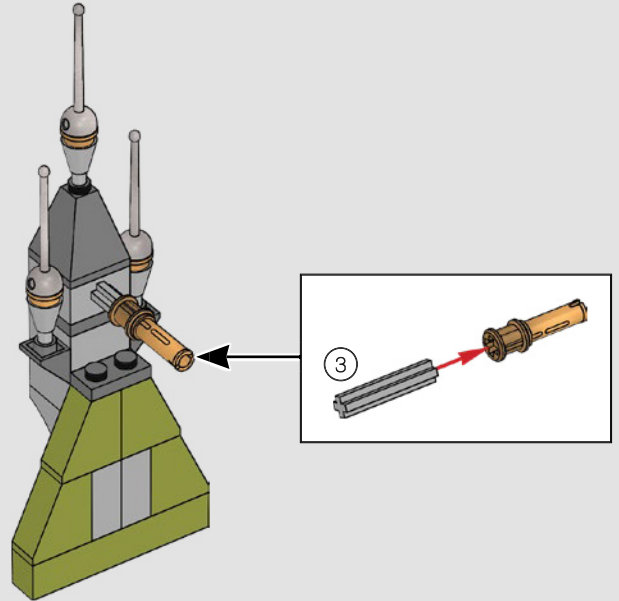

318

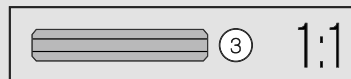
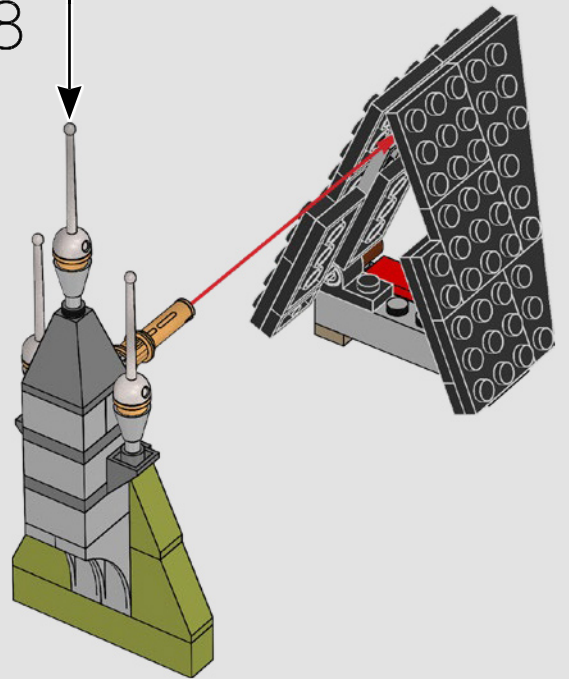

319

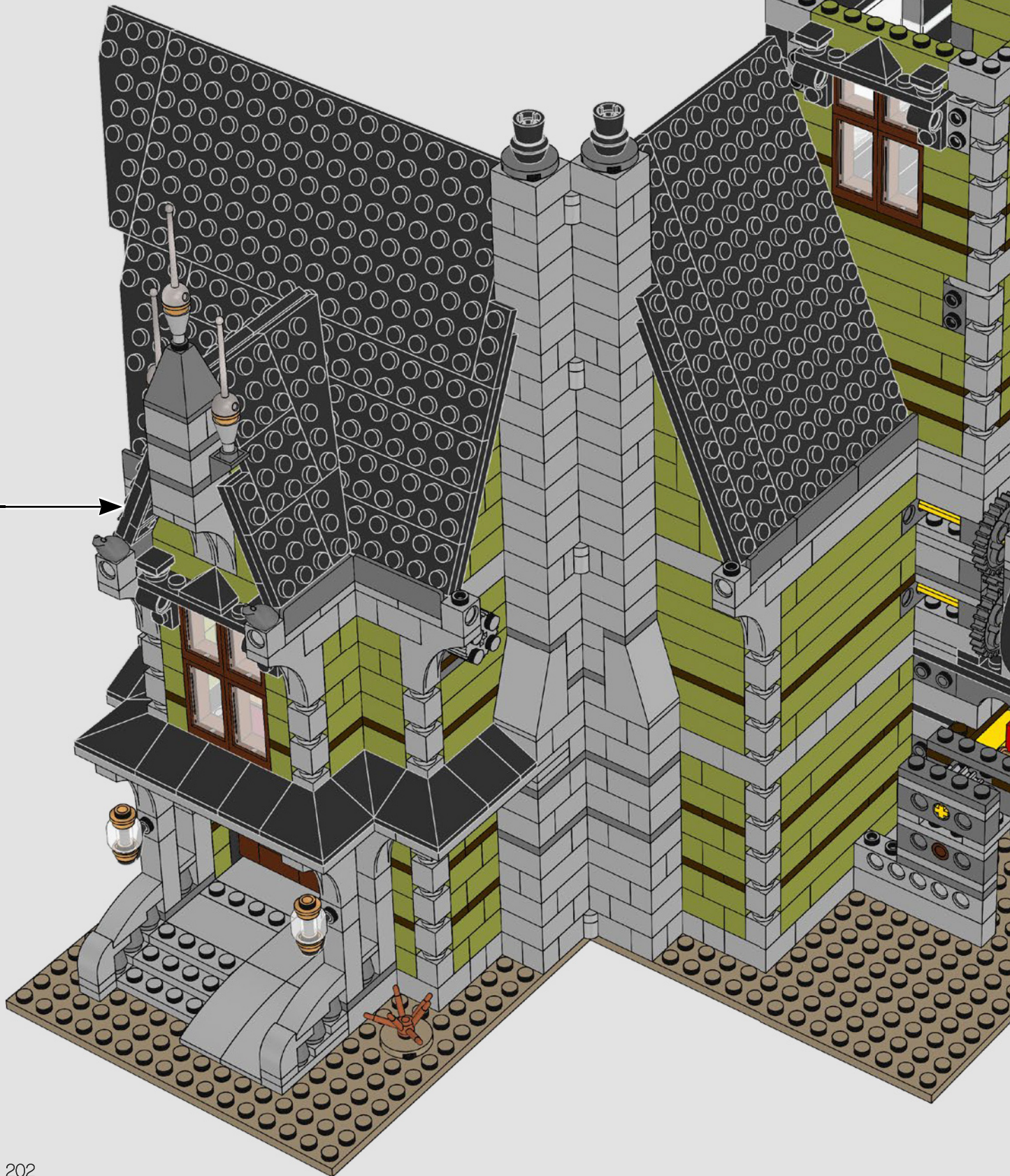

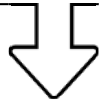

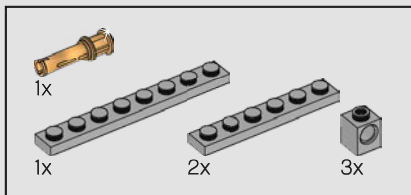

320

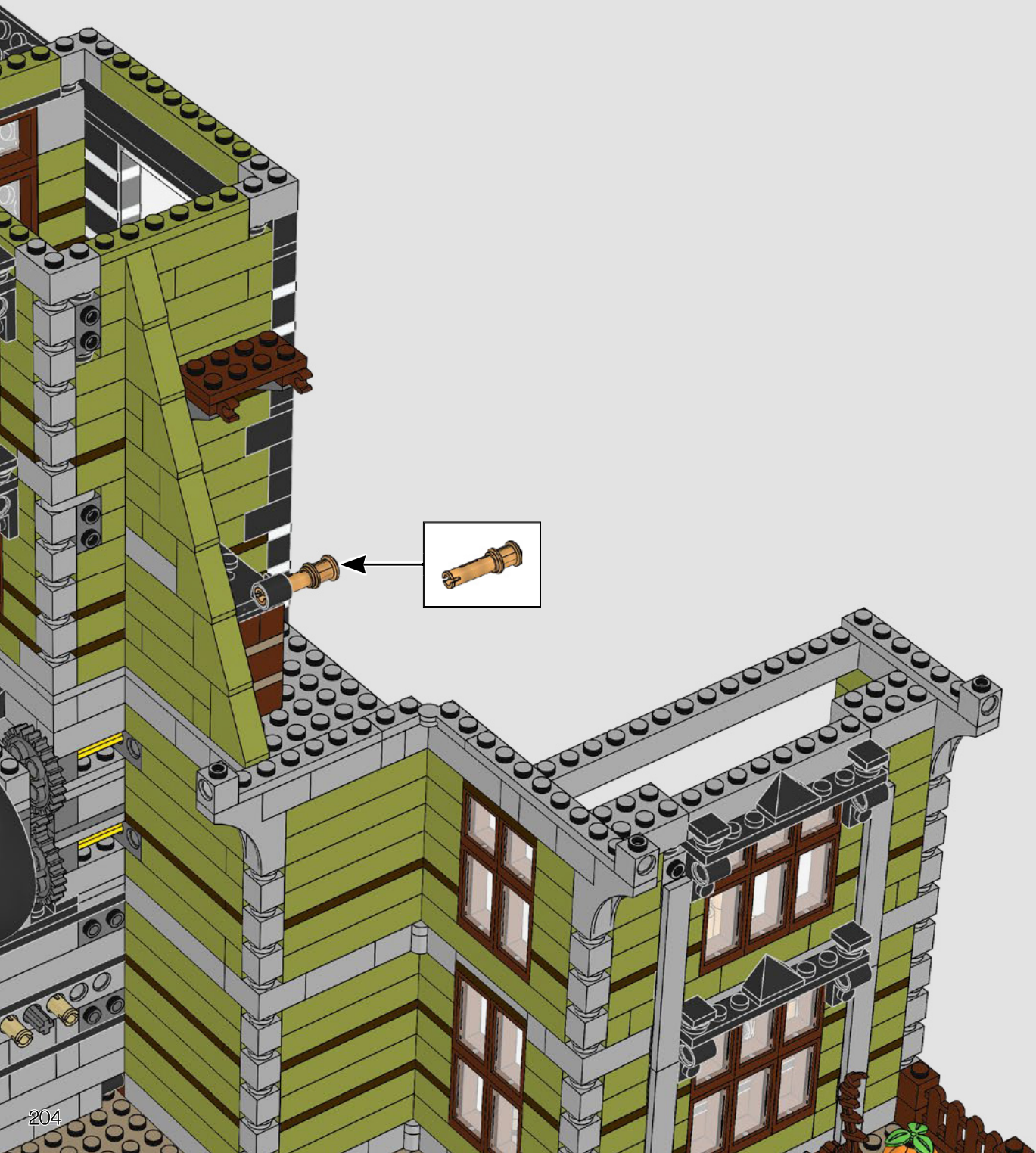

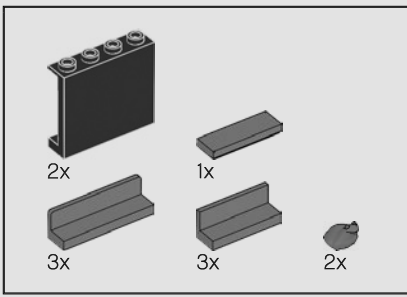

321

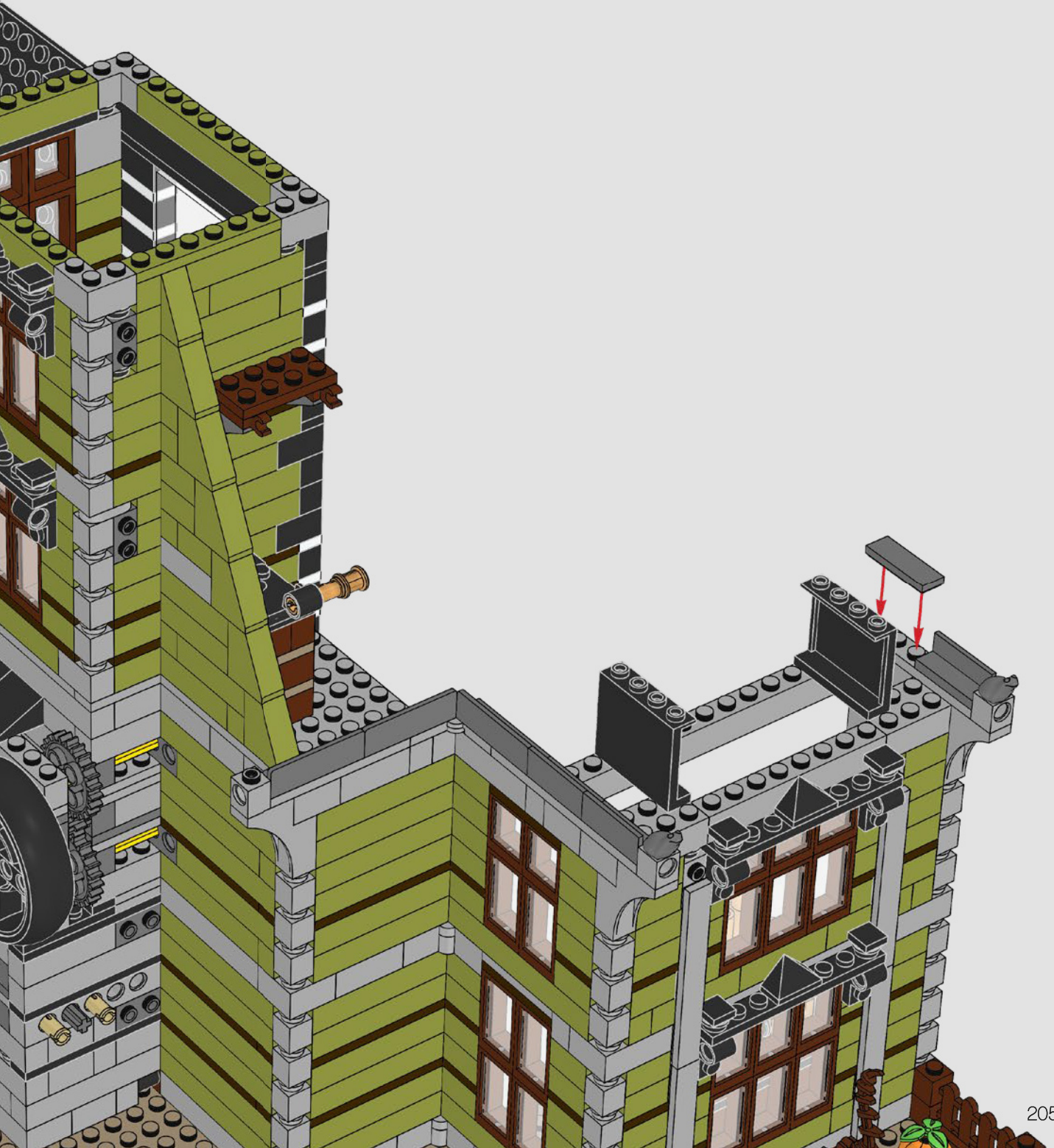

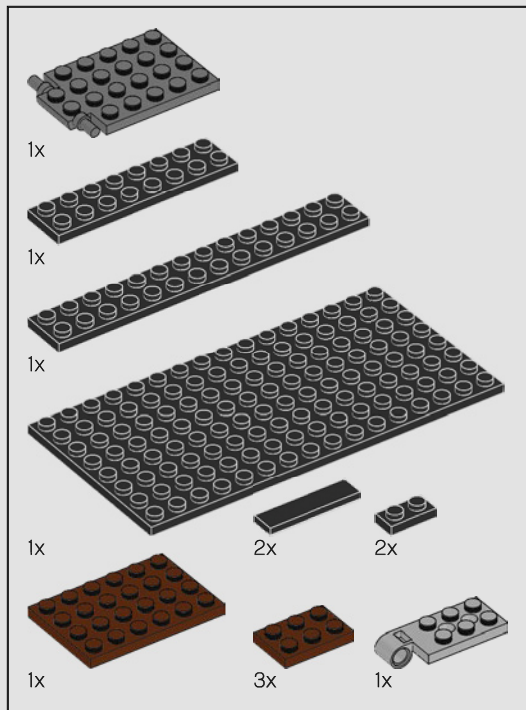

322

1

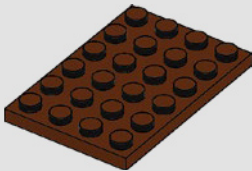

2

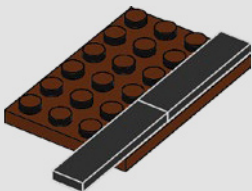

3

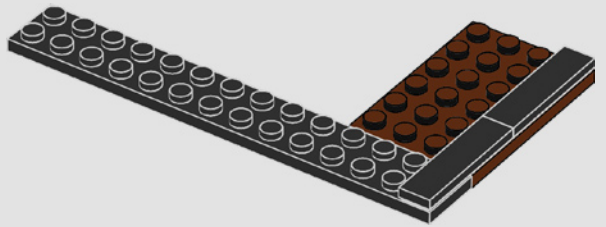

4

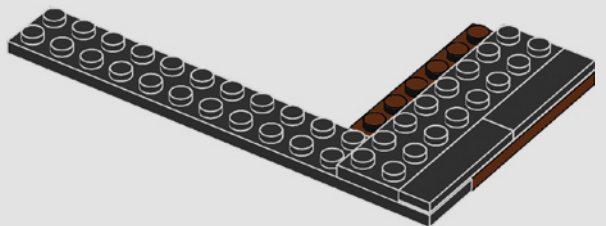

5

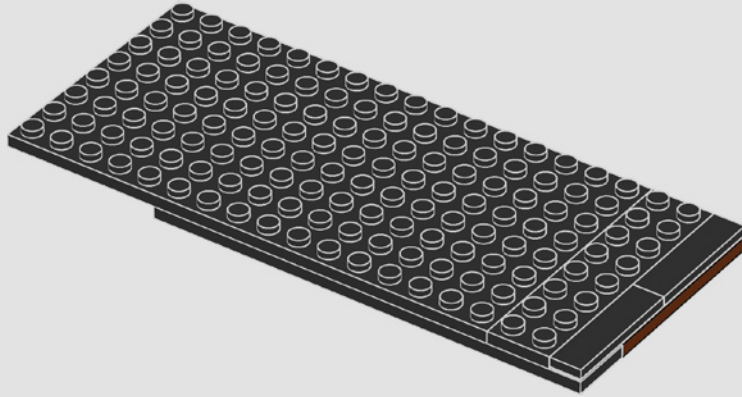

6

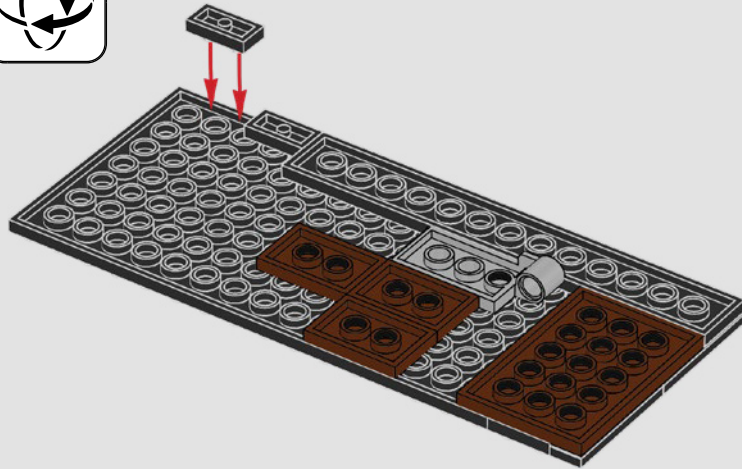

7

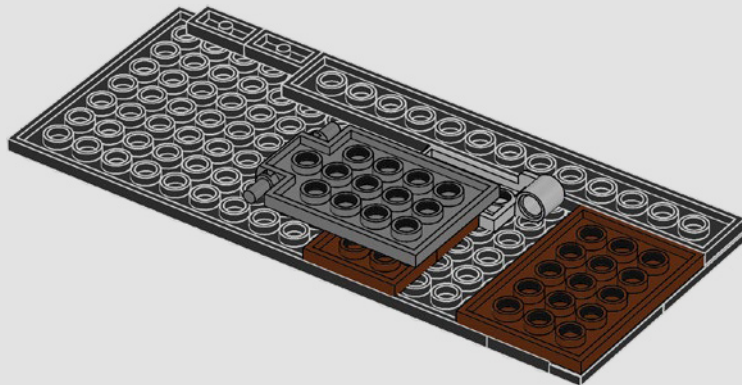



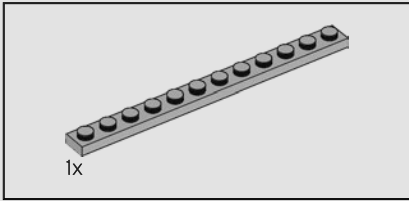
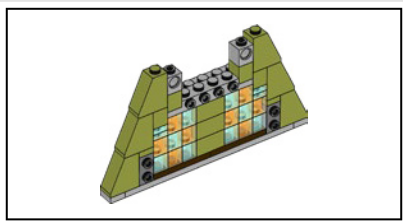

323

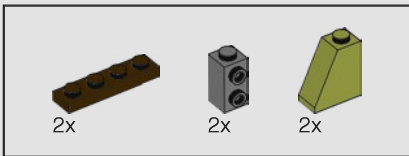
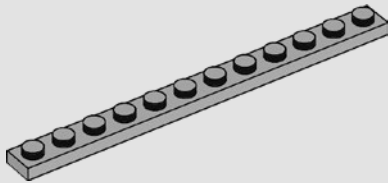

324

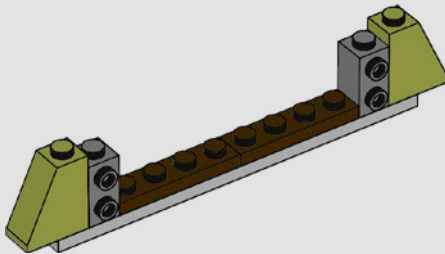

325

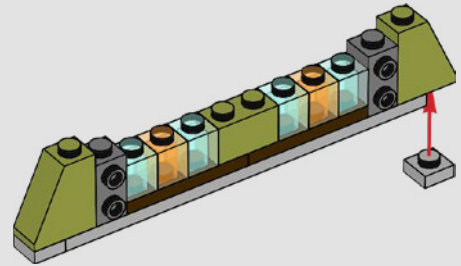

326

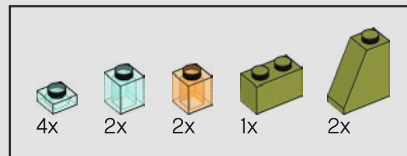
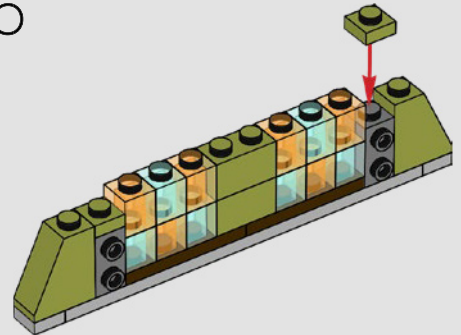

327

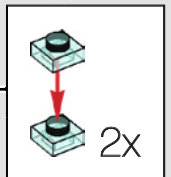
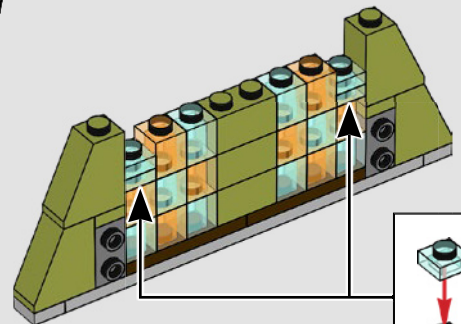

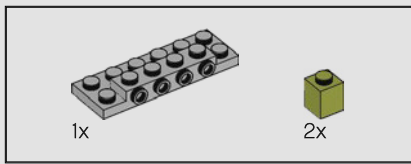

328

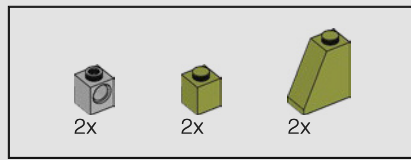
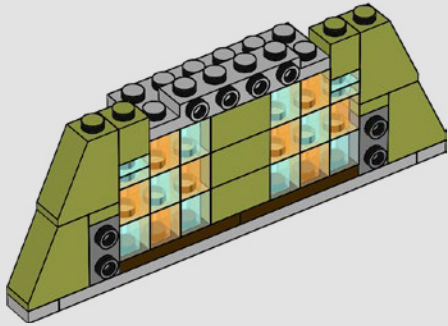

329

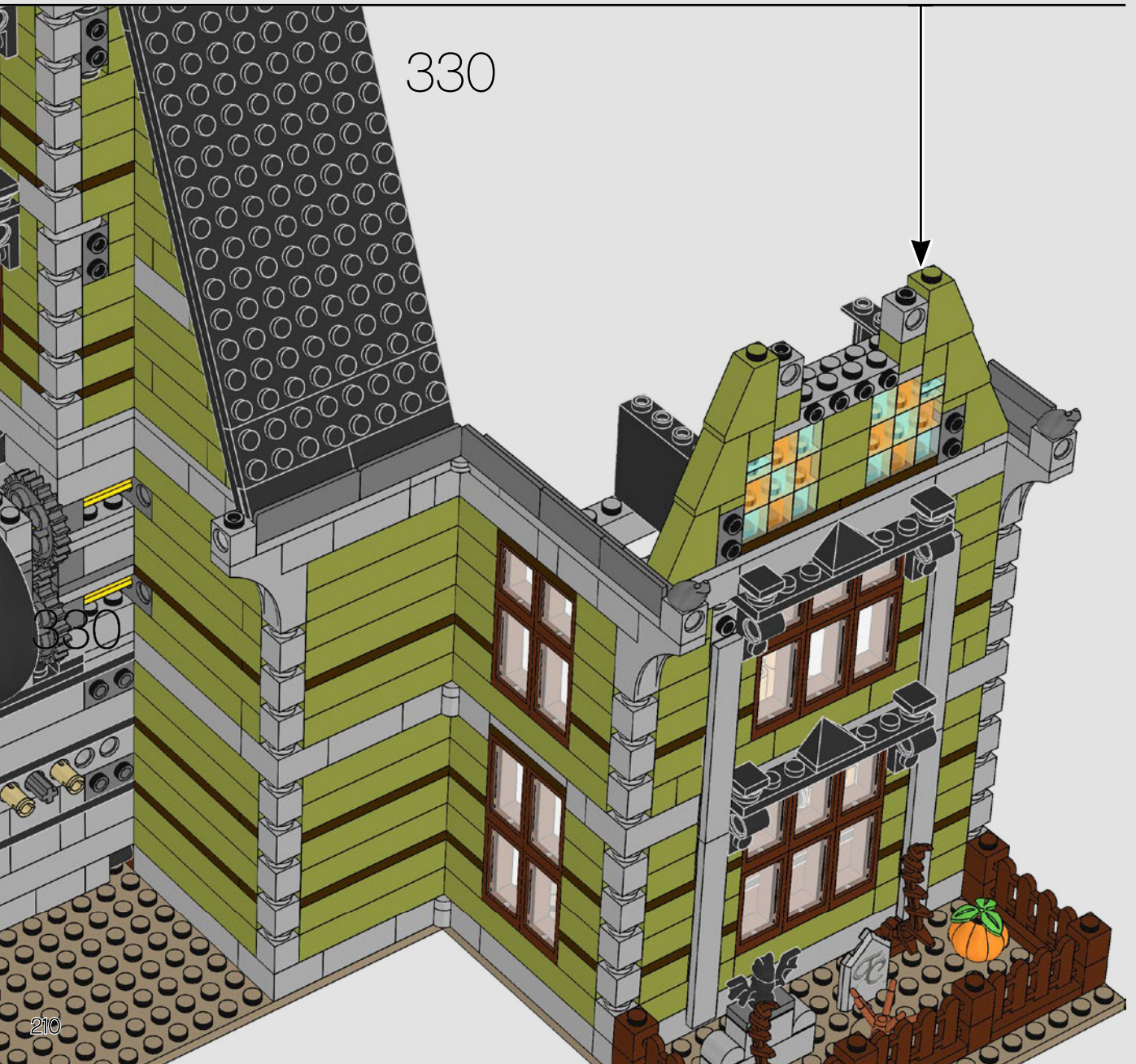
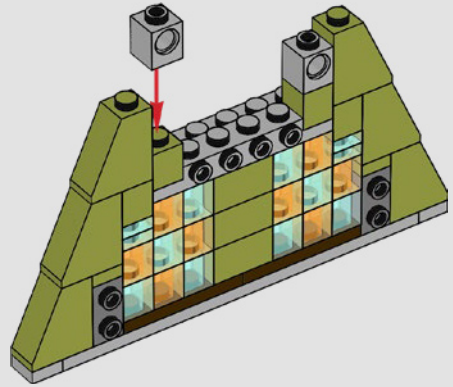

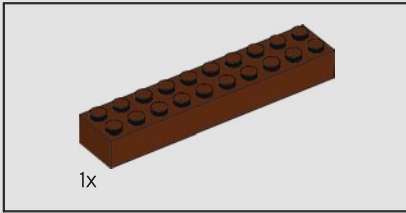
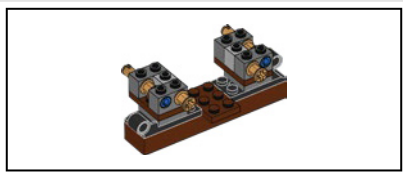

1x

330

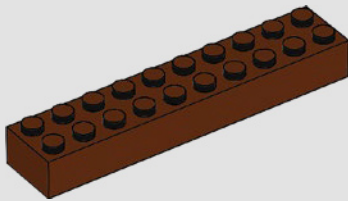

2x

1x

331

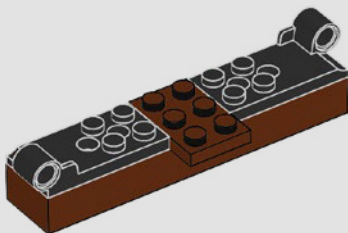

2x

332

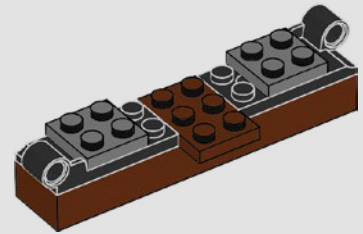

2x

333

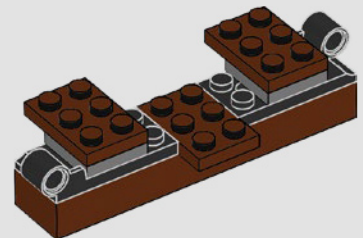

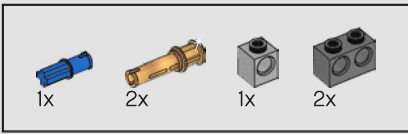

334

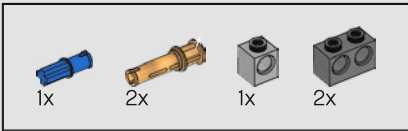
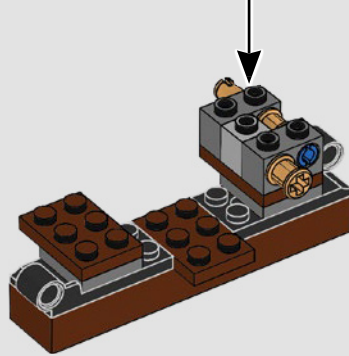
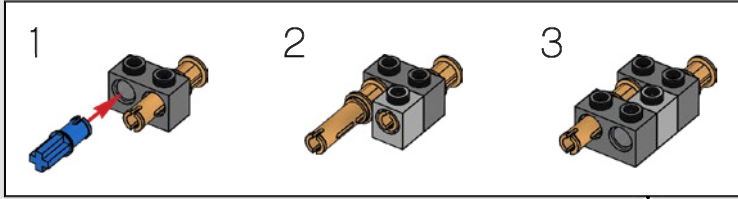

335

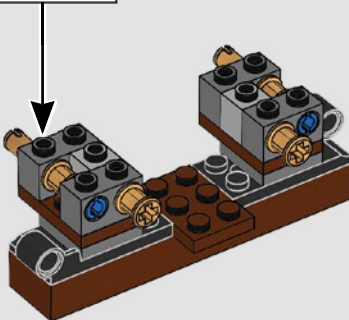
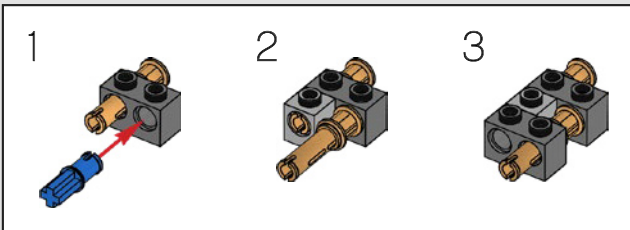

336



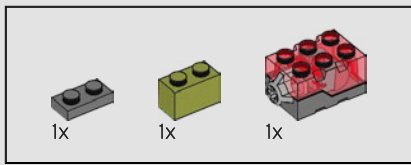

337

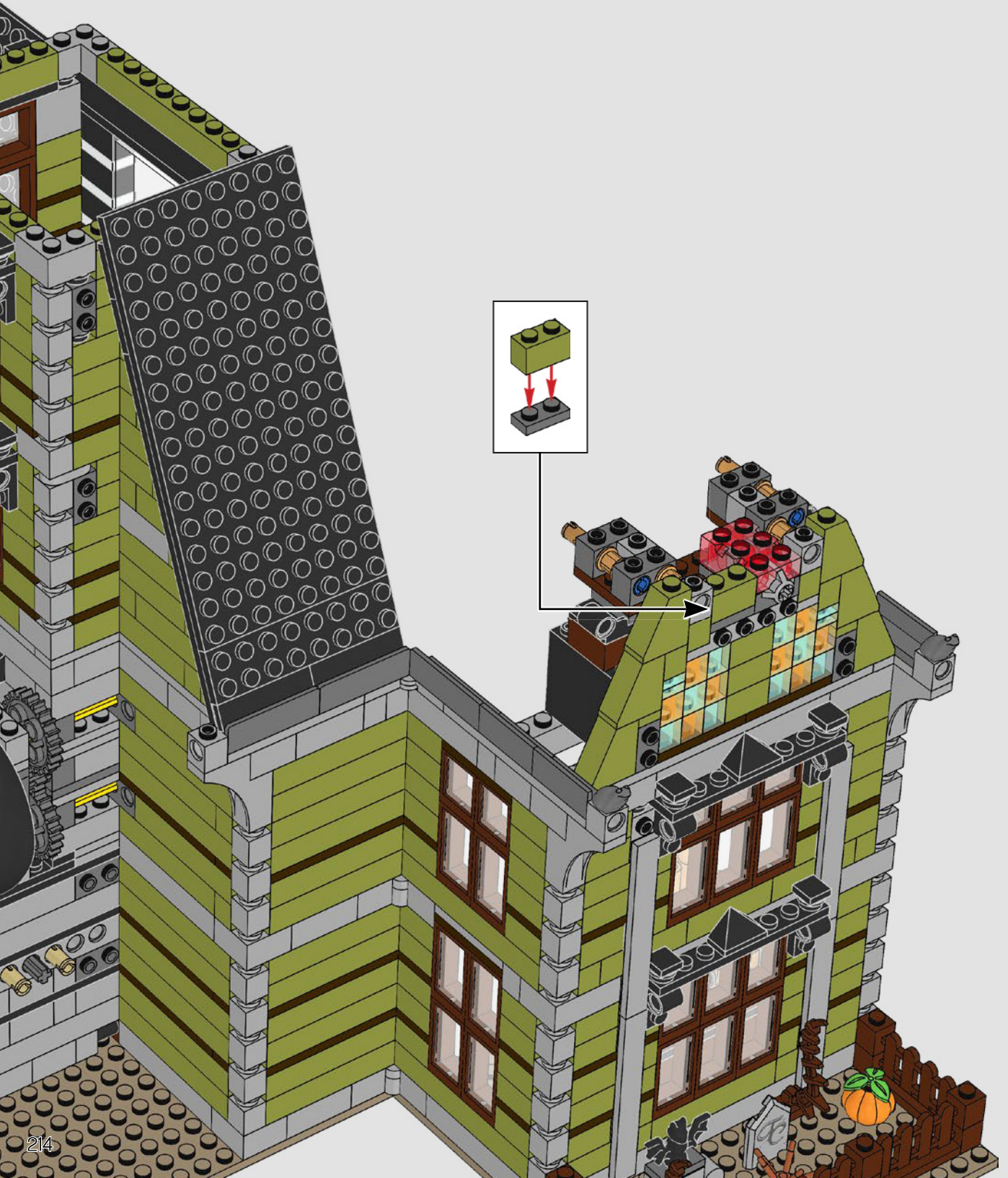
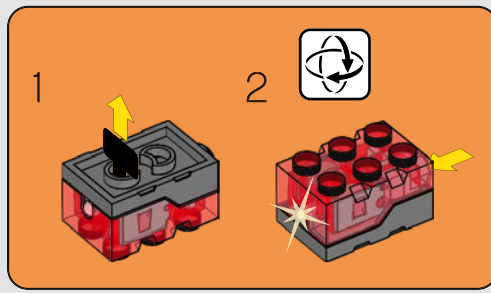

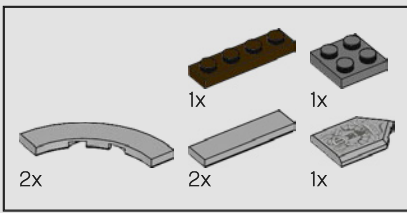

338

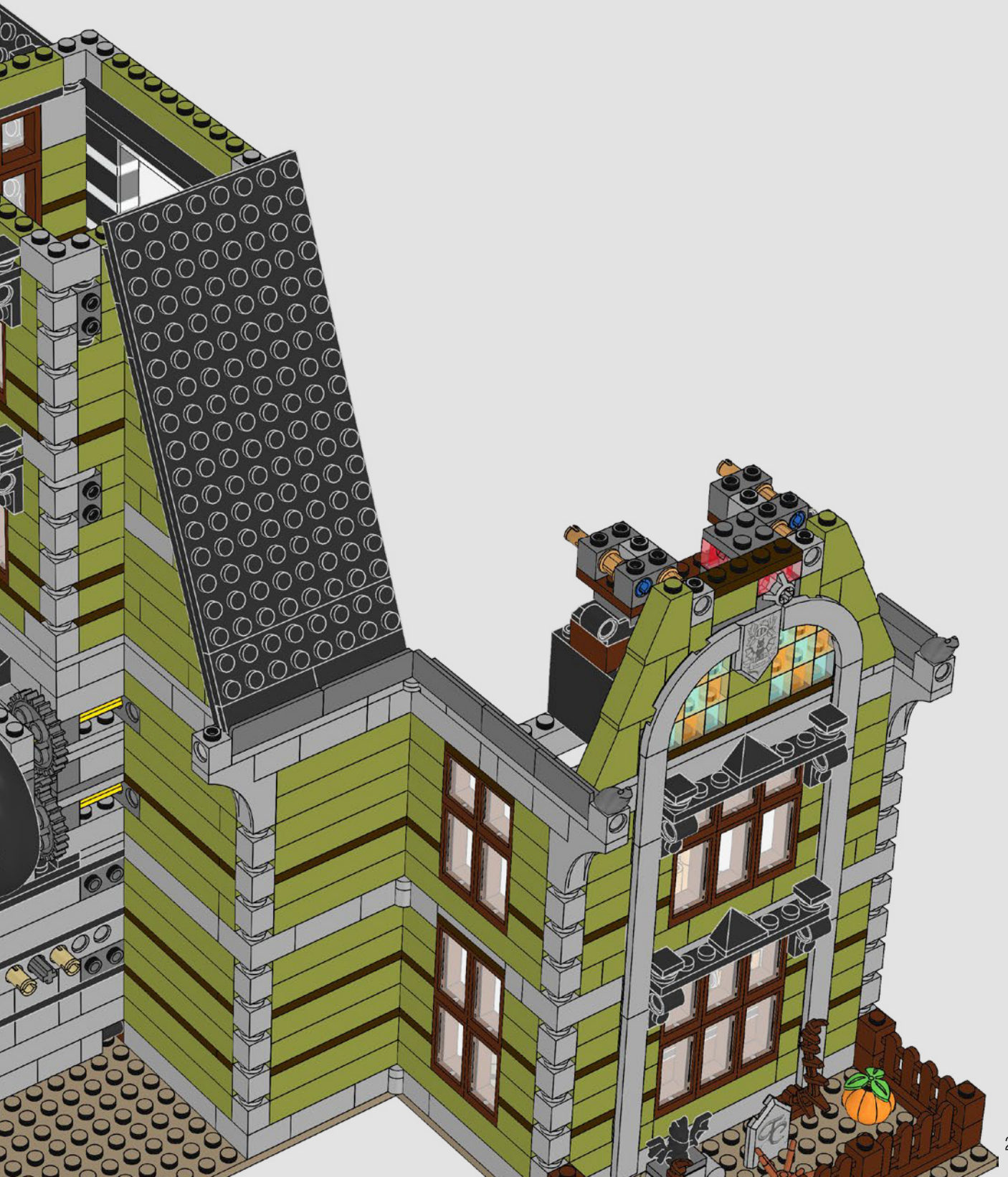

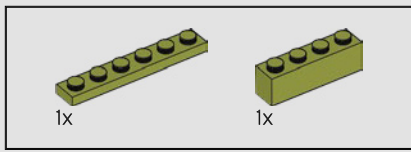

339

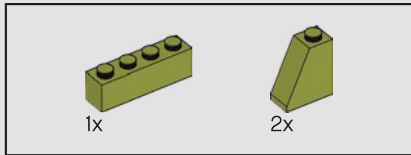
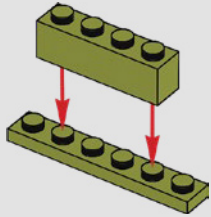

340

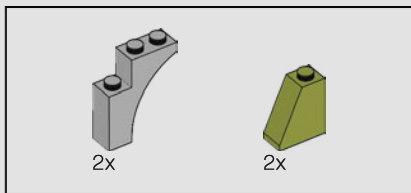
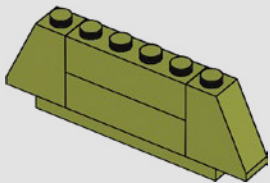

341

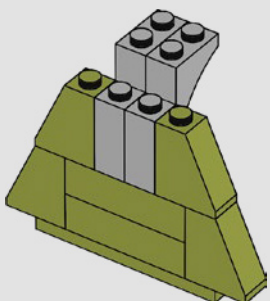

342

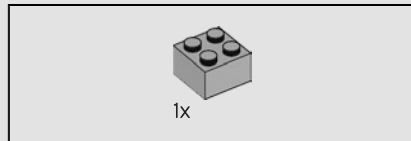
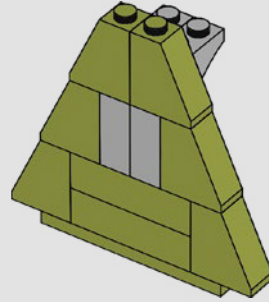

343

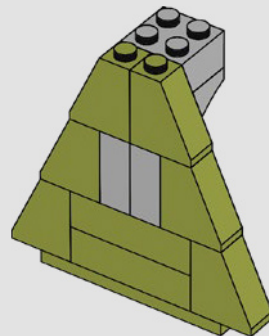

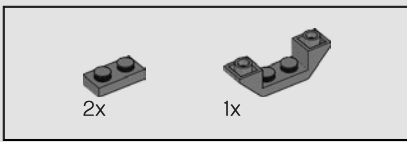

344

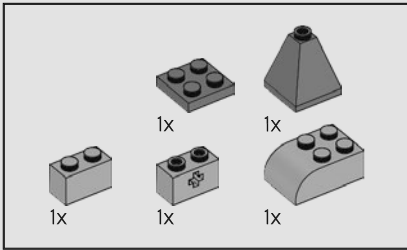
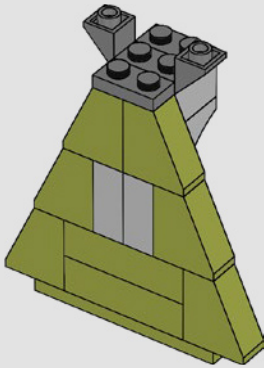

345

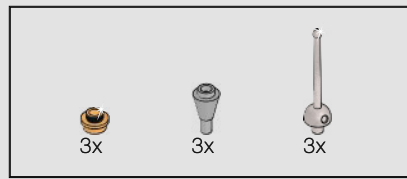
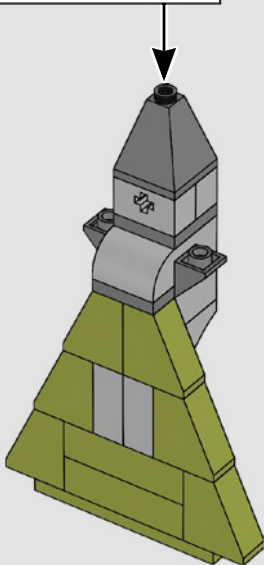
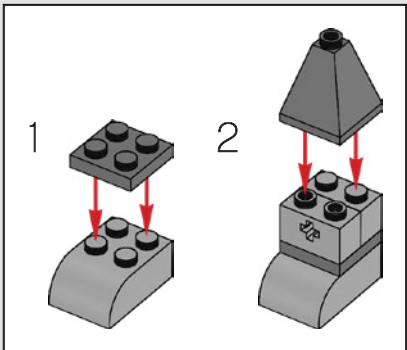

346

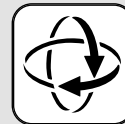
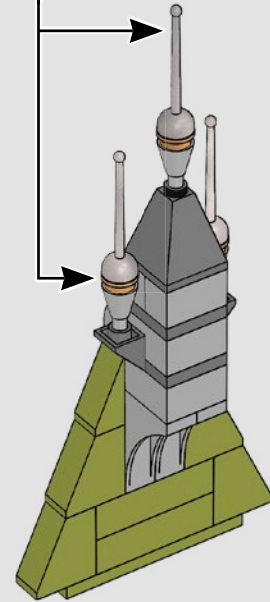
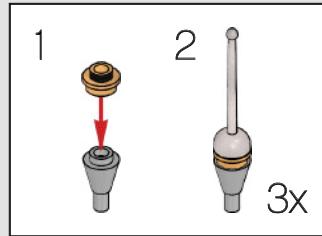

347

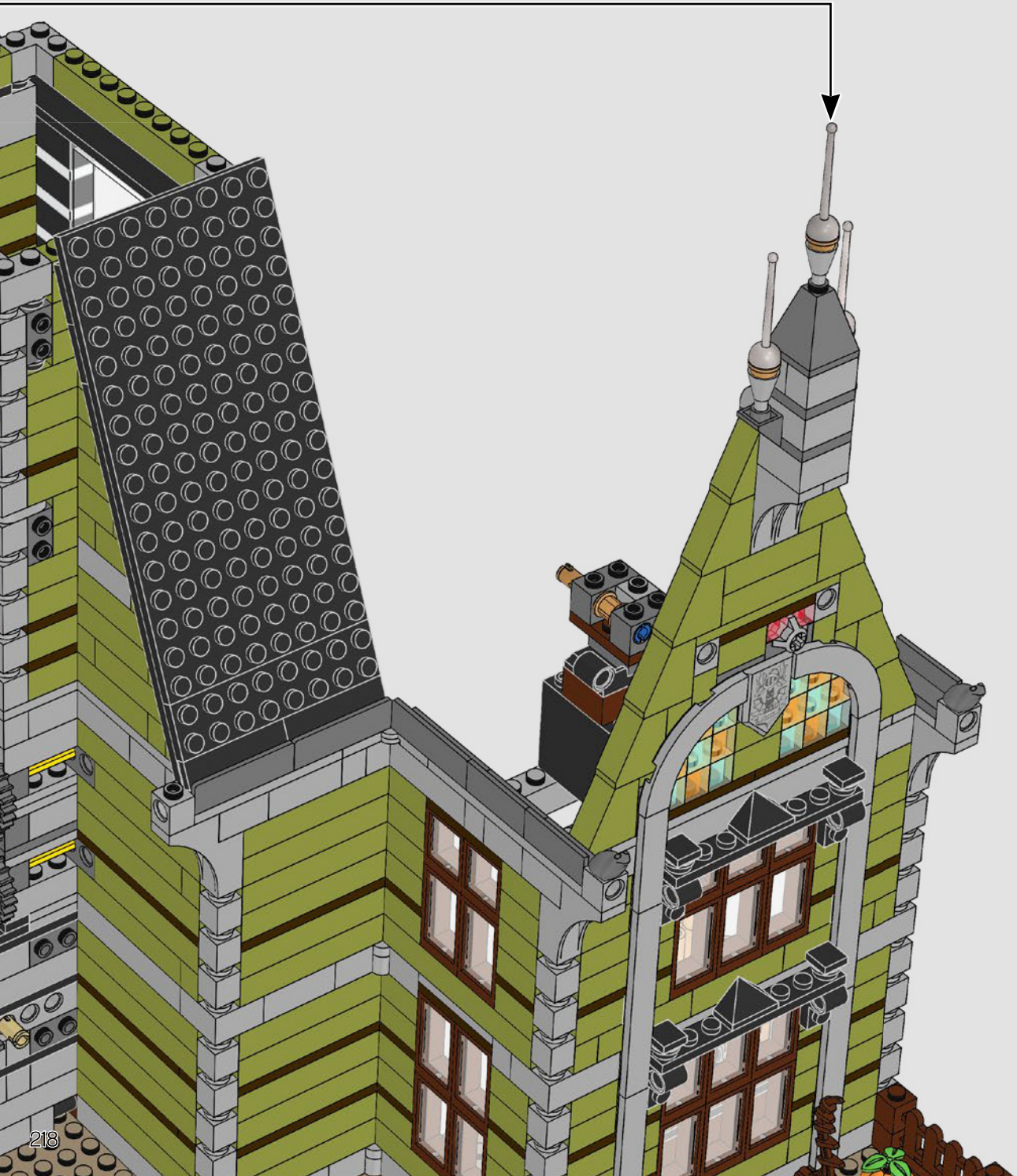

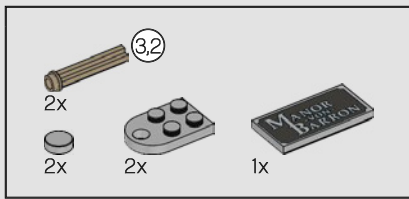

348

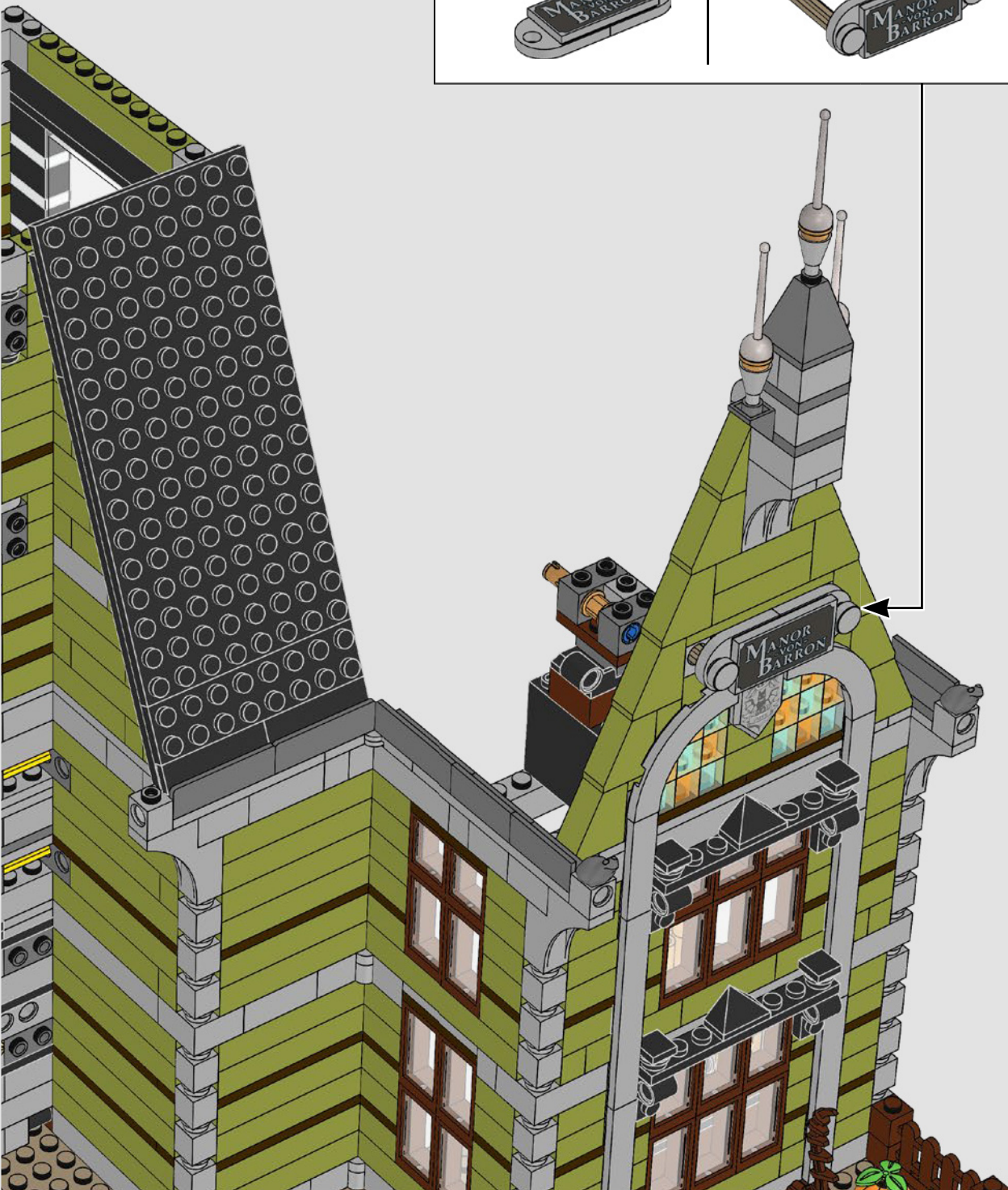
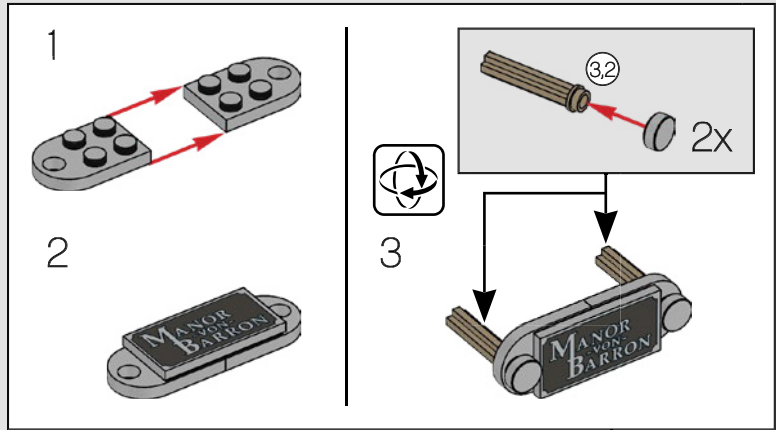
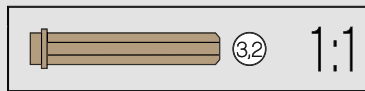

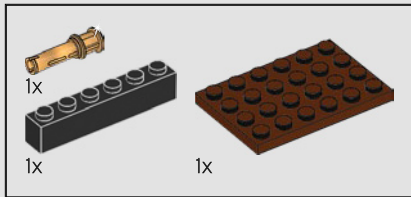

349

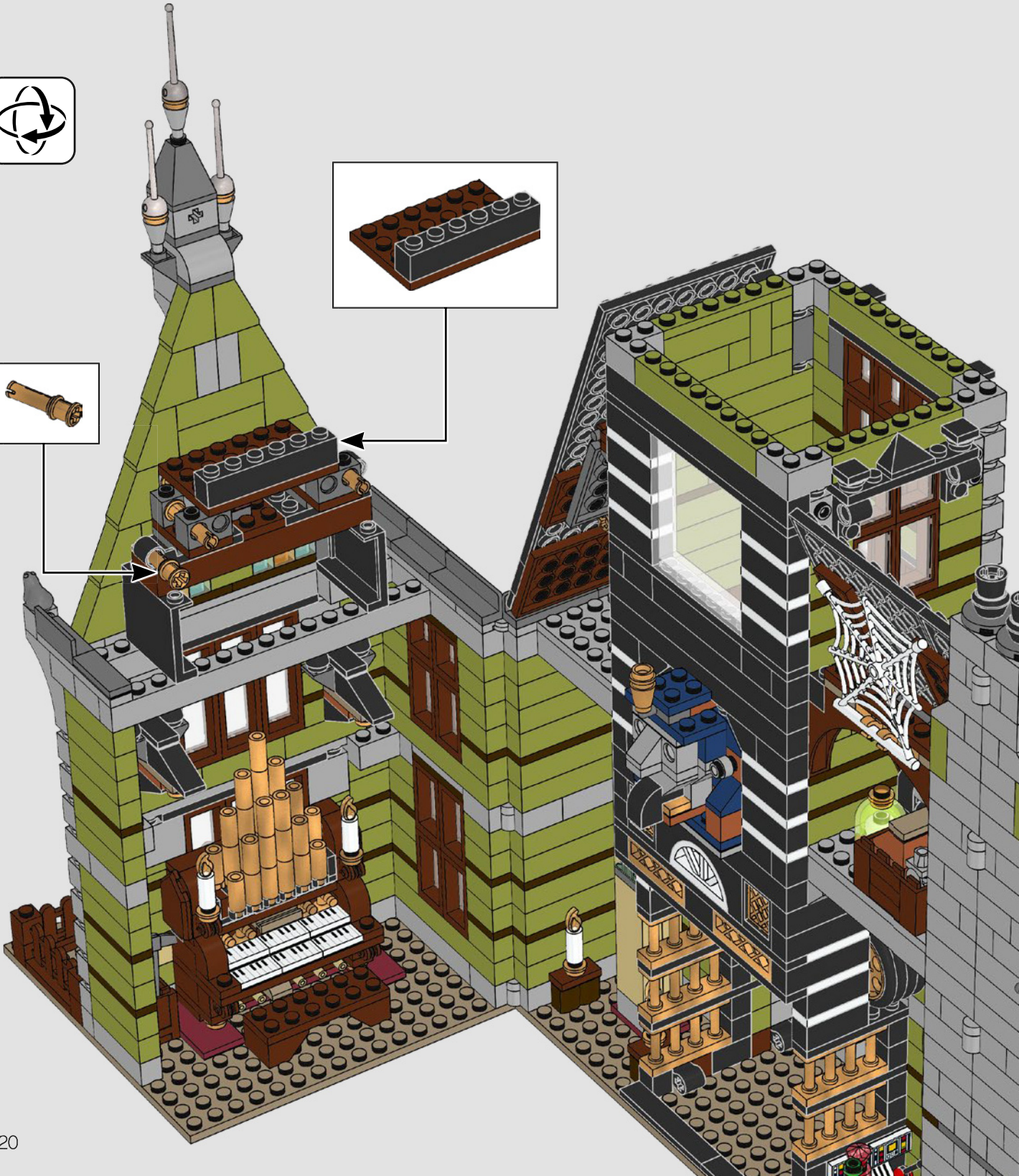
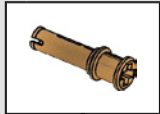
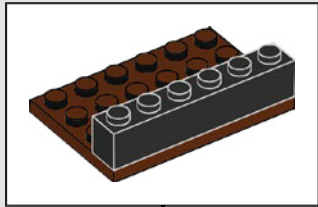

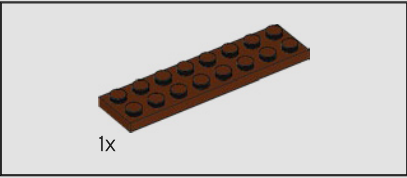
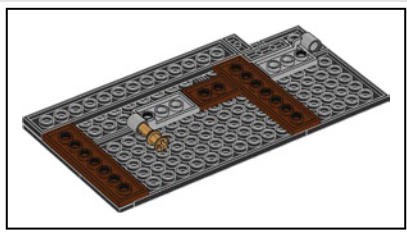

350

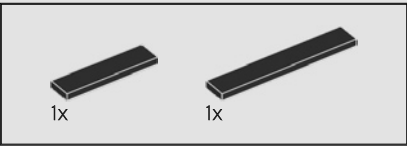
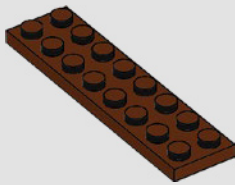

351

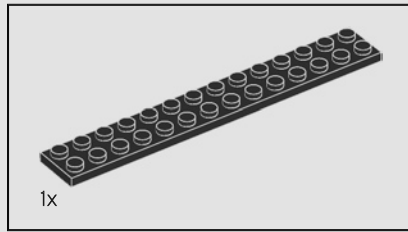
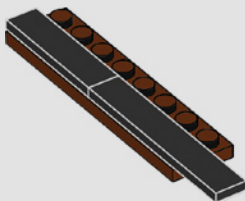

352

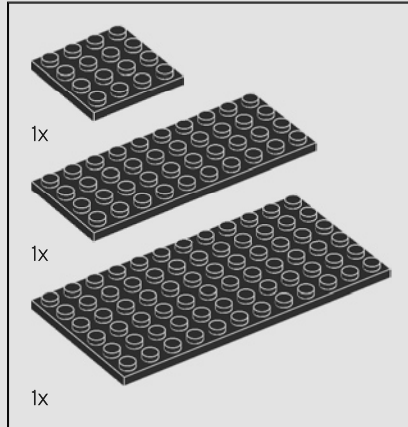
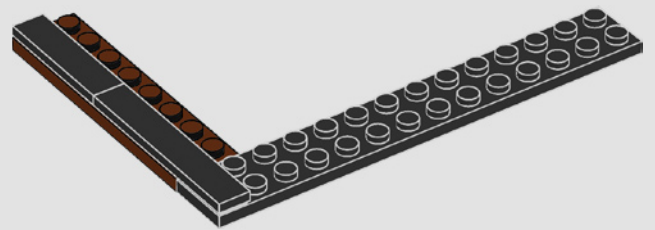

353

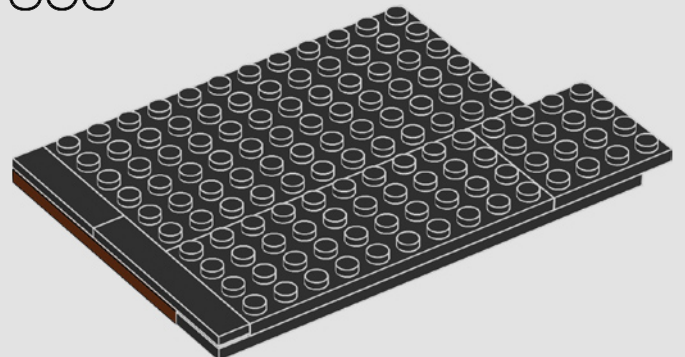

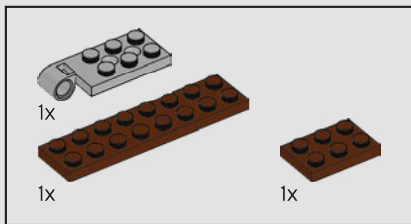

354

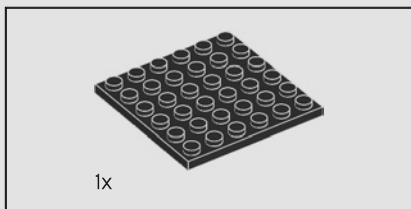
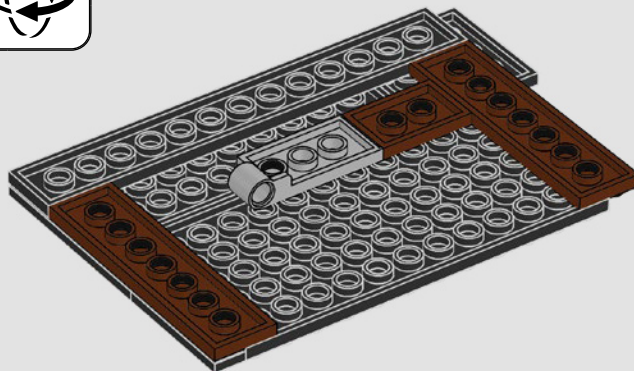

355

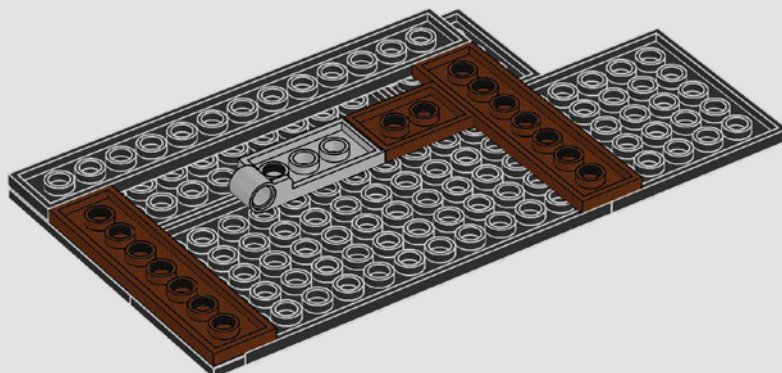

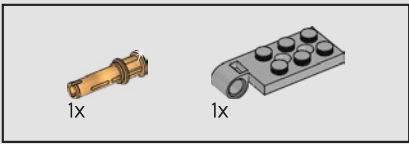

356

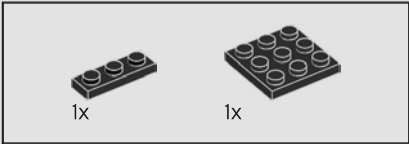
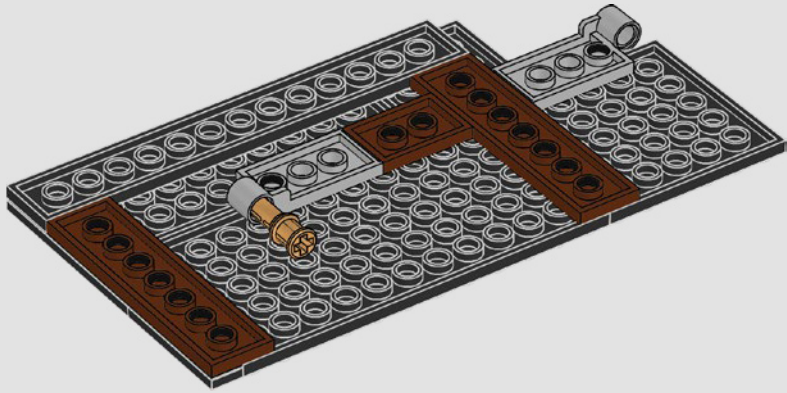

357

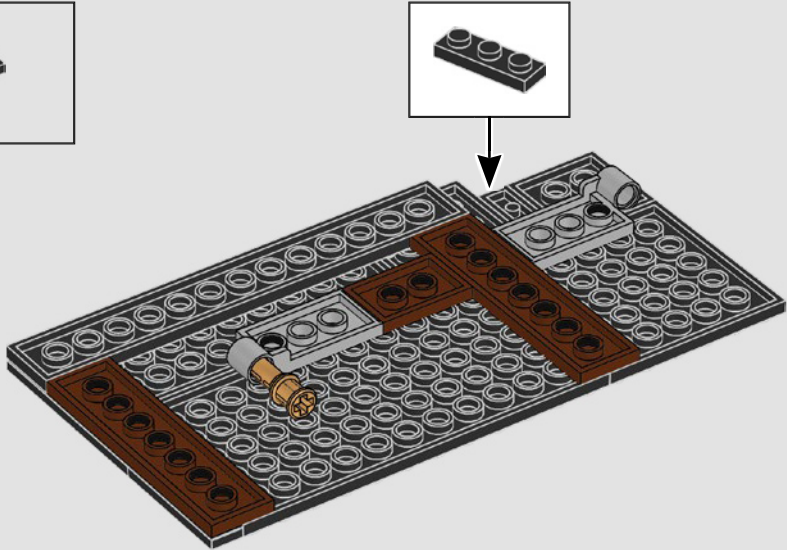

358

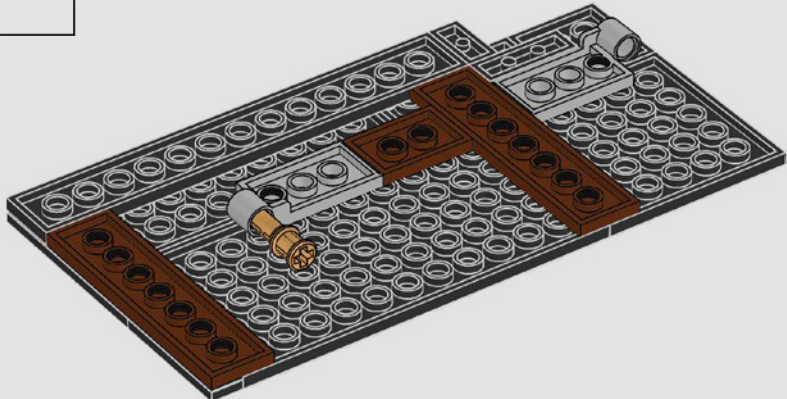

359

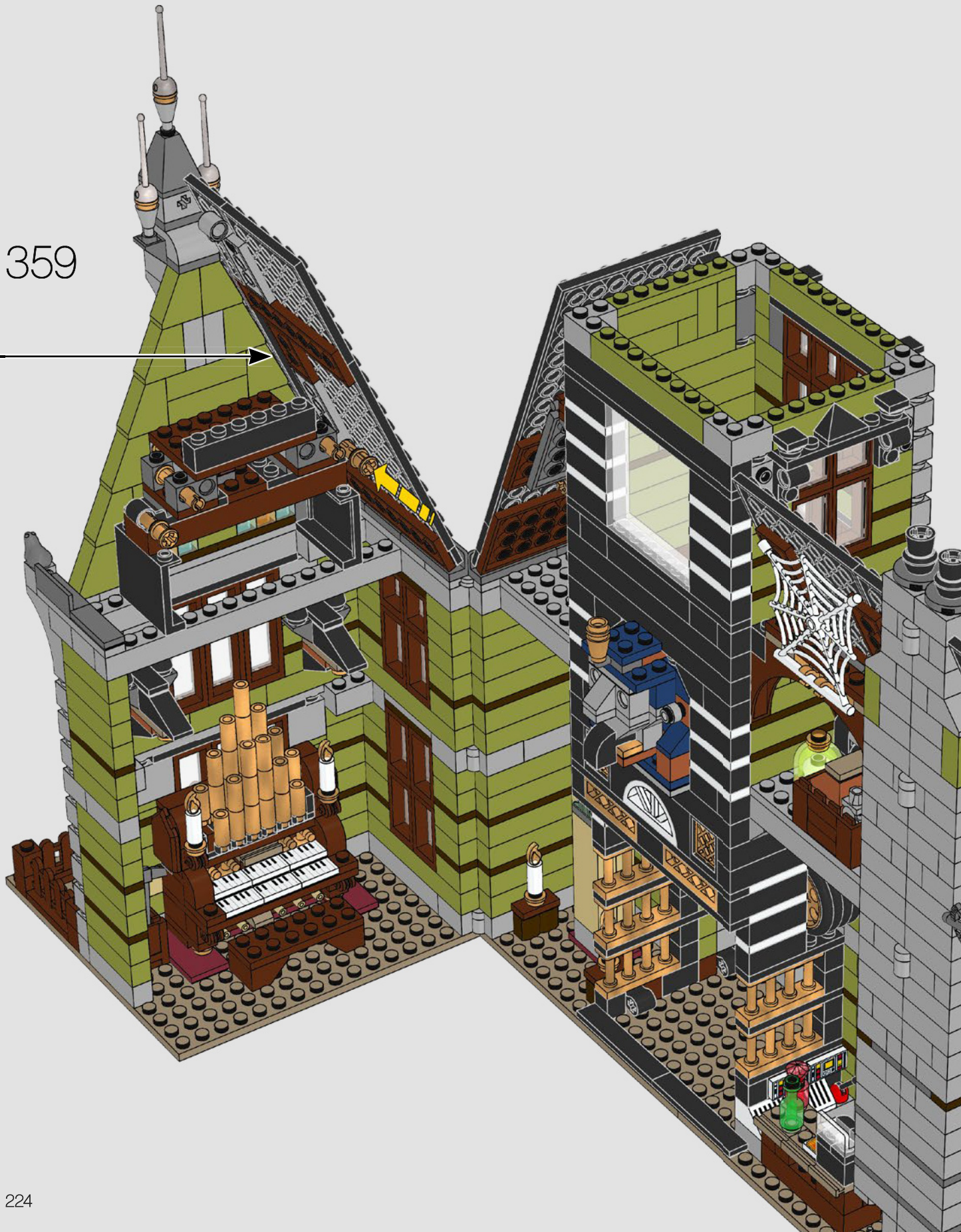

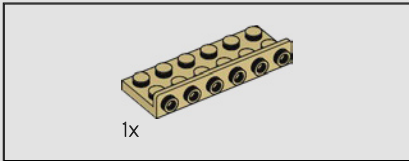

360

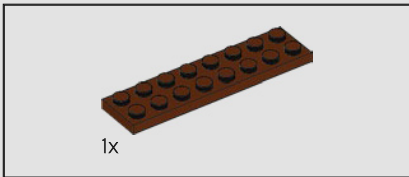
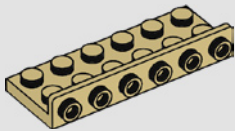

361

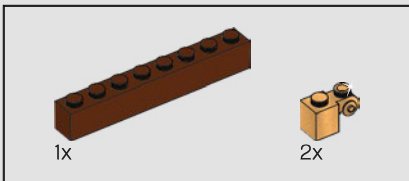
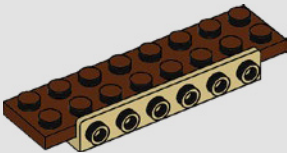

362

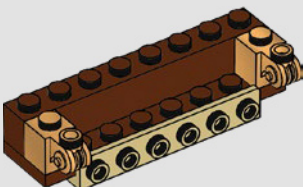

363

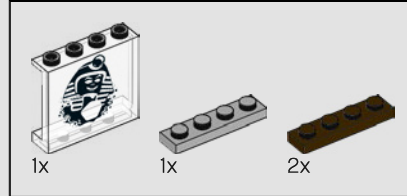
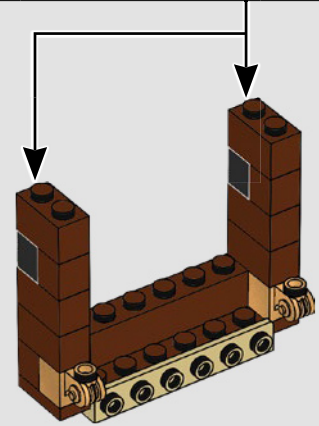
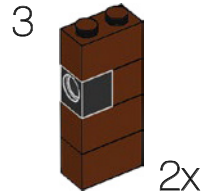
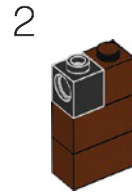
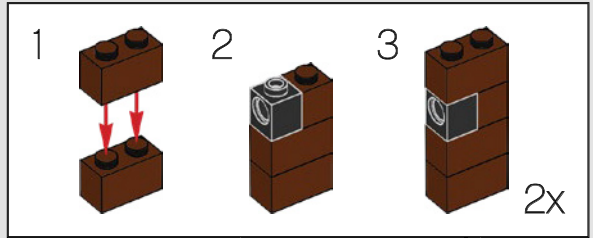

364

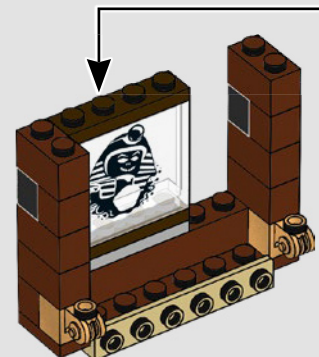
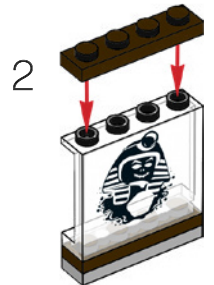
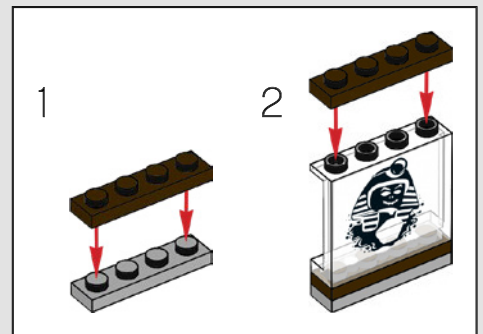



365

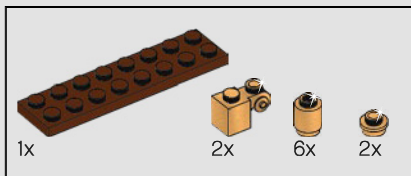

366

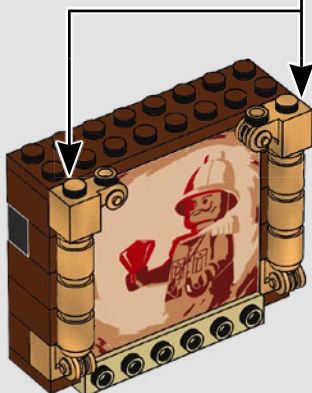
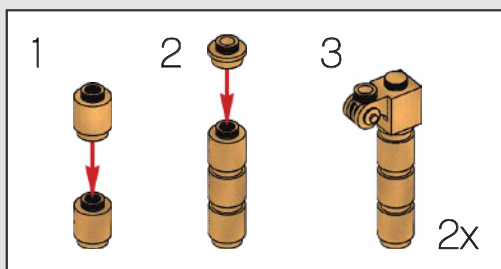

367

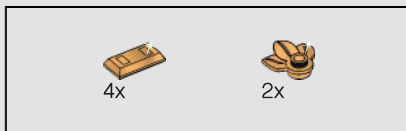
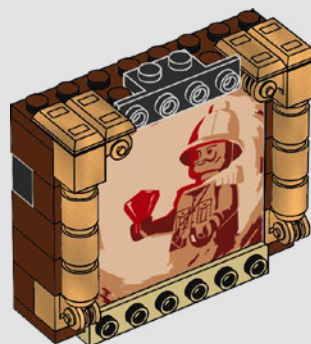

368



Das Porträt von Samuel von Barron

Als das Porträt fertig war, begann der Rubin seltsam zu leuchten. Da von Barron von der Mumie mit einem Fluch belegt worden war, trieben ihn die schrecklichen Witze des Pharaos Hotep in den Wahnsinn.

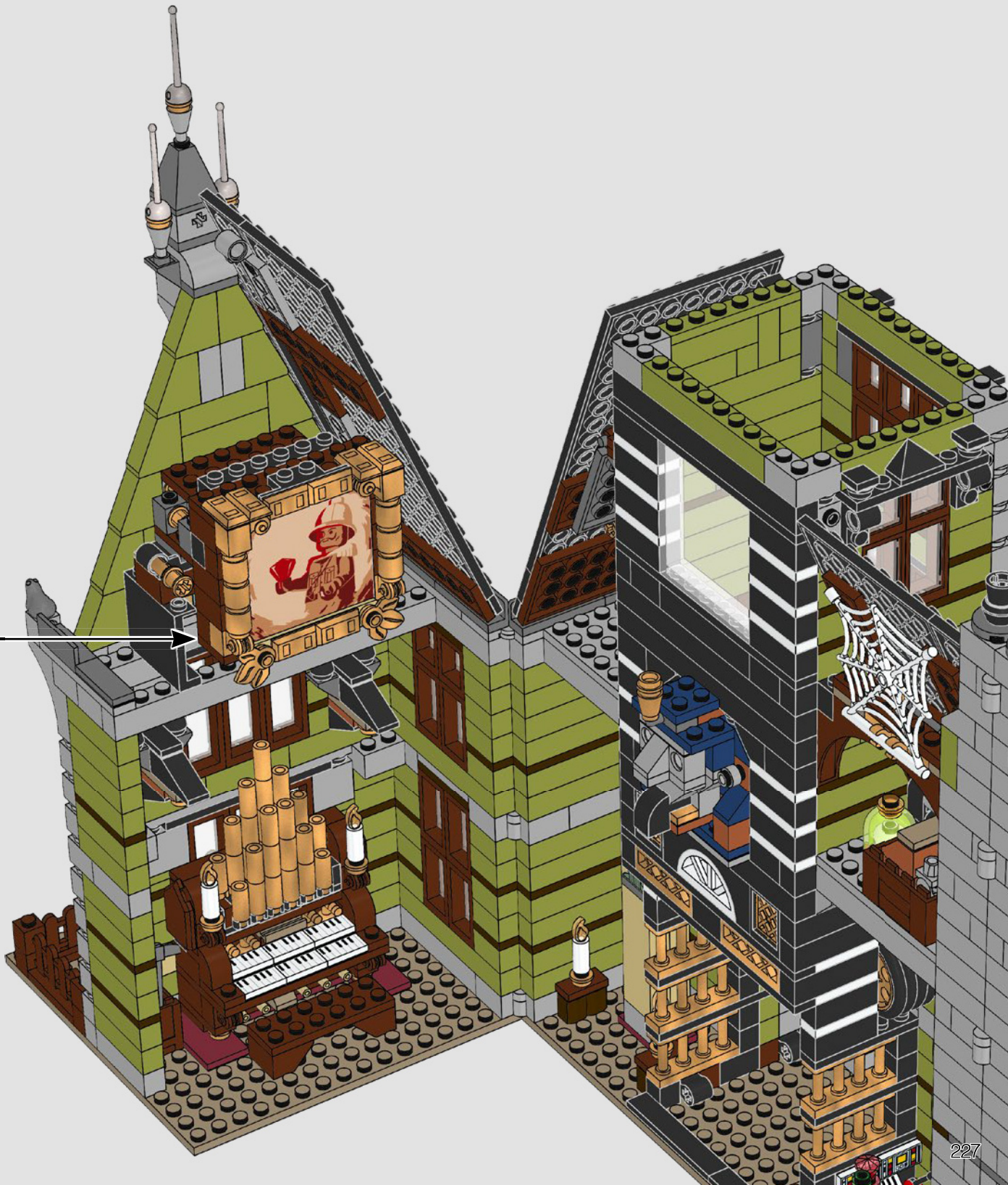

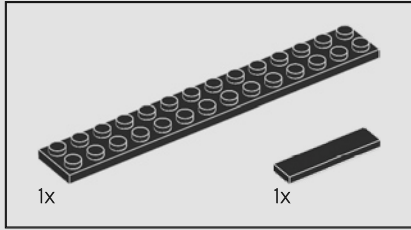
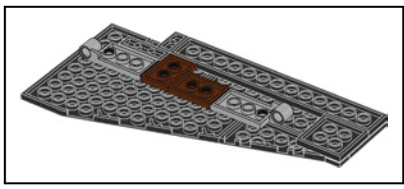

370

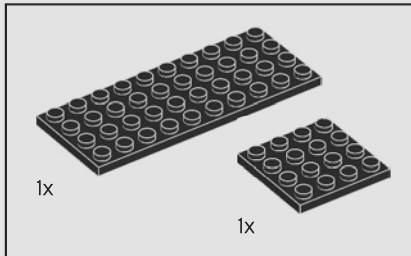
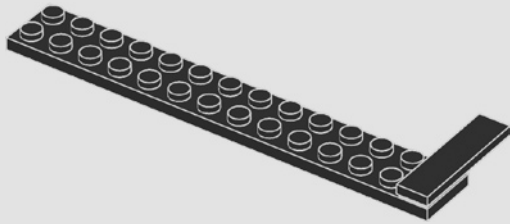

371

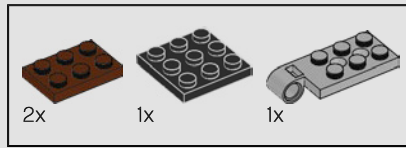
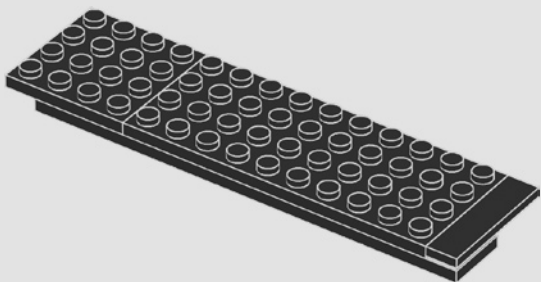

372

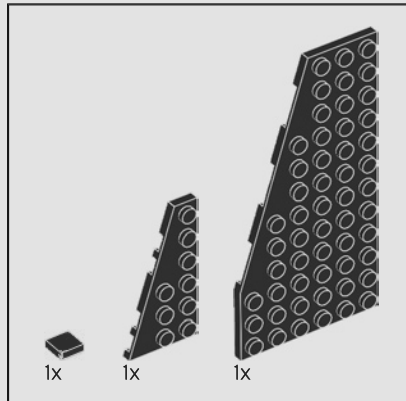
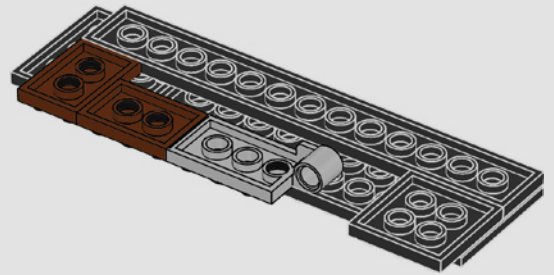

373

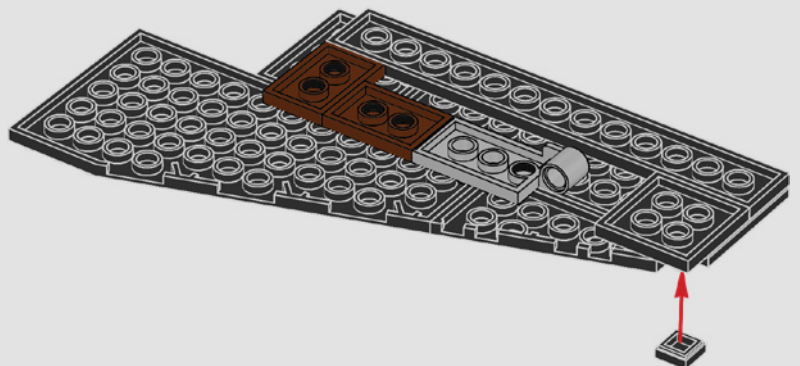

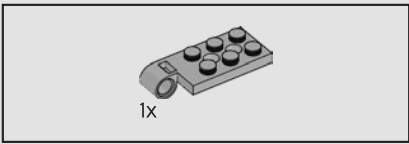

374

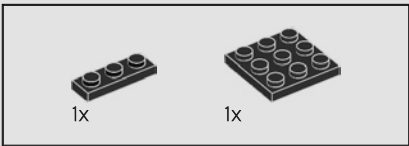
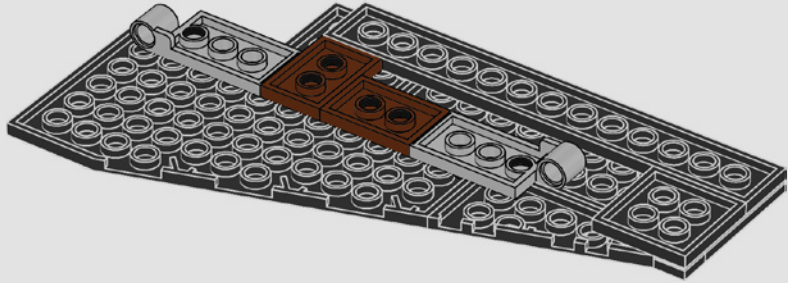

375

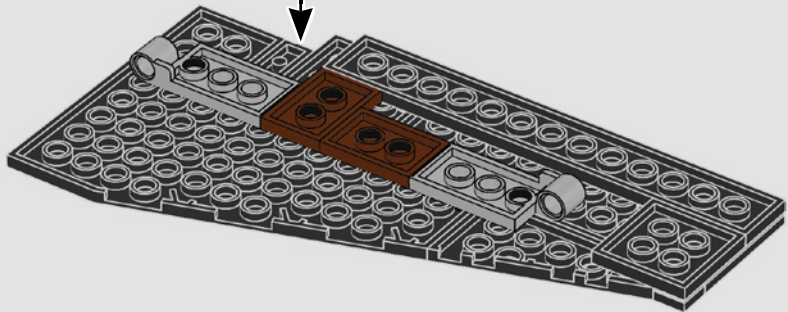
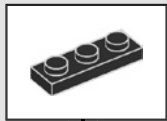

376

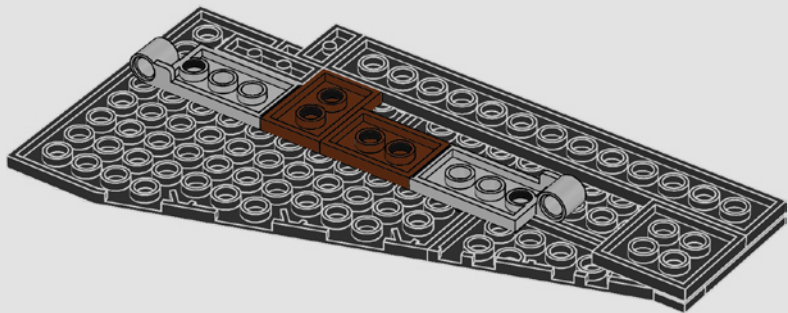

377

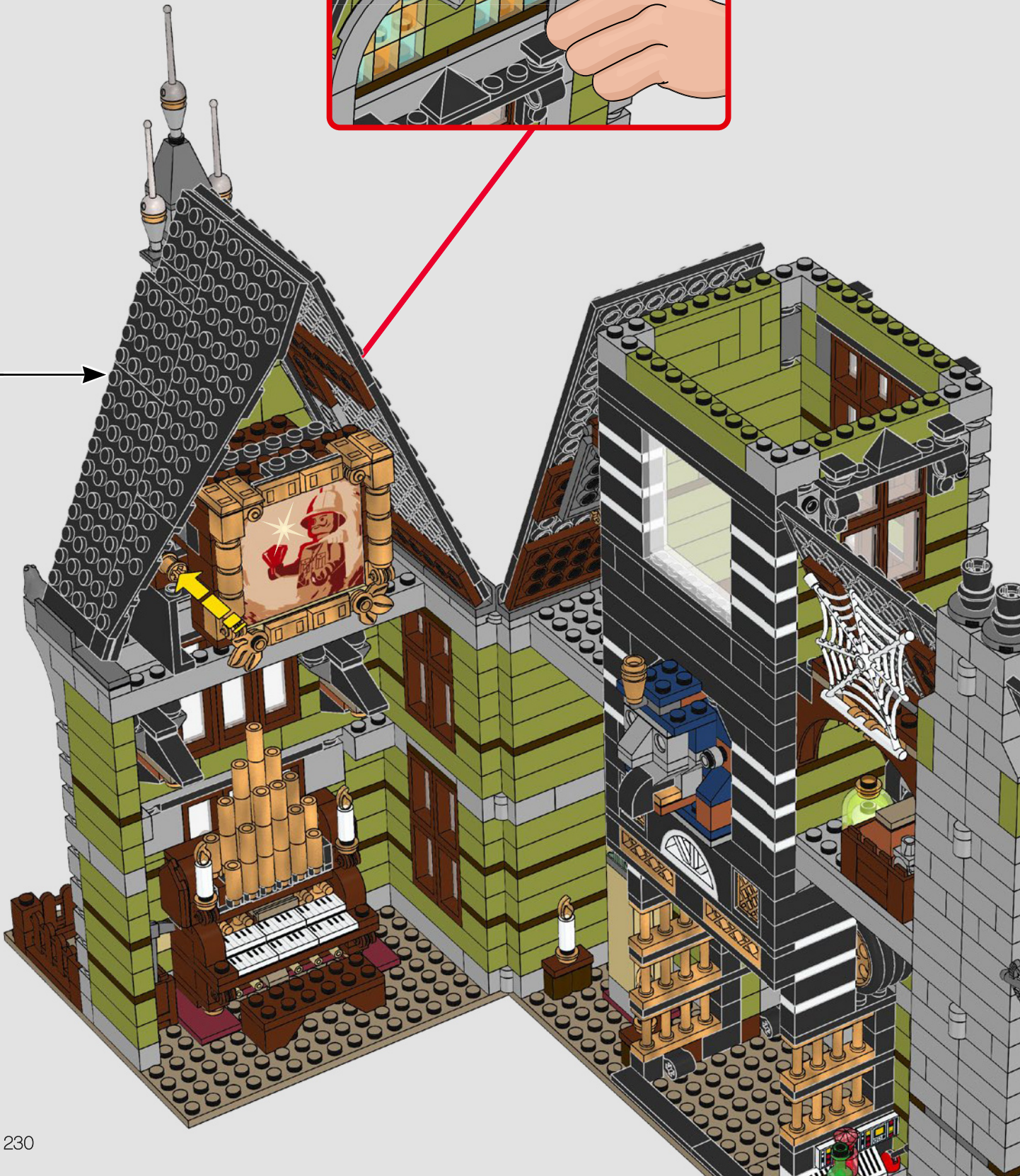
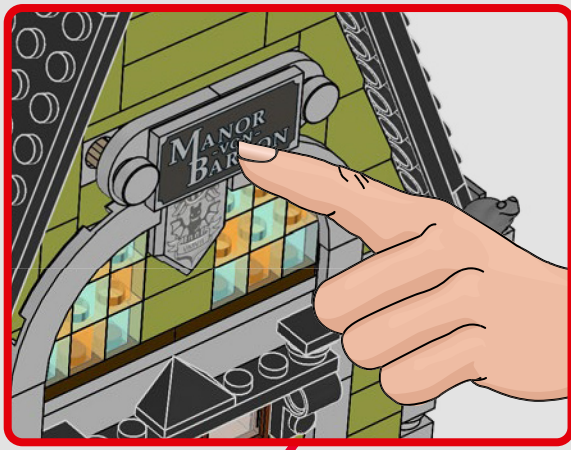

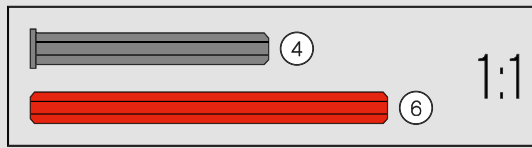
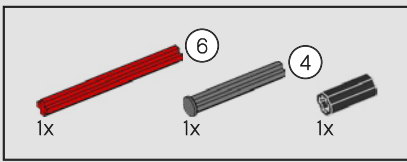

378

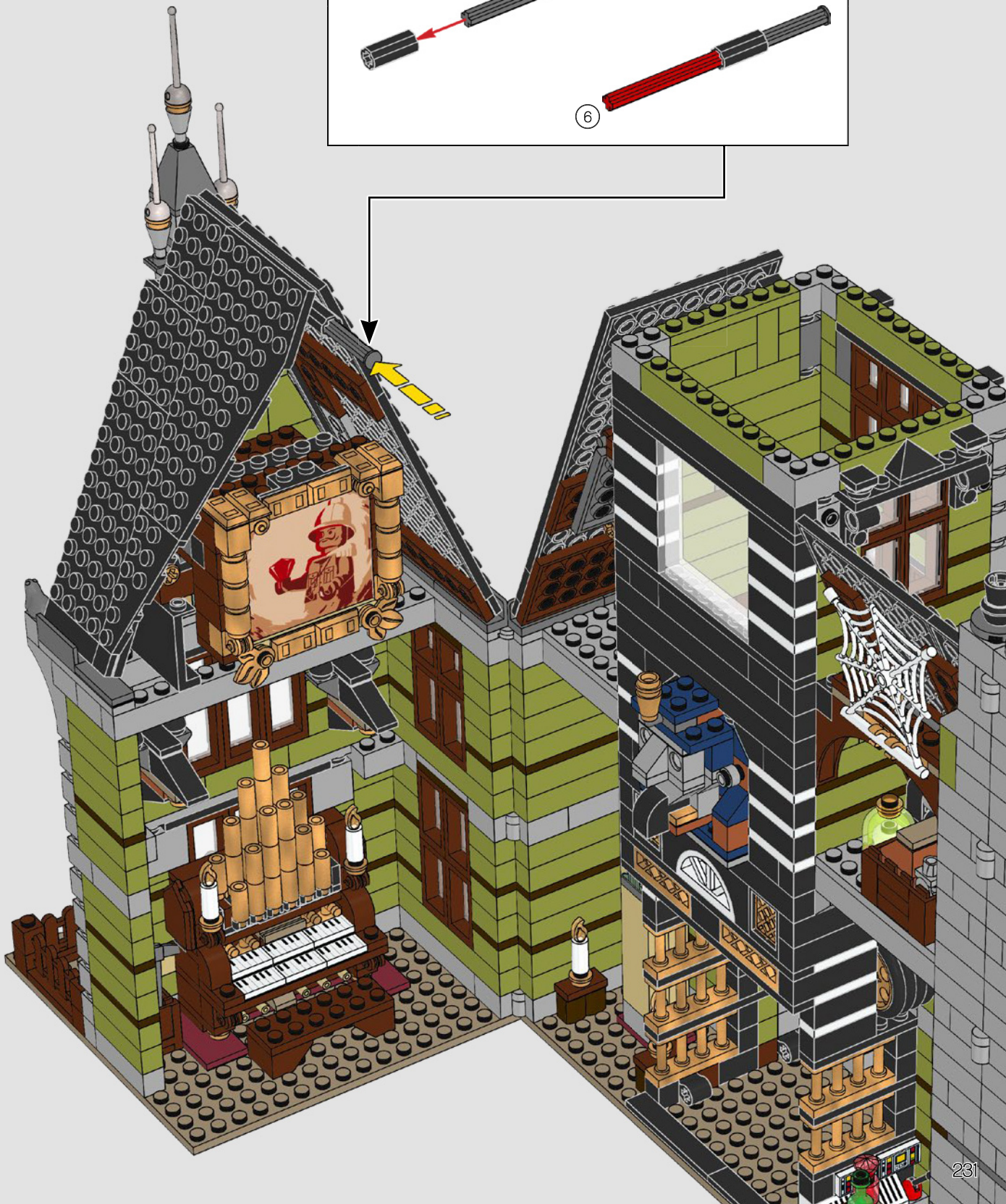
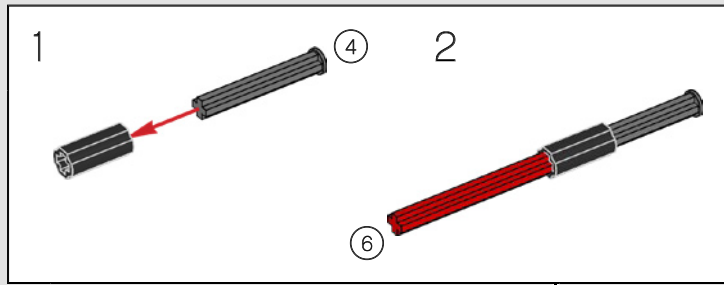

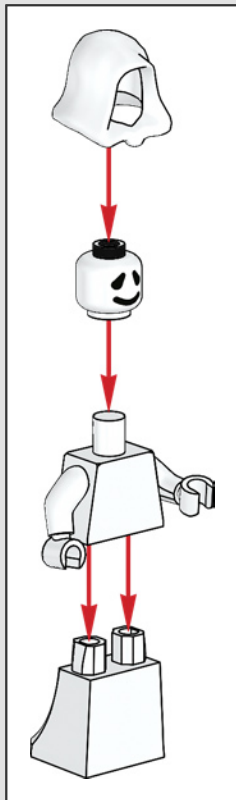
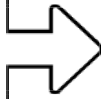

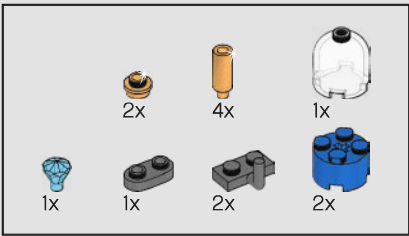

379

1

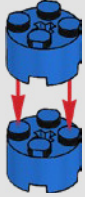

2

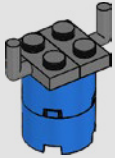

3

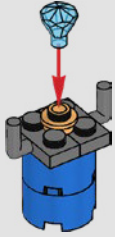

4



5

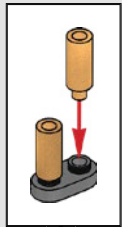

6



Der Resonator

Bei dem gescheiterten Versuch, die Kraft des Re-Gou-Rubins mit diesem Gerät zu nutzen, rief von Barron versehentlich zwei freundliche Geister aus dem Jenseits herbei.



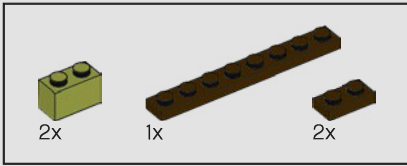
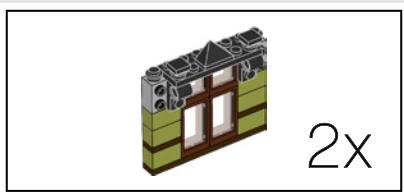

380

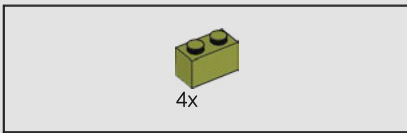
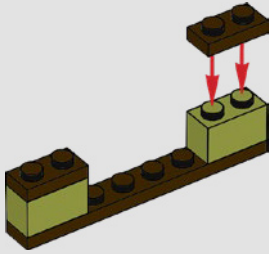

381

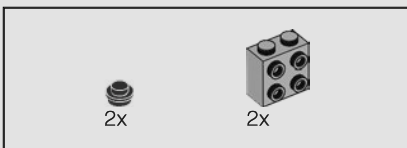
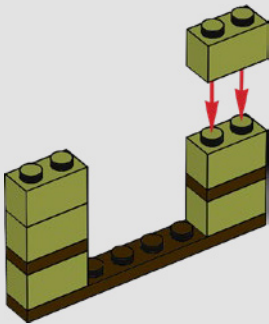

382

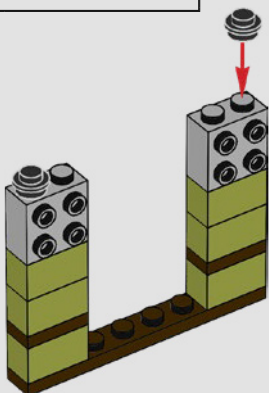

383

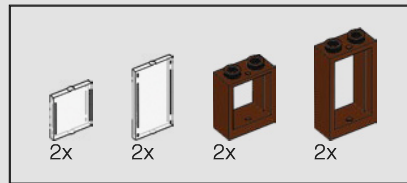
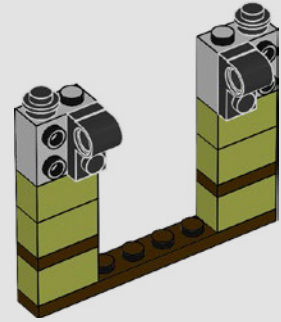

384

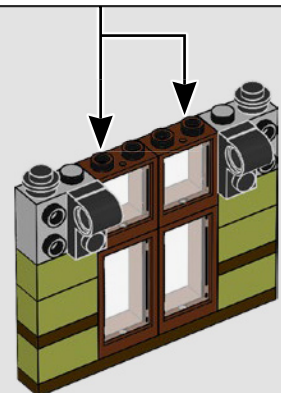
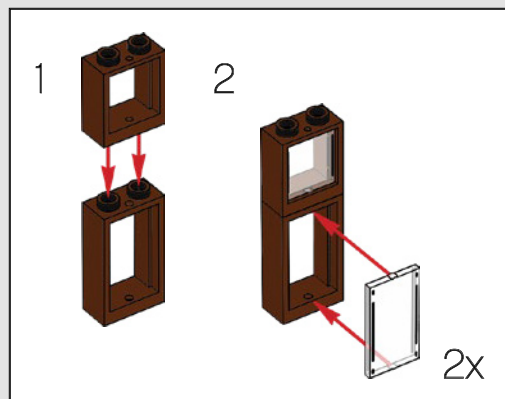

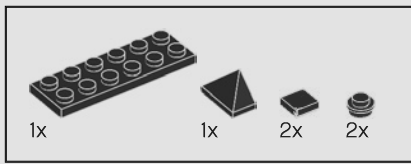

385

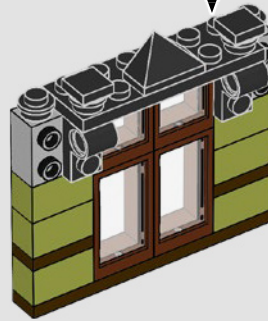
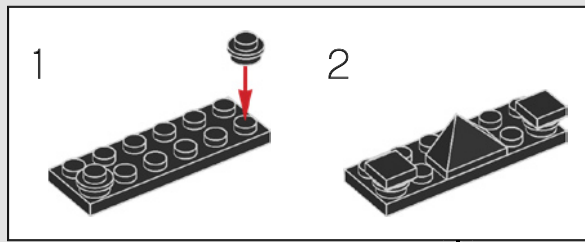

2x

386



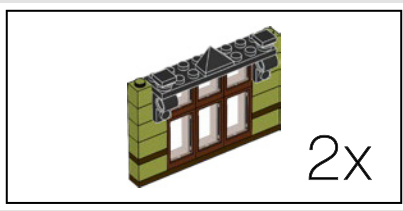

2x

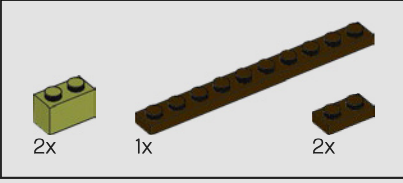

2x

1x

2x

387

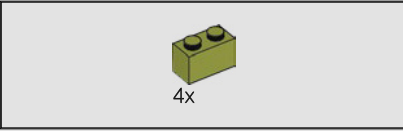
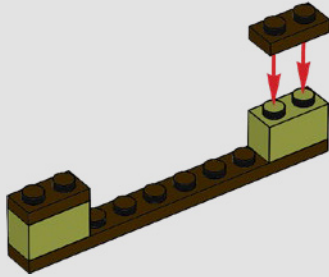

4x

388

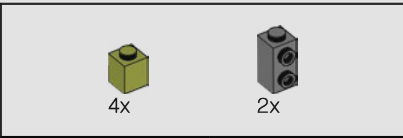
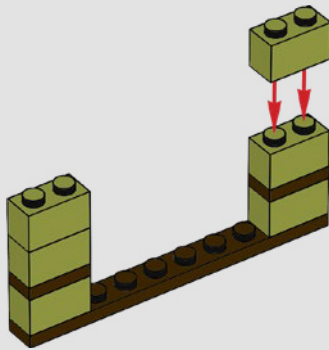

4x

2x

389

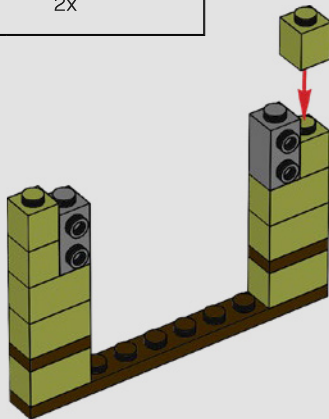

2x

390

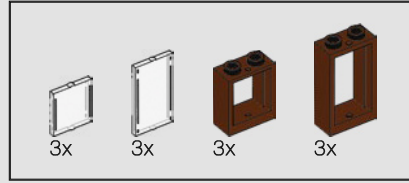
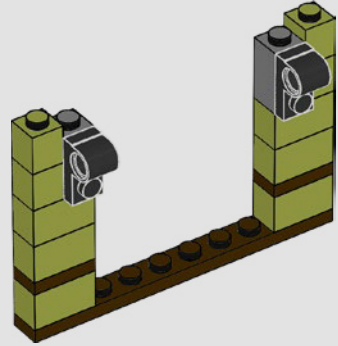

3x

3x

3x

3x

391

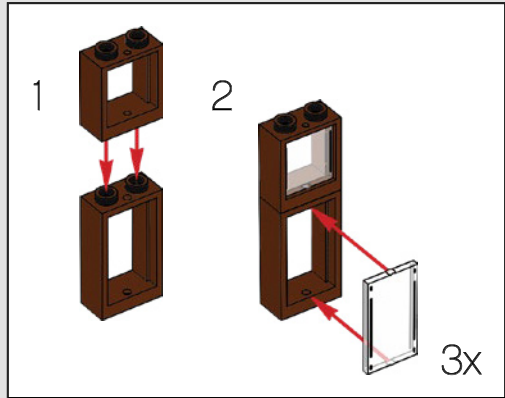

1

2

3x

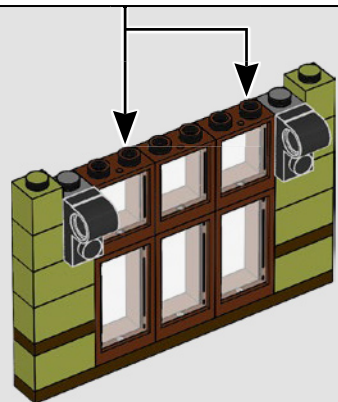

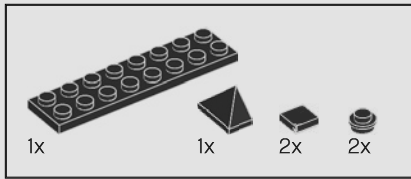

392

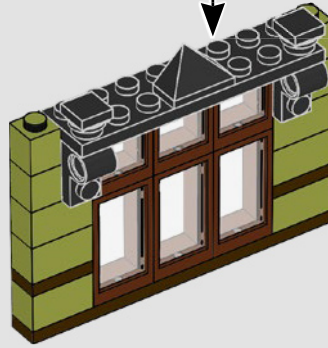
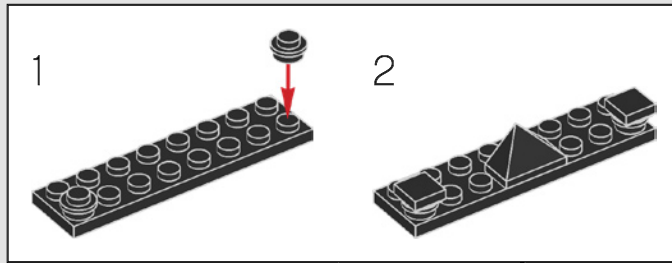

2x

393



20x

16x

394

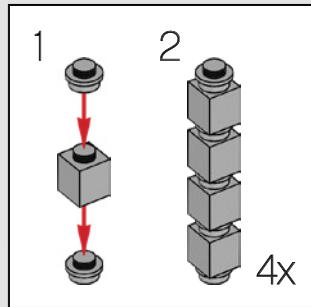

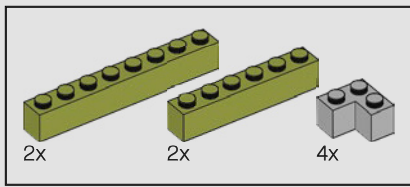

395

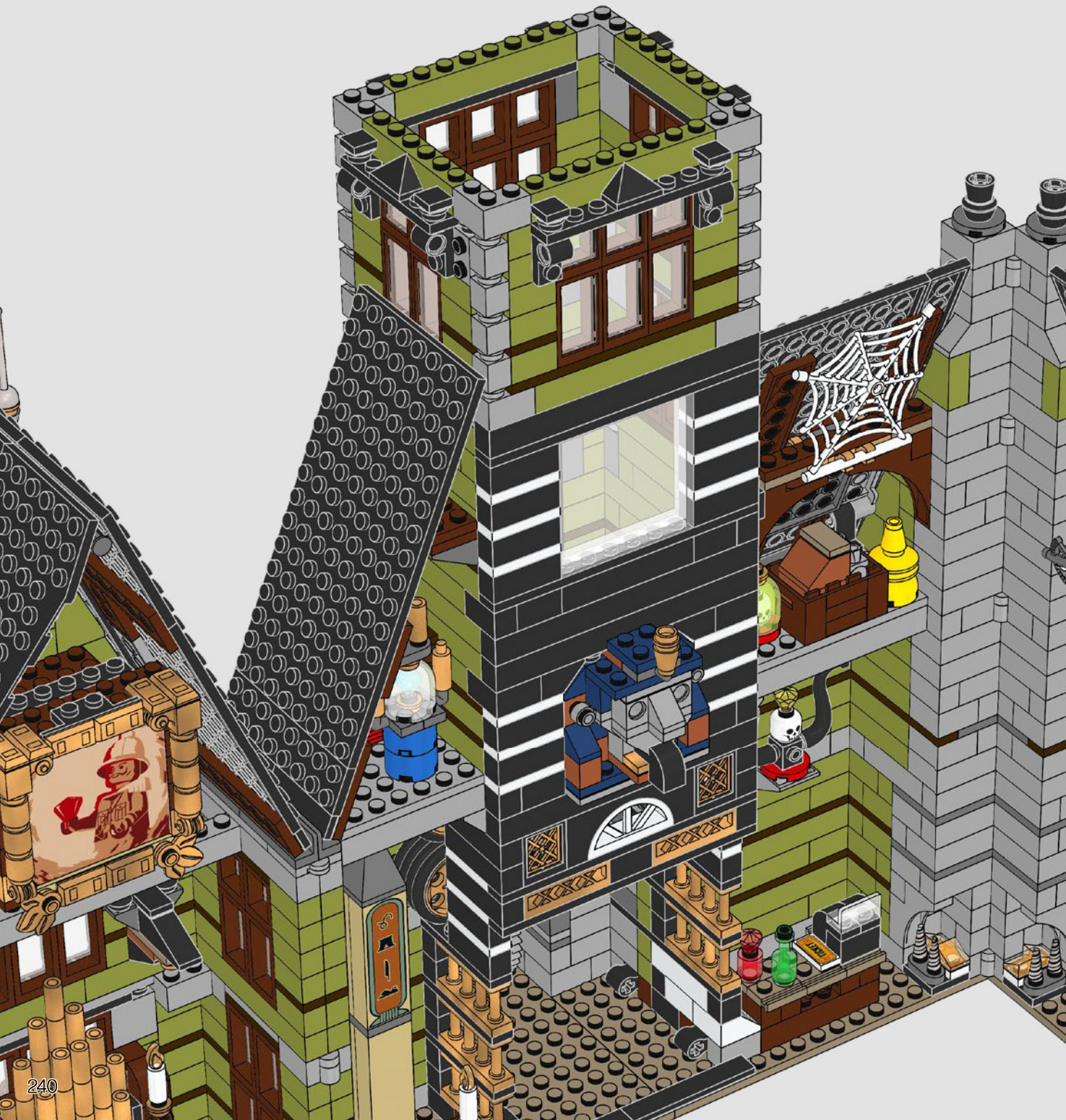

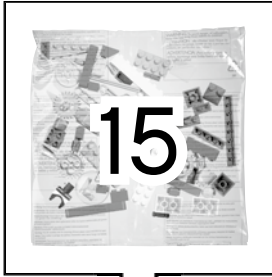

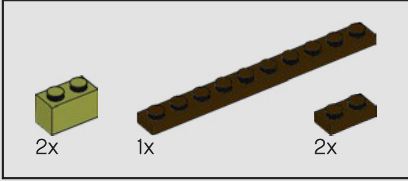
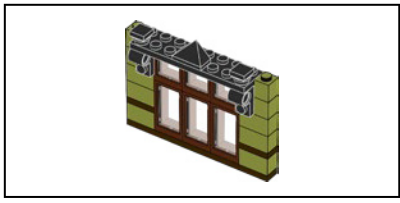

396

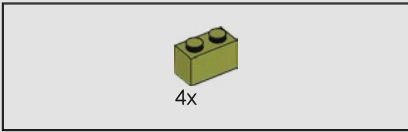
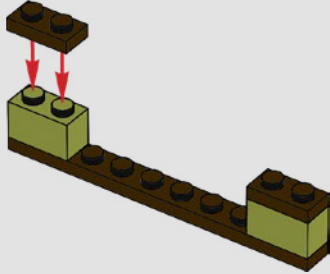

397

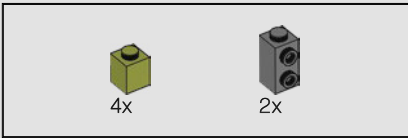
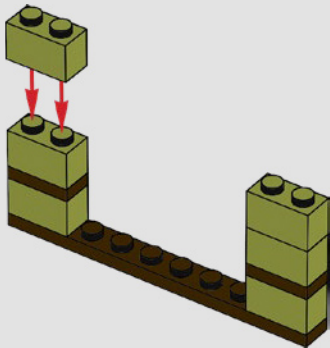

398

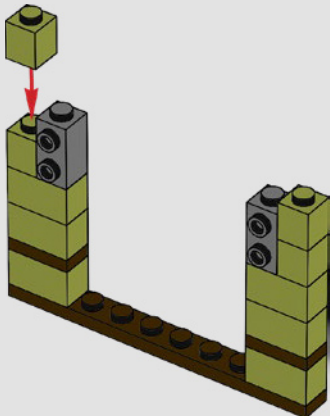

399

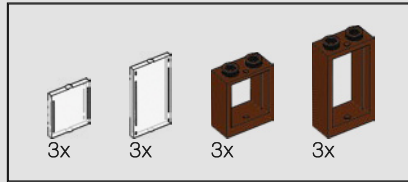
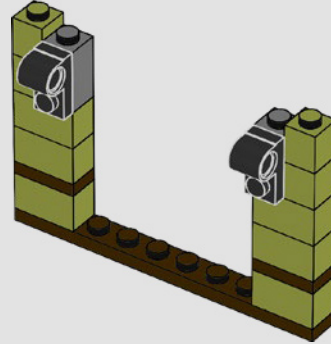

400

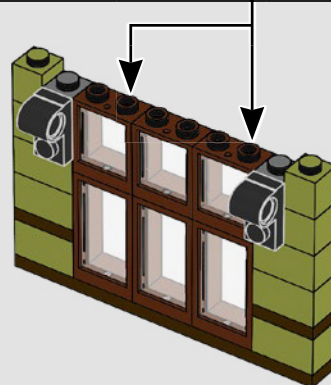
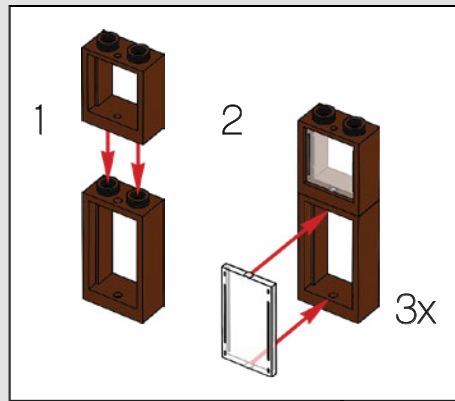

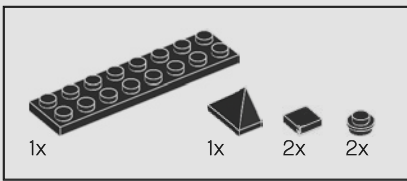

401

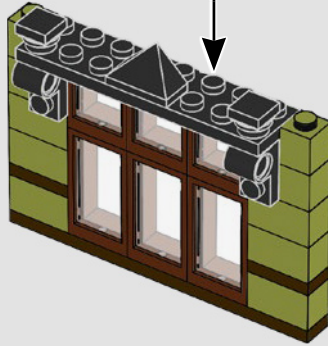
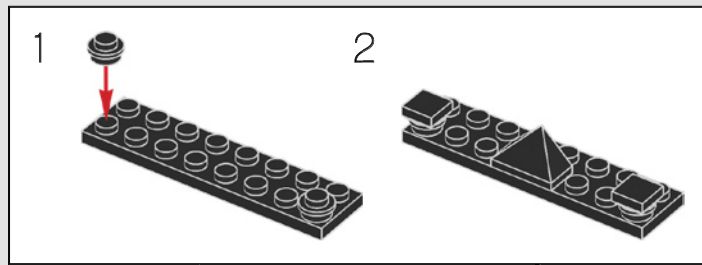

402

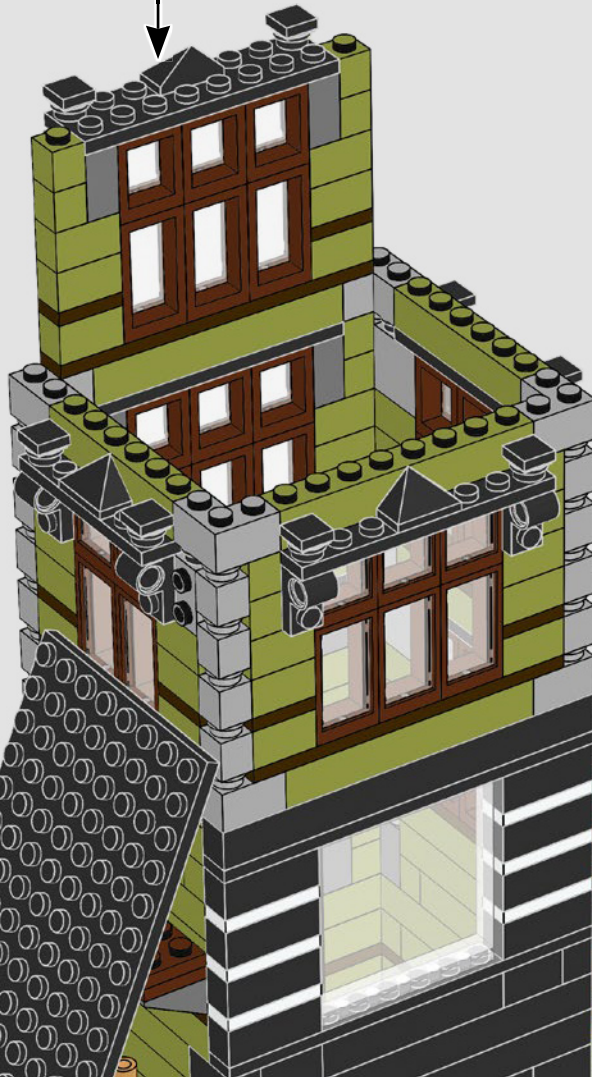



403

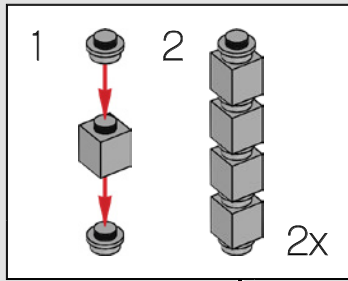

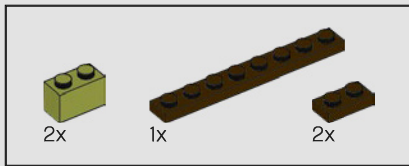
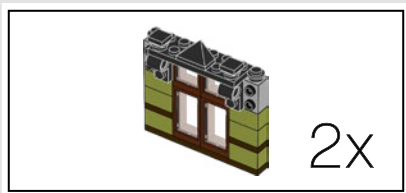

404

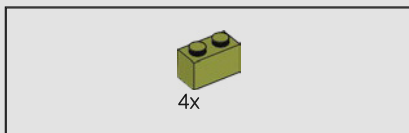
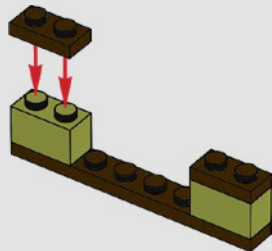

405

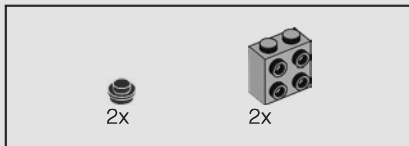
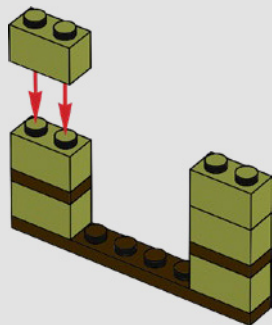

406

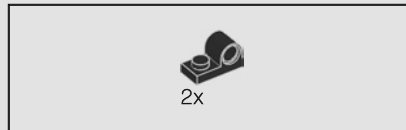
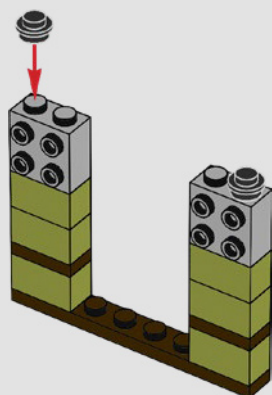

407

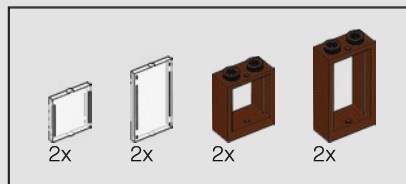
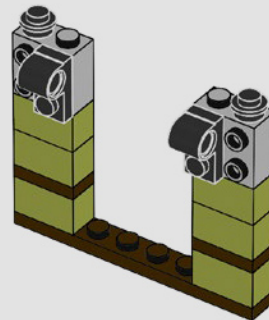

408

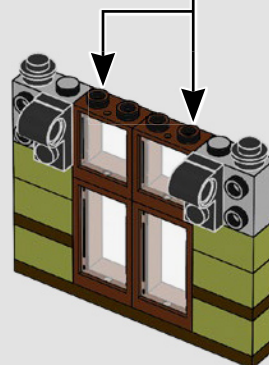
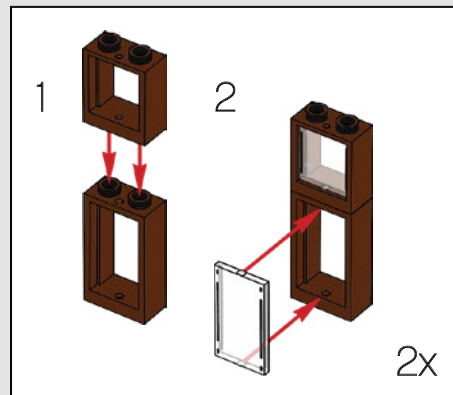

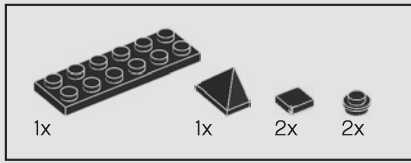

409

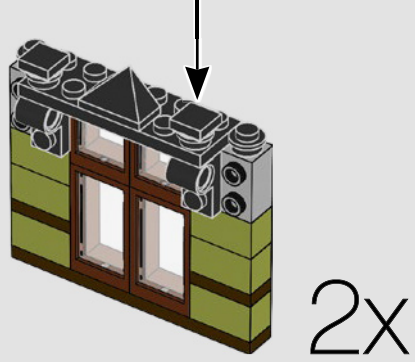
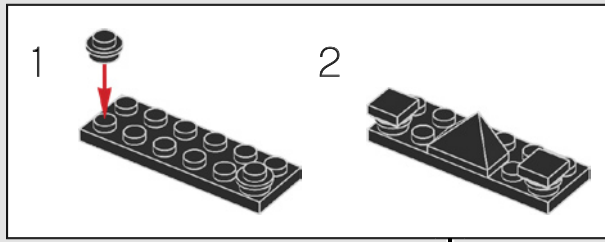

410



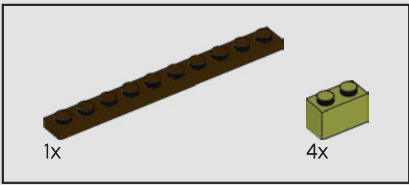

411

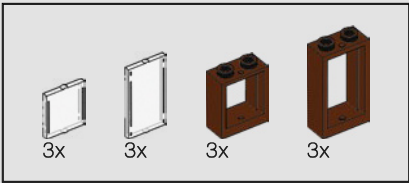
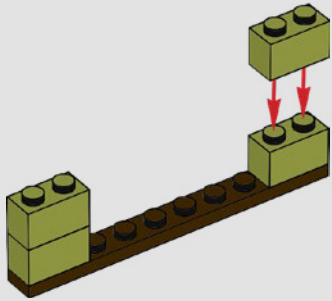

412

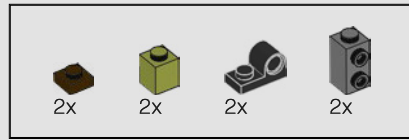
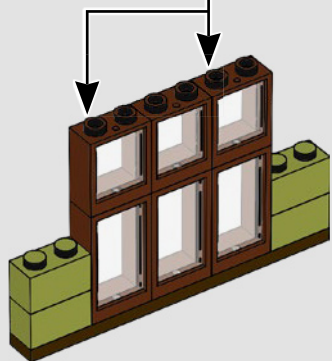
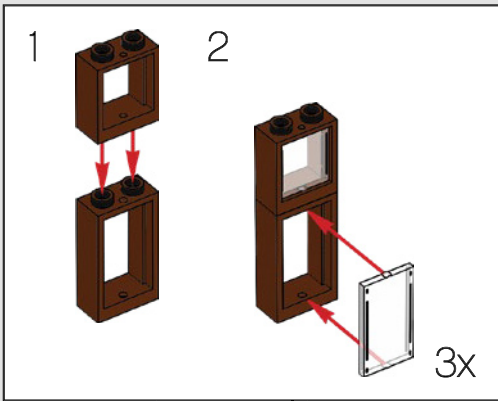

413

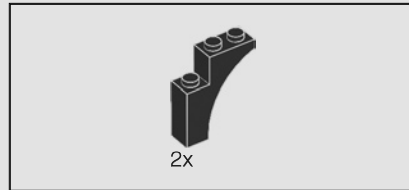
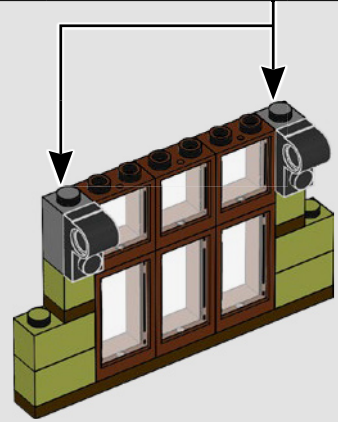
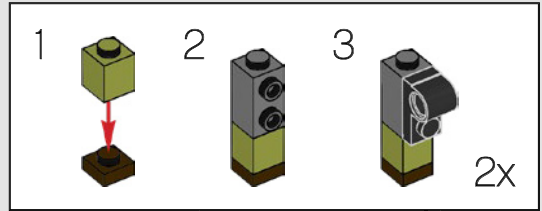

414

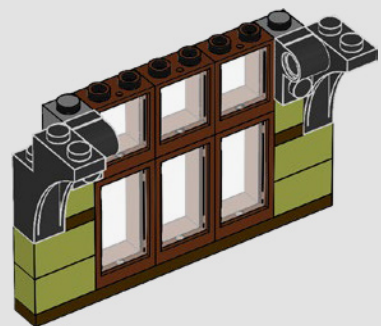





416

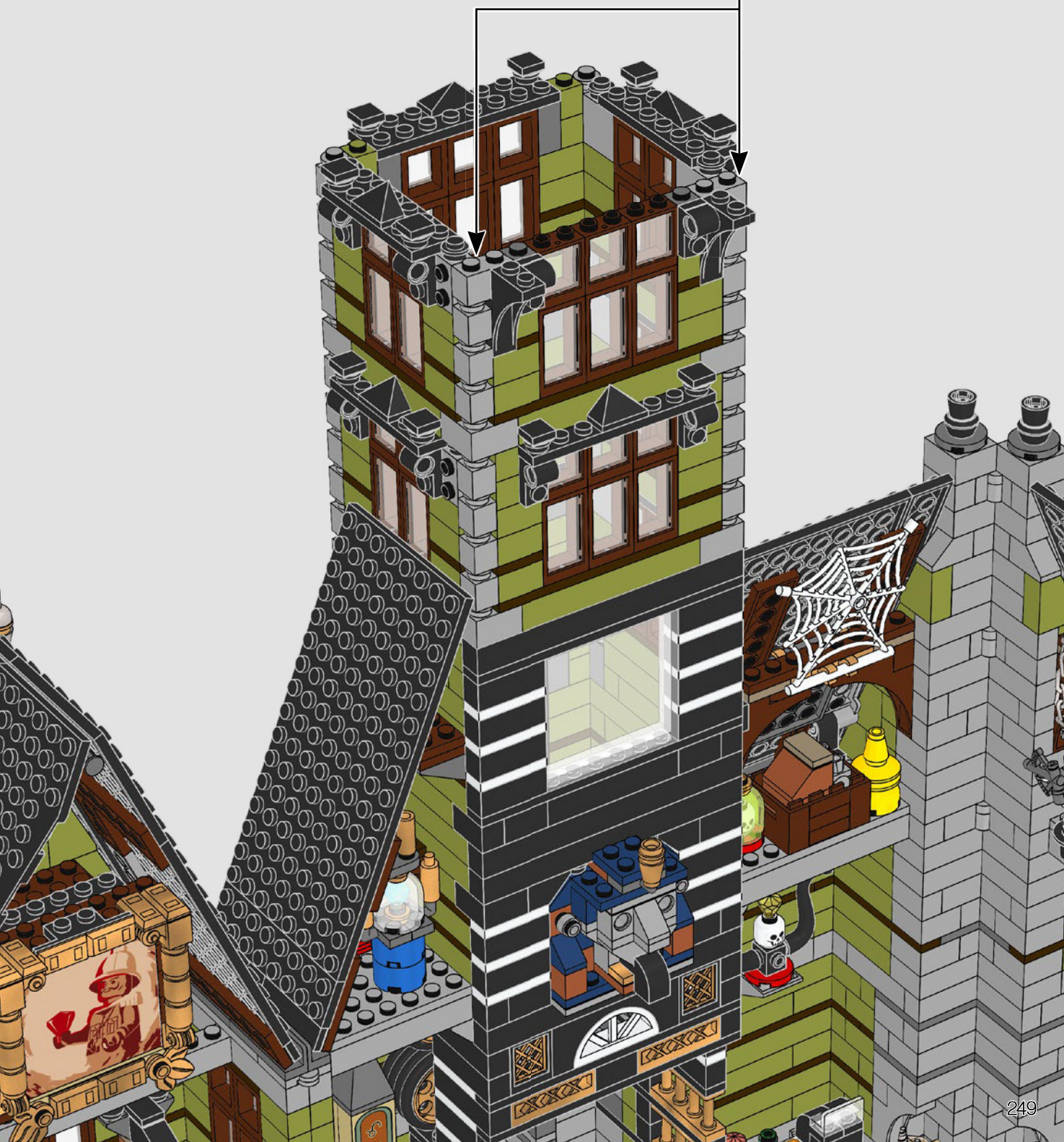
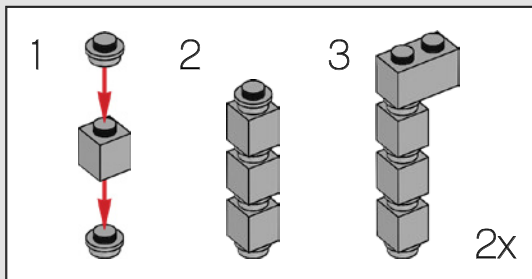

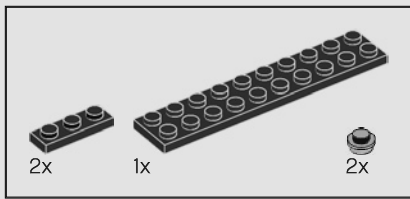

417



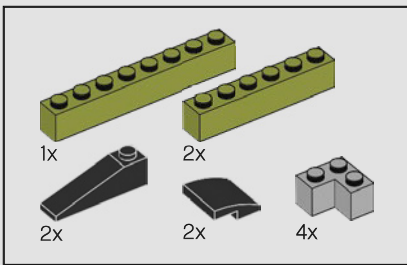

418

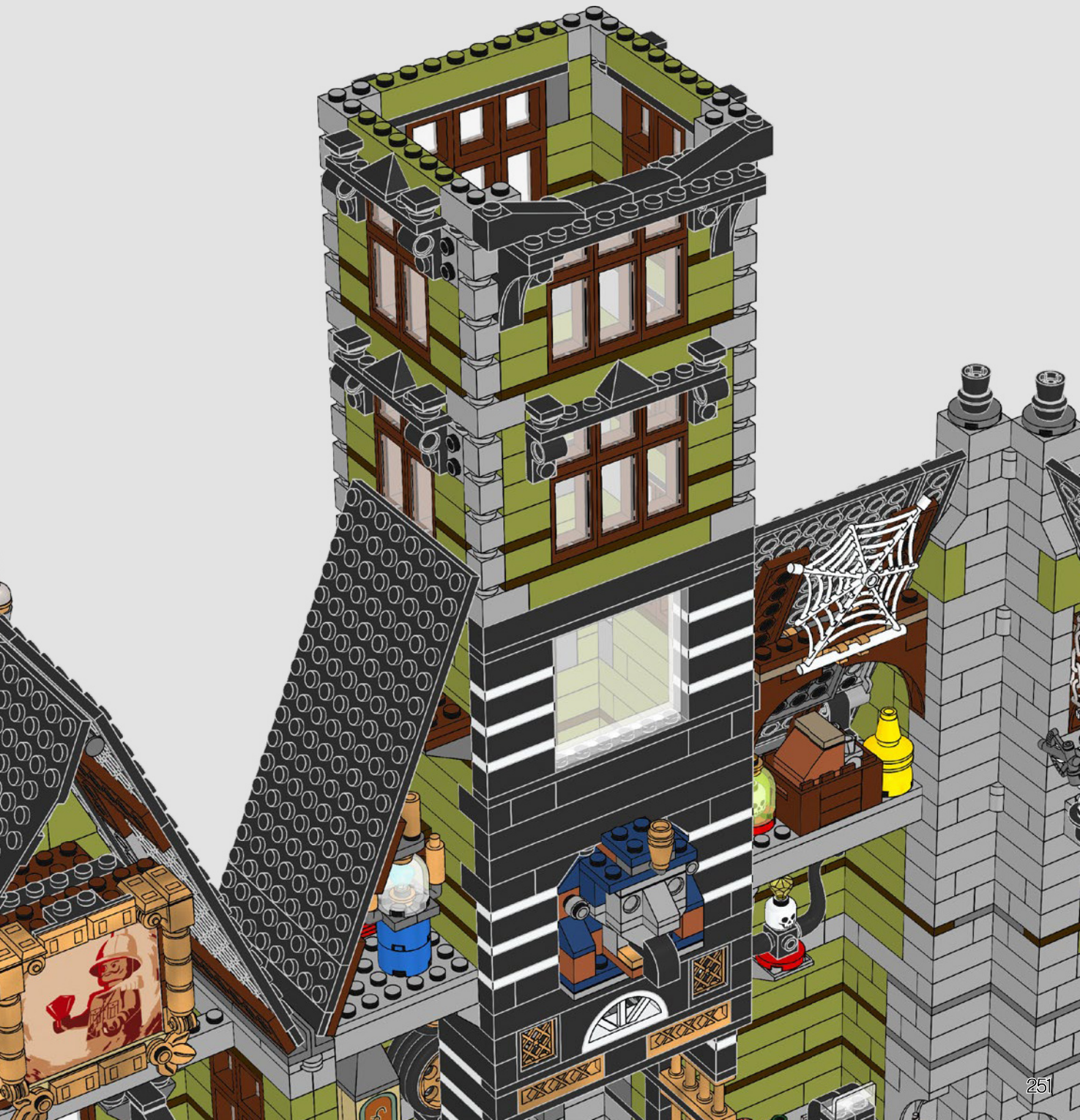

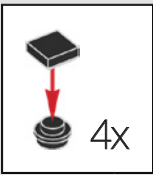

419





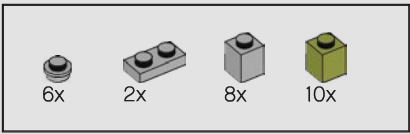

420

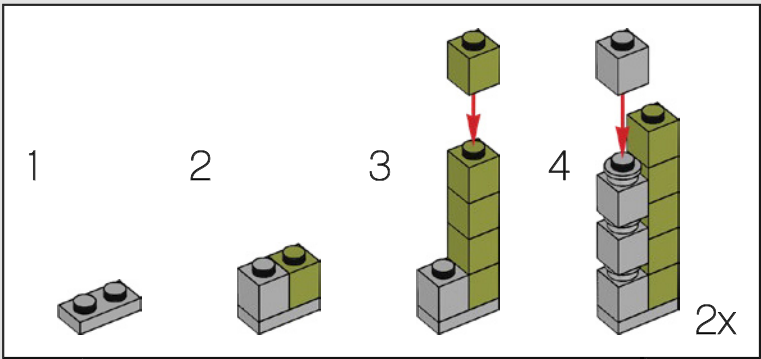

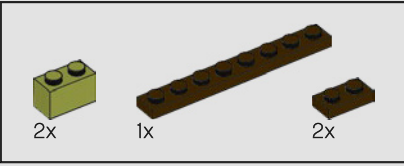
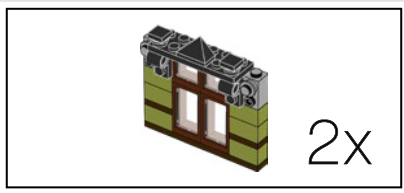

421

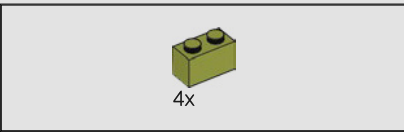
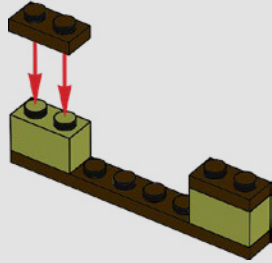

422

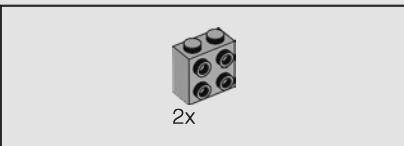
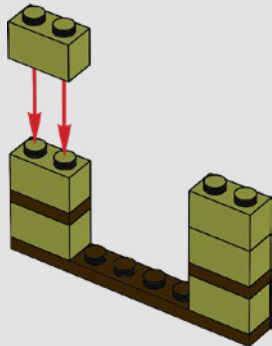

423

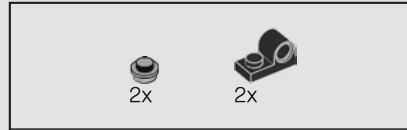
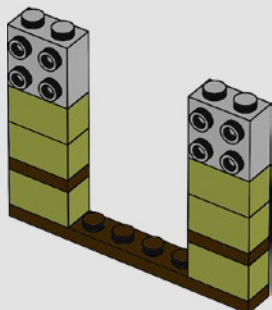

424

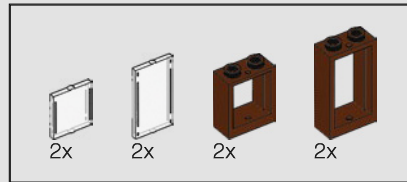
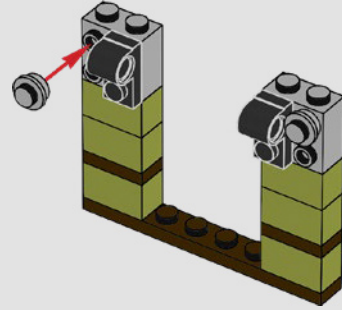

425

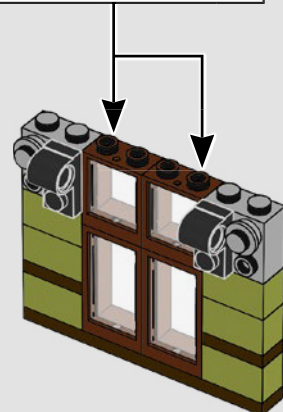
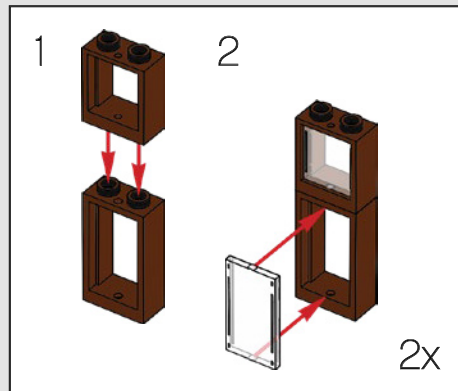

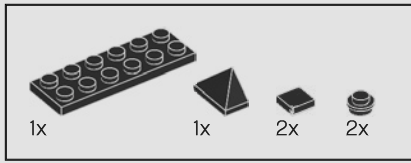

426

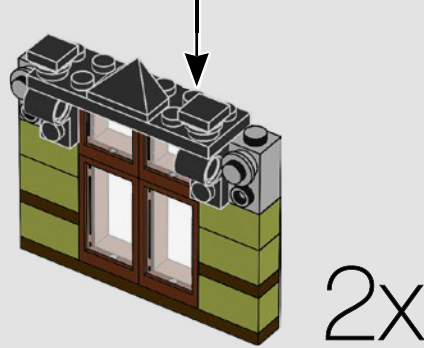
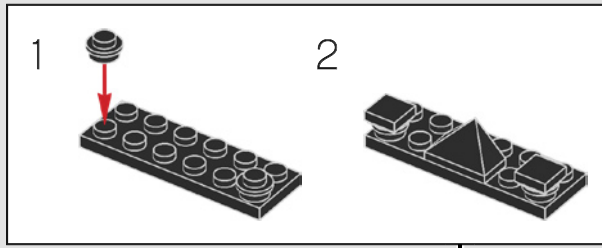

427

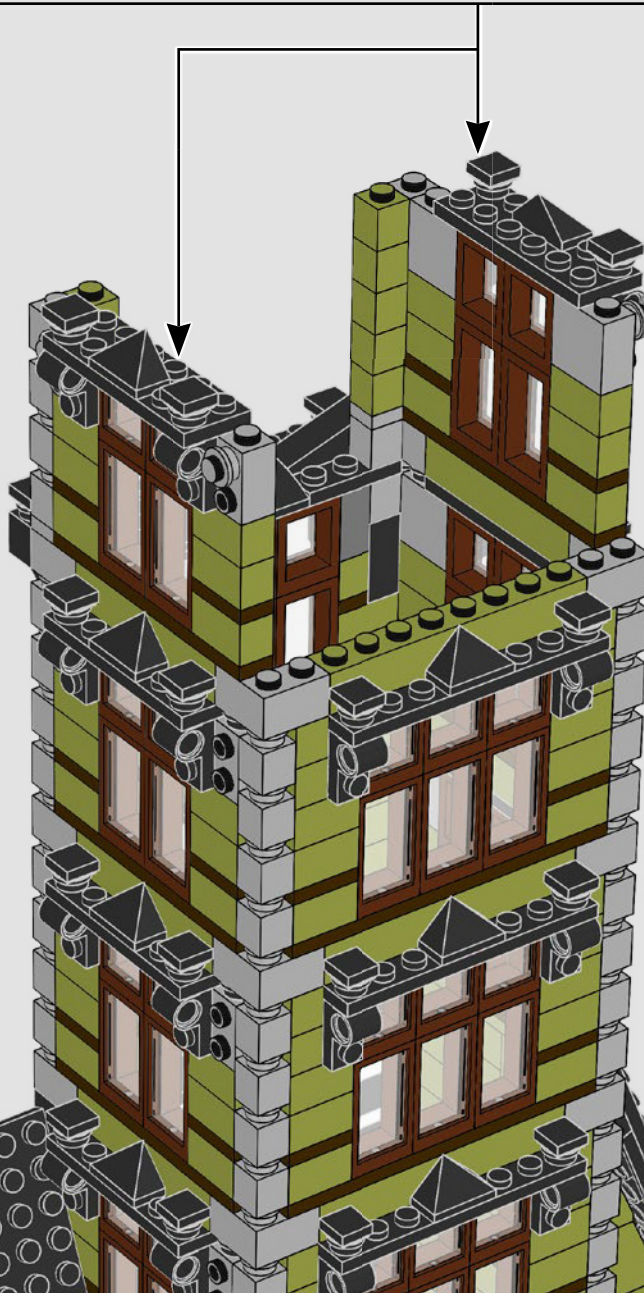

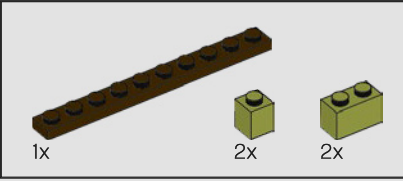
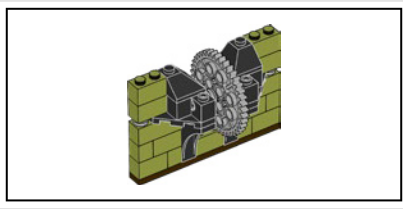

428

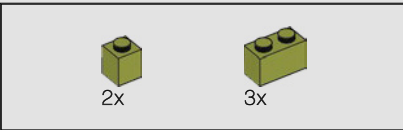
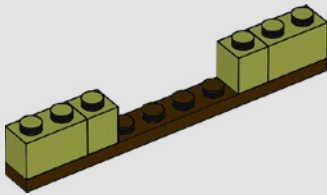

429

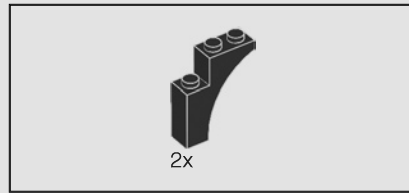
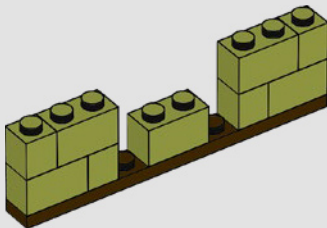

430

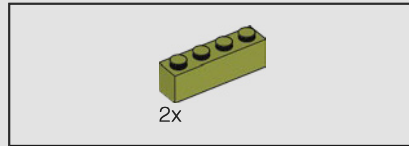
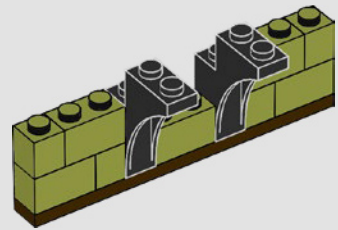

431

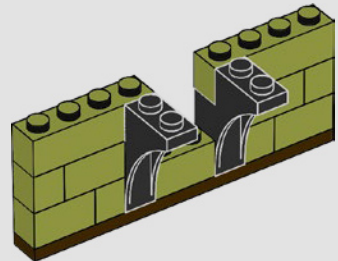



432

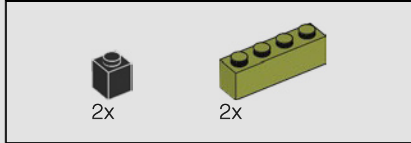
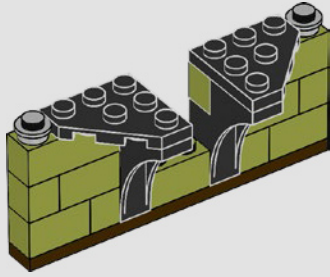

433

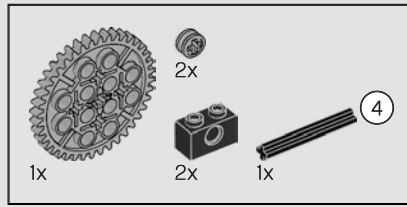
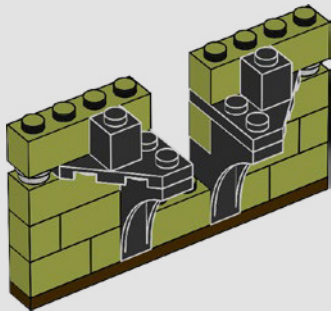

434

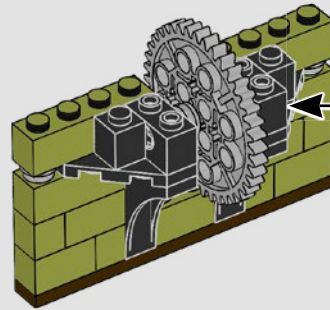
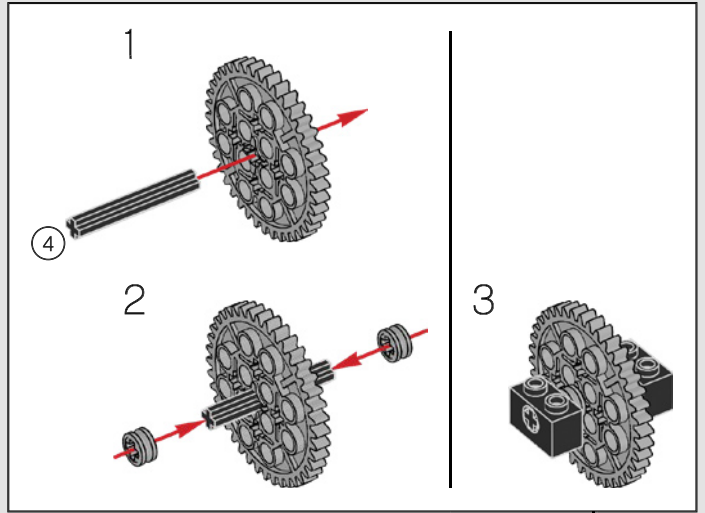

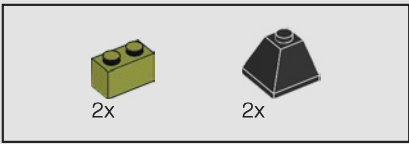

435

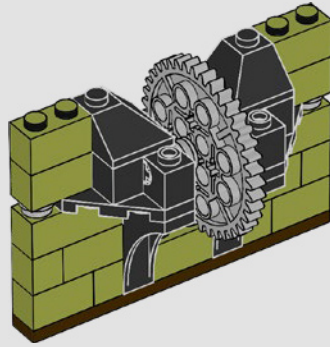

436



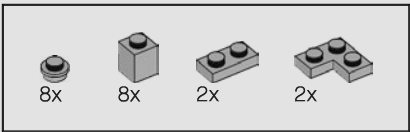

437

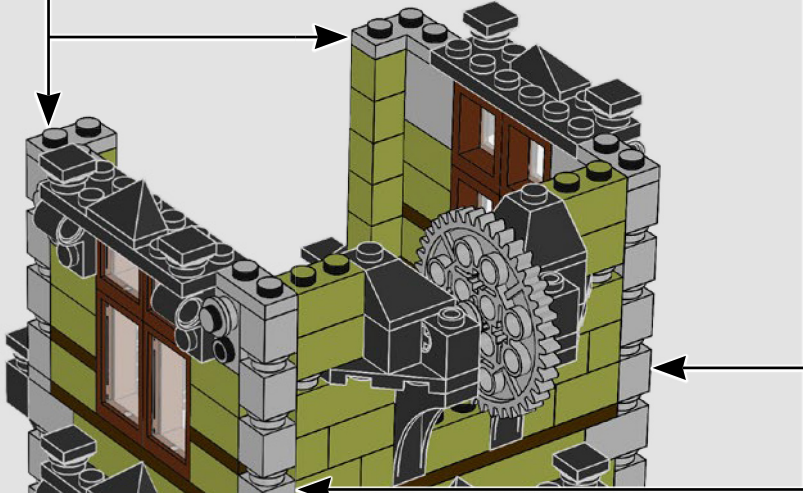
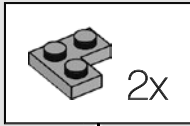
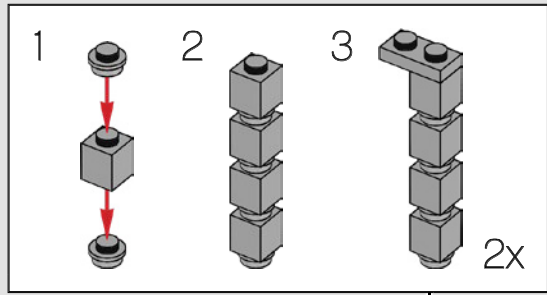

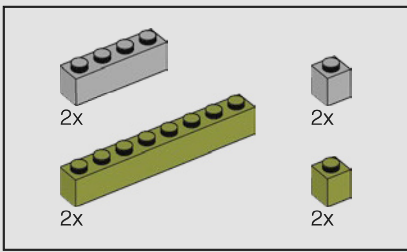

438

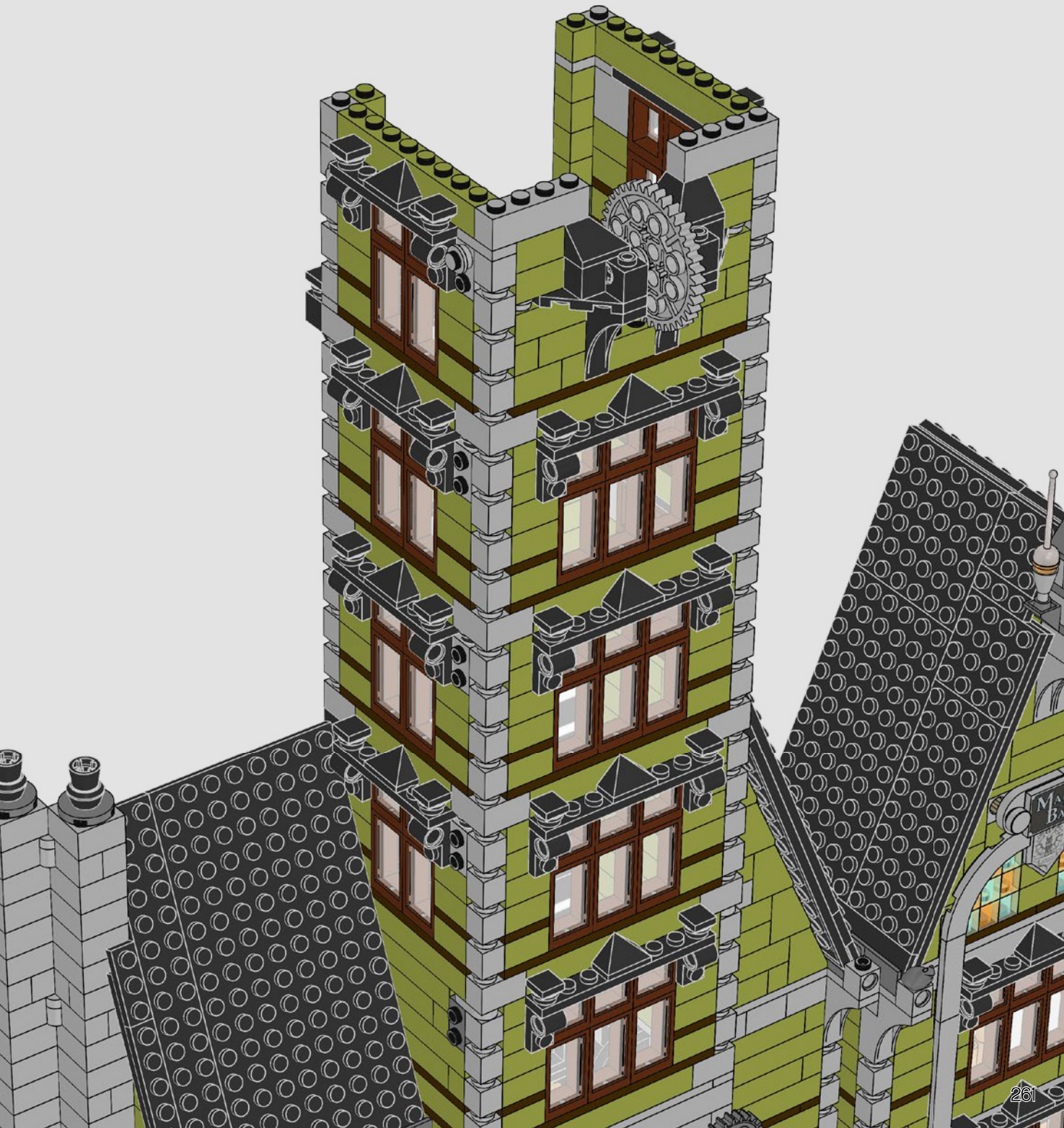

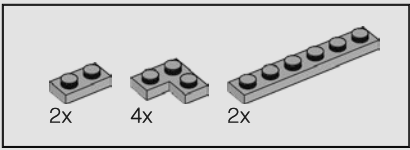

439

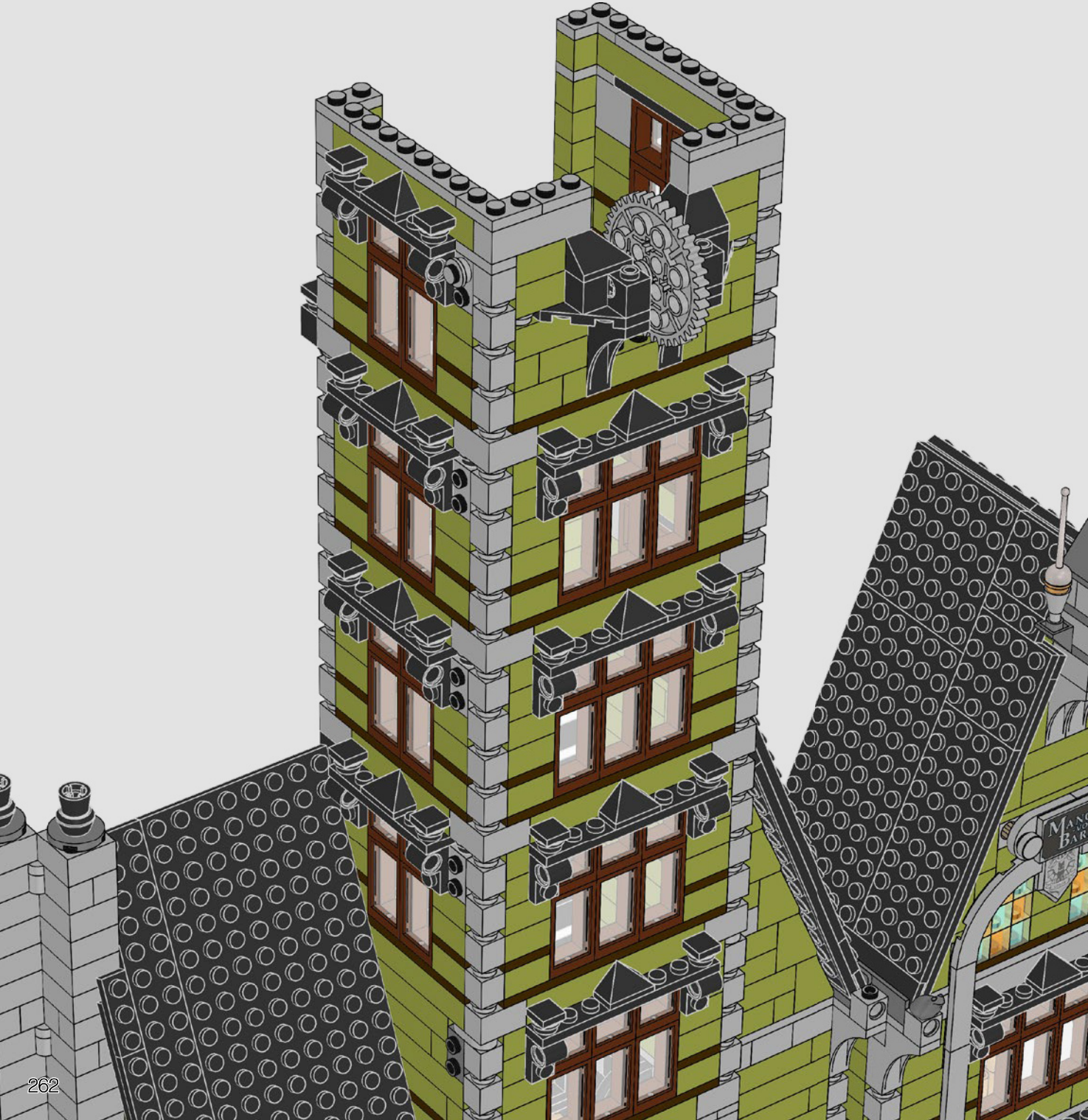

149x



2x

440

1



74x

2

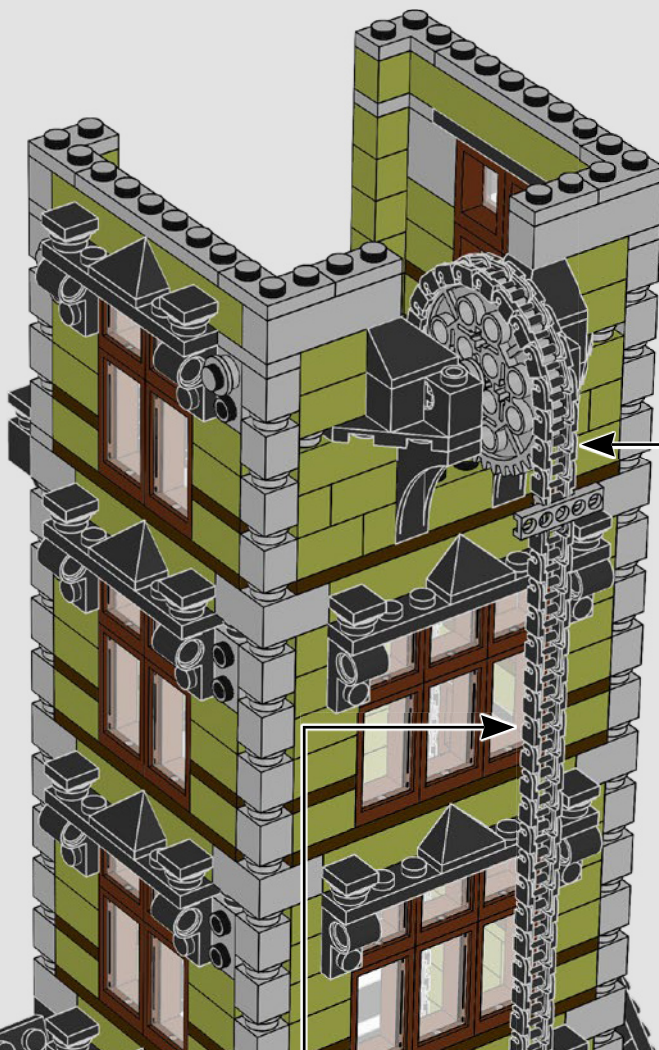
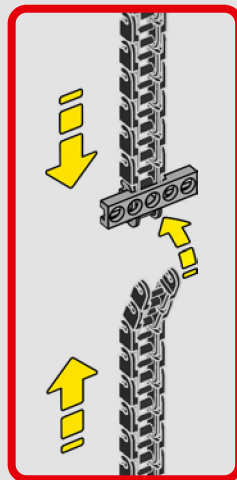

1



75x

2

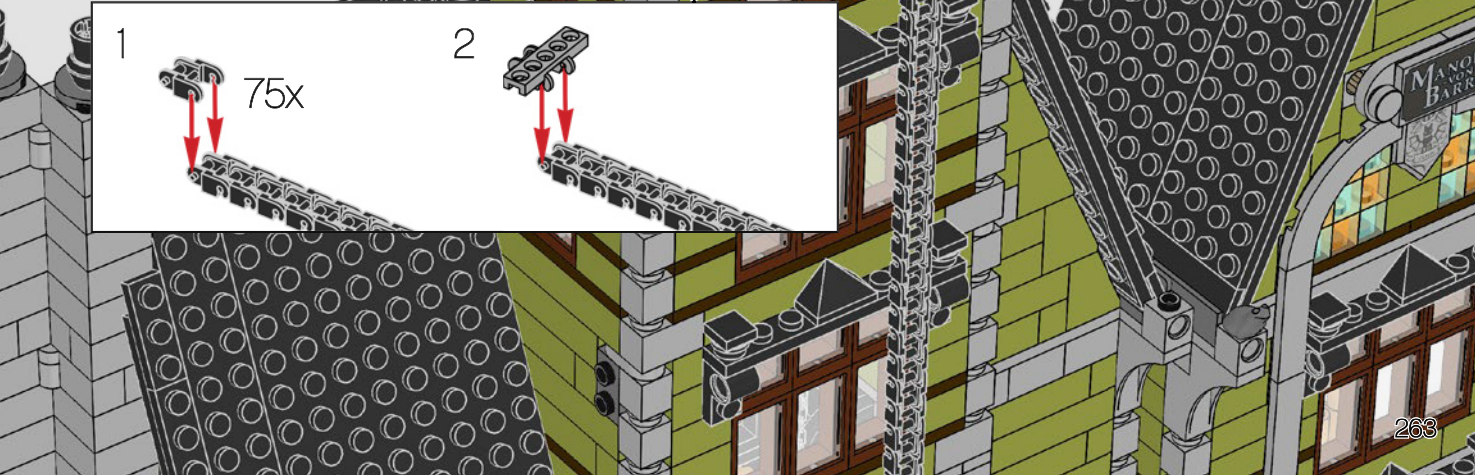

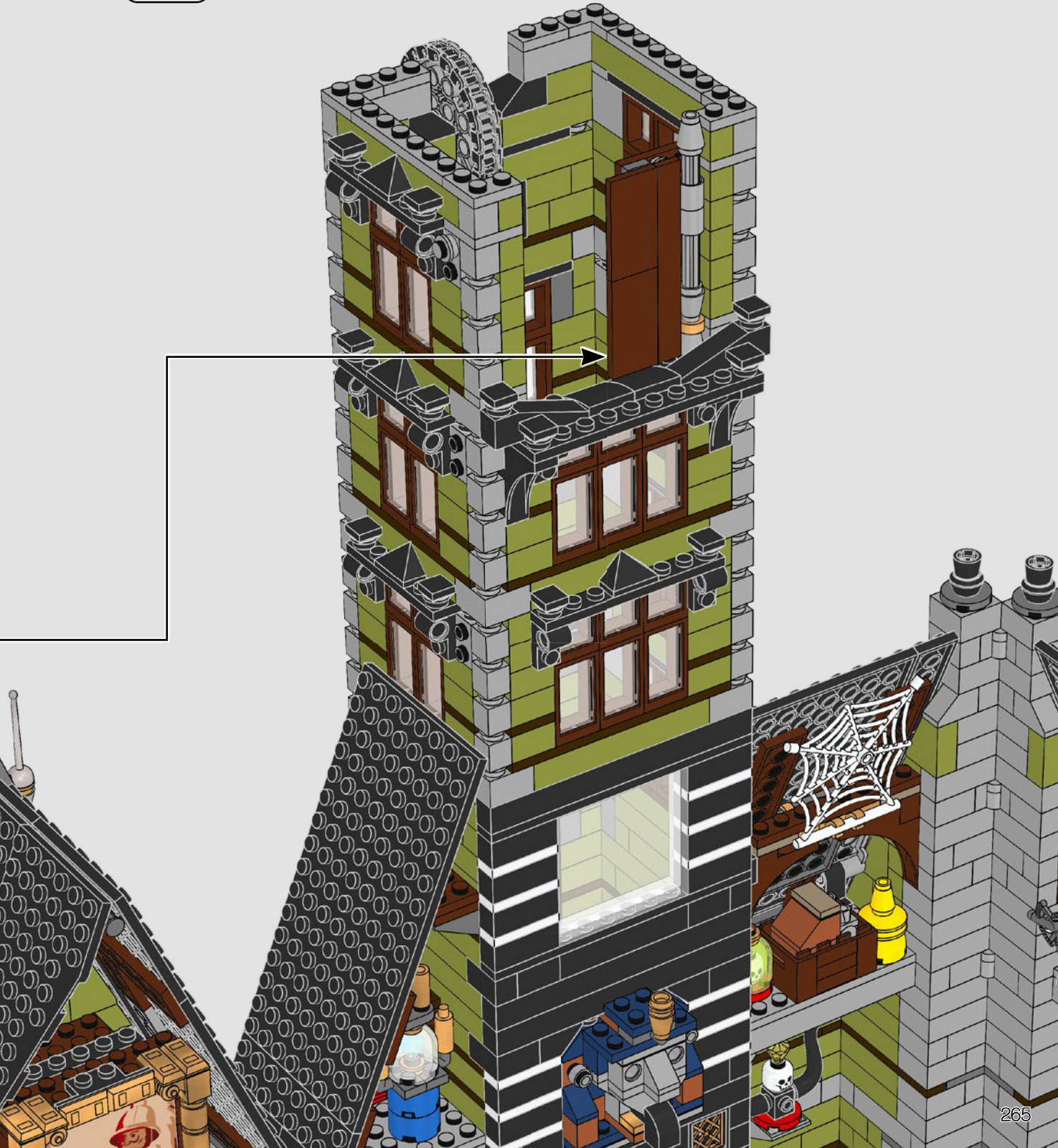

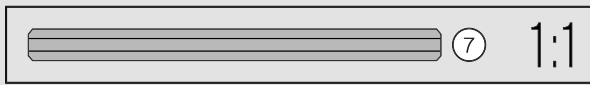
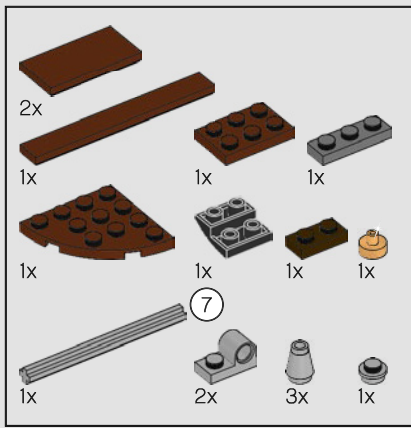

442

1

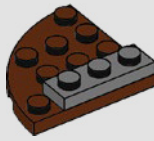

2

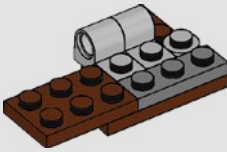

3

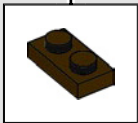
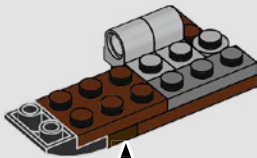

4

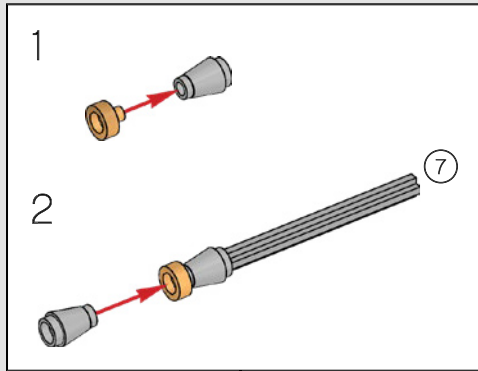
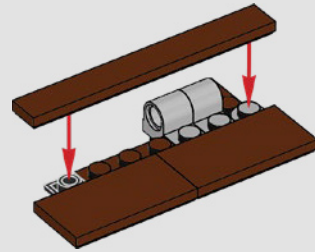

5

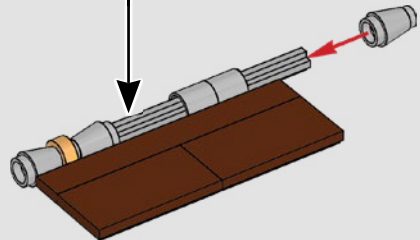

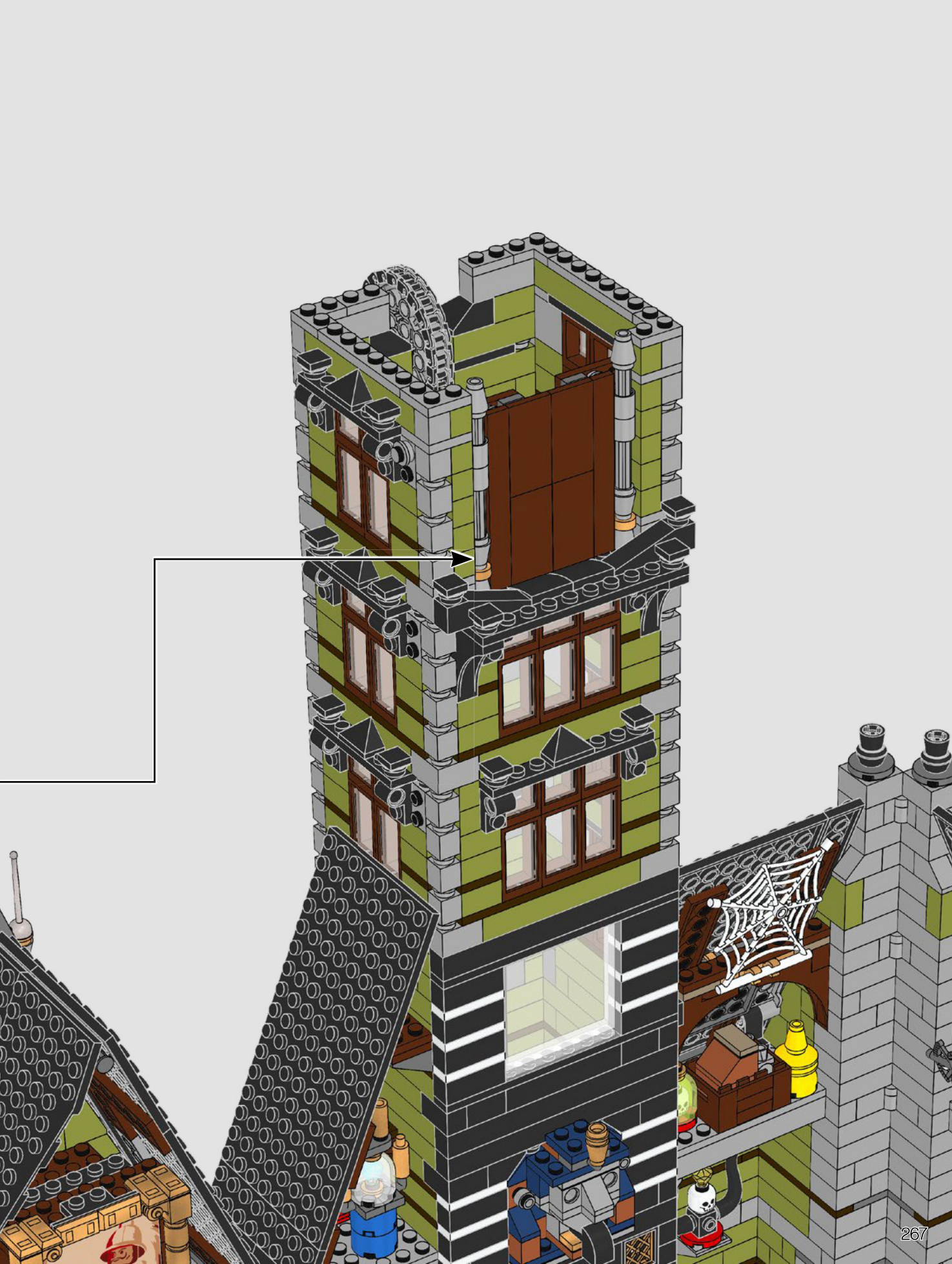



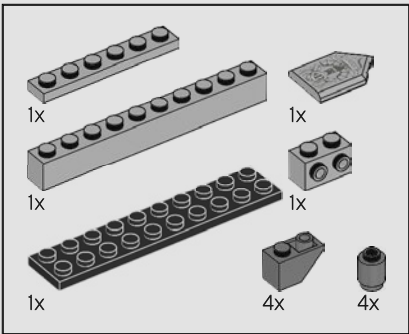

443

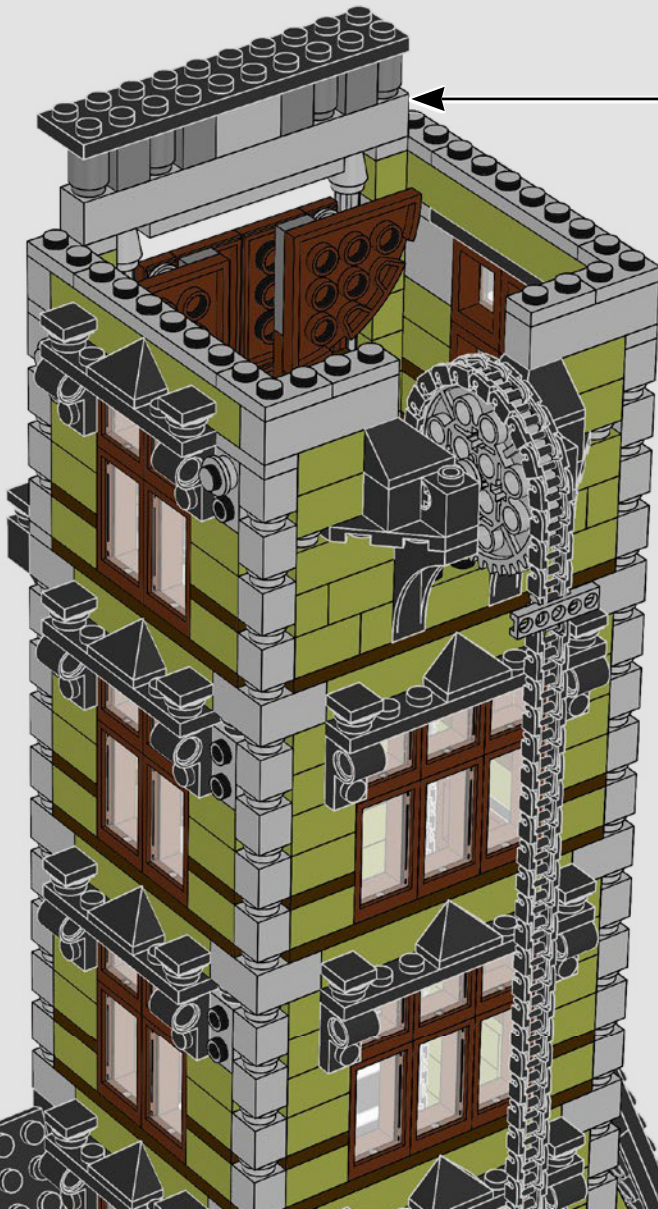
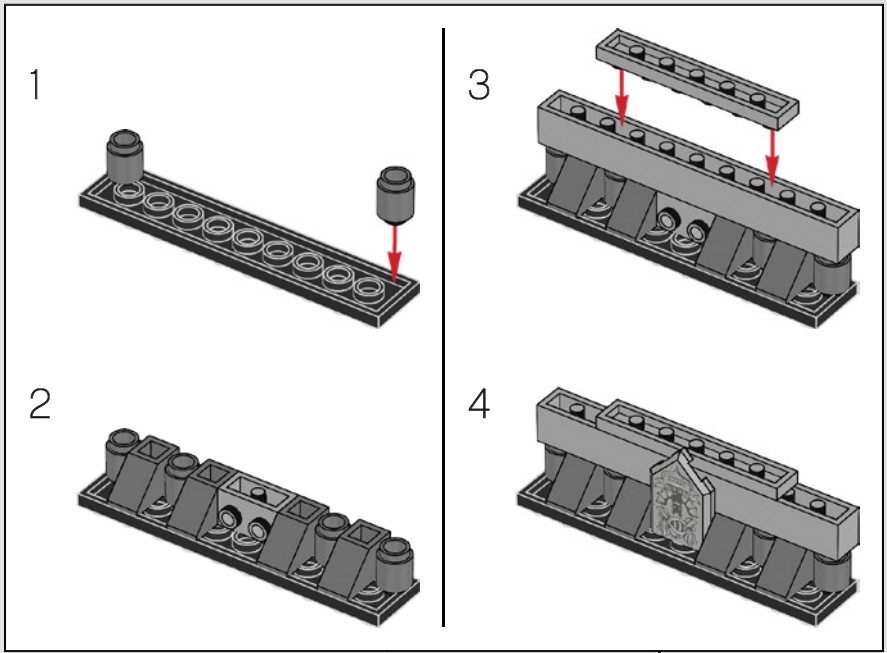

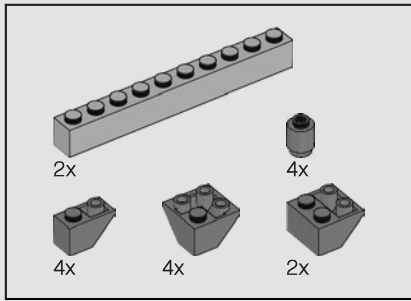

444

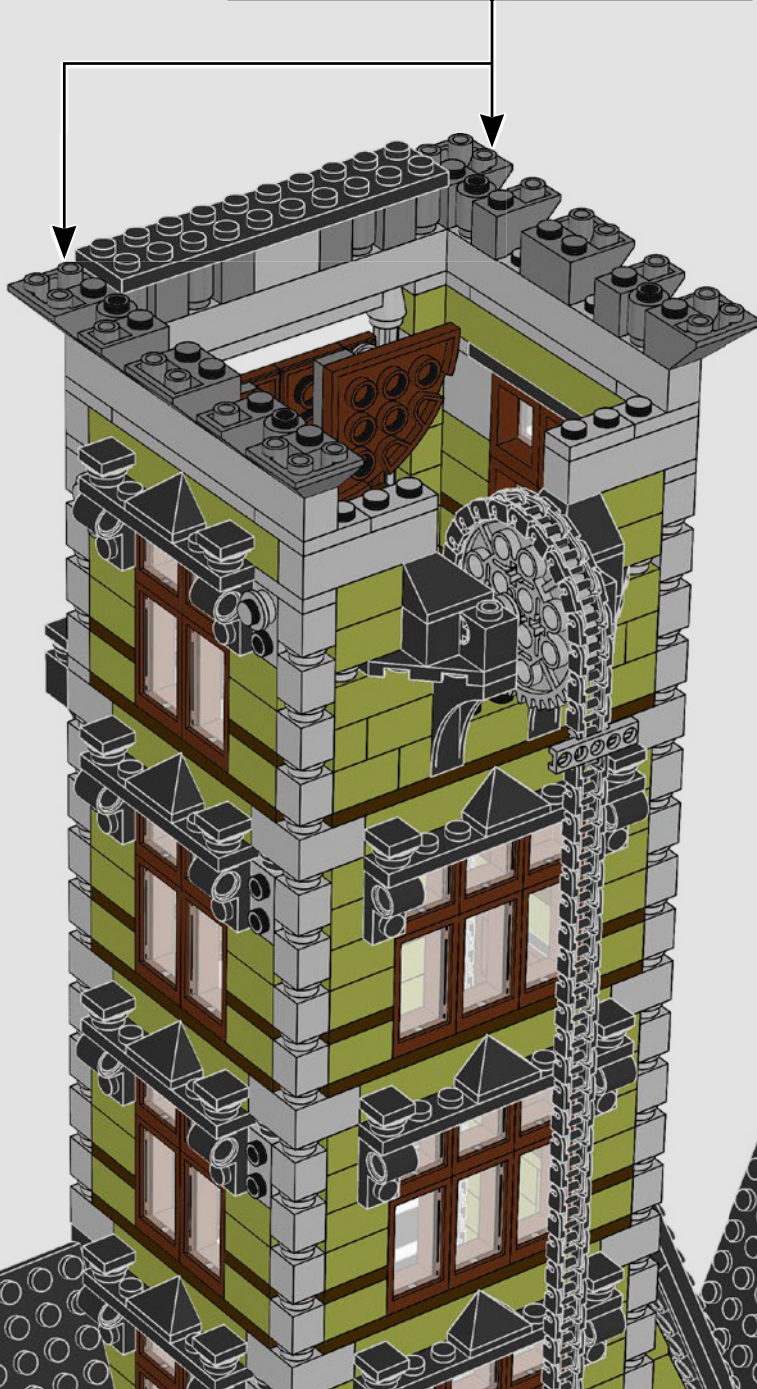
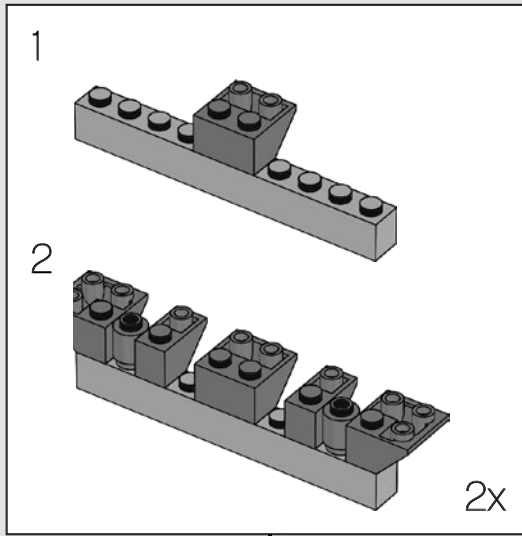

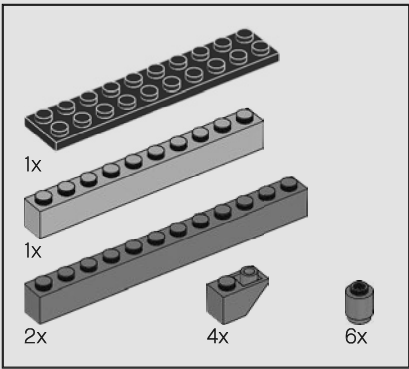

445

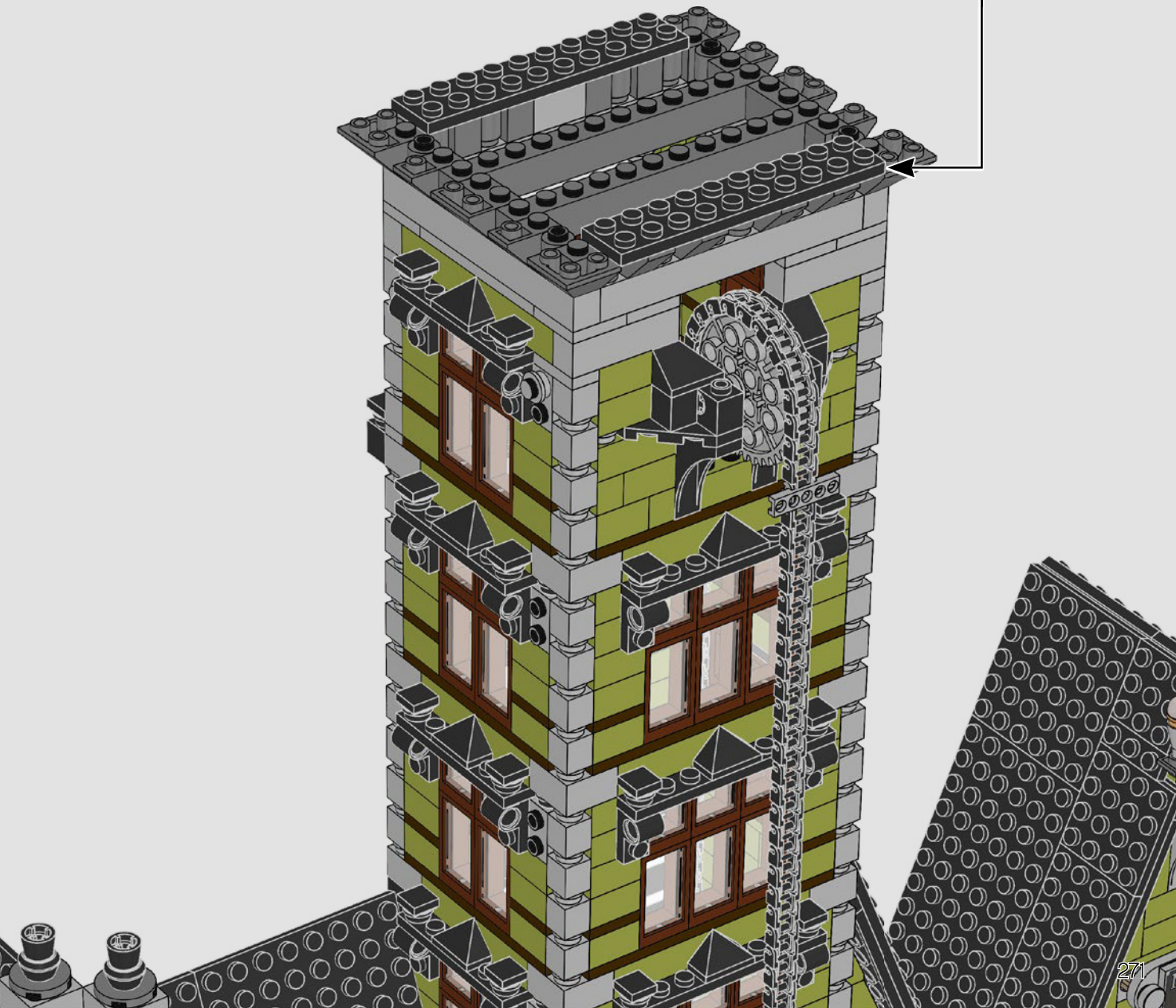
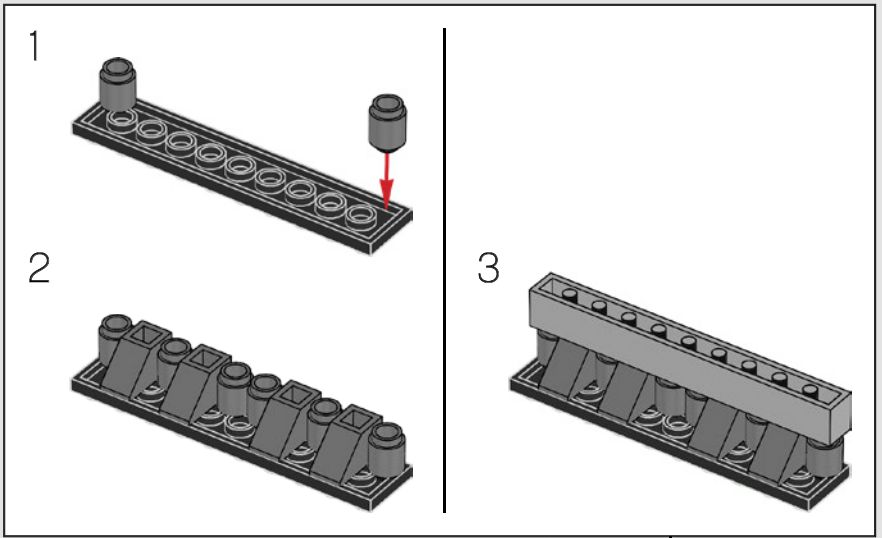

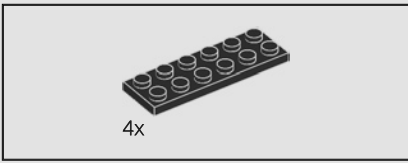

446



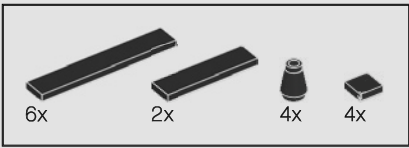

447

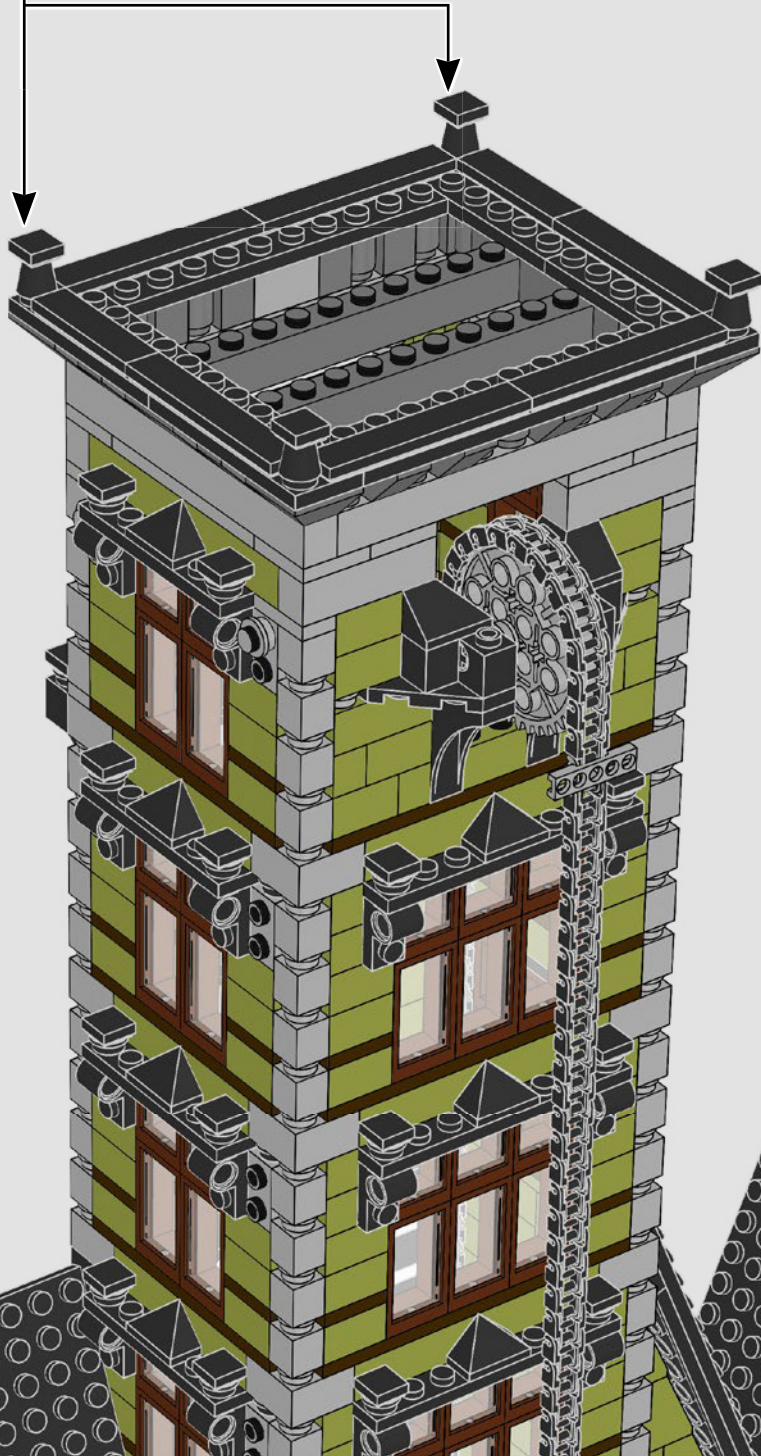
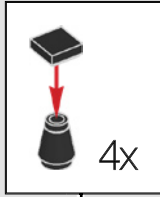

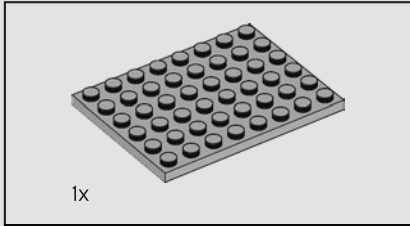
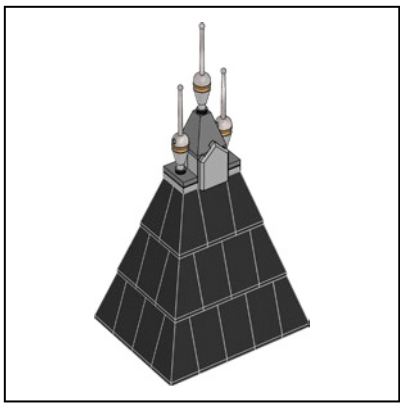

448

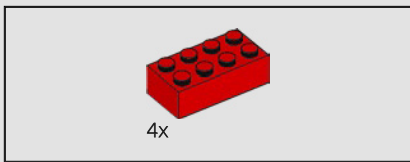
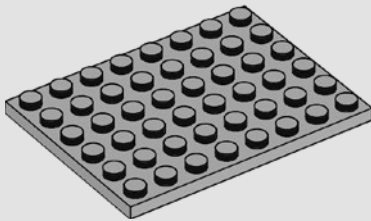

449

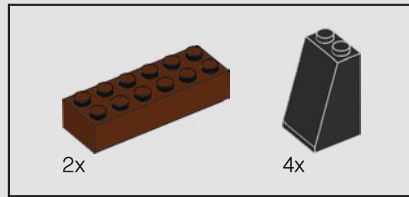
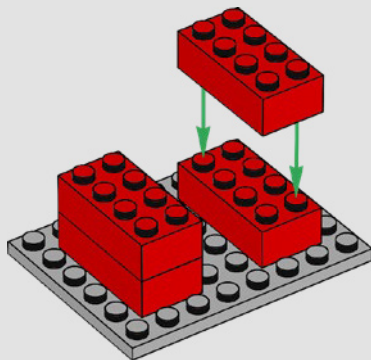

450

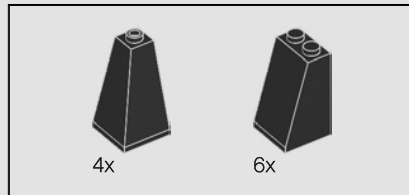
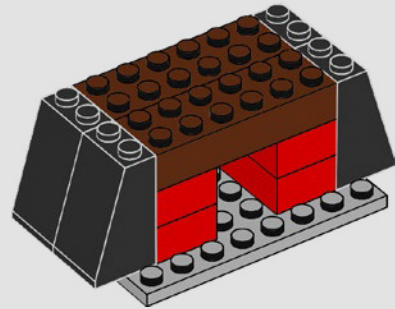

451

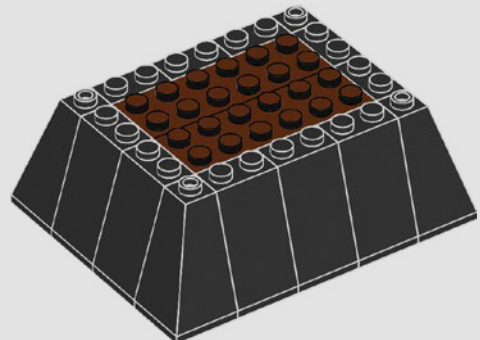

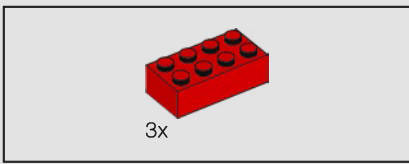

452

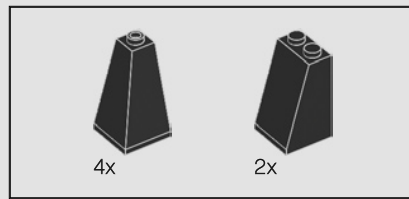
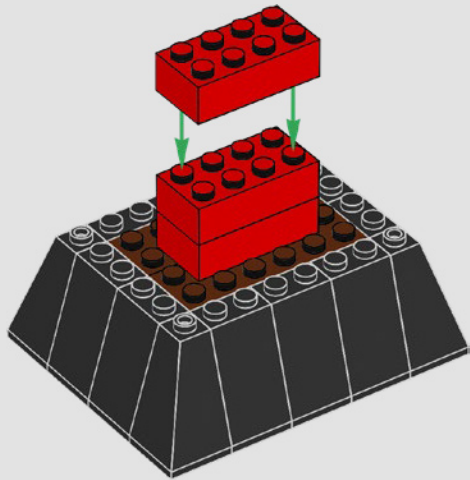

454

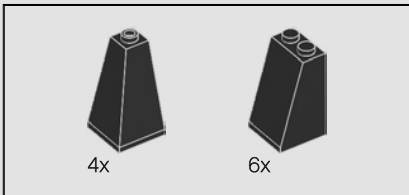
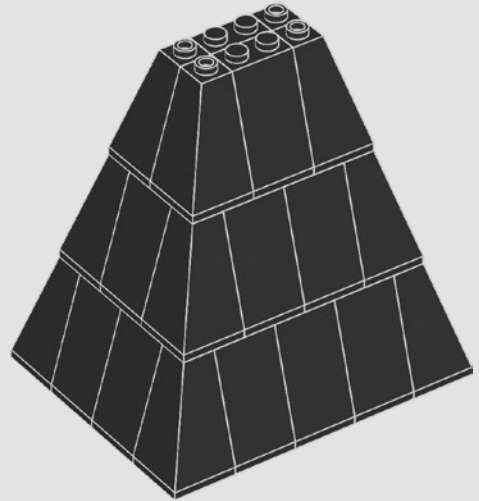

453

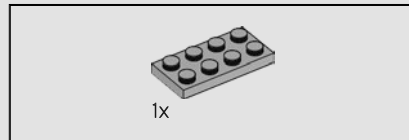
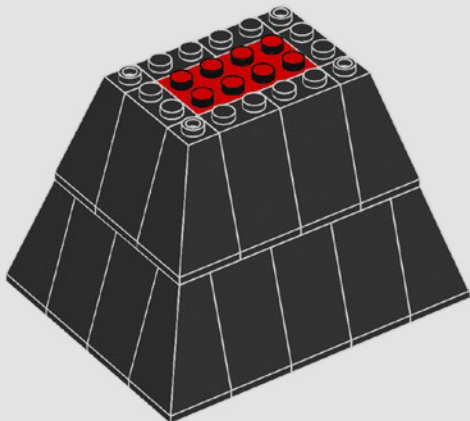

455

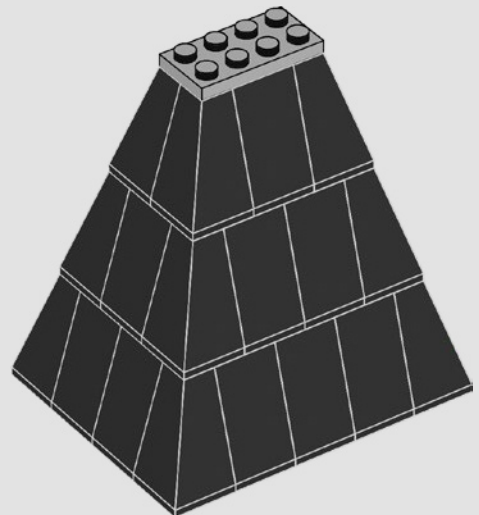

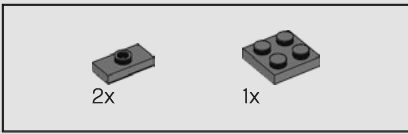

456

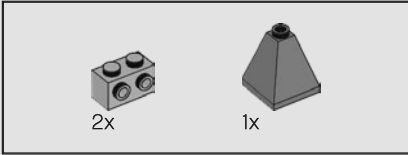
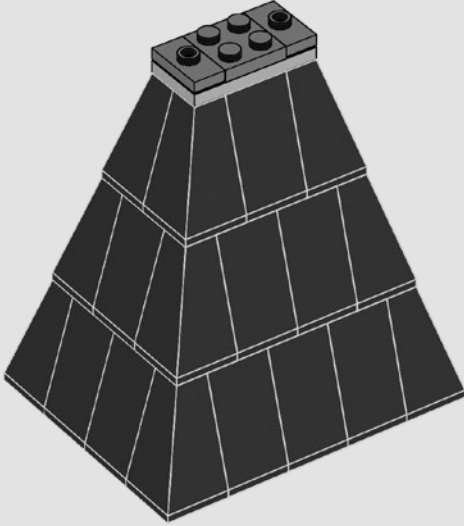

457

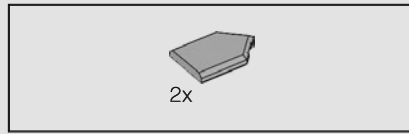
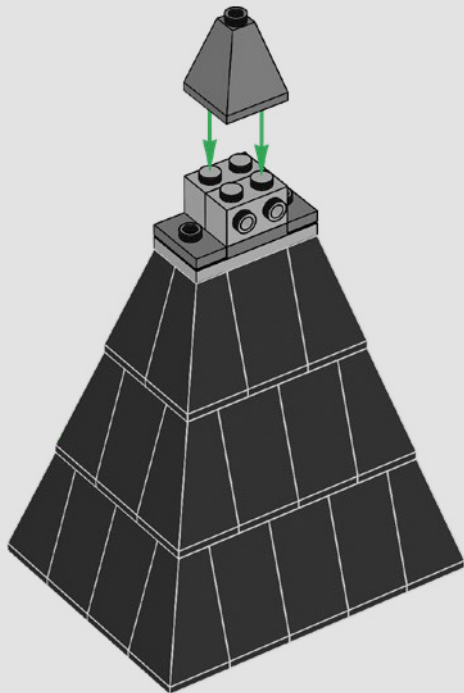

458

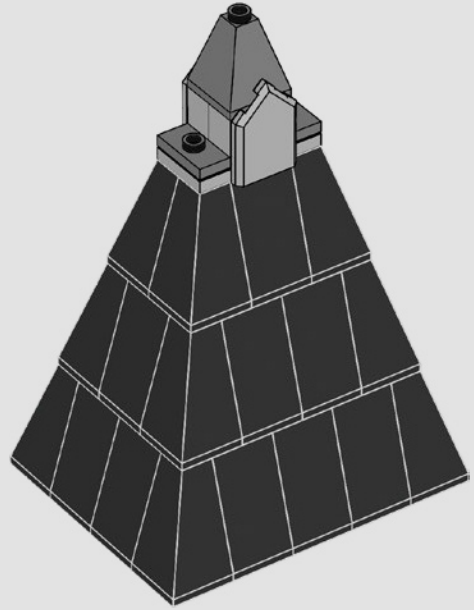

459

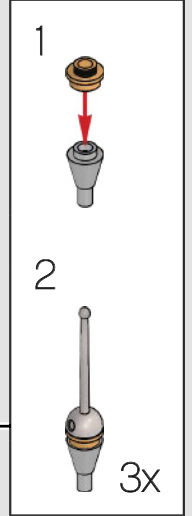
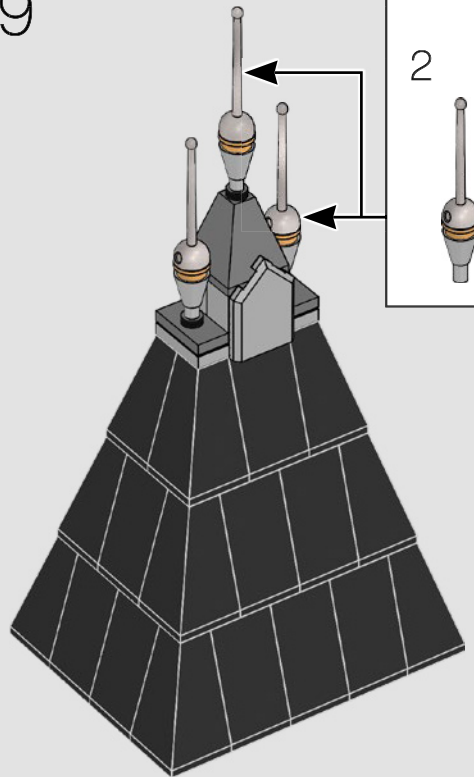

460

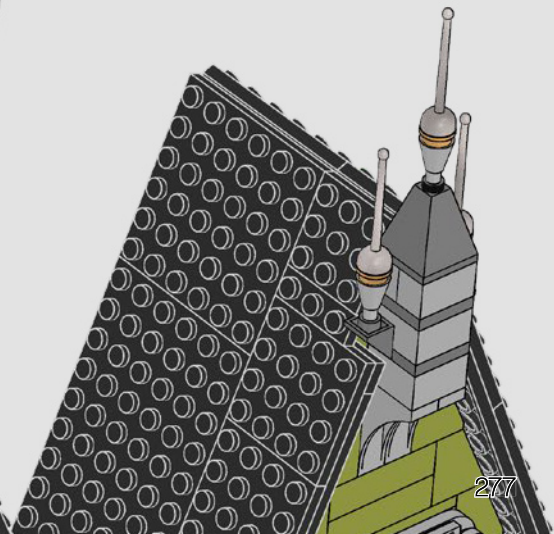
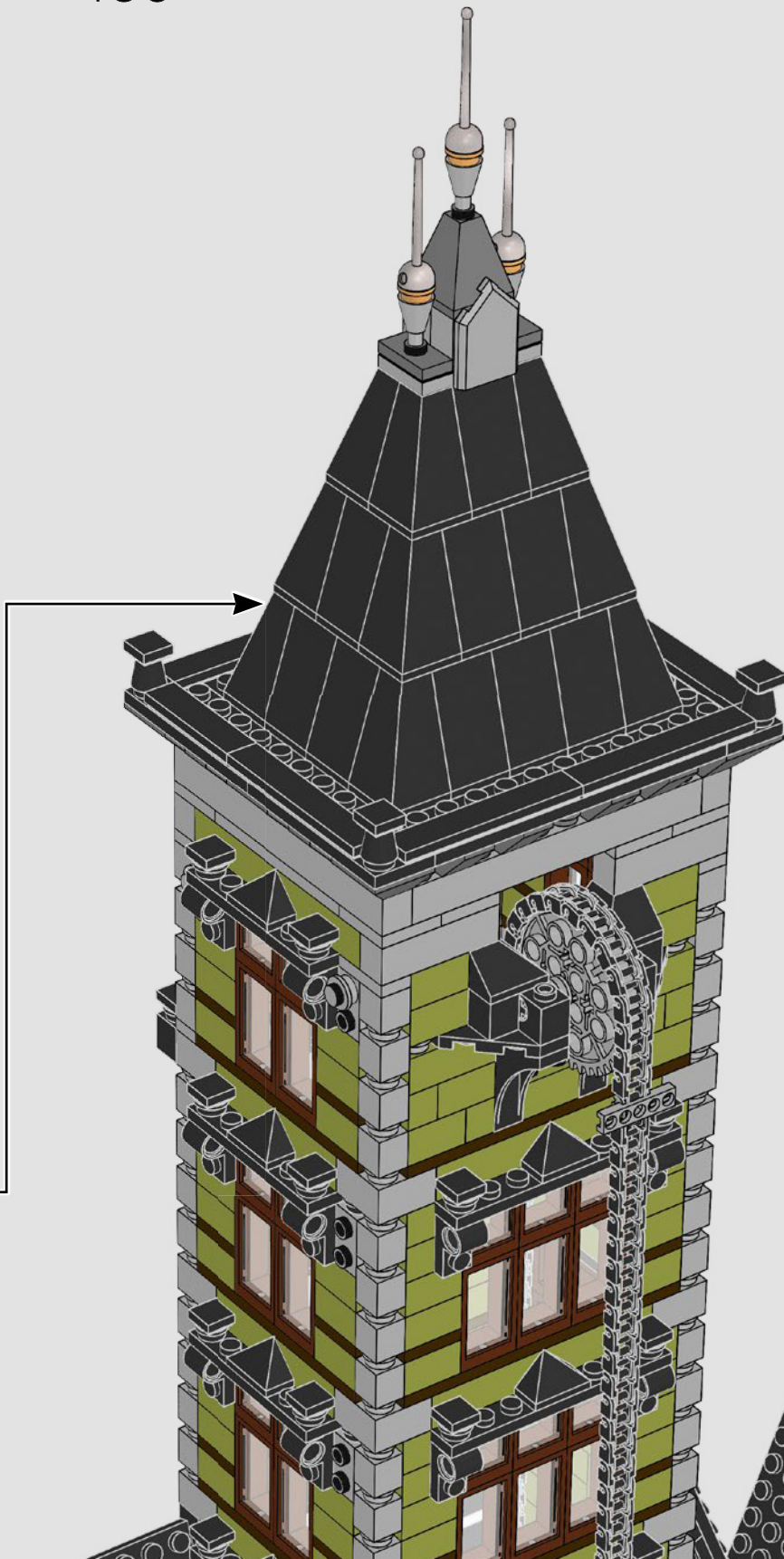

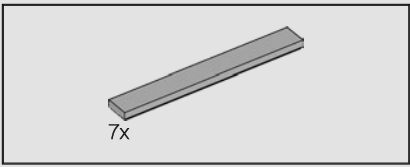

461



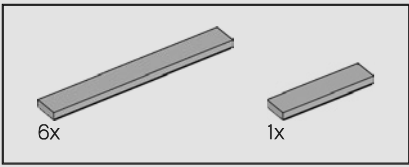

462

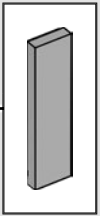

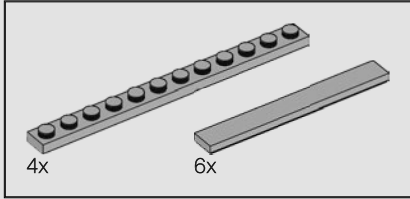
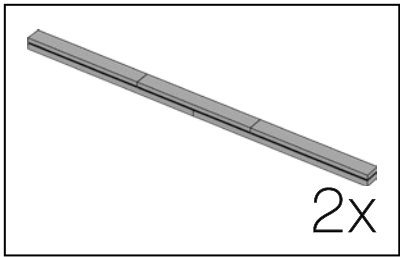

463

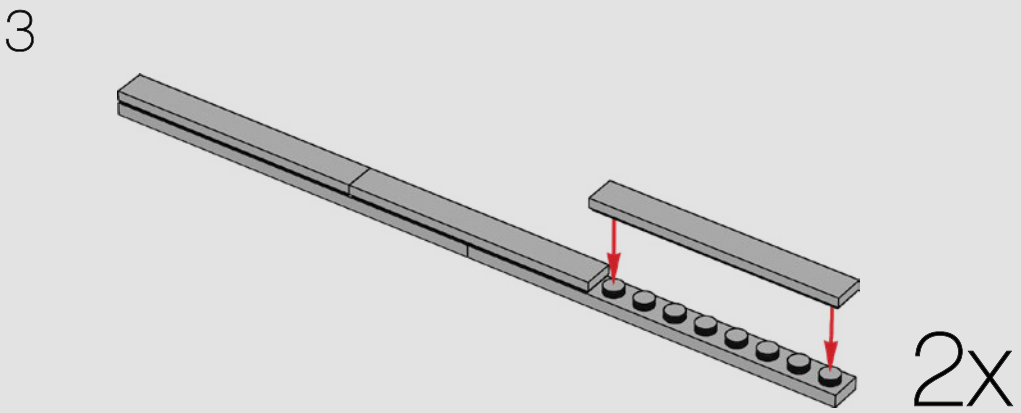
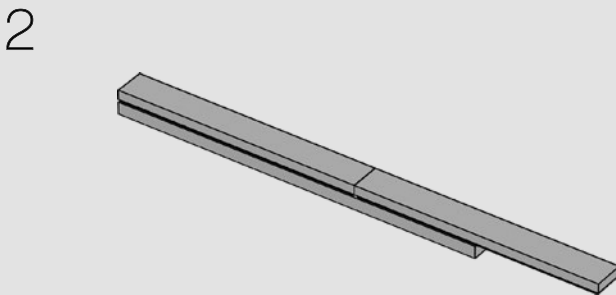
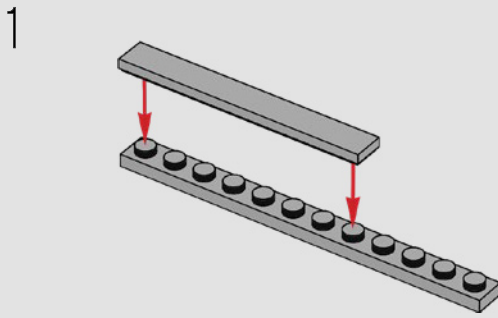

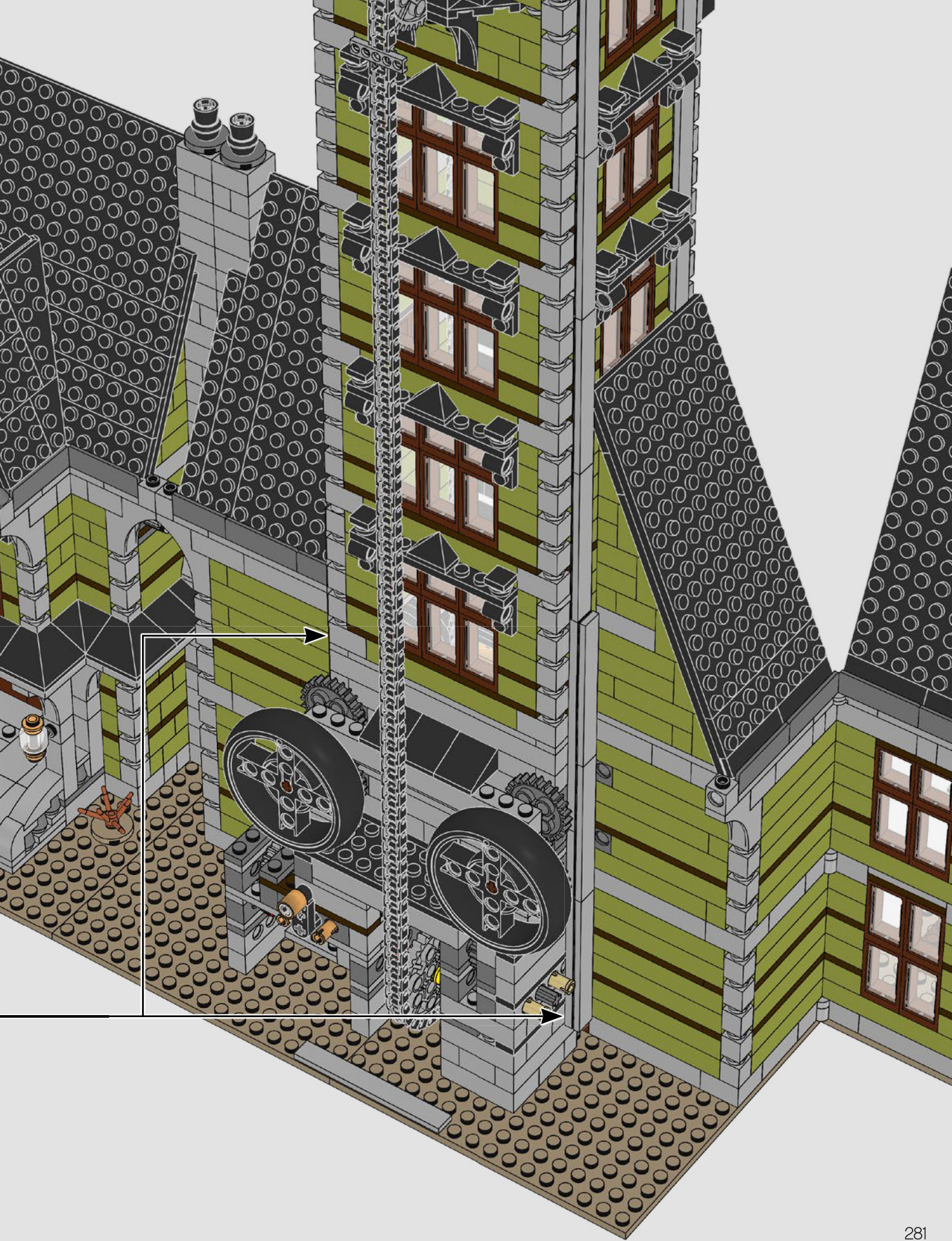





4x

464

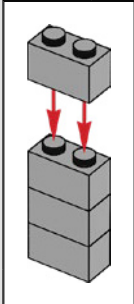

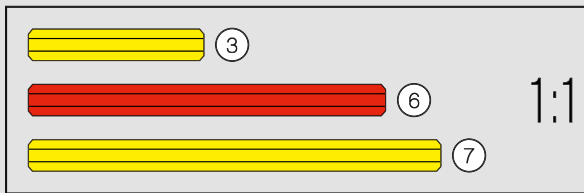
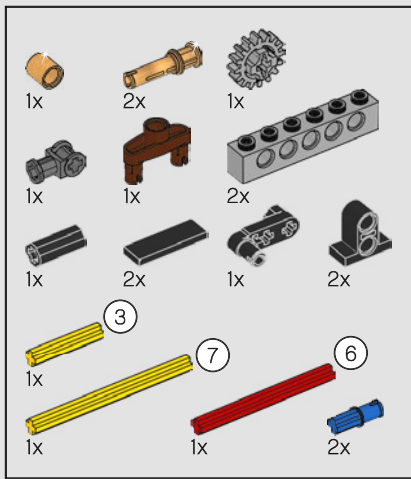

465

1

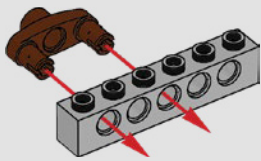

2

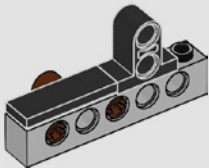

3

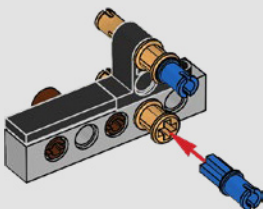

4

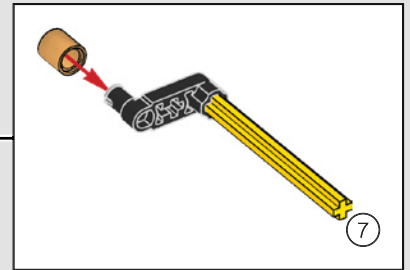
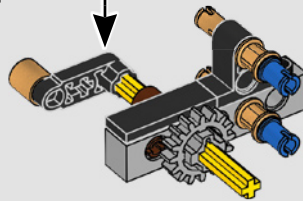

5

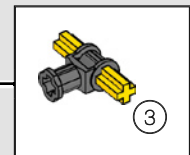
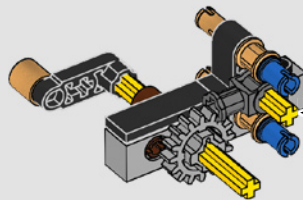

6

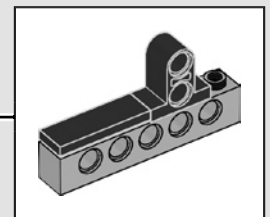
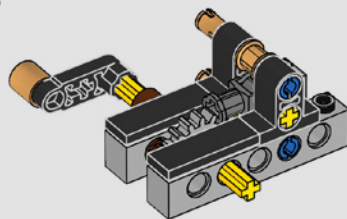

7

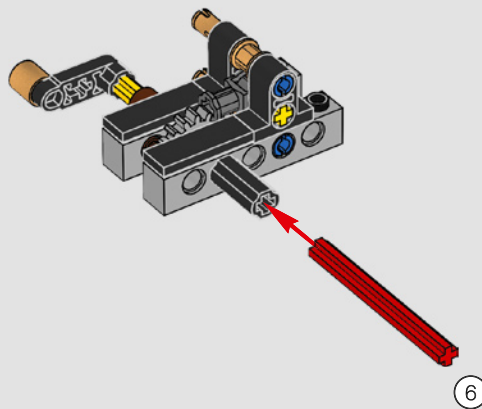

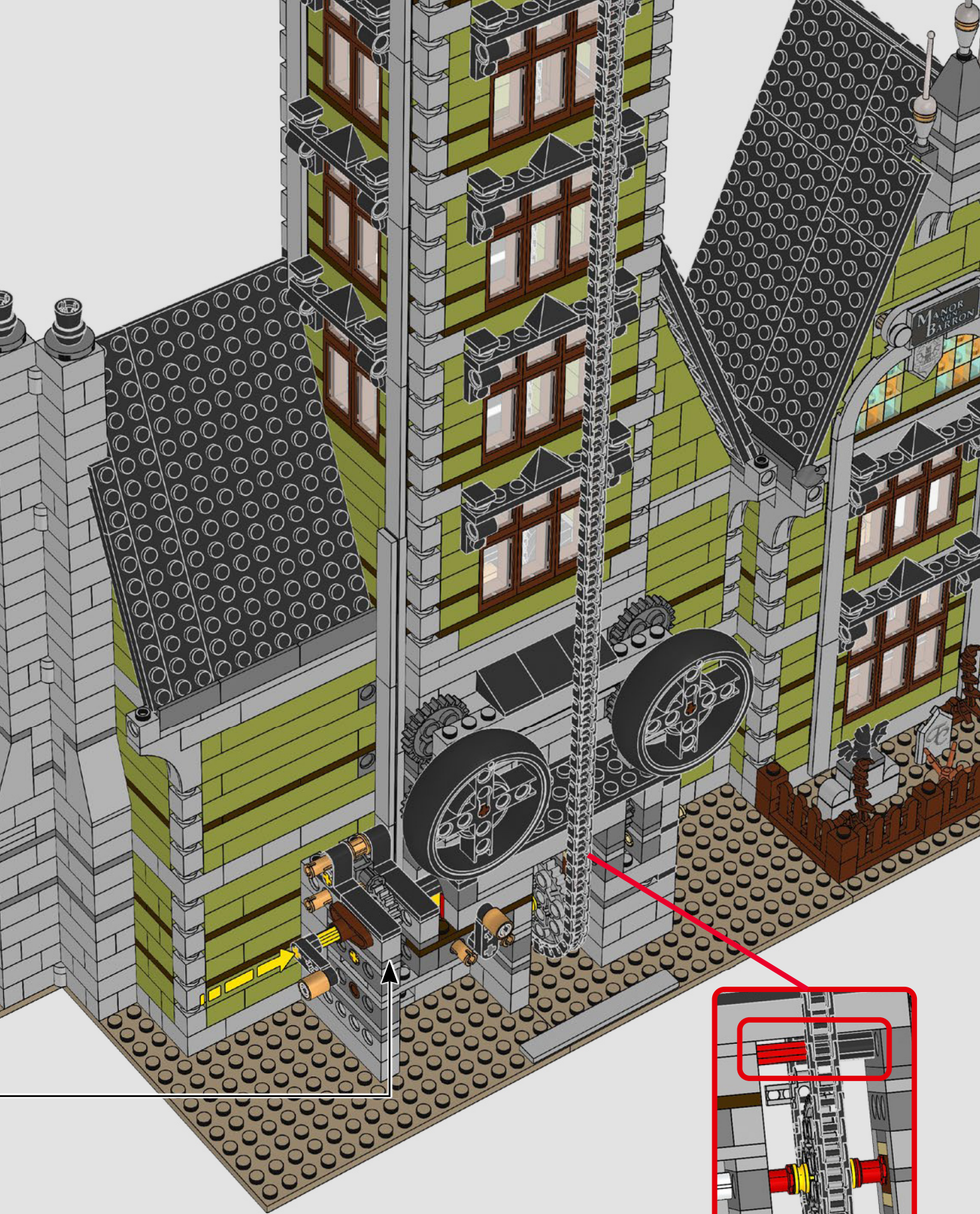

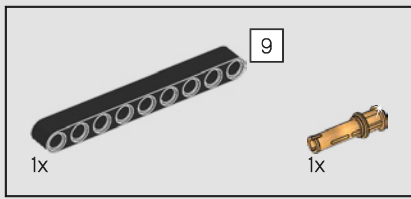

466

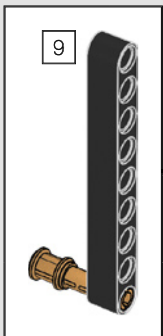
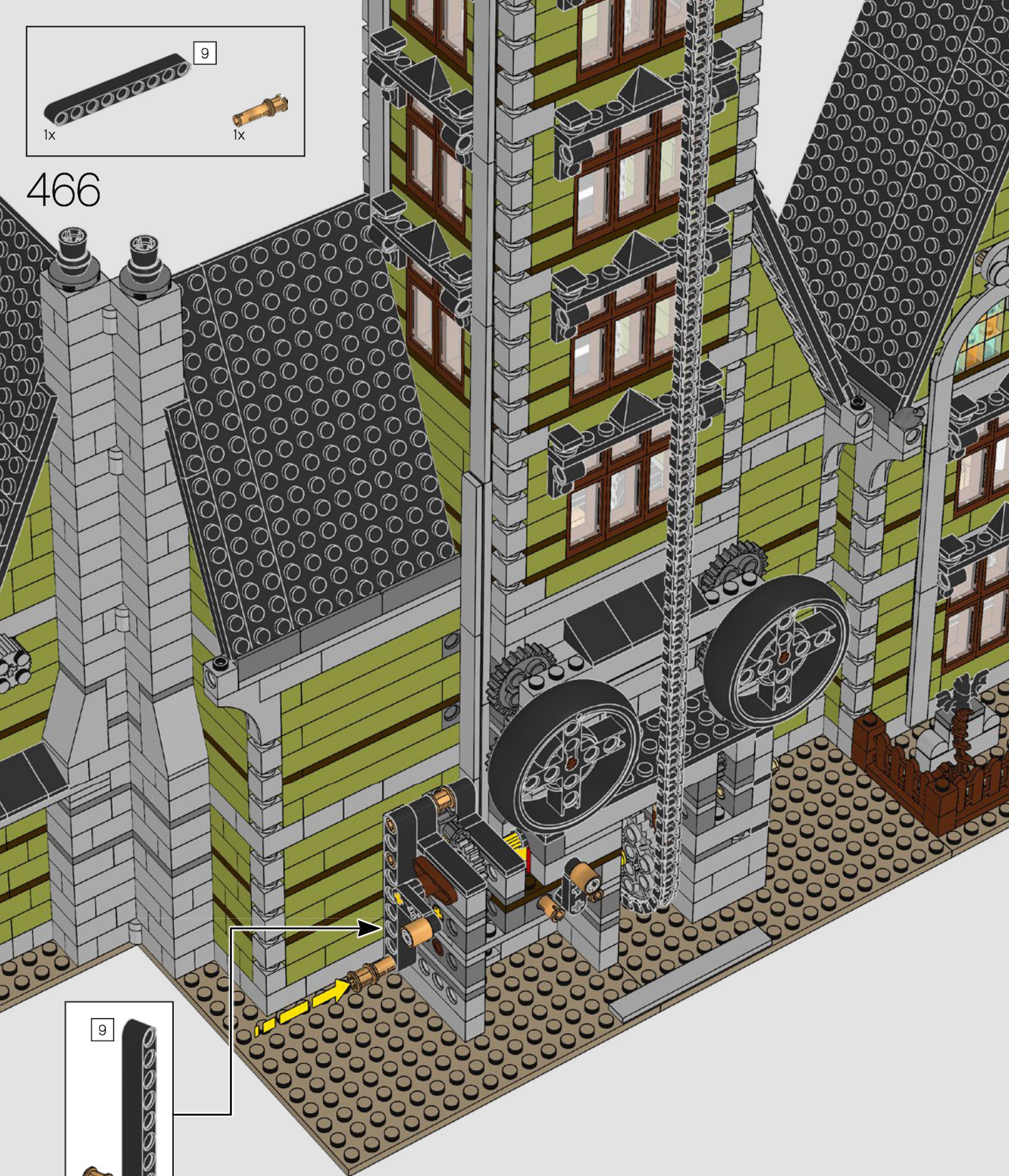

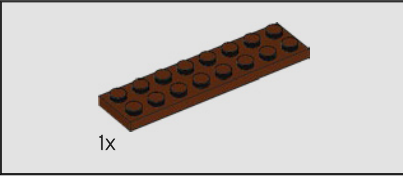
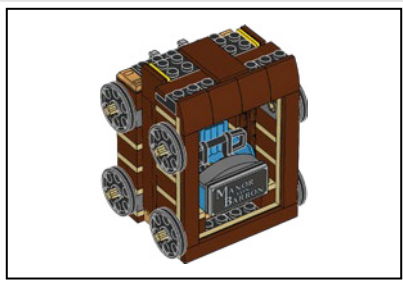

467

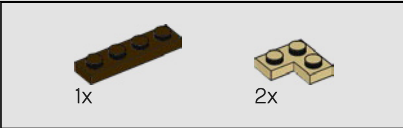
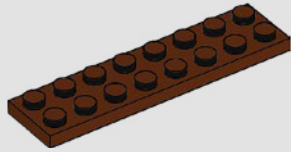

468

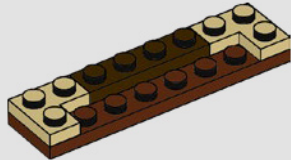

469

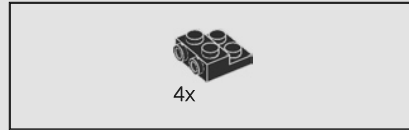
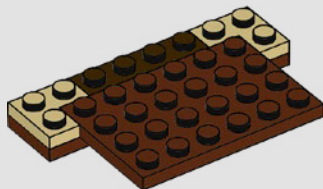

470

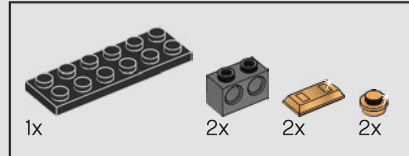
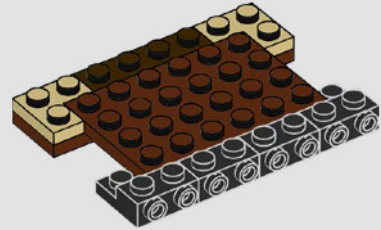

471

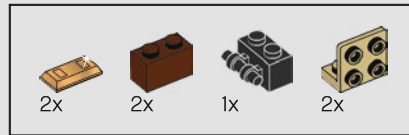
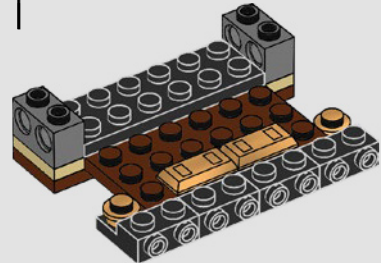

472

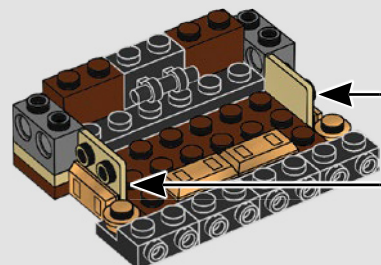
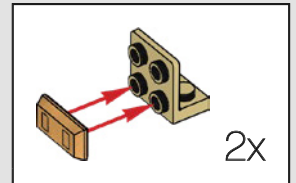

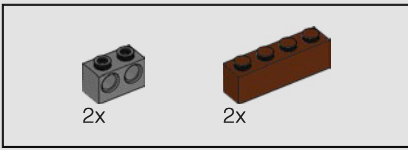

473

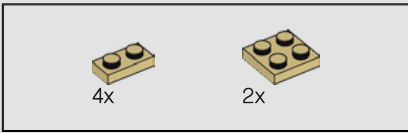
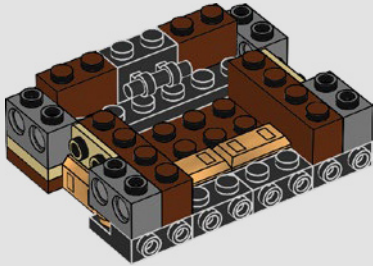

474

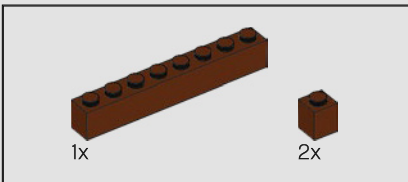
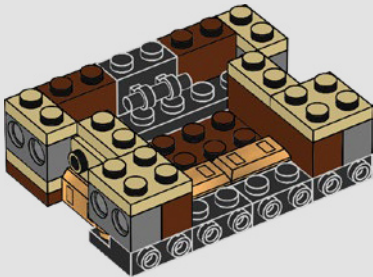

475

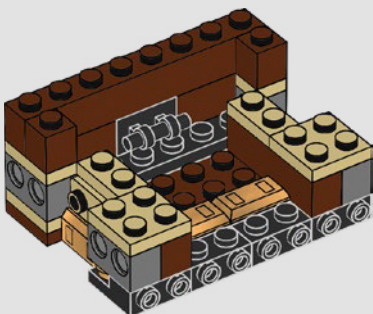

476

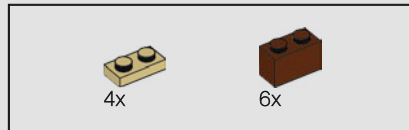
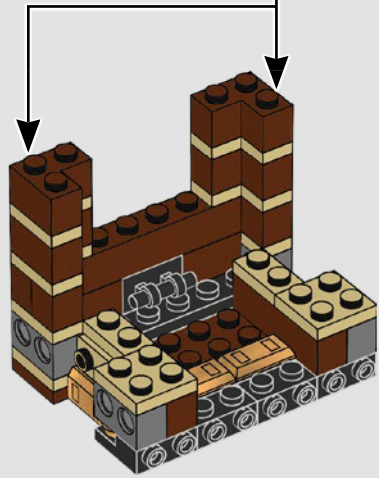
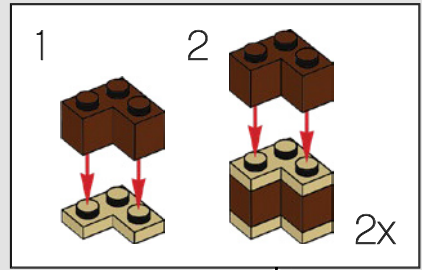

477

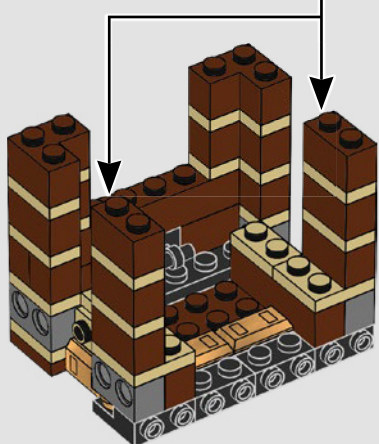
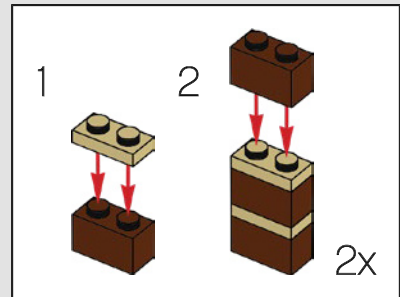



478

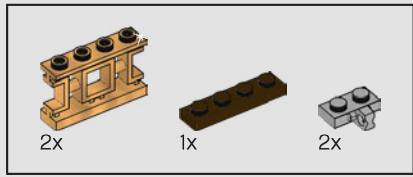
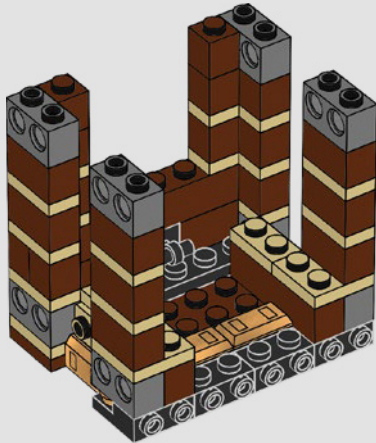

479

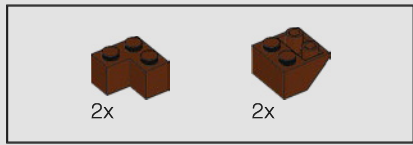
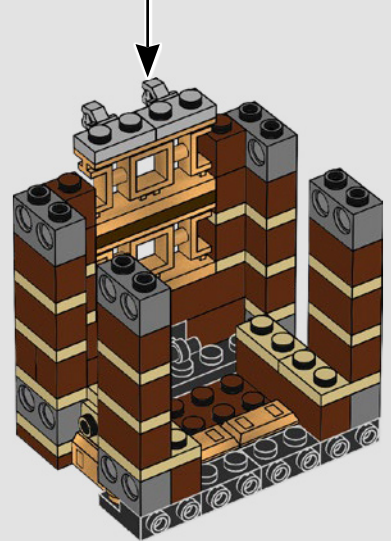
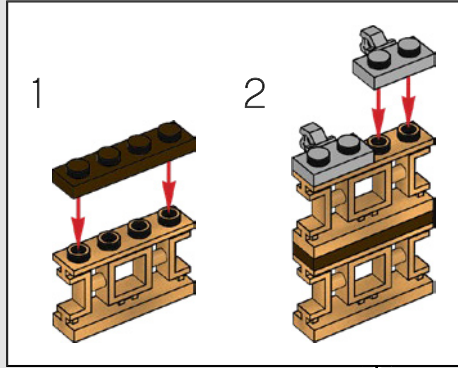

480

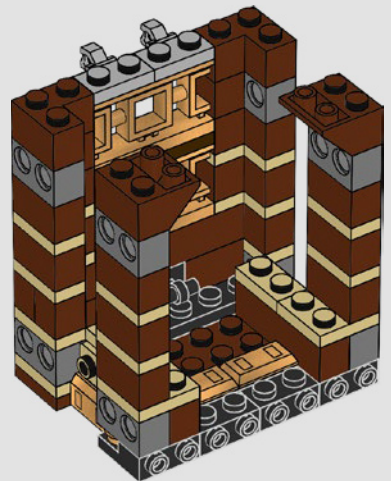

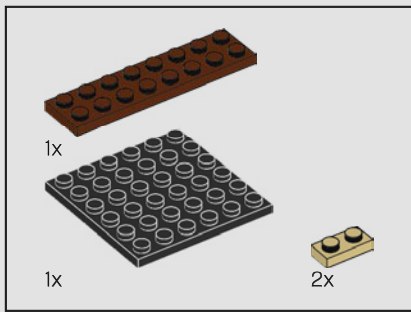

481

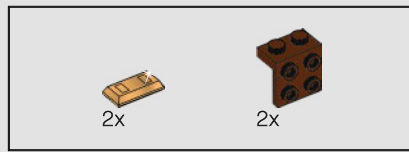
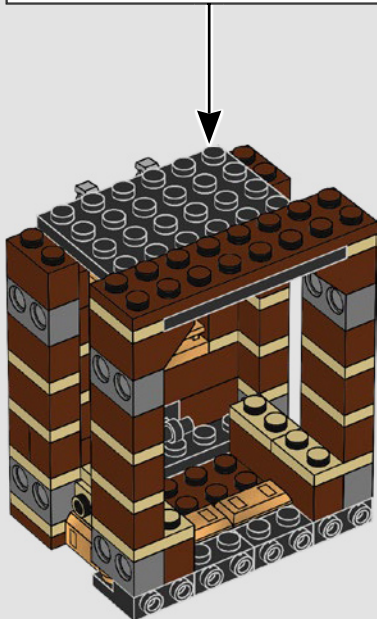
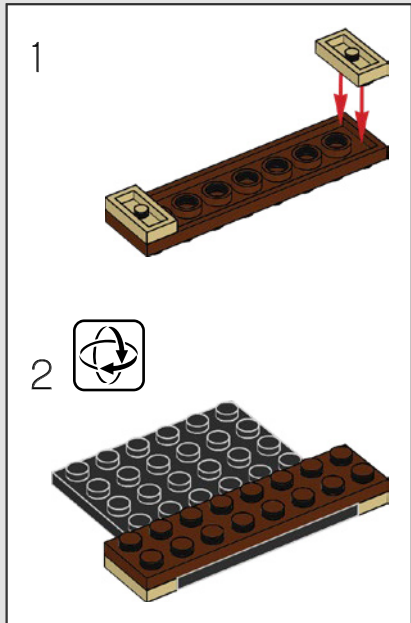

482

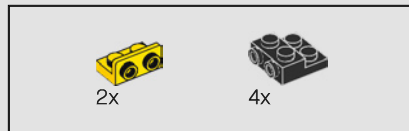
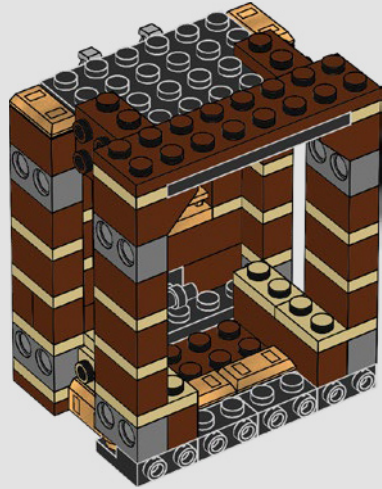

483

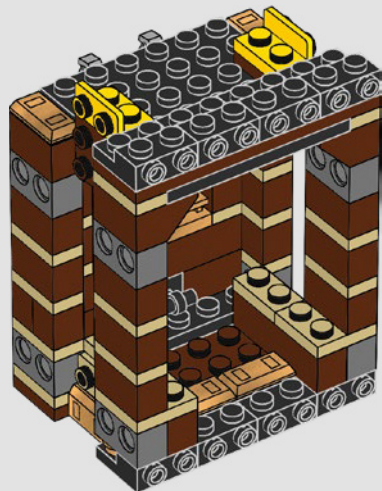

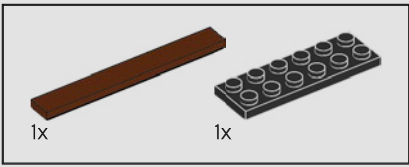

484

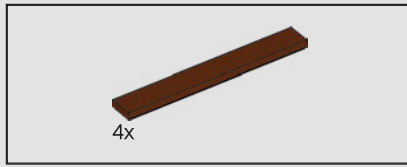
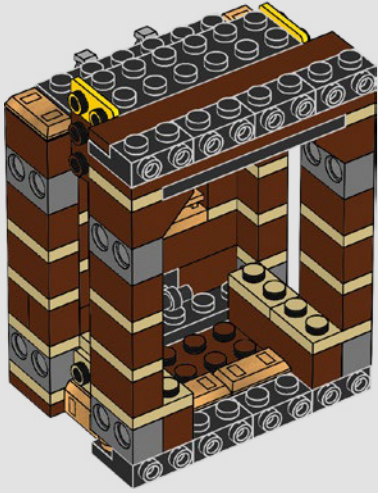

486

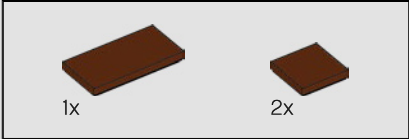
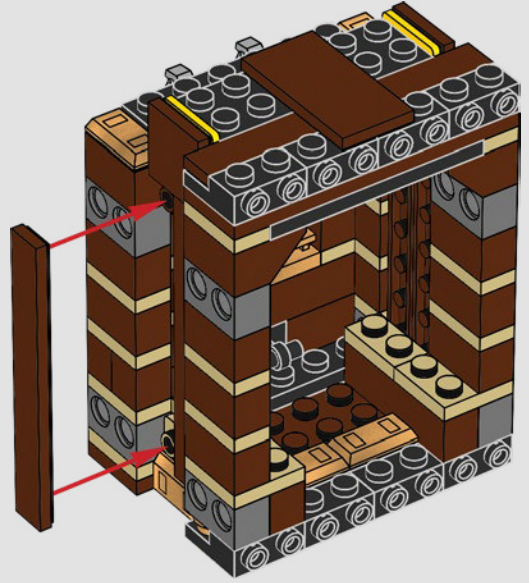

485

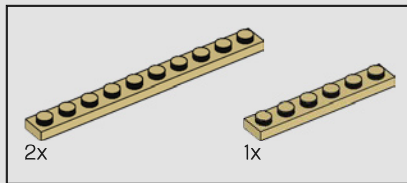
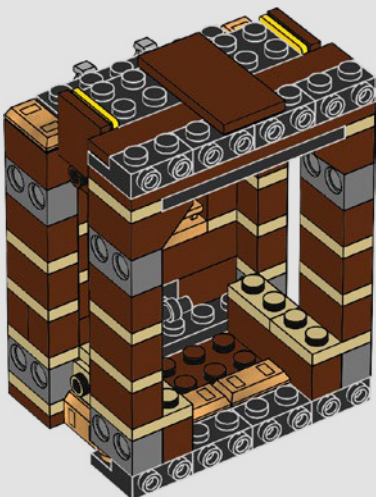

487

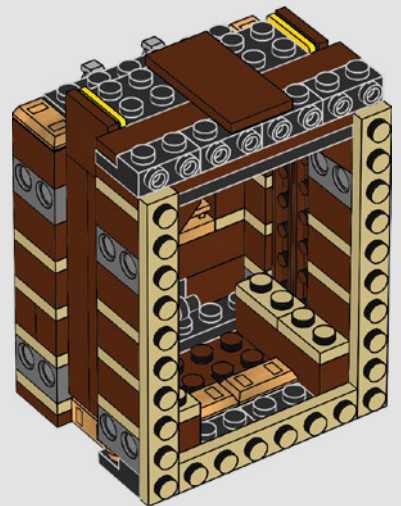

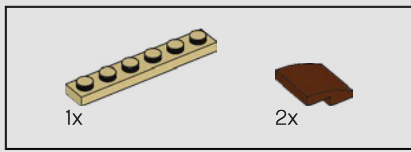

488

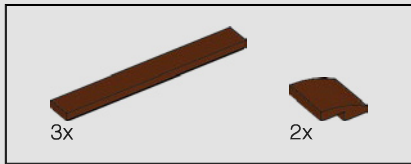
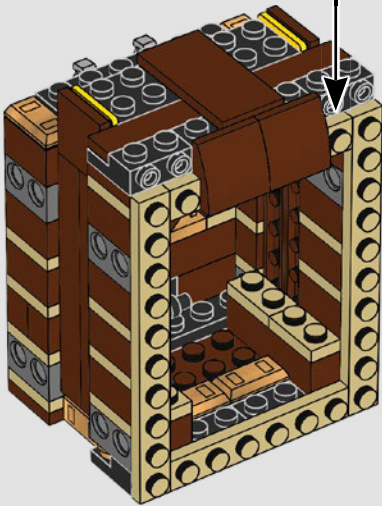
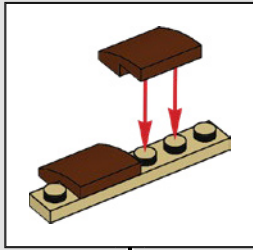

489

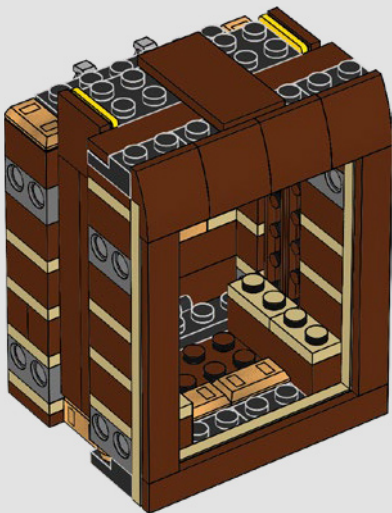

490

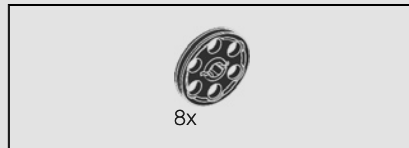
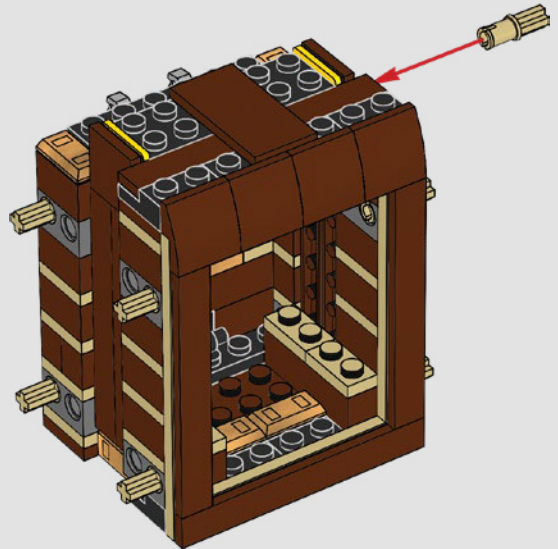

491

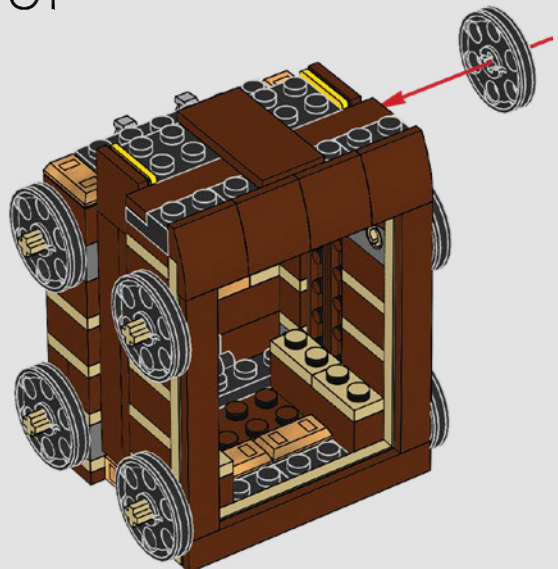

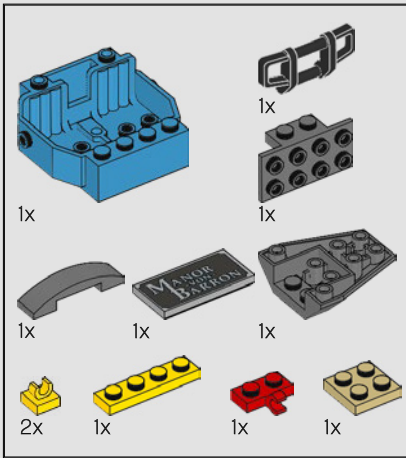
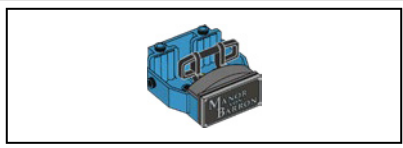

492

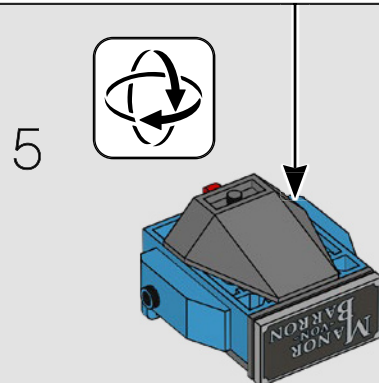
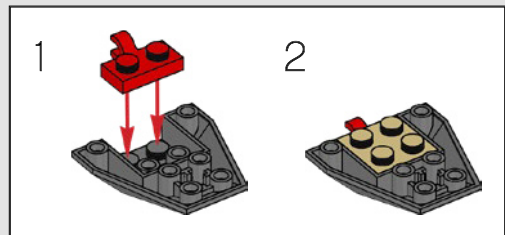
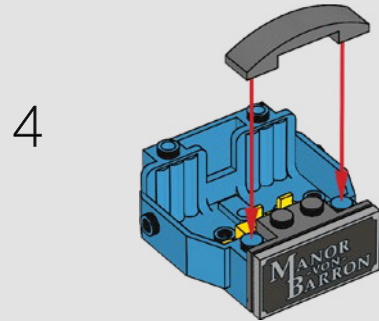
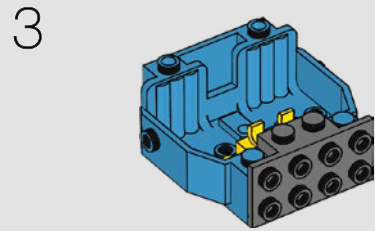
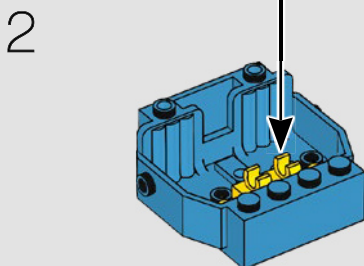
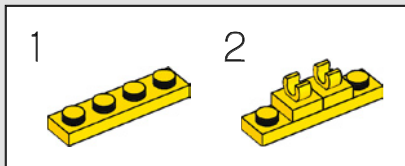
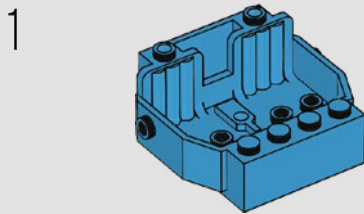

Der Aufzug des verrückten Mannes

„Was soll das heißen, mein Aufzug fährt ins Nirgendwo?
Er hat seine Aufs und Abs. aaaHAHAHaAaaHA!“
– Der verrückte Baron

6

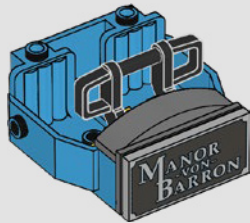

7

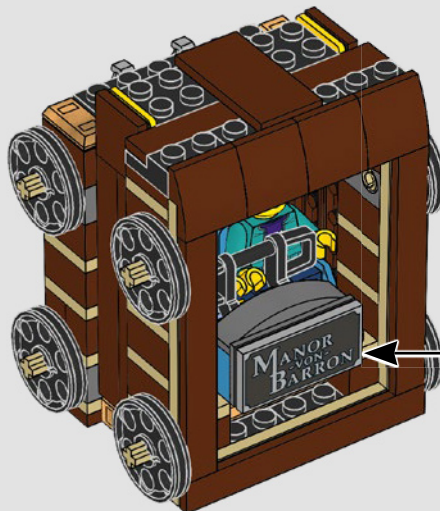

493



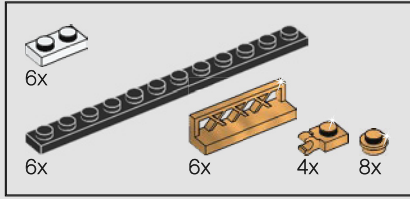
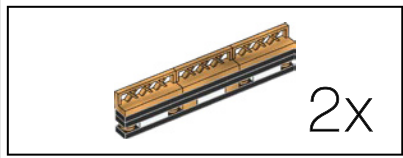

494

1

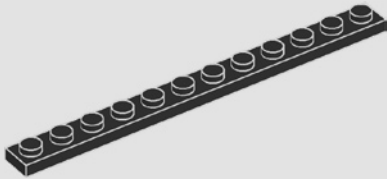

2

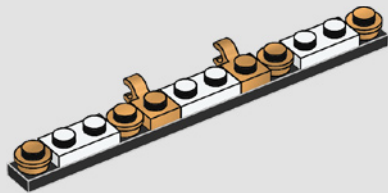

3

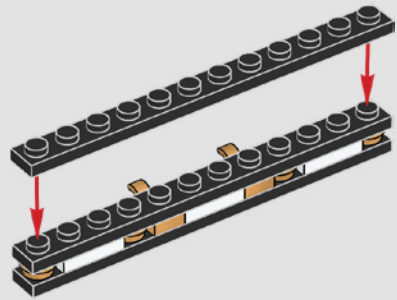

4

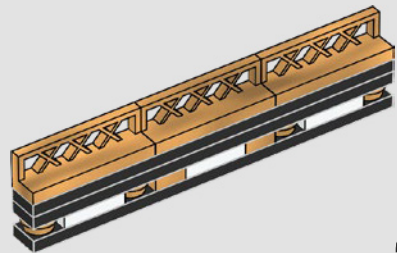



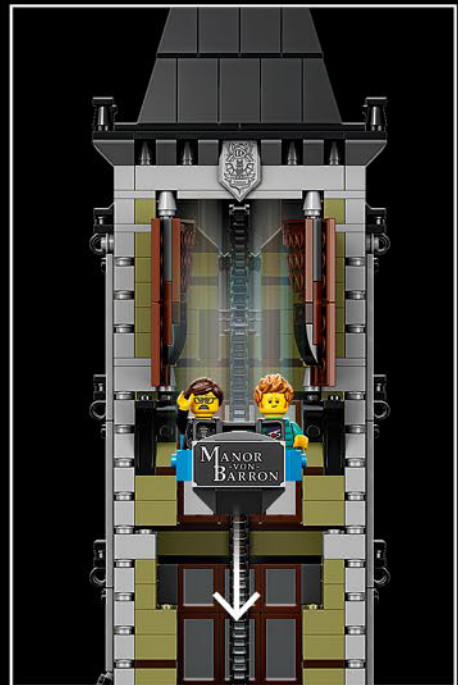
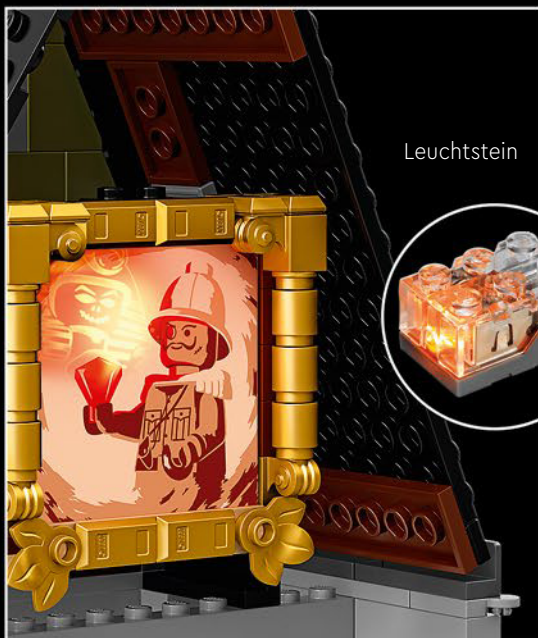
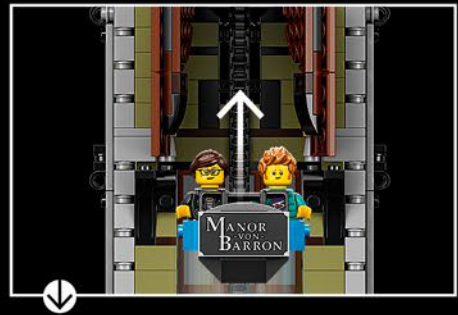
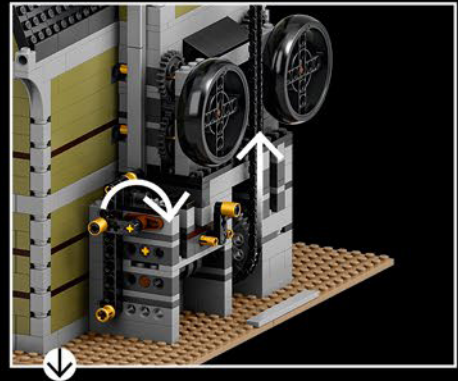
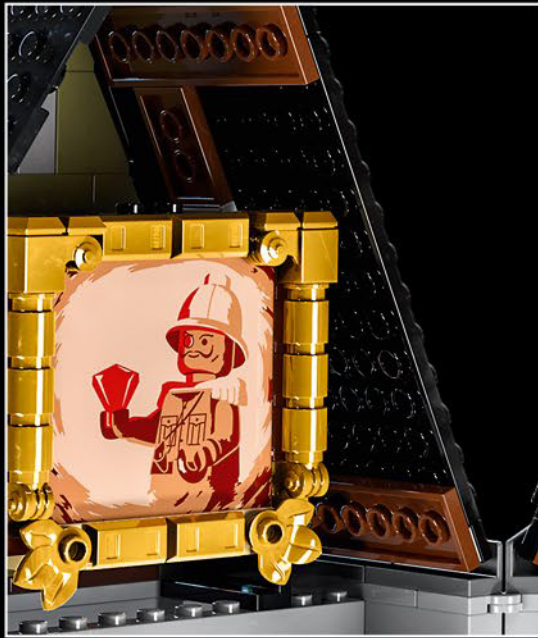

Bereit für Powered Up Funktionen



10273

+



88009

+



88008 x2

+



LEGO® Powered Up
LEGO.com/apps

=



LADE DIR DIE KOSTENLOSE APP HERUNTER

ELEKTROMOTOREN

SMARTPHONE ODER TABLET ERFORDERLICH,
ABER NICHT ENTHALTEN

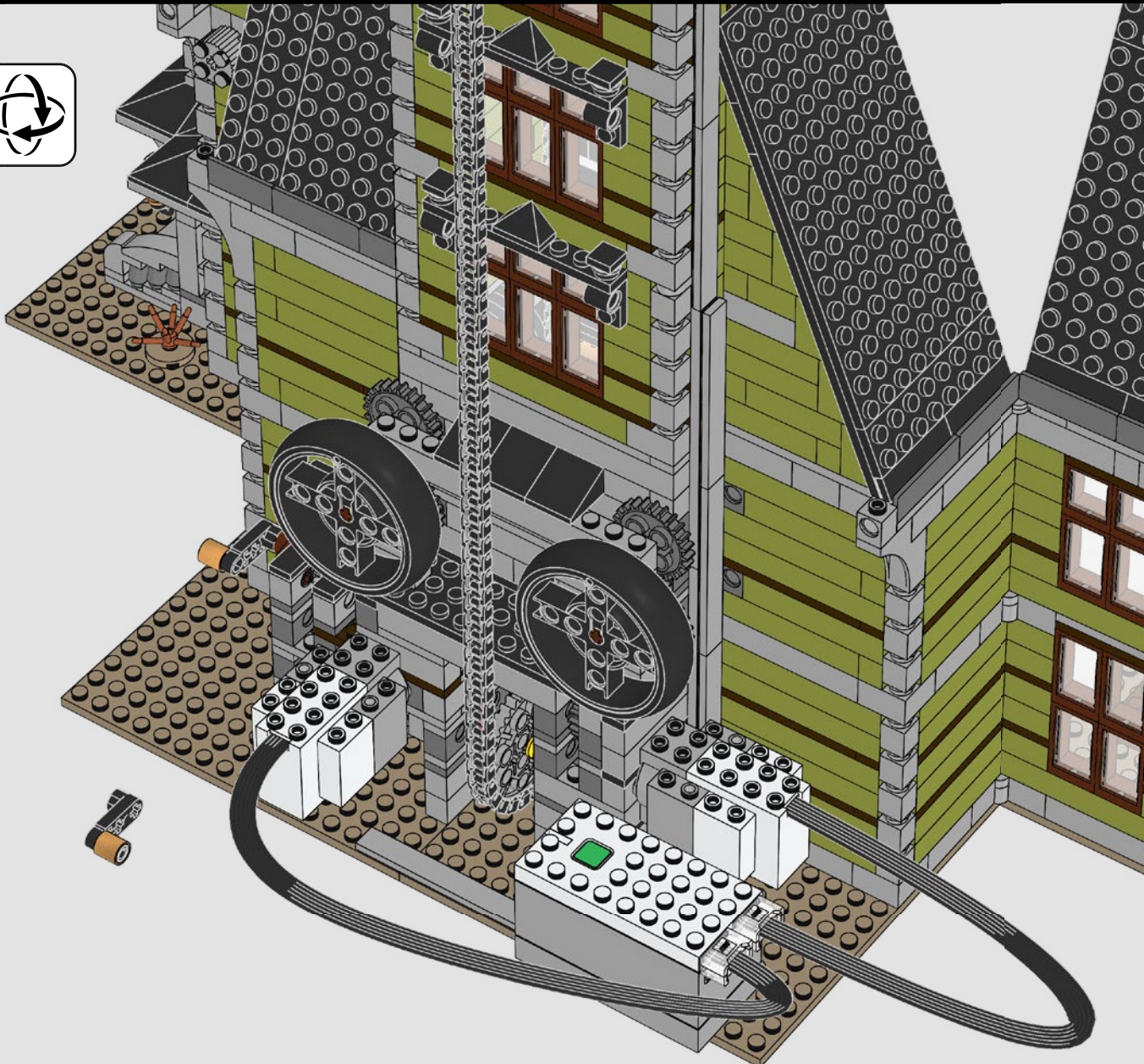

EN

Important information about batteries

Never use different types of batteries together, or a combination of old and new batteries. Always remove the batteries if the product is not to be used for a long time or if the batteries have run down. Never use damaged batteries. Only use alkaline type batteries. Insert the batteries so that the poles are correctly positioned. Never attempt to recharge non-rechargeable batteries. Never short-circuit the battery holder.

DE

Wichtige Informationen zu Batterien

Benutzen Sie niemals unterschiedliche Arten von Batterien oder alte und neue gleichzeitig. Nehmen Sie stets die Batterien heraus, wenn mit dem Modell längere Zeit nicht gespielt wird oder wenn die Batterien leer sind. Verwenden Sie niemals beschädigte Batterien. Verwenden Sie ausschließlich Alkali-Batterien. Achten Sie beim Einsetzen der Batterien auf die richtige Polung. Versuchen Sie unter keinen Umständen, „normale“ Batterien wieder aufzuladen. Schließen Sie das Batteriefach niemals kurz.

FR

Informations importantes concernant les piles

Ne jamais utiliser un mélange de différents types de piles, ou de piles neuves et de piles anciennes ou déjà utilisées. Toujours retirer les piles si le produit n'est pas utilisé durant une période prolongée ou si les piles sont vides. Ne jamais utiliser de piles endommagées. N'utiliser que des piles alcalines. En insérant les piles, respecter scrupuleusement le sens d'orientation des pôles (+/-). Ne jamais essayer de recharger des piles non rechargeables. Ne jamais court-circuiter le compartiment des piles.

IT

Importanti informazioni sulle batterie

Non usare mai contemporaneamente batterie di tipo diverso o batterie nuove e usate insieme. Rimuovere sempre le batterie qualora il prodotto non venga utilizzato per periodi prolungati, oppure se le batterie sono esauste. Non utilizzare mai batterie danneggiate. Utilizzare solo batterie di tipo alcalino. Inserire le batterie avendo cura che la loro polarità sia corretta. Non tentare mai di ricaricare batterie non ricaricabili. Non cortocircuitare mai il portabatterie.

NL

Belangrijke informatie over batterijen

Gebruik nooit verschillende soorten of een combinatie van oude en nieuwe batterijen tegelijkertijd. Verwijder de batterijen altijd als je het product lange tijd niet wilt gebruiken of als batterijen leeg zijn. Gebruik nooit beschadigde batterijen. Gebruik alleen alkalinebatterijen. Plaats de batterijen met de polen in de juiste richting. Probeer nooit niet-oplaadbare batterijen opnieuw op te laden. Laat de batterijhouder nooit kortsluiten.

ES

Información importante acerca de las pilas

No use pilas de diferentes tipos ni pilas nuevas y antiguas para alimentar el producto. Extraiga las pilas del producto si este va a permanecer sin uso durante un período prolongado de tiempo o aquellas se han agotado. No use pilas dañadas. Use solo pilas alcalinas. Inserte las pilas de modo que los polos queden situados en las posiciones correctas. No trate de cargar pilas no recargables. No cortocircuite el compartimento de las pilas.

DA

Vigtige oplysninger om batterier

Brug aldrig forskellige batterityper sammen eller en kombination af gamle og nye batterier. Fjern altid batterierne, hvis produktet ikke skal bruges i lang tid, eller hvis batterierne er flade. Brug aldrig beskadigede batterier. Brug kun alkaliske batterier. Sæt batterierne i, så polerne vender den rigtige vej. Forsøg aldrig at oplade ikke-genopladelige batterier. Kortslut aldrig batteriholderen.

IS

Mikilvægar upplýsingar um rafhlöður

Aldrei skal nota mismunandi gerðir rafhlaðna samtímis, né nýjar og eldri rafhlöður samtímis. Ef ekki á að nota tækði í lengri tíma eða ef rafhlöðurnar eru orðnar tómar skal fjarlægja rafhlöðurnar. Aldrei skal nota rafhlöður sem hafa skemmt. Eingöngu má nota alkaline-rafhlöður. Setja skal rafhlöðurnar í þannig að plús- og mínusskaut þeirra snúi rétt. Aldrei skal reyna að endurhlaða rafhlöður sem ekki eru endurhlaðanlegar. Aldrei ætti að valda skammhlaupi í rafhlöðuhöfðinu.

FI

Tärkeää tietoa paristoista

Älä koskaan käytä erityyppisiä paristoja yhdessä. Älä myöskään käytä samassa laitteessa sekä vanhoja että uusia paristoja. Poista paristot tuotteesta aina, kun se on pitemmän aikaa käyttämättä, tai kun paristot ovat tyhjentyneet. Älä koskaan käytä viiallisia paristoja. Käytä vain alkaliparistoja. Aseta paristot siten, että navat osoittavat oikeaan suuntaan. Älä koskaan aiheuta oikosulkuja pariston kosketintien välillä.

SV

Viktig information om batterier

Använd aldrig olika sorters batterier samtidigt, och inte heller en kombination av gamla och nya batterier. Ta alltid ur batterierna om produkten inte ska användas under en längre tid eller om batterierna är slut. Använd aldrig skadade batterier. Använd endast alkaliska batterier. Sätt i batterierna så att polerna hamnar i rätt läge. Försök aldrig ladda icke-laddningsbara batterier. Kortslut aldrig batteriutrymmets kontaktytor.

NO

Viktig informasjon om batterier

Bruk aldri ulike typer batterier sammen og heller aldri gamle og nye batterier sammen. Ta alltid ut batteriene hvis produktet ikke skal brukes på lang tid, eller hvis batteriene er brukt opp. Bruk aldri skadde batterier. Bruk bare alkaliske batterier. Sett inn batteriene med polene vendt riktig vei. Forsøk aldri å lade opp ikke-oppladbare batterier. Kortslett aldri batteriholderen.

PT

Informação importante sobre as pilhas

Nunca use diferentes tipos de pilhas em simultâneo, ou uma combinação de pilhas usadas e novas. Retire sempre as pilhas se o produto não for usado durante muito tempo ou se as pilhas já não tiverem carga. Nunca use pilhas danificadas. Use apenas pilhas alcalinas. Insira as pilhas de forma a que os polos fiquem corretamente posicionados. Nunca tente recarregar pilhas não recarregáveis. Nunca deixe o compartimento das pilhas entrar em curto-circuito.

EL

Σημαντικές πληροφορίες για τις μπαταρίες

Μην χρησιμοποιείτε ποτέ διαφορετικούς τύπους μπαταριών μαζί και μην συνδυάζετε παλιές και καινούργιες μπαταρίες. Αφαιρείτε πάντα τις μπαταρίες αν δεν σκοπεύετε να χρησιμοποιήσετε το προϊόν για αρκετό καιρό ή αν οι μπαταρίες έχουν αδειάσει. Ποτέ μην χρησιμοποιείτε μπαταρίες που έχουν φθορές. Χρησιμοποιείτε μόνο αλκαλικές μπαταρίες. Τοποθετήστε τις μπαταρίες με τους πόλους στη σωστή θέση. Μην επιχειρήσετε ποτέ να επαναφορτίσετε μη επαναφορτιζόμενες μπαταρίες. Ποτέ μην βραχυκυκλώνετε τη θήκη των μπαταριών.

JA

電池取扱いに関する重要事項

異なるタイプの電池や古い電池を混ぜて使用しないでください。商品を長時間使用しないときや電池が切れたときは、電池を必ず取り外してください。不具合のある電池は絶対に使用しないでください。アルカリタイプの電池のみを使用してください。電極を確認して電池を正しい向きに入れてください。充電式ではない電池は絶対に充電しないでください。電池ホルタをショートさせないでください。

ZH

电池使用注意事项

请勿同时使用不同类型的电池，或把新旧程度不同的电池混合使用。如果产品将有很长时间不会使用，或者电池已经没电，请注意取出电池。切勿使用已破损的电池。仅可使用碱性电池。装入电池时请注意正负极。请勿尝试给非充电电池充电。切勿对电池仓进行短路连接。

KO

배터리 사용 시 주의사항

다른 종류의 배터리를 함께 사용하거나, 새 전지와 오래된 전지를 혼용하지 마세요. 배터리가 방전되었거나 장기간 제품을 작동하지 않을 때에는 반드시 배터리를 분리하세요. 파손된 배터리는 사용하지 마세요. 알칼라인 타입의 배터리만을 사용하세요. 양극과 음극의 위치를 잘 맞춰서 넣으세요. 일반 배터리는 충전해서 사용할 수 없습니다. 배터리 홀더의 접촉부에 배터리를 정확히 끼워서 사용하세요.

RU

Необходимая информация об элементах питания

Ни в коем случае не используйте одновременно элементы питания различных типов, а также элементы питания с разным сроком годности. В обязательном порядке вынимайте элементы питания из терминалов в случае, если вы не пользуетесь прибором в течение долгого времени, либо в случае, если в элементах питания закончился заряд. Ни в коем случае не используйте поврежденные элементы питания. Используйте только элементы питания щелочного типа. Установите элементы питания, соблюдая указанную полярность. Ни в коем случае не пытайтесь подзаряжать непerezаряжаемые элементы питания. Ни в коем случае не пытайтесь замкнуть полюса в устройстве для элементов питания.

PL

Ważne informacje dotyczące baterii

Nigdy nie należy stosować razem różnych rodzajów baterii ani stosować równocześnie starych i nowych baterii. Jeżeli produkt nie jest używany przez dłuższy czas lub jeżeli baterie się wyczerpały, należy wyjąć baterie. Nigdy nie należy stosować uszkodzonych baterii. Należy używać wyłącznie baterii alkalicznych. Przy wkładaniu baterii należy zwrócić uwagę na właściwe położenie biegunów. Nigdy nie należy próbować ładowania baterii jednorazowych. Nigdy nie należy doprowadzać do zwarcia w gnieździe baterii.

CZ

Důležitá informace o bateriích

Nikdy nepoužívejte najednou různé typy baterií nebo kombinaci starých a nových baterií. Nebude-li se výrobek delší dobu používat nebo jsou-li baterie vybité, vždy je vyjměte z výrobku. Nikdy nepoužívejte poškozené baterie. Používejte pouze alkalické baterie. Baterie instalujte se správnou orientací pólů. Nikdy se nesnažte nabíjet baterie, které nejsou nabíjitelné. Nikdy nezkratuje kontakty v prostoru pro baterie.

SK

Dôležitá informácia o batériách

Nikdy nepoužívajte naraz odlišné typy batérií ani nekombinujte staré batérie s novými. Batérie vždy vyberte, ak sa výrobok nebude dlhšie používať, alebo ak sa batérie vybili. Nikdy nepoužívajte poškodené batérie. Používajte iba alkalické batérie. Batérie vkladajte so správnou orientáciou pólou. Nikdy sa nesnažte nabíjať batérie, ktoré nie sú nabíjateľné. Nikdy neskratuje kontakty v priestore pre batérie.

HU

Fontos tudnivalók az elemekről

Soha ne használjon különböző típusú elemeket, illetve ne használjon vegyesen új és használt elemeket. Mindig távolítsa el az elemeket, ha a készülék előre láthatóan hosszabb ideig nem fogják használni, vagy ha az elemek lemerültek. Soha ne használjon megrongálódott elemeket. Csak alkáli elemeket használjon! Az elemeket helyesen helyezze be, a polaritásuknak megfelelően. Soha ne próbálja meg feltölteni a nem tölthető elemeket. Soha ne hozzon létre rövidzárlatot az elemtartó kivezetésén.

UA

Необхідна інформація про батареї

Ніколи не використовуйте одночасно батареї різних типів або батареї з різними терміном придатності. Обов'язково вилучайте батареї з приладу, якщо довго не користуєтесь ним, або якщо в батареях уже скінчився заряд. Ніколи не використовуйте пошкоджені батареї. Використовуйте лише лужні батареї. Вставляйте батареї, враховуючи задану полярність. У будь-якому випадку не намагайтеся підзарядити батареї, що не підлягають підзарядці. У будь-якому випадку не намагайтеся зробити коротке замикання в приладі для батарей.

HR

Važne obavijesti o bateriji

Nikada nemoj koristiti različite vrste baterija zajedno, isto tako ni kombinaciju starih i novih baterija. Uvijek izvadite baterije ako dugo nećeš koristiti proizvod ili ako su one potrošene. Nikada nemoj koristiti oštećene baterije. Upotrebļjavajte samo alkalne baterije. Umetni baterije pazeći da dobro okreneš polove. Nikada ne pokušavaj puniti baterije koje nisu predviđene za punjenje. Nikada ne izazivaj kratki spoj u držaču baterija.

SR

Важне информације о батеријама

Nikada ne koristite različite tipove baterija zajedno niti kombinaciju starih i novih baterija. Uvek izvadite baterije ukoliko proizvod neћete dјue vreme koristiti ili ukoliko su baterije prazne. Nikada ne koristite ošteћene baterije. Koristite samo alkalne baterije. Stavite baterije tako da su o polovima pravilno pozicionirani. Nikada ne pokušavajte da punitе baterije koje ne mogu da se pune. Nikada ne izazivajte kratak spoj u kuћишту za baterije.

MK

Важни информации за батериите

Nikoгаш не користете различни типови батерији заедно или комбинацију од стари и нови батерији. Секогаш отстранувајте ги батериите доколку не го користите производ подолго време или доколку се потрошиле. Никогаш не користете оштетени батерији. Користете само алкални батерији. Вметнете ги батериите така што точно ќе ги наместите половите. Никогаш не обидувајте се да ги полните батериите за еднократна употреба. Никогаш не предизвикувајте краток spoj на држачот за батерији.

SL

Pomembne informacije o baterijah

Nikoli ne uporabljajte skupaj različnih baterij ali kombinacije starih in novih baterij. Vedno odstranite baterije, če izdelka dlje časa ne boste uporabljali ali če so iztrošene. Nikoli ne uporabljajte poškodovanih baterij. Uporabljajte le alkalne baterije. Baterije vstavite tako, da so njihovi poli pravilno obrnjeni. Nikoli ne poskušajte polniti baterij, ki niso akumulatorske. Pazite, da ležišč za baterije ne boste spravili v kratek stik.

RO

Informații importante despre baterii

Nu folosiți niciodată împreună tipuri diferite de baterii, sau o combinație de baterii vechi și noi. Îndepărtați întotdeauna bateriile dacă produsul nu este folosit timp îndelungat sau dacă bateriile s-au epuizat. Nu folosiți niciodată baterii deteriorate. Utilizați numai baterii de tip alcalin. Introduceți bateriile astfel ca poli să fie poziționați corect. Nu încercați niciodată să reincercați baterii nereîncercabile. Nu scurcircuitați niciodată suportul bateriei.

BG

Важна информация за батериите

Nikoга не използвайте едновременно различни типове батерији или комбинация от стари и нови батерији. Винаги изваждайте батериите, ако изделието няма да се използва продължително време или ако батериите са се изтозили. Никога не използвайте повредени батерији. Използвайте само алкални батерији. Поставете батериите така, че полюсите да са разположени правилно. Никога не опитвайте да зареждате батерији, които не са акумулаторни. Никога не свързвайте на късо контактите на отделението за батериите.

LV

Svarīga informācija par baterijām

Nekad vienlaikus nelietojiet dažādu tipu, kā arī vecas un jaunās baterijas. Vienmēr izņemiet baterijas, ja tās ir izlādējušās vai ja produkts ilgāku laiku netiek lietots. Nekad nelietojiet bojātas baterijas. Izmantojiet tikai sārna tipa baterijas. Ievērojiet pareizu polaritāti. Nekad nemeģiniet uzlādēt baterijas, kas nav uzlādējamas. Nepieļaujiet īssavienojumu bateriju nodalījumā.

ET

Oluline teave patareide kohta

Ära kunagi kasuta koos erinevat tüüpi patareisid, samuti vanu ja uusi patareisid. Kui mänguasja ei kasutata pika aja jooksul, võta patarei sellest välja. Ära kunagi kasuta kahjustatud patareisid. Kasuta ainult leelis-patareisid. Pane patareid mänguasja sisse nii, et pluss- ja miinusleemi asend oleks õige. Ära kunagi proovi akulaadijaga laadida tavalisi patareisid. Patareipesa klemmide vahel ei tohi tekkida lühist.

LT

Svarbi informacija apie elementus

Vienu metu nenaudokite skirtingų elementų, taip pat su naujais elementais nenaudokite senų. Jei nenaudosite gaminio ilgesnį laiką arba jei elementai išsekę, visuomet išimkite juos iš gaminio. Niekada nenaudokite pažeistų elementų. Naudokite tik šarminius elementus. Elementus dėkite atsižvelgdami į jų poliškumą. Niekada nebandykite įkrauti vienkartinį elementų. Saugokitės, kad elementų dėklė nesukeltumėte trumpojo jungimo.

TR

Piller hakkında önemli bilgiler

Hiçbir zaman farklı tipte pilleri ya da eski pillerle yeni pilleri bir arada kullanmayın. Ürün uzun süre kullanılmayacaksa ya da piller bitmişse, pilleri ürünün içinden çıkarın. Hiçbir zaman zedelenmiş piller kullanmayın. Sadece alkalın piller kullanın. Pilleri kutularını doğru konumda olacak şekilde yerleştirin. Hiçbir zaman, şarj edilebilir olmayan pilleri şarj etmeye çalışmayın. Hiçbir zaman pil kutusuna kısa devre yaptırmayın.

AR

معلومات مهمة عن البطاريات

يحظر استخدام أنواع مختلفة من البطاريات معا أو مزيج من البطاريات القديمة والجديدة. احرص دائما على نزع البطاريات في حال عدم استخدام المنتج لفترة طويلة أو إذا نفذت طاقة البطاريات. تجنب استخدام البطاريات التالفة. لا تستخدم إلا البطاريات القلوية فقط. قم بتكيب البطاريات بحيث تكون الأقطاب في موضعها الصحيح. يحظر إعادة شحن البطاريات غير القابلة لإعادة الشحن. تجنب إحداث دائرة قصر في حامل البطارية.

ID

Informasi penting tentang baterai

Jangan gunakan baterai yang jenisnya berlainan, atau mencampur baterai lama dan baterai baru. Lepas baterai jika produk tidak akan digunakan untuk waktu lama atau jika baterai sudah lemah. Jangan gunakan baterai yang rusak. Gunakan hanya baterai alkali. Masukkan baterai dengan posisi kutub yang tepat. Jangan pernah coba mengisi ulang baterai biasa. Jangan pernah membuat arus pendek pada dudukan baterai.

MS

Maklumat penting tentang bateri

Jangan guna jenis bateri yang berbeza bersama-sama, atau gabungan bateri baharu dan lama. Tanggalkan bateri jika produk tidak akan digunakan untuk tempoh masa yang lama atau jika bateri telah kehabisan kuasa. Jangan guna bateri yang rosak. Guna bateri jenis alkali sahaja. Selitkan bateri supaya paksi berada pada kedudukan yang betul. Jangan cuba untuk mengemas semula bateri yang tidak boleh dicaskan semula. Jangan pintas litar pemegang bateri.



EN
Protect the environment by not disposing of this product with your household waste.
Check with your local authority for recycling advice and facilities.

DE
Schützen Sie die Umwelt und entsorgen Sie dieses Produkt nicht mit Ihrem Hausmüll.
Informationen zu Recycling-Möglichkeiten erhalten Sie bei den örtlichen Behörden.

FR
Protégez l'environnement : ne jetez pas ce produit avec vos autres déchets ménagers.
Contactez les autorités locales pour obtenir des informations sur le recyclage et connaître les points de collecte.

IT
Proteggi l'ambiente! Non smaltire questo prodotto con i rifiuti domestici.
Per consulenza sul riciclaggio dei rifiuti e le strutture di riciclaggio, rivolgersi alle proprie autorità locali.

NL
Bescherm het milieu: gooi dit product niet samen met het andere huisvuil weg.
Raadpleeg de plaatselijke instanties voor locaties van milieustations en advies over hergebruik.

ES
Proteja el medio ambiente no deshaciéndose de este producto junto con sus residuos domésticos.
Solicite asesoramiento e información sobre instalaciones de reciclaje a las autoridades locales.

DA
Beskyt miljøet! Smid ikke dette produkt ud sammen med husholdningsaffaldet.
Få vejledning om genbrug og genbrugsstationer hos din kommune.

IS
Stuðlið að umhverfisvernd með því að farga þessari vöru ekki með heimilissorpi.
Leitið upplýsinga um endurvinnslu- og förgunarstaði hjá yfirvöldum á hverjum stað.

FI
Tämä tuote on hävitettävä ympäristöstävällisesti ja erillään muusta talousjätteestä.
Tietoja kierrätyksestä ja keräyspisteiden sijainnista saat paikkakuntasi teknisestä virastosta.

SV
Skydda miljön genom att inte kasta denna produkt bland ditt hushållsavfall.
Kontakta din kommun för frågor om återvinning och miljöstationer.

NO
Beskytt miljøet. Ikke kast dette produktet i husholdningsavfallet.
Kontakt kommunen for veiledning om gjenbruk og miljøstasjoner.

PT
Proteja o ambiente não eliminando este produto com o seu lixo doméstico.
Consulte as autoridades locais para informação sobre reciclagem e sistemas de recolha.

EL
Προστατέψτε το περιβάλλον. Μην πετάτε αυτό το προϊόν μαζί με τα συνηθισμένα οικιακά απορρίμματα.
Επικοινωνήστε με τις τοπικές αρχές σχετικά με συμβουλές και εγκαταστάσεις ανακύκλωσης.

JA
環境保護のため、本製品は家庭ごみとは別に処分してください。
リサイクルに関する指示や施設については、お住まいの地方自治体にお問い合わせください。

ZH
注意保护环境，请勿将本产品与生活垃圾一起丢弃处理。
请咨询当地相关部门，了解与回收相关的设施与建议。

KO
환경 보호를 위해 이 제품을 생활폐기물과 함께 버리지 마십시오.
재활용 방법 및 시설에 관한 사항은 현지 관계 당국에 문의하십시오.

RU
Позаботьтесь об окружающей среде: не утилизируйте этот продукт вместе с бытовым мусором.
Узнайте в органах местного самоуправления правила вторичной переработки и утилизации таких отходов.

PL
Aby chronić środowisko naturalne, nie należy wyrzucać tego produktu wraz z odpadkami z gospodarstwa domowego.
W celu uzyskania wskazówek dotyczących recyklingu oraz adresów zakładów należy skontaktować się z lokalnym urzędem.

CZ
Nevyhazujte tento produkt do domácího odpadu, chraňte životní prostředí.
Zjistěte si prosím u místních úřadů možnosti recyklace a dostupná zařízení.

SK
Nevyhádzajte tento produkt do domáceho odpadu, chráňte životné prostredie.
Zistite si na miestnych úradoch možnosti recyklácie a dostupné zariadenia.

HU
Környezetét óvja, ha ettől a terméktől nem a háztartási hulladékkal együtt válik meg.
Érdeklődjék a lakóhelyéhez közel eső hatóságnál az újrahasznosítás módjáról és lehetőségeiről.

UA
Допоможіть захистити довкілля: не утилізуйте цей виріб разом із побутовим сміттям.
Вказівки з утилізації та відомості про пункти прийому з'ясуєте в місцевих компетентних органах.

HR
Zaštitite okoliš tako da ovaj proizvod ne odložite u otpad zajedno s kućanskim otpadom.
Od lokalnih vlasti zatražite savjet ili informacije o pogonima za recikliranje.

SR
Zaštitite životnu sredinu tako što nećete da odlažete ovaj proizvod sa kućnim otpadom.
Raspitajte se kod lokalnog nadležnog organa o načinu reciklaže i o sabirnom centru.

MK
Zaštitite ja okolinata taka što nema da se oslobodite od proizvodot co domashniot otpad.
Konultirajte se co lokalnite vlasti za da doznaete za sovetite i objektite za recikliranje.

SL
Zaščitite okolje! Okolje varujte tako, da tega izdelka ne zavržete skupaj z gospodinjiskimi odpadki.
Pri krajevni upravi preverite, kakšne možnosti in kateri obrati za recikliranje obstajajo v vaši okolici.

RO
Protejați mediul înconjurător și nu vă debarasați de acest produs împreună cu deșeurile menajere
Consultați autoritățile locale pentru îndrumări și facilități de reciclare.

BG
Защитете околната среда и не изхвърляйте този продукт заедно с битовите си отпадъци.
Свържете се с местните власти относно съвети и съоръжения за рециклиране.

LV
Lai saudzētu vidi, neizmetiet šo izstrādājumu kopā ar sadzīves atkritumiem.
Vērsties vietējās varas iestādēs, lai noskaidrotu, kur un kā tas nododams pārstrādei.

ET
Keskkonda saate kaitsta nii, et ei kõrvalda seda toodet koos olmejäätmetega.
Nõuandeid toote taaskasutusse võtmise ja ümbertöötlemispunktide kohta saate asjaomaset kohalikult asutusest.

LT
Saugokite aplinką: nemeskite šio produkto kartu su buitinėmis atliekomis.
Atsižvelkite į savo vietos valdžios rekomendacijas dėl pakartotinio panaudojimo ir sąlygas.

TR
Bu ürünü, evsel atıklarla birlikte atmayarak çevreyi koruyun.
Gerİ dönüşüm tavsiyeleri ve tesisler hakkında bilgi için yerel yönetimle iletişİm kurun.

AR
احم البيئة بعدم التخلص من هذا المنتج مع الخلفات المنزلية.
استشر السلطة المحلية لديك للحصول على نصح بخصوص إعادة تدوير الخلفات ومرافقها.

ID
Jagalang lingkungan dengan tidak membuang produk ini bersama sampah rumah tangga Anda.
Periksa peraturan pemerintah setempat tentang saran dan fasilitas daur ulang.

MS
Lindungi alam sekitar dengan tidak melupuskan produk ini bersama sisa isi rumah anda.
Rujuk pihak berkuasa tempatan anda tentang nasihat dan kemudahan kitar semula.



EN
WARNING: This product contains a Button or Coin Cell Battery.
A swallowed Button or Coin Cell battery can cause internal chemical burns in as little as two hours and lead to death. Dispose of used batteries immediately. Keep new and used batteries away from children. If you think batteries might have been swallowed or placed inside any part of the body, seek immediate medical attention.

DE
ACHTUNG: Dieses Produkt enthält eine Knopfzellenbatterie.
Eine verschluckte Knopfzellenbatterie kann innere chemische Verbrennungen verursachen und in weniger als zwei Stunden zum Tod führen. Entsorge umgehend gebrauchte Batterien. Halte neue und gebrauchte Batterien von Kindern fern. Wenn du glaubst, dass Batterien verschluckt wurden oder sich in einem Körperteil befinden, hole umgehend medizinische Hilfe.

FR
AVERTISSEMENT : Ce produit contient une pile bouton.
L'ingestion d'une pile bouton peut provoquer des brûlures chimiques internes en seulement deux heures et provoquer la mort. Jeter immédiatement les piles usagées. Conserver les piles neuves et usagées hors de portée des enfants. Si vous suspectez l'ingestion d'une pile ou sa présence où que ce soit à l'intérieur du corps, consultez immédiatement un médecin.

IT
ATTENZIONE: questo prodotto contiene una batteria a bottone.
Se inghiottita, una batteria a bottone può causare ustioni chimiche interne in sole due ore, con possibile morte. Smaltire immediatamente le batterie usate. Tenere le batterie nuove e usate lontano dai bambini. Se si pensa che una batteria sia stata inghiottita o inserita in una parte del corpo, rivolgersi immediatamente a un medico.

NL
WAARSCHUWING: dit product bevat een knoopcelbatterij.
Als een knoopcelbatterij wordt ingeslikt, kan deze binnen twee uur chemische brandwonden veroorzaken in het lichaam. Het inslikken van een dergelijke batterij kan zelfs leiden tot overlijden. Gooi gebruikte batterijen onmiddellijk weg. Bewaar nieuwe en gebruikte batterijen buiten bereik van kinderen. Als je denkt dat een kind batterijen heeft ingeslikt of ze in een lichaamsopening heeft gestopt, raadpleeg je direct een arts.

ES
ADVERTENCIA: Este producto contiene una pila de botón.
Ingerir una pila de botón puede dar lugar a quemaduras químicas internas en tan sólo dos horas y provocar la muerte. Las pilas usadas deben desecharse inmediatamente. Mantenga las pilas nuevas y usadas fuera del alcance de los niños. Si sospecha de la ingestión o la introducción de pilas en cualquier parte del cuerpo, busque atención médica inmediatamente.

DA
ADVARSEL: Dette produkt indeholder et knap- eller møntcellebatteri.
Hvis et knap- eller møntcellebatteri sluges, kan det forårsage indvendige ætsninger på blot to timer og medføre døden. Bortskaf brugte batterier omgående. Hold både nye og brugte batterier uden for børns rækkevidde. Hvis du har mistanke om, at batterierne kan være blevet slugt eller kommet ind i nogen del af kroppen, skal du omgående søge lægehjælp.

IS
VIÐVÖRUN: Þessi vara inniheldur hnapparahlöðu eða flata rafhlöðu.
Ef hnapparahlöðu eða flöt rafhlaða er gleypt getur hún valdið innvortis efnabruna á innan við tveimur klukkustundum og leitt til dauða. Fargaðu notuðum rafhöldum tafarlaust. Geymdu nýjar og notaðar rafhöldur þar sem börn ná ekki til. Ef þú telur að rafhöldur hafi verið gleyptar eða á annan hátt komist inn í einhvern hluta líkamans skaltu tafarlaust leita læknaðstoðar.

FI
VAROITUS: Tämä tuote sisältää pienen tai isokokoisen nappipariston.
Niellynä pieni tai isokokoinen nappiparisto voi aiheuttaa sisäisiä kemiallisia palovammoja jo kahden tunnin kuluessa ja johtaa kuolemaan. Käytetyt paristot on toimitettava heti keräyspisteeseen. Pidä uudet ja käytetyt paristot poissa lasten ulottuvilta. Jos epäilet jonkun nielelleen pariston tai laittaneensa pariston kehoonsa, vie hänet välittömästi lääkäriin.

SV
VARNING: Denna produkt innehåller ett knapp- eller myntcells batteri.
Förtäring av ett knapp- eller myntcells batteri kan orsaka inre kemiska brännskador på så kort tid som två timmar och leda till döden. Kassera förbrukade batterier omedelbart. Förvara nya och använda batterier utom räckhåll för barn. Om du tror att batterierna kan ha svalts eller placerats inuti någon del av kroppen, sök omedelbart läkarvård.

NO
ADVARSEL: Dette produktet inneholder et knapp- eller myntcellebatteri.
Ved svelging kan knapp- eller myntcellebatterier gi kjemisk brannskade innvendig på bare to timer og føre til død. Brukte batterier skal avhendes øyeblikkelig. Nye og brukte batterier skal oppbevares utilgjengelig for barn. Hvis du tror at batterier har blitt svelget eller puttet inn andre steder i kroppen, må du kontakte lege øyeblikkelig.

PT
AVISO: Este produto contém uma pilha tipo botão ou moeda.
Uma pilha tipo botão ou moeda que tenha sido engolida pode provocar queimaduras químicas internas em menos de duas horas e levar à morte. Elimine as pilhas usadas imediatamente. Mantenha as pilhas novas e usadas fora do alcance das crianças. Se pensa que as pilhas podem ter sido engolidas ou colocadas no interior de alguma parte do corpo, procure de imediato assistência médica.

EL
ΠΡΟΕΙΔΟΠΟΙΗΣΗ: Αυτό το προϊόν περιέχει μία Στρογγυλή Μπαταρία Μεγέθους Κοιμπίου ή Κέρματος.
Η κατάποση μιας Στρογγυλής Μπαταρίας Μεγέθους Κοιμπίου ή Κέρματος μπορεί να προκαλέσει εσωτερικά χημικά εγκαύματα σε μόλις δύο ώρες και να οδηγήσει σε θάνατο. Πελάστε αμέσως τις χρησιμοποιημένες μπαταρίες. Κρατήστε τις καινούριες και τις χρησιμοποιημένες μπαταρίες μακριά από τα παιδιά. Εάν νομίζετε ότι κάποια μπαταρία έχει καταποθεί ή τοποθετηθεί εντός οποιουδήποτε μέρους του σώματος, ζητήστε αμέσως ιατρική βοήθεια.

JA
警告：本製品には、ボタン型またはコイン型の電池が使用されています。
ボタン型またはコイン型電池は誤飲すると2時間以内に体内で科学火傷を起こし、死に至る恐れがあります。使用済みの電池は直ちに廃棄してください。新しい電池および使用済み電池は、どちらもお子様の手の届かないところに保管してください。電池を誤飲した恐れがある、または電池が身体のどこかに入った恐れがある場合は、直ちに医師の診察を受けてください。

ZH
警告：本品内含一颗纽扣电池。
吞咽的纽扣电池仅在两小时内就会引起体内化学灼伤并导致死亡！
请立即处理使用过的电池。请将新、旧电池放置到儿童接触不到的地方。如果电池被不慎吞下，或被置入身体的任何一个部位，请立即就医！

KO
경고: 이 제품에는 버튼 또는 코인 셀 배터리가 포함되어 있습니다.
코인 셀 배터리를 삼킬 경우, 빠르면 2시간 이내에 체내에서 화학적 화상이 일어나고 심하면 사망에 이를 수 있습니다. 다 쓴 배터리는 즉시 폐기하십시오. 배터리를 어린이의 손에 닿지 않는 곳에 보관하십시오. 배터리를 삼켰거나 신체 어느 부위에든 들어간 것으로 판단될 경우, 즉각 의사의 도움을 구하십시오.

RU
ПРЕДОСТЕРЕЖЕНИЕ. Эта игрушка работает от батарейки таблеточного или кнопочного типа.
Проглатывание батарейки таблеточного или кнопочного типа может (в течение двух часов) вызвать химические ожоги внутренних органов и привести к летальному исходу. Своевременно утилизируйте использованные батарейки. Храните новые и использованные батарейки в местах, недоступных для детей. Если у вас есть основания полагать, что ребенок проглотил батарейку или она попала внутрь какой-либо части его тела, немедленно обратитесь за медицинской помощью.

PL
OSTRZEŻENIE: w tym produkcie znajduje się płaska okrągła bateria.
Połknięcie takiej baterii może spowodować chemiczne oparzenia wewnętrzne już po dwóch godzinach, a także doprowadzić do śmierci. Gdy bateria się zużyje, należy ją natychmiast zutylizować. Nowe i używane baterie należy przechowywać z dala od dzieci. W przypadku stwierdzenia, że baterie mogły zostać połknięte lub inaczej trafić do organizmu, należy natychmiast poszukać pomocy lekarskiej.

CZ
VAROVÁNÍ: Tento výrobek obsahuje knoflíkovou nebo mincovou baterii.
Spolknutí knoflíkové nebo mincové baterie může během pouhých 2 hodin způsobit vnitřní poleptání sliznice a v některých případech mit za následek smrt. Použité baterie ihned vyjměte a zlikvidujte. Nové i použité baterie uchovávejte mimo dosah dětí. V případě spolknutí či uviznutí baterie v některé části těla okamžitě vyhledejte lékařskou pomoc.

SK
POZORNENIE: Tento produkt obsahuje gombíkovú alebo mincovú batériu.
Prehĺtnutie gombíkovej alebo mincovej batérie môže spôsobiť vnútorné chemické popálenie už do dvoch hodín a viesť k úmrtiu. Použité batérie ihneď vyhodte. Nové aj použité batérie uchováajte mimo dosahu detí. Ak si myslíte, že mohlo dôjsť k prehĺtnutiu batérie alebo sa batéria mohla dostať do vnútra ktorejkoľvek časti tela, okamžite vyhľadajte lekársku pomoc.

HU
FIGYELMEZTETÉS: Ez a termék gomebelemet illetve lapos gomebelemet tartalmaz!
A lenyelt gomebelem vagy lapos gomebelem akár két óra alatt is belső vagy sérüléseket okozhat, ami halálhoz vezet. Az elhasznált elemeket azonnal dobja ki! Az új és a használt elemeket ne adja gyermekek kezébe! Ha úgy gondolja, hogy valaki lenyelt egy elemet, vagy bekerült valakinek valamely testrészébe, akkor azonnal kérjen orvosi segítséget!

UA
ОБЕРЕЖНО. Продукт містить мініатюрну батарейку типу «таблетка». Якщо проковтнути мініатюрну батарейку, вона може спричинити внутрішні хімічні опіки протягом двох годин і призвести до смерті. Негайно утилізуйте використані батарейки. Зберігайте нові та використані батарейки недоступними для дітей. Якщо вам здається, що дитина проковтнула батарейку чи вона опинилася в будь-якій частині тіла дитини, негайно зверніться до лікаря.

HR
UPOZORENJE: Ovaj proizvod sadrži gumbastu bateriju ili bateriju oblika kovanice. Ako se gumbasta baterija ili baterija oblika kovanice proguta, za samo dva sata može uzrokovati unutarnje kemijske opekline i izazvati smrt. Iskorištene baterije odmah odložite u otpad. Čuvajte nove i stare baterije dalje od djece. Ako mislite da je baterija progutana ili je dospjela u bilo koji dijela tijela, odmah zatražite liječničku pomoć.

SR
УПОЗОРЕЊЕ: Овај производ садржи дугмасту батерију. Прогутања дугмаста батерија може да доведе до интерних хемијских опекотина већ за два сата и доводи до смрти. Одмах одложите искоришћене батерије у отпад. Чувајте нове и искоришћене батерије ван домаћаја деце. Ако мислите да је дошло до гутања батерија или стављања у било који део тела, одмах потражите помоћ лекара.

MK
ПРЕДУПРЕДУВАЊЕ: Овој производ садржи батерија тип копче или тип монета.

Проголтувањето на батерија тип копче или тип монета може да предизвика внатрешно хемиско горење во рок од два часа и да доведе до смрт. Искрфлете ги веднаш искористените батери. Држете ги новите и користените батерији подалеку од деца. Ако мислите дека е можно батериите да се проголтани или поставени во кој било дел на телото, веднаш побарајте медицинска помош.

SL
OPOZORILO: Ta izdelek vsebuje gumbasto baterijo. Če oseba požre gumbasto baterijo, lahko to povzroči kemične opekline notranjih organov že v dveh urah po zaužitju. Tovrstne poškodbe lahko vodijo v smrt. Iztrošene baterije takoj zavrzite. Pazite, da nove ali iztrošene baterije ne bodo v dosegu otrok. Če menite, da je oseba zaužila baterijo ali si jo vstavila v kateri koli del telesa, takoj poiščite zdravniško pomoč.

RO
AVERTIZARE: Acest produs conține o baterie de tip pastilă. Înghițirea unei baterii de tip pastilă poate cauza arsuri chimice interne în doar două ore, ducând la deces. Debarasați-vă imediat de bateriile uzate. Nu lăsați bateriile noi și uzate la îndemâna copiilor. Dacă credeți că bateriile ar fi putut fi înghițite sau ar fi putut ajunge în interiorul oricărei părți a corpului, solicitați imediat asistență medicală.

BG
ПРЕДУПРЕЖДЕНИЕ: Този продукт съдържа батерия тип „копче“ или „монета“. При поглъщане батериите тип „копче“ или „монета“ могат да предизвикат вътрешни химически изгаряния в рамките на по-малко от два часа и да доведат до смърт. Незабавно изхвърляйте използваните батерии. Дръжете новите и стари батерии далеч от деца. Ако смятате, че е възможно батериите да са били поглънати или да са попаднали където и да е вътре в тялото, потърсете незабавно медицинска помощ.

LV
BRĪDINĀJUMS. Šim produktam ir pogas jeb monētas tipa akumulators. Ja pogas jeb monētas tipa akumulators tiek norīts, tas jau divu stundu laikā var izraisīt iekšējus ķīmiskus apdegumus un izraisīt nāvi. Nekavējoties utilizējiet izlietotos akumulatorus. Jaunus un lietotus akumulatorus glabājiet bērniem nepieejamā vietā. Ja uzskatāt, ka akumulators varētu būt norīts vai ievietots kādā ķermenā daļā, nekavējoties vērsieties pēc medicīniskās palīdzības.

ET
HOIATUS! See toode sisaldab nõõp- või müntpatareid. Alla neelatud nõõp- või müntpatarei võib tekitada sisemisi keemilisi põletusi kõigest kahe tunni jooksul ning põhjustada surma. Kõrvaldage kasutatud patareid viivitamatult. Hoidke uusi ja kasutatud patareid lastele kättesaamatus kohas. Kui arvate, et keegi on patareid alla neelanud või need on sattunud mõnda kehaosasse, pöörduge kohe arsti poole.

LT
ĮSPĖJIMAS. Šiame gaminyje yra sagos arba monetos formos baterija. Praryta sagos arba monetos formos baterija gali sukelti vidinius cheminius nudeginimus greičiau nei per dvi valandas ir galiausiai sukelti mirtį. Panaudotas baterijas nedelsiant utilizuokite. Naujas ir panaudotas baterijas laikykite atokiau nuo vaikų. Jei manote, kad vaikas galėjo praryti arba įsprausti bateriją sau į kūną, nedelsdami kreipkitės medicininės pagalbos.

TD

TR
UYARI: Bu ürün bir düğme pil içerir. Yutulmuş düğme pil, iki saat gibi kısa bir sürede iç kimyasal yanıklara neden olabilir ve ölüme yol açabilir. Kullanılmış pilleri derhal atın. Yeni ve kullanılmış pilleri çocuklardan uzak tutun. Pillerin yutulmuş ya da vücudun başka bir yerine sokulmuş olabileceğini düşünüyorsanız derhal doktora başvurun.

AR
تحذير: يحتوي هذا المنتج على بطارية خلايا قرصية أو بطارية خلايا على شكل عملة. قد يؤدي ابتلاع بطارية خلايا قرصية أو بطارية خلايا على شكل عملة إلى حدوث حروق كيميائية داخلية خلال فترة قصيرة لا تتجاوز ساعتين وقد يؤدي إلى الوفاة. يرجى التخلص من البطاريات المستعملة على الفور مع الاحتفاظ بالبطاريات الجديدة والمستعملة بعيداً عن متناول الأطفال. إذا كنت تعتقد أن البطاريات تم ابتلاعها أو إدخالها إلى أي جزء من أجزاء الجسم، فاطلب المساعدة الطبية على الفور.

ID
PERINGATAN: Produk ini berisi Baterai Sel Kancing. Baterai Sel Kancing yang tertelan dapat mengakibatkan luka bakar kimiawi dalam tubuh minimal setelah dua jam dan dapat mengakibatkan kematian. Segera buang baterai yang sudah tidak digunakan. Jauhkan baterai baru maupun bekas dari jangkauan anak-anak. Jika Anda curiga baterai telah tertelan atau masuk ke dalam tubuh, segeralah minta bantuan dokter.

MS
AMARAN: Produk ini mengandungi Bateri Sel Butang atau Syiling. Tertelan bateri Sel Butang atau Syiling boleh mengakibatkan lecuran kimia dalaman dalam tempoh sekurang-kurangnya dua jam dan menyebabkan kematian. Buang bateri terpakai dengan serta-merta. Jauhkan bateri baharu dan terpakai daripada anak-kanak. Jika anda mendapati bateri mungkin telah ditelan atau termasuk ke dalam mana-mana bahagian badan, dapatkan rawatan perubatan dengan segera.

EN Please retain the leaflet as it contains important information
 DE Die Broschüre bitte aufbewahren, sie enthält wichtige Informationen
 FR Veuillez conserver le dépliant car il contient des informations importantes
 IT Conserva l'opuscolo in quanto contiene informazioni importanti
 NL Bewaar a.u.b. de folder: die bevat belangrijke informatie
 ES Conserve el folleto; contiene información importante
 DA Gem hæftet, da det indeholder vigtige oplysninger
 IS Geymið bæklinginn þar sem hann inniheldur mikilvægar upplýsingar
 FI Säilytä esite, koska se sisältää tärkeää tietoa
 SV Spara broschyren eftersom den innehåller viktig information
 NO Heftet inneholder viktig informasjon og skal beholdes
 PT Por favor guarde o folheto, pois contém informação importante
 EL Κρατήστε το φυλλάδιο γιατί περιέχει σημαντικές πληροφορίες
 JA 説明書には重要な情報が含まれていますので保管しておいてください
 ZH 本说明书包含重要信息，请务必妥善保存
 KO 중요한 정보가 담겨있으므로 리플릿을 보관해 두세요
 RU Пожалуйста, сохраните упаковку, поскольку она содержит важную информацию
 PL Prosimy zachować ulotkę, ponieważ zawiera ona ważne informacje
 CZ Ponechte si prosím leták, neboť obsahuje důležité informace
 SK Ponechajte si prosím leták, pretože obsahuje dôležité informácie
 HU Kérjük, őrizze meg a szórólapot, mert fontos tudnivalókat tartalmaz
 UA Будь ласка, зберігайте упаковку, оскільки вона містить важливу інформацію
 HR Spremite letak jer sadrži važne obavijesti
 SR Молимо да сачувате упутство јер се у њему налазе важне информације
 MK Чувајте ја брошурата бидејќи содржи важни информации
 SL Prosimo, da brošurico shranite, saj so v njej pomembne informacije
 RO Vă rugăm să păstrați broșura întrucât conține informații importante
 BG Запазете листовката, тъй като вътре има ценна информация
 LV Lūdzu, saglabājiet bukletu, jo uz tā ir norādīta svarīga informācija
 ET Hoidke infoleht alles, sest sellele on märgitud oluline teave
 LT Išsaugokite informacinį lapelį, nes ant jos pateikiama svarbi informacija
 TR Önemli bilgiler içerdiğinden dolayı lütfen broşürü saklayın
 AR الرجاء الاحتفاظ بهذه النشرة لاحتوائها على معلومات هامة
 ID Harap simpan lembaran ini karena berisi informasi penting
 MS Sila simpan lembar maklumat kerana ia mengandungi maklumat penting

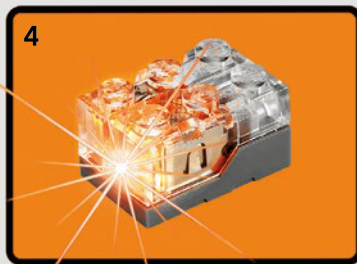
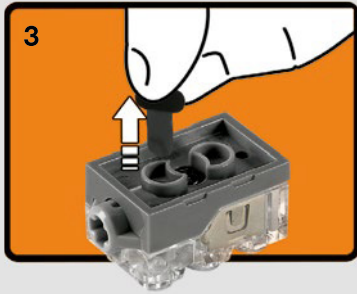
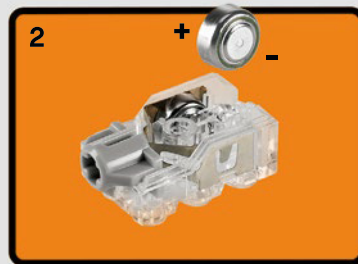

1:1
2x  1.5V

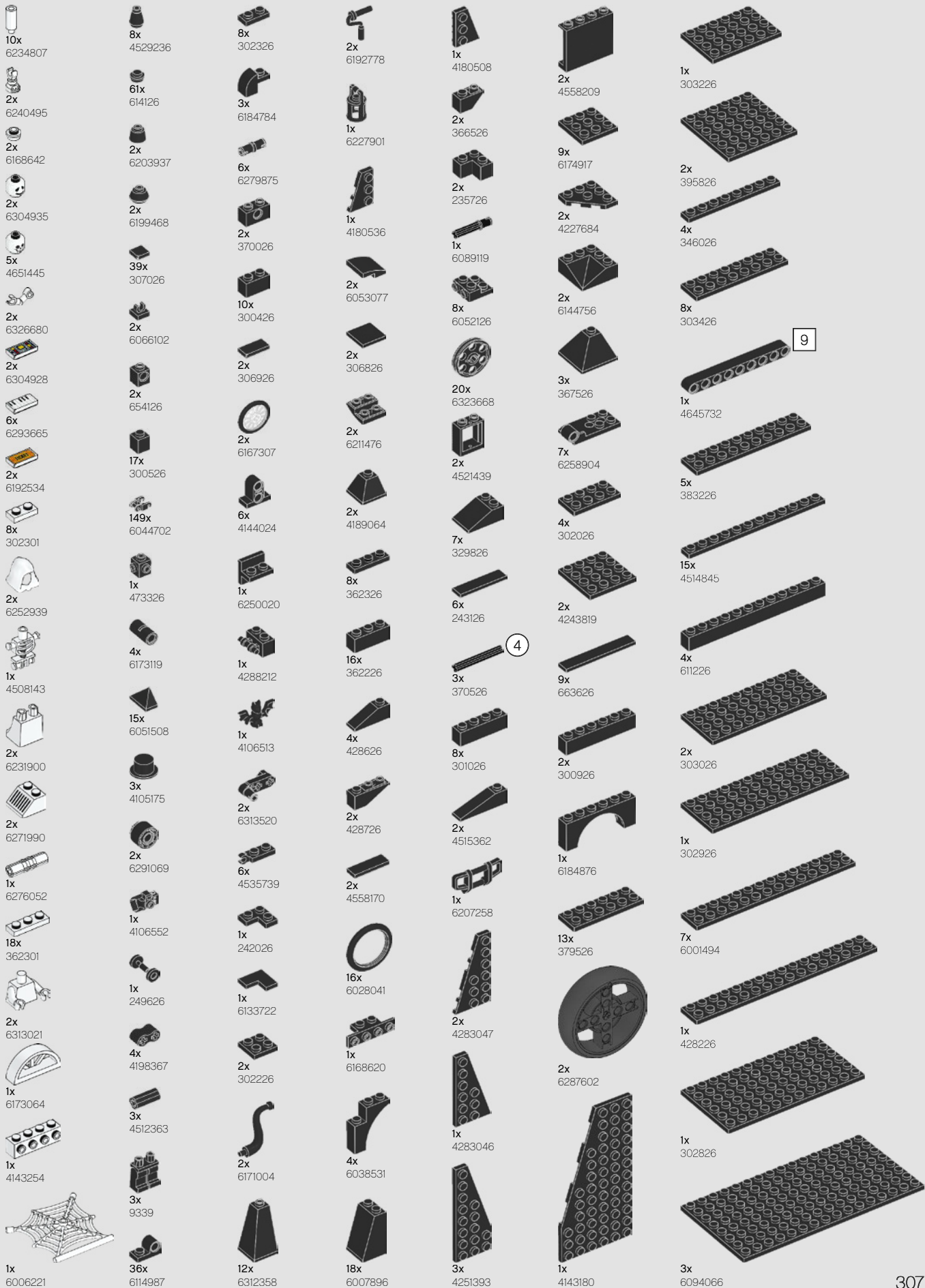

9

4

26x 4211242	3x 4629736	15x 4211189	1x 4211247	6x 4529241	6x 6011459	2x 4211436
2x 6071274	2x 6117976	5x 6150305	2x 4216945	9x 6167667	64x 4211388	1x 4211815
4x 4620075	2x 6008297	1x 4211185	15x 4585337	2x 6284071	18x 4211398	2x 6251044
2x 6270052	2x 4565394	5x 4579690	2x 4263776	144x 4211525	2x 4211437	2x 6304933
1x 4550736	4x 6146858	1x 4211186	3x 4271874	6x 6271165	2x 6206249	28x 4211428
6x 6172757	2x 4271949	2x 4211225	1x 6096701	12x 4211399	4x 6225230	13x 4211429
10x 4531751	6x 4211200	2x 4211225	10x 4211211	2x 4211415	3x 6015344	1x 6211969
19x 4211149	1x 4211202	1x 6280388	3x 4211207	2x 6281998	2x 6266251	2x 6245254
2x 6092590	4x 4211221	4x 6159763	3x 4211207	2x 6262085	2x 6285778	2x 4251163
2x 4211252	1x 4520638	3x 4221590	1x 6096716	4x 6061702	18x 6123809	18x 6225228
2x 6192310	2x 6245259	2x 4636170	1x 4223729	141x 4211389	3x 4211614	2x 4211419
10x 4211150	1x 4211220	2x 4655611	1x 6055145	13x 4211535	1x 6088708	1x 4211773
4x 4211151	2x 4211152	2x 4655611	1x 6055145	2x 4213567	6x 4211461	1x 4217918
51x 6058084	1x 6323704	2x 4655611	1x 6055145	1x 4211508	1x 6304930	1x 4217918
4x 6035547	1x 6323704	2x 4655611	1x 6055145	2x 6248890	2x 4211397	24x 4211386
37x 4595814	4x 6044725	3x 4216615	2x 6004996	2x 6190437	41x 4211349	1x 4211570
				1x 4650645	9x 4211353	1x 6297209
				2x 4640536	15x 4211387	3x 4211356
				1x 4227657	2x 6007894	27x 4211394

23x
4211445

1x
4211441

1x
74335

12x
6236437

2x
6254484

2x
4579260

1x
6163633

2x
6304922

11x
6256117

1x
4525464

1x
6240227

2x
4570877

2x
6232135

1x
6290270

1x
6102769

2x
6163989

2x
6271167

4x
6245265

2x
4615606

4x
4565452

1x
6227248

1x
4211395

4x
4211466

1x
6182787

8x
6240550

1x
6212081

5x
6286492

4x
6214214

5x
4560183

2x
4211452

2x
4261301

1x
6247785

2x
6269941

8x
4666579

9x
6222063

4x
4622742

2x
4211452

1x
6275271

1x
6247785

1x
6248859

2x
6321305

1x
6132264

4x
4211385

1x
6102575

1x
6123730

1x
6238673

2x
6000743

12x
4113917

2x
6064049

2x
6195314

1x
4211795

1x
6270320

1x
6225808

5x
4613761

2x
6174925

2x
6132790

6x
4211393

4x
4211406

1x
6290549

4x
6252043

2x
6208727

3x
4114084

2x
6132767

5x
4211438

2x
4211408

2x
6071270

8x
6240551

3x
6186003

6x
4114077

1x
6093064

2x
4211805

1x
4166618

1x
4216656

1x
6247793

2x
4162916

3x
4114064

1x
4496699

9x
4211392

1x
4211405

2x
4169960

1x
6247795

4x
6103405

1x
6037890

12x
4528604

3x
4211425

1x
4211405

2x
6057458

1x
6247364

2x
4264569

3x
4124067

2x
6132768

24x
4211481

1x
4211401

2x
6130007

1x
6047056

1x
4667595

1x
6288331

4x
4616711

6x
4251149

6x
4514846

1x
4153707

1x
6267125

2x
4264569

3x
4124067

2x
4626904

5x
4211521

3x
4211522

1x
371024

1x
6235080

1x
6097420

2x
4143409

1x
6015424

3x
4211366

3x
4211366

1x
366624

6x
6130009

1x
6285134

4x
4613196

1x
6240515

3x
4211366

3x
4211366

10x
4206482

2x
614323

1x
379528

1x
6240515

1x
6240515

3x
4211366

3x
4211366

2x
614323

1x
6240515

1x
6240515

1x
6240515

1x
6240515

3x
4211366

3x
4211366

2x
614323

1x
6240515

1x
6240515

1x
6240515

1x
6240515

3x
4211366

3x
4211366

2x
614323

1x
6240515

1x
6240515

1x
6240515

1x
6240515

3x
4211366

3x
4211366

2x
614323

1x
6240515

1x
6240515

1x
6240515

1x
6240515

3x
4211366

3x
4211366

2x
614323

1x
6240515

1x
6240515

1x
6240515

1x
6240515

3x
4211366

3x
4211366

2x
614323

1x
6240515

1x
6240515

1x
6240515

1x
6240515

- 4x 6171103
- 8x 4529240
- 14x 4211090
- 3x 6012451
- 3x 6221607
- 19x 4211063
- 3x 6092572
- 3x 6261355
- 1x 6184977
- 1x 6269999
- 24x 4210762
- 4x 6230233
- 2x 6055313
- 12x 4211096
- 2x 6100124
- 2x 6126083
- 7x 4211094
- 19x 6228923
- 1x 4568734
- 7x 4211133
- 5x 6149768
- 2x 4211068
- 6x 4211001
- 1x 4648256
- 8x 6092649
- 2x 6313189
- 1x 4222693
- 1x 6100931
- 4x 4210862
- 4x 4211000
- 4x 4645099
- 5x 6133119
- 1x 4211006
- 1x 4211007
- 4x 6083620
- 2x 6185675
- 1x 4210999
- 10x 4213607
- 6x 6039176
- 2x 4227398
- 2x 6118832
- 2x 4508553
- 1x 6079036
- 3x 4595710
- 2x 4210798

4

55

- 1x 6274738
- 2x 6168665
- 51x 6252258
- 37x 6254552
- 1x 6286876
- 1x 6246888
- 1x 6304920
- 1x 6245253
- 1x 6304919
- 16x 6207933
- 1x 6300091
- 4x 6257902
- 13x 6285441
- 5x 6060803
- 2x 6195089
- 8x 4536675
- 13x 4523159
- 25x 6190252
- 4x 6186672
- 2x 6256803
- 4x 6146054
- 32x 6290401
- 6x 6060800
- 1x 4529247
- 1x 4505990
- 2x 6295686
- 20x 4523160
- 2x 6212377
- 2x 6219088
- 4x 6112307
- 1x 6092594
- 1x 306221
- 4x 6271820
- 4x 4142865
- 1x 403221
- 1x 6133493
- 1x 6132541

- 1x 6100930
- 1x 6219677
- 1x 6178488
- 1x 6092565
- 6x 6209519
- 1x 243121
- 1x 6286432
- 7x 300121
- 2x 6130002
- 1x 6167932
- 17x 6194729
- 1x 6065515
- 1x 6093516
- 2x 4519970
- 52x 6058221
- 1x 6046943
- 2x 6177917
- 20x 6252667
- 12x 6223039
- 12x 4519946
- 7x 6312357

6

- 1x 6152450
- 1x 6275092
- 1x 6205345
- 1x 6310580
- 1x 6271205
- 2x 6219624
- 2x 6058245
- 100x 6058242
- 4x 6016483
- 33x 6312356
- 192x 6024722
- 46x 6062697
- 2x 6278089
- 31x 6020143
- 39x 6058219
- 1x 6273354



Customer Service
Kundenservice
Service Consommateurs
Servicio Al Consumidor
LEGO.com/service or dial

- 00800 5346 5555 :
- 1-800-422-5346 :



FEEDBACK AND WIN

FEEDBACK AND WIN

Your feedback will help shape the future development of this product series.

Please visit:

FEEDBACK UND GEWINNEN

Dein Feedback trägt zur Weiterentwicklung dieser Produktreihe bei.

Geh auf:

COMMENTEZ ET GAGNEZ

Vos commentaires nous aideront à concevoir les futurs produits de cette gamme.

Rendez-vous sur :

COMENTA Y GANA

Tu opinión nos ayudará a dar forma al desarrollo de esta serie de productos en el futuro.

Visita:

反馈有奖

您的反馈将有助于我们在今后改进本系列产品。

请访问：

[LEGO.com/productfeedback](https://www.lego.com/productfeedback)

By completing, you will automatically enter a drawing to win a LEGO® set.

Terms & Conditions apply.

Durch Ausfüllen nimmst du automatisch an der Verlosung eines LEGO® Preises teil.

Es gelten die Teilnahmebedingungen.

En envoyant vos commentaires, vous serez automatiquement inscrit(e) à un tirage au sort qui vous permettra de remporter un prix LEGO®.

Offre soumise à conditions.

Al contestar, participarás automáticamente en el sorteo y podrás ganar un set LEGO®.

Sujeto a Términos y Condiciones.

完成我们的反馈调查，即可自动进入抽奖环节，赢取乐高® 套装。

适用《条款和条件》。

