



# STAR WARS



10240



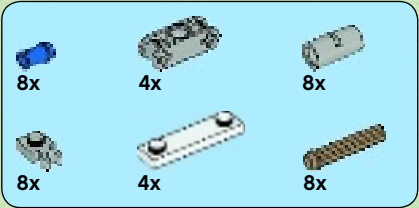
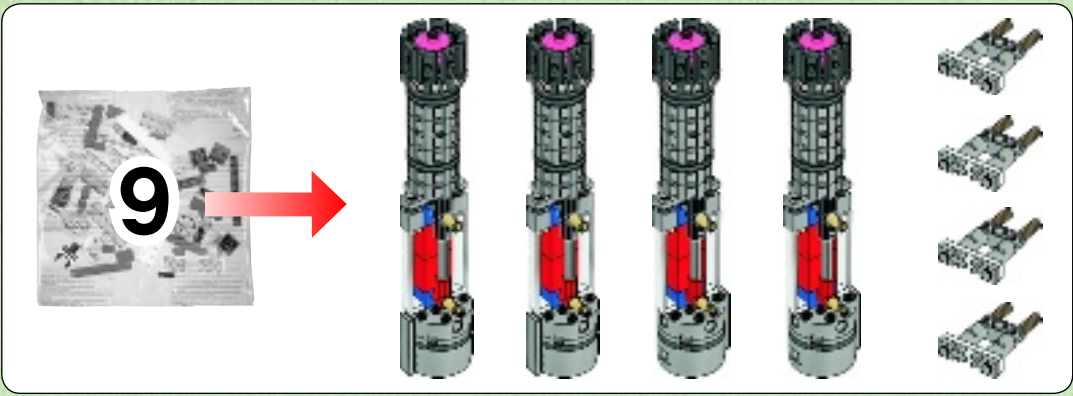

**55**

- 1
- 2
- 3

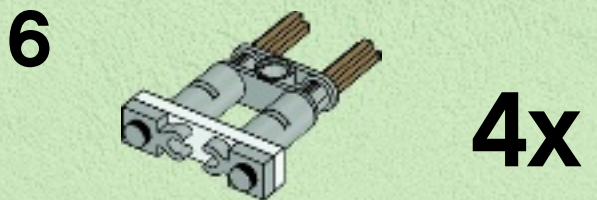
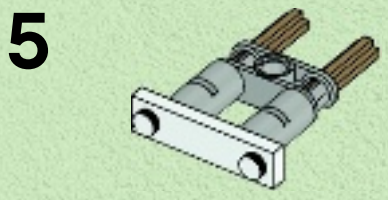
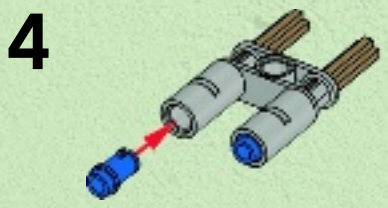

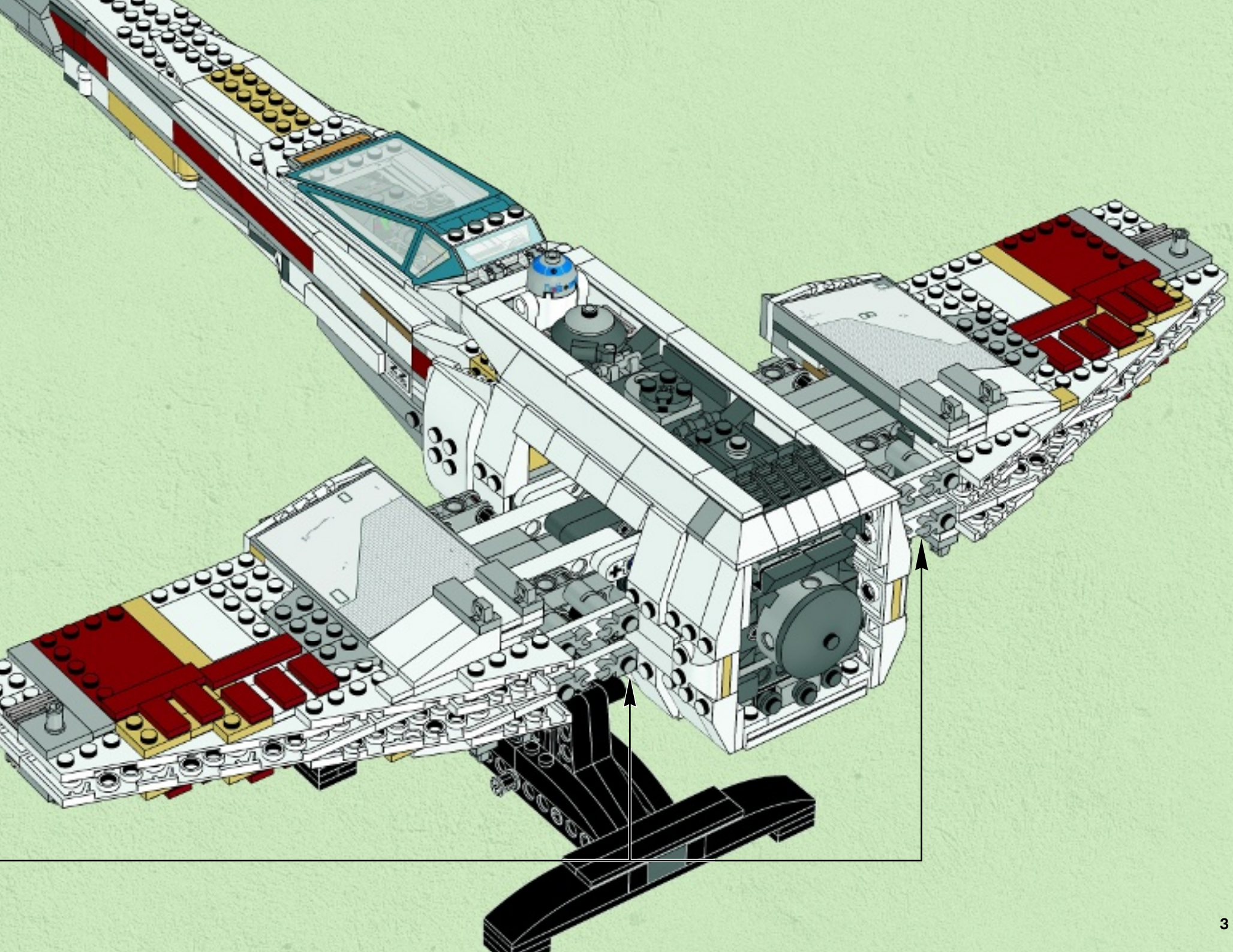

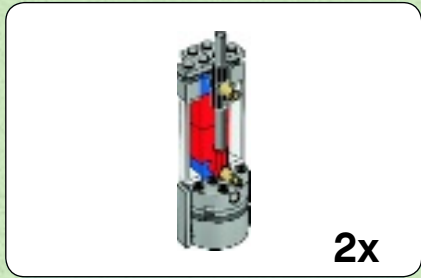
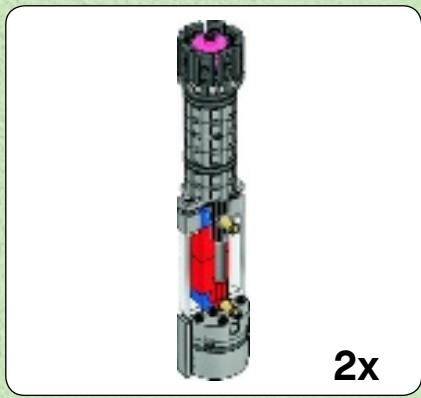

1

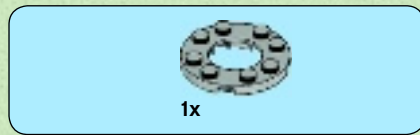

2



3



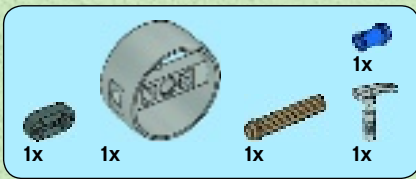

4

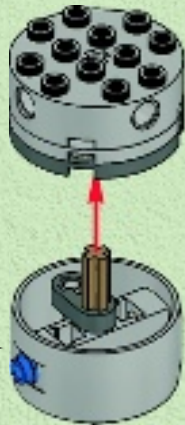
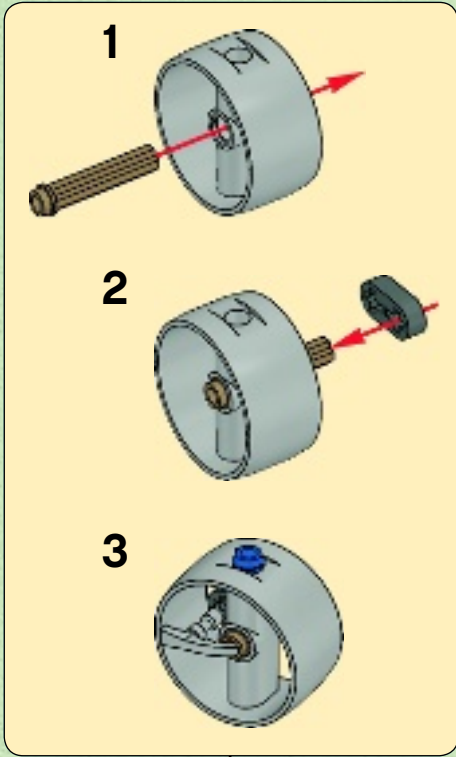

5

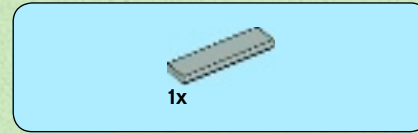
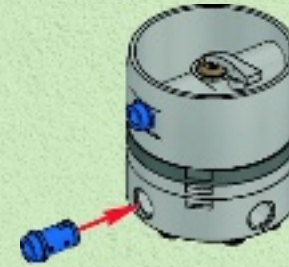
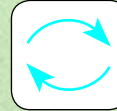

6

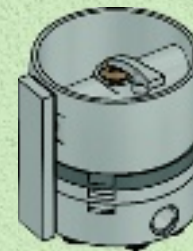



7

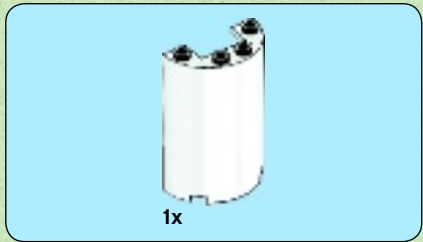
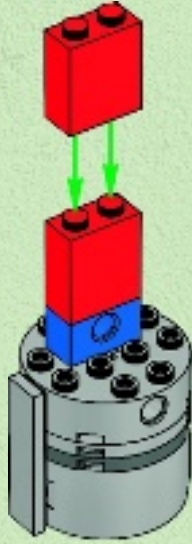
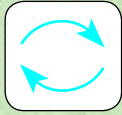

8

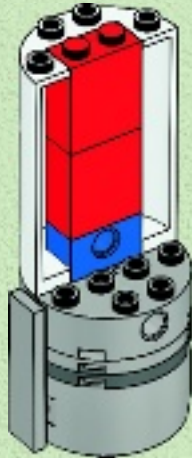

9

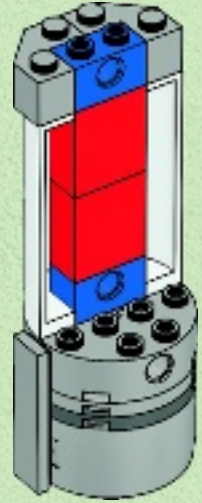

10

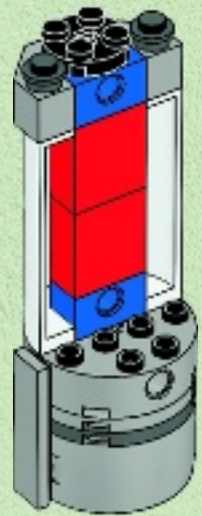

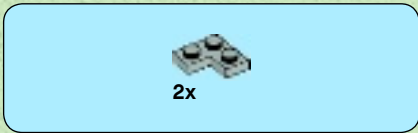

11

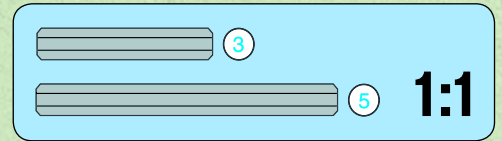
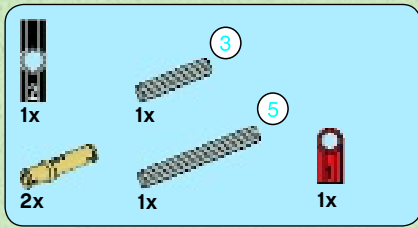
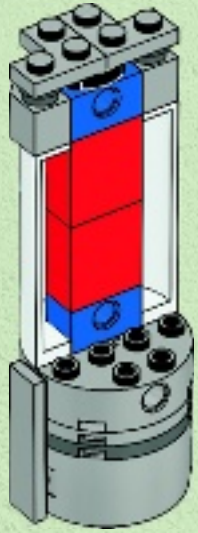

12

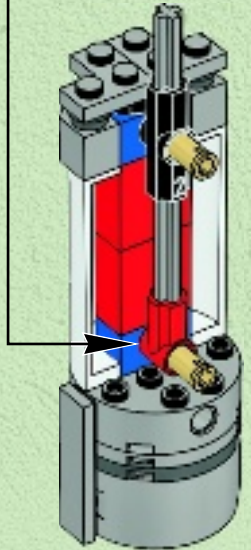
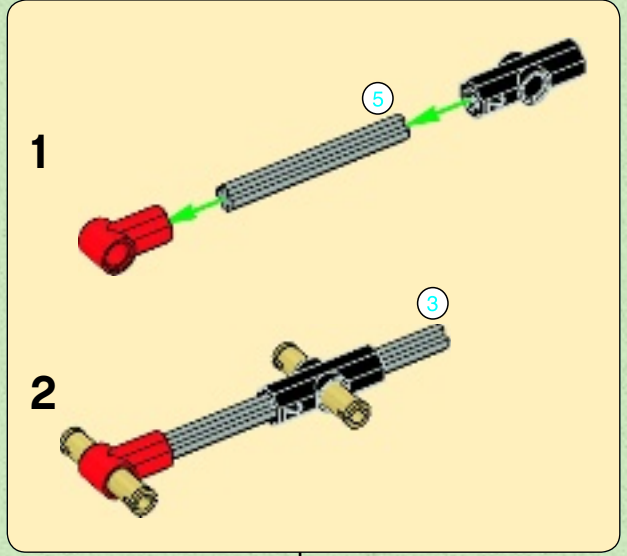

2x 7



2x

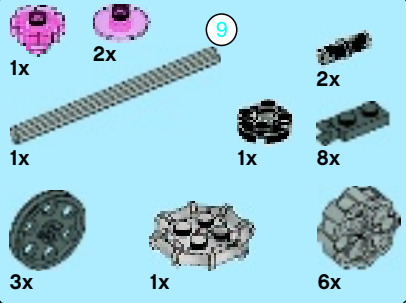

# 13

1



2

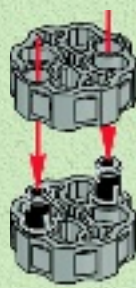

3



4

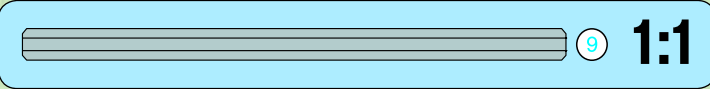



5



6



7



8



9

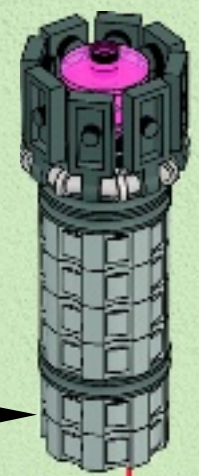
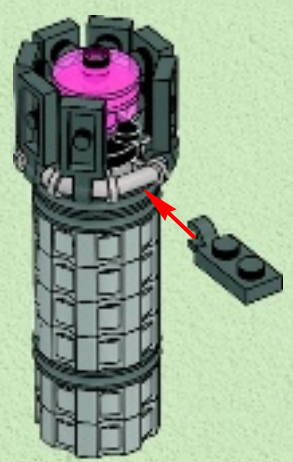

2x

56

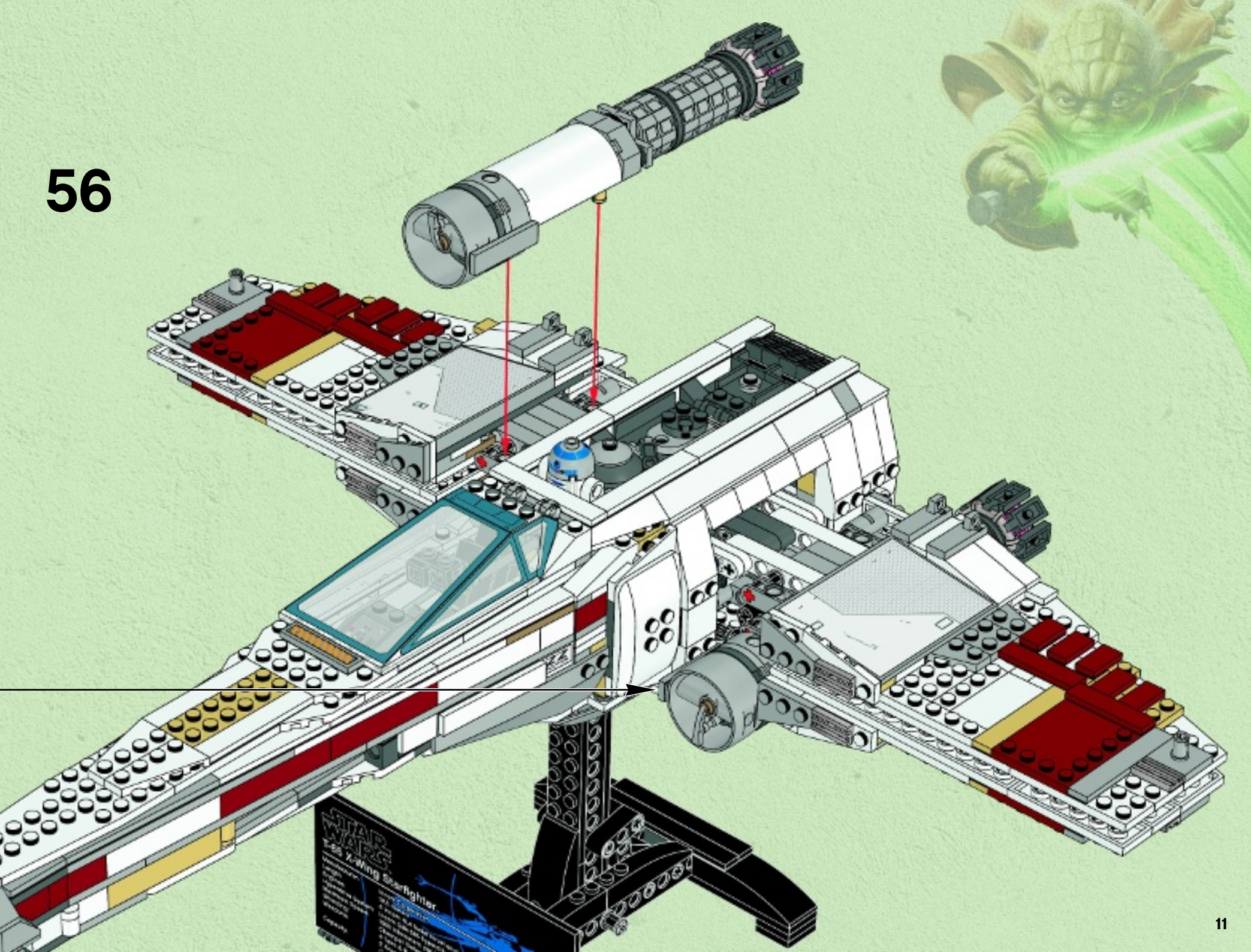

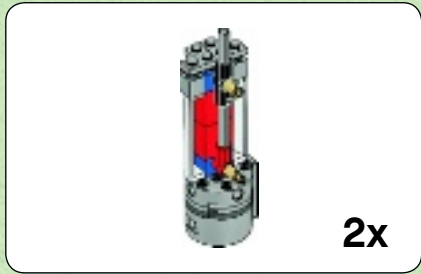
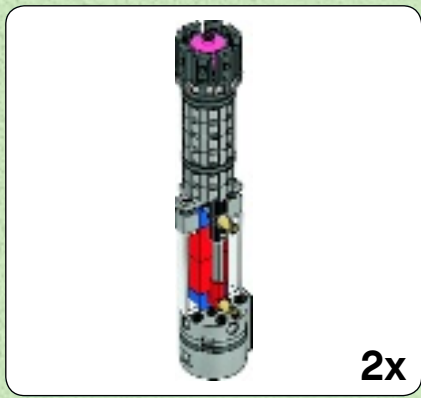

1

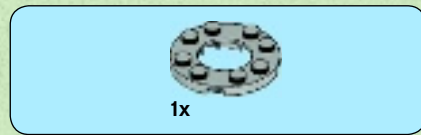

2

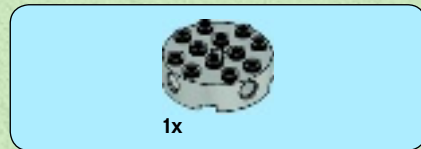

3



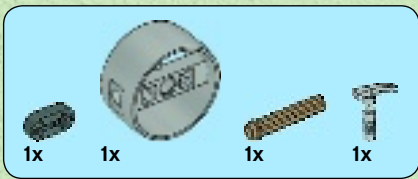

4

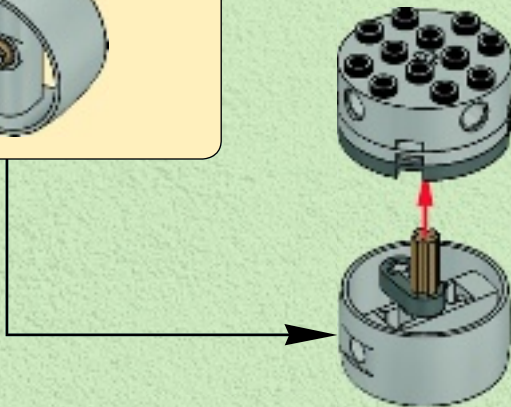
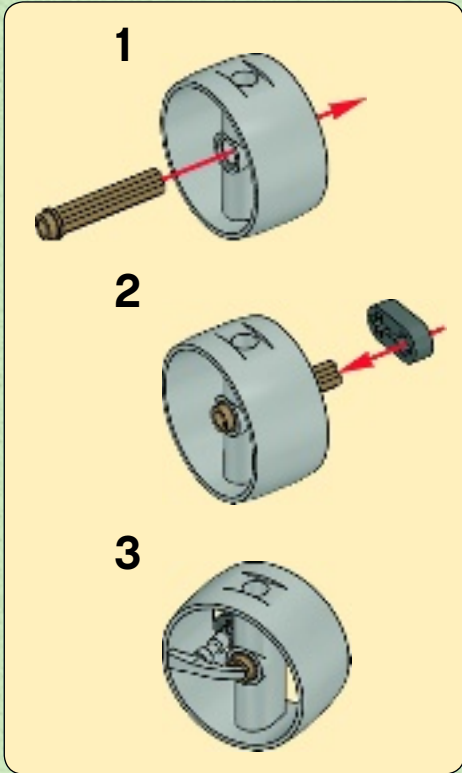

5

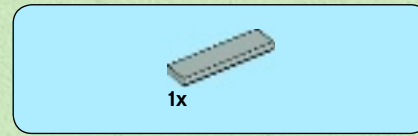
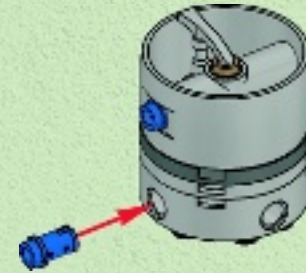
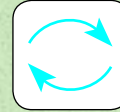

6

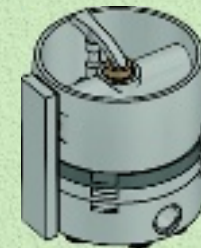



7

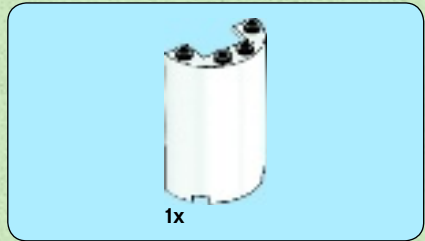
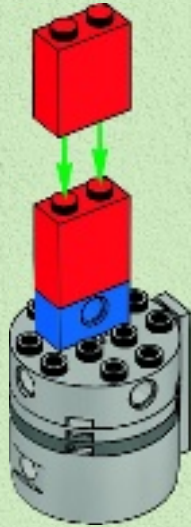

8

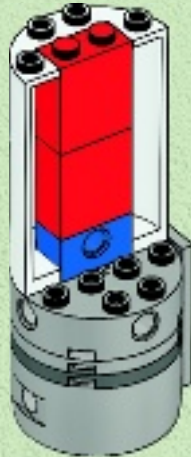

9

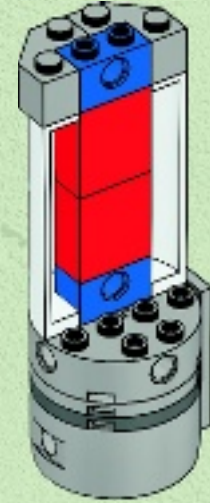

10

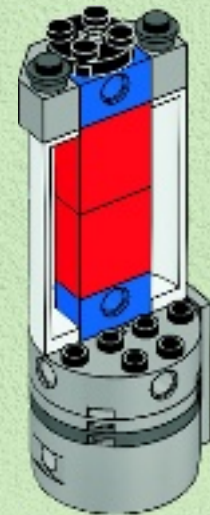

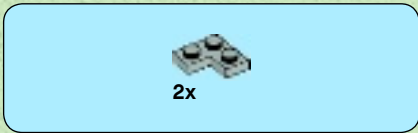

11

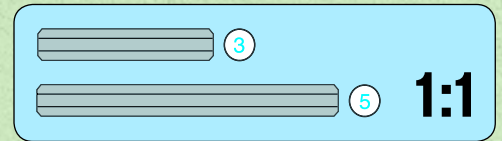
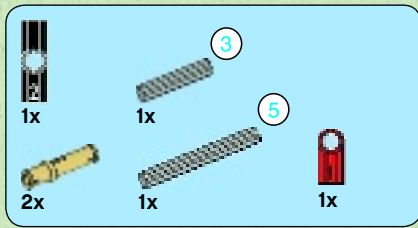
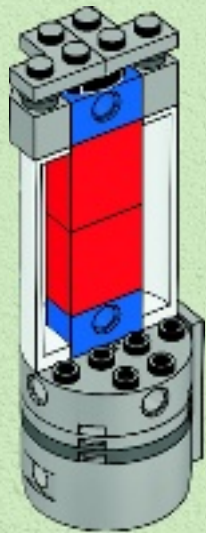

12

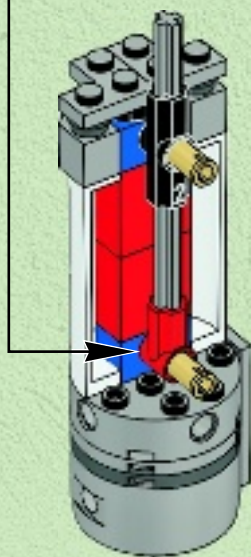
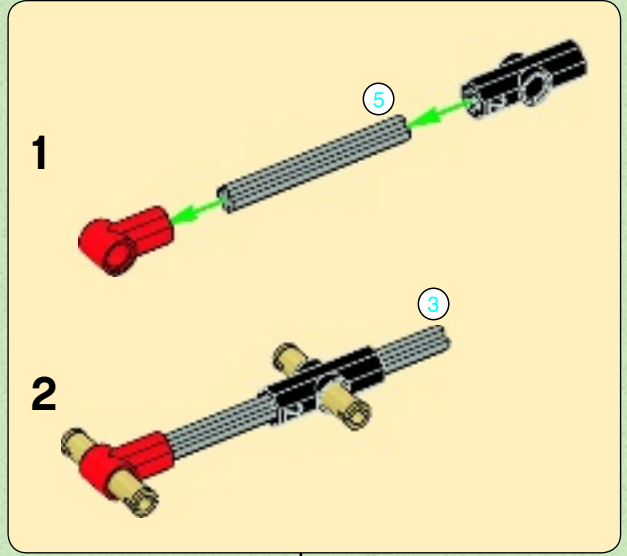

2x 15



2x

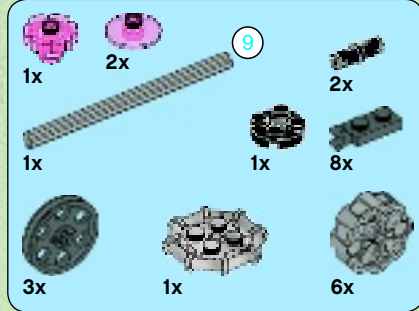

# 13

1



2

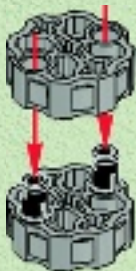

1:1

3



4



5



6





7



9

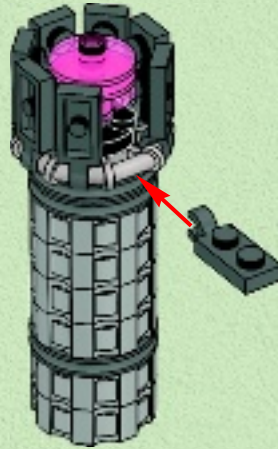

8

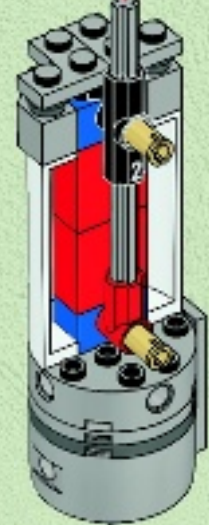
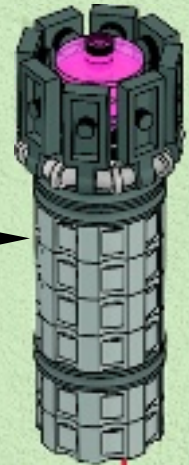

2x

57

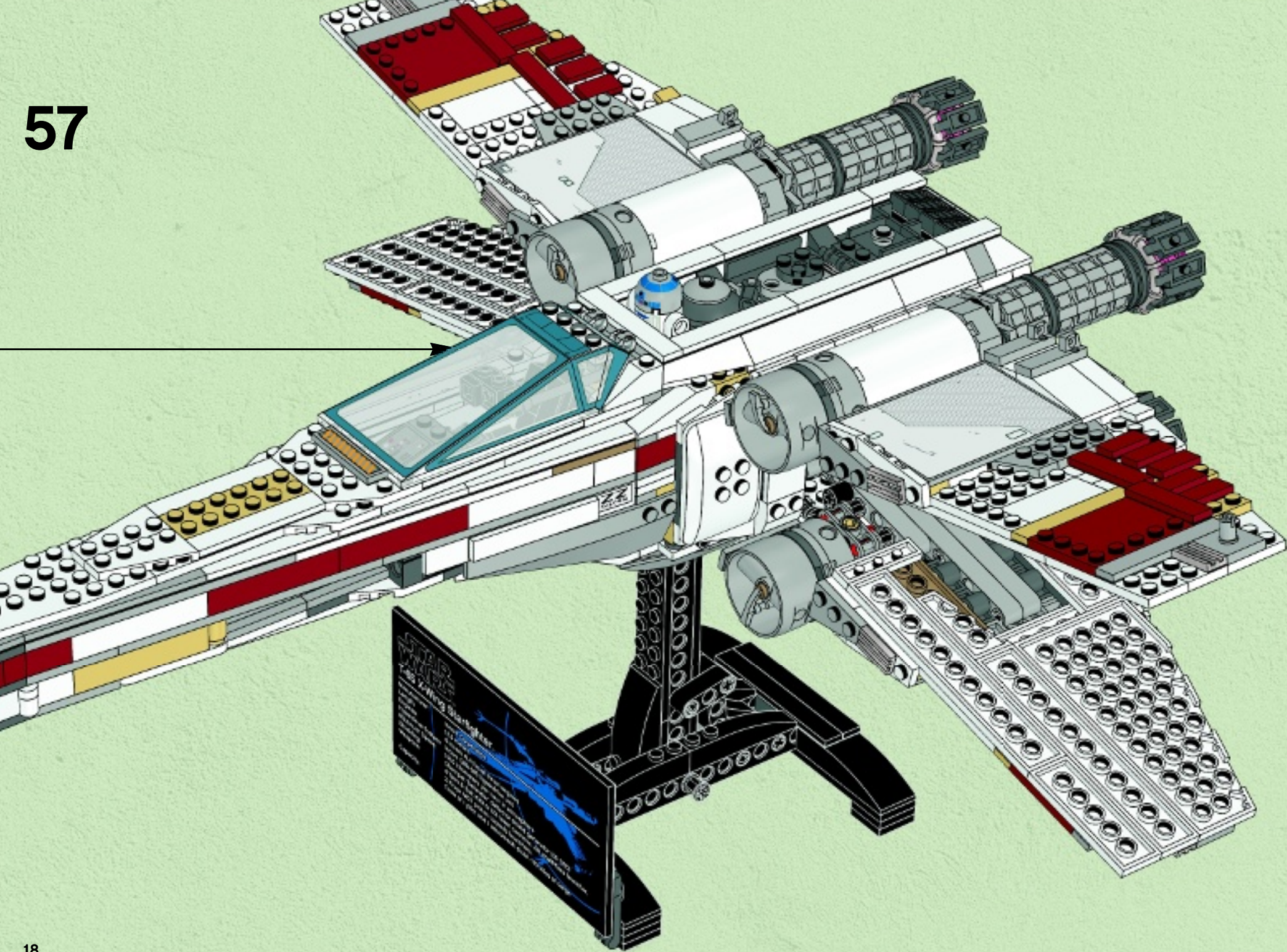

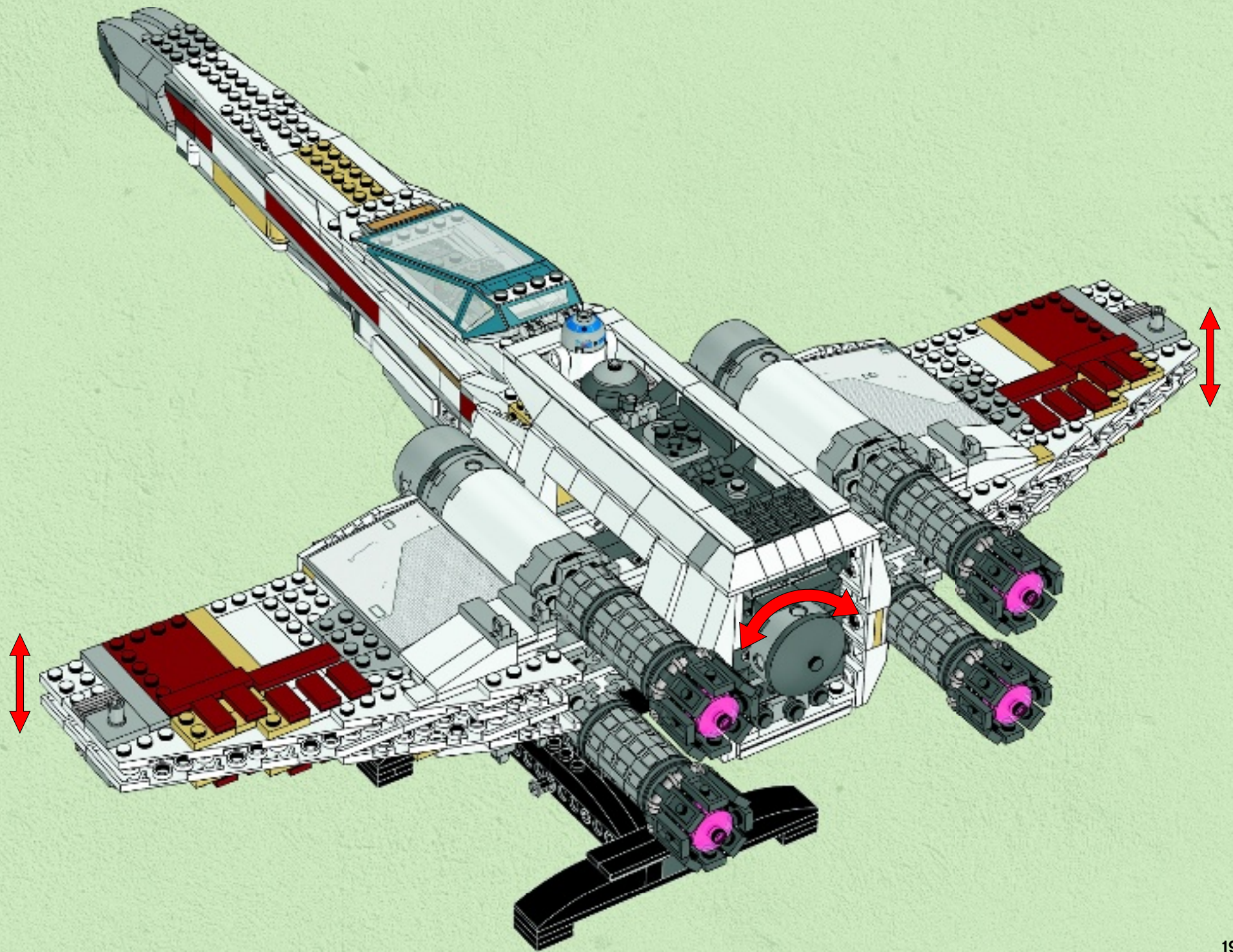

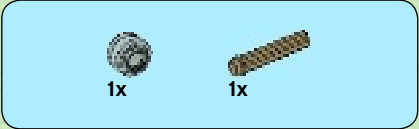
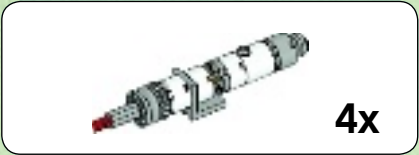
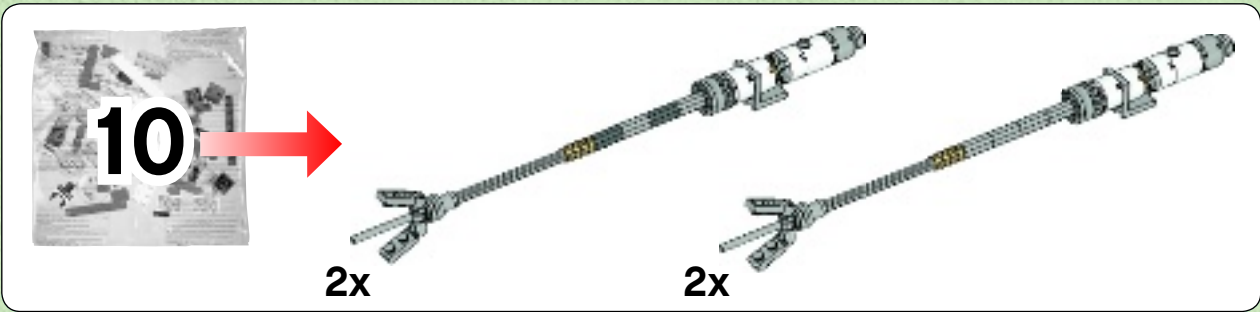

**1**

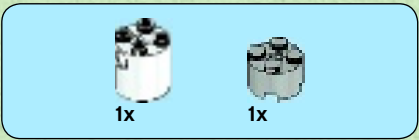
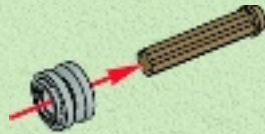

**2**

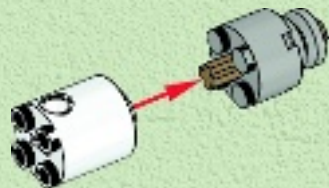

**3**

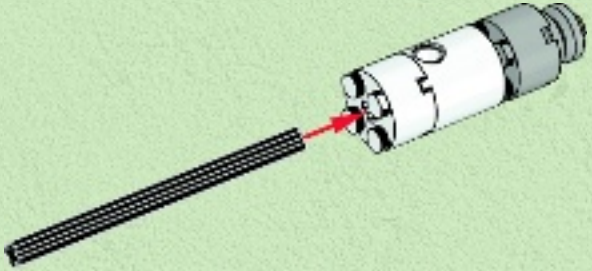

**4**

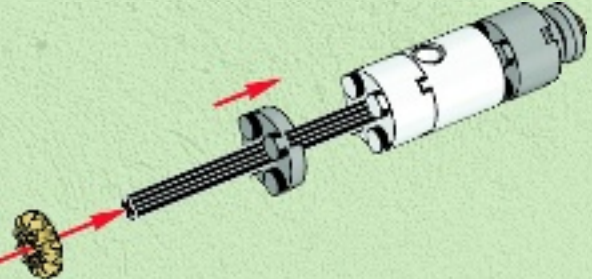

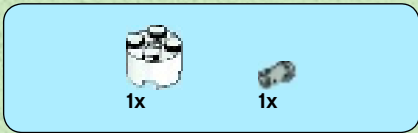

5

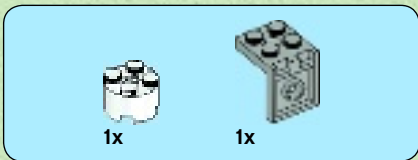
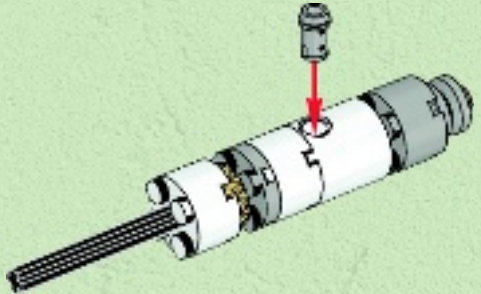

6

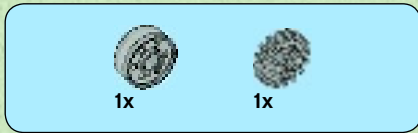
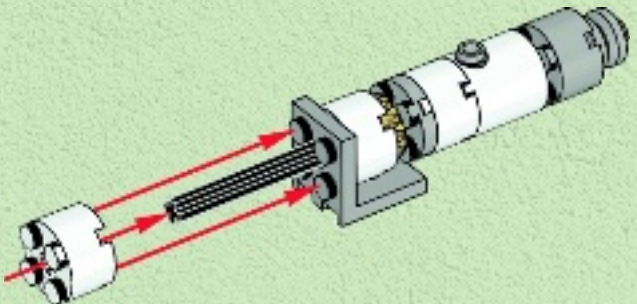

7

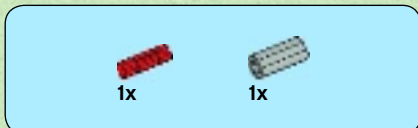
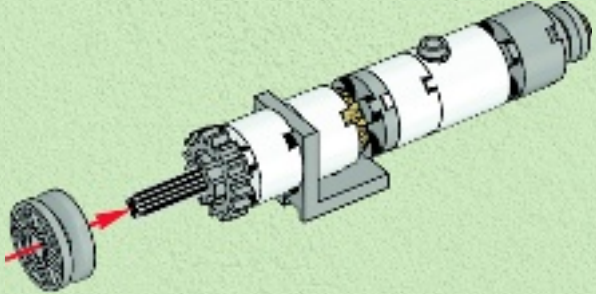

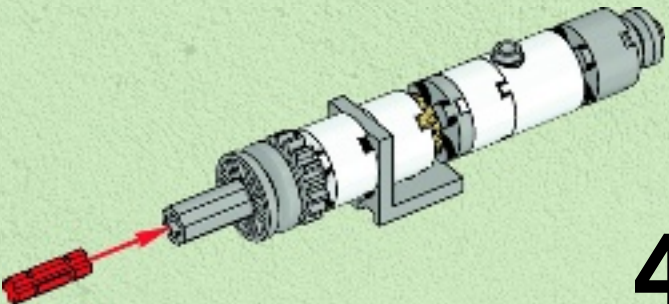

8

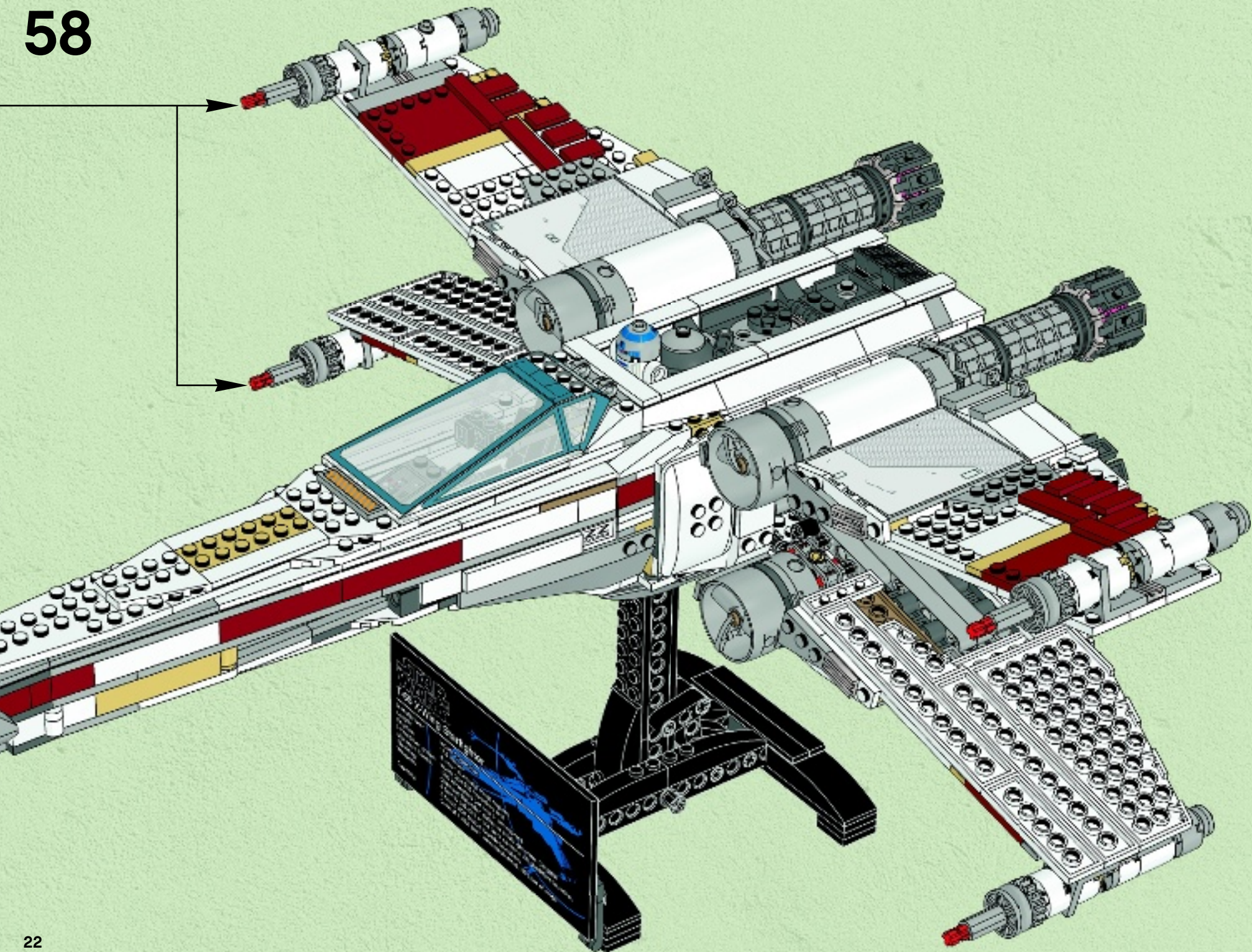

58



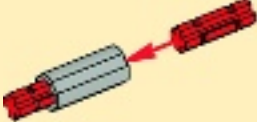
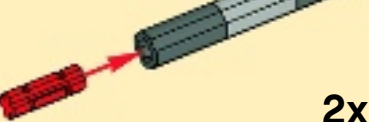

3x  1x  2x 

59

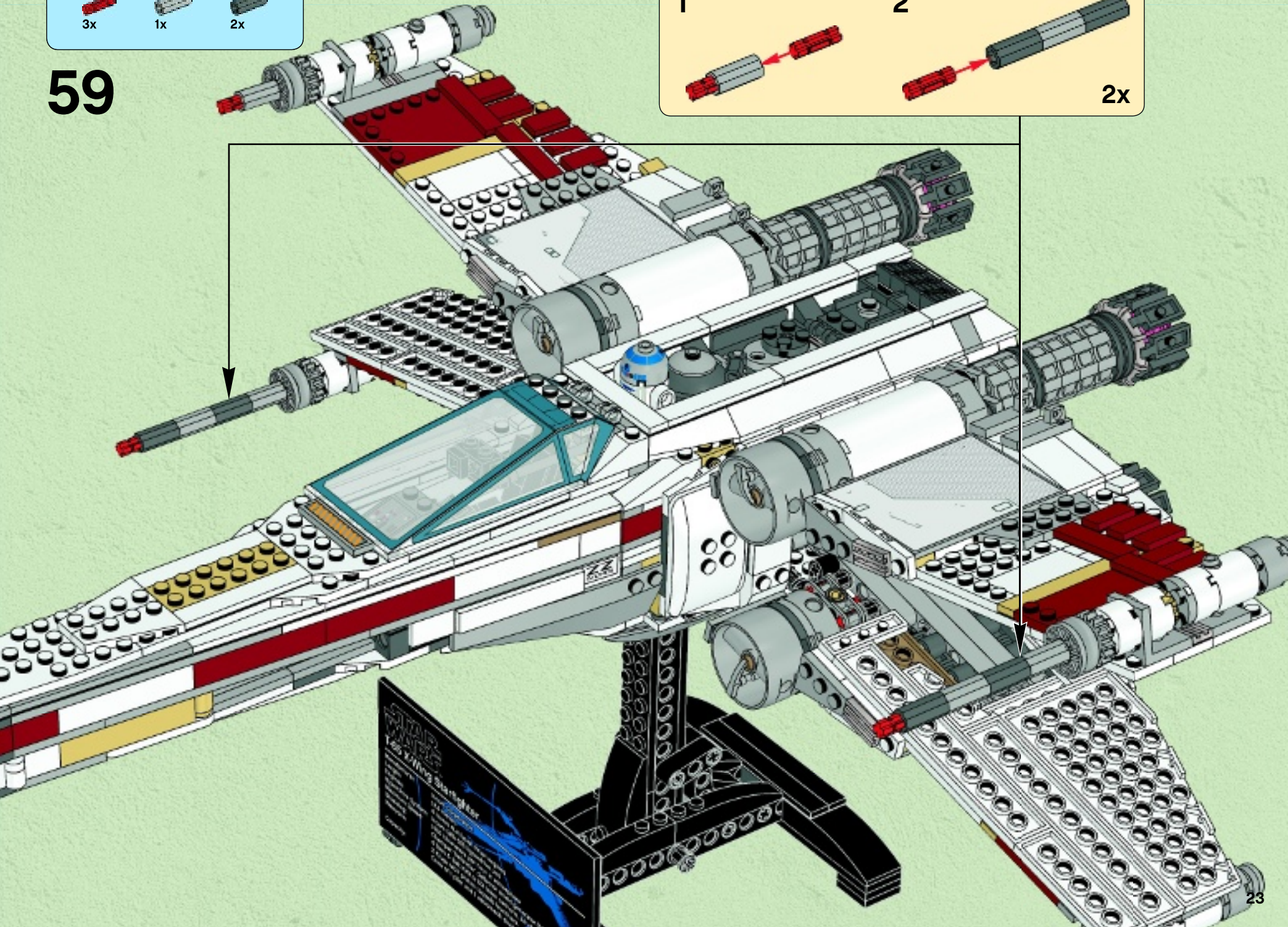
1  2  2x



3x  3x 

60

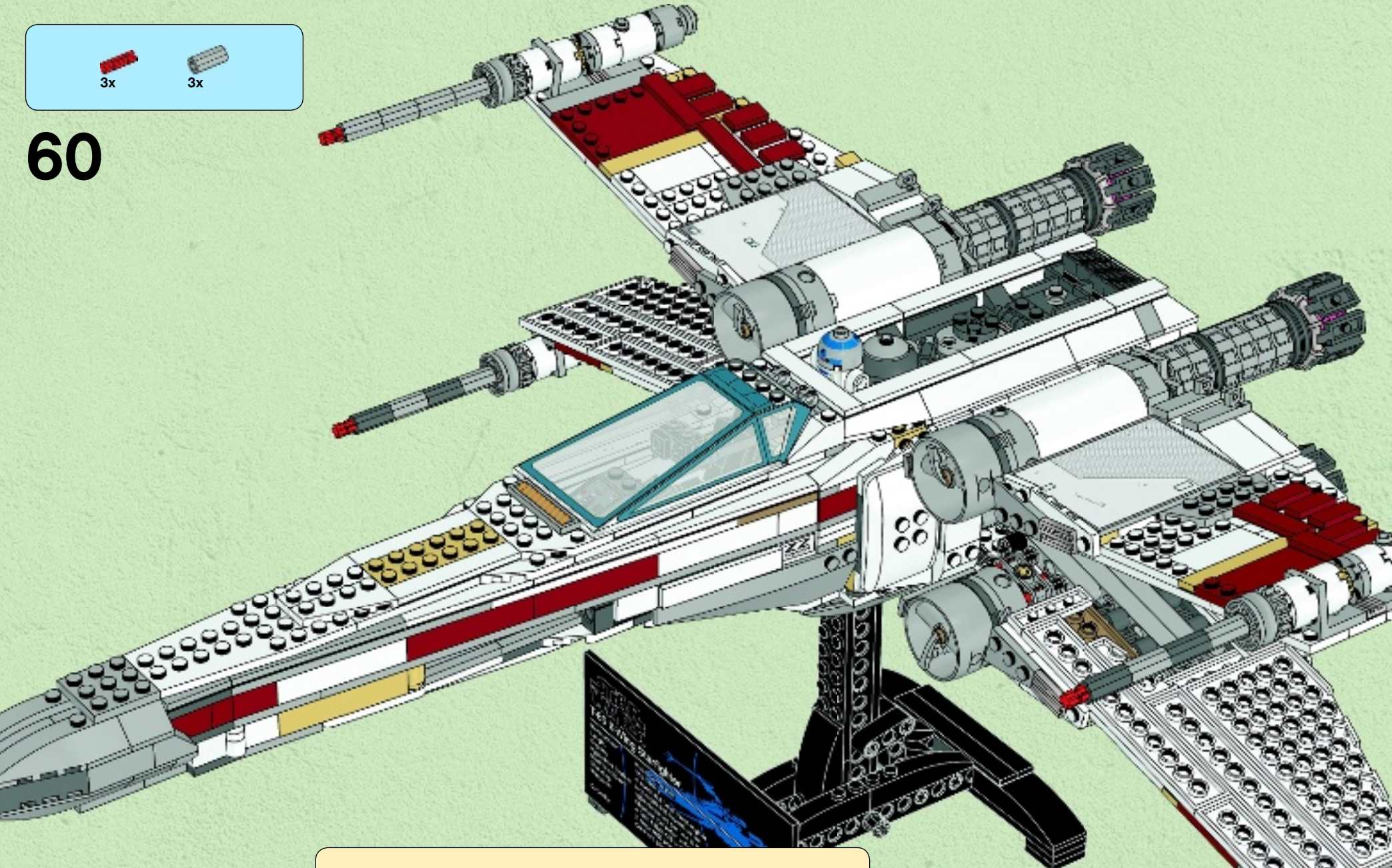

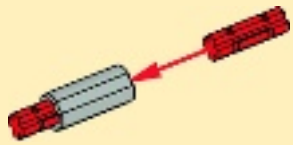
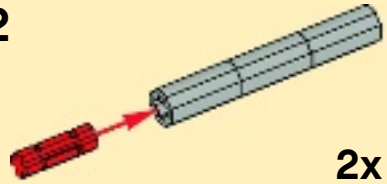
1  2  2x

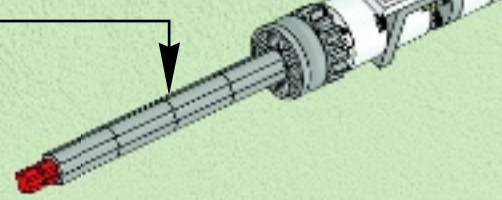



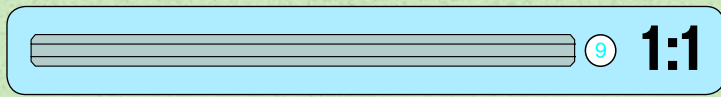
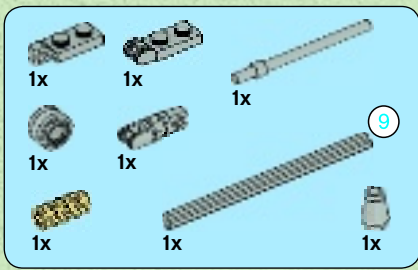

# 61

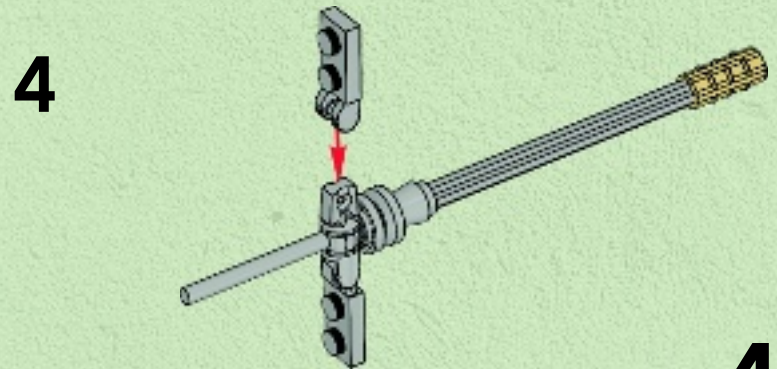
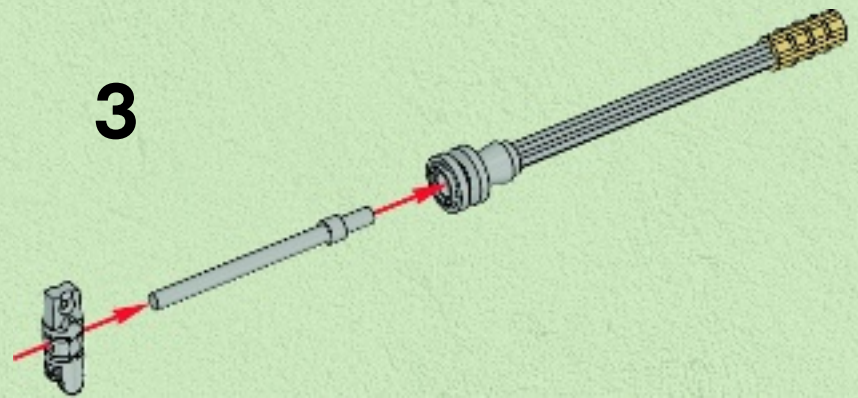
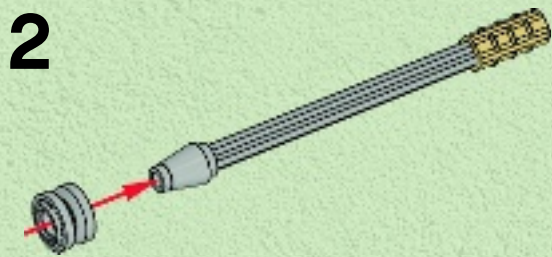
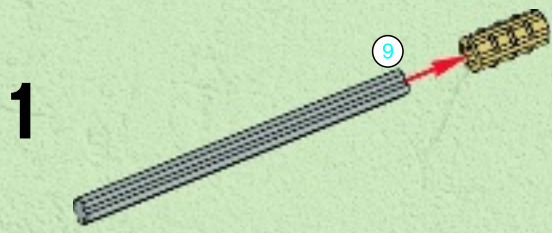

**4x**



61

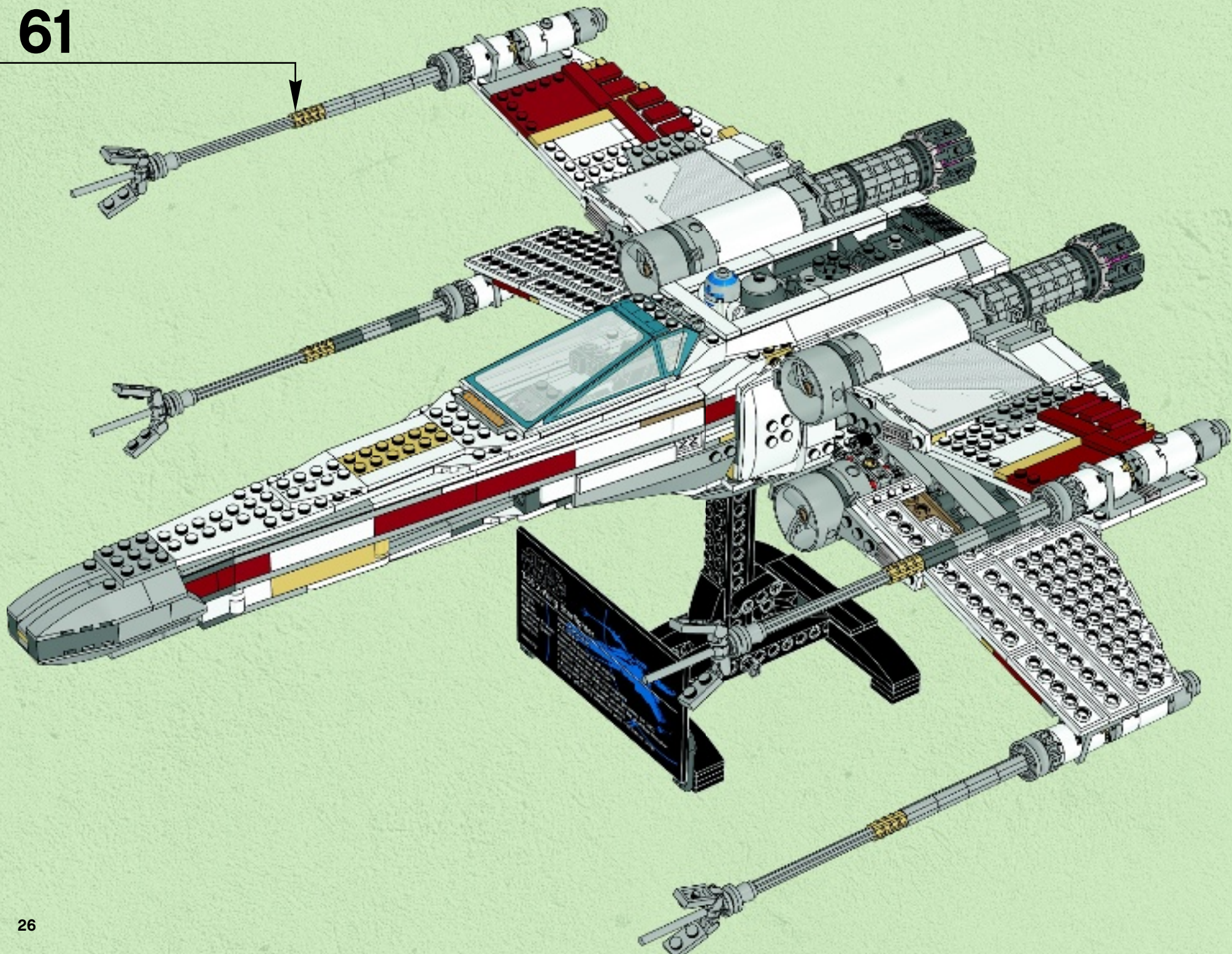

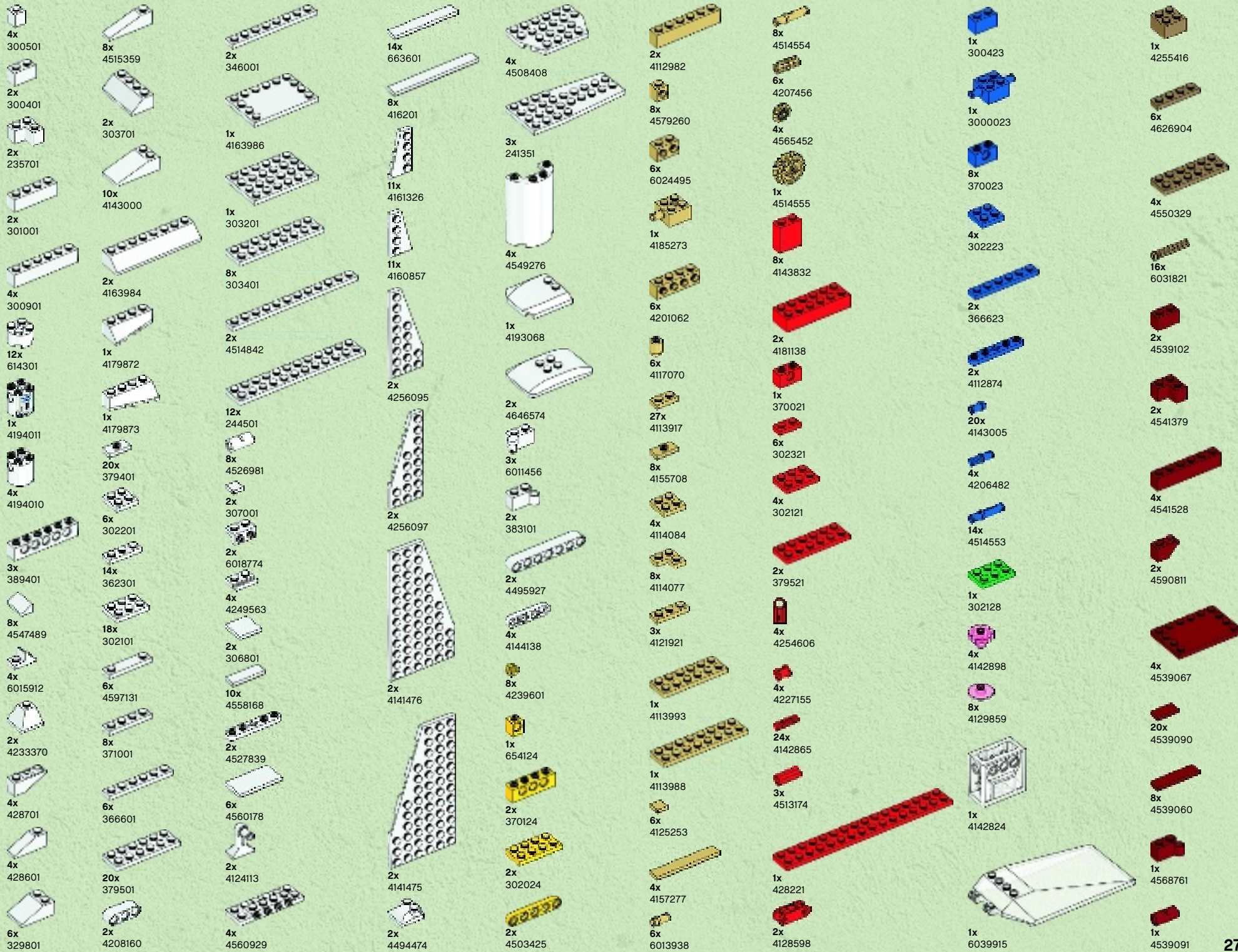

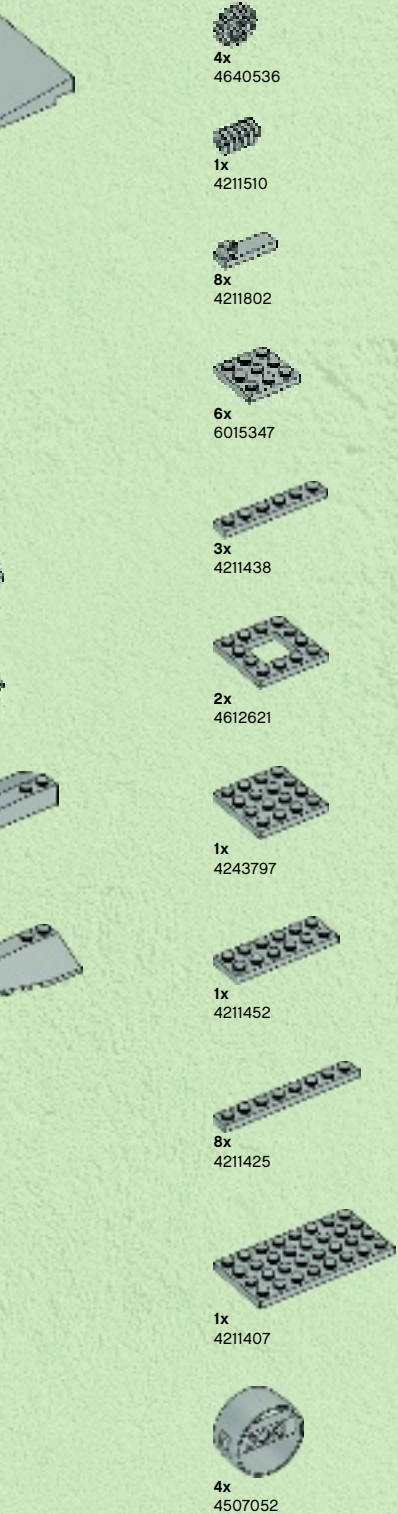
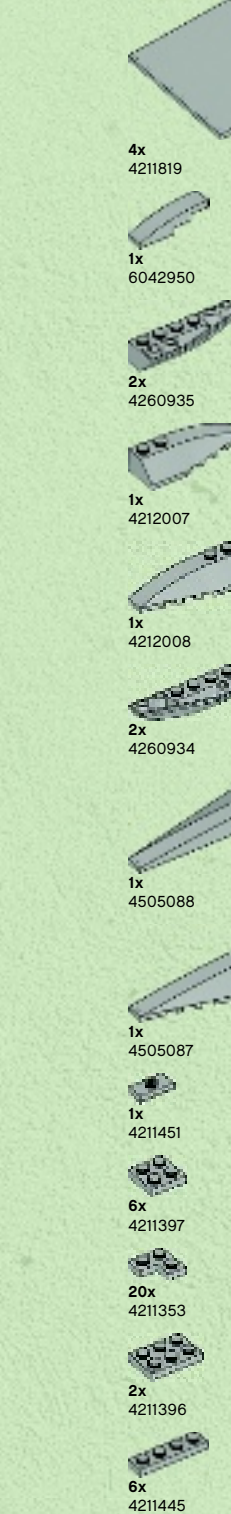
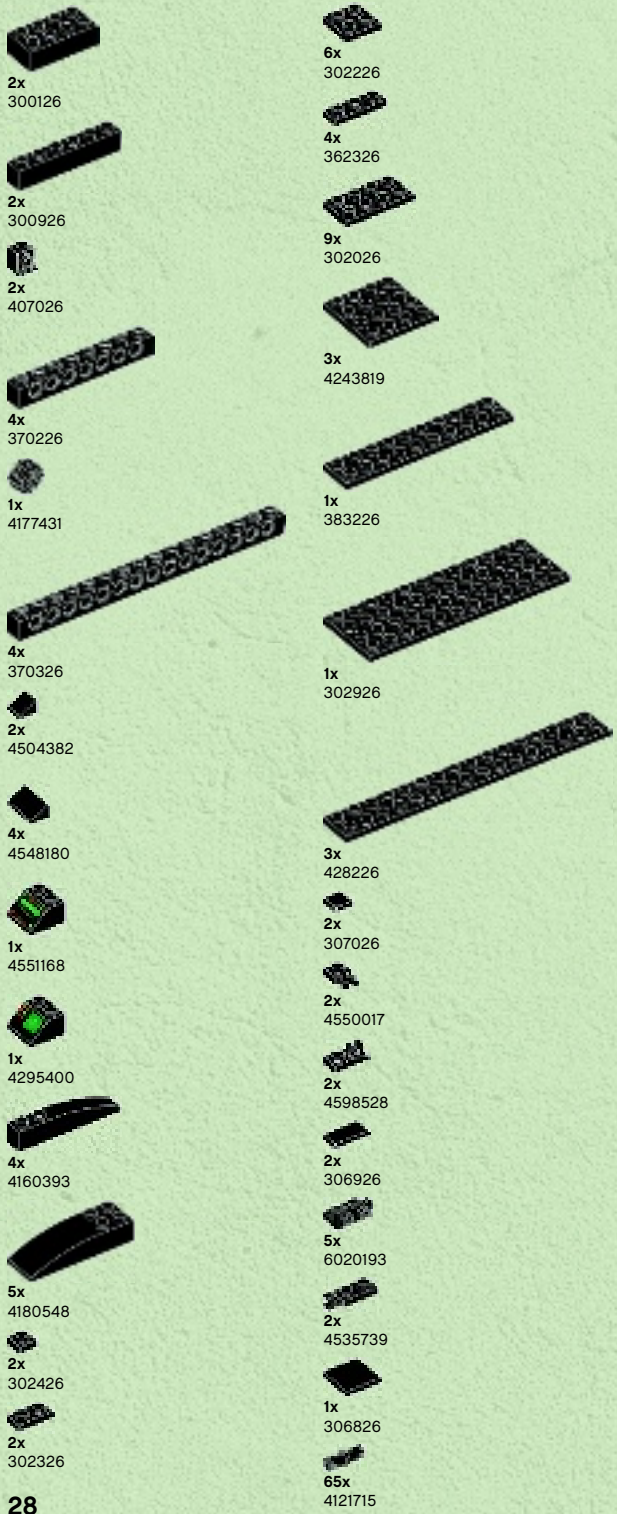



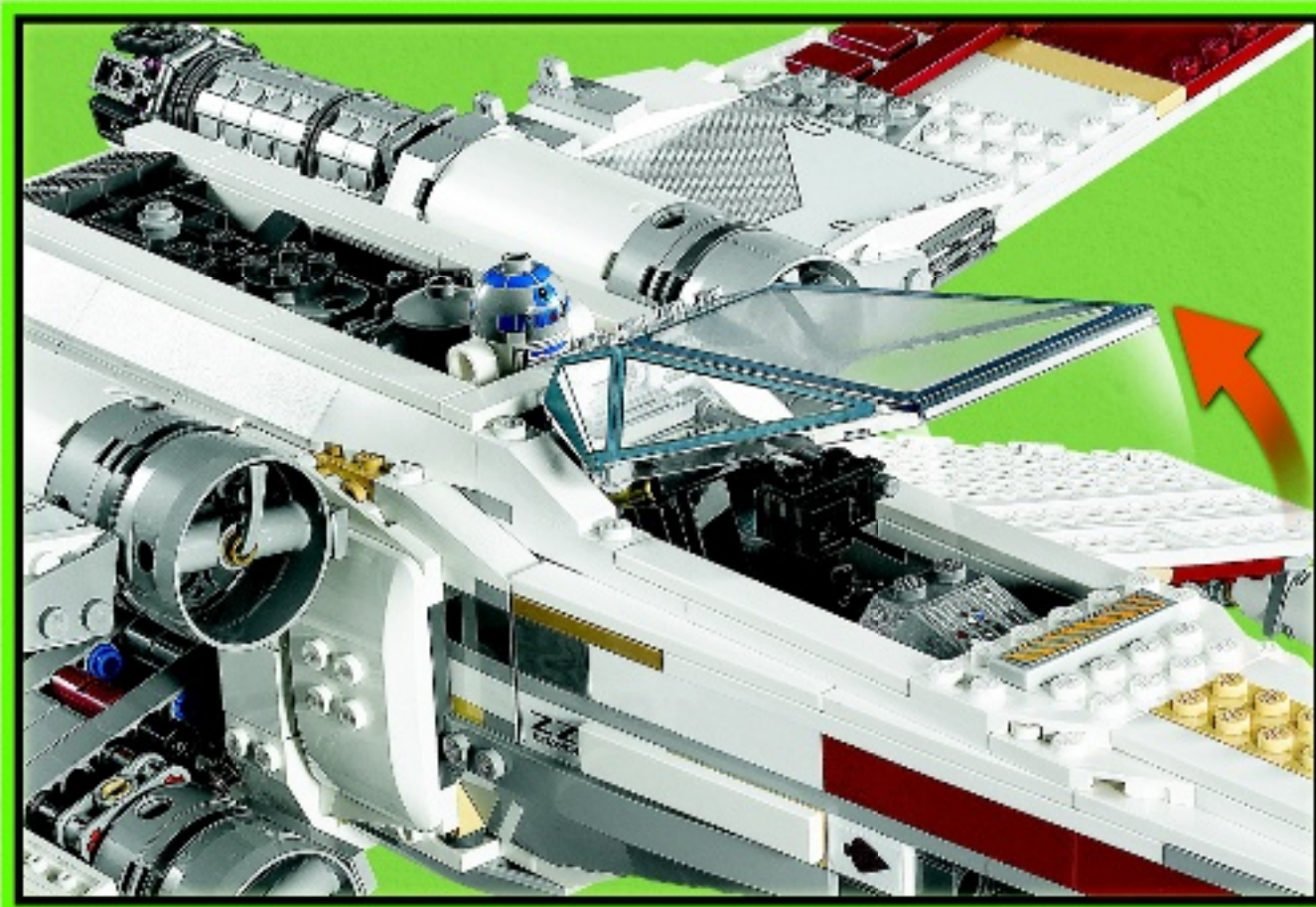

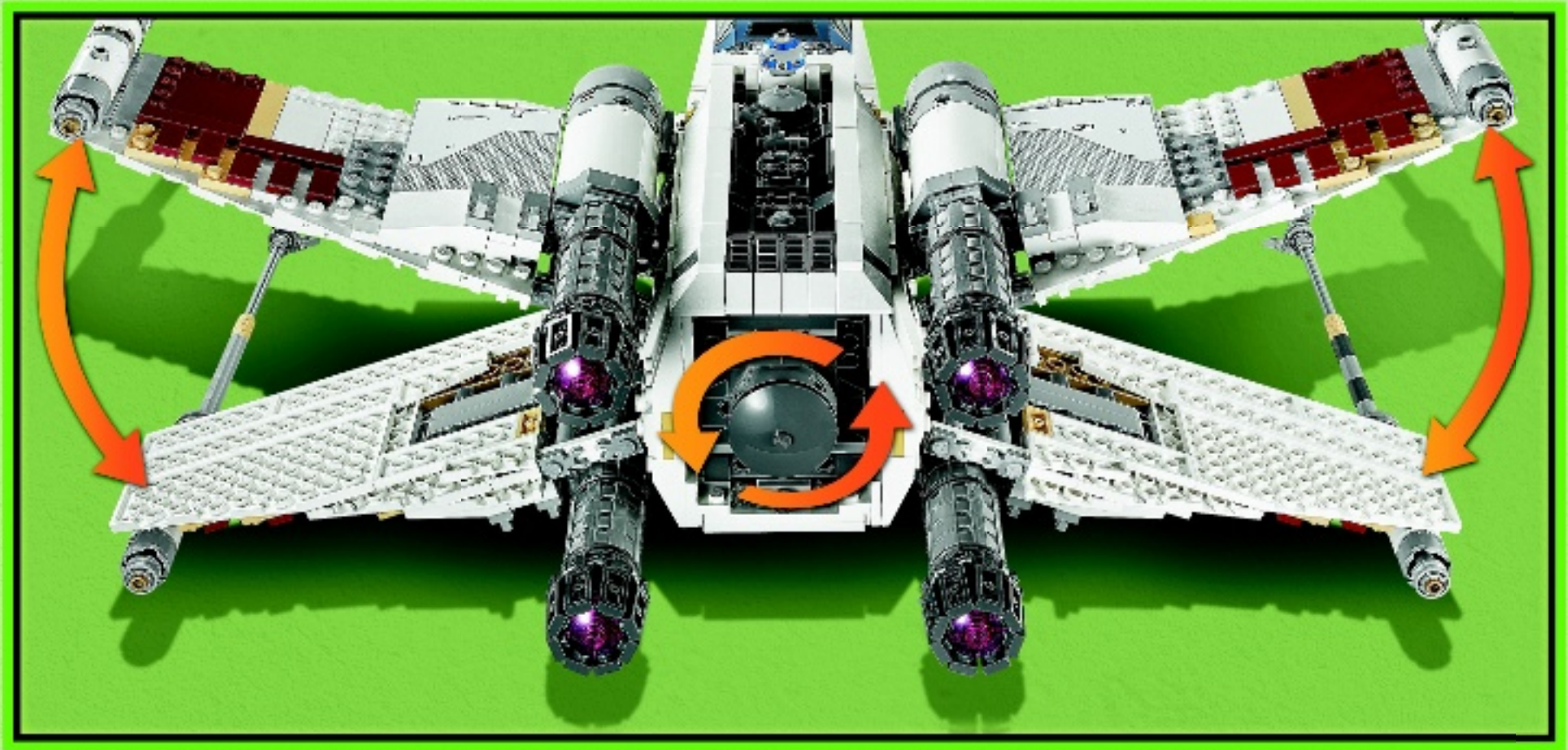



# WIN!

Go to [www.LEGOsurvey.com/product](http://www.LEGOsurvey.com/product) to fill out a survey for a chance to win a cool LEGO® Product.

No purchase necessary.

Open to all residents where not prohibited.



## [www.LEGOsurvey.com/product](http://www.LEGOsurvey.com/product)

### GEWINNE!

Nimm an der Umfrage auf [www.LEGOsurvey.com/product](http://www.LEGOsurvey.com/product) teil und hab die Chance ein cooles LEGO® Produkt zu gewinnen!

Die Teilnahme am Gewinnspiel führt zu keinerlei Kaufverpflichtungen. Teilnahme in allen nicht ausgeschlossenen Ländern möglich.

### WIN!

Ga naar [www.LEGOsurvey.com/product](http://www.LEGOsurvey.com/product), vul een enquêteformulier in en maak kans op een cool LEGO® product.

Geen aankoopverplichting. Iedereen mag deelnemen, uitgezonderd ingezetenden van landen waar een enquêteverbod geldt.

### GAGNE!

Visite [www.LEGOsurvey.com/product](http://www.LEGOsurvey.com/product) pour répondre à un questionnaire et avoir une chance de gagner un produit LEGO® très cool!

Aucune obligation d'achat. Ouvert à tous les résidents des pays autorisés.

### 当てよう!

[www.LEGOsurvey.com/product](http://www.LEGOsurvey.com/product) にアクセスして、アンケートにご記入ください。当選者にはレゴ製品を差し上げます。

お買い上げの必要はありません。禁止されていない限り、すべての皆様にご利用いただけます。