

10226

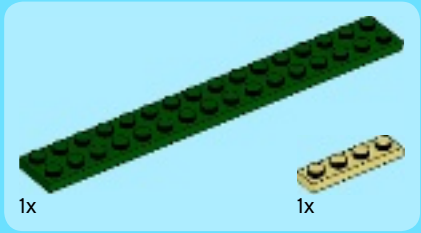

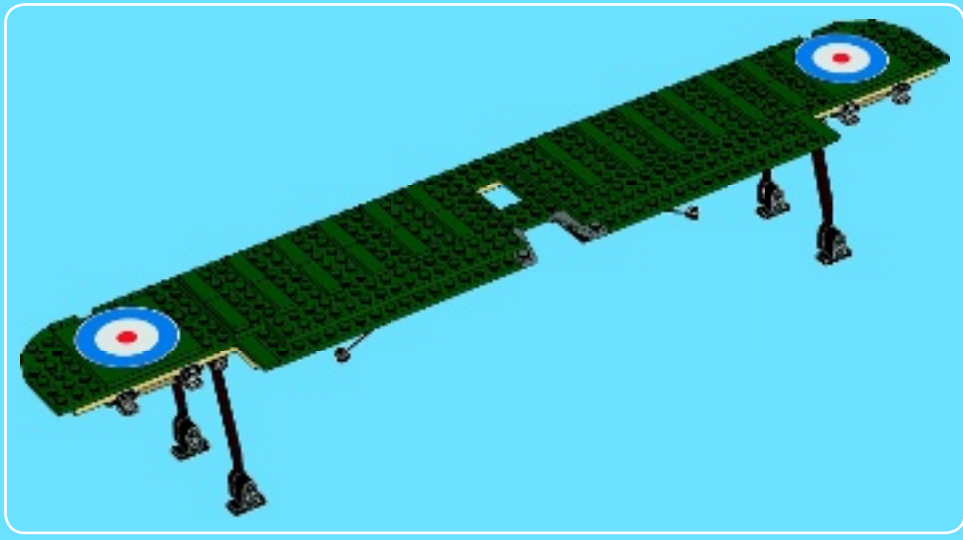

1

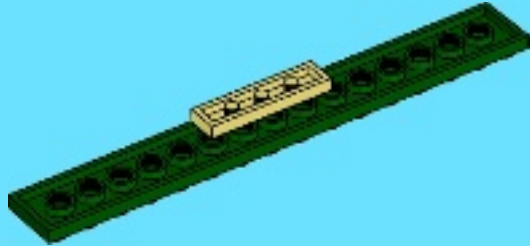

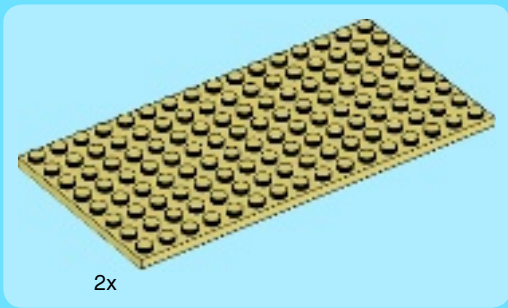

2

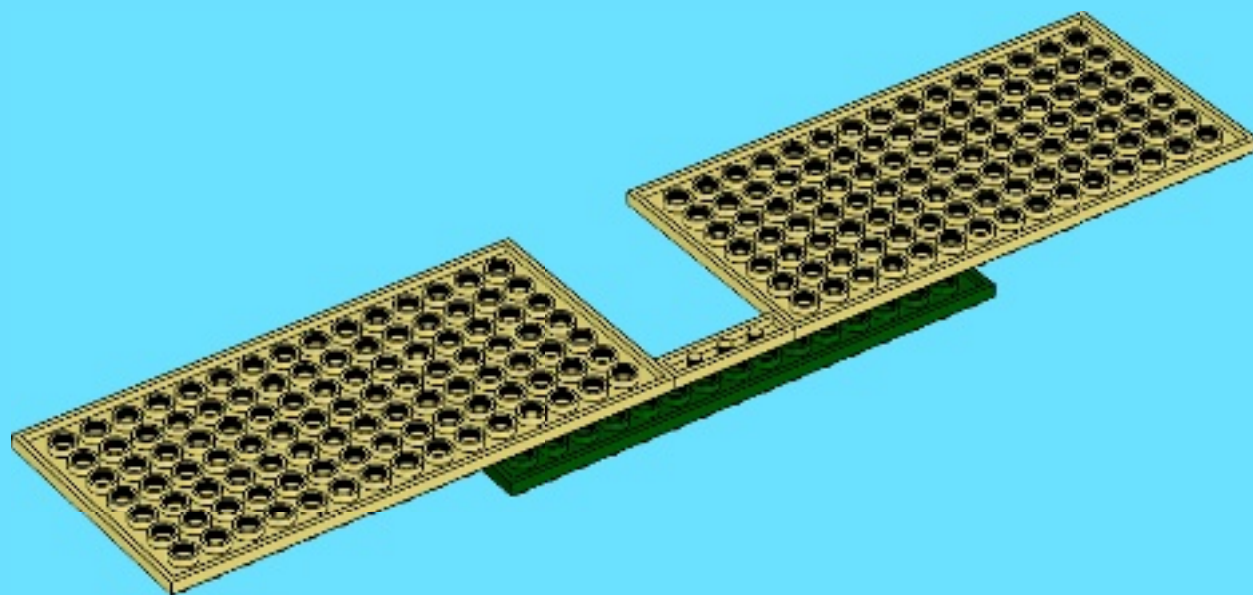

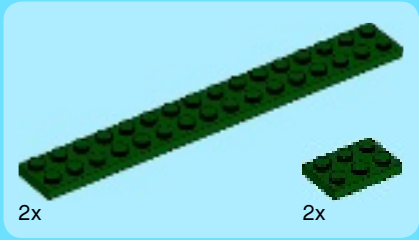

3

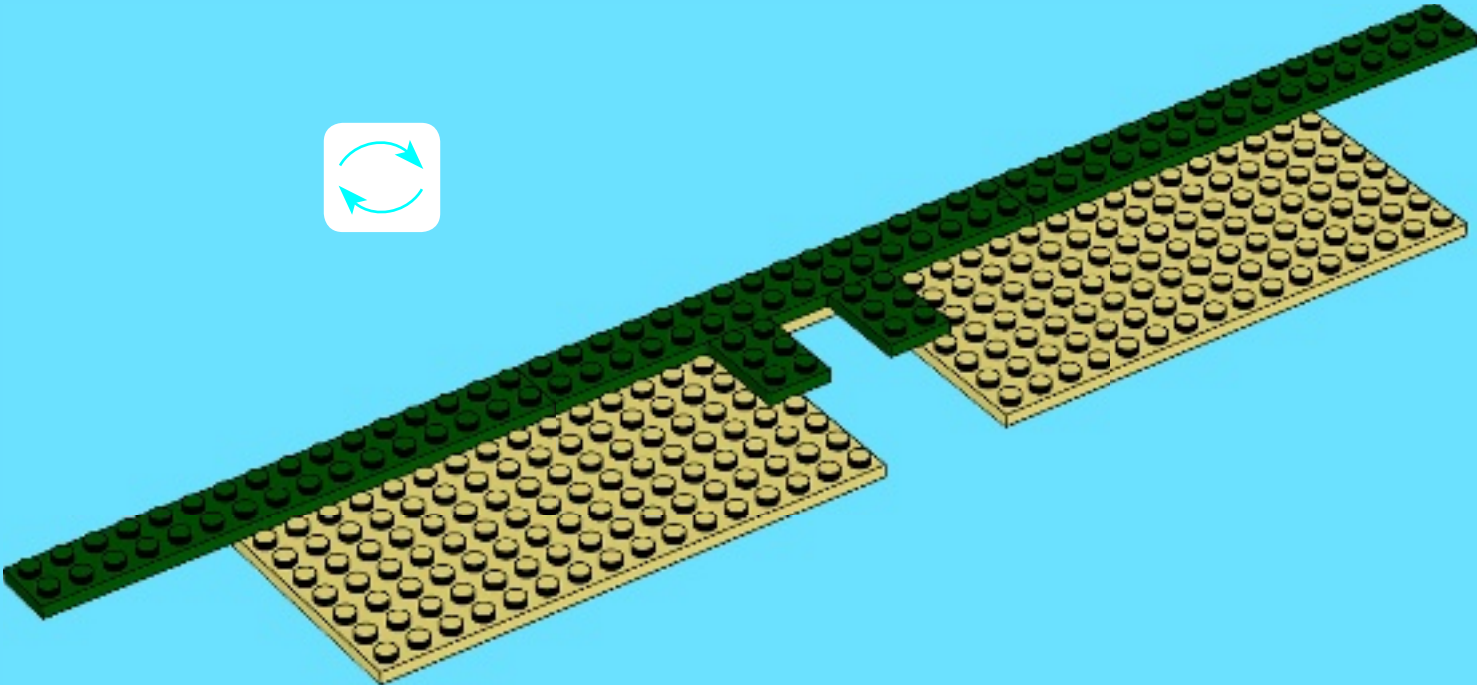

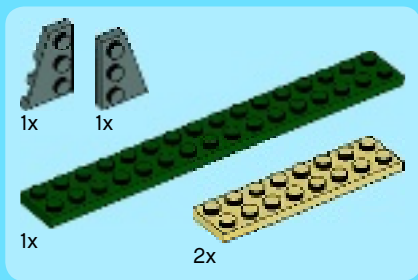

4

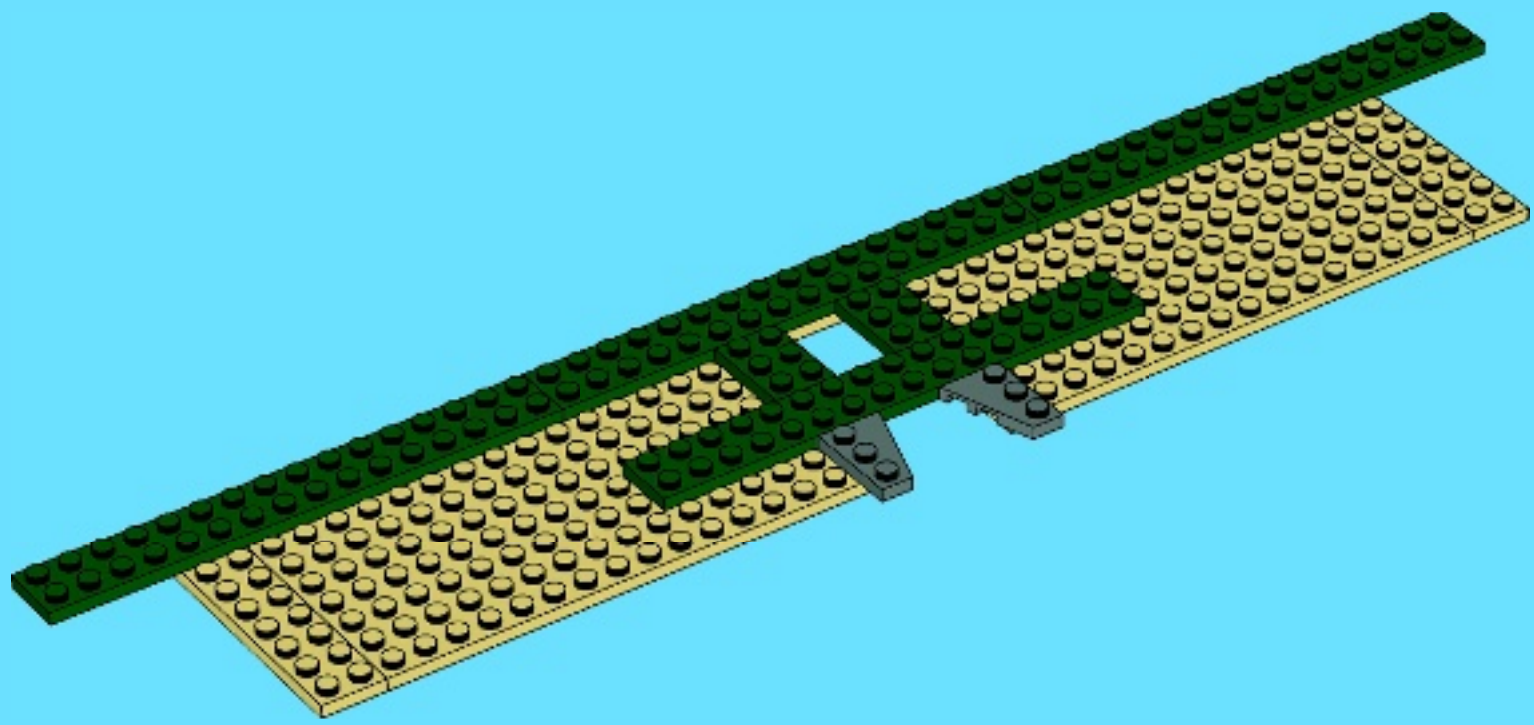

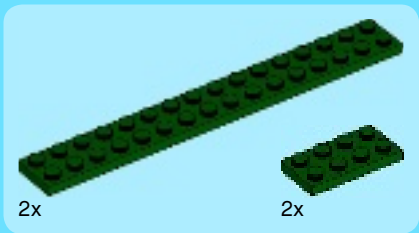

5

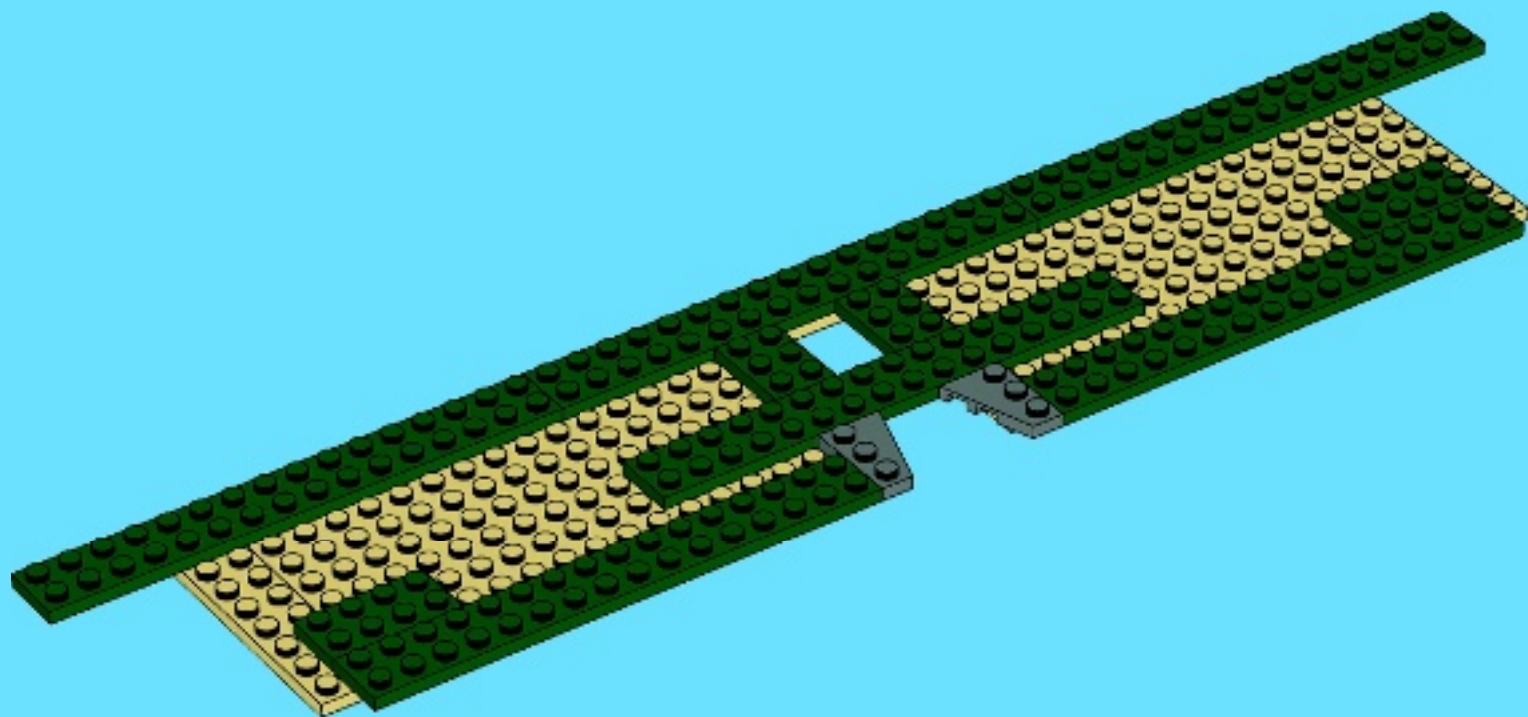



6

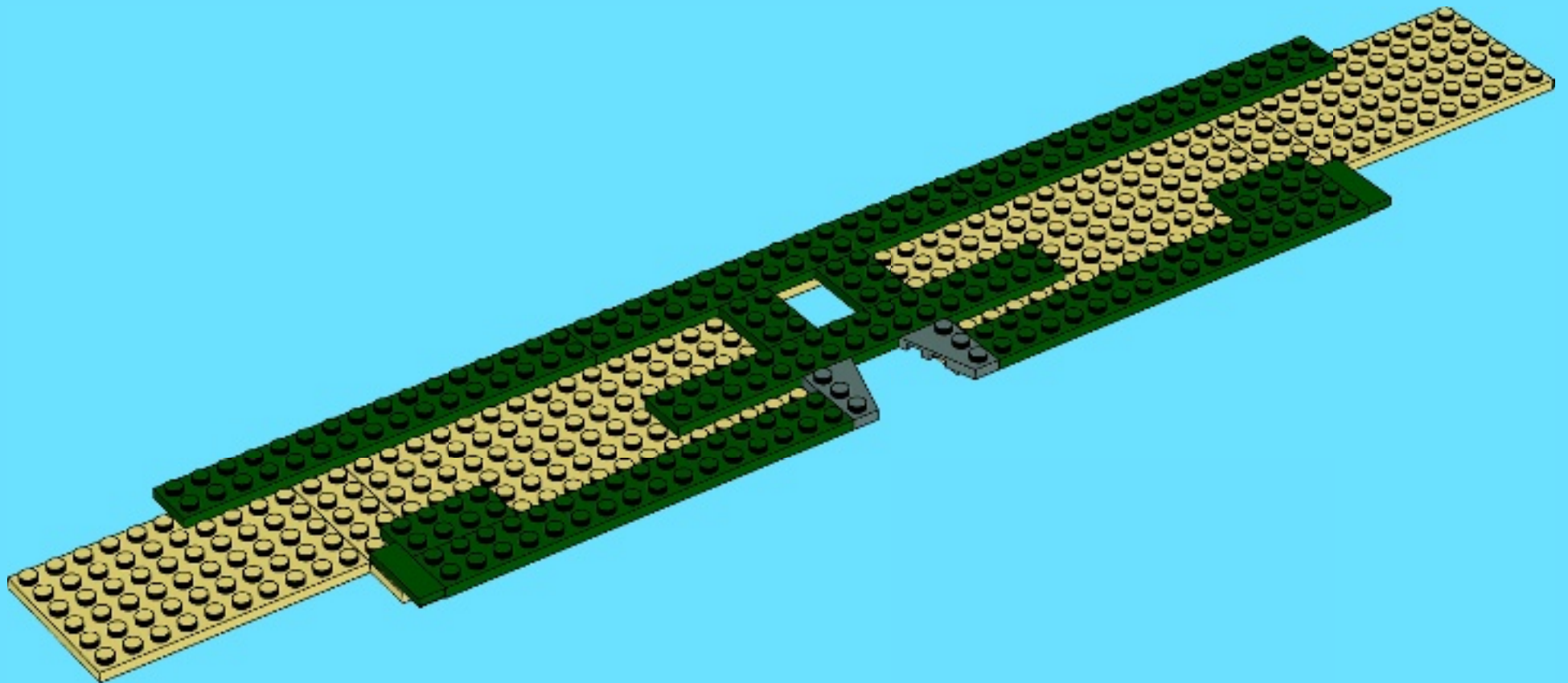

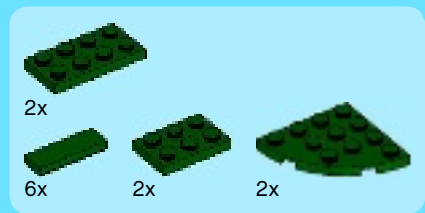

7

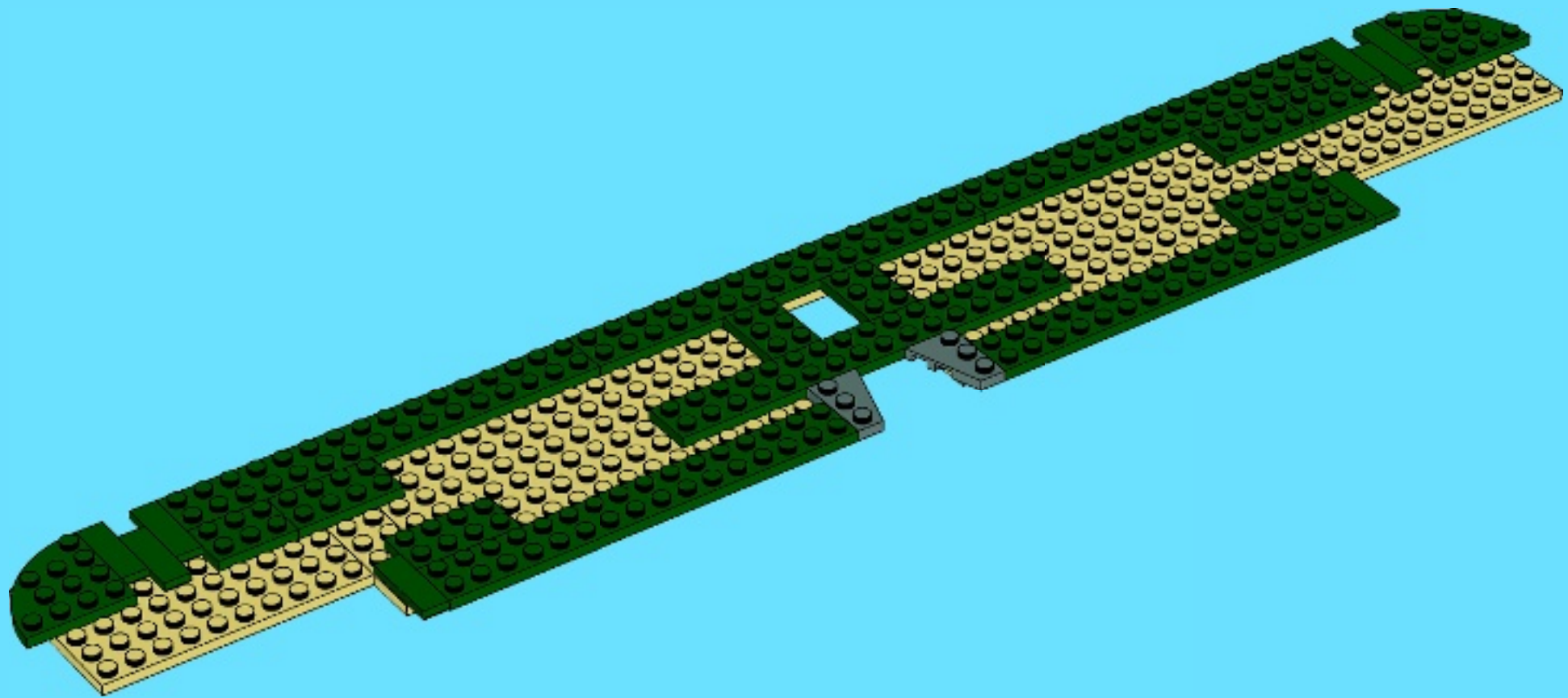

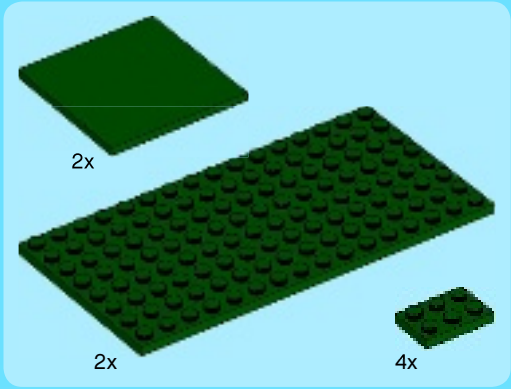

9

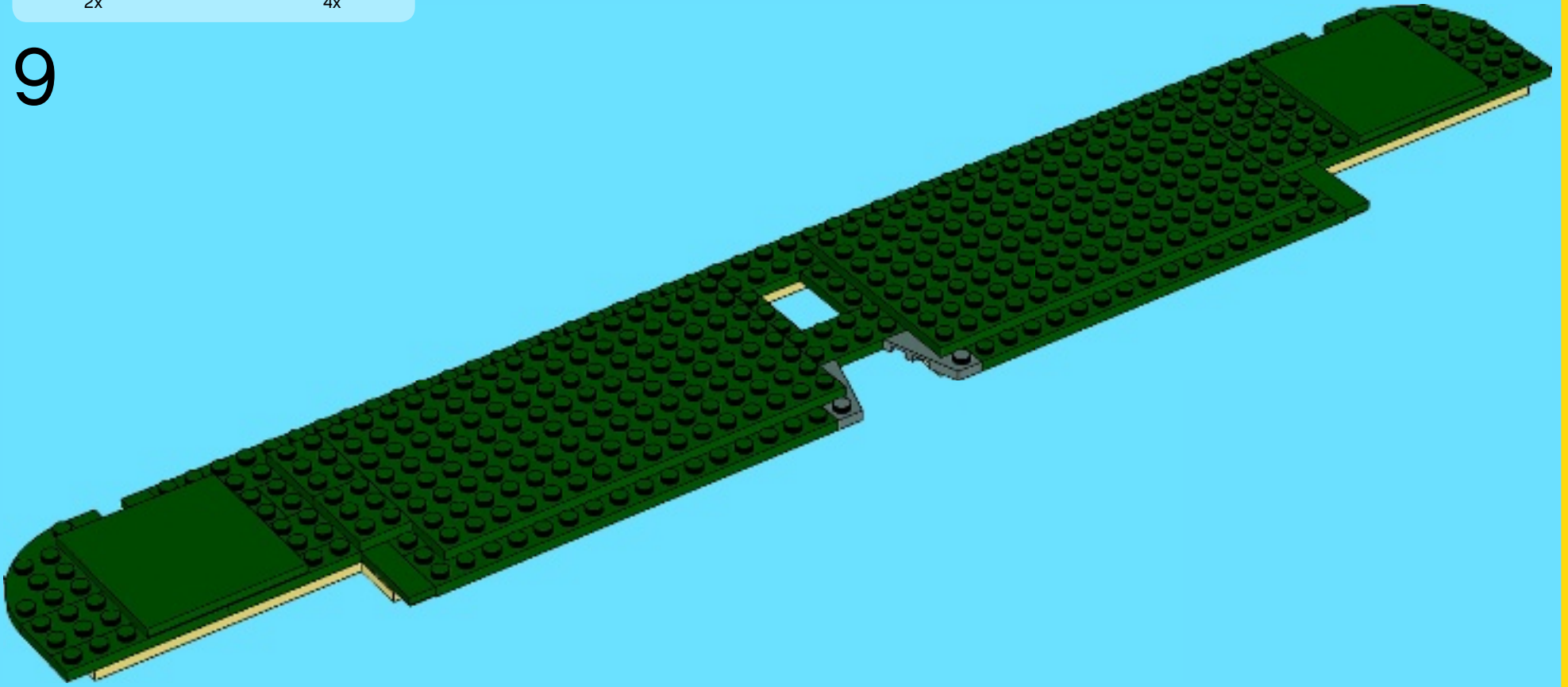



24x

10

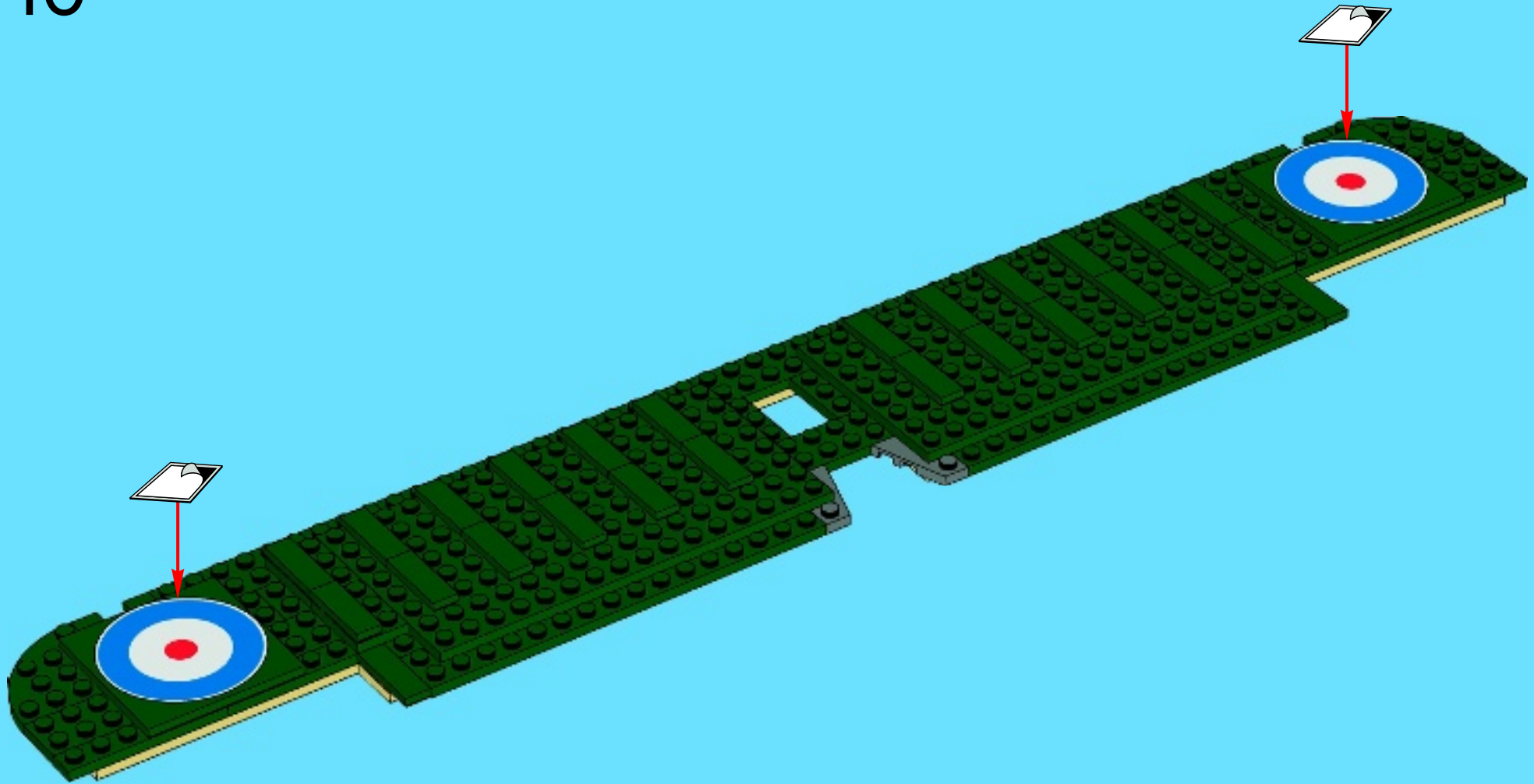

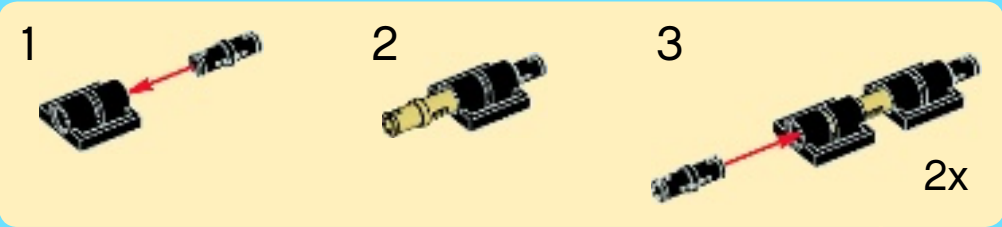
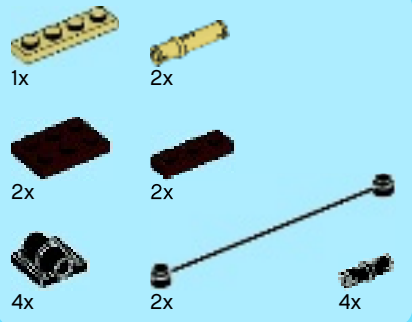

11

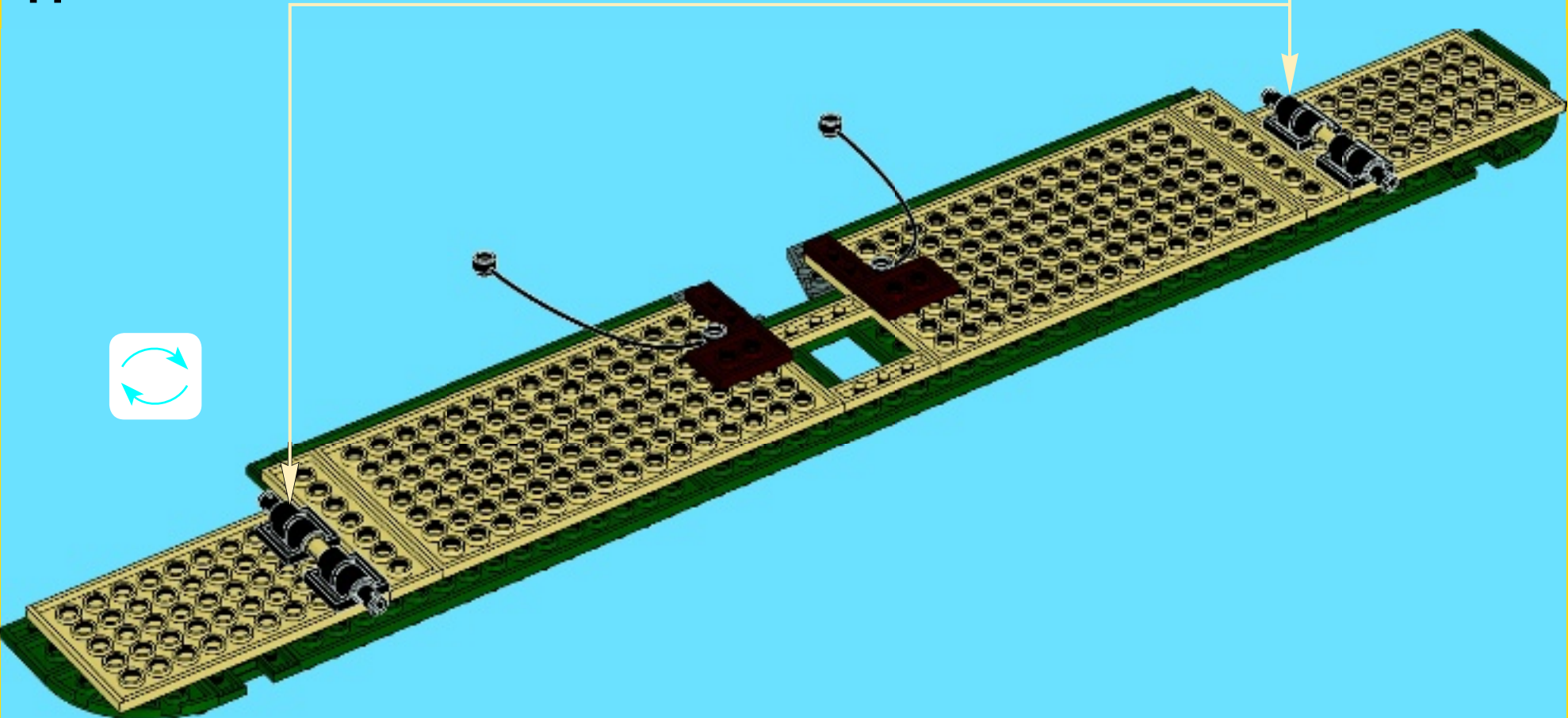

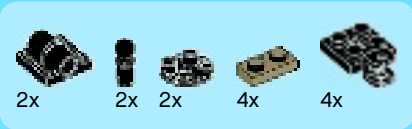

12

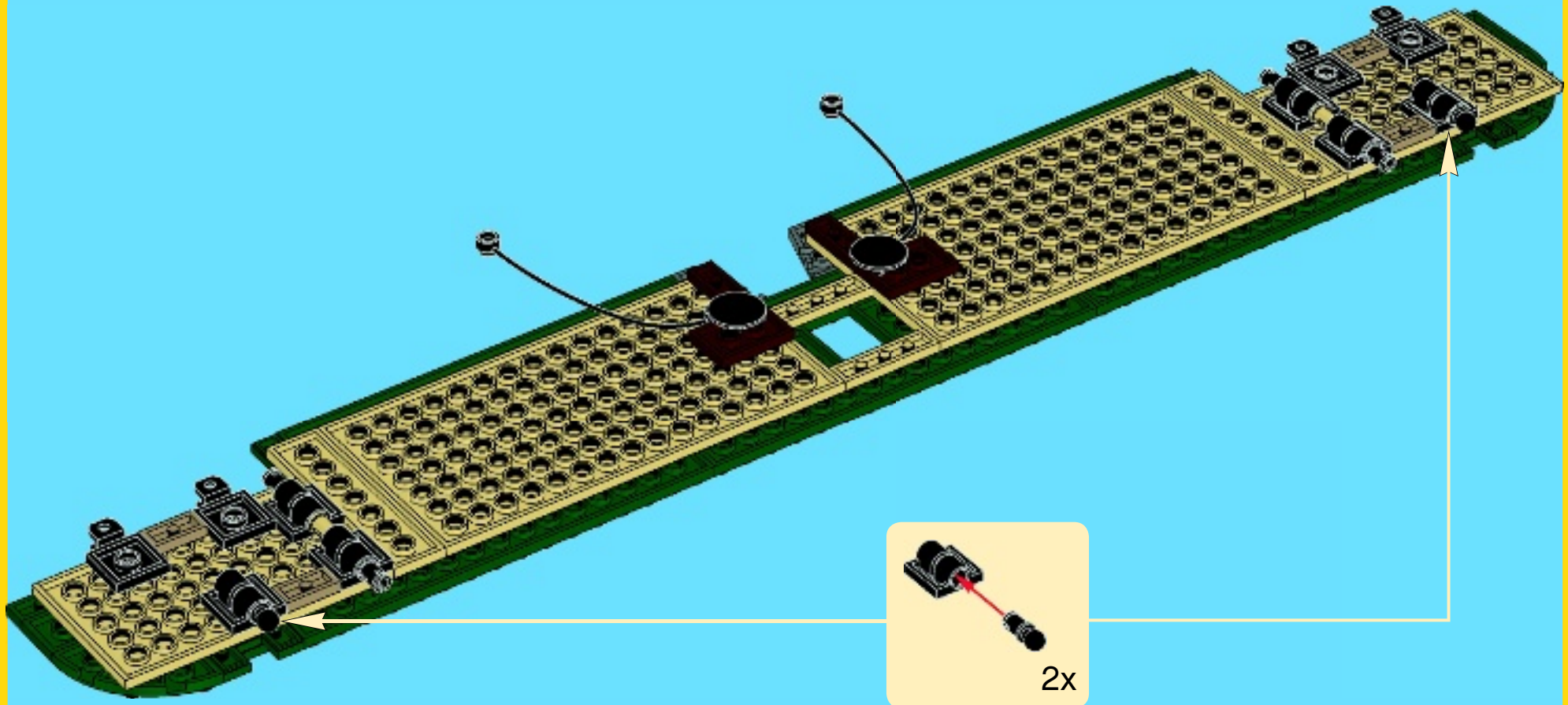

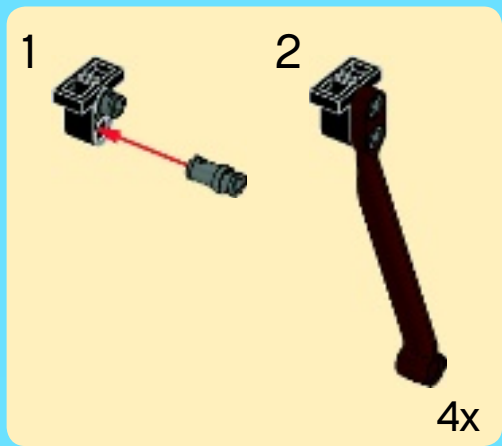
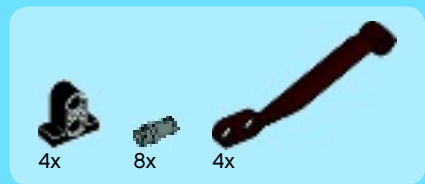

13

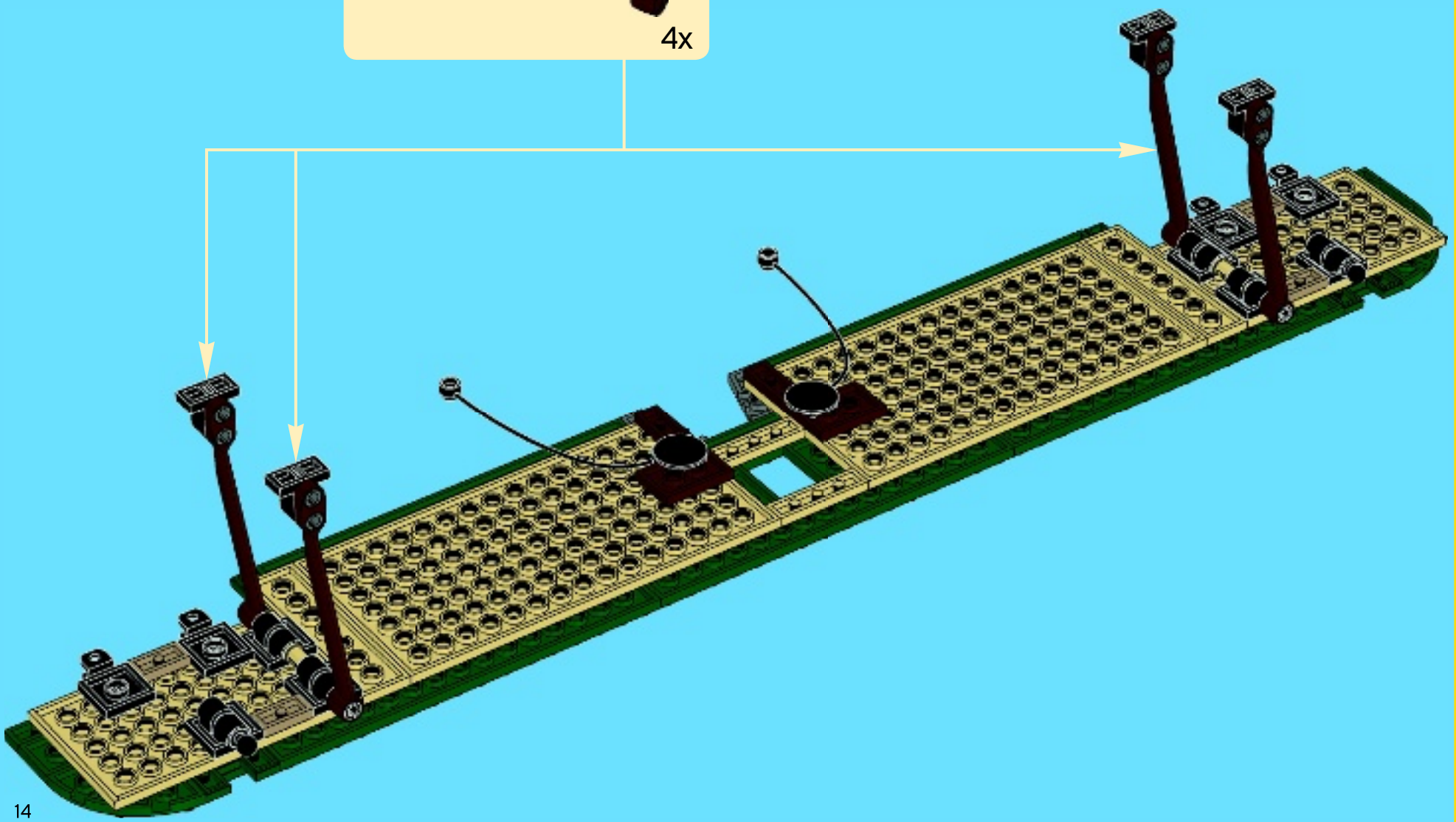

53

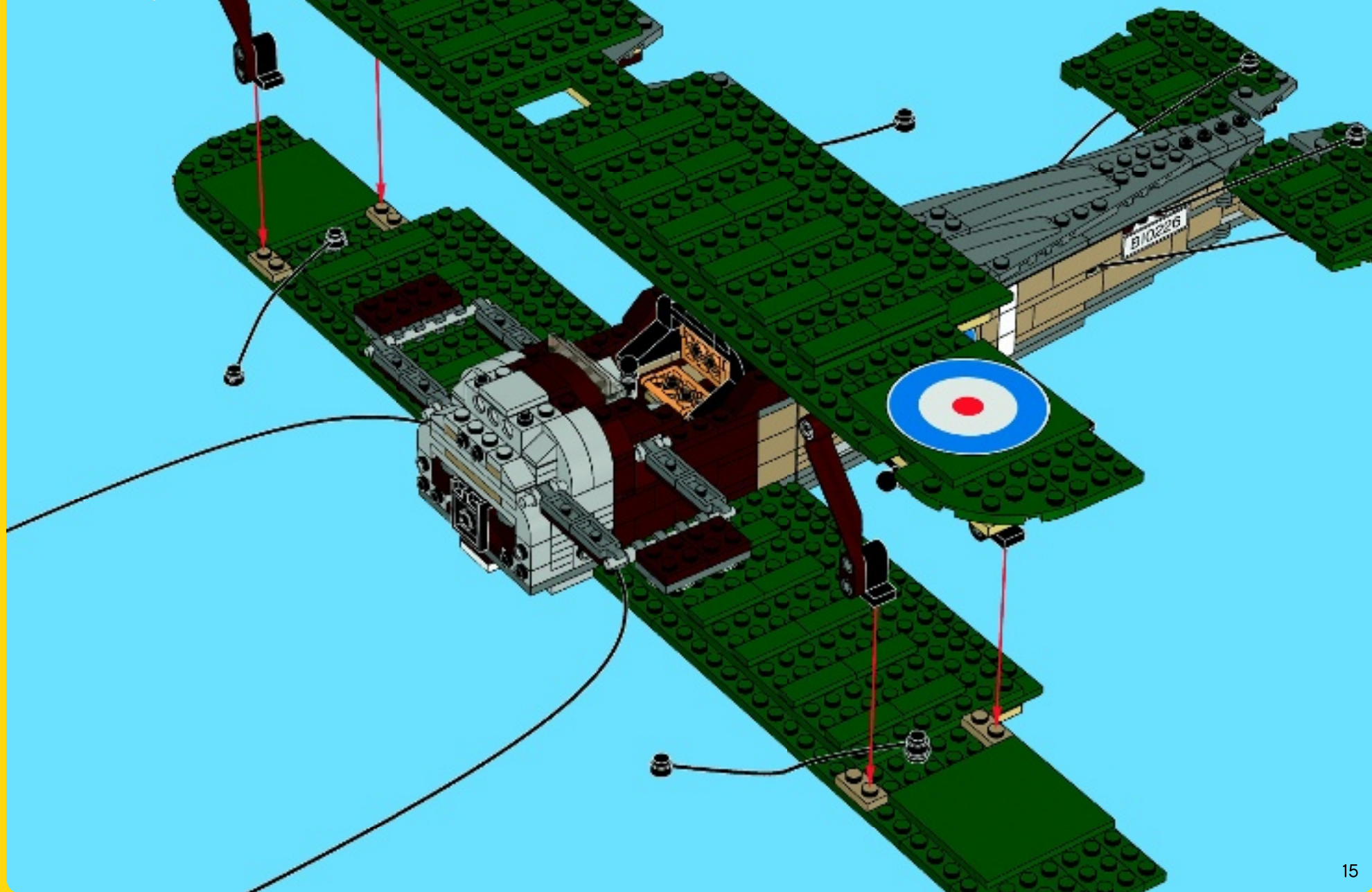

54

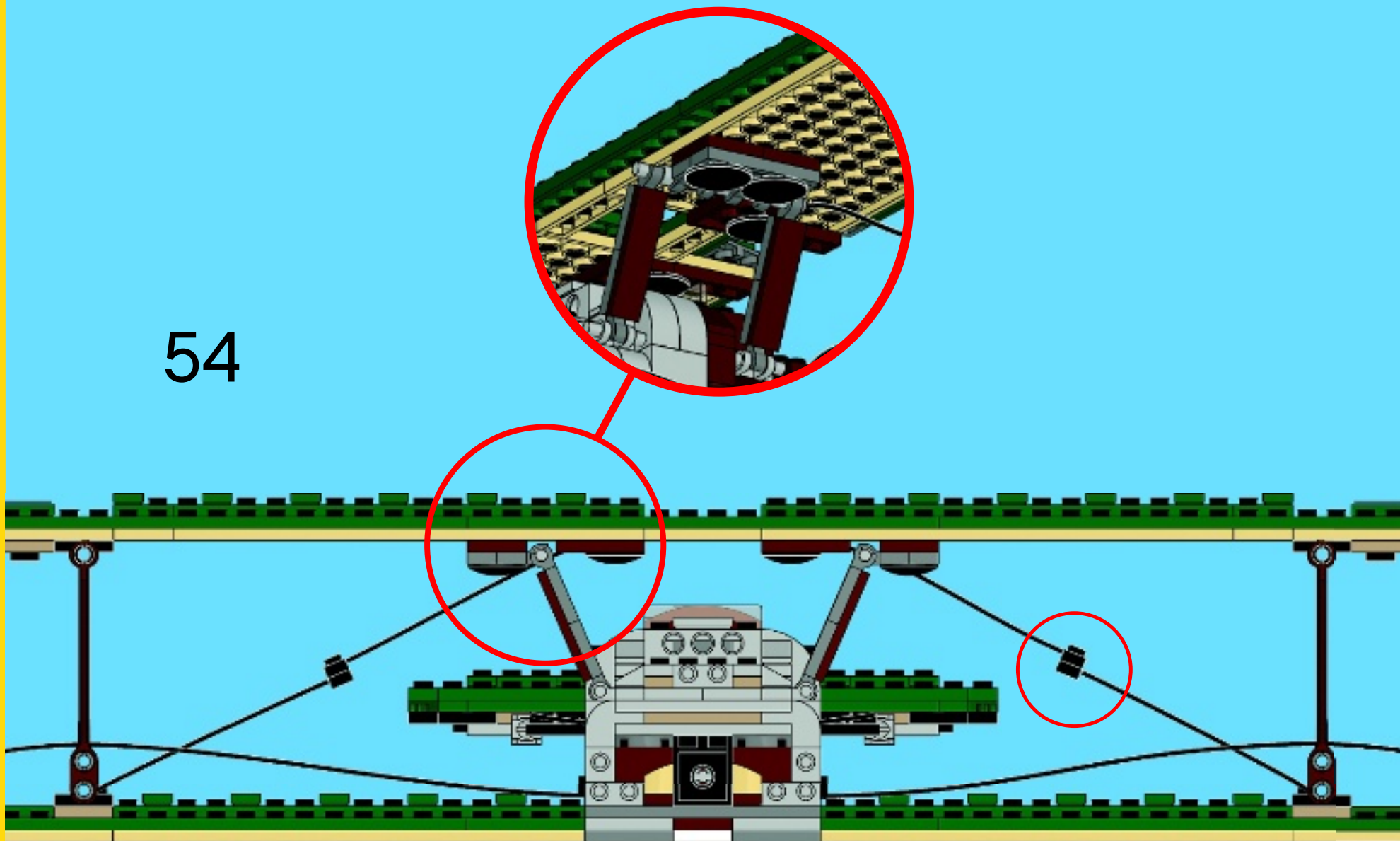

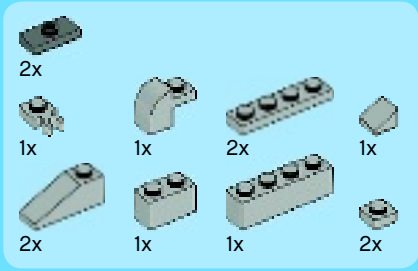

55

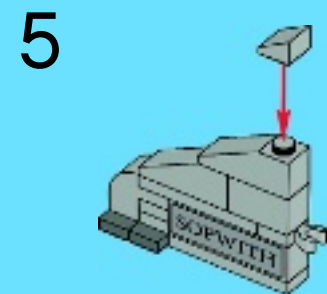
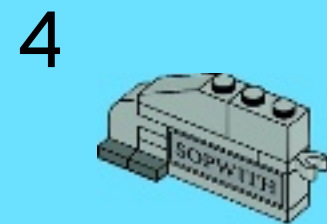
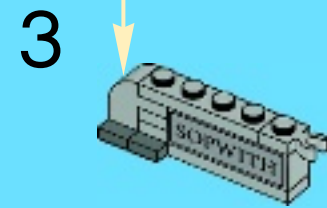
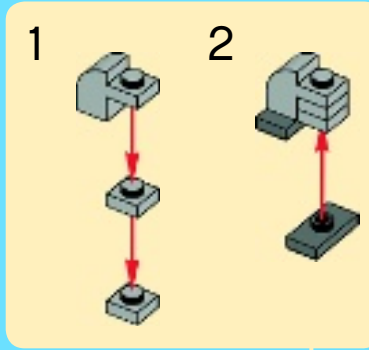
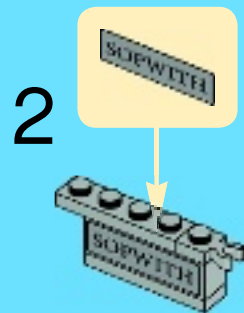
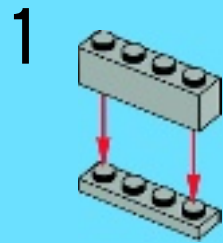

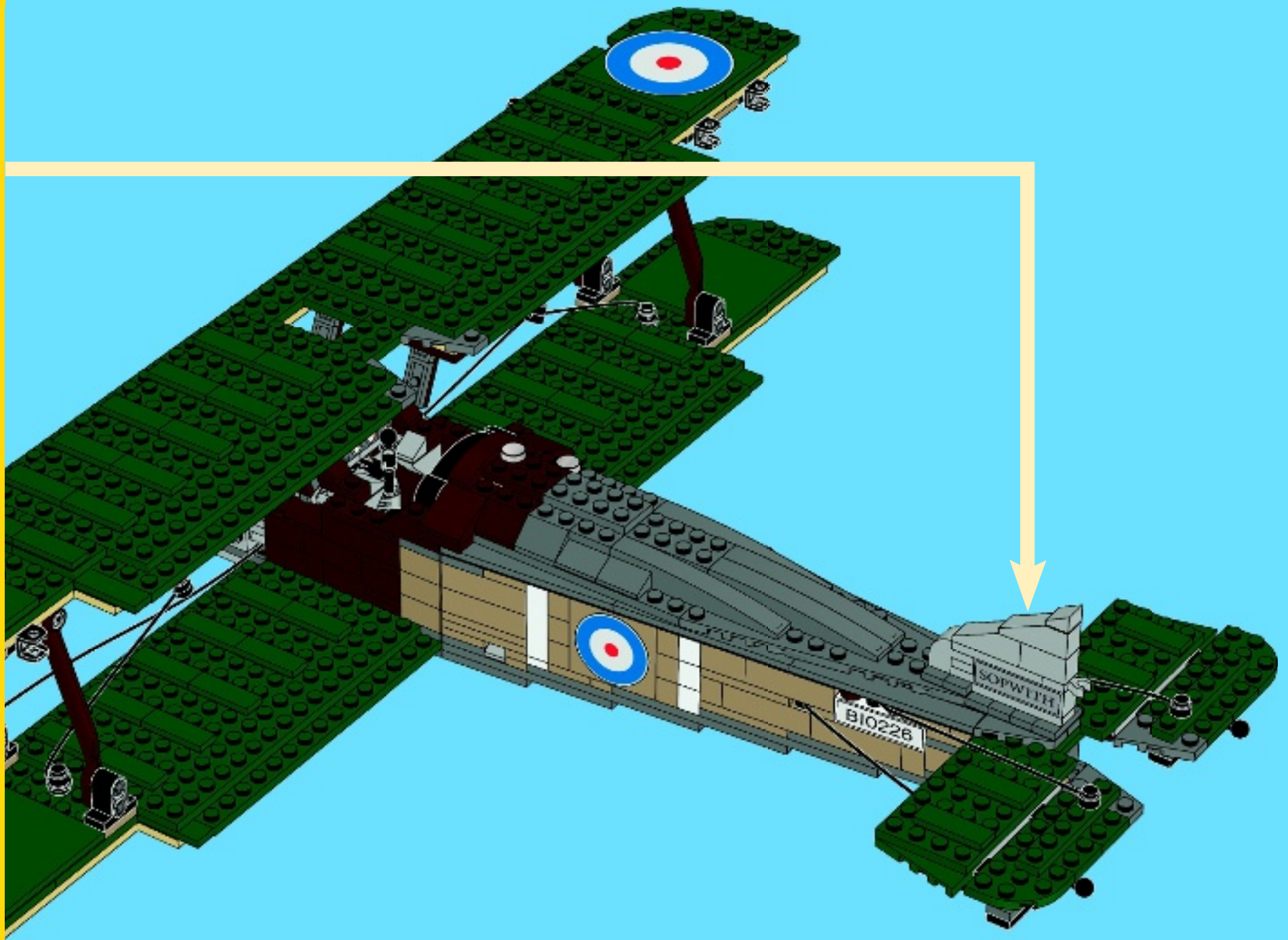

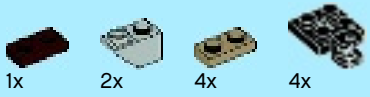

56

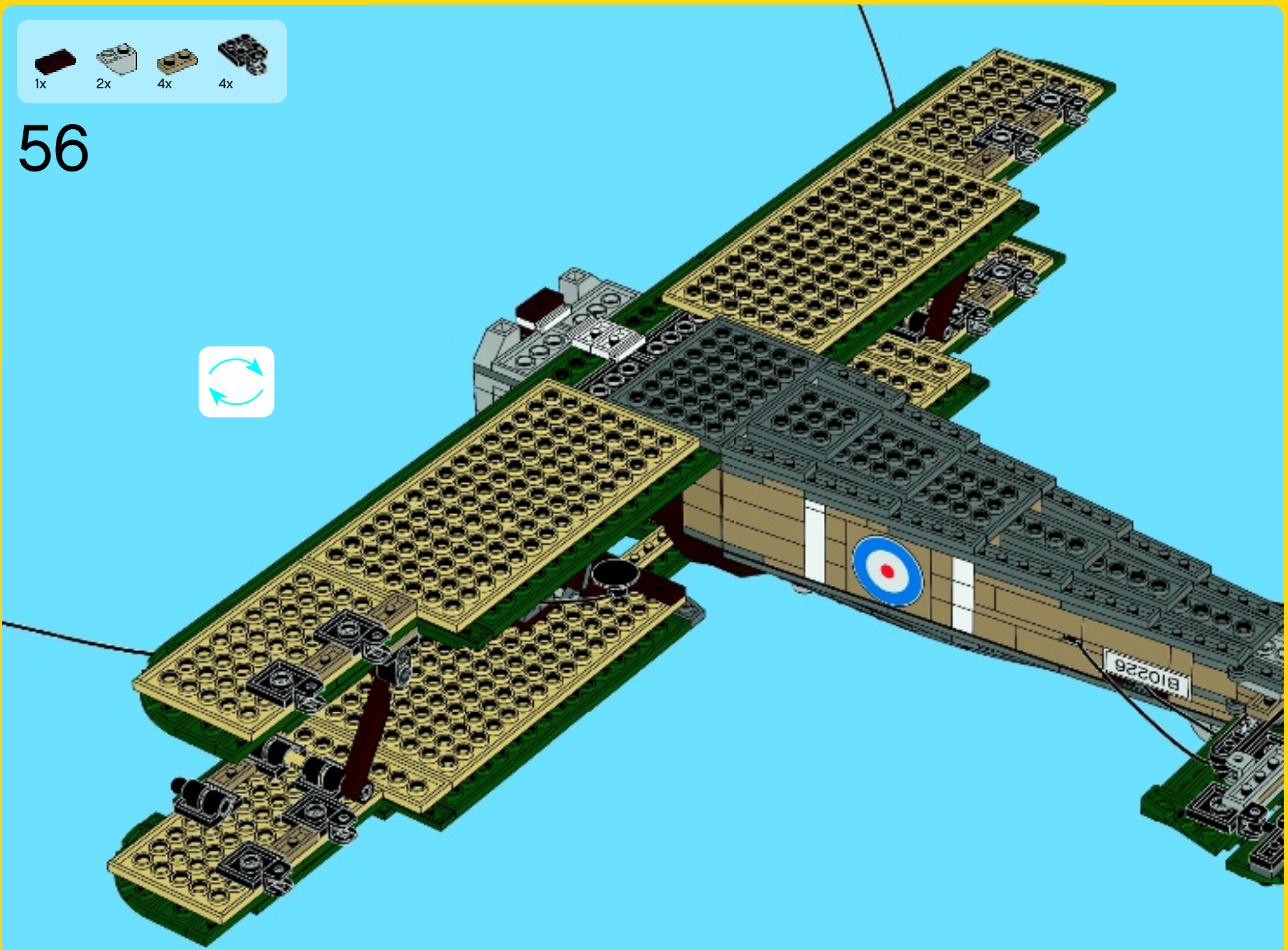

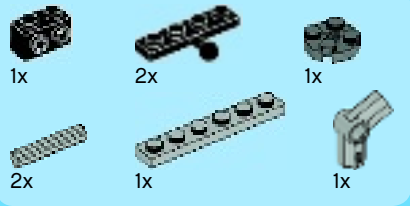

57

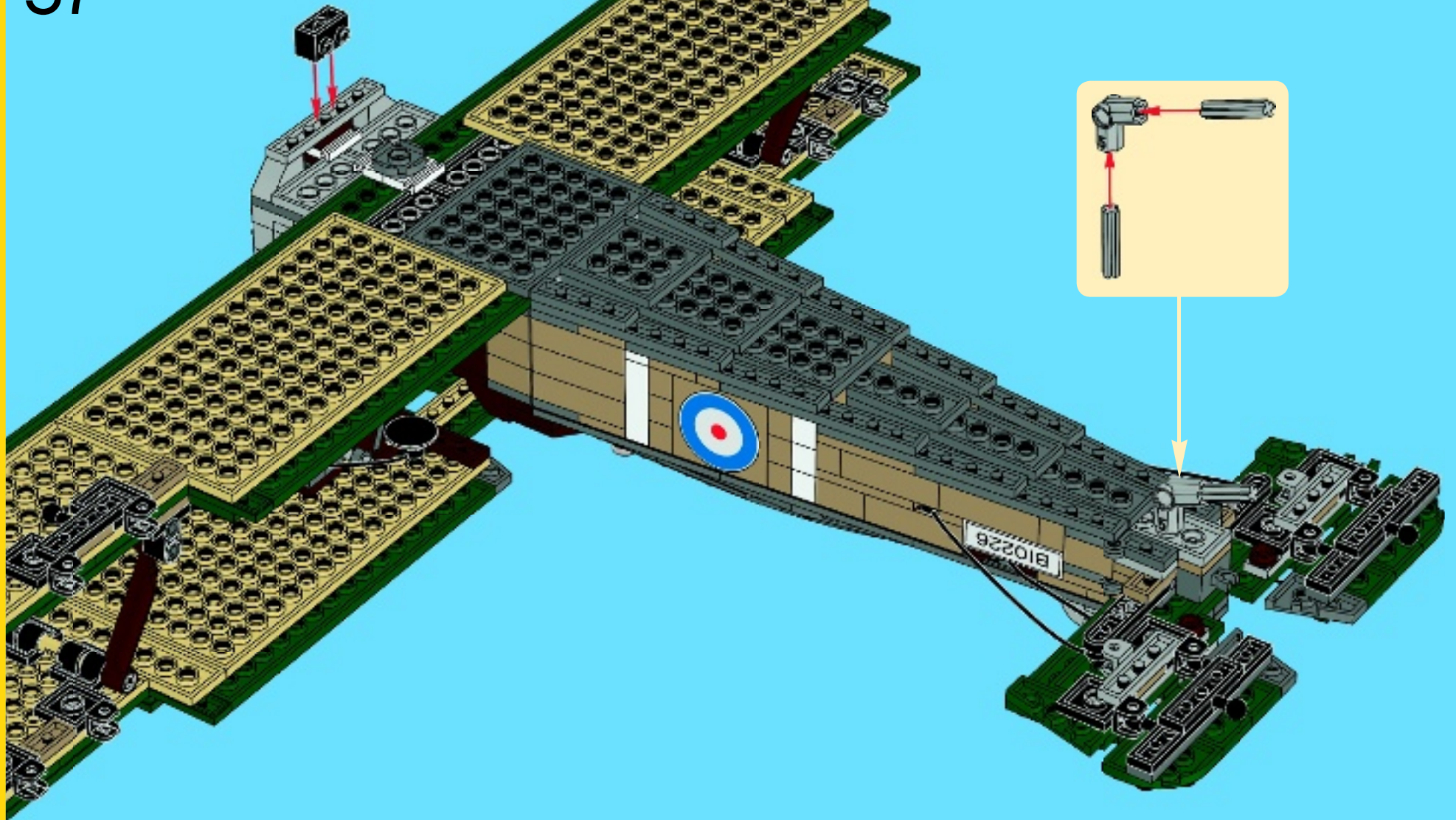

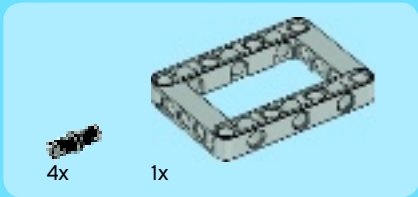
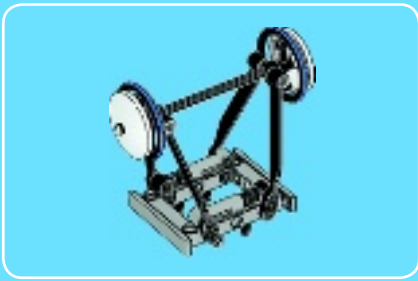

1

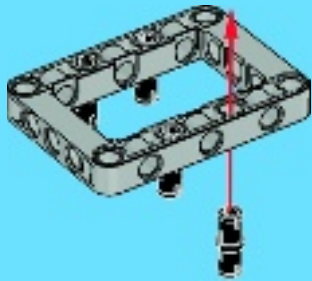

2

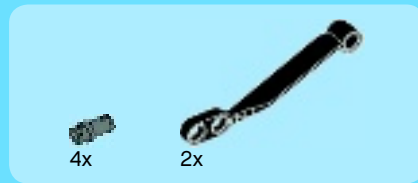
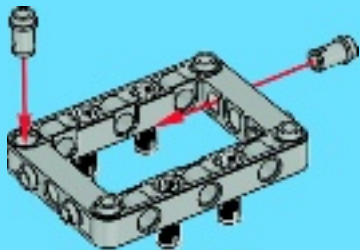

3

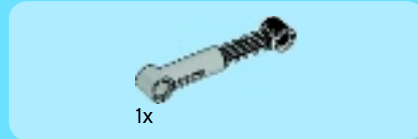
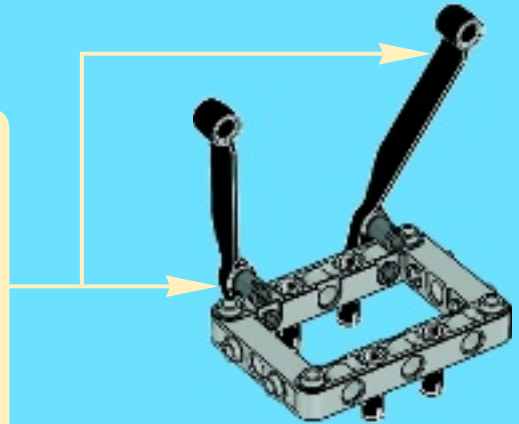

4

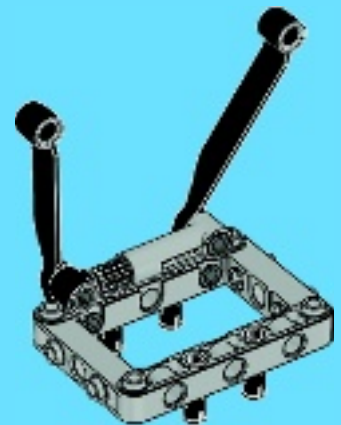

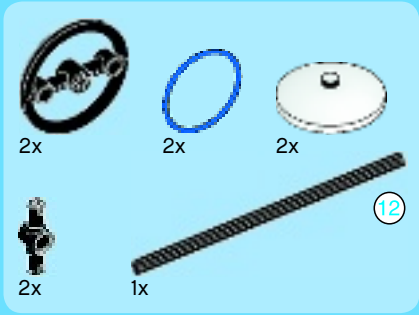

5

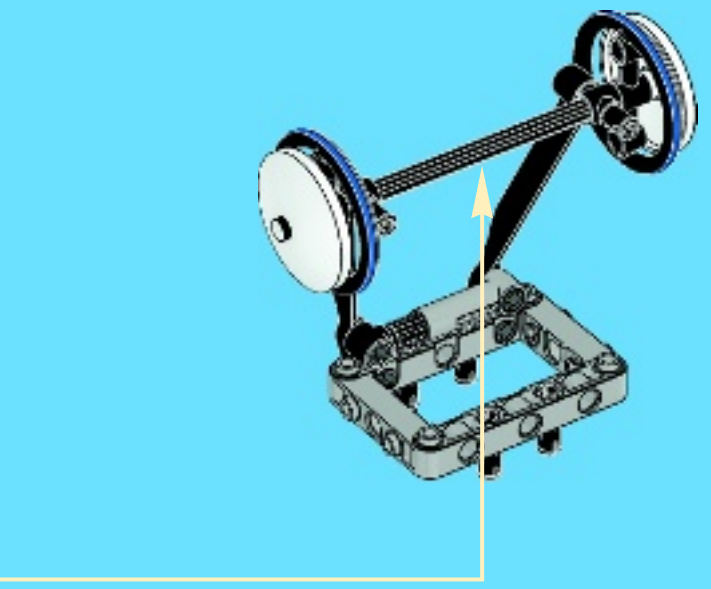
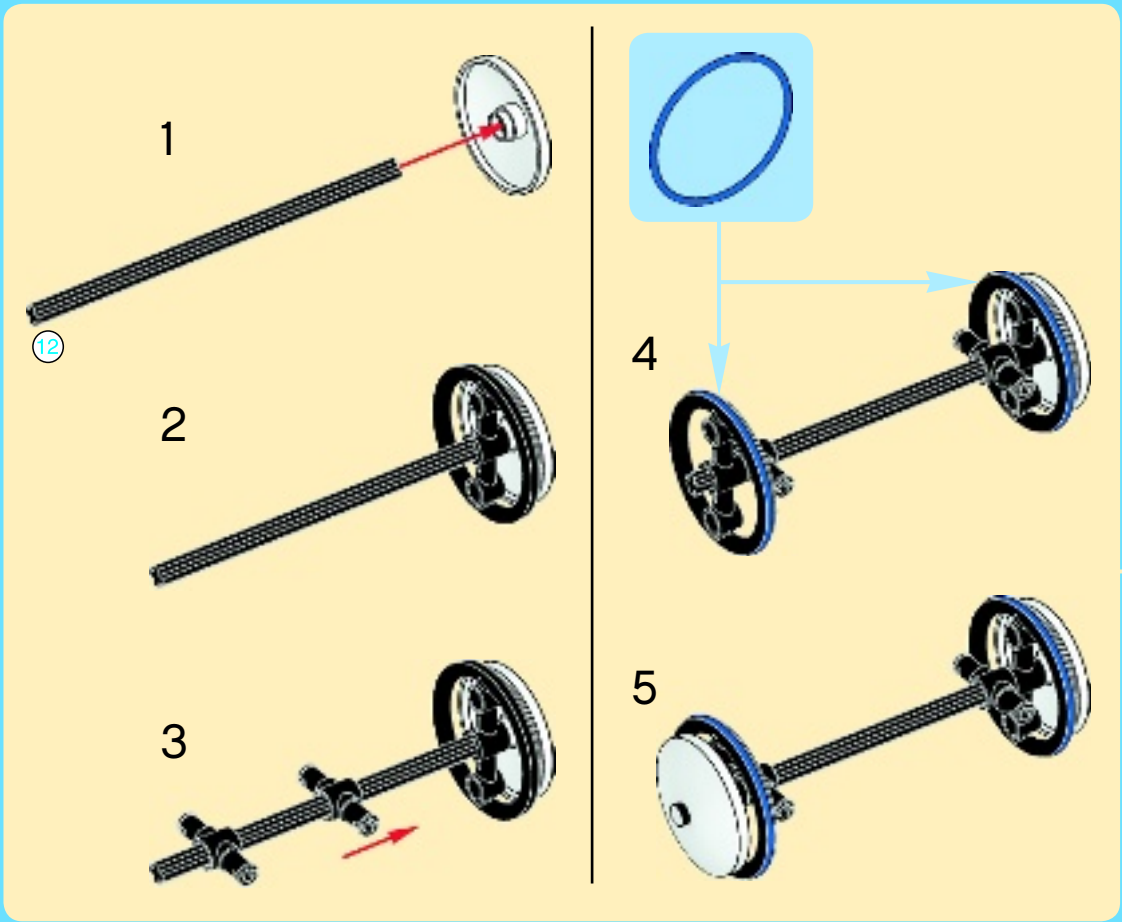

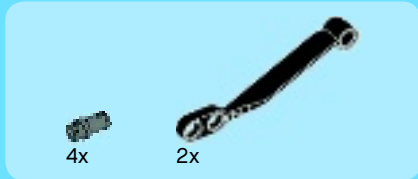

6

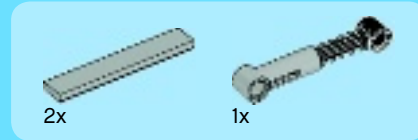
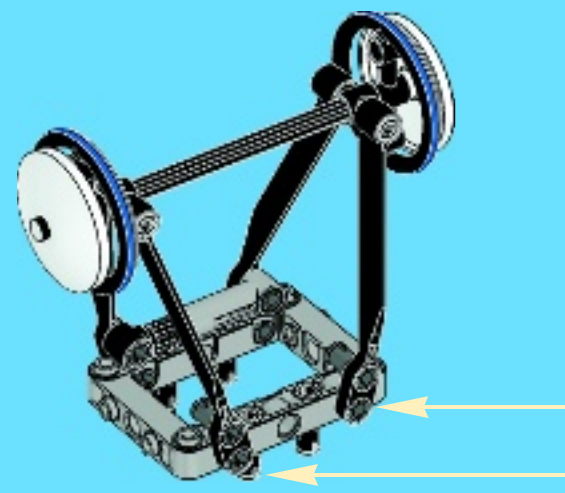
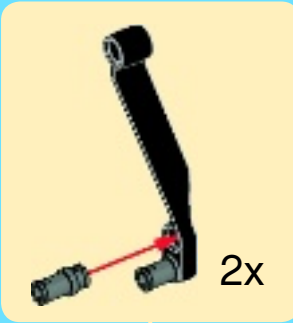

7



58

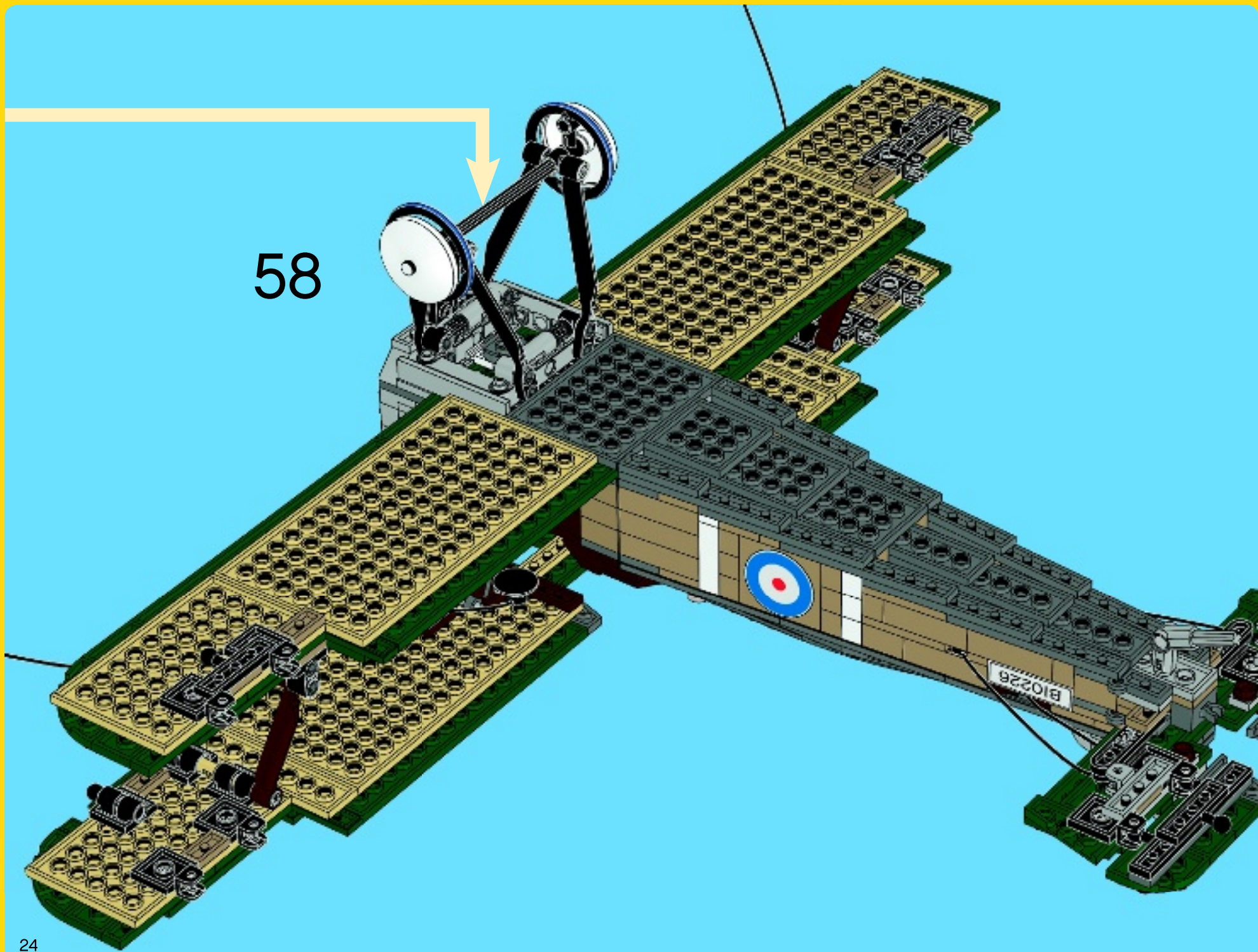

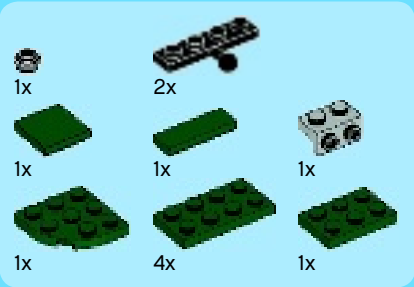

59

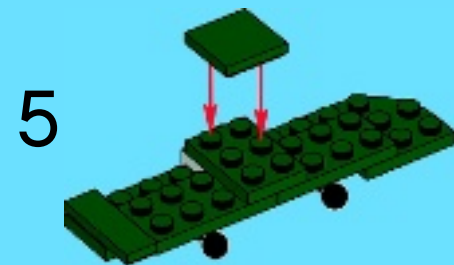
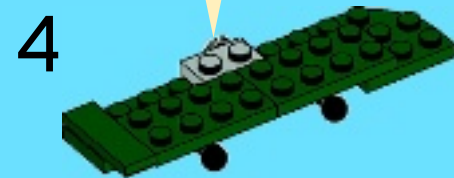
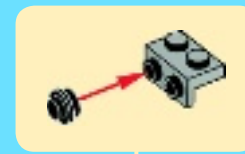
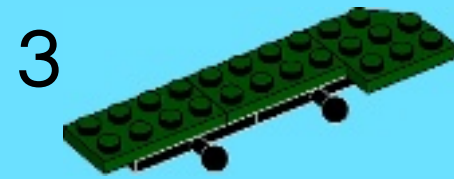

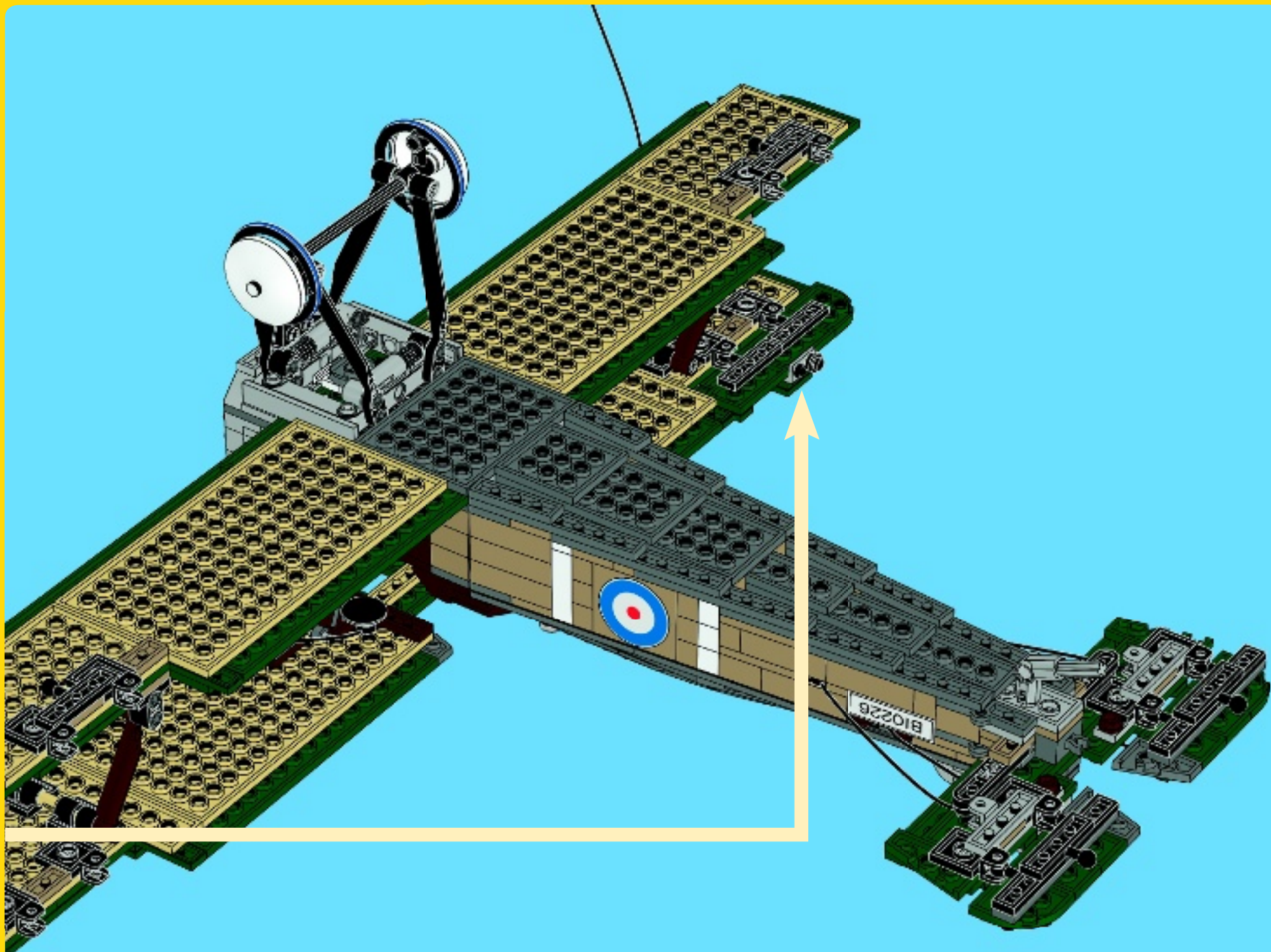

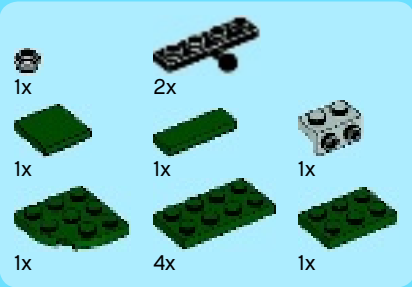

60

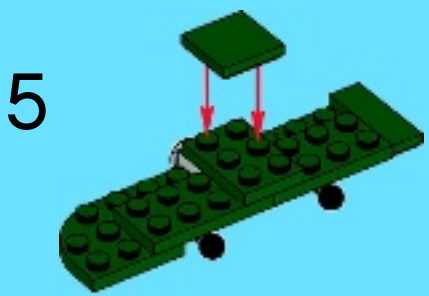
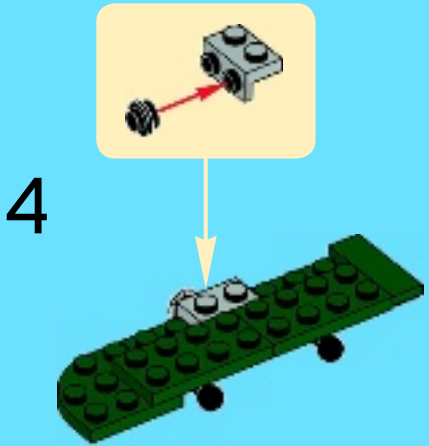
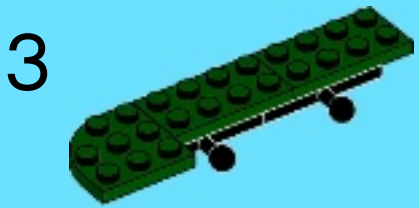

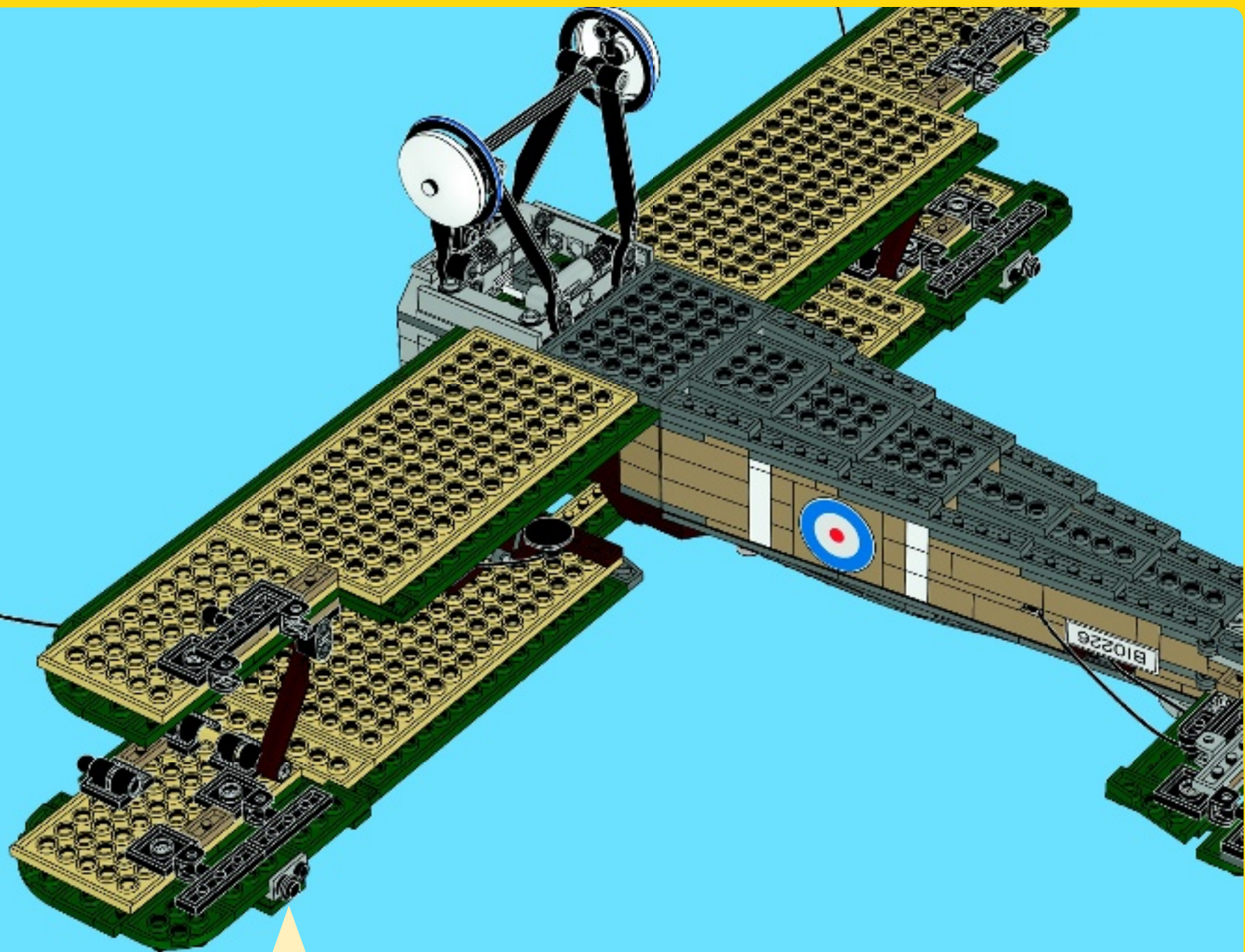

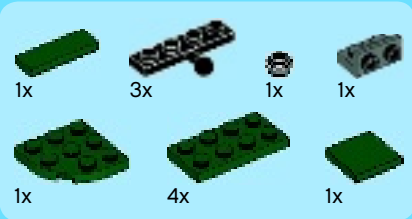

61

1



2



3

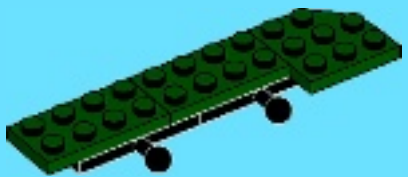

4

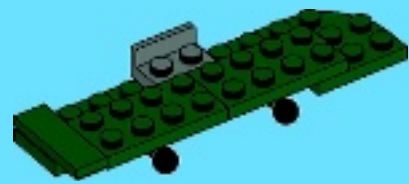

5

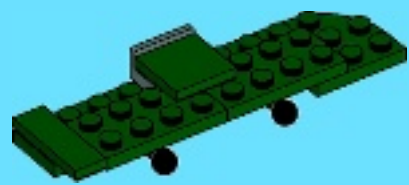

6

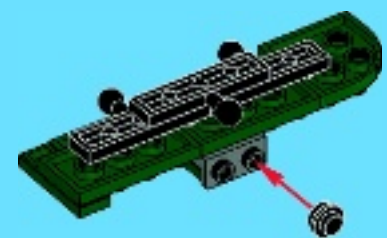

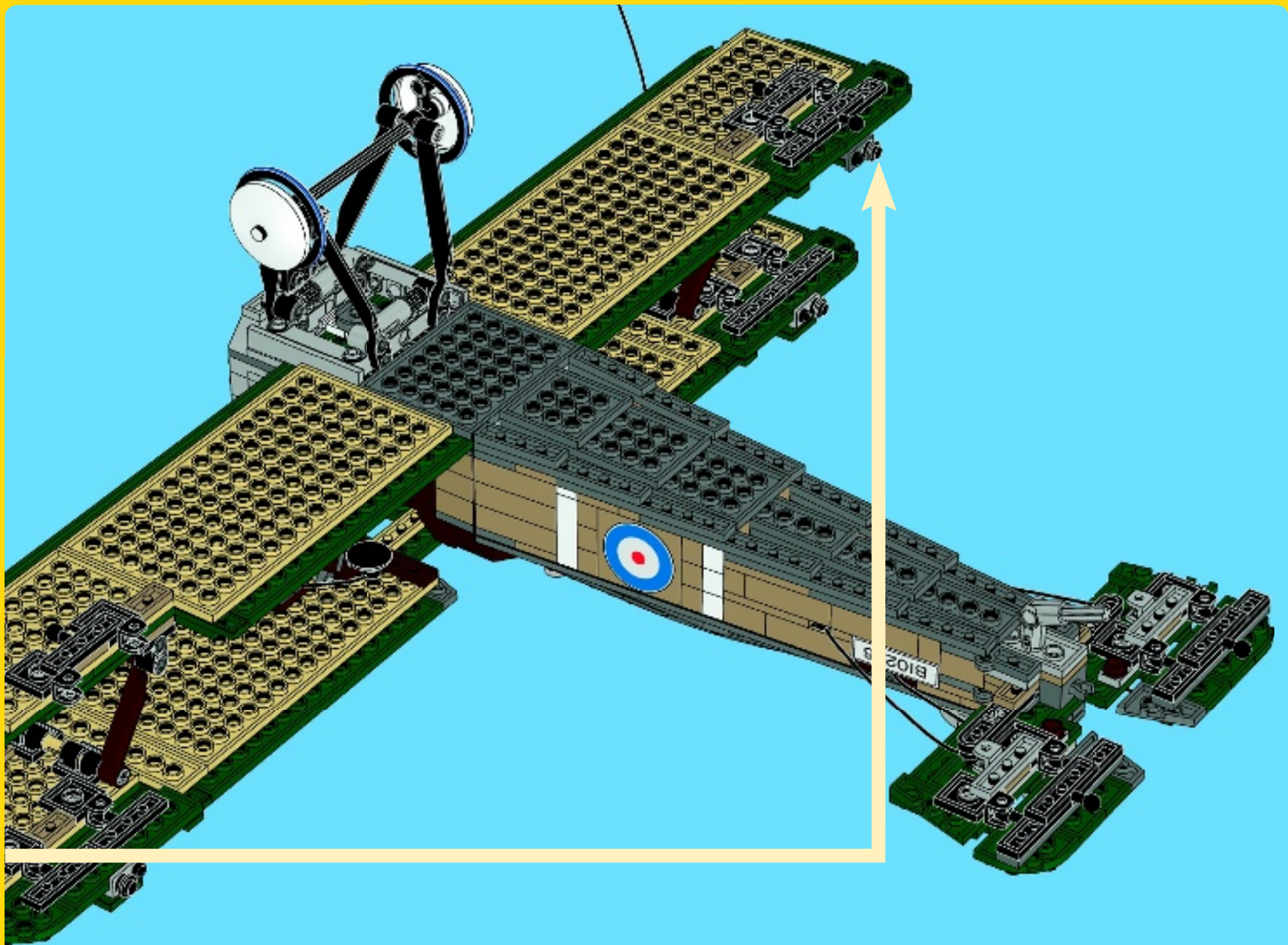

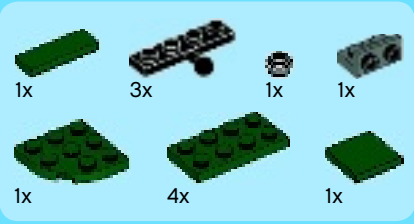

62

1



2



3



4

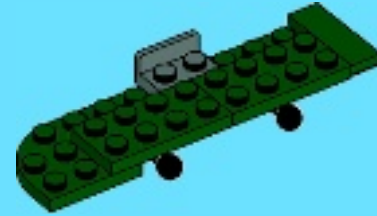

5

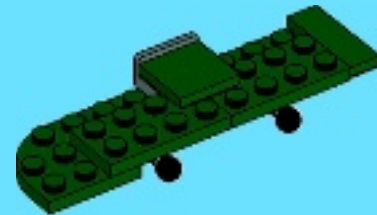

6

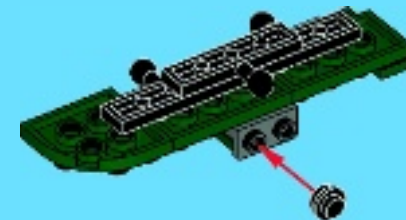

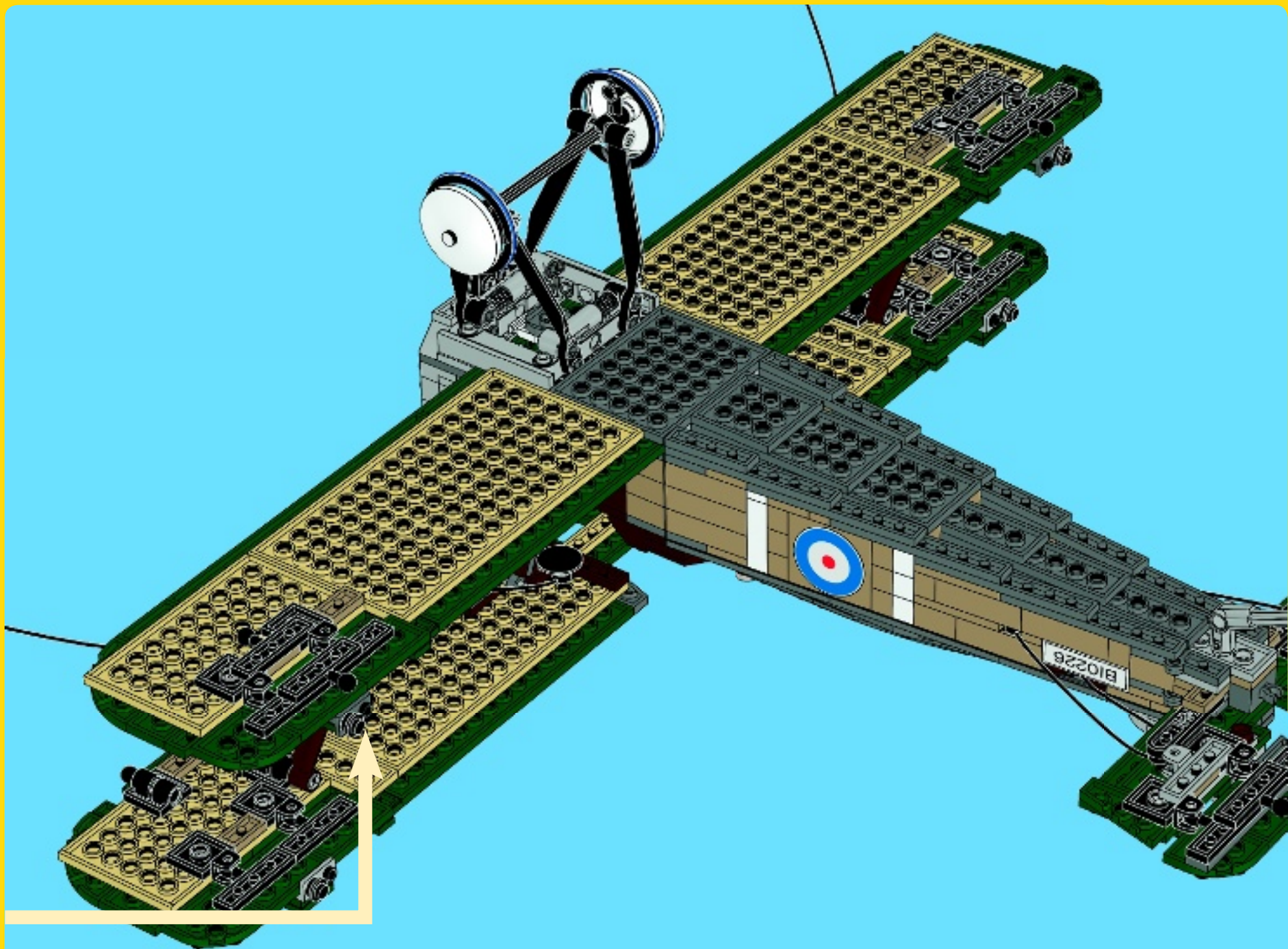



4x

63

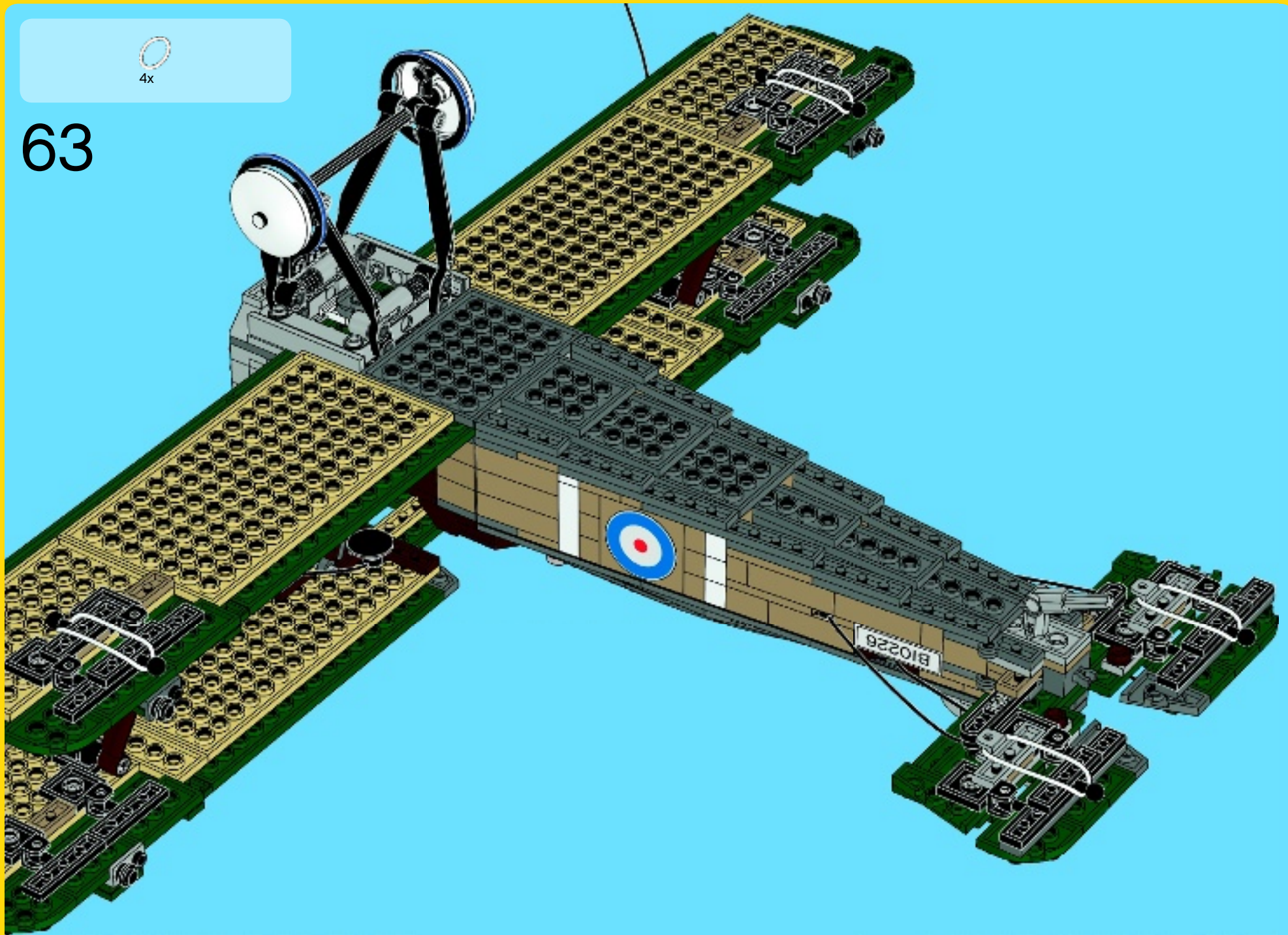

64

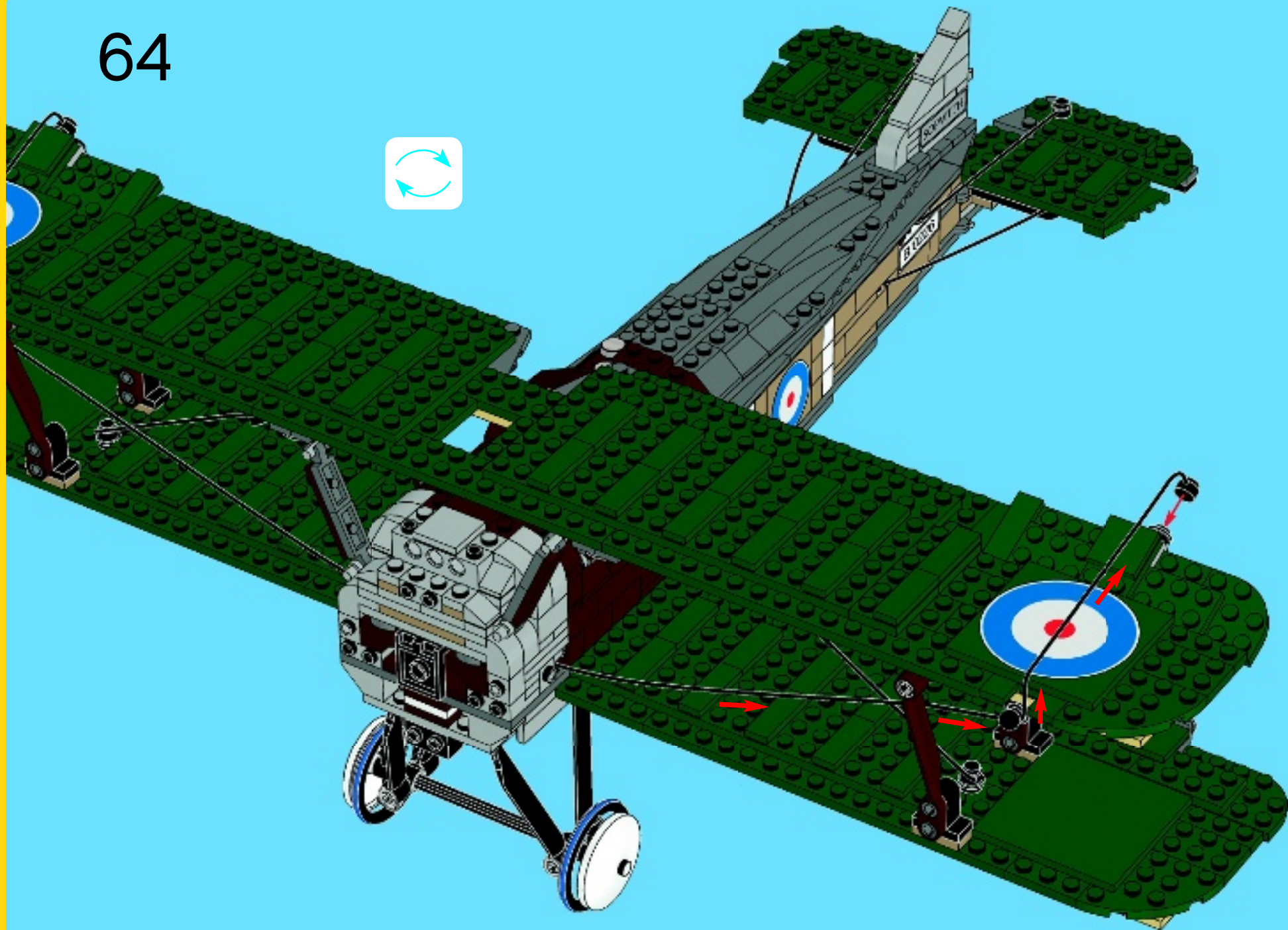



65

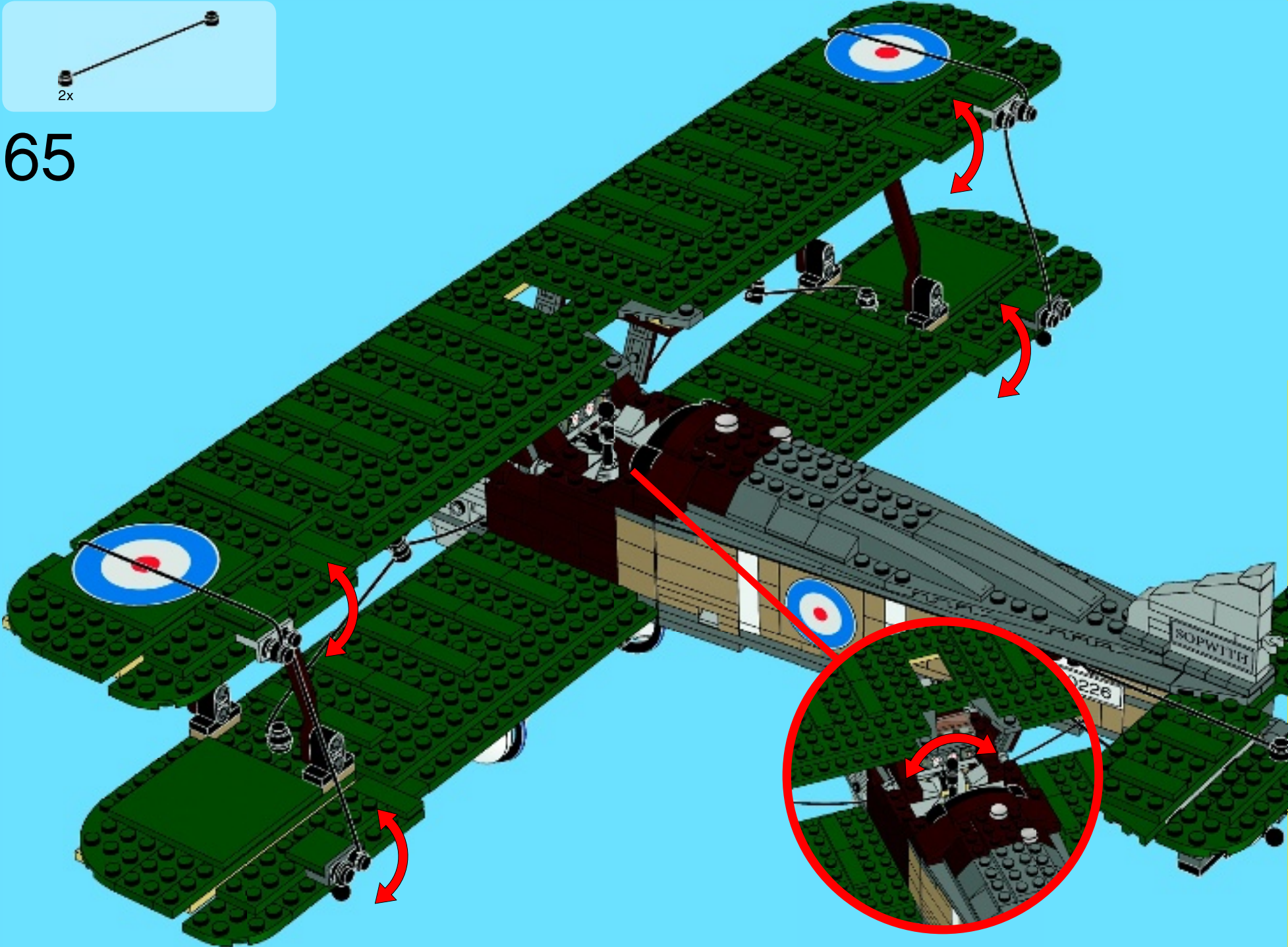

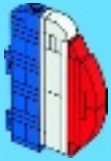

1



2

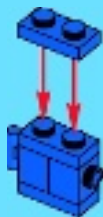

3

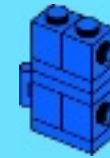

4





5



6



7



8

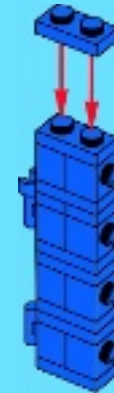



9

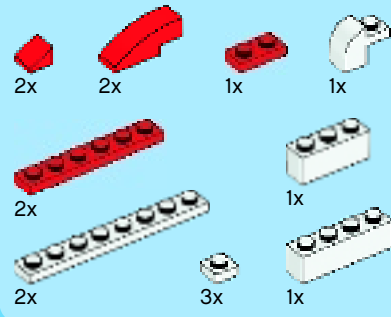
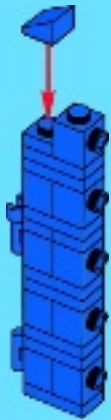

10

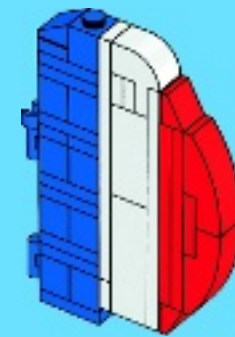
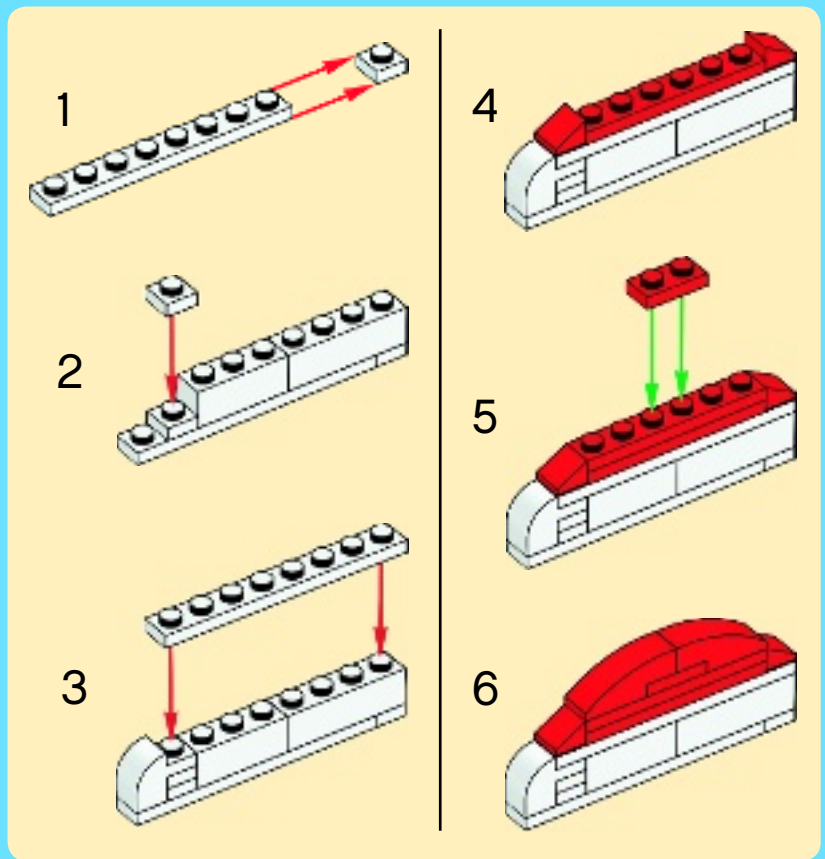

66

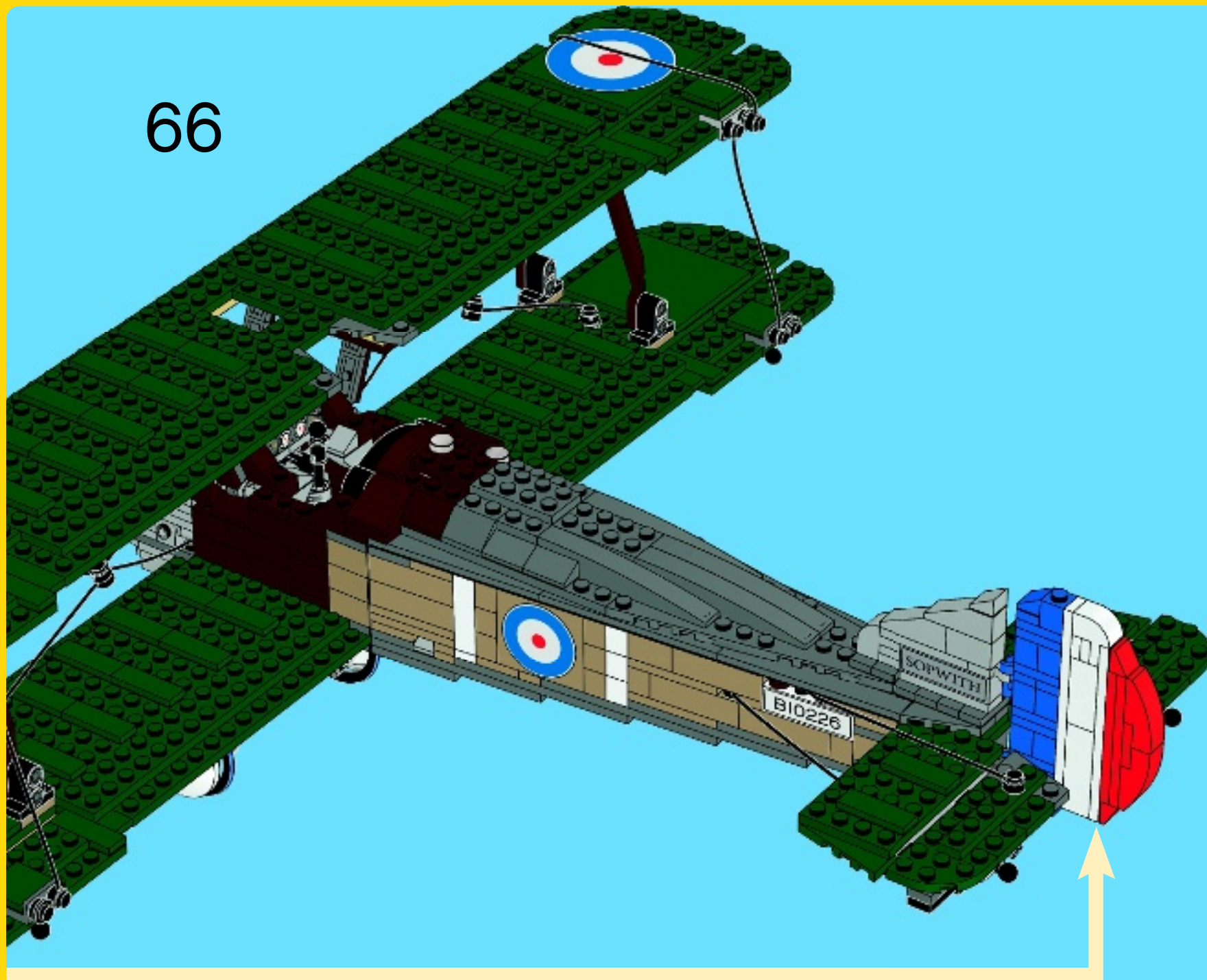



8x

67

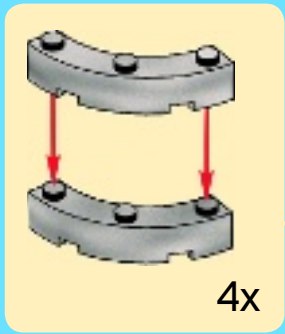

4x

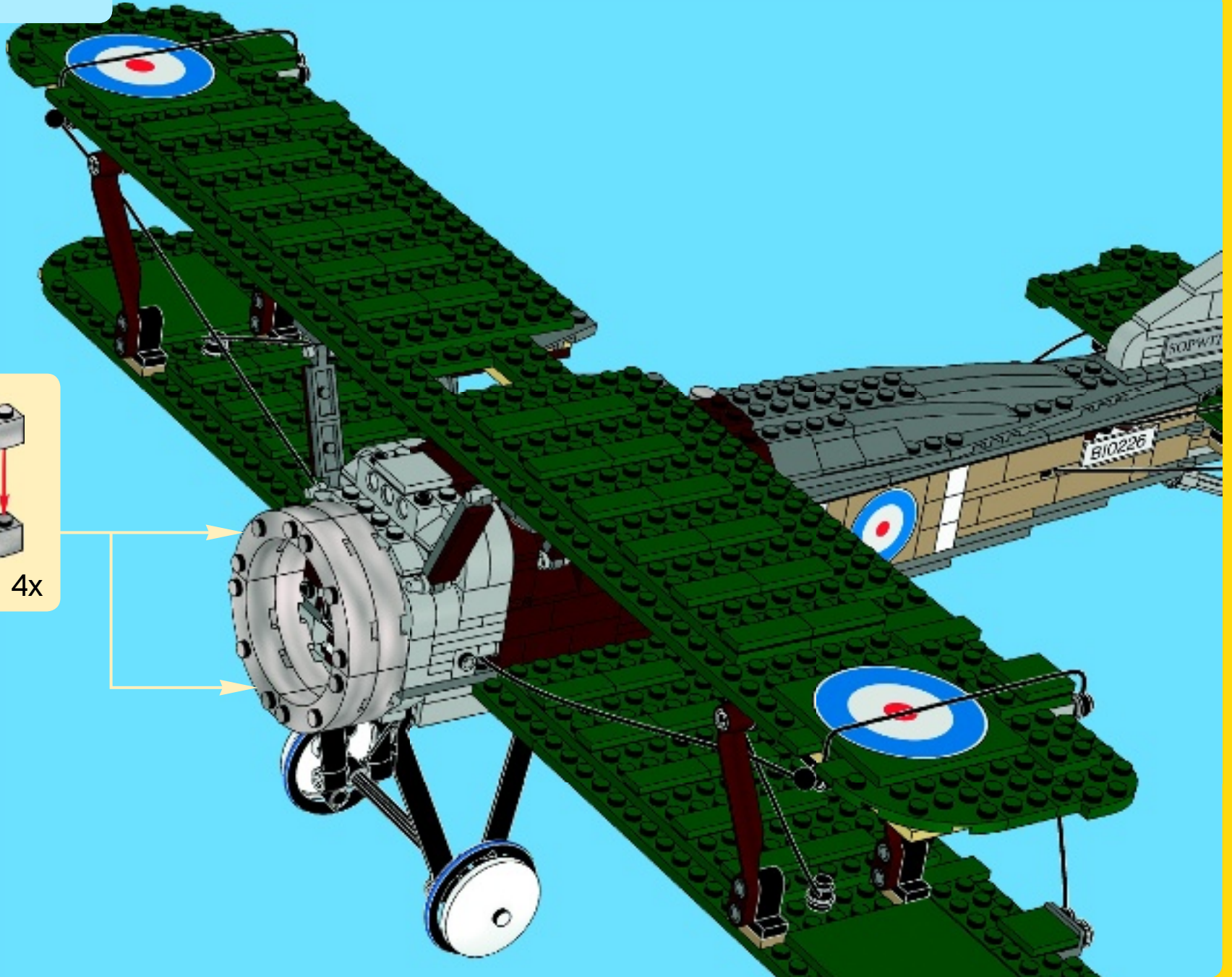



2x



2x



2x

68

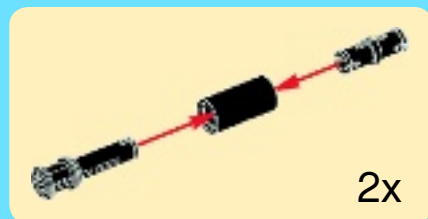

2x

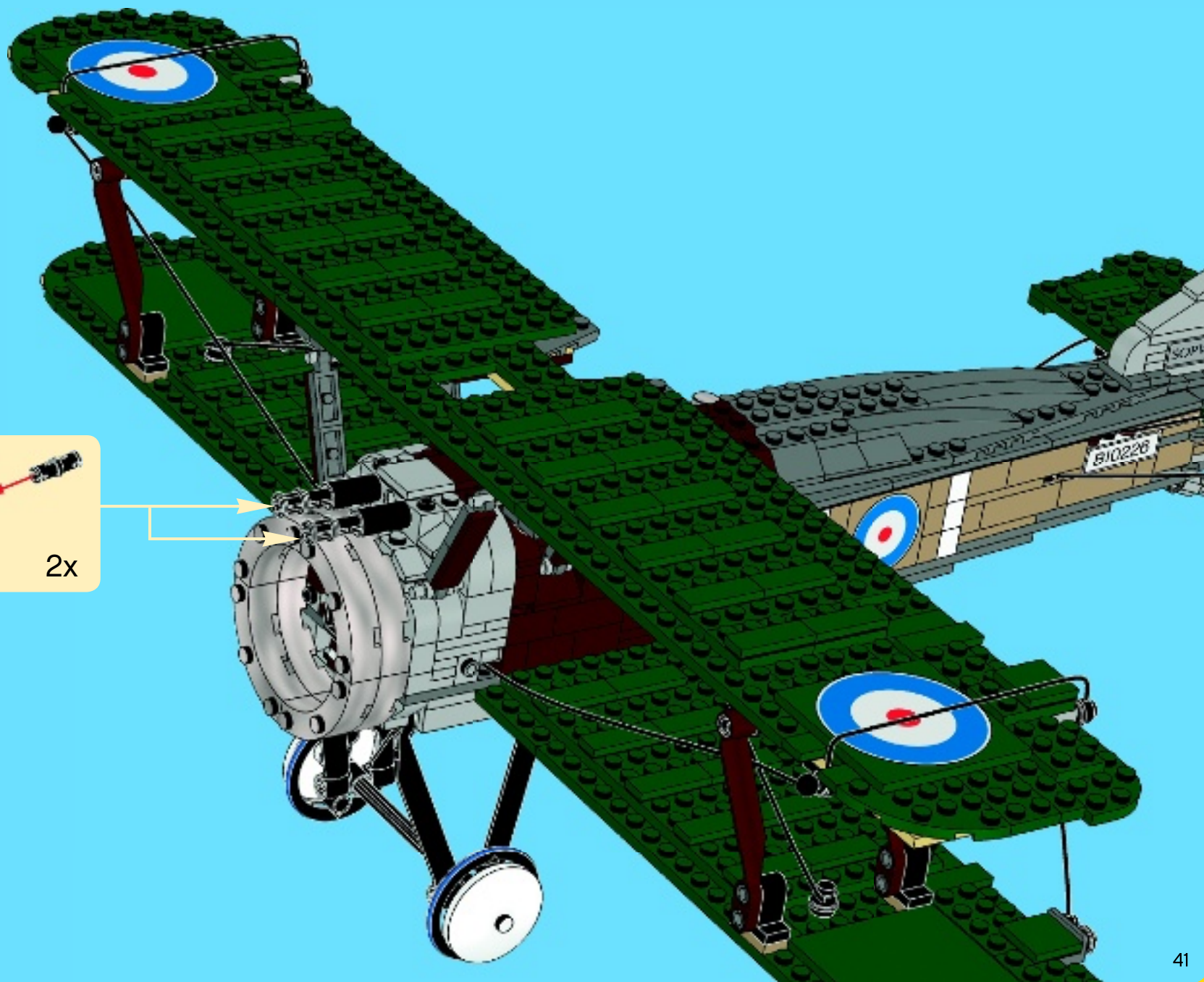

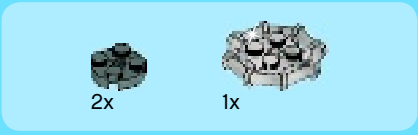
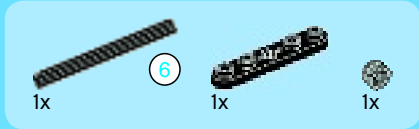

3

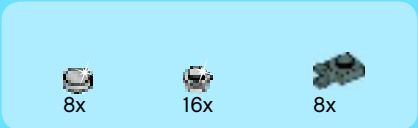
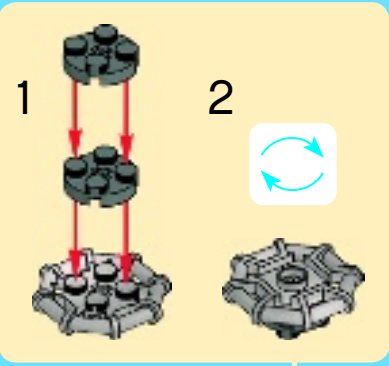

4

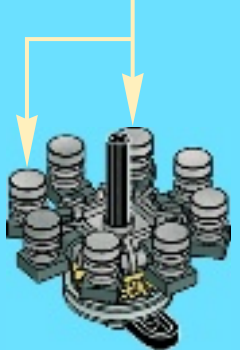
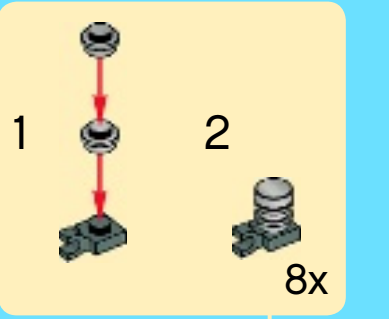



5

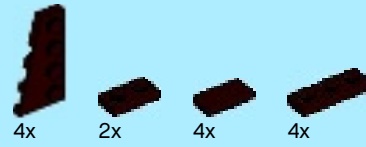

6

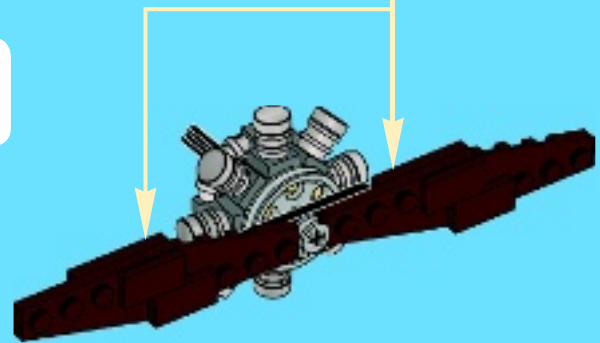
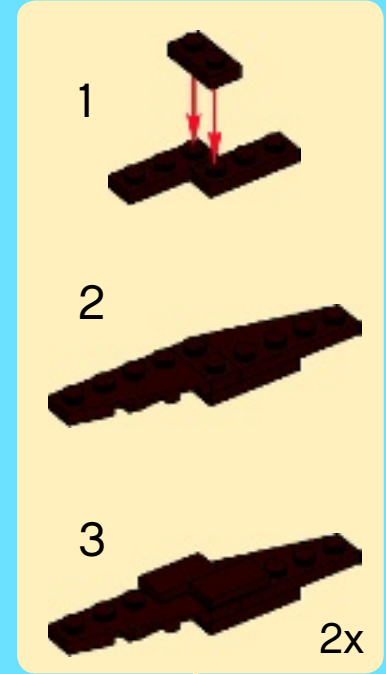

69

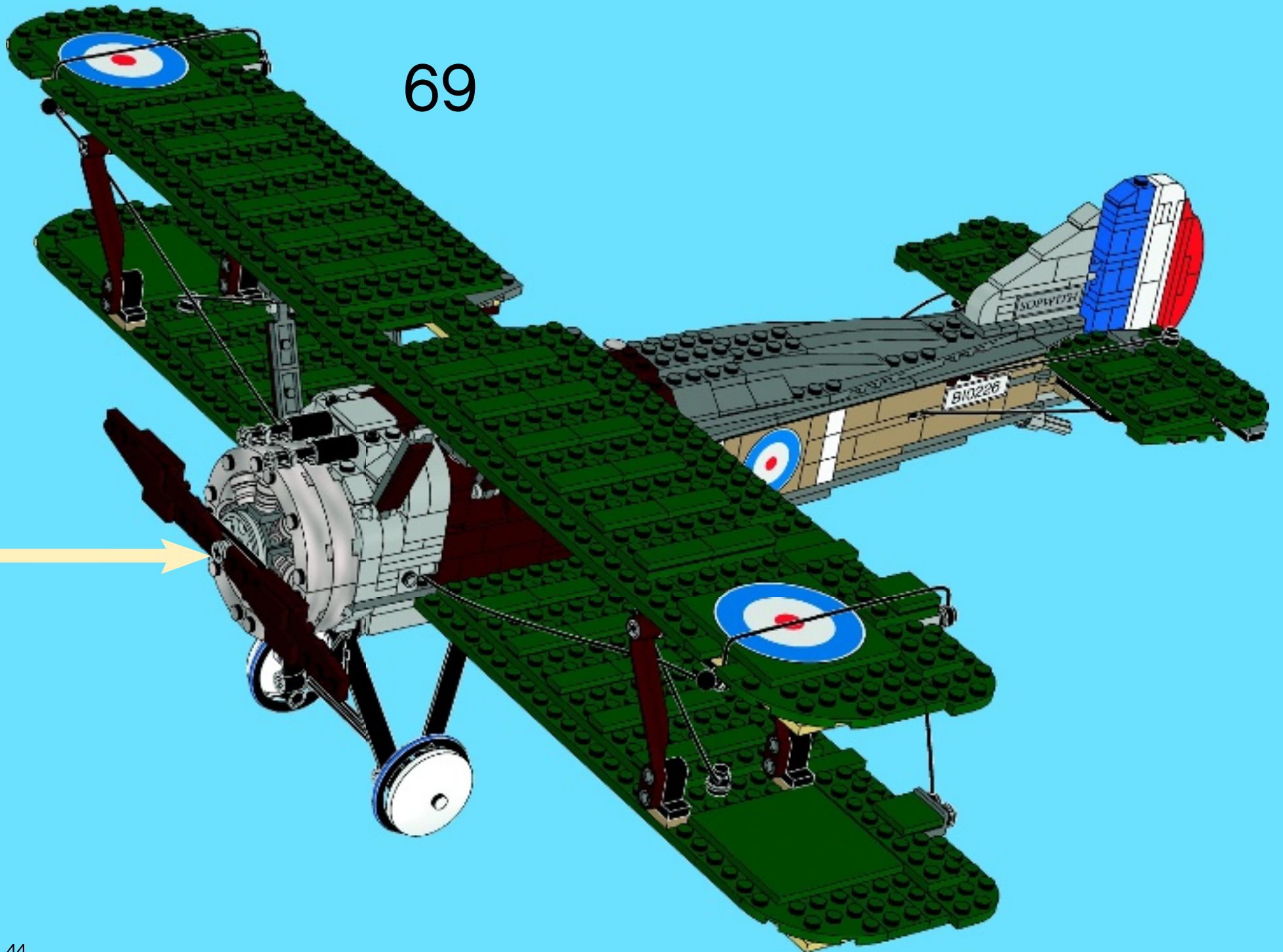

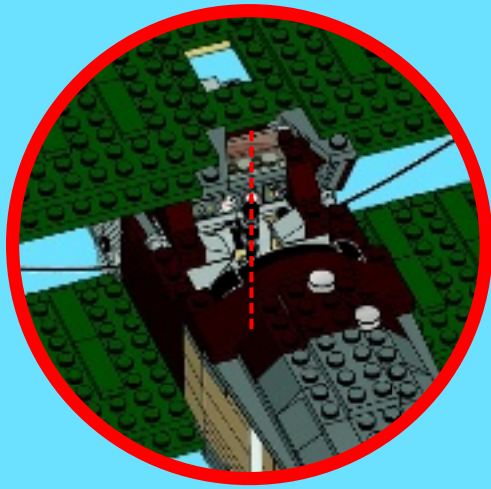

1

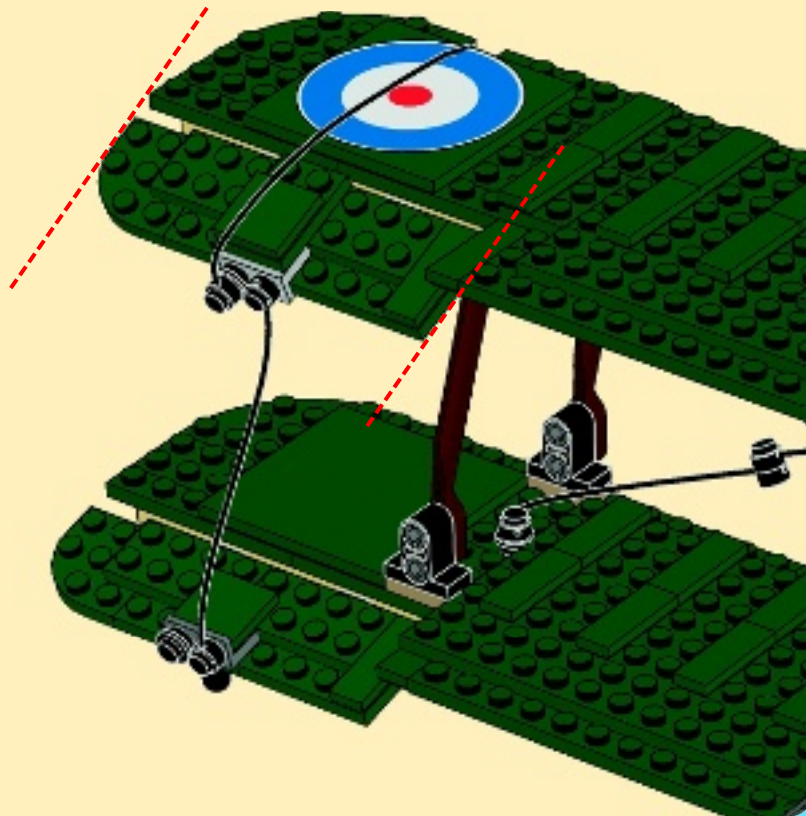

2

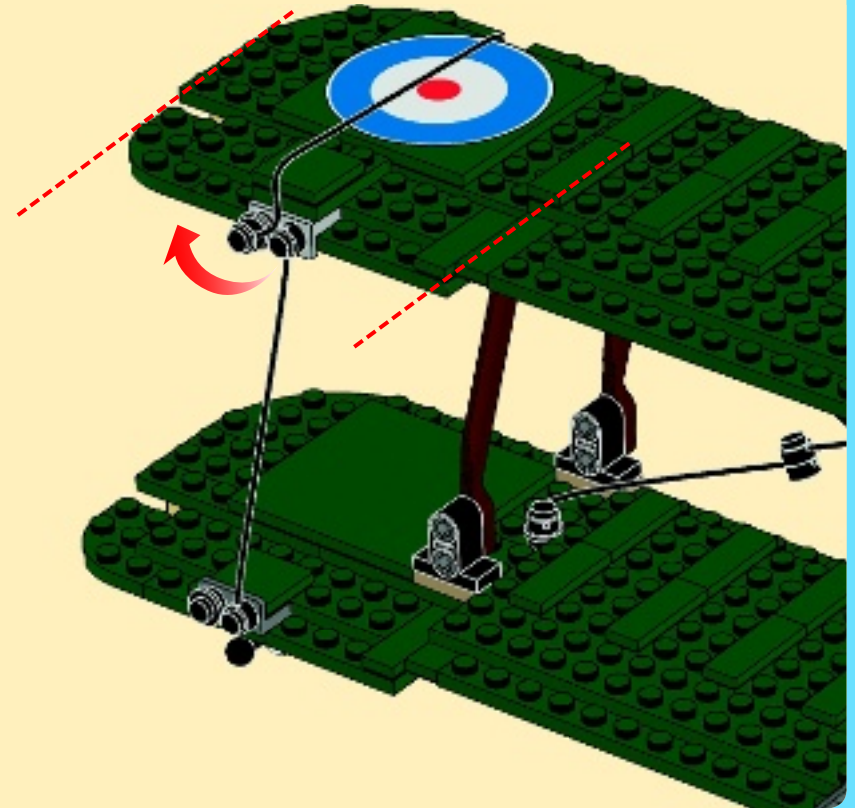

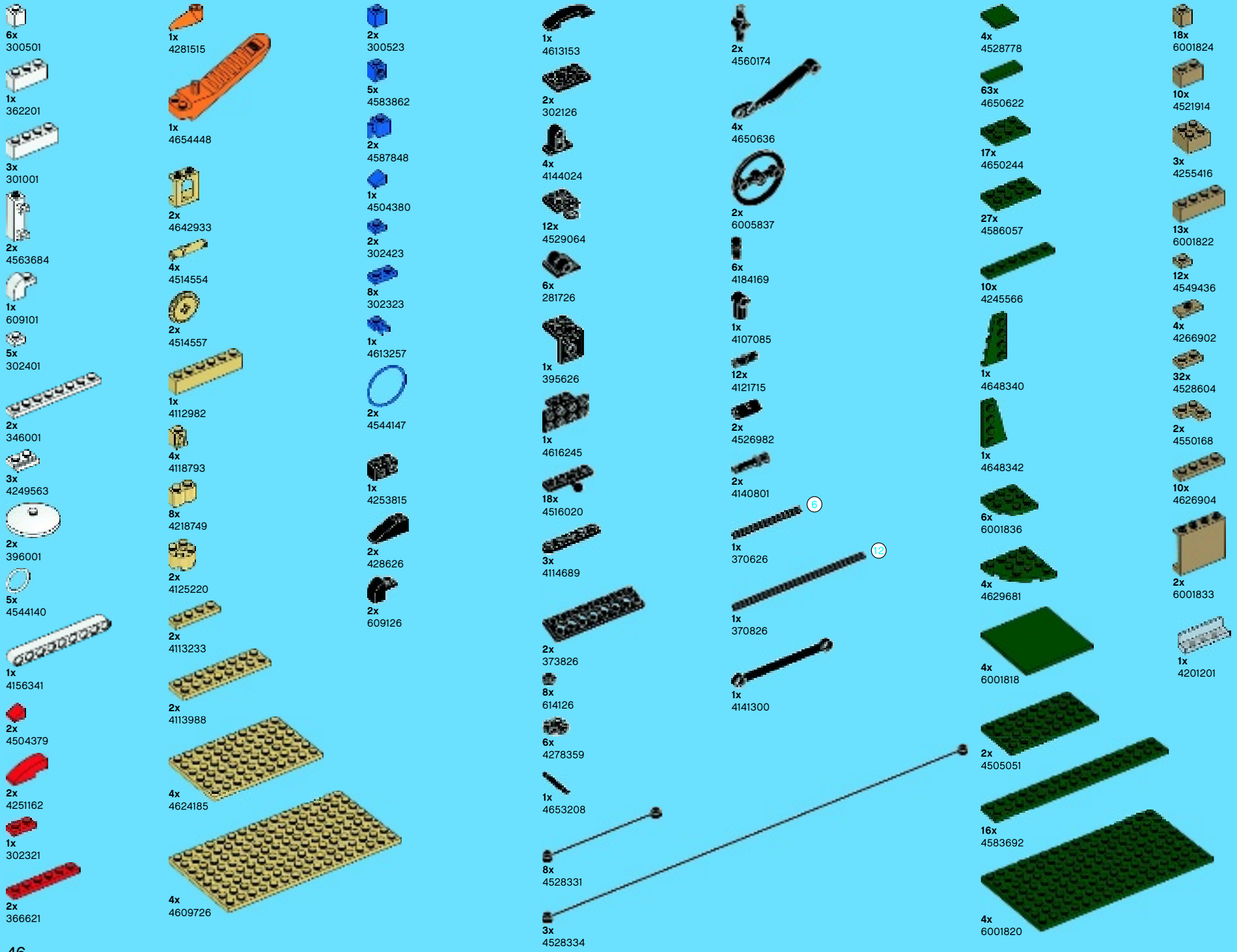

6x 300501
 1x 362201
 3x 301001
 2x 4563684
 1x 609101
 5x 302401
 2x 346001
 3x 4249563
 2x 396001
 5x 4544140
 1x 4156341
 2x 4504379
 2x 4251162
 1x 302321
 2x 366621

1x 4281515
 1x 4654448
 2x 4642933
 4x 4514554
 2x 4514557
 1x 4112982
 4x 4118793
 8x 4218749
 2x 4125220
 2x 4113233
 2x 4113988
 4x 4624185
 4x 4609726

2x 300523
 5x 4583862
 2x 4587848
 1x 4504380
 2x 302423
 8x 302323
 1x 4613257
 2x 4544147
 1x 4253815
 2x 428626
 2x 609126

1x 4613153
 2x 302126
 4x 4144024
 12x 4529064
 6x 281726
 1x 395626
 1x 4616245
 18x 4516020
 3x 4114689
 2x 373826
 8x 614126
 6x 4278359
 1x 4653208
 8x 4528331
 3x 4528334

2x 4560174
 4x 4650636
 2x 6005837
 6x 4184169
 1x 4107085
 12x 4121715
 2x 4526982
 2x 4140801
 1x 370626
 1x 370826
 1x 4141300

4x 4528778
 63x 4650622
 17x 4650244
 27x 4586057
 10x 4245566
 1x 4648340
 1x 4648342
 6x 6001836
 4x 4629681
 4x 6001818
 2x 4505051
 16x 4583692
 4x 6001820

18x 6001824
 10x 4521914
 3x 4255416
 13x 6001822
 12x 4549436
 4x 4266902
 32x 4528604
 2x 4550168
 10x 4626904
 2x 6001833
 1x 4201201

- 4x 4211149
- 5x 4211210
- 2x 4211200
- 4x 4211220
- 2x 4211225
- 2x 4620075
- 6x 4211199
- 4x 4211202
- 4x 4216625
- 2x 4658005
- 2x 4655611
- 4x 4216695
- 10x 4211152
- 5x 4211189
- 2x 4211211

- 18x 4211150
- 10x 4211257
- 5x 4211151
- 5x 4211194
- 8x 4216581
- 4x 4205470
- 4x 6001838
- 3x 4211388
- 1x 4211394
- 4x 4558953
- 4x 4211441
- 1x 4211640
- 10x 4521921
- 6x 4211437
- 2x 4211488

- 5x 4211519
- 4x 4625619
- 12x 4211399
- 5x 4211429
- 3x 4211445
- 5x 4211438
- 5x 4211452
- 1x 4211425
- 1x 4594238
- 2x 4654582
- 4x 4211632
- 1x 4211413
- 3x 4654577
- 2x 4667166
- 10x 4211444

- 3x 4211549
- 1x 4515351
- 2x 4538098
- 1x 4521532
- 1x 4539880
- 1x 4630114
- 1x 4494222
- 1x 4211573
- 8x 4211483
- 2x 4211375
- 2x 4211807
- 1x 4211551
- 2x 4211815
- 2x 4265688

- 5x 4265794
- 4x 4567887
- 2x 4211054
- 4x 4579241
- 6x 4211119
- 7x 4211001
- 4x 4211065
- 1x 4243831
- 12x 4210998
- 2x 4211061
- 1x 4210794
- 4x 4211067
- 1x 4256149

- 16x 4579354
- 2x 6000606
- 8x 4581225
- 1x 4215740
- 8x 4271344
- 6x 4211008
- 3x 4210872
- 3x 4210869
- 8x 4211042
- 16x 4211050
- 1x 4560177
- 1x 4299022

- 1x 4586562
- 1x 4209014
- 2x 4541873
- 8x 6005857
- 16x 4249039
- 10x 4655241
- 1x 4631264



WIN!

Go to www.LEGOsurvey.com/product to fill out a survey for a chance to win a cool LEGO® Product. No purchase necessary. Open to all residents where not prohibited.



www.LEGO.com



www.LEGOsurvey.com/product

GEWINNE!

Nimm an der Umfrage auf www.LEGOsurvey.com/product teil und hab die Chance ein cooles LEGO® Produkt zu gewinnen! Die Teilnahme am Gewinnspiel führt zu keinerlei Kaufverpflichtungen. Teilnahme in allen nicht ausgeschlossenen Ländern möglich.

WIN!

Ga naar www.LEGOsurvey.com/product, vul een enquêteformulier in en maak kans op een cool LEGO® product. Geen aankoopverplichting, iedereen mag deelnemen, uitgezonderd ingezetenden van landen waar een enquêteverbod geldt.

GAGNE!

Visite www.LEGOsurvey.com/product pour répondre à un questionnaire et avoir une chance de gagner un produit LEGO® très cool ! Aucune obligation d'achat. Ouvert à tous les résidents des pays autorisés.

当てよう!

www.LEGOsurvey.com/product にアクセスして、アンケートにご記入ください。当選者にはレゴ®製品を差し上げます。お買い上げの必要はありません。禁止されていない限り、すべての皆様にご利用いただけます。