



# STAR WAR



10225





9



2x



1x

1

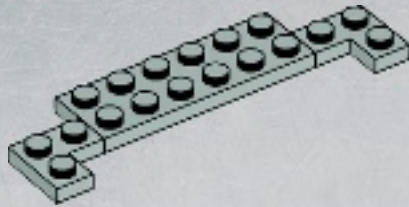

2x



1x



1x

2

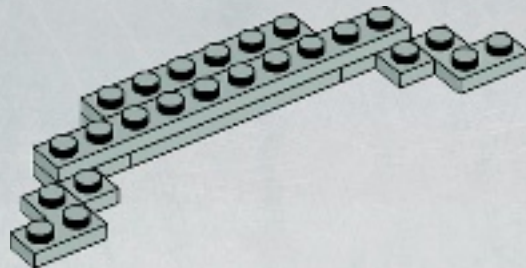





4x



2x

# 3

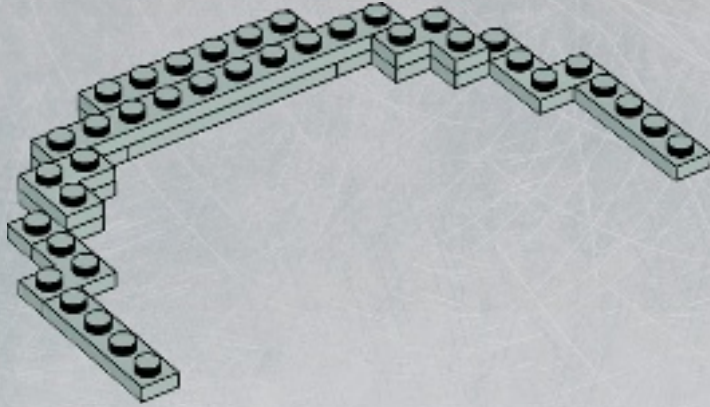

2x



2x

# 4

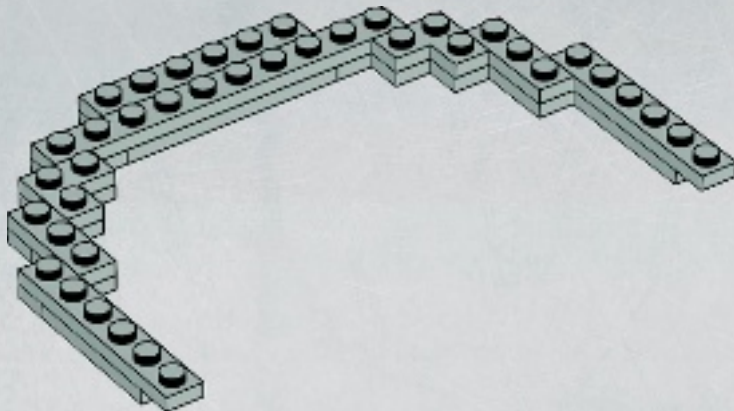



4x

5

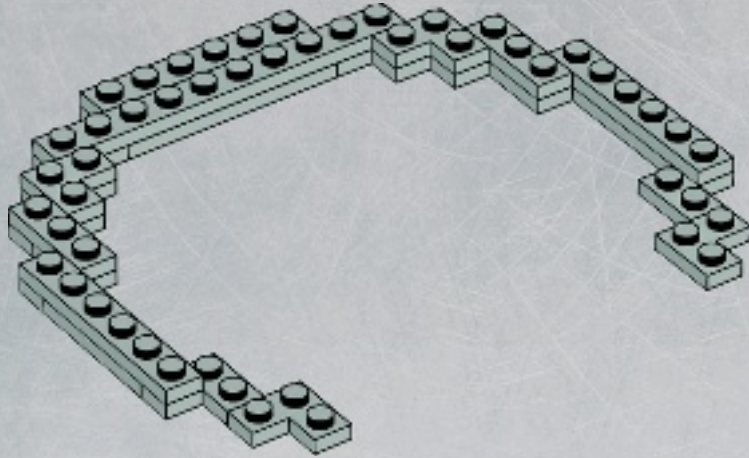

2x



2x

6

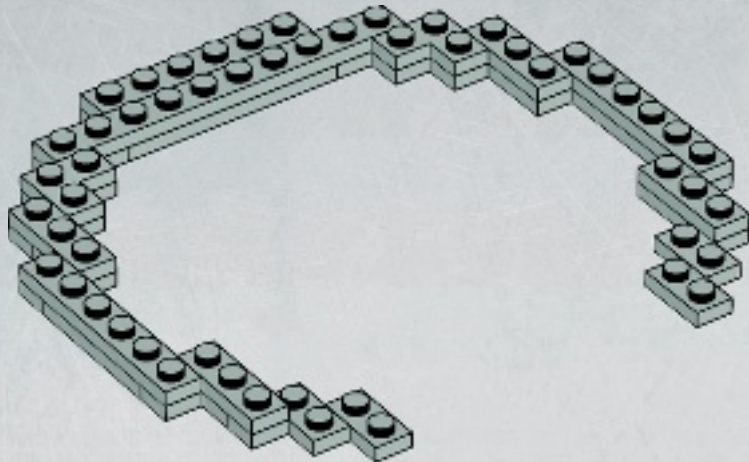





4x



1x

# 7

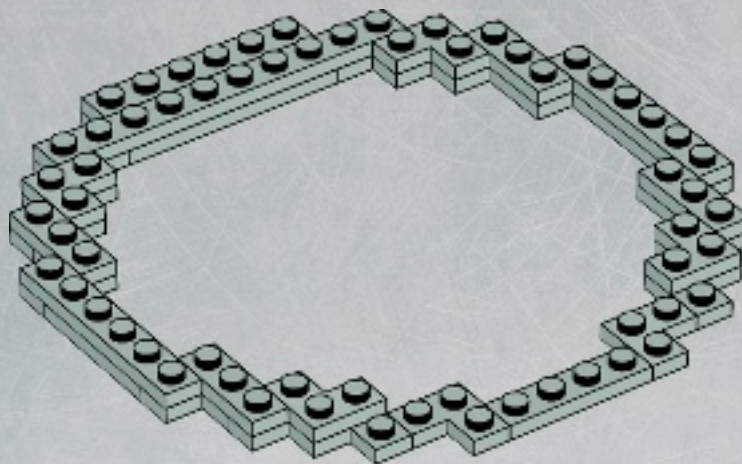

2x



1x

# 8

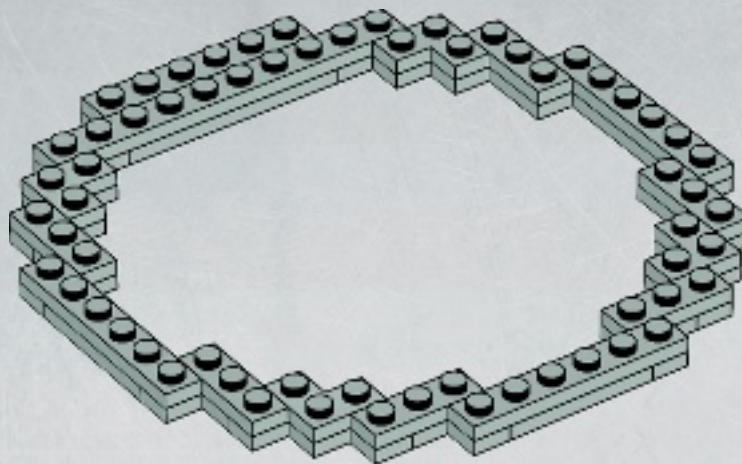



9

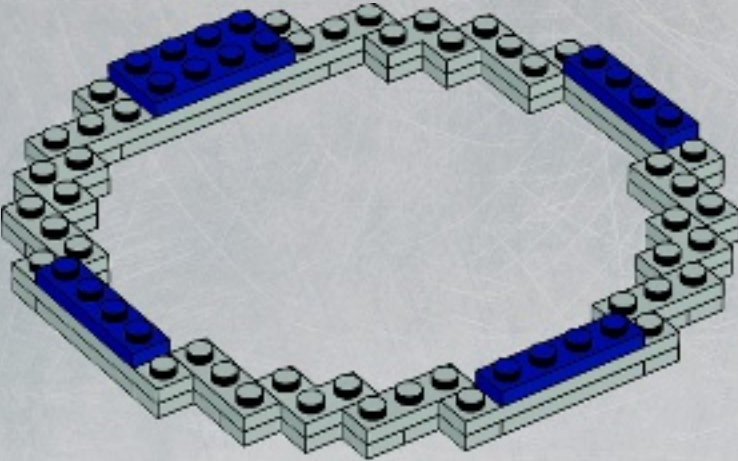

10

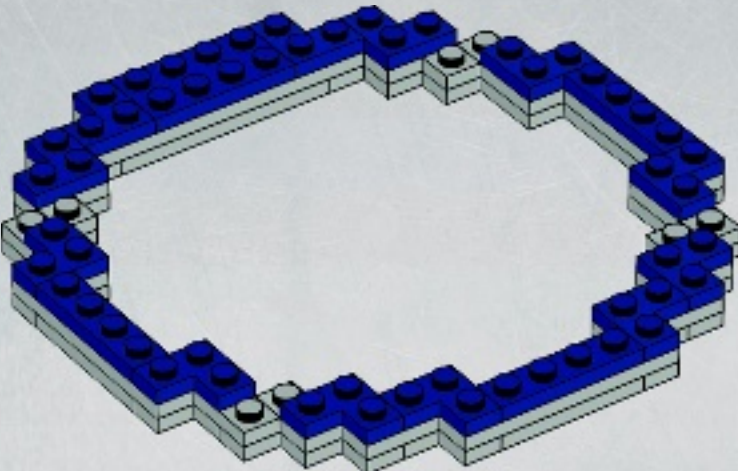





4x

# 11

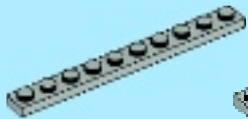
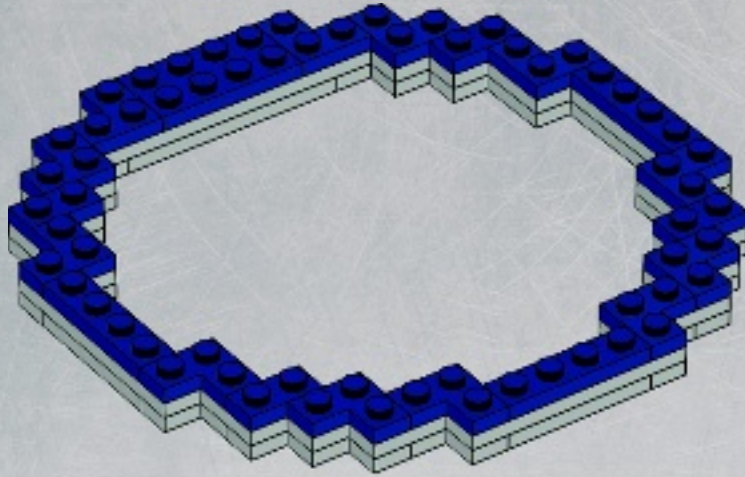

1x



4x

# 12

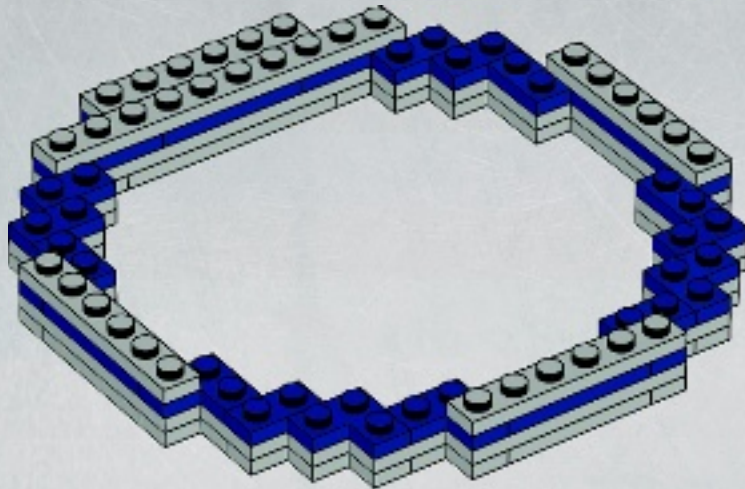



1x



5x

# 13

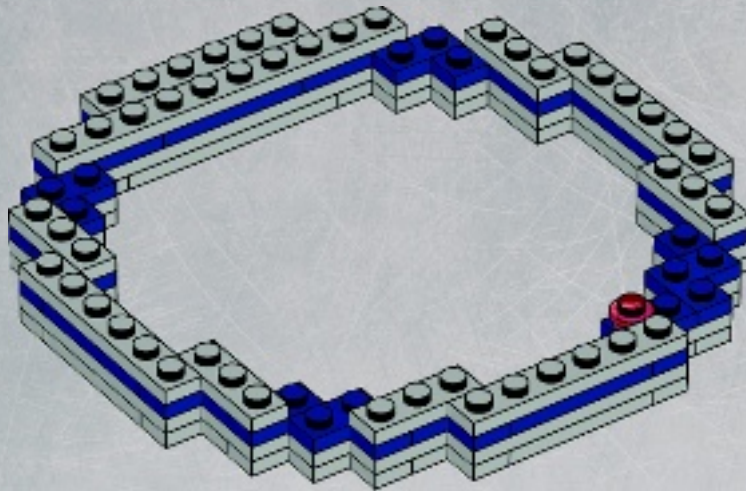

5x



1x

# 14

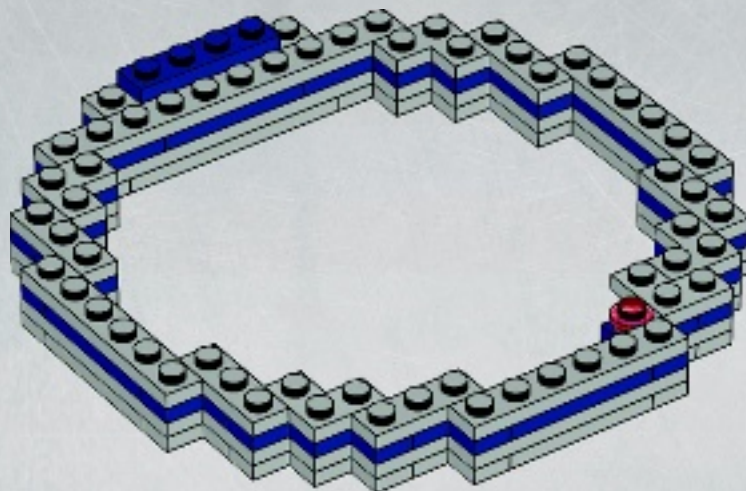



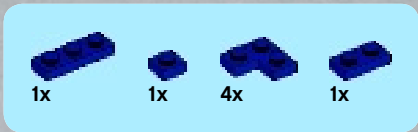

15

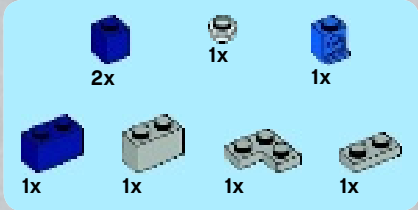
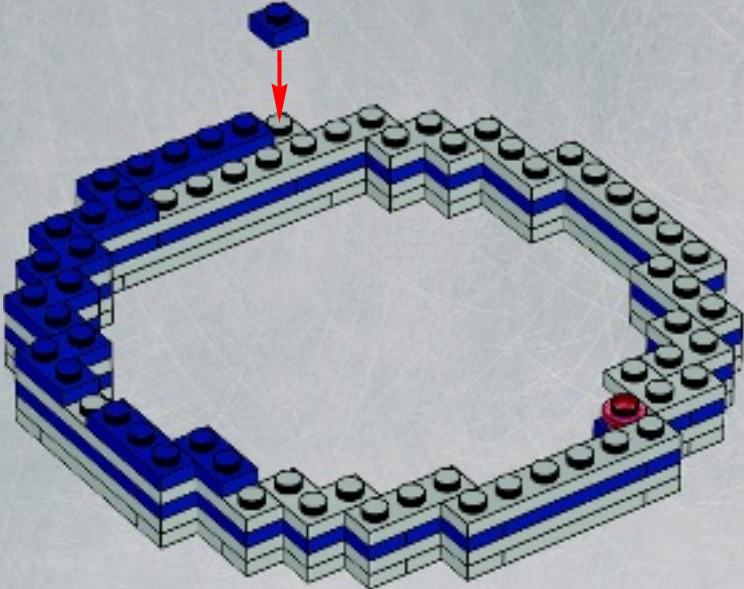

16

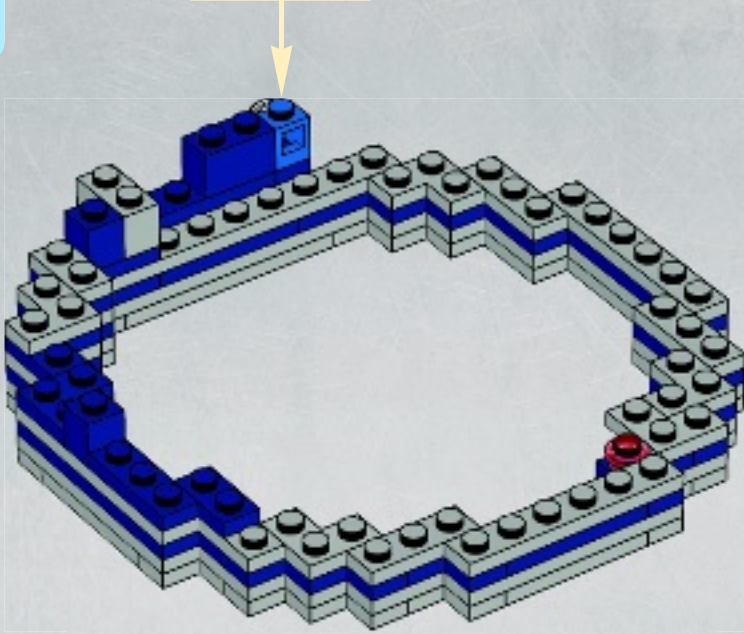
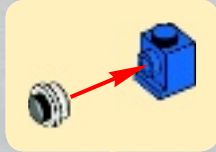



# 17

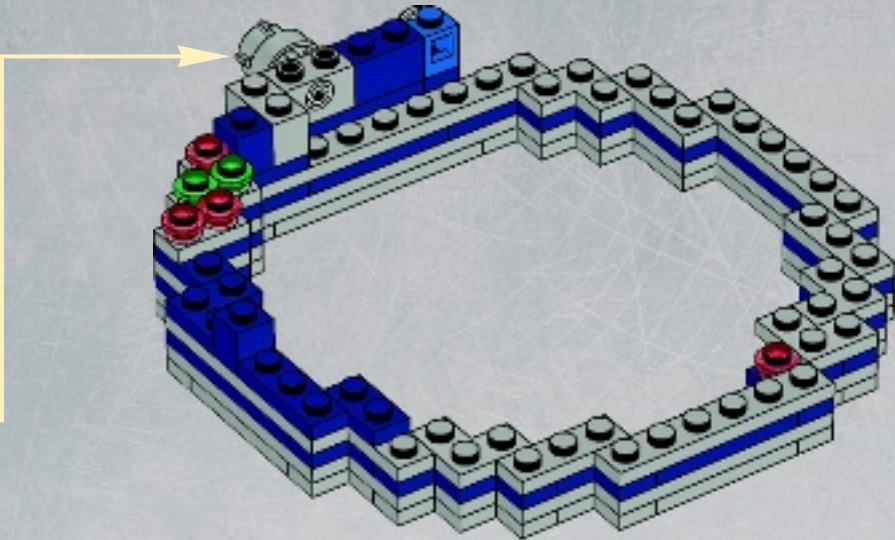
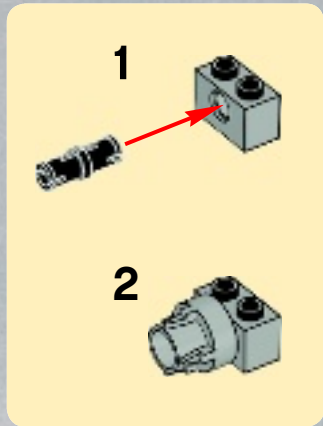

# 18

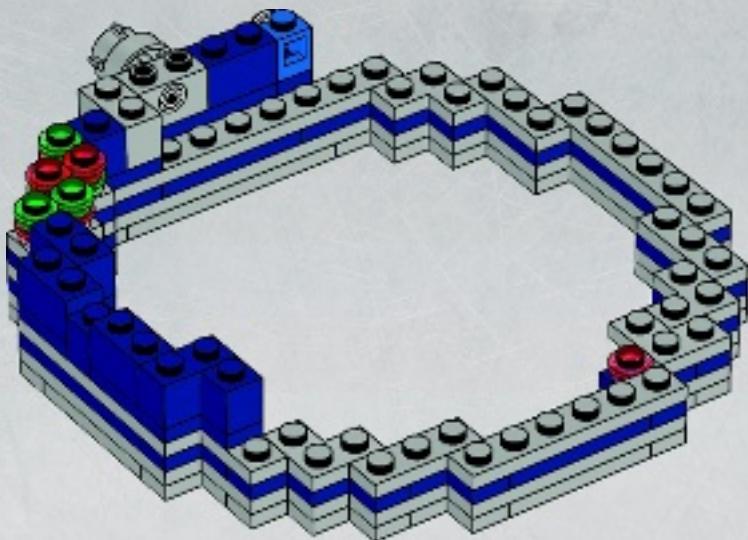



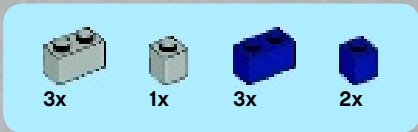

19

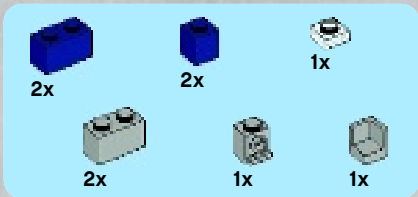
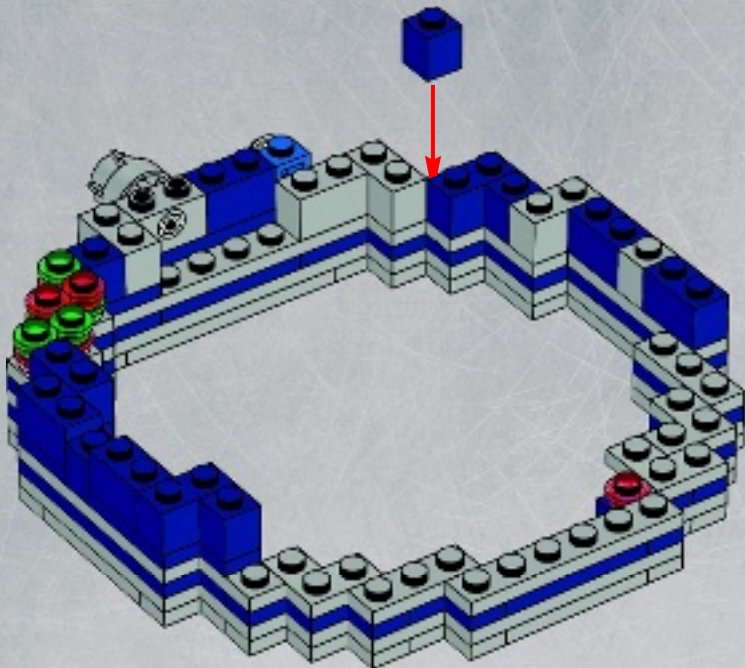

20

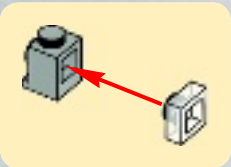
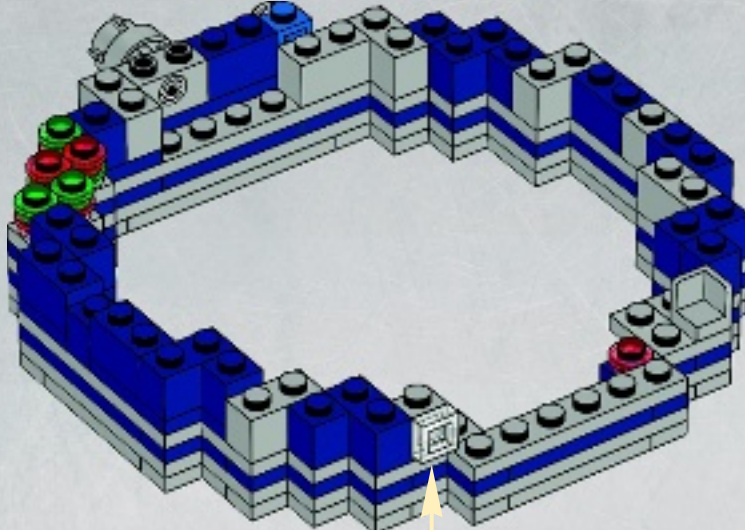

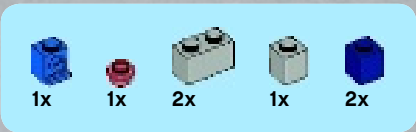

# 21

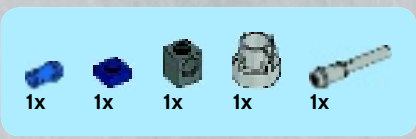
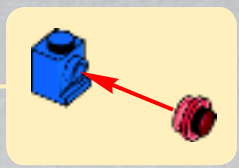
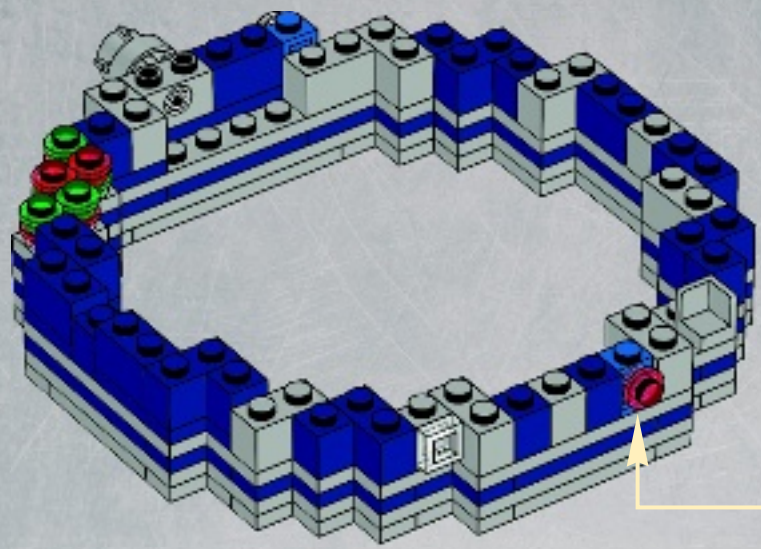

# 22

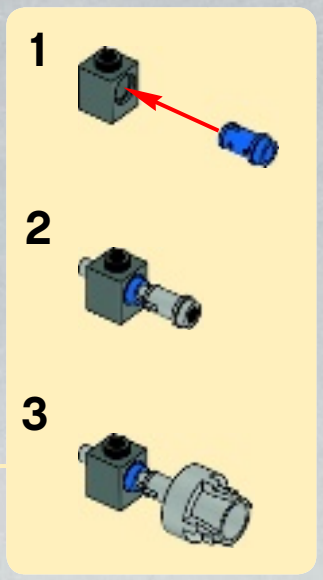
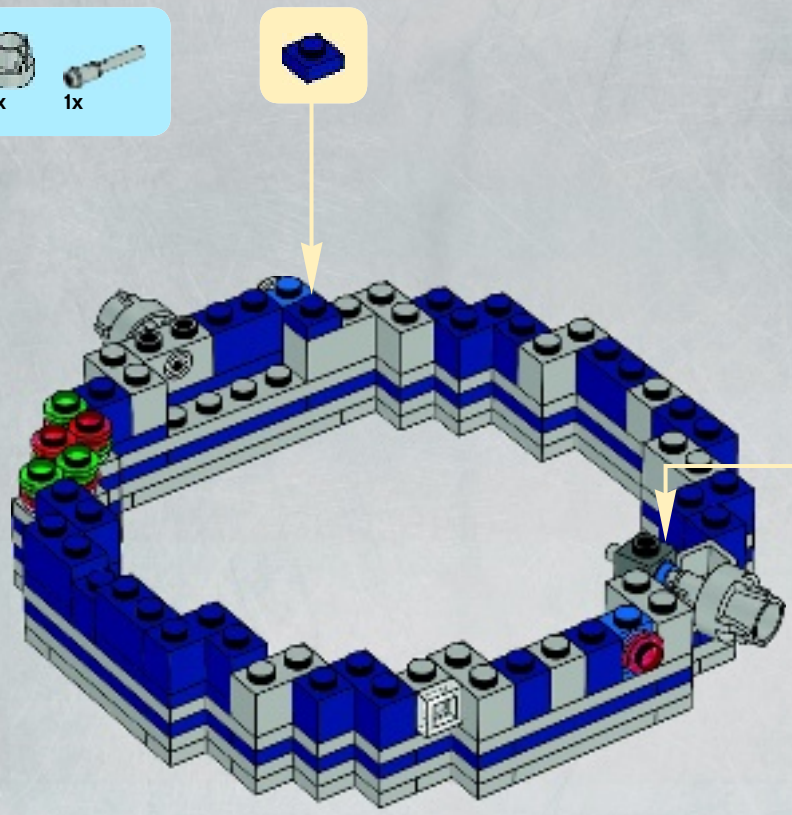



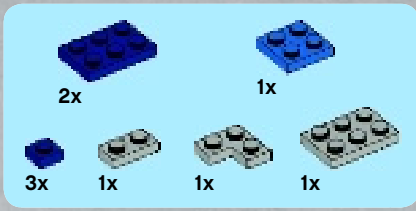

# 23

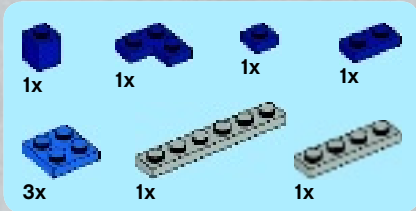
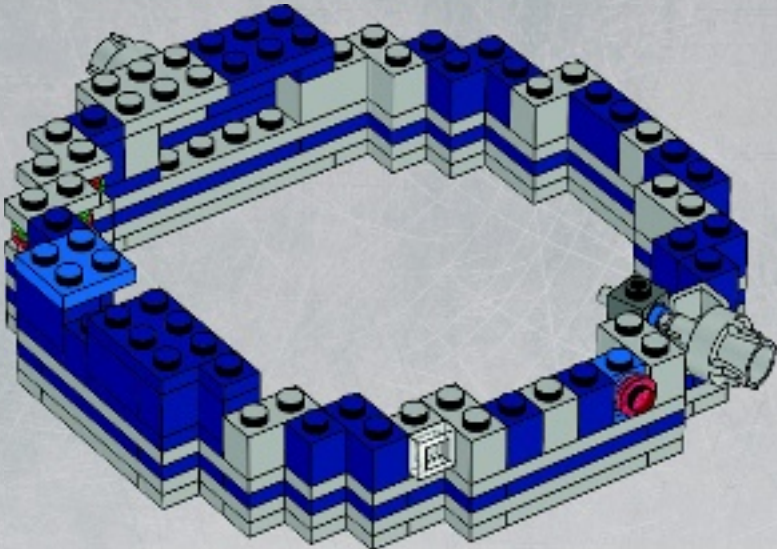

# 24

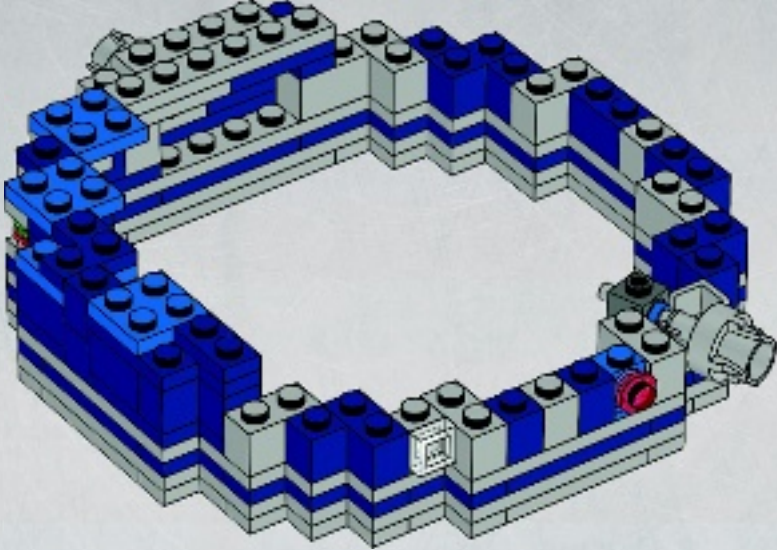

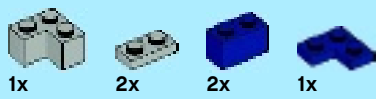

25

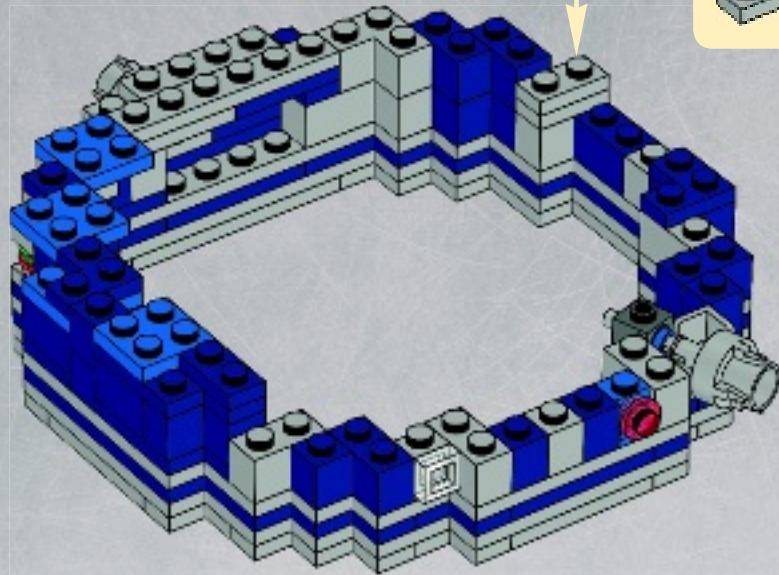
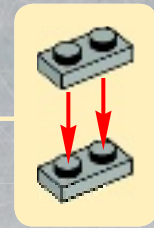

26

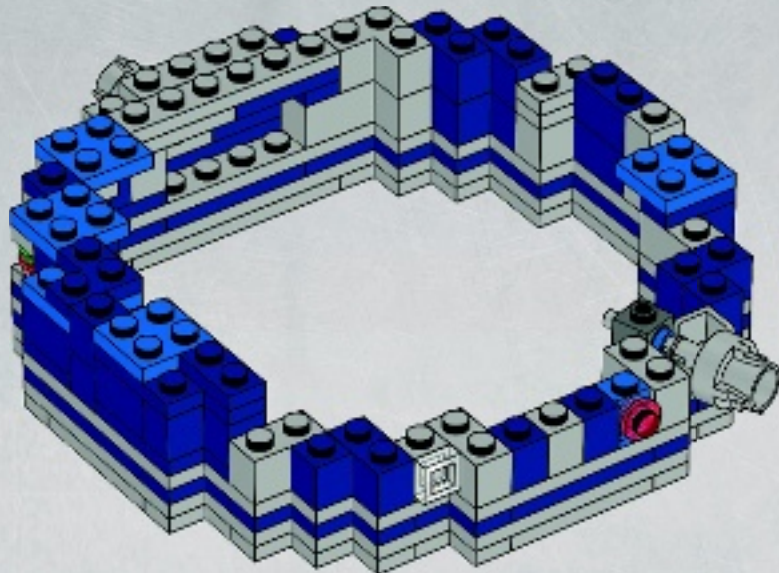



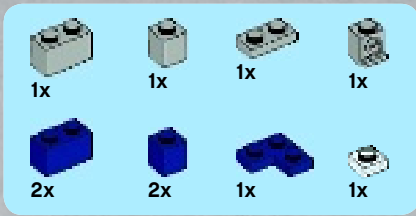

27

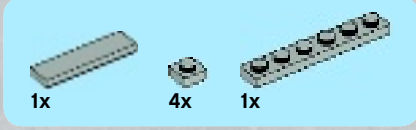
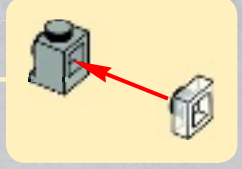
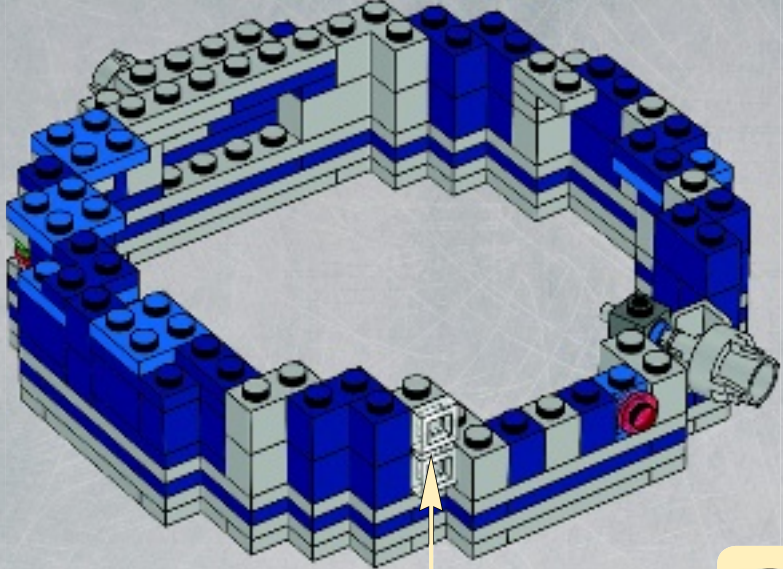

28

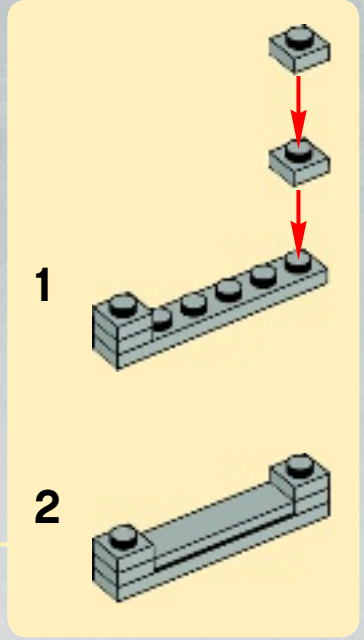
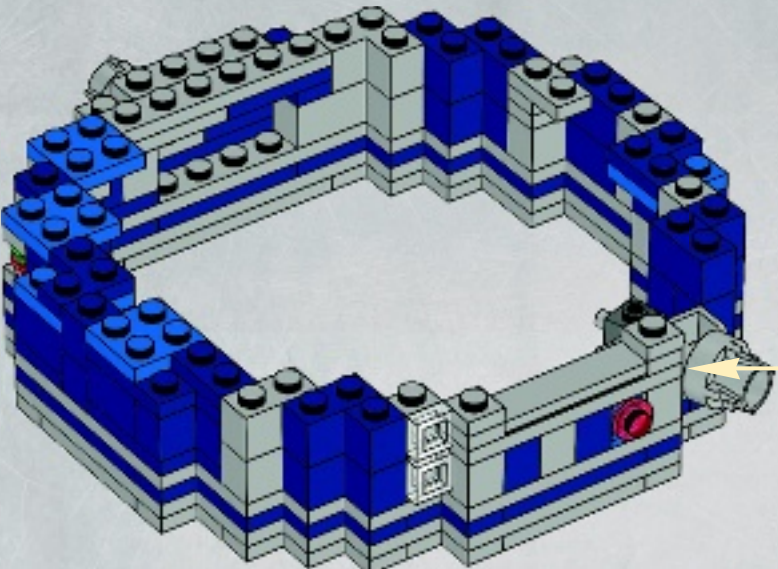

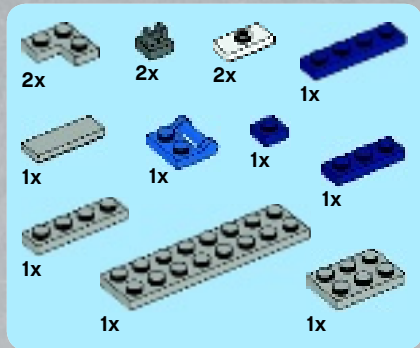

# 29

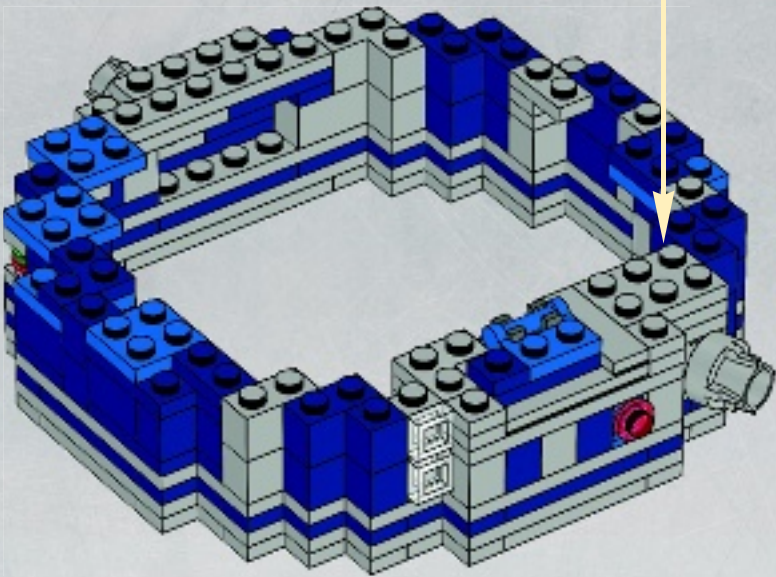
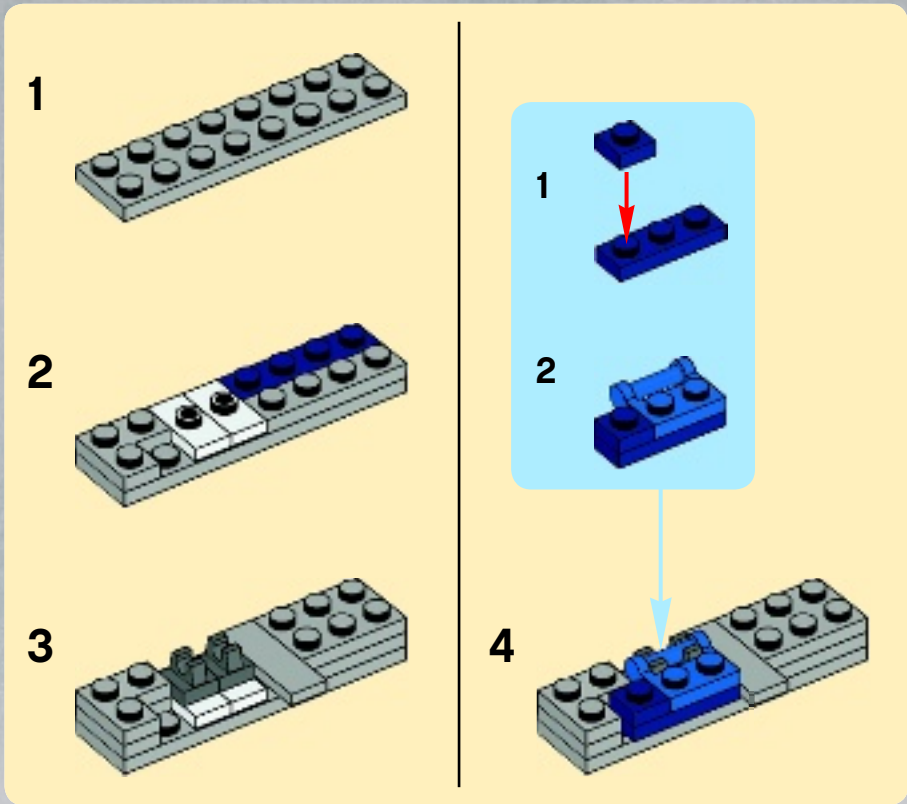





3x



3x

# 30

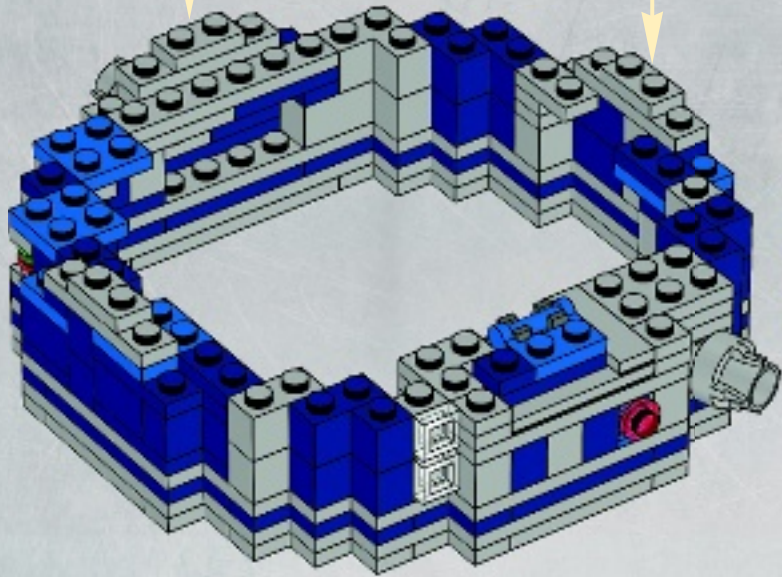
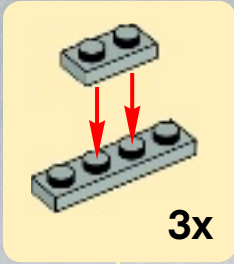

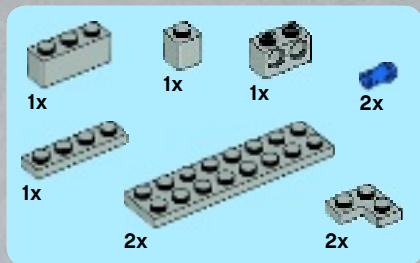

# 31

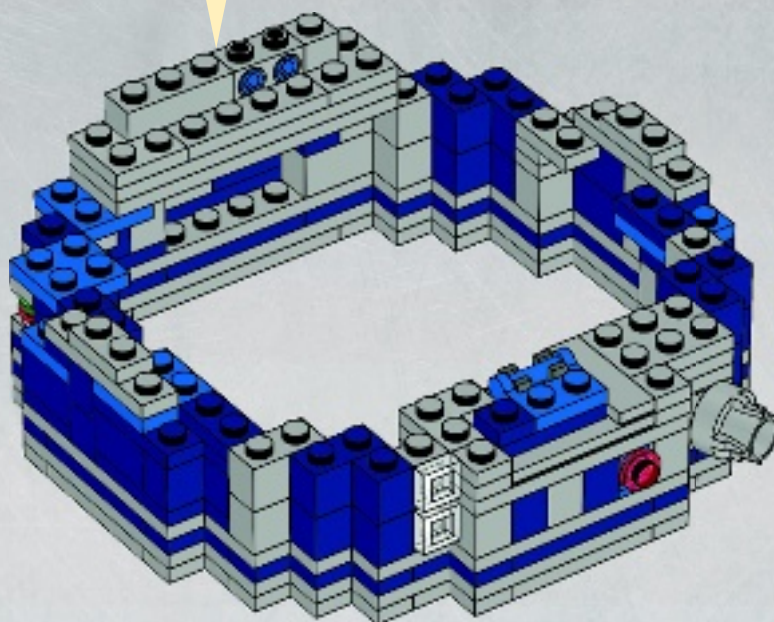
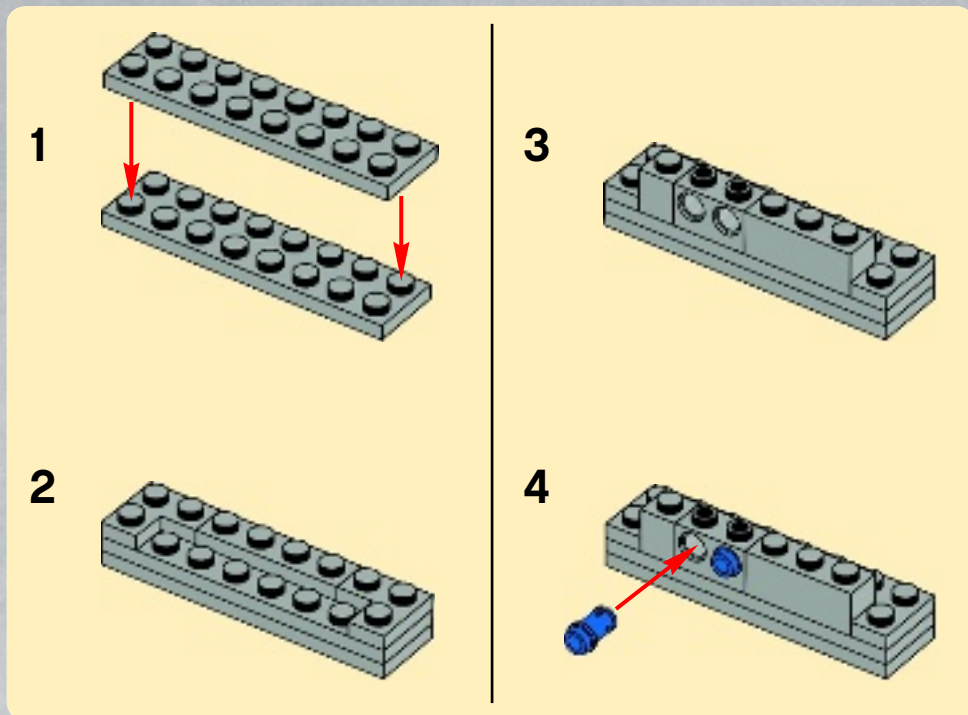



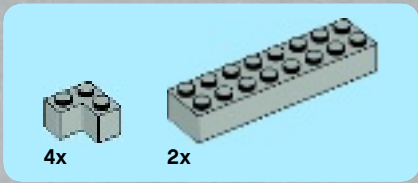

32

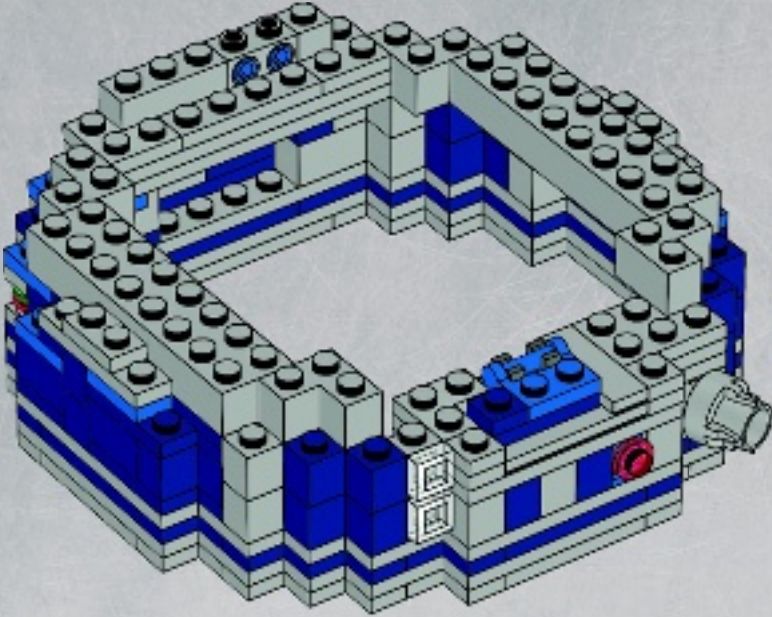

33

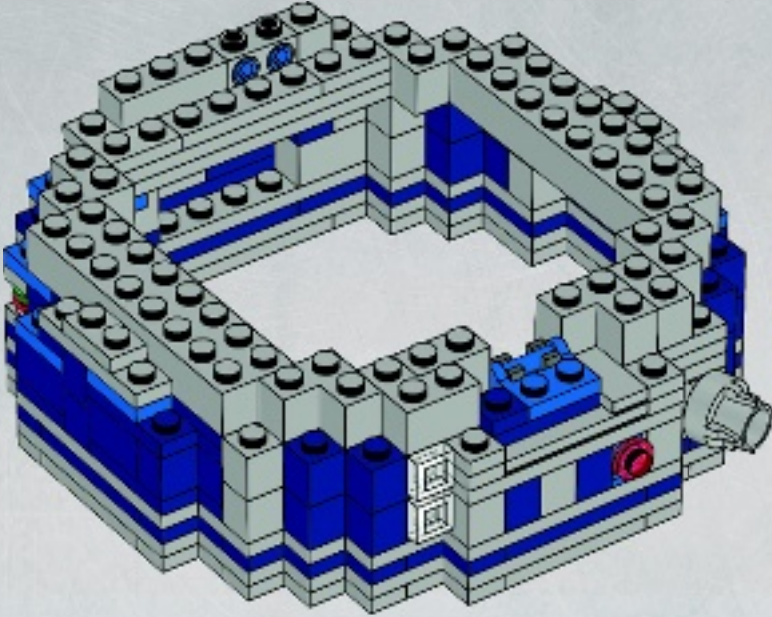





8x

# 34

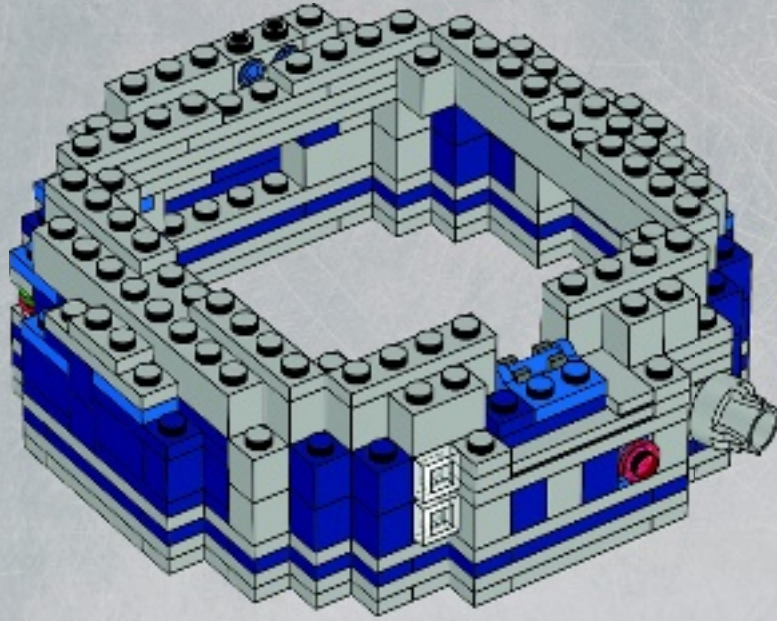

4x



4x

# 35

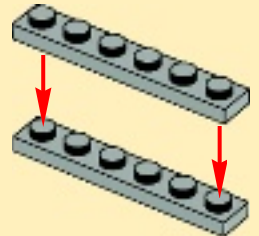
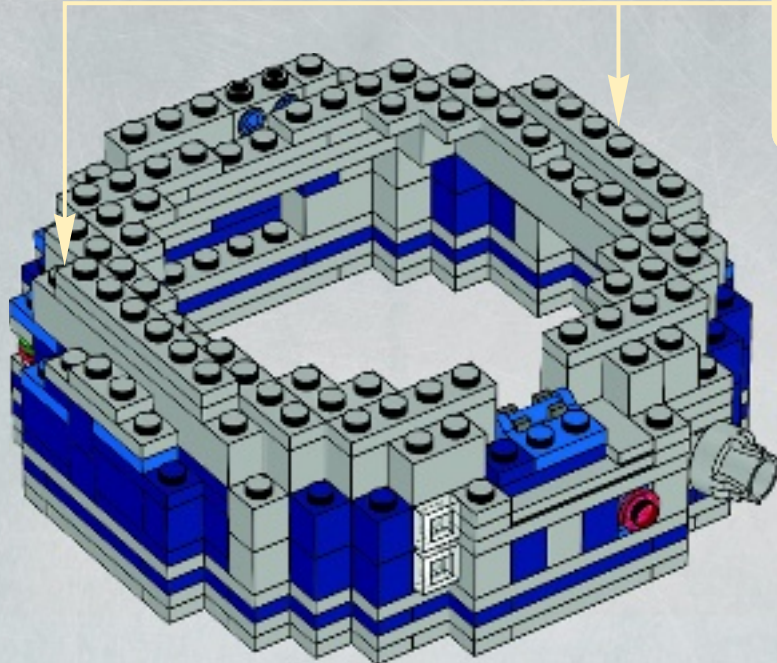

2x



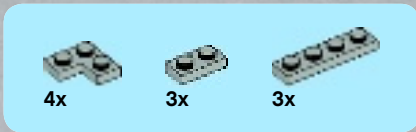

36

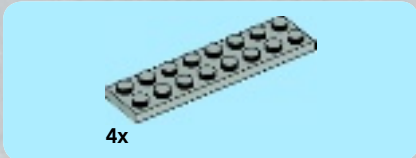
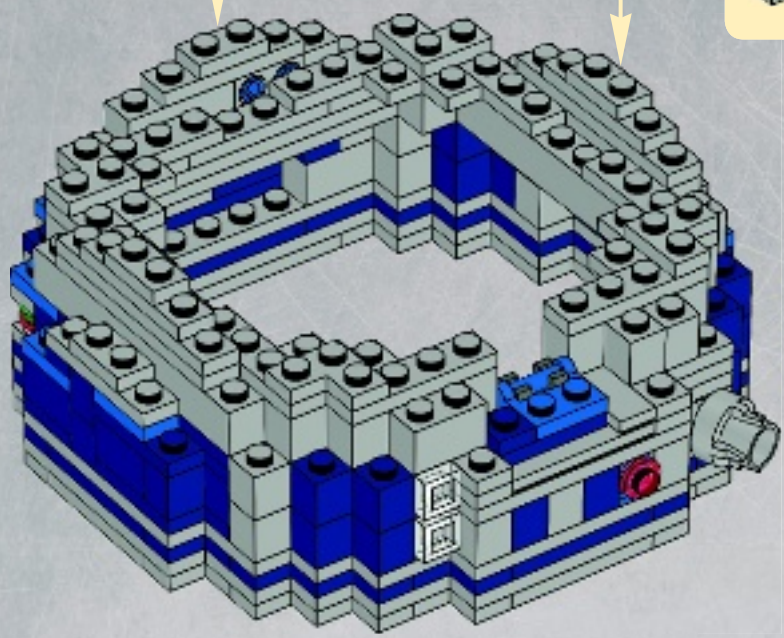
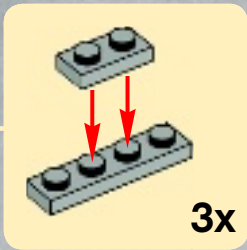

37

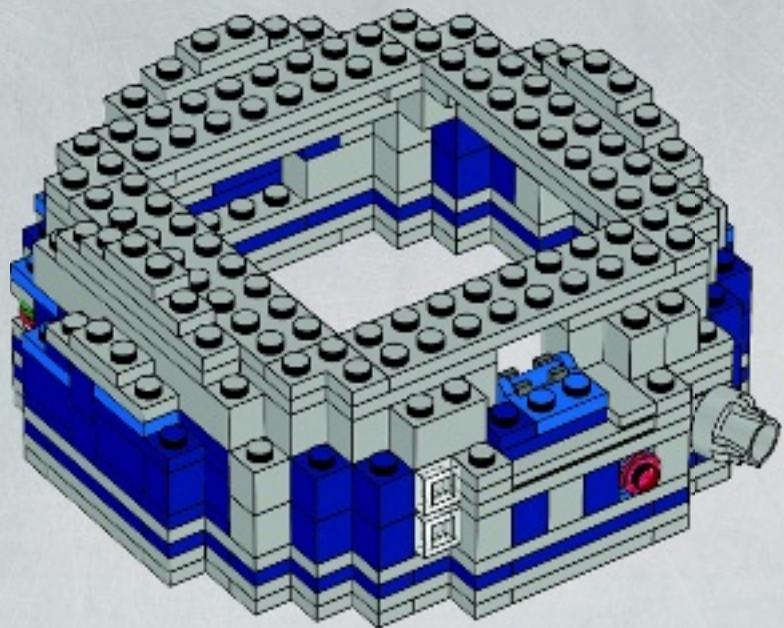



4x

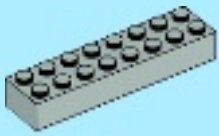

4x

# 38

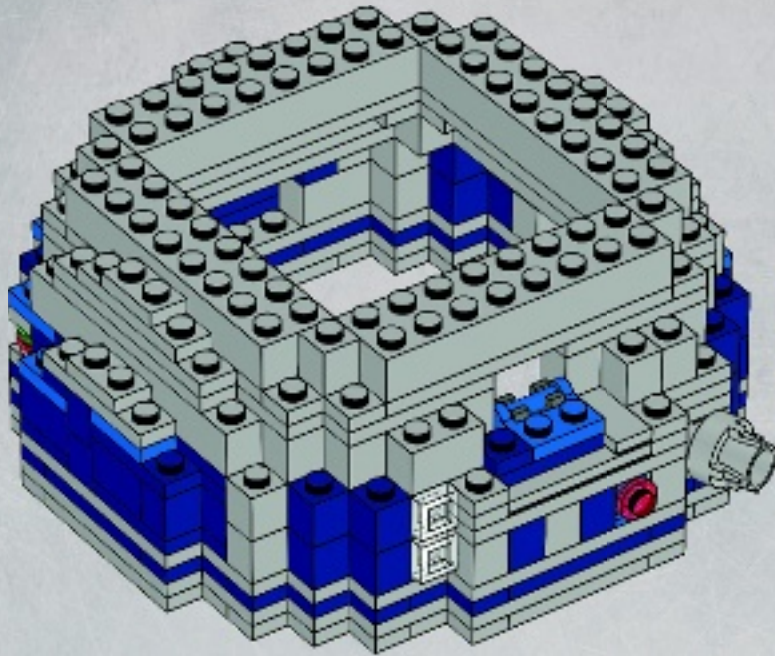





# 39

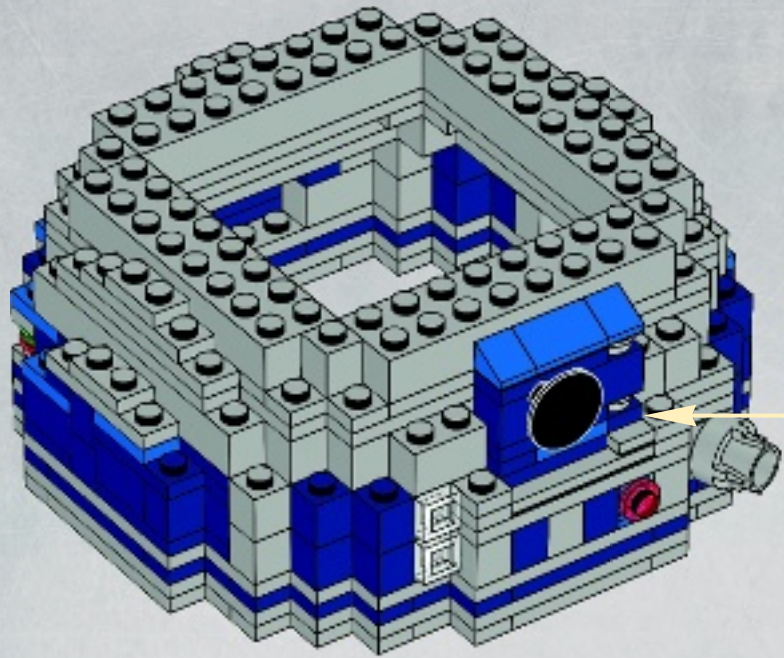
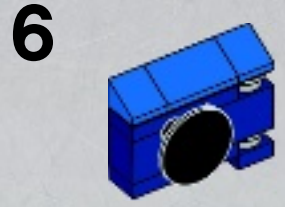
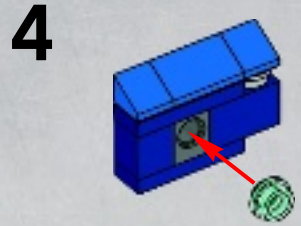
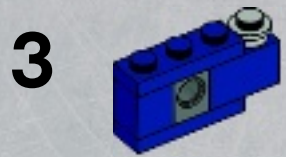
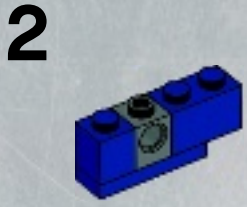



10

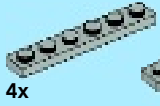
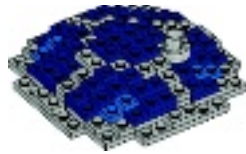

4x



4x



4x

40

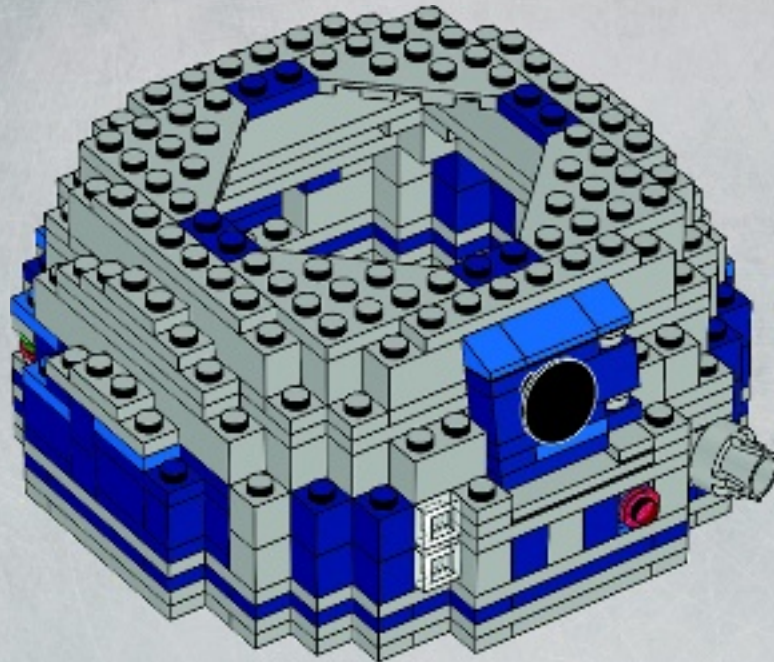



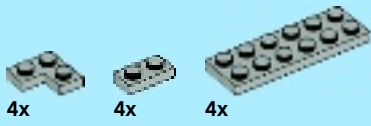

41

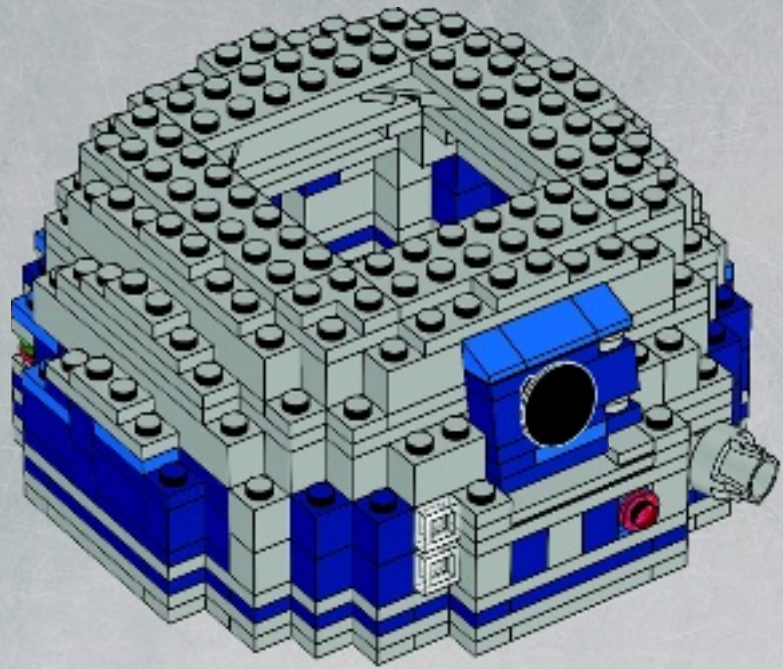

42

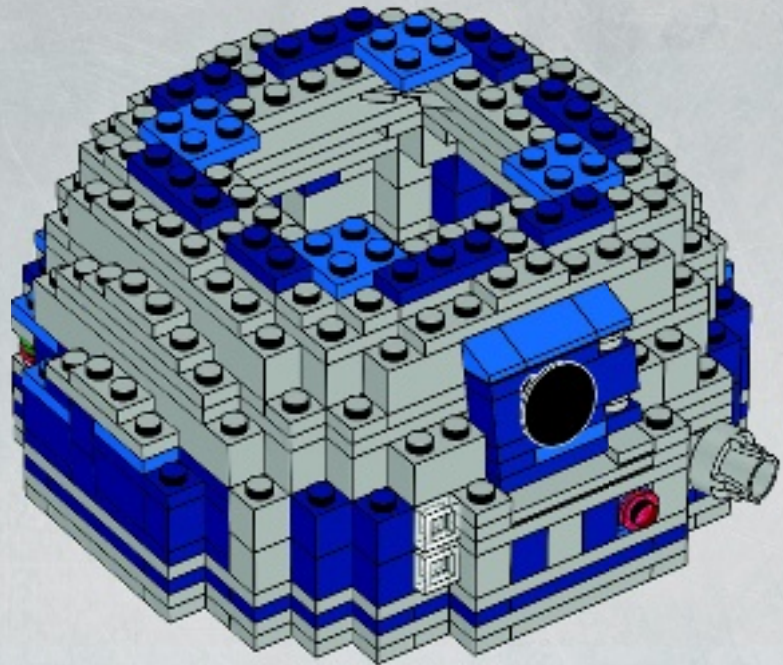



4x



4x

# 43

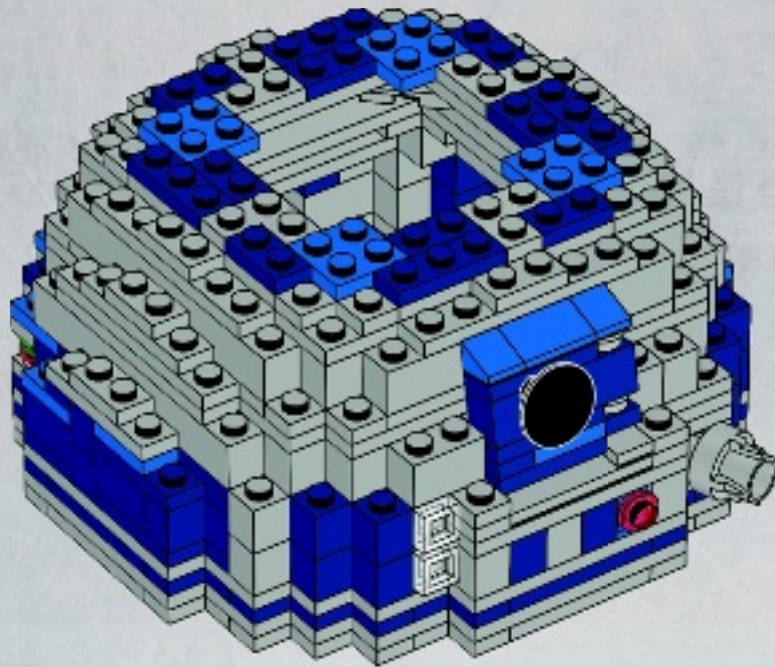



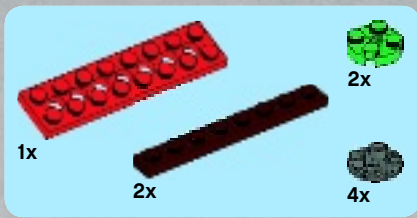

# 44

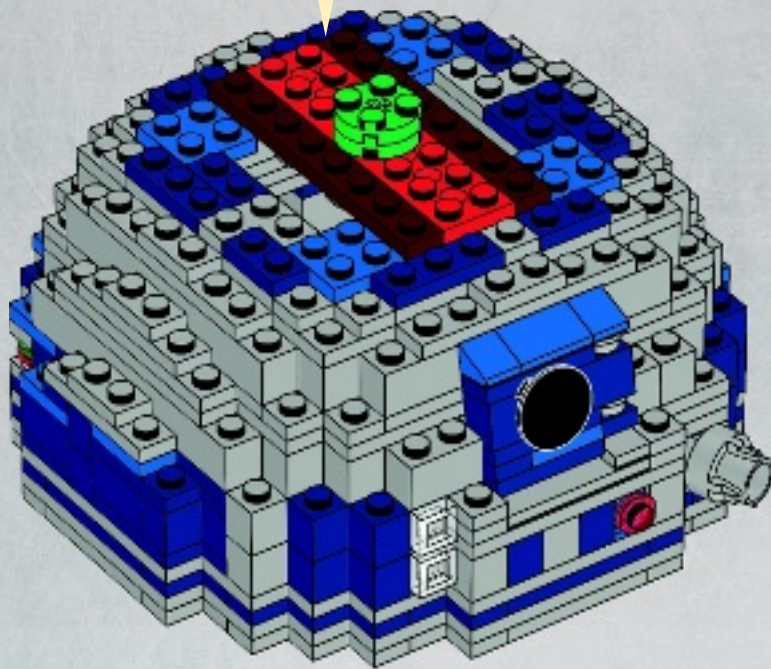
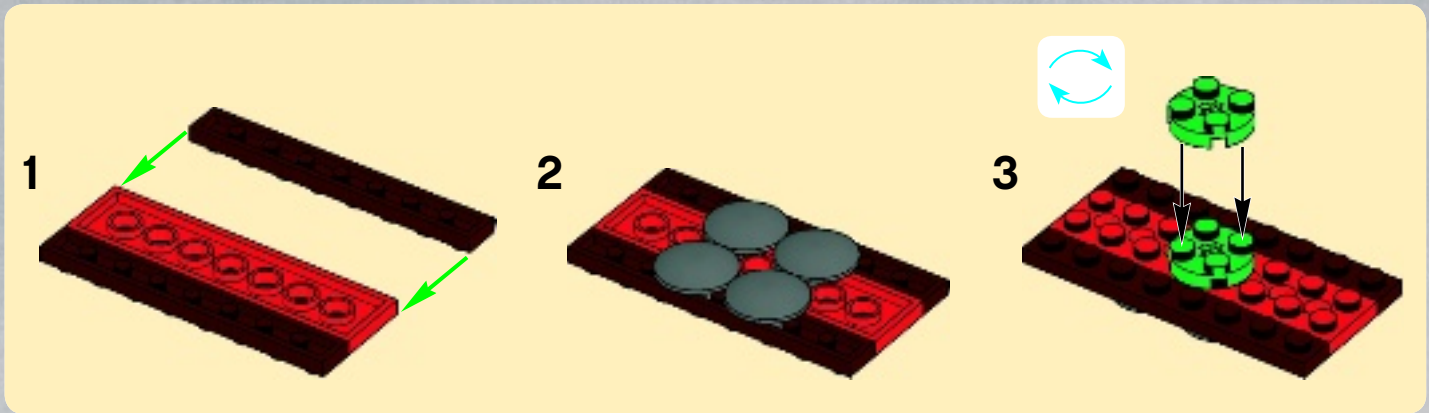



45

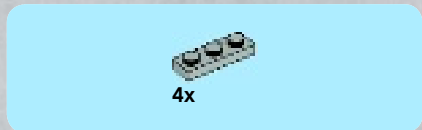
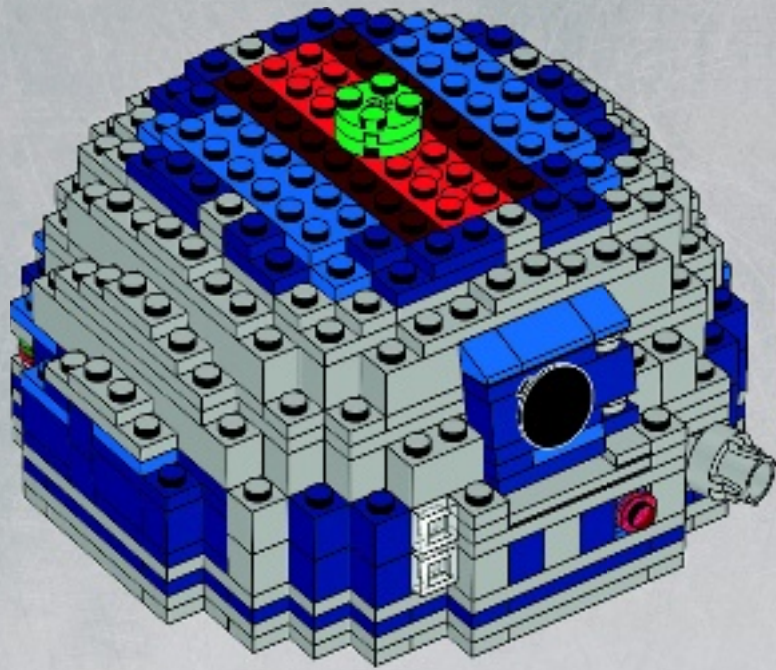

46

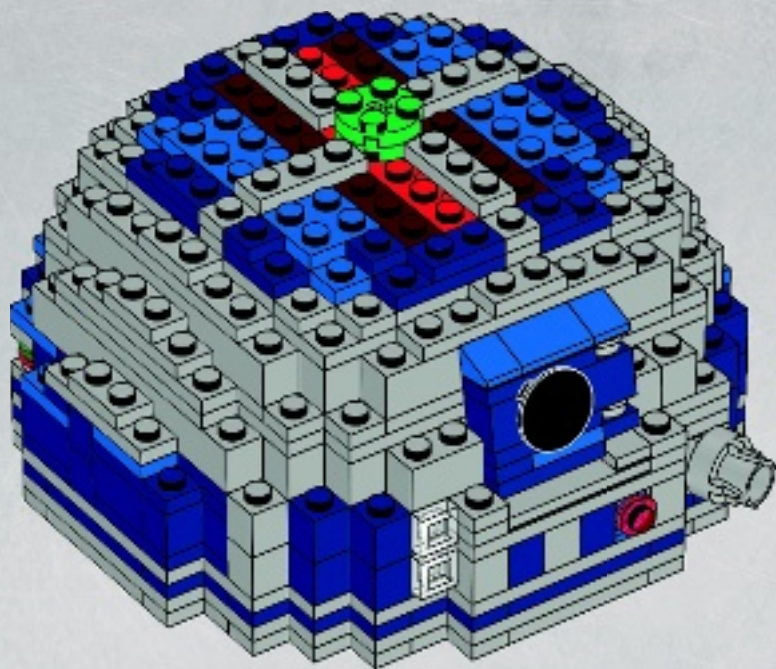





47

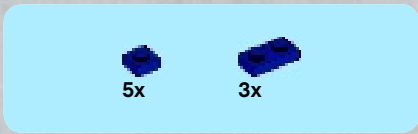
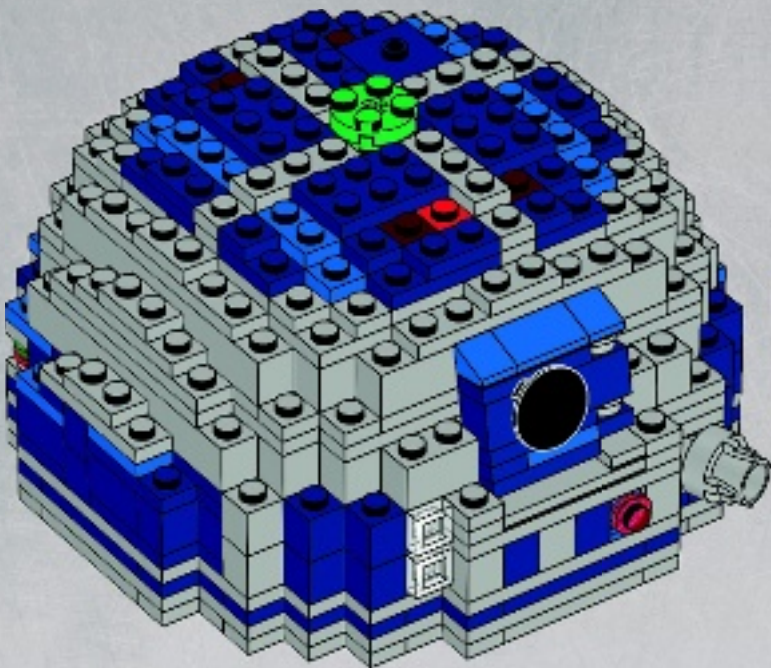

48

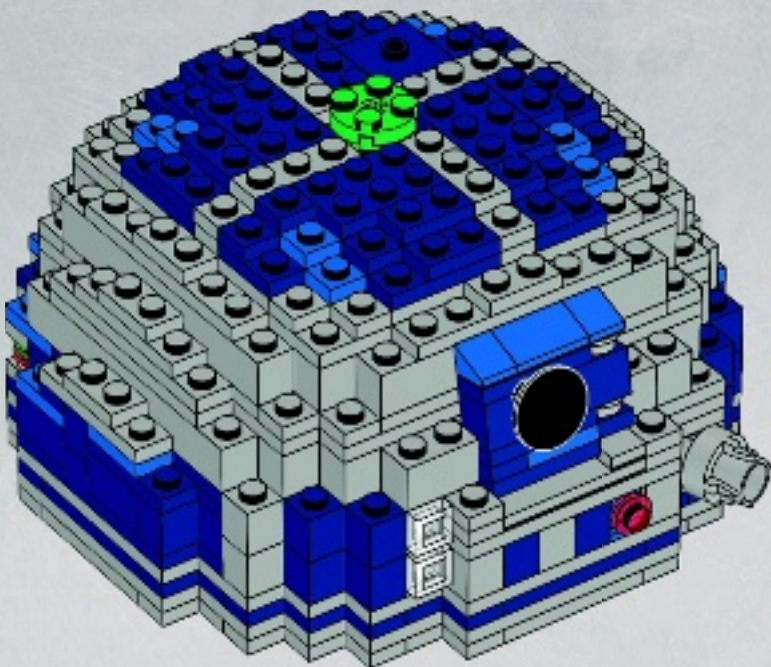





49

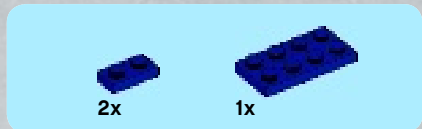
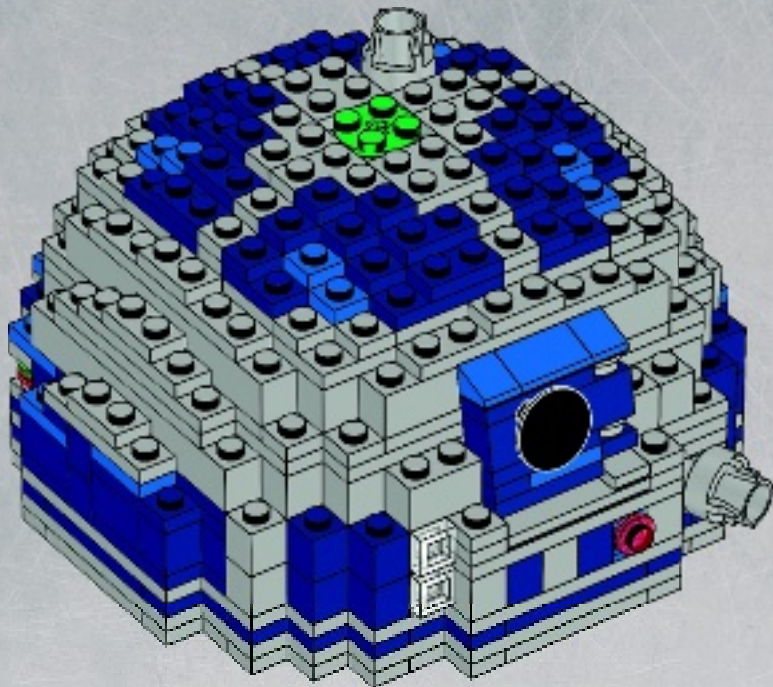

50

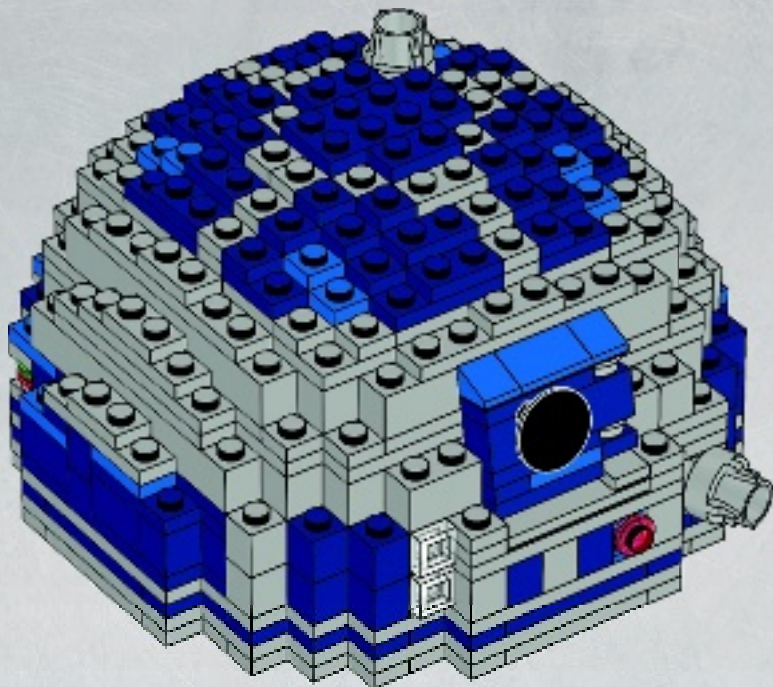



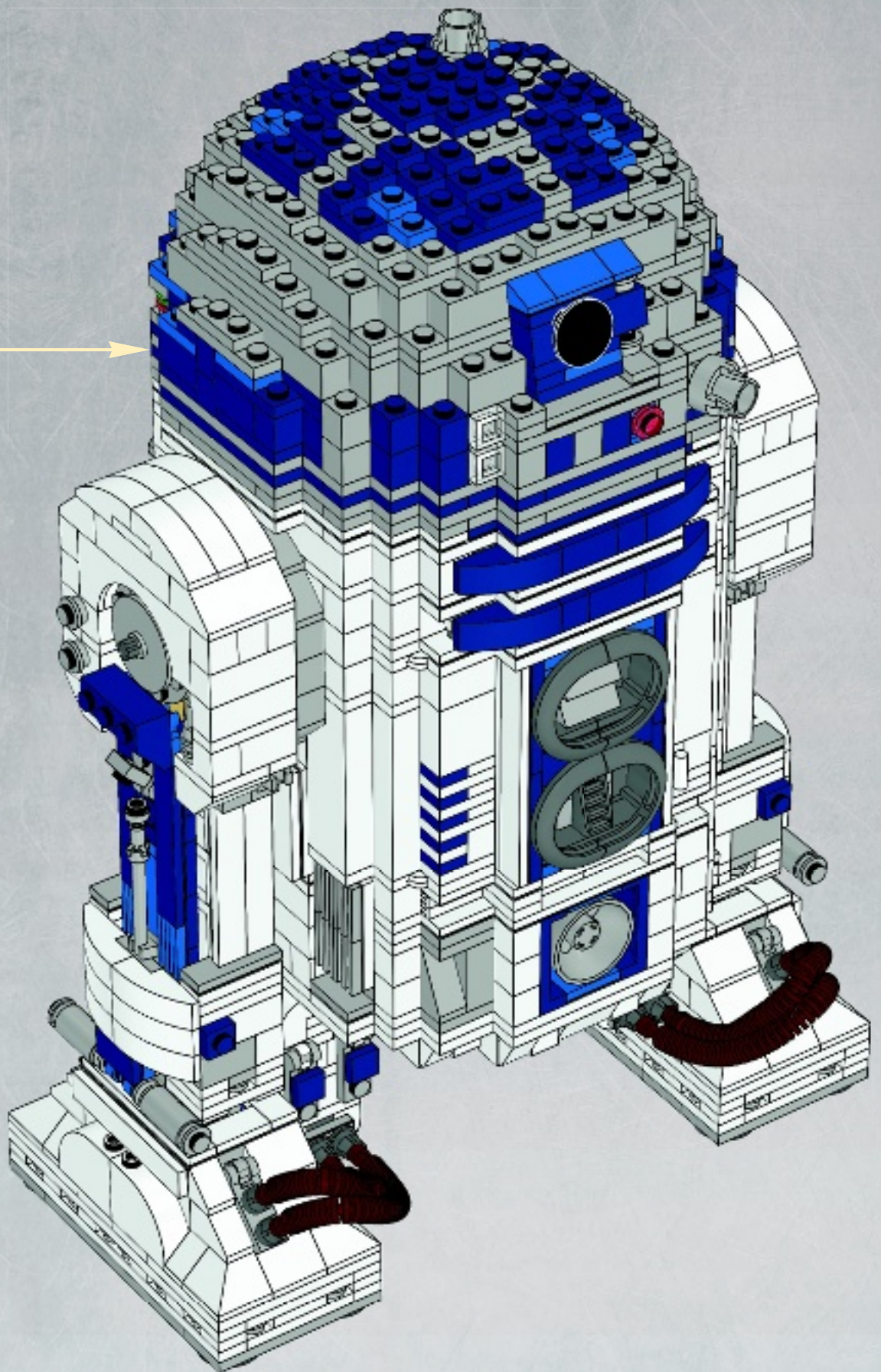



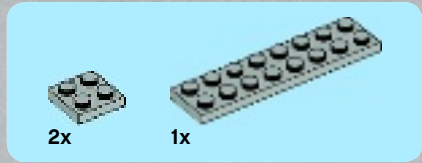

1

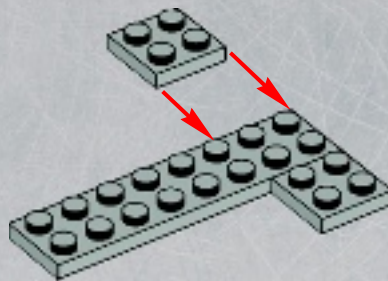

2

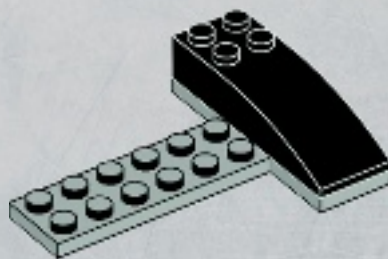

3

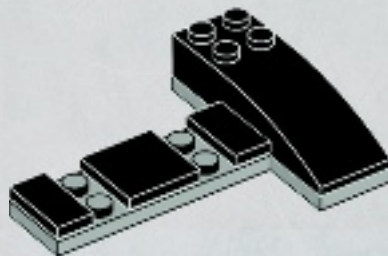



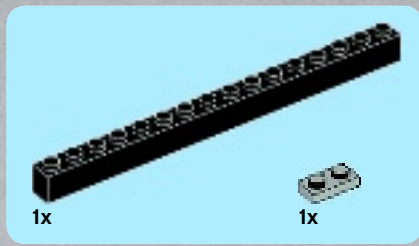

4

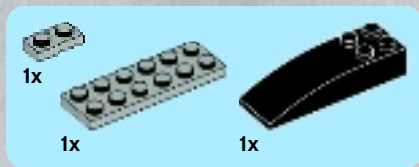
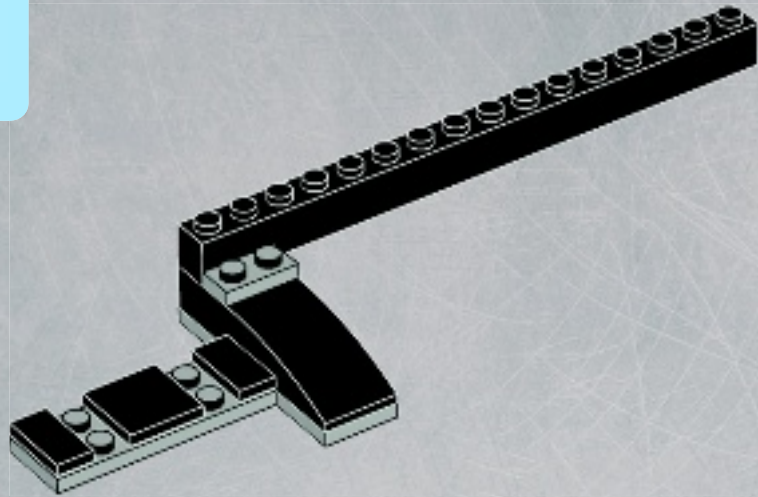

5

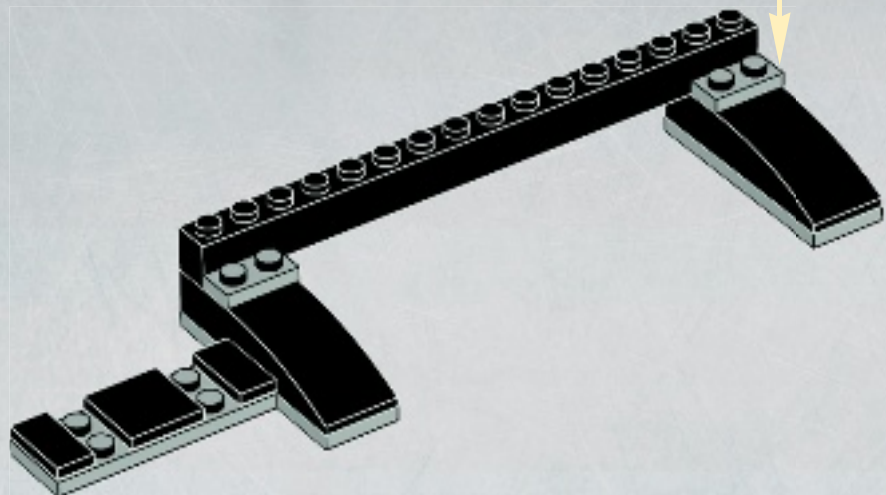
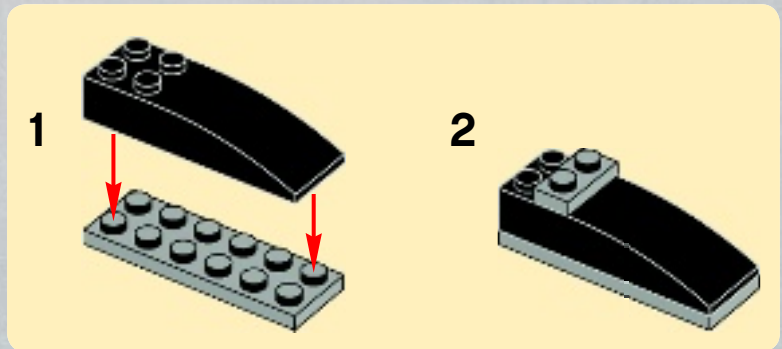



4x

6

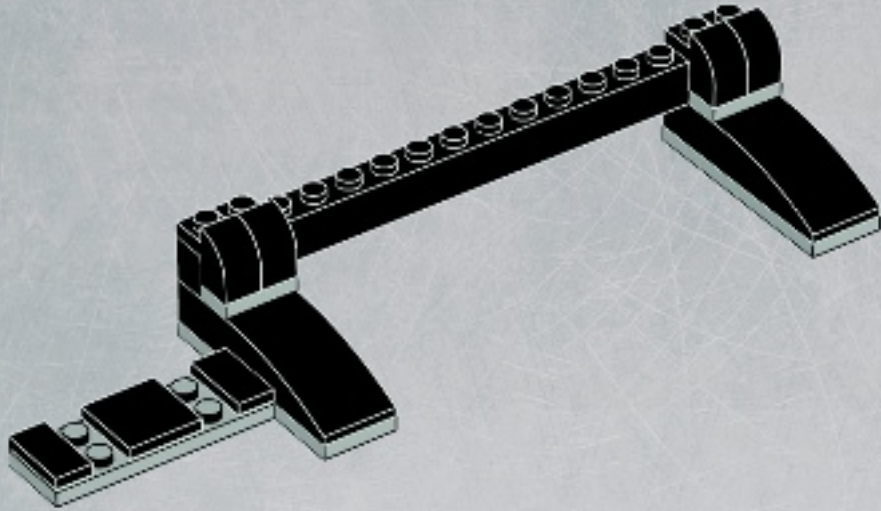

2x



2x

7

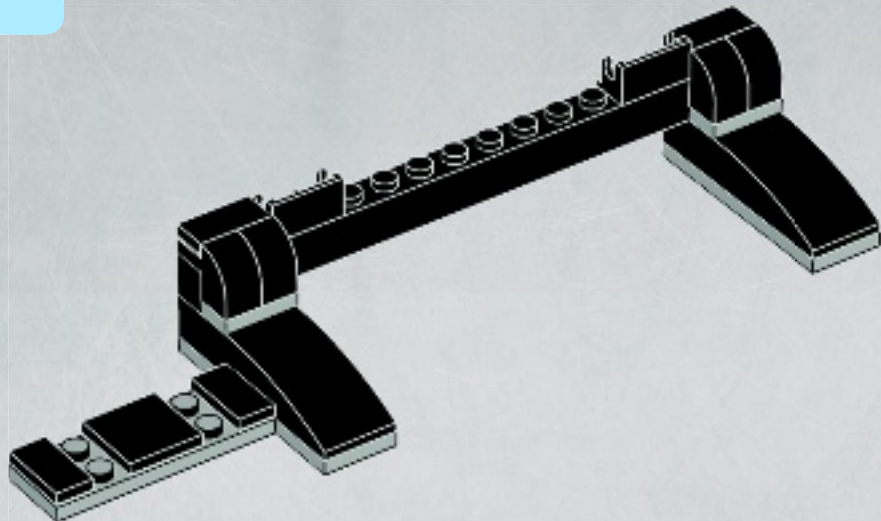



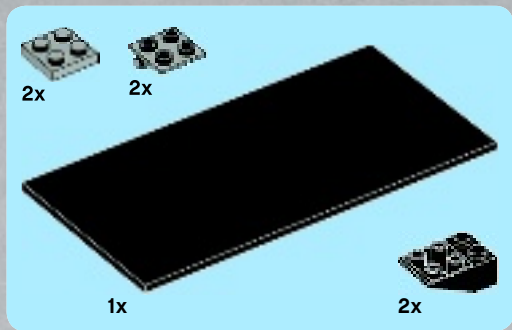

8

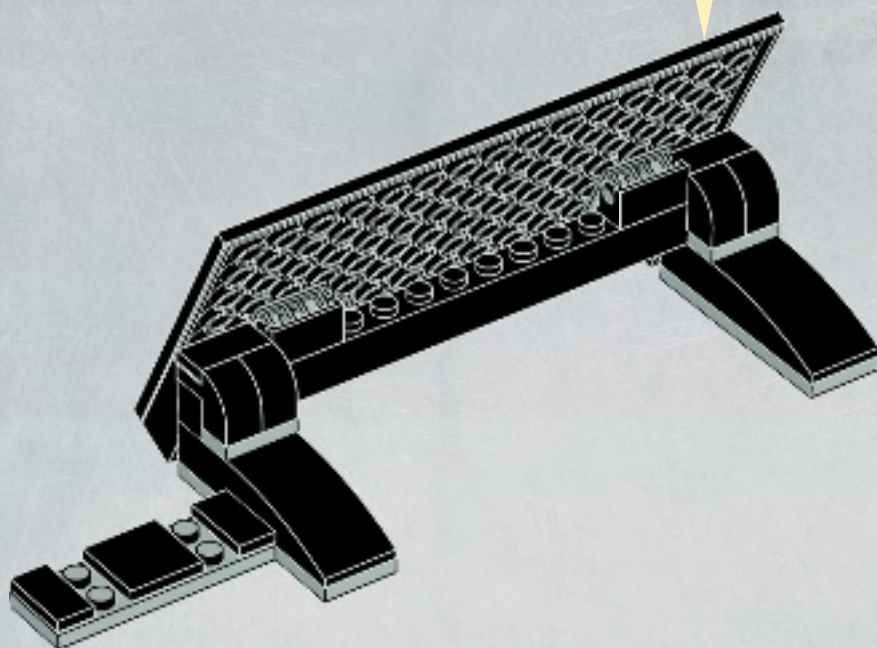
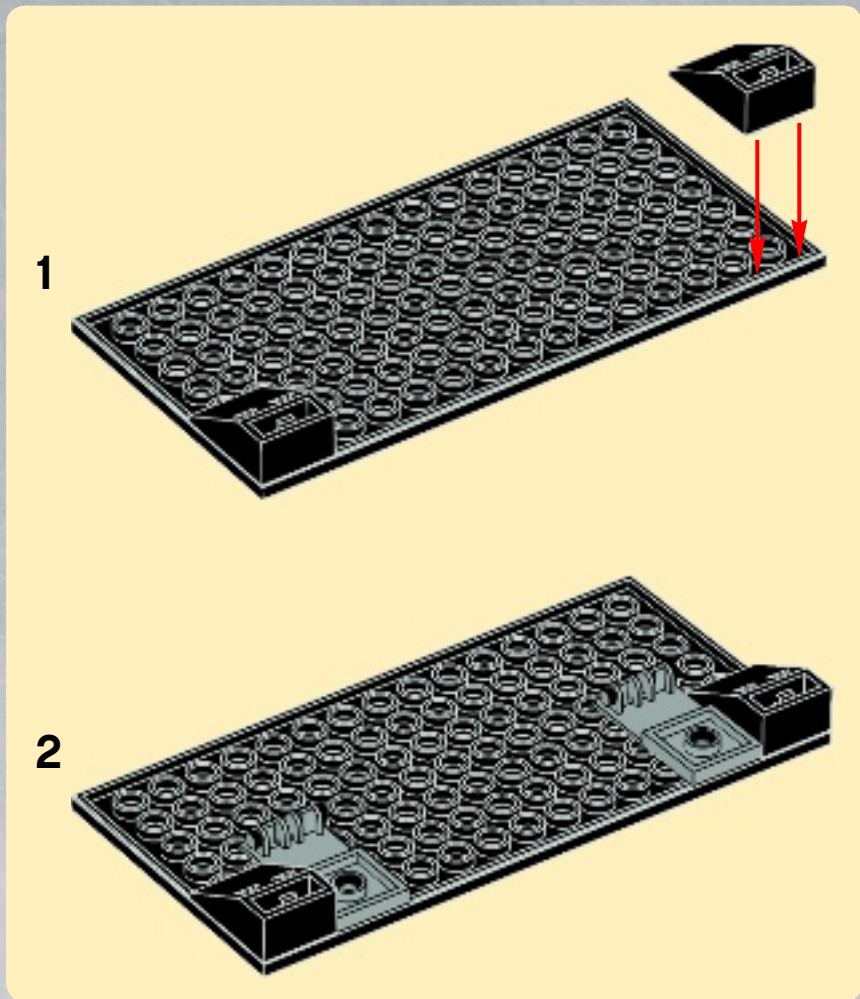

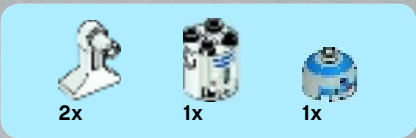

# 9

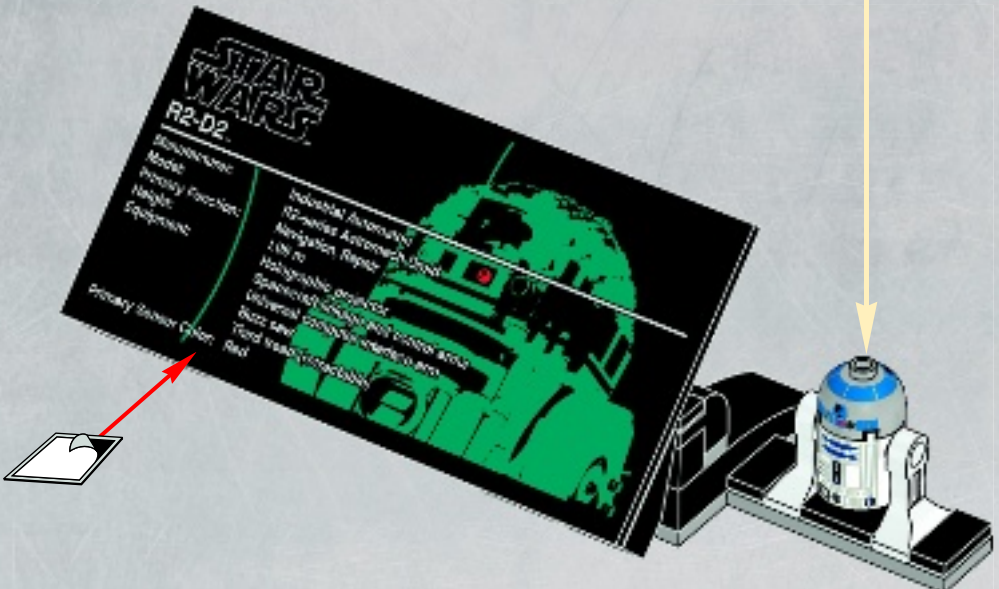
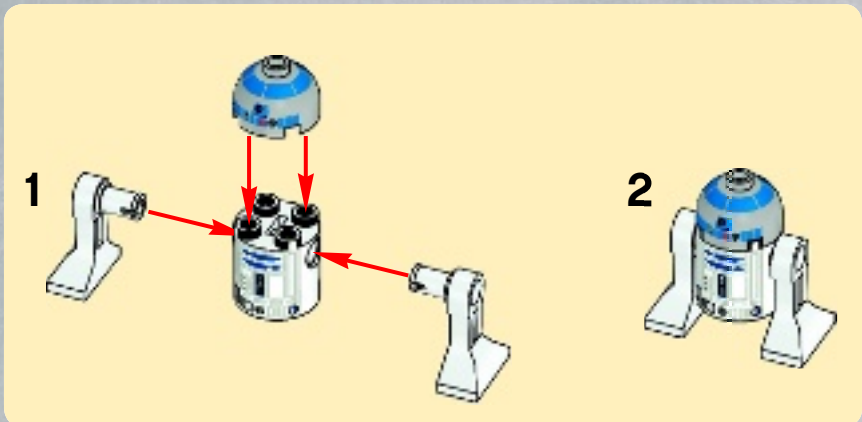







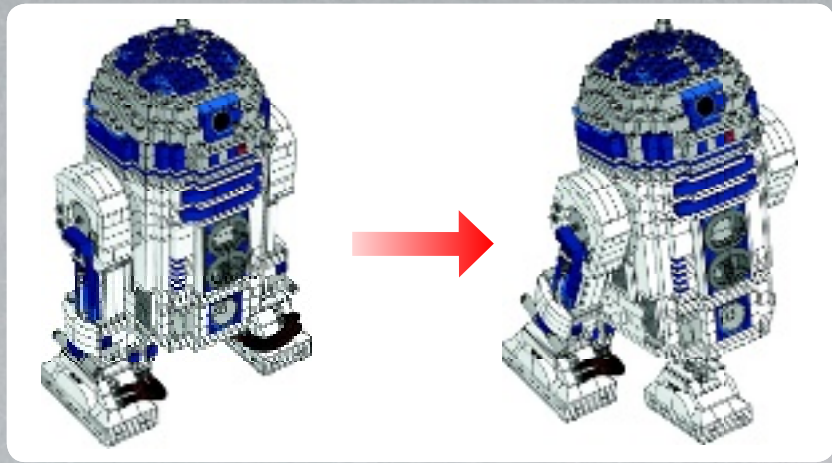

1

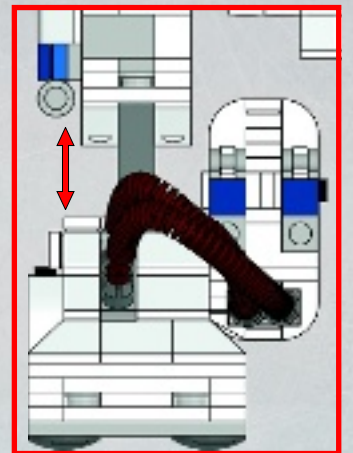
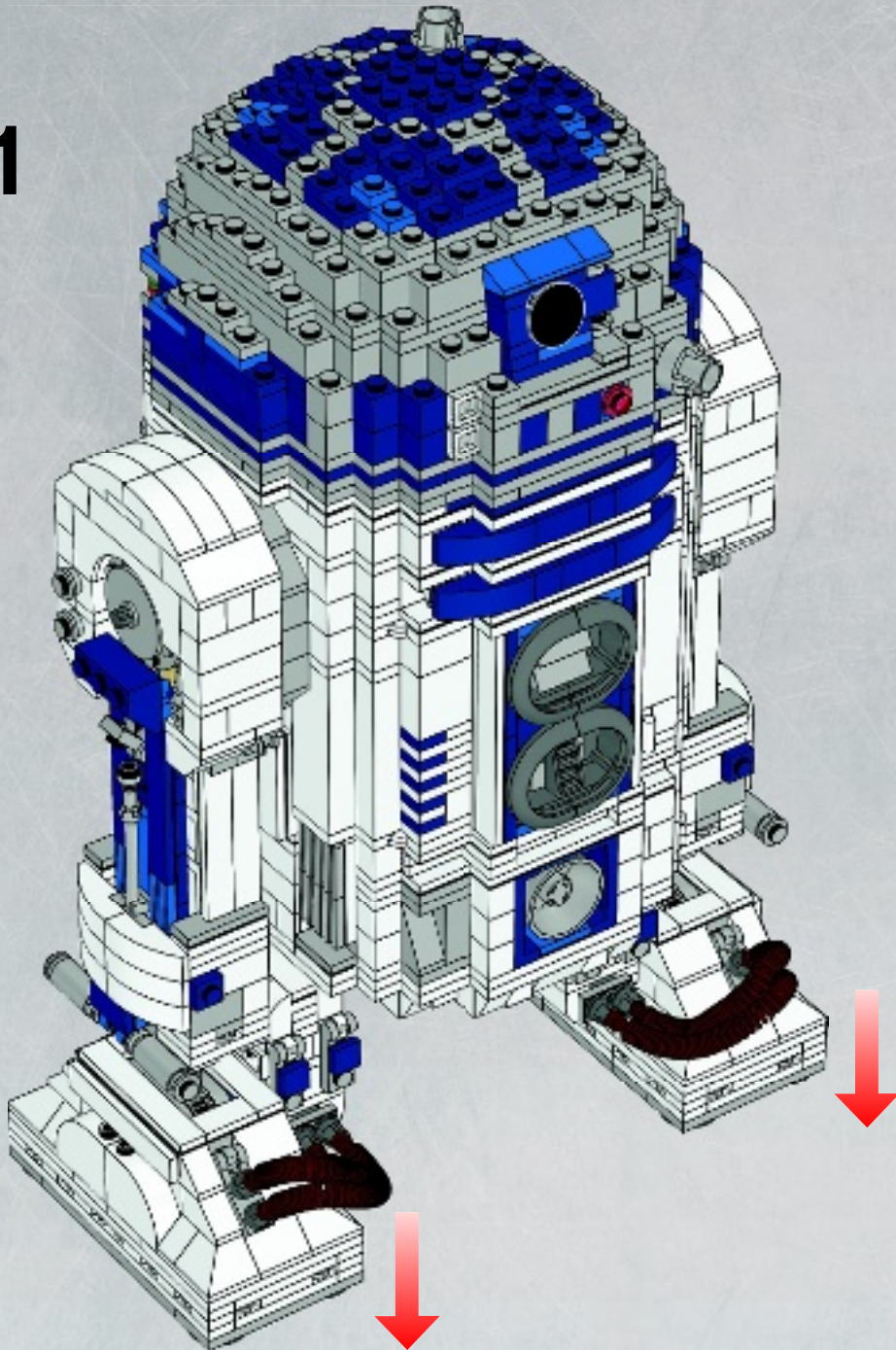



2

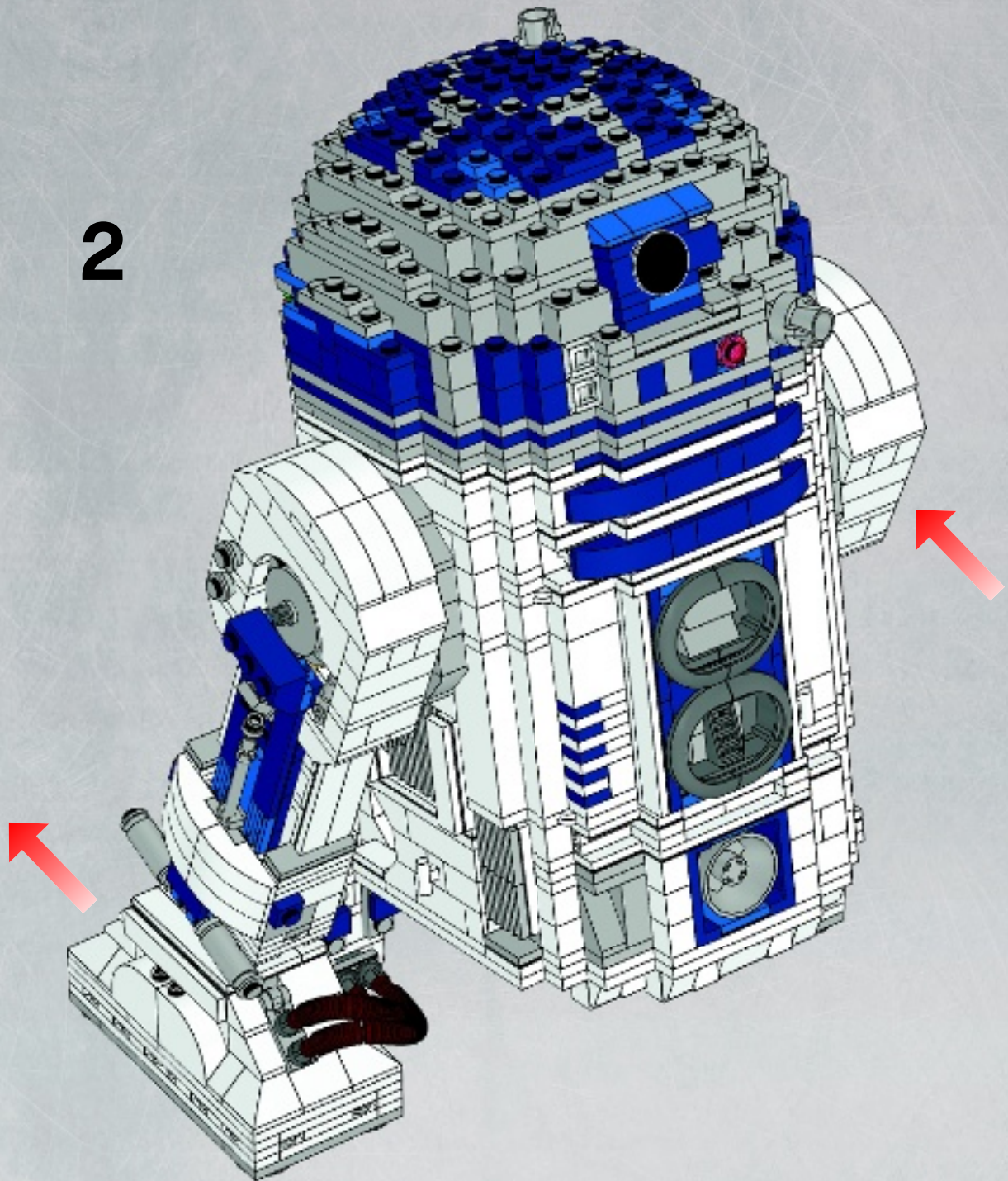



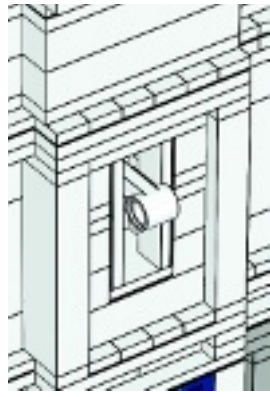
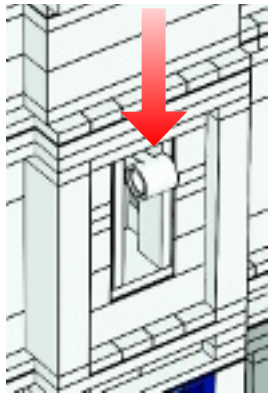

3

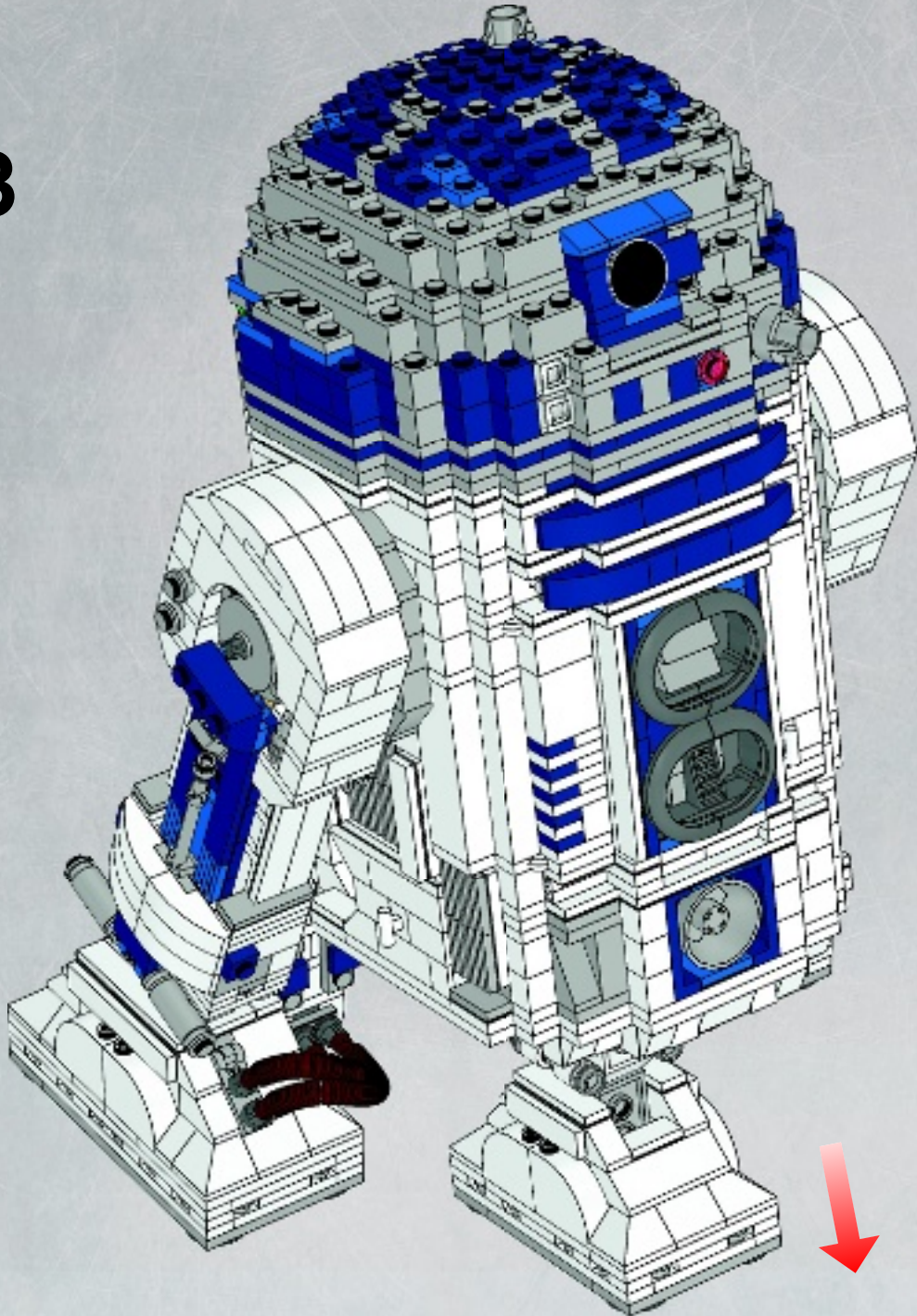



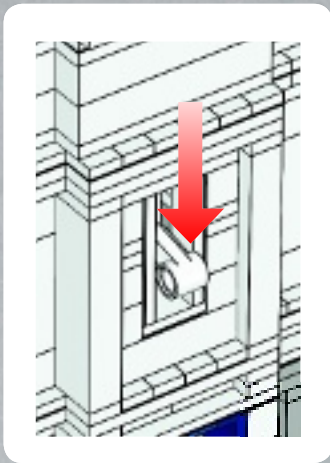

4

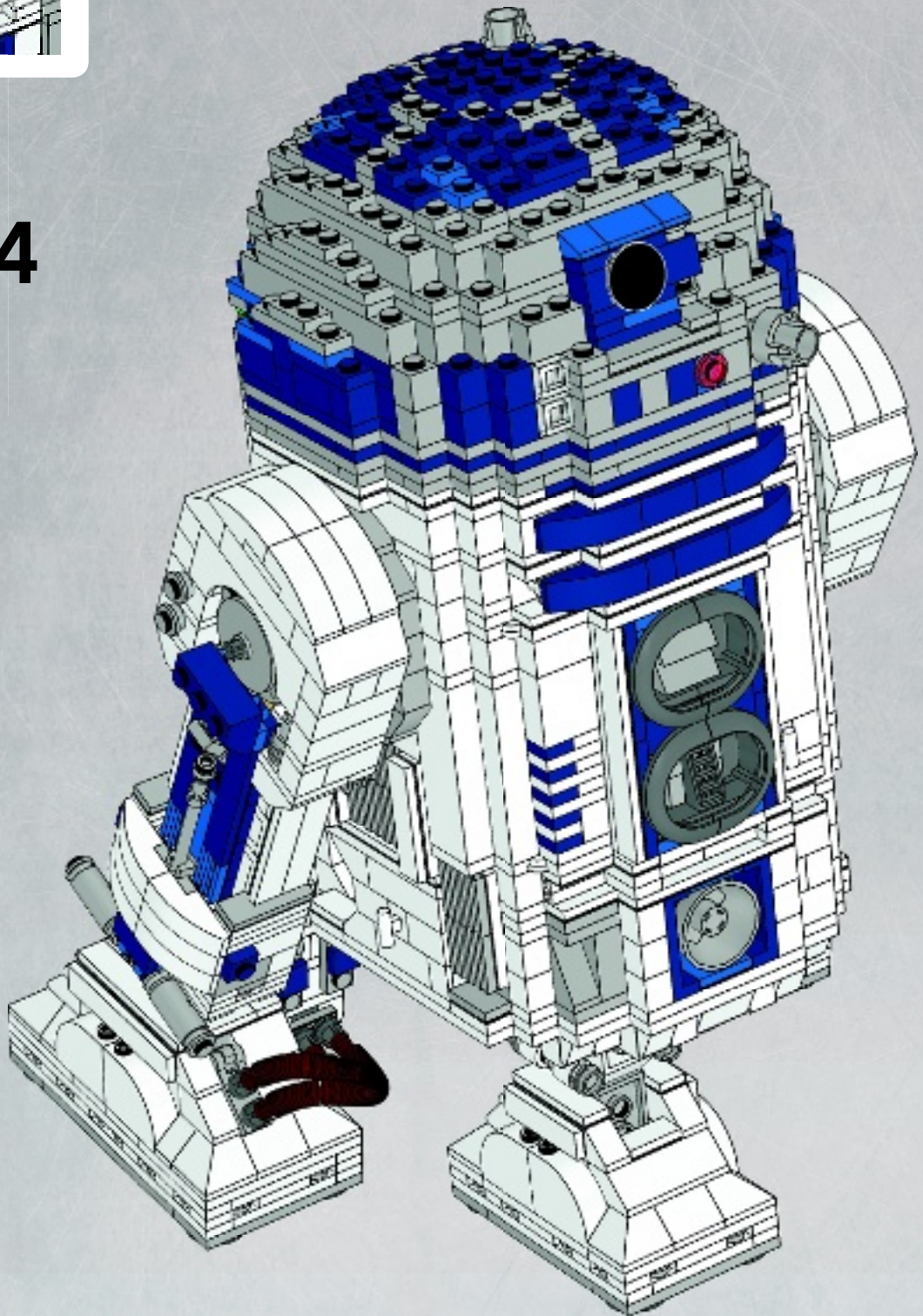



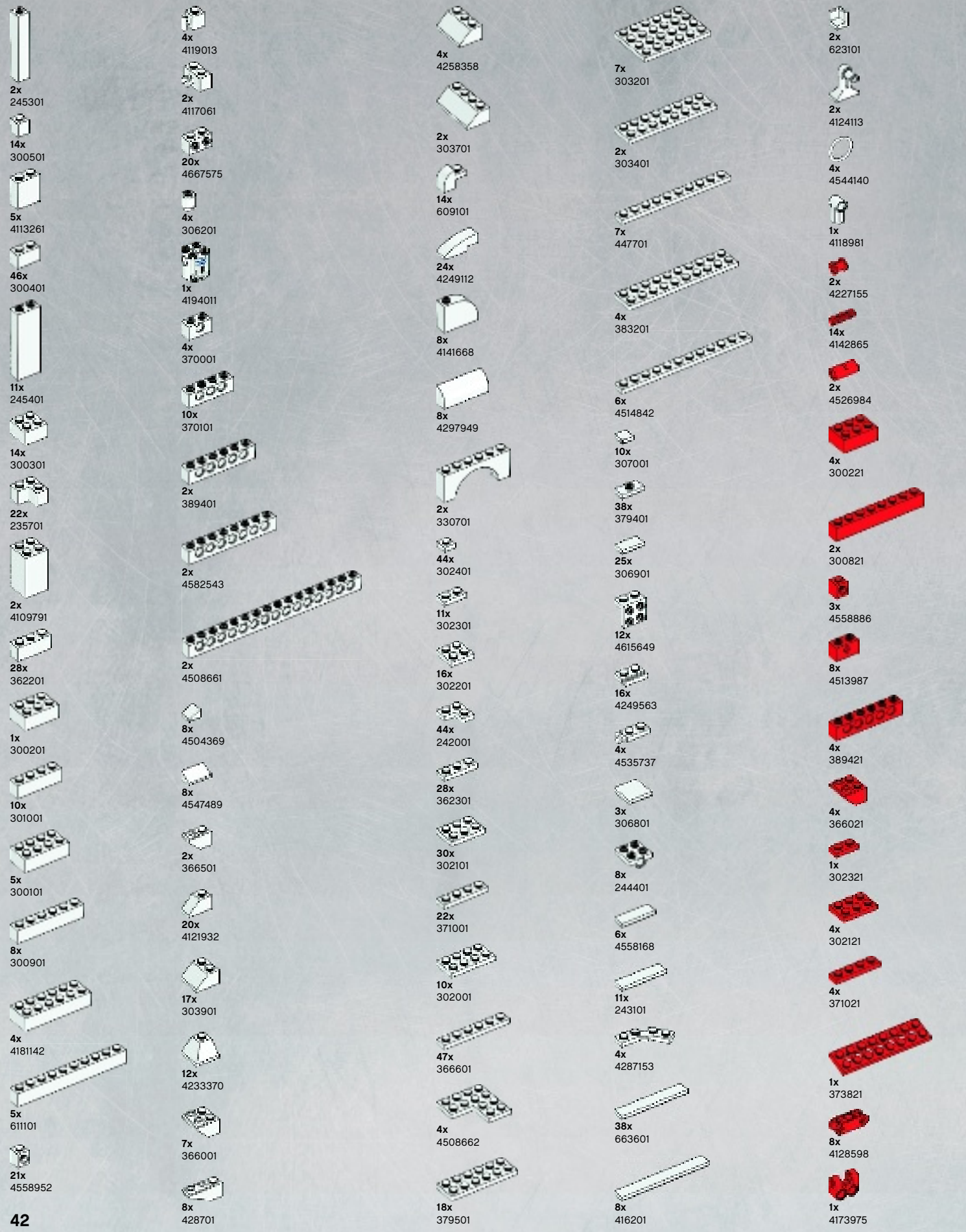

2x 245301  
14x 300501  
5x 4113261  
46x 300401  
11x 245401  
14x 300301  
22x 235701  
2x 4109791  
28x 362201  
1x 300201  
10x 301001  
5x 300101  
8x 300901  
4x 4181142  
5x 611101  
21x 4558952

4x 4119013  
2x 4117061  
20x 4667575  
4x 306201  
1x 4194011  
4x 370001  
10x 370101  
2x 389401  
2x 4582543  
2x 4508661  
8x 4504369  
8x 4547489  
2x 366501  
20x 4121932  
17x 303901  
12x 4233370  
7x 366001  
8x 428701

4x 4258358  
2x 303701  
14x 609101  
24x 4249112  
8x 4141668  
8x 4297949  
2x 330701  
44x 302401  
11x 302301  
16x 302201  
44x 242001  
28x 362301  
30x 302101  
22x 371001  
10x 302001  
47x 366601  
4x 4508662  
18x 379501

7x 303201  
2x 303401  
7x 447701  
4x 383201  
6x 4514842  
10x 307001  
38x 379401  
25x 306901  
12x 4615649  
16x 4249563  
4x 4535737  
3x 306801  
8x 244401  
6x 4558168  
11x 243101  
4x 4287153  
38x 663601  
8x 416201

2x 623101  
2x 4124113  
4x 4544140  
1x 4118981  
2x 4227155  
14x 4142865  
2x 4526984  
4x 300221  
2x 300821  
3x 4558886  
8x 4513987  
4x 389421  
4x 366021  
1x 302321  
4x 302121  
4x 371021  
1x 373821  
8x 4128598  
1x 4173975



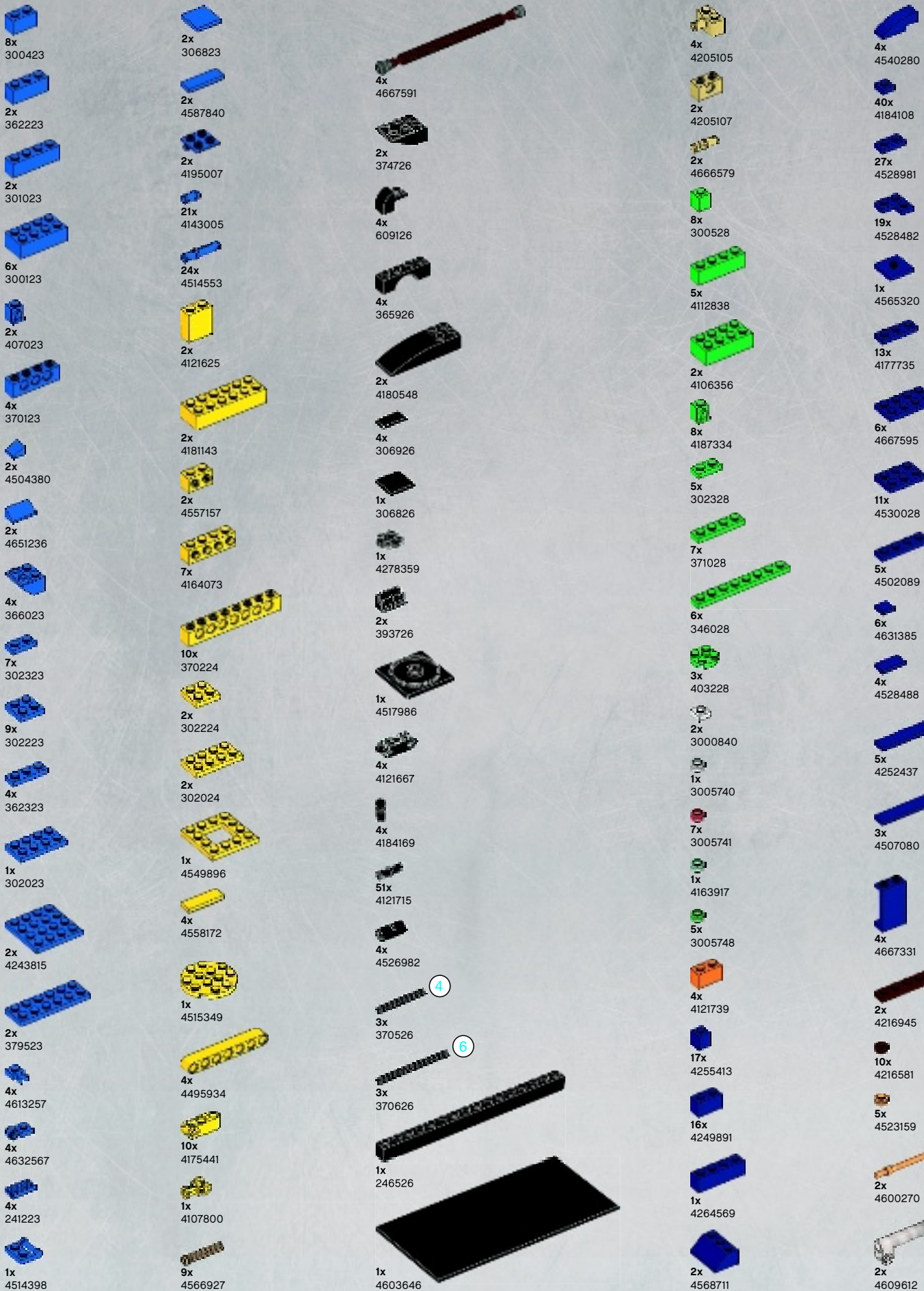

8x 300423  
 2x 362223  
 2x 301023  
 6x 300123  
 2x 407023  
 4x 370123  
 2x 4504380  
 2x 4651236  
 4x 366023  
 7x 302323  
 9x 302223  
 4x 362323  
 1x 302023  
 2x 4243815  
 2x 379523  
 4x 4613257  
 4x 4632567  
 4x 241223  
 1x 4514398

2x 306823  
 2x 4587840  
 2x 4195007  
 21x 4143005  
 24x 4514553  
 2x 4121625  
 2x 4181143  
 2x 4557157  
 7x 4164073  
 10x 370224  
 2x 302224  
 2x 302024  
 1x 4549896  
 4x 4558172  
 1x 4515349  
 4x 4495934  
 10x 4175441  
 1x 4107800  
 9x 4566927

4x 4667591  
 2x 374726  
 4x 609126  
 4x 365926  
 2x 4180548  
 4x 306926  
 1x 306826  
 1x 4278359  
 2x 393726  
 1x 4517986  
 4x 4121667  
 4x 4184169  
 51x 4121715  
 4x 4526982  
 3x 370526  
 3x 370626  
 1x 246526  
 1x 4603646

4x 4205105  
 2x 4205107  
 2x 4666579  
 8x 300528  
 5x 4112838  
 2x 4106356  
 8x 4187334  
 5x 302328  
 7x 371028  
 6x 346028  
 3x 403228  
 2x 3000840  
 1x 3005740  
 7x 3005741  
 1x 4163917  
 5x 3005748  
 4x 4121739  
 17x 4255413  
 16x 4249891  
 1x 4264569  
 2x 4568711

4x 4540280  
 40x 4184108  
 27x 4528981  
 19x 4528482  
 1x 4565320  
 13x 4177735  
 6x 4667595  
 11x 4530028  
 5x 4502089  
 6x 4631385  
 4x 4528488  
 5x 4252437  
 3x 4507080  
 4x 4667331  
 2x 4216945  
 10x 4216581  
 5x 4523159  
 2x 4600270  
 2x 4609612

4

6



5x  
4558169

1x  
4211356

70x  
4211525

2x  
4515351

4x  
4160560

1x  
4215513

2x  
4211628

2x  
4538098

2x  
4529550

1x  
4533122

2x  
4211483

8x  
4211807

4x  
4512360

2x  
4211862

4x  
4552348

2x  
4211655



**Customer Service**  
**Kundenservice**  
**Service Consommateurs**  
**Servicio Al Consumidor**  
[www.lego.com/service](http://www.lego.com/service) or dial

00800 5346 5555 :   
 1-800-422-5346 :

11x  
4211349

1x  
4211428

4x  
4211392

6x  
4211391

2x  
4211476

4x  
4535764

1x  
4211541

3x  
4211440

2x  
4211441

2x  
4211640

4x  
4211614

2x  
4568637

4x  
4211437

3x  
4515374

4x  
4251163

4x  
4211489

3x  
4211564

4x  
4211387

13x  
4211389

13x  
4211388

6x  
4211369

2x  
4541978

2x  
4211480

2x  
4211414

4x  
4211451

2x  
4657366

8x  
4211450

5x  
4520320

1x  
4211503

8x  
4211566

4x  
4211573

2x  
4640844

2x  
4539481

4x  
4526985

10x  
4211815

3x  
4278756

2x  
4211508

3x  
4667578

2x  
4211881

9x  
4211399

53x  
4211398

24x  
4211350

10x  
4515369

48x  
4211353

16x  
4211397

15x  
4211429

2x  
4211396

26x  
4211445

5x  
4211395

22x  
4211438

13x  
4211452

2x  
4211425

8x  
4211406

2x  
4251149

1x  
4211407

6x  
4542577

2x  
4522937

6x  
4645730

1x  
4211065

2x  
4211115

4x  
4211088

4x  
4210762

2x  
4211055

2x  
4521187

8x  
4211053

1x  
4529240

6x  
4211069

2x  
4211042

16x  
4278274

4x  
4260124

1x  
4540386

12x  
4210639

2x  
6006141

4x  
4211050

7x  
4560177

2x  
4508553  
4x  
4514559



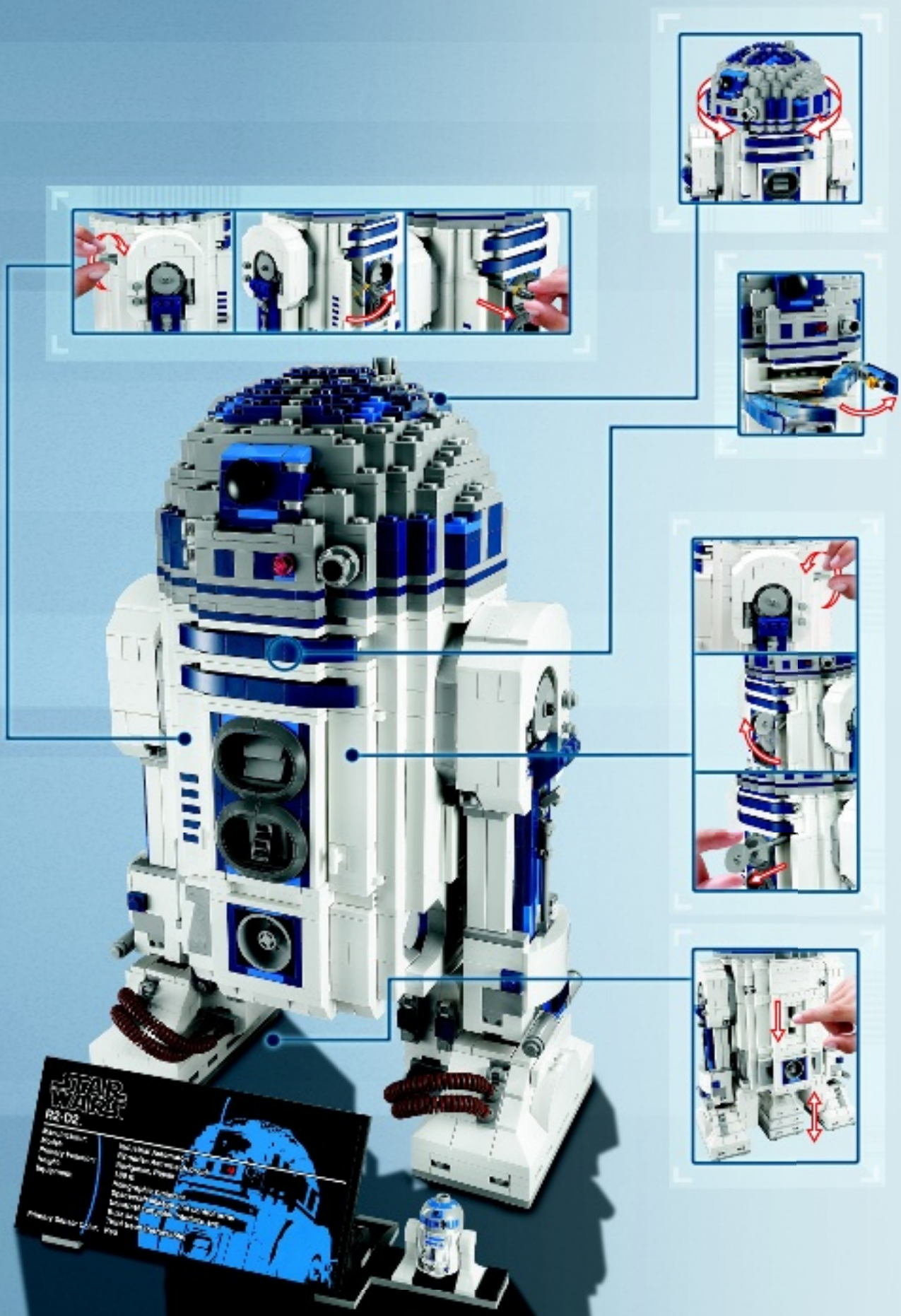

**LEGO STAR WARS**  
**R2-D2**

Manufacturer	LEGO
Product Name	R2-D2
Product Number	75098
Year	2008
Material	ABS
Color	White, Blue, Grey
Dimensions (H x W x D)	28 x 18 x 18 cm
Weight	1.2 kg
Number of Pieces	1,000
Price	~\$100

Product of Denmark © 2008





9496



9500



9497



9498



9515



9499



9516





9496



9496



9496



9496



9497



9497



9497



9498



9498



9498



9499



9499



9499



9499



9500



9500



9500



9515



9515



9515



9515



9515



9515



9516



9516



9516



9516



9516



9516



9516



9516



9516



9516





# WIN!

Go to [www.LEGOsurvey.com/product](http://www.LEGOsurvey.com/product) to fill out a survey for a chance to win a cool LEGO® Product.

No purchase necessary.

Open to all residents where not prohibited.



[www.LEGO.com](http://www.LEGO.com)



## [www.LEGOsurvey.com/product](http://www.LEGOsurvey.com/product)

### GEWINNE!

Nimm an der Umfrage auf [www.LEGOsurvey.com/product](http://www.LEGOsurvey.com/product) teil und hab die Chance ein cooles LEGO® Produkt zu gewinnen!

Die Teilnahme am Gewinnspiel führt zu keinerlei Kaufverpflichtungen. Teilnahme in allen nicht ausgeschlossenen Ländern möglich.

### WIN!

Ga naar [www.LEGOsurvey.com/product](http://www.LEGOsurvey.com/product), vul een enquêteformulier in en maak kans op een cool LEGO® product.

Geen aankoopverplichting. Iedereen mag deelnemen, uitgezonderd ingezetenden van landen waar een enquêteverbod geldt.

### GAGNE!

Visite [www.LEGOsurvey.com/product](http://www.LEGOsurvey.com/product) pour répondre à un questionnaire et avoir une chance de gagner un produit LEGO® très cool!

Aucune obligation d'achat. Ouvert à tous les résidents des pays autorisés.

### 当てよう!

[www.LEGOsurvey.com/product](http://www.LEGOsurvey.com/product) にアクセスして、アンケートにご記入ください。当選者にはレゴ製品を差し上げます。

お買い上げの必要はありません。禁止されていない限り、すべての皆様にご利用いただけます。