

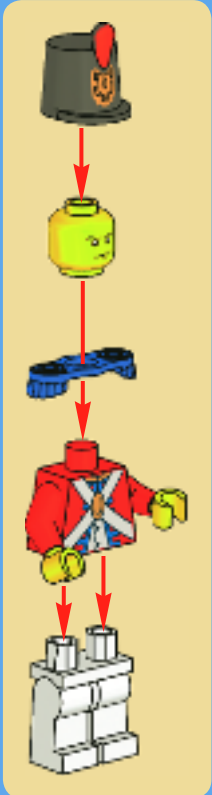

IMPERIAL FLAGSHIP LE VAISSEAU AMIRAL

10210





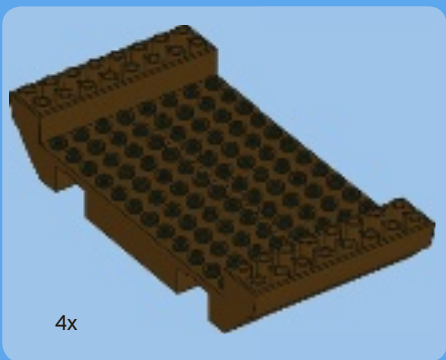

4x

1

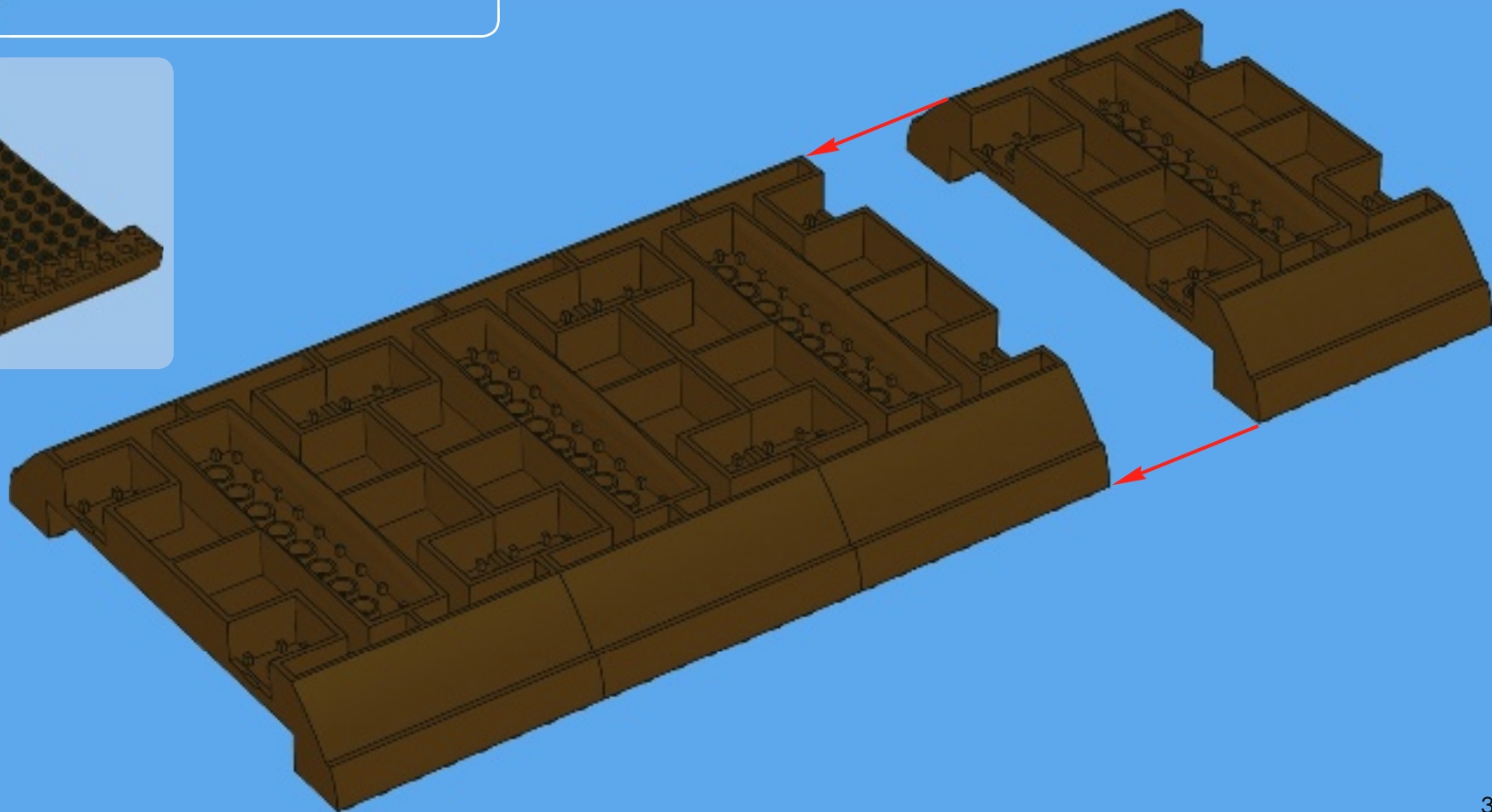



6x



4x

2

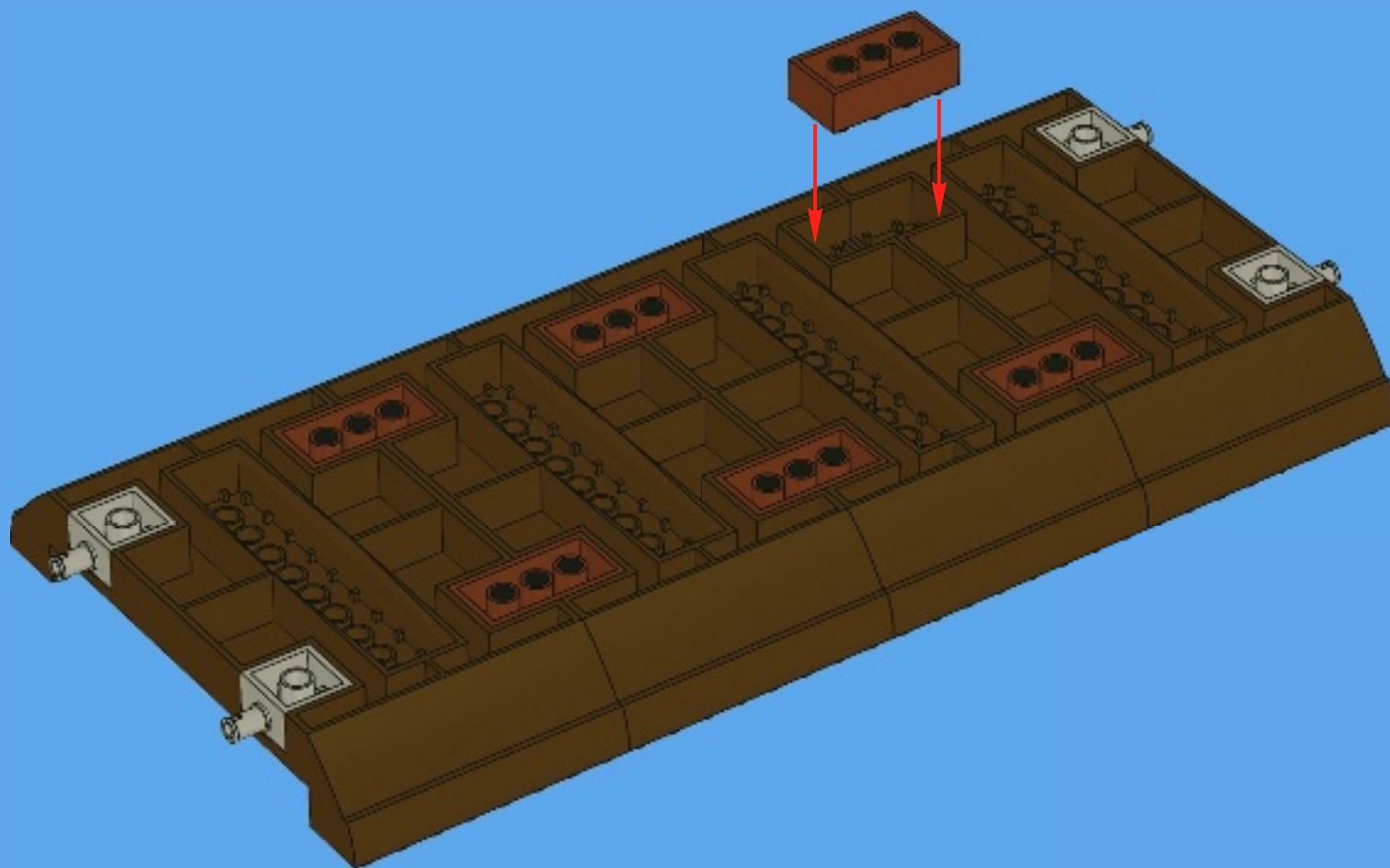



16x



16x



2x

3

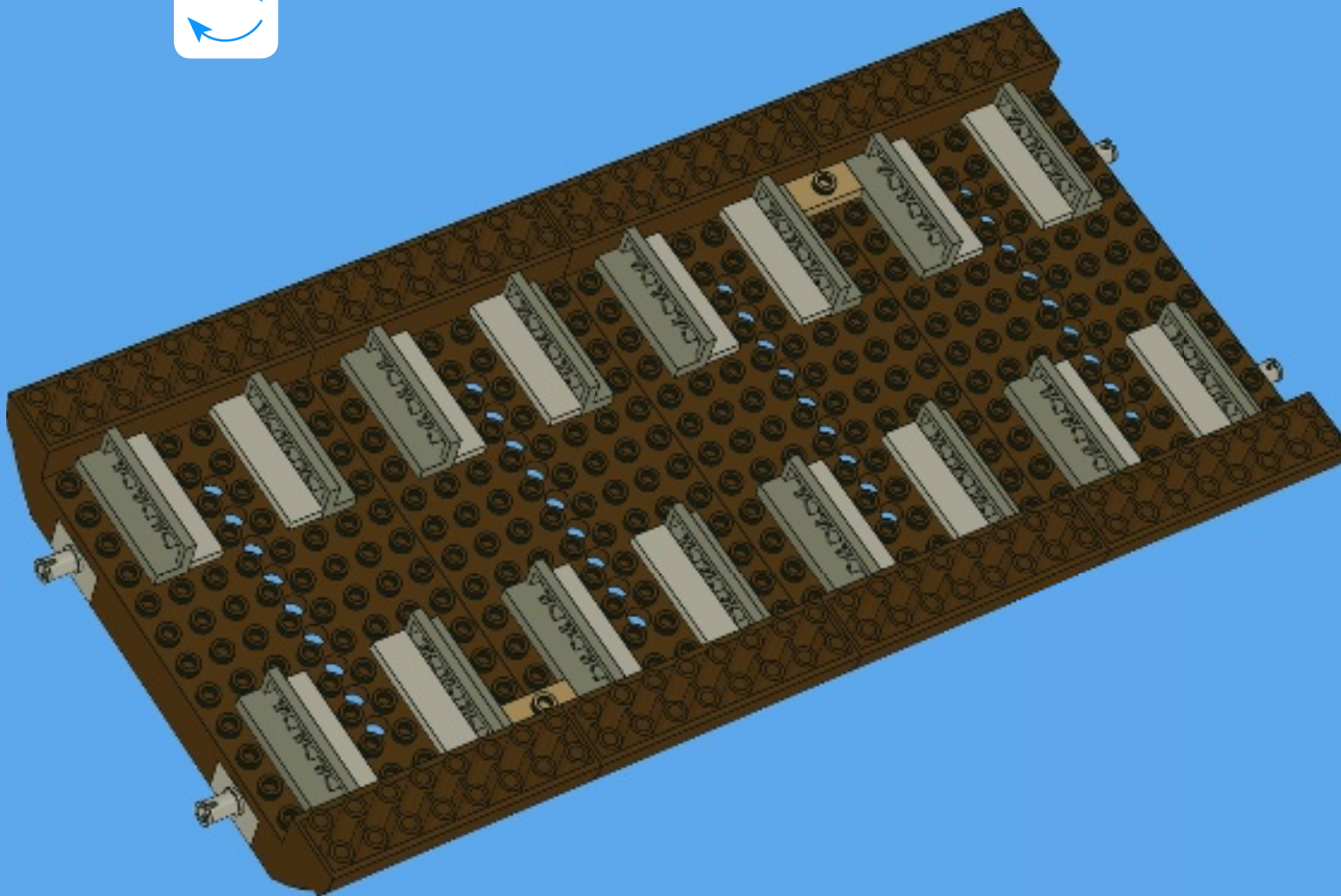

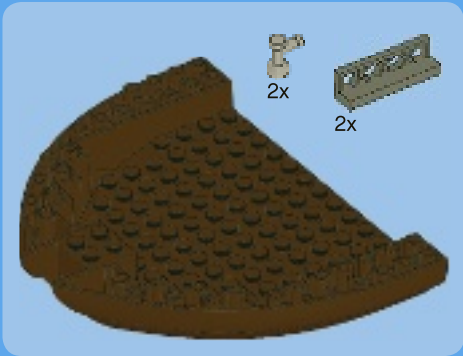

1

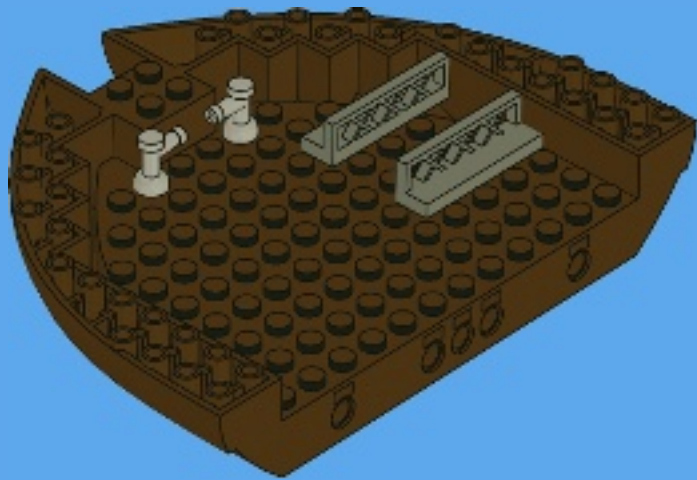

2

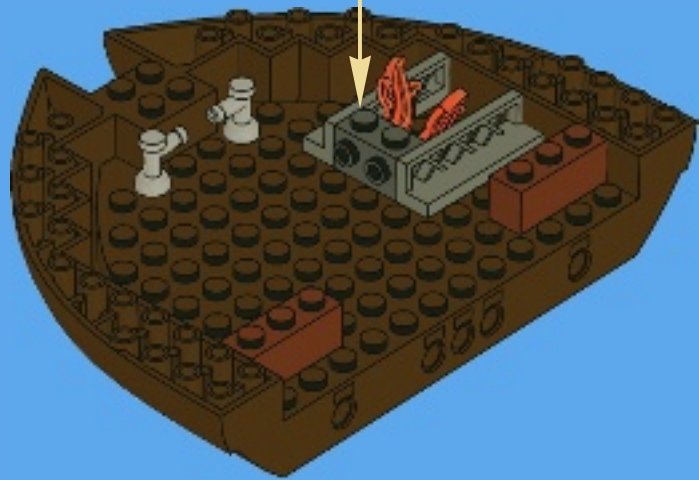
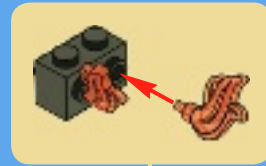



3

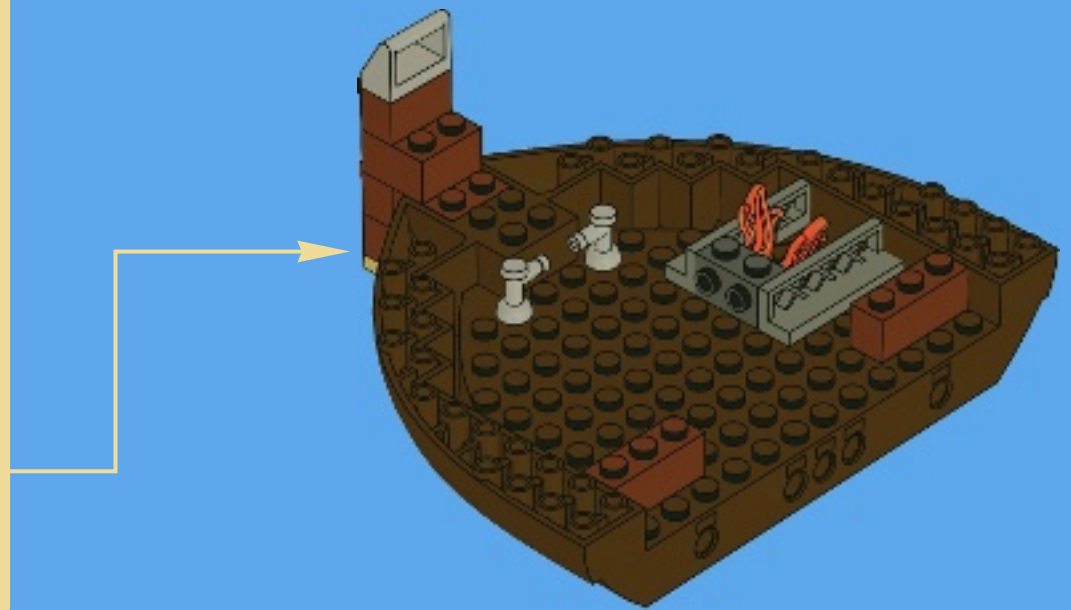
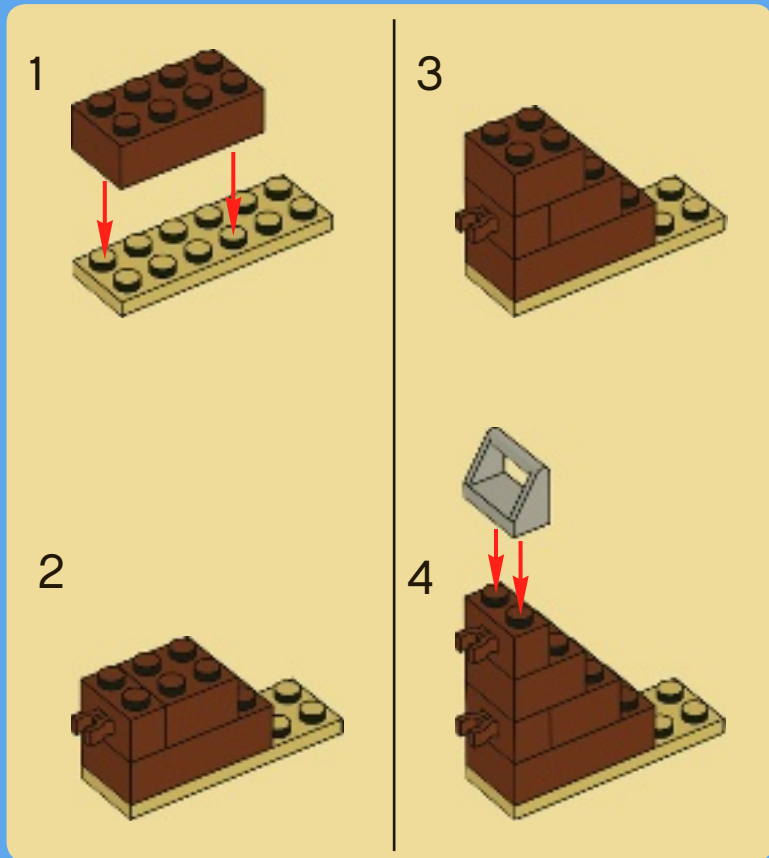



2x



2x



2x

4

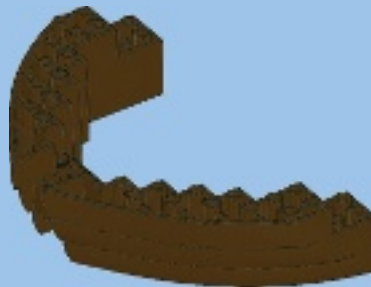
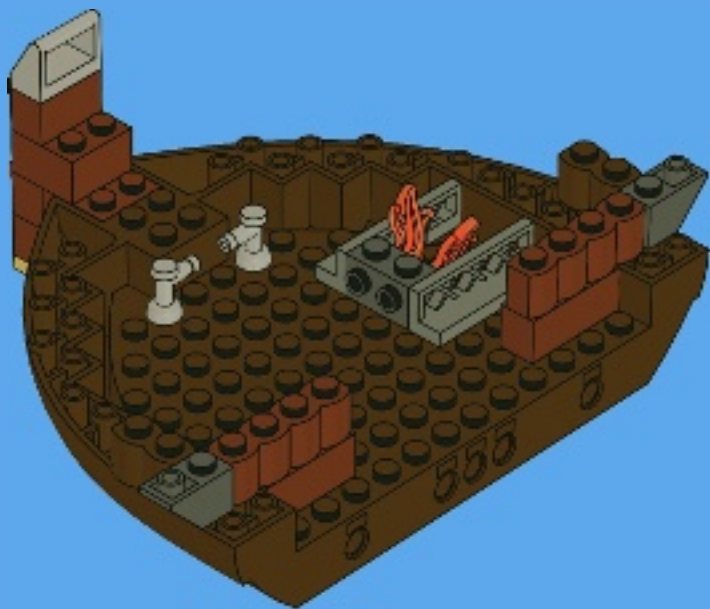

1x

5

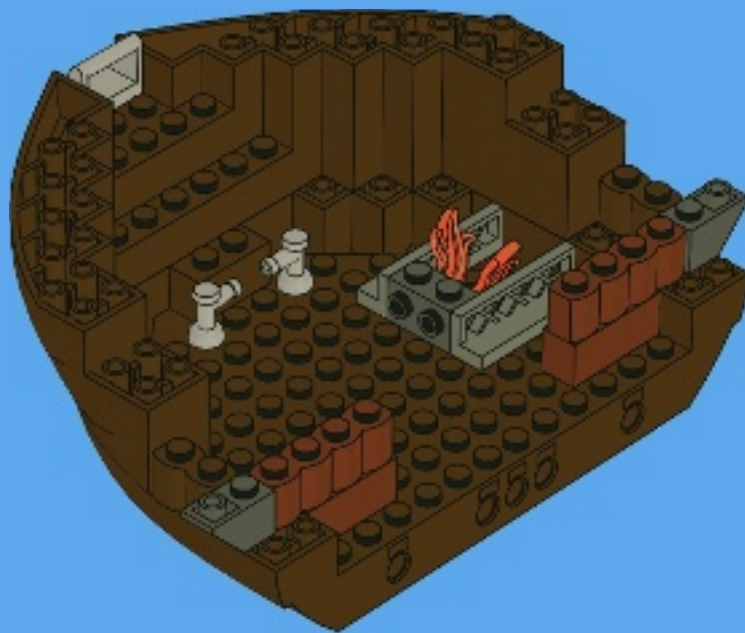



1x



4x

6

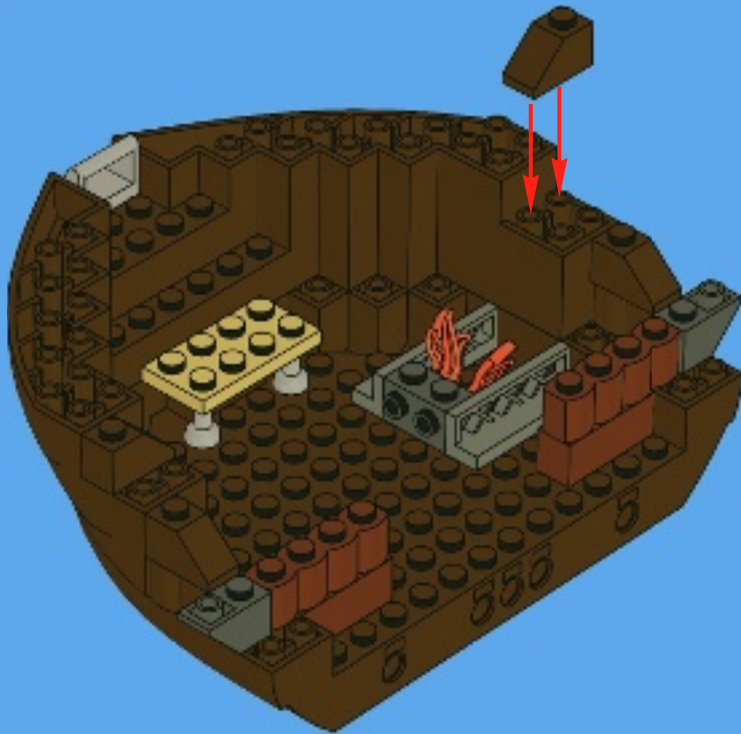

2x



1x



1x



1x



2x

7



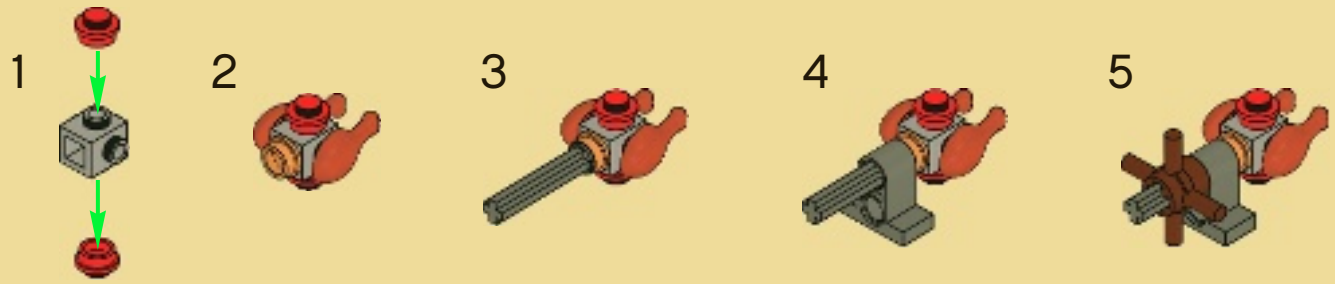

8

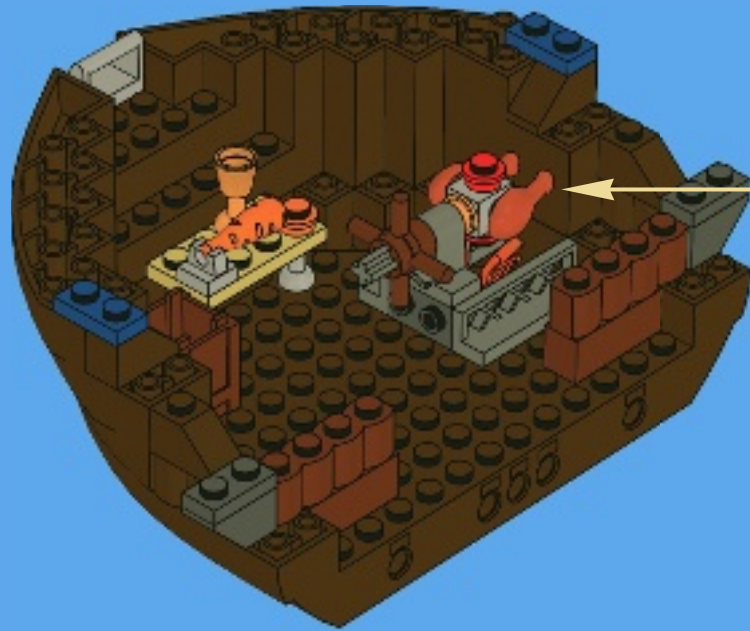



2x



4x



2x

9



2x



4x



2x



4x

10

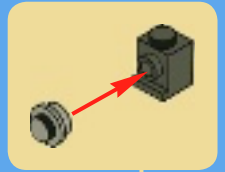
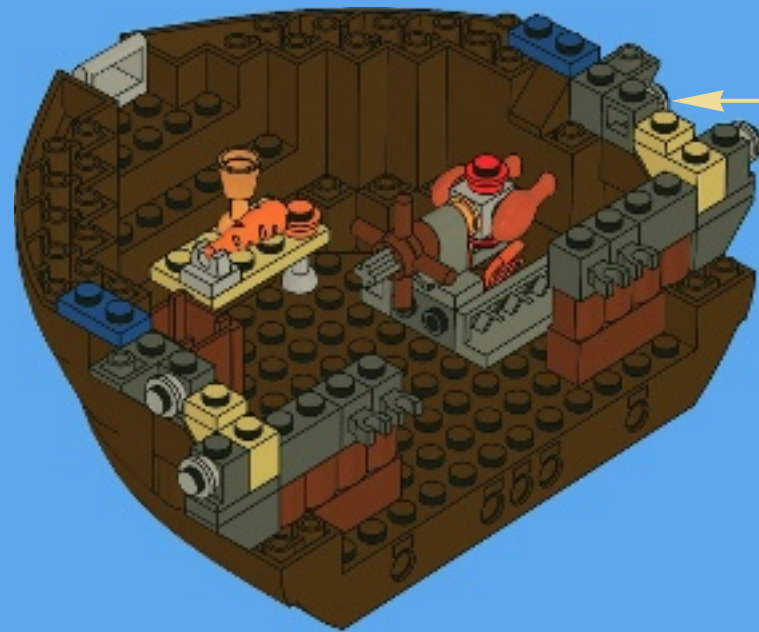

4x

2x

2x

11

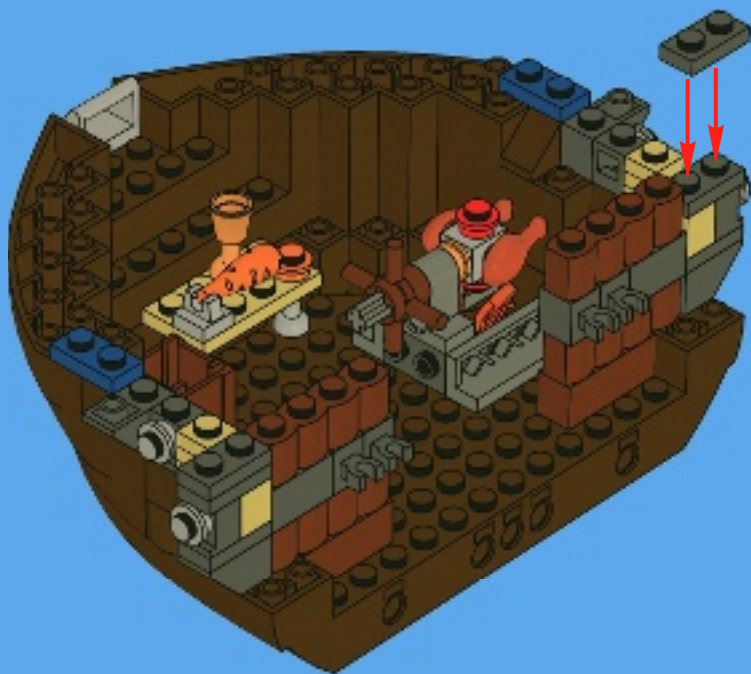

2x

2x

2x

12



2x

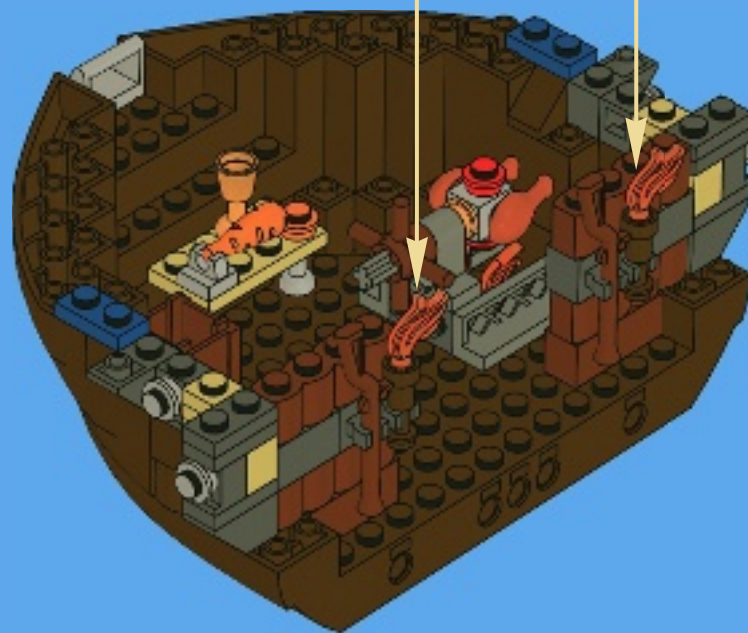

4

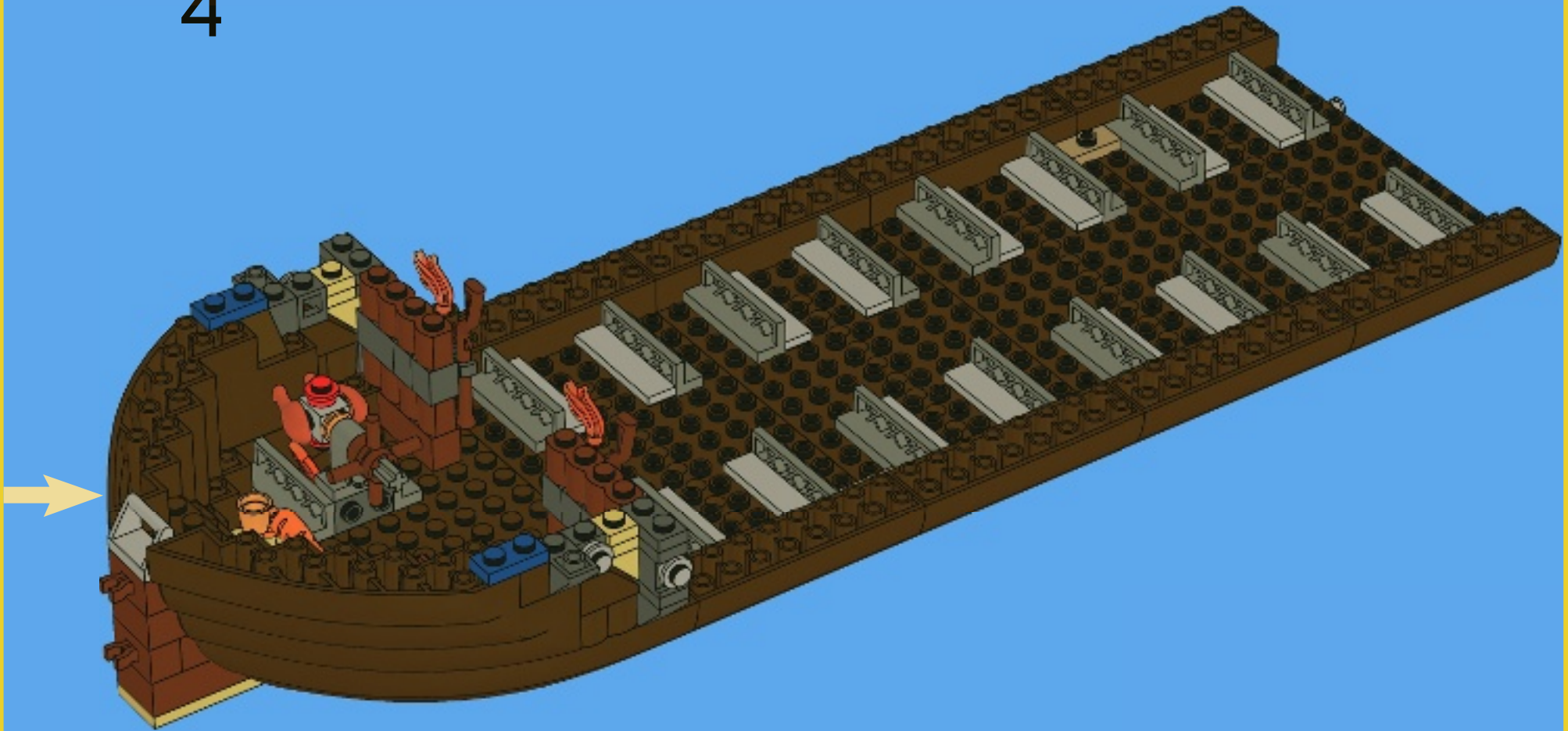

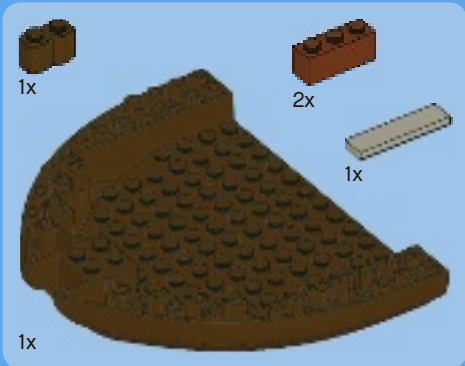

1

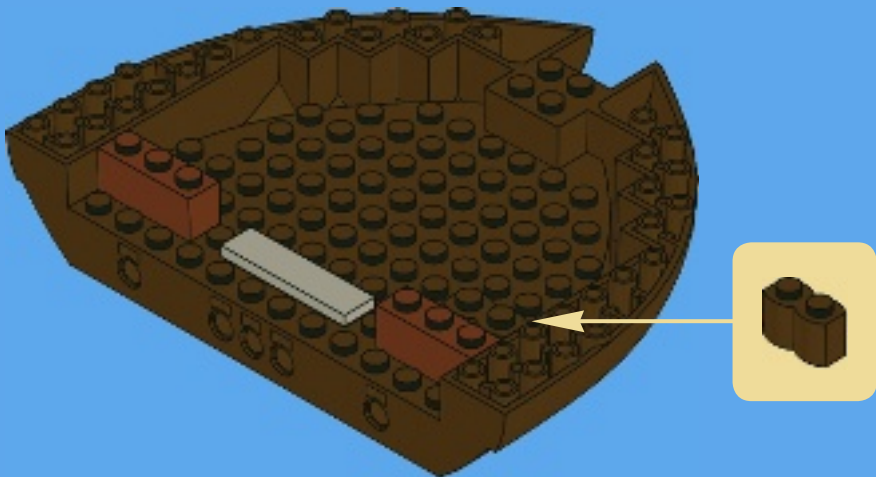

2

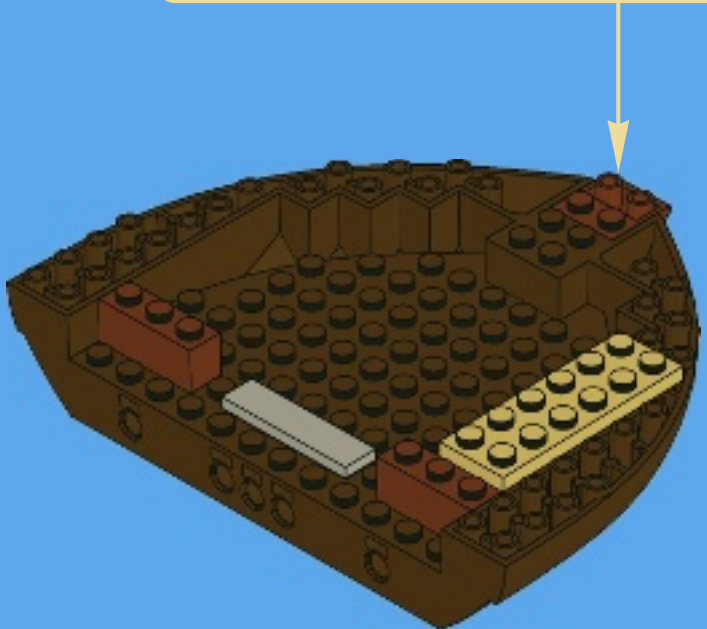
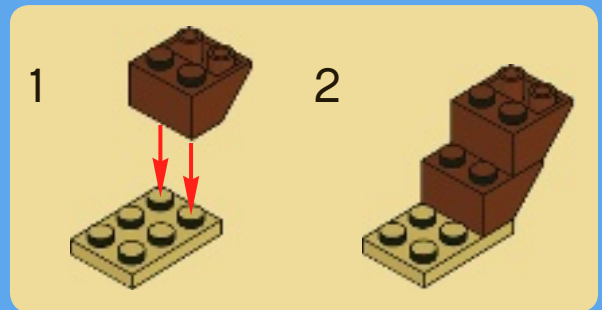

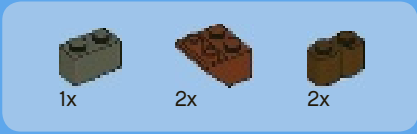

3

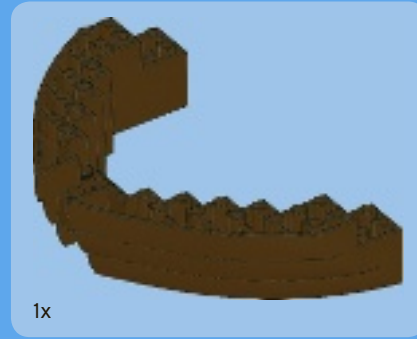
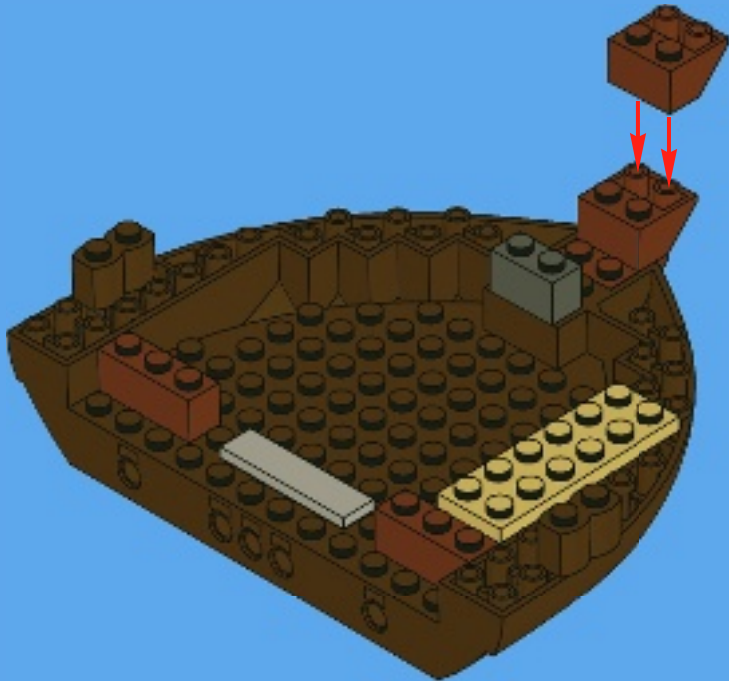

4

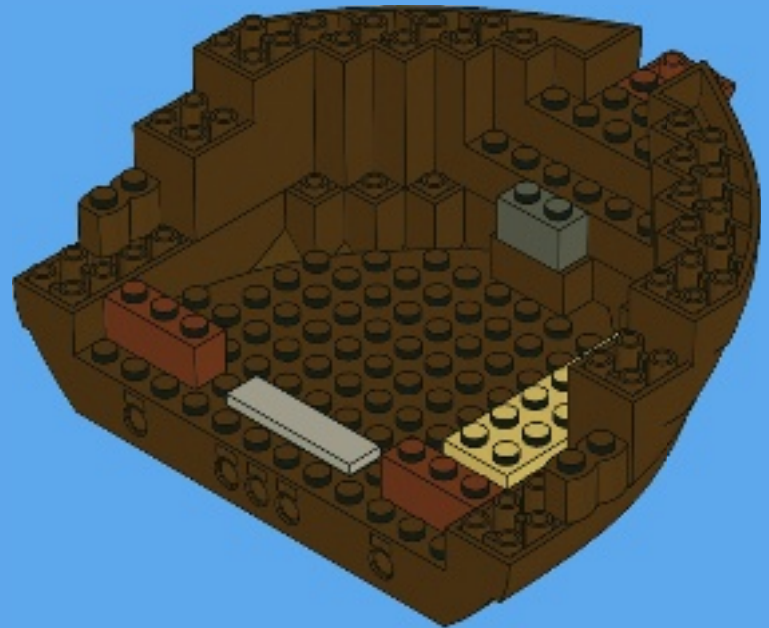



5

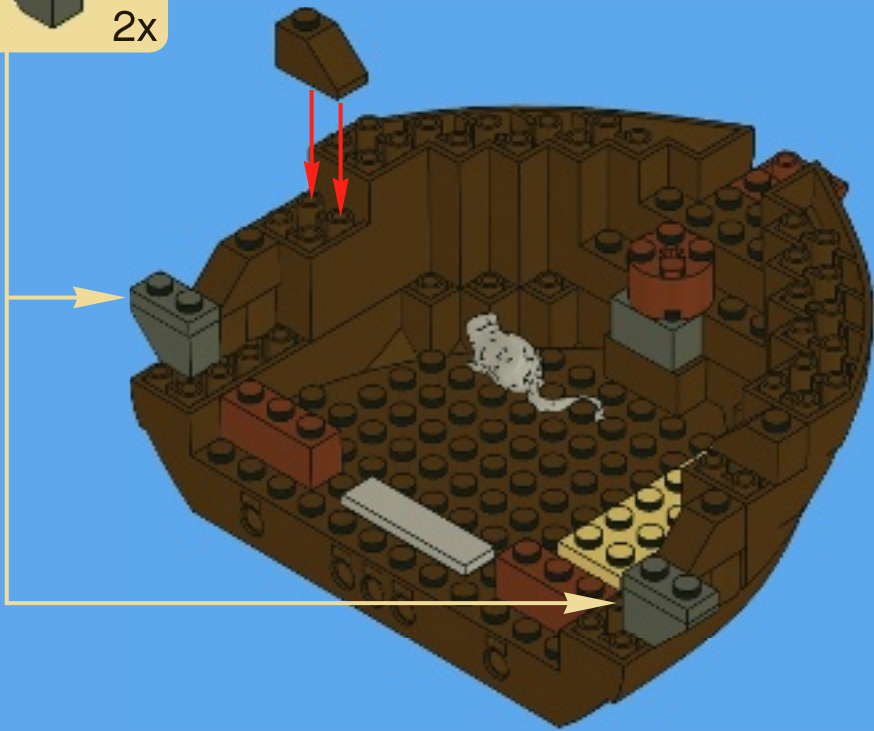
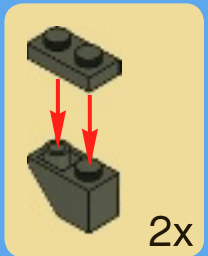

6

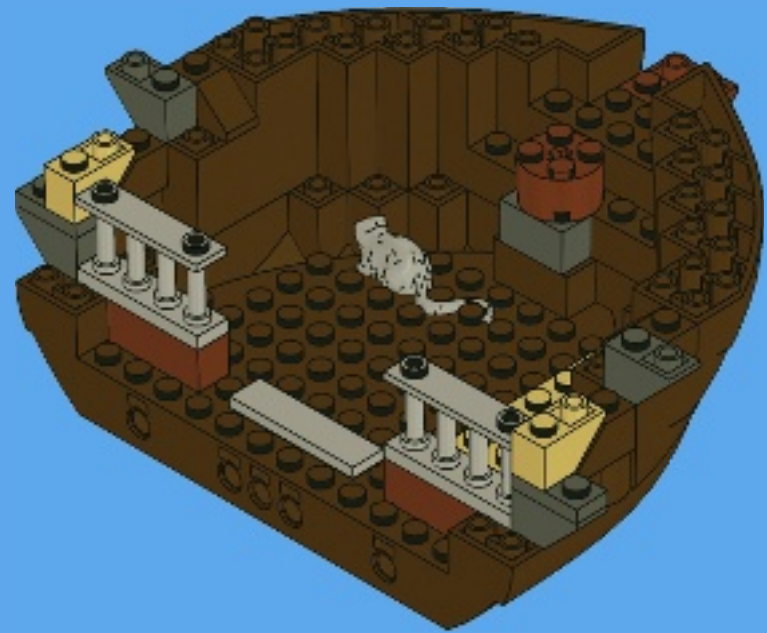



4x



4x



2x

7

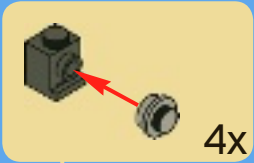

4x

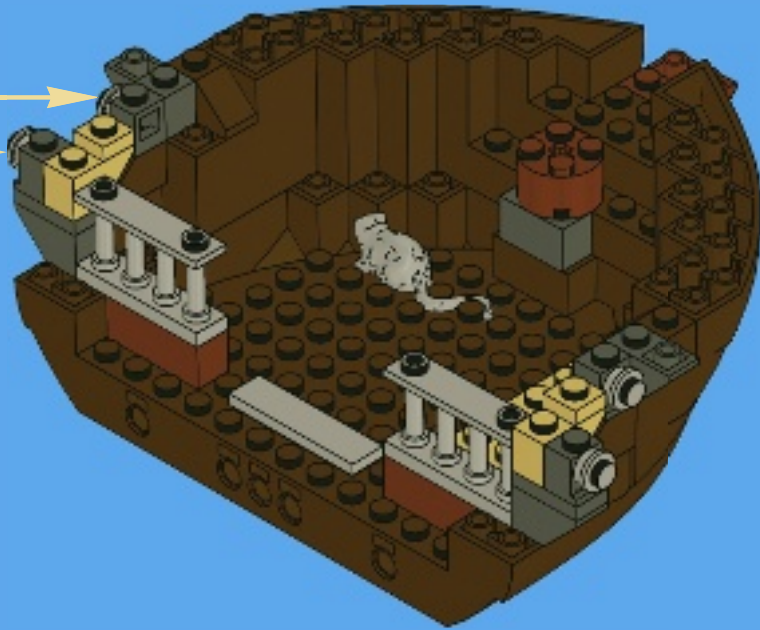

2x



4x



4x



2x



1x

8

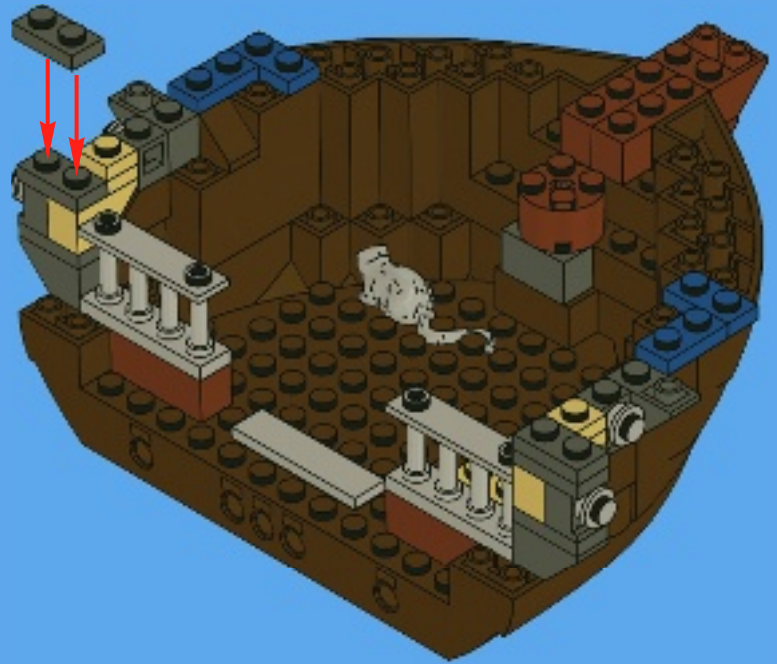

5

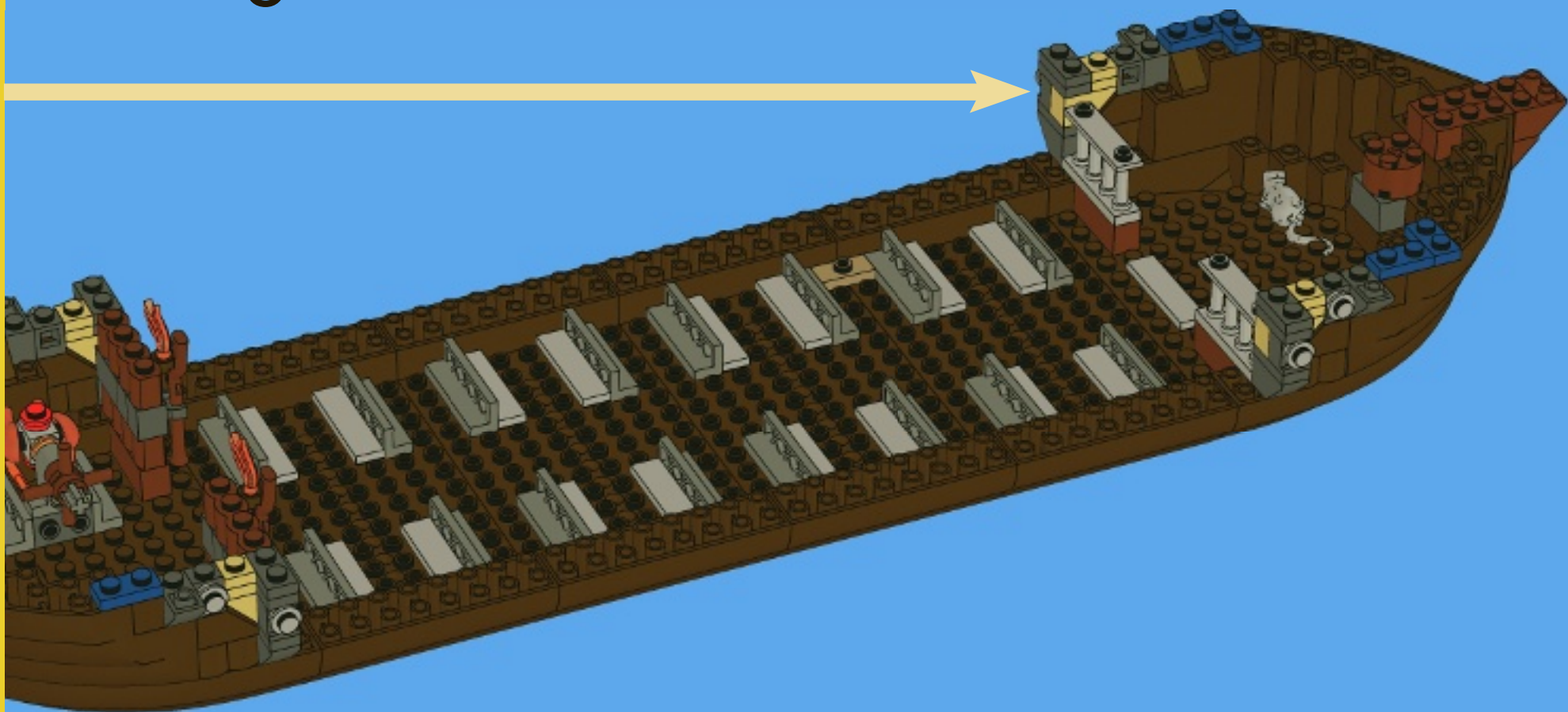



16x



26x

6

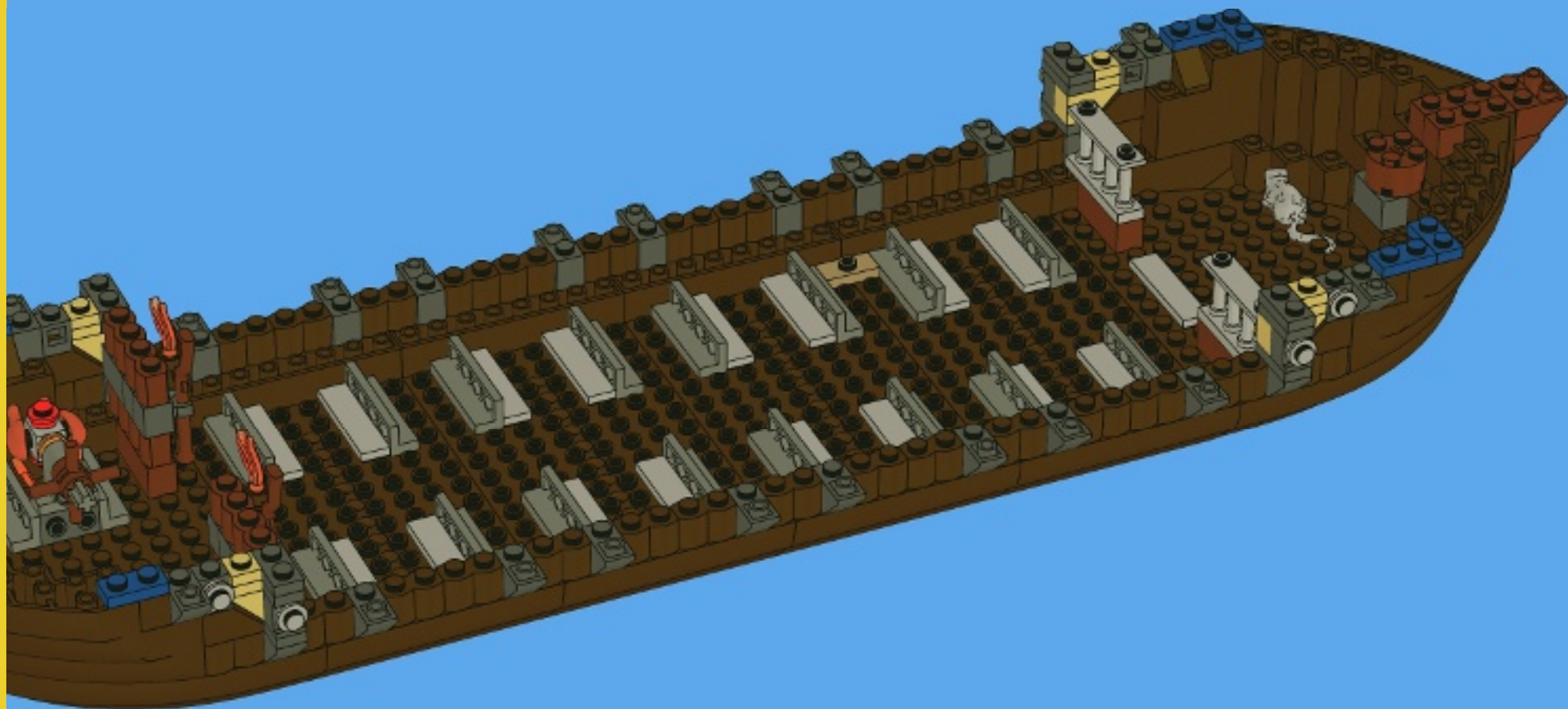

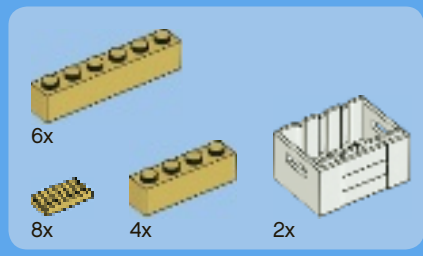

7

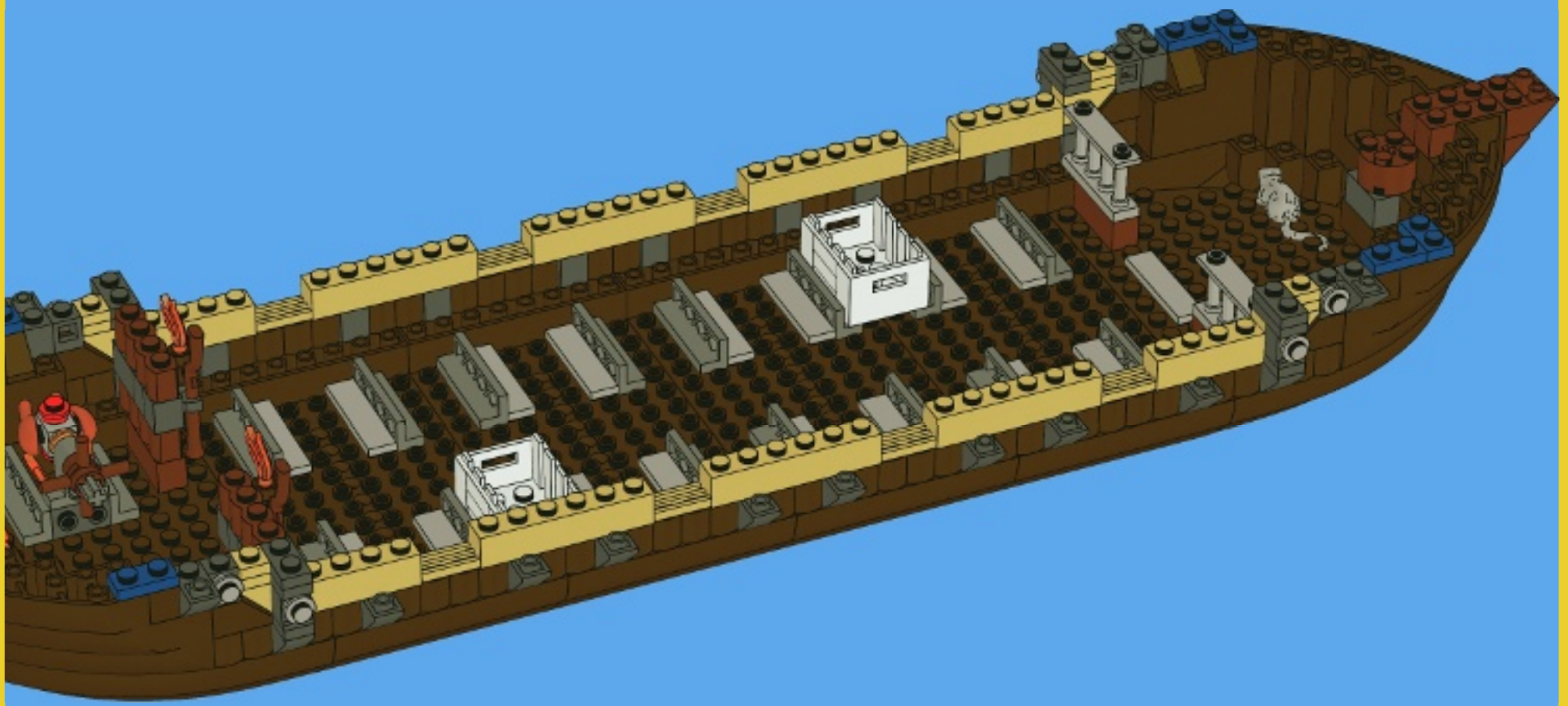



16x



16x

8

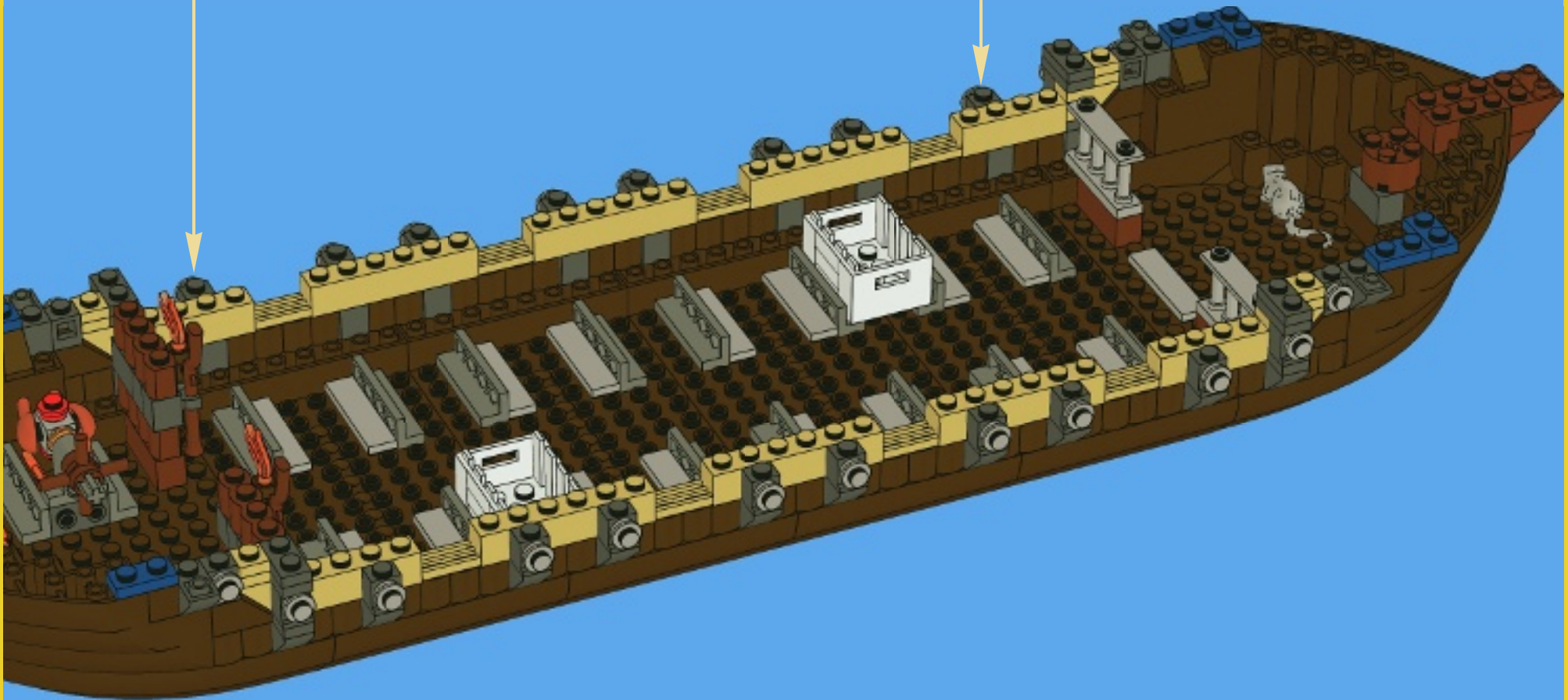
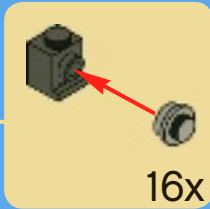

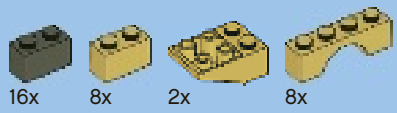

9

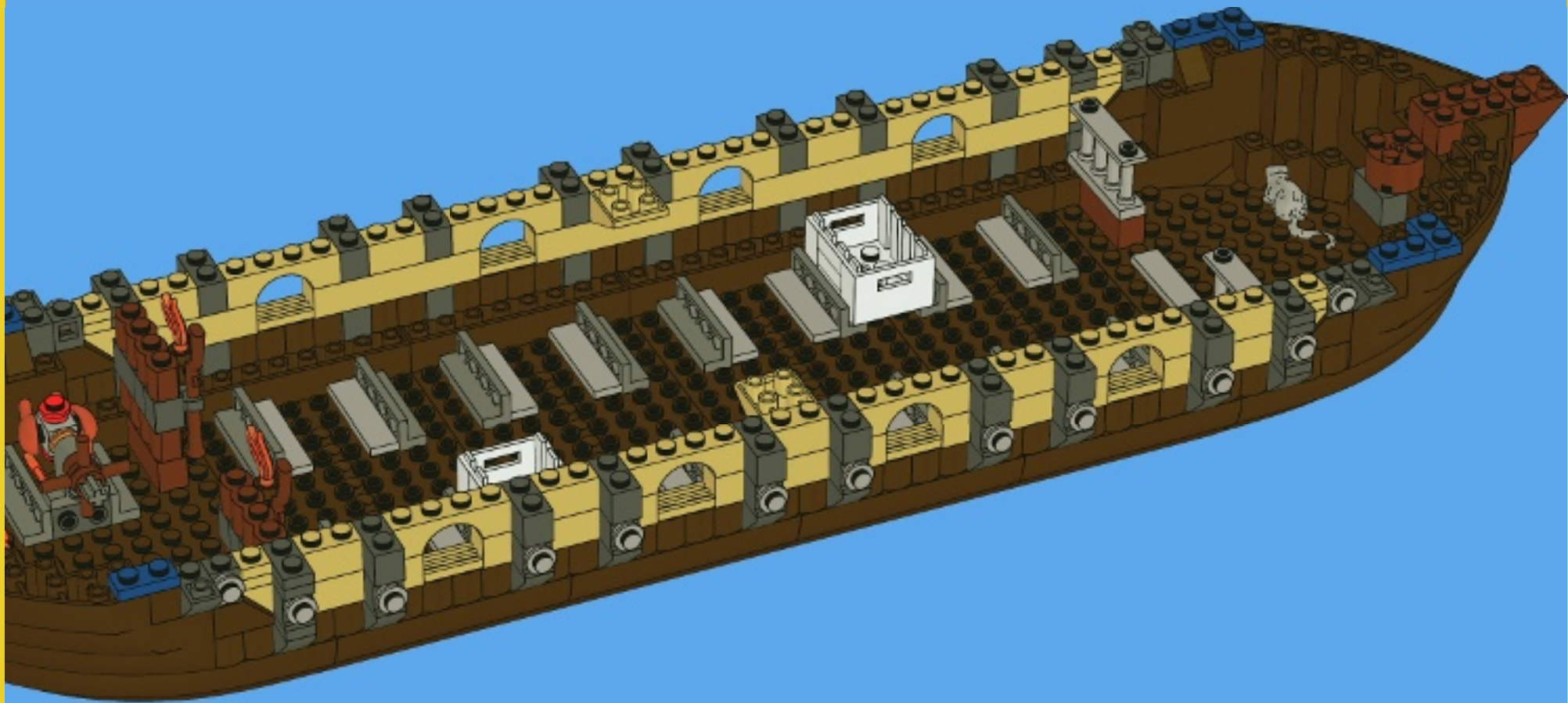

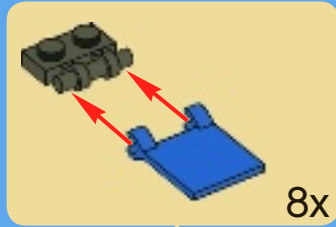
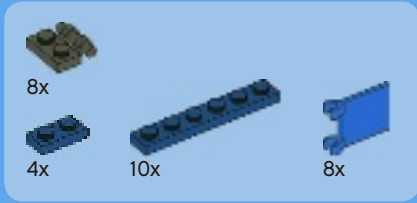

10

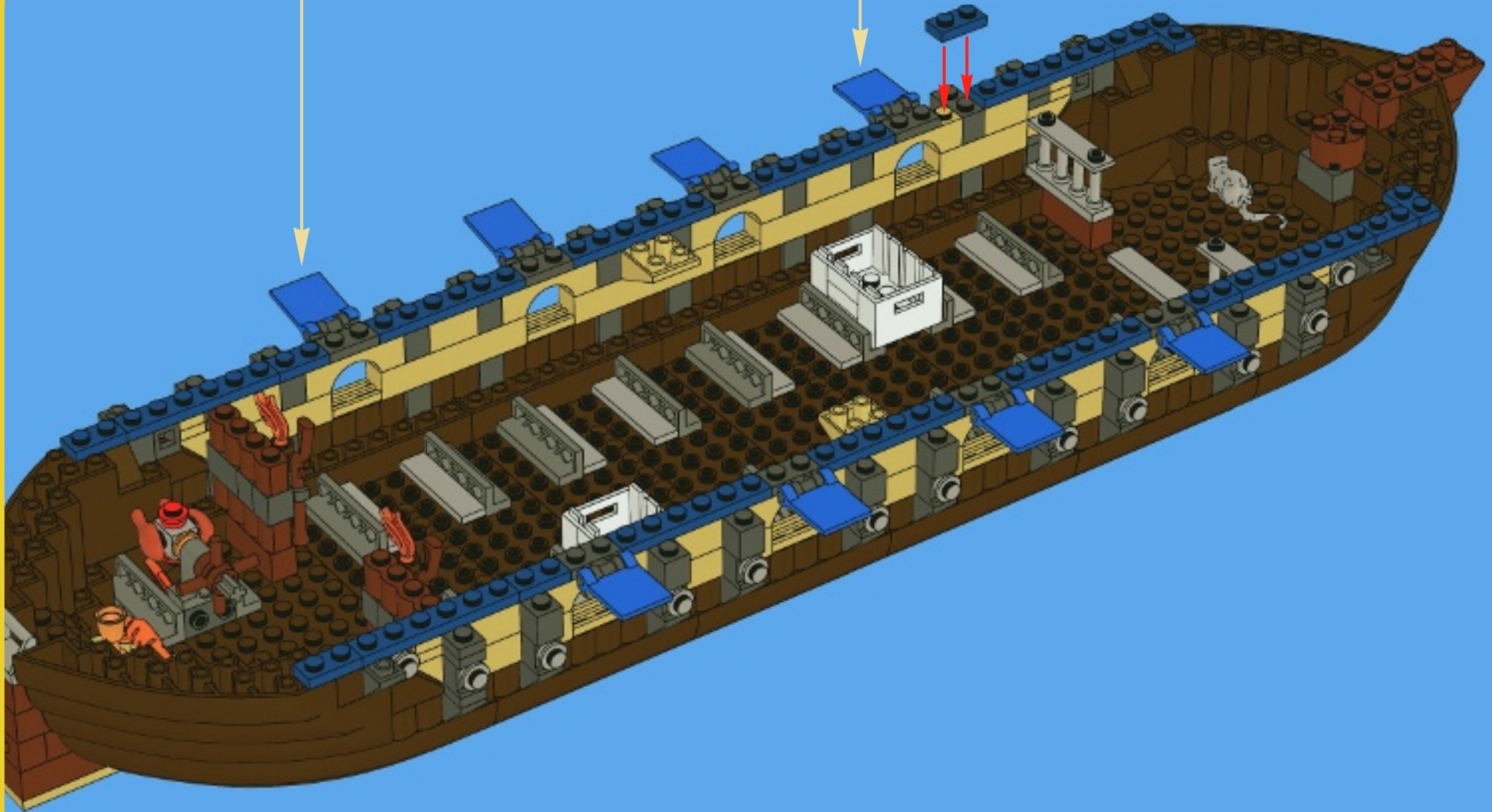



11

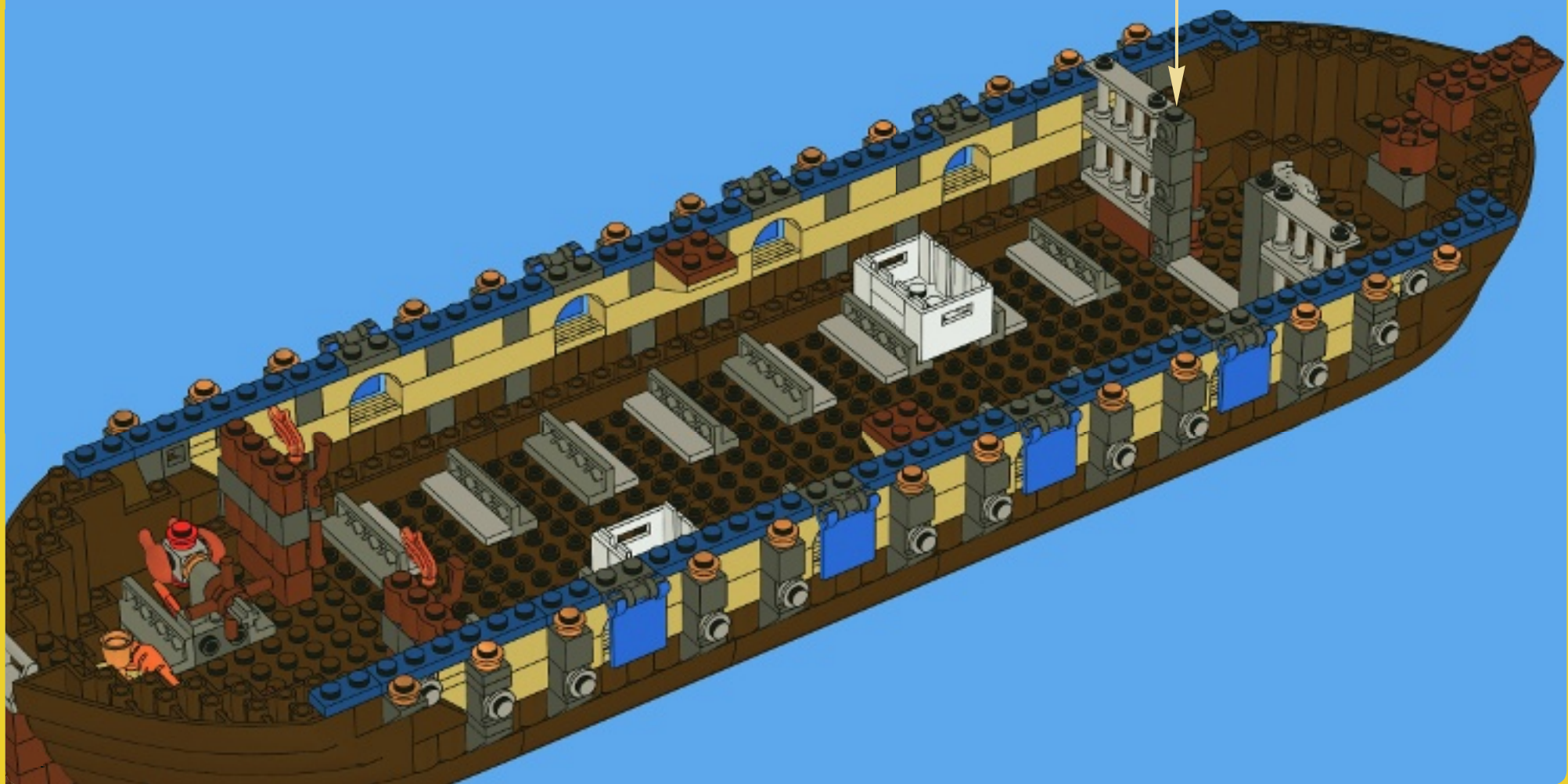
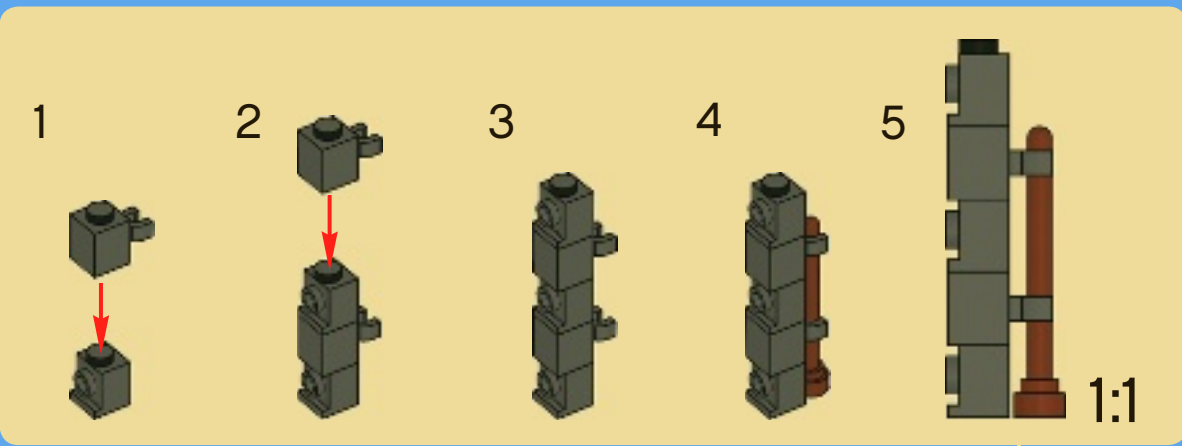

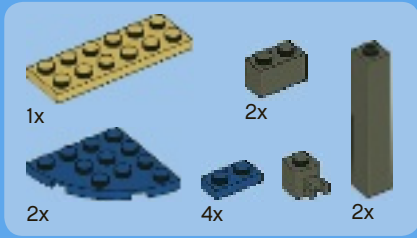

12

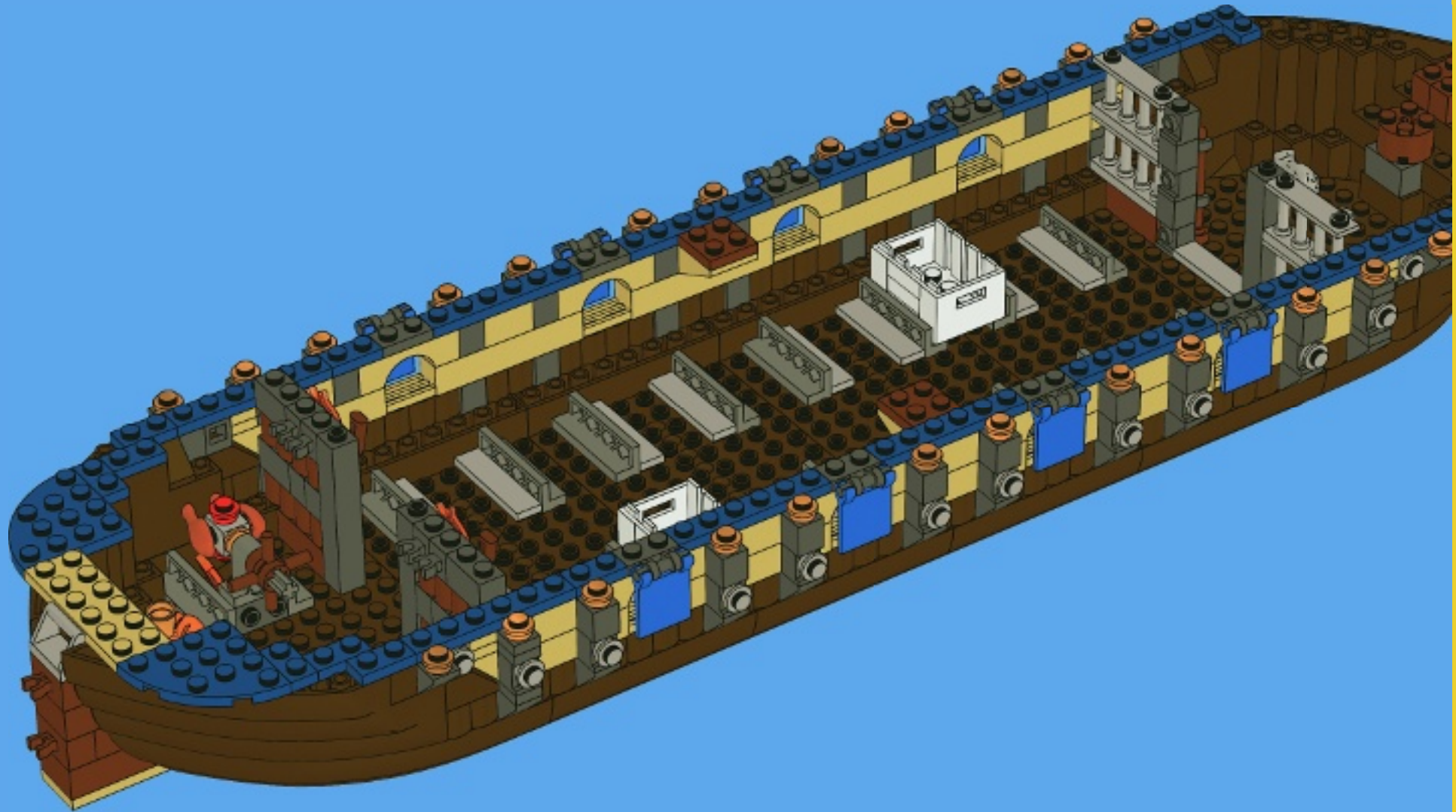

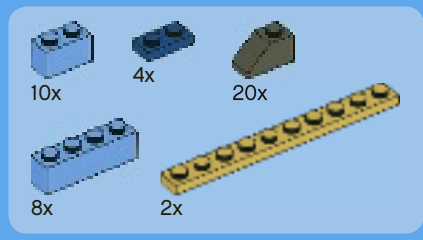

13

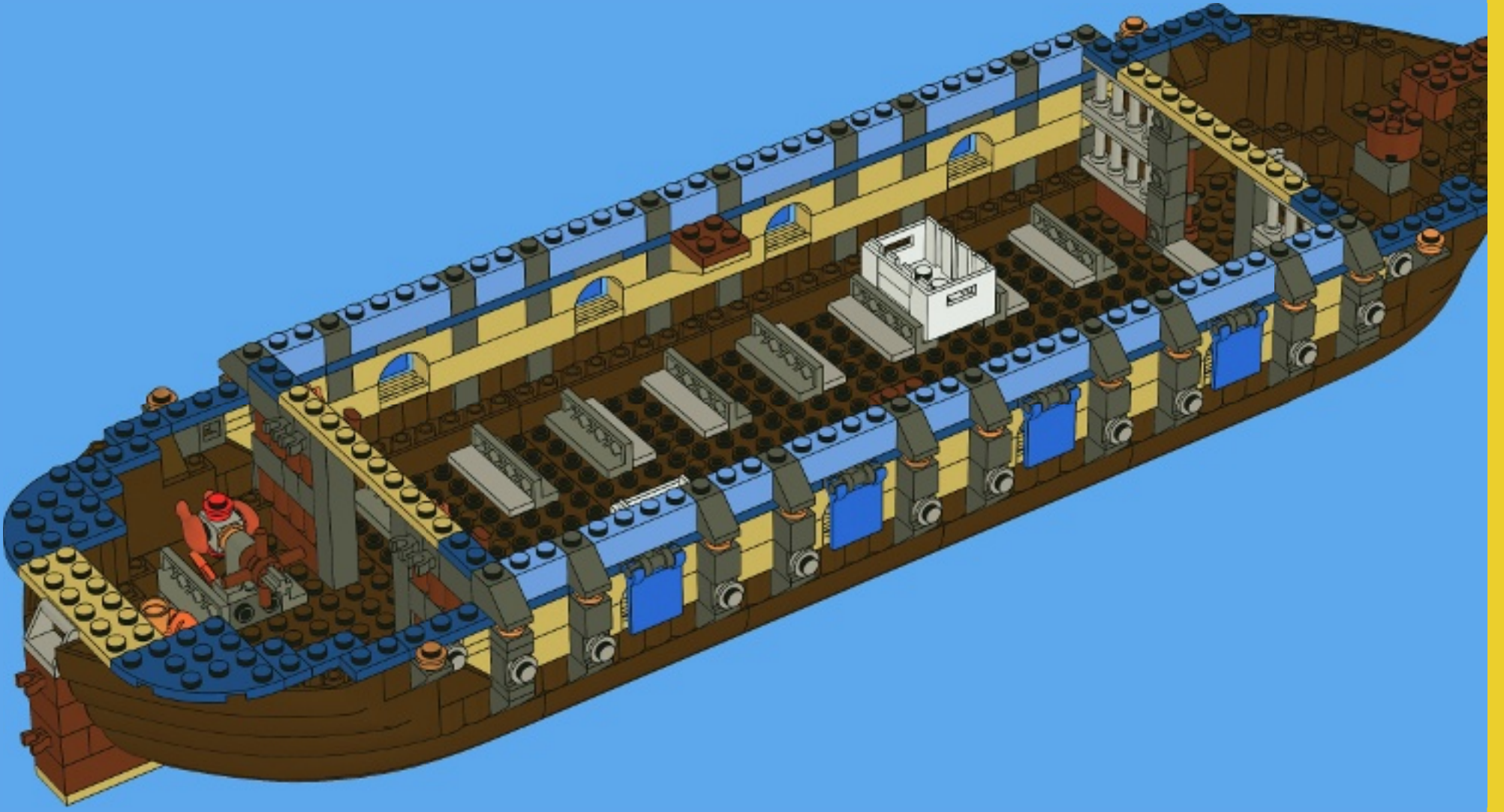

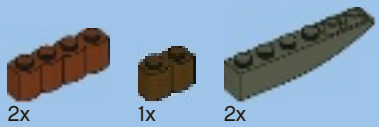

14

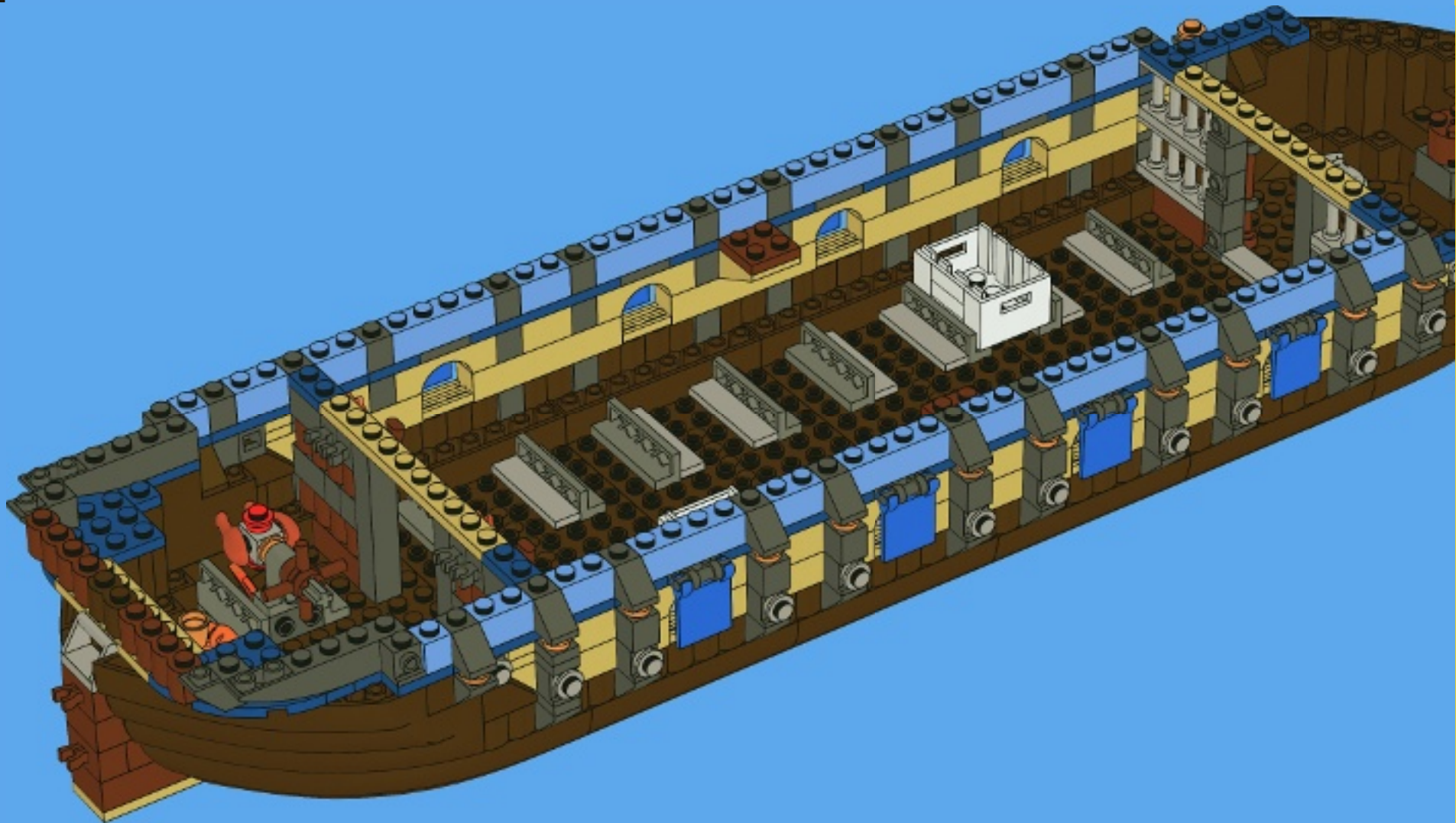



4x



19x

15

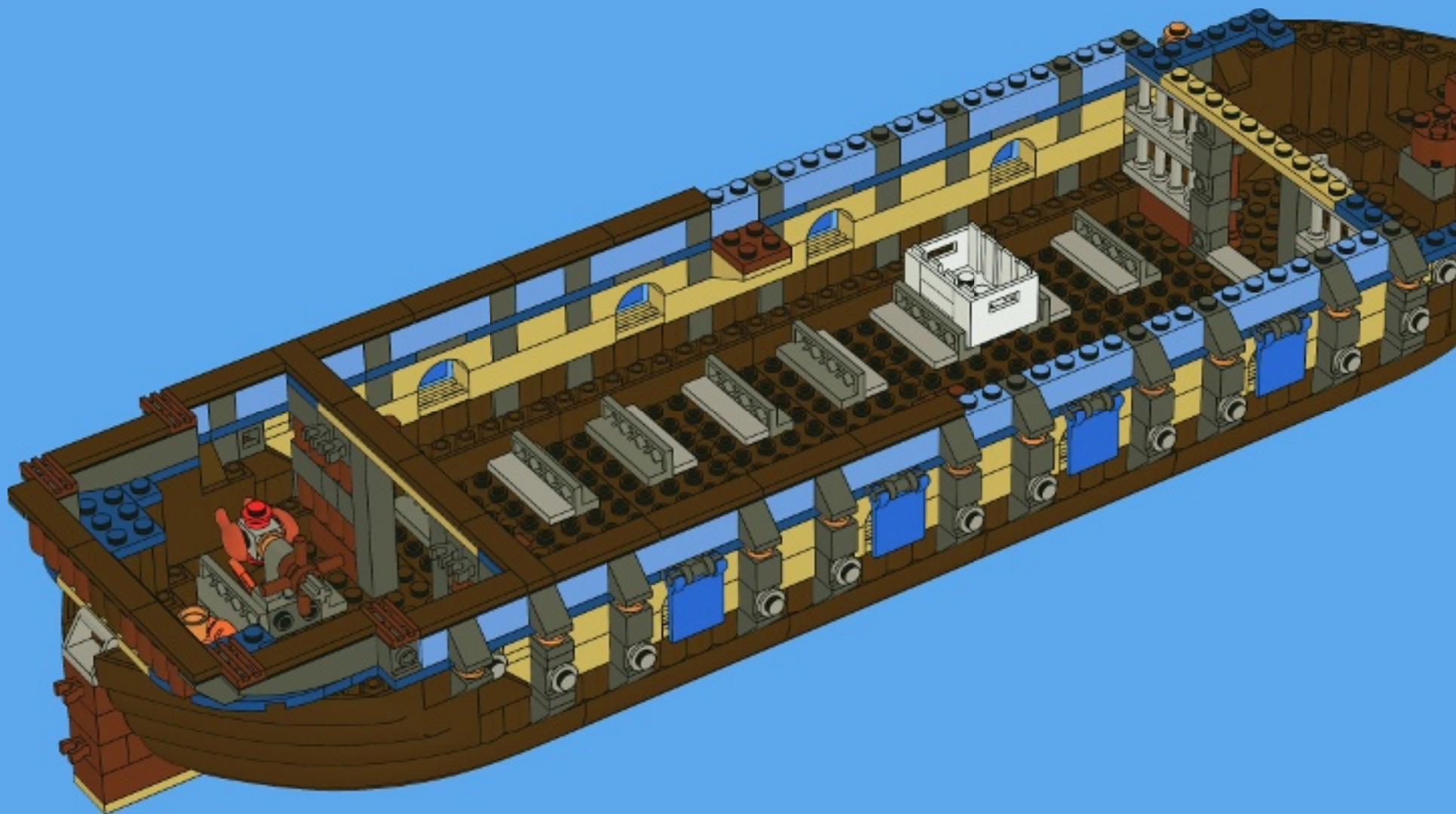

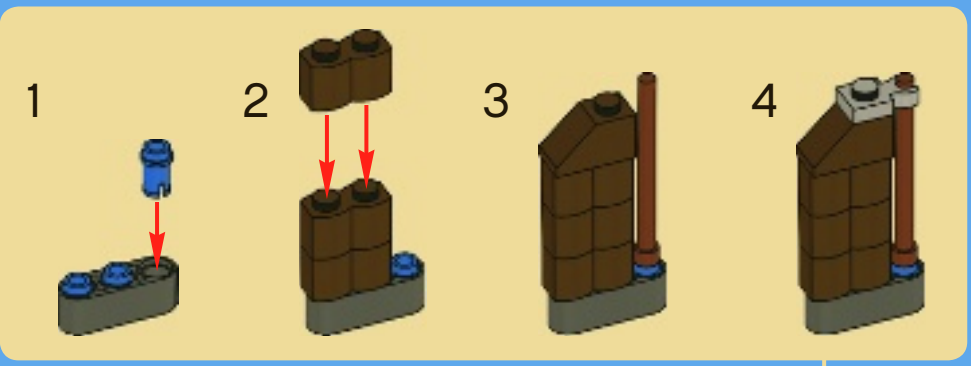

16

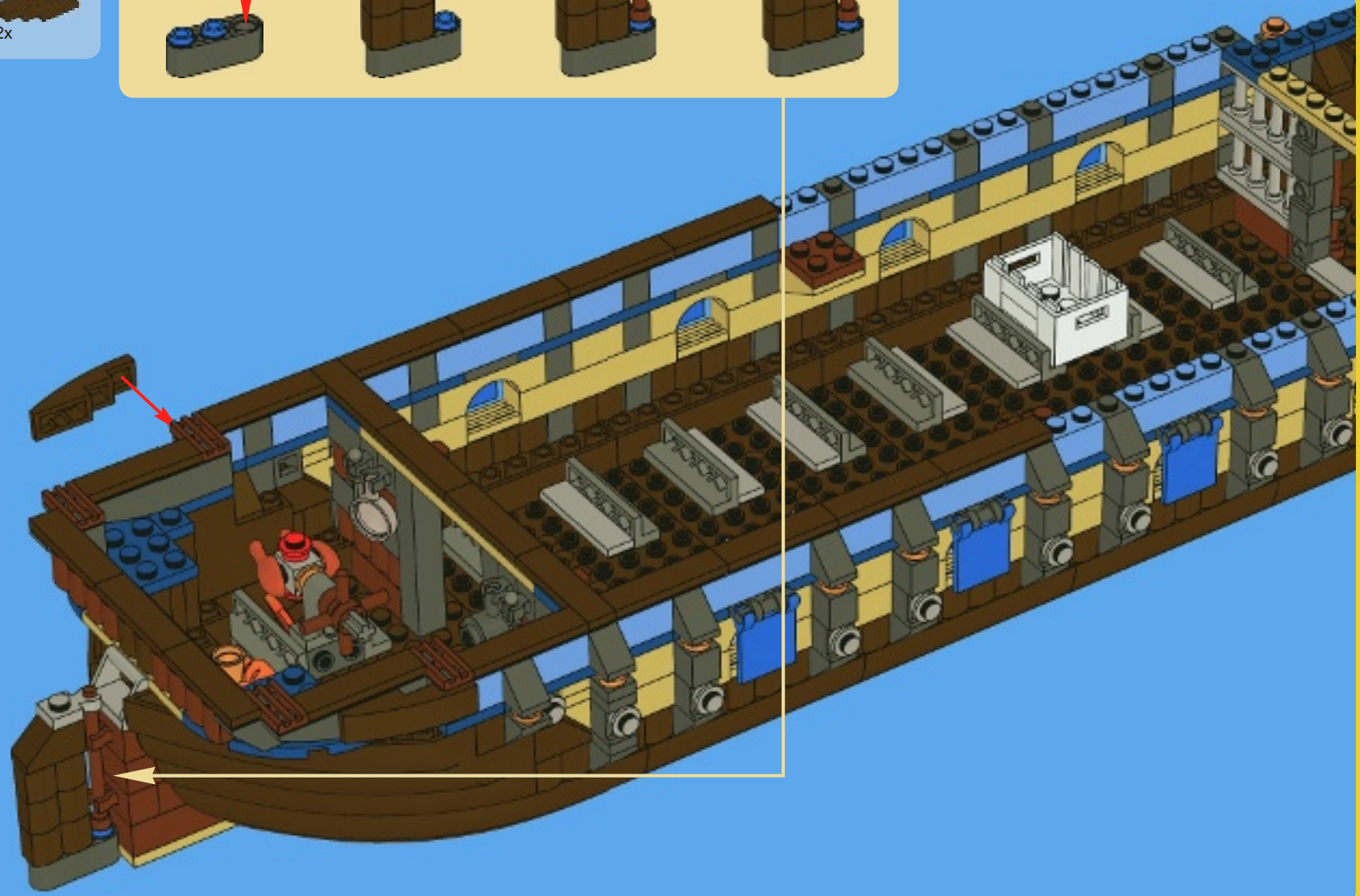



2x



20x

18

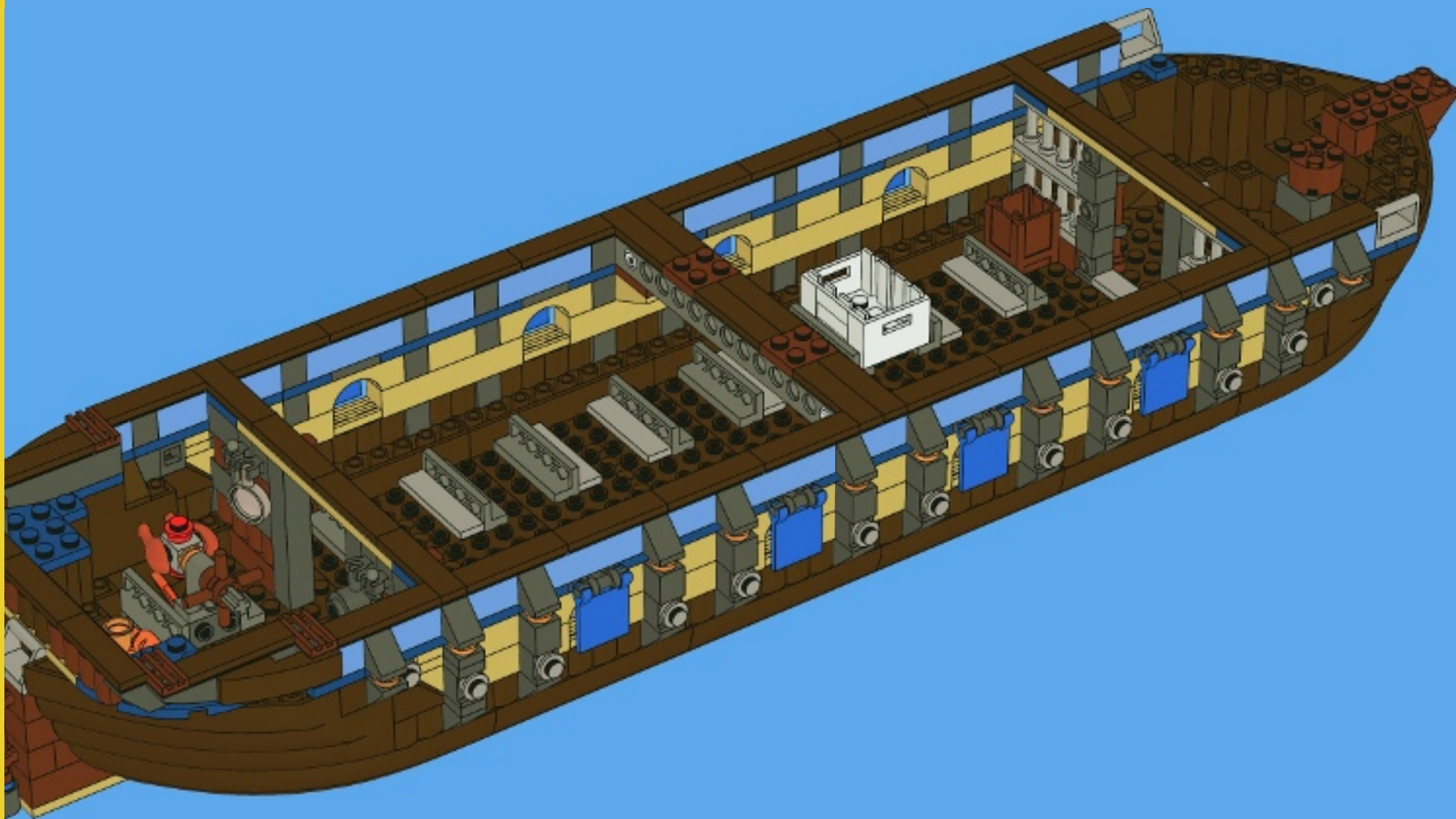



19

<p>1</p>	<p>3</p>	<p>5</p>
<p>2</p>	<p>4</p>	<p>6</p>

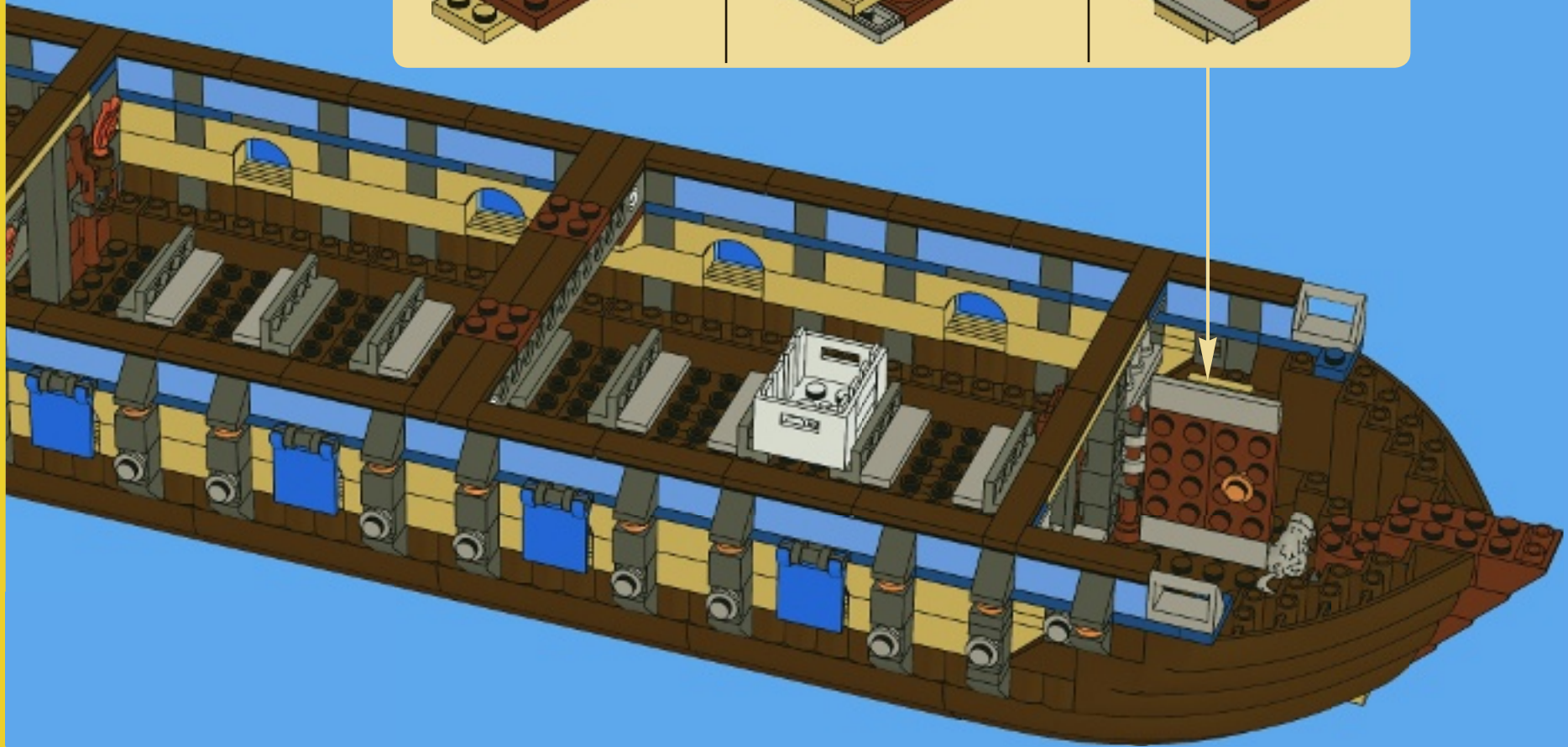

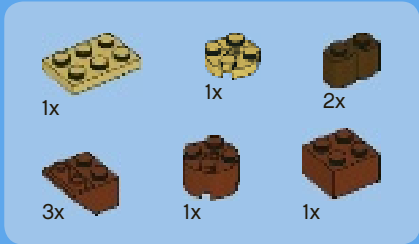

20

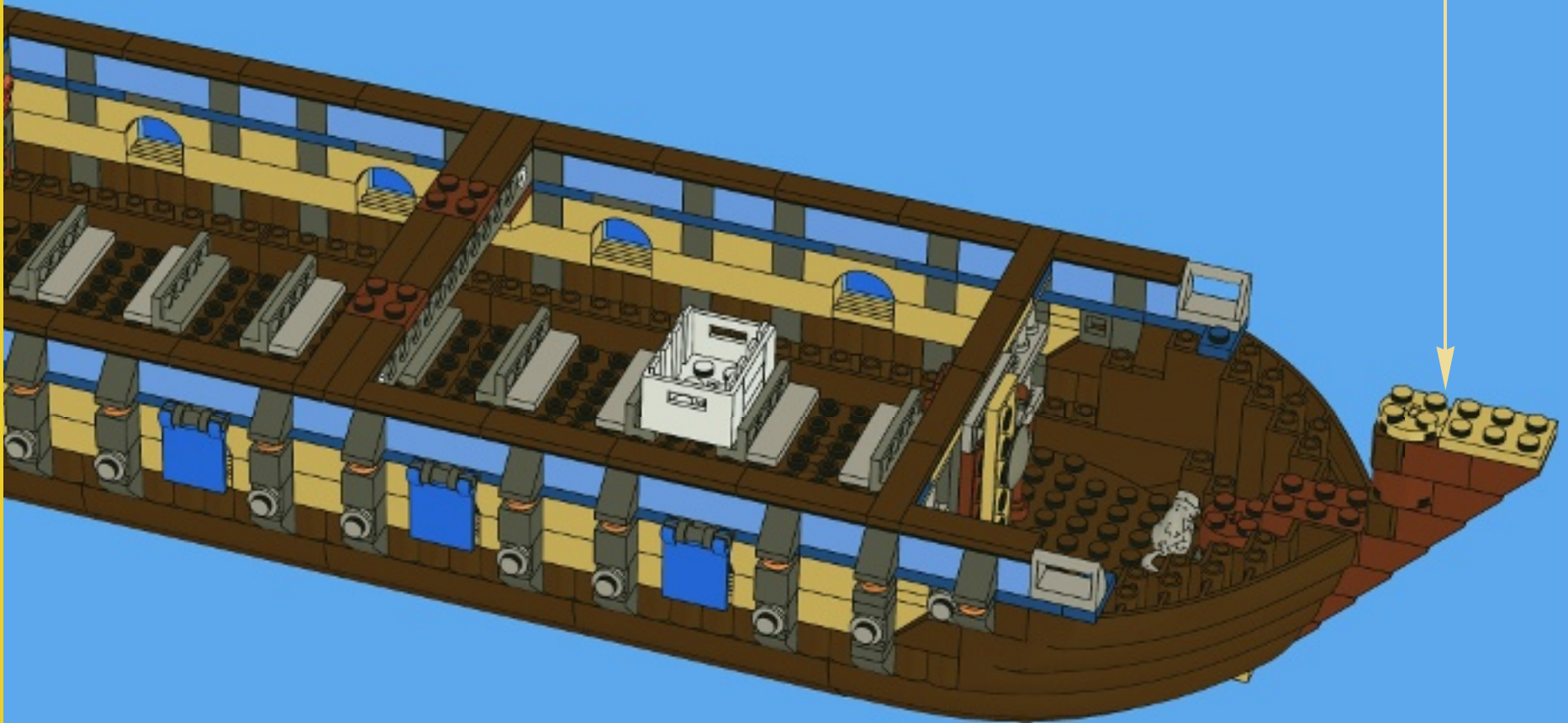
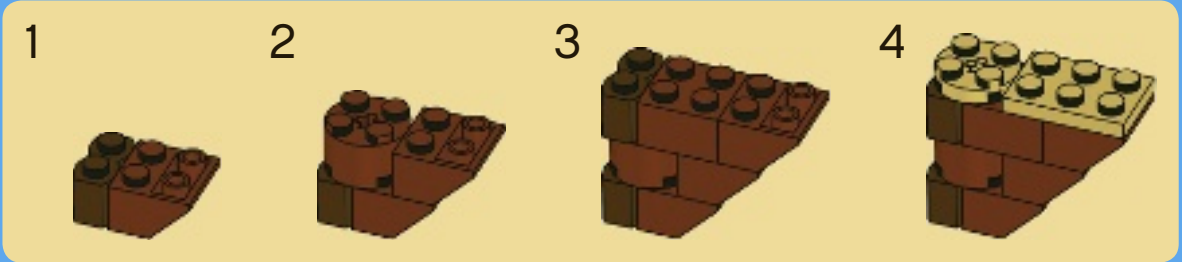



3x



1x



1x



5

1:1

21

1

5

2

3

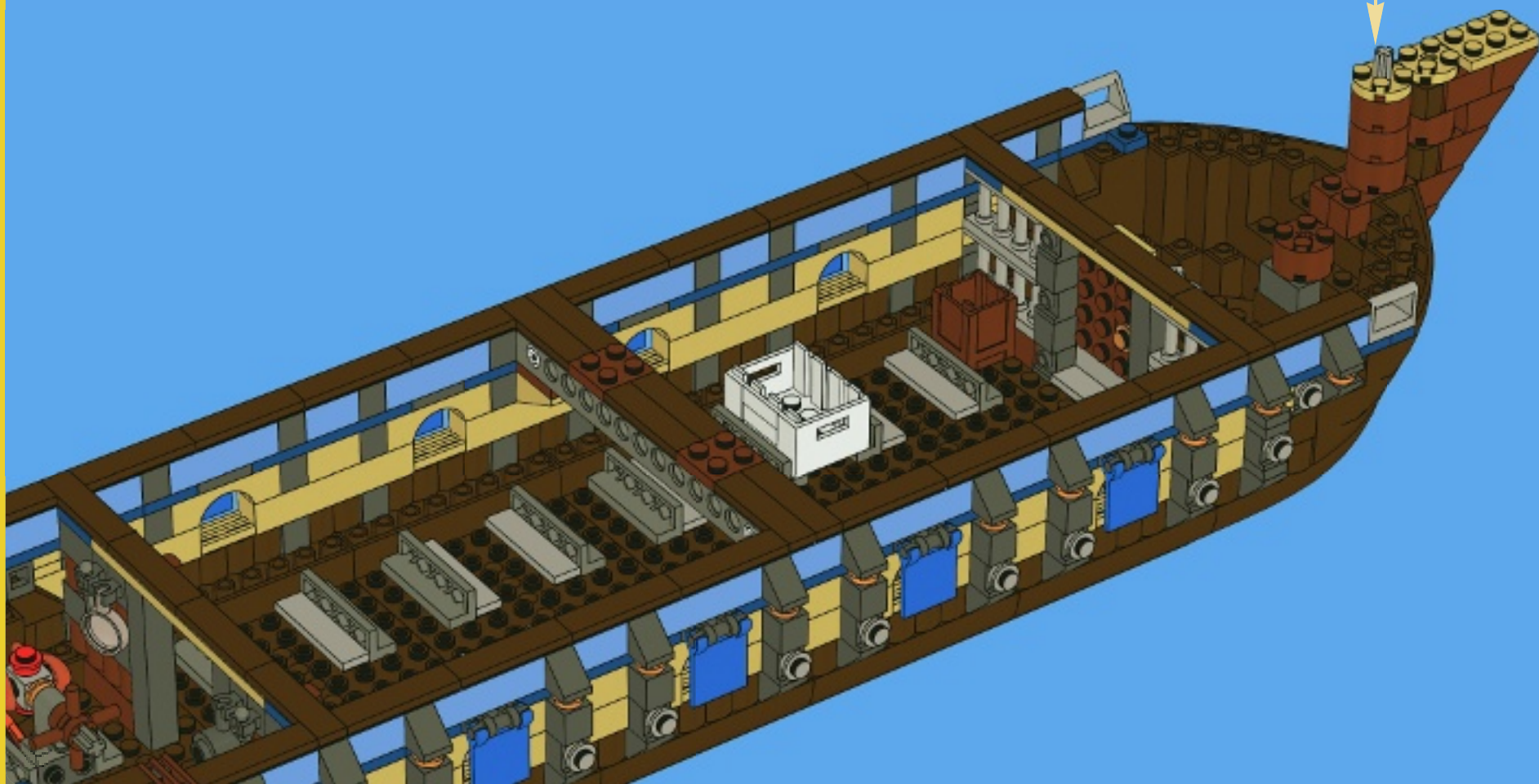

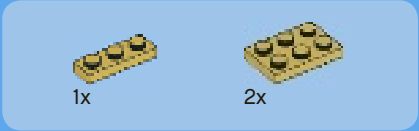

1

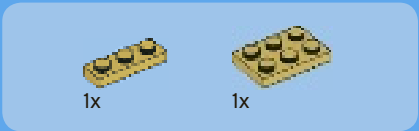
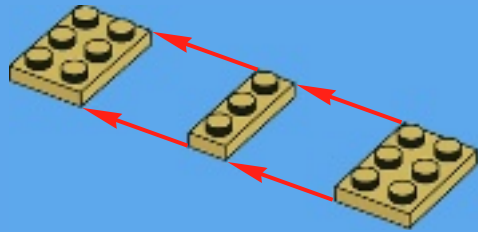

2



3



4



1x

1x

2x

5

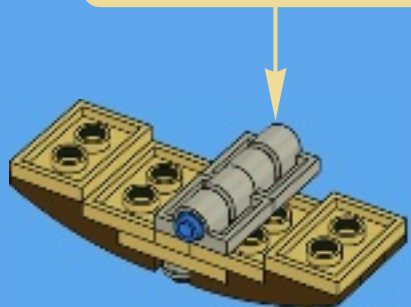
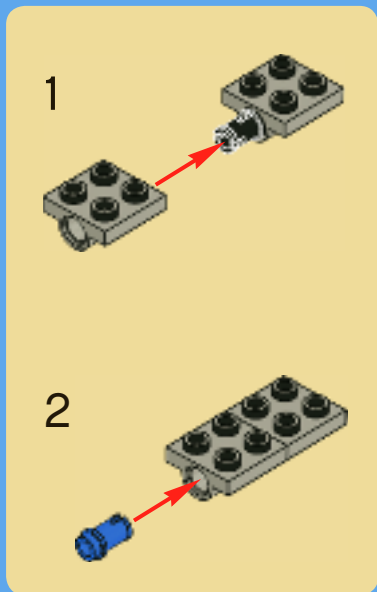

1x

1x

2x

6

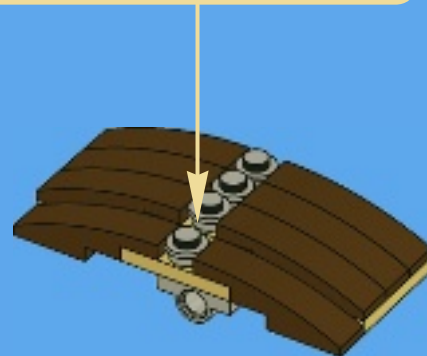
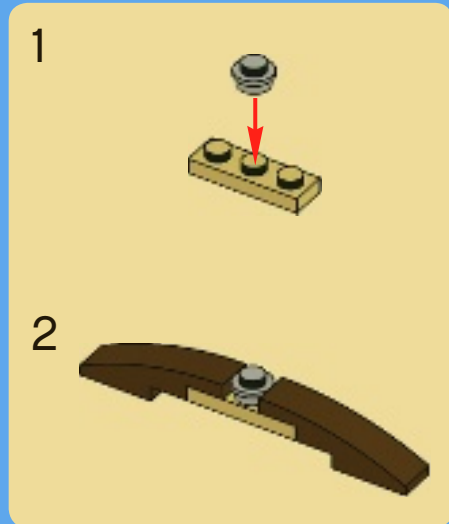

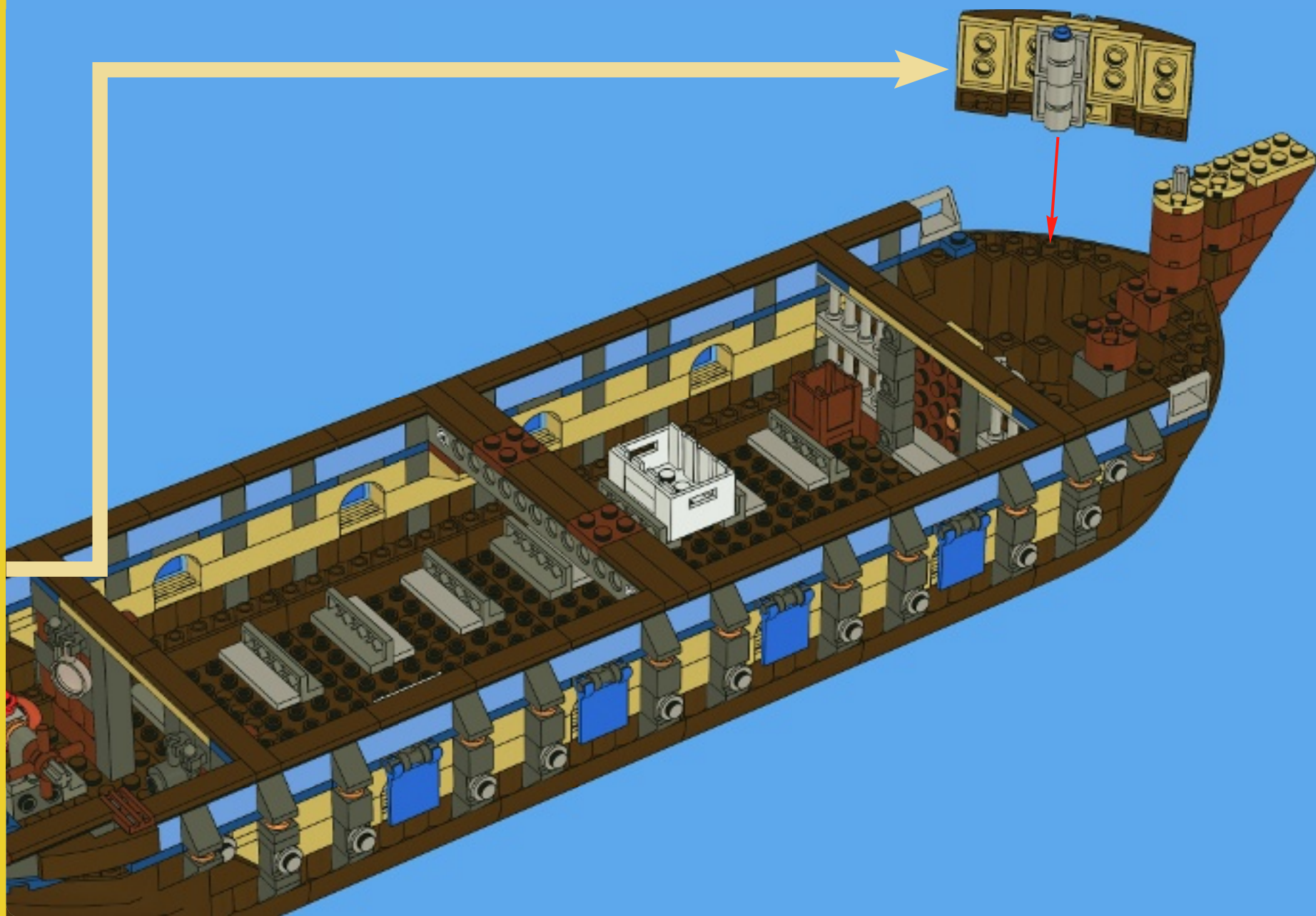

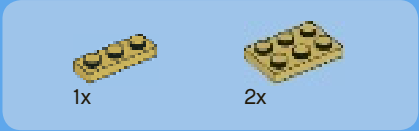

1

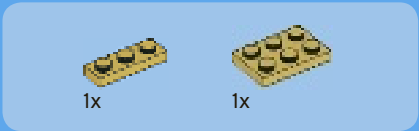
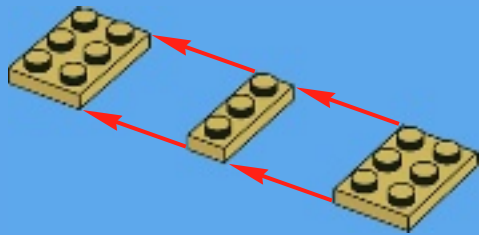

2

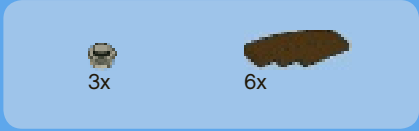

3





5

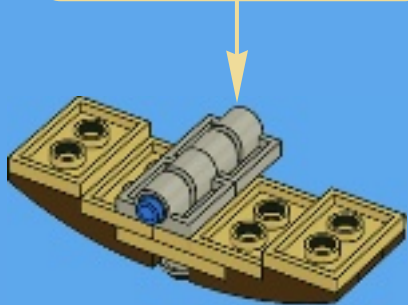
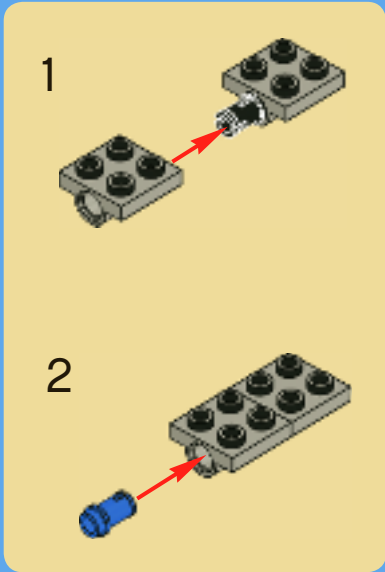

6

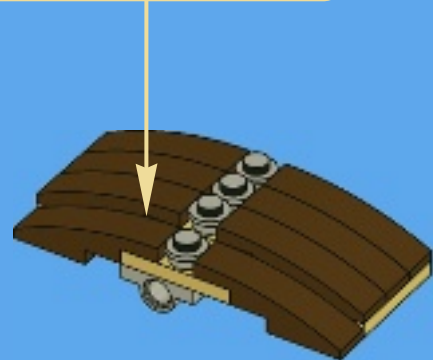
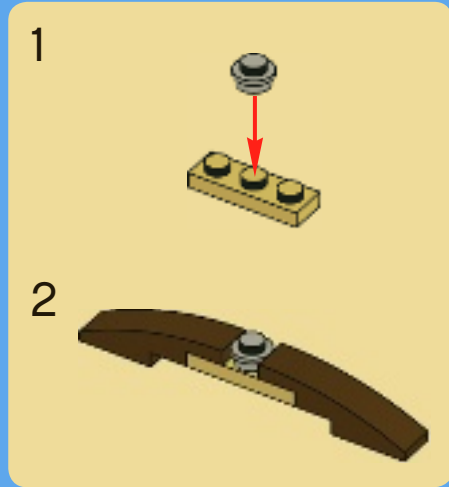

7



23

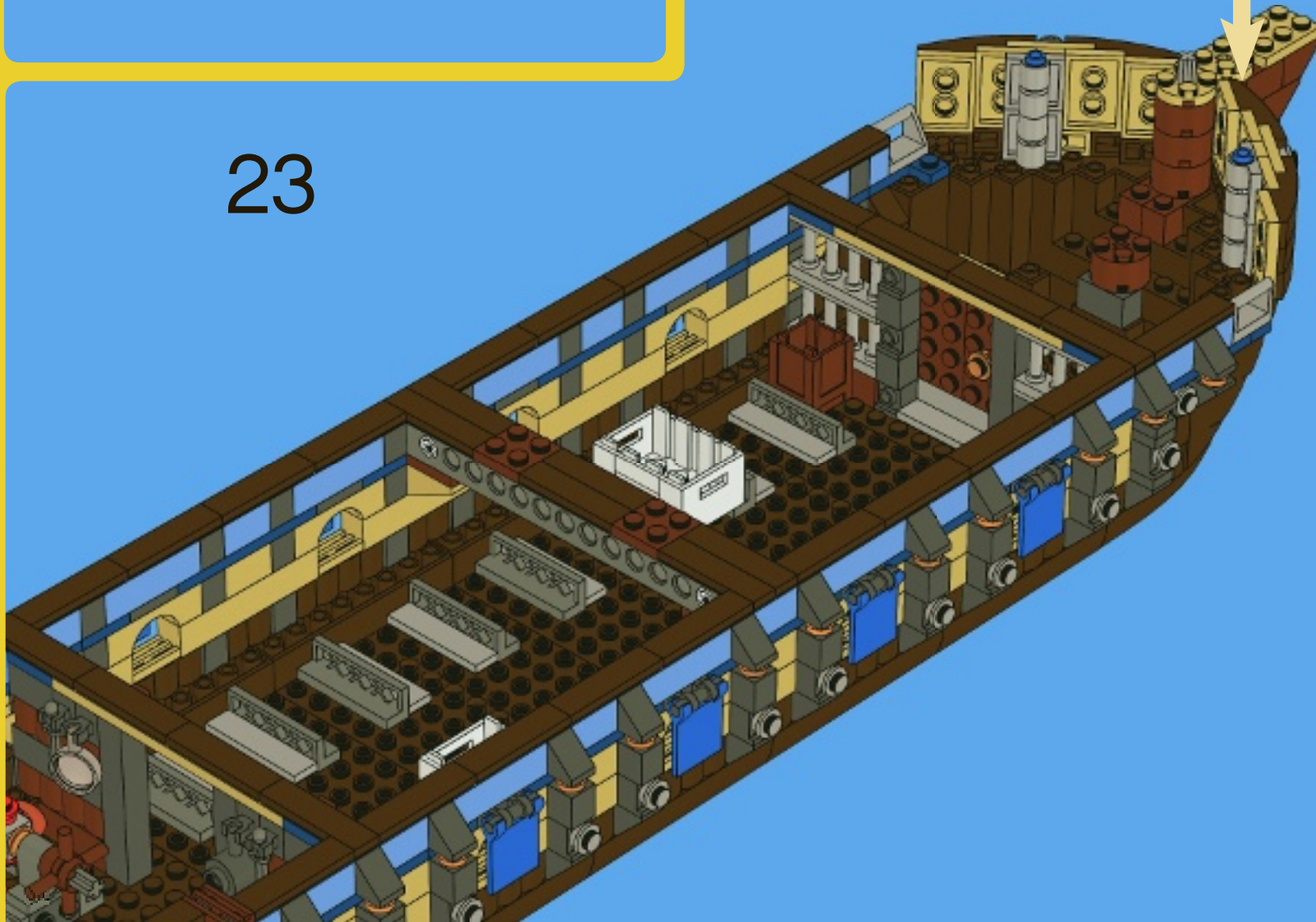

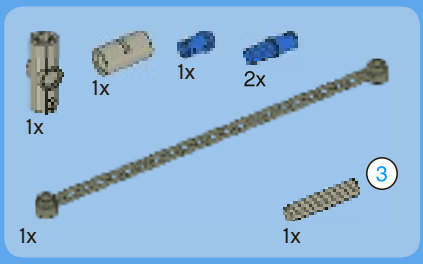

24

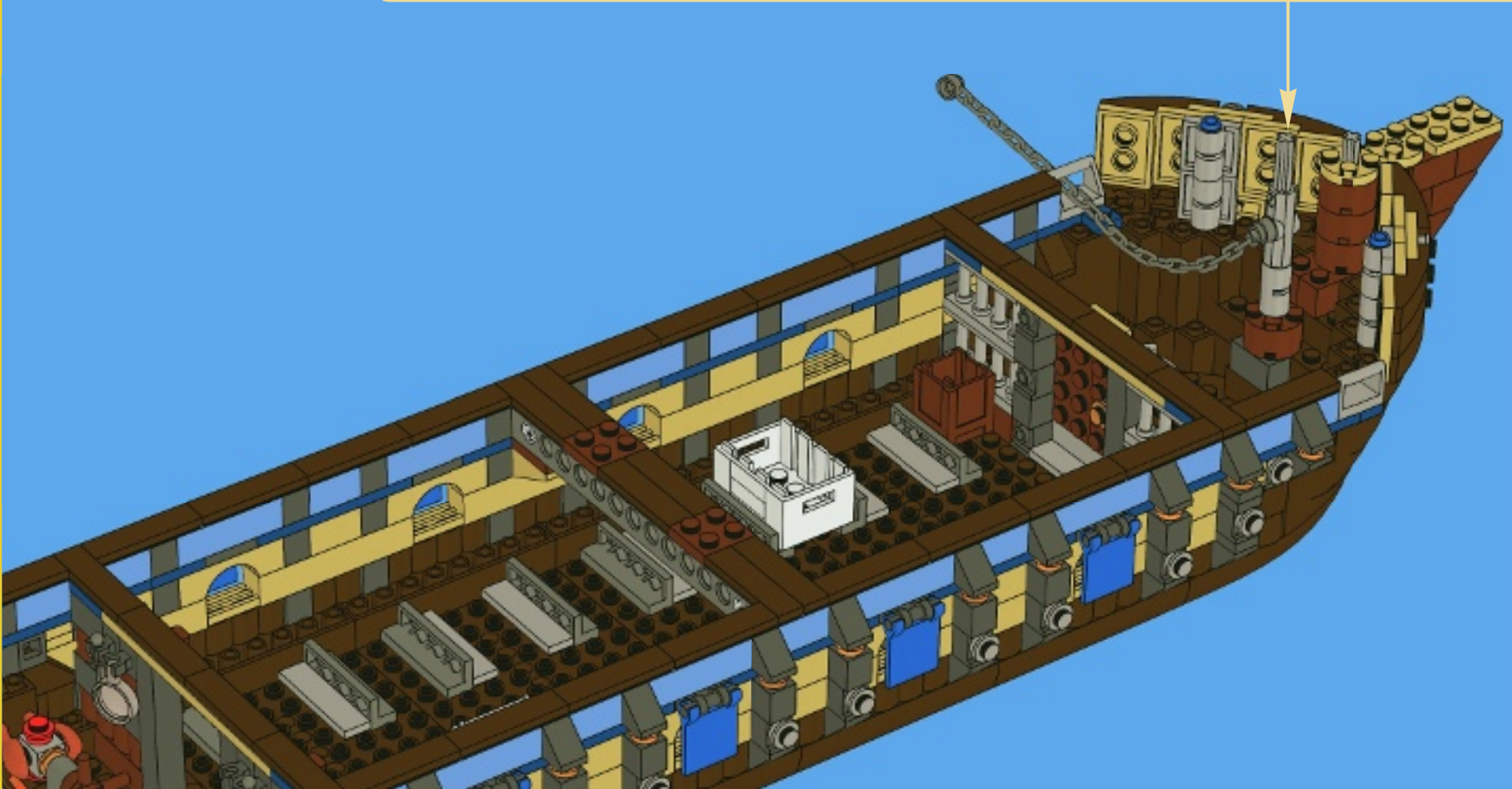
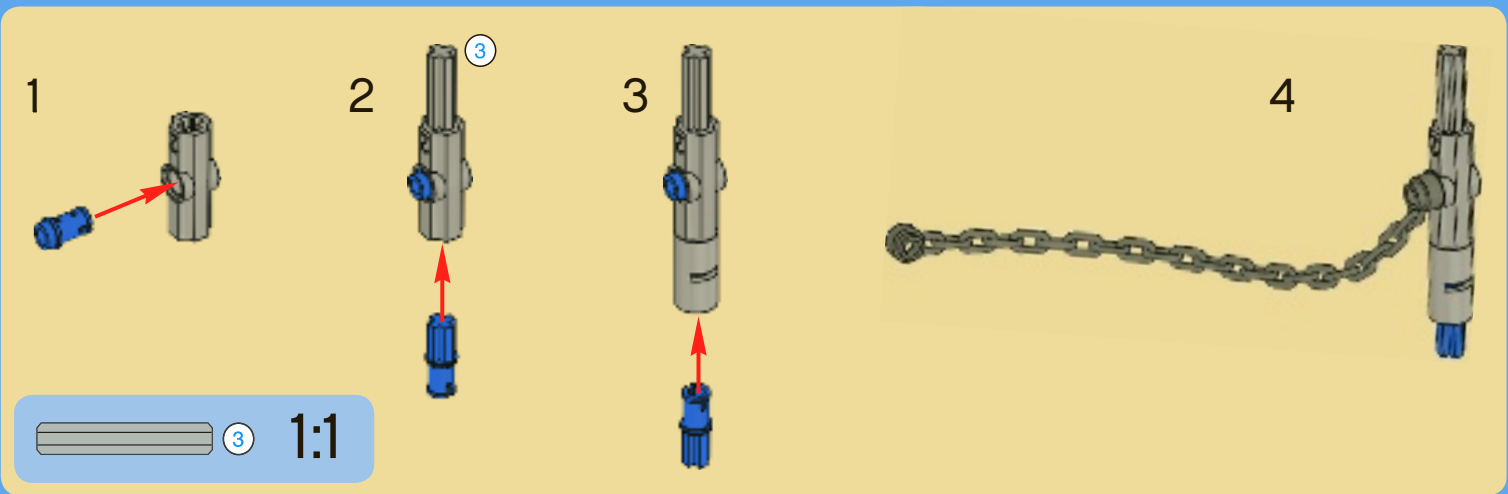

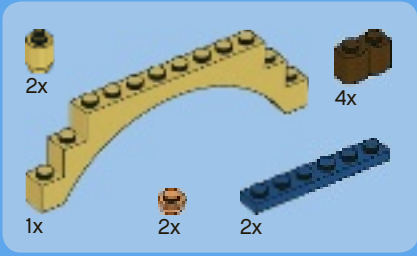

25

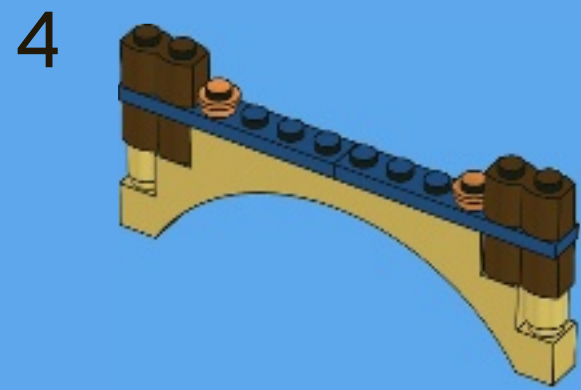
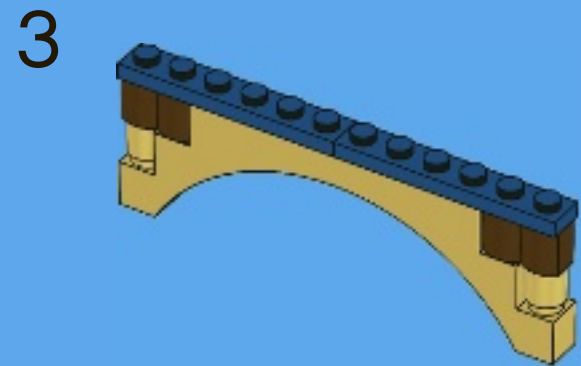
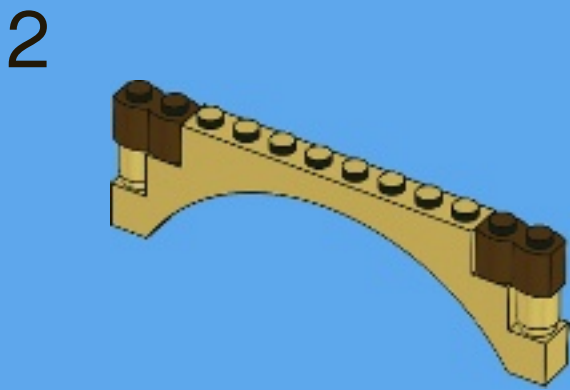
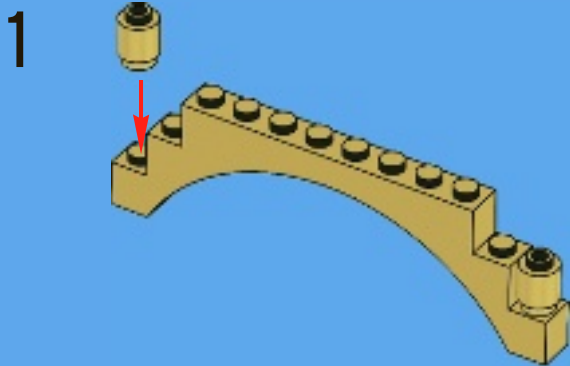

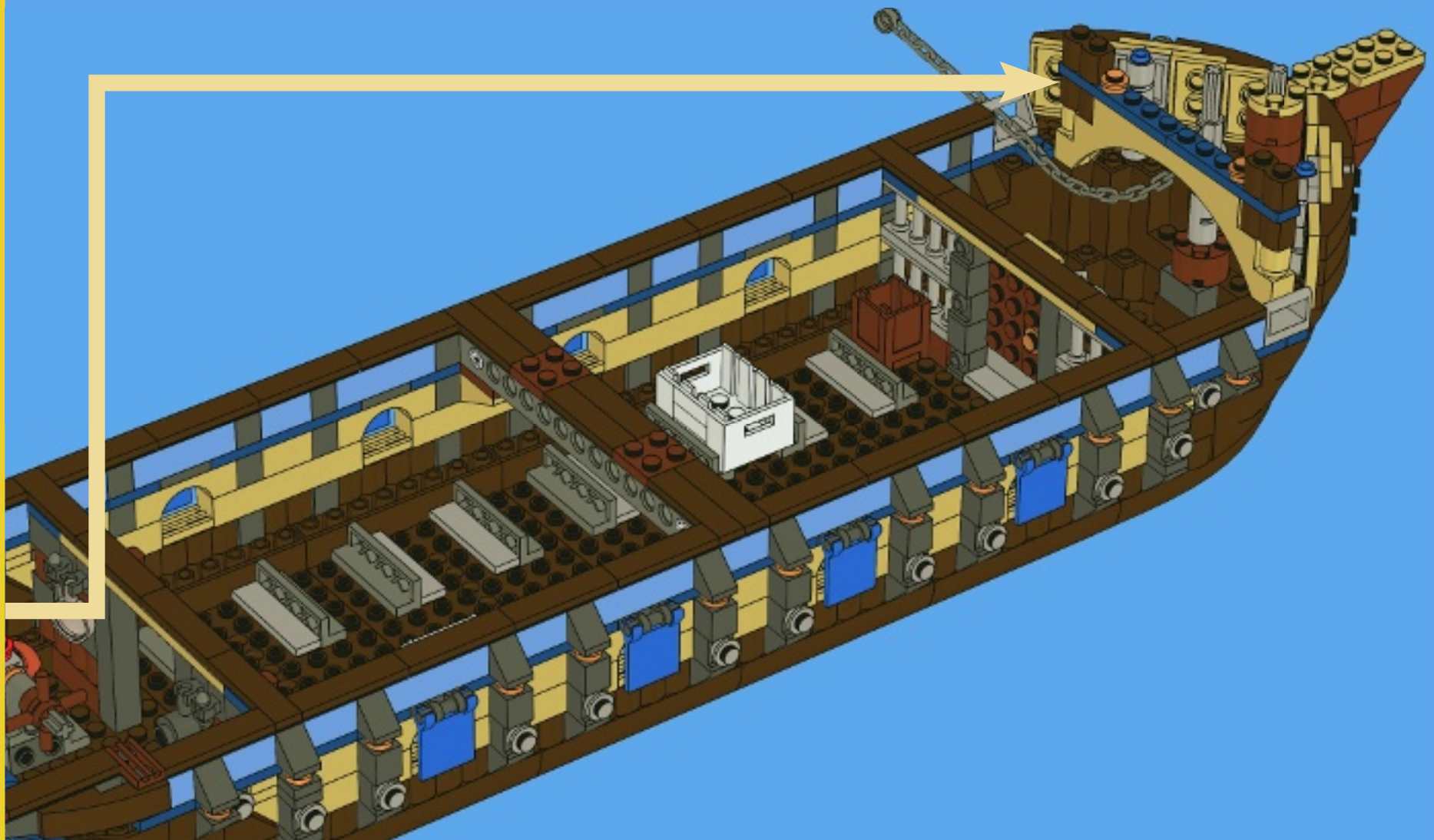



2x



1x

26

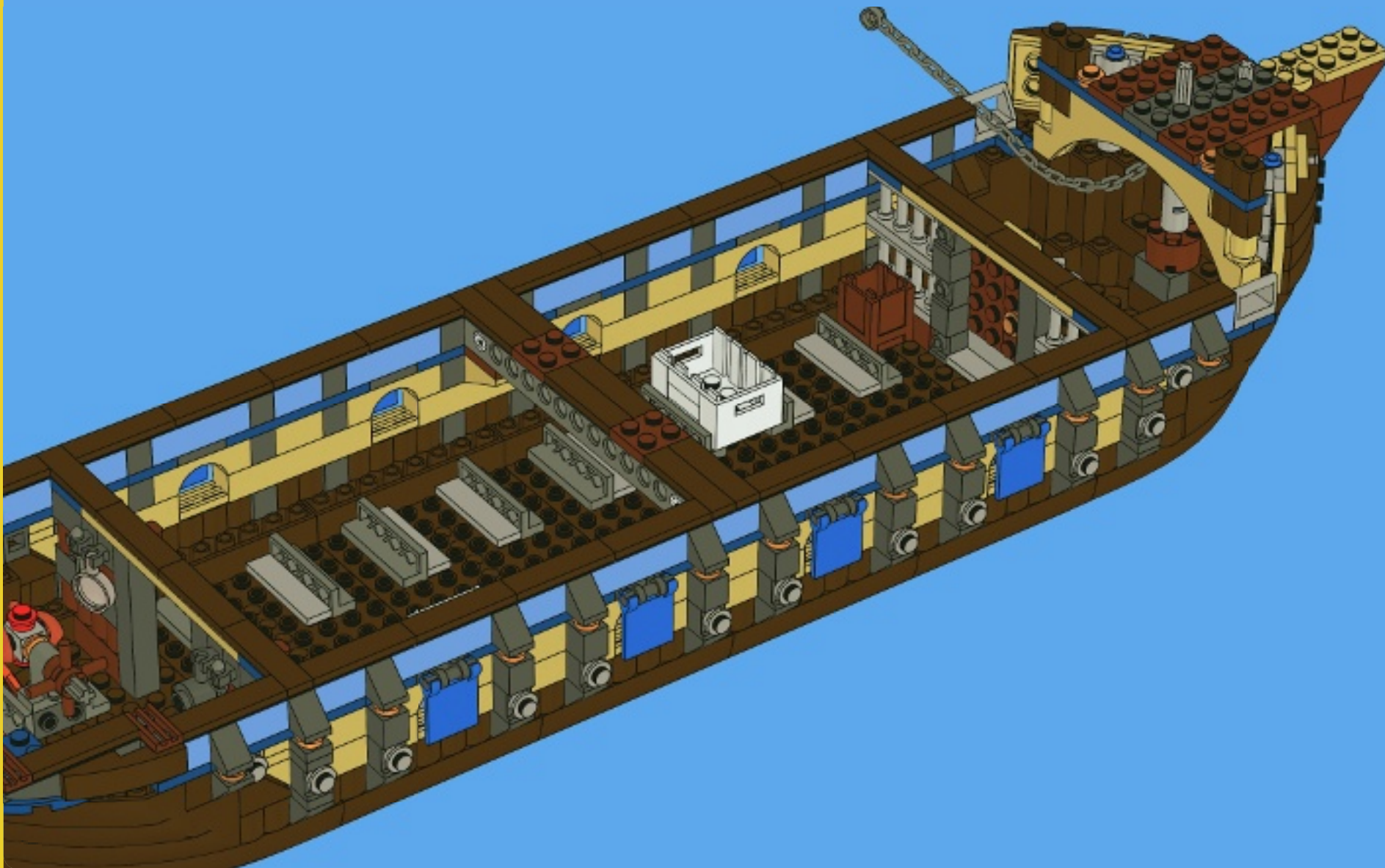

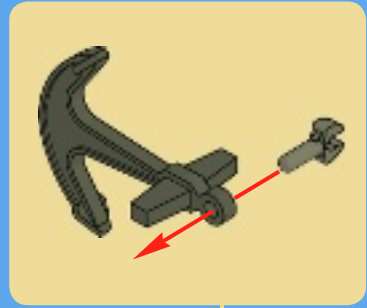
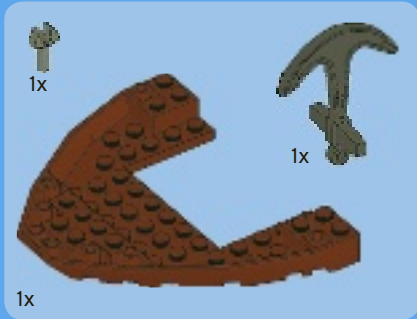

27

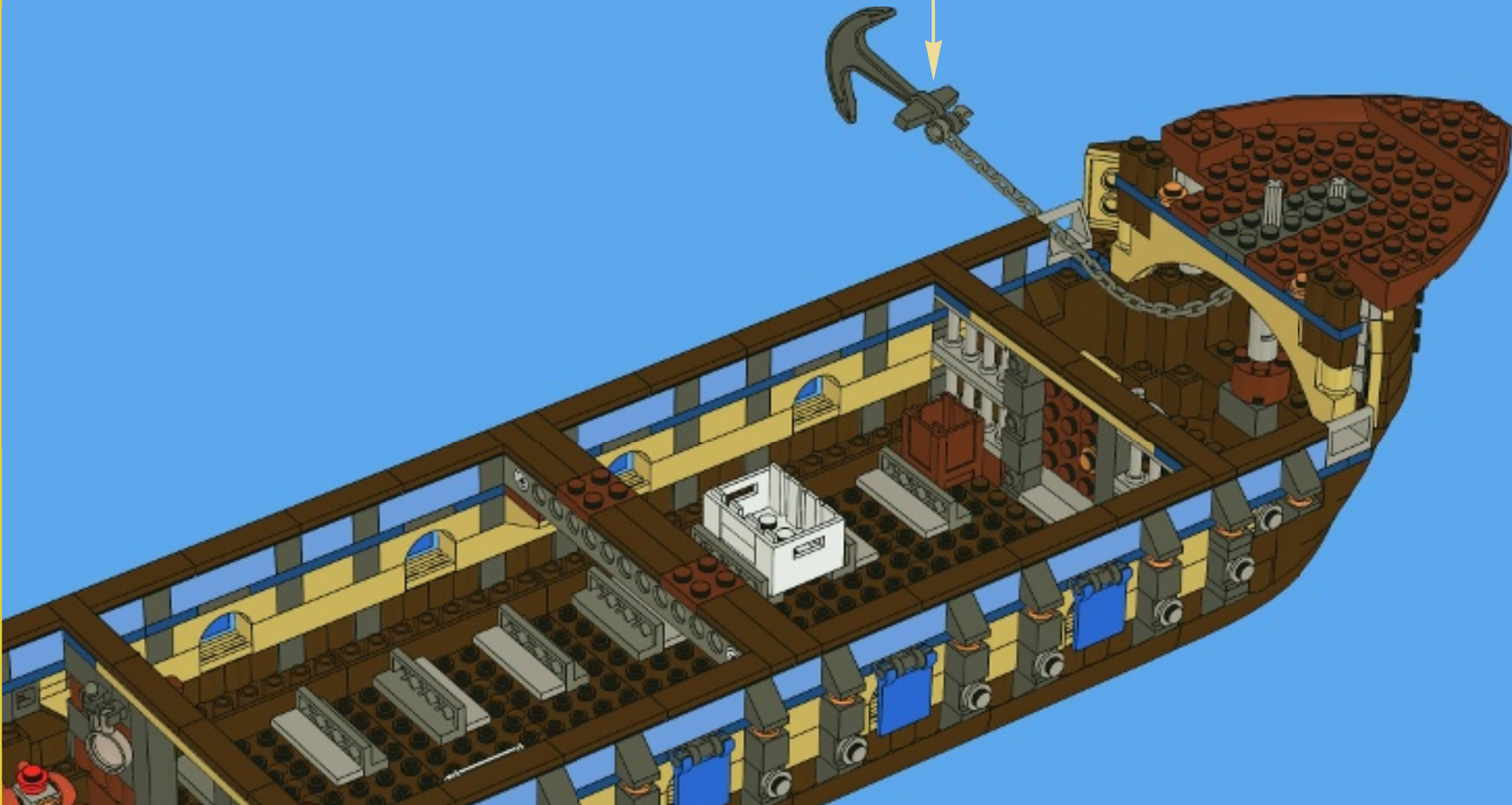

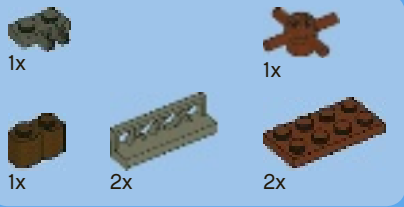

28

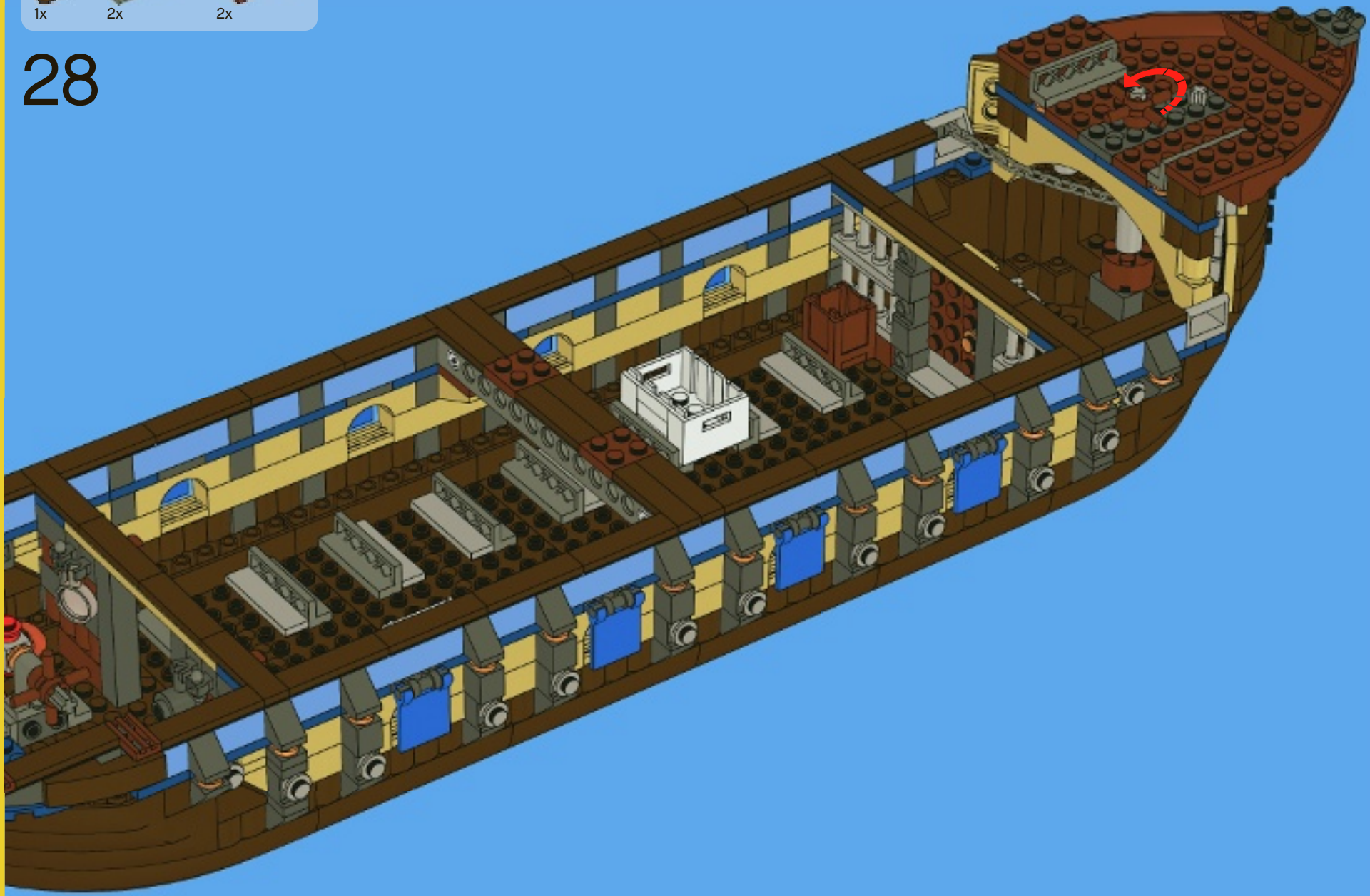

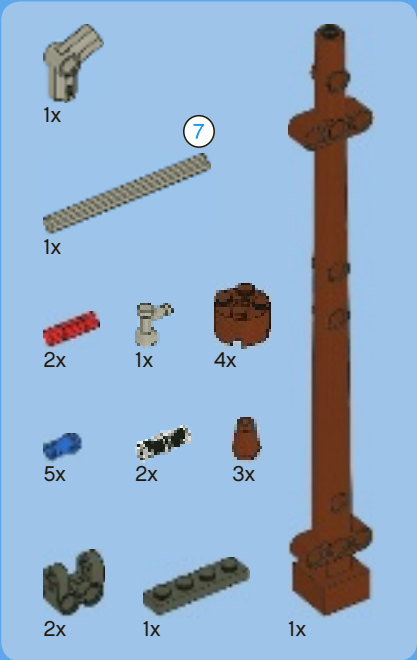

7 1:1

29

1



2



3



4



5



6



7



8



9



10





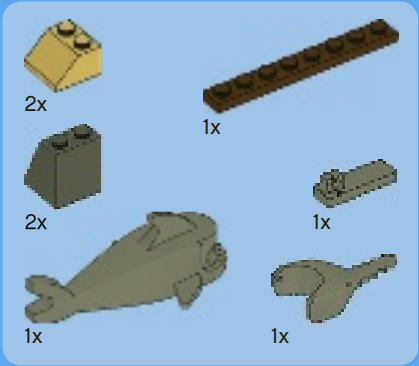

30

1

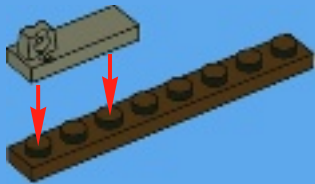

2



3

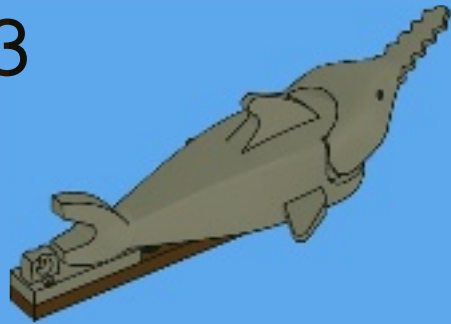

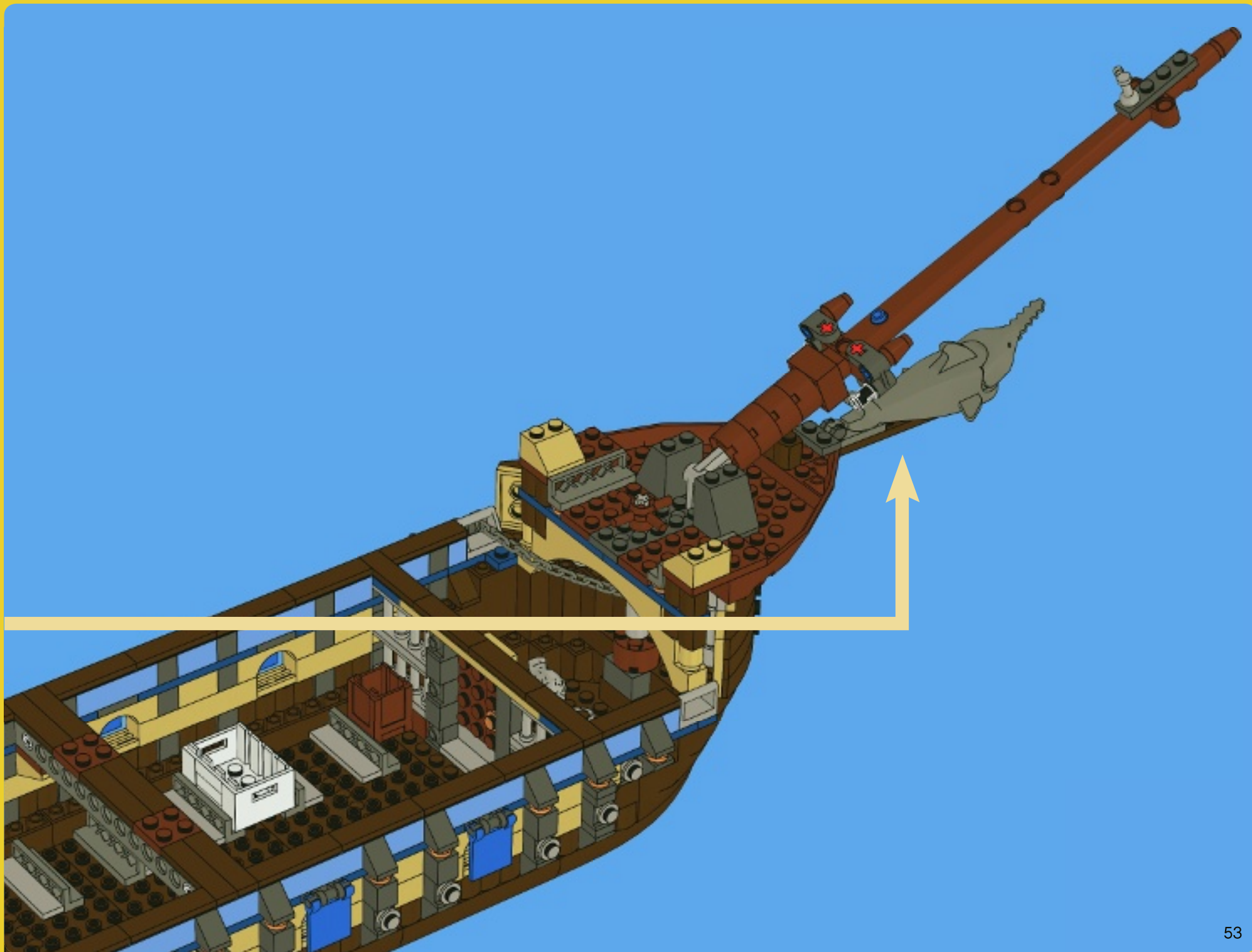

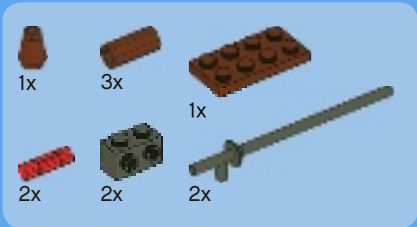
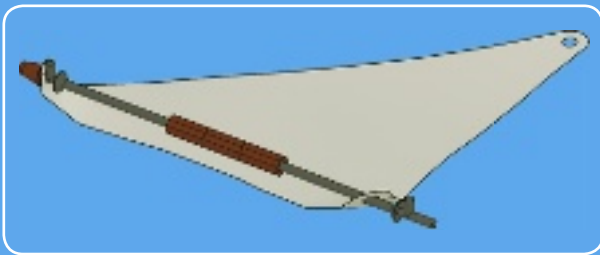

31

1

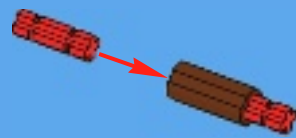

2



3

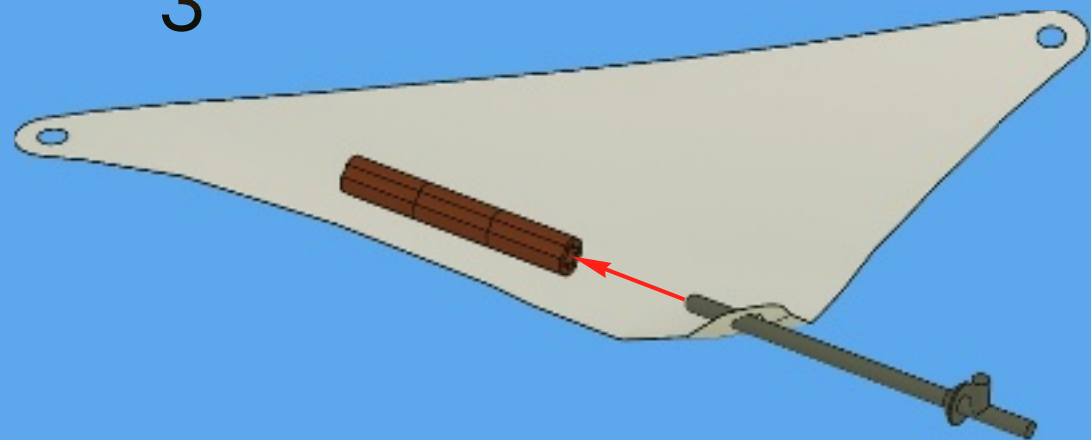

4

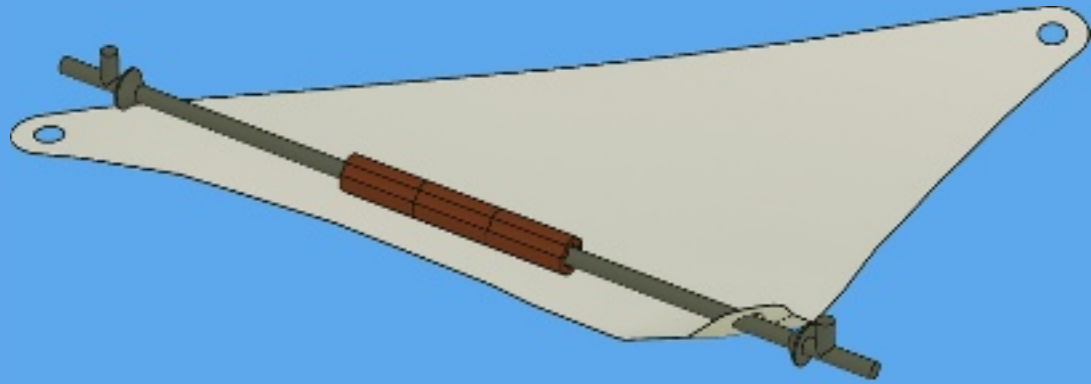

5

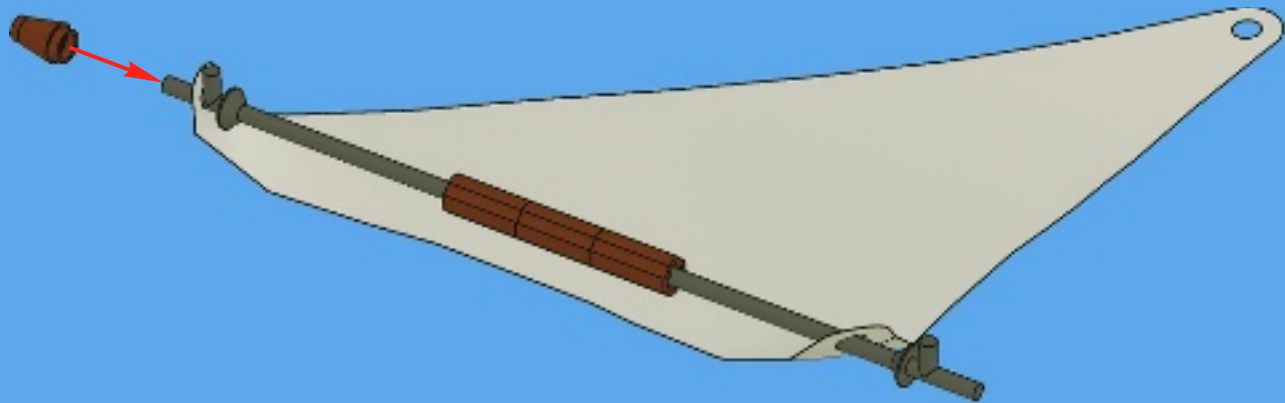

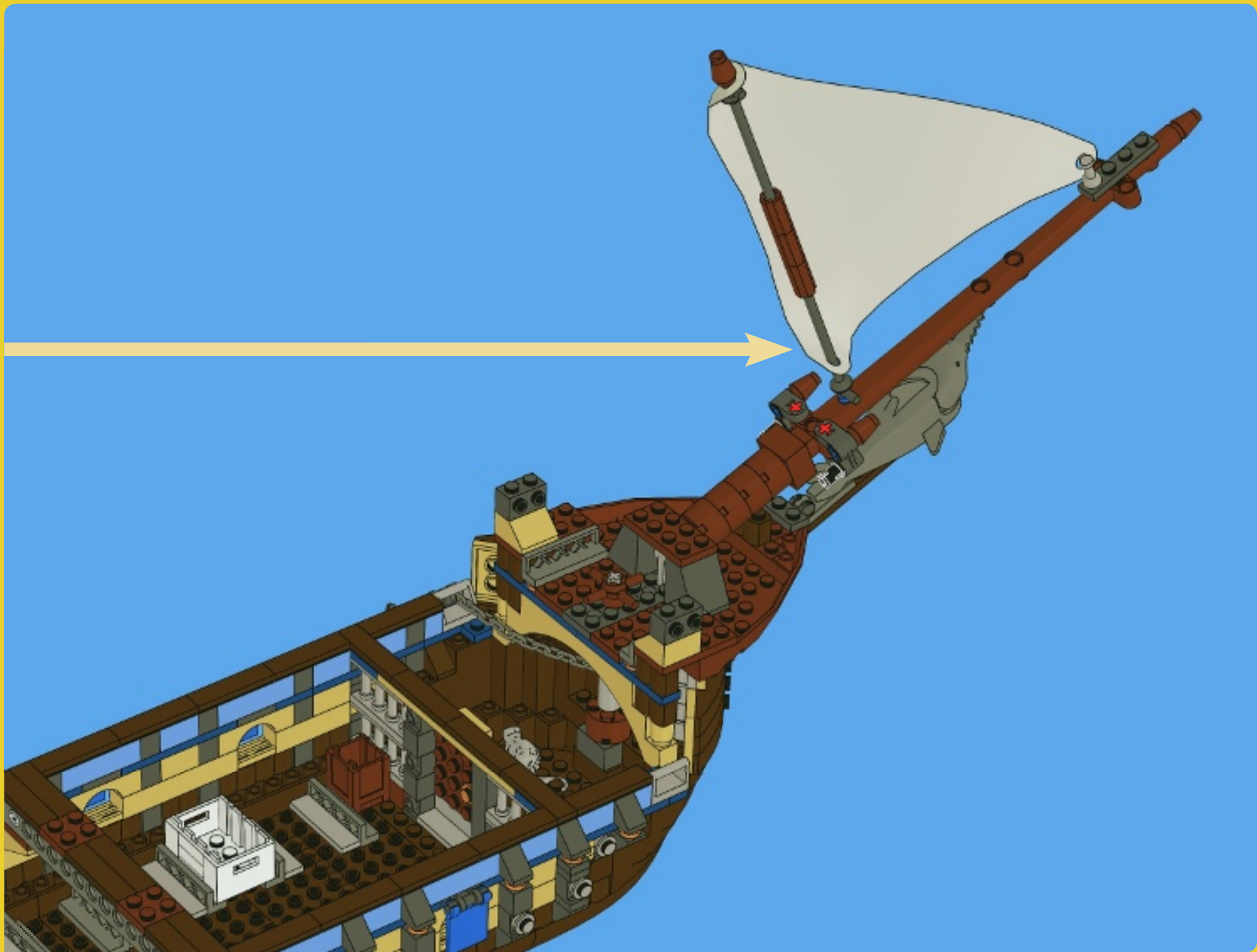

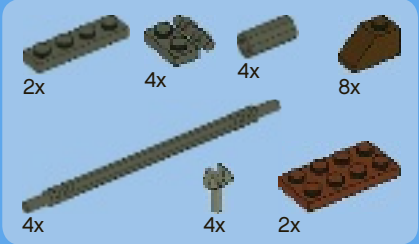
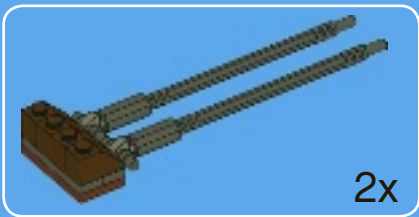

32

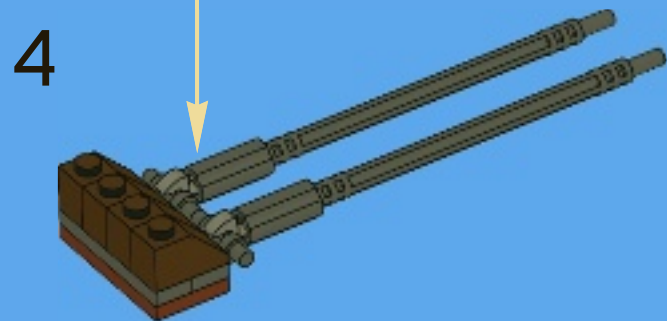
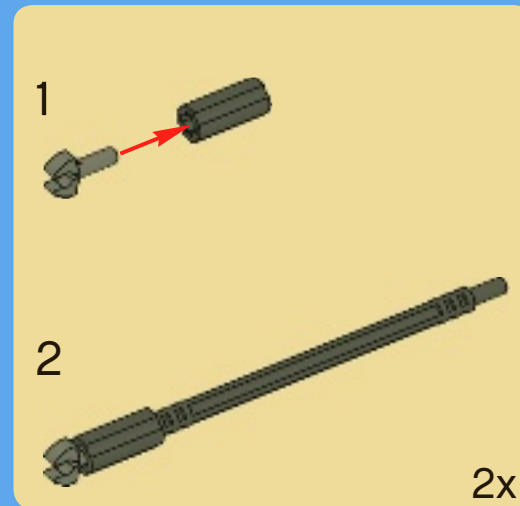
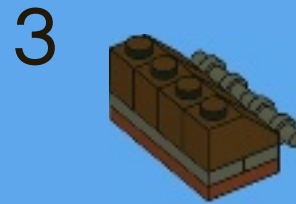

5

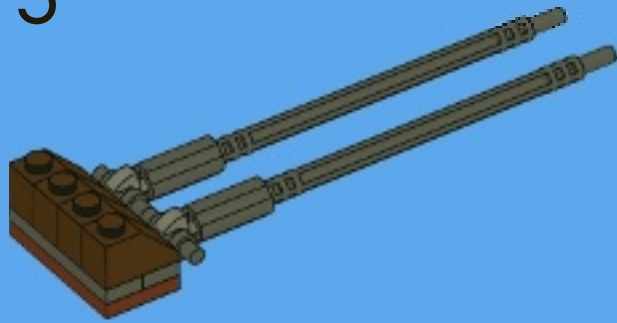

2x

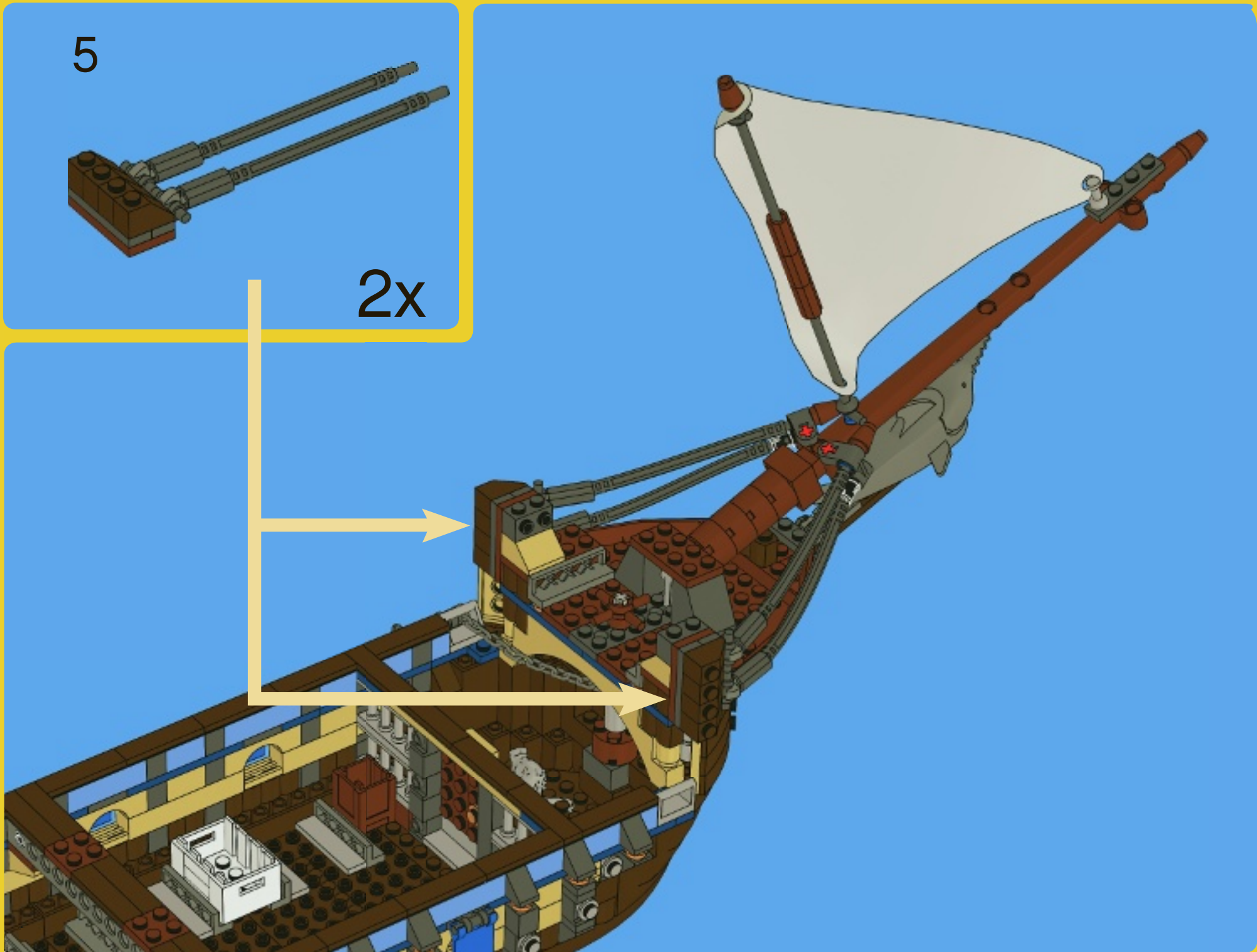

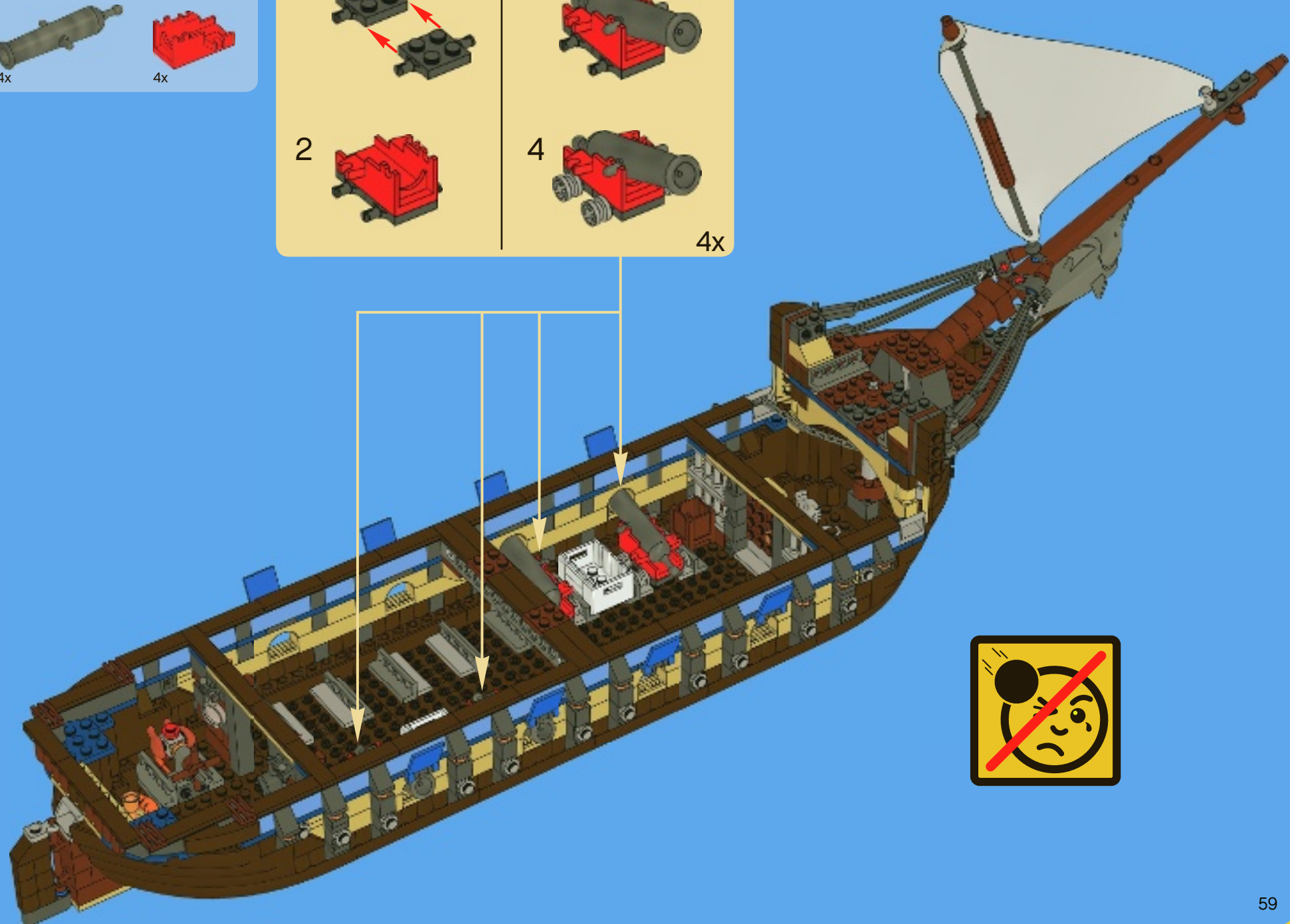
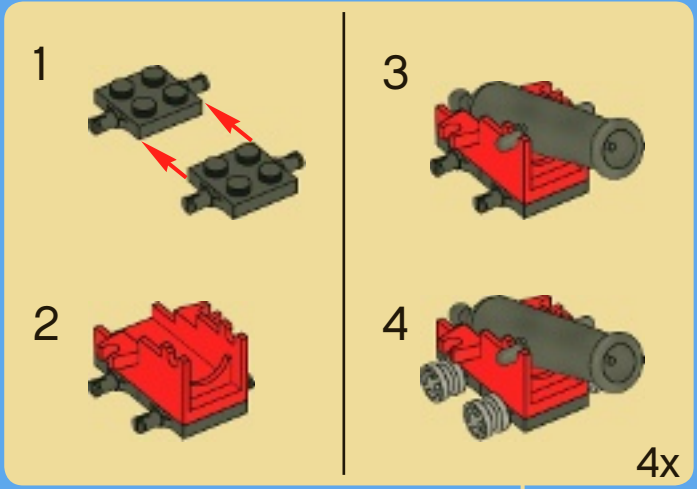
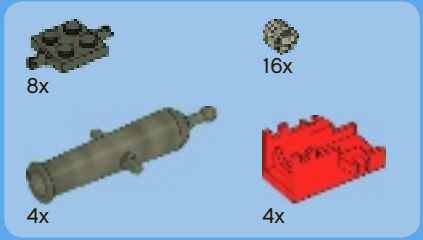



34

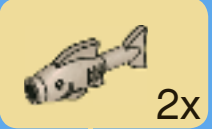
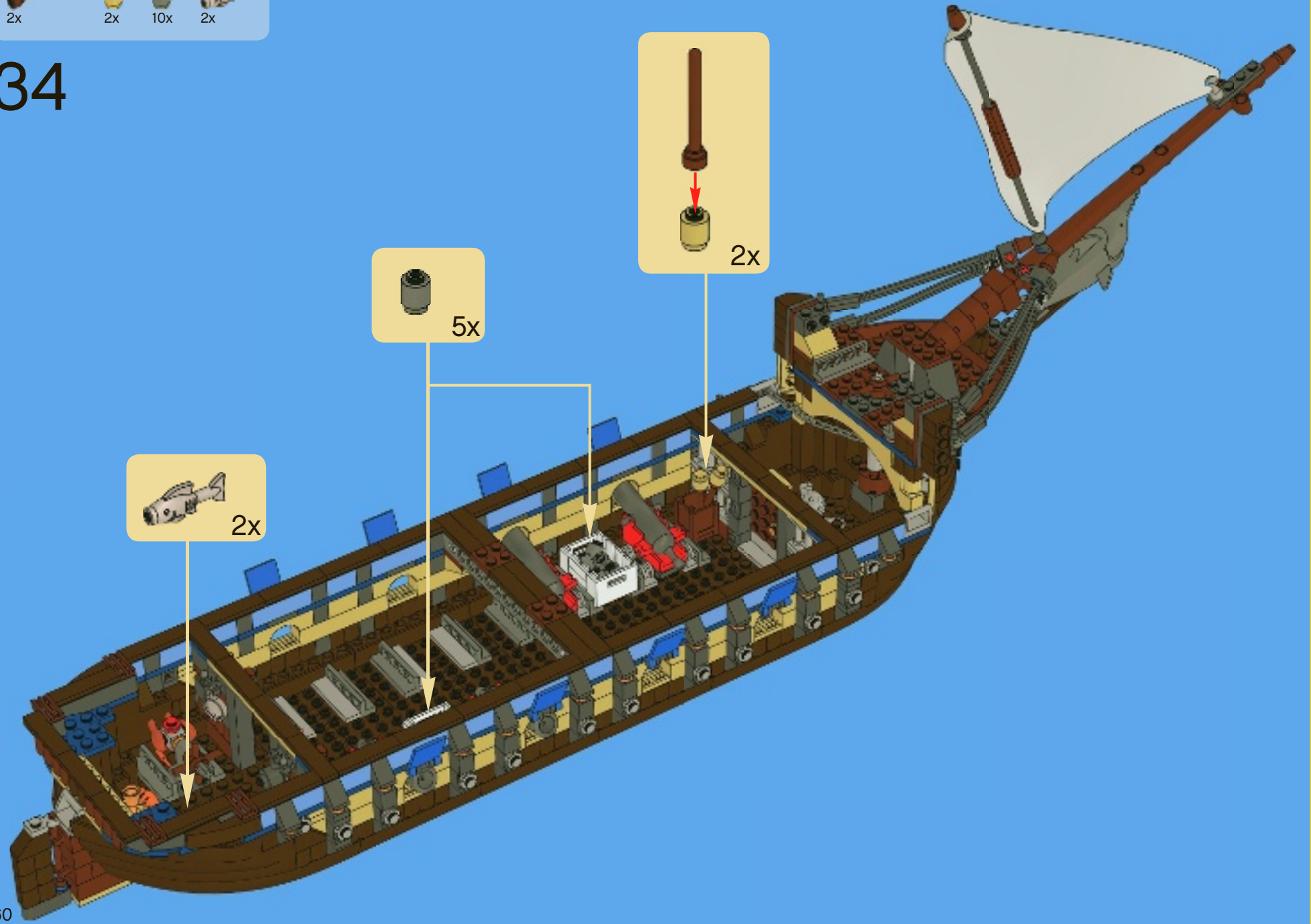

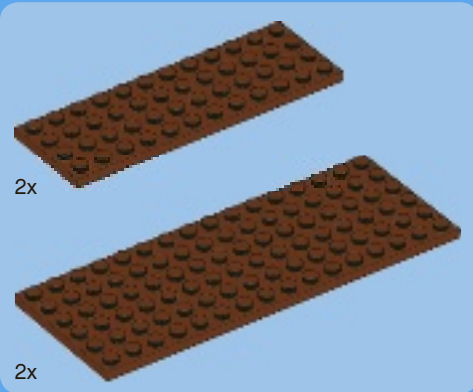

1

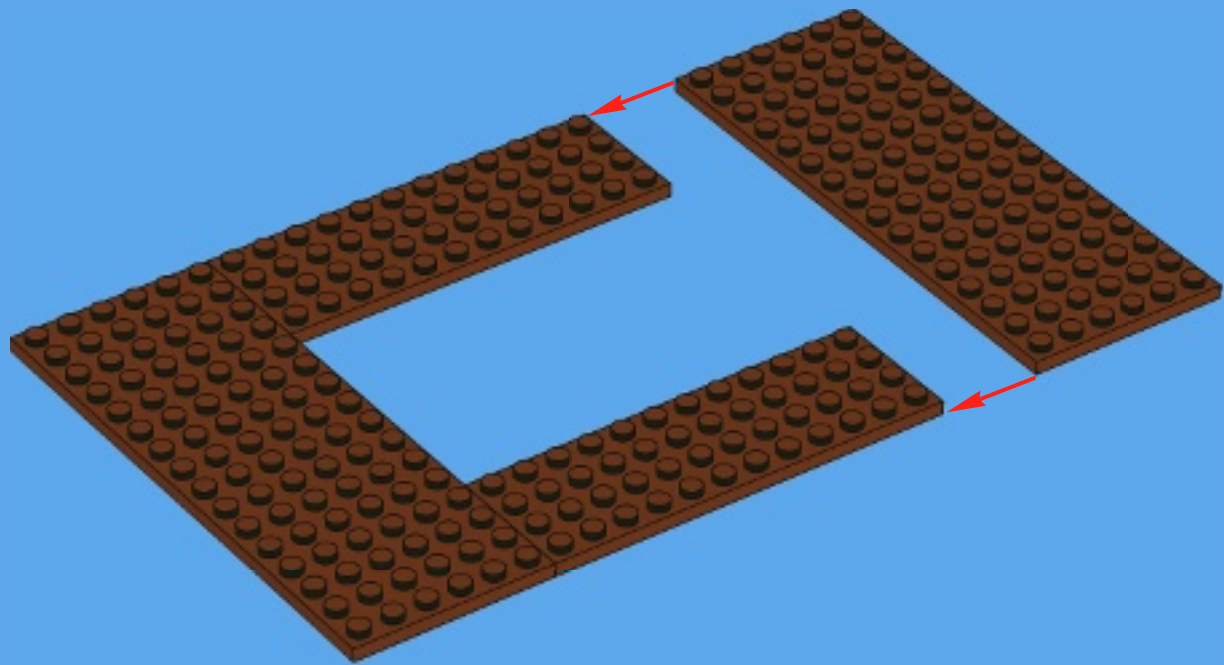



8x



4x

2

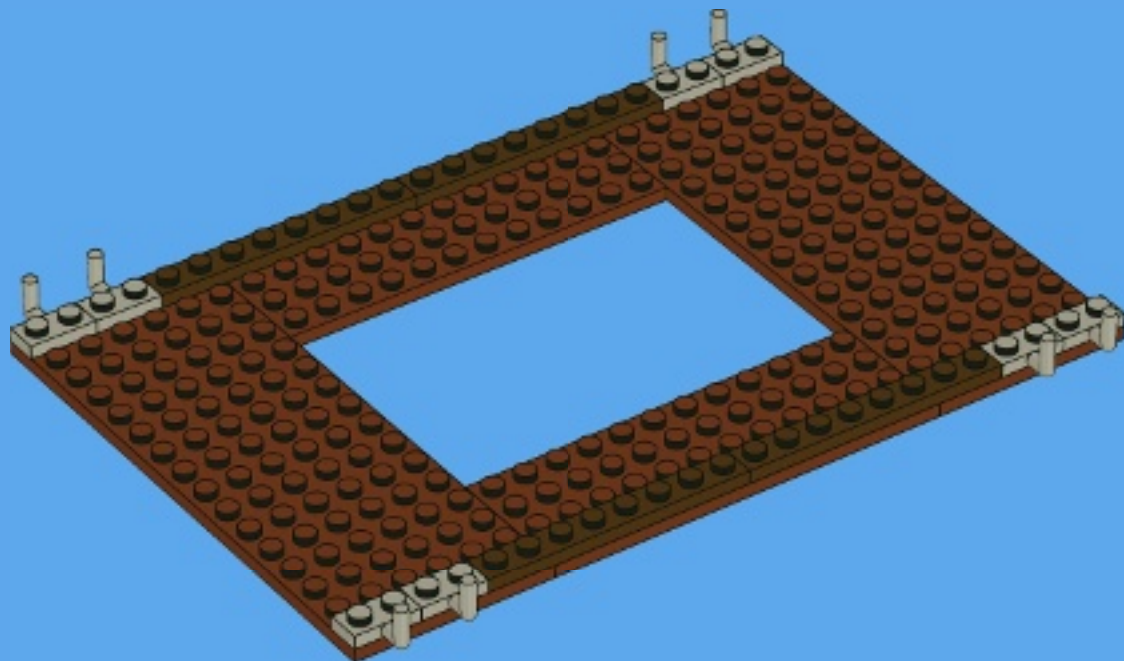

6x



4x

3

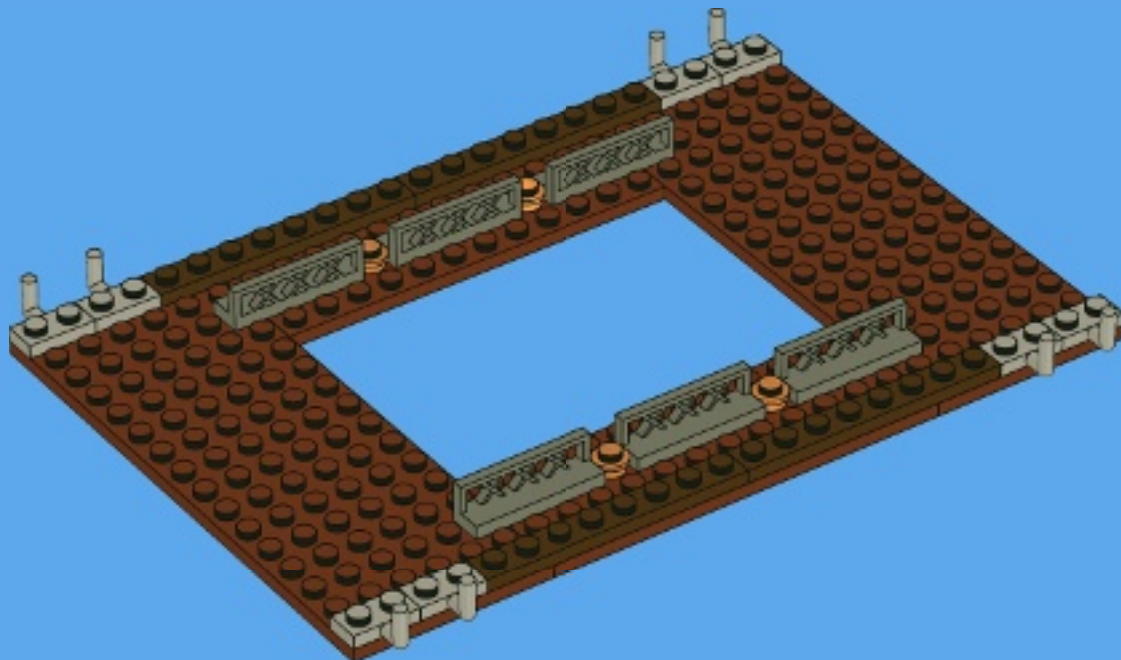

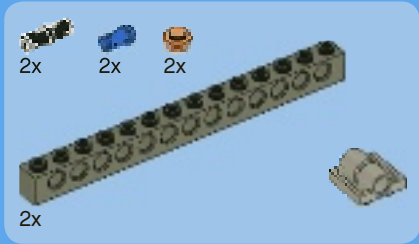

4

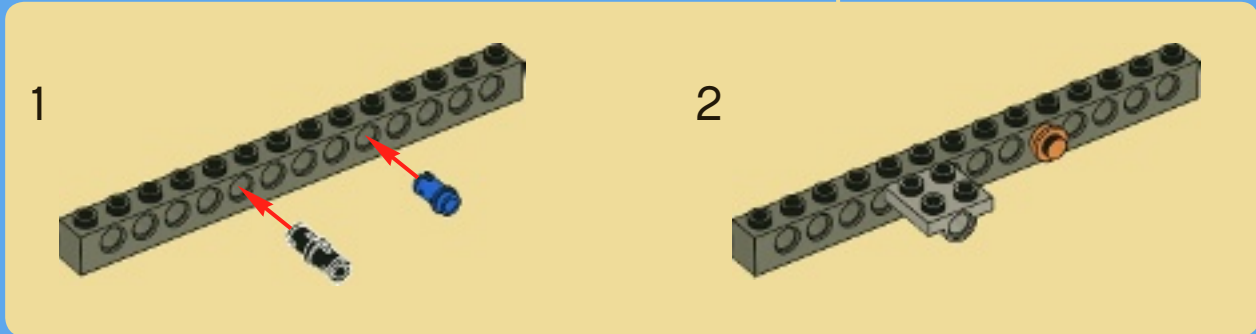
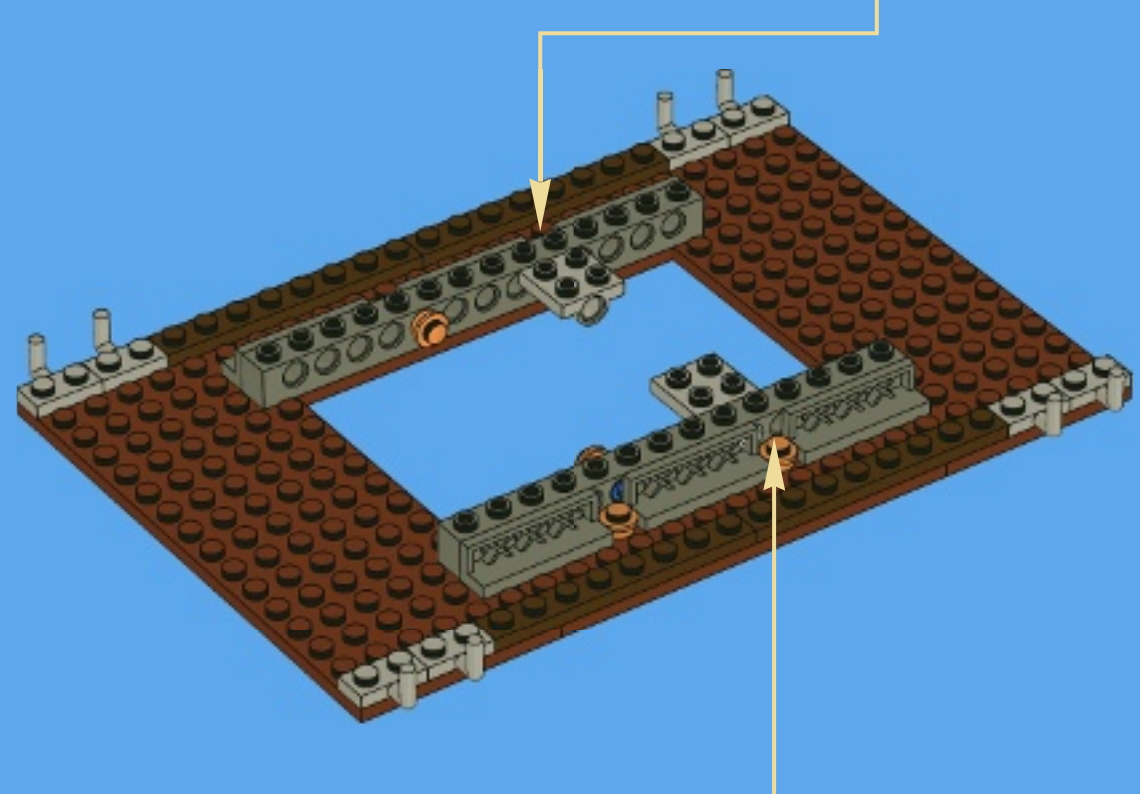
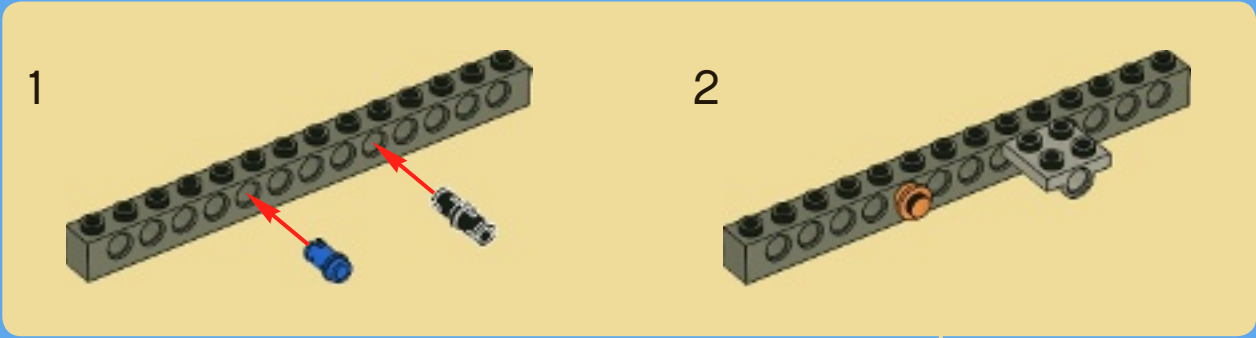



5

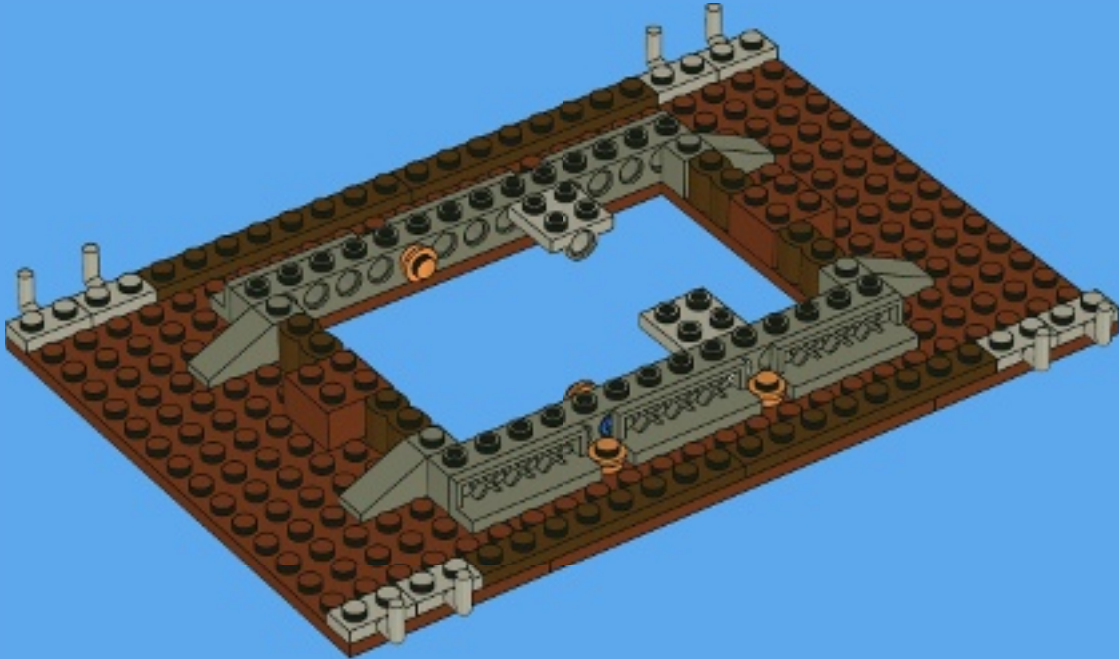

6

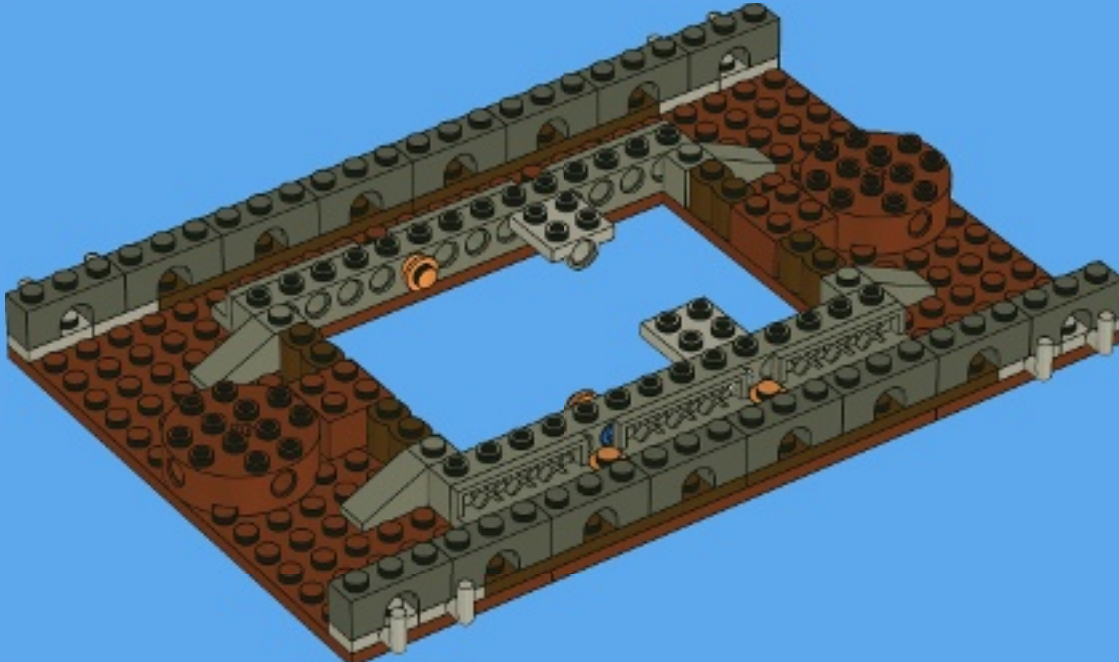



8x



6x

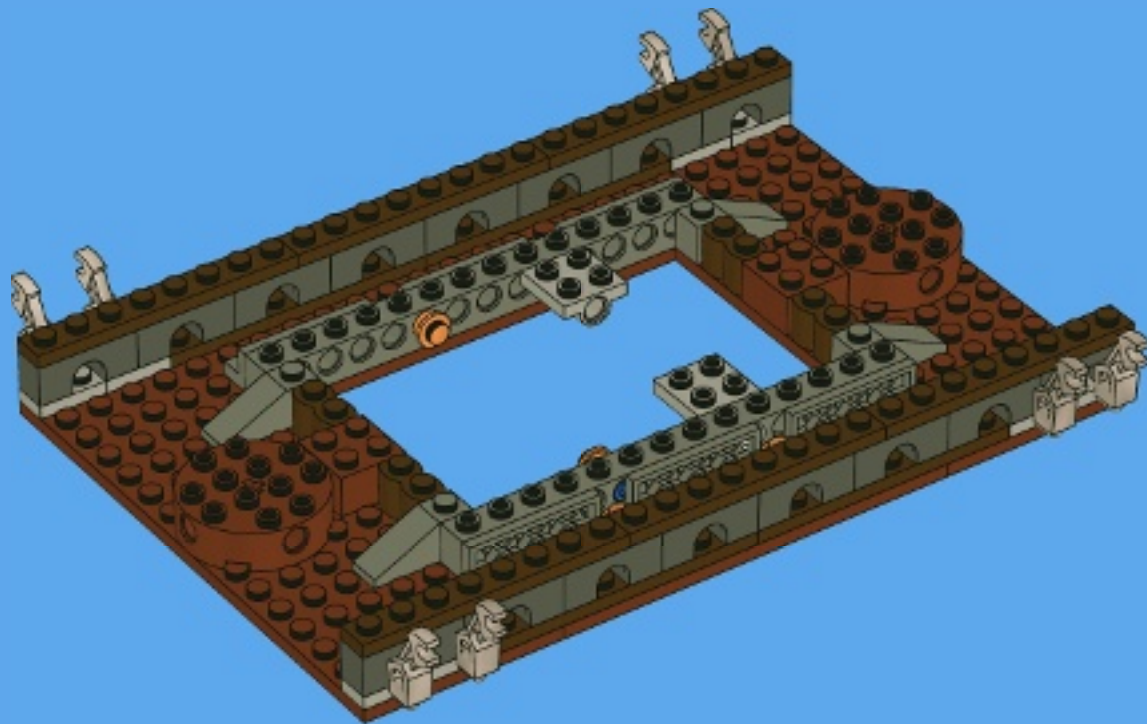

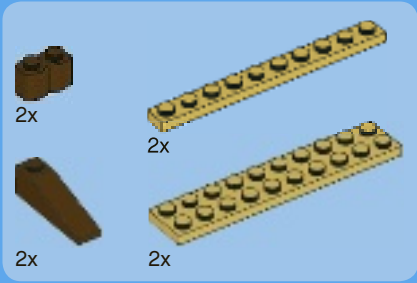

8

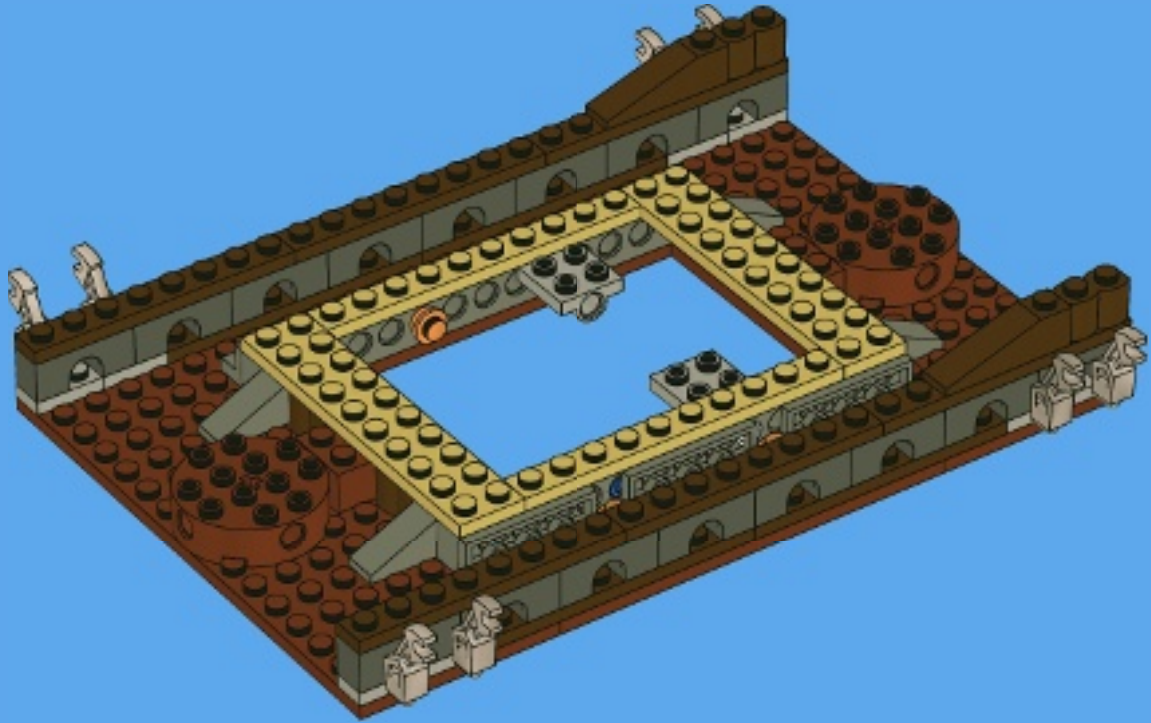



2x



2x



2x



2x

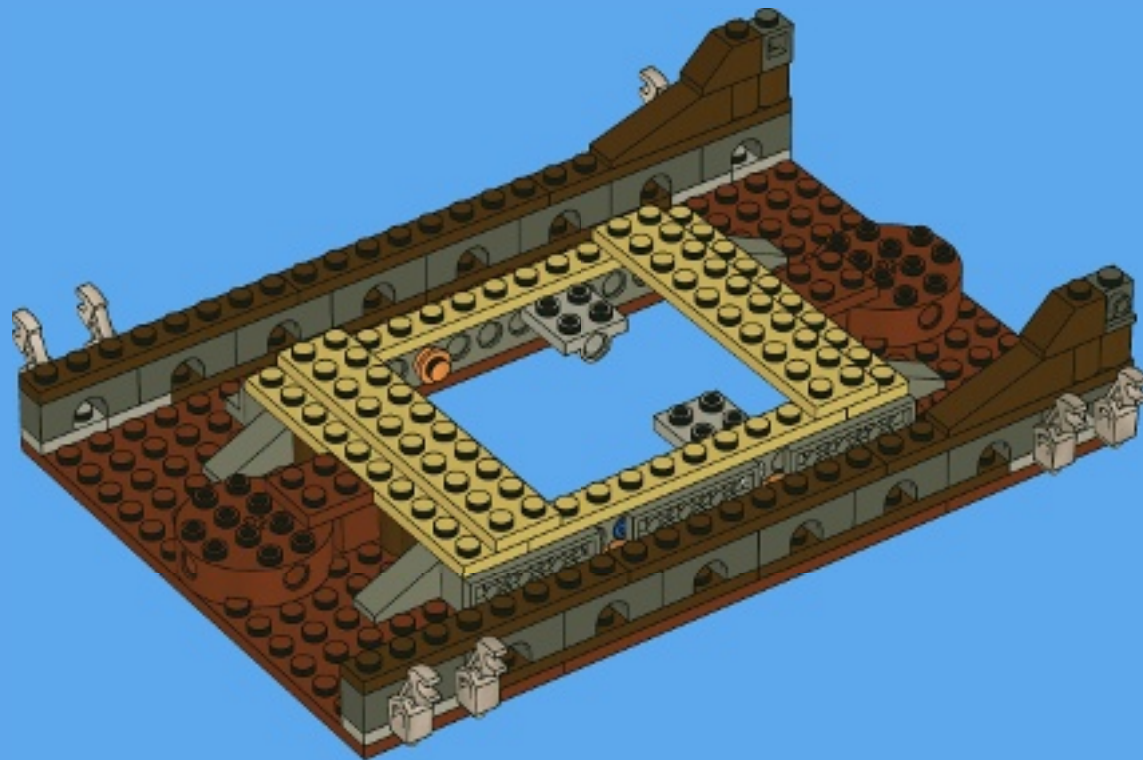

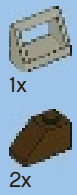

10

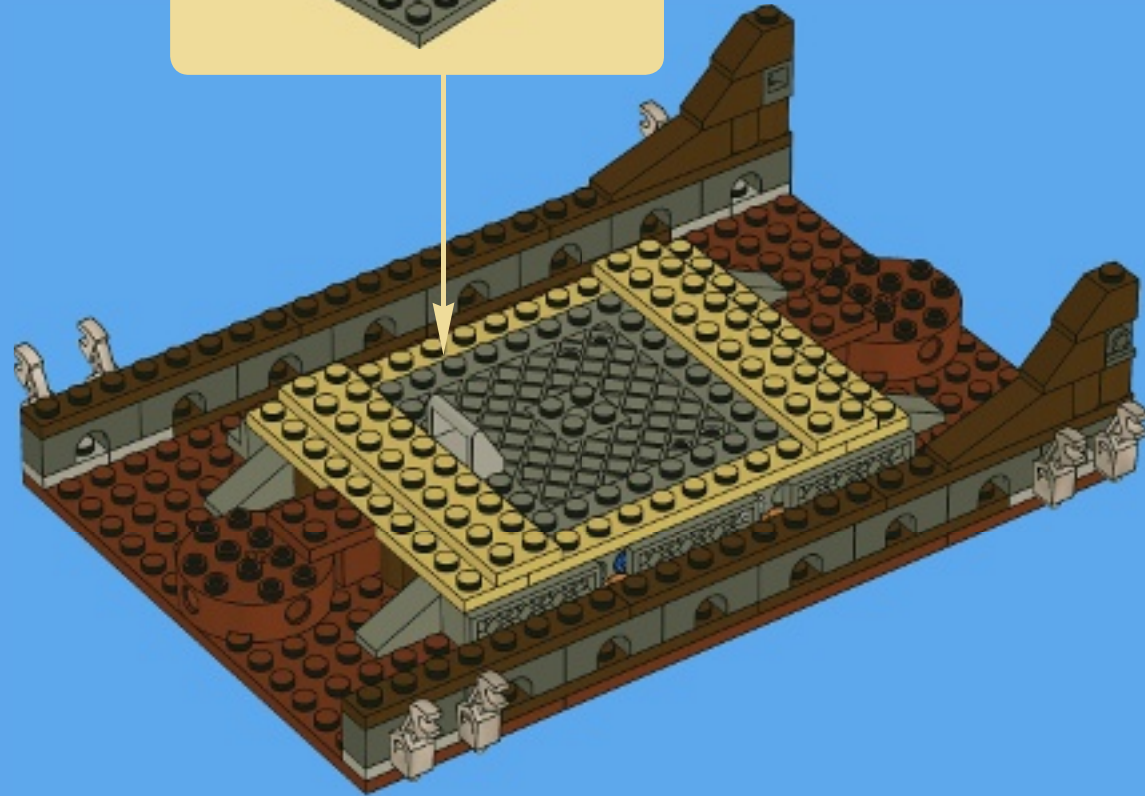
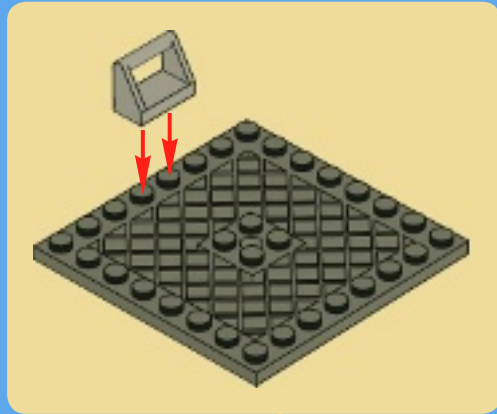

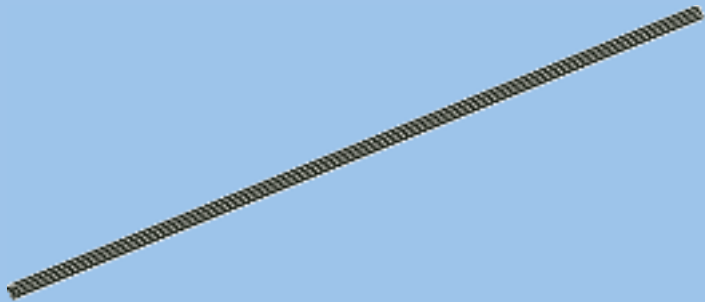

2x

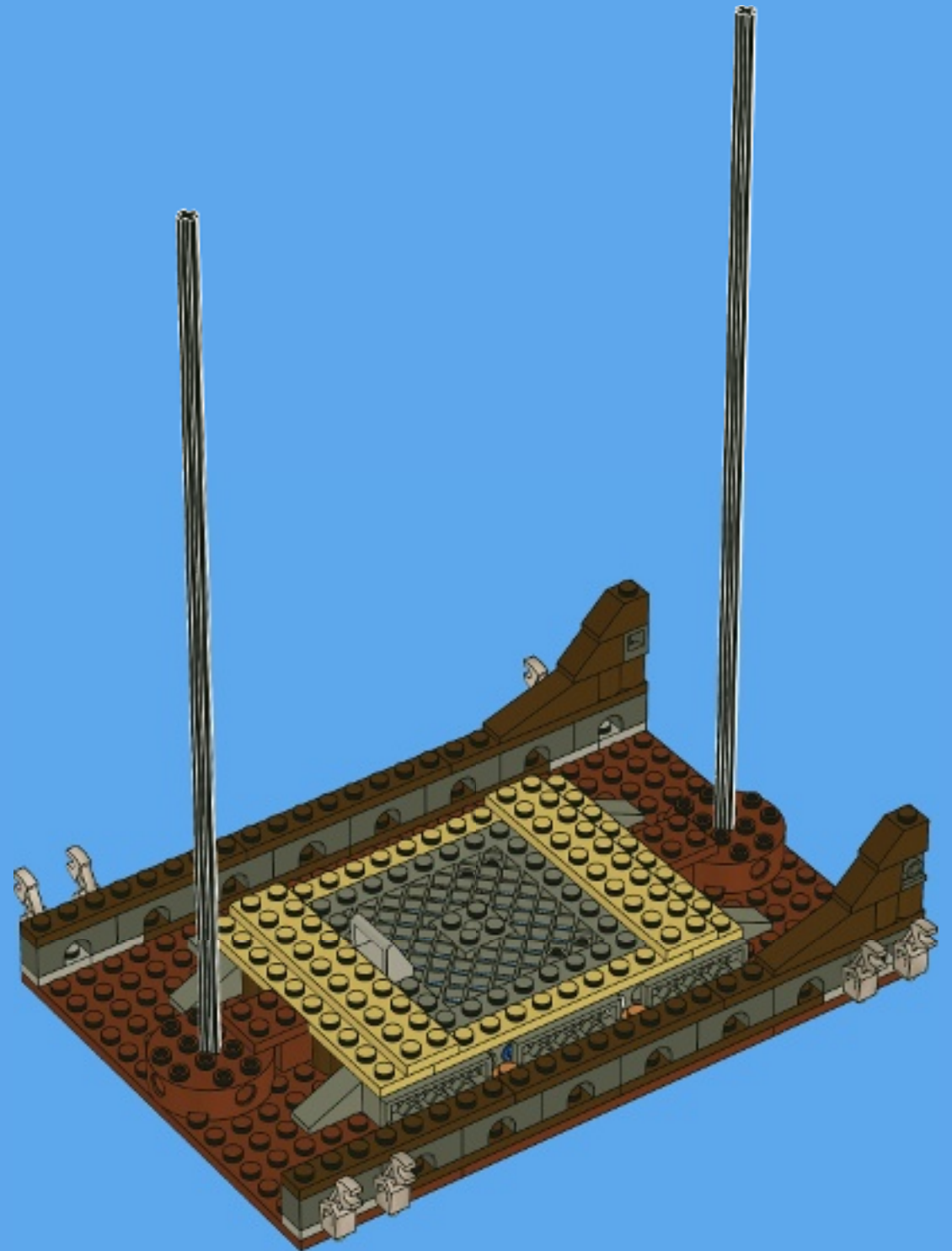



5x



1x

12

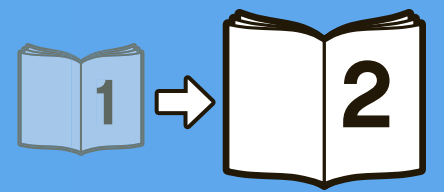
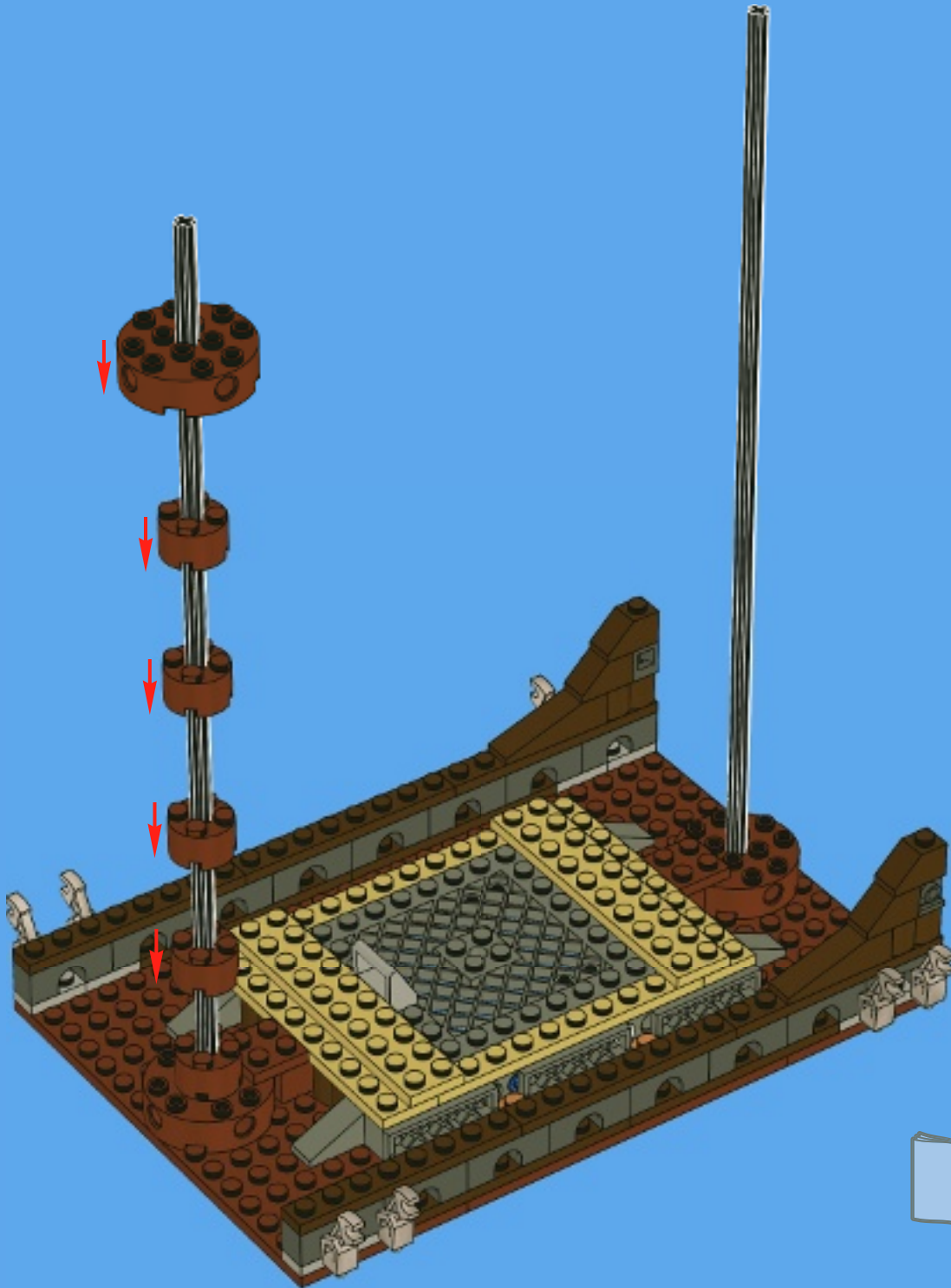



WIN!

Go to www.nielsen.com/LEGO to fill out a survey for a chance to win a cool LEGO® Product. No purchase necessary. Open to all residents where not prohibited.

 www.LEGO.com



www.nielsen.com/LEGO

GEWINNE!

Nimm an der Umfrage auf www.nielsen.com/LEGO teil und hab die Chance ein cooles LEGO® Produkt zu gewinnen!

Die Teilnahme am Gewinnspiel führt zu keinerlei Kaufverpflichtungen. Teilnahme in allen nicht ausgeschlossenen Ländern möglich.

WIN!

Ga naar www.nielsen.com/LEGO, vul een enquêteformulier in en maak kans op een cool LEGO® product.

Geen aankoopverplichting. Iedereen mag deelnemen, uitgezonderd ingezetenden van landen waar een enquêteverbod geldt.

GAGNE!

Visite www.nielsen.com/LEGO pour répondre à un questionnaire et avoir une chance de gagner un produit LEGO® très cool!

Aucune obligation d'achat. Ouvert à tous les résidents des pays autorisés.

当てよう!

www.nielsen.com/LEGOにアクセスして、アンケートにご記入ください。当選者にはレゴ®製品を差し上げます。

お買い上げの必要はありません。禁止されていない限り、すべての皆様にご利用いただけます。